

HUNTING THE SECRET OF LIFE

POPULAR MECHANICS

★

MAGAZINE

WRITTEN SO YOU CAN UNDERSTAND IT

REG. U.S. PAT. OFF.

DEC.
25 CENTS
30c IN CANADA

SEE PAGE 808



ENTER

**"PRESTONE"
ANTI-FREEZE**



EXIT

**WINTER
WORRY!**

When you put "Prestone" brand anti-freeze in your car, winter worry is *out*—for this anti-freeze *will not fail!* One shot of "Prestone" anti-freeze gives you *complete* protection against costly freeze-up. There's no replacing, because "Prestone" anti-freeze will not boil away or foam off. There are no obnoxious fumes. No fire hazard. "Prestone" brand anti-freeze *prevents* rust and corrosion. **GUARANTEED IN WRITING.** See your dealer now.

The words "Prestone" and "Eveready" are registered trade-marks of National Carbon Company, Inc.



"PRESTONE" Anti-freeze

"YOU'RE SAFE—AND YOU KNOW IT!"

\$2⁶⁵
PER
GALLON

HOW SUPERFINISH PUTS FRICTION ON THE SKIDS

in the 1941 Plymouth

Revolutionary new Method of Finishing Engine Parts Produces Amazingly Smooth Surfaces—Extra Quietness, Long Life, and Economy in the 1941 Plymouth

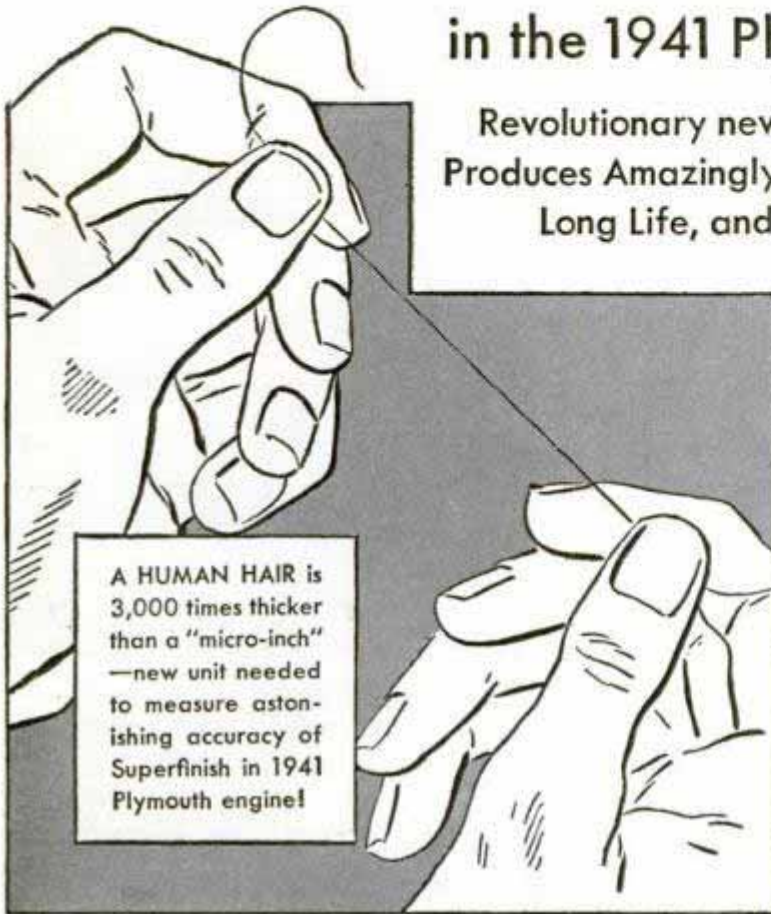

SUPERFINISHED surfaces of the 1941 Plymouth engine are virtually *immune* to friction and operating wear, when properly lubricated! Superfinish *scrubs off* tiny, sharp surface irregularities that might otherwise puncture the microscopically thin film of oil which separates and prevents wear between the moving parts of the engine!

MICRO-DIAGRAMS SHOWING MAGNIFIED SURFACE PROFILES

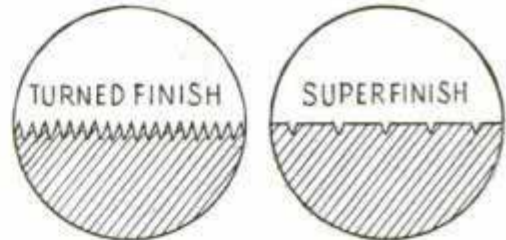

Note absence of wear-causing points in Superfinished surface (right).



For extra-long life, smoothness—1941 Plymouth engine is Superfinished at 35 points!

IN ADDITION to Superfinish and all its other famous long-life engineering, Plymouth for 1941 brings you 19 great new advancements!

Performance is stepped-up 4 ways...increased horsepower, increased torque—new transmission and axle ratios! There's new Powermatic Shifting...new Fashion-Tone Interior...big 117-inch Wheelbase!

See and drive this new whirlwind performer today! PLYMOUTH DIVISION OF CHRYSLER CORPORATION.

TUNE IN MAJOR BOWES' HOUR, C.B.S., THURSDAYS, 9 TO 10 P.M., E.S.T. SEE THE NEW 1941 LOW-PRICED PLYMOUTH COMMERCIAL CARS!



This One



5TQ11-FGR-56.I3

OUR PART IN NATIONAL DEFENSE

The Bell System is a nation-wide telephone system — ready to serve the United States in normal times or emergency. It has . . .

1. The trained forces to operate telephone equipment and plant.
2. The trained staffs to direct these operations.
3. The latest motorized, mechanized telephone groups of great mobility which can concentrate anywhere quickly.
4. A dependable service of supply that reaches anywhere in the United States.
5. A source of supply — the Western Electric Company, devoted to telephone manufacture.
6. A great laboratory that brings the advance of science to bear on the improvement of telephony.

7. The financial strength to keep going and work ahead for the future.

* * *

Each is important. All are necessary for good telephone service from day to day and for the needs of national defense.

It is the organization, the team-work, that counts. That means trained, experienced men and management, working together and planning ahead, so that the right material and the right "know how" will be at the right place at the right time.

Walter S. Gifford



Walter S. Gifford, President, American Telephone and Telegraph Company

The Bell System is ready to do its part in the Nation's Program of National Defense



Popular Mechanics Magazine

H. H. WINDSOR, Founder

H. H. WINDSOR, Jr., Editor and Publisher

December, 1940

Vol. 74, No. 6

IN THIS ISSUE

Hunting the Secret of Life	801
Planning the World of Tomorrow	808
Switching on the Rainbow	Coloroto
Building for Defense	828
Millions from Waste	834
Keeping a Big Bridge Young	840
Rubber Grown in Factories	846
Flying Cowboys	851
They're Tiny—but They Work	856
The Camera in Industry	861
Sailors of the Sky	866
Try These in Your Home	872
America Goes Calling by Short Wave	882
More Work for Infra-Red	893

(Continued on next page)

Five Million Miles on a Pound

FANTASTIC, we'd call it ourselves, if Dr. R. M. Langer of California Institute of Technology were not the author. Telling of the imminent harnessing of the atom's power, this eminent physicist talks of a one-pound package of uranium that will drive your car 5,000,000 miles. We'll fly, he says, several thousand miles an hour—faster than earth's rotation; no two points in the world will be more than seven hours apart. Read "The Miracle of U-235" in the January issue. You'll long for the universal comfort of the coming age of uranium.

Exploring a Frozen Continent

JUST a few weeks ago it was seventy-five below zero down at Little America, but it's summer there now and the men of Uncle Sam's Antarctic expedition are out exploring the bottom of the world by ski and plane, tractor and dog sled. A feature in January brings you news and the latest pictures from the southernmost habitation of the earth.

Next Month

UP IN the control tower the green light shows. Propellers howl, and the great liner moves down the runway, faster, faster. The tail is up. The hangars across the field are coming toward you at an alarming rate. But there's a gentle tug at the wheel and you're lifting away. If you've never traveled in the cockpit, read next month's Coloroto story, "At the Controls with an Air Line Pilot," written by the pilot himself. It's illustrated by eight pages of color photographs.

Homes Built to Last

MASS production at last is being applied to home construction. The result is a modern home of steel and brick and concrete, built like a medieval castle and intended to last as long, yet costing no more than a shanty. Precast concrete joists, factory-stamped metal form sheets, smooth concrete walls inside and out—walls that will withstand anything short of artillery fire. Read how it's done in the January article, "Low-Cost Homes Built to Last."

Sight-Effects Man

SINCE the television camera cannot lie, the "sight-effects" man must. To achieve the effect on the television screen of a machine gun mowing down a row of glass jars, one sight-effects man hooked up a row of mousetraps and etched the jars so they'd shatter as the traps snapped. A feature next month offers a glimpse of this newest profession.

Published monthly by POPULAR MECHANICS COMPANY, 200 East Ontario Street, Chicago, U. S. A. Single copy in the United States, 25 cents; subscription rates in United States and possessions, and countries of the Pan-American Postal Union including Spain, \$2.50 a year, \$4.00 for two years, \$5.00 for three years. Single copy in Canada, 30 cents; subscription rates, \$3.00 a year, \$5.00 for two years, \$6.50 for three years. To all other countries add \$1.00 a year over United States prices for overseas postage. Changes in address must be reported to us immediately to eliminate delay. Entered as Second Class Matter, Sept. 15, 1903, at the Post Office at Chicago, Illinois, under Act of March 3, 1879. Entered as Second Class Matter at the Post Office Department, Canada. Copyright 1940, by Popular Mechanics Company, in the United States, Australia, and France. Printed in the U. S. A.

Note to Motorists

You have a large investment in the automobile you own. It is your desire to protect that investment. That's why we feel you will take the few moments necessary to read the following. One way in which you can add to the protection of your automobile investment is by the regular use of Pyroil. In order that you may know exactly why this is so, we give you a vivid explanation of Pyroil's important function. This interesting story is told in the words of the lubrication scientist. Read it carefully.



IMPROVEMENT IN ENGINE OPERATION

Pyroil is a valuable lubrication process in highly concentrated, liquid form which goes beyond the usual or regular lubrication methods in its ability to protect and improve engine operation. It is to be added to—**does not replace**—your present lubricant. It has been used by millions of car owners for many years.

The addition of Pyroil to the fuel tank and to the crankcase of an engine has several important benefits.

HOW PYROIIL WORKS

When Pyroil is supplied to the engine through the gasoline tank—in the proportion of one ounce of Pyroil to each five gallons of gasoline—it is then fed to the cylinders through the carburetor in the form of a fine mist of tiny particles. On the compression stroke these particles of Pyroil are condensed on the piston head, the cylinder walls, the valves and rings in the form of tiny droplets. Pyroil has a great tendency to spread out on metal surfaces and consequently these droplets spread rapidly and unite, forming a film over the entire cylinder area. This is the secret of Pyroil's performance.

The Pyroil film (1) tends to prevent carbon matter from adhering to the metal surfaces, thus effectively preventing hard carbon deposits. (2) It prevents acid-corrosive materials which are regularly formed as products of combustion from reaching the metal surfaces, thus effectively inhibiting acid-corrosive attack. (3) It aids in proper lubrication of valves and rings. (4) It exerts a powerful solvent action on gummy residue formed on valve stems and rings.

MARKED RESULTS

The importance of these effects can scarcely be over-emphasized. Extensive repairs and expensive bills are commonly offset. Because of the elimination of upper cylinder acid-corrosion, bore and ring wear are drastically reduced. This means continued better engine performance and longer useful engine life.

How Pyroil protects bearings, pistons and other parts in the base, when used in the crankcase, will be told in a follow-up to this advertisement soon. Clip this ad and save it for your reference.

Drive into a service station or garage today, and ask for an inexpensive treatment of Pyroil. Enjoy the difference in your driving from now on! Mail coupon for free Booklet. Manufactured and guaranteed by Pyroil Company, W. V. Kidder, Founder, 512 Pyroil Bldg., LaCrosse, Wisconsin, U.S.A.



ADD
MERELY
OUNCES TO
GAS & OIL

**DISTRIBUTORS:
CHECK AND MAIL
COUPON FOR FRAN-
CHISE FACTS.**

PYROIL COMPANY,
512 Pyroil Bldg., LaCrosse, Wisconsin.
Please send me your Free Booklet, "Questions and Answers about the efficiency of Pyroil."
 Send Details of your plan for Distributors.
Name.....
Address.....
City or town..... State.....

(Contents—Continued)

AUTOMOTIVE

Ring for horn button easy to install.....	804
Truck carries empty trailer to save gas.....	833
Meter charts bumps per mile on road surface.....	838
Night driving glasses are dark at edges.....	838
X-ray trailer aids soldiers wounded at front.....	839
Cleansing tissue holder under glove container.....	844
Knock-free gasoline would double mileage.....	844
Cars slow selves upon entering town.....	849
Heater under front seat spreads warmth evenly.....	854
Army tractor pulls five-ton howitzer at fifty.....	860
Dew blamed for tarnish of auto finishes.....	860
Brake tester for car operated by hand.....	864
Stock car given speedster body of sheet metal.....	865
Wind machine tests cars for stability on highway.....	870
Pocket gauge checks alignment of auto wheels.....	876
Home and office on wheels includes laboratory.....	886
Dolly cradles the flat tire to station.....	122A
Electric highway flare throws bright red light.....	144A

AVIATION

'Chute jump from stratosphere tested in chamber.....	812
Flying time of rented plane recorded by meter.....	816
Twin-engine plane flies 500 miles an hour.....	839
Truck serves as mobile base for balloon.....	844
Airplane landed by fifty-two-foot parachute.....	848
Twin posts let plane down for servicing.....	860
Strychnine helps vision of high flying pilots.....	864
Making warplanes hard to see in sky.....	876
Dive bomber adds fire power to carrier.....	877
Flying sausage on string still eye of army.....	886

BOATS AND BOATING

Outboard boat fitted with torpedo rack on deck.....	850
Three propellers balance speedboat power.....	855
Radio-controlled target boat for navy bombers.....	859
Huge Diesel-electric tugs attend fleet at sea.....	865

CONSTRUCTION

House built of metal lath and concrete.....	871
Jetty with open walls makes beach "grow".....	881
Diesel highway liner built of stainless steel.....	889

HOUSEHOLD

Plug-in gas unit for furnace.....	804
Desks have sliding baskets and revolving trays.....	876
Flexible rubber molding for edge of bathtub.....	880
Sub-zero "barrel" keeps foods frozen.....	890
Refrigerator air-conditioner absorbs odors.....	891
Plastics and glass feature novel furniture.....	892
Three-filament bulb fits any lamp.....	896
Cigarette holder ejects one at a time.....	142A

PHOTOGRAPHY

Speed lights on wheels stop action at night.....	807
Camera swung in ninety-degree arc.....	850
Silent camera saves time in making movies.....	854
Camera fan turns eight snapshots into one.....	890
Film viewers help amateurs plan home show.....	896

RADIO AND ELECTRICITY

Retractable "mike" lets fans hear disputes.....	812
V-belt resists static and will not short.....	816
Cleaner for electric contacts quenches sparks.....	838
Conical antenna for television sends pictures.....	854
Tiny personal receiver is easily portable.....	935
Low-cost broadcast receiver and phono amplifier.....	936
"Snapshots in sound" by home recording.....	938
Practical radio suggestions.....	939
D.C. to A.C. inverter for phono motors.....	940
Five-tube set built into world globe.....	940
Over-the-shoulder portable is light and compact.....	940
Ten-tube 35-watt mobile amplifier unit.....	940

SCIENCE AND INDUSTRY

Electric screen faster than hand work.....	848
Goldfish clean jar for chemist.....	850
Silver may replace tin if shortage occurs.....	870
Heavy sulphur may help solve secrets of life.....	880
Mine safety phone prevents escape of sparks.....	880
Gas blanket for hardening steel.....	130A

SPORTS

Magnetic "men" and football board teach plays.....	838
Metal landing net for boat clamps over fish.....	864
Golf club head permits left-hand swing.....	877

(Continued to page 6A)



"HEY, SKINNY! THAT'S NO JOB FOR YOU"

PACKARD NO. 1 GAUGE CABLE: "Look at you—wasting all that power from the battery to the starting motor because you ain't big enough for the job. I'll bet you aren't any more than a No. 4 gauge cable!"

UNDERSIZE CABLE: "Who ya callin' skinny? I'm as big around as you are—and besides, I've been starting this car all right through the summer."

PACKARD NO. 1 GAUGE CABLE: "Sure, you're as big around on the *outside*, but it's what's inside that counts. You've only got 50% of my copper core—50% of my carrying capacity! That's why this Certified Re-Wiring Station is putting *me* in and taking *you* out for cold-weather starting!"

Packard Battery Cables are Full No. 1 Gauge

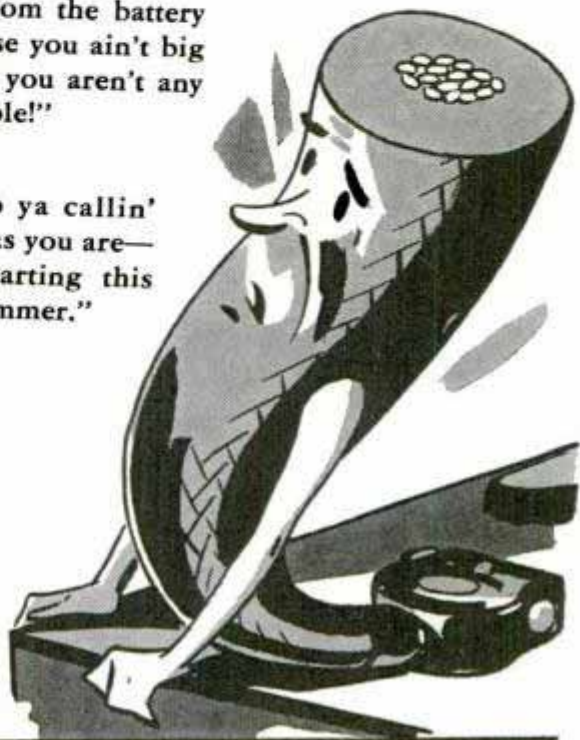

GET A CERTIFIED RE-WIRING CHECK-UP FOR SURE STARTING THIS FALL AND WINTER

Undersize battery cables and loose or dirty connections are the most common cause of hard starting. That's why you should drive into a Certified Re-Wiring Station before cold weather begins, and let a trained mechanic check your starting circuit. He'll do the job right, because he uses only Packard No. 1 gauge battery cables for replacement.

Packard Certified Re-Wiring Stations have the right tools and equipment to trace down troubles in your electrical system and put it in A-1 shape—starting circuits, ignition circuits, lighting

circuits and accessory circuits. Your car will run better for this service, and it may very likely save you costly repairs to major electrical units later on. Packard Electric Division, General Motors Corporation, Warren, Ohio.



Packard

REG. U.S. PAT. OFF.
TRADE MARK

THE STANDARD WIRING EQUIPMENT OF THE AUTOMOTIVE INDUSTRY



• Motorcycling opens up a whole new world of fun and excitement for you. And a 1941 Harley-Davidson will make your dreams of thrills and adventure really come true! Glorious zooming power and rugged dependability to take you any place you want to go — anytime. Yes, and plenty of good times with other riders on club runs and gypsy tours, at races, hillclimbs and other exciting events. See your Harley-Davidson dealer — get the thrilling story of motorcycling, the world's greatest outdoor sport, and ask about his Easy Pay Plans.

Mail coupon NOW!



FREE



HARLEY-DAVIDSON
WORLD'S *Champion* MOTORCYCLE
DAVIDSON

HARLEY-DAVIDSON MOTOR CO.
Dept. P, Milwaukee, Wisconsin.

Send FREE copy of big 24-page "Enthusiast" magazine filled with thrilling motorcycle pictures and stories. Also literature on the 1941 Harley-Davidsons. Stamp is enclosed for mailing cost.

Name

Address

TOOLS

Floor nailer feeds one nail at a time.....	804
Pull-chain in ratchet wrench removes nuts.....	812
Clamp to shut off water hose.....	843
Saw and file unit fits small electric drill.....	859
Hand tool to bend metal.....	870
Tool removes broken light bulbs safely.....	885

MISCELLANEOUS

How mines help to guard America's harbors.....	813
The world's biggest bomber.....	814
Shoes of plastic materials shimmer in dark.....	816
Rope lowers riders from stalled aerial car.....	833
Walking tractor plows truck garden.....	843
Dogs noseprinted as aid to identification.....	845
Fan spreads steam-heated air from ceiling.....	848
Air-powered gun fires 10,000 shots a minute.....	849
Grain shock loader is powered by tractor.....	859
Light beam gun "sight" spots target in dark.....	871
Spikes stop birds from roosting on roof.....	880
Army asks inventors for light machine gun.....	881
Ukulele built from kit of parts.....	885
Electric safety lamp useful in mines.....	887
Model of home tilts to show floor plan.....	887
Luxury bus has "snack bar" and washroom.....	888
Ship's deck on hospital aids recovery of sick.....	891
"Shock stick" of 5,000 volts controls gorilla.....	891
Memo sheet holder feeds out one at a time.....	126A
"Fire cards" are revival of old weapon.....	140A

(Craftsman and Shop Notes)

AUTOMOTIVE

Auto shortcuts.....	957
Checking motor trouble with neon pencil.....	958
Cotter key provides stop for bottle spout.....	958
Creeper converted into small hand truck.....	958
Setting heater fan correctly on motor shaft.....	958
Easy to oil windshield wiper.....	959
First-aid kit always at hand in trunk.....	959
Plugging crack in motor block.....	959
Strap keeps garments on auto coat rail.....	959
Level helps measure diameter of auto cylinder.....	960
Trunk tray handles several packages at a time.....	960

FARM

Ladder altered to prevent children from climbing it.....	918
Keeping calf from unlatching gate.....	944
Rubber-tired cart pulled easily on soft ground.....	944
Auger for taking soil samples.....	946
Pressure-gun fittings to grease wagon wheels.....	946
Horseshoe holds lines on wagon.....	955
Short rope permits easy closing of barn door.....	956

HAND TOOLS

Rubber shield for oilstone.....	902
Vise clamps attached in one unit.....	902
Scratch brush from screen wire.....	909
Bench holder for hand grinder.....	918
Converting saw vise to handle band-saw blades.....	926
Door stop clamps work in miter box.....	928
Handy pocket scriber made from automatic pencil.....	934
Spanner wrench made from pair of pliers.....	946
Tin shield for blowtorch carried in toolbox.....	946
Hammer holds cold chisel to cut rivets.....	951
Worn-out fountain pens used as test prods.....	952
Deepening screw slot with hammer.....	954
Fixture to grind skates on circular saw.....	955
Clamp holds blowtorch for filling.....	956
Straightening a bent auger bit.....	956

HOUSEHOLD

Bookcase in closet door utilizes space.....	899
Solving home problems.....	900
Reaming plaster cracks for patching.....	902
Memo cabinet in kitchen includes a mirror.....	907
Making plug of electric cord fit tightly.....	912
Old heater repaired with firebrick.....	925
Rubber plugs for clothesline post sockets.....	928

(Continued to page 8A)



Plan Your Future

Choose Your Field NOW For Success

Will you master fate or will fate master you? That's a question deserving your honest answer . . . right now! Actually it is largely up to you. You can do with Life almost what you will. LaSalle will help you establish yourself for real success by providing you with the comprehensive, specialized training for which it is so famous. Choose your field . . . now! Check the coupon below for the free booklet you want us to send you. It can be your first step toward assured success.

Opportunities in Traffic Management

The field of Traffic Management offers real opportunity only to the man who knows. Spare time study and the will to succeed have pushed scores of Traffic employees up the ladder to financial success. Many LaSalle-trained traffic managers—both in the railroad and industrial field—now command salaries of \$3,000.00 to \$5,000.00 a year—and better. Investigate. Find out how you can qualify for these higher positions through LaSalle home-study and guidance.

Law for Business Success

And it isn't necessary to practice law to get this Success. In fact probably most of the men who study law today have no idea of taking the bar examination or becoming lawyers—they want law training to give them mastery of men and situations in business. You know that—

- (1) the man with legal training is a leader—not a follower.
- (2) legal training keeps your mind—clears away the problems that stump the ordinary fellow and makes you master instead of man.
- (3) knowledge of law simplifies the complications of executive work.
- (4) Many top executive places are filled by men who have studied law.

No matter whether you are in a big corporation or a small business—in a great city or a little town—a practical knowledge of law cannot fail to be of real and vital help to you in making a more successful career.

In every state in the union you'll find law-trained men who came up through LaSalle. What others have done, you can do.

And LaSalle offers either a full law course leading to LL. B. or a shorter business law training—whichever you prefer. All text material, including valuable 14-volume Law Library. Training comprises the most effective features of modern law instruction.

Executive Training

Executives who are efficient managers command responsible positions and good incomes. And the need for

trained executives is growing rapidly. We train you thoroughly at home in your spare time for every type of executive work—teach you the principles and practices used by our most successful business leaders and help you develop your management capacity—by a training built with the aid of outstanding executives.

Become an Expert Accountant The Profession That Pays

The demand for skilled accountants—men who really know their business—is increasing rapidly. New state and federal legislation requires much more, and more efficient accounting from business—big and small. Corporations are in constant need of expert counsel in matters relating to Auditing, Cost Accounting, Business Law, Organization, Management, Finance. Men who prove their qualifications in this important branch of business are rapidly promoted to responsible executive positions—given an opportunity to earn real salaries. The range is from \$2,000.00 to \$10,000.00 a year—even to higher income figures.

Under the LaSalle Problem Method you can at home acquire a thoro understanding of Higher Accountancy, master its fundamental principles, become expert in the practical application of these principles—this without losing an hour of work or a dollar of pay.

Your training will be under the direct supervision of a staff of legal, organization and management specialists, business efficiency engineers and Certified Public Accountants.

Preliminary knowledge of bookkeeping is unnecessary. We train you from the ground up, or from where you now are, according to your individual needs.

Mr. Salesman: What's Wrong?

Why aren't you making more sales—more money? Is it you—or your proposition? Check up first on yourself. Other men—no better than you—have found their earnings jump and stay up when they trained with LaSalle. Literally thousands of men—many of them years at the game—have increased their sales volume and earnings through home study with LaSalle guidance. Sound—practical—usable—right from field experience. Train for top-notch production with LaSalle.

LASALLE EXTENSION UNIVERSITY A CORRESPONDENCE INSTITUTION Dept. 1254-R CHICAGO

I would like to have your special booklet—without any cost or obligation to me—about my opportunities and your success training in the business field I have checked.

- | | | |
|---|--|--|
| <input type="checkbox"/> Higher Accountancy | <input type="checkbox"/> Commercial Law | <input type="checkbox"/> Business English |
| <input type="checkbox"/> Law: Degree of LL.B. | <input type="checkbox"/> Expert Bookkeeping | <input type="checkbox"/> Business Correspondence |
| <input type="checkbox"/> Traffic Management | <input type="checkbox"/> C. P. A. Coaching | <input type="checkbox"/> Effective Speaking |
| <input type="checkbox"/> Modern Salesmanship | <input type="checkbox"/> Industrial Management | <input type="checkbox"/> Stenotypy |
| <input type="checkbox"/> Business Management | <input type="checkbox"/> Modern Foremanship | |

Name..... Age.....

Position..... Address.....





SAVE REPAIR COSTS WITH P.W.

Plastic Wood has 1001 uses in the home and workshop. Handles like putty; hardens quickly to permanent wood.

In cans or tubes at Paint, Hardware, 10¢ Stores.



PLASTIC WOOD



Refrigerators Need 3-IN-ONE

Periodical lubrication with HEAVY BODY 3-IN-ONE Oil helps electric refrigerators to give longer, quieter service with fewer repair bills. Get it at Hardware, Drug, Grocery, 10¢ Stores. Try it!

Ask for

HEAVY BODY

3-IN-ONE Oil



(Contents—Continued)

HUNTING, FISHING, CAMPING

Protecting minnow net against wear on rocks.....	912
Clothes wringer dries pelts of animals quickly.....	919
Crotched stick serves as camp bootjack.....	926

PHOTOGRAPHY

Vertical photo enlarger has "vernier" focusing.....	929
Shock absorbers on light stand protect bulbs.....	932
Trimming picture to fit a frame.....	933
Uniform lettering on glossy prints.....	933
Viewing box for photo negatives.....	933

POWER TOOLS

Brace straightens scroll-saw blades.....	928
Threading pipe in a lathe.....	952
Chisel rack hinged to lathe.....	954

STORE AND SHOP

Sealing glue containers easily.....	902
Cutting sheet rubber accurately with tin shears.....	943
Preserving rollers of printing press.....	943
Painting ends of molding strips to show length.....	944
Shielding bolt ends on butcher's block.....	944
Straight-line graphs to tabulate shop data.....	945
Envelopes removed quickly from deep boxes.....	951
Rollers on meat hooks for easy handling.....	952
Shoe boxes removed from high shelf without ladder.....	952
Safety on high scaffolds.....	953
Dab of grease substitute for ink-tube cap.....	956

TOYS AND NOVELTIES

Wooden fence resembles stone wall.....	909
Bracelets and necklaces from walnut shells.....	913
Fairyland dollhouse forms playhouse when enlarged.....	915
Bookmark made from ribbon and bobby pins.....	918
Child's hand mirror shaped like a squirrel.....	919
Large tricycle pedals shorten reach for child.....	926

WOODWORKING

Inlaying your turnings.....	897
Dowel rods from these table legs.....	910
Veneering increases scope of craftwork—Part II.....	947

MISCELLANEOUS

Float valve from scrap parts.....	899
How to cut glass.....	899
Quickly cast sled runner for wheelbarrow.....	902
Flock your Christmas cards.....	903
Let the jigsaw solve your gift problem.....	904
Pins ornamented with sealing wax.....	907
Irregular curves drawn with linoleum binding tape.....	908
Making tumbler lock pickproof.....	908
Simple electric switch assembled quickly.....	908
Small headlight handy for carpenters.....	908
Dog's table keeps food from being upset.....	909
Flexible clip to hold papers on newsstand.....	912
Homemade electric glue pot.....	912
Vise attachment for small work.....	912
Avoiding vapor lock in furnace humidifier.....	914
Powdered colors match paints for touch-up jobs.....	914
Small spring-operated vise for modelmakers.....	914
Stiff springs clamp objects to ring stand.....	918
Figure skating is skating in curves.....	920
Christmas tree improved by re-arranging branches.....	925
Cover of tidbit box locks in raised position.....	925
Substitute for a set of bar clamps.....	926
Spanish-styled banjo clock.....	927
Using scratch brush to make paper pulp.....	928
Glass fuses used as water-color cups.....	934
When and how to spot weld.....	941
Lines inked on drawing board cover save time.....	945
Bar solder as soft anvil for small work.....	951
Adhesive for making transformers.....	955

IMPORTANT NOTICE

It is the intention of this magazine to provide its readers with information regarding the latest developments in the mechanical arts. We take no responsibility as to whether the disclosures contained in our articles are covered by patents and advise readers to investigate this subject before making, using, or selling any of the products, machines, or processes described, in order to avoid possible liability for patent infringement.

MUSKETS

CAN'T COMPETE WITH

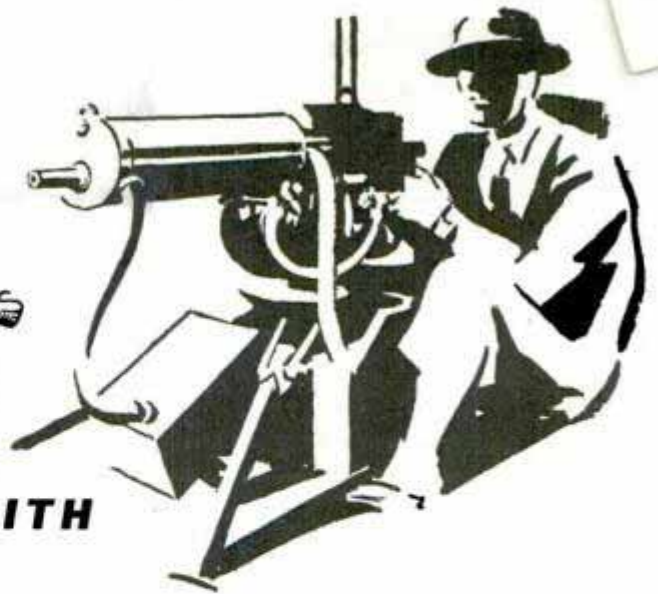

MACHINE GUNS!

No sane person would tackle a machine-gun nest armed with a smoothbore musket! • Yet thousands of men try to get ahead in Business and Industry armed with training as obsolete as a flintlock—and wonder why they don't succeed! • You can storm the fortress of Success—and achieve it!—only if your training is sound, practical and up-to-the-minute. One way to get that kind of training is through the International Correspondence Schools! Thousands of I. C. S. graduates have “moved up” into positions of leadership and larger rewards, because they knew that, other things equal, *learning* means *earning*! • This coupon will bring you complete information that's vital to *your* success! Mail it—not tomorrow, but *right now*!

INTERNATIONAL CORRESPONDENCE SCHOOLS

BOX 5590-J, SCRANTON, PENNA.

★ Without cost or obligation, please send me a copy of your booklet, “Who Wins and Why,” and full particulars about the course *before* which I have marked X: ★

TECHNICAL AND INDUSTRIAL COURSES

- | | | | | |
|---|---|---|---|--|
| <input type="checkbox"/> Agriculture | <input type="checkbox"/> Air Brake | <input type="checkbox"/> Cotton Manufacturing | <input type="checkbox"/> Mfg. of Pulp and Paper | <input type="checkbox"/> R. R. Section Foreman |
| <input type="checkbox"/> Air Conditioning | <input type="checkbox"/> Diesel Engines | <input type="checkbox"/> Electrical Drafting | <input type="checkbox"/> Marine Engines | <input type="checkbox"/> R. R. Signalmen's |
| <input type="checkbox"/> Architectural Drafting | <input type="checkbox"/> Electrical Engineering | <input type="checkbox"/> Electric Drafting | <input type="checkbox"/> Mechanical Drafting | <input type="checkbox"/> Refrigeration |
| <input type="checkbox"/> Architecture | <input type="checkbox"/> Electrical Engineering | <input type="checkbox"/> Electric Lighting | <input type="checkbox"/> Mechanical Engineering | <input type="checkbox"/> Sanitary Engineering |
| <input type="checkbox"/> Auto Engine Tune-up | <input type="checkbox"/> Fire Bosses | <input type="checkbox"/> Foundry Work | <input type="checkbox"/> Mine Foreman | <input type="checkbox"/> Sheet Metal Work |
| <input type="checkbox"/> Auto Technician | <input type="checkbox"/> Fruit Growing | <input type="checkbox"/> Heating | <input type="checkbox"/> Navigation | <input type="checkbox"/> Steam Electric |
| <input type="checkbox"/> Aviation | <input type="checkbox"/> Heat Treatment of Metals | <input type="checkbox"/> Highway Engineering | <input type="checkbox"/> Patternmaking | <input type="checkbox"/> Steam Engines |
| <input type="checkbox"/> Boilermaking | <input type="checkbox"/> House Planning | <input type="checkbox"/> Locomotive Engineer | <input type="checkbox"/> Pharmacy | <input type="checkbox"/> Steam Fitting |
| <input type="checkbox"/> Bridge Engineering | <input type="checkbox"/> Machinist | <input type="checkbox"/> Management of Inventions | <input type="checkbox"/> Plumbing | <input type="checkbox"/> Structural Drafting |
| <input type="checkbox"/> Building Estimating | <input type="checkbox"/> Management of Inventions | <input type="checkbox"/> Mfg. of Pulp and Paper | <input type="checkbox"/> Poultry Farming | <input type="checkbox"/> Structural Engineering |
| <input type="checkbox"/> Chemistry | <input type="checkbox"/> Management of Inventions | <input type="checkbox"/> Marine Engines | <input type="checkbox"/> Practical Telephony | <input type="checkbox"/> Surveying and Mapping |
| <input type="checkbox"/> Civil Engineering | <input type="checkbox"/> Management of Inventions | <input type="checkbox"/> Mechanical Drafting | <input type="checkbox"/> Public Works Engineering | <input type="checkbox"/> Telegraph Engineering |
| <input type="checkbox"/> Coal Mining | <input type="checkbox"/> Management of Inventions | <input type="checkbox"/> Mechanical Engineering | <input type="checkbox"/> Radio, General | <input type="checkbox"/> Textile Designing |
| <input type="checkbox"/> Concrete Engineering | <input type="checkbox"/> Management of Inventions | <input type="checkbox"/> Mine Foreman | <input type="checkbox"/> Radio Operating | <input type="checkbox"/> Toolmaking |
| <input type="checkbox"/> Contracting and Building | <input type="checkbox"/> Management of Inventions | <input type="checkbox"/> Navigation | <input type="checkbox"/> Radio Servicing | <input type="checkbox"/> Welding, Electric and Gas |
| | | <input type="checkbox"/> Patternmaking | | <input type="checkbox"/> Woolen Manufacturing |

BUSINESS COURSES

- | | | | | |
|--|---|---|---|---|
| <input type="checkbox"/> Accounting | <input type="checkbox"/> Advertising | <input type="checkbox"/> College Preparatory | <input type="checkbox"/> Foremanship | <input type="checkbox"/> Railway Postal Clerk |
| <input type="checkbox"/> Bookkeeping | <input type="checkbox"/> Commercial | <input type="checkbox"/> Commercial | <input type="checkbox"/> French | <input type="checkbox"/> Salesmanship |
| <input type="checkbox"/> Business Correspondence | <input type="checkbox"/> Cost Accounting | <input type="checkbox"/> Cost Accounting | <input type="checkbox"/> Grade School | <input type="checkbox"/> Secretarial |
| <input type="checkbox"/> Business Management | <input type="checkbox"/> C. P. Accounting | <input type="checkbox"/> C. P. Accounting | <input type="checkbox"/> High School | <input type="checkbox"/> Sign Lettering |
| <input type="checkbox"/> Cartooning | <input type="checkbox"/> Civil Service | <input type="checkbox"/> First Year College | <input type="checkbox"/> Illustrating | <input type="checkbox"/> Spanish |
| | | <input type="checkbox"/> First Year College | <input type="checkbox"/> Lettering Show Cards | <input type="checkbox"/> Sign Lettering |
| | | <input type="checkbox"/> Management of Inventions | <input type="checkbox"/> Managing Men at Work | <input type="checkbox"/> Traffic Management |

HOME ECONOMICS COURSES

- | | | |
|---|---|--|
| <input type="checkbox"/> Advanced Dressmaking | <input type="checkbox"/> Home Dressmaking | <input type="checkbox"/> Tea Room and Cafeteria Management, Catering |
| <input type="checkbox"/> Foods and Cookery | <input type="checkbox"/> Professional Dressmaking and Designing | |

Name..... Age..... Address.....
 City..... State..... Present Position.....

Canadian residents send coupon to International Correspondence Schools Canadian, Limited, Montreal, Canada
 British residents send coupon to I. C. S., 71 Kingsway, London, W. C. 2, England

HOW A "TIP" GOT TOM A GOOD JOB



I will train YOU too at Home in Spare Time for Good Jobs in Radio

**J. E. Smith, President
National Radio Institute
Established 25 years**

If you can't see a future in your present job, feel you'll never make much more money; if you're in a seasonal field, subject to lay offs, IT'S TIME NOW to investigate Radio. Trained Radio Technicians make good money, and you don't have to give up your present job or leave home to learn Radio. I train you at home nights in your spare time.

I Trained These Men



Makes \$50 to \$60 a Week
"I am making between \$50 and \$60 a week after all expenses are paid, and I am getting all the Radio work I can take care of, thanks to N.R.I."
H. W. SPANGLER
120 1/2 S. Gay St., Knoxville, Tenn.

\$10 to \$20 Week in Spare Time
"I repaired some Radio sets when I was on my tenth lesson. I made \$600 in a year and a half, and I have made an average of \$10 to \$20 a week—just spare time."
JOHN JERRY, Room 17
1529 Arapahoe St., Denver, Colo.



Operates Public Address System
"I have a position with the Los Angeles Civil Service, operating the Public Address System in the City Hall Council. My salary is \$170 a month."
R. H. ROOD, R 136, City Hall
Los Angeles, Calif.

Jobs Like These Go to Men Who Know Radio

Broadcasting Stations employ Radio Technicians, operators, installation and maintenance men, and pay well. Radio manufacturers employ testers, inspectors, servicemen in good-pay jobs with opportunities for advancement. Radio jobbers and dealers employ installation and servicemen. Many Radio Technicians open their own Radio sales and repair businesses and make \$30, \$40, \$50 a week. Others hold their regular jobs and make \$5 to \$10 a week fixing Radios in spare time. Automobile, Police, Aviation, Commercial Radio; Loudspeaker Systems, Electronic Devices, are newer fields of opportunity for which N. R. I. gives the required knowledge of Radio. And my Course includes Television and Frequency Modulation which promise to open many good jobs soon.

Why Many Radio Technicians Make \$30, \$40, \$50 a Week

Radio is already one of the country's large industries even though it is still young and growing. The arrival of Television, the use of Radio principles in industry, are but a few of many recent Radio developments. More than 28,000,000 homes have one or more Radios. There are more Radios than telephones. Every year millions of Radios go out of date and are replaced. Millions more need new

Get Facts About THIS



HEY, TOM!
HOW ARE
YOU, OLD
BOY?

BILL! GOSH, I DIDN'T
KNOW YOU IN THOSE
NEW CLOTHES AND
THAT SNAPPY CAR.
SOMEBODY LEAVE
YOU A MILLION?



ONLY A SHORT TIME
AGO YOU WERE
SLAVING AWAY AT
THE SAME JOB AS
THE REST OF US.
NOW LOOK AT YOU.
HOW COME?

WELL, TOM, I DECIDED
I'D NEVER GET
ANYWHERE UNLESS
I PICKED A BUSINESS
WITH LOTS OF OPPOR-
TUNITIES AND TRAINED
MYSELF FOR THEM--
SO I PICKED RADIO

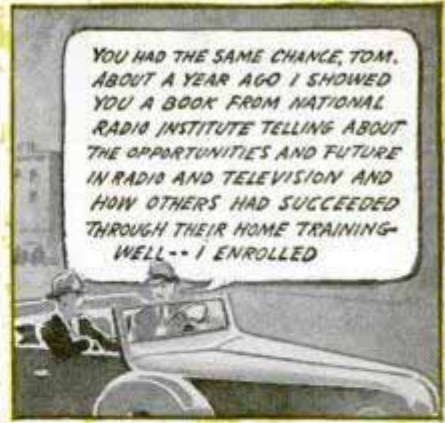

YOU HAD THE SAME CHANCE, TOM.
ABOUT A YEAR AGO I SHOWED
YOU A BOOK FROM NATIONAL
RADIO INSTITUTE TELLING ABOUT
THE OPPORTUNITIES AND FUTURE
IN RADIO AND TELEVISION AND
HOW OTHERS HAD SUCCEEDED
THROUGH THEIR HOME TRAINING--
WELL-- I ENROLLED



YOU CERTAINLY
KNOW RADIO.
MINE NEVER
SOUNDED BETTER

THANKS. N.R.I. TRAINING
CERTAINLY PAYS. I JUST STARTED
A FEW MONTHS AGO AND I'M
ALREADY MAKING \$5 TO \$10 A
WEEK IN MY SPARE TIME.



ON TOM, IT'S WONDERFUL
YOU'VE GONE AHEAD SO FAST
IN RADIO. WE NEVER
COULD HAVE GOTTEN
MARRIED ON WHAT YOU
WERE EARNING BEFORE

OUR WORRIES ARE OVER. I'M
A TRAINED RADIO TECHNICIAN
NOW. THERE'S A BRIGHT
FUTURE AHEAD FOR US IN
RADIO AND TELEVISION

tubes, repairs, etc. Over 5,000,000 auto Radios are in use and thousands more are being sold every day. In every branch Radio offers opportunities for which I give you the required knowledge of Radio at home in your spare time. Yes, the few hundred \$30, \$40, \$50 a week jobs of 20 years ago have grown to thousands.

Many Make \$5 to \$10 a Week Extra in Spare Time While Learning

The day you enroll, I start sending you Extra Money Job Sheets—start showing you how to do actual Radio repair jobs. Throughout your Course I send plans and directions which have helped many make \$5 to \$10 a week extra in spare time while learning. I send you special Radio equipment to conduct experiments and build circuits. This 50-50 training method makes learning at home interesting, fascinating, practical.

Find Out What Radio and Television Offer

Act today. Mail coupon for my 64-page book, "Rich Rewards in Radio." It points out Radio's spare time and full time opportunities and those coming in Television; shows more than 100 letters from men I trained, telling what they are doing and earning. Read my money back agreement. Find out what Radio, Television offer you. Mail coupon in envelope or paste on penny postcard—Now.

J. E. SMITH, President
Dept. ONP, National Radio Institute,
Washington, D. C.

THIS
Free Book
HAS HELPED
HUNDREDS OF MEN
MAKE MORE
MONEY



TESTED WAY TO BETTER PAY

You Get This Professional Servicing Instrument . . .



This instrument makes practically any test you will be called upon to make in Radio service work on both spare time and full time jobs. It can be used on the test bench, or carried along when out on calls. It measures A.C. and D.C. voltages and currents; tests resistances; has a multi-band oscillator for aligning any set, old or new. You get this instrument to keep as part of your N.R.I. Course.

GET THE FACTS,
MAIL THIS COUPON
NOW!

THIS COUPON GOOD FOR ONE FREE COPY OF MY BOOK!

J. E. SMITH, President, Dept. ONP
National Radio Institute, Washington, D. C.

Dear Mr. Smith: Mail me FREE, without obligation, your 64-page book "Rich Rewards in Radio" which points out spare time and full time opportunities in Radio, those coming in Television, and explains your 50-50 method of training men at home in spare time to be Radio Technicians. (No salesman will call. Write Plainly.)

Age.....

Name.....

Address.....

City..... State.....

How to PROTECT YOUR

Secure Your Exclusive Right to Sell. Market

WITH A U.S.



RECORD YOUR INVENTION

A model is usually unnecessary. Your first step is to make a sketch and description of your invention and have it dated and witnessed by a friend. If you mail the coupon we will send you FREE a "Record of Invention" form on which to make your sketch and description in legal form.

The U. S. Patent Laws are enacted for your benefit—to give you the exclusive right to make, use and sell your invention. But to secure these benefits, it is important to APPLY FOR YOUR PATENT PROMPTLY—because this is a large country and millions of persons have the same opportunity as you to develop an invention similar to yours. Where rival inventors are involved, the law tends to favor the one WHO FILES HIS PATENT APPLICATION FIRST.

How We Serve You Before The Patent Office

One purpose of the Patent Law is to protect those features of your invention which are patentable. And these features must be legally and concisely set forth in the form of "Claims"—a phase of procedure so complex that the Patent Office advises the inventor to engage a competent Registered Patent Attorney because "without skillful preparation of the specification and claims, a patent grant is of doubtful value." We have a large and competent staff—carefully trained registered patent attorneys—expert draftsmen—experienced searchers—to serve you every step of the way. Our Free Book explains our services. Mail coupon.

The First Steps You Should Take

Make no mistake—obtain the services of a Registered Patent Attorney and establish the date of your invention. Our Book tells you *how* to do this, and our Free



PATENT YOUR INVENTION

Mail a Coupon for our Free Book, "Patent Guide for the Inventor"—48 fascinating pages of facts you should know about patents and inventions—what to do, when to do it, pitfalls to avoid, steps to take. We stand ready to give you prompt, efficient service in preparing, filing and prosecuting your patent application.

Record of Invention Form *helps* you to do it quickly. The next step is to have a search made of the Patent Office records to determine whether or not your invention is probably patentable. We, as your patent attorneys, do this for you—BEFORE FILING YOUR APPLICATION. This time and money-saving step is fully explained in our Book. Mail the coupon for your Free copy.

Simple Inventions, Improvements, Often Big Commercial Successes

Inventions need not be complicated to be successful. Many outstanding successes have been made by simple devices. The zipper, thumb-tack, collar-button, safety-pin, paper clip, etc.—and methods of making them—have proved profitable to their inventors. The overall buckle is said to have made a fortune for its inventor. Remember, too, that patents are granted on improvements over already-existing inventions. You can secure a Patent for such an improvement, even though you do not hold the patent on the original invention. Sometimes improvements—as was the case, for example, with the zipper—are more valuable than the original invention. Business is constantly striving

CLARENCE A. O'BRIEN

Send for 48 page Patent Guide and "Record of Invention" form, Address:

INVENTION and Profit from it... PATENT

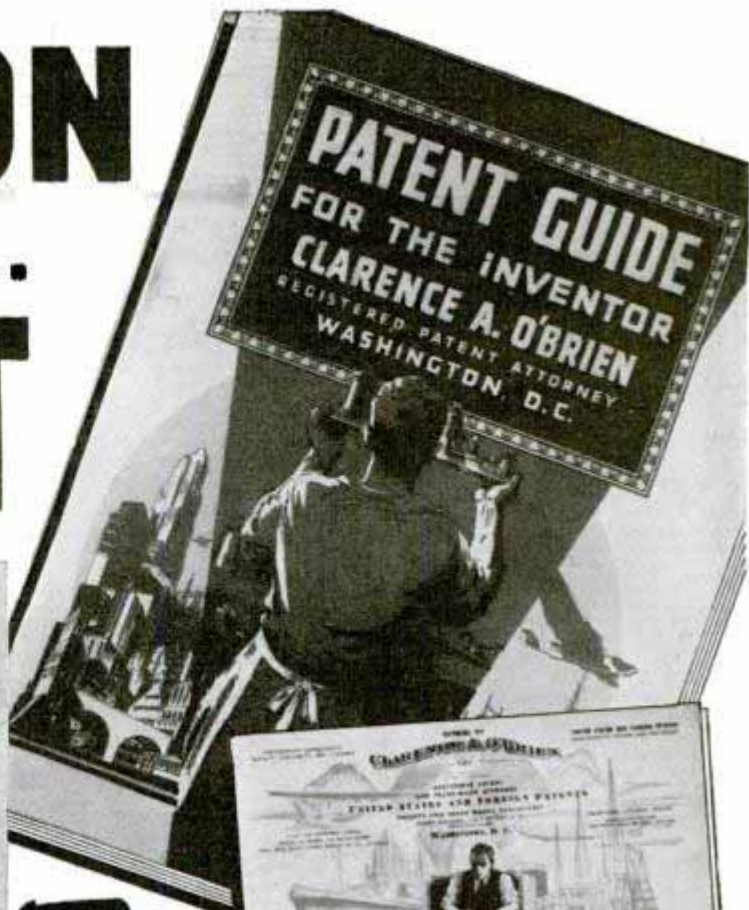

Free

Mail the Coupon today, for 48-page "Patent Guide" which tells you what you should know about making application for your Patent—also "Record of Invention" form which will enable you to visibly record proof of your invention and have it witnessed in legal form.



3

SELL YOUR PATENT

Once your rights are defined by your United States Patent, secured through this office, we can give you sound advice and guidance. We analyze patent claims, prepare instruments of assignments, royalty agreements, etc., or review them if prepared by others to see if the terms and stipulations are correct. Details in our Free Book. Mail Coupon.

to improve its products, and the invention of improvements, if commercially practicable, offers a profitable field for inventors. Our Book contains many examples of patents on improvements. Mail coupon for your copy.

SEND NOW FOR FACTS

The word "NOW" is important in patent matters, for prompt action is frequently the key to success. So, NOW is the time for you to get and read our FREE BOOK—to get and use our Record of Invention form. The book—crammed with vital facts and fascinating illustrations—shows you every step to take. The Record of Invention form—especially prepared for the inventor—makes it EASY for you to take the first step, without cost or obligation, toward patenting your invention. Mail the coupon now—on a penny postcard, or in an envelope.

MAIL this Coupon Now

Mail Coupon Now for FREE Book

CLARENCE A. O'BRIEN, Registered Patent Attorney
Dept. OM1, Adams Building, Washington, D. C.

Please send me your 48-Page Patent Guide and your Specially Prepared "Record of Invention" form FREE. This request does not obligate me.

Name.....

Address.....

City..... State.....

(Please write or print plainly.)

REGISTERED PATENT ATTORNEY
WASHINGTON, D.C.

Dept. OM1, Adams Building



AUTO

BOOKS SENT FREE

on approval. Just mail the coupon and we'll send you a set of these remarkable auto books. Whether you are a mechanic or helper, expert or apprentice, auto owner or driver, if you're interested in knowing all about automobile mechanics, take advantage of this FREE EXAMINATION OFFER.

GET A BETTER JOB

A better job—in the gigantic auto industry. BIGGER PAY—a chance to go into business for yourself and get a share of the profits, are waiting for any man who even half tries to improve himself. Learn auto engineering with these wonder books a new way—a quick reference method. Simply use the JIFFY INDEX to look up the answer to any auto problem. Built by eleven of America's great automobile engineers, and written in simple language so you can understand it.

Privilege of consulting Automobile Engineers for one year without extra cost if you mail coupon immediately.

Send promptly and we will include a New EXTRA volume with over 300 pages including late cars with wiring diagrams and data sheets on each.

CAN YOU FIX IT?

These wonder books tell step by step HOW to take out "play" in differential—to kill the shimmy in steering—to set TIMING—how to put your finger on engine trouble and the expert way to FIX it.

6 BIG VOLUMES

2500 pages, 2000 illustrations, wiring diagrams, etc., including Marine Engines, Aviation Motors, Diesel engines, etc. De Luxe edition, gold-stamped flexible binding.

AMERICAN TECHNICAL SOCIETY (Publishers—Home Study Courses), Drexel Ave. & 58th St., Dept A919, Chicago, Illinois. I would like to see the 6-volume edition of your AUTO BOOKS. I will pay the delivery charges only, but if I choose to, I may return them express collect. If after 10 days use I prefer to keep them, I will send you \$2 and pay the balance at the rate of only \$3 a month, until \$24.80 is paid. Please include consulting service and extra Volume No. 7, as per your offer above.

Name
Address
City State
Please attach letter stating age, occupation and name and address of employer and that of at least one business man as reference.

AUDELS Carpenters and Builders Guides

4 vols. \$6



Inside Trade Information for Carpenters, Builders, Joiners, Building Mechanics and all Woodworkers. These Guides give you the short-cut instructions that you want—including new methods, ideas, solutions, plans, systems and money saving suggestions. An easy progressive course for the apprentice and student. A practical daily helper and Quick Reference for the master worker. Carpenters everywhere are using these Guides as a Helping Hand to Easier Work, Better Work and Better Pay. To get this assistance for yourself, simply fill in and mail the FREE COUPON below.

Inside Trade Information On:

How to use the steel square—How to file and set saws—How to build furniture—How to use a mitre box—How to use the chalk line—How to use rules and scales—How to make joints—Carpenters arithmetic—Solving mensuration problems—Estimating strength of timbers—How to set girders and sills—How to frame houses and roofs—How to estimate costs—How to build houses, barns, garages, bungalows, etc.—How to read and draw plans—Drawing up specifications—How to excavate—How to use settings 12, 13 and 17 on the steel square—How to build hoists and scaffolds—skylights—How to build stairs—How to put on interior trim—How to hang doors—How to lath-lay floors—How to paint.



THEO. AUDEL & CO., 49 W. 23rd St., New York City

Mail Audels Carpenters and Builders Guides, 4 vols., on 7 days' free trial. If O.K. I will remit \$1 in 7 days, and \$1 monthly until \$6 is paid. Otherwise I will return them. No obligation unless I am satisfied.

Name
Address
Occupation
Reference P.M.

Easy to Play

THE SMALLEST, LIGHTEST, FULL-VOLUMED 90 BASS ACCORDION EVER DESIGNED. IT'S THE NEW SOPRANI AMPLIPHONIC MIDGET

● Think of it! 34 treble, and 90 bass keys, beautiful tone, amazing volume. See and try this wonderful new Soprani at your dealer's, or write for FREE booklet.

SOPRANI, INC. Dept. 1229
630 S. Wabash, Chicago, Ill.

FREE BOOK

TRI-STATE COLLEGE

B. S. Degree in 2 Years

World famous for technical 2-year courses in Civil, Electrical, Mechanical, Chemical, Radio, Aeronautical Engineering, Business Administration and Accounting. Special preparatory department for those who lack required high school work. Short diploma courses (36 weeks) in Surveying, Drafting. Low tuition. Low living costs. Students from every state and many foreign countries. 57th year. Graduates successful. Enter January, March, June, September. Write for catalog. 4120 College Ave., ANGOLA, IND.

RADIO TECHNOLOGY

RCA Institutes offer an intensive course of high standard embracing all phases of Radio and Television. Practical training with modern equipment at New York and Chicago Schools. Also specialized courses in Aviation Communications, Radio Servicing and Commercial Operating. Illustrated Catalog on request.

RCA INSTITUTES, INC. Dept. PC-40
A Radio Corporation of America Service
75 Varick St., New York 1154 Merchandise Mart, Chicago

TOOL & DIE MAKERS

Machinists, Screw Machine Men

EARN BIG PAY

Skilled metal workers earn up to \$50-\$60 a week. Learn these trades by actual work in ALLIED SHOPS. Fully equipped. State Approved. Low Fee. Enter any time. Day and Evening classes. FREE Employment Service. Write for NEW Illustrated Catalog.

ALLIED SCREW MACHINE CO., (School Division)
Dept. PM-12, 609 W. Lake Street, Chicago, Illinois

Learn CARTOONING

FREE TRIAL LESSON! Cash in on your sense of humor—AT HOME—BY MAIL. Have fun! Make money! No experience needed to start. Write today for FREE LESSON, mailed postpaid. No obligation.

MOON Gag-Cartoon School, Dept. A, Fall Creek, Wis.

RAILWAY PASSENGER TRAFFIC INSPECTOR

BE A PASSENGER TRAFFIC INSPECTOR

Our home-study training prepares you quickly for interesting, necessary job in transportation. We help place graduates or refund tuition. Many good opportunities. Graduate Inspectors earn up to \$135 per mo. plus expenses to start.

STANDARD BUSINESS TRAINING INSTITUTE (Est. 1918), Div. 212, Buffalo, N. Y.

White FREE BOOKLET

VOICE

100% Improvement Guaranteed

We build, strengthen the vocal organs—not with singing lessons—but by fundamentally sound and scientifically correct silent exercises... and absolutely guarantee to improve any singing or speaking voice at least 100%... Write for wonderful voice book—sent free. Learn WHY you can now have the voice you want. No literature sent to anyone under 17 years unless signed by parent.

PERFECT VOICE INSTITUTE, Studio 1359
64 E. Lake St., Chicago

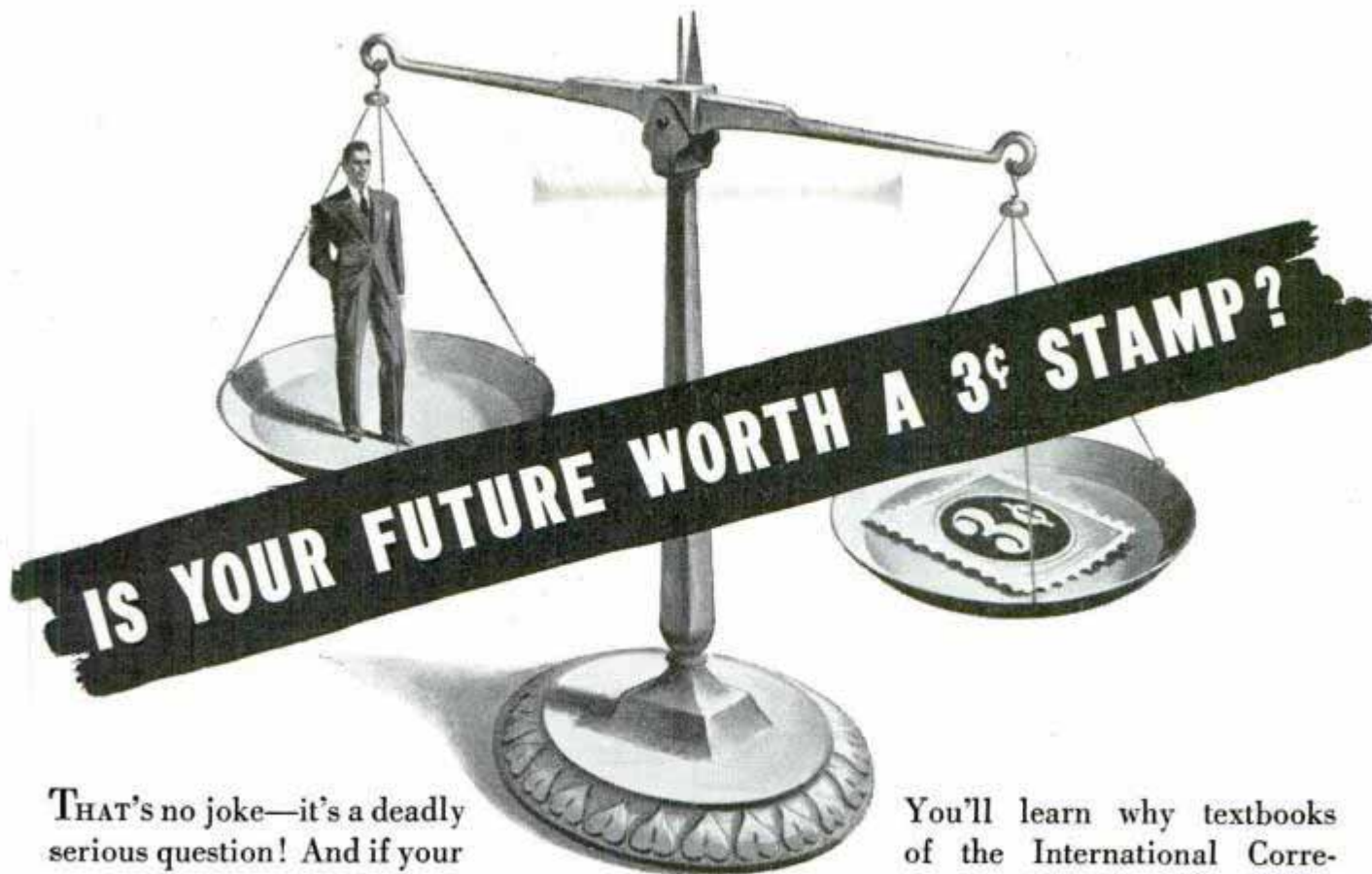

THAT'S no joke—it's a deadly serious question! And if your answer is "Yes," then check the coupon below, and mail it *right now!*

That three-cent investment will bring you complete information on the organization that has trained tens of thousands of men for successful careers—whose graduates include the heads of a great automotive corporation, a major airline, a vast mining corporation and others whose names are famous.

You'll learn why textbooks of the International Correspondence Schools are being used by scores of leading colleges and universities. You'll learn why the training *methods* of I. C. S. are commended by famous educators. You'll learn how I. C. S. can help *you* achieve *your* ambitions.

Remember — it's not too late to start to succeed now. But some day it will be! Here's the coupon.

INTERNATIONAL CORRESPONDENCE SCHOOLS

BOX 5591-J, SCRANTON, PENNA.

★ Without cost or obligation, please send me a copy of your booklet, "Who Wins and Why," and full particulars about the course *before* which I have marked X: ★

TECHNICAL AND INDUSTRIAL COURSES

- | | | | | |
|---|---|---|---|--|
| <input type="checkbox"/> Agriculture | <input type="checkbox"/> Air Brake | <input type="checkbox"/> Cotton Manufacturing | <input type="checkbox"/> Mfg. of Pulp and Paper | <input type="checkbox"/> R. R. Section Foreman |
| <input type="checkbox"/> Air Conditioning | <input type="checkbox"/> Architectural Drafting | <input type="checkbox"/> Diesel Engines | <input type="checkbox"/> Marine Engines | <input type="checkbox"/> R. R. Signalmen's |
| <input type="checkbox"/> Architecture | <input type="checkbox"/> Architecture | <input type="checkbox"/> Electrical Drafting | <input type="checkbox"/> Mechanical Drafting | <input type="checkbox"/> Refrigeration |
| <input type="checkbox"/> Auto Engine Tune-up | <input type="checkbox"/> Auto Engine Technician | <input type="checkbox"/> Electrical Engineering | <input type="checkbox"/> Mechanical Engineering | <input type="checkbox"/> Sanitary Engineering |
| <input type="checkbox"/> Aviation | <input type="checkbox"/> Auto Technician | <input type="checkbox"/> Electric Lighting | <input type="checkbox"/> Mine Foreman | <input type="checkbox"/> Sheet Metal Work |
| <input type="checkbox"/> Bridge Engineering | <input type="checkbox"/> Boilermaking | <input type="checkbox"/> Fire Bosses | <input type="checkbox"/> Navigation | <input type="checkbox"/> Steam Electric |
| <input type="checkbox"/> Building Estimating | <input type="checkbox"/> Foundry Work | <input type="checkbox"/> Fruit Growing | <input type="checkbox"/> Pattermaking | <input type="checkbox"/> Steam Engines |
| <input type="checkbox"/> Chemistry | <input type="checkbox"/> Heating | <input type="checkbox"/> Heat Treatment of Metals | <input type="checkbox"/> Pharmacy | <input type="checkbox"/> Steam Fitting |
| <input type="checkbox"/> Civil Engineering | <input type="checkbox"/> Highway Engineering | <input type="checkbox"/> House Planning | <input type="checkbox"/> Plumbing | <input type="checkbox"/> Structural Drafting |
| <input type="checkbox"/> Coal Mining | <input type="checkbox"/> House Planning | <input type="checkbox"/> Locomotive Engineer | <input type="checkbox"/> Poultry Farming | <input type="checkbox"/> Structural Engineering |
| <input type="checkbox"/> Concrete Engineering | <input type="checkbox"/> Machinist | <input type="checkbox"/> Management of Inventions | <input type="checkbox"/> Practical Telephony | <input type="checkbox"/> Surveying and Mapping |
| <input type="checkbox"/> Contracting and Building | | | <input type="checkbox"/> Public Works Engineering | <input type="checkbox"/> Telegraph Engineering |
| | | | <input type="checkbox"/> Radio, General | <input type="checkbox"/> Textile Designing |
| | | | <input type="checkbox"/> Radio Operating | <input type="checkbox"/> Toolmaking |
| | | | <input type="checkbox"/> Radio Servicing | <input type="checkbox"/> Welding, Electric and Gas |
| | | | | <input type="checkbox"/> Woolen Manufacturing |

BUSINESS COURSES

- | | | | | |
|--|--|--|---|---|
| <input type="checkbox"/> Accounting | <input type="checkbox"/> Advertising | <input type="checkbox"/> College Preparatory | <input type="checkbox"/> Foremanship | <input type="checkbox"/> Railway Postal Clerk |
| <input type="checkbox"/> Bookkeeping | <input type="checkbox"/> Business Correspondence | <input type="checkbox"/> Commercial | <input type="checkbox"/> French | <input type="checkbox"/> Salesmanship |
| <input type="checkbox"/> Business Management | <input type="checkbox"/> Business Management | <input type="checkbox"/> Cost Accounting | <input type="checkbox"/> Grade School | <input type="checkbox"/> Secretarial |
| <input type="checkbox"/> Cartooning | <input type="checkbox"/> Civil Service | <input type="checkbox"/> C. P. Accounting | <input type="checkbox"/> High School | <input type="checkbox"/> Sign Lettering |
| | | <input type="checkbox"/> First Year College | <input type="checkbox"/> Illustrating | <input type="checkbox"/> Spanish |
| | | | <input type="checkbox"/> Lettering Show Cards | <input type="checkbox"/> Traffic Management |
| | | | <input type="checkbox"/> Managing Men at Work | |

HOME ECONOMICS COURSES

- | | | |
|---|---|--|
| <input type="checkbox"/> Advanced Dressmaking | <input type="checkbox"/> Home Dressmaking | <input type="checkbox"/> Tea Room and Cafeteria Management, Catering |
| <input type="checkbox"/> Foods and Cookery | <input type="checkbox"/> Professional Dressmaking and Designing | |

Name..... Age..... Address.....
 City..... State..... Present Position.....

Canadian residents send coupon to International Correspondence Schools Canadian, Limited, Montreal, Canada
 British residents send coupon to I. C. S., 71 Kingsway, London, W. C. 2, England



MACHINE SHOP MEN

Learn to set up and run ANY kind of machine; MAKE MORE MONEY NOW by learning quickly **HOW TO DO THINGS** which usually take years of study and practice. The demand for **SKILLED** men is **ALREADY** ahead of the supply, then what **WILL IT BE** a month or two from now?

Needed NOW!

Bigger Pay Don't miss this chance to qualify for promotion, don't miss this Big Opportunity which is yours almost for the asking. Eight Big Books chockful of important mechanical facts told simply and clearly. Over 3000 pages, nearly 3000 illustrations cover every subject fully, including Tool Making, Pattern Making, Foundry Work, Mechanical Drawing, Forging, Machine Shop Practice and Management, and hundreds of other subjects.

8 Big Books (1940 Edition) Sent FREE to you for examination. With them we send a **Big Binder** of nearly 800 pages with 267 original shop tickets with 1200 illustrations. These show, step by step, how to set up and run almost any kind of job and are in **addition** to the 8 books. Decide in your own home or place of business whether or not you want to keep them, check up on any facts you want to. Note their great **MONEY MAKING** value, then, if you want them, pay on the easiest kind of payments. Send **NOW** and we will include a year's consulting service without extra charge.

American Technical Society, Publishers—Home Study Courses.

American Technical Society, Dept. 5919, Drexel at 58th St., Chicago. You may send me the 8 big NEW books and binder of shop tickets for free examination. I will pay the delivery charges only, unless I decide to keep them in which case I will send \$2.00 in ten days and \$3.00 per month until the total price of only \$34.80 is paid. If I return them in 10 days I will owe you nothing. Because I send now you agree to give me a certificate entitling me to consulting privileges with your experts for one year.

Name.....
Address.....
Please attach a letter stating age, occupation, employer's name and address and that of at least one business man as reference.

PLUMBERS & STEAM FITTERS

Audels Plumbers and Steamfitters Guides



4 Vols. \$6

A practical, illustrated, Reference Library and Study-Course for Master Plumbers, Journeymen and Apprentice Steamfitters, Gas Fitters and Helpers, Sheet Metal Workers, Draughtsmen, Master Builders, Engineers and all Building Trade Students. This valuable set of handy, pocket-size Guides explains in practical concise language and well-done illustrations all the principles, advances and short cuts of the Plumbing and Heating trade—based on modern practice. Contains careful, detailed instructions

on how to figure and estimate various jobs. Use **FREE COUPON** below to examine, without obligation, this valuable work.

INSIDE TRADE INFORMATION ON:

Soldering, tinning. Joint wiping, bending, beating. Pipe—iron—steel, threading. Mathematics, tables, physics. Materials—iron, steel, copper, brass, lead, tin, antimony, etc. Sheet metal—galvanized—plate. Sanitation, syphonage, tanks. Drainage, sewage, purification. Fixtures—bath—kitchen. Pipe fittings, soil pipe, tools. Laying out work. Roughing. Screwed fittings, flanges, joints. Pipe bending, examples. Elbows. Heating, ventilation, air conditioning, refrigeration. Water supply, mains, wells, tanks. Gas-fittings. Sheet metal work, problems, methods. Brazing, heating, lead burning. Welding, various welds, methods. Blacksmithing, forges, tools. **Air Conditioning.**

THEO. AUDEL & CO., 49 W. 23rd St., New York City

Mail Audels Plumbers Guides, 4 vols., on 7 days' free trial. If O. K. I will remit \$1 in 7 days, and \$1 monthly until \$6 is paid. Otherwise I will return them. No obligation unless I am satisfied.

Name.....
Address.....
Occupation.....
Reference..... P. M.

When writing please mention Popular Mechanics

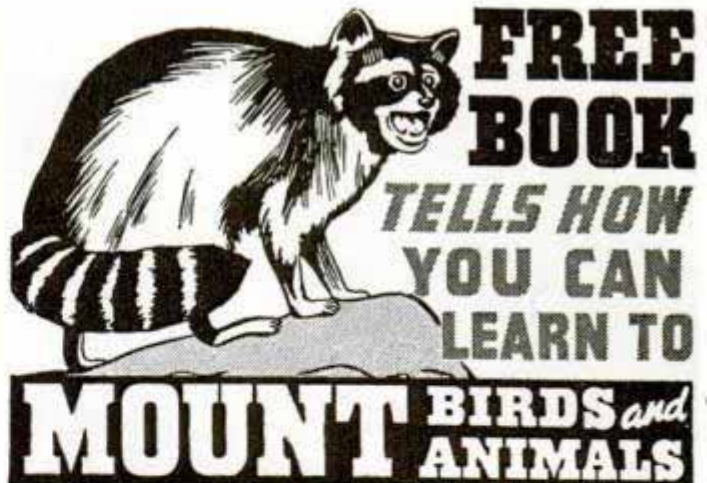

FREE BOOK TELLS HOW YOU CAN LEARN TO

MOUNT BIRDS and ANIMALS

BE A TAXIDERMIST—Learn by Mail

Easy home lessons teach you quickly how to **MOUNT BIRDS, ANIMALS, GAME-HEADS, FISH—TO TAN LEATHERS, FURS.** Save your hunting trophies. Have a home museum. It's thrilling! Taxidermy is wonderful, **FUN, A PLEASURE HOBBY AND A MONEY MAKER!**—Investigate! Get this strange **FREE BOOK.** **EXTRA MONEY!**—Earn in your spare time. Sell your mounts; and do work for other sportsmen. Students report \$30 to \$75 and more per month. Big demand. Fine prices. If you want **REAL PROFIT** from spare time **WRITE TODAY.**

Game is growing scarcer—every specimen valuable!

FREE BOOK—with 100 photos of wild game. Tells about Taxidermy and how **YOU** can learn easily, quickly. Old reliable school. 275,000 students. — **STOP** this minute and **TEAR OUT THIS AD NOW** as a reminder; then write; get the free book. You will be delighted, **AMAZED.** RUSH postal or letter and learn how to have more **FUN, FASCINATION, PROFIT.** State your **AGE.**

Northwestern School of Taxidermy, Dept. 3379, Omaha, Neb.



Thomas E. Lattin
President

I WANT TO TRAIN YOU For A Big-Paying Job IN THE MEAT BUSINESS

I have trained hundreds of men like you to become expert Meat Cutters. Good pay. Steady jobs everywhere. Government figures show over 50,000 new meat markets. My school offers you quick, short, intensive training. Actual practice in big cutting rooms and retail department. Union card **FREE.** Pay after graduation. Valuable employment service. Write me today for my big **FREE** catalog and all details.

National School of Meat Cutting, Inc., Dept. U-13, Toledo, Ohio.

LAW STUDY AT HOME

Legally trained men win higher positions and bigger success in business and public life. Greater opportunities now than ever before. Big corporations are headed by men with legal training.

More Ability: More Prestige: More Money

We guide you step by step. You can train at home during spare time. Degree of **L.L.B.** Successful graduates in every section of the U. S. We furnish all text material, including 14-volume Law Library. Low cost, easy terms. Get our valuable 48-page "Law Training for Leadership" and "Evidence" books **FREE.** Send for them **NOW.**

LaSalle Extension University, Dept. 1264-L Chicago
A Correspondence Institution

ENGINEERING

DEGREE IN TWO YEARS

TECHNICAL AND APPLIED COURSES. Nonessentials omitted. TIME AND MONEY SAVED. Degree 2 yrs., diploma 1 yr. **Electrical, Mechanical, Architectural, Structural, Civil, Aeronautical, including Air Conditioning, Refrigeration, Diesel.** Intensive courses, 3 and 4 months in **Electricity, Power Plant, Diesel, Refrigeration, Drafting.** Extensive shop equipment. **LOW TUITION.** Part-time work for room and board. Thousands successful graduates in U. S. and foreign lands. Approved by industry, endorsed by educators, recommended by alumni. One and two-year courses open Sept. 18 to Oct. 18, short courses start specified dates, beginning Sept. 18. 41st Year. No home study courses. Catalog free.

1001 Indiana Ave. FINLAY ENGINEERING COLLEGE Kansas City, Mo.

EARN A DEGREE AT HOME

From A Chartered Institution of Higher Learning
Employers Now Demand College Graduates With Degrees

88 Degree Courses in Arts; Sciences; Philosophy; Education; Public Health; Medical Jurisprudence; Psychology; Sociology; Physics; Chemistry; Geology; Pol. Science; Theology; Law; Business Training; Accounting; Statistics; Agriculture; Electrical, Civil, Mechanical, Drafting, Architectural, Automotive, Steam, Diesel, Aeronautical, Radio, Structural, Industrial, Highway, Petroleum, Mining, Marine, Refrigeration, Air Conditioning, Chemical Engineering. Founded 1908. Chartered, McKinley-Roosevelt Graduate College, 4610-P Sheridan Road, Chicago

LEARN WATCH REPAIRING



AT HOME You can learn by our modern and original system of instruction every part of the **Watch Repairing Trade** at home. You can earn money while learning and prepare yourself for a well paying position or start in business after completing our course of instruction. Good watch repairers are in demand and generally earn very good salaries. For particulars apply to the **Wisconsin School of Watch Repairing** 524 E. Mason St., MILWAUKEE, WIS.

Take YOUR Place in Aviation
Beside *these fellows!*

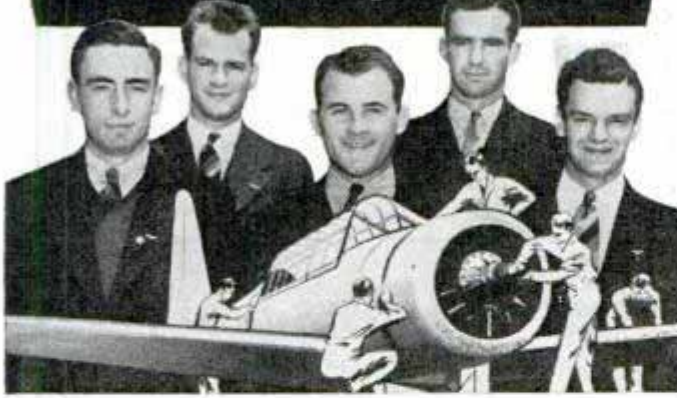

—they are building famous fighting planes, and are ALSO building substantial futures for themselves. These are Aero ITI-trained men. You would be proud to step into aircraft work beside them —if you had the same proven training behind you. You would be proud to have won the technical knowledge and practical ability Aero ITI demands that its graduates possess—to assure a sound start in Aviation. You would be confident, too, of your broad, thorough training as a means of steady advancement and security in a great and growing industry. Hundreds of men now in Aviation are profiting from their Aero ITI training. Find out about it NOW.

EXECUTIVE BOARD

John K. Northrop
President
Northrop Aircraft, Inc.

Robert E. Gross
President, Lockheed
Aircraft Corporation

C. A. Van Dusen
Vice Pres., Consolidated
Aircraft Corporation

AERO INDUSTRIES TECHNICAL INSTITUTE
5253 W. SAN FERNANDO ROAD, LOS ANGELES, CALIFORNIA
Five Courses in AIRCRAFT MECHANICS and AERONAUTICAL
ENGINEERING—Including 12 Month Aircraft Mechanics Course
Approved by U. S. Civil Aeronautics Board

THERE'S MONEY IN CARTOONS!
RAYE BURNS will teach you HOW to CREATE ORIGINAL CARTOONS, at home, you may SELL! Cost is unusually low. Write for FREE details, miniature lesson plates, and addresses of successfully trained students. No obligation. RAYE BURNS SCHOOL, Studio M, Box 3853, Cleveland, O.

Minstrels Comedy Strips Plays Songs
Unique First Parts for complete show with special songs and choruses. Make-up. Catalog free.
T. S. Denison & Co., 203 N. Wabash, Dept. 19, Chicago

STATEMENT OF THE OWNERSHIP, MANAGEMENT, CIRCULATION, ETC. REQUIRED BY THE ACTS OF CONGRESS OF AUGUST 24, 1912, AND MARCH 3, 1933, of Popular Mechanics Magazine, published monthly at Chicago, Illinois, for October 1, 1940.

State of Illinois, County of Cook, ss.

Before me, a Notary Public in and for the State and county aforesaid, personally appeared H. H. Windsor, Jr., who, having been duly sworn according to law, deposes and says that he is the Editor of the Popular Mechanics Magazine and that the following is, to the best of his knowledge and belief, a true statement of the ownership, management (and if a daily paper, the circulation), etc., of the aforesaid publication for the date shown in the above caption, required by the Act of August 24, 1912, as amended by the Act of March 3, 1933, embodied in section 537, Postal Laws and Regulations, printed on the reverse of this form, to wit: First, That the names and addresses of the publisher, editor, managing editor, and business managers are: Publisher, Popular Mechanics Company, 200 East Ontario St., Chicago, Ill.; Editor, H. H. Windsor, Jr., 200 East Ontario St., Chicago, Ill.; Managing Editor, H. W. Mudge, 200 East Ontario St., Chicago, Ill.; Business Manager, Willis S. Brown, 200 East Ontario St., Chicago, Ill. Second, That the owner is: (If owned by a corporation, its name and address must be stated and also immediately thereunder the names and addresses of stockholders owning or holding one per cent or more of total amount of stock. If not owned by a corporation, the names and addresses of the individual owners must be given. If owned by a firm, company, or other unincorporated concern, its name and address, as well as those of each individual member, must be given.) Popular Mechanics Company, 200 East Ontario St., Chicago, Ill.; L. H. Windsor, 200 East Ontario St., Chicago, Ill.; H. H. Windsor, Jr., 200 East Ontario St., Chicago, Ill.; H. H. Windsor, Jr., Trustee under the will of Lina B. Windsor, Deceased, 200 East Ontario St., Chicago, Ill., and H. H. Windsor, Jr., Trustee under the will of H. H. Windsor, Sr., Deceased, 200 East Ontario St., Chicago, Ill. Third, That the known bondholders, mortgagees, and other security holders owning or holding 1 per cent or more of total amount of bonds, mortgages, or other securities are: (If there are none, so state.) None. Fourth, That the two paragraphs next above, giving the names of the owners, stockholders, and security holders, if any, contain not only the list of stockholders and security holders as they appear upon the books of the company, but also in cases where the stockholder or security holder appears upon the books of the company as trustee or in any other fiduciary relation, the name of the person or corporation for whom such trustee is acting, is given; also that the said two paragraphs contain statements embracing affiant's full knowledge and belief as to the circumstances and conditions under which stockholders and security holders who do not appear upon the books of the company as trustees, hold stock and securities in a capacity other than that of a bona fide owner; and this affiant has no reason to believe that any other person, association, or corporation has any interest direct or indirect in the said stock, bonds, or other securities than as so stated by him. H. H. Windsor, Jr., Editor. Sworn to and subscribed before me this 30th day of September, 1940. N. E. Tomka, Notary Public. (My commission expires March 24, 1944.)

Not Expensive to Learn
SCIENTIFIC CRIME DETECTION

The Steady Pay Profession
Good Times—or Bad

"I will teach you Finger Print Identification — Firearms Identification—Police Photography—and Secret Service!" That's what I told the men who now handle the good jobs listed in the column at the right. Give me a chance and I'll train YOU to fill an important position in the fascinating field of scientific crime detection.

Learn
FINGER PRINTING
*
FIREARMS
IDENTIFICATION
*
POLICE
PHOTOGRAPHY
*
SECRET SERVICE
METHODS



I TRAINED
THE MEN
WHO THEN
GOT THESE
BIG JOBS

Here are a few of the 600 bureaus headed by our students and graduates.

- STATE BUREAU OF DELAWARE
- STATE BUREAU OF FLORIDA
- STATE BUREAU OF MAINE
- STATE BUREAU OF MICHIGAN
- STATE BUREAU OF NEW MEXICO
- STATE BUREAU OF RHODE ISLAND
- STATE BUREAU OF SOUTH CAROLINA
- STATE BUREAU OF TEXAS
- STATE BUREAU OF UTAH
- LINCOLN, NEBRASKA
- CONCORD, N. H.
- ALBANY, N. Y.
- TRENTON, N. J.
- CANTON, OHIO
- TULSA, OKLA.
- MOBILE, ALA.
- PHOENIX, ARIZ.
- LOS ANGELES, CALIF.
- SEATTLE, WASH.

GET IN NOW!

But don't be misled. Scientific crime detection is not simple. It's a science—a real science, which requires very special training. I teach you this science so that you should be competent to do the work of a thoroughly trained employee in a bureau of identification, for the rest of your life. I give you something nobody can ever take from you.

LOOK AT THE RECORD!

47% of ALL Identification Bureaus in the United States are headed by our students and graduates. They have regular jobs—salaries—often collect reward money—and many of these men knew absolutely nothing about this work before they began their training with me.

FREE BLUE BOOK OF CRIME

This book is full of exciting information on scientific crime detection. It will show YOU how YOU, at a cost so low you shouldn't even think of it, can get started without delay. Don't wait. Clip coupon . . . send it NOW!

INSTITUTE OF APPLIED SCIENCE
1920 Sunnyside Ave. Dept. 9359 Chicago, Ill.

INSTITUTE OF APPLIED SCIENCE
1920 Sunnyside Ave., Dept. 9359, Chicago

Gentlemen: Without any obligation on my part, send me the "Blue Book of Crime," and complete list of 600 bureaus employing your graduates, together with your low prices and Easy Terms Offer. (Literature will be sent ONLY to persons stating their age.)

Name

Address

Age

POPULAR INVENTIONS

For Your Home

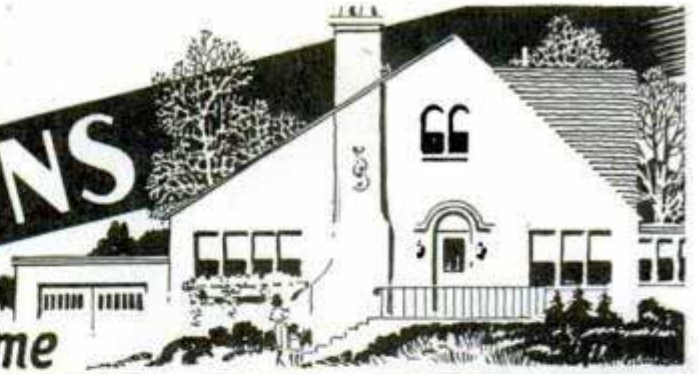

Dispenser for Waxed Paper Mounts on Wall



Waxed paper is always at your finger tips when kept in a metal cabinet that fastens on the kitchen wall. The cabinet is of ivory enamel, and can be mounted in the most convenient place in two minutes. It holds a 125-foot roll of waxed paper.

Warming Plate for Refrigerator Softens Butter for Spreading

To keep butter at just the right temperature for easy spreading, there is an electric plate that goes into the refrigerator. On this base a butter dish is set. Thermostatically controlled, the electric plate keeps the butter at fifty-eight degrees Fahrenheit, regardless of refrigerator temperature. Thus the butter is always ready to spread, and need not be "thawed." The unit is insulated so no heat escapes into the refrigerator. Using one and one-half watts a.c. or d.c., it is connected to the house circuit by a cord which may be brought out of the door at the hinged side.

Warpproof Metal Ironing Board Has Vents to Release Steam



Built for lifetime service, an ironing board just placed on the market is warpproof, being entirely of metal. Its folding legs disappear into the surface of the board when not in use. Vents that dot the entire surface of the board allow the steam to escape, helping to keep the pad dry and expedite the ironing.



(More Popular Inventions on page 28A)

Lee-See Mfg Co

1901

Badger Paper Mills, Inc. Peshtigo Wis

General Electric Co. Cudahy Ark Conn

*2930
Junk 49c
with 2 rolls*

K 1001

Butter plate \$1.75 - \$3.95

New-England Ave. Chicago

SAVE UP TO 50%

On this New 1941 **15-TUBE** *MIDWEST* **RADIO**

with **FREQUENCY MODULATION**
and **TELEVISION ADAPTATION**



FACTORY-TO-YOU *only*

EASY TERMS

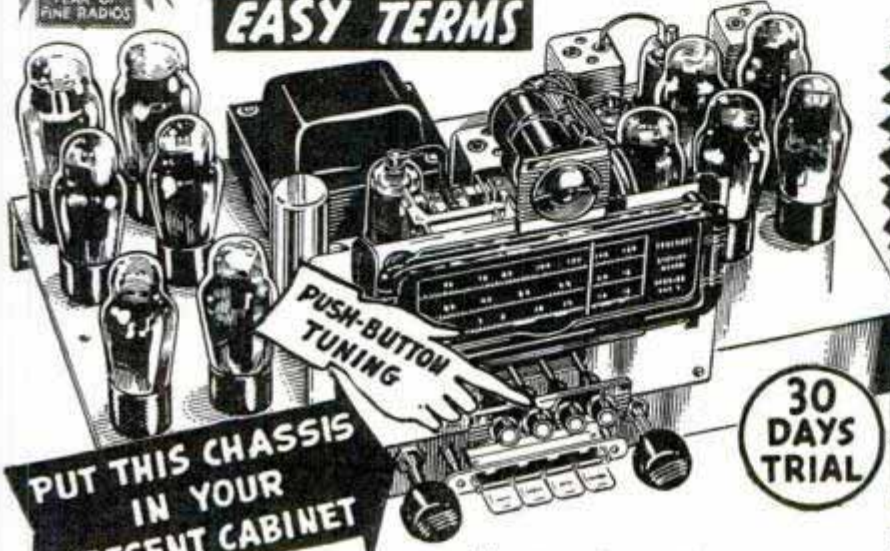

\$19⁹⁵ **COMPLETE**
CHASSIS
WITH TUBES
AND SPEAKER

**PUT THIS CHASSIS
IN YOUR
PRESENT CABINET**

**GET THRILLING WORLD-WIDE
FOREIGN NEWS DIRECT!**

Radio enthusiasts and merchandising experts who have seen the sensational new 1941 Midwest Radios say that they represent today's outstanding values! If you get a big "kick" out of owning a super powerful radio that

will out-perform ordinary sets, you will be particularly delighted with the brilliant performance, beautiful tone and world-ranging ability of these super Midwests. Just imagine being able to pull in world-distant broadcasts from the capitals of Europe—to hear history in the making before it

appears in your local paper or is announced over your local radio. We say: You can get thrilling world-wide foreign news, sports broadcasts and musical programs better and more clearly with a Midwest!

THIS
15-TUBE
CABINET MODEL
ONLY
\$29⁹⁵
COMPLETE

Fifteen tubes include Rectifiers, Control and Tuning Eye Tubes.



Just think! Here's a super powerful 15-tube radio—complete in cabinet—at a price you would ordinarily pay for a 7 or 8-tube set. Never before have you been offered so much radio for so little money!

UP TO \$25⁰⁰ TRADE-IN ALLOWANCE
ON YOUR OLD RADIO



Now, you can not only save up to 50% by buying direct from the Midwest factory—but, Midwest allows you up to \$25 on your old radio—on many models shown in the big, FREE Midwest Catalog. Send for this catalog and see for yourself that it actually brings the Midwest factory to you, that it pictures and dramatizes many beautiful, 1941 factory-to-you radio values—from 6 to 18 tubes—up to 5 wave bands—including Automatic Record-Changing Radio-Phonographs, Home Recorders, etc.

(Model Z-18 shown at left)
18-TUBES
5-BANDS

FILL IN COUPON AND MAIL TODAY OR JUST SEND YOUR NAME AND ADDRESS ON A POSTCARD

MIDWEST *factory-to-you* **RADIOS**

MANUFACTURERS OF QUALITY RADIOS SINCE 1920

Midwest Radio Corporation
Cincinnati, Ohio, U. S. A.
Dept. 15GG

Name.....

Send me your new FREE Catalog, complete details of your liberal 30-day Trial offer and factory-to-you prices.

Address.....

Town..... State.....

User-Agents Make Easy Extra Money. Check here () for details.



MAIL COUPON FOR FREE CATALOG

Our famous 30-day prove-it-yourself plan fully protects you and enables you to prove Midwest's super performance in the privacy of your own home. Absolutely no obligation.

ELECTRICAL BOOKS

shipped
FREE

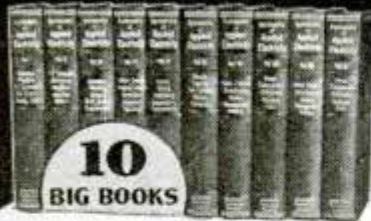

**10
BIG BOOKS**

FOR EXAMINATION
**MODERN
ELECTRICITY
INCLUDING RADIO
AND TELEVISION**

Here's great news for anybody interested in Electricity. NEW 17th. edition of Applied Electricity brought right down to date with NEW Electrical subjects fully covered. 10 big Volumes and all shipped **FREE** for examination.

**For
Beginners
and Experts**

over 3000 pages—hundreds of illustrations—the most complete work of its kind we have ever published. Dynamos, motors, power stations, Radios, television, everything electrical explained so anyone can understand it.

BIG FIELD! Big Demand! Big Pay!

Men who understand electricity are urgently needed in thousands of industries. Autos, airplanes, machine shops—practically every industry depends on electricity and men who know this subject make big money. Pleasant, fascinating work, easy to learn and do; learn with these books. Send coupon for a set for **FREE** examination and see for yourself.

**SEND
NOW**

[A year's consulting privileges with our engineers now given to all buyers of this famous Cyclopeda of Electricity.]

**AMERICAN TECHNICAL SOCIETY
(Publishers—Home Study Courses)**

American Technical Society, Dept. E919, Drexel at 58th St., Chicago Send for 10 days' free use, NEW 10 volume set of Applied Electricity. Because I send NOW you agree to send me a certificate entitling me to consulting privileges for one year. I will pay the delivery charges only on the books. If I wish I may return them in 10 days and owe you nothing, but if I keep them, I will send \$2.00 after 10 days, then \$3.00 a month until the total price of only \$29.80 is paid.

NAME.....

ADDRESS.....

CITY.....STATE.....

Please attach letter stating age, occupation and name and address of employer and give at least one business man as reference.

Learn this Profitable Profession



in 90 Days at Home

Hundreds of men and women of all ages 18-50 make \$10.00 to \$20.00 in a single day giving scientific Swedish Massage and Hydro-Therapy treatments. There is a big demand from Hospitals, Sanitariums, Clubs, Doctors and private patients as well as opportunities for establishing your own office. Learn this interesting money-making profession in your own home by mail, through our home study course. Same instructors as in our **NATIONALLY KNOWN** resident school. A diploma is awarded upon completion of the course. Course can be completed in 3 to 4 months. High School training is not necessary. Many earn big money while learning.

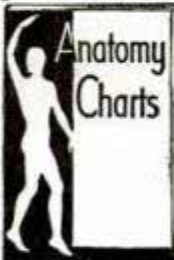

Anatomy Charts & Booklet FREE

Enroll now and we will include uniform coat, medical dictionary, patented reducing roller and Hydro-Therapy supplies without extra cost. The reducing course alone may be worth many times the modest tuition fee.

Send coupon now for Anatomy Charts and booklet containing photographs and letters from successful graduates. These will all be sent postpaid—**FREE**.

THE College of Swedish Massage
Dept. 964—30 E. Adams St., Chicago.
You may send me **FREE** and postpaid, Anatomy Charts, booklet containing photographs and letters from graduates, and complete details of your offer.

Name.....

Address.....

City.....State.....

LET ME PROVE I CAN MAKE YOU A NEW MAN

I changed myself from a 97-lb. weakling to winner of title "World's Most Perfectly Developed Man." Let me prove that my secret of Dynamic Tension can give you powerful muscles, smashing strength, a handsome build! All I ask is a 7 DAY TRIAL. Write for my 48-page **FREE BOOK**. **CHARLES ATLAS**, Dept. 812, 115 East 23rd Street, New York City.



**SEND
FOR MY
FREE BOOK**

PHOTO-ENGRAVING TASOPE' SINCE 1931

FREE—a copy of the Tasope' Magazine, monthly treasure chest of photographic and photo-engraving information. Learn why Aurora, Mo., is the photo-engraving, photographic center of America... how hundreds of amateurs, free-lance photographers are making money with pictures. No-obligation postcard brings your copy. **TASOPE', DEPT. PM-23, AURORA, MO.**

ENGINEERING DEGREE IN TWO YEARS

B. S. Degree courses in engineering: Electrical, Civil, Chem., Mechanical, Radio or Aeronautical. 1 yr. Mech. Drafting. Approved by Civil Aeronautics Authority, participation in Pilot Training Program. Large industrial center. Prep courses without extra charge. Earn board if desired. Low tuition. Enter December, March, June, September. Write for Catalog. 5120 E. Washington Blvd., Fort Wayne, Ind.

INDIANA TECHNICAL COLLEGE

Learn PHOTOGRAPHY at Home

Splendid opportunities. Prepare in spare time. Easy plan. No previous experience needed, common school education sufficient. Send for free booklet "Opportunities in Photography", particulars and requirements. **American School of Photography** 3601 Michigan Ave., Dept. 1359, Chicago, Ill.

Correspondence Courses in RADIO and ELECTRICAL ENGINEERING LOW AS \$25

ELECTRICAL ENGINEERING. Get good grasp of wide electrical field. Modern. Very understandable. Theory made easy. **RADIO ENGINEERING.** Extra fine course in radio, public address, photo-electric work. Trains you to be super-service man, real vacuum tube technician. Tuition **ONLY \$25**, either course. Deferred payment plan. Experiment kits furnished. **FREE LINCOLN ENGINEERING SCHOOL**, Box 531-P24, Lincoln, Nebr.

AMAZING NEW ELECTRIC ARC WELDER

RETAILS ONLY \$2.95 COMPLETE
FULLY GUARANTEED



Amazing new **HANDI-WELD** Electric Arc Welder—operates from 110 volt A.C. or D.C. same as other arc welders higher priced—generates tremendous heat to weld all kinds of metal. Not a toy welder that uses carbons, but actually uses standard coated rods—sizes 1/16" and 3/32". Generous supply furnished with welder. Guaranteed not to burn out. Repairs fenders, auto bodies, radiators, pre-heated small castings and machinery parts. Take **HANDI-WELD** anywhere to job, operate from light socket. Sturdily built of finest materials to last years. Fully guaranteed by Big Manufacturer.
SEND NO MONEY! You'll find a thousand uses for the **HANDI-WELD** around your home, garage, work shop. Also by garages, factories, repair shops, mechanics, farmers, inventors, tin shops, plumbers, etc. Order **HANDI-WELD** now. Send no money. We'll rush one to you, complete with rods and goggles. Pay post-WELD in 5 days from receipt and money paid for it will be refunded instantly. Rush your order now.
KUMFY PRODUCTS INC., Dept. L-202, Cincinnati, Ohio.

PARKS AIR COLLEGE

PARKS AIRPORT EAST ST. LOUIS, ILL.

Offers YOU COLLEGE and PROFESSIONAL TRAINING
Majoring in AVIATION

Accredited by the Illinois Superintendent of Public Instruction, U.S. approved as a Commercial Ground and Flying School and Mechanics' School. Accredited by and cooperating with the United States Army Air Corps in giving flight and mechanical training. Open to high school graduates.
FOUR courses lead to B.S. degrees in Professional Piloting, Aviation Operations, Maintenance Engineering, Aeronautical Engineering.
EIGHTEEN TRAINING PLANES are used in professional flight training which prepares graduates for airline flight operations. 76,000 hours flight training given, 3900 hours being flown monthly.
FACULTY of 73 specialists in various fields of aviation.
 1569 graduates. Enrollment limited to a total of 300 commercial aviation students. Total enrollment 560.
 100-acre airport, 28 buildings devoted to school purposes exclusively. Dormitories and dining hall at the College.
 Winter Term January 6. Send postcard for new 64-page catalog.
14th YEAR Registrar, Dept. PM-12
PARKS AIR COLLEGE, East St. Louis, Ill.

CRIME DETECTION SECRET SERVICE AND FINGER PRINTS

SECRET SERVICE BOOK FREE

For 30 Days Reading
 No Money Down—Actual Crime Cases—
 If You Act Quick! We will send you this stirring book on Crime Detection, Secret Service and Identification Work for 30 days free reading. Send no money. If you decide to keep it, then send me only \$1. If not, return it. WRITE TODAY. Literature will be sent only to persons stating their age.

T. G. COOKE, Dent. 1379, 1970 Sunnyside Ave., Chicago, Ill.

Regain Perfect Speech, If You STAMMER

Every stammerer should have the new 287 page book "Stammering, Its Cause and Correction." Sent free to stammerers. It describes the Bogue Unit Method for the scientific correction of stammering and stuttering. Method successfully used at Bogue Institute for 39 years—since 1901. Endorsed by physicians. Write for full information. No obligation. Benjamin N. Bogue, Dept. 1321 Circle Tower, Indianapolis, Indiana.

FREE BARGAIN CATALOG of BOOKS

25,000 books of all publishers listed in our 46th Annual Bargain Catalog of 320 pages. Old-time favorites—latest "best sellers." Reference, Fiction, Juvenile, History, Scientific, etc. Supplying schools, colleges, libraries and thousands of individual customers. Send postcard today for our new 1941 catalog, "Bargains in Books."

THE BOOK SUPPLY COMPANY, Dept. 133
 564-566 West Monroe Street, Chicago, Illinois

NEW WAY TO CHOOSE A CAREER

LET SCIENCE PICK A JOB FOR YOU!

TODAY, getting a job or choosing a career is no longer a hit-or-miss task. Science can now accurately determine for you, in advance, just what type of work or profession you are best suited for.

FREE Send your name on a penny postcard for FREE booklet explaining this new proven way to greater success.

Vocational Guidance Associates, Dept. 112, Tucson, Ariz.

RADIO-TELEVISION

Oldest, largest Radio-Television school in West trains you for good pay job. Complete instruction including Radio Construction and Service, Broadcast Operating, Sound, Talking Pictures, Television, Public Address, etc. Flexible plan to meet specific needs of those with or without jobs. Transportation allowed to L.A. Earn room and board while learning. Request Free Catalog.

NATIONAL SCHOOLS Dept. PMR-12
 Los Angeles

MONEY for MEN ALL FREE

THE PLASTEX Industry needs manufacturers on small scale and for big production of Lamp and Clock Stands, Art Goods and Novelties in Plastex and Marble imitation. Experience unnecessary. 1st material makes regular 10c store sellers. Rubber moulds furnished for speed production. Small investment brings big returns. WE ARE NOW PLACING BIG CHAIN STORE ORDERS WITH MANUFACTURERS. Ambitious men have chance for real prosperity. Our FREE booklet will interest and benefit you. **PLASTEX INDUSTRIES, Dept. P, 1085** Washington Ave., New York, N. Y.

Prepare NOW for PROMOTION



This complete drawing outfit,—everything to work with,—including drafting table, drawing board, supplies and drawing instruments,—ALL SENT TO YOU AT NO EXTRA COST if you are a Chicago Tech student.

MAIL COUPON BELOW

DRAFTING

The draftsman's work comes first. New machines,—new construction work,—new bridges,—new buildings,—all must first be laid out on paper by the draftsman. So the first man that must be hired is the draftsman.

Drafting Offers Opportunity

In the machinery and building fields,—in aircraft,—in diesels and air conditioning,—and in many other industries, Drafting offers real opportunities for promotion. It is one of the steadiest employment fields. Drafting is clean, interesting, well-paid and important work. Find out now what Drafting offers you!

In Spare Time,—at Home!

(or at the College in Chicago)

With our easy step-by-step lessons, (and the tools we furnish), you can learn in your spare time at home. To prove to you how easy it is to learn Drafting by the Chicago Tech Method we'll send you a Trial Lesson FREE. No charge for this lesson either now or later. Send a post card or the coupon now for

FREE TRIAL LESSON

free TRIAL LESSON
 Send Coupon

CHICAGO TECHNICAL COLLEGE

Member National Home Study Council

S-201 Tech. Bldg., 118 East 26th St., Chicago, Illinois
 Please send me FREE Trial Lesson in DRAFTING showing how to learn at home by C. T. C. plan. No obligation of course.

Name

Address

City..... State.....

Occupation..... Age.....

When writing please mention Popular Mechanics



DRAFTING

BOOKS SENT FREE!

ON APPROVAL
5 VOLUMES—SECOND EDITION

Only 15 minutes a day with these WONDER BOOKS can prepare you for a good drafting job. Mechanical and architectural drafting from simple straight lines to important complex plans. A step at a time! Built especially for beginners, for men with only grammar schooling. Drafting room practice, PLUS ENGINEERING, made easy and clear. Includes complete information on blue print reading for building and machine trades.

Big Field Big Demand Big Pay
Competent draftsmen are urgently needed in all building and manufacturing lines at \$30.00 to \$75.00 a week. That's just the beginning—FOR DRAFTSMEN HAVE GOOD CHANCES FOR ADVANCEMENT. Pleasant, fascinating work, easy to learn and do. Learn quickly with these books—send coupon for a set and see for yourself.

[A year's consulting service now given to all buyers of this famous cyclopedia of drafting]

Be prompt and we will include a brand new circular slide rule to carry in coat pocket. Invaluable in solving all kinds of engineering problems.

**AMERICAN TECHNICAL SOCIETY
Publishers—Home Study Courses.**

For Beginners or Experts

Written so you can understand every word, by well known engineers and architects. De Luxe flexible binding, nearly 2,000 pages, 1546 blueprints, charts and diagrams; prepares you for a good drafting job in mechanical or architectural lines. Sent for 10 days' free use if you mail coupon immediately.

Slide Rule Included



American Technical Society, Dept. D919, Drexel at 58th St., Chicago, Ill. Send for 10 days' trial, 5 volumes set of drafting. I will pay the delivery charges only. If I wish, I may return books in 10 days and owe you nothing, but if I decide to keep them, I will send \$2.00 after 10 days, then only \$3.00 a month until \$24.80, the total price is paid. Send latest edition and include slide rule and consulting Service Certificate.

Name.....
Address.....
Please attach letter stating age, occupation, employer's name and address and that of at least one business man as a reference.



**“GET ON”
Uncle Sam's
PAYROLL**

**START
\$1260 to
\$2100 Year**

Get Ready Immediately for 1941 EXAMINATIONS

Thousands appointments each year
Men—Women
32 Page Civil Service Book
Mail Coupon Today—SURE

Franklin Institute
Dept. K195
Rochester, N. Y.

Gentlemen: Rush to me FREE of charge, list of U. S. Government big pay jobs. Send me FREE 32-page book describing salaries, vacations, hours and work. Tell me how to qualify for one of these jobs.

COUPON

Name.....
Address.....



Follow This Man!

**Secret Service Operator
No. 38 is On The Job!**

Follow him through all the excitement of his chase after the counterfeit gang. See how a crafty operator solves a murder with tell-tale finger prints! Thrills! Mystery!

FREE! The Confidential Reports No. 38 Made to His Chief Earn a Regular Monthly Salary

Write for reports and free "Blue Book of Crime." Learn how YOU can become a Finger Print Expert, at home, in spare time, at small cost. Our graduates run 47% of all

the Identification Bureaus in America! Send for list of over 600 bureaus employing our graduates. Write today! Literature sent only to persons stating their age.

INSTITUTE OF APPLIED SCIENCE
1920 Sunnyside Avenue Dept. 1359 Chicago, Ill.



**We Teach You TO MOUNT BIRDS, FISH
Animals, Pets, Game-heads & Tanning**

FASCINATING, PROFITABLE, EASY At Home
Professional Home Study Course under supervision of Museum Taxidermist teaches you the fascinating Art of TAXIDERMISTRY. No other course like it. Mount your own game for home decoration. Make spare time or full time profits. **FREE BOOKLET**—send postcard NOW. Get full, interesting facts how you may earn as you learn.
CHICAGO SCHOOL OF TAXIDERMISTRY P. O. Box 343, Dept. A-12, CHICAGO, ILLINOIS



Auto-Diesel

Master a real trade. Auto Mechanics, Diesel Mechanics, Arc Welding, Acetylene Welding, etc. Let us train you to be an expert Auto-Diesel Mechanic and help you get a good job. The cost to you is reasonable. Learn on modern equipment with tools under experienced instructors. Real shop work. Steam heated buildings. Room and board in our steam heated dormitory. We pay your fare to Nashville. For free catalog write

Nashville Auto-Diesel School, Dept. 75 Nashville, Tenn.

ELECTRICAL CAREERS

Become a Bliss technician in one year—ready to take advantage of increasing opportunities in the electrical field. Bliss men, today, fill key positions in many different electrical industries. All received the same course in fundamental theory and practice.
Modern laboratories. Successful placement, 48th year. Ask for free vocational chart, 122 Takoma Ave., Wash., D.C.

BLISS ELECTRICAL SCHOOL

Learn **ADVERTISING** at Home

Greater opportunities now in advertising. Learn easily and quickly in spare time. Practical work. No text books. Old established school. Low tuition—Easy terms. Send for free booklet and requirements.
Page-Davis School of Advertising
Dept. 1359, 3601 Mich. Av., Chicago



LEARN CARTOONING!

Let an internationally famous cartoonist teach you this WELL PAYING—fascinating profession. PERSONAL instruction by mail. Recommended by America's foremost cartoonists. Send for FREE booklet. (State age)
DORMAN H. SMITH, Box C597, San Rafael, Calif.

MAKE MONEY AT HOME

RUBBER MOLDS

Low as **6¢** EA.

Amazing rubber mold-making outfit makes perfect flexible molds of plaques, ash trays, book-ends, etc. Molds cost from 6c to 25c each. Each mold makes hundreds of novelties and gifts to sell up to \$1.00 apiece! No experience necessary. Quick and easy. Start profitable business in your home... sell to stores, gift shops, friends, resorts, road stands, by mail. Full or spare time. "Molders Handy Book" and list of buyers FREE. Write
SO-LO WORKS
Dept. P-827 Cincinnati, Ohio



Always write your name and full address clearly when answering advertisements.

Easiest

OF INSTRUMENTS TO PLAY
... yet Richest in Opportunity

Why be just one of the crowd? Enjoy the thrill of the spotlight, the praise of friends, the lifelong pleasure of creating your own music. It's easy with the Deagan Marimba, fastest-growing instrument in the music world today. The ideal home instrument—in demand at dances, clubs, radio stations, etc.—and yet easiest of all instruments to play. Models and terms to suit every budget. Convincing FACTS on request—write for them today!



J. C. DEAGAN Inc. DEPT. 4459, CHICAGO

GET INTO THE BAKING BUSINESS!

National Baking Institute announces a new home study course in commercial baking. Baking now America's fifth industry in wages. Nearly a depression-proof business. Good field for ambitious men. Common school education sufficient. Send for free booklet "Opportunities in Commercial Baking" and requirements.



National Baking Institute
3601 Michigan Ave. Dept. 1359, Chicago, U. S. A.

AVIATION APPRENTICES



AIRMINDED YOUNG MEN INTERESTED IN TECHNICAL TRAINING FOR ENTERING THE WELL PAID FIELD OF AVIATION AS APPRENTICES—Write immediately, enclosing stamp.

MECHANIX UNIVERSAL AVIATION SERVICE CO.

Wayne County Airport, Box 857. Dept. E, Detroit, Mich.

NEW YORK SCHOOL OF MECHANICAL DENTISTRY

Learn how to make Crowns, Bridges, Plates in this OLDEST Laboratory Center. Practical training. Day, Eve, Easy terms. Ask for free Catalog P and tool offer. N. Y. SCHOOL of MECHANICAL DENTISTRY, 125 W. 31 St., N. Y. C.

TOOL & DIE MAKING MACHINIST

Acety & Arc Welding. Body & Fender Repair. Practical Shop Training. Michigan's Oldest & Largest Trade School. Unlimited training period without extra charge.

Wolverine School of Trades, 1408 W. Fort, Detroit, Mich.

FREE CIRCULAR

STUDY ENGINEERING AT HOME

Earn a Degree at Home

From A Chartered Institution of Higher Learning Employers Demand Degree Men For Key Positions

88 Degree Courses in Electrical, Civil, Mechanical, Drafting, Architectural, Automotive, Steam, Diesel, Aeronautical, Radio, Structural, Mining, Industrial, Highway, Petroleum, Marine, Refrigeration, Air Conditioning, Chemical Engineering; Arts; Sciences; Philosophy; Education; Public Health; Medical Jurisprudence; Psychology; Sociology; Physics; Chemistry; Geology; Pal. Science; Theology; Law; Agriculture; Business Training; Accounting; Statistics. Founded 1908. Chartered. McKinley-Roosevelt Graduate College, 4610-R Sheridan Road, Chicago



Begin today. Write for our New Free Book, "How to Become a Good Penman," it contains specimens and tells how others learned to write in spare time. Enclose 10c for a Professional Pen Point and your name beautifully written. Write today.

THE TAMBLYN SCHOOL OF PENMANSHIP
441 Ridge Building Kansas City, Mo.

FREE! \$6.00 Full Size FOOD & HOUSEHOLD PRODUCT ASST.

SEND NO MONEY! Rush name and address for big Assortment of FOODS, GROCERIES, SOAPS, ETC.—full size packages, worth \$6.00. Yours ABSOLUTELY FREE! Show these products to friends, neighbors. Take orders for sensational values, more than 200 quality products used in every home. Earn big profits, full or spare time. No experience necessary. Write for FREE \$6.00 Assortment of Products NOW. ZANOL, 4357 Monmouth, Cincinnati, Ohio.



LEARN AUTO MECHANICS

Authorities say there's greatest demand in history for TRAINED men. Good mechanics earn up to \$50 a week or more. Good practical training will fit you for a job that's waiting. Read how McSweeney-trained men make good. Hundreds of others will tell you facts equally as interesting. Don't look for a job! TRAIN for it!

8 weeks shop Course

No books, no lessons, the McSweeney practical way. First we show you, then you do the job yourself under competent instructors. You work on real equipment with real tools. Quickly you are TRAINED to hold down a permanent BIG PAY job. Any man 16 to 50 can learn. Write today for New Low Tuition Offer!

McSweeney Men Make Good!

Mesopotamia, Ohio
Dear Mac: After graduating, received job one week later in Lakewood at Willys-Knight Service. Three raises in the first year. At the end of 3 years, was assistant Service Manager. I quit at the end of 6 years to take a better job offered me in Canton, Ohio, at the Peerless Garage. Worked one year when I quit to go into business for myself. I still do most of my own service work. Your training along with practical work sure does help one in difficult problems.
—L. E. Bates.

Mt. Vernon, Ill.
Dear Mac: I am getting along fine. Have been working for the Oldsmobile dealer here in Mt. Vernon for fifteen months. I will have to give you credit for starting me out on the road to success. I feel that I owe you a debt that cannot be paid. Wishing you and all the boys the best of luck.—Loren Brown.

AVIATION & DIESEL COURSE!

Aviation is here! Each plane needs many mechanics on the ground. McSweeney's Auto Mechanical course is combined with Aviation and Diesel engine mechanical course.

LOW TUITION COST!

Learn Now and Pay for Part of Your Course Later!

In a few weeks of intensive training, actual shop work with real tools on real equipment qualify you to accept a Big Pay Job as a mechanic.

FREE! Write today for Big Free Book on AUTOS, AVIATION, DIESEL. Get the facts about jobs, and Low Tuition Offer. Mailing the coupon does NOT obligate you. It obligates ME to tell YOU how you can train for Big Money in a few weeks! WRITE TODAY!

McSWEENEY SCHOOLS

AUTO - AVIATION - DIESEL WELDING - BODY & FENDER

DETROIT, MICH. Address Your Nearest School KANSAS CITY, MO.

Mail Coupon for Free Book NOW!

McSWEENEY SCHOOLS, DEPT. T-7.

Without cost or obligation, send me your BIG FREE BOOK on Autos, Aviation, Diesel Mechanics, etc., also full information about your Low Tuition Offer.

NAME.....

STREET.....

TOWN..... STATE..... AGE.....

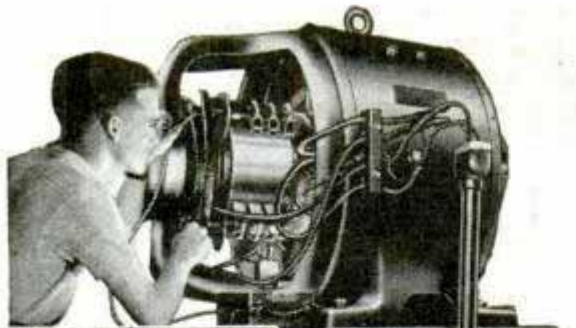

TRAIN FOR ELECTRICITY

America's Defense Program Opens
Good-Pay Jobs for Trained Men

"LEARN BY DOING" IN 12 WEEKS

Electricity is the backbone of America's big defense program. Get ready for NEW good-pay jobs. Coyne offers practical training on full-size electrical equipment. No previous experience or advanced education needed.

I'll finance your training. "Earn While You Learn" Plan. "Job Help After Graduation." NOW ... extra 4-weeks RADIO Course at no extra tuition charge. Send coupon TODAY for Big FREE Book and all facts.

H. C. LEWIS, President
COYNE ELECTRICAL SCHOOL
500 S. Paulina St., Dept. 90-72, Chicago, Illinois

MAIL THIS COUPON TODAY

H. C. LEWIS, Pres., Coyne Electrical School
500 S. Paulina St., Dept. 90-72, Chicago, Ill.
Send me your Big FREE Book and all the facts about Coyne, even though I have very little money.

NAME.....

ADDRESS.....

CITY.....STATE.....



It's Easy To Be A Contractor

Learn to estimate, to plan buildings, to take contracting jobs, and make money on them. Here are 9 up-to-the-minute books on building, estimating, and contracting which cover in an interesting way, the subjects that carpenters, builders, and contractors should know to make the most out of their jobs. Roof Framing, The Steel Square, Architectural Drawing and Design, Estimating, Painting and Decorating, Heating, Air Conditioning, Building, Contracting, Concrete Forms and other subjects are all well covered.

"Boss" Carpenters in Demand NEW 1940 EDITION

Vast public works jobs, immense projects, and the rapid growth of home building, are making jobs for MEN WHO KNOW HOW. These books give you quick training. With them you shouldn't be afraid to tackle any job, for needed facts can be found in a hurry.

These books are the most up-to-date, complete we have ever published on these subjects.

Coupon Brings Nine Books FREE For Examination

AMERICAN TECHNICAL SOCIETY (Publishers—Home Study Courses)
Dept. G919, Drexel at 58th Street, Chicago, Illinois

You may ship me the new 1940 edition of your nine big books, "Building, Estimating, and Contracting" without any obligation to buy. I will pay the delivery charges only, and if fully satisfied in ten days, I will send you \$2.00, and after that only \$3.00 a month, until the total price of only \$29.80 is paid. I am not obligated in any way unless I keep the books.

Name.....

Address.....

City.....State.....

Please attach a letter stating your age, employer's name and address, and that of at least one business man as a reference.

NEW models EASIER TO PLAY

Find out about these sensational new Conn Band Instruments. Many wonderful, exclusive features! Today, more than ever, Conns are the "choice of the artists." You'll advance faster and take more pride in a genuine Conn—made by the world's largest manufacturer. See your dealer or write us for Home Trial, Easy Payment offer. Mention instrument.

C. G. CONN, LTD.
1231 Conn Bldg., Elkhart, Ind.

WRITE FOR FREE BOOK

CONN
BAND INSTRUMENTS

CARTOONING PAYS WELL

Exclusive instruction by an internationally known cartoonist makes it easy to learn at home. Write for Free Booklet describing details of the course. State age.

NATIONAL SCHOOL OF CARTOONING
437 Penton Bldg. Cleveland, Ohio

WELDERS WANTED!

ELECTRIC ARC—OXY-ACETYLENE
Skilled Welders earn \$8 to \$15 a day. The demand now greater than the supply. Learn this highly paid trade in 3 weeks by actual shop work. One of America's leading schools. Established 1902. 7 floors of shops. Endorsed by welding industry. Limited number of students. 3 weeks course in Electric Arc or Acetylene Welding, including room and board, only \$105. Write or wire for reservation. Ask for "Welding Facts." State age.

GREER COLLEGE, Dept. 1120, 2024 S. Wabash Ave., Chicago

Learn Now To STUDY, TEACH, PRACTICE, OR LECTURE!

Psychology, Metaphysics, Mental Science, Philosophy, in most modern form. Outstanding instructors in these increasingly popular fields. College chartered under Illinois Laws. Degrees conferred on home students. Ask for free copy, new, illustrated, descriptive Prospectus. College of Universal Truth, 20-B East Jackson Blvd., Chicago, Ill.

BUCHSTEIN'S FIBRE LIMB

Soothing to stump, cool, light, strong. Correct fit. Braces for all deformities. Fair terms.

D. BUCHSTEIN CO.
610 3rd Ave. South, Minneapolis, Minn.

FOR COMFORT

MONEY IN RABBITS—CAVIES

WE BUY and put you in touch with other markets. Catalog and copy of magazine 10c. Or send 25c for Book Catalog and Price List and Year's Subscription to the AMERICAN SMALL STOCK FARMER.

OUTDOOR ENTERPRISE CO., BV 919, PEARL RIVER, N. Y.

do-it-with-SQUABS

Raised in ONLY 25 DAYS. Why breed for ordinary poultry trade when luxury markets want all the squabs you can ship, every day in year? Go after this profitable poultry trade now. Write postcard, get eye-opening free poultry business guide.

RICE FARM, 635 H. ST., MELROSE, MASS.

WILL YOU WEAR THIS SUIT

and Make up to \$12 in a Day!

Let me send you a fine all-wool union tailored suit FREE OF ONE PENNY COST. Just follow my easy plan and show the suit to your friends. Make up to \$12 in a day easily. Partial Payment Plan. No experience—no house-to-house canvassing necessary.

SEND FOR SAMPLES—FREE OF COST

Write today for FREE details. ACTUAL SAMPLES and "sure-fire" money-getting plans. Send no money.

H. J. COLLIN, PROGRESS TAILORING COMPANY
500 So. Throop Street, Dept. M-216, Chicago, Illinois

Partial Payment Plan Pays BIG!

LIVE DANGEROUSLY

--- said Nietzsche, Philosopher



**Learn To Wrest
The Utmost From Life!**

DON'T HOLD BACK—life is yours to live and enjoy each conscious moment. Not in a sheltered, routine living, but only in a tempest of life's forces—which challenges every element of your nature—will you receive that inspiration, those ideas, which will bring you personal supremacy and happiness. *Live boldly but knowingly*—learn to utilize nature's laws to the fullest extent.

A FREE Book of Facts

Let the Rosicrucians (not a religious organization) show you how to direct *little-known* laws of life and mind—used by the sages for centuries. Write for the free book, "The Secret Heritage" today. Address Scribe: G. H. M.

The ROSICRUCIANS (AMORC)
San Jose, California, U. S. A.

TOOL & DIE MAKING DESIGNING

Machinists Trade, Machine Drafting and Design. Practical shop training in the world's Industrial center. Write today for full information.
NATIONAL SCHOOL OF MECHANICAL TRADES
Dept. 24 628 W. Lake St. Chicago, Ill.

Landscaping is Profitable

Fascinating career or hobby for men and women. Interesting profession. Learn at home in spare time. Send for free booklet "Success Thru Landscape Training." Give age, occupation.
American LANDSCAPE School, 6252 Grand Ave., Des Moines, Iowa.

Learn Public Speaking

At home—in spare time. Many overcome "stage-fright," gain self-confidence and increase earning power, this easy way. Write for free booklet, *How to Work Wonders With Words* and requirements.
North American Institute, Dept. 1359
3601 Michigan Ave., Chicago, Illinois

Learn AUTO-DIESELS

Practical, tested training. Backed by 35 years experience. Course includes Auto Mechanics, Diesel Service and Operation, Diesel Power Generation, Machine Shop Practice, Auto Electrics, etc. Flexible plan to meet specific needs of those with or without jobs. Oldest, largest trade school in West qualifies you and helps you get a good pay job. Transportation allowed to L. A. Earn room and board while learning. Request Free Catalog.

NATIONAL SCHOOLS Dept. PMA-12
Los Angeles

FREE 68 Pages of Facts About PATENTS and SELLING INVENTIONS

Many pictures and examples from inventive history make these excellent guide books for inventors.

OTHER MEN HAVE READ AND PROFITED BY THESE FREE BOOKS

IF you have an invention—or an idea for one—you should have these free books. They tell you real facts like these: How the patent laws protect you. Why you need the protection of a U. S. Patent. What a competent, registered patent attorney can do for you. They tell what kind of sketch or model is needed and how to make proper disclosure of your idea to help establish your claims. They tell how some successful inventors have secured financial assistance. They show 115 different mechanical principles.



HOW WE SERVE YOU

For more than a third of a century—we have represented thousands of inventors. We answer questions. We study each device to bring out its best patentable possibilities. Often, also, we advise inventors against going ahead with inventions which could not possibly be protected. By carefully developed methods, we try to keep expense at a minimum and we can arrange a deferred pay-

ment plan when needed. With the books, we will also send you a copy of our "Evidence of Invention" form on which you can sketch and describe your invention and establish a date of disclosure. Such a date of disclosure may later prove important to you. You can deal with us in strictest secrecy. Learn the facts. Simply sign and mail the coupon below. Take that first step today.

VICTOR J. EVANS & Co.

Merlin M. Evans
REGISTERED PATENT ATTORNEYS

MAIN OFFICE—560-P Victor Bldg., Washington, D. C.
Pittsburgh Office—514-N Empire Bldg.

Rush by return mail **FREE** copies of your books, "Patent Protection" and "When and How to Sell an Invention" also important **EVIDENCE OF INVENTION FORM.**

Name.....

Address.....

City or Town.....

When writing please mention *Popular Mechanics*

Do you want

- ..to go to College?
- ..or to enter a Profession?
- ..or get an Office Position?

(Such as Accounting, Architecture, Nursing, Dentistry, Teaching, Social Work, Osteopathy, Beauty Culture, Optometry, Embalming, Chiropraxy, Law, Medicine, etc.)

To get anywhere, you practically **MUST** finish High School **FIRST**. You can complete our simplified High School Course in **SPARE** time at home, as **FAST** as your time and abilities permit. Equivalent to resident school work—prepares you for college, pre-professional examinations, business, industry. Standard texts furnished. Diploma. Credit for H.S. subjects already completed. Single subjects if desired. Low tuition, easy terms. American School, Chicago, est. 1897—endorsed by educators. Finish your high school education **NOW**. Write **TODAY!**

High School Course at Home

Many Finish in 2 Years

American School, Dept. H945, Drexel Ave. at 58th St., Chicago, Ill.

Gentlemen: Send me **FREE** information covering special training in subjects checked below. No obligation on my part.

- | | |
|--|---|
| <input type="checkbox"/> High School Course | <input type="checkbox"/> Diesel Engineering |
| <input type="checkbox"/> Accounting and Auditing | <input type="checkbox"/> Drafting and Design |
| <input type="checkbox"/> Architecture and Building | <input type="checkbox"/> Liberal Arts |
| <input type="checkbox"/> Automotive Engineering | <input type="checkbox"/> Private Secretary |
| <input type="checkbox"/> Business Management | <input type="checkbox"/> Mechanical Engineering |
| <input type="checkbox"/> Aviation | <input type="checkbox"/> Radio and Television |
| <input type="checkbox"/> Electrical Engineering | <input type="checkbox"/> Salesmanship |
| <input type="checkbox"/> Elec. and Gas Refrigeration | <input type="checkbox"/> Business Law |
| <input type="checkbox"/> Air Conditioning | <input type="checkbox"/> Retail Merchandising |

Name.....

Address.....



Know Electricity as Experts Know It—and Get an Expert's Pay!

What about your future? Who is safe today? Surely not the man who is contented to stand still! Know your job thoroughly—prepare yourself for jobs ahead. To do just this thousands of men have used

The Croft Library of Practical Electricity

The Croft Library is a complete electrical educator. It is founded on practice—on 20 years of shirt-sleeve experience—on work as it is actually done. It is jammed from cover to cover with the kind of hard-headed facts you want. Written so that the beginner can easily understand it, yet so sound, so thorough, that it is the daily guide of 29,000 highly paid electrical workers and engineers. Croft tells you the things you need to know about motors, generators, armatures, commutators, transformers, circuits, switchboards, distribution systems—electrical machinery of every type—illumination in its every phase—the most improved methods of lighting—lamps and lamp effects, etc.—how to do a complete job, from estimating it, to completion.

**6 volumes, 2155 pages—New low price
No money down—Easy payments.**

Fill in and mail the coupon attached and we will send you the entire set of six volumes for ten days' Examination on approval. We take all the risk—you assume no obligation. If you decide to keep the books, send \$1.50 in ten days and the balance at the rate of \$3.00 a month. Send the coupon **NOW** and see the books for yourself.

EXAMINATION COUPON

McGraw-Hill Book Co., 330 W. 42nd St., New York, N. Y.

Send me for ten days' examination on approval the Croft Library of Practical Electricity. If satisfactory I will send you \$1.50 in 10 days and \$3.00 monthly until the price of \$16.50 is paid. If not wanted, I will return the books postpaid. (To insure prompt shipment write plainly and fill in all lines.)

Name.....
Home Address.....
City and State.....
Position.....
Name of Company..... PM-12-40



LEARN... PROGRESS... EARN MORE... SUCCEED... \$
Your own achievement, popularity, success through music. Learn in your home. Check course: Piano, Voice, Accordion, Saxophone, Mandolin, Tenor Banjo, Clarinet, Organ, Cornet, Guitar. If juvenile, parent's signature must accompany inquiry. Low cost. Easy terms. **FREE** catalog. Write! Dept. U-105, 1525 East 53rd Street, Chicago, Illinois

UNIVERSITY EXTENSION CONSERVATORY

NEW! NO 1941 MODEL I
Tubes Batteries Plug In
DURABLE PLASTIC CABINETS



Dual Bands—Magictenna—Microdial
Fits your pocket or purse—Wt. 6 ozs. Small as cigarette package. Receives standard & some short wave. **PATENTED POWER CRYSTAL**. No tubes, batteries. Hi-ratio easy tuning slide. "MICRODIAL" M. E. OF ILL. SAYS: "MIDGET RADIO WORKS FINE!"

ONE YEAR GUARANTEE!

Sent complete ready to listen with instructions & tiny phone for use in homes, offices, hotels, in bed, etc. **SIMPLE TO OPERATE—NO ELECTRICITY NEEDED!** SEND **NO MONEY!** Pay postman only \$2.99 plus postage charges on arrival or send \$3.99 (Check, M. O., Cash) and yours will be sent postpaid. A **MOST UNUSUAL VALUE! ORDER NOW! FREE! PLUG IN "MAGICTENNA"—ELIMINATES OUTSIDE WIRES!**

MIDGET RADIO CO. Dept. P-12 Kearney, Nebr.



MECHANICAL DENTISTRY

Short course—personal, individual, instruction—best technical teachers. Profession offers unlimited opportunity—not affected by Machine Age. Most modern and complete methods embracing every branch from plate to porcelain work. Qualifies you to work for dentists or own business. Day or night school. No books—no classes. Catalog upon request.

OR STUDY AT HOME. Write for information on our Home Study Course. **McCARRIE SCHOOL OF MECHANICAL DENTISTRY**
207 N. Broad St. Dept. 763 Philadelphia, Pa.



ELECTRIC LIGHTS AND POWER

Build Your Own Wind Plant from old generator. Dime brings complete **PLANS** and 1940 catalog listing over 900 Electrical Supply Bargains.
LeJay Mfg., 1447 LeJay Bldg., Minneapolis, Minn.

Build a BOAT for PLEASURE or PROFIT



EXACTLY HOW TO BUILD 15 DIFFERENT BOATS

This is the new edition with 42 added pages, 6 new books, and conversion of Ford motor for marine use. Full directions and details for cabin cruiser, racing, hydroplane, outboard runabout, sail boats, kayak, sled type—15 boats in all. Also sectional boat to carry on car.

These Are the Boats:

- "Roamer".....16 ft. Cruiser
- "Popular Flyer".....12 ft. Hydroplane
- "Crack".....16 ft. Runabout
- "Ramble".....16 ft. Inboard
- "Flash".....14 ft. Runabout
- "Saunterer".....12 ft. Rowboat
- "Chum".....12 ft. Sailing Boat
- "Sailing Skiff".....12 ft. Sailing Boat
- "Sea Saucer".....9 ft. Sailing Boat
- "Skip".....8 ft. Dinghy
- "Half Pint".....12 ft. Sea Sled
- "Rowboat".....15 ft. Flat Bottom
- "Kayak".....17 1/2 ft.
- "Racing Shell".....17 1/2 ft.
- "Sectional Rowboat".....12 ft.

EASY—LOW COST with POPULAR MECHANICS BOAT BOOK

Build a boat at home! You can do it. Just the kind you've wanted—power, sail, or row boat. The "Boat Book" shows you how in simple step-by-step directions. Specially prepared for those with limited tools, little skill and money. Build boats to sell for profit too. Book tells how.

GIVES PLANS, METHODS AND MATERIALS

Actual working plans and photos of real boats under construction makes building easy. Shows materials needed and rock-bottom costs. Hundreds of pictures. No chance for mistake. Includes also, navigation and pilot rules, handling sailing craft, boat kinks, boating terms. Everything a boat enthusiast should know. Size 7x10 inches. 312 pages. Fine cloth binding. \$2.00.

We pre-pay postage if money is sent with order, or forward C. O. D. anywhere in U. S. A.

POPULAR MECHANICS PRESS
200 E. Ontario St. Dept. 1240 Chicago

WELDING

Get in Line Now
for a Good Job
in Welding

The national emergency program brings new opportunities in the technical fields,—especially in Welding (including Aircraft). Industry demands capable, trained welding operators, technicians, engineers and mechanics. The application of gas and electric welding in all lines of business is almost unlimited,—aircraft, automobiles, diesels, building, etc.



TWO PLANS OF TRAINING

Choose the one that suits you best.

1. Day and Evening Classes at the College in Chicago. Start any Monday. Train in modern shops completely equipped. Rapid progress through short Intensified courses.
2. Home Training combined with shorter course at our shops in Chicago, thus permitting you to earn while learning in your spare time.

FREE BLUE BOOK Send post card today for Free Blue Book. Contains helpful information about Welding and other technical fields. Please state which training plan you favor.

CHICAGO TECHNICAL COLLEGE

5-600 Tech Bldg., 118 East 26th St., Chicago, Ill.

SENSATIONAL NEW BURNER INVENTION

Makes and burns its own clean, hot gas, when and as needed. No noise, no smoke, no soot, no ashes. Burns 96% air and 4% cheap kerosene. Millions of prospects. Sells fast to homes, restaurants, roadside stands, factories and hundreds of others. Big money-maker for agents and distributors. Write quick.
Liberty Burner Co., Dept. A1612, 620 N. Michigan Ave., Chicago, Ill.

Learn to MOUNT BIRDS



Tan SKINS, make up FURS

Be a Taxidermist. Double your hunting fun. We teach you at Home. Mount Birds, Animals, Fish, Heads, common specimens. Fun and profits. Decorate home and den **MAKE MONEY**. Mount game, tan for others. Big profits in spare time. **WRITE TODAY.** 100 game pictures in **FREE BOOK**.

Hunters, get your copy. It's **Now Free**. Send post card. State your AGE. **NORTHWESTERN SCHOOL OF TAXIDERMISTRY**
Dept. 9379 Omaha, Nebraska

FREE BOOK

427 RADIO DIAGRAMS

HOW TO REPAIR ANY SET



In this large manual you have all the diagrams of the most often serviced radios. Over 80% of all sets serviced every day are included. These important, hint-giving, trouble-shooting circuits permit quick repairs.

ALL CIRCUITS YOU NEED

Save time and money by having 4 out of 5 circuits you will ever need. 1926 to date. Includes 427 diagrams of 46 mfg. service hints, alignment data, and parts lists. 244 pages, 8 1/2 x 11 in. Get your copy of this radioman's best helper and save time on your next radio repair. Satisfaction guaranteed or your money back. Order **\$1.95** today. Postpaid, only...

SUPREME PUBLICATIONS 3729 W. 13th St. CHICAGO, ILL.

MUSIC LESSONS

for less than
7¢ a day!



Learn your favorite instrument quickly, easily right at home

Did you think learning music was expensive? That you had to spend a lot for a private teacher, sheet music and other incidentals? Then here's grand news! You can now learn to play your favorite instrument for **LESS THAN SEVEN CENTS** a day! No extras of any kind. And it takes less time than you ever thought possible.

Play a Tune In One Lesson

You start playing a familiar melody in your very first lesson. You go on from one tune to another. Your rapid progress is amazing. You learn to play by playing—just as you learned English by speaking it. You learn by a remarkable short-cut method that skips all tedious drills and exercises. A method that has enrolled over 700,000 pupils from all over the world.

It's actually fun learning this way.



The lines are always E-G-B-D-F. Memorize the sentence, "Every Good Boy Deserves Fun"—and there you are! And the spaces—are always F-A-C-E. That spells "Face"—simple enough to remember, isn't it?

"One picture is worth a thousand words." That's the secret of this easy way to learn music. Your lessons are in print and picture form. They show you every position, every move—like a teacher beside you, explaining, coaching you.

See how easy it is to learn music this modern way. How inexpensive. Mail the coupon, checking your favorite instrument. Instruments supplied if needed, cash or credit. U. S. School of Music, 712 Brunswick Bldg., N. Y. C., N. Y.

U. S. School of Music, 712 Brunswick Bldg., N. Y. C.
Please send me Free Booklet and Print-and-Picture Sample. I would like to play instrument checked below. (Do you have instrument.....)

Piano	Accordion	Clarinet	Banjo
Violin	Saxophone	Trumpet	Ukelele
Guitar	Mandolin	Trombone	Other Instrument

Name.....

Street.....

City..... State.....

SPRAYBERRY RADIO TRAINING

Includes FULL EQUIPMENT!



Experience Easily Acquired at Home

Over 100 Experiments plus Many Other Special Features . . . ALL Designed To Help You Make Fast Progress

SPRAYBERRY Training starts right at the beginning of Radio . . . unfolds each subject in a simplified, logical, understandable style. You easily learn Television, Frequency Modulation, Signal Tracing, Mobile Radio (Auto-Tank), Aviation Radio, Electronics, Facsimile Radio, Radio Set Repair and Installation work.

Training Prepares You For A Business Of Your Own . . . Or Good Radio Jobs at Excellent Pay

The great fascinating and progressive field of Radio offers many opportunities to the man who wants to get ahead. My Training is designed to give you quick access to these opportunities. SPRAYBERRY Methods are thorough and practical. Your Training will not interfere with your present work.

No Previous Experience Needed

It makes no difference what your education has been. I can fit you quickly for a good-paying Radio job. I make it easy for you to grasp Radio principles and remember them. Your success is my full responsibility.

You Get Professional Test Equipment Plus Experimental Outfits

. . . Includes 146 RADIO PARTS (to build complete Receiver), RADIO TOOLS and a modern TESTER-ANALYZER. You also receive 8 BIG SHIPMENTS OF RADIO EQUIPMENT for conducting actual experiments with your own hands.

Earn While You Learn

My BUSINESS BUILDERS show you how to put your equipment to actual use in handling money-making Radio Service Jobs shortly after you begin Training.

THE SPRAYBERRY COURSE IS SOLD UNDER MONEY-BACK AGREEMENT



RUSH COUPON for BIG FREE BOOK

SPRAYBERRY ACADEMY OF RADIO
F. L. Sprayberry, President
310-M University Place, N. W.
Washington, D. C.

Please rush my FREE copy of "HOW TO MAKE MONEY IN RADIO."

Name..... Age.....
Address.....
City..... State.....
(Mail in envelope or paste coupon on penny postcard)



POPULAR INVENTIONS

For Your Home

(Continued from page 18A)

K754. Phoenix, N.Y.
Clothesline Rolls on Pulleys
Holding Wash with Clips

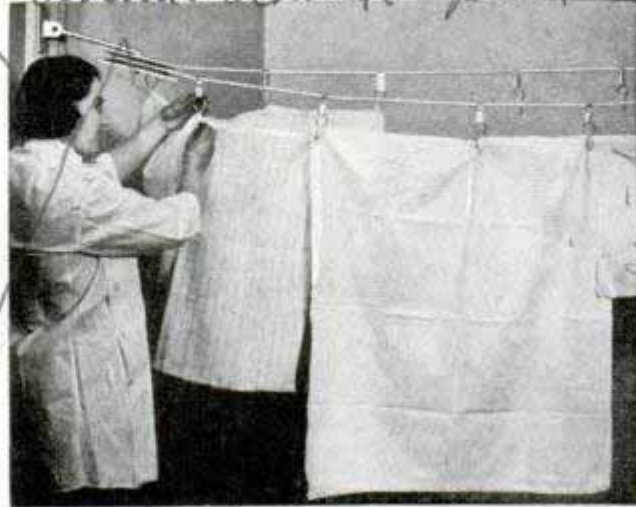

Much of the work of hanging clothes on a line to dry is eliminated by using a clothesline mounted on pulleys, which doubles the hanging space and lets the housewife stand in one spot and move the line at her convenience. A new pulley line has tabs which grip the clothes firmly and they can be hung at any interval.

K754.
Recipes Spin Past the Window of Twin-Roller Cookbook



Twist the red plastic knob of a cooking guide and your favorite recipe quickly rolls into view. The guide is mounted on twin rollers, the recipes appearing behind a transparent plastic window. The white enamel case is non-inflammable.

Send your inquiry, with a stamped, self-addressed envelope, to our Bureau of Information to learn the name of the maker of any article described in this department.

M M MECHANICS-WELDERS - COLLISION MEN

GOOD JOBS and MIGHTY GOOD PAY

Do you want to earn big money? If so let us know which of the following trades you prefer. You learn by doing. Practical work. Expert teachers. Low tuition. Personal attention. It will pay you to investigate AT ONCE. Just check the courses you'd like to take and mail today. You will receive full information, absolutely without cost or obligation. But don't delay.

Check the Trade You'd Like to Learn

- | | |
|---|---|
| <input type="checkbox"/> Complete Auto Mechanics (including Diesel) | <input type="checkbox"/> Electric Arc and Acetylene Welding |
| <input type="checkbox"/> Auto Collision | <input type="checkbox"/> Spray Painting |
| <input type="checkbox"/> Metal Finishing | <input type="checkbox"/> Body and Fender Bumping |

Ask about our "Pay After Graduation Plan"

Name.....
Address.....
Mail the above at once to

MICHIGAN TRADE SCHOOL

FREE 32 PAGE CATALOG

3758 Woodward Ave. Detroit, Mich.

motors metal wks Co 597-6 motor use \$3.00 - \$6.00

Pat 499

ZOOM into AVIATION



AN AVIATION CAREER OFFERS YOU A GREAT FUTURE!

The greatest opportunity of your lifetime exists today. There never was such an opportunity in AVIATION for you. There may never be another. Aviation desperately needs trained men; they are at a premium and advancements for them are rapid. You can get in on the ground floor by training now, BUT you must choose the right school for your training. This is imperative, since your choice of a school in which to take your training will determine your whole future in Aviation and how much money you will make all the rest of your life. Curtiss-Wright Tech's career training is carefully designed to do just one thing—**MAKE MORE MONEY FOR YOU.** Our hundreds of successful graduates have proven that our training gets results and always pays. It has provided them with a profitable occupation and secure future, since it trained them in advance for the highest position they could ever expect to occupy. It can make you independent and self-supporting for life. Curtiss-Wright Tech is located on Grand Central Air Terminal in the heart of the Aircraft Industry. Established in 1929, this famous school is recognized as the nation's leading institution for the training of **MASTER AVIATION MECHANICS and AERONAUTICAL ENGINEERS.** (No flying involved.) We honestly believe that every student who enrolls here will be able to obtain immediate employment upon graduation. A position awaits you. **WARNING!—DON'T "MISS THE BOAT!"** Send for catalog today. Give age and course desired. Dept. PM-12



**CURTISS WRIGHT
TECHNICAL INSTITUTE**

Glendale (Los Angeles)
California

THIS TOWER OVERLOOKS AVIATION'S MOST DISTINGUISHED SCHOOL OF AERONAUTICS

MECHANICS

KNOW
YOUR
CAR

You Need
this
Book

JUST
OUT!

Ask
to
See it!

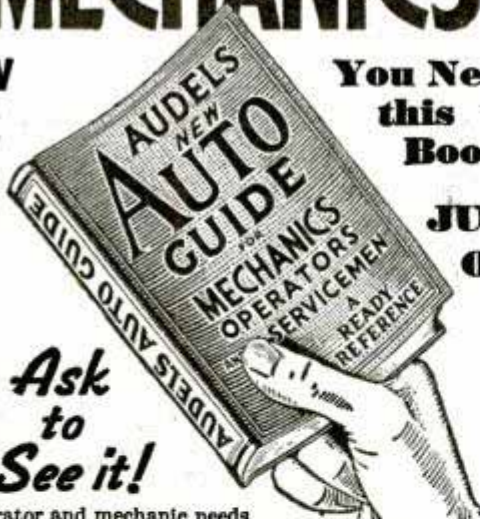

Every operator and mechanic needs **AUDELS NEW AUTO GUIDE.** This book saves time, money and worry. Highly endorsed. It presents the whole subject of auto mechanics: 1—Basic principles, 2—Construction, 3—Operation, 4—Service, 5—Repair. Easily understood. Over 1500 pages—1540 illustrations showing inside views of modern cars, trucks and buses with instructions for all service jobs. Diesel Engines fully treated, fully illustrated. To Get This Assistance for Yourself Simply **4** Fill in and Mail Coupon Today.

4 COMPLETE • PAY ONLY \$1. A MONTH ←

THEO. AUDEL & CO., 49 WEST 23rd STREET, NEW YORK
Please send me postpaid AUDELS NEW AUTOMOBILE GUIDE (\$4) for free examination. If I decide to keep it, I will send you \$1 within 7 days; then remit \$1 monthly until purchase price of \$4 is paid. Otherwise, I will return it to you promptly.

Name

Address

Occupation

Reference

PM

IMPORTANT Message To INVENTORS

We Will Send You Our FREE BOOKLET

"HOW TO PROTECT YOUR INVENTION"

and INVENTION RECORD FORM

Our laws favor the inventor who makes a dated record of his invention, and who is diligent in filing his patent application.

You owe it to yourself, if you value your invention, to make an accurate, dated, and witnessed record of your invention, and then take steps to apply for a patent just as quickly as possible.

PERSONAL SERVICE

Hence, our service can be important to you: As soon as you write us, we send, by return mail, an "Invention Record" form for you to fill out. And then, when you return it to us, our prompt and personal service begins: We personally direct the search of the Patent Office Records. Personally report to you. Personally supervise the preparation and filing of your application and the handling of your case. There is no lost motion, no lost time.

PATENT AND SELL YOUR INVENTION

We handle your case skillfully and thoroughly with a view to securing the best possible patent for you—giving you the full benefit of our training as patent attorneys and our years of experience serving hundreds of inventors. We make personal calls at the Patent Office when required. And beyond this, we will endeavor to give you useful hints and suggestions on selling your invention.

WRITE US TODAY...

When your invention comes to us it is strictly confidential. All correspondence is handled personally by us. We take a personal interest in your success, so you can write us fully.

IMPORTANT TO GET STARTED RIGHT

Know how the laws protect you, and what steps to take. We will send you Complete FREE Booklet "How To Protect Your Invention", and FREE "Invention Record" Form. Write us, or mail this coupon today—McMorrow and Berman, Registered Patent Attorneys, 135-C Barrister Building, Washington, D. C.

MAIL COUPON NOW

McMORROW & BERMAN REGISTERED PATENT ATTORNEYS

135-C Barrister Building Washington, D. C.

Name

Address

City..... State.....

Write or Print Name Clearly

Say you saw it in Popular Mechanics!

PATENTS

Booklet Free Highest References
Promptness Assured Best Results

Send drawing or model.

ALL BUSINESS GIVEN PROMPT AND PROPER ATTENTION

Listed Patent Lawyer in the latest editions of the Rand-McNally Directory of Bankers and Bank-Recommended Attorneys, published by Rand-McNally & Co., Chicago, Ill.; American Lawyers Annual, Cleveland, Ohio; Bankers Service Legal Directory, published by Bankers Service Co., Boston, Mass.; and the Snow-Church Directory Co. Lawyers List, published in New York City.

WATSON E. COLEMAN, Victor Building, 724 Ninth Street, N. W.
REGISTERED PATENT LAWYER **WASHINGTON, D.C.**

INVENTORS PATENT YOUR IDEAS SEND FOR FREE BOOK



HOW TO OBTAIN A PATENT

Written by a Former Member of the Examining Corps (1922-24) of the U.S. Patent Office. If you want to profit by your idea, you should take steps to apply for a U. S. Patent at once. Your first step is to get this Free Book. This interesting illustrated book contains valuable information you should have. It tells you fully how to obtain a patent on your idea in the quickest way. With this Free Book you will also receive a "Record of Invention" form on which you can easily record your idea. Personal and Confidential Service: Your case will be personally handled only by a Registered Patent Attorney who is also a Former Member of the Examining Corps of the U. S. Patent Office. All communications confidential.

MAIL COUPON TODAY for FREE PATENT BOOK and RECORD OF INVENTION Form.

CARL MILLER
REGISTERED PATENT ATTORNEY
FORMER MEMBER EXAMINING CORPS U. S. PATENT OFFICE

Woolworth Bldg., 35th Floor, Dept. 120-A, New York City
MILLER BUILDING, Dept. 120-A, WASHINGTON, D. C.
Please send me your Free Book, "How to Obtain a Patent," and your "Record of Invention" form.

NAME

ADDRESS

Inventions Wanted Patented or Unpatented

We have been successfully selling inventions, patented and unpatented, since 1924. Write us, if you have a practical, useful idea for sale.

Chartered Institute of American Inventors
Dept. 4, Barrister Building, Washington, D. C.

BENJAMIN AIR PISTOL WITH HAND PUMP



For Target—Small Game—Camping—Etc. Guaranteed—Accurate—Practical—Economical—Safe—Clean—Quiet. Adjustable Force—Amazing Maximum Velocity. No Smoke or Puffs. Bolt Action—Hammer Fire—Hair Trigger—Safety Lock—Hand Pump. Single Shot BB \$8.50; Single Shot cal. 177 or 22 with rifled barrel \$8.50; BB 8-Shot \$10.00; Holster \$2.00. Also a complete line of Benjamin Genuine Compressed Air Rifles for BB and cal. 177 or 22. No license required from dealer or factory. Write today for complete specifications and free targets.

BENJAMIN AIR RIFLE CO., 890 Marion St., St. Louis, Mo., U. S. A.

PATENTS—TRADE MARKS

All cases submitted given personal attention
Form "Evidence of Conception" with instructions for use and "Schedule of Government and Attorneys' Fees"—FREE!

LANCASTER, ALLWINE & ROMMEL

Patent Law Offices

412 Bowen Bldg. Washington, D. C.

INVENTORS who derive largest profits know and heed certain simple but vital facts before applying for patents. Our book, Patent-Sense, gives those facts; sent free. Trade Marks—Copyrights.
LACEY & LACEY, Est. 1869, 635 F St., N. W., Dept. 5, WASHINGTON, D. C.

ALBERT E. DIETERICH

PATENT ATTORNEY

Register No. 5669

SUCCESSOR TO FRED G. DIETERICH & CO.

Former Member Examining Corps, U. S. Patent Office

511-B COLORADO BUILDING WASHINGTON, D. C.

Booklet on patents sent free on request.

INVENTIONS MANUFACTURED AT LOW COST!

Inventions manufactured in any size, any shape, any quantity, by old established (36 years old) reputable company. (No branches anywhere). Also developing, designing, engineering, moldmaking, stampings, metal specialties, dies, models, etc. FREE estimates. FREE catalog giving "inside" information. Write today.



CRESCENT TOOL CO., DEPT. V-A, CINCINNATI, OHIO

Always write your name and full address clearly when answering advertisements.

FREE

EXCITING BOOK CATALOG!
HUNDREDS OF BOOKS!
MANY NOT SOLD IN STORES!



Send right now for this great big book catalog! Thumb through its interesting pages! Notice the tremendous selections of books on virtually every subject . . . and at money-saving prices. Notice how many books you can get that are not sold in stores—books that bring extra joys to living, books that help you increase your income—putting extra cash into your pocket! . . . Home, Farm, Garden, Photography, Nude Art are only a few of the subjects listed.

SEND NO MONEY! JUST MAIL POST CARD!

Don't send a penny. Just write your name and address on a penny post card, and mail today! This grand catalog with beautifully colored cover will be rushed to your home! Send for it now!

POPULAR MECHANICS PRESS, Dept. 12A, 200 E. Ontario, Chicago

To PROTECT YOUR INVENTION - Use this coupon, NOW

Delays are dangerous and may be very costly. My personal service assures prompt action, strict confidence, and a minimum of expense. I suggest that you send me a model or drawing, or sketch and description of your invention, and \$5.00. I will make a search and report

promptly as to its patentability and send you a copy of my 72-page booklet. Or, if you prefer to read my booklet first, mail the attached coupon at once. I will also send my "Record of Invention" form. (Over 38 years experience as a Registered Patent Attorney.)

L. F. Randolph, 302-D Victor Bldg., Washington, D.C.

Please send me at once, free of charge, your 72 page booklet and "Record of Invention" form.

Name

Address

A PERSONAL CONFIDENTIAL PATENT SERVICE

Inventors—Get Patent Facts!

If you have already constructed a device, or merely have an idea on paper—now is the time to give it the protection it deserves. You can feel perfectly sure in dealing with this reputable, old-established firm. Prompt, confidential service and best results.



This Is
Our 65th Year!

Your Ideas May Be Worth Money

Mail this coupon for **FREE BOOKS** that tell you how to proceed. Special "Certification of Invention" form also sent.

C. A. SNOW & CO.

Patent Attorneys Since 1875

1012 SNOW BLDG., WASH., D. C.

Please send me free books on patent procedure without cost or obligation.

NAME.....

ADDRESS.....

How to obtain a patent . . .

How you can commercialize your patent . . .

Why you need a patent . . .

Correct way to proceed and costs . . .

RUPTURED?

Get Relief This Proven Way

Why try to worry along with trusses that gouge your flesh—press heavily on hips and spine—enlarge opening—fail to hold rupture? You need the Cluthe. No leg-straps or cutting belts. Automatic adjustable pad holds at real opening—follows every body movement with instant increased support in case of strain. Cannot slip whether at work or play. Light. Waterproof. Can be worn in bath. Send for amazing **FREE** book, "Advice To Ruptured" and details of liberal truthful 60-day trial offer. Also endorsements from grateful users in your neighborhood. Write:

CLUTHE SONS, Dept. 31, Bloomfield, New Jersey

Your Place in Aviation...

SPARTAN
SCHOOL OF AERONAUTICS



Come to SPARTAN for today's finest expert training for your choice of aviation careers—Flying, Engineering, Mechanics, Radio. Approved by U. S. Civil Aeronautics Authority. 15 modern airplanes, latest aircraft engines; completely equipped shops, laboratories—private practice fields; 23 modern buildings; club-like dormitories. \$350,000 expansion program making SPARTAN even greater. *New semester starts January 6th.* Write for free catalog.
CAPTAIN MAXWELL W. BALFOUR, Director
Dept. PM-120 Tulsa, Oklahoma

RADIO ENGINEERING, broadcasting, aviation and police radio, servicing, marine and Morse telegraphy taught thoroughly. 48 weeks' engineering course equivalent to three years' college radio work. School established 1874. All expenses low. Catalog free.

Dodge's Institute, Ada St., Valparaiso, Ind.

Become a **DIESEL** Expert!

**LEARN AT HOME
EARN BIG MONEY**

Get into an industry just beginning to grow and grow with it. Prepare now for profitable work as consulting or operating Diesel engineer, manufacturing foreman or supervisor. Our training fits men for good starting jobs with unrivalled opportunities for promotion. Learn at home in spare time, small cost. Write for Free bulletin now.

AMERICAN SCHOOL, Dept. D945
Drexel at 58th, Chicago, Ill.

LACO Brings You New Heating Comfort
at **"SITTING" Level!**



Laco "Nu-Comfort" Oil Heater

For the utmost in heating comfort, just try this remarkable new LACO Oil Heater! With the top only 35 inches from the floor, heat pours into the Lower Levels of the room. That's where you LIVE—so that's where you want the heat! You sit in perfect comfort with heat "around" you, not above you! Besides, full-opening radiant doors give added "oven-door" heat if you wish. Complete with LACO's famous "Two-Stage" burner unit—a touch gives you any desired volume of heat. Immediately above the burner is LACO's improved Inner Heating Unit of heavy steel walls. Air, circulating up through the intensely hot walls of this unit, is delivered into the room to warm it thoroughly. Outer cabinet of heavy steel, beautifully finished. Guar.

WRITE See your local LACO dealer, or send name for Free Folder and Low Prices! Send NOW!

LACO OIL BURNER CO., 1120 UNION AVE., GRISWOLD, IOWA

LACO Gun-Type

Ideal for your furnace. Easy to install. Big volume heat from little fuel. Prices less than you think. See your dealer or write today!



Say you saw it in Popular Mechanics!

"GET THE FACTS!" Engineer Dobe, Div. 3379
Libertyville, Illinois.
Please send me full facts on "Drafting and Industrial Designing". Also how you assist your graduates to good positions in these fields.
Name Age.....
Address
Town State.....



Chain store and mail order competition easy to beat! Ask about our "Direct-to-Dealer" plan.

DEALERS

1940 1941 1942 1943 1944 1945 1946 1947 1948 1949

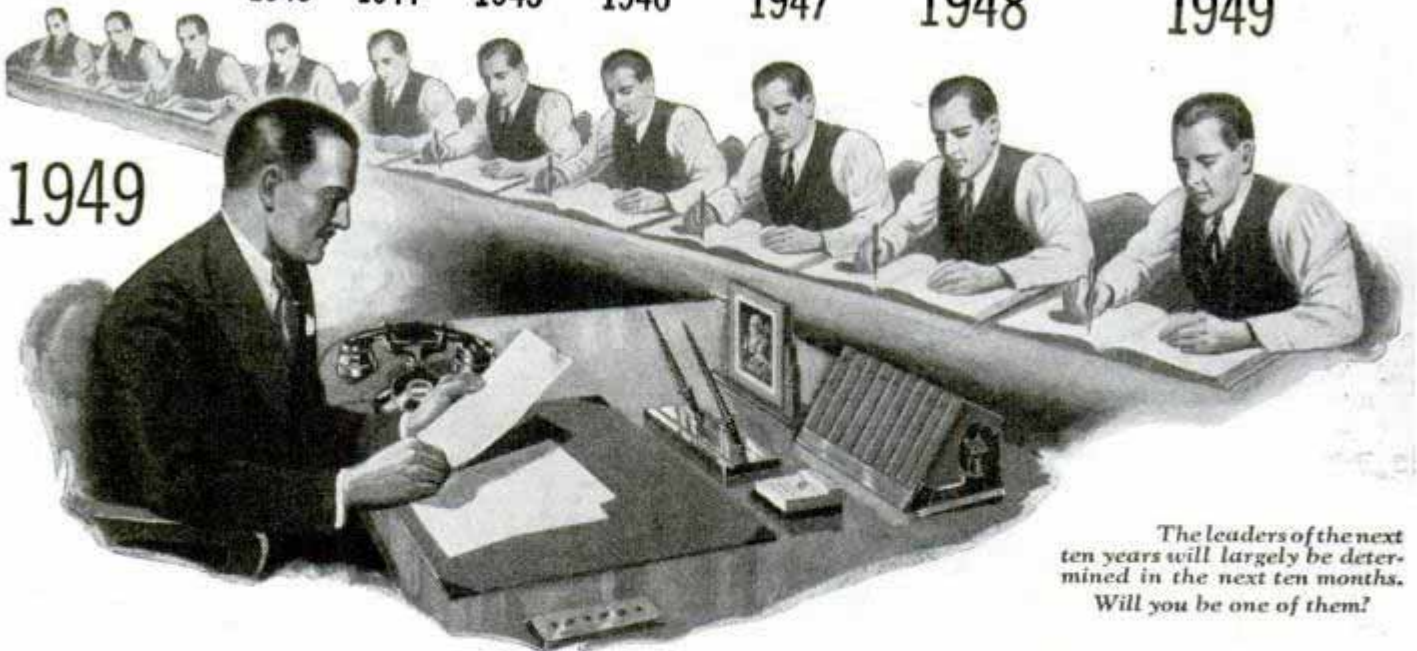

The leaders of the next ten years will largely be determined in the next ten months. Will you be one of them?

Will You Be Clerk or Manager Ten Years from Now?

"SURELY, this could never happen to me," you say—"that I should be sitting at the same desk—be doing the same work—for ten straight years!"

But wait a minute—

Exactly that same thing has happened to thousands upon thousands of men. It has probably happened to men right in the company you now are working for. And—unless you fit yourself for a better job—there is a very good chance that it may happen to you!

Unthinkable? That's what J. N. Dixon of Columbus, Ohio, said to himself. Yet lack of training kept him slaving away at low wages for a long time.

TRIPLES INCOME

Here is Mr. Dixon's own story—"Just after I returned from the war, one of your representatives found me plugging away at a bookkeeper's job in Marietta, Ohio. He performed a real service and explained to me the need of further training, and induced me to take the LaSalle training in Higher Accountancy. After a few months of study, I secured a position with the Trust Department of a National Bank. This was the stepping stone I needed to various responsible positions including handling of receiverships and other important duties. That quickly boosted my income several hundred percent."

ANOTHER AMAZING SUCCESS STORY

If you think Mr. Dixon's success story too unusual read what J. H. Krouse of Memphis, Tennessee, says. "When I decided to take your training in Higher Accountancy, I was a clerk. Today I am Chief Consultant Accountant for the U. S. Engineer's Office in Memphis, Tenn. Whatever success or recognition I have had, I owe to your training. I have had no other specialized training along this line. Your method of teaching is not only instructive but highly engaging. I have observed other courses, but firmly believe LaSalle has the best to be had anywhere."

Another bit of evidence is Mr. R. P. Barthalow's experience. Mr. Barthalow is Chief of the Sales Tax Section of the Tax Commission of Ohio, a department which handles over \$50,000,000 a year. Mr. Barthalow attributes much of his success to LaSalle training.

SEND FOR These Two Books and Start Toward Bigger Success

Need you hear more before you investigate the opportunities in Accountancy?

Or will you face the problem of your future NOW—and send to LaSalle and get further facts and particulars?

Without cost or obligation, the coupon will bring you two interesting books—one a 48-page book entitled "Accountancy, the Profession that Pays"; the other "Ten Years' Promotion in One."

How about those next ten years—will you wait or will you START TODAY to realize the tremendous opportunities that may lie ahead of you through sound and practical home-study business training?

Measure your grit and ambition by what you do with this coupon—NOW.

LaSalle Extension University ^A CORRESPONDENCE INSTITUTION

Dept. 1264-HR CHICAGO

Opportunities in Accountancy—Check below and we will send you a copy of "Accountancy, the Profession that Pays," also copy of "Ten Years' Promotion in One," all without obligation.

Higher Accountancy: Leading to position as Auditor, Comptroller, Certified Public Accountant, Cost Accountant, etc.

Other LaSalle Opportunities: If more interested in one of the other fields of business indicated below, check that.

- | | | |
|--|---|---|
| <input type="checkbox"/> Business Management | <input type="checkbox"/> Traffic Management | <input type="checkbox"/> Stenotypy |
| <input type="checkbox"/> Expert Bookkeeping | <input type="checkbox"/> Law: Degree of LL. B. | <input type="checkbox"/> Business English |
| <input type="checkbox"/> C. P. A. Coaching | <input type="checkbox"/> Industrial Management | <input type="checkbox"/> Commercial Law |
| <input type="checkbox"/> Modern Salesmanship | <input type="checkbox"/> Modern Business Correspondence | <input type="checkbox"/> Effective Speaking |



Name Age

Present Position Address



CLASSIFIED Advertisements



Advertisements in this section, 35 cents per word, each insertion, minimum 10 words, payable in advance
 To be inserted under proper classification in January issue, copy should be in our office November 8th
 January issue on sale December 1st
 Popular Mechanics Magazine, 200 East Ontario Street, Chicago, Illinois

YOU'LL PROFIT
 By reading and answering the classified ads in this section. Hundreds of opportunities to make and save money.

Popular Mechanics Magazine, Chicago, Ill.

Dear Sirs: We have received an inquiry from one of our good customers asking our opinion regarding the best magazine in the mechanical field in which to advertise. As Popular Mechanics has consistently led our list in sales, not inquiries, we are sending him your address. We also stated that your magazine led our total list, not only the mechanical magazines, but all mediums of every type. The sales cost per dollar is much lower in Popular Mechanics. We possibly receive more inquiries from other types of mediums but PM leads in actual sales. Proving therefore, that Popular Mechanics reaches the buying reader rather than the curiosity seeker.

(Original letter on file in our office)

Yours very truly,
THE WESTERN STATIONERY CO.

AUTOMOBILES—MIDGET CARS

AUTOMOTIVE Crankcase winter sludge preventor. Constant, forced-draft crankcase and valve chamber ventilation at all engine speeds. Dual-vacuum governed. Removes all dilution and sludge-forming, piston blowby vapors, before they are allowed to condense in crankcase oil. Combined top oiler. No engine odors or fumes, filter, moving parts, or maintenance. Fool-proof. \$7.50 postpaid. For Ford V-8, Mercury, Plymouth, Dodge, DeSoto; GMC AC models. International trucks. Give model; year; passenger car or truck. Guaranteed. Sales engineered catalogue for distributors. Thermo-Syphon, Miami, Oklahoma.

KUNS' Fifth edition Automobile Racing Book. Tells how to build dirt track bodies, frames, engines. Records, superchargers, rules, formula, plans, stock conversions, roadster racing, fast Fords. \$1.00 postpaid; \$1.15 C.O.D. Ray Kuns, Department 24, Madisonville, Cincinnati, Ohio.

BUILD This powerful, inexpensive supercharger for any automobile. Adds up to 8 horsepower. Complete plans 35c coins. Box 43, East San Diego, California.

R AND R Mfg. Co., Anderson, Ind. Racing cars, midgets and speed equipment. Catalogue 25c. Instructions \$1.00. Fuel chart 75c.

PROFESSIONAL Midget racers. Two-passenger roadsters. Midget motorcycles, motorscooters. Guaranteed motors, wheels, parts, plans. Handbook catalog—90 illustrations—29c. Midwest, Box 1959-CG, Chicago.

GASOLINE Saving device 50c. Ford 1934-1940. Chevrolet 1935-40. Walert Co., 3429 N. 10th St., Milwaukee, Wis.

MIDGET Motorscooter motors (used), \$5.00 up. List 100 used motors, cars, parts—20c. Catalog building kits, parts, plans—10c. Circulars free. Shipp's Midgets, Box 543-H, Zanesville, Ohio.

AUTOMOBILE Superchargers \$3. Guaranteed mileage increase 20%; power 10%. University of Detroit test. Any car; give make, year. Wrench installs 15 minutes. John Hanley, Manufacturer, 5719 Loraine, Detroit, Mich.

MAKE And sell my motor tune-up oil under your label. Real money-making proposition. Schafer, 547B Melrose, Chicago.

AUTOMOBILE Books—Latest titles—Bargain catalog free. Popular Mechanics, 633 St. Clair, Chicago.

AUTO SUPPLIES AND EQUIPMENT

STORAGE Battery clamps quickly removed with wrench. Agents wanted. Samples 20c. Waters Terminal Co., Atlantic, Iowa.

BARGAINS—Welders, compressors, battery chargers, car washers. Liberal trial terms. Write Hobart Equipment, Box M-12403, Troy, Ohio.

GUARANTEED Used auto parts: state needs; quotation rushed return mail. American, 1443-A Cuyler, Chicago.

ANTI-KNOCK Super fuel formula. 50c. H. Devereaux, Box 212, Battle Creek, Michigan.

BORING Bar top plates for V8 and Plymouth motors. Unique Manufacturing Co., 4807 North 31 Ave., Omaha, Nebraska.

FREE Bargain catalogue, auto supplies, tires, tubes, tools. Garage, shop, service station equipment. For dealers only. American, 1211 Bedford Ave., Brooklyn, N. Y.

ARE You handy with tools? Be independent. Buy our regrooving equipment. Complete \$12.50. Regroove smooth tires. Litt Miracle, 140 West End Ave., New York City.

PISTON Rings—Steel seal design. Quick seating, stops oil pumping. For all cars. Send for circular. Piston Ring Sales Co., 4022 West Lake Street, Chicago.

RECLEAN Used oil without cost. Particulars. P. Gerwin, Fairview, Okla.

PLATING Outfits for auto parts. Connect to a battery. No tanks used. Free particulars and proofs. Gunmetal Co., Ave. J, Decatur, Ill.

AUTO TRAILERS

READY Now—Plans for nine new Jim Dandy Trailers including six modern house trailers. Catalog 10c. Also new edition of Trailer Builders Manual and catalog of parts, supplies and equipment. Price 25c. Both 35c postpaid. Trailer Supply Co., 5120-A Fulton St., Wausau, Wis.

MOTORCYCLES, BICYCLES, MOTOR SCOOTERS AND SUPPLIES

MOTO-SCOOTERS—New overstocked 1940 models drastically reduced for clearance—only 50 machines—act fast. List prices \$111.50 to \$189.00. Reduced to these sacrifice prices—Solo DeLux \$79.50—Solo Torpedo \$92.50—Delivery DeLux \$89.50. Make money delivering; have low cost transportation to work. Write for folder. J & R Motor Supply Co., 201 E. 20th Street, Chicago, Ill.

"WHIZZER" Bicycle motor. Quiet, dependable, 4-cycle, 1 3/4 h.p., bicycle structure not weakened. Center of gravity unchanged. Looks like motorcycle. Easily installed. Further information and nearest place to see. Write Breene-Taylor Engineering Corporation, 6800 McKinley, Los Angeles, California.

MOTORCYCLISTS. Let's get acquainted. We can save you money on parts and accessories. List and decal free. Triangle, 1111 Washington, Chicago.

BICYCLE Motor-outboard, rides on own pneumatic wheel, junior and heavy duty models. Richardson Mfg. Co., Dept. MP, Aurora, Missouri.

MOTORCYCLE Police tires. Fresh stock. Good tread. \$3.00, \$2.00. Tipsword Bros., Pana, Ill.

BUILD Power scooters, midget cars. We supply tires, wheels, motors. Lowest prices. Send 10c for plans, etc. Build-Your-Own Devices, Dept. 12-A, 536 North Parkside, Chicago.

"SAVE 70%." Thousands assembling own Comet motorscooter! It's easy! We supply parts, tires, wheels, motors. World's best. Literature drawing 10c. Hurry! Comet Cycle Co., Box 3032, Madison, Wis.

MOTORSCOOTERS. Midget cars! Easily built. Complete plans and literature on wheels, tires, motors, transmissions, clutches, etc., 10c. Honsakers, Masontown, Penna.

CROCKER—Sensational new streamlined scooter. 110 m.p.g. E-Z riding spring frame. Automatic starter clutch. Dealers, rider agents wanted. Big profits. Stamp for catalogue. Clymer Sales, U. S. Distributors, 222 West Pico, Los Angeles, Calif.

MOTORCYCLES. Reconditioned. New, used, parts and accessories. All makes. Large stock. Bargains. Illustrated catalogue, 15c. Indian Motorcycle Sales, Kansas City, Mo.

ALLOY Pistons \$3.00—Harley, Indian, Henderson, Excelsior, Cleveland. Cylinder grinding, rings, bearings, gaskets, chains, sprockets, helmets, goggles, accessories, parts new and used for less. Catalogue and wings pin 10c. Ballak, 811 N. 9th, St. Louis, Mo.

MOTORCYCLE Parts, accessories. Most complete stock. New and used. We specialize on mail orders. What do you need? 35 page catalog 10c. Whitman Motorcycle & Supply Co., 405-9 Southwest Blvd., Kansas City, Mo.

MOTOR Scooters, engines, parts. Literature 6c. Goldi Motor Scooters, Niles, Michigan.

AVIATION

PROPELLERS For aircraft, sleds, boats, etc. Propeller repairing, sled and airboat blueprints. Hubs, face plates, snow sled skis. Catalog 10c. Banks Propeller Co., Love Field, Dallas, Texas.

WARTIME Aviation books, new, used. Photographs. Nickel brings list, photo. Airbooks, 958 New Rochelle, N. Y.

AIRCRAFT & Engine Mechanics Book. Prepares for both ratings. Bristles with new questions and answers covering recent examinations. Illustrated. \$3.00 postpaid or C.O.D. Quiz System, 1435 Flower St., Glendale, Calif.

AERO-SLEDS Custom-built, ice or snow, air-cooled engines. Supplies, plans, literature 10c. Adastik Bros., Grand Rapids, Mich.

BUILD And fly your own motorcycle powered monoplane, home. Easy, cheap. Tested plans, guaranteed, \$1.00. Aerotech, Box 1000, Dearborn, Mich.

100 AIRPLANES \$45 Up, located everywhere. Complete catalogue 25c. Used Aircraft Directory, Athens, Ohio.

AVIATION Wants more Lincoln trained men for positions as airline mechanics, aeronautical engineers, airplane factory mechanics, commercial pilots. This Lincoln Government Approved School of Aviation placing graduates in fine big pay positions. Opportunities for many more. Courses from 8 weeks to 2 years prepares for immediate employment. Reasonable rates. Write today for information. Lincoln Aeronautical Institute (Inc.), 2008 Aircraft Building, Lincoln, Nebraska.

PROPELLERS For airplanes, sleds. Iced-steel blueprints, supplies. Catalog dime. Lorenzen Propellers, Niles, Michigan.

AVIATION Books—Latest titles—Bargain catalog free. Popular Mechanics, 633 St. Clair, Chicago.

AIR CONDITIONING

WINTER—Summer air conditioner plans \$1.00. Wayne Engineering, Greenville, Ohio.

REFRIGERATION—Repairing instructions, plans; postpaid, \$1.00. Appliance, 5200 Delancey, Philadelphia.

FURNACE Blowers—\$22.50 up; attic blowers, cooling blowers and air conditioning blowers—all sizes. Guaranteed. Write for literature. Reynolds Mfg. Co., Grand Rapids, Mich.

AIR Conditioning books—Latest titles—Bargain catalog free. Popular Mechanics, 633 St. Clair, Chicago.

BATTERIES, GENERATORS, ETC.

FARMLIGHT Batteries, new insides. Agents proposition, Box 577, Hastings, Nebr.

EDISON Storage batteries for light-power systems. Non-acid. Odorless. Fifteen year life. Five year unconditional guarantee. Bargains in complete lighting systems. Low prices. Free illustrated literature. "See-Jay" Battery Co., 82 Sterling Ave., Yonkers, N. Y.

1/2 HORSE Repulsion induction, heavy duty 3400 speed motors \$9.75. Butler Electric Company, 1885 Milwaukee, Chicago.

EDISON Lifetime storage batteries for light and power. Eliminates acid battery diseases. Long guarantee. All kinds rebuilt generating plants, motors, and miscellaneous articles at bargain prices. Free interesting literature. T. Hawley Smith Co., Croton Falls, N. Y.

ELECTRICAL SUPPLIES—EQUIPMENT

ELECTRICITY Simplified, have you received our free details. No contract to sign. Conner School of Electricity, 56-W. Washington St., Chicago, Ill.

HEALTH Lamp: Dual ray—ultra violet—infra red. AC-DC. Sun-Tan vitamin "D". \$3.90 postpaid. Beyer Mfg., 4515-H Cottage Grove, Chicago.

FLUORESCENT Fixtures. Any type. Get our prices first. Wholesale Distributors Co. (Manufacturers), 5800 N. Broadway, Chicago, Ill.

ELECTRIC Pencil: Write-engraves all metals. \$1.00 postpaid. Beyer Mfg., 4515-H Cottage Grove, Chicago.

FLUORESCENT AC daylight lighting for desk; office; windows; home. Latest sensation. 50% discount. Literature free. McGee Radio, F-20, Kansas City, Mo.

ELECTRIC FENCING

BALL Bearing fence easily made from auto coil. Complete plans and catalog 10c. LeJay Manufacturing, 947 LeJay Building, Minneapolis, Minn.

WELDING—SOLDERING—PLATING

75-200 AMPERE Welders from old generators. Complete plans 35c. Plans show single and dual welder connections. LeJay Manufacturing, 347 LeJay Building, Minneapolis, Minn.

ACETYLENE Welding generators, latest type. \$25.00. Johnson Generator Co., Brookfield, Missouri.

BARGAINS, Demonstrator arc welders, gasoline and electric drive. Liberal trial, easy terms. Write Hobart Welder Exchange, Box 12402, Troy, Ohio.

BUILD 60-200 Amp. a-c welder for \$10. Several plans \$1.00. Information dime. Hi-Point Electric Products, Dept. W. Bellefontaine, Ohio.

SPOT Welding, soldering outfit \$2.95. Lynnpeltcher, 4772 Del Monte, San Diego, California.

D.C. Arc-welder. Build it yourself from Dodge generators, vehicle motors, light plant generators. Plans \$1.00 each (three for \$2.00). Welders Club, AB-3432 M-Mart, Chicago. (Fifty arc-welding lessons 50c.)

ACETYLENE Welding outfits, \$36.56; electric welders, \$66.25; easy-payment plan. Superior Oxy-Acetylene, Hamilton, Ohio.

A.C. Welders, plans, material. Free literature. Holgerson's Service, Canton, Kas.

WELDING, Soldering, plating books—Latest titles—Bargain catalog free. Popular Mechanics, 633 St. Clair, Chicago.

ENGINES, MOTORS, DYNAMOS

REBUILT Motors. Home workshop tools. Grinders; drills; saws. Bargain pricelist. Mailorder Electric, 713 South Dearborn, Chicago.

600 NEW Motor diagrams, tables, and controller connections for the practical electrician. Makes dual-voltage, multi-speed, star and Delta circuits clear and simple. Also includes all standard split phase, repulsion, induction, compensated, series, two and three phase. Data for re-winding and reconnecting all types. Over 100 valuable tables. Money-back guarantee. Price \$2.00 prepaid. Educational Advancement Company, Lakewood, New York.

BARGAINS—Welders, electroplating, motor generators, guaranteed, liberal terms. Write Hobarts, Box 12401, Troy, Ohio.

MOTORS, 1/4 H.P. General Electric, etc. \$3.50, guaranteed. Larger sizes. List 10c. A. C. Motors, 3008 Bailey, Philadelphia, Penna.

SMALL High speed 1/10 h.p. Universal motors \$2.50. McConnell, 701 Wolff, Racine, Wis.

WINDING Data 200 motors, growlers, test transformers \$1.00. Sabina Armature, Peebles, Ohio.

MOTOR Winding data, diagrams and winding lessons. Beginning lesson \$2.00. Particulars, stamp. Motor Data Company, Box 7631, Kansas City, Missouri.

ALTERNATING And direct current generators, motors, converters; bargain prices. State your needs. Queen City Electric, 519 South California, Chicago.

BARGAIN—1/2 Hp. motors, 60 cycle, 1 phase, 110 volt, like new, guaranteed, \$7.40. Send check to Erie Electric Motor Co., 120 Church, Buffalo, N. Y.

ALTERNATING, 1/2 Horse, 110 volt, induction motors. Rebuilt, guaranteed, \$7.25. Wilnot Auto Supply, 2247 St. Paul Ave., Chicago.

AIR Compressors 1 3/4 x 1 3/4 \$6.00; 2 x 2 \$7.00; 2 1/2 x 2 \$8.00; electric drills 1/4 in. \$5.95. Free folder. National, 1915 S. State, Chicago.

MACHINERY, TOOLS AND SUPPLIES

BUILD Your own machine tools. Equip your shop at big savings. We furnish castings, materials, blue prints for milling machine, shaper, band saw, and 21 other metal and woodworking tools. Send 10c for new 1941, 32-page, illustrated catalog. Lewis Machine Tool Co., Dept. M-12, Box 116, Station A, Los Angeles.

7" BENCH Model metal shaper at \$175.00. Semi-machined with blueprints at \$125.00. Castings only with blueprints at \$60.00. Ford Machine Co., 1030-32 Herriek Ave., Racine, Wis.

WANTED: Saw filer, hand or power. Box 582, Park Ridge, N. J.

WE Buy complete plants, lathes, shapers, milling machines, drills, presses, motors, etc. Steinberg Machinery Company, 1132 Lake Street, Chicago, Illinois.

SCREWS, Bolts, nuts, washers, lugs, springs, rivets, brackets, etc. Big 10 pound assortment, over 1000 handy gadgets, \$7.50 value. All for only \$1.98. Satisfaction guaranteed. Manufacturers Products, 216W Hubbard, Chicago.

FOR 9" South Bend lathes—Milling attachments; threading dials; taper attachments—Also mica undercutters; boring bar holders; collet chuck attachments; 8" face plates and four jaw chucks for all small lathes. Unique Manufacturing Co., 4807 North 31 Ave., Omaha, Nebraska.

USED 10" Screw-cutting lathe, \$45; band, circular, jig saws; drill. Service, Newfane, Vermont.

MACHINISTS Tool chests at bargain prices. Circular free. Cepuder, 3602 Wesley, Berwyn, Ill.

ALL-PURPOSE Lathe tool, improves accuracy, resourcefulness. Sizes including 1 1/2"; \$1.00 postpaid, if direct order. Dimension opening through toolpost. Tit-bit Tools, 41 East Orange, Lancaster, Penna.

CONCRETE Building block machines and molds. Easy payments. Catalog free. Concrete Machine Co., 5129 South Compton Ave., St. Louis, Mo.

6 FT. Flexible shaft mounted on 1/2 horse alternating motor \$19.50. Butler Electric Company, 1885 Milwaukee, Chicago.

13" x 5" WILLARD Lathe with gap. No. 2 Pratt & Whitney hand milling machine, four step cone drive. Write for full particulars. Cincinnati Machinery & Supply Company, 217 E. Second St., Cincinnati, Ohio.

BOATS, OUTBOARD MOTORS, ETC.

KAYAKS, Outboards, Rowboats, Duck boats. Weldwood ready-cut kits. Catalog F. Cre-Craft Boats, Millburn, New Jersey.

TEN Plywood boat plans 50c. Free catalog boatbuilding plans. The Rudder, 15 Murray Street, New York.

OUTBOARD Motors, all makes. Used motors and parts. Stamp brings motor list. Outboard Headquarters, 305 Atlantic Ave., Boston, Mass.

EASY To build rowboats, kayaks, outboards, inboards. Complete kits. Send 10c big catalogs, 20 designs. Newest models. Kayak Boat Co., 154-K East 129th, New York.

BUILD Your own boat with Bay City prefabricated frames and materials. Save up to 2/3s. Lumber, fittings, engines and equipment. Illustrated catalog 100 boats 9 to 75 feet 10c. Bay City Boats, Inc., 1552 Adams St., Bay City, Mich.

BOAT Plan booklet 10c. Build now during winter. Free blue-prints with motor purchased. Over 300 new and rebuilt motors to select from. All guaranteed. 5c brings list. Masters & Son, 804 N. Clark St., Chicago's largest dealer.

FORD-Mercury-Zephyr marine conversions. Catalog 10c. Lehman Engineering Company, Dept. D, Newark, N. J.

MARINE Conversion parts for all auto engines. Buy here and save. Conversion Parts Co., 278 Adams St., Boston, Mass.

FULL Size, cut-to-shape boat patterns—blueprints—specifications. Big selection. Designed by naval architects. Real bargains. Send 10c (coin) for illustrated catalog. Book "How to Build Boats," \$1.00 postpaid. Cleveland Boat Blueprint Co., Station A-66, Cleveland, Ohio.

MARINE Power—Easily convert any Ford motor (domestic and foreign) with Osco parts and kits. Complete catalogue 25c (coin). Osmithson, 3644 Lawrence St., Philadelphia, Penna.

OUTBOARDS—Save 1/2. Good used parts, all makes and models. Bargains rebuilt motors. Crandall Hicks Co., 959 Commonwealth, Boston, Mass.

BOAT Designers are highly paid professionals. Complete course by mail. Catalog. Westlawn, Montville, N. J.

SPORTING GOODS, GUNS, FISHING TACKLE, ARCHERY

GET Fur-Fish-Game. Subscribe now—save 80c. Buy a whole year's pleasure for yourself and sportsmen friends—twelve monthly copies of Fur-Fish-Game packed with fascinating, true, hunting, trapping, fur farming, dog, fishing experiences, fur markets, questions, Christmas special—one year (regular \$1.80 newsstand value) for \$1.00, including free gift card, or 6 months for 50c. Clip ad, send with name, address, remittance to Fur-Fish-Game, 168 E. Long St., Columbus, Ohio.

SEND For free illustrated catalog of Lawrence leather belts, holsters, gun cases and other sporting equipment. George Lawrence Company, Portland, Oregon.

ARCHERY, Fishing, hunting items! See our catalogue. Mershon Company, Glendale, Calif.

LIKE Guns? Enjoy shooting? Send 6c stamps sample copy 64-page monthly magazine, exclusively about guns. The American Rifleman, 1610 Rhode Island Ave., Washington, D. C.

GUN-SIGHTS, Trade. Original. Sight-Exchange, Box 265-N, Paoli, Penna.

SPEED Actions for Enfields \$8.00, Krags \$5.00. Adjustable trigger. Enfield cocks on opening. K. Clark, Madera, Calif.

BEAUTIFUL Skating self-taught. Correct fundamentals. Men, women, children 35c. Skaters Manual, Box 5, Tacoma, Washington.

BARGAINS! Gun catalog 5c, camera catalog 10c, archery catalog 5c, ski catalog 5c, medal-award catalog 10c. Warshal's, First-Madison-PM, Seattle.

ARCHERY Equipment—Catalogue free. Mid-West Archery, 2209-A East 75th, Chicago.

GOLF Clubs. Five club matched set \$2.50. Lincoln Surplus, 123 Galena, Freeport, Ill.

COMPLETE Camping, hunting, outdoor equipment, used guns. Catalog. Howe Fur Company, Coopers Mills, Maine.

ARCHERY! Complete archery instruction book, 70 pages—200 illustrations—30c. Catalogue free. Triangle Archery Company, Harrison-State Streets, Chicago.

INDOOR And outdoor sports—Latest books—Bargain catalog free. Popular Mechanics, 633 St. Clair, Chicago.

FIELD GLASSES, TELESCOPES AND MICROSCOPES

LENSES—Assortment of fifteen, ground and polished. High quality. Slight imperfections as small chip on edge. Diameters 10mm. to 53mm. Various focal lengths, including negative eyepieces. Suitable for telescopes, microscopes, field glasses, etc. \$1.00 postpaid. Satisfaction guaranteed or money refunded. American Lens Company, 324 North Mayfield, Chicago.

ASTRONOMICAL Telescopes, binoculars, cameras, microscopes; bought, sold, repaired. Send 10c for list of instruments desired. Rasmussen, Box 294, Amsterdam, N. Y.

TELESCOPES, Microscopes, binoculars; bargain catalog free. Brownscope Company, 5 West 27th Street, New York.

CASH For used microscopes, binoculars, any optical merchandise. Gordon's, 162-P Madison, Chicago.

ANTIQUES, RELICS, INDIAN GOODS, CURIOS

30 **GENUINE** Indian arrowheads, \$1.00. Catalog. Geo. Holder, Glenwood, Ark.

WANTED—Old slot machines, nickel slot pianos, arcade machines. Boyer, 2700 Wabash, Chicago.

INDIAN Skulls, \$5.75, postage free. Bernard, Box 192, Oakland, California.

\$100.00 **PAID** For certain Indian relics. Illustrated identification chart 25c. Glen Groves, 6601 Oshkosh, Chicago, Ill.

INDIAN Relics, coins, bills, gems, crystals, curios, etc. Illustrated catalog 5c. 100 ancient arrowheads \$3.00. H. Daniel, Hot Springs, Ark.

SWORDS, Rapiers, pistols, daggers, armor list 10c. Robert Abels, 860A Lexington Ave., New York.

CHINQUILLA'S Indian Craft Museum. Handwork of all Indian tribes. Jamaica, N. Y.

INDIAN Relics, beadwork, coins, curios, minerals, old glass. Catalog 6c. Indian Museum, Osborne, Kansas.

TAXIDERMY

DEER Eyes—Size 26mm. 40c. Headforms and supplies. Send for catalog No. 3. Penn Taxidermy, Hazleton, Penna.

GLASS Eyes, taxidermists', furriers' supplies. Big catalog free. Elwood Company, 222 Smith Bldg., Omaha, Nebr.

NEW American made deer eyes. Patented process produces natural, lifelike Jonas-Eyes superior to best European glass. Lower in cost, too! Unbreakable. Special trial offer—Sample pair 65c. Satisfaction guaranteed or money back. Order today or write for price list of eyes and other supplies. Jonas Bros., 1049 Broadway, Denver, Colorado.

DOGS, PETS, BIRDS

BIRDS? Get American Canary Magazine monthly. Year, \$1.00. 2839-P North Halsted, Chicago.

NORTHERN Coonhounds. Terms. Price-list, description (dime). Lakeland Fur-exchange, Salem, Michigan.

BEAUTIFUL Pure white police dogs. Ansonia Kennels, Mose, N. Dak.

PUPPIES, All kinds, free details. Book 104 photos recognized breeds described 25c. Royal Kennels, Chazy, N. Y.

SPORTSMEN: 200 Pointers, setters, straight cooners, combination hunters, rabbit and fox hounds. Reasonable. List free. Ramsey Creek Kennels, Ramsey, Illinois.

TREES, SHRUBS, ROOTS, HERBS

COLORADO Blue Spruce trees, 2-year-old. Extra strong. From the bluest of the blue trees. 25 prepaid for \$1.00. Rocky Mountain Evergreen Co., Evergreen, Colo.

JUST Out! World's greatest "Herbalist Almanac." Beautifully illustrated in natural colors. Contains over 200 old fashioned herb medicine recipes for home use. 10c (coin) postpaid. Botanic, Box 1109, Evergreen Park, Ill.

POULTRY AND FARM SUPPLIES

LOW Factory prices on poultry equipment. Wire fabrics. Free 100-page catalog. Bussey Pen Products, 5151 West 65th Street, Chicago.

BUY Davis chicks for fall broilers, 6-10 weeks and you can develop Davis chicks into hothouse broilers. Write for free spring catalog. Davis Poultry Farm, Route 34, Ramsey, Indiana.

WE Loan you a brand new brooder if you raise Carney chicks this year. Hatches each week. Write for catalog and details. Carney Hatchery, Box 36, Shelbyville, Ind.

BROILER Prices up. Make more money raising fast growing embryo fed chicks. Hatches every week. Prices low. Jackson County Hatchery, Box 32, Seymour, Ind.

LOW Prices for fall chicks for broilers or layers. Write for 1941 catalog and prices. Hatches each week. Greensburg Hatchery, Box 40, Greensburg, Indiana.

DO You want chicks that are bred to make money? Then order my Champion chicks—6 year mating with ROP and pedigree stock. Hatches every week all fall and winter. Salem Hatchery, Box 81, Salem, Indiana.

WHEN Buying chicks for broilers or layers be sure, buy Seymour chicks. I can make prompt shipment. Free 1941 catalog. Seymour Hatchery, Box 61, Seymour, Ind.

MORE Chicks for less money. Highest quality, low price. Can make immediate shipment. Dubois County Hatchery, Box 912, Huntingburg, Indiana.

COLORED Pictures of poultry and common poultry diseases supplement valuable information which enables you to increase profit. Six months 10c, two years 25c. American Poultry Journal, 575 South Clark, Chicago.

MONEY To be made in poultry this year. Poultry Item tells why and how. This leading poultry magazine 4 months 10c. Highly illustrated. Best writers. Get big bargain winter issues. The Poultry Item, Box 71, Sellersville, Penna.

LEADING Turkey magazine, devoted exclusively to turkey raising. Explains newest methods. \$1.00 a year. Turkey World, Desk 70, Mount Morris, Illinois.

MAKE Money with poultry. Read America's leading poultry magazine. Five years \$1.00; one year 25c. Poultry Tribune, Dept. E-60, Mount Morris, Illinois.

FARM MACHINERY AND SUPPLIES

BUILD A tractor that really works. Buick motor, clutch, starter, lights. Fordson axle, transmission. Instructions, drawings, \$1.50. L. C. Zellers, Route 1, Rochester, Mich.

FARMS, FARM LANDS, REAL ESTATE

FLORIDA Lakefront tracts \$100.00. Five acre highway fronts \$50.00. Ten acres citrus and tung oil land \$50.00. \$5.00 down \$5.00 monthly. R. W. Stewart, Inverness, Florida.

MORE New farm land, Washington, Minnesota, Idaho, western Montana, Oregon. Dependable crops, favorable climate. Write for impartial advice, literature and list of typical bargains. Specify state. J. W. Haw, 119 Northern Pacific Ry., St. Paul, Minn.

DESIRABLE Farms, Griggs county, N. Dak. Good improvements. Good groves. Close to good towns. \$8.00 per acre and up, quick sale. R. S. Lunde, Cooperstown, N. Dak.

GOVERNMENT Land—10c acre up. Information all states 25c. Nat. Tax Service Bureau, 1037A Majestic Bldg., Detroit.

GROVE And home facing gulf, 3½ acres, 110 oranges and grapefruit, on paved highway, lovely views of water; 5 rooms, electricity and bath, 2-car garage; only \$2700, terms; page 50-C supplement and big free catalog. Strout Realty, 255-P 4th Ave., New York City.

SEE The Highlands of Louisiana now while prices are low. Choice cut-over land sold on liberal terms. Literature furnished upon request, without obligation. Long-Bell Farm Land Corporation, 863 R. A. Long Bldg., Kansas City, Mo.

40 **ACRES**, Near White River, unimproved; poultry land. \$175, \$5 down, \$5 monthly. Free list and literature. Hubbard, 216 Grossman Bldg., Kansas City, Kans.

PROFITABLE OCCUPATIONS

DOMESTIC Rabbits pay. Read Small Stock Magazine—America's leading magazine devoted to commercial and fancy rabbit industry. Introductory, year 50c; sample 10c. Dept. 5, Lamoni, Iowa.

OPERATE Steady business resilvering mirrors. Making chipped glass nameplates, signs. Write Sprinkle, Plater, 288, Marion, Indiana.

MOLD-MAKING, Plaster casting, monemaking home business. Valuable folder 3c. Kemico, 100, Park Ridge, Ill.

MEN—Women, operate "Specialty Candy Factory" home. All or spare time. Opportunity for good steady income. (Our 31st year.) Ragsdale Candies, Dept. 62, East Orange, N. J.

\$40.00 **WEEKLY** Growing mushrooms for us, fresh or dried. Dominion patent 331583, free spawn. North American, 169P Yonge, Toronto, Canada.

START Profitable sign business. Make signs, show cards, gold window letters, easily with Master Patterns and free copyrighted instructions. Economical Signs, 1572-74 North Halsted, Chicago.

ANGORA Wool rabbits pay. America's fastest growing industry. Start now. Dakota Rabbitry, Oakes, North Dakota.

EARN Cash daily raising mushrooms in cellar, shed, garage. We buy all you raise, instruct you, and furnish guaranteed materials. Established 1908. Book free. United, 3848-AC Lincoln Ave., Chicago.

WILL You give us 5% first \$600 you make? Afternoons free! Work home. \$1,000 month reported (exceptional—full-time). Expect surprise! National, Box 1240-C, San Bernardino, Calif.

ANNOUNCING New home study course in commercial baking. Good field for ambitious men. Nearly depression proof business. Common school education sufficient. Send for free booklet "Opportunities in the Baking Industry" and requirements. National Baking Institute, 3601 Michigan Avenue, Dept. 3434, Chicago.

RAISE Rabbits and cavies for us. Full details. Catalog, contract and magazine 10c. Or send 25c for book, catalog and year's subscription to Small Stock Farmers Magazine. Stahl's, Box 10, Holmes Park, Missouri.

GAMES—ENTERTAINMENT

BINGO Games and equipment, lowest prices. Warwick Press, Conimicut, R. I.

PLAYS, Operettas, musical comedies, complete minstrel first-parts with song programs, blackface skits, vaudeville acts, monologs, dialogs, recitations, juvenile plays and songs, musical readings, entertainments, make-up goods. Catalog free. T. S. Denison & Co., 203 N. Wabash, Dept. 11, Chicago.

"**ALPHA-BETA** Word Game" for Christmas. New, educational. (47 catalin pieces) 50c postpaid. Ramond Games, 406-M Stern Bldg., New Orleans.

BOOKS, PERIODICALS, PICTURES, POSTCARDS

REPRODUCTIONS Of Currier & Ives early American lithographs, 11x16 inches, beautifully colored, 12 different scenes for \$1.85 postpaid. Sample 35c. L. Fischel, 175 West Jackson, Chicago.

EXCELLENT Sparetime profits taking subscriptions—2500 magazines. Agents confidential catalogue, complete starting supplies free! Dept. 16, Pines, 583 Monroe, Brooklyn, N. Y.

5c **BUYS** Back dated magazines. Domestic, foreign, art, 100,000 used, new books, Catalog 10c (refunded). Cicerone's, 863(A) First Avenue, New York City.

AMAZING Money making secrets exposed. Price \$1.00. Order your copy now. Woelfel Sales, 109 South Fairview, Upper Darby, Penna.

FREE Catalogues! All books! Old Prof's Book Shop, M16 Arcadia Ct., Pontiac, Mich.

MAGAZINES, Back numbers, list 3c. Magazine Mart, Roslyn, N. Y.

THRILLING, Snappy, Cuban, Mexican art pictures, books, miscellaneous, samples, lists, 50c (refunded). Jordanart, 16 Cedarlane, Boston.

PHOTOGRAPHS: Entire listings, sample, 12c. Albert E. McGoldrick, Mansfield, Mass.

BACK Number magazines: Popular Mechanics, Fortune, National Geographic or most any magazine you want. Send 6c for new price list. James G. Anderson, Broad and Stanton Sts., Trenton, N. J.

MAGIC TRICKS, PUZZLES, JOKER NOVELTIES

GET This big new catalog of magic. 228 pages, 500 illustrations. World's largest line of quality magic. Send 35 cents for catalog. Your money refunded with first \$2.00 order. National Magic Company, 119 S. State St., Chicago, Ill.

PATTERNS—20 Novelty 25c, 15 gift and toy 30c, 6 what-not shelves 25c. Kranz Novelty, 1730 Wayside Road, Cleveland, Ohio.

MAGIC Novelty catalog and 3 gifts, 10c. Frank Wencil, Hamtramck, Mich.

FREE Tricks! Join Magicians' Fraternity! Monthly magazine, sample 10c. International Magicians, Mt. Morris, Illinois.

HOUSE Of 1000 mysteries! Professional magic! Pocket tricks! Jokes! Puzzles! Novelty! Giant surprise catalog! Bigger-better than ever! Only 10c! Vick Lawson, Dept. J8, Queens Village, N. Y.

BE A magician. Large professional magic catalogue of latest tricks 25c. Cash paid for complete Tarbell Magic Courses. Write, Ireland, C-109 North Dearborn, Chicago.

MYSTERY Coin trick 20c, magic book free. Visco, Box 4741, Philadelphia.

TRICKS And joker's novelties. Catalog and sample 5c. Ess-Jay, 5019-C Winthrop, Chicago.

TRICKS You can do! For pocket, parlor, stage. With coins, cards, cigars, ropes, balls, thimbles, watches! Escapes, mindreading, spirit and mental magic! Illusions, magical books and stage supplies! Largest assortment! Lowest prices! 100 page catalog 500 popular tricks 10c. 80 page catalog larger stage magic 10c. Write today! Lyle Douglas, Station A-5, Dallas, Texas.

HOLLYWOOD Special! Magicians button, catalogue, ghost illusion and free trick for 25c. Magic House of Charles, Box 888, Hollywood, California.

MAGICIANS' Headquarters. 216-page catalog pocket, parlor, professional tricks, 25c. Kanter's, 1311 Walnut, Philadelphia.

EARN Money in any crowd. Call names of strangers, tell unspoken questions. Professional course mind reading, spirit writing, etc., \$1. Henderson, Box 341, San Bernardino, Calif.

WORLD'S Largest professional magic shop keeps you in touch with latest tricks. To receive mailings send 25c for 1940 catalog. Holden, 220 W. 42nd St., New York.

LARGE Magic catalog 25c. Hundreds of tricks. Chicago Magic Company, 2300 N. Mason Avenue, Chicago.

RARE COINS

GET Profit and pleasure in collecting old coins. Send 10c for 56-page illustrated coin catalog. You'll be delighted with it. Send for it now. B. Max Mehl, 370 Mehl Building, Fort Worth, Texas. Largest rare coin establishment in U. S. Established 40 years.

CATALOGUE U. S. coins, all types illustrated and priced, 48 pages for 25c. Nivison, Webster, N. Y.

OLD Money wanted. Will pay \$100.00 for 1894 dime, S. mint, \$50.00 for 1913 Liberty head nickel (not buffalo). Big premiums paid for all rare coins. Send 4c for large coin folder. May mean much profit to you. Numismatic Co., Dept. 20, Fort Worth, Texas.

COIN Guide for beginners. Selling, collecting, etc. 20c. Lawrence, Plentywood, Montana.

INDIAN Head penny with list 10c. Charles Banker, Salina, Kansas.

15 DIFFERENT Coins 25c. Oddehon, Box 44, Overland, St. Louis, Mo.

WE Pay \$10 for certain Lincoln pennies! Indianheads \$150; dimes \$700. Catalogue 10c. Federal Coin Exchange, Columbus, Ohio.

COIN Packet, 75 coins of 75 countries, attributed in envelopes, \$5.00 postpaid. Koeppl's Coins of World, 8th at Broadway, Los Angeles.

RARE U. S., foreign coins, war medals. Catalogue 10c. Mengelle, Colorado Springs, Colo.

BUY By mail! U. S. and foreign coins. Collectors' accessories. Illustrated catalogue 10c. 3000 quotations. Dime refunded first order. James C. Randall, 37 West Van Buren, Chicago.

FREE! Foreign coin, banknote and large 36 page illustrated coin catalogue to approval service applicants. Send 3c postage. Tatham Coinco, Springfield-125, Mass.

COMMEMORATIVE \$1⁵. Columbus, Stone-Mountain, Cleveland, Illinois, \$1.00 ea. New catalogue 10c. Norman Shultz, Salt Lake, Utah.

I MAY Have just the scarce U. S. coins you want. Send me list. "Meet me by mail." William H. Kenworthy, Waterville, Maine.

STAMP COLLECTING

175 U. S. commemoratives, presidentials, etc., 20c. Lloyd Johnson, Hawarden, Iowa.

FREE—International album—Scott's newest Jr. edition covering entire world. Illustrated and descriptive spaces for over 33,000 stamps. Also—1941 Scott's catalogue, the Encyclopedia of Philately—and valuable Western Hemisphere collection. All these absolutely free when purchases are made from our foreign approvals. Plymouth, Dept. B9, Bell, Calif.

ASSASSINATION! Complete unused Sarajevo assassination issue from Herzegovina, perforation gauge, three other complete sets. All only 3c. Approvals. Gopher Stamp, 5432 South Aldrich, Minneapolis.

YOU Can now have famous Spanish Goya nude stamp, world's largest diamond stamp and world's largest triangle. These beauties sent for only 5c to collectors requesting approvals. To make this the year's biggest bargain, we will include absolutely free collection of 100 varieties containing weird scarce stamps from Transcaucasia, Georgia, Azerbaijan, etc. Cactus Junior, Box 1870-B, Tucson, Ariz.

COSTA Rica airmails C 3-4, 10, 14, worth 50c, only 5c. Approvals. Correcto-gauge free to customers. Treasure Chest, 1416 N. Lockwood, Chicago.

FREE—The Stamp Finder! Send today for big new edition, fully illustrated, enabling you instantly to identify all difficult stamps! Also fine packet strange, fascinating stamps from Bosnia-Herzegovina, Monaco, Patiala, Cyprus, etc., including maps, ships, animals and strange scenes. All free to approval applicants inclosing 3c postage. Garcelon Stamp Co., Box 900, Calais, Maine.

UNBELIEVABLE! Large United States collection over 250 different 1857, 1869, etc. Guaranteed biggest bargain ever offered! \$1.10 postpaid! Worth several times this. Limited supply! Order today! Be amazed! Franklin, 223 Franklin, Rochester, N. Y.

SPECIAL—Airmails! 23 different, including triangles, zeppelins, Latin Americas, etc., 5c to applicants for best value, attractively priced approvals. Continental Stamp Co., Dept. B, Sandy Hook, Conn.

SENSATIONAL Combination offer! Big packet 105 all different including Greenland (new country), Congo, Manchukuo, Costa Rica triangle, air-mails, commemoratives, giant diamond-shaped stamp, \$4 United States; complete set United States telegraphs, cataloging 20c, scarce set Siberia cataloging 50c. Packet British colonies including Gwalior, Hyderabad, Burma (new country), jubilee and coronations. Total catalog price over \$3.00! Everything for only 5c to approval applicants! World-Wide Stamp Company, Department 600, Camden, New York.

VENEZUELA—Six different historic commemoratives—only 25c to approval applicants. Free packet and lists included. W. Torgesen, West Englewood, N. J.

FREE—50 Different stamps if you request approvals. 3c postage. World Stamp Co., Flint, Mich.

1000 ALL Different stamps from world \$1.00. Catalogue value about \$25.00. 500—50c. DeMers, Box 1033, Milwaukee, Wis.

SPECIAL U. S. album—free! The "Famous American" issue of the U. S. government is too new to be represented in regular albums. We therefore offer a special album for these xx series, giving the history and achievements of each famous American under the space reserved for each stamp. This album can be completely filled at little cost. Just what you need! We will send it free for 5c handling expense, but only to sincere approval applicants. Approval Headquarters, Globus Stamp Company, 268 - 4th Ave., New York City, Dept. 201.

WEST Indies, British only: 100 different \$1.00 (banknote). Satisfaction guaranteed. Harold Rajnauth, Box 267, Trinidad, B. W. I.

325 DIFFERENT Stamps (catalogue approximately \$7.00) including French, Russian pictorials, 10c to applicants for our profit sharing approvals. Official Stamp Company, Department P12, Fairlawn, New Jersey.

UNITED States stamps on approval. Lowest net prices in America. Stamp Company, Dept. S, Albany, New York.

CHRISTMAS Suggestion. 50 commemoratives, Clark to Connecticut, \$2.50. Frederick Gittings, Rolling Road, Catonsville, Maryland.

BEST Ad we've ever had! Fifteen years advertising—but we honestly think this offer is "tops." Seychelles, Nejd, Caymans, Manchukuo, Brunel, Turks Caicos, British Solomons (Cannibaland). Everything 3c with approvals. Viking, 130-Z Clinton St., Brooklyn, N. Y.

DEALERS' Lots—Wide assortment. Splendid value assured. \$2.00-\$5.00. Sample lot \$1.00. Whitney Safford, Burlington, Vermont.

U. S. used C 7-9 and C 20-24 sixty cents, ten \$4.50. Shoenbach's, Box 180, Station "G," New York.

NO. 1 10 Different including Siam 10c. Approval applicants. World Stamps, 1566 East 48th, Brooklyn, N. Y.

DEALERS! Philatelic forms, Samples for stamp. Keelerprint, 3822-W Ogden, Chicago.

UNITED States approvals, selected copies at reasonable prices. Write today. Seminole Stamp Studio, Box 416, Miami Beach, Florida.

50 DIFFERENT Finland 15 cents with approvals. Pocono Stamp Company, Dept. P, Box 512, Wilkes-Barre, Penna.

STAMP Wallet with 25 pictorials, air-mails, 10c. Approvals. Buckley, Ludlow Bldg., Dayton, Ohio.

PRECANCEL Approval. One cent each. Mailed weekly. Gilmore, Oswego, N. Y.

175 MIXED Stamps 5c! With approvals. Dawson, 1308-F, The Dalles, Oregon.

FREE 20 Commemoratives to approval applicants. Sawpit Co., 287 Olivia, Port Chester, N. Y.

FIFTY Different stamps 10c. Approvals on request. O'Brien, 704 Broadway, Utica, N. Y.

1940 WHOLESALE Catalogue free—Eighty pages. Empire Stamp, Dept. 5, Toronto, Canada.

25 BRITISH Colonies, 5c with approvals. Weil, 827 Agatite, Chicago.

AIRMAILS—Seven different U. S. air-mails 10c. Elsea, Bowling Green, Ohio.

APPROVAL Sheets. Frederick B. Driver, 401 Finance Bldg., Philadelphia, Penna.

"SPAIN Goya Nudes" complete 10c. Approvals sent. Jewells, Tamaqua, Penna.

SAAR 50 Diff. \$1.75. Bellini, 441 W. 49, New York.

\$2.00, \$5.00, \$10.00 U. S. free! Davison, Box 568c, Manchester, N. H.

150 GOOD Mixed foreign stamps, 5c coin. Stanton, Niantic, Conn.

40000 VARIETIES Available on approvals 1/4c up. Large selections, low prices. Adults only. PKeigwin Stamp Company, Vineland, N. J.

GENUINE Hawaii 1894 pictorial, Samoa, etc. 10c with approvals. Alatalo, Maynard, Mass.

BURNED Zeppelin! Big packet including Hindenburg zeppelin; tiny triangle; Indo-China airmail; Mozambique; Liberia; Canada coronation; silver jubilee; Italian East Africa; Holy Lands packet (Palestine, Lebanon, Iraq, etc.) many others. To approval applicants only 5c. Frederick M. Pitts Co., Framingham, Massachusetts.

U. S.—60 different, including commemoratives, airmails, dues—with elaborate bargain pricelist 10c. No approvals. Seidenberg, Baroda, Mich.

TRADING Plan and 15 different U.S.A. 19th century stamps for 100 mixed U.S.A. and 10c. Waldo, Box 266, Dallas, Texas.

HUNDREDS Of stamps. Triangles, diamonds, airmails, etc. Ten cents to approval applicants. Herold, Box 1167, Woodhaven, N. Y.

FREE! 100 Stamps approval applicants promising returns ten days. Postage 3c. Foreign and United States 1c up. Hinges 10c 1000. Elmer's, 196A Washington Street, Boston.

STUPENDOUS Offer! Selangor (mosque), Turkey (Obelisk), Malaya (ferocious tiger), Saar (dead country), Poland (swiatowit), 10 different Chile, 25 different China, 5c to approval applicants. Knopp, Box 1381, Bristol, Conn.

COMPLETE Sets: Belgium, Liege-Antwerp exhibitions; Estonia, wounded soldiers; Roumania, aviation. Also 53 different singles, Nigeria, Victoria, Philippines, etc. Everything 5c with approvals. Stamp Service, 53-E Webster Avenue, Brooklyn, N. Y.

EXCHANGE With collectors everywhere. Dime brings list and application. Modern, Box 995-S, New Haven, Conn.

SNAKE Triangle plus dollar packet free to approval applicants. Dearborn Stamp Co., 5439 Aberdeen, Chicago.

SOVIET Russia, 23 different. Complete sets and commemoratives 10c. Lufbery, Middletown, Connecticut.

BRITISH Colonies, 55 different, including jubilees, coronations, 10 cents with approvals. Swedell, 3038 Harriet, Minneapolis, Minn.

25 JUGOSLAVIA 5c With approvals. Knight, Box 3780, Portland, Oregon.

UNITED States mixtures. The best 50c lb., 5 lbs. \$2.00. Canada 70c. Foreign \$1.00. Mission, 4512 North Racine, Chicago.

NEW Low prices! U. S. illustrated list, 3c. Cannella, 516 Palisade, Jersey City, N. J.

UNPICKED Mixture: 40c pound! 100 U. S. revenues on documents—10c! Vanvoorhis, Hyndman, Penna.

100 ALL Different U. S. 15c. Monjar, 15 1/2 Waverly, Cincinnati, Ohio.

UNITED States 1/4 catalog or less. List, Winehold, Woodbine, Penna.

12 DIFFERENT U. S. 1862-1908, 3c. Weston, Box 383, Ponca City, Okla.

FREE! Complete zeppelin airmail set with approvals. Riedell, Greensburg, Penna.

FREE 5 Triangles, Approvals. Send postage. Poggenburg, Oak Lane, Philadelphia.

NEW Pan American set, Ecuador 10c to approval applicants. Wilson, Box 2232, Tulsa, Okla.

250 MIXED. Good grade, worldwide 5c. Approvals. McCurdy, 2505 Highland Drive, Salt Lake City, Utah.

INTERESTING \$1.00 Value—5c. Station "C," Box 4542, Kansas City, Mo.

20 DIFFERENT United States free (postage 3c) with approvals. References. LeDuc, Saint Petersburg, Florida.

AIRMAIL 25 Diff. 9c with approvals. 50 diff. 43c. Hoydars, Selah, Wash.

FREE: 25 Canada, 1914 war set (approvals). Lee, 113 Sutherland, LaPorte, Ind.

GOYA Nude with 50 stamps, 10c with approvals. Pageboy Stamp Company, Box 282, El Monte, California.

EIGHT Varieties old Deccan 5c with approvals. Hughes, Auburn, Nebr.

DIME A dozen—12 old Canadians 10c. Garlock, 1018 N. Rampart, Los Angeles, Calif.

300 U. S. commemoratives, etc. 10c. 1000, 25c. Arden, 826 Amsterdam, New York City.

1000 MIXED Foreign, 25c. Well worth sorting for values. Plaza Stamp Co., Santa Fe, N. Mex.

50 DIFF. Sweden 5c. Superior penny approvals. John Laursen, Walnut St., Teaneck, N. J.

COSTA Rican diamond, valuable Bolivian triangle, etc., 3c. Approvals, Globe, 11257 Greenbay, Chicago.

GEO VI. Pictorials, ten different 5c with 1c to 5c general approvals. Lang, East Freetown, Mass.

LET Us send you our 1c approval book of 1,000 different foreign stamps. Adults only. Philatelic Lobby, 3075P Telegraph, Berkeley California.

NICARAGUA "Will Rogers" airmail set, five varieties, complete. 5c with approvals. Bouchard, 210 Pite, Bonne Terre, Mo.

ASK For our wonderful one cent approvals. Prospect Stamp Co., 225 Broadway, Toronto, Canada.

FIFTEEN Different bird stamps. Approvals. N. Greenstreet, Tracyton, Wash. U. S. Mixture, 3 lbs. \$1.00. Holmes Stamp Co., New Albany, Ind.

120 AMERICAN 25c. 125 Foreign 20c. Commemorative album 8 5/8" x 11 1/4"—30c. Kenchal's, 271 Madison, West Hempstead, New York.

5 TRIANGLES, Giant diamond, 10 airmails, 5 unusual sets, 25 different U. S. Everything only 10c with approvals. Stamps, E. Rochester, N. Y.

NUDE Beauty, largest map, 75 different U. S., foreign 10c. Story Service, Gloucester, Massachusetts.

50 FREE, Catalogued \$1. Album 3c. Bullard, 13 Winter Hill, Mass.

311 MIXED British, 21 different Denmark, set new Iceland, 22 mint Russia, set Czechoslovakia commemoratives, 24 different Canada, ten foreign airmails, 29 different unused French Colonies, 103 different foreign, 27 different Czechoslovakia, 32 different Argentine, (589 stamps), 1,000 Hillside (finest) hinges; all postpaid 25 cents stamps or coin to general foreign approval applicants with references. Hillside Stamp Shop, Box 937, Binghamton, N. Y.

25 FAMOUS Statesmen of the world, 3c with approvals. Tire Stamp Co., 976 So. Westmoreland, Los Angeles, Calif.

FREE—100 All different stamp wallet, perforation gauge, 3c to approval applicants. Gordon Stamp Company, 875 Marlborough Avenue, Detroit, Michigan.

BRITISH Colonials, 75 different 10c with approvals. "Crescent Stamps," London, Canada.

GIGANTIC Stamp mounting outfit consisting of stamp tongs, watermark detector, perforation gauge and hinges only 5c with approvals. Kaybe Stamp Company, 1729 Penn Avenue, Pittsburgh, Penna.

CANADA'S Three largest, 10c. Last 50c, 12c. Dufort's, 4402 Chateaubriand, Montreal, Canada.

100 PERAK, Siam, Manchukuo, etc. Free. Foreign approvals. Lee, Bridgeport, N. Y.

50 RAILROADS, Ships, etc. 10c. Approvals. Buchanan, 307 East 23rd, New York.

FREE Roumania semipostal aviation complete to approval applicants inclosing postage. Walt Sochor, 114 Glenwood Avenue, Merchantville, New Jersey.

10 BEAUTIFUL Stamps 3c. Approvals. Stamps, 5805 Delmar, St. Louis, Mo.

FREE—Scott's 1941 catalog. Send 10c for 75 diff. British Colonies. Approvals and details about amazing offer. Mann's, 157 Russell St., Brooklyn, N. Y.

COLLECTION 50 Diff. Balkan. Near-East stamps—6c with approvals! Saxon, Valley Stream, N. Y.

FREE—World's only octagonal (eight-sided) set and 25 different Japanese pictorials to approval applicants. Charles Cleveland, 806 North Humphrey, Oak Park, Illinois.

UNITED States approvals—At half catalogue. Ireton, Box 92, Station "A," Los Angeles, California.

FREE—12 Different from Roumania or Czecho or Poland to approval applicants only. Reimers, Fort Worth, Texas.

TRIANGLES, (3) Free with approvals. Chester, Box 545-P, Utica, N. Y.

300 DIFFERENT 20c; 600, 50c; 1000, \$1.00; 2,000, \$3.00. Fred Onken, 630 79th St., Brooklyn.

50 DIFFERENT U. S. to approval applicants only. 5c. Theodore Stevens, 3576 Maryland Ave., Detroit, Mich.

LOW Priced U. S. approvals, Postage paid both ways. Kaiser Stamp Co., 302 Hurley, St. Paul, Minn.

WORLD'S Smallest airmail—largest map, diamond and triangle stamps, free stamp magazine, magnifier to study stamps with large packet of stamps from scarce countries, big bargain 5c with approvals. Capital Stamps, Little Rock, Ark.

SCARCE Diamond airmail! Wonderful packet 115 different from strange countries. British colonies, Haiti, Tasmania, pictorials, etc. 5c to approval applicants. Reliable Co., Box 139, Dept. 3, Church Annex, New York.

SEND Postage for free United States price list. Stanley Gibbons, 38-P Park Row, New York.

50 DIFFERENT, Fine U. S. including perforation gauge, 10c with approvals. The Stamp Shop, 809 Holland Bldg., St. Louis, Mo.

UNITED States: special to new approval applicants: fourteen different postage dues, 10c; twenty different revenues, 10c. Southern Stamps, Box 70M, Miami, Florida.

FREE! Pony Express set (facsimiles). Postage 3c. Roberts, 406 Shearer Bldg, Bay City, Michigan.

SEVEN Different triangles only 5c to approval applicants. Tatham Stamp Co., Springfield-30, Mass.

FOUR Star approvals! Nothing like them! Write today, 312 mixed U. S. 10c. Kessels, Tucson, Arizona.

SOUTH American—100 different 10c—with approvals. Davis, Silver Lake, Ind.

AIRMAILS And commemoratives, 25 different, including Columbians, Panama-Pacific, Edison, Zeppelin, etc., only 5c with exceptionally fine United States and foreign approvals. Marco Stamp Co., Box 888, San Francisco, Calif.

FREE! Austria war set, Postage 3c. Williams, 606 Archer Bldg, Bay City, Mich.

WEEKLY Stamp magazine, thirteen weeks, 10c. Stamp Journal, Kalamazoo, Mich.

200 DIFFERENT 10c. Big 50% approvals. Covert Stamp, 39 State, Rochester, N. Y.

CANADA 100 Different 25c—approvals all countries. Lists, Victoria Stamp Co., London, 4, Canada.

PENNY Approvals, that satisfy. Neil Gronberg, Box 5441-P, Philadelphia, Penna.

25 UNITED States, including \$4 and \$5 stamps free to approval applicants, 3c postage. Brownie Stamp Shop, Flint, Mich.

SMOKY Mountain commemorative sheet, largest U. S. stamp issued, and 33 U. S. including commemoratives, airmail, revenues, etc. Catalogs 75c—To approval applicants for 5c. Curhan Stamp Company, Gloucester, Mass.

WHOLESALE Dealer's catalog. Illustrated, Postage 5c. Frank's, 4900 Chalmers, Baltimore, Md.

WHOLESALE Supplements to dealers for 10c postage. Hundreds of bargains. Grossman Stampco, 102 West 42nd, New York.

GIANT Packet 200 all different from Africa, South America, Asia, South Sea Islands, etc. Includes world's smallest stamp; triangle and diamond-shaped stamps; animal stamps. Nicaragua "Will Rogers" airmail; many others. Also packet 17 different United States (cataloging 50c)—all obsolete, including \$4 denomination, commemoratives, etc. Total catalogue price over \$5.00! Everything for only 5c to approval applicants! Mystic Stamp Company, Dept. 80-N, Camden, New York.

HOBBIES AND COLLECTIONS

MATCH Book albums—no paste needed—make swell Christmas gifts. 75c and \$2 prepaid. Matchless Album, G. C., P. O. Box 120, New York.

COLLECT Rarities in Union buttons. Twenty different, obsolete, \$1.00. Adams Curios, Box 221-P, Flint, Michigan.

WANTED Old cigarette cards. Write Bray, 1127 Jackson, Easton, Penna.

GRAND Christmas gifts! 25 different cactus plants, \$2. Eulalia Turner, Azusa, Calif.

PACIFIC Ocean water, sand. Souvenir vial 50c. Pacific, Moss Beach, California.

MATCHBOOK Cover albums. Write Adams Sales, Dept. 35, State Tower, Syracuse, N. Y.

LISTS, 400 Match collectors, 10c. Hobby Bureau, Hawthorne Sta., Chicago.

EXCHANGE Your duplicate stamps, match covers, etc. with collectors everywhere. List, swappers, dime. (Mention hobby.) Secretary, Box 2166, Denver, Colo.

MATCH Book hobby. "Bulletin" membership blank, stamp, B-1111, Rochester, N. Y.

UNUSED Book match covers, 100 all different, \$1.00. Free list. Charles Edelman, 1311C East 84, Cleveland, Ohio.

HOBBY Books—Latest titles—Bargain catalog free. Popular Mechanics, 633 St. Clair, Chicago.

CAMERAS, PHOTO SUPPLIES

CAMERAS And supplies. Free illustrated catalog listing everything photographic—still and movie cameras, films, lenses—at tremendous savings. Hundreds of bargains, new and used. All guaranteed. We take your old camera or equipment in trade. Write now for your free copy of our newest money-saving bargain book—just out! Limited edition. Hurry! Central Camera Co., (Photographic Headquarters since 1899) 230 S. Wabash, Dept. L-16Z, Chicago, Ill.

MAKE Money with your camera! Thousands of dollars paid for pictures. Our big 136 page book tells you what to shoot and where to sell your pictures. Complete information on 2,000 different buyers of photographs. Arranged by market and alphabetically for quick reference. Have fun. Make money with your pictures. Send 50c for your copy or write for free details. Photo Markets, 112 Exchange Place, Hanover, Penna.

MAKE Money in photography. Learn quickly at home. Easy plan. Previous experience unnecessary. Common school education sufficient. Interesting booklet and requirements free. American School of Photography, 3601 Michigan Avenue, Dept. 3432, Chicago.

SPEED-O-COPY Groundglass focusing attachment for Leica, Contax, Argus C-2 and C-3. Send for literature. D. Paul Shull, Dept. PM-12, 240 S. Union, Los Angeles.

VICTOR No. 3 F 2.7 \$73.50, sound projector \$247.50. Univex, Keystone, etc. Terms arranged, free literature. Bulk films, processing, Corona Laboratories, 200 E. 34, Brooklyn, N. Y.

ENLARGER \$1.59. Enlarges eight times size of small negatives. Fully guaranteed. Paramount Sales Company, 89 Dudley Street, Boston, Mass.

CASH For used cameras and equipment. Gordon's, 162-C Madison, Chicago.

CAMERA Repairing. Bellows made to order, shutters repaired. Bellows made to fit all standard cameras! United Camera Co., Inc., A-1515 Belmont, Chicago.

BASS Says: Shrewd buyers, write Bass. For 30 years headquarters for everything in photography. 72-page Bargaingram No. 242 is interesting and free. Write for your copy. Don't trade until you write Bass Camera Company, Dept. AG, 179 West Madison St., Chicago, Ill.

HAVE You a camera? Send ten cents for recent number of our big magazine, showing how to make better pictures and earn money. American Photography, 116 Camera House, Boston, 17, Mass.

CAMERAS. Films, paper 25% to 35% discount. Paramount Photo Division, 327 East 92nd St., New York.

PHOTOGRAPHIC Books—Latest titles—Bargain catalog free. Popular Mechanics, 633 St. Clair, Chicago.

PHOTO FINISHING

35MM. Rolls fine grain developed, vaporated and enlarged, 3 1/4" x 4 1/2" for \$1. Guaranteed minimum 25. "Electric-eye" precision. Deckled prints. Embossed margin and date. Free mailers. 8 exposure rolls beautifully finished in free album, 25c. Satisfaction guaranteed or money back. Mailbag Film Service, Box 5440 A, Chicago.

TECHNIFINISH—35mm. 36 Exposure rolls including "Mercury" fine grain developed and perfectly enlarged to 3" by 4" glossy prints. 85c. New, exclusive methods and equipment make this low price possible. Cartridge reloaded with Eastman Plus X. 30c. One day service. Satisfaction guaranteed or money back. Write for free mailing bags and information. Technifinish Laboratory, 461-M Brown St., Rochester, N. Y.

20 REPRINTS 25c. Hundred reprints \$1.00. Rolls developed and 16 prints or 8 prints and 2 enlargements—25c. Mercury Studios, Dept. L, 109 N. Dearborn, Chicago.

FREE! Best snapshot on attractive photo button with 16 prints each roll 25c. Beautiful novelty premiums. Novel-Ad Co., BM-3327 North Ave., Chicago.

THIS Ad worth 1 free photo Christmas card personalized from your own snapshot. Enclose this ad with your negative and send to us. We will return immediately your beautiful free Christmas card with illustrated folder, showing choice of styles 25 for \$1. No obligation. Mail-N-Save, Box 310-25, Quincy, Mass.

8 ENLARGEMENTS And films developed, 116 size or smaller, 25c coin. Special offer, enclose this ad and negative for double weight hand colored enlargement free. Enlarge Photo, Box 791, Dept. PM, Boston, Mass.

IDEAL Photos beautifully finished, wide border deckle edged, 25c per roll of 8 and free enlargement. Christmas card folders, calendars. Send negative and 25c for sample of each. Ideal Photos, Box 2255, Paterson, N. J.

EMBOSSSED Christmas cards, including envelopes, from your own negative 60c dozen. Minimum 4 for 25c. Film Capitol Service, Box 504, Rochester, New York.

20 REPRINTS 25c, 100—\$1.00. Roll developed 16 prints 25c. 5x7 enlargements 10c. 3—25c. Nordskog, 4 Maywood, Illinois.

ENLARGEMENTS From negatives, five 5x7, 25c (coin). Garrett's, Pittsburg, Kansas.

PHOTOGRAPHY For pleasure and profit. Prepare for profitable business or fascinating hobby at home. Common school education sufficient. Write for information and requirements. American School of Photography, 3601 Michigan Avenue, Dept. 3456, Chicago.

FREE: To Popular Mechanics readers: Any roll developed, 16 sparkling Nu-Art neverfade enameled prints plus two beautiful Hollywood enlargements and two free Leathertone frames only 25c. 20 reprints 25c; 100—\$1.00. Overnight service. NuArt Studios, F-39, Des Moines, Ia.

ENLARGEMENTS At your price. Finest work. Individual composition each negative. 8x10, 20c; 11x14, 40c. Earl Lehman, 1107 Broadway, New York City.

FINER Double weight 8x10 enlargements 3 for 50c. Send negatives. Lee Photos, P.O. Box 2053, Chicago.

SIXTEEN Prints. Roll developed—25c. \$1.00 enlargement coupon and favorite movie star's photo free. Hollytints, P-1350, Hollywood, California.

ROLL Developed free, 8 deckled glossy prints 20c. Reprints 2c each. Eastern Photo, 55 Myrtle Ave., Danbury, Conn.

EIGHT 4x6 Enlarged prints, or 16 regular prints, from your roll, 25c. Sunbeam Film Service, Box H-876, LaCrosse, Wis.

FREE Trial—16 sparkling Lifetime prints, three lovely Hollywood enlargements, and free Leathertone frame with roll—25c. 20 reprints 25c; 100—\$1.00. Overnight service. Lifetone Studios, L-39, Des Moines, Iowa.

GUMMED, Perforated, stamp-size photographs. Negative unnecessary, 100—\$1.00. 25—50c. Wardwoode, MP-1, Wallingford, Connecticut.

TWELVE Beautiful deckledge enlargements with roll developed 25c. 12 enlargements from negatives 25c. Overnight service. Lifetone Studios, X-39, Des Moines, Iowa.

FREE Beautiful album with cellophane envelopes plus roll developed and two sets of prints, 25c. Same-day service. Pho-T-Pho, Box 24-F9, Highland Park, Mich.

TRIPLE Size pictures from every negative. 116 size enlarged 5x7, 120 enlarged 4x6, 127 enlarged 3 1/2 x 4 1/4. Inbetween sizes enlarged proportionately, triple size. 8 exposure rolls developed and 8 triple size pictures, 25c. 12 exposure rolls, 35c. 16 exposure, 50c. All reprints, 8 triple size, 25c. Tri-Plex Photo Service Co., Box 369, San Francisco.

FOR The discriminating amateur—8 exposure rolls, 2 prints each 25c. Miniature rolls enlarged 3 to 6 times, 8 exposures 25c, 16 exposures 50c. 35mm. 36 exposures, 3x4 enlargements \$1.00. Christmas cards from your negative, embossed, deckled, 10 for 49c, sample 5c. Unexcelled quality, prompt service. Paramount Photo, 327 E. 92nd Street, New York.

ROLL Developed 16 prints, or 8 prints, 2 enlargements, or 8—4x6 enlargements 25c. Credit for unprintable negatives. Reprints 2c, 100—\$1.00. Include this ad for free surprise. Peerless Studio, Great Northern Bldg., Chicago.

PRINT Your photos on fabrics, cards, etc., use any negative. No experience required. Complete outfit \$1.00. Trial size 25c. Lynmore Co., 1869 West 9th, Brooklyn, N. Y.

FREE! Eight chromium finish enlargements with every roll developed, 25c. Same day service. Giant Fotos, Box 632, Lincoln, Nebr., Dept. PM.

DEVELOP. Print, enlarge your films. Start own business. Simplified, easy instructions one dollar. Fred Carpenter, Box 264, Hamlin, Texas.

25c COIN—2 Sets Velox prints 8 exposure rolls. Free mailing bags. Dixie Photo, 1636 Buena Vista, Miami, Florida.

ROLL Developed and 8 beautiful enlargements 2 to 6 times larger—high gloss—deckled edge. Any 8 exposure roll 25c coin. Reprint enlargements 3c each. Alden Photos, 94-B Astor Sta., Boston, Mass.

OVERSIZE Prints. Your roll developed and 8 oversize prints 25c; from 116, 120, or 127 size negatives you receive 4x6 inch prints. All smaller sizes receive 3 1/2 x 4 1/2 inch prints. Reprints 3c each. Overnight service. Pacific Photo Service, Box 666, San Francisco, Calif.

ROLL Developed 8 prints and two enlargements 25c. Beautiful photographic Christmas cards or calendars from your negatives. 4 for 25c; 17, \$1.00, envelopes included. Young Photo Service, 405-C, Albany, N. Y.

FREE 3 Professional 5x7 enlargements of your own choice, 2 guaranteed sets of prints with your roll film developed—all for 25c, original order only. Aro Studios, Dept. 12, Des Moines, Iowa.

100 REPRINTS \$1.00, 116 or smaller. Rex Photo, Ogden, Utah.

ROLL Developed, 16 guaranteed prints, enlargement coupon, 25c. Reprints 2c each. Bay Photo, 838 Broadway, Bayonne, N. J.

OIL Coloring photographs a fascinating hobby or profitable business. Learn at home by easy simplified method. Previous experience unnecessary. Send for free information and requirements. National Art School, 3601 Michigan Avenue, Dept. 3437, Chicago.

FREE—One roll developed and printed free. Just to get acquainted, we will beautifully develop and print your first 6 to 16 exposure roll free plus 5x7 inch enlargement free, also sensational, new folding folio to frame your prints, all free with this ad. (Enclosing 10c for handling and mailing appreciated.) Dean Studios, Dept. 1039, Omaha, Nebraska.

IMMEDIATE Service! Pictures returned same day order is received. Sixteen guaranteed deckled-edge prints from roll, 25c. One colored or two plain enlargements plus 8 deckled-edge Velox prints only 25c. Special! Coupon for 8x10 enlargement given with each 25c order. Any 36 exposure 35mm. film fine-grain developed Vaporate Treated and each good negative enlarged to 3x4 on deckled-edge Velox paper, only \$1.00! Reloads: 36 exposure, 50c; 18 exposure, 35c. 3x4 deckled-edge reprints, 4c each. 24 hour service. Details, sample and mailers free on request. American Studios, Box 51, LaCrosse, Wis.

DOUBLE Size prints. Roll developed, 8 prints all enlarged to nearly postcard size, 25c. Willard Studios, Dept. 34, Cleveland, Ohio.

ROLLS Developed and 16 prints or 8 prints and 2 enlargements—25c. 35mm. rolls developed and 36 3x4 enlarged prints \$1.00. 3x4 reprints from miniature negatives 4c each. Mercury Studios, Dept. M, 109 N. Dearborn, Chicago.

ROLL Developed and 8 lustrous, natural finish, permanent Velox glossy prints 25c—reprints 3c each. Fotoprint Service, Box I, Roanoke, Virginia.

PROMPT Service—Quality work; 2 beautiful doubleweight gloss enlargements, 8 guaranteed neverfade prints each roll 25c. Excel Photos, Dubuque, Iowa.

FINER Finishing specials 25c. 6—8 exposure rolls developed, your choice—16 prints or 8 prints with 2 professional enlargements or 8 prints and one colored enlargement. Genuine nationally known Moentone superior quality. Moen Photo Service, 431 Moen Bldg., La Crosse, Wis.

CANDID Special. 35mm. rolls enlarged to 3 1/2 x 4 1/2. \$1.00. 18mm. rolls 60c. 3 1/2 x 4 1/2 reprints 3c. Brown Photo Company, 1910-61 Emerson, Minneapolis, Minn.

ONE 6 1/2 x 8 1/2 Plate sunk enlargement or one 5x7 hand colored enlargement with each roll developed and 8 prints 25c. 36 exposure roll developed and 36—3 1/2 x 4 1/2 enlargements \$1.35. 18 exposure roll 75c. Vidor, 321-P Hennepin, Minneapolis, Minn.

BEAUTIFUL Enlargement from each picture on roll 25c. Cut Rate Photos, Dept. B-4, Janesville, Wis.

ROLL Developed, 16 Velox prints 25c. Dividend coupon, 16 Velox reprints 25c. Willard Studios, Box 3535-A, Cleveland, Ohio.

TWO Beautiful prints from each picture on roll 25c. Twenty years of satisfied customers. Quick service. Lens Photos, Dept. J-4, Janesville, Wis.

ROLL Developed—16 guaranteed prints, two coupons on enlargements, 25c. Smart Photo. Winona, Minnesota.

PROMPT Service! Rolls developed, two Velox prints each negative 25c. Hench Studios, Harrisburg, Penna.

18 LIFETIME Prints, 2 sparkling Hollywood enlargements each roll 25c. 21 reprints 25c; 100—\$1.00. Finished 3 hours. 25 other bargains. Overnight Studio, Albany, Wis.

ROLLS Developed, two prints each and two free enlargement coupons, 25c; reprints, 2c each; 100 or more, 1c. Summers' Studio, Unionville, Mo.

THREE Prints each good negative in roll 25c. Reprints 3c. Fred D. Eastman, Bode, Iowa.

MOTION PICTURES AND SOUND EQUIPMENT

SPECIAL. 100 Feet 16mm. ortho film including processing \$1.75. Write for bargain price list. Dept. PM2, Morrison's, 43 Province St., Boston, Mass.

FREE! 32 Page catalogue nationally advertised movie cameras, projectors, films, accessories. Payments low as \$2.50 monthly. Dept. 22, Don Elder's, 739 Boylston Street, Boston, Mass.

MOVIE Dollars go farther! Films, new and used equipment. State your needs. Amateur Movie Supply, Box 47, Aliquippa, Penna.

FREE—16mm., 8mm. Film rental catalog. Low rates. Shipped anywhere. Send postage. Large discounts on slightly used cameras and projectors. National Cinema Service, 71 Dey Street, New York.

LOOK! Natural colored art films. Lists free. Box 82, Cincinnati, Ohio.

RELIGIOUS Films. 16mm. sound. Screenart, 729 7th Ave., New York.

UNUSUAL Art catalog; sample film dime. Erwine's Laboratories, Allentown, Penna.

"HER Hollywood Test!" Send for free listing. Startlingly "different" films, positively unobtainable elsewhere. Sample artistic film 10c. Sensational Films, Box 1504, Hollywood, California.

ART Sample, 10c; other kinds, lists free. Goodwill Company, Jackson, Tennessee.

"TURRET-LENS" Palomar titler for good titles, closeups of flowers, insects, small objects. Individual titler for each make and style cine camera. Film Specialties, P.O. Box 111P, El Monte, Calif.

OUTDOOR Film 100 ft. 16mm. \$1.98. 25 ft. double 8mm. 98c. Processing included. Projectors \$1.00 up. Free bargain lists. Home Movies, Box 216, Easton, Penna.

LEARN Theatre management, projection. Big opportunities. Free catalog. Give age. Theatre Institute, Elmira, N. Y.

35MM. Odd reels 75c, sound \$1.00. Projectors. Savarese, Woodcliff Lake, N. J.

LOW Prices on movie titles. Whiteman's 16mm Service, 312 E. 7th, Clovis, N. M.

"ALL-AROUND" Reflector Company's new motion picture reflector guaranteed to increase screen illumination 40%. 10111 Euclid, Cleveland, Ohio.

GREATER Home movies, world news, sports, travel, fun cartoons, novelties, 8mm., 16mm. Send postcard for list. Film Specialties, P.O. Box 111P, El Monte, California.

GET Mogull's Xmas News free. Many photographic bargains. 16-35mm. sound, silent equipment. Large selection, low prices. B-H, Victor, R.C.A., DeVry. Trades accepted. Easy terms. Used film subjects from \$5 for 400', 8-16 mm. library serves U. S. Catalogs free. Mogull's, 64 West 48th, New York.

JOIN Now. 8 and 16 mm. Castle films. Movie a Month Association, Box 525, Reynoldsville, Penna.

ART Films. Sample dime. Titles word 3c. Sound 50c. Used films \$5.00 400 feet. Bulk film 100 feet \$1.00. Processing 50c. Artcraft Laboratories, 1219 East 6th Ave., Gary, Indiana.

SELLING Out. Lists 3c. Clifford Hoffman, 57 Broad, Albany, N. Y.

8-16MM. Films silent and sound. "All subjects." Sold-rented-exchanged. Bargains in equipment. 400 foot subjects sold at \$5. Free illustrated catalogue (with sample art 10c). Garden Film, 317 West 50th, New York.

SAVE 60% On movie films. Stamp for sample and circulars. Genera Company, Davenport, Iowa.

BASS Says: The new Revere double 8 camera at \$29.50 with F:3.5 lens is a honey. The new Revere projector at \$59.50 is great value. Both described in our new catalog No. 245, 84 pages. Write for it. New RCA Model PG-170 16mm. sound on film projector is ready. Greatest \$300.00 value. Literature on request. Write Cine Headquarters, Bass Camera Company, Dept. A, 179 West Madison St., Chicago, Ill.

GUARANTEED 8mm., 16mm., 24-hour reversal processing. Eso-S, 3945 Central, Kansas City, Missouri.

ART Films. Sample, dime; catalog free. Cineart, 4224 Lincoln, Chicago.

ART Film! Sample, catalogs, gift offers, dime. Parisian, 4228-A Lincoln, Chicago.

16MM. VELOTEX. Perfect outdoor film. 100 ft. rolls \$1.95 including free processing, sample free. Velotex Laboratories, 600-B, Gary, Indiana.

MONEYMAKER! "The World's Greatest Passion Play," 16mm. and 35mm. Specify sound or silent. Rent or purchase. Superior than Oberammergau play. Hemenway Film Co., 37F Church Street, Boston, Mass.

15% TO 25% Discount on still or movie cameras. Free circular. Paramount Co., 327 E. 92nd St., New York City.

RADIOS, SUPPLIES, INSTRUCTION

DO Your own broadcasting with Mystic Mike, precision-built transmitter, complete with microphone \$3.95. No wires connected to radio. Clear pickup. Hundreds of uses. Money-back guarantee. Write for bulletin PC-12. Olson Mfg. Co., 362 Wooster Ave., Akron, Ohio.

ANY Radio circuit 25c. Specify manufacturer, model. Supreme Publications, 3727 West 13th, Chicago.

REVISED Plans 18 long distance crystal sets: "Radiobuilder"—year, 25c. Laboratories, 1406-C 77th Avenue, Oakland, Calif.

UNSURPASSED Distance and loudness! Allwave! 25 "copyrighted" crystal radio, —batteryless telephone plans; silicon; galena—only 25c! "W8TLI," 15889M Princeton, Detroit.

BATTERY Radios \$4.99. Agents wanted. Vogue Radio, 8422 S. Ashland, Chicago.

RADIO Engineering, broadcasting, aviation and police radio, servicing, marine and Morse telegraphy taught thoroughly. All expenses low. Catalog free. Dodge's Institute, Ames St., Valparaiso, Ind.

RADIO Service men and experimenters send for our giant radio catalog. Save dollars. United Radio Co., 1000 M, Newark, N. J.

RADIOS—\$8.95 Up. Save 50%. Windchargers, electric fences, power plants. Home agents wanted. Catalog free. Marco-F-30, Kansas City, Mo.

RADIO Books—Latest—Bargain catalog free. Popular Mechanics, 633 St. Clair, Chicago.

MUSIC AND MUSICAL INSTRUMENTS

SONGWRITERS. Write for free booklet. Profit sharing plan. Allied Music, Box 507, Cincinnati, Ohio.

SONG Poems solicited. A different proposition. Richard Broughton, Sioux Falls, S. D.

SONGS Wanted! Guaranteed publication without charge. Details rushed free. Rainbow Melodies Music Company, 1658 Broadway, New York City.

WANTED! Original song poems. Richard Brothers, 24 Woods Building, Chicago.

SONGWRITERS! Poems, melodies. Amazing offer. Hibbeler, C-5, 2157 N. Avers, Chicago.

ORIGINAL Music composed to your words \$5. Song recorded, printed. Reginald Belcher, Chatham, New Jersey, 30 years church organist.

SONGS, Poems considered for publication; royalty basis; no publication costs. Dept. M, Radio Music Company, 5517 Carlton Way, Hollywood.

WANTED—New songwriters. Big opportunity. Free booklet. Write today. Songwriters Institute, 43-C Park Place, Brooklyn, N. Y.

SPECIAL! Brilliant melody to your words. \$1. Professionals, Sausalito, Calif.

PHONOGRAPH Records 10c. Catalogue. Paramount, AK-358 East Market, Wilkes-Barre, Pennsylvania.

MUSIC Composed to words. Wonderful proposition. Bauer Bros., Oshkosh, Wis.

DUO-FLEX Reeds for clarinets, and saxophones eliminate your reed troubles. Write for circular. Duo-Flex Reeds, 1204 1st Ave., Evansville, Ind.

SONGWRITERS! Music composed to words. Amazing offer. Masters of Melody, Box 82, Dept. M, Beloit, Wis.

POEMS Wanted to be set to music. Submit for approval. Five Star Music Masters, 6 Beacon St., Boston.

ORCHESTRATIONS—Popular back numbers, 10—\$1.00. Silverman, 3303 Lawrence, Chicago.

FREE Book to songwriters—Original poems, songs wanted. Variety, Dept. V, Salem, Indiana.

SONG Poems wanted. Free examination. McNeil, Master of Music, 510-PM South Alexandria, Los Angeles, Calif.

MUSIC Composed to words. Rhyming pamphlet on request. Phonograph recording of completed songs. Send poem for consideration. Keenan's Studios, Dept. PM, Box 2140, Bridgeport, Conn.

WRITE Songs. Big money and reputation. Write for information. J. Gordon Pub. Co., 261 N. Hoyne Ave., Chicago.

WANTED! Lyrics, melodies for songs. We arrange, publish, sell. Superior Song Studios, Passaic, N. J.

SONG Writers. Send for publishing agreement. McKinley Music Publishers, 1501 E. 55th St., Chicago.

SONGS—Song poems wanted. No charge for melodies. Free examination. Hollywood Recording Studios, 8732 Preuss Sta., Los Angeles.

BUSINESS OPPORTUNITIES

POPCORN Machines, caramelcrisp crispettes, cheese coat, potato chips. Long Eakins, 2035-M High St., Springfield, Ohio.

ONE-MAN Printshop. \$10 brings 4x6 in. hand press, type, ink, for personalizing Christmas cards. Peck Brothers (117) Mt. Carmel, Conn.

START A business of your own. Can put you next to 22 new business opportunities. Particulars free. E. P. Gallagher, Camp Taylor, Grandview, Wis.

SMALL Capital starts "route" coin operated peanut, gum and amusement machines. Particulars free. Robbins Co., 1141P DeKalb Ave., Brooklyn, N. Y.

START Home business making statuary, plaques, art goods, novelties, souvenirs, concrete pottery, garden furniture, artificial marble flooring, liquid marble. Make your own flexible molds. Amazing profits. Valuable folder free. Creative Publishers, (P12), Glencoe, Illinois.

WE Show you how to obtain capital for your business; how to protect and market your invention. Write Enterprise Bureau, Syracuse, N. Y.

INVENTORS—Patent your invention. Secure booklet "How to Protect Your Invention." No obligation. McMorro and Berman, Registered Patent Attorneys, 134-E Barrister Building, Washington, D. C.

RAISE Angora rabbits. Wool brings \$5.00 pound—steady demand. Particulars free. Grinstead's, Carrollton, Illinois.

SUCCESS By mail. 60 pages money-making ideas 10c. Bryant-Lloyd Building, Seattle, Wash.

OPERATE Steady business resilvering mirrors. Making chipped glass nameplates, signs. Write Sprinkle, Plater, 127, Marion, Indiana.

SELL By mail! Books, novelties, bargains! Big profits! Large catalog free! Ellico, B-438 North Wells, Chicago.

MAKE Your mail order business pay! Use genuine original letters of mail order buyers. Particulars free! Crown Mail Order, 164MP Monroe Street, New York.

START Photo finishing business; develop films; make money. Details, stamp. Photo Promotion Service, 126-B, Grandy, Minn.

START Good paying mail business! Amazing new folio shows how! Thorne's, 436N Jackson, Jackson, Michigan.

BIG Paying mail order business in your own home. Miller's, 1444 Webster, Wabash, Indiana.

"INDEPENDENT Operator"—Professional mailorder magazine—10c. Kraft Publications, Syracuse, New York.

REAL Estate foundation all wealth. Large commissions. Taught by mail. Easy lessons. Reasonable. Start today. Write Morrison School, Dept. 9, 100 North LaSalle, Chicago.

MAKE Plaster artware and novelties. Materials available your locality. Commercial methods fully explained. Complete illustrated course \$1.00. Ideal Service, 40-M. Park Ridge, Ill.

MAKE Money easily! New 924 page illustrated instruction book for making 10,000 profitable products. \$1.50 postpaid. C.O.D. Adam Brown Company, Chestnut Hill, Massachusetts.

CHIPPING Glass signs. Folder free. Beveridge, 160-22 P Locust, Jamaica, New York.

MAIL Order business course shows you how to make money, spare or fulltime. Teaches professional mail order technique—not penny-catching schemes. Free details. Nelson Company, 500 Sherman, Dept. 404-L, Chicago.

FOR Free information concerning an extremely profitable, lifetime business, write, Cole Associates, Syracuse, N. Y., immediately.

PLASTEX Industries offers industrious men an opportunity to start a business of their own, manufacturing art goods, novelties, souvenirs, etc., in Plastex and marble imitation. 5c material makes \$1 articles. Rubber moulds furnished for speed production. Small investment brings big returns. We are now placing big chain store orders with manufacturers. Write for interesting booklet mailed free. Plastex Industries, Dept. A, 1085 Washington Ave., New York.

CAN You wield paint brush or do small carpentering? Then learn office furniture renovation. Plenty work at fine pay for spare hours. Or thousand dollars yearly in permanent trade-business. Send 10c for valuable illustrated employment booklet. Dime refunded if asked. Opportunity Book Company, Planned Jobs Division, Flushing, New York.

OWN And operate a general appliance repair shop. Small capital establishes you in profitable steady repeat business. Complete illustrated course enables mechanically inclined men to have lifetime business. All phases of general appliance repairing, how to secure business, etc., covered. Send today for free literature. Christy Supply Co., 2835 N. Central Ave., Chicago.

BUILD Combination burglar alarm and electric fence. Tremendous demand. Farmers, merchants, coal dealers, etc. Large profits. Complete plans \$1.00. Electric Laboratories, 8 Jackson Place, Indianapolis, Ind.

MAKE Money metallizing baby shoes! Simple! Big market, profits! Inquire, Novelty Metallizers, Box 933 Church St. Annex, New York.

HANDY Men—Earn money home operating Community "Fix-It" Shop. Stafford, 708 Rawlins, Carbondale, Illinois.

SOAPMAKING: Money-making home business. No machinery. Formulas, complete instructions \$1.50. Ideal Co., 179S, Park Ridge, Ill.

START Profitable collection business your community. Fine income assured. Convincing literature free. Morrison Business Service, Pontotoc, Miss.

START Photo finishing business. (Shoestring capital). Everybody takes pictures time and again, 130 million repeating prospects. Details stamp. Fotoprint Art Service, 600-B, Hebbroville, Texas.

"MAIL OLOGY" Magazine, a dynamic mailorder monthly. Sample copy 10c. B. Root, Publisher, Scappoose, Oregon.

MAKE Artificial marble, glazed tiles, uncanny. Tabletops, plaques, novelties, sanitary flooring. Hard, fireproof, inexpensive, cement secrets. Brilliant samples 3c. Latex \$2.00 quart postpaid. Multicolor pencils (a riot), hurry. John A. Payn, 945 Grande Vista Avenue, Los Angeles, Calif.

300 MONEYMAKERS—68 Pages: no advertisements—25c. Kraft Publications, Syracuse, New York.

TURN Tin cans into money. Instructions 25c. H. Chaney, 1130 E. 16th St., Jacksonville, Fla.

VENDORS. Big income operating 5 for \$11.75. Davis Metal Fixture Co., Lansing, Mich.

MONEYMAKING Opportunities, plans, etc. Valuable tips! Literature free. H. Flury, 1602 Locust, Des Moines, Iowa.

FASCINATING—Profitable self employment opportunity. Details for stamp. Zenith, 2016 W. 23rd, Little Rock, Ark.

MAKE Money selling secrets. Particulars 25c. Vine's, 316 New St., Newark, New Jersey.

FIVE Income-increaser suggestions, dime. Dick's Agency, Twin Bluffs, (MP), Wisconsin.

SUPER-PROFIT Business plans. Particulars. Creative Service, Box 872, Milwaukee, Wisconsin.

PROFITABLE Business via postcard. Eight practical plans, 25c. E. DeWitt, Orchard Park, N. Y.

LET Us show you how to raise capital for your business enterprise. Wright, Box 363 Warren, Ohio. Your service.

ADD To your income this winter! Grow mushrooms in spare time in cellar, shed, garage. We buy all you raise and furnish materials. Write today for big, free book. United, 3848-AB Lincoln Ave., Chicago.

STEADY Home business. Whole plan 50c. Will Saunders, Forest Glen, Md.

SPARETIME. Moneymaking plan. Amazing profits reported. Complete plan 35c. Dean Hays, University Place Station, Box 1097, Des Moines, Iowa.

START Your own manufacture. Free particulars how to build your own independent business. With little working space. Art Rubber Mold, 2012 Fletcher, Chicago, Illinois.

AMBITIOUS? Publish "Community Magazine." 1246 South Sawyer, Chicago. Samples, dime.

UNEXCELLED Opportunities. Succeed first, pay later. Fitzallen, Box 16, Station J, New York.

FILING Saws easy this new way. A dollar hour easy. 25c brings instructions. Harvey Pickett, Garden City, Ia.

FREE—200 Clever mailorder, homework, local business, agency offers—all snappy moneymakers. Lewis Co., 828-C Carpenter, Oak Park, Ill.

RECAST Old batteries into new. Latest achievements. Battery Laboratories, St. Paul, Minnesota.

WE Help start you in business, furnishing outfits and instruction, operating "Specialty Candy Factory" home. Men-women, opportunity to earn good steady income, all or spare time. (Our 31st year.) Booklet free. Ragsdale Candies, Dept. 4, East Orange, N. J.

MAKE Money! Open a film rental library. Small investment! Big profits! Garden Film Service, 317 West 50th, New York.

BELTS, Suspenders, Make'em yourself! Dandy Xmas gifts! No tools! Sample belt 25c. Artoe Leather, 400 Joseph Ave., Rochester, N. Y.

"RUBBER Mold Making." Plaster casting. Instructions 25c. Guaranteed rubber, \$4.95 gallon. Southern Service, 3303-A Jacksonville, Fla.

CHINESE Goods are cheapest in the world. Become rich by importing handbags, dollies, slippers, laces, handkerchiefs, bags, chair covers, table cloth, etc. Sample collection \$5 postpaid in draft or postal money order. Export and import in general. New Continental Trading Co., Ltd., 14 Museum Road, Shanghai, China.

SWISS Music box works \$1.25 to \$2.10. Suitable for many novelties. Mermod Manufacturers, 147 West 46th Street, New York.

COLOR Concrete with chemicals. Washing wells, Stucco-rock, Benches. Spin concrete pottery, Cement artistry. Garden ornaments. Cold glaze. Concrete paints, Marbling. Sample 10c. Hollywood Cement Craft, 8527 Wonderland, Hollywood, Calif.

RANGE Oil burners Complete \$7.00. Send for pamphlet. Royal Hardware, 1200 Springwood, Asbury Park, N. J.

TIRED Of drudgery, job hunting? Start business of your own. Full or spare time. Office or home. 120 exceptional money-making plans. Full particulars free. Monarch Publications, 715A Haas Bldg., Los Angeles, Calif.

MAKE. Sell latest popular products. Easily made. Literature free. Law, 1700-M Madison, New York.

DO You want agents for your proposition? Your ad in this space will place your message before hundreds of men seeking fast-selling products. My folder "How to Secure Agents," is filled with proof. I'll gladly send you a copy free. F. W. Johnson, Manager Classified Advertising. Popular Mechanics Magazine, 200 E. Ontario St., Chicago.

WILL You give us 5% first \$600 you make? Afternoons free! Work home. \$1,000 month reported (exceptional—fulltime). Expect surprise! National, Box 1240-B, San Bernardino, Calif.

UNUSUALLY Interesting opportunities for greater profits. Particulars free. Colonial Bulletin, Lackawanna, New York.

LIQUID Marble—Marvellous, colorful! Brushed, molded, sprayed. Rubberlastic molds! Composition flooring! Particulars free. Marbleizing Service, Edwardsville, Illinois.

WHERE To buy at lowest wholesale prices. Information free. Yorena, Box P-312, Bayonne, N. J.

"IDEAS" 68 Pages monthly. Plans, tips, articles, advice—10c. Box 105, Dorchester, Center, Mass.

EARN Money at home making imitation diamond jewelry, bracelets, bairpins, millinery ornaments, religious medals, etc. High prices now paid on account of German and French jewelry shortage. Exceptional spare or full time opportunity. Write, United Jewelry Manufacturers, Dept. A, 1892 Boston Road, New York City.

"MAIL MONEY Facts." Outstanding mailorder magazine. Copy, opportunity offers, 10c. Vernon Publishers, West Fairview, Penna.

"MAIL ORDER Directory"—300 firms listed: 51 classifications—15c. Kraft Publications, Syracuse, New York.

OPERATE Profitable "route" four compartment vendors. Small investment. Penny King, 1233 Chouteau, St. Louis.

OPERATE Mail order business at home. Details dime. Maples, 3418 South Marshfield, Chicago, Illinois.

OWN A cash business? No selling. Operate "Silver King" vendors, \$3.95 up. Free instructions. Automatic, 2422-A Fullerton, Chicago.

WE Successfully sell inventions, patented and unpatented. Write us, if you have a practical, useful idea for sale. Chartered Institute of American Inventors, Dept. 4-C, Washington, D. C.

MOLD Making, plaster casting, tremendous profits. Foolproof rubber. 24 page instructive catalogue free. Plastic Arts, 711 Neely, Muncie, Indiana.

MAKE Color-glazed concrete pottery, gravestones, tiles, floors, walls. Basement waterproofing, etc. Booklet 3c stamp. National Potteries, Minneapolis, Minnesota.

INVENTION Finance Magazine. 80-G Wall Street, New York. Important particulars free.

MAIL Order business is your opportunity. Many began small, now earn thousands yearly. No personal contact. Boundless opportunities. Have had over 30 years experience; will help you succeed. Send 25c for valuable booklets, none free. B. Breniser, 257 E. 21st, Philadelphia.

A REAL Future for you with Red Comet fire control products. Low prices. Proved seven years. Splendid sales outfit free. Some good territory open. Exclusive. Write quick, 766 Red Comet Building, Littleton, Colorado.

SUCCEED With your products. Make-sell them. Formulas. Processes. Accurate analyses. Catalog free. B. Thaxly Co., Washington, D. C.

GOOD Paying business silvering mirrors, plating autoparts, reflectors, bicycles, bathroom fixtures by late method. Free particulars and proofs. Gunmetal Co., Ave. H, Decatur, Ill.

ELITE Collection of business plans, contains 127 tested plans and scores of formulas. Start own business; home, office. Particulars free. Elite Co., 214 Grand St., New York.

100 PROFITABLE Mail order and local plans. Gilbert Supply, 5-P West 24th, New York.

127 WAYS To make money, in home or office, business of your own. Full particulars free. Elite Co., 214 Grand St., New York.

HOW And where to obtain capital fully explained, free particulars. Star Service, Wapakoneta, Ohio.

MAKE Money by mail, the way we do. Free information. Maywood, P-1107 Broadway, New York.

MONEYMAKING OPPORTUNITIES

SELL By mail, 15c brings gold mine mail order information. Chas. Sierer, 311 Railroad, Ironton, Ohio.

AGENTS—Clean up! Amazing toy submarine 10c. Williamson, 617 W. 143rd, New York.

MAIL ORDER Opportunities, publication, plans, sell by mail. Harvey Teeple, Decatur, Indiana.

"LUMINOUS Paint" shines in dark. Easily made. 300 other formulas, plans—1st 25c. Ideal Service, 300P12, Park Ridge, Ill.

BOOKKEEPERS Make money operating "new idea" bookkeeping service. Ralph Lee, Vicksburg, Michigan.

SPARE Time profits—Make, sell lawn ornaments, book ends, door stops. Sample pattern and details 10c. Wickman Co., Dept. 215, Dayton, Ohio.

OPERATE Steady business resilvering mirrors. Making chipped glass nameplates, signs. Write Sprinkle, Plater, 287, Marion, Indiana.

120 WAYS To make money. Graff Co., Box 567, Cedar Rapids, Iowa.

MILLION Articles. Buy wholesale. Valuable directory 10c. Ideal Service, D-12, Park Ridge, Ill.

XMAS Income taking magazine subscriptions. Details free. New York Circulation, Thirty Church, New York.

MAKE Money! Start photo finishing business! Learn how. Details—stamp. Premier Photo Service, 4511-a Alice, St. Louis.

FREE Literature—Profitable home opportunities. Franklin, Box 866-M Hilltop Sta., Columbus, Ohio.

PAYING Home business. Make—sell honey nut bars. Formula, instructions 25c. Schultz, Noel, Mo.

NEW! "On the Spot" work-book! Plans, instructions, home manufacturing, mail order business starting. Book, supplements, both prepaid 25c. Menden, 10531 Mack, Detroit, Michigan.

1000% PROFIT. Manufacture amazing product. Complete details \$1.00. Ives, Box 102, Iowa City, Iowa.

FORTUNE. Success, happiness? Read "How." Brochure free. Novex, 1210N 11th Ter., Birmingham, Ala.

MAILORDER Opportunities! Send name—postal. Schroeder, 803 Wisconsin, Peoria, Illinois.

EARN Money at home this winter raising mushrooms in cellar, shed, garage. We pay cash for all you raise. M. M. earned \$1174 for exceptional crop. Materials furnished. Write today for free book. United, 3848-AD Lincoln Ave., Chicago.

500 PROFITABLE Plans. Literature free. Box 4542, Station "C," Kansas City, Mo.

EARN Money compiling names. We tell you how. Inexperience, location no handicap. Golliday Company, 1514 Long, Columbus, Ohio.

"PORT OF Opportunities" published monthly—66 pages—offering latest mail-order projects; services; business starters. Copy 10c. Farm & Home Publishers, Gardenville, New York.

\$25.00 WEEKLY Plan, 3 moneymaking magazines 10c. Parker Publications, Peterboro, Ont., Canada.

INVESTIGATE—Making money by mail. Read "Mail-Trade" magazine. 68 pages monthly, chock full of "money-making" ideas, inspirational articles and business opportunities—for everybody. Sample copy only 10c. Langley Publisher, 631 Roscoe St., Chicago.

EXTRA Money, at home, it's easy. Collier's Master lesson, teaches professional technique. Write Successful Income Builders, Hollywood, Calif.

INCREASE Your income—Write for publication. Ready market. Simple method. Details free. Glen Donaghey, 17 Groton, Lowell, Mass.

MAKE Money repairing scales. Big opportunities. We show you how. Send stamped envelope. Ackerman, Box 1653, Charlotte, N. C.

BUY Wholesale—Sell by mail or local. Wetzel, Valhalla, N. Y.

WHOLESALE Sources, 500,000 articles. Free directory. Maywoode, 1107 Broadway, New York.

WILL You give us 5% first \$600 you make? Afternoons free! Work home. \$1,000 month reported (exceptional—full-time). Expect surprise. National, Box 1240-A, San Bernardino, Calif.

CREATE Self employment, that pays 50c to \$1 hour. Valuable instructions 25c. Homecraft Arts, Lakeside, Calif.

MOULDS. Guaranteed, for casting toy soldiers, Indians, trappers, warships, sinker moulds, 244 kinds. Send 5c for illustrated catalogue. Send \$1.00 for large sample mould. Henry C. Schiercke, 645 Spencer, Ghent, N. Y.

BE A professional scrapbooker. Big fees. Unlimited opportunities. Can be done at home. No competition. No capital needed. Write to Scrapbookers Guild, 59 Park Place, New York, N. Y.

MONEYMAKING Ideas—Latest books—Bargain catalog free. Popular Mechanics, 633 St. Clair, Chicago.

FORMULAS, PLANS, ETC.

MAKE Fast selling products. "Chemist Approved Formulas." Catalog free. Kemico, 12-M, Park Ridge, Illinois.

FORMULAS—Latest, best. Analysis. Literature free. Belfort, Engineering Building, Chicago.

160 SINGLE-INGREDIENT Formulas—No manufacturing. Information free. A. Kinford, Wayne, Penna.

THAXLY Formulas, processes, for successful products. Accurate analyses. Catalog free. B. Thaxly Co., Washington, D. C.

REAL Manufacturing formulas. Lists free. Cummings, Chemist, Gordon Avenue, Syracuse, N. Y.

ELITE Formulas and plans; make and sell your own products. Descriptive booklet free. Elite Co., 214 Grand St., New York.

FORMULAS—All kinds. Real moneymakers. Lowest prices. Catalog free. Clover Formulary, 108-PM, Niles Center, Ill.

AUTHENTIC Formulary. Used by leading manufacturers, formula dealers. Instructions for easily making 10,000 profitable products. Supply sources. Complete book—924 pages, \$1.50. Postpaid-C.O.D. Adams Brown Company, Chestnut Hill, Massachusetts.

FORMULAS: 15 Proven moneymaking formulas \$1.00. (Not stock-formula catalogue stuff), real unusual offers. List free. Marvel Laboratories, 6629 No. Maplewood, Chicago.

TEN New money-making formulas. Satisfaction guaranteed. 25c. Box 53, Cedar Rapids, Iowa.

MONEY Making formulas—You can make \$10-\$20 a day making soap. I teach you how to make soap powder, can soap and bar soap. Send \$1.00. Harold Englehart, Conley, O.

SULPHOLENE Cleaners: New, original. 6 formulas 25c. Baran, Bay City, Mich.

10,000 FORMULAS—\$1.25 Postpaid. Details. Prudential, 331-A Hopkinson, Brooklyn, New York.

MAKE Imitation marble! Formula 50c. Harwell, Box 293, Byrdstown, Tenn.

HIGH Grade penetrating oil formula. \$1.00. Schafer, 547B Melrose, Chicago.

CHEMISTRY

FREE Catalog: chemistry, mineralogy, biology, binoculars, microscopes. Tracey Laboratories, Evanston, Illinois.

FREE: 40 Page catalog of chemical and laboratory supplies for amateur chemists. Wollensak microscopes and supplies, scientific books at big discount. JE12-Winn, 124 West 23 Street, N. Y. C.

CHEMICAL Magazine—research, experiments, magic. Sample 10c. Waltman, 398 Broadway, New York.

FREE Chemistry catalog. Supplies at 5c! Equip complete laboratory. Kemkit Scientific Corp., 397P Bridge St., Brooklyn, N. Y.

CHEMICALS, Laboratory, glassware, apparatus. Send 3c for catalog CP1. Biological Supply Company, 1176 Mt. Hope Avenue, Rochester, N. Y.

SPECTROSCOPE For quick chemical analysis \$2.50. Kutting Sons, Campbell, California.

CHEMICALS In 5c quantities. Catalog 5c. Fleischer's Laboratories, Medford, Mass.

HELP WANTED

MAKE Big money demonstrating amazing Handyman Tool, 101 uses. Pulls posts, roots, small stumps; jacks up trucks, tractors, wagons; lifts buildings; stretches fences; splices wire; makes cider press; dandy auto bumper jack, etc. Lifts, pulls, pushes with 3-ton power. Write. Harrah, Dept. L-61, Bloomfield, Indiana.

EARN Money—sell. Brink Printing, 1130 Holmes, Menominee, Mich. Details 10c.

BIG Money taking orders; shirts, ties, hosiery, underwear, pants, jackets, raincoats, uniforms, etc. Sales equipment free. Experience unnecessary. Nimrod, 4922-BG Lincoln, Chicago.

CALL On service stations, factories, restaurants, businesses, professions; with lettered advertising uniforms, shirts, work suits, etc. 100 styles. Exclusive features. Big advance commissions. Free outfit. Toops, Dept. R-7, Rochester, Ind.

DEALER For cone type mop wringer, rubber cushion wet mop, automatic floor wax applicator. Fulton Sales Corp., Lancaster, Penna.

MEN And women wanted to raise mushrooms at home this winter in cellar, shed, garage. No experience necessary. We furnish materials and pay cash for all you raise. (Company established 1908.) Write today for free book. United, 3848-AA Lincoln Ave., Chicago.

STEADY Work—Good pay. Reliable man wanted to call on farmers. No experience or capital required. Pleasant work. Home every night. Big money every day. Wonderful new proposition. Particulars free. Write McNess Co., Dept. 446, Freeport, Illinois.

EARN Money in your spare time taking subscriptions to Popular Mechanics. Unlimited possibilities, every family a prospect. Easy to sell. Bonus paid in addition to liberal commission. Send postcard for further details today. Circulation Dept. Popular Mechanics Magazine, 200 E. Ontario St., Chicago.

AGENTS WANTED

5000 CHRISTIANS Wanted. Sell Bibles, greeting cards, mottoes, religious novelties, etc. Handsome profits. Write for catalog. John T. Benson Publishing Company, Dept. P, Nashville, Tennessee.

I WANT Local man or woman to introduce 200 foods, groceries, household products, etc., to friends, neighbors. Sensational values, free premiums, big sales. I give you \$6.00 assortment actual full size products free. Experience unnecessary. Zanol, 2037 Monmouth, Cincinnati, Ohio.

MEN—Women. Big money making opportunity! Sell popular priced, quality cosmetics. Fast sellers! Free merchandise. Special sample offer. Eldore, 299 Madison Ave., New York.

MYSTERY Invention, carried in pocket keeps hands, feet, ears, body comfortably warm on coldest days. Lasts years. Stays warm 10 to 12 hours. Uses cigar lighter fluid—refills one-half cent. Everybody buys—workmen, housewives, schoolboys, farmers, sportsmen, spectators. Sell football games and other out-door gatherings. Low prices. Big profits. Write quick. Kumfy Warmer, Dept. D-2301 Eastern Ave., Cincinnati, Ohio.

MAN Wanted to supply Rawleigh's household products to consumers. We train and help you. Good profits for hustlers. No experience necessary to start. Pleasant, profitable, dignified work. Write today. Rawleigh's, Dept. A-53-PPM, Freeport, Ill.

SELL New artistic patriotic picture! Lincoln's Gettysburg Address, beautifully illustrated 12½x19. Sells on sight to everyone! Special profits! 12 copies \$1.00 postpaid. LeBrow, 4 Watsessing Ave., Bloomfield, N. J.

JUST Out! Beautiful Thanksgiving, Christmas tinsel signs, 11x14, cardboard. Retail 35c, cost \$4.50, 100, \$1.00 brings 15 samples, postpaid. Achy, 306 Bowery, New York.

MERCHANTS Wall signs. Big profit. 3 samples, particulars 15c. Richards the Printer, Indianapolis.

MAGNETIC Sponge draws dirt from clothing. Used like brush. Saves dry-cleaning. Slick discovery. Samples sent on trial. Write "Inventor," 122 Kristee Bldg., Akron, Ohio.

WEAR Fine hose I send without cost with large outfit while taking orders for amazing new hosiery. Replacement guaranteed against holes, snags, and runs. Rush name and hose size. Wilknit, Desk SS-37, Greenfield, Ohio.

SCHOOL Seniors—Sell graduation cards. America's largest, fastest selling display, 30% commission. Free cards. Universal Engraving & Printing, Box 745-M, Pittsburgh, Penna.

FREE Water and our concentrates make 68 products. We supply labels, bottles. Enormous profits. Qualco, E-20030 Russell, Detroit.

GOOD Sideline for printing and advertising salesmen. Decalcomania name plates in small quantities. Great demand. Also make money applying initials on automobiles. Free samples. "Ralco," 1305 Washington St., Boston, Mass.

CHRISTMAS Cards. Everyone uses. All kinds. Samples on approval. Freeman Line, 35 High, New Haven, Conn.

600% PROFITS Demonstrating instant silver cleaner. NuProcess, Dept. 80, Aurora, Ill.

WHY Work for others? Be your own boss. Sell products with your name on the labels. Employ agents yourself. Cosmetics, toilet articles, extracts, etc. Details free. National Scientific Co., Box 5269-2, Richmond, Va.

OPERATE Steady business resilvering mirrors. Making chipped glass nameplates, signs. Write Sprinkle, Plater, 128, Marion, Indiana.

AGENTS—Men's suits 88c, pants 23c, overcoats 41c, ladies coats 36c, dresses 10c, sweaters 25c. Other used clothing bargains. Catalog free. Portnoy, 566-P Roosevelt, Chicago.

BIG Money taking orders; shirts, ties, hosiery, underwear, pants, jackets, raincoats, uniforms, etc. Sales equipment free. Experience unnecessary. Nimrod, 4922-AN Lincoln, Chicago.

HOLIDAY Dollars. Fast selling 10c novelty nets big profit. 30 second demonstration makes sale. Prospects everywhere. Special holiday appeal as fill in gift with sox, neckties, handkerchiefs, cards, etc. remembrances. Every man can use it. Sample one dime. No stamps. Button-Latch Industries, Station V, Box 2035, Los Angeles, Calif.

AGENTS. Sell revolutionary indoor radio aerial. No wiring. Works on all sets. Tremendous profit. Sample \$1.00. Satisfaction guaranteed or money back. Sterle, 815 Addison, Chicago.

SENSATIONAL Opportunity for aggressive men to sell fluorescent lighting fixtures and supplies. Write to Ajax, Box 53, Cedar Rapids, Iowa.

AGENTS—Excellent opportunity. Mailing our literature. New amazing community sales methods get results. Free details. Elquin, Drawer 570, Madison, Wis.

HUGE Profits, selling our sensational valve cap for automobiles. Sample 10c. Cap Sales, Box 427, Waterbury, Conn.

SELL California Thanksgiving and Christmas fruit packs—Combine with present work. Sterling Food Products, 3715 Avalon Blvd., Los Angeles, Calif.

BIG Pay every day—New and different copyrighted item. Artistic House Marker, 4916 Stanford, Dallas, Texas.

MAKE-SELL Finest maple syrup. Big profit. Formula, full instructions and maple flavor, enough for 4 gallons—only \$1.00. Manufacturers Sales Co., 301 West 29th, New York.

"ALADDIN'S Magic Lamp!" Glows brightly in darkness. No batteries or wires. Eternal light. 1000 uses. Sample 25c. 15 for \$1.00 postpaid. Western, 432 Climax Bldg., Cleveland, Ohio.

MAGIC Gold embossing ink. Prospects galore. 25c package 15c, doz. \$1.50. Box 120M, Arkansas, Wis.

RADIOS \$1.25; Wrist watches \$1.55; cameras 30c and up. Make 200% profit. Vogue Co., 8420 S. Ashland, Chicago.

500% PROFIT. Gold and silver colored sign letters. Offices—stores. Large sizes 1c. Free samples. Modernistic, B-3000 Lincoln Ave., Chicago.

KLEER-VU Cleans eye-glasses like magic. Whirlwind seller. Big profits. Samples 25c. Dixie Laboratories, 4308 Greenwood Ave., Chicago.

SELL Business cards—one-half commission. Samples free! Gibsonprint, 5005 Vincennes, Chicago.

LONG Profit, fast selling item for motorists, car dealers, service stations and stores. Virgin territories. Little or no competition. Proved item. Thousands of prospects everywhere. Small light weight package. Write for complete details today! Lakeside Products, Inc., Dept. P110, 343 South Dearborn, Chicago.

SELL Ties, wonderful proposition: free outfit. Eureka, 307 West 38th, New York.

SELL Graduation and name cards; monogrammed stationery. Large profits. Samples free. Dunbar, Middlebush, N. J.

AGENTS Make big profits on food products, bargain deals. Low wholesale prices. Rush name for trial outfit offer. Ho-Ro-Co, 2810-U Dodier, St. Louis, Mo.

BIG Profits on amazing new Enduro. Cleans, polishes and waxes in one operation. Demonstration sells most skeptical auto owner or housewife. Protected territory. Send 10c for trial size. Enduro, 2420 Grand River, Detroit, Mich.

DIME Brings sample new automobile polish. Details free. Ward, 97B Saybrook, Connecticut.

SELL Used clothing bargains from home, store, auto. Shoes 15c, men's suits, overcoats 75c, dresses 10c. Experience unnecessary. Free wholesale catalog. Superior Jobbing, 1250-KD Jefferson, Chicago.

START Profitable home business manufacturing soapless suds. Amazing discovery. Eliminates hard scrubbing. Costs 1c quart. Formula, sample 25c. Details free. Linothex, 14006 Colt, Cleveland.

ONE Reference and 25c stamps bring you sample outfit to start making money immediately with Mexican art goods. Tremendous market. Big profits. Marquez Company, Apartado 1176, Mexico City.

WINDOW Sign letters. Penny each, large sizes. New styles. Absolutely beautiful. Free samples. Atlas, 7941 Halsted, Chicago.

AGENTS: Smash go prices! Santos coffee 12c lb. 4-oz. vanilla 8 $\frac{1}{2}$ c. Razor blades 10 for 8 $\frac{1}{2}$ c. 100 sticks chewing gum 12c. Christmas cards, 21 in box, 14c. 150 other bargains. Premiums. Experience unnecessary. Carnation Company, PO, St. Louis, Mo.

CALL On service stations. New item, necessity, big profits. Knipp, Long Beach, California.

AGENTS: Stamping names on pocket-key protectors. Sample check with your name, address, 25c. Stamping outfits. Emblem checks, check-fobs, name plates. Hart Mfg. Co., 303 Degraw St., Brooklyn, N. Y.

FREE Sample—Amazing cleaner: sells homes, taverns, everywhere. Big profit—fast repeater. Betco, 5007 Irving Park, Chicago.

SUCCEED With your products. Make-sell them. Formulas. Processes. Accurate analyses. Catalog free. B. Thaxly Co., Washington, D. C.

MANUFACTURE Specialties, hire agents yourself. Big money. Free literature. Gilbert Supply, 5-P West 24th, New York.

AGENTS—300% Profit selling gold leaf letters; stores and offices. Free samples. Metallic Letter Co., 438-B North Clark, Chicago.

ENGRAVED Name plates, numbers, signs, etc., easily sold, profits large. Brett Bros., Winthrop, Mass.

GOOD Paying business silvering mirrors, plating autoparts, reflectors, bicycles, bathroom fixtures by late method. Free particulars and proofs. Gunmetal Co., Ave. N, Decatur, Ill.

AGENTS—Opportunity make money; book containing 127 successful business plans; home-office; send for free introductory booklet. Elite Co., 214 Grand St., New York.

AGENTS—To mail our literature. Good profits. Home business. Maywood, 1105-1107 Broadway, New York.

MEN—Forty or over. We offer dignified, profitable, permanent selling connection. Write now! Keller Manufacturing Corporation, 1809 West 6th, Los Angeles, Calif.

AGENTS! Two a day—keeps the poor-house away. See advertisement page 147A. National Laboratories.

HIGH-GRADE SALESMEN

REVOLUTIONARY Loud speaking inter-communication system. Talk privately, back and forth, to one or any number of stations, even 2,000 feet away. Any station originates calls. One electrical connection. No servicing. Easily installed. Guaranteed. Technical experience unnecessary. Two-minute spectacular demonstration. Thousands prospects, factories, offices, stores, auto dealers, lumber yards, restaurants, etc. We carry the accounts. Free trial to customers—sells itself. New low price. Men earning high as \$150 week. Protected territory available. Free demonstrator offer. Inter-Communication System of America, Dept. 311, 2440 Lincoln Ave., Chicago.

EXPERIENCED Salesmen for direct selling of patented made to measure form fitted shirts. Cannot be purchased in stores. Excellent side line for tailoring salesmen. Prices \$2.00 to \$5.00. Very attractive proposition. Bona-Fit Shirt Co., Paterson, N. J.

PROFITABLE Side line for roulemen and salesmen calling on farm trade, taking orders for Chestnut Baby Chicks, from Illinois' oldest U. S.-approved hatchery. Operating entire year. Liberal commission paid promptly on immediate and future orders. Write for details today. Chestnut Hatchery, Box 117B, Chestnut, Illinois.

DISTRIBUTORS. Salesmen: Just out. Park-Yer-Pipe holder. Fits auto steering post. California dealers bought thousands first month. 100% profit selling dealers: tobacco, drug, auto accessory, sporting goods, novelty, etc. Retail 39c. Details free. Sample 35c; dozen \$1.75, prepaid. Park Yer Pipe Sales Co., Box 148 Amb. Sta., Los Angeles, Calif.

SAVE Your pants. Just out! U. S. patented trouser-guards. Protects men's pants from fraying and wear on bottoms of cuffs. Sensational. No competition. Retail 25c. Illustrated details free. National Trouser-Guards Company, 222 Simon Building, Shreveport, Louisiana.

ADVERTISING Cigar lighters—Two models, quick profits, don't fail to investigate. Write today Richardson Mfg. Co., Dept. ML, Aurora, Missouri.

\$300 PROFIT Next month on \$425 sales. America's finest automatic fire protection. Largest commissions. Complete line. Territories. PyroTecTor, Bradley Beach, N. J.

BIG Commissions—selling to stores celluloid pricing tickets, metal shelf moulding. To restaurants, menu covers, signs. P. Pricing Press, 124 White St., New York.

SENSATIONAL Quick-cash opportunity. My route building plan gives you chance for good steady income. Real future. Handle regular route local stores. Collect, deliver orders for famous 5c—10c counter display goods. Nationally advertised in 120 magazines and radio. Show merchants proven plan for beating competition and increasing sales, profits. Experience unnecessary. Use home as headquarters. Chance to operate Silver Fleet service truck. Facts free. World's Products Co., Dept. 10-F, Spencer, Indiana.

SALESMEN: America's finest sideline. 40% commission daily. 1000 fast selling repeat items. Every business uses and must buy. No investment. Sales portfolio free. David Lionel Press, 312 So. Hamilton, Dept. DG, Chicago.

DON'T Be a job hunter—Start your own business on our capital. No hard times; no lay-offs; always your own boss. Hundreds average \$3,000 to \$5,000 annual sales year after year. We supply stocks, equipment on credit. 200 home necessities. Selling experience unnecessary to start. Wonderful opportunity to own pleasant, dignified, profitable business backed by world-wide industry. Write Rawleigh's, Dept. L-U-PPM, Freeport, Ill.

OVER 2000 Business necessities, printing, calendars, Xmas greetings, advertising specialties, stimulators, etc. Lowest prices. Commissions advanced. Experience unnecessary. Samples free. Northwestern, 625-TF Jackson, Chicago.

ADVERTISING Book matches—World's largest manufacturer of union label book matches. Fast selling line. Large sales producing kit. Sample matches, complete cut catalog, 9 color combinations makes selling easy. Commission in advance. Superior Match Co., 7530 Greenwood, Dept. M-12, Chicago.

SELL Business cards, stationery, book matches, gummed tape, tags, restaurant necessities, salesbooks, advertising specialties, pencils, picture cards, calendars, Christmas cards. Lowest prices. Experience unnecessary. 40% commission. Free deals. Sales portfolio free. Willens, 2130 Gladys, Dept. CZ, Chicago.

"GALLOPING Ivories"—Nicknamed by salesmen. It's really hot! Plenty immediate - repeat commissions. Every retailer—service station wants it. Hurry! Universal, 2222 Diversey, Dept. C512, Chicago.

INCREASE Your earnings selling new fabric cement. Symplex, Lamoni, Iowa.

SELL New simplified bookkeeping system. Huge profits. Best season now. Records Co., 2636 Irving N., Minneapolis, Minn.

SELL Outstanding necessity every bank, business establishment. Big profits. Rimer, Silver Springs, N. Y.

REVOLUTIONARY New invention. Thousands prospects everywhere. Men earning high as \$100.00-\$150.00 week. Placed on free trial. Sells itself. Orders financed by factory. Protected territory available. Free demonstrator offer. Salesmanager, 2440 Lincoln Ave., Dept. R-518, Chicago.

AMAZING Patented screw-holding screw drivers! Factories, stores buy quantities; big profits, fast sellers, quick repeats. Free trial! Sevan Co., Dept. 101, 7 East 42nd St., New York.

ADVERTISING Book matches offer liberal earnings—full, spare time. Experience unnecessary. Factory direct. Low prices for fine quality, quick deliveries, help get orders; faster repeats. All business firms prospects. Free outfit, instructions. American Match & Printing Co., Dept. 612, 4822 South Trumbull Ave., Chicago.

SALESMEN—Distributors: 200 items, brushes, mops. Marvelous magnetic brush excels vacuum cleaner. Highest commissions. Neway Brush Works, Hartford, Conn.

AT Home, your own manufacturing business, making popular \$1 novelties. Cost you 3c to 15c. Everything supplied. Write So-Lo Works, Dept. P-842, Cincinnati, Ohio.

GOING South this winter? Carry with you Travelrack, the gadget that every touring motorist must have. 35c sale, large profits, grand satisfaction. District representatives also wanted. Send 35c for sample (refundable) or free circular. Nicholas Company, 7137 Cottage St., Philadelphia.

MAN Wanted—Trustworthy, steady worker. Manufacturer established 50 years will finance responsible man with complete stock of guaranteed food, farm and household necessities—you pay when sold. Mighty attractive proposition. Products well advertised on radio—a big help to success. Pleasant outdoor work. Experience not necessary. No slack seasons or layoffs. Write for no-investment offer. McCannon and Co., Room TM-66, Winona, Minn.

SELL Grocers, butchers, restaurants, new changeable paper window signs, 400 varieties, large commission. Rueby Displays, 29 North Water, Rochester, N. Y.

NEW Specialty—Sells every business and professional man. Four \$15 sales daily pay \$280 weekly. Farrell cleared over \$1,000.00 monthly. Write F. E. Armstrong, President, Dept. PM, Mobile, Ala.

SELL Quality portraits, frames. Lowest prices—big profits. Catalogue free. Friedman's Studio, 528 Cornelia, Chicago.

CHRISTMAS Leaders! 21 piece flash assortment 15c; 50 imprint folders 25c; 100 piece gift wrap box 25c. Bargain packages 1c each. Samples \$1.00 postpaid. Illustrated catalog free. Elkko, 440 North Wells, Chicago.

CALENDARS—Beautiful complete line, all sizes, including jumbos. Samples free. Also Christmas cards. Fleming Calendar Company, 6539 Cottage Grove, Chicago.

BLADES—Big profits. Best quality. Factory prices. Postpaid. Ace Blades, Buffalo, N. Y.

A REAL Future for you with Red Comet fire control products. Low prices. Proved seven years. Splendid sales outfit free. Some good territory open. Exclusive. Write quick. 704 Red Comet Building, Littleton, Colorado.

EXCELLENT Opportunity selling our complete line of brushes, largest commissions. Write for sales plan. Wire Grip Sanitary Brush Company, 2300 5th Ave., New York.

EDUCATIONAL AND INSTRUCTION

LEARN Big pay trades in a few weeks. Decorating, paperhanging, graining, marbling, sign and pictorial painting. Catalog free. Chicago Painting School, 102 West Lake Street, Chicago.

"HOW To Break and Train Horses"—A book every farmer and horseman should have. It is free; no obligation. Simply address Beery School of Horsemanship, Dept. 11012, Pleasant Hill, Ohio.

SCRAPBOOK Keeping taught. Instruction 25c. National Education Bureau, 814 Mass. Ave., N. E., Washington, D. C.

ENTER New, uncrowded, big money profession. Free details. Write Box 508, Hollywood, Calif.

AIR Conditioning—Electric refrigeration. Rapid growth creates big demand for trained men. Earn up to \$35-\$50 weekly. Write for free facts. Utilities Engineering Institute, 1314 Belden Ave., Dept. 102, Chicago.

WANT A super memory? Write "Dw." Info Company, Box 1122, Chicago.

DRAFTING—Home taught. Reasonable. Thorough. Davison Technical School, 7 East Grand Avenue, Detroit.

ACCOUNTING Offers outstanding opportunities for ambitious men and women with a knack for business. Employment surveys prove this one of the highest paid professions, with exceptionally steady employment. Readily mastered at home in spare time. No previous experience needed. Prepare for beginner's position in 3 to 5 months—\$100 to \$150 a month position within a year. Eventual earnings \$3000 to \$5000 yearly or more. School established 1897—course approved by National Home Study Council, Washington, D. C. Low tuition. Monthly payments. Selective employment service. Free bulletin sent without obligation. Write immediately: American School, Dept. AC45, Drexel at 58th, Chicago.

WATCH Repairing is steady profitable work. Experts usually in demand. You can learn watchmaking trade at home, spare time. New original instruction system. Script engraving course included. Write for free details today! Nelson Co., 500 Sherman, Dept. L-2001, Chicago.

U. S. government jobs. Commence \$105-\$175 month. Prepare immediately. Try next examinations. Particulars telling how to qualify—list positions, free. Write today. Franklin Institute, Dept. L3, Rochester, N. Y.

WELDING—Electric arc. Learn profitable trade quickly through actual practice. Individual welder instruction at bare cost of materials. Full particulars free. Valuable welding lessons book 50c. Hobart Welding School, Box M-12404, Troy, Ohio.

GOVERNMENT Jobs. Quickest plan. Free particulars. National Service Bureau, Dept. P, 610 South Broadway, Los Angeles, Calif.

DRAFTING And Design, the cornerstone of industry. Exceptionally well paid work, readily learned at home in spare time. No experience or artistic talent needed. Train for a beginning position in 8 to 10 months—detailer's position (\$130-\$225 a month) in 14 to 18 months. School established 1897—course approved by National Home Study Council, Washington, D. C. Low tuition. Monthly payments. Selective employment service. Free bulletin sent without obligation. Write today to American School, Dept. DDC45, Drexel at 58th, Chicago.

LEARN Auto mechanics, body, repairing, welding electricity, refrigeration, Diesel. Stevinson's, 2008A Main, Kansas City, Mo.

CLINICAL Laboratory technic taught in your own home. Practice outfit supplied. Bulletin free. Imperial Technical Institute, Box 494-E, Elkhart, Indiana.

HIGHER Arithmetic teaches shortest methods of figuring. Frederick A. Smith, 2410 Bernard Street, Chicago.

LEARN Telegraphy! Opportunities now available to beginners due to new railroad retirement act. Expenses low. Catalog free. Dodge's Institute, Hiatt Ave., Valparaiso, Ind.

U. S. Gov't jobs pay up to \$40 a week to start. Get ready for next examinations; railway postal, rural carrier, mail carrier, office help and others. Free book tells how you may qualify. Write quick. Patterson School, Dept. P. M., Rochester, N. Y.

SECRET Investigation. Experience unnecessary. Detective particulars free. George Wagner, M-2640 Broadway, N. Y.

LEARN All about Diesel engines by reading "Principles of the Diesel Engine." 214 pages, cloth binding, 102 illustrations. Dictionary of Diesel engineering terms included. Special introductory price, only \$1.00 postpaid. Diesel Publications, Inc., 192 Lexington Avenue, New York, N. Y.

GET A better job. Our books will help you advance. Bargain catalog free. Popular Mechanics, 633 St. Clair, Chicago.

CARTOONING, COMMERCIAL ART, SHOWCARD WRITING, SIGN PAINTING

LEARN Cartooning. Complete course \$1. Clink Dehaan, 9935 S. Lafayette, Chicago.

HAVE Your own money making business. Learn show card writing, sign painting. Write for details. Begley Specialty, 1472P Broadway, New York.

MONEY In portrait sketching. Progressive steps teach you. 20 complete lessons \$1.00. Harold Parks, R. 3, Ypsilanti, Mich.

COMPLETE Cartoon course with special 25 piece cartoonist's working kit, \$1.00. Cartoon Publishers, West Springfield, Mass.

CHALK Talks. Laugh producing program. \$1.00. Catalog 10c. Balda, the Cartoonist, Oshkosh, Wisconsin.

BE A professional signwriter. No training necessary. Send for book—"Modern Signwriting Simplified" 25c coin. Showcarder, 523 N. Prior, St. Paul, Minn.

AMATEUR Cartoonists, earn cash, spare time, copying advertising cartoons. Ad-Service, Arkyle, Wis.

ART Magazine including directory art books—free! Send 10c postage. Art Headquarters, Doty Street, Madison, Wisconsin.

PEN And ink drawings. Let us draw your advertising and catalogue illustrations, from photos, copies or objects. Best work and fair prices. Heraldic Studios, 1914P Oakdale Avenue, Chicago, Ill.

CARTOONING Course:—30 illustrated lessons, over 500 sketches, drawing paper, pens and pencils, \$1.00 complete postpaid. Montes Studio, Box 985, Pasadena, Calif.

PLAYS, STORIES, MANUSCRIPTS

FREE Test for writers! Send postcard for free market test. Hundreds of paying markets seek stories and articles. Learn the markets best suited to you—and sell. We help you! No obligation! Comfort Writer's Service, Dept. 546, St. Louis, Mo.

WANTED! Stories, articles, books for publication! New, unknown authors assisted. Manuscripts marketed, revised, criticized. Christopher Carr, 3636A Chestnut, Philadelphia, Penna.

ADVERTISING AGENCIES, LETTER WRITERS, FOR ADVERTISERS

INCREASE Your sales, read dynamic brochure "What Makes a Letter Pull?" Free! Cables, Norton, Kansas.

LEARN Advertising at home. Easy practical plan. No text books. Common school education sufficient. Interesting booklet and requirements free. Page-Davis School of Advertising, 3601 Michigan Avenue, Dept. 343B, Chicago.

FREE Booklet! "Planned Mail Order Selling." Outline your purposes now for free analysis, recommendations. Walter Greb, Greene, New York.

ADVERTISE: 24 Words, 149 newspapers \$6.50. Lists free. Advertising Bureau, 4515-C Cottage Grove, Chicago.

ADVERTISING Placed all magazines, newspapers, radio. Lowest rates. Free service. 54 page rate book free. Baker Advertising Agency, A-189 West Madison, Chicago. Successors to Ankrum. Established 28 years.

FREE—New Advertisers Rate Guide, 44 pages. Includes everything. Lowest rates. E. H. Brown Advertising Agency, 140 S. Dearborn, Chicago.

BUSINESS SERVICE

\$2 MONTHLY Maintains Washington, D. C., (downtown) "branch office." Mail reforwarded daily. Hawkins Mail Service, 908 Fourteenth.

NOW—Only 2c daily pays for New York office under your own name. Co-Operative Offices, 126 Lexington Avenue, New York.

FIFTH Avenue, N. Y. C. address for business or personal mail \$1.00 monthly. Mail forwarded anywhere. Dispatch Mail Service, 545 Fifth Avenue.

1,000 ORIGINAL Letters—Agents and mail order buyers—\$4.00. Particulars free. Crown Mail Order, 164-PM Monroe Street, New York.

ATTENTION—Get more business at low cost! 1000 guaranteed fresh names mail order buyers, opportunity seekers on perforated gummed paper, ready to stick on envelopes \$1.00. Saves time! Metro Sales, 75 Arlene, Youngstown, Ohio.

RUBBER STAMPS AND OFFICE SUPPLIES

3 LINE Cushioned 25c, 2 for 45c. Stamp-rite, Wauwatosa, Wis.

SUPERIOR, Indexed, cushioned, Two lines, 25c; three 35c. Slocum, 814 Bradley, Peoria, Illinois.

KNOB Handle, cushioned, 2 lines 25c. 3—35c. Stamp Works, Centerport, N. Y.

CUSHION Handle, 2 lines 25c; 3, 35c. Schultz, Pleasant Ave., Bergenfield, New Jersey.

2 LINES 25c, 3 Lines 35c. Stamp Works, Auburn, Nebr.

TYPEWRITERS, DUPLICATORS, OFFICE DEVICES

INCREASE Business now. "Excellerograph" Rotary Stencil Printer reprints thousands everything you typewrite, hand-write, draw or trace. Colors, \$19.75 to \$44. Terms. Illustrated literature free to business or professional men. Pittsburgh Typewriter Supply, Department K-2, Pittsburgh, Penna.

TYPEWRITERS. Adder, mimeograph, multigraph, addressograph. Send for free lists of machines that will help you at half price. Pruitt, 28 Pruitt Bldg., Chicago.

PRINTING, MULTIGRAPHING, MIMEOGRAPHING, GUMMED LABELS

500 MIMEOGRAPHED Letters (8½x11) \$2.15. Letterheads, multigraphing. Details mailed. Multitype, 487 Broadway, New York.

THOUSAND Neat business cards \$1.00. Special printing prices every month. Eaton Press, 1316 Main, Gardner, Kansas.

50 SALESBOOKS—3½x5½ Printed, delivered, \$4.95. Winther Printing, Marinette, Wisconsin.

QUALITY Printing, lowest prices. Samples. Churchill, 123 Oakdale, Syracuse, N. Y.

ATTRACTIVE Printing, lowest prices. Samples. Hosley Press, 8 Seminary Street, Auburn, New York.

RULED Forms our specialty, send your copy for quotations. Modern Litho, Jefferson City, Missouri.

125 8½x11 BOND Letterheads and 125 6¾ envelopes \$1.00. Benneville, 907 West Roosevelt, Philadelphia.

STENCILS \$2.00. Ink \$1.00. Eco, 39 West Adams, Chicago, Ill.

250 LETTERHEADS. Envelopes, statements or 6x9 handbills, \$1.00 postpaid. All \$3.50. Dollar Printery, Princeton, Ind.

2000 CARDS \$1.75. Free stickers. Irving Andler, Wayland St., Boston.

500 STICKERS 2½"x½". Four lines, 25c. Labels, Cott's, Waverly, Kansas.

5,000 BUSINESS Cards—\$3.69 postpaid. Other printing equally reasonable. Write your problem. Merchants Press, Lamoni, Iowa.

HAMMERMILL Bond at new low prices. Samples. Western Stationery, Topeka, Kansas.

100 LARGE Envelopes, 100 letterheads \$1.00 prepaid. Crown Print, Adelphi, Ohio.

CHRISTMAS Cards, 50 for \$1.00 with name imprinted. Cheser, 3111 Monroe, Chicago.

PRINT Anything, quick, reasonable. State requirements. Gibsonprint, 5005 Vincennes, Chicago.

SILVER Gummed labels, special—1,000, \$1.75. Samples. Jobey Press, D-184 West Washington, Chicago.

1,000 LETTERHEADS (8½x11). Envelopes (6¾), both printed \$4.95 prepaid. Morton Press, 1472 Broadway, New York City.

WHOLESALE Prices everything printed. Wholesale, 318-K East McDaniel, Springfield, Mo.

SHOP Aprons for printers, machinists, shipping clerks, made of blue denim, 36 inches long, postpaid 75c. Mechanics Apron Supply, 2324 Benton Blvd., Kansas City, Mo.

1000 ELEGANT Envelope slips, \$1.75; 5000, \$3.90 prepaid. All printing lowest prices. Samples. Goodprint, Harrisonburg, Va.

LETTERHEADS, 6¾ Envelopes, shipping labels, statements—250, \$1.00 postpaid. Franklin Printery, Box 5062, Chicago.

50 SHEETS, 25 Envelopes 25c prepaid. Samples. George, West Burke, Vermont.

1,000 3¾x6½ ENVELOPES Printed \$1.89. Samples free. Nixen's, Stevens Point, Wis.

500 ¾x2¼ FOUR Line gummed stickers, 25c. Moritz Printery, Saginaw, Mich.

PRINTING OUTFITS AND SUPPLIES

INEXPENSIVE 6x9 Printing press. Details free. Novelty Shop, Downsville, Louisiana.

ATF Foundry type, lines, sorts. Linotype. Ornaments, Box 4464, Philadelphia.

STEREOCAST Cuts—Sample 25c. Flint, 2311 Sixth Ave., Chattanooga, Tennessee.

HAND Press wanted. Describe fully. Menkin, 208 North Wells, Chicago.

PRINT Your own cards, stationery, circulars, advertising. Save money. Simple rules furnished. Print for others, nice profit. Junior outfit \$8.25, senior outfits \$16.55. Details free. Kelsey, Inc., T-11, Meriden, Conn.

BARGAINS, Presses, type, List 3c. Exchange, D-15, 190 Cook, Meriden, Conn.

PRESSES, Complete bargain equipment catalog. Send stamp. Bradshaw, 3214-P Huron, Chicago.

PRESSES, Type, supplies. List free. Catalog ten cents. Model Press Co., York, Penna.

PRINT At home. 10c will bring a complete catalog of presses, type and supplies. P. Peiffer & Company, 6 Columbia St., Newark, N. J.

BARGAINS — Presses, type, supplies. Send stamp. 159 Harvard, Cambridge, Mass.

USED Presses, type, supplies. Lists 3c. Turnbaugh Service, Loysville, Penna.

PATENT ATTORNEYS

INVENTORS: Send immediately for your copies of our new free books, "Patent Protection" and "Suggestions on Selling an Invention." Sixty-eight pages of interesting facts. They tell how Patent Laws protect you; kind of sketch or model needed; simple steps to take without cost; how successful inventors have secured financial assistance; show interesting inventions; illustrate important mechanical movements. With books we also send free Evidence of Invention form to help establish date of disclosure. Prompt service, reasonable fees, special deferred payment plan. Strictest secrecy. Forty-two years' experience. Highest references. Write us today. The facts in our books are worth money to the man with a good invention. Address: Victor J. Evans & Co., Registered Patent Attorneys, 561-P Victor Building, Washington, D. C.

INVENTORS: Take first step toward protecting your rights to your invention—without obligation. Write for free "Record of Invention" form and complete instructions for making legal disclosure of invention and establishing date. We also send—without obligation—48-page book, "Patent Guide for the Inventor," telling importance of prompt action; how to sell and market your invention; how to make application for patent; showing examples of successful inventions; explaining convenient payment plan. Write today for free "Patent Guide" and "Record of Invention" form. See page 12A for further information. Clarence A. O'Brien, Registered Patent Attorney, OMIB Adams Building, Washington, D. C.

INVENTORS—Patent your invention—Send now for our new free copyrighted booklet "How to Protect Your Invention" and "Invention Record" form. This booklet guides the inventor from the first step toward patent protection to final profit making from his invention. Reasonable fees, conscientious counsel. McMorro and Berman, Registered Patent Attorneys, 134-D Barrister Building, Washington, D. C.

PATENTS Secured promptly. Information free. Personal confidential service. 30 years experience, registered patent attorney engineer. Henry Price Ball, 141 5th Ave., New York City.

INVENTORS—Before disclosing your invention to anyone send for form "Evidence of Conception"; "Schedule of Government and Attorneys' Fees" and instructions. Sent free. Lancaster, Allwine & Rommel, 411 Bowen Building, Washington, D. C.

PATENTS. Protect your idea by securing free "Proof of Invention" folder. Exceptional personal service. Established 1906. E. E. Vrooman, 871 Woodard Bldg., Washington, D. C.

"INVENTOR'S Guide" free; full information about patenting, selling inventions. Frank W. Ledermann, 154 Nassau Street, New York.

INVENTORS—Send for free booklet "Patent-Sense." Information based on 64 years experience. Lacey & Lacey, Dept. 5A, 635 F St., Washington, D. C.

PATENTS. Booklet free. Highest references. Best results. Promptness assured. Watson E. Coleman, Patent Lawyer, 724 Ninth St., Washington, D. C.

L. F. RANDOLPH, 302-B Victor Bldg., Washington, D. C. Low cost. Book and information free.

FOR INVENTORS

INVENTORS: Take first step toward protecting your invention—without obligation. Write for free "Record of Invention" form for establishing date of invention. We also send free—48 page book, "Patent Guide for the Inventor"—telling importance of prompt action, confidential search service; how to sell and market inventions; details of convenient payment plan. Send for free "Patent Guide" and "Record of Invention" form today. Clarence A. O'Brien, Registered Patent Attorney, OMIA Adams Building, Washington, D. C.

WE Build models which "put over" your idea. Complete engineering service, developing and designing. We market and manufacture in any quantity. Write for bulletins. R. & S. Engineering Co., Dept. AF-12, 17 East 42nd Street, New York City.

"WHEN And How to Sell an Invention"—helpful, 24 page booklet gives you preparation steps necessary to commercialize your ideas and six basic approaches to use in selling your invention. Information vital to every inventor. Get your copy free. Victor J. Evans & Co., 506-P Victor Building, Washington, D. C.

HAVE You a sound, practical invention for sale, patented or unpatented? If so, write Chartered Institute of American Inventors, Dept. 4-A, Washington, D. C.

MANUFACTURERS Addresses—25 any line, \$1 postpaid. Manufacturers Directory, 35 North Ninth, Columbus, Ohio.

INVENTORS! Unpatented inventions completely protected at total cost \$1.50. Show valuable ideas to prospective buyers. Safeguarded against theft. Also protects songs, short stories, scenarios before copyright. Send \$1.00 for Inventor's Protection Plan. Moroney, 321a 92nd St., Brooklyn, N. Y.

SHOW Your unpatented invention with absolute safety. Send \$1.00 for complete details and necessary forms. No other expense. Young, 9 W. Illinois, Chicago.

YOUR Invention protected costs less than \$1. Detailed information on procedure to legally protect your invention. No need to show ideas or design to anyone until after you have followed my printed instructions. Send \$2 for information. Address, J. C. Green, P. O. Box 9595, Station S, Los Angeles, California.

SEVERAL New inventions we recently developed have been placed successfully by us for sale in department and chain stores. New items needed. Items manufactured on cooperative basis. We design and develop your invention; obtain patents; manufacture tools, dies, stampings. We specialize in plastics. Write for free estimates. R. & S. Engineering Co., Dept. AW-12, 17 East 42nd Street, New York City.

INVENTORS: Profit by your invention. A practical talk to inventors by an experienced manufacturer. Our 68 page booklet "Mind vs. Matter" mailed upon receipt of 25c. Rex Engineering Co., Cincinnati, Ohio, Dept. D.

INVENTORS—A complete national service—Patent searches, models, drawings, engineering, testing. Ideas commercialized and sold. Write for free booklet, "Inventing for Profit." Camco Institute of Invention, Camco Bldg., Grand Rapids, Mich.

INVENTOR'S Universal Educator; contains 900 mechanical movements; 50 perpetual motions; instruction on procuring, and selling patents and selecting an attorney, etc. Suggests new ideas. Price \$1 postpaid in U.S.A. Address Albert E. Dieterich, 511-B Colorado Bldg., Washington, D. C.

I SELL Patents. Established in 1900. Charles A. Scott, 773PM Garson Ave., Rochester, N. Y.

INVENTING Taught at your home by Trofimov School of Inventive Practice, Hanna Rd., Willoughby, Ohio.

CASH For practical ideas and inventions. Mr. Ball, AB-9441 Pleasant, Chicago.

INVENTORS: "Making Inventions Pay" our 32-page illustrated book mailed absolutely free. Crescent Tool Co., Dept. ZS, Cincinnati, Ohio.

WE Locate buyers meritorious patented, unpatented inventions. If will sell, reply immediately. Descriptive booklet, references, free. Invention Reporter, 5A-11236 South Fairfield, Chicago.

INVENTORS—Send for 72-page book on patents. Reasonable terms. Conscientious treatment to inventors. L. F. Randolph, Registered Patent Attorney, 302-E Victor Bldg., Washington, D. C.

INVENTIONS WANTED

SIMPLE. Practical inventions wanted by manufacturers, patented or unpatented. For information write Chartered Institute of American Inventors, Dept. 4-D, Washington, D. C.

INVENTIONS Wanted: Have you an invention to sell? Write for free booklet describing amazing low-cost service offering specialized list of manufacturers seeking patented, unpatented inventions. Inventors Information Service, 10 E. 43rd Street, New York, Dept. M.

"ALL Year invention showroom" shows inventions to investigated business people only. \$1 up monthly, free selling assistance! Invention Showroom, Box 702, Grand Central Annex, New York City.

CASH For inventions—Patented or unpatented. Mr. Ball, A-9441 Pleasant, Chicago.

MAKE Your inventions pay. We help you. 36 year old firm offers complete services, free estimates. Ample facilities regardless size of invention. Stampings, metal specialties, dies, models, etc. Catalog giving "inside" information free. Crescent Tool Co., Dept. W, Cincinnati, Ohio.

WANTED—Meritorious patented, unpatented inventions. Booklet, references, free. Invention Reporter, 5B11236 South Fairfield, Chicago.

INVENTION Finance Magazine, 80-G Wall Street, New York. Important particulars free.

SMALL Inventions wanted by manufacturers. I'll help you sell your invention. Write for free circular. Stanley Hull, 7829-K Euclid Avenue, Cleveland, Ohio

PATENTS FOR SALE

SELF Flouring rolling pin, made cheap. Good seller, porcelain made. Sell outright, make offer. E. Perteit, 4626 Indiana Ave., Chicago, Ill.

PATENTED. New individual salad mold. Outright or royalty. Viola Drake, Unionville, Mo.

MANUFACTURERS. New self using electric hair clipper. Patent for sale, or royalty. Write Harry King, International Falls, Minn.

SELL Your patent through a small classified ad in Popular Mechanics. Many inventors have found buyers in this way. Ask me for proof—I'll gladly send it to you. F. W. Johnson, Manager Classified Advertising, 200 E. Ontario St., Chicago.

MANUFACTURING

DIES. Stampings, models, product engineering. Hagstrom Manufacturing Company, Kansas City, Missouri.

STAMPINGS. Parts, manufacturing, get our estimate. Porsberg Engineering, Northfield, Ohio.

INVENTIONS Manufactured by an experienced company, in any quantity at low cost. Metal specialties, novelties, stampings, dies, and models. Free estimates. Our booklet "Mind vs. Matter" sent upon receipt of 25c. Rex Engineering Co., Cincinnati, Ohio, Dept. C.

MANUFACTURING. Any material, any quantity, inventions developed. Milburn, Burlington, Kentucky.

INVENTIONS Developed and manufactured. Send us your ideas. Model Engineering, Osgood, Ind.

INVENTIONS— Manufactured in any quantity at low cost by old-established reputable company. No branches anywhere. Stampings, metal specialties, dies, models, etc. Free estimates. Free catalog. Crescent Tool Co., Dept. XS, Cincinnati, Ohio.

MODELS AND MODEL SUPPLIES

IMMENSE 53-Page Mini-Train railroad catalog! 1227 different items. Send 25c. Vanden Boom's, 3821 Broadway, Kansas City, Mo.

"MBW" Motor boat kits: Four beautifully designed hulls for gas motors; universal marine propeller, flywheel, transmission equipment. Full technical details, 6c. Morristown Boat Works, Morristown, N. J.

STEAM Driven locomotives. O gauge. Catalog 15c. P. Maurer, Importer, 106 Pompton Ave., Verona, N. J.

BRASS Gears, models and model supplies. Send 3c for catalog. Pierce Model Works, Tinley Park, Ill.

MODEL Makers lathe; photographs for dime. Depoy Model Shop, Muncie, Ind.

ENGINE Catalogue castings, supplies, 25c. Howardco, A-2417 North Ashland, Chicago.

RAILROAD Equipment and supplies. Guaranteed reconditioned rolling stock. Complete lending library. Model Railroad Equipment Co., 55 West 42d St., New York.

SUBMARINE—Beautiful 15" model—kit 35c postpaid. Spotts Models, 3925 N. Broad, Philadelphia, Penna.

MINIATURE Steam locomotives, new catalog listing all builders' needs 25c. Little Engines, Wilmington, California.

BUILD Railroads, planes, boats. Catalog 10c. Ideal Company, 26½ West 19th, New York.

RAILROAD Model Shop, Dept. PM, Dunellen, New Jersey. Catalog 10 cents.

MODELS—Practical models put over your ideas. We develop models from the crude to perfect working devices. Your idea might have large commercial value. Services confidential. Bank references. Registered graduate engineers at your service. Send 25c for our 68 page booklet "Mind vs. Matter." Rex Engineering Co., Cincinnati, Ohio, Dept. B.

WORKING Models of anti-aircraft, naval and railroad guns. Circulars and photos 25c. William Gregory, 229 Sixth Ave., Newark, N. J.

THOUSANDS Ship fittings, hundreds kits, catalog 10c. Polk's, 429 Seventh Ave., New York, N. Y.

GAS Motor power airplane catalog 6c. Polk's, 429 Seventh Ave., New York.

GOOD Working models with eye appeal. We have spent 36 years developing ideas into practical working models! Let us help you! Free catalog. Crescent Tool Co., Dept. Y-SA, Cincinnati, Ohio.

CARVED Hull ship model kits. Ship and yacht model fittings; model yacht sails. Illustrated catalog 20c. A. J. Fisher, 1002-M Etowah Ave., Royal Oak, Mich.

BLUEPRINTS AND PLANS

HOUSE Plan books—Latest titles—Bargain catalog free. Popular Mechanics, 633 St. Clair, Chicago.

HOME CRAFTSMEN

LUCITE—Transmits light around curves—beautiful clear plastic. Bargain 1 lb. assortment of odd lengths ½ to 1 inch diameter rods (approximately 8 rods), \$1.00 postpaid. Craft Service, Dept. L, 337 University Avenue, Rochester, New York.

SOUVENIR Makers—Get your hard to find materials from Stanton's. Thermometers, metal coin bank tops, small hinges. Send 10c for samples and prices. Stanton's, Lake Ozark, Mo.

BUILD Streamlined plywood kitchen cabinets. Plans 25c. Roger Underwood, 4617 Johnson Avenue, Western Springs, Illinois.

PLASTICS—Bakelite, Catalin, sufficient for cigarette or powder box, four rings, two bracelets, five ornaments, five jewelers findings. Twenty pieces \$1.25 cash with order. Dependable Machy, Co., 1011 Harrison, Oakland, Calif.

GET Free leathercraft instruction pamphlets, prices of leathers, tools, projects. Make extra money. Beautiful gifts. Leather samples 5c. Wilder & Company, 1038 Crosby, Dept. 12F, Chicago, Illinois.

PROFITABLE. Interesting, inexpensive. Make aluminum castings from scrap aluminum. Instructions 50c. Elden L. Creed, Northfield, Vermont.

CEDAR Name pins are easily carved with proper jigsaw blade. Quarter brings six blades, information. Woodcraft, Iowa Park, Texas.

22 LAWN Ornament patterns 25c. Other patterns: 15"-20" high; Dutch girl, Dutch boy, pirate, bull terrier, Mexican girl, Mexican boy, dwarf, penguin, flower girl, 10c each; 3 for 25c. 25 novelty patterns 30c. All 56 full size patterns \$1.00 postpaid. Strother, Box 383-BT, Belington, West Virginia.

ORIGINAL Patterns: 20 novelty, 25c; 15 lawn ornament, 20c. Wayne Gorman, Box 1272-DP, Amarillo, Texas.

CRAFTSMEN, Hobbyist! Work out your own brainchild. Space, tools and machinery for rent. Information phone Canal 6-9443. New York City.

LEATHERCRAFTSMEN: Send 10c for handbook and catalogue of tools and supplies. E. A. Sweet Company, Inc., Leathercraft Division, Dept. A-41, 143 State St., Binghamton, N. Y.

SHELF Brackets, 15 full size patterns, 30c (coin). Albright Service, 6901 Railroad Ave., Omaha, Nebr.

FREE 2¼" Metal-sawing blade, power tool catalog. Send 6c postage, names three workshopers. Limited quantity. Supply, Newfane, Vermont.

MEXICAN Wood novelties easily made! 20 patterns complete instructions 25c. 20 cowboy silhouette patterns 25c. 10 lawn ornament patterns 15c. Mexican Artercrafts, Eagle Pass, Texas.

MAKE Beautiful majestic rock veneer urns, birdbaths, etc. Use home materials and equipment—unique. Illustrated instructions \$2.00. Roc Veneer System, Brady, Texas.

"PRACTICAL Finishing Methods"—New Delta illustrated 64-page manual gives complete instructions for every possible finishing operation: Preparation, staining, filling, varnishing, lacquering—with brush or spray gun—mixing low cost materials, silk screen process, finishing metals, making decorations. 50c postpaid. Dept. 652, Delta Manufacturing Company, 600-634 E. Vienna Ave., Milwaukee, Wis.

DESIGNS Made to order, any size, from any clear illustration for any handicraft, monogram, hand embroidery. Service information 3c. Mountain Studio, RFD No. 1, Narrowsburg, N. Y.

WOODWORKERS—Send for valuable new data book with complete line plywood, veneers. Save up to 33% buying from direct mill representatives. See our offers. Send 10c to cover mailing (refunded on first order). S. Beck Plywood & Lumber Co., 1309 N. Halsted, Chicago.

PATTERN Catalog finely illustrating 250 plywood novelties, silhouettes, lawn ornaments, decal transfer decorations, and other lines. Wo-Met Shop, Ashburn, Georgia.

80 PATTERNS. 20 Lawn ornaments, 20 silhouette, 20 novelties, 20 lawn ornaments, 30c each set, all for \$1.00. Modern Woodcraft, Saginaw, Mich.

LIKE To make things? Latest craft books tell how. Bargain catalog free. Popular Mechanics, 633 St. Clair, Chicago.

WATCHES, JEWELRY, OLD GOLD, ETC.

LOCKETS, Crosses, neck chains, cameo and stone rings. Send \$2.00 for saleable samples. (Retail value \$10.00.) National, 417 Central Ave., Brooklyn, N. Y. (Watches repaired, 75c labor.)

1941 BULOVA'S, Elgins, \$10-\$25 allowance for old watches. Simms, Warwick, New York.

WATCHES—Hamilton, Elgin, Waltham, Bulova as low as \$2.75. Diamond rings at lowest prices. Postal brings free illustrated catalog. Quaker City Jewelry Company, Wholesale Jewelers, 8th and Walnut Sts., Philadelphia, Penna., Dept. "S."

SEMI-PRECIOUS Stones, how to cut them, book \$1.00. Information stamp, Home Lapidary Shop, Madera, California.

BULOVA, Gruen, Hamilton, Elgin, Waltham wrist and pocket watches for ladies and gents. Positively lowest wholesale prices. 1941 styles now available. Write for free money making wholesale catalogue. Norman Rosen, Wholesale Jeweler, Dept. P.M., 801 Sansom Street, Philadelphia, Penna.

GOLD \$35 Ounce. Ship old gold teeth, crowns, jewelry, watches—receive cash by return mail. Satisfaction guaranteed. Free information. Dr. Weisberg's Gold Refining Co., 1500-Q Hennepin, Minneapolis, Minn.

HIGHEST Prices for old gold—Mail your teeth, watches, jewelry. 100% full cash value mailed day shipment received. Satisfaction guaranteed or articles cheerfully returned. Information free. Chicago Gold Smelting Company, 300-P Champlain Building, Chicago.

AUSTRALIA'S Lovely opals. Illustrated catalogue free. Good selection \$5.00. Norman Seward, Melbourne, Australia.

ELGIN, Waltham watches \$3.50. Make big money. Free watch and jewelry catalog. Plymouth Jewelry Exchange, 163-A Canal St., New York.

AGATES, Fossil woods, three pounds \$1.25 postpaid. Jay Ransom, Aberdeen, Wash.

WATCHMAKERS' Materials— Tools, watches, jewelry. Bought, sold, exchanged. Best prices for old gold, diamonds. Ben Segal Company, 5 South Wabash, Chicago.

WATCHMAKERS' Tools, supplies. Watch parts. Lowest prices. Write for price list 43. Dean Company, 87 Nassau St., New York.

5000 REBUILT Watches! Free catalogue—Diamonds, jewelry, (3c postage). The New York Jobbers, 74 Bowery, Dept. M, New York, N. Y.

FOR THE HOME

SCANDINAVIAN Cookery: Book containing over 100 delicious, tested recipes (in English) mailed for 25c. Home Service, 4744-P Clinton, Minneapolis, Minn.

TOBACCO

GOLDEN Leaf guaranteed, cigarette, pipe or chewing, 5 lbs. \$1.00, ten \$1.75. Pay when received. Pipe, box cigars free. Reeves Tobacco Co., Paducah, Ky.

RAZORS, BLADES, SHARPENING

MEN Don't pull whiskers out. Send 10 cts. coin for full instructions how in 4 minutes you can make your electric shaver run fast as new. Enebo Enterprises, Stevensville, Mont.

SURVEYING INSTRUMENTS

GUARANTEED Factory rebuilt transits and levels for rent (with purchase option) or sale (cash or terms). Order now before prices advance. We will repair, trade in, or buy your old instruments. Ship prepaid for estimate and valuation. Write for List M-512 and complete information to Warren-Knight Co., 136 N. 12th St., Philadelphia, Penna.

WANTED—MISCELLANEOUS

MERCURY (Quicksilver). \$1.00 pound remitted, promptly. Ship express. Wholesale Terminal, Norwood, Massachusetts.

CASH Paid for used microscopes, binoculars, slide rules, drawing sets, scientific instruments, tools, cameras, transits. Satisfaction guaranteed. Elman's, 108-ML South Clark, Chicago.

CASH For anything. Justice Jewelry Jobbers, 59-P East Madison, Chicago.

MERCURY (Quicksilver). Tungsten, molybdenum, cadmium, nickel anodes, tin, pewter, rare and semi-rare metals, metallic residues purchased in any quantity. Write for quotations. Metallurgical Products Company, 35th and Moore Streets, Philadelphia, Penna.

PERSONAL

STAMMERING Scientifically corrected. Normal Speech Mail Course, 236 Palmer, Grand Rapids, Mich.

CONTEST Bulletin. 22 big pages of contest helps. 10c. General Contest Service, 1609-P East 5th, Duluth, Minn.

MEXICAN Legal matters, Wm. A. Cocke, American Attorney, ElPaso, Texas.

ROSICRUCIAN Secret teachings are offered to those who seek to use them solely for the perfection of their inner faculties, and in the mastering of the daily obstacles of life; the International Organization of Rosicrucians will be happy to receive the requests of those who believe that worthiness and sincerity determine the right for one to have such wisdom; to them, a copy of "The Secret Heritage," a fascinating book, will be given without price; let this book guide you to the conservative plan whereby you may widen your scope of personal power. Simply address your letter to Scribe G.H.N., Amorc Temple, Rosicrucian Park, San Jose, California.

REMOVE Your own tattoos. Start profitable business. Write Tattoo Supply House, 651 South State, Chicago.

SICK—Discouraged? Conquer fear, worry, nervousness and all negative thoughts. Health, happiness, success assured. Inspiring information free. Metaphysics, Mooresville, Ala.

WIN Prize money: Booklet—"Successful Contesting" shows how, 10c postpaid. Bulletin listing \$100,000.00 prizes included. World Publishers, 4515-B Cottage Grove, Chicago.

PRAYER Band of the Mails invites new members. Free information! Box B-49, Noroton, Conn.

JOHN Francis Langan write me regarding estate. William Langan, 1034 Quincy, Topeka, Kansas.

MISCELLANEOUS

GENUINE Artists oil painting on canvas, any subject, 12x18 size \$5.00; 18x24, \$9.00. Your favorite landscape, view or snapshot beautifully done in oils. For home, den or office. Send subject. Additional information sent free. Altmeyer, 956 4th Avenue, New Kensington, Penna.

STREET Gloves cheap. Folder, Wood's Factory, 204 Burton, Johnstown, N. Y.

CUTS Anybody can make. Zinc etching process. Specimens, particulars, testimonials for stamp. Jiggs C. Day, Westfall, Indiana.

MAIL Order business course shows you how to make money, spare or fulltime. Teaches professional mail order technique—no penny-catching schemes. Free details. Nelson Company, 500 Sherman, Dept. 408-L, Chicago.

12 DRESSES \$1.18. Army shoes \$1.18. Fur coats, suits, shoes. New, used clothing. Barkains. Free catalog. Farmers' Mail Order, 75-P Grand Street, New York.

COCOONS. Butterflies, collectors' supplies, free lists. Maynard, 1192 Lewiston, Rochester, N. Y.

TATTOOING. Also engraving outfits, 1941 list. Jensen, 412 South Main Street, Los Angeles.

TATTOOING Pays enormous profits. Complete beginner's outfit, \$7.85. Free instructions. Write Tatuco, 651 South State, Chicago.

INFORMATION. Any subject. Moderate fee. The Roxbys (formerly International Research), 2737 Francis Ave., Los Angeles, California.

GET Rid of your debts easily. New plan. Regent Service, Alfred Station, Detroit.

KEYS Duplicated 20c. Locksmith-Brannon, 1628 Caldwell, Conway, Ark.

ANYTHING From Mexico. For Christmas presents, Mexican curios, typical goods. Send for circular. Fernando Montes de Oca, Apartado 2686, Mexico City, Mexico.

GOOD Eyesight without glasses. Use my new invention. No drugs. A. E. Jacobson, Upsala, Minnesota.

TRADE Or sell articles you don't need for those you want. Send dime for list. Dept. PM, Swapper's Guide, Delphos, Ohio.

"1940 MERRY Christmas man postcard." Cleverest greeting out. Mails for 1c, 50 for \$1.00. Christmas Card Cap, Black River Falls, Wisconsin.

RECEIVE Gigantic mails, magazines, samples. Your name in numerous mailing lists 10c. Howard, 396 Broadway, New York.

FIFTY Inventors names and addresses. National Employment Foundation, Marietta, Ohio.

IMITATION Marble: Make statuary, flooring, etc. Formula 25c. Ideal Service, 11-M, Park Ridge, Ill.

AMATEUR Cartoonists, earn cash, spare time, copying advertising cartoons. Ad-Service, Arzyle, Wis.

COATS Of arms and crests, correctly painted in colors or black and white, from heraldic description or furnished copy, \$10.00 and up. Highest grade work. Heraldic Studios, 1914P Oakdale Avenue, Chicago, Ill.

CASH For used drawing sets, tools, any scientific instruments. Gordon's, 162-D Madison, Chicago.

CHRIST Is coming. Get free proofs. Sheal, 263, Duluth, Minn.

TATTOOING, Engraving outfits. Illustrated list free. Percy Waters, Anniston, Ala.

CIGARETTES—Camels, Luckies, Golds, Chesterfields, \$1.50 carton postpaid. Tom Thumb, Nauvoo, Ill.

EYEGLASSES Made sparkling bright! Wiped with Clean-Omist they cannot fog up under any conditions. Specially treated, non-linting tissues in handy, vest pocket booklets—approved by leading opticians. One wiping lasts a day. Send stamped envelope for free sample—or 50c for six months' supply. Clean-Omist, 522 W. Broadway, New York City.



NOW a DYNAMIC HEAVY DUTY INDUSTRIAL WELDER

Works off 110 volt electric light circuit. For this unheard of price you can get the marvelous Dynamic Super-Charged Welder complete—ready to plug into light socket. The Dynamic does both metallic and carbon arc welding. You can also solder and braze on the lightest material.

for Only **\$19.75** RETAIL EASY PAYMENTS

WORKS ON IRON, STEEL, TIN, BRASS, COPPER AND ALL OTHER METALS

With our free instructions you can tackle anything and in no time at all you will be able to do finished repair jobs. Once you have the Dynamic outfit, you are all set in a profitable welding business of your own. In a year a Dynamic Welder Costs you Less Than 6c a Day. Write for FREE particulars TODAY.

DYNAMIC WELDER CO., 2226-NX, Silverton Road, Chicago, Illinois

WELDS BUMPERS, FENDERS, CYLINDER BLOCKS, BODIES, FRAMES, ETC. Does Farm, Factory and Home Repairs

Without previous welding experience you can make for yourself as much as \$5.00 on a repair job that can be done in less than one hour. Many welders make as much as \$15.00 to \$20.00 a day. The Dynamic Welder is light and easily portable.

AGENTS WANTED

Get our big profit plan and 10-day trial offer. Send for it TODAY.

BROOKLYN YMCA TRADE SCHOOL



- Unlimited Instruction without extra charge until you have mastered every part of the Course.
- Full Shop Equipment
- Unexcelled Instruction
- Fireproof Dormitories.
- Special Privileges. Check your interests on coupon to receive free literature.
- Aviation Mechanic
- Machinist
- Mechanical Pre-Engineering
- Diesel Engines
- Diesel Pre-Engineering
- Aeronautical Pre-Engineering
- Auto Mechanic
- Refrigeration
- Television and Radio Mechanic
- Architectural-Mechanical Drafting
- Armature Winding
- Welding
- Tool and Die Making
- Oil Burner
- Talking Pictures
- Electrical

MAIL COUPON

1117 Bedford Ave., Dept. P.M. Brooklyn, New York City, N. Y.

Name.....
Address.....

LEARN AVIATION In Los Angeles NATION'S AVIATION CAPITAL



Aviation Mechanics
4 to 12 Months

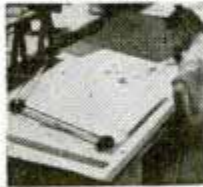

Aeronautical Engineering
—Drafting 4 to 14 Months



Airline & Commercial
Piloting 10 to 24 Months

**THIS TRAINING PLACES YOU
IN AVIATION IN 4 TO 14 MONTHS**

Huge increases in Los Angeles aviation activity insuring splendid positions, rapid advancement for California Flyers graduates. Train at one of America's most modernly equipped, strategically located schools. Training fleet of 15 modern planes, Link Trainer, latest instrument flying equipment. Government approved shops. Located on famous Los Angeles Airport, C.A.A. test field, plant and airline proving ground. Career training courses in Airline and Commercial Piloting (10 months to 2 years), Aeronautical Engineering (14 months), Master Mechanics (12 months), Production Mechanics (4 months), Aircraft Drafting (4 months), Instrument Technician (6 months), Flying optional with Engineering and Mechanics training. Government approved for Flight, Ground and Master Mechanics courses. Low tuition, living costs. Dormitories. Write for new 64 page Catalog and Vocational Guide. State age.

**WE CAN'T
SUPPLY THE
DEMAND FOR
GRADUATES**



SEND FOR THIS FREE CATALOG

CALIFORNIA FLYERS
SCHOOL OF AERONAUTICS DEPT. PM-12
LOS ANGELES MUNICIPAL AIRPORT • INGLEWOOD, CALIF.

DRAFTSMEN MAKE MONEY!

Train at Home for a Profitable Job

No machine can ever take the draftsman's place. Machines depend on him; he's father of them all. There are fine rewards; steady employment and promotion, with **Openings in all Lines ... Pay \$40 to \$50 a week**. Easy to learn **at home**. Our training provides every essential to **success** but determination. You supply that. Low cost. Terms if desired. Write for **free** bulletin today. American School, Dept. DD945, Drexel at 58th St., Chicago

Prepare yourself for Success NOW!



TRAIN AT HOME FOR A CAREER IN COMMERCIAL ART

CARTOONING
ILLUSTRATING

Train to be an Artist in your spare time! Trained Artists are capable of earning \$30, \$50, \$75 a week. Our practical method has trained men and women of all ages since 1914. COMMERCIAL ART, CARTOONING, and DESIGNING all in one complete course. No previous Art experience necessary. FREE BOOK, "Art for Pleasure and Profit" describes course, opportunities in art and TWO ART OUTFITS included with training. Mail coupon today.



FREE BOOK gives details!

Washington School of Art, Studio 1212P
1115—15th St., N. W., Washington, D. C.

Yes! I am interested in learning to draw. Please send me your Free Book, "Art for Pleasure and Profit."

Name..... Age.....
Address.....
City..... State.....

**Increased
production
means more**



Jobs for MACHINISTS and bigger pay for men who know their work

This home-study course gives you the practical facts on modern machines, up-to-date methods, you need to advance in machine shop work. Take advantage of the other man's experience as found in books, to solve your problems, increase your efficiency, with

The NEW AMERICAN MACHINISTS' LIBRARY

5 volumes—2014 pages—1853 illustrations
(A combined home-study course and reference library)

This library of machine shop practice was written for practical men. It gives you the best methods for every kind of machine shop work. It fully explains lathes, drills, and other machine tools and their operation, automatic screw machines, speeds and feeds, gear design and production, punch and die work, metal surfacing, etc., etc. Plainly written—completely illustrated—the best kind of help to the machine shop man who wants to advance himself.

No money down—special price—easy payments.

EXAMINATION COUPON

McGraw-Hill Book Co., 330 W. 42nd St., New York

Send me for ten days' examination the new American Machinists' Library. If satisfactory I will send you \$1.50 in 10 days and \$3.00 monthly until the price of \$16.50 is paid. If not wanted, I will return the books postpaid. (To insure prompt shipment write plainly and fill in all lines.)

Name.....
Home Address.....
City and State.....
Position.....
Name of Company..... PM-12-40

DIESEL ENGINES are Vital to NATIONAL DEFENSE PROGRAM

The Diesel Engine is in the headlines today, more than ever before. Tanks—Trucks—Airplanes—Ships, all vital implements of National Defense, are now being powered with Diesels. Millions of dollars of government contracts have been let for Diesel-powered equipment...and Hemphill Diesel Schools are training men to operate and service modern Diesel engines.

HEMPHILL DIESEL SCHOOLS

A NATION-WIDE INSTITUTION

NEW YORK 31-26 Queens Blvd., L. I. C.
CHICAGO 517 South Western Avenue
MEMPHIS 417 Monroe Avenue
LOS ANGELES 2120 San Fernando Road
VANCOUVER, B. C. 1363 Granville Street

HEMPHILL DIESEL SCHOOLS (use nearest address)

*Please send data on your Diesel courses, also free copy of illustrated booklet "March of Diesel."

NAME..... AGE.....
STREET.....
CITY..... STATE..... m-51-p

Be an AERONAUTICAL ENGINEER



LINCOLN TRAINS YOU FOR A CAREER IN AVIATION

**BIG MONEY PAID
EXCEPTIONAL OPPORTUNITIES**

Big demand for Aeronautical Engineers. Lincoln's 2 year course including wide practical experience in Airplane design and construction, prepares you for life-time career in this fascinating field. Course adjustable to high school or college graduates. Next class starts January.

BE AN AIRLINE MAINTENANCE MECHANIC. Lincoln's Government Approved Mechanics Training prepares for responsible position with Airline or at Airport as Gov't. Rated Airplane and Engine Mechanic. These Graduates taking fine good-pay positions. Jobs for many more.

BE A COMMERCIAL PILOT Lincoln Government Approved Flight Training prepares you for BOTH a Commercial Pilot and Flight Instructor Rating.

ACT NOW

Get Lincoln's book "Contact." It tells How Men are Trained for Aviation. **WRITE TODAY** for complete information.



LINCOLN AERONAUTICAL INSTITUTE (INC)
LINCOLN AIRPLANE & FLYING SCHOOL DIVISION
5712 Aircraft Building Lincoln, Nebraska

HOW TO DO AUTO REPAIRING

By **FACTORY** Methods

Based on Official **FACTORY** Books Covering ALL Cars 1935-1941 Inclusive



Regardless of the car you want to repair, MoToR's new Shop Manual will show you the factory-correct way to do the job! Gives official manufacturers' data needed by every mechanic for overhauling or adjusting every American automobile made since 1934. Used daily by thousands of repair shops, students and men who like to "fix their own."

500 BIG 8 1/4 x 11 PAGES — 800 PHOTOS, DRAWINGS, CHARTS, TABLES — Give Nearly 200,000 Vital Facts On:

Engine overhaul — Electric system — Fuel system — Cooling system — Clutch — Transmission — Universals — Rear End — Wheels — Brakes — Front End — Shock absorbers — Steering — Ignition timing — Lubrication — Valve adjustments — Engine specifications and clearances — Generators — Starting motors — Starter controls — Carburetor adjustment — Automatic chokes — Gasoline gauges — Oil filters — Cylinder head tightening — Generator controls — Clutch boosters — Headlamp adjustment — Brake boosters — Wheel alignment — and hundreds of other detailed subjects.

PRICE ONLY **\$3**

Your Money Back if not Satisfied

ORDER C. O. D. NOW!

MoToR, Book Department, Room 500, 572 Madison Ave., New York

Please rush me copy of MoToR's 1941 Factory Shop Manual. I will pay postman \$3 plus a few cents delivery charge; but it is understood that if book does not satisfy me I may return it within 7 days (and in its original condition) and have the \$3 purchase price refunded immediately.

NAME _____

ADDRESS _____

CITY _____

Say you saw it in Popular Mechanics!

"Hi Fellers! I'M GETTING A GRETSCH DRUM THIS CHRISTMAS!"



You'll never forget the thrill of owning your first real drum... a GRETSCH DRUM... the kind that big-name drummers play, stars like Bernie Mattinson, Billy Gladstone, O'Neil Spencer. Drums that big band leaders prefer above all others. Here's a present for you ambitious chaps that leads to a money-making career later. No tedious lessons necessary; playing a drum comes naturally to any regular boy! Cultivate a hobby today that can make big money for you tomorrow.

Send penny postcard for FREE DRUM Catalogue and full information about EASY-PAYMENT Plan and FREE TRIAL through your GRETSCH dealer. Address Dept. PM-121.

The FRED. GRETSCH MFG. CO.
Musical Instrument Makers Since 1883
60 BROADWAY, BROOKLYN, N. Y.

**EASY TO PLAY
★
EASY TO PLAY**

GRETSCH also offers SUPER VALUES in Guitars, Saxophones, Trumpets, Trombones, Accordions. Send for FREE catalogue. Mention instrument.

Want a Career in Photography?

Ever consider photography as a money-making career? Fascinating field. Splendid opportunities. Practical, thorough, individual training under expert personal guidance. Commercial, News, Portrait, Advertising, Motion Picture, and Color Photography. Learn for pleasure or career. Personal Attendance and Home Study courses. Booklet FREE!

NEW YORK INSTITUTE OF PHOTOGRAPHY
10 West 33 Street (Dept. 49) New York City



WIRING

VOL. VII AUDELS NEW ELECTRIC LIBRARY—A MASTER BOOK ON WIRING
728 PAGES, 1200 ILLUSTRATIONS. \$1.50

House and Power Wiring Diagrams—Problems and Calculations

fully explained in clear practical language, easy to use and understand including helps and hints for all electrical workers that will save time, trouble and money.

AUDELS NEW ELECTRIC LIBRARY— A progressive Home Study and Reference Course in applied electricity. Easy to understand. Questions and answers plainly written for a complete working knowledge of modern electrical practice, necessary to every electrician, engineer, mechanic and student.

LEARN THE AUDEL WAY! You ask the question—Audels New Electric Library gives the answer—9500 simplified outlines, graphic illustrations and precise explanations covering Construction, Operation and Machine Maintenance.

BOOK A MONTH PLAN— Order the volume that interests you—today! We will send that volume on 7 days' free trial. If the book helps you, send us \$1.50. If it does not help you, mail book back to us.

FREE EXAMINATION COUPON

Theo. Audel & Co., 49 W. 23rd St., New York City

Mail Vol. VII on 7 days free trial. If O.K. I will remit \$1.50 otherwise I will return it. Also please send further information about the Electric Library—no obligation unless I am satisfied.

Name.....

Address.....

Occupation.....

Reference.....PM

NEW 25¢ LIBRARY SHOWS YOU HOW TO SAVE MONEY - MAKE MONEY

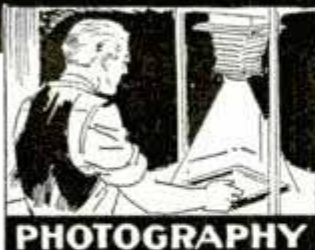

PHOTOGRAPHY



HOME

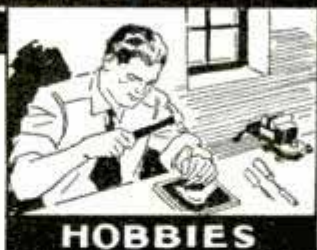

HOBBIES



Money Making Opportunities

TESTED IDEAS . . . COMPLETE PLANS . . . USEFUL INFORMATION
COSTING THOUSANDS OF DOLLARS

NOW YOURS FOR ONLY **25¢** PER VOLUME



CHECK ANY FOUR...GET ONE FREE...SEND NOW

1. **PHOTO ENLARGERS** —how to build either a condenser lens type or simple vertical and horizontal enlargers.
2. **OUTBOARD RUNABOUT**—fast, V-bottom boat, 14 feet long which you can build for from \$30 to \$40.
3. **ELECTROPLATING**—Expert tells secrets of plating with copper, nickel, chromium, gold, silver, lead, zinc and cadmium.
4. **WOODWORKING POWER TOOLS**—Build your own power tools, mostly from old automobile parts at low cost.
5. **WELDERS**—electric are welder which operates on 110-volt, 50 or 60 cycle. Also a 110-volt, 60 cycle spot welder.
6. **COLORING CONCRETE GARDEN FURNITURE**—Complete details so you can make for fun or profit garden benches, pottery, flower boxes, etc.
7. **BIRD HOUSES**—Easy to build homes for all kinds of birds. Also how to build bird baths, cages, feeding stations.
8. **FARM AND GARDEN TRACTORS**—Two tractors you can build from old automobile parts at low cost.
9. **TAXIDERMISTRY**—It's fun to mount your own birds, fish and small animals, and obtain life-like poses.
10. **AUTOMOBILE KINKS**—You can easily save \$100 a year on your automobile by following these hints.
11. **CLEANING FORMULAS**—How you can make your own cleaning preparations for woodwork, automobiles, paint brushes, wallpaper, etc.
12. **COSMETIC FORMULAS**—With these formulas it is easy to make your own hand lotions, shaving creams, etc.
13. **TREASURE FINDERS**—Build your own treasure finder and metal locator. Details for both large and small radio types.
14. **LOG CABINS AND TOURIST COTTAGES**—Two distinctive types of year-round cabins of logs. All details given.
15. **FOOD PRODUCTS FORMULAS**—100 formulas for making everyday necessities, etc.
16. **GARDEN WOODWORK AND FURNITURE**—Gives details for fixing up your outdoor living room and beautifying your garden.
17. **SOLDERING AND BRAZING**—Tells how to use new fluxes and solders.
18. **MIRACLE PLANTS**—How you can mix your own Vitamin B1 solution to grow plants either in your home or garden.
19. **HOME WORK OPPORTUNITIES**—Simple handicraft projects anyone can do to earn money in their spare time.
20. **TELESCOPES**—Complete details on a 4-in reflecting telescope you can build for less than \$10.
21. **METAL PLATING AND COLORING**—This gives dozens of essential formulas for metal plating, coloring and decorating.
22. **FAST ICE YACHT**—Build your own Class-E ice yacht. Every detail of the construction and sailing of this craft is carefully explained.
23. **EXTRA ROOMS IN ATTIC**—Add to the value of your home by building an extra room in your attic.
24. **BASEMENT PLAYROOMS**—Get away from unsightly coal bins and build an attractive playroom in your basement.
25. **PHOTO PRINTER AND DRYER**—Now you can build your own printer easily. In addition there is a split-second timer.
26. **SAILING DINGHY**—This 14-foot boat combines strength and light weight. It carries 140 sq. ft. of canvas and weighs about 350 pounds.
27. **TRAILERS**—Midget house and utility type trailers which anyone can build in spare time.
28. **METAL CRAFT**—Here is one of the most interesting of all hobbies. Simple instructions for brass tapping and the making of novelties.
29. **MAGIC FOR EVERYBODY**—Simple tricks to puzzle your friends "Mind reading," card and match tricks.
30. **CANOEING**—You can easily build your own 16-ft. Indian type canoe.
31. **LOWER YOUR FUEL COST**—Practical little kinks that will save you hundreds of dollars in the heating of your home.
32. **WOOD TURNING**—Tells how to use a home workshop lathe correctly. Covers use of chisels, facemate work and split turnings.

SAVE MONEY - MAKE MONEY BY DOING INTERESTING THINGS EASY WAY... IT'S FUN!



Free! ONE BOOK FREE WITH EVERY ORDER OF 4
SEND NO MONEY!

Get one book free with your order of four (4). Just encircle book numbers and mail now! Discover the thrill of doing things yourself! Learn how to save money, make money, build things, etc. Every Popular Mechanics Book contains ideas, plans and information that have cost hundreds of dollars to test and prove. They're written in non-technical language. Only simple household tools required. Expensive photographs and diagrams illustrate every detail. Yet the cost is amazingly low—only 25c per volume!

10 DAYS FREE INSPECTION Read descriptions at left. It's best to select at least 4 books—get one free! Orders under \$1.00 must be accompanied by cash. So encircle 5 on coupon below. Clip, mail and send no money. Just pay postman \$1.00 plus postage C.O.D. fee. You have ten (10) full days to read, and inspect every page. You must be satisfied or it costs you nothing! You take no risk!

Your Satisfaction Is Guaranteed

Select any of these books with utmost confidence. They will enable you to make and have many things you otherwise could not afford! Order now!

Free Catalog!

Get this great 128-page catalog free! Lists hundreds of helpful books and plans. Order books and send for catalog now!



MAIL COUPON NOW/SEND NO MONEY

Popular Mechanics Press
200 E. Ontario St., Dept. 1240
Chicago, Illinois.

Please send me books I've encircled and free catalog. I will pay postman upon arrival for books plus postage.

1	2	3	4	5	6	7	8	9	10
11	12	13	14	15	16	17	18	19	20
21	22	23	24	25	26	27	28	29	30
31	32								

Name

Address

City..... State.....

NOTE: Orders under \$1.00 and all orders outside U. S. A. must be accompanied by remittances.

POPULAR MECHANICS PRESS 200 East Ontario St.
Dept. 1240, Chicago, Ill.

Success in Life Begins at Home

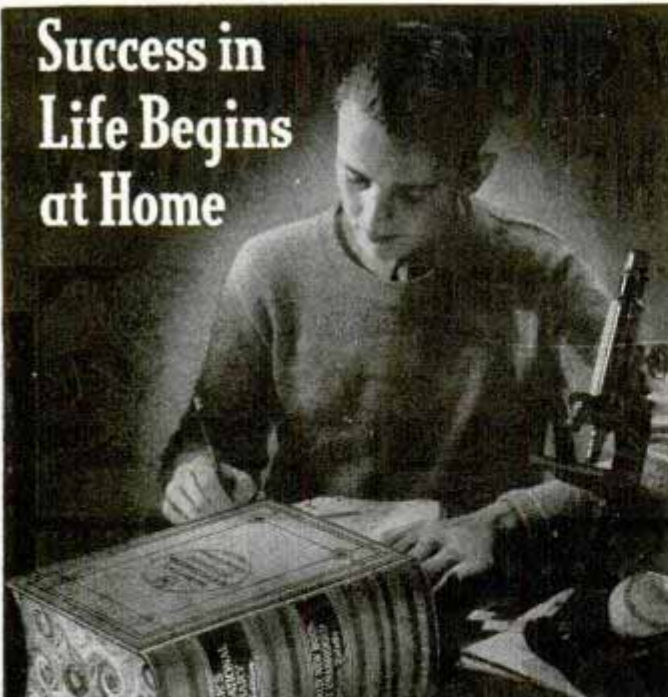

Give your child the benefit of this universal question-answer during his formative years. The New Merriam-Webster offers a wealth of information in every field of knowledge. 3350 pages. At bookdealers and stationers, or write for free illustrated booklet to G. & C. Merriam Company, Dept. 502, Springfield, Massachusetts.

WEBSTER'S NEW INTERNATIONAL DICTIONARY • Second Edition

MAKE POULTRY PAY YOU A GOOD LIVING FOR LIFE



POULTRY RAISING PAYS GOOD PROFITS FOR THOSE WHO KNOW ITS SECRETS

Healthful, interesting occupation for whole or part time in country, village or city suburbs. Win independence of low wages, uncertain employment with your own Poultry Business. **TRAIN AT HOME IN SPARE TIME TO BE A SUCCESSFUL POULTRYMAN** For over twenty years, Harry M. Lamon, formerly Senior Poultryman, U. S. Dept. of Agriculture, has been teaching people how to make money in their own business of preparing them for well-paid jobs in the Poultry Industry. His famous Home Study Course, endorsed by graduates, successful poultrymen, colleges, shows success secrets of experts, how to avoid costly mistakes, to increase profits. Time tested methods plus complete, modern scientific advancements all covered in these fascinating, easy-to-learn lessons.

FREE BOOK TELLS HOW

Whether you are keeping chickens now or are just planning to enter the Poultry Business, you should read Mr. Lamon's FREE BOOK describing his courses of Home Study Training.



Mail NOW for FREE Book

Harry M. Lamon, Pres. NATIONAL POULTRY INSTITUTE Dept. 50-R, Adams Center, N. Y.

Dear Mr. Lamon: Send me your FREE BOOK, "HOW TO RAISE POULTRY FOR PROFIT." I want to know more about my opportunity to make a good living for life in this business. Also send list of testimonials.

NAME:
 STREET:
 TOWN: STATE:

Say you saw it in Popular Mechanics!

U.S. GOV'T JOBS

SHORT HOURS-GOOD PAY -VACATIONS-PENSIONS

Stop worrying about strikes, layoffs, hard times! Get on the government payroll. No special education or experience usually required. Short hours; steady work; vacations. Open to men and women citizens, of ages 18 to 50.

SEND FOR FREE BOOK

It tells about government positions; what to do to get job you want. Mail letter or postal card now for FREE book "How to Secure a Government Position". Address PATTERSON SCHOOL, 812 Mercantile Bldg., Rochester, N. Y.

RAILWAY POSTAL CLERK

Start at \$1850 a year

INSPECTOR OF CUSTOMS

Start at \$2100 a year

RURAL MAIL CARRIER

Start at \$1800 a year

POST OFFICE CLERK

Start at \$1700 a year

New York Electrical School Established 1902
 Ask for free illustrated booklet
 44 West 17th St., N. Y. C.

RELIABLE MEN
 Wanted to operate movie circuits in theatreless communities. Earn \$50.00 to \$100.00 weekly. No experience necessary. Everything furnished. Write Southern Visual, Dept. PM-11-3, Box 2404, Memphis, Tenn.

ARTISTS MAKE MONEY

Find out your ability. Send name, age, occupation and address for Free Vocational Art Test. Federal Schools, Inc., 12130 Federal Schools Bldg., Minneapolis, Minn.



U. S. Manufacturers desire men to learn Electric Arc Welding and get practical experience under actual production conditions in the laboratories of the School of Engineering. Moderate training fee. Accepted applicants will be fully trained until ready to pass rigid test and assisted in securing employment.

AIRCRAFT WELDING

"We want more planes!" That's the demand on every side. No wonder there is a shortage of aircraft welders. Other industries need welders, too. There's almost no limit to what Milwaukee School of Engineering trained welders can do. They get good pay because they know the "how and why" of Welding, Metallurgy, Drawing, Blueprint Reading, Set-up Work and Fabrication—and they enable manufacturers to cut production costs. Remember—industries need practical trained Aircraft Welders, Arc Welding Operators, Technicians and Welding Engineers and Air Conditioning and Refrigeration Technicians. Don't be satisfied to struggle along on ordinary, hit-or-miss jobs with poor pay—when in a short time you can become a trained specialist. Send coupon today—classes begin within a month.

MILWAUKEE SCHOOL of ENGINEERING

Institute of Electrotechnics

P. M. 1240 North Broadway and E. State, Milwaukee, Wis.

- Without obligation send Free Booklet "The Dawn of a Gigantic Industry and its Outstanding Opportunity." Also tell me how to become an
 Arc Welding Operator (3 mo.)... Air Conditioning & Refrig. Tech. (4 mo.)...
 Air Craft Welder (3 mo.)... Radio Serviceman (6 mo.)...
 Welding Technician (3 mo.)... Commercial Electrical Engineer (1 yr.)...
 Welding Engineer (1 yr.)... Commercial Radio Engineer (1 yr.)...
 Electrical Engineer... Student Loan Plan
 B. S. Degree (4 yrs.)... Earn Part Expense Plan

Name: Address:
 City & State: Arc: P.M. 1240



Easier THAN EVER

To Master, this New 1941 P-A
21 Major Improvements

* Just touch a key and blow normally; you can't miss. So easy, and such beautiful tone. Nothing to compare with these new P-A Saxes, Clarinets, Trumpets, and other P-A instruments. Fully guaranteed; your success assured. See your music dealer or write direct for beautiful **FREE BOOK**. No obligation. Easy terms. Greatest fun, easiest with P-A.

PAN-AMERICAN 1420
1203 P-A Bldg. Elkhart, Ind.

Have You Tried a P-A in the Last 30 Days?

DRAFTING

DRAFTSMEN NEEDED in all manufacturing and building lines—\$30 to \$50 a week and UP. Learn *quickly* at home in spare time. *Selective Employment Service*. **FREE Bulletin**. No obligation. *Write immediately!*

American School
Dept. DR-945, Drexel & 58th, Chicago

NEW WRITERS NEEDED *Send for Test*

Our unique **FREE** Market-Test shows new writers the way to write for pay. Learn what you may write best—and sell! Mail postcard **Today!** No obligation.

COMFORT WRITER'S SERVICE, DEPT. 550, ST. LOUIS, MO.

LEARN MONEY-MAKING CARTOONING

Same Simplified Method that has helped train creators of "Ferry & Pirates," "Wash Tubbs," "Out Our Way," "Winnie Winkle," "Reg'lar Fellers," "Strange As It Seems," "Secret Agent X-9," and many others. Earn while learning. Rush 10c for Picture Chart (to test your ability), and full details. (State age.)

THE LONDON SCHOOL, 15-D National Bldg., Cleveland, Ohio

TENNIS

SAVE on our NEW LOW PRICES

Earn money—save money re-stringing rackets! Buy Gut tennis strings direct from factory. Silk strings; Restringer's vises, equipment, instructions. Catalog **FREE H. E. WILLS CO., 1047 W. 47th ST., DEPT. PM120, CHICAGO**

MONEY AT HOME

Earn cash daily raising mushrooms for us in cellar, shed, garage. We buy all you raise at guaranteed prices, instruct you, and furnish materials. No experience necessary. (Established 1908). Write today for amazing "Guaranteed Success Plan" and valuable book with pictures—all free.

UNITED MUSHROOM CO., 3848 Lincoln Ave., Dept. 308, Chicago.

A Billion Ideas

POPULAR MECHANICS BOOK CATALOG

Every man who reads Popular Mechanics will want this new big illustrated catalogue of practical, helpful and money making books.

It describes over 1750 informative and authoritative books and 400 homecraft plans. It's an amazing guide to the world's **BEST** practical books and plans. You must see it to appreciate its value. Only limited edition printed. Send your name and address on penny post card. Do it today.

Popular Mechanics Press
208 E. Ontario St., Chicago

SEND YOUR NAME TODAY



WANT A GOVERNMENT JOB?



START \$1260 to \$2100 Year

GET READY NOW FOR 1941 EXAMINATIONS.

Railway Postal Clerks

Railway Postal Clerks get \$1,900 the first year regular, being paid on the first and fifteenth of each month. (\$79.17 each pay day.) Their pay is automatically increased yearly to \$2,450. Advance may be had to Chief Clerk at \$2,700 a year. (\$12.50 each pay day.) Men, 18 to 35.



3 Days On—3 Days Off—Full Pay

Railway Postal Clerks on long runs usually work 3 days and have 3 days off duty or in the same proportion. During this off duty their pay continues just as though they were working. They travel on a pass when on business. When they grow old, they are retired with a pension.

City Mail Carriers, Post Office Clerks

Clerks and Carriers now get \$1,700 the first year on regular and automatically increase \$100 a year to \$2,100 and \$2,300. Open to men—women 18 to 48.



Ass't Statistical Clerk

Open to Men—Women 18 to 50. Entrance salary \$1,620 year. Appointments as Statistical Clerks and Clerks in the Departments at Washington, D. C., and elsewhere are made from this examination.

Many Other Positions

Many other positions are obtainable. Those wishing these positions should qualify at once.

Get Free List of Positions

Fill out the following coupon. Tear it off and mail it today—now, at once.

This small investment may result in your getting a big-paid government job.

FRANKLIN INSTITUTE, Dept. K-173, Rochester, N. Y.

Rush to me, entirely free of charge (1) a full description of U. S. Government Jobs; (2) Free copy of illustrated 32-page book, "U. S. Government Positions and How to Get Them"; (3) List of U. S. Government Jobs; (4) Tell me what to do to qualify for one of these.

Name.....

Address.....

Use This Coupon Before You Mislaid It. Write or Print Plainly

When writing please mention Popular Mechanics

Replace with a **DELCO** battery



Whatever the make or model of your car, there is a Delco battery to meet your needs . . . a Delco battery with the same quality construction and advanced features of design that assure quick starting and long battery life on 43 per cent of all new cars being sold in America.

Leading cars in every price field come equipped with powerful Delco bat-

teries because their manufacturers know the dependability this Delco-Remy product provides. When you need a new battery for your car, regardless of make or model, there is no surer way to get real value than to follow the example of these car manufacturers.

Replace with a Delco battery . . . there's a Delco battery dealer near you.

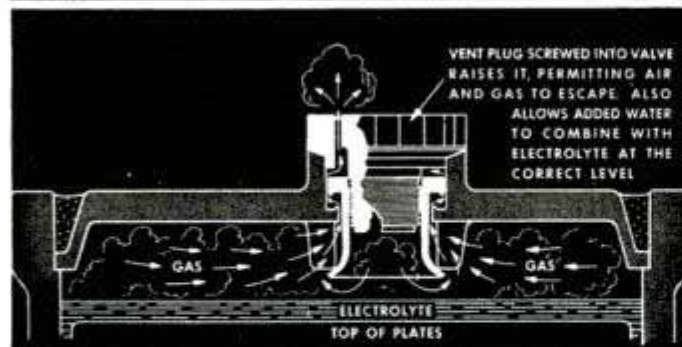
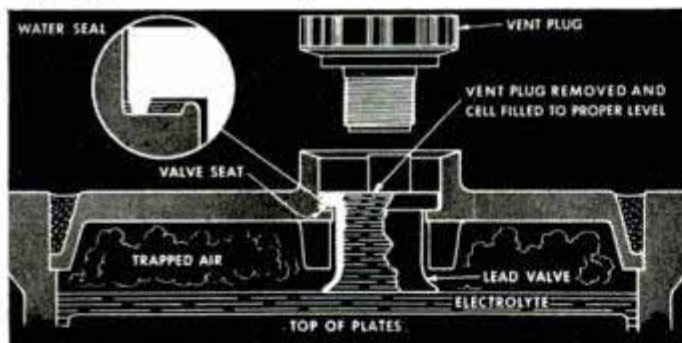

THE NEW DELCO ELECTRO-LEVEL *Safeguards against over- filling . . . automatically*

Delco batteries now feature the Delco Electro-Level, which simplifies the filling problem and prevents over-filling. It goes into action immediately and automatically when the vent plug is removed. A valve sleeve drops down and forms a water-sealed air lock in the cell when the right electrolyte level is reached; there are no extra steps—it is entirely automatic in operation.

Delco-Remy

Anderson, Indiana

World's Largest Manufacturer of Automotive Electrical Equipment

Popular Mechanics Magazine

REGISTERED IN U. S. PATENT OFFICE AND CANADA

WRITTEN SO YOU CAN UNDERSTAND IT

Vol. 74

DECEMBER, 1940

No. 6

HUNTING the SECRET of LIFE

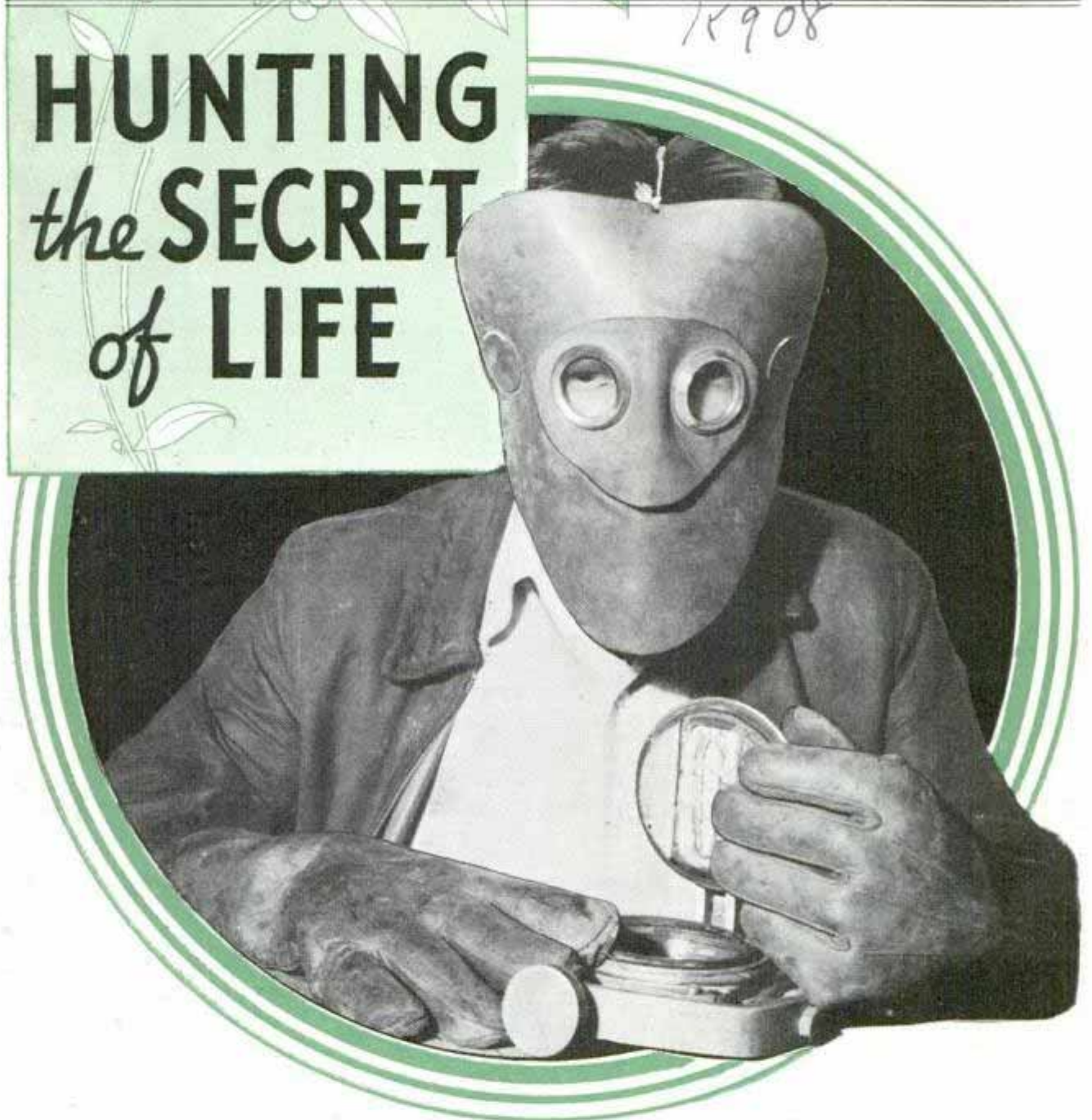

Laboratory worker protected by lead mask and gloves is shown removing radio-active carbon from the target of the cyclotron. Radio-active carbon dioxide is created by bombardment

IF THE sun's energy were delivered to the earth in the form of coal instead of light rays we might expect to find a coal pile weighing seventy or eighty tons on each acre of ground at the end of each month.

Scientists estimate that during the ninety-day summer growing season enough solar energy to equal 243 tons of coal is received by an acre of ground. One per-

cent of this is used by plant life for transforming chemicals into food, and the rest is wasted.

Sunlight is a cheaper source of power than coal or gasoline but only plants have the ability to use it efficiently. By photosynthesis they employ light to transform carbon dioxide from the air, and water from the ground, into sugar and other car-

DECEMBER, 1940

Cont. Thomas E. Stinson, Jr. 801
10442
Heinrich

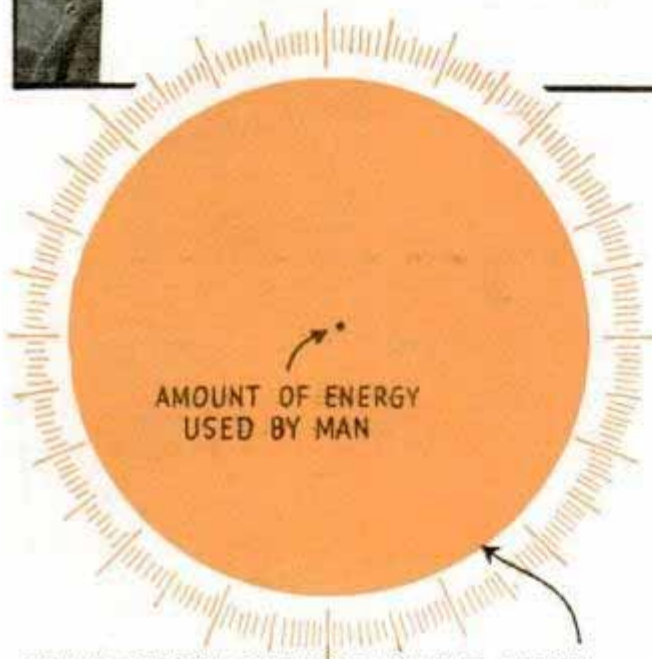
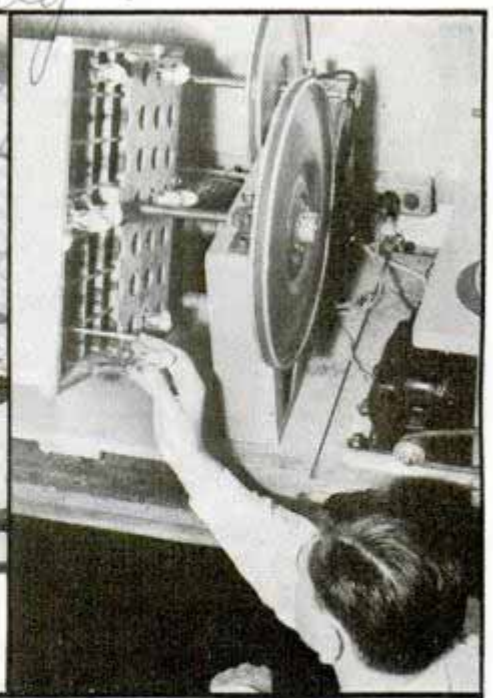

Top, left, citrus seedlings in water-culture bath. By controlling bath ingredients, presumably amount of chlorophyll in leaves can be increased or decreased, aiding in studies of photosynthesis. Right, agitating green and purple bacteria so each receives light quota. Circle, comparing sun's energy with that man uses. Bottom, plant algae being fed radio-active carbon dioxide in constant-temperature bath under electric light

No one expects that photosynthesis will ever be used to manufacture foods artificially. The vegetable kingdom is already doing that efficiently for us. But science would find a thousand and one important jobs for photosynthesis in effecting chemical transformations that are not now possible. For one thing, it might be the key to creating hydrocarbons at will, a discovery that would free civilization from the

bohydrates. This is a chemical reaction that not even the most advanced chemists can duplicate. The method that plants have perfected is one of the most perplexing puzzles yet unsolved by science and is the objective of various research groups concentrating on studies of plant mechanics.

Charles F. Kettering's statement that he wants to find out "why grass is green" is one way of expressing the problem, while others suggest that we will have gone a long way toward solving the mystery of life when the mechanism of plants is understood, because plants alone create their own food from the elements. All other forms of life are parasites on the vegetable kingdom.



worry of its dwindling petroleum reserves. Too, photosynthesis might provide a cheap way for creating vitamins.

Chlorophyll, the green coloring matter in plants, is the agent that captures and uses sunlight. It is a complex compound that contains iron, magnesium and other material, and is organized like the hemoglobin of blood. A score of million particles of this pigment occur in a square inch of leaf surface, contained in special chloroplast cells. It can be extracted as a dark-green substance, and recently has been used effectively in treating common colds and other bacterial infections. In the test tube, unfortunately, it has none of the photosynthetic qualities that it has in a live plant.

A square yard of leaf surface, it is estimated, produces one-third of an ounce of sugar a day, or nearly three pounds in a growing

(Continued to page 152A)

Top, target in place in cyclotron for bombardment. Center, photomicrograph showing spiral nature of tubes in stem of plants that conduct water to leaf cells where sugars are manufactured. Bottom, left, closeup of cross-section of plant showing chloroplast cells and tubes. Right, solar water heater

Photos (right and below) by Eldon Cairns

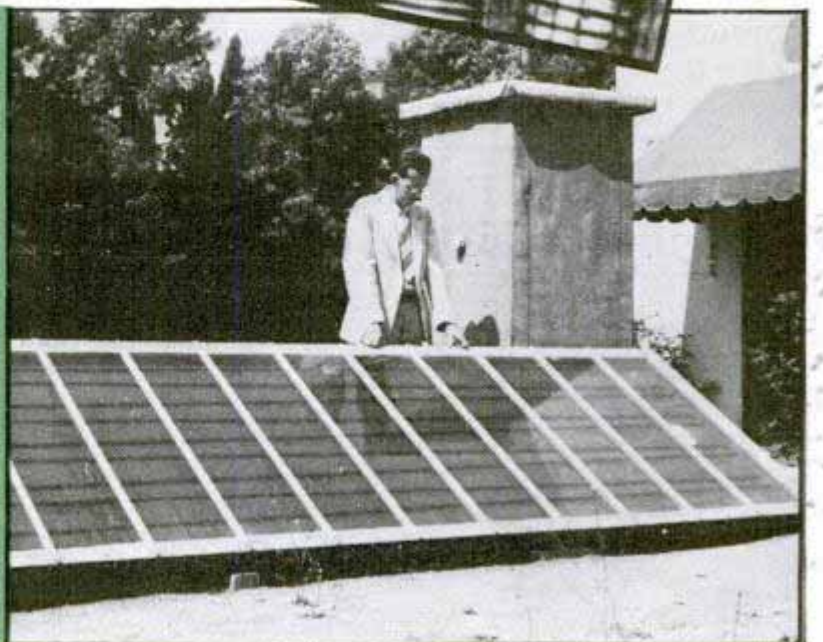
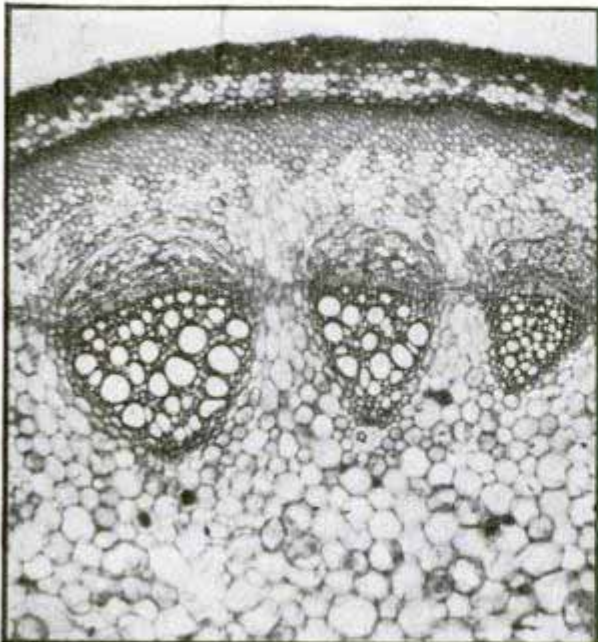
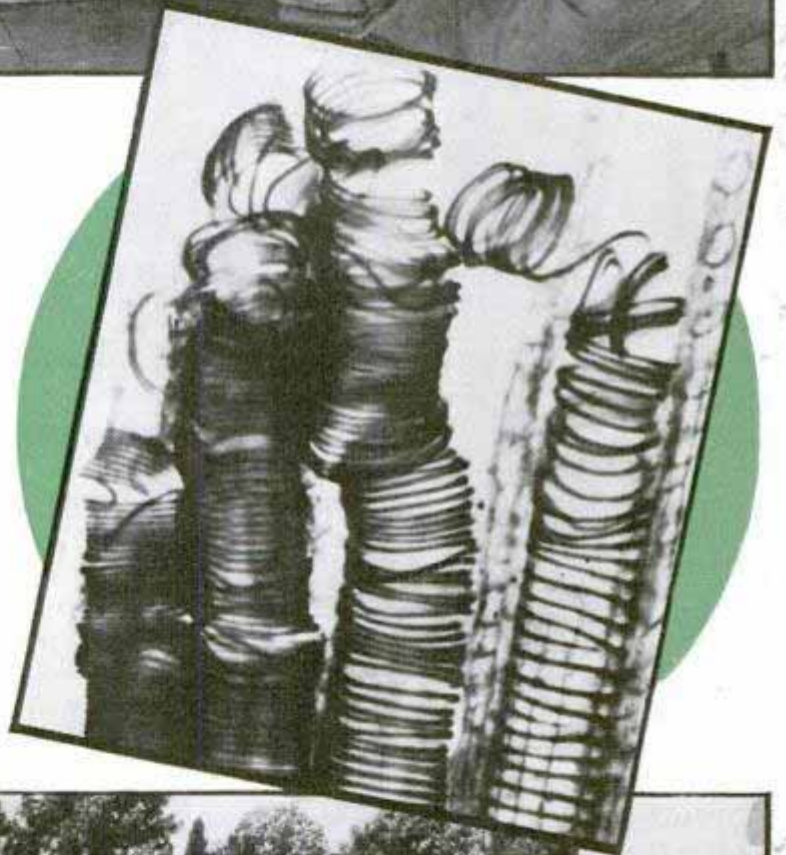

Gas Unit Plugs into Furnace for Between-Season Heating

\$49.50



When steady heat is not needed the housewife simply plugs the automatic gas-burning unit into the door of the furnace

For the fall and spring seasons, when changeable weather makes it difficult to keep the house at an even temperature with a hand-fired furnace, there is a "plug-in" gas unit that anyone can install in the furnace. Thermostat-controlled, it supplies heat automatically on chilly days and is cut off on Indian summer or warm spring days, eliminating the bother of building a furnace fire one day and letting it die or overheat the house the next. The unit is portable, weighing only twelve pounds, and is attached easily without nuts, bolts or wrenches, and without any pipes to disconnect. When winter cold arrives the unit is withdrawn and the furnace operated in the usual way. The gas heater is designed to fit in the door of warm-air furnaces or hot-water boilers.

Horn Ring Is Easy to Install in Place of Button

Par Horn



No tools are needed to install a chrome-plated horn ring, now on the market, on the horn button of a Ford, Mercury or Zephyr car. It forms a semi-circle inside the low-

er half of the steering wheel, the connection to the center button lying flat along the two spokes of the wheel. To install it, first remove the original horn button by giving it a quarter-turn to the left. This button and the spring beneath are replaced by special ones as the new horn ring is applied. Then give the button a quarter-turn to the right and the installation is complete.

Trigger-Fed Floor Nailer Stops Hammer Marks

Many difficulties of nailing floors are overcome with a machine claimed to do the job neater and fifty per cent faster. It reduces split tongues and surfaces, and does away with cut or bruised fingers often caused by wood splinters or burrs on nails. Weighing but three pounds, the nailer is easy to handle, automatically placing one flooring nail at a time at the correct angle so the operator can drive and set it with one or two blows on a plunger, without making hammer marks on the floor. A pull of the trigger slides the nail down a track into position for nailing. The magazine holds 250 nails. Any type of tongue-and-groove boards can be nailed with the machine, and when fitted with a special shoe it can be used for surface nailing.



Floor nailer drives and sets nail with plunger; trigger operated with left hand feeds a nail at a time

Charleslam, Mass
39 Warren Ave.
Eli Natale D'Voodo, Inc

Public Service Co. of Northern Illinois
72 W. Adams, Chicago
Peters and Russell, Inc.
Starnesfield, Ohio

10442 Hebrew Lane Los Angeles

ROBOT TELEVISION BOMBER

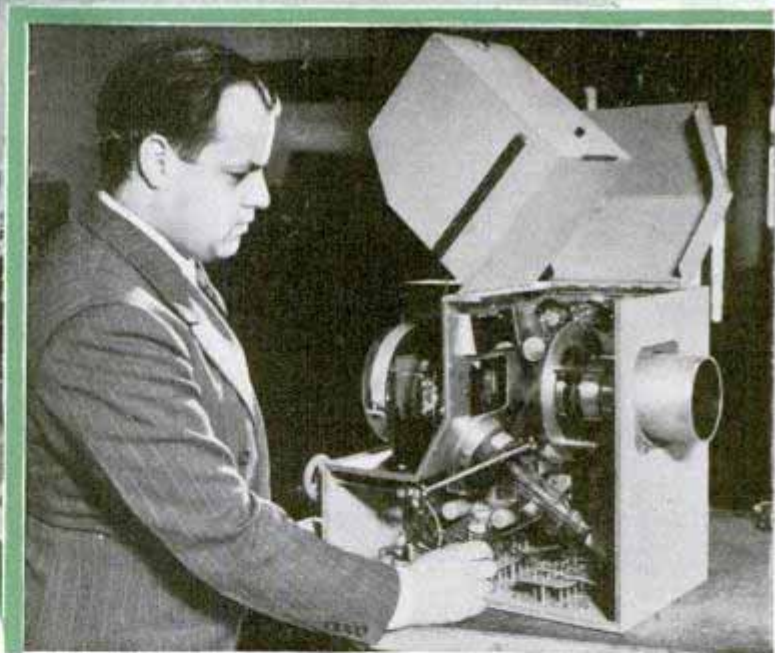
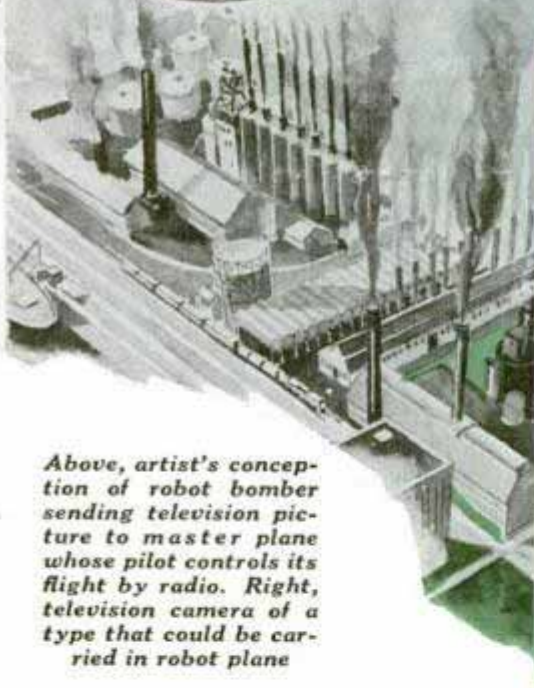
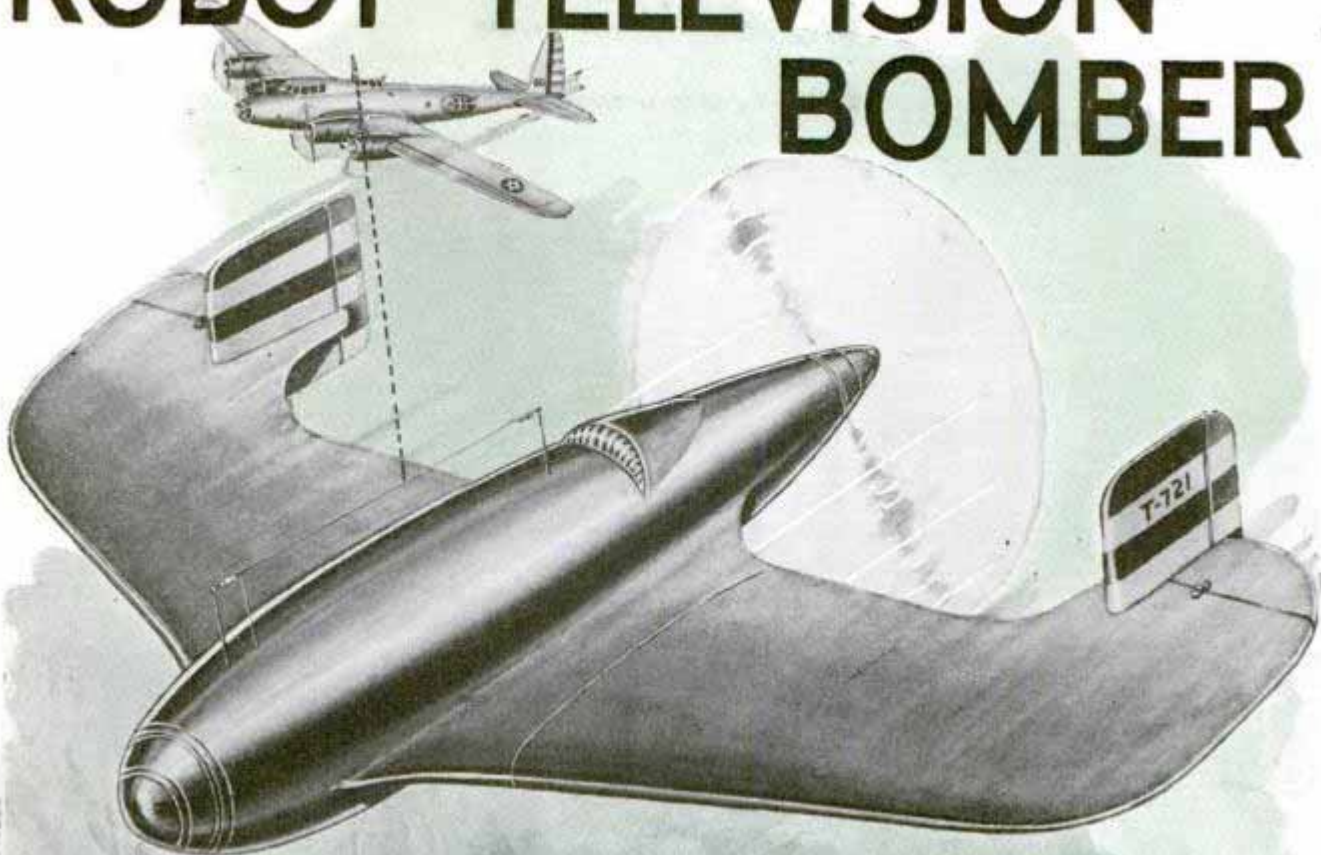

Above, artist's conception of robot bomber sending television picture to master plane whose pilot controls its flight by radio. Right, television camera of a type that could be carried in robot plane

A ROBOT bombing plane, literally a flying bomb with a mechanical eye for seeking out its target, is the proposal of Dr. Lee De Forest and U. A. Sanabria, Chicago television engineer, who believe that such planes, built at an approximate cost of \$10,000 each, would be a simple and practical method of greatly increasing the accuracy of aerial bombardment.

In flight such a plane would be steered and operated by radio from a control plane that could remain as far as ten miles away.

The engineers envisage a single-engine airplane loaded with either one large or a number of smaller bombs and containing in its fuselage a television transmitter and a radio-command receiver. Using a frequency-modulation circuit, the television transmitter would be hard to "jam" and would radiate a picture of the ground in front or below the robot plane. Using the information relayed to him from the robot plane's television set, the pilot of the control plane would be able to steer the robot

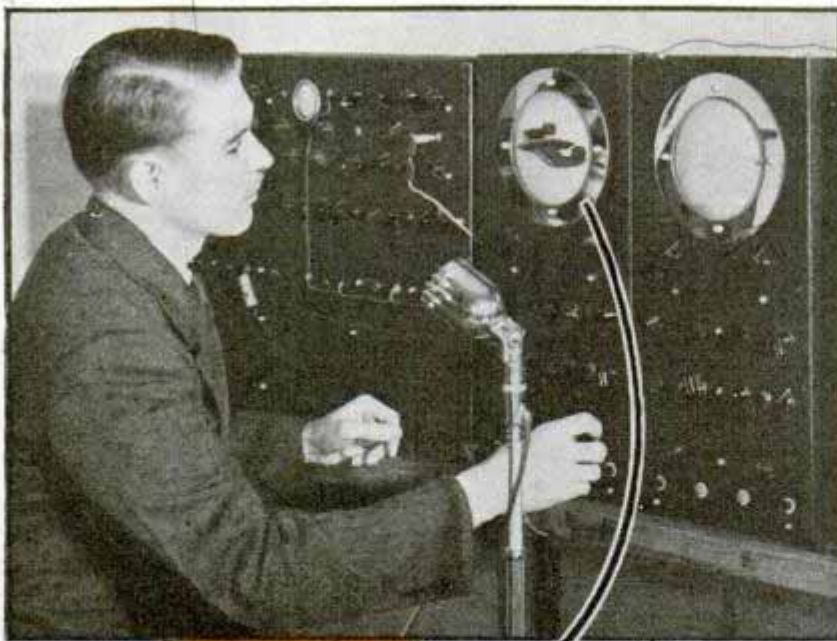

the bomb release devices. The radio control signals would be received by the robot by means of a dipole antenna in the tail, using a copper-tube shielded lead-in that would prevent reception of any signals except those from the control plane.

The flying bomb would be flown from its takeoff field by means of ground radio control, after which the control plane would take over its direction. It could be used for scattering bombs on a number of targets, for flying

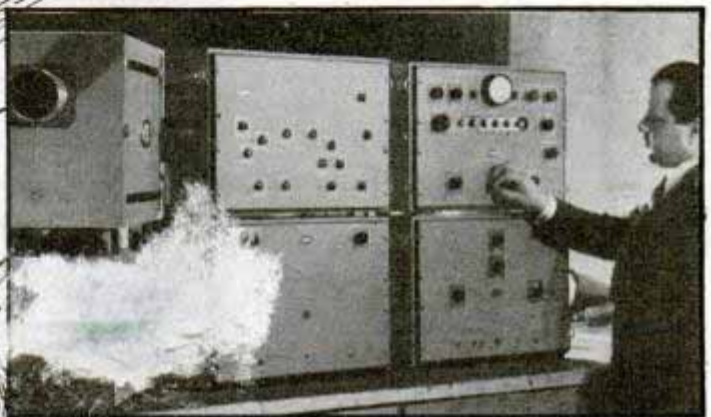
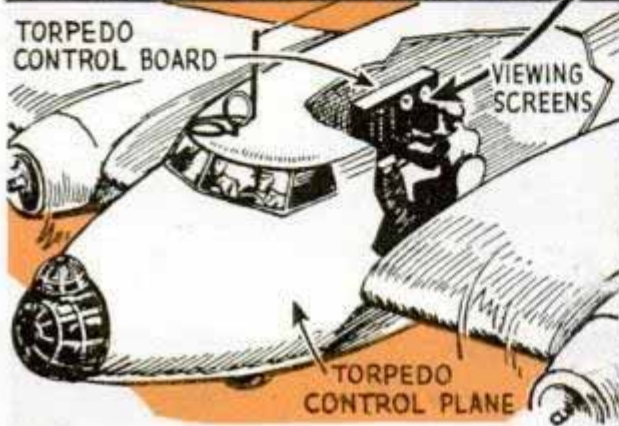

directly over the target and then dive it into the ground. Control of the robot plane would be by means of super-high frequency radio, modulated with super-sonic frequencies. The control pilot would have some ten selector circuits at his command, each circuit operating through a relay on the robot plane to operate a small motor. One motor would control the throttle, two the elevators, two the rudders and ailerons, two the television mirror, one the tele-transmitter, and one or two would control

a super-bomb to one particular target, or for reconnaissance work at low altitude in areas where it could be expected to be destroyed by anti-aircraft fire after at least some valuable information had been transmitted back by its television eye. The project embodies no new or untried devices and the engineers consider that it is entirely practical. On major raids it would be possible for the control plane to direct the operation of a whole fleet of robot bombers instead of a single plane.

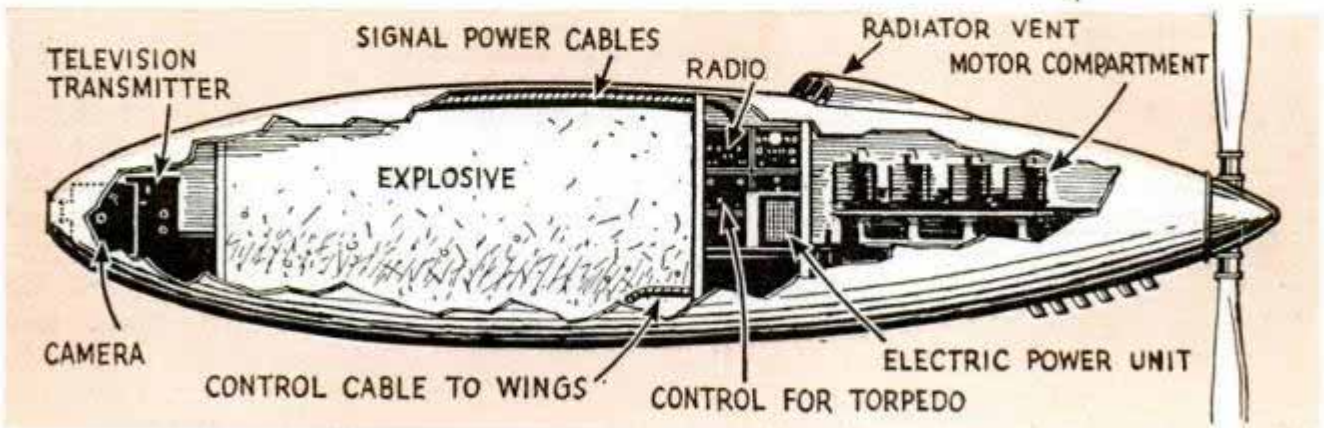

Top of page, television receiver and viewing screen in master control room, with arrow indicating its position in plane; center, right, television camera, control units, amplifier and signal generators used in preliminary tests. Bottom, cutaway drawing of robot as visualized by artist

Chicago
Dec. 1940 168

Speed Lights on Wheels Stop Action at Night



Edgerton

Fast action in night football games this fall was "frozen" by high-speed lights that made possible exposures of $1/34,000$ of a second. The lights were mounted on a rubber-tired carriage which followed the action up and down the field, and as the photographer aimed his camera an assistant aimed the lamps, another turned the current on and off, and another pushed the carriage. Special reflectors permit focusing on distant plays. The light from one lamp was equal to that of about 40,000 fifty-watt household bulbs. The lights are expected to be of especial value in photographing sports events at night.



Ref: Chicago Tribune

The brilliant flash of the battery of high-speed lights captured the fast action of a night football game (top) in an exposure of only about $1/34,000$ of a second. The cameraman and his light crew are shown below. The three lamps in special reflectors produce light equal to 120,000 fifty-watt bulbs. On their rubber-tired dolly the lights could be rolled up and down the sidelines to follow the action of the game

PLANNING *the*

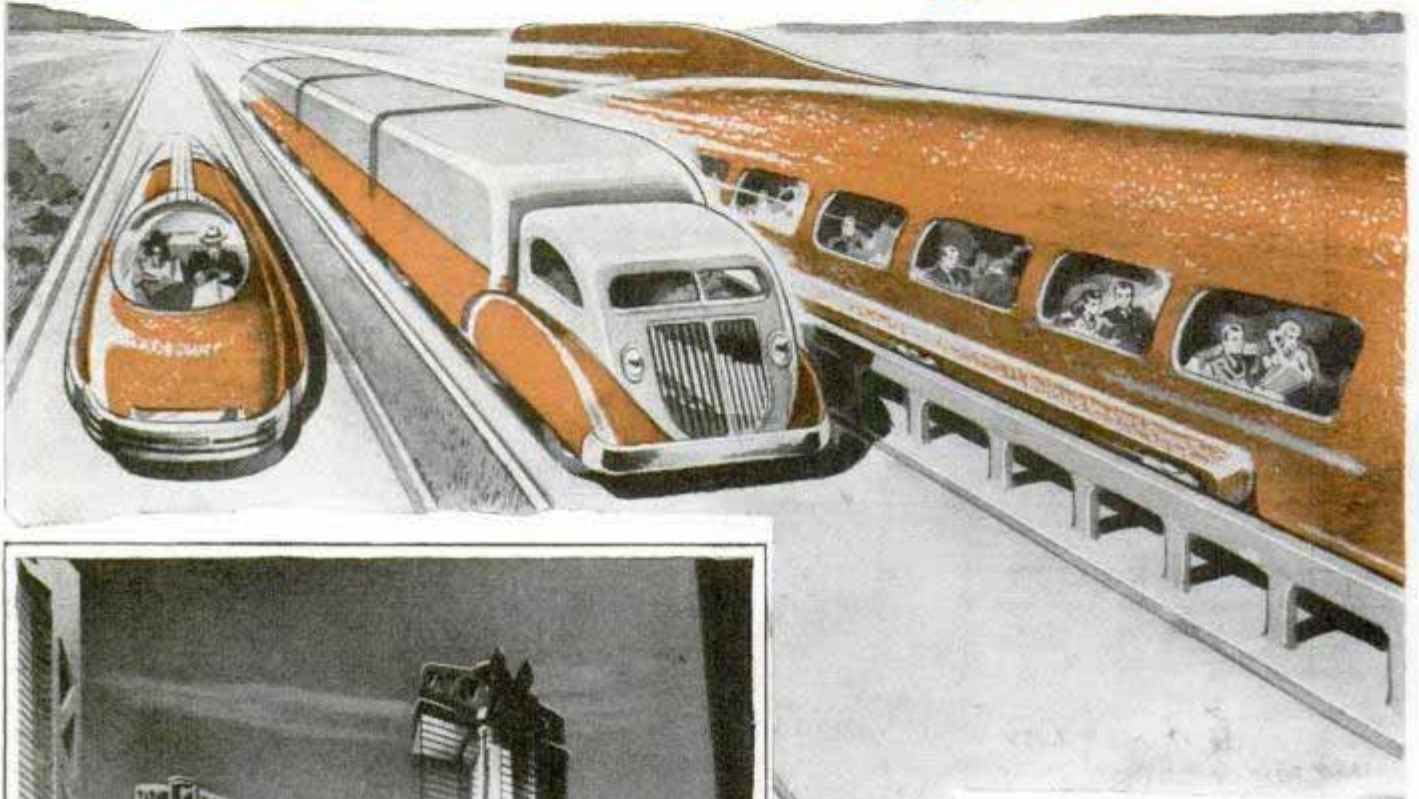
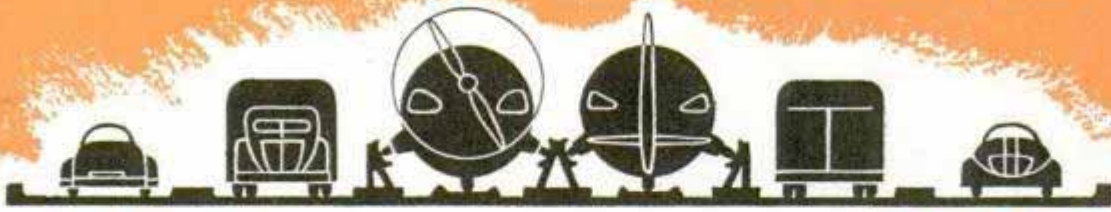

Drawing of transportation system suggested by the author. Above, six-lane system in silhouette. Left, future metropolis as designed by Mr. Teague for U. S. Steel exhibit at New York World's Fair

By Walter Dorwin Teague

Industrial Designer and Author of "Design This Day; The Technique of Order in the Machine Age," published by Harcourt Brace

444 modern life nyc.
A BETTER world than we have ever known can and will be built. But the builders must feel into the future, groping carefully, ready to adapt their plan, at any moment, to new truths and unforeseen conditions that may be revealed as they progress.

Our better world may be expected to make equally available for everybody such rare things as interesting, stimulating work,

WORLD of TOMORROW

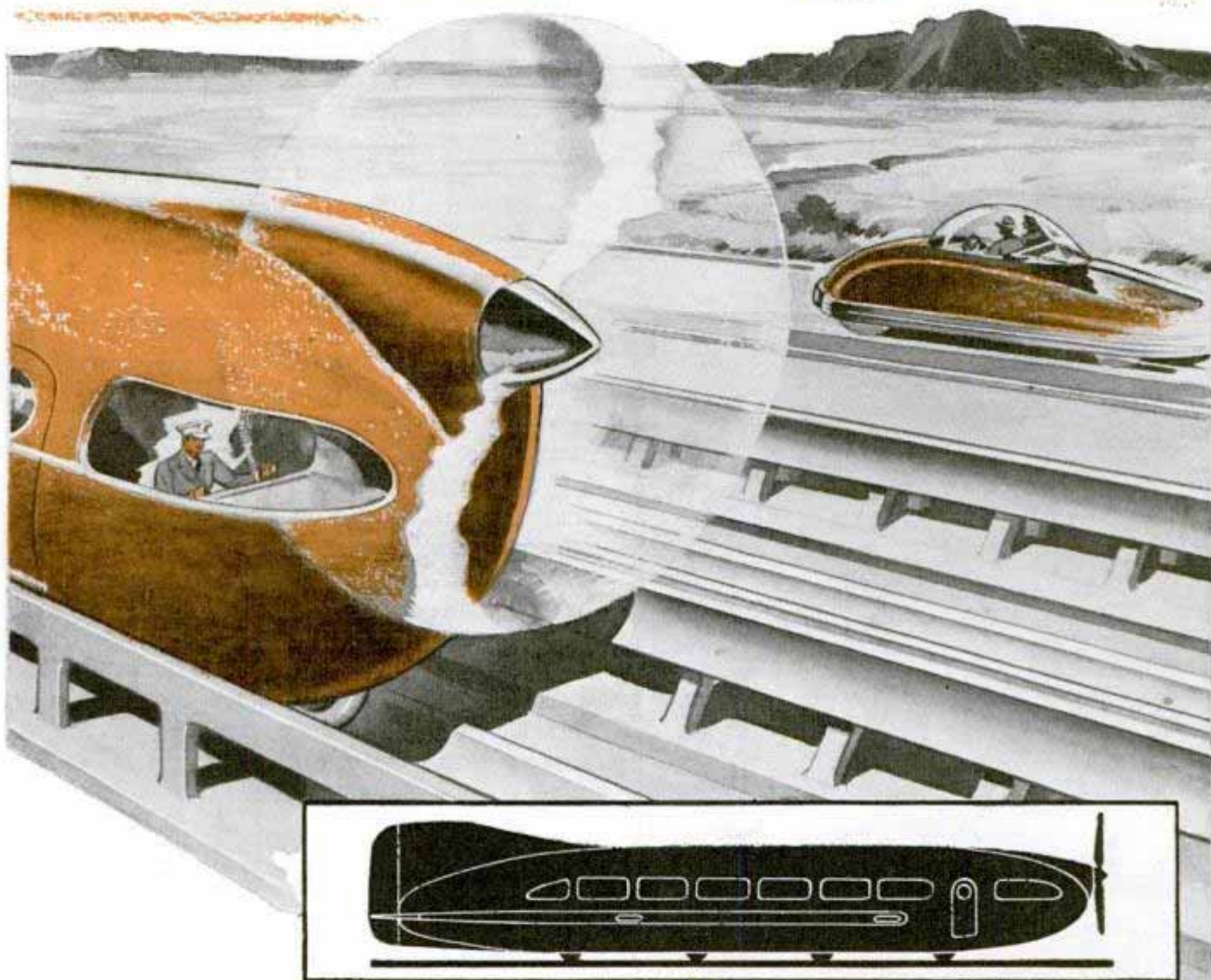

emancipation from drudgery and a gracious setting for daily life, freedom of movement, free exchange of thought, bodily well-being and mental equanimity. But since even such simple conveniences as modern kitchens and bathrooms have not yet become general in America, attainment of these more difficult objectives by a majority of our people is far in the future.

The reform of our railroads is certainly among the most pressing problems confronting us today, because our social and economic system, if it persists, will continue to be based on the free movement of goods and men. Railroads maintain broad

Note that the rail car travels on a single wheel, with supporting wheels at either side. Inset, the car in silhouette. Note tail fin which would make for stability at high speed.



units of relatively small size and low cost, powered by internal-combustion engines and borne on rubber tires. These privately operated, specialized highways then could perform a service which the public highways cannot perform and would relieve public highways of a vast load of commercial traffic.

The center lanes of these reborn "railroads" would be concrete-paved but steel-walled channels which would carry very high-speed traffic. Torpedolike vehicles, automatically controlled,

would be shot through these channels at speeds only reached by airplanes now—perhaps in excess of 200 miles per hour, since necessity for human steering and control would be eliminated. Instead of a Twentieth Century Limited leaving New York once a day for an overnight trip to Chicago, we would have capsules of a manageable size departing on their breathless four-hour runs at hourly intervals, or oftener.

These vehicles would have teardrop forms. An airplane motor and propeller mounted on the nose might be the mo-

(Continued to page 158A)



Top, author pointing out to his son, a graduate engineer, details of house appliance in the modern styling. Left, radio tower in "Farm of the Future" diorama at U. S. Steel exhibit. Below, another view of the future metropolis with multi-level traffic systems and multi-story buildings

rights-of-way that usually are the shortest lines through the densest concentrations of population. These rights-of-way are almost gradeless as compared with automobile highways, they have no sharp curves and they are becoming free from obstruction by cross traffic. Suppose these rights-of-way were paved with concrete from edge to edge. Suppose they were divided into traffic lanes for varying services, and all their passengers and freight were carried in light powerful



Flameproofed Cotton Prevents Spread of Fire

Cotton made flameproof by a special process provides a low-cost, lightweight and durable insulation for homes and attics, as well as a safe material for decorative purposes, as on Christmas trees. The fibers of the cotton are "wrapped up" in crystals of certain substances that make the fibers incapable of flaming up. To test its fireproof quality, a common rivet heated to 1,500 degrees was buried in two pounds of the cotton and left until it cooled to a normal temperature. A loss of less than five per cent in the weight of the cotton resulted. It can be cut through with a torch, as in the accompanying illustration, but the flame will not spread.



No blaze results when torch is applied to flameproof cotton, as at right; material burns away where flame hits it, but the fire will not spread beyond limited area

R 10 36.

Lesson Moving on a Screen Teaches Speed in Typing

Typewriter students learn accuracy and speed typing in easy stages with the aid of a self-contained projector and screen that unrolls the lesson in front of the class.

Plainly visible to all the pupils, two lines at a time are shown as the "copy" moves steadily upward at speeds which may be controlled by the teacher. Starting, say, with twenty words a minute, the teacher may increase the speed by stages of five words a minute. Unaware of the increased tempo, students acquire speed without conscious effort, eventually attaining a rate of 200 words per minute. For use in the mechanical educator, lessons are typed with a specially inked ribbon on a six-inch-wide continuous roll of Cellophane. As this unrolls through the projector, which consists of curved lenses, a curved mirror, electric lamps, a specially surfaced mirror and a magnifying lens, its message is cast on the back of a silk screen. A chart of the typewriter keyboard is placed below the screen as a reference for beginners.



Pupils develop speed on the typewriter with the aid of "moving-lesson" projector at the top of picture

Tyler Kay Co. Buffalo

K960

Retractable "Mike" at Plate Lets Fans Hear Disputes

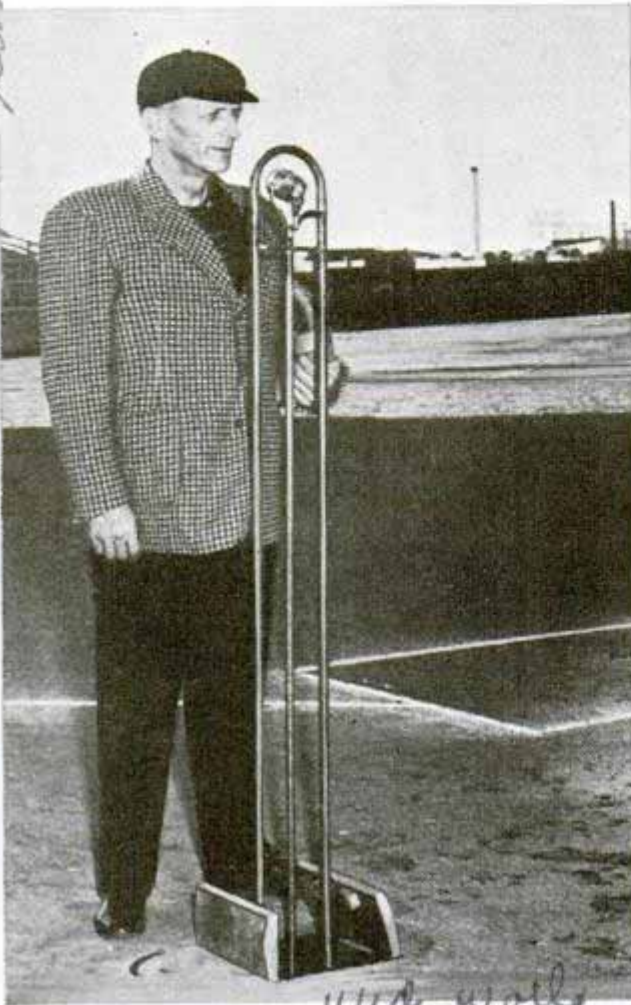

wide walk
Announcing batteries at start of game, the umpire lifts the microphone from ground with foot lever

Squabbles at home plate are put on the air by a "disappearing mike" that rises from the ground at the touch of a foot lever. With it the umpire can make announcements over the loud-speaker system or let the fans "in" on decisions and arguments during the baseball game.

K1022

Pull-Chain in Ratchet Wrench Removes Nuts Quickly

Nuts can be removed speedily when a pull-chain ratchet wrench is used. You



A few jerks of chain spins nut on or off the bolt

simply give a few quick tugs on the pull-chain, which passes through the handle, and the nut comes off in a hurry. Reverse the ratchet and it spins the nut on just as fast. It is not necessary to remove the socket or wrench until the job is completed, since it performs the entire operation of tightening or loosening. The tool saves the usual ratcheting back and forth in tight places that often slows difficult assembly work and general repairing.

K981

'Chute Jump from Stratosphere Tested in Pressure Chamber

In preparation for a parachute jump from an altitude of 35,000 feet, Arthur H. Starnes conducted tests in a low-pressure chamber at Northwestern University. By duplicating conditions as they exist in the stratosphere he was able to study the effects of sudden changes in air pressure during a seven-mile drop, both upon himself and his instruments and equipment. The 'chutist's apparatus included an oxygen mask, a pneumograph to record



one
Parachute jumper in low-pressure chamber testing some of the apparatus for high-altitude leap

changes in breathing, electrodes for fastening to his wrists to chart heart action, microphones to be strapped to his throat for broadcasting a description of the descent and a motion-picture camera to be fastened under his arm.

The Recall Tool Co. Hubbard & Co. East Alton, Ill. Paul Fair umpire at Semi. Pro national baseball career. Wichita Kans

How Mines Help Guard America's Harbors

Q-3047, Mine Planting Bldg, Washington, D.C.

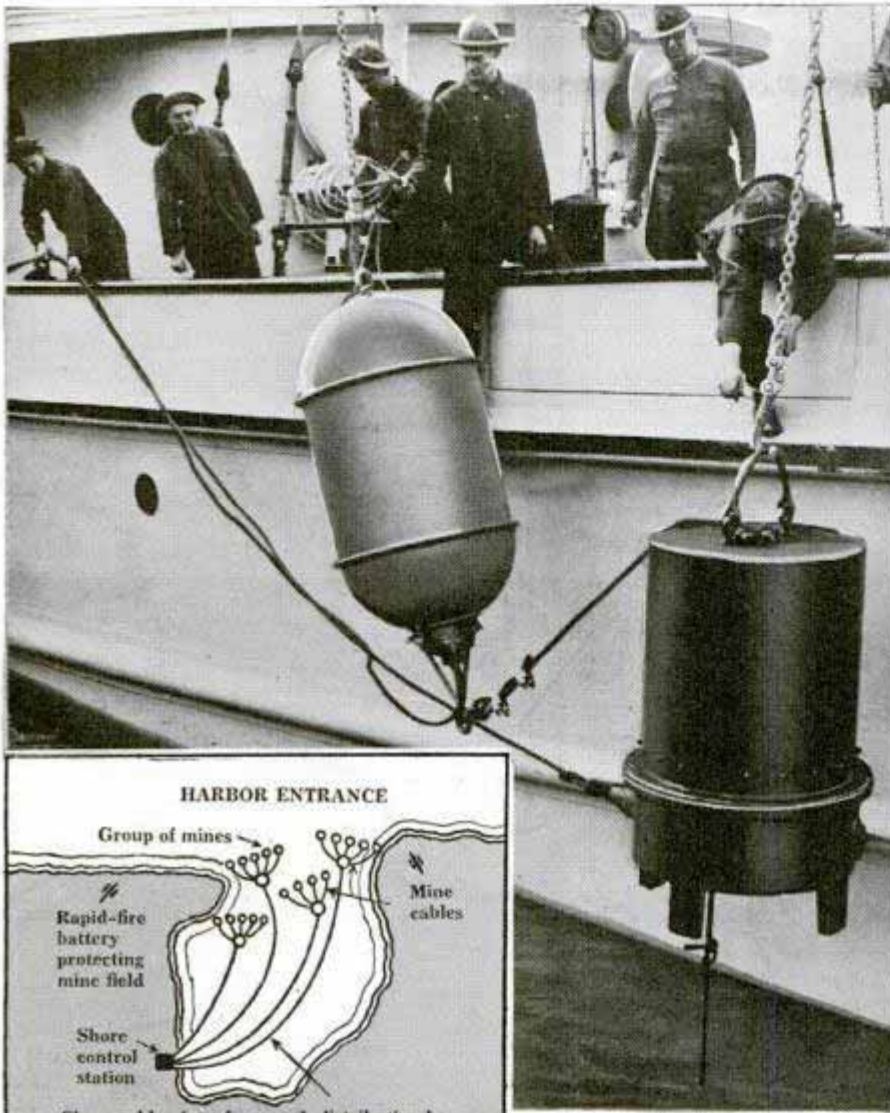

Forbes mines, Virginia Battery Co. 2nd C.A.

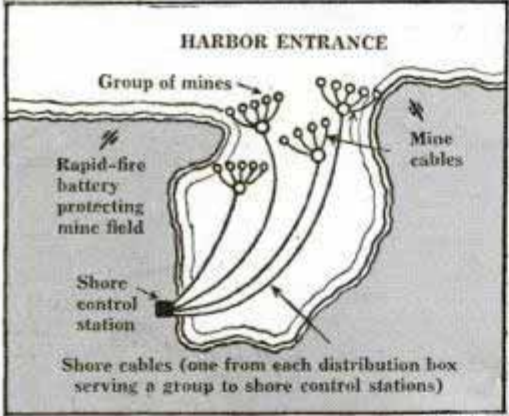

Mines controlled from shore are among the devices employed to protect American harbors. Top, left, about to release a mine and its anchor from mine-planting ship. Right, mine exploded from shore by means of electricity

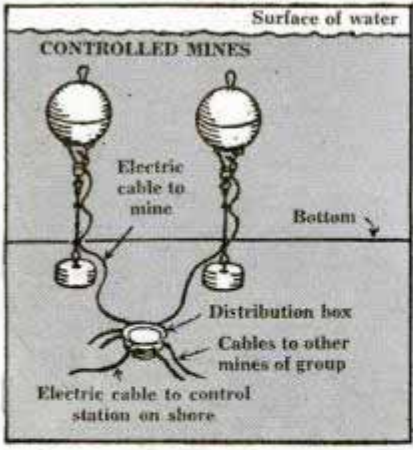

Photos courtesy Coast Artillery, U. S. Army

Above, sketches of how electric mines are laid and of how the mine is controlled from shore. Right, loaded mines and equipment ready to be placed aboard mine planter. Floating mines that explode on contact and submarine nets which trap submersible craft are other means of protecting U. S. harbors

R-958

The WORLD'S

Langley Aircraft Corp. Santa Monica Calif.

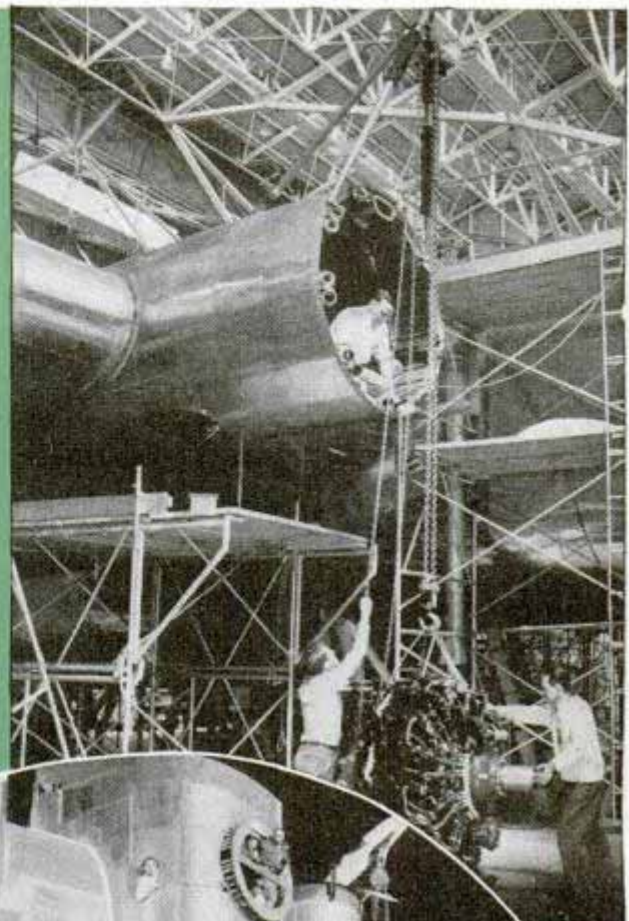
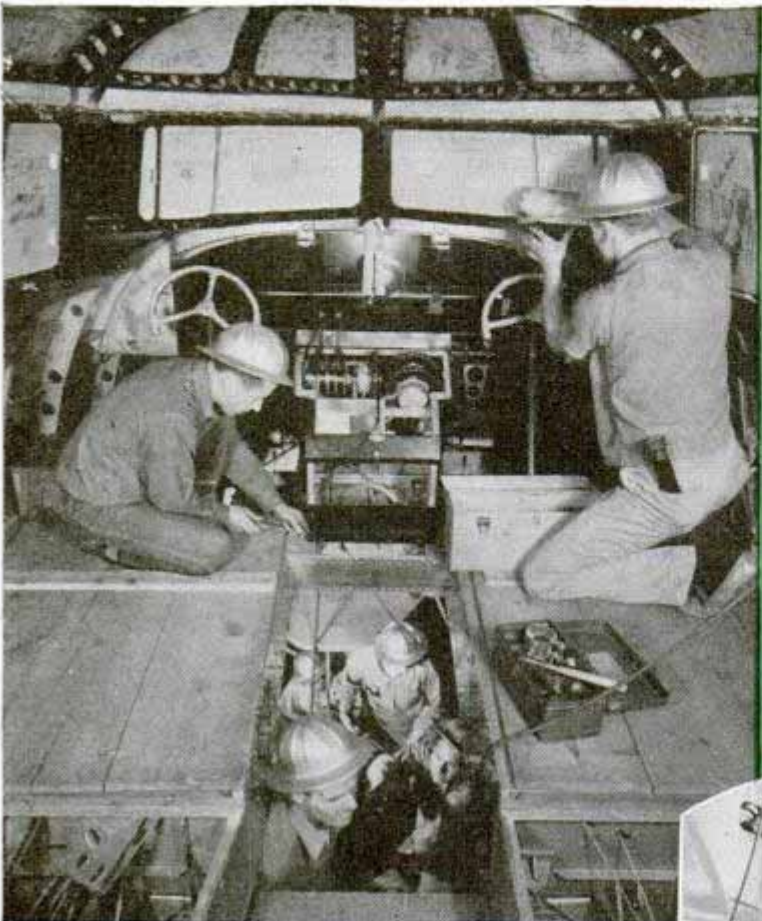

Completion of work and test flights soon will give the U. S. Army the world's largest bombing aircraft, which will have a gross weight of up to 164,000 pounds. The plane has more than 7,500 miles cruising range, 210-miles-per-hour top speed, a bomb capacity of eighteen tons and a fuel capacity of 11,000 gallons. Top, left, mechanics finishing operating cockpit. Right, raising one of the four 2,000-horsepower engines into place

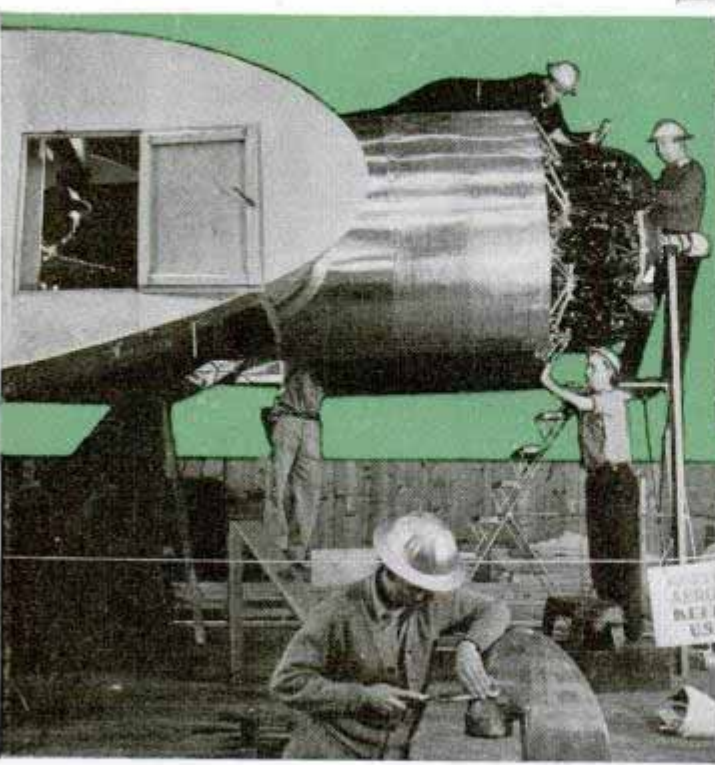
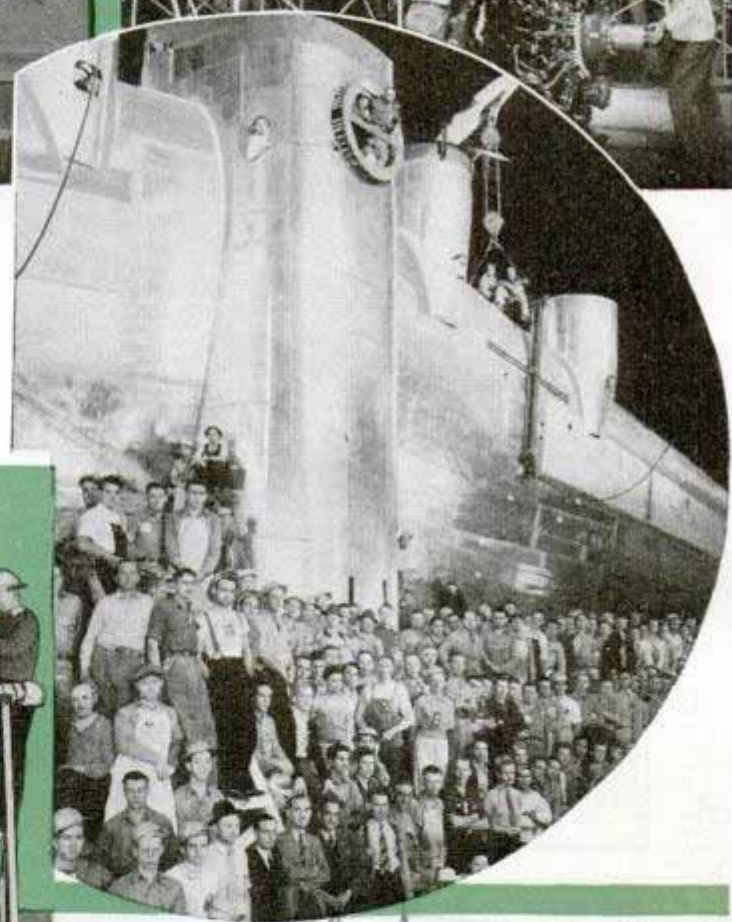

dent.
Left, one of the mighty engines on test stand. Above, one of the two shifts of mechanics that built the big bomber. Note the men leaning from openings high up on fuselage and engine housings. Because of the huge size, the wing had to be constructed in vertical position, as shown in this photo. Three million rivets were used in the aircraft

BIGGEST BOMBER

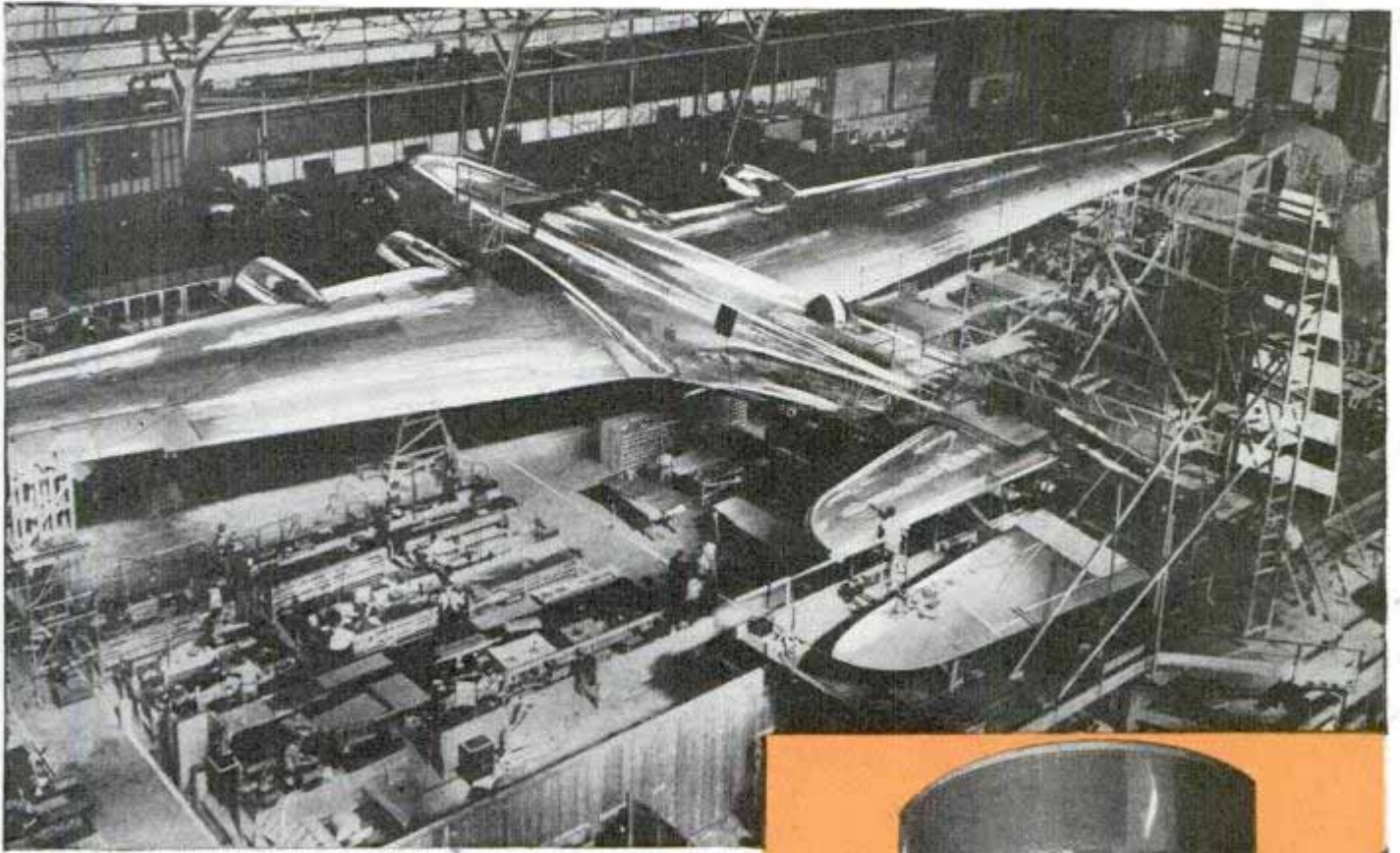

Above, general view of the giant bomber which will be armed also with machine guns and cannon. The all-metal plane has tricycle landing gear to facilitate landings. As a transport, it could carry 125 soldiers with complete equipment. Right, completing work on one of the four engine nacelles in the wing. The tin hats protected the workmen from being injured by objects falling from some spot high above them. One and one-quarter million hours of shop time were required to build the ship

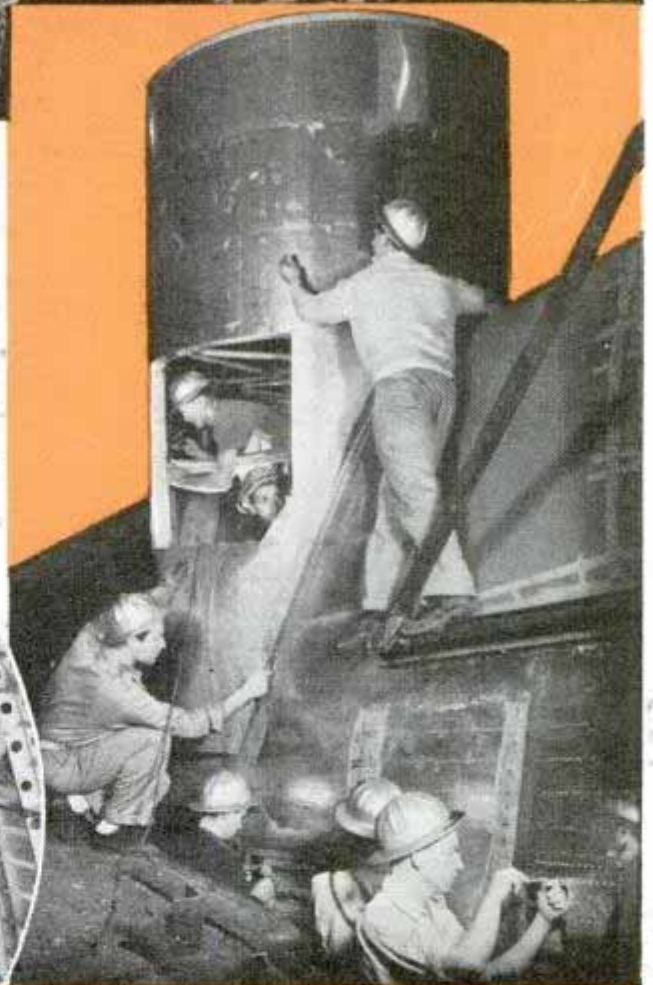

Left, mechanics finishing construction in the fuselage. A crew of ten will be required—pilots, gunners, engineer, radioman and navigator. The plane could fly an eighteen-ton load of bombs from the Pacific to the Atlantic coast and return, non-stop. The wing is 212 feet from tip to tip, main landing wheels are 100 inches in diameter

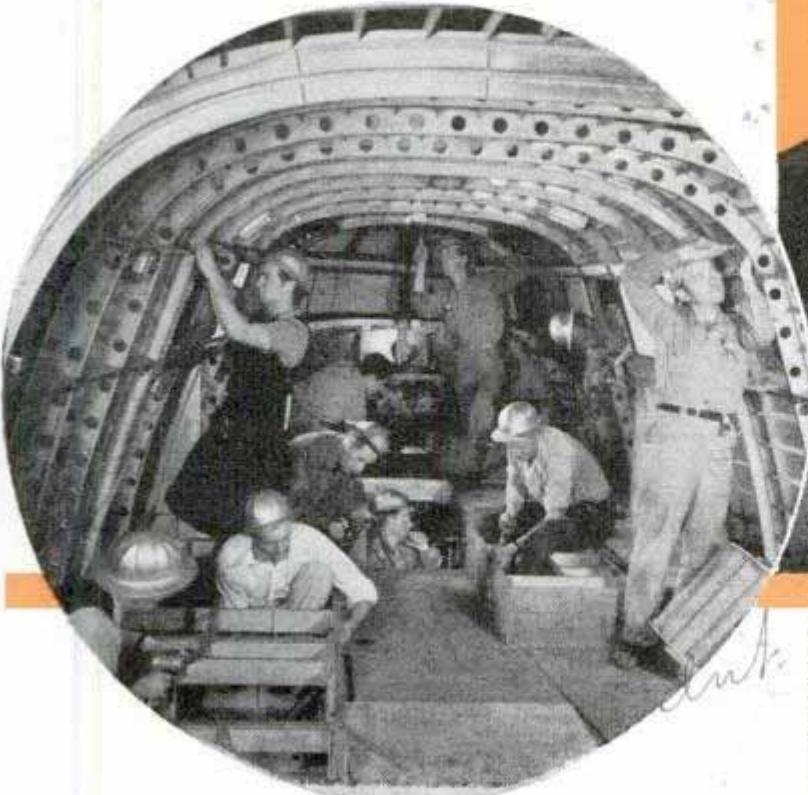

Shoes of Plastic Materials Shimmer in the Dark

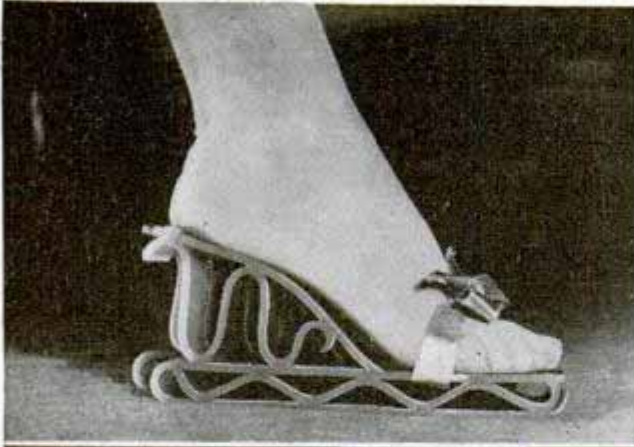

Top, plastic sled-shaped mules of orange-red color; bottom, these emit shimmery reflections in dark

Color combinations and other pleasing effects heretofore unknown in women's shoes are made possible with plastic materials now used. Because of their ability to reflect light, some shimmer beautifully in the dark when stray beams strike them.

V-Belt Resists Static Electricity Averting Danger of Spark

Difficulties caused by V-belts accumulating static electricity and then discharging it all at once, are conquered with a belt now being manufactured that does not permit such a charge to be built up. The new



Resistance to static built into V-belt prevents large electrical discharges and stops short circuit

V-belt retains its static-discharging qualities during its entire service life. The resistance built into the belt is enough to keep currents from passing through it, thus removing the danger of it causing a "short" between the motor and operator. It is of particular value in machinery where static discharges might create a fire hazard, as in gasoline pumps and machines for explosives and milling plants. Such discharges sometimes occur in domestic appliances, such as washing machines, but they are more alarming than dangerous.

Flying Time of Rented Airplane Recorded by Meter

Airplanes rented to civilian pilots under a new fly-it-yourself service are paid for on the basis of the number of hours they actually fly, the rates ranging from eight dollars an hour to \$47.50, depending on the type of ship, with a minimum charge for each day the plane is rented. The rental includes gas, oil and every type of insurance necessary. To check the flying time



If you ever rent an airplane it's likely to carry one of these meters to show how many hours you fly

while in the air, a clock meter is built into the plane, either under the seat or under the instrument panel. It keeps a six-day record, registering on a circular face only when the motor is turning at flying speed by tearing away a strip of the paper face around the circle. Two separate circles are provided in the meter, one for each three days. The service has been established at Roosevelt field, Mineola, Long Island, by Howard Ailor, veteran pilot, who expects to extend branches to other major airports of the country.

The R. F. Boardman Co.
 754.5th Ave
 New York City
 K 1010
 K 980
 K 1053
 Service Recorders
 Acme
 50 W. 5th

SWITCHING *on the* RAINBOW

869



Electric & Metal
 Westinghouse Electric Corp.
 Schenectady, N.Y.

Color illumination in the home calls for careful study of mixing various colors produced by electric lamps. Above, a bewildering array produced by focusing red, green and blue spotlights on a white screen, then interposing a small disk with a hole in it to break up the combining colors of light. Right, colors prominent in several types of vapor lamps.

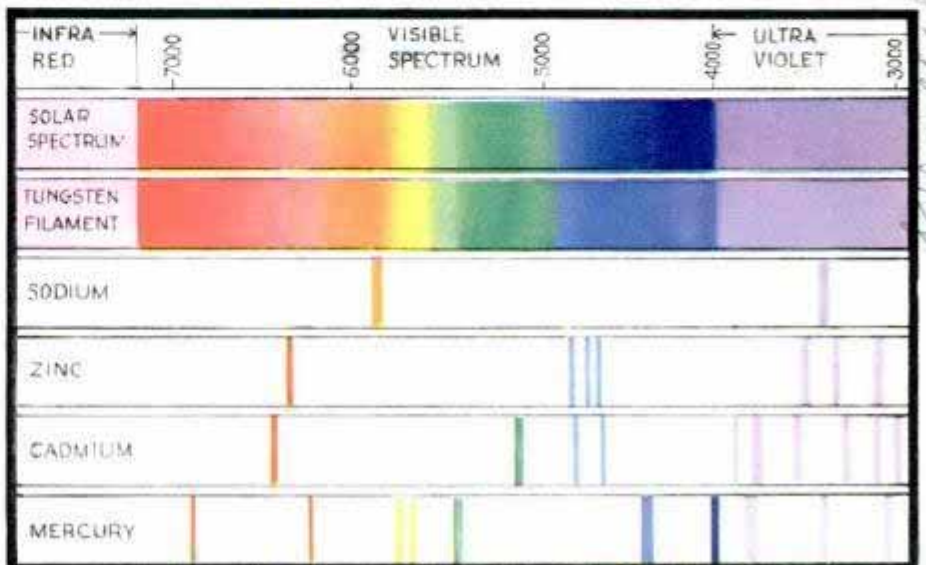



BY JULIAN P. LEGGETT

BY touching a few buttons, the hostess of tomorrow will create a festive atmosphere for a party through the medium of electric lamps producing gaily colored light. If she wishes a quiet atmosphere, perhaps a formal dinner, lamps rich in appropriate colors will help her to achieve it.

Changing the color scheme of a room will be accomplished by flipping a switch. If a wintry storm rages outside, our hostess will turn on red, amber and yellow lights to impart a definite feeling of warmth to the home. And in summer, she will switch on blue, green and bluish-white lights to create a feeling of coolness. Lights may even be arranged to suit her particular mood, or to offset it; stimulating illumination would combat those "Monday blues."

Electric lamps and fixtures for producing almost any color effect are on the market and installations are not expensive. The home owner may begin experimenting with color illumination immediately, if he desires. Meanwhile, interior decorators and lighting engineers are working out applications for this new home-beautifying tool and soon we may expect rec-

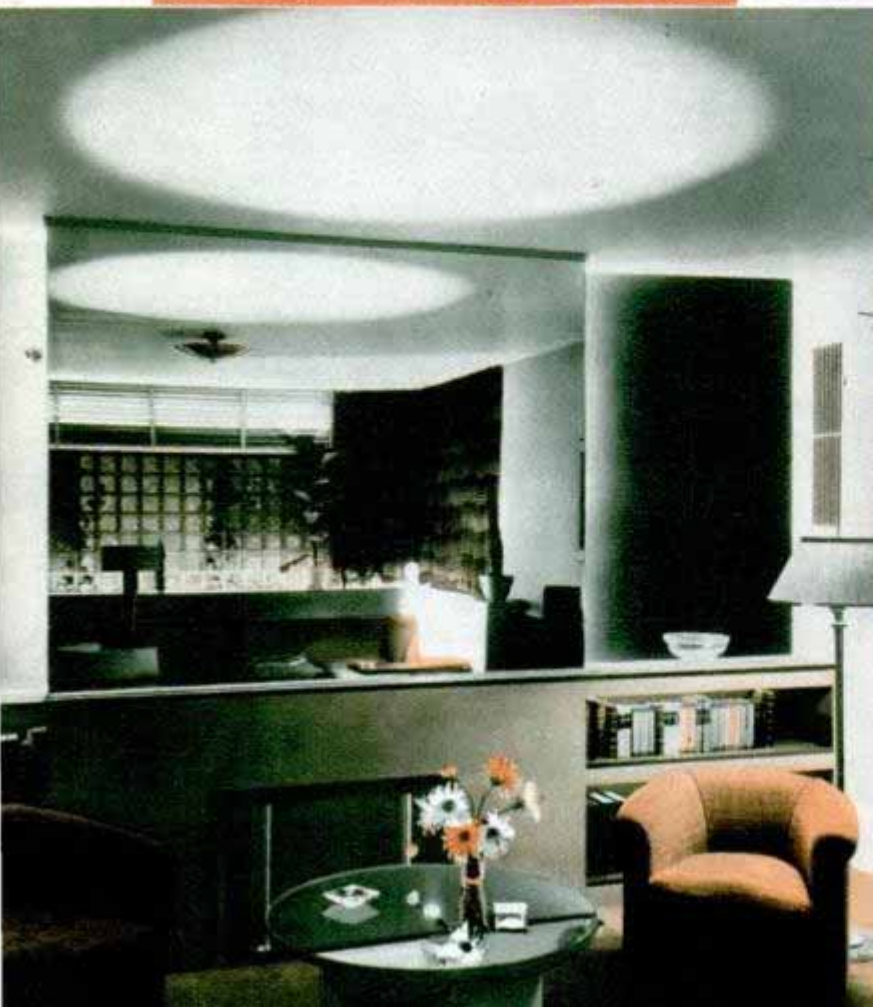

Top, locomotive headlamps on "torture rack" for testing. Bottom, left, interior of demonstration living room with three circuits of colored lamps back of mirror edges and lumiline lamps in bookcases. Circle of light on ceiling is escaping from small hole in center of the cocktail table. Diagram (below) shows how spotlight is installed in table.

Woolworth

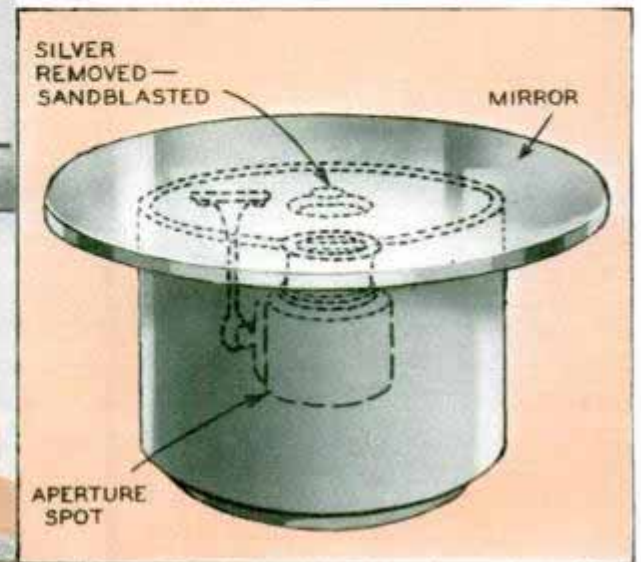



819 X684
 ommendations not only on the proper colors for walls, draperies and floor coverings, but also on the kinds and combinations of color lamps to use when we wish to switch from one color scheme to another.

Samuel G. Hibben, director of applied lighting for the Westinghouse Lamp Division, says:

"Color, especially in the home, is inevitably the partnership between qualities of radiation or light and qualities of surfaces. The same surface—and this is one of the newer arts in mobile decoration—can be made to take on a vitally differing series of colors merely through a sequence of changes in the light itself. By some such means we can adjust the tints and shades in a room now to either the seasons of the year or to the atmosphere of a particular holiday or perhaps just to conform to our personal moods. Here begins a new idea in home coloring, a flexibility in lighting that is aptly termed 'mood conditioning.'

"Just so far as we care to go in producing lights of differing tints and qualities, just so far can we enjoy a variety of appearances of interior objects and decorations. Should we elect

Marion Hughes.
 Left, illuminating dressing table with fluorescent lamps. Right, demonstrating fluorescent installation in floor lamp. Bottom, pinhole lighting of dining table with spotlights mounted above the false ceiling.

John S. Bailey
Westinghouse





SODIUM VAPOR



CADMIUM VAPOR



INCANDESCENT

820
to paint our walls and ceilings of a living room with a matte surface of a very neutral gray, we could produce the following changes: with candles or flame-tint Mazda lamps, the appearance would be rich warm gray; with rose-tinted bulbs, the surfaces would seem almost pink; with mercury vapor lamps, they would be yellowish-green; with still bluer lights, they might appear lavender, sky-blue or cold blue; under sodium vapor lamps, the interior would have a lemon-yellow appearance, and under orange or red bulbs, the surface would be one or the other of those colors.

"We might have changing color of lighting, from rosy hues in the breakfast room, through the golds and reds of a sunset to the pale tints of summer moonlight in the music room.

"Not long ago when production of artificial light was expensive, we gratified our color desires by changing interior decorations, not illumination. That was when lamp bulbs cost sixty cents each and electricity ten or fifteen cents per kilowatt-hour. Now electricity costs about three cents per unit and average size Mazda lamps about ten to fifteen cents each, so now we may employ



GREEN AND DAYLIGHT

RED AND DAYLIGHT

Special color photos taken by Westinghouse Lamp Division show: top row, left to right, effect under sodium vapor lights, which strongly emphasize yellow; cadmium vapor lamps, which bring out red, green and blue, and the familiar incandescent. Bottom of page, comparing fabrics. Green lamps, in cabinet at left, were replaced with red lamps. Daylight lamps in right side of the cabinet were unchanged.



light for other than strictly utilitarian seeing purposes. In addition, with the advent of the fluorescent lamp, we have a means of generating tints of colors of light directly without wasting any of the generated light through absorption of filtering."

Of course no one should turn all his attention to color illumination. E. W. Comnery of General Electric Company points out:

"Surveys show a great usage of fixtures employing exposed and unshaded lamp bulbs with resulting glare and harshness. We are using relatively meager amounts of light for eye conservation and real ease of seeing. Light for beauty has hardly been touched and color effects have been employed in a negligible number of homes. The one exception is that we all burst out once a year with the colorful Christmas tree.

Top, left, false windows in dining room of General Electric Company's demonstration house contain diffusing glass lighted from behind with lamps of three colors. White lamps give stimulating effect at breakfast. Right, milady makes up at boudoir mirror lighted at either side by large luminaires of diffusing glass or plastic containing fluorescent lamps. Bottom, comparing zinc vapor illumination, which emphasizes red and blue, with incandescent.



ZINC VAPOR



INCANDESCENT



K 684
822

Since the appearance of fluorescent lamps, however, new and remarkably efficient sources of colored light have been available, and as a result we are now finding here and there a few homes in which some thought has been given to the use of colored light for creating a variety of atmospheres and beautiful effects.

"In recent years the home lighting adviser has come into existence and she is bringing the benefits of light in the home to many thousands of homemakers, who in turn are taking their first steps toward making changes. At this time the most marked step is toward obtaining more light of better lighting quality in the living room. Today we are still living in an age in which there is often a preference for rather marked differences in light and shadow. In the future we would assume very substantial increases of both general and localized lighting, still with light and shadow, but with considerably less contrast. Rooms that have five to ten times the amounts of

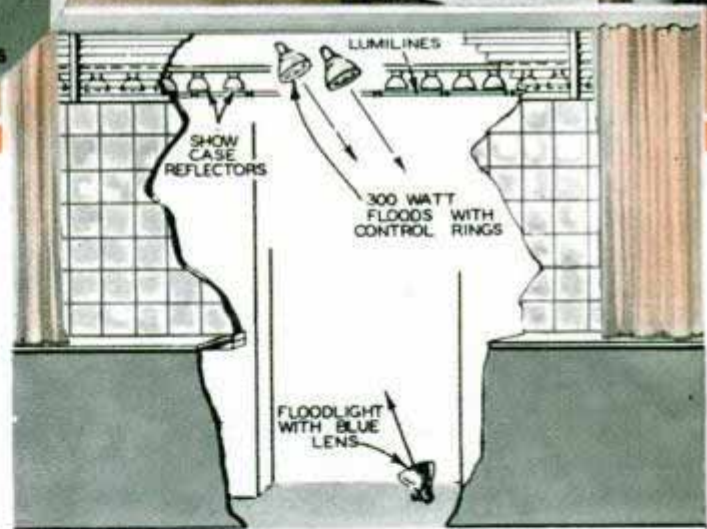

Realistic glow of sunshine created at night or in windowless room by using incandescent lamps and projection equipment back of glass block windows. Sketches show glass block and portable ledge installations.

*Westinghouse Lamp Co
@ Bloomfield, N.J.*

both general and localized lighting than now are employed generally are found to be entirely homelike, charming and beautiful. The principal sources of light, instead of becoming brighter, may be expected, to become greater in area so they need not become brighter in order to provide more light.

"For those who may indulge in careful advance planning, the new home will carry more of its lighting in the struc-

ture itself. It will be considered at the time the house is being created on the drawing board. When lighting becomes an integral part of the structure, we shall have more variety than we ever enjoyed before. Perhaps we shall be able to change many of our decorating schemes, for with changes of light distribution, amounts of light and color of light, rooms can be transformed completely."

Lighting engineers are busy with ways and means of introducing color illumination into the home, studying light mixing, developing lamps that emphasize certain colors and so on. They find that if a blue beam and a yellow beam of light are projected on a screen, the portion where they overlap will be white. These colors are said to be complementary and this method of combining colored beams is called the additive method of color mixing. The primary colors for this method are red, green and blue. Red and green combine to give yellow and all the intermediate hues or tints; red and blue give magenta; green and blue give a blue-green.

If a beam of white light is made to pass through a piece of yellow glass and a piece of blue-green glass placed behind one another, the light passing through will be seen as green. This is called subtractive color mixing and the tendency is to obtain less light and to approach black, in contrast to the additive

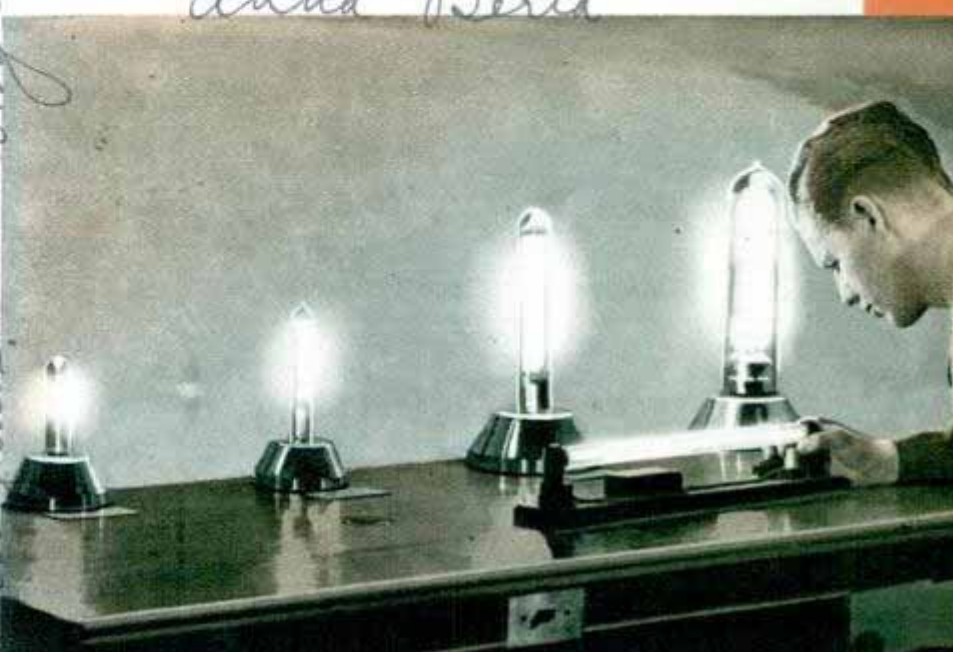
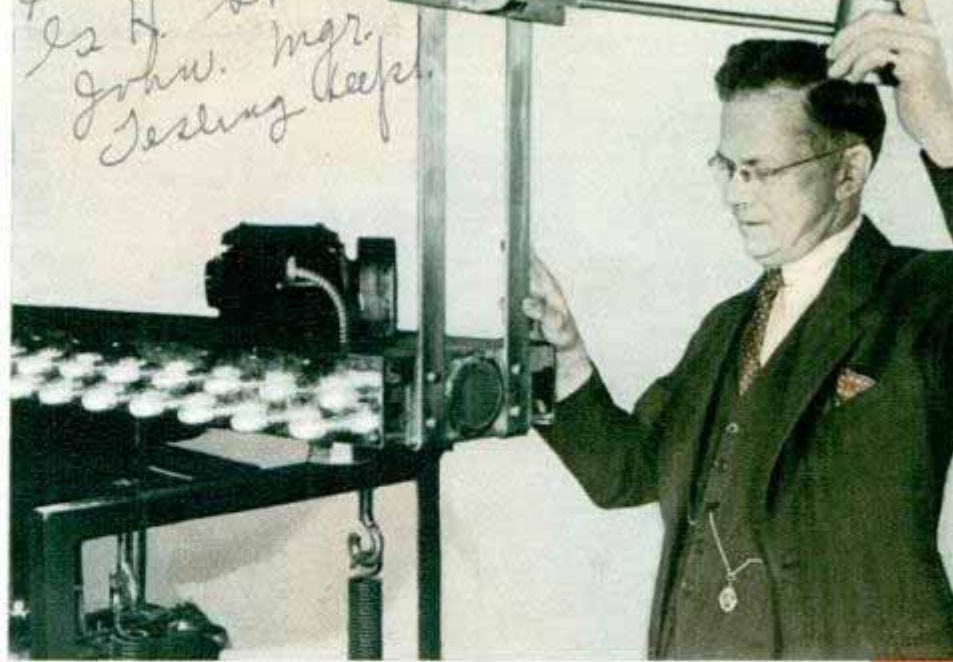

Top, steel mallet ready for jolting test of house appliance lamps. Center, intricate machine employed in manufacture of Mazda lamps is capable of turning out 9,000 in eight hours. Bottom, C. F. Krueger of Westinghouse studying demonstration fluorescent lamp. On rear of table are three mercury vapor lamps and a sodium lamp.

John Mgr. Jersing

Anna Berta

Westinghouse

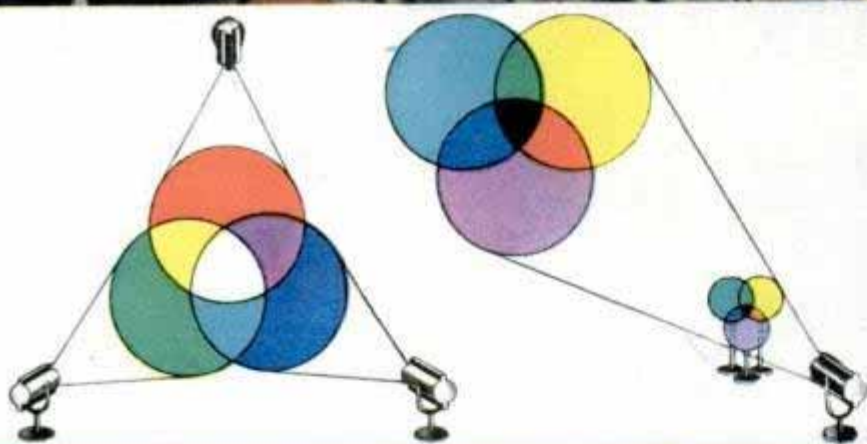

K 68 d 424
 Westinghouse color photo showing gaseous discharge tubes on rack. Top to bottom, helium, neon, mercury and nitrogen. Left, color mixture by addition of wave lengths of light and by subtraction. Bottom, fluorescent lamps of all colors being tested at Nela Park, headquarters of General Electric lamp department.



method in which the tendency is to obtain more light and to approach white. Blue-green, magenta and yellow are the primary colors in the subtractive method.

When electric current is passed through certain gases, light is produced of a color characteristic of the particular gas employed. For instance, neon gas gives a reddish-orange light, mercury-vapor a blue-green, helium a pinkish white and sodium vapor a yellowish light. By far the most efficient means of obtaining colored light are the fluorescent Mazda lamps, consisting of a tube
 (Continued on page 128A)

Rotating Camera Films Full-Circle Panorama

381-4th Ave. New York City

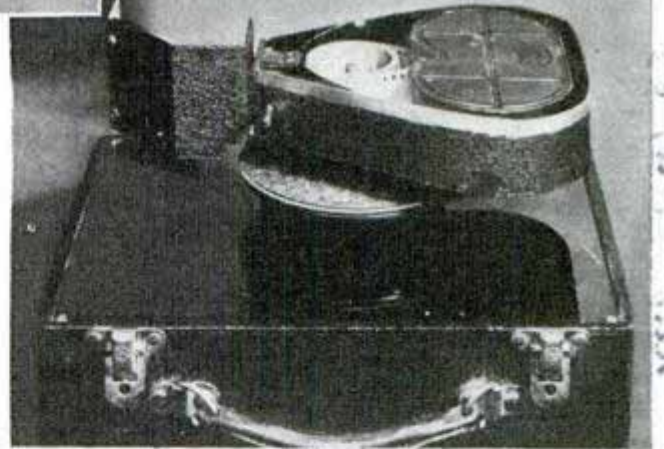
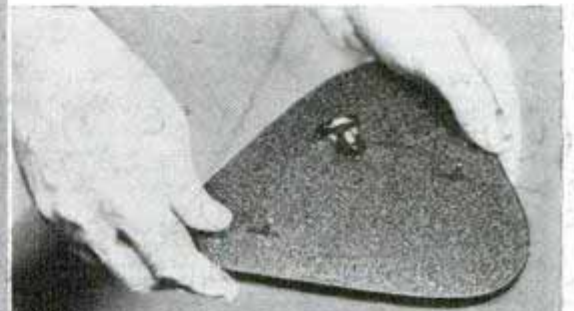
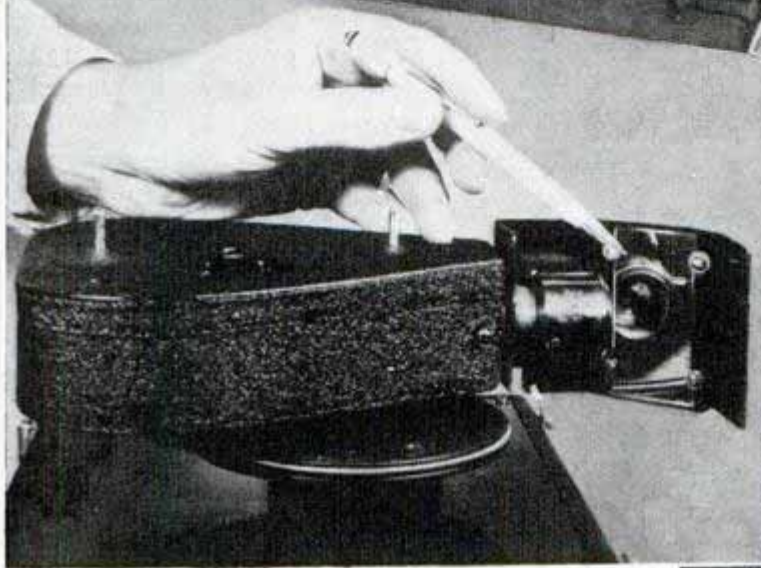

Top, section of full-circle panorama as would be taken by police photographer. Below, rotating camera, showing mirror in front of lens and film magazine

Turning in a full circle around its fixed sprocket, a revolving camera makes a complete 360-degree panorama photograph on six inches of thirty-five-millimeter film. Simple to operate, it is especially adaptable for police photography. Instead of making a series of snapshots at the scene of a crime, the panorama camera can record the entire scene at once. A spring-driven motor rotates the camera when a lever starts it, the shutter remaining open while the camera is being operated. Exposing one-sixteenth inch of film at a time, the exposure taking one-tenth second, the 360-degree picture requires fifteen seconds. The film magazine holds fifty feet of

film, enough for 100 complete panoramas. In front of the wide-angle lens is a mirror which reflects the image at a sixty-degree angle in reverse; for indoor or night photography a 500-watt illuminator is set on top of the camera, revolving with it and throwing a narrow beam of light.

Vaccine to Prevent Measles May Avert Epidemics in Army Camps

Discovery of a vaccine for measles, said to be effective for both children and adults, may result in protection for soldiers from fatal attacks of pneumonia, such as followed the outbreak of measles in military

camps during the first World War. Developed by Dr. Joseph Stokes, Jr., University of Pennsylvania, and Dr. Geoffrey Rake, Squibb Institute for medical research, this is the first vaccine for this disease.

K1055

now @ runswick N.J.

vacine service

Light Motor Bike Is Powered by Semi-Diesel

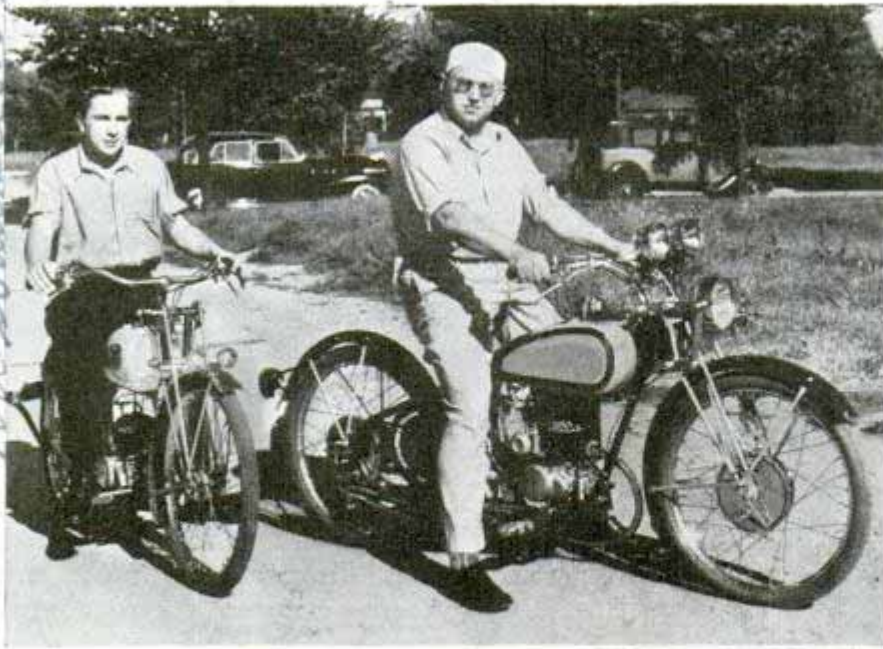

Powered by a single-cylinder, two-cycle engine of semi-Diesel type, a lightweight motor bicycle just introduced offers low-cost transportation for messenger service or for sport. The builder claims that it travels 150 to 165 miles on a gallon of low-grade gasoline. Both wheels are equipped with brakes, the single foot pedal operating the rear brake while the clutch, front-wheel brake and accelerator controls are at the fingertips. The engine has an internal clutch and two-speed transmission.

Two versions of the semi-Diesel motorcycle, above, offer economical transportation, particularly for "messenger fleets"

'Crash Pad' on Car Panel Reduces Injuries in Collision

Extending all the way across the top edge of the instrument panel, a resilient "crash pad" is designed to lessen the severity of bumps, bruises and injuries suffered in auto collisions. Made with a base of sponge rubber and covered with leather or other material matching the interior trim, the pad softens the impact if an occupant of the car is hurled against the front board. The idea is borrowed from the airplane, where similar pads are installed to guard pilots. The crash pad can be built into new cars or "buttoned on" the panel of recent models.

Bulging upper edge of instrument panel is "crash pad" that absorbs shock if riders bump against it



Long Bus 'Jointed' in Center Bends as It Crosses Humps



City transit buses elongated to carry as many passengers as streetcars can carry, require special construction for handling on narrow streets and around sharp curves. By dividing the bus in two sections, with a hinge and heavy rubber "knee joint" near the middle, the vehicle is allowed to bend up and down as it negotiates sharp grades of bridges and viaducts, and

"Knee joint" permits bus to arch in middle to keep all wheels on street

1 Dublin drive... 5589 Dr. Longway Rd. Dr. Wamboldt

1023 Esidge W Walker New Center Rd. Deloit Rich

and George W. Walker Industrial Lease not New Center Deloit Rich

K1049 Sample Town

Swain Coach Co.

K 7057

shocks caused by rough pavement are thereby prevented from traveling between the front and rear sections. The bus body, however, does not curve as it turns a corner, but swings around as sharply as the shorter type because front and rear wheels are synchronized in steering so the rear wheels follow in the tracks of the front pair. In other words, the driver steers only the front wheels, a compressed-air device automatically operating the rear wheels. Electricity generated by a Diesel engine in the rear end propels a third axle and pair of wheels located in the center of the bus. Another model of the twin body unit is designed to operate as an electric trolley coach. A bus forty-seven feet long seats fifty-eight, with standing room for about sixty more passengers, as compared with seating capacity of forty in a standard city bus.

Target Airplane on Trolley Trains British Air Gunners



British camera gun and trolley target may be set up either indoors or outdoors for training aerial gun crews in defense against air raiders

One target used by Britain to train her air gunners is a model airplane running on wires. As the plane, suspended on a roller, is drawn past the gunner, he pulls the trigger of a camera gun at the instant the model enters the field which, in actual flight, would be the effective range of his gun. This sort of target practice speeds up training in the use of the service sights with which gunners must be familiar. It is usually done in the open, but if weather is bad the target can be converted for indoor use.

100,000-Gallon Pumps Reclaim Rich Farms from Jungle

K 995
see Oct. 1940. 545
Sixteen thousand acres of potentially rich farmland have been reclaimed from the Everglades jungles of Florida by a drainage system that employs a series of huge pumps—six of them having a six-foot



Each of these Diesel-driven pumps has a capacity of 100,000 gallons per minute

discharge diameter and a capacity of 100,000 gallons per minute each. Altogether there are twenty-two pumps with a combined capacity of 930,000 gallons per minute. The area at the start was waste land, largely under water, and required a water-control system that would drain off excess, retain the moisture in dry seasons, and also shut off the penetration of salt water into the canals at high tides. The tract was cut into 200 diked and ditched eighty-acre island farms, each one a separately drained and water-controlled unit. Dams on the canals were constructed so that drainage proceeded during low tides but the gates automatically shut out tide-water when the tide was high. The 100,000-gallon pumps are driven by six-cylinder Diesel engines with a multiple V-belt drive.

Couch. Mfg Co, Isrant.

*South Slade Farms due...
James...
F...
F...
F...*

BUILDING

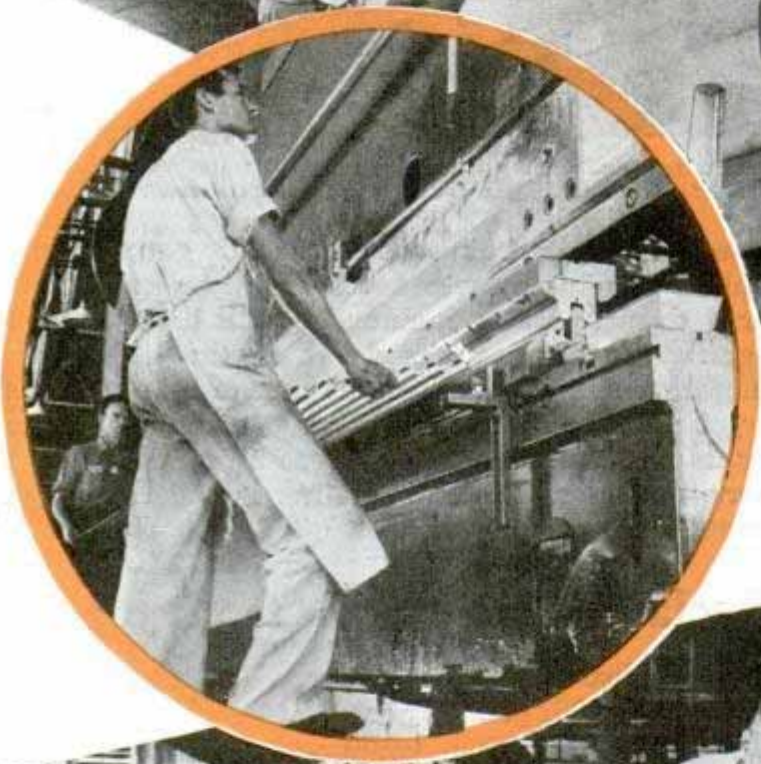
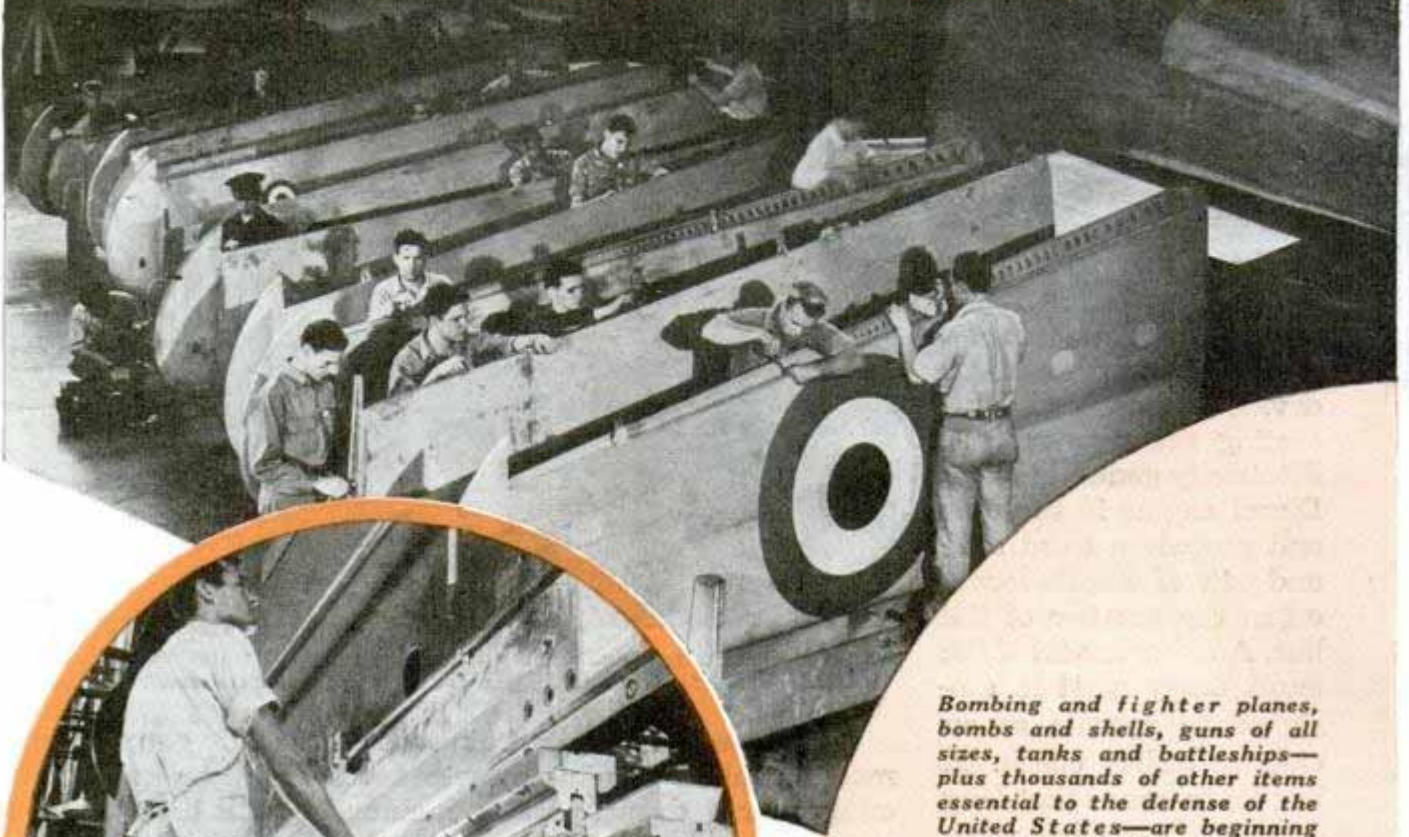

Bombing and fighter planes, bombs and shells, guns of all sizes, tanks and battleships—plus thousands of other items essential to the defense of the United States—are beginning to pour from the maw of this nation's mighty industrial machine and from the government's arsenals. Production so soon after inauguration of the several-billion dollar program is small, necessarily, but a steadily increasing output may be expected with each succeeding month. Above, assembling wings in airplane factory. Circle, big power brake used at Douglas Aircraft plant for turning out corrugated sheets. Bottom, inspecting old 75-millimeter guns in Rock Island arsenal. If the barrels are found in good condition, the weapons are modernized

John J. McSively

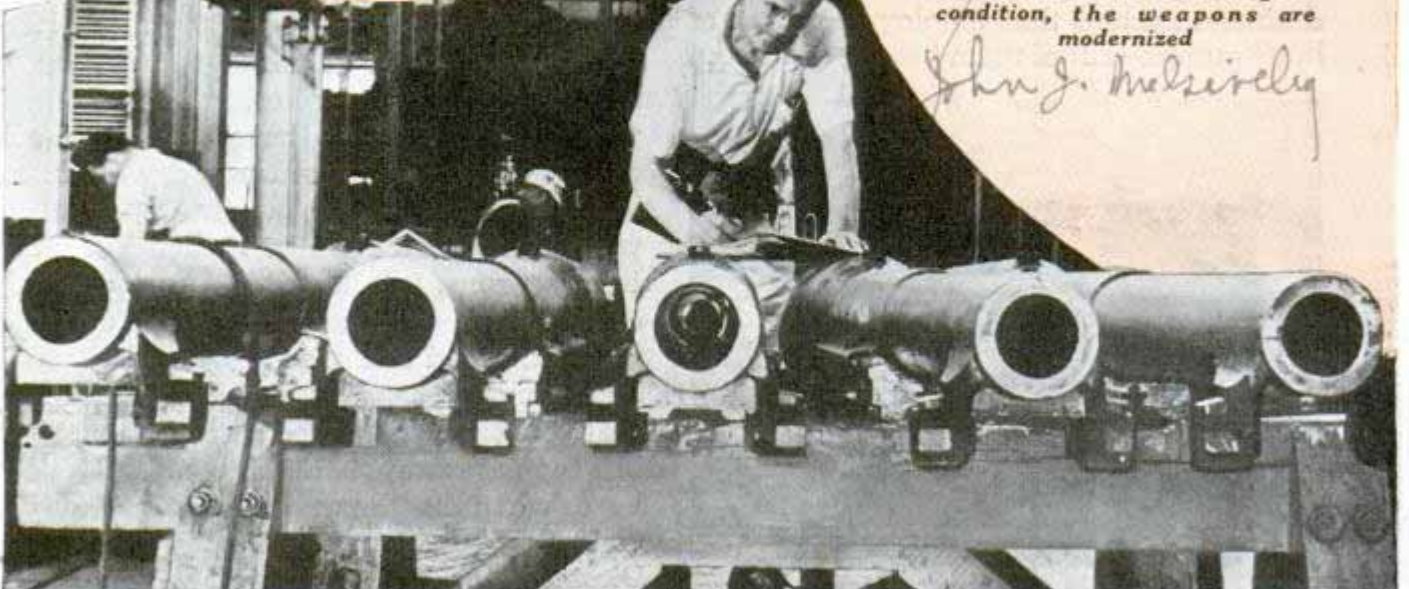

for DEFENSE

Above, fuselages of Douglas dive-bombers ready for tail groups and wings. Circle, searching for hidden flaws in small airplane parts with aid of X-ray light at Lockheed factory. Bottom, Douglas bombers ready for test flights. Airplanes being built for defense cost about \$7.50 a pound, compared to about thirty cents per pound for popular-priced automobiles. Plant expansion required to meet the nation's air defense needs is costing approximately \$500,000,000 — what France spent on the ineffective Maginot line. Eventually 800,000 men will be working in the aircraft industry, compared to 100,000 at the beginning of the program. A goal of 50,000 warplanes per year has been set, but production is not expected to reach that mark before the middle of 1945

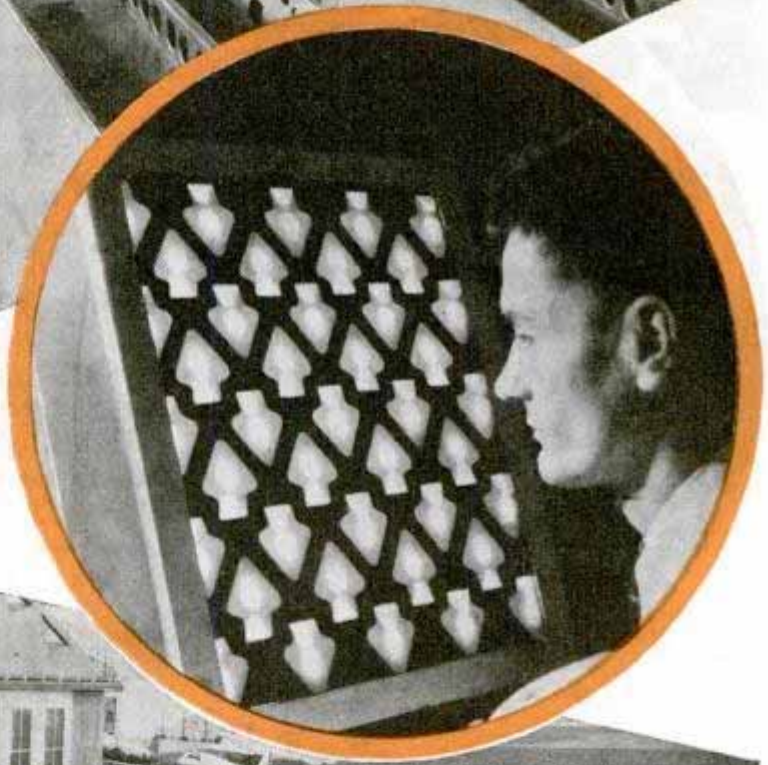

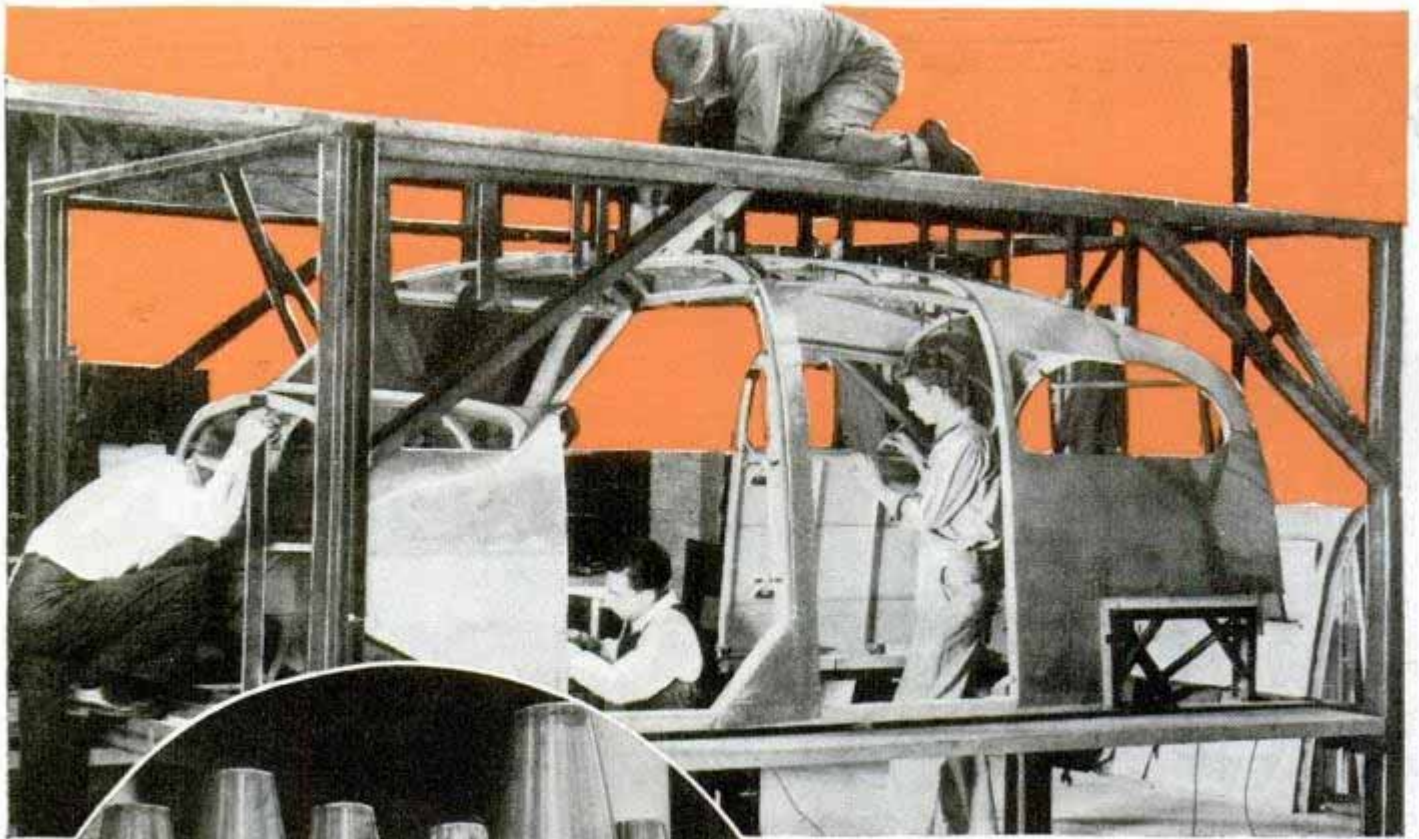

Above, heavy steel framework or jig inside of which a Vega airplane fuselage is being assembled. Left, machinist-inspector measuring new torpedo rear sections in the Navy's plant at Alexandria, Va. Some parts of modern torpedoes must be accurate within 1/10,000 inch. A torpedo costs several thousand dollars, considerably more than the cost of the biggest and deadliest bomb which does not require such delicate mechanism

Right, wing jigs inside of which wing sub-assemblies are mounted and attached together. This is another view of work in a modern airplane factory. Research on planes must be speeded up and extended considerably, under the defense aims of America, because if designs aren't improved from time to time, the planes produced will be found far inferior to those with more advanced design, equipment and engines. More speed and more fighting power are two objectives of the war-plane maker

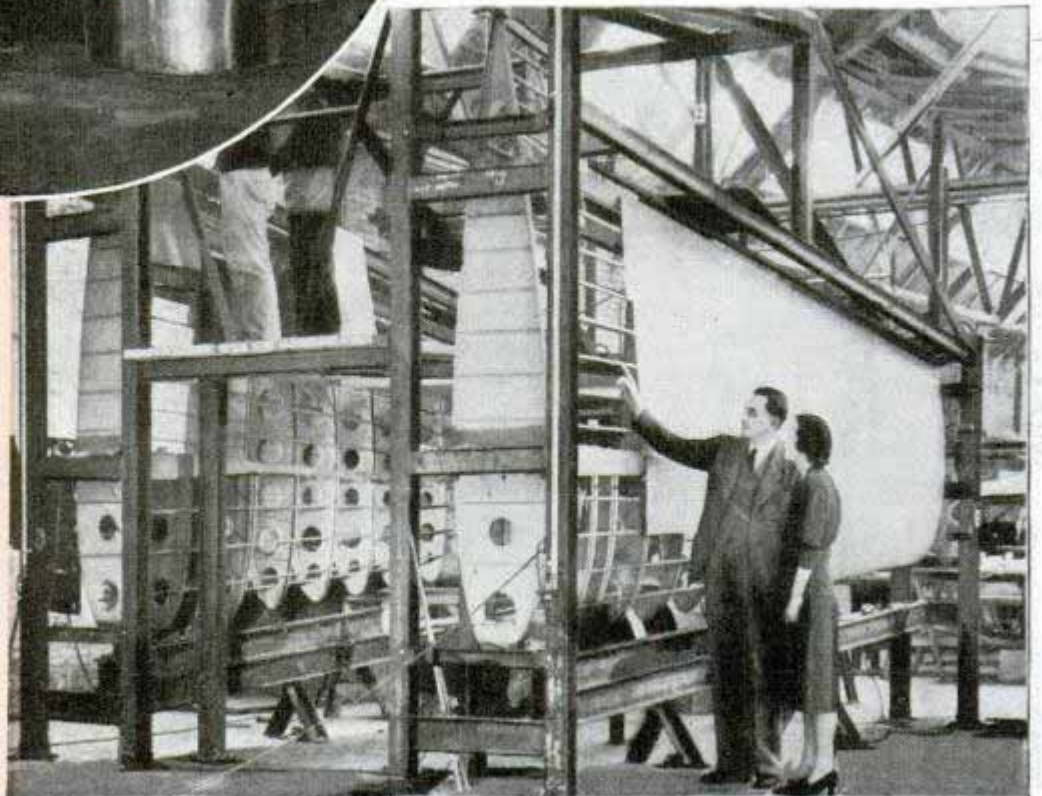

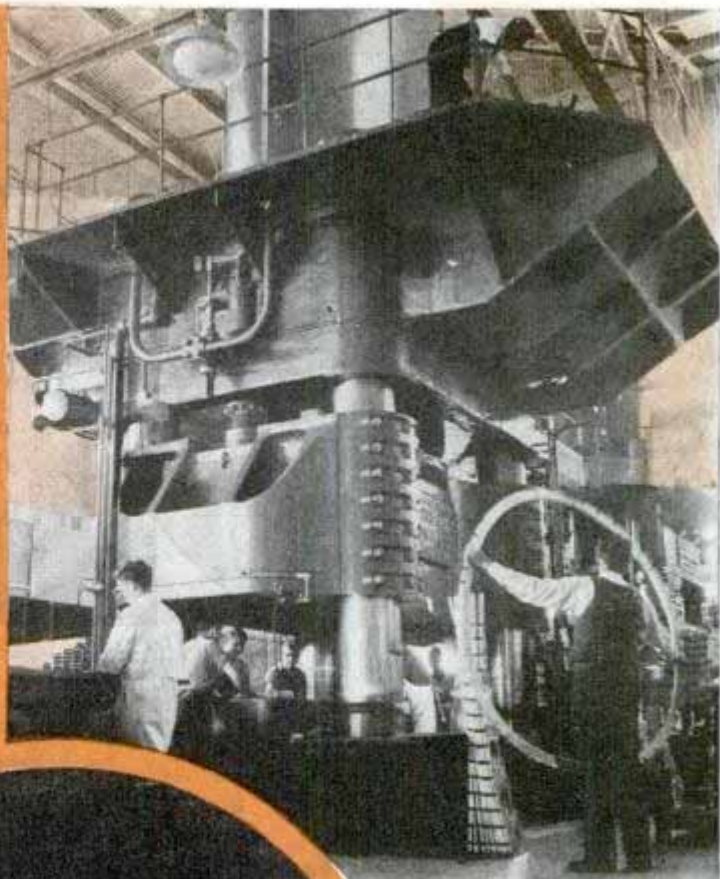
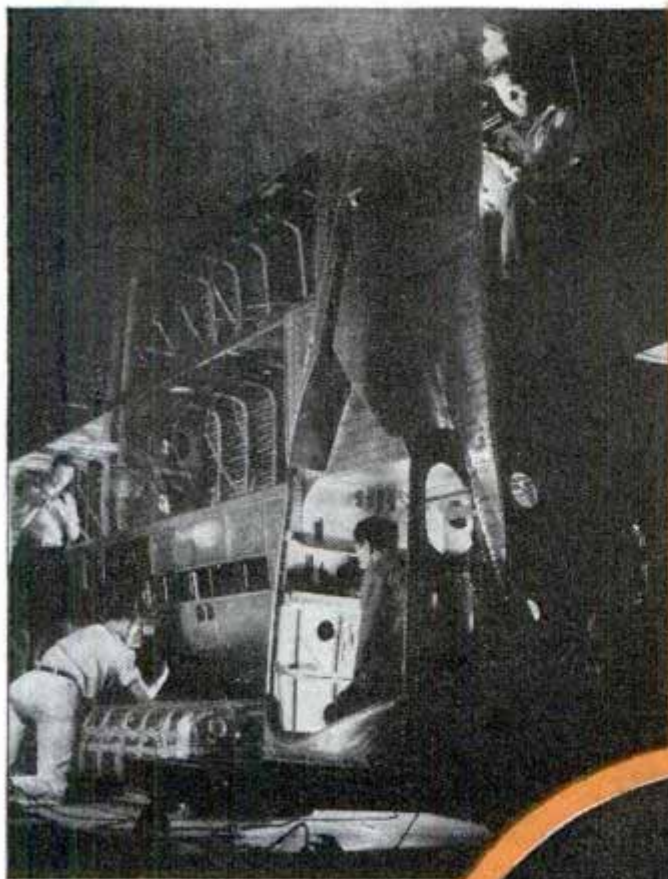

Above, final assembly of a big Douglas transport wing. Circle, workman at Rock Island arsenal inspects rifling of a 155-millimeter howitzer barrel. This gun is of the world war period and will be reconditioned if the rifling is satisfactory

Above, 5,000-ton drop hammer in Douglas plant. Bottom, general view of Washington navy yard workshop with big rifle (foreground) being lowered into pit for installation of lining

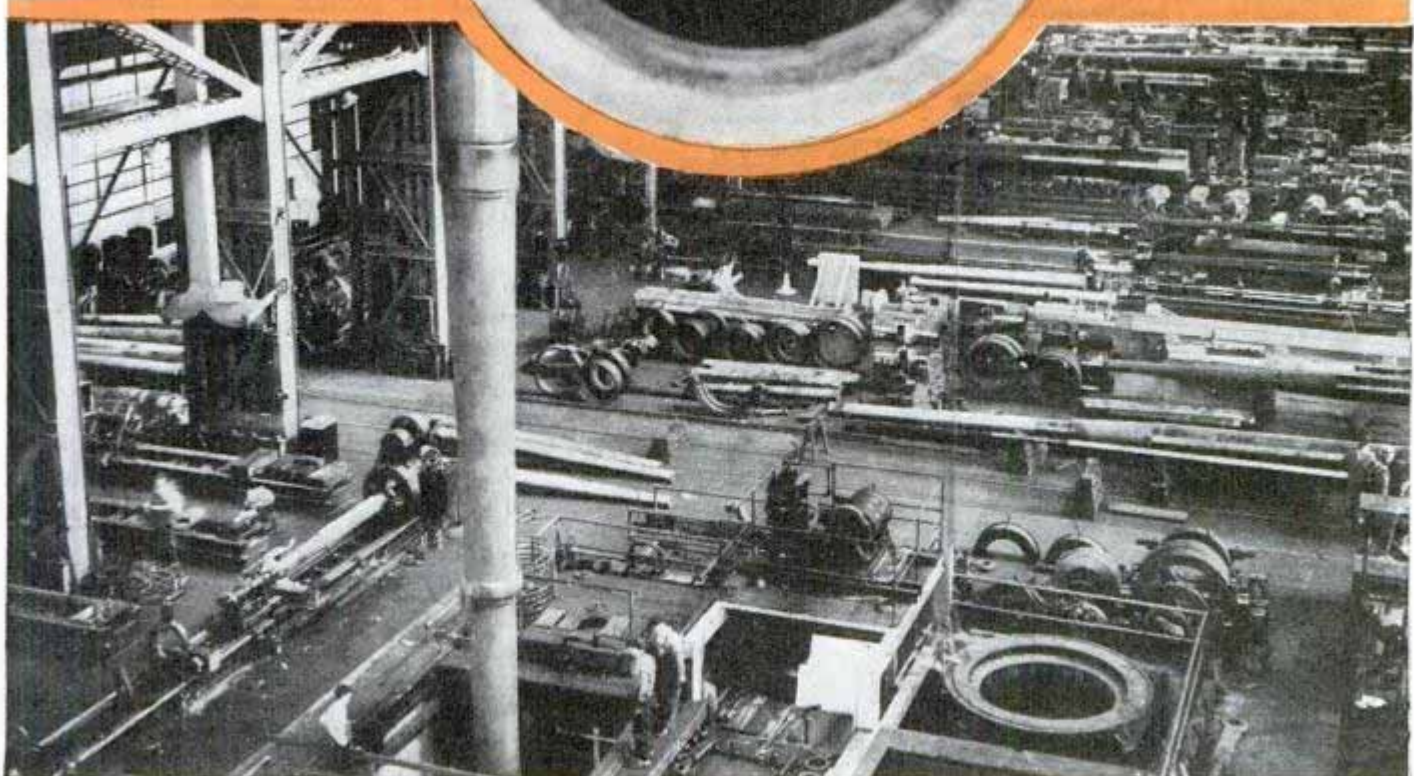

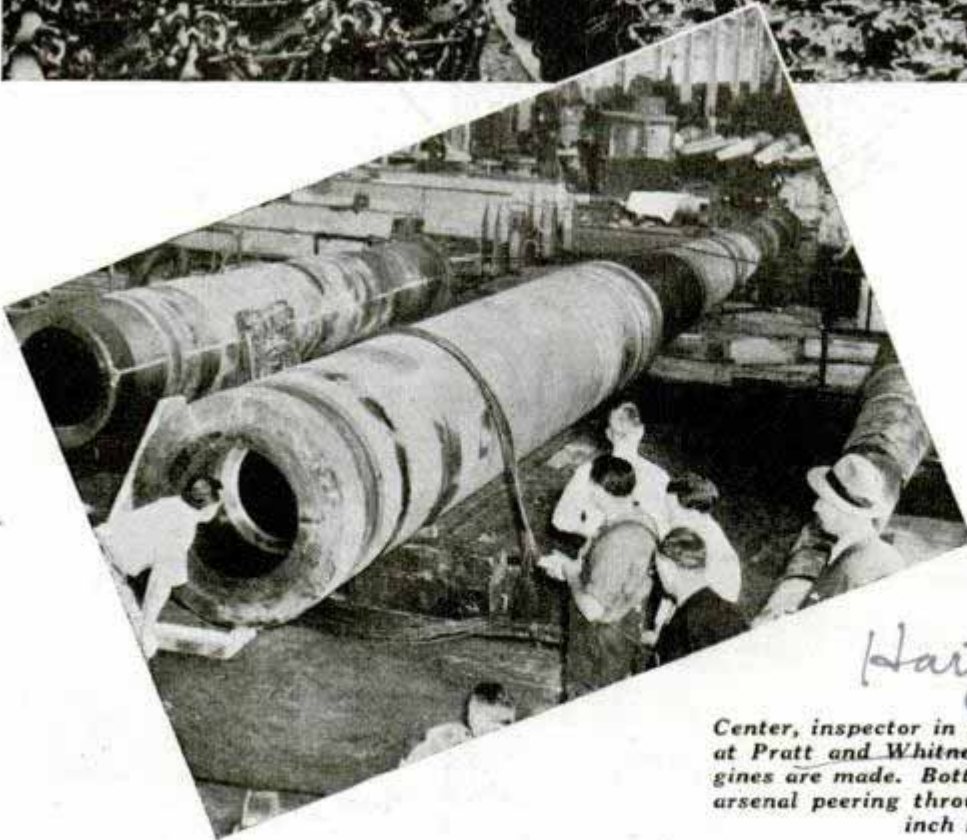
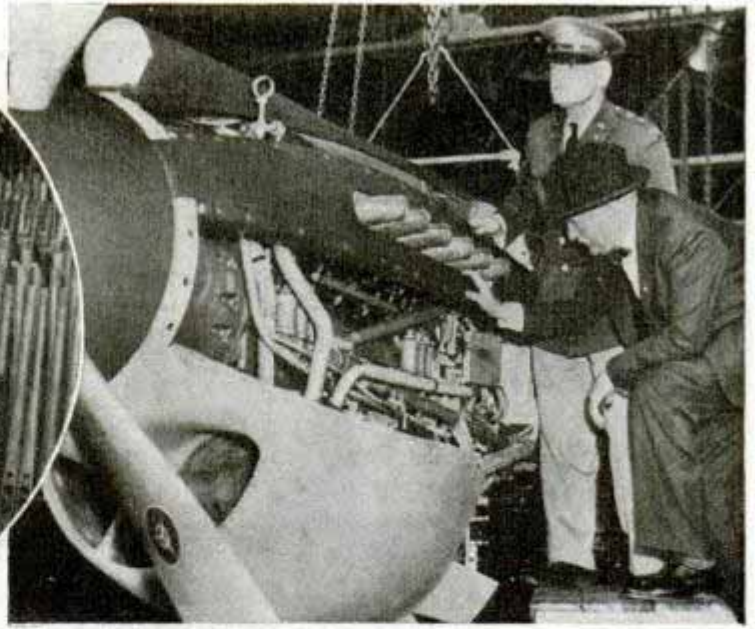
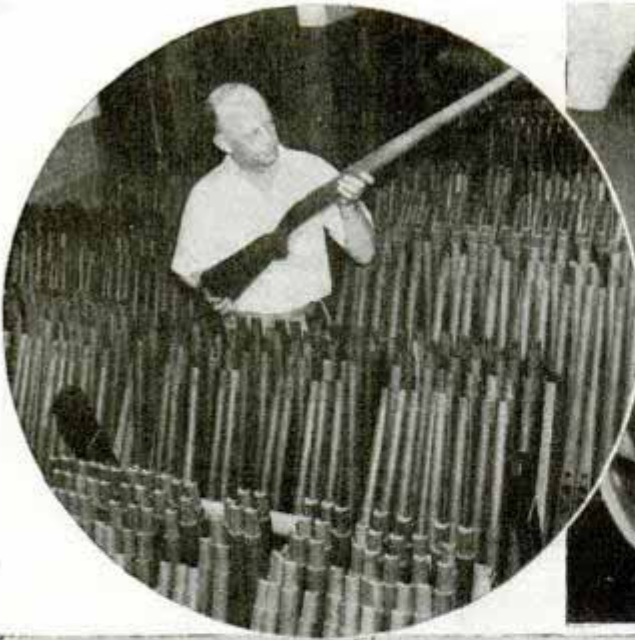

Top, left, stacks of rifle stocks for Garand semi-automatic rifles. The weapon fires 30 to 100 shots a minute. Right, William S. Knudsen, production chief of defense commission, stoops to inspect engine of Curtiss P-40, new pursuit plane. Gen. H. H. Arnold, chief of Army Air Corps, is shown with Mr. Knudsen

*Hartford
Conn*

Center, inspector in field of completed cylinders at Pratt and Whitney plant where aviation engines are made. Bottom, workman at Waterliet arsenal peering through barrel of huge sixteen-inch navy cannon

Rope Lowers Aerial Riders If Car Is Stalled

Passengers on the Swiss Santis aerial tramway, which reaches a height of 8,346 feet, need not fear being stranded long in the air if the car stalls somewhere along its ten-minute route. They may be transferred to a cabin brought alongside, but a more exciting way out, in case of emergency, is to descend by means of a special harness and rope found in a locker beneath the floor of the cabin. Usually two cars are operated simultaneously on pairs of parallel wires serving as tracks, one car going up as the other comes down, balancing each other.

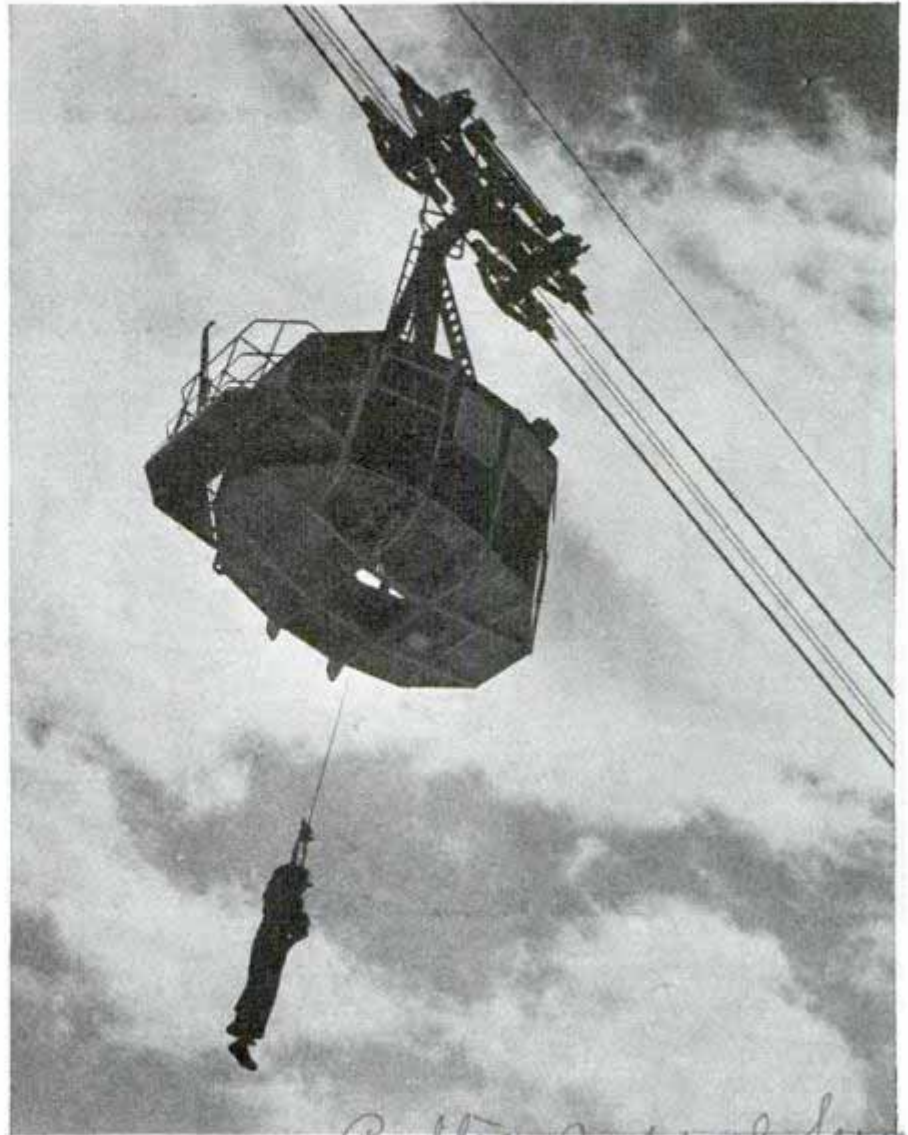

Here is how passengers may get back to earth if aerial car on Swiss Santis cableway should become stalled. A rope with special harness provides a safe descent

K937

Public Recreational Service

Empty Trailer Rides on Truck to Save Gas on Steep Climb

Logging trucks of one company have been equipped to pick up and carry their own trailers back over mountain trails to

the logging camp after unloading the timber at the water's edge. Because of the steep, rocky roads through the woods, the



Truck saves severe wear on both tires and working parts by carrying empty trailer instead of towing it up rocky roads

task of towing a heavy, four-wheeled trailer on the return trip was made more arduous by loss of traction which caused slipping and sliding that resulted in excessive wear on both the tires and the truck mechanism. It was to give the trucks better traction that the pickaback plan was devised. Each truck now has a special carrier and a simple winch device for loading the trailer onto the truck; a similar method being used to unload it at the scene of logging operations. Weighted with the trailer, the trucks make the return trip in less time, with a considerable saving in fuel and tires.

MILLIONS

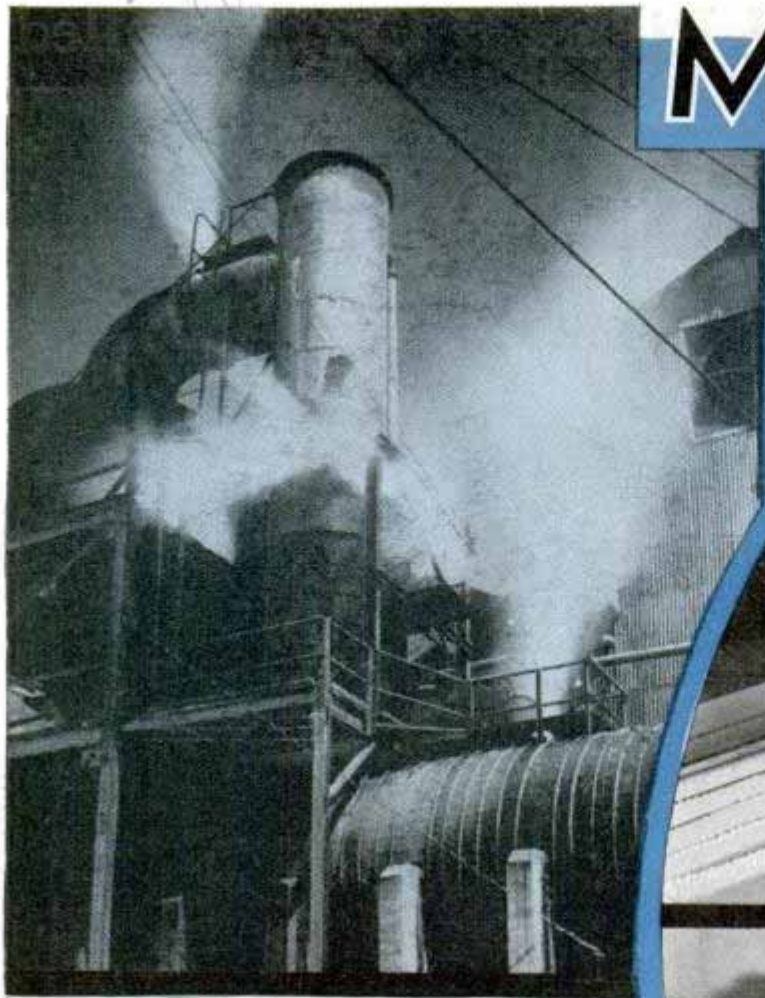

SKIM milk and sawdust, cornhusks and cull potatoes, whey and wood trimmings, peanut hulls and prune pits and pine-tree needles—just a few farm and forest wastes—are being converted into products worth millions of dollars. And crop surpluses, instead of being allowed to flood food markets or rot in the field, are being turned into cash in a variety of forms.

It is possible today to build houses of straw, to fashion clothing from grass and to make paper from cornstalks. But the cost is too high. Simplifying and cheapening the processes for accomplishing these things, thus making them economically feasible, are the problems being attacked on all fronts—by the scientist, the farmer, the lumberman, the fruit grower, the industrialist and the government.

Grapefruit may now appear in women's clothes, not as stains but as part of their colors. The oil crushed from grapefruit seeds has been found useful in sulfonated form for fixing colors in textiles so they will not fade. It also may be used in salads. Oil extracted from prune pits offers similar possibilities and oil crushed from grape or raisin seeds can be employed in paint and varnish.

Left, where wood wastes are made into boards by Masonite. Above, U. S. Dept. of Agriculture man working with potato-skim milk paste. Below, the paste, when cooked, becomes appetizing wafers

Anti-freeze alcohol and flour are being made from cull potatoes at an Idaho plant. Glutamic acid, a salable product, is being recovered from wastes accruing from the processing of beet sugar in Ohio. Apples ground to a pulp and mixed with skim milk at a cost of one cent per pound form a new food, apple milk. Flavored, it makes

see 'New Wonders of Agriculture'

June 1934 - 354

C. F. Sen Eyer, Calif

from WASTE

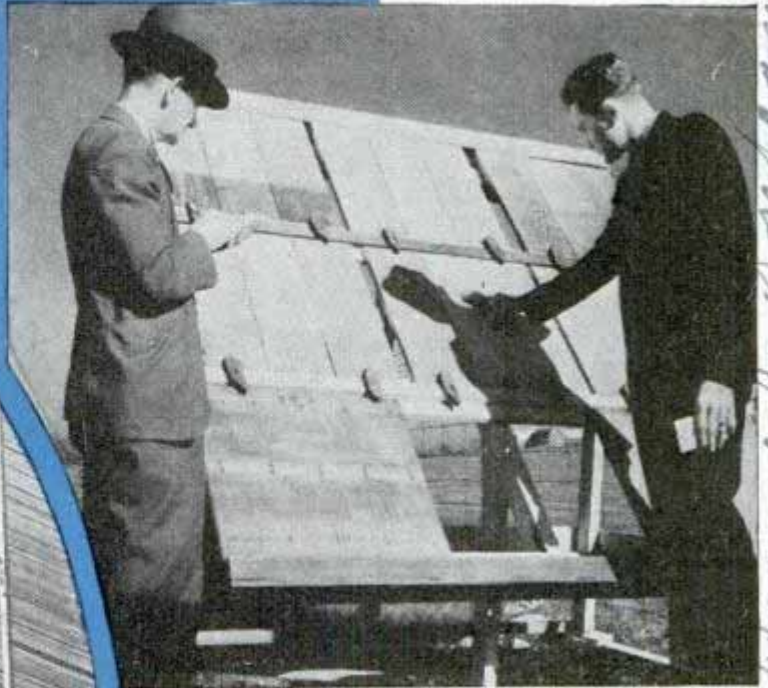
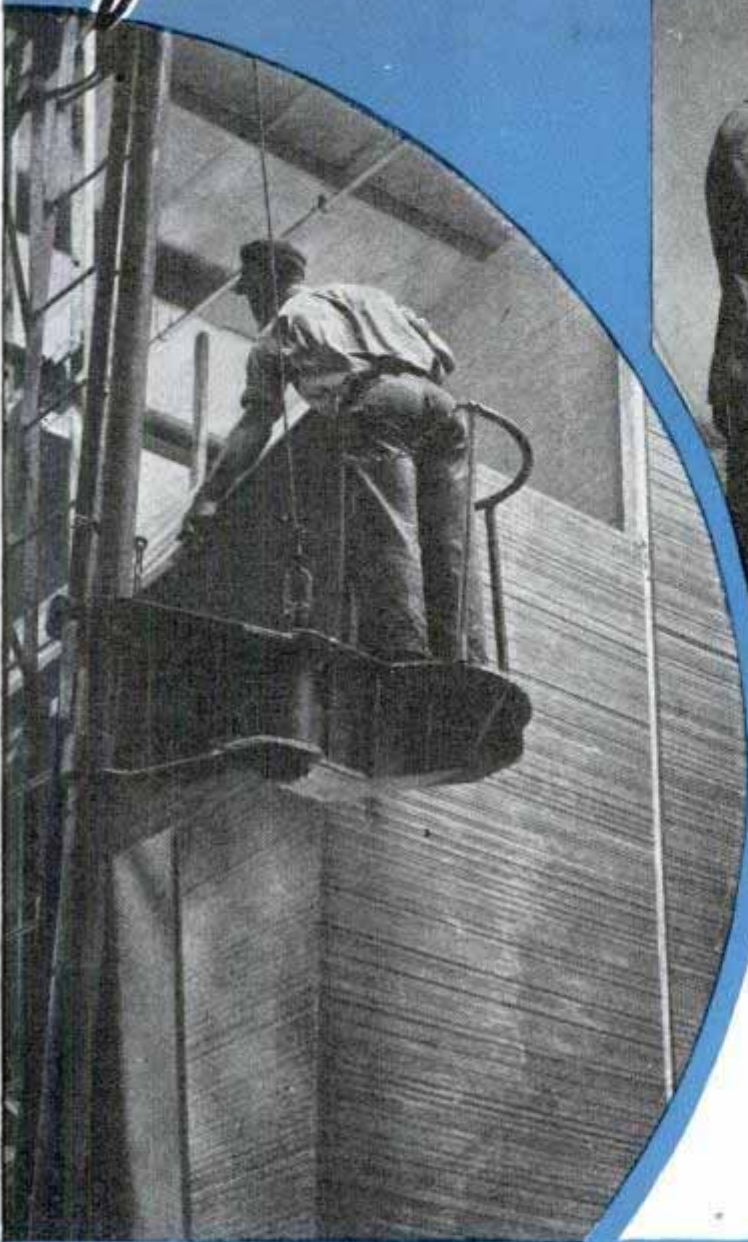

Left, towering stacks of finished boards produced from waste wood. Below, room with walls of the finished boards. Above, inspecting test panels of soybean-oil varnish

good candy; and for medicinal purposes, it contains ingredients already widely used for infant diarrhea.

Cornhusks are useful in more than a dozen products—bedding for stock, chair cushions, cloth, hats, door mats, fodder, horse collars; hot tamales, rugs, mattresses, oilcloth, polishing wheels and paper. From cornstalks, we can obtain cellulose—a material that ranks with basic metals in importance—building

blocks, charcoal, dietetic food, dynamite absorbent, fiber, fuel, furfural, gun-cotton, lumber substitutes, oxalic acid, paper pulp board, rayon, wall-board and other valuable things. Even the pith from cornstalks is useful, having been employed in making absorbent, face powder, gunpowder, insulating lining for refrigerators, linoleum, novelty pottery, packing for wooden war vessels, pipe covering, varnish and other products.

Waste from wood-pulp mills is being utilized in



Leguminal Soybean
Chemical Laboratory

Aug 14 3 55 PM '38

July 11



the fragrance of the forest, it lends itself to the scenting of soaps, bath salts and bath oils, to the thinning and perfuming of paint and varnish and to the imparting of an odor of outdoor freshness to interiors of homes, stores and theaters.

There is even the possibility of obtaining power from farm and forest wastes. By putting cellulose waste, such as cornstalks and straw, through a process like that used in treating sewage in a septic tank, the Illinois experiment station produced enough gas to run an engine. The gas so generated is similar to common consumer gas.

As the result of the development of a processed charcoal made from wood waste—sawdust, tree tops and stumps—a steel industry may be established on America's northwest coast. The charcoal would be used instead of coke made from coal. The Northwest has about

Top, displaying wool-like fiber made from casein by Bureau of Dairy Industry, U. S. Dept. of Agriculture. Circle, soybean flakes ready to be made into plastics. Below, plastics molded from soybean phenolic powder



Photos courtesy U. S. Dept. of Agriculture

plastics and converted into yeast. A new yeast plant in Canada expects to process 10,000,000 gallons of waste-pulp liquor annually. Vanillin, used as a flavoring material, is also made from pulp-mill waste. The U. S. Forest Service has developed means of using wood waste as a base for lignin plastic, as well as the source of furfural, acetic and formic acids and activated carbon. Wood employed in this manner may be waste by-product of pulp mills or in the form of sawdust, trimmings, short lengths having no value as lumber, and small, second-growth trees unsuitable for milling. Oil can be extracted from balsam-tree needles and twigs. Having an aroma reminding one of

*Recd. Aug. 1938
Feb 1938
Dec. Feb 1937-1938*

fifty million tons of wood waste per year, as a result of its lumbering activities. The charcoal is made from wood to which a tar is added, resulting in a "wood coke" strong enough to withstand the pressure of tons of ore in a blast furnace.

From sugarcane bagasse, the residue left after extraction of the juice, chemists of the U. S. Department of Agriculture have produced a plastic compound which they estimate can be made for less than half the cost of the cheapest synthetic plastic compound on the market. Thus plastics may be used in the manufacture of furniture, building materials and automobiles, since the raw material would

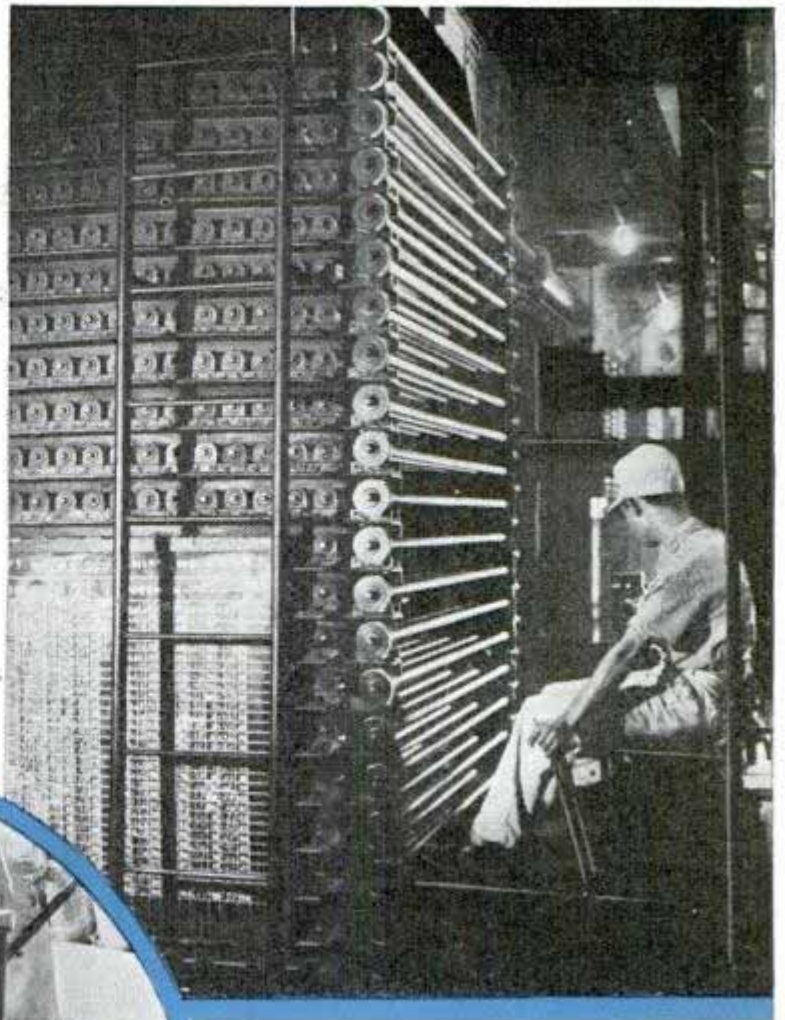

Above, racks loaded with blankets of wood material on way to press for conversion into boards. Circle, whey draining off in cheese manufacture. Below, wallboard made from soybeans

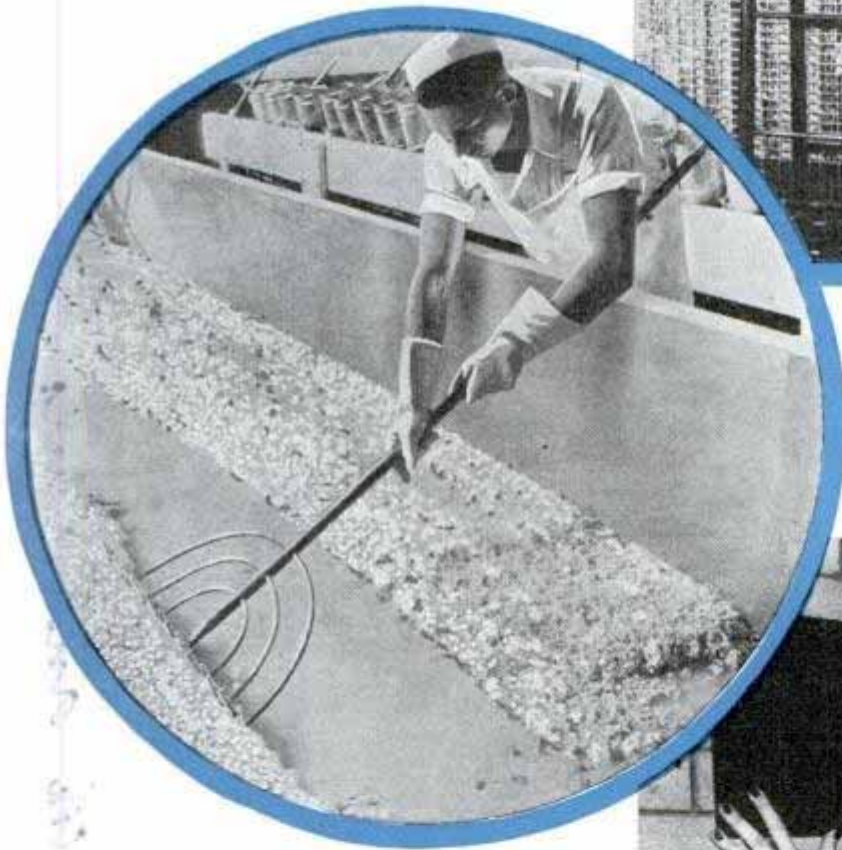

cost less than that of materials now used.

One of the gigantic problems to which science has turned its attention is the utilization of approximately thirty billion quarts of skim milk, buttermilk, cheese whey and casein whey, all left-over materials accruing from the annual production of cream, butter, cheese and casein. Only about six billion quarts are converted

(Continued to page 146A)



Magnetic 'Football Players' Illustrate Strategy of Game

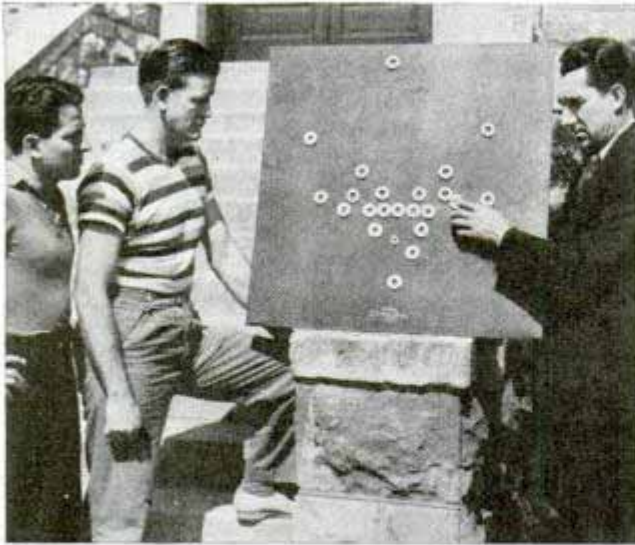

Football coach uses this metal board and magnetic pieces representing men to teach strategy of game

As an aid in demonstrating various strategic plays and formations to his players, the University of Kansas football coach has invented a portable board made of metal that takes the place of the common blackboard used extensively by football and basketball coaches. Players are represented on a forty-by-forty inch field by doughnut-shaped pieces lined with magnets to make them stick readily wherever they are placed on the steel board. The "ball" is distinguished from the "players" by its smaller size and oval shape. The device may be taken on tours and set up inside a bus, railroad car or airplane.

Driving Glasses Dark at Edges Cut Glare as Head Is Tilted

Night driving is easier on the eyes with a pair of goggles having lenses which are



Night driving glasses with clear center and dark edges reduce headlight glare when head is tilted

crystal clear in the center but become dark toward the edges, gradually increasing to a deep black at the rim. It is possible for the driver wearing them to reduce the glare from headlights by tilting his head slightly, yet this does not impede his vision through the center of the lens, which may be kept focused on his own side of the road.

Meter Charts Bumps per Mile on Surface of Highway

Construction of roads with a minimum of rough surface is aided by a meter that records on a moving chart the approximate location of bumps on the highway and also indicates their severity. Mounted under the cowl of an automobile, the meter has a

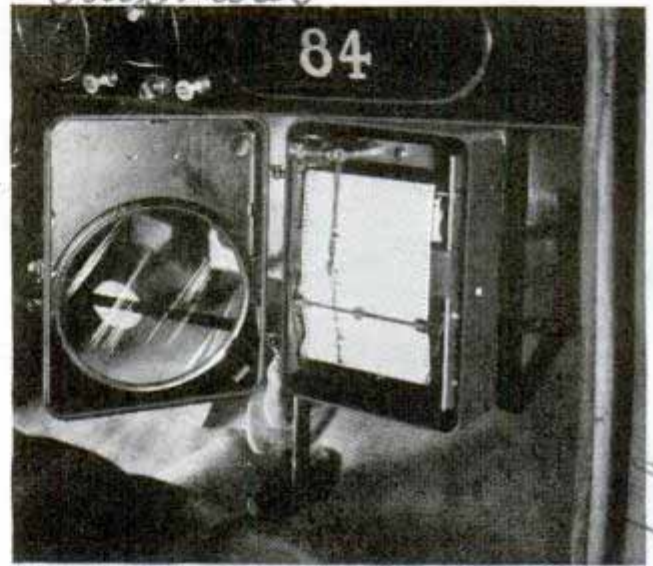

Pen of meter mounted under cowl records up-and-down motion of car, showing road's actual bumps

connection running to the knee action arm of the left front wheel. Vertical motion of the arm caused by bumps moves a pen to record the bumps per mile.

Cleaner Stops Electric Sparks by "Lubricating" Contacts

Sparking between electric contact points is quenched with a liquid that cleans and lubricates the contacts without producing resistance to the current. When applied to switches, commutators or slip rings it removes grease and stops sparks immediately, eliminating the need for scraping with sand or emery paper. Electrical parts so treated will not collect dirt. The lubricant is of particular value around grain elevators, mills and chemical industries where sparks might cause fires and explosions.

Handwritten notes:
 - Top left: "Via Har..."

Top right: "Midland Mich"

Left margin: "Chicago Optical Co. 2. 42 nd."

Right margin: "Phil", "4820 Warrington ave"

Center: "K918", "K993", "K1052"

X-Ray Clinic in Trailer Serves at War Front

Long Island City, N.Y.

Lives of many soldiers wounded in action will be saved with the help of a traveling X-ray laboratory that can make radiographic records of hundreds of patients a day near the battle front where hospital facilities are out of reach. Contained in a twenty-two-foot trailer, the compact X-ray equipment, built by Westinghouse X-Ray company, is equal in efficiency to that of many American hospitals. If no outside electric power is available, a miniature built-in power station uses the truck's engine to build up X-ray charges as high as 90,000 volts. A newly developed condenser-discharge machine stores up the voltage, fed in small quantities from an electric generator, and when the necessary amount of current has been "saved up" the charge is released automatically in a single bolt of high voltage to the X-ray tube.



2-16-43
inspecting trailer-housed X-ray clinic, equipped with power station to develop own current close to front lines where it will aid the wounded

E. L. Campbell, O.P. & Esen, N.Y.
 The trailer is divided into a lead-lined X-ray chamber and a darkroom for developing and studying radiographic pictures.

Twin-Engine Interceptor Plane Flies 500 Miles an Hour



R. 959
Army men call this the world's fastest fighting plane. It lands at seventy miles an hour, has gasoline capacity for a cruise of 1,100 miles

Lockheed Aircraft
 One of America's deadliest contributions to war in the air is the new Lockheed interceptor, a twin-engine plane reported to have a speed of 500 miles an hour. Built to chase bombers out of the sky, it can climb 4,000 feet a minute. The Lockheed "P-38" carries a one-pound rapid fire cannon and five machine guns. It has a forty-two-foot wing span and is thirty-eight feet long. If it lives up to its reputation of bettering eight miles a minute, it is probably the world's fastest warplane.

10442 Alborn Lane
Keeping a **BIG BRIDGE**

Erddan. Capte B. w. in a big...
Lush! Borgg, Precicio of labor, San Francisco



Left, directing traffic on Golden Gate bridge from electrical control booth. Above, portable wind recorder mounted on automobile hood is moved to various locations on bridge to check wind velocities. Below, an engineer inspects cable 740 feet above the water

Sergt. Carroll
Courtesy Redwood Empire Association

WHAT holds a big bridge up? Not the towers and cables that support it but its engineers. The minute a great bridge is finished the engineering staff starts a never-ending battle to keep it from falling down.

One bitter day Russell G. Cone, engineer in charge of the Golden Gate bridge that spans the entrance of San Francisco Bay, made an emergency inspection tour. A seventy-five-mile hurricane was pounding his mile-long structure. In the wind the bridge sounded like a gigantic orchestra. Steel suspender ropes hummed and screamed, lighting standards howled, and the girders under the deck kept up a muffled roar. Walking was dangerous and foot traffic had been stopped. Automobiles weaved from side to side as their drivers fought the gale.

Sighting along the roadway 220 feet above the water, Cone saw that the bridge had bent out of shape. The middle of the span was ten feet out of line, curved out by the wind. But he was pleased instead of alarmed. The world's greatest bridge, the "bridge that couldn't be built," was bending with the wind as had been planned.

The west side of the Golden Gate bridge is heavier than the east side because the prevailing wind blows off the ocean and necessitates a

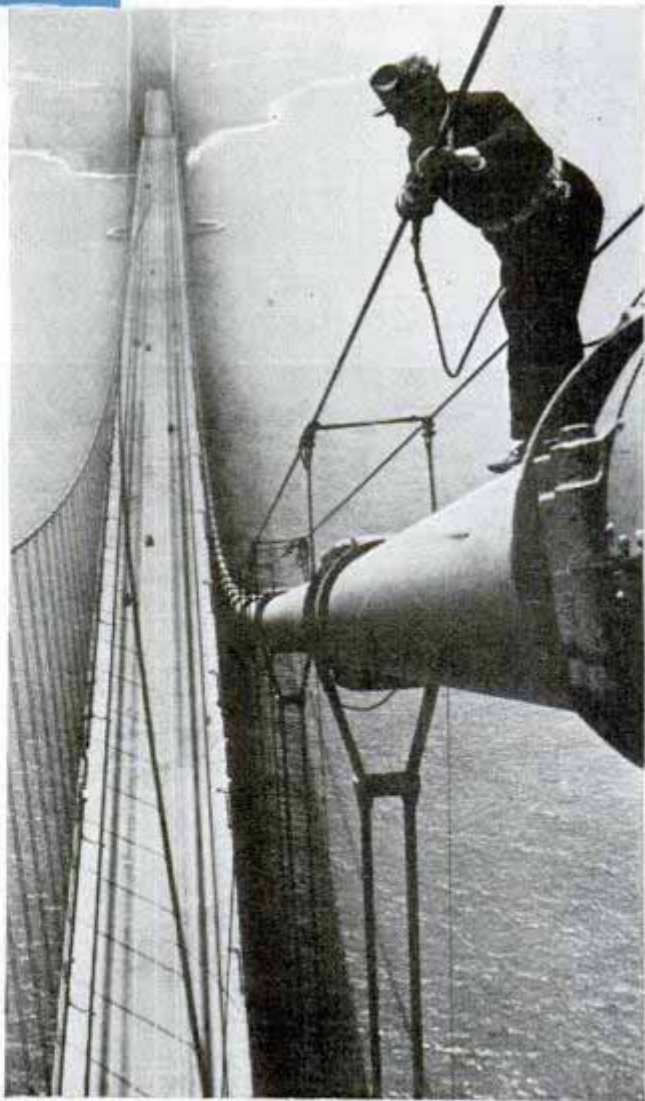

YOUNG



heavier paint coat on that side. Sometimes one side of the bridge is longer than the other side. Near either horizon, the sun heats up one side of the bridge more than the other and makes it longer. The roadway lengthens in hot weather. Cooling off, it bulges up like a hill in the middle, as much as fifteen feet. But all these movements were anticipated when the bridge was built. Even an earthquake strong enough to hurl a man from his feet can't hurt the bridge.

Rust is the bridge's greatest enemy, and the chief weapon against rust is paint. But the location of the bridge, exposed to the full drive of Pacific storms, is a

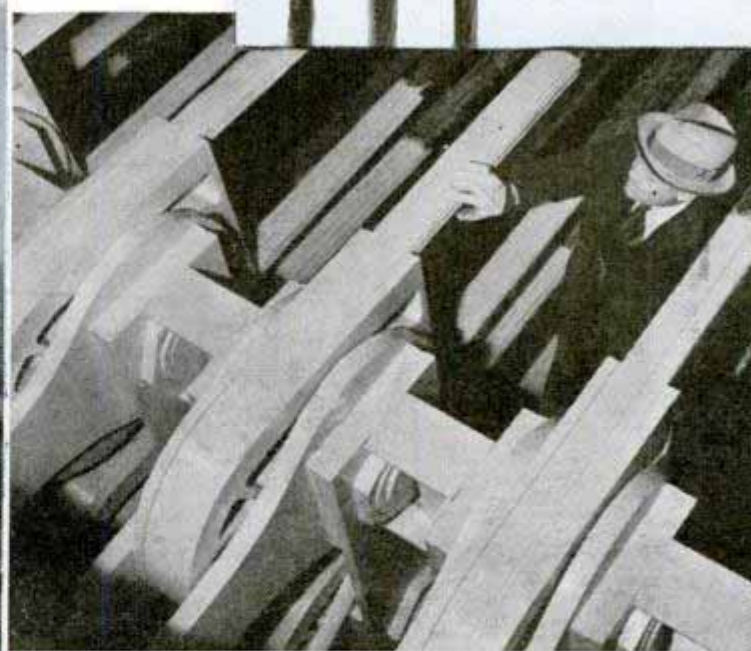
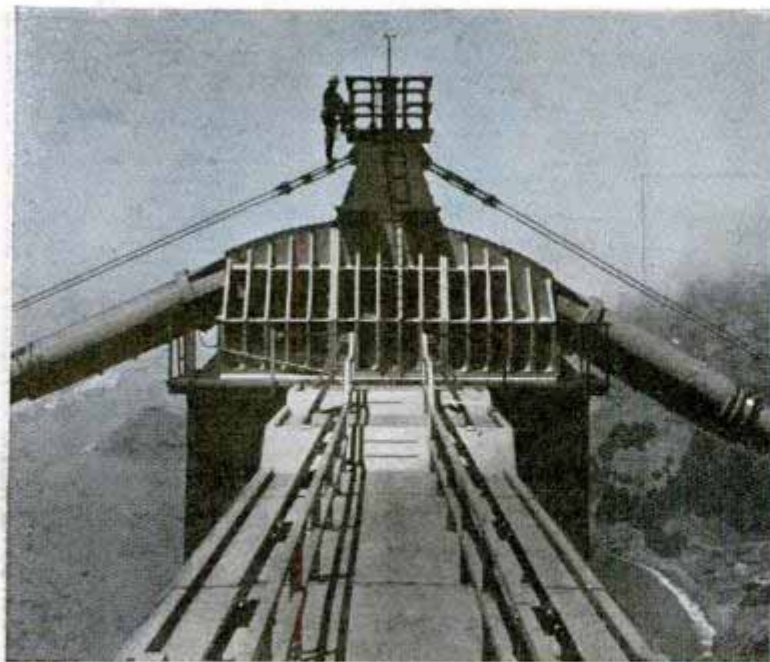

The 6,450-foot suspension bridge, top, cost \$35,000,000. Painters (right) go over every inch of it periodically. Lower left, yard-thick cable bends over tower and holds up bridge deck by suspender ropes; right, wire ropes connected to steel eyebolts buried in concrete anchorage block

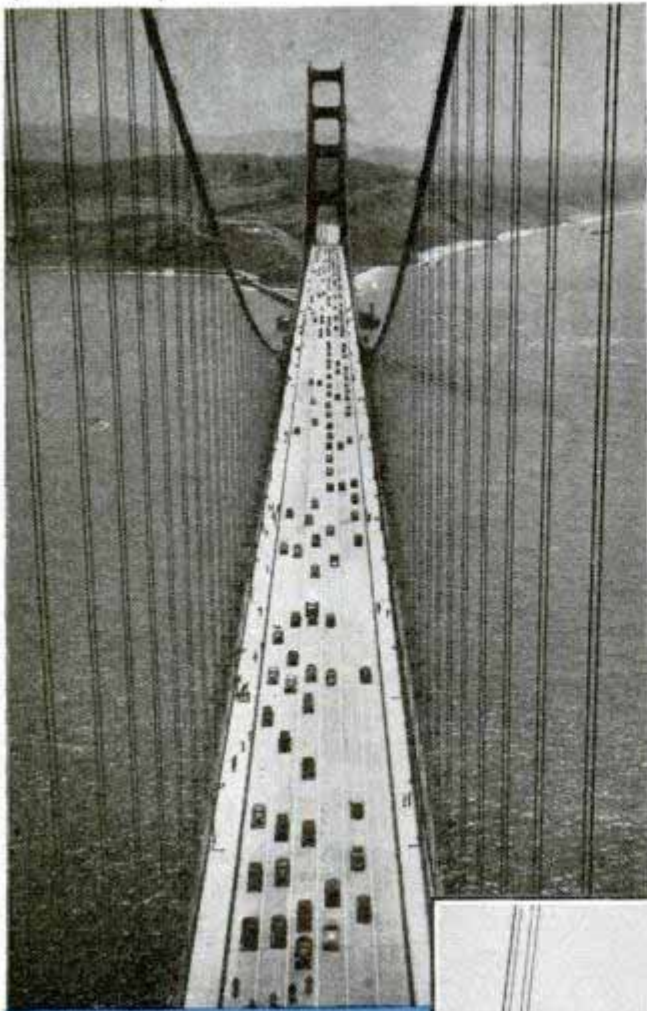

critical one. Paint can be destroyed by the elements. Heat and cold, wind, rain, fog, and salt corrosion attack the paint. Against these forces of nature Engineer Cone and his staff of trained bridgemen wage a spectacular battle.

Part of their campaign is a regular patrol of the whole structure. Every vital part is inspected, from the tops of the towers to the underground caverns where the cables fan out and tie in to the great concrete anchor blocks. Rivets are examined, roadway expansion joints are lubricated, and the paint coat scrutinized. A fresh coat for this bridge requires 780 tons of paint. Although a complete coat is expected to last five years the work is never finished.

To watch a painting crew at work you enter an elevator in one of the towers. Your hearing dulls with the changes of altitude during the eight-minute ride to the top, 746 feet above the water. Down below, where cars driving across the bridge appear like small black beetles, the weather

is pleasant but up here you grip the handrail against the stiff cold wind. The cups of the wind recorder blur with speed.

Curving down from the top of the tower are the yard-thick cables that support the roadway below. Wearing non-skid shoes, the painters climb up and down the cables to their working areas. Each man snaps a life line to one of the taut steel ropes that stretches above the cables. If he slips he will fall only a few feet instead of a seventh of a mile. To paint the vertical suspender ropes the men lower themselves from the cable on bosuns' chairs.

Down under the roadway another crew is repainting the underside of the bridge. Working from a wide traveling scaffold suspended below the deck, the men clean off the old paint and the mill scale with air-driven chipping hammers, burn the surface with wide oxyacetylene torches, wire brush the metal, and apply the priming coat of paint. The paint is brushed on by hand, using vertical strokes on vertical surfaces to assist the runoff of rain and moisture. The second coat is tinted darker than the first

Above, traffic crossing the bridge. Right, painters at work on suspender ropes, sitting in their bosuns' chairs. Below, panels of paints and compounds being weather-tested before being used on the bridge



so that skipped areas can be seen. The top finish coat is of international orange.

New coats of paint at the bases of the towers, where the exposure is especially severe, are tested after they are dry by sweeping the surfaces with a thick brush of fine wire that is connected through a high-frequency coil and a buzzer to the ground. If the bristles find bare steel the buzzer sounds a warning.

Shady and sunny areas, horizontal and vertical faces, each receive different mixtures of paint. Every square inch of the 83,000 tons of structural steel in the bridge except the portions that are buried in concrete receive periodic inspection and care. More than half a dozen different paint formulas are used, ranging from coal-tar primers on steel at the tower bases to red lead, copper base, chlorinated rubber, carbon black in oil, and pigmented lead paints.

An average of thirty painters are on the staff and in addition riggers, electricians, fire and tow-truck servicemen, as well as toll collectors, guards, and office workers are employed. The electricians have charge of the 150 K.V.A. standby emergency generator set that automatically takes over the lighting load within a few seconds if the regular 11,000-volt power supply fails. In addition, they have charge of the elevators in the bridge towers, maintain the private telephone system that has sixteen stations, and guard the navigation and aviation lights on the bridge. One of the towers has a full-fledged lighthouse built into its base, channel lights mark the middle of the span, and revolving beacons on the tower tops and cable-outline lights show aviators the location of the bridge.

Not everyone can work comfortably in high places and the bridgemen eat a special diet to avoid any chance of their becoming dizzy while they are at work. The danger from inhaling lead fumes is the greatest hazard that the painters face and they wear breathing masks when working in confined spaces inside the towers. Each man receives a periodic health examination and those who seem to be absorbing dangerous quantities of lead are put on high vitamin diets.

One of the strangest occupational injuries of the bridgemen has been the bruised arms and elbows received by the collectors at the toll gate. Accepting money from a driver, a collector was apt to

(Continued to page 151A)

DECEMBER, 1940

Small-Size Garden Tractor Uses Pint of Gas an Hour



Even a child can operate this garden tractor that plows, mows or cultivates field at walking pace

All the power needed for plowing truck, nursery and greenhouse gardens is supplied by a walking-type tractor that a child could operate. Its one-horsepower engine can be throttled down to two-thirds of a mile per hour for light work such as shallow cultivating of small plants, or it will operate at two to three and one-third miles an hour for larger plants. The tractor also will mow, or run belt machinery.

Clamp to Shut Off Water Hose Saves Fire Fighter's Time

Precious moments in fighting a fire can be saved by the use of a hand clamp for shutting off charged hoses that need replacement. Cutting off the water under pressure at any point on the



hose eliminates the necessity for running back to the pumper or hydrant. Downward pressure on the handle automatically locks the jaws. The clamp is a convenience whenever it is necessary to add hose, replace a broken hose or relieve pressure when carrying hose to the top of a ladder.

American La France 843

Firefighting Corp.

Truck Serves as Mobile Base for Army Observation Balloon



A winch mounted behind the cab handles more than 4,000 feet of steel cable anchoring the observation balloon to its mobile base

Observation balloons of the U. S. Army are accompanied by trucks which serve both as mobile mooring masts and eleven-ton anchors. A winch mounted at the rear of the truck cab and powered by a 125-horsepower motor raises and lowers the balloon by means of a steel cable more than 4,000 feet long. The balloons are used for "spotting" the fire of the big guns. They have interchangeable motor gondolas and observation baskets, and within ten minutes can switch from a motor-driven airship to a captive balloon. A fleet of trucks carries equipment and spare parts for maintenance and repair of the balloons.

Knock-Free Fuel Would Double Mileage or Engine Power

When gasoline can be produced entirely free from knock, it should not be hard to

get either double the present-day mileage or double the power per gallon, but not both, in the opinion of T. A. Boyd, of General Motors Research laboratories. An engine burning such a fuel probably would be of much smaller displacement than that of today. At present, fuels have an octane number of about seventy, costing about five cents a gallon to produce. It is pointed out that even if it would cost twice as much to manufacture gasoline with 100-octane number, the car owner still would get more "miles per dollar" with the higher-price gas.

Cleansing Tissue Stored in Handy Car Dispenser

Another home convenience for the automobile is an inexpensive dispenser for cleansing tissue which fits under the glove compartment in the Pontiac. New boxes of tissue are inserted easily into the container from which sheets may be taken one at a time as needed.



Dispenser keeps supply of cleansing tissue within easy reach of driver or front-seat passenger

Cmd. Walter Chamberlain, B-29, 1945
 A. P.

... ..

General Motors Corp.

... ..

R 703 *Madison Ave* *240*
Dogs Are Noseprinted as Aid to Identification *B of New York City*

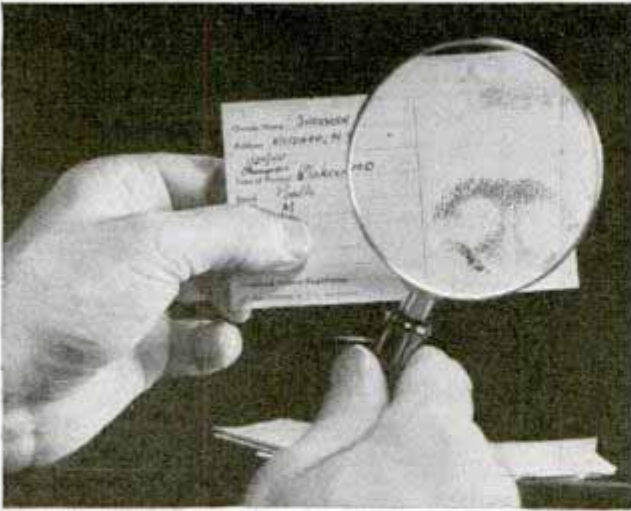

John Landero
Chemical Engineer
Fingerprint Expert.

Noseprinting of dogs, as an aid to identification, is just coming into use. Above, the magnifying glass is employed to reveal details of noseprint on identification card, which the dog will carry on his collar. This card contains complete information that will be useful if the animal becomes lost or stolen. In addition, reference to the noseprint files will enable an owner to identify his dog in case of disputes



Is Robinson

Above, identification pendant being attached to the dog's collar. Left, how the noseprint is taken with the aid of an inking pad and a process that is said to prevent smudging, thus resulting in a clear print which will have distinctive grooves and other markings. Noseprinting is closely akin to fingerprinting, which governmental agencies use to help establish the identity of humans



Right, comparing prints of two dogs. All dogs' noses vary in size and shape and are uneven in texture. The skin is made up of irregularly shaped small islands surrounded by deep grooves or furrows. Close observation shows these islands possess depressed parts. An impression on any part of the nose will show clearly these dots or islands which fall into distinct patterns

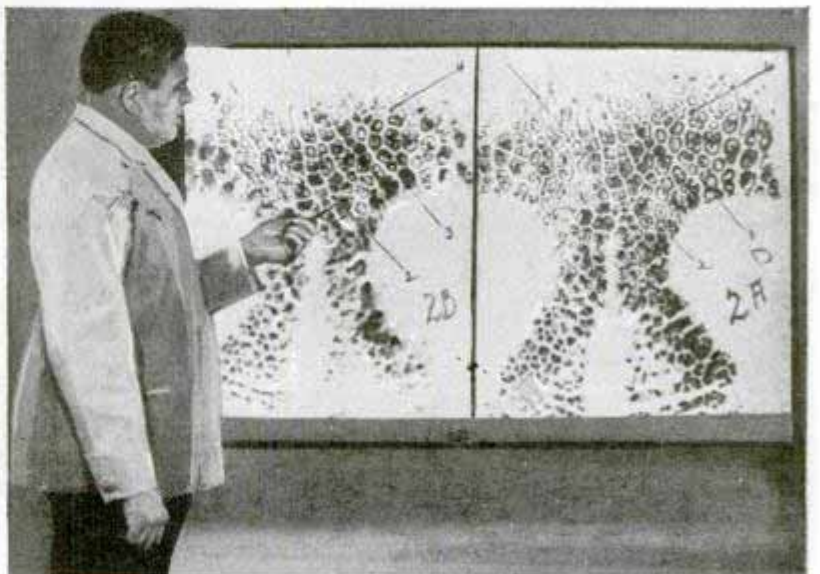

RUBBER "GROWN"

B. F. Goodrich Co. Akron - Ohio
Firestone Tire & Rubber Co. Akron - Ohio



Top, buna emerges as a liquid; it is a synthetic rubber product of petroleum cracking. Below, lining a tank with Kerozeal for handling acids; right, sheets of Ameripol (left) and natural rubber (right)

PRODUCTION of synthetic rubber in large quantities is an important phase of America's defense program, in that this country soon may be freed from dependency upon foreign supplies of natural rubber. About ninety per cent of the imported rubber comes from the war-involved East Indies.

Already government officials have conferred with companies owning or controlling synthetic-rubber processes, several of which have been developed beyond the experimental stage, and plans are being worked out for construction of plants where the man-made rubber may be produced. Its conversion into automobile tires and other products may be accomplished with standard machinery, necessitating no changes in present plant equipment. Processes controlled by Goodrich, du Pont and Standard Oil of New Jersey are now in production.

Goodrich today is making tires from synthetic rubber which the company calls Ameripol. The

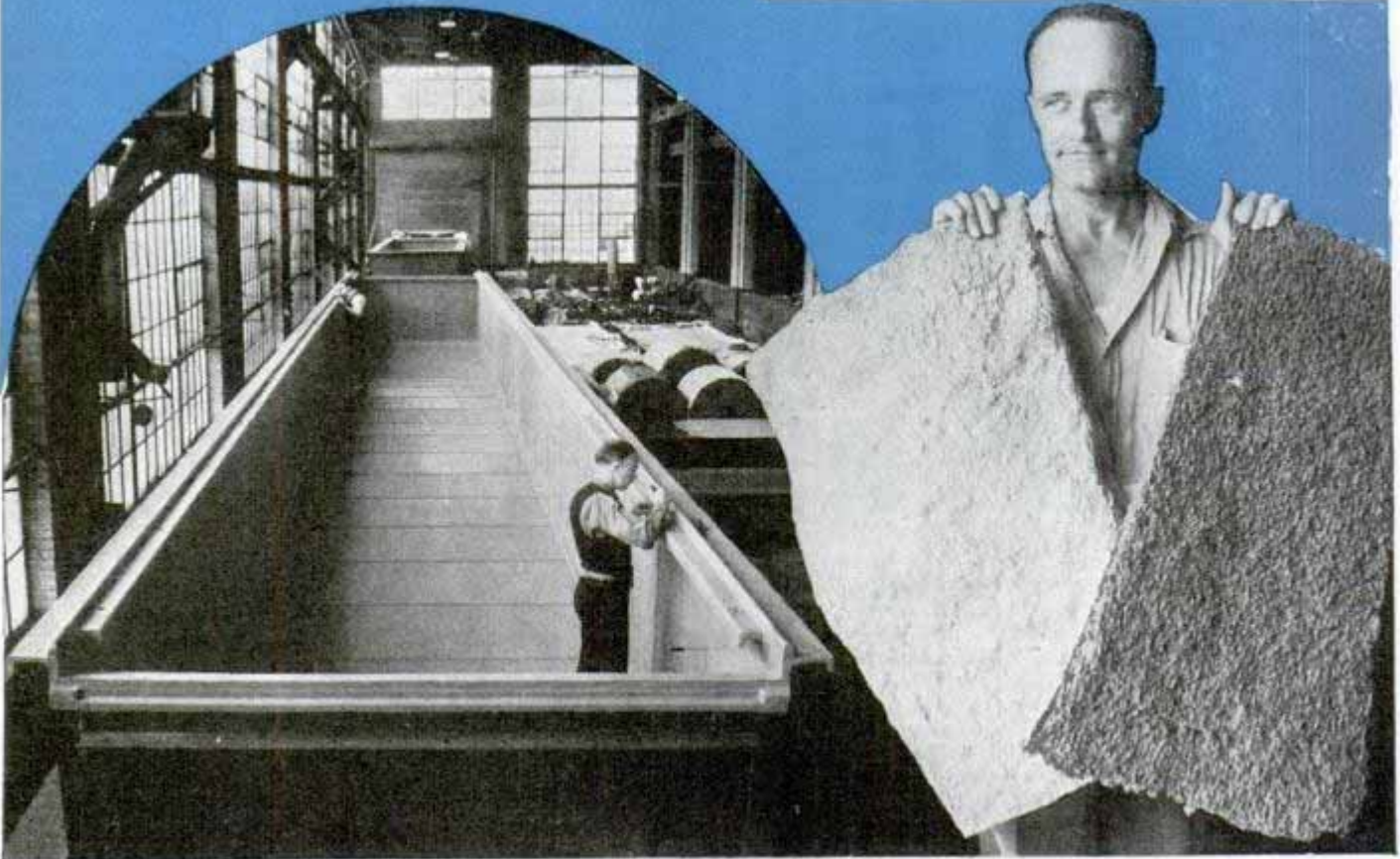

in FACTORIES

While synthetic rubber is "masticated" by rollers of mixing mill (upper left) sulphur, carbon black and pigments are added. Right, a tire of Ameripol, identical in appearance to natural-rubber casing. Bottom, curds of synthetic rubber rise to top of vat



basic material is petroleum, a black, sticky substance which is broken down by "cracking" into a mixture of simple molecules. From this mixture can be separated a gas which under pressure liquefies to give butadiene. This is mixed with other ingredients prepared from natural gas and air, and then made into a milky emulsion, using soap produced from American agricultural sources. Upon heating and agitation, these ingredients react to form an emulsion or synthetic rubber quite similar to the latex obtained from rubber trees. From here on, the process of obtaining a sheeted rubber is like that used for natural rubber.

Under a licensing agreement

(Continued to page 134A)



Screen Powered by Motor Sifts Ten Times Faster



Electric screen, shaken by a rotating head connected with motor, quickly sifts material shoveled into it

Driven by a one-sixth horsepower motor, an electrically agitated screen is said to be ten times more effective than working by hand. Material on the riddle is subjected to a speedy screening action by a gyrating head driven by the motor.

Fan Spreads Steam-Heated Air from Ceiling Fixture

Heated air is blown downward to warm the room from a combination fan and

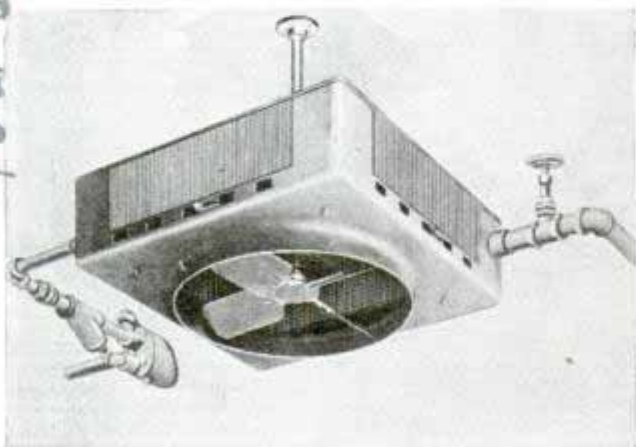

Steam heater has fan to blow warm air toward floor

steam-heated unit that hangs from the ceiling. The heater consists of coiled tubing, fitted with inlet and outlet connections, through which steam flows. Air drawn in from all sides by the electric fan is heated as it passes the tubing, and then is sent floorward where it spreads out evenly. Motor and fan assembly may be removed for inspection or service without disconnecting the steam pipes. Besides heating rooms the unit may be used to dry clothes or commercial products.

K939 Airplane Landed by Parachute from 500-Foot Height

Showing how disabled planes may be brought down without crashing if properly equipped, Jimmy Goodwin, of Newport, Ky., landed an airplane by parachute

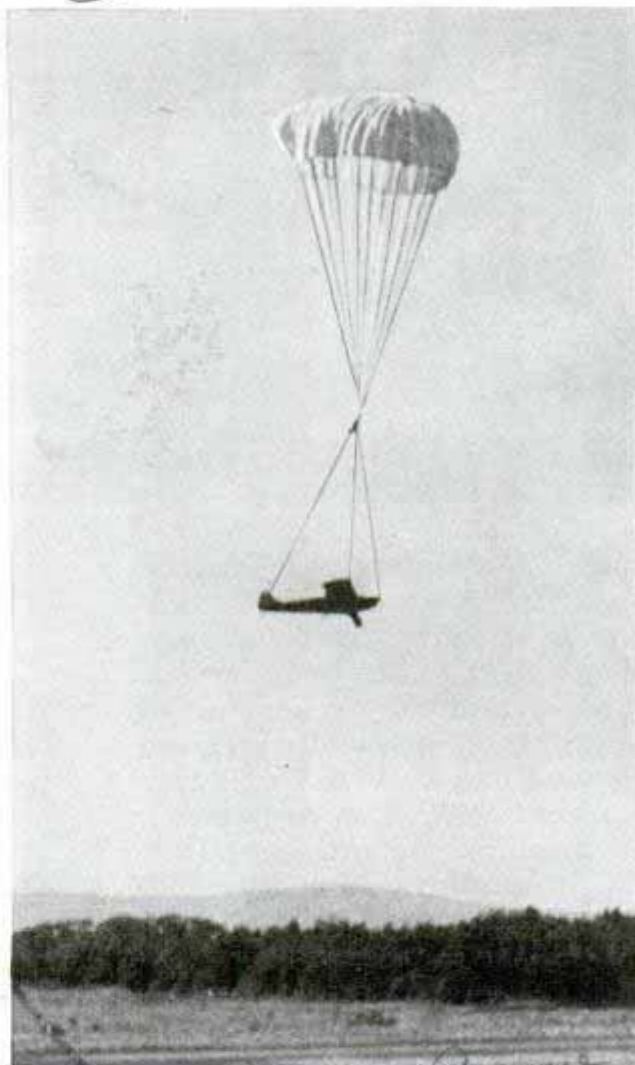

At a height of 500 feet from the ground this plane opened a fifty-two-foot parachute for a safe landing

recently as a special feature of an air meet in Maine. For making the unconventional descent, the craft carried a 'chute fifty-two feet in diameter which was opened 500 feet above the ground.

Jefferson Machine Tool Co.
15' outb. Cutter and Sundry
Remains
Ohio
C.A. Dunham Co. Chicago
452 E. Ohio

Signal Worked by Car Reduces Speed in Town

New York Times 8/18/48

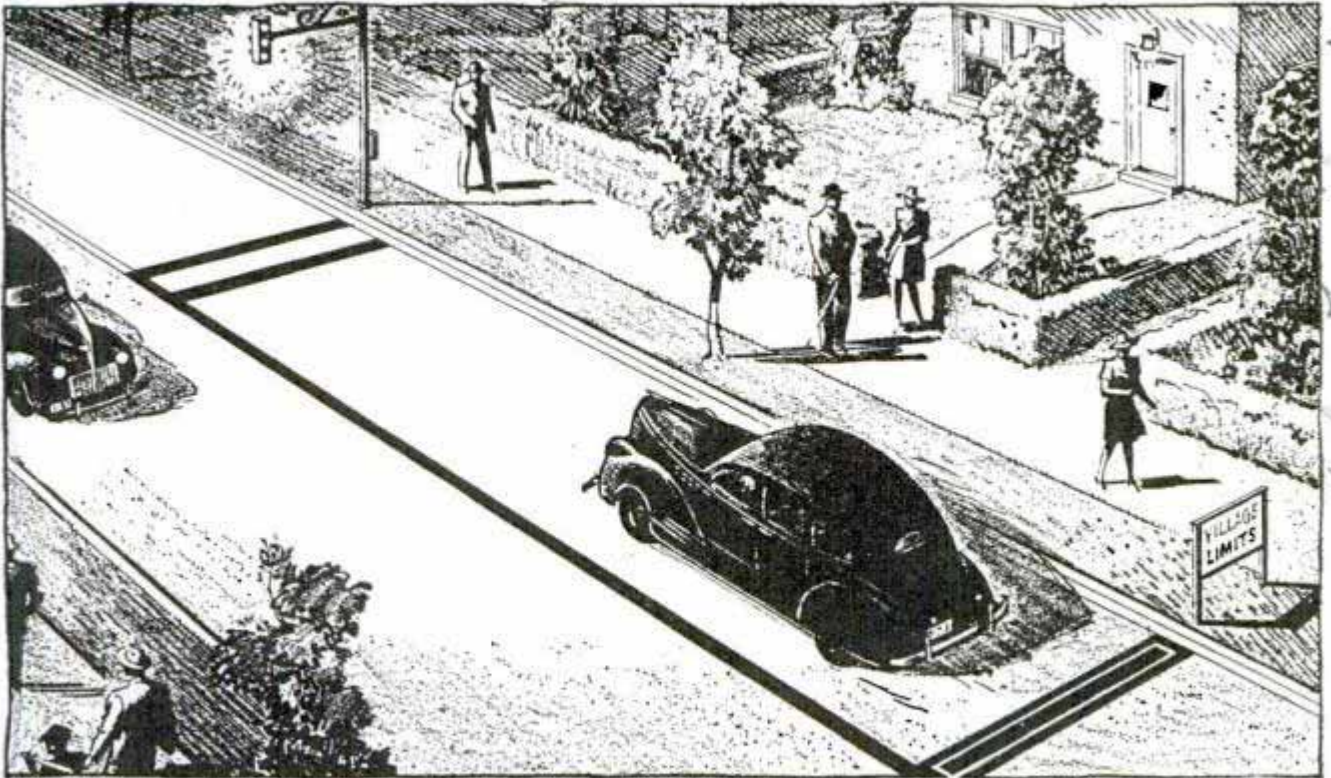

Diagram shows how cars entering town must slow to safe speed before they reach stop-and-go light. Signal remains red until car passes over switch, then after brief wait it changes to green

Automobiles entering either of two Delaware towns at excessive speeds are slowed down by a traffic signal which they operate themselves. The detector, connected by wires to the signal, is embedded in the right-hand lane of the highway about 200 feet in advance of the signal, which normally displays a red light. When a car passes over the detector, a delayed-action control is set in motion that changes the

Middletown and Bridgeville

signal from red to green after a lapse of several seconds, this delay being equal to the number of seconds required for the vehicle to travel the 200 feet at the maximum speed fixed for safe entrance into the town. Thus if he travels too fast the driver must wait for the "go" light when he reaches the signal; but if he reduces his speed sufficiently, the light will change from red to green just as he reaches it.

8948

Air-Powered Machine Gun Fires 10,000 Shots a Minute

Instead of firing its bullets with noisy explosions, a silent machine gun, invented by William B. Hale and Durand Beam, shoots with compressed-air power. In recent tests the rifle, which resembles a sub-machine gun, discharged 10,000 shots a minute, reducing three-inch oak planks to kindling and turning airplane armor plate into steel mosquito netting. As firing starts, the barrel cools, instead of heating, due to use of air as the propelling power.

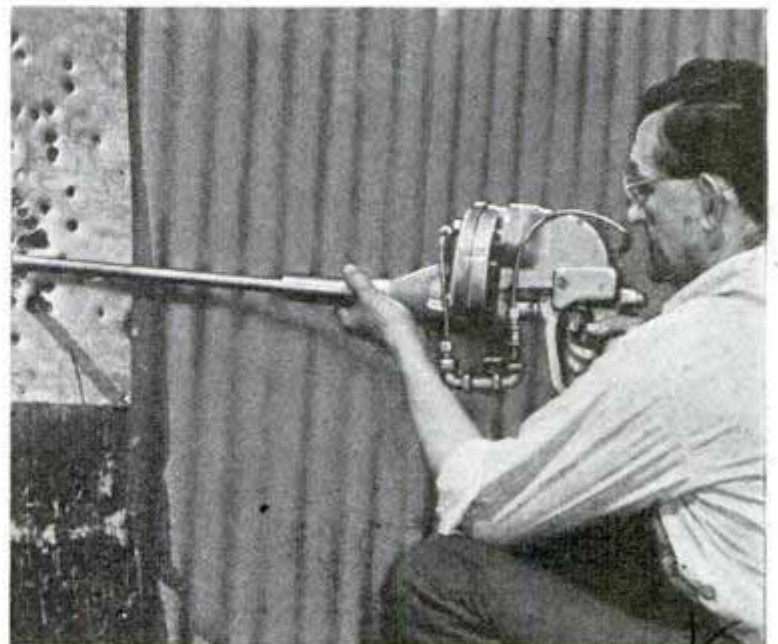

Silent rifle powered by compressed air instead of gunpowder is shown at right with steel target riddled by bullets in test

*10535 Oxford Ave. 849
Chickadee Oil*

K 975

Outboard Boat Fitted for War
with a Torpedo Sling on Deck



Preparing to fire a dummy torpedo with the "sling shot" coil spring arrangement built on deck of an outboard racing boat for a demonstration.

How a fleet of outboard racing boats could be converted into a fleet of torpedo boats for harbor protection in wartime was demonstrated recently at Long Beach, Calif. One of the little outboards was fitted with a torpedo rack on its deck, from which a small dummy torpedo was launched with a simple coil spring.

K 1054

Goldfish Save Work for Chemist
by Keeping Jar Clean

Once a research chemist spent seven hours a week keeping a certain glass jar clean, but now three goldfish, costing thirty cents, do the work without one penny of expense. The jar is used in a General Electric laboratory to keep a constant temperature bath for measuring viscosity in plastic materials. The inside of this jar had a tend-

ency to collect a sticky scum, which had to be removed by scouring once or twice a week, because it was necessary to make frequent observations of what took place in glass tubes inserted into the bath. After trying acids which failed to do the work, the chemist used snails, but these died when the temperature of the water rose. By chance he bought the three goldfish and put them in the jar. They set to work and within two or three days the scum had disappeared. Since then the jar has remained clean. The fish find food in the work they do, so it is unnecessary to feed them.

K 795

Tilting Top Swings
Camera in Arc
of 90 Degrees

Lightweight but strong, a metal tilting head made to fit all standard tripods permits the camera to be swung in a full ninety-degree arc from vertical to horizontal, holding any position rigidly. It is built to support any camera from the miniature type to a heavy five-by-seven.

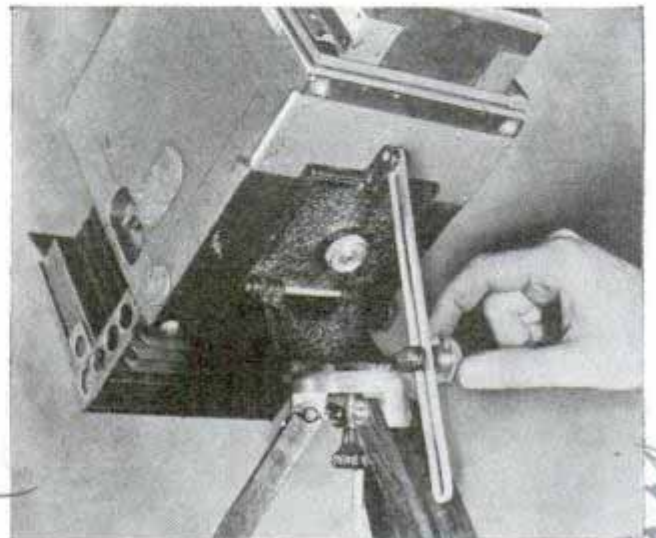

Camera is slanted for a steep angle shot on the tilting head that fits on a standard tripod

Mayor Harry L. Patterson
Compton, Calif.

1357
10442
10442
Norman & Sumner
Hobbs Jan
Looney

FLYING COWBOYS

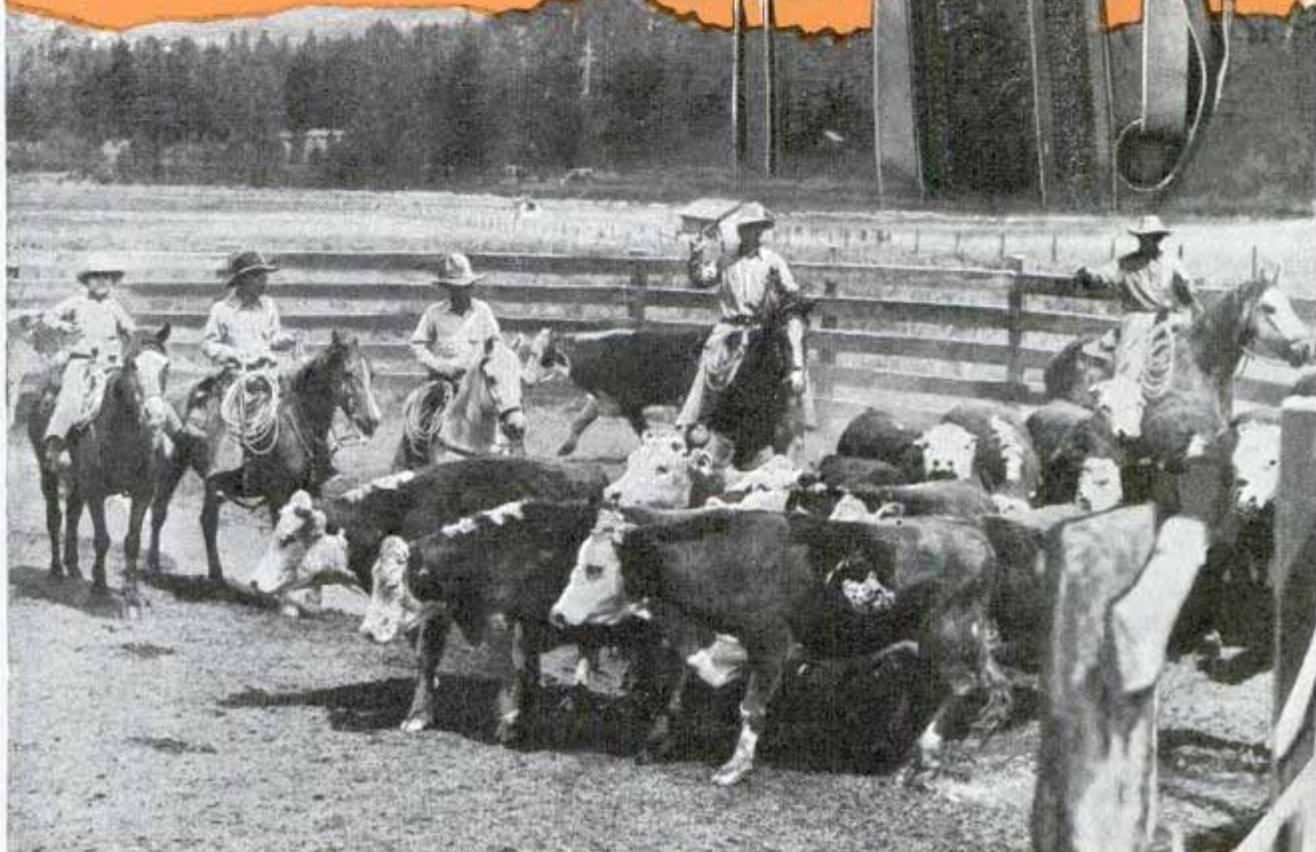
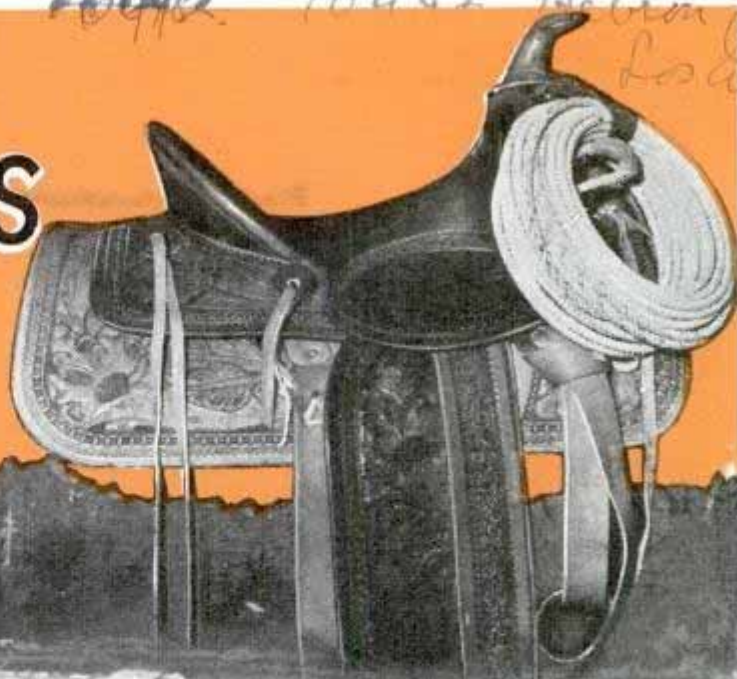

Top, right, modern stock saddle. Center, preparing to ship fattened steers. Bottom, unloading saddles from small plane used for scouting and transporting equipment

A BAND of renegade cattle was at large in the mountains and the cowpunchers knew they had a fight on their hands. The wild animals were too valuable and too dangerous to abandon and it was going to be a tough job to capture them. Missing for more than a year, they had been located by a Forest Service pilot who had been asked to scout them from the air.

Plunging through the rocks and brush, wild cattle are faster than horses over short



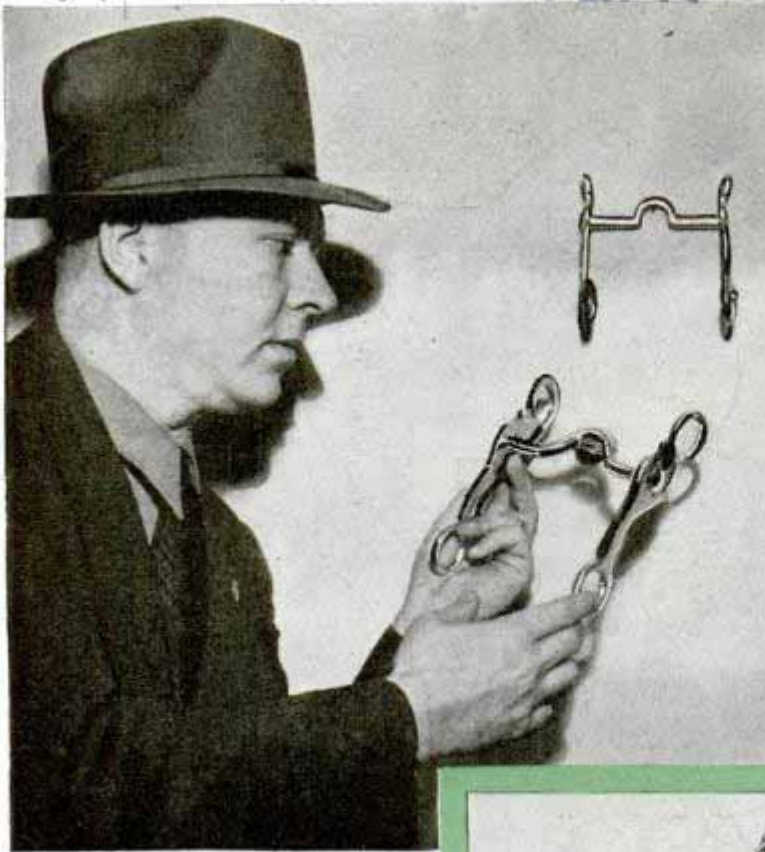

Cal Godshall photos

distances. A big animal can jump a seven-foot fence, and in spite of its awkward appearance it makes amazing speed. Weighing close to a ton, a snorting charging steer can knock down a horse and kill the rider. A man on foot wouldn't stand a chance against it and even an experienced mounted cowhand needs a partner. The trick in capturing one is for two men to rope the animal so that if it charges one man the other can snub him to a halt.

When Cal Godshall of the C-Bar-G ranch near Victorville in California finds that some of his cattle have turned wild on the summer mountain range he organizes a special roundup to bring them in. Modern breeds of cattle are inherently gentle but now and then an animal, possibly a throw-back by nature,

turns wild after roaming for a few months. Other cattle follow the renegade and soon a band of smart and wary animals is on the loose. Capturing them is an adventure in itself, then comes the task of gentling them.

"If we have some tame cattle in the hills we lash one of the wild animals to a gentle one," Godshall explains. "The tame animal acts as an anchor every time the wild one tries to get away and by the time they have been driven down to the winter range the renegade has forgotten that he once acted like a four-legged tornado.

"Another way to take the fight out of a wild animal is to tie it to a husky sapling for the night. The bending tree gives with each of his lunges but the farther he moves the greater is the strain against him and by sun-up he has gentled himself. If we don't have time for that remedy another method is to tie a yard-long chain to one of the ankles. The chain drags harmlessly as long as the animal walks along calmly but as soon as he



Top, modern riding horse bit made of cast aluminum compared to old-style iron bit hanging on wall. Center, short dull spurs of today (in lower hand) compared to sharp spurs (upper hand); chain bit hangs on wall. Bottom, loading horse into truck for trip to range

starts to run the chain wraps around his legs and hobbles him down."

Life on the cattle ranges is much the same as it was in the heyday of the West although the modern cowboy has been able to adapt many of the developments of industry to his special needs. Not every ranch has its own airplane although airplanes are often pressed into service, especially after storms that drift the herds away from their own ranges. Snow or rain beats out their trails. An observer in an airplane can find the cattle in a few hours where it might take weeks of searching from the ground. The cattle may be loaded into trucks and trailers for the trip home. If they are bunched in rough country the cowboys load their riding horses in the trucks and drive as close as they can, then use their horses for herding the cattle back to the ranch.

The cowboy's horse is



still his most valuable tool and a good one may be worth several hundred dollars. He uses only four or five instead of twice as many, as in the old days, because the modern cow horse is a larger and stronger, more intelligent animal. Each horse is trained in its job and does more than its share of the work in cutting out animals from a herd or in keeping a rope tight to hold a thrown calf on the

(Continued to page 124A)

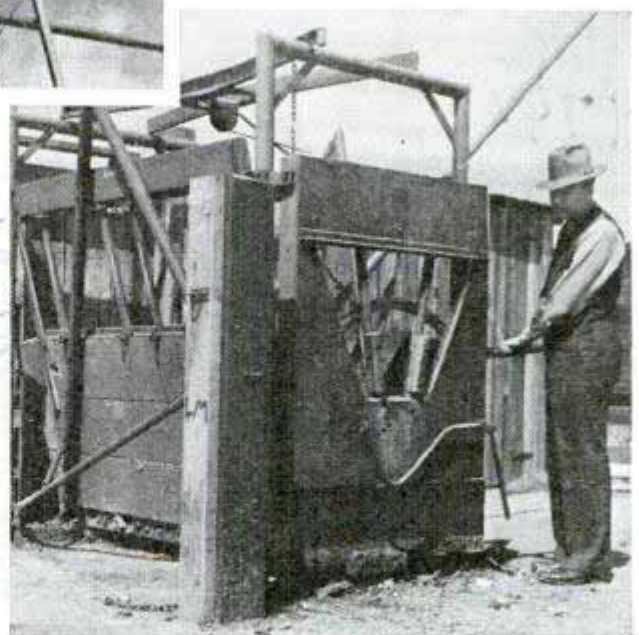
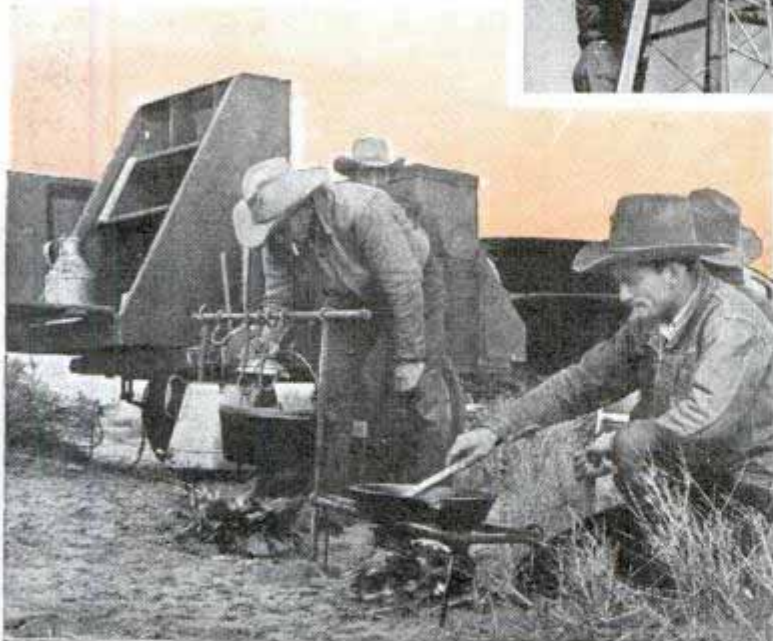

Top, branding horse on head with a painless chemical solution replaces old method of using a hot branding iron. Center, cowhand adjusting pump mechanism of windmill at a mechanical water hole. Bottom, left, preparing supper on the range with aid of cookhouse trailer drawn by car or truck. Right, "squeeze" cage used as operating room for cattle. Its sides draw together and hold animal motionless

K952 Liberty Rockford, Ill

Two-Way Heater for Any Car Fits under Seat

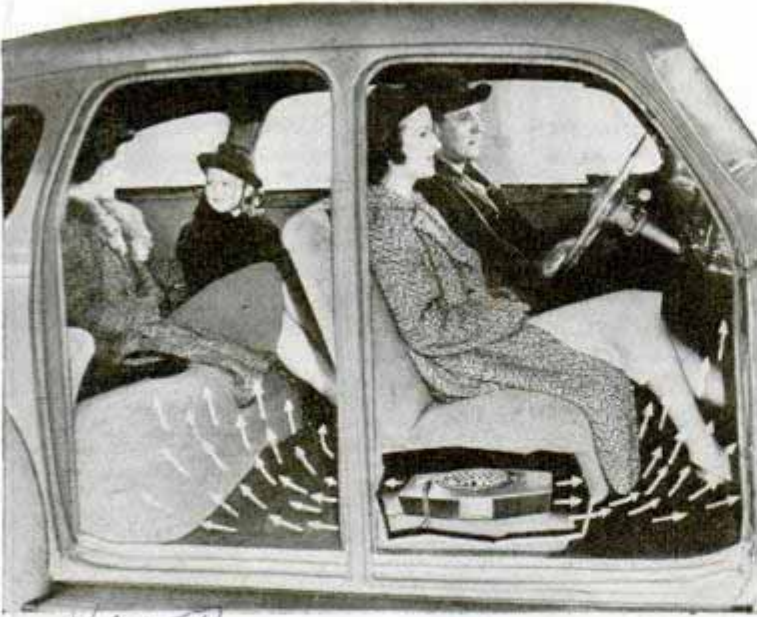

Both the front and rear of the car can be made comfortable for winter driving with an under-the-seat heater now on the market. A powerful seven-inch fan draws cold air from the floor and door crevices, then distributes it in all directions after it is heated. The heater can be installed in any car having a fore-and-aft passageway under the front seat.

Equal comfort is distributed by under-seat heater to occupants in front and rear sections of car. Air is drawn from floor which is usually the coldest spot

K957

Conical Antenna for Television Starts Sending Pictures

Research is developing new equipment, making television transmitting apparatus obsolete almost before it is put into service. General Electric engineers have just installed a conical television antenna at the Helderberg station near Schenectady, for experimental use in transmitting the pictures on this winter's television programs.

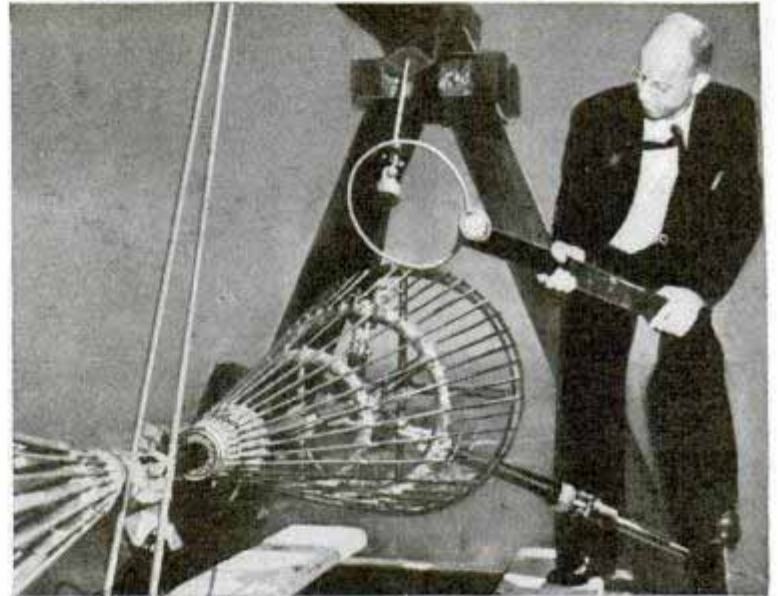

At the right is the cage-like conical antenna being used in experimental television broadcasting from General Electric's Helderberg station. The antenna puts the pictures on the air

K974

Silent Movie Camera Saves Time in Production of Sound Pictures



Silent gears and motors, along with other improvements in Hollywood's latest motion-picture camera, will result in saving thirty to forty hours in the ordinary twenty-four-day shooting schedule. It marks the end of the huge soundproof "blimps" which house the older movie cameras to prevent camera noises from being recorded on the sound track. The new camera is being used by Twentieth-Century Fox. It has an improved finder and remote control for focusing and uses coated lenses for better light transmission.

Hollywood Calif

At left is the standard movie camera inclosed in its "blimp," compared with new time-saving, noiseless one

Tri-Motor Speedboat Has Three Propellers



The "Gray Goose III," at left, operates as smoothly as an automobile on straight-away because outer propellers revolve in opposite directions to counterbalance each other. Below, three propellers and rudder. Bottom, each of three motors can deliver 175 horsepower at 5,000 revolutions per minute

183 Drake Ave
New Rochelle, N.Y.

Regarded as the first successful tri-motored racing hydroplane, in which each of three engines operates a separate propeller, the "Gray Goose III," built for George C. Cannon, is so constructed as to reduce the tendency to turn on straightaways. Proof of its performance came when the speedster set a world's record of 92.309 miles per hour for non-supercharged craft, and then tied for second place in the 1940 Gold Cup races, even though one engine failed to function. The "Gray Goose" has a novel three-point suspension hull with wide stabilizing fins which give forward support to compensate for distribution of power among three propellers. Three standard 175-horsepower Lycoming racing engines operate with throttles so connected that pressure on a single foot pedal feeds them fuel at the same rate, except when making a turn when, contrary to what might be expected, the outer engine is slowed down automatically. There are three individual clutches, the driver operating two and the mechanic the third. Propeller throw is eliminated

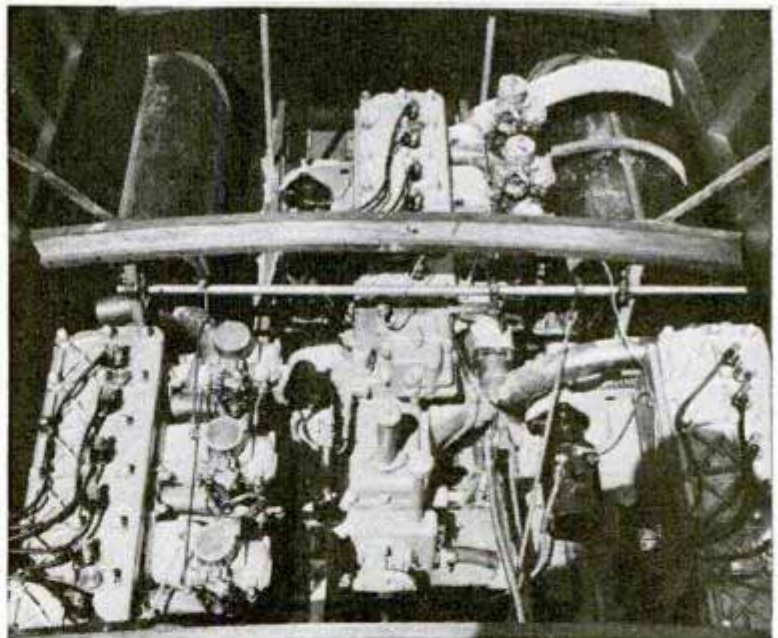
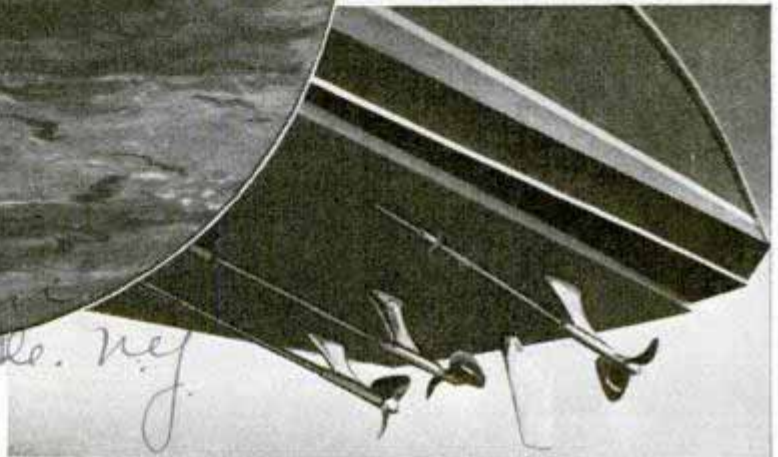

by turning the center and starboard propellers in a right-hand direction and the port screw to the left, thus making the two outboard propellers counterbalance each other. Each engine has its own separate starter button, ignition switch, oil pressure gauge, water temperature indicator and tachometer on the instrument board. The craft weighs 3,450 pounds.

THEY'RE TINY-

R 4 2 3
 cont. R. L. With Miller
 457 S. Serrano Ave
 Los Angeles Calif

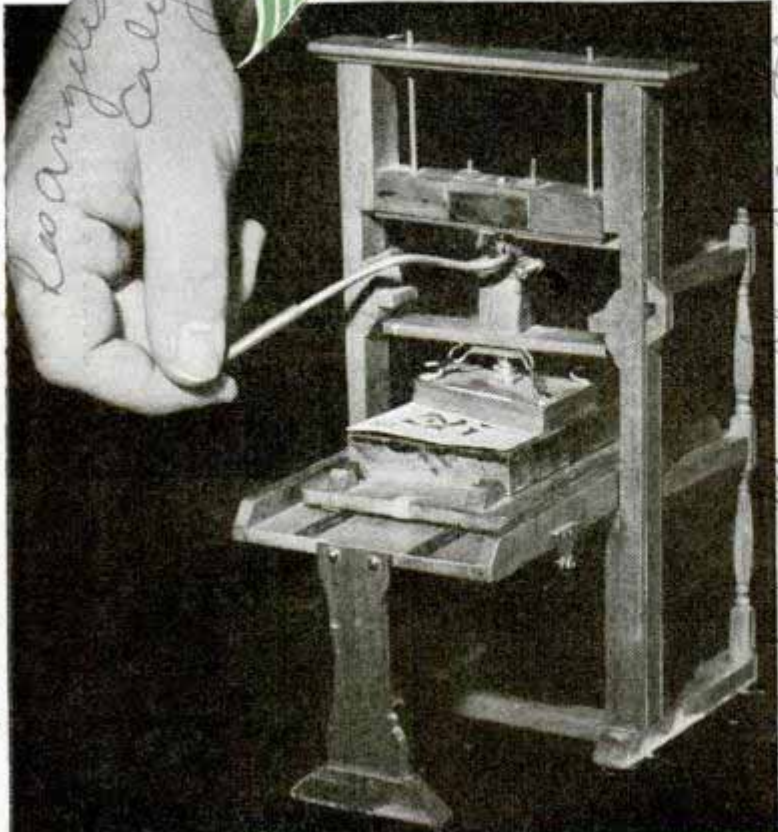

643 S. Lockwood St. San Francisco Calif

THE boy looked at the tiny, exquisitely carved, jeweled bird, so small that it seemed only a gleaming speck on his hand. He nodded to the Paris shopkeeper.

"I'll take it," he said. "I like tiny things. Sometimes I wonder just how small things can be, just how tiny a world could be made by human hands."

That was almost half a century ago. Today the world knows just how small things can be, just how delicately human fingers can work. For Jules Charbneau, who as a boy bought the jeweled bird in Paris, has collected perhaps the world's strangest assemblage of minute man-made objects.

That a violin half the size of a man's little finger can play with a delicate sweet tone, that bread can be baked in an electric oven hardly more than an inch high and ice frozen in an electric refrigerator no larger, that an electric motor smaller than a match head can run or a globe of 1/1,000,000 candle-

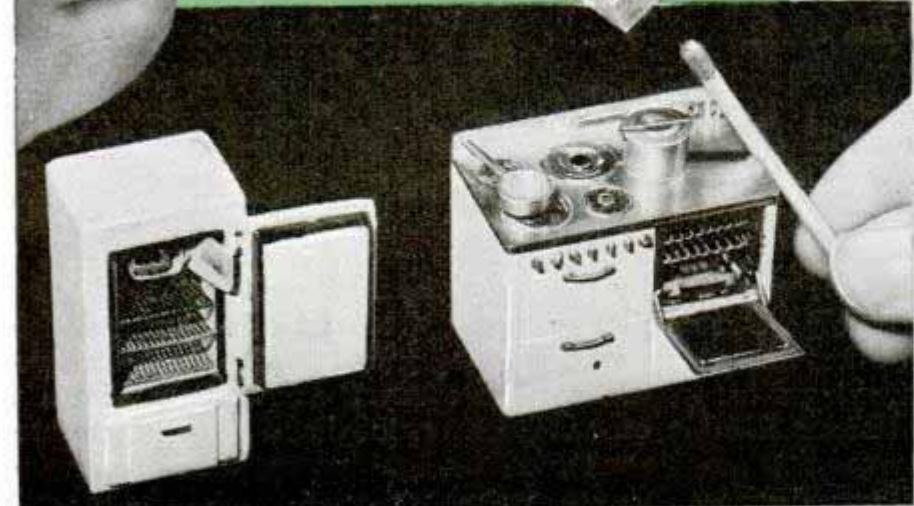
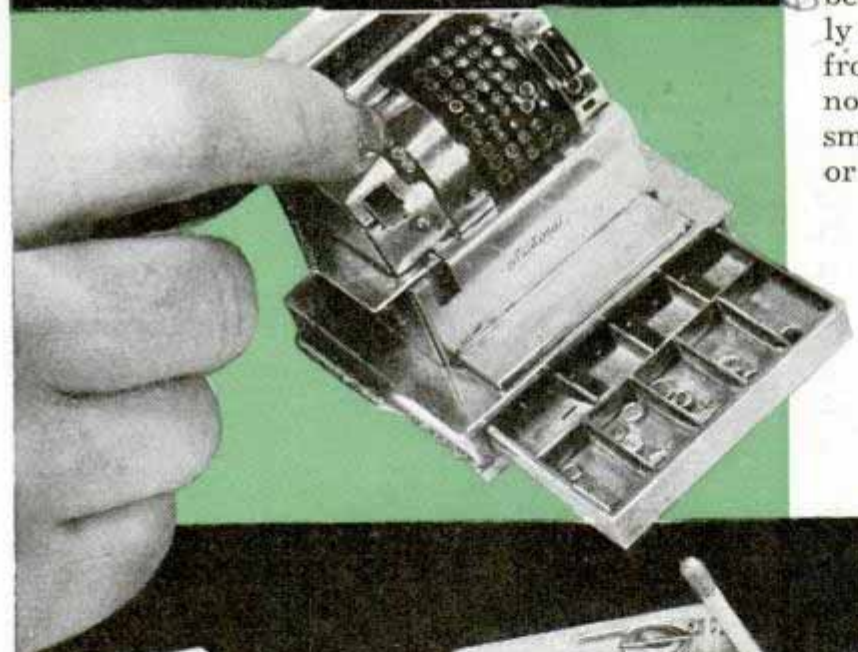

Top, tiny model of Franklin's printing press. Center, cash register on which sales may be rung up with a toothpick. Bottom, left, electric refrigerator and range compared to a match. Right, tiny model of radial airplane motor

BUT THEY WORK

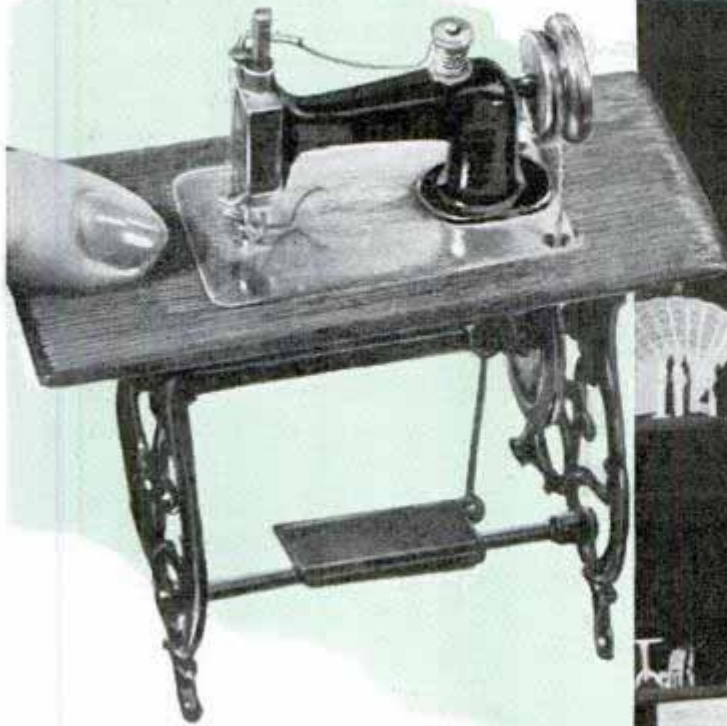

power burn—all these things sound so impossible that only through your own eyes or the lens of a camera can they be made real.

Yet there are 28,000 such impossibilities in Charbneau's collection—a vase so small that it will not hold one drop of water, books which can be placed on a thumbnail with space left over, 3,000 golden spoons which fit into a hazelnut shell and twenty pairs of dressed fleas.

Many of the items were collected by Charbneau during four trips around the world. Dealers throughout the world know him, send him their choicest miniatures.

But Charbneau is more than a collector. The most astonishing of his items are creations of his own mind, creations which he has seen patient craftsmen bring into minute reality.

One day as he sat listening to his wife play the piano, he visualized a miniature piano, a piano less than an inch high, yet which would have a complete keyboard and could be played—should a be-

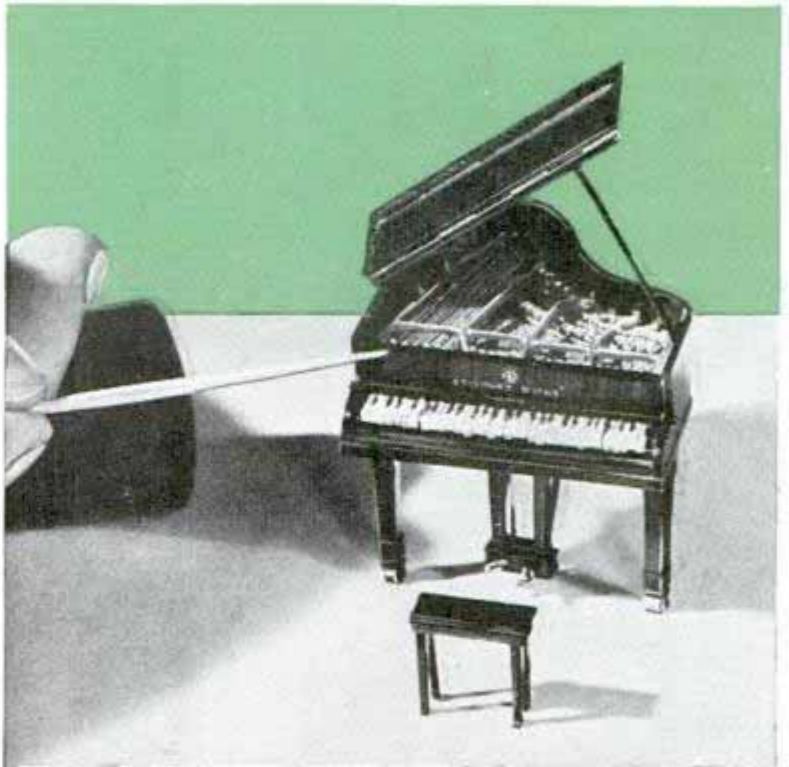

Top, left, midget sewing machine, with human finger at left illustrating its size. Right, Jules Charbneau with ivory carvings. Bottom, miniature piano, with thirty-six keys, being played with a toothpick in hand at left



and bit, and a pair of pliers, which are kept in a chest about the size of a match box. The shaft of the hammer is as long as the first joint of a woman's little finger, the head of the hammer less than the width of a child's finger nail.

Even a rabbit whisker was too large to string the bow of Charbneau's one and five-eighth-inch model of a Stradivarius violin. So the craftsman who made the violin strung the bow with hairs from his mother's head. The violin has the same number of strings as a full-

ing with fingers tiny enough ever come from fairyland.

Charbneau went to Steinway and Sons, asked them if they could construct such a piano.

"We would like to," they told him. "We will give you all possible cooperation—but it can't be done."

But today there is such a piano. It is a model of a concert grand, accurate even to the casters under the legs. It can be played—with a toothpick.

Four craftsmen worked for six months on the piano. Unbelievably skilled fingers, working under powerful magnifying glasses, succeeded in creating this marvel of minute intricacy.

Also in the collection are 20,000 wood screws which fit into a thimble, and hammers, saws, planes, a screwdriver, a brace

sized instrument, and would be played in the same way if there were hands tiny enough to finger the strings. When played without fingering, it emits a very sweet, soft tone.

Everything Charbneau sees he visualizes in miniature—working miniature. A cash register inspired him to set craftsmen to work building one two inches high and two and a half inches wide. Yet if you press, say the two-dollar and three-dollar keys, a sale of five dollars will be rung up. The bell rings, too. And you've guessed it; there is tiny money in the drawer.

Many other familiar items of American life are found in the collection. There is a sewing machine which sews beautifully with a lock stitch, yet which is so small a human finger would cover the treadle.

(Continued to page 130A)

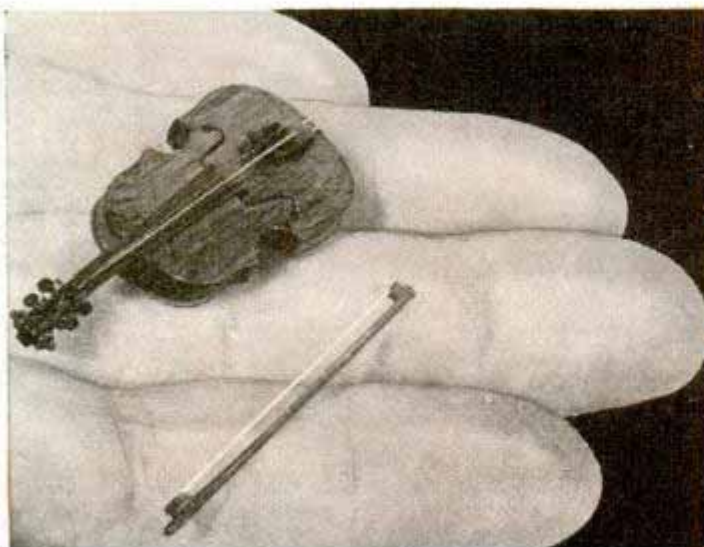

Top, chess set with ordinary cigarette leaning against tiny table. Bottom, left, miniature violin that can be played. Right, one of world's smallest cameras with pictures it makes (left) and film roll (right), lying on one piece of four-by-five film

Hay or Grain Loader Is Powered by Tractor

To save labor during the threshing season a South Dakota farmer invented a shock-loading machine for grain or hay. Resembling a common hay loader, it has a new type of elevator and a reel. Grain shocks are tipped by the reel onto the elevator conveying the bundles from the ground to the rack wagon. The loader operates with a power takeoff from its tractor. Primarily designed for loading grain shocks, the machine is also used in the hayfield. Six-inch tines set in the angle-iron cross-bars of the elevating mechanism pick hay from the ground and keep it from rolling back. A metal bottom prevents leaves and bundles from dropping through the elevating chain.



This tractor-operated machine built by a South Dakota farmer picks up either grain shocks or hay and loads the rack wagon

Radio-Controlled Target Boats Help Train Navy Bombers

Navy bombers have a new target boat at which they may dive and drop bombs without endangering lives. Controlled by

radio from the cabin of one of the bombers the thirty-four-foot boat needs no operator aboard. It skims along at thirty-five miles an hour and is said to be unsinkable. It was developed for the navy by Chris-Craft. In wartime it could be used as a torpedo by loading it with high explosives and sending it crashing into a battleship.



Radio-controlled boat, without pilot, may take the place of suicide boats to blast battleships, or serve as bombing targets for navy flyers

Speedy Electric Saw and File Unit Will Fit on Any Small Power Drill

Attached to any small electric drill, from which it gets its power, a handy and accurate saw cuts through wood or metal in hard-to-get-at places where most other tools fail. By fitting it with a special chuck it will take a one-quarter-inch shank file and save time as a filing machine. The drill is held in the right hand and the saw unit guided with the left. Either saw or file works in any direction and at any angle, and is useful to electricians, plumbers, carpenters and mechanics.

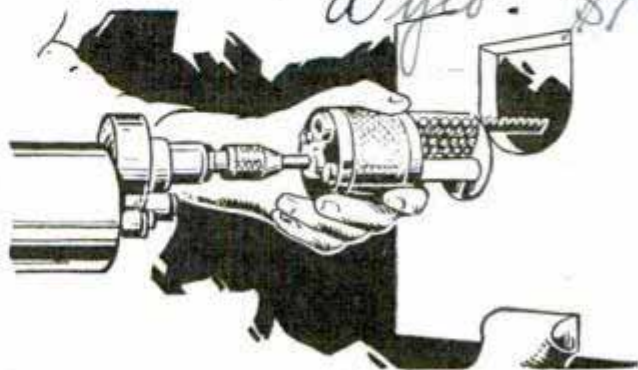

Accurate saw or file, powered by electric drill, cuts to the line in any direction or at any angle

*Luverne, Minn
d no. Walter Karli
Valley Springs, S.D.*

K976

K994

comes

Wyo. \$15.00

*Wagoner & Staff, Inc.
Hubbard, Pl.*

Twin Posts Let Plane Down to Easy Height for Servicing



To service the plane it is hoisted by twin posts, wheels are retracted, then it is lowered within easy reach of mechanic

Instead of climbing hazardous scaffolding to service airplane motors, the mechanic can lower the plane to a convenient height by means of a twin-post lift just brought out. The operation is similar to that of the greasing lift in the automobile service station. With the wheels retracted, the airplane can be let down nearly to the floor. The lifts are operated either pneumatically or by electric motor.

Dew Revealed as Spoiler of Auto Body Finish

For many years sunshine has been believed to be the main cause of the tarnishing of auto body finishes, but evidence gathered recently indicates that some mysterious action of dew is to blame. Dew was first suspected when investigations showed that the worst paint "failures" occurred during months of least sunshine, and that exposure from midnight to noon when dew was present showed more failure than expo-

sure from noon to midnight. Then followed the development of a new dew meter which, according to Ralph J. Wirshing of the General Motors Research laboratories, has served to confirm the suspicion that sunshine rates second to dew in destructive effects on automobile paints and lacquers.

Fast Army Tractor Pulls Five-Ton Load at Fifty

One of the answers to the demand for a military tractor that can "take it" under all sorts of road conditions, is a six-and-one-half ton, four-wheel drive vehicle propelled by a seventy-five-horsepower six-cylinder engine, developed by Minneapolis-Moline power implement company. With a five-ton load in tow, such as a 155-mm. howitzer, its top road speed is forty to fifty miles an hour, and it can haul its burden up a forty-per-cent incline. Air brakes are operated by foot pedal, and a hand brake lever enables the operator to brake or lock either rear wheel. A front roller-bumper twelve inches in diameter helps ease the way over obstructions and across ditches. In tests the tractor smashed a path through a grove of trees up to three inches thick. It has a forty-inch fording depth and can tilt sidewise to fifty-eight degrees without toppling.



Rugged army tractor can travel over roughest terrain or keep up with caravan at fifty miles an hour with howitzer in tow

The CAMERA *in* INDUSTRY

QUICK to adopt machines and methods with which products may be improved and sold, American industry is turning more and more to photography. Indeed, some large companies use more motion-picture film in a year than is required in the making of a Hollywood "super-colossal" epic.

Yet not one foot of the industrial film may have the slightest "box-office" appeal. Instead, it is employed by engineers as a valuable aid in creating a better automobile, a faster locomotive, a more economical refrigerator or a new lightweight steel possessing unusual qualities.

The automotive industry, for instance, finds the camera has innumerable uses: from aerial photographs of manufacturing plants to microscopic sections showing the molecular structure of steel,



Top, photographing moving gears with stroboscopic illumination. Center, attaching telltale lights so each will trace moving line of light across photographic plate (bottom) in test of Plymouth riding qualities. Note irregular line of wheel light indicating spring action

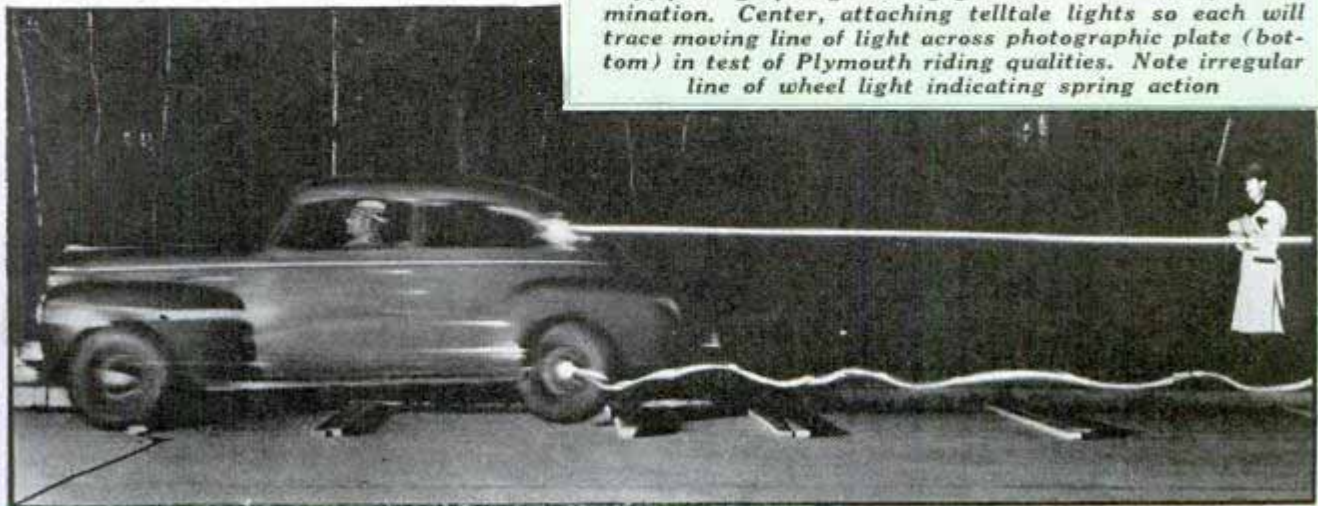

Campbell. Ewald General Motors (Eds. Detroit)

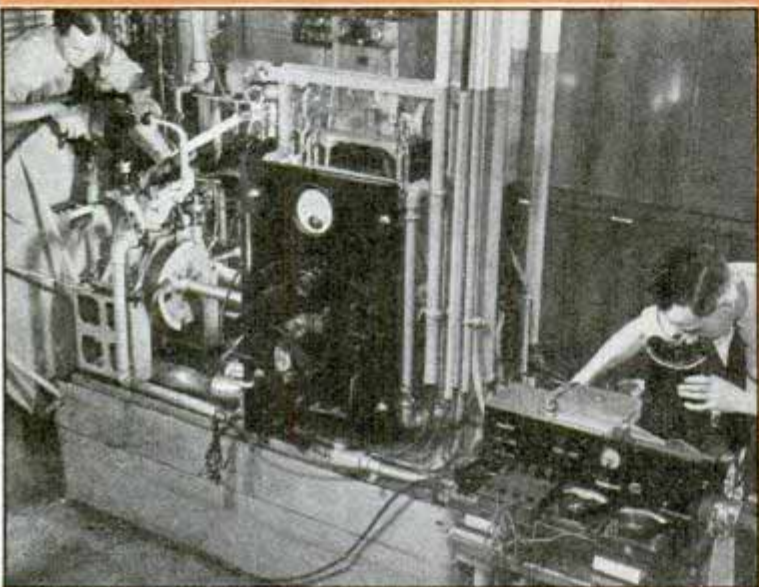
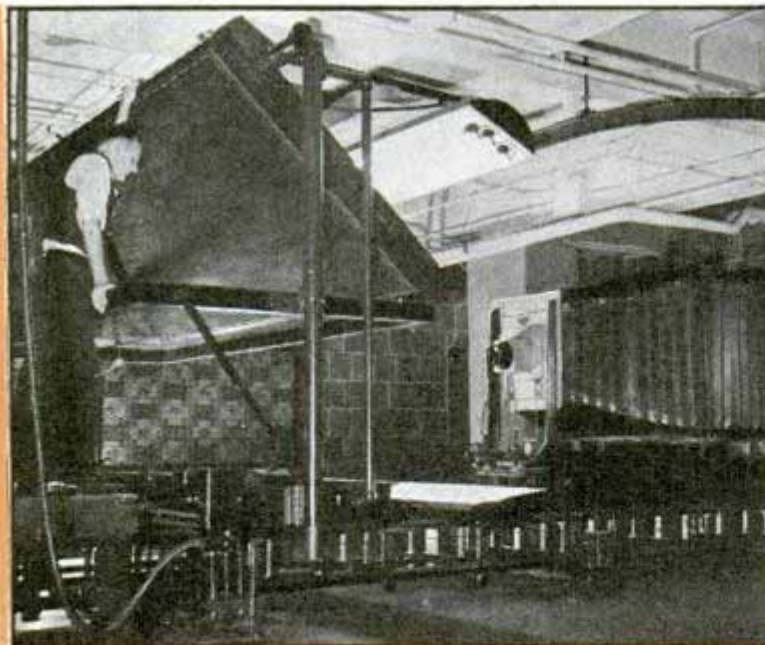

Courtesy Chevrolet Motor Div.

Top, some of giant equipment used in industry. Center, arrangement for studying fuel combustion in one-cylinder engine by using high-speed camera. Bottom, mounting section of enlargement on plywood in making photo mural

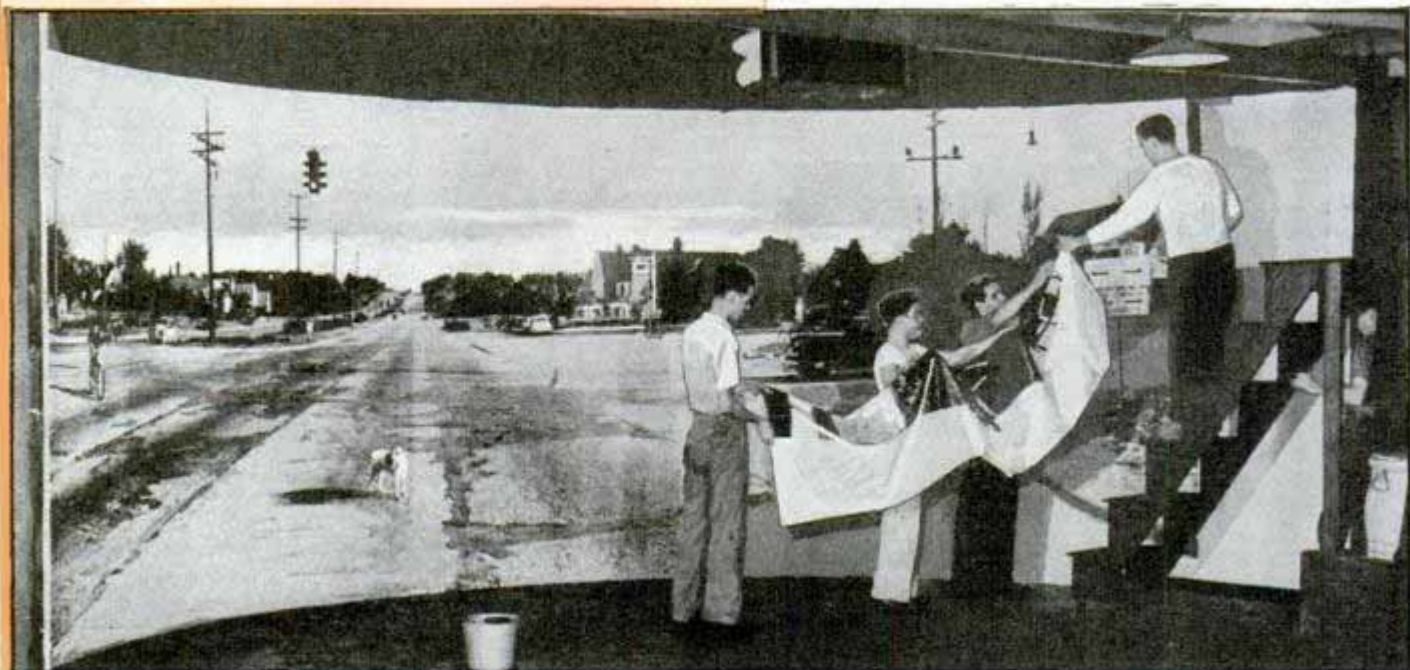

from beautiful advertising illustrations to thousands of prosaic but important record pictures of small parts, from hundreds of "story-telling" newspaper shots to intricate laboratory pictures of the interior of engine combustion chambers.

Still pictures, movies, photomicrographs, even "television" apparatus, all are playing a part in assisting the development of important mechanical improvements in the automobile.

In the metallurgical laboratory of the Chevrolet forge plant, polished steel samples are studied and photographed under a powerful microscope in order to keep a constant check on the structure and quality of steel from which crankshafts and other parts are made. Through their photographic libraries, metallurgists keep a year-to-year record of different grades of metal, showing their fatigue capacities resulting from various kinds of processing.

In combination with the microscope or other instruments, the camera permits the auto maker to study accurately many parts of the car not possible to observe with the human eye. Fast-action cameras click thousands of times before the manufacturer is ready to present a new steering-post gear shift or a new transmission.

Special acoustics studies of the

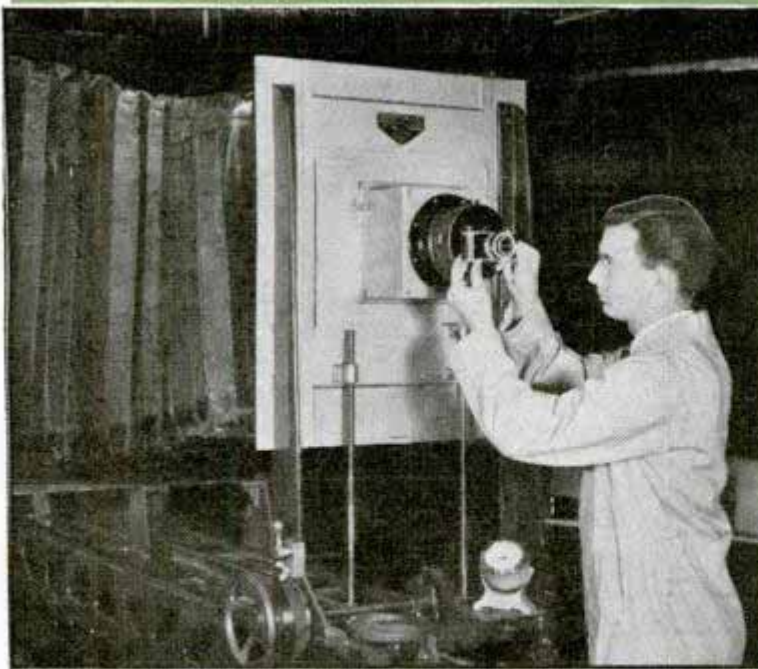

Left, photographer holds miniature camera in front of giant camera to show range in sizes of cameras used in auto industry. Right, making high-speed movie of crankshaft in motion on balancing machine

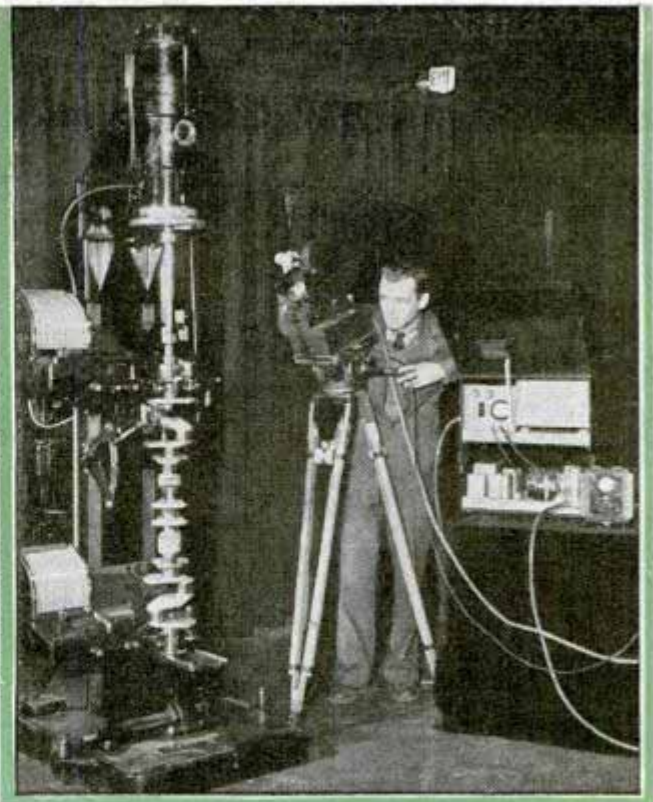

nature of sound waves inside the automobile, such as those made by Plymouth to improve the riding qualities, are made with the oscillograph—a cathode-ray tube similar to those used in television, which records for the movie camera actual pictures of sound waves in motion. Study of these films enables engineers to select proper soundproofing materials.

One of the newest branches of photography, natural color, is being utilized extensively by the automotive industry. Chev-

rolet recently presented its product to its field force through one of the largest series of natural-color film slides ever made. Fast-lens miniature cameras, like those employed by advanced amateurs, are often used to make "candid" pictures of sales meetings. Copies of engineering drawings are made on one of the largest cameras in the world—a camera so big that the operators actually load films and even develop them while standing within the body of

(Continued to page 137A)

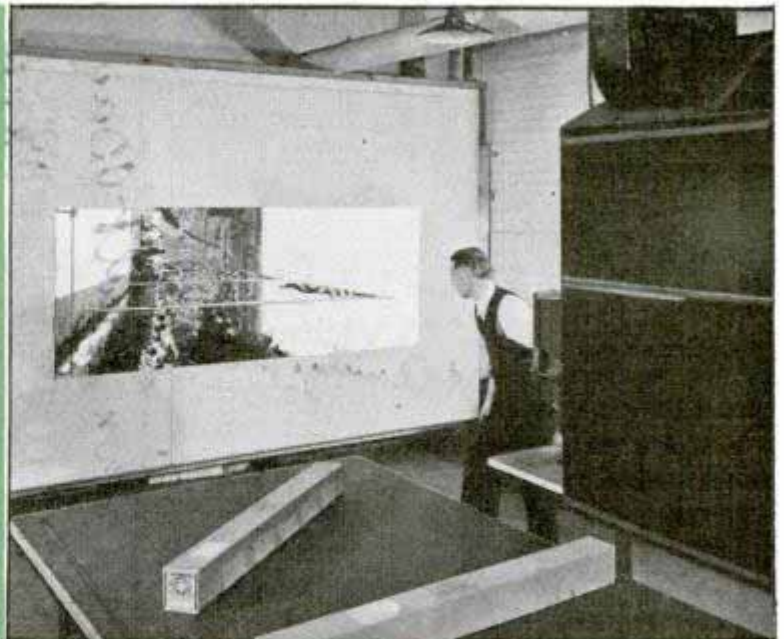
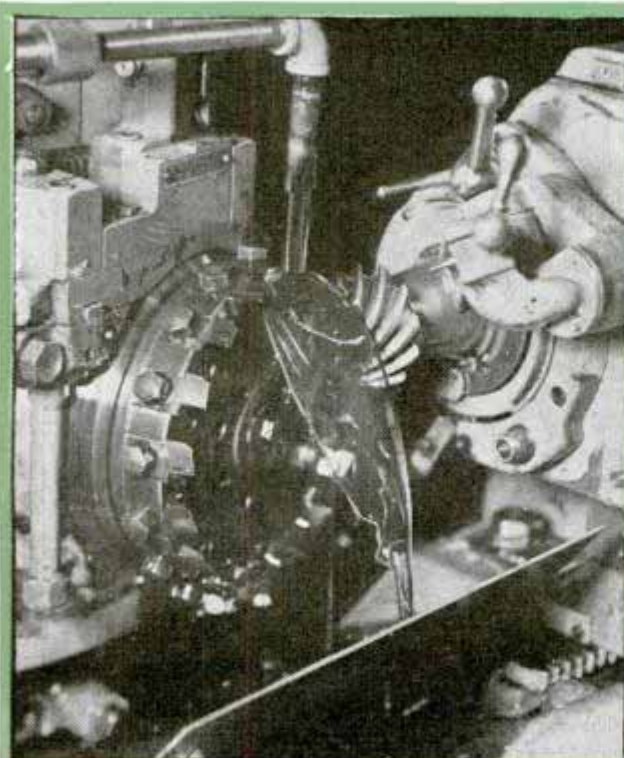
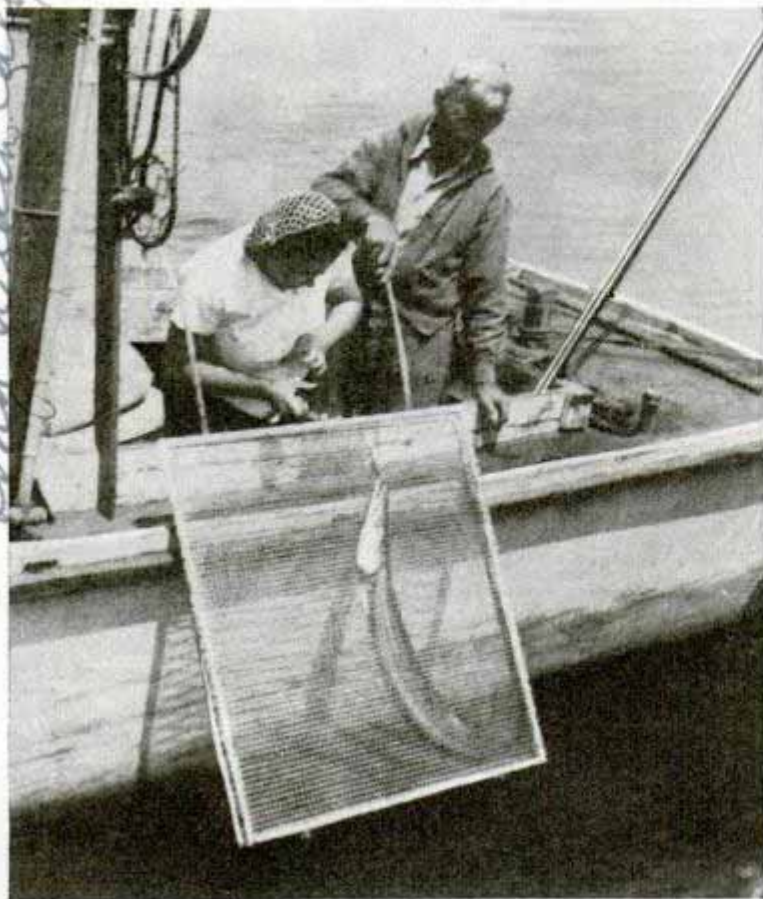

Photo at left, courtesy Pontiac Motor Div.

Left, fast photolight, in 30,000th of a second, "freezes" oil so it appears as solid sheet. To naked eye the oil appears to cover gear and grinding teeth. Right, making a mural

R 91 J.

Fish Locked in Landing Net Is Easy to Haul from Water



Fish can't get away when it is locked between two parts of metal landing net that resembles two hinged window screens

Landing fish in a boat is simplified with a metal net in two parts that closes around the catch for hoisting it over the side and removing the hook. Two pieces of wire netting, each a yard square, are stretched over frames of one-half-inch metal pipe. The net hangs at the side of the boat just clear of the water until a fish is hooked. Then it is opened and lowered into the water with the line passing through it. As the fish is brought into the net it is closed and the prize cannot escape.

R 1002

Drops in Altitude Pilots' Eyes Found Aid to Vision

Henry and Amelia Proctor

Stratosphere flyers may have strychnine drops put in their eyes to correct impaired vision at high altitudes, as a result of research reported by Dr. Clifford P. Seitz, of the University of Alabama, and Dr. Charles M. Rosenthal, of the Long Island College of Medicine. At high altitudes lack of oxygen causes a widened "blind area" in the field of vision, making it difficult for the pilot to watch the numerous instruments and other objects he must keep in

sight constantly. The doctors made tests with a subject seated within a low-pressure chamber capable of duplicating conditions found at a 17,500-foot altitude. As the characteristic broadening of the blind area was noted, they put three drops of strychnine in one eye of their subject and plain water in the other, with the result that the blind area became smaller in the eye treated with the strychnine drops.

R 962

Plane or Car Brake Tested by Hand-Operated Gauge

Quick tests of the brakes on airplane wheels, dual-wheeled trucks and automobiles can be made with a simple, hand-operated gauge just invented. It consists of two steel grips which fit around top and bottom of the tire, one attached to a steel lever and the other to a pressure gauge which is attached to the lever. With the vehicle on jacks and the brakes set, pressure is applied by hand to the lever. At the point where the wheel starts turning, the gauge is read; similar readings of the other wheels are then taken, and the brakes are adjusted until all are equalized. All four wheels of a car can be tested in three minutes.



Pressure is applied to hand lever with brakes set, and gauge is read as wheel begins to slip

C. S. Proctor, 249 & Third St. S.W. Pensacola, Fla.
 Science Service
 15/44
 University Ala

Huge Diesel-Electric Tugs Attend Fleet at Sea

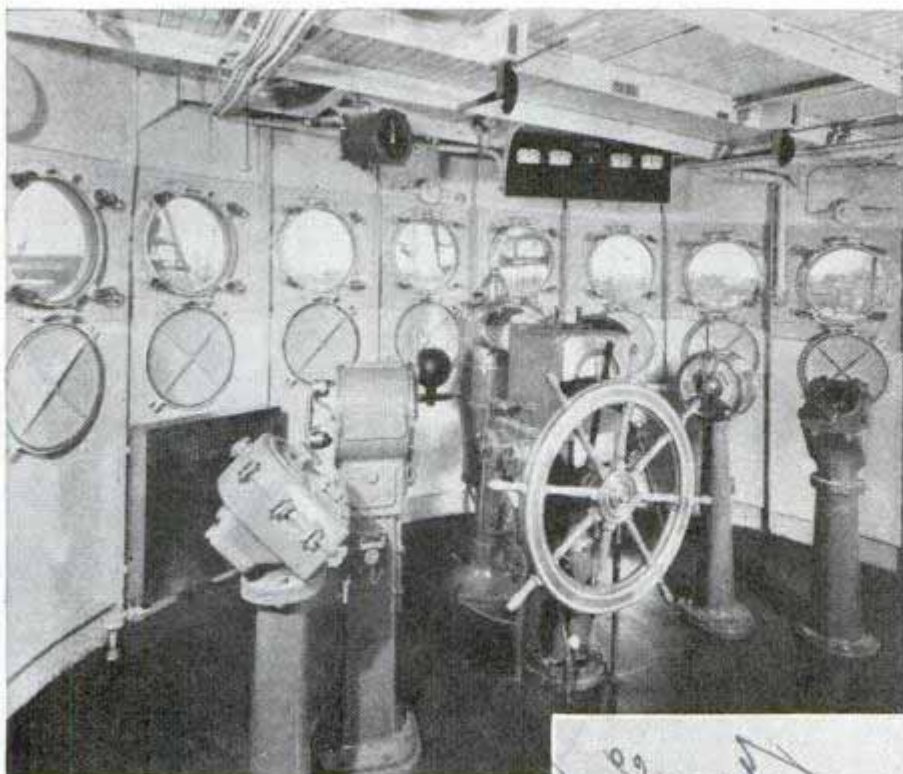

Below is the 205-foot sea-going tug "Navajo," one of three U. S. Navy tugs recently commissioned. With 3,800 horsepower available from four main Diesel engines, this powerful tender can handle a battleship; each twelve-cylinder engine is connected directly to a 600-kilowatt generator. At left is the navigating bridge. Sister ships are the "Seminole" and "Cherokee"

Three powerful Diesel-electric tugs, largest of their kind, have been commissioned as floating service stations for the U. S. Navy. The "Navajo," "Seminole" and "Cherokee" are 205 feet long overall, each of them powered by four main Diesel engines totaling 3,800 horsepower, and so capable of handling the greatest dreadnaughts in harbor maneuvers or at sea. To each of the four Diesel engines a 600-kilowatt generator is directly connected. The Diesels are twelve-cylinder, two-cycle V types. The boat can be operated from full speed ahead to full speed astern by one hand wheel on the motor panel, or by the pedestal control in the pilot house.

also pedestal motor and control. General Electric & Schenectady

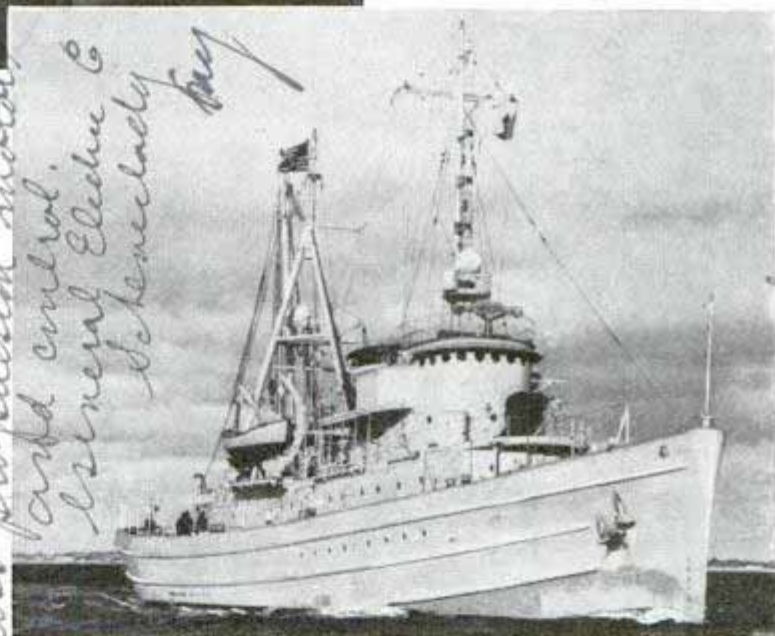

Built at Staten Island yard Bethlehem Steel Company

Its extreme flexibility of drive permits operation at better than half speed by only one main engine at little above idling speed.

Stock Car Made into Speedster with Body of Sheet Metal

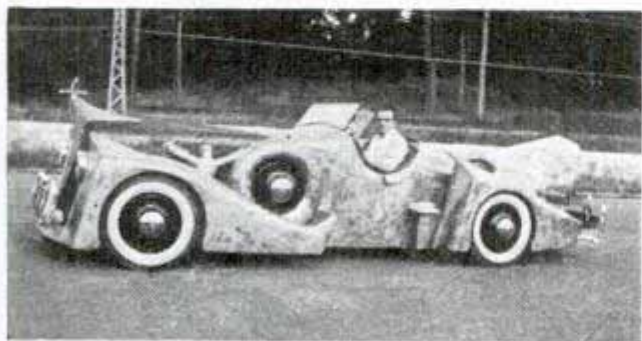

This is how his 1931 stock model car looks after the owner gave it a new streamline body of sheet metal

Using the chassis of a 1931 model automobile, one owner fashioned a new body along the lines of a speedster, without making any mechanical changes in the car. Strap iron of various sizes was welded to form the skeleton for the body, over which twenty-gauge sheet metal was riveted for covering. The car is forty-eight inches high at the windshield, measures nineteen feet from bumper to bumper, and carries four passengers.

John J. Lagaria, 221 1/2 St.

SAILORS

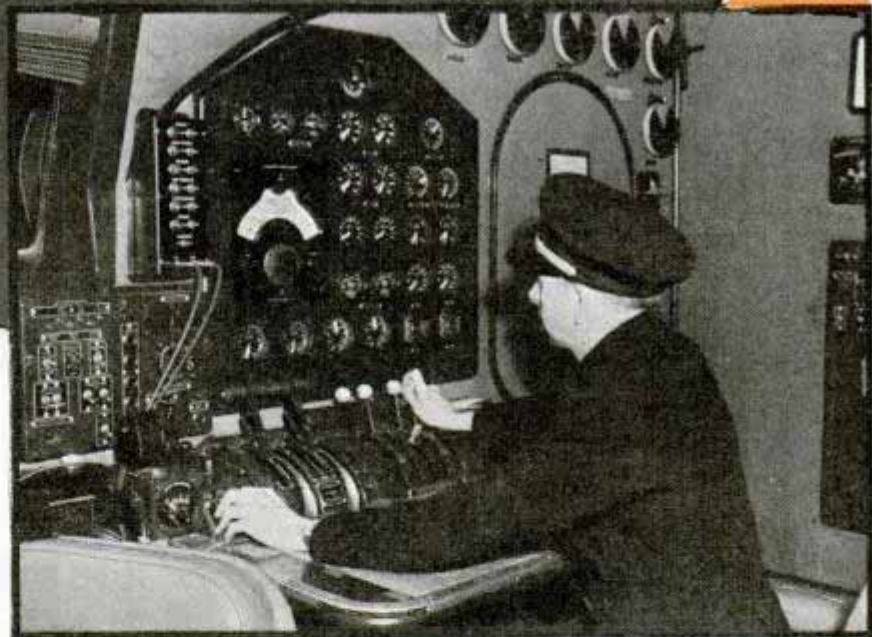

FOR a behind-the-scenes look at how the crew goes about its task of flying a great four-engined Clipper across the Atlantic on regular schedule, let's assume we are aboard one of the big air liners, bound for Europe at 150 miles an hour.

Climbing from our quarters on the passenger deck, we find the entire upper deck of the 82,500-pound ship devoted exclusively to the crew's working quarters. Its space equal to that of the whole passenger compartment on a standard American land transport plane, this deck houses the pilot's compartment for the two pilots constantly on duty; the navigator's post; a complete radio station; a

Circle, giant Clipper roars away on a cross-Atlantic trip. Upper left, navigating officer plotting Clipper's position. Lower right, engineer at his station from which he controls complete mechanical operation, regulation of fuel, setting and adjustment of throttles, propellers, etc. One instrument shows temperature readings at forty-one different engine and aircraft points

post for the engineering officer, and the captain's office. That "captain's office" item makes this airplane closely akin to an ocean liner—and that, in its organization, is what it is, an ocean liner of the air.

of the SKY

Chrysler Bldg. New York

Forward on this upper deck, just aft and above the bow compartment which contains the craft's extensive marine gear, is the pilot's post, where at least two pilots—often three—are on duty at all times. The third pilot, of course, is the important labor-saving device known as the automatic gyroscopic pilot. The human pilots may be any two of the five qualified ocean pilots carried on transatlantic flights. These include the captain, the first officer and usually three junior flight officers.

Wright Cyclone

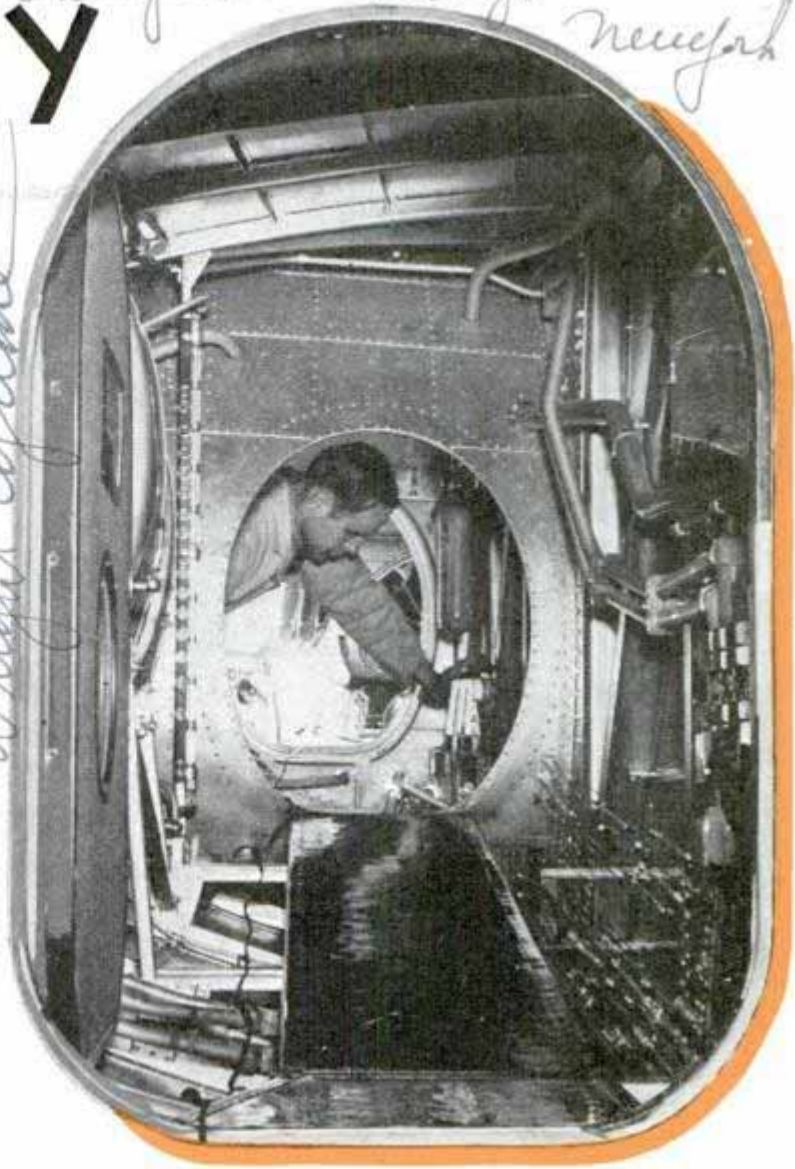

Essentially the captain is master of the aircraft. His position and his duties are comparable to those of the captain of the largest ocean liners. It is his responsibility to be available any time during flight at a moment's no-

Washoe

Right, Clipper engines are serviced through catwalk in wing. Below, general view of flight deck with officers at their stations



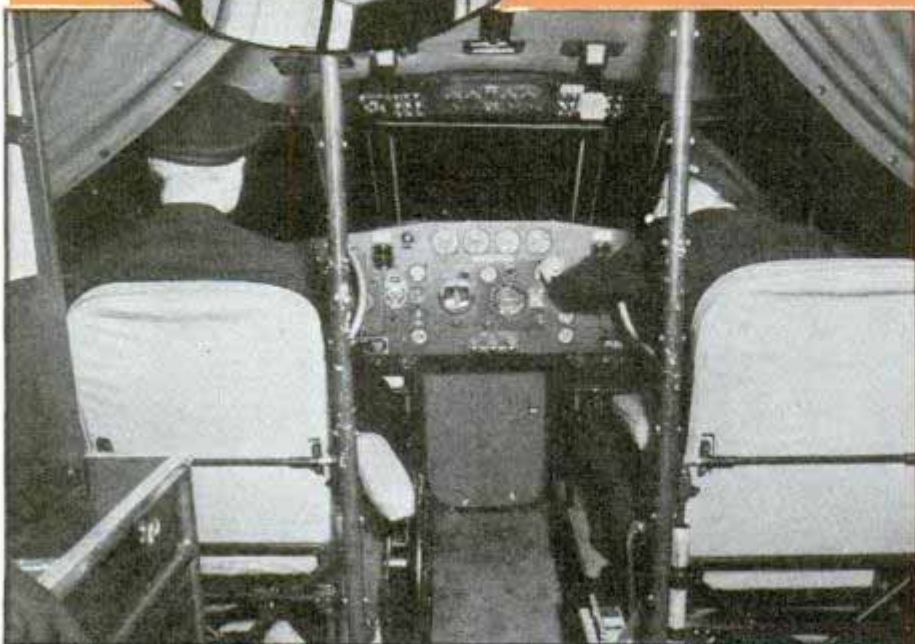
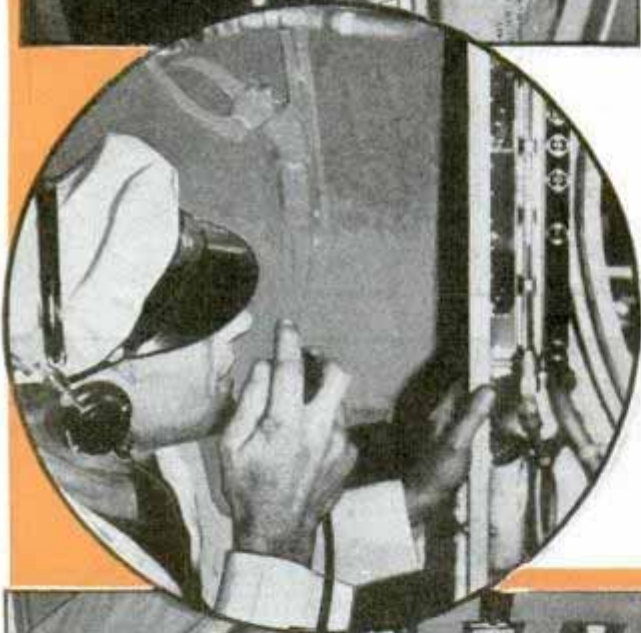

tice, if he is needed. He is qualified to take over any post on the Clipper and he holds the highest ranking available to a commercial pilot anywhere in the world—that of Master of Ocean Flying Boats. Actually, in flight, the captain is in the left-hand pilot's seat during takeoff and landing, though he may delegate the actual flying job at this time to his first officer, who sits on the right-hand side. Thereafter, during flight, the captain takes his regular trick at the wheel.

The captain spends much of the remaining time while the ship is in flight reviewing navigation, consulting with his officers on the progress and condition of the flight and correlating the work of the various officers on duty so that the maximum efficiency of the aircraft may be utilized, the flight conducted in accordance with the most rigid regard to safety, and so that he may keep himself fully informed at all times about every phase of the operation.

About forty per cent of the captain's time is spent on the main deck with the passengers, for in addition to being the technical master of the aircraft, he also is its chief diplomatic officer and social leader.

Whether or not the captain is in attendance, the flight deck, of course, is a scene of continuous activity. Perhaps the busiest man there is the flight officer assigned to navigation. This may be any one of the four pilot officers under the captain. All these officers rotate at the tasks of naviga-

Top, glass-enclosed turret in top of wing permits full visibility to get bearings on celestial bodies. Circle, reporting engine condition to engineer by telephone from catwalk in wing. Below, left, pilot officers at controls. Right, using radio direction finder

tion and piloting. The navigator's primary job, of course, is to guide the aircraft on its course and keep constant and minute track of its position. At his command are several methods of accomplishing this, all of which he uses separately or in combination. These methods include determination of position by dead reckoning—that is, by presuming position on the basis of elapsed time at a known constant air speed and course, and estimated, but carefully checked, wind speed and direction; by celestial observation, taking cross bearings on sun, stars and moon; or by radio bearings taken on radio stations, the positions

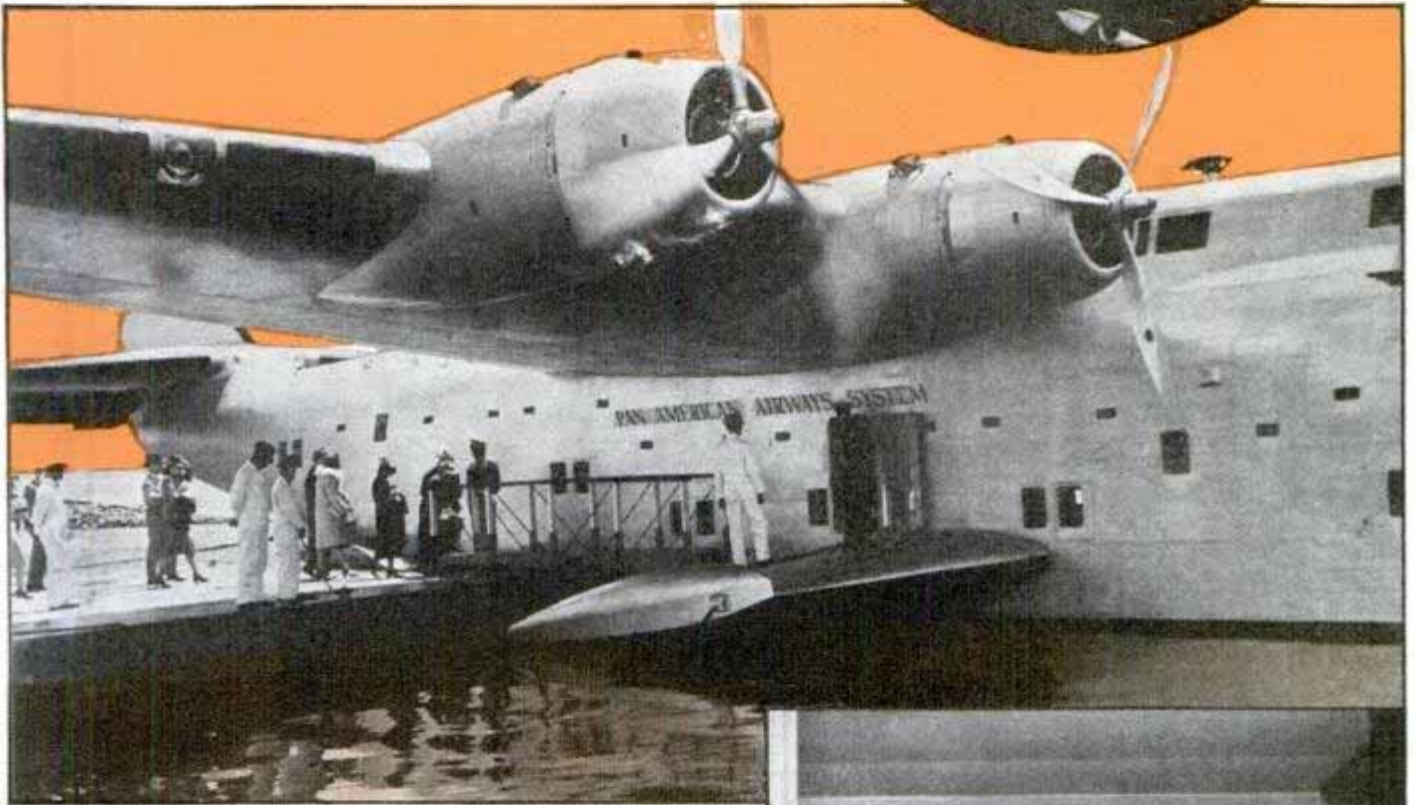

Circle, radio operator at his post, which is a complete broadcasting and receiving station. Center, passengers going aboard. This gives you an idea of the Clipper's size. Bottom, all the comforts of home—and perhaps a few more—are offered passengers

of which are known, such as ground radio stations or ships at sea. There are many combinations of these three basic methods which aid in the solution of the problem. A single bearing by radio may be combined with a single celestial observation. A dead reckoning estimation of latitude may be crossed with a celestial observation of longitude and so on. All these observations, along with many hundreds of the notations and calculations which assist in determining the final answer, are entered on the navigator's ocean chart, forming a

(Continued to page 141A)



Wind Machine Tests Cars for Stability on the Highway

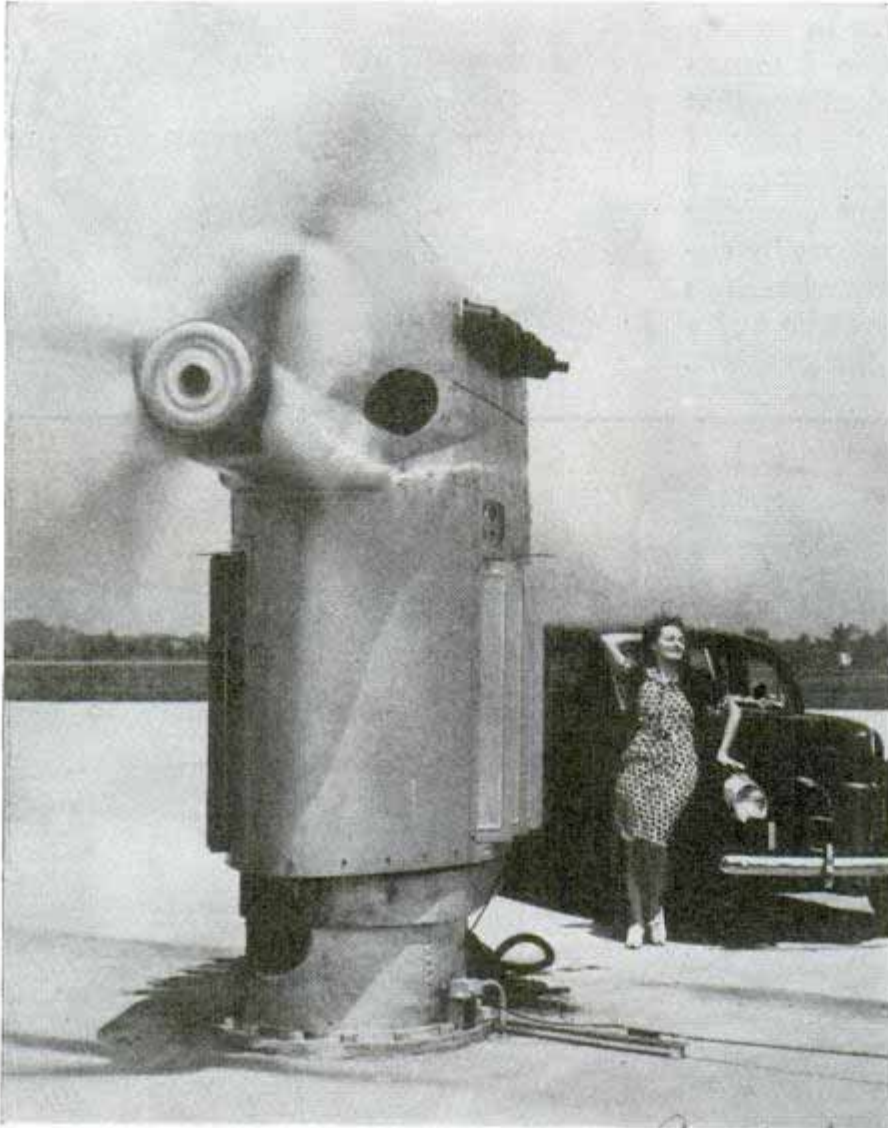

Cars are driven past this big fan on the proving-ground track while drivers and observers watch the effect of the fifty-mile side wind

What happens when a fifty-mile-an-hour blast of wind hits a speeding automobile from the side? To test the stability of new cars under varying wind conditions, a powerful motor was set up on the Ford test track at Dearborn, Mich. A four-blade, fourteen-foot propeller spins at various angles, fanning the test track with breezes up to fifty miles an hour, while engineers drive cars past the big fan.

Silver May Take the Place of Tin If Wartime Shortage Occurs

If war should cut off overseas sources of tin, silver might be used as a substitute. Silver-lined food cans, for example, could replace tin cans. A sheet-steel base plated with copper and then with silver only one-millionth of an inch thick has produced a superior food container. Silver

would also fit into national defense plans as a metal for high-grade motor bearings, or, alloyed with aluminum and magnesium, for aircraft construction. The photographic industry may use less silver in the future, due partly to the growing popularity of color films and partly to the recovery of hitherto wasted silver in the development of films and prints. One promising field for large-scale use of silver, however, is in disinfecting city water. One part of silver in ten to twenty million parts of water will render even heavily infected water safe for human consumption. The cost would be small.

Hand Tool to Bend Metal Saves Cost of Die Making

Where a small number of parts are to be shaped the cost of making forming dies can be eliminated entirely by using a hand bending tool just introduced. It will duplicate shapes accurately, bending round, square or flat rods, tubes, wire and strip stock. Parts to be formed can be cut to the exact length before forming.

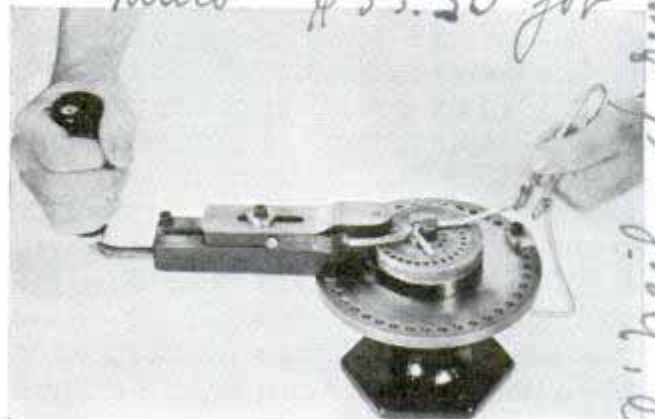

Turning a wire with the hand bending tool, which does many forming jobs simply without requiring dies

*Service Service
re d. 11. 1940*

K10 29

acme

K844

*of the are d.
5/6
Wfg. Co.
micro \$35.50 for
D'Neil. A man
men*

*870 Alexander Safety
Institute of Safety*

Small House Built of Metal Lath and Concrete

Concrete and steel construction of small homes at low cost has been achieved by the use of light steel channels to support metal lath on which cement mortar and plaster are laid to form the walls. A typical metal-lath house at Sheboygan, Wis., measuring twenty-three feet by thirty, included only \$13.75 worth of lumber. It is fireproof, and highly resistant to wind-storm, lightning, earthquake and vermin attacks. Outer walls, two inches thick, were made by troweling cement mortar on both sides of a screen of metal lath supported by rod-like steel channels. A similar screen supports the room plastering, and mineral-wool blankets fill the space between outer and room walls. Expanded steel joists two feet apart support the floor slab, formed by spreading nearly three inches of stiff concrete over ribbed metal lath. The surface was troweled smooth to take linoleum, and the roof slab was formed like the floor.

Partitions two inches thick were formed like the outer wall slab, with mortar on both sides of metal lath. A skeleton of steel angles so light that hoisting apparatus

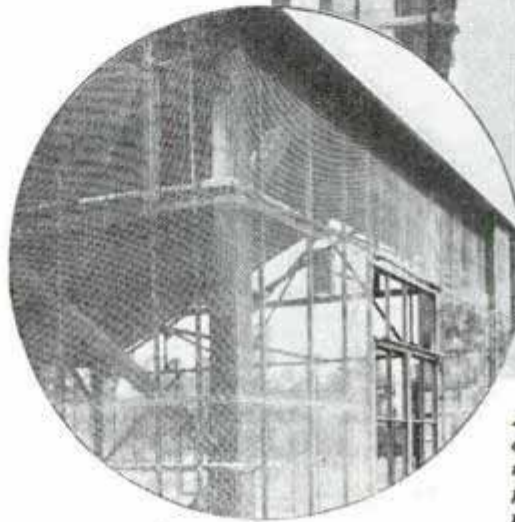

Curie
Above, applying plaster to metal lath forming partition. Left, metal lath of outer wall, supported by light steel channels, ready to receive cement mortar

was not necessary supports the house, the frame being bolted together and anchored to the foundation, which is no thicker than that required for a frame house.

Light-Beam 'Sight' for Revolver Spots Target in the Dark

To help policemen protect themselves while tracking down armed criminals in

the dark, a spotlight for attachment to the service revolver has been introduced. It eliminates the awkward method of carrying a gun in one hand and flashlight in the other, in areas too dark for use of the gun sights. Weighing but seven ounces, the new light-beam device fits on the gun barrel, with which it is aligned so when the light is thrown on an object the bullet automatically would strike within the area lighted. Thus when the policeman spots his quarry with the light, his gun is trained on the target.



Tested by Webster Police
Fitting light-beam "sight" over barrel of policeman's revolver. Gun is aimed in same direction as beam so bullet will strike within spotlight circle

TRY THESE in YOUR

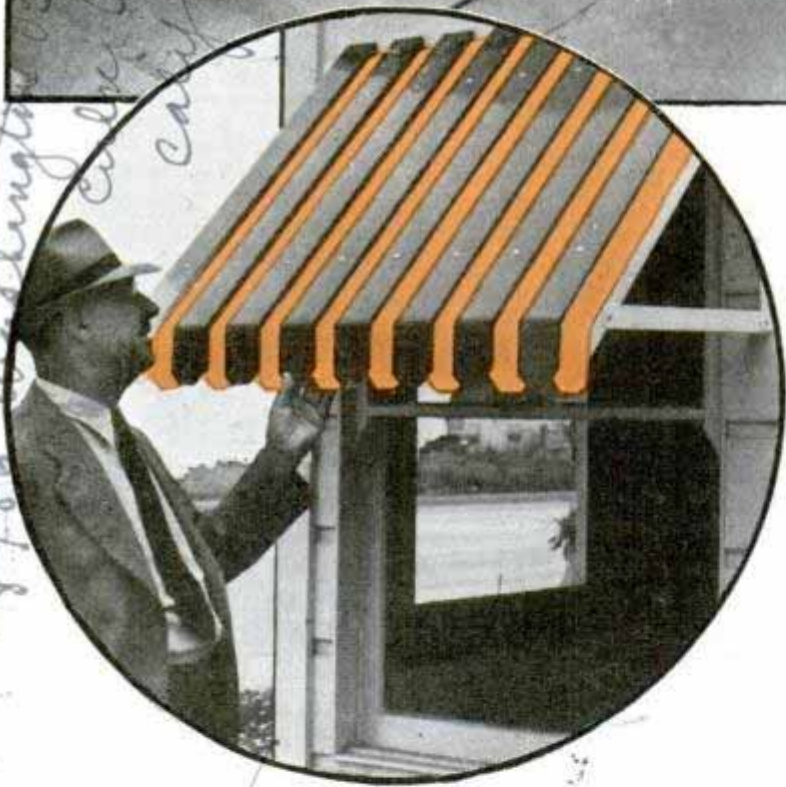
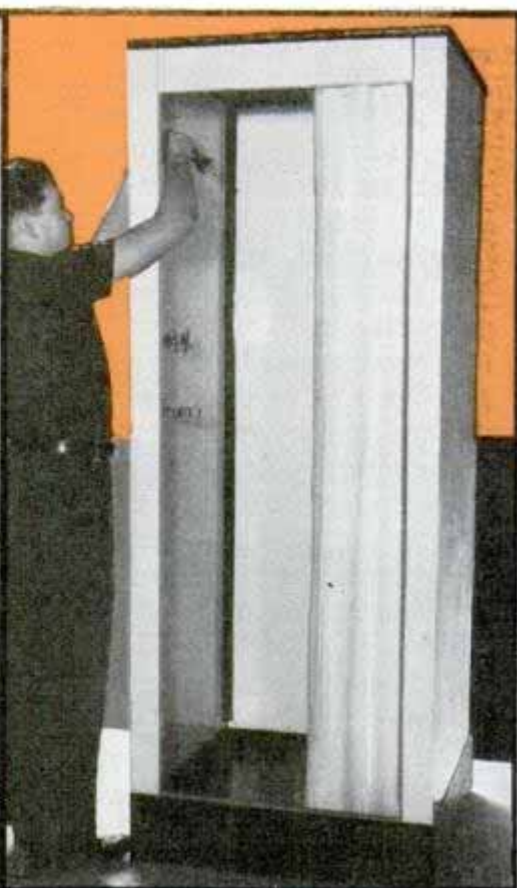

Roof spray (upper left) which keeps house temperature eight to fifteen degrees below outside is automatically turned on when sun expands gas in control tube. Above, installing shower stall. Below, air circulates between strips of metal awning

front mirror. Some of them are illuminated by fluorescent tubes on each side, on others the lighting is from behind the side mirrors, the light shining through clear windows in the mirror surfaces. Some of the cabinets have hinged shelves that swing out from behind the main mirror panel. Bathroom doors are being equipped with buttons on the interior knob that lock the door until the interior knob has been turned again.

NEW materials and new conveniences are making modern homes vastly different from old-fashioned houses. But you don't need to build a new house to benefit by the improvements because many of them are available as built-in units, ready for installation in a wall.

Bathroom scales, hinged to the wall, fold back into the wall when not in use. Metal shower cabinets that are leakproof and inexpensive are available as units for installation in a corner. There are also clothes hampers and shoe-shine cabinets in metal units built into a wall.

The newest bathroom cabinets have swinging side mirrors flanking the main

For the kitchen, metal shelf cabinets are replacing wooden shelves and closets. These

*Washington
April 1946
Shaver Co
4126
also
Western
8786
Washington
Calif*

Building material

542 N. Kallbecker
Los Angeles

HOME



Above, fan clips into stove's ventilating stack. Clock, right, uses electricity generated by thermopile in heat of stove's pilot light. Setbacks give each room (center) an open corner. Air conditioner (below) fans air through radiator containing hot or ice water.

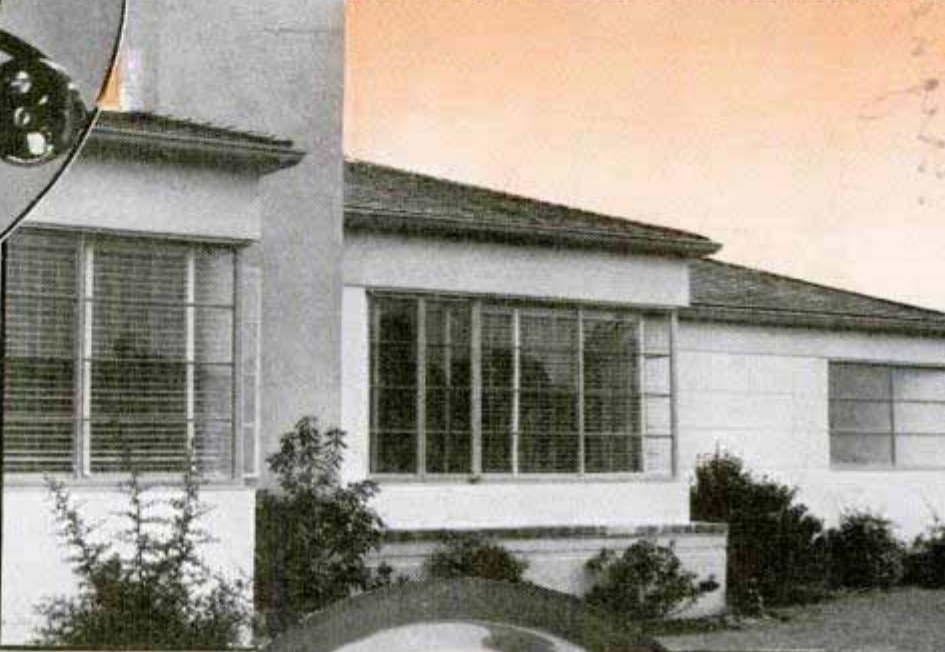

built-in fixtures may be placed under worktables and drain boards or attached to the walls. Even matchboxes are built in today, with only the front of the box appearing as an opening in the wall. Overhead lights and overhead ventilating fans are built into the ceilings, flush with the surface, and the newest kitchen fan is a little one, with a $\frac{1}{200}$ -horsepower motor and fitted with prongs of spring wire that hold it rigidly in place when it is forced up into a ventilating stack above a stove. Required by many building ordinances, these stacks are of little value unless some positive source of wind is furnished. Such a fan sweeps kitchen odors out of the house instead of allowing them to drift through the other rooms.

Sets of metal trays that are made to fit into a kitchen



Pyne to 1240 E 33rd
Los Angeles

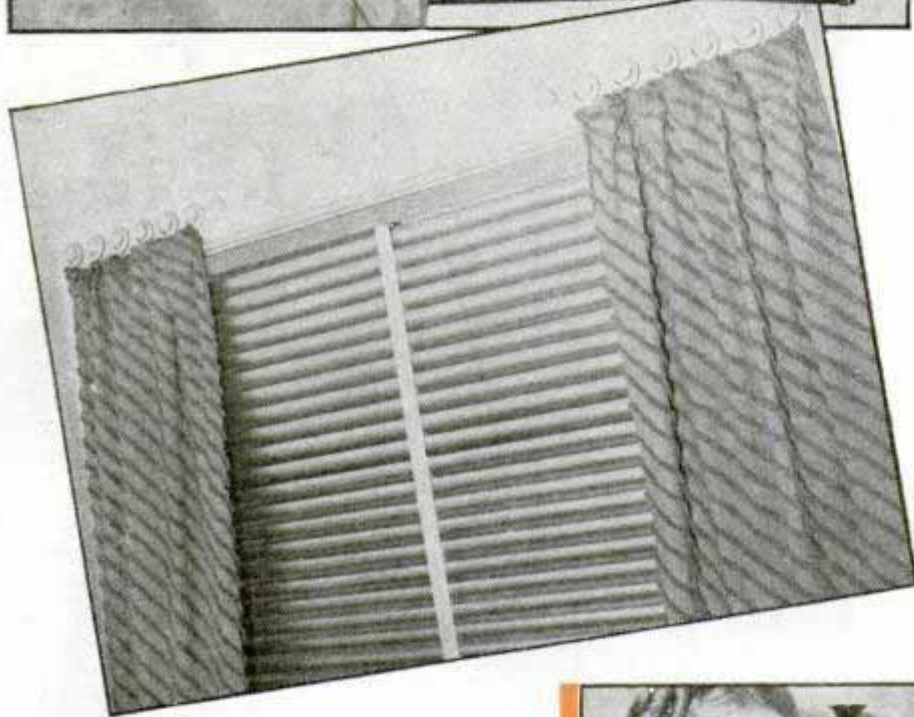
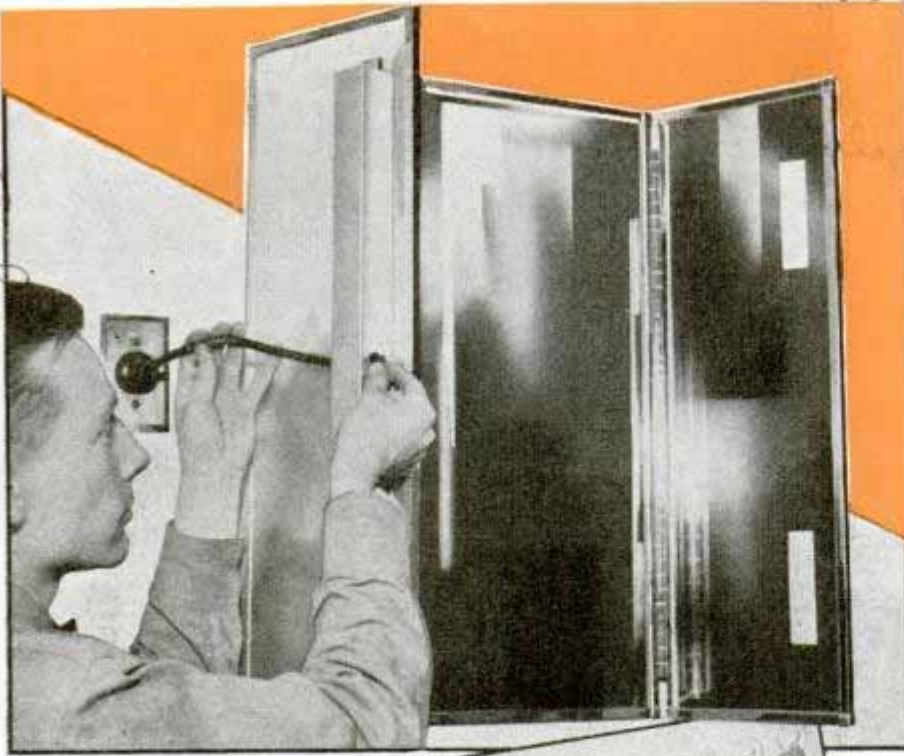

Bathroom cabinet (top) has side mirrors lighted from back. Center, drapes hang from knobs on wall instead of rods. Right, tank for softening small amounts of water

cooler closet are supported on one metal rod that has an oil trap at the top and bottom to prevent ants and other insects from reaching food stored on the shelves. Portable water softeners are available for attaching to the water supply when needed. Some cooking ranges have glass windows in the oven for inspection of roasts and cakes without opening the door. A gadget not yet on the market is an electric clock for gas stoves that obtains its electricity from

the stove's pilot flame. A thermopile kept hot by the pilot flame generates a constant flow of electric current that in turn operates the electric clock.

Package compartments and milk receptacles that pierce an exterior wall come as units ready for installation and are theft-proof. The exterior door locks automatically as soon as a package or bottle is placed inside and the door is closed, staying locked until the interior door is opened and the contents removed. Built-in steel or wooden ironing boards that swing out from wall cabinets have been improved by adjustments that permit them to be raised or lowered. Ironing can be done now while sitting down. The boards may be swung to one side and the cabinets have dryer racks that swing out from the wall.

The latest type of door chime is motor-driven instead of being operated magnetically. It plays eight notes when the front doorbell switch is pressed, a low note for the rear



K846 20 articles

169 7/27
Burlington
Kearney
San Angelo

Wilmer Stewart

Harding
Burlington
Alabama

door, and a high note for the side door. Some of the smaller chime sets may be recessed into the wall.

Metal fireplace forms around which the bricks are laid also contain sheet-metal ducts that circulate heat from the double-walled firebox to other parts of the room or to adjoining rooms. A "log-lighter" gas jet installed in a fireplace may be turned on and off at will and may be used instead of kindling to start larger pieces burning. Fireplace spark screens of flexible metal mesh that hang like curtains from a rod above the fireplace opening take up no room and may be drawn together to close the fire, or pushed out of the way at each side. The newest type of gas heater contains a closely wound coil of metal ribbon heated by the flame and which, according to claims, gives off no injurious fumes.

Insulation against heat and cold used to be expensive, but new materials and new ways to use old materials are bringing costs down. One building paper is heavily coated on each side with aluminum paint as shields to keep sum-

(Continued to page 144A)

Gas heater (top) uses coiled metal ribbon as radiator. Center, light and economical arched roof design. Below, model of swimming pool which can be built with filter system for not much more than \$1,000. Right, electric cabinet sterilizes brushes

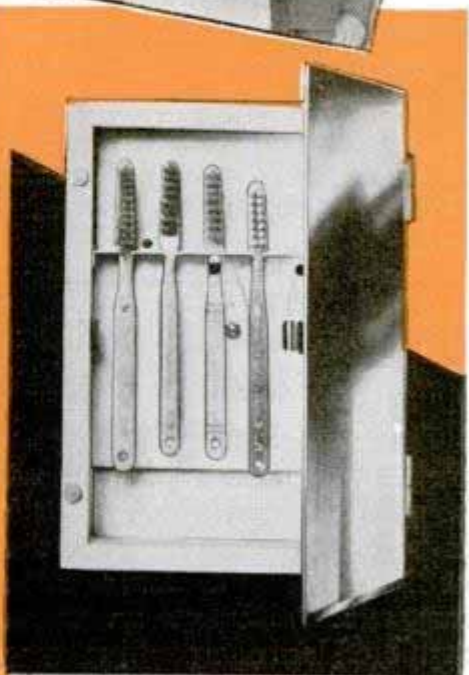
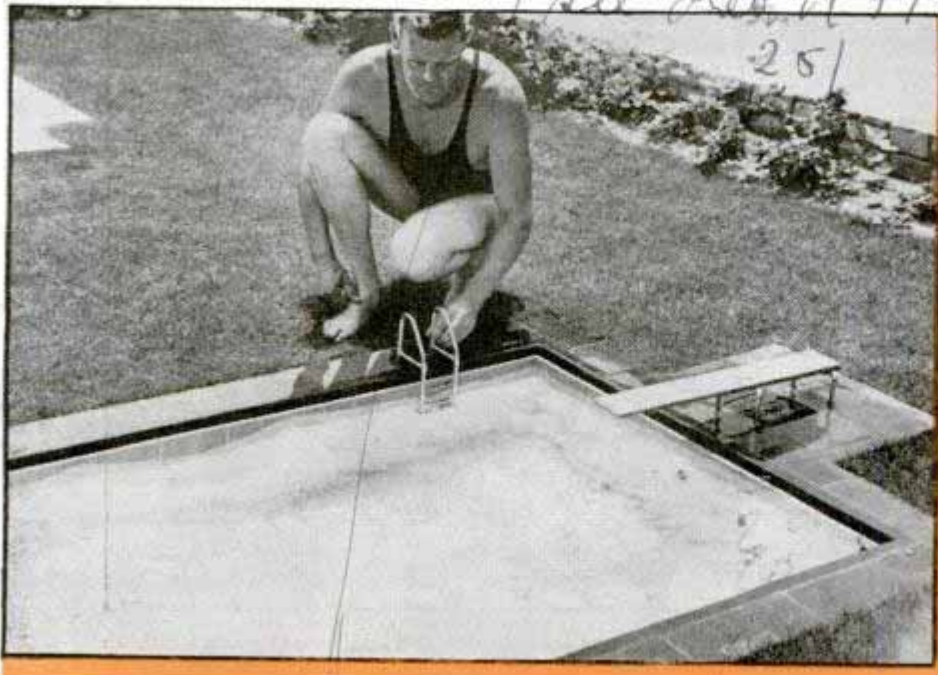

Desks Have Sliding Baskets and Revolving Trays

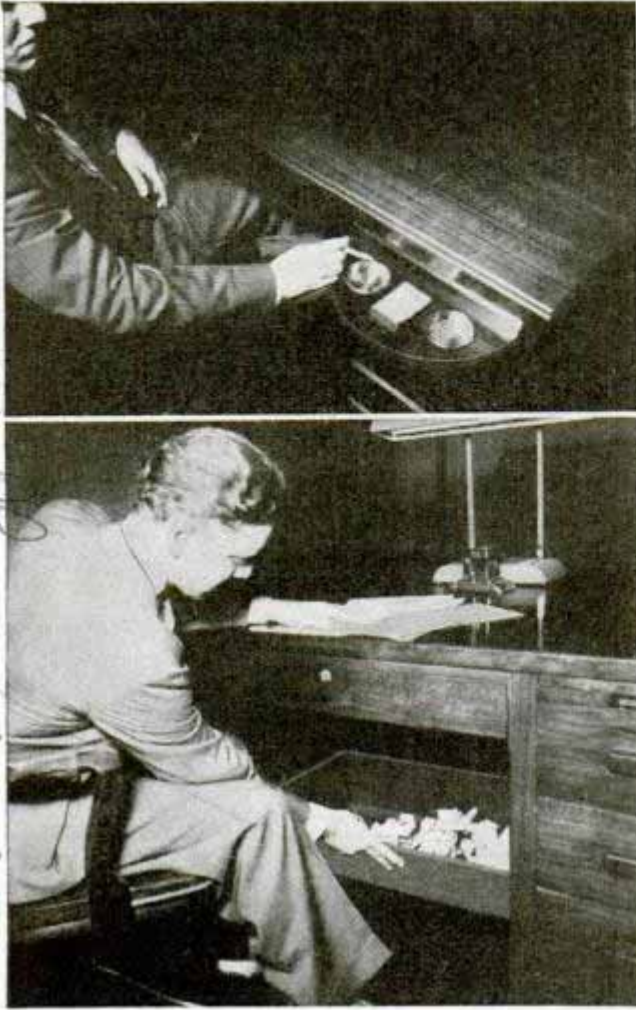

Upper desk has disappearing tray for clips, ashes, etc.; lower desk features a sliding wastebasket

Built-in wastebaskets and revolving trays offer extra conveniences in office desks just brought out. The wastebasket, matching the desk, slides on runners and disappears beneath the center of the desk, where paper can be pitched out of sight. It is emptied by pulling forward and lifting. The rotating tray of another desk is hidden in a panel of what appears to be a top drawer. By revolving it, various receptacles for pins, clips, cigar ashes, etc., are brought forward.

Warplanes Made Difficult to See in Day and Night Sky

Assertions from Europe that battle planes have been painted with a secret varnish making them invisible may be merely an excuse for poor marksmanship of the defenders. Complete invisibility is impossible although an airplane may be rendered less conspicuous by applying cer-

tain well-known principles. Mere transparency, however, is not enough, as can be seen by examining a piece of glass. Though light passes through it freely, glass is quite visible because it changes the speed and direction of light rays; yet a sheet of glass ordinarily is much less conspicuous than a similar sheet of opaque material. Some experts say that if an airplane were made of a glasslike substance, such as transparent plastic, it would be very difficult to see in the daytime except at low altitudes, even though the engine and many other parts would require metal. Giving all surfaces a mirrorlike finish, so they would reflect lots of light and appear bright as the sky, would have a somewhat similar effect. A different factor is involved in seeing planes against the dark background of the night sky, when ground observers depend on light reflected back from searchlight beams. If the lower surfaces of the fuselage and wings are painted with a flat black paint, most of the light will be absorbed, and scarcely any reflected back to the ground.

Pocket Gauge Checks Alignment of Automobile Wheels

Wheel alignments can be checked quickly and easily with a portable gauge small enough to fit in the garage man's pocket. It can be used to determine camber, caster, toe-in and rear-axle conditions without the use of racks or turntables, to test the car for twisted frame or body, or it can be converted into a level protractor.

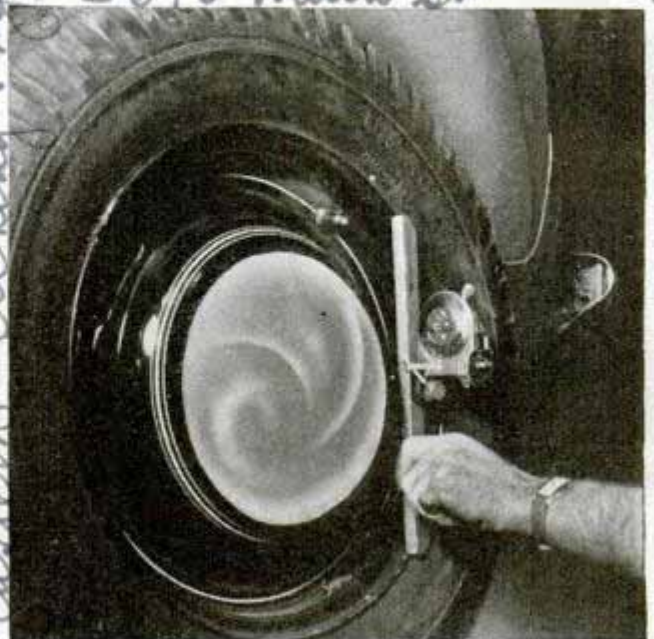

Testing a car wheel with the alignment gauge, which is small enough to fit in the mechanic's pocket

O.C. d. Olsen Co. 2527 Madison St. Chicago

Springfield, Mass.

Science Service

8/30/40

3640 main St.

Custom Etching & Engraving

Dive Bomber Adds Fire Power to Carrier

30 Rockefeller Plaza, New York

Offensive power greater than that possible heretofore will be provided for United States aircraft carriers with the completion of an all-metal dive bomber, known as XSB2C-1, built by Curtiss-Wright corporation. Of low-wing construction and powered by a 1,700-horsepower, double-row Wright Cyclone engine of fourteen cylinders, the warplane carries large bomb loads at high speed over long distances from its base, and is equipped with formidable machine guns that give it unusually heavy fire power for aircraft of its type.

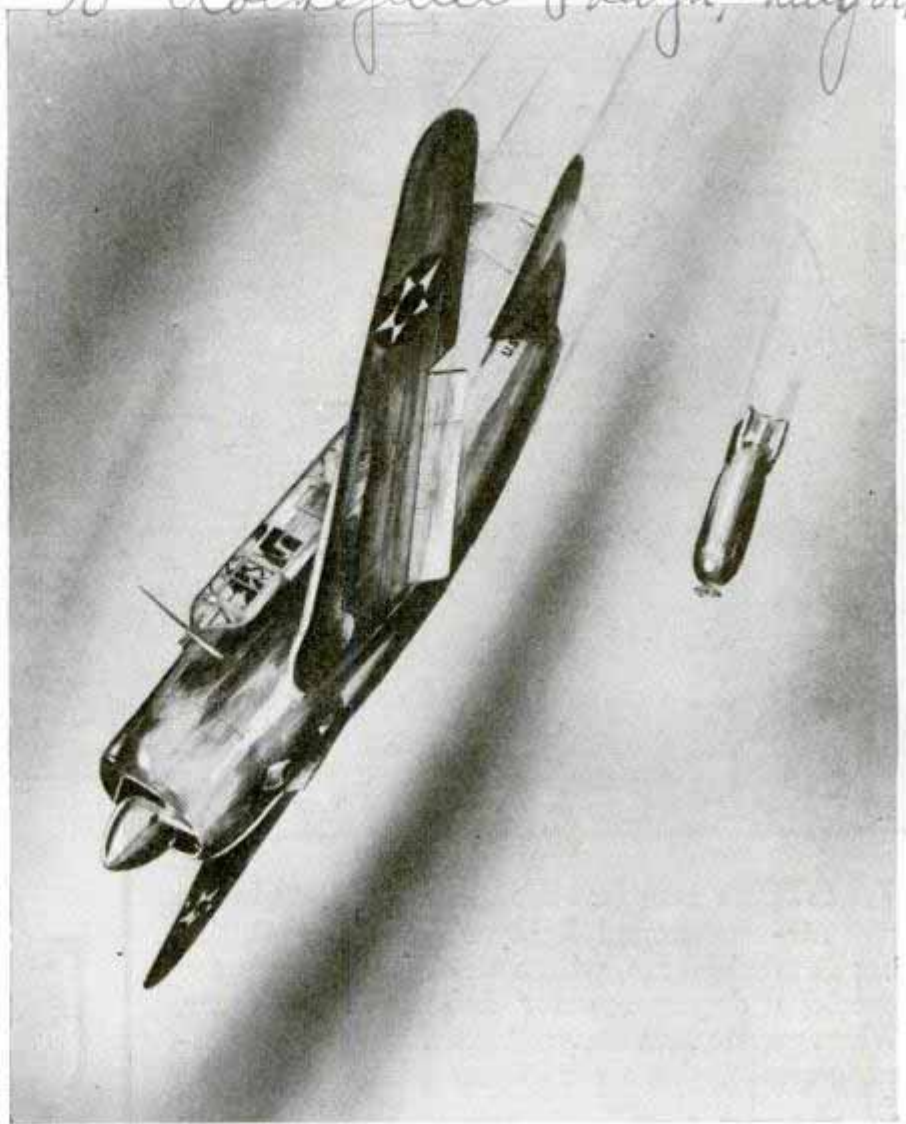

Designed for use on airplane carriers, this dive bomber mounts machine guns of unusually heavy fire power for such a plane, and carries large load of bombs. It is capable of making extra long flights from ship

K 951

Snap-On Metal Golf-Club Head Permits Left-Hand Swing

at Cedarbrook Country Club, Phila

Golfers who normally use right-hand clubs sometimes must take a left-hand swing at the ball should it come to rest

near a tree or other hazard. To save carrying a left-hand club for such situations, an aluminum shell that reverses the striking face of a right-hand club is now available. It snaps over the back of the club head, fitting most of the popular models of No. 3 iron and many No. 2 irons. Weighing about four ounces, it can be carried conveniently in the ball pocket of the golf bag. Its broad, flat sole helps guard against digging in, and distances up to 125 yards have been made with it. No holes or attachments are needed for fastening the shell to the club head.

Lefty

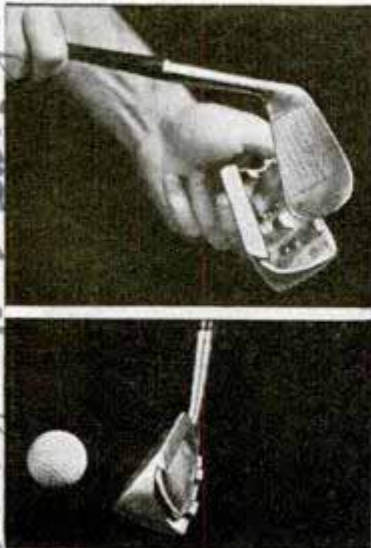

Two views at left show how left-hand head slips on right-hand club for emergency shots. Right, player taking left-hand swing near tree

*Roller Casting Co. Inc.
2814 Bridge St. Phila*

Edw. Joseph Deha Jr. Pro

SEALING HISTORY away

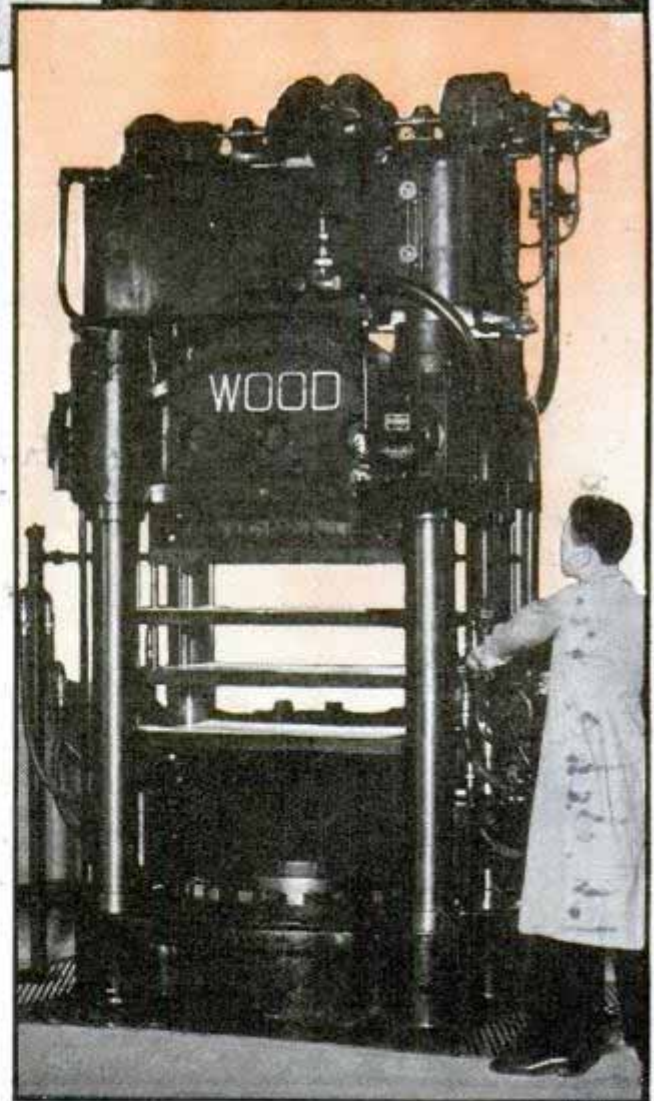
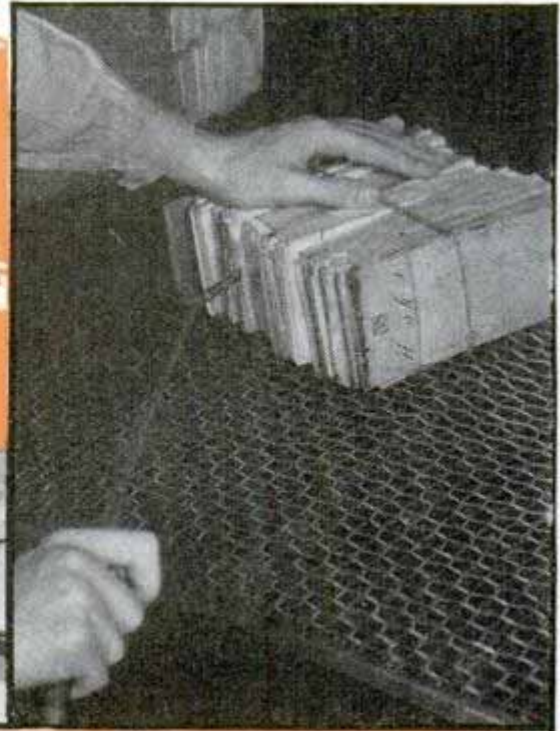
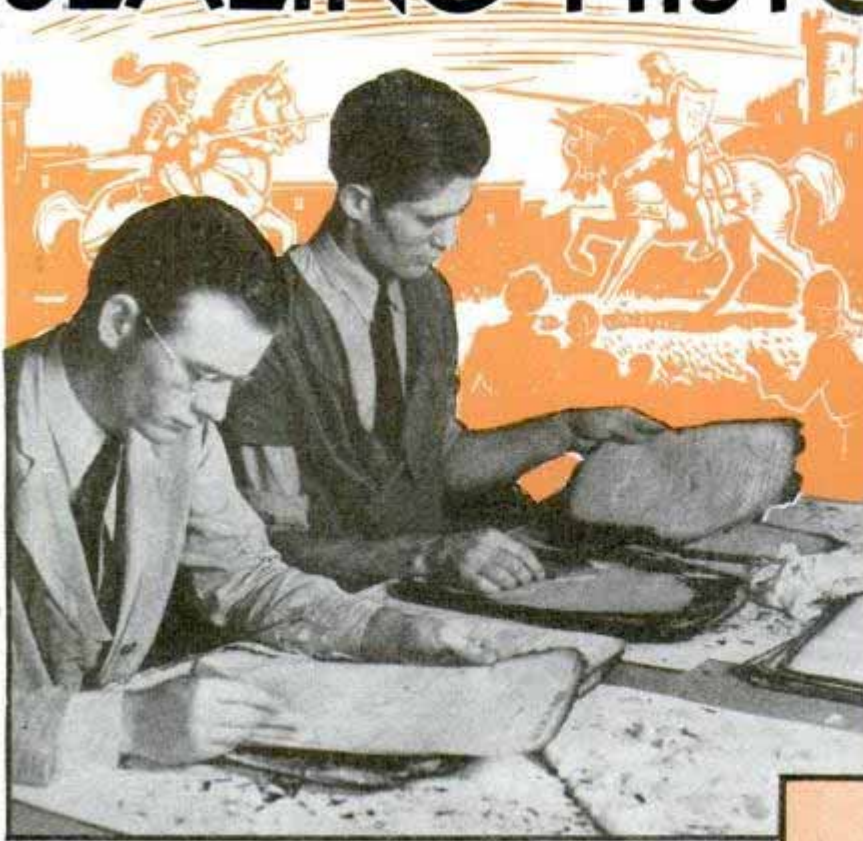

HISTORY is as safe as man can make it in the air-conditioned, lightproof Archives Building at Washington, where Uncle Sam files away precious documents for safekeeping forever. When papers first arrive there they are fumigated in steel tanks; air is evacuated, then ethylene oxide and carbon-dioxide gas enter to kill all insects, mold and fungi. Next, dust is blown from the documents with a compressed-air gun and caught in dust collectors. The papers are flattened by hand, subjected to moist air and then ironed on an ordinary mangle or ironing machine to remove all wrinkles and folds. The documents are then ready to be "laminated," sandwiched in between sheets of transparent cellulose acetate and sealed away from air for all time. The "sandwich" is placed between two highly polished metal plates and submitted to pressure in a hydraulic press, the heat and pressure "melting" the thin acetate sheets into the pores of the paper and making them adhere to each other. After this pressure treatment the paper is thinner and takes up less room than it did originally, a big advantage when storing away billions of papers in the national archives. The historical paper and the cellulose acetate wrapper come from the polished metal plates as a single sheet. The danger of decay or insect attack is minimized, and aging tests indicate this laminating process makes the historical record as permanent as it is possible to make

Top, left, hand-treating charred documents; right, dusting with compressed air. Below, press seals paper in transparent film

The National Archives, Washington, D.C.

for KEEPS

Right, ironing out creases; center, paper sealed between cellulose acetate sheets. Bottom, fumigating tanks where gas kills insects and fungi

any paper record. The paper can be written on with ink, and the writing later washed off. The document files are kept at a constant temperature and are fire-proof. An elaborate detection system warns when an unauthorized person enters the filing room and even tells which drawer has been tampered with. The \$12,000,000 Archives Building is really one cube within another, its inner cube a concrete storage vault. The archives filed there, open to anyone with legitimate research projects, include not only government documents but a vast amount of material covering the history of America.

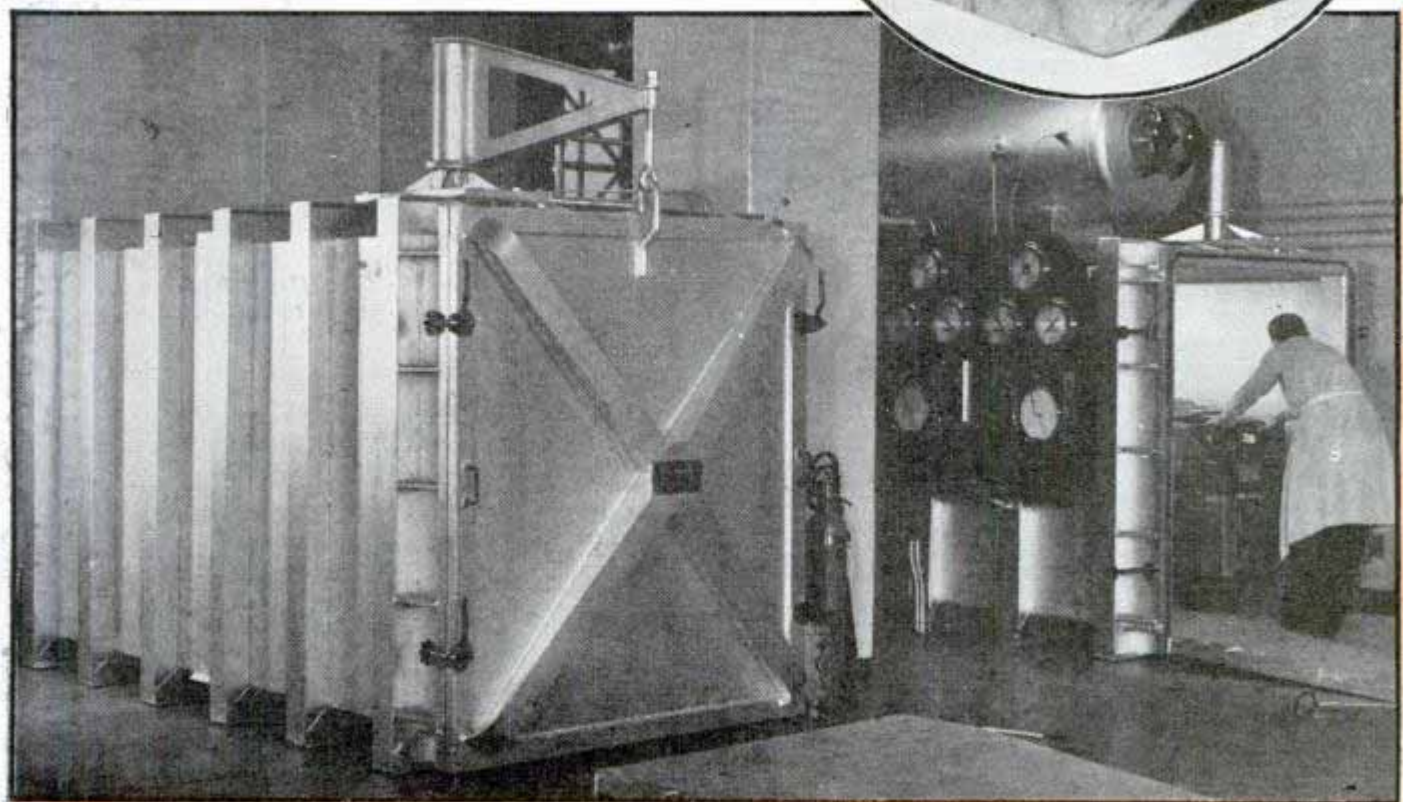
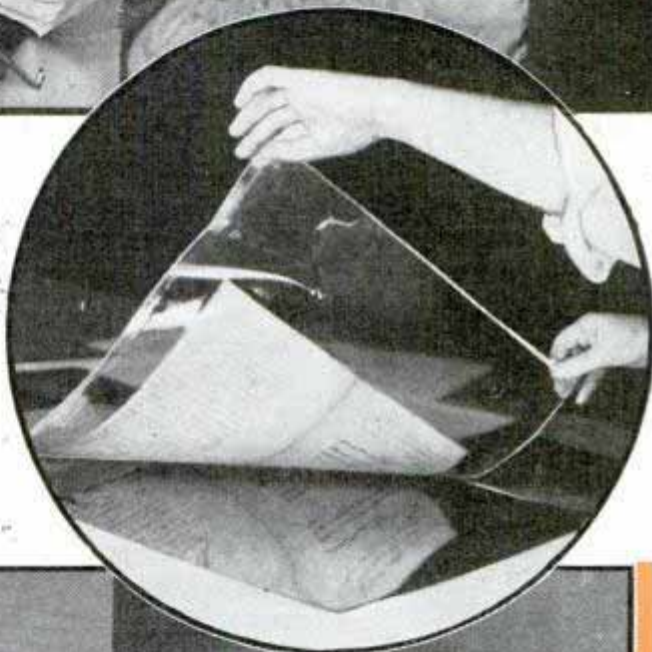

K 931
Birds Kept from Roosting on Edges of Roof

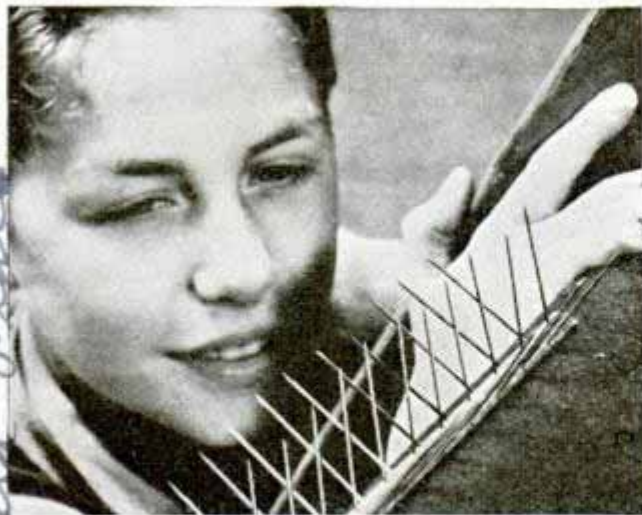

Sharp spikes made of stainless steel are installed in ten-foot strips along roof edges

Birds can be kept from gathering on roof edges and cornices of buildings by installing strips of sharp spikes. These rustproof prongs of stainless steel, set in aluminum, are offered in strips ten feet long and can be set wherever birds habitually roost. The spikes are spaced an inch apart and point in three directions.

K 932
Rubber Molding for the Bathtub Bends to Fit Curves

Made of sponge rubber, with a facing of hard rubber that hot water and soap do not affect, molding now available for use on bathtubs can be stretched, compressed and bent easily to conform to the contour

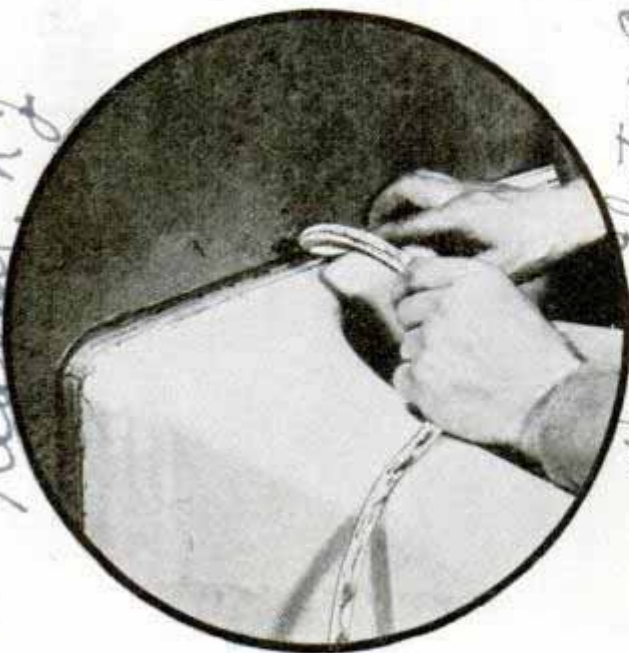

Rubber molding to provide seal between bathtub and wall does not loosen or break with seasonal changes

330 W. 42nd St. N.Y.C.
 of the tub. The hard-rubber surface provides a watertight seal, and the resiliency of the sponge-rubber backing yields readily to seasonal changes without breaking.

K 1004
Heavy Sulphur May Help Solve Secrets of Life

Heavy sulphur, which weighs one-seventeenths more than the ordinary one-cent-ounce variety but costs \$1,500 an ounce, may help to solve the questions of sulphur's role in the chemistry of life. Sulphur 34, the heavy element, has been produced at Columbia University by a chemical method adaptable to quantity production, and at Cornell experiments are being made in the metabolism of sulphur. By using the heavy atoms, the sulphur can be "tagged" at the beginning of an experiment, traced through the chemical reactions in metabolism, then identified in the end products by mass spectrographic analysis.

K 793
No-Spark Safety Phone for Mine Has Parts Sealed Inside



There is no chance for sparks from this telephone to ignite gases in a mine since all parts are inclosed

Electric sparks from the telephone, which sometimes cause fires or explosions in mines, are eliminated by a new-type instrument. All parts of the phone are securely encased to prevent the escape of sparks from the bell or other connections that might ignite gases in the air.

Paint that kills typhoid-fever germs nine weeks after a wall is painted and stops the growth of mold and yeasts in damp atmospheres has been developed by adding chlorine or iodine to the oils used in the paint.

Handwritten notes:
 Repeller Co. of America
 1001 1/2 Ave. of the Americas
 New York, N.Y.
 Cinnanna Scher
 Prof. H.C. Meyer
 Dept. of Chemistry
 Need of the
 Bird
 K 932
 Rubber Molding for the Bathtub
 Bends to Fit Curves
 Made of sponge rubber, with a facing of hard rubber that hot water and soap do not affect, molding now available for use on bathtubs can be stretched, compressed and bent easily to conform to the contour
 Western Electric Co. 146 B Washington St. Wash. D.C.
 clw.
 There is no chance for sparks from this telephone to ignite gases in a mine since all parts are inclosed
 Electric sparks from the telephone, which sometimes cause fires or explosions in mines, are eliminated by a new-type instrument. All parts of the phone are securely encased to prevent the escape of sparks from the bell or other connections that might ignite gases in the air.
 Paint that kills typhoid-fever germs nine weeks after a wall is painted and stops the growth of mold and yeasts in damp atmospheres has been developed by adding chlorine or iodine to the oils used in the paint.
 clw.
 S. S. Epstein
 305
 Foster H. S. Well Ave. Washington 81
 305

Jetty Has Open Walls to Make Beach 'Grow'

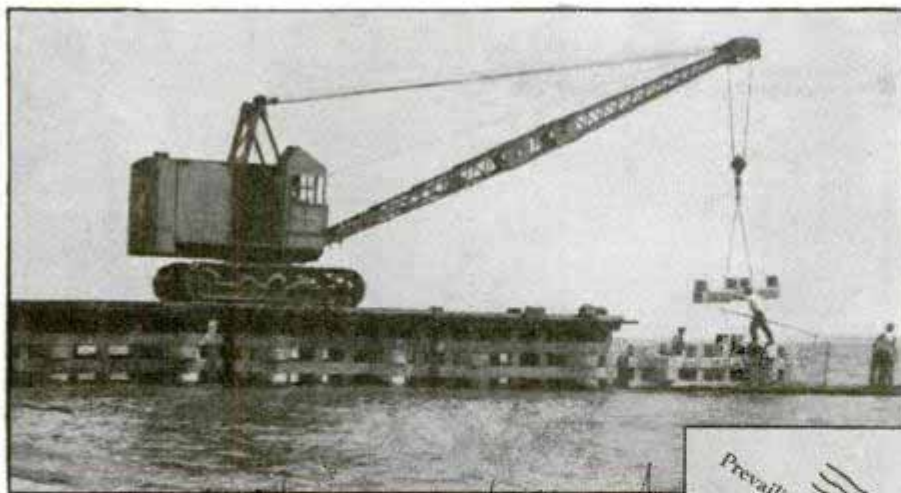

Left, crane placing section of concrete jetty undergoing construction; note openings in sides to slow down water and allow sediment to sink. Diagram, center, indicates action of current along shore in vicinity of jetty built with openings becoming progressively larger toward the top. Bottom, looking down on jetty to see how concrete sections are joined together

Water dashing along the shore is made to deposit sand and other sediment to form public beaches by slowing its pace with jetties built of precast concrete sections that leave openings for the waves to pass through. According to Sydney M. Wood, consulting engineer, who developed the idea, "open faced" or permeable jetties not only protect the shore, like the ordinary solid kind, but also prevent the scouring action of waves and currents which sometimes carry away the sand instead of allowing it to gather. Therefore the bottom is free from dangerous holes often found where jetties permit a turbulent backwash. Openings in the new-type jetties may be regulated to fit the current and other local conditions so the velocity of the water may be lowered enough to permit the sand it carries to sink to the bottom.

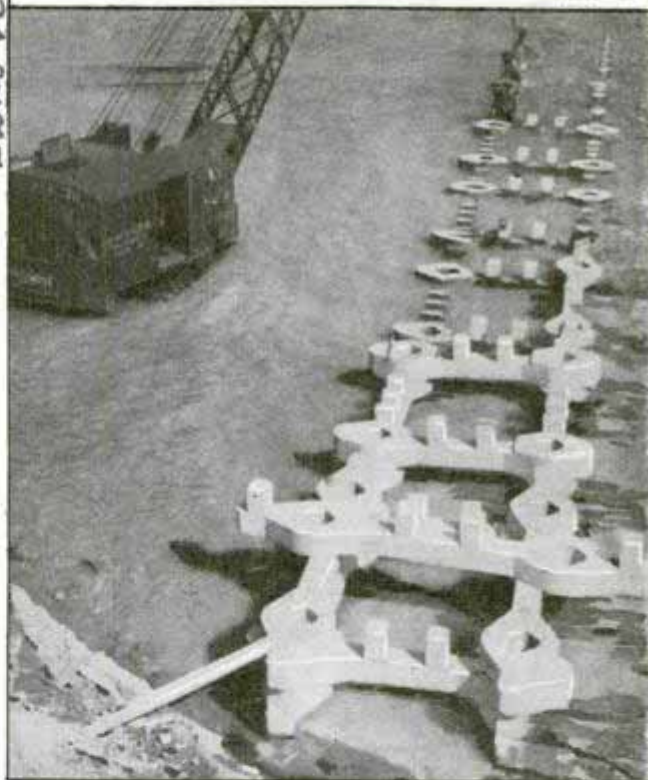
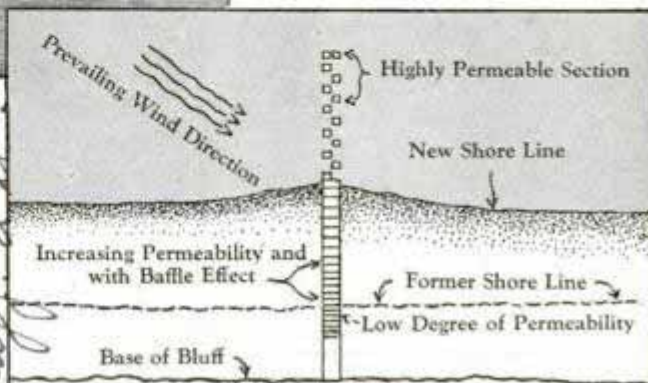

Army Wants New Machine Gun Air Cooled, Lightweight

Inventors have been invited by the United States army's ordnance department to develop a light machine gun before October, 1941, when tests will begin. In general, the gun must not weigh more than twenty-two pounds nor be more than thirty-eight inches over-all; mounted on its tripod it should not exceed eighteen inches in height. Air cooling is one requirement, and the barrel must be capable of being unscrewed from the front so a new barrel can be put on in a few seconds. It is to be bored and chambered for the standard .30-caliber army cartridge, and heavy enough to fire 300 to 350 shots a minute for five minutes without stopping. Ammunition

is to be fed in from the left side, in metal-link belts, the cloth-web belts and box-magazine and clip feeds being considered unsatisfactory. Although there are other specifications, a gun that meets these requirements, and can stand rough usage under field conditions is said to have a good chance of competing with the best weapons offered for adoption by the army as the standard type.

4600 W. 83rd / Park, Kans
National Broadcasting Co. N.Y.C. Radio City
New York City



AMERICA goes CALLING

By Guy C. Hickok

Program Director, International Division
National Broadcasting Company

A HUSH falls over the great chamber as the President starts speaking before congress. His message is an important one, senators and representatives are out en masse and there's not a vacancy in the press section or spectator's gallery.

Before him is a battery of microphones carrying the speech into millions of homes. The world is listening, too, for in a corner of NBC's New York offices a handful of men hover over a teletypewriter with one eye on the clock and the other on the keys. Paragraph by paragraph the text is ripped from the clucking machine and carbons handed to linguists for translation into Italian, German, French, Spanish and Portuguese.

Three men rush the speech into Italian. Every second counts. It's just after 2 o'clock and the daily Italian hour (received

Important news stories are covered by special-events men (top) whose bulletins travel around the world. Bottom, building 25,000-watt short-wave transmitter

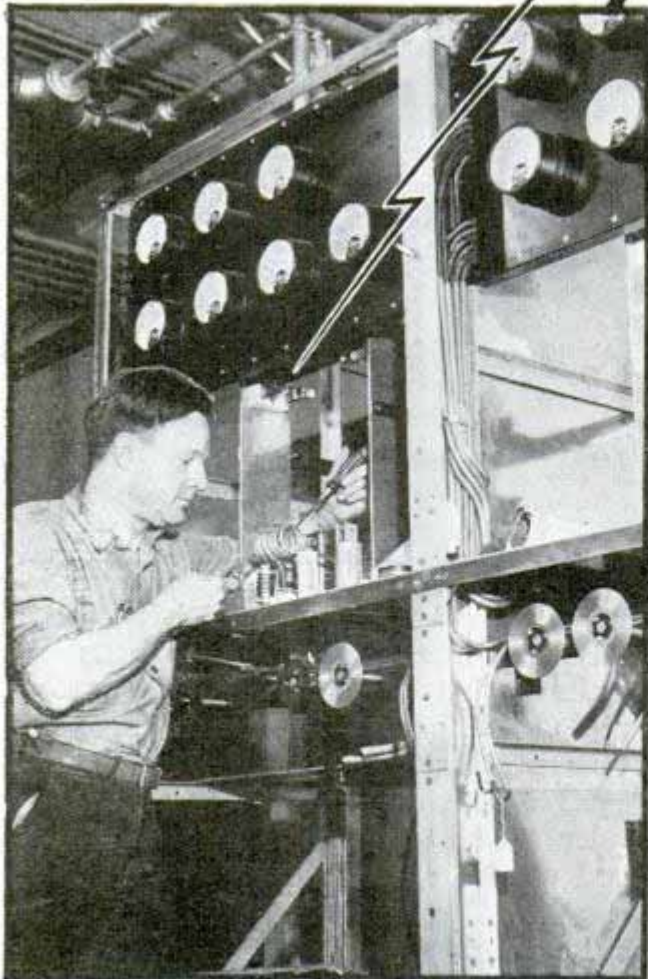

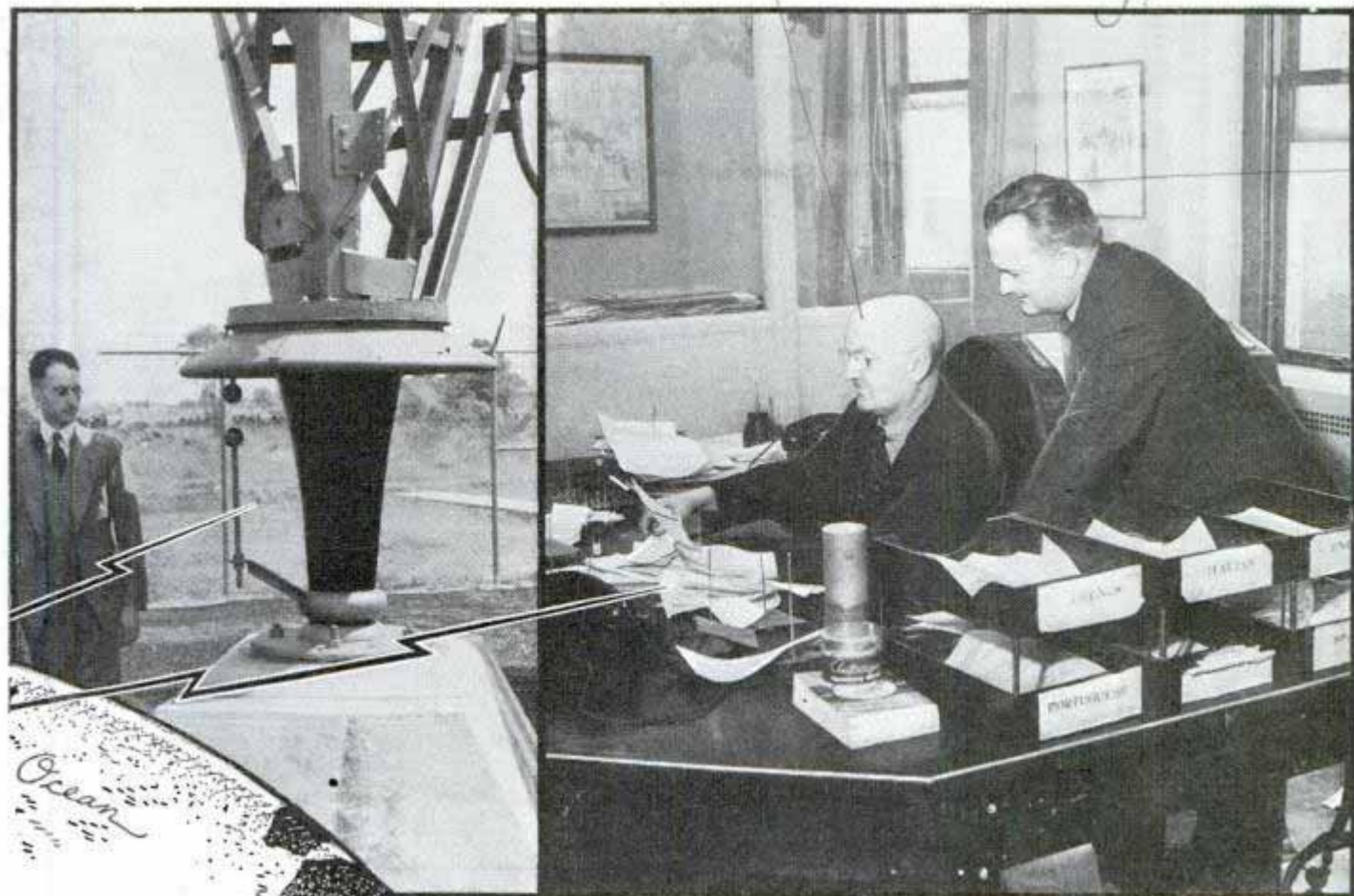

by SHORT WAVE

in Italy between 7:00 and 8:00 p.m.) of NBC's short-wave service is on the air. They work at lightning speed and before the President has finished speaking in Washington an announcer is reading it into a microphone. The speech travels by land line to Bound Brook, N. J., where towering antennas scrape the clouds. Several buttons are pressed and the text is beamed toward Italy where it will be picked up as clearly as though the voice came from a local station. An hour later, a German-speaking newscaster sends the address winging toward Berlin and Cologne where, behind closed doors, wary listeners crouch forward toward their loud speakers. Tuning in a foreign news dispatch is

Top, left, base of Bound Brook, N. J., radio tower; right, planning a foreign broadcast. Bottom, fan mail from eighty nations



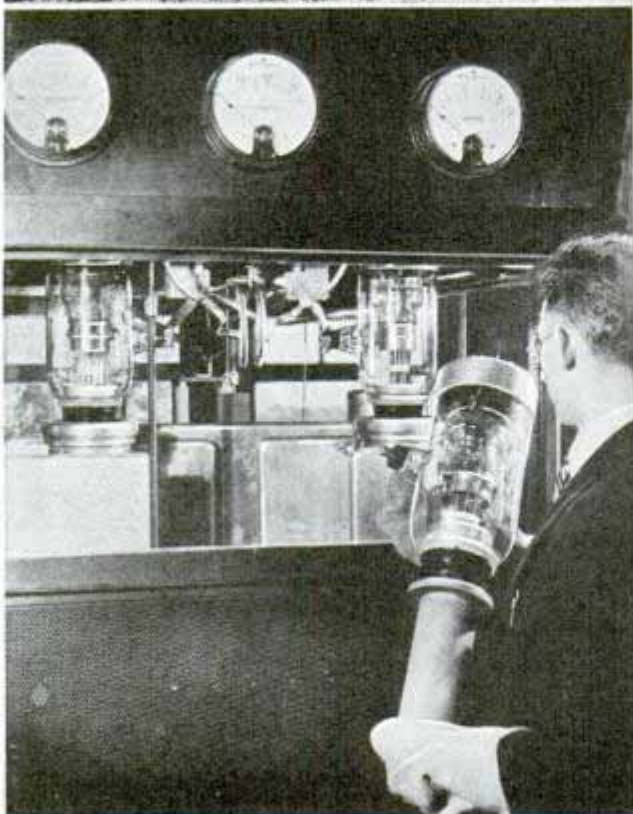
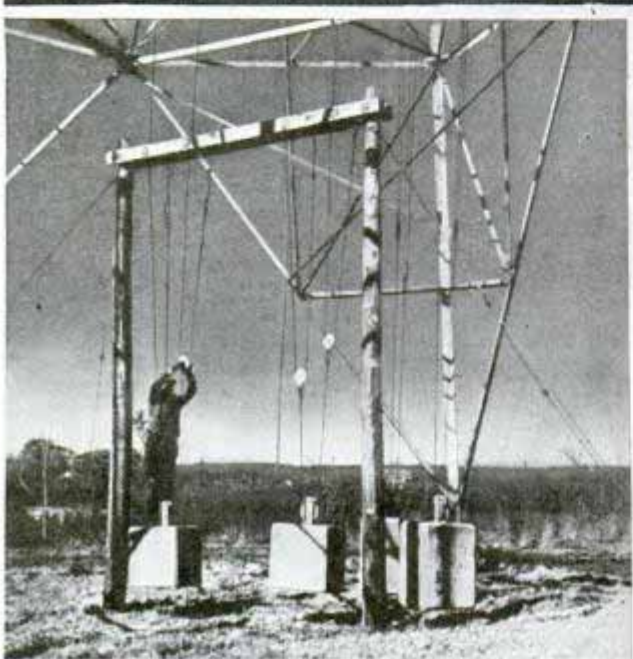
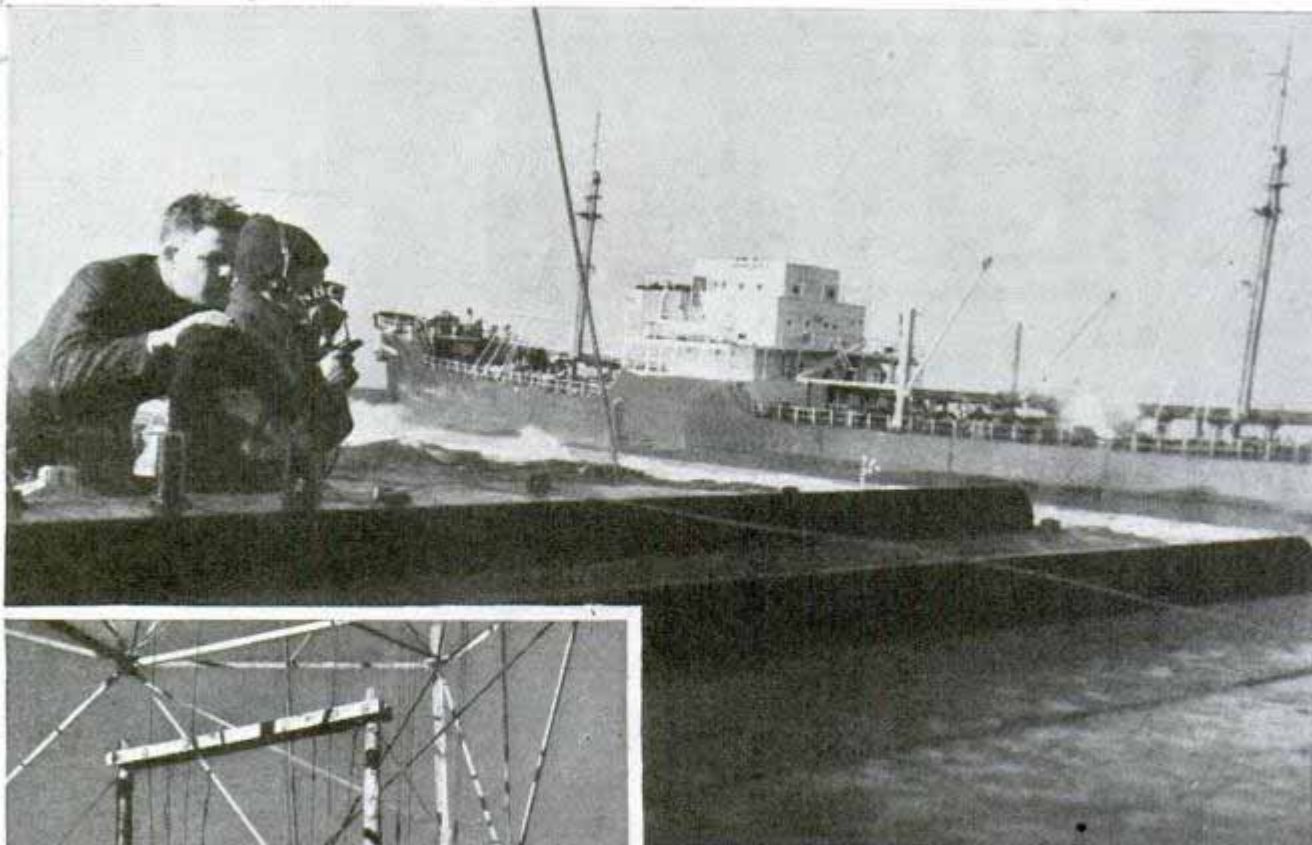

Above, a special-events man covers news at sea. Left, counterweights protect the 600-foot antenna spans against ice. Bottom, changing a transmitting tube at Bound Brook station calls for asbestos gloves

“verboten”—but no matter, they must know the truth about matters vital to them.

Next France hears the speech, then England and Latin America. And before the minute men of radio call it a day, a polyglot international audience has heard the President's speech. The Montevideo dock worker in a waterfront cafe speculates on its import as does the oil engineer in Saudi Arabia; an American army officer in Alaska has heard it almost simultaneously with the crowd gathered around a loud speaker in a park in Angola, South Africa.

Two repeat broadcasts in the President's voice, by electrical transcription, are made for English speaking listeners who might have missed the first direct broadcast. One late at night is beamed southward for the 30,000 Americans in the Canal Zone, the British subjects in the West Indies, and for Americans scattered in oil fields, nitrate and tin mines in South America. This program also is heard in Little America, passes on under the Pole and comes up in Australia, picks up listeners along the China coast and finally in Alaska. The second broadcast by transcription is directed toward Europe to reach listeners who might have missed it the first day.

That's the way America goes calling on

some eighty or more foreign countries these days. And usually, the welcome mat's out. A large international audience has been built up not so much by the red-letter events such as a presidential speech, as by the daily series of multiform yet well-balanced programs emanating from two powerful short-wave stations sixteen hours a day, seven days a week. Last year out of 16,500 international programs some 12,150 were designed to acquaint certain groups of listeners on the five continents with customs, life, and ideals of America.

Although news is but one dish on the international short-wave menu it is by far the most popular, for were it not for these newscasts many foreigners would have no way of learning what's going on within their own country and beyond its borders. Short wave ignores the censorships.

Long before the first gun was fired in the European explosion, war lords set the propaganda mills grinding to put across their ideologies. With all the intensity of a blitzkrieg, the war of words has been sprayed over twenty republics of Latin America for some time, particularly in the more important cities where both the dictators and their opponents claim large numbers of transplanted patriots and heavy commercial interests.

Consequently the newscasts emanating from North America are virtually the only unbiased, impartial ones coming their way. They know, too, America has no particular ax to grind other than the promotion of good will, hence there's no need for a censor to be standing by with blue pencil and scissors to "doctor" the copy before it's put on the air.

The time factor has helped their popularity, too. Filtering news through government-controlled channels takes time, so much that NBC broadcasts news over the air as much as twenty-four hours ahead of radio stations operating in totalitarian countries. Even on history-making news breaks such as the agreement of Russia to Hitler's non-aggression pact, continental Europeans tuned to the American station got the alliance fully five hours before it was released by European broadcasters. When Der Fuehrer met Mussolini at Brenner Pass there was a thirteen-hour difference between the American broadcast in Italian and the official bulletins from the Italian stations.

(Continued to page 118A)

Ukulele Built at Home from Kit of Parts

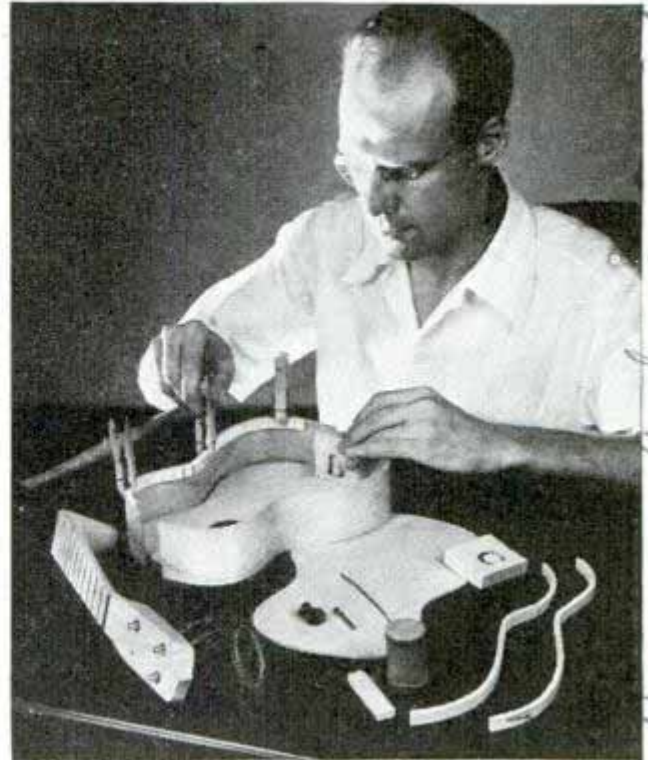

Here the homemade ukulele begins to take shape. Full instructions are furnished with the kit of parts

All the essentials for building a ukulele at home are included in a kit of parts now available. Only the simplest of home tools are required for assembling the parts, which form an instrument of standard size. Instructions for the assembling are included in the kit.

Broken Lamps Removed Safely with Shockproof Tool

Broken light bulbs can be unscrewed from their sockets easily with a lamp-base remover that reduces the danger of shocks, short circuits and cut fingers. At one end is a hollow rubber grip that is inserted into the broken base, with the hand at a safe distance, to remove it quickly even when the current is on.

Two sizes are made, one for medium and one for mogul screw bases.



Musical Instrument
3211 W. Escondido Ave
Regal
1934
75¢ @ 8 1/2 \$1.25
The Ersson Co. 5716 - East St.

Flying 'Sausage' on a String Is Still Eye of Army

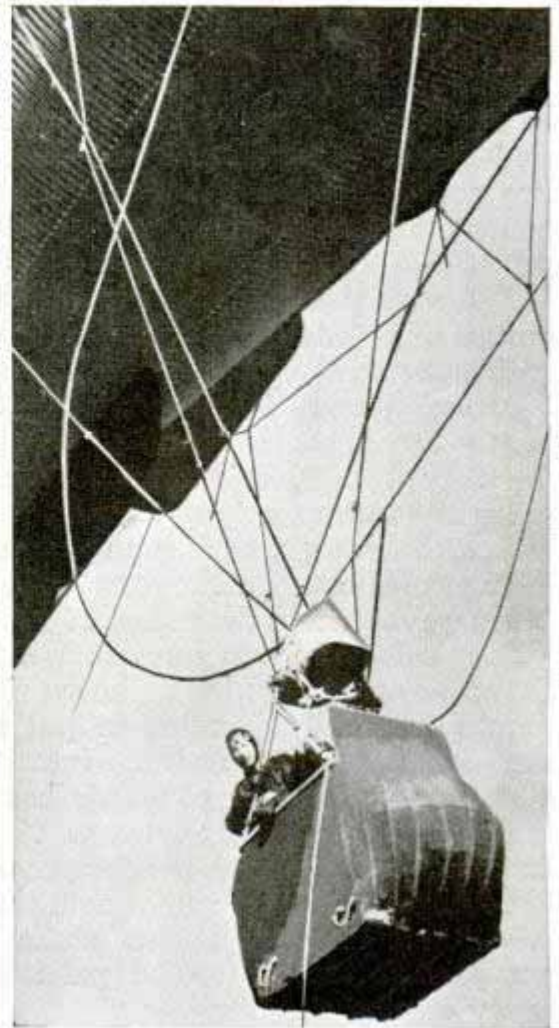
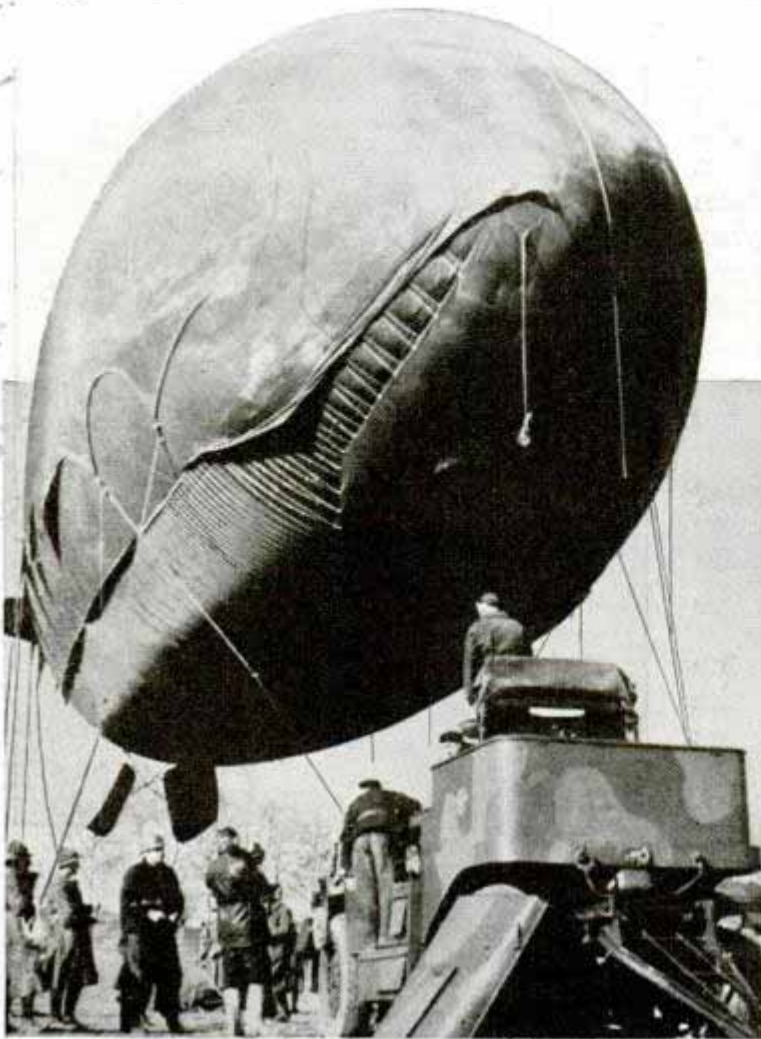

Ground crew, left, making one of the "sausages" ready for upward ride back of the lines to "stand watch" and report enemy movements. Right, basket swinging from balloon carries crew of two men

One phase of warfare hasn't changed much in twenty-five years. As in the first world war, the captive "sausage" balloon still goes aloft back of the lines to watch

the movements of the enemy from a distance. Anchored to the ground, raised and lowered by cranking up a long rope on a windlass, the balloons carry two observers.

Home and Office on Wheels Includes Laboratory Space

Serving the threefold purpose of a comfortable home, business office and research laboratory while touring the country, a streamline "dewdrop" automobile, designed

for use of the president of a large manufacturing concern, includes a combination living room, dining room and office, sleeping quarters at the rear, and laboratory space containing extra large sink. Among the conveniences are a desk with built-in radio, couch that can be turned into an extra bunk, table folding away into a etupboard, heating and air conditioning operated by push button, electric outlets for razor, lamps and toaster, four-burner "bottled-gas" range, refrigerator, bathroom with shower and toilet, and hot and cold running water. Screened windows are fitted with venetian



Combining business with home comforts, this truck-size auto houses living room and office, sleeping room and laboratory

Handwritten notes on the left margin:
 K. 9.20.
 Johnson Co.
 Rainie Wis
 Pres. Inc.
 Mercury motor

Handwritten notes at the bottom:
 Built by Linn
 Bond Co. Inc. Chicago Ill

blinds, and rooms have indirect lighting. The "house" car is twenty-five feet long and eighty-eight inches wide, weighing about 8,000 pounds. It uses front-wheel drive, eliminating the drive shaft and permitting rooms to be built six feet and two inches high. The power plant, an ordinary ninety-five horsepower engine, runs an air compressor that furnishes pressure for the water system or to pump up tires. It has a top speed of eighty-five miles an hour.

1840

Electric Lantern for Miners, Oil Workers

Being particularly useful in mines, chemical plants, oil fields and other places where danger of explosion is high, a new safety lamp has been introduced for workers. It has a swivel base which permits setting the lantern down and directing its light at any angle. A slide switch instantly ejects broken bulbs. The glass dome is protected by a heavy wire guard.

Richard L. H. Co. \$5.50

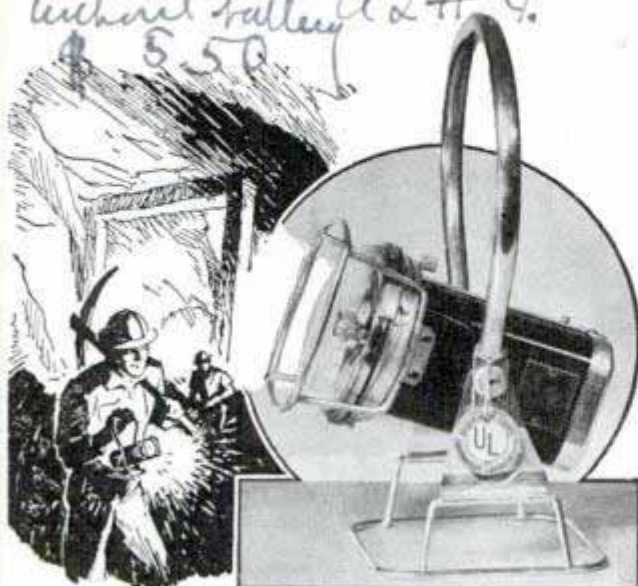

New-type electric lamp designed particularly for use where danger of explosion exists

Tiny Model of New Home Is Tilted to Show Drawing of the Floor Plan



Tilt the miniature home backward and here is what you see: a complete blueprint drawing showing how rooms, halls and stairways are laid out

Tiny models of houses built to scale are used by some lumber dealers to help sell homes. A single display may consist of half a dozen or more miniatures, each presenting a different exterior and interior design. Placed in neat order on a dark-green panel of fiber board that looks like a lawn, the houses have individual color schemes, and the setting is completed with realistic plants, shrubs, sidewalks and garages. The layout of the home interior is shown by a floor plan, drawn in blueprint form, under each house. To view this the customer swings the tiny house upward on a hinge which joins the back of the house to the panel. The dealer is prepared to supply construction blueprints, specifications and material costs for the houses.

Johns. Inmanville Co. 22 E. 40th

Burgess Battery Co.

Luxury Bus Has 'Snack Bar' and Washroom

Southeastern Greyhound Lines
 1935-36
 No. 809
 Washington
 D.C.



Today's luxury liners of the highway offer comforts and speed undreamed of only a decade ago. Between Chicago and California cities, for example, Burlington trailways, Greyhound and other buses run on schedules as low as fifty-nine hours—actually swifter than standard trains



On this page are some views aboard the "Sun Chief," a Cincinnati-to-Florida bus of Southeastern Greyhound lines which offers faster service and extra comforts at slightly extra fare. There's a "snack bar" aboard, shown in the top picture, at which the steward prepares tray luncheons for the passengers. Below, he is serving sandwiches and a soft drink. There's also a lavatory, with running water from a forty-gallon tank. Average time between stops on this route is six hours. A "ship's bell" clangs at departure time, with ballyhoo, as if starting a cruise

Diesel Highway Liner Built of Stainless Steel

A vast fleet of new stainless-steel buses made its debut recently in transcontinental service. These thirty-seven-passenger "super-coaches" are Diesel-driven, the 175-horsepower "package" being installed at the rear where it is pulled out for servicing almost as easily as a dresser drawer. Ventilating ducts provide 1,200 cubic feet of cool air per minute in summer, warm air in winter. The air-conditioning plant is shown at lower left, the Diesel at right. Passengers' baggage is stored in compartments under the seats

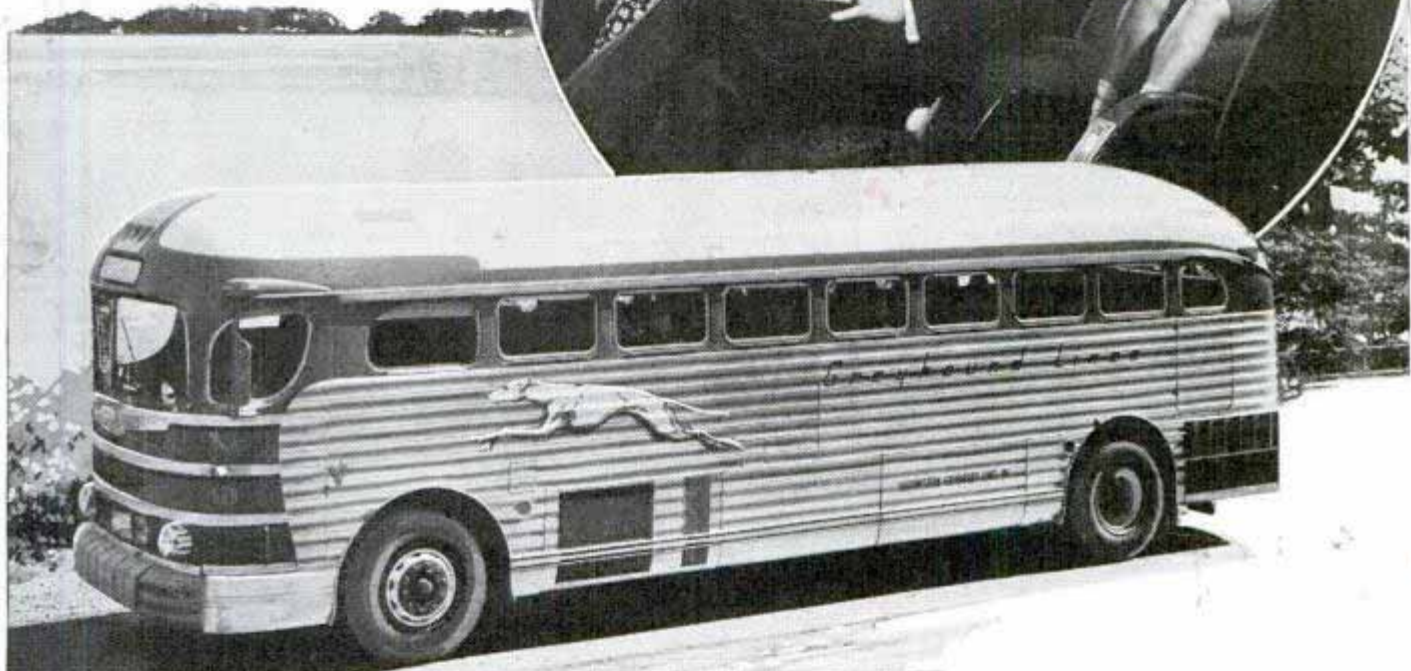

Camera Fan Turns Eight Snapshots into One

H.A. Scheafner 5640 W. Fletcher Chicago
 Deep. Freeze. (North Chicago) 2301 Davis St. Ill. (Motor Products Corp.)

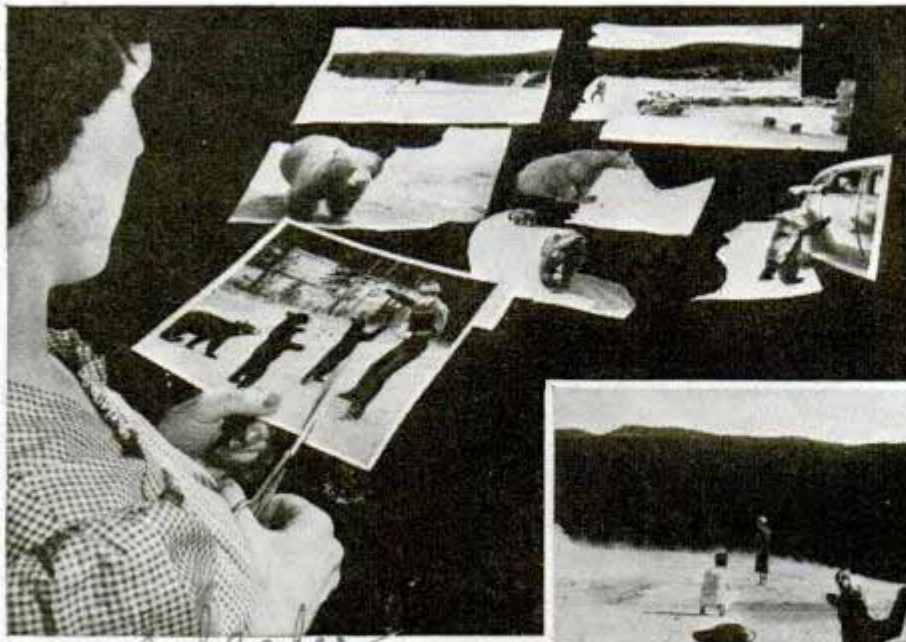

Several different snapshots are being cut out along irregular lines (at left). Afterwards they are pasted together as a composite and the resulting picture is rephotographed as seen below



Eight snapshots of bears, tourists and scenery were turned into one picture by a vacationing photographer to represent a tourist's impression of Yellowstone Park. To conceal the trickery he ran the shears along broken contours of objects such as tire tracks on the road or the outline of a bear, then rearranged the cutout pictures. After pasting the pictures together he rephotographed the whole.

Sub-Zero "Barrel" for the Home Keeps Foods Frozen

Foods can be kept frozen and fresh indefinitely in a "food barrel" for the home, which maintains zero or sub-zero temperatures at an electricity expense approximately that of your household refrigerator.

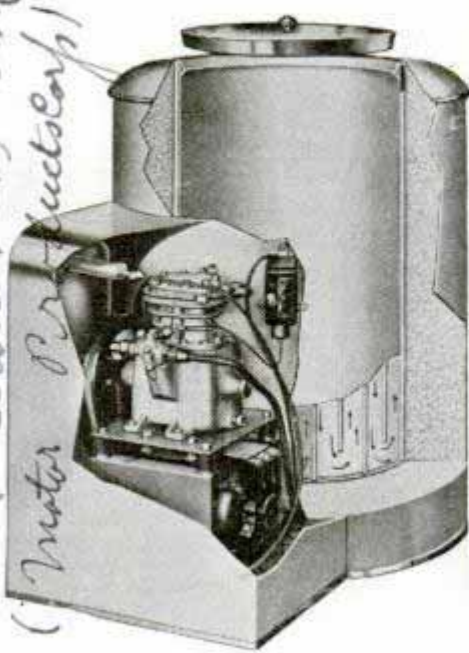

The housewife thus can take advantage of lower prices for quantity buying, ordering a quarter of beef at a time or laying in a supply of frosted foods. The farmer can butcher at any season and store meat for future use. The sportsman can keep fish and game fresh. The food is kept in an upright cylinder about the size of a barrel; the compressor is housed under a small hood at the side. Set at the factory to operate at zero, the unit can be ad-

Sectional view of home food barrel at left shows thickness of insulation

justed for any temperature down to twenty degrees below zero. There is negligible loss of cold when the lid is removed, since the cold air stays down in the barrel. The entire wall surface of the food compartment comprises the freezing unit, and this is surrounded by four-inch walls of insulation. Defrosting is unnecessary. Buckets of ice can be frozen quickly. The frozen-food barrel eliminates the usual vacuum and operates on back pressure, reducing the power consumption considerably.

K924
Ship's Deck Atop Hospital Aids Recovery of Sick

On the roof of a hospital in New York, the promenade deck of an ocean liner has been reproduced where patients recuperate in the open sunshine, far removed from the atmosphere of the sickroom. They loll in steamer chairs, play deck games and have tea and cake served by the deck "steward," simulating an ocean voyage. The time of day is given on the ship's bell, and there are real lifeboats, cabins, portholes, ship ventilators, nautical instruments and a gangplank. The patients forget they are in a hospital.



Patients "go to sea" on hospital roof where sight of ship's promenade deck makes them forget hospitals and sickrooms

'Shock Stick' Controls Gorilla with 5,000 Volts of Persuasion

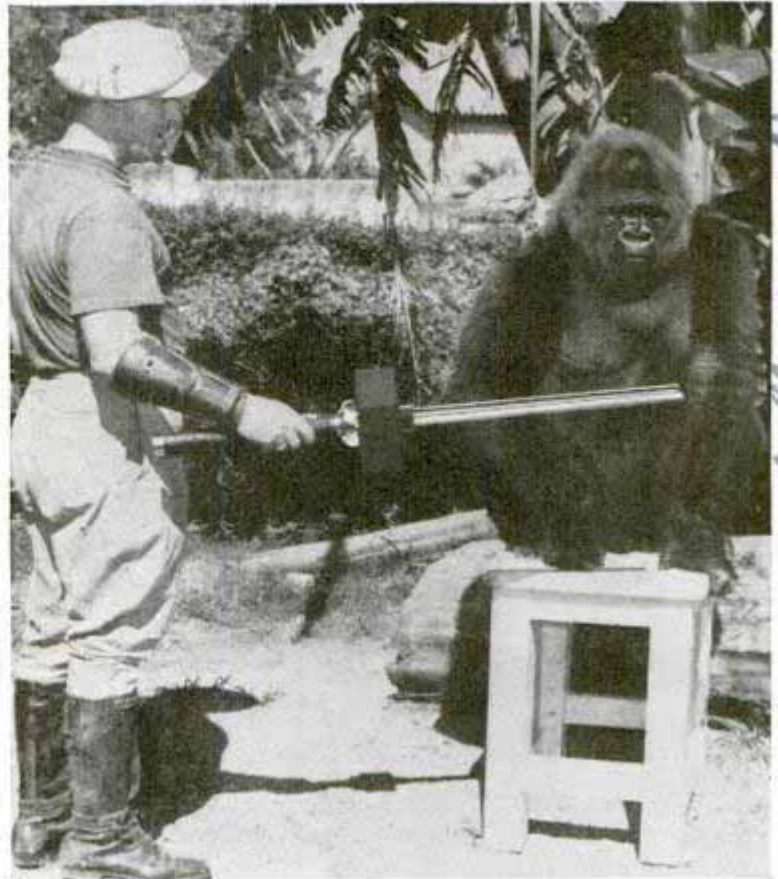

A touch with this 5,000-volt electric shock stick makes "Toto" behave. Its amperage is too low to do injury

"Toto" is usually very docile, having lived her eight years in comfortable human surroundings. Still, a 400-pound gorilla is a hazardous companion and you can't take chances. So Toto's keeper now carries a "shock stick" that can add 5,000 volts of persuasion if the animal should become unruly. A box at the center of the electric "billy" contains an induction coil. The shock is enough to compel respect, but low amperage prevents any injury. Toto was captured as a baby in Africa.

K 997
Food-Odor Absorber

Food odors are removed from the refrigerator by a small package of high-grade activated carbon, chemically treated to absorb all types of odors such as those from onions, cheese, garlic and fish. Compact and simple to use, it will function for months when placed far back in the box on a corner of a shelf, according to the manufacturer.

*W
 Schenck
 G. J. Williams
 D. D. Inf. Co.*

Polychromis Medical

Plastics and Glass Feature Novel Furniture

*W. S. L. Co. 16-170
Merchandise Dept.
1638 Merch.*

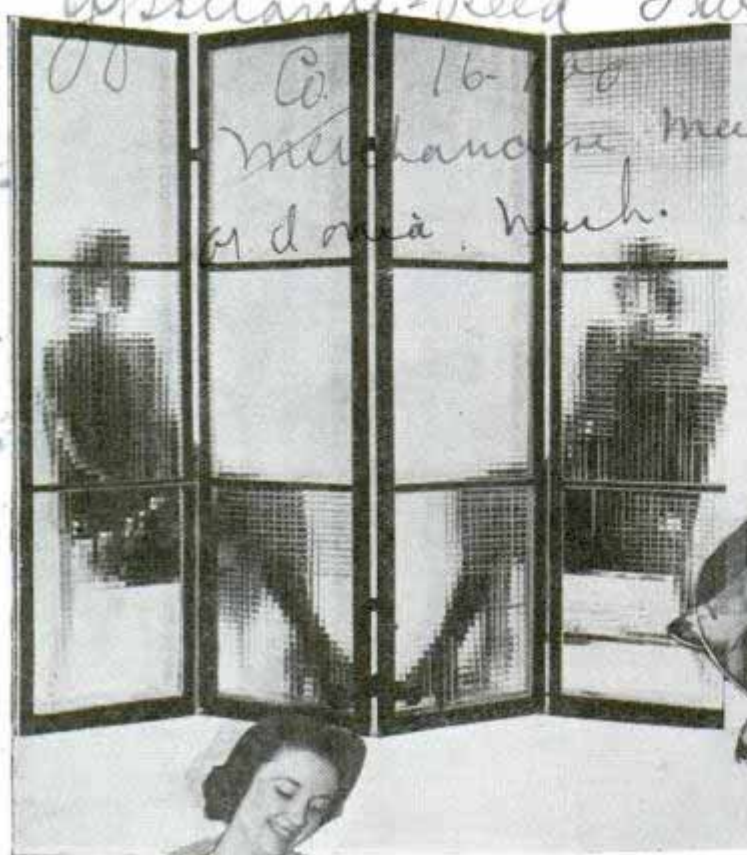

*Blumberg
1638 Merchandise*

Crystal Glass, Miss Deane, Sandal, Industries, England



Patricia Stanley
Novel ideas and new materials add to the attractiveness of modern furniture. Above, a glass table top rests on decorative sea horses



*West End Furniture Co
1638 Merchandise Dept.*

Furnishings of glass and plastics are particularly popular. At upper left is an eye-catching transparent screen of Tenite, the new plastic that is five times as strong as aluminum. Below, at left, a handy bed or chair table that has legs on one side only, but is as steady and sturdy as if it were a conventional quadruped. At right, a chifonier with "portholes" that reveal your shirt supply at a glance

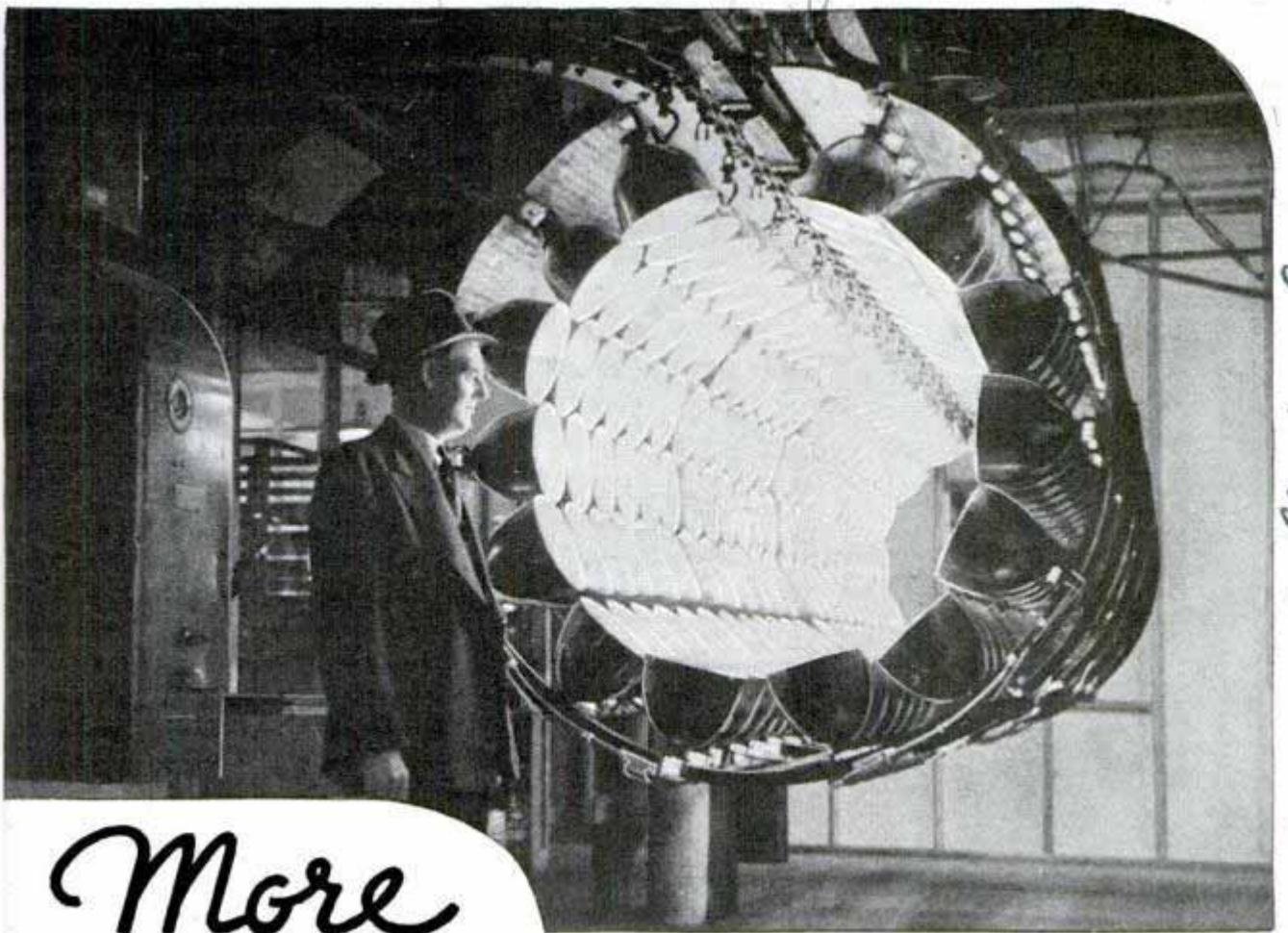

*General Electric Co
Park Cleveland, Ohio*

More WORK for INFRA-RED

WHEN white light is spread out, by means of a glass prism, you see the spectrum—a band of color ranging from violet through blue, blue-green, green, yellow, orange, red and deep red—representing light of different wave lengths. When daylight is split by raindrops, you see the same thing, in the form of a rainbow.

What the human eye fails to see are the invisible radiations at either end of the spectrum, as well as the rainbow. These radiations, science and industry have found, are extremely useful. One band, known as ultraviolet, extends beyond the violet in the spectrum. The other band, known as infra-red, extends beyond the red. Ultraviolet is of short wave lengths, infra-red of wave lengths longer than the red. As the wave lengths increase in the infra-red group, the radiation merges into heat waves and finally into the radio waves.

Important applications of infra-red radiation are just coming into use in the industrial field. Drying lamps, designed to



Courtesy General Electric Co
Top, battery of infra-red lamps used for drying.
Bottom, popping popcorn with "invisible" light

Photography by Eastman Kodak Co Rochester

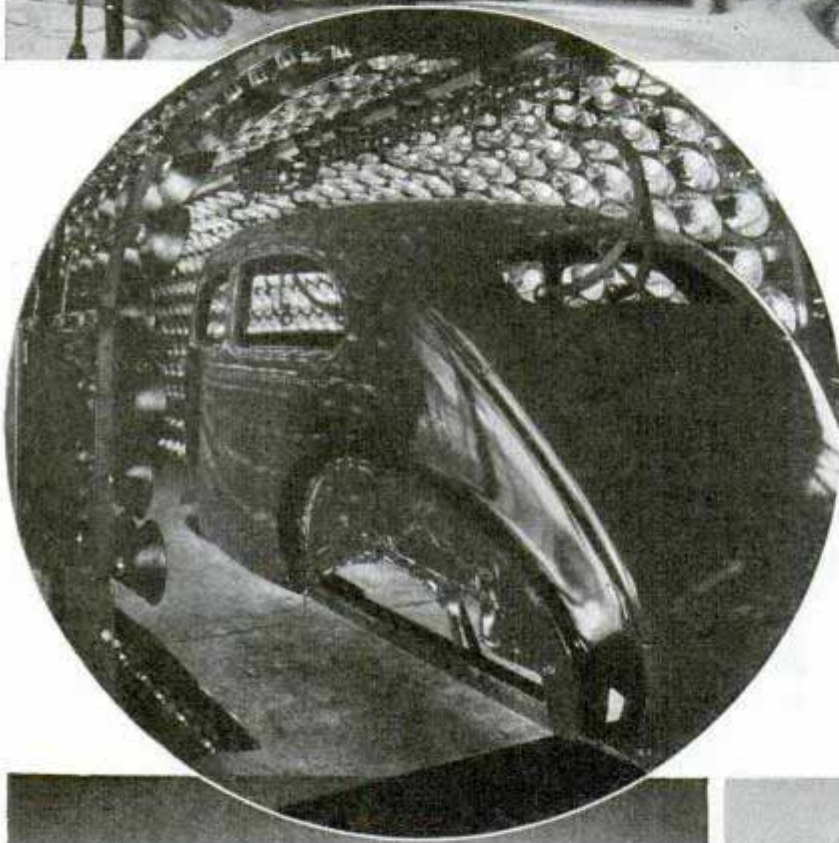
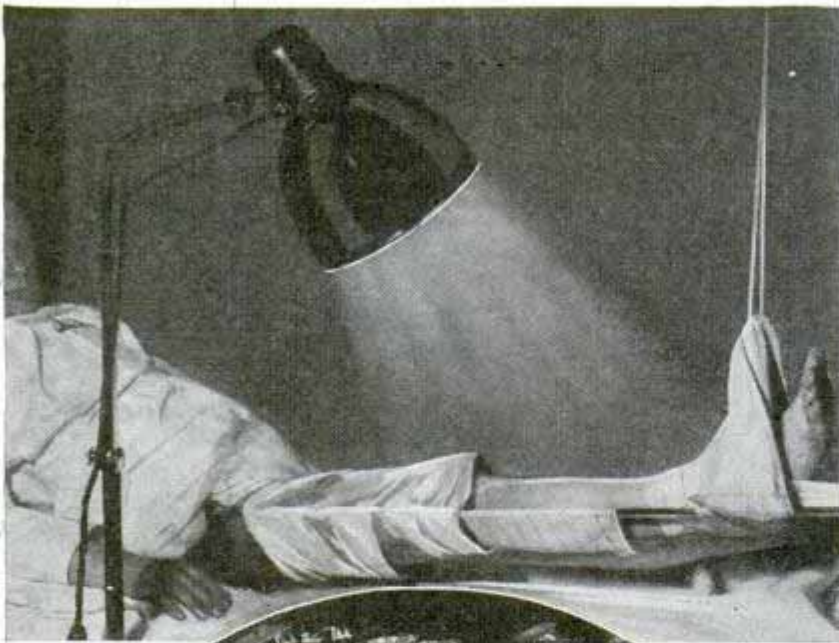

produce a wealth of effective infra-red (heat rays) instead of light, have been developed. Radiation from these lamps is of such a nature as to dry and bake industrial finishes of many kinds, dry photographic prints, foodstuffs, paper products and the like at a faster rate and at generally less cost than conventional drying equipment.

The automobile industry is employing large numbers of infra-red lamps, Ford using more than 10,000 on a variety of operations, such as the drying of priming coats of paint, first-coat enamel, some finish enamel and repair enamel. In the River Rouge plant is a ninety-foot tunnel containing 4,800 drying lamps of 260 watts each, with which a priming coat of paint on an auto body may be dried in ten or fifteen minutes, compared to one hour by old methods.

Considerable experimentation is under way on development of infra-red equipment for speeding up the drying of printing inks, thus increasing production of newspapers and magazines. Volatile inks, which harden for the most part by evaporation, have



Top, heat lamp speeding treatment of fractured leg. Circle, heat-lamp oven used in Ford plant for baking car enamel. The process is completed in about one-quarter the time required by conventional methods. Bottom, left, photo made with infra-red sensitive plate. Right, same scene made with ordinary film

Written Folder #87



Eastman Kodak

Photos courtesy Eastman Kodak Co.

Left, portrait made on infra-red sensitive plate. Compare it with portrait made on ordinary film (right). Note how infra-red whitens. Circle, battery of heat lamps employed in drying operations. Bottom, portable drying unit baking enamel on auto

been produced in an attempt to overcome one of the biggest obstacles to fast printing. That is "offset," which is the transference of ink from the top printed side of a sheet to the under side of the next sheet as the sheets come off the press. Of course the result of "offset" is smudging. In color printing, some means of drying ink so quickly that smudging will be prevented is of great importance.

Another industrial application is the heating of asphalt-impregnated fiber board so that it may be bent into any shape desired. This material can be bent by heating it to between 150 to 180 degrees Fahrenheit, a job performed satisfactorily by infra-red.

Radiation of this type also is employed successfully in the medical field. Among the therapeutical uses are the treatment of skin grafts following wounds, treatment of infec-

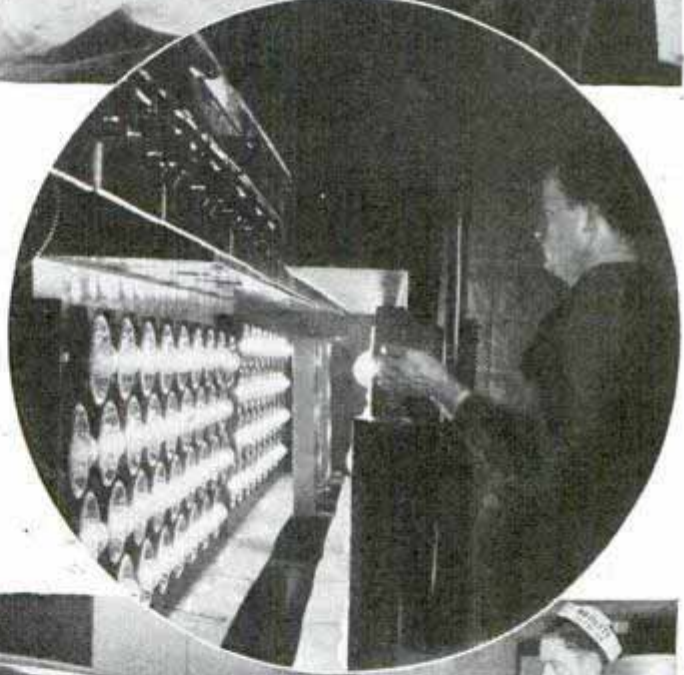

10/14 July 1942

(Continued to page 120A)

Photo courtesy North American Electric Lamp Co.

therm portable

R919
Film Viewers for Stills and Movies
Help Amateurs Plan Home Show

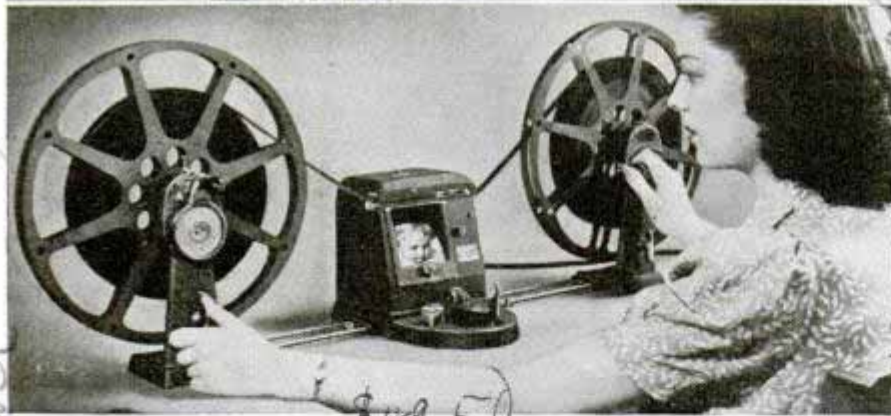
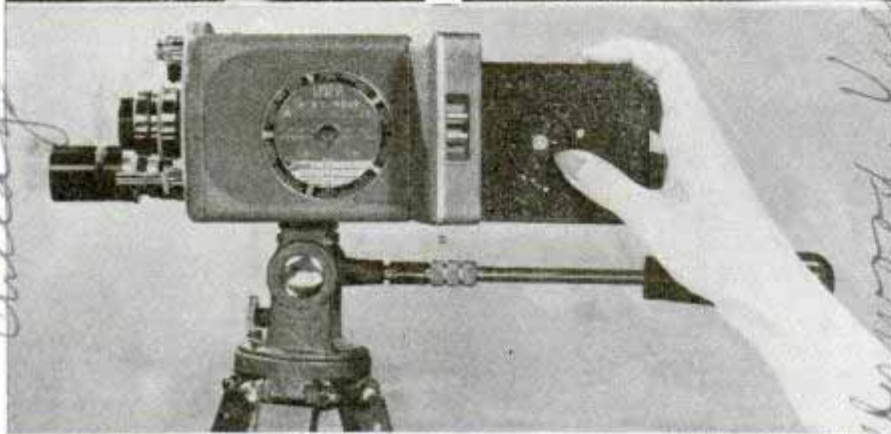
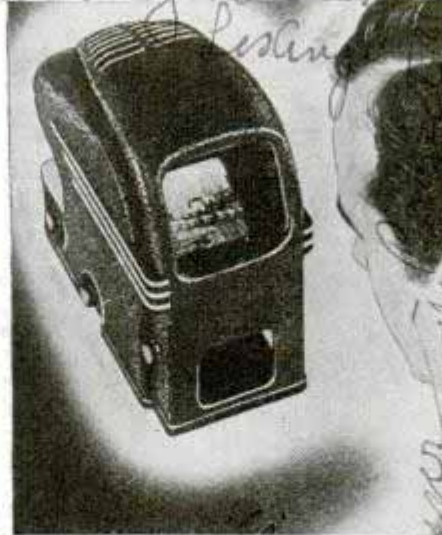

195-10
 Top, combined projector-viewer for still pictures; center, three-lens magazine-loading movie camera; below, viewer showing movies as movies

Home picture shows, both of movies and stills, are constantly being improved by the appearance of new equipment for the amateur. One important new aid for the moviemaker is a film viewer which permits editing the film as a motion picture instead of a series of stills. With the conventional viewer, the individual frame is seen clearly on the ground glass screen but when the film is drawn through rapidly it appears as a blur. The new type has an optical compensator composed of a block of glass, through which the image passes, revolving as the film is drawn through the viewer and so keeping the image centered on the viewer screen to produce the effect of motion. This facilitates rapid editing. There is also a new viewer-projector for still pic-

tures. Look into its "eye-angle" window and you see the slide, bright and clear even in daylight, projected on its internal miniature screen. Flip a knob and the viewer's mirror swings out of the way, converting it into a 100-watt projector. The first multi-lens magazine loading movie camera has just been introduced for sixteen-millimeter fans. This gives the home moviemaker wide latitude in filming; the magazine slips in and out easily, allowing quick change from color film to black-and-white or to film of different emulsion speed; the rotating turret permits immediate change to wide-angle, speed or telephoto. Viewfinders corresponding with the lens being used automatically move into place to show the exact field of the lens.

118-33
Three-Light Bulb Fits Any Lamp

With a bulb containing three separate filaments you can have a choice of either a forty, sixty or 100-watt light by simply twisting the selector switch—a Bakelite phenolic collar—to low, medium or bright. The three-light bulb fits any regular socket and may be used in any floor or table lamp.

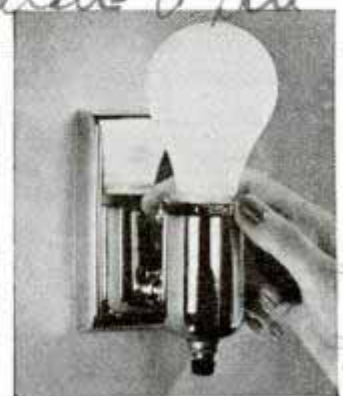

Hand Centimeter Camera
1801 Archmont Ave.
Chicago
Ill.
1649 W
Washington Blvd
Leslie
from Bakelite
select a lamp
dayed and under
each new



The CRAFTSMAN

INLAYING

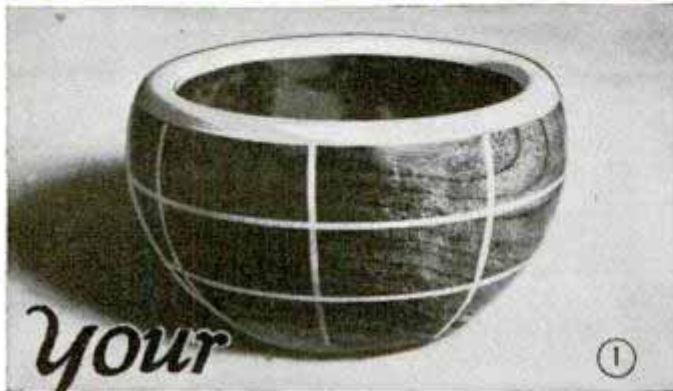

TURNINGS

WOOD bowls and similar turnings can be given an unusual appearance by inlaying them with strips of contrasting woods. While this is extra work, the beauty of the finished article makes the added work worth-while. A single walnut block was used in constructing the bowl shown in Fig. 1, but it would be a simple matter

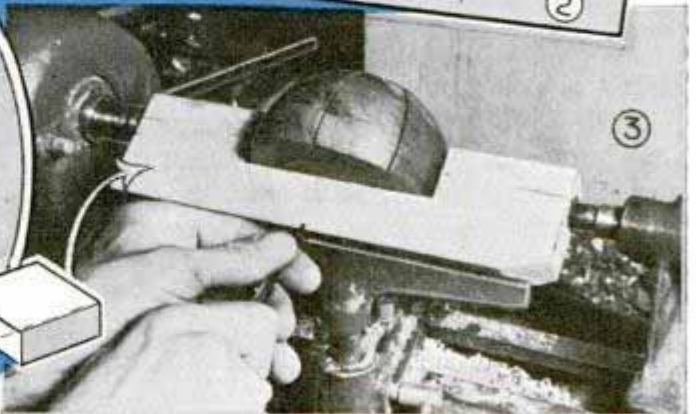
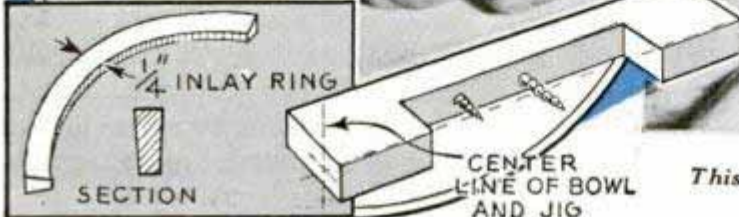
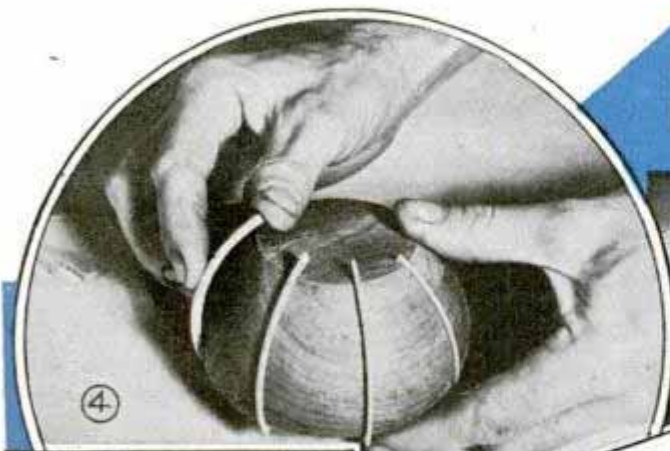
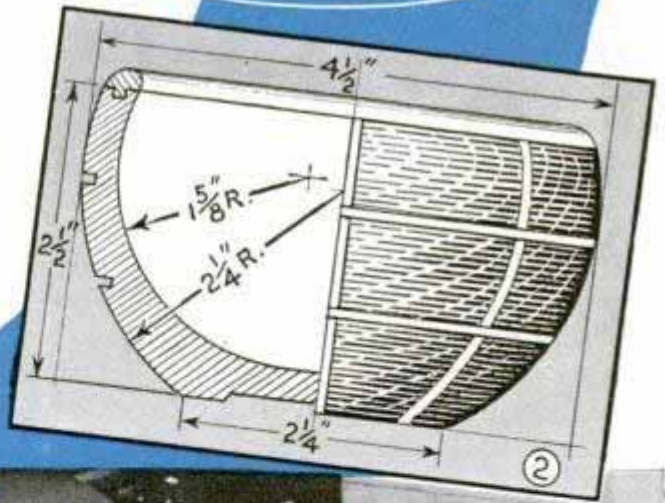
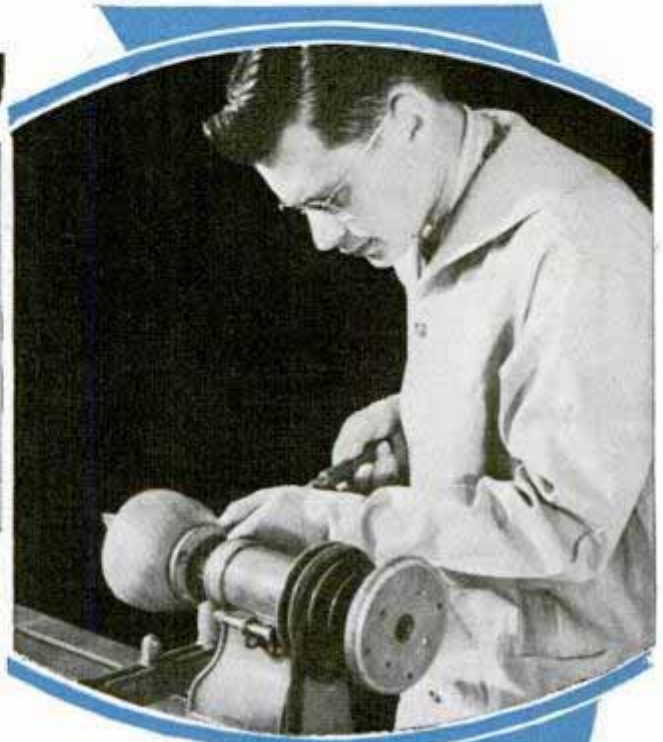

This jig holds the bowl blank between lathe centers to cut grooves for the vertical inlays

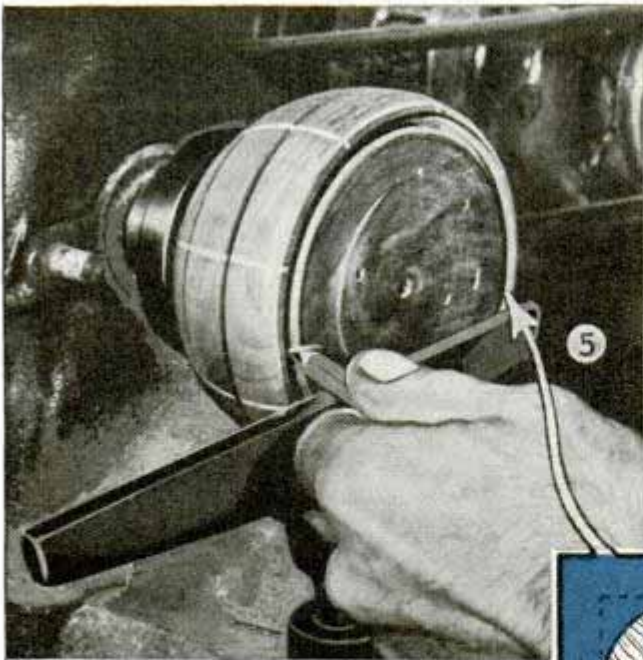

to use built-up wood, covering the joints with the horizontal inlays. The inlay work and the maple rim are completed before the block is hollowed out to form the bowl.

To begin, first turn the block to the outside shape of the bowl. Dimensions are given in Fig. 2. Then cut the grooves to take the vertical inlay pieces. These are $\frac{1}{8}$ in. deep, and you will have to use a jig similar to the one shown in Fig. 3 for mounting the work between centers. Be sure that the work and jig are set so that the center line of the bowl coincides with the center line of the lathe centers. The grooves are cut with a specially prepared tool made from a small, flat file, the tang of which is ground to make the grooves $\frac{1}{16}$ in. wide.

The inlay strips are made by turning maple rings $\frac{1}{16}$ in. wide on the inner edge and slightly thicker at the outer edge, Fig. 6. This slight variation is necessary so that the inlays may be forced into the grooves to fit snugly. Two maple rings $4\frac{1}{2}$ in. in diameter are needed for the vertical inlays, each ring being cut into four pieces. The strips are forced in place easily by first clamping the work between the jaws of a woodworkers' vise to hold it in position, and then tapping the strips into the grooves with a soft-wood block. Use scrap pieces of wood between the work and the vise jaws to prevent marring it, and coat the inlay strips lightly with glue before inserting them. After the glue has dried, put the block back on the faceplate and sand down the projecting edges of the strips.

Next comes the horizontal inlay grooves.

After these have been cut, make a groove in what will be the upper edge of the finished bowl to take the maple rim as in Fig. 5. This groove is $\frac{1}{8}$ in. deep and $\frac{3}{16}$ in. wide. Again remove the bowl from the lathe and put it in the vise ready for inserting the horizontal inlay strips. These are made in the same way as the vertical ones, except that the maple rings are cut in half. After fitting the inlay strips in the grooves, turn the maple rim, leaving $\frac{1}{8}$ in. projecting on the underside to be glued into the groove at the top of the bowl. Glue the rim in place, and when dry put the

work back on the faceplate. Now turn out the inside of the block to form the bowl and smooth it inside and out with fine sandpaper.

A French polish finishes the bowl nicely. To do this, apply a coat of shel-

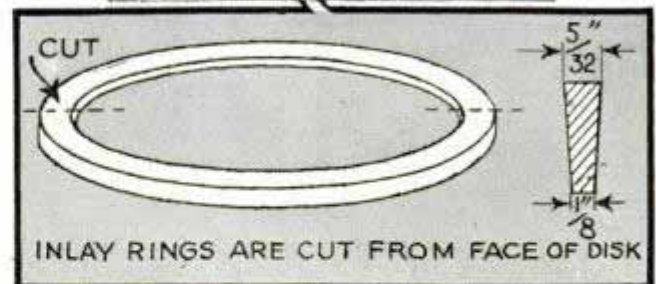
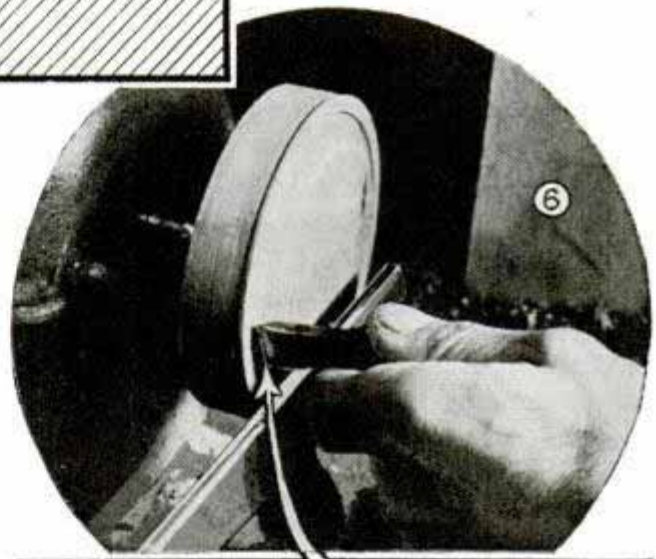
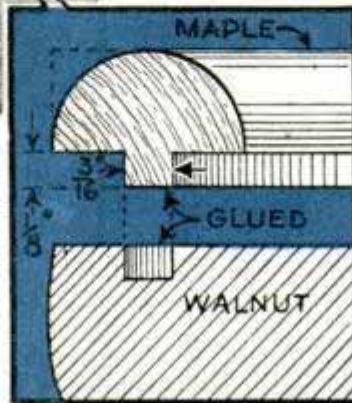

lac and when it begins to dry, start the lathe and hold against the bowl a cloth on which some shellac and equal parts of linseed oil and alcohol have been dropped. Run the lathe at high speed, and keep the cloth moving back and forth across the work to produce a highly glazed finish. Gluing thin felt or blotting paper to the bottom of the bowl to prevent marring furniture completes the work.

Bookcase in Closet Door Utilizes Waste Space

Space behind the door of a closet can be put to excellent use by converting the door into a bookcase or knickknack shelf. Doors having a single panel are the most suitable as the panel can be used for backing of the shelves. A depth of 6 to 9 in. is best, and the shelves can be constructed in the usual manner. Quarter-round molding is used around the edge of the opening and half-round molding is used across the front edge of each shelf. The shelf assembly is fastened to the door on the rear side with 2-in. corner irons, and molding nailed in place. In some cases it may be necessary to reinforce the upper hinge.

Simple Trick in Cutting Glass Assures Uniform Break

An expert glazier, employed by one of the large glass manufacturers to call on dealers and demonstrate his methods, employs this simple trick to cut large glass to size. If the extra piece to be removed is 2 in. or more in width, he makes the score across the sheet in the usual manner, then pulls it to the edge of the counter, which must be perfectly smooth and free from bits of glass or other material, and, lifting it to the angle indicated, brings it down so that the cut line slightly overlaps the edge. The overhanging piece snaps off instantly. By practicing a few times with waste glass, any workman may acquire this trick.



Float Valve from Scrap Parts

A float valve that will maintain a constant level of liquid in a tank or other vessel can be made from an old automobile tire valve and a wooden disk. First mount the valve inside of the tank with rubber washers on each side to make a liquid-proof seal. Then remove the valve cap, dig out the rubber in the top and make two or three slots through the knurled portion. Drill a hole through the end of the block to take a small finishing nail. Insert this in a cap with the head on the underside and drive it part way into a small wooden block, which is to serve as your float. Reassemble the valve and cap and provide a guide on the side of the tank to keep the wooden float in place. In use, the weight of the float will compress the valve spring until a predetermined level has been reached.

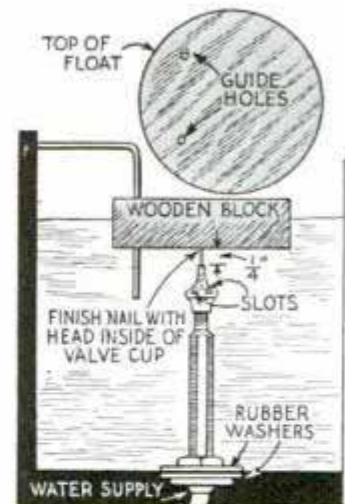

—R. R. Henderson, Madison, Me.

Solving HOME

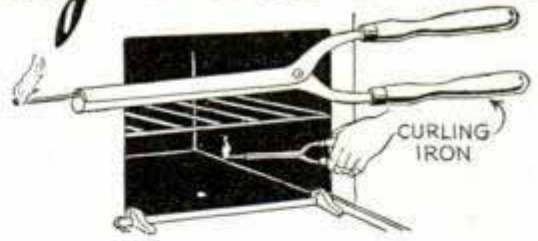

Spring-type clothespins clipped horizontally to a flat stick stuck vertically into the center of the flowerpot as above, provide a substitute for a miniature trellis that can be assembled quickly. If you have a gas stove in which the oven burner is so placed that it is difficult to reach with a lighted match, and you are apt to burn your hand or arm in the operation, simply use a curling iron as an extension arm to hold the lighted match, as above

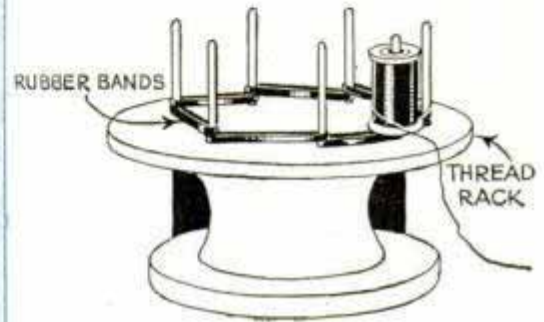

Difficulty of pulling a heavy coat sleeve over a child's arm may be simplified by slipping the foot of a silk stocking over the hand and dress sleeve. This will eliminate the usual trouble of pulling down the dress sleeve after the coat is in place. Rubber bands slipped over the spindles of a spool rack will help to keep the spools from spinning rapidly and tangling the thread when it is being removed

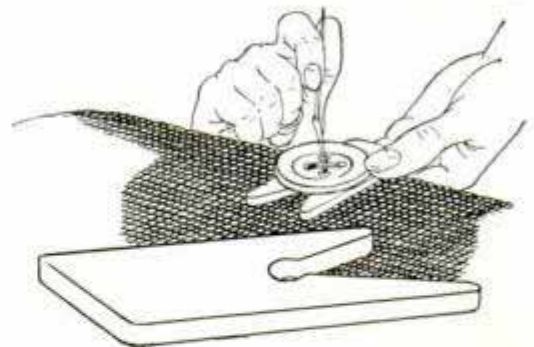

To prevent chairs from damaging the finish of your dining table when they are pushed against it, drive rubber-headed tacks into the chair backs at the level of the table top, as shown at the left. To space buttons from heavy cloth so that they will button easily, use a piece of notched cardboard as above, when the sewing is being done. After the button has been sewed, several windings are made around the thread beneath it

PROBLEMS

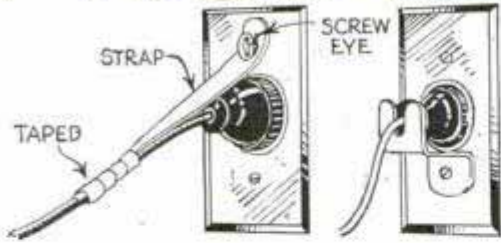

When driving a number of tacks that must be spaced uniformly, you can save time and do a good job if the tacks are first stuck through a strip of cardboard as at the right. To prevent an electric plug from pulling out of a wall outlet, you can use either a slotted spring-brass clip or a strip of rubber taped to the cord and fastened to the outlet cover as above.

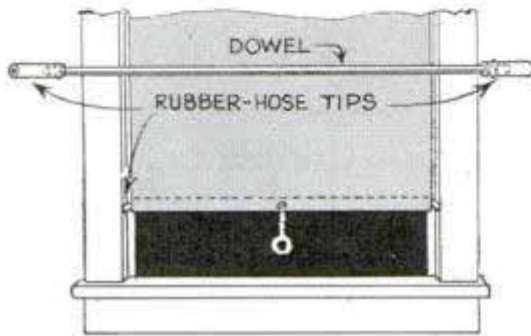

Annoyed by having books fall to one side when adjoining books were removed from the shelves, one man tacked strips of molding along the front edges of the shelves to tilt the books so that they would contact the back of the case. To keep a window shade from flapping in the wind, substitute a dowel tipped with pieces of rubber hose for the flat stick in the bottom hem. The hose pieces should wedge the shade firmly at any point.

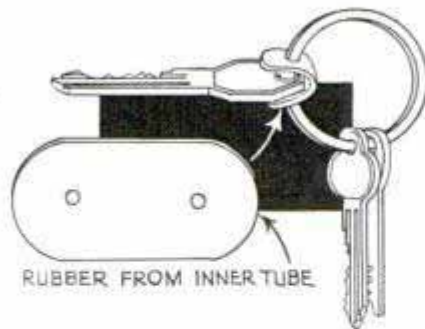

To stretch and hold strips of metal linoleum binding while tacking it, slit a length of rubber hose along each side and slip this over the metal. Pressure of the knee on the rubber will cause it to grip and hold the strip at any tension. If you wish to isolate a much-used key from others on a ring, cut a small piece of rubber and slip it over the key and ring as above.

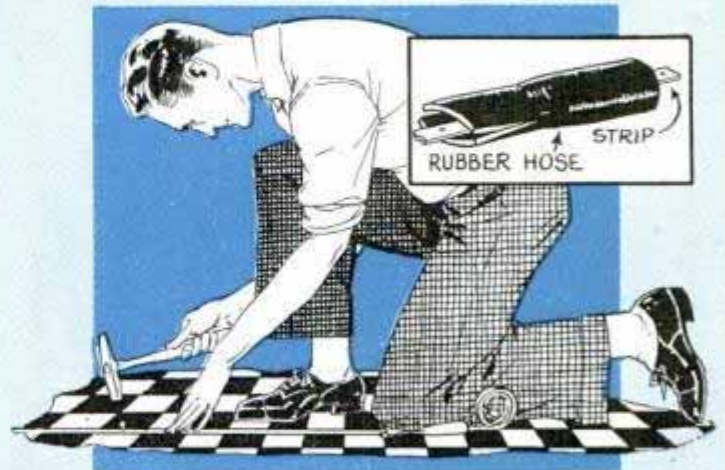
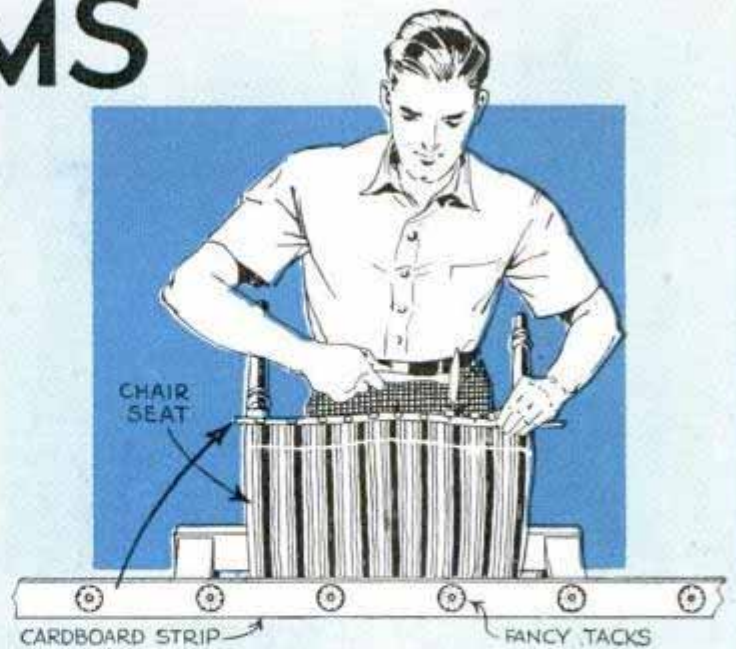

Wheelbarrow Converted to 'Sled' for Winter Use

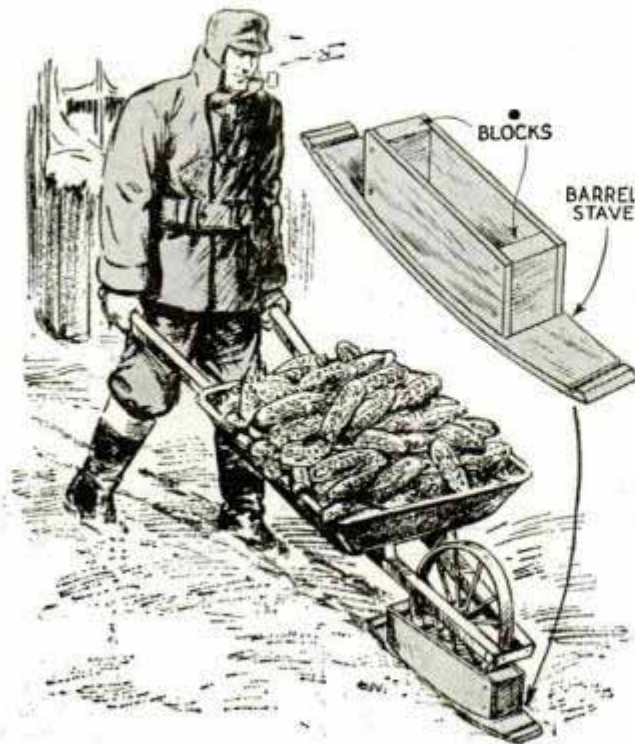

The difficulty of pushing a wheelbarrow over frozen ground or ground covered with snow can be avoided by fitting it with a runner of the type shown. This is nothing more than a barrel stave fitted with a box made of blocks to take the wheel. The runner is attached instantly by merely lifting the wheel into the box.

Rubber Jacket Protects Oilstone Against Dust Particles

If an oilstone is not kept in a wooden case, dust may collect on it and greatly impair its efficiency. Both sides will be protected from dust by cutting a band from an old inner tube and slipping it over the

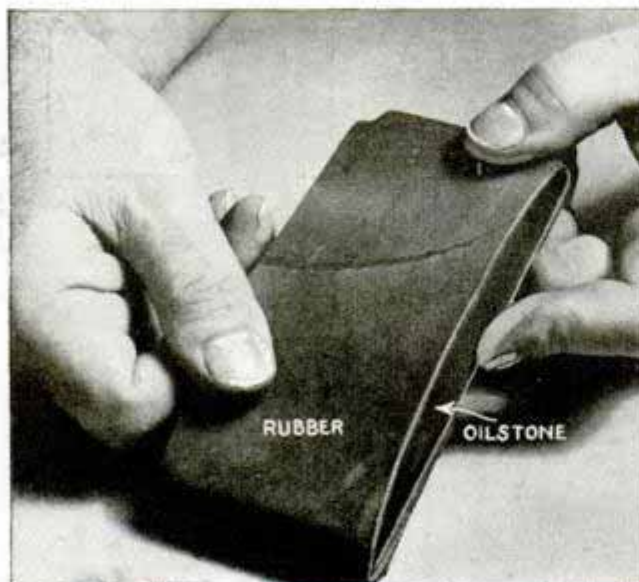

stone. The band will also lessen the chance of breakage if the stone is dropped accidentally.—Kenneth Murray, Colon, Mich.

Countersink Reams Plaster Cracks to Patch Them

In patching cracked plaster it is best to make the cracks V-shaped to get a good bond between the plaster and the patching material. One of the easiest ways of doing the job is to put a countersink in an electric drill and go over the cracks with it. The patching is done in the usual way.

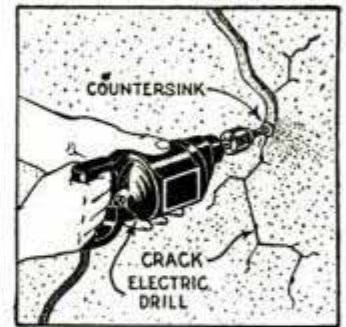

—Eugene Morrison, Columbus, Ohio.

Sealing Glue Containers Easily

When a can of glue is used frequently about the home shop, do not bother to pry off the can lid or to replace it with a hammer or mallet. Sooner or later the lid will become bent and will admit air, drying up the contents of the can. A better method is to smear a little of the glue around the top of the opening and press a piece of waxed paper over it. This can be ripped off and replaced with a fresh piece in no time, and the liquid glue will remain fresh.



Vise Clamps in One Unit

These fiber vise clamps are permanently attached together so they are always at hand, ready for instant use. The fiber is fixed to two wooden blocks, and these are screwed to a piece of spring steel.

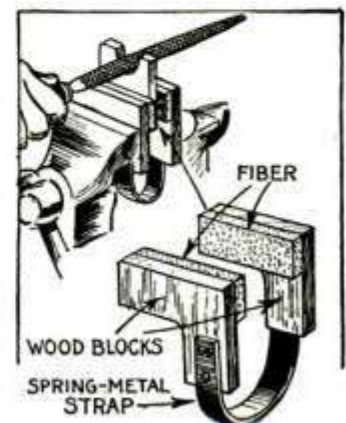



Method 2
A PAPER OR METAL STENCIL CONFINES THE BINDER TO THE AREA TO BE FLOCKED



Method 3
ON PRODUCTION RUNS, THE BINDER CAN BE APPLIED WITH A SILK-SCREEN STENCIL

Dress Up Your CHRISTMAS CARDS

FLOCKING your Christmas cards gives them a distinctive appearance that raises them out of the ordinary "mine-run" class. Flock, which is finely shredded rayon or wool fibers, is applied by spraying or sifting it over a tacky binder to produce a clothlike surface. While clear varnish will serve as a binder, coverage is best when a binder of the same color as the flock is used. Figs. 1, 2 and 3 show the simplest method of applying the flock. For cards on which several spots are to be flopped, the method illustrated in Figs. 4, 5 and 6 is better. On production runs of a number of cards, the binder is best applied with a silk-screen stencil, Fig. 7. Several cards are treated at one time.

Let the JIGSAW solve

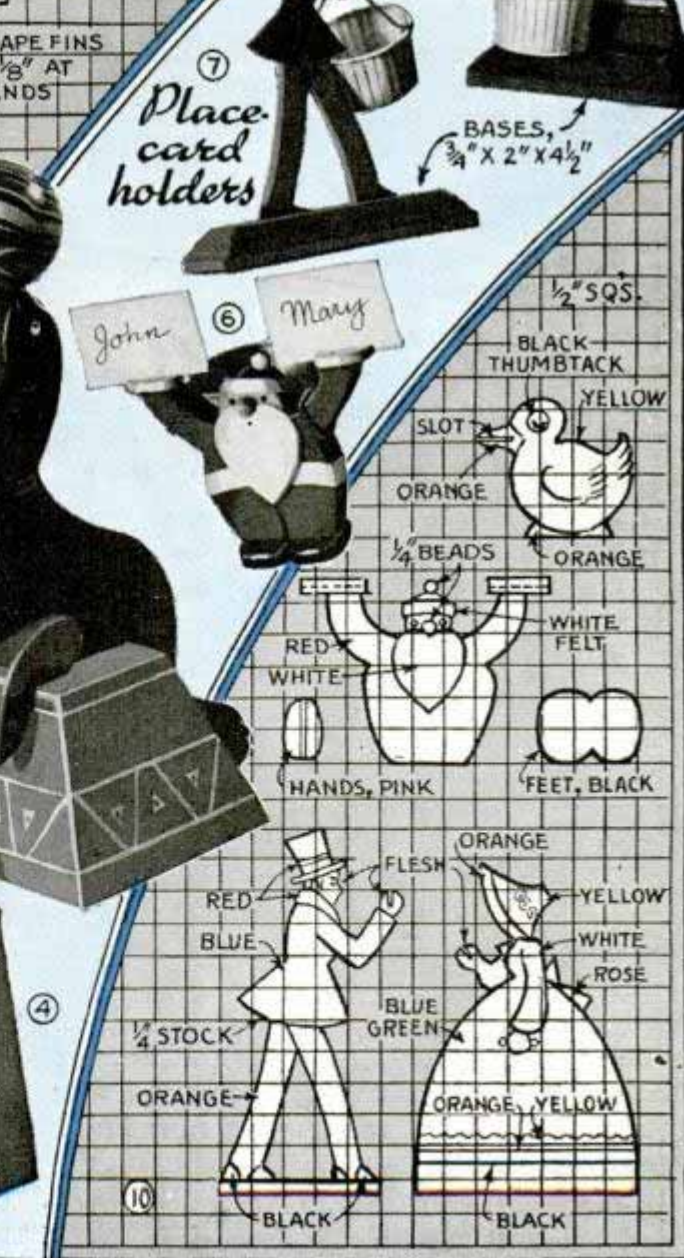
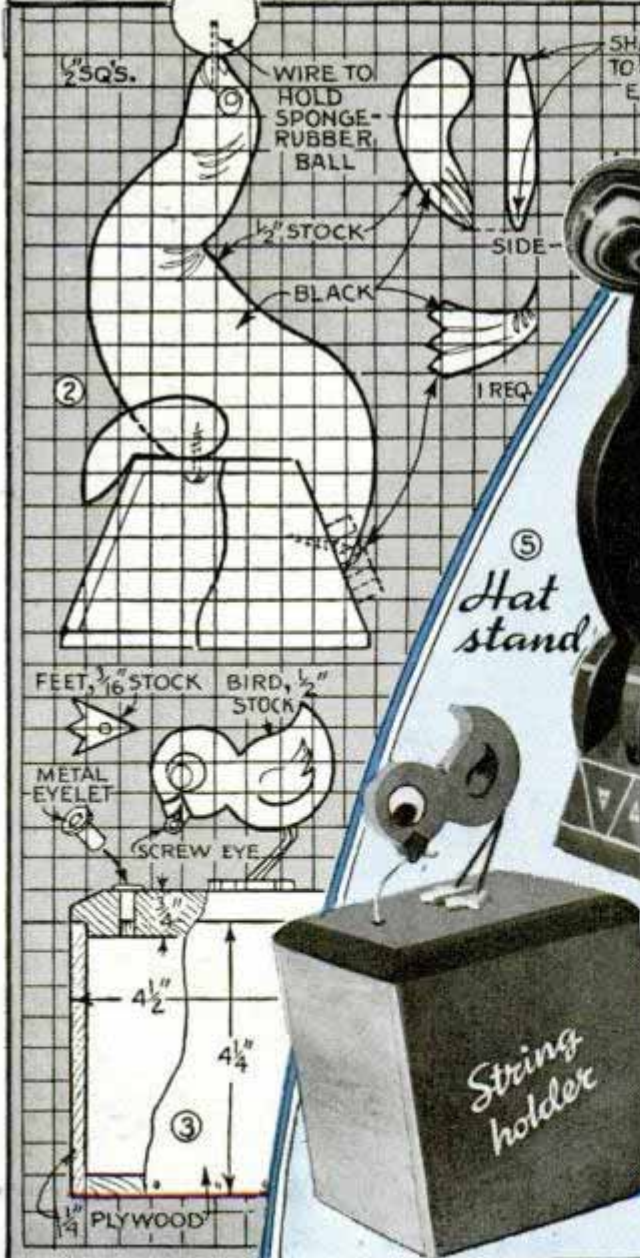
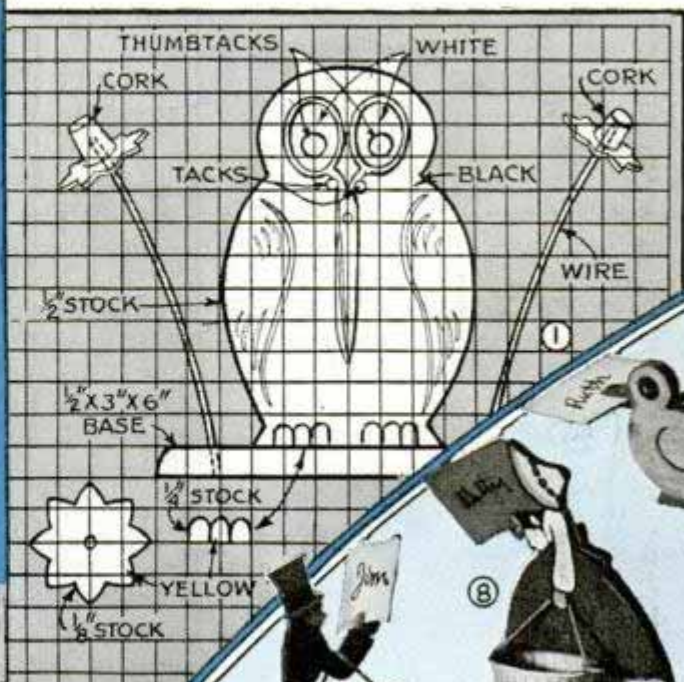

your GIFT PROBLEM

by Bess Livings



Sewing kit

Shoe-shine box

Colorfully painted in the scheme indicated, any one of these clever items will be an appropriate gift which can be made in spare time from scrap wood



IF YOU enjoy making things for Christmas gifts, here are a number of clever items which can be completed almost entirely on your jigsaw.

The comical expression of the scissor-billed sewing bird shown in Figs. 1 and 11, is achieved by a pair of red-handled scissors held in place by two tacks painted black. The body is cut from 1/2-in. plywood, while the feet are carved from 1/4-in. material. Nails and glue are used to fasten the bird to the base. The strange-looking plants on each side consist of a curved-wire stem extending through the base and into the center of a flower made from a cork glued to the center of a petal-shaped disk of wood. The flower is removable so that spools of thread slipped over the wire may be replaced easily. The cork center of one flower serves as a pincushion, while the other holds a thimble.

The balanced ball on the tip of the seal's nose shown in Figs. 2 and 5, provides a perfect perch for a hat. The 1/4-in. plywood pieces comprising the stool are mitered, glued and nailed together, and the seal is attached to the top with screws. After carving and attaching the fins and tail, a length of wire is inserted in a hole bored in the nose and topped with a small ball of sponge rubber or wood.

Vainly tugging at what appears to be a worm, but actually is the end of a ball of string stored below, the little bird perched

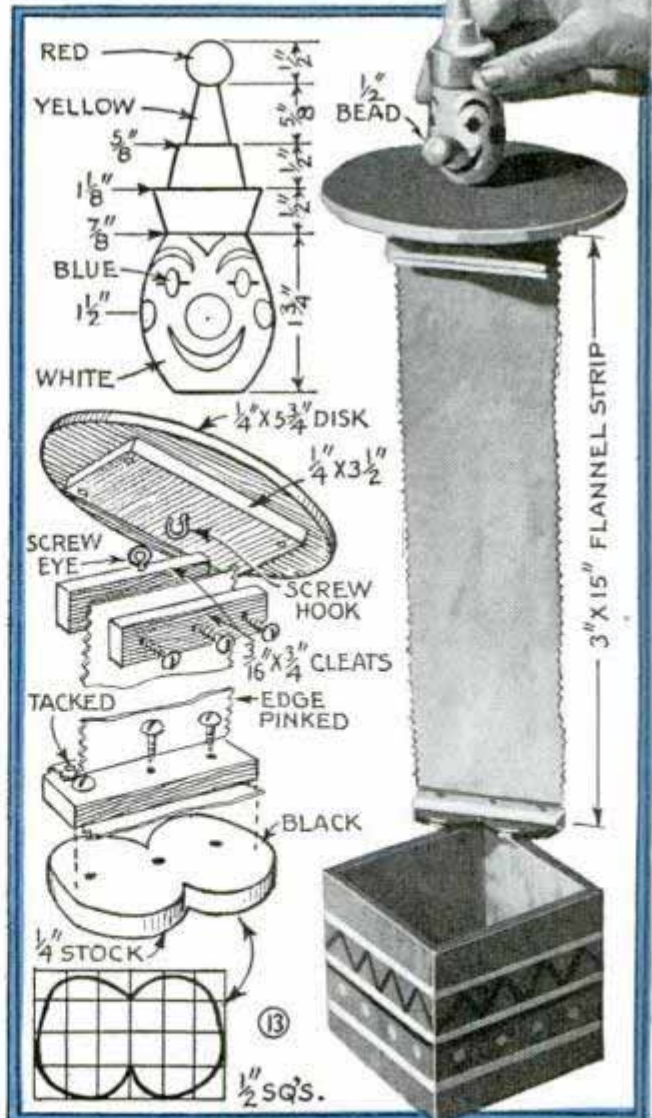

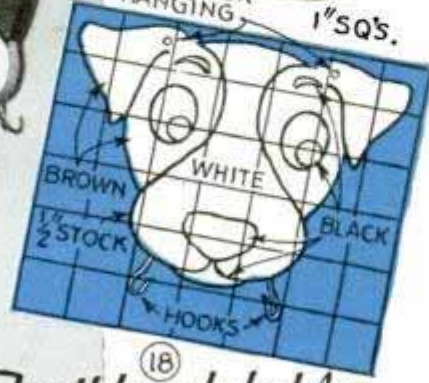
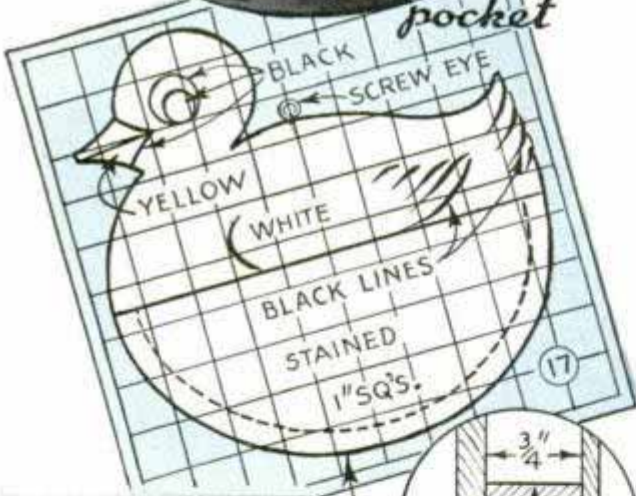
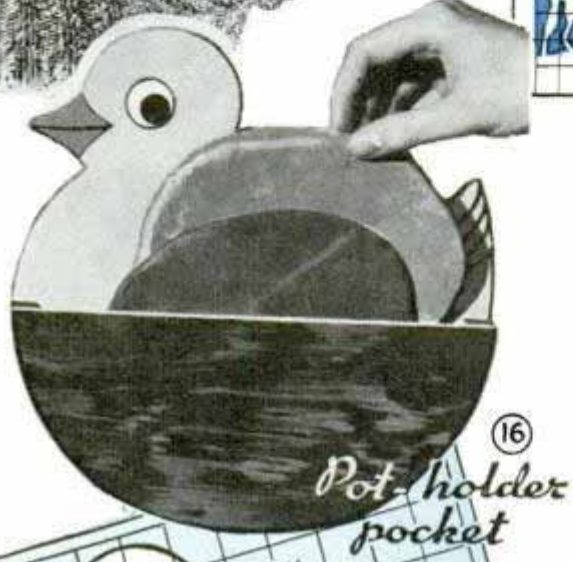
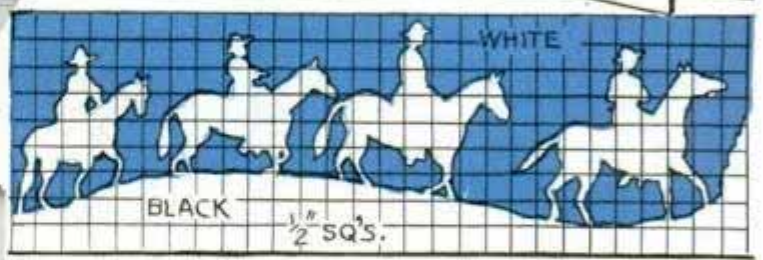
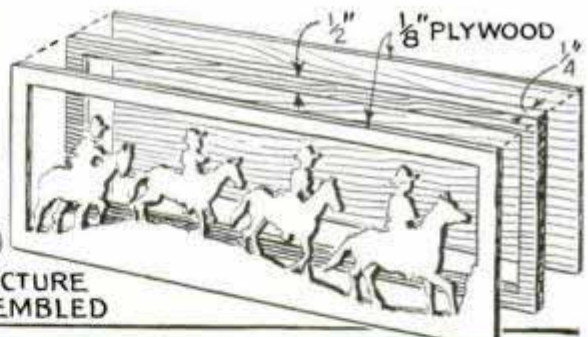

on the box shown in Figs. 3 and 4, keeps the end of the latter easy to grasp. The string is threaded through a metal eyelet in the removable, rabbeted lid and passed through a screw eye in the bird's bill.

Provision for place cards, and mints or nuts is combined cleverly in the suggestions given in Figs. 6 to 10 inclusive. The items shown in Figs. 8 and 9 are cut from 1/4-in. plywood and glued in grooved bases. The Santa Claus in Fig. 6 has a paper cup held on his back with a rubber band. His beard is shaped from a separate piece and glued on. The cover of a round thumbtack box glued to the back of the duck in Fig. 9, forms a standard for the figure and provides a removable cup for nuts or candy.

The jovial clown, shown in Figs. 12 and 13, serves as a polishing cloth when he is lifted from his gaily painted hideout, which provides space also for several cans of shoe paste. Make the box about 4 in. square, using 1/4-in. plywood. The head is attached to the "collar" disk with a screw.

Giving the illusion of depth by casting shadows on a light background, the silhouette plaque in Fig. 14 makes an attractive wall decoration. The design is cut from 1/8-in. plywood and is built up of three layers as shown in Fig. 15.

The nest in which the bird shown in Figs. 16 and 17 appears to be sitting, forms a pocket for egg-shaped hot-dish holders.

The mischievous-looking pup shown in Fig. 18 is effective for holding a child's toothbrush. Two brass hooks are fitted under his chin. By laying the brush crosswise instead of from the end as shown, he will appear to be holding it in his mouth. Use 1/2-in. plywood for this so that the hooks will not split the wood.

Memo Cabinet in Kitchen Includes a Mirror

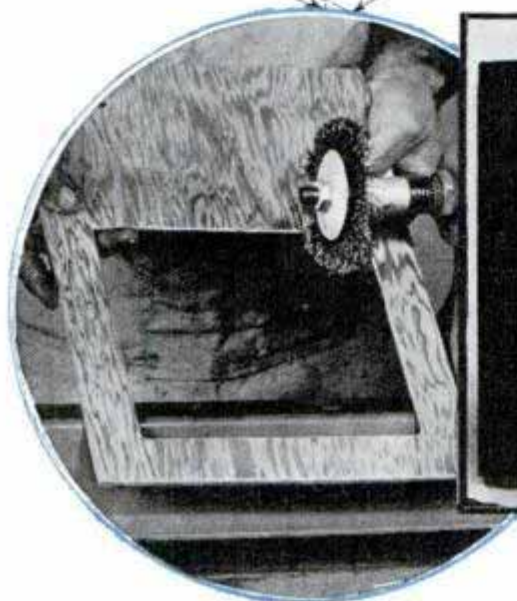
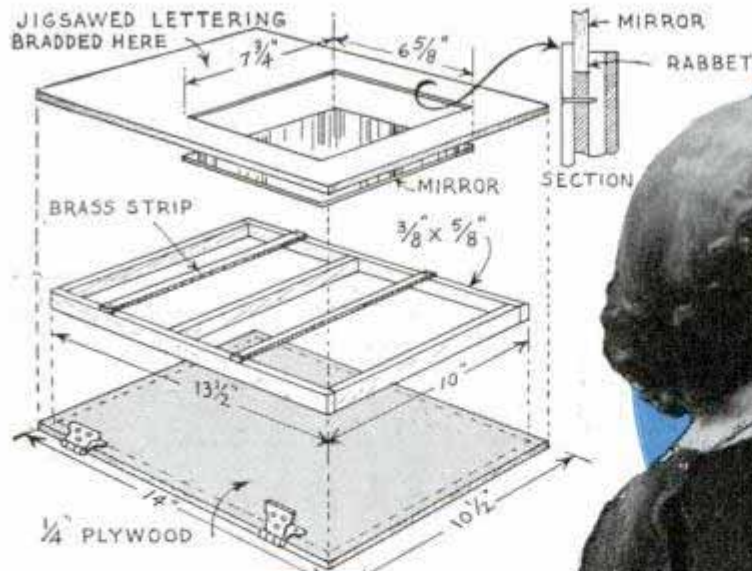

This tiny kitchen cabinet with a mirror set in its front, encloses a small blackboard and has pockets for note and cook books as well as chalk and pencils. Front and back are made of $\frac{1}{4}$ -in. plywood. Two coats of blackboard slating paint are applied to the back to provide a writing surface for chalk. The front has a window which is rabbeted to take the mirror from the inside. For a novel effect, round the front corners and score the wood with a wire brush. Then finish in ivory or white and rub some burnt umber or other pigment into the scored scratches, wiping the whole surface clean. Jigsaw the letters and paint the sides, then brad them in place and paint the top surfaces. Nail and glue wooden strips to the back of the lid to form the pockets, sides and bottoms. Mortise narrow brass strips into the side pieces to hold articles in the pockets. The hinges must be mortised to their full depth when folded, with the pins standing well out so that the front can

swing out more than at right angles. Two holes at the top of the blackboard fit over screwhooks in the wall to hold the memo.

Pins Ornamented with Wax

By merely heating and covering the heads with sealing wax, common pins may be made highly ornamental and suitable for special purposes. Treatment consists in forming a round or tear-shaped drop of sealing wax over the head, but of course the shape may be altered in any way desired. A large variety of sealing waxes in various colors is available, and one stick will treat hundreds of pins. The pin heads do not break off easily.



Carpenter Wears Small Headlight to Leave Both Hands Free



A small electric lamp of the type that is worn around the head will be found handy by carpenters who must sometimes work in dark places. The lamp throws light on the work as they look toward it and leaves both hands free to use the tools.

Making Tumbler Lock Pickproof

To make a tumbler lock pickproof is a simple matter if you proceed as shown in the details. First take out the cylinder, remove the pins and file a groove as shown at B and C, Fig. 1. Make the groove $\frac{1}{8}$ in. wide and $\frac{3}{32}$ in. deep. Next replace the pins and insert the key to see that all pins are in alignment. Then remove the key

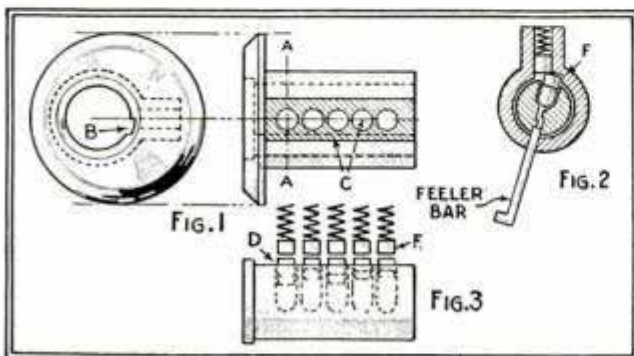

and fill the holes above the pins with short pins long enough to project above the cylinder about $\frac{1}{16}$ in. as shown at D. Then replace the cylinder and insert the final pins and springs as shown at E, Fig. 3. Fig. 2 shows a section through the cylinder at AA. When a feeler bar is inserted into the key slot preparatory to using a pick as at F, it will be impossible to push the pins upward. However, when the key is entered into the lock, it brings the proper break between the pins.

Simple Switch Assembled Quickly

Using odds and ends of materials found about the home, the electric switch shown can be assembled quickly for operating devices and causing electrical effects secretly and mysteriously. By varying the width of the sponge-rubber spacers, the switch can be adjusted to operate effectively under either light or heavy pressure.

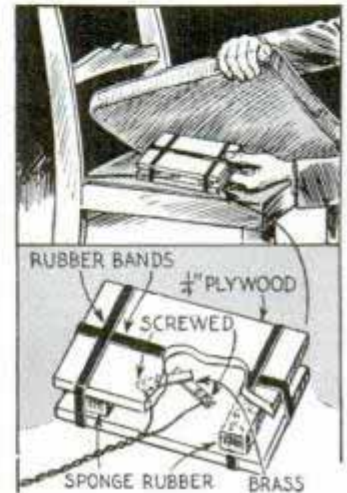

Irregular Curves Drawn Easily with Linoleum Binding Tape

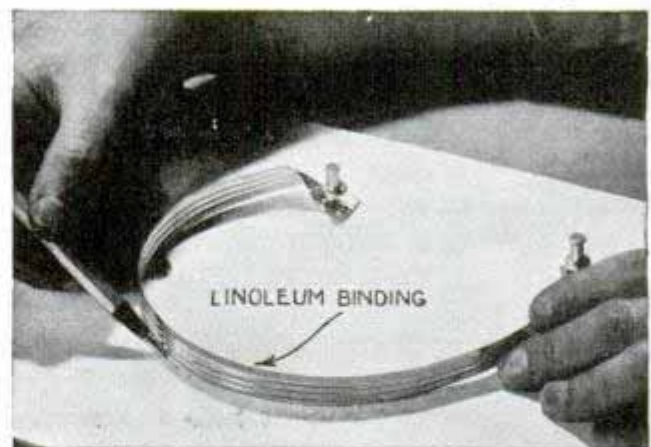

Artists can do a neat job in drawing irregular curves by using a length of zinc linoleum binding tape with the ends bent over so they can be attached to the drawing board with push pins as shown. The strip can be formed into any curve desired and is sufficiently rigid to guide a pencil or pen. It is important to use tape having narrow corrugations running lengthwise.

suggested Justrite Mfg. Co. 206 Southport Ave. Chicago.

Dog's Table Keeps Its Food from Being Upset

If you have a dog or cat, this table will save work in caring for it. Besides being a neat way to keep its food and water always at hand, your pet will be unable to overturn the food dishes. The table can be cut out of almost any kind of wood. First get the bowls or pans to be used as food dishes. They can be of almost any size or kind, such as glass cereal bowls purchased at a dime store. Then cut the openings in the table top to fit them. When using glass bowls, it is well to get those having narrow flanges around the tops so that they will fit all the way down in the openings. Finish the table with a good grade of enamel.—Russell E. Mathias, Indianapolis, Ind.

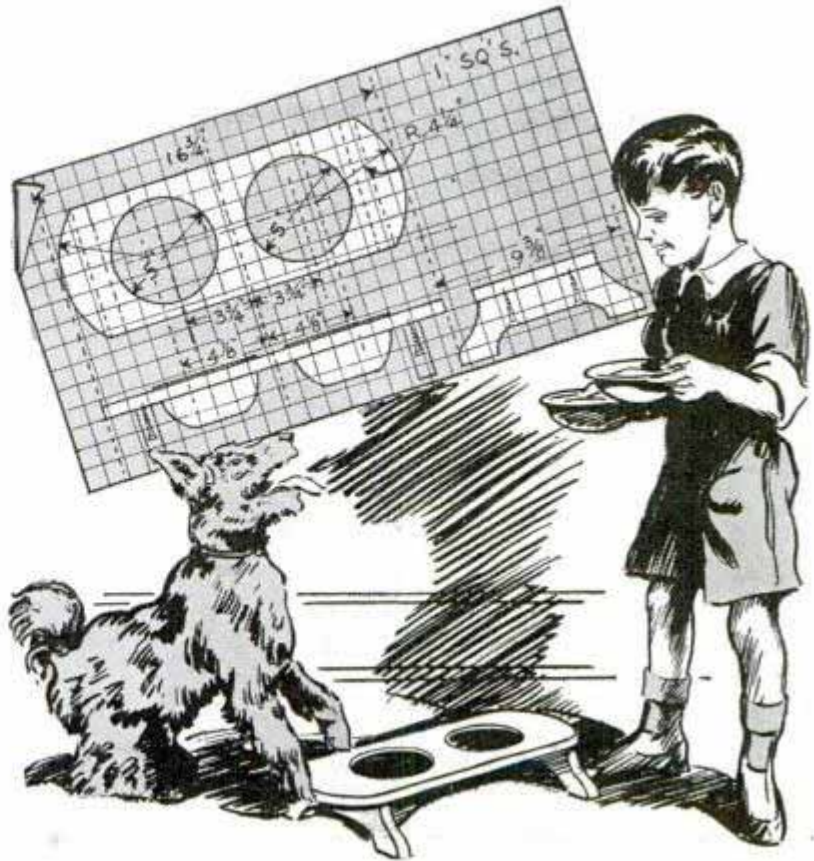

Substitute for Scratch Brush Is Made from Wire Screen



Having worn out the wire scratch brush for my hand grinder, and not being able to secure another without delay, I made a very satisfactory substitute by cutting disks from ordinary galvanized screen wire. These were fitted to a mandrel in the grinder chuck and smoothed up with a dressing stone. The result is a scratch brush that does first-class work at a cost of a fraction of a cent.

—Kenneth Murray, Colon, Mich.

Novel Garden Fence of Jigsawed Wood Blocks Looks Like Rock Wall

A novel and artistic fence that gives the appearance of stone at a distance, is made readily from wood blocks which are jigsawed to odd shapes and then suspended between the top and rails of a fence by means of rope, as indicated. The blocks are painted white and the rope is left in the natural color.

—R. L. Fairall, Los Angeles, Calif.

¶ If you will leave a space of 2 or 3 in. between the back of the electric refrigerator and the wall, warm air from the coils can escape easier and this will help to keep down the operating cost.



DOWEL

form these

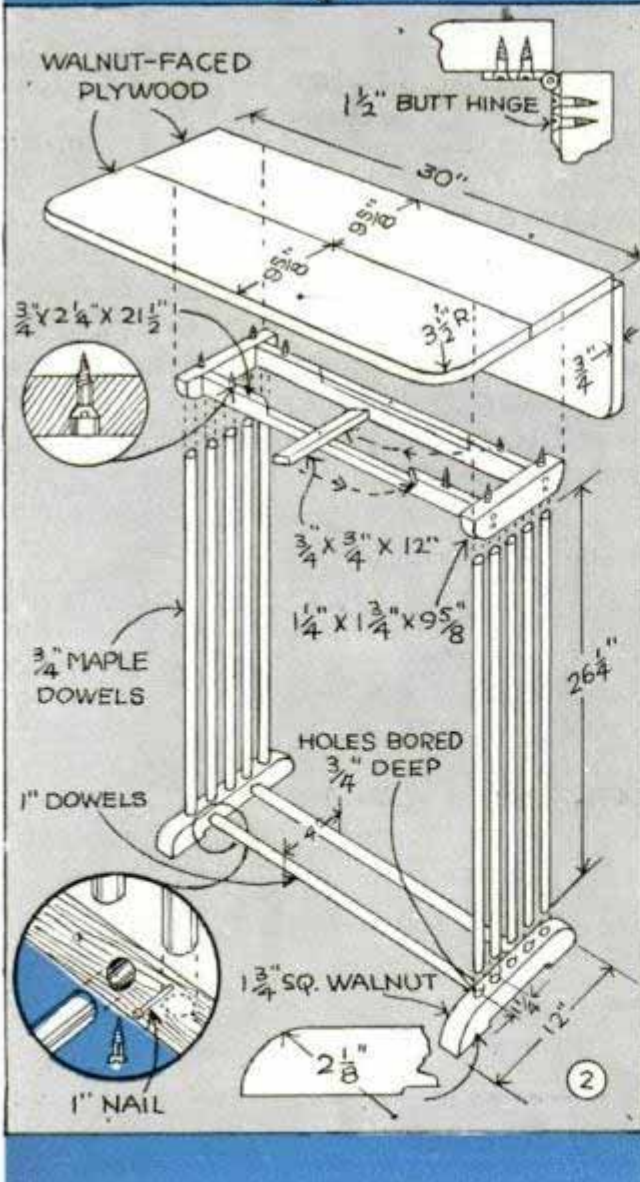
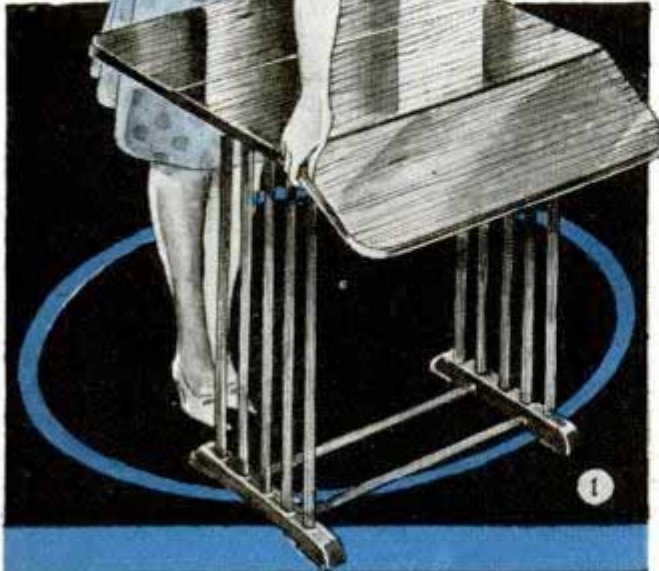

AS STURDY and rigid as tables having conventional leg design, this simplified construction comprises rows of standard dowels as a substitute. Utilizing dowels in this way enables one to produce many attractive pieces of furniture that have simplicity of line as well as simplicity of construction, since the joints consist merely of holes into which the dowels are glued. For beautiful two-toned effects, maple and walnut stock may be combined to harmonize pleasingly with the natural finish of the dowels.

As examples of what can be done, two designs are presented—a drop-leaf table and a smoking stand—which incorporate the use of dowels for legs. A larger table, of the type shown in Figs. 1 and 2, can be built following the same general method of construction. Select the dowels for straightness, and also see that they are a full $\frac{3}{4}$ in. in diameter. Many of them you will find undersize, and therefore, to assure snug-fitting joints, it is a good plan to make a trial fit of each, in a hole bored in a small block, when they are being purchased. The feet are cut from $1\frac{3}{4}$ -in. square stock, undercutting the bottom edge $\frac{1}{4}$ in. deep. By clamping both pieces together temporarily while they are being cut and sanded, two identical pieces will be had. Mark a centerline down the top edge of each piece and lay out the position of the holes, working each way from a midpoint. If a drill press is available, the holes can be bored to a uniform depth quickly. However, if these must be bored by hand, an improvised stop block fitted to the bit will prevent boring too deeply. At right angles to these holes additional holes are made in the inside face of each block to receive two dowel stretchers, spaced 4 in. apart. Finishing nails, 1 in. long, are used to fasten the dowels in the holes. These are driven from the inside face of the block, set below the surface, and put-tied. The holes in the end aprons at the top must line up accurately with those in

RODS

table legs

the feet so that the dowels will be uniformly parallel. Two of these holes are counter-bored for the screws that are used in attaching the top. For this reason, the dowels are glued in the holes after the top has been screwed in place. Fasten the cross rails containing the swinging supports for the drop leaves to the end pieces, with screws, spacing them about 8 in. apart. The top can be of plywood or solid stock. Either a rule or a plain butt joint may be employed along the hinged edges.

The stand shown in Figs. 3 and 4 is equally as simple to make. Here a center column of five dowels is used to support the circular turned top. The base is quite effective when made up of pieces of light and dark woods. You will notice that the three center pieces are notched on the bottom so that when they are placed together, a recess will be had into which a lead weight may be set flush. This will provide added weight to the stand to prevent tipping. The three inner pieces are "threaded" on two dowels running crosswise through the base and entering blind holes in the outer pieces. While glue alone will hold the upright dowels securely to the base, they also may be nailed. In this case the nails are driven in through the side of the center piece before gluing and clamping into a unit. The upper ends of the dowels enter holes drilled in the half-lapped cross members which support the top. Unless you are able to swing 12-in. work over the lathe bed, the top will have to be turned on the outer end of headstock. A wood upright in the top of which the shank of the lathe tool rest may be fitted temporarily, will provide an improvised rest to support the turning chisel. To prevent the screws used in attaching the faceplate from entering the finished work too deeply, a scrap block of wood is glued to the bottom of the tray into which the screws may be driven. For simplicity, the top may be merely a flat disk with the lower edge rounded to relieve the plainness.

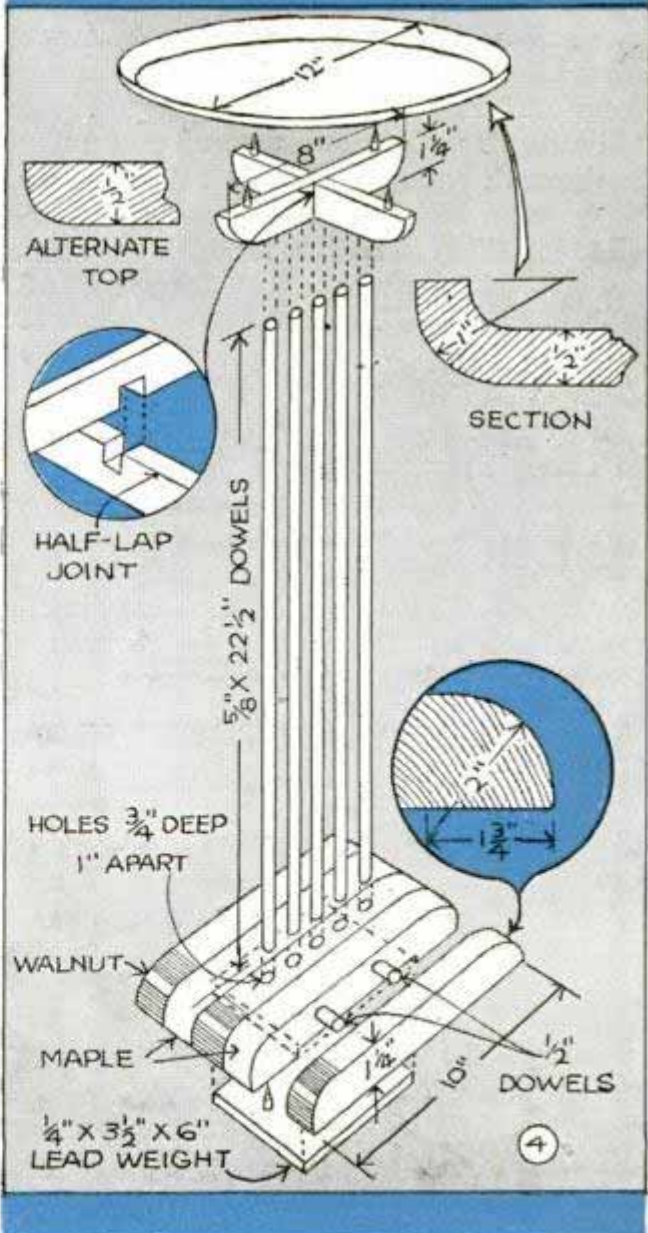

Clip Keeps Papers in Position on Open Newsstand



A self-adjusting clip to hold newspapers from blowing off a newsstand can be made from a narrow strip of rubber cut from an old auto tire. Opened outward and nailed to the wall back of the stand, the free end of the strip will rest on the stack of papers, allowing them to be removed one at a time but preventing them from being blown off.

Vise Attachment for Small Work

If you have a few small pieces of work to clamp in a vise while finishing them, and there is only a large vise available, this attachment will come in handy. It converts the large vise to the easy manipulation of a small one. The attachment consists of two lengths of flat iron, one drilled and tapped near the ends and in

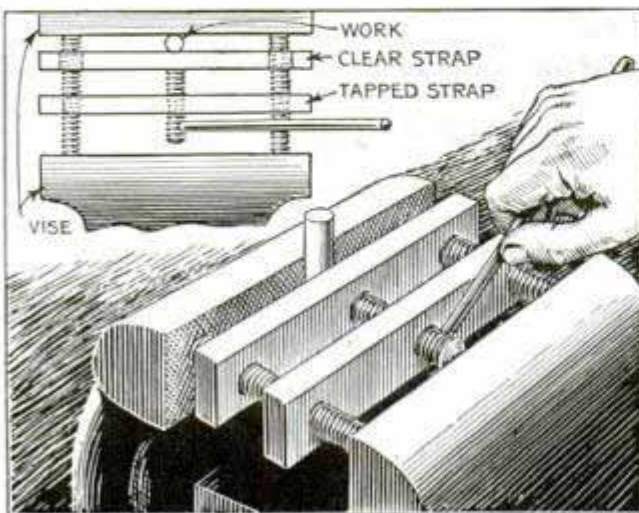

the center to take studs as shown, and the other drilled to slide freely over the outer studs. The center stud is fitted with a short handle and bears against the free-sliding piece of flat iron to press it against the work when the handle is turned. The tapped flat-iron strip is quickly adjusted for the work so that a slight movement of the clamping handle loosens or tightens the free-sliding strip against the work.

—H. Moore, Leeds, Eng.

Wire Solder Protects Minnow Net from Rocks and Pebbles

To prevent wear on a minnow net from rocks or pebbles, one sportsman uses wire solder. This is threaded through the net and around the iron hoop.



Homemade Electric Glue Pot



An inexpensive baby bottle warmer makes an excellent heating unit for the home-workshop glue pot. By using a ½-pt. bottle or jar with a wide mouth, a 2-in. brush can be inserted into the hot glue. This warmer has many other uses around the home shop such as quickly heating small quantities of water and other liquids.

Prongs of Electric-Cord Plug Twisted to Get Good Grip

When an electric-cord plug does not fit snugly into the connecting socket, twist each one of the prongs slightly with a pair of pliers. This will cause the prongs to fit tightly in their sockets so that they make a good electrical contact with them.

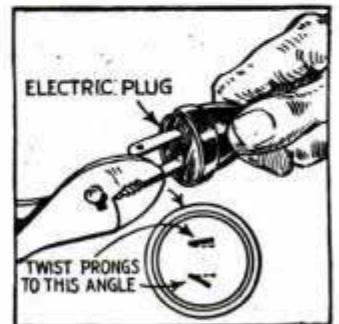

Bracelets and Necklaces from Walnut Shells

UNUSUAL and attractive pieces of "costume jewelry" can be made from black-walnut shells, which are so hard and close-grained that they take a beautiful polish, and are strong enough to withstand reasonably hard usage. The necklace and bracelet shown are but a few of the possibilities of this material. Buttons, pins and novelty hat decorations also may be worked out. After selecting several regular shaped nuts, scrub the shells clean with soap and water, and saw off slices or disks, using any fine-tooth saw. To facilitate holding the nuts, which are placed endwise between the jaws of a vise while sawing, the ends

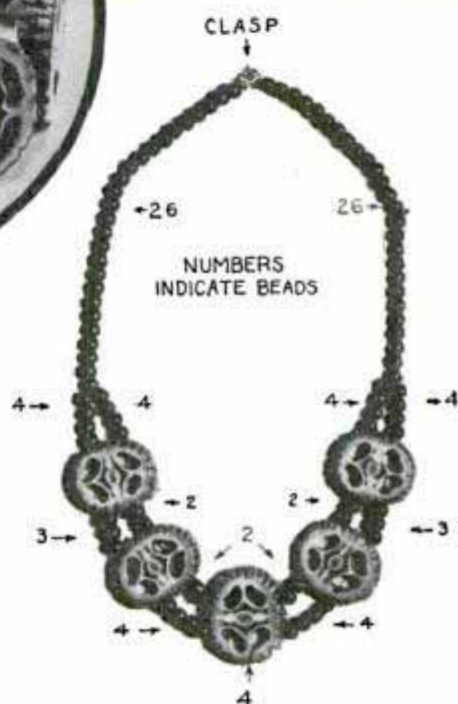
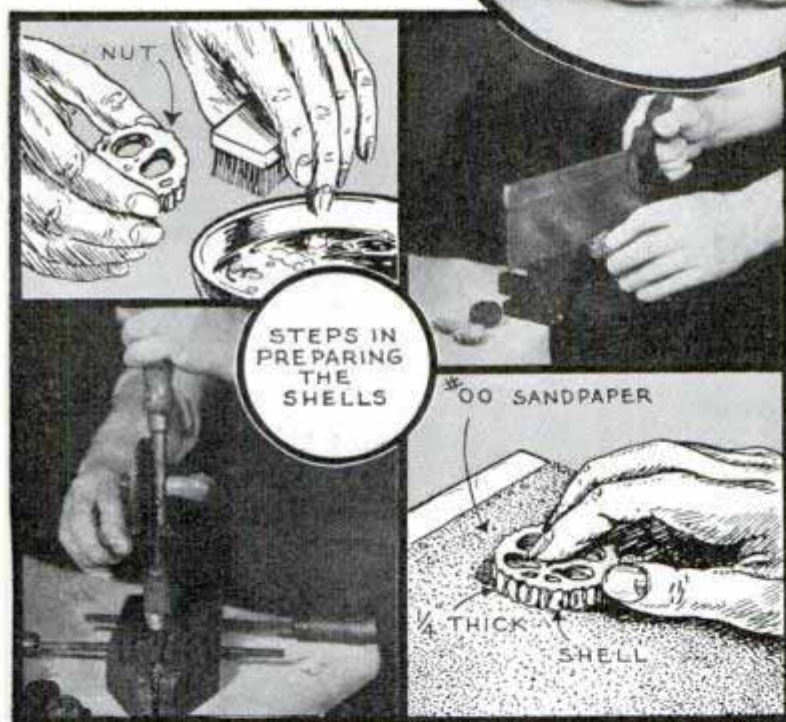
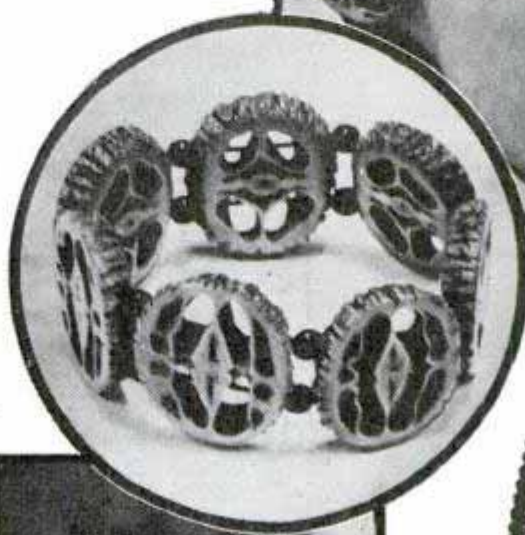

are flattened slightly with a file. The nut is squeezed between the jaws with just enough pressure to hold it. After sawing halfway through the nut, a spacer of cardboard is forced into the saw kerf to prevent breaking or binding, and the nut is turned over to continue the cutting.

The sections are placed in a vise or hand screw and holes are drilled about $\frac{1}{2}$ in. apart through the edges for the thread or elastic. The faces of each section are smoothed with sandpaper and polished to a fine sheen with wax. Six or seven sections of uniform size are required for the

bracelet. Two $\frac{1}{8}$ -in. beads, one on each elastic, are required as spacers between each disk. The elastic is drawn fairly tight and knotted so that the knots will come within one of the large openings of the shell to help conceal them.

The necklace is strung on strong linen thread and provided with a metal clasp. Here you can use pieces of the same diameter, or you can use a large one in the center and have progressively smaller ones toward the end. The quantity of beads between sections and above them is indicated by numbers on the photo of the necklace. Brown, black or crystal beads are appropriate for this jewelry.

Oilcloth will be easy to clean if it is kept thoroughly waxed.

Small Spring-Operated Vise for Modelmakers

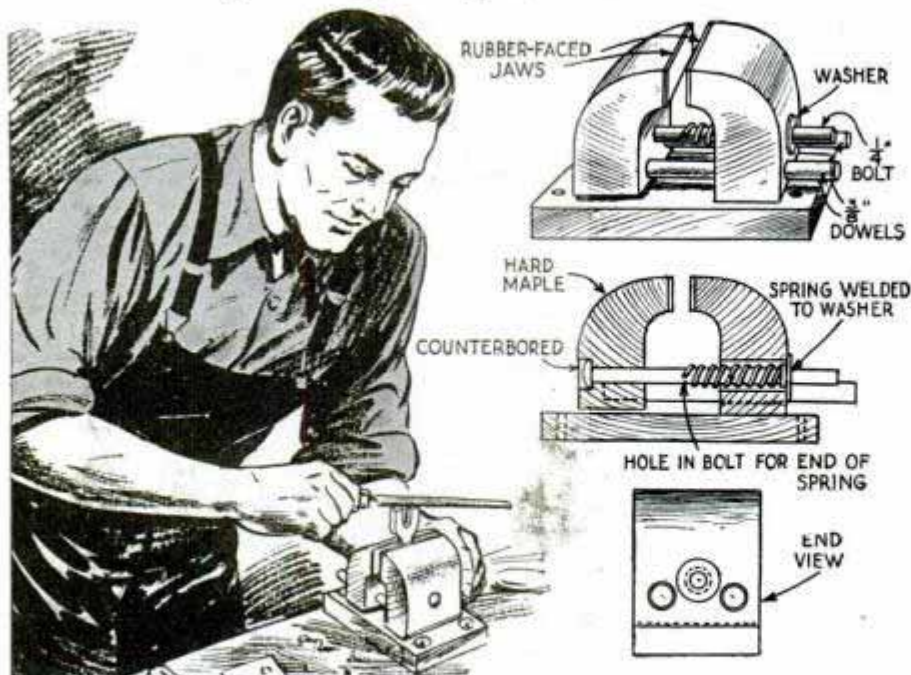

Handy for many small jobs done by the modelmaker, this simple little spring vise is easy to make. Hard maple is used for the jaws and base, and $\frac{3}{8}$ -in. dowels for the slides. A $\frac{1}{4}$ -in. bolt with a spring and washer over it provides the compression. A handle may be added if desired. Larger vises with stronger springs can be used for heavier work, the base being bolted to the bench top.—Paul H. Smith, Norfolk, Mass.

Vapor Lock Makes Humidifier on Furnace Inoperative

Difficulty experienced with the humidifying apparatus in an air-conditioned furnace, in that the supply of water to the evaporating pans could not be maintained, was found to be caused by a bubble or vapor lock forming in a fitting in the line between the water tank and the evaporating pans. The upper detail of the drawing shows the general layout of the system in the furnace and the lower detail shows the fitting where the bubble formed. To avoid the bubble, the top part of the fitting was tapped to take a copper pipe, over which was fitted a length of rubber tubing to reach to the water tank. This prevented air or vapor from accumulating at the top of the fitting, and the rubber tube carried any water that might overflow back to the tank.—Geo. C. Crom, Jr., Buffalo, N. Y.

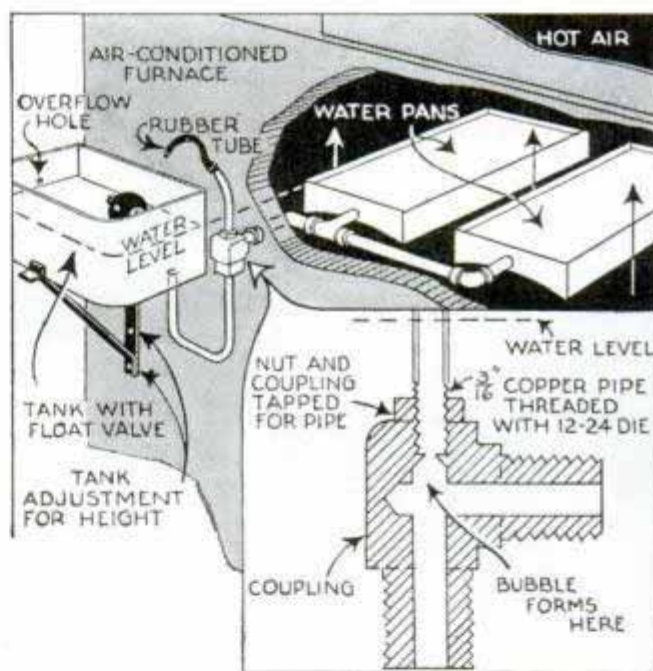

Powdered Colors Are Handy to Match Paints for Small Touch-Up Jobs



A variety of powdered colors that can be obtained inexpensively from art dealers is handy to have in your workshop for matching paints for small touch-up jobs. When a painted article has to be matched, select the paint that most nearly matches it and add to it a little powdered pigment of the desired color.

☛ To give added gloss to reed furniture, dip a stiff brush in furniture polish and brush the furniture well.

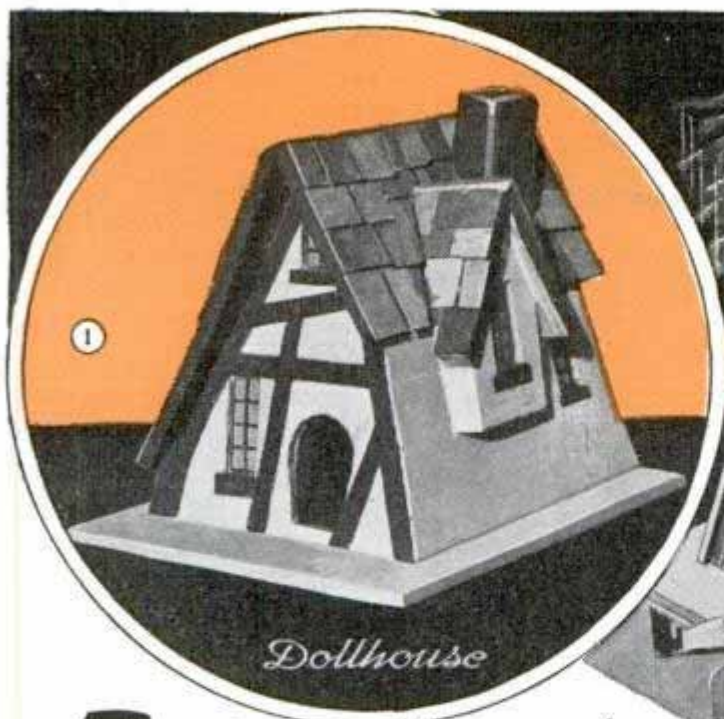

Fairyland DOLLHOUSE

forms playhouse when enlarged

HERE'S the chance for dad or big brother to satisfy the home-making instinct of a little girl member in the family. You can make her either a small house in which to mother her dolls or, you can build the same house on an enlarged scale as an outdoor playhouse. Figs. 1 and 3 show the dollhouse, and Fig. 2 the playhouse.

For the dollhouse, use $\frac{1}{4}$ or $\frac{3}{8}$ -in. plywood. Shape the sides, ends and roof pieces to size as in Fig. 4, and cut the window openings. The inner edges are recessed to receive the windows flush. Each one is cut out of two stiff pieces of cardboard. Tracing cloth is sandwiched between to simulate glass, Fig. 5. Stain the cardboard walnut and set in the opening with glue. After the windows have been completed, paint the end and side pieces. Painting them now is much easier than after they have been fastened together. When dry, assemble them with brads, allowing the side sections to extend beyond the ends about $\frac{1}{4}$ in.

Now come the gables and chimney. It will be well to paint them, before

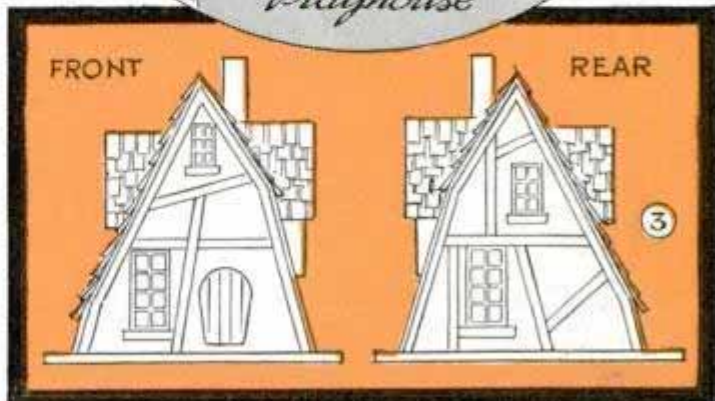
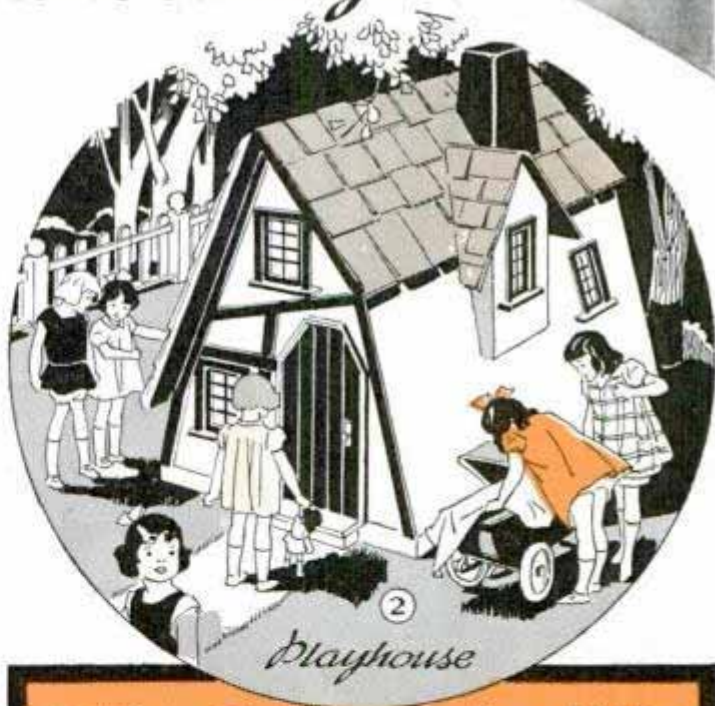



SIDES EXTEND $\frac{1}{4}$ " BEYOND ENDS

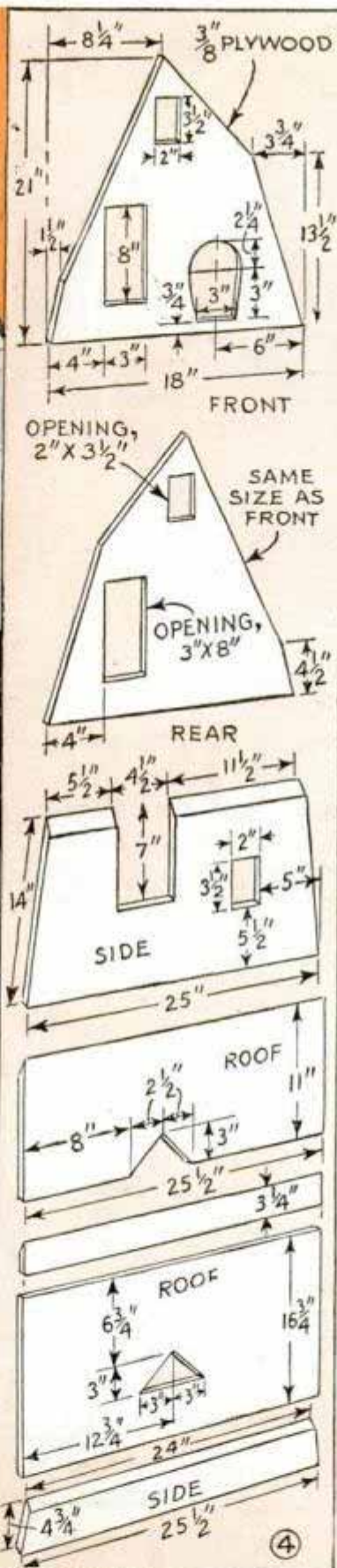

attaching to the main section. The removable part of the roof is held in place by two cleats. The half-timbered effect is obtained by gluing or tacking on pieces of cardboard that have been stained and dried. Shingles are rectangular pieces of cardboard of various sizes glued or fastened with brads. They should be painted various colors, such as orange, yellow, red, green or blue.

The house can be mounted on a piece of wood about $\frac{3}{4}$ in. thick of whatever size you want. When you are finished with the job, take a small water-color brush and go over the outside with dark stain to produce a weathered appearance. The dollhouse can be illuminated with a string of Christmas-tree lights.

For those who like to build a playhouse, Figs. 6 and 7 give detailed construction. The two sills which support the structure should rest either on stones or concrete blocks to prevent rot. For the floor joists use 2 by 4-in. stock and cover them with shiplap. The rafter sections are 1 by 3-in. stock, fastened together by overlapping boards.

Shakes are used for roofing, but if you are unable to obtain them, a good substitute can be made with $\frac{1}{4}$ -in.-thick boards. As with the dollhouse, these should be varied both in width and

length. Use either shiplap or waterproof plywood on the sides. Plywood is the better as it will present a surface without cracks, and it can be laid out so that the joints are covered with the half timbers, which are used to produce the "fairyland effect." These timbers are 1 by 3-in. boards

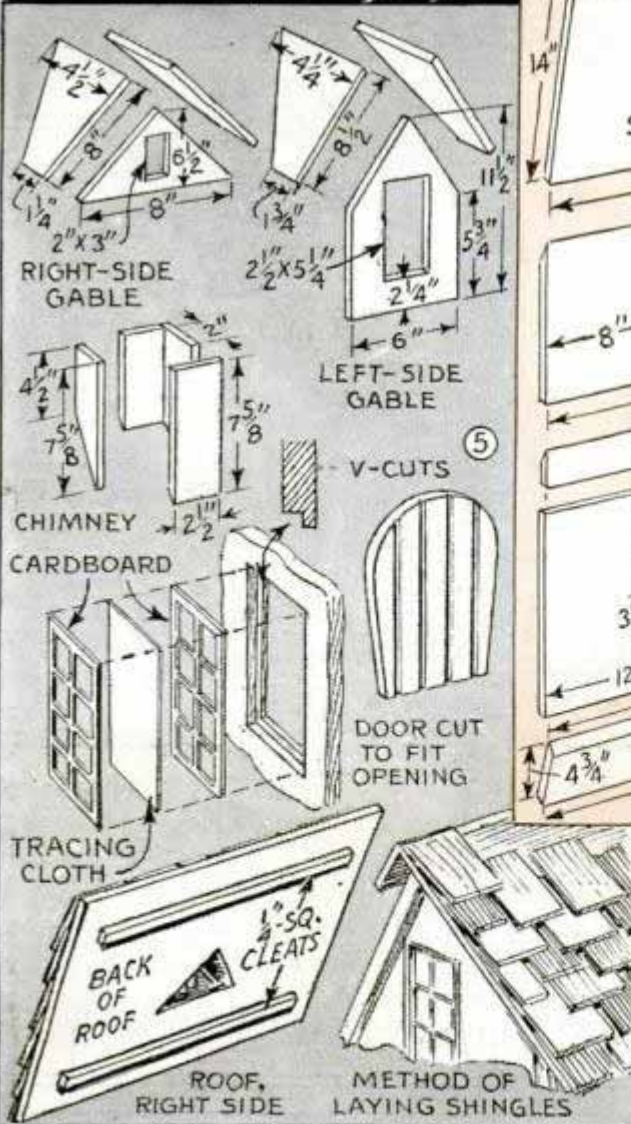

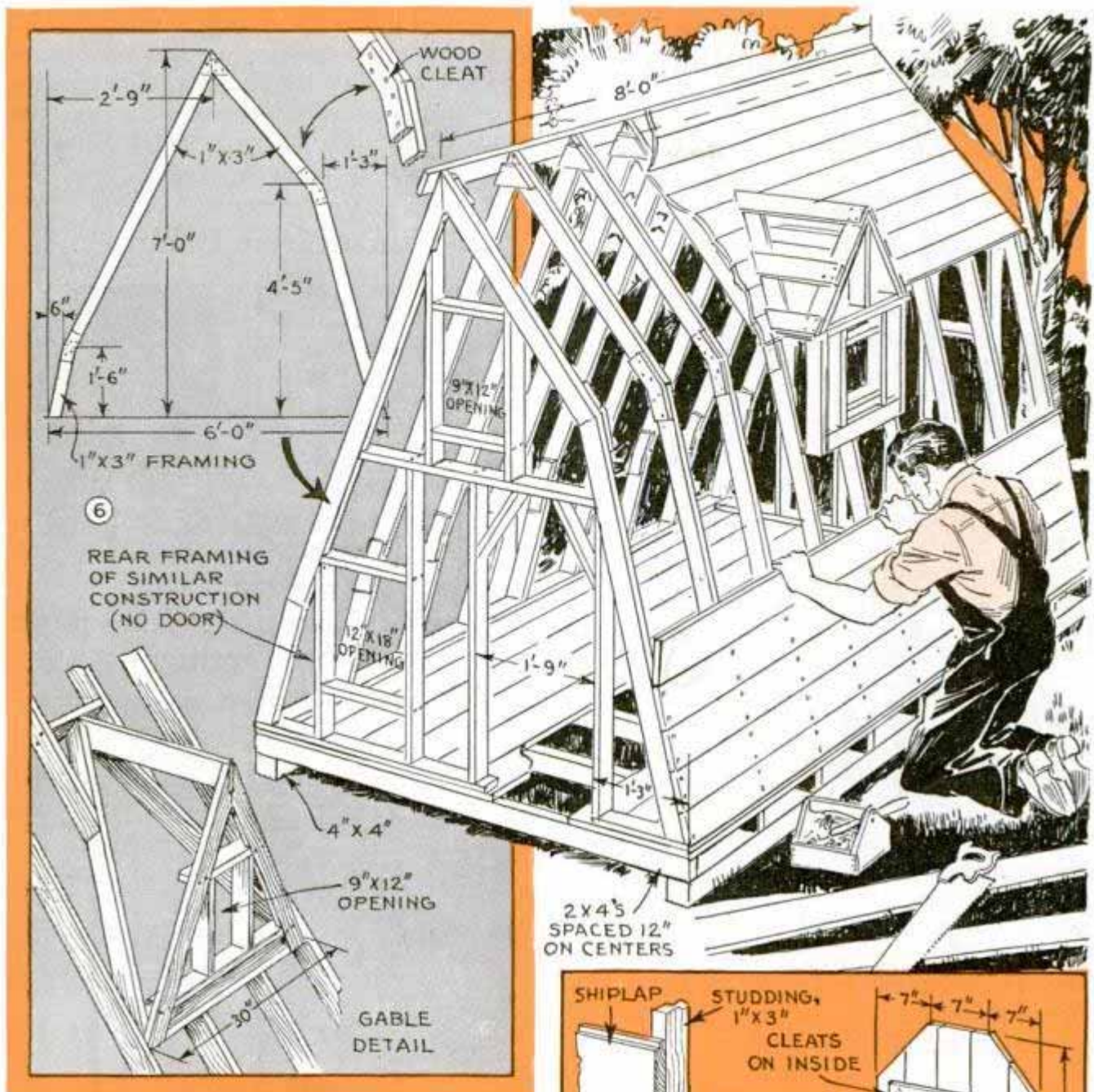

nailed over the wall as indicated. Paint the house as suggested for the dollhouse, or an all-white house with bright-colored shingles would be effective. The inside can be lined with wallboard, plywood, or even heavy cardboard, tinted or stained to suit. Or, you can use wallpaper. Linoleum and rugs for the floors will also please the young owner. Built-in furniture such as a table, benches and bookcases will make the house more "livable."

If desired, electric lights can be installed with wall switches and ceiling lamps complete. Also, if you want the house as realistic as possible, you can put in running water, using small pipe or tubing to carry it where desired. If the house is placed permanently in the yard, a garden hose can be used to convey the water to the playhouse piping system. And, of course,

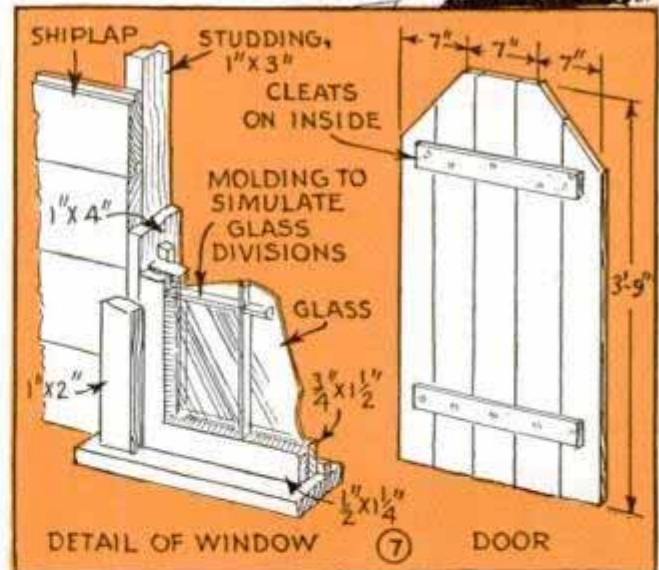

you will want a sink and kitchen wall cabinets. In the original house, a false fireplace was installed. Built of wood, it was painted to simulate brick. The inside was lined with sheet asbestos and an electric heater installed. Also, there was a bell in the playhouse for calling the young mistress for meals.

Windmill Ladder Is Removable So Children Cannot Climb It

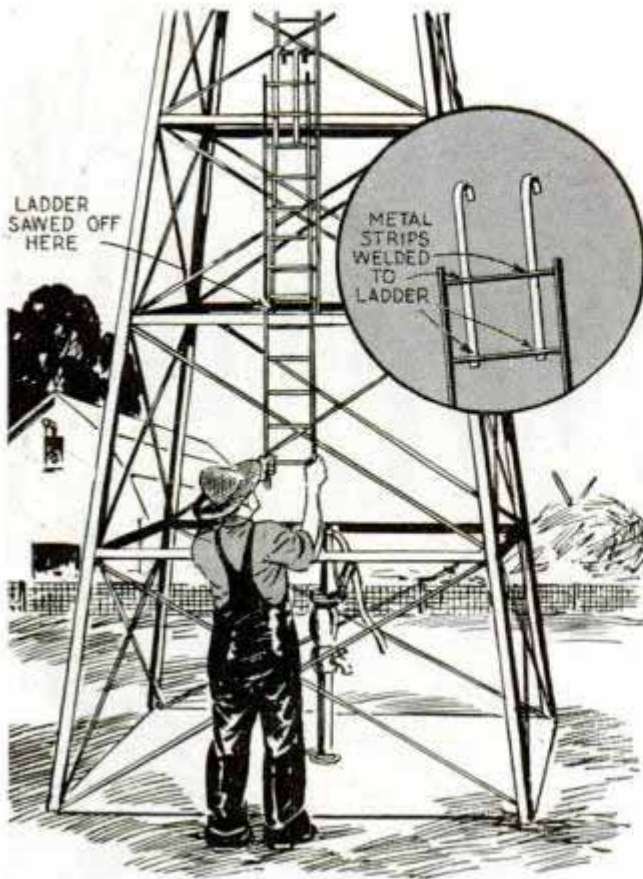

To prevent small children from climbing the ladder of a windmill, one farmer cut it several feet above the ground so that it could be removed and suspended out of reach. Flat-iron strips with hooks bent on the ends were welded or bolted to the upper end of the removable section to permit suspending the ladder safely.

Bench Holder for Hand Grinder

Two spring-steel broom holders are mounted side by side to form this holder. As the springs are made to hold an object having a smaller diameter than that of the grinder, it is necessary to spread them a

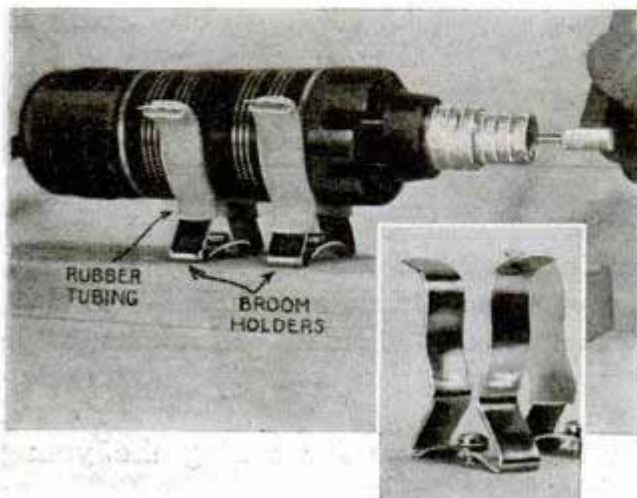

bit before mounting. Short pieces of rubber tubing are fitted over the springs to prevent marring the grinder. The holder permits the grinder to be used for various kinds of bench grinder work with metal, wood or plastics.—Allen Fiske, Chicago.

Bookmark from Bobby Pin

A simple yet permanent bookmark is made easily from a bobby pin and a piece of ribbon. Slip the end of the ribbon through the top of the pin and clip it on the book back.



Apparatus Clamped to Ring Stand by Stiff Spring

If your chemical apparatus does not include a number of special clamps or supports for holding pipes, rods or tubes, you can secure parts of this nature to an ordi-

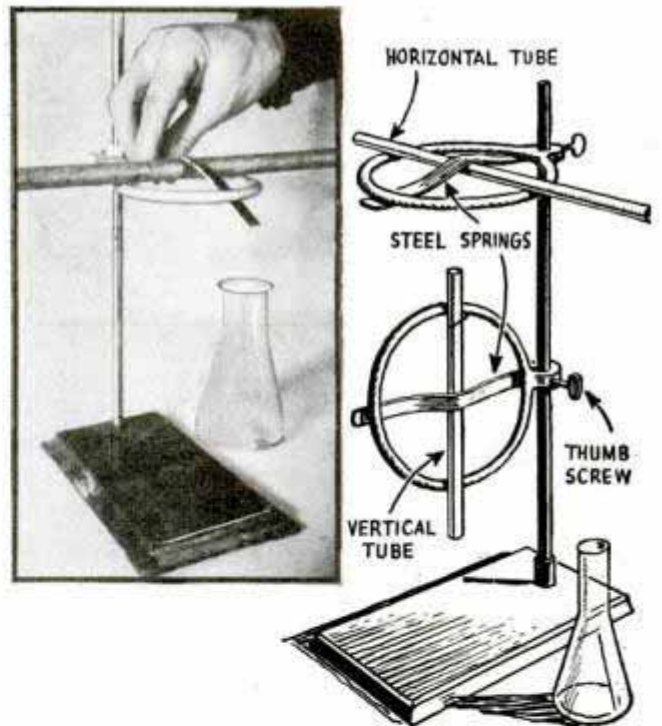

nary ring stand by using a flat-steel spring. Just place the rod or tube over the center of the ring and insert the steel strip from beneath the ring, running it over the tube and under the ring again on the other side. This will hold the tube firmly in a horizontal position. If it is necessary that the tube be held vertically, this may be done by clamping a second ring to the shank of the first one as shown.

Child's Hand Mirror Shaped Like a Squirrel

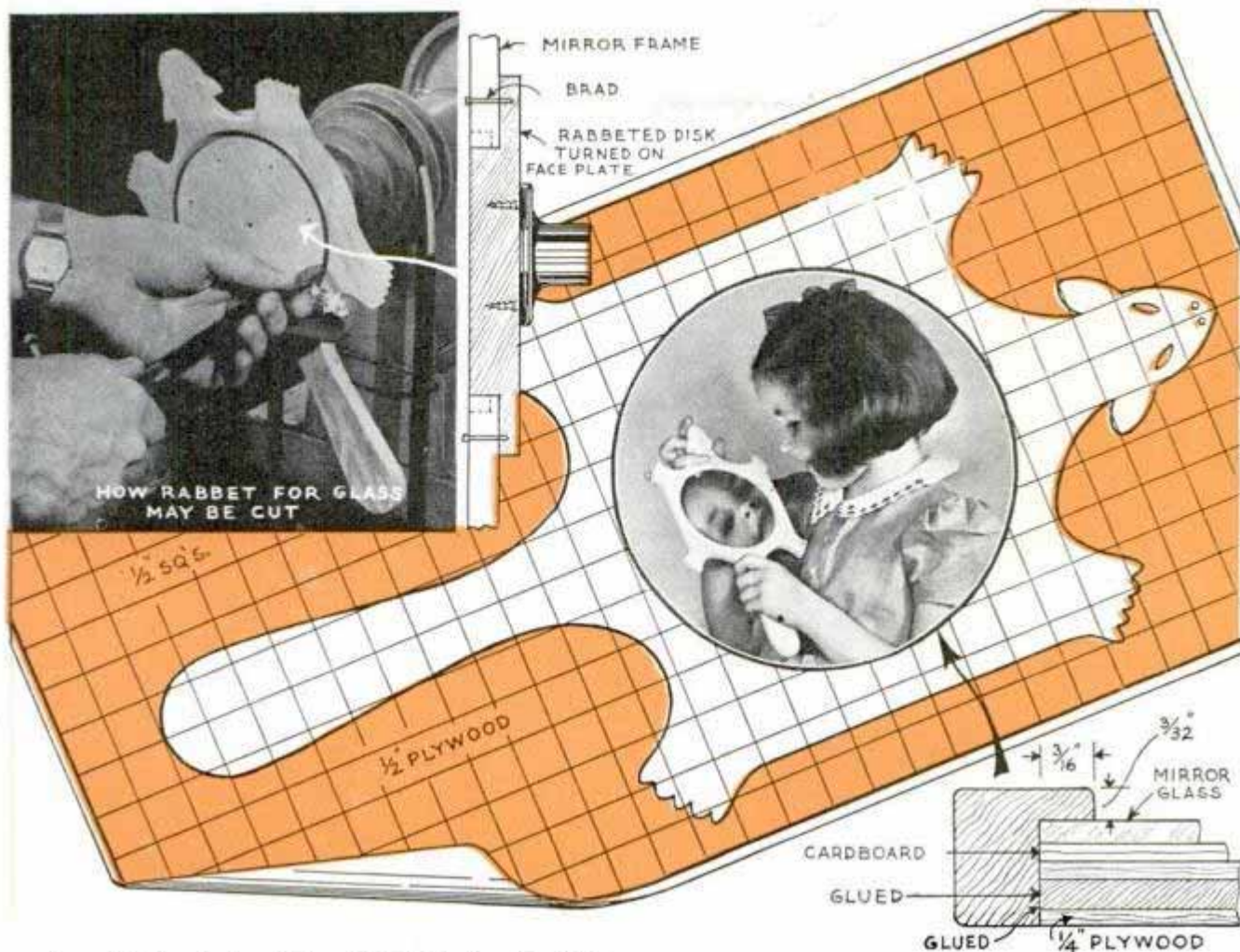

Any little girl will be delighted with this hand mirror, which resembles a flying squirrel with the legs and tail extended in a soaring leap. Five-ply, $\frac{1}{2}$ -in. plywood for the frame and $\frac{1}{4}$ -in., 3-ply plywood for the mirror backing are the materials needed. First jigsaw the mirror opening and true it up so that it can be used as a guide in cutting the rabbet for the mirror on a

shaper or drill press. If these are unavailable, you can use a lathe as shown in the upper details. Paint the frame ivory including the back of the bevel, which reflects in the mirror. Insert the mirror, padding the back with cardboard and paper to bring the back flush with the frame. A few drops of glue will hold the back in place.

Clothes Wringer Dries Pelts of Small Animals Quickly

Fur pelts ordinarily take a long time to dry, even when carefully cleaned by an experienced hand of all excess fat and moisture. Amateur trappers on farms and in small towns are prone to rush the drying process with artificial heat. This causes the pelt to crack and greatly reduces its value. Trappers in the Louisiana swamps, one of the greatest fur-producing territories in the United States, run the freshly stripped pelt, nose first, through an ordinary clothes wringer. If the pelt has a tail on, it is run through to the tail and then reversed and backed out. Of course, only cased pelts can be so treated.—K. Keith, Keokuk, Ia.

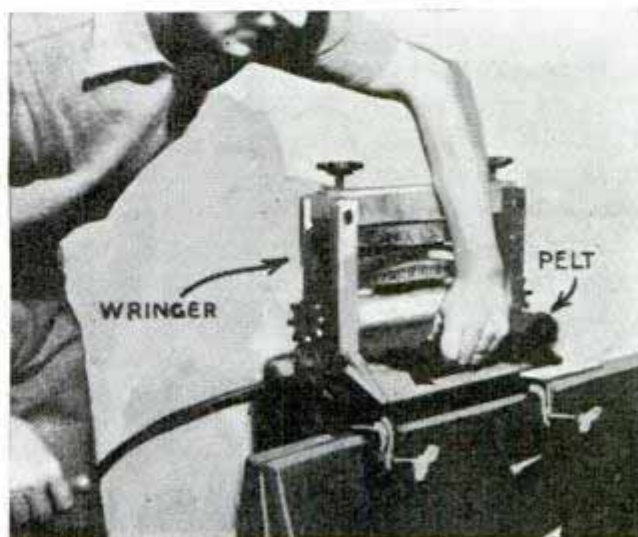
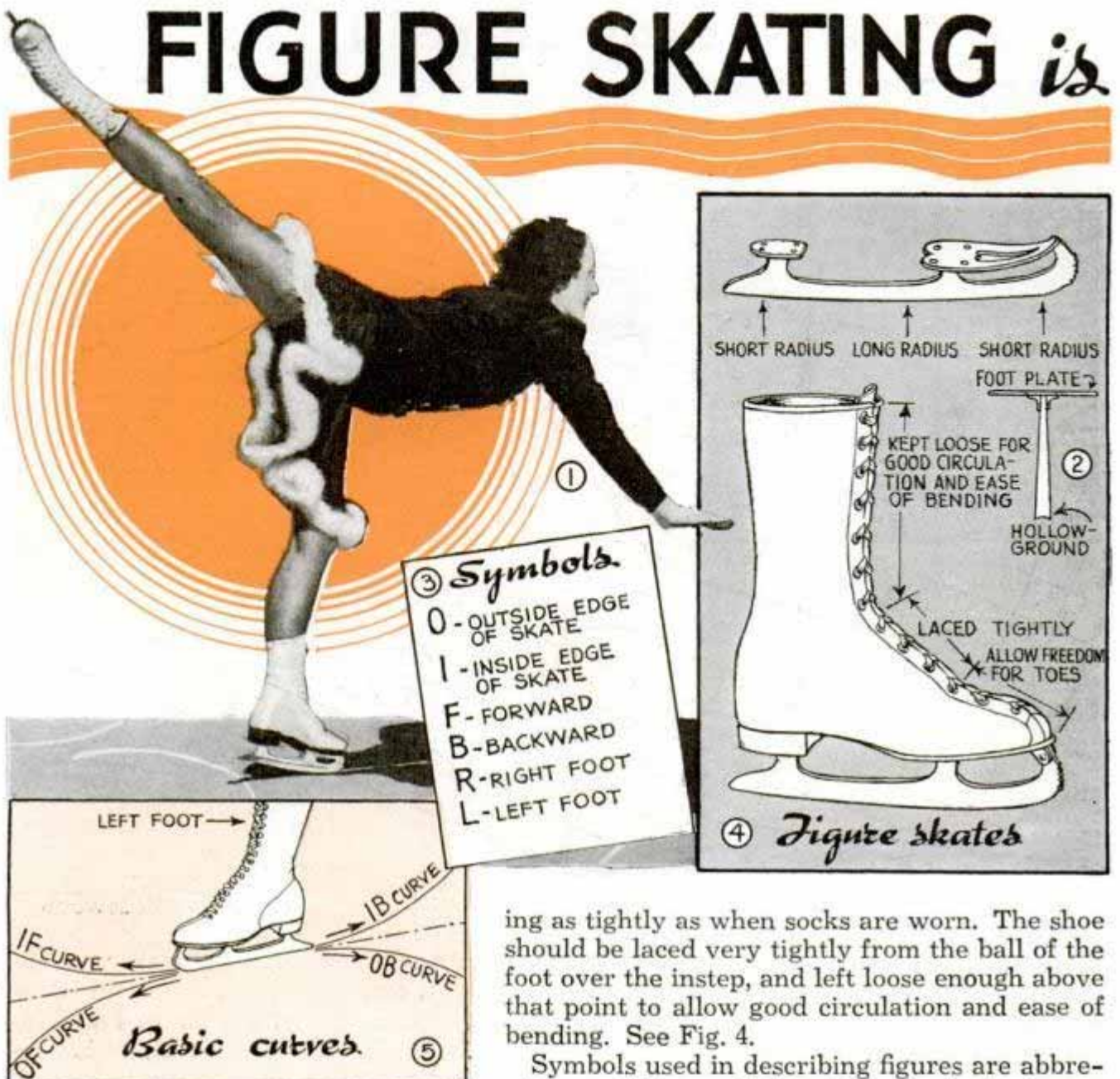

FIGURE SKATING *is*



By THOMAS P. LAKE

FIGURE skating is basically the use of four curves, which are made on the forward, inside and outside edges, and on the backward, inside and outside edges as in Fig. 5. Figure skates are designed to make curves and spins possible. From front to back, the edge of a skate is a smooth curve which changes from a very short radius at toe and heel to a very long radius in the center. The edge is fairly thick and is ground carefully to a mirror-finished hollow section as in Fig. 2. The shoes are usually leather-lined and, when used indoors, are often worn without socks. The bare skin adheres to the leather, and the skate is then firm on the foot without the necessity of lac-

ing as tightly as when socks are worn. The shoe should be laced very tightly from the ball of the foot over the instep, and left loose enough above that point to allow good circulation and ease of bending. See Fig. 4.

Symbols used in describing figures are abbreviations of the words describing the basic curves, as given in Fig. 3. Correct position of legs, body, arms and head is essential. Generally, the body must be erect as in Fig. 6. The chest should be expanded, and the shoulders held squarely. The head should be erect, and never tilted more than a moment to look at the ice. The ice should be seen only in brief glimpses. Beginners often cramp their figures by too much looking down.

Arms control balance and supply the slight impetus necessary to begin many maneuvers. In skating, the hands should be kept below the shoulders, the palms inward or downward—never upward. Also, the skating leg always should be bent at the knee, and kept relaxed. The balance leg should be well separated from the skating leg, the knee bent, the leg rotated outward until the leg is about at right angles to the skating leg, and the toe pointed down, as in Fig. 7 and the insert of Fig. 9.

The four basic curves may be skated in the form of figure-eight circles in order to exercise

skating in curves

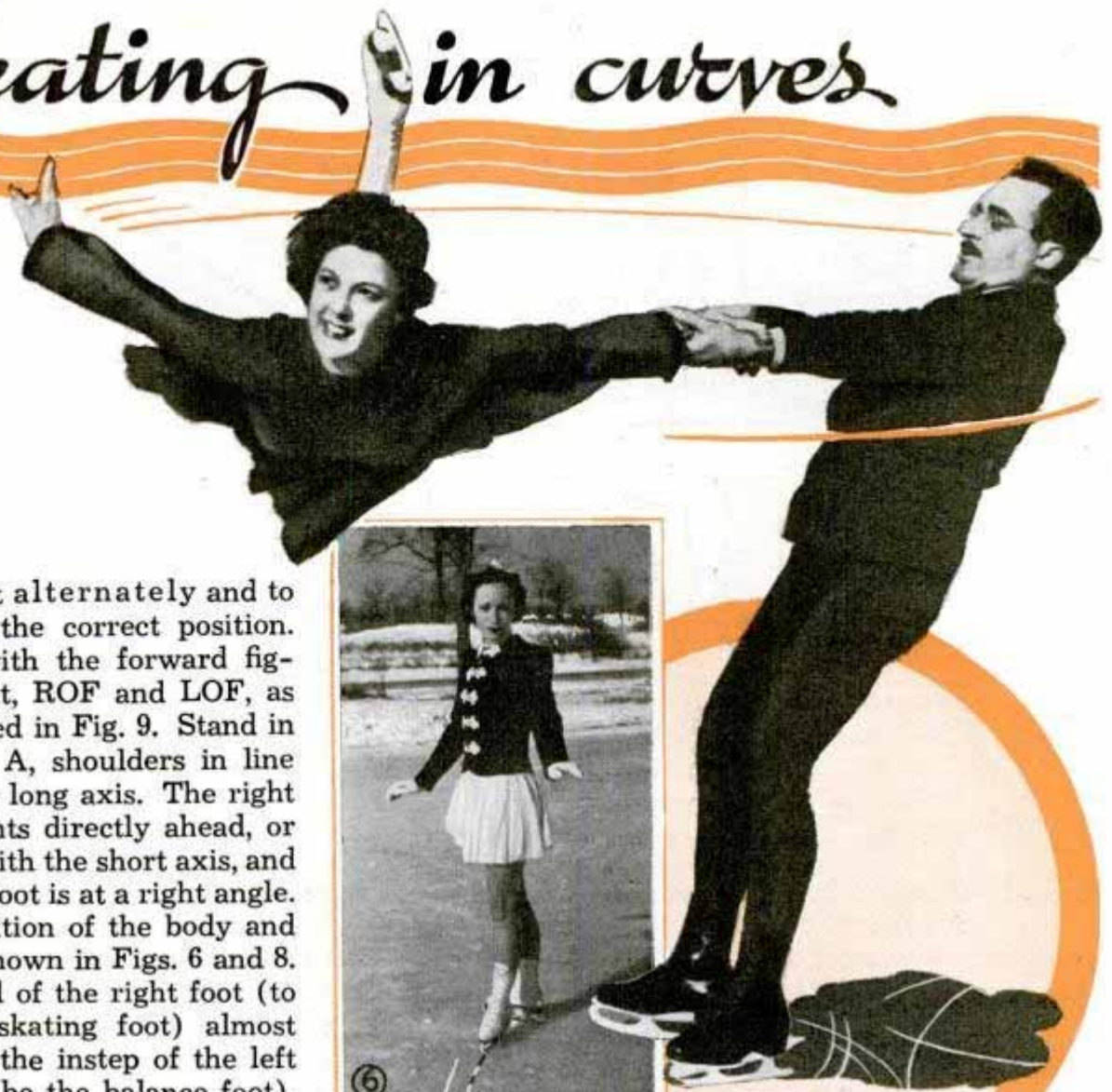

both feet alternately and to acquire the correct position. Begin with the forward figure-eight, ROF and LOF, as illustrated in Fig. 9. Stand in position A, shoulders in line with the long axis. The right foot points directly ahead, or in line with the short axis, and the left foot is at a right angle. The position of the body and feet is shown in Figs. 6 and 8. The heel of the right foot (to be the skating foot) almost touches the instep of the left foot (to be the balance foot). Bend the knees, and push sharply with the inside edge of the left foot, using the center portion only—not the toe.



To start

After starting, look over the right shoulder toward point X. The body is inclined to the right, or toward the center of the circle, and as the ankle is almost straight, the curve is skated on the outside edge. During the first quarter of the circle, the shoulders are kept almost parallel to the long axis. At the quarter point, the shoulder over the skating foot leads, and the back is toward the center of the circle. See position B, Fig. 9. This position is held until up to the halfway point of the circle. Then it gradually changes so that in the last quarter of the circle, the shoulders have been brought around until they are parallel to the long axis, and the body faces the direction of motion as in position D. In the first part of the circle, the balance foot is carried behind the skating foot, toe down, and the knee is rotated until the leg is at right angles with the skating leg, as shown in position B and the insert of Fig. 9. This position is important, and at first is a strain on unused muscles. After passing the halfway point in the circle, position C shows how you



Fig. 6 shows the position for starting, also detailed in Fig. 8. After the start, the balance leg, toe pointed downward, is separated from the skating leg as in Fig. 7, and is turned so that it will be at right angles to the skating leg—also see insert of Fig. 9. Notice the easy, unstrained position of the arms and the erect position of the body

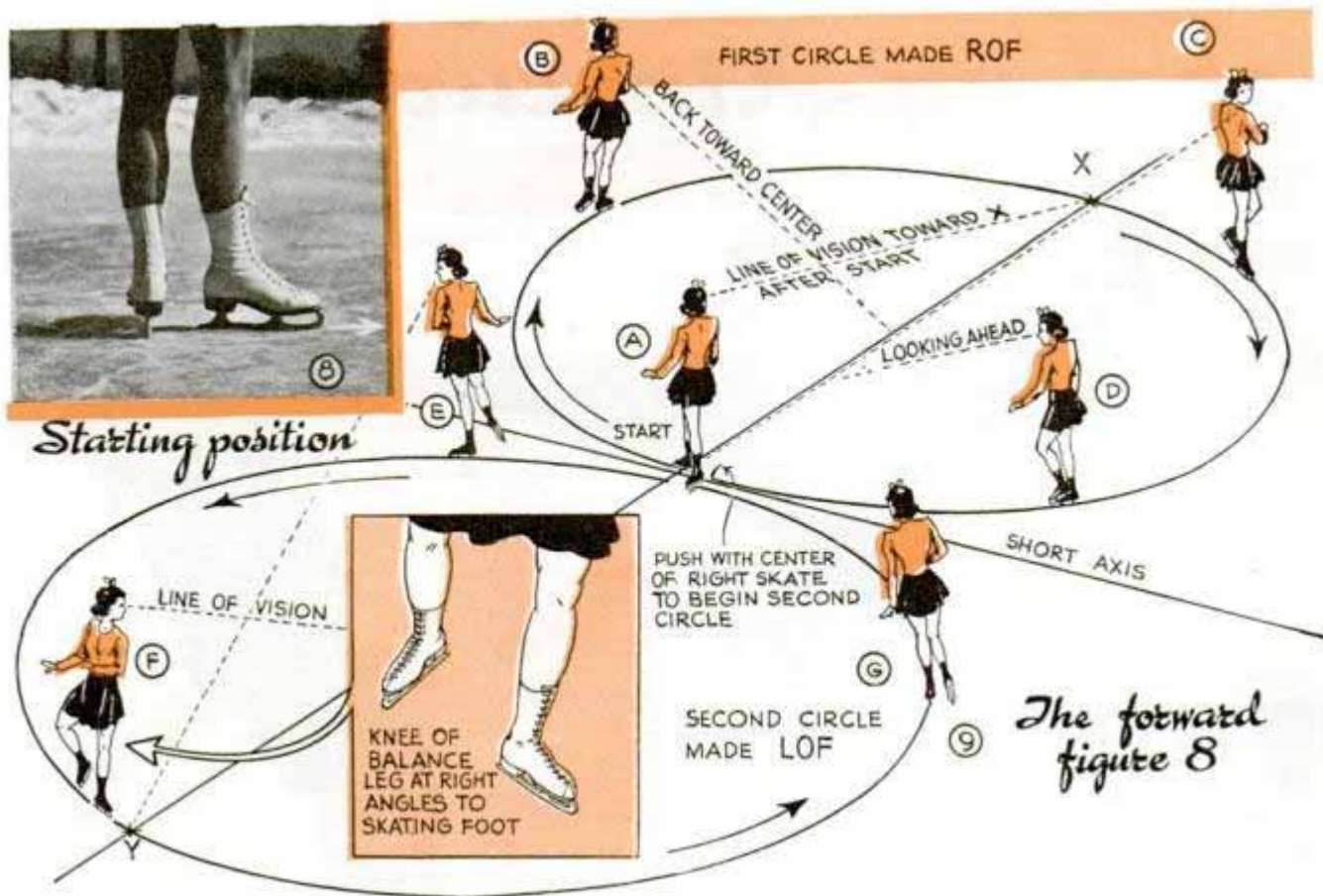

begin to draw the balance foot forward in a smooth motion that brings it to a leading position at the finish of the circle. All this time the toe is pointed down. At the beginning of the circle, the right arm is held with the forearm across the body; the left arm is extended and held almost over the balance leg, as in position B. Then the left arm is brought forward with the balance leg, and the right arm is straightened and placed at the side. After the completion of the first circle, the left foot is placed on the ice at the instant the right foot is turned sharply at right angles to supply the push for the next circle. This push should be obtained by a partial straightening of the knee; the force should be applied against the center of the skate blade—not the toe. In position E, the left forearm is held across the body, while the right leg and arm are used to balance. Now, the skater's line of vision is toward point Y. At position F the skater's back is toward the center of the circle, while the line of vision is diametrically opposite. Then position C is repeated with opposite arms and feet to position G, which is similar to D but with the left arm straightened and the right foot and arm advancing.

After the OF edges, begin with the IF edges, also skated as a figure-eight. See left detail of Fig. 10. Start in the opposite

direction as before, looking toward point X. The left instep should almost touch the right heel and the right foot should point in the direction of the short axis. After bending the knees, push off by partly straightening the left knee. After making a half-circle, look back toward the starting point, and gradually bring the balance foot to a leading position, when it is ready for the next stroke on the other circle.

Next come the two backward edges. Begin with OB figure-eight as in the center detail of Fig. 10, by standing with the body facing point X, both feet parallel to the long axis. Pick up the right foot (which is to trace the circle), turn the toe inward, bend the knees, and replace the right foot on the ice at the instant of pushing off with the inside edge of the left skate. In the first part of the circle, the balance foot remains in the following position. Turn the head and look over the left shoulder. In the second part of the circle, change the balance foot to leading position. The back is all the time partly turned toward the center of the circle. When the starting point is approached, bring the balance foot back, place it on the ice, and at the instant of contact turn the right foot at right angles and push with bent knee.

The IB figure-eight, as in the right detail of Fig. 10, is begun with the back

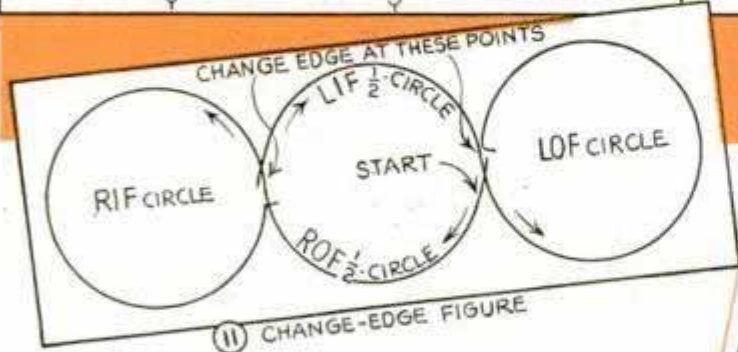
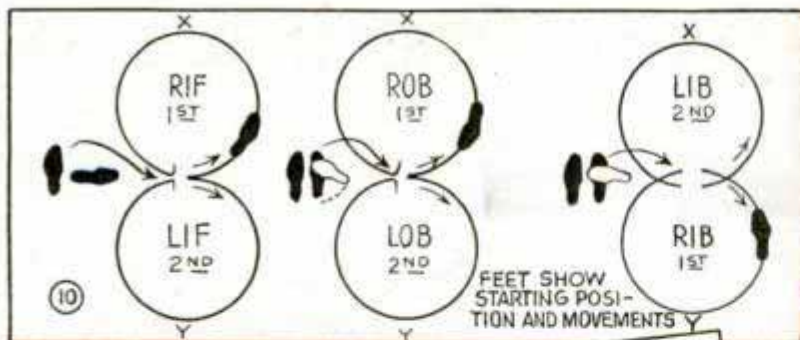

turned toward the center of the first circle to be skated. Pick up the skating foot, turn the toe in, and replace it with the toe near the instep of the other foot. At the instant of contact, push from bent knee. The right arm is back, having assisted with the initial swing; and the left leg is forward. The eyes should watch the trace for the first third of the circle, and then look to the center, at the same time bringing the balance leg back until it leads the body, which faces the center of the circle. The position is now identical with that shown in Fig. 12. When the center is reached, drop the leg to skating position, and place it on the ice as the other foot is turned at right angles for the push.

After the four edges have been mastered, the change-edge figures can be attempted. In these a change is made from a curve on one edge to the opposite curve on the other edge of the same skate. For example, from a start on ROF, a change is made to RIF. If the change is made after a half-circle on ROF, the next half-circle on RIF makes a figure-S. In symbols, the maneuver is ROF to RIF. The change of edge is made during a shift of weight from the front part of the skate (in OF curve) to the rear part (in IF curve). The impulse for the change ROF-RIF is acquired by first moving the balance foot to leading position, and then swinging it back to following position. During the latter motion, the change edge is accomplished. The change-edge figures may take the form of a three-circle eight, as in Fig. 11, with the semi-circle on one edge followed by a full circle on the other edge, and repeated on the other foot.



Three turns

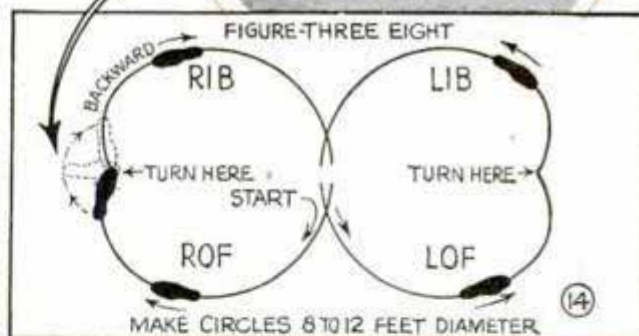

After the change edge you come to the figure-threes. Where the change edge accomplishes a change of edge without a change in direction, the figure-three changes both edge and direction. As in Fig. 14, start with ROF, just as in the OF circle except that the right arm is advanced. Look at the place where the turn will be made. Keep the skating knee well bent, and allow the swing of the balance foot to provide the initial impetus for the turn. Aid the turn by pointing the right skate to the right, whereupon the body will continue on over the skating foot. As this occurs, the weight is placed on the toe



⑮ *Double threes.*

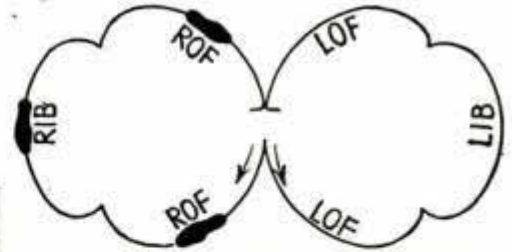

MAKE CIRCLES 10 TO 12 FEET DIAMETER.

VERY SHORT ON RIB

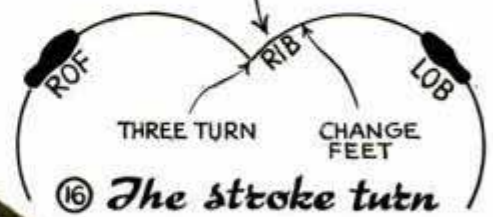

⑯ *The stroke turn*

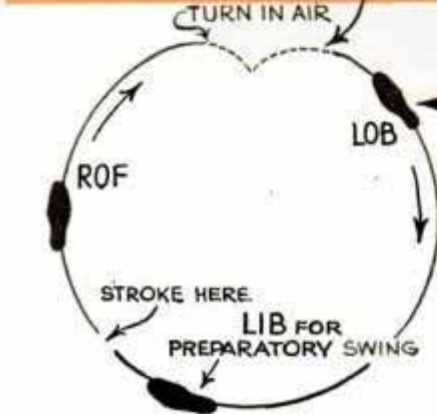

⑰ *Cross Mohawk jump*



of the skate and the heel swung around through 180 degrees. In Fig. 13, the skate is shown as this pivot about the toe is almost completed. After the turn, the balance foot leads, the position is similar to that shown in Fig. 12. The three-turns and the change edges are accompanied by a change of balance which is very similar to that of a bicyclist, who changes his direction by first steering slightly in the opposite direction in order to throw his balance correctly for the real curve which follows immediately. Likewise, this is true in skating, a curve in one direction is initiated first by a slight curve in the opposite direction. It is this preliminary twist that gives the correct inclination to the body for the lengthy curve.

Double-threes, shown in Fig. 15, consist of an OF-three followed by an IB-three, practiced alternately on each foot. Practice this figure in large proportions, and hold each position for a few seconds. The next figure is a simple stroke, which is a turn on one foot followed by a curve on the other foot. See Fig. 16. For example, from a ROF curve, make a three-turn, but instead of continuing on RIB, place the left foot on the ice in a LOB curve. This step should be practiced on all edges.

When the turn of a stroke is combined with a short leap into the air, as in Fig. 19, the turn is the Cross Mohawk jump, also called the flying three, and three-jump. By crouching deeply on the skating leg before the jump and sinking deep on the landing leg, the jump is made to look much higher than it actually

is. Fig. 17 shows the skater descending in a three-jump, or Cross Mohawk, while Fig. 18 shows the early part of the landing position. On landing, the balance leg is lifted backward and the arms are outstretched, whereupon the position is similar to that in the back-stop, or Charlotte scratch, shown in Figs. 1 and 20.

Cover of Tidbit Box Locks in Raised Position

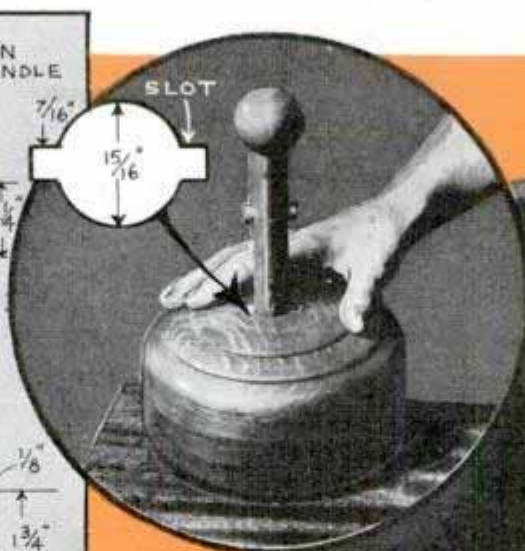
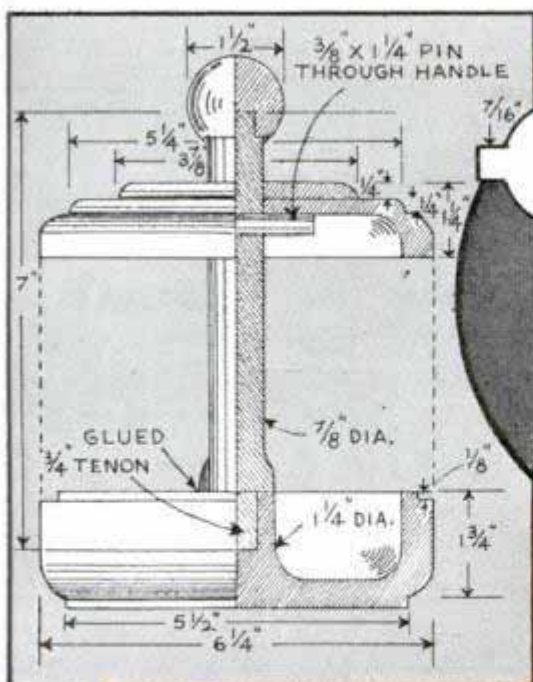

Neat and unusual in appearance, this tidbit box has a cover that locks in the raised position when lifted to the top of the handle and given a slight turn. The cover is closed by reversing this procedure—turning the cover slightly to allow the pin in the handle to pass through a slot in the cover. Dimensions and assembly are shown in the left-hand detail. First, turn the box to shape, leaving a projection 1 1/4 in. in diameter in the center. Drill this vertically for the handle, which is turned

with a tenon on both ends, one to slip into the box projection and the other to take the knob or ball at the upper end. Next, turn the lid, drill it in the center to slip over the handle, and slot opposite sides of the hole to pass a pin, which is inserted through the handle as indicated. Assemble the box and finish as desired.

Old Heating Stove Can Be Repaired Easily with Firebricks



If the lining inside an old heating stove has burned out and you would still like to get a few more years service out of it, line it with firebrick. Twelve to fourteen bricks and a dime's worth of fire clay to use as mortar will be sufficient for most stoves.

Improving the Christmas Tree

An unbalanced Christmas tree may be adapted for decorative purposes by re-arranging some of the branches. Cut off excess branches close to the tree and taper the ends of them with a knife. Then bore holes in the trunk where additional branches are needed and insert the tapered ends of the extra ones in the holes, anchoring them in a natural position with glue and small nails.

Guides Permit Filing Band Saw in Ordinary Saw Vise

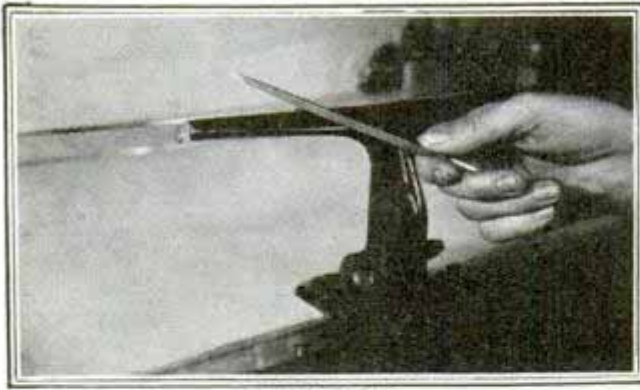

The addition of these guides to the ends of the stationary jaw of your saw vise converts it to hold a band-saw blade. Drill and tap both ends of the jaw so that rectangular pieces of sheet metal can be pivoted to them to support the blade at the correct height above the jaws.

Substitute for a Set of Bar Clamps

If you do not own a set of bar clamps for handling boards to be glued edge to edge you can make a pair for light work from a couple of large radiator-hose clamps of the type having thumbscrews for tightening them. Sweat or braze an additional sheet-metal strap to each side of the clamp, these straps having holes drilled about an inch apart throughout their lengths. To use the clamps, set them over the edge of

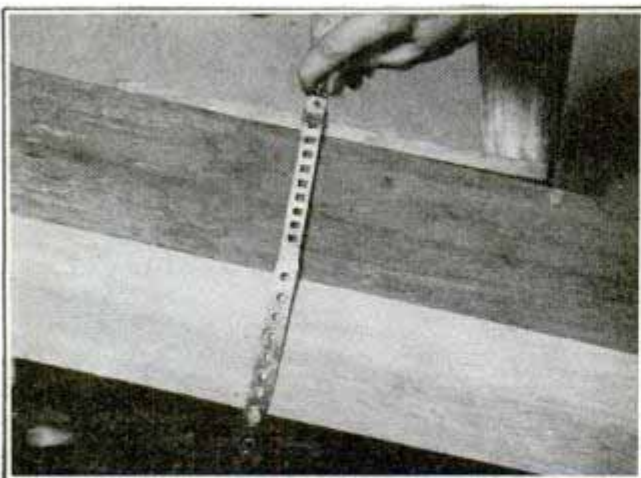

one of the boards of the assembly and insert a large nail or steel rod through the pair of holes that just clear the opposite edge. Insert waste-wood pieces under each nail and also under each thumbscrew to prevent marring the work. Screwing down the thumbscrews with pliers brings the boards tightly together. In case the jointing is not perfect, just lay the assembly on a flat surface with the nail end of the clamps extending over the edge and put a heavy weight over the work.

Tricycle Pedals Shorten "Reach" for Small Children

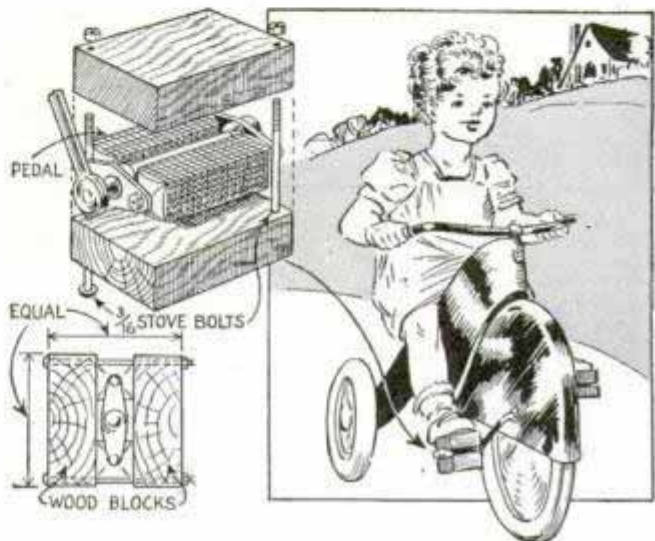

To make the "family" tricycle as easy for the smallest member to pedal as for the largest, one man provided oversize treads for the pedals. Consisting of two blocks of wood clamped to each pedal with stove bolts, these auxiliary treads can be attached or removed in a jiffy.

Crotched Stick Driven in Ground Serves as Camp Bootjack

Campers who wear rubber boots will find that a crotched stick will serve as bootjack to remove them. Use a strong stick and drive it into the ground at an angle.



Ⓞ Bone handles of steel knives may be whitened by rubbing them with a flannel cloth dipped in peroxide of hydrogen.

Spanish-Styled BANJO CLOCK

has storage compartment

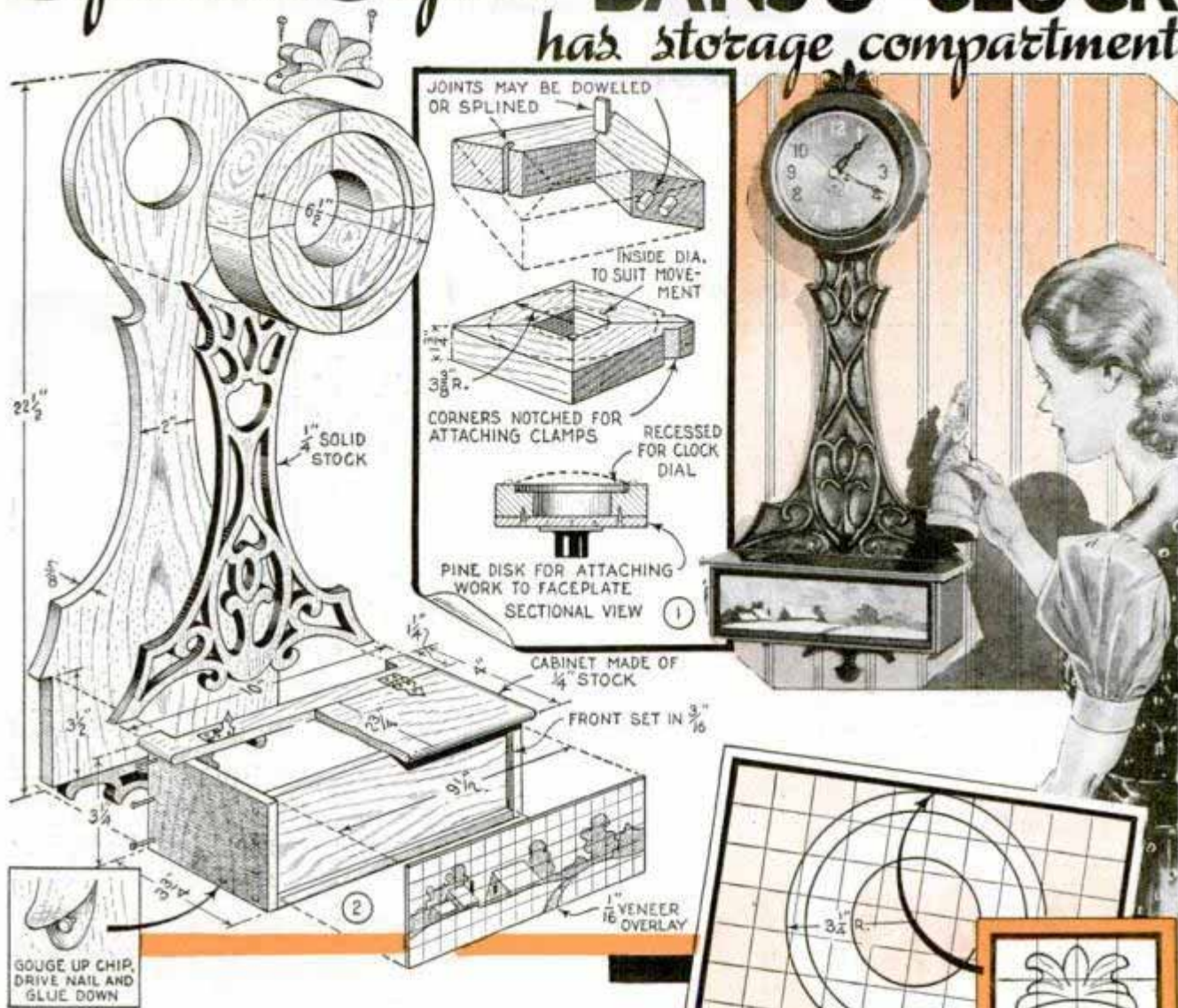

WHILE the banjo clock is essentially American, we have modified it here to embody a touch of southern Spanish style having a carved, scroll throat. Fig. 2 shows the general assembly. The drum of the clock is turned from a blank built up in segments, Fig. 1. A center hole is turned in the drum to take the works, and is recessed around the edge to fit the dial mounting. The back is jigsawed to shape from a single piece, and is fitted with a scrolled overlay, Figs. 3 and 4, glued and screwed in place. After completing the drum, glue and screw it in place on the back. The box at the bottom is of simple construction except that the inlay front panel is set 3/16 in. inside the end and bottom pieces of the box to give a framed effect to the picture. The panel is decorated with an overlay jigsawed from thin veneer and glued in place. A lid hinged to the top of the box makes it a handy place to store numerous small articles.

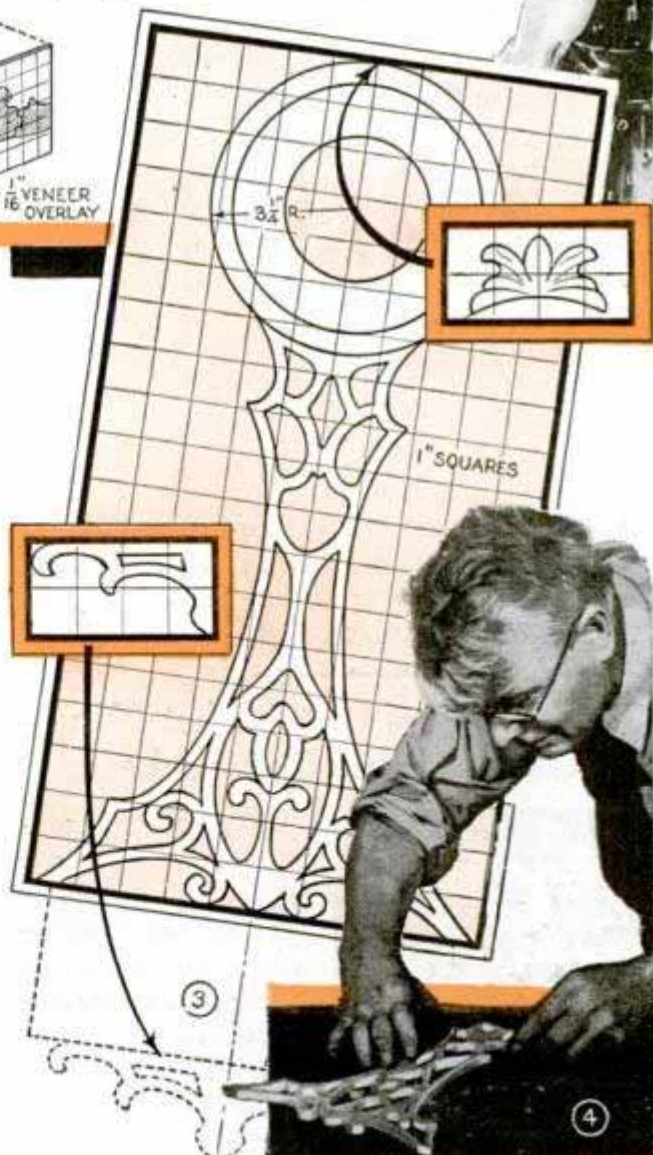

Scratch Brush Shreds Magazines for Paper-Pulp Novelties

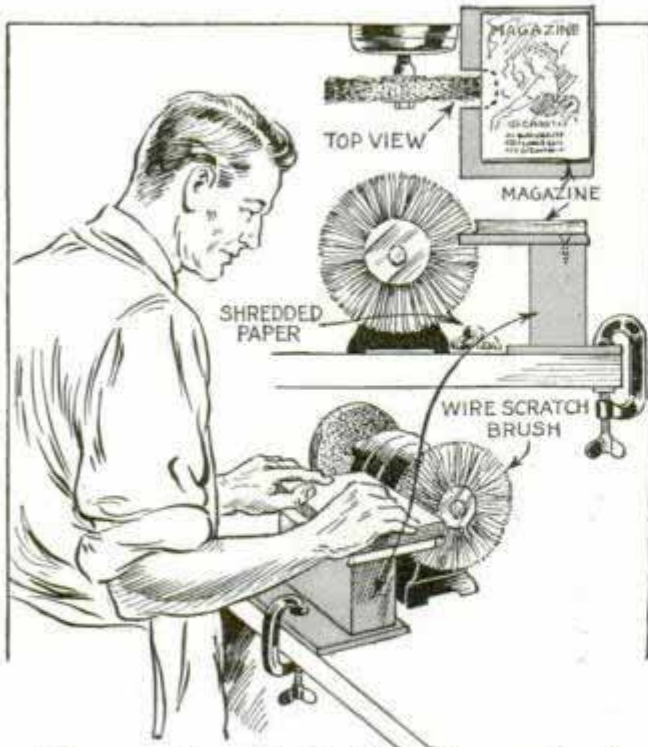

The usual method of making pulp for molded-paper construction is to soak the sheets in water until they are thoroughly saturated and then to agitate the mass until it is sufficiently broken up into small particles. A much better and quicker way to obtain pulp is to shred a number of old pulp magazines with a steel scratch brush. Make a slotted table as shown and set it up close to the wheel. Dampen the magazines to be used as the pulp supply and run them, one at a time, slowly over the table. The wheel will quickly shred the paper into minute particles. The paper can be run through dry, but dampening it is to be preferred as it keeps down dust. Gather up the accumulation of paper shreds and soak it for an hour in warm water and liquid glue. The mass is then ready to mold into any desired shapes.

Sink Stoppers Better Than Plugs as Clothesline-Post Sockets



Pipe sockets anchored in the ground for the insertion of removable clothesline posts, are usually provided with projecting, wooden plugs to keep out dirt and water

when not in use. One housewife replaced them with rubber sink stoppers, purchased at the local dime store. The stoppers may be inserted so that they are practically invisible and flush with the ground. The attached rings make it easy to remove them when desired.

Rubber Door Stop Holds Work in Miter Box

The difficulty of holding a board securely in the miter box can be overcome by clamping a rubber door stop onto the box so that the blunt end of the wedge rests firmly against the board. The wedge may be lifted easily for the adjustment or removal of the board.



Brace Straightens Scroll-Saw Blade

A scroll-saw blade will not operate satisfactorily unless it is at right angles to the saw table, and much time can be saved by using a metal corner brace as a guide when

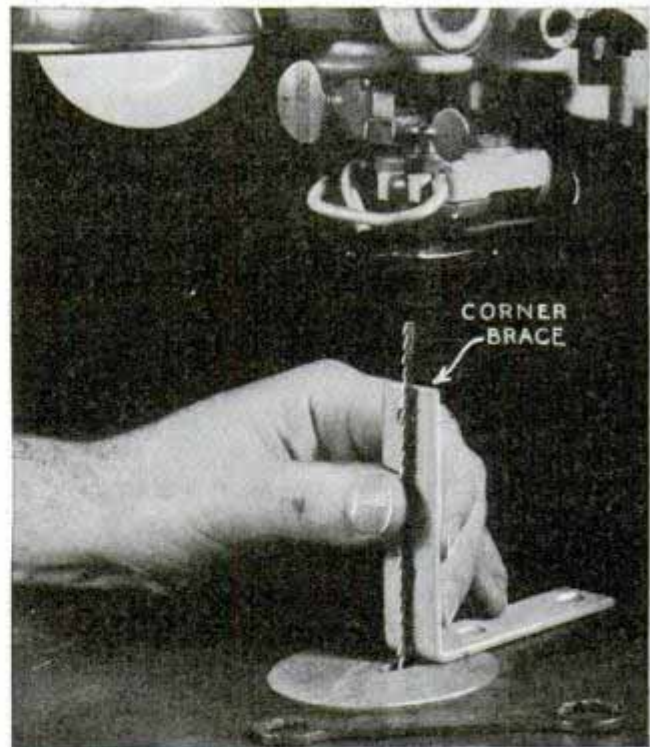

replacing blades. By holding the blade against the guide, which rests on the table, the blade will be absolutely perpendicular. It can then be locked permanently into the chucks without testing.

VERTICAL PHOTO ENLARGER

has "vernier" focusing

By ALEXANDER MAXWELL

EMBODYING features found in expensive commercial models, the enlarger shown in Fig. 1 offers the home photo finisher an efficient unit which can be built inexpensively, using ordinary hand tools.

Details of the construction of the vertical framework, which can be made of birch, mahogany or other hardwood, are given in Fig. 7. The groove in the fork-shaped standard which provides a track for the lamp-house carriage, is formed by fitting $\frac{1}{2}$ -in. thick spacer blocks at each end of two outer members as shown in the circular detail. The detail below Fig. 7 shows the type of joint used in joining the legs to the lower end of the track. Lay this out carefully, using a protractor and a bevel gauge to transfer the lines accurately to both sides of the piece. When fitted properly, this will give the standard the required 5-degree rake. The base is made of plywood, around the outer edge of which is screwed a metal frame of brass angle. To the corners of this frame are bolted the legs of the standard and the tubular supports. To offset the weight of the overhanging lamp house, a 25-lb. lead weight must be attached to the base as shown. This you can cast in a simple wood form from scraps of lead pipe.

Fig. 6 gives full di-

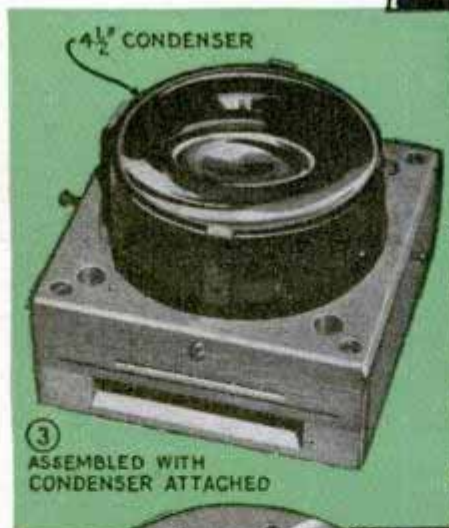

③ ASSEMBLED WITH CONDENSER ATTACHED

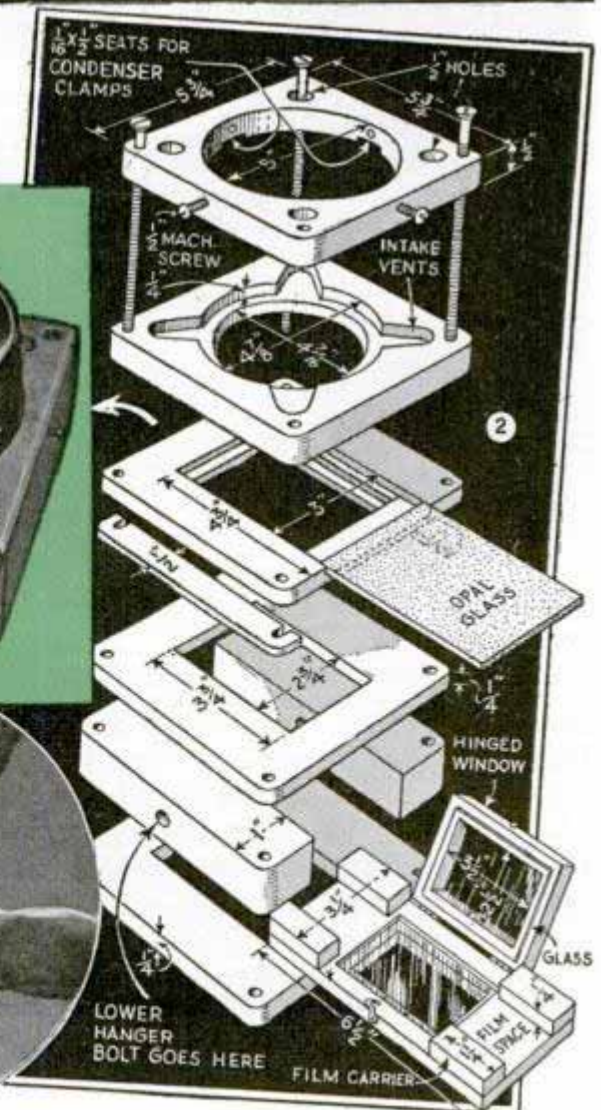
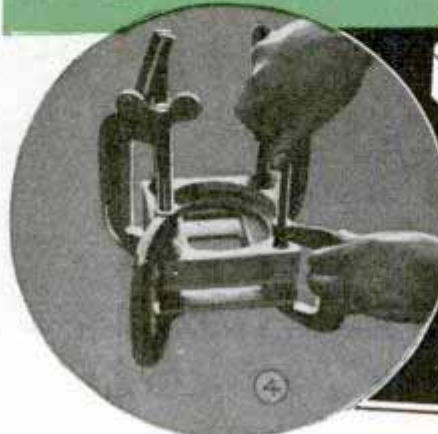

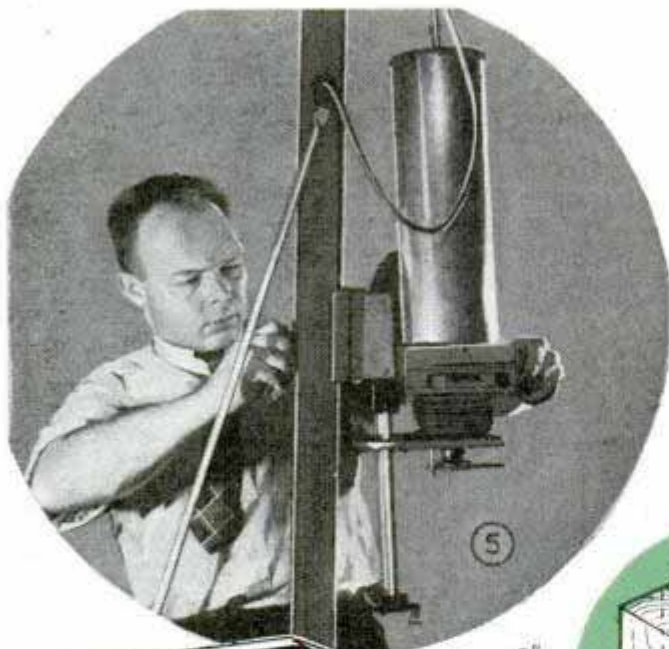

ted with a large washer and wingnut as shown in Figs. 5 and 8. Referring to Fig. 6, you will notice that a slot is provided in the lower end of the hanger. This is to permit adjustment of the lamp house, which must set perfectly plumb to assure square and undistorted projections. Either a plumb line or level held against the side of the tubing will check this accurately. This, however, is a final adjustment, which is made after the enlarger has been completed.

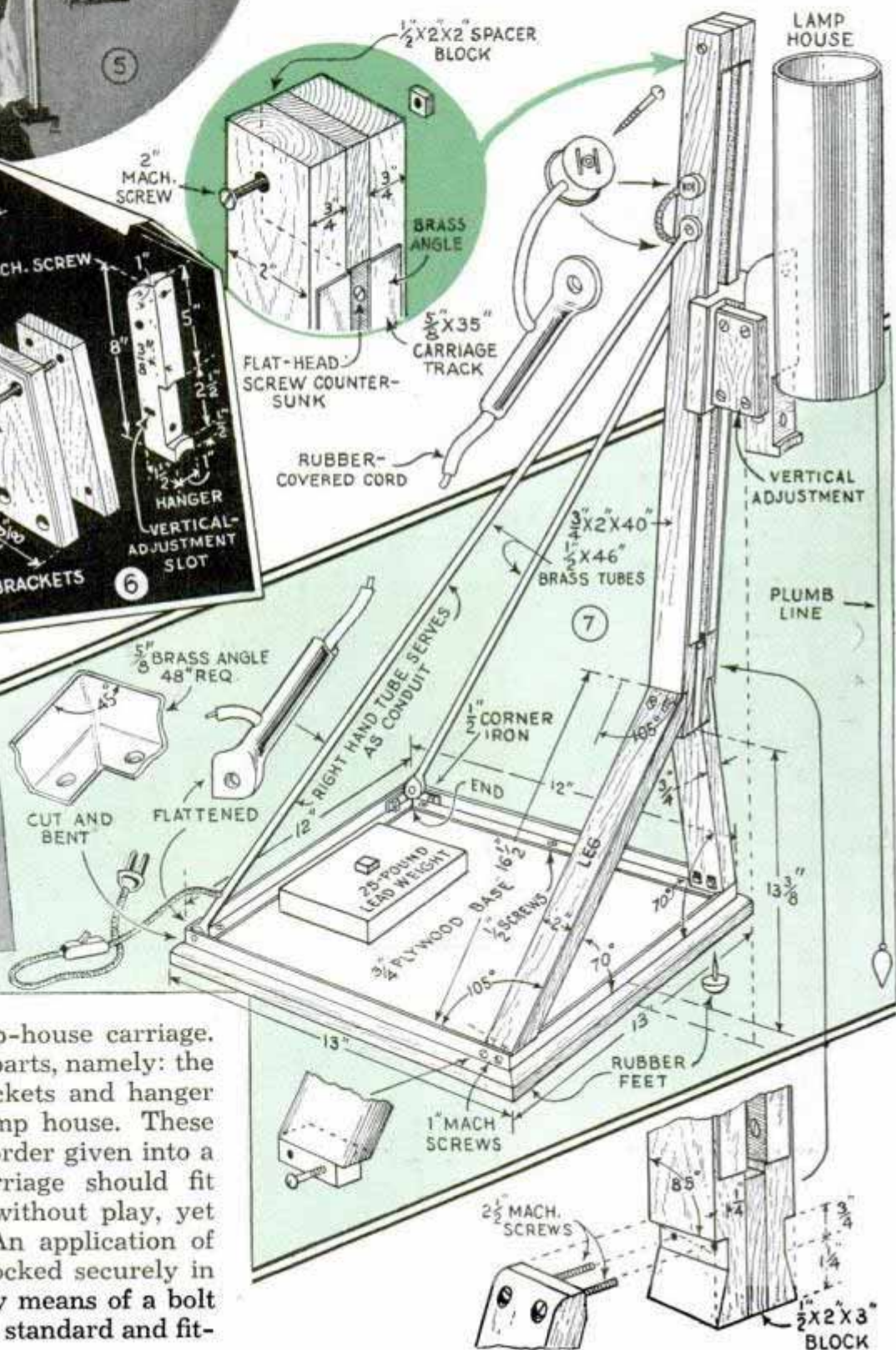
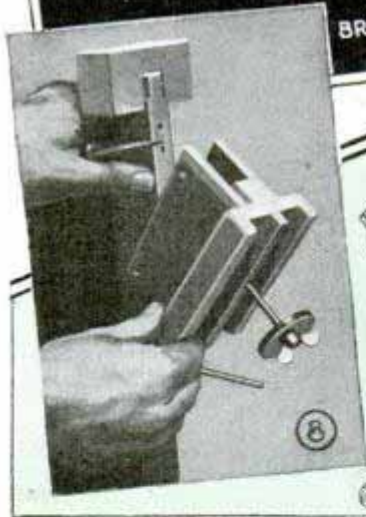
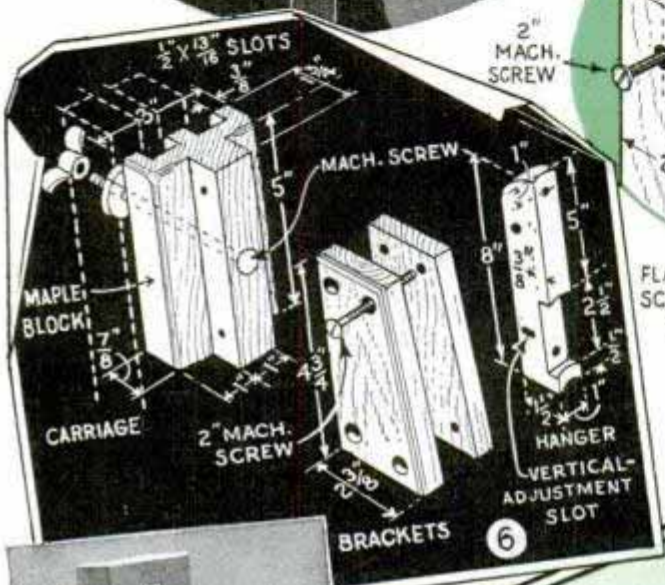

mensions for the lamp-house carriage. This consists of three parts, namely: the carriage, and the brackets and hanger which support the lamp house. These are assembled in the order given into a single unit. The carriage should fit snugly in the track, without play, yet should slide freely. An application of wax will help. It is locked securely in the desired position by means of a bolt extending through the standard and fit-

The lamp house, Fig. 10, is made up of several standard items which are improvised for the inner parts. The shell is of brass tubing, the upper end being capped with a rabbeted wood disk through which the light fixture is suspended. The lower end of the tube is attached to the built-up negative holder which is detailed clearly in Figs. 2, 3 and 4. This is made up in sandwich form to accommodate the lower end of

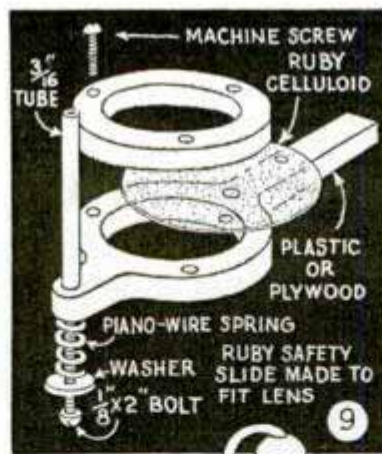

Three complete turns of the handle are possible before the image fades into a blur. This fine ratio gives sharp definition to your print

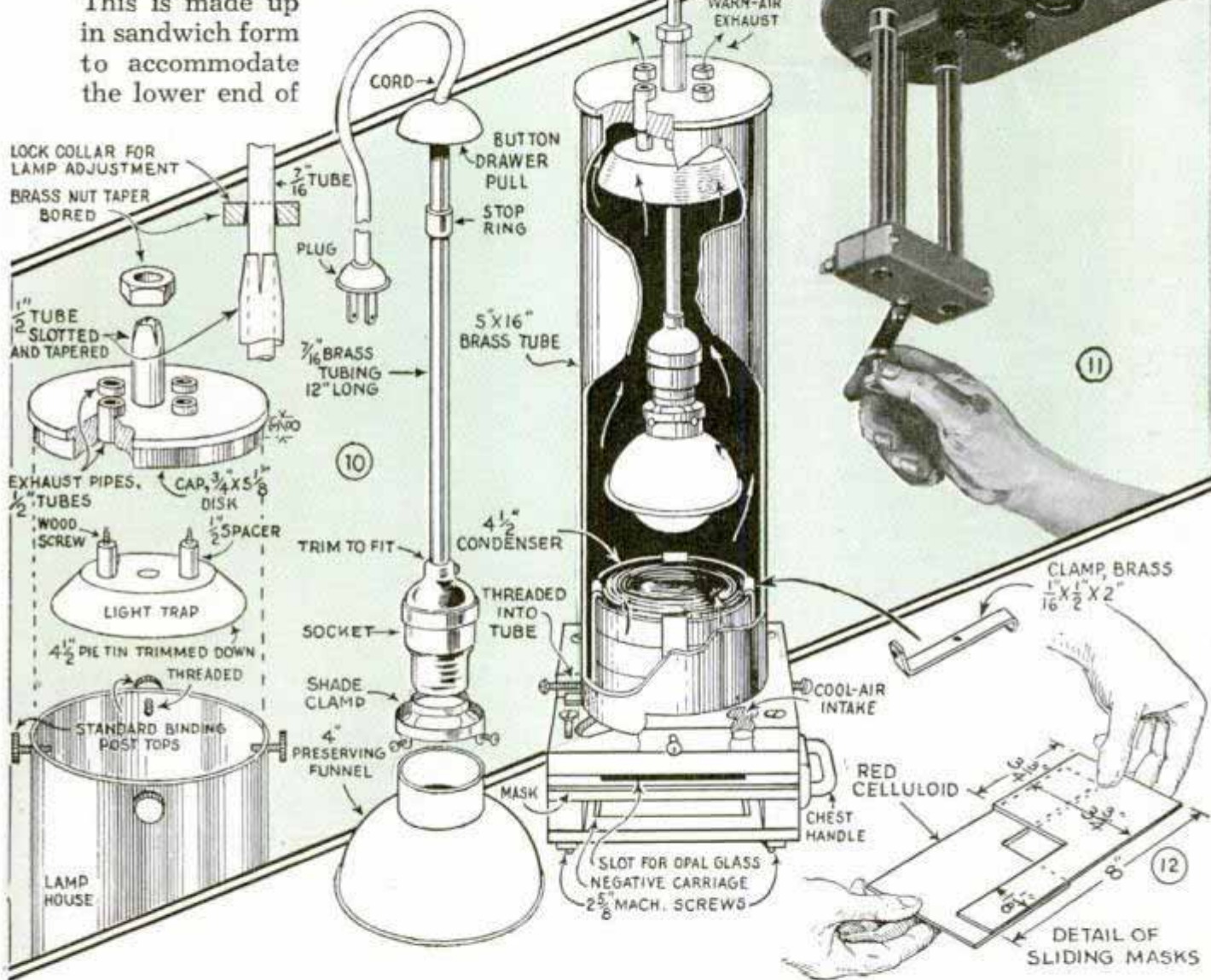

the lamp house, a standard 4½-in. condenser, opal ground glass, masks and a film carrier. The opal glass is provided to diffuse the strong light passing through the condenser, while the masks, Fig. 12, permit undesirable portions of the negative to be blocked off. The film-carrier will accommodate 35-mm. film, and cut films up to 2½ by 3½ in. The condenser is clamped in the assembled unit with four brass strips bent as shown in Fig. 12. These engage in

notches cut in the underside of the top layer, Fig. 2, and are held with set screws which pass through tapped holes in the lamp house and butt against the strips.

To the lower end of the lamp-house hanger is attached the focusing unit shown in Figs. 11 and 14. The lens board travels vertically on two parallel tubular guides by means of a lead screw supported in small ball bearings mounted in head and foot blocks. Mount the bearings so that

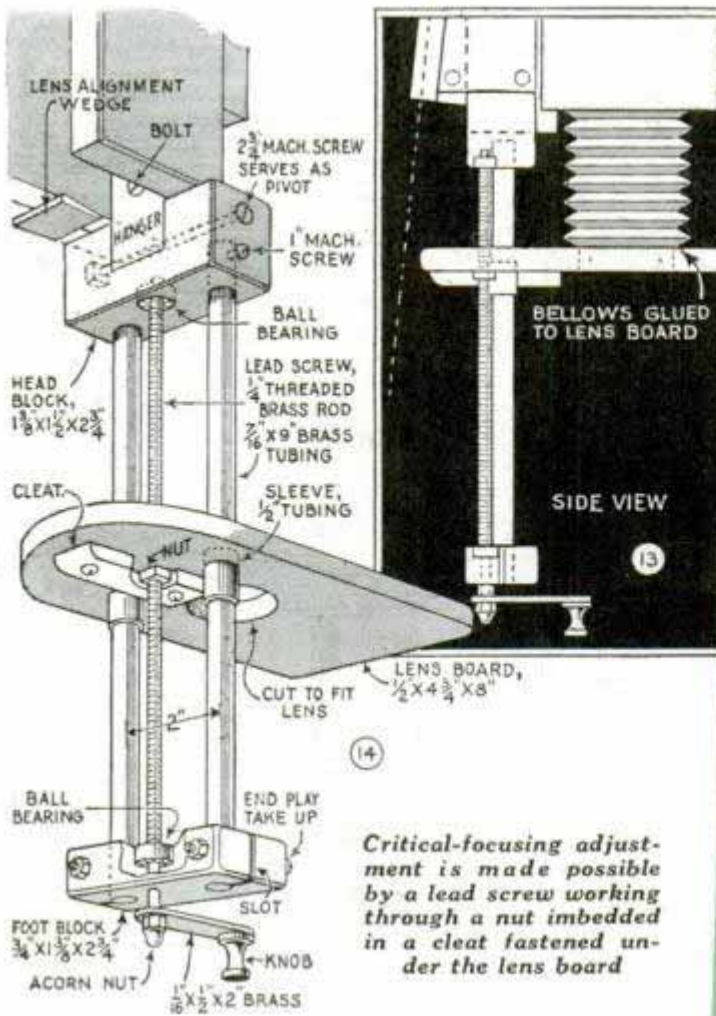

Critical-focusing adjustment is made possible by a lead screw working through a nut imbedded in a cleat fastened under the lens board

the thrust bears against the outer race. These as well as the sleeves and lead screw should be kept clean and oiled. A swinging ruby shield, Fig. 9, which serves as a safelight and allows the bulb in the lamp house to burn continuously while in use, is attached to the underside of the lens board as shown in Fig. 11.

If you prefer making the bellows instead of purchasing it, Fig. 15 shows successive steps to follow in folding one of paper or heavy cloth. To make it fold properly, the end pleats must be reversed alternately. That is, if the crease is inward, press it outward. Make a complete round of each fold before starting the next. When completed, the bellows is glued in place over the opening in the lens board and to the underside of the lamp house, as shown in Fig. 13.

It is recommended that a lens of high quality be mounted in the lens board, preferably a F. 3.5 or F. 4.5 having a focal length of $3\frac{1}{2}$ in. and an iris diaphragm of at least an F. 22 stop. Such type lens, made expressly for enlargers, can be purchased from camera or optical supply houses. While the construction of the lamp house permits the use of much larger bulbs without excessive heating, a 60-watt bulb will

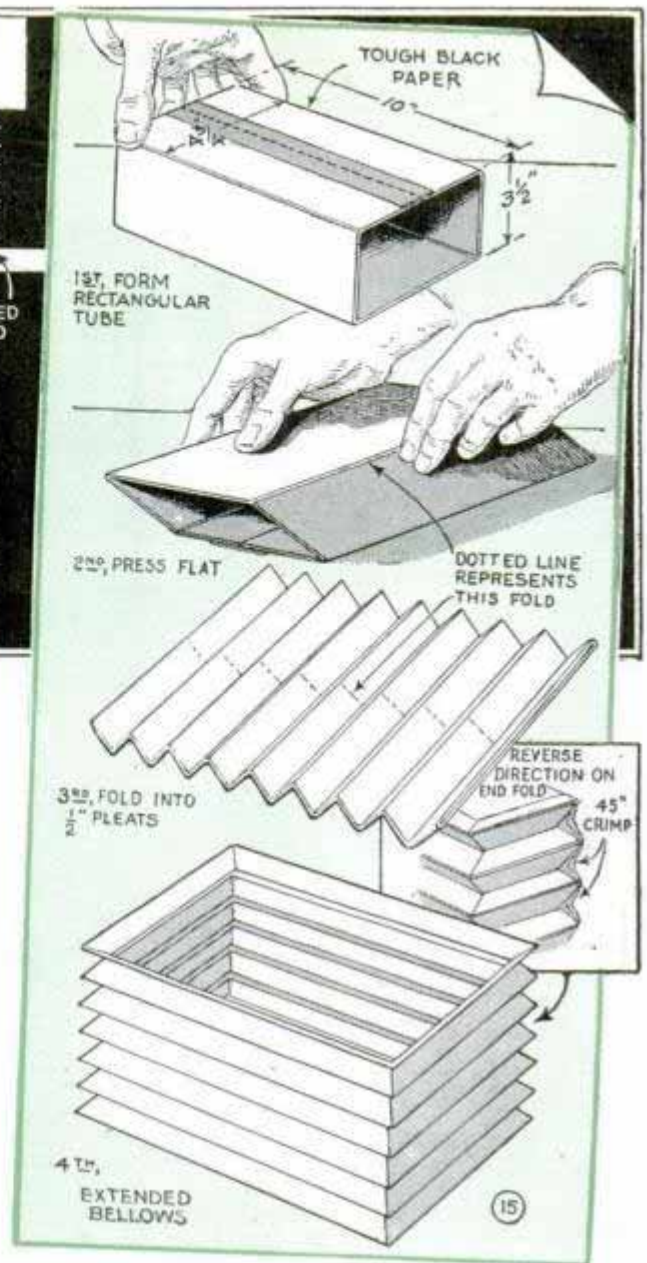

be found adequate. If 110-volt current is not available, a high-intensity searchlight bulb may be used, operating it from a regular 6-volt storage battery.

'Shock Absorbers' on Light Stand Protect Bulb Filaments

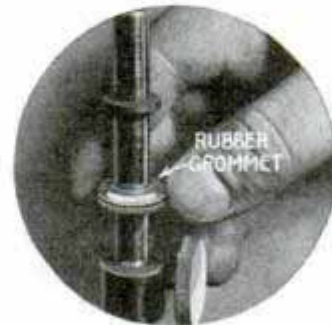

When a telescoping reflector stand is lowered quickly, the shock caused by the sections coming together is sometimes sufficient to break the filament of a photoflood bulb. If the stand is taken apart and a soft-rubber grommet slipped over each section, the grommets will absorb the shock and prevent injury to the bulb.

Simple Viewer to Check Your Photo Negatives

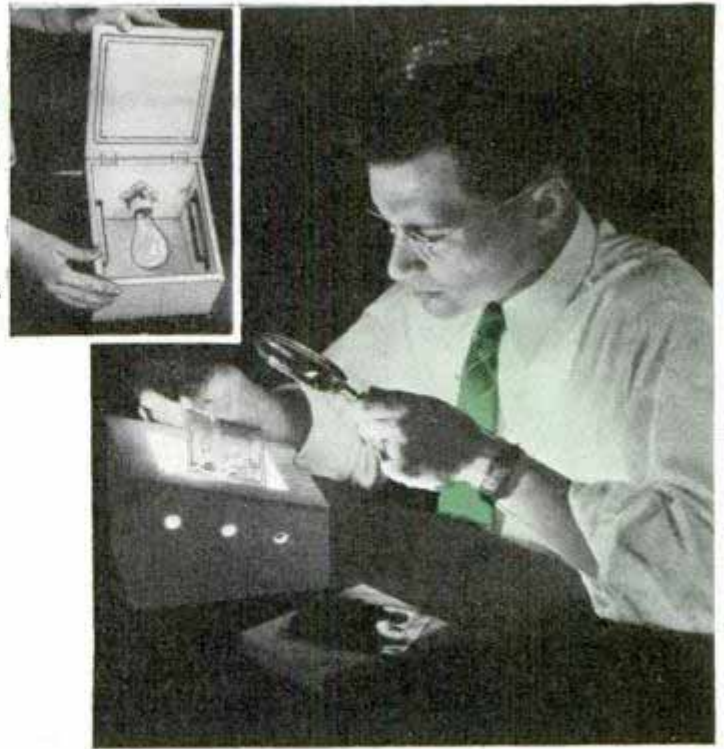
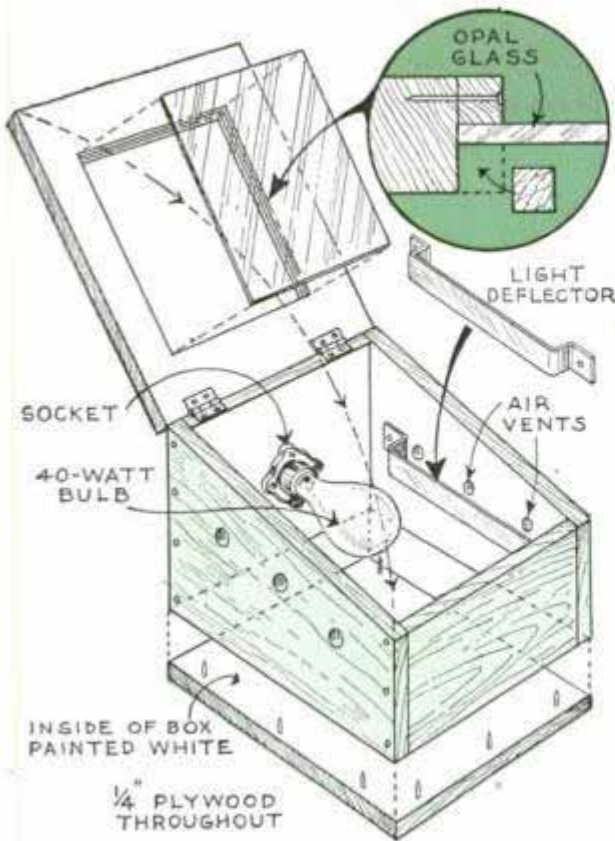

Amateur photographers will find this viewer handy for examining negatives or color transparencies. It is nothing more than a small plywood box having a sloping, hinged cover, which has an opening cut in it to take a piece of frosted glass, which is

mounted as indicated in the circular detail. A socket and lamp inside the box are wired to a switch mounted at the back for controlling the light. Ventilating holes are cut in the sides near the top. Strips of sheet metal painted black are fastened about $\frac{1}{2}$ in. behind the holes to prevent direct rays from escaping through them.

Lettering Lines Scored on Glossy Prints with a Ruling Pen

Uniform lettering can be done on glossy photographs if guide lines are first scribed with a ruling pen. Set the jaws of the pen as wide as the letters are to be high and draw it very lightly across the print. The lines will show well enough to do the lettering but will not be noticeable afterward.

Trimming Picture to Fit Frame



Although the method shown here is very simple, it is seldom thought of when it is necessary to trim a picture to fit a frame. Remove the glass from the frame and lay it on the picture, moving it until it covers the desired part. Then trim around the edges with a sharp knife or a razor blade.



Burned-Out Electric Fuses Used as Water-Color Cups



Electric fuses having glass cases provide neat cups for holding small amounts of water color used for tinting snapshots and

photographs. Just remove the metal parts, fill the glass cup with color and you are ready to start work.—C. M. Black, Chicago.

Safety Pocket Scriber Made Easily from Automatic Pencil

An ordinary ten-cent automatic pencil can be converted into a pocket scriber by merely substituting a No. 55 drill for the lead. The drill is ground to a sharp point and hardened before using. As the pencil mechanism will pull the drill in and out of the end in the same way that it would the lead, this gives you a scriber that can be carried safely in the pocket and is also already fitted with a pocket clip.

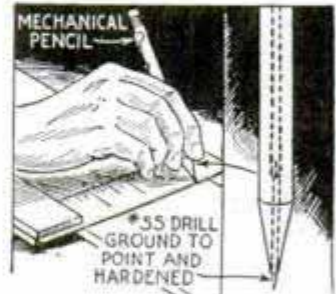

—Ralph H. Graham, Gatun, Canal Zone.

YOU'LL BE PROUD of *These* MODELS

Do you want a model of one of the most outstanding warships in history? Then build the "Sovereign of the Seas." Complete information on the construction of this ornately decorated and highly picturesque model, 34 in. long and 26 in. high over all, is given in our plans Nos. 828 to 835 incl., priced at \$1.50. Descriptive text in bound book, \$1.00 additional

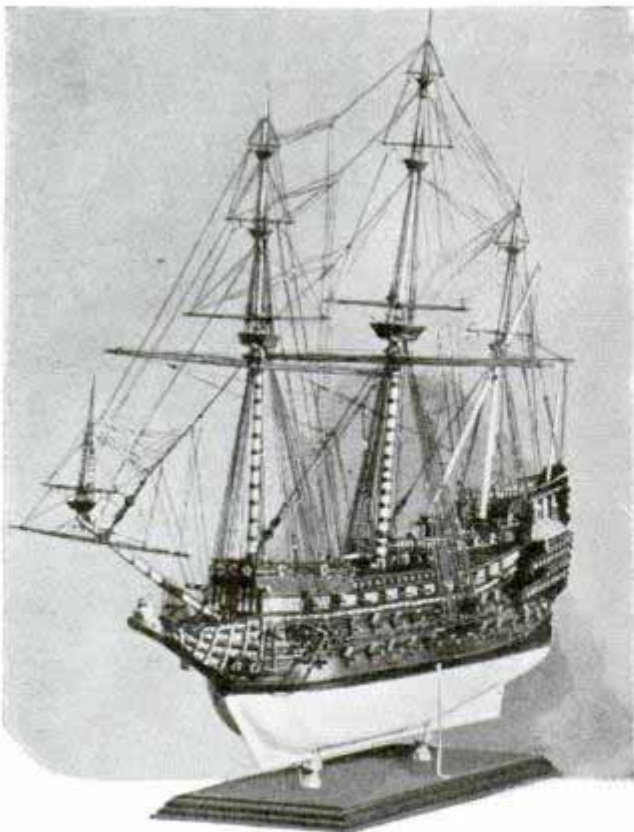

Other Worth-While Models

"Flying Cloud" Clipper Ship—709 to 714A: No collection is complete without a clipper. Plans include full-size lift templates. \$1.25. Descriptive data in book form \$1.25 extra.

"Grecian Trireme"—1036 to 1039: A model that is decidedly unusual. Hull is carved from 36-in. length of 2 by 6-in. fir. \$1.00.

"Half Moon"—717 to 718A: Model of boat used by Dutch Seaman, Henry Hudson. Fine example of ships of early 1600's. 24 in. long. \$1.00.

"Atlantic" Locomotive—1032 to 1035: Working model of world's first mountain climber. 1/48th actual size. Runs on 0-gauge track. \$1.00.

"Railplane"—1040 and 1041: Latest design in air-propelled streamlined locomotives for attic railroaders. No machine work required. 50c.

"Sea Bee"—965 to 968: 32-in. speed boat for circular race courses. Powered by midget gas engine. Develops speed of 20 to 25 m.p.h. \$1.00.

Model Colonial Cannon—735: Perfect 10-in. miniature of guns used during days of 1776. 25c.

Any six individual plans (not sets of plans) will be sent postpaid upon receipt of \$1.00

Address—Popular Mechanics Plan Service, 200 East Ontario Street, Chicago, Ill.

R A D I O



TINY PERSONAL RECEIVER

ONE of the smallest practical radio receivers ever built, this completely self-contained battery portable has built-in antenna, and no exposed controls. Despite its compact size and 4-lb. weight, it is claimed to be able to pick up stations 50 or more miles away by day or night.

Four miniature RCA tubes, a little more than an inch in length, were designed especially for the receiver and developed after three years of research. It operates on the two batteries, an A-type (ordinary flashlight variety) of 1½ volts and a new type 67 ½-volt B-battery. Housed in a black metal shell measuring approximately 9 in. long, 3½ in. wide and 3 in. deep, it is equipped with a strap so that it may be slung over the shoulder, like a camera. A black steel cover, containing an inbuilt loop antenna, protects the speaker and dials. Raising the lid turns the power on automatically. Space is provided on the chromium face of the cover for the owner's initials.



Suitable for use in home or office as indicated in photo (1), it is carried as shown in photo (2), or the shoulder strap may be employed if desired. Photo (3) is an interior view with bottom cover removed.

The receiver covers the standard broadcast band and may be used in hotels, on trains, boats or in cars to hear important world news. An efficient built-in speaker provides

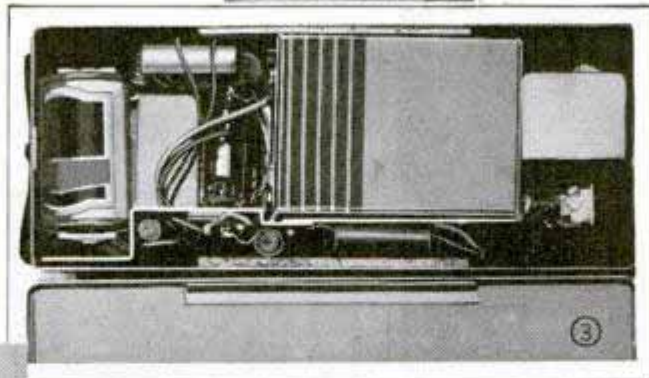

entertainment for small groups at the beach, on hikes, picnics or skating parties. Similar larger portables are frequently seen at baseball and football games, the owners listening to sports announcers broadcasting the game, play by play, over local stations.



Photo (3), interior view showing A and B-batteries in position; (4), comparative size as indicated by cradle-type phone

LOW-COST RECEIVER



HERE is an easy-to-build set for the experimenter who wants not only a receiver but also an amplifier for playing phonograph records. The unit is inexpensive, thanks to the simplicity of the two-tube circuit which employs a pair of the new dual-purpose tubes, yet has over a watt of good clean audio output with surprisingly good tone quality.

Two volume controls are provided on the set, so that the "radio" section can be shut off and the amplifier portion of the receiver used to amplify the output of any inexpensive "record player." Suitable record players, complete with pick-up and motor-driven turntable, are available at prices ranging from \$6.00 up. The more expensive the player, of course, the better the tone quality.

The tubes used in the unit are the 25B8-GT and the 70L7-GT. The former is a combined pentode and triode used as an r.f. amplifier and power detector, while the 70L7-GT serves as a rectifier and beam-power output tube. When employed as a phono amplifier, the triode section of the 25B8-GT provides a driver audio stage, swinging the 70L7-GT to an output level which is sufficient for the average room if the volume control is turned on fully.

To simplify construction the set is built in an open "panel-chassis" layout. A standard 2 by 7 by 9-in. chassis base, available from radio parts houses for about 40 cents, is punched and drilled as shown in Fig. 1; the front panel consists of a piece of Celotex, 1/2 by 8 by 10 in., cut and drilled as detailed in sketch, sanded, and given a coat

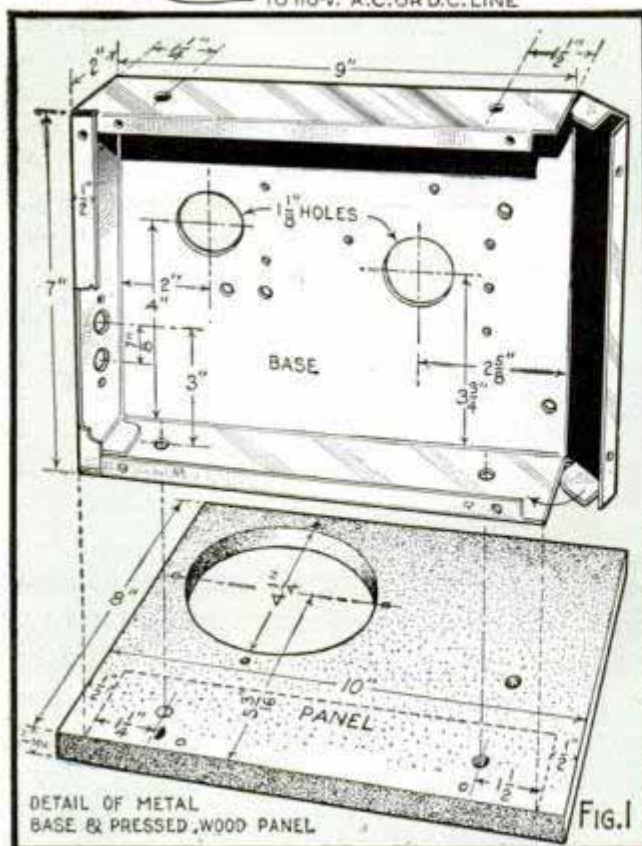
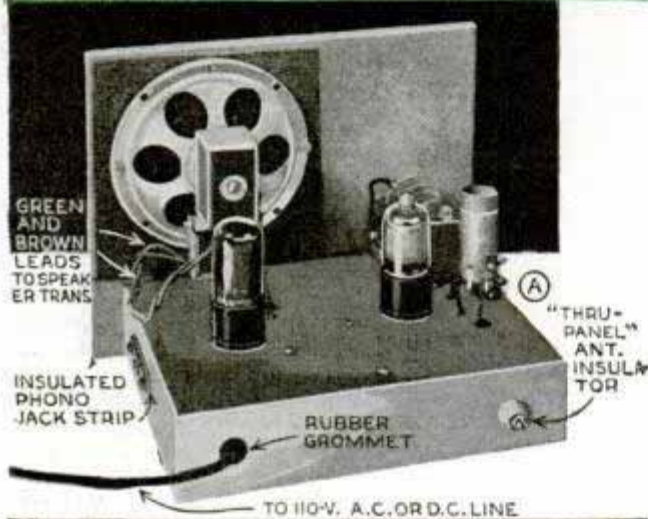

and PHONO AMPLIFIER

of aluminum paint. This panel provides an excellent baffle effect and adds materially to the tone of the set. The speaker is a 5-in. permanent-magnet dynamic type bolted to the panel against a piece of grille cloth as indicated in photos A and B. This speaker comes with locking lugs for mounting the speaker output transformer in the position shown in photo C.

Although the circuit is a little unusual, wiring is quite simple, all connections being indicated clearly in the simplified wiring diagram, Fig. 2, and schematic circuit diagram Fig. 3. Please notice that the chassis base is not used for the standard "ground return" leads as all of the B negative leads are carried on insulated tie-strips instead. Rubber insulating grommets are employed where it is necessary to run leads through the chassis. A large rubber grommet is also used to pass the power cord through the chassis base. It will be noted that the r.f. coil (L_2) is mounted on top of the base by means of a small bracket, the position of which determines the numbering code employed in the diagrams. Antenna coil (L_1) is installed in a horizontal position under the

(Continued to page 132A)

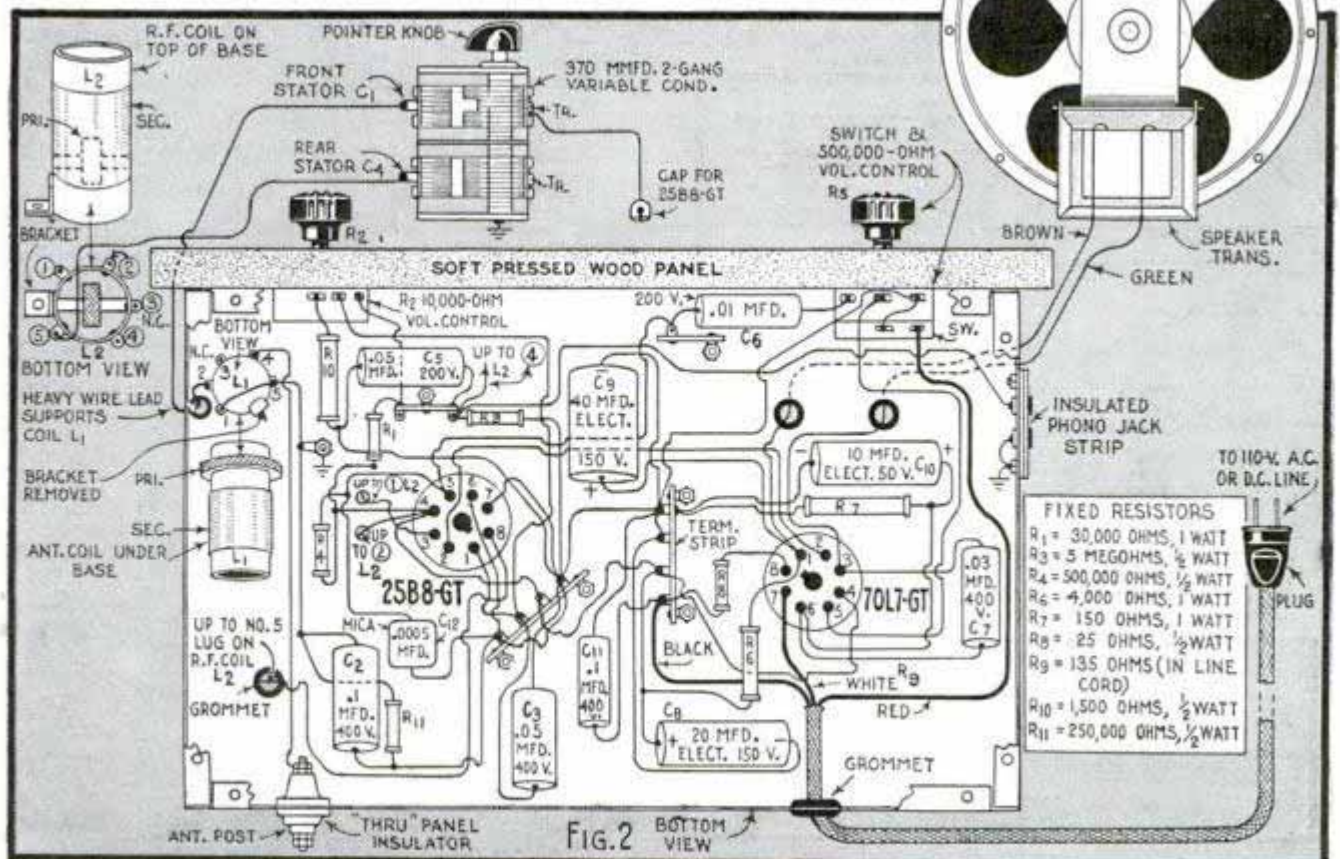
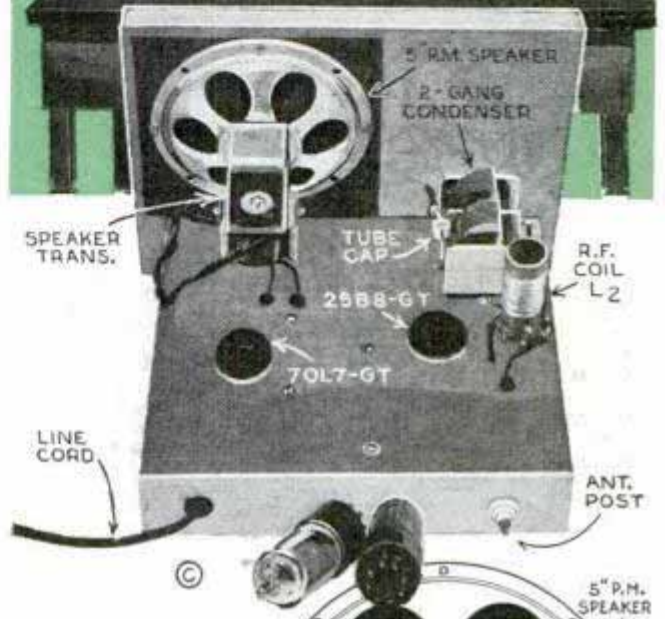
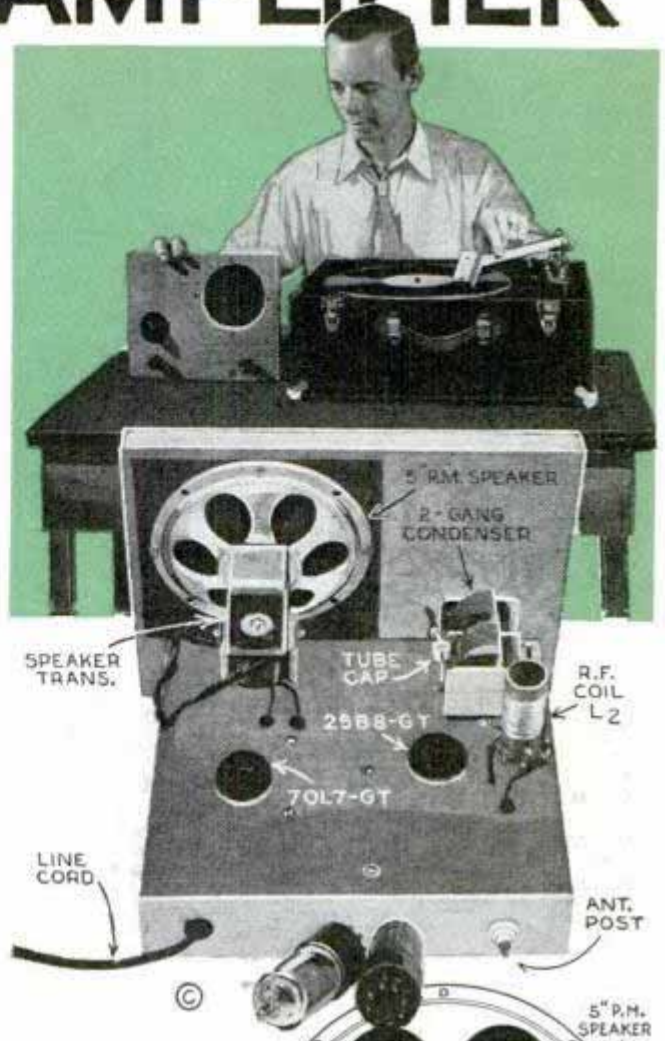

"Snapshots in Sound" by Home Recording



HOME recordings are like photographic snapshots, one records voices and the other likenesses. Many of the new phonoradio receivers and record players now include recording facilities complete with cutting head, extension cord and microphone. Home recording with these units provides the owner with a means for making his own library of "snapshots in sound"—of the voices of his family and friends, of parties and state occasions, and of important radio broadcasts. It also offers many practical applications in addition to furnishing entertainment. The records may be played back immediately.

The portable unit (A) is a recording record player for making and playing records of any type in conjunction with a modern receiver, thus combining the functions of a record player and recorder. Photos (B) and (C) show table model recorder-radiophono combinations; the girls in the lower photo are making a recording of piano and song for their collection. Although anyone can soon learn to make good recordings, a few pointers for the beginner will be helpful. When making records, a tiny weight-limiting scale should be used, as shown in Fig. 1, to adjust the cutting head to the manufacturer's specifications. Correctly adjusted needle for accurate tracking when playing back records will prevent uneven wear on a needle point and greatly increase the useful life of the record, as clearly shown in Figs. 2 and 3.

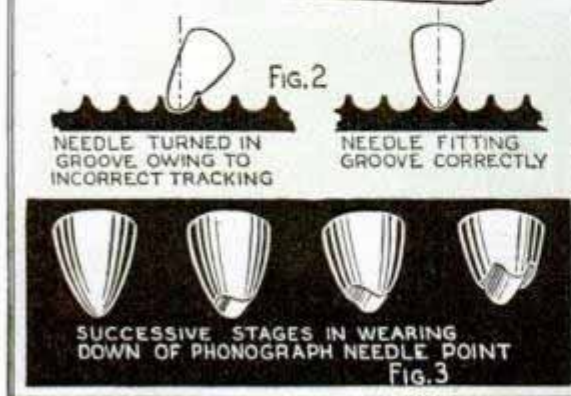

Practical RADIO SUGGESTIONS

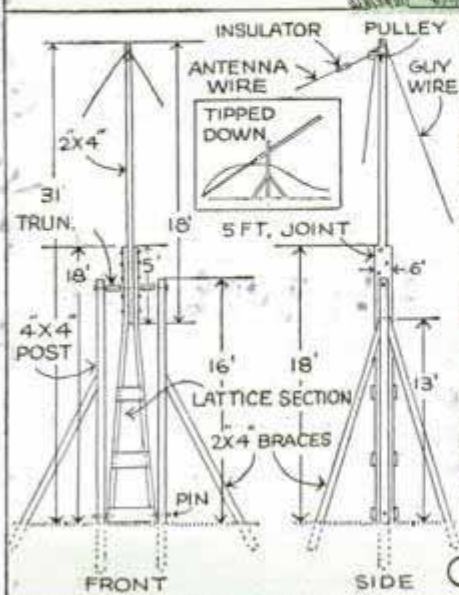

(1) "Well-sweep" antenna mast makes adjustments easy. Sweep support made with two 18-ft. 4 by 4-in. pieces placed 4 ft. apart and set 2 ft. in cement. Braces, with ends in concrete, support uprights. Mast proper is an 18-ft. 2 by 4-in. piece and two 3/4 by 6-in. pieces 18 ft. long lapped as shown; bottom ends are spread 3 1/2 ft. apart. Mast is counter-balanced on 3/4-in. pipe trunnion and spacing blocks

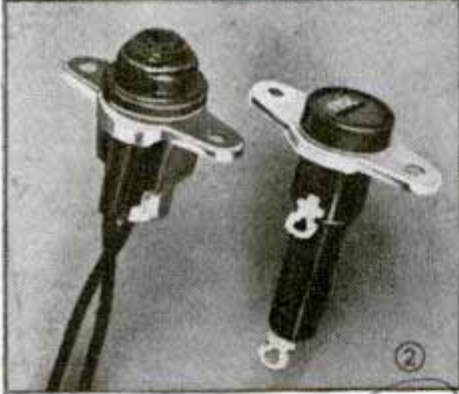

(2) Compact jewel pilot-light assembly and a fuse holder which mount directly on panel or base by means of two small machine screws. Fuse holder has slotted top for screwdriver removal to replace fuse.
 (3) Simple wave trap eliminates amateur code interference in broadcast receivers; standard or home-made plug-in short-wave coils used. Winding given is for 80-meter band. Inexpensive coils are available for all amateur bands

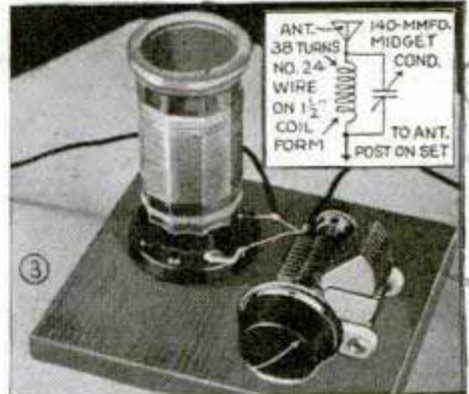

(4) Center-tapped resistors made from carbon rods removed from old flash-light cells. Carbons are boiled in strong soda solution and dried.
 (5) Small bench vise made from strap hinge. (6) Miniature filament-type pentode tubes; A-battery drain for 2 tubes in series is only 30 milliamperes at 1.4 volts.
 (7) "Accordion edge" speaker for low-frequency response in small cabinets. (8) High-impedance iron-core R.F. choke of improved design

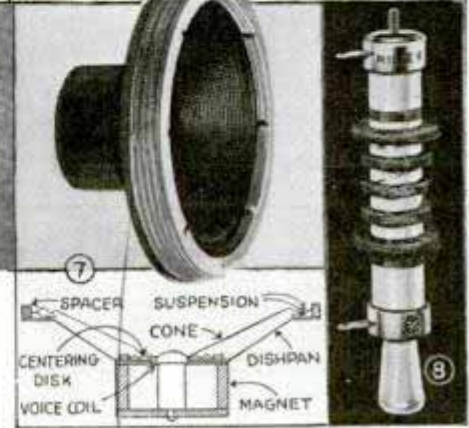
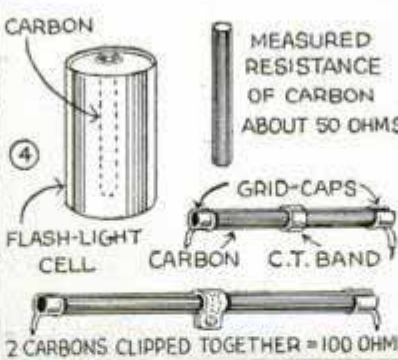

Right, cross-sectional view of loud-speaker with an accordion-type suspension

Raytheon Production Corp
 55 Chapel St., Newton, Mass
 RCA Victor Co.
 Camden, N. J.
 James Miller
 malden, mass

Over-the-shoulder portable set
**Over-the-Shoulder Portable Set
 Is Light and Compact**



Less than 5 in. high, 10 in. wide and 4 in. deep, this strap-around portable uses a specially designed shoulder strap in which the antenna is braided and concealed. Fifty inches of antenna surface make pick-up simple, no matter where the set is used.

Ten-Tube 35-Watt Mobile Unit



This improved mobile public-address amplifier is entirely self-contained; there is no power pack to buy or attach. Ideal for both rural and city districts for use with sound trucks, or at dances, carnivals and political meetings, it operates eight speakers without external transformers. A 12-in. turntable is included with an "off-

on" switch so that the amplifier can be operated with or without phono. Operates on 6-volt battery or 110-volt a.c. line.

D.C. to A.C. Phono Inverter

Midget phonograph inverter for operating a.c. motor-driven phono turntables on direct-current lines. Inverts 110 volts d.c. to 110-volts a.c., 60 cycles at 15-watt output. Also works electric razors and similar a.c. devices.



Five-Tube Radio in World Globe

Housed in a world globe, this unusual receiver employs five tubes and speaker in a compact chassis; two tubes are dual-purpose types. Set is tuned by revolving the globe. Switch, volume control and pilot light are located on base.



Blueprints covering radio construction articles in this and past issues are available for 25 cents each. Original material lists, with names of manufacturers and dealers, can be obtained from our Radio Department upon receipt of postage.

NEXT MONTH—How to Build an A.C.-D.C. Two-Tube All-Wave Receiver. A simple and efficient all-wave set with standard plug-in coils; easy to build, low in cost and an excellent performer on broadcast and short waves. Operates 5-in. speaker. Also—**How to Build a Combination Crystal Receiver and Test Set**

Montgomery Ward Dept. 10 Chicago

American

*Dr. Paul Mumm
 Radio Co. 200 E. 4th
 Dayton
 Mitchell, Mfg. Co. 1550
 Chicago*



SHOP NOTES

When and How to SPOT-WELD



By J. B. MULLEN

NEW possibilities in the field of sheet-metal work are open to a craftsman who is efficient with a spot welder. It enables him to build articles that he would not attempt to put together with other types of fastenings. Sheet-metal cabinets and shelves, small tables, tool racks and supports, cases, tackle boxes, and toys are among the many articles on which spot-welding can be used to advantage.

Spot-welding technique: Spot-welding is a simple process in which two metal parts are welded at a series of points or "spots" along the seam joint. The work to be joined is placed between the electrodes, or welding coppers, as shown in Fig. 2. Pressure on the foot pedal or hand lever brings the electrodes together, thereby pressing the parts into intimate contact and at the same time causing the heavy welding current to flow through the joint. The heat thus produced fuses the parts together.

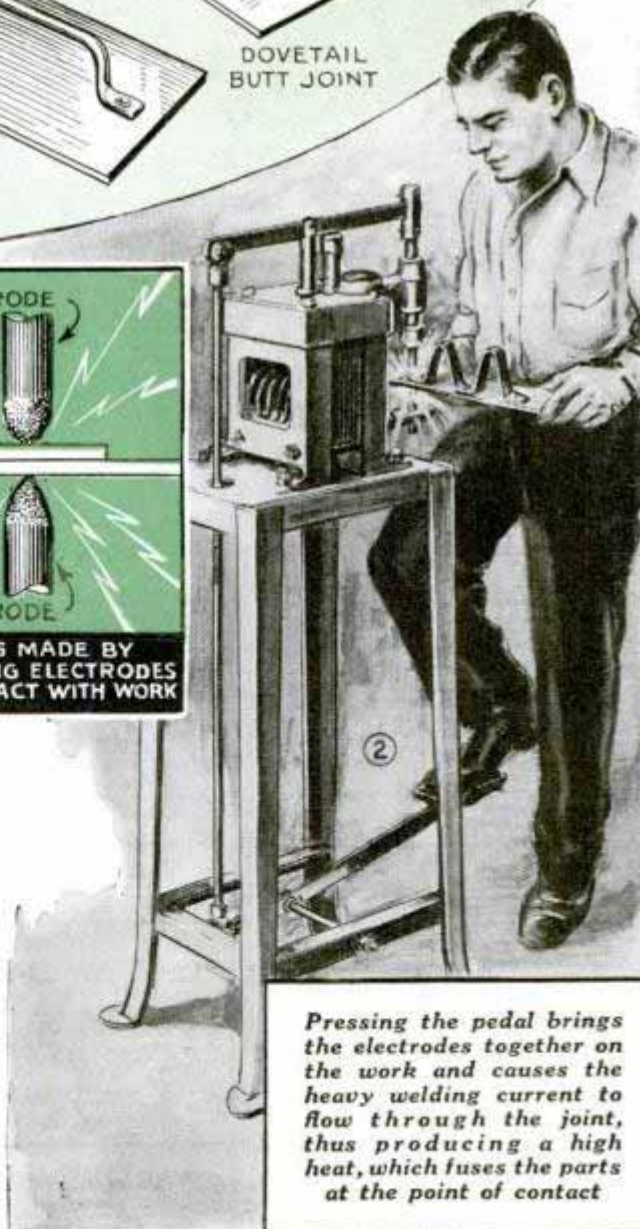
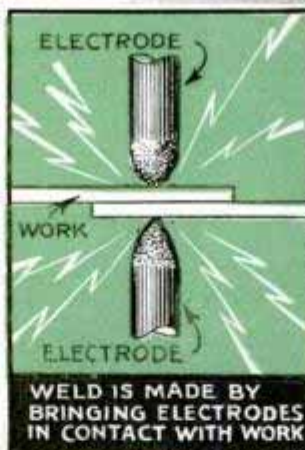

Pressing the pedal brings the electrodes together on the work and causes the heavy welding current to flow through the joint, thus producing a high heat, which fuses the parts at the point of contact

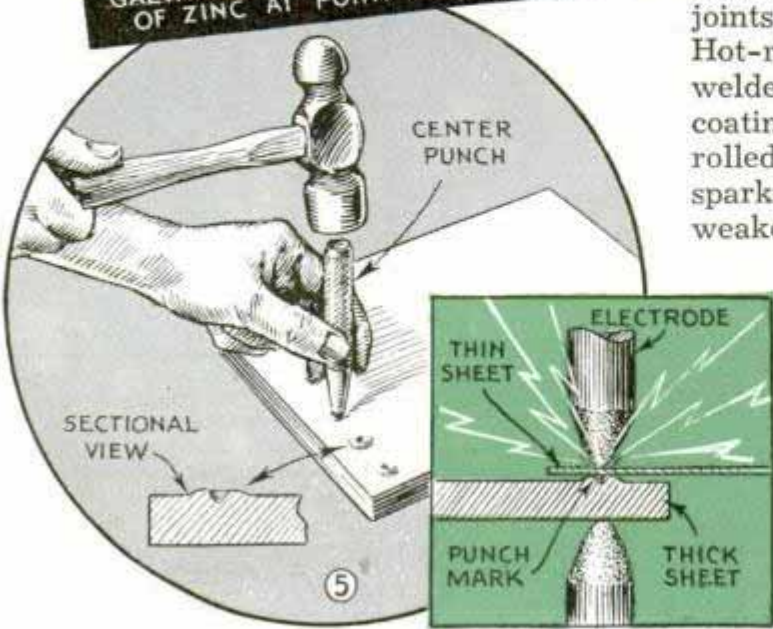

er at the point of electrode contact, producing a spot weld.

With a little practice, excellent welds on a variety of metals up to $\frac{1}{16}$ in. in thickness can be made on small, low-priced spot-welding equipment. However, aluminum, copper, and alloys such as brass containing these metals cannot be spot-welded successfully on the type of machine usually found in the small shop, as their electrical resistance is too low to generate enough heat except on very high-capacity welders of special design. In spot-welding it is important to use the proper pressure on the electrodes and not to hold the current on for too long a time. If too much pressure is used, there will be a pronounced "dimple" at the spot weld, while if the current is left on for too long a time, burning of the metal and sticking of the electrodes will result.

Preparation for spot-welding: It is essential in spot-welding, as in any type of welding, that the work be thoroughly clean and free from grease and oily matter. Scrubbing the metal with a stiff brush in hot soapy water containing a little washing soda will generally remove this oily film, Fig. 3. The work should be rinsed well in hot water to remove all soap, and then dried before welding. In some cases, additional preparation is necessary to remove plating, rust, scale, or other surface coating and expose a clean metal surface suitable for welding.

Spot-welding iron and steel: No pretreatment, other than removing the greasy film, is required in spot-welding cold-rolled steel. This metal is primarily a machine-shop material and the sketches in Fig. 1 illustrate time-saving spot-welded joints that can be made on this material. Hot-rolled steels and black iron can be welded in the same manner, but the black coating or mill scale usually found on hot-rolled steels is likely to cause flashing or sparking during welding, and also tends to weaken the weld. Warm, uncut hydrochloric (muriatic) acid applied on the area to be welded, after removal of the grease film, is usually sufficient to remove the interfering coating in about a minute. The acid should be rinsed off thoroughly in hot water as soon as the scale has been removed.

Galvanized iron: Zinc coatings on iron or steel tend to produce a

weaker and more brittle weld and make corrosion of the electrode tips more rapid. Where there is any strain on the weld itself, such as in the brackets and supports shown in Fig. 4, the galvanizing must be removed from the surfaces to be welded by brushing them with hydrochloric (muriatic) acid diluted with an equal quantity of hot water. After one minute, rinse the acid off with hot water and dry the pieces thoroughly before welding. The weld can be protected against rust by a coating of good aluminum paint.

On small parts made of galvanized iron, in which there is no strain on the weld and strength is not important, it is possible to make a "tack" weld to hold the parts in position by spot-welding. However, the weld will be brittle and it is recommended that the zinc coating be stripped off before spot-welding galvanized iron.

Tin plate (terne plate): Tin coatings on steel cause little or no interference, and a joint made by spot-welding tin plate is strong and durable. Cleaning other than removing grease is not necessary. Tin plate will be found excellent for making air ducts, vents, small boxes or containers, and numerous other articles on the spot welder.

Stainless steel: Since stainless steels have a high electrical resistance, spot-welding is one of the best methods of joining them. The welds are strong and the stainless properties of the finished object are not impaired at the joints by the addition of other metals, as is the case in other types of welds on stainless steel. The blue discoloration around each spot weld usually can be removed by rubbing the spot with fine emery paper and polishing either on a buffing wheel or by hand.

Applications of spot-welding: Spot-welding can be applied, in general, to any joint or seam in sheet metal in the various metals outlined above. While it is possible to spot-weld heavier stock, it requires very large currents and is beyond the capacity of small welding equipment. Fig. 1 shows a number of types of joints that can be made with a small spot welder. When thin sheets are spot-welded to thick sheets, the latter are center-punched as in Fig. 5. The punch marks tend to localize the heat and a good weld results.

☐ Next time you have to use a radiator brush, slip an old stocking over it.

Drying of Printing-Press Rollers Avoided by Oil Bath

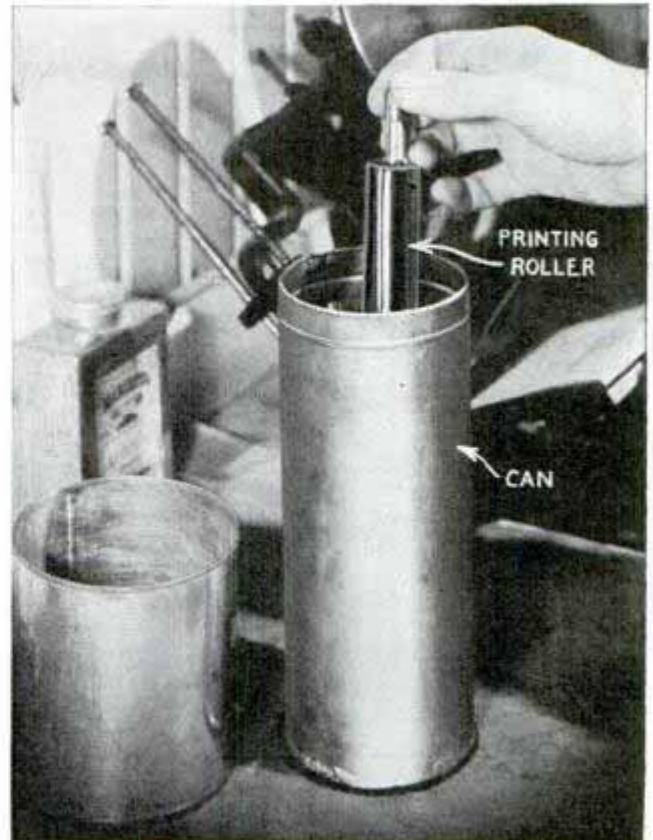

The tendency of glue-coated rollers on a small job-printing press to soften in moist weather and to harden in dry weather, can be avoided by storing them in an oil bath when not in use. A long container that is oil tight will do for storing and is filled with a mixture of kerosene and auto lubricating oil. This is easily washed off the rollers with gasoline.

Cutting Sheet Rubber Accurately

The next time you have some sheet rubber to cut, try covering both sides of it with Cellophane. This tends to prevent the rubber from "creeping" under the blade of the shears. A piece of Cellophane, such as that taken from a package of cigarettes, will serve the purpose for small work.

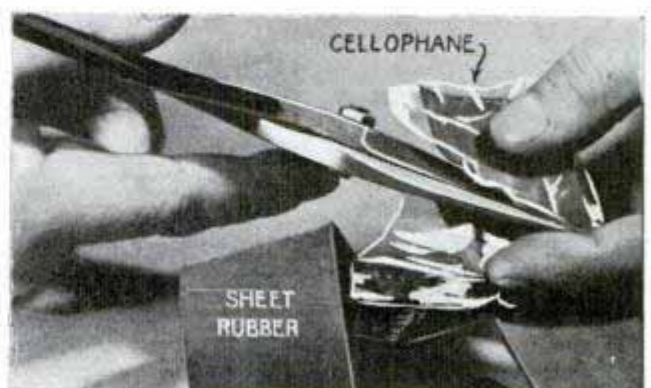

Bolt Ends on Butcher's Block Shielded to Protect Clothes

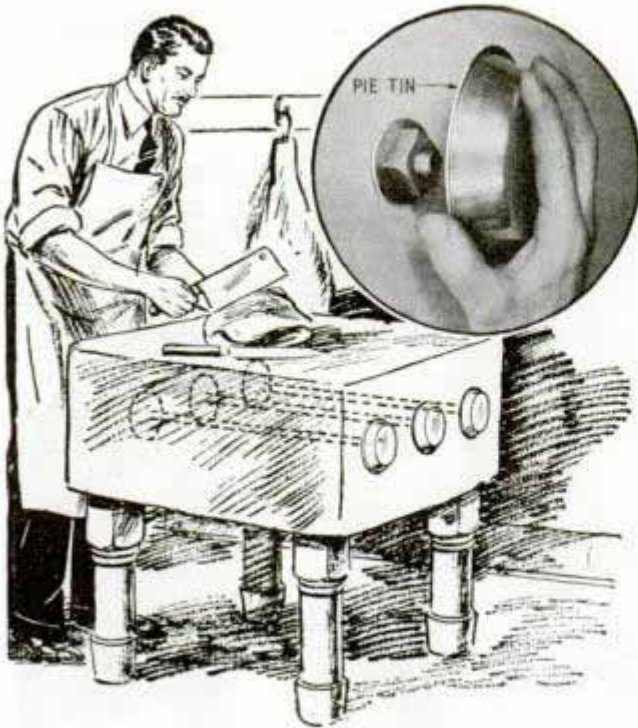

After damaging his clothing on the exposed tie-rod ends of his meat-cutting block, one butcher shielded the ends with metal. Individual pie tins are ideal for this purpose and can be purchased at any ten-cent store. They can be attached with short brads or tacks.

Rubber-Tired Cart Pulled Easily on Soft Ground

Rubber-tired wheels on this cart permit moving heavy loads easily over soft ground. The wheels and axle are the front end assembly from an old car, the wheels being set in a straight-ahead position and the steering arms locked to the axle to keep them in place. The box, which is bolted to the axle, is made of any lumber available and is of a size to hold approximately 12 bushels of corn. A length of angle iron bent to a V-shape and bolted to

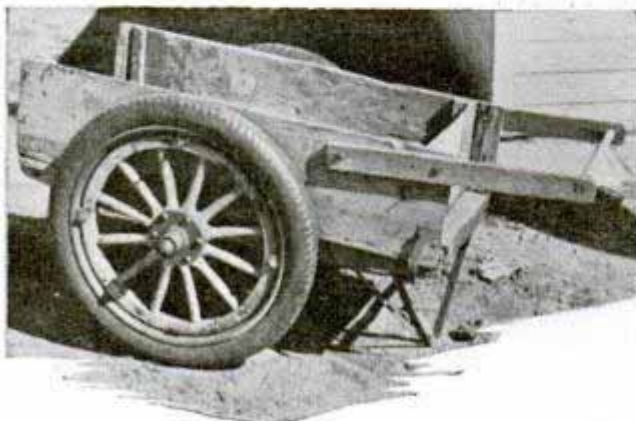

the underside of the box near the rear end serves as a rest to prevent tipping when the operator lets loose of the handles.

Flap over Hook Keeps Calf from Opening Gate

To keep a calf from nosing open the latch of its pen gate, one farmer tacked a flap of fairly stiff rubber over it as shown. The flap prevented the calf from lifting the latch but was easily pushed down by the attendant when the gate was to be opened.

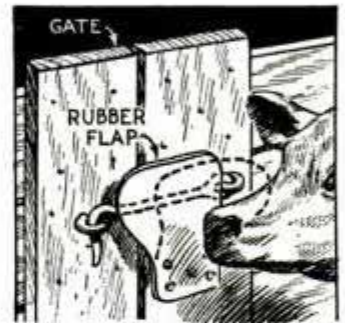

Handling of Molding in Stock Simplified by Color Chart

By painting the ends of molding strips in colors corresponding to those on a chart posted on the wall, a lumber company keeps its stock balanced according to lengths, and greatly simplifies taking of an inventory. Before the strings are cut on

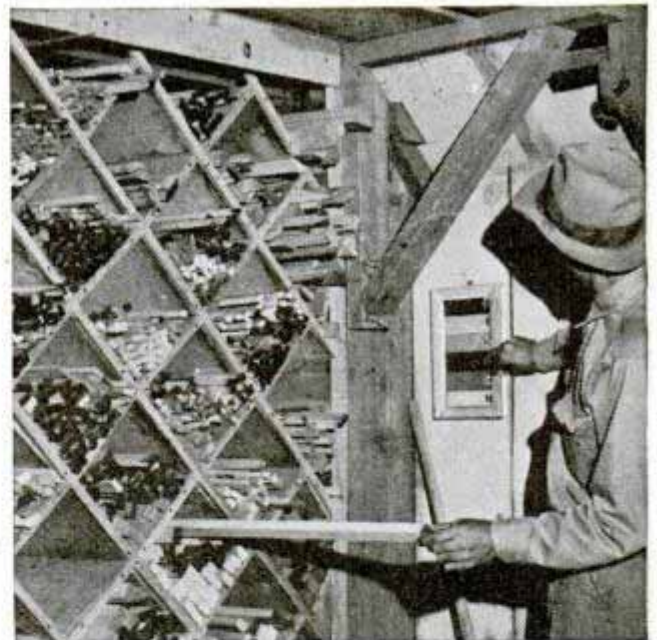

the bundles of each size of molding, a brush full of paint is wiped across the ends of the molding strips, after which the strips are sorted into bins according to sizes. When taking an inventory, the stockman can tell at a glance at the colored ends of the pieces just how much lineal feet of each size he has on hand.

—L. S. Flint, Boulder, Colo.

Straight-Line Graphs to Tabulate Shop Data

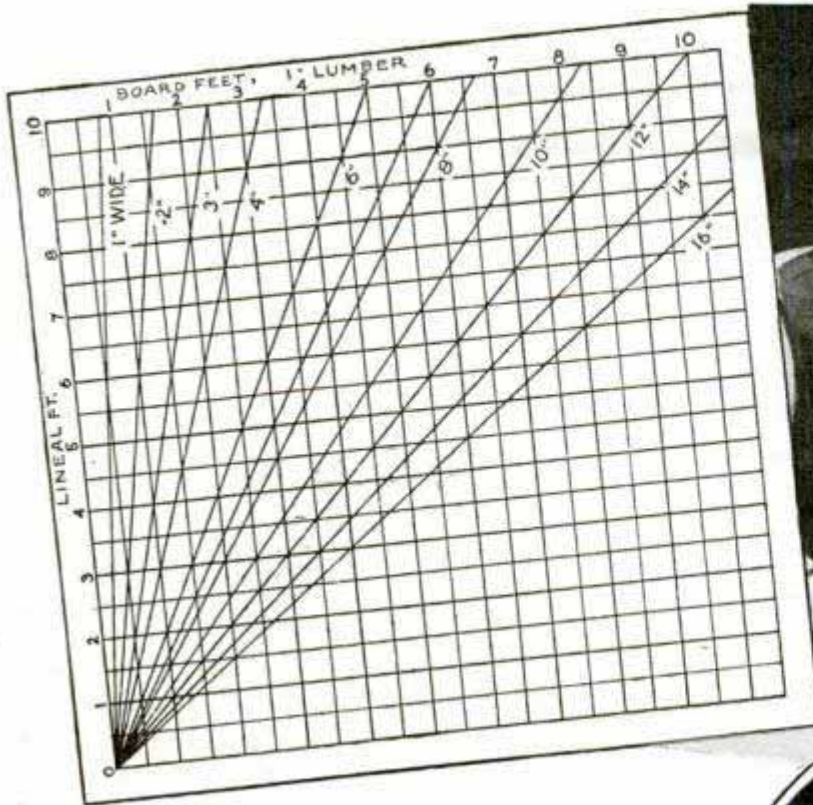

In shops and other places where various values and other information must be computed frequently on the same subject, graphs can be made that will show at a glance the area of sheets of copper, brass, iron, etc., weights of sheets of given gauge, weights of wire of a given gauge and length, as well as the tapers of given lengths of work, number of turns of wire in a given coil layer, number of nails in a pound and dozens of other uses. For example, you can find the number of board feet in any piece of lumber at a glance with the graph illustrated. To make it, on paper marked off in squares, lay out a scale, using the vertical lines to represent lineal feet and the horizontal ones to represent board feet. A 12-in. board 1 in. thick and 10 ft. long contains 10 board feet.

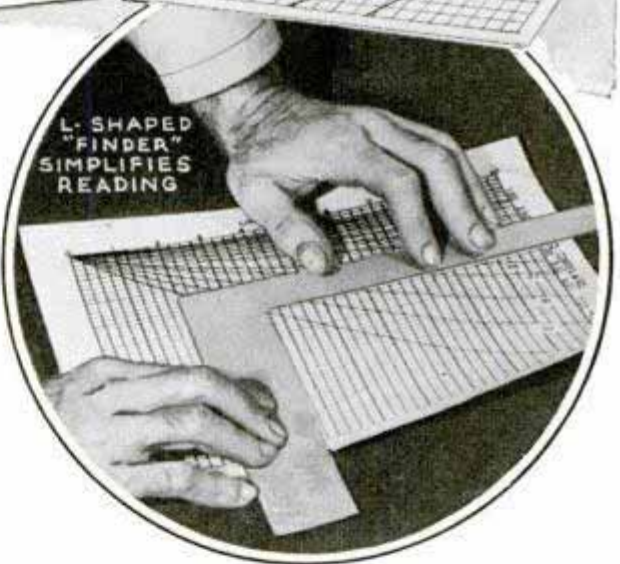

A straight line drawn from 0 to the intersection of the 10-ft. line with the 10 board-foot line shows all possible values in steps of 3 in. in length, or forty values in all, as the result of one easy computation.

Master Plan Inked on Drawing-Board Cover Saves Time

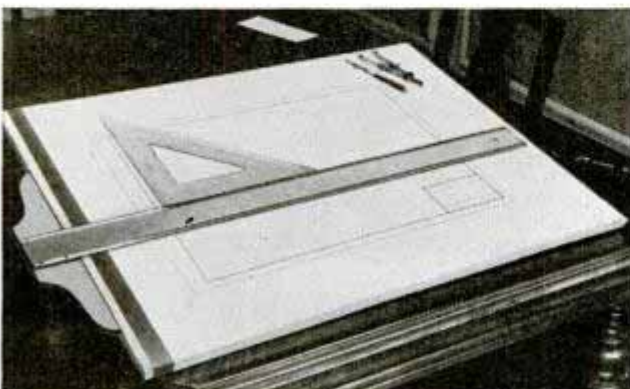

When making a series of sheets, all with the same size margin and title space, time is saved by covering your drawing board with white oilcloth on which these lines are heavily inked. They show through cloth or paper and are easily traced. When finished, they may be washed off with soap and water. The cover also preserves the surface of the board and it will remain smooth and flat much longer than if left exposed.—J. R. Carr, Chicago.

Pressure-Gun Fittings to Grease Wheels of Farm Wagon

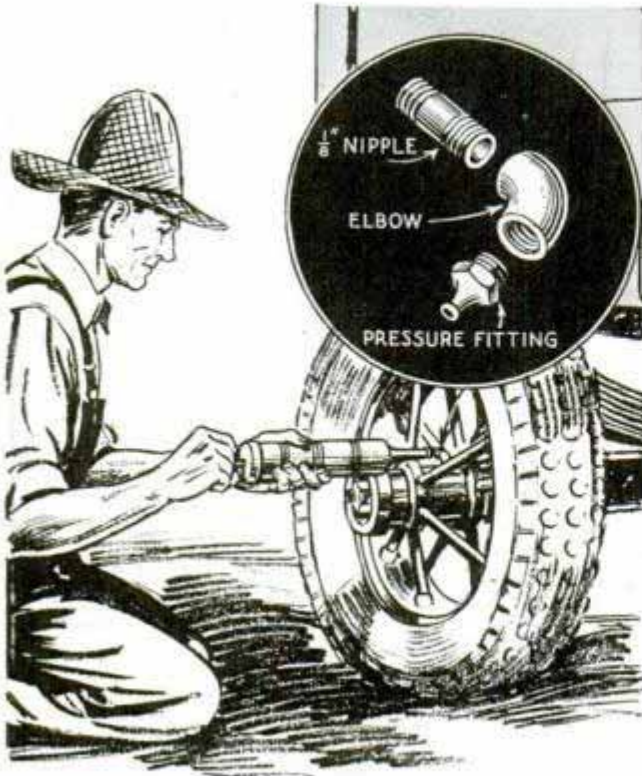

Why strain your back lifting the wheels off a heavy wagon, or fuss with a clumsy jack to lubricate them when you can install a pressure fitting in the hub of each wheel and do the job in a fraction of the usual time? A hole is tapped as near the center of the hub as possible for a pipe nipple, usually $\frac{1}{8}$ in. for the common fitting. Then install the nipple and an elbow into which the fitting is screwed. On most wheels this is necessary to get the fitting out where you can reach it easily with the gun. On certain iron wheels with straight hubs there is no need for the nipple or elbow. Use a 45° fitting. Wood wheels can be provided with the fittings by tapping a short length of iron pipe into the iron bushing inside the wheel.

Tin Shield Protects Blowtorch Carried in Toolbox

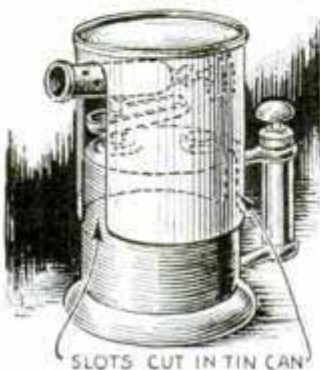

Plumbers, electricians, and others who often have to carry a small blowtorch in a box with other tools can prevent the mechanism of the torch from being damaged by slip-

ping a metal shield over it as indicated. The shield is nothing more than a tin can of suitable size with one end removed and a slot cut in one side to slip over the nozzle.

Spanner Wrench Is Improved from Pair of Pliers

Users of replaceable chaser die heads of the type shown will find this adjustable spanner wrench handy. It is made by drilling and tapping the jaws of a pair of cheap gas pliers to take two short pins made from $\frac{1}{4}$ -in. drill rod. The pins are hardened and should project about $\frac{1}{2}$ in. above the plier jaws.

—S. J. Gancher, Richmond Hill, L. I., N. Y.

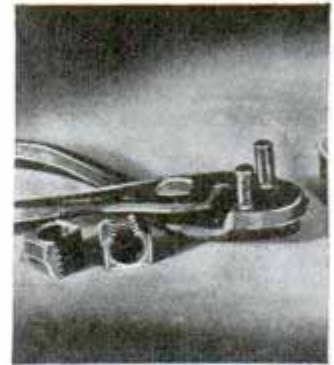

Auger to Take Deep Soil Samples Made with Wood Auger Bit

A worm-type soil auger for taking samples of subsoil on farms and other places where such work is important, can be made from an old $1\frac{1}{2}$ -in. wood auger bit. Grind off the point and lips and file the end of the

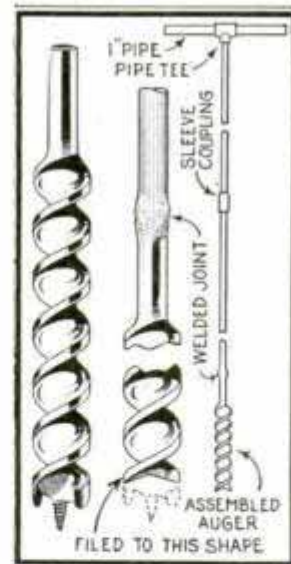

bit as indicated. Pitch of one cutting edge should be slightly greater than that used for boring wood. After this has been done, cut off the shank of the bit and weld a 6-ft. length of $\frac{1}{2}$ -in. rod to it. For deep borings, a coupling sleeve can be provided and more than one length of rod used. A handle can be made from pipe and fittings.

material list - on how material dry

VENEERING

Increases Scope of CRAFTWORK

PART II

FOLLOWING the simpler types of veneering, such as making panels, matching veneers, etc., described last month, we now progress into the more intricate types, such as inlaying bands and borders, making curved panels and doing hammer veneering.

Inlay bands and borders: Inlay bands are available in a variety of widths and patterns in lengths of about 40 in. Usually, the banding is taped together with the veneers

Inlay bands and borders

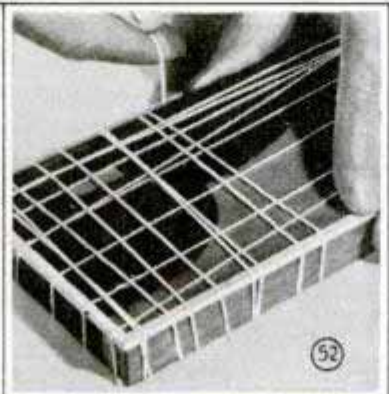
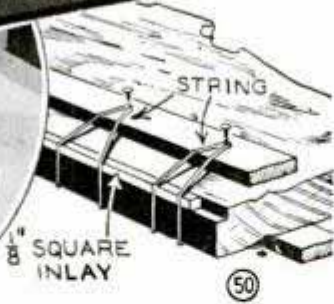
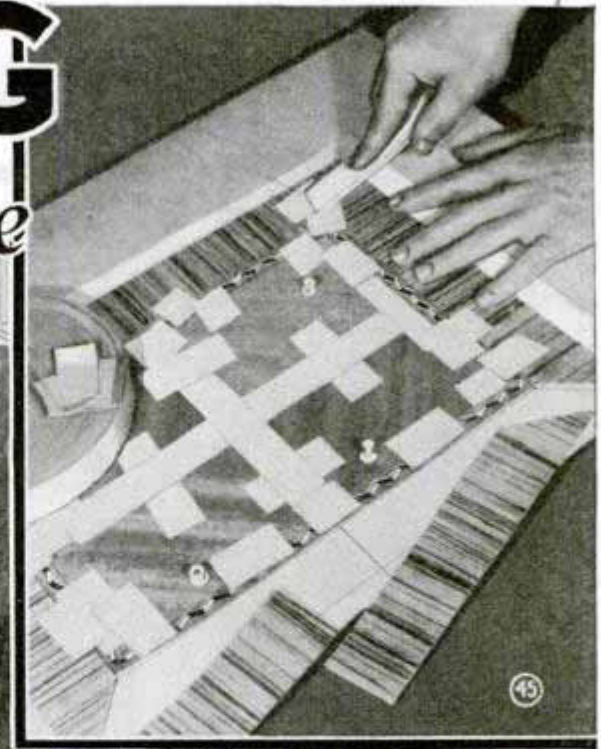

previous to gluing. Fig. 45 shows a typical panel comprising a mahogany diamond with banding and border being assembled. The work is done on a full-size paper pattern. Push pins or dabs of glue can be used to hold the various pieces in place. Both the banding and border should be matched at the mitered corners. This is done by matching two pieces together as in Fig. 47, and then mitering. Holding the two pieces in the same position, the joint is cleaned up by sanding as in Fig. 48. The border strips are cut across the grain from a suitable piece of veneer. Then adjacent strips are placed together so that the grain matches, after which the corner is mitered and sanded as before. Fig. 46 shows the finished panel after gluing and cleaning up.

Very narrow bandings are often laid in a groove routed in the veneered surface, Fig. 49. Glue is applied to the banding, which is then pressed into the groove, as in Fig. 51. It should fit tightly and

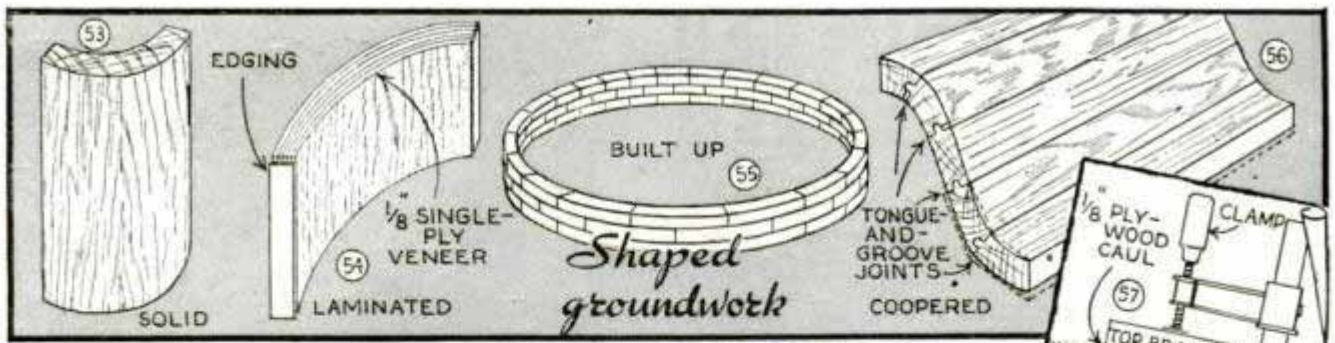

Making a curved panel

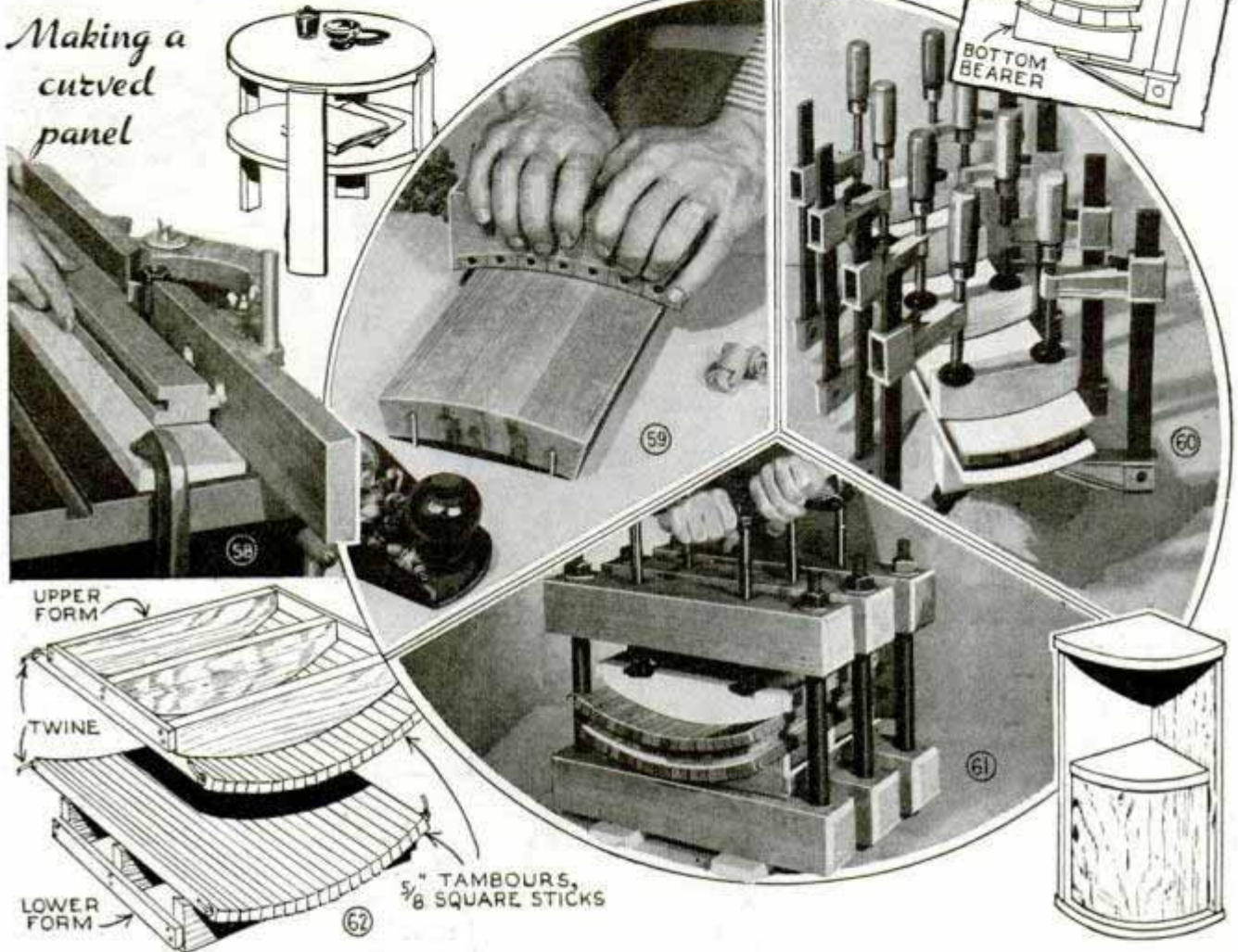

should project slightly above the surface so that it can be sanded flush after the glue has dried. Lengths of square inlay, commonly called strings, frequently are inlaid at the edges of a veneered surface. They can be held in place by wrapping with string, Fig. 52, or, if the work is large, by using the method shown in Fig. 50.

Shaped groundwork: Curved surfaces over which veneer is to be laid can be made by using one of the four methods shown in Figs. 53 to 56 inclusive. Small work usually can be cut from solid stock, as in Fig. 53. Laminating, Fig. 54, is ideal for large work. The built-up or bread-and-butter groundwork is made easily and has the advantage that scrap cuttings can be cleaned up and used as cauls. Coopered

curves, Fig. 56, are a standard method of working, excellent in structural soundness but demanding considerable handwork in shaping the surface.

Making a curved panel: The groundwork is made first, using soft wood such as poplar or white pine. Construction will depend on the nature of the work. In the case of a table leg curved across the face, a coopered groundwork would be suitable. A full-size paper pattern is made to show the number of pieces required and the angle at the joints. The pieces are then cut on a shaper, Fig. 58, and assembled with glue. Handwork with sandpaper tacked to shaped blocks, as shown in Fig. 59, is the most practical method of securing a finished surface, although roughing can be

done with a variety of other tools. The work can now be veneered. Both cross-banding and veneer are used in first-class work, but good results can be obtained with veneer only. A simple method of clamping the veneer in place is shown in Figs. 57 and 60. Thin cauls of $\frac{1}{8}$ -in. plywood are used, together with a number of curved bearers. The general application is the same as a flat panel, both sides being veneered in one pressing.

Another example of curved work, a paneled door, is shown in Figs. 61 and 62. This features a laminated groundwork, and is one of the best methods of handling the job. Two pressings are required, one in the assembly of the groundwork and the other in the application of the veneer. Fig. 62 shows the method of working. Three or more lower bearers are band-sawed to the required curve and are held together with wood strips to make a form. The upper form is made in the same manner. Tambours, which are $\frac{5}{8}$ -in. square sticks held loosely together with twine, are used in place of cauls. The five or more layers of single-ply $\frac{1}{8}$ -in. poplar or basswood

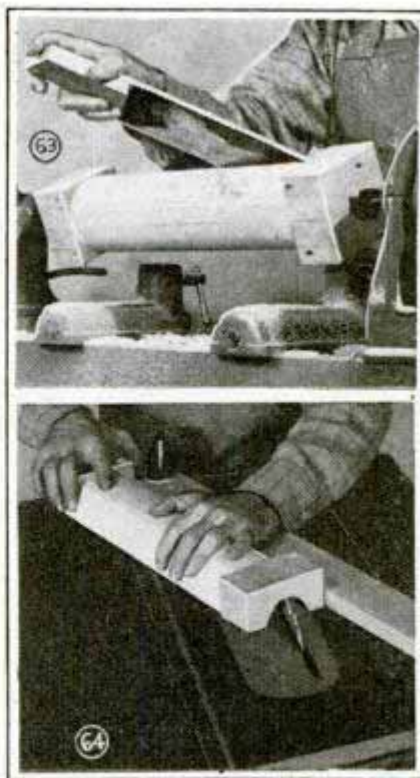

Veneering around a corner

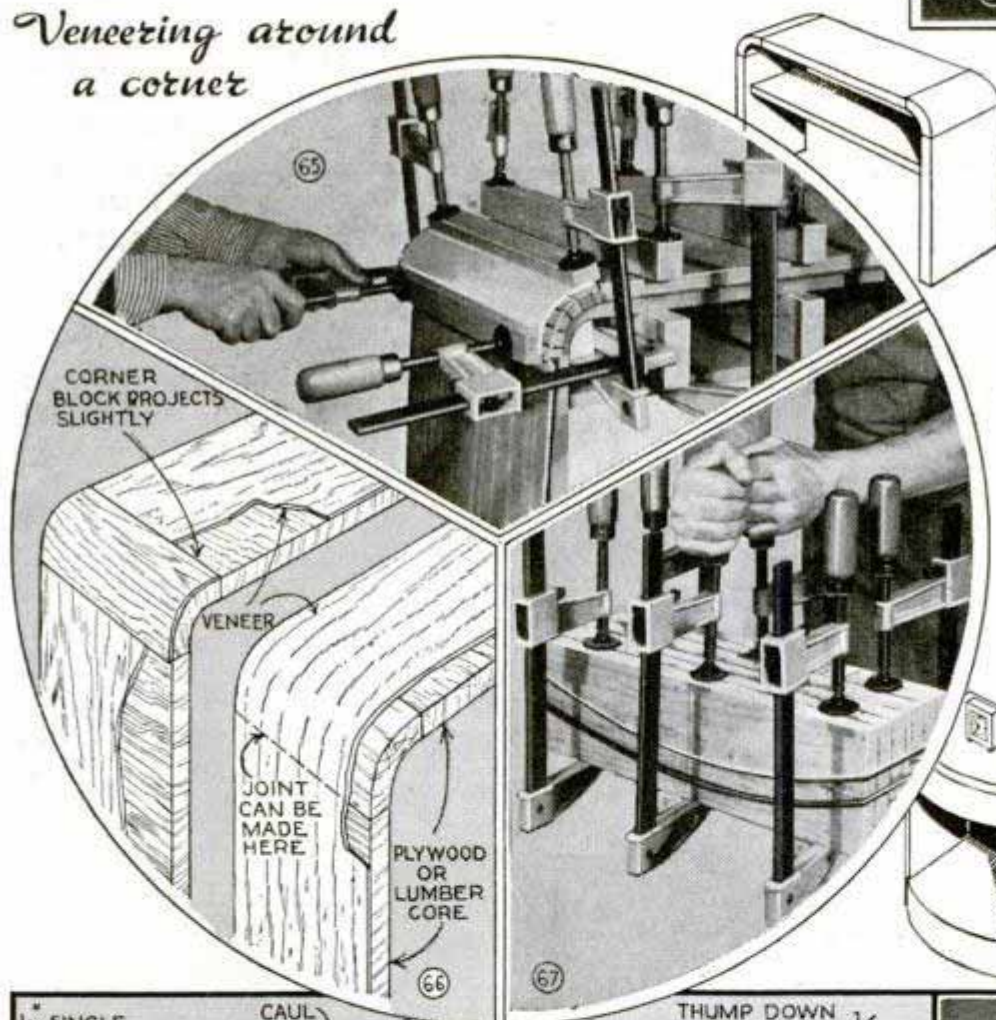

veneer for the core are glued up, glue being spread on both sides of each piece. The pieces are assembled with the grain in all pieces running the same way, and a nail is driven through the complete thickness at the center of each end. A folded piece of newspaper is placed on each side of the work to catch surplus glue, and

Solid cauls

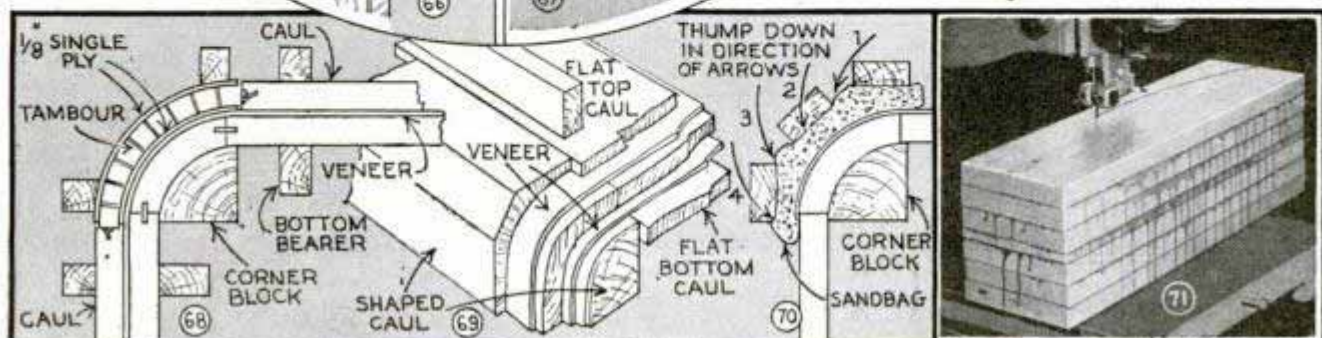

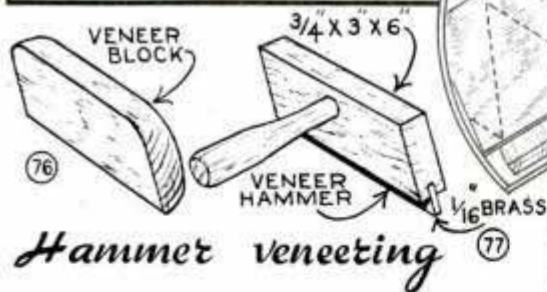
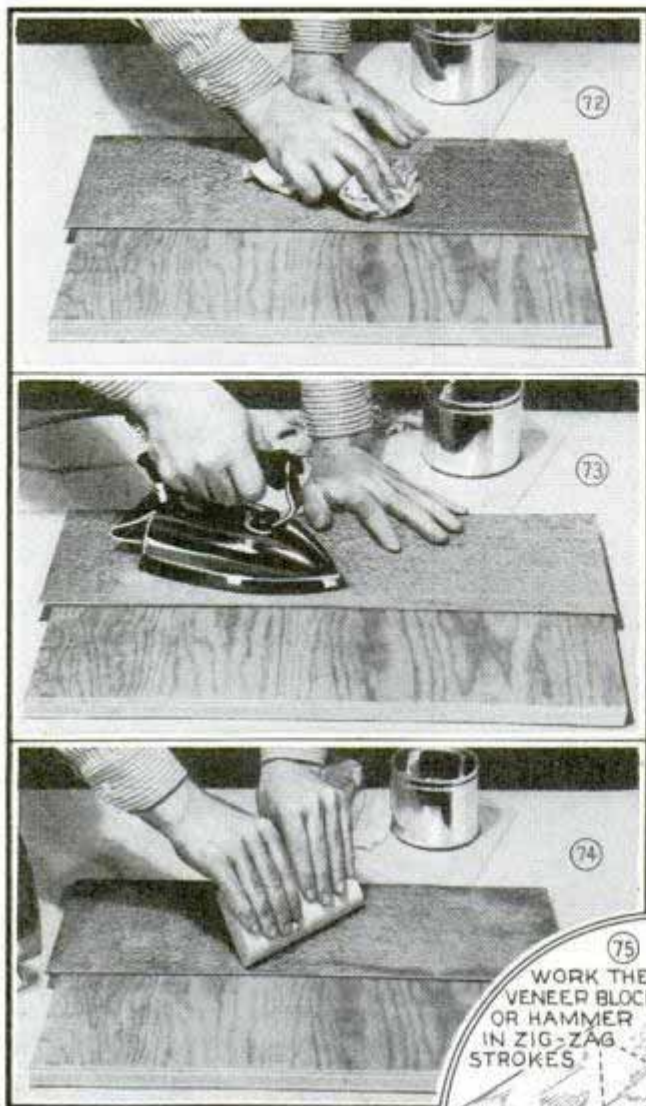

Hammer veneeting

over the paper is placed a sheet of $\frac{1}{8}$ -in. single-ply veneer. Tambours are then fitted in place, followed by the forms, after which the work is ready for the veneer press, as shown in Fig. 61. After the work has dried, hardwood edgings are fitted, as shown in Fig. 54, and the panel is then veneered, using the same method as before.

Veneering around a corner: The round corner is widely used in modern furniture construction, a typical example being the bench shown below Fig. 64. The groundwork is prepared by turning and cove cutting, as shown in Figs. 63 and 64, after which the curved pieces are tenoned or doweled to flat panels. The work is then ready for veneering. In a simple method of

working, only the flat panels are veneered, as shown in the left-hand detail of Fig. 66. If the grain of the veneer runs crosswise, a very good job can be done in this way. In better work, the veneer runs right around the curve, or is jointed once at the lower edge, as indicated by the dotted line in the right-hand detail. Fig. 65 shows the veneer being fitted around the curve, and Fig. 68 shows the work in cross section. As one side only is being veneered, the corner blocks on the underside need not extend across the work, but are only of such length as to accommodate the clamps. Fig. 69 shows another method of working. In this case, both sides of the work are being veneered, the two shaped cauls extending completely across the work. A simple way of making shaped cauls of this kind is to band-saw the work in short lengths and then face the curve with a layer of $\frac{1}{8}$ -in. single-ply veneer. This breaks the joints and also levels the sawed surface. As many short lengths as are re-

quired can be made quickly and faced in this manner, although if more than three short pieces are used to make one caul, the joints should be doweled to obtain the required stiffness.

A sandbag offers a simple and practical method of working. This is thumped down around the curve, as shown in Fig. 70, and is then topped with bearers and clamped.

Solid cauls: The groundwork for shaped drawer fronts and similar work is usually

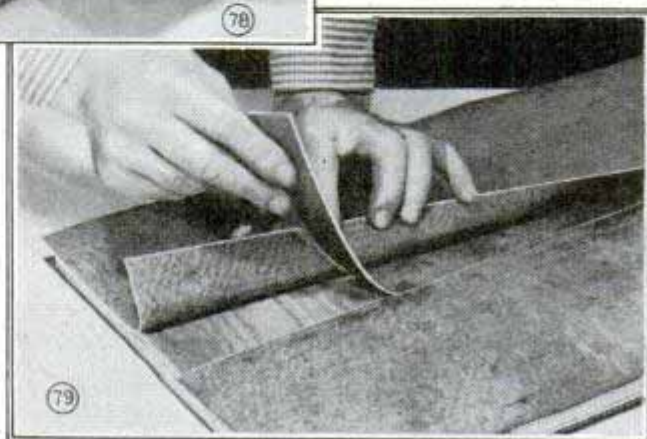

made by the built-up method. If the pad is made sufficiently large, the scrap pieces obtained by band-sawing, Fig. 71, can be used as cauls when applying the veneer, as shown in Fig. 67. A layer of felt or blotting paper should be used between the cauls and veneer to equalize the pressure. The same method can be used when the groundwork is cut from solid stock.

Hammer veneering: Hammer veneering can be done on both flat and curved surfaces, and differs from veneering as previously described in that it is done with hot animal glue. The veneer hammer is not a hammer at all, but simply a block of wood or other device, as shown in Figs. 76 and 77, used to press the veneer in place. In the typical example shown in the photos, two pieces of veneer are fitted together to form a flat panel. The groundwork and veneer are first brushed with glue. It is immaterial whether or not the glue chills after application. One of the veneer pieces is then fitted in place, and it is quite likely that the glue will be tacky enough to hold it in position. After sponging the veneer with water to prevent burning, Fig. 72, the chilled glue is again made liquid by the application of a moderately warm iron, as shown in Fig. 73. The veneer is then immediately pressed in place with the hammer, Fig. 74, working with zig-zag strokes as in Fig. 75, so that all surplus glue is squeezed out. The second piece of veneer is similarly glued, allowing a 1-in. overlap. The joint is then cut with a sharp chisel or knife, using considerable pressure so that one stroke will cut through both thicknesses, Fig. 78. A light touch with the iron will then soften the glue enough so that the veneer can be peeled back to remove the waste piece, as in Fig. 79, after which the whole surface is damped and hammered.

Rubber Bands and Hammer Hold Cold Chisel



One mechanic assures greater safety in holding a rivet-cutting cold chisel by attaching the chisel to the end of a hammer. Large rubber bands are snapped around the chisel and hammer head.

Large Envelopes Quickly Removed from Deep Boxes



To obtain large envelopes of different sizes quickly from deep boxes piled in tiers upon his shelves, one stationer cut a slot across the front of the inner container of each box. By simply raising up the outer cover slightly, the ends of the envelopes are exposed and can be withdrawn without pulling out the box and removing its cover. The cover of the box drops down over the slot, keeping the contents in place.

Bar Solder Serves as Soft Anvil for Small Work

Clamped in the vise jaws or on the bench edge, a section of ordinary bar solder will serve as a soft anvil for use with model or other small work. The metal is soft enough to prevent any injury to the finish of the work and tough enough to offer plenty of resistance under the hammer or punch. The utility of the bar as solder is not affected in the least by being battered out of shape. Even small brass or steel punchings imbedded in it by a punch are not objectionable as they may be wiped away when the solder is melted.

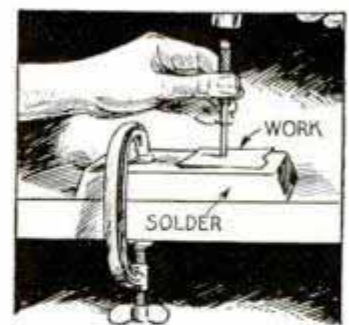

Device to Remove Shoe Boxes from High Shelves

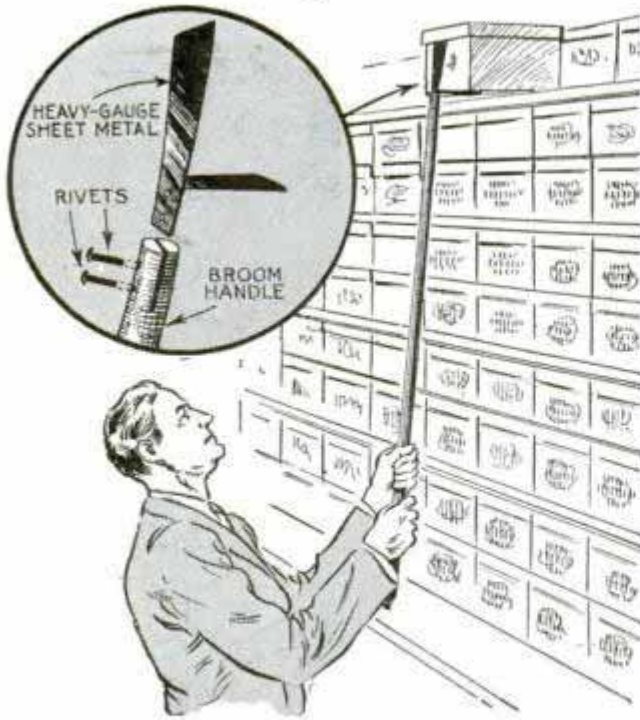

Instead of the usual practice of climbing up a ladder to reach shoe boxes on high shelves, the owner of one shoe store uses a broom handle with a special attachment on the end. The attachment is shaped from heavy sheet metal to form two blades as shown. In use, one blade slips under the bottom of the box and the other slips under the edge of the lid at the end.

Simple Attachment Threads Pipe in Small Machine Lathe

Working in a small shop where considerable pipe threading was done and only a small machine lathe available for the job, I made this attachment to do the work in the lathe. A short length of round stock was threaded at one end to screw on the lathe shaft and the other end was bored

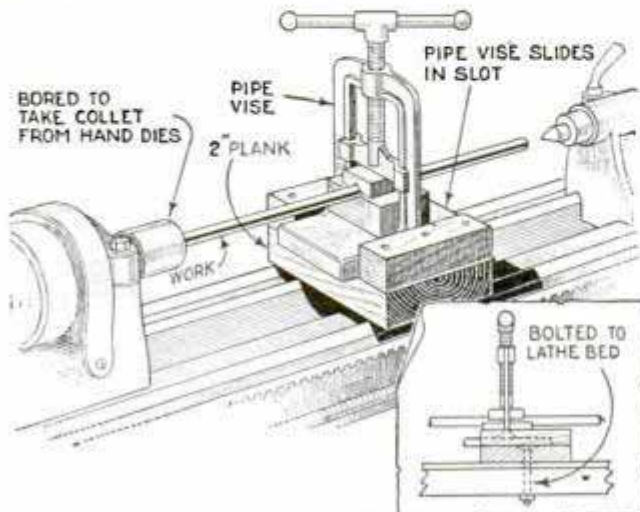

out to hold the collet from the hand-threading dies. Then a fitting to take a pipe vise was made from wood blocks and bolted to the lathe bed. The vise was bolted to a block, which slid in a slot or track formed by the fitting on the lathe. In use, the pipe to be threaded was held in the vise and fed into the die. As the threads were cut, the pipe and vise were moved in the track toward the die, extending into the hollow lathe spindle as required.

—W. A. Pierce, Fort Ann, N. Y.

Worn-Out Fountain Pens Used as Test Prods

When the prods of my electrical tester became broken I made a pair from a couple of old fountain pens. The inner parts of the pens were removed and chucks from a couple of automatic pencils were inserted into the threaded ends. Steel points were slipped into the chucks and connected to wires which entered the barrels of the pens through the openings that formerly contained the trigger mechanisms for filling them. This provided a couple of prods over which the regular pen caps could be screwed to protect the sharp ends while carrying them in my pocket.

—F. J. Gillis, Fort Lee, N. J.

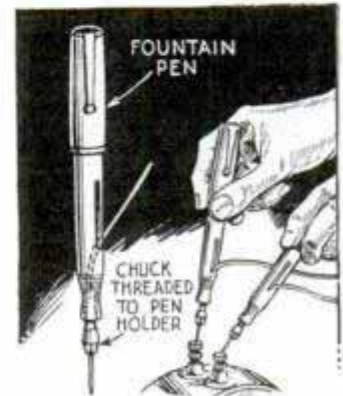

Pipe Rollers on Meat Hooks Save Labor in Butcher Shop

Butchers who are obliged to lift heavy pieces of meat to move them back and forth on the storage rack of the refrigerator will find that the job can be simplified by providing the hooks with rollers. This may be accomplished by having the upper ends of the hooks straightened and short lengths of small pipe slipped over them, after which the hooks are bent down to their original shape.

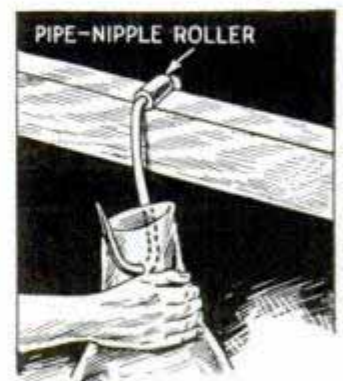

SAFETY *on* HIGH SCAFFOLDS

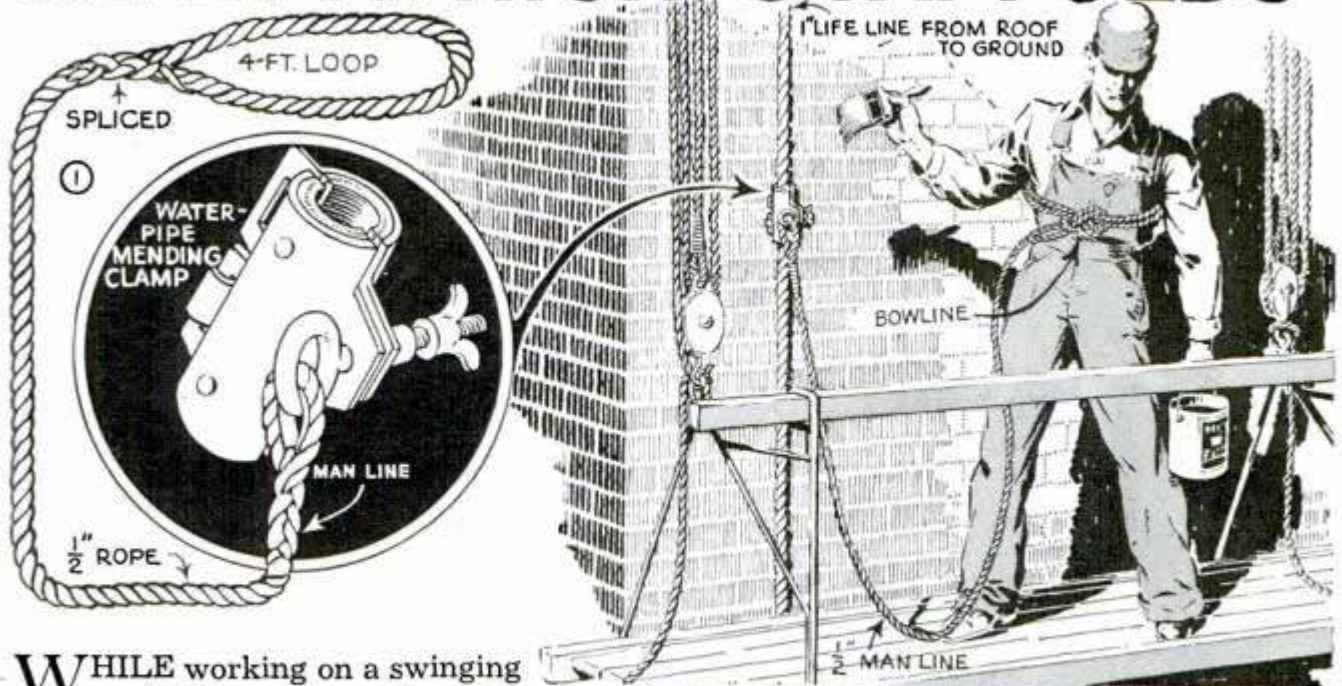

WHILE working on a swinging scaffold, safe practice demands the use of a life line, which is a rope tied securely to a rigid object on the roof of the building, and long enough to reach to the ground. The workman either ties the end of the line around his waist, or uses a short rope, called a man line, tied to his waist. In most cases, the weight of the life line around the waist makes its use objectionable, and the time wasted in tying and adjusting the man line is somewhat inconvenient. The clamp shown in Figs. 1 and 2 overcomes these objections. Attached to one end of the man line, it is fastened quickly to the life line and is adjusted up or down after a nut is loosened. Removing it from the life line is just a matter of unscrewing the nut. The clamp is lined inside with pieces of split hose to assure a positive friction grip on the life line. Small rivets hold the lining in place. Fig. 3 shows the steps in tying a bowline knot, which is used in attaching the man line around the workman's waist.

Another kink in connection with safety on scaffolds is to use U-bolts instead of rope to fasten the cradle-like irons to the platform, Fig. 4. In assembling the scaffold, each iron is placed directly under a rung of the platform, after which it takes only a moment to drop the U-bolt over both the iron and rung, and turn on the nut. Notice that one leg of each U-bolt is shorter than

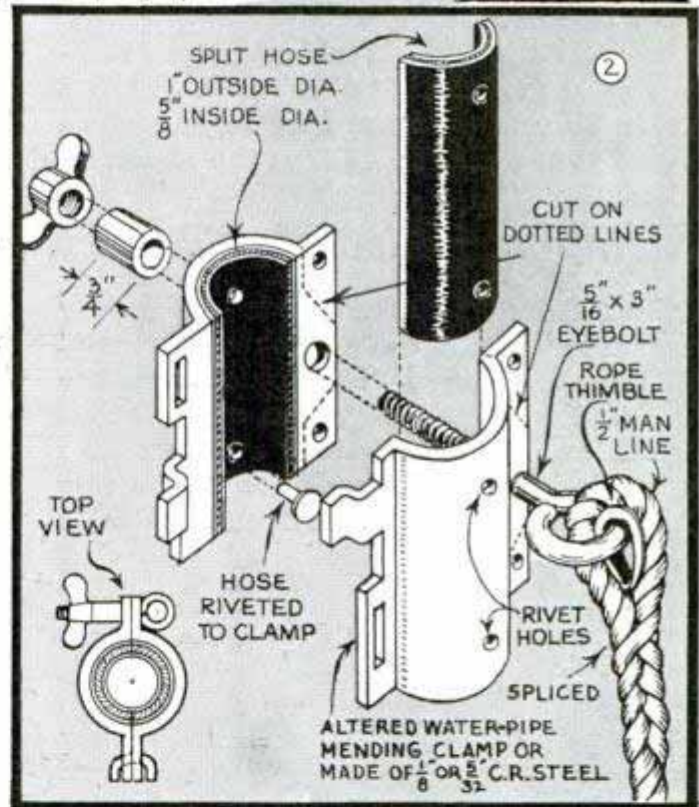

1ST STEP MAKE LOOP (A) IN DOUBLED END OF ROPE



2ND DRAW DOUBLED END (B) THROUGH LOOP (A)



3RD BRING PORTION (C) OF ROPE THROUGH LOOP (B)

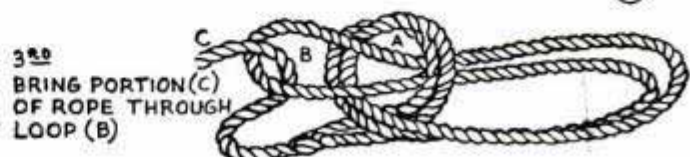

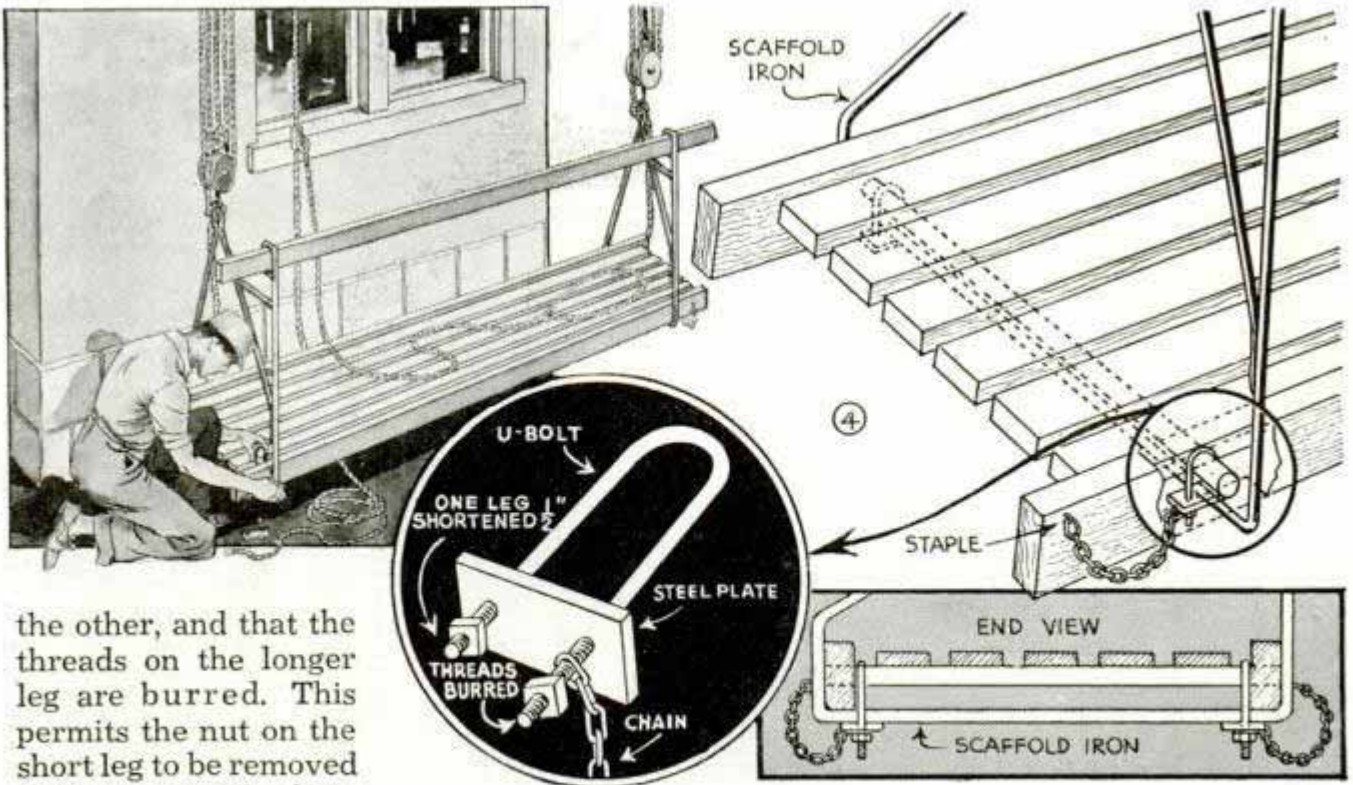

the other, and that the threads on the longer leg are burred. This permits the nut on the short leg to be removed and the steel plate dropped off it without taking the plate entirely off the long leg of the bolt. A short chain slipped over the long leg and fastened to the platform keeps the assembly

with the platform, where it is always at hand when assembling the scaffold. It is best not to draw up the nuts too tightly on the U-bolts. Leave them slightly loose.

Swinging Chisel Rack Is Hinged to Leg of Lathe Bench

This swinging chisel rack is particularly useful to the owner of a combination metal and woodworking lathe who does only occasional wood turning, and who doesn't want the chisels to occupy valuable wall space in back of the machine. The rack is merely a board with its front left edge

hinged to the right front leg of the lathe bench. The chisels themselves rest in slots in a shallow shelf. When the rack is swung outward, the chisels are instantly available. When the job is finished, the board is pushed back and the chisels are protected by the overhanging end of the table.

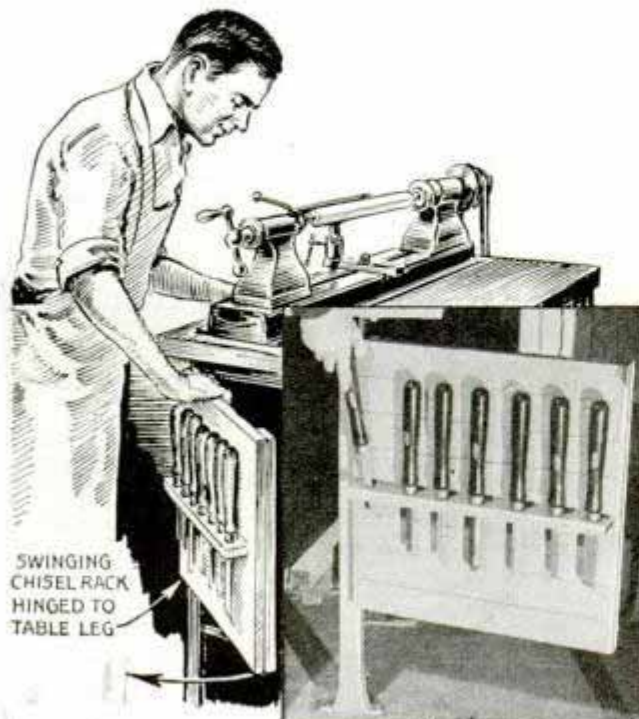

Slot in Worn Screw Deepened by Hammering Edges

If the slot of a screw is so worn or shallow that a screwdriver will not operate in it, place the head of the screw on a metal surface and strike the slot ends with a hammer.

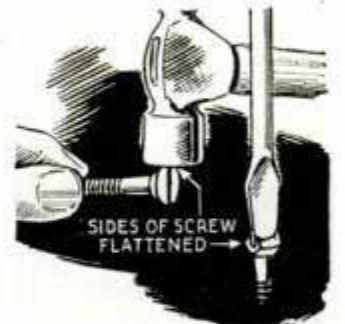

This will deepen the slot at the ends and often permit the screw to be driven with little trouble. The points may be driven down again afterward, if necessary.

ⓘ Do not allow a door to drag over a rug, because it will wear it badly eventually.

Fixture to Grind Skates on Your Circular Saw

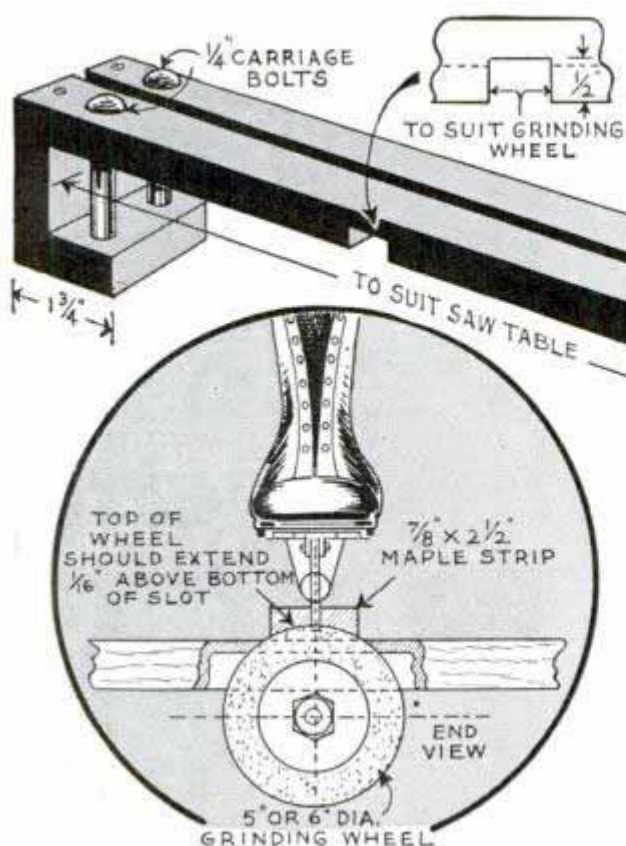

This inexpensive fixture to fit on the table of a circular saw will enable you to grind a pair of skates accurately in a fraction of the time usually required. After substituting a grinding wheel for the saw blade, a strip of hardwood is slotted lengthwise to take the skate blade and crosswise to take the grinding wheel. The strip can be made as shown in the upper detail to

slip over the edges of the saw table, or it can be clamped in place. In either case, be sure that the strip is located so that the centerline of the skate slot coincides with the centerline of the grinding wheel. The skate blade is placed in the slot and pushed over the wheel, which is adjusted to extend $\frac{1}{16}$ in. above the bottom of the slot.

—Hugh Humphreys, Cincinnati, Ohio.

Pivoted Horseshoe on Front of Wagon Box Holds the Lines

A heavy horseshoe, pivoted onto the front of a farm wagon box, may be swung over to the position shown to hold the driving lines so that they will not fall under the horses' feet when left unattended. A pull on the free ends of the lines will swing the horseshoe back out of the way when it is not needed.

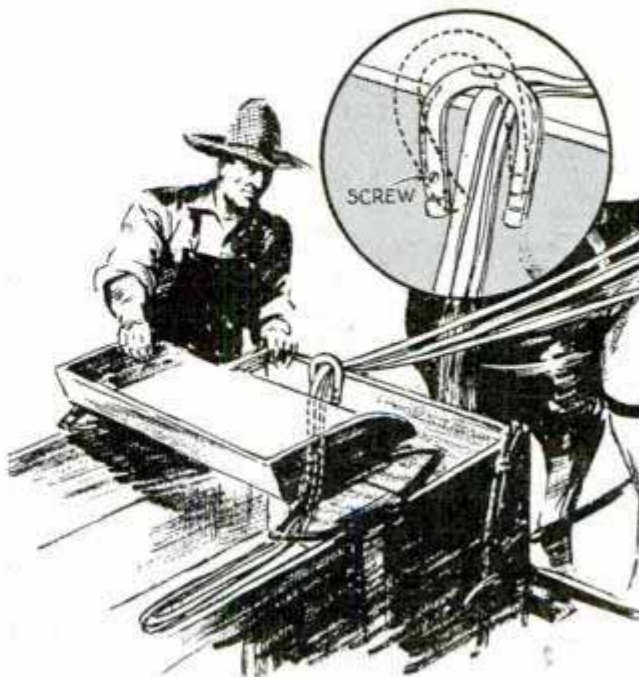

Adhesive for Transformers

In winding coils and transformers where an insulating paper is put between layers of wire, a good adhesive to hold the paper in place is made by melting together equal parts of rosin and beeswax. This is applied with a small brush. It hardens quickly and saves time in winding transformers having a number of layers.

Sliding Clamp under Workbench Holds Blowtorch to Fill It

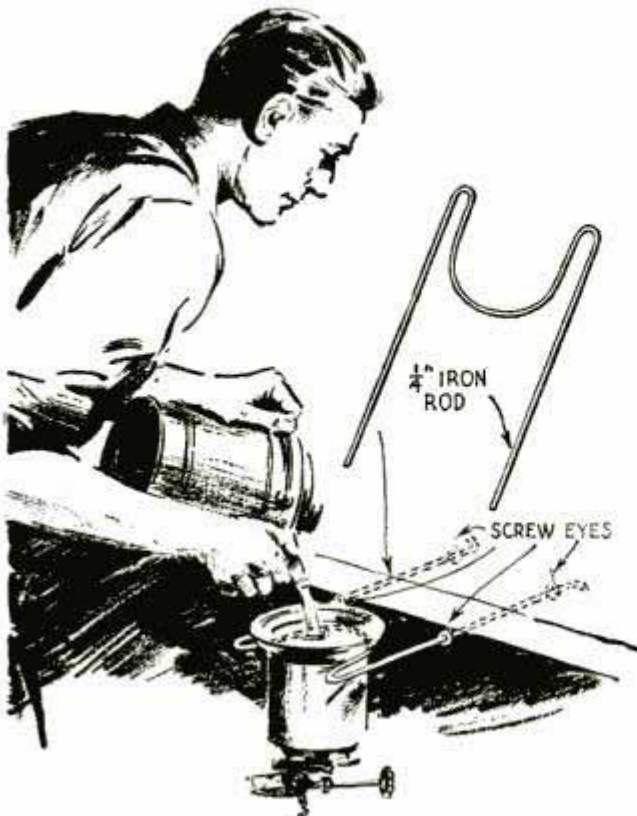

To hold his blowtorch safely inverted for filling with gasoline, one workman bent a length of $\frac{1}{4}$ -in. iron rod as indicated, and attached it to the underside of his bench. Screw eyes were used for this so that it could be pulled out to hold the torch, or pushed in out of the way when not in use.

Straightening a Bent Auger Bit

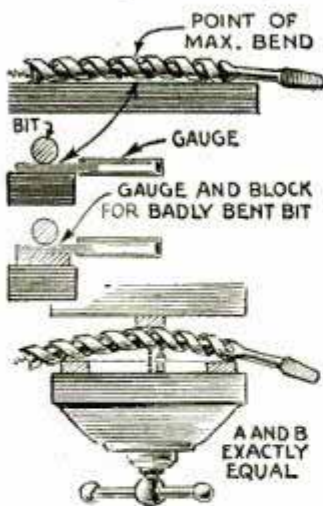

If an auger bit is bent you can straighten it as follows: Place the bit on a perfectly flat surface and roll it until the point of greatest bend clears the table a maximum distance. Carefully measure this distance, using a thickness gauge, or, if the bit is extremely out of line, the gauge and a flat piece of metal of known thickness. Make two pieces of metal or hardwood having thicknesses exactly equal to the clearance distance, and fasten them to the ends of a hardwood block which is thick enough to resist bending when placed in the vise.

Make two pieces of metal or hardwood having thicknesses exactly equal to the clearance distance, and fasten them to the ends of a hardwood block which is thick enough to resist bending when placed in the vise.

Place the bit on this jig with the ends of the spiral contacting the raised end pieces. Put the assembly in the vise and, using a small block between the jaw and the point of greatest bend in the bit, turn the screw until the bit touches the surface of the jig body. This bends the bit an equal amount in a direction opposite the original bend. When released the tool usually will spring back to perfect alignment.

Dab of Grease Is Substitute for Lost Ink-Tube Cap

When the cap of an ink tube is mislaid, workmen in a printing shop seal the contents by placing a dab of hard grease over the opening. The grease is wiped off when the ink is to be used again.

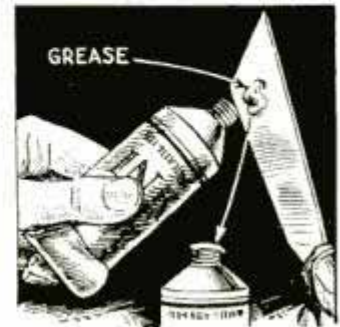

Short Rope Permits Easy Closing of Barn Door

The difficulty of pulling the top section of a barn door shut from the inside may be overcome by attaching a short length of rope to the door and frame by means of screw eyes. When the door is opened the rope is taut and out of the way, but may be reached easily and pulled down to close the door with little effort.

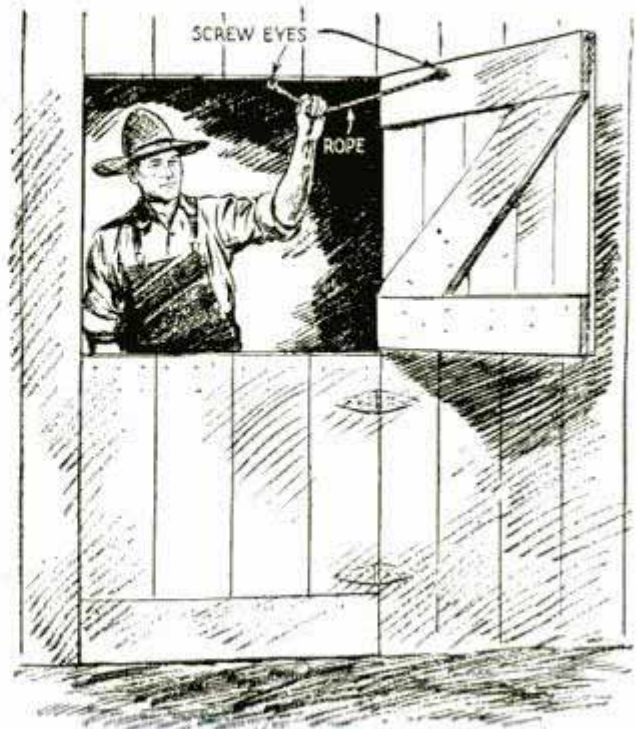

AUTO SHORTCUTS

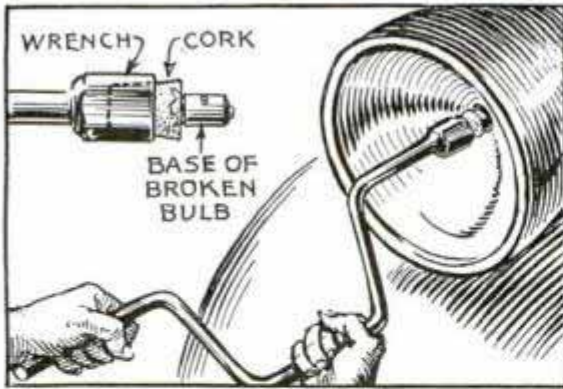

There's no risk of injuring your fingers when removing a broken light bulb if you use a speed wrench with a cork pressed tightly into the socket as above. Ice and sleet on a windshield will come off easily when scraped with an aluminum cake turner as at the right. Use only the aluminum type of turner as other metal may scratch the glass

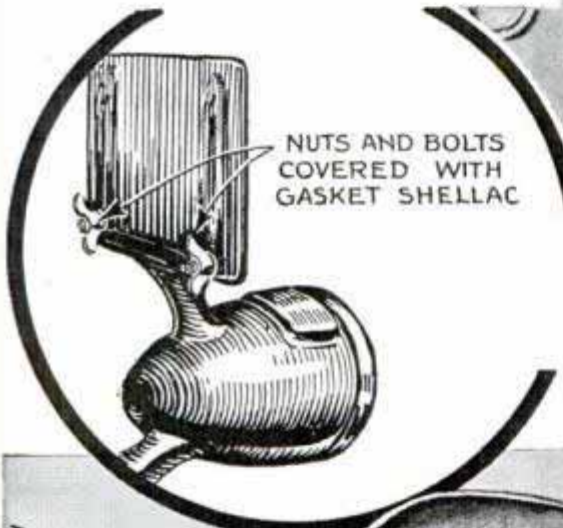
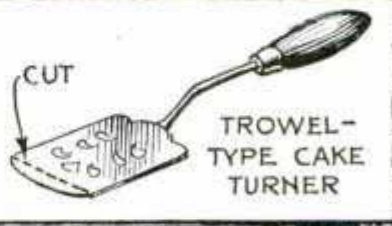

A coat of gasket shellac on license-plate bolts will prevent the nuts from rusting fast to them and makes it easier to remove old plates. Below, sun glare from the hood is avoided by painting the lower part of the windshield

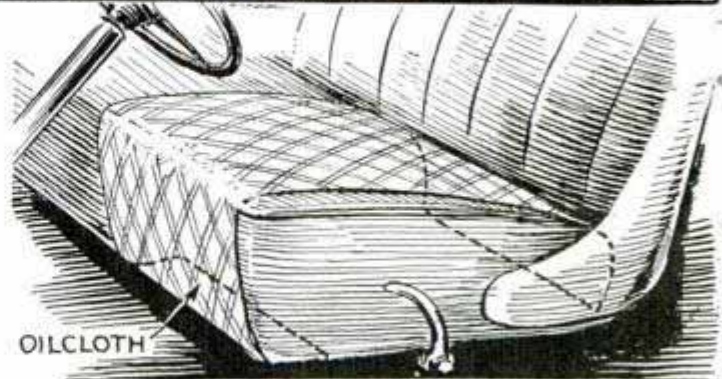
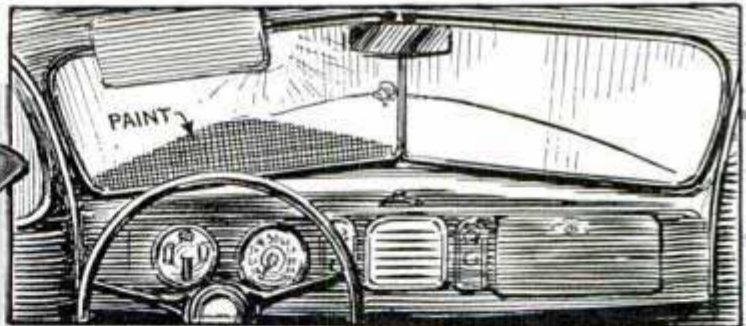

Water seeping into the sponge-rubber seal around some trunks and freezing the lid tight can be avoided by putting olive oil on the rubber. This helps to exclude water and does not injure the rubber. Cover the driver's side of the seat with oilcloth, as above, and you can slide under the wheel easily when wearing a heavy overcoat

Garage Creeper Used as Truck to Haul Small Loads

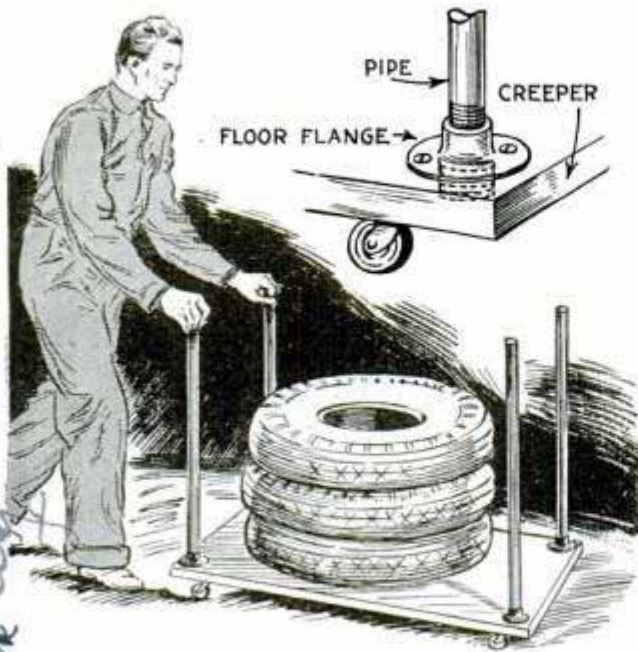

A mechanic in one garage converts his creeper into a small hand truck by simply adding pipe stakes at each corner. The stakes are held by floor flanges screwed to the creeper, and are removed or put in place quickly.

Checking Motor for Trouble with Neon Pencil

A neon pencil enables anyone to determine some causes of motor trouble easily. The pencil contains a tiny neon tube that glows a brilliant red when touched to a spark-plug terminal, if the motor is firing properly. Trouble is indicated by the change in the color of the spark within the tube, or by its absence. With the motor idling, this spark should occur about 100 times per minute, or a trifle faster than it is possible to count. If the spark is irregular or is absent, the cylinder is misfiring. The actual cause of the "miss" is determined by a simple series of tests. First remove the wire from the plug and test its

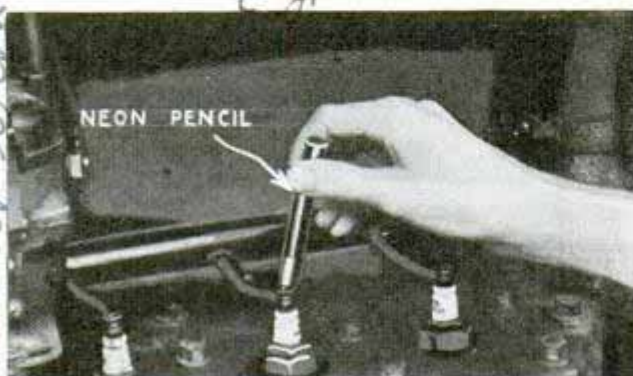

end with the pencil. If the spark occurs regularly, the timer points, the wire and the distributor may be eliminated as the cause of the trouble. An irregular spark is an indication that the plug is at fault and a new one should be installed. If the new plug fails to remedy the trouble, note carefully the color of the neon spark. A dark spark alternating with a brilliant red one indicates loss of compression within the cylinder, or a faulty adjustment of the carburetor. If adjusting the carburetor does not stop the trouble, the piston rings or the valves are at fault. A poor condenser is shown at any plug by an almost continuous string of thin sparks instead of the normal red one. The sparks are irregular and entirely out of time with the motor.

—A. H. Vance, Linn Creek, Mo.

Bent Cotter Key Provides Stop on Oil-Bottle Spout



To prevent the spout of an oil bottle from slipping and spilling oil over the motor when filling the crankcase, use a cotter key as shown. One leg of the key is slipped over the end of the spout to serve as a stop or rest.

Proper Setting of Heater Fan Determined by a Gauge

Many manufacturers of hot-water heaters for autos recommend that the fan be located on the motor shaft so that the blades will clear the radiator fins from $\frac{1}{4}$ to $\frac{5}{16}$ in. To assure accurate settings at the first trial, one mechanic made a wooden gauge having a central hole to clear the end of the shaft. This gauge is laid on the radiator fins and the fan, clamped loosely to the shaft, is set in place. The gauge, contacting the blades,

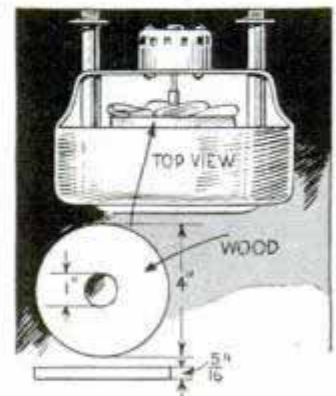

Wholesale only: - Karston Specialty Co
 14th St. New York City
 34-42 W.

Montgomery Ward

forces the fan up the shaft to the proper distance. Tightening the set screw holds it there permanently. The motor and fan are then lifted and the gauge removed.

—W. C. Wilhite, Carlinville, Ill.

Motors of Windshield Wipers Oiled Through Shaft

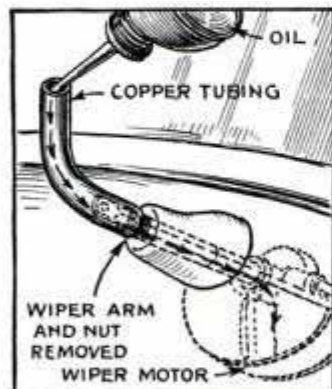

I solved the problem of oiling the vacuum windshield motor by putting the oil in at the shaft that carried the blade. This saved the trouble of removing the motor, which was quite a job. Instead of

taking the time to let the oil run down the shaft a drop at a time, I fitted a copper tube over the end of the shaft, filled it with oil and started the car motor to help suck in the oil.—G. L. Lupton, San Antonio, Tex.

First-Aid Kit Always at Hand in Car Trunk

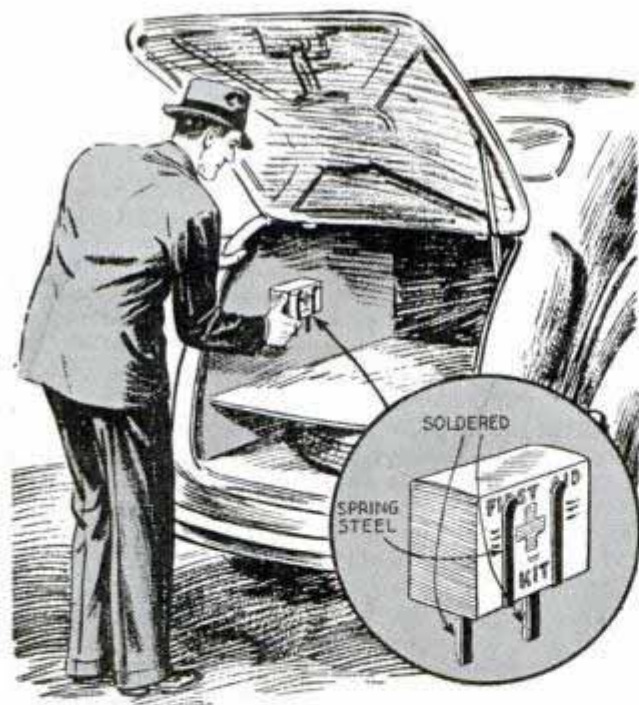

One motorist who did a lot of traveling carried a small first-aid kit in the trunk of his car. Two spring-steel brackets soldered inside the trunk held the kit out of the way, yet permitted it to be reached easily when needed. On some cars the lining will have to be cut to fit the brackets.

Garments on Coat Rail of Auto Kept in Place by Strap

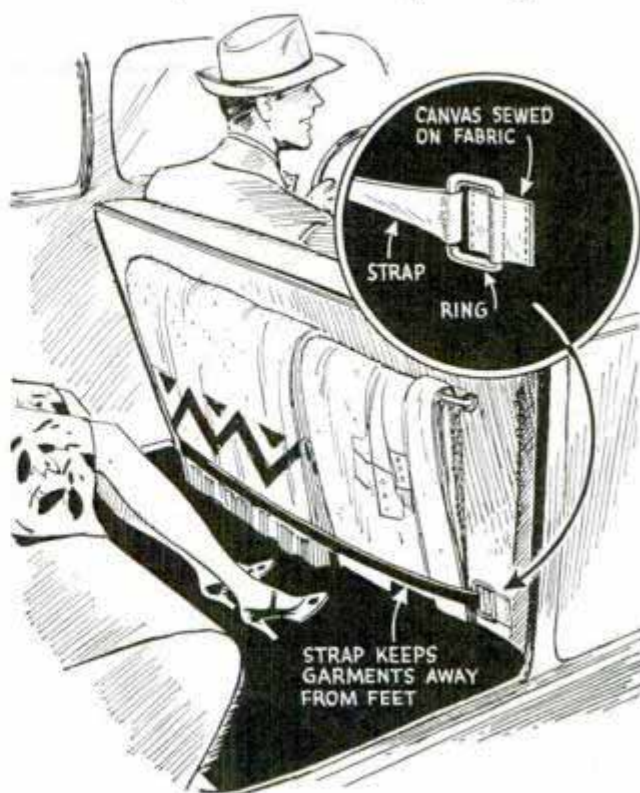

When garments are hung on the coat rail on the back of the front seat, the tilt of the seat brings them in just the position where the passengers in the back seat rub their feet on them. To avoid this, put a strap on the back of the front seat as indicated. The strap will keep the garments close to the back of the seat.

Plugging Crack in Motor Block

Cracks at the edge of a valve seat of a motor block are frequently repaired by threading a small bar of special metal and screwing sections of it into a series of holes tapped into the crack. First, a plug is tapped into the hole at the edge of the crack, then each succeeding plug back of it is made to crowd the last one. Finally, the plugs are trimmed with a chisel, peened and ground off.

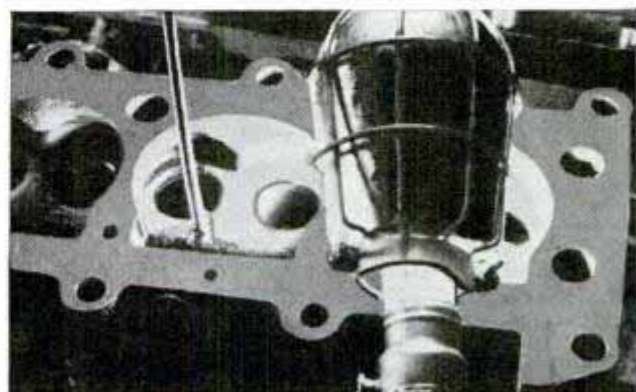

Trunk Tray to Handle Packages Several at a Time

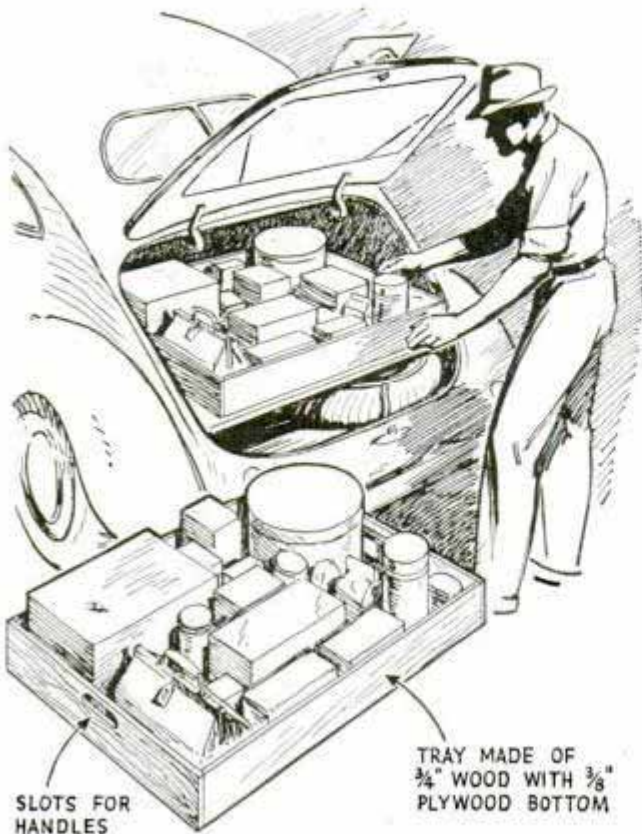

Salesmen and others who have to carry a number of small, light packages in the trunks of their cars and remove them frequently, will find a tray similar to the one

shown handy. It permits the entire assembly of packages to be removed together and carried about as a unit. The tray can be partitioned as desired, and can be reinforced at the corners with metal angle brackets if necessary.

—Opie Read, Jr., Chicago.

Level Assures Right Measurement of Auto-Motor Cylinder

An improvement on the often-used rod method of calipering the inside diameter of a motor cylinder, is to fit it with a small level. The level shows when the rod is held at exactly right angles to the cylinder walls. This is necessary if the measurement is to be correct, as any deviation from a right angle would indicate a diameter greater than the actual one of the cylinder. The level can be spot-soldered to the rod to keep it in place.

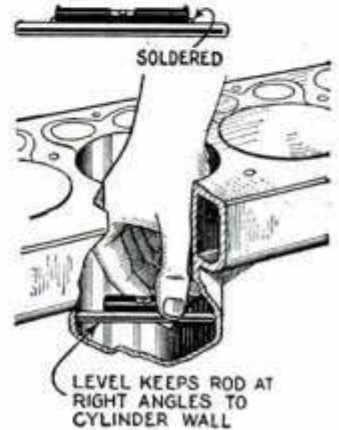

WHAT to MAKE for Christmas

You can make your own gifts easily if you have this 188-page, 1941 edition of "What-To-Make"—filled with projects of interest to home craftsmen



168 THINGS TO BUILD

This unusual book contains shop-tested projects and it tells you not only what to make, but how to make it—things you have wanted for your home and garden, furniture, novelties for gifts and toys, and games for the children.

MORE THAN 500 PICTURES

You see exactly how everything is done because over half of this book is made up of pictures. Drawings and illustrations show every step in construction and also the completed project. You do not have to be an expert and your success will amaze your family and friends.

PARTIAL LIST OF CONTENTS

Built-in vanities, fireplaces, glass decorations, lighting fixtures, re-caning chairs, garden furniture, log cabins, porch furniture, tables, hostess trays, sideboards, benches, footstools, desks, lamps, book ends, chairs, fireplace screens, bookcases, wall cabinets, glass furniture, picture frames, cottage furniture.

Sent postpaid for only 50¢

(Money back if not satisfied)

POPULAR MECHANICS PRESS

200 E. Ontario, Dept. 1240

Chicago, Ill.

**OUTDOORS
IN SUNLIGHT**

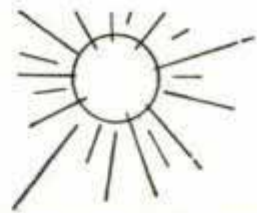

*...and it's hard to
choose between them*



**INDOORS
AT NIGHT**



BECAUSE Kodak Super-XX Film is about four times as fast as ordinary film, it makes even a beginner and a \$1 Baby Brownie a capable team for pictures at night. Getting excellent snapshots, under Photofloods, indoors after dark is a matter of using the right film. Be sure to load with Kodak Super-XX Film. You can then, from the very first, count on snapshots at night that are just as good as those you've been getting outdoors in the sun. Any camera will do, just as long as it takes Kodak Super-XX Film.

NIGHT SNAPSHOTS *simple as A.B.C. with* **KODAK SUPER-XX FILM**

A... Load your present camera with Kodak Super-XX Film

B... Use a couple of inexpensive Mazda Photoflood lamps in Kodak Handy Reflectors

C... Follow the few simple directions in the FREE Booklet

A few minutes with this helpful booklet and you're headed for splendid nighttime snapshots. Photos, diagrams, easy-to-understand directions. At your dealer's ... Eastman Kodak Company, Rochester, N. Y.



YOU NEVER SEE HIM — BUT SKILL FLIES WITH



THE ARMCHAIR above is his cockpit—but Bill Miller flies as many as 100 planes a day. North, south, east, and west from New York's LaGuardia Field (*air view right*) his radio control-room directs the flying course of *American's* giant flagships.

Flier, navigator, engineer, traffic executive all in one—yes, flight superintendent Bill

Miller is a man with the extras—a man who *gets* the smoking extras, too... in Camels.

For Camel's costlier tobaccos and slower way of burning give you more than mildness—they give you extra mildness and coolness with a flavor that holds its appeal right through the last extra puff. Camels also give you extra smoking per pack (*see right*).

GET THE "EXTRAS"—WITH SLOWER-BURNING

CAMELS

THE CIGARETTE OF

HIS EXTRA YOU EVERY MILE!

WILLIAM H. MILLER—Flight Supt., American Airlines



Copyright, 1940
B. J. Reynolds
Tobacco Company
Winston-Salem,
North Carolina

**EXTRA
MILDNESS**

**EXTRA
COOLNESS**

**EXTRA
FLAVOR**

In recent laboratory tests, CAMELS burned 25% slower than the average of the 15 other of the largest-selling brands tested—slower than *any* of them. That means, on the average, a smoking *plus* equal to

**5 EXTRA SMOKES
PER PACK!**



COSTLIER TOBACCOS

NEWS FOR YOU

NOW-FOR THE FIRST TIME

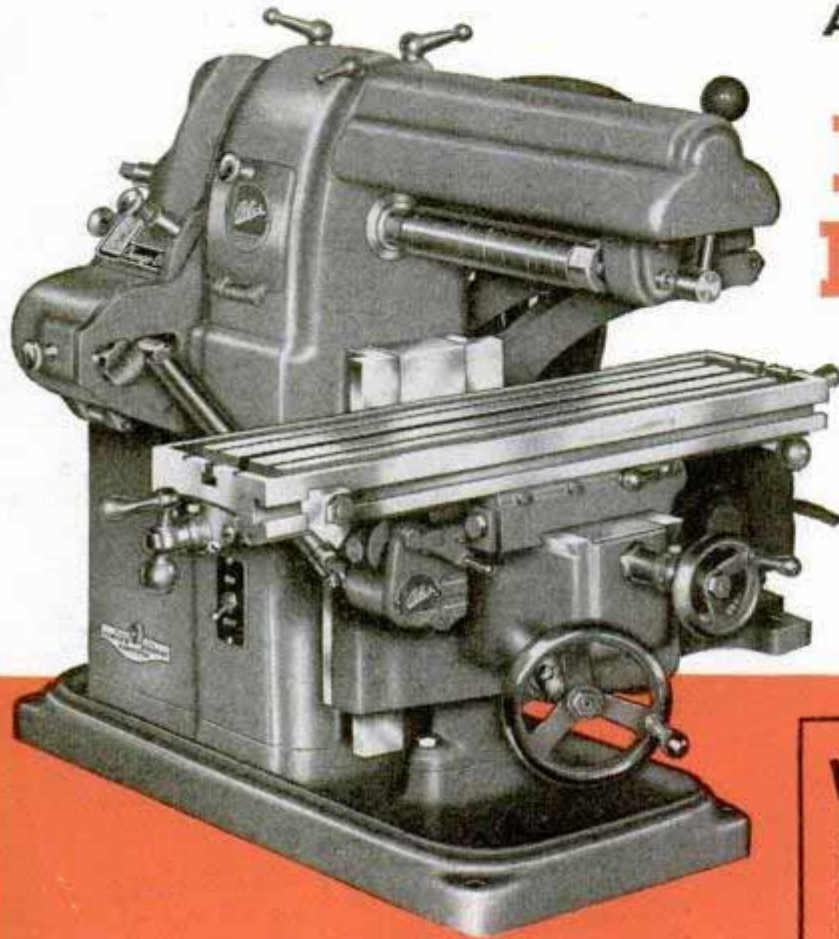

A POPULAR PRICED
PRECISION

MILLING MACHINE

\$175⁰⁰

AND UP
COMPLETE LESS MOTOR

Illustrated is Model MF with
Change-O-Matic Feeds
Simply turning a knob gives you
choice of four table feeds.

IT'S the biggest news of the season!

For the first time in machine tool history you can buy a compact precision bench Milling Machine as low as \$175! Atlas modern engineers have made an outstanding contribution to the metal working field in developing this remarkable miller for you.

Here are a few facts about it. Table working surface is $4\frac{1}{2}$ " x 18", longitudinal travel 12" (manual) or 10" (with "Change-O-Matic" feed), cross travel $3\frac{1}{2}$ ", vertical travel 6". Timken tapered roller bearings give you 12 spindle speeds between 54 and 3225 RPM. Overall dimensions $25\frac{1}{2}$ " x $32\frac{1}{2}$ " x 22" high. Operates from $\frac{1}{3}$ HP 1740 RPM motor.

These are just the highlights. For full details see your Atlas dealer and send the coupon to reserve your 1941 Atlas Catalog.

What It Will Do For You

Modelmakers, inventors, experimental shops, and all types of metal working shops will find many uses for this rugged, accurate, efficient machine.

Die making, metal pattern work, gear cutting, end, form, and straddle milling, slabbing and facing, keyways, slotting, grooving, dovetailing, profiling, indexing, boring, slitting, layout work, finishing—all can be handled to perfection with the Atlas. See the 1941 Atlas Catalog for complete information.

SEND THIS

FROM *Atlas*!

Joins These Other Well Known *Atlas* Machines



Atlas F-SERIES
10" METAL
LATHE

Industrial tool rooms, metal working shops, and workshop owners throughout the world praise the versatile operating features, accuracy, and sensible low prices of Atlas Lathes.

F-Series models have full 10" swing, Power Cross Feed, V-belt drive, precision-ground bed, custom-bored bearings, backgeared power, wide screw-cutting range, 16 speeds. These are but a few of the many modern Atlas features. Priced as low as \$99.75 less motor.

6" LATHES

Give you all the accuracy and dependability of the larger lathes. 12" or 18" between centers—\$61.50 or \$64.50 less motor.

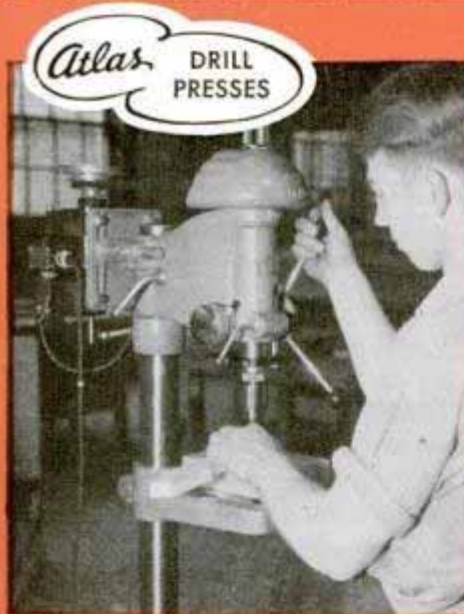
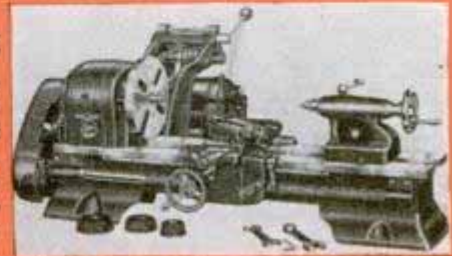

Atlas DRILL PRESSES

One of the Atlas "marvels" is this new metal shaper. All the precision and power of larger machines has been built down to scale for work within a 7" stroke, 4 speeds, 5 automatic cross feeds. \$245 less motor.

FREE..
1941 CATALOG

For smoothness and long accurate service buy an Atlas Drill Press with floating drive spindle design and SKF ball bearings. 4 sizes, 4 prices from \$17.25 to \$44.75 less motor.

ATLAS PRESS CO.

1243 N. Pitcher St., Kalamazoo, Mich.
NEW YORK PHILADELPHIA
130 W. 42nd St. 113 N. Third St.
CHICAGO
35 E. Wacker at Wabash

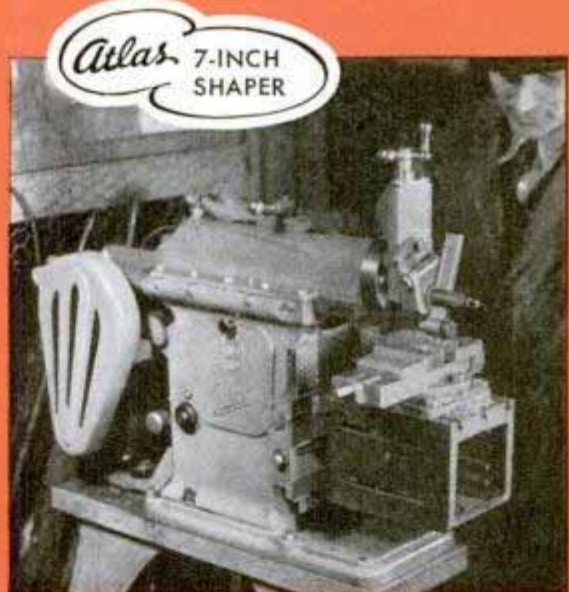

Atlas 7-INCH SHAPER

The big new 1941 Atlas Catalog will soon be off the press. It's full of the best values in machine tools you have ever seen. Use this coupon to reserve your copy.

COUPON TODAY!

ATLAS PRESS CO.
1243 N. Pitcher St., Kalamazoo, Mich.

Please put my name down to receive your 1941 Catalog on:

- | | |
|--|---|
| <input type="checkbox"/> New Milling Machine | <input type="checkbox"/> 10" Metal Lathes |
| <input type="checkbox"/> Drill Presses | <input type="checkbox"/> 6" Metal Lathes |
| <input type="checkbox"/> Arbor Presses | <input type="checkbox"/> 7" Metal Shaper |

Name.....

Address.....

City and State.....

America Goes Calling

(Continued from page 885)

The radio staff engaged in this work is made up of men and women who have lived a total of 325 years in foreign countries. At the outset we realized this was a job calling for men who spoke foreign languages with the accents and idioms of the man in the street. It called for men who knew the customs, habits, and preferences of their listeners. They had to feel, act, and think like foreigners, yet be imbued with a love for America, its government and ideals. The men in the international department can speak, read or write fourteen languages fluently. Even the office boy speaks two languages. They have spent an average of eighteen years each in foreign lands, yet are predominantly American. Eleven are natives, three naturalized Americans, one is a Swiss, one a Chilean, two others, Argentinean and Brazilian.

Music, being the universal language, ranks next to news in popularity. When these daily hour shows were being formulated we consulted with officials in Washington as to whether jazz should be included in the program for Latin America along with classical music. Most of them advised against it but soon we began receiving requests from swing fans south of the border demanding we devote a part of the time to classics in jive.

Miscellaneous talks on American life and industry, sports, aviation, travel, photography, Hollywood, and philately are welcome also. Program-makers have found it politic to weave special shows in honor of foreign holidays. When Toscanini plays for audiences in America an electrical transcription of the concert is made to be used the day following for European and South American broadcasts.

A high spot of international broadcasting was the commercially sponsored blow-by-blow description of the Louis-Godoy fight. A Spanish-speaking sports announcer described the battle at ringside where it was sent by short wave to South America and picked up by some 130 stations of that country. More than 20,000 letters were received from listeners.

The stream of technical improvements in this field has been unending and the present quality of reception compares favorably with conventional broadcasting. Naturally, though, the short wave encoun-

ters more trouble than the long wave because it has farther to go and has more geological and atmospheric hurdles to surmount.

Sunspots have given engineers plenty to worry about as they perturb the ionosphere, causing the radio waves to be cast back to earth where they are picked up by the receivers, thus affecting reception of foreign listeners. They now can be predicted with some mathematical precision. They become active, it appears, in twenty-seven-day cycles and engineers are learning ways to minimize their interference. The short-wave broadcasters have four frequencies on which they can operate, but even with this choice, terrific sunspot blasts on the ionosphere cause complete fadeouts sometimes. Then too, violent magnetic storms frequently follow sunspot activity and this adds up to more interference.

The mention of interference brings up the subject of the deliberate, man-made style about which there's been so much comment. Engineers smile at the legend of wholesale "jamming" of short-wave broadcasts by authoritarian stations. Interference occurs, and frequently, but the dictatorships suffer from it nearly as much as the democracies. Usually it is due to the fact there are more stations than good frequencies.

In international calls, the most advanced type of antenna in the world is used. It's the steerable beam, which, by pressing a button, can be directed either toward eastern (Portuguese-speaking) or western (Spanish-speaking) South America. Power gain is effectively increased twenty-two times that of the non-directional antenna. The steerable beam is used by WRCA on 9,670 kilocycles. The other frequency on this 25,000-watt station is 21,630. The companion station, also 25,000 watts, is WNBI operating on two channels, 17,780 and 6,100 kilocycles.

In truth, short-wave broadcasting, apart from the entertainment and informative values, is helping further the unity of the two Americas. And, in a world in which radio is largely used to arouse man against man, it's heartening to feel this powerful weapon is being employed with success to further the cause of democracy and "good will toward men."



"SHE USED TO BUCK LIKE A BRONCHO!"

HOW A BALKY CAR WAS MADE TO RUN SMOOTHLY BY ONE SIMPLE CHANGE



MY CAR HAD THE JITTERS. The motor missed, backfired and bucked like a broncho. It had no power on the hills. I couldn't figure what was wrong until—



A SERVICE MAN PUT ME HEP to Auto-Lite Spark Plugs. "They'll give your car new life," he said. "Those old plugs now waste plenty of gas, that costs you money."



RUNS SMOOTH AS SILK NOW! My motor purrs like a kitten. And say, I've sure cut my gas bills since I put those new Auto-Lite Spark Plugs to work for me.

Is your car spark-weary? Let the Auto-Lite mystery spark give it new life!

YOU'LL be amazed at the difference in the performance of your car when you replace old, gas-wasting spark plugs with sensational new Auto-Lites! Lazy motors suddenly take on new pep, gain lively pickup and smooth, responsive power. Gas wastes are eliminated.

Auto-Lite Spark Plugs deliver an amazing *Mystery Spark* that steps up the efficiency of the entire ignition system. To harness this

remarkable ignition spark, Auto-Lite's famous staff of engineers created a new-type electrode, made of a new Konium alloy in a new geometric gap design. They developed a new "Ziramic" insulator and other revolutionary features.

Try this new kind of spark plug in *your* car. Discover for yourself why thousands of car owners coast to coast are switching every week. Remember—Auto-Lites cost no more than ordinary plugs.



ROASTED AT 2000°—Testing insulator resistance at twice temperatures found in average engine operation guarantees Auto-Lite durability. This is one of many exhaustive laboratory tests which safeguard Auto-Lite quality.

THE ELECTRIC AUTO-LITE COMPANY
TOLEDO, OHIO • Merchandising Division • SARNIA, ONTARIO

Ignition Engineered by Ignition Engineers

Change to **AUTO-LITE SPARK PLUGS**

More Work for Infra-Red

(Continued from page 895)

tions, contusions and burns, healing after operations, application of heat to produce muscle relaxation of injured legs and arms, and treatment after compound fracture with radial nerve injury. Local applications, that is, to the injured member directly, of heat is regarded as one of the most valuable forms of therapy at the physician's command.

Photography employing infra-red extends the vision of the camera far beyond the limits of the human eye, affording a new photographic and pictorial dimension as well as a medium for making valuable record and technical photographs that would be impossible otherwise. Anyone owning a camera may take interesting and unusual infra-red pictures. Film is available for every type of amateur camera and the only other equipment needed is an A-filter, which if purchased as an unmounted gelatin filter costs but a few cents.

The value of infra-red photography lies in the fact that infra-red radiation and light often are reflected and transmitted quite differently by common objects. The chlorophyll in green foliage absorbs a large percentage of the visible radiation which falls upon it but does not absorb the invisible infra-red, which is reflected almost entirely by the leaf structure and therefore is recorded by means of infra-red sensitive plates and films. Many dyes which are brightly colored to the eye do not absorb infra-red and therefore record as white. The skin is somewhat transparent to infra-red radiation and therefore infra-red photography sometimes is of value in medicine in diagnosing abnormal conditions immediately beneath the surface. Infra-red photography has been used successfully in criminology, photomicrography, botany, paleontology and other scientific fields.

Infra-red landscape photographs usually result in pictures in which the sky is almost black, clouds and snow are white, shadows are quite dense and lack detail, grasses and leaves appear very light as if covered by snow, and distant details are rendered with remarkable clarity. Evergreen foliage, however, appears black because evergreens reflect no appreciable amount of infra-red light. Photos taken by infra-red outdoors in sunlight and then printed slightly darker than normal have

a quality suggesting they were taken by moonlight. One outstanding thing about this form of photography is the penetration of atmospheric haze by the camera. Objects invisible to the eye may be photographed sharply and clearly on infra-red sensitive films or plates. Some remarkable photos of cities and mountains at distances of fifty and more miles have been produced.

Since infra-red radiation is invisible, infra-red photographs can be made readily in total darkness. However, there must be some form of radiation, such as tungsten or photofloods screened with filters which absorb all visible light but transmit freely the infra-red rays to which the photographic material is sensitive. Photos of hot bodies, such as a flatiron or soldering iron, may be made by using the invisible infra-red emitted by the object. This type of photography is valuable in studying the temperature distribution of hot bodies which are just below red heat, such as cooling ingots and castings, stoves, engine parts, high-pressure boilers and the like.

Infra-red, coupled with the camera, has many applications in the war on crime, such as detection and deciphering of erasures and forgeries, detection of stains and irregularities in cloth, detection of certain kinds of secret writing, deciphering of charred documents, study of fingerprints, examination of the contents of sealed envelopes, and others. In the field of examinations of documents, infra-red forms a valuable adjunct to ultraviolet photography, helping to reveal overwriting, obliteration by application of ink, invisible inks, deliberate chemical bleaching and mechanical erasures. Inks, pigments and other materials which appear identical to the human eye frequently appear quite differently in an infra-red photograph.

The physician finds infra-red photography an invaluable aid to diagnosis, since it is possible to make pictures showing the superficial veins, some of which are not revealed by ordinary photographs. Infra-red photos of the iris of the eye reveal details which escape in conventional pictures.

In plant pathology, infra-red has provided a means of studying and diagnosing plant diseases in which there is change in pigment or cellular material. Different

(Continued to page 122A)

WITH SIGHTLESS EYES I GUIDED 10 TONS OF DESTRUCTION!



A true experience of JOHN FENIMORE, St. Louis, Missouri



"THE RAIN WAS COMING DOWN in buckets as I took my heavy transport truck down a long hill," writes Mr. Fenimore. "Suddenly I thought the end of the world had come. Lightning had blasted the road a few feet ahead of my truck!"

"THE BOLT BLINDED ME, but somehow I managed to bring that 10 ton truck to a stop. I groped in the darkness for my flashlight, then stood by the truck and flashed an appeal for help.



"I WAS PICKED UP and rushed to a hospital, where prompt medical attention saved my eyesight. That I enjoy the blessing of normal vision today is due to 'Eveready' fresh DATED batteries. You can bet I'm never going to be without them!

(Signed) *John E. Fenimore*

The word "Eveready" is a registered trade-mark of National Carbon Co., Inc.

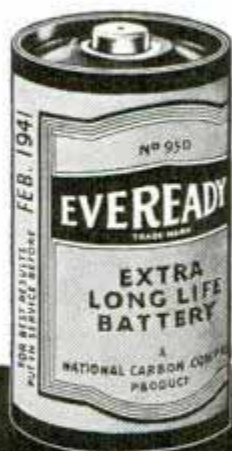

FRESH BATTERIES LAST LONGER... Look for the DATE-LINE

NATIONAL CARBON COMPANY, INC., 30 EAST 42nd STREET, NEW YORK, N. Y.
Unit of Union Carbide **UIC** and Carbon Corporation

K 739

kinds of wood show marked variation in their transparency to the infra-red. In the textile industry, infra-red photography has been applied successfully to detection of irregularities in dyeing and weaving of cloth and damage to fibers. Infra-red sensitive plates have found use in differentiating between light and dark blues, in multicolor printing and in preparing the negative of the black printing plate from originals prepared in specially selected colors. In the field of technology, other applications are the study of interiors of furnaces while they are operating, detection of carbons in lubricating oils and the study of the porosity of tin plate.

Hundreds of new lines have been recorded in the spectra of the elements and much has been learned of the composition of the stars and of the atmospheres of the planets with the aid of infra-red photography. Photos, made through the haze of nebulae, show to startled astronomers the stars normally invisible beyond. And large numbers of new stars have been discovered by the infra-red radiation which they emit.

Much use has been made of infra-red in photomicrography, revealing details of internal structure of deeply pigmented tissues and the thicker microscopic sections and specimens which are not visible in ordinary photomicrographs.

Authenticity of paints—the old masters, for instance—may be determined by means of infra-red photography, employed with chemical study, X-ray and ultraviolet photography. Pigments vary in the way they transmit and reflect the infra-red, though they may appear identical in color. Thus may be detected the presence of overpainting and other alterations, as well as distinguishing between an original painting and a later copy. Important factors are the varnish and medium, which differ in their infra-red transparency according to their nature and age. Paintings which have so deteriorated, due to darkening of varnish, that detail can be seen with difficulty, may be revealed by this means. Photographs, engravings, maps, drawings and other documents which have become faded with age or badly discolored are being photographed successfully with infra-red.

A method of analysis employing fingerprints of molecules, which is so delicate that it can detect an impurity of a thousandth of one per cent in a few drops of

chemical solution, has been developed recently. Furthermore, even those few drops can be returned unchanged after the test, for it consists merely in passing beams of invisible infra-red light through them.

The method depends on the fact that highly complex molecules of organic chemicals, that is, those containing carbon, produce characteristic "fingerprints" or patterns when the infra-red rays are spread out into a spectrum. Glass cannot be used to do this, because it is opaque to the rays. A prism of rock salt, however, separates the radiation into its various wave lengths.

If our eyes could see infra-red rays, we should view a spectrum, crossed by dark lines where certain wave lengths are absorbed by the molecules. Since the rays are invisible, and unable to affect even a photographic plate, they are detected with a thermopile, which measures their heating effect. This can detect a temperature rise of a hundred-millionth of a degree.

The analysis method consists in plotting the pattern made by the absorption bands, and comparing this with the pattern for known organic substances. When the two match, just as when two fingerprints match, it is known that the same individual produced them.

See many times in the Daily Worker 6836 Rodney St. W. Oakland

K 801
**Dolly Cradles the Flat Tire
to Nearest Service Station**



Handy as an "ambulance" is a small three-wheel truck that cradles the car to a garage or service station. When a tire goes flat, the car is rolled onto the low dolly above ground while driving.

Larry

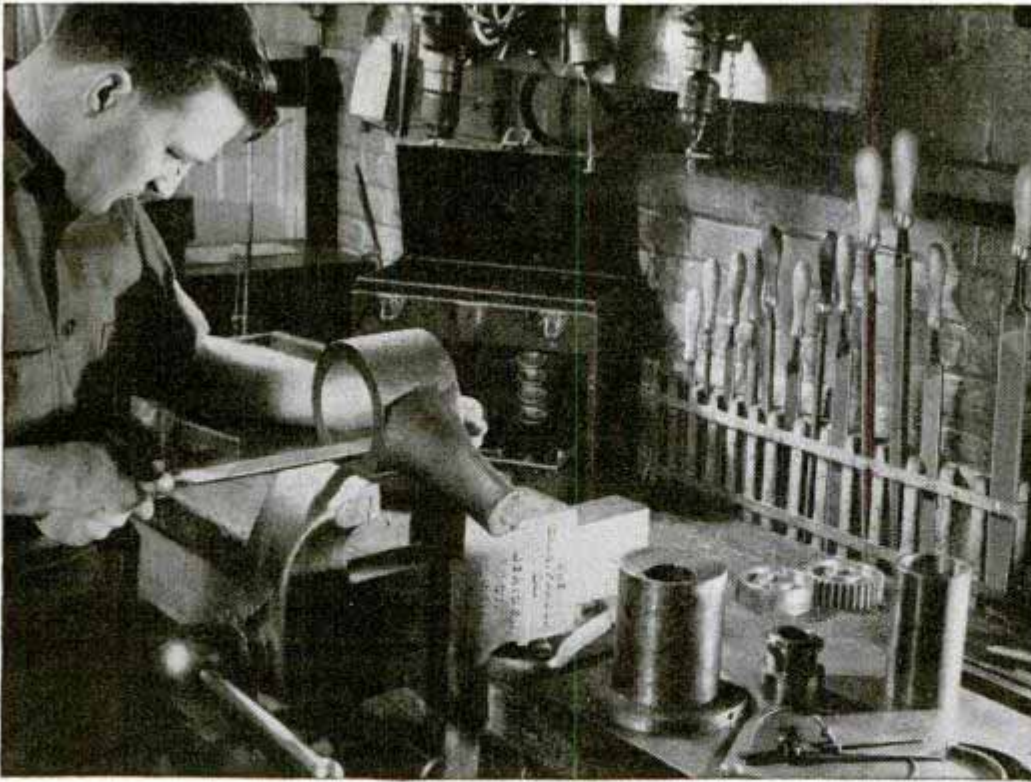

A mechanic is known by the tools he uses

WOULD YOU be proud, or embarrassed, to show a prospective employer your private workshop or work-bench — where you “experiment,” build models, “gadgets,” practical devices, keep household equipment in repair . . . where you add to your mechanical training toward greater earnings? • Begin with your files. Are they cheap, little-known brands? Are they battered and worn? Nicholson and Black Diamond Files are the pride of skilled mechanics. Their superior performance far outweighs their small extra cost. • Nicholson — largest file manufacturer in the world — makes more than 3000 kinds, sizes and cuts of files, including many special-purpose files—such as Die-makers, Aluminum, Die-cast, Brass, Foundry, Long Angle Lathe, and Stainless Steel. Good hardware and mill-supply dealers carry a practical variety.



← THESE
USEFUL →
FILES



are now being widely featured by hardware dealers. *Left*—SLIM TAPER SAW FILES (triangular) for hand-saw sharpening and many other uses. *Above*—HANDY FILE—two files in one! Single-cut on one side; double-cut on the other—for both smooth and rough filing jobs. Rounded flat hang-up handle. Files Cellophane-wrapped. Both these items obtainable in either Nicholson or Black Diamond brand.

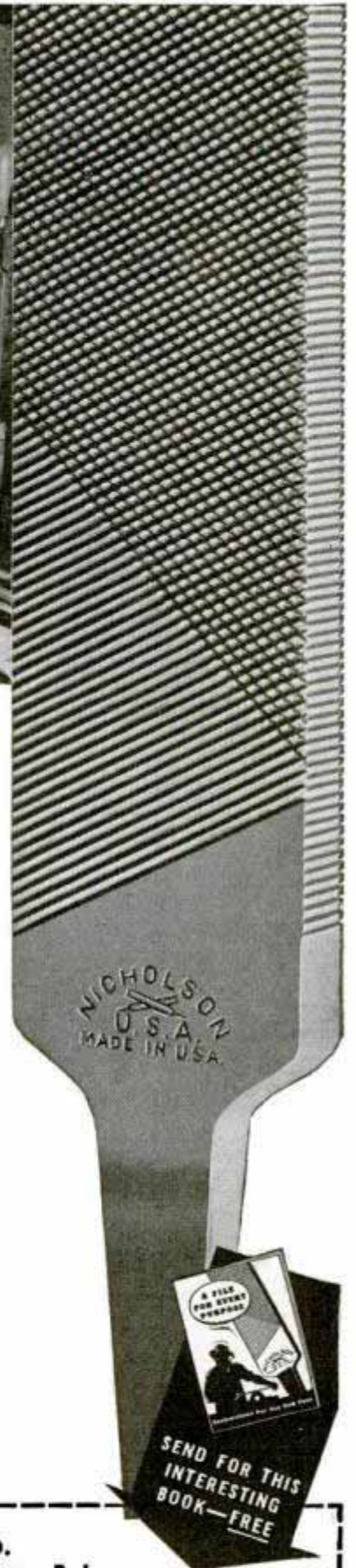

NICHOLSON

FILES FOR EVERY PURPOSE



NICHOLSON FILE CO.

22 Acorn St., Providence, R. I.

Send free book, “A File for Every Purpose.”

Name _____

Address _____

R359

Flying Cowboys

(Continued from page 853)

ground. These days the horse has learned to ride in a truck or trailer. Carrying his horse to work enables the cowboy to sleep at the "home ranch" most nights instead of camping out, and a man and horse now cover much more country than they once did. Horses work just as many hours as always but many of them have ridden far greater distances on four wheels than they have traveled on their own feet.

Except during storms, cattle rarely stray from their ranges now because of the cowboy invention known as the mechanical water hole. Previously cattle depended on natural springs and water holes for water but these days a ranch owner drills a series of wells in a circle around his range. A windmill at each well draws the water and stores it in a large steel tank, adjoining which are pools or troughs. A float lever in the pool replenishes the water when it is low and shuts off the flow from the storage tank when the pool is full again. Each water hole runs automatically for months on end without attention. At seasons when there is little wind one of the cowboys tows a power jack from well to well, pumping enough water from each to refill its storage tank. When a herd exhausts the feed in the vicinity of one water hole it makes its way to the next, moving in a circle around the ranch.

Most of the great cattle ranches have been broken up and even the few that still run to hundreds of thousands of acres are now mainly under fence. The C-Bar-G, running 2,000 head of cattle on forty square miles of summer range and another forty square miles of winter range, is an average-sized cattle ranch today.

The big-time roundup came to an end when the fence arrived and removed the need for each owner to sort his own brand from the common herd. Each cattle ranch holds its own series of roundups now, one in the spring for branding spring calves, again in the fall for branding fall calves, and one in the summer for cutting out the beef cattle that are to be sent to market or to special feed lots. All animals are dehorned except the cows, whose horns are left on so that they can protect their young.

"Treat 'em gentle" are standing orders

(Continued to page 126A)

TAKE A TIP

from a Real Home Craftsman

MAKE IT A CHRISTMAS HE'LL ALWAYS REMEMBER ... GIVE HIM A STANLEY TOOL CHEST!



No. 861-31 Stanley Tools in a hardwood cabinet with convenient panel to hold small tools.

STANLEY Tool Chests make the ideal gifts for men and boys of all ages because they provide an opportunity for both fun and useful training. Starting with inexpensive sets for the beginner, there are fourteen assortments of tools to fit the purse and purpose of everyone. Each includes directions for making useful articles. And because they're Stanley Tools, you can be sure they'll be even more appreciated.

Write for free copy of the new folder showing Stanley Tool Chests.

STANLEY TOOLS

DIVISION OF THE STANLEY WORKS

NEW BRITAIN, CONN., U. S. A.

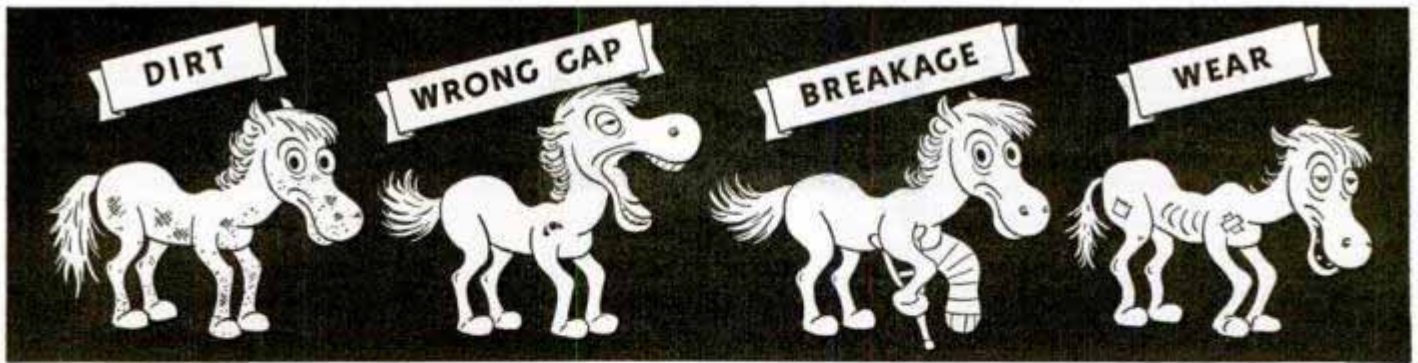

ONLY FOUR THINGS CAN HAPPEN TO ANY SPARK PLUG and AC has the Cure for them all

DIRT

The most common cause of spark plug trouble. If the deposit is black, it's carbon or soot. If it's red, white,

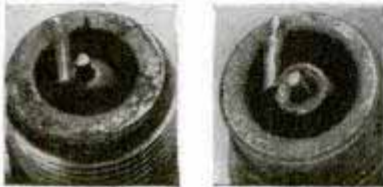

fused, or blistered, it's oxide, —a residue of combustion.

The Cure

is a thorough cleaning (5c a plug) in the special machine developed by AC engineers. You will find this machine in service at more than 70,000 Registered AC Cleaning Stations. There's one near you. (Cleaning and regapping are needed every 4,000 miles.)

WRONG GAP

Wear causes this condition. Sometimes, gaps widen too

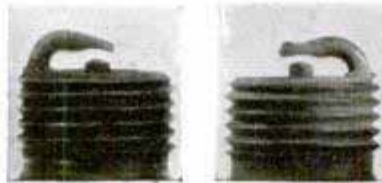

quickly. This indicates that the plug in use cools too slowly, or is of the wrong type.

The Cure

For normal wear—gap adjustment with the special AC tools used by Registered AC Cleaning Stations. Accuracy is assured by the special round wire gauge, which correctly measures concave gaps. The cure for abnormal wear is a new plug of correct type and temperature range. Better make it an AC.

BREAKAGE

Breakage of the upper insulator is always the result of a blow, as when a wrench slips. A broken lower insulator results from an attempt to adjust the gap by bending the center wire; or from use of a plug which cools too slowly, or is of the wrong type.

The Cure is a new plug.



For More
Than 31 Years
The Quality
Spark Plug

Standard equipment on America's finest cars, trucks, buses, tractors, and engines, AC's assure you of best engine performance.

WEAR

It is reasonable to expect about 10,000 miles of economical service from any standard make of plug.



The Cure

A new plug, or a set of new plugs. You'll be sure of full satisfaction if those new plugs are AC Quality Spark Plugs.

LOOK for this
SIGN-
70,000 Service
Places
Display It

Have Plugs
CLEANED
by the
AC METHOD

Cleaning Includes
REGAPPING
to the
Engineers' Standards

The Cost is only
5c EACH
the biggest nickel's worth
you ever got

Replace worn plugs with New AC's for Better Performance

all through the West and cowhands might lose their jobs for hazing animals or treating them roughly. Rough treatment is apt to scare or injure an animal and an unhappy cow or steer loses weight, reducing its market value. When cattle are being moved from one range to another they are transported carefully in trucks if the distance is great or at a slow walk if the distance is short. Baby calves tend to get foot-sore and if this happens each calf is picked up and roped to a saddle in front of a rider.

Grown animals are worth too much money to risk injury by roping and throwing when they are to be dehorned or given other treatment. Instead each is driven into a narrow chute at the end of which is a "squeeze cage," the sides of which are drawn together to imprison the animal and prevent it from struggling. An iron bar is lowered down to secure its head, after which it may be dehorned, vaccinated, or branded without any chance of injury and in a fraction of the time that used to be required.

The cattle business is becoming specialized. Many great ranges are used only for calves that are growing to yearling size, after which the calves are shipped to "feeder" pastures where by means of concentrated foods, as well as the fresh grass, they gain an extra year's weight in a short time. In the feeder pens and pastures, cattle may be fed fish meal, molasses, Manihot meal that is a by-product of tapioca, cottonseed meal, and such other by-products of agriculture as pineapple pulp and orange meal. Prunes, grapes, cantaloupes and watermelons are fed the cattle when surplus crops are available. Such diets are balanced scientifically to do the cattle the most good.

Fencing eliminated the old range wars but it has had little effect on cattle rustling. Stock thieves are still as great a menace as ever. They no longer drive large herds up into the hills and on to distant markets, because such wholesale methods are too easy to discover. On the other hand, meat animals are worth much more today than in the past. The rustlers steal young unbranded animals, rework the brands of others and slaughter animals on the open range. Their equipment is a rifle with silencer attached and a car and trailer. A big steer butchered may bring them \$75 or

\$80 from an unscrupulous meat market. Brand inspectors and stock detectives are always busy.

Today the cowboy still wears his traditional costume because each item of his apparel has been tried and tested in service and fits his work. Even the characteristic vest has its use as a carrying place for tobacco which would be hard to reach and probably crushed if he carried it in his pants pocket while in the saddle. The cowhand is still a rough-riding buckaroo on his days off and his favorite sports are those of the rodeo, competing against his companions in riding wild horses and wrestling with steers. Boys who are growing up on the range first ride calves and then older cattle, unsaddled, to learn of balance before they tackle horses. Part of their horsemanship is to ride bucking animals bareback for the training it gives them.

Cowpunchers don't make much money and most of them earn less than \$75 per month. Room, board and horses are furnished by the ranch owner. Many smart cowboys make a deal with their employers and instead of drawing all their pay as it is due they take it out in young cattle, assembling the nucleus of a small herd so that after a few years each can go into the cattle business himself.

K 359
Memo Sheets Fed One at a Time from "Touch-Control" Case
DeLodex



Memorandum paper is kept on a desk, without sacrificing neatness, in a tidy holder that feeds one sheet at a time with a touch of the hand. Filled, it contains 230 three-by-five-inch slips of paper. Above the sheets and near the front of the case is a roller that when it is revolved picks up and delivers a sheet.

Depuy's American Corp. 310-4-7th

**THEY
WHISTLE**

**THEY'RE
ALL-
ELECTRIC**

**THEY
BUZZ
WITH ACTION**



Built with No. 8½
Erector Set



Built with No. 9½
Erector Set

BOYS!

Look at that towering Erector parachute jump, with electrically illuminated top. You build it yourself. Piece by piece you fit the long gleaming girders together—attach the parachute rigging—and install the powerful Erector reversing electric engine. . . . And now for thrilling action! Blow your whistle . . . throw your engine into gear and your parachutes are hoisted up and up until they strike the release mechanism. Then, like a flash, they plummet downward—unfold—and lazily float to the ground.

Now get a load of that mighty Ferris wheel. It whistles—twinkles with light—operates in either direction at slow or high speed. You can build hundreds of spectacular, realistic mechanical marvels with *one* Erector set. And how the Erector electric engine makes them buzz with action! See the new Erectors at your nearest toy store. Take Dad along.

A. C. Gilbert, Founder of the Gilbert Hall of Science, the home of Erector, American Flyer Trains, Gilbert Chemistry Sets, Gilbert Microscopes and other Gilbert Scientific Toys.

● **All-Electric No. 8½ Erector** — Crammed with exciting electric features. Whistle. 110 Volt reversing electric engine, with automobile-type gear shift. Electric lights. Electro-magnet so powerful it grabs up steel girders before it touches them. Contains total of 15 pounds of up-to-the-minute parts for building bascule bridge, giant Ferris wheel, magnetic crane, oil drilling rig and many other colossal, whistling, engine driven, electrically lighted engineering marvels. Builds over 100 models. Price \$12.95. Other Erector Sets from \$1.00.



**The COLOSSAL
ALL-ELECTRIC
ERECTOR**

FREE



Big 24-page illustrated book "It's Fun to Be a Boy Engineer"—Boys, getting this book is as exciting as going to the movies. Over 100 illustrations. Mail coupon or post card. The A. C. Gilbert Co., 605 Erector Square, New Haven, Conn. Rush big book. (Offer good only in U. S. A. and Canada.)

Name.....
Street.....
City..... State.....

Switching on the Rainbow

(Continued from Coloroto Section)

coated with "phosphors," or fluorescent powder, energized by short-wave ultraviolet produced by a low-pressure mercury vapor discharge between preheated electrodes at each end of the tube. The colors available at present are green, pink, blue, daylight and white—all produced directly by the powder inside the tube. In addition, red and gold lights are obtained by the use of red and gold filters in the form of a spray applied directly to the glass tube.

Efficiency of the fluorescent lamps is revealed by comparing a thirty-watt, thirty-six-inch lamp with a 200-watt incandescent lamp equipped with filters for producing the same color. The green fluorescent produces seventy-five lumens (units of light) per watt; the 200-watt incandescent with filter, only four lumens per watt.

Investigation by lighting engineers has shown that men prefer the warm colors of light, the reds, yellows and ambers, for instance, and women like the "cold" colors, blue, green and bluish-white. Yellow and amber tinted light is definitely stimulating and has been known to increase the pulse rate of the more emotional types of people. Bluish-white and other cool colors of light are restful and soothing, provided the color is not too strong. Purple and violet light, the home owner experimenting with color illumination will need to remember, may be depressing and uncomfortable to a marked degree, if used alone.

Generally, men and women do not like bold, vivid colors in lighting. They do like, however, tinted light—a fact the hostess of tomorrow may use to her advantage.

Among innovations which the homemaker may wish to try, Miss Myrtle Fahsbender, home-lighting director for Westinghouse suggests, is built-in lighting, such as fluorescent or incandescent installations in ledges that may not be integral parts of the house. Built-in lighting can be made in portable sections like a sectional bookcase and moved about to conform to the limitations of a small or large room. The frame might be wood with a channel twelve inches deep and lamps concealed by a strip of flashed opal glass—crystal glass with a thin coating of opal—which provides excellent diffusion with a high transmission of light.

Cove lighting, which Miss Fahsbender also mentions, is a system of indirect lighting consisting of a trough in which lamps are recessed and concealed by a molding of wood, metal or glass. It may be continuous around a room or balanced at opposite ends of a room, or placed over windows and doors. Tubular-type lamps, in white or color, should be used to avoid spotty lighting, since the tubes may be placed end to end to produce an unbroken line of illumination.

Luminous panels may be used in the decoration of the home. Covered with diffusing glass, they can be recessed in ceilings, walls, columns, window frames or built in. White or tinted lamps can be employed to good effect behind window valances to send some light to the ceiling and some down to enhance the beauty of draperies; concealed behind a baffle of the bookshelf to give a pleasing glow to colorful book bindings, and behind each side of a large mirror, perhaps extending from the top of the fireplace to the ceiling, to flood walls on each side. Indirect lighting by means of a special type pinhole projector below a small opening in the mirrored glass top of a coffee table also is effective. A translucent statuette or a vase of flowers may be placed over the pinhole beam to obtain varied effects.

The living room is, of course, the most important from a lighting standpoint. The first step is to provide adequate light for severe seeing tasks, such as reading and sewing. From there, the homemaker may advance to fixtures whose sole purpose is decoration. Perhaps the room is in one of the more modern structures and has a glass block wall at one end. Appropriate tinted lamps, perhaps yellow and amber, back of that wall, will create the effect of a warm summer sun. Blue and green lamps will provide a cooling effect and a moonlight effect may be obtained through still others. Colored lamps may be used in the bookcase. The dining room also is adaptable to colored lighting. White or colored tube-type lamps, installed in plaster, metal or glass coves around the room or at opposite ends of the room, make possible many interesting effects.

The mirror in the bathroom is the most

(Continued to page 130A)

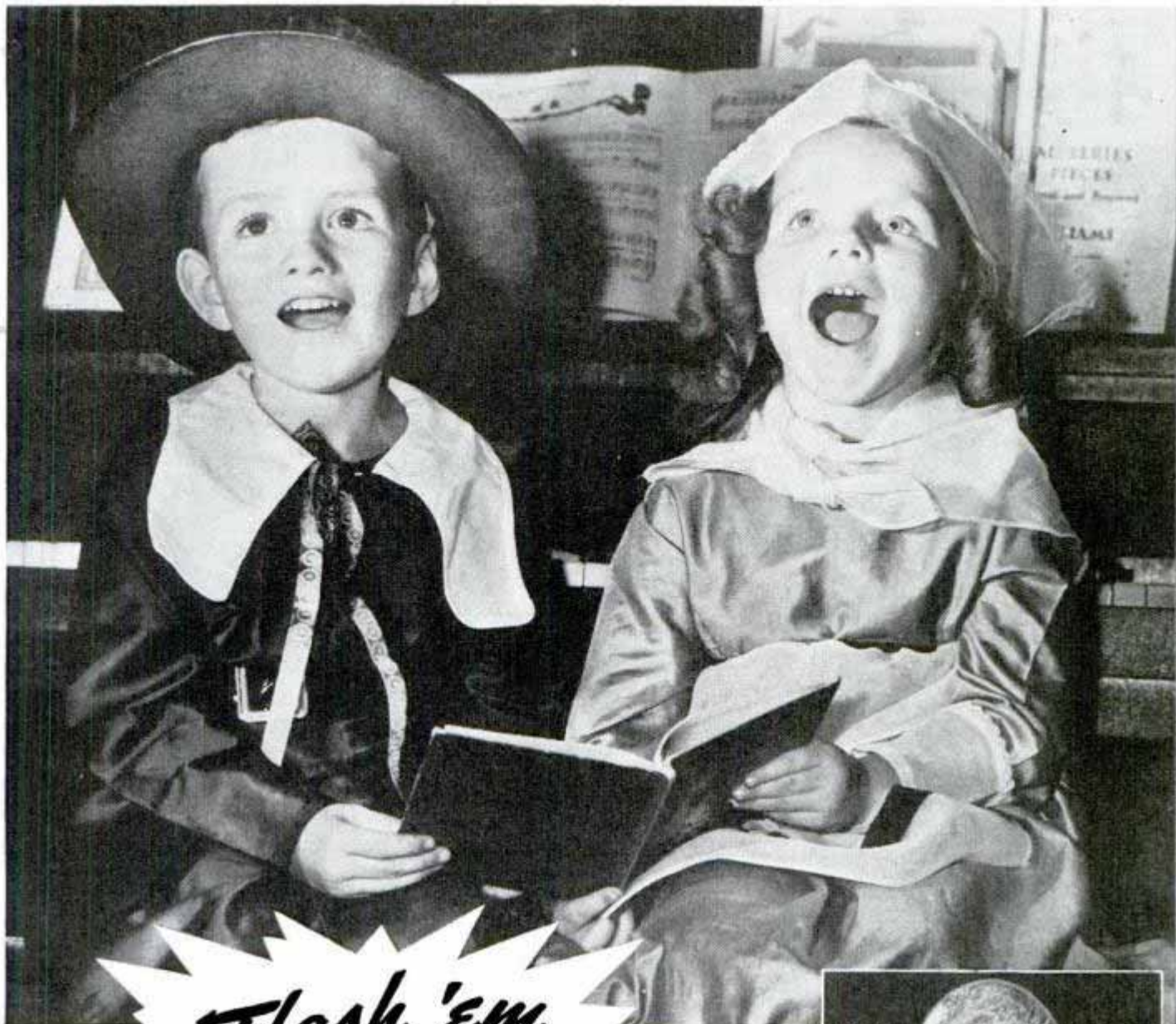

Flash 'em

with G-E MAZDA Midgets
... for crisp, clear snaps of precious scenes

• Thanksgiving, birthdays and many other occasions cry for snapshots! Flash them... before they can get away... with Midget G-E MAZDA Photoflash Lamp No. 5. No larger than a golf ball, G-E No. 5 is grand in the new low-cost synchronized flash cameras. It's sensational in new "directed flash" reflectors for synchronizers. Plenty of light is available so you can stop down for extra detail and depth. And when it comes to convenience, G-E No. 5 is a wow! You can put up to 30 in one suit-coat pocket. There is no need to be out of bulbs when that "prize" moment comes along. Get a supply of G-E MAZDA Mighty Midgets now, so you'll be ready for these shots that come but once a year!



NOW ONLY

13¢ EACH

Ask your dealer about
 new quantity prices

GENERAL  ELECTRIC
MAZDA PHOTOFLASH LAMPS

Movie makers: G-E MAZDA Photoflash lamps are just what you need for sparkling indoor scenes in black-and-white or color. New low prices . . . G-E No. 1, 15c . . . G-E No. 2, 30c

important one in the home. The best illumination, says Miss Fahsbender, is provided by framing the mirror on top and two sides with built-in panels and lighting from lamps hidden behind diffusing glass.

Again in the game or recreation room, the homeowner may let his imagination run riot in experiments with lighting. In most cases low ceilings necessitate close-fitting or recessed lights. Portable lamps, plus general illumination, provide "seeing" light. Special lights producing plenty of illumination for the ping-pong table should be arranged so that they may be lifted off their hooks and disconnected from a center outlet when dancing is desired. If the room has a bar, white or tinted lighting may be used—perhaps a small circular cove over the bar and a luminous glass-rod panel at the back. Fluorescent lamps may be employed to encircle the ceiling, being placed end to end.

Thus, the new tool for beautifying the home may be used in innumerable places, but the homemaker would be wise to consult the lighting engineer before investing too heavily in color fixtures. Since the luxury of color is a new experience for most of us, we may wisely learn, and experiment before fitting this new feature into our daily living.

J. R. Smith, Research Engineer, Washington

K1025

Gas Blanket for Hardening Steel Prevents Loss of Carbon

"Heat burn" and the loss of carbon during hardening of steel is prevented by a gas blanket just developed by research engineers. Under heat treatment at 1,500 to 2,300 degrees Fahrenheit, the surface of steel tends to oxidize, soften and lose the carbon put in it to give hardness and resistance to wear. The new gas, called "Endogas," is made by mixing air with natural gas or some other inexpensive fuel gas and heating them to 1,850 degrees in an electric chamber; it contains enough carbon to balance the carbon in the steel, and thus prevents "evaporation" of carbon from the steel while it is going through the hardening process.

¶If you will send stamped, self-addressed envelope to our Bureau of Information, you will be given the name and address of the manufacturer of or dealer in any article described in this magazine.

They're Tiny—But They Work

(Continued from page 858)

There are radio receiving sets, ranging in size from a two-inch replica of a recent table model to the smallest receiving sets in the world, so tiny that they are kept in capsules. One is but one-thirty-second of an inch square. Yet all the radios work and have received programs from broadcasting stations. Charbneau has his own broadcasting station. It is the smallest one in the world and can be placed in a coat pocket.

There is even a tiny working model of the Model-T Ford motor. The motor is not as long as a cigarette. Right now Charbneau is working on plans for building a minute but working model of an entire auto. When he gets the auto done, he'll probably photograph it with one of the world's smallest cameras, which is a part of his collection. Taking a picture one-fourth by five-eighths of an inch in size, this real "minnie" has already been used to take the illustrations for the world's smallest tooled leather book.

Whenever Charbneau decides to have a replica made of something historical, he demands absolute accuracy. Recently he decided to have built a five-inch working miniature of Franklin's original printing press. Not satisfied with photographs or statistics, he secured permission from the Smithsonian Institution to have his craftsmen make their own measurements.

Under one of Charbneau's powerful microscopes is the world's smallest inscription. It was written by an American on a piece of glass smaller than the point of a pin. The inscription contains 294 letters.

Being the Gulliver of the Lilliputian world naturally has its problems. A whole set of tiny chess men is liable to get lost in a paper match packet, or a dozen fully dressed flea brides and grooms be drowned when a fountain pen leaks. All of the 28,000 items can be packed in one trunk.

Recently, when Charbneau was moving his collection, 200 elephants escaped. You would think that elephants would be fairly easy to locate. But these pachyderms had been carved from ivory with the aid of a rat's tooth, and were all kept in a single hollow seed. The elephants were accidentally spilled on the floor. It took three persons, using powerful magnifying glasses, four hours to find all of the 200 miniatures.



SCALE MODELS

Lionel train outfits with engine, tender, cars, track and transformer from \$7.95.

GREATEST THRILL ON WHEELS!

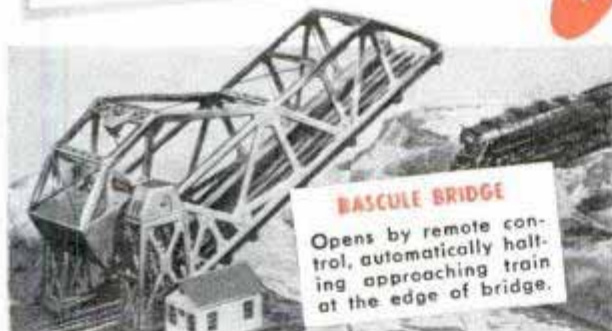

BASCULE BRIDGE

Opens by remote control, automatically halting approaching train at the edge of bridge.



LOG LOADER

Electric elevator lifts logs for loading cars by remote control.



ENGINE WHISTLES

Any whistle of the Official Railway Code — by remote control.



New Engines! New Cars! New Scale Model Realism!

Send at once for a copy of the new 1940 Lionel Catalog and have a look at the greatest array of scale model railroading equipment Lionel has ever built. 64 full-color pages of railroading fun, thrills and excitement.

Now, Two Trains On One Track

Read about Magic Electrol, the sensational Lionel invention that enables two trains to operate on the same track circuit, with each independently controlled. See pictures of new freight cars. Examine details of electro-magnetic couplers and electrically actuated cars that unload by remote control. Don't delay. Mail coupon below.



MAGNET CRANE

Greatest accessory of 1940. Lifts steel beams by magnetism and revolves electrically.



BLOCK SIGNAL

New Lionel signal prevents collision when two trains operate on the same track layout. Electric operation.

CLIP AND MAIL
COUPON TODAY

LIONEL

Scale Model Headquarters

THE LIONEL CORPORATION, Dept. 61,
15 East 26th Street, New York, N. Y.

Enclosed is 10 cents to cover postage and handling.
Please send a copy of the new Lionel Catalog at once.

NAME _____

ADDRESS _____

CITY _____

STATE _____

**THE GREATEST
CATALOG IN RADIO!**

**ABSOLUTELY
FREE!**

**SEND TODAY!
PASTE COUPON ON PENNY
POST CARD**

BARGAINS IN EVERYTHING

The greatest values ever offered in Radio between the covers of one great book! From the smallest part to big automatic phono-combinations, everything is here. Lafayette Radios for the home, farm, camp or car—pick the one you want and whether you'll pay \$10 or \$100 you'll be saving real money.

FOR THE EXPERIMENTER

Build-it-yourself Kits for new Frequency Modulation, or Television, Amateur transmitting sets, etc. Thrills, excitement, education—and what's more, good solid training for future big paying jobs. Get this FREE Catalog and see for yourself.

FOR THE SERVICEMEN

Thousands of parts, every type tube. Save time and money, shop Lafayette. Own up-to-the-minute test and sound equipment. Don't waste valuable hours looking around—you know you can get it from Lafayette, so rush coupon now.



64 RADIO MODELS



BUILD-IT-YOURSELF
KITS



SOUND SYSTEMS



RADIO PARTS

**MAIL THE
COUPON!**

**BIG XMAS GUIDE
SAVE ON GIFTS!**

Here's the way to save money this Xmas on worthwhile gifts. This Free book lists hundreds of great "Buys" in radio, cameras, toys and appliances. All the "Big Names" at reduced prices—send for your copy now.

Lafayette Radio

NEW YORK, N. Y.
100 Sixth Ave.
CHICAGO, ILL.
901 W. Jackson Blvd.
ATLANTA, GA.
245 Peachtree Street
BOSTON, MASS.
BRONX, N. Y.
NEWARK, N. J.
JAMAICA, L. I.

LAFAYETTE RADIO CORP. Dept. 7M
901 W. JACKSON BLVD., CHICAGO, ILL.
or 100 SIXTH AVENUE, NEW YORK, N. Y.

- Please rush FREE Catalog No. 82
- Please rush FREE XMAS Book

FREE

NAME

ADDRESS

CITY STATE

Receiver and Phono Amplifier

(Continued from page 937)

base, the bracket being removed and the coil supported by the heavy wire lead running up to the stator of condenser section (C₄), as shown in Fig. 2. The 2-ganged 370-mmfd. condenser is mounted directly on the chassis base by means of two short

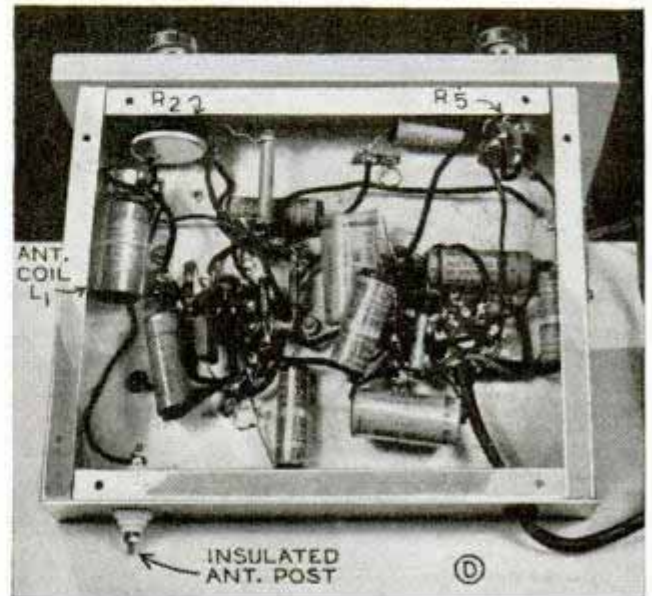

machine screws. A detailed list of materials is available from Popular Mechanics Magazine radio department without charge.

To test the set, turn audio volume control (R₅) full on, advance r.f. volume control about 3/4 on and rotate the variable condenser until a station is tuned in. To line up the set, tune in a station at about 1,400 kc. and adjust the trimmers (Tr.) on C₁ and C₄ for maximum volume. For phono amplifier use, remove the antenna and plug the phono pick-up into the phono jack strip. Turn "radio" volume control (R₂) back until there is no signal. Volume of the record player is controlled by (R₅). Blueprint number for this article is R-285.

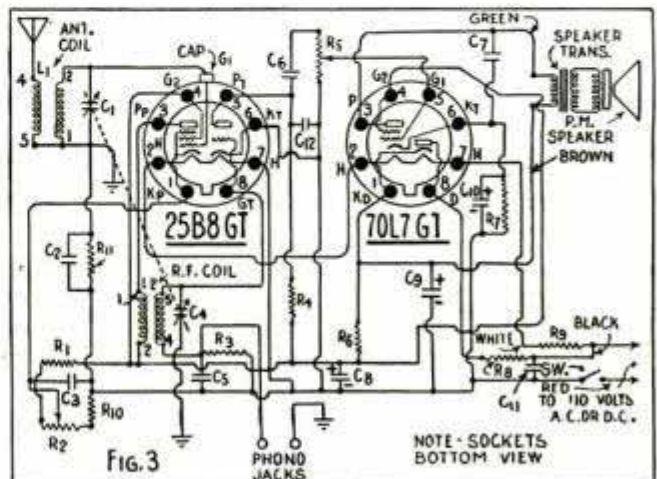

New Drill Press

IS COMPLETE SHOP IN ONE TOOL!

New 14" Delta Drill Press is six tools in one—Performs Efficiently: Wood and Metal Drilling, Sanding, Routing, Mortising and Grinding.

● Every workshop can use this new versatile Delta Drill Press. It takes drills up to $\frac{1}{2}$ " in diameter; also takes all standard wood bits with $\frac{1}{2}$ " shanks; and can be used for boring holes up to 2" with standard multi-spur bits. With proper Delta attachments, this drill press becomes an efficient mortising machine, making square end mortises $\frac{1}{4}$ " to $\frac{1}{2}$ " wide of any length—also sander, grinder and router. Thousands of craftsmen say it is the most useful tool in their shop.

HAS MANY EXCLUSIVE FEATURES

Here is the only drill press that because of exclusive patents gives you the combination of BOTH Self-Aligning Drive and Free Floating Spindle that guarantees accurate alignment. Other features include: "Sealed-for-Life" Ball Bearings that require no lubrication for the life of the bearing; Graduated Quill; Adjustable Depth Pointer; Tilting Table with Index Pin and many others. For the complete story, specifications and low prices, see the latest Delta catalog.

INSIDE SECRETS OF DELTA QUALITY "Dynamic Balancing"

To insure true running of revolving parts, such as on pulleys and wheels, Delta uses a special operation known as "Dynamic Balancing."

Many machine tools have these parts "Statically Balanced," a method by which the part is mounted upon a shaft and then placed between two horizontal parallel knife edge supports so that the heavy part of the pulley will naturally swing to the bottom. The "heavy" part of the pulley is thus found and by means of a drill the excess metal is removed so that the pulley is better balanced.

"Static Balancing" is not good enough for Delta tools because it does not balance accurately enough. "Dynamic Balancing," done with special delicate electrical apparatus, locates and corrects all heavy spots—so that the revolving part is in perfect balance.

Therefore, only in Delta machines are you assured of absolutely true-running, vibrationless operation which means life-long accuracy for you.

This is another exclusive Delta feature—an extra, costly operation which is done for you—a feature impossible to see with the eye but one which assures you satisfactory operation when you buy Delta machines.

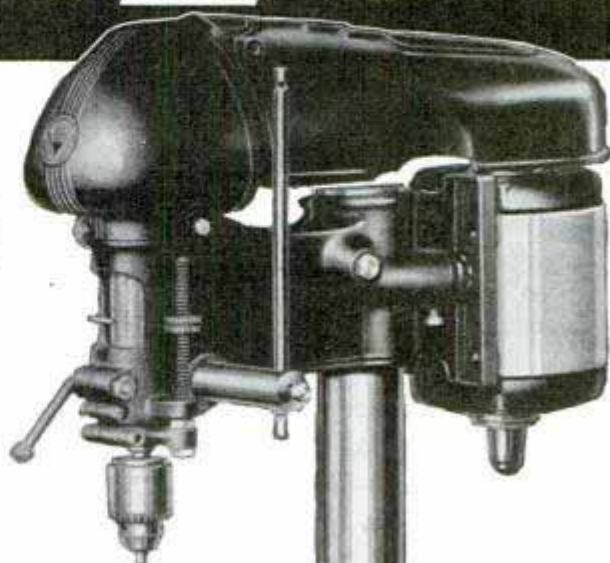

SEND FOR CATALOG

of Delta "Quality" wood and metal working tools. (Also send for Project Book No. 7 crowded with new projects, including working drawings, photographs and full instructions.)

DELTA MFG. CO.

600-634 EAST VIENNA AVENUE
MILWAUKEE, WISCONSIN

DELTA MANUFACTURING COMPANY
600-634 E. Vienna Ave., Milwaukee, Wis.

Gentlemen: Send me the latest Delta Catalog listing the complete line of Delta Lathes, Circular Saws, Band Saws, Jointers, Scroll Saws, Shapers, Sanders, and Drill Presses.

I enclose 10c (stamps or coin) for which please send me the new Delta Project Book No. 7.

Name

Address

City.....State.....

Check here if you are a Delta user now. (Dept. A1240)

EVERYTHING IN RADIO AT LOWEST PRICES!

GET ALLIED'S GREAT 1941 RADIO CATALOG!

FREE 212 PAGES

DEPEND ON ALLIED—THE WORLD'S LARGEST EXCLUSIVE RADIO HOUSE!



83 New Radios! Real "hits"—new plastic models; world-wide sets; "Camera" and 3-way portables; Phono and Recorder combinations, Auto Sets, Amateur Receivers—the sets you've been waiting for—all at lowest prices!

24 New Sound Systems! For every P.A. application—7 to 75 watts—exclusive new features—amazingly low-priced. Easy Time Payment Plan—15 Day Trial Offer. Also everything in P.A. in a special 35-page section.



New! Radio Dictionary! Just out—compiled by leading authorities under ALLIED supervision. Gives concise, easy-to-understand definitions of all commonly used radio words and terms. For everyone in Radio. Only..... **10c**

Radio Builders' Handbook—learn and have fun. Build your own radio. Get this valuable beginners' book on radio; tells how to select circuits, read diagrams, build sets, etc. Illustrated; worth having. Order by coupon below. Only..... **10c**

ELECTRONIC LAB OFFER



A wonderful offer made by ALLIED to Radio Students, Builders, Beginners, Experimenters. Brand new genuine RCA kits that teach you radio by practical construction, at less than half the regular price! **1 TUBE KIT.** Build a real 1-Tube Receiver, an electronic burglar alarm, Home Broadcaster, Morse Code Practice Set, etc. Kit includes: 1 RCA tube, socket, condensers, resistors, coils, soldering iron and solder, wire, transformer, headphone, microphone, electric relay, telegraph key, wiring diagrams, 15-page instruction book. Shpg. wt., 7 lbs. Regular price, \$7.50. **\$2.95** For limited time only.....

2 TUBE KIT. Same as kit at right; makes all projects but builds 2 tube set instead of 1 tube set. Shpg. wt., 7 lbs. Regular price, \$8.95. Now only... **\$3.75**

ALLIED RADIO

833 W. Jackson Blvd. Dept. 5-M-1
Chicago, Illinois

- Rush me your FREE 1941 Fall Radio Catalog
- I enclose 10c for Radio Builders' Handbook
- I enclose 10c for New Radio Dictionary.
- I enclose \$2.95 (plus postage) for 1 Tube RCA Kit.
- I enclose \$3.75 (plus postage) for 2 Tube RCA Kit.

Name.....

Address.....

City..... State.....

Rubber "Grown" in Factories

(Continued from page 847)

with Standard Oil of New Jersey, Firestone Tire and Rubber company has begun production of buna, a synthetic rubber, which will be manufactured into products with some qualities superior to those of natural rubber. Buna's high resistance to swelling and deterioration, when in contact with oil or gasoline, makes it ideal for hoses, gaskets and other products in many fields of industry. It also is highly resistant to the deteriorating effects of age and heat and to abrasion. Two types are receiving Firestone's attention, buna N and buna S, the first particularly adaptable to manufacture of mechanical rubber goods and the other to use in auto tires.

For the past three years, Goodyear Tire and Rubber company has been developing "Chemigum," a synthetic rubber derived from petroleum. Tires in limited quantities are being produced from the material and it is being used in gasoline hose, airplane brakes, gaskets and other products. A factory now under construction will increase the output of Chemigum considerably.

Neoprene, developed by the du Pont company several years ago, is a rubberlike product created by intricate processes from coal, limestone and salt. It looks like natural rubber, acts like rubber, serves wherever rubber serves, but it is many more times resistant to oil, grease and gasoline, and to alkalis and acids; it offers far superior resistance to sunlight, oxygen, heat and age, and it is less permeable to gases. At present, du Pont is making and shipping about 550,000 pounds of neoprene a month. When commercial production began, its price was \$1.05 a pound; now it is sixty-five cents. Neoprene is being processed by 250 manufacturers into sealing strips around windows of high-altitude airplanes, parts for automobiles, essential items in shipbuilding and the machine tool, electrical and petroleum industries; it also is used for garments, shoes, gloves, hospital equipment and many other lines. It is being employed commercially in solid tires for trucks, and experimentally in pneumatic tires for highway service.

Back in 1925 Dr. J. C. Patrick was working in his Kansas City laboratory, trying to devise a new way to make an automobile anti-freeze solution. He had mixed

Thiokol Corp. Union S. Trent

two chemicals, ethylene dichloride and sodium polysulphide, which he thought might combine to form a desirable new anti-freeze. Instead of a new liquid, a gummy looking mass formed in the beaker, much to his surprise. Examination showed that the mass was rubbery and possessed enough properties to warrant being called synthetic rubber. Today it is marketed under the name of Thiokol. It is compounded of elements taken from a sulphur mine, a salt mine and gas wells, all of which are abundant in the United States.

Thiokol is employed to advantage in the automobile, oil, printing, cable and other industries. For instance, when you drive into a filling station, the attendant thrusts into your tank a gasoline hose made of Thiokol or some other synthetic rubber. Such hose lasts two or three times longer, is more flexible and is lighter in weight than rubber-metal hose formerly used.

Among other rubberlike materials being made in this country is Koroseal, a Goodrich product. It is produced by combining ordinary lime, coke and salt; polymerizing the compound, then heating with a solvent and cooling. In great steel mills today, vats are lined with the material to resist the action of the violently corrosive mixture of nitric and hydrofluoric acids used to pickle stainless steel. Applied to cloth, Koroseal renders it impervious to acids, alcohols and stains, as well as to sunlight and water. Such varied products as shower curtains, draperies, upholstery, umbrellas, raincoats, food covers and sports wear are being made from it. Some other rubber companies have produced somewhat similar materials, all of which find wide usage, because more than 35,000 different articles are being made from rubber or rubber substitutes.

Automobile tires made of Goodrich's Ameripol already are on sale at a price higher than that of natural rubber tires. The price of Ameripol is about sixty-five cents per pound, whereas natural rubber sells for about twenty cents per pound. After the World War rubber went up to \$1.25 a pound. If its price ever again is forced upward, by shortage due to war or control of the supply by foreign nations, American manufacturers can turn to synthetic rubber, and the motorist can be assured of an adequate supply of tires for his car, as well as of other rubber goods, at a price not much higher than he now pays.

10 J. Isoborn A. Krom, Ohio

MY BEST GIFT



YANKEE HANDYMAN

SPIRAL SCREW DRIVER

AMAZING
\$1.25
VALUE



Perfect gift for hobbyists or any one who does odd jobs about the house. Makes screw driving easier, quicker. "Yankee" quality.

"Yankee-Handyman" No. 133H has spring in handle. "Quick-Return" spring keeps bit in position while bringing handle back for next stroke. Drives screws—draws screws and can be made rigid. An excellent drill when used with Chuck and Drill Points.

No. 330H Accessory Pak, containing extra Chuck, 3 Drill Points, Countersink and 5/32" Screw Driver Bit, is only 75¢.

See "Yankee-Handyman" Displays at your Dealer's

\$2.25



No. 233H—Finest "Yankee-Handyman". The COMPLETE tool. Transparent magazine handle contains 5/32" Bit, extra Chuck, 3 Drill Points, 1/4" Bit in chuck. An exceptional gift.

"YANKEE" TOOLS

make better mechanics

North Bros. Mfg. Co. Philadelphia, U. S. A.

3
sizes
\$5.95
10.95
12.50



SYNCRO JIG SAWS make Ideal Christmas Gifts

Working tool to gladden the heart of any man or youth who enjoys the thrill of useful construction. Make model boats, plaques, maps, puzzles, household novelties; any kind of scrollwork, marquetry or inlay.

For model builders, cabinet workers, sign builders, hobbyists, home furniture builders. Cut fast, with smooth edges. Electro magnetic powered, requiring no motor. Is safe, efficient, economical. Delivers 7200 cutting strokes per minute. Plugs into light socket. No rotating parts. No oiling. Accidental injury practically impossible. Handles veneer, plywood, bakelite, masonite as well as wood. Throat clearances of models 8"; 13½"; 16". Sold by your favorite dealer.

SYNCRO MINIATURE GAS ENGINES

HEAD OF THE B CLASS

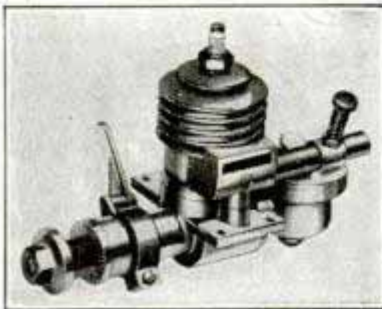

Syncro B30

Syncro B30 is sweeping the country. Enthusiasts like it for its light weight, speed, power, easy starting and low price. Develops 1/7—1/6 H. P. 700-15,000 RPMs. Bore 13/16", stroke 9/16". Displacement .292. Weight 5½ oz. Has positive set carburetion. No timer points to set or adjust. Cylinders and manifold of normalized aluminum. Three piston rings. Force-feed lubrication. Supplied with coil, condenser, spark-plug. The latest and best development in the miniature engine field. Registered class B under AMA rules. Ideal power for model airplanes, race cars, launches. This engine may be inverted. Never before has so much value and quality been offered at the unheard-of price of **\$6.95**

Send for catalog A40

SYNCRO DEVICES, Inc., 743 Beaubien St., Detroit, Mich.
N. Y. Sales Office, 200 Fifth Avenue

RINGS FOR YOUR CLUB
\$1.50
PINS 30¢

Knit your group closer together and enhance pride of membership with pins or rings. Bastian's big selection, low prices, traditional clean-cut quality work has led the field for 46 years.

WRITE TODAY FOR NEW FREE CATALOG!
BASTIAN BROS. Dept. 72, Rochester, N. Y.

\$13.95
Full Set



MICROMETERS

Six piece set, in velvet lined leather case. Special price, only \$13.95. Precision machined in one thousandths, up to 4" outside and 3¾" inside measurements. Guaranteed accurate, easy to read and adjust. Satisfaction guaranteed or money back.

FREE FOLDER

This is your opportunity to get one at a Bargain Price if you act now. Shipped prepaid on receipt of remittance. On C.O.D. shipments, send deposit of \$2.00.
MICRO PRODUCTS, 529 E. Jefferson Ave., Detroit, Mich.

PERSONAL

Are you the type of person who can smile while others boil? You can be—when you use "Prestone" anti-freeze—the winter protection that will not boil away!

See Inside Front Cover and Inside Back Cover

Use Your Bench Saw for Jointing and Cutting Mouldings

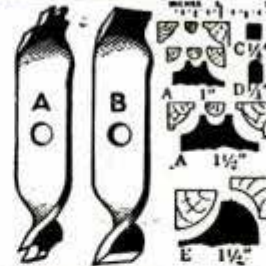

ATTACH THESE SIX INCH TOOL STEEL CUTTERS IN PLACE OF SAW CUT DESIGNS SHOWN AND MANY OTHERS.

Moulding Cutters A1' \$1.25, A1½' \$1.50.
Jointing Cutters B1' \$1.25, B1½' \$1.50.
Groove Cutters C or D ¼" \$1.25, ½" \$1.25.
E 1½" (MAKES ¾" STOCK) \$1.50.

STATE SIZE HOLE. POSTPAID
John A. Sandstrom, Box 317, Stow, N. Y.

PISTON TYPE COMPRESSOR



EASY PROFITS IN PAINT SPRAYING

Paint walls, ceilings, screens, furniture, radiators, machinery faster, better! ¼ H. P. motor 110 Volt 60 Cycle AC, complete with Spray Gun, 15 ft. hose. Weighs only 44 lbs. Carry anywhere. FULLY GUARANTEED. Complete with motor only \$31.15, or only \$25.00 less motor, f. o. b. Chicago. \$5 Deposit, Balance COD, or SEE YOUR DEALER. Circular FREE.

Get started making money NOW! **\$2500 Less Motor**
Ideal Automatic Pump Co.
Dept. PM-12, 801 Washington Blvd., Chicago, Illinois

BURN YOUR NAME ON TOOLS

WITH THE ARKOGRAF

PROTECT YOUR TOOLS FROM THEFT

Write with electricity any name or design on the hardest and finest tools and instruments, or any metal, like writing on paper with pen or pencil. Complete Outfit \$3.50—Prepaid Anywhere. Interesting illustrated circular free. Write today. Agents wanted.
ARKOGRAF PEN CO., 3927 S.E. Stark St., Portland, Ore.

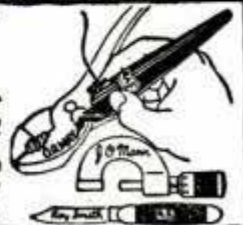

The Camera in Industry

(Continued from page 863)

the camera itself. This camera used film three and one-half feet by five feet in size.

At the proving ground, new cars are torn down and every part is photographed, so that permanent records may be kept. Duplicate cars which have been driven on scheduled test runs are also disassembled and a record photograph is made of each integral part. Many pictures, both movies and stills, are made of cars doing unusual jobs or undergoing tests—such as the recent 100,000-mile run by a Chevrolet truck through deep snow, over mountain roads and on hot desert sands.

Trick photography, which makes no pretense of emulating the synthetic sets frequently employed in Hollywood, is sometimes required to tell the story of an engineering accomplishment. Some of these are made by the unusual use of light, such as night pictures with point sources of light attached to cars to show spring action on rough roads or top action on cabriolets; others are made by combining parts of several photographs in one picture.

One form of photography used in the auto industry—the form that is perhaps best known to the public—is advertising illustration. Camera artists spare no effort to secure the effects assigned by art directors. They arrange their properties and pose their models carefully and many who “paint” with light and lens are as well known in their field as the top-ranking painters who used palette and brush as their medium of expression.

Most of these illustrations are made outdoors, using the best source of illumination of all, the sun, but many are made in huge studios, with painted or photographic backgrounds and thousands of watts of artificial light. These “Kliegs” and “hot spots” sometimes create unnatural glare on cars, necessitating “makeup” such as milady must use to appear her best before a portrait photographer. The “makeup” is not powder or paint, but ordinary condensed milk, sprayed on with a paint gun.

Sales departments make use of many other types of pictures to acquaint both the public and their own field force with facts about the product or activities within the organization. Pictures of new models, and

(Continued to page 140A)

SHORT CUTS FOR THE HOME CRAFTSMAN



How to give a good rub down!

- Fine abrasive powder, mixed with water or oil, can be used to rub down final coats of enamel, lacquer or other material, to produce an even texture or special effect. This is only one of the many polishing operations you can do by mixing a little Carborundum Brand Silicon Carbide or Aloxite Brand Aluminum Oxide Powder with water or oil, and rubbing the work with it.

The illustration shows how to rub down a sprayed lacquer surface. Use a cloth or felt pad and reduce the pressure towards the end of the finishing operation. Then polish with a woolen cloth. This produces a fine satiny gloss. Many more helpful hints are given in the booklet offered below.

Ask your hardware dealer or mill supply house to show you the complete line of Carborundum-made coated abrasives, sharpening stones, grinding wheels and other abrasive products for the home craftsman. Send 10¢ coin or stamps, for souvenir sharpening stone and valuable illustrated manual on how abrasive products can save time and help you do better work.



Write Dept. M 120

THE CARBORUNDUM COMPANY

REG. U. S. PAT. OFF.

Niagara Falls, N. Y.

[Carborundum and Aloxite are registered trade-marks of] and indicate manufacture by The Carborundum Company]



NEVER WASTE anti-freeze in a dirty radiator. It's expensive—and dangerous! Clean out rust, sludge, sediment and scale *before* you add anti-freeze. You can do it yourself with Sani-Flush. It costs only 10c (25c for the largest truck or tractor).

If you prefer, ask your service station to do the job for you with Sani-Flush. Be sure and be safe. This chemical compound cannot injure motor or fittings. It opens the delicate veins of the radiator. Motors run cool. Power is saved. You'll find Sani-Flush in most bathrooms for cleaning toilet bowls. *See directions on can.* Sold by grocery, drug, hardware, and 5-and-10c stores. 10c and 25c sizes. The Hygienic Products Co., Canton, Ohio.

Sani-Flush Safe NOT CAUSTIC

CLEANS OUT RADIATORS

SpeedWay DRILL **7⁹⁵** GRINDER **5⁹⁵**



KIT
\$14⁹⁵



STAND
\$3⁹⁵

QUALITY TOOLS

... products of SpeedWay, for 30 years leading manufacturers of electric tools. Specially wound high torque 110V universal tool motors. Improved design, correct speeds, 1000 RPM Drill with die cast handle has 1/4" capacity in steel. 20,000 RPM Hand Grinder has speed essential for efficiency and collars for both 1/4" and 3/32" arbors. Drill and Grinder sold singly or together with 5 accessories in fitted Steel Kit. Stand takes either drill or grinder.



ROUTER
\$3⁹⁵



GRINDER
\$9⁹⁵

Router Frame convert. grinder into router. Bench Grinder is complete with motor. Write for Circulars. SpeedWay Mfg. Co., 1842 S. 52nd Ave., Cicero, Ill.

A 250

Portable Unit Freezes Ice Cream Electrically in Ten Minutes



Start this ice-cream freezer while you're eating the first course and it will produce dessert in time

Modern counterpart of the hand-turned ice-cream freezer is a portable electric unit that freezes two quarts in ten minutes. It is available in two, four and six-quart sizes, and it serves many other purposes—auxiliary refrigerator for summer cottage, picnic pack box or ice bucket.

K 396

Hand-Cranked Knife Sharpener Removes Nicks in Blade

Household knives of all kinds can be sharpened in a hand-cranked unit that is screwed to the wall or table end. Designed



This hand-cranked sharpener, mounted on wall or table, puts an edge on knife without marring finish

for a lifetime use, the manufacturer says it will not scratch the finest stainless-steel blade. A guide slot holds the knife in correct position for sharpening, and its action corrects nicks or flaws on the blade.

4295 8/276
 Frigidella pens
 Mendota, Ill.
 Wulf & S. Mfg. Co. 428 W. Jackson St. Cicero, Ill.

The New GOLDEN BANDED 1000-SHOT RED RYDER Saddle CARBINE

LICENSED BY STANLEY KRAMERSON, INC., N.Y.



BOYS! Send coupon to Red Ryder for your **FREE Christmas Reminder Kit**, enclosing 3c stamp, please, to help cover our handling-postage cost. Kit contains printed "messages" to be signed by you, pictures of all Daisy Air Rifles, complete directions. It's **FUN** to use! Put "Reminders" under milk bottles. In mail-box, on Dad's easy chair. They'll **HELP** you get a Daisy for Christmas. If you **HAVE** money now (or can get it) buy your Daisy **NOW**. If your Dealer hasn't it, or no Dealer is near you, send us the price of your favorite Daisy in cash or Money Order and we'll mail it **POSTPAID**. (Duty added in Canada.) Or—rush coupon, 3c stamp, for Christmas Reminder Kit.

The Popular 500 SHOT LIGHTNING-LOADER CARBINE Only \$2.50

Daisy's original 500-Shot Carbine features Lightning-Loader invention and Adjustable Double-Notch Rear Sight. This handy, beautiful, accurate Carbine only \$2.50 at Dealers or direct.

Double Barrel 100-Shot Repeater. Break Action. Automatic Safety. \$5

50-Shot Pump Repeater. Forced-Feed Magazine. Engraved jacket. American Walnut stock. Take-down model. \$4.50

Buck Jones Special. 60-Shot Outdoor Model. Genuine compass. Saddle in stock. \$3.50

USE DAISY BULLS EYE SHOT TUBE 5c

DUTY ADDED IN CANADA



\$2.95 DUTY ADDED IN CANADA

Send Coupon For **FREE CHRISTMAS Reminder KIT**

RED RYDER (Care of DAISY MANUFACTURING COMPANY, 5412 Union St., Plymouth, Michigan, U. S. A.)

Dear Red: I enclose 3c stamp for postage-handling expense. Please send me Free, COPYRIGHTED Christmas Reminder Kit.

NAME _____

ST. & NO. _____

CITY _____ STATE _____

Check here if you want Daisy Catalog also.

DAISY AIR RIFLES

MENDS MOST ANYTHING

Iron Glue holds tight, is extra strong. You can buy it 'most anywhere— $\frac{1}{4}$ pt. to 1 gal. cans or 10c bottles. **FREE:** Send post card for booklet, "Better Results with Glue," to: McCormick Sales Co., 402 Light St., Baltimore, Md.



IRON GLUE AN ELEPHANT FOR STRENGTH

***Home Craftsmen Like EMPIRE LEVELS!**

NEW "CIGAR SHAPED" ALUMINUM "TORPEDO" LEVEL. Won't tear pocket. Serves many uses for workmen or in homes, 9" long. Shows plumb, level, 45°, 35°, 15° pitch. Grooved bottom. Only \$1.40.

POCKET LEVEL—FOUNTAIN PEN SIZE. Beautiful Chrome Aluminum. Clips to vest pocket. Always handy. Accurate. Level vial has pitch graduations. Great value, Only 75c.

EMPIRE LEVEL MFG. CO., Dept. P-11
717 So. Sixth St. Milwaukee, Wis.

Patented

*Order direct, or from local Dealer. Send 10c for catalog. Good Craftsmen Everywhere Use EMPIRE "Extreme Accuracy" Levels.

HOLD-E-ZEE AUTOMATIC GRIP SCREWDRIVERS

Hold, start and set-up screws in unhandy places. Gripper instantly released by spring action, sliding up out of way when not in use. Finest materials thru-out, chrome vanadium blades; many have transparent, insulating unbreakable handles. (Illustrated.)

No more expensive than ordinary screw drivers. Models for recessed-head screws. Handiest ever. Get one today. At auto-supply, hardware or electrical stores.

UPSON BROS., INC. 86 EXCHANGE ST. ROCHESTER, N. Y.



Do more Earn more Work less with a Red Universal E Tractor

You plow, disc, cultivate, mow, haul, do belt work, for about 33c a day. Safe, trouble-free long life. New plow lift, new reverse. Hundreds used. Save by buying from maker. Two weeks trial. **FREE** catalog. Write today.

PIONEER MFG. COMPANY
Dept. V-120 West Allis, Wis.

BOICE-CRANE ANNOUNCES A Great New BAND SAW

NOW—Faster—Smoother Safer Band Sawing

Once again—this time in a sensational new 14" Band Saw—Boice-Crane is first with new features and ingenious engineering.

Unlike ANY Band Saw You've Seen To build this new kind of band saw with all its features at our low price, required new materials, new production methods, and a clean break with traditional design. Just think! It cuts 100% faster and smoother; runs so quiet it barely "purrs"; frame is built like a skyscraper and just as strong. Other new features galore!

SEND FOR 1941 CATALOG

Learn all about the sensational Band Saw and other 1941 B-C Tools. Include 10c for book that tells how to spin metal on your shop lathe.

Name _____

No. _____

City _____ State _____

BOICE-CRANE CO., DEPT. 5120 TOLEDO, OHIO

KEEN BUYERS

Proud to Mark Their Tools



New ATKINS "2000"

Your Own Initials on It!

Yes! Every proud owner of the amazing new Atkins "2000" Hand Saw gets his own initials on it—absolutely free. See it at your dealer's. Notice the trim, modern handle—and the grip designed closer to the famous taper-ground, Silver Steel blade.

And remember—you can have your own identifying initials on this great new saw. A special card is attached to every Atkins "2000" Saw. You print your name on the card, mail it, and Atkins promptly sends you handsome gold-and-black decal letters. No wonder Atkins "holds the edge" in popularity.

ATKINS Silver Steel SAWS

E.C. ATKINS & COMPANY, 426 S. Illinois St., Dept. M, Indianapolis, Ind.

A HULL Streamline AUTO COMPASS JUST WHAT I WANTED

SAPPHIRE BEARING
BUILT-IN COMPENSATOR
ATTRACTIVE GIFT BOX

ONLY \$2.95 AT YOUR DEALER

Write for Circular
P. O. Box 246-D12
WARREN, O.

HULL MFG. CO.

THE GIFT HE'LL LIKE Best AND USE Longest

100 TOOLS in ONE

Only \$9.85 POST PAID

The genuine Dremel Moto-Tool is the ideal gift for a craftsman's Christmas. Grinds, polishes, sharpens, drills, engraves, etc., etc. Saves time, cuts cost, does finer work. Owners find it the handiest tool in the home or shop... use it daily. Same tool as used on precision jobs in factories. Over 25,000 r.p.m. (the speed necessary to con-

serve cutters, do fine work). Has oil-less (oil sealed) bearings... dynamically balanced armature, vibrationless, 110 V. universal (AC-DC)... has built-in cooling fan.

6 oz. Model 1 Moto-Tool complete with chuck and 1/8" collet, only \$9.85. Master Model 2, faster, heavier, more powerful, with chuck and 1/8" collet only \$16.50.

10-DAY MONEY TRIAL BACK

See genuine Dremel Moto-Tools and complete kits at better dealers or order direct from factory on 10-day money back trial. Send only \$5.00 with order. We ship C.O.D. for balance.

DREMEL MFG. CO., Dept. 110-M, Racine, Wis.

Modern Craftsman's Kits
KIT NO. 1 with 23 high grade accessories and Model 1 Moto-Tool in hard-wood case... \$17.50
KIT NO. 2, same as above with Master Model 2 \$23.50

MASTER MODEL \$16.50

WRITE FOR FREE CATALOG!

new manufacturing methods are distributed to newspapers and other publications throughout the world. Pictures of testing processes in experimental laboratories and on proving grounds are sent to the press and distributed to sales forces in illustrated house organs, or company publications. Huge enlargements are often made for exhibition use. Chevrolet recently executed for one exhibit a photo mural measuring twelve feet by 128 feet, and for another, ten stage backdrops, each measuring fifteen by thirty-five feet.

Educational motion pictures in both black and white and in color, and even animated cartoons, are made for distribution to motion-picture theaters. These are especially useful in rural communities where many people never have the opportunity of attending automobile shows.

Small wonder, then, that vast amounts of all kind of film are employed in the automotive industry. A twelve-month supply of film for the photographic section of General Motors may read something like this: Translite film, 7,200 square feet; eight-by-ten film, 19,800 pieces; four-by-five, 17,376 pieces; lantern slides, 26,640 pieces; Kodachromes (color film), 68,700 square inches; offset film, 40,000 square feet. In addition, there are other users of film with the organization, such as Buick, G. M. Truck, the G. M. proving ground, Diesel plant and Research division, so the total used by the corporation would be of startling proportions.

Many other industries are employing the camera so effectively in the correlation of engineering data and particularly in the study of metals that the influence of photography is being felt indirectly by millions of purchasers of American products.

"Fire Cards" Scattered by Plane Are Revival of Old Weapon

One of the rare "new" weapons to appear in the European war is the phosphorus card scattered over Germany by British planes to start fires, but in reality it is only a new form of an old weapon. These "fire leaves" are flat sheets of pressed guncotton containing phosphorus, which bursts into flame when it dries out. Years ago the British used very small incendiary bombs to destroy grain fields during warfare against tribes in northwestern India.

Science Service
9/11/40

Sailors of the Sky

(Continued from page 869)

continuous and fully annotated record of the Clipper's progress.

One of the primary purposes of this careful charting of progress is for the continuous advice of the guarding ground stations at either end of the route. Every half hour the captain radios a complete position report to these stations, and herein lies the importance of the air liner's radio officer. This man, a specialist in his field, has as his responsibility the maintenance of continuous radio communication with the ground—the only link between the Clipper, flying high above the vast ocean, and a couple of radio stations on land, several hundred miles away, or an occasional ship. The radio officer has at his disposal two complete radio installations, both transmitters and receivers, as well as the loop antenna used for taking radio bearings. In addition to relaying the half-hourly position reports, it is his duty also to take the numerous radio bearings so important to navigation of the aircraft. Also, for the sake of continuous check on the operation of the communications equipment, he makes a radio contact with the ground station nearest the Clipper every ten minutes.

The purpose of sending half-hourly position reports is primarily one of safety. By following a regular schedule of these reports the ground station, which charts and records each position as it is announced from the airplane, is enabled to keep constant track of progress; furthermore, should trouble develop, the ground station knows just where the aircraft is, precisely as of the last half-hourly report, and very closely beyond by a projection on the chart by using the Clipper's speed and course following the last given position. The technicians on the ground therefore are in a position to render all possible aid with the least delay, should help be requested.

The position reports as sent from the plane include the Clipper's altitude, speed, latitude and longitude, wind direction and velocity and a picture of prevailing conditions relative to clouds and sea.

The heart of an airplane is, of course, its engines; in the case of the Clipper, there are four, each of 1,500 horsepower, fourteen-cylinder, double-bank Wright Cy-

(Continued to page 142A)

FREE to CASCO USERS ..the first Project Service by FAMOUS DESIGNERS



★ **GILBERT ROHDE**, noted industrial designer whose successful "modern group" of 8 associated living room pieces is continued.



24 original projects to build in your own home workshop



★ **RUSSEL WRIGHT**, specialist in design for the American home, creates, for Casco, new projects in the modern manner.

★ **HERMAN HJORTH**, well-known author of woodworking books. His new "traditional" projects are authentic.

STOP wasting good workmanship on poor design. Build professionally planned projects!

Casco Projects are sponsored by Casco Powdered Casein Glue, the standard for heavy-duty wood gluing. 10¢ to 65¢ at Hardware, Paint and Lumber Dealers'.



SEND FOR THIS FREE BOOK

16 pages. Illustrates all the 1941 Casco Projects. Tells how to get free working plans through each purchase of a 25¢, or larger, can of Casco Glue. Includes other helpful home workshop information.

CASEIN COMPANY OF AMERICA, Dept. PM-1240
350 Madison Ave., New York, N.Y.

Send me a copy of the new, free "CASCO PROJECTS" by return mail.

Name _____

Address _____

City _____ State _____

Save 2c... stick coupon on penny post card.

Fast Xpert Shells Get the Jump on Game



The instant a leaping cottontail starts to make his getaway, the shot charge of the fast shooting Western XPERT shot shell is on him—a dense, escape-proof pattern of hard-hitting shot pellets. XPERT gets the jump on game. Your dealer has XPERT in the gauge you want. Mail the coupon below for full particulars.



WESTERN CARTRIDGE COMPANY
Dept. L46, East Alton, Ill.

Mail, free, the 76-page helpful Western Ammunition Handbook. Also leaflet on XPERT and SUPER-X shot shells.

Name _____

Address _____

Post Office _____

State _____

TYPEWRITER ^{1/3} PRICE

STANDARD OFFICE MODELS
1/3 MFRS. ORIG. PRICE

Easiest Terms as Low as **60¢ A WEEK**

All late models completely rebuilt like brand new. FULLY GUARANTEED.

No Money Down - 10 Day Trial

Free price-smashing catalog shows all makes in colors. FREE COURSE IN TYPING INCLUDED. See catalog before you buy. SEND NOW.

INTERNATIONAL TYPEWRITER EXCH.

Dept. 1201 231 W. Monroe St., Chicago, Ill.



10c A DAY

ALL-STEEL GUN AND TACKLE CABINETS AT NEW LOW PRICES!



No. 7038 (above)
Green or Brown, \$15.95
OTHER CABINETS FROM **\$9.75**
Write for Facts Today

10 DAYS' TRIAL Keep Sports equipment in safe, dry place. Smartest design, heavy gauge welded steel. Ample gun space, wardrobe section, spacious top shelf. Insulated, sound proof doors. Cylinder lock, 2 keys included. Factory direct to you, low prices—Guaranteed finest quality and craftsmanship. Order now.

FREE: Beautiful 24-page color catalog shows complete line of all steel, guaranteed gun and utility cabinets. Get details of our 10-day Trial Offer. Write today.

FARRELL STEEL CABINET COMPANY
2500 East 75th Street, Dept. 12 P.M., Chicago

clones. Their regulation and control is entirely the function of the engineering officer. At the captain's direction, this important member of the crew makes appropriate changes in the engines' power output and speed for the purpose of conserving fuel and maintaining schedule in the most efficient manner. Before him on an instrument board are the myriad instruments vital to proper functioning of this great 6,000-horsepower plant. These instruments, in the absence of an officer assigned especially to supervision and control of the engines, would have to come under the jurisdiction of the pilot, but under the system of multiple-member crews developed by Pan American Airways, the pilot is relieved entirely of this responsibility. In the cockpit proper there are only the so-called "flight instruments"—altimeter, air-speed indicator, compasses, gyroscopic pilot, turn-and-bank indicator. It will be seen from all this that the mechanical task of operating a Clipper across vast stretches of ocean is a highly specialized job, requiring the services of highly trained men in several fields and requiring also a rigid system of division of duty, both to attain maximum efficiency in each position and to reduce fatigue from too many tasks.

"Jack-in-the-Box" Cigarette Case Has Clock in the Lid

One cigarette at a time springs out as the lid of a combination cigarette dispenser, ash tray and clock is rotated. Cigarettes are set upright in sockets arranged about the center ash tray, a spring beneath each "smoke" applying pressure to eject it.

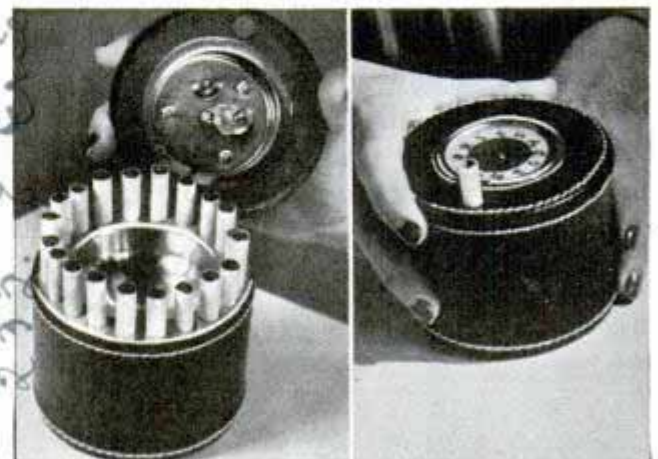

Cover removed from case, left, shows cigarettes in slots. Right, one has sprung up from hole in cover

Auto Accidents, Health, Fame!

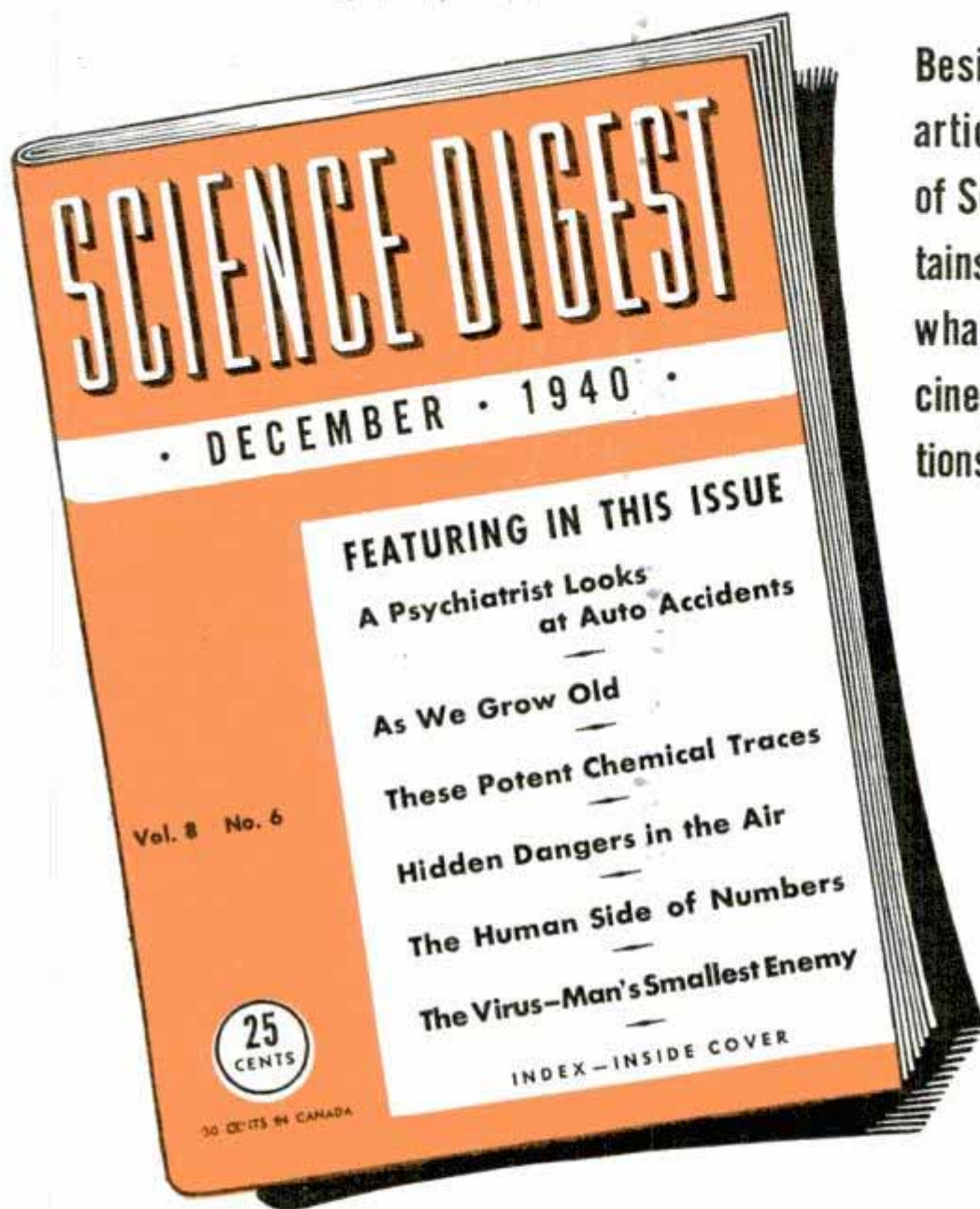

Besides its featured articles, each issue of Science Digest contains sections telling what's new in medicine, in patents, inventions and processes.

For his own protection every driver of a car is interested in reducing the number of automobile accidents. That's why every driver should buy the December issue of Science Digest and read—"A Psychiatrist Looks at Auto Accidents." Every worker is interested in health and full-time pay and so he should read "Hidden Dangers of the Air." It deals with both living and working conditions. And someone who reads this advertisement

undoubtedly will achieve fame. The age when he most likely will do the work that gains him fame is given in the article—"As We Grow Old." These three articles of almost universal interest are merely "appetizers" for the ninety-six pages that make up the attention-holding December issue.

SCIENCE DIGEST, INC.
631-643 St. Clair St., Chicago

ON NEWSSTANDS NOW—25 CENTS

30 CENTS IN CANADA

Try These in Your Home

(Continued from page 875)

mer heat out of the house and winter heat in. Vermiculite, a unique mineral that resembles mica and that is expanded to fifteen times its original size by heat treatment, is a light, fireproof insulating material that is poured into the side walls or over the ceilings of rooms as an insulator both against temperature and sound. Copper roofs are permanent and also expensive, but now copper roofing material is available as a thin foil attached to roofing paper, providing the advantages of copper at only a fraction of its former cost.

Shades inside a window are not nearly as effective for keeping heat out as are shades installed outside a window. One manufacturer is building permanent exterior metal awnings for window openings consisting of strips of metal with alternate strips raised over the others to provide air circulation between without permitting rain to drip through. Another concern makes permanent wooden awnings that have adjustable blades and these blades may be tilted to any angle from inside the house. Keeping out the heat is also one of the purposes of a new kind of window screen. The screen has fine horizontal copper strips set at an angle like a Venetian blind yet from a distance resembling the ordinary wire-mesh screen. Easy to look through at most angles, the screen presents an unbroken copper shield to the sun after the sun has risen more than half way above the horizon. It excludes as much as ninety per cent of the sun's direct heat.

Linoleum has moved up from its place as a floor covering and is now also widely used as a wall covering. Rubber wall tile is being manufactured and like linoleum is easy to keep clean. Fire-resistant wall panels of colored plastic materials baked onto base materials are being made for use in bathrooms and kitchens. Curved metal shapes are available for nailing into the corners of floors where dust is difficult to sweep out.

With the new materials that are being made available, new architectural styles and structural designs become possible. One such innovation is a new roof design that takes advantage of the structural strength of materials that are manufactured in large sheets, such as Celotex or plywood. In the new design such sheets

are formed into a roof that has normal pitch but that curves down at the eaves, transmitting its load vertically to the walls. The roof is "skin stressed" like an airplane and is supported by itself and by laminated arched rafters four feet apart. The roof has no outward thrust and needs no interior ties.

The design weighs half as much, costs a quarter less, and has the same load-bearing characteristics as conventional roof designs. It has been engineered for spans of thirty-two feet although greater widths are contemplated. When one of the various insulating boards is used for the structural sheets the insulation that it affords provides savings of as much as twenty-five per cent in heating costs.

One Los Angeles builder who wanted to find out just what he could do with this roof design decided to build a model home that would also include every new feature and material that would help keep his costs down. His house has 672 square feet of floor space and contains a kitchen, living room, two bedrooms, and a bath as well as closets. Complete with bathroom fixtures and other built-in features it is ready for occupancy at a cost of \$1,775. Even where material prices are higher the cost should not exceed \$100 above his price.

All in all, you can buy more for your money when you build a house today than you ever could before. You may even have your own private swimming pool, if you like, and at a fraction of what pools used to cost. Complete with filtration systems, engineers will install a pool in your backyard at not much more than \$1,000.

Electric Flare for the Highway Throws Bright Red Light



A six-volt electric flare for use on the highway sheds a bright light behind the halted truck or automobile. Its lens is designed to produce an even red light, without any dark zones.

Sept. 19 40. 416 - Dugercoll's fuel & elec. 310 S. Michigan - Chicago - Pa. 46

Max Vermiculite Co. Springfield, Ill. 46
Barbark Calif
410 S. Grand

1100
1100
Ray Lumps Co

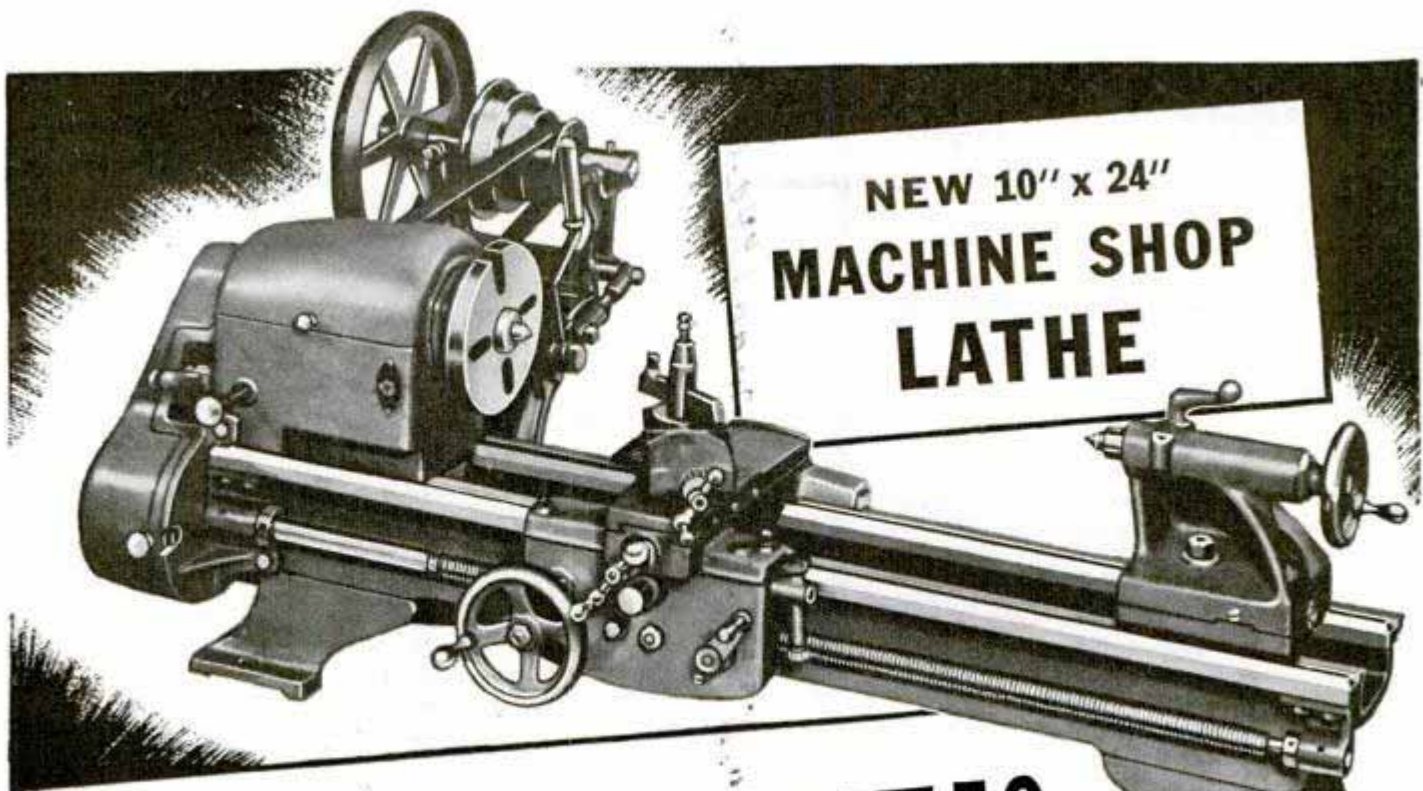

**NEW 10" x 24"
MACHINE SHOP
LATHE**

FAMOUS NEW-DEPARTURE
Ball Bearing
HEADSTOCK SPINDLE

\$147⁵⁰

No. 700 Model

F. O. B.
Chicago
Less Motor,
Stand, and
Chip Pan.

Features Unheard-of Under \$500:

1. Speeds: 12 Speeds with back gears. **2. Bed:** With V and flat-ways... annealed, hand-scraped, and honed. **3. Bearings:** With power cross and longitudinal feeds, machine-cut steel gears. Adjustable front and rear gibs. **4. Headstock:** Ball-bearing spindle, fully ground, tempered steel. No. 3 Morse Taper with No. 2 Adaptor. **5. Tailstock:** Self-ejecting type. Sets over to 11/16 in. **6. Drive:** Cone pulleys with flat belt drive. **7. Gears:** All machine-cut steel or cast iron. Thread range 4-216. Equipment Includes: Flat Belt, Pulleys, 6" Face Plate, Tool Post, Adjustable Thread Cutting Dial, Centers for Headstock and Tailstock Spindles, and Wrenches.

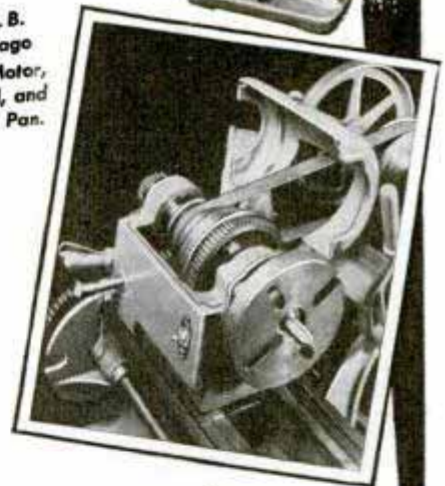

The Only Lathe...
with positive locking
back-gear assembly-
rack and pinion type.
Fully enclosed.

MONTGOMERY WARD



Use as Floor Model
Lathe Shown Below



MONTGOMERY WARD & COMPANY
RETAIL SALES DEPT., CHICAGO., ILLINOIS

Please send me your retail catalog describing your new metal turning lathe and other industrial power-tool equipment.

PM-12-40

Name.....

Address.....

City & State.....

FREE 48 PAGE BOOK

AMERICAN FLYER

3/16" scale trains

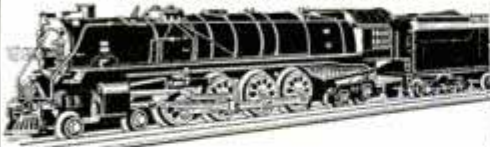

Crammed with illustrations. Full advance news on world's most complete line of scale-model trains—realistic locomotives, cars and equipment built true-to-life from railroad blueprints. Read all about new worm-drive locomotives—new remote control whistling direct from train—talking railroad station—realistic Lucite Block signal system—remote directional control locomotives that banish jiggling back and forth after stops—never-fail automatic coupling and uncoupling—8 wheel drive locomotives—"build'em-yourself" kits and other spectacular American Flyer features. Mail coupon or post card. American Flyer Trains, 415 Erector Square, New Haven, Connecticut.

Name.....
Street.....
City.....State.....

PHOTO ENLARGEMENTS

Is Photography your hobby? Do you want a profitable easy business at home? Make PHOTO ENLARGEMENTS for yourself and others. Your cost 35¢ each and less. The Ideal Photo Enlarger is AUTOMATIC. No experience required. Also COPIES any picture. \$5.94 COMPLETE. Interesting circular FREE.

Ideal-O, 148 West 23rd St., New York City

5¢ ANY SIZE

SKIP IT!

Skip freeze-up worries. Put "Prestone" anti-freeze in your car now—one shot protects you all winter. You're safe—and you know it!

See Inside Front Cover and Inside Back Cover

Millions from Waste

(Continued from page 837)

into marketable forms each year. Casein, which is made from skim milk, has many uses. More of it is used in coating of paper than for all other purposes. It binds clay and other material to the paper stock. It also is employed in the paint industry; as a base for insecticide sprays; as a filler for certain cloths; in the processing of leather and linoleum; and as a plastic which may be formed into belt buckles, buttons, knitting needles and many other articles.

A synthetic fiber having the appearance of high-grade wool can be manufactured from casein, so milk wastes some day may be the source of a large part of our clothing. Skim milk contains about three per cent casein. Four thousand pounds of milk, approximately the amount produced annually by the average cow in the United States, makes about 100 pounds of casein fiber.

Scientists of the U. S. Bureau of Dairy Industry have perfected a process for making a transparent rubber-like substance from lactic acid of whey that has many promising uses in industry. While softer and more flexible than organic glass, the substance is still very tough and elastic. The lactic acid is obtained from casein whey, the waste left after casein is extracted from skim milk, by fermenting the lactose with suitable organisms to produce crude lactic acid or its salts. National Dairy Products Corporation points out that lactic acid also is used in making ices and sherbets, pickles, jams and jellies, yeast; as an aid in dyeing; in tanning; in manufacture of plastics and as a flux for soft solders.

When whey is dried, a light cream-colored powder readily soluble in water is obtained for use in creamed soups, gravies, bread, muffins, cakes and candies. Reinforced with milk minerals, it may be used in liquids, in chocolate milk, in fruit or vegetable juices or in carbonated water. It also may be sprinkled in soups, over cereals or taken dry. The function of such products is to establish good intestinal hygiene and to provide milk minerals, especially calcium and phosphorus, in concentrated and readily available form.

From the forest wastes—scraps, edges, slabs, irregular pieces, sawdust and second-growth scrub pine trees—the Masonite

(Continued to page 149A)

See Jan 19 37 - 77
 Jan 19 39 - 77
 May 19 40 - 1948

CRAFTSMAN

REG. U. S. PAT. OFF.



*** 1941 *
MODELS**

INDEX

Band Saws.....	2, 9
Bench Saws.....	1-4
Carving Machine.....	10
Circular Saws.....	1-5
Crafty.....	18, 19
Drill Presses.....	30-34
Electric Drills.....	79
Flexible Shafts.....	38, 39
Grinders.....	40, 41
Hack Saw.....	28
Jig Saws.....	10-15
Jointer-Planers.....	14, 15
Lathes.....	21-27
Motors.....	42, 43
Paint Sprayers.....	48, 49
Sanders.....	16, 17
Shapers.....	13
Welders.....	36, 37

Sears Guarantee
Complete Satisfaction

SEARS, ROEBUCK AND CO.
World's Most Complete Line of Power Tools

GET YOUR NEW FREE Catalog of CRAFTSMAN Power Tools America's Most Popular Line

Here's the power tool catalog every craftsman wants! The CRAFTSMAN Power Tool Catalog for 1941. Bigger than ever! 48 big pages, packed with tools that every home craftsman will want to read about. Every tool is priced at Sears easy-to-pay prices.

Many Interesting New Developments. Contains many new tools to make your work easier . . . better! Includes a sensational low priced, full size, portable belt sander . . . a streamlined, super-power rotary electric tool and many others.

Get Your FREE Copy Today. Get a copy of this catalog today at your nearest Sears Retail Store, or write your nearest Sears Mail Order House (listed below), ask for RF54057.

Sears, Roebuck and Co.

Chicago	Philadelphia	Boston
Kansas City	Minneapolis	Atlanta
Memphis	Dallas	Seattle
		Los Angeles

Write with Electricity



NEW MODEL ELECTROGRAF

Astonishes everyone! Writes easily on the hardest tools or instruments. Identifies & protects tools against theft. Permanent writing. Requires few seconds only. Anyone can operate. Pays for itself many times.

\$1.98

Order Yours Today—Sent C. O. D. If Desired

Agents! Are you interested in \$10.00 Daily? If so write at once to

NATIONAL LABORATORIES, Portland, Ore.

POSTPAID

OTTAWA LOG SAW \$39

BIG BOOK FREE



PUTS THIS OTTAWA to work for you. **MAKE MONEY!** Wood is valuable. Does more than 10 men. Easily operated. Falls trees—saws limbs. Use 5-hp. engine for other work. Write for **FREE BOOK.**

SAW 10 TO 20 CORDS A DAY

OTTAWA MFG. CO.
3827 Wood St., Ottawa, Kans.

HAVE DEPENDABLE FORD BRAKES

Your Ford Car is listed in the so-called lower priced class but has more brake lining area and larger drums than the others, in fact as much or more brake area than all but the higher priced cars. You can have safe, sure, unfailing mechanical brakes. Install easily yourself our **Simplex Floating Wedges** to center the shoes for mechanical assurance with hydraulic performance. A set of four, one for each wheel, all for \$1.75. All models 1928 to 1938—Send for circular.



SIMPLEX WEDGE EXCHANGE, Dept. PM-12, 613 Jefferson St., Ottawa, Ill.

DASH CONTROLLED GAS TANK LOCK

NO KEYS—FITS ALL CARS. Attractive, convenient, dependable, stops loss of gas and caps. The finest, the fastest-selling, and the most **PERFECT CHRISTMAS GIFT** out. Distributors, dealers, jobbers, here is a year round seller with a good profit. Write today.



SNAP-UP GAS CAP CO. DEPT. 7 ASHLAND, KY.

IT'S FREE THIS FASCINATING NEW BOOK



“THE WONDERS OF MODERN CHEMISTRY”

Explore the mysteries of chemical science and amaze your friends as you perform the thrilling experiments described in the book.

With Chemcraft Outfits, and the manuals that are included, you also secure practical knowledge in Chemistry—the science used by great organizations to develop new products.

CHEMCRAFT REG. U. S. PAT. OFF. **OUTFITS**

are for sale at most leading stores, or you may order direct from us. But be sure to insist upon Chemcraft—the original chemistry outfits which include many exclusive features not found elsewhere.



Chemcraft No. 5 contains 62 chemicals and pieces of apparatus, together with many special features, including Bryan Chemical Illustrators. Manuals explain 498 experiments in chemistry and glass blowing. Price \$5.00

SEND FOR YOUR FREE COPY

You'll find fun and adventure in performing the many experiments described in this fascinating book. Read about the great opportunities Chemistry offers for the future. Send for Free Copy today.

THE PORTER CHEMICAL COMPANY
45 Prospect Ave. Hagerstown, Md.

GIFTS FOR MEN!



Gift Set No. 301
Waterproof Match Box and Coat Compass. Postpaid, \$1.75

60¢ to \$5



Gift Set No. 305. Woodcraft Knife with Staghorn Handle, Waterproof Match Box and Coat Compass. Postpaid, \$5.00.

No gift you can make will bring greater pleasure. Every true sportsman knows the name "Marble's" stands for highest quality.

In addition to the two Gift Sets shown above, we recommend the following:

- No. 181 Marble's Waterproof Match Box. Postpaid, 60c.
- No. 182 Marble's Coat Compass, stationary dial. Postpaid, \$1.25.
- No. 082 Marble's Coat Compass, revolving dial. Postpaid, \$1.50.
- No. 187 Marble's Wrist Compass, with leather strap. Postpaid, \$1.50.
- No. 60 Marble's Sport Knife, 4 in. blade, leather handle with leather sheath. Postpaid, \$1.50.
- No. 2 Marble's Safety Axe. All steel handle. Blade protected by folding guard. Postpaid, \$3.25. No. 6, wood handle, \$2.25.
- No. 304 Gift Set like No. 305 shown above, but knife has leather handle. Postpaid, \$4.00.

Order direct if your Dealer does not carry the items you want.

MARBLE ARMS & MFG. CO.

578 DELTA AVE. GLADSTONE, MICH., U. S. A.

MANUFACTURING OPPORTUNITIES



IN BUILDING INDUSTRY—with machine and process producing permanent construction with savings of 1/3 labor, 1/2 mortar, and 1/3 material costs—ashlar, hollow, veneer or solid walls—plain or 40 colors.

WE EQUIP YOU with Automatic Machinery—large production only one or two men. Equipment costs but fraction of other processes with equal capacity.

INVESTIGATE—let us show you why building today offers you the greatest opportunity for growth, expansion and profit in a business of your own, using raw materials available in your territory. Write today.

W. E. DUNN MFG. CO.
600 West 24th St. Holland, Mich.

FREE Stove Catalog

Factory Prices

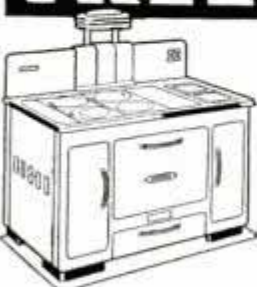

New streamline designs! New features! 136 Styles and Sizes. Coal Wood Ranges; Combination Gas-Coal or Oil Ranges; Electric Ranges; Oil Ranges; Oil Heaters; Coal-Wood Heaters; Furnaces. 30 Days Trial. 24 hour shipments. 1,600,000 Satisfied Users. Stoves \$5 Down, up to 18 months to pay.

"A Kalamazoo Direct to You"

KALAMAZOO STOVE & FURNACE CO., Mfrs.
391 Rochester Avenue
Kalamazoo Michigan

ACE
LATHE TOOL SET
\$14.50



Be permanently tooled-up for every operation on your Metal Cutting Lathe

The ACE Set is complete—there's nothing more to buy. Drop forged by the manufacturers of cutting tools used by 96 per cent of the plants and shops in industry they are correctly designed, are of special steel, are finely finished, are stronger—will last a lifetime. You can cut easier, faster and more accurately with ACE TOOLS.

At your Hardware Store—Circular FREE.

ARMSTRONG BROS. TOOL CO.

"The Tool Holder People"
368 N. Francisco Ave., CHICAGO, U.S.A.

3 Turning Tools, 2 Cutting Tools, Boring Tool, Threading Tool, High Speed Steel Cutters and Blades, and 2 Wrenches in Filled Steel Case.

NEW TURN SIGNAL

FLASHES from REAR WINDOW—DASH Control AGENTS A whirlwind seller. Drivers buy on flash demonstration. Dealers buy 3 to 12. Your profit mark-up as high as 264%. Biggest sensation of year. Rush name quick for facts and Demonstrator sample plan. All Free! Rush. **WATCH-MY-TURN SIGNAL CO., Dept. W-1612, Walnut Bldg., Des Moines, Iowa**

LATEST RECORDS—8¢

Victor, Columbia, Decca, etc. Slightly used. Guaranteed to play like new, or money refunded. Such artists as Bing Crosby, Benny Goodman, Wayne King and hundreds of others. 10 different records \$1.00, in large quantities 8c each. Write for free particulars.

C. HOODWIN CO., Dept. A-2, 4419 Broadway, Chicago, Ill.

SMALL POWERFUL ALNICO MAGNETS

Our Alnico magnets are licensed under the ALNICO patents of the General Electric Co. THOUSANDS in stock. 2 oz. horseshoe—75c. Chromium plated—\$1. Lifts many times own weight. 1/4" x 1/4" x 6" bars—90c pr. They FLOAT. For Tool & Die Makers. Circulars of 18 other sizes—3c.

TERRY SALES CO., Dept. M, Central Sta., P.O. Box 781, Toledo, Ohio

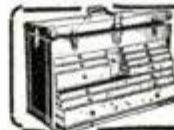

GERSTNER Tool Chests

Practical and Desirable at all times—an Ideal Christmas Gift. Free Catalog of many styles.

GERSTNER TOOL CHESTS
440 Columbia St., Dayton, Ohio

DO YOU WANT a new business profession of your own, with all the trade you can attend to? Then become a foot correctionist, and in a few weeks earn big income in service fees,—not medical nor chiropody—easy terms for home training, no further capital needed, no goods to buy, no agency. Established 1894. Address **Stephenson Laboratory, 1 Back Bay, Boston, Mass.**

KINKADE GARDEN TRACTOR

and Power Lawnmower
A Practical Power Plow and Cultivator for Gardeners, Suburbanites, Florists, Truckers, Nurserymen, Fruit Growers
Low Prices - Easy Terms
American Farm Machine Co.
1058 33rd Av. SE. Minneapolis, Minn. **Catalog Free**



FREE

EXCITING BOOK CATALOG!
HUNDREDS OF BOOKS!
MANY NOT SOLD IN STORES!

Send right now for this great big book catalog! Thumb through its interesting pages! Notice the tremendous selections of books on virtually every subject . . . and at money-saving prices. Notice how many books you can get that are not sold in stores—books that bring extra joys to living, books that help you increase your income—putting extra cash into your pocket! . . . Home, Farm, Garden, Photography, Nude Art are only a few of the subjects listed.

SEND NO MONEY! JUST MAIL POST CARD!

Don't send a penny. Just write your name and address on a penny post card, and mail today! This grand catalog with beautifully colored cover will be rushed to your home! Send for it now!

POPULAR MECHANICS PRESS, Dept. 12B, 200 E. Ontario, Chicago



Corporation is turning out wallboard, insulating board, wood tile and even plastics that may be formed into a great variety of marketable shapes. Wood chips are conveyed into "guns" into which steam is introduced until a high pressure is reached. Then the pressure is raised quickly and held about two seconds before the gun discharges into a "cyclone," or vessel where the steam and fibers are separated. The fibers are dropped into a container, mixed with water and constantly agitated before being pumped through refiners to a forming machine that removes part of the water by suction or pressure rolls. From there the blankets of material go into presses that dry and compress them, resulting in dense hard-surfaced boards.

Seeds of cotton, once a waste and a nuisance, now have a value of \$200,000,000 in a billion-and-a-half dollar cotton crop. Cottonseed oil goes into soaps, candles, lamp oil, cooking and other uses. Cotton linters, another farm waste, are now an initial material in the manufacture of rayon, and in coated fabrics that go into handbags, wall coverings and automobile upholstery. More than 100 commercial uses have been developed for corn, ranging from glycerin used in explosives to carbon-dioxide used in "Dry-Ice." More than one-tenth of the corn crop now has the factory as its market. More and more uses are being found for the soybean. Wheat straw is made into corrugated paper boxes. Furfural produced from oat hulls is being sold in tank carlots.

Of highest importance in the disposal of farm and forest wastes and crop surpluses is the fact that cellulose, an invaluable raw material, makes up the bulk of all plants. From it is made all paper, all rayon, a family of plastics that is being put to thousands of uses, huge quantities of building boards, cements for the leather industry and an endless list of other goods. In general, cellulose extracted from wood is cheaper than that derived from farm crops, and wood is the product which nearly one-third of the land of the United States is best suited to growing. But if and when agricultural science bridges that gap of cost, it stands to augment the supplies for an already enormous, ever-expanding industrial cellulose market.

STOP

Your Worries About Rupture

Why put up with days . . . months . . . YEARS of discomfort, worry and fear? Learn about this perfected invention for all forms of reducible rupture. Surely you eagerly CRAVE to enjoy life's normal activities and pleasures once again . . . with the haunting fear of rupture banished from your thoughts . . . with no more suffering from an ill-fitting, gouging, burning, hard-pad truss. Over 3,000,000 persons before you have used the BROOKS Appliance. Enjoy the comfort and safety of the Patented Air-Cushion Support, **yourself!** Over 9,000 physicians use the Brooks themselves or recommend it to patients.

Cheap - Sanitary - Comfortable

Anyone can afford a BROOKS patented Air-Cushion and enjoy the Paradise of comfort and security it affords. The Brooks has no springs, no metal girdle. The yielding Air-Cushion of the BROOKS, the velvety body band . . . these



will be utterly new to you . . . and how you will bless the day you discover this complete security. The BROOKS Appliance adjusts itself to every body movement. The Patented Air-Cushion does not gouge in and spread the rupture. Thus Nature has a chance to close the opening and make a truss unnecessary. We do not *promise* this result . . . but thousands of BROOKS wearers have joyously reported its occurrence.

SENT ON TRIAL! You are not asked to risk any money. You can try a BROOKS at *our risk*. If you don't think it is wonderful, simply return it, and the trial costs nothing. But avoid imitations. The BROOKS is never sold through stores. It is made to your individual measure. Write for full information, **Free.** **And remember a Brooks will be sent on trial.**

BROOKS APPLIANCE CO.
457-G STATE ST. MARSHALL, MICH.

MAIL THIS COUPON TODAY!

BROOKS APPLIANCE CO.
457-G State St., Marshall, Mich.

In PLAIN ENVELOPE, please send your FREE BOOK on Rupture, PROOF of Results, and TRIAL OFFER. No one is to call on me personally about my Rupture.

Name.....
Street.....
City..... State.....
State whether for Man..... Woman..... or Child.....

ANNOUNCING

The Sensational New

PECK POSTCARD PRINTER



Ink rollers, 4 x 6" chase, standard type, ink, paper, sample Xmas cards, ready for orders

\$20 VALUE
Only **9⁹⁵**

15" High
5 1/2 lbs. Wt.
20 Lbs.

Send No Money

FOR THE FIRST TIME, if you are ambitious and work, you can quickly build a business of your own, and as proprietor make profits 3 times wages. There's a large volume of small printing to be had—all kinds of slips, tags, tickets, blotters, office & shop records, postcards.

CHRISTMAS CARDS, MOVIE TITLES, IMPRINTING

Church & Lodge tickets, meeting notices, menus, dance programs, price lists. **Grocery & Drug store week-end specials**, Memorial cards for funerals, statements, line cuts, electrots, linoleum blocks, coarse screen halftones, black and simple color work.

B. Franklin, America's first great printer, admired this handpress. Now, modernized, simplified, streamlined, and built—not one at a time—but on a production basis like motor cars, with all the savings passed on, you get an amazing big value for your money. Double toggle action, multiple force impression. Clean. Sharp. Speed, 1000 an hour. Two rollers, revolving ink plate, even ink distribution. Type area 4 1/2" x 3 1/2" scant. Max. sheet 8 1/2" x 11 1/2".

COMES COMPLETE—276 pc. set (2 boxes) of 12 pt. standard metal Copperplate Gothic, spaces, riglets, lock-up screws, paper, ink, sample Xmas cards, ready for your first order.

PONY OUTFIT—Extra 12 pt. Gothic, font *small Gothic (8 pt. on 12), **24 pt. Outline, Extra 12 pt. quads & spacers, Wood type case, Tweezers, 1/4 lb. black ink, 50 Xmas cards. Reg. val. \$6.85. Special with press \$4.95. Mail order today before steel prices advance. 7 day trial. **MONEY BACK GUARANTEE**. If ordered C.O.D. give bank references or attach \$1.00 on delivery. All prices F.O.B. factory. Shpg. wt. 20 lbs.

PECK BROTHERS, 2522 WHITNEY AVE., MT. CARMEL, CONN.

*AAA †A
†AAA †A

METAL-TURNING Precision LATHE



Best "buy" in U. S. on 6"x18" Metal-Turning Precision Lathe—only \$17.45 F.O.B. St. Louis!

Only **\$17.45**
FREE CATALOG

Lathe includes 3-inch 4 Jaw Chuck, Face Plate and Lathe Dog, V Bed. Equipped with two 60° Centers, Compound Carriage with tool post and Tool Steel, 4 Step Pulley, No. 0 Morse Taper, Tailstock mounted on riser block providing for transverse adjustment. Length of bed 20 1/2"; length overall, 29 1/2". Performance equal on metal or wood—equivalent to larger, more expensive machines. Works equally well on metal or wood—Order from ad or write for new **FREE** catalog. Includes sensational low prices on Spray Equipment, Power Tools, Electric Motors, Electric Drills, etc. Write today!

ACE COMPANY, Dept. F, 1601 Market, ST. LOUIS, MO.

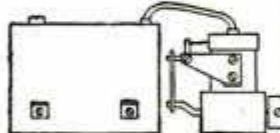

FOR OLDTIMERS and beginners in the model boat game, Model SE-3, a two cylinder, slide-valve steam engine with burner and propeller. Bore 5/16". Stroke 1 1/2". Length 7", Width 3", Height 4". Price ready to run, \$3.00. Postage extra, shipping wt. 1 1/2 lb.

SHAWNEE ENGINE CO.
Box 162, Station D, Cincinnati, Ohio



WORLD'S LOWEST PRICED ADDING MACHINE

IDEAL XMAS GIFT GUARANTEED ACCURATE. Not a toy. Operates with only a finger flick. Adds, subtracts, multiplies, divides. Counts up to ten million. Pays for itself over and over. Ideal Gift—for Business, Income Tax and School use. **MONEY BACK GUARANTEE**. Send name and address. Pay postman only \$2.50 plus postage. (Send full cash if outside U. S.) Money back in 10 days if not delighted. **AGENTS WRITE.**

CALCULATOR MACHINE COMPANY (Mrs.)
DEPT. 112, P. O. BOX 1118 CHICAGO, ILLINOIS



ELECTRIC EYE ANNUNCIATOR AND BURGLAR ALARM

STORES, Homes, Taverns, Shops, Garages—scores of others—waiting for the **RAY-ALARM** Burglar Alarm and Annunciator. Real protection—guards against intrusions. Invisible beam of "Black Light," when interrupted, sounds continuous alarm. Plugs in any light socket. Unfailing demonstration takes 10 seconds—makes sales on the spot.

SEND NAME Huge profits. Write AT ONCE for particulars of Distributor Plan or Agent proposition. No money. Just send name. **RAY-ALARM, 225 Fifth St., Dept. R-1612, Des Moines, Iowa**

UNBREAKABLE FLASHLIGHT

Handy as a fountain pen. Clips on pocket. Drop tools on it, step on it, let fall on cement floor. You can't break it. Solid copper case with baked bronze enamel finish—guaranteed for life. A necessity to every mechanic. Complete with battery. Your name etched on case to prevent loss, only 25c extra. Order direct. Send no money. Pay postman \$1 plus few cents postage on delivery, or \$1.25 with name. We pay postage on cash orders. Red hot seller for agents. Write today.



Rush Your Order to **STREAMLITE COMPANY**
3760 Main Ave. Dept. PM-12, Norwood, Ohio

BIG MONEY Assembling NEW MEAD KI-YAK



MEAD'S complete cut-to-fit KI-YAK Kit easily assembled for pleasure

Light . . . Fast. Highest quality. Low cost. 3 models 20 lbs. to 45 open a new world of sport for you both in sailing, paddling. Also 2 portable Outboard Models. Finished double-blade paddle or Oars now INCLUDED with your KI-YAK. Write now for illustrated circulars, low Factory-to-You prices!

WRITE for big illustrated FREE Circulars!

MEAD GLIDERS, 15 S. Market, Dept. B-120, Chicago

TRAFFORD PLASTICS

For catalog, samples, 48-page Trafford Portfolio, send 25c (returned on 1st \$1.00 order). Experimental Kit \$3.00 pstpd. Trafford, Dept. 781, 360 Worthington St., Springfield, Mass.

TRAILER BUILDERS' GUIDE & CATALOG only 10c

Build a Trailer easily in spare time with world's best line of trailer parts, axles, hitches. Complete working blue prints only 50c. Universal Draw Bar, readily attached to any car. **SEND 10c TODAY FOR CATALOG.**



HAMMER BLOW TOOL COMPANY, Dept. 112, Wausau, Wis.

Attractive FREE Catalog

Artistic pins, rings and emblems for classes and clubs. Attractive prices. Finest quality, gold plated, silver, etc. Over 300 designs. Write Dept. N, **METAL ARTS CO., Inc., Rochester, N. Y.**

PINS 30c UP



CATCH FISH!

minnows, eels, mink, muskrat, with our folding galvanized **Steel Wire Traps**. Walton's Automatic Hooks are so constructed that when a fish gives the slightest pull on the bait the upper hook reaches down and gets a hold that lands him. 3 for 50c. Write for descriptive catalog of Traps, Hooks, Lures, and other specialties. **Walton Supply Co., 3567 Juniata Ave., St. Louis, Mo.**

MYSTERIOUS DEVICE WELDS BRAZES AND SOLDERS ANYONE CAN OPERATE

Now, an electric welding, brazing and soldering Torch, complete with power unit, goggles and supplies. **Works INSTANTLY off any light socket.** Does a thousand and one repair jobs at amazingly **LOW COST** on aluminum, iron, steel and other metals. **Indispensable** for Auto, Body and Fender Repairs, and home repairs—shop, factory, farm, engineer, janitor, sheet metal, radio and bicycle repairs. Anyone can handle without previous experience with our simple **10-DAY HOME TRIAL** instructions. Write at once for Special Introductory Low Price Offer. Try 3 in 1 Electric Torch for 10 days at our risk or get one free by helping to introduce it. **ELECTRO-TORCH CO., 2613-LY Michigan Ave., Chicago**



In addition to existing government bureaus and the many industrial companies with research efforts directed at utilizing wastes and surpluses, the federal government has four large laboratories under construction to further the cause.

Confronting the research man is the problem, among others, of what to do with the annual agricultural wastes amounting to approximately eighty-five million tons of wheat straw, rye straw, barley straw, corncobs, oat hulls, rice hulls, cotton stems and pods, corn stover. Again it is estimated that between twenty and twenty-five per cent of the average forest tree is lost in converting the log into lumber. So, while vast strides have been made, much remains to be done in this job of turning waste into money.

Keeping a Big Bridge Young

(Continued from page 843)

receive a shock from the static energy stored in the vehicle. The jolt sometimes slammed his arm back against the wall of his metal booth and injured him. Ordinary catwhisker discharge wires set in the pavement to scratch against the underside of approaching cars didn't always discharge the static and now sturdy wire scrapers fixed to special grounds are used.

Four million cars per year are driven over the bridge and more than 30,000,000 people have crossed it in the three and a half years since it was opened. The Golden Gate bridge is the longest single-span bridge in the world and its towers are taller than those of any other bridge. The length of the suspended structure is 6,450 feet. Each tower weighs 22,200 tons and supports a 61,500-ton load. Each cable is 7,650 feet long and consists of 27,572 separate wires. The cables are anchored in 120,000-ton blocks of concrete buried in the rock on each shore. A few miles away from the Golden Gate bridge is the world's other largest bridge, the San Francisco-Oakland Bay bridge whose eight miles of length is the longest of all.

What is the useful life of a great bridge? Engineers used to say that a bridge should last for a century, but now, with modern protective measures, they think that there is no reason why such a bridge as the one that spans the Gold Gate should not last for 1,000 years.

BUILD THIS GRAND *Doll House* FOR CHRISTMAS

WRITE FOR

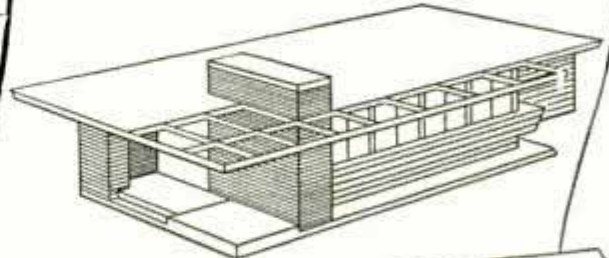

Free Plans!

A MODERN DOLL HOUSE—created by a nationally known designer. A marvelous gift for the young lady of today. Exceptionally easy to build *strong and sturdy* with Masonite Tempered Presdwood. It makes a permanent gift that can be passed down through generations because Tempered Presdwood does not deteriorate . . . *will not warp*, chip, split or crack when used according to instructions.

Your nearby Masonite dealer can supply you with Masonite Presdwood and Tempered Presdwood "shorts"—small pieces of this remarkable material at very reasonable cost. And Masonite Corporation will supply you with **FREE** plans and specifications for this easy-to-build Doll House. Mail the coupon.



MASONITE TEMPERED PRESDWOOD

THE WONDER WOOD OF A THOUSAND USES
Sold by Lumber Dealers Everywhere

COPYRIGHT 1940, MASONITE CORPORATION



FREE PLANS AND SAMPLE

MASONITE CORPORATION, Dept. PM-12
111 W. Washington Street, Chicago, Ill.

Please send **FREE** plans of the easy-to-build Modern Doll House and **FREE** samples of Masonite Presdwood and Tempered Presdwood.

Name _____

Address _____

City _____ State _____

ENLARGE YOUR OWN PICTURES

Beautifully

WITH THIS NEW
Lafayette
STURDY EASEL



Now you can afford a fine enlarging easel. This improved Lafayette model is all metal, with chrome trim. Takes all paper up to 11 x 14". Masking bands with supporting metal guides. Marginal adjusting device for accurate borders up to 2". Base, with non-skid strips, has white focusing surface and automatic lift-stay for "hand-free" operation. CA9305—only **\$4.59**

ECONOMY MODEL—Similar to Lafayette Superior Easel save for marginal release device and lift-stay. CA9304..... **\$3.19**

FREE BOOK OF PHOTO VALUES!

Send for copy of the big FREE Lafayette Camera catalog. It is full of money-saving values in cameras and photographic equipment. Mail this coupon for your free copy today.

Lafayette camera

LAFAYETTE CAMERA
DEPT. 7MC—100 SIXTH AVE., NEW YORK.

I enclose \$..... Rush my order.
 Please Rush FREE Catalog No. 81.

NAME

ADDRESS

CITY

STATE

NEW YORK, N. Y.
100 Sixth Ave.
CHICAGO, ILL.
901 W. Jackson Blvd.
ATLANTA, GA.
265 Peachtree Street
BOSTON, MASS.
BRONX, N. Y.
NEWARK, N. J.
JAMAICA, L. I.

**NEWEST—MOST IMPROVED—
MOST ADVANCED
10" TILTING
ARBOR SAW**

**BEST EXISTING
CONSTRUCTION
Plus
IMPROVEMENTS
AND ADDED
REFINEMENTS**



• The Duro 10-inch Tilting Arbor Saw is the product of research and exhaustive tests covering all known types of saw construction. Its outstanding features include 36"x30" working surface, chute that guides saw dust past the working parts, built-in compartment for extra saw blades, DeLuxe Mitre Gauge, heavy rip fence,—that locks at both front and rear,—saw guard, splitter and anti-kick-back and it is designed to use any standard type motor.

The new 1941 Catalog describes this Saw and the full line of new Duro Tools. Write for your free copy.

DURO METAL PRODUCTS CO.
DEPT. PM12 2653 N.KILDARE AVE., CHICAGO, ILL.

Hunting the Secret of Life

(Continued from page 803)

season, using nothing but carbon dioxide and water as raw materials. This sugar, in turn, is utilized by the plant in creating its structure. A large pine tree adds the amount of material in an ordinary broomstick to its size every day.

In the laboratory it is possible to change carbon dioxide and water into sugar by first grouping the raw materials into a formaldehyde as an intermediate step. This artificial sugar hasn't the nutritional value of its natural relative and the process isn't



Apparatus for breaking down plant structure and separating it into its elements for study

nearly as efficient as the plant's method, but for a long time it was assumed that plants created sugar by a somewhat parallel process. Now this idea has been disproved by Dr. S. Rubin of the University of California who, using carbon dioxide that has been made radio-active in the cyclotron, has traced the absorption of carbon dioxide in a plant. Contrary to expectations, no radio-active formaldehyde has been found and the conclusion is that some other process is involved instead.

The radio-active carbon dioxide is created by the bombardment of boron, and the carbon atoms that are knocked off the boron are converted into carbon-dioxide molecules. These in turn are fed to barley, wheat and sunflower plants and the plants are later analyzed to learn what trans-

(Continued to page 154A)



BOYS! MYSTIFY YOUR FRIENDS
WITH UNCANNY FEATS OF CHEMISTRY

GILBERT

No. 6A Double Feature Desk Type Laboratory

Combination Chemistry Laboratory and Glass Blowing Outfit in big blue wooden cabinet. Five feet of test tube racks and shelf room, 63 pieces of chemicals and apparatus. Two books describing over 400 exciting experiments. Complete with sturdy corrugated cardboard desk, \$6.95. Without desk, \$5.00. Other Gilbert Chemistry Sets \$1.00 to \$15.00. See them at your nearest toy store.

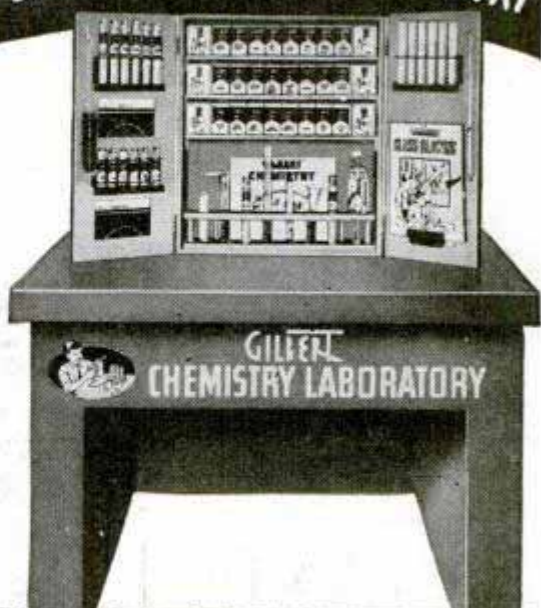

WATCH your friends gasp with wonder when you make strange chemicals change color, turn a lemon into an electric cell, write messages in fire ink, make a chemical weather flag, produce your own paints, sparklers, soda water. You can perform hundreds of spectacular experiments with a Gilbert Chemistry Set. More boys have won fame and big awards with Gilbert Chemistry Sets than any other kind—so be sure the box reads "Developed at the Gilbert Hall of Science." Also, see the new Gilbert Polaroid Microscope sets that reveal nature's hidden secrets and colors.

\$200.00 Annual Awards—Mr Gilbert will award \$100.00 in cash to the boy doing what he considers the most important research in Chemistry, Microscopy or Electricity in 1941—and \$10.00 each to the ten boys doing the next most important research. Mail coupon for full details.



FREE BIG ILLUSTRATED BOOK—"IT'S FUN TO BE A BOY CHEMIST" 24 large pages crammed with color pictures of latest scientific toys developed at the Gilbert Hall of Science. Mail coupon or post card.

The A. C. Gilbert Co. (Home of Erector, American Flyer Trains and other Gilbert Toys) Room 304, Gilbert Hall of Science, Erector Square, New Haven, Conn.

Name.....
Street.....
City..... State.....

Now A FAST, POWERFUL Electric MOTO-SAW



Cuts on an Average of 1' per Min. up to 3/4" Med. Hard Wood

More like magic than any tool you ever saw. Imagine an electric scroll saw only slightly heavier than a hand coping saw... a tool that takes no effort to run, no pressure to feed. Works at any angle—on big assembly jobs or on the tiniest piece you can hold in your fingers. Runs 7200 strokes a minute... so fast blade seems to stand still. Sturdily built... only two moving parts... never needs oiling. As safe to handle as a hand saw. Operates on 110-120 V., 50 or 60 cycle alternating current. Has built-in grip switch. If your dealer does not yet have **MOTO-Saw**, send \$4.95... we'll pay postage. Or, send \$1 with order, pay postman balance plus postage. **MONEY BACK** if not delighted after inspection.

EASILY CUTS INTRICATE DESIGNS—50 SMOOTH IT ELIMINATES SANDING

MOTO-SAW With 3 Blades **\$4.85** POST-PAID

DREMEL MFG. CO., Dept. S110-M, Racine, Wis.

Big Money for Workers In Home or Shop



MONEY-MAKING PROJECTS. Color-glazed concrete lawn, cemetery pottery made without molds or cores. New, Patented method. Use only sand, cement, cheap materials. Tiles, walls, gravestones. Statuary, giftware. Basement waterproofing. Booklet, details 3c stamp.

NATIONAL POTTERIES COMPANY
Dept. 6, 13 W. 26th St. Minneapolis, Minn.

SAVE MONEY ON DOG FOOD

EARN 25 lb. BAG without cash. WRITE

and have a better dog. New low prices. Shipped direct from mill to you. All needed vitamins, minerals and other elements. Write for low prices and full information.

THE DERWOOD MILL, Box 1, Derwood, Maryland

Ask Bass FOR HIS New CINE BARGAINGRAM

Fascinating collection of thousands of bargains in 8-16 and 35 mm SILENT AND SOUND equipment... Get your free copy by writing to Department P

BASS CAMERA CO.
179 W. MADISON ST. CHICAGO, ILL.

"MARVEL-OUS" TRAILER PARTS

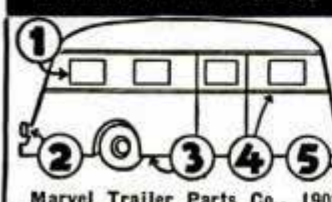

(1) "Famous" Marvel Windows, (2) tail lights, (3) complete undercarriage equipment, (4) body moldings, (5) couplers. Also refrigerators, stoves, lighting fixtures, everything you need in highest quality. Largest trailer equipment stock in U. S. Immediate delivery. Low prices. Send 10c coin for 44-page illustrated catalog.

Marvel Trailer Parts Co., 19020 Celestine Ave., Detroit, Mich.

REAL ENGINE VALUE



The G. H. Q. is a miniature gasoline engine that really operates. Over 15,000 sold this year. Now is your chance to buy the **New Improved** kit for \$4.95. Absolutely complete with coil, plug, instructions, etc. Only a screwdriver needed. For boats, planes, midget cars, etc. All parts guaranteed. Send only \$1.—Shipped Collect C. O. D. same day. Send for **FREE** literature or 6c for Jumbo catalog.

Now Only **\$4.95**

GHQ MOTORS, Dept. B, 40 East 21 St., New York, N. Y.

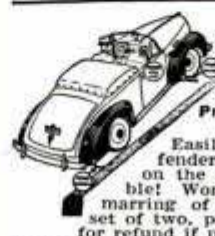

Equip Your Car With... FENDER WHISKERS

Protects Fenders, Hub Caps, Tires Against Contact With Curbs, Garage Doors, Any Object

Easily attached to front right fender and rear right fender, **FENDER WHISKERS** flash a warning red light on the dash the instant they touch any object. Flexible! Won't break! Weatherproof! No adjustments! No marring of fenders! Send \$1.50 for set of two, postpaid. Return in 10 days for refund if not delighted. **ORDER NOW!**

CAR OWNER AGENTS WANTED

NIEDERST HUTTER CO., 3508 S. Michigan Ave., Dept. 10, Chicago, Ill.

The Practical Low-Cost Way of Making Home Repairs

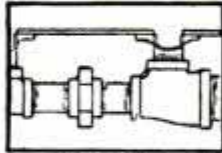

Pipe Leaks

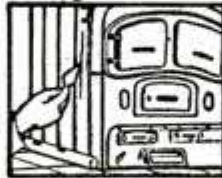

Boiler Leaks

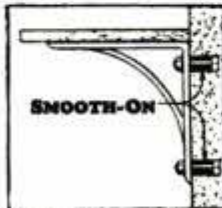

Anchoring in masonry

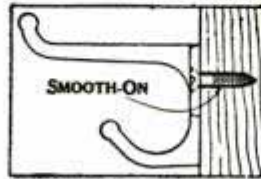

Tightening loose or stripped screws

Smooth-On No. 1 will enable any handy man to do dozens of repair jobs like stopping leaks of steam, water, oil or gas in boilers, heaters, tanks, and piping; sealing cracks in castings of furnaces, radiators, automobile engines, gear cases, and machinery; tightening metal fixtures and loose parts of furniture, utensils, hardware, and around the automobile.

Smooth-On costs little, is easy to apply, and assures a lasting repair which strengthens with time. A small-size can contains enough Smooth-On for a large number of jobs, and the unused portion does not deteriorate. Buy a can today, so you will be prepared for emergencies that might occur at any time.

Buy Smooth-On No. 1 in 1 3/4-oz., 7 oz., 1-lb. or 5-lb. cans from your hardware store or, if necessary, from us. For your protection, insist on Smooth-On, used by mechanics and repair men since 1895.

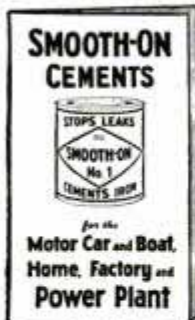

FREE

40-Page Repair Handbook which contains dozens of suggestions, not published elsewhere, for saving time and money on household, auto, and shop repairs. 170 Diagrams. To obtain your copy of this useful manual without charge, fill in and mail the coupon today.

SMOOTH-ON MFG. CO.,
574 Communipaw Ave.,
Dept. 37, Jersey City, N. J.

Please send the free Smooth-On Repair Book.

Name.....

Address.....

12-40



Do it with SMOOTH-ON

(Continued from page 152A)

formations have occurred in the carbon. The carbon loses its radio-activity in six hours and a different isotope of carbon that has a radio-active half-life of half a million years is now being created in the cyclotron for additional tests.

Photosynthesis is such a baffling study that on the west coast several groups are attacking it by different methods. Besides the radio-active trace studies, a Carnegie Institution group on the Stanford University campus is studying the composition of chlorophyll and other plant pigments, a Stanford group working at the Hopkins Marine Station at Pacific Grove is investigating the way that green and purple bacteria use light, and at the University of California, Los Angeles, the formation of chlorophyll is being studied.

Two interesting facts about photosynthesis are that all types of plants use exactly the same method for converting elements into food and that this method has remained the same all through evolution. The world's largest trees and smallest algae, and marine plants that grow below the surface of the water as well as desert shrubs, all have photosynthetic apparatus. Not all plants, of course, are green. Some kelp is yellow brown and some desert shrubs are grey. Yet the green chlorophyll is present in each, either mixed in with the other pigments or arranged below the surface. In fact there are two different green chlorophylls and twelve different yellow pigments that seem to make up the mechanism, although the exact role that each specialized pigment plays is not yet known.

Most plants absorb solar energy from both ends of the visible spectrum, using more red and blue light than any of the wave lengths in between. The so-called purple bacteria, however, which are microscopic plants that have the power of locomotion, use a small amount of light from the red end of the spectrum and a considerable percentage of energy in the infra-red region. Green bacteria, another primitive species, use none of the light visible to us and depend on solar radiations between 7,000 and 8,000 Angstrom units in the infra-red region. In each case this probably is because both types of plants inhabit mud and marshy places and live

(Continued to page 156A)

OPPORTUNITY KNOCKS

a
Thousand
Times
in a



THOUSAND HELPFUL BOOKS

SELECT FROM THIS LIST. SEND FOR FREE 128-PAGE BOOK AND PLAN CATALOG

- | | |
|---|---|
| <p>BLUEPRINT READING
for the Building Trades.....\$1.25</p> <p>STEEL SQUARE
How to Figure Angles of Rafters, etc.....\$1.00</p> <p>1000 SPARE TIME MONEY-MAKING IDEAS
Start a business of your own.....\$1.00</p> <p>WHAT TO MAKE
2-Vol. Library of worthwhile projects for craftsmen.....\$0.98</p> <p>MECHANICAL DRAWING
Learn Drafting; Good Salaries.....\$1.00</p> <p>PRACTICAL MATHEMATICS
Real help for everyone who uses figures.....\$2.00</p> <p>PLASTERING & STUCCO WORK
Interior & Exterior.....\$1.25</p> <p>TURN SCRAP INTO MONEY
Use Old Auto Parts.....\$1.00</p> <p>MAKING AMATEUR PHOTOGRAPHY PAY
Where to submit & how to sell.....\$1.00</p> <p>AUTO BODY & FENDER REPAIRS
New Book Covers All Details.....\$3.00</p> <p>REFRIGERATION
Electric, Gas, Be a Service Expert.....\$5.00</p> <p>WOOD FINISHING
Methods, Tools.....\$2.00</p> <p>CIVIL SERVICE
Home Study Courses, Federal, State & City Positions.....\$1.00</p> <p>PROSPECTOR'S HANDBOOK
How to Mine, Appraise, Equip.....\$3.00</p> <p>ROPP'S CALCULATOR
Cuts figuring to a minimum (Kraft Leather).....\$1.00</p> <p>SOILLESS PLANT GROWTH
Complete Directions.....\$2.75</p> <p>BOOK OF OPPORTUNITIES
A Dictionary of 3500 American Occupations.....\$3.00</p> | <p>REWINDING ELECTRIC MOTORS
Enables anyone to become expert.....\$1.00</p> <p>PAINTING & DECORATING
New Book.....\$1.50</p> <p>TOYS
Build for Amusement or Profit.....\$1.50</p> <p>TRAILER BUILDING
Four Tested Plans.....\$1.00</p> <p>UPHOLSTERY
Always a Big Market Start Own Business.....\$2.00</p> <p>AUTO RACING
How to Build Cars, Speed up Fords.....\$1.00</p> <p>NEW SMALL HOMES
59 Popular Designs.....\$0.50</p> <p>MONEY-MAKING FORMULAS
New 480 Page Book.....\$4.35</p> <p>PRACTICAL BRICKLAYING
Step-by-step Instructions.....\$1.75</p> <p>BLUEPRINT READING
for Machine Trades.....\$1.50</p> <p>HOUSE WIRING
Methods, Materials.....\$2.50</p> <p>SHOP NOTES LIBRARY
Thousands of useful ideas. Set of six big volumes.....\$2.45</p> <p>ARC WELDING
Procedure Handbook, New Ed. Just Out.....\$1.50</p> <p>CONCRETE
1001 Ways to Use.....\$1.98</p> <p>HOUSE CONSTRUCTION DETAILS
Shows standard methods.....\$2.89</p> <p>FLEXIBLE MOLDS
Fun and profit from casting novelties.....\$1.00</p> <p>KNOTS, TIES, SPLICES
For Everyone Who Handles Rope.....\$1.00</p> <p>CARPENTRY
Carpentry & Joinery in all Forms.....\$2.00</p> <p>SOLDERING
New Tricks and Methods.....\$0.25</p> |
|---|---|

Send No Money!

Order from above list. If in U. S. or possessions, and order amounts to \$1.00 or more, pay postman on delivery plus small C.O.D. fee. We pay postage if remittance is sent with order. Send for big 128-page book of helpful books and plans FREE. Order today.

POPULAR MECHANICS PRESS

Room 1240A 200 East Ontario St., Chicago



COOK and HEAT
without **COAL or WOOD** in Your PRESENT STOVE
INTENSE HEAT AT SMALL COST—No Dirt or Ashes
QUICK HEAT AT TURN OF VALVE

An Amazing Oil Burner Which Experts and Users Say BEATS ANY CHEAP BURNER EVER GOTTEN OUT FOR LOW COST, EFFICIENT PERFORMANCE. Burns Ordinary Low Priced Free Flowing Oil Without Pre-generating or Clogging Up. READ BELOW HOW YOU CAN TEST THIS REMARKABLE SUPER FLAME OIL BURNER in Your Own Home AT OUR RISK. Then Mail Coupon.

OVER 40,000 SOLD

Satisfaction Guaranteed

Why burn coal or wood with its dirt and drudgery of building and feeding fires? Why carry ashes and get uneven, slow-starting heat? Burn ordinary low priced free flowing oil and get **INTENSE HEAT** at **SMALL COST**—and have **QUICK HEAT** regulated by a simple turn of a valve. Positively guaranteed **NOT TO CLOG OR STOP UP**. Has a record of over 11 years constant use without ever needing any cleaning. Simple—safe—economical—no electrical connections—no moving parts to wear out. **QUICK, CONVENIENT, EFFICIENT HEAT** by simply turning valve.

Engineer of National Reputation Says: Combustion principles are simple, efficient, excellent—assures economical oil consumption and maximum heat. Tests made on burner with one year's hard service prove no evidence of dirt or residue or any carbon on interior parts. No nozzles or tips to "choke up" or stop up.—C. W. Lovelace—K. C., Mo.

USERS SAY: Fifteen oil burners of different kinds here but Heat King is cheapest, best.—J. R. Goldthorp—Washington.

I get more heat from your burner than I ever had from coal or anything burned in my furnace.—W. C. Nicholson—Ind.
Reduced coal bill fifty percent.—W. S. Collins—Pa.

SENT ON TRIAL

SENT ON TRIAL for 30 days. If you want quick, efficient heat at small cost you may try the "HEAT KING" AT OUR RISK. Write now for full information. Prove that it ends drudgery and dirt of coal or wood, prove its efficiency, convenience and economical operation. You must be satisfied under our liberal guarantee or **YOU PAY ABSOLUTELY NOTHING FOR THE BURNER.**

Special Offer to AGENTS and salesmen who will demonstrate and take orders. Send no money—just sign and mail coupon (or 1c postcard will do)—be first in your locality to learn how satisfactory oil heat can really be and how you can **MAKE REAL MONEY** spare or full time. Mail Coupon or 1c postcard today—NOW.

UNITED FACTORIES

P-751 Factory Bldg. KANSAS CITY, MO.



AGENTS SALESMEN BIG MONEY

No wonder salesmen and distributors are breaking records in sales. They show how it gives **QUICK INTENSE HEAT, MORE CONVENIENT, WITHOUT DIRT AND ASHES,** and how economical it is in operation—then, reap **BIG CASH PROFITS.**

SALESMEN SAY:

Installed one when 10 degrees below zero. Kephthouse well heated. I can dispose of 250.—F. Silver—Canada.

I am a plumber, but never knew such a thing to get that much heat out of oil. There is money in selling them.—W. C. Nicholson—Ind.

Write now for Agents Special Offer. Act quick. Be **FIRST** in your locality—MAIL COUPON or 1c postcard today—NOW.

MAIL COUPON

UNITED FACTORIES P-751 Factory Bldg., Kansas City, Mo.

Without cost or obligation rush full particulars of generous TRIAL OFFER on wonderful "HEAT KING" Oil Burner.

CHECK HERE

Name.....

If interested in special and money-making offer to producers.

Address.....

City..... State.....

Give Everything You Make An EXPERT FINISH

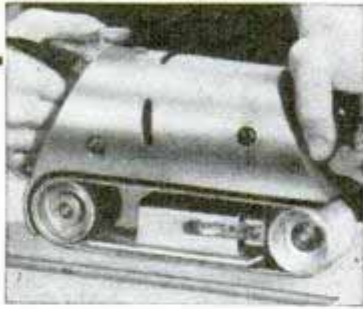

NOW!
You Can **DO IT**
10 TIMES
FASTER

with

New **Guild** PORTABLE ELECTRIC **Sander**

This Popular-Priced Sander Gives
you **BETTER** Work **EASIER!**

For one or a score of purposes, you'll say that GUILD-SANDER is the *handiest* tool in your shop. Driven by a powerful electric motor; plugs into any socket. Weighs only 9 lbs. Endless abrasive belt sands with a clean, straight stroke—*with the grain*—assuring an expert job—*10 times faster!* GUILD-SANDER is ideal, either for homeshop or industrial production. See your hardware dealer; **TRY IT OUT FOR YOURSELF**—or write direct for complete information, price, dealer's name.

SYRACUSE GUILDTOOL COMPANY
1741-12C No. Salina St., Syracuse, N. Y.

IDEAL for

- SANDING
 - Wood
 - Stone
 - Plastics
- GRINDING
 - Bronze
 - Steel
- REMODELING
 - Paint
 - Varnish
 - Lacquers
- SHARPENING
 - Knives
 - Hand tools
- POLISHING
 - Metal

CROSMAN *Silent* RIFLES

For Every Season, Indoors or
Out, City or
Country

Crosmans shoot with hair-splitting accuracy, silently, powerfully, with no recoil, using the terrific force of compressed air—instantly adjustable for long or short range. Rifled barrels, .22, .177 cal. Single Shot and Magazine Loader Models. Low Cost Ammunition. Ask Your Dealer to Show You a Crosman.



FREE BOOK

"Target and Game Shooting Facts." 24 pages, fully illustrated. Write:

SuperPells Ammunition for all .177 and .22 cal. air guns. Heavier, longer, more perfectly formed (secret process). Harder hitting, more accurate. Folder free.
CROSMAN ARMS CO., Inc., 402 St. Paul St., Rochester, N. Y.

No License
Required

ENGINES

A real Money Maker for farm or factory. Uses cheap fuels—pays for itself out of savings. Low factory prices—Easy Terms. Write for Engine and Log Saw Catalog.



WITTE ENGINE WORKS 4749 OAKLAND AVE.
KANSAS CITY, MO.

SAW-FILING

Pays up to \$2 or \$3 an Hour

A FOLEY Automatic Saw Filer files hand, circular and hand saws better than the best hand filer. Cash business, no canvassing, no eyestrain. No experience needed. Louis P. Wadonick, Ohio, says, "I have filed 764 saws in spare time and have earned \$850.00 in carpenter work due directly to my saw filing contacts." Send coupon for FREE PLAN, no obligation.



FOLEY MFG. CO., 1216-40 Foley Bldg., Minneapolis, Minn.
Send Free Plan on Saw Filing business.

Name.....
Address.....

(Continued from page 154A)

beneath films of mud that are opaque to light but not to infra-red.

Occasionally nature produces an albino plant that is devoid of chlorophyll. Lacking the apparatus for photosynthesis, such a plant grows until it exhausts the nutriment stored in its seed and then dies because it has no way of manufacturing food for itself. In the laboratory these waxy plants can be grown to maturity by supplying them with sugar and carbohydrates in a water solution. A strange freak of nature in California is a white redwood, a tall growing tree that is a sucker from its parent tree and whose bark and leaves are white. Apparently chlorophyll from the parent tree is blocked off somehow, so that the white redwood survives only because of the food that its parent tree furnishes it. Mushrooms and other members of the vegetable kingdom that exist in the dark need no photosynthesis apparatus because they are parasites and feed on foods stored in the soil instead of creating their own foods.

Meanwhile, attempts to find other ways to harness the sun are continuing. At the Massachusetts Institute of Technology a group is seeking ways of turning solar heat into power. Possibly 20,000 solar water heaters are used in the southern states for heating domestic water, the system employing a heat trap on the roof, with coils of pipe inside the trap.

Still, photosynthesis appears to be the most efficient way to utilize solar energy and to the scientists it is the most challenging. Some of the conclusions that they have reached are that plants create carbohydrates by an involved process in which small amounts of minerals possibly act as catalysts, instead of by a simple conversion from carbon dioxide and water. The main work that solar energy performs seems to be in removing oxygen from the raw materials, and the chemical conversion itself perhaps takes place in the dark, below the leaf surface. So far, every likely idea as to how photosynthesis occurs has been proved wrong, yet today the scientists feel they are very close to finding the right answer.

☐ (Stamped, self-addressed envelope, sent to our Bureau of Information, will bring you the name and address of the maker of any article described in Popular Mechanics.

AMAZING PERFORMERS NEW MONEY-MAKERS

EIFEL-GEARED PIERRENCH KIT-7" & 8 1/2"



"Pocket Machine Shops" that do the work of \$50 worth of other tools. Amazingly Quicker, Better - Easier!

- Now of ALLOY Steel—65% Stronger! • NEW PLANT..
- Quadrupled Capacity.
- Now have your Own Business in a New Selling Case. Full-time men making \$1,500 to \$4,000 Yearly... Part-timers in proportion. We need Many More!

NEW FREE



Bottle-Cap Opener, etc.

Mail Your Address Today (on a post card will do) Get FREE—this 6-Edge End-&-Angle Screw-driver and 101-Picture Manual of Mechanics, with... User Offers: or, with... DISTRIBUTOR, Territory, Demo. and SELLING Kit Offers!

AMERICAN PIERRENCH CORP. PMZ-4611 N. RAVENSWOOD AV. CHICAGO, ILL.

Get this Super Gas Value!



CLEVELAND VIKING

Big 48" span. Easy to build. May be used in either Class "A" or "B". Keep in looks and flights. Complete Kit GP-5020. \$150 (except power unit) only.....

Scale Models Everyone Envies!

Don't delay building these authentic 1/2" and 1/4" scale flying beauties CURTISS F11C-2, Span 23 3/4", Complete Kit SF-49. \$2.50; Dry Kit D-49 (Span 15 1/4"), 85c. SEVERSKY FIGHTER (Span 24"), Complete Kit SF-61. \$2.25; Dry Kit D-61 (Span 16"), 85c. BOEING P26A (Span 21"), Complete Kit SF-60. \$2.25; Dry Kit D-60 (Span 14"), 85c. TURNER-TURNER-LAIRD (Span 18 1/2"), Complete Kit SF-72. \$1.75; Dry Kit D-72 (Span 12 3/4"), 50c. And many, many others.

BIG Catalog of "America's FIRST LINE of Models"—gas, rubber, scale, Gliders, Race Cars, Engines, Balsa, etc.—and all supplies. Send name, address and 10c (none free).

CLEVELAND MODEL & SUPPLY CO., 4508D122 Lorain Ave., Cleveland, Ohio

ARCADE POWER TOOLS



Drill Press, \$5.50; Disc Sander, \$5.00; Jig Saw, \$5.50 and \$22.50; Belt Sander, \$8.00; Shaper, \$16.50 and \$20.50; Lathe, \$9.50; Band Saw, \$18.00; Bench Saw, \$11.00 and \$22.50. In far west slightly higher. Other Tools and Model Makers. Dealer or direct. FREE CATALOG. **ARCADE MFG CO., 1219 Shawnee St., Freeport, Illinois.**

QUALITY AT LOW COST

MAKE RINGS, BRACELETS, BROOCHES, PENDANTS, PAPER KNIVES, CIGARETTE BOXES, AT HOME OF GEM-LIKE PLASTICS



In sixteen lustrous colors, translucent, or opaque. Easily sawed, carved, or turned. Durable, non-inflammable, modern. 20 page complete, illustrated instruction book, 8 page illustrated catalog, both for 18c in stamps.

FELLOWCRAFTERS, INC., 64 STANHOPE ST., BOSTON, MASS.

BRUSH PLATING OUTFITS

for autoparts, reflectors, faucets, bicycles. No tanks necessary. Free particulars.

GUNMETAL CO., AVE. M, DECATUR, ILLINOIS

4000 BARGAINS



You will find illustrated, many handy articles for the small work-shop and home, also office specialties, carded goods, food products, etc., at wholesale prices, for agents, dealers, salesmen. All sold under a money back guarantee.

260 Page Wholesale Book. Cost about 25c, yours for 10c to cover cost of mailing, packing, etc. You get your dime back with first order. Hurry your request for the catalog—today.

SPORS CO., 10-40 MAIN, LE CENTER, MINN.

A AND N SUPPLY CO.



Bargains—Military, Sport Goods, Firearms, Clothes, Shoes, etc. Send 10¢ for new catalog, to be redeemed on first order.

A & N Supply Co., 4772 Lester St., Richmond, Va.

FREE TRAILER PARTS CATALOG

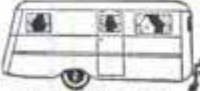

We'll save you money on—axles, springs, wheels, couplers, windows, sinks, water pumps, brakes, refrigerators, beds, lamps, inside and out, 6V lamps, furniture, jacks—everything. Special discount to mfrs. **NATIONAL TRAILER EQUIPMENT CO. Successors to Kar-A-Van Industries, Inc. Dept. P. 714 W. Wisconsin Ave., Milwaukee, Wis.**

BUILD YOUR GRANDFATHER CLOCK



Send 25c for Simple SHOP TESTED COPYRIGHTED BLUEPRINT. The Simple Sensible Red-i-Knit way as thousands have. DIME brings Plans and sixty picture "HOW" Book pricing many fine brass weight Westminster, tube chime, electric and battery movements showing nine beautiful colonial grandfather cases. Build now and save half.

KUENPEL CHIME CLOCK CO., Bldg. 47, Guttenberg, Iowa.



WHEN DID HE SAY TO CALL?
WHEN IS THAT MEETING?
WHAT WAS THAT NUMBER?
WHEN IS HER BIRTHDAY?
WHEN IS THAT NOTE DUE?
HOW MUCH DID I QUOTE?

WHY DON'T I GET MORE BUSINESS?

WHY go through life forgetting the simple but important business and social details which mean the difference between success and failure... when for less than the cost of a couple of neekties you can have an efficient, simple method of organizing your affairs so you can't forget? If you want to be more efficient, more successful, make more money, write at once for full details of the famous **Mem Index System**—the **Automatic Memory on Cards** that won't let you forget. Leather **POCKET CASE** for daily memos and temporary data—**DESK UNIT** for permanent records. Handy dated and otherwise indexed cards at both—no transcribing. Used by thousands of successful business and professional people and U.S. Gov't depts.

Free Dated Cards for the remainder of 1940 with all orders for 1941 Mem Index.

WILSON MEM INDEX CO., 173 St. Paul St., Rochester, N. Y.

Write for **FREE BOOKLET "Memory on Cards"**

100X TELESCOPE LENS KIT \$1.95



100 Power Complete Lens Kit

Make your own high powered telescope in one evening of easy work. All optical parts completely finished for 6 ft. long refracting telescope. Kit contains 3" diameter 75" F. L. ground and polished objective lens and 2 astronomical eyepieces 50X and 100X. See the mountains and craters on the moon, the ringed planet Saturn, the moons of Jupiter, double stars, etc. Complete lens kit with full directions for mounting at the special price of only \$1.95 postpaid.

BROWNSCOPE CO. Dept. 412 5 W. 27th St., New York

NEW! LOW COST! RESPIRATOR



Wear DUPOR No. 1 when operating sander; paint spray gun, grinder. While sweeping, dusting, cleaning furnace. Industries use for nuisance dusts, lint, coal, cement, grain dusts. Can be worn while talking, eating, smoking. Handy as pair of glasses. Unbreakable. Has 9 sq. in. filter area. Weighs only 1 ounce. Book on DUPOR Respirators sent FREE.

H. S. COVER, Dept. PM, South Bend, Ind.
PIONEER RESPIRATOR DESIGNER SINCE 1894

Order Today \$1.00 POST PAID

PROSPECTORS, TREASURE HUNTERS!



Use the Hedden Metal Locator to help find your lost or buried Treasure. Locates all conducting metal or ore which will sustain induction through any known substance including water. Hedden instruments are covered by U. S. Basic patent, are precision and scientifically built.

HEDDEN METAL LOCATOR INC.
Dept. A, 6230 N. W. 2nd A, Miami, Fla.

New Adding Machine Fits Vest Pocket!..



Adds, subtracts and multiplies up to one billion. Weighs only 4 ounces. Not a toy—strong guarantee. Absolutely accurate, very fast. Sells to offices, stores, homes—wherever figures are used. Write quick for **FREE AGENTS** sample offer and Money-making Plan.

VE-PO-AD, Dept. 210, 303 W. Monroe St., Chicago

Costs only \$2.95

GUNSMITHING for PLEASURE or PROFIT!



WORLD'S GREATEST GUN CATALOG! Stoeger's 1941 Edition. Only complete gun tool section for amateur and professional finest hand tools. All American—most imported Guns, Accessories, LATEST REVISIONS & PRICES. Ballistics, Restocking, Reloading All Gun Parts, Stocks, Barrels, Targets, Shooter's Articles, etc. Send a Dollar Bill, check, coin, m.o. or stamps for this 512 Page Volume.

512 PAGES 17,000 ITEMS 6,000 PICTURES

STOEGER ARMS CORP.
507 FIFTH AVE. (at 42nd St.) NEW YORK, N. Y.

(Continued from page 810)

tive power. The vehicles would be borne on wheels placed in a single line below the body, but as speed increased, most of the weight would be lifted off the wheels. Fins and automatically operated ailerons at the tail would assist in maintaining equilibrium. Stubby winglike projections at each side would enclose rubber-tired wheels which would contact the steel sidewalls, eliminating the necessity for directional control. Spacing, starting and stopping would be automatic.

Adjoining the central high-speed lanes there would be lanes for long-haul, heavy traffic carried in trailer trains longer than are practicable on today's highways, but far short of present freight-train lengths. These trailer trains would be broken up at loading points and destination, for convenient transport over public streets and roads. Thus the traffic on this new system would be door-to-door traffic, except in the case of the super-speed capsules. Outer lanes would be for fast, short-haul traffic, both passenger and freight. Here cruising speeds of 100 miles an hour or more would be normal. Access to public highways would be provided at convenient intervals by means of over or underpasses without crossing of lanes.

On these roadways vehicles in the same lane would be kept a safe distance apart by automatic controls. The entire system would be operated under strict supervision to maintain maximum speeds with safety.

A step in the direction of this reborn "railroad" system already has been taken in the construction of a high-speed highway upon a railroad right-of-way between Harrisburg and Pittsburgh, Pa. This broad ribbon of pavement runs through a number of tunnels along a fairly level route marked by the absence of sharp curves, and provides an "all-weather" route, because vehicles may operate on it through winter's storms.

Our public highway system inevitably will develop along the lines indicated by the more advanced construction of today. Multiple lanes and elaborate clover-leaf intersections are not uncommon and will be greatly expanded in the future, the whole plan being to canalize traffic according to speeds and to eliminate inter-

No. 101
CHICAGO FLYING SCOUT
 Roller Skates

Get Busy—Select your Gift now! demand "CHICAGO" Flying Scout—Silent Flash or Zephyr, the fastest streamline skates made. See at your dealer or send for **FREE BOOK** on Roller Skating. Enclose 10c if you want beautiful Gold finish Skate Pin.

CHICAGO ROLLER SKATE CO.
 4414 W. Lake St., Chicago, Ill.

Quality Rink and Sidewalk Roller Skates for 38 years.

Get FREE Booklet and CLUB PIN VALUE 25¢

Just Ain't XMAS without "CHICAGO'S"

No. 181 Noiseless Rubber Tires

No. 173 Solid Steel Wheels

NEW BENJAMIN AIR RIFLES WITH HAND PUMP
 MADE IN U.S.A.

22
177
BB

HARD ACCURATE SHOOTING WITH CHAMBERED AIR

You can use new model BENJAMIN AIR RIFLES WITH LEVER HAND PUMP anywhere, for practice firing or just plinking, around the house or camping, fishing, hunting, etc., at lowest cost. Shooting force is adjustable with amazing maximum power and accuracy—no recoil or forward lunge to disturb your aim. Bolt Action—Hammer Fire—Hair Trigger—Safety Lock—Hand Pump. Single Shot BB \$7.50; Single Shot Cal. 177 or 22 with rifled barrel \$8.50; BB 25 Shot \$9.00. Also a complete line of BENJAMIN GENUINE COMPRESSED AIR PISTOLS from dealer or factory. Write Today for details and Targets. BENJAMIN AIR RIFLE CO., 895 Marion St., St. Louis, Mo., U. S. A.

U.S. DEFENSE

U. S. Defense Forces have again selected "Prestone" anti-freeze to safeguard vital equipment—because it's the safest, surest anti-freeze ever made!

See Inside Front Cover and Inside Back Cover

Say you saw it in Popular Mechanics!

ference, friction and cross-movements. Multiple street levels in cities have existed on paper for years and tentative beginnings been made toward their construction.

It is impossible to predict the development of our vehicles of transportation because any radical development depends upon discoveries and inventions not yet made. These may be in the form of new motive power, either in fuel or engine design. Control of atomic energy may be attained or we may discover "cool power" as we are now nearing a realization of "cool light." New metal alloys of greatly increased tensile strength probably will influence vehicular design. Automobiles undoubtedly will be more cleanly streamlined, less easily damaged in collision and have higher power-to-weight ratios. Trains, as we know them, will cease to exist. Commercial water transport will produce simpler forms with improvement in speed and reduction of operating cost, perhaps with planes supplanting luxury liners as a means of rapid transport.

Aviation's continued progress depends upon certain basic discoveries and inventions yet to come. One of these might be the discovery of some way to control or counteract the force of gravity. At the moment, we only know the effect of that force. Airplane engines have been developed so that part of this force is counteracted indirectly by employing the lifting power of air. Perhaps some radio-magnetic device might be devised for eliminating the pull of gravity directly, thus relieving engines of the great task of getting planes off the ground by the present indirect application of their power. A long-range research program aimed at finding the means of reducing or eliminating the pull of gravity might bring results sooner than expected.

In the meantime plastics may be employed in construction of planes, superseding metal alloys and resulting in lighter, stronger, cheaper and swifter craft. Undoubtedly there will be great advancement in the control of flight by radio beams and other automatic agencies.

Our improved railroad and highway systems may be expected to complete the decentralization of industry. Factories will not need to be on railways, workers will not need to live near factories. Thus great

(Continued to page 161A)

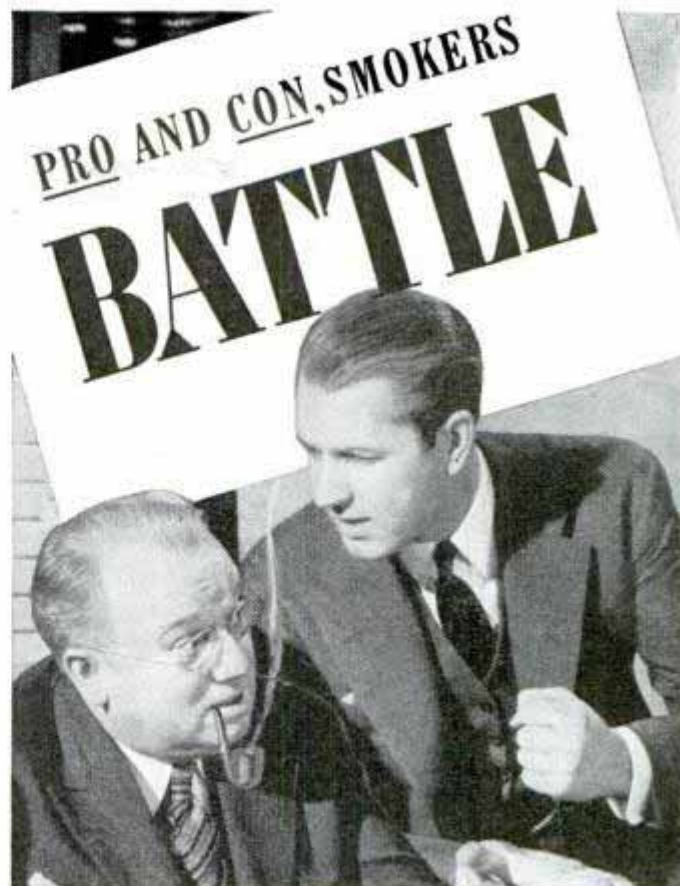

They disagree about this genuinely AROMATIC Pipe Mixture. You either like it or dislike it.

Bond Street is *too* different for everybody's taste. But *you* know tobacco. Here is "custom-blend" flavor and bite-free coolness.

In fairness to yourself—*open* a tin of Bond Street. Sniff the rare, aromatic tobacco. Light up a pipeful... smoke it around the house. *Even women* like the aroma!

Get the generous pocket tin of Bond Street today... 15¢. It may well be the smartest smoking-move you ever made!

15¢



**Today—try a tin of
BOND STREET
Pipe Tobacco**

A Product of PHILIP MORRIS

New! BARGAINS FOR WOOD WORKERS

Harold F. Hunt's
Big 1941
Catalog

Craftsmen! Get This Big Book of Rare Woods, Veneers, Inlays, Plywoods, Jig Saw Patterns, Tools and Supplies



Just out! Big new 1941 Bargain Catalog No. 14 for Woodworkers. Send for yours TODAY. 148 pages—20 pages of rare and domestic woods in FULL NATURAL COLORS. Every page crammed with fascinating projects—new inlay methods—short-cut wood-finishing processes—hundreds of fascinating scroll saw projects for making book ends, tables, lamps, furniture and novelties.

If It's Wood—I Have It

Big bargains in rare woods from Asia, Africa, and the Indies. NEW LOW PRICES. Complete stock of American woods, veneers, inlays, ornaments, hard-to-get hardware items, tools, etc. Immediate shipment at real money-saving prices. Get this book TODAY. Send only 10¢—coin or stamps—refundable on first order.

CRAFTSMAN WOOD SERVICE CO.
2729 S. Mary St., Dept. S-4, Chicago, Ill.

148 PAGES
only 10¢

BIG BARGAINS IN—
Rare Woods • Inlays
Veneers • Bandings
Plywoods • Hardware
Jig Saw Patterns
Ornaments • Tools
All Kinds Supplies

Harold F. Hunt, President, **CRAFTSMAN WOOD SERVICE CO.**
2729 S. Mary St., Dept. S-4, Chicago, Ill.

Enclosed find 10¢ (refundable on my first order) for which please send me your big new 1941 Catalog No. 14.

Name.....
Address.....
City..... State.....

A CHRISTMAS THRILL FOR ANY CHILD SKUDDER CAR For Boys and Girls



PATENTED
OVERDRIVE

No other toy can give the same thrilling, safe, speedy ride. Self-propelled with exclusive patented features. 1 YEAR GUARANTEE. Develops children physically. Age sizes 3-5, \$7.95; 6-9, \$8.95; 10-14, \$9.95. At your dealer, or order direct.

JANESVILLE MFG. CO.
Dept. M-1, 2334 S. Michigan Ave.,
Chicago, Ill.

\$2.50 POSTPAID—19" KIT U. S. SUBMARINE SCALE MODEL

Water ballast chamber and air control valve for diving. Runs on surface or under water. 54 parts ready to assemble. Die cast conning tower, naval gun, keel parts. 19 inch Model completely assembled.....\$3.50 P. P.
13 inch Model completely assembled.....\$1.75 P. P.
13 inch Kit, 40 parts, \$1.25 P. P. Send 3c for catalog of other models
WESTLAKE MODEL CO., DEPT. PM-124, ERIE, PA.



DOENUT WHEELS with Outside Valves



These new wheels wear longer, ride easier, prevent jolting and spillage. Developed by Musselman, the inventor of the airwheel for airplanes. No matter how carelessly tire is allowed to run under-inflated, valve cannot be cut or damaged by "creeping".

Three sizes—10" x 2.75"; 12" x 3.30"; 16" x 4.40". Unless you are a rated manufacturer, enclose 10¢ postage in writing for literature.

For boys wishing to build wheelbarrows, wagons, scooters or bicycle trailers, we supply blue prints at 25¢ each.

MUSSELMAN PRODUCTS CO.
6225-X ST. CLAIR AVE. CLEVELAND, OHIO

CONVERT YOUR DRILL PRESS INTO A WOOD PLANER-ROUTER PANELER-RABBETER AND TENONER

\$7.50
COMPLETE



• The Barron 5-in-1 Multi-Purpose Planer is the only tool of its kind—fits any 3/4 h.p. or larger drill press—planes, parallels, surfaces all types of woods with precision and absolute smoothness. Will not gouge, chip, check or rough work. Special Moly-Tung Hi-Speed blades now permit planing painted and varnished surfaces and plywoods. No adjustment necessary to panel, rabbet, rout and tenon. Indispensable to the workshop—safe to use—cannot harm drill press—absolutely accurate. Try it out yourself.

Free Trial Money Back Guarantee

Send check, money order or order C.O.D. for \$7.50. Postage prepaid in U. S. A. Use it five days and get a full refund if not entirely satisfied. YOU RISK NOTHING!

FITS ANY DRILL PRESS

Write for
Free Folder

BARRON TOOL CO., INC., 324 ARCHITECTS BLDG., DETROIT, MICH.

THE BARRON MULTI-PURPOSE 5-IN-1 ROTARY WOOD PLANER

ACTUAL SIZE V-PLUG



65c

MODEL BUILDERS—ATTENTION!

Champion has designed 3 spark plugs for model gas engines which give the same dependable performance as the regular spark plugs. Sillment sealed. Sillimanite insulator. Alloy needlepoint electrodes for easy starting. One piece construction.

	V	V-2	V-3
Hex	1/2"	3/8"	3/16"
Thread	3/8"-24	1/4"-32	1/4"-32
Thread Length	7/32	7/32	5/32
Weight, Grams	8	3 1/2	2 1/2

CHAMPION SPARK PLUG CO.

900 Upton Ave.
Toledo • Ohio

Light Your Head and Tail Lamps with MAKE-A-LITE GENERATOR



No more battery expense—attach a Make-A-Lite Generator for brilliant head and tail lights. Precision-built generator supplies the current for standard 6-V. lamp bulbs. Pat. Automatic Governor prevents bulbs blowing out at high speeds. Thousands of satisfied users. Only \$2.95 for Generator, \$4.50 for Generator, Head and Tail Lamp. Send check or money order to **MAKE-A-LITE, Inc., Dept. M, Fairfield, Ill.**

OWN A Printing Business

Cards, Tickets, Stationery, etc. Good profit in spare time. PRINT YOUR OWN greeting cards, movie titles, church work, etc. Save money. Easy rules supplied. **Junior Press 58, Senior Outfits \$16 up.** Have home shop. Raised printing like engraving too. Sold direct from factory only. Write for free catalog and all details. **KELSEY, INC. X-37, MERIDEN, CONN.**

DIRT WON'T STICK

to hands covered with the greaseless cream called **Du Pont PRO-TEK.** It acts like an invisible glove—prevents grime and paint adhering to the skin. To remove, just wash the hands in running water. This dissolves the protective film, and carries away the dirt with it. Write **DU PONT, Wilmington, Delaware,**

GOLDENTONE..50% OFF

AGENTS WANTED

Deal Direct, Factory Prices
Over 60 models to choose from
—4 to 12 tubes. Portables \$5.95 up. Tube sets \$8.95 up. Car sets \$8.95 up. Foreign hand sets \$8.95 up. Samples 50% off. Quantity discounts.
Free 1941 Bargain catalog gives details of 10 day FREE trial, agent's proposition and discounts. No obligation. Mail postcard to **GOLDENTONE RADIO CO., Dept. P.M., Dearborn, Mich.**

10 DAY TRIAL
\$4.95 UP
READY TO PLAY
YEAR GUARANTEE

Free Catalog
RCA
LICENSED

(Continued from page 159A)

numbers of workers may be enabled to escape the city slums. Light, cleanliness, order, healthful conditions are already the commonly accepted objectives of industrial planning. Factories are acquiring the bright, metallic, orderly aspect which thrills us in so many of our modern products, but they are only the forerunners of the factories of the future. From these factories drudgery and mere burden-bearing will have disappeared. Laboratories, engineering departments and drafting rooms will be proportionately larger than any today; the work of creating, discovering, planning, designing will have grown to overshadow all other activities in the industrial world. Work will be creative.

The flight from cities has already become something of a mass exodus. The city will become a place of business, barter, intellectual and artistic exchange, social enjoyment and amusement, rather than a place of residence, in our better world. It will be sparsely built, a collection of tall towers separated by gardens and greenward, crossed by transport systems moving at different levels. The air will be clean, for coal will not be burned within its limits. Our internal-combustion engines will actually complete their combustion internally and the air will be free of gases and fumes. The country will become urbanized—that is, the population will be spread more evenly over its surface. Dwellings will be of two types: one a development of the present apartment house, the other a type of detached house. The apartment house, or living tower, will be built in areas where there is a reason for congestion of population, perhaps fifteen to twenty families per acre—which is considered sparse settlement today. Not more than ten per cent of the ground area will be occupied by buildings. Space between living towers will be used for playgrounds, parks and gardens.

Detached houses, semi-detached or row houses will be built in areas where land is less in demand. Well-to-do people will build houses as they please, of course, but the great improvement will be in the homes of people of moderate or little means. These will be constructed of large-scale, prefabricated units and will represent a far greater value for their cost than can be

(Continued to page 163A)

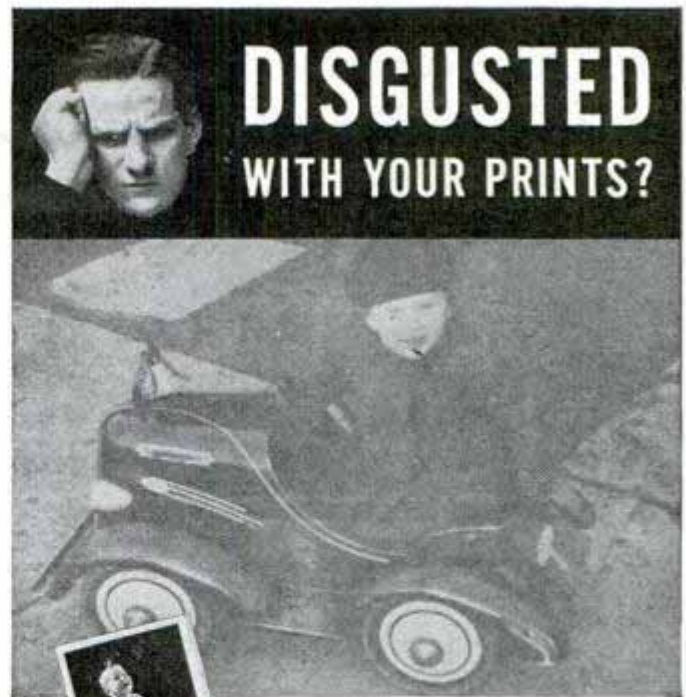

Send for this
FREE BOOKLET

There's no need for you ever to be disappointed with your still or movie pictures! This free booklet explains, in plain, understandable language, how you can get sharp, correctly exposed pictures every time you use your camera. It tells *why* you so often get poor pictures . . . and shows *how* you can avoid picture disappointments, due to incorrect exposure, simply by using the compact WESTON Exposure Meter. Every beginner or occasional photographer should have a copy. Send for yours today; or, have your dealer demonstrate the WESTON Meter. Weston Electrical Corporation, 671 Frelinghuysen Ave., Newark, N. J.

WESTON
Exposure Meters



INSURE PERFECT PICTURES WITH YOUR CAMERA



OLE DOC. "GLUEKY"

HERE I AM!
To Fix That Broken Chair

Just apply Rogers Glue to broken section—place piece, joint or splinter in position—clamp . . . then chipped, splintered and broken articles will become, look and remain like new when repaired with Rogers Glue . . . *incredibly* strong—easy to apply. Sells 10c and up in tube, jar or can at hardware stores *only*, or send 10c for full size jar plus free illustrated book giving new ideas, new plans for making useful articles—New 1940 sets of free projects sheets are also available—write Dept. A-1.

ROGERS GLUE, GLOUCESTER, MASS.



ROGERS

"A TON OF STRENGTH IN EVERY DROP"

Re Cor Freshman Photo Kit

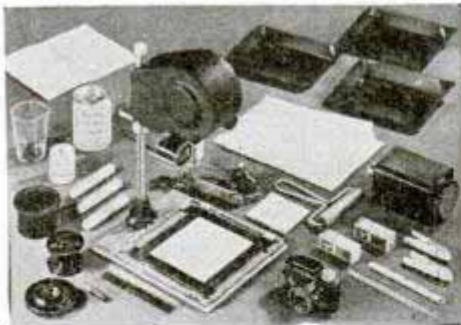

Complete outfit for taking pictures, developing film and making enlargements.

Only
\$7.95

Now for the first time the Re Cor Photographic Kit for young amateurs... complete from camera and film to darkroom equipment, developing tank, chemicals, enlarger, and all the essentials for producing the final print. Never before in photographic history has there ever been offered this practical, workable assembly of excellent photographic equipment at this amazingly low price! Every item has been tested and proven satisfactory! Will turn out finished pictures equal in quality with the finest and most expensive equipment! And look at all you get for the money! The complete Re Cor Kit consists of the following: Re Cor Camera, Re Cor Enlarger, Developing Tank, Three 4x6 Trays, 4 oz. Graduate, Thermometer, Stirring Rod, 2 Rolls of Agfa Planachrome (R12) Roll Film, Package of 24 sheets 2 1/4 x 2 1/4" Paper, Package of Photographic Blotting Paper, 4" Squeegee Roller, Darkroom Lamp with red and orange filter—complete with bulb, Package Fine Grain Film Developer, Package Hypo Fixing Powder, 3 M. Q. Tubes (Enlarging Paper Developer), 2 Film Clips, Focusing Test Strip and complete instruction book. Just imagine—all this for only \$7.95. Don't delay—send \$7.95 today—we will pay postage. Or C.O.D. plus few cents postage.

RE COR DISTRIBUTORS, 303 Fifth Avenue, New York City

MAKE BIG MONEY at HOME! NEW INVENTION Electroplates by Brush



New, patented invention makes possible big earnings AT HOME. Replate auto-parts—worn articles in homes, stores, hotels, restaurants, etc.—with durable, sparkling, new coat of metal—with stroke of brush. Easy, simple, quick. Genuine Gold, Silver, Nickel, Cadmium, etc. Everything furnished. Outfit complete, ready for use. No shop required. Clear from \$2 to \$5 an hour in lifetime business. Small investment starts you in business. Steady repeat. Machine can pay for itself in week. Send TODAY for FREE SAMPLE and illustrated BOOKLET how you can have a life income from a business of YOUR OWN built upon satisfied customers. Act at once!

FREE
SAMPLE and
BOOKLET
EXPLAINS ALL

WARNER ELECTRIC COMPANY
360 N. Michigan Ave., Chicago, Ill., Dept. 5-H

DOES OIL WEAR OUT?

U. S. Bureau of Standards states: "Oil does NOT wear out mechanically and may be used over and over again." (After reclaiming).

Thousands of car, truck and tractor owners have proven the truth of this statement with the use of 'RECLAIMO.' This revolutionary device filters and reclaims crankcase oil as you drive.

Saves Time, Trouble and Money!

Our 36-page illustrated booklet, "OIL FACTS," contains complete details and startling oil truths that will amaze you.

Write for your copy today—it's FREE.

(Sold direct and by reliable dealers everywhere.)

RECLAIMO MFG. CO., 2306 N. Western, Dept. 51, CHICAGO

'RECLAIMO'



RECLAIMS AS IT FILTERS

POWERlite

AMERICA'S FINEST—
MOST POWERFUL
ELECTRIC LANTERN

80 to 100 HOURS LIGHT
On One 6-Volt Dry Battery

● TWO LIGHTS on a double action switch. 800 ft. spot beam from front reflector; broad floodlight from top. Handle reverses. Unbreakable lens, 6 1/2" high. At sport, hardware, electrical dealers or write for literature.

DELTA ELECTRIC COMPANY
300 W. 33rd ST., MARION, INDIANA

\$3.35
Less
Battery

Buy Only a GENUINE DELTA

The easiest way to paint!



Get a professional finish with lacquers, enamels; cover rough surfaces as wickerware, screens and radiators, quickly and easily. Dozens of other uses: spraying insecticides, moth-proofing, humidifying, etc.

• This guaranteed spray unit includes 110V AC-DC Motor, 6 ft. of cord and plug, piston type cast iron compressor, efficient gun with 1/2 pt. glass container and 10 ft. of air hose.

COMPLETE WITH
110 V. MOTOR
\$9.85
ONLY

Send \$1.00 today—pay Postman balance or shipped prepaid if full price accompanies order.

MILLER-SIMONS, INC., 2903 S. 61st Ct. Cicero, Ill.

New Electric Tool Marker Only

WRITE YOUR NAME ON TOOLS WITH
ELECTRO NAME ETCHER

Guard against tool thieves. Amazing new Electro Name Etcher writes your name, any design on tools, instruments—any metal. Easy—just plug in and write. SEND NO MONEY! Mail order today—pay postman only \$1.00 plus few cents postage on delivery. Electro Name Etcher, Dept. L-600, 274 Robb St., Cincinnati, Ohio



110 Volt AC ELECTRICAL EXPERIMENTAL KIT

Wire up thief detector, arc welder, 1/2-mile arc light, elec. furnace, stove, tester, rectifier, A.C. motor, transformer, spark coil, suntan rays, and hundreds other experiments. Use regular 110-volt power 25-Piece Deluxe Kit and 3 Electrical Books...

XMAS SPECIAL

\$3.99

COMPLETE

ELECTRICAL SALVAGE CO.

Box 524-D-2

Lincoln, Nebr.

MONUMENT \$9.00 UP FREIGHT PAID

Write For Catalog and Samples Of Genuine Marble & Granite. Low prices. Guaranteed satisfaction. Erecting Service. Free lettering. U. S. MARBLE & GRANITE CO., A-18, Oneco, Fla.

MAKE MONEY in new Kind of CONCRETE Business

START YOUR
OWN SPARE-TIME OR
FULL TIME BUSINESS

Here's a world beating opportunity to start a profitable business right at home, making salable articles of all kinds from concrete. Make garden furniture—bird baths—statuary—vases and hundreds of other products from both the conventional and the new colored concretes. All these things are in big demand. Little or no capital needed.

256 PAGE BOOK TELLS HOW

Get "1001 Ways to Use Concrete" the amazing new book that covers the whole field of making money in concrete work. Explains all methods and materials, trade secrets, simple equipment you can make—gives 146 short cuts to extra profits. Hundreds of pictures and sixteen full-colored plates. It's the key to a new and growing industry, that you can use now.

SEND NO MONEY. Pay Postman

Price, complete \$1.98. Postpaid upon receipt of remittance. If you live in the U. S. or possessions you may pay postman on delivery, plus few cents charges. Money back if not satisfactory. Order now and get started at once.

POPULAR MECHANICS PRESS
Dept. 1240, 200 E. Ontario Street, Chicago

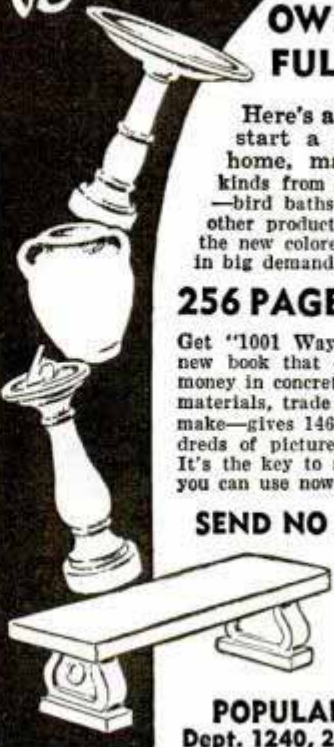

(Continued from page 161A)

obtained by any sort of building methods today. Perhaps a home site will be rented instead of purchased and the home may be easy to set up and take down. Some system for financing these low-cost houses as are automobiles today may be devised. It may even become possible to trade in the old house on a new one fitted with the latest conveniences.

People living in our better world may be expected to form neighborhood groups—composing villages or towns numbering 4,500 to 10,000 individuals—which will support schools, shops, amusements and recreational facilities, but which will be small enough for mutual acquaintance and a coherent social life.

K 967
**Grip Gauge for Fitting Bowlers
Has 140,000 Combinations**



Natural span of the bowler's grip is measured with the adjustable plugs of this gauge

There are 140,000 possible combinations in a bowlers' grip gauge designed to assure absolute accuracy in fitting a ball to the hand. It is a ball that has been dapped out, with rubber plugs containing finger holes of all sizes to fit the dappings. First the fingers are tested for the proper size hole, then the plugs are put in place and adjusted for exactly the correct span.



**CORONA'S THE BUY
THIS CHRISTMAS**

Corona offers three Speedline Models to choose from—each equipped with famous Floating Shift. Priced from \$49.50 to \$64.50. Also two Zephyr Coronas... the top values of their price class. Corona Zephyr, \$29.75, De Luxe Zephyr, \$34.75. Go now to your Corona Dealer. You can buy any Corona on a pay as you type plan.



CORONA

L C SMITH & CORONA TYPEWRITERS INC
Desk 12, 723 E. Washington St., Syracuse, N. Y.

**THE PRIZE GIFT for
JUNIOR, DAD
and GRANDPA**



Does just about everything on metals, wood, alloys, plastics, horn, bone, glass, etc. Uses 300 different accessories to grind, drill, polish, cut, carve, rout, saw, sand, sharpen, engrave.

ORIGINAL AND FINEST HOBBY TOOL. Nothing like a Handee to keep boys happy. Gives men a real hobby making useful and beautiful gifts or things to sell—ship, train or plane models, costume jewelry, wood carvings, puppets, initialed tumblers, engraved trays, etc. Why—with a Handee a fellow can set up shop wherever there is an electric outlet. Be sure to give a Handee this Christmas, or get one for yourself.

ORDER ON 10-DAYS MONEY BACK TRIAL
De Luxe Model 25,000 r.p.m. with 7 accessories \$18.50 postpaid. Standard Model 18,000 r.p.m. with 3 accessories \$10.75 postpaid.

HANDEE HOBBIES—Scale drawing plans of fascinating new projects. 25c for portfolio of 10.

SEND FOR FREE 64-PAGE CATALOG about Handee Products and their wide application in crafts and industry all over the world.

CHICAGO WHEEL & MFG. CO.
108 S. Aberdeen St. Chicago, Ill.



HANDEE
TOOL OF 1001 USES

Save
Hours of Hand
Work

Your HAIR

IS IT THINNING OR FALLING OUT?

If your hair is causing you this kind of trouble and it is due to poor blood circulation in the scalp, rent a Crosley XERVAC and try home treatments with this amazing machine. It is designed to help correct just such conditions of the scalp as the lack of proper blood circulation.

Rent a CROSLLEY XERVAC

Write for free particulars, how you can rent a brand new machine, the same type now used in many barber shops and scalp clinics, for a small rental fee per month, without any obligation to buy. The Crosley XERVAC operates on the principle of alternate vacuum and pressure, known to be effective for forcing fresh, stimulating blood into the deep-rooted blood vessels. Very compact, easy to use. Now that you can rent one you can get its benefits on easiest of terms. Write for details of home rental plan.

THE CROSLLEY CORPORATION
Dept. M-10 Cincinnati, Ohio

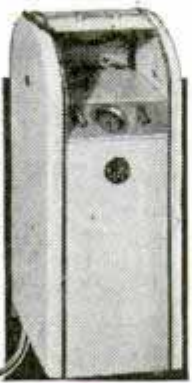

ZIM JAR OPENER

Opens Anything that Wears a Cap
Practical, new patented wall fixture—always handy, swings down out of the way when not in use. ZIM quickly and easily opens jars (including Mason Jars), glasses, bottles, cans with screw caps, pry-up caps. Also tightens screw caps. Approved by Good Housekeeping.



PREVENTS BREAKAGE—SAVES TIME AND TEMPER
Lasts a lifetime. Nothing to break or get out of adjustment. Send for ZIM in shade to match your color scheme.
MAKES ATTRACTIVE CHRISTMAS GIFT—Any housewife will be proud to own the newest, most convenient kitchen item on the market. Modern, streamline design.
See at stores or order on Money-Back Guarantee. Your choice of white, green, red, ivory, black, with harmonizing trim \$1.25; Chromium \$1.35; Silver finish \$1.00 postpaid. **ORDER YOURS AT ONCE.**
ZIM MFG. CO., 3049 W. Carroll Ave., Chicago, Ill.

HOW COLD WAS IT THIS MORNING?

This highly visible **Accurate OUTDOOR THERMOMETER** is easily installed outside your window. Adjusts to any angle . . . Made of chrome plated brass — **WEATHERPROOF, RUSTPROOF** . . . Has 3" dial with big, readable black figures . . . Sent in gift box with all fittings for only
DE LUXE MODEL, 4" DIAL \$1.50
Guaranteed **BIGGEST THERMOMETER VALUE** or Money Back.
TIPEX INSTRUMENT CO., 50, BRAINTREE, MASS.

TEST-O-LITE

Tests Everything Electrical From 100 to 550 Volts
A real necessity for electricians and home because it has 1001 uses. Equipped with a Neon light which tells instantly where trouble lies in electric circuits, fuses, cut-outs, motors, radios, all kinds of electric appliances, etc. Tells A. C. from D. C. Far superior to ordinary clumsy test bulb. Fountain pen size with clip for carrying in vest pocket. Lifetime guarantee.
PATENTED
L. S. BRACH MFG. CORP.
55 Dickerson St., Newark, N. J.

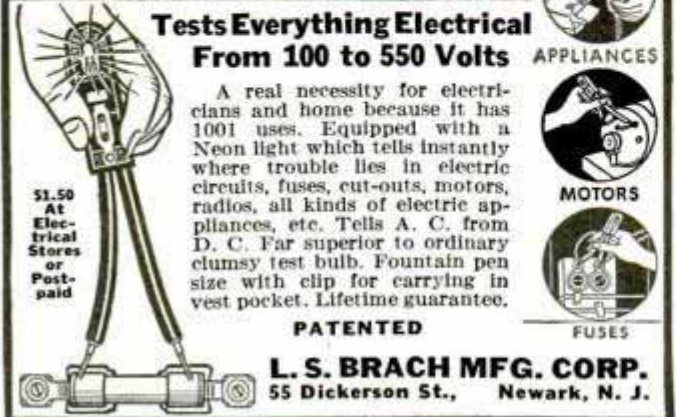

Say you saw it in Popular Mechanics!

PAINT STRIPING TOOL

As Easy to Use as a Pencil! **ONLY \$1.00 POST PAID**

With this new low priced **TOOL** (not a brush) you can now do professional striping—on furniture, autos, models, tiled walls, toys, boats—and all home workshop projects. Tool uses paint, enamel, lacquer, etc. Thousands of satisfied users in home, workshops, garages, furniture stores, etc. (We also make commercial and industrial models.) Send only \$1.00 for complete tool with gravity feed container, 1/16" striping wheel, adjustable guide, operating instructions, etc. Sold on Money Back Guarantee. Narrower or wider stripe widths available. Write today for free literature.
Dealers: Write for catalog, prices and discounts

Stripes add beauty to every painted article **WENDELL MFG. CO.**
2500 N. Ashland Ave. Chicago, Ill.

BIG NEW STREAMLINED LATHE

AT SENSATIONAL BARGAIN PRICE
Imagine! This extra heavy wood lathe, steel bed 48" long, at low prices. Heavy duty head stock, 4-step cone pulley for V-belt. No. 2 Morse Taper Centers. Sealed ball bearings. 6" face plate screws onto spindle. Tool rest 10" long. Complete line of accessories at amazing low prices. Write today for free catalog describing Blue Star full line precision woodworking machinery. Lowest prices.
BLUE STAR PRODUCTS, 612 Lawn Ave., Fairfield, Iowa



SHAW DU-ALL GARDEN and SMALL FARM TRACTOR

Small sizes, for gardens and lawns. Larger sizes do **ALL JOBS** on small farms—small jobs on **ALL FARMS**. Walk or ride; sizes 3/4 to 8 H.P. Write for Factory prices—Free Catalog.
SHAW MFG. CO., 4512 Front St., Galesburg, Kan.;
5812-G Magnolia Ave., Chicago, Ill.; 130-G West 42nd St., New York City; 668-G North 4th St., Columbus, Ohio.



DO YOU WANT THE MOST EFFICIENT, FINEST CUTTING AND THE EASIEST OPERATING SAW, THEN GET THE NEW SHEBEL SAW FILER
and you will have saws that the costliest filing machine cannot equal. Files all saws. Experience not necessary. For full particulars just write your name and address on a postal.
A. P. SHEBEL 730 S. 2nd ST. MILWAUKEE, WIS.

Turn SCRAPS into MONEY

NEW USES FOR AUTO GENERATORS. RELIABLE, CONVENIENT HOUSE CURRENT FOR YOU IN THE HOME, CAMP, OR BOAT. BRILLIANT LIGHTS, RADIO YOU WILL ENJOY, TOASTERS AND APPLIANCES.

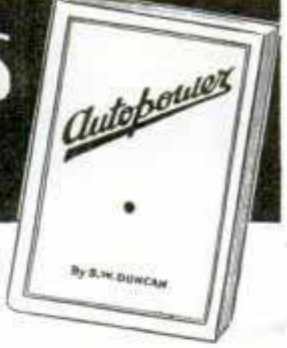

AUTOPOWER shows you how to make alternating and direct current generators and motors from automobile generators. These changes make the generators adaptable to uses such as **WELDING, LIGHT, POWER, SOUND TRUCKS, GRINDERS, RADIO, PUBLIC ADDRESS, MOVIES, BOATS**, etc.
The generators can be driven by the fan belt of a car, wind propellers, water wheels, or various types of engines. Complete instructions for building water and wind power plants, A. C. welding transformers, soldering pliers, portable grinders, electric eye, and heavy duty D. C. welders. It also includes hundreds of electrical definitions, questions and answers that will make this on any other electrical book easily understood. No previous experience or special tools are needed to make these simple reliable devices.
START TODAY IN THIS NEW AND INTERESTING FIELD OF TURNING SCRAP INTO MONEY. Price \$1.00.

POPULAR MECHANICS PRESS
200 E. Ontario St. Dept. 1240 Chicago

A Revelation—Our new 1941 Catalog of "HARD-TO-GET" MATERIALS

For Industrial Arts Departments in Schools, Institutions, etc., Furniture Repair Men, Cabinet Makers, Souvenir and Antique Shops, Homecrafters, etc. Send 10c cash or stamps for this new catalog.

A few of the items we sell: Chest hardware, locks, hinges, supports, tray lifts, copper trim, also mouldings, overlays, etc. Finishing materials, glue, stain, varnish, abrasive papers, sanding blocks, stick shells, etc. Upholstering supplies, coverings and tools. Electrical findings for lamp manufacture, also clusters and indirect fixtures. Chair cane, spline, reeds, craft fibre cord, etc. Trays and glass liners for smoking stands. Large line electric and spring clock movements, with and without dials. Complete line Venetian Blind hardware, cord, tapes, etc. Table slides and supports. Tea wagon wheels and casters. Wood dowels, also dowel screws, dowel centers, wood screw hole buttons. Large line card table leg supports. Bed hardware of every description. Desk pens complete with funnels and fasteners without base. Water transfers, inlays, small mouldings, etc. Glides and casters, office chair spiders, wood legs and K. D. chair frames. Small box hardware of every description. Large selection pulls, knobs, handles, hinges, locks, catches, etc. Perforated steel panels, chair braces, revolving chair fixtures, recker springs, candle-stick sockets, billboard clamps, instapost table hardware, metal drawer slides, brass jack chain, drawer follower blocks, etc. Many styles corner braces, bolts, etc. Step ladder braces, plaster strips, sliding track and sheaves. Typewriter desk hardware, blowings, mirrors, nut bowl hardware, salt and pepper inserts, music box movements, etc. Bar pins for novelties, dress clips, etc. Catalin plastics, crib hardware, swivel top table fixtures, sectional bookcase hardware, clamp nails, electric pens for burning, etc.

THURSTON SUPPLY COMPANY, Dept. PM, Anoka, Minnesota

Hobbycrafts LARGEST AND MOST COMPLETE
132 page Catalog ONLY 10¢

MODEL
• AIRPLANES
• SHIPS
• RAILROADS

MEGOW Dept. PM., Howard & Oxford Sts., Phila., Pa. or 217 N. Desplaines St., Chicago, Ill.

LIGHTS ITSELF

SELLS ITSELF

Quick Action (1940) Perfected Self Starting Lighter

Lights cigar, cigarette or pipe—Instantly. Never fails. IMPROVED PRINCIPLE IN IGNITION. No flint. No friction. Send 25c for sample and large can of fluid. Start now. Agents report big earnings.

NEW METHOD MFG. CO.
Box PMD-96 Bradford, Pa., U.S.A.



ONE-MAN SAWMILL LOW AS \$59



TURN TREES INTO MONEY WITH A BELSAW

Pays for itself quickly—thousands in use. Capacity 10 to 30 ft. Mechanical feed. Write for Free Lumber Hand Book and catalog of New Improved 1941 Models.

BELSAW MCH. CO., 3542 C-1 Main St., Kansas City, Mo.

Wonder-Tone NOISE ELIMINATOR

Just attach to your radio (long, short wave) and enjoy reception free from distracting noises. Send-No-Money Pay Postman 50c plus postage or send 50c and we'll send postpaid. Returns in 5 days for refund if not delighted.

WONDER-TONE COMPANY, Dept. I, 7078 N. Clark St., Chicago, Ill.



110 VOLT AC LIGHT PLANTS

& generators furnish AC current same as in city. 350 to 10,000 watts, list \$44.50 & up. Also rotary converters, frequency changers, Diesels, DC motors with AC take-off, AC&DC generators, etc. Write for circulars. **KATOLIGHT, 13 Elm St., MANKATO, MINN., U. S. A.**

BUILD THESE PROJECTS

For garden or lawn. Easy to build. Easy to sell. Detailed Blueprints Model B-25 Dutch Windmill 50¢; Model OM-60 Old Mill, 85¢. Lawn Figure Patterns—Sunbonnet Girl, Dutch Boy, Tulip Girl, Holland Pair, 35¢ each, all 4—\$1.00. Catalog illustrating many models, send 10¢ today.

CRAFTSMAN'S MODEL CO., Dept. P-47, 2030 N. 41st St., Milwaukee, Wis.

Ready Now New TRAILER PARTS Catalog

and TRAILER BUILDERS MANUAL—25 cents
80 Illustrated Pages packed with ideas and suggestions for Trailer Builders, Buyers, and Owners. Largest and most complete line of Trailer Parts, Supplies and Equipment at America's Lowest Prices. Rush 25c (in U. S.) for this book today. Satisfaction guaranteed! **TRAILER SUPPLY CO., BOX 390-A, WAUSAU, WIS.**



When writing please mention Popular Mechanics

"You can earn \$150 to \$300 extra profit monthly with this HOBART WELDER"

Liberal Trial
in your shop on your own work to prove it
SEND for complete details

IT'S EASY TO GET BIG PROFITS WITH HOBART ARC WELDING EQUIPMENT

Because of big profits realized with the Hobart 40-Volt "Simplified" Arc Welder you can start a big paying business of your own . . . with almost no investment! Arc welder prices are the lowest in history, making it possible for even the smallest shop to own one of these money-makers. Extra profit from a single job is often more than enough to take care of the small monthly payments. Arc welding is today's profit opportunity . . . don't miss it!

Remote Control. This is an important feature you get at no extra cost with Hobart. It lets you control your welder from any working point. Saves time, temper and eliminates the need for a helper on overhead or concealed work. **Easy to Operate.** Hobart Welders have "Simplified" operation. This means faster welding—with the right current for every job. Hobart is so simplified that any one of your men can weld easily and successfully.

60% Extra Capacity over old style 25-Volt Welders . . . necessary for welding with the new coated rods. Automatic reactance lets you handle light welder work without losing the arc.

"Pays-for-itself" Terms. You can try this complete Hobart Welder in your own shop for a liberal trial to prove that extra earnings and savings obtainable with this improved welder makes it easy for you to own a Hobart with practically no cash outlay.

Own this PROFIT MAKER for only \$20 MONTHLY

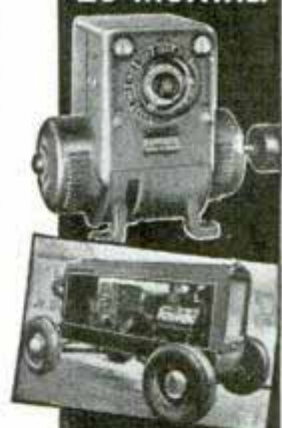

ECONOMICAL HOBART A. C. ARC WELDER

Now you can get all the advantages of the finest arc welding at low cost! This new welder lets you handle hundreds of jobs with far more profit on repair and general job shop work. It's easy to use; easy to own; economical to operate. Comes complete with all accessories, electrodes and instructions for use. Ask for liberal trial. Quickly pays for itself on . . . \$12⁵⁰ months of



Build Your Own Arc Welder with above Hobart unit SAVES YOU \$300 TO \$500

Use this Coupon to get FREE Arc Welding Book

HOBART One of the World's largest builders of Arc Welders

HOBART BROS. CO., Box M-1240, Troy, Ohio

Tell me more about—

- Building My Own Portable Welder
- Complete Gas Engine Drive
- Electric Drive Welder
- Send FREE Book on "New Profits in Arc Welding"

Name

Address

Interested in LIBERAL TRIAL. EASY TERMS



WORLD'S FINEST

Ski with the World's Finest! Use Northlands! Designed by great skiers like Hannes Schneider (above)! When hinting about that Christmas gift, don't say "skis", say "Northlands". Free "How to Ski" booklet on request!

NORTHLAND SKI MFG. CO.
World's Largest Ski Manufacturers
95 Merriam Park St. Paul, Minn.

MAKE YOUR OWN! SMART PHOTO GREETING CARDS

ONLY 2¢ EACH

Distinctive! Individual! Personalized! Make your Christmas Greeting Cards stand out by making contact prints from YOUR FAVORITE NEGATIVES

Twelve separate negatives of hand lettered and handsomely decorated greeting sentiments. You can combine any greeting negative with any of your own favorite negatives. Send Christmas cards showing your house, fireplace, children, family, or pet.

COMPLETE KEL-KARD-KIT \$1

The famous KEL-KARD-KIT is yours from your dealer or postpaid, for only \$1.00. Contains embosser, embossing tool, masking paper and tape, two double masks with guides for greeting negatives and your own pictures—and 12 hand lettered greeting negatives, with decorations. At camera stores, or send \$1.00.

KELLEY PHOTO SUPPLY CO., 328 N. Michigan Ave., Chicago, Ill.

ONAN ELECTRIC PLANTS ALTERNATING AND DIRECT CURRENT

Produce Current, same as City Power Lines, for FARMS, SCHOOLS, THEATRES, PUBLIC BUILDINGS... Operate Lights, Radios, Motors, All Appliances.

Over 40 STOCK MODELS—350 to 50,000 Watts. Any Voltage—Any Frequency. Combination A. C. - D. C. Types. Manual, Full Automatic and Self-Starting. \$99 up. Shipped—COMPLETE, READY FOR OPERATION. THOUSANDS IN USE IN ALL PARTS OF THE WORLD.

Write for Complete Details.

D. W. ONAN & SONS
1052 Royalston Avenue - MINNEAPOLIS, MINN.

BUILD YOURSELF A MIDGET CAR

WE SPECIALIZE IN WHEEL SETS, ENGINES, ETC., for building Cars, Scooters, Trucks, etc. We carry only the best at the lowest prices. Send 10c for parts catalog and plans for three Midget Racers, Scooters and other vehicles. It pays to use only reliable plans and parts—We guarantee satisfaction. **Build-Your-Own** Devices, 536 North Parkside, Dept. PM-12, Chicago

A Midget Car or Scooter outfit is an ideal Xmas gift

new POWER JOINTER

only 6.50 "The Jointmaker"

postpaid (Outside U. S. A. \$7; C. O. D. \$6.75)

FREE CATALOG describing \$150 Prize Contest (1st prize \$25; 2nd \$15; 3rd \$10; 41 other cash and merchandise prizes.) Cat. illustr. complete power tool line: Jig Saw, \$1.50; Sander, Circular Saw with oilless bearings, \$3 each; Drill Press, \$2.50; Sander, \$1; completely equipped lathe, \$2.00 and \$4.00. Sold direct only. Order today or send card for Catalog.

\$150 PRIZE CONTEST

Just think of it, a real 4" power jointer at this astonishingly low price! "The Jointmaker" performs every joint-making operation (planes, cuts angles, etc.) smoothly and quickly. Weighs 8 lbs., is overall 4 1/2" high by 8 1/2" wide by 13 1/2" long; has 4 1/2" wide table with 4 tempered carbon steel knives set in solid safety-type fence fully adjustable without iron. Frame and legs solid cast iron.

J. & H. Metal Products Co.
5 Commercial St., Rochester, N. Y.

EASIEST TOOL TO USE

BECAUSE IT HAS A Flexible SHAFT AND Pencil-Size HANDPIECE

New skill, new ease for experienced craftsmen and newcomers to the homecraft hobby. **Foredom** "finger-tip" control for precision work in hard-to-reach-places and for delicate jobs. Note the flexible shaft—the lightweight, pencil-size handpiece. Versatile, can use over 200 accessories. Hundreds of uses: grinding, polishing, milling, engraving, sharpening, slotting, gem-setting, sawing, carving, cleaning, sanding, glass etching, finishing dies, molds, castings, etc., etc. Only \$14.95 for the complete Portable Workshop, as illustrated.

YOURS ON 10-DAY FREE TRIAL

Order this Model 45 FOREDOM Flexible Shaft Workshop today. Enclose \$14.95 check or M.O.—or, we can ship C.O.D. Try it for 10 days. If not completely satisfied, return set—we refund money at once. **FOREDOM**—fine tools since 1922.

Write for complete catalog.

FOREDOM ELECTRIC CO., Dept. 181,
27 Park Place, New York, N. Y.

ONLY \$14.95
Including 50-piece Accessory Set

New WITTE 40HP DIESELECTRIC

Your present power bill will buy a WITTE that produces power and light for 1c a K.W.H. Save up to 75%—a size for every need, 2500 to 30000 watts; 1, 2 and 4 cylinders.

Write today for finance plan, literature and name of dealer.

WITTE ENGINE WORKS 1749 OAKLAND AVE. KANSAS CITY, MO.

Choose from World's Largest Line of Power Tools!

FREE New 1940 Catalog covers Metal and Woodworking Tools, accessories, motors for every purse. Write Walker-Turner Co., Inc., 1120 South Ave., Plainfield, N. J.

DRIVER Engineered POWER TOOLS

Earn Cash at Home!

We paid M. M. \$1174 for exceptional cellar crop Snow-King mushrooms! We furnish materials; buy all crops. Big FREE picture book tells if your cellar, shed, barn, suitable. Est. 1908. Write today. United Co., 3848 Lincoln Av., Dept. 309, Chicago

AGENTS 300% Profit SIGN LETTERS

For Store Fronts and Office Windows. Anyone can put them on. Free Samples. Liberal Offer to general agents.

METALLIC LETTER CO., 438 N. Clark St., Chicago

SAVE 1/2 ON WELDING OUTFITS

Heavy-duty Welding Outfits, \$28.73 to \$63.34; Heavy-duty Welding Torches, \$11.52; Sheet Metal & Airplane Torches, \$8.08; Heavy-duty Arc Welders, \$59.90 to \$90.00; Regulators with gauges, \$8.98. Superior Machine Company, Hamilton, Ohio.

Calling All Cars

A MYSTERIOUS DISCOVERY SAVES UP TO 30% ON GASOLINE or Costs Nothing to Try

Stop wasting Gas!—trim dollars off gas bills—get more power—quicker pickup—faster acceleration! **AUTO OWNERS everywhere** praise **VACU-MATIC!** Proven so efficient, it is guaranteed to satisfy, or the trial costs you nothing.

Automatic Supercharge Principle

Vacu-matic is entirely different! It operates on the supercharge principle by automatically adding a charge of extra oxygen, drawn free from the outer air into the heart of the gas mixture. It is entirely automatic and allows the motor to "breathe" at the correct time, opening and closing as required. Saves up to 30% on gas costs, with better motor performance.

FITS ALL CARS

Constructed of six parts fused into a single unit, adjusted and sealed at the factory. Easily and quickly installed by anyone in a few minutes.

AGENTS Get Yours FREE

FOR INTRODUCING. Here's a splendid opportunity for unusual sales and profits. Every car, truck, tractor owner a prospect. Send name and address now for big money making offer and how you can get yours Free. **The Vacu-matic Co., 7617-537 W. State Street, Wauwatosa, Wis.**

Say you saw it in Popular Mechanics!

Best of All CHRISTMAS GIFTS



GIVE YOURSELF . . . GIVE OTHERS!! PRACTICAL AND HELPFUL BOOKS

Here are the finest gifts of all Books that help to better jobs . . . bigger pay . . . make jobs easier . . . futures brighter. Invest your Christmas money in these helpful books. Give them to yourself . . . to your friends and relatives. They will pay big dividends year after year.

CHOOSE FROM THIS LIST!

AUTO BODY AND FENDER REPAIRS: New book covering every phase that will put you right into this profitable business. \$3.00.

DYKE'S AUTO ENCYCLOPEDIA: World's greatest auto book. New 19th edition. Real help for auto and shop mechanics. 1451 pages. 4700 illus. \$6.00.

AUDELS WELDERS GUIDE: New book. Covers operation and maintenance of all welding machines, both electric and oxy-acetylene. Over 400 pages. \$1.00.

DIESEL ENGINE MANUAL: For those who desire knowledge of the Diesel engine. \$2.00.

BOOKKEEPING MADE EASY: Written and illustrated in such a concise manner that the beginner will find most complex problems perfectly clear. \$1.00.

WHAT TO MAKE: Remarkable 2-volume library of projects and ideas for home craftsmen. De Luxe cloth \$2.45; paper \$0.98.

FURNISHING THE HOME GROUNDS: Hundreds of suggestions for increasing the attractiveness of your yard and garden. \$0.80.

UPHOLSTERED FURNITURE: Describes every important operation in craft and group of upholstery projects. \$2.00.

PRACTICAL MATHEMATICS: Deals with fundamentals of mathematics. Real help for everyone who uses figures. \$2.00.

COURSE IN WOOD TURNING: Everything you need to know about wood turning. \$1.50.

EASY TO MAKE TOYS: Seventy-seven projects and each one a favorite with children. \$1.44.

WOODCARVING MADE EASY: Add a few simple carvings to your next craftwork project. \$1.25.

LETTERING OF TODAY: Modern ideas, good taste and correct letter construction. \$1.00.

BOOKBINDING MADE EASY: Earn extra money by rebinding old books and magazines. \$1.00.

DICTIONARY OF TECHNICAL TERMS: Defines terms commonly used in more than 70 different fields. \$2.25.

A. B. C. SHORTHAND: Requires but few hours to master. \$1.00.

THE LOCKEYIST: Solves maintenance problems of locking devices. \$1.89.

MANUAL ON PLUMBING, DRAINAGE AND SEWAGE: Covers all kinds of plumbing installation, estimating, questions and answers for master plumbing exams. \$2.00.

ROPP'S CALCULATOR: Figuring made easy for mechanics, business men. \$0.50.

STEEL SQUARE POCKET BOOK: Describes and illustrates best methods of using steel square in carpentry work. \$1.00.

NEW RADIOMANS GUIDE: Just out! For radio mechanic, service man and student. Late television data. \$4.00.

THE BOY MECHANIC: Completely new edition of this famous book. Makes fine present. \$2.00.

SHEET METAL WORK: Self-instruction in pattern drafting and construction. Both light and heavy-gauge metal. \$2.50.

STEAM AND HOT WATER FITTING: How to design modern systems, select equipment and install it correctly. \$2.00.

STEEL CONSTRUCTION: Gives facts and formulas needed in designing structural steel framework for buildings. \$3.50.

MACHINE SHOP WORK: Approved shop methods including construction and use of tools and machines, details of operation and modern production methods. \$2.75.

PLANNING THE LITTLE HOUSE: Treats things person building, buying or remodeling should consider. \$2.75.

AUTOPOWER: Turn old auto generators into practical A.C. and D.C. motors and generators, for lighting, welding, etc. Also tells how to make soldering pliers, portable grinders and electric eye. \$1.00.

SHEET METAL WORKERS' MANUAL: Real help for those engaged in sheet metal work. \$2.00.

OXY-ACETYLENE WELDING AND CUTTING: Electric and thermit welding, annealing tempering, hardening. \$0.89.

AIR CONDITIONING: Non-technical. Covers all types of equipment. \$3.50.

HOUSE WIRING: Approved methods for homes and buildings. Thorough and complete. \$2.50.

REFRIGERATION: Electric and gas. Refrigeration in all its branches. Just what you need to be service expert. \$5.00.

SHOP NOTES LIBRARY: Thousands of practical money making time and labor saving ideas. Complete set of six big volumes—1936, '37-'38-'39-'40 and '41 only \$2.45. Single volumes \$0.50.

AERONAUTICS SIMPLIFIED: 150 pages of facts vital to student's success as a flyer. \$1.50.

AIR CONDITIONING—HEATING AND VENTILATING: Principles and general application of steam, hot water, vapor and vacuum heating with air conditioning of all types of buildings. \$4.00.

ARMATURE WINDING: Clearly written book on construction, winding and repairing of A.C. and D.C. motors and generators. \$2.00.

BLUEPRINT READING FOR BUILDING TRADES: An excellent and very popular book. \$1.25.

CIVIL SERVICE HANDBOOK: Complete home study courses for Federal, State and City civil service examinations. \$1.00.

THE BOAT BOOK: Shows exactly how to build 15 popular boats—for pleasure or profit. \$1.98.

ABC OF AVIATION: Instruction book for everyone interested in aviation. \$2.50.

HOUSE WIRING: Up-to-date book for electricians, apprentices and students. \$1.00.

MONEY-MAKING FORMULAS: Popular Mechanics' new book. Formulas and all the other information you need to start a small manufacturing business of your own. \$4.00.

CARPENTRY AND JOINERY: A very popular book for carpenters and apprentices. \$2.89.

BLUEPRINT READING FOR MACHINE TRADES: How to read assembly, scale and working drawings. \$1.50.

PAINTING AND DECORATING: Principles and application of commonly used paints, varnishes. Includes estimating. \$1.50.

PATTERN MAKING: Practical treatise on woodworking and wood turning, tools and equipment. \$2.00.

CONCRETE: 1001 Ideas for using. Most complete book on the subject. \$1.98.

**2000 WAYS TO MAKE MONEY
A THOUSAND WAYS TO MAKE \$1,000:**
Tried and Tested Methods That Work — That You Too, Can Use. How hundreds of men made their first \$1,000 in their own business. \$2.50.

MONEY MAKING IDEAS: 1000 spare time ways to make money. Practical guide for young and middle aged men and women, students, boys, girls. \$1.00.



SEND NO MONEY—BOOKS SHIPPED C. O. D. IN U. S.

Select books from list above. Help yourself and friends to more profitable—more enjoyable days. Send No Money. Pay postman above prices plus postage. (C.O.D. in U. S. only). Outside U. S. A. add ten cents for each book for postage. Act Now.

POPULAR MECHANICS PRESS

200 East Ontario St., Dept. 1240, Chicago, Ill.



MAKE YOUR SHOP COMPLETE

with this SOUTH BEND LATHE

Does all metal working jobs — turning, boring, drilling, reaming, cutting screw threads, milling, polishing, filing, facing, and honing.

Used in manufacturing plants, machine shops, auto repair shops, laboratories and home work-shops.

No. 415-YC, 9 1/4" swing by 3' bed Workshop Bench Lathe with 1/4 h.p. reversing motor and countershaft. Shipping weight 320 lbs.

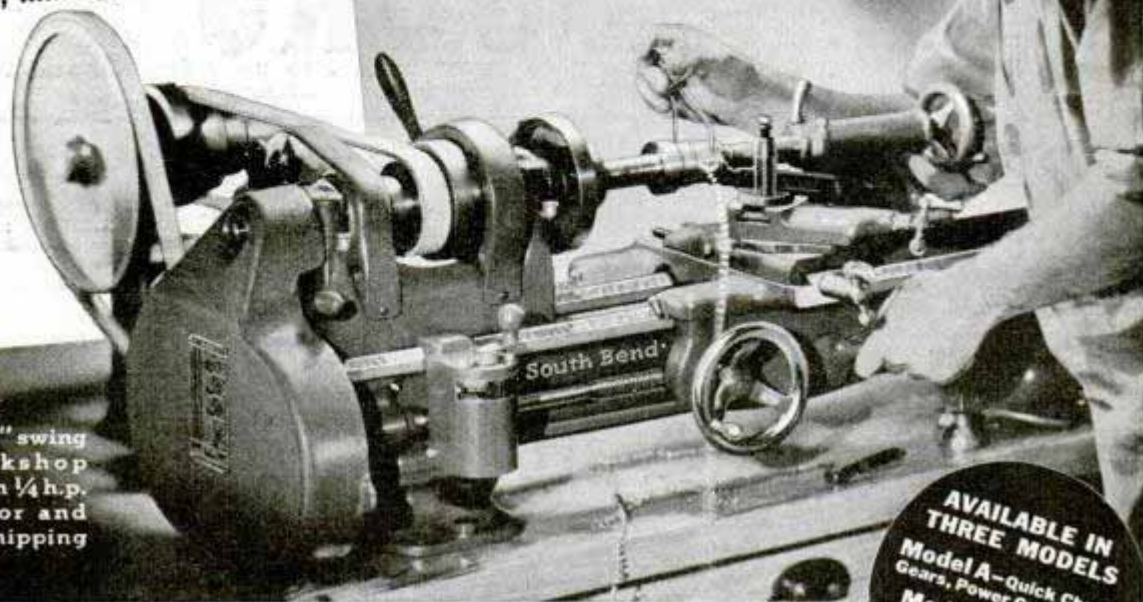

AVAILABLE IN
THREE MODELS
Model A—Quick Change
Gears, Power Cross Feed.
Model B—with Power
Cross Feed.
Model C—Hand
Cross Feed.

● The South Bend 9-inch Workshop Lathe is known among mechanics as the Universal tool. Practically every type of machine work can be done on this back-gearred, screw-cutting precision lathe. The variety of work done on the lathe makes it an essential tool for any shop.

Practical Attachments For All Classes of Work

- GENERAL** — Milling, Grinding, Drilling, Boring, Wood Turning.
PRODUCTION — Bed Turret, Double Tool Rest, Hand Lever Collet Equipment, Hand Lever Tailstock.
TOOL ROOM — Taper Work, Hand Wheel Collet Equipment, Micrometer Carriage Stop, Thread Dial Indicator.
AUTOMOTIVE — Valve Refacing, Armature Truing, Piston Finishing, Connecting Rod Boring, Differential Truing.

SOUTH BEND LATHE WORKS

612 East Madison St., South Bend, Ind., U. S. A.

Baltimore, Md. — Carey Mach. & Supply Co.
 Boston, Mass. — South Bend Lathe Works*
 Buffalo, N. Y. — R. C. Neal Company, Inc.
 Chicago, Ill. — South Bend Lathe Work †
 Cleveland, Ohio — Reynolds Machinery Co.
 Detroit, Mich. — Lee Machinery Company
 Los Angeles, Cal. — Eccles & Davies Mach. Co.
 Milwaukee, Wis. — W. A. Voell Machinery Co.
 Newark, N. J. — J. R. Edwards Machinery Co.
 New York, N. Y. — A. C. Colby Machinery Co.
 Philadelphia, Pa. — W. B. Rapp, Machinery
 Portland, Ore. — Portland Machinery Company
 Providence, R. I. — Geo. T. Reynolds & Son
 Rochester, New York — Ogden R. Adams
 San Francisco, Cal. — Moore Machinery Co.
 *Boston Sales Office, 67 Broadway, Kendall Sq.,
 Cambridge, Mass.; Telephone Trowbridge 6369.
 †Chicago Sales Office, Room 308 Machinery Sales
 Building; Telephone State 7283.

On Display
In Principal
Cities

INSIST— On These Features

- Heat-treated alloy steel head-stock spindle with capillary oiling system.
- Hand-scraped lathe bed V-ways.
- Precision machine cut gears.
- Hand-scraped, lapped dovetails.
- Precision lead screw.
- Thread range 4 to 160 per inch.
- All steel and iron construction.
- Precision graduated steel micrometer collars.
- Ball thrust bearing on spindle.
- Drum type reversing switch.

Popular In Industry

The above features are responsible for the popularity of the 9-inch Workshop Lathe in industrial shops. This lathe is used by the Caterpillar Tractor Co., Bell Telephone Lab., Ford Motor Co., National Cash Register Co. and thousands of other manufacturers.

SOUTH BEND 
Precision **LATHES**
 LATHE BUILDERS SINCE 1906

When you've got to get there—depend on
“PRESTONE” Anti-freeze

TRADE-MARK

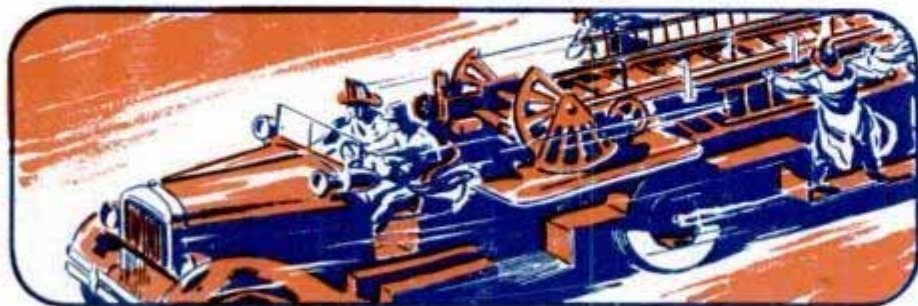

Fire Departments use “Prestone” brand anti-freeze because it will not fail. It has proved itself in more cars than any other brand of winter protection ever made!

Ambulances and doctors' cars “get there” with “Prestone” anti-freeze... the winter protection that banishes freeze-up, boil away, foaming, fumes, rust and corrosion. One shot lasts all winter!

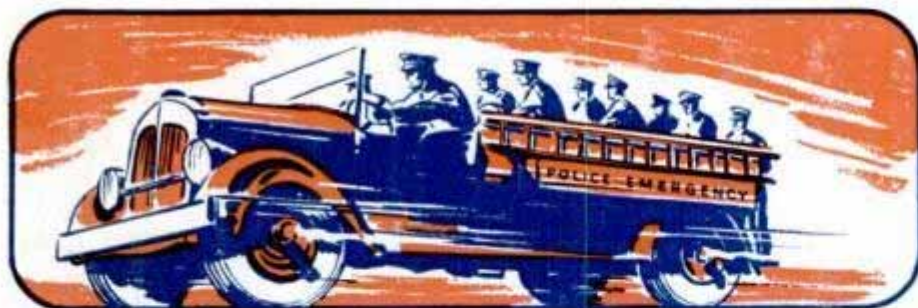

Police Departments rely on “Prestone” anti-freeze. So do the armed forces of the United States Government. “Prestone” anti-freeze is made to an *exclusive* formula. **GUARANTEED IN WRITING.** See your dealer.

The words “Prestone” and “Eveready” are registered trade-marks of National Carbon Company, Inc.



\$2.65

A GALLON

“YOU’RE SAFE AND YOU KNOW IT”



for Christmas
...give the
cigarette that satisfies

A carton of Chesterfields
with their **MILDER BETTER TASTE**
will give your friends more
pleasure than anything else
you can buy for the money.

The attractive Gift
Carton that says

Merry Christmas