

The 1941 CARS - in color

POPULAR MECHANICS

MAGAZINE

WRITTEN SO YOU CAN UNDERSTAND IT



REG'D. TRADE MARK, GREAT BRITAIN, NO. 410428

REG. U.S. PAT. OFF.

NOV.
25 CENTS
30c IN CANADA



SEE PAGE 666



HIS SMELLY PIPE WAS OVER-RIPE

—but he's out of the dog house now!



"OUT YOU GO, PETER! I won't marry a human smoke-screen! Where'd you get that tobacco anyway—in a fire sale? Snap out of it! Switch to a mild and fragrant blend."



PIPE AT A WEDDING? Sure! Pete made such a hit with his mild, grand-smelling Sir Walter Raleigh burley blend that even his mother-in-law smiled her approval!

New!

Cellophane tape around lid seals flavor in, brings you tobacco 100% factory-fresh!



UNION MADE

Tune in... **UNCLE WALTER'S DOG HOUSE**
 EVERY TUESDAY NIGHT ★ NBC ★ PRIZES FOR YOUR "DOG HOUSE" EXPERIENCE

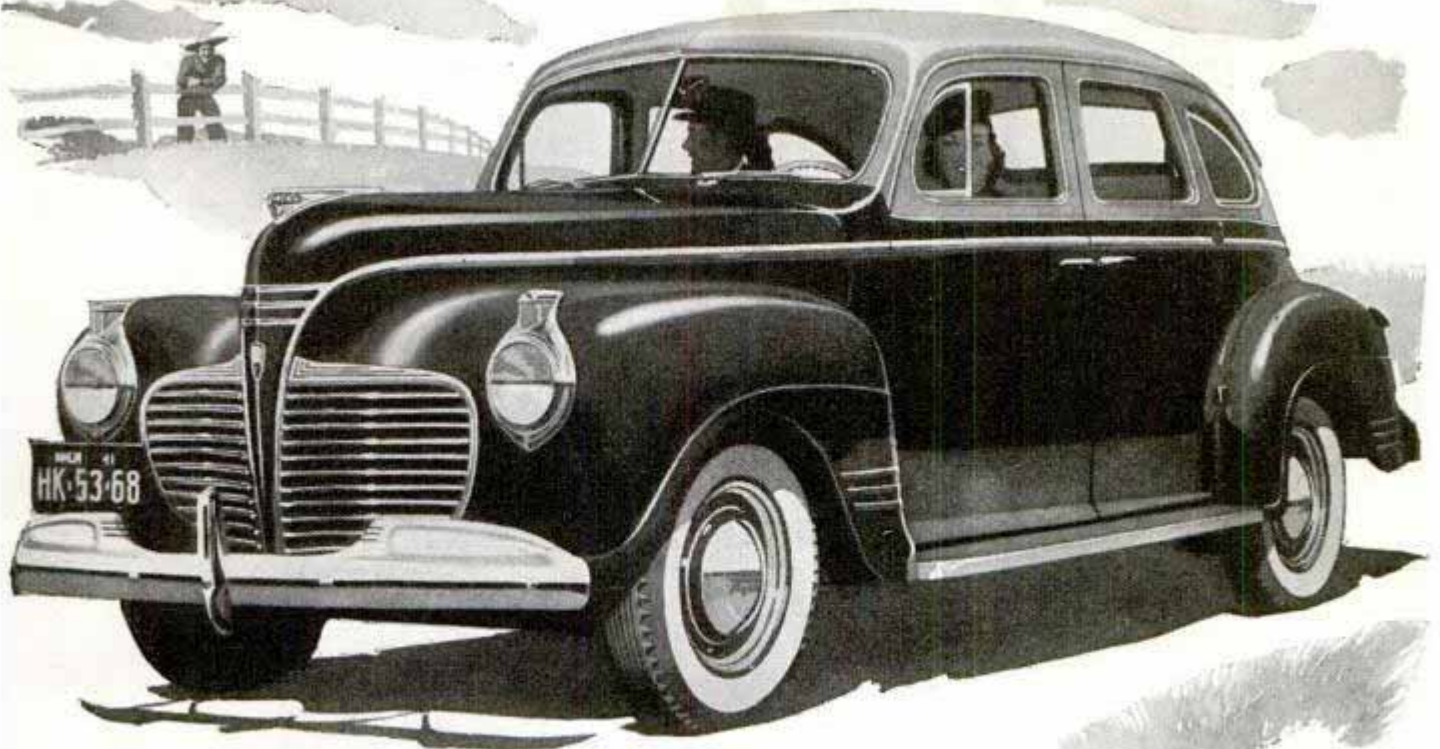

Here's the "One" for '41



See the Brilliant New
Plymouth—Magnificent
new Artistry of Design—
New Powermatic Shifting
—New 4-Way Step-up
in Performance—New
Fashion-Tone Interior—
19 Great Advancements!



Powermatic Shifting—
vastly easier—elimination of
certain usual shifting motions.



Fashion-Tone Interior:
rich, luxurious. 2-tone uphol-
stery in the Special De Luxe.

IT'S A PLEASURE to remind you
that this stunning 1941 Plym-
outh—so beautiful, so long, wide,
low-swung—is a *low-priced car!*

You'll be delighted with its
Fashion-Tone Interior—a miracle
of color, fabric, appointments...
with its 4-way Step-Up in Per-
formance that gives you new mas-
tery of hills, traffic, distance.

And Plymouth announces
Powermatic Shifting, easiest ever
...in all, 19 great advancements!

Today, see and drive this Big

Beauty at your nearby Plymouth
dealer! PLYMOUTH DIVISION OF
CHRYSLER CORPORATION.

Other New Features

- COUNTERBALANCED TRUNK LID—
goes up or down easily at a touch.
- NEW SAFETY RIMS ON WHEELS to
prevent "throwing" of the tire in
case of blowout or puncture.
- NEW SEALING throughout body
against dust, water, noise, heat.
- 11 SMART NEW COLORS. New 2-
tone color combinations available
on the Special De Luxe sedans.



4-way Step-up in Perform-
ance—more horsepower, new
transmission and axle ratios.

This One





**AMERICA'S
FIRST LINE
OF DEFENSE**

Not a cannon, but the 130,000-pound shaft for a great electric generator being built by General Electric.

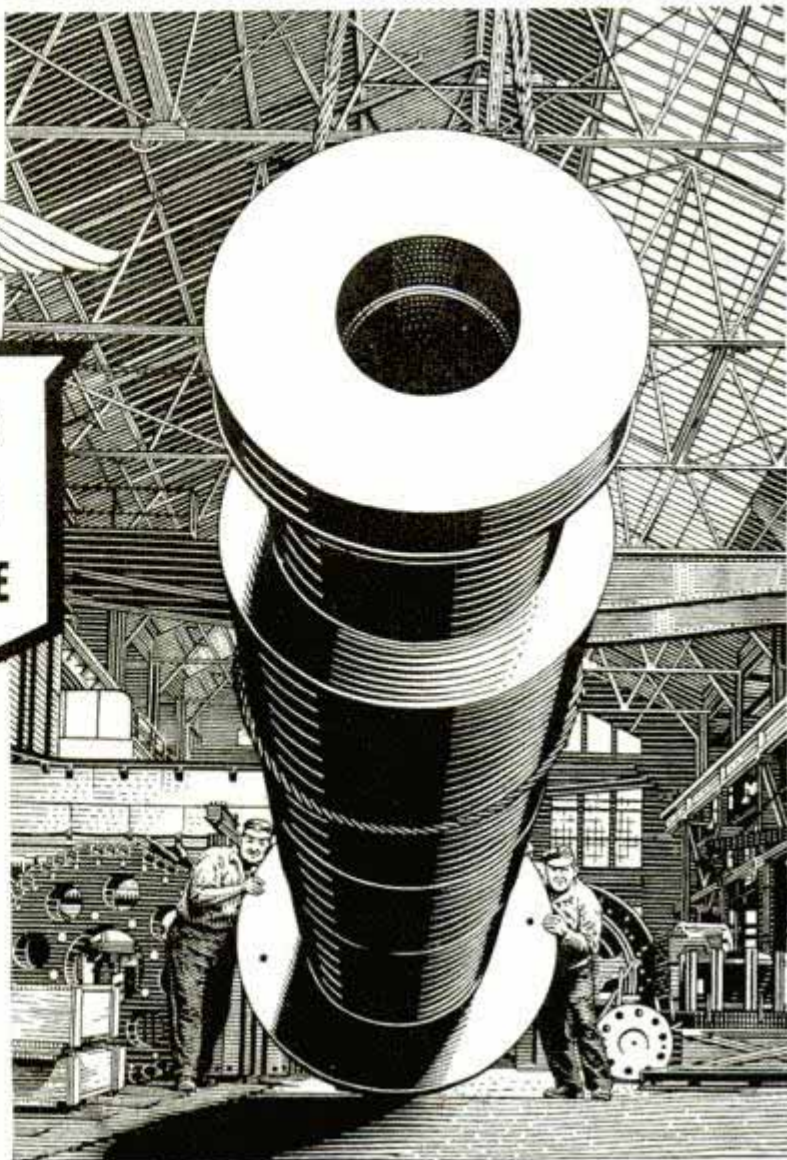

AMERICA'S first line of defense is American industry. It is to industry that the nation looks today for the armaments to protect America's high living standards, to defend the American way of life.

In the last two generations American industry has built a great nation. Its workmen, scientists, and engineers have given us electric lights in 24 million American homes and electric refrigerators in 13 million—conveniences which represent the highest standard of living in the world. And the manpower, the inventive and manufacturing genius, the

experience, the daring to tackle difficult tasks—assets which have helped to produce this high standard of living—are among America's strongest resources today.

Industry today undertakes the task of building, not only armaments, but, equally important, the machines that can be used to manufacture these armaments. And General Electric, which for more than sixty years has been putting electricity to work in America's peacetime pursuits, is today applying it to the new job—the job of defending the benefits electricity has helped to create.

G-E research and engineering have saved the public from ten to one hundred dollars for every dollar they have earned for General Electric

GENERAL  ELECTRIC

958-7782

Popular Mechanics Magazine

H. H. WINDSOR, Founder

H. H. WINDSOR, Jr., Editor and Publisher

November, 1940

Vol. 74, No. 5

IN THIS ISSUE

80,000 Fledglings for Defense	641
Fighting Forest Fires from the Air	648
The 1941 Cars	Coloroto
Automobiles of Tomorrow	666
Counting in the Next President	669
Seaplaning—Three Sports in One	674
Growing 'Em Bigger with Chemicals	680
Pin Your Name on a Comet	691
Tom Thumb Cars Burn Up the Track	696
Training Your Dog for the Game Trail	706
Trappers of the Deep	712
Foiling the Gold Swindlers	722
Exploring the Heart of the Atom	732

(Continued on next page)

Switching On the Rainbow

WHY change the wallpaper? The flip of a switch will change the color scheme of a room. On blustery winter days, turn on warm red and amber lights; on sultry summer nights, "chill" the room with cool blues and greens. That's how tomorrow's hostess will dress her home, switching on the rainbow to create the mood desired. Already it's being done with the new incandescent, fluorescent, ultraviolet and sodium vapor lamps that are a magic palette of color. The eight-page Coloroto section in December introduces home decoration with light.

Hunting the Secret of Life

TELL the world why grass is green and your fame will go down in history. The best scientists can't do it. If they could duplicate the chemical feat by which plants turn carbon dioxide and water into sugar, many of civilization's problems—like the dwindling petroleum stores—might vanish. A December story tells how near science is to the answer.

Next Month

WEEK after week the ocean liners of the air, the flying Clippers, take off from their American bases for tiny islands in vast oceans. Then they streak on to find "home base" unerringly. Two pilots are always at the controls; five are available. The navigator is constantly plotting the course. The radioman phones "home" every half hour. Read "Sailors of the Sky," a December feature that takes you aboard a Clipper for Lisbon for a glimpse of its busy crew at work.

Ideas for Your Home

YOU need not build a new house to benefit by modern improvements. Many of them come in "package" form. Shower stalls are ready for installation in a corner of the bathroom. Shades and screens outside the window help insulate the house. Bathroom scales that fold into the wall can be built in. A host of ideas for bringing the old home up to date in comfort and convenience are contained in a story next month, "Try These in Your Home."

Millions from Waste

PRUNE pits and pine needles, peanut hulls and whey are being salvaged from waste piles and fabricated into products worth millions. Oil crushed from grapefruit seeds, for example, can be used to fix non-fading colors in dresses. An interesting account of new and strange uses being developed for waste materials will be found in the December issue.

Published monthly by POPULAR MECHANICS COMPANY, 200 East Ontario Street, Chicago, U. S. A. Single copy in the United States, 25 cents; subscription rates in United States and possessions, and countries of the Pan-American Postal Union including Spain, \$2.50 a year, \$4.00 for two years, \$5.00 for three years. Single copy in Canada, 30 cents; subscription rates, \$3.00 a year, \$5.00 for two years, \$6.50 for three years. To all other countries add \$1.00 a year over United States prices for overseas postage. Changes in address must be reported to us immediately to eliminate delay. Entered as Second Class Matter, Sept. 15, 1903, at the Post Office at Chicago, Illinois, under Act of March 3, 1879. Entered as Second Class Matter at the Post Office Department, Canada. Copyright 1940, by Popular Mechanics Company, in the United States, Australia, and France. Printed in the U. S. A.

... and don't forget to add Pyroil!



When the gasoline tank is being filled and the crankcase checked, DON'T FORGET TO ADD PYROIL. A mere three ounces in the gas tank. Two ounces in the crankcase for each quart of oil added. That small amount, used regularly, does the near wonders that millions of car owners enjoy!

Ask your service station salesman to tell you about the great satisfaction this famous lubrication process gives. How it enables your car, from the beginning, to run with more power and smoothness. How it protects your expensive engine against dangerous contaminations—hard carbon deposits; gum that clogs; murky sludge; acid-corrosion that can ruin vital parts.

Whether your car is brand new or old, add Pyroil every time you buy gasoline or oil. It's the regular use of it that saves you money. That gives you longer useful car life. We would like to send you a Free interesting Booklet giving you further important facts about Pyroil. There is no obligation. Simply mail coupon below. Manufactured & Guaranteed by Pyroil Company, W. V. Kidder, Founder, 511 Pyroil Bldg., La Crosse, Wisconsin, U. S. A.



ADD MERELY OUNCES TO GAS & OIL

DISTRIBUTORS:
CHECK AND MAIL COUPON FOR FRANCHISE FACTS.

PYROIL COMPANY,
 511 Pyroil Bldg., LaCrosse, Wisconsin.
 Please send me your Free Booklet, "Questions and Answers about the efficiency of Pyroil."
 Send Details of your plan for Distributors.
 Name.....
 Address.....
 City or town..... State.....

(Contents—Continued)

AUTOMOTIVE

Trailer brake control for auto or truck.....	646
"Airmobile" turns around at a mile a minute.....	652
Garment bag fits flush against ceiling.....	652
Closed-in motorcycle taxi vies with rickshaw.....	653
Geared tool for truck wheels speeds servicing.....	656
Water in gasoline tank easily detected.....	656
Spare air from spare tire for emergencies.....	679
Element fitting oil filters has metal conversion unit.....	684
Guard protects auto fenders from side swiping.....	688
Car-rocker finds squeaks and spreads lubricants.....	694
Fog lamp slants rays to avoid bright curtain.....	700
Gun tractor tested for rough going.....	700
Speed-light warns when limit is reached.....	704
Tool for marking tires has movable letters.....	720
Strip to balance wheel hidden in metal ring.....	725
Car with two-pedal drive operated by one foot.....	726

AVIATION

130-pound engine delivers seventy-five horsepower.....	656
Metal autogiro rises vertically from ground.....	695
Windows to absorb deadly rays in stratosphere.....	700
Electric release spaces bombs by ground speed.....	710
Talking tape records sixteen sounds in planes.....	711
Indicator showing ground speed aids pilot.....	726
Radio marks an "X" on map to aid pilot.....	730

HOUSEHOLD

Portable air conditioner has own water supply.....	679
Water heater uses heat wasted by furnace.....	690
Decorative plaque for wall covers electric switch.....	699
Fluorescent lights for ceiling.....	704
Tabletop grill has drawer for broiling steaks.....	710
Portable electric heater holds two gallons.....	736

MODELS

Clay bank sculptor carves with a pocketknife.....	673
Engine runs on 300-foot railway.....	678
Propeller drives racer forty-five miles an hour.....	694
Timer releases pick-a-back models in flight.....	699
Model trains on the production line.....	728

RADIO AND ELECTRICITY

Radio dry cells recharged by house current.....	688
Reel for electric wire feeds flat extension tape.....	690
Electric keyboard on piano plays orchestral tunes.....	695
Uranium atom starts radio station.....	705
Mobile studio records war for later broadcast.....	721
Radio "lighthouse" spins signals to guide pilot.....	731
Vertical antenna installations.....	775
How to build a wearable radio hearing aid.....	776
One-tube battery amplifier for beginners.....	778
Helpful radio hints.....	779
Armchair phono-radio is automatic.....	780
Portable 3-in-1 all-wave receiver.....	780
Radio facsimile printer operates at high speed.....	780
Universal 20-watt amplifier is self-contained.....	780

SCIENCE AND INDUSTRY

Lightweight trailer welded of stainless steel.....	678
Lie detector relies on sweat-gland activity.....	683
Robot reports weather by automatic radio.....	688

SPORTS

Spring-operated target trap fixed to rifle.....	646
Boys' camp on city roof has lake.....	665
Paddle-shaped grip for golf putter.....	683
Pendulum on golf club helps attain smooth swing.....	684
Submarine portholes help guard bathing pool.....	685
Machine-gun shooting gallery.....	720
Mirror on bowling alley helps correct faults.....	721
"Land" roller skate has single large wheel.....	726
Twin engine-driven bike carries three riders.....	727
"Spillproof" surfboard has W-shaped stern.....	736

TOOLS

Flexible file holder bends to suit work.....	684
Planting tool digs up plant with soil.....	694
Razor blade knife and scraper has seven uses.....	705
Six-ton hammer.....	736

WAR

Highway traps of wire entangle armored cars.....	647
Dummy guns train soldiers for handling real guns.....	653
Stretcher on bicycle wheel speeds rescue work.....	656
Cylindrical gun fires bomb, gas or flare.....	673

(Continued to page 6A)

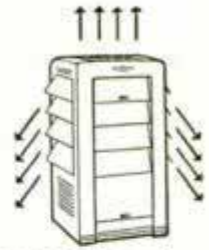

SUPERFEX is the only oil heater with heat-directing shutters that direct heat downward to warm the floor. They're patented!

"Gee, mom, does that feel swell!"

Only SUPERFEX gives you *Radiant* heat directed down to warm the floor... plus continuously circulating warm air!

Only SUPERFEX gives you complete oil heater comfort. For only SUPERFEX has the Heat-directing shutters. They're patented! With shutters closed, SUPERFEX circulates warmed air through the room and connecting rooms. With shutters opened or directed down... on any or

SUPERFEX IS IDEAL FOR HOME, OFFICE AND SHOP

all three sides... radiant heat, like sun rays, floods the room—warms the air without draft or "blow." And—warmed air continues to circulate!

Enjoy complete, healthful comfort in your home all winter long! There's a SUPERFEX size and price for every need—easy pur-

chase plan. Get the free illustrated booklet... send the coupon today.



PERFECTION PORTABLE HEATER

For quick, comforting heat in homes and business places. 10 to 12 hours of comfort from gallon of kerosene.

SUPERFEX OIL HEATERS

The Mark of Quality

PRODUCTS OF PERFECTION STOVE CO.



PERFECTION STOVE COMPANY
7262-B Platt Ave., Cleveland, Ohio

Please send me FREE booklet describing SUPERFEX Heat-Directors or PERFECTION Portable Heaters .

Name _____

St. or R. F. D. _____ Post Office _____

County _____ State _____

Can You BRING BACK SUMMER IN November?



YOU COULD WITH *Filmo* MOVIES!

WHEN November blasts whistle around the chimney corner, you'd get a real thrill from movie scenes of your youngsters at play last summer. How fast they grow up! You can hardly believe your own eyes. And in a few years those scenes would be *priceless*.

Can you think of any better hobby than this?

You need not be expert to get good movies with a *Filmo* 8. Loading can be done in twenty seconds. Film drops into place without threading over sprockets. Press the button—*what you see, you get*, in black-and-white or full, natural color, even in slow motion. Newsreel-length scenes at snapshot cost!

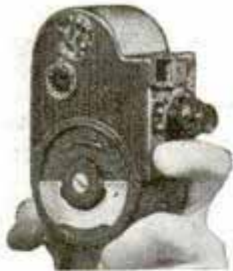

PALM-SIZE *Filmo* 8
Only \$49⁵⁰
Filmo Auto Load 16 mm.
Movie Cameras from \$115

Precision-built by the makers of Hollywood's professional movie equipment, with four speeds, device for animating cartoons, and provision for adding accessories as your skill grows, *Filmo* 8 is a basic camera that will meet present and future needs. See it at your camera dealer's. He knows *Filmos*. Bell & Howell Company, Chicago; New York; Hollywood; London. Est. 1907.

★ ★ FREE MOVIE BOOKLET ★

BELL & HOWELL COMPANY
1844 Larchmont Ave., Chicago, Ill.
Send free, 16-page booklet telling all about
Filmo 8 mm. Cameras and Projectors.



Name

Address

City..... State..... PM 11-40

PRECISION-MADE BY
Bell & Howell

(Contents—Continued)

Flashlight electric machine gun fires silently.....689
Armored jacket stops bullets of high-powered rifle..699

MISCELLANEOUS

Remote control for bombs workable for two miles.....646
Retractable curb divides boulevard traffic.....647
Insulation sealed to brick veneer forms slab.....652
"Planetarium" umbrella points out the stars.....679
Air-raid helmet protects head from concussion.....684
Electric cabinet ages hams in seven weeks.....685
Fun with balancing tricks.....687
Color mixed into paint can at store.....689
Fist billy loaded with shot is adjustable.....689
Deer traps used in restocking forests.....690
Quest for blind fish discloses hidden caves.....701
Art from the workbench.....702
Film to mend drawings applied with heat.....704
Floodlights travel on a track for servicing.....705
Seaplane tender U.S.S. "Albemarle" launched.....710
When men build mountains.....718
Flashlight bulb extension arm bends easily.....720
Machine exercises eyes to correct defects.....721
Pill box snaps open at a touch.....725
Roadside stand sells honey to motorists.....727
Lifesaving overcoat can support four men.....730
Plastic boat cast in one piece.....730
Bridge replaces oldest U. S. ferry.....731
"Good temper" specs keep up spirits.....735
Pencil pointer worn like wrist watch.....735

Craftsman and Shop Notes

AUTOMOTIVE

Badly clogged radiator-core tubes cleaned by hand.....797
Cleaning valve stems in a drill press.....797
Slotted screws to adjust brakes externally.....797
Battery compound melted in coffeepot.....798
Locating punctures in inner tubes.....798
Lug on car door lock simplifies opening.....798
Peephole in sun visor aids driver.....798
Strap helps close door on right-hand side.....798
Hub reflectors are a safety precaution.....799
Lock on door changed to steering-wheel side.....799
Pliers remove slotted type hub caps.....799
Protecting shock absorbers.....799
Removable step to enter rumble seat.....799
Temporary repair for broken valve spring.....799
Car ammeter has multiple connections on one post.....800
Holding car door open with rubber band.....800
Leaky cylinders cause loss of pedal reserve.....800

FARM

Blocks protect door frames from wagon wheels.....784
Protecting cattle salt from rain.....786
Slotted plank straightens small wire.....786
Swinging floodgate in fence.....786
Barbed wire prevents hogs tipping over troughs.....793
Guides aid in driving team through gateway.....794

HAND TOOLS

Adjustable drill-sharpening gauge.....742
Beam compass made inexpensively.....744
Screw handle locks chisel in holder.....746
Sharpening small split dies.....746
Tiny panel saw for modelmakers.....752
Attachment for welding pipe vise.....753
Rubber ball is hand shield on file.....758
Improved parallel clamps.....786
Lead-covered cable slit with can opener.....793

HOUSEHOLD

Solving home problems.....740
Jigsawed hat rack folds flat.....751
Repairing broken venetian-blind slats.....765
Paper bag makes mitten when cleaning stove.....766

LAWNS AND GARDENS

Wooden duck in the garden flies realistically.....745
Fall care of your flower bulbs.....747
Small trowel made from large spoon.....759

MODELS AND MODELMAKERS

Simple hitch for model trains.....742
Inexpensive case for a ship model.....745
Needle pegs help in gluing small pieces.....746
Tiny clamp for modelmakers.....766

(Continued to page 8A)



SUCCESS—

Will You Pay the Price?

IF you are normal, you want the comforts and luxuries which are the by-products of success—a home of your own—a new car—the leisure to read—the means to travel.

You want these things very much.

But—you are keen enough to perceive that experience and facility in handling *routine* work will never get them for you.

What, then, are you doing to gain that *specialized* experience—that *trained* ability—for which business firms are willing to pay real money?

* * *

During the past thirty-one years more than 1,000,000 men have found the answer to that question in home-study training under the LaSalle Problem Method.

Evening after evening, they have seated themselves, to all intents and purposes, at the desks of men in high-salaried positions, and have squarely faced the *problems* of those positions.

Evening after evening, they have been shown the *principles* involved in the solution of such problems—and how those principles are applied by highly successful business houses.

Evening after evening, they have tackled concrete problems, lifted bodily from business life, and under the direction of some of the ablest men in their respective fields *have worked those problems out for themselves.*

That they have been *well rewarded* for their foresight and their earnestness is shown by the fact that during only six months' time as many as 1,248 LaSalle members reported salary increases totaling \$1,399,507—an average increase per man of 89%.

* * *

Many men, *knowing* what home-study training under the LaSalle Problem Method can do for them,

nevertheless prefer to think that there's "nothing in it." That's the excuse they make for their futures.

If you—knowing these facts—are content to drift, you will not profit by reading further.

If on the other hand you have imagination enough to *visualize* your goal—to actually see yourself in a home of your own, enjoying the comforts and luxuries of life—if, in short, you are a man of *purpose*, the coupon below may shorten your journey to success by many years.

Note, please, that the coupon names different lines of training and that it will bring you full particulars of the training which appeals to you, together with a 48-page booklet discussing the opportunity and requirements of that field—all without obligation.

If you want success, and are willing to pay the price, ACT!

LaSalle Extension University

A Correspondence Institution

Dept. 1164-R

Chicago

I would welcome an outline of the LaSalle plan, together with a copy of "Ten Years' Promotion in One," all without obligation.

- | | |
|---|--|
| <input type="checkbox"/> Business Management | <input type="checkbox"/> Law—Degree of LL.B. |
| <input type="checkbox"/> Modern Salesmanship | <input type="checkbox"/> Commercial Law |
| <input type="checkbox"/> Higher Accountancy | <input type="checkbox"/> Credit and Collection |
| <input type="checkbox"/> Traffic Management | <input type="checkbox"/> Correspondence |
| <input type="checkbox"/> Modern Business Correspondence | <input type="checkbox"/> Industrial Management |
| <input type="checkbox"/> Business English | <input type="checkbox"/> Modern Foremanship |
| <input type="checkbox"/> Effective Speaking | <input type="checkbox"/> Expert Bookkeeping |
| | <input type="checkbox"/> C. P. A. Coaching |
| | <input type="checkbox"/> Stenotypy—Stenography |

Name.....Age.....

Present Position.....

Address.....

OFFICE

Laminated desk set has roll-top trays.....	737
Weighted end keeps pencil point from breaking...	739
Paper clip holds pen points for ruling lines.....	742
Keeping papers on desk slide.....	766

PAINT AND PAINTING

Lacquer used as a wood stain.....	752
Economical paintbrush cleaner.....	758
Fountain "brush" saves time for sign painter.....	768

PHOTOGRAPHY

Smoke etchings for cards and bookplates.....	751
Midget photoflash gun carried in your pocket.....	769
Removing excess water from films.....	769
"Frozen action" shots you can get.....	770
Cleats hold reflector cords neatly.....	774
Tape makes neat borders on colored prints.....	774

POWER TOOLS

Circular-saw belt guard serves as accessory rack...	739
Drill-press sander has two grades of abrasive.....	744
Fixture to handle angle drilling.....	750
Rotating tailstock center for lathe.....	752
Direct-drive table saw has varied uses.....	765
Adapter for drill press to use pin drills.....	768
Speed wrench to adjust lathe chuck jobs.....	786
V-vise to hold round work in machines.....	786
Chucking irregular work in a lathe.....	794

STORE AND SHOP

Block pattern saves time when cutting glass.....	784
Safe disposal of used matches in the shop.....	784
Blackboard on scales for figuring weights.....	786
Store doors converted for additional window display.....	786

TOYS AND NOVELTIES

Tin-can stilts for small children.....	758
Screen-door pulls on sled protect hands.....	766
"Payload" bobsled has pilot's seat at rear.....	767

WOODWORKING

Panel-door frames made from flooring.....	750
Guncraft in the home workshop—Part II.....	754
Providing air vents in dowels.....	768
Strip moldings cut safely with this jig.....	785
Veneering increases scope of craftwork.....	788

MISCELLANEOUS

Perforated paper patterns made on sewing machine.....	739
Skis waxed with chemical heat pad.....	739
Skate adjusting screws enlarged for easy gripping.....	742
Tray on drawing board holds artist's accessories.....	742
Winter snack shacks for birds.....	743
Dairy thermometer reading marked by hose clip.....	744
Picture frames cut and assembled in miter board.....	744
Jig to cut tiny pieces of inlay stock.....	746
Dog kennel built in back-door steps.....	750
Spring corks for ink bottles.....	750
Jig for truing bicycle wheel.....	752
Shields for high-top shoes.....	752
Alarm clock shuts off radio automatically.....	753
Repairing broken pipe lines.....	753
Light bulb used as valve float.....	758
Space saving hangers for football helmets.....	758
Stand and chimney make hurricane lamp.....	759
Where does the extra square come from in puzzle?.....	759
Gem cutting a double hobby.....	760
Bar graphs made with tape.....	766
Curtain rod is straightedge when cutting glass.....	768
Watch on bench protected with rubber ball.....	768
Making good electrical contacts.....	781
Pen point serves as chemical scoop.....	784
Measuring length of endless belt.....	785
Cutting-torch guide for flat work.....	793
Sleeve keeps toggle bolt tight.....	794
Uniform tie wires for concrete forms.....	794
Indirect water heater connects to boiler.....	795
Extinguishing fire in gas main.....	796

IMPORTANT NOTICE

It is the intention of this magazine to provide its readers with information regarding the latest developments in the mechanical arts. We take no responsibility as to whether the disclosures contained in our articles are covered by patents and advise readers to investigate this subject before making, using, or selling any of the products, machines, or processes described, in order to avoid possible liability for patent infringement.

A PROTRACTOR-RULE

and a

REPAIR HANDBOOK

both sent

FREE

if you mail the coupon



Here are TWO handy helps that every householder and handy man should have, and which are available without charge to the readers of this magazine.

1—A durable metal protractor, with black letters on a white background for greatest legibility, with angles reading in both directions, and with an inch scale on the straight side.

2—The 40-page Smooth-On Handbook, with simple instructions for time-saving, labor-saving and money-saving repairs to household and auto equipment, etc. Illustrated by 170 diagrams.

The instructions in this handbook are based on the experience of thousands of mechanics and repair men, and include much information not to be found in any other publication. Some of the subjects covered:

How to seal cracks in boilers, stoves, water heaters, radiators, pipes, auto engine water jackets, gear cases, etc.

How to stop leaks at seams, bolts, rivets, threaded or flanged joints, etc.

How to tighten loose parts of furniture, apparatus, fixtures, utensils, tools, etc.

How to waterproof concrete, brick or stone floors, walls, cisterns, pools, etc.

Get Smooth-On No. 1 in 1½-oz., 7-oz., 1-lb. or 5-lb. can from your dealer, or if necessary from us. For your protection, insist on SMOOTH-ON, used by mechanics and repair men since 1895.

Send the coupon TODAY to be sure to receive the free protractor and repair handbook before the supply is exhausted.

SMOOTH-ON MFG. CO., Dept. 37
574 Communipaw Ave.,
Jersey City, N. J.

Please send the Protractor and the Smooth-On Repair Book.

Name.....

Address.....

11-40.....



Do it with SMOOTH-ON

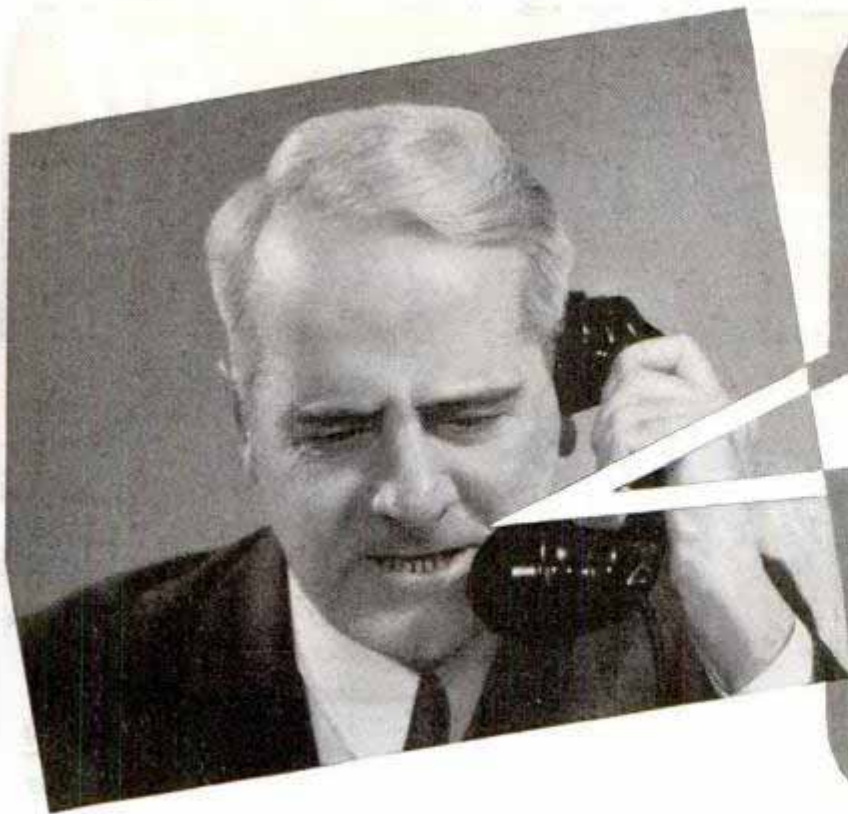

**I can't hire
the man
who says:
"I CAN DO
ANYTHING!"**

"There's no room in my business—or in most others—for the jack-of-all-trades. What we're looking for is men who are trained to do one thing, and do it well!

"That's why we pay special attention to applicants who are I.C.S. graduates. We know they're ambitious, intelligent, able to concentrate—and we know that the International Correspondence

Schools provide their students with sound, practical, modern training!"

More than 4,000,000 men have studied I.C.S. courses. Today, many are business and industrial leaders. Where will you be five years from today? This coupon will bring you complete information on an I.C.S. course in your field. Check it—and mail it—right now!

INTERNATIONAL CORRESPONDENCE SCHOOLS

BOX 5588-J, SCRANTON, PENNA.

★ Without cost or obligation, please send me a copy of your booklet, "Who Wins and Why," and full particulars about the course *before* which I have marked X: ★

TECHNICAL AND INDUSTRIAL COURSES

- | | | | | |
|---|---|---|---|--|
| <input type="checkbox"/> Agriculture | <input type="checkbox"/> Air Brake | <input type="checkbox"/> Cotton Manufacturing | <input type="checkbox"/> Mfg. of Pulp and Paper | <input type="checkbox"/> R. R. Section Foreman |
| <input type="checkbox"/> Air Conditioning | <input type="checkbox"/> Diesel Engines | <input type="checkbox"/> Electrical Drafting | <input type="checkbox"/> Marine Engines | <input type="checkbox"/> R. R. Signalmen's |
| <input type="checkbox"/> Architectural Drafting | <input type="checkbox"/> Electrical Engineering | <input type="checkbox"/> Electric Lighting | <input type="checkbox"/> Mechanical Drafting | <input type="checkbox"/> Refrigeration |
| <input type="checkbox"/> Architecture | <input type="checkbox"/> Fire Bosses | <input type="checkbox"/> Foundry Work | <input type="checkbox"/> Mechanical Engineering | <input type="checkbox"/> Sheet Metal Work |
| <input type="checkbox"/> Auto Engine Tune-up | <input type="checkbox"/> Fruit Growing | <input type="checkbox"/> Heating | <input type="checkbox"/> Mine Foreman | <input type="checkbox"/> Steam Electric |
| <input type="checkbox"/> Auto Technician | <input type="checkbox"/> Heat Treatment of Metals | <input type="checkbox"/> Highway Engineering | <input type="checkbox"/> Navigation | <input type="checkbox"/> Steam Engines |
| <input type="checkbox"/> Aviation | <input type="checkbox"/> House Planning | <input type="checkbox"/> Locomotive Engineer | <input type="checkbox"/> Patternmaking | <input type="checkbox"/> Steam Fitting |
| <input type="checkbox"/> Boilermaking | <input type="checkbox"/> Machinist | <input type="checkbox"/> Management of Inventions | <input type="checkbox"/> Pharmacy | <input type="checkbox"/> Structural Drafting |
| <input type="checkbox"/> Bridge Engineering | <input type="checkbox"/> Management of Inventions | | <input type="checkbox"/> Plumbing | <input type="checkbox"/> Structural Engineering |
| <input type="checkbox"/> Building Estimating | | | <input type="checkbox"/> Poultry Farming | <input type="checkbox"/> Surveying and Mapping |
| <input type="checkbox"/> Chemistry | | | <input type="checkbox"/> Practical Telephony | <input type="checkbox"/> Telegraph Engineering |
| <input type="checkbox"/> Civil Engineering | | | <input type="checkbox"/> Public Works Engineering | <input type="checkbox"/> Textile Designing |
| <input type="checkbox"/> Coal Mining | | | <input type="checkbox"/> Radio, General | <input type="checkbox"/> Toolmaking |
| <input type="checkbox"/> Concrete Engineering | | | <input type="checkbox"/> Radio Operating | <input type="checkbox"/> Welding, Electric and Gas |
| <input type="checkbox"/> Contracting and Building | | | <input type="checkbox"/> Radio Servicing | <input type="checkbox"/> Woolen Manufacturing |

BUSINESS COURSES

- | | | | | |
|--|---|--|---|---|
| <input type="checkbox"/> Accounting | <input type="checkbox"/> Advertising | <input type="checkbox"/> College Preparatory | <input type="checkbox"/> Foremanship | <input type="checkbox"/> Railway Postal Clerk |
| <input type="checkbox"/> Bookkeeping | <input type="checkbox"/> Commercial | <input type="checkbox"/> Cost Accounting | <input type="checkbox"/> French | <input type="checkbox"/> Salesmanship |
| <input type="checkbox"/> Business Correspondence | <input type="checkbox"/> C. P. Accounting | <input type="checkbox"/> First Year College | <input type="checkbox"/> High School | <input type="checkbox"/> Secretarial |
| <input type="checkbox"/> Business Management | <input type="checkbox"/> First Year College | | <input type="checkbox"/> Illustrating | <input type="checkbox"/> Sign Lettering |
| <input type="checkbox"/> Cartooning | <input type="checkbox"/> Civil Service | | <input type="checkbox"/> Lettering Show Cards | <input type="checkbox"/> Spanish |
| | | | <input type="checkbox"/> Managing Men at Work | <input type="checkbox"/> Traffic Management |

HOME ECONOMICS COURSES

- | | | |
|---|---|--|
| <input type="checkbox"/> Advanced Dressmaking | <input type="checkbox"/> Home Dressmaking | <input type="checkbox"/> Tea Room and Cafeteria Management, Catering |
| <input type="checkbox"/> Foods and Cookery | <input type="checkbox"/> Professional Dressmaking and Designing | |

Name.....Age.....Address.....
City.....State.....Present Position.....

Canadian residents send coupon to International Correspondence Schools Canadian, Limited, Montreal, Canada
British residents send coupon to I. C. S., 71 Kingsway, London, W. C. 2, England

I Jumped from \$18 a week to \$50

--A FREE BOOK STARTED ME TOWARD THIS

Good Pay in Radio

*--- HERE'S HOW IT HAPPENED
by S.J.E. (NAME AND ADDRESS SENT UPON REQUEST)*

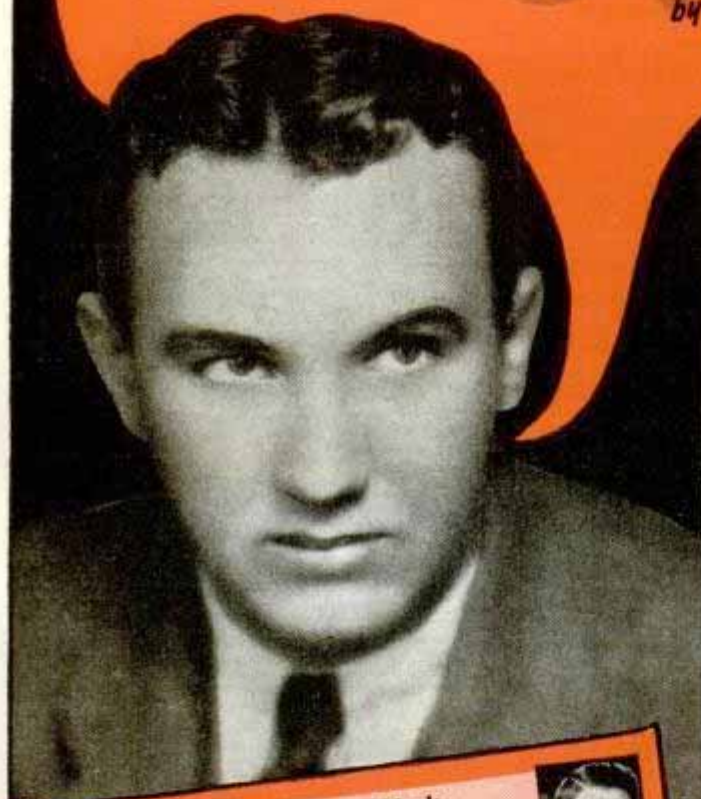

"I had an \$18 a week job in a shoe factory." He'd probably be there today if he hadn't read about the opportunities in Radio and started training at home for them.

Be a RADIO

Find out How I Train

If you can't see a future in your present job, feel you'll never make much more money; if you're in a seasonal field, subject to lay offs, IT'S TIME NOW to investigate Radio. Trained Radio Technicians make good money, and you don't have to give up your present job or leave home to learn Radio. I train you at home nights in your spare time.

Why Many Radio Technicians Make \$30, \$40, \$50 a Week

Radio broadcasting stations employ operators, technicians. Radio manufacturers employ testers, inspectors, servicemen in good-pay jobs. Radio jobbers, dealers, employ installation and servicemen. Many Radio Technicians open their own Radio sales and repair businesses and make \$30, \$40, \$50 a week. Others hold their regular jobs and make \$5 to \$10 a week fixing Radios in spare time. Automobile, Police, Aviation, Commercial Radio; Loudspeaker Systems, Electronic Devices are other fields offering opportunities for which N.R.I. gives the required knowledge of Radio. Television and Frequency Modulation promise to open good jobs soon.

Many Make \$5 to \$10 a Week Extra in Spare Time While Learning

The day you enroll, I start sending you Extra Money Job

Makes \$50 to \$60 a Week

"I am making between \$50 and \$60 a week after all expenses are paid, and I am getting all the Radio work I can take care of, thanks to N. R. I."

H. W. SPANGLER
126 1/2 S. Gay St., Knoxville, Tenn.



Operator in Broadcasting Station

"I was chief engineer of KFPW, Fort Smith, Ark., for over seven years, which position I resigned to become transmitter operator of KGKO, Fort Worth, Tex., where I am now employed."

WILLARD DOAN
406 W. First St., Arlington, Texas.



\$15 a Week Extra in Spare Time

"I am doing spare time Radio work, and I am averaging from \$700 to \$850 a year. Those extra dollars mean so much—the difference between just barely getting by and living comfortably."

JOHN WASHKO
97 New Cranberry, Hazleton, Penna.





"The training National Radio Institute gave me was so practical I was soon ready to make \$5 to \$10 a week in spare time servicing Radio sets."

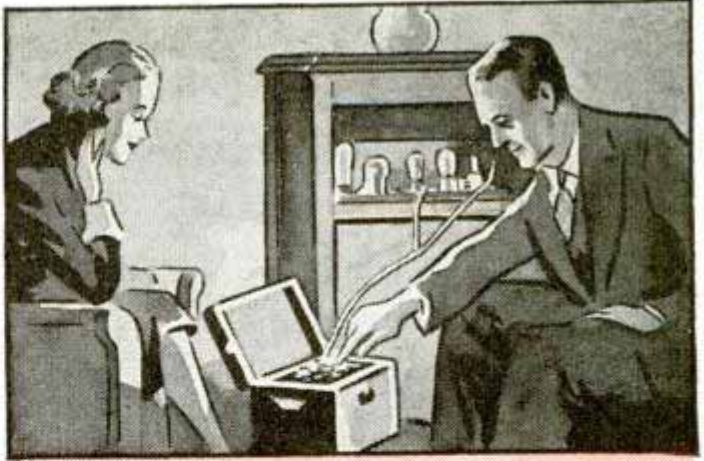

"When I finished training I accepted a job as Radio serviceman. In three weeks I was made service manager at \$40 to \$50 a week, more than twice my shoe factory pay."

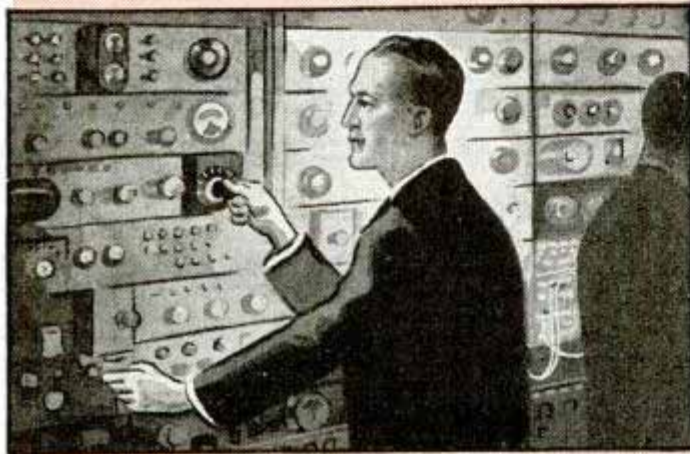

"Eight months later N. R. I. Graduate Service Department sent me to Station KWCR where I became Radio Operator. Now I am Radio Engineer at Station WSUI and connected with Television Station W9XK."



"N. R. I. Training took me out of a low-pay shoe factory job and put me into Radio at good pay. Radio has enjoyed a colorful past. It will enjoy an even greater future."

Technician

You at Home



J. E. SMITH, President
National Radio Institute
Established 25 Years

He has directed the training of more men for the Radio Industry than anyone else.



Sheets—start showing you how to do Radio repair jobs. Throughout your Course I send plans and directions which have helped many make \$5 to \$10 a week extra in spare time while learning. I send special Radio equipment to conduct experiments and build circuits. This 50-50 training method makes learning at home interesting, fascinating, practical. YOU ALSO GET A MODERN, PROFESSIONAL ALL-WAVE, ALL-PURPOSE, SET SERVICING INSTRUMENT to help you make money fixing Radios while learning and equip you for full time work after you graduate.

Find Out What Radio, Television Offer You

Act Today! Mail the coupon for my 64-page book, "Rich Rewards in Radio." It points out Radio's spare time and full time opportunities and those coming in Television; tells about my Course in Radio and Television; shows more than 100 letters from men I have trained, telling what they are doing and earning. Read my money back agreement. MAIL COUPON in an envelope or paste on a penny postcard—NOW!

J. E. SMITH, President, Dept. OMP
National Radio Institute, Washington, D. C.

MAIL THIS NOW
Get 64 Page Book Free

J. E. SMITH, President, Dept. OMP
National Radio Institute, Washington, D. C.

Dear Mr. Smith: Mail me FREE without obligation, your 64-page book "Rich Rewards in Radio." (No salesman will call. Write plainly.)

Age.....
Name.....
Address.....
City..... State.....

INVENTORS

Act Now TO PROTECT
YOUR INVENTION WITH U.S. PATENT

Small Ideas May Have Large Commercial Possibilities

Inventions do not have to be complicated to be profitable when Patented. The 5c and 10c stores flourish on simple Patented products which are commercially successful. The zipper, safety pin, thumb tack, paper clip, collar button—all are simple yet familiar inventions—brought their inventors rich rewards. If you have a Patentable invention—act to protect it. Send for our FREE 48-Page Book that tells you how.

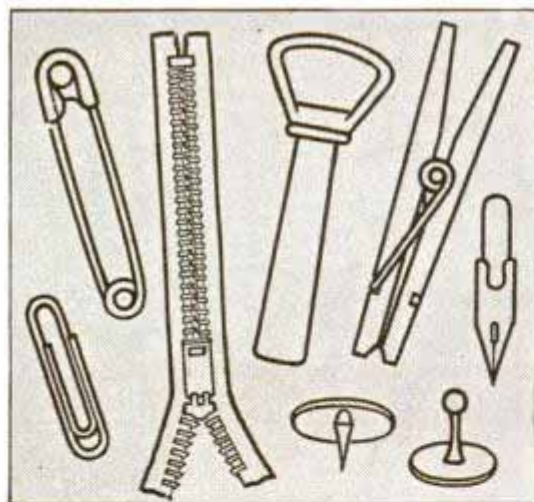

CLARENCE A. O'BRIEN
Dept. O11, Adams Building, Washington, D. C.
Registered Patent Attorney before U. S. Patent Office

Free Book TELLS IMPORTANCE OF QUICK ACTION—HOW TO OBTAIN PATENT AND MARKET INVENTIONS

If you have invented something, if you're interested in inventing something, you need our new 48-page book that gives the entire Story of Patents. It tells you for the first time about new phases of invention, how others succeeded, how the patent laws protect you, how to market your invention, where to obtain finances, how to form a company, partnership, or arrange for royalties from your invention's sale.

PRACTICAL BENEFITS OF THIS BOOK

You will find 6 complete pages illustrated with simple inventions that have succeeded in six different fields of industry. Over 100 illustrations are in this book. You will read the stories of ten (illustrated) of America's most famous inventors. You will find an experienced and thorough survey of market conditions affecting the inventor—showing the possibilities for commercial invention today. Entire chapters are devoted to the value of a patent in promoting the final success of your invention. The importance of quick action in applying for patent is stressed—facts revealing danger of delay are emphasized.

If you expect to realize profits from your invention you must protect it with a U. S. Patent. Otherwise you may find that all your time and labor have been lost, because it often happens that other inventors are working on the same invention. If you have an invention, or an ambition to invent—get the information on obtaining patent AT ONCE!

FREE RECORD OF INVENTION FORM

When you send for our FREE BOOK, we include, also Free, our specially prepared Record of Invention blank, on which you can quickly make and date a sketch and description of your invention. This "disclosure" as it is called, may be absolutely invaluable as evidence for you, should your rights ever be contested. Be sure to get it and use it.

CLARENCE

REGISTERED PATENT ATTORNEY before U. S. Patent Office

for
Quick
Action

GET FREE 48-PAGE BOOK
and Free Form for Recording Your Invention



MAIL COUPON NOW
TO CLARENCE A. O'BRIEN
Registered Patent Attorney
 BEFORE U. S. PATENT OFFICE

Clarence A. O'Brien, Dept. OL1, Adams Building, Washington, D. C.
 Please send me your Big, Free 48-Page Book for Inventors and your Specially Prepared Record of Invention form. This request does not obligate me.

Name.....
 Address.....
 City..... State.....

(Please write or print plainly).



You Can Patent IMPROVEMENTS IN MACHINERY, ARTICLES, DESIGNS, FORMULAS, ETC., IF NEW

Every year thousands of Patents are granted. Very few, however, represent the discovery of entirely new principles. Most of them provide new methods of doing some every-day thing in a better way—changes for greater efficiency, usefulness, adaptability, or beauty in some previously Patented thing. These IMPROVEMENTS are patentable if new, and actually represent new inventions. These Improvement Patents offer large chances for profit if commercially useful. The business world wants improved products and services.

FINISHED DRAWINGS NOT NECESSARY

Our Big Book tells you how you can start immediately to apply for Patent Protection even if you haven't finished models or drawings available now. It will tell you how we can prepare the specifications and finished drawings necessary in the form prescribed by the Patent Office—so as to secure for you full Patent Protection. Mail Coupon for Our Big Book TODAY.

OUR SERVICES TO YOU

We are Registered Patent and Trade-Mark Attorneys, serving Inventors all over the United States and abroad. Our Organization is complete. We have Draftsmen, experienced Searchers and Attorneys to serve your interests. We can act as your legal adviser in all Patent Matters. Our complete service is described in Our Big Book. Mail Coupon for it NOW.

REASONABLE FEES—CONVENIENT TERMS

Don't worry about finances. Our fees are very reasonable—we can arrange convenient terms of payment. It is our custom to permit clients to pay for our services in installments as the application progresses in our office. See our Big Book for fees in obtaining Patent. It explains our arrangements clearly. Send for it NOW.

GET FREE BOOK—MAIL COUPON NOW

If you have an invention in the making—if you simply have the crude elements of an invention in mind—you should have our Big FREE BOOK without delay. It will guide you every step of the way—from the preliminary search stage to the issuance of the final patent grant. This book contains twenty-five chapters describing in plain man-to-man language the story of obtaining a patent and marketing an invention. This book is absolutely FREE—just tear off the above coupon or write us a letter or postcard TODAY!



Get
These Free
MAIL
COUPON

A. O'BRIEN

Dept. OL1, Adams Building WASHINGTON, D. C.

WELDING

**Get in Line Now
for a Good Job
in Welding**

The national emergency program brings new opportunities in the technical fields,—especially in Welding (including Aircraft). Industry demands capable, trained welding operators, technicians, engineers and mechanics. The application of gas and electric welding in all lines of business is almost unlimited,—aircraft, automobiles, diesels, building, etc.



TWO PLANS OF TRAINING

Choose the one that suits you best.

1. Day and Evening Classes at the College in Chicago. Start any Monday. Train in modern shops completely equipped. Rapid progress through short intensified courses.
2. Home Training combined with shorter course at our shops in Chicago, permitting you to earn while learning in spare time. Round trip transportation & room included in tuition.

FREE BLUE BOOK Send post card today for Free Blue Book. Contains helpful information about Welding and other technical fields. Please state which training plan you favor.

CHICAGO TECHNICAL COLLEGE

P-600 Tech Bldg., 118 East 26th St., Chicago, Ill.



AUTO

BOOKS SENT FREE

on approval. Just mail the coupon and we'll send you a set of these remarkable auto books. Whether you are a mechanic or helper, expert or apprentice, auto owner or driver, if you're interested in knowing all about automobile mechanics, take advantage of this FREE EXAMINATION OFFER.

GET A BETTER JOB

A better job—in the gigantic auto industry. **BIGGER PAY**—a chance to go into business for yourself and get a share of the profits, are waiting for any man who even half tries to improve himself. Learn auto engineering with these wonder books a new way—a quick reference method. Simply use the **JIFFY INDEX** to look up the answer to any auto problem. Built by eleven of America's great automobile engineers, and written in simple language so you can understand it.

Privilege of consulting Automobile Engineers for one year without extra cost if you mail coupon immediately.

Send promptly and we will include a New **EXTRA** volume with over 300 pages including late cars with wiring diagrams and data sheets on each.

6 BIG VOLUMES
2500 pages, 2000 illustrations, wiring diagrams, etc., including Marine Engines, Aviation Motors, Diesel engines, etc. De Luxe edition, gold-stamped flexible binding.

AMERICAN TECHNICAL SOCIETY (Publishers—Home Study Courses), Drexel Ave. & 58th St., Dept. A819, Chicago, Illinois. I would like to see the 6-volume edition of your **AUTO BOOKS**. I will pay the delivery charges only, but if I choose to, I may return them express collect. If after 10 days use I prefer to keep them, I will send you \$2 and pay the balance at the rate of only \$3 a month, until \$24.80 is paid. Please include consulting service and extra Volume No. 7, as per your offer above.

Name.....
Address.....
City..... State.....
Please attach letter stating age, occupation and name and address of employer and that of at least one business man as reference.

**LET ME PROVE
I CAN MAKE
YOU A NEW MAN**

I changed myself from a 97-lb. weakling to winner of title "World's Most Perfectly Developed Man." Let me prove that my secret of Dynamic Tension can give you powerful muscles, smashing strength, a handsome build! All I ask is a 7 DAY TRIAL. Write for my 48-page FREE BOOK. **CHARLES ATLAS**, Dept. 811, 115 East 23rd Street, New York City.



**SEND
FOR MY
FREE BOOK**

Learn To MOUNT BIRDS

TAN SKINS—MAKE UP FURS

Be a Taxidermist. We teach you at Home. Mount Birds, Animals, Pets, Heads, Fish. Save your hunting trophies. Decorate home and den. Make Money. Mount and tan for others. Fun and Profit! Don't delay. **WRITE TODAY—NOW—FOR FREE BOOK with 100 game pictures.** Hunters, get your copy—It's Now Free. Send post card. State your AGE, N. W. SCHOOL OF TAXIDERMY, Dept. 9378, Omaha, Nebr.



Thomas E. Lattin
President

I WANT TO TRAIN YOU For A Big-Paying Job IN THE MEAT BUSINESS

I have trained hundreds of men like you to become expert Meat Cutters. Good pay. Steady jobs everywhere. Government figures show over 50,000 new meat markets. My school offers you quick, short, intensive training. Actual practice in big cutting rooms and retail department. Union card FREE. Pay after graduation. Valuable employment service. Write me today for my big FREE catalog and all details.

National School of Meat Cutting, Inc., Dept. U-12, Toledo, Ohio.

TOOL & DIE MAKERS Machinists, Screw Machine Men

**EARN
BIG PAY**

Skilled metal workers earn up to \$50-\$60 a week. Learn these trades by actual work in ALLIED SHOPS. Fully equipped. State Approved. Low Fee. Enter any time. Day and Evening classes. FREE Employment Service. Write for NEW illustrated Catalog.

ALLIED SCREW MACHINE CO., (School Division)
Dept. PM-11, 609 W. Lake Street, Chicago, Illinois

**THERE'S
MONEY
IN**

CARTOONS!

RAYE BURNS will teach you HOW to CREATE ORIGINAL CARTOONS, at home, you may SELL! Cost is unusually low. Write for FREE sample lesson plates, drawing test, and addresses of successfully trained students. No obligation. **RAYE BURNS SCHOOL**, Studio M, Box 2194, Cleveland, Ohio

EARN A DEGREE AT HOME

From A Chartered Institution of Higher Learning
Employers Now Demand College Graduates With Degrees

88 Degree Courses in Arts; Sciences; Philosophy; Education; Public Health; Medical Jurisprudence; Psychology; Sociology; Physics; Chemistry; Geology; Pol. Science; Theology; Law; Business Training; Accounting; Statistics; Agriculture; Electrical; Civil; Mechanical; Drafting; Architectural; Automotive; Steam; Diesel; Aeronautical; Radio; Structural; Industrial; Highway; Petroleum; Mining; Marine; Refrigeration; Air Conditioning; Chemical Engineering. Founded 1908. Chartered. McKinley-Roosevelt Graduate College, 4610-P Sheridan Road, Chicago

RADIO

ENGINEERING, broadcasting, aviation and police radio, servicing, marine and Morse telegraphy taught thoroughly. 48 weeks' engineering course equivalent to three years' college radio work. School established 1874. All expenses low. Catalog free.

Dodge's Institute, Ada St., Valparaiso, Ind.

Correspondence Courses in
RADIO and ELECTRICAL ENGINEERING

LOW AS
\$25



ELECTRICAL ENGINEERING. Get good grasp of wide electrical field. Modern. Very understandable. Theory made easy.
RADIO ENGINEERING. Extra fine course in radio, public address, photo-electric work. Trains you to be super-service man, real vacuum tube technician. Tuition ONLY \$25, either course. Deferred payment plan. Experiment kits furnished.
Write for free copies of school catalogs, student magazines, etc.
FREE LINCOLN ENGINEERING SCHOOL, Box 931-P23, Lincoln, Nebr.

**"AL HAS A LOT
ON THE BALL,
ALL RIGHT!"**



WHAT DO THEY SAY ABOUT YOU?

No ONE respects the man who doesn't carry his share of the load.

In your work, do you lack the training you need to hold up your end of the job? Do your fellow workers say: "We have to do our work, and his too!"?

Students of the International Correspondence Schools are almost always respected and well-liked—because they are *trained to do their jobs well!* And they're ready for a more responsible job when opportunity knocks!

Think it over! The coupon will bring you complete information—show you how you can become eligible for a trained man's position.

INTERNATIONAL CORRESPONDENCE SCHOOLS

BOX 5589-J, SCRANTON, PENNA.

★ Without cost or obligation, please send me a copy of your booklet, "Who Wins and Why," and full particulars about the course *before* which I have marked X: ★

TECHNICAL AND INDUSTRIAL COURSES

- | | | | | |
|---|---|---|---|--|
| <input type="checkbox"/> Agriculture | <input type="checkbox"/> Air Brake | <input type="checkbox"/> Cotton Manufacturing | <input type="checkbox"/> Mfg. of Pulp and Paper | <input type="checkbox"/> R. R. Section Foreman |
| <input type="checkbox"/> Air Conditioning | <input type="checkbox"/> Architectural Drafting | <input type="checkbox"/> Diesel Engines | <input type="checkbox"/> Marine Engines | <input type="checkbox"/> R. R. Signalmen's |
| <input type="checkbox"/> Architecture | <input type="checkbox"/> Auto Engine Tune-up | <input type="checkbox"/> Electrical Drafting | <input type="checkbox"/> Mechanical Drafting | <input type="checkbox"/> Sanitary Engineering |
| <input type="checkbox"/> Auto Engine Tune-up | <input type="checkbox"/> Auto Technician | <input type="checkbox"/> Electrical Engineering | <input type="checkbox"/> Mechanical Engineering | <input type="checkbox"/> Sheet Metal Work |
| <input type="checkbox"/> Aviation | <input type="checkbox"/> Boilermaking | <input type="checkbox"/> Electric Lighting | <input type="checkbox"/> Mine Foreman | <input type="checkbox"/> Steam Electric |
| <input type="checkbox"/> Bridge Engineering | <input type="checkbox"/> Building Estimating | <input type="checkbox"/> Fire Bosses | <input type="checkbox"/> Navigation | <input type="checkbox"/> Steam Engines |
| <input type="checkbox"/> Building Estimating | <input type="checkbox"/> Chemistry | <input type="checkbox"/> Foundry Work | <input type="checkbox"/> Patternmaking | <input type="checkbox"/> Steam Fitting |
| <input type="checkbox"/> Civil Engineering | <input type="checkbox"/> Coal Mining | <input type="checkbox"/> Fruit Growing | <input type="checkbox"/> Pharmacy | <input type="checkbox"/> Structural Drafting |
| <input type="checkbox"/> Concrete Engineering | <input type="checkbox"/> Contracting and Building | <input type="checkbox"/> Heating | <input type="checkbox"/> Plumbing | <input type="checkbox"/> Structural Engineering |
| | | <input type="checkbox"/> Heat Treatment of Metals | <input type="checkbox"/> Poultry Farming | <input type="checkbox"/> Surveying and Mapping |
| | | <input type="checkbox"/> Highway Engineering | <input type="checkbox"/> Practical Telephony | <input type="checkbox"/> Telegraph Engineering |
| | | <input type="checkbox"/> House Planning | <input type="checkbox"/> Public Works Engineering | <input type="checkbox"/> Textile Designing |
| | | <input type="checkbox"/> Locomotive Engineer | <input type="checkbox"/> Radio, General | <input type="checkbox"/> Toolmaking |
| | | <input type="checkbox"/> Machinist | <input type="checkbox"/> Radio Operating | <input type="checkbox"/> Welding, Electric and Gas |
| | | <input type="checkbox"/> Management of Inventions | <input type="checkbox"/> Radio Servicing | <input type="checkbox"/> Woolen Manufacturing |

BUSINESS COURSES

- | | | | | |
|--|--|--|---|---|
| <input type="checkbox"/> Accounting | <input type="checkbox"/> Advertising | <input type="checkbox"/> College Preparatory | <input type="checkbox"/> Foremanship | <input type="checkbox"/> Railway Postal Clerk |
| <input type="checkbox"/> Bookkeeping | <input type="checkbox"/> Business Correspondence | <input type="checkbox"/> Commercial | <input type="checkbox"/> French | <input type="checkbox"/> Salesmanship |
| <input type="checkbox"/> Business Management | <input type="checkbox"/> Business Management | <input type="checkbox"/> Cost Accounting | <input type="checkbox"/> Grade School | <input type="checkbox"/> Secretarial |
| <input type="checkbox"/> Cartooning | <input type="checkbox"/> Civil Service | <input type="checkbox"/> C. P. Accounting | <input type="checkbox"/> High School | <input type="checkbox"/> Sign Lettering |
| | | <input type="checkbox"/> First Year College | <input type="checkbox"/> Illustrating | <input type="checkbox"/> Traffic Management |
| | | | <input type="checkbox"/> Lettering Show Cards | |
| | | | <input type="checkbox"/> Managing Men at Work | |

HOME ECONOMICS COURSES

- | | | |
|---|---|--|
| <input type="checkbox"/> Advanced Dressmaking | <input type="checkbox"/> Home Dressmaking | <input type="checkbox"/> Tea Room and Cafeteria Management, Catering |
| <input type="checkbox"/> Foods and Cookery | <input type="checkbox"/> Professional Dressmaking and Designing | |

Name..... Age..... Address.....
City..... State..... Present Position.....

Canadian residents send coupon to International Correspondence Schools Canadian, Limited, Montreal, Canada
British residents send coupon to I. C. S., 71 Kingsway, London, W. C. 2, England

DON'T MISS HALF THE FUN IN LIFE!

Learn your favorite instrument without a teacher

Now it's easy to learn music at home, without a teacher. It's fun to learn this new, fascinating way, in your spare time—and imagine the fun it will be, in just a short time, to sit down and play most any piece you wish for your admiring friends at parties.

You don't need any special talent or previous musical experience to learn. The U. S. School of Music's fascinating, print-and-picture method is easy as A-B-C, yet it assures you of professionally thorough training. From the very first lesson, you learn real tunes—without old-fashioned, monotonous exercises. First you are told what to do—then a picture shows you how to do it—then you do it yourself and hear it. It's like playing a game—and it's so easy you can't go wrong. Best of all, this quick, easy key to pleasure and popularity costs you only a few cents a day, whatever instrument you choose.



WRITE FOR FREE ILLUSTRATED BOOKLET

Mail coupon today for Free Booklet and Print-and-Picture Sample explaining this fascinating method in detail. Mention your favorite instrument. Instruments supplied when needed—cash or credit.

U. S. SCHOOL OF MUSIC, 711 Brunswick Bldg., New York City.

U. S. School of Music, 711 Brunswick Bldg., N.Y.C. Please send me Free Booklet and Print-and-Picture Sample. I would like to play instrument checked below. (Do you have instrument.....)

Piano	Accordion	Clarinet	Banjo
Violin	Saxophone	Trumpet	Ukelele
Guitar	Mandolin	Trombone	Other Instrument

Name.....
Street.....
City..... State.....

Learn this Profitable Profession



in 90 Days at Home

Hundreds of men and women of all ages 18-50 make \$10.00 to \$20.00 in a single day giving scientific Swedish Massage and Hydro-Therapy treatments. There is a big demand from Hospitals, Sanitariums, Clubs, Doctors and private patients as well as opportunities for establishing your own office.

Learn this interesting money-making profession in your own home by mail, through our home study course. Same instructors as in our NATIONALLY KNOWN resident school. A diploma is awarded upon completion of the course. Course can be completed in 3 to 4 months. High School training is not necessary. Many earn big money while learning.



Anatomy Charts & Booklet FREE

Enroll now and we will include uniform coat, medical dictionary, patented reducing roller and Hydro-Therapy supplies without extra cost. The reducing course alone may be worth many times the modest tuition fee.

Send coupon now for Anatomy Charts and booklet containing photographs and letters from successful graduates. These will all be sent postpaid—FREE.

THE College of Swedish Massage
Dept. 864—30 E. Adams St., Chicago.
You may send me FREE and postpaid, Anatomy Charts, booklet containing photographs and letters from graduates, and complete details of your offer.

Name.....
Address.....
City..... State.....

Write and Speak MASTERLY ENGLISH



Learn correct English with Sherwin Cody's new invention. No rules to memorize. Like a fascinating game. Spare-time study, 15 minutes each day, quickly gives you command of English. Send for free book, "How You Can Master Good English in 15 Minutes a Day." Write today. SHERWIN CODY SCHOOL OF ENGLISH
511 Searle Bldg., Rochester, N. Y.

TRI-STATE COLLEGE

B. S. Degree in 2 Years

World famous for technical 2-year courses in Civil, Electrical, Mechanical, Chemical, Radio, Aeronautical Engineering, Business Administration and Accounting. Special preparatory department for those who lack required high school work. Short diploma courses (36 weeks) in Surveying, Drafting. Low tuition. Low living costs. Students from every state and many foreign countries. 57th year. Graduates successful. Enter January, March, June, September. Write for catalog, 4110 College Ave., ANGOLA, IND.

LAW STUDY AT HOME

Legally trained men win higher positions and bigger success in business and public life. Greater opportunities now than ever before. Big corporations are headed by men with legal training. More Ability: More Prestige: More Money. We guide you step by step. You can train at home during spare time. Degree of LL. B. Successful graduates in every section of the U. S. We furnish all text material, including 14-volume Law Library. Low cost, easy terms. Get our valuable 48-page "Law Training for Leadership" and "Evidence" books FREE. Send for them NOW. LaSalle Extension University, Dept. 1164-L Chicago A Correspondence Institution

We Teach You TO MOUNT BIRDS, FISH

Animals, Pets, Game-heads & Tanning

FASCINATING, PROFITABLE, EASY At Home

Professional Home Study Course under supervision of Museum Taxidermist teaches you the fascinating Art of TAXIDERMISTRY. No other course like it. Mount your own game for home decoration. Make spare time or full time profits. **FREE BOOKLET**—Send postcard NOW. Get full, interesting facts how you may earn as you learn. CHICAGO SCHOOL OF TAXIDERMISTRY P. O. Box 343, Dept. A-11, CHICAGO, ILLINOIS

VOICE

100% Improvement Guaranteed

We build, strengthen the vocal organs—not with singing lessons—but by fundamentally sound and scientifically correct silent exercises... and absolutely guarantee to improve any singing or speaking voice at least 100%... Write for wonderful voice book—sent free. Learn WHY you can now have the voice you want. No literature sent to anyone under 17 years unless signed by parent. **PERFECT VOICE INSTITUTE, Studio 1358**
64 E. Lake St., Chicago

RAILWAY BUS BE PASSENGER TRAFFIC INSPECTOR

Our home-study training prepares you quickly for interesting, necessary job in transportation. We help place graduates or refund tuition. Many good opportunities. Graduate Inspectors earn up to \$135 per mo. plus expenses to start. **STANDARD BUSINESS TRAINING INSTITUTE (Est. 1918), Div. 211, Buffalo, N. Y.**

Write for FREE BOOKLET

ARTISTS MAKE MONEY

Find out your ability. Send name, age, occupation and address for Free Vocational Art Test. **Federal Schools, Inc., 11130 Federal Schools Bldg., Minneapolis, Minn.**

MAKE MONEY AT HOME

RUBBER MOLDS

Low as 6¢ EA.

Amazing rubber mold-making outfit makes perfect flexible molds of plaques, ash trays, book-ends etc. Molds cost from 6¢ to 25¢ each. Each mold makes hundreds of novelties and gifts to sell up to \$1.00 apiece! No experience necessary. Quick and easy. Start profitable business in your home... sell to stores, gift shops, friends, resorts, road stands, by mail. Full or spare time. "Molders Handy Book" and list of buyers FREE. Write **SO-LO WORKS**
Dept. N-827 Cincinnati, Ohio



Send for my 50c book, how to develop

STRONG ARMS and SHOULDERS ONLY 25¢

with 20 full pages of illustrations, showing and fully describing exercises that will quickly develop, beautify and make you gain great strength in your Shoulders, Arms, Wrists, Hands and Fingers.

WITHOUT ANY APPARATUS

This is really a remarkable course of Physical Culture exercises. Don't fail to send for it NOW. 25c coin or 30c U. S. Stamps.

A. BARKER, (Studio M-8) 1235 Sixth Ave., N.Y.C.
Individual instruction at my Physical Culture Studio, for Health and Strength

ENGINEERING

DEGREE IN TWO YEARS

TECHNICAL AND APPLIED COURSES. **Nonessentials omitted. TIME AND MONEY SAVED.** Degree 2 yrs., diploma 1 yr. **Electrical, Mechanical, Architectural, Structural, Civil, Aeronautical,** including Air Conditioning, Refrigeration, Diesel. Intensive courses, 3 and 4 months in **Electricity, Power Plant, Diesel, Refrigeration, Drafting.** Extensive shop equipment. **LOW TUITION.** Part-time work for room and board. Thousands successful graduates in U. S. and foreign lands. Approved by industry, endorsed by educators, recommended by alumni. One and two-year courses open Sept. 18 to Oct. 18, short courses start specified dates, beginning Sept. 18. **41st Year.** No home study courses. Catalog free.

FINLAY ENGINEERING COLLEGE

1001 Indiana Ave.

Kansas City, Mo.

AVIATION APPRENTICES



AIRMINDED YOUNG MEN INTERESTED IN HOME STUDY TRAINING FOR ENTERING THE WELL PAID FIELD OF AVIATION AS APPRENTICES—Write immediately, enclosing stamp, **MECHANIX UNIVERSAL AVIATION SERVICE CO.** Wayne County Airport, Box 857, Dept. E, Detroit, Mich.

RADIO-TELEVISION

Oldest, largest Radio-Television school in West trains you for good pay job. Complete instruction including Radio Construction and Service, Broadcast Operating, Sound, Talking Pictures, Television, Public Address, etc. Flexible plan to meet specific needs of those with or without jobs. Transportation allowed to L.A. Earn room and board while learning. Request Free Catalog.

NATIONAL SCHOOLS Dept. PMR-11 Los Angeles

ANY BOOK IN PRINT!

Delivered at your door. We pay postage. Standard authors, new books, popular editions, fiction, reference, medical, mechanical, children's books, etc.—**all at guaranteed savings.** Send card now for Clarkson's 1941 Catalog.

FREE Write for our great illustrated book catalog. A short course in literature. The buying guide of 300,000 book lovers. The answer to your Christmas gift problem. **FREE** if you write **NOW—TODAY!**

CLARKSON PUBLISHING COMPANY
Dept. PM40, 1253 So. Wabash Ave., Chicago, Ill.



SECRET SERVICE BOOK FREE

For 30 Days Reading No Money Down—Actual Crime Cases—
If You Act Quick! We will send you this stirring book on Crime Detection, Secret Service and Identification Work for 30 days free reading. Read no money. If you decide to keep it, then send me only \$1. If not, return it. **WRITE TODAY!** Literature will be sent only to persons stating their own.

T. G. COOKE, Dept. 1358, 1920 Sunnyside Ave., Chicago, Ill.

MONEY for MEN ALL FREE

THE PLASTEX Industry needs manufacturers on small scale and for big production of Lamp and Clock Stands, Art Goods and Novelties in Plastex and Marble imitation. Experience unnecessary. 1/2c material makes regular 10c store sellers. Rubber moulds furnished for speed production. Small investment brings big returns. **WAR CAUSES GREAT SHORTAGE OF THESE GOODS.** Ambitious men have chance for real prosperity. Our **FREE** booklet will interest and benefit you. **PLASTEX INDUSTRIES, Dept. P, 1085 Washington Ave., New York, N.Y.**



Start \$1260 to \$2100 a Year

Get Ready Now for Examinations In Your Section

Railway Postal Clerks

Railway Postal Clerks get \$1,900 the first year regular, being paid on the first and fifteenth of each month. (\$79.17 each pay day.) Their pay is automatically increased yearly to \$2,450. Advance may be had to Chief Clerk at \$2,700 a year. (\$112.50 each pay day.)

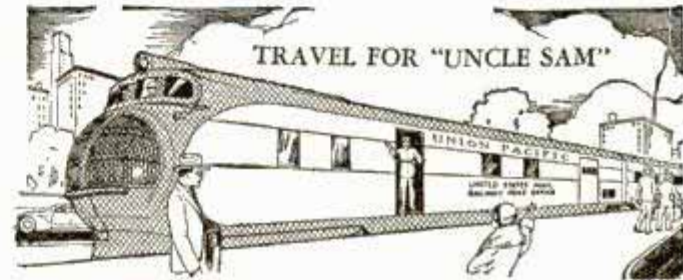

3 Days On —3 Days Off—Full Pay

Railway Postal Clerks on long runs usually work 3 days and have 3 days off duty or in the same portion. During this off duty their pay continues just as though they were working. They travel on a pass when on business. When they grow old, they are retired with a pension.

City Mail Carriers, Post Office Clerks

Clerks and Carriers now get \$1,700 the first year on regular and automatically increase \$100 a year to \$2,100 and \$2,300.

GOVERNMENT CLERK



Many Other Positions

Many other positions are obtainable. Rural Carriers—Stenographers—Typists—Assistant Statistical Clerks—Accountants—Messengers—Office Machine Operators—etc. Those wishing these positions should qualify at once.

Get Free List of Positions

Fill out the following coupon. Tear it off and mail it today—now, at once.

This investment may result in your getting a big-paid government job.

FRANKLIN INSTITUTE, Dept. J173, Rochester, N. Y.

Rush to me, entirely free of charge (1) a full description of U. S. Government Jobs; (2) Free copy of illustrated 32-page book, "U. S. Government Positions and How to Get Them"; (3) List of U. S. Government Jobs; (4) Tell me what to do to qualify for one of these jobs.

Name.....

Address.....

Use This Coupon Before You Mislaid It. Write or Print Plainly.

GOOD BYE

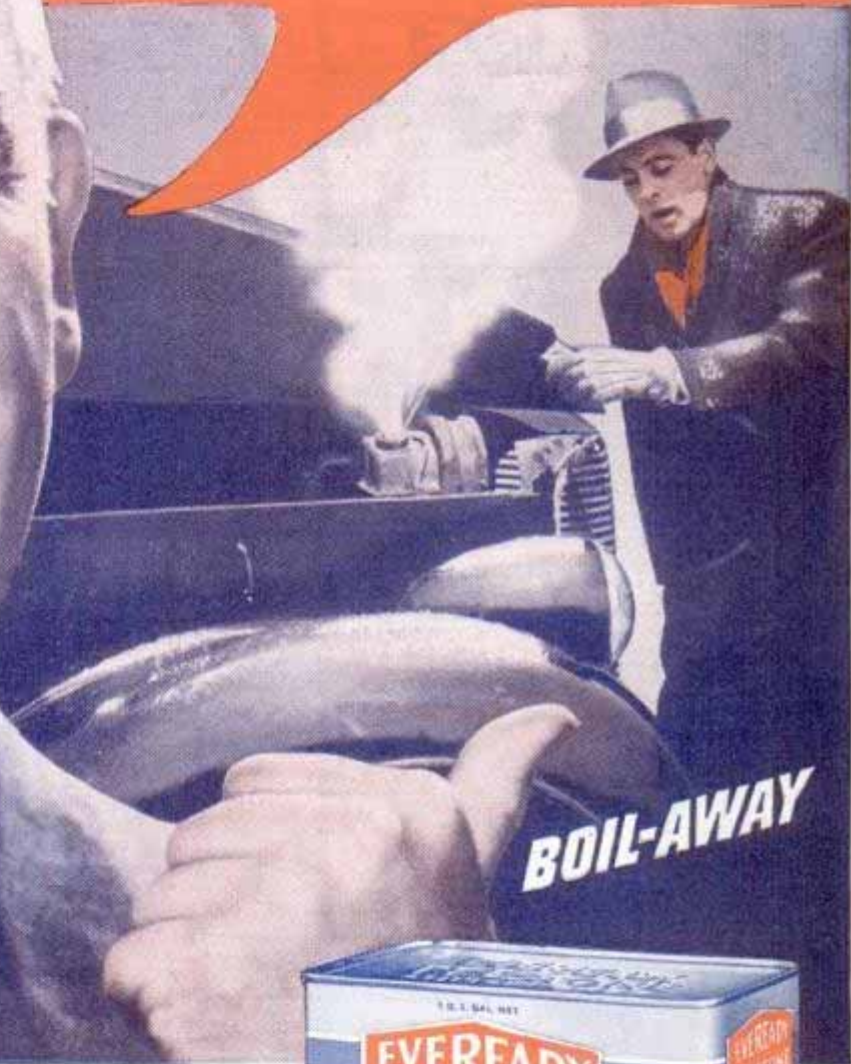
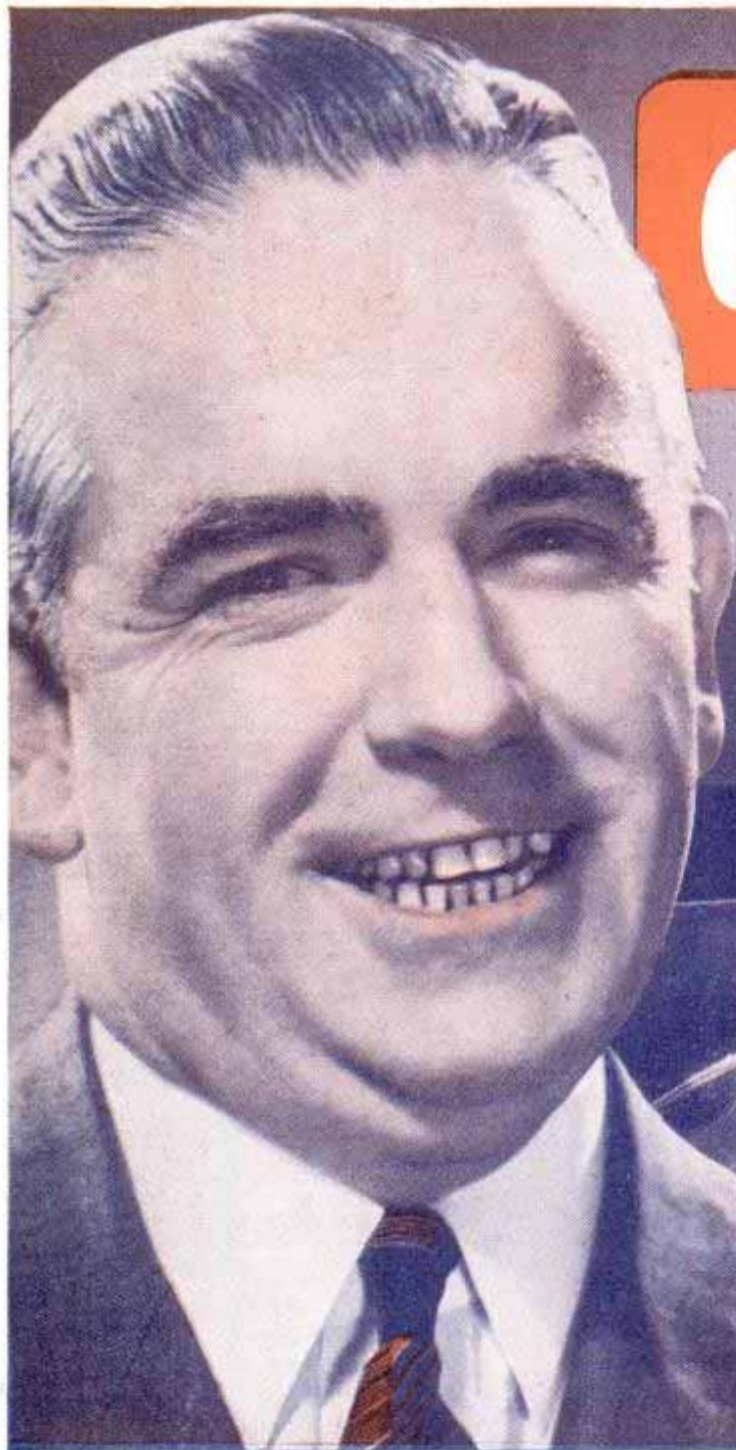

"PRESTONE" Anti-freeze

**is used in more cars
than any other brand!**

Last winter alone "Prestone" anti-freeze saw motorists through more than 24 billion miles of carefree driving. It's the choice of the U. S. Army, Navy and Marines for protecting vital equipment from freeze-up!

\$2.65
PER
GALLON



TO ALL THAT!



GET THE ANTI-FREEZE THAT ENDS WORRY NOW!

Put "Prestone" anti-freeze into your car now . . . and put worry out of your mind!

Unlike "dollar-a-gallon" alcohol base anti-freeze, one shot of "Prestone" anti-freeze protects *all winter long*. "Prestone" anti-freeze contains no alcohol . . . no glycerine. It will not boil off. There's no odor . . . no obnoxious fumes . . . absolutely no risk of harm to your motor.

Unlike new and untried "all-winter" types of winter protection, "Prestone" anti-freeze has *proved . . . in billions of miles of driving . . .* that it will not plague you with foaming, leaking, rust or corrosion. Guaranteed in writing!

The words "Prestone" and "Eveready" are registered trade-marks of the National Carbon Company, Inc.



"PRESTONE" Anti-Freeze

"YOU'RE SAFE-AND YOU KNOW IT!"

Do you want

- ..to go to College?
- ..or to enter a Profession?
- ..or get an Office Position?

(Such as Accounting, Architecture, Nursing, Dentistry, Teaching, Social Work, Osteopathy, Beauty Culture, Optometry, Embalming, Chiropraxy, Law, Medicine, etc.)

To get anywhere, you practically MUST finish High School FIRST. You can complete our simplified High School Course in SPARE time at home, as FAST as your time and abilities permit. Equivalent to resident school work—prepares you for college, pre-professional examinations, business, industry. Standard texts furnished. Diploma. Credit for H.S. subjects already completed. Single subjects if desired. Low tuition, easy terms. American School, Chicago, est. 1897—endorsed by educators. Finish your high school education NOW. Write TODAY!

High School Course at Home

Many Finish in 2 Years

American School, Dept. H-845, Drexel Ave. at 58th St., Chicago, Ill.

Gentlemen: Send me FREE information covering special training in subjects checked below. No obligation on my part.

- | | |
|--|---|
| <input type="checkbox"/> High School Course | <input type="checkbox"/> Diesel Engineering |
| <input type="checkbox"/> Accounting and Auditing | <input type="checkbox"/> Drafting and Design |
| <input type="checkbox"/> Architecture and Building | <input type="checkbox"/> Liberal Arts |
| <input type="checkbox"/> Automotive Engineering | <input type="checkbox"/> Private Secretary |
| <input type="checkbox"/> Business Management | <input type="checkbox"/> Mechanical Engineering |
| <input type="checkbox"/> Aviation | <input type="checkbox"/> Radio and Television |
| <input type="checkbox"/> Electrical Engineering | <input type="checkbox"/> Salesmanship |
| <input type="checkbox"/> Elec. and Gas Refrigeration | <input type="checkbox"/> Business Law |
| <input type="checkbox"/> Air Conditioning | <input type="checkbox"/> Retail Merchandising |

Name

Address

MECHANICS

KNOW YOUR CAR

You Need this Book

JUST OUT!

Ask to See it!

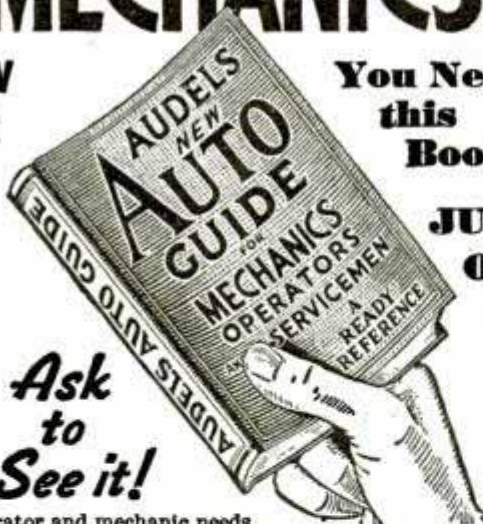

Every operator and mechanic needs AUDELS NEW AUTO GUIDE. This book saves time, money and worry. Highly endorsed, it presents the whole subject of auto mechanics: 1—Basic principles, 2—Construction, 3—Operation, 4—Service, 5—Repair. Easily understood. Over 1500 pages—1540 illustrations showing inside views of modern cars, trucks and buses with instructions for all service jobs. Diesel Engines fully treated, \$4 fully illustrated. To Get This Assistance for Yourself Simply Fill in and Mail Coupon Today.

4 COMPLETE • PAY ONLY \$1. A MONTH ←

THEO. AUDEL & CO., 49 WEST 23rd STREET, NEW YORK
Please send me postpaid AUDELS NEW AUTOMOBILE GUIDE (\$4) for free examination. If I decide to keep it, I will send you \$1 within 7 days; then remit \$1 monthly until purchase price of \$4 is paid. Otherwise, I will return it to you promptly.

Name

Address

Occupation

Reference

Say you saw it in Popular Mechanics!

ELECTRICAL CAREERS

Become a Bliss technician in one year—ready to take advantage of increasing opportunities in the electrical field. Bliss men, today, fill key positions in many different electrical industries. All received the same course in fundamental theory and practice.

Modern laboratories. Successful placement. 48th year. Ask for free vocational chart, 121 Takoma Ave., Wash., D.C.

BLISS ELECTRICAL SCHOOL

LEARN AVIATION

IN LOS ANGELES • Nation's Aviation Capital



Huge increase in Los Angeles aviation activity has assured splendid positions for graduates. Career training offered for airline piloting, engineering, mechanics, drafting, production mechanics and instruments. Train at America's most modern, fully equipped and strategically located school, fully approved by the U. S. Government for flight, ground and mechanics courses. Write for free 64 page catalog. State age.

CALIFORNIA FLYERS

SCHOOL OF AERONAUTICS - Dept. PM-11

LOS ANGELES MUNICIPAL AIRPORT, INGLEWOOD, CALIF.

LEARN WATCH REPAIRING



AT HOME You can learn by our modern and original system of instruction every part of the Watch Repairing Trade at home. You can earn money while learning and prepare yourself for a well paying position or start in business after completing our course of instruction. Good watch repairers are in demand and generally earn very good salaries. For particulars apply to the

Wisconsin School of Watch Repairing
524 E. Mason St., MILWAUKEE, WIS.

Regain Perfect Speech, If You

STAMMER

Every stammerer should have the new 287 page book "Stammering, Its Cause and Correction." Sent free to stammerers. It describes the Bogue Unit Method for the scientific correction of stammering and stuttering. Method successfully used at Bogue Institute for 39 years—since 1901. Endorsed by physicians. Write for full information. No obligation. Benjamin N. Bogue, Dept. 1320 Circle Tower, Indianapolis, Indiana.

GET INTO THE BAKING BUSINESS!

National Baking Institute announces a new home study course in commercial baking. Baking now America's fifth industry in wages. Nearly a depression-proof business. Good field for ambitious men. Common school education sufficient. Send for free booklet "Opportunities in Commercial Baking" and requirements.

National Baking Institute
3601 Michigan Ave. Dept. 1358, Chicago, U. S. A.



PHOTO-ENGRAVING

TASOPE SINCE 1931

FREE—a copy of the Tasope Magazine, monthly treasure chest of photographic and photo-engraving information. Learn why Aurora, Mo., is the photo-engraving, photographic center of America . . . how hundreds of amateurs, free-lance photographers are making money with pictures. No-obligation postcard brings your copy.

TASOPE, DEPT. PM-22, AURORA, MO.



Begin today. Write for our New Free Book, "How to Become a Good Penman," it contains specimens and tells how others learned to write in spare time. Enclose 10c for a Professional Pen Point and your name beautifully written. Write today.

THE TAMBLYN SCHOOL OF PENMANSHIP
441 Ridge Building Kansas City, Mo.

Learn PHOTOGRAPHY at Home

Splendid opportunities. Prepare in spare time. Easy plan. No previous experience needed, common school education sufficient. Send for free booklet "Opportunities in Photography", particulars and requirements.

American School of Photography
3601 Michigan Ave., Dept. 1358, Chicago, Ill.

FREE!

\$6.00 Full Size FOOD & HOUSEHOLD PRODUCT ASST.

SEND NO MONEY! Rush name and address for big Assortment of FOODS, GROCERIES, SOAPS, ETC.—full size packages, worth \$6.00. Yours ABSOLUTELY FREE! Show these products to friends, neighbors. Take orders for sensational values, more than 200 quality products used in every home. Earn big profits, full or spare time. No experience necessary. Write for FREE \$6.00 Assortment of Products NOW. ZANOL, 1994 Monmouth, Cincinnati, Ohio.



POPULAR MECHANICS



Easy to Play
THE SMALLEST, LIGHTEST, FULL-VOLUMED 90 BASS ACCORDION EVER DESIGNED. IT'S THE NEW SOPRANI AMPLIPHONIC MIDGET

● Think of it! 34 treble, and 90 bass keys, beautiful tone, amazing volume. See and try this wonderful new Soprani at your dealer's, or write for FREE booklet.

SOPRANI, INC. Dept. 1129
630 S. Wabash, Chicago, Ill. 299



BE A LAYOUT ARTIST

• Make big money designing advertising. Successful Chicago Art Director shows you how, exactly as taught in large universities and art schools. Study at home. No previous art training necessary. Send name, address, age and vocation today for FREE DETAILS. National Advertising Academy, Dept. B, 43 East Ohio Street, Chicago, Ill.

GET A DRAFTING JOB

Drafting Jobs Often Pay \$175.00-\$350.00 month. Trained draftsmen always in demand. Learn easily at home in spare time. Experience unnecessary. Common education enough. Employment service FREE. Write today for complete information. No obligation. No Salesmen. MONROE INSTITUTE, Dept. A-111 Alton, Illinois

LEARN MECHANICAL DENTISTRY



Be A Dental Technician
Learn how to make Crowns, Bridges, Plates in this oldest school, licensed by the State of New York. 5,000 feet up-to-date equipment. Day and Evening Sessions. Easy terms. Write NOW for free catalog P and tool offer. N. Y. School of Mechanical Dentistry 125-127 West 31st Street, Dept. 9, New York City



CARTOONING PAYS WELL

Exclusive instruction by an internationally known cartoonist makes it easy to learn at home. Write for Free Booklet describing details of the course. State age. NATIONAL SCHOOL OF CARTOONING 437 Penton Bldg. Cleveland, Ohio

Stop Slamming Doors AMAZING MONEY MAKER!



Kant-Slam Door Check
is an amazing invention that closes all doors silently and automatically. Closing speed easily adjusted by turning screw at top of check. Holds doors open when wanted open. Operates on hydraulic principle. Low priced. Permanent. Easily installed in ten minutes. Never needs attention.

A Real Demonstrator Furnished Every Agent.
You get orders quickly demonstrating actual sample on easy to carry miniature door. Every office, factory, store, institution, and public building needs a Kant-Slam for every door. Rush name and address for details of amazing money-making opportunity. KANT-SLAM DOOR CHECK CO. Demonstrator Furnished to Workers Dept. C-53, Bloomfield, Ind.

68 Pages of facts for INVENTORS

These books were prepared for men of ideas—men who have an article in mind that will make money, save money, save labor or give pleasure. Leading thinkers agree that the world of a few years from now will be radically different because of the contributions to progress that inventors will make. Now is the time—if you have an idea—to see about protecting it.

Many Little Ideas May Have Big Commercial Possibilities

Don't think that to be profitable an idea needs to be complicated. Simple articles—just a person's hunch—have often proved profitable. The crinkly hair pin, the metal tip for shoe laces, the paper clip are good examples. Also improvements on patented articles sometimes prove more profitable than the original article itself.

Don't Delay—Send for These Free Books Now

Many a man has waited until too late to protect an idea by a United States Patent. Remember someone else may be thinking along the same lines that you are, and the Patent Laws favor the man who files his application for a patent first. Delays of even a few days can sometimes mean the loss of a patent. So learn the important facts about Patent Protection at once.

42 Years of Proven Service

For forty-two years, this capable organization has served inventors from all over the country. Our large staff of patent specialists gives you expert and prompt service. Our fees are reasonable; we also help with deferred payments.



VICTOR J. EVANS & Co.

REGISTERED PATENT ATTORNEYS

MAIN OFFICE: 560-M, VICTOR BUILDING WASHINGTON, D. C.

Pittsburgh Office: 514-N, Empire Building

Send me FREE copies of your books, "Patent Protection" and "When and How to Sell an Invention."

Name.....

Street and No.....

City or Town..... State.....

When writing please mention Popular Mechanics

MAIL COUPON TODAY FOR YOUR COPIES

POPULAR INVENTIONS

For Your Home

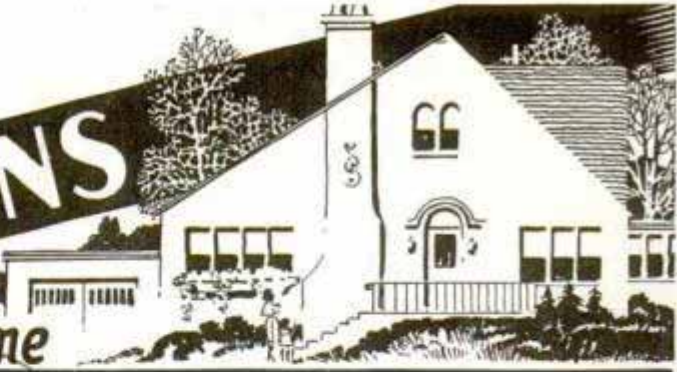

K912

Fluorescent Bed Lamp Gives Cool Light



Emitting cool light, a six-watt "baby" fluorescent tubular lamp recently announced by Westinghouse finds one of its first uses in a bed lamp. Other applications probably will be in closets, over mirrors, portraits and paintings. The new lamp is only nine inches long.

Metal Tab Helps Lift Paraffin from Top of Jelly Glass

Paraffin caps used for sealing jam and jelly put up in glasses at home come off



Reichel 12

easily if a metal tab available for housewives is employed. It also provides extra protection by holding a metal cover on the glass. Made of metal that will not contaminate the preserves, the device has a flat section that is placed on top of the preserve and a stem that protrudes after the paraffin is poured around it to seal the jar. A cover has a slot through which the stem may be brought and bent to lock the cover in place. To open the jar, the stem is straightened, the cap lifted off, and a pull on the stem draws out the tab and paraffin.

Wick-Fed Moth-Repellent Cone Sheds Vapor in Closet

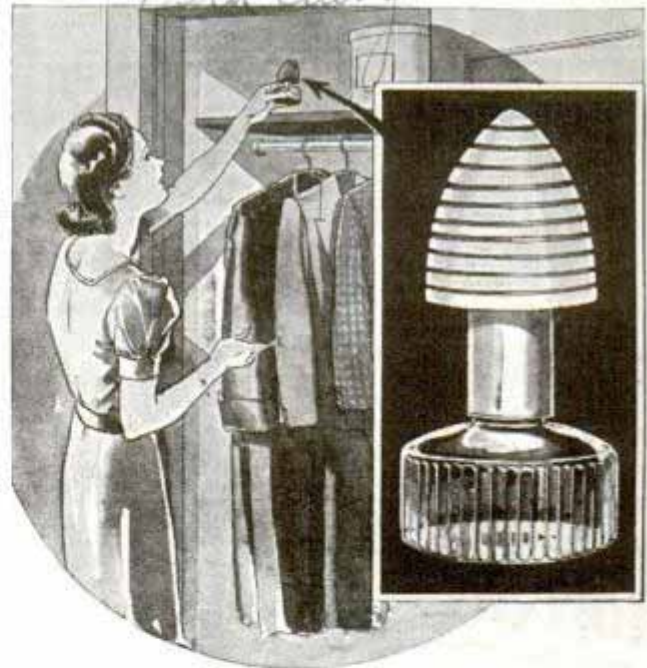

One way to make life miserable for moths is to place on a high shelf in the clothes closet a cone which sheds a moth-repellent vapor. The cone is self-feeding, drawing fluid by means of a wick from a glass container underneath. The penetrating vapors drive out moths but are harmless to humans. The odor disappears soon after the clothing is taken into the open air.

Electro Mfg Co
Lamp Blvd
Blomfield N.Y.

H & H Company
Mountain Lakes, N.J.

POPULAR MECHANICS
O-Cedar Corp
4501 S. Western Blvd

SAVE UP TO 50%

On this New 1941 **15-TUBE**
with FREQUENCY MODULATION
and TELEVISION ADAPTATION **MIDWEST**
RADIO



FACTORY-TO-YOU only

EASY TERMS

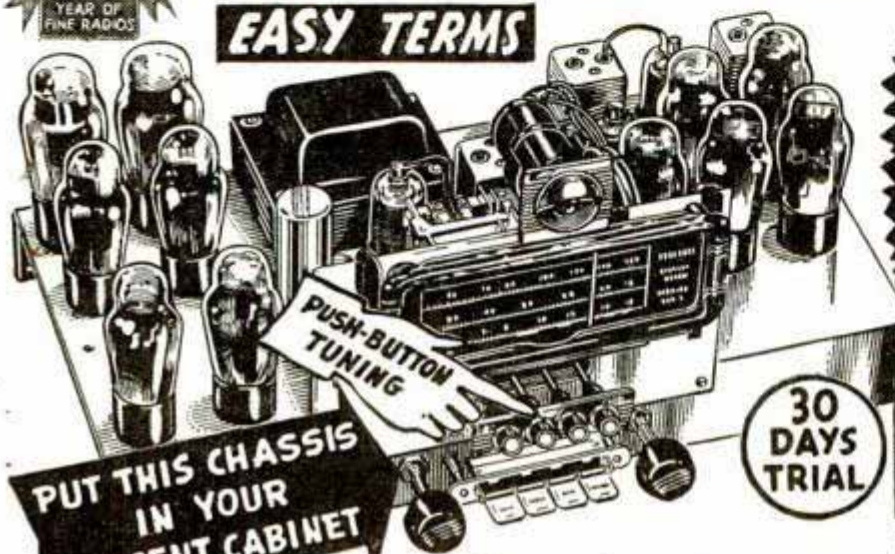

**PUT THIS CHASSIS
 IN YOUR
 PRESENT CABINET**

**30
 DAYS
 TRIAL**

\$19⁹⁵
 COMPLETE
 CHASSIS
 WITH TUBES
 AND SPEAKER

**GET THRILLING WORLD-WIDE
 FOREIGN NEWS DIRECT!**

Radio enthusiasts and merchandising experts who have seen the sensational new 1941 Midwest Radios say that they represent today's outstanding values! If you get a big "kick" out of owning a super powerful radio that

will out-perform ordinary sets, you will be particularly delighted with the brilliant performance, beautiful tone and world-ranging ability of these super Midwests. Just imagine being able to pull in world-distant broadcasts from the capitals of Europe—to hear history in the making before it

appears in your local paper or is announced over your local radio. We say: You can get thrilling world-wide foreign news, sports broadcasts and musical programs better and more clearly with a Midwest!

Fifteen tubes include Rectifiers, Control and Tuning Eye Tubes.

**THIS
 15-TUBE
 CABINET MODEL
 ONLY
 \$29⁹⁵
 COMPLETE**



Just think! Here's a super powerful 15-tube radio—complete in cabinet—at a price you would ordinarily pay for a 7 or 8-tube set. Never before have you been offered so much radio for so little money!

**UP TO \$25.00 TRADE-IN ALLOWANCE*
 ON YOUR OLD RADIO**



*Now, you can not only save up to 50% by buying direct from the Midwest factory—but, Midwest allows you up to \$25 on your old radio—on many models shown in the big, FREE Midwest Catalog. Send for this catalog and see for yourself that it actually brings the Midwest factory to you, that it pictures and dramatizes many beautiful, 1941 factory-to-you radio values—from 6 to 18 tubes—up to 5 wave bands—including Automatic Record-Changing Radio-Phonographs, Home Recorders, etc.

(Model Z-18 shown at left)

**18-TUBES
 5-BANDS**

**FILL IN COUPON AND MAIL TODAY OR JUST
 SEND YOUR NAME AND ADDRESS ON 1¢ POSTCARD**

MIDWEST *Factory-to-You* RADIOS

MANUFACTURERS OF QUALITY RADIOS SINCE 1920

Midwest Radio Corporation
 Cincinnati, Ohio, U. S. A.
 Dept. 15-FF

Send me your new FREE Catalog, complete details of your liberal 30-day Trial offer and factory-to-you prices.

Name.....

Address.....

Town..... State.....

User-Agents Make Easy Extra Money. Check here () for details.

**1941
 RADIO
 CATALOG**

**MAIL COUPON
 FOR FREE
 CATALOG**

Our famous 30-day prove-it-yourself plan fully protects you and enables you to prove Midwest's super performance in the privacy of your home. No obligation.



DRAFTING

BOOKS SENT FREE!
ON APPROVAL

5 VOLUMES—SECOND EDITION

Only 15 minutes a day with these WONDER BOOKS can prepare you for a good drafting job. Mechanical and architectural drafting from simple straight lines to important complex plans. A step at a time! Built especially for beginners, for men with only grammar schooling. Drafting room practice, PLUS ENGINEERING, made easy and clear. Includes complete information on blue print reading for building and machine trades.

Big Field Big Demand Big Pay

Competent draftsmen are urgently needed in all building and manufacturing lines at \$30.00 to \$75.00 a week. That's just the beginning—FOR DRAFTSMEN HAVE GOOD CHANCES FOR ADVANCEMENT. Pleasant, fascinating work, easy to learn and do. Learn quickly with these books—send coupon for a set and see for yourself.

[A year's consulting service now given to all buyers of this famous cyclopedia of drafting]

Be prompt and we will include a brand new circular slide rule to carry in coat pocket. Invaluable in solving all kinds of engineering problems.

AMERICAN TECHNICAL SOCIETY
Publishers—Home Study Courses.

**For Beginners
or Experts**

Written so you can understand every word, by well known engineers and architects. De Luxe flexible binding, nearly 2,000 pages, 1546 blueprints, charts and diagrams; prepares you for a good drafting job in mechanical or architectural lines. Sent for 10 days' free use if you mail coupon immediately.

**Slide
Rule
Included**



American Technical Society, Dept. D819, Drexel at 58th St., Chicago, Ill. Send for 10 days' trial, 5 volumes set of drafting. I will pay the delivery charges only. If I wish, I may return books in 10 days and owe you nothing, but if I decide to keep them, I will send \$2.00 after 10 days, then only \$3.00 a month until \$24.50, the total price is paid. Send latest edition and include slide rule and consulting Service Certificate.

Name.....
Address.....
Please attach letter stating age, occupation, employer's name and address and that of at least one business man as a reference.

TRAIN FOR A JOB IN ELECTRICITY the POWER Behind America's Defense Program



Quicker, Easier Way

Are you getting YOUR share of America's NEW PROSPERITY. Train NOW for one of the NEW jobs in Electricity created by our gigantic defense program and industrial expansion. Here at Coyne we train you in Electricity in 12 short weeks. You "Learn-By-Doing", not by books. Not a correspondence course. You learn aviation ignition, armature winding, power plant operation, house and factory wiring, etc. It's EASY TO LEARN. Previous experience or advanced education are NOT necessary. Don't let shortage of money stop you, for—

AN EXTRA
4 WEEKS
COURSE IN
RADIO
INCLUDED

**MAIL
COUPON
NOW**

I'll Finance Your Training

Get your training NOW... pay for it later, beginning 60 days after your training period ends. Part-time work if you need it to help pay your living expenses. Low-cost Board and Room Plan. Lifetime Employment Service. Mail coupon NOW for Big FREE Picture Book and all the facts.

H. C. LEWIS, President
COYNE ELECTRICAL SCHOOL
500 S. Paulina St., Dept. 80-72, Chicago

H. C. LEWIS, Pres., Coyne Electrical School
500 S. Paulina St., Dept. 80-72, Chicago, Ill.
Please send me your BIG FREE BOOK and all the facts about Coyne, and your plans to help fellows like me get ahead.

NAME.....
ADDRESS.....
CITY..... STATE.....

PARKS AIR COLLEGE

PARKS AIRPORT EAST ST. LOUIS, ILL.

Offers YOU COLLEGE and PROFESSIONAL TRAINING
Majoring in AVIATION

Accredited by the Illinois Superintendent of Public Instruction. U.S. approved as a Commercial Ground and Flying School and Mechanics' School. Accredited by and cooperating with the United States Army Air Corps in giving flight and mechanical training. Open to high school graduates.

FOUR courses lead to B.S. degrees in Professional Piloting, Aviation Operations, Maintenance Engineering, Aeronautical Engineering.

EIGHTEEN TRAINING PLANES are used in professional flight training which prepares graduates for airline flight operations. 76,000 hours flight training given, 2800 hours being flown monthly.

FACULTY of 46 specialists in various fields of aviation. 1569 graduates. Enrollment limited to a total of 300 commercial aviation students. Total enrollment 560.

100-acre airport, 28 buildings devoted to school purposes exclusively. Dormitories and dining hall at the College.

Winter Term January 6. Send postcard for new 64-page catalog.

14th YEAR Registrar, Dept. PM-11
PARKS AIR COLLEGE, East St. Louis, Ill.

ENGINEERING DEGREE IN TWO YEARS

B. S. Degree courses in engineering: Electrical, Civil, Chem., Mechanical, Radio or Aeronautical. 1 yr. Mech. Drafting. Approved by Civil Aeronautics Authority, participation in Pilot Training Program. Large industrial center. Prep courses without extra charge. Earn board if desired. Low tuition. Enter December, March, June, September. Write for Catalog.
5110 E. Washington Blvd., Fort Wayne, Ind.

INDIANA TECHNICAL COLLEGE

RADIO REPAIR HINTS

Learn how to test and fix all radio sets. Hundreds of service short-cuts for all circuits. Get this new 32 page Radio Book for only a dime. **10c**
Supreme Publications, 3727 W. 13th St., Chicago, Ill.

NEW WAY TO CHOOSE A CAREER

LET SCIENCE PICK A JOB FOR YOU! TODAY, getting a job or choosing a career is no longer a hit-or-miss task. Science can now accurately determine for you, in advance, just what type of work or profession you are best suited for. FREE Send your name on a penny postcard for FREE booklet explaining this new proven way to greater success. Vocational Guidance Associates, Dept. 111, Tucson, Ariz.

Learn CARTOONING

FREE TRIAL LESSON! Cash in on your sense of humor—AT HOME—BY MAIL. Have fun! Make money! No experience needed to start. Write today for FREE LESSON, mailed postpaid. No obligation.
Moon Gag-Cartoon School, Dept. A, Fall Creek, Wis.



TOOL & DIE MAKING MACHINIST

Acety & Arc Welding, Body & Fender Repair, Practical Shop Training. Michigan's Oldest & Largest Trade School. Unlimited training period without extra charge.
Wolverine School of Trades, 1408 W. Fort, Detroit, Mich. **FREE CIRCULAR**

AMAZING NEW ELECTRIC

ARC WELDER

RETAILS ONLY **\$2.95** COMPLETE
FULLY GUARANTEED



Amazing new HANDI-WELD Electric Arc Welder—operates from 110 volt A.C. or D.C. same as other arc welders higher priced—generates tremendous heat to weld all kinds of metal. Not a toy welder that uses carbons, but actually uses standard coated rods—sizes 1/16" and 3/32". Generous supply furnished with welder. Guaranteed not to burn out. Repairs fenders, auto bodies, radiators, pre-heated small castings and machinery parts. Take HANDIWELD anywhere to job, operate from light socket. Sturdily built of finest materials in last years. Fully guaranteed by Big Manufacturer.

SEND NO MONEY! You'll find a thousand uses for the HANDIWELD around your home, garage, work shop. Also by garages, factories, repair shops, mechanics, farmers, inventors, tin shops, plumbers, etc. Order HANDIWELD now. Send no money. We'll rush one to you, complete with rods and goggles. Pay post-weld in 5 days plus few cents postage. If not delighted, return HANDIWELD instantly. Rush your order now.
KUMFY PRODUCTS INC., Dept. K-202, Cincinnati, Ohio.

SENSATIONAL BURNER IMPROVEMENT

MAKES OIL BURN Just Like CITY GAS!



AT LESS THAN 1/2 THE COST

Produces HOT, CLEAN (White-Heat) FLAME

NOT like any oil burner you've ever seen. No noisy roar—no smoke—no soot—no clogged jets. DORTANE makes cheap oil burn as clean and hot as city gas, at one-third to one-half the cost. Slips into any wood or coal range—attached in few minutes—operated efficiently by anyone.

5 MODELS FOR ALL USES
SAFE No Gasoline No Explosive Oils

ALL THESE PROSPECTS Will heat stoves, ranges, urns, steam tables, grills, vulcanizers, water coils, ovens, griddles, pressing machines, tanks, etc.

WIDE OPEN FOR DISTRIBUTORS AND AGENTS
A sensational seller to homes and business men. BIG PROFITS for CITY DISTRIBUTORS and agents in rural communities.
FREE Don't lose a minute. All facts are FREE. Rush your name quickest way for book showing and describing all models Liberty Burners. No money. Just your name and address.
LIBERTY BURNER CO.
Dept. A1611, 620 N. Michigan Ave., Chicago, Ill.

GOV'T. JOBS

Men-Women, age 18-50. Start \$25 to \$40 weekly. Advancement opportunities. Thousands of U. S. vacancies yearly. Get ready now for your examination. Write immediately for valuable Free information. Ozment Instruction Service, 111-D, St. Louis, Mo. (Est. 1907—No salesmen.)

WELDERS WANTED!

ELECTRIC ARC—OXY-ACETYLENE
Skilled Welders earn \$8 to \$15 a day. The demand now greater than the supply. Learn this highly paid trade in 3 weeks by actual shop work. One of America's leading schools. Established 1902. 7 floors of shops. Endorsed by welding industry. Limited number of students. 3 weeks course in Electric Arc or Acetylene Welding, including room and board, only \$105. Write or wire for reservation. Ask for "Welding Facts." State age.
GREER COLLEGE, Dept. 1110, 2024 S. Wabash Ave., Chicago

DRUM YOUR WAY TO FAME AND FORTUNE!

Begin now to be a big-name drummer. A money-making career awaits you if you will plan now, today, to master the drum...it's easy, requires no long study, comes naturally. Start with a **GRETSCH DRUM**, chosen above all others by Bernie Mattinson and dozens of other star drummers. Lots of fun learning, easy to pay on liberal GRETSCH terms.

BERNIE MATTINSON with HORACE HEIDT

Send penny postcard for literature and FREE photograph of your favorite drummer; also full information about EASY-PAYMENT PLAN and FREE trial. Give street number; address Dept. PM 111.
The FRED. GRETSCH MFG. CO.
Musical Instrument Makers. Since 1883
60 BROADWAY, BROOKLYN, N. Y.

EASY TO PLAY * EASY TO PAY

GRETSCH also offers SUPER VALUES in Guitars, Saxophones, Trumpets, Trombones, Accordions. Send for FREE catalogue. Mention instrument.

LEARN AUTO MECHANICS

Authorities say there's greatest demand in history for TRAINED men. Good mechanics earn up to \$50 a week or more. Good practical training will fit you for a job that's waiting. Read how McSweeney-trained men make good. Hundreds of others will tell you facts equally as interesting. Don't look for a job! TRAIN for it!

8 weeks shop Course

No books, no lessons, the McSweeney practical way. First we show you, then you do the job yourself under competent instructors. You work on real equipment with real tools. Quickly you are TRAINED to hold down a permanent BIG PAY job. Any man 16 to 50 can learn. Write today for New Low Tuition Offer!

McSweeney Men Make Good!

Mesopotamia, Ohio
Dear Mac: After graduating, received job one week later in Lakewood at Willys-Knight Service. Three raises in the first year. At the end of 3 years, was assistant Service Manager. I quit at the end of 6 years to take a better job offered me in Canton, Ohio, at the Peerless Garage. Worked one year when I quit to go into business for myself. I still do most of my own service work. Your training along with practical work sure does help one in difficult problems.
—L. E. Bates.

Mt. Vernon, Ill.
Dear Mac: I am getting along fine. Have been working for the Oldsmobile dealer here in Mt. Vernon for fifteen months. I will have to give you credit for starting me out on the road to success. I feel that I owe you a debt that cannot be paid. Wishing you and all the boys the best of luck.—Loren Brown.

AVIATION & DIESEL COURSE!

Aviation is here! Each plane needs many mechanics on the ground. McSweeney's Auto Mechanical course is combined with Aviation and Diesel engine mechanical course.

LOW TUITION COST!

Learn Now and Pay for Part of Your Course Later!

In a few weeks of intensive training, actual shop work with real tools on real equipment qualify you to accept a Big Pay Job as a mechanic.

FREE! Write today for Big Free Book on AUTOS, AVIATION, DIESEL. Get the facts about jobs, and Low Tuition Offer. Mailing the coupon does NOT obligate you. It obligates ME to tell YOU how you can train for Big Money in a few weeks! WRITE TODAY!

McSWEENEY SCHOOLS

AUTO - AVIATION - DIESEL WELDING - BODY & FENDER
DETROIT, MICH. Address Your Nearest School KANSAS CITY, MO.

Mail Coupon for Free Book NOW!

McSWEENEY SCHOOLS, DEPT. 5-7.
Without cost or obligation, send me your BIG FREE BOOK on Autos, Aviation, Diesel Mechanics, etc., also full information about your Low Tuition Offer.

NAME.....
STREET.....
TOWN.....STATE.....AGE.....

Say you saw it in Popular Mechanics!



MACHINE SHOP MEN

Learn to set up and run ANY kind of machine; MAKE MORE MONEY NOW by learning quickly HOW TO DO THINGS which usually take years of study and practice. The demand for SKILLED men is ALREADY ahead of the supply, then what WILL IT BE a month or two from now?

Needed NOW!

Bigger Pay Don't miss this chance to qualify for promotion, don't miss this Big Opportunity which is yours almost for the asking. Eight Big Books chockful of important mechanical facts told simply and clearly. Over 3000 pages, nearly 3000 illustrations cover every subject fully, including Tool Making, Pattern Making, Foundry Work, Mechanical Drawing, Forging, Machine Shop Practice and Management, and hundreds of other subjects.

8 Big Books (1940 Edition) Sent FREE to you for examination. With them we send a Big Binder of nearly 800 pages with 267 original shop tickets with 1200 illustrations. These show, step by step, how to set up and run almost any kind of job and are in addition to the 8 books. Decide in your own home or place of business whether or not you want to keep them, check up on any facts you want to. Note their great MONEY MAKING value, then, if you want them, pay on the easiest kind of payments. Send NOW and we will include a year's consulting service without extra charge.

American Technical Society, Publishers—Home Study Courses.

American Technical Society, Dept. 5819, Drexel at 58th St., Chicago. You may send me the 8 big NEW books and binder of shop tickets for free examination. I will pay the delivery charges only, unless I decide to keep them in which case I will send \$2.00 in ten days and \$3.00 per month until the total price of only \$34.80 is paid. If I return them in 10 days I will owe you nothing. Because I send now you agree to give me a certificate entitling me to consulting privileges with your experts for one year.

Name

Address
Please attach a letter stating age, occupation, employer's name and address and that of at least one business man as reference.



Know Electricity as Experts Know It—and Get an Expert's Pay!

What about your future? Who is safe today? Surely not the man who is contented to stand still! Know your job thoroughly—prepare yourself for jobs ahead. To do just this thousands of men have used

The Croft Library of Practical Electricity

The Croft Library is a complete electrical educator. It is founded on practice—on 20 years of shirt-sleeve experience—on work as it is actually done. It is jammed from cover to cover with the kind of hard-headed facts you want. Written so that the beginner can easily understand it, yet so sound, so thorough, that it is the daily guide of 50,000 highly paid electrical workers and engineers. Croft tells you the things you need to know about motors, generators, armatures, commutators, transformers, circuits, switchboards, distribution systems—electrical machinery of every type—illumination in its every phase—the most improved methods of lighting—lamps and lamp effects, etc.—how to do a complete job, from estimating it, to completion.

**6 volumes, 2155 pages—New low price
No money down—Easy payments.**

Fill in and mail the coupon attached and we will send you the entire set of six volumes for ten days' Examination on approval. We take all the risk—you assume no obligation. If you decide to keep the books, send \$1.50 in ten days and the balance at the rate of \$3.00 a month. Send the coupon NOW and see the books for yourself.

EXAMINATION COUPON

McGraw-Hill Book Co., 330 W. 42nd St., New York, N. Y.

Send me for ten days' examination on approval the Croft Library of Practical Electricity. If satisfactory I will send you \$1.50 in 10 days and \$3.00 monthly until the price of \$16.50 is paid. If not wanted, I will return the books postpaid. (To insure prompt shipment write plainly and fill in all lines.)

Name
Home Address
City and State
Position
Name of Company PM-11-40

Learn to Mount BIRDS

SEND FOR FREE BOOK!

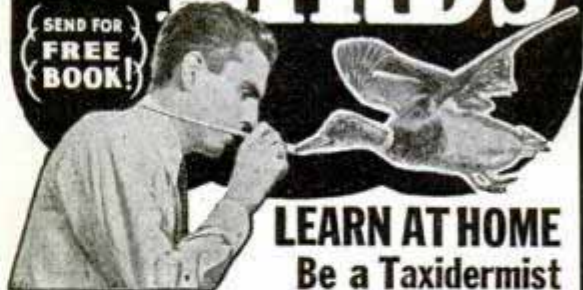

LEARN AT HOME Be a Taxidermist

Real FUN, great Hobby, sure spare-time profits. Save your hunting trophies. Mount BIRDS, ANIMALS, HEADS, FISH, TAN furs and hides. Mount common specimens into fine groups. Wild-game not needed. Easily, quickly learned. Investigate!

FREE BOOK Yes FREE. 100 pictures. Tells how YOU can be a Taxidermist, make a home museum, have fun and PROFIT from your HOBBY. Old reliable school, 250,000 successful students. Students earn BIG PROFITS mounting specimens for others. This strange FREE BOOK will interest and amaze you. Nothing like it—Send TODAY—this MINUTE—for YOUR Free copy. State your AGE.

N. W. School of Taxidermy, 3378 Elwood Bldg., Omaha, Nebr.

U.S. GOV'T JOBS

SHORT HOURS-GOOD PAY -VACATIONS-PENSIONS

Stop worrying about strikes, layoffs, hard times! Get on the government payroll. No special education or experience usually required. Short hours; steady work; vacations. Open to men and women citizens, of ages 18 to 50.

SEND FOR FREE BOOK

It tells about government positions; what to do to get job you want. Mail letter or postal card now for FREE book "How to Secure a Government Position". Address PATTERSON SCHOOL, 811 Mercantile Bldg., Rochester, N. Y.

RAILWAY POSTAL CLERK

Start at \$1850 a year

INSPECTOR OF CUSTOMS

Start at \$2100 a year

RURAL MAIL CARRIER

Start at \$1800 a year

POST OFFICE CLERK

Start at \$1700 a year

Learn AUTO-DIESELS

Practical, tested training. Backed by 35 years experience. Course includes Auto Mechanics, Diesel Service and Operation, Diesel Power Generation, Machine Shop Practice, Auto Electrics, etc. Flexible plan to meet specific needs of those with or without jobs. Oldest, largest trade school in West qualifies you and helps you get a good pay job. Transportation allowed to L. A. Earn room and board while learning. Request Free Catalog.

NATIONAL SCHOOLS Dept. PMA-11
Los Angeles

Learn ADVERTISING at Home

Greater opportunities now in advertising. Learn easily and quickly in spare time. Practical work. No text books. Old established school. Low tuition—Easy terms. Send for free booklet and requirements.

Page-Davis School of Advertising
Dept. 1358, 3601 Mich. Av., Chicago

TOOL & DIE MAKING DESIGNING

Machinists Trade, Machine Drafting and Design. Practical shop training in the world's industrial center. Write today for full information.

Dept. 23 NATIONAL SCHOOL OF MECHANICAL TRADES
628 W. Lake St. Chicago, Ill.

MONEY IN RABBITS—CAVIES

WE BUY and put you in touch with other markets. Catalog and copy of magazine 10c. Or send 25c for Book Catalog and Price List and Year's Subscription to the AMERICAN SMALL STOCK FARMER.

OUTDOOR ENTERPRISE CO., BV 919, PEARL RIVER, N. Y.

In answering advertisements always write name and full address clearly.

MAKE POULTRY PAY YOU A GOOD LIVING FOR LIFE



POULTRY RAISING PAYS GOOD PROFITS FOR THOSE WHO KNOW ITS SECRETS

Healthful, interesting occupation for whole or part time in country, village or city suburbs. Open to young and old. Win independence of low wages, uncertain employment, uncongenial labor, with a Poultry Business of your own.

PROVED METHODS BRING SUCCESS FROM START

Harry M. Lamon, nationally known Poultry Expert, former Senior Poultryman U. S. Dept. of Agriculture, quickly trains ambitious men and women for Poultry Success from start. His famous Home Study System, endorsed by thirty leading Agricultural schools. Fascinating study, easy to learn, complete in every detail, shows valuable success secrets used by leaders, how they avoid losses. How to start in small way. Make business grow from sale of Poultry, Eggs and Baby Chicks. Big, ever increasing demand. Or prepare for a good job in large poultry plant. Established nearly twenty years—a multitude of graduates attest the success of his time-tested methods.

Mr. Lamon has prepared a big 32-page book "How To Raise Poultry for Profit", chock full of money-making poultry facts. He offers to send it Free to anyone interested in learning the splendid money-making opportunities in Poultry Raising. If you are "not sure" on your future, send for this Free Book today.

Address: Harry M. Lamon, President, NATIONAL POULTRY INSTITUTE, Dept. 50-Q, Adams Center, N. Y.

FREE BOOK TELLS HOW

A multitude of poultry-raisers large and small are making money in this most interesting and profitable occupation.

Whether you have ever kept chickens or not—whether you have ten hens or ten hundred, you should read this FREE BOOK. It's yours for the asking.



Your Place in Aviation... SPARTAN SCHOOL OF AERONAUTICS



Come to SPARTAN for today's finest expert training for your choice of aviation careers—Flying, Engineering, Mechanics, Radio. Approved by U. S. Civil Aeronautics Authority. 15 modern airplanes, latest aircraft engines; completely equipped shops, laboratories—private practice fields; 22 modern buildings; club-like dormitories. \$350,000 expansion program making SPARTAN even greater. *New semester starts January 6th. Write for free catalog.*
CAPTAIN MAXWELL W. BALFOUR, Director
Dept. PM-110 Tulsa, Oklahoma

Landscaping is Profitable

Fascinating career or hobby for men and women. Interesting profession. Learn at home in spare time. Send for free booklet "Success Thru Landscape Training." Give age, occupation.
American LANDSCAPE School, 6199 Grand Ave., Des Moines, Iowa.

Learn Public Speaking At home—in spare time. Many overcome "stage-fright," gain self-confidence and increase earning power, this easy way. Write for free booklet, *How to Work Wonders With Words* and requirements.
North American Institute, Dept. 1358
3601 Michigan Ave., Chicago, Illinois

EVERYDAY LAW & EVERYDAY MATHEMATICS

Two unusual books you must have. Saves time, money, worry. Written in simple language. Easily understood. Quick reference material and practical help to everyday problems. Ideal for home study and preparation for better position and better pay ONLY 50c each postpaid. (Agents wanted) Special attractive discounts for quantity orders.
EVERYDAY PUBLISHING Corp., 11 West 42nd St., New York, N.Y.

LEARN MONEY-MAKING CARTOONING

Same Simplified Method that has helped train creators of "Terry & Pirates," "Wash, Tubbs," "Out Our Way," "Winnie Winkle," "Regular Fellers," "Steenie As It Scans," "Secret Agent X-9," and many others. Earn while learning. Rush 10c for Picture Chart (to test your ability) and full details. (State age.)
THE LONDON SCHOOL, 13-N National Bldg., Cleveland, Ohio

STUDY ENGINEERING AT HOME

Earn a Degree at Home From A Chartered Institution of Higher Learning Employers Demand Degree Men For Key Positions
88 Degree Courses in Electrical, Civil, Mechanical, Drafting, Architectural, Automotive, Steam, Diesel, Aeronautical, Radio, Structural, Mining, Industrial, Highway, Petroleum, Marine, Refrigeration, Air Conditioning, Chemical Engineering; Arts; Sciences; Philosophy, Education; Public Health; Medical Jurisprudence; Psychology; Sociology; Physics; Chemistry; Geology; Pol. Science; Theology; Law; Agriculture; Business Training; Accounting; Statistics. Founded 1908. Chartered.
McKinley-Roosevelt Graduate College, 4610-R Sheridan Road, Chicago

IMPORTANT Message To INVENTORS

We Will Send You Our FREE BOOKLET

"IMPORTANT PATENT FACTS FOR INVENTORS"

and INVENTION RECORD FORM

Our laws favor the inventor who makes a dated record of his invention, and who is diligent in filing his patent application.

You owe it to yourself, if you value your invention, to make an accurate, dated, and witnessed record of your invention, and then take steps to apply for a patent just as quickly as possible.

PERSONAL SERVICE

Hence, our service can be important to you: As soon as you write us, we send, by return mail, an "Invention Record" form for you to fill out. And then, when you return it to us, our prompt and personal service begins: We personally direct the search of the Patent Office Records. Personally report to you. Personally supervise the preparation and filing of your application and the handling of your case. There is no lost motion, no lost time.

PATENT AND SELL YOUR INVENTION

We handle your case skillfully and thoroughly with a view to securing the best possible patent for you—giving you the full benefit of our training as patent attorneys and our years of experience serving hundreds of inventors. We make personal calls at the Patent Office when required. And beyond this, we will endeavor to give you useful hints and suggestions on selling your invention.

WRITE US TODAY...

When your invention comes to us it is strictly confidential. All correspondence is handled personally by us. We take a personal interest in your success, so you can write us fully.

IMPORTANT TO GET STARTED RIGHT

Know how the laws protect you, and what steps to take. We will send you Complete FREE Booklet "Important Patent Facts for Inventors", and FREE "Invention Record" Form. Write us, or mail this coupon today—McMorrow and Berman, Registered Patent Attorneys.

MAIL COUPON NOW

McMORROW & BERMAN REGISTERED PATENT ATTORNEYS

135-B Barrister Building Washington, D. C.

Name

Address

City..... State.....

Write or Print Name Clearly

When writing please mention Popular Mechanics

YOU CAN BECOME A MONEY-MAKING RADIO EXPERT

WITH THE **New SPRAYBERRY**

Personalized
HOME TRAINING in

RADIO
and
TELEVISION



You Learn Easily in Your Spare Hours . . . By Doing Many Experiments with Up-To-Date Equipment

Here's a really fine, up-to-the-minute Radio and Television Training that's specially designed to give you quick results.

Training Prepares You For Good Radio Jobs... at Excellent Pay

My training starts right at the beginning of Radio . . . unfolds each subject in a simplified, logical, understandable style. You easily learn Television, Electronics, Facsimile Radio, Radio Set Repair and Installation Work, etc.

I Supply

146 RADIO PARTS



RADIO TOOLS



ALL PURPOSE ANALYZER



No Previous Experience Needed

It makes no difference what your education has been. I can fit you for a good-paying Radio job. Your success is my full responsibility.

Get Your Professional Test Equipment Plus Experimental Outfits

. . . Includes 146 Radio Parts (to build complete Receiver), Tools, All-Wave, All-Purpose Analyzer, and Experimental Outfits for conducting actual experiments with your own hands.

Earn While You Learn

My **BUSINESS BUILDERS** show you how to put your Equipment to practical use in handling actual money-making Radio Service Jobs shortly after you begin training.

The Sprayberry Course is Sold Under a Money-back Agreement



RUSH COUPON for BIG FREE BOOK

Sprayberry Academy of Radio
F. L. Sprayberry, President
310-L University Place, N. W., Washington, D. C.
Please rush me FREE copy of
"HOW TO MAKE MONEY IN RADIO"

Name.....Age.....
Address.....
City.....State.....
(Mail in envelope or paste coupon on penny postcard)



It's Easy To Be A Contractor

Learn to estimate, to plan buildings, to take contracting jobs, and make money on them. Here are 9 up-to-the-minute books on building, estimating, and contracting which cover in an interesting way, the subjects that carpenters, builders, and contractors should know to make the most out of their jobs. Roof Framing, The Steel Square, Architectural Drawing and Design, Estimating, Painting and Decorating, Heating, Air Conditioning, Building, Contracting, Concrete Forms and other subjects are all well covered.

"Boss" Carpenters in Demand NEW 1940 EDITION

Vast public works jobs, immense projects, and the rapid growth of home building, are making jobs for **MEN WHO KNOW HOW**. These books give you quick training. With them you shouldn't be afraid to tackle any job, for needed facts can be found in a hurry.

These books are the most up-to-date, complete we have ever published on these subjects.

Coupon Brings Nine Books FREE For Examination

AMERICAN TECHNICAL SOCIETY (Publishers—Home Study Courses)
Dept. G819, Drexel at 58th Street, Chicago, Illinois

You may ship me the new 1940 edition of your nine big books, "Building, Estimating, and Contracting" without any obligation to buy. I will pay the delivery charges only, and if fully satisfied in ten days, I will send you \$2.00, and after that only \$3.00 a month, until the total price of only \$29.80 is paid. I am not obligated in any way unless I keep the books.

Name.....
Address.....
City.....State.....

Please attach a letter stating your age, employer's name and address, and that of at least one business man as a reference.

EASY to play

With an easy playing Conn band instrument, you can be ready for band or orchestra in 4 to 6 weeks. A sure road to popularity if you start on a Conn. Choice of the world's greatest artists. Magnificent tone. Many exclusive features—yet they cost no more.

Ask to see the marvelous new models now being displayed by Conn dealers.

WRITE FOR THIS NEW FREE BOOK

Home trial. Easy payments. Write us for free book on whichever instrument interests you most. Mention instrument.

C. G. CONN, LTD., 1131 CONN BLDG. ELKHART, IND.

CONN
BAND INSTRUMENTS

MAKE BIG PROFITS

Recapping or retreading with Miller's latest improved convex' shoulder full circle molds. By using Miller's patented collapsible rims and flat base curing tubes one mold handles 10 to 20 tire sizes. Furnished for steamline or with boiler. Model 29 handles 70% of the pleasure car tires, complete for steamline \$288.00.

Write or wire for catalog of tire shop equipment and supplies.

C. E. MILLER MFG. CORP.
DEPT. M Anderson, Indiana, U. S. A.

OPTOMETRY

Be a Doctor of Optometry. An uncrowded profession. Excellent faculty. Not operated for profit. Limited classes. Unexcelled clinical facilities. High School education required. Coeducational.

Monroe College of Optometry, 164 N. Wacker Dr., Chicago, Ill.

EARN THE DEGREE

Doctor of Psychology (Ps.D.), Divinity—others. General Courses in Science, law, business, etc. Incorporated in state of Washington. Send for 32-page FREE Bulletin at once. No Obligation.

TEMPLE BAR COLLEGE, INC., (A Correspondence Institution)
Dept. 3-R, 1411 Fourth Avenue, Seattle, Washington, U. S. A.

LEARN CARTOONING!

Let an internationally famous cartoonist teach you this WELL PAYING—fascinating profession. PERSONAL instruction by mail. Recommended by America's foremost cartoonists. Send for FREE booklet. (State age)

DORMAN H. SMITH, Box C597, San Rafael, Calif.

EXPERT PHOTOGRAPHY MADE EASY

Successful photography as a career, for sparetime earnings or as a hobby—made easy through N.Y.I. Training! Personal coaching by leading photographers. Fascinating field. Splendid opportunities. Commercial, News, Portrait, Motion Picture, Advertising and Color Photography. Personal Attendance and Home Study Courses. Booklet FREE!

N. Y. INSTITUTE OF PHOTOGRAPHY
Dept. 49, 10 West 33rd St., New York, N. Y. (30th Year)



A NEW CEILING
with the Stratoliners

A NEW Success CEILING
FOR THE AERO ITI-TRAINED MEN
BUILDING THESE GREAT TRANSPORTS

Like these fellows, how pleased you would be to have won your start in Aviation with training that gives YOU a new "ceiling"... for success. Aero ITI courses in Aeronautical Engineering and Aircraft Mechanics equip you with the broad, diversified knowledge and abilities to merit steady advancement... to enjoy security... to go farther in Aviation. Aviation is calling YOU, too. Answer its call with THIS kind of training. Get complete information on Aero ITI courses for aircraft work as a lifetime career. Write NOW.

EXECUTIVE BOARD
JOHN K. NORTHPROP
President, Northrop Aircraft, Inc.
ROBERT E. GROSS
President, Lockheed Aircraft Corporation
C. A. VAN DUSEN
Vice-Pres., Consolidated Aircraft Corporation

AERO INDUSTRIES TECHNICAL INSTITUTE
 5253 WEST SAN FERNANDO ROAD, LOS ANGELES, CALIFORNIA
 Five Courses in AIRCRAFT MECHANICS and AERONAUTICAL ENGINEERING—Including 12 Month Aircraft Mechanics Course
 Approved by U. S. Civil Aeronautics Board

FREE BARGAIN CATALOG of BOOKS

25,000 books of all publishers listed in our 46th Annual Bargain Catalog of 320 pages. Old-time favorites—latest "best sellers." Reference, Fiction, Juvenile, History, Scientific, etc. Supplying schools, colleges, libraries and thousands of individual customers. Send postcard today for our new 1941 catalog, "Bargains in Books."
THE BOOK SUPPLY COMPANY, Dept. 132
 564-566 West Monroe Street, Chicago, Illinois

AUTO-MECHANICS & WELDERS

Auto Mechanics and Welders are in big demand. Complete courses in arc and acetylene welding, body and fender bumping, spray painting and metal finishing. Pay after graduation plan. Special low rates. Write today.
MICHIGAN TRADE SCHOOL
 3758 Woodward Ave., Detroit, Mich.

Write for **FREE CIRCULAR**

Earn Cash at Home!

We paid M. M. \$1174 for exceptional cellar crop Snow-King mushrooms! We furnish materials; buy all crops. Big FREE picture book tells if your cellar, shed, barn, suitable. Est. 1908. Write today.
 United Co., 3848 Lincoln Av., Dept. 306, Chicago

AGENTS 300% Profit SIGN LETTERS

For Store Fronts and Office Windows. Anyone can put them on. Free Samples. Liberal Offer to general agents.
METALLIC LETTER CO., 438 N. Clark St., Chicago

Best Poultry Paper 6 BIG ISSUES 10¢

Helps increase Poultry Profits. Send coin or stamps, 50 cents for 3 years or 10 cents for 6 months trial. Agents wanted. American Poultry Journal
 532 So. Clark Street Chicago, Illinois

Prepare NOW for PROMOTION



This complete drawing outfit,—everything to work with,—including drafting table, drawing board, supplies and drawing instruments,—ALL SENT TO YOU AT NO EXTRA COST if you are a Chicago Tech student.

MAIL COUPON BELOW

DRAFTING

The draftsman's work comes first. New machines,—new construction work,—new bridges,—new buildings,—all must first be laid out on paper by the draftsman. So the first man that must be hired is the draftsman.

Drafting Offers Opportunity

In the machinery and building fields,—in aircraft,—in diesels and air conditioning,—and in many other industries, Drafting offers real opportunities for promotion. It is one of the steadiest employment fields. Drafting is clean, interesting, well-paid and important work. Find out now what Drafting offers you!

In Spare Time,—at Home!
 (or at the College in Chicago)

With our easy step-by-step lessons, (and the tools we furnish), you can learn in your spare time at home. To prove to you how easy it is to learn Drafting by the Chicago Tech Method we'll send you a Trial Lesson FREE. No charge for this lesson either now or later. Send a post card or the coupon now for

FREE TRIAL LESSON

Free TRIAL LESSON
 Send Coupon

CHICAGO TECHNICAL COLLEGE
 Member National Home Study Council

P-201 Tech. Bldg., 118 East 26th St., Chicago, Illinois

Please send me **FREE Trial Lesson in DRAFTING** showing how to learn at home by C. T. C. plan. No obligation of course.

Name.....
 Address.....
 City..... State.....
 Occupation..... Age.....

PATENTS

Booklet Free Highest References
Promptness Assured Best Results

Send drawing or model.

ALL BUSINESS GIVEN PROMPT AND PROPER ATTENTION

Listed Patent Lawyer in the latest editions of the Rand-McNally Directory of Bankers and Bank-Recommended Attorneys, published by Rand-McNally & Co., Chicago, Ill.; American Lawyers Annual, Cleveland, Ohio; Bankers Service Legal Directory, published by Bankers Service Co., Boston, Mass.; and the Snow-Church Directory Co. Lawyers List, published in New York City.

WATSON E. COLEMAN,
REGISTERED PATENT LAWYER

Victor Building, 724 Ninth Street, N. W.
WASHINGTON, D. C.

INVENTORS PATENT YOUR IDEAS SEND FOR FREE BOOK



HOW TO OBTAIN A PATENT

Written by a Former Member of the Examining Corps (1922-24) of the U. S. Patent Office. If you want to profit by your idea, you should take steps to apply for a U. S. Patent at once. Your first step is to get this Free Book. This interesting illustrated book contains valuable information you should have. It tells you fully how to obtain a patent on your idea in the quickest way. With this Free Book you will also receive a "Record of Invention" form on which you can easily record your idea. Personal and Confidential Service: Your case will be personally handled only by a Registered Patent Attorney who is also a Former Member of the Examining Corps of the U. S. Patent Office. All communications confidential.

MAIL COUPON TODAY for FREE PATENT BOOK and RECORD OF INVENTION Form.

CARL MILLER

REGISTERED PATENT ATTORNEY
FORMER MEMBER EXAMINING CORPS U. S. PATENT OFFICE

Woolworth Bldg., 35th Floor, Dept. 110-A, New York City
MILLER BUILDING, Dept. 110-A, WASHINGTON, D. C.

Please send me your Free Book, "How to Obtain a Patent," and your "Record of Invention" form.

NAME

ADDRESS

BENJAMIN AIR PISTOL WITH HAND PUMP



For Target—Small Game—Camping—Etc. Guaranteed—Accurate—Practical—Economical—Safe—Clean—Quiet. Adjustable Force—Amazing Maximum Velocity. No Smoke or Fumes. Bolt Action—Hammer Fire—Hair Trigger—Safety Lock—Hand Pump. Single Shot \$8.50; Single Shot cal. 177 or 22 with rifled barrel \$8.50; BB 8-Shot \$10.00; Holster \$2.00. Also a complete line of Benjamin Genuine Compressed Air Rifles for BB and cal. 177 or 22. No license required from dealer or factory. Write today for complete specifications and free targets.

BENJAMIN AIR RIFLE CO., 890 Marion St., St. Louis, Mo., U. S. A.

PATENTS—TRADE MARKS

All cases submitted given personal attention
Form "Evidence of Conception" with instructions
for use and "Schedule of Government
and Attorneys' Fees"—FREE!

LANCASTER, ALLWINE & ROMMEL
Patent Law Offices

412 Bowen Bldg. Washington, D. C.

New Ideas now Salable Before Patenting

Practical, useful inventions may now be safely marketed without patenting expense. Write us for particulars, if you have an unpatented (or patented) idea for sale.

Chartered Institute of American Inventors
Dept. 4, Barrister Building, Washington, D. C.

INVENTORS who derive largest profits know and heed certain simple but vital facts before applying for patents. Our book, Patent-Sense, gives those facts; sent free. Trade Marks—Copyrights.
LACEY & LACEY, Est. 1869, 635 F St., N. W., Dept. 5, WASHINGTON, D. C.

ALBERT E. DIETERICH

PATENT ATTORNEY

Register No. 5669

SUCCESSOR TO FRED G. DIETERICH & CO.
Former Member Examining Corps, U. S. Patent Office
511-B COLORADO BUILDING WASHINGTON, D. C.
Booklet on patents sent free on request.

PATENTS—TRADE MARKS

Former Examiner U. S. Patent Office

LAWRENCE L. COLBERT

402 Barrister Bldg., Washington, D. C.
545 Fifth Ave., New York City

INVENTIONS MANUFACTURED AT LOW COST!

Inventions manufactured in any size, any shape, any quantity, by old established (36 years old) reputable company. (No branches anywhere). Also developing, designing, engineering, modelmaking, stampings, metal specialties, dies, models, etc. FREE estimates. FREE catalog giving "inside" information. Write today.

CRESCENT TOOL CO., DEPT. V-A, CINCINNATI, OHIO



BUCHSTEIN'S FIBRE LIMB

Soothing to stump, cool, light, strong.

Correct fit. Braces for all

deformities. Fair terms.

D. BUCHSTEIN CO.

610 3rd Ave. South, Minneapolis, Minn.



FOR COMFORT

1755 HELPFUL BOOKS

A GUIDE TO SUCCESS AND ADVANCEMENT
This attractive, 128-page book will not only give you the help you need in seeking personal advancement, to get a better job, to start a small business of your own, but full information on trades, professions, opportunities, crafts and hobbies. This big catalogue, just off the press, lists more than 1,700 bargain books on popular subjects and over 400 plans. It will prove invaluable to you. Don't miss it! Send three cents today to

POPULAR MECHANICS PRESS

DEPT. 1140, 200 EAST ONTARIO STREET, CHICAGO, ILL.



To PROTECT YOUR INVENTION—Use this coupon, NOW

Delays are dangerous and may be very costly. My personal service assures prompt action, strict confidence, and a minimum of expense. I suggest that you send me a model or drawing, or sketch and description of your invention, and \$5.00. I will make a search and report

promptly as to its patentability and send you a copy of my 72-page booklet. Or, if you prefer to read my booklet first, mail the attached coupon at once. I will also send my "Record of Invention" form. (Over 38 years experience as a Registered Patent Attorney.)

L. F. Randolph, 302-D Victor Bldg., Washington, D. C.

Please send me at once, free of charge, your 72 page booklet and "Record of Invention" form.

Name

Address

A PERSONAL CONFIDENTIAL PATENT SERVICE

Turn SCRAPS into MONEY

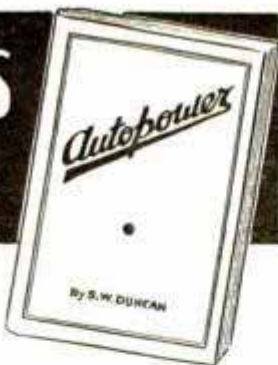

NEW USES FOR AUTO GENERATORS. RELIABLE, CONVENIENT HOUSE CURRENT FOR YOU IN THE HOME, CAMP, OR BOAT. BRILLIANT LIGHTS, RADIO YOU WILL ENJOY, TOASTERS AND APPLIANCES.

AUTOPOWER shows you how to make alternating and direct current generators and motors from automobile generators. These changes make the generators adaptable to uses such as WELDING, LIGHT, POWER, SOUND TRUCKS, GRINDERS, RADIO, PUBLIC ADDRESS, MOVIES, BOATS, etc.

The generators can be driven by the fan belt of a car, wind propellers, water wheels, or various types of engines. Complete instructions for building water and wind power plants, A. C. welding transformers, soldering pliers, portable grinders, electric eye, and heavy duty D. C. welders. It also includes hundreds of electrical definitions, questions and answers that will make this or any other electrical book easily understood. No previous experience or special tools are needed to make these simple reliable devices.

START TODAY IN THIS NEW AND INTERESTING FIELD OF TURNING SCRAP INTO MONEY. Price \$1.00.

POPULAR MECHANICS PRESS

200 E. Ontario St. Dept. 1140 Chicago



A BIG-PAY JOB AWAITS YOU

Industry demands more draftsmen and designers. Salaries of \$175 to \$375 per month and up offered to men who qualify. Train for one of these High-income jobs in your spare time. No experience needed. Step-by-step lessons. Complete, Practical Training. Prepare yourself under the direction of former Ohio State Univ. and Capital Univ. faculty member. No useless theory. Instruments furnished. Act Today! Learn how to get a salary boost by writing for free catalog.

OHIO INSTITUTE OF TECHNOLOGY
Room 11-M, Greenville, Ohio

Auto-Diesel

Master a real trade. Auto Mechanics, Diesel Mechanics, Arc Welding, Acetylene Welding, etc. Let us train you to be an expert Auto-Diesel Mechanic and help you get a good job. The cost to you is reasonable. Learn on modern equipment with tools under experienced instructors. Real shop work. Steam heated buildings. Room and board in our steam heated dormitory. We pay your fare to Nashville. For free catalog write

Nashville Auto-Diesel School, Dept. 75 Nashville, Tenn.

U. S. GOVERNMENT JOBS

Railway Postal Clerks



Many Other Government Jobs
Mail Carriers—Clerks—Assistant Messengers—
Post Office Clerks—Stenographers, Etc.

INVENTORS

these Free Books tell

How To Protect And To Profit From Your Ideas • How You Can Save Time and Money

• Right now is the time for you to take the first steps to protect your ideas — and this costs you nothing! C. A. Snow & Co. can save you time and expense by giving you advice based on 65 years' experience. If you want competent, professional advice and service, mail the coupon now for our free books on patent facts and special "Certification of Invention" form.



MAIL NOW FOR FREEBOOKS

C.A. SNOW & CO.

Registered Patent Attorneys Since 1875

Dept. 1011 SNOW BUILDING, WASHINGTON, D. C.

Gentlemen: Please send me absolutely free and without obligation on my part, your original document "Certification of Invention" together with your two guides for Inventors, "How We Protect You" and "Suggestions On How to Commercialize Your Invention."

Name.....
Street and No.....
City or Town..... State.....

EASIEST

OF INSTRUMENTS TO PLAY

... yet Richest in Opportunity

Why be just one of the crowd? Enjoy the thrill of the spotlight, the praise of friends, the lifelong pleasure of creating your own music. It's easy with the Deagan Marimba, fastest-growing instrument in the music world today. The ideal home instrument—in demand at dances, clubs, radio stations, etc.—and yet easiest of all instruments to play. Models and terms to suit every budget. Convincing FACTS on request—write for them today!



J. C. DEAGAN Inc. DEPT. 4458, CHICAGO

START

\$1260 to \$2100 Year

Mail Coupon Before You Lose It

FRANKLIN INSTITUTE, Dept. J195,
Rochester, N. Y.

Sirs: Rush to me without charge—copy of 32-page book, "How to Get U. S. Government Jobs," with list of positions and full particulars telling how to qualify for them.

Name.....

Address.....

The *NEW* OPPORTUNITY in .. ACCOUNTING ..

—and how *YOU* can take advantage of it

NEVER before, has there been as great an opportunity as now faces efficient bookkeepers and accountants.

You know, of course, that accounting has always been a profession of outstanding opportunity—a field in which the capable, trained man could go faster and farther than in almost any other field. But we believe that all past opportunities are going to be surpassed in the next five years.

And here's why:

In the first place, every firm will watch its accounting as never before. This depression has taught executives the vital necessity of knowing all the facts about their business, where their company stands all the time.

Then our governmental policy—forces the keeping of better and more complete records in every office and plant. It will not be a matter of choice with any firm—it will be necessity.

For instance Federal Securities Act, with its insistence upon publicity of *complete* facts about every company selling its securities publicly, compel more frequent and more accurate financial statements—and these in turn call for more and better accounting.

Then the Social Security tax, the unemployment regulations, the Wages and Hour Act, and the new taxes bound to come with the national defense measures—all center around more complete accounting records.

And as business gains momentum, there will be a greater demand for trained bookkeepers and accountants—they will go back to work sooner and in larger proportion than any other group—in fact, accountants tell us the demand will probably soon exceed the supply.

Ask for the Facts

We need not tell you what that means in opportunity for the capable man already in accounting and for the able man who gets into accounting now. Nor need we argue for the practicality and value of LaSalle training in Accountancy—over 500,000 men and women, and 1,800 C. P. A.'s have already tested and proved that.

The only question is about *you*—whether you fit into this field and whether you can and will prepare yourself adequately. For accounting is no magic wand to summon success—it demands much from

the man whom it rewards highly.

You can answer that question wisely only when you know the facts. And the coupon below will bring you full facts about these demands and opportunities in accounting today together with the details about the LaSalle home-study training in Accountancy.

If you are dissatisfied with your present situation—and in earnest about achieving success—get the facts—use the coupon—**NOW**.

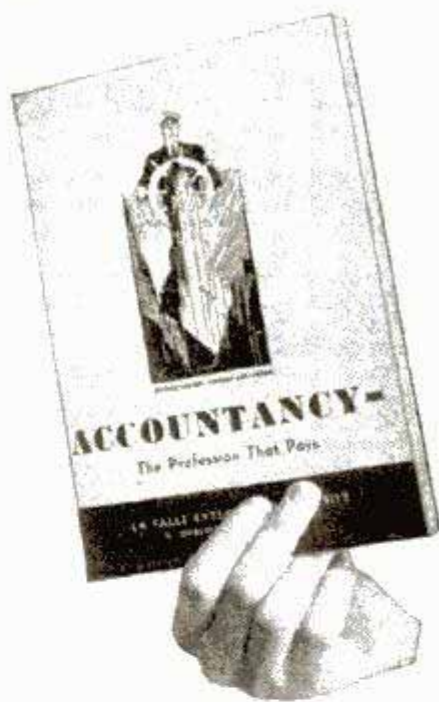

I'd like to see whether I should take up accountancy. Send me—without obligation or cost to me—your booklet *Accountancy, the Profession That Pays*, and full information about your Accountancy training program.

Higher Accountancy

**LASALLE
EXTENSION
UNIVERSITY**

Dept. 1164-HR, Chicago
**A CORRESPONDENCE
INSTITUTION**

Other LaSalle Opportunities:

If more interested in one of the fields indicated below, check and mail now.

- | | | |
|--|---|--|
| <input type="checkbox"/> Business Management | <input type="checkbox"/> Commercial Law | <input type="checkbox"/> Business Correspondence |
| <input type="checkbox"/> Modern Salesmanship | <input type="checkbox"/> Modern Bookkeeping | <input type="checkbox"/> Business English |
| <input type="checkbox"/> Law - Degree of LL.B. | <input type="checkbox"/> C. P. A. Coaching | <input type="checkbox"/> Stenotypy |

Name.....Age.....

Present Position.....

Address.....

**WORLD'S
BEST
WANT AD
MEDIUM**

CLASSIFIED Advertisements



Advertisements in this section, 35 cents per word, each insertion, minimum 10 words, payable in advance
To be inserted under proper classification in December issue, copy should be in our office October 8th
December issue on sale November 1st
Popular Mechanics Magazine, 200 East Ontario Street, Chicago, Illinois

YOU'LL PROFIT

By reading and answering the classified ads in this section. Hundreds of opportunities to make and save money.

AUTOMOBILES—MIDGET CARS

AUTOMOBILE Superchargers \$3. Guaranteed mileage increase 20%; power 10%. University of Detroit test. Any car; give make, year. Wrench installs 15 minutes. John Hanley, Manufacturer, 5719 Loraine, Detroit, Mich.

KUNS' Fifth edition Automobile Racing Book. Tells how to build dirt track bodies, frames, engines. Records, superchargers, rules, formula, plans, stock conversions, roadster racing, fast Fords. \$1.00 postpaid; \$1.15 C.O.D. Ray Kuns, Department 23, Madisonville, Cincinnati, Ohio.

R & R Mfg. Co., Anderson, Indiana. Racing cars, midgets and speed equipment. Illustrated 1941 catalogue 25c.

PHOTOGRAPHS. World's finest automobiles. Handbook, 10c. Automobiles, Box 534, Saint Cloud, Minnesota.

GASOLINE Saving device 50c. Chevrolet 1935-40. Walert Co., 3429 N. 10th St., Milwaukee, Wis.

MIDGET Motorscooter motors, (used), \$5.00 up. October lists (100 motors, cars, parts) now ready—20c. Catalog new plans, kits, parts—10c. Circulars free. Shippo Midgets, Box 543-H, Zanesville, Ohio.

PROFESSIONAL Midget racers, two-passenger roadsters, Midget motorcycles, motorscooters. Guaranteed motors, wheels, parts, plans. Handbook catalog—90 illustrations—20c. Midwest, Box 1959-CF, Chicago.

MAKE And sell motor tune-up oil. Fastest, soundest, money making proposition ever offered. Schafer, 547-A Melrose, Chicago.

AUTO SUPPLIES AND EQUIPMENT

NITERIDER, Chexar, Boys! Every sensational automobile novelty for your car. Catalog dime. Universal Specialties, Aurora, Ill.

ARE You handy with tools? Be independent. Buy our regrooving equipment. Complete \$12.50. Regroove smooth tires. Litt Miracle, 140 West End Ave., New York City.

BARGAINS—Welders, compressors, battery chargers, car washers. Liberal trial terms. Write Hobart Equipment, Box M-11403, Troy, Ohio.

NIGHT Drivers—There's not a better device to save your life. Nighthawk, an electrical unit, makes certain you stay awake at the wheel. At the slightest nod, Nighthawk awakens you. \$3.50. Nighthawk Mfg. Co., Prospect, Ohio.

REPAIR Parts, accessories, low priced! New and used transmissions, rear ends, etc., for cars, trucks, tractors. State car make, model, year, for immediate quotation. Wholesale Parts Co., 3135-P Lawrence, Chicago.

BORING Bar top plates for V8 and Plymouth motors. Unique Manufacturing Co., 4807 North 31 Ave., Omaha, Nebraska.

Mr. F. W. Johnson, Classified Ad Mgr., Popular Mechanics, Chicago, Ill.

Dear Sir: One of the big advantages of advertising in the classified section of Popular Mechanics is that replies do not cease coming in when a new issue appears, but continue for many months afterward. Apparently Popular Mechanics is not discarded like other magazines, but is kept for future reference, or given to a friend for his perusal. We are still receiving occasional orders from some of our ads placed in the classified section nearly a year ago. These orders are especially profitable, since the cost of the ad has been charged off long ago.

(Original letter on file in our office)

*Very truly yours,
ATLAS PROMOTION SERVICE.*

PISTON Rings—Steel seal design. Quick seating, stops oil pumping. For all cars. Send for circular. Piston Ring Sales Co., 4022 West Lake Street, Chicago.

RECLEAN Used oil without cost. Particulars, F. Gerwin, Fairview, Okla.

LEARN To repair speedometers at home. Details 10c. Ostrander Speedometer Service, 1042 State St., Schenectady, N. Y.

ANTI-KNOCK Super fuel formula. 50c. H. Devereaux, Box 212, Battle Creek, Michigan.

1940 IGNITION Supercharger. E. G. Sales & Mfg. Co., New York.

PLATING Outfits for auto parts. Connect to a battery. No tanks used. Free particulars and proofs. Gunmetal Co., Ave. J, Decatur, Ill.

AUTO TRAILERS

READY Now—Plans for nine new Jim Dandy Trailers including six modern house trailers. Catalog 10c. Also new edition of Trailer Builders Manual and catalog of parts, supplies and equipment. Price 25c. Both 35c postpaid. Trailer Supply Co., 5120-A Fulton St., Wausau, Wis.

MOTORCYCLES, BICYCLES, MOTOR SCOOTERS AND SUPPLIES

CROCKER—Sensational new streamlined scooter. 110 m.p.g. E-Z riding spring frame. Automatic starter clutch. Dealers, rider agents wanted. Big profits. Stamp for catalogue. Clymer Sales, U. S. Distributors, 222 West Pico, Los Angeles, Calif.

BUILD Power scooters, midget cars. We supply tires, wheels, motors. Lowest prices. Send 10c for plans, etc. Build-Your-Own Devices, Dept. 11-A, 536 North Parkside, Chicago.

MOTORCYCLISTS. Let's get acquainted. We can save you money on parts and accessories. List and decal free. Triangle, 1111 Washington, Chicago.

"THE Shippo Clipper," America's greatest "assemble-your-own" motorscooter. Save 3/4! Literature free. Complete plans, 25c. Shippo Midgets, Box 543-MH, Zanesville, Ohio.

SAVE 70%. Thousands assembling own motorscooters! We supply parts, tires, wheels, engines. Literature, drawing 10c. Comet Cycle Company, Box 3032, Madison, Wisconsin.

MOTO-SCOOT, 17 Slightly used 1939 and 1940 models. 1 1/2 and 2 1/2 horsepower engines. All with light generators, clutches or transmissions, starters, etc. Write for special price today. Moto-Scout Mfg. Co., 8425 South Chicago Ave., Chicago.

MOTORCYCLES, Reconditioned. New, used, parts and accessories. All makes. Large stock. Bargains. Illustrated catalogue, 15c. Indian Motorcycle Sales, Kansas City, Mo.

ALLOY Pistons \$3.00—Harley, Indian, Henderson, Excelsior, Cleveland, Cylinder grinding, rings, bearings, gaskets, chains, sprockets, helmets, goggles, accessories, parts new and used for less. Catalogue and wings pin 10c. Ballak, 811 N. 9th, St. Louis, Mo.

MOTORCYCLE, Parts, accessories. Most complete stock. New and used. We specialize on mail orders. What do you need? 35 page catalog 10c. Whitman Motorcycle & Supply Co., 405-9 Southwest Blvd., Kansas City, Mo.

BICYCLE Motor, Push-a-Bike outboard motor, complete with pneumatic tire, ready to attach. Dept. P, Richburn Company, Aurora, Missouri.

MOTOR Scooters, engines, parts. Literature 6c. Goldi Motor Scooters, Niles, Michigan.

FREE—Big list of helpful books. Popular Mechanics Press, 200 E. Ontario St., Chicago.

AVIATION

PROPELLERS For airplanes, sleds, boats, dehydrators. Sled blueprints, hubs, face-plates, snow sled skis. World's largest propeller catalog 10c. Banks Propeller Co., Love Field, Dallas, Texas.

AVIATION Wants more Lincoln trained men for positions as airline mechanics, aeronautical engineers, airplane factory mechanics, commercial pilots. This Lincoln Government Approved School of Aviation placing graduates in fine big pay positions. Opportunities for many more. Courses from 8 weeks to 2 years prepares for immediate employment. Reasonable rates. Write today for information. Lincoln Aeronautical Institute (Inc.), 2008 Aircraft Building, Lincoln, Nebraska.

AVIATION Apprentices — Airminded young men interested in technical training for entering aviation as apprentice see ad on page 17A.

AERO-SLEDS, Air-cooled engines. Literature 10c. Adastik Bros., Grand Rapids, Mich.

AIRCRAFT And shipbuilding industries need thousands trained men now—for building, piloting, electrical, radio and engineering. Start right, secure accurate, complete information from Dusty Rhoades (aviation advisor) on your course and school to attend right in the world's aviation center; be successful. Write enclosing 50 cents (no stamps). Dusty Rhoades, 2651 1/2 Ellendale Place, Los Angeles, Calif.

AIRCOOLED Ford. Powerful aircooled aircraft, snowsled engines, \$82.50. Conversion \$39.50. Lightning Aircraft, St. Paul, Minn.

PROPELLER Special limited, all types, save 50%, price list free. Aircooled Ford A conversion diagrams, instructions, illustrated light plane literature, including flying manual, 25c. Standard Aero-craft, Ft. Worth, Texas.

PROPELLERS For airplanes, sleds. Iced-steel blueprints, supplies. Catalog dime. Lorenzen Propellers, Niles, Michigan.

100 AIRPLANES Located everywhere. Complete catalogue 25c. Aircraft Directory, Athens, Ohio.

AIR CONDITIONING

FURNACE Blowers—\$22.50 up; attic blowers, cooling blowers and air conditioning blowers—all sizes. Guaranteed. Write for literature. Reynolds Mfg. Co., Grand Rapids, Mich.

WINTER. Summer air conditioner plans \$1.00. Wayne Engineering Co., Greenville, Ohio.

AIR Purifier completely revitalizes stuffy, stale, foul air, immediately. Air Purification, 2526 Grand Ave., Detroit, Mich.

BATTERIES, GENERATORS, ETC.

SELL Big wind-electrics and batteries direct from pioneer wind-plant factory. Write for dealership. Air-Electric Company, Lohrville, Iowa.

EDISON Storage batteries for light-power systems. Non-acid. Odorless. fifteen year life. Five year unconditional guarantee. Bargains in complete lighting systems. Low prices. Free illustrated literature. "See-Jay" Battery Co., 52 Sterling Ave., Yonkers, N. Y.

BUILD Electric plant operated by wind from old generator. Complete plans and 1940 catalog 10c. LeJay Manufacturing, 447 LeJay Building, Minneapolis, Minn.

SECRET Battery charger hook-up saves electricity 25%. Tungar bulb life 300%. Plans \$1. Schafer, 547-A Melrose, Chicago.

EDISON Lifetime storage batteries for light and power. Eliminates acid battery diseases. Long guarantee. All kinds re-built generating plants, motors, and miscellaneous articles at bargain prices. Free interesting literature. T. Hawley Smith Co., Croton Falls, N. Y.

1/2 HORSE. Repulsion induction, heavy duty 3400 speed motors \$9.75. Butler Electric Company, 1885 Milwaukee, Chicago.

ELECTRICAL SUPPLIES—EQUIPMENT

REFRIGERATION, Compressors, motors, Units, Freezers. New, used, reconditioned. Cheap. Refrigerator Repairs, 10023 Free-land, Detroit.

FLUORESCENT AC daylight lighting for desk; office; windows; home. Latest sensation. 50% discount. Literature free. McGee Radio, P-20, Kansas City, Mo.

ELECTRO-SCRIBE: Electric pencil. Writes—engraves all metals \$1.00. Health Lamp: Dual ray—ultra violet infra red. Promotes sun-tan Vitamin "D." Automatic ac-dc current. \$3.90. Details, Beyer Mfg. Co., 4515-H Cottage Grove, Chicago.

WELDING, SOLDERING, PLATING

BARGAINS. Demonstrator arc welders, gasoline and electric drive. Liberal trial, easy terms. Write Hobart Welder Exchange, Box 11402, Troy, Ohio.

ELECTROPLATE Small parts. Low priced outfit for laboratory or amateur. Choate Mfg. Co., 2464-E Principio Ave., Cincinnati, Ohio.

D.C. Arc-welder. Build it yourself from Dodge generators, vehicle motors, light plant generators. Plans \$1.00 each (three for \$2.00). Welders Club, AB-3433 M-Mart, Chicago. (Fifty arc-welding lessons 50c.)

BUILD 60-200 Amp. a-c welder for \$10. Illustrated plans \$1.00. Information dime. Hi-Point Electric Products, Dept. W, Bellefontaine, Ohio.

ACETYLENE Welding outfits, \$36.56; electric welders, \$66.25; easy-payment plan. Superior Oxy-Acetylene, Hamilton, Ohio.

A.C. Welders, plans, material. Free literature. Holgerson's Service, Canton, Kas.

WELDING And hundreds of money making and money saving ideas. 762 illustrations and 214 pages in 1940 Shop Notes, 50c. Popular Mechanics Press, Room C40, 200 E. Ontario, Chicago.

ENGINES, MOTORS, DYNAMOS

"PEPY" Governors make automobile engines power units. Sensitive and accurate. Low price. \$9.50 postpaid. Trial and refund guarantee. Circulars, Harris Machinery, Minneapolis, Minnesota.

SMALL High speed 1/10 h.p. Universal motors \$2.50. McConnell, 1619 Edegwood, Racine, Wis.

MOTOR Winding data, diagrams and winding lessons. Beginning lesson \$2.00. Particulars, stamp. Motor Data Company, Box 7631, Kansas City, Missouri.

BARGAINS—Welders, electroplating, motor generators, guaranteed, liberal terms. Write Hobarts, Box 11401, Troy, Ohio.

DEALERS—Motors capacitor—induction type 3400 speed—1/2 h.p. \$7.95, 1/3—\$5.95, 1/25 speed—1/2 h.p. \$12.75, 1/3—\$8.75. Motor driven display table complete \$2.75. Wholesale catalog one dime. Cmco, 1111 Washington, Chicago.

ELECTRIC Motors, 3/4 h.p. \$16.50, 1 h.p. \$18.50, 2 h.p. \$25.00. Others 1/4 to 50 h.p. Motors and machinery bought, sold, exchanged. Temps Brothers, 809 Myrtle Ave., Brooklyn, New York.

ALTERNATING And direct current generators, motors, converters; bargain prices. State your needs. Queen City Electric, 519 South California, Chicago.

ALTERNATING, 1/2 Horse, 110 volt, induction motors. Rebuilt, guaranteed, \$7.25. Wilmot Auto Supply, 2247 St. Paul Ave., Chicago.

BARGAIN—1/2 Hp. motors, 60 cycle, 1 phase, 110 volt, like new, guaranteed, \$7.40. Send check to Erie Electric Motor Co., 120 Church, Buffalo, N. Y.

AIR Compressors 1 3/4 x 1 3/4 \$6.00; 2 x 2 \$7.00; 2 1/2 x 2 \$8.00; electric drills 1/4 in. \$5.95. Free folder. National, 1915 S. State, Chicago.

MACHINERY, TOOLS AND SUPPLIES

FOR 9" South Bend lathes—Milling attachments; threading dials; taper attachments—Also mica undercutters; boring bar holders; collet chuck attachments; 8" face plates and four jaw chucks for all small lathes. Unique Manufacturing Co., 4807 North 31 Ave., Omaha, Nebraska.

BUILD Your own machine tools. Castings and blue prints at nominal cost. Send 10c for 2 color 28 page catalog, 34 prints covering 12 metal-working projects, \$1.50, 23 prints covering 6 wood-working projects, \$1.00. Lewis Machine Tool Co., Dept. M-11, 1000 Alhambra Ave., Los Angeles.

MODEL Makers lathe; photographs for dime. Depoy Model Shop, Muncie, Ind.

TREMENDOUS Surplus of factory tools selling out. Drills, taps, files, hacksaws, etc. Send for free lists, include six cents postage. Travers Tool Co., 264 Jackson Ave., Long Island City, N. Y.

HANDYCRAPTERS! All the parts you're always seeking. 10 pound plated assortment of screws, bolts, nuts, washers, lugs, springs, rivets, brackets, etc. 1000 handy gadgets! No junk. \$7.50 value, yours for only \$1.98. Satisfaction guaranteed. Manufacturers Products, 224 West Hubbard, Chicago.

ALL-PURPOSE Lathe tool, improves accuracy, resourcefulness. Sizes including 1x1/2; \$1.00 postpaid, if direct order. Dimension opening through toolpost. Tit-bit Tools, 41 East Orange, Lancaster, Penna.

UNIVERSAL 4" Chucks, few, \$10. Bargains—lathes, milling attachments, cutters, L.H. taps. "Supply," Newfane, Vt.

CONCRETE Building block machines and molds. Easy payments. Catalog free. Concrete Machine Co., 5129 South Compton Ave., St. Louis, Mo.

6 FT. Flexible shaft mounted on 1/2 horse alternating motor \$19.50. Butler Electric Company, 1885 Milwaukee, Chicago.

13" x 5" WILLARD Lathe with gap. No. 2 Pratt & Whitney hand milling machine, four step cone drive. Write for full particulars. Cincinnati Machinery & Supply Company, 217 E. Second St., Cincinnati, Ohio.

BOATS, OUTBOARD MOTORS, ETC.

KAYAKS. Outboards. Rowboats. Duck boats. Weldwood ready-cut kits. Catalog. Cre-Craft Boats, Dept. F, Millburn, New Jersey.

FORD-Mercury-Zephyr marine conversions. Catalog 10c. Lehman Engineering Company, Dept. D, Newark, N. J.

BUILD Your own boat with Bay City prefabricated frames and materials. Save up to 2/3s. Pay as you build. Lumber, fittings, engines and equipment. Illustrated catalog 100 boats 9 to 90 feet 10c. Bay City Boats, Inc., 1552 Adams St., Bay City, Mich.

12 FOOT Flat bottom rowboat—complete plans 25c. Free boat building catalog. The Rudder, 15 Murray St., New York.

BUILD Your own boat from our paper patterns, frames or ready-cut materials. Rowboats, outboards, inboards, sailboats, cruisers. Send 10c for circulars. Germain Boat Company, 502 S. Niagara, Saginaw, W.S. Michigan.

EASY To build rowboats, kayaks, outboards, inboards. Complete kits. Send 10c big catalogs. 20 designs. Newest models. Kayak Boat Co., 154-K East 129th, New York.

BUILD A boat by the Welch System. We supply ready cut parts for Welch designed boats. Everything for building and equipping boats. Send 10c for catalog, marine hardware, finishing materials, and marine motors. Welch Boat Company, Station K-1, Milwaukee, Wisconsin.

MARINE Conversion parts for all auto engines. Buy here and save. Conversion Parts Co., 278 Adams St., Boston, Mass.

FULL Size, cut-to-shape boat patterns—blueprints—specifications. Big selection. Designed by naval architects. Real bargains. Send 10c (coin) for illustrated catalog. Book "How to Build Boats," \$1.00 postpaid. Cleveland Boat Blueprint Co., Station A-66, Cleveland, Ohio.

MARINE Power—Easily convert any Ford motor (domestic and foreign) with Osco parts and kits. Complete catalogue 25c (coin). Osmithson, 3644 Lawrence St., Philadelphia, Penna.

OUTBOARDS—Save 1/2. Good used parts, all makes and models. Bargains re-built motors. Crandall Hicks Co., 959 Commonwealth, Boston, Mass.

BOAT Designers are highly paid professionals. Complete course by mail. Catalog. Westlawn, Montville, N. J.

SPORTING GOODS, GUNS, FISHING TACKLE, ARCHERY

BARGAINS! Gun catalog 5c, camera catalog 10c, archery catalog 5c, ski catalog 5c, golf catalog 5c, medal-award catalog 10c. Warshal's, First-Madison-PM, Seattle.

READ Fur-Fish-Game—Be better informed on outdoor subjects. This real sportsmen's magazine in addition to general articles each month has departments on guns, fur farming, dogs, fishing, trapping, questions and answers. Send your name, address and 50c for a six months trial subscription (regular 90c newsstand value) to Fur-Fish-Game, 168 E. Long St., Columbus, Ohio.

LIKE To hunt or shoot? Send 6c stamps sample copy 64-page monthly magazine, exclusively about guns. The American Rifleman, 1610 Rhode Island Ave., Washington, D. C.

BUY Your equipment where professional hunters, trappers go. Lowest prices—biggest bargains. Send postcard for free catalog. Hill Bros. Fur Co., Dept. 305, St. Louis, Mo.

ARCHERY Equipment—Catalogue free. Mid-West Archery, 2209-A East 75th, Chicago.

BEAUTIFUL Skating self-taught. Correct fundamentals 35c. Skaters Manual, Box 5, Tacoma, Wash.

RIFLES, Colts, target pistols, police goods, etc. Catalog 5c. Wineholt Co., Box C-5, Woodbine, Penna.

GOLF Clubs. Five club matched set \$2.50. Lincoln Surplus, 123 Galena, Freeport, Ill.

COMPLETE Camping, hunting, outdoor equipment, used guns. Catalog. Howe Fur Company, Coopers Mills, Maine.

ARCHERY! Complete archery instruction book, 70 pages—200 illustrations—30c. Catalogue free. Triangle Archery Company, Harrison-State Streets, Chicago.

FIELD GLASSES, TELESCOPES AND MICROSCOPES

TELESCOPES, Microscopes, binoculars; bargain catalog free. Brownscoe Company, 5 West 27th Street, New York.

INSTRUCTIONS Free! Powerful astronomical telescope kits. "Craftsmen," 76 Ridgewood, New Jersey.

BINOCULARS, Telescopes, radios, cameras, etc. Buy at wholesale. Make up to 200% profit. Free catalog. Vogue Co., 8420 S. Ashland, Dept. BC-110, Chicago.

CASH For used microscopes, binoculars, any optical merchandise. Gordon's, 162-F Madison, Chicago.

ANTIQUES, RELICS, INDIAN GOODS, CURIOS

ALASKAN Indian made moccasins, fur clothing, ivory, etc. Dealers discount. Catalog. Alaska Native Brotherhood. Established 1913, Juneau, Alaska.

GLASS, Books, minerals, curios, catalog 5c. Junes Antiques, Northbranch, Kansas.

SWORDS, Rapiers, pistols, daggers, armor list 10c. Robert Abels, 860A Lexington Ave., New York.

INDIAN Relics, coins, bills, gems, crystals, curios, etc. Illustrated catalog 5c. 100 ancient arrowheads \$3.00. H. Daniel, Hot Springs, Ark.

INDIAN Relics, beadwork, coins, curios, minerals, old glass. Catalog 6c. Indian Museum, Osborne, Kansas.

CHINQUILLA'S Indian Craft Museum. Handiwork of all Indian tribes. Jamaica, N. Y.

TAXIDERMY

GLASS Eyes, taxidermists', furriers' supplies. Big catalog free. Elwood Company, 222 Smith Bldg., Omaha, Nebr.

NEW American made deer eyes. Patented process produces natural, lifelike Jonas Eyes superior to best European glass. Lower in cost, too! Unbreakable. Special trial offer—Sample pair 65c. Satisfaction guaranteed or money back. Order today or write for price list of eyes and other supplies. Jonas Bros., 1049 Broadway, Denver, Colorado.

LEARN By mail to mount birds and animals, tan skins, make leather. Old reliable school teaches, easily, quickly, at low cost. Over 250,000 students. Rush postal for free 48 page book. Northwestern School of Taxidermy, 775 Elwood Bldg., Omaha, Nebr.

DOGS, PETS, BIRDS

CHAMELEON, 25c. New illustrated catalogue. Quivira Specialties Co., Winfield, Kansas.

PUPPIES, All kinds, free details. Book 104 photos recognized breeds described 25c. Royal Kennels, Chazy, N. Y.

FOX, Deer, coonhounds, Shipper 37 years. Stephens Kennels, Marshall, Ark.

SPORTSMEN: 200 Pointers, setters, straight cooners, combination hunters, rabbit and fox hounds. Reasonable. List free. Ramsey Creek Kennels, Ramsey, Illinois.

BEAUTIFUL Pure white police dogs. Ansonia Kennels, Mose, N. Dak.

TREES, SHRUBS, ROOTS, HERBS

COLORADO Blue Spruce trees, 2-year-old. Extra strong. From the bluest of the blue trees. 25 prepaid for \$1.00. Rocky Mountain Evergreen Co., Evergreen, Colo.

JUST Out! World's greatest "Herbalist Almanac." Beautifully illustrated in natural colors. Contains over 200 old fashioned herb medicine recipes for home use. 10c (coin) postpaid. Botanics, Box 1109, Evergreen Park, Ill.

POULTRY AND FARM SUPPLIES

MAKE Money with poultry. Read America's leading poultry magazine. Five years \$1.00; one year 25c. Poultry Tribune, Dept. E-60, Mount Morris, Illinois.

FARM MACHINERY AND SUPPLIES

GARDEN And small farm tractors, 3/4 to 8 horse-power, \$75.00 and up. Ride or walk. Catalog free. Shaw Mfg. Co., Dept. PM-11, Galesburg, Kansas.

FARMS—FARM LANDS—REAL ESTATE

TWO Improved Griggs county farms, good groves, 3 miles from town, quick sale, \$8.00 per acre. R. S. Lunde, Coopers-town, N. Dak.

IMPROVED Farms cheap. Pictures, terms, descriptions. Pinch Realty, Charlotte, Michigan.

\$800 SECURES 77 Acres, crops, horses, 9 cows and heifers, poultry, machinery, hay, oats, potatoes, etc., included; lake and village close, 6 rms., bath and elec., 62 ft. barn, other bldgs.; only \$2600, easy terms; pictures pg. 63 free catalog and new supplement. Strout Realty, 255-P 4th Ave., New York City.

GOOD Farms available. Washington, Minnesota, Idaho, western Montana, Oregon. Dependable crops, favorable climate. Write for impartial advice, literature and list of typical bargains. Specify state. J. W. Haw, 119 Northern Pacific Ry., St. Paul, Minn.

SEE The Highlands of Louisiana now while prices are low. Choice cut-over land sold on liberal terms. Literature furnished upon request, without obligation. Long-Bell Farm Land Corporation, 863 R. A. Long Bldg., Kansas City, Mo.

40 ACRES, Near White River, unimproved; poultry land. \$175, \$5 down, \$5 monthly. Free list and literature. Hubbard, 216 Grossman Bldg., Kansas City, Kans.

PROFITABLE OCCUPATIONS

NOW—You can paint signs and show cards right from the start, with Master Patterns and our copyright instructions. Details free. Economical Signs, 1572 North Halsted, Chicago.

OPERATE Steady business resilvering mirrors. Making chipped glass nameplates, signs. Write Sprinkle, Plater, 288, Marion, Indiana.

M. M. Earned \$1174 in spare time for exceptional "cellar crop" Snow-King mushrooms! Free book tells if your cellar, shed suitable. We buy crops. United, 3848 Lincoln Ave., Dept. 63, Chicago.

MEN—Women, operate "Specialty Candy Factory" home. All or spare time. Opportunity for good steady income. (Our 31st year.) Ragsdale Candies, Dept. 62, East Orange, N. J.

BIG Money raising Angora Woolers. Stamp for photo reproductions and details. A. Lewis, Exchange Bldg., Spokane, Washington.

PROFITABLE Evenings. Details for stamp. Mid-West, 208 N. Wells, Chicago.

VENETIAN Blinds, Everything ready to paint. Instructions, price list for quarter. Venetian, Clarkston, Mich.

WILL You give us 5% first \$600 you make? Afternoons free! Work home, \$1,000 month reported (exceptional—full-time). Expect surprise! National, Box 1240-C, San Bernardino, Calif.

HAND Assembled leather belts. Make yourself, 200% profit. Samples, information, dime. Edward Carey, South Mountain, Pennsylvania.

ANNOUNCING New home study course in commercial baking. Good field for ambitious men. Nearly depression proof business. Common school education sufficient. Send for free booklet "Opportunities in the Baking Industry" and requirements. National Baking Institute, 3601 Michigan Avenue, Dept. 3434, Chicago.

RAISE Rabbits and cavies for us. Full details. Catalog, contract and magazine 10c. Or send 25c for book, catalog and year's subscription to Small Stock Farmers Magazine. Stahl's, Box 10, Holmes Park, Missouri.

ANGORA Wool rabbits pay. America's fastest growing industry. Start now. Dakota Rabbitry, Oakes, North Dakota.

GAMES—ENTERTAINMENT

PLAYS, Musical comedies, Christmas pageants, full evening's performance \$3, no royalties. Reginald Belcher, Chatham, New Jersey, 30 years church organist and playwright.

G-MAN Playing cards, exciting, fascinating, different from anything you've seen. Every card a finger-print. Entertaining, educational, play rummy, 500, pinochle. \$1.00 postpaid. Tell-Tale, Kenosha, Wis.

PLAYS, Operettas, musical comedies, complete minstrel first-parts with song programs, blackface skits, vaudeville acts, monologs, dialogs, recitations, juvenile plays and songs, musical readings, entertainments, make-up goods. Catalog free. T. S. Denison & Co., 203 N. Wabash, Dept. 11, Chicago.

BOOKS, PERIODICALS, PICTURES, POSTCARDS

EXCELLENT Sparetime profits taking subscriptions—2500 magazines. Agents confidential catalogue, complete starting supplies free! Dept. 15, Pines, 583 Monroe, Brooklyn, N. Y.

PHOTOGRAPHS: Entire listings, sample. 12c. Albert E. McGoldrick, Mansfield, Mass.

4c BUYS Back dated magazines. Domestic, foreign, art, 100,000 used, new books. Catalog 10c (refunded). Cicerone's, 863 First Avenue, New York City, N. Y.

MECHANICAL Instruction book (latest) "Machine Shop Operations." Stamp for immediate particulars. General Publishing Company, Toronto, Canada.

MAGAZINES, Back numbers, list 3c. Magazine Mart, Roslyn, N. Y.

MAGIC TRICKS, PUZZLES, JOKER NOVELTIES

HOUSE Of 1000 mysteries! Professional magic! Pocket tricks! Jokes! Puzzles! Novelties! Giant surprise catalog! Bigger-better than ever! Only 15c! Vick Lawton, Dept. J7, Queens Village, N. Y.

JOIN Magicians' Fraternity! Monthly magazine, sample 10c. Tricks free! International Magicians, Mt. Morris, Ill.

TRICKS You can do! For pocket, parlor, stage. With coins, cards, cigars, ropes, balls, thimbles, watches! Escapes, mindreading, spirit and mental magic! Illusions, magical books and stage supplies! Largest assortment; lowest prices! 100 page catalog 500 popular tricks 10c. 80 page catalog larger stage magic 10c. Write today! Lyle Douglas, Station A-5, Dallas, Texas.

BE A magician. Large professional magic catalogue of latest tricks 25c. Cash paid for complete Tarbell Magic Courses. Write, Ireland, C-109 North Dearborn, Chicago.

HOLLYWOOD Special! Magicians button, catalogue, ghost illusion and free trick for 25c. Magic House of Charles, Box 888, Hollywood, California.

MAGICIANS' Headquarters, 216-page catalog pocket, parlor, professional tricks, 25c. Kanter's, 1311 Walnut, Philadelphia.

EARN Money in any crowd. Call names of strangers, tell unspoken questions. Professional course mind reading, spirit writing, etc., \$1. Henderson, Box 341, San Bernardino, Calif.

WORLD'S Largest professional magic shop keeps you in touch with latest tricks. To receive mailings send 25c for 1940 catalog. Holden, 220 W. 42nd St., New York.

LEARN Ventriloquism, 3c stamp brings particulars. Smith, 801 Bigelow, Peoria, Illinois.

LARGE Magic catalog 25c. Hundreds of tricks. Chicago Magic Company, 2300 N. Mason Avenue, Chicago.

RARE COINS

THREE Foreign coins and price list 10c. Joseph Coffin, 1182 Broadway, New York.

COIN Guide for beginners. Selling, collecting, etc. 20c. Lawrence, Plentywood, Montana.

OLD Money wanted. Do you know that coin collectors pay up to \$100.00 for certain U. S. cents? And high premiums for all rare coins? We buy all kinds. Send 4c for large coin folder. May mean much profit to you. Numismatic Co., Dept. 20, Fort Worth, Texas.

WANTED Coins from circulation. Catalog 10c. Dennis Sibert, 17 Middagh St., Brooklyn, N. Y.

50,000 COINS, Medals, papermoney. Lists free. Nagy, 8-P South 18th, Philadelphia, Penna.

COIN Packet, 75 coins of 75 countries, attributed in envelopes, \$5.00 postpaid. Koeppl's Coins of World, 8th at Broadway, Los Angeles.

15 DIFFERENT Coins 25c. Oddehon, Box 44, Overland, St. Louis, Mo.

RARE U. S., foreign coins, war medals. Catalogue 10c. Mengelle, Colorado Springs, Colo.

BUY By mail! U. S. and foreign coins. Collectors' accessories. Illustrated catalogue 10c. 3000 quotations. Dime refunded first order. James C. Randall, 37 West Van Buren, Chicago.

WILL Pay \$10 each for certain Lincoln pennies! Indianheads \$150; dimes \$700. Catalogue 10c. Federal Coin Exchange, Columbus, Ohio.

FREE! Foreign coin, banknote and large 36 page illustrated coin catalogue to approval service applicants. Send 3c postage. Tatham Coinco, Springfield-125, Mass.

GET Profit and pleasure in collecting old coins. Send 10c for 56 page illustrated coin catalog. You'll be delighted with it. Send for it now. B. Max Mehl, 370 Mehl Building, Fort Worth, Texas. Largest rare coin establishment in U. S. Established 40 years.

COMMEMORATIVE \$1.50. Columbus, Stone-Mountain, Cleveland, Illinois, \$1.00 ea. New catalogue 10c. Norman Shultz, Salt Lake, Utah.

I MAY Have just the scarce U. S. coins you want. Send me list. "Meet me by mail." William H. Kenworthy, Waterville, Maine.

STAMP COLLECTING

SCARCE United States stamps. Find those hard-to-get, yet inexpensive stamps in our approval books containing over 1500 varieties. Write for a selection now and learn about America's outstanding service. Reasonable prices. United States only. Southern Stamp Co., Box 70-M, Miami, Florida.

SENSATIONAL Combination offer! Big packet 105 all different including Greenland (new country), Congo, Manchukuo, Costa Rica triangle, air-mails, commemoratives, giant diamond-shaped stamp, \$4 United States; complete set United States telegraphs, cataloging 20c. scarce set Siberia cataloging 50c. Packet British colonies including Gwalior, Hyderabad, Burma (new country), jubilee and coronations. Total catalog price over \$3.00! Everything for only 5c to approval applicants! World-Wide Stamp Company, Department 600, Camden, New York.

10 AIRMAILS 5c. To applicants for "Scotch" approvals. Garlock, 1018 N. Rampart, Los Angeles, Calif.

\$10 U. S. stamp. 15 different Egyptian stamps 5c. Approvals. Southern Stamp Specialist, 517B Ave. A, Rome, Georgia.

25 FAMOUS Statesmen of the world 3c with approvals. Tiptre Stamp Co., 976 So. Westmoreland, Los Angeles, Calif.

NEJD (Arabland), Bolivia triangle, Caymans, Negri Sembilan, Turks Caicos, Manchukuo, Bahamas, British Solomons (Cannibaland). Everything 3c with approvals. Viking, 130-Z Clinton St., Brooklyn, N. Y.

FREE—World's only octagonal (eight-sided) set and 25 different Japanese pictorials to approval applicants. Charles Cleveland, 806 North Humphrey, Oak Park, Illinois.

CLOSING Out all but Hawaiians, \$12.00 value \$1.00. Hawaiian approvals each order, if requested. M. Spencer, 1555 Palama, Honolulu, Hawaii.

210 JUNGLE Lands! Pacific islands! Gigantic all different collection from Asia, Africa, French and British Colonies, etc., 10c with approvals. H. P. Wisehart Co., Dept. 10, Frankfort, Ohio.

GIFT Edition stamp annual free—Sixty pages with hundreds of illustrations featuring Canadians, Newfoundlands, United States, Colonials, foreign, supplies. Sent free. Gray Stamp Company, Dept. PM, Toronto, Canada.

325 DIFFERENT Stamps (catalogue approximately \$7.00) including French, Russian pictorials, 10c to applicants for our profit sharing approvals. Official Stamp Company, Department P11, Fairlawn, New Jersey.

FINE Approvals, freshly filled books and sheets. Tell me what you want and I will send them. Skinner, 306 East Fourth, Long Beach, Calif.

40000 VARIETIES Available on approvals 1/4c up. Large selections, low prices. Adults only. P. Keigwin Stamp Company, Vineland, N. J.

UNITED States approvals—At half catalogue. Ireton, Box 92, Station "A", Los Angeles, California.

CZECHOSLOVAKIA—100 Different 19c. Approvals. Neiderstadt, 4727 West Beloit, Milwaukee, Wisconsin.

TWO Liberia triangles, fifty different—five cents. Approvals. Stampola, Waukau, Wisconsin.

THOUSANDS Different approvals 1c—2c. Premiums too! Essex Stamps, Beverly, Mass.

FREE—Supplies, stamps, 3c postage. Palmer, 304 Hardy, Norfolk, Virginia.

AIRMAILS 25 Diff. 9c with net approvals. Hoydars, Selah, Wash.

625 DIFFERENT Stamps, 53c; 1000, \$1. 127 Washingtonbridge Station, New York.

CANADIAN Royal visit—Mint 9c. Approvals. Music Box, Broad St., Pawtucket, R. I.

1,111 ASSORTED—25c. Approvals. Premiums. Utechts, 1143D North Keeler, Chicago.

ATTRACTIVE Approvals. State preferences. Stephen Link, Box 397, Union, N. J.

FREE! Scarce Papua coronation! Approvals. Gramatan, Box 302, Mount Vernon, New York.

FRENCH Colonies, 10 different sets 20c. S. Morrell, 203 Fenimore St., Brooklyn, New York.

BRITISH Colonials, 75 different 10c with approvals. "Crescent Stamps," London, Canada.

PORTUGAL 100 Different 25c. Approvals. Hermes Stamp Company, Box 276, Hempstead, N. Y.

FREE—Five beautiful airmails to approval applicants. Green and Company, Norwood, Ohio.

300 U. S. commemoratives, etc. 10c. 1000, 25c. Arden, 826 Amsterdam, New York City.

72 DIFFERENT U. S. 10c. approvals. Album Service, Route 57-13, Sioux City, Iowa.

PREMIUMS Given for purchases from my approvals. Moulblow, Box 11, Rosebank, New York.

200 DIFFERENT—Only 5c with approvals! Far Sea Co., Box 2154, Houston, Tex.

SWITZERLAND, 200 Different \$2.00; 110 different \$1.00; 50 projuventute \$1.50. Janz, 201 West 85th, New York.

100 DIFFERENT Stamps, perforation gauge, packet hinges, all for 10c to approval applicants. Livingston, St. Ignace, Mich.

U. S. 1861-1939, 200 different \$1.00. Liberty Stamp Co., St. Louis, Mo.

ASK For our wonderful one cent approvals. Prospect Stamp Co., 225 Broadview, Toronto, Canada.

AIRMAILS, 20 Different 5c with approvals. 100 different \$1.00. Paltra, 3204F Hull Avenue, The Bronx, N. Y.

UNITED States approvals. Seminole Stamp Studio, Box 416, Miami Beach, Florida.

MEXICAN \$20 Bill and 12 different airmail stamps 10c. Nagles, 346 North 12th, Reading Penna.

FREE Premium to new approval applicants. Send postcard. C. Haas, Pittsburgh (6), Penna.

SNAKE Triangle plus dollar packet free to approval applicants. Dearborn Stamp Co., 5439 Aberdeen, Chicago.

CANADA No. 40, 10c. List free. Pinard, Box 525, Sherbrooke, Que.

SUPERB Approvals, net prices. Stamps 1/3 to 1/8 catalogue. P. G. Beals, 170A Tremont St., Boston, Mass.

AFGHANISTAN To Zanzibar: Also Abyssinia, North Borneo, triangle stamps, airmails, British Colonies, United States commemoratives and possessions. All in our "generous" packet for only 10c to approval applicants. Vogelmann, 404 South Western Avenue, Chicago, Ill.

FREE—12 Different from Roumania or Czecho or Poland to approval applicants only. Reimers, Fort Worth, Texas.

UNPICKED! 100 U. S. revenues on documents—10c! (700—50c.) Scott's 1941 catalog—\$2.35! Vanvoorhis, Hyndman, Penna.

1940 NEW Zealand centennial set. Giant airmail, Cuban cigar, Paraguayan tri-color, plus 50 different 3c with approvals. Stanley Melzer, 3120 South Adams Ave., Milwaukee, Wisconsin.

ASSASSINATION! Complete unused Sarajevo assassination issue from Herzegovina, perforation gauge, three other complete sets—All only 3c. Approvals. Gopher Stamp, 5432 South Aldrich, Minneapolis.

\$5.00 STAMP; 50 U. S. 1861-1903, wholesale 10c. Quality Stamps, 622 Travis, Fort Worth, Texas.

25 VARIETIES Asia, Belgium, Canada, France, Japan or Poland, 5c each. Mission, 4512 North Racine, Chicago.

10 BEAUTIFUL Pictorial stamps 3c to approval applicants. Stamp Shop, 5805 Delmar, St. Louis, Mo.

APPROVED, Approvals; nothing free. References. Thiese, 10526 Anzac Ave., Los Angeles, Calif.

55 UNITED States commemoratives, airmails 15c. Motzer, 1022 Liberty, Cincinnati, Ohio.

111 DIFFERENT 5c With trading plan. Aspen Trader, Richmond, Mo.

LATVIA 10 Different 6c with approvals. LeDuc, Saint Petersburg, Florida.

PHILIPPINES, 20 Different and pictorials 15c. Approvals. French, 60 Arcade, Cleveland.

1000 WORLDWIDE Stamp mixture 25c. Monjar, 1542 Waverly, Cincinnati, Ohio.

50 DIFFERENT U. S. commemoratives 15c. 100 different 75c. Approvals. Morrison, East Elbon, Chester, Penna.

NETHERLANDS Charity, 20 different, \$1.00. Clement, 80 Dorothy, Rochester, New York.

100 DIFFERENT United States, \$3.00 catalog, 35c. McKay, 7200 Yale, Chicago.

25 U. S. commemoratives 5c with approvals. Stamp Exchange, Stillwater, Maine.

20 MEXICO 3c With approvals 1/4c. up. Josiab Babcock, St. Joseph, Michigan.

30 DIFFERENT Triangular stamps \$1. McMath, Box 444, Centralia, Illinois.

N. Y. world's fair last day covers 10c. Schedler, 335 Simons, Hackensack, N. J.

10,000 VARIETIES 1c Each! Gordon Davison, Box 568, Manchester, N. H.

5 COMPLETE Sets. Free with approvals. R. S. McGregor, 715 Walnut St., Hattiesburg, Mississippi.

U. S. 60 diff. commemoratives, etc., 6c. Lists. Approvals. Moseley, 4932 Forestpark, St. Louis, Mo.

10 AIRMAILS Free with approvals. Harlan, 5307 South Marshfield, Chicago.

10 DIFF. Manchukuo 3c with approvals. Stamputopia, Binghamton, N. Y.

TRIANGLES, (3) Free with approvals. Chester, Box 545-P, Utica, N. Y.

ZEPPELIN Airmail free set (13) presidential coils 30c. Jem Stamps, Port Jefferson, N. Y.

300 DIFFERENT 20c; 600, 50c; 1000; \$1.00; 2,000, \$3.00. Fred Onken, 630 79th St., Brooklyn.

U. S. parks complete 19c. Better approvals. Box 488, Minneapolis, Minnesota.

BARGAINS! 315 Different 15c; 515, 35c; 1015, 75c. Approvals. Star, 148 Forbell, Brooklyn, New York.

U. S. commemoratives, 58 different 25c. Crvstal Stamp Co., Racine, Wis.

50 FREE, Approval applicants. Harford Stamp Co., 4809 Richard Ave., Baltimore, Md.

LARGE Stockbook, perforation gauge, watermark detector, stamps worth 50c. 10c to approval applicants. A-B Stamp Company, Helix, Oregon.

175 U. S. commemoratives, etc., 10c, 500 25c. P. O. Box 457, Newark, N. J.

80 DIFFERENT Including airmails, commemoratives, pictorials, etc., 3c to approval applicants. Hunziker's, Box 225-NM, Minneapolis, Minn.

50 DIFFERENT U. S. to approval applicants only. 5c. Theodore Stevens, 3576 Maryland Ave., Detroit, Mich.

CZECHOSLOVAKIA! 50 Different! 5c to approval applicants. Cactus Junior, Box 1870, P. Tucson, Arizona.

UNITED States—35 different beautiful commemoratives 20c. Seidenberg, Baroda, Michigan.

MYSTIFYING Jungleland plus "hard countries" assortment. Only 3c with approvals! Saxons Company, Valley Stream, N. Y.

LOW Priced U. S. approvals. Postage paid both ways. Kaiser Stamp Co., 302 Hurley, St. Paul, Minn.

SEND Postage for free United States price list. Stanley Gibbons, 38-P Park Row, New York.

WORLD'S Smallest airmail—largest map, diamond and triangle stamps, free stamp magazine, magnifier to study stamps with large packet of stamps from scarce countries, big bargain 5c with approvals. Capital Stamps, Little Rock, Ark.

EXCHANGE With collectors everywhere. Free listing application for stamp. Modern, Box 995-S, New Haven, Conn.

50 BEAUTIFUL Colonials, 10c, approvals. Kravat Company, 1925-Q Quentin Road, Brooklyn, N. Y.

SCARCE Diamond airmail! Wonderful packet 115 different from strange countries. British colonies, Haiti, Tasmania, pictorials, etc., 5c to approval applicants. Reliable Co., Box 139, Dept. 3, Church Annex, New York.

FREE—The Stamp Finder! Our new 24 page edition, fully illustrated, which will enable you to instantly identify all difficult stamps. Also fine packet of odd and unusual stamps from Bosnia-Herzegovina, Monaco, Patiala, Cyprus, etc., including maps, ships, animals and strange scenes. All free to approval applicants inclosing 3c postage. Garcelon Stamp Co., Box 900, Calais, Maine.

50 DIFFERENT, Fine U. S. including perforation gauge, 10c with approvals. The Stamp Shop, 809 Holland Bldg., St. Louis, Mo.

UNITED States; special to new approval applicants; fourteen different postage dues, 10c; twenty different revenues, 10c. Southern Stamps, Box 70M, Miami, Florida.

FREE! Pony Express set (facsimiles). Postage 3c. Roberts, 406 Shearer Bldg., Bay City, Michigan.

SEVEN Different triangles only 5c to approval applicants. Tatham Stamp Co., Springfield-30, Mass.

FOUR Star approvals! Nothing like them! Write today, 312 mixed U. S. 10c. Kessels, Tucson, Arizona.

SOUTH American—100 different 10c—with approvals. Davis, Silver Lake, Ind.

AIRMAILS And commemoratives, 25 different, including Columbians, Panama-Pacific, Edison, Zeppelin, etc., only 5c with exceptionally fine United States and foreign approvals. Marco Stamp Co., Box 888, San Francisco, Calif.

YOU Can now have famous Spanish Goya nude stamp, world's largest diamond stamp and world's largest triangle. These beauties sent for only 5c to collectors requesting approvals. To make this the year's biggest bargain, we will include absolutely free collection of 100 varieties containing weird scarce stamps from Transcaucasia, Georgia, Azerbaijan, etc. Cactus Junior, Box 1870-B, Tucson, Ariz.

FREE! Austria war set. Postage 3c. Williams, 606 Archer Bldg., Bay City, Mich.

WEEKLY Stamp magazine, thirteen weeks, 10c. Stamp Journal, Kalamazoo, Mich.

200 DIFFERENT 10c. Big 50% approvals. Covert Stamp, 39 State, Rochester, N. Y.

CANADA 100 Different 25c—approvals all countries. Lists. Victoria Stamp Co., London, 4, Canada.

PENNY Approvals, that satisfy. Neil Gronberg, Box 5441-P, Philadelphia, Penna.

THREE Sets for 3c stamp! Jack Reed, Jr., Houtzdale, Pennsylvania.

25 UNITED States, including \$4 and \$5 stamps free to approval applicants, 3c postage. Brownie Stamp Shop, Flint, Mich.

SMOKY Mountain commemorative sheet, largest U. S. stamp issued, and 33 U. S. including commemoratives, airmail, revenues, etc. Catalogs 75c—To approval applicants for 5c. Curhan Stamp Company, Gloucester, Mass.

WHOLESALE Dealer's catalog. Illustrated. Postage 5c. Frank's, 4900 Chalmers, Baltimore, Md.

WHOLESALE Supplements to dealers for 10c postage. Hundreds of bargains. Grossman Stampco, 102 West 42nd, New York.

GIANT Packet 200 all different from Africa, South America, Asia, South Sea Islands, etc. Includes world's smallest stamp; triangle and diamond-shaped stamps; animal stamps. Nicaragua "Will Rogers" airmail; many others. Also packet 17 different United States (cataloging 50c)—all obsolete, including \$4 denomination, commemoratives, etc. Total catalogue price over \$5.00! Everything for only 5c to approval applicants! Mystic Stamp Company, Dept. 80-N, Camden, New York.

50 FREE, Catalogued \$1. Album 3c. Bullard, 13-Winter Hill, Mass.

HOBBIES AND COLLECTIONS

A NEW Hobby! Collect poster stamps. Send 5c for free poster stamps, price lists of over 300 items, and information on how to collect poster stamps. National Poster Stamp Society, 2445 South Damen, Chicago, Illinois.

MATCH Covers, 2 for 1c. Postage additional. Jerry's, 2515 Seventh Avenue, Hollywood, California.

STANDARD Albums for match books, paste unnecessary, 75c postpaid. Write Matchless Album, G. C. P.O. Box 120, New York.

EXCHANGE Your duplicate match folders, stamps, cigar bands. Write for information. Mention your hobby. "Hobby," Box 211, Zion, Ill.

TWENTY-FIVE Different cactus plants postpaid \$2.00. Eulalia Turner, Azusa, Calif.

EXCHANGE Your duplicate stamps, match covers, etc., with collectors everywhere. List, swappers, dime. (Mention hobby). Secretary, Box 2166, Denver, Colo.

MATCH Book hobby. "Bulletin" membership blank, stamp. B-1111, Rochester, N. Y.

ALBUM Mounts matchbook covers without paste. Write Adams Sales, Dept. 34, State Tower, Syracuse, N. Y.

WINDSHIELD Stickers, Arizona, Canada, etc. 10 different 25c. Thompson, 2423 Boulder, Los Angeles, Calif.

UNUSED Book match covers, 100 all different, \$1.00. Free list. Charles Edelman, 1311C East 84, Cleveland, Ohio.

CAMERAS, PHOTO SUPPLIES

PRINTIMER—Split-second printing and enlarging timer. Complete time cycle shown by amber lighted rotating dial—Emergency stop button—\$12.50. Potter & Brumfield Mfg. Co., Princeton, Ind.

CAMERAS And supplies. Free illustrated catalog listing everything photographic—still and movie cameras, films, lenses—at tremendous savings. Hundreds of bargains, new and used. All guaranteed. We take your old camera or equipment in trade. Write now for your free copy of our newest money-saving bargain book—just out! Limited edition. Hurry! Central Camera Co., (Photographic Headquarters since 1899) 230 S. Wabash, Dept. K-16Z, Chicago, Ill.

ENLARGER \$1.59. Enlarges eight times size of small negatives. Fully guaranteed. Paramount Sales Company, 89 Dudley Street, Boston, Mass.

MAKE Money in photography. Learn quickly at home. Easy plan. Previous experience unnecessary. Common school education sufficient. Interesting booklet and requirements free. American School of Photography, 3601 Michigan Avenue, Dept. 3432, Chicago.

SPEED-O-COPY Groundglass focusing attachment for Leica and Contax. Send for literature. D. Paul Shull, Dept. PM-10, 240 S. Union, Los Angeles.

ENLARGER—DeLuxe A takes 35mm. negatives up, makes quality prints up to 8x10. Complete professional enlarger—not a toy. Write for circular. Special \$4.85 postpaid. DeLuxe Photo Co., Springfield, Illinois.

20—35MM. 2x2 Slides \$1.00. Unusual scenic, travel views—including toned colors—mounted, ready to show, 10—2x2 art slides \$1.00. Art Slide Co., Sippo Lake, Canton, Ohio.

CASH For used cameras and equipment. Gordon's, 162-C Madison, Chicago.

CAMERA Repairing. Bellows made to order, shutters repaired. Bellows made to fit all standard cameras! United Camera Co., Inc., A-1515 Belmont, Chicago.

BASS Says: Shrewd buyers, write Bass. For 30 years headquarters for everything in photography. 72-page Bargaingram No. 242 is interesting and free. Write for your copy. Don't trade until you write Bass Camera Company, Dept. AG, 179 West Madison St., Chicago, Ill.

HAVE You a camera? Send ten cents for recent number of our big magazine, showing how to make better pictures and earn money. American Photography, 116 Camera House, Boston, 17, Mass.

CAMERAS, Films, paper 25% to 35% discount. Paramount Photo Division, 327 East 92nd St., New York.

PHOTO FINISHING

TRIAL Offers! Six or eight exposure rolls developed, printed 20c; or two colored enlargements and eight prints 25c. Twenty reprints 25c. Skrudland, 6444-T Diversey, Chicago.

FREE Beautiful album with cellophane envelopes plus roll developed and two sets prints, 25c. Free mailers. Same-day service. Pho-T-Pho, Box 24-F8, Highland Park, Mich.

AMAZINGLY Beautiful 8x10 enlargements from any negatives, four for \$1.00. Free surprise. Ultramodern, 1305 Walnut, Cincinnati.

THE Photo Mill. Immediate service: No delay! Eight-exposure roll developed, carefully printed and your choice of two beautiful 5x7 double weight professional enlargements, one tinted enlargement, or eight reprints for 25c coin. Reprints three cents each. Highest quality guaranteed. The Photo Mill, Box 629-12, Minneapolis, Minn.

ROLL Developed and 8 beautiful enlargements 2 to 6 times larger—high gloss—deckled edge. Any 8 exposure roll 25c coin. Reprint enlargements 3c each. Alden Photos, 94-B Astor Sta., Boston, Mass.

TECHNIFINISH—35mm. 36 Exposure rolls including "Mercury" fine grain developed and perfectly enlarged to 3" by 4" glossy prints, 85c. New, exclusive methods and equipment make this low price possible. Cartridge reloaded with Eastman Plus X. 30c. One day service. Satisfaction guaranteed or money back. Write for free mailing bags and information. Technifinish Laboratory, 109-L Lexington, Rochester, N. Y.

OVERSIZE Prints. Your roll developed and 8 oversize prints 25c; from 116, 120, or 127 size negatives you receive 4x6 inch prints. All smaller sizes receive 3 1/4x4 1/2 inch prints. Reprints 3c each. Overnight service. Pacific Photo Service, Box 666, San Francisco, Calif.

ROLL Developed 8 prints and two enlargements 25c. Beautiful photographic Christmas cards or calendars from your negatives, 4 for 25c; 17, \$1.00, envelopes included. Young Photo Service, 405-C, Albany, N. Y.

PHOTOGRAPHY For pleasure and profit. Prepare for profitable business or fascinating hobby at home. Common school education sufficient. Write for information and requirements. American School of Photography, 3601 Michigan Avenue, Dept. 3456, Chicago.

ROLL Developed, 16 Velox prints and 2 professional enlargements, 25c, 20 Velox prints, 25c; 100—\$1.00. Same-day service. Superior Finishers, Monroe, Wis.

START Photo finishing business; develop films; make money; details stamp. Photo Promotion Service, 126-B, Grandy, Minn.

INTRODUCTORY Offer. Get 4 beautiful enlargements for only 10c. Send us any 4 negatives of the same size (up to 2 1/2" x 4 1/2") and we will return your enlargements deckled and dated on Velox. Guaranteed non-fading. Send this ad with your negatives and 10c in coin to Mail-N-Save, Box 310-Z, Quincy, Mass.

FREE 3 Professional 5x7 enlargements of your own choice, 2 guaranteed sets of prints with your roll film developed—all for 25c, original order only. Aro Studios, Dept. 12, Des Moines, Iowa.

PERSONAL Attention given each roll, 8 prints 25c. Voris Studio, 1718 Alvin Ave., Cleveland, Ohio.

100 REPRINTS \$1.00, 116 or smaller. Rex Photo, Ogden, Utah.

ROLL Developed, 16 guaranteed prints, enlargement coupon, 25c. Reprints 2c each. Bay Photo, 838 Broadway, Bayonne, N. J.

ROLL Developed. Triple size pictures from every negative, 116 size enlarged 5x7, 120 enlarged 4x6, 127 enlarged 3 1/4x4 1/4. Inbetween sizes enlarged proportionately, triple size, 8 exposure rolls developed and 8 triple size pictures, 25c, 12 exposure rolls, 35c, 16 exposure, 50c. All reprints, 8 triple size, 25c. Tri-Plex Photo Service Co., Box 369, San Francisco.

ROLL Developed, eight Velox prints, two portrait enlargements 25c. Christensen Studios, 729 Pacific, Waukegan, Illinois.

OIL Coloring photographs a fascinating hobby or profitable business. Learn at home by easy simplified method. Previous experience unnecessary. Send for free information and requirements. National Art School, 3601 Michigan Avenue, Dept. 3437, Chicago.

FREE—One roll developed and printed free. Just to get acquainted, we will beautifully develop and print your first 6 to 16 exposure roll free plus 5x7 inch enlargement free, also sensational, new folding folio to frame your prints, all free with this ad. (Enclosing 10c for handling and mailing appreciated.) Dean Studios, Dept. 1039, Omaha, Nebraska.

IMMEDIATE Service! Pictures returned same day order is received. Sixteen guaranteed deckled-edge prints from roll, 25c. One colored or two plain enlargements plus 8 deckled-edge Velox prints only 25c. Special! Coupon for 8x10 enlargement given with each 25c order. Any 36 exposure 35mm. film fine-grain developed Vaporate Treated and each good negative enlarged to 3x4 on deckled-edge Velox paper, only \$1.00! Reloads: 36 exposure, 50c; 18 exposure, 35c. 3x4 deckled-edge reprints, 4c each, 24 hour service. Details, sample and mailers free on request. American Studios, Box 51, LaCrosse, Wis.

DOUBLE Size prints. Roll developed, 8 prints all enlarged to nearly postcard size, 25c. Willard Studios, Dept. 34, Cleveland, Ohio.

BARGAINS. Speedy, eight prints, two enlargements 25c. Fotoservice, 1942-D Marlow, Toledo, Ohio.

ROLLS Developed and 16 prints or 8 prints and 2 enlargements—25c. 35mm. rolls developed and 36 3x4 enlarged prints \$1.00. 3x4 reprints from miniature negatives 4c each. Mercury Studios, Dept. M, 109 N. Dearborn, Chicago.

FREE—To Popular Mechanics readers: Any roll developed, 16 sparkling Nu-Art neverfade enameled prints plus two beautiful Hollywood enlargements and two free Leathertone frames only 25c. Overnight service. Lifetone Studios, F-39, Des Moines, Iowa.

CANDID Developing trial—36 exposures enlarged 3x4, including free enlargement coupon—65c. Micrograin Laboratories, N-39, Des Moines, Iowa.

ROLL Developed and 8 lustrous, natural finish, permanent Velox glossy prints 25c—reprints 3c each. Fotoprint Service, Box I, Roanoke, Virginia.

FREE Trial—16 sparkling lifetime prints, three lovely Hollywood enlargements and free Leathertone frame with roll—25c. Overnight service. Nu-Art Studios, L-39, Des Moines, Iowa.

PROMPT Service—Quality work; 2 beautiful doubleweight gloss enlargements, 8 guaranteed neverfade prints each roll 25c. Excel Photos, Dubuque, Iowa.

FINER Finishing specials 25c. 6—8 exposure rolls developed, your choice—16 prints or 8 prints with 2 professional enlargements or 8 prints and one colored enlargement. Genuine nationally known Moentone superior quality. Moen Photo Service, 431 Moen Bldg., La Crosse, Wis.

CANDID Special. 35mm. rolls enlarged to 3½x4½, \$1.00. 18mm. rolls 60c. 3½x4½ reprints 3c. Brown Photo Company, 1910-61 Emerson, Minneapolis, Minn.

ONE 6½x8½ Plate sunk enlargement or one 5x7 hand colored enlargement with each roll developed and 8 prints 25c. 36 exposure roll developed and 36—3½x4½ enlargements \$1.35. 18 exposure roll 75c. Vidor, 321-P Hennepin, Minneapolis, Minn.

BEAUTIFUL Enlargement from each picture on roll 25c. Cut Rate Photos, Dept. B-4, Janesville, Wis.

ROLL Developed, 16 Velox prints 25c. Dividend coupon, 16 Velox reprints 25c. Willard Studios, Box 3535-A, Cleveland, Ohio.

TWO Beautiful prints from each picture on roll 25c. Twenty years of satisfied customers. Quick service. Lens Photos, Dept. J-4, Janesville, Wis.

ROLL Developed—16 guaranteed prints, two coupons on enlargements, 25c. Smart Photo, Winona, Minnesota.

PROMPT Service! Rolls developed, two Velox prints each negative 25c. Hench Studios, Harrisburg, Penna.

18 LIFETIME Prints. 2 sparkling Hollywood enlargements each roll 25c. 21 reprints 25c; 100—\$1.00. Finished 3 hours. 25 other bargains. Overnight Studio, Albany, Wis.

ROLLS Developed, two prints each and two free enlargement coupons, 25c; reprints, 2c each; 100 or more, 1c. Summers' Studio, Unionville, Mo.

THREE Prints each good negative in roll 25c. Reprints 3c. Fred D. Eastman, Bode, Iowa.

FOR The discriminating amateur—Rolls developed 2 prints each, 25c. Reprints 3c. Superior workmanship. Same day service. Paramount Co., 327 E. 92nd St., New York.

MOTION PICTURES AND SOUND EQUIPMENT

30 NEW Features. Free catalog. 16mm. silent programs, 7 reels, \$2.25. Arts, Asha Films, 785 St. Johns, Brooklyn, N. Y.

NEW Reflector for motion picture projectors, guaranteed to increase screen illumination 40%. "All-Around Reflector Co., 10111 Euclid, Cleveland, Ohio.

SAVE 60% On movie films. Stamp for sample and circulars. Genera Company, Davenport, Iowa.

SPECIAL. 100 Feet 16mm. ortho film including processing \$1.75. Write for bargain price list. Dept. PM1, Morrison's, 43 Province St., Boston, Mass.

GUARANTEED 8mm., 16mm., 24-hour reversal, processing. Eso-S, 3945 Central, Kansas City, Missouri.

ART Films. Sample, dime; catalog free. Cineart, 4224 Lincoln, Chicago.

"HER Hollywood Test": other sensational films. Send dime for artistic sample film. Box 1504, Hollywood, California.

ART Film! Sample, catalogs, gift offers, dime. Parisian, 4228-A Lincoln, Chicago.

BASS Says: The new Revere double 8 camera at \$29.50 with F:3.5 lens is a honey. The new Revere projector at \$59.50 is great value. Both described in our new catalog No. 245. 84 pages. Write for it. New RCA Model PG-170 16mm. sound on film projector is ready. Greatest \$300.00 value. Literature on request. Write Cine Headquarters, Bass Camera Company, Dept. A, 179 West Madison St., Chicago, Ill.

BULK Films—16mm., double 8mm., 100 ft. \$1.25. Cameras, projectors, lists free. Corona Laboratories, 200 East 34, Brooklyn, N. Y.

OUTDOOR Film 100 ft. 16mm. \$1.98. 25 ft. double 8mm. 98c. Spooled, processing included. Free bargain lists. Home Movies, Box 216, Easton, Pennsylvania.

TREMENDOUS 8mm. or 16mm. film library, rent, sale and exchanges. Join now. Stamp for catalogs. Abbe Films, 1265 Broadway, New York.

HOLIDAY Sale: 16-35mm. sound, silent equipment. Large selection, low prices. B-H, Victor, R.C.A., DeVry. Trades accepted. Easy terms. Used film subjects from \$5 per 400'. 8-16mm. library serves U. S. Catalogs free. Mogull's, 64 West 48th, New York.

CLEARANCE! Shorts, features—silent, sound, 25c reel. Cinematic, Owosso, Mich.

MOVIE Film processing outfit \$2.95. Roycraft, Box 1810, Milwaukee, Wis.

35MM. Silent, sound list 5c. Bedner, 5300 S. Talman, Chicago.

ART Films. Lists free. Sample 10c. Box 108, Lefferts, Brooklyn, N. Y.

LEARN Theatre management, projection. Big opportunities. Free catalog. Give age. Theatre Institute, Elmira, N. Y.

SENSATIONAL 8-16mm. Movies "Presidents McKinley to Roosevelt." Thousands other subjects. Sold-exchanged. Films rented everywhere. Bargains in equipment. Trades accepted. Free illustrated catalogue (with sample art 10c). Garden Film, 317 West 50th, New York.

PROJECTOR Films. Bargain list 3c stamp. Clifford Hoffman, Albany, N. Y.

8-16MM. Films, cameras, projectors. Westerns, dramas, cartoons, scenics. 3c stamp catalogue. Excel Home Movies, 634 Acklin, Toledo, Ohio.

16MM. VELOTEX. Perfect outdoor film. 100 ft. rolls \$1.95 including free processing, sample free. Velotex Laboratories, 600-B, Gary, Indiana.

WRITE For new large two color 1940 catalogue nationally advertised movie cameras, projectors, films, accessories. Payments low as \$2.50 monthly. Don Elder's Home Movies, Dept. 20, 739 Boylston Street, Boston, Mass.

MONEYMAKER! "The World's Greatest Passion Play," 16mm. and 35mm. Specify sound or silent. Rent or purchase. Superior than Oberammergau play. Hemenway Film Co., 37F Church Street, Boston, Mass.

UNUSUAL Art catalog; sample film dime. Erwine's Laboratories, Allentown, Penna.

MOVIE Film. Develop yourself. Univex, Eastman, etc. Chemical samples 15c. Raw film wholesale. Lake Camera Exchange, Gary, Ind.

15% TO 25% Discount on still or movie cameras. Free circular. Paramount Co., 327 E. 92nd St., New York City.

FREE—Big list of helpful books. Popular Mechanics Press, 200 E. Ontario St., Chicago.

RADIOS, SUPPLIES, INSTRUCTION

RADIO Engineering, broadcasting, aviation and police radio, servicing, marine and Morse telegraphy taught thoroughly. All expenses low. Catalog free. Dodge's Institute, Ames St., Valparaiso, Ind.

DISTANCE Radio—Complete with cabinet—\$2.50. Kit \$2.00, c.o.d. Sensation Circuit, mounted crystal—25c. Esco-PM, Kansas City, Mo.

AMPLIFIERS. Radio parts bargain list free. Guy Fleming, Huntsville, Missouri.

"RADIO Repair Hints." 32 page booklet, 10c. Supreme Publications, 3727 13th Street, Chicago.

ANSWERS Government radio-operator examinations. Details free. UHF Publications, 3890 Merchandise Mart, Chicago.

RADIO Service men and experimenters send for our giant radio catalog. Save dollars. United Radio Co., 1000 M, Newark, N. J.

AMAZING New four tube miniature portable radio. Looks and carries like camera yet everything self-contained in stunning black unbreakable case trimmed with chromium. Has four inch dynamic speaker and provision for headphones. Economical as flashlight, but powerful and sensitive. Free circular. De Luxe Radios, Box 876, Beverly Hills, Calif.

RADIOS—\$8.95 Up. Save 50%. Wind-chargers, electric fences, power plants. Home agents wanted. Catalog free. Marco-F-30, Kansas City, Mo.

FREE—Big list of helpful books. Popular Mechanics Press, 200 E. Ontario St., Chicago.

MUSIC AND MUSICAL INSTRUMENTS

LEARN Swing piano! Postal brings free folder. Christensen, 451 Kimball Hall, Chicago.

MUSIC Composed to words. Wonderful proposition. Bauer Bros., Oshkosh, Wis.

SONGWRITERS. Write for free booklet. Profit sharing plan. Allied Music, Box 507-N, Cincinnati, Ohio.

WANTED—Songpoems, melodies. We compose, arrange, publish. Amazing offer. Universal Music Service, 1241 Broadway, New York.

SONGS And poems wanted. No charge for melodies. Free examination. Hollywood Recording Studios, Box 87EB Preuss Sta., Los Angeles.

DUO-FLEX Reeds for clarinets, and saxophones eliminate your reed troubles. Write for circular. Duo-Flex Reeds, 1204 1st Ave., Evansville, Ind.

SONGWRITERS! Music composed to words. Amazing offer. Masters of Melody, Box 82, Dept. M, Beloit, Wis.

WANTED! Lyrics, melodies. We sell, compose, arrange. Song agents. National Songwriters, 1674E Broadway, New York.

SONGWRITERS—Get the inside facts. Be successful. Write today for free booklet. Songwriters Institute, 43-C Park Place, Brooklyn, N. Y.

POEMS Wanted to be set to music. Submit for approval. Five Star Music Masters, 6 Beacon St., Boston.

SONGS Rearranged, recorded by radio stars for publication approval. Shepherd Recording, 5840 Second, Detroit.

SONGS, Poems, composed, arranged, no publication costs, royalty basis. Free information. Radio Music Company, Dept. M, Hollywood.

COMPLETE All electric phonograph with built in amplifier at popular price. Guaranteed. Marvelous tone—so good dealers use it for demonstrating records. Music Master Mfg. Co., 508 So. Dearborn, Chicago.

POPULAR Piano course complete \$2.00. Amazing efficiency. Short practice. National Music-D. 532 16th, Oakland, Calif.

PHONOGRAPH Records 10c. Catalogue. Paramount, AJ-358 East Market, Wilkes-Barre, Pennsylvania.

WANTED! Original song poems, any subject, for immediate consideration. Richard Brothers, 24 Woods Building, Chicago.

ORCHESTRATIONS—Popular back numbers, 10—\$1.00. Silverman, 3303 Lawrence, Chicago.

SONGWRITERS Outstanding proposition. Newark Song Publications, 1207 Carbon, Syracuse, N. Y.

SONGS; Songpoems; bought, composed, published, recorded, radio broadcast. Best offer. Free advice. Metro-Melody Music Publishing Company, San Francisco.

FREE Book to songwriters—Original poems, songs wanted. Variety, Dept. V, Salem, Indiana.

SONG Poems wanted. Free examination. McNeil, Master of Music, 510-PM South Alexandria, Los Angeles, Calif.

MUSIC Composed to words. Rhyming pamphlet on request. Phonograph recording of completed songs. Send poem for consideration. Keenan's Studios, Dept. PM, Box 2140, Bridgeport, Conn.

WRITE Songs. Big money and reputation. Write for information. J. Gordon Pub. Co., 201 N. Hoyne, Ave., Chicago.

WANTED! Lyrics, melodies for songs. We arrange, publish, sell. Superior Song Studios, Passaic, N. J.

SONG Writers. Send for publishing agreement. McKinley Music Publishers, 1501 E. 55th St., Chicago.

BUSINESS OPPORTUNITIES

EARN Good money preserving books. Three dollars buys quart. Treats 160 books. Charge fifteen cents each. Guarantees against mold, roaches, etc. Waterproof. Send one dollar for business set-up and source of supply. Unlimited possibilities. Harvey Industries, 1108 Formosa St., Winter Park, Fla.

SMALL Capital starts "route" coin operated peanut, gum and amusement machines. Particulars free. Robbins Co., 1141P DeKalb Ave., Brooklyn, N. Y.

MAKE More money—Paint signs and showcards with Master Patterns and copyright instructions. Economical Signs, 1572 North Halsted, Chicago.

START Home business making statuary, plaques, art goods, novelties, souvenirs, concrete pottery, garden furniture, artificial marble flooring, liquid marble. Make your own flexible molds. Amazing profits. Valuable folder free. Creative Publishers, (P11), Glencoe, Illinois.

CHINESE Goods are cheapest in the world. Become rich by importing handbags, dollies, slippers, laces, handkerchiefs, bags, chair covers, table cloth, etc. Sample collection \$5 postpaid in draft or postal money order. Export and import in general. New Continental Trading Co., Ltd., 14 Museum Road, Shanghai, China.

WE Show you how to obtain capital for your business or invention. Write Enterprise Bureau, Syracuse, N. Y.

START Profitable business making auto glaze, auto cleaner, household cleaner. Amazing profits. Three formulas \$1.00. Barton Chemical Co., 2157 Venice Blvd., Los Angeles, Calif.

SWISS Music box works \$1.25 to \$2.10. Suitable for many novelties. Mermod Manufacturers, 147 West 46th Street, New York.

OPERATE Steady business resilvering mirrors. Making chipped glass nameplates, signs. Write Sprinkle, Plater, 127, Marion, Indiana.

LEARN Cedar mothproofing. Instructions \$1.00. L. Peniston, 92 South St., Orange, N. J.

CAPITAL Seekers. Put your project before 260 key-men. Cost trifling. Details free. Amster Leonard, Fox Theater Building, Detroit, Michigan.

CALIFORNIA Product. Easily makes you big income. Full or part time. No selling. Be in business for yourself. Only \$100 capital necessary. Write Reliable, 1827 South Hope, Los Angeles, California.

"RUBBER Mold Making." Plaster Casting. Working instructions 25c. Ideal Service, R-11, Park Ridge, Ill.

POPCORN Machines, carmelcrisp crispettes, cheese coat, potato chips. Long Eakins, 2035-L High St., Springfield, Ohio.

MAIL Order business course shows you how to make money, spare or fulltime. Teaches professional mail order technique—not penny-catching schemes. Free details. Nelson Company, 500 Sherman, Dept. 404-K, Chicago.

COLOR Concrete with chemicals. Wishing wells. Stucco-rock. Benches. Spin concrete pottery. Cement artistry. Garden ornaments. Cold glaze. Concrete paints. Marbling. Sample 10c. Hollywood Cement Craft, 8527 Wonderland, Hollywood, Calif.

M. M. Earned \$1174 in spare time for exceptional "cellar crop" Snow-King mushrooms! Free book tells if your cellar, shed suitable. We buy crops. United, 3848 Lincoln Ave., Dept. 61, Chicago.

RANGE Oil burners Complete \$7.00. Send for pamphlet. Royal Hardware, 1200 Springwood, Asbury Park, N. J.

MONEYMAKING Opportunities, plans, etc. Valuable tips. Literature free. H. Flury, 1602 Locust, Des Moines, Iowa.

TIRED Of drudgery, job hunting? Start business of your own. Full or spare time. Office or home. 120 exceptional money-making plans. Full particulars free. Monarch Publications, 715A Haas Bldg., Los Angeles, Calif.

MAKE Sell latest popular products. Easily made. Literature free. Law, 1700-M Madison, New York.

ADDED Income and bargain opportunities 10c. Lehigh Service, Box 153, Emmaus, Penna.

START Profitable collection business your community. No capital. Very profitable. Convincing literature free. Morrison Business Service, Pontotoc, Miss.

"MAILOGOLOGY" Magazine. A dynamic, monthly publication. Sample copy 10c. Free folder. B. Root, Publisher, Scappoose, Oregon.

FOR Free information concerning an extremely profitable, lifetime, office business, write, Cole Associates, Syracuse, N. Y., immediately.

BIG Mail for you. Latest moneymaking offers, opportunities, catalogs, magazines. Name listed in directory 10c. Ideal Service, 111-M, Park Ridge, Ill.

EVERYBODY Uses ink. Profitable sideline. 25c package makes gallon. Jalco, Box 132, Alliston, Mass.

MAKE Money developing films. Start "your own" photo finishing business. Home, part, fulltime, locally, by mail. Details stamp. Write: Fotoprint Art Service, 600-A Hebbroville, Texas.

TELEPATHY. Unusual study, guaranteed. Dr. Green, Box 1177pm, San Francisco, Calif.

PLASTEX Industries offers industrious men an opportunity to start a business of their own, manufacturing art goods, novelties, souvenirs, etc., in Plastex and marble imitation. 5c material makes \$1 articles. Rubber moulds furnished for speed production. Small investment brings big returns. You are just in time for big wholesale season now starting. Write for interesting booklet mailed free. Plastex Industries, Dept. A, 1085 Washington Ave., New York.

COST 1c. Sell 25c. Manufacture bleach, glass spray, cleaning fluid, foaming cleaner, etc., from Phospholene. Sample 25c. Literature free. Western, 401 Climax Bldg., Cleveland.

START Good paying mail business! New folio shows how! Thorne's, 436N Jackson, Jackson, Michigan.

ONE Quart liquid rubber guaranteed for mold making with free instructions \$1.95. Gallon \$4.95. Southern Service, 3303-A, Jacksonville, Fla.

DO You want agents for your proposition? Your ad in this space will place your message before hundreds of men seeking fast-selling products. My folder "How to Secure Agents," is filled with proof. I'll gladly send you a copy free. F. W. Johnson, Manager Classified Advertising, Popular Mechanics Magazine, 200 E. Ontario St., Chicago.

WILL You give us 5% first \$600 you make? Afternoons free! Work home, \$1,000 month reported (exceptional—fulltime). Expect surprise! National, Box 1240-B, San Bernardino, Calif.

BE First with presidential plaques, busts, bookends, 800% profit. 25c brings sample, details. Willman Industries, 2415 9th Street, Berkeley, Calif.

UNLIMITED Money possibilities with our plan. Stamp for information. 212 Exchange Bldg., Spokane, Washington.

BE Commercial investigator. Earn nice money all or part time. Curiosity seekers beware, \$5.00 starts you. Free information. G. Edgar Joyner, Box 429, Rocky Mount, North Carolina.

UNUSUALLY Interesting opportunities for greater profits. Particulars free. Colonial Bulletin, Lackawanna, New York.

BELTS, Suspenders, Make'm yourself! Dandy Xmas gifts! No tools! Sample belt 25c. Artea Leather, 400 Joseph Ave., Rochester, N. Y.

HANDY Men—Earn money home operating Community "Fix-It" Shop. Stafford, 708 Rawlins, Carbondale, Illinois.

PROVEN Mail order business. Individual plans. Inexpensive. Practical. Circular free. Dean, 747 Kingsley, Pomona, Calif.

OPERATE Profitable business at home. Details free. Tee Gee Distributors, Box 454, Wilkes-Barre, Penna.

POLISHPUFFS. Silverfox rabbits. Amazing profits. Propositions 10c. Hickorydell, Glenbeulah, Wisconsin.

PROFITS Without any investment whatsoever. Stamp. Volchok, 1064 Sheridan, New York.

RECAST Old batteries into new. Latest achievements. Battery Laboratories, St. Paul, Minnesota.

PAYING Mail business spare time. Staebler, 79-20-45th, Elmhurst, N. Y.

LIQUID Marble—Marvelous, colorful! Brushed, molded, sprayed. Rubberlastic molds! Composition flooring! Particulars free. Marbleizing Service, Edwardsville, Illinois.

YOU—Easily make-sell, today's largest-selling specialty-necessities! Stamp brings many unequalled opportunities. Miller's Chemists, Tampa, Florida.

SELL Books, folios by mail. Earn thousands yearly. Write Garden Publishers, Adel, Georgia.

MAKE Artificial marble. Glazed tiles, uncanny. Tabletops, plaques, sanitary flooring, novelties. Cement secrets. Brilliant samples 3c (nothing free). Liquid latex. Multicolor pencils, wholesale and retail, they're a riot! John A. Payn, 945 Grande Vista Avenue, Los Angeles, Calif.

WHERE To buy at lowest wholesale prices. Information free. Yorena, Box P-312, Bayonne, N. J.

FOR Best established sales-representative for government work and surrounding territory of Washington, D. C., write Riddell, 300 B-st., S. E.

ESTABLISH Own business. Quality products, excellent proposition. Walters, M-14861 Greenfield, Detroit, Mich.

AUTOMOBILISTS Buy on sight. Rapid sales—large profits. River Workshop, 959 First Avenue, New York.

"IDEAS" 68 Pages monthly. Plans, tips, articles, advice—10c. Box 105, Dorchester, Center, Mass.

FREE—200 Clever mailorder, homework, local business, agency offers—all snappy moneymakers. Lewis Co., 828-C Carpenter, Oak Park, Ill.

\$50.00 WEEKLY. Home. Bonafide mail-order business. Manufacture cosmetics, medicines, flavorings. Employ agents. 57 highgrade formulas, instructions, dollar bill. Rossean, Station A, Box 821P, Grand Rapids, Mich.

EXTERMINATING Business; profitable outfit \$2.95. Particulars. A. Kaplan, Gen. Delivery, Baltimore.

MAKE Your telephone work for you between 6:30 and 8:30 p.m. Plan 25c. M. Hoening, 4745 N. 13th St., Philadelphia, Penna.

COLLIER'S Mail order business course shows you how to make money, teaches professional technique. Write Successful Income Builders, Hollywood, California.

\$1.00 AN Hour spare time; build your own business. Graham Company, Lakewood, Ohio.

INVESTIGATE The mail order business. It may be your opportunity. Big 68 page magazine explains. Copy 10c. Dunbar, Middlebush, N. J.

OWN And operate a general appliance repair shop. Small capital establishes you in profitable steady repeat business. Complete, illustrated course enables mechanically inclined men to have lifetime business. All phases of general appliance repairing, how to secure business, etc., covered. Send today for free literature. Christy Supply Co., 2835 N. Central Ave., Chicago.

EARN Money at home making imitation diamond jewelry, bracelets, barmpins, millinery ornaments, religious medals, etc. High prices now paid on account of German and French jewelry shortage. Exceptional spare or full time opportunity. Write, United Jewelry Manufacturers, Dept. A, 1692 Boston Road, New York City.

INCREASE Your earnings in a business of your own, with all the trade you can attend to. Become a Foot Correctionist and in a few weeks earn big income in service fees—not medical or chiroprody. Easy terms for home training, no further capital needed, no goods to buy, no agency. Address: Spencer System, 533 Back Bay, Boston, Mass.

"INDEPENDENT Operator"—Professional mailorder magazine—10c. Kraft Publications, Syracuse, New York.

"MAILMONEY Facts." Outstanding mailorder magazine. Copy, opportunity offers, 10c. Vernon Publishers, West Fairview, Penna.

"MAILORDER Directory"—300 firms listed; 51 classifications—15c. Kraft Publications, Syracuse, New York.

OPERATE Profitable "route" four compartment vendors. Small investment. Penny King, 1233 Chouteau, St. Louis.

WE Help start you in business, furnishing outfits and instruction, operating "Specialty Candy Factory" home. Men-women, opportunity to earn good steady income, all or spare time. (Our 31st year.) Booklet free. Ragsdale Candies, Dept. 4, East Orange, N. J.

OPERATE Mail order business at home. Details dime. Maples, 3418 South Marshfield, Chicago, Illinois.

OWN A cash business? No selling. Operate "Silver King" vendors, \$3.95 up. Free instructions. Automatic, 2422-A Fullerton, Chicago.

WE Successfully sell inventions, patented and unpatented. Write us, if you have a practical, useful idea for sale. Chartered Institute of American Inventors, Dept. 4-C, Washington, D. C.

MOLD Making, plaster casting, tremendous profits. Foolproof rubber, 24 page instructive catalogue free. Plastic Arts, 711 Neely, Muncie, Indiana.

MAKE Color-glazed concrete pottery, gravestones, tiles, floors, walls. Basement waterproofing, etc. Booklet 3c stamp. National Potteries, Minneapolis, Minnesota.

INVENTION Finance Magazine, 80-G Wall Street, New York. Important particulars free.

MAIL Order business is your opportunity. Many began small, now earn thousands yearly. No personal contact. Boundless opportunities. Have had over 30 years experience; will help you succeed. Send 25c for valuable booklets, none free. B. Brenner, 257 E. 21st, Philadelphia.

A REAL Future for you with Red Comet fire control products. Low prices. Proved seven years. Splendid sales outfit free. Some good territory open. Exclusive. Write quick, 766 Red Comet Building, Littleton, Colorado.

SUCCEED With your products. Make-sell them. Formulas, Processes, Accurate analyses. Catalog free. B. Thaxly Co., Washington, D. C.

GOOD Paying business silvering mirrors, plating autoparts, reflectors, bicycles, bathroom fixtures by late method. Free particulars and proofs. Gunmetal Co., Ave. H. Decatur, Ill.

ELITE Collection of business plans, contains 127 tested plans and scores of formulas. Start own business; home, office, Particulars free. Elite Co., 214 Grand St., New York.

100 PROFITABLE Mail order and local plans. Gilbert Supply, 5-P West 24th, New York.

127 WAYS To make money, in home or office, business of your own. Full particulars free. Elite Co., 214 Grand St., New York.

HOW And where to obtain capital fully explained, free particulars. Star Service, Wapakoneta, Ohio.

MAKE Money by mail, the way we do. Free information. Maywood, P-1107 Broadway, New York.

MONEYMAKING OPPORTUNITIES

"MONEY By Mail" magazine brings business plans, tested moneymakers, formulas, trade secrets, spare time starters, and mailorder plans. Three months, 25c (silver). Atlatm, 4418 W. 63 Street, Chicago.

EARN Money taking magazine subscriptions. Details free. New York Circulation Service, Thirty Church, New York.

M. M. Earned \$1174 in spare time for exceptional "cellar crop" Snow-King mushrooms! Free book tells if your cellar, shed suitable. We buy crops. United, 3848 Lincoln Ave., Dept. 64, Chicago.

OPERATE Steady business resilvering mirrors. Making chipped glass nameplates, signs. Write Sprinkle, Plater, 287, Marion, Indiana.

MAKE Money repairing scales. Big opportunities. We show you how. Send stamped envelope. Ackerman, Box 1653, Charlotte, N. C.

"LUMINOUS Paint" shines in dark. Easily made. 300 other formulas, plans—all 25c. Ideal Service, 300P11, Park Ridge, Ill.

AMAZING, Profitable, moneymaking book. Literature free. Bell, Twisby, Englewood, N. J.

BUY Wholesale—Sell by mail or local. Wetzel, Valhalla, N. Y.

MAILORDER Opportunities! Send name—postal. Schroeder, 803 Wisconsin, Peoria, Illinois.

"PORT Of Opportunities" published monthly—offering latest self employment; ideas; plans; schemes, \$1.00 year, copy 10c. Farm & Home Industries, 26 Seneca, Gardenville, N. Y.

BOOKKEEPERS—Operate new profitable bookkeeping service. Ralph Lee, Vicksburg, Michigan.

TIN Cans, tons of expensive tin junked daily. Can be detinned. Instructions 25c coin. D. Kirk, Box 930, Harrisburg, Penna.

24 DOLLAR Secrets, valuable money-making guide, opportunities galore 25c. Statham, 6731 Division Ave., Birmingham, Ala.

MILLION Articles. Buy wholesale. Valuable directory 10c. Ideal Service, D-11, Park Ridge, Ill.

FILING Saws easy this new way. One dollar hour easy. 25c brings instructions. Harvey Pickett, Garden City, Ia.

OPPORTUNITIES Galore. 3 money-making magazines 10c. Parker Publications, Peterboro, Ont., Canada.

WHOLESALE Sources, 500,000 articles. Free directory. Maywoode, 1107 Broadway, New York.

ALL Dollars in your mail 100% yours—as "Co-Operator," supplying millions jobless satisfying employment information. We fill Co-Operator's orders! Co-Operative Service, 77 Swan, Buffalo, New York.

WILL You give us 5% first \$600 you make? Afternoons free! Work home, \$1,000 month reported (exceptional—full-time). Expect surprise. National, Box 1240-A, San Bernardino, Calif.

CREATE Self employment, that pays 50c to \$1 hour. Valuable instructions 25c. Homecraft Arts, Lakeside, Calif.

EARN Money compiling names. We tell you how. Inexperience, location no handicap. Golliday Company, 1514 Long, Columbus, Ohio.

MAILORDER Opportunities, publication, plans, sell by mail. Harvey Teeple, Decatur, Indiana.

OPPORTUNITIES Unlimited—3 magazines, formulas, plans, 10c. Goodeve, Bergenfield, New Jersey.

MAILORDER Businesses build fortunes! Free literature explains your opportunity for mailorder profits! Jay, 1129 East 61st, Chicago.

MYSTIFYING Pig, moves eyes, ears, tail. Manufacture 1c. Fast seller, \$10 daily. Instructions \$1.00. Act quick. Gaddis, Co. 2224, Rahway, N. J.

START Film developing business at home—by mail. Make money. Complete instructions 25c. Circular free. Dunbar, Middlebush, N. J.

MAKE 20c On 25c sales. Liberty, Box 1704, Cleveland, Ohio.

BE Funny, make money. Learn gag writing. Stamp brings information. Don Ush Studios, B-518 Wrightwood, Chicago.

GENERAL Contest Bulletin, 22 big pages of contest helps, 10c, 1609 East 5th, Duluth, Minn.

MOULDS, Guaranteed, for casting toy soldiers, Indians, trappers, warships, sinker moulds, 244 kinds. Send 5c for illustrated catalogue. Send \$1.00 for large sample mould. Henry C. Schiercke, 645 Spencer, Ghent, N. Y.

BE A professional scrapbooker. Big fees. Unlimited opportunities. Can be done at home. No competition. No capital needed. Write to Scrapbookers Guild, 59 Park Place, New York, N. Y.

"RAISE Earthworms for profit," new, interesting home business. Bureau Zoological Research, 106A Broadway, Peoria, Ill.

FORMULAS, PLANS, ETC.

REAL Manufacturing formulas. Lists free. Cummings, Chemist, Gordon Avenue, Syracuse, N. Y.

ELITE Formulas and plans; make and sell your own products. Descriptive booklet free. Elite Co., 214 Grand St., New York.

MONEY-MAKING Formulas—Thousands of new "make-it-yourself" trade secrets and compounds. Illustrated circulars free. F. Warren, 15 Park Row, New York.

PROVEN Formulas 25c. Satisfaction or money refunded. Norv Breuer, Loveland, Ohio.

FORMULAS—All kinds. Real moneymakers. Lowest prices. Catalog free. Clover Formulary, 108-PM, Niles Center, Ill.

FORMULAS: Latest, best, selected sellers. Literature free. Baran, Bay City, Mich.

ATHLETES Foot and poison oak. Itch formula—50c. T. Skele, 1814 Harrison, Butte, Mont.

MAKE Fast selling products. "Chemist Approved Formulas." Catalog free. Kemico, 12, Park Ridge, Illinois.

FORMULA Guaranteed to relieve toe itch, 25c. E. Page, 1705 Dogwood Place, Jacksonville, Florida.

ANY Formula \$1.00. Analysis. Assaying. Formula Supply, 1449 Vermont, Detroit, Michigan.

AUTHENTIC Formulary. Used by leading manufacturers, formula dealers. Instructions for easily making 10,000 profitable products. Supply sources. Complete book—924 pages, \$1.50. Postpaid-C.O.D. Adams Brown Company, Chestnut Hill, Massachusetts.

YOU—Easily make-sell, today's largest-selling specialty-necessities! Stamp brings many unequalled opportunities. Miller's Chemists, Tampa, Florida.

160 SINGLE-INGREDIENT Formulas—No manufacturing. Information free. A. Kinford, Wayne, Penna.

THAXLY Formulas, processes, for successful products. Accurate analyses. Catalog free. B. Thaxly Co., Washington, D. C.

ICELESS Ice! Colder! Cleaner! Cheaper! Instructions 25c. Duffy, Covington, Ky.

65 PROVEN Industrial formulas. Send \$2.00. Mundhenke, 531 S. W. 1st Ave., Portland, Oregon.

CHEMISTRY

FREE Catalog, chemistry, mineralogy, telescopes, binoculars, microscopes. Tracey Laboratories, Evanston, Illinois.

FREE: 40 Page catalog of chemical and laboratory supplies for amateur chemists. Wollensak microscopes and supplies, scientific books at big discount. JE11 Winn, 124 West 23 Street, N. Y. C.

FREE Chemistry catalog. Supplies at 5c! Equip complete laboratory. Kemkit Scientific Corp., 397P Bridge St., Brooklyn, N. Y.

CHEMICALS, Laboratory, glassware, apparatus. Send 3c for catalog CPI. Biological Supply Company, 1176 Mt. Hope Avenue, Rochester, N. Y.

SPECTROSCOPE For quick chemical analysis \$2.50. Cutting Sons, Campbell, California.

CHEMICALS In 5c quantities. Catalog 5c. Fleischer's Laboratories, Medford, Mass.

HELP WANTED

MAKE Big money demonstrating amazing Handyman Tool, 101 uses. Pulls posts, roots, small stumps; jacks up trucks, tractors, wagons; lifts buildings; stretches fences; splices wire; makes cider press; dandy auto bumper jack, etc. Lifts, pulls, pushes with 3-ton power. Write. Harrab, Dept. K-61, Bloomfield, Indiana.

CALL On service stations, factories, restaurants, businesses, professions; with lettered advertising uniforms, shirts, work suits, etc. 100 styles. Exclusive features. Big advance commissions. Free outfit. Topps, Dept. P-7, Rochester, Ind.

M. M. Earned \$1174 in spare time for exceptional "cellar crop" Snow-King mushrooms! Free book tells if your cellar, shed suitable. We buy crops. United, 3848 Lincoln Ave., Dept. 62, Chicago.

CELLULOSE Menu covers. Sell easily. Samples dime. Transparent specialties, Box 15, Station "D," Los Angeles, Calif.

BIG Money taking orders; shirts, ties, hosiery, underwear, pants, jackets, raincoats, uniforms, etc. Sales equipment free. Experience unnecessary. Nimrod, 4922-BG Lincoln, Chicago.

IF You want better job write immediately. Jobfinder, Box 2061, Dallas, Texas.

BOYS, Girls—Earn spending money; outfit free. Vosacek, 1634A Monroe, Chicago.

STEADY Work—Good pay. Reliable man wanted to call on farmers. No experience or capital required. Pleasant work. Home every night. Big money every day. Wonderful new proposition. Particulars free. Write McNess Co., Dept. 446, Freeport, Illinois.

GET The job you've dreamed of. We assist talented, industrious, ambitious men and women of all ages. Whether now employed or not. Job consultants that make good—not employment agency nor application-letter writers. For eye-opening booklet address Gatto Associates, Trenton, N. J.

EARN Money in your spare time taking subscriptions to Popular Mechanics. Unlimited possibilities, every family a prospect. Easy to sell. Bonus paid in addition to liberal commission. Send postcard for further details today. Circulation Dept., Popular Mechanics Magazine, 200 E. Ontario St., Chicago.

POPULAR MECHANICS

AGENTS WANTED

SELL The Lightning Calculator, the new type calculating machine that adds, subtracts, multiplies and divides. Make big profits every day on the only deluxe machine on the market, available in a range of colors to suit your prospects' fancies. Guaranteed five years. 137,000 already sold. Easy to sell, because it is priced \$30.00 less than competitive machines. Agents wanted everywhere. For particulars write Lightning Calculator Company, Grand Rapids, Michigan, Dept. 18.

CHRISTMAS Card leader brings you quick cash profits. Sensational "Beauty Queen" 21-card assortment sells \$1.00. You make 100%. Ten other fast-selling assortments. Personal Christmas cards, 50 for \$1. up. Samples on approval. Chilton Greetings, 147 Essex, Dept. B-2, Boston, Mass.

FREE Samples easily sell mechanics Protex-Ur-Hands! Constant repeater. 100% profit. American, 491-P William, East Orange, N. J.

SELLS Like hot cakes. Big profits. New laundry soap flakes. Perfumes clothes when washing. Territory given. Sunset Laboratories, Lynbrook, New York.

AGENTS Make big profits on food products, bargain deals. Low wholesale prices. Rush name for trial outfit offer. Ho-Ro-Co, 2810-U Dodder, St. Louis, Mo.

REVOLUTIONARY Window cleaning tool. Good Housekeeping approval. Only ten \$2.25 sales daily to housewives. factories, schools, stores will make you \$350.00 monthly. Carter Products Corp., 911 Front Ave., Cleveland, Ohio.

STOVE Lining—Furnace. Iron. Fits all. Patented. Circulars free. Benjamin Co., Granite City, Ill.

SELL Gabardines, reversibles, tweeds, jackets, etc. \$2.98 up. Larger commissions. Free outfit. Consumers Raincoat, 608 So. Dearborn, Dept. B, Chicago, Ill.

SELL Ready tied ties. Sample 25c coin or stamps. U. S. only. J. and G. Sturm, 39 8th Ave., Passaic, N. J.

FREE Assortment of actual packages foods, groceries, household products worth \$6.00, if you promise to show friends and neighbors and try to take orders. Fine profits. Spare time. Experience unnecessary. Zanol, 2036 Monmouth, Cincinnati, Ohio.

MAN Wanted to supply Rawleigh's household products to consumers. We train and help you. Good profits for hustlers. No experience necessary to start. Pleasant, profitable, dignified work. Write today. Rawleigh's, Dept. K-53-PPM, Freeport, Ill.

MAGIC Clothes brush. Revolutionary invention. "Erases" dirt like magic. Saves drycleaning. Sensational seller. Samples sent on trial. Rush name. Kristee, 121, Akron, Ohio.

WEAR Fine hose I send without cost with large outfit while taking orders for amazing new hosiery. Replacement guaranteed against holes, snags, and runs. Rush name and hose size. Wilknit, Desk RR-37, Greenfield, Ohio.

500% PROFIT. Gold and silver colored sign letters. Offices—stores. Large sizes 1c. Free samples. Modernistic, B-3000 Lincoln Ave., Chicago.

CHRISTMAS Card agents: Premium doubles sales! Box 451M, Fitchburg, Mass.

OPERATE Steady business resilvering mirrors. Making chipped glass nameplates, signs. Write Sprinkle, Plater, 128, Marion, Indiana.

PATENT Combined brush and comb, to eliminate dandruff. Free sample. Peter Chiarello, 1319 East Falls Street, Niagara Falls, N. Y.

FASHION Styled organdie aprons. Fast selling item. 100% profit. Write today. A. Brenmore, 55 West 42nd, New York.

AGENTS! Men's suits 88c, pants 23c, top coats 50c, ladies' coats 36c, dresses 10c. Other bargains. Catalog free. Portnoy, 566-P Roosevelt, Chicago.

HAND Painted copper Christmas cards; 60c box. Sell \$1.00. Desert Studios, Box 1765, Tucson, Arizona.

PHYSICAL Perfection course 10c. (Agents \$1.00 per 100). Sid's System, Southgate, California.

AGENTS! Two a day—keeps the poor-house away. See advertisement page 133A. National Laboratories.

AGENTS Rush 25c for sample spectacular seller. Ward, 97B, Saybrook, Conn.

XMAS Bird pictures with real feathers. Sample 10c. Importer, C. Staff, No. F. 8716 Lambert, Detroit, Michigan.

AGENTS—300% Profit on amazing new discovery. Cleans, polishes, waxes cars in 30 minutes. Magic all-purpose polish. Instant demonstration sells most skeptical auto owner and housewife. Send 25c for 75c size. Enduro, 2420-F Grand River, Detroit, Mich.

SELL New, used clothing from home, auto, store. Men's suits 77c, leather jackets 29c, overcoats 54c, dresses 20c, ladies' coats 36c. Other bargains. Catalog free. National, 436 East 31st, Chicago.

BIG Money taking orders; shirts, ties, hosiery, underwear, pants, jackets, raincoats, uniforms, etc. Sales equipment free. Experience unnecessary. Nimrod, 4922-AN Lincoln, Chicago.

START Profitable home business manufacturing soapless suds. Amazing discovery. Eliminates hard scrubbing. Costs 1c quart. Formula, sample 25c. Details free. Linothex, 14006 Colt, Cleveland.

SELL Used clothing bargains from home, store, auto. Shoes 15c, men's suits, overcoats 75c, dresses 10c. Experience unnecessary. Free wholesale catalog. Superior Jobbing, 1250-GD Jefferson, Chicago.

PHOTOSTAMPS Personalizing stationery, outfit 50c. Excellent opportunity. Royal Service, P.O. Box 1275, Washington, D. C.

SPLENDID Earnings for part time work—A quality line that positively repeats—Build up or work with your present route. Write for full particulars. Sterling Food Products, 3715 Avalon, Los Angeles, Calif.

AGENTS. Our door openers will help you make more sales. Write Silksaver, 5125 Pensacola, Chicago.

"SOL-VO." Brand new invention. Genuine motor residue solvent. Greatest internal motor cleaner known. Harmless! Distributors wanted. Thermo-Solvoil, Peoria, Ill.

150 AMAZING Money-making secrets. Free samples. Formico Novelty Service, Dayton, Ohio.

CHRISTMAS Cards. Largest profits from complete line box assortments, inexpensive and deluxe personals, stationery. Heather Greetings, Springfield 99, Mass.

SPOTS-OFF—Amazing spot remover. Whirl-wind seller. Great repeater. Splendid money-maker. Write Hopkins, 564 Florence Branch, Los Angeles.

FREE Water and our concentrates make 68 products. We supply labels, bottles. Enormous profits. Qualco, E-20030 Russell, Detroit.

VALUABLE Gifts—watches, cameras, etc.—in addition to doubling your money by easy selling of our 64 piece Masterpiece Box of French-fold Christmas cards and seals. Cards and seals in attractive colors by a master designer, all 64 pieces cost 25c—sell on sight at 50c. Write for free sample set, and gift plan today. Be first in your community with this quick seller. American Card Co., Box C-95, Lancaster, Penna.

ONE Reference and 25c stamps bring you sample outfit to start making money immediately with Mexican art goods. Tremendous market. Big profits. Marquez Company, Apartado 1176, Mexico City.

MONOGRAMMING Automobiles real money maker. Write for samples. International Co., Box 9360, Philadelphia, Pa.

EVERYBODY Buys sensational "Golden Rule" assortment. 21 Christmas folders including souvenir calendar. Free Christmas motto with each box. Unparalleled value. Costs you 50c, sells on sight for \$1.00. Actual retail value \$3.00. Ten other bargain assortments. Everybody, all ages, making easy-as-pie sales. Nothing to lose. Sample "Golden Rule" assortment sent on approval, with free offer. Silver Swan Studios, 320 Fifth Avenue, Department 46, New York.

WINDOW Sign letters. Penny each, large sizes. New styles. Absolutely beautiful. Free samples. Atlas, 7941 Halsted, Chicago.

AGENTS: Smash go prices! Santos coffee 12c lb. 4-oz. vanilla 8½c. Razor blades 10 for 8½c. 100 sticks chewing gum 12c. Christmas cards, 21 in box, 14c. 150 other bargains. Premiums. Experience unnecessary. Carnation Company, P.O. St. Louis, Mo.

CALL On service stations. New item, necessity, big profits. Knipp, Long Beach, California.

AGENTS: Stamping names on pocket-key protectors. Sample check with your name, address, 25c. Stamping outfits. Emblem checks, check-fobs, name plates, Hart Mfg. Co., 303 Degraw St., Brooklyn, N. Y.

FREE Sample—Amazing cleaner; sells homes, taverns, everywhere. Big profit—fast repeater. Betco, 5007 Irving Park, Chicago.

BIG Money applying initials on automobiles. Easiest thing today. Free samples. Also, sideline salesmen for short order decalomania name plates. "Ralco," 1305 Washington, Boston, Mass.

SUCCEED With your products. Make-sell them. Formulas, Processes. Accurate analyses. Catalog free. B. Thaxly Co., Washington, D. C.

MANUFACTURE Specialties, hire agents yourself. Big money. Free literature. Gilbert Supply, 5-P West 24th, New York.

AGENTS—300% Profit selling gold leaf letters; stores and offices. Free samples. Metallic Letter Co., 438-B North Clark, Chicago.

ENGRAVED Name plates, numbers, signs, etc., easily sold, profits large. Brett Bros., Winthrop, Mass.

GOOD Paying business silvering mirrors, plating autoparts, reflectors, bicycles, bathroom fixtures by late method. Free particulars and proofs. Gunmetal Co., Ave. N, Decatur, Ill.

AGENTS—Opportunity make money; book containing 127 successful business plans; home-office; send for free introductory booklet. Elite Co., 214 Grand St., New York.

AGENTS—To mail our literature. Good profits. Home business. Maywood, 1105-1107 Broadway, New York.

HIGH-GRADE SALESMEN

BUILD A profitable lifetime business selling the only low cost nationally known automatic combined fire extinguisher with alarm having Underwriters Laboratories listing. Ten year successful record. Openings for producers in choice territories. AutoFyrstop Company, Dept. P-1, 2035 Washington Ave., Philadelphia.

SELL Chestnut chicks. Make real money. Wonderful opportunity for aggressive salesman with car, calling on farmers, Illinois' oldest U. S.-approved hatchery, operating entire year. Liberal commission paid promptly on immediate and future orders. Exclusive territories. Write for details today. Chestnut Hatchery, Box 117A, Chestnut, Illinois.

SCULPTURED Ornamental, religious, patriotic plaques. Retail \$1.00 to \$3.00. Liberal commissions. Write, Zinkote Sales Co., 3867 Harvard Rd., Detroit, Michigan.

FOUR Color processed business signs. Sell fast. 400% profit. 20 assorted \$1.00. Tinselled sacred mottoes, 12 assorted, \$1.00. Samples 10c. Lists free. Johnson Sign Service, Morristown, Tennessee.

WANTED: Permanent representative for Hoover uniforms—waitresses, doctors, nurses. Slack ensembles, aprons, frocks. Smartest styles. Finest quality. Exceptional commissions. Line free. Hoover, 251 W. 19th St., Dept. KK-10C, New York City.

NEW Kind of man's shoe increases height two inches. Also styles that zip on and off. Pays salesmen ready cash every day. Complete sales kit, including almost 250 styles for men and women, sent free. No experience needed. Write manufacturer established 38 years. Mason Shoe Manufacturing Company, Dept. BC-41, Chipdewa Falls, Wisconsin.

SENSATIONAL Quick-cash opportunity. My route building plan gives you chance for good steady income. Real future. Handle regular route local stores. Collect, deliver orders for famous 5c—10c counter display goods. Nationally advertised in 120 magazines and radio. Show merchants proven plan for beating competition and increasing sales, profits. Experience unnecessary. Use home as headquarters. Chance to operate Silver Fleet service truck. Facts free. World's Products Co., Dept. 10-E, Spencer, Indiana.

SELL Complete line calendars and printing at cut prices. 100 four color calendars \$1.95; 2,000 business cards \$1.50; 1,000 envelopes or statements, etc. \$1.75; 25 printed sales books \$1.50; 1,000 process embossed cards \$1.50; 2,000 two-color labels, free holder \$1.50; 2,500 printed handbills \$1.75. One-third comm. Free outfit. Bargain Prtg. Co., 189-F W. Madison, Chicago.

MAKE Money selling calendars. Largest, most complete line in field. Widest price range. Newest designs—De luxe, hangers, direct on, commercial, thermometer, metal, miniature, Christmas card calendars. Big commissions. Four different selling outfits sent free. Write today. Capitol Calendars, Dept. 511, Gladys at Hamilton, Station D, Chicago.

ADVERTISING Book matches—World's largest "direct selling" book match factory offers advance cash earnings calling on every type of business. Experience unnecessary; full, part time. Low prices for high quality; quick deliveries, help you get orders. Good repeat profits. Free kit, instructions. Match Corp. of America, 3343 West 48th Pl., Dept. E-11, Chicago.

REVOLUTIONARY Loud speaking inter-communication system. Talk privately, back and forth, to one or any number of stations, even 2,000 feet away. Any station originates calls. One electrical connection. No servicing. Easily installed. Guaranteed. Technical experience unnecessary. Two-minute spectacular demonstration. Thousands prospects, factories, offices, stores, auto dealers, lumber yards, restaurants, etc. We carry the accounts. Free trial to customers—sells itself. New low price. Men earning high as \$150 week. Protected territory available. Free demonstrator offer. Inter-Communication System of America, Dept. 310, 2440 Lincoln Ave., Chicago.

BIG Commissions—selling to stores celluloid pricing tickets, metal shelf moulding. To restaurants, menu covers, signs. P. Pricing Press, 124 White St., New York.

BIG Firms need men—you. With or without experience they offer you daily cash money for your spare or full time. You can choose the company from hundreds of well established firms who are ready to help you make money working for them. No matter where you live or what your age is, here is your chance. Long established magazine tells how. Six issues sent to you free to get acquainted. No obligation now or ever. Send name on card today to "What to Sell." Box M11, 168 N. Michigan, Chicago, Ill.

SALESMEN, Route men, distributors. Cash in our new fast selling 10 cent side line that will pay all expenses. Write today. Lovely, 1734-A Washington, St. Louis, Mo.

SELL New simplified time saving book-keeping system. Big profits. Record Pub. Co., 2626 Irving, No. Minneapolis, Minn.

SELL Grocers, butchers, restaurants, new changeable paper window signs. 400 varieties, large commission. Rueby Displays, 29 North Water, Rochester, N. Y.

SALESMEN, Distributors, 200 items, brushes, mops, marvelous magnetic brush excels vacuum cleaner. Highest commissions. Neway Brush Works, Hartford, Conn.

ADVERTISING Book matches—World's largest manufacturer of union label book matches. Fast selling line. Large sales producing kit. Sample matches, complete cut catalog. 9 color combinations makes selling easy. Commission in advance. Superior Match Co., 7530 Greenwood, Dept. M-11, Chicago.

NEW Specialty—Sells every business and professional man. Four \$15 sales daily pay \$280 weekly. Farrell cleared over \$1,000.00 monthly. Write F. E. Armstrong, President, Dept. PM, Mobile, Ala.

CALL On friends with greeting card assortments. Easter, birthdays, other occasions. Big demand. Big profits. Also personal stationery. Experience unnecessary. Samples free. Wallace Brown, 225 Fifth Ave., Dept. T-34, New York.

AT Home, your own manufacturing business, making popular \$1 novelties. Cost you 3c to 15c. Everything supplied. Write So-Lo Works, Dept. N-842, Cincinnati, Ohio.

SALESMEN: America's finest sideline. 40% commission daily. 1000 fast selling repeat items. Every business uses and must buy. No investment now or ever. Sales portfolio free. Willens, 2130 Gladys, Dept. CC, Chicago.

SELL Quality portraits, frames. Lowest prices—big profits. Catalogue free. Friedman's Studio, 528 Cornelia, Chicago.

"GALLOPING Ivories"—Nicknamed by salesmen. It's really hot! Plenty immediate - repeat commissions. Every retailer - service station wants it. Hurry! Universal, 2222 Diversey, Dept. C511, Chicago.

SELL Custom shirts. Liberal commission. Outfit free. Merit Shirts, Bridgeport, Conn.

EXPERIENCED Salesmen for direct selling of patented made to measure form fitted shirts. Cannot be purchased in stores. Excellent side line for tailoring salesmen. Prices \$2.00 to \$5.00. Very attractive proposition. Bona-Fit Shirt Co., Paterson, N. J.

DISTRIBUTORS, Crew managers, organizers of agents, send quick for news of amazingly-seasonable device for traveling autoists. Thirty-five cents retail or more value. Quick easy seller. Light, permanent. Immense commissions. Act promptly. Nicholas Company, 7137 Cottage St., Philadelphia, Penna.

CHRISTMAS Leaders! 21 piece flash assortment 15c; 50 imprint folders 25c; 100 piece gift wrap box 25c. Bargain packages 1c each. Samples \$1.00 postpaid. Illustrated catalog free. Elkko, 440 North Wells, Chicago.

CALENDARS—Beautiful complete line, all sizes, including jumbos. Samples free. Also Christmas cards. Fleming Calendar Company, 6539 Cottage Grove, Chicago.

BLADES—Big profits. Best quality. Factory prices. Postpaid. Ace Blades, Buffalo, N. Y.

A REAL Future for you with Red Comet fire control products. Low prices. Proved seven years. Splendid sales outfit free. Some good territory open. Exclusive. Write quick. 704 Red Comet Building, Littleton, Colorado.

EXCELLENT Opportunity selling our complete line of brushes, largest commissions. Write for sales plan. Wire Grip Sanitary Brush Company, 2300 5th Ave., New York.

EDUCATIONAL AND INSTRUCTION

WANT Your pay raised? What are you doing to deserve it? Since 1897, our promotion training has fitted graduates for better paid positions. Accounting, air conditioning, architecture, drafting and design, electricity and 11 other big commercial and industrial lines. Also complete high school (many finish in 2 years) and liberal arts. Selective employment service for advanced students and graduates. Big bulletin and employment facts free. State line of work you like best. No obligation. Write immediately to American School, Dept. C-845, Drexel and 58th, Chicago.

BLUEPRINT Reading taught by mail. Write Blueprint Reading Institute, Box 5662 Metropolitan Sta., Los Angeles.

SIMPLIFIED Shorthand. First six lessons dime. Speedscript Company, 1127 Mississippi, Pittsburgh, Penna.

DRAFTSMEN—Earn extra hundreds. Introductory detailed saleable ideas, \$1. Guaranteed. Draftsmen's Foundation, West Medford, Mass.

"HOW To Break and Train Horses"—A book every farmer and horseman should have. It is free; no obligation. Simply address Beery School of Horsemanship, Dept. 11011, Pleasant Hill, Ohio.

EARN More money—Learn decorating, paperhanging, graining, marbling, pictorial and sign painting. Catalog free. Chicago Painting School, 102 West Lake Street, Chicago.

WELDING—Electric arc. Learn profitable trade quickly through actual practice. Individual welder instruction at bare cost of materials. Full particulars free. Valuable welding lessons book 50c. Hobart Welding School, Box M-11404, Troy, Ohio.

LEARN Auto mechanics, body, repairing, welding electricity, refrigeration, Diesel. Stevinson's, 2008A Main, Kansas City, Mo.

WATCH Repairing is steady profitable work. Experts usually in demand. You can learn watchmaking trade at home, spare time. New original instruction system. Script engraving course included. Write for free details today! Nelson Co., 500 Sherman, Dept. K-2001, Chicago.

LEARN Real estate through home study by twelve experts. High commissions, easy, reasonable, new, college education not necessary. Write Morrison School, 100 North LaSalle, Chicago, Illinois.

AUTO Finance course, \$7.50 postpaid. Nebraska Finance Co., Lincoln, Nebraska.

AIR Conditioning—Electric refrigeration. Rapid growth creates big demand for trained men. Earn up to \$35-\$50 weekly. Write for free facts. Utilities Engineering Institute, 1314 Belden Ave., Dept. 10Y, Chicago.

CLINICAL Laboratory technic taught in your own home. Practice outfit supplied. Bulletin free. Imperial Technical Institute, Box 494-E, Elkhart, Indiana.

HIGHER Arithmetic teaches shortest methods of figuring. Frederick A. Smith, 2410 Bernard Street, Chicago.

"HOW To Win a Job and Keep It." "125 Ways to Make Money on Your Typewriter." "Modern Webster Dictionary." and "Holy Bible." All new books, \$1.00 each, postpaid. Bookhouse, Box 251, Tampa, Florida. Satisfaction or money refunded.

U. S. government jobs, men, women. New plan. Quicker start. Free particulars. National Service Bureau, 610 South Broadway, Los Angeles, Calif.

WANT Super memory? Write "DY." Info Company, Box 1122, Chicago.

CONSTRUCTION Men learn hoisting engineering. 200 questions and answers \$2.00. H&P Pub. Co., Sta., H, Buffalo, N. Y.

CLAIM Adjusting. Complete \$5.00 course prepaid 25c silver. Box 302, Alhambra, California.

WANT A government job? Commence \$105-\$175 month. Men-women. Prepare now at home for examinations. Full particulars and list positions, free. Write today. Franklin Institute, Dept. K3, Rochester, N. Y.

DEFEND Your future! Prepare for chemical, electrical, refrigeration, or radio career. No tuition. Diploma Particulars. Bookery, Box 3941, Cleveland, Ohio.

LEARN Watchmaking. Material instructions for start and wholesale supply catalog, all \$1.00. Refund not O.K. Stewart's, 721 Olive, St. Louis, Mo.

DRAFTING, Mechanical, sheet-metal, home taught. Davison Technical School, 7 East Grand, Detroit.

LEARN Telegraphy! Opportunities now available to beginners due to new railroad retirement act. Expenses low. Catalog free. Dodge's Institute, Hiatt Ave., Valparaiso, Ind.

U. S. Gov't jobs pay up to \$40 a week to start. Get ready for next examinations; railway postal, rural carrier, mail carrier, office help and others. Free book tells how you may qualify. Write quick. Patterson School, Dept. P. M., Rochester, N. Y.

CLAIM Adjusting. Excellent pay. Investigate tragic accidents, fires; outfit fraudulent claimants. Burns School, 311 Morewood, Pittsburgh, Penna.

SECRET Investigation. Experience unnecessary. Detective particulars free. George Wagner, M-2640 Broadway, N. Y.

FREE—Big list of helpful books. Popular Mechanics Press, 200 E. Ontario St., Chicago.

PLAYS, STORIES, MANUSCRIPTS

FREE Information on selling your stories, articles. Charbeth, Box 62, Philadelphia, Pennsylvania.

SEND Best story, play—for revision, marketing. Free reading. Childress, McMinnville, Tennessee.

PUBLISHERS Need manuscripts. Information free. Besner-PM, 30 Church, New York.

FREE Test for writers! Send postcard for free market test. Hundreds of paying markets seek stories and articles. Learn the markets best suited to you—and sell. We help you! No obligation! Comfort Writer's Service, Dept. 519, St. Louis, Mo.

STORIES, Articles, books wanted for publication. New, unknown authors assisted. Manuscripts marketed, revised, criticized. Christopher Carr, 3636A Chestnut, Philadelphia, Penna.

YOUR Story ideas built into salable short stories—revised, marketed. Free analysis. Author's Bureau, Rhinebeck, N. Y.

CARTOONING, COMMERCIAL ART, SHOWCARD WRITING, SIGN PAINTING

BE A professional signwriter. No training necessary. Send for book—"Modern Signwriting Simplified" 25c coin. Showcarder, 523 N. Prior, St. Paul, Minn.

ANIMATED Cartooning! Illustrated! Professional! Home course! (Copyrighted) simplified method! Compared to \$50 courses! \$5 complete! Particulars 3c. Hazell Studio-Animatooning, Box 246, Hollywood, California.

AMATEUR Cartoonists, earn cash, spare time, copying advertising cartoons. Ad-Service, Arkyle, Wis.

NEW Cartoon selling plan \$1.00. Particulars free. Smith's Service, Wenatchee, Wash.

TEST Your cartooning ability. Send dime for big test picture chart, full details of outstandingly successful simplified method. Landon School, 199-N National Bldg., Cleveland, Ohio.

MIGS School of Cartooning. Send for free details. Box 893, Springfield, Mass.

CRAY-ARTS! Now anyone can draw nature scenes instantly. Discovery amazes everyone! Special crayons—no lessons. Folder, original drawing, free. Write. Cray-Arts, complete \$2.00 (Canada \$2.25). Townsend Company, 309-E Cutler Bldg., Rochester, N. Y.

LEARN To draw—by simplified method. Complete course \$1.00. John Leon, 121 So. Hill St., Los Angeles, Calif.

ART Magazine including directory art books—free! Send 10c postage. Art Headquarters, Doty Street, Madison, Wisconsin.

PEN And ink drawings. Let us draw your advertising and catalogue illustrations, from photos, copies or objects. Best work and fair prices. Heraldic Studios, 1914P Oakdale Avenue, Chicago, Ill.

CARTOONING Course—30 illustrated lessons, over 500 sketches, drawing paper, pens and pencils. \$1.00 complete postpaid. Montes Studio, Box 985, Pasadena, Calif.

ADVERTISING AGENCIES, LETTER WRITERS, FOR ADVERTISERS

ADVERTISE Profitably: \$15 reaches 5,000,000 Sunday newspaper readers with 24-word ad. Newspaper, magazine, mailing-list ratebook, free. Chicago Advertising Agency, 20-PA West Jackson, Chicago.

LEARN Advertising at home. Easy practical plan. No text books. Common school education sufficient. Interesting booklet and requirements free. Page-Davis School of Advertising, 3601 Michigan Avenue, Dept. 343B, Chicago.

DISPLAY. 60 Words, 40 mail trade magazines, thrice \$2.90; 24 words, thrice \$1.00. Gibbs, 502 W. 151, New York.

25 WORDS, 169 Pulling national magazines \$5.00. Piersimone's, 1231 Spofford, New York.

ADVERTISE: 24 Words, 149 newspapers \$6.50. Lists free. Advertising Bureau, 4515-C Cottage Grove, Chicago.

CURRENT Lists opportunity seekers—\$5 thousand. Darnell Service, Jackson, Tennessee.

ADVERTISING Placed all magazines, newspapers, radio. Lowest rates. Free service. 54 page rate book free. Baker Advertising Agency, A-189 West Madison, Chicago. Successors to Ankrum. Established 28 years.

FREE—New Advertisers Rate Guide, 44 pages. Includes everything. Lowest rates. E. H. Brown Advertising Agency, 140 S. Dearborn, Chicago.

BUSINESS SERVICE

IF You type your letters, you need Letter-Gram, most business-like way to handle all short written messages. Free samples and particulars. Valley Printing Co., Indianola, Nebr.

1,000 ORIGINAL Letters—Agents and mail order buyers—\$4.00. Particulars free. Crown Mail Order, 164-PM Monroe Street, New York.

ATTENTION—Get more business at low cost! 1000 guaranteed fresh names mail order buyers, opportunity seekers on perforated gummed paper, ready to stick on envelopes \$1.00. Saves time! Metro Sales, 75 Arlene, Youngstown, Ohio.

HONOLULU, Hawaii, mail address and reforwarding service. Enclose stamp. Hawaii Mailing Service, Box 2017.

CHICAGO (Downtown) mail address \$1 monthly. Your mail reforwarded daily. General Business, 56 West Washington; (established 1919.)

RUBBER STAMPS AND OFFICE SUPPLIES

CUSHION Handle, 2 lines 25c; 3, 35c. Schultz, Pleasant Ave., Bergenfield, New Jersey.

2 LINES 25c, 3 Lines 35c. Stamp Works, Auburn, Nebr.

CUSHIONED, 3 Lines 35c. Frederich Company, Box 412-D, East Pittsburgh, Penna.

CUSHIONED Indexed 3 lines 35c. pads 25c. Lentz, Box 402, Youngstown, Ohio.

SUPERIOR. Indexed, cushioned. Two lines, 25c; three 35c; four 50c. Slocum, 814 Bradley, Peoria, Illinois.

KNOB Handle, cushioned. 2 lines 25c, 3—35c. Stamp Works, Centerport, N. Y.

TYPEWRITERS, DUPLICATORS, OFFICE DEVICES

CASH For good portable typewriters. Write Sootin's, 230 Northwest Second Avenue, Miami, Florida.

INCREASE Business now. "Excellograph" Rotary Stencil Printer reprints thousands everything you typewrite, hand-write, draw or trace. Colors. \$19.75 to \$44. Terms. Illustrated literature free to business or professional men. Pittsburgh Typewriter Supply, Department K-2, Pittsburgh, Penna.

NEW Low priced duplicating machines will save you time, money. Complete line supplies. Write free circular. Fidelity Corporation, Syracuse, Ohio.

STENCILS \$2.00. Duplicating ink \$1.00. Ribbon Ink Co., Cicero, Ill.

TYPEWRITERS, Adder, mimeograph, multigraph, addressograph. Send for free lists of machines that will help you at half price. Pruitt, 28 Pruitt Bldg., Chicago.

PRINTING, MULTIGRAPHING, MIMEOGRAPHING, GUMMED LABELS

THOUSAND Neat business cards, \$1.00 cash postpaid. Other printing. Eaton Press, Gardner, Kans.

1000 2 COLOR Shipping labels 4¼x3—\$1.25. 500 6¾ envelopes \$1.50. Postpaid. Guaranteed! Samples. Perritt's, 1504 Juliet, Austin, Texas.

PRINT Anything. Reasonable. State requirements. Hamilton Press, 4341 P. Meade, Chicago.

SHOP Aprons for printers, machinists, shipping clerks, made of blue denim, 36 inches long, postpaid 75c. Mechanics Apron Supply, 2324 Benton Blvd., Kansas City, Mo.

250 LETTERHEADS 8½x11, Envelopes 6¾, billheads 7x8½, \$1.35 each. Packard Press, 160 William St., Newark, N. J.

125 8½x11 TWENTY Pound bond letterheads and 125 6¾ envelopes \$1.00. Benneville, 907 West Roosevelt, Philadelphia.

PRINTING? Reasonable prices. Samples free. Griglak Printery, West Leisenring, Penna.

1000 ELEGANT Envelope slips, \$1.75; 5000, \$3.90 prepaid. All printing lowest prices. Samples. Goodprint, Harrisonburg, Va.

25 100-PAGE Duplicating salesbooks \$1.50. 3,000 business cards \$2.00. Samples. Manness, 5019 Keyser, Philadelphia, Penna.

500 BUSINESS Cards, free case. \$1.00. Hosley Press, 8 Seminary Street, Auburn, New York.

50c POSTPAID—50 8½x11 Bond letterheads and 50 6¾ bond envelopes. Superior Press, 1517 Pendleton, Columbia, S. C.

RAISED 100 Letterheads and envelopes \$1.00. Perry Press, Albion, Maine.

125 8½x11 WHITE Letterheads and 125 6¾ envelopes. High grade workmanship. 24 hr. service. \$1.00 postpaid. Satisfaction guaranteed. McConnells Press, 411 Nth Gilbert, Danville, Illinois.

LETTERHEADS, 6¾ Envelopes, shipping labels, statements—250, \$1.00 postpaid. Franklin Printery, Box 5062, Chicago.

BOND Letterheads, 20 lb., 8½x11, envelopes 6¾, \$2.50 per thousand delivered. Brink, 1130 Holmes, Menominee, Mich.

500 STICKERS 2¼"x¾". Four lines, 25c. Labels. Cott's, Spickard, Mo.

PRINTING. Reasonable. State requirements. Wessling Press, 352 New York Ave., Jersey City, New Jersey.

BARGAINS: Stencils, ink, paper, etc. Dixiegraph, King, N. Car.

50 SHEETS, 25 Envelopes 25c prepaid. Samples. George, West Burke, Vermont.

1000 MODERN, Thin-plate business cards (twenty words) \$1.00 postpaid. Golden Rule Printers, Peoria, Illinois.

HARVEY Labels, Berea, Ohio. Better label values. Interesting samples free.

PERSONAL Stationery—Your name and address (3 or 4 lines) printed on 300 sheets bond paper and 100 envelopes \$1.00 postpaid. Polzin, 1702-A West Winona, Chicago.

CHRISTMAS Cards reasonable. Write today. Cheser, 3111 West Monroe, Chicago.

48 HOUR Service, thousand 8½x11 letterheads, 6¾ envelopes, 5½x8½ billheads, statements, \$2.95 prepaid. 5,000—\$10.00. Gibson Printers, 5005 Vincennes, Chicago.

1,000 3½x6½ ENVELOPES Printed \$1.89. Samples free. Nixen's, Stevens Point, Wis.

6x9 CIRCULARS—2,500, \$3.49; 5,000, \$5.78, 50% deposit. Record Press, Lancaster, Ky.

MIMEOGRAPHING. Illustrated letters, circulars. Samples. Bur-Wil, 24 Louisa, Binghamton, N. Y.

500 MIMEOGRAPHED Letters (8½x11) \$2.15. Multigraphing. Prices, samples mailed. Multitype, 487 Broadway, N. Y.

HAMMERMILL Letterheads, envelopes, all colors, 30 styles type. Free particulars. Woodruff's, 217A Lewis, Duluth, Minn.

500 3¼x2¼ FOUR Line gummed stickers, 25c. Moritz Printery, Saginaw, Mich.

PRINTING OUTFITS AND SUPPLIES

PRINT Your own cards, stationery, circulars, advertising. Save money. Simple rules furnished. Print for others, nice profit. Junior outfit \$8.25, senior outfits \$16.55. Details free. Kelsey, Inc., T-11, Meriden, Conn.

ELECTRIC Printing multigraph, Davidson automatic feed \$175.00, 8041 Exchange, Chicago.

BARGAINS, Presses, type, List 3c. Exchange, D-15, 190 Cook, Meriden, Conn.

PRESSES, Complete bargain equipment catalog. Send stamp. Bradshaw, 3214-P Huron, Chicago.

INEXPENSIVE 6x9 Printing press. Details free. Novelty Shop, Downsville, Louisiana.

PRESSES, Type, supplies. List free. Catalog ten cents. Model Press Co., York, Penna.

PRESSES, Type, cabinets, supplies. Catalogue for stamp. Lincoln Press, 220-E Hartwell, Fall River, Mass.

PRINT At home. 10c will bring a complete catalog of presses, type and supplies. P. Peiffer & Company, 6 Columbia St., Newark, N. J.

BARGAINS — Presses, type, supplies. Send stamp. 159 Harvard, Cambridge, Mass.

USED Presses, type, supplies. Lists 3c. Turnbaugh Service, Loysville, Penna.

PATENT ATTORNEYS

PATENTS: Inventors, take first step to protect your rights to your invention—without cost. Write for free "Record of Invention" form and complete instructions for making legal disclosure of invention and establishing date. We also send, without cost, 48-page book, "Patent Guide for the Inventor" telling importance of prompt action; how to sell and market your invention; how to make application for patent; showing examples of successful inventions; explaining convenient payment plan. Write for free book and Record of Invention form. See page 12A for further information. Clarence A. O'Brien, Registered Patent Attorney, Dept. OLiB Adams Building, Washington, D. C.

INVENTORS—Send immediately for two free books, "Patent Protection" and "When and How to Sell an Invention." Fully explain many interesting points to inventors and illustrate important mechanical principles. With books we also send "Evidence of Invention" form. Prompt service, reasonable fees, forty-two years experience. Avoid risk of delay. Address Victor J. Evans & Co., Registered Patent Attorneys, 561-M Victor Building, Washington, D. C.

INVENTORS—Patent your invention—Send now for our new free copyrighted booklet "Important Patent Facts" and "Invention Record" form. This booklet guides the inventor from the first step toward patent protection to final profit making from his invention. Reasonable fees, conscientious counsel. McMorro and Berman, Registered Patent Attorney, 134-C Barrister Building, Washington, D. C.

PATENTS Secured promptly, information free, personal confidential service, 30 years patent experience, engineer patent attorney. Henry Price Ball, 141 5th Ave., New York.

REGISTERED Patent attorney. Personal service. Low fees. Preliminary advice free. Eric B. Prime, 4123 West Sixteenth Street, Chicago.

"INVENTOR'S Guide" free: full information about patenting, selling inventions. Frank W. Ledermann, 154 Nassau Street, New York.

INVENTORS—Send for free booklet "Patent-Sense." Information based on 64 years experience. Lacey & Lacey, Dept. 5A, 635 F St., Washington, D. C.

PATENTS. Booklet free. Highest references. Best results. Promptness assured. Watson E. Coleman, Patent Lawyer, 724 Ninth St., Washington, D. C.

L. F. RANDOLPH, 302-B Victor Bldg., Washington, D. C. Low cost. Book and information free.

FOR INVENTORS

VICTOR J. Evans & Company, 506-M Victor Building, Washington, D. C.—one of world's largest firms of Registered Patent Attorneys, established 1898—will send you free—68 pages of facts for inventors. Two plainly written books tell you how to apply for patent—give six basic methods of selling your invention. Fees reasonable; terms arranged. Delay may be costly; write today.

INVENTORS: Profit by your invention. A practical talk to inventors by an experienced manufacturer. Our 68 page booklet "Mind vs. Matter" mailed upon receipt of 25c. Rex Engineering Co., Cincinnati, Ohio, Dept. D.

INVENTORS—Time counts. Don't delay. Protect your idea with a patent. Get 48 page Patent Guide free. No charge for preliminary information. Write today. Clarence A. O'Brien, Registered Patent Attorney, OLA Adams Building, Washington, D. C.

MAKE Your invention patent pending. Protection covers two years, costs less than \$2.00. Particulars 50c. Marian Washburn, 514 19th Street N. W., Washington, D. C.

INVENTORS! Unpatented inventions completely protected at total cost \$1.50. Show valuable ideas to prospective buyers safeguarded against theft. Also protects songs, short stories, scenarios. Send \$1.00 for Inventor's Protection Sheet. Maurice Moroney, 321 - 92nd St., Brooklyn, N. Y.

MANUFACTURERS List; only \$1.00. Your Field National Promotion, 4115 Port Washington, Dept. P-1, Milwaukee, Wis.

INVENTORS—Meet 25 buyers. Inventions accurately drawn, with 25 prints, and list of 25 manufacturers, \$5. Trusted secretary, U. S. Drafting Co., 91 Wall Street, New York.

INVENTORS—A complete national service—Patent searches, models, drawings, engineering, testing. Ideas commercialized and sold. Write for free booklet, "Inventing for Profit." Camco Institute of Invention, Camco Bldg., Grand Rapids, Mich.

WE Build models which "put over" your idea. Complete engineering service, developing and designing. We market and manufacture in any quantity. Write for bulletins, R. & S. Engineering Co., Dept. AF-11, 17 East 42nd Street, New York City.

INVENTOR'S Universal Educator; contains 900 mechanical movements; 50 perpetual motions; instruction on procuring and selling patents and selecting an attorney, etc. Suggests new ideas. Price \$1 post-paid in U.S.A. Address Albert E. Dieterich, 511-B Colorado Bldg., Washington, D. C.

I SELL Patents. Established in 1900. Charles A. Scott, 773PM Garson Ave., Rochester, N. Y.

INVENTING Taught at your home by Trofimov School of Inventive Practice, Hanna Rd., Willoughby, Ohio.

CASH For practical ideas and inventions. Mr. Ball, AB-9441 Pleasant, Chicago.

INVENTORS: "Making Inventions Pay" our 32-page illustrated book mailed absolutely free. Crescent Tool Co., Dept. ZS, Cincinnati, Ohio.

WE Locate buyers meritorious patented, unpatented inventions. If will sell, reply immediately. Descriptive booklet, references, free. Invention Reporter, 5A-11236 South Fairfield, Chicago.

INVENTORS—Send for 72-page book on patents. Reasonable terms. Conscientious treatment to inventors. L. F. Randolph, Registered Patent Attorney, 302-E Victor Bldg., Washington, D. C.

HAVE You a sound, practical invention for sale, patented or unpatented? If so, write Chartered Institute of American Inventors, Dept. 4-A, Washington, D. C.

INVENTIONS WANTED

SIMPLE. Practical inventions wanted by manufacturers, patented or unpatented. For information write Chartered Institute of American Inventors, Dept. 4-D, Washington, D. C.

CASH For inventions—Patented or unpatented. Mr. Ball, A-9441 Pleasant, Chicago.

MAKE Your inventions pay. We help you. 36 year old firm offers complete services, free estimates. Ample facilities regardless size of invention. Stampings, metal specialties, dies, models, etc. Catalog giving "inside" information free. Crescent Tool Co., Dept. W, Cincinnati, Ohio.

WANTED—Meritorious patented, unpatented inventions. Booklet, references, free. Invention Reporter, 5B11236 South Fairfield, Chicago.

INVENTION Finance Magazine, 80-G Wall Street, New York. Important particulars free.

SMALL Inventions wanted by manufacturers. I'll help you sell your invention. Write for free circular. Stanley Hull, 7829-K Euclid Avenue, Cleveland, Ohio

PATENTS FOR SALE

NEW Type truck and trailer signal for sale. Good manufacturing proposition. Address Stenger, 903 W. 84 St., Los Angeles, Calif.

TIRE Pressure indicator. Indicates from instrument panel low pressure tire. Patent pending. Otto E. Dietrich, Morton, Ill.

SELL Your patent through a small classified ad in Popular Mechanics. Many inventors have found buyers in this way. Ask me for proof—I'll gladly send it to you. F. W. Johnson, Manager Classified Advertising, 200 E. Ontario St., Chicago.

NEW Smoking pipe. Outright or royalty. Patentable, manufacturer wanted. Harvey Slagell, Flanagan, Ill.

ROYALTY Or outright for new fan and new design dresser and wardrobe. George W. Harding, 162 W. Cross St., Baltimore, Md.

MANUFACTURING

INVENTIONS Developed and manufactured. Send us your ideas. Model Engineering, Osgood, Indiana.

INVENTIONS Manufactured by an experienced company, in any quantity at low cost. Metal specialties, novelties, stampings, dies, and models. Free estimates. Our booklet "Mind vs. Matter" sent upon receipt of 25c. Rex Engineering Co., Cincinnati, Ohio, Dept. C.

METAL Spinning, by expert. Low prices on experimental or production. Frank Probst, 4126 Brookside Ave., Minneapolis, Minn.

ENGINEERING Service—Research, design, production in mechanical, electrical, chemical; also formulas, processes. All communications confidential. Choate Engineering Co., 152 West 42nd, New York.

MANUFACTURING. Any material, any quantity, inventions developed. Milburn, Burlington, Kentucky.

INVENTIONS Developed and manufactured. Send us your ideas. Model Engineering, Osgood, Ind.

INVENTIONS — Manufactured in any quantity at low cost by old-established reputable company. No branches anywhere. Stampings, metal specialties, dies, models, etc. Free estimates. Free catalog. Crescent Tool Co., Dept. XS, Cincinnati, Ohio.

WOODWORKING Power tools — Make them yourself. Lathe, scroll saw, saw table, drill press, portable sander, bandsaw, motorized plane. Complete details only 25c. Popular Mechanics Press, 200 E. Ontario Street, Chicago.

MODELS AND MODEL SUPPLIES

BEAUTIFUL Ship models, coach models. Finest quality. Complete kits by oldest "direct-to-you" manufacturer. California Redwood hulls completely shaped and sanded "Constitution" special model \$1.45. Others proportionately inexpensive. 3c stamp for catalog. Miniature Ship Models, Dept. R, Perkassie, Penna.

MINIATURE Steam locomotives, new catalog listing all builders' needs 25c. Little Engines, Wilmington, California.

BUILD Railroads, planes, boats. Catalog 10c. Ideal Company, 26½ West 19th, New York.

RAILROAD Model Shop, Dept. PM, Dunellen, New Jersey. Catalog 10 cents.

SUBMARINE 24" Kit to build \$1.00. Spotts, 3925 N. Broad, Philadelphia.

MODELS—Practical models put over your ideas. We develop models from the crude to perfect working devices. Your idea might have large commercial value. Services confidential. Bank references. Registered graduate engineers at your service. Send 25c for our 68 page booklet "Mind vs. Matter." Rex Engineering Co., Cincinnati, Ohio, Dept. B.

ENGINE Catalogue castings, supplies, 25c. Howardco, A-2417 North Ashland, Chicago.

WORKING Models of anti-aircraft, naval and railroad guns. Circulars and photos 25c. William Gregory, 229 Sixth Ave., Newark, N. J.

POWER Models. Electric railways, steam locomotives, steam and gasoline engines, all accessories, metals, tools. 84 page catalog 35c. Chas. Cole, Ventura, Calif.

IMMENSE 52 Page Mini-Train railroad catalog, 1227 different items. Vanden Boom's, 3821 Broadway, Kansas City, Mo.

THOUSANDS Ship fittings, hundreds kits, catalog 10c. Polk's, 429 Seventh Ave., New York, N. Y.

GAS Motor power airplane catalog 6c. Polk's, 429 Seventh Ave., New York.

GOOD Working models with eye appeal. We have spent 36 years developing ideas into practical working models! Let us help you! Free catalog. Crescent Tool Co., Dept. Y-SA, Cincinnati, Ohio.

CARVED Hull ship model kits. Ship and yacht model fittings; model yacht sails. Illustrated catalog 20c. A. J. Fisher, 1002-M Etowah Ave., Royal Oak, Mich.

BLUEPRINTS AND PLANS

BUILD Your own beautiful 12x22 garage. Blueprints, complete instructions \$1.00. Clark, 218 E. Lexington, Baltimore, Md.

HOME CRAFTSMEN

DESIGNS Made to order, any size, from any clear illustration for any handicraft, monogram, hand embroidery. Service information 3c. Mountain Studio, RFD No. 1, Narrowsburg, N. Y.

CRAFTSMAN'S Library of valuable handbooks, catalogs, manuals, project plans. Send 25c (coin). Major Marketers, Bonbright Bldg., Philadelphia, Penna.

PLASTICS Sheets, rods, tubes, samples 25c. Walter Fratesi, Box 3625z, Washington, D. C.

ORIGINAL Patterns: 20 novelty, 25c; 15 lawn ornament, 20c. Wayne Gorman, Box 1272-NP, Amarillo, Texas.

CARVED Shelf design. Owl amid foliage. 16¼x6¾. 35c. Dewey Mack, Goshen, Ind.

LAWN Ornament patterns, all new, full sizes—Flying duck, rooster, hen and chick, parrot, 15c each; all four 50c, post-paid. Wickman Co., Dept. 207, Dayton, Ohio.

PLASTICS—Bakelite, Catalin, sufficient for cigarette or powder box, four rings, two bracelets, five ornaments, five jewelers findings. Twenty pieces \$1.25 cash with order. Dependable Machy, Co., 1011 Harrison, Oakland, Calif.

GET Free leathercraft instruction pamphlets, prices of leathers, tools, projects. Make extra money. Beautiful gifts. Leather samples 5c. Wilder & Company, 1038 Crosby, Dept. 11F, Chicago, Illinois.

22 LAWN Ornament patterns 25c. Other patterns: 15"-20" high; Dutch girl, Dutch boy, pirate, bull terrier, Mexican girl, Mexican boy, dwarf, penguin, flower girl, 10c each; 3 for 25c. 25 novelty patterns 30c. All 56 full size patterns \$1.00 post-paid. Strother, Box 383-BQ, Belington, West Virginia.

NEW Sand-Craft novelties in wood or glass. Easily made. Instructions, 20 patterns 25c. Sand-Craft Service, Oshkosh, Wis.

OUTSTANDING Leather projects. Make attractive gifts. Art Leather, 400 Joseph Ave., Rochester, N. Y.

LEATHERCRAFTSMEN: Send 10c for handbook and catalogue of tools and supplies. E. A. Sweet Company, Inc., Leathercraft Division, Dept. A-40, 143 State St., Binghamton, N. Y.

KNOCKDOWN Furniture. lumber, veneers. Illustrated catalog 10c. Gilles-Kendall Co., Decatur, Alabama.

MEXICAN Wood novelties easily made! 20 patterns complete instructions 25c. 20 cowboy silhouette patterns 25c. 10 lawn ornament patterns 15c. Mexican Artcrafts, Eagle Pass, Texas.

PROFITABLE Employment assembling cedar chests. Free instructions. Brown's Cedar Works, Coleman, Georgia.

SQUAREKNOTTERS! Make belts, handbags, etc. Quality cord samples with catalog, free. Beginners book, catalog and samples, 10c. Special! Regular \$1 book with 50c beginners outfit, all for \$1. P. C. Herwig Co., Dept. J-23, 121 Sands St., Brooklyn, N. Y.

UNIVERSAL 4" Chucks, few \$10. Workshop bargains. "Supply," Newfane, Vt.

WOODWORKERS—Send for valuable new data book with complete line plywood, veneers. Save up to 33% buying from direct mill representatives. See our offers. Send 10c to cover mailing (refunded on first order). S. Beck Plywood & Lumber Co., 1309 N. Halsted, Chicago.

VENETIAN Blinds, supplies, machinery, wholesale catalog 10c. "Manufacturing Booklet" \$1.00. "Roberta," Box 260, Gloversville, New York.

PATTERN Catalog finely illustrating 250 plywood novelties, silhouettes, lawn ornaments, decal transfer decorations, and other lines. Wo-Met Shop, Ashburn, Georgia.

80 PATTERNS, 20 Lawn ornaments, 20 silhouette, 20 novelties, 20 lawn ornaments, 30c each set, all for \$1.00. Modern Woodcraft, Saginaw, Mich.

ELECTRICAL Work and hundreds of other new, money making and money saving ideas. 1940 Shop Notes, 50c. Popular Mechanics Press, Room C40, 200 E. Ontario, Chicago.

OLD GOLD, WATCHES, JEWELRY, PRECIOUS STONES

BULOVA, Gruen, Hamilton, Elgin, Waltham wrist and pocket watches for ladies and gents. Positively lowest wholesale prices. 1941 styles now available. Write for free money making wholesale catalogue. Norman Rosen, Wholesale Jeweler, Dept. P.M., 801 Sansom Street, Philadelphia, Penna.

GOLD \$35 Ounce. Ship old gold teeth, crowns, jewelry, watches—receive cash by return mail. Satisfaction guaranteed. Free information. Dr. Weisberg's Gold Refining Co., 1500-Q Hennepin, Minneapolis, Minn.

HIGHEST Prices for old gold—Mail your teeth, watches, jewelry. 100% full cash value mailed day shipment received. Satisfaction guaranteed or articles cheerfully returned. Information free. Chicago Gold Smelting Company, 300-P Champlain Building, Chicago.

GEMS, Agates, minerals. 20 rough gemstones \$1.00. Pricelist free. Hill, Route 7, Salem, Oregon.

AUSTRALIA'S Lovely opals. Illustrated catalogue free. Good selection \$5.00. Norman Seward, Melbourne, Australia.

WATCHES—Hamilton, Elgin, Waltham, Bulova as low as \$2.75. Diamond rings at lowest prices. Postal brings free illustrated catalog. Quaker City Jewelry Company, Wholesale Jewelers, N. W. Cor. 8th and Walnut Sts., Philadelphia, Penna. Dept. "S."

REBUILT Watches, guaranteed. Pontiac Watch Co., Box 576-P, Pontiac, Mich.

ELGIN, Waltham watches \$3.50. Make big money. Free watch and jewelry catalog. Plymouth Jewelry Exchange, 163-A Canal St., New York.

AGATES, Fossil woods, three pounds \$1.25 postpaid. Jay Ransom, Aberdeen, Wash.

WATCHMAKERS' Materials — Tools, watches, jewelry. Bought, sold, exchanged. Best prices for old gold, diamonds. Ben Segal Company, 5 South Wabash, Chicago.

WATCHMAKERS' Tools, supplies. Watch parts. Lowest prices. Write for price list 43. Dean Company, 87 Nassau St., New York.

5000 REBUILT Watches! Free catalogue—Diamonds, jewelry, (3c postage). The New York Jobbers, 74 Bowery, Dept. M, New York, N. Y.

FOR THE HOME

QUICK Furnace lighter—without kindling. \$3.50. Guaranteed. Lorain Furnace Lighter, Lorain, Ohio.

TOBACCO

PIPE, Pouch tobacco. \$2.50 value for \$1.00. Remit. Patterson Pipes, 340 E. 4th St., New York City.

CIGARETTES—Popular brands. \$1.50 carton postpaid. Tom Thumb, Nauvoo, Ill.

GOLDEN Leaf guaranteed, cigarette, pipe or chewing, 5 lbs. \$1.00, ten \$1.75. Pay when received. Pipe, box cigars free. Reeves Tobacco Co., Paducah, Ky.

SMOKE. Chew, and talk with this dust mask. 50c each with filters. Noseit Co., 3165 Berea Rd., Cleveland, Ohio.

RAZORS, BLADES, SHARPENING

BELL-O Abrasivtropol; Gardner, Massachusetts. Booklet? 250,000 komforted! Gillette months! Belloized blade, send 3c.

FOR SALE—MISCELLANEOUS

BUY Wholesale, anything desired. Information sent. Feil Jobbers, Delft, Minn.

\$150 RADIO Operated treasure machine, only \$75. Excellent condition. Used 20 hours. Write Thomas Robertson, c/o Corbitts, Henderson, N. C.

WANTED—MISCELLANEOUS

CASH Paid for used microscopes, binoculars, slide rules, drawing sets, scientific instruments, tools, cameras, transits. Satisfaction guaranteed. Elman's, 108-MK South Clark, Chicago.

WILL Buy your unused United States stamps. Small discount. What have you? Mint Sheet Brokerage Co., 418 Caxton Building, Cleveland, Ohio.

MERCURY (Quicksilver), Tungsten, molybdenum, cadmium, nickel anodes, tin, pewter, rare and semi-rare metals, metallic residues purchased in any quantity. Write for quotations. Metallurgical Products Company, 35th and Moore Streets, Philadelphia, Penna.

PERSONAL

STAMMERING Scientifically corrected. Practical, home training. Normal Speech Mail Course, 236 Palmer, Grand Rapids, Mich.

NERVOUSNESS, Nervous fears! Real help available! Free (very special) information. Write—describe your trouble. John Englund, Box 335, Ironwood, Mich.

BOOKS! All subjects! Catalogues free! Old Prof's Book Shop, M16 Arcadia Ct., Pontiac, Mich.

SICK—Discouraged! Conquer fear, worry, nervousness and all negative thoughts. Health, happiness, success assured. Inspiring information free. Metaphysics, Mooresville, Ala.

ROSIKRUCIAN Secret teachings are offered to those who seek to use them solely for the perfection of their inner faculties, and in the mastering of the daily obstacles of life; the International Organization of Rosicrucians will be happy to receive the requests of those who believe that worthiness and sincerity determine the right for one to have such wisdom; to them, a copy of "The Secret Heritage," a fascinating book, will be given without price; let this book guide you to the conservative plan whereby you may widen your scope of personal power. Simply address your letter to Scribe D.L.B., Amore Temple, Rosicrucian Park, San Jose, California.

REMOVE Your own tattoos. Start profitable business. Write Tattoo Supply House, 651 South State, Chicago.

"HOW To Overcome Self-consciousness," educational book complete 35c. coins. Box 43, East San Diego, California.

WIN Prize money: Booklet—"Successful Contesting"—shows how, 10c postpaid. Bulletin listing \$100,000.00 prizes included. World Publishers, 4515-B Cottage Grove, Chicago.

SUCCESS Or failure? Personality decides which. Learn secret of being irresistible! "Success" shows how. 60c. Doherty, 4816 46th, Woodside, N. Y.

MISCELLANEOUS

TIME-SAVING Structural design charts for architects and engineers, 25c. Tabatchnik, 44 Court, Brooklyn, N. Y.

IMITATION Marble: Make statuary, flooring, etc. Formula 25c. Ideal Service, 11-M, Park Ridge, Ill.

"1940 MERRY Xmas Man," cleverest Xmas greeting out, 50 for \$1.00. Christmas Card Cap, Black River Falls, Wis.

SANTA Claus postmark on all Christmas cards and picturesque postals sent directly from Santa Claus, Indiana. Free descriptive folder. Bob, Holtzman, Fulda, Ind.

AMATEUR Cartoonists, earn cash, spare time, copying advertising cartoons. Ad-Service, Arkyle, Wis.

COCOONS, Butterflies, supplies, free lists. Maynard, 1192 Lewiston, Rochester, N. Y.

TATTOOING Machines, outfits, New 1941 illustrated list free. Jensen, 412 South Main Street, Los Angeles, Calif.

MEATLESS Roast beef—Six meatless meat recipes 25c. Nuway, 139 1/2 Chandler, Jamestown, New York.

MAIL Order business course shows you how to make money, spare or fulltime. Teaches professional mail order technique—not penny-catching schemes. Free details. Nelson Company, 500 Sherman, Dept. 408-K, Chicago.

I WANT To send you proof of the wonderful pulling power of Popular Mechanics Magazine's classified pages. What's your proposition? Write me today. F. W. Johnson, Manager Classified Advertising, 200 E. Ontario St., Chicago, Ill.

COATS Of arms and crests, correctly painted in colors or black and white, from heraldic description or furnished copy, \$10.00 and up. Highest grade work. Heraldic Studios, 1914P Oakdale Avenue, Chicago, Ill.

FROG Raising! Book for \$1.00. Roberts Frog Farm, Orange, Texas.

FARM And garden tractors you can build. Complete constructional details 25c. Use old auto parts. Popular Mechanics Press, Room C40, 200 E. Ontario, Chicago.

EYEGLASSES Broken? Mend with Orstix, 50c. Optician, 7612 - 68 Ave., Ridgewood, N. Y.

BUYERS Club. Save 25%. Details stamp. Urban Co-Operative, Ferndale Drive, Binghamton, N. Y.

12 DRESSES \$1.18. Army shoes \$1.18. Bargains. New, used clothing. Free catalogue. Farmers' Mail Order House, 75-P Grand Street, New York.

CASH For used drawing sets, tools, any scientific instruments. Gordon's, 162-D Madison, Chicago.

BARGAIN! Powerful magnifying telescopes 35c. Empire Novelties, Peterboro, Ont., Canada.

RECEIVE Gigantic mails, magazines, samples. Your name in numerous mailing lists 10c. Howard, 396 Broadway, New York.

RECEIVE Free, literature, booklets, brochures covering timely subjects. 10c brings extensive listings, details. Publisher, 5027 North Troy, Chicago.

ADDRESS Of 10 parties who sell devices for locating hidden metals, 25c. Wyss, 104 1/2 Francis, St. Joseph, Mo.

NEW, Different. Imported from Old Mexico, hand made alligator belts. Hand sewed with leather. Width 1 1/2". Light or dark brown. All sizes, \$2 each postage paid. Guaranteed to please or your money back. E. C. Bridgers, P.O. Box 385, Bishop, Texas.

BEGINNERS' Tattooing outfits. Engraving machines. Free catalog. Tatuco, 651 South State, Chicago.

CHRIST Is coming. Get free proofs. Sheal, 263, Duluth, Minn.

NEW Lettering guide makes seven sizes, innumerable styles, letters, figures, monograms, \$1.00. Drafting Devices, Box 541, Pompton Plains, N. J.

WIN Money! Prizes! Contest Magazine 10c. Butler, 473PM, Sebring, Florida.

GOOD Eyesight without glasses. No drugs. Use my unique home treatment. A. Jacobson, Upsala, Minnesota.

TATTOOING. Engraving outfits. Illustrated list free. Percy Waters, Anniston, Ala.

START Plating business at home. Amazing profits. Make your own outfit. Inexpensive. Illustrated instruction booklet 25c. Popular Mechanics Press, 200 East Ontario, Chicago.

BE FIRST TO KNOW!

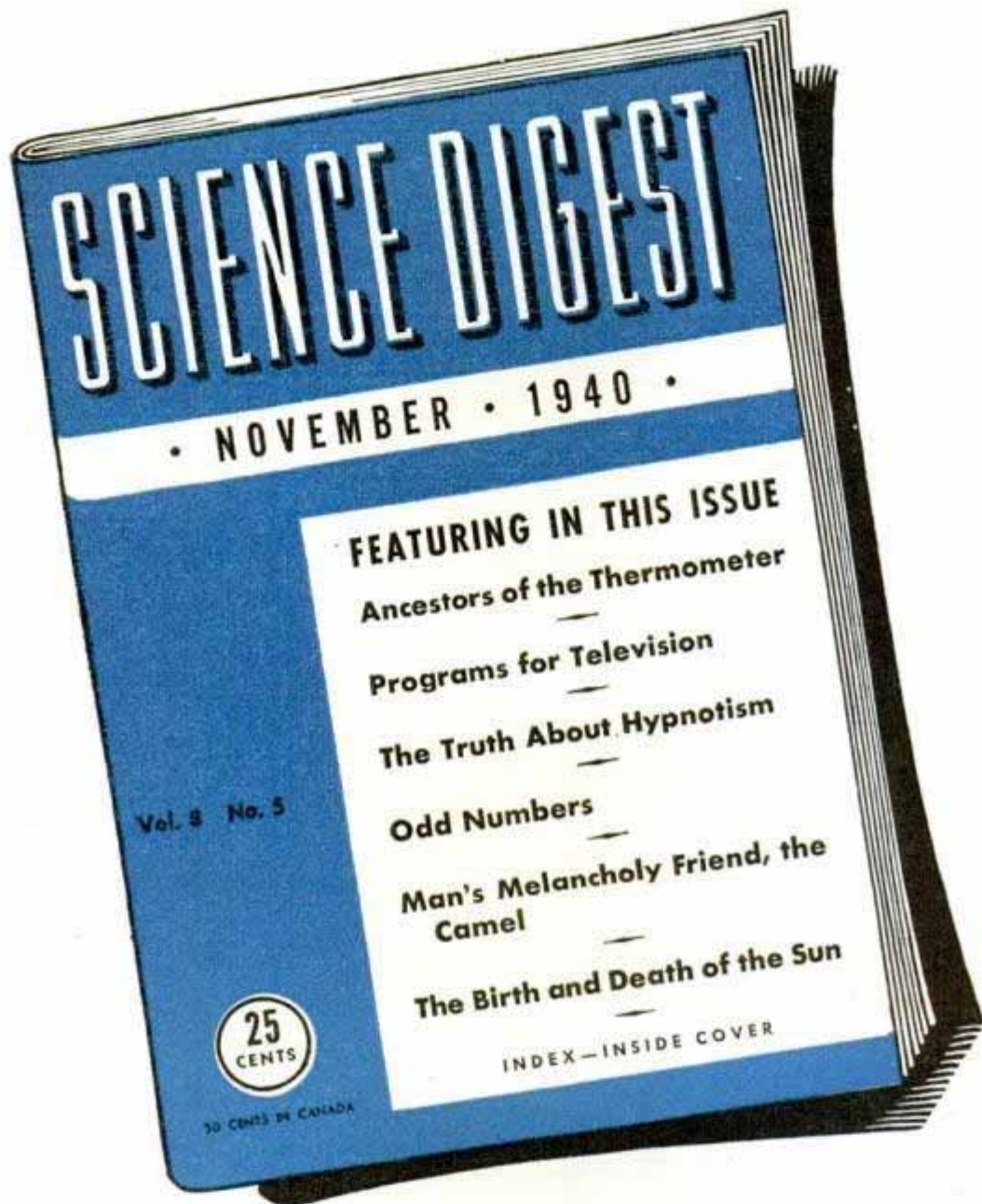

With the exception of the readers of some journal covering only one specialized branch of science, the readers of Science Digest may be the first to learn of some discovery destined to change completely men's thoughts and methods in dealing with some great human problem.

Only recently a publication of large circulation rightly complimented itself on having had an article on sulphanilamide in January, 1938. Readers of Science Digest, however, had read in August, 1937 an article on this compound that has revolu-

tionized the treatment of many human ills.

Among other subjects presented in Science Digest before they became popularized were: Nylon, Hybrid Corn, Plant Hormones, Lucite, new developments in Vitamin Therapy.

Yes, Science Digest does cover all branches of science and gathers its news from all corners of the globe. And renders this service for only twenty-five cents a month.

SCIENCE DIGEST, INC.

631-643 St. Clair St., Chicago

ON NEWSSTANDS NOW—25 CENTS

30 CENTS IN CANADA

ZOOM into AVIATION



AN AVIATION CAREER OFFERS YOU A GREAT FUTURE!

The greatest opportunity of your lifetime exists today. There never was such an opportunity in AVIATION for you. There may never be another. Aviation desperately needs trained men; they are at a premium and advancements for them are rapid. You can get in on the ground floor by training now, BUT you must choose the right school for your training. This is imperative, since your choice of a school in which to take your training will determine your whole future in Aviation and how much money you will make all the rest of your life. Curtiss-Wright Tech's career training is carefully designed to do just one thing—**MAKE MORE MONEY FOR YOU.** Our hundreds of successful graduates have proven that our training gets results and always pays. It has provided them with a profitable occupation and secure future, since it trained them in advance for the highest position they could ever expect to occupy. It can make you independent and self-supporting for life. Curtiss-Wright Tech is located on Grand Central Air Terminal in the heart of the Aircraft Industry. Established in 1929, this famous school is recognized as the nation's leading institution for the training of **MASTER AVIATION MECHANICS and AERONAUTICAL ENGINEERS.** (No flying involved.) We honestly believe that every student who enrolls here will be able to obtain immediate employment upon graduation. A position awaits you. **WARNING!—DON'T "MISS THE BOAT!"** Send for catalog today. Give age and course desired. Dept. PM-11.



**CURTISS WRIGHT
TECHNICAL INSTITUTE**

Glendale (Los Angeles)
California

THIS TOWER OVERLOOKS AVIATION'S MOST DISTINGUISHED SCHOOL OF AERONAUTICS

AUDELS Carpenters and Builders Guides

4 vols. \$6



Inside Trade Information for Carpenters, Builders, Joiners, Building Mechanics and all Woodworkers. These Guides give you the short-cut instructions that you want—including new methods, ideas, solutions, plans, systems and money saving suggestions. An easy progressive course for the apprentice and student. A practical daily helper and Quick Reference for the master worker. Carpenters everywhere are using these Guides as a Helping Hand to Easier Work, Better Work and Better Pay. To get this assistance for yourself, simply fill in and mail the **FREE COUPON** below.

Inside Trade Information On:

How to use the steel square—How to file and set saws—How to build furniture—How to use a mitre box—How to use the chalk line—How to use rules and scales—How to make joints—Carpenters arithmetic—Solving mensuration problems—Estimating strength of timbers—How to set girders and sills—How to frame houses and roofs—How to estimate costs—How to build houses, barns, garages, bungalows, etc.—How to read and draw plans—Drawing up specifications—How to excavate—How to use settings 12, 13 and 17 on the steel square—How to build hoists and scaffolds—skylights—How to build stairs—How to put on interior trim—How to hang doors—How to lath—lay floors—How to paint.



THEO. AUDEL & CO., 49 W. 23rd St., New York City

Mail Audels Carpenters and Builders Guides, 4 vols., on 7 days' free trial. If O.K. I will remit \$1 in 7 days, and \$1 monthly until \$6 is paid. Otherwise I will return them. No obligation unless I am satisfied.

Name
Address
Occupation
Reference P.M.

Sweeping the Country! AMAZING CHEAP OIL BURNER INVENTED!

COOK and HEAT
without **COAL or WOOD** in Your **PRESENT STOVE**

INTENSE HEAT AT SMALL COST—No Dirt or Ashes
QUICK HEAT AT TURN OF VALVE

An Amazing Oil Burner Which Experts and Users Say **BEATS ANY CHEAP BURNER EVER GOTTEN OUT FOR LOW COST, EFFICIENT PERFORMANCE.** Burns Ordinary Low Priced Free Flowing Oil Without Pre-generating or Clogging Up. **READ BELOW HOW YOU CAN TEST THIS REMARKABLE SUPER FLAME OIL BURNER in Your Own Home AT OUR RISK.** Then Mail Coupon.

OVER 40,000 SOLD

Satisfaction Guaranteed

Why burn coal or wood with its dirt and drudgery of building and feeding fires? Why carry ashes and get uneven, slow-starting heat? Burn ordinary low priced free flowing oil and get **INTENSE HEAT AT SMALL COST**—and have **QUICK HEAT** regulated by a simple turn of a valve. Positively guaranteed **NOT TO CLOG OR STOP UP.** Has a record of over 11 years constant use without ever needing any cleaning. Simple—safe—economical—no electrical connections—no moving parts to wear out. **QUICK, CONVENIENT, EFFICIENT HEAT** by simply turning valve.

Engineer of National Reputation Says: Combustion principles are simple, efficient, excellent—assures economical oil consumption and maximum heat. Tests made on burner with one year's hard service prove no evidence of dirt or residue or any carbon on interior parts. No nozzles or tips to "coke up" or stop up.—C. W. Lovelace—K. C., Mo.

USERS SAY: Fifteen oil burners of different kinds here but Heat King is cheapest, best.—J. R. Goldthorp—Washington.

I get more heat from your burner than I ever had from coal or anything burned in my furnace.—W. C. Nicholson—Ind.

Reduced coal bill fifty percent.—W. S. Collins—Pa.

SENT ON TRIAL

SEND ON TRIAL for 30 days. If you want quick, efficient heat at small cost you may try the "HEAT KING" **AT OUR RISK.** Write now for full information. Prove that it ends drudgery and dirt of coal or wood, prove its efficiency, convenience and economical operation. You must be satisfied under our liberal guarantee or **YOU PAY ABSOLUTELY NOTHING FOR THE BURNER.**

Special Offer to AGENTS and salesmen who will demonstrate and take orders. Send no money—just sign and mail coupon (or 1c postcard will do)—be first in your locality to learn how satisfactory oil heat can really be and how you can **MAKE REAL MONEY** spare or full time. Mail Coupon or 1c postcard today—**NOW.**

UNITED FACTORIES
N-751 Factory Bldg. KANSAS CITY, MO.

MAIL COUPON UNITED FACTORIES
N-751 Factory Bldg., Kansas City, Mo.

Without cost or obligation rush full particulars of generous **TRIAL OFFER** on wonderful "HEAT KING" Oil Burner.

Name
Address
City State

CHECK HERE

If interested in special and money-making offer to producers.



Slips Into Any STOVE RANGE or FURNACE

AGENTS SALESMEN BIG MONEY

No wonder salesmen and distributors are breaking records in sales. They show how it gives **QUICK INTENSE HEAT, MORE CONVENIENT, WITHOUT DIRT AND ASHES,** and how economical it is in operation—then, reap **BIG CASH PROFITS.**

SALESMEN SAY:

Installed one when 10 degrees below zero. Kephouse well heated. I can dispose of 250.—F. Silver—Canada.

I am a plumber, but never knew such a thing to get that much heat out of oil. There is money in selling them.—W. C. Nicholson—Ind.

Write now for Agents Special Offer. Act quick. Be **FIRST** in your locality—**MAIL COUPON** or 1c postcard today—**NOW.**

Now is the time for you to get into DRAFTING



Complete Outfit Furnished
All necessary tools, including drawing table, sent to you at once—without extra charge.

—Learn at home from an Engineer

With industry working feverishly on rearmament, new products, new production methods—the field for DRAFTSMEN is bigger than ever! Get into a better job with more pay and fascinating, pleasant work. I will train you at home in your spare time until you are ready for a better paying position by my practical applied method—on actual jobs—as I have done with many hundreds of successful students.

Industrial Designing Included

My practical training in drafting also includes a working course in Industrial Designing as applied to new products, improving, restyling and modernizing—all extremely valuable to draftsmen. Send coupon for complete details on "Drafting and Industrial Designing". Engineer Dobe, Libertyville, Illinois.

GET THE FACTS! Engineer Dobe, Div. 3378 Libertyville, Illinois.

Please send me full facts on "Drafting and Industrial Designing". Also how you assist your graduates to good positions in these fields.

Name Age.....
Address
Town State.....

There's MONEY IN ARC WELDING!



U. S. Manufacturers

desire men to learn Electric Arc Welding and get practical experience under actual production conditions in the laboratories of the School of Engineering. Moderate training fee. Accepted applicants will be fully trained until ready to pass rigid test and assisted in securing employment.

AIRCRAFT WELDING

"We want more planes!" That's the demand on every side. No wonder there is a shortage of aircraft welders. Other industries need welders, too. There's almost no limit to what Milwaukee School of Engineering trained welders can do. They get good pay because they know the "how and why" of Welding, Metallurgy, Drawing, Blueprint Reading, Set-up Work and Fabrication—and they enable manufacturers to cut production costs. Remember—industries need practical trained Aircraft Welders, Arc Welding Operators, Technicians and Welding Engineers and Air Conditioning and Refrigeration Technicians. Don't be satisfied to struggle along on ordinary, hit-or-miss jobs with poor pay—when in a short time you can become a trained specialist. Send coupon today—classes begin within a month.

MILWAUKEE SCHOOL of ENGINEERING

Institute of Electrotechnics

P.M. 1140 North Broadway and E. State, Milwaukee, Wis.

Without obligation send Free Booklet "The Dawn of a Gigantic Industry and its Outstanding Opportunity." Also tell me How to Become an
Air Welding Operator (3 mo.)... Air Conditioning & Refrig. Tech. (4 mo.)...
Air Craft Welder (3 mo.)... Radio Serviceman (6 mo.)...
Welding Technician (5 mo.)... Commercial Electrical Engineer (1 yr.)...
Welding Engineer (1 yr.)... Commercial Radio Engineer (1 yr.)...
Electrical Engineer... Student Loan Plan
B. S. Degree (4 yrs.)... Earn Part Expense Plan

Name Address
City & State Age P.M. 1140



EASIEST to master!

THIS NEW P-A

Such beautiful tone, and so easy to play! Just touch a key and blow normally; you can't miss. Nothing to compare with these new P-A Saxes, Clarinets, Trumpets, and other P-A instruments. Fully guaranteed; your success assured. See your music dealer or write direct for beautiful free book. No obligation. Easy terms. Greatest fun, easiest with P-A. Write today sure.

PAN-AMERICAN
1103 P-A BUILDING ELKHART, INDIANA

RUPTURED?

Get Relief This Proven Way

Why try to worry along with trusses that gouge your flesh—press heavily on hips and spine—enlarge opening—fall to hold rupture? You need the Cluthe. No leg-straps or cutting belts. Automatic adjustable pad holds at real opening—follows every body movement with instant increased support in case of strain. Cannot slip whether at work or play. Light. Waterproof. Can be worn in bath. Send for amazing FREE book, "Advice To Ruptured" and details of liberal truthful 60-day trial offer. Also endorsements from grateful users in your neighborhood. Write: CLUTHE SONS, Dept. 31, Bloomfield, New Jersey

do-it-with-SQUABS

Raised in ONLY 25 DAYS. Why breed for ordinary poultry trade when luxury markets want all the squabs you can ship, every day in year? Go after this profitable poultry trade now. Write postcard, get eye-opening free poultry business guide.

RICE FARM, 635 H. ST., MELROSE, MASS.

Increased production means more



Jobs for MACHINISTS and bigger pay for men who know their work

This home-study course gives you the practical facts on modern machines, up-to-date methods, you need to advance in machine shop work. Take advantage of the other man's experience as found in books, to solve your problems, increase your efficiency, with

The NEW AMERICAN MACHINISTS' LIBRARY

5 volumes—2014 pages—1853 illustrations
(A combined home-study course and reference library)

This library of machine shop practice was written for practical men. It gives you the best methods for every kind of machine shop work. It fully explains lathes, drills, and other machine tools and their operation, automatic screw machines, speeds and feeds, gear design and production, punch and die work, metal surfacing, etc., etc. Plainly written—completely illustrated—the best kind of help to the machine shop man who wants to advance himself.

No money down—special price—easy payments.

EXAMINATION COUPON

McGRAW-HILL BOOK CO., 330 W. 42nd St., New York

Send me for ten days' examination the new American Machinists' Library. If satisfactory I will send you \$1.50 in 10 days and \$3.00 monthly until the price of \$16.50 is paid. If not wanted, I will return the books postpaid. (To insure prompt shipment write plainly and fill in all lines.)

Name
Home Address
City and State
Position
Name of Company PM-11-40

Monastery Secrets

... THE FORBIDDEN KNOWLEDGE OF TIBET

What strange secrets of nature are locked within the mountain fastness of Tibet? What control over the forces of the Universe do these cloistered sages exercise? For centuries the world has sought to know the source of their power—to learn their mastery of life, and their faculty for overcoming problems with which the masses of mankind still struggle. Have they selfishly deprived humanity of these rare teachings?



WRITE FOR THIS FREE BOOK

Like the streams that trickle from the Himalayan heights to the plateaus below, the great truths of these brotherhoods have descended through the ages. One of the preservers of the wisdom of the Orient is the Rosicrucian Brotherhood (not a religious organization). They invite you to write today for their FREE Sealed Book, with its amazing revelations about these mysteries of life. Address: Scribe D.L.A.

The ROSICRUCIANS
AMORC
San Jose, Calif.
U.S.A.



New York Established 1902
Electrical School
Ask for free illustrated booklet
44 West 17th St., N. Y. C.

Learn MECHANICAL DENTISTRY
Short course—personal, individual, instruction—best technical teachers. Profession offers unlimited opportunity—not affected by Machine Age. Most modern and complete methods embracing every branch from plate to porcelain work. Qualifies you to work for dentists or own business. Day or night school. No books—no classes. Catalog upon request.
OR STUDY AT HOME. Write for information on our Home Study Course, **McCARRIE SCHOOL OF MECHANICAL DENTISTRY**
207 N. Broad St. Dept. 762 Philadelphia, Pa.

BROOKLYN YMCA TRADE SCHOOL



- Unlimited Instruction until you have mastered every part of Course without additional charge.
Full Shop Equipment
Unexcelled Instruction
Fireproof Dormitories.
Special Privileges. Check your interests on coupon to receive free literature.
- Aviation Mechanic
 - Machinist
 - Mechanical Pre-Engineering
 - Diesel Engines
 - Diesel Pre-Engineering
 - Aeronautical Pre-Engineering
 - Auto Mechanic
 - Refrigeration
 - Television and Radio Mechanic
 - Architectural-Mechanical Drafting
 - Armature Winding
 - Welding
 - Tool and Die Making
 - Oil Burner
 - Talking Pictures
 - Air Conditioning
 - Electrical

NEW JOBS NOW OPENING UP!

Learn PRACTICAL ELECTRICITY AT HOME!

NO PREVIOUS KNOWLEDGE NEEDED

GET into ELECTRICITY and the big money now. Thousands of new jobs in factories, laboratories, radio stations, government defense, etc.! PRACTICAL ELECTRICITY FOR HOME STUDY gives you the sound practical working knowledge you need. You learn quickly, easily right at home. Begins with simple fundamentals and takes you by easy steps through entire field—motors, dynamos, electro-magnets, radio, electro-hydraulic power, etc. By Frederick C. Raeth, President, Canadian School of Electricity. FOUR big volumes, about 1300 pages, nearly a THOUSAND ILLUSTRATIONS and diagrams; bound in fine library cloth. Brand new, up to date, nothing like it ever published before.

SEND NO MONEY—Examine 10 Days FREE

Just mail the coupon. The 4 volumes come postpaid. After 10 days return them or send only \$2.95 and \$2.00 a month until the price of ONLY \$8.95 is paid. Send NOW!

D. VAN NOSTRAND CO., Inc.,
250 Fourth Ave., New York (P.M. 11-40)

Send PRACTICAL ELECTRICITY FOR HOME STUDY in 4 vols. Within 10 days I will return it or send \$2.95 and \$2.00 a month for 3 months, total \$8.95 (5% discount for cash).

Name.....
Address.....
City and State.....
Reference.....
Address.....



Be an ARTIST!

Learn at home in your spare time

Prepare now for a fascinating career as an Artist. Our practical method has trained men and women of all ages since 1914. COMMERCIAL ART, CARTOONING, and DESIGNING all in one complete course. Trained Artists are capable of earning \$30, \$50, \$75 a week. No previous Art experience necessary. FREE BOOK, "Art for Pleasure and Profit" describes course. TWO ART OUTFITS included with training. Mail coupon today.

FREE BOOK gives details!

Washington School of Art, Studio 1211 P
1115—15th St., N. W., Washington, D. C.

Yes! I am interested in learning to draw. Please send me your Free Book, "Art for Pleasure and Profit."

Name.....Age.....
Address.....
City.....State.....

MAIL COUPON

1117 Bedford Ave., Dept. P.M.
Brooklyn, New York City, N. Y.

Name.....

Address.....

TO EARN MORE MONEY • HAVE MORE FUN

Invest in PRACTICAL PROFITABLE Books



Whatever your interest—whatever your need—here are books that will help you. Popular Mechanics experts have selected them for you. Books to help you on your job . . . to help you to a better job . . . to help you earn extra money in spare-time work . . . to profitably develop a hobby . . . to gain advancement through home study. Other books for entertainment and recreation.

Successful businesses . . . profitable sidelines . . . doubled incomes . . . have resulted from a single idea. Popular Mechanics Books are filled with money-making ideas. Select from the list on this page. Profit with the latest and best-proven facts—ideas and information.

SELECT FROM THIS LIST

BOOKKEEPING MADE EASY: Written and illustrated in such a concise manner that the beginner will find most complex problems perfectly clear. \$1.00.

WHAT TO MAKE: Remarkable 2-volume library of projects and ideas for home craftsmen. \$0.98.

FURNISHING THE HOME GROUNDS: Hundreds of suggestions for increasing the attractiveness of your yard and garden. \$0.80.

UPHOLSTERED FURNITURE: Describes every important operation in craft and group of upholstery projects. \$2.00.

PRACTICAL MATHEMATICS: Deals with fundamentals of mathematics. Real help for everyone who uses figures. \$2.00.

COURSE IN WOOD TURNING: Everything you need to know about wood turning. \$1.50.

EASY TO MAKE TOYS: Seventy-seven projects and each one a favorite with children. \$1.44.

WOODCARVING MADE EASY: Add a few simple carvings to your next craftwork project. \$1.25.

LETTERING OF TODAY: Modern ideas, good taste and correct letter construction. \$1.00.

BOOKBINDING MADE EASY: Earn extra money by rebinding old books and magazines. \$1.00.

DICTIONARY OF TECHNICAL TERMS: Defines terms commonly used in more than 70 different fields. \$2.25.

CARPENTRY AND JOINERY WORK: Beginner's text on principles of modern residential construction. \$2.89.

THE LOCKEYIST: Solves maintenance problems of locking devices. \$1.89.

MANUAL ON PLUMBING, DRAINAGE AND SEWAGE: Covers all kinds of plumbing installation, estimating, questions and answers for master plumbing exams. \$2.00.

ROPP'S CALCULATOR: Figuring made easy for mechanics, business men. \$0.50.

STEEL SQUARE POCKET BOOK: Describes and illustrates best methods of using steel square in carpentry work. \$1.00.

MACHINE SHOP WORK: Approved shop methods including construction and use of tools and machines, details of operation and modern production methods. \$2.75.

PLANNING THE LITTLE HOUSE: Treats things person building, buying or remodeling should consider. \$1.50.

AUTOPOWER: Turn old auto generators into practical A.C. and D.C. motors and generators, for lighting, welding, etc. Also tells how to make soldering pliers, portable grinders and electric eye. \$1.00.

SHEET METAL WORKERS' MANUAL: Real help for those engaged in sheet metal work. \$2.00.

OXY-ACETYLENE WELDING AND CUTTING: Electric and thermit welding, annealing, tempering, hardening. \$0.89.

AIR CONDITIONING: Non-technical. Covers all types of equipment. \$3.50.

HOUSE WIRING: Approved methods for homes and buildings. Thorough and complete. \$2.50.

REFRIGERATION: Electric and gas. Refrigeration in all its branches. Just what you need to be service expert. \$5.00.

SHOP NOTES LIBRARY: Thousands of practical money making time and labor saving ideas. Complete set of six big volumes—1938, '37-'38-'39-'40 and '41 only \$2.45. Single volumes \$0.50.

2000 WAYS TO MAKE MONEY

A THOUSAND WAYS TO MAKE \$1,000: Tried and Tested Methods That Work — That You Too, Can Use. How hundreds of men made their first \$1,000 in their own business. \$2.50.

MONEY MAKING IDEAS: 1000 spare time ways to make money. Practical guide for young and middle aged men and women, students, boys, girls. \$1.00.



AUTO BODY AND FENDER REPAIRS: New book covering every phase that will put you right into this profitable business. \$3.00.

DYKE'S AUTO ENCYCLOPEDIA: World's greatest auto book. New 19th edition. Real help for auto and shop mechanics. 1451 pages. 4700 illus. \$6.00.

AUDELS WELDERS GUIDE: New book. Covers operation and maintenance of all welding machines, both electric and oxy-acetylene. Over 400 pages. \$1.00.

DIESEL ENGINE MANUAL: For those who desire knowledge of the Diesel engine. \$2.00.

NEW RADIOMANS GUIDE: Just out! For radio mechanic, service man and student. Late television data. \$4.00.

THE BOY MECHANIC: Completely new edition of this famous book. Makes fine present. \$2.00.

SHEET METAL WORK: Self-instruction in pattern drafting and construction. Both light and heavy-gauge metal. \$2.50.

STEAM AND HOT WATER FITTING: How to design modern systems, select equipment and install it correctly. \$2.00.

STEEL CONSTRUCTION: Gives facts and formulas needed in designing structural steel framework for buildings. \$3.50.

AERONAUTICS SIMPLIFIED: 150 pages of facts vital to student's success as a flyer. \$1.50.

AIR CONDITIONING—HEATING AND VENTILATING: Principles and general application of steam, hot water, vapor and vacuum heating with air conditioning of all types of buildings. \$4.00.

ARMATURE WINDING: Clearly written book on construction, winding and repairing of A.C. and D.C. motors and generators. \$2.00.

BLUEPRINT READING FOR BUILDING TRADES: An excellent and very popular book. \$1.25.

CIVIL SERVICE HANDBOOK: Complete home study courses for Federal, State and City civil service examinations. \$1.00.

THE BOAT BOOK: Shows exactly how to build 15 popular boats—for pleasure or profit. \$1.98.

ABC OF AVIATION: Instruction book for everyone interested in aviation. \$2.50.

HOUSE WIRING: Up-to-date book for electricians, apprentices and students. \$1.00.

MONEY-MAKING FORMULAS: Popular Mechanics' new book. Formulas and all the other information you need to start a small manufacturing business of your own. \$1.00.

CARPENTRY AND JOINERY: A very popular book for carpenters and apprentices. \$2.89.

BLUEPRINT READING FOR MACHINE TRADES: How to read assembly, scale and working drawings. \$1.50.

PAINTING AND DECORATING: Principles and application of commonly used paints, varnishes. Includes estimating. \$1.50.

PATTERN MAKING: Practical treatise on woodworking and wood turning, tools and equipment. \$2.00.

CONCRETE: 1001 Ideas for using. Most complete book on the subject. \$1.98.

SEND NO MONEY—BOOKS SHIPPED C. O. D. IN U. S.

Select books from list above. Help yourself to more profitable—more enjoyable days. Send No Money. Pay postman above prices plus postage. (C.O.D. in U. S. only). Outside U. S. A. add ten cents for each book for postage. Act Now.

POPULAR MECHANICS PRESS

Dept. 1140—200 East Ontario St., Chicago, Ill.



Be an AIRLINE MAINTENANCE MECHANIC



Have a big-pay job with an Airline or at Airport. Earn up to \$2000 a year as Government Rated Airplane and Engine Mechanic. This **Lincoln Government Approved School** offers Government Approved Training preparing for these positions. Airlines and Airports calling on us for more of these Graduates. **BE AN AERONAUTICAL ENGINEER.** Earn up to \$4000 a year. Lincoln Engineering Students get practical experience in Airplane Design and Construction. **BE A HIGH PAID COMMERCIAL PILOT.** Learn here to fly fast modern Airplanes. Lincoln Government Approved Training prepares you for BOTH a Commercial Rating and Flight Instructor Rating. Exceptional opportunities for our Commercial Pilot Graduates.

AIRPLANE FACTORIES WANT LINCOLN TRAINED MEN. Placing our Graduates in good-pay jobs with Airplane Factories coast to coast. Lincoln Training gets you ready for one of these jobs in 8 to 12 weeks.

Mail Coupon Today for complete information about Lincoln Training and the big-pay opportunities in Aviation.

LINCOLN AERONAUTICAL INSTITUTE, (INC.)
LINCOLN AIRPLANE & FLYING SCHOOL DIVISION
 5711 Aircraft Building, Lincoln, Nebraska

LINCOLN AERONAUTICAL INSTITUTE, (INC.)
LINCOLN AIRPLANE & FLYING SCHOOL DIVISION
 5711 Aircraft Building, Lincoln, Nebraska.

I'd like to take advantage of the opportunities in Aviation. Please rush complete information about Lincoln Training.

NAME..... AGE.....
 ADDRESS.....
 CITY..... STATE.....

New LACO OIL HEATER

Lots of Heat at the "SITTING" Level



Here's the very newest oil-burning heater in the industry! It's LACO's new "Nu-Comfort" model. Gives you more heating comfort . . . operates at unusually Low Fuel Cost . . . and is priced lower, feature for feature, than any other you can buy! It's only 35 inches high—so it delivers an abundance of heat, without fan, at **SITTING LEVEL!** This brings the heat level of the room down lower than ordinary—just where you like it. New full-opening radiant doors provide "oven-door" heat when you want it. Equipped with LACO's long-proved "Two-Stage" burner unit, which gives you any desired volume of heat, at a touch. Also LACO's famous Inner Heating Unit with heavy steel walls that become intensely



hot to deliver an extra volume of slow-moving, moist heated air into the room. Outer cabinet of rugged auto-body steel is beautifully finished. Guaranteed. Also several upright models.

DEALERS Beat chain store and mail order competition by featuring the nationally-known LACO line of oil burners and heaters. "Direct-To-Dealer" plan lowers prices one-third! Write today for Dealer Offer!

HOME OWNERS See your local LACO dealer. Or, send name for free folder and Low Prices!

LACO OIL BURNER CO., 1110 Union Ave., Griswold, Iowa

LACO Gun-Type
 Easy to install in your furnace. Gives surprising heat from little fuel. America's lowest priced! See your dealer, or write today for free folder, low prices.

Operator No. 38



FOLLOW THIS MAN

Secret Service Operator No. 38 is on the job! Running down dangerous Counterfeit Gang. Tell-tale finger prints in murdered girl's room.

Free The Confidential Report Operator No. 38 made to his chief. Write for it.

Earn a Regular Monthly Salary

YOU can become a Finger Print Expert at home, in your spare time, at small cost. Write for confidential full report and details. Literature will be sent only to persons stating their age.

INSTITUTE OF APPLIED SCIENCE

Dept. 1358 1920 Sunnyside Ave. Chicago, Ill.

He Makes a Good Living

FILING SAWS

"Last year I sharpened 2309 hand saws, for which I got \$1154.50. The Foley Saw Filer has made a good living for me!"—John Joseph, Calif. A FOLEY Automatic Saw Filer files hand, circular and band saws better than the best hand filer. Cash business, no canvassing, no eyestrain. No experience needed. Send coupon for FREE PLAN, no obligation.



FOLEY MFG. CO., 1116A-40 Foley Bldg., Minneapolis, Minn.

Send Free Plan on Saw Filing Business.

Name.....
 Address.....



BIG PROFITS and RESTRINGING BADMINTON RACKETS AT HOME!

It's easy—and profitable restringing Badminton, Tennis rackets at home, in your spare time, at small cost. Write for confidential full report and details. Literature will be sent only to persons stating their age. Write for FREE Catalog of strings, re-stringer's tools, low prices! Hurry!
H. E. WILLS CO., 1047 W. 47th St., Dept. PM-110, Chicago



NOW a DYNAMIC HEAVY DUTY INDUSTRIAL WELDER

Works off 110 volt electric light circuit. For this unheard of price you can get the marvelous Dynamic Super-Charged Welder complete—ready to plug into light socket. The Dynamic does both metallic and carbon arc welding. You can also solder and braze on the lightest material.

for Only **\$19.75** RETAIL
 EASY PAYMENTS

WORKS ON IRON, STEEL, TIN, BRASS, COPPER AND ALL OTHER METALS

With our free instructions you can tackle anything and in no time at all you will be able to do finished repair jobs. Once you have the Dynamic outfit, you are all set in a profitable welding business of your own. In a year a Dynamic Welder Costs you Less Than 6c a Day. Write for FREE particulars TODAY.

DYNAMIC WELDER CO., 2226-NH, Silverton Road, Chicago, Illinois

WELDS BUMPERS, FENDERS, CYLINDER BLOCKS, BODIES, FRAMES, ETC. Does Farm, Factory and Home Repairs

Without previous welding experience you can make for yourself as much as \$5.00 on a repair job that can be done in less than one hour. Many welders make as much as \$15.00 to \$20.00 a day. The Dynamic Welder is light and easily portable.

AGENTS WANTED

Get our big profit plan and 10-day trial offer. Send for it TODAY.

OL' JUDGE ROBBINS

THE SHERIFF BACK HOME WRITES, 'HERE'S TO OUR NEXT PIPELOAD OF PRINCE ALBERT, AND MY BEST REGARDS TO CHUBBINS.' THAT'S NICE, DAD... OH! HERE'S THE PARADE!

DAYS OF 1881 CELEBRATION PIERRE, S.D.

THIS CITY'S RIGHT ON THE ROUTE TAKEN BY THE FAMOUS U.S. ARMY PIONEERS, LEWIS AND CLARK, IN 1804

OH, YES, THEY WERE THE FIRST TO LEAD AN EXPEDITION TO THE WEST COAST OVER THE NORTHERN ROUTE

LEWIS AND CLARK WERE SMART—THEY AVOIDED TROUBLE WITH THE INDIANS BY GIVING THEM CULTIVATED TOBACCO

YES, I GUESS THE INDIANS WERE PRETTY THANKFUL FOR A CHANGE FROM THEIR OWN HARSH STUFF

YOU BET. EVEN LEWIS AND CLARK'S TOBACCO MUST HAVE BEEN A GREAT IMPROVEMENT OVER THAT HOT-BURNING INDIAN VARIETY

JUST IMAGINE HOW GRATEFUL EVERYONE WOULD HAVE BEEN FOR OUR MODERN COOL-BURNING PRINCE ALBERT

IN RECENT LABORATORY "SMOKING BOWL" TESTS, PRINCE ALBERT BURNED

86 DEGREES COOLER

THAN THE AVERAGE OF THE 30 OTHER OF THE LARGEST-SELLING BRANDS TESTED—*COOLEST OF ALL!*

IT'S DELIGHTFUL HOW COOL AND MILD PRINCE ALBERT SMOKES. THERE'S NO EXCESS HEAT TO BLUR THE FINE TASTE AND AROMA OF CHOICE TOBACCO

YES, P.A. PUTS REAL COMFORT IN PIPE-SMOKING. THERE'S NO OTHER TOBACCO LIKE IT!

HIT THE HAPPY TRAIL TO Smoother Smokes

PRINCE ALBERT'S COOL BURNING, CRIMP CUT, AND NO-BITE PROCESS GIVE THE RIGHT OF WAY TO PIPE DELIGHT!

PRINCE ALBERT IS THE EXPRESS ROUTE TO FAST-ROLLED 'MAKIN'S' SMOKES, TOO — EASIER, SMOOTHER, MILDER, TASTIER

TAKE THE CLEAR LANE TO BETTER PACKING, EASIER DRAWING, BETTER CAKING — TRY P.A.

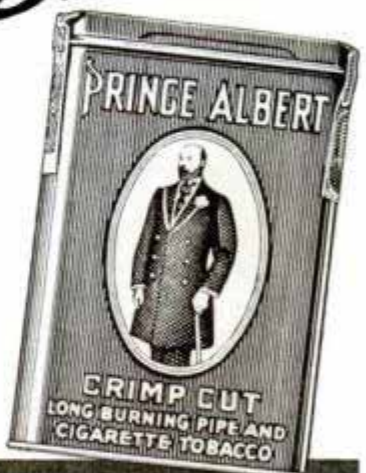

Copyright, 1940, R. J. Reynolds Tob. Co., Winston-Salem, N. C.

50 pipefuls of fragrant tobacco in every handy pocket tin of Prince Albert

PRINCE ALBERT THE NATIONAL JOY SMOKE

Popular Mechanics Magazine

REGISTERED IN U. S. PATENT OFFICE AND CANADA

WRITTEN SO YOU CAN UNDERSTAND IT

Vol. 74

NOVEMBER, 1940

No. 5

80,000 FLEDGLINGS *for* DEFENSE

Leggett
PILOTS by the thousands and ground crew specialists by the tens of thousands will be needed to man and service the 50,000 planes a year which experts say are needed to defend this country.

In this long-range program, the Civil Aeronautics Board has undertaken the job of building up a huge reservoir of civilian pilots, qualifying them for specialized training which will convert them quickly into fighting pilots. By June 30, 1941, eighty thousand will have completed civilian training. Twenty-five thousand already have been graduated.

As a result of the Civil Aeronautics program, the United States will not be faced with the unhappy situation which existed at the time of the World War when it became necessary to train military pilots with such terrific haste and cost in human life. The pressure was so great then that more student pilots were killed in the training process in American camps than were killed afterward in air battles over France. Those



Clustered around their instructor, who is seated in the cockpit of a basic training plane at the "West Point of the Air," Randolph Field, Tex., four of America's future army pilots learn by gestures about a maneuver in the air. After this lesson on the ground they'll go aloft to try it



who complete the preliminary and secondary courses of the training program will have had the equivalent of the military primary training. They will be young men who have cleared the first hurdles, who have demonstrated their mental and physical fitness for the highly specialized function of piloting an airplane, and as a result of this training their chances of successfully and safely completing the intensive Army and Navy flying course will have been increased enormously.

Of the 80,000 pilots completing their training by next June 30, the government expects to have a reservoir of at least 68,000 airmen qualified for the Army and Navy training courses, after allowing for those who fail to make the grade or drop out for other reasons. While this reservoir is being filled, the nation's military services are turning out hundreds of fighting pilots—men who enlisted and took the complete Army or Navy course instead of getting civilian licenses first and then moving on to military training.

Regarding the Civil Aeronautics Board's program, Robert H. Hinckley, assistant secretary of commerce, who has been in charge of the training plan, says:

"The initial experimental program was concluded with the graduation of 313 stu-

*Civil Aeronautics Authority
Department of Commerce*

Cadets, top, study 1,200-horsepower engine. Center, supply sergeant checks engines for training program. Lower left, students examine skeleton of an elevator; right, teaching technique of parachuting

Public Liaison Letter

San Diego



at flight school. I. J. Infantry School

dents in the spring of 1939 at thirteen colleges throughout the United States. Out of this group about one-third applied for further training in the Army and Navy. Nearly all who applied for military training were accepted.

"Those who did not apply for advanced or specialized military training continued with their college studies and kept their interest in aviation through flying clubs. Banding together in the purchase of one or more planes, many of the original group have maintained and improved their pilotage with regular practice. We hope to see the club idea further adopted and developed in proportion to the expanding program. This method not only helps maintain the reservoir for national defense, but it stimulates and promotes widespread private ownership of airplanes.

"Following the successful conclusion of the original experimental program nearly 10,000 students were enrolled in the fall of 1939 in what became known as a preliminary training course. More than 9,000, or about ninety per cent, finished the course last spring. By this time, 1,139 students who continued with summer flying have completed the secondary phase of training.

"The preliminary course gives a student between thirty-five and fifty hours of flight training in the basic principles of aviation. He is taught to fly a straight course, to land and take off, to land without

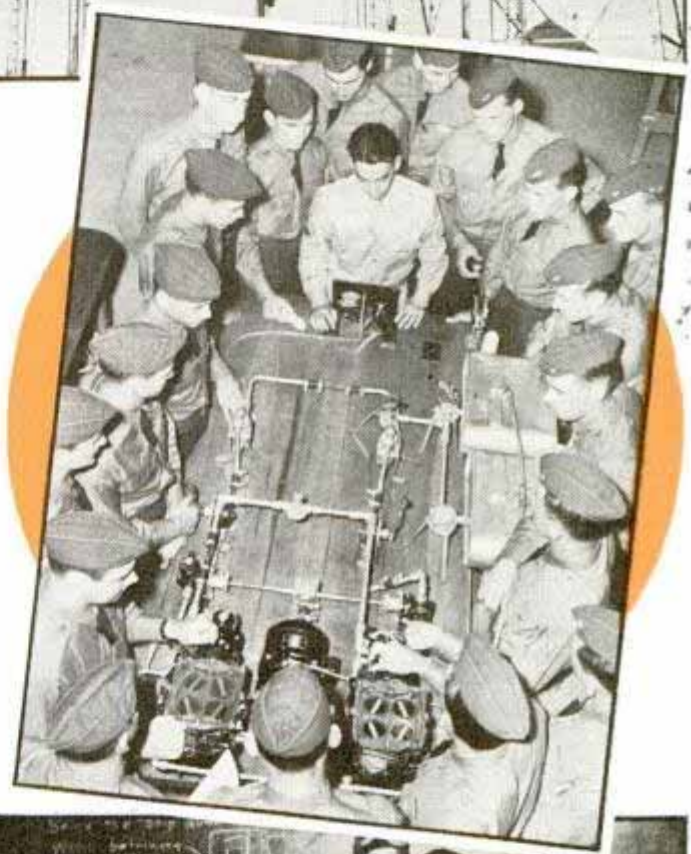

Consolidated

Upper left, drilling rivet holes in bomber's wing at San Diego vocational school; right, army parachutist makes "captive" jump from 125-foot tower. Center, studying model of a plane's fuel system. Bottom, illustrating maneuvers with model planes

North American Factory
Inglewood Calif.



One of the first things a flying cadet learns about is the "aerial life raft" or parachute, top. Center, one of the new BT-14 basic training planes. Right, refueling at Randolph Field

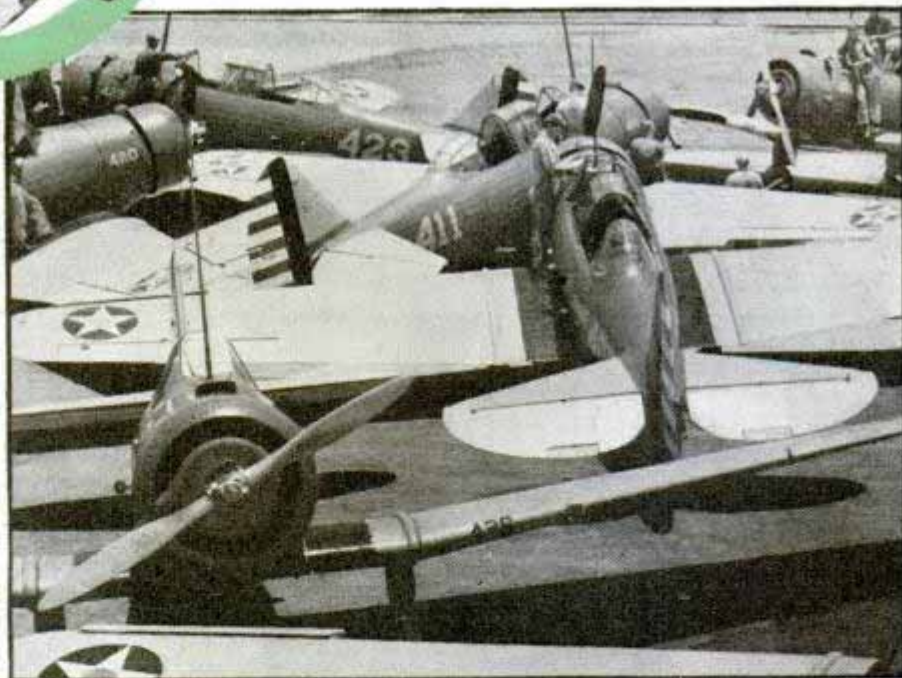

power as in a forced landing, and to recover from stalls and spins. We require that each student have a minimum of thirty-five hours but he may be given fifty of dual instruction and solo practice if his instructor feels that he needs it. Our records show that the average preliminary student gets thirty-seven hours of dual and solo practice. The course also includes seventy-two hours of ground instruction in the theory of flight and other pertinent subjects.

"The secondary course includes an addi-

tional forty-five to fifty hours in the air and an additional 145 hours of ground instruction. Our records show that secondary students get an average of forty-four in acrobatics, cross-country and other flight training. Thus a student who has completed both the preliminary and secondary courses has flight training equivalent to the primary courses given by the Army and Navy.

"Besides the Army and Navy, numerous opportunities are open to graduates of the two civilian flight courses. The industry is expanding rapidly and nearly all will be absorbed in one or another aviation occupation if they so desire. Those who do not find a place to keep up their flying practice will be provided with the fifteen hours of flying required annually to keep a private pilot's certificate active.

"Combining the flying

schools, the flying clubs and other efforts, we aim to establish an active flight-training program on virtually every airport in the United States where it will not conflict with air-line traffic.

"During the past school year the training program operated with thorough effective-

ness in centers distributed through every state in the union, Alaska, Hawaii and Puerto Rico. At these centers 538 private commercial operators were organized to furnish the controlled and proven course of flying instruction. Facilities for ground-school instruction were made available at 435 colleges and universities. In seventy-five communities training was conducted on a non-college basis and graduated 750 students. More than 400,000 hours of flight training were given in the combined program. Colleges participating this fall total 499 in 202 communities.

"Civil Aeronautics recently graduated seventy-seven students from two experimental schools employing new types of aircraft designed to eliminate the spinning characteristics of the conventional airplane. The spinproof airplane, besides great inherent stability, has a simplified control system and is therefore easier to fly. At the same time it is less maneuverable than the conventional type and is therefore unadaptable to acrobatics and other military requirements. The spinproof airplane is intended essentially as air transportation for the individual who would like to own and pilot his own airplane but does not have the time to apply himself to the more exacting pilot requirements of other types.

"Applicants for the government's preliminary flying course must be between the ages of eighteen and twenty-six and must pass a rigid physical examination. It is intended to be equivalent to the Army and Navy medical requirements. College students must meet the educational requirements of their schools. Non-college flight students are required to attain a high standing in the ground course given prior to their flight training. At this time there are approximately 15,000 non-college applicants competing for approximately 2,000 vacancies.

(Continued to page 147A)

NOVEMBER, 1940

Army's Split-Trail Field Gun Fires Shell Almost Vertically



For high-angle firing, the front of the gun carriage is raised on a jack, forming a tripod with the split trail

Its split trail enables the U. S. army's new experimental 144-millimeter "T-3" howitzer to fire almost straight up, higher than any other army weapon. It sends a ninety-five pound shell over a range of 10,000 yards. The gun was put in action for the first time recently on the artillery range at Fort Bragg, N. C. The front of its carriage is raised on a jack to form a tripod for firing.

"Baby Blitzkrieg" Car Given Test as Troop and Supply Carrier

Two-cylinder economy is offered in two small cars proposed to the U. S. army for troop and supply transports. One is an open car designed to carry four fully equipped soldiers and ammunition at speeds up to fifty miles an hour, traveling fifty miles on a gallon of gasoline. The engine is air-cooled. A similar car of the "covered wagon" type is offered for the transportation of supplies and equipment as well as to carry soldiers.



These two cars, suggested for military use, are powered by two-cylinder air-cooled engines economical in fuel use

645

Target Trap Fixed to Rifle Is Operated by Spring



Below, loading the target into the throwing arm; above, aiming at the target after its release

Skeet and trapshooters can toss up their own targets with a spring-operated trap that fastens to the barrel of the rifle. An adjustment on the spring permits throwing the target near or far. The target thrower weighs fourteen ounces and fits almost all single-barrel .22 caliber rifles or .410 bore shotguns. Released by a separate trigger, the throwing arm comes to rest underneath the barrel without spoiling the aim.

Trailer Brake-Control in Auto Mounted at Steering Wheel



Hand control of trailer brakes for the convenience of automobile or truck driver is provided by a unit fastening to the dashboard or steering column. It permits brakes to be applied in-

dependently of the car brakes, thus overcoming the tendency of the trailer to jack-knife on slippery roads. The equipment includes two gauges to show vacuum available in the system and the applied vacuum in the control lines.

Remote Detonator for Bombs Effective for Two Miles

Claimed to work at distances up to two miles, a remote-control device invented by a Californian explodes bombs or other explosive charges. A directed, or focused, invisible beam, like a radio wave, is said to be the secret of the detonating machine. One anticipated use of the device is the setting off of enemy bombs that fail to explode, thus eliminating the risk of attempting an examination of the explosive. Another use might be in blasting, with the detonator replacing fuses and unhandy electrical equipment.



Inventor with device which projects an invisible beam that will set off explosive charges

83
 C. F. Messberg & Sons Inc. New Haven
 131 St. John St. New Haven
 Bender Products, Inc.
 1000 Bond St.
 K 919

K 843
 Edward C. Ward
 1250 1/2 Ave.

4258 14th Chicago Park District

Retractable Curb Divides Boulevard Traffic



Curbs that vanish into the pavement along a two-mile stretch of lake shore boulevard in Chicago permit division of the highway into six northbound and two southbound lanes during the evening rush hour, the reverse during the morning rush, and four north and four southbound lanes the rest of the day. Without this arrangement a twelve-lane boulevard would have been necessary to handle the heavy traffic. Controlled from the end of the 2.2-mile stretch, hydraulic jacks elevate the curbs eight inches above the ground, or cause retract-

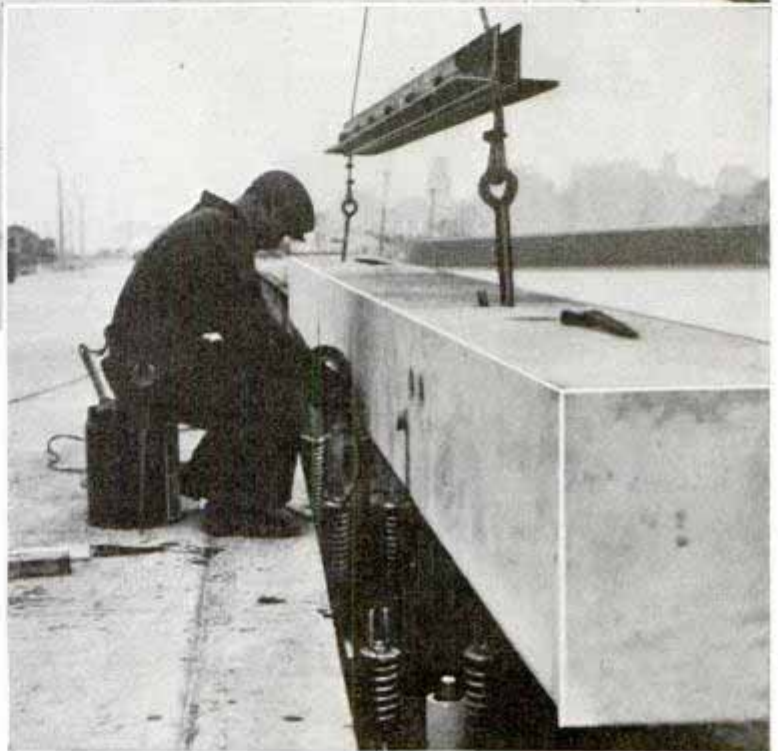

Top, retractable curbs being installed on Chicago's lake shore drive; below, a glimpse of retracting springs under curb

ing springs to lower them flush with the pavement. Lowering the entire length of curb takes only ten to twenty seconds.

1853

Highway Traps of Wire Coils Entangle Armored Cars

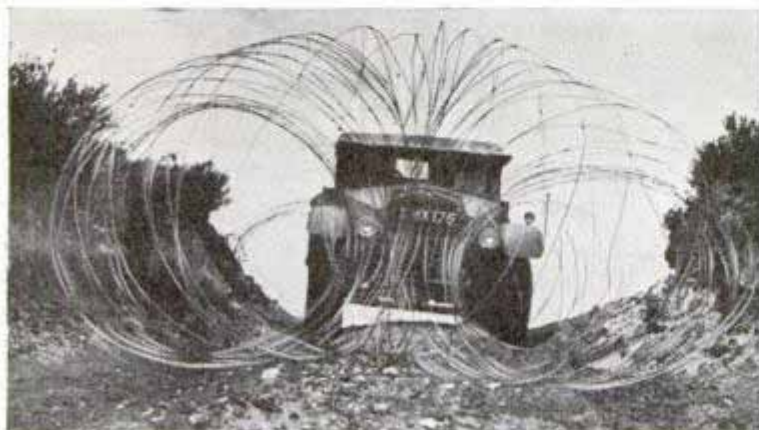

Coils of wire are placed on English roads to impede invasion

One simple defense against mechanized troops is to place coils of wire in the path of the trucks and armored cars. Although not impressive, these light coils entwine themselves around any car that has exposed axles and snarl it helplessly just as a rope stops the propeller of a motorboat. The British army used the wire coils liberally, particularly along narrow country roads, in preparing against invasion.

FIGHTING FOREST FIRES



Above, dressing two parachutists for a jump from the specially built monoplane. At right, parachute mantles a tree as the jumper lands in Chelan National Forest. Below, guiding a parachute down within seventy feet of target



FIRE-FIGHTING forces of Uncle Sam's Forest Service have been streamlined in an effort to reduce losses, such as the 1939 toll of 36,353 acres in the high mountain country of the Northwest Region No. 1 of national forests.

Perhaps the greatest single advancement in control work has been the inauguration of parachute squads. Men, specially trained and equipped, drop from the sky directly on the fire line, within minutes after look-outs have turned in the smoke report.

Parachuting was tried out experimentally last fall in the Chelan Forest near Wenatchee, Wash. A professional jumper, Frank Derry, was hired for the experiments. He was dressed in a padded suit, with football helmet, high leather collar and wire-mesh face protector. He wore a quick-opening parachute and an emergency army 'chute.

Cont. Karl Stoffel, Wenatchee, Wash.

Washington D.C.

in Chelan Forest
Chel. Derry

from the AIR

On his first jump Derry floated down gently, only to get hopelessly tangled in the tree tops. Once rescued, he had plenty of suggestions. The 'chute worked fine. It opened quickly and he was able to guide himself directly over the target. But the suit was too tight, cumbersome and binding. So the suit was revamped. The one now in use is of two-piece duck. The jacket, closely belted above the hips, has a zipper opening from top to bottom. The trousers, reaching high above the natural waistline and fitting snugly over the jacket, zip open from waistband to feet. In one trouser leg is a large pocket, to hold a lowering rope. Both garments are padded with thick wool felt over vulnerable spots, in the maner of a football suit. The collar is padded

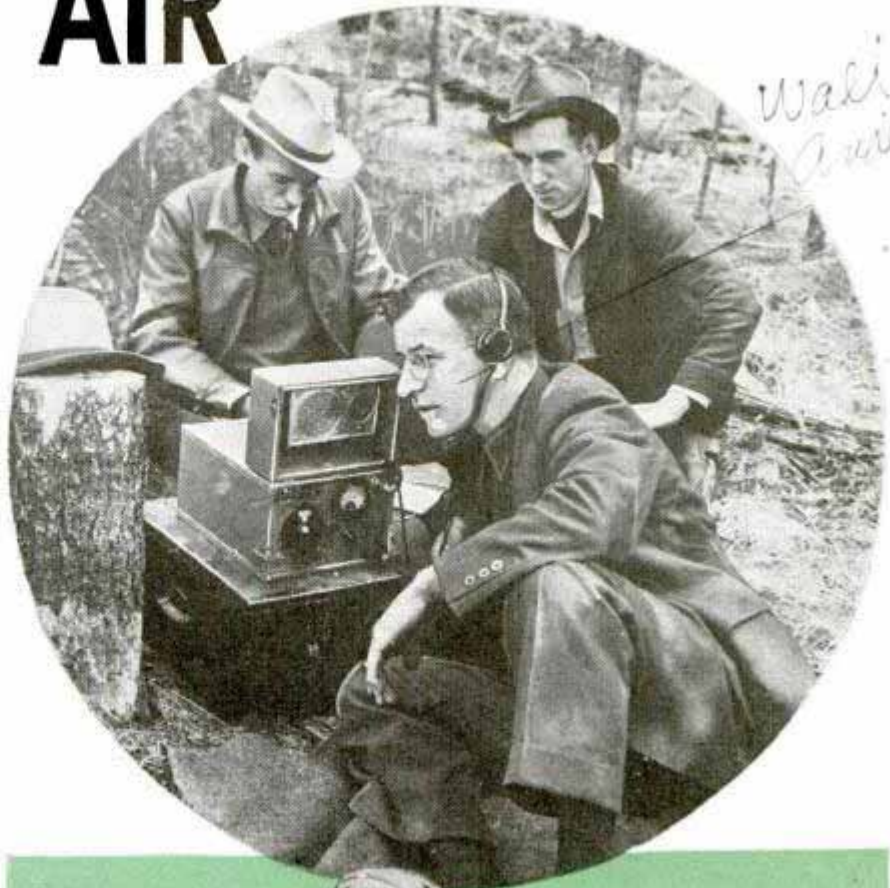

*Wall
Am... ..*

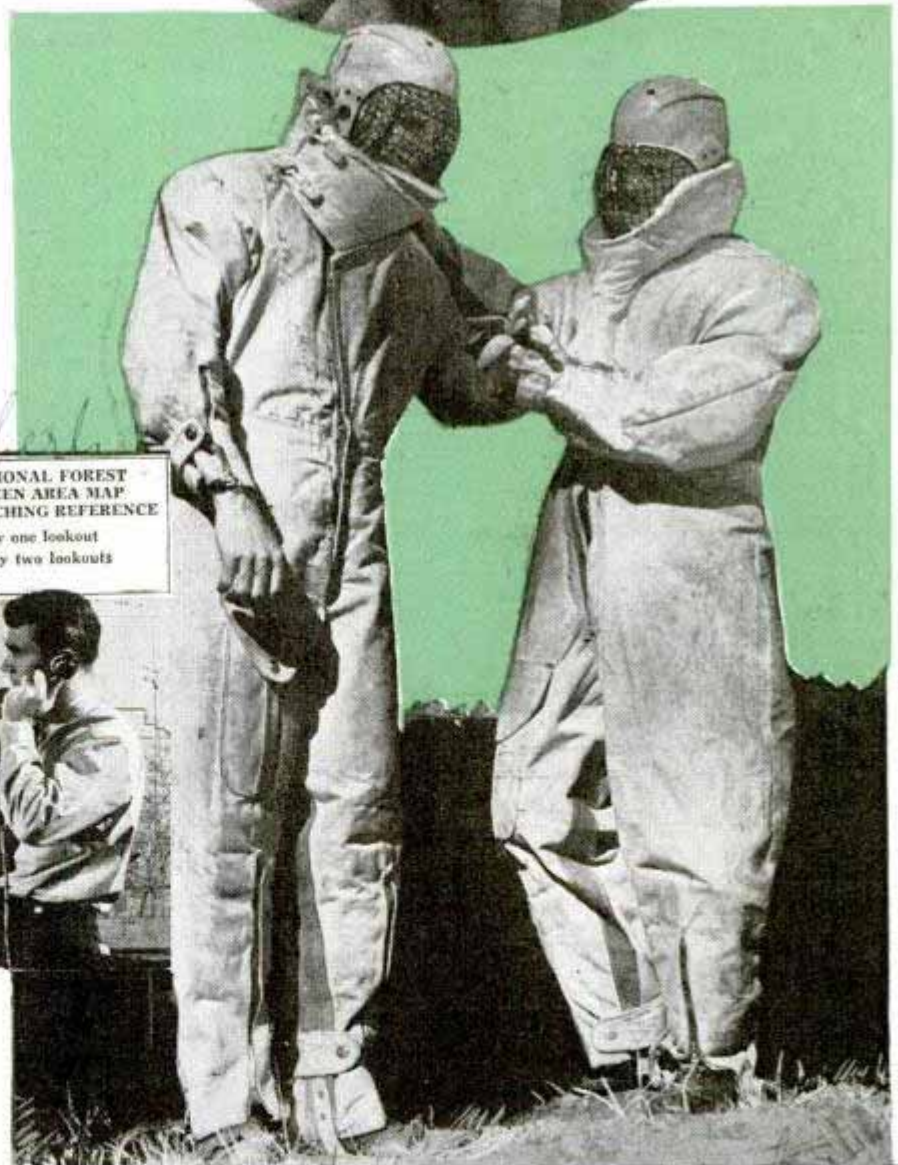

Top, ranger gets radio report from parachute jumper who has just landed at forest fire. Below, right, jumpers are protected for rough landings; left, crossed strings on dispatcher's map show location of fire

Ed. *Allen* *Black*

Winter trail Forest
C.C.C. Camps - Long Pine district
Feb. 1930 and
Inferwood

Carl Adams

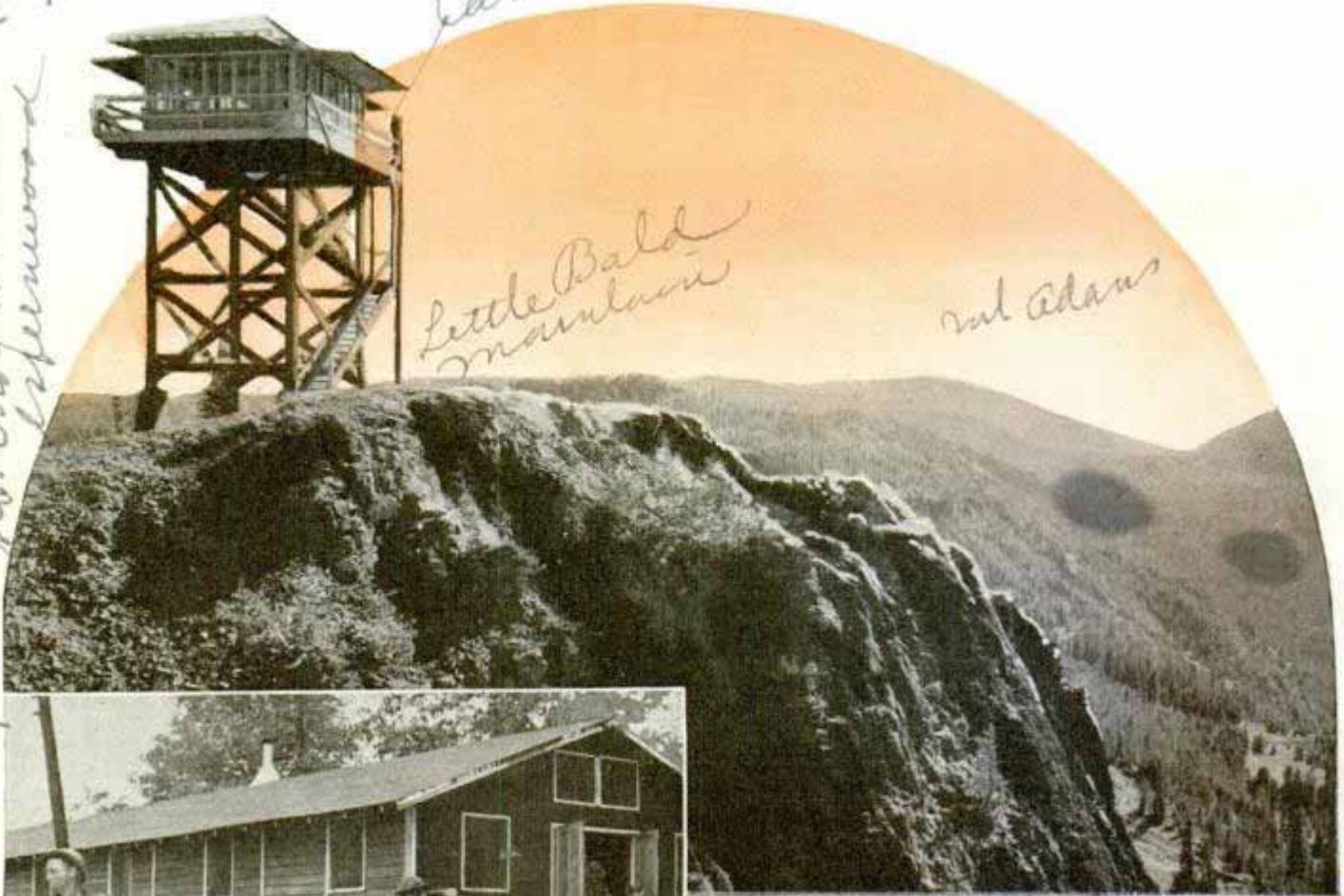

Little Bald
mountain

Carl Adams



Above, fire-control lookout in Snoqualmie National Forest. Left, the fire-fighting squad snaps into action and is on its way before the alarm bell stops clanging. Below, at field headquarters the proper tools are speedily handed out to the men and no time is lost in getting at the blaze

Carl Adams

and sufficiently flexible so the jumper can bend his head forward or backward, for better visibility. The 'chute harness permits the jumper to detach himself from the 'chute and reach the ground by a rope.

When the testing was finished, Derry instructed a group of experienced fire guards and rangers in the jumping technique. Early this summer, these men in turn conducted jumping schools in regional forests.

The smoke-jumping procedure is fairly simple. The pilot flies across the spot of smoke and releases a ten-pound bag of sand to which a small 'chute is attached. The plane circles and the men watch the action of the wind and air currents on the test 'chute. Then, approaching the mark for the second time, the pilot makes correction for wind drift before signaling the jumper to let go. Planes are equipped with special steps and handholds to enable jumpers to get into the air properly.

Then the pilot circles again and drops a



burlap 'chute with fire-fighting tools, lamp, two days' rations, first-aid kit, water canteen and small articles. The smoke jumper spots these supplies coming down by attached streamers and makes his way to the pack as soon as he has climbed out of his suit. He is then ready to go to the fire, put it out if it is not too large or report by radio if he needs help. He carries a ten-pound portable radio set.



Although new and spectacular, and highly advantageous in many respects, smoke jumping has supplemented rather than replaced standard methods of fighting fire. Important for all purposes is the general use of short-wave radio sending and receiving sets. Scouting units are now organized and may be sent to the fire line ahead of the fighters. In a matter of minutes after their arrival they start making reports. At headquarters, is a draftsman with a map. As reports come in from the fire line, he draws a scale map of the action and the fire chief is able to deploy his men to the best advantage. Line scouts report on wind, condition of the forest, speed of the fire and progress of the battle. The man in charge of a big fire can get a much better picture of a big blaze now in an hour than he could have gotten with-



...Chelan, Wash. ...



Top, CCC boy weights down "X" marker after starting smudge to attract pilot's attention. Right, jumper wearing experimental suit and carrying supplies for fighting remote fire. Bottom, building a fire line

out the radio in many hours or even days.

In every forest headquarters today are assembled complete fire-fighting outfits, called smoke-chaser units. Light and compact but with all the essentials, these units are stowed in packs with a total weight of only thirty-two pounds.

There are one-man, two-man, eight-man or forty-man units. The packs contain the regulation combination ax and hoe, a shovel, emergency rations for two days, flash lamp, first-aid kit, water canteen and one double-action hand pump with a five-gallon collapsible rubber bag.

Food in the packs, canned and condensed, is for use by smoke chasers on small fires

(Continued to page 150A)

Regjessa Kowch
Chelan

'Airmobile' Turns Around at a Mile a Minute

Whizzer

*Bought by Bill Clark
K. % Union Babersville, Ok
708*

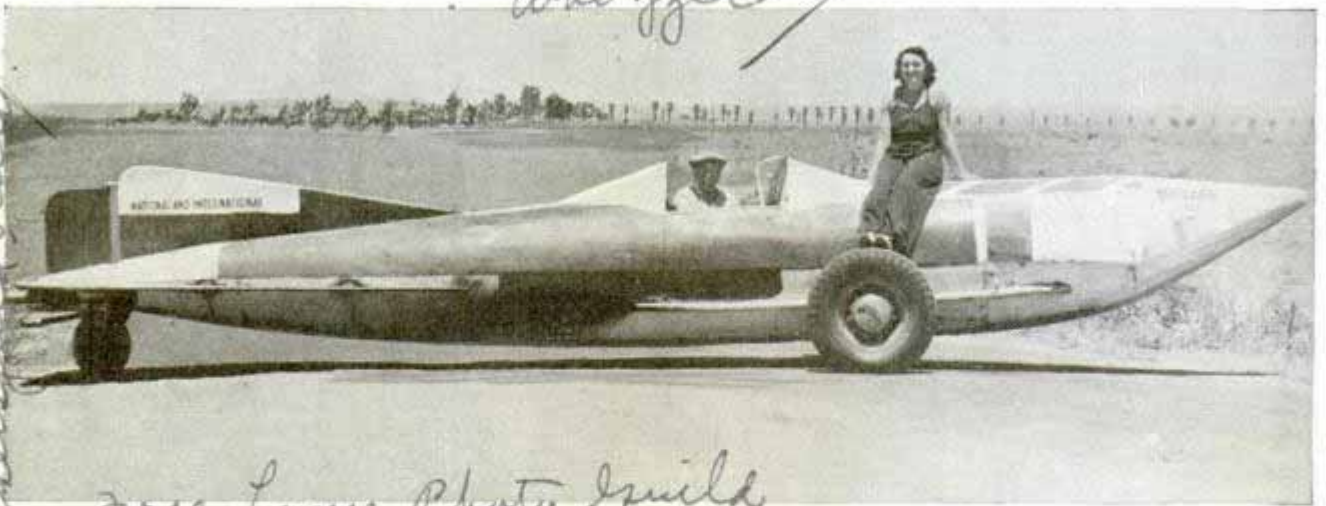

Free Lane Photo Studio
Independent braking on the two forward wheels permits the operator to swing this "airmobile" in a circle at high speed. The car is used in a carnival performance; its owner says it will do 140 miles an hour

Twice the length of an ordinary automobile, a three-wheel car that looks more like an airplane than a highway vehicle is causing a sensation on western roads. The Oklahoma built "airmobile" can make a complete reversal of direction at sixty miles an hour, turning in its own length and starting in the opposite direction. There are independent brakes on the two front drive wheels, and when one is braked the single tail wheel swings around in a circle with the braked wheel as a pivot.

The cockpit, too, resembles that of an airplane. The steering wheel operates both the rear wheel and the rudder, which, along with the tail and its stabilizers, required precision construction to prevent any wobbling in the air stream. The builder claims a speed of 140 miles an hour and says the streamlining helps obtain 41.2 miles per gallon of gas. The car has been appearing in a carnival fire act, plunging through a seventy-five foot circle of fire formed by lighting oil-soaked straw.

Garment Bag in Top of Automobile Folds Out of the Way

None of the used space in the automobile is taken up by a garment bag now on the market that folds flat against the top, where it remains out of the way until

wanted. The frame that holds the bag fastens flush against the ceiling by spring clips and may be adjusted to fit cars of any width. Clothing is carried in the bag without getting wrinkled or dusty.

*Container, Lamp, etc.
inside*



Top, bag folded; bottom, easy to reach when unfolded

Insulation Sealed to Brick Veneer to Form a Solid Slab

Brick veneer or stone bonded by waterproof portland cement mortar to a half-inch layer of a fiber insulating board forms a new building material. Brick of standard width and length is used, but only one-half inch thick. With its insulating back and

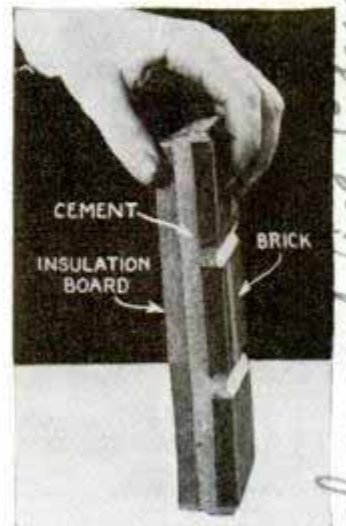

*Brick and Stone
1/2 inch thick
3/12/22*

the quarter-inch bond of mortar the slab is one and one-fourth inch thick, three bricks high and three bricks long. These slabs fasten to the sheathing, but rest on the existing foundation which need not be built out. The panels are bonded in a mold under light pressure and in fifteen minutes can be removed for curing.

1922
**Motorcycle Taxicab
 Latest 'Rickshaw'
 for Shanghai**

Time-honored rickshaws on the streets of Shanghai, China, have a new competitor in the form of an ordinary motorcycle with sidecar attached, capable of carrying two passengers. The vehicle is enclosed in a steel body, and the driver, riding on the motorcycle seat, operates and steers the machine in the usual way. Luggage is stored in a compartment at the rear. The high price of gasoline in China makes ordinary taxicab business next to impossible, but the new motorcycle unit sidesteps this economic handicap.

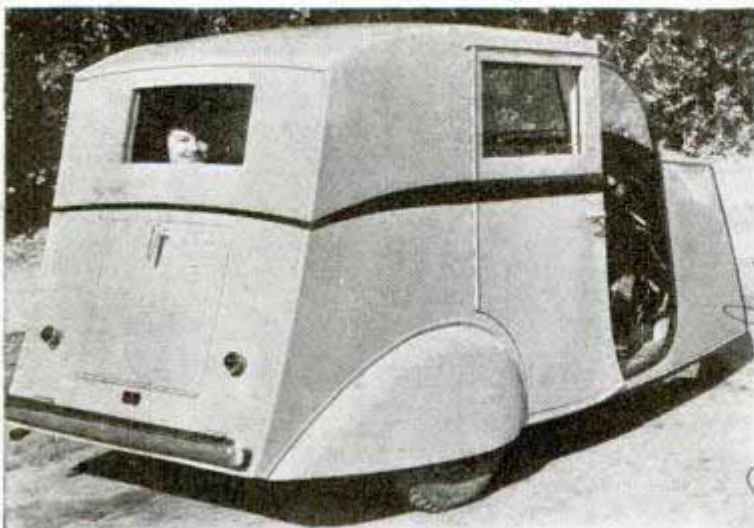

New taxicab for streets of Shanghai is this motorcycle and sidecar enclosed in steel body that can carry two passengers

NOVEMBER, 1940

Advance Autobody
 1111 100th St. Minneapolis

**Dummy Guns Train Soldiers
 for Handling Real Weapons**

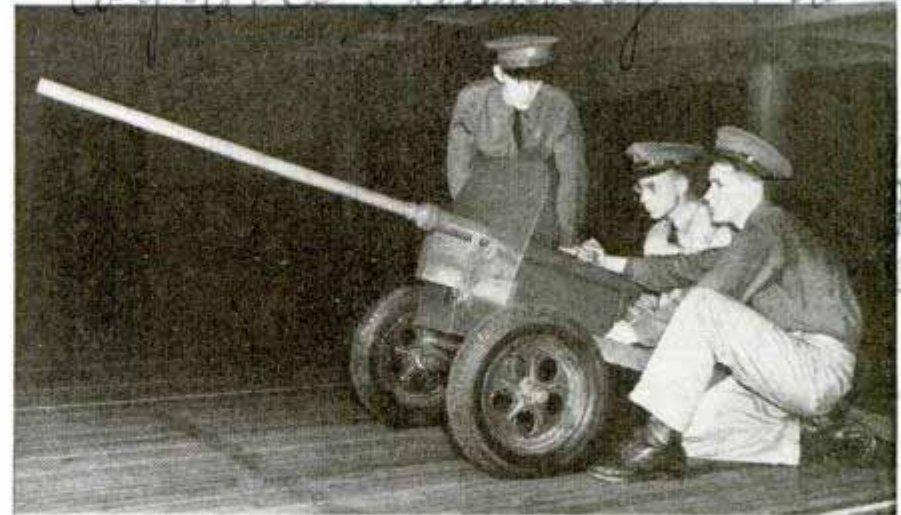

At top is a copy of the thirty-seven millimeter anti-tank gun; below, a guardsman practices with a dummy fifty-caliber machine gun

For want of enough real arms to train the expanding army, the 71st National Guard regiment gives its recruits preliminary training with dummy guns. One is an imitation of the fifty-caliber machine gun, made of wood and pipes; another, mounted on a rubber-tired truck, is a copy of a thirty-seven-millimeter anti-tank gun. Since the guns don't fire, the soldiers are simply taught their theoretical use in maneuvers. Real weapons will replace the dummy guns as fast as they can be produced.

Soldier C. Schwab
 re: def

A Swedish mining firm has produced an arsenic compound for impregnating timber to make it proof against rot or insect attack; the treated wood is slightly green in color, tinged with brown, and does not require painting.

Compressed Air
 Aug 1940 653

United States Line
One Broadway, New York
AMERICA'S

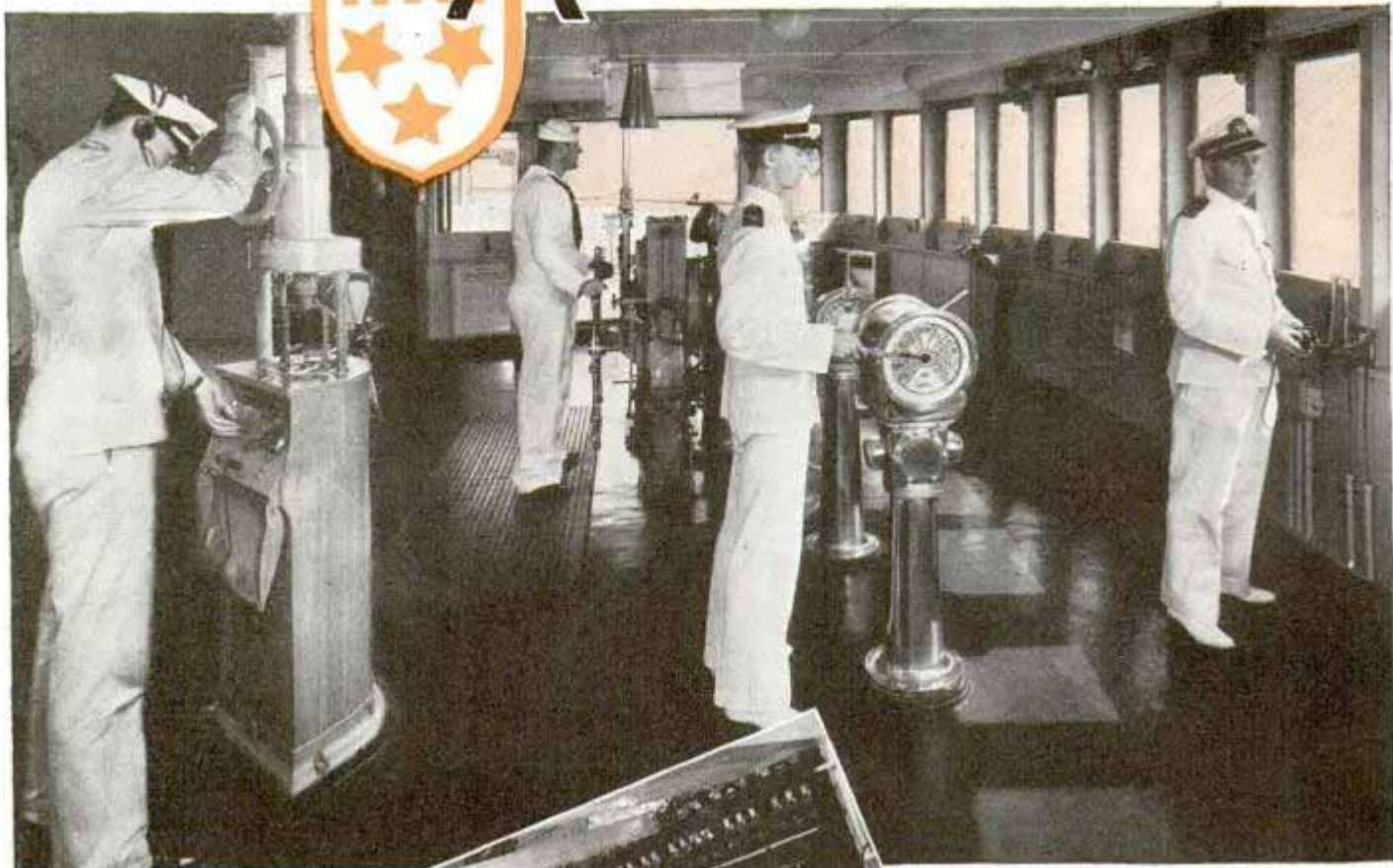

On the navigation bridge of the S.S. "America," above, is the radio compass with which the liner's position can be determined. At left is the engine room and main switchboard. The ship's two sets of triple expansion turbines develop 34,000 shaft horsepower at 128 revolutions per minute, giving her a twenty-three knot speed

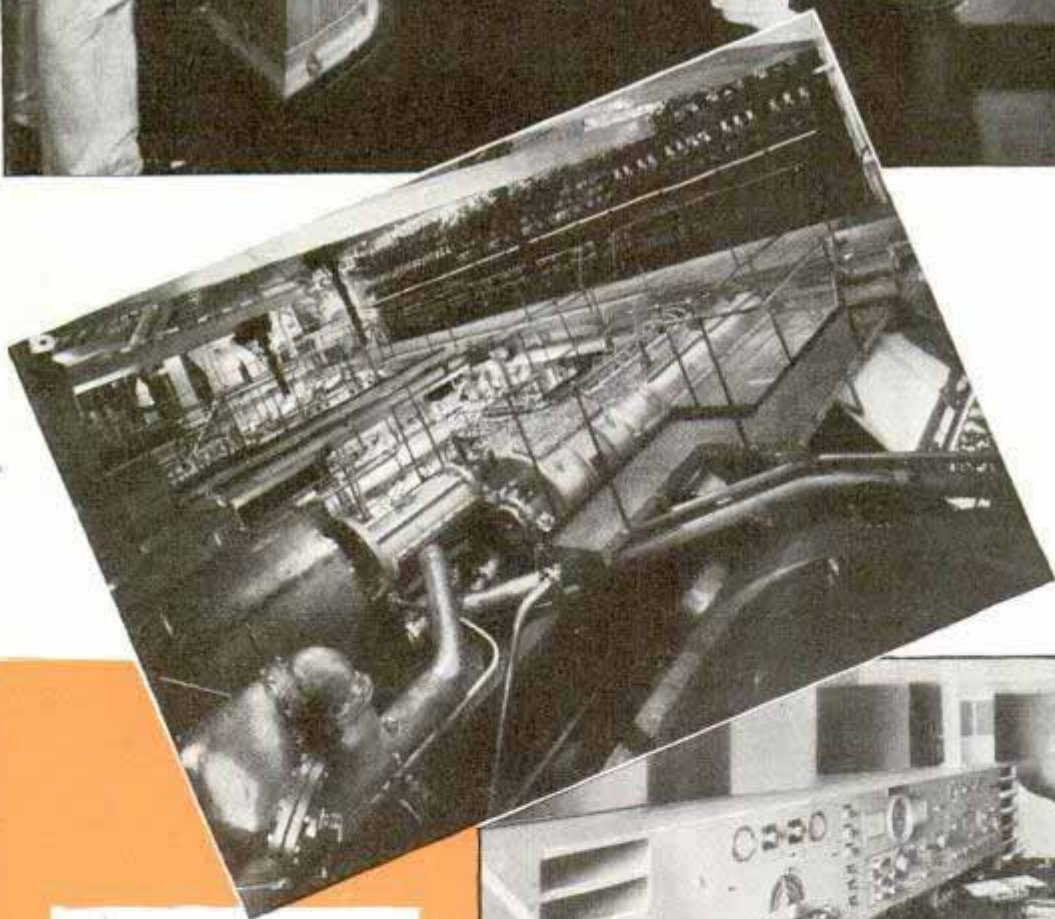

The main radio room of the "America" (right) has five transmitters and receivers, four of them for radiotelegraphy and one for telephony, and a radio auto alarm



R 963

BIGGEST LINER

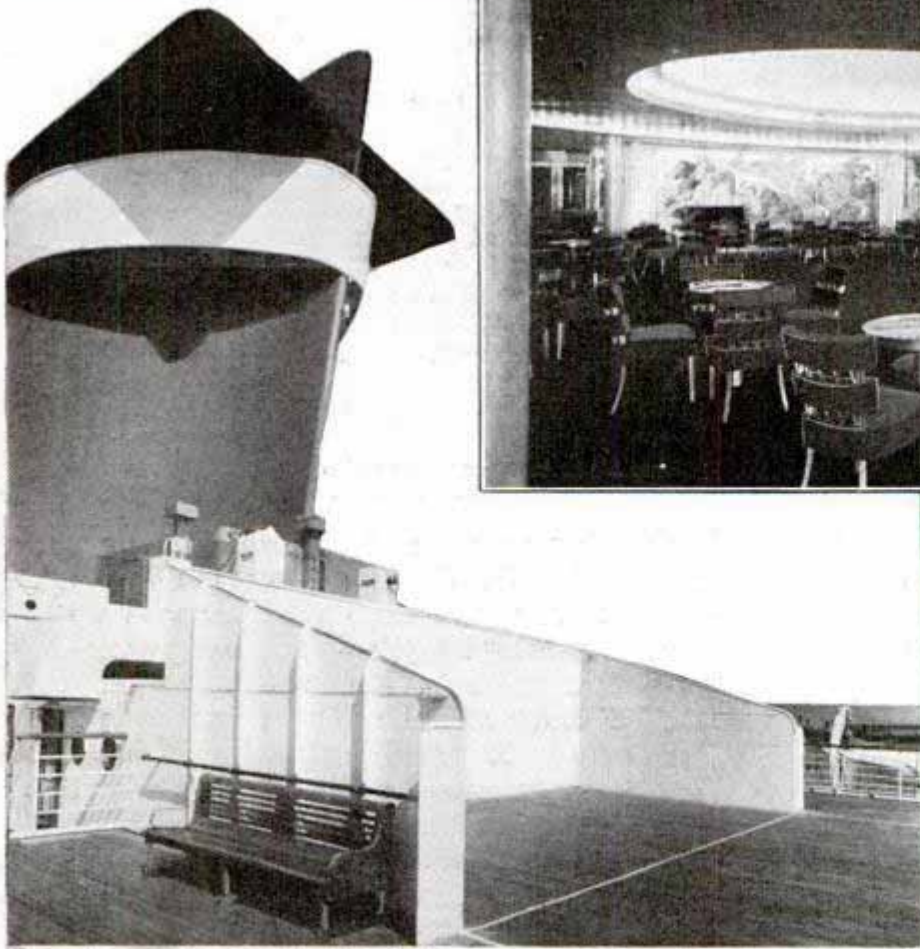
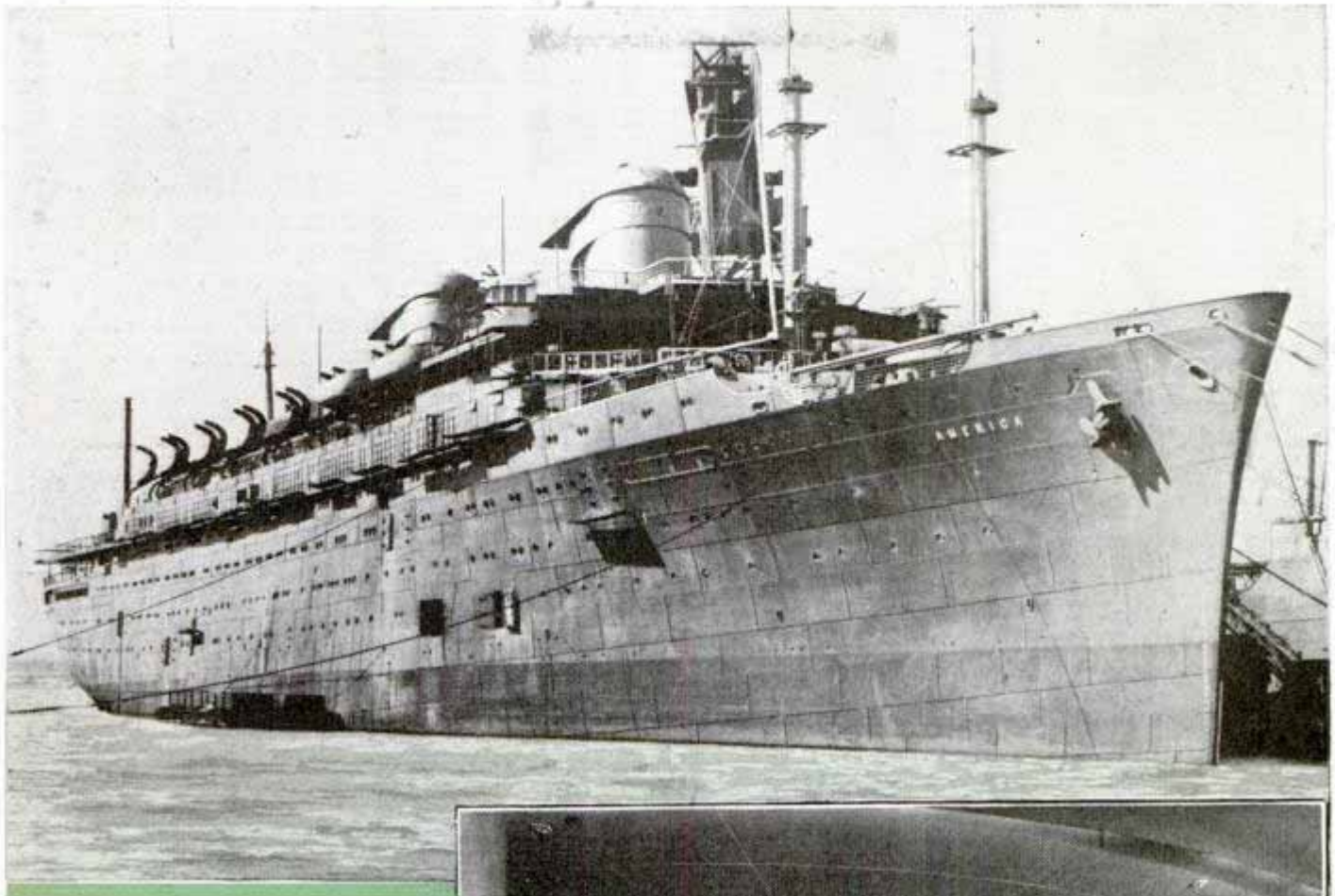

Pride of the American merchant fleet, the U. S. liner "America" is 723 feet long, with 92-foot beam, accommodating 1,219 passengers and crew of 639. Above, the grand ballroom, with silver leaf on ceiling and columns. Left, handball court. Projections on funnels keep soot from falling on deck

K 907

130-Pound Airplane Engine Delivers 75 Horsepower

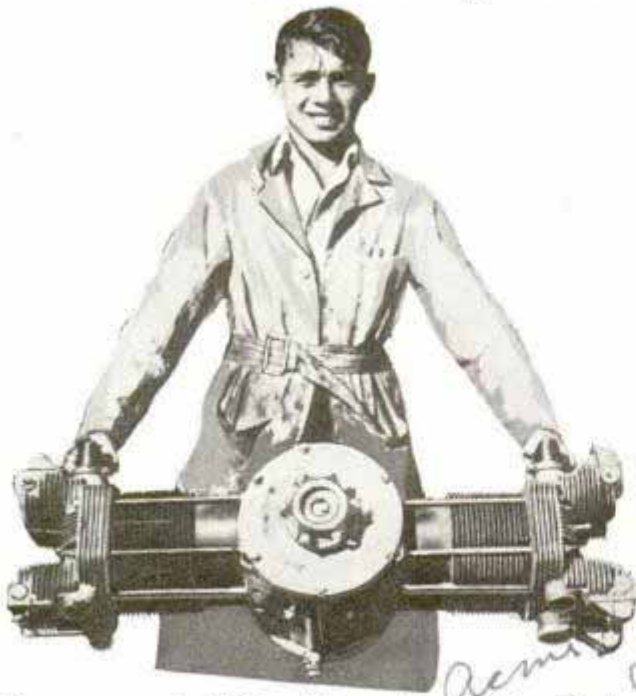

One man carries lightweight engine capable of flying two-passenger plane. Note arrangement of cylinders

Light enough to be picked up by a mechanic, yet supplying power to fly a plane carrying two passengers, an engine built by a California inventor develops seventy-five horsepower and weighs only 130 pounds. Of the double-opposed type, the engine includes a built-up roller-bearing crankshaft created by the same inventor.

K 847

Stretcher on a Bicycle Wheel Speeds War Rescue Work

Air-raid defense officers in an English city developed a mono-wheel stretcher to facilitate rescue work in wartime disasters. The standard steel stretcher is mounted on



Since one man can handle this mono-wheel stretcher, the rescue squad can work twice as fast

Water in Gasoline Tank Detected by Paste on Fuel Gauge

K 963 Buffalo, N.Y.

Water in Gasoline Tank Detected by Paste on Fuel Gauge

Water in the gasoline or fuel oil tank can be detected easily by a simple test with a gauge stick that changes color in the presence of moisture. The stick is covered with a thin layer of a chemical paste which is available in tubes. The paste is pink, but when thrust to the bottom of the fuel tank, any water there will turn it white.

K 839

Geared Tool for Wheel Wrench Simplifies Truck Servicing



How the geared tool is used with regular wrench for removing a dual wheel

Offering power and smooth operation, an adapter for the wheel wrench has a three-to-one gear ratio which speeds up truck servicing by quickly removing or replacing wheel nuts. Even the most tightly locked outer wheel nuts on dual wheel jobs may be loosened easily without damage to inner wheel nuts, studs or wheel parts. The tool is used with a regular wheel wrench and can be handled efficiently by one man on jobs that otherwise might tax the strength of two men.

The 1941 CARS



Pontiac



Plymouth



ABOVE, one of the Torpedo Fleet, a two-tone sedan whose beauty is caught by the camera in full natural color. Left, another two-tone beauty, the Plymouth Special Deluxe. Note unusual design of bumper, as well as the front-end treatment by which appearance of great strength is achieved

657



Ford

658

By Julian Leggett

MORE miles per gallon, flashier performance, roomier and lower bodies on longer wheelbases and exterior colors that promise to convert America's highways into kaleidoscopic ribbons are features of 1941-model automobiles revealed in a comparison with last year's cars.

New entries in the low-price field include the Nash "600," with an economy rating of twenty-five to thirty miles per gallon of gasoline, and the equally thrifty "Americar," smartly styled successor to the Willys.

Buick introduces compound carburetion, a development designed to achieve unusual economy in an automobile of that weight without sacrificing performance. It consists of two dual carburetors mounted on the engine to provide better mixture ratios of air to gasoline; the Series 40, smallest of the line, gets slightly more than

TOP, Ford Super-Deluxe Tudor with 114-inch wheelbase. Center, sketch of Buick compound carburetion (left) and ball combustion design (right). Below, Mercury sedan with body so wide it partly conceals running boards

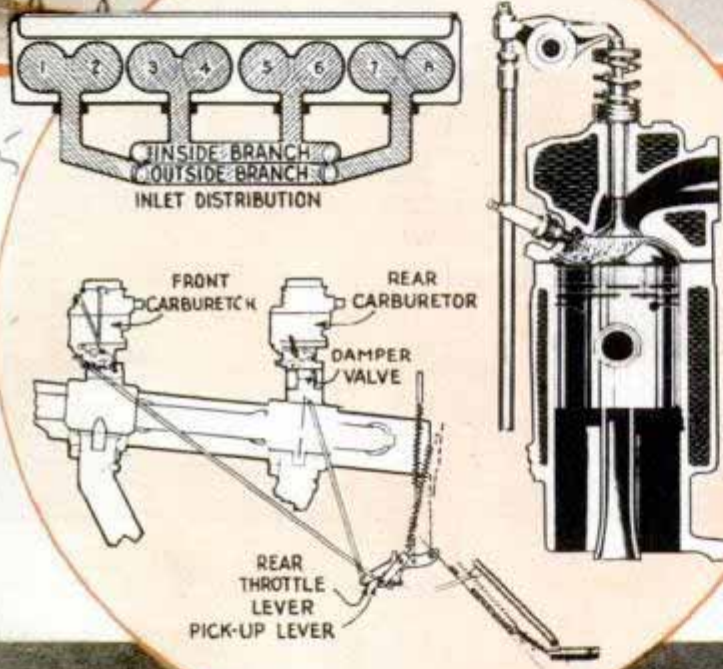



Chevrolet

1855
659

twenty miles per gallon when equipped with it and the larger models, on which it is standard equipment, are proportionately frugal. For so-called full-throttle operation, in high gear, the system works like this: below fifteen miles per hour, the front carburetor's main fuel system is functioning, the rear one is not; fifteen to twenty miles per hour, the front carburetor's main system is working and the rear one is just beginning to feed gasoline; thirty-five to forty, both carburetor main systems working. Hill-climbing, acceleration and top speed are said to be far superior when compound carburetion is employed. Hand-in-hand with this development is the reshaping of Buick engine combustion chambers so that the fuel charge is compressed into a ball around the spark plug, affording improved combustion and sharply reducing detonation ("pinging") tendencies.

With compound carburetion, the 115-horsepower Buick 40 engine develops 125 horsepower; the larger motor, which has the carburetion system at no extra cost, 165 horsepower. This is a considerable increase

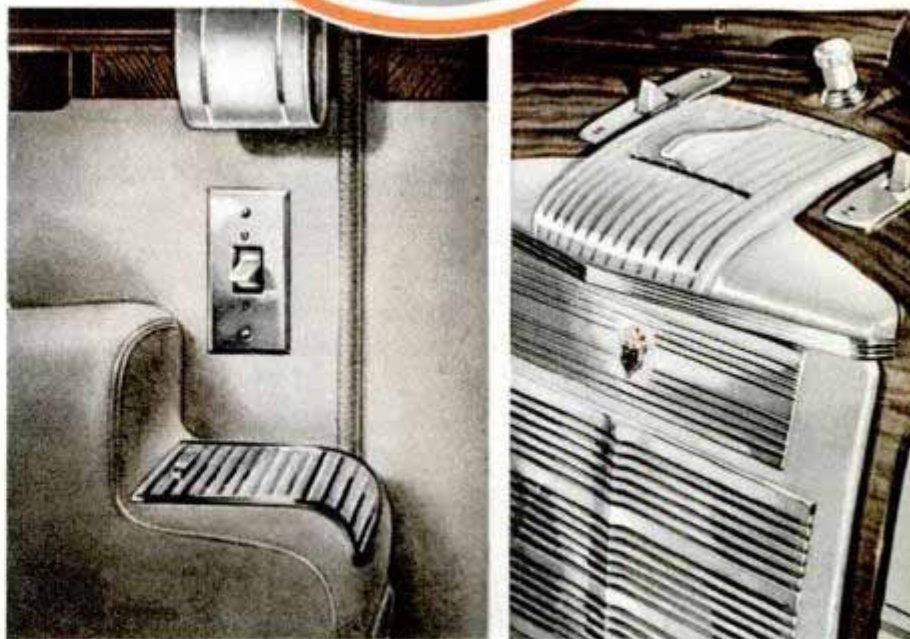
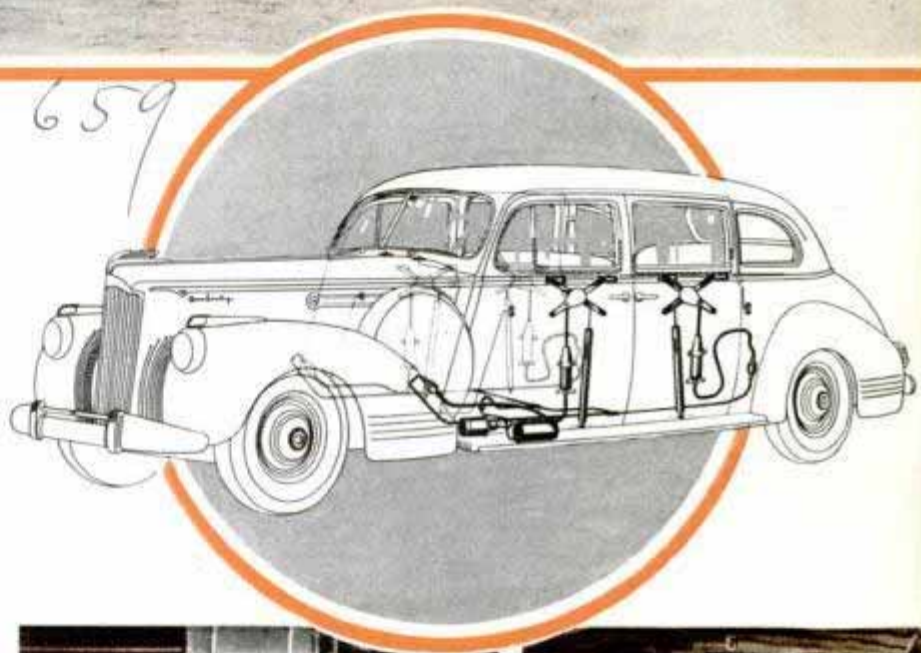

AT TOP is the longer, higher-powered Chevrolet in the sedan model. Circle, sketch revealing Packard's hydraulic automatic window lift. Windows are raised or lowered by this mechanism by touching a button in rear or front compartments (bottom)



Studebaker



Nash

STUDEBAKER sedan, in two-tone finish (top), the Nash (center) and Chrysler (below), all depicted in their full beauty by color film. The Nash 600 is styled identically with the sedan pictured above

660

in power over last year's engines and is characteristic of the industry.

Chevrolet, for instance, has stepped from eighty-five to ninety horsepower, accompanying it with an increase of three inches in wheel-base, to 116 inches. The Chevrolet body has been widened and made more massive looking; running boards have been replaced by convenient rubber-ribbed safety steps concealed by the skirt of each door and in most models, concealed hinges are used. The Chevrolet is marked by advances in streamlining—"valleys" between hood and front fenders are eliminated; windows, rear windows and upper portion of the sides are increased in slope, and the whole body is set lower. Arrangement is made for attaching the front license plate to the center of the



Chrysler



Buick

661 K855

bumper, with a steel guard underneath to protect it from flying gravel.

Plymouth, too, increases horsepower to eighty-seven, and has a wheelbase of 117 inches. A mechanical innovation is the "get away gear," which permits starting in second-gear position under virtually all conditions. First or low gear is utilized only for uphill starts or pulling out of mud or sand. Plymouth also has a new safety rim wheel, common to all Chrysler built automobiles this year, which prevents a flat tire from coming off the wheel, even at high speeds. With this new rim, a completely flat tire gives the same performance as a tire inflated to ten pounds of air pressure on the standard wheel. Thus, the new rim serves the double purpose of holding the flat tire on the rim and of providing sufficient traction to aid in



De Soto

TOP, the Sedanet, a six-passenger, two-door sedan with sharply sloping back. Center, head on view of De Soto sedan. Both cars are in natural colors. Below, the Super-Six in two-tone finish

Hudson





Dodge

662

1869
stopping the car safely in case of blowouts. Another all-Chrysler feature is the safety speedometer which has a translucent indicator that shows green at speeds up to thirty miles an hour, amber up to fifty and red above fifty. New high-duty bearings, another Chrysler feature, give three to five times longer bearing life than the bearings they replaced and dissipate heat more rapidly. The Plymouth battery has a special device that shows when the proper amount of water has been put in, the fluid apparently changing color when the proper level is reached.

So satisfactory was the public's reception of the "torpedo" design, Pontiac introduces an entire torpedo fleet, the smallest with a ninety-horsepower six-cylinder engine and 119-inch

SPECIALLY equipped Dodge two-door brougham (top); running board of Pontiac and other General Motors cars is concealed by flared skirt of door (center); smart instrument panel of Chevrolet (bottom, left) and Dodge front end (bottom, right) with gravel deflector and special bumper guards

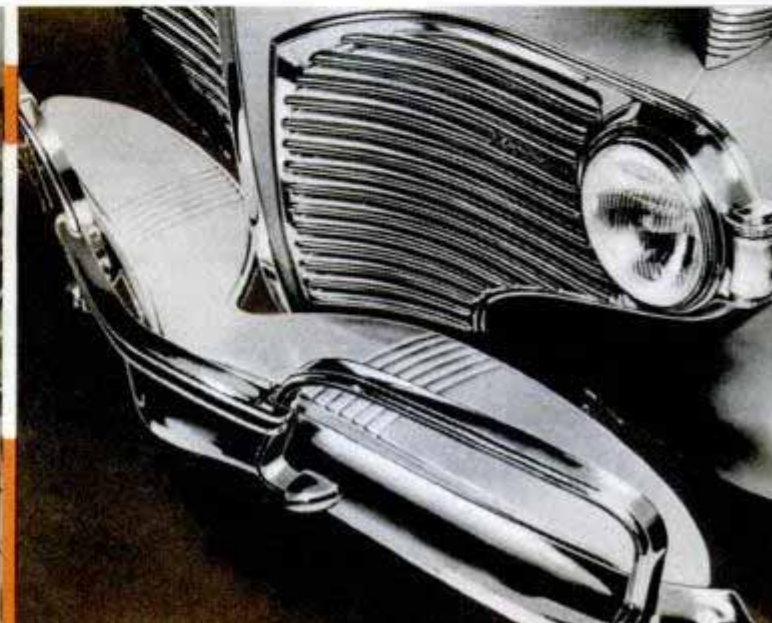
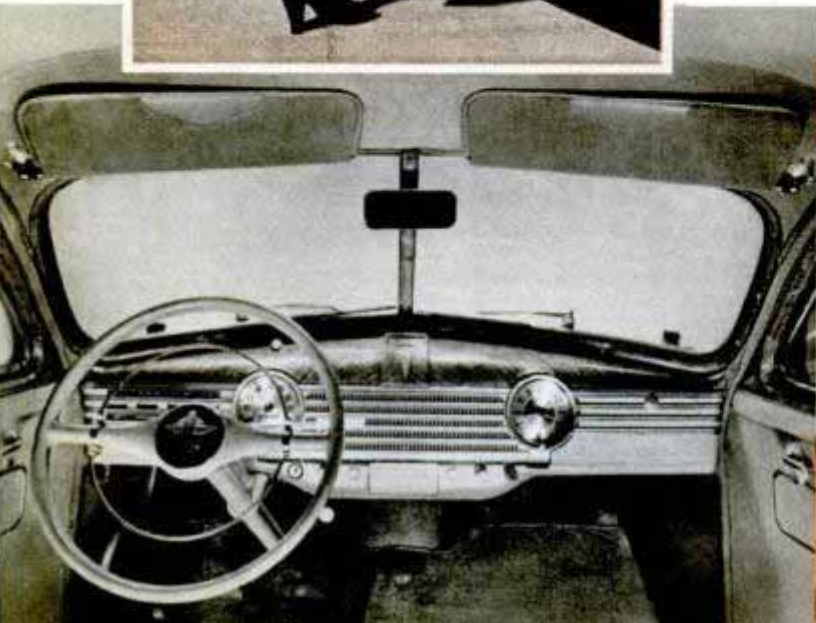



Lincoln Zephyr

wheelbase and the largest with a 105-horsepower eight-cylinder engine and 122-inch wheelbase. Feature model of the line is a Streamliner with unbroken line from roof to rear bumper. This design, a Fisher Body development, is carried into other General Motors cars. Running boards are replaced by individual door steps which are enclosed and concealed by a flare in the lower edge of the doors. A new-type door hinge holds the door in position when fully open, preventing accidental closing. A two-spoke steering wheel has horn-operating keys set into the spokes. Automatic lighting of the Pontiac's interior is provided. When either front door is opened, a switch located on the rear edge of the door pillars turns on the dome light. The oil cleaner is built in, being located at the inlet to the oil line in the crankcase where all oil must pass on the way to bearings and working parts. A settling chamber built around the inlet to the oil system, a rounded chamber at the top of the inlet tube, and a flat



TOP, a sedan model with beautiful lines. Right, two-spoke steering wheel featured by Dodge. Note instrument visibility. Below, left, Hudson's ventilator sidetracks water into rear of motor compartment. Right, Willys under a new name—Americar

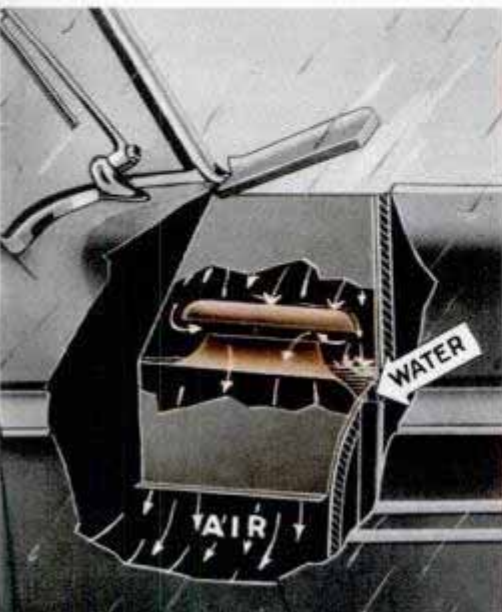

Americar (WILLYS)





Packard



1K
850

664

baffle reverse the flow of oil and cause dirt particles to be thrown out and into the settling chamber. Thus microscopic pieces of grit are removed. Many chassis parts of the Pontiac are prelubricated and sealed so no further lubrication is needed for the life of the car under ordinary driving conditions.

A big stride toward economy and smooth operation is taken by the Chrysler Corporation in making the Fluid Drive available on all Dodge, De Soto and Chrysler models this year, Fluid Drive is an ingenious coupling, in which a light oil is used, which enables drivers to climb grades or maneuver through crowded traffic with-

(Continued on page 114A)

TOP, Packard two-tone 110 sedan. Center, Packard's maroon convertible. Bottom, Olds' Dynamic Cruiser. Note rear-end styling. Natural color film is the means employed to present these new cars in all their true beauty



Oldsmobile

K812. Weber Orcaiter 1100 6. 5th St. Los Angeles
 Pat. # 219, 7401

Semi-Trailer Stretches to Fit Load of Any Size

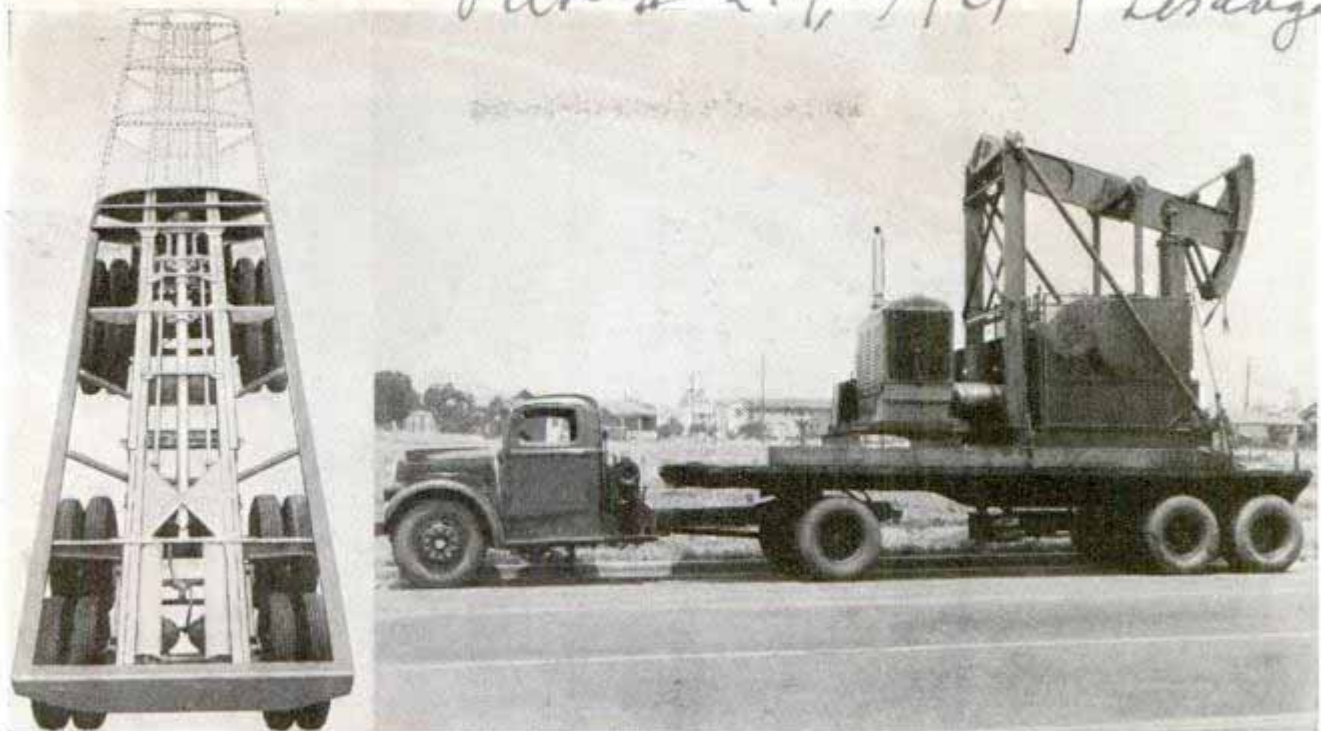

At the right, the semi-trailer is contracted to its shortest span to carry a compact and heavy load. At left, the dotted lines indicate the various lengths to which it can be extended

Four different wheel bases are available in one semi-trailer of adjustable length, permitting the operator to accommodate the trailer to any type of cargo. Fully extended, it can haul such loads as long pipes, oil-well casing or poles; retracted to its minimum length it provides correct load distribution for draw works, compressors and other short, heavy loads. The adjust-

ment of length is made quickly and easily by removing the lock pins, driving the tractor forward or backward to change the wheel base, then replacing lock pins. Telescopic joints of metal lines for air or vacuum brakes eliminate the necessity of coiling extra lengths of hose, the brake lines automatically adjusting themselves as the length of the trailer is changed.

Three Lines, 55 W. 42nd, New York

Homemade Electric Vibraphone Is Played Like a Piano

Desiring to add a vibraphone to his orchestra, but having no one to play it, one

mechanically inclined leader built what he calls an electric vibrachord that any pianist can play. Using a vibraphone, he added electric resonators and a set of electric magnets to strike the metal bars. Keys arranged on a piano keyboard at standard height have contact points underneath which operate the magnets electrically. There are thirty keys, or two and one-half octaves. A damper on each bar, as in a piano, is released when the key is struck, remaining so as long as the key is held. The resonators may be turned on or off by separate switches controlling them. The instrument cost approximately \$600 to build, and most of the parts were made by hand.



Any pianist can play this vibraphone built by orchestra leader

Stanley Le Waal 665
 211 Broadway Ave

AUTOMOBILES

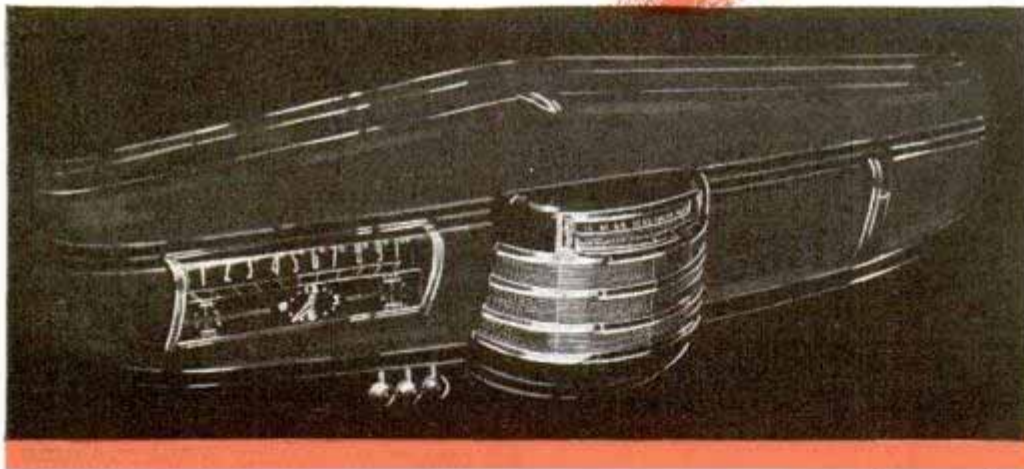
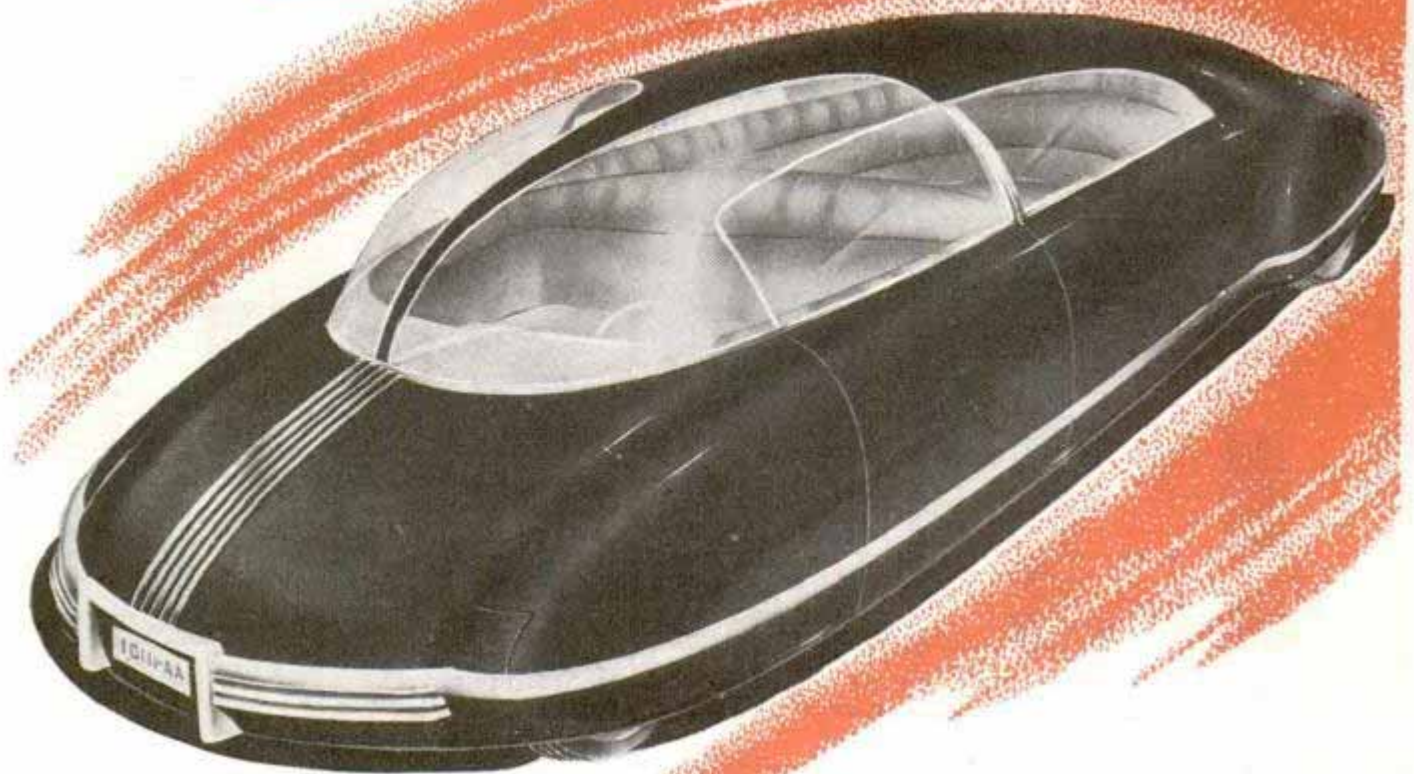

Above is one conception of the car of the future, drawn especially for *Popular Mechanics* by the author. Note its circular lounge in the rear and the wide visibility offered by its transparent plastic roof. On the cover of this issue is another special design by Mr. Walker. At left, an instrument panel with airplane-type controls

By George W. Walker

Auto Designer and Industrial Stylist

OUTSTANDINGLY different will be the motor car of the future—a future that is not far distant, as time goes.

It will be an automobile carrying its engine in the rear, where the engine has belonged all along, and this placement of the power plant will make not only for far greater motoring comfort, but it will contribute materially to the unprecedented roominess of the car's interior.

It will offer entirely new concepts of comfort—"living room luxury"—with new spaciousness, radically changed seating ar-

rangements, complete summer and winter air-conditioning system, and many other innovations.

The body of the car of the future, even to its windshield and windows, will be of new synthetic materials, probably some forms of molded plastics. In this car will be found the last word in devices that will make for the safety of driver and passengers—windows and windshields of clear, transparent substances, which neither shatter nor fly under impact and thus do not cut; airplane-type "crash pads" designed right

of TOMORROW

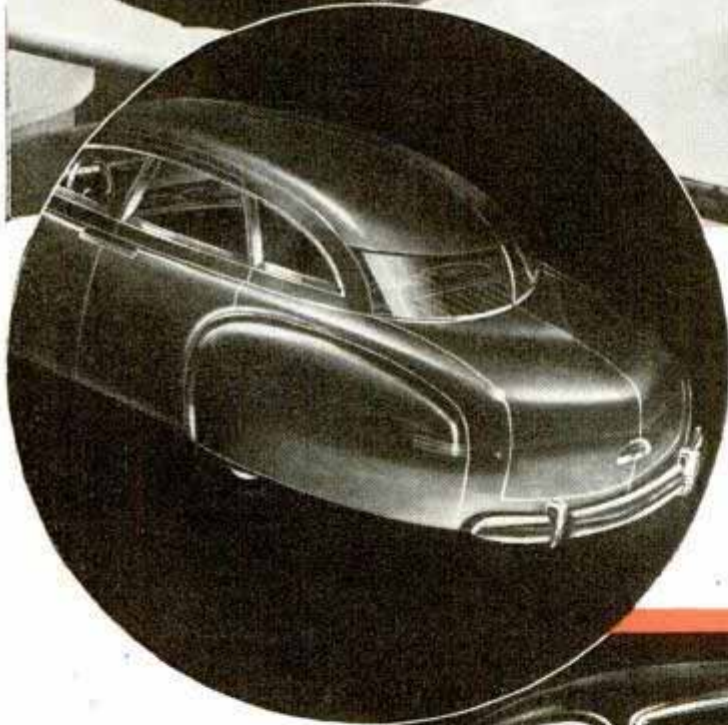

into the interior at strategic points, thus protecting occupants from hard bumps in road accidents; strong, spring-mounted bumper, running entirely around the body and an integral and pleasing part of the over-all design, capable of absorbing far more of the shattering force of collisions than bumpers do now.

(Continued to page 120A)

At top Mr. Walker is studying a miniature car, pointing to plastic top. His plan for a car of plastics is shown in circle; it would never need paint, and fading and chipping are impossible for color is molded right into the substance of the body. Unity of design in grille and shock-absorbing bumper are achieved in car at right

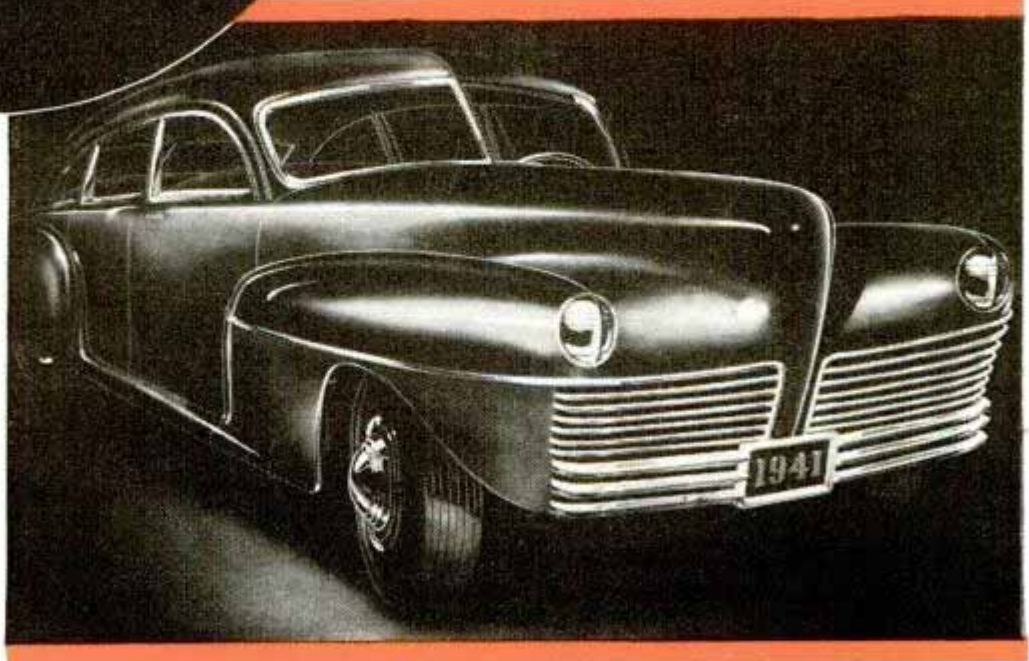

876 Cornell Becker Mfg. Co. Machine, d. 117

Doll-House Furniture in Kit Is Assembled by Buyer

True Scale. 50c each

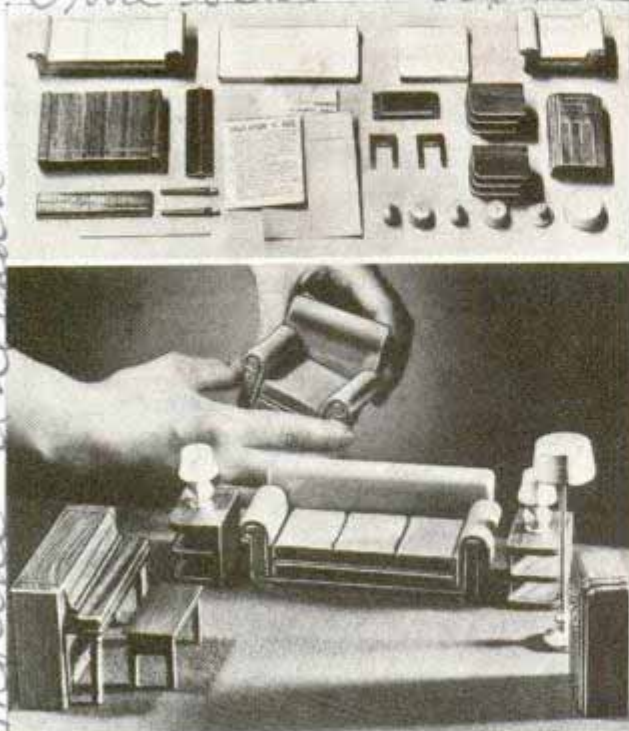

Parts for living room in ready-to-assemble kit, top; bottom, same set assembled and ready for doll house

Kits of doll-house furniture, all cut and ready to assemble, are now available for purchasers who take pride in doing their own work. Each piece may be painted by the individual to suit his taste. The complete set consists of tiny furniture for the living room, dining room, bedroom, bathroom and kitchen.

Stronbeck-Becker Mfg. Co. Machine d. 117

C-Clamp with Double Action Keeps Work from Slipping

Work will not shift or swing out of a double-action C-clamp that has an extra

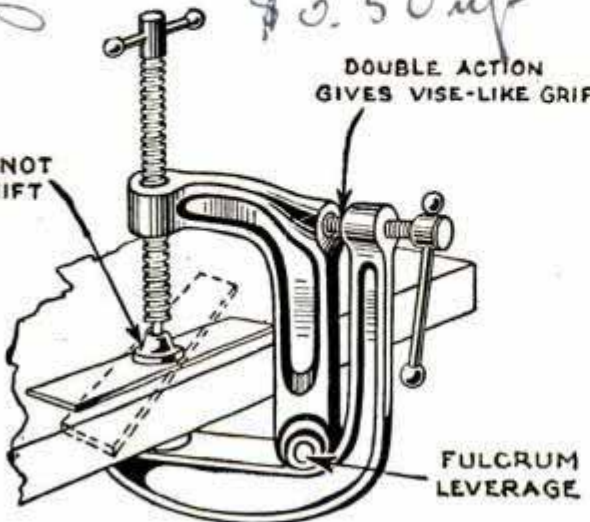

Work held in clamp does not shift when vise-like pressure is applied by horizontal screw at right

visc screw for tightening it after being set by the conventional adjustment screw. Leverage obtained by a pivoted arm increases the holding strength with no extra effort. With a few turns of the vise screw the clamp closes in a straight and firm grip without imparting any twisting motion to the jaws. It works in close quarters where lack of space prevents placing an ordinary clamp or turning the screw.

1831

Auto Safety Switch Prevents Fire by Disconnecting Battery

Positive protection against fire hazards in an automobile or truck is provided by a switch that disconnects the battery and generator from the wiring circuit. Installed in the floor near the driver's feet, it is flipped on or off with a kick. In case of an

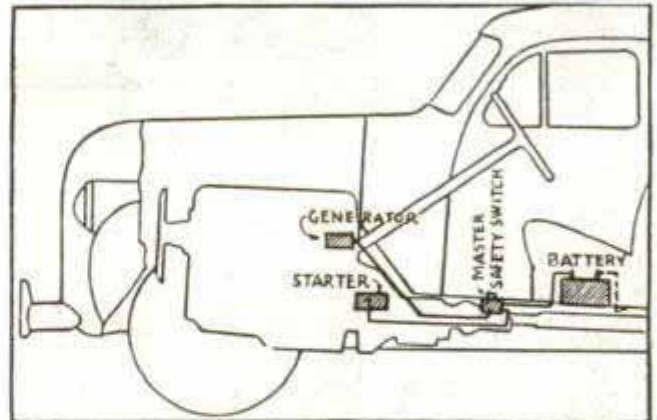

At top arrow points to "kick switch" near driver's foot; diagram, below, shows how it cuts out battery

accident, the switch shuts off automatically if the force of the impact equals that at which the mechanism has been set. A pilot light on the instrument board reminds the driver to kick the switch to "off" position when parking the car.

Ray Mfg. Co. 134 1/2 W. 1st St. Merced, Ca.

David B. Pecarics Co. 3101-27 Broadway Ave. N928

COUNTING IN *the* NEXT PRESIDENT

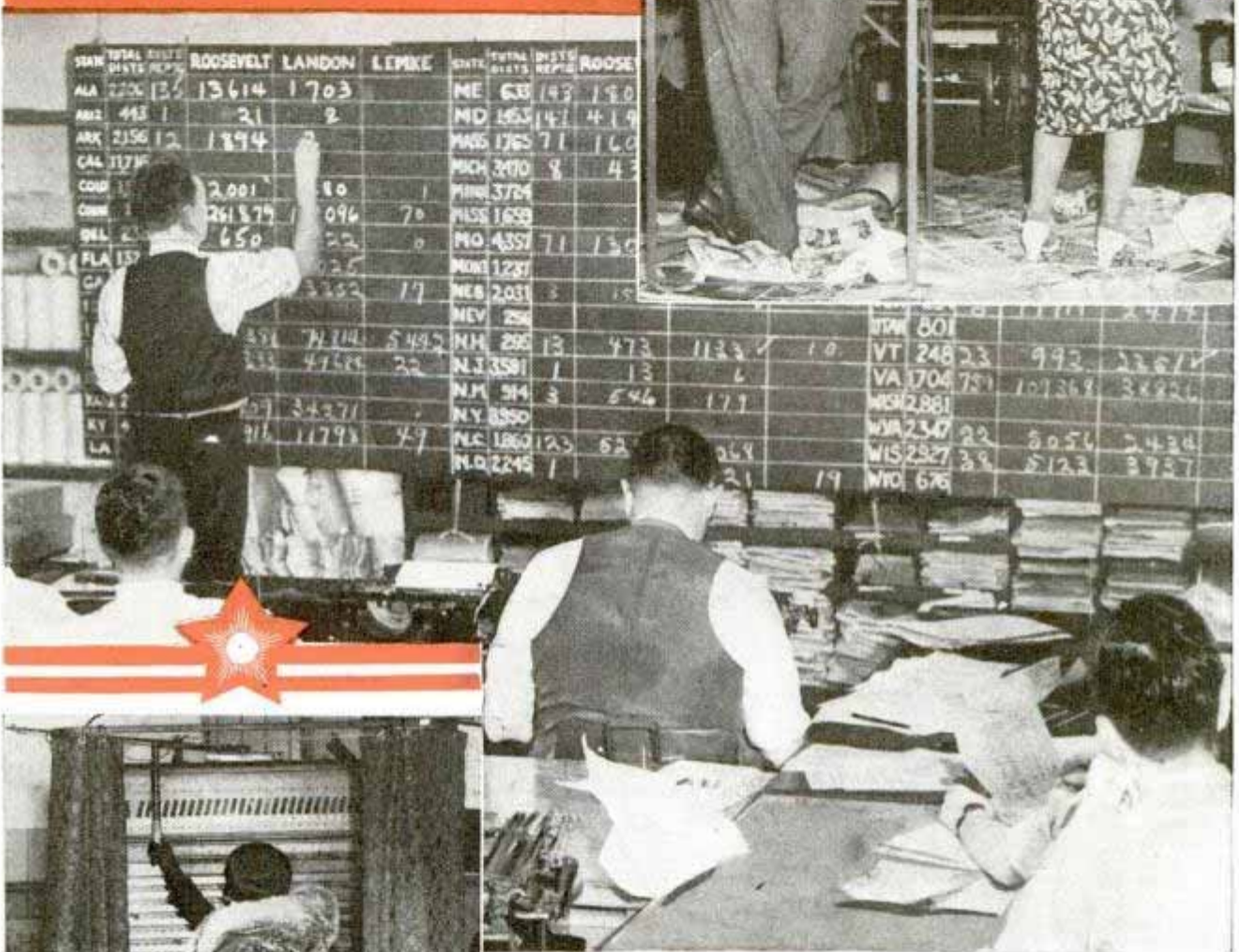

STATE	TOTAL	ROOSEVELT	LONDON	LEPKE	STATE	TOTAL	ROOSEVELT
ALA	2756	135	13614	1703	ME	633	193
ARK	493	1	21	2	MD	1653	147
ARK	2156	12	1894	2	MASS	1765	71
CAL	11736				MICH	3170	8
COLO		2,001	80	1	MINN	3724	
CONN		261,879	096	70	MISS	1653	
DEL		650	52	0	MO	4357	71
FLA	137		225		MONS	1227	
GA		3352	17		NEB	2031	3
		351	7114	5432	NEV	258	
		333	47524	22	NH	295	13
		57	34371		N.J.	3581	1
IND		316	11793	49	N.Y.	314	3
IA					NY	8390	
IL					NC	1860	123
IN					N.D.	2245	1

VT	801		
VT	248	23	993
VA	1706	751	101369
WASH	2881		34226
WA	2347	22	8056
WIS	2927	38	5123
WYO	676	19	

By Roderick M. Grant

ON THE night of November 5 you'll turn from the dinner table to the early newspaper "extras" and the radio for the first straws showing which way the election winds are blowing. Three months of tense campaigning will be ended, with probably fifty-five million ballots cast to decide one of the keenest contests in years. A President has been elected, the balance of power in a new Congress determined.

What is the result? Officially, you won't know for weeks after election. The government has geared its machinery not much faster than a century ago when the returns trickled in to Washington by canal boat and courier, weeks later. Officially, you'll know some day, probably in December, when the House and Senate together perform the perfunctory



© Ewing Galloway
Behind curtains (upper right) voters mark their ballots. Bottom, a citizen operates an automatic voting machine in New York. Center, election tabulators and writers at Associated Press headquarters

60 Rockefeller Blazgo
Dumfries St

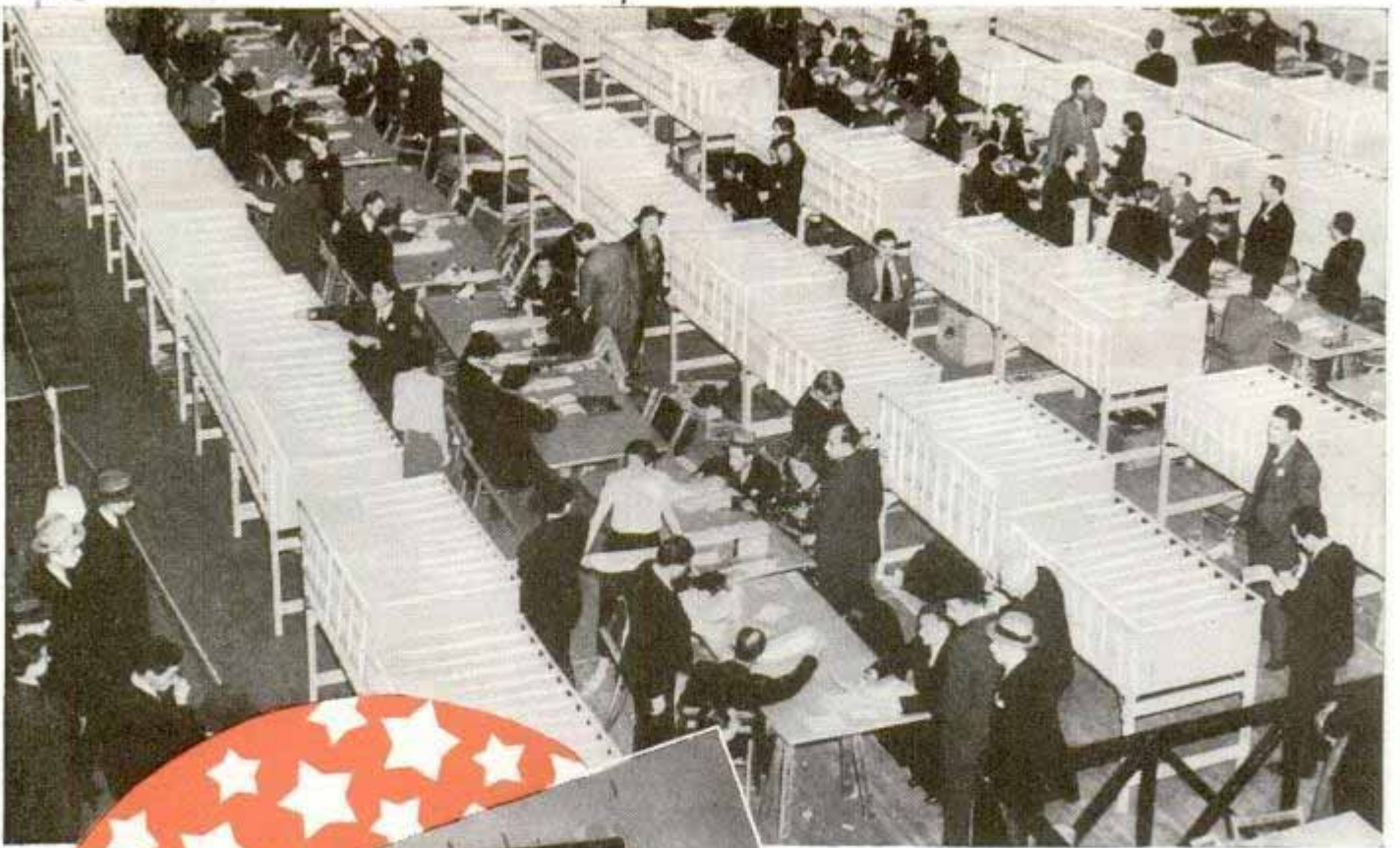

Top, sorting ballots after a New York election. Left, Associated Press control board for routing wire circuits to bureaus and newspapers. Below, tabulating election results at Chicago AP bureau

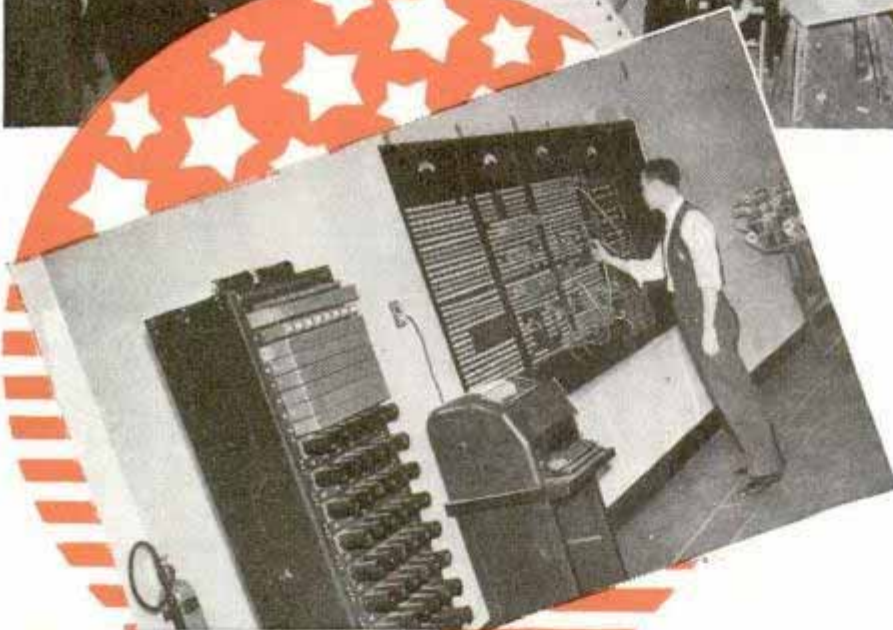

ceremony of counting the votes of the presidential electors you chose; a dignified scene, but hardly thrilling news.

Well, you can't wait for that. Perhaps they could wait in the more leisurely eighteen hundreds for the electors to choose Andrew



Jackson or James Madison, but government and business and foreign affairs would be in a nice dither in these times if the election results dragged through a long period of uncertainty.

So, some time between dinner and midnight election night, you'll buy yourself a newspaper or tune in the radio and find out the name of the next President. It's not official, but it might as well be. And, barring such a close race as that between Hughes and Wilson in 1916, when the result hung in the balance until nearly midnight Thursday, you'll probably know by midnight who's to live in the White House next January; and your morning paper will strike a balance for you between Republicans and Democrats in the next Congress.

Fifty-five million votes to count and collect from the ranchers of Arizona, from the 4,376 crowded precincts of Chicago and its suburbs,

from the Tennessee hills and the Bad Lands of South Dakota. Who does the job, announces the vote a few hours after the polls close? Fifty thousand newspaper editors, writers, correspondents, telegraph operators, tabulators and messengers organized into an efficient, country-wide election machine by the cooperative Associated Press.

Key unit in this vast tabulating system is the precinct. As fast as the judges at any precinct polling place add up the votes for any office from state legislator to president, the total is telephoned to the county reporter for the Associated Press, who relays the figures over a leased wire to election headquarters at the principal AP bureau in the state. In the 1936 election 122,464 precinct reporters collected returns; the wires over which the figures flow election night would, in a single circuit, circle the globe nearly ten times.

Promptly at the close of the polls the count starts pouring in. From a county correspondent in Spartanburg, S. C., who may be a county clerk or a local news writer, comes a first report to AP at Columbia, S. C.: **BLANK SIX SPARTANBURG COUNTY FIVE PRECINCTS LEWIS 109 JOHNSON 56.** An operator at Columbia copies the figures on a

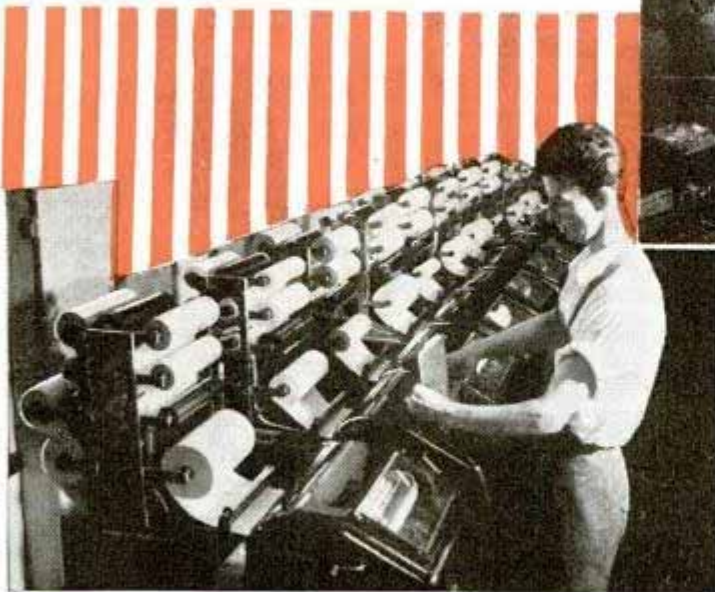
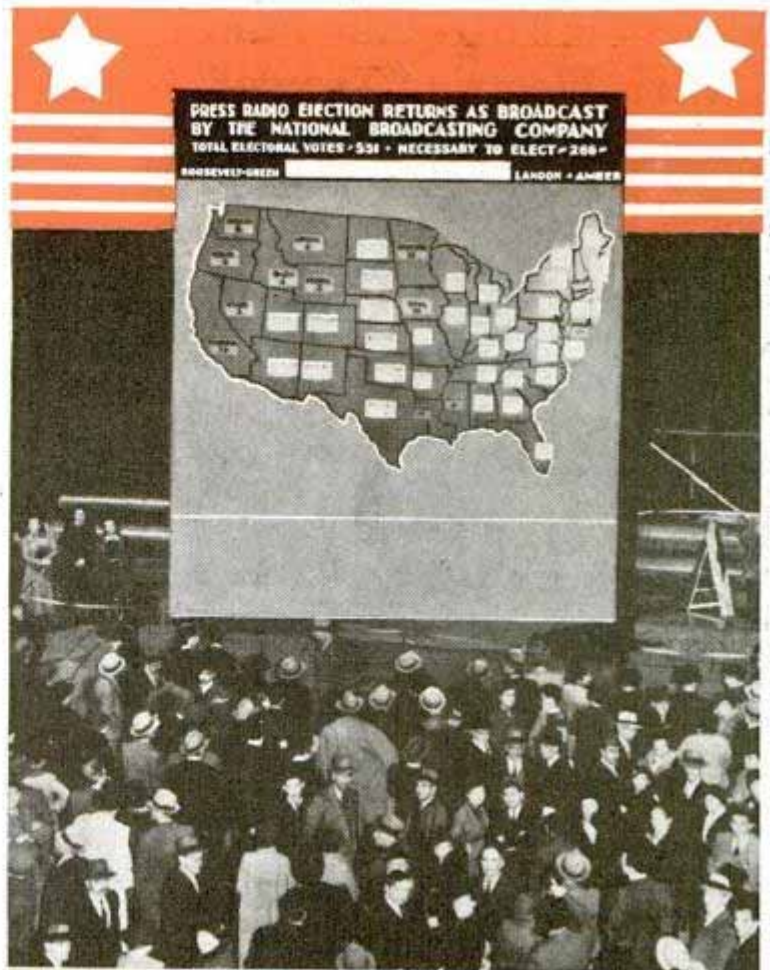

Top, crowd watching election map as returns come in at Rockefeller Center. Lower right, AP operator sends election "lead" over the printer wire. Left, a bank of telegraph printers in New York AP office

corresponding blank, representing the race for governor, state treasurer or other office. Later returns on the same race from Spartanburg county include those previously reported, and from time to time the figures from other counties are run off on adding machines to produce a county table showing the state total for any particular contest up to the minute.

Meanwhile at each state bureau an editor watches and analyzes the vote, notes a

(Continued to page 143A)

R 902. *Whiteman Int'l Co. 3060 Glendale Blvd Los Angeles*

Floor Finished Like Marble with Electric "Trowel"



Gyrating paddles of electric "trowel" impart finish like marble to surface of newly laid concrete floor

Newly laid concrete floors are given a marblelike finish with an electric tool resembling an upside-down fan. Its three rotating trowels are said to accomplish as much as six men working by hand. With fingertip control, the machine is moved easily under its own power.

R 923

Hand-Type Electric Jig Saw Makes Smooth Cut

High cutting-speed is claimed for an electric jig saw that weighs only seventeen ounces and handles with the ease of a hand saw. The magnetic motor, mounted be-

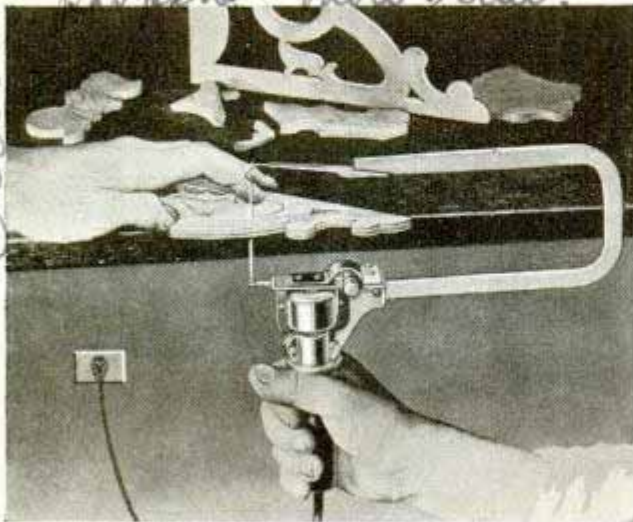

Hand simply guides this jig saw as its magnetic motor imparts 7,200 cutting strokes a minute to blade

tween the frame and the grip, delivers 7,200 strokes per minute, and the length of the stroke can be adjusted from one-eighth to five-sixteenths of an inch. Started and stopped by a switch in the handle, the saw cuts through medium hard wood one-eighth to three-fourths of an inch thick at an average speed of twelve inches per minute and it can saw to the center of a twenty-inch panel.

R 871

Lightweight Aluminum Suitcase Built for Lifetime Use

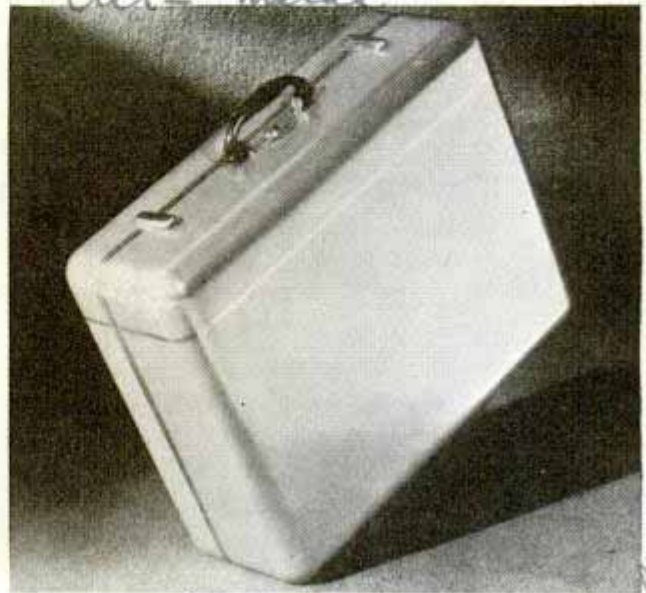

Nine men resting their weight on a new aluminum alloy suitcase to prove its sturdiness

Luggage of "airplane metal," just introduced, offers travel cases of light weight that will last for years. These suitcases are made of strong aluminum alloy, formed in heavy dies into one-piece sides which fit together accurately. The edges are sealed in live rubber with tension catches to maintain close fits, making the case waterproof and dustproof.

4059 Woodwin Ave Los Angeles
Erle P. Hartley, Inc.

Clay Bank Sculptor Carves with a Pocketknife

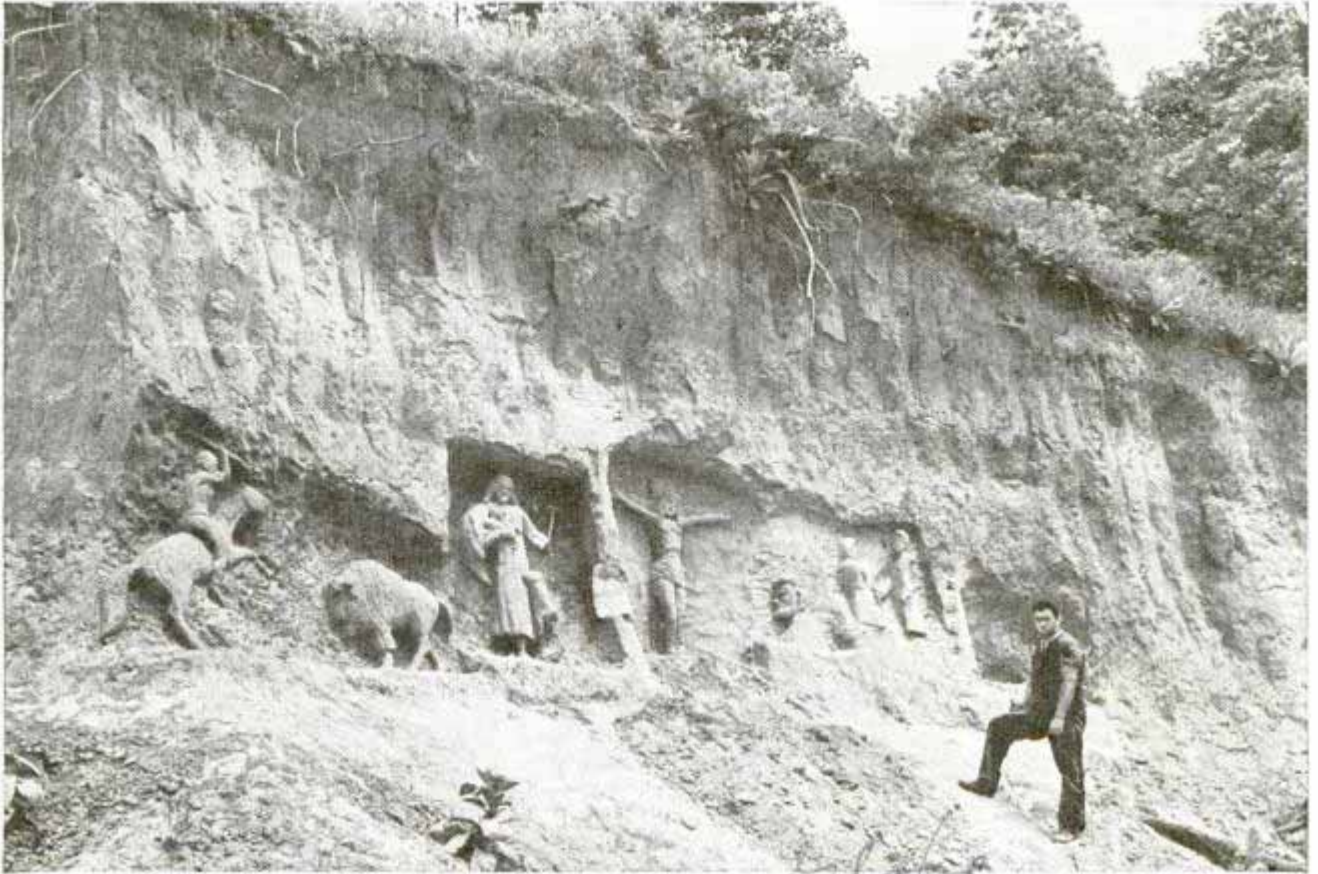

Only the crudest tools and materials were available to this Illinois youth, yet in this clay bank near his home he has carved and molded historical and Biblical figures that have attracted wide attention

With only a pocketknife and his hands for tools, an amateur sculptor at Fieldon, Ill., is attracting attention by carving figures in a clay bank near his home. The

sculpture is the work of Floyd Harold Bull, nineteen-year-old farm boy. As a youngster he was a proficient whittler, but has never had any training in the sculptor's art.

Twelve-Shot Cylindrical Gun Fires Bomb, Gas or Flare

Fragmentation bombs, gas or smoke shells or parachute flares can be fired from a twelve-cylinder gun developed by an American manufacturer. A cylindrical

magazine which can be inserted and changed in three seconds holds the projectiles for the many-purpose weapon, which is of one and one-half inch caliber.

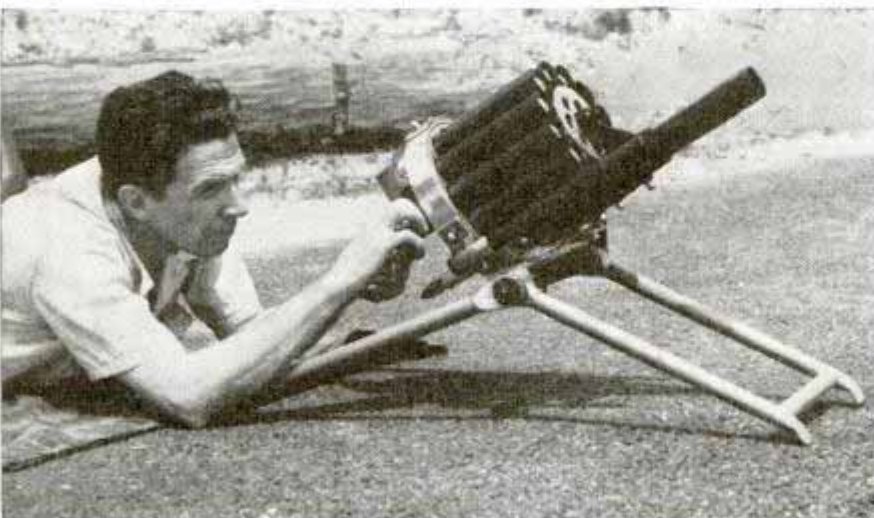

The gun and support, weighing only forty pounds, fold up quickly for carrying, and it takes but three seconds to change magazines

The gun has a 500-foot range with a four-ounce gas projectile, a 1,000-foot range with an eight-ounce projectile and fires a one-pounder up to 2,500 feet. Several guns of this type could protect an airport from parachute troops, or lay a barrage of smoke shells to hide a position. The all-purpose gun weighs only forty pounds, including its support, and it can be folded up for carrying or set up ready for action in a few seconds.



SEAPLANING--



AMERICA is discovering a new sport. The thrill of flying from sparkling water instead of from dusty airports has boomed the sport of seaplane flying. Mountain lakes, inland rivers, and protected bays along the coasts are home to busy seaplane operators on pleasure and instruction flights.

Seaplaning is fun because it combines the sports of flying, powerboating, and sailing into one. Seaplanes actually make accessible many parts of the country that cannot be reached by planes that land on wheels. Small planes on floats, as well as larger amphibians and giant navy flying boats, have flown



Top, left, ready for instruction flight in seaplane. Circle, starting the engine. Below, left, doughnut lights for making seadrome. Right, Waco ship on pontoons skims the surface

Mustine
Waco aircraft

K65
Capt. Thomas E. Stinson, Jr.
10442 Hebron Lane
Los Angeles

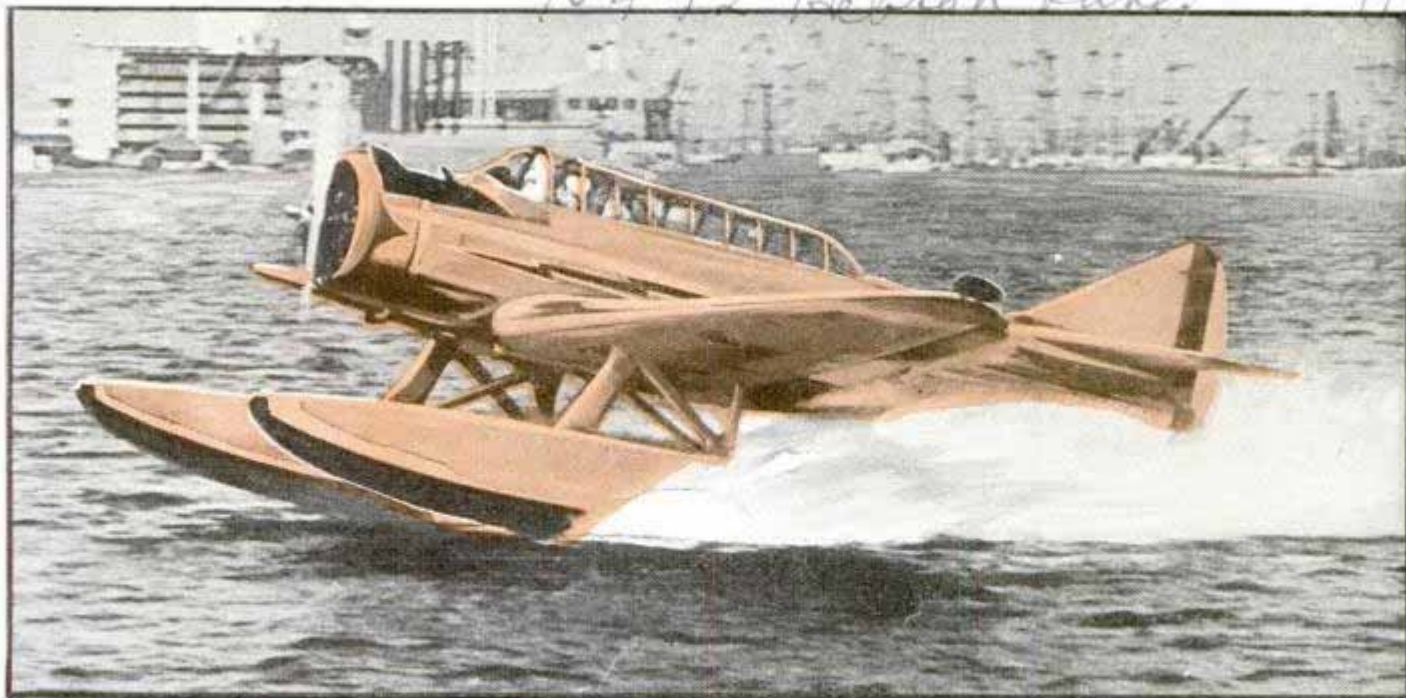

THREE SPORTS IN ONE

coast to coast many times in perfect security with a wide choice of routes. City reservoirs make good landing places if no other water is handy. Pilots have landed pontoon-equipped seaplanes on lawns and fields and flown them off again to demonstrate their adaptability.

One reason why seaplanes weren't more popular in the past was the lack of landing facilities. There were only a few private ramps and the seadromes of a few large cities. To make up for this lack the Civil Aeronautics Board and the National Youth Administration have jointly built about 300 seaplane bases at strategic spots and are still constructing additional facilities. Thirty have been built in Florida, forty in Michigan. For a small sum a city can participate in the program, the government bodies furnishing the plans and doing the work. A base costs no more than a few hundred dollars. Floats to which seaplanes can be moored and pro-



Top, Edo-float equipped plane roaring along the surface. Circle, Consolidated four-engine flying boat taking off from rough water

viding a gangway ashore are being built at some resorts, elsewhere wooden ramps are built into the water with beaching gear on wheels so seaplanes can be taken ashore.

One flier who built his own ramp at a total cost of thirty-eight dollars uses a windlass to haul his plane out of water. To

Edo Aircraft Corp., College 675

Specialty. Caddy machine. 10. 11. 12. 13. 14. 15. 16. 17. 18. 19. 20. 21. 22. 23. 24. 25. 26. 27. 28. 29. 30. 31. 32. 33. 34. 35. 36. 37. 38. 39. 40. 41. 42. 43. 44. 45. 46. 47. 48. 49. 50. 51. 52. 53. 54. 55. 56. 57. 58. 59. 60. 61. 62. 63. 64. 65. 66. 67. 68. 69. 70. 71. 72. 73. 74. 75. 76. 77. 78. 79. 80. 81. 82. 83. 84. 85. 86. 87. 88. 89. 90. 91. 92. 93. 94. 95. 96. 97. 98. 99. 100.

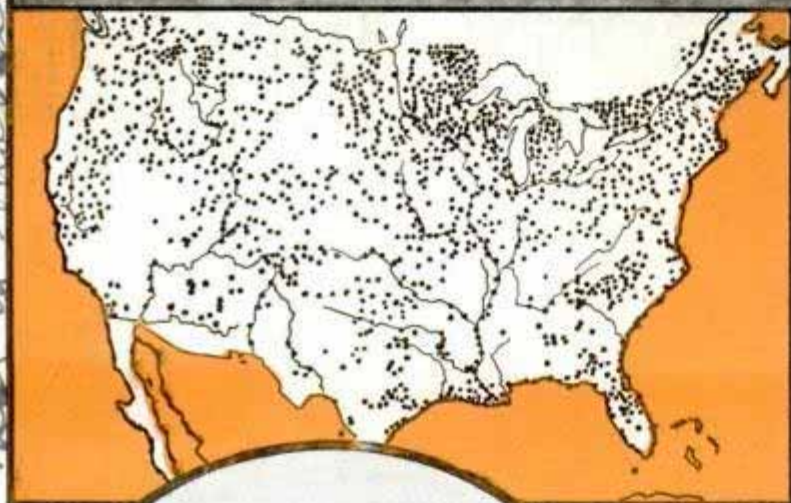
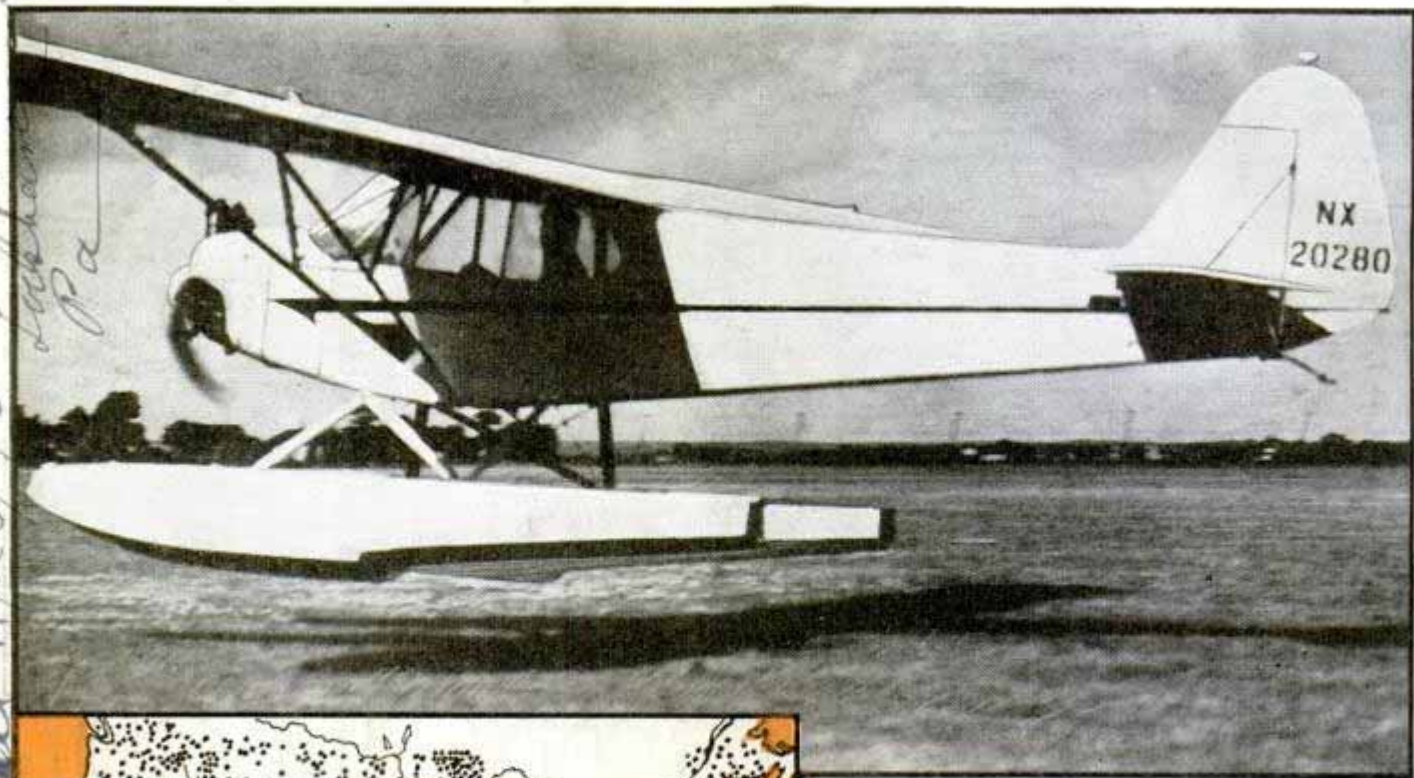

Above, plane fitted with pontoons landing on grass. Left, map showing water landing spots for seaplanes. Circle, a smooth takeoff from the water



take off, he releases the anchoring lines, starts the motor, and wiggles the tail surfaces to start the plane sliding down to the water. Other owners use automobiles to haul their planes up the ramp.

With a seaplane a pilot can fly to mountain lakes only an hour or so away by air,

with no possible landing place for wheeled planes. Once he has landed he can taxi to a likely spot, anchor, and break out his fishing tackle. If the fish aren't biting, the chances are that another lake can be found after a short flight. For more extended trips camping gear is packed in

the cabin and a canoe is lashed to the struts above one of the pontoons.

A few years ago this was a rich man's sport but now pontoons are built for many brands of light planes, including Aeroncas and Cubs. For several hundred dollars you can buy a pair of sturdy duralumin pontoons complete with struts for attaching them to the fuselage. At additional cost you can install pontoons with retractable wheels that make the plane equally at home on water or land.

One light plane manufacturer is offering a tiny flying boat, a two-place plane that lands on its hull like a China Clipper. Its seventy-five-horsepower engine has enough power to take off from lakes in high mountain country.

Metal parts of a seaplane should be "metalized" with sprayed aluminum before they are painted. Planes to be used on salt water should be provided also with stainless-steel control cables. All parts are

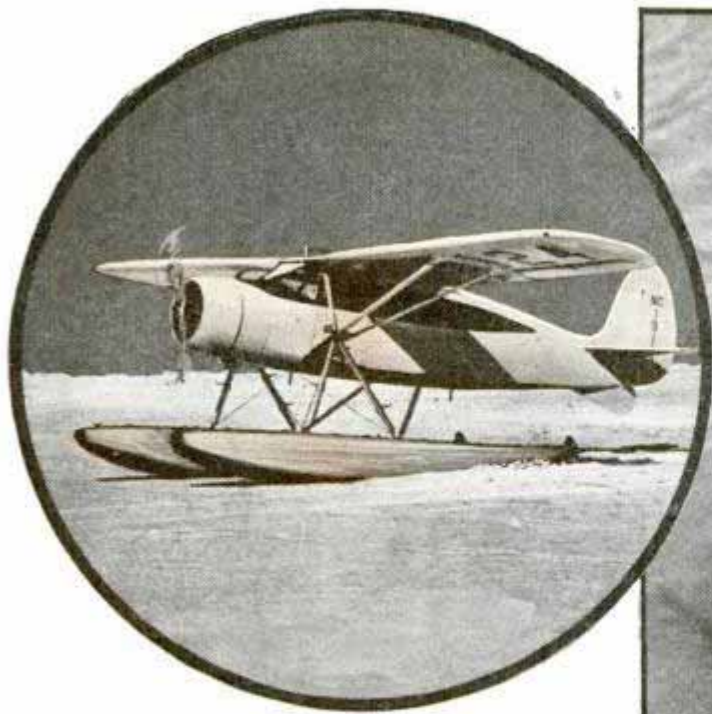

treated and kept well greased to prevent corrosion. Fabric is usually waxed and polished.

Seaplane operators say that students who learn to fly from the water are usually ready to solo sooner than those who learn on land planes. The tension of the beginner is reduced because there is less hazard in a forced landing. With more room below him the student has more confidence, and he can get in more practice landings than at a busy airport.

An airplane isn't quite as fast and doesn't climb as rapidly when

(Continued to page 141A)

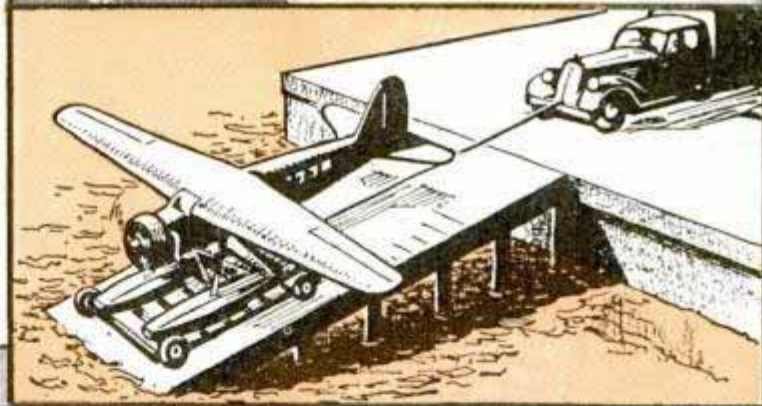

Circle, pontoon-equipped plane preparing to take off from snow. Right, top, inspecting interior of pontoon for leaks. Center, drawing of one method of launching small seaplane. Bottom, plane being moored

K80
Stenau, U. S. City
1079 31 Harper
Belmont, Mass

Lightweight Trailer Welded of Stainless Steel

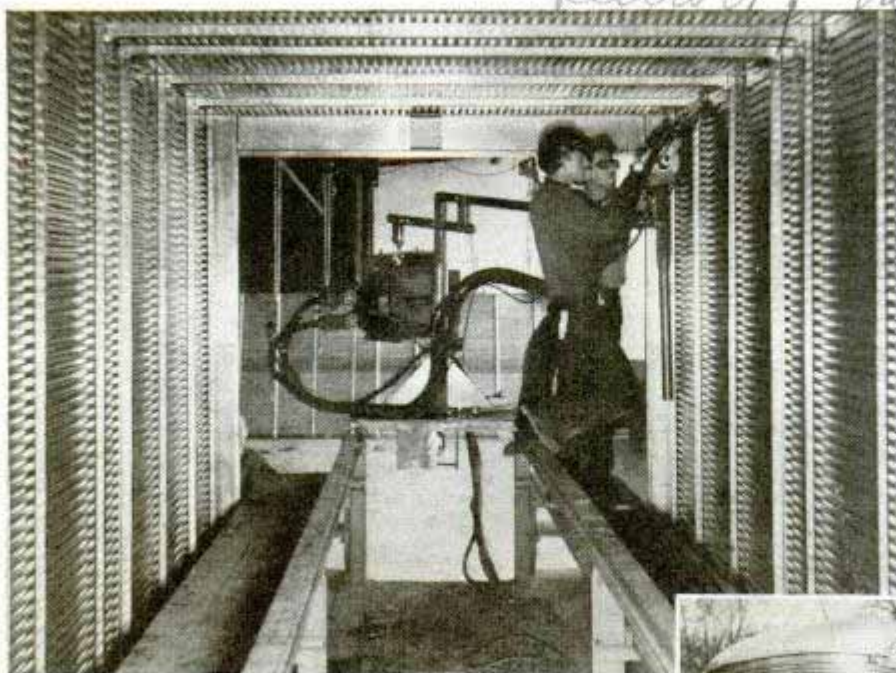

At left, welders are at work on the roof and wall of the stainless-steel cargo trailer, which is seen completed below. Stainless-steel bodies, built by the shotwelding process, can be made of lighter gauge metal as strong as ordinary heavy steel

From 1,500 to 5,000 pounds of weight are saved in the latest cargo trailers built of stainless steel as compared with some similar trailers of conventional steel bodies. This is because stainless steel, being stronger, can be fabricated in lighter gauges of metal than ordinary steel. The stainless steel body and roof are constructed by the shotwelding method.

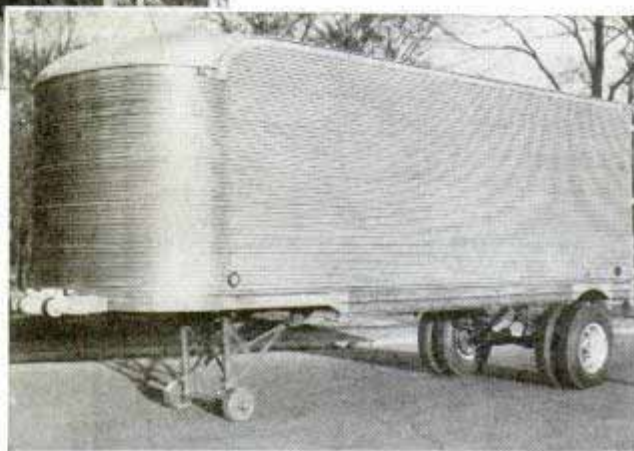

K877

Engine Built from Steam Auto Runs on 300-Foot Railway

When Harold Parkinson of Smithfield, R. I., wants to visit his next door neighbor he gets up steam in his miniature locomotive and drives over. The homemade engine, its boiler with 300 copper tubes, its cylinder and piston arrangement all salvaged from an old Stanley Steamer automobile, runs on a 300-foot railway through the yards of Mr. Parkinson and two neighbors. The owner was formerly an English railroader, and his locomotive is patterned after an English engine. It burns vaporized gasoline, runs all day on two gallons.

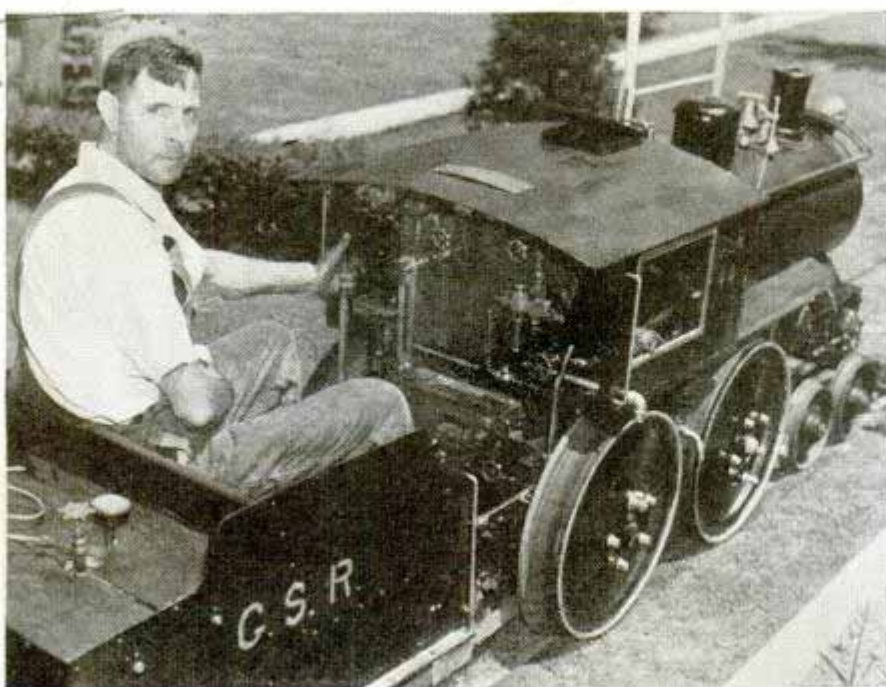

An erstwhile English railroad man built this locomotive for his private railway, parts of it salvaged from an old Stanley Steamer automobile

Send stamped envelope to our Bureau of Information for name of maker of any device described in this magazine.

Comb. James F. Fresh. R. 7
 Greenville, R. 7

4330 Tube
C.M. Lindsay, Los Angeles

K890

Superior J. & White
Visual Aid Project (WPA)
Ventura County, Ventura, Calif

'Planetarium' Umbrella Points Out the Stars

Amateur and student astronomers in California are learning about the skies with the help of an "umbrella planetarium." On its under side the names and outlines of the constellations are marked by embroidered colored thread, and there are buttonhole openings for the stars. When the umbrella is held up to the night sky and its Big Dipper matched with that in the sky, the handle of the umbrella points to the North Star; thus other "landmarks" in the sky can be located. The umbrella can be used as a compass. Names of stars are read with a flashlight.

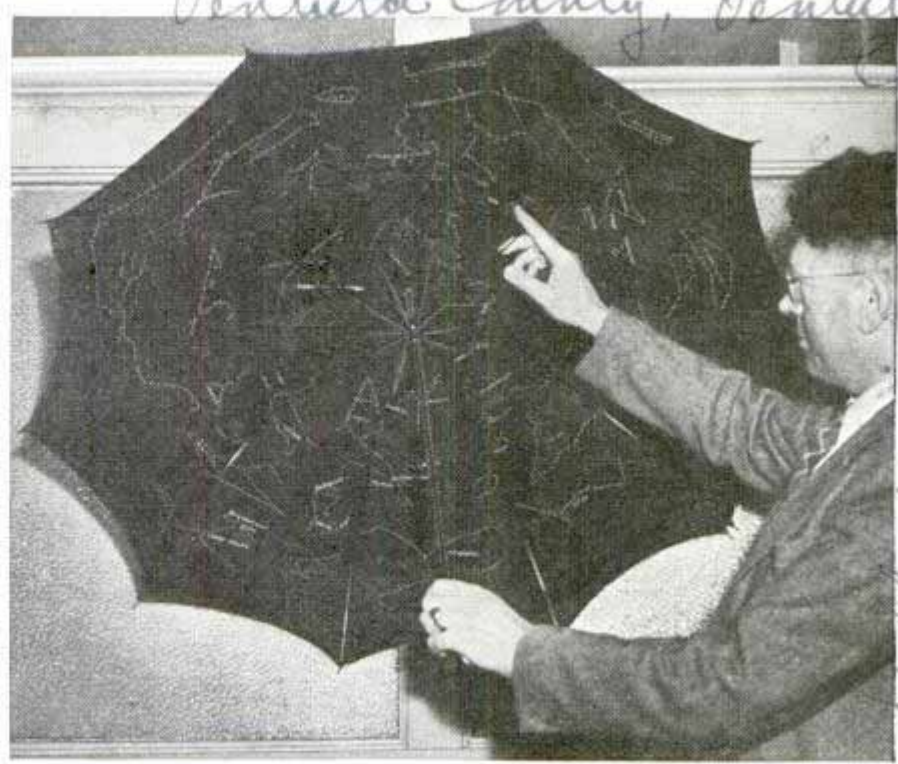

Pointed to the north star, the underside of this umbrella forms a map of the skies, locating and naming the stars and constellations

Portable Room Cooling Unit Has Its Own Water Supply



The view at left shows the wall of excelsior which is kept moist to cool the air passing through it, evaporating three gallons a day

Carrying its own supply of water for evaporation, a portable air conditioner may be placed near an open window and need not be attached to the home water supply. An electric fan draws fresh air through the window and through a thin wall of excelsior which is kept moist by water pumped from its three-gallon reservoir. The water pump operates from a fan placed in the wind stream of the main electric fan.

Emergency Hose Inflates Tire with Air Transferred from the Spare

Keep the spare tire pumped up and you always have spare air on hand for emergencies. An inflation unit just brought out makes it possible to transfer enough air from the spare to inflate a flat tire in an emergency. A thumb lock connects the hose to the flat tire, and in about two minutes the tire on the car can be inflated enough for travel.

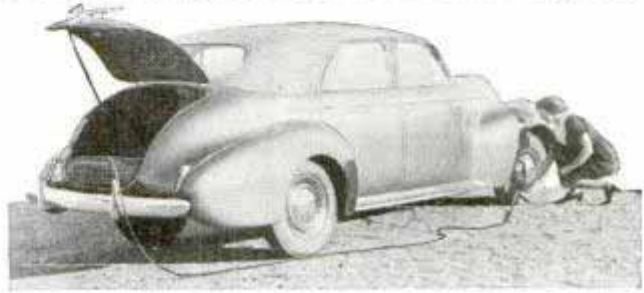

Transferring air from spare tire to a flat front

Spare Air, plus... well, sure.

GROWING 'EM BIGGER

Cont. O. A. Fitzgerald, Univ. of Idaho
 Nov. 1944

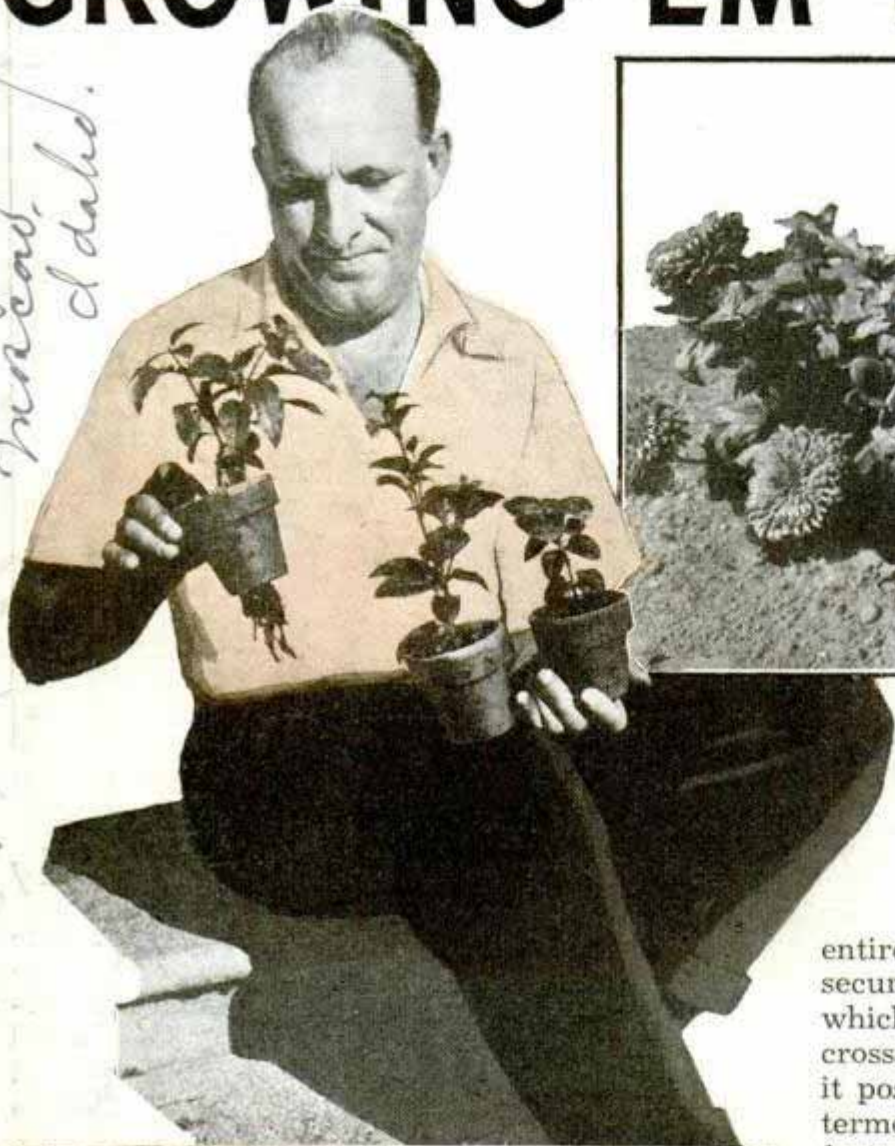

MODERN plant engineers have found a chemical, colchicine, which completely upsets long-established laws of plant heredity. With it entirely new varieties are being secured through mating plants which in nature have been uncrossable. Other chemicals make it possible to grow seedless watermelons, tomatoes, and other fruits in which seeds are a decided nuisance.

Some chemicals speed up plant growth amazingly; others slow it down to a snail's pace. Some make plants and cuttings shoot out roots faster than Jack's beanstalk shot skyward, so that plants of enormous dimensions, veritable monstrosities, have been produced in the laboratories.

Already scientists have produced super-giant marigolds, zinnias, snapdragons, cosmos, petunias, calendulas, dahlias ten inches across on plants so tall you need a stepladder to pick them, and cuttings which speedily produce masses of roots. Most of this chemical plant growing is in the experimental stage but enough has come from the laboratories to assure us that the era of the chemical plant engineer is here.

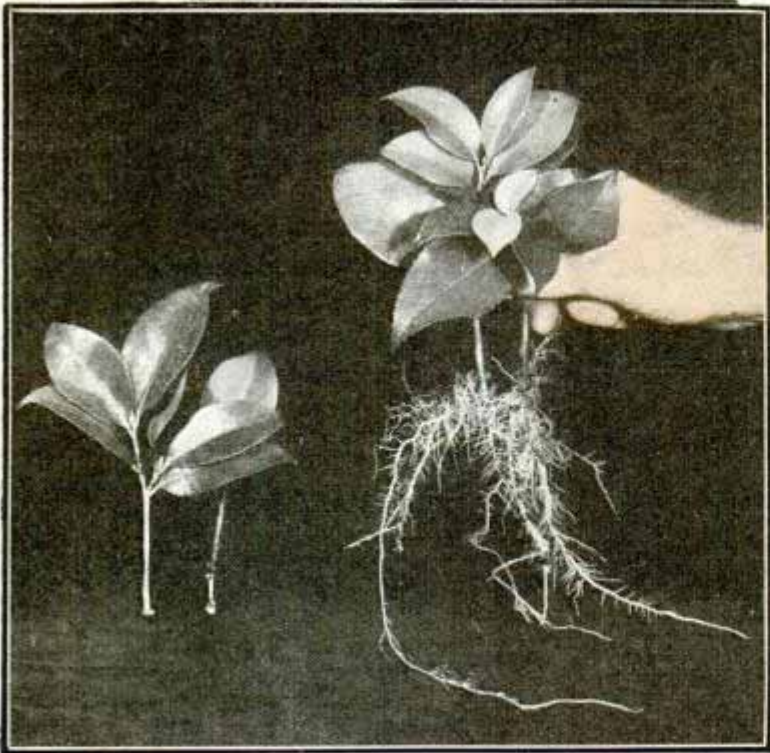

Top, fuchsia plants, two treated with B-1 solution, and the small one untreated. Right, six-inch zinnias. Bottom, how synthetic hormones speed up rooting

with
CHEMICALS



Of the chemicals used in redirecting plant life, most belong in a group known as synthetic plant-growth substances. They fool the plant into believing they are nature's own growth hormones—chemical substances produced in one part of the plant and transmitted to another where they tell that part how to grow and how fast to grow. Colchicine, an ancient drug long used medicinally, not only makes plants do strange things but alters the basic heritable characters of the plant so the changes become part of it and are passed on from generation to generation.

"It has been known for years that Mother Nature occasionally produces over-size plants differing fundamentally from their fellows," explains Gordon Morrison, geneticist for Ferry-Morse. "These are called mutations or mutants. Examine the tissue of these larger plants under the microscope and we see that the size of the cells is doubled. And what's equally important, each cell has a double dose of the heredi-

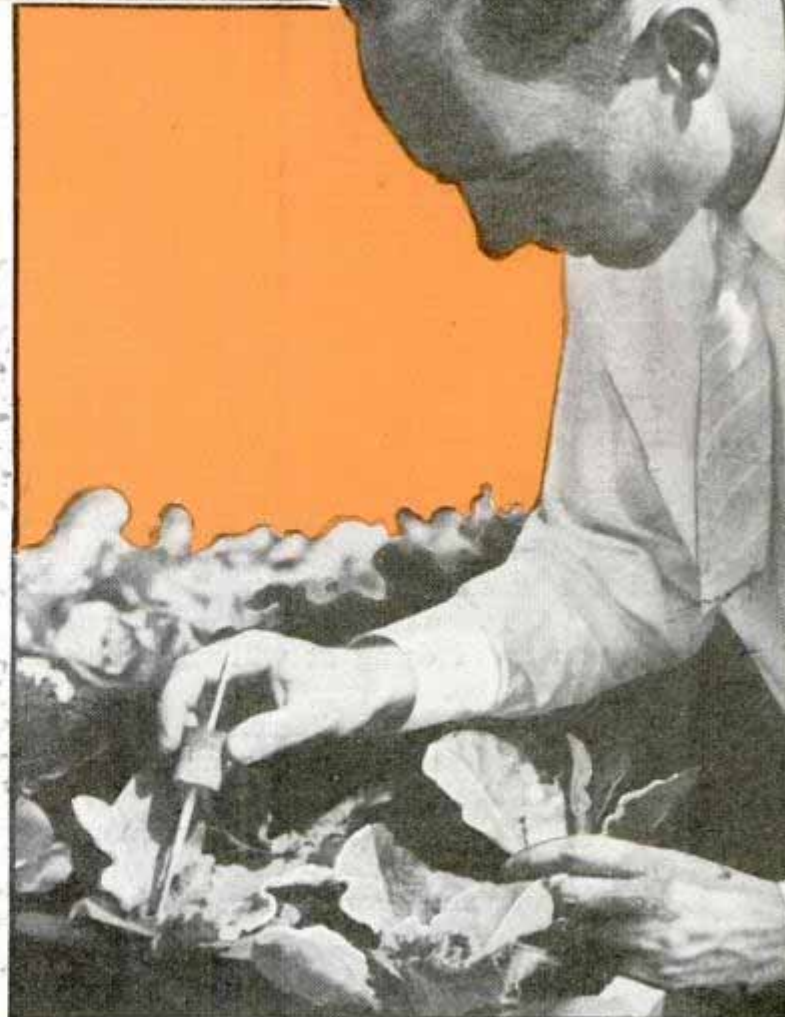

Top, year-old apple tree with desirable branch angles produced by hormone treatment. Circle, administering colchicine to dormant tobacco seeds. Bottom, treating growing point of hybrid tobacco plant with colchicine emulsion

Used: G. Brunel and Morrison

Sept. 1937-40.

18th and Hunting Park in Phila

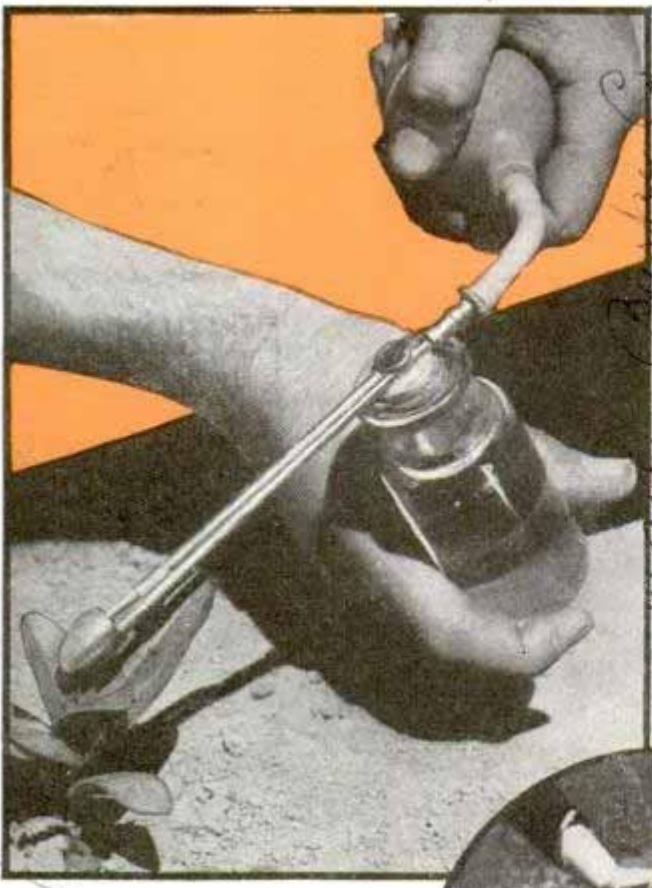

to the next. The colchicine is applied either to the seed, to the seedling, or to the growing plants in liquid or paste form.

Thanks to this strange drug, gardens this year are parading the first new flowers ever created by the use of a chemical. Burpee plant breeders created a giant marigold by giving a popular standard variety such a terrific internal colchicine "shock" it developed into a bigger plant. Using colchicine, Ferry-Morse has developed giant-flowered zinnias and cosmos as well as marigolds. The Bodger company also has put colchicine to work in developing new strains. Next year will see many new introductions of colchicine-developed flowers in seed catalogues.

When introducing the new giant marigold, David Burpee predicted: "I expect in the next few years to have some of the most amazing marigolds to show you that you could ever imagine." He will get these new marigolds by natural mating of the colchicine-produced variety with standard strains which could not be crossed because they did not have the same chromosome counts.

tary factors that determine the size of the plant, the color, size and fragrance of the blossoms, and other plant characteristics. These natural over-size plants yield over-size offsprings."

Nature is grudging in her production of such over-size offsprings; the odds against one are around a million-to-one. Furthermore, they are likely to occur where giant size is of no advantage, or in some out-of-the-way place where they never will be found. Plant scientists are constantly on the lookout for these breaks in the plan of nature, hence many of our fruits and flowers trace to an accidental over-size offspring which breeders located and made the foundation of a new strain. At the same time the search has been going on in the laboratory for a way of doing at will what nature does by whim.

There was great excitement in the plant-breeding world about four years ago when Dr. A. F. Blakeslee, plant scientist at the Carnegie Institution of Washington, reported that colchicine could be used to drug plants and alter the basic units of all plant life, the chromosomes, the microscopic bodies carrying the genes that transmit plant characters from one generation

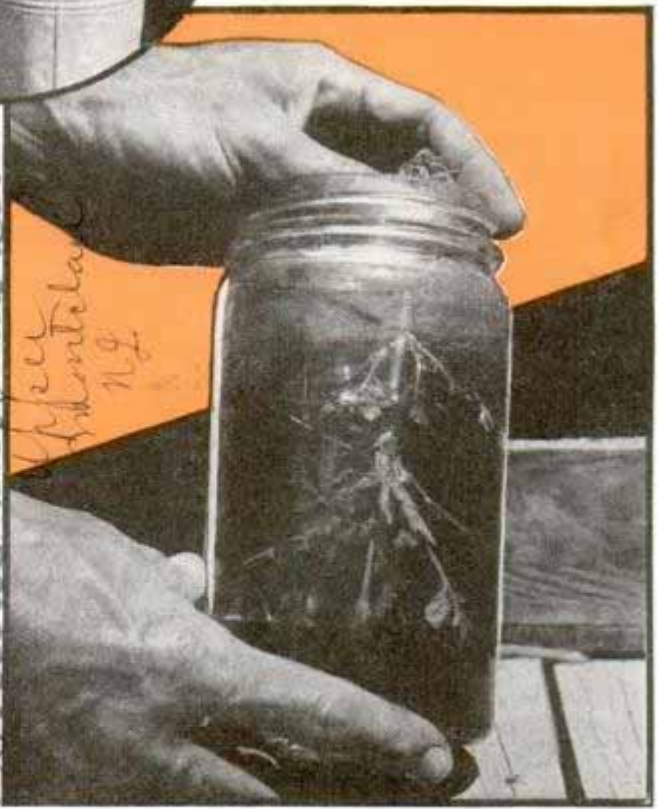

Top, spraying colchicine on growing plant tips where greatest growth activity occurs. Circle, putting chemical in bucket to be fed through garden hose. Bottom, plants are immersed in colchicine, then set out

see Dec. 1939 1599

Albert Bruce Laboratories

The Bodger Co. Phila

X 714 see vol. 1937-682 K915
Austin.

Plant scientists at the U. S. Department of Agriculture point out that colchicine opens new fields of research in breeding cotton, cereals, tobacco, fruits and grasses by crossing varieties which hitherto could not be mated. In experiment stations throughout the country scientists are drug-ging sugar beets, berries and fruits, seeking superior varieties. At the New York agricultural experiment station, Drs. Bernhard R. and Mabel Nebel are trying the power of colchicine to produce fruits that are bigger, more alluringly colored and juicier. They have used the drug to develop ten new snapdragons with blossoms of deeper color and plants of sturdier stems and to get a new spearmint with an aroma different from that of ordinary spearmint.

Colchicine is not for the average gardener to toy with. It is a deadly poison, and to use it successfully requires a thorough knowledge of the fundamentals of plant heredity. Neither is it a growth stimulator or a fertilizer.

Next let's turn to synthetic plant-growth substances. Less than ten years have passed since the first natural plant-growth hormones were extracted and reduced to crystalline form. That was the signal for chemists to start finding duplicates in the world of chemistry, substances which produce, under certain conditions, hormone-like reactions in plants. Included in the list are names like indole-butyric acid, indole-3-acetic acid, naphthalene acetic acid and a host of others. *Sept 1937*

One of the principal effects of some of the chemicals that masquerade as hormones is to make cuttings and plants root faster, which tends to speed up growth. These powerful root-forming chemicals commonly are diluted at the rate of one to 1,000 or sometimes as high as 100,000 parts of water or inert dust or paste carrier. Two California Institute of Technology scientists reported that a single ounce of one of the chemicals was capable of producing at least 10,000,000,000 new roots.

When it was found that synthetic hormones made plants and cuttings root with amazing speed, greenhouse and nursery people were quick to realize the value of this discovery. Now it is common practice for them to treat all cuttings before setting them out in the propagating beds.

At the U. S. Plant Introduction Gardens at Glenn Dale, Md., scientists with the Bu-

(Continued to page 136A)

Super-Sensitive Lie Detector Registers Any Emotion



She cannot tell a lie without showing it in lie detector through two electrodes fastened to palm

Relying on activity of the sweat glands induced by emotional reactions, instead of upon changes in the subject's blood pressure, breathing and temperature, a new lie detector called a psychometer is said to be more sensitive than former instruments. In making tests, two electrodes are strapped to the palm of the subject, and each time he attempts to tell an untruth a needle indicator swings far to the right. Emotions such as love, hate, sympathy and fear, sending electrical impulses through the nerve centers and activating the sweat glands, cause the needle to jump.

Putter with Paddle-Shaped Grip Improves Golfer's Game

Not satisfied with the grip of conventional putters, one professional golfer designed and patented a new-type handle which he attached to his regular club. The shaft and head of the club remain unchanged, but the old grip is replaced



by a paddle-shaped block of wood having four flat sides. The inventor claims greater putting accuracy results from its use.

U.S. Clava Clava City Clava
W. H. W. W. W.
Dr. Paul Curran
Marie Co. Minneapolis Minn.
K908
Acme
W. H. W. W. W.

Air-Raid Helmet Protects Head from Concussion



Trying protecting headgear on a yawning child. Note head area that is guarded

After several years of investigation a specialist in nervous diseases has designed a helmet to protect the wearer's head from harmful effects resulting from concussion caused by bursting bombs or shells. The helmet is being produced in England. Frontal regions of the skull, the temples, ear openings and the base of the skull are guarded by the helmet, which is made of rubber containing millions of air cells.

Pendulum Attached to Golf Club Helps Attain Smooth Swing.



Practicing putting and short strokes with a pendulum attached to your golf club helps to develop a perfect swing, for the pendulum swings parallel to the club shaft as the stroke approaches perfection. This golf

swing "detector," just put on the market, fastens to the shaft by a clamp. With it you can practice golf strokes either outdoors on a green or indoors on a rug.

Element Fitting All Oil Filters Has Metal Conversion Unit

Made to fit oil filters of all sizes, a filter element now available is made of cotton, and is of uniform density designed for long service. A

metal conversion unit is supplied, to adapt the element to all makes and sizes of filters.



Pistol-Grip Flexible File Holder Bends Blade to Suit Work

Both curved and flat surfaces may be filed with equal efficiency by fitting a flexible file blade into a new frame that holds the tool flat or bends it into various degrees of concave or convex shape. The holder, equipped with pistol grip, has an automatic stop to prevent bending files beyond their breaking point. The tool works with wood, steel, iron, hard rubber or marble.

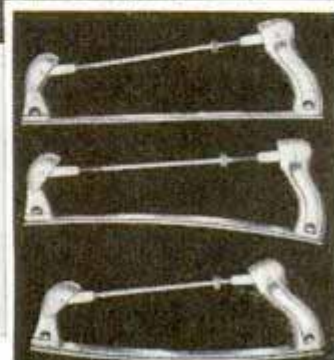

Above, filing concave surface; below, tool adjusted (top to bottom) for flat, convex and concave surfaces

K 794.

Roosevelt Park,

Isleview, Ill.

Underwater Portholes Guard Swimming Pool

Lifeguards at a new circular bathing pool in Illinois have an underwater lookout room fitted with portholes through which they can watch swimmers beneath the surface. The room is built below a diving tower located in the middle of the tank where the water is deepest. Other guards stand watch at the top of the island.

Diving tower, right, with lookout room below where lifeguards may keep watch of swimmers beneath the surface; below, photograph of swimmer as seen through one of the portholes

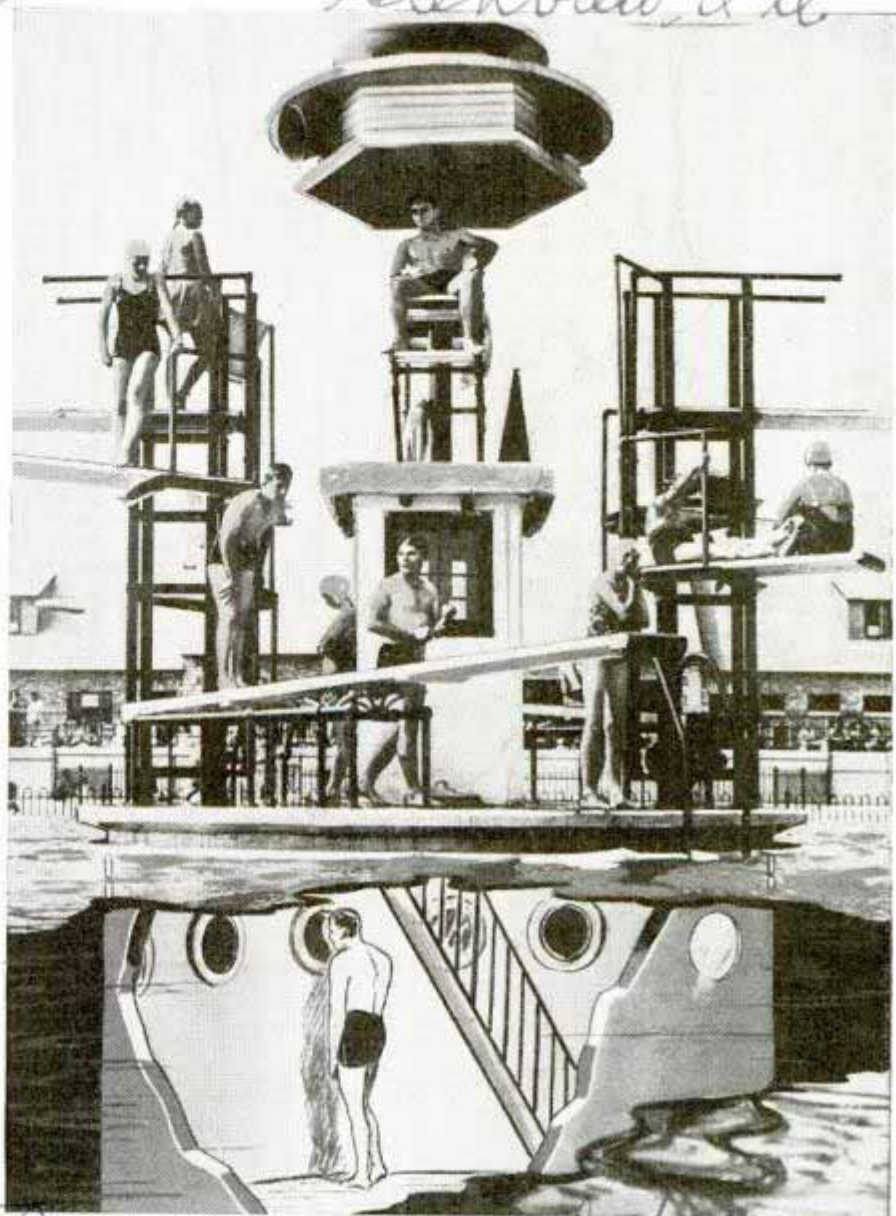

K 850

d.w.

Four-Foot Electric Cabinet Ages Hams in Seven Weeks



Fifteen hams at one time can be cured in this electric cabinet, which can be plugged in wherever there is a 110-volt outlet

It used to take from one to three years to give hams that "country-cured" flavor. Now the aging is accomplished in seven weeks in an electric cabinet, the modern successor to the traditional smokehouse. The cabinet measures twenty-four by thirty by forty-eight inches, and can be used wherever there is a 110-120-volt outlet. It is insulated, and inside is a 200-watt bulb and a thermostat which keeps the temperature at 110 degrees. One test of the cabinet showed a shrinkage of only nine and one-half per cent, while smokehouse shrinkage sometimes reaches twenty per cent.

Developed by Tennessee Valley Authority, Knoxville

FUN with

John A. Moore, 1114 Walnut, Wausau, Wis.

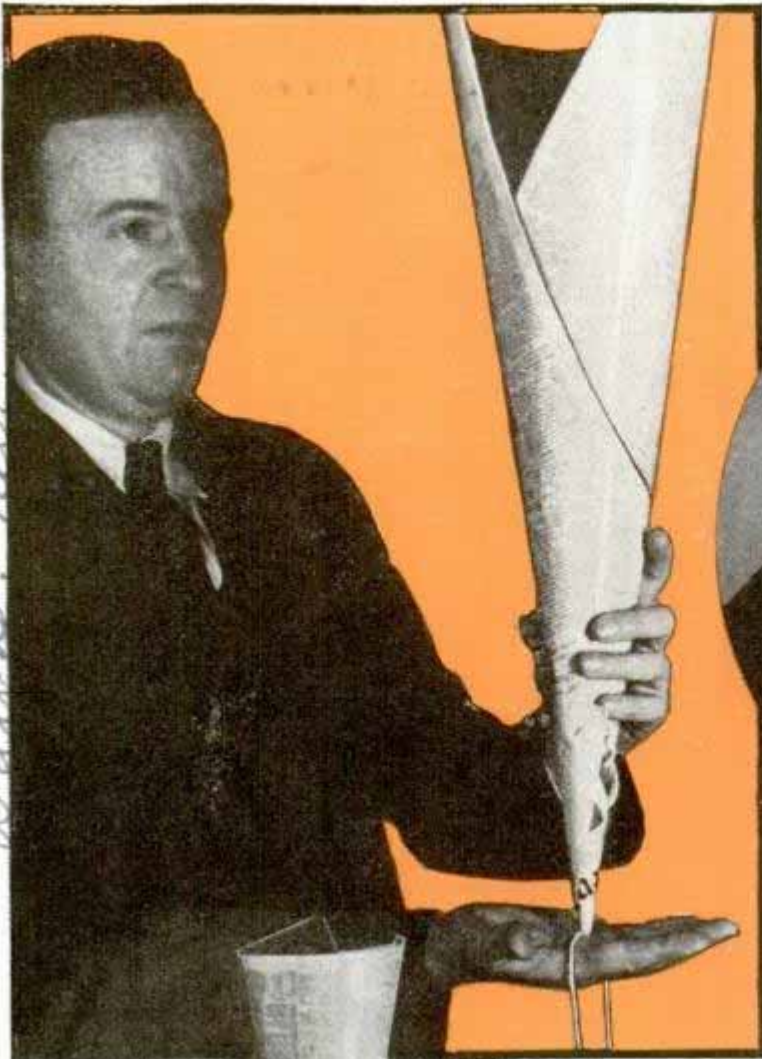

Steady hands are needed to balance the cone on a slack string. After deciding how much slack you want in the string, two knots are tied, marking the distance. Now lay string loosely over palm of right hand, placing cone on the string and balancing it in that position (left). Quickly catch the hanging string between thumb and palm of left hand, turn both hands with palms vertical (above), and the trick is begun. Getting this started is the hardest part, but you must remember to watch top of cone as string is slackened



As indoor amusement, balancing a paper cone is safe for both the household and yourself. It looks difficult, but its air resistance compensates for its lightness. Cone is made from two pages of newspaper fastened with two pins. First try balancing it on your finger, as at right, keeping eyes on top of cone. On the chin (circle) you learn all over again because you view it differently. Then (above) pull out your necktie for a support; this one is easy



BALANCING TRICKS

7688



Having mastered the paper cone, let's step out in the back yard with the kitchen broom, where there is no bric-a-brac to damage. Right, it is easy to juggle the broom on one hand after practice with the paper cone. Below, if broom slips from your chin it is easy to dodge, but try to make it fall away from you. Don't let your neck muscles do all the balancing; if you use the muscles of the lower back, the exercise will be a pleasant surprise



Above, the elbow balance is more difficult as all control comes from the trunk muscles; after you have tried this, place the broom on your shoulder and balance. Circle, toe balance requires a supple left ankle, since the body must be supported and balanced by the left foot and leg while the right leg balances the broom, and you look it all over from above. If you have a tendency to wander in performing these stunts, you can discipline yourself by keeping the left foot in place all the time, even at the expense of losing balance. If one broom becomes too simple, try two at a time

Radio Dry Cells Recharged by House Current



Rectifying unit, using house current, here seen plugged into portable radio to charge dry batteries

Dry cells of portable radio sets, hearing-aid devices and similar appliances can be recharged overnight with house current by means of a small rectifier unit with a new type of vacuum tube. Both "A" and "B" batteries are charged at the same time.

Guard Protects Auto Fenders from Curb or Side Swiping

Ready for attachment to all popular makes of cars, a metal guard protects the rear fenders from side swiping and from

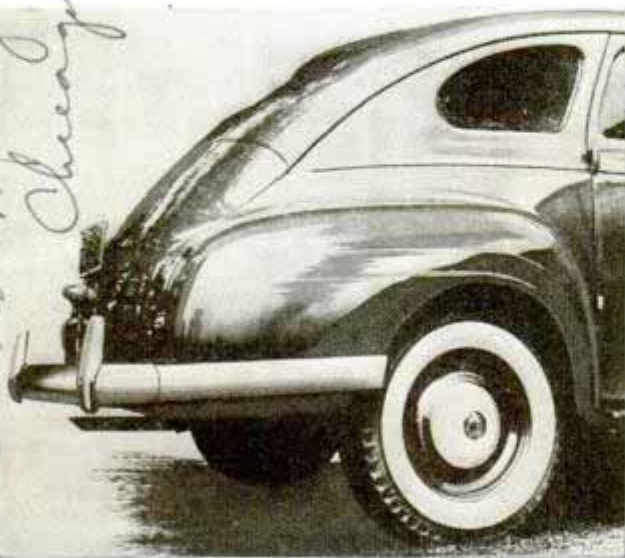

Steel bar attached to bumper and chassis guards rear fender from side swiping and scraping against curbs

scraping on curbs. Made of spring steel and chromium plated, the protective bar attaches to the bumper with strong bolts, requiring no boring of holes. It does not touch the fender, but curves around the fender section nearest the rear wheel and is secured with a clamp to the chassis.

Robot Reports State of Weather by Automatic Radio

Self-reporting weather instruments are making it possible to collect data from points far removed from any human habitation. The latest of these is a radio robot

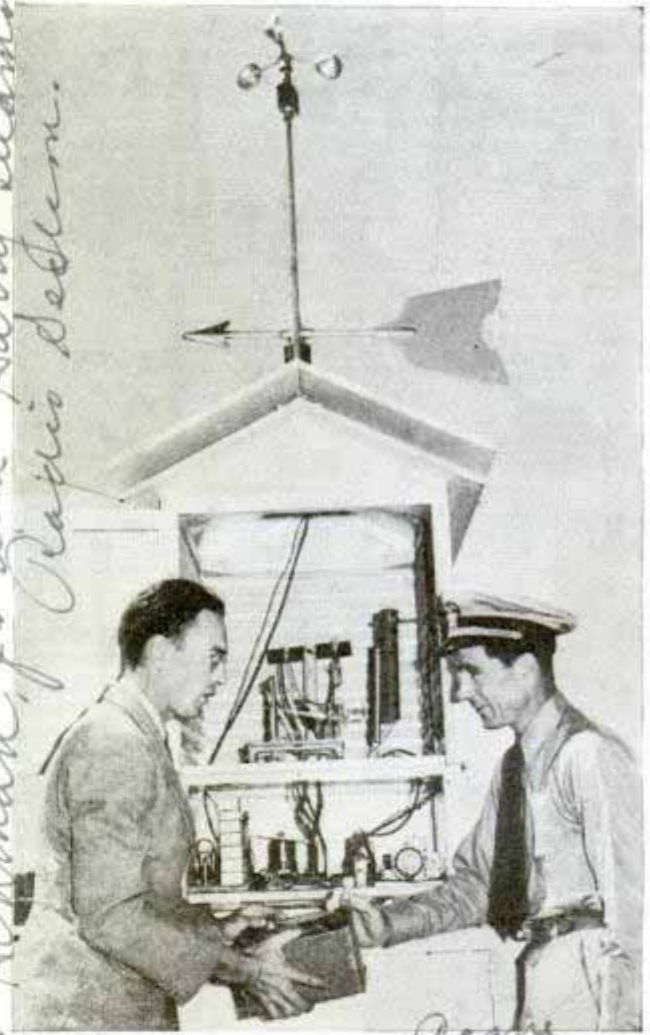

Remote weather station gathers information and automatically transmits radio reports at fixed periods

developed by experts of the National Bureau of Standards. It will report automatically by radio at fixed intervals the barometric pressure, temperature, humidity, wind direction and velocity, and rainfall.

Grand Coulee dam contains sufficient concrete to provide a souvenir weighing thirty-six and one-half pounds for every person in the United States.

K889
 L. V. Snover, 542 N. Wilkes
 St. Louis, Mo. Angeles Cal.
 K873
 Lenton Specialty Co
 1823 Michigan
 Chicago
 W. D. Henman, Jr. and Harry Leonard
 Radio Section
 acme
 Washington, D. C.

K822 Original Invention, Holt, Texas

Flashless Electric Machine Gun Fires Silently

Magnetic coils jerk bullets through the barrel of an electric machine gun that fires silently, without a flash. Still in the experimental stage, the working model built by a Texas inventor fires its bullets with a muzzle velocity of 400 feet per second; to be effective in warfare, a velocity of 3,000 feet per second would be essential. Steps are being taken to produce a higher-powered gun. Since there is neither flash nor smoke, the gun could spray bullets at an enemy without being detected, and it can fire continuously without heating. Batteries or power line furnish the propellant, and in actual maneuvers electricity could be supplied by a generator on the truck carrying the gun. The model fires only seventy .44-caliber shots a minute, but the full-scale gun would be built to fire 600 a minute.

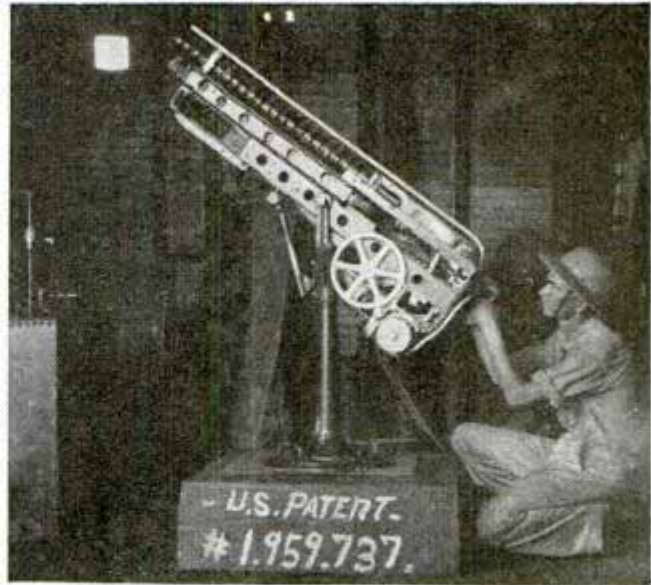

Top, working model of powderless machine gun using magnetic coils to fire bullets without flash, noise or smoke. Bottom, sketch shows proposed details of full-size electric gun calculated to fire 600 shots a minute with muzzle velocities near 3,000 feet a second

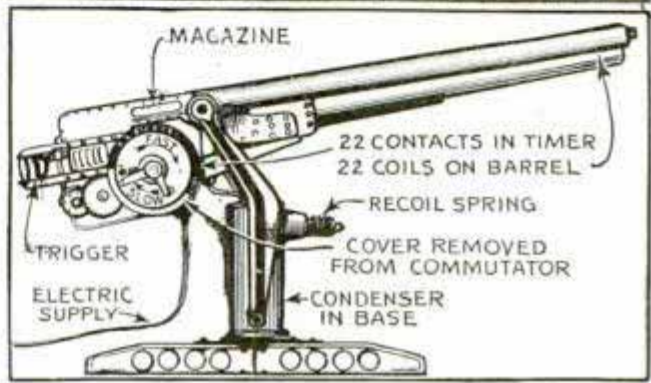

see June 19 33-819

K820

Paint Color Mixer for Store Saves Carrying Large Stock

Present methods of merchandising paint in stores may undergo a change if a re-

Paint Color



With this mixer storekeeper can blend any desired color in can of base paint while customer looks on

cently patented paint color mixer is adopted for general use. Enabling the storekeeper to carry an unlimited variety of colors with only a small number of cans of base paint, the machine ejects the selected color from a cartridge-like tube into any size can, then mixes it thoroughly by a rotary motion while you wait. The operation requires no more than two minutes.

K897

Fist Billy Loaded with Lead Shot Adjusts to Fit the Hand

Police and other law officers are fortifying their hands with a "fist billy," a heavy leather fist cover that is loaded with fine shot. It is held on by straps, adjustable to fit the officer's hand.



Letter and photo 5/16/42

*Can. W. Wash. Chicago
Lumrite
1/8 29*

The Brown Co

Reel Holding Electric Wire Feeds Flat Extension Tape



Flat electric cord on reel extends up to fifteen feet from wall plug to reach electric appliance

Fifteen feet of flat electric extension cord are housed in a metal-cased reel that feeds out the exact amount needed to reach the appliance. There is a rewind lever in the recessed bottom of the container. The end of the cord plugs into the floor or wall socket, the appliance plug connects with the socket in the side of the reel case.

Hot-Water Unit in Furnace Flue Captures Waste Heat

Heat that escapes into the flue is made to heat water circulating through a unit.

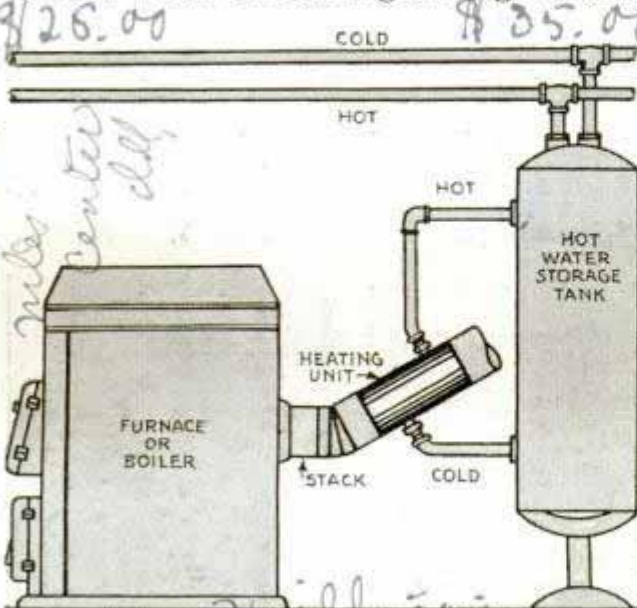

Water-heating unit installed between plant and chimney uses escaping heat to keep water hot in tank

installed in the flue pipe between the furnace or boiler and the damper. It will heat water directly for household use or deliver pre-heated water to hot-water heaters, and the units are adapted for installation on hot-water, steam, vapor or warm-air heating plants whether they are fired by coal, oil or gas.

Deer Traps Baited with Apples Used in Restocking Forests

Two-compartment traps are used in the Ozark National Forest of Arkansas for capturing deer to be used in restocking other areas. The front compartment is five by five by six feet, made of strong, fine-mesh wire; the rear compartment of rough lumber is three by three by nine. The traps are used chiefly in winter, and are baited with apples. A deer smells the apple and



Setting trap baited with apples to catch deer in one forest for removal to another that needs restocking

steps into the front compartment. As it reaches for the apple it touches a wire, tripping a figure-four trigger and dropping the front door behind it. The way is clear to the rear and the deer leaps forward, only to trip another wire which closes the middle door as a rope releases the rear door. The deer is caught in the rear compartment, ready for removal by rangers to an area where deer are scarce.

(Stamped, self-addressed envelope, sent to our Bureau of Information, will bring you the name and address of the maker of any article described in Popular Mechanics.

Vertical handwritten notes on the left margin:
 576
 867
 26.00
 35.00
 Center
 ddy
 Home - Nites Center
 3 4

K254. 813 Santa Barbara, Calif. Pasadena, Calif.

PIN Your NAME in a COMET

By R. S. Richardson
and Glenn C. Moore
of Mount Wilson Observatory

WOULD you get a thrill out of glancing upward some night and casually remarking to your friends, "Well, I see my comet is much brighter than it was last week?"

Would you like to feel you have a place among the stars, no matter how small? Then why not hunt comets as a hobby? They are much easier to find than you might suppose.

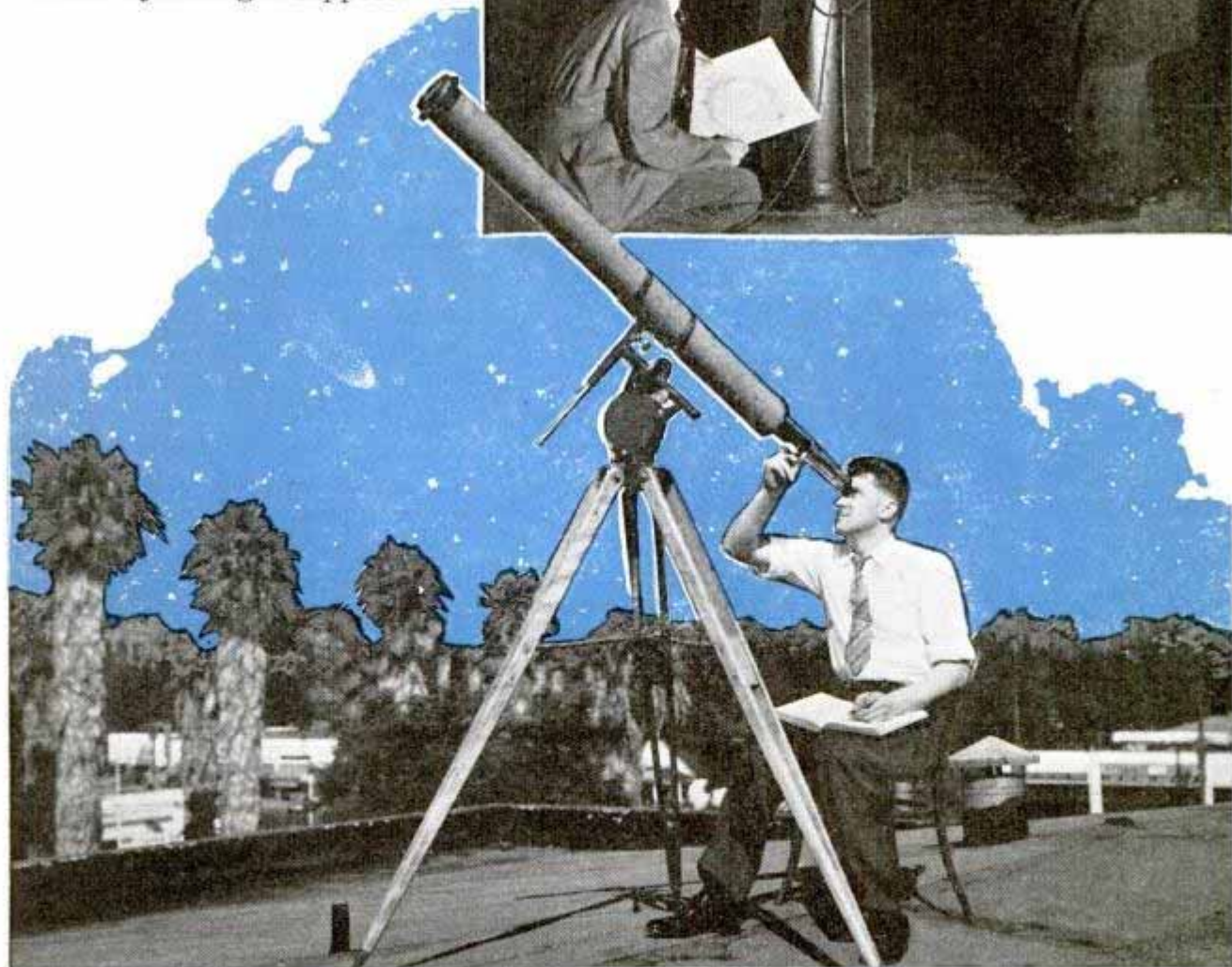
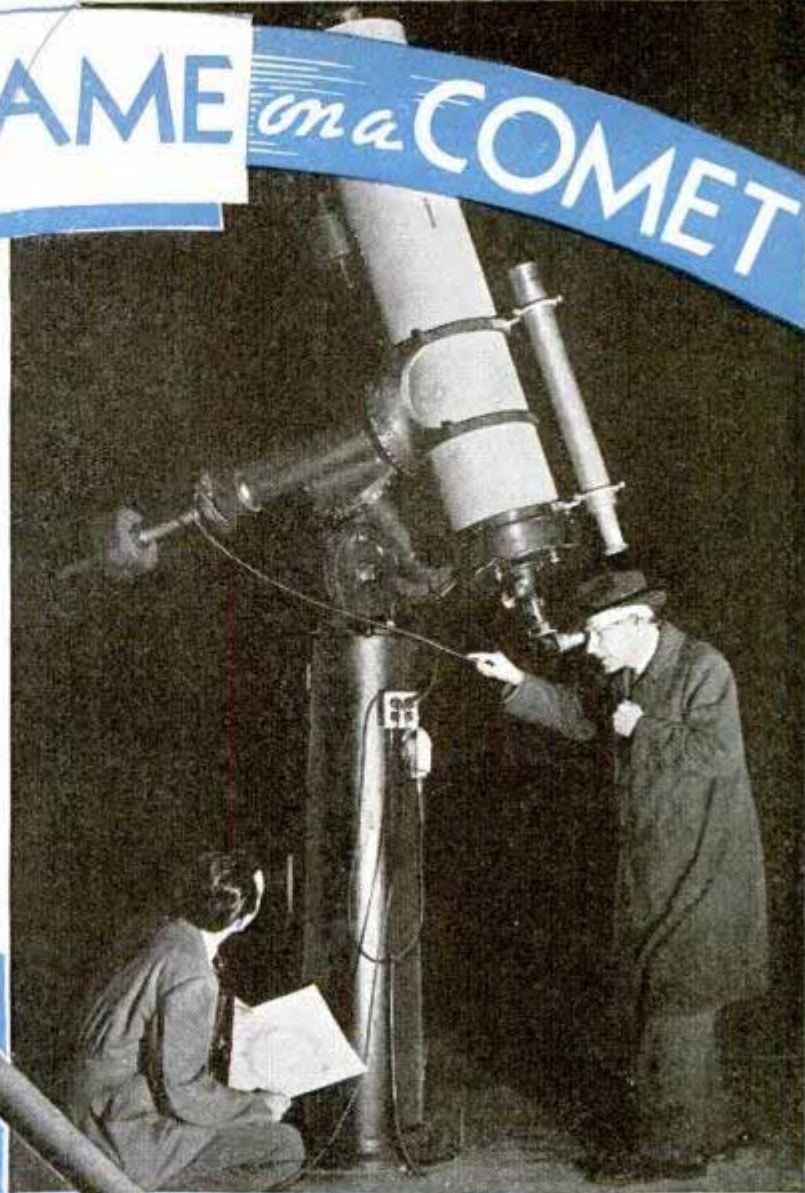

Top, two astronomers on a comet hunt. Comets have been discovered with telescopes much smaller than instrument at bottom; Messier, French 18th century astronomer, found thirteen with a two-foot telescope

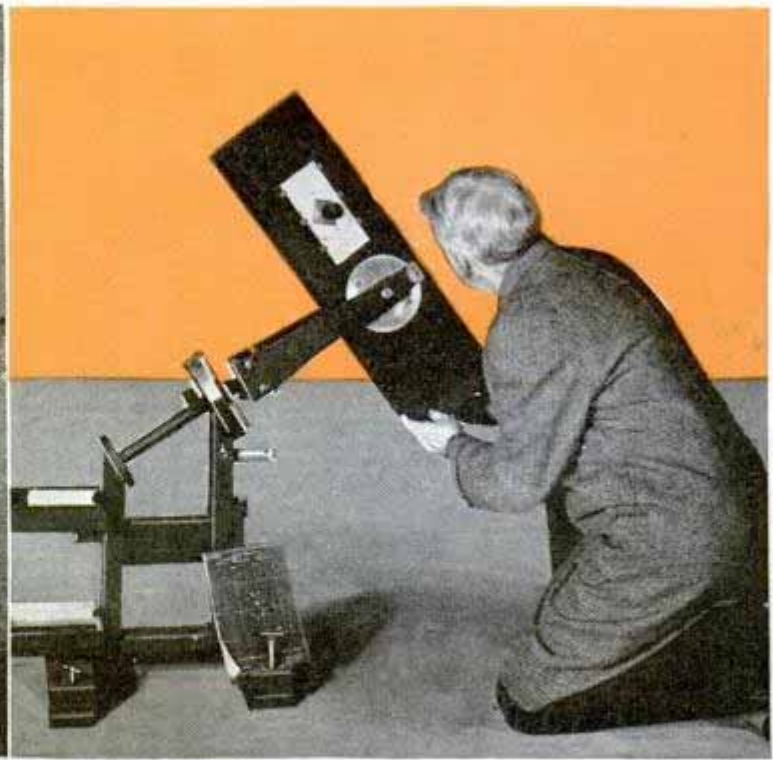

Left, finding comet's position by measuring distance from star trails on photographic plate. Right, a good comet seeker is made for a few dollars. Below, adjusting position of ten-inch photographic telescope

But, you object, you have only a little homemade reflector, or perhaps a spyglass with a two-inch lens. You couldn't compete against professional stargazers with their powerful instruments.

The answer is that you don't need a big telescope. In fact, a big telescope is actually a handicap in this work. Most comets are picked up by amateurs exploring the sky simply for fun. The discovery of Nagata's comet is an example.

Masaji Nagata was a Japanese farmer in the Imperial Valley of California. At night he loved to lay aside his tools and study the heavens with his three-inch telescope. On the evening of July 15, 1931, examining the planet Neptune, he noticed a hazy star near by, so near the horizon he was unable to watch it for more than a few minutes. The following night he searched earlier and found it had moved a considerable distance from its position the night before.

Now the stars stay fixed in the sky with respect to each other, but planets and comets keep moving about. Nagata knew it was not a planet because of its hazy appearance. He suspected at once, therefore, that he had come across a comet. He communicated his observations to the Mount Wilson Observatory which soon confirmed his discovery. Nagata was presented with a medal by the Astronomical Society of the Pacific, in addition to having the comet named after him. Today Nagata is dead, but his comet still pursues its path across the sky.

A big telescope is a handicap because it magnifies too much. It is like searching for a collar button with a high-power microscope. A big telescope magnifies so much that it can only see an area in the sky equal to about ten per cent of that covered by the full moon. A small telescope takes in an area hundreds of times greater. The chief requirement in success-

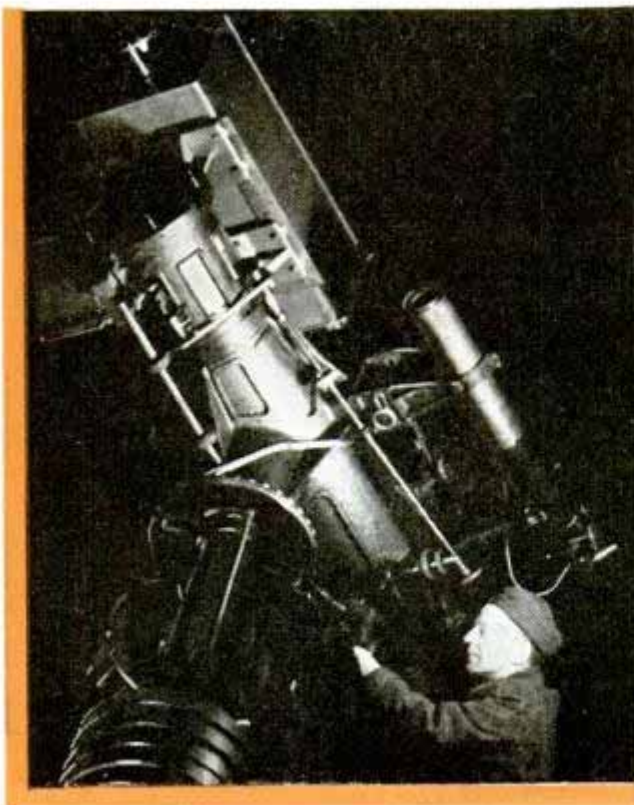

1254

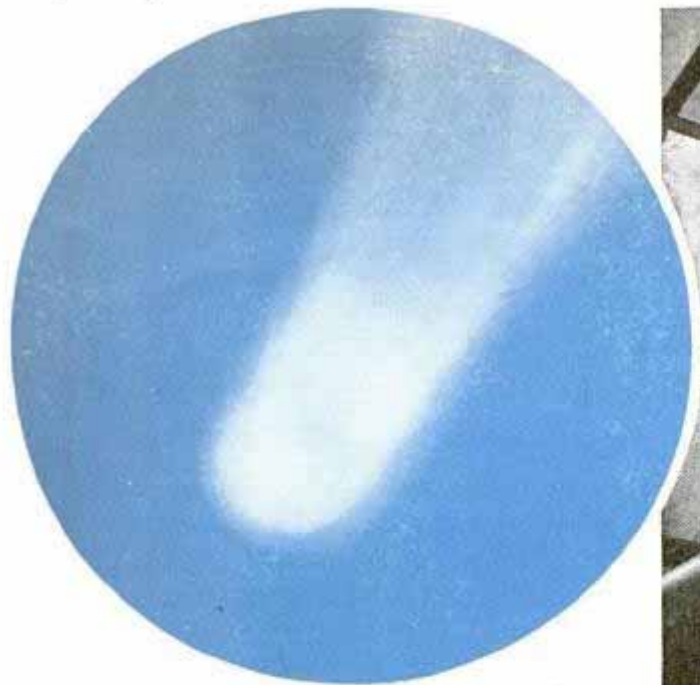

Above, Halley's Comet in 1910. Right, light from stars reflects from mirror at bottom of tube to eyepiece at top. Center, photo shows comet clearly as telescope follows it, stars appear as streaks. Bottom, two back-yard comet chasers



ful comet hunting is persistence. Charles Messier, French astronomer of the eighteenth century, discovered thirteen comets with a telescope two feet long!

The comet hunter stalks his prey in a systematic manner. He carefully scans a narrow strip of the sky, pausing occasionally to study some suspicious object. Then he shifts his telescope slightly, and repeats the process. He may continue in this way for months and even years without seeing anything more exciting than a shooting star. But he does not become discouraged because he knows that by keeping at it he is practically certain to find a comet in the end.

People generally picture a comet as a bright star with a long tail streaming behind. Instead most of them appear in the telescope as a faint blur, often without a following train of light. Sooner or later the amateur will see such a faint blur. Immediately his spirits soar. A comet at last!

But wait a minute. Before announcing your discovery to the world, make sure you have not found a star cluster or a nebula.

(Continued to page 134A)

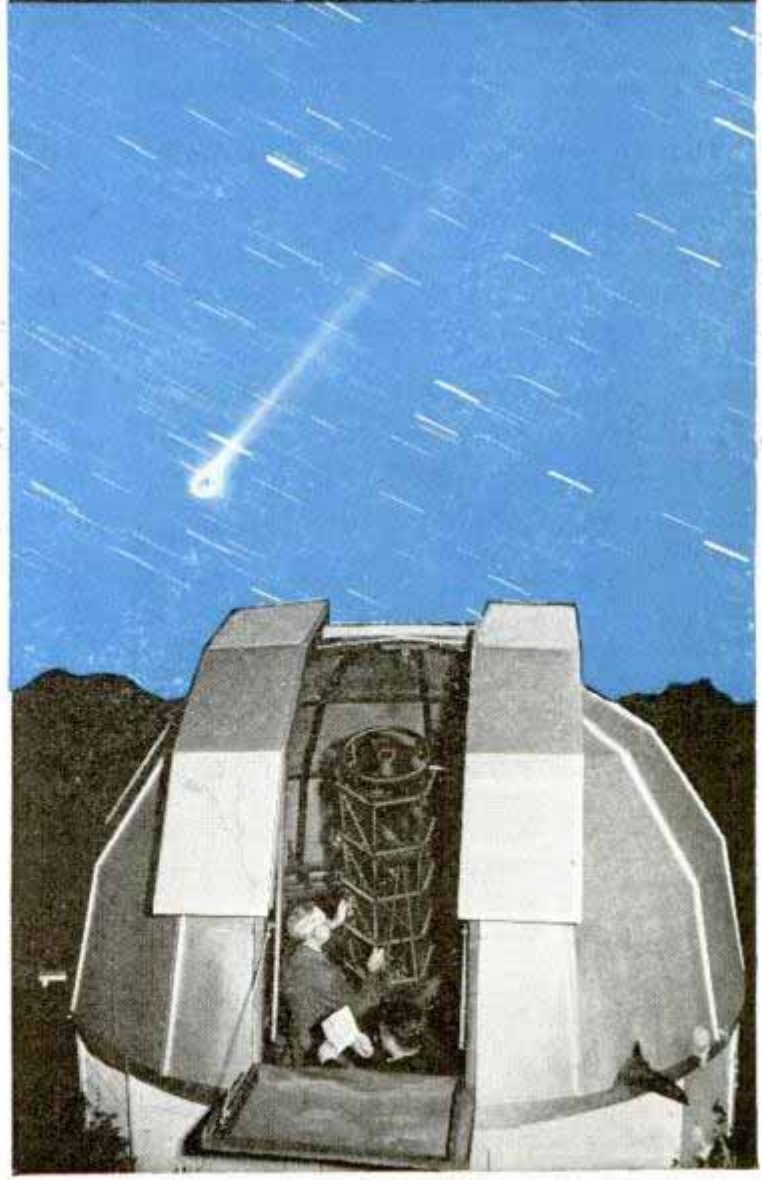

1937
Hubble's Comet
Problem raised Aug 9 1937

Car Rocker Finds Squeaks and Spreads Lubricants

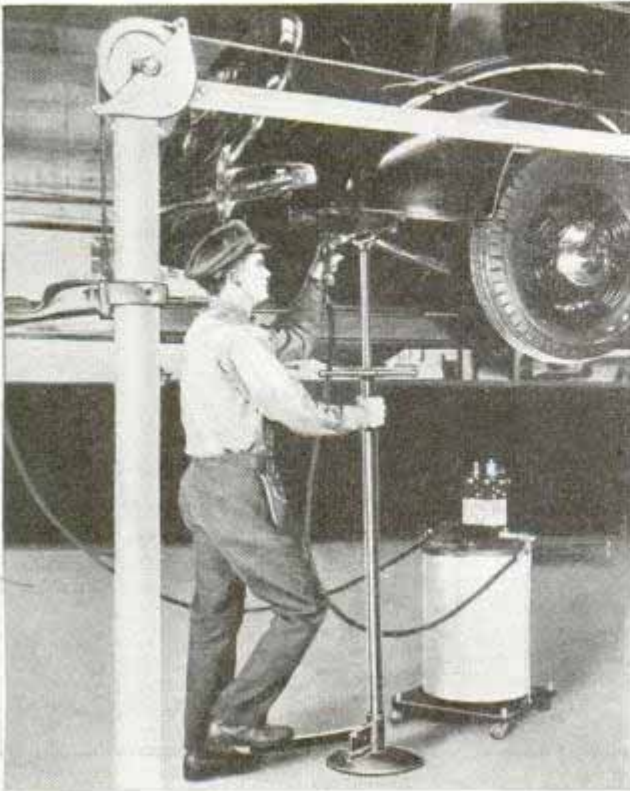

Automobile service man rocks car with foot-powered jack to find squeaks and work grease into all parts

Hidden squeaks in automobiles may be detected by a new jack that rocks the car and helps in spreading grease to parts ordinarily hard to lubricate. Operated by a foot pedal, a fifty-pound pressure exerts more than 400 pounds pressure on the load. The pedal folds and the jack may be moved to another job by rolling it on its base.

Propeller Drives Model Racer Forty-Five Miles an Hour

Its frame made from an old apple box and its body of balsa wood, a model racing car driven by a pusher air propeller trav-

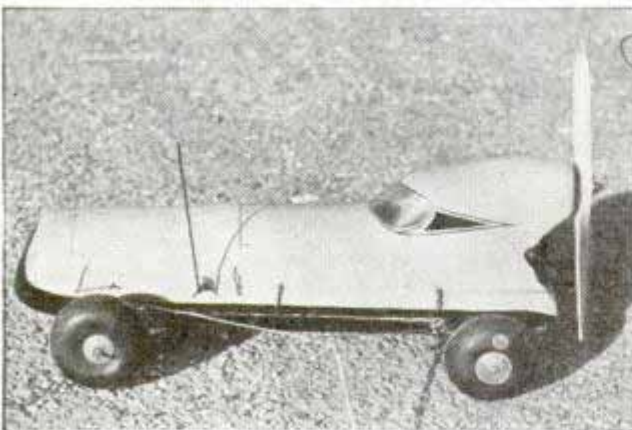

One-fifth horsepower motor drives the pusher propeller of this four-pound miniature racer

els forty-five miles an hour. A bridle attached on the left side keeps the car going in a circle around the operator, who can stop it by tapping a vertical rod which cuts a switch at the edge of the hood. The one-fifth horsepower motor is in the rear, while the coil, batteries and ignition switch are under the hood. The racer weighs only four pounds.

Transplanting Tool Digs Up Plant with Earth-Packed Roots

Plants and bulbs are easily set in the soil or transplanted with a simple garden tool that removes plants intact from the ground with enough earth around the roots to give them a good start. The tool, operating like a posthole digger, is placed around the

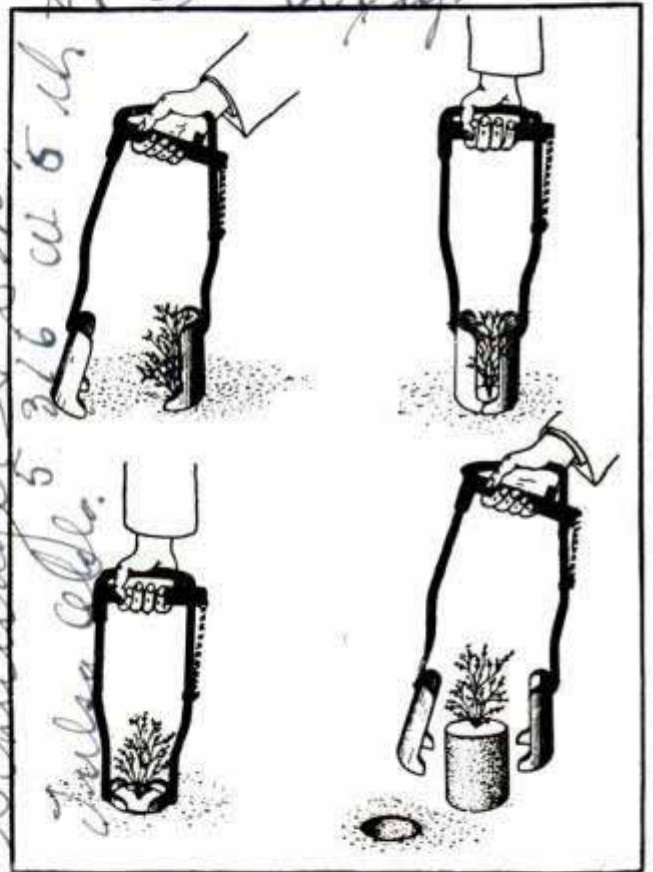

To dig up plant, place tool over it, squeeze tool closed, force into ground, pull up and release grip

plant or shrub and with a downward push it is forced to the desired depth. To break the earth core the tool is rotated and the plant is ready to be pulled from the ground. Several sizes are available, the smaller ones being operated entirely by hand, and the larger tools by foot.

Send stamped, addressed envelope to our Bureau of Information for name of maker of any device described in this magazine.

Walker Mfg. Co.
 Corcoran, Wis.
 Build by Jerry Heller, San Antonio
 1252 Birch Place
 848
 Schilling, 316 W. 5th
 Tulsa, Okla.

Brown, Jr.

1883 *Hatboro, Pa.*
Metal Autogiro Rises Vertically from Ground *Harold F. Pitcairn Pres.*

Your back yard is an ample landing field for the newest autogiro, despite the garden fence, the telephone lines and the neighboring chimneys. A rotor mechanism invented by Agnew Larsen, engineer and general manager of the Pitcairn Autogiro Corporation, makes the all-metal craft capable of vertical flight. In its first public demonstration recently the PA-36 autogiro climbed straight up to clear an artificial hazard and then was driven forward by the single propeller in its nose. The three big rotor blades provide lifting power and allow a takeoff or landing in a tiny area. The new autogiro is an enclosed type.

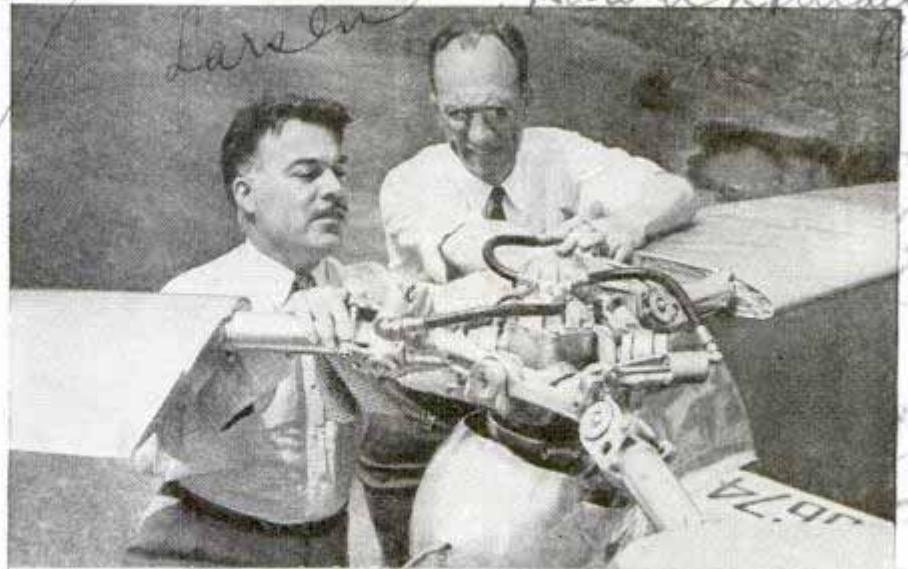

Top, rotor hub of autogiro, heart of the rotor blade mechanism, undergoes inspection by Agnew Larsen, its inventor, at left, and Harold F. Pitcairn, president of the autogiro company. Bottom, the new PA-36 autogiro, in first public demonstration, rose vertically from ground and then was flown horizontally over artificial obstacle, to show the craft's independence of ground hazards

Baby Keyboard Added to Piano Plays Orchestral Tones *1885*



Electric keyboard is attached at right side of piano

Tones of the flute, strings, reeds and a variety of other orchestral sounds can be produced by a small electric keyboard which is attached to the right side of the piano. This new instrument is the Solovox, invented by Laurens Hammond and based upon the same principle as his Novachord, which derives its tones from controlled oscillations of many radio tubes. The Solovox has fourteen tubes, with a range of six octaves and tablets to control the various voices. It can be played by any amateur musician. A cable leads from the keyboard to the tone cabinet under the piano.

*Hammond Instrument Co. 695
2915 N. Western Ave*

TOM THUMB CARS

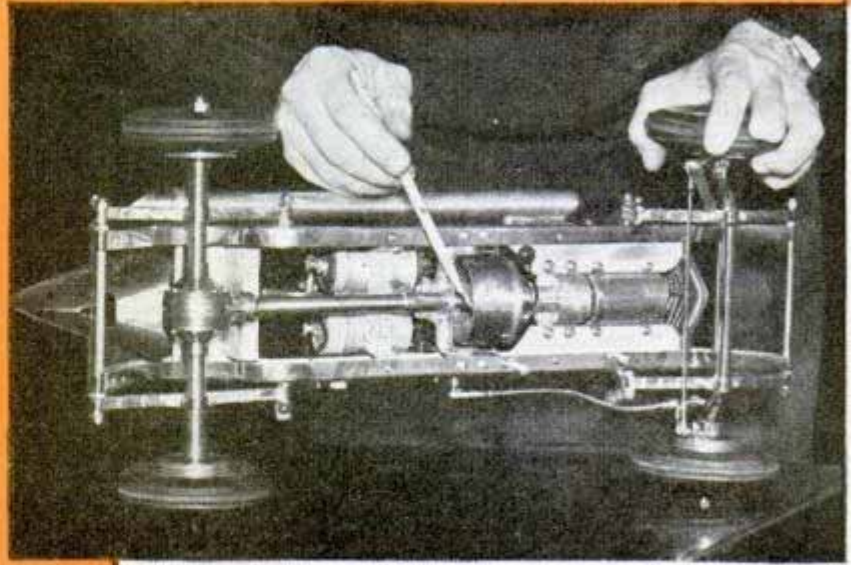

Left, owner working on his midget racing car. Above, combination clutch and universal joint that operates by centrifugal force. Below, crowd watching miniature racing-car events at New York world's fair. Note tiny speedster hurtling along at left. It is held on its course by a cable, invisible in photo, attached to swivel at center of course



"CAR 9 on the track—No. 15 on deck—"

The announcer's voice is lost in the noise from the starting table adjoining the track. A miniature racing car is being tuned up for a run. With the deftness of a watch repairer, the car owner manipulates the needle valve of the carburetor until the scream of the motor satisfies him, then moves his car to the starting line and tethers it to an airplane cable running to a swivel in the center of the circular course.

The starter nods and with a quick push he sends the car roaring on its way. Around

the circular track it streaks, gathering speed. Three test laps completed, two of the track officials press on their stop watches and the race against time begins.

Spectators move to the edge of their seats. First-timers rub their eyes in amazement—the speed of the car is as incredible as the noise of its exhaust. When the car has negotiated eight laps, it is brought to a halt by the owner tripping its ignition switch with a handkerchief. He unbridles his car to make way for the next and awaits the announcement of his car's time.

James Mc Sweeney 4600 W 8 St
Overland Park, Kas

1527

BURN UP the TRACK



Time clocks are checked against each other and with the aid of a slide rule, the clerk calculates Car No. 9's average speed. Others take their turn and when all times are posted, the champion is named, and, if it happens to be an intercity or a sectional meet, team standings are tabulated on a point system. If the company's fast, the top car may be close to the present record of 62.23 miles per hour.

Although the beginnings of vest-pocket racing are clouded in obscurity, California hobbyists went off the deep end for it last year and soon their enthusiasm fanned out over the country, climaxing in races at the New York and San Francisco expositions. Since then it has proved a magnet for crowds and in a few localities is outdrawing the regular midget race tracks. Miniature racing has, from the outset, been adult in appeal. In virtually every racing association garage mechanics, butchers, hotel clerks, salesmen, office workers, and professional men will outnumber high-school youths five to one.

Ready-built cars cost twenty-five dollars and up—and up, if your tastes run to high-precision, custom-made jobs. On an average track, a driver spends about forty dollars for his first racing equip-

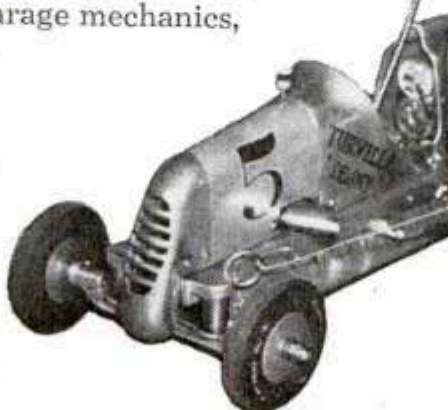

Top, left, driver stopping car by tripping ignition switch. Right, tuning up car on electrically driven starting table. Bottom, driver attaching car's "bridle" to cable leading to pivot pole

no address known

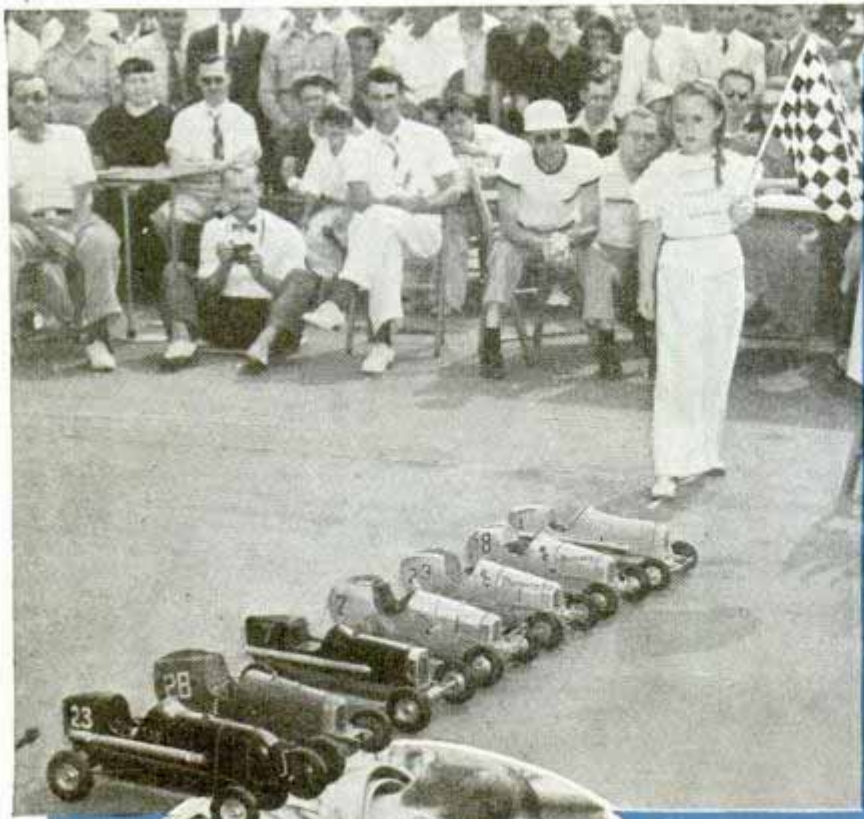

ally will go over 100 miles an hour!

Knockdown kits of complete cars that a hobbyist can assemble are highly popular and, of course, a lot easier on the pocketbook. A home-workshop owner with the necessary tools and patience can build his own racer, with the exception of the motor and tires.

Experimenting is a part of the fun. Different body styles will challenge the driver's interest and his quest for an ideal fuel for his motor is apt to be unending. The owner of a front-drive racer will set about to probe the advantages of the back drive and vice versa. The same is likely to be true in test-

ing the relative merits of friction and gear drives, and after a time, will come the urge to "hop up" a motor or work out a supercharger.

The regulation track is one-sixteenth of a mile and in its center is a swivel or pivot made out of a ball-bearing roller skate fastened to a securely moored pipe, eighteen inches to three and a half feet high. Fine steel airplane cable

(Continued to page 124A)

Carl Badami



ment. He may feel the urge for a new car that will give him greater speed and if he's ready to plank down \$175 he can have one built to his own specifications. Its parts will be dynamically balanced and weighed to the hundredths of an ounce and the precision grinding of important parts will be accurate down to 1/10,000 of an inch. Engineers making these hand-built jobs feel that their speed eventu-



Col. G. Alexander

Top, several miniature cars participating in events at world's fair. Circle, fueling tiny car. Bottom, former racing-car designer, who has become top-flight builder in miniature field, at work on the small speedsters

R. 887 Fred Trauer and
Lebe Sherman

Timer Releases Pick-a-Back Models in Flight



Closeup at left shows how the smaller plane rests in a wire cradle atop its carrier. Below they are in flight together, and in a few seconds an automatic timer will release them. Each plane has a gasoline engine set to run for twenty seconds

San Antonio, Tex

Two gas-engined model planes built by members of the San Antonio Gas Model Club take off together for pick-a-back flight and then separate in air, released by a timer. The smaller monoplane rests in a wire cradle atop the fuselage of the "carrier" plane, and is held by a catch which the timer frees when the planes are about seventy-five feet above the ground.



Armored Jacket Stops Bullets from High-Powered Rifle

Weighing only fifteen pounds, a laminated steel jacket designed as the suit of armor for modern soldiers has stopped bullets from a submachine gun and from

a German Mauser pistol fired at a twenty-five-yard range. With a solid sheet of heavy steel instead of the laminated steel and rubber, the jacket would weigh twenty-one pounds and would withstand high-power rifle fire, the inventor says. Three layers of steel 25/1,000 of an inch thick are used in front, two layers in back, separated by narrow strips of rubber.

Chas. S. Gerald Langhlin



Soldier wearing bullet-resistant jacket of laminated rubber and steel is protected on all sides

K 897

Decorative Plaque for Wall Covers Electric Switch

Electric switches on the home walls can be covered with an ornamental plaque which fits snugly against the wall. As the plaque is moved up or down it turns the hidden toggle switch on and off.

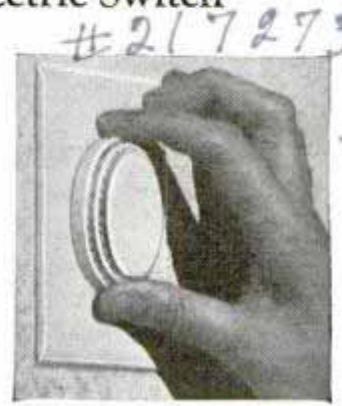

#217273

Decorative Switch Plate
47 Avon St
New York City

U.S. Army Corp

Rough Riding Gun Tractor Goes through Severe Tests

no further data

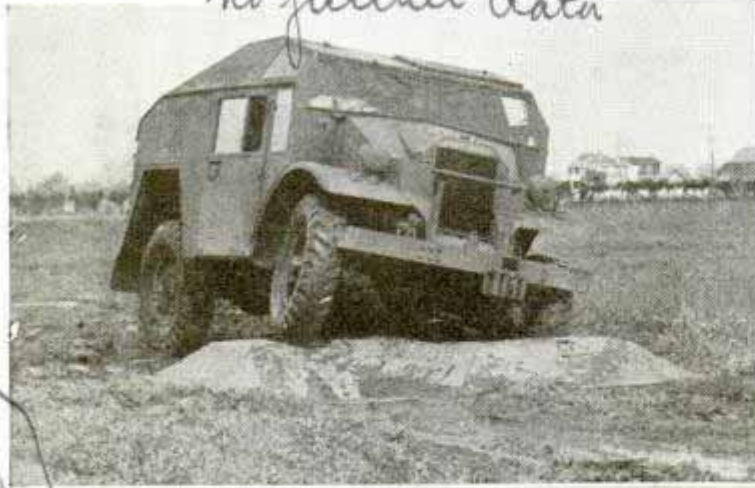

Gun tractor built for rough going, top, climbs slippery obstruction; bottom, kicks up rear wheels bouncing from pit

Designed to negotiate almost impossible terrain, a new type of British gun tractor has completed severe tests at the Ford Canadian plant. Among other requirements, the tractor must crawl over obstructions greasy with mud and it must travel over a deep ditch, a test that causes it to bounce like a bucking bronco.

Sunburn Prevented by Windows in Stratosphere Planes

Although stratosphere flying is not as yet commercially practical, the optical industry already is prepared to equip airplane windows with glass that will absorb invisible ultraviolet rays which can destroy the human skin in two or three minutes, and even destroy life, at altitudes of fifteen miles or more. On earth we are protected from the severity of these rays, which cause sunburn, because the very short wave lengths they contain are filtered out by ozone in the atmosphere. One kind of glass will not pass ultraviolet but admits

heat in the form of infrared, yet it will keep the heat from escaping once it is inside. Another kind of glass absorbs both the ultraviolet and infrared, thus also excluding the heat rays. On a stratosphere ship equipped with sliding windows having these two types of glass, the pilot would manipulate them to protect against the invisible rays and also control the interior temperature.

Fog Lamp Slants Its Rays to Avoid Bright Curtain

Better visibility in fog is the purpose of an all-glass automobile lamp closely resembling the "sealed-beam" headlamps recently introduced. The new fog lamp has a small black hood in front of its filament and five opaque stripes horizontally across the inner surface of the lens. The hood and stripes intercept "wild" rays which, unless controlled, shine ahead and create a bright fog curtain that hampers the driver's view in "soupy" weather. The lamp throws practically no light above the horizontal plane.

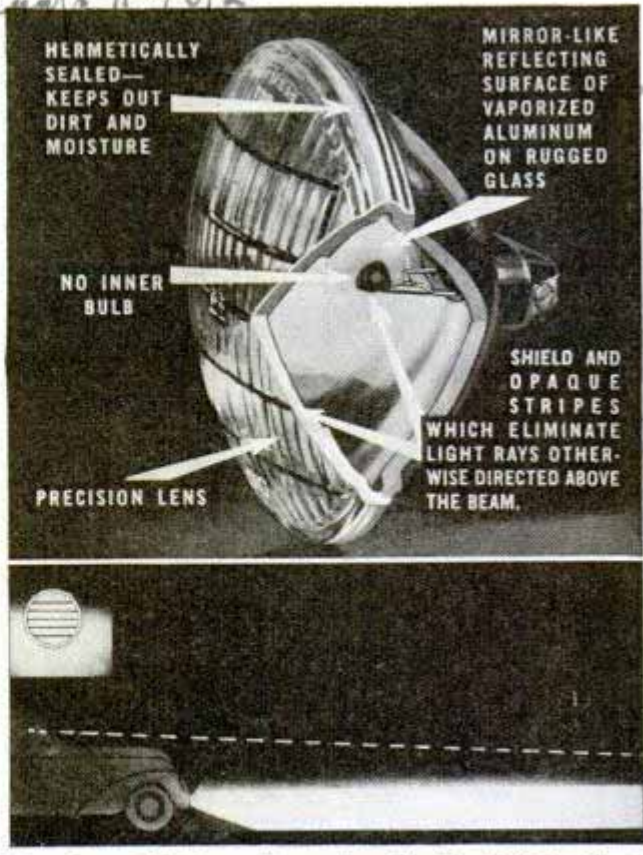

Drawing at bottom shows how the hooded fog lamp throws its beam low and avoids lighting up the mist

Ref: Dr. E. D. Tullyer. American Optical Co. Southbridge, Mass.

Crystal # 110. Amber # 876

Windsor Ont. Leds # 4012

Cruite

Original drawing by...

1808.

Quest for Blind Fish Discloses Hidden Caves



Back in 1938 two guides were sent into recesses of Mammoth Cave, Kentucky, to obtain specimens of blind fish for exhibition. They traveled subterranean rivers and tortuous crawlways, discovering magnificent caverns still unopened to the public. Scientists describe them as more beautiful and geologically valuable than the familiar caves. Above, guides exploring with rope

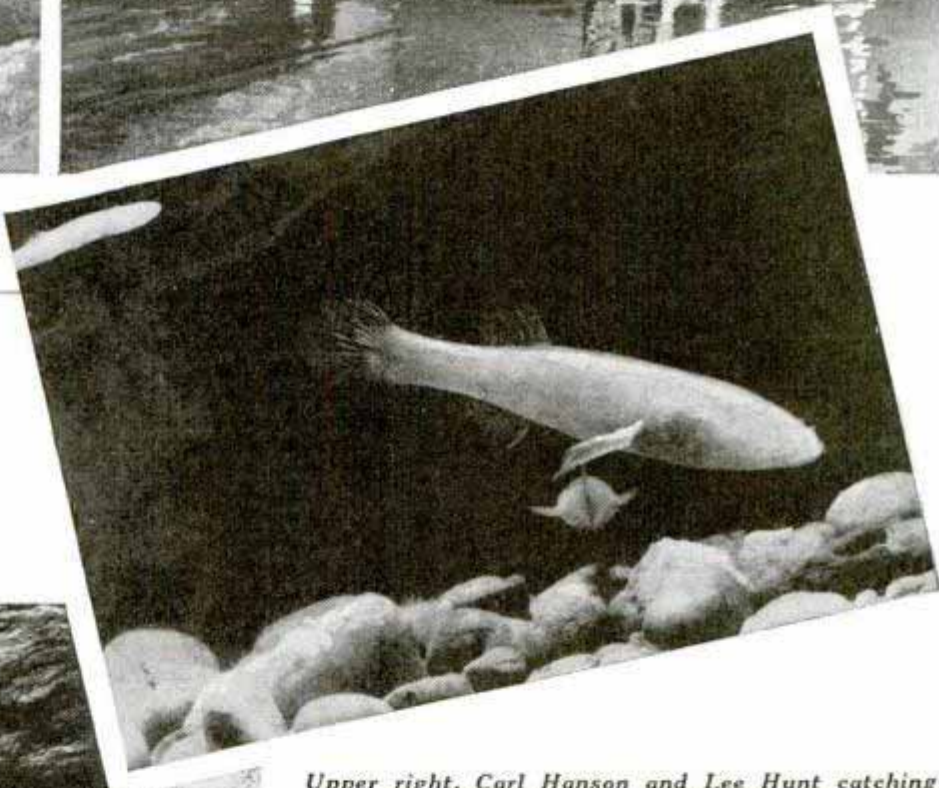

Upper right, Carl Hanson and Lee Hunt catching blind fish (center picture) in Roaring river. Lower left, guides emerge from 800-foot crawlway into new-found labyrinths. In that distance they could seldom rise to hands and knees. Below, a deposit of cave pearls. Explorers are making extensive studies before admitting public to new sections



K 672.

ART

Cond. A. W. Elliott, 120 E. 34th, New York

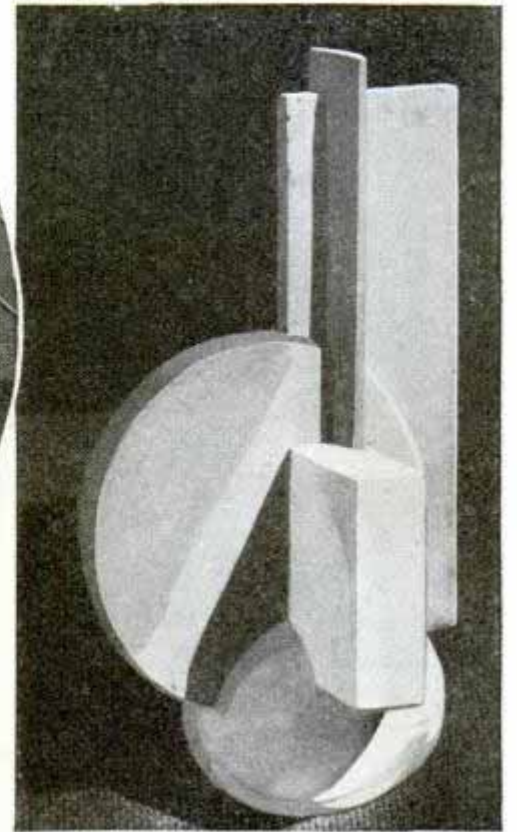

Art students, expecting to be taught at the traditional desk with pencil and paper, are surprised to find themselves seated at a workbench upon entering classes at some modern art schools where the pupils work with wire, solder, sheet metal, plastic wood, plaster and lead, using metal shears, pliers, hammers and other tools, to learn how things really are formed, instead of how they look to the eye. Students thus learn to handle the same material and tools which they are likely to use in earning their living in the mechanical trades. In one of the first lessons, students put together nature's favorite forms, the sphere, disk, cylinder and cone, and man's invented form, the rectangle, like plastic wood group above, in pleasing, though unfamiliar, combinations. Circle, fashioning cowboy and lariat with pliers. Left, artistic example of pomp and strut modeled in sheet-metal lady. Straining cowboy and balking horse, below, indicate how lights on metal emphasize life and action

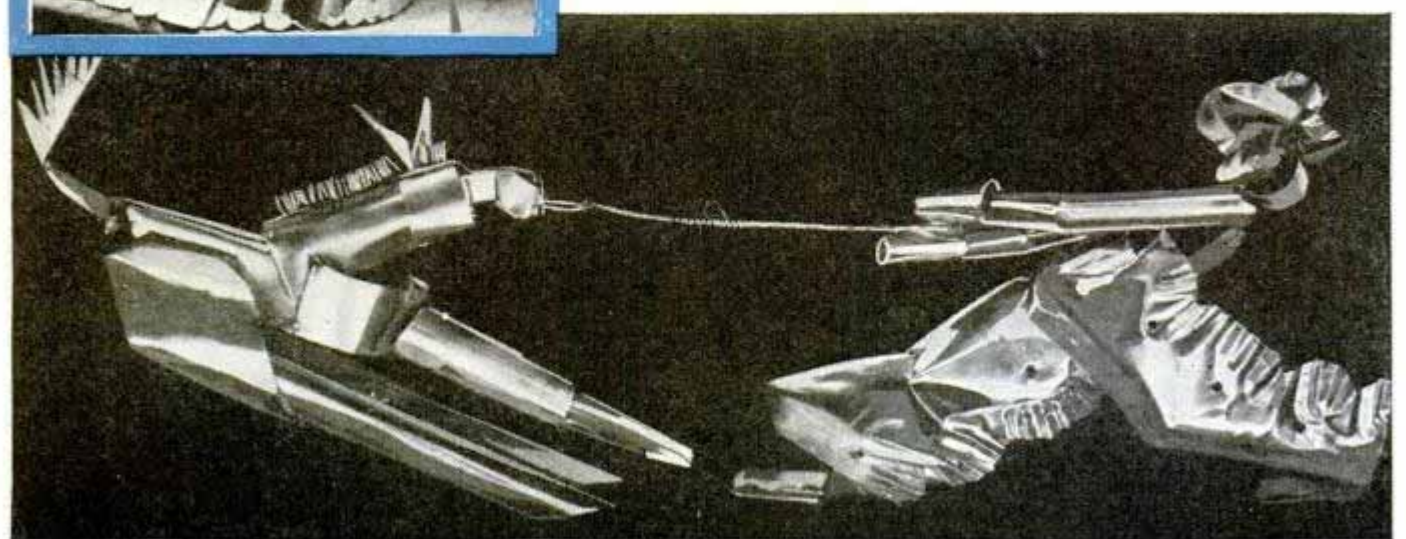

from the WORKBENCH

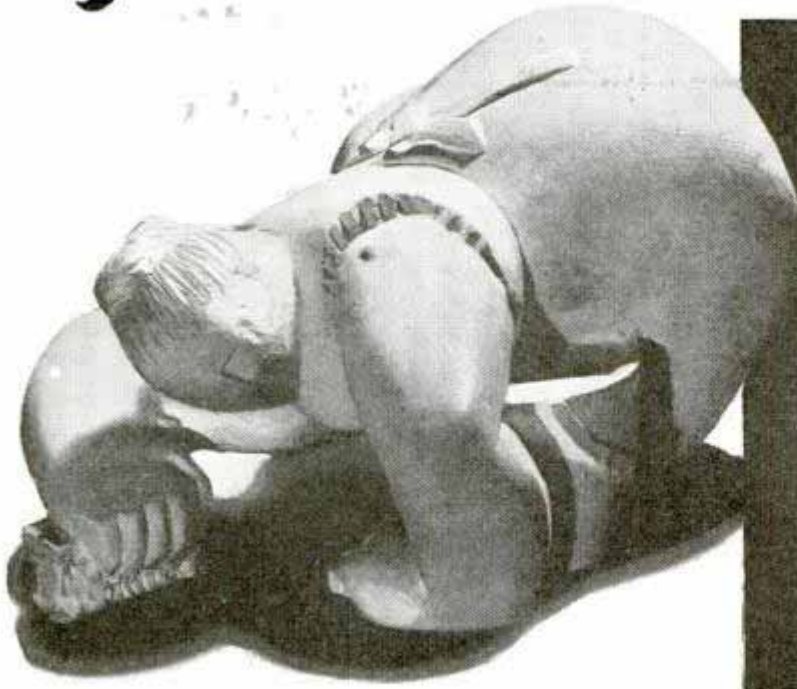

In final "bench" lessons, the student is given an opportunity to create a familiar figure from life in three dimensions, sculpturing his model in plastic wood or plaster. Above, symbolic figure suggesting a husky scrub woman bearing down with soap, water and scrub brush. Right, student modeling group showing mother washing child

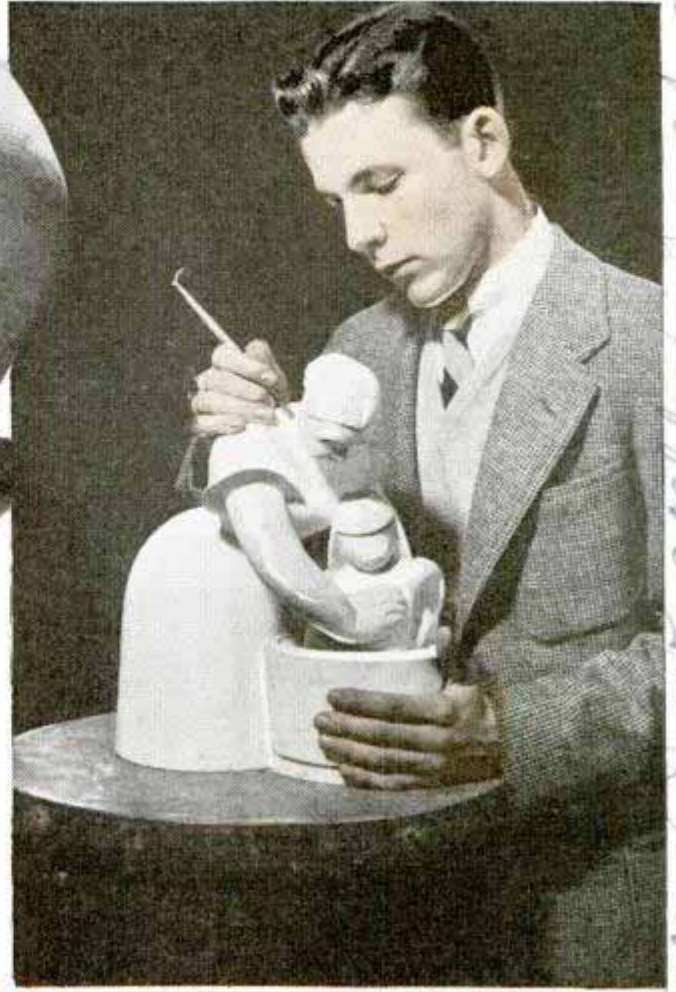

Alexander G. Costello, Director of the Pratt Institute School of Art



At left, student working with thin sheet metal learns how to enclose bulk by plane surfaces and to give emphasis to form by employing light reflections; metal shears are the tools used. Below, wire race horse and jockey created by student depicts both volume and action in simple lines better than could be done with pencil lines on paper. The purpose of this new kind of training, as employed at the Pratt Institute in Brooklyn, is to teach the fundamentals of art by experience in creating actual objects, giving the student a clearer conception of form and outline than is possible with theoretical forms produced by pencil, which the student must forget until he has finished the preliminary course

215 Rivers on

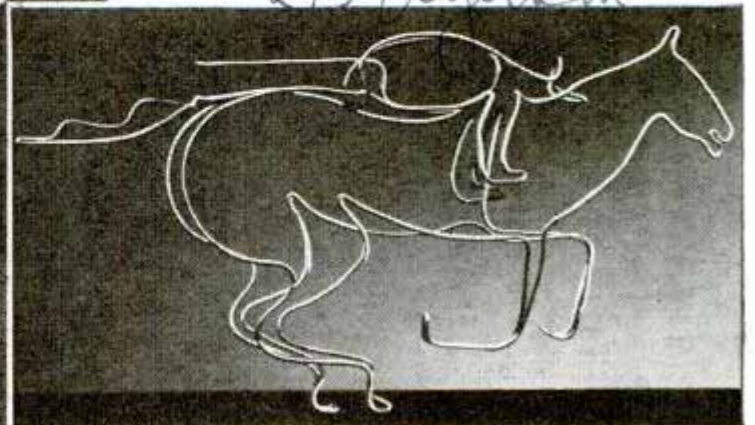

Speed-Light Warns Driver When Limit Is Reached



Top, turning control knob to set auto speed-light; sketch below shows installation of light and switch

Lighting automatically as soon as the car exceeds the speed at which it is set, an indicator helps the driver stay within the desired limit. The lamp is a small plastic head with a suction cup that may be stuck any place on the windshield. A control knob mounted either beneath or through the instrument panel enables the driver to set the maximum speed at which he wishes the device to function, depending on the speed laws of his locality. Wind coming from the fan operates the switch, which is attached at the front end of the motor.

Invisible Film to Mend Drawings Is Applied with Heat

Torn blueprints and drawings can be mended with a "vanishing" film which is applied with a thermostatically controlled welding iron. This transparent film has no oozy adhesive which will seep out and become sticky in the blueprint machine or when the drawings are filed away. When

a blueprint is made from a tracing previously mended with the thermoplastic patch, the mend cannot be seen on the blueprint.

Fluorescent Lights for Ceiling

Suspension fixtures for installation of fluorescent lights at the ceiling are now available, offering bright light at low wattage without the heat of the incandescent lamp. There are two, three and four-tube units, the tubes snapping into Bakelite sockets, while the starter switch and reactor are built into the fixture. The fluorescent tubes are available in "sunlight," warm white, green, blue, red, pink and gold.

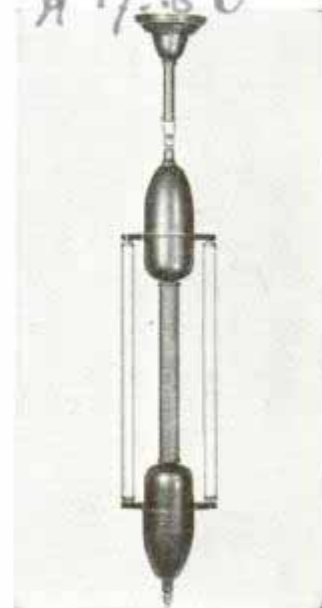

Razor Blade Knife and Scraper Has Many Handy Uses

Seven features are combined in a pocket tool that includes a folding razor blade and fingernail file. A screwdriver blade at the tip of the file, a nail cleaner, bottle opener and cigar cutter are included. The tool may be converted into a scraper by inserting the blade crosswise at one end.

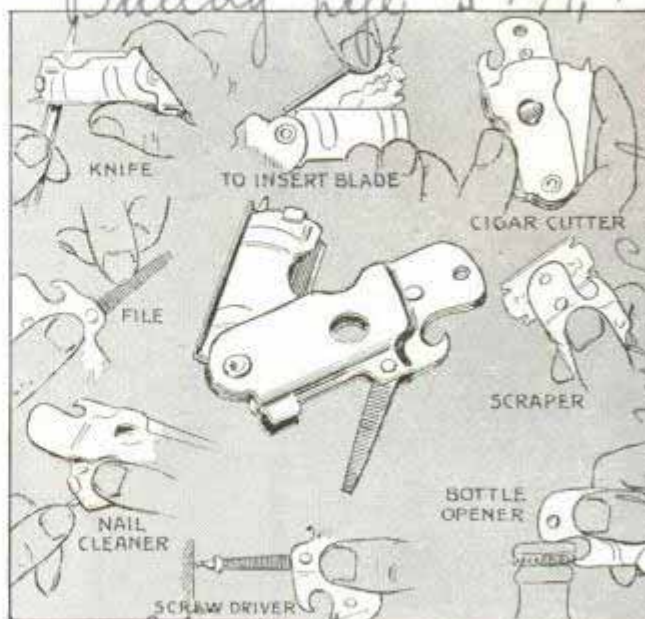

Seven-purpose tool opens easily to take new blade; its many uses are illustrated at sides and bottom

Handwritten notes:
 60
 1535 W. 22nd Ave
 K 590
 Chicago
 \$19.50
 K 733
 Buddy file # 171,9925
 Kit # 3.00 Patch
 Shelton
 Englewood
 lighting
 Victor's
 17. Armory St.
 Paramount
 1532 W. Cleveland Ave
 25 cent

Floodlights Travel on a Track for Servicing

At right is the facade of a Chicago building made into a pylon of light by fluorescent-tube lamps, which are moved up and down on their tracks by cranks inside the building. Below, connecting one of the seven-foot sections after cleaning. Two sets of three-foot fluorescent tubes are installed in each section

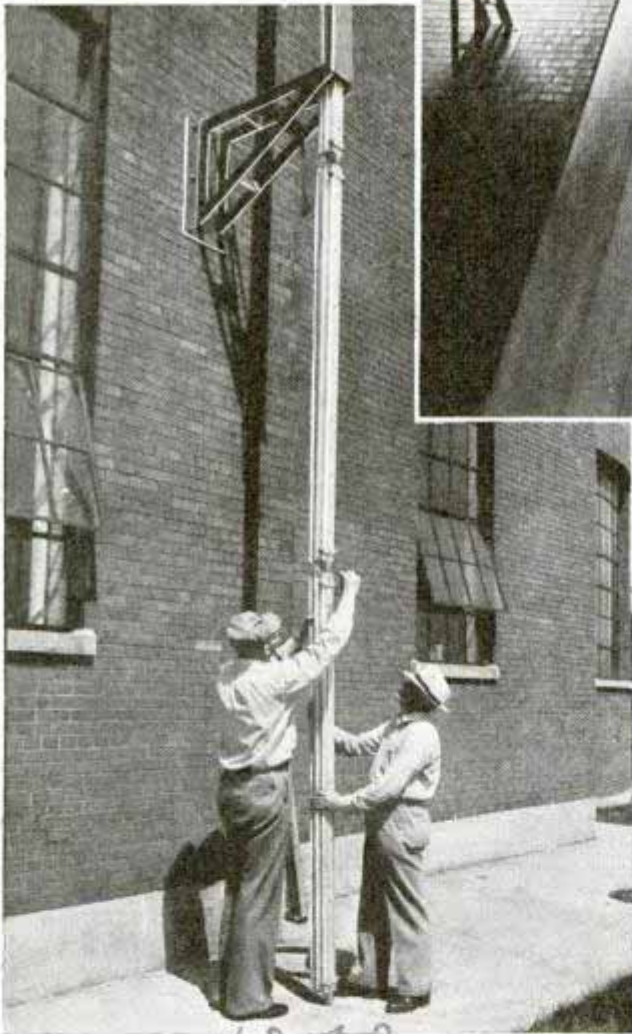
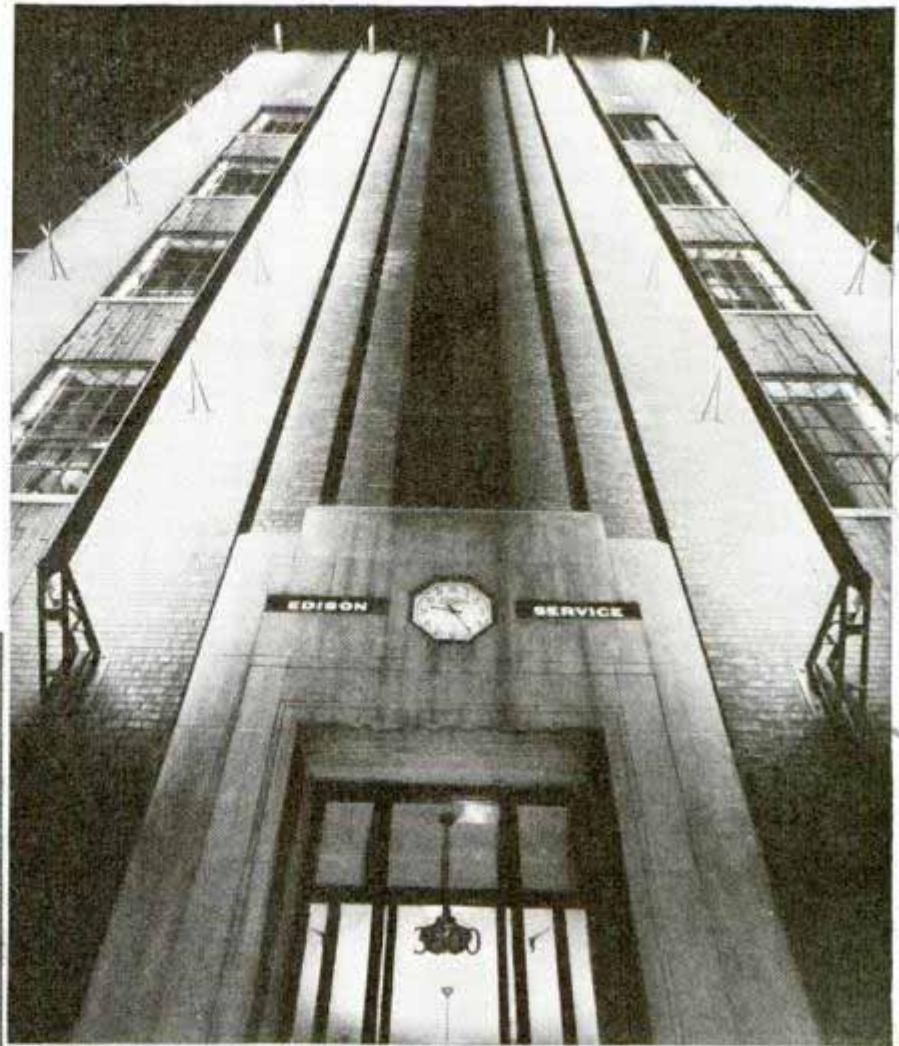

Problems of servicing the fluorescent floodlights that make a Chicago building a 100-foot pylon of light were solved by mounting the tube lamps in seven-foot sections or "cars" on vertical tracks. Each section contains twin sets of three-foot fluorescent tubes, coupled together with removable pins. They are raised and lowered by means of a hand winch inside the building, and as each section comes down within reach of the operator it is disconnected mechanically and electrically and is ready for cleaning or replacement. To facilitate easy starting of the lights during zero weather a ten-watt heating element is installed at the base of each section.

Uranium Atom U-235 Does Its First Work Starting a Radio Station

The uranium atom U-235, on which scientists focus their hopes for the harnessing of atomic energy, made its debut recently as an actual source of power. The explosive force of a single U-235 atom was put to work starting a chain of electrical re-

actions which turned on the new transmitter of a New England radio station. A sharp click, clearly audible to the radio audience, went on the air as the 200,000,000 electron volts of the split atom switched the program to the new transmitter.

Dr. E. A. Condon, associate director, Research Laboratories 705

Northern Service Bldg. Commonwealth Edison, 3500 N. LaSalle



TRAINING *Your* DOG



Left, running-noose collar helps teach dog to obey. Circle, right, Labrador retriever swimming in with duck. Circle, bottom, trainer and two retrievers, a Labrador and a spaniel

WITH a little effort you may teach your dog to be a useful hunting companion. Retrievers, pointers, setters, spaniels, and some other breeds have the instinct for bird hunting and sometimes a common "mutt" also makes a good hunting dog.

First comes a course in obedience. Your dog won't mind you in the field until he has learned obedience in the yard. From eight to twelve months of age is the best time to start, although an older dog can be taught if you take the time. The dog must be trained every day for half an hour. Keep the pupil cool by working him in the shade, away from distracting influences.

At the gun-dog training quarters of A. H. Asmus & Sons in Bellflower, Calif., bird dogs are taught to sit, to drop game on command, to drop and stay there, walk at your heels, whoa, come to voice or whistle, and retrieve. Ed Asmus, the trainer, says:

"Sternness and force are part of the training system, with praise and petting mixed in. If you lose your temper or are cruel you fail."

After the pup has learned his name and has become used to a collar and lead he

Cont. Thomas G. Thurston, Jr.
18678 Inglewood Blvd N 510
1107 42 Hebron
Way
Los Angeles

should be taught to heel. That means the dog is to stick close to your left or right side, a little behind you. Use a short lead and keep him in position as you walk around, tapping him on the nose with a switch when he runs forward and jerking him ahead if he drags back. Command him to "heel" every time he tries to get away. Within a week the dog should follow on a loose lead after you have called "heel." If an ordinary collar isn't enough to give him the idea after a few days, use a force collar of the running-noose type that tightens up on his neck and cuts his wind when he tries to get away. It won't hurt him. After several weeks you can drop the lead and let him drag it, then in another week remove it.

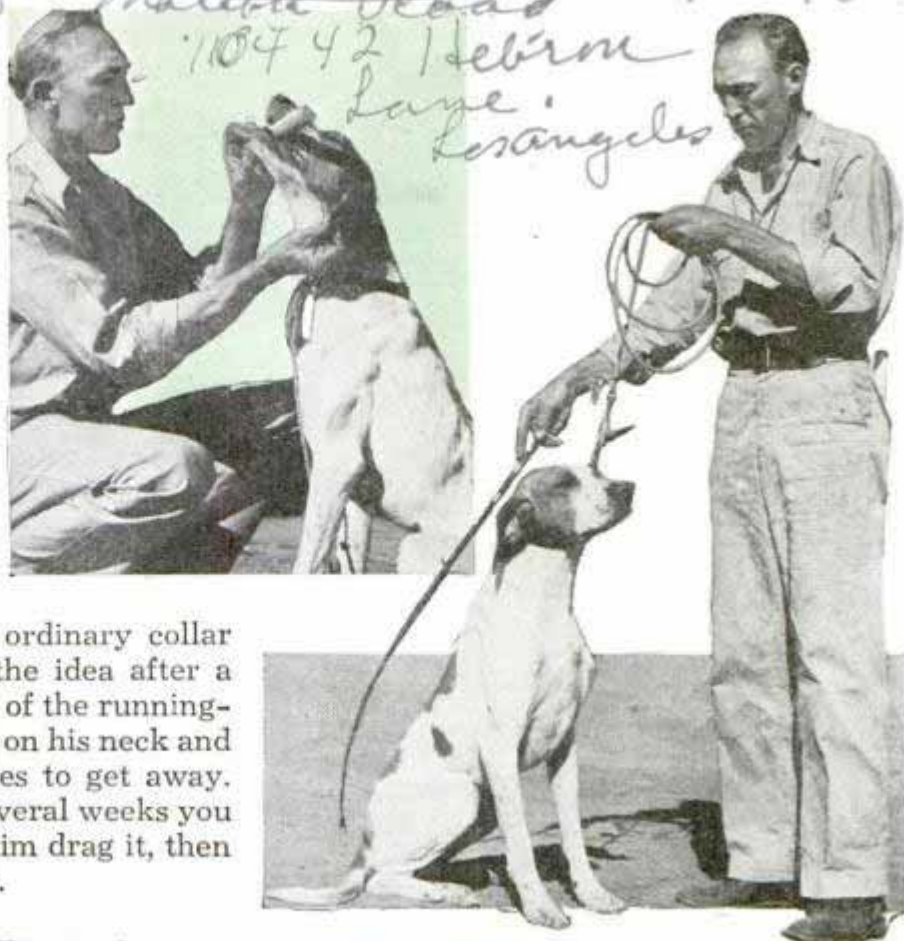

for the GAME TRAIL

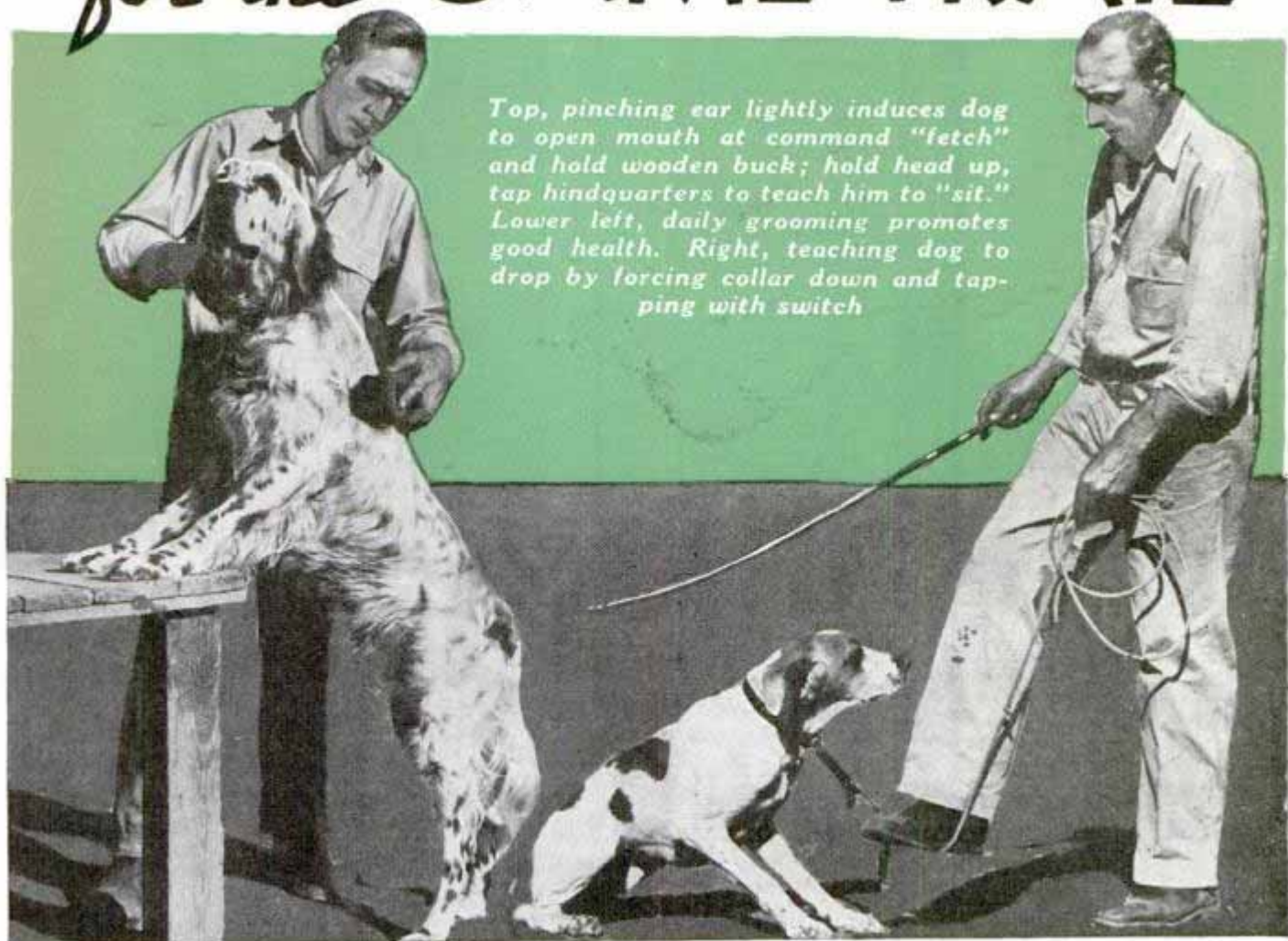

Top, pinching ear lightly induces dog to open mouth at command "fetch" and hold wooden buck; hold head up, tap hindquarters to teach him to "sit." Lower left, daily grooming promotes good health. Right, teaching dog to drop by forcing collar down and tapping with switch

72510

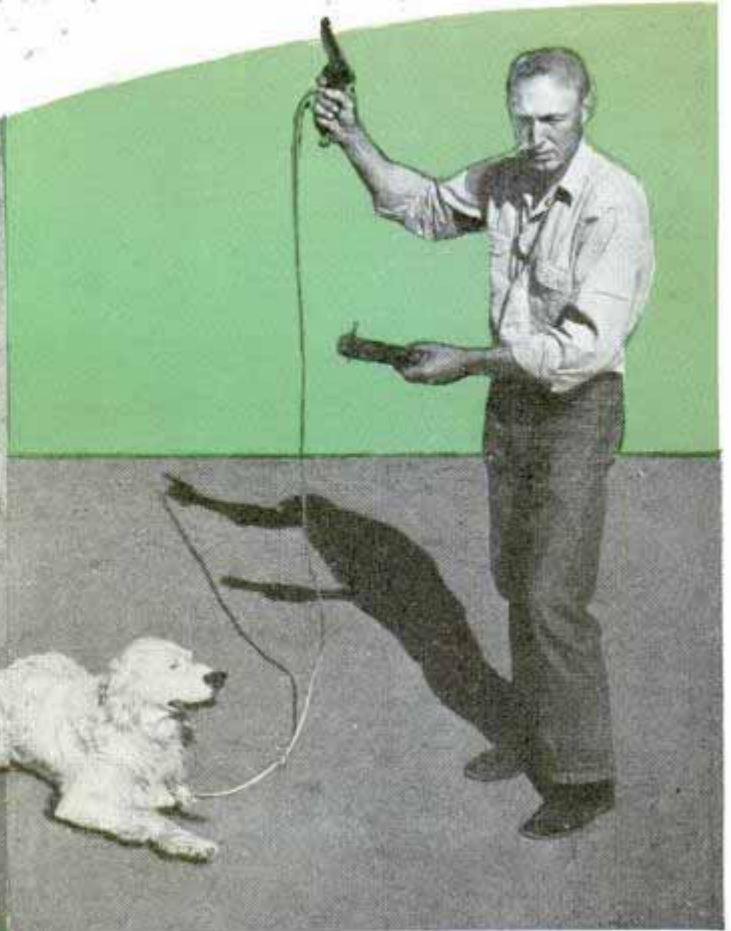

Left, early step in retrieving. Dog is "dropped" on ground and taught to pick up buck at command "fetch here." Right, tossing feathered buck. Trainer fires cap pistol after dog is executing "fetch here" to prevent gun shyness. Below, hunting dog is taught to sit and hold the game

While the dog is learning this, teach him also to sit. Command "sit" and hold his head up with the lead while tapping his hindquarters with a switch or pushing them down. Keep his head in the air if he tries to lie down. Next is "sit and stay there." Give the command, walk off a few feet, and if the dog follows, take him back and tell him again to "stay there." Eventually you should be able to go out of sight while the dog sits still.

At the command "drop" the dog should drop to the ground on all four feet. Start with the sitting position, command "drop," and force his head down with the lead, tapping his shoulders with the switch at the same time. Later on make him "drop and stay there" no matter what distractions there may be.

To teach the dog to come to you, use a short lead at the beginning. Call "come here to me" and use his name, pulling him to you at the same time. Later on graduate to a rope thirty feet long and bring him in with a sharp yank if he doesn't come promptly at command. The dog should be taught also to come at a whistle; in the field he may range beyond your voice.

"The dog should be letter perfect in all these commands within six weeks or two months," says Asmus. "Always use the same commands. In the last stages of training nearly all dogs need the force collar to prove to them that you mean what you command. As they improve, drop the lead and let it trail and finally remove it, but go back to it if necessary."

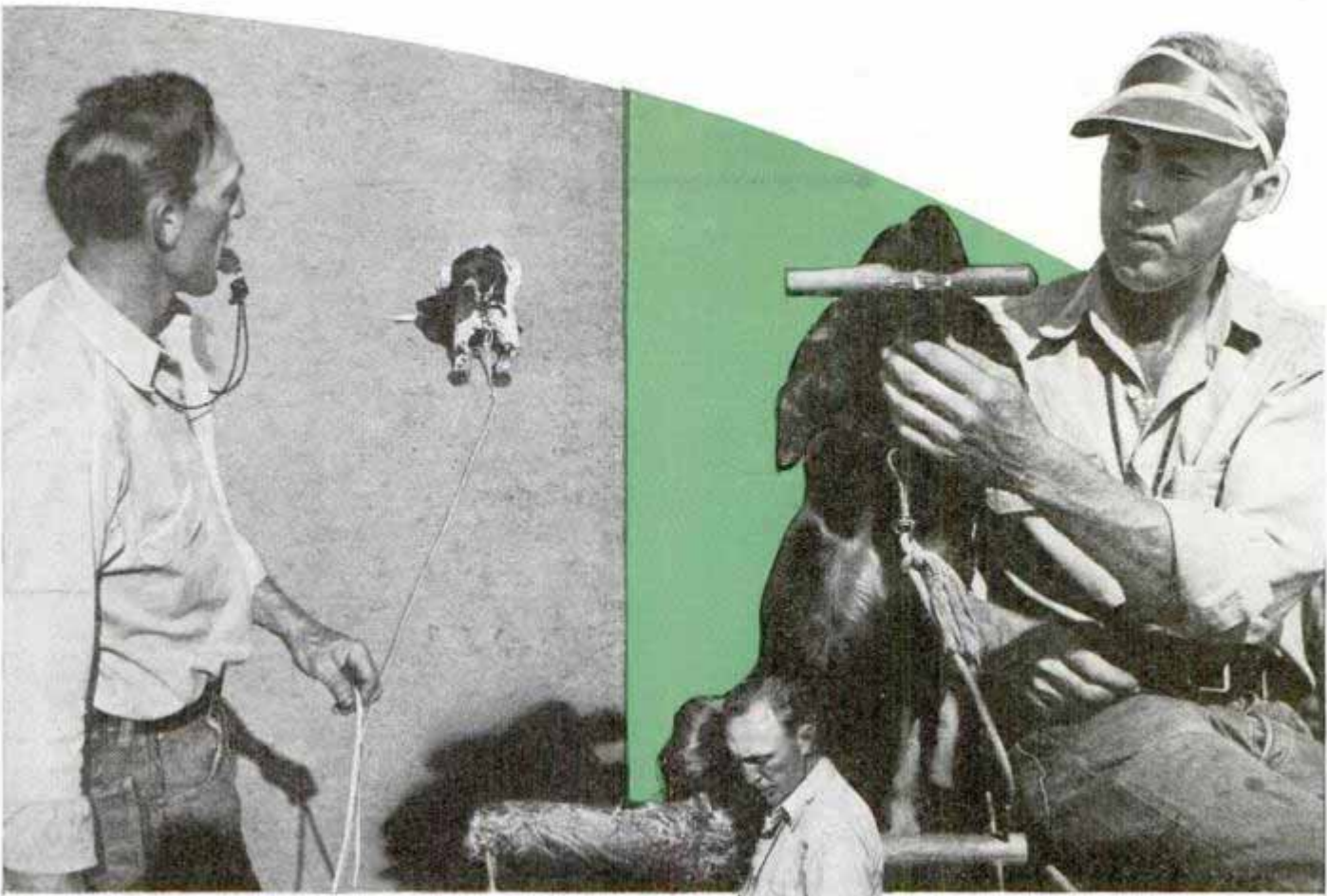

To teach the dog to stop at the command "whoa," use the long lead and the force collar. Let him break to chase or to retrieve, and just before he hits the end of the rope, command "whoa." The sharp jerk may throw him to the ground, and it won't take many lessons for the command "whoa" to bring him to a stop. Later on you can improve this to "whoa drop" to make the dog drop in his tracks and lie still.

Retrieving is a special art. Many dogs are natural retrievers and pick it up through play, or by being worked with other dogs. Even these, Asmus declares, should be force trained. A natural retriever enjoys his work but does it the way he wishes. Training makes him work more surely.

"A six-inch length of broomstick makes a good object to start with in teaching the dog to hold," Asmus says. "Make him sit and hold the stick, called a buck, in his mouth. Command 'fetch' every time you put it in his mouth. Force him to hold it until you take it away with the command 'give.' After he learns to do this, hold the buck in your hand in front of his face, command 'fetch,' and

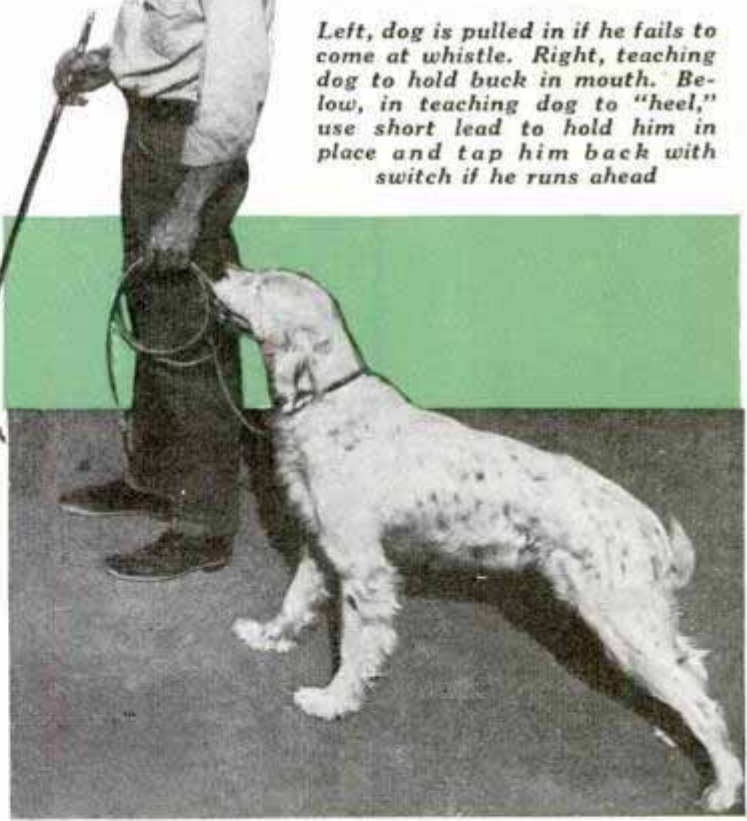

Left, dog is pulled in if he fails to come at whistle. Right, teaching dog to hold buck in mouth. Below, in teaching dog to "heel," use short lead to hold him in place and tap him back with switch if he runs ahead

pinch his ear. Pinching his ear or using some other kind of force makes him open his mouth and take the buck. When the dog learns to take the buck from your hand at command, you are ready for the next step. This time he is to take the buck from

(Continued to page 128A)

Floating Garage for Planes Is Launched by U. S. Navy



Sliding down the ways is United States navy's latest seaplane tender equipped with supplies and tools for emergency repairs

Christened the U.S.S. "Albemarle," after Albemarle Sound, N. C., scene of pioneer aviation experiments, the navy's newest seaplane tender was launched recently at Camden, N. J. Described by the navy as a "floating garage," the ship has quarters for the officers and personnel and will carry supplies as well as tools and machinery for making repairs.

Electric Release Spaces Bombs According to Ground Speed

Giving a series of electrical impulses at a predetermined spacing, a robot bombardier automatically releases bombs in any desired number and at any interval. Just invented, the machine takes into account the ground speed of the airplane, and it is connected simply by plugs so that it can be removed from one plane and installed in another. The time control is by motor, which is connected to a dial indicating the intervals between bombs on a series of concentric circles corresponding

to different ground speeds. The aviator adjusts the motor until the hand points to the desired interval for dropping bombs at the correct ground speed. Then he sets another dial for the number of bombs. Another instrument patented recently by a Czecho-Slovakian inventor measures the speed of an approaching airplane. The observer sights through the instrument, counts the seconds elapsing while the plane passes between two points on a horizontal index; then the observer plots the altitude—found by another instrument—on the dial and reads the plane's speed.

Tabletop Grill Has Drawer for Broiling Steaks

Two electric grills just offered will cook an entire meal on the dining table. One has interlocking switches that throw up to 1,100 watts into either burner on "high," with proportionate reductions in other positions; there is a hinged removable griddle for grilling, and a broiler drawer accommodating half chickens.



Upper unit has hinged griddle and broiler drawer, lower, a removable pan for broiling

New York Shipbuilding Yards
Scene Service 7/31/46

Orange 1995
over 1.00
Quartzbaugh

Everhot - 10.25

Seller Magnograph Co. 66 38 Santa Monica Blvd

Talking Tape Records Sixteen Sounds in Plane

Hollywood, Calif. Planelet.

Right, new device records plane vibrations and observer's voice simultaneously. Below, the recording and control mechanism. Bottom, four typists, or more, can work from same machine at the same time

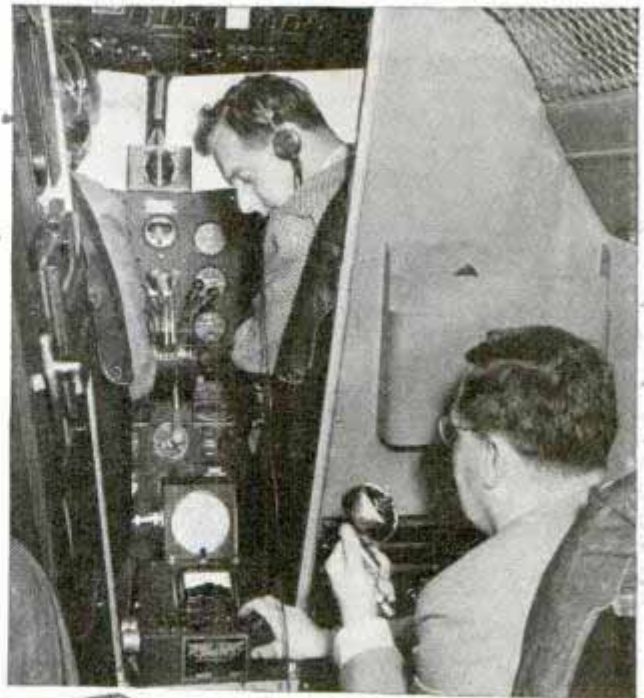

recording as it does before. There is merely a magnetic field on the tape and this field reproduces the voice or other sound. The machine will record the vibration and noise itself, from which flutter is detected. Alternating or direct current may be used. The message may be played right back, no processing being required as in the case of a film recorder. The control unit has a button for each sound track on the tape and the pilot simply presses as many buttons as there are separate sounds he wishes to record at the same time. If a large plane is tested, sixteen observers may talk into the machine



Capable of recording sixteen different voices or vibrations at the same time, a "talking" tape machine is expected to simplify and reduce the cost of testing new airplanes. It is particularly useful in one-place planes which have no room for observer or flight test engineer, thus leaving it to the pilot to record all instrument readings and test the plane himself. The quarter-inch steel tape looks the same after the

steadily for one hour, telling what they notice about the craft's performance, and the single filling of tape will record 192,000 words. The "talking" tape machine also is expected to find wide usage in business offices as a new means of handling dictation. On a four-track recorder, for instance, four stenographers could take four separate messages or letters simultaneously from the same tape.

Kalsman Instrument Co. 45th Ave 711

K 601.

TRAPPERS of the

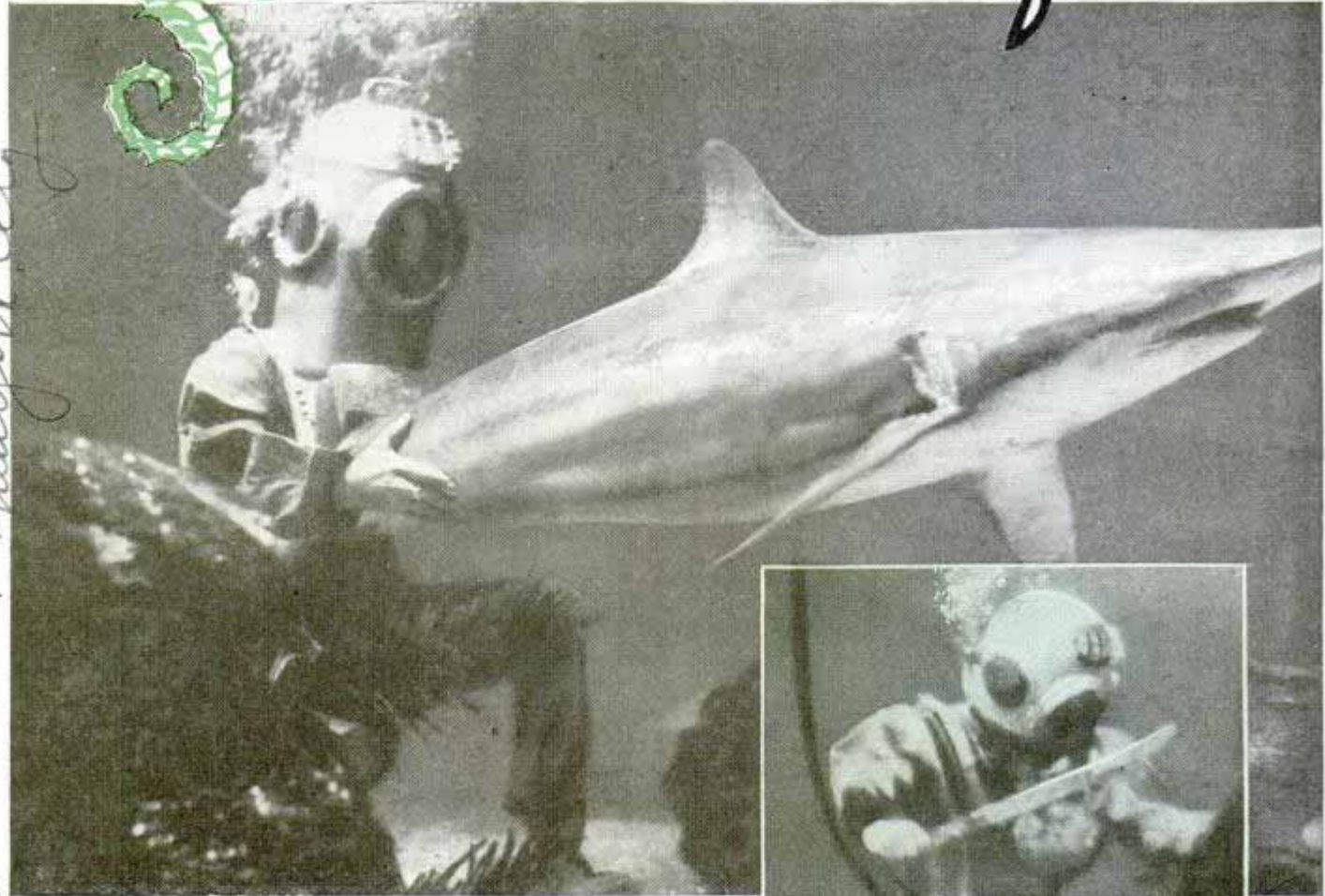

Ultraviolet rays some day may protect divers from sharks (top); probing rocks for lurking sea monsters (center); diver keeping air line from fouling (bottom)

EXPLORERS and scientists have risked their lives in rubber diving suits and cumbersome metal apparatus, in diving bells and other submersible chambers, yet the world beneath the ocean's surface still remains the Great Unknown. Hampered by the apparatus necessary to sustain life under water, the deep-sea explorer until recently was under a tremendous disadvantage in observing marine life, receiving only an occasional clue to the many varieties of creatures that remain unclassified.

When Dr. William Beebe and Otis Barton made their daring descent in the bathysphere a few years ago, they glimpsed indistinctly through its quartz window fish and other large creatures of species entirely unknown. Their glimpses lasted but a short time. Only those compelled by curiosity remained close enough to be observed. Other scientists have had less luck because they could not pursue the finny creatures in their native element.

Pondering this problem, Vincent Palmer, a young scientist, a friend and associate of Dr. Beebe, Max Nohl, Capt. John Craig and other undersea explorers, evolved a

Cont. Emile C. Schumacher, 108 E 66 St. New York City

Columbia Broadcasting

K601

DEEP

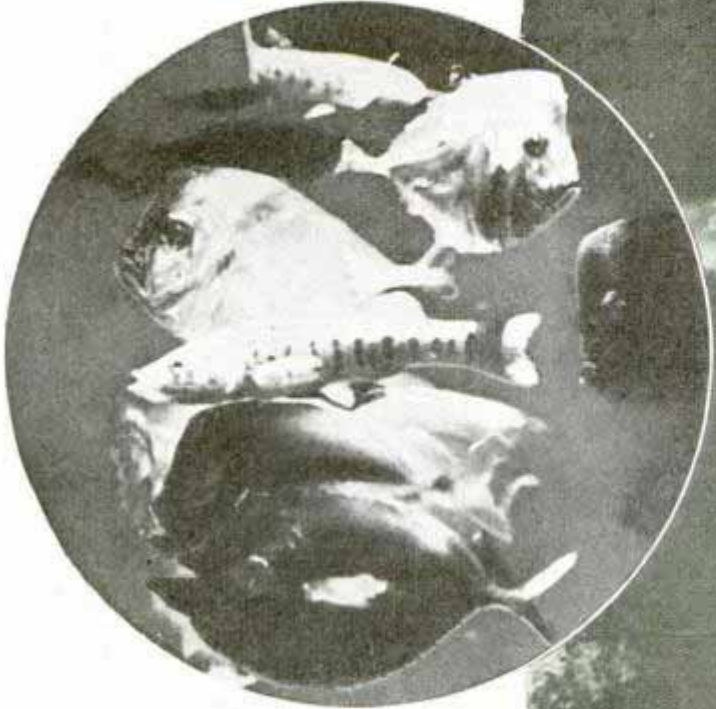

novel theory. Since physical conditions made it impossible for the under-sea explorer to pursue his quarry, that quarry must be lured to him.

On an expedition with Dr. Beebe, he had seen fish attracted by a fluorescent light. Light, he decided, might be the means of trapping the elusive creatures since they displayed positive phototropism—they responded like moths to light. Experimenting with various types of lights, he discovered that when he used an ultraviolet ray, it produced a strange and, in some cases, deadly effect upon fish.

"The fish become fascinated by it," he said. "It literally hypnotizes them as they enter its rays. Brilliant lights attract them from the distance just as blood does a shark. At first there will be a few fish swimming toward the beam, then more and

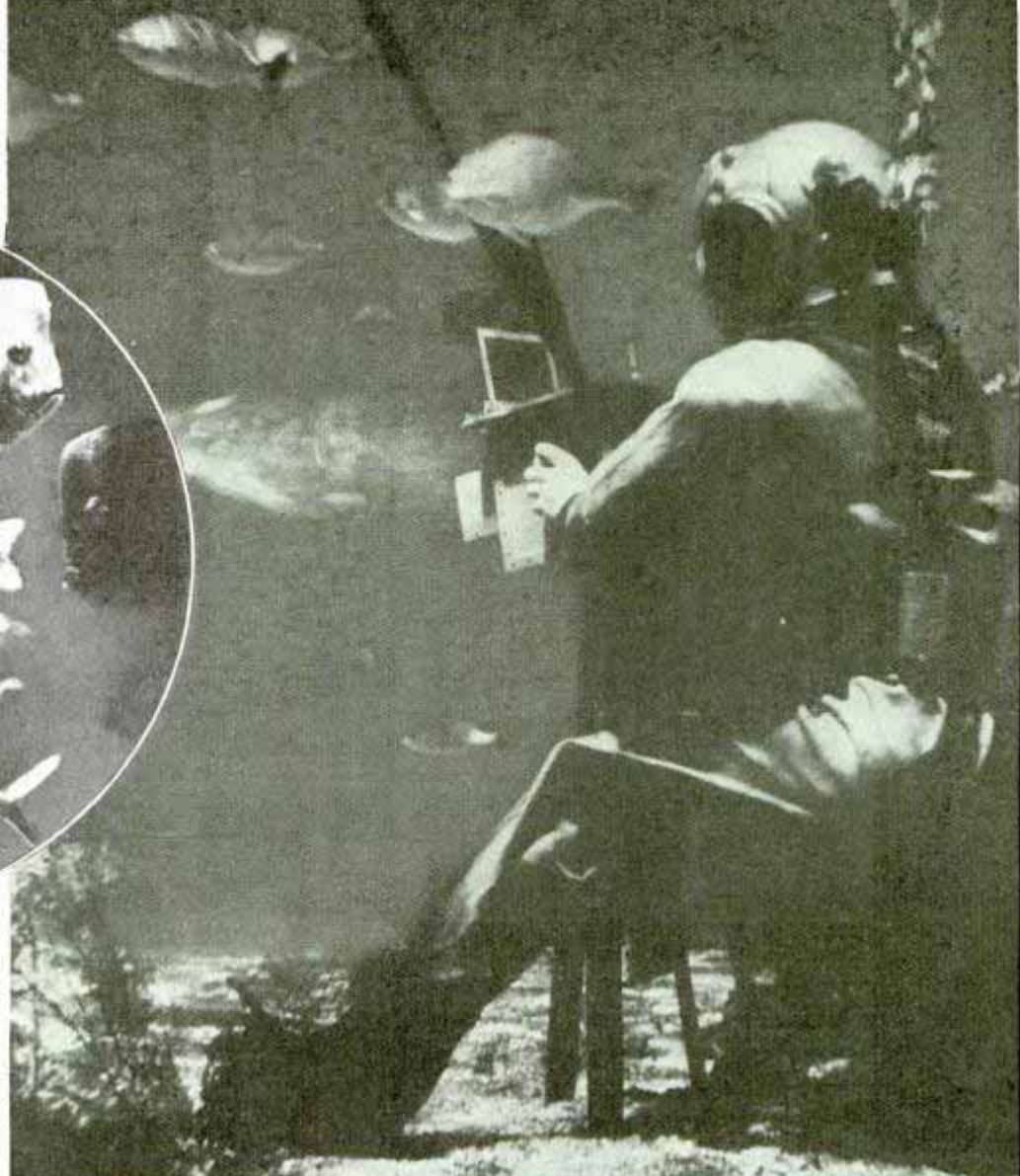

Circle, small creatures held in light beam. Top, taking pictures after fish have been lured into range by "death ray." Bottom, preliminary dive to look over bottom before setting up light apparatus and camera



more until there appears to be a whole mass of fish held prisoners within the bounds of the beam."

Palmer used a fluorescent light which projected ultraviolet rays through optical quartz lenses. For this purpose he employed an arc light with very high voltage projecting a beam from twelve to fifteen feet in length, at which distance it is approximately three feet wide.

"The ultraviolet rays, invisible to the human eye, have a toxic effect on the small organisms," said Palmer. "They swim in circles, often rolling over and over as if intoxicated. They seem unable to leave the beam. Shortly they turn belly up and float to the surface. Even larger fish find difficulty in leaving the beam. Their resistance appears to be lowered and they do not seek to escape even when a net is being passed around them."

Once Palmer descended with the light and a motion-picture camera to photograph some small fish. With painstaking care he rigged up the light and set up the camera on its tripod.

Switching on the light, he waited for a few minutes until the small fish were attracted and began to circle in the ultraviolet rays. Suddenly a huge shape flashed through the water, upsetting the camera and sending him sprawling. It attempted to swallow the light.

"It was a porpoise," Palmer said ruefully. "It thought the light was something good to eat. Before it found out differently the light was demolished and I had to build another. This time I made one less tempting in appearance."

On another occasion Palmer was wading out in shallow water with his equipment when a long snakelike arm whipped out of a dark recess. It was the tentacle of a large octopus. Then another and another tentacle slid around him.

"There was no use in fighting," he said. "I knew that an octopus possesses a great deal of curiosity and I was hoping for the best. Slowly the tentacles passed over and around my body as I stood stock still, scarcely daring to breathe. Then it explored the camera, feeling it over carefully. After what seemed an eternity, the tentacles relaxed and then withdrew.

Evidently deciding that I meant no harm, the octopus disappeared.

Palmer uses two different methods in op-

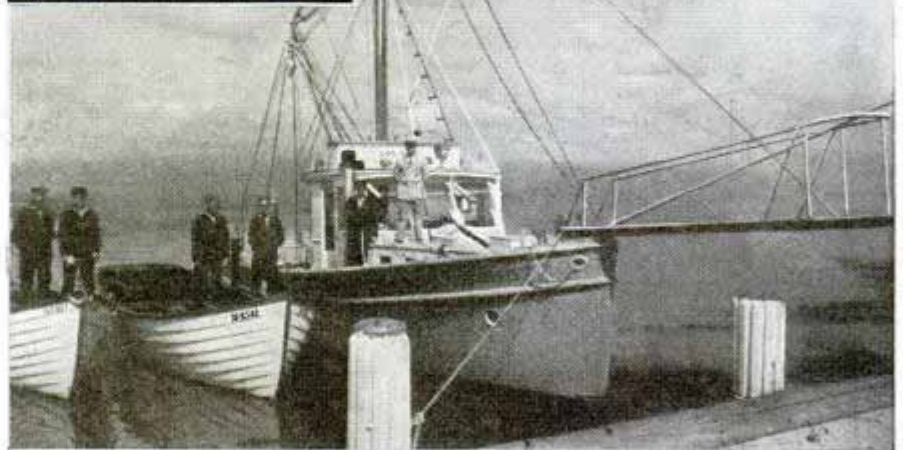
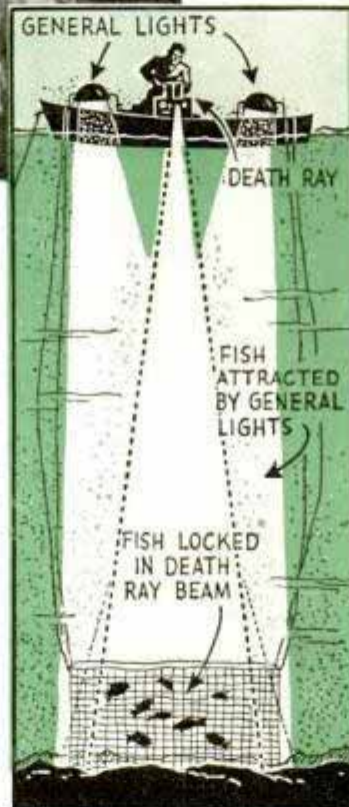

Top, directing "death ray" downward in trapping from surface. Center, how ray is used in surface work. Bottom, crew at Marineland, Fla., where Palmer has worked with his ultraviolet light apparatus



erating his underwater "death ray." The simpler one is from the surface. First a net is lowered to a pre-determined distance. Then two strong lights are turned on, their beams shooting downward from the surface craft. Between these lights, also pointing downward, the ultraviolet death ray is turned on. Then as the fish are held powerless in its beam, the net is raised, imprisoning them and hauling them to the surface.

The second method Palmer uses when exploring beneath the sea or making still or motion pictures. With the aid of his ultraviolet light he is able to film fish in their native element before they succumb to the effects of the ray. In this operation, the ultraviolet light is encased in a small "diving suit" of its own, a device which presented several problems which he had to work out. One was building up sufficient air pressure so that the light would not be crushed like an eggshell when operated at depth. Another was efficient functioning in its diving suit, since the light is

(Continued to page 140A)



Left, preparing to set up equipment under water. Right, top, curious porpoises look over the camera. Center, one big fellow upsets camera. Bottom, setting up the photographic equipment under difficult circumstances

Folding Crate to Carry Dog Packs into Small Space



Folded dog crate, left, is carried by its suitcase handle; right, it opens into roomy carrier for dog

Folding into a flat package with suitcase handle for carrying, a crate for carting or shipping dogs is a convenience to dog-show exhibitors and pet owners living in apartments. Screen windows at both sides provide cross ventilation, and positive-acting locks assure rigidity of the crate when unfolded. Weighing only eight pounds, it is made of composition board and covered with imitation leather.

Water Purifier for the Home Fits on Kitchen Wall

Attachable to any water faucet without special plumbing connections, a water purifier

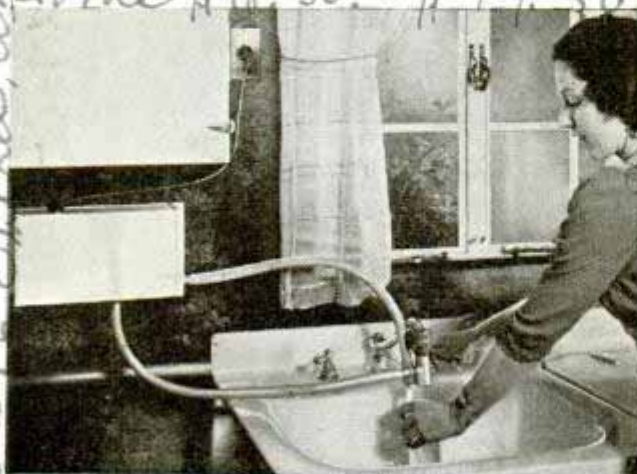

No special plumbing connections are needed for this ozonizer, which "sweetens" water at little cost

ifier for home use can be installed on the wall over the kitchen sink, plugging into the nearest electric outlet. This ozonizer eliminates objectionable tastes and odors in the water, giving it a clear, sparkling appearance, and destroys some types of bacteria. When the water is running it uses eighteen watts, treating two gallons of water a minute.

Ball-Bearing Washer for Faucet Reduces Wear and Friction

Rotating on a ball bearing, instead of grinding against the faucet seat, a newly developed washer is claimed to last longer. With finger-tip pressure on the valve, the washer cuts off water instantly, eliminating drip.



Filter in Bowl of Smoking Pipe Stops Small Ash Particles



Smoking-pipe filter fits easily into bowl. Inset shows its position when properly installed in pipe

Made of stainless steel that will not rust, a smoking-pipe filter is designed to keep small particles of tobacco and ashes from being drawn through the stem and into the smoker's mouth. It consists of a coiled wire suspended in the bowl, which is claimed to give a cooler smoke and prevent wet waste tobacco infused with nicotine from accumulating in the bowl.

K 70
 Selma
 G. Crate Co
 Fayetteville, Ala
 Fold
 Automatic Electrical Service
 -Co. 3249
 Shrid, Arkansas
 K 665
 \$18.50
 \$49.50
 \$15.00
 Patent
 306
 Modifiers
 are

Battle Creek, Mich
 K 764
 K 765
 150
 Milwaukee

Test Seat Finds Comfort for Average Driver

Average driving comfort for motorists has been determined with the use of an intricate test seat designed by engineers of University of Michigan. The cushion, seat back and floor-and-toeboard can be moved up or down, forward or back, or tilted at various angles to suit the comfort of any individual. With the subject seated, coil springs in the cushion and back are adjusted individually by levers. When the subject is satisfied that he is most comfortable, a photographic record is made of scales which indicate weight distribution, spring tension and other statistics relating to the test. In 250 such tests the average age of the subjects was 38.5 years, average weight 149.7 pounds, and height five feet

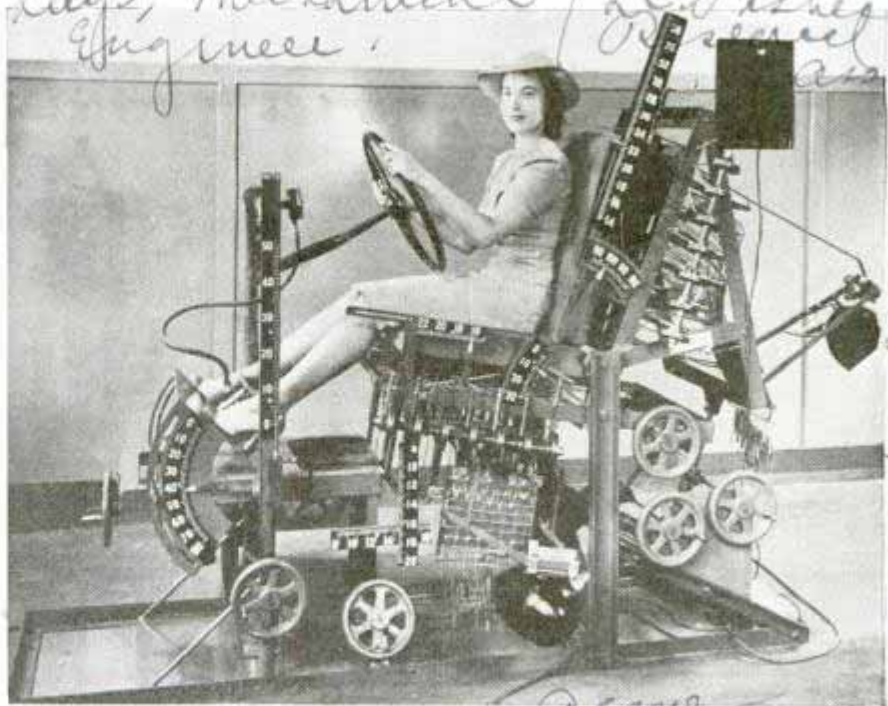

Hedged about with scales, wheels and levers, this robot comfort-testing chair helps find the most satisfactory auto seat for average motorist

and 7.4 inches. This new method of determining seat and back-cushion comfort in cars is expected to aid in attaining a design comfortable to the majority of motorists.

'Shivering' of Giant Rotor Cured by Letting It Sag Evenly

Engineers found a simple cure for the shivering action set up by a huge rotor when it reached a speed of 3,600 revolutions per minute. The cause was traced to

longitudinal grooves which were cut on two sides of the rotor to permit the insertion of the windings. Each time these grooves were in top and bottom positions the rotor would sag, which happened twice for each revolution. Instead of trying to stiffen the rotor, it was decided to make it sag evenly throughout its revolution. This was accomplished by cutting crosswise slots in the solid portions of the rotor, between the grooved regions, thus giving it the desired flexibility.

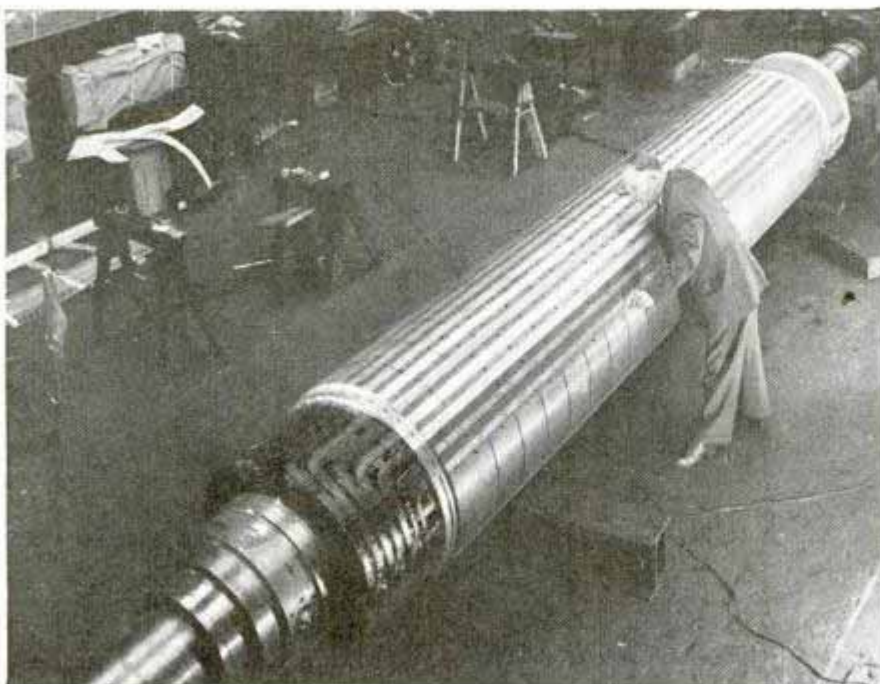

It looks straight enough here, but this rotor sags about 15/1,000 inch. Crosswise slots in solid portion permit constant sag while it is running

K 986. Ann Arbor, Mich. says, mechanical Engineer. Murray Carrougher of Amesbury 700 Adams St. West. K 997. Westinghouse. S. M. Kallio. 204 1/2 E. 1st St. S. P. 1940.

K 670
 Cont. Marshall Perham, 1128 Stearns Drive
 Los Angeles, Calif.

WHEN MEN *Build* MOUNTAINS

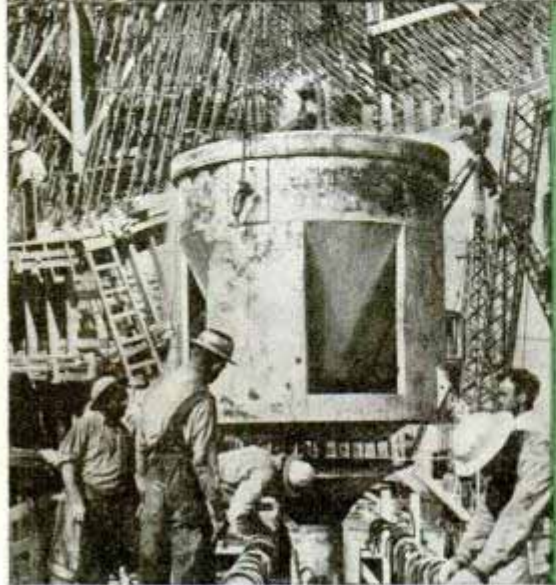

*Dumpler
 Kocher Co
 1940's*
 With mighty machines of his own making, man is building mountains to control flood waters in southern California, where the adobe soil fails to sustain usual type dams. Of a dozen to be built, Hansen dam is the greatest to date, requiring 14,000,000 cubic yards of earth, divided by a concrete spillway. Top photo, derrick lifting tractor over fill; center, "scuttle" dump truck. Note arrangement of tires for extra power on hills. Bottom, left, placing concrete from huge bucket amid forest of reinforcing steel; right, this apparatus scoops up and dumps six cubic yards at a time into giant truck

Sterling Motor Truck Co.

Carlinghouse Bros
2416 E. 16th St
Los Angeles
Calif

K 6 70

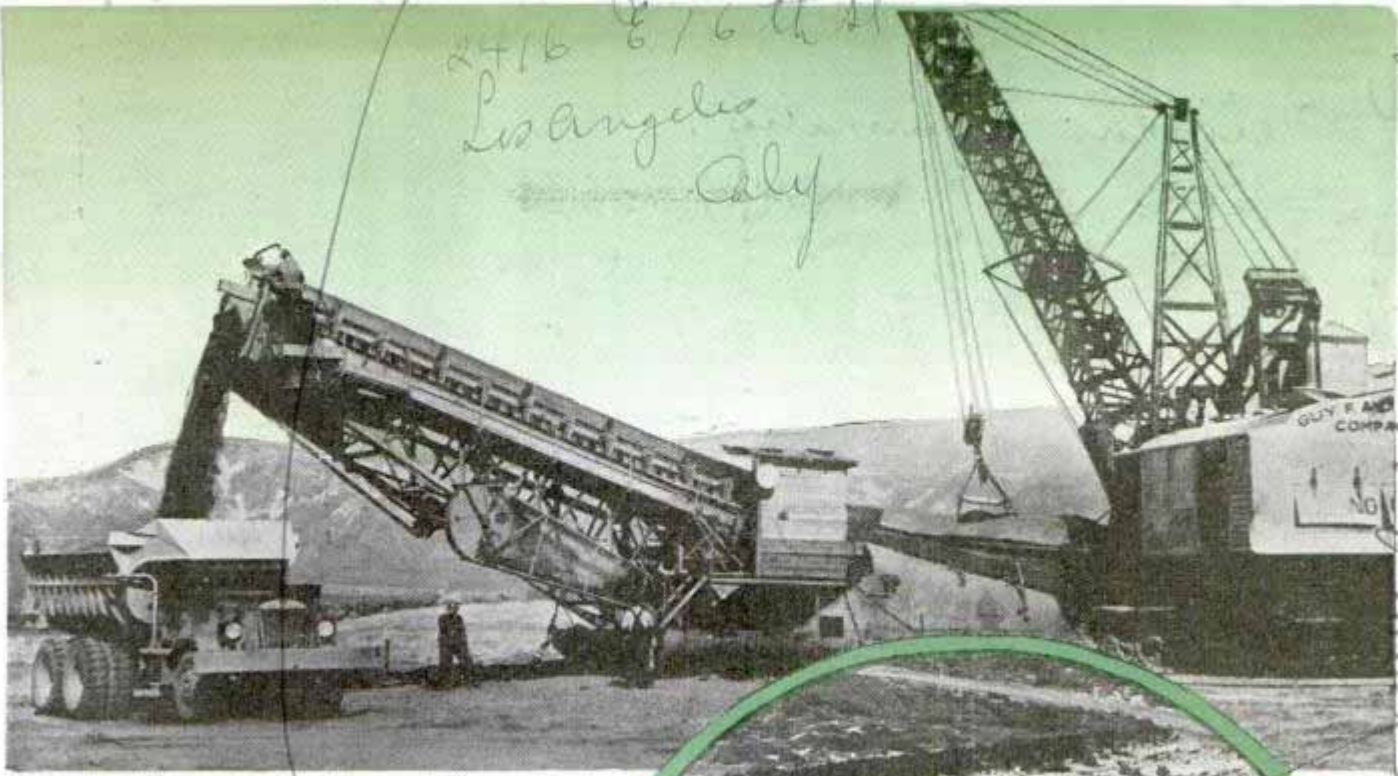

Patented by the Carlinghouse Bros, Los Angeles, Calif.

Top, called a "dragveyor," this monster pours a steady stream of earth into truck by means of a conveyor belt, a power shovel and drag line keeping supply going. Circle, gigantic scraper, coupled to a 160-horsepower Diesel engine on two wheels, picks up twenty-five cubic yards with ease. This revolutionary earth mover, known as a Tournapull, can do the work of 300 horse-drawn wagons like the one shown at right in the picture

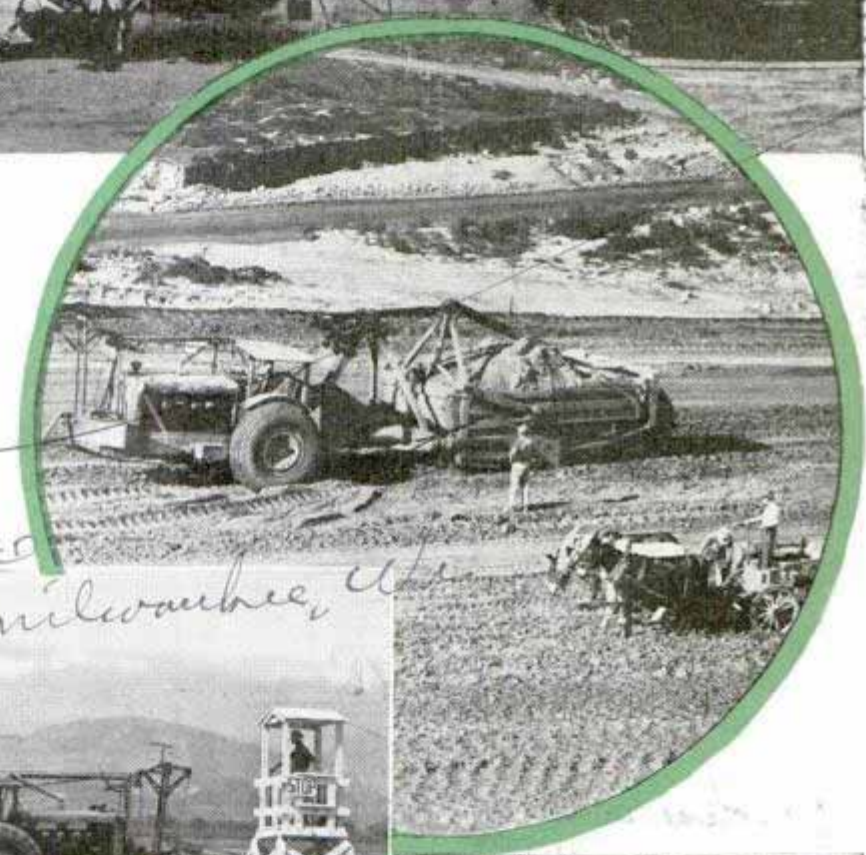

Panayus Eric
South Milwaukee, Wis



Officer in signal tower, above, directs traffic at crossing to prevent other vehicles from being run down by speeding Tournapull which travels forty miles per hour on level ground. Right, tractors at front and rear help load Tournapull; rear tractor's function is obvious from its name, "billygoat"

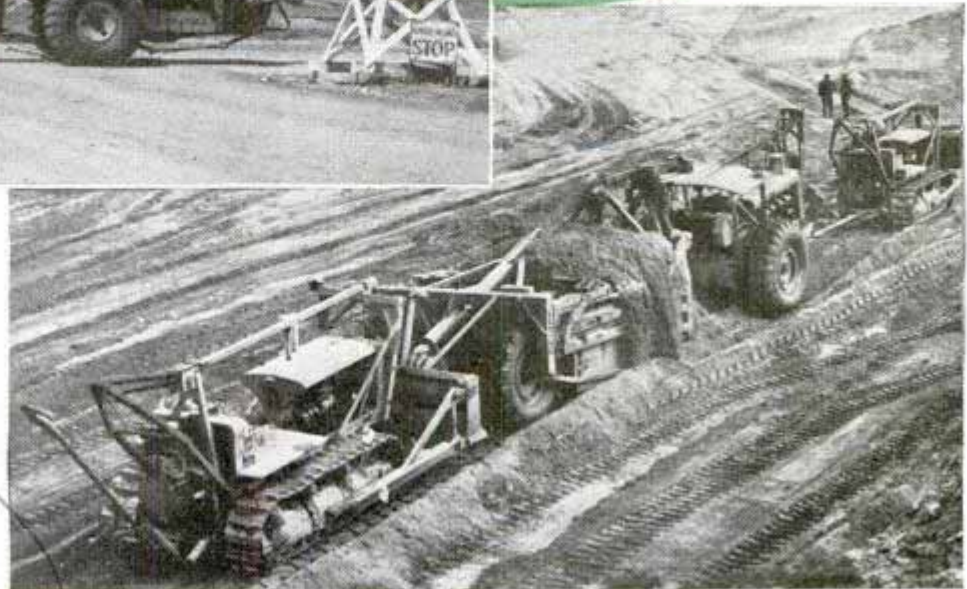

Caterpillar Tractor Co

Target-Range Machine Gun Uses Air-Rifle Shot

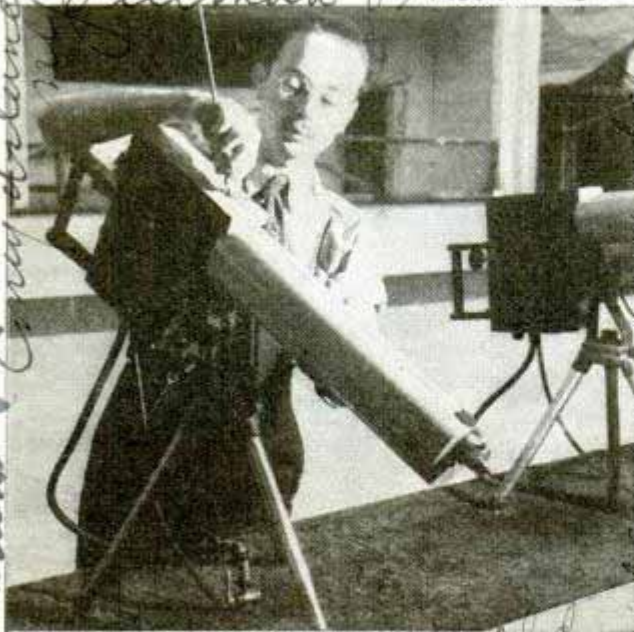

These air-pressure machine guns in a Coney Island shooting gallery fire at toy planes and parachutists

Clay pigeons have been outmoded by toy parachutists and tiny airplanes at Coney Island's new shooting gallery where a machine gun has replaced repeating rifles. Air-rifle shots instead of real bullets are fired by air pressure, and the gun keeps firing until the trigger is released. One loading consists of a hundred shots.

Tools for Marking Tires or Wood Have Movable Letters

Branding irons are used by operators of large truck fleets to mark the tires for identification, and to facilitate records of

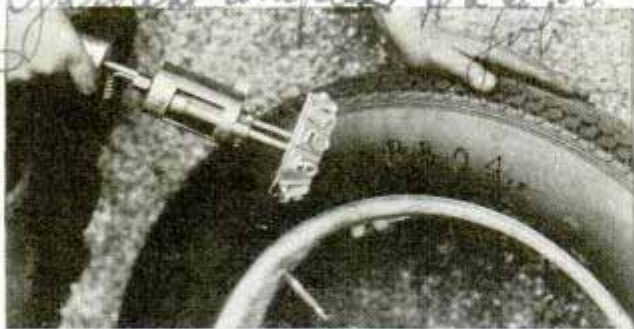

Above is the gasoline-burning tool branding a tire; below, the electrically heated marker

Sierra Nevada Calif
tire mileage. The irons have interchangeable letters and numbers, which are heated in one unit by a gasoline burner and in another by plugging in an electric heating element. The branding irons can be used also for marking lumber, crates, barrels, tool handles, etc.

Flashlight Bulb Extension Rod Can Bend around Corners

Light from a flashlight can be spotted closely in hard-to-get-at places with an extension arm capable of bending and small enough to enter openings seven-sixteenths inch diameter and other places a flashlight cannot reach. Made of special wire encased in aluminum alloy tubing,

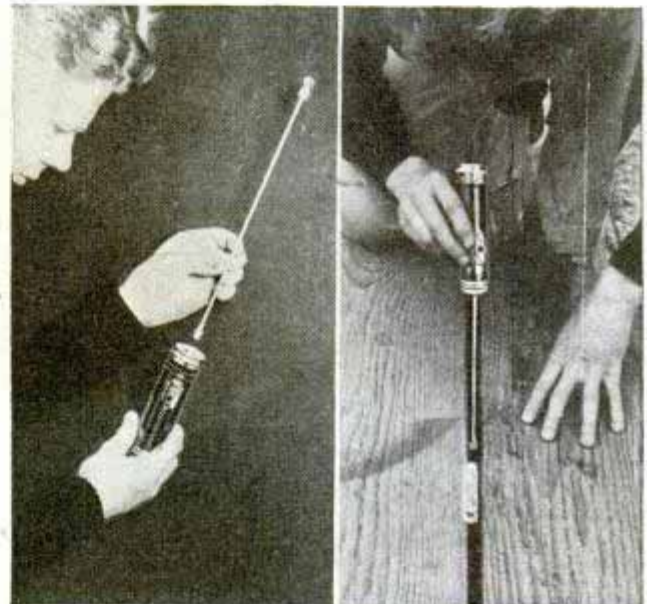

Screwed into the flashlight socket, the extension lamp lights up work at inaccessible spots

the extension has a flashlight plug at one end and a socket for the bulb at the other. Around the house it is handy for locating lost articles and for making repairs, while for mechanics it has unlimited uses such as inspecting gears, lathe bores, inside of molds, automotive engines, brakes, and all sorts of intricate mechanism.

K 800
 K 769
 K 799
 Everhot Mfg Co. Maywood, Ill.
 Deltona
 machine gun
 gas
 electric
 35.00
 gas
 \$26.00
 to 1056076

1870 American Optical Co. 3/15 W. 5th St. Los Angeles, Calif.

Machine Exercises Eyes to Correct Defects

Certain weaknesses of the eyes can be treated with an electric machine just developed. The patient looks into a darkened field in which moving prisms give flashing lights the effect of motion. As the eyes follow these flashes, the optical muscles obtain healthful exercise.

M.C.
P1



At the right is the "gymnasium" for the eyes. By following moving lights in its darkened field the eye muscles are strengthened and certain weaknesses may be corrected

1809

Mirror over Bowling Alley Helps Player Detect Faults

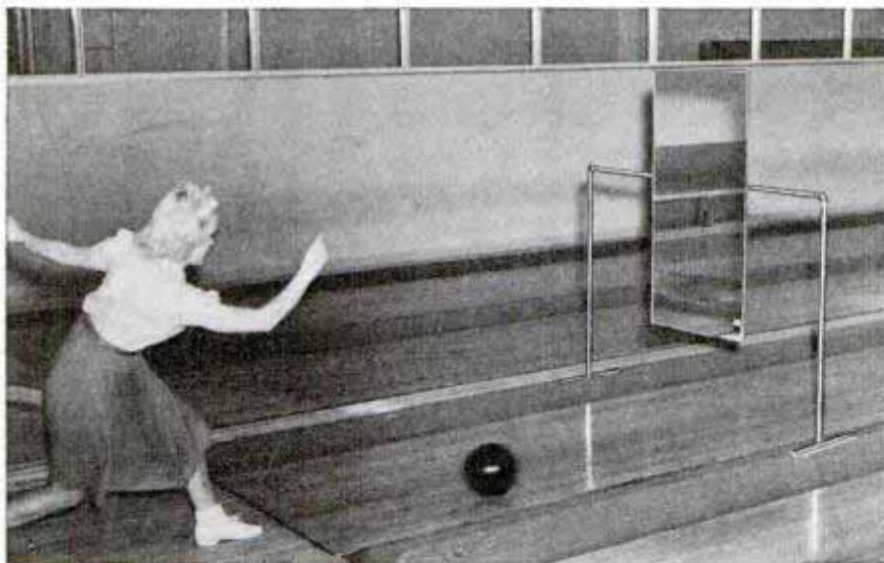

Bowlers are aided in improving their scores by a mirror suspended eight to ten feet from the foul line. This is the approximate spot where the player's eyes should be focused, so when he delivers the ball it is possible for him to study his own form and try to correct any faults he sees.

Mounted above alley at the point where bowler's eyes should be focused, the mirror reflects player's form

1811

Armored Mobile Sound Studio Makes War Records for Broadcast

Housed in an armored truck, a sound-recording unit designed to operate in the war zone under severe conditions has been tested by the Canadian armed forces. The traveling studio is equipped to record activities of the Canadian troops at the front for later broadcast by short-wave radio to Canada. A crew of five, with an engineer in charge, operates the truck.

Canadian activities at front are recorded by this truck for broadcast by radio to the folks at home



Canadian Broadcasting Corp.

*1810 American Optical Co. 3/15 W. 5th St. Los Angeles, Calif.
Cant. James Montague Ryan and Hatch
517 Harbor Commission Bldg. Toronto 2 and Canada*

FOILING *the* GOLD

Cont. May well be a diamond, 946 ounce
 Dec. Los Angeles Call



moned into the laboratory. "This stuff ran so high I could hardly believe it," said the assayer. "Take a look."

"YES, sirree!" nodded the bewhiskered prospector, sizing up the prosperous stranger. "This gravel runs plenty high in gold. I wouldn't sell this claim if I didn't need money right away. Here, pan a little and see for yourself."

He dumped a shovelful into a gold pan, scooped up a little water, and handed the pan to the visitor, who swirled it rapidly, washing the coarse material out. Fat yellow specks gleamed from the concentrate in the bottom.

"Looks like gold," agreed the stranger. "I'll buy your claim if it runs high enough to pay—but you'll have to let me take a sample for assay."

"Sure thing," the prospector assented. He shoveled together a pile of gravel, divided it into quarters, then discarded two of them. The balance he heaped up and quartered again, repeating the mixing and quartering until finally the stranger took away a paper bag full of the remainder.

When he called at his assayer's for the report, he was sum-

He dropped a tiny pinch of gold dust onto a glass slide and slipped it under a microscope. The other peered, saw the tiny grains magnified to the size of boulders. But unlike boulders, they were jagged. Across many of them ran deep scratches.

"Did you ever see any square-cornered gold dust from a river bed?" demand-



Slicing thin section of rock on diamond-studded wheel. Top, examining ore under petrographic microscope to study the appearance of individual grains and, right, gold dust being rolled in cigarette

SWINDLERS



ed the assayer. Placer gold rolls among the pebbles as it is carried downstream and soon gets rounded and smoothed. Notice those file marks. Somebody must have improved this sample with a little gold dust—from a watch case or a ring, probably.”

The miner grew indignant when



Top, photographing spot where samples have been taken, a safeguard against salting. Center, false rivet in shovel handle allows gold dust to drop into gravel. Bottom, needling gold solution into sample bag

accused of trying to salt his claim, but the prospective buyer suddenly grabbed the shovel used in quartering the sample. He examined it and learned the miner's secret. When turned a certain direction, the hollow handle lined up two holes to release the hidden gold dust it contained—"sweetening" the sample to bonanza richness.

Thirty-five-dollar gold has made suckers even more eager than in the old days—but modern laboratory magic

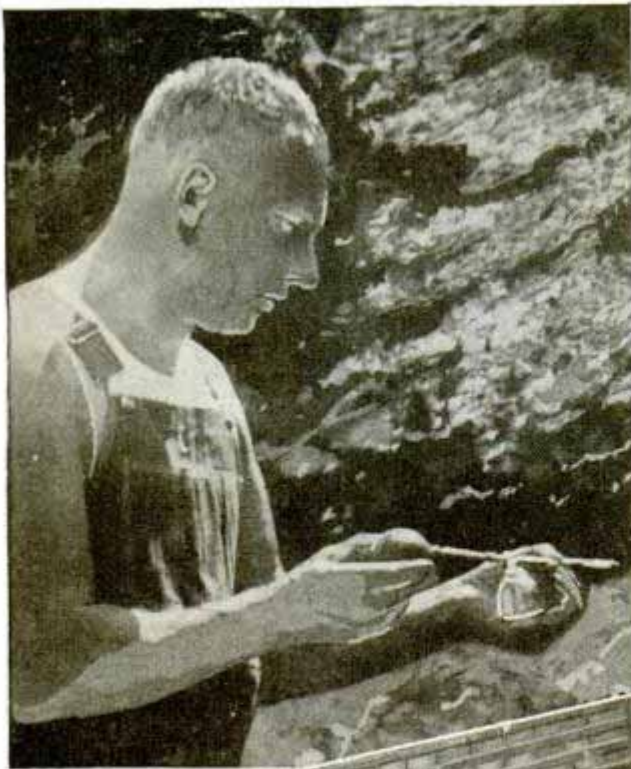

milligrams or so of gold, enough to make the assay show sensational values. But again the microscope betrays the true character of the grains. If polished from rolling in a stream bed, they would be out of place in a hard-rock mine where the ore must be picked or blasted from solid quartz.

Modern "snapshot" assaying quickly gives so clear a picture of an unknown rock's composition, that it's foolish to guess. The old time-tried fire assay method still is standard for measuring the exact amount of gold or silver in a specimen—but often the unknown piece of rock has small amounts of impurities which give strong hints as to its origin. It's easy enough, now, to determine all the minerals

present in a sample without the long series of intricate chemical tests that used to require many days.

Just pulverize the chunk with mortar and pestle; mix well, then put a pinch about the size of a pea into the spectrographic arc. The arc flares out to



now gives them a better break. During the early gold rushes, the sound of a shotgun often meant that salters were firing gold-laden cartridges at the face of a drift where samples were to be taken. Today, a look with the petrographic microscope would quickly show the assayer how the gold particles had been flattened against the rock by the blast, like falling raindrops. And a spectrographic examination of the sample might even reveal remnants of the powder used in the shell.

Carelessly flicking the ash from his cigarette as he picked off chunks of ore, an old-time salter could easily load the samples with gold dust. An ordinary, roll-your-own cigarette can be loaded with 200



Top, spraying gold solution onto rock to salt sample. Center, assayer tagging pans containing parts of samples which have been assayed. Bottom, hole down center of this drilling bit lets gold dust fall out

make a snapshot upon a strip of movie film. When the assayer puts it side by side with a master film, he can call the roll of the metals simply by comparing black bars on the negative. A machine like that costs \$3,000, but the assayer can give you a complete, all-mineral assay, sensitive to one part in 100,000. That's a quick but accurate way of sizing up suspicious-looking assays and is well worth while because it may reveal unsuspected rare minerals overlooked in the conventional assay.

Gold, wherever you find it, looks much the same to the eye—but not to the spectrograph. Perhaps a rare element, one part in 50,000, may show up in a specimen; but if some samples from a mine betray the rare "impurity" while others do not, you had better take a fresh batch of samples.

When promoters tried to interest a wealthy man in a mercury mine, they produced samples which by ordinary methods showed plenty of mercury. But the buyer, equally shrewd, brought the sample into the laboratory. The spectrograph showed the mercury to be mercuric chloride—better known as ordinary drug-store calomel.

Precision instruments for scientific ore analysis now make every piece of rock reveal individual earmarks. Two ores may assay exactly the same in gold, yet they may be put together differently. If a question arises, the assayer can saw a thin section of rock, cement it to a rotating, lathe-like affair, and grind it down thinner than paper. Under a petrographic microscope and illuminated by a strong light from beneath, it becomes quite transparent. The smallest grains of metal stand out clearly in their "matrix" of common rock. Hardly any two ores look alike under this test, and a rock tossed in by the salter stands out clearly.

Much information can be read from the way individual grains look. An expert at reading the life story of a grain of gold by eagle-eyed microscopic study knows that big, rough particles probably didn't travel far from the original lode. Small, well-rounded grains, on the other hand, have been battered over many a pebble. If the two are mixed, it may mean that the mine has two dissimilar veins furnishing gold—or it may mean salting.

The fineness or purity of gold is another guiding point. Natural gold runs from fifty to ninety-nine per cent pure, and if two samples, supposedly from the same mine,

(Continued to page 126A)

Lead Strip to Balance Wheel Is Hidden in Metal Ring

Balancing auto wheel by inserting length of rubber-covered lead strip at proper spot in metal trim ring

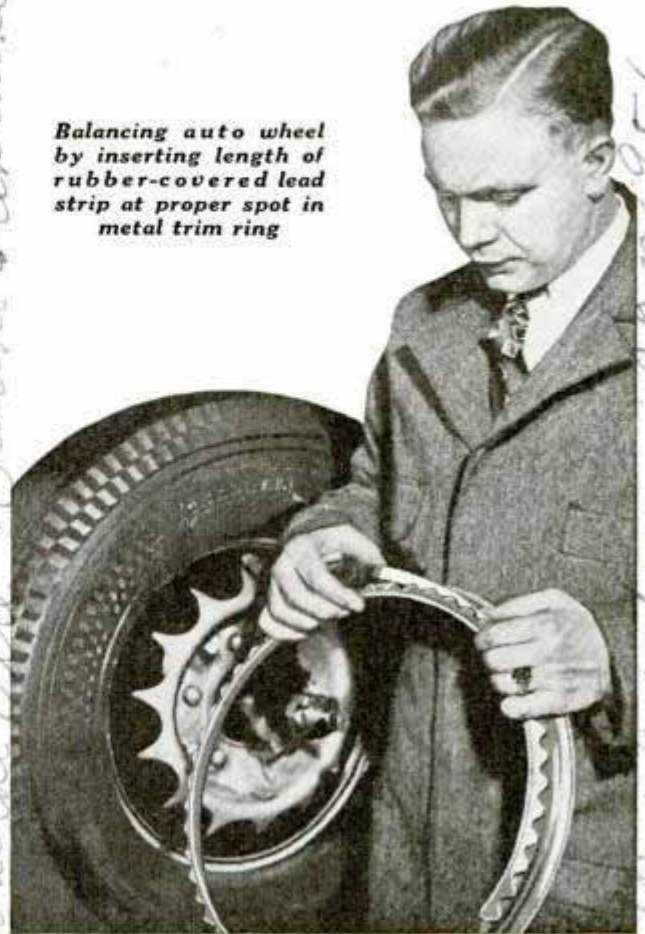

Rubber-covered lead strips are employed for balancing automobile wheels in a system just introduced. Supplied to the automotive trade in continuous strips wound on a steel reel and marked in one-ounce lengths, the strips can be cut off easily to the exact length needed for proper balance, and then inserted in the metal trim rings with which most de luxe cars are equipped. Thus concealed they do not detract from the car's appearance and are just as efficient as when attached to the rim of the wheel itself.

Pill Box Snaps Open at a Touch

No more fingernails need be broken trying to pry open the little tin pill boxes in which such medicinal tablets as aspirin are sold. A new style pill box snaps open when you press the back of the lid.



Single-Wheel Roller Skate Useful on Rough Surface



These roller skates for the rural dweller are provided with stirrups and leg braces

Roller skating is made practical for people who live where there are no sidewalks or paved roads by the invention of "land" skates which are designed for use in the country. Each skate has a single large wheel and a stirrup in which the skater places his foot. Additional support is provided by a leg brace.

Indicator Showing Ground Speed Aids Pilot Flying Blind

Secret development of an instrument that shows the exact ground speed of an airplane promises to be a great aid to navigation in thick weather. Independent of winds and drift, the pilot would know at all times how fast he is covering ground and could figure his position and arrival

time accurately without the intricate calculations now necessary. A bombing plane could take off in dense fog, and with knowledge of the ground speed could drop bombs when the instrument indicated the objective had been reached. A U. S. army officer invented the device. Little is known except that it operates on the electric induction from the earth's magnetic field and thus far has shown ground speeds accurately up to 300 miles an hour. It is reported that the instrument can be applied to a map so that a needle would travel over the map and show the position of the plane constantly. It may be used on boats as well as aircraft.

Car with a Two-Pedal Drive Is Operated by One Foot

Necessity again proved the mother of invention when a Chrysler automobile executive suffered a broken leg, and, to drive his car, had the clutch pedal removed. The clutch and brake were made integral so far as initial operation was concerned. Press-



Top, brake pedal releases clutch and operates brake; below, button on gearshift lever operates clutch

ing on the conventional brake pedal released the clutch and operated the brake in the usual manner. Thus one foot could do all the work, operating clutch and brake with one pedal and the accelerator with the other. In another Chrysler built for one-foot driving, the foot-operated clutch was eliminated and a vacuum-control button installed on the gearshift lever to disengage the clutch at a touch.

4653

Self-Service Roadside Stand Sells Honey to Motorists

Finding that he had tons of honey on hand without a market for it, a bee raiser in Minnesota erected a roadside stand where customers may help themselves, placing their money in an open earthen pot. This "honeyteria" brings in about \$100 a month during the late summer and fall. Loss by theft averages less than three per cent. Tourists slow up when they see live bees flying through a hole in a signboard with a beehive painted in front. Upon examination they find there is a real hive set flush against the back of the board, but before they have a chance to pick up speed, the honeyteria comes into view.

Iver C. Anderson
Lake Benton
Minn



Attracted by a roadside beehive, a tourist stops to make a purchase on the "honor system"

Three-Seat Twin Bicycle Is Motor-Driven

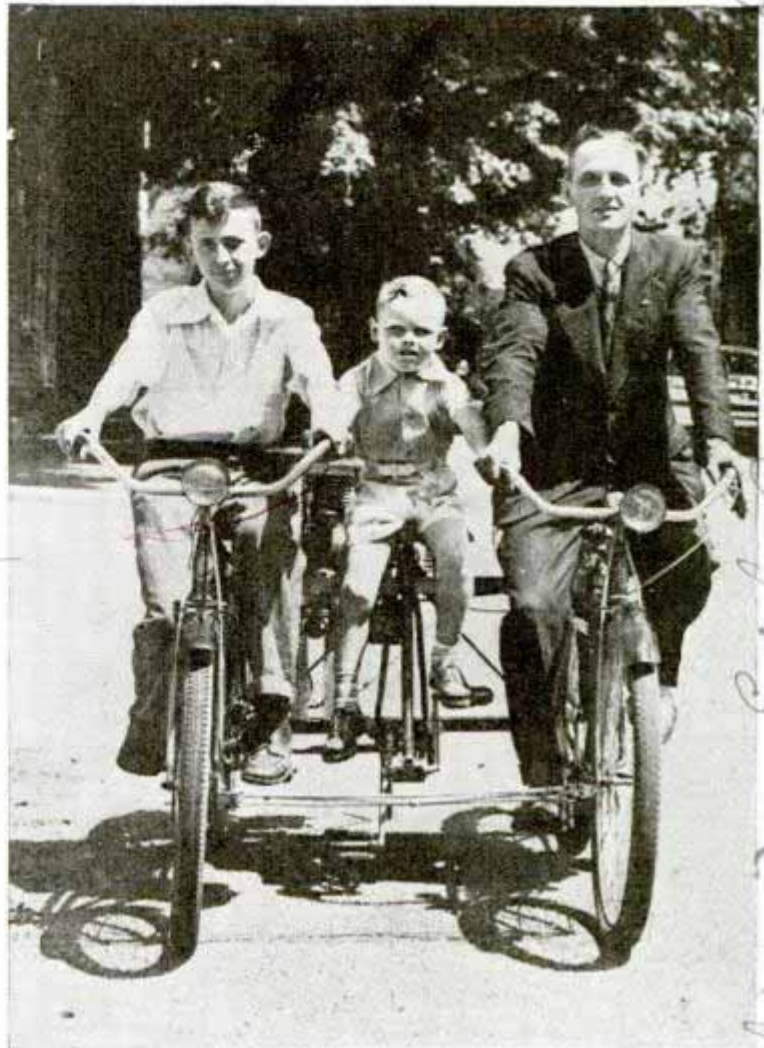

When the engine of this three-seater runs out of gasoline, there are three sets of pedals and you can do your own work

Two bicycles joined side by side with an ingenious arrangement of angle iron and braces is a vehicle built for three. The third rider occupies a seat placed between the two bikes. Driven by a washing-machine type engine, its inventor claims it has a top speed of fifteen to twenty miles an hour and runs seventy-five miles on a gallon of gasoline. Throttle control is on the handle bars of the left-hand bicycle, which is the driver's side, and the clutch can be reached easily from the rear. Three sets of pedals permit any one or all three of the riders to pedal the cycle if it runs out of gas or the motor breaks down.

There are 9,500 books on electricity in the New York Public Library, and only 7,000 on astronomy, a science thousands of years old; but mining and metallurgy are represented by more than 12,000 volumes.

Rec...
Merryman; clud.
405 S. 6th St.
Div. Mr. Estel

W. W. ...

R 57

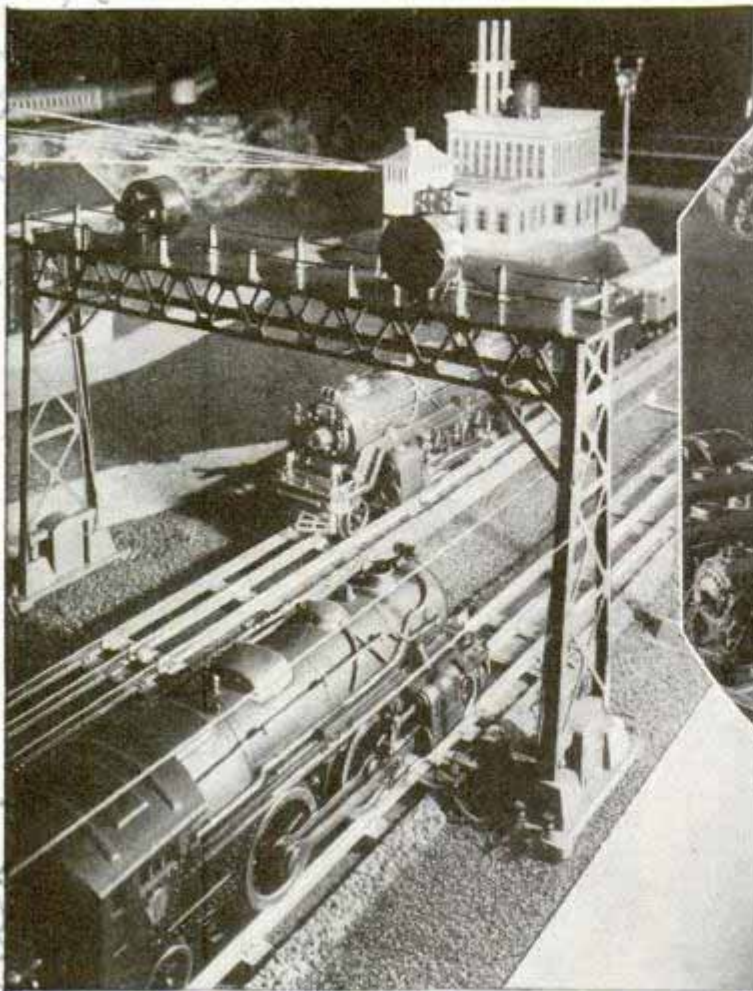

New models, at left, run hour after hour in tests to find possible defects; above, making final adjustments at end of assembly line. Below, left, applying handrails to tank cars; right, queer-looking machine winds armatures

MODEL TRAINS *on the*



Geared at high speed to meet demands of model railroaders and purchasers of toy trains, production lines in miniature railroad factories, as complete and efficient as those of large automobile plants, now turn out in one year 550,000 tiny locomotives, 1,650,000 cars and more than 5,000,000 feet of track. About ninety per cent of this is sold in the month preceding Christmas

Lionel Corp. 15 E. 26th St. New York N.Y. 10010
The main square

K.577

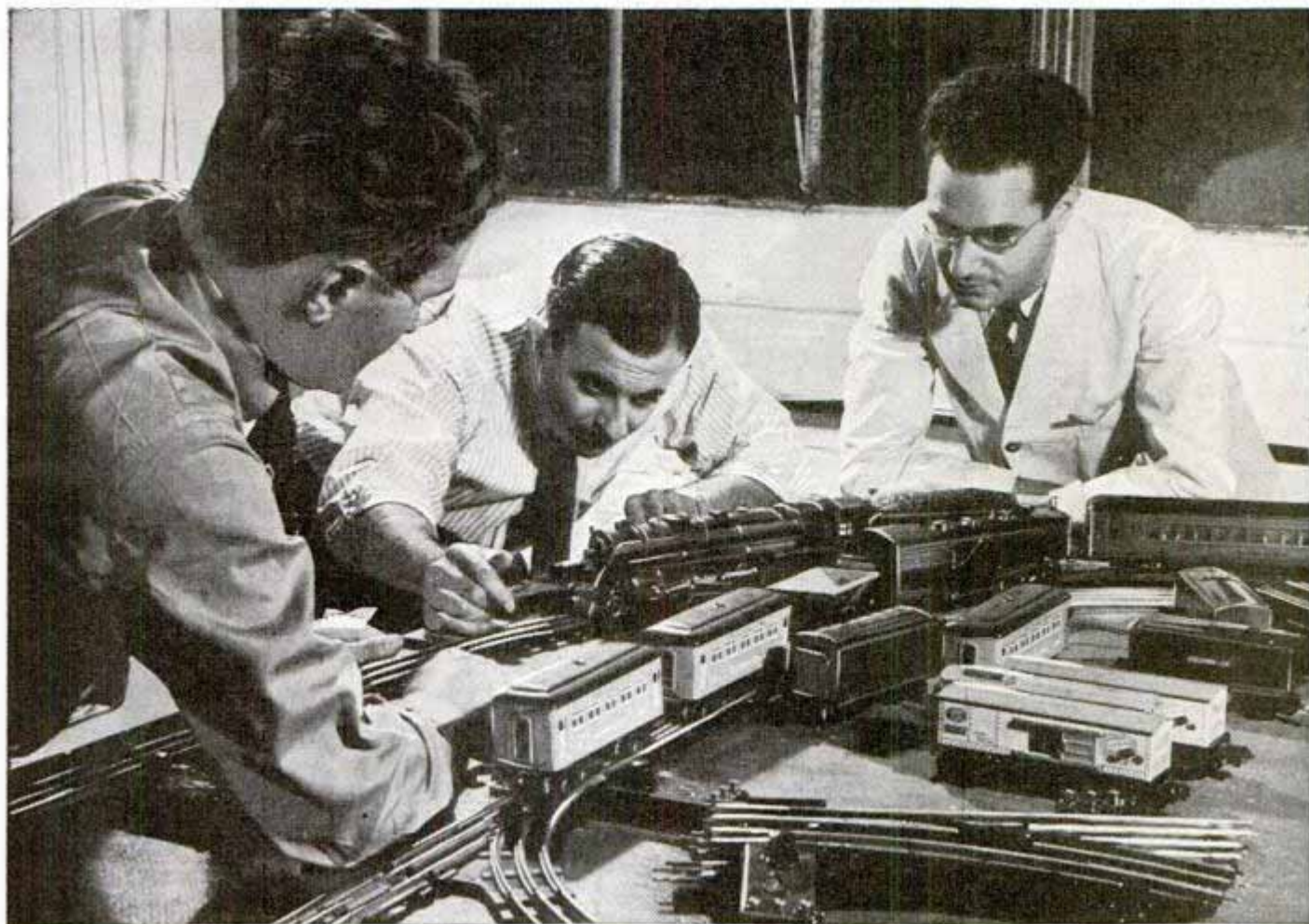

PRODUCTION LINE

Top of page, designers and engineers at Lionel Corporation watch working model of new design make test run; in circle, first rough casts of top and bottom of locomotive. Bottom, left, scale model of New York Central Hudson type; right, trays of newly painted locomotive tops and caboose roofs emerging from the "baking" tunnel

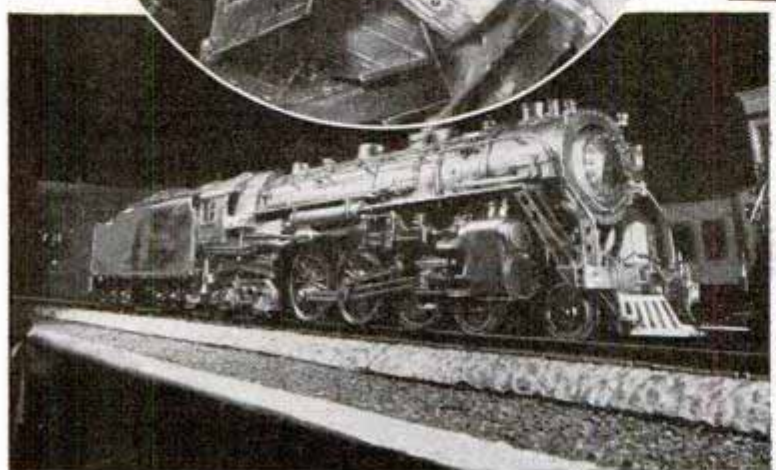
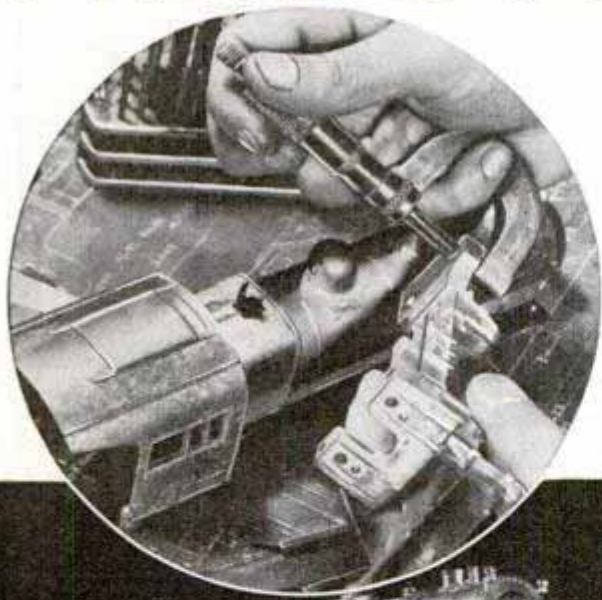

Lifesaving Overcoat Will Support Four Men



Here's a seagoing overcoat you need not hang on a hickory limb, for it's more buoyant than cork and will keep you afloat more than three days. Left, jumping overboard for a demonstration; below, afloat in the jacket. Developed in England, it is lined with a super-buoyant material and need not be inflated



Four men can be supported in the sea by a lifesaving jacket claimed to have a buoyancy six times that of cork. Introduced in England, the coat, which needs no inflation, will keep its wearer afloat more than seventy-two hours. It derives its buoyancy from a patented fabric lining woven with a material called "Rapok." Finished in gabardine, the garment is lighter in weight, but warmer than the present service coat which it may replace for duty on water.

Lightweight Boat Made of Plastic Molded in One Piece

Seamless construction, light weight, smooth interior, easy to keep clean and

less danger of leakage are advantages claimed for a small boat made of plastic cast in one piece, with reinforced stem and transom. Tests indicate that the material is hardy enough to weather snow, sleet, wind, salt and fresh water, and even the desert sun. Its light weight makes it especially useful as an auxiliary boat that must be taken aboard a larger craft or kept on the beach while it is not in actual use.



Molded plastic boat resists weather and corrosion

Radio Marks an "X" on Map to Show Pilot His Position

Carrying the automatic direction-finder a step further, an inventor has developed a radio device that traces two white lines on

British Combine Photos. do not air any letters.
 Western Plastics Inc. 709 W. 8th St. Los Angeles

Shellite

7,000-Foot Bridge to Island Replaces Oldest U. S. Ferry

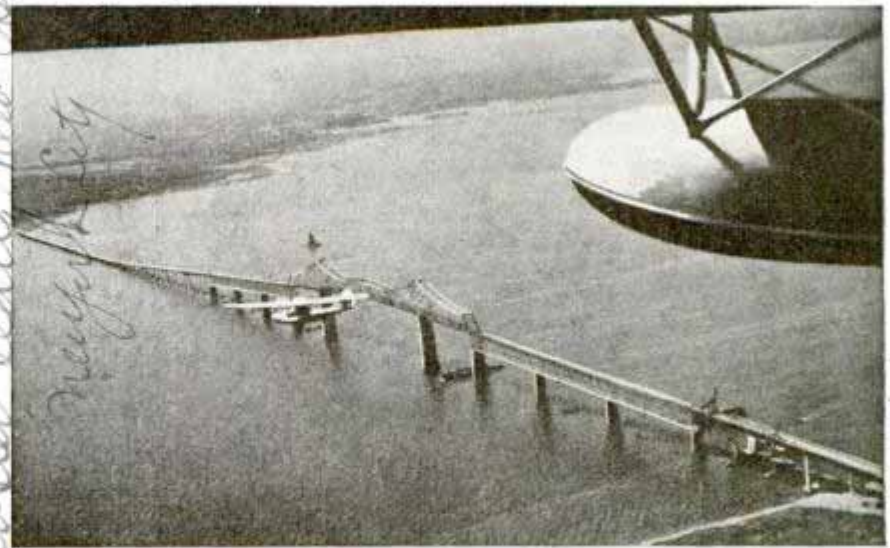

View from seaplane shows the new Jamestown bridge linking Rhode Island shore with Conanicut Island. It replaced a ferry operated since 1675

America's oldest transportation line, the Jamestown-Saunderstown ferry which has operated continuously since its founding in 1675 by Gov. Caleb Carr, has been supplanted by a \$3,000,000 bridge connecting the Rhode Island mainland with Conanicut island, on which Jamestown is located. The 6,982-foot span crosses the west channel of Narragansett Bay and eliminates a forty-five minute ferry trip.

a map. The point where they cross is the pilot's position. Two radio receivers in the plane tune in two stations on a rotating loop antenna. The receivers control two beams of cathode rays in a vacuum tube, and as the beams oscillate they trace two lines on a screen similar to that of the television receiver. The direction of these lines is fixed by the bearings of the stations tuned in. A projector throws a map on the same screen, and thus the pilot sees the map with the two lines superimposed. The map and screen are kept oriented, regardless of the direction of flight, by a gyrocompass which rotates the entire indicating mechanism. Thus, for example, north would be kept at the top at all times.

Radio "Lighthouse" Spins Signal to Guide Pilot on Course

Five metal rods only two feet long form the antenna system of a radio "super-

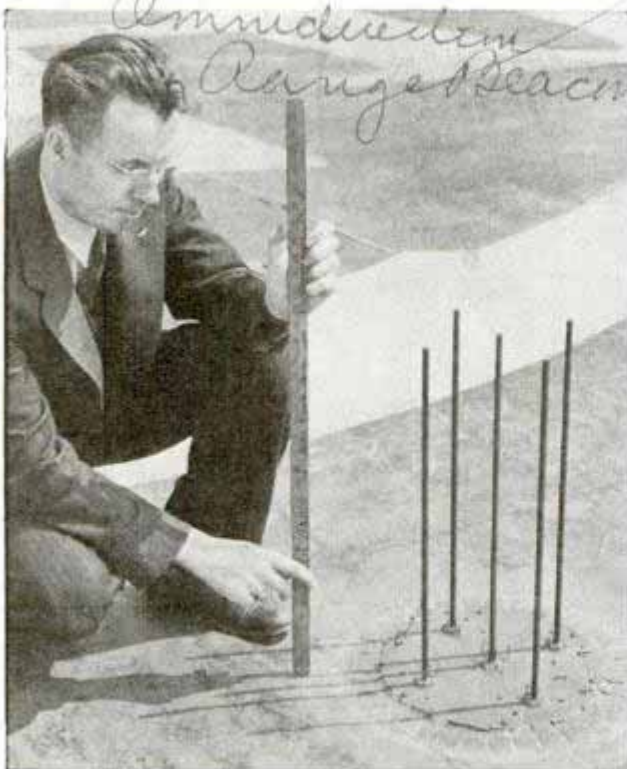

These small rods may replace the 125-foot pole antenna now used for transmitting radio range signals

lighthouse" just developed to guide airplanes to port without regard to any fixed courses between cities. Thus the air pilot who has wandered far off the conventional radio beam, indicated at present by a fixed tone in his earphones, can learn his course by a glance at a dial in the cockpit. The system works like a lighthouse sending out two beams, one which sweeps around steadily sixty times per second, and the other sending out a flash in all directions every time the rotating beam points north. By timing automatically the interval between reception of the flash and the sweeping beam, the exact direction of the lighthouse from the plane is indicated. On the dial the pilot watches a marker in a ring of light; if the marker stays in one position the flier is on his course; if he moves off course, the drift of the marker shows him the direction to return to his course. The simple antenna system of five twenty-four-inch rods eliminates the large system of 125-foot poles spaced 600 feet apart, forming the present long-wave radio range systems now in use.

EXPLORING *the*

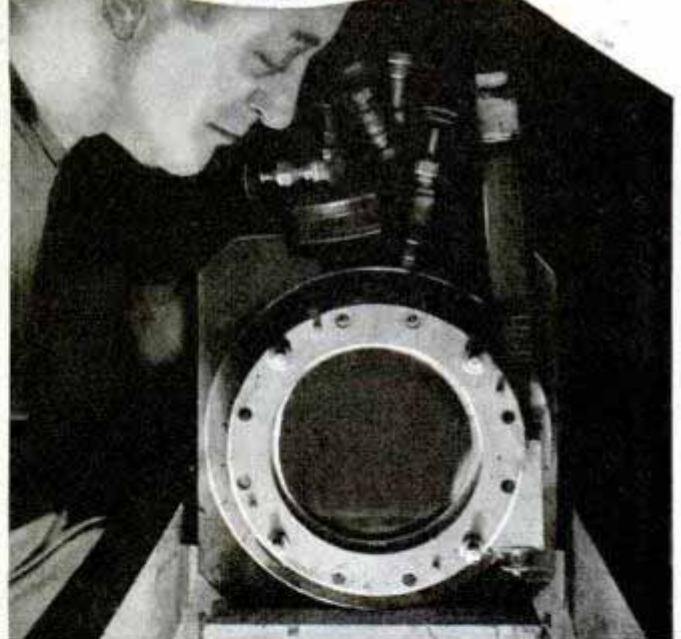
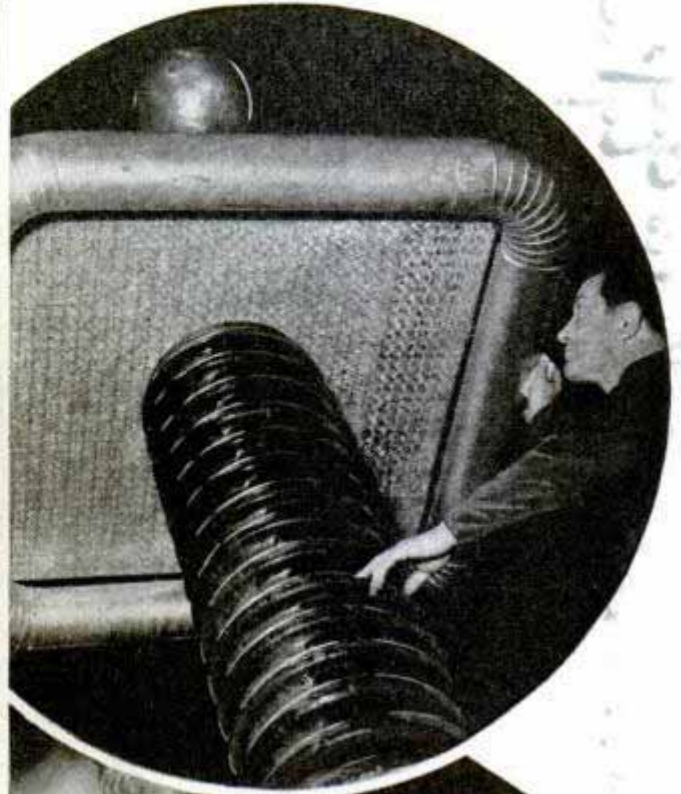
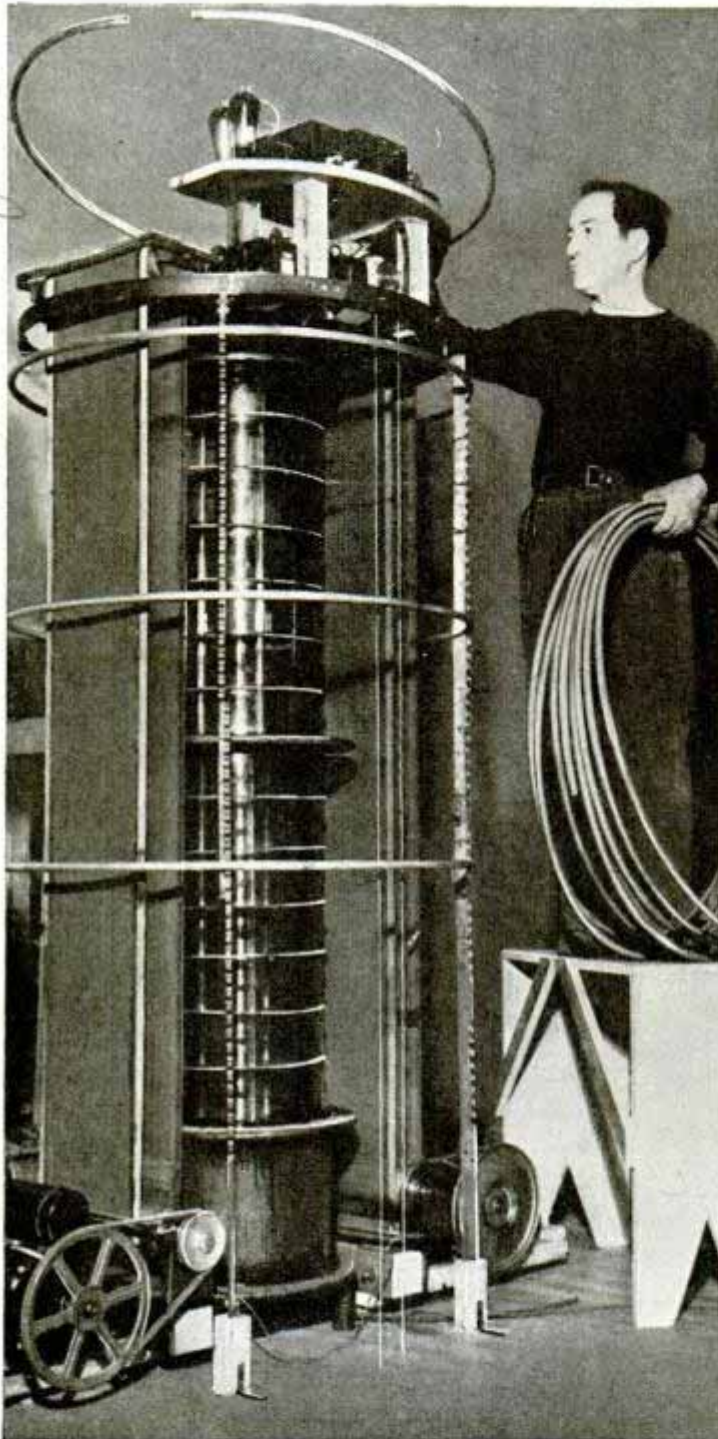

Left, placing protective aluminum rings around traveling belts of electrostatic generator. In circle is the anti-corona shield at top of tall vacuum tube; below, looking through glass slide into cloud chamber where sub-atomic particles leave their tracks when shot through

INSIDE a protective wire cage in the high-tension laboratory of the California Institute of Technology an engineer pressed a foot switch and there was a blinding flash. A tremendous noise shook the building.

Two million volts from a lightning generator had been discharged into a giant vacuum tube.

Within a concrete room that housed the

base of the tube a weird violet-hued ray glowed in the dark. A stream of wild electrons shooting out of the base of the tube had momentarily excited the air molecules.

Shoot the electrons into a transparent Bakelite target and the target breaks down inside. The electrons enter the target at such high speed that the surface is untouched yet inside, where they slow down enough to become destructive, a strange

R 419
Cmt. Thomas E. Stinson Jr. 1044 2 Helton Lane Los Angeles

K419

HEART *of the* ATOM

branchlike pattern is made. A slab of glass used as a target below the electron tube is discolored by the speeding particles. Calcite crystals, bombarded by the electrons, radiate golden light for minutes afterward.

The nine-foot vacuum tube, built up of porcelain rings, is being investigated by Dr. Arno Brasch to determine its value in atomic research. An intensive campaign to rob the atom of its mysteries is being conducted in a score of research centers. Though much has been learned about the atom, many perplexing questions remain unsolved.

Scientists visualize the atom as a tiny solar system, having a nucleus that consists of neutral particles of energy called neutrons and a number of positively charged protons. Around this nucleus revolve electrons that balance the charge of the protons. Smash the nucleus apart or remove some of its neutrons and the atom becomes an atom of a different

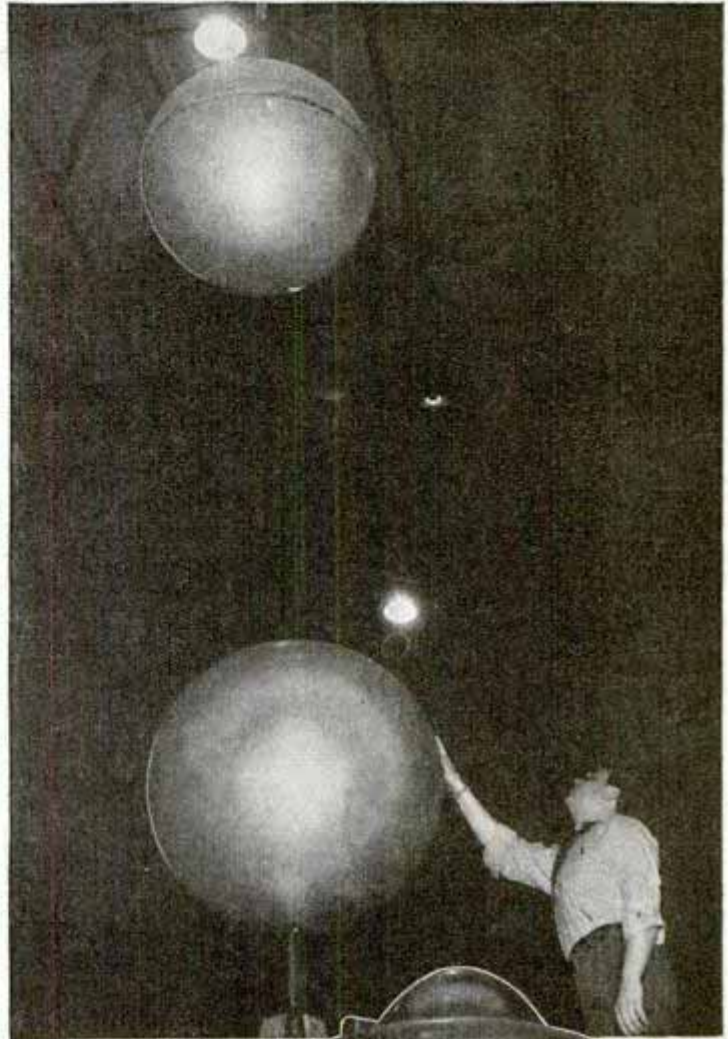

Metal balls, top, form spark gap for measuring voltage of 2,000,000-volt surge generator for atomic research. Left, bank of condensers for "lightning" generator. Right, huge transformer producing high potentials

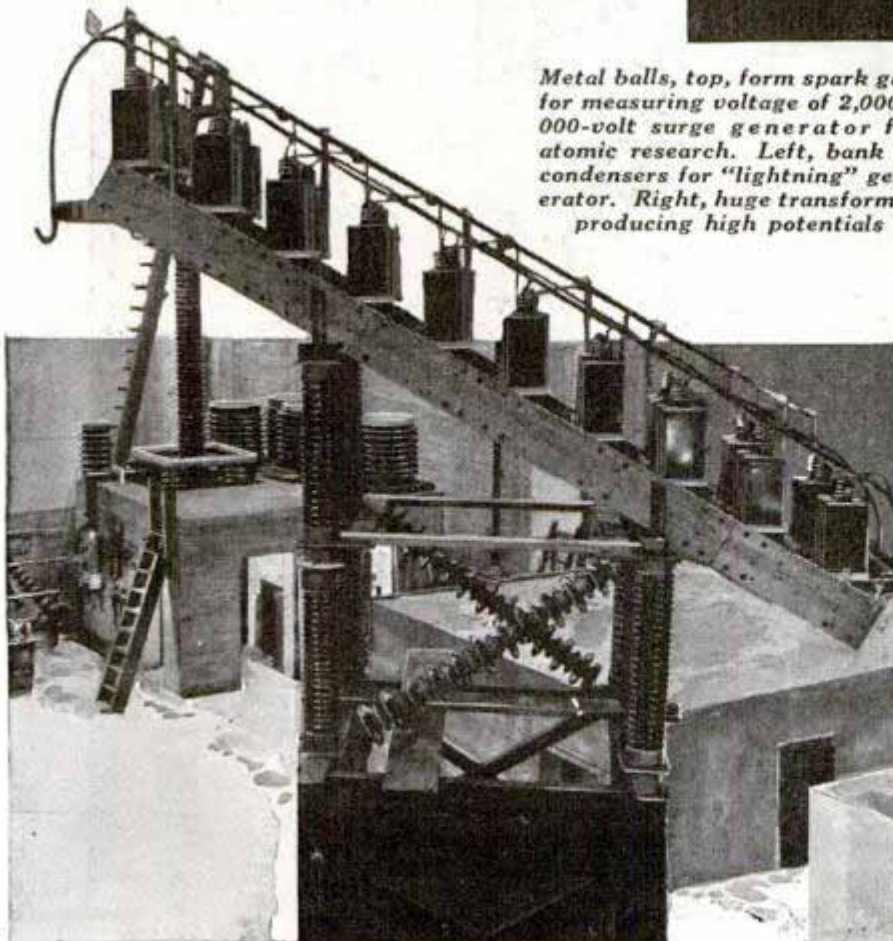

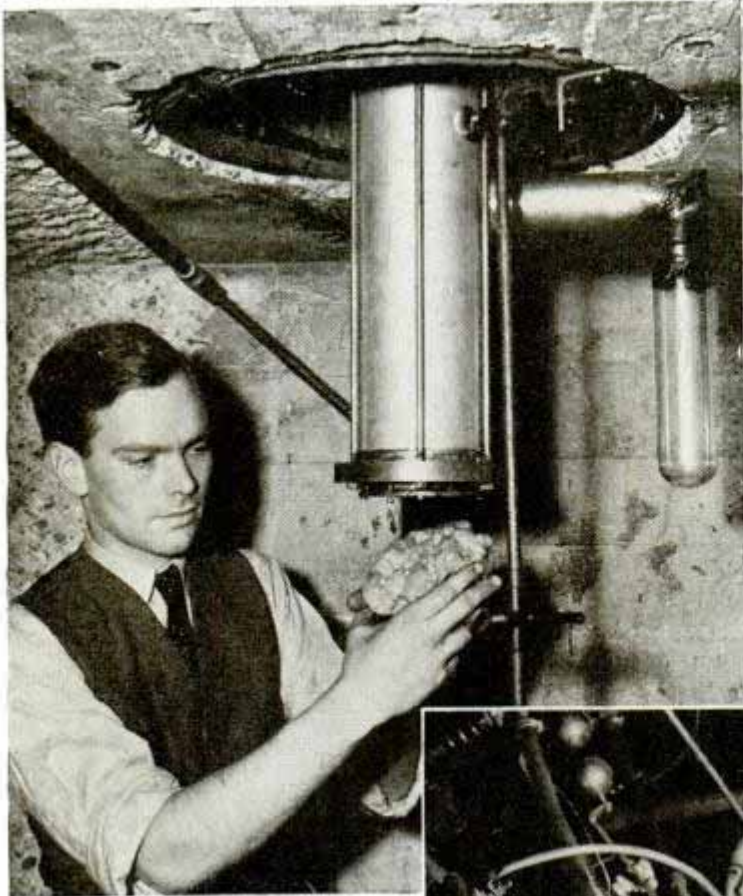

Above, calcite crystals held under aluminum "window" at foot of vacuum tube are made to glow under electron radiation from tube. Right, closeup of condensers. Bottom, nine-foot vacuum tube

element. Often the new material is unstable and is radioactive for a time.

Physicists have been transmuting elements for years, but by the atom instead of by the pound. All but two of the ninety-two known elements have been transformed into other elements of lower atomic weights although usually in sub-microscopic amounts. The physicists are much more interested in learning more about the mechanics of transmutation, in the energy that is released, or in some of the things that fly off from disintegrating atoms, when they are smashed, than in merely changing one material into another.

To break atoms up, the scientists use particles of energy that they strip from other atoms. In some cases neutrons are used, in other cases protons. Deuterons, the nuclei of heavy hydrogen atoms, are also used. Recently for the first time in atomic research electrons were employed

as bullets, the electrons smashing up beryllium atoms into two atoms of helium and one spare neutron.

An atom is tied firmly together by some sort of mysterious "cosmic glue" and the atom bullets must have tremendous speed or energy to break them up. This is the reason why the big electrical machines used in atomic research have been built. The cyclotron whirls its missiles around in an alternating magnetic field until they attain high velocity. A new kind of atom smasher at Cornell uses a short-wave radio generator to accelerate sub-atomic projectiles in a straight line inside an eight-foot horizontal vacuum tube. The electrostatic

generator, such as Westinghouse's huge pear-shaped four-million-volt atom smasher, produces high voltages that impart terrific speed to the particles being used to bombard atoms. It is estimated that, depending on the kind of particle used and the voltage, speeds of from 10,000 miles per

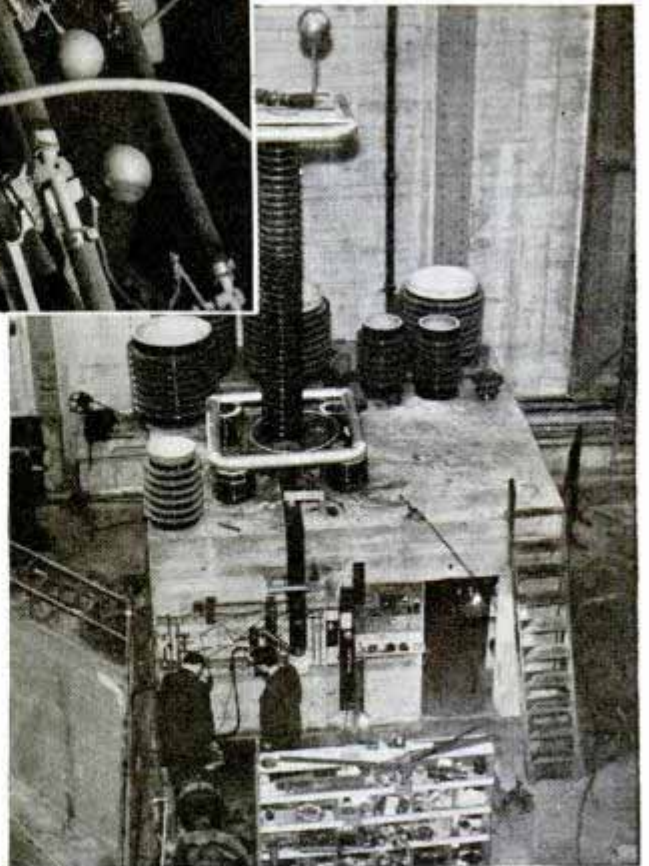
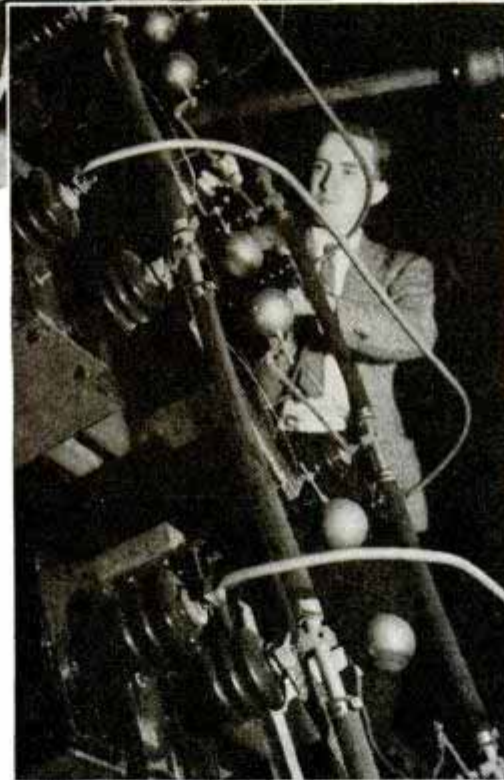

second to nearly the speed of light are attained by the flying particles.

When an atom is torn apart tiny bits of sub-atomic energy are often set free. These include protons, alpha particles, gamma rays, negative electrons, positive electrons, and negative and positive electrons in pairs. Such stray bits of energy are being studied by means of cloud chambers, ionization chambers, linear amplifiers, and electroscopes. Passing through the saturated atmosphere of a cloud chamber, for instance, a speeding particle ionizes the air and leaves a track that can be seen or photographed. Emission of an alpha particle from a disintegrating atom is often determined by placing an unexposed photographic plate in its path. The alpha particle exposes a few grains of emulsion in passing through the plate and these can be examined through a microscope.

One of the fields being investigated at California Tech. is the critical voltage needed to give a particle exactly the right speed to disintegrate its atomic target. Using an electrostatic generator to energize the particles, Dr. C. C. Lauritsen and others are hurling various particles at different speeds at a variety of atomic targets, charting the speed each kind of particle needs to break into the atoms under bombardment.

Studies of electrons have vastly increased the competence of X-ray machines, the radio, and telephony in the last decade.

Unstable elements that are radioactive, created in the laboratories, are being used as "tracer" materials for studying biological processes, both in animals and plants. At the University of California Prof. Ernest O. Lawrence has been using his cyclotron to create streams of particles destructive to cancerous tissue. It was found that neutrons slowed down by a thick block of paraffin are several times more effective against cancer than fast neutrons that had already shown promise.

At some research centers a concerted drive is being made in splitting heavy atoms and studying the effects. Research on the heavy atoms has been stimulated by experiments that suggest the possibility of harnessing atomic power. The enormous release of energy that occurs when uranium atoms are broken up, and the apparent chain reaction that seems to make disintegration continuous once it has been

(Continued to page 122A)

"Good Temper" Spectacles Fad in War-Weary Land

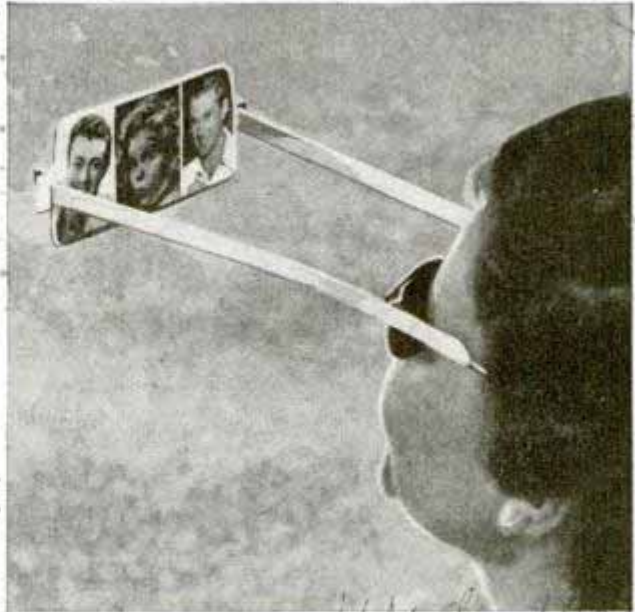

Latest wartime fad in Europe keeps eyes focused on smiling faces of movie stars instead of war bulletins

Looking at pictures of the smiling faces of movie stars, instead of at bad news from the war front, helps some Europeans keep up their spirits while nations are at strife. Mounted in a frame that fits on ordinary spectacles, the pictures are held at a suitable distance for viewing.

Pencil Pointer Worn on Wrist Is Handy for Draftsmen

For convenience of artists and draftsmen in keeping pencil points sharp for doing fine line work, a pencil pointer worn like a wrist watch is now available. Always within easy reach, the pointer consists of a sandpaper holder and cleaning pad.

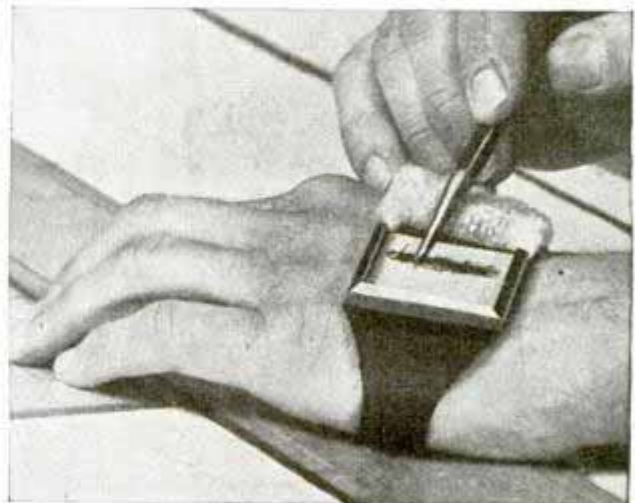

Only a few strokes of lead across pencil pointer strapped to wrist are needed to grind a fine point

Pro-Pointer Headquarters
425, Monterey Blvd

Smooth-Riding Aquaplane Stabilized by "W" Hull



Shaped by steam-bending lengths of mahogany and spruce, this aquaplane rides more smoothly

Making radical changes in the undergearing of a new aquaplane, a Canadian athlete and a California engineer have designed a new board embodying a triple combination of safety features. The bow is of conventional U-shape, but as it draws toward the stern the hull gradually changes to a W-shape, serving to make the board cushion in rough water. A series of

fore and aft steps allow it to follow a racing speedboat in direct line. These changes in design, wrought by steam-bending lengths of three-quarter-inch mahogany and spruce, alternated, reduce the aquaplane's tendency to pound, pitch and upset the rider in a rough sea. The board measures seventy-one inches long and thirty inches wide, has a two and one-half inch draft, and weighs sixty-four and a half pounds.

Six-Ton Hammer Does Work of Twenty-Six Ton Unit

Equipped with a rising anvil, a six-ton drop hammer does the work of a hammer of twenty-six tons. The anvil operates at the same speed as the falling hammer, thus utilizing the full energy of the impact. Both units return to operating position after the blow, resulting in shockless, vibrationless operation.

Portable Electric Water Heater Holds Two Gallons

Two-gallon electric water heaters that can be installed in the kitchen or bathroom or even in the farmer's barn supply an inexpensive service where a small amount of hot water is needed. Handy for shaving, for making hot drinks, or for preparing livestock feed, these heaters are being used also in barber shops, roadside stands and tourist homes.



Mounted conveniently in a kitchen, this small electric heater supplies hot water at small cost

G. L. Hawthorne 1898
 Silverwood Terrace Los Angeles
 Dale Carpenter
 20 Maple Street
 K 324

K 882
 Pneumatic Drop Hammer
 K 324
 Cochet
 K 324



The CRAFTSMAN

Laminated **DESK SET** has roll-top trays

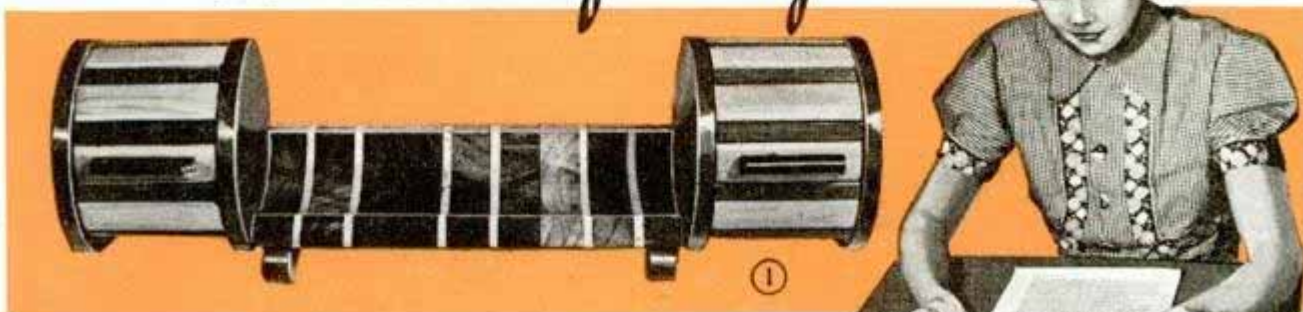

RICH, pleasing contrast of walnut and maple, carefully rubbed to a satin finish, makes this set, Fig. 1, a worthy piece on any desk. Begin with the pencil tray, which is made from walnut and maple disks arranged as in Fig. 2, glued together and then turned inside to form a cylinder as in Fig. 3. The cylinder is divided and cut into three equal sections as in Fig. 4. Next, the sections are assembled end to end with dowels and glue as in Fig. 5, and fitted at each end with two turned feet.

Now you are ready for the roll-top trays. For the ends of these, you need four walnut disks. These are glued in pairs to a small block with a paper disk between them as in Fig. 9, and are turned to size on the faceplate. Then the grooves to receive

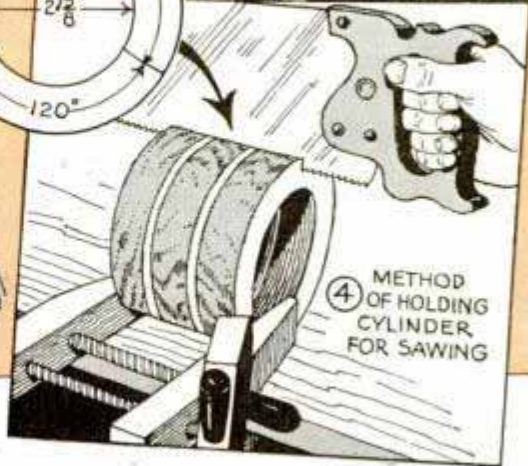
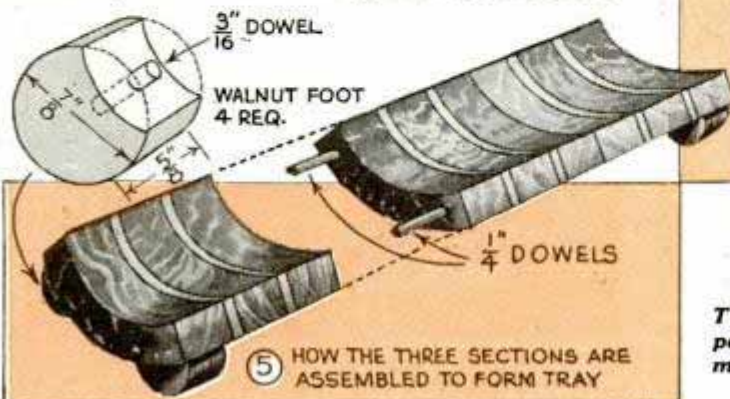
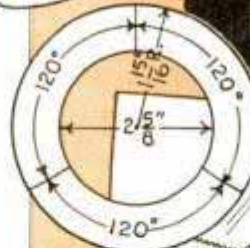
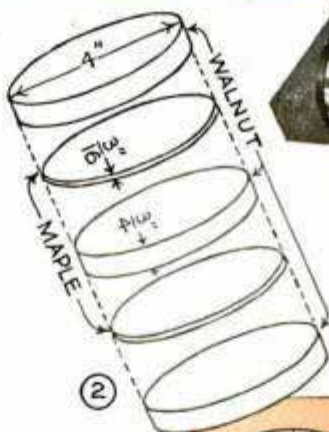

This elegant, modern-styled desk set for your pens, with roll-top trays for clips, pins, etc., is made of walnut and maple or birch, which give an attractive two-tone effect

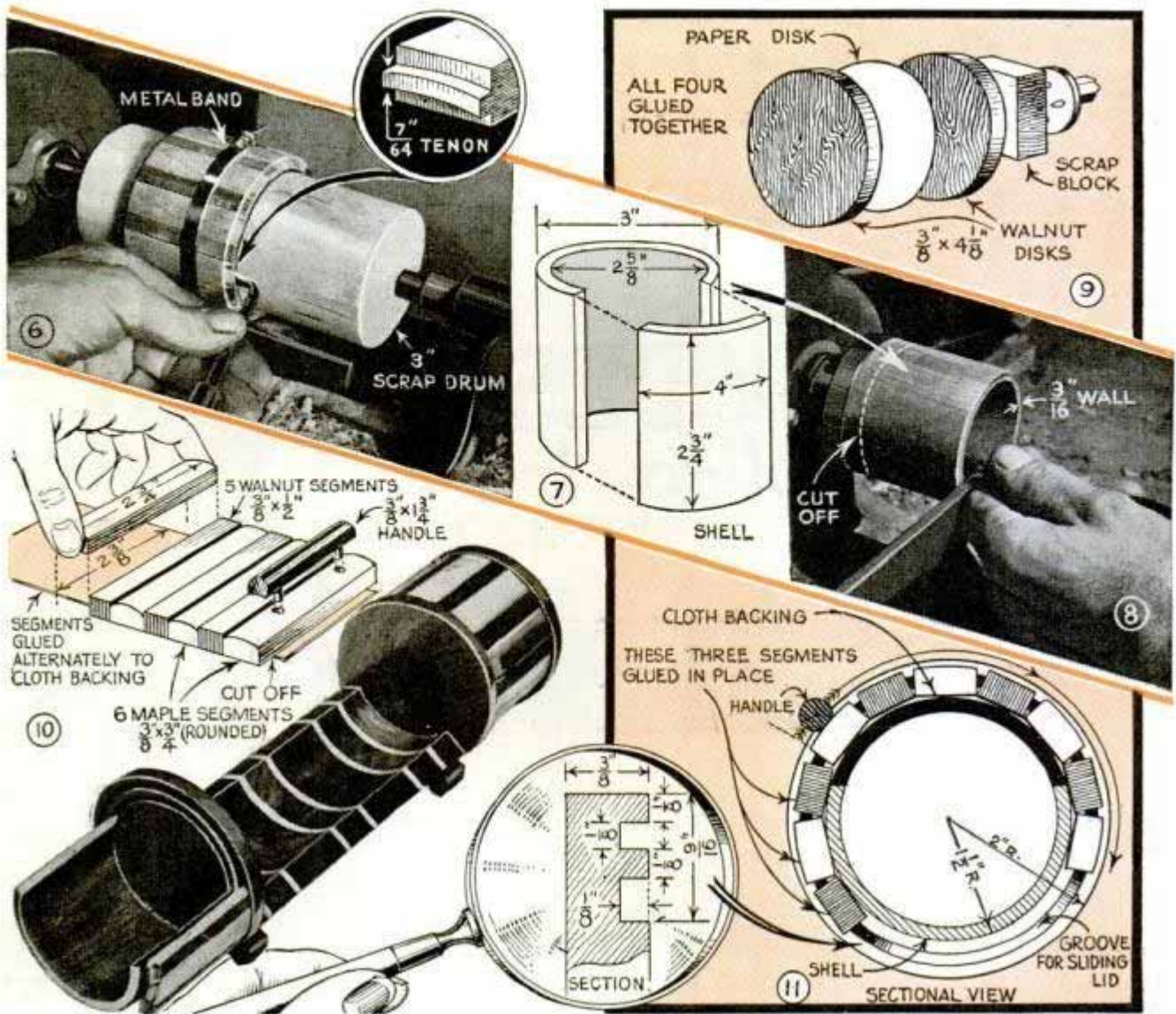

the cylindrical body and roll top are cut in the face of one disk and the back of the other. See the magnified detail of Fig. 11. Next, the disks and block are separated at the paper-and-glue joints and sanded. This procedure permits the grooves to be cut without mounting each disk individually. Repeat this work on the other two disks and attach two of them to the ends of the trough with dowels and glue. Make the two cylindrical bodies as in Figs. 7 and 8, and you are ready for the roll tops. These are made up by gluing walnut and maple segments to a cloth backing as in Fig. 10. Notice in Fig. 11 that three of the segments are not glued to the cloth, but are glued directly in the grooves of the end disks and serve as stops for the tops. After the segments have been glued to the cloth, the assembly is clamped to a drum mounted between lathe centers as in Fig. 6. Tenons are turned on the ends of the segments to slide in the grooves of the end pieces. As the fabric-and-segment assembly does not form a complete cylinder, it will be

necessary to fill in between its ends with scrap pieces so that a metal-band clamp can be used. After assembling the trays, finish the set with two coats of shellac which can be rubbed down to remove the luster if desired.

Space-Saving Chisel Holder

An efficient chisel holder can be made quickly by lacing together three pieces of leather cut to size desired. The lace forms the compartments, and the center piece should be $\frac{1}{2}$ in. higher than the side pieces. The leather can be oiled to protect the chisels against rust.



Belt Guard on Circular Saw Holds Accessories

A belt guard that holds several accessories is a useful addition to a home-shop circular saw of the type that has the motor pulley and belt overhanging the table. The guard is made of wood and is hinged to one leg of the table. An eye bolt screwed to the guard fits through a hole in the other leg and makes the belt and pulley accessible for inspection. On the outside surface of the guard are mounted the most used accessories.

Waxing Ski Runners

I have found a chemical heat pad effective in warming ski runners before waxing them. When the wax is put on the warm runners it will flow freely and can be rubbed on in a few seconds.

—F. D. Slayton, Wilmette, Ill.

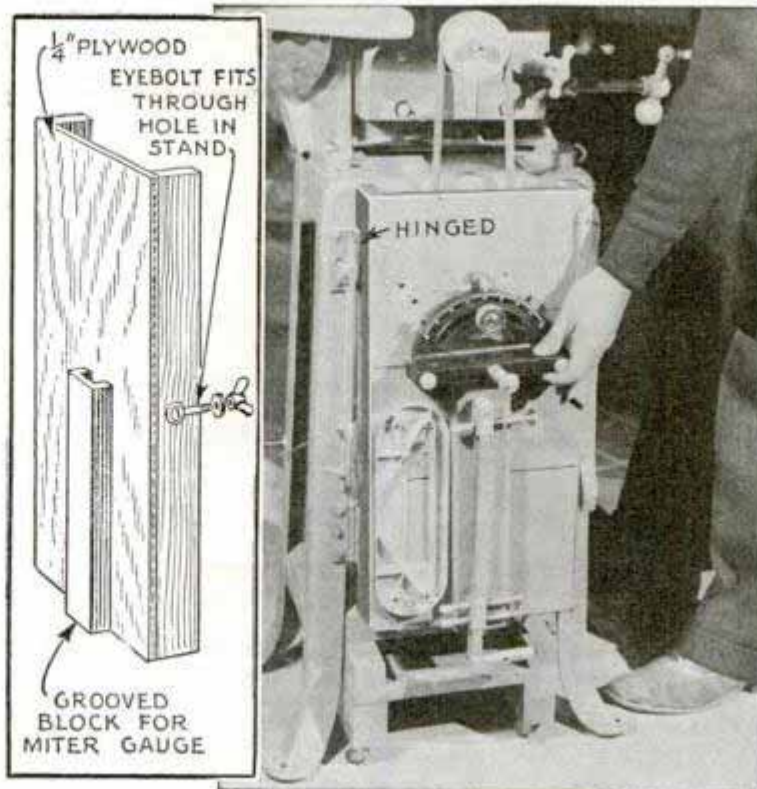

Perforated Paper Pattern Made on Your Sewing Machine



If a design is to be used numerous times on different articles, the easiest way to transfer it is with a perforated pattern. To make such a pattern, stitch the outline on a sewing machine, from which the thread has been removed. First draw it on firm, non-absorbent paper. Heavy vellum tracing paper is best and can be purchased by the yard at art stores. The space between the perforations can be regulated by adjusting the length of the stitches. Charcoal, lampblack, talcum powder, paste made by melting wax crayons or ready-prepared stamping wax can be used to transfer the design onto the material. This is applied easily with a felt or cotton pad. The pastes require a small amount of naphtha or benzine to moisten them sufficiently.

Pencil with Weighted End Will Not Break When Dropped on Floor

The point of a lead pencil is not likely to break when dropped, if the opposite end of the pencil is weighted so that it will reach the floor first. A simple weight that does not interfere with use of the pencil consists of a piece of wire solder wrapped around the pencil and crimped in place.

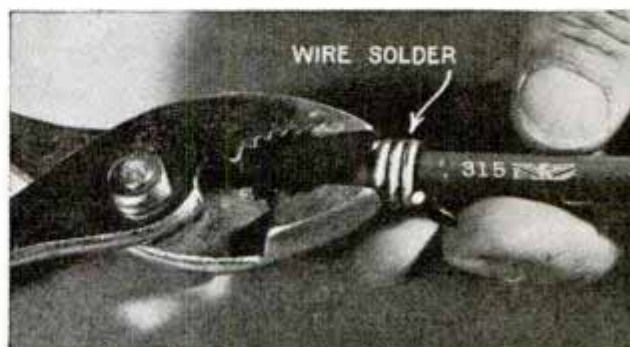

☞ A mattress turned regularly will keep in good condition twice as long.

Solving HOME



A piece of rubber shaped as above and fastened to the food chopper with a band is a safety precaution when feeding pieces of meat into the chopper with the hand. The rubber stands vertically out of the way when not in use

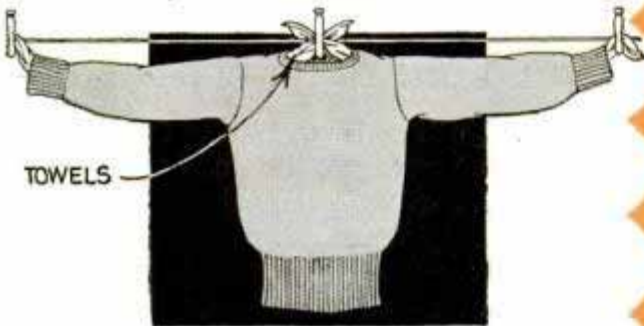

Your laundered sweater need not be marred with clothespins or stretched out of shape when drying if you suspend it with a towel run through each sleeve and attached to the line with clothespins at the neck and cuffs as above



If you have had fish jump out of a bowl at night, a hairnet will solve the problem. Get one of the type that has an elastic band around the outer edge and slip it over the top of the bowl. It's easy to remove or put in place, allows plenty of ventilation and presents a neat appearance on the bowl



Slipped over a chair leg or rung, the holder above will keep a ball of yarn off the floor while knitting. Holder is made of spring wire, and rubber over the coiled portion protects the chair finish as indicated

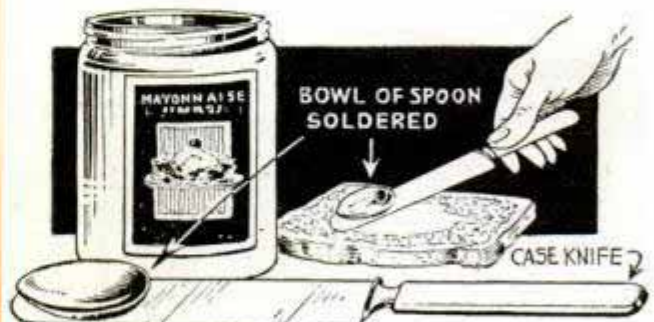

The tray at the left is just the thing for serving tea while you chat on a davenport. By soldering the bowl of a spoon to a case knife as above, you can dip semi-solids such as sauces and salad dressings, and spread them on the bread slices in one operation when making sandwiches

PROBLEMS

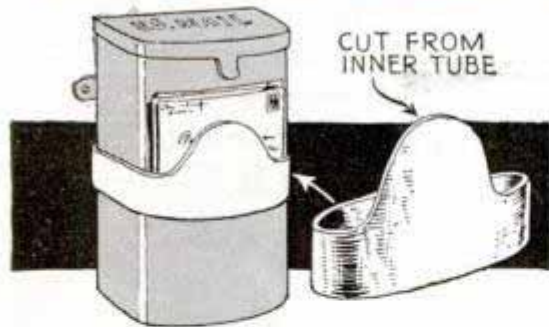

Letters to be picked up by the postman will be visible readily yet protected from being blown away if a rubber sleeve is stretched over the outside of the mailbox under which they may be inserted. A piece of old inner tube is used for this, cutting it to the shape shown above to provide a flap to take the letters.



The back of a closet door, when fitted with a narrow shelf across the bottom, makes a convenient out-of-the-way place to store a small stepladder. A strap with the ends nailed to the door near the top of the ladder is used to hold it in place when opening and closing the door.



Staple a length of ordinary chicken wire across the studding of your garage and you'll have a good hanger from which your garden rake cannot be jarred accidentally. The teeth engaging the mesh make it difficult to dislodge the rake, yet allow it to be hung up or removed quickly.

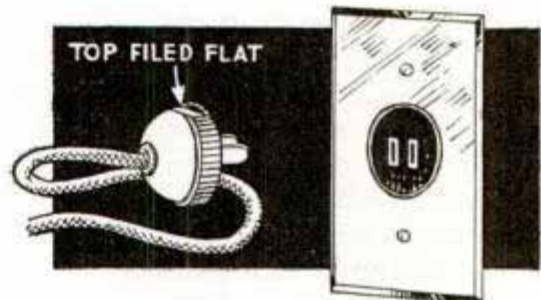

File a flat spot on the top of an electric plug so that you can feel with your thumb when the prongs are in a vertical position. This helps inserting the plug into a wall outlet located in a dimly lighted place where it is hard to see.

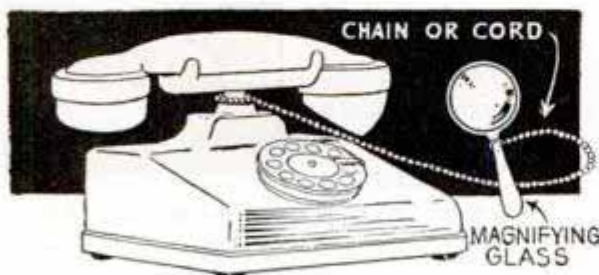

Persons who find it difficult to see the numerals on dial-type telephones will appreciate the use of a small reading glass when it is attached conveniently to the phone with a chain or cord as above. A bevel planed across the top of your storm windows as at the right, will prevent swelling and rotting of the wood by allowing water to drain off the sash.



Tray on Artist's Drawing Board Keeps Accessories Handy

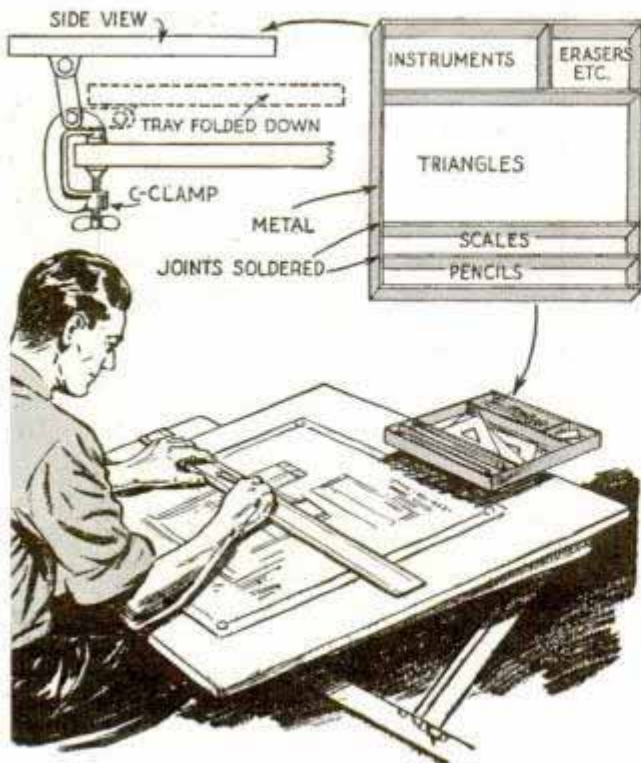

Your drawing instruments, erasers, triangles, etc., will always be together and close at hand if they are kept in a metal tray like the one shown. It is attached to the board with a C-clamp, which permits it to be removed quickly. Use of bolts and wing nuts to pivot the link between the tray and clamp permit the tray to be adjusted at any angle desired.

Paper Clip Holds Pen Points for Ruling Lines

When it is necessary to draw a number of parallel lines, several can be made at one time by holding the required number of steel pen points in a spring paper clip like the one shown. All the pens must be

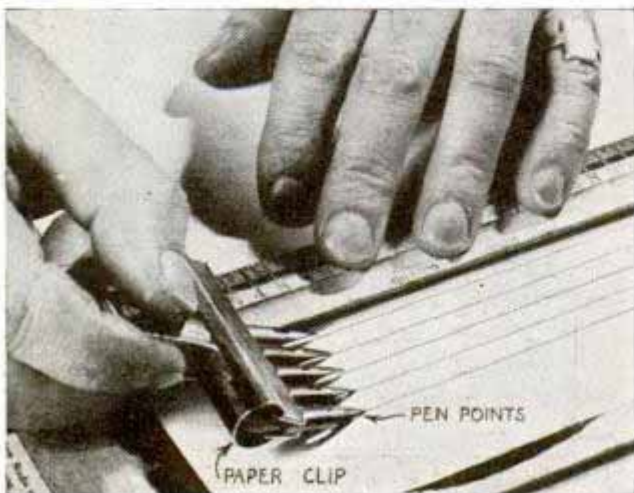

of the same size, although the type of points may vary if desired. The inner surfaces of the clip jaws should be lined with narrow strips of rubber, so that the pens will remain in position without sliding.

Enlarging Ice-Skate Screw to Grip It Easily

If the adjusting screws of your clamp-type skates are so small that they are difficult to turn while wearing gloves, wrap them with a few turns of friction tape. The larger diameter and the additional friction provided will make the job easy.



Adjustable Drill-Grinding Gauge

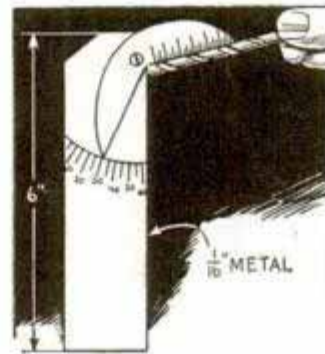

I often have to sharpen drills at various angles for use on special jobs in my work and find the adjustable gauge shown handy in quickly getting the correct angles. A bevel protractor was

used in laying off the degree divisions, and the angle finder is pivoted with a machine screw, the head of which is countersunk.

—Versel Behlke, West Allis, Wis.

Simple Model-Train Hitch

In building a model train the difficulty in getting a hitch that is rigid, yet allows sufficient freedom for the cars to move around on a curved track, is solved by using ordinary snap fasteners such as used on garments. Both sections of a fastener are attached as shown.

—Everett Hanson, Argyle, Wis.



ⓘ Never brush suede shoes while they are damp. Dry them, then use a wire brush.

Winter SNACK SHACKS for Birds

By providing feeding shelters for birds in winter, when snow and sleet seal up their natural food supply, they will reward you by becoming quite tame and interesting subjects for study and observation. The shelter at the right is pivoted on a post and swings around in the breeze so that food will not blow away. A sliding feeder suspended from a line as shown below can be moved a little closer to the house each day so that you can observe the habits and antics of the birds at close range. A sheaf of grain on a pole is also welcome to snowbound birds.

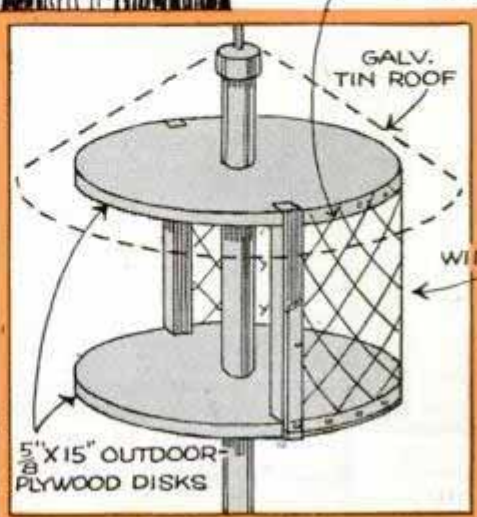
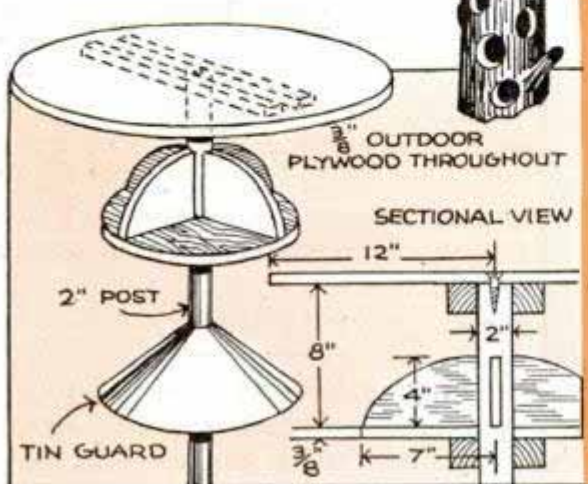
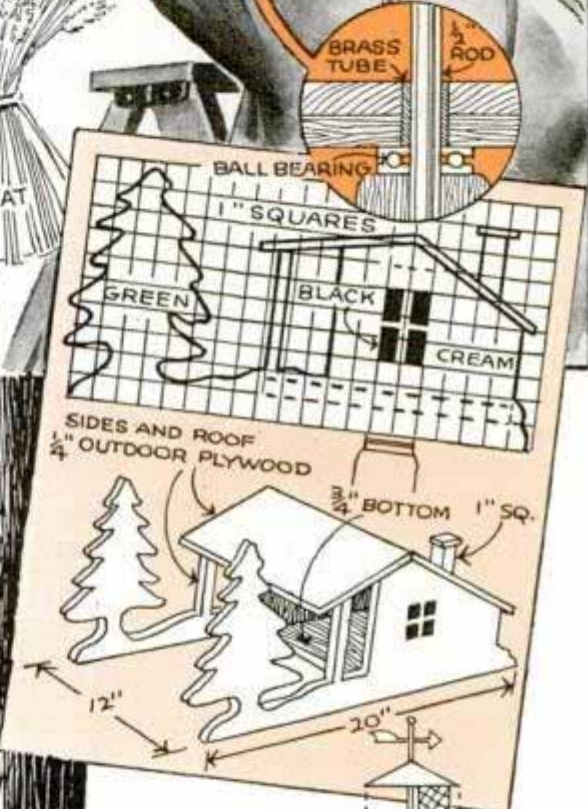
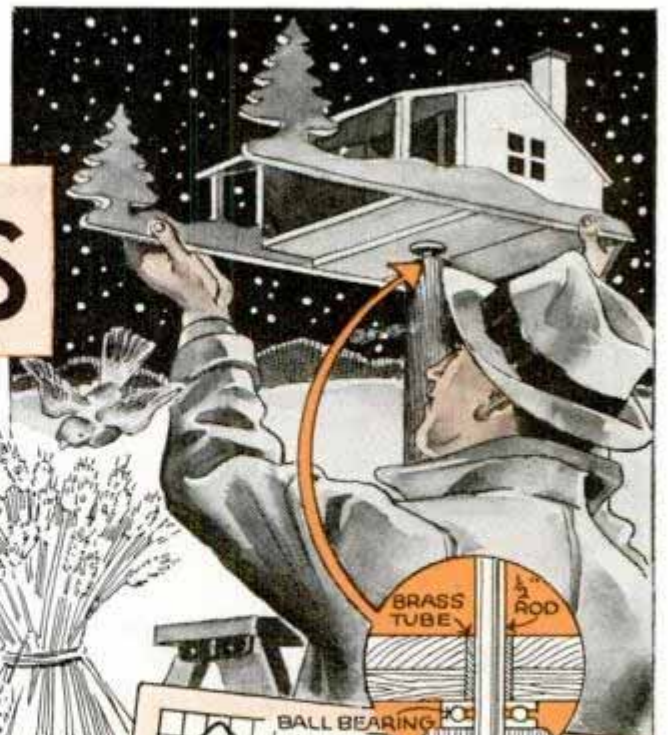
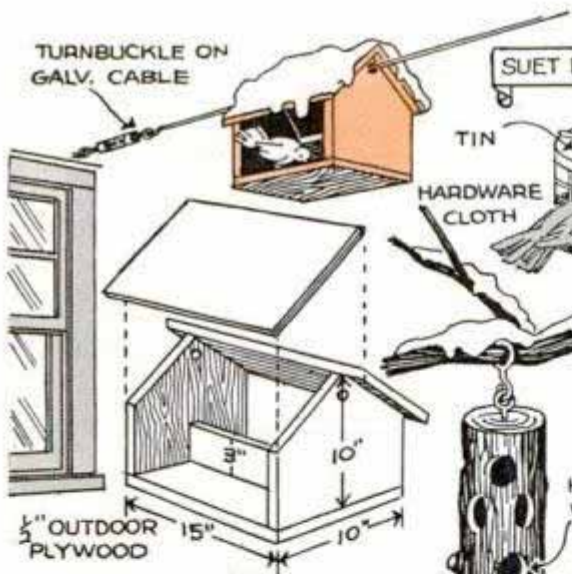

Picture Frame Cut and Assembled Quickly in This Miter Board

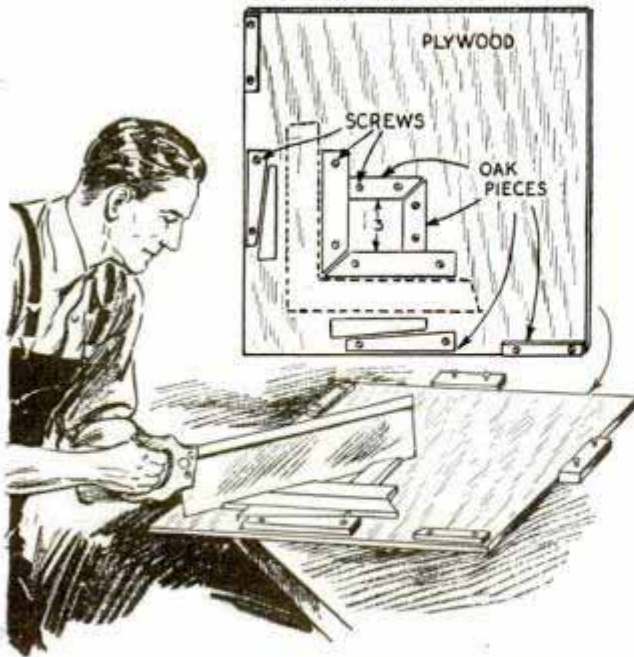

Picture and similar frames can be cut accurately and assembled right in this miter board. The stock to be mitered is held by wedges as indicated. After the miter has been cut, glue can be applied and the joint nailed while the assembly is held by the board.—L. B. Robbins, Harwich, Mass.

Reversible Drill-Press Sander Has Two Grades of Paper

Different abrasive surfaces are made available with this sanding drum by merely changing ends in the drill-press chuck. The drum is turned from hardwood, and the projecting spindles or shafts are headless bolts having the threaded ends turned into tight-fitting holes in the drum. The abrasive paper is wedged in the drum slot with a hack-saw blade. This was found better than a wood wedge as the teeth

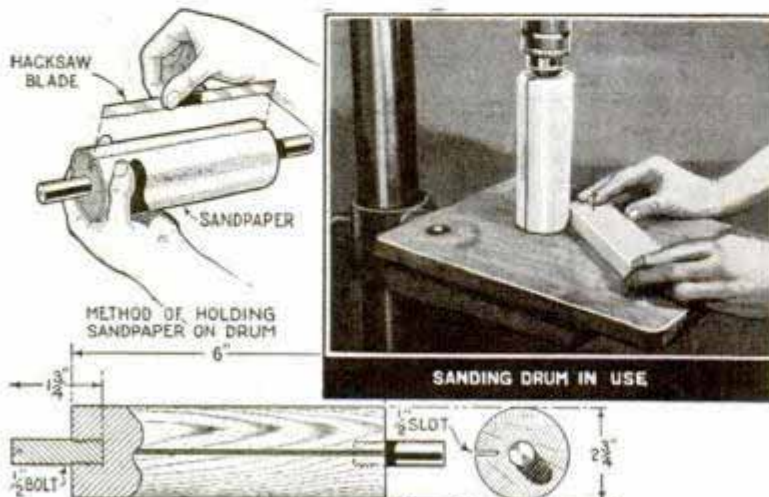

tended to bite into the paper and force it tightly into the groove. In use, different grades of paper are put on at each end of the drum.

—Aremen Tashjian, Springfield, Mass.

Reading of Dairy Thermometer Marked by Rubber Hose Clip

Desiring to register the reading of his dairy thermometer for easy consultation, a Wisconsin butter maker cut a section from a small rubber hose and slipped this around the thermometer.

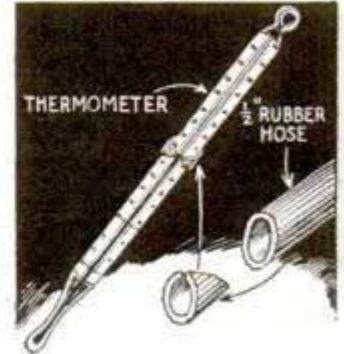

The hose is small enough to grip the thermometer firmly against accidental dislocation, but may be slid up or down to a different reading in an instant.

Inexpensive Beam Compass

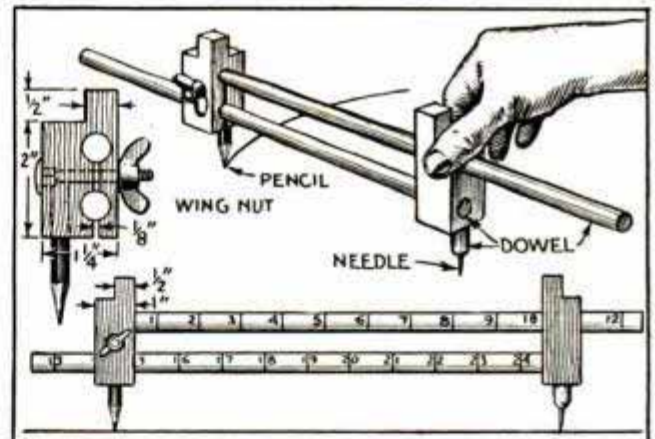

A practical beam compass that can be used also as inside or outside calipers can be made easily by anyone. Dowels are used for the beams and wood blocks in which the dowels slide carry the compass point and pencil. Opposite ends of the dowels are anchored firmly in the blocks while the other ends slide freely to permit adjustment. One block is slotted as shown and a bolt and wing nut are provided to lock the adjustment.

—Al Belanger, Chicago.

Ⓢ Storing leftover food scraps in a refrigerator is a waste of space and often spoils other foods.

Wooden Duck in Garden "Flies" Realistically

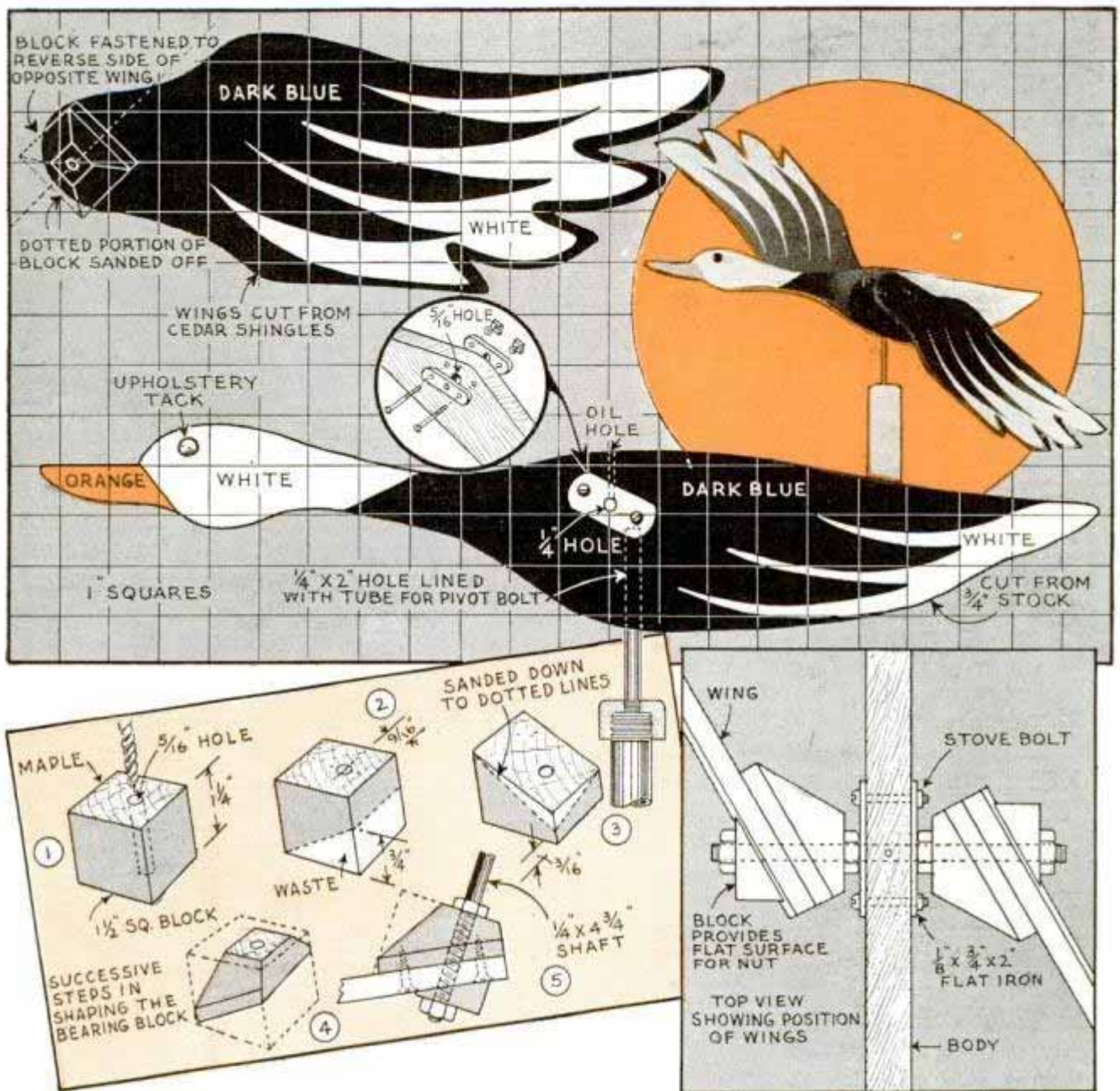

You'll have to look twice to see that this is not a real duck in flight. Colorfully painted and mounted atop the garage or trellis, it provides an amusing touch to any back yard. The body is sawed from cypress or cedar stock, while the wings are cut

from shingles. Bearings for the wing shaft are small metal plates bolted to the sides of the body. The wings, which are held at the proper angle with blocks shaped as shown, are fastened to the shaft with nuts drawn up against small shouldered blocks.

Neat Case for Your Ship Model Is Assembled from Wood and Celluloid



Made of wood and sheet celluloid, this case will protect small models against dust. If care is taken in finishing the wood and attaching the celluloid, the case will have a very neat appearance.

☐ If you coat the inside of a catsup-bottle cover with paraffin it will prevent objectionable discoloration.

Tiny Pieces of Inlay Cut Safely with This Grooved Jig

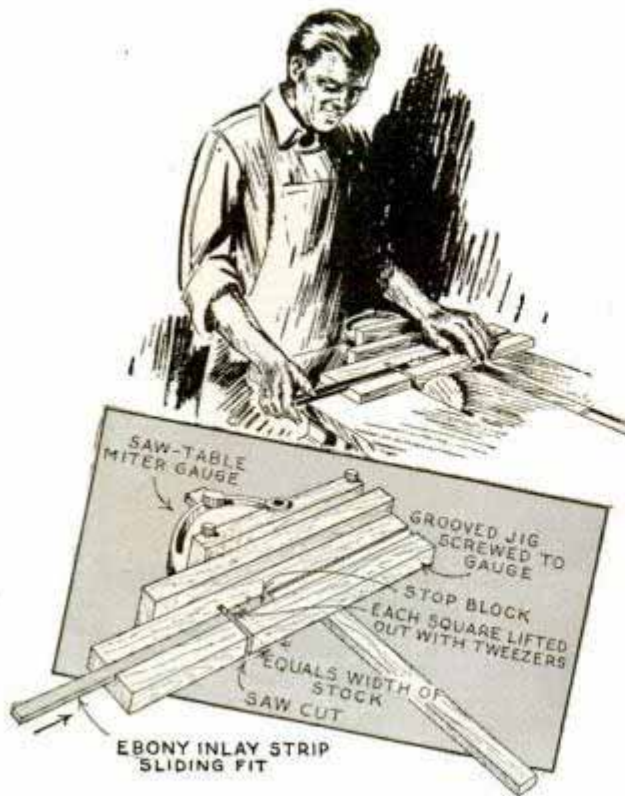

Having several strips of ebony to be cut into tiny pieces $\frac{3}{8}$ in. square for inlays, I solved the problem of holding such tiny pieces and also preventing chipping of the work as shown. A pine block was grooved lengthwise to take the strips with a snug, sliding fit. The block was then screwed to an upright piece, which in turn was attached to the saw miter gauge. A small stop block, to permit the strip to be moved an equal distance after each cut, was fitted in the groove at the proper point from the entering saw cut. By using a fine blade, I was able to produce perfectly cut pieces quickly.—Wayne C. Leckey, Aurora, Ill.

Chisel Kept in Holder by Handle



the handle is a length of rod threaded to screw into one side of the fitting. The end

The safety of having a holder when working with a chisel is more than worth the time to make this one. A twist of the handle loosens the chisel for removal. The body of the holder is a Y-pipe fitting, and

of the handle is beveled to provide a good bearing surface against the chisel.

—Chas. H. Willey, Penacook, N. H.

Dies Sharpened on a Drill Press

I have found the simple method illustrated very effective in sharpening small dies. To do this, a steel rod slightly smaller in diameter than the holes in the die is chucked in a drill press, which is then turned on, valve grinding compound being applied to the rod. I take each hole separately, first on the starting-thread side of the die and then on the finishing-thread side, applying a little more compound as I proceed.

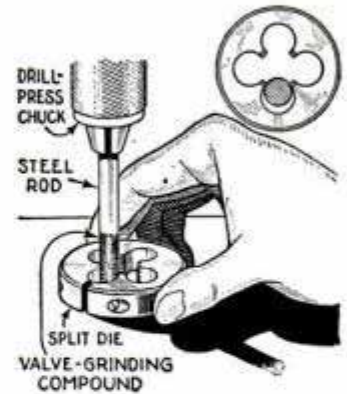

—Henry Wyma, Jr., Chicago.

Needle Pegs Help in Gluing Small Pieces Together

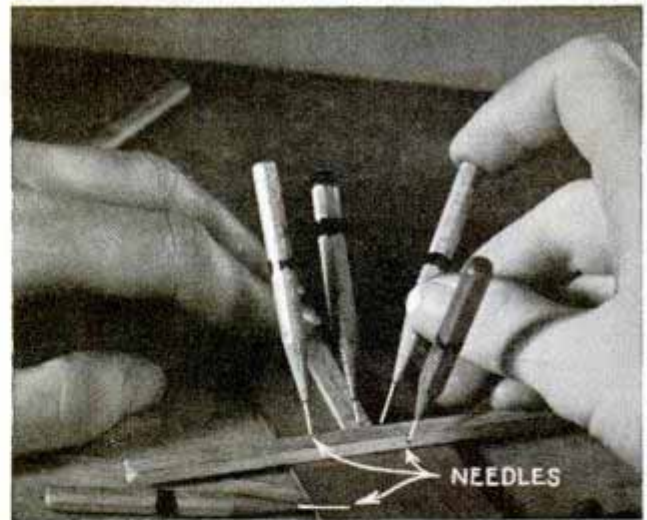

Modelmakers and others who work with pieces of wood so small that it is difficult to use clamps on them when nailing or gluing the parts together, will find these little needle pegs helpful. They consist of $\frac{3}{16}$ -in. strips of maple with headless needles inserted into the tapered ends. The pegs are used by pushing the needles through the part to be clamped into the part to which it is to be fastened.

—M. J. Stair, Chicago.

☞ A clothespin split in two provides small wedges for silencing rattling windows.

Fall Care of Your FLOWER BULBS

By
ROBERT STAHLER



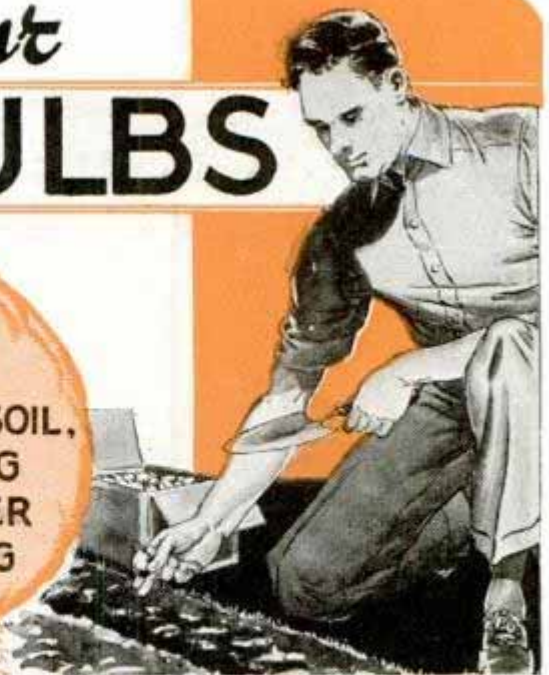

DO YOU inadvertently abandon your flower bulbs after they have bloomed? Then, it is no wonder that they do so poorly the following season. Proper treatment of bulbs, corms and tubers will cut to a minimum the annual losses, and will produce better flowers.

Bulbs may be divided into two classes, namely: the hardy types Fig. 1, those that flower in the spring, and the tender species Fig. 4, that bloom later in the season. The term "bulb" is a rather broad one. Hyacinths, lilies, tulips, etc., are true bulbs, but the term is also applied to the corms of gladioli (glads), the tubers of dahlias, and the thick fleshy root stocks or rhizomes of iris. All of these have in common several cultural requirements. They require a fairly rich soil, well drained and not too heavy. It should be spaded deeply, especially for bulbs that must be

TIMELY HINTS ON PREPARING SOIL, PLANTING AND WINTER MULCHING

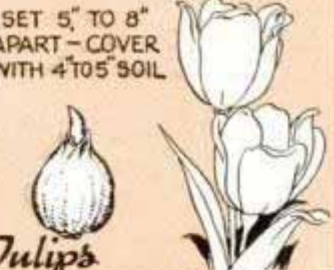

1 PLANTING CHART FOR HARDY BULBS

 <p>SET 2" OR 3" APART--COVER WITH 2" SOIL</p> <p><i>Crocus</i></p>	 <p>SET 3" APART--COVER WITH 2" SOIL</p> <p><i>Snowdrops</i></p>
 <p>SET 7" TO 8" APART--COVER WITH 4" SOIL</p> <p><i>Hyacinths</i></p>	 <p>SET 5" TO 8" APART--COVER WITH 4" TO 5" SOIL</p> <p><i>Tulips</i></p>
 <p>SET 3" APART--COVER WITH 3" SOIL</p> <p><i>Scillas</i></p>	 <p>SET 6" TO 12" APART--COVER WITH 4" SOIL</p> <p><i>Narcissus</i></p>

Lilies

Base-rooting species:

- Nankeen Lily (*Testaceum*) plant 5 in. deep
- Madonna Lily (*Candidum*) . . . 4 to 5 in.
- Sierra Lily (*Parvum*) 4 in.
- Star Lily (*Concolor*) 4 in.







Stem and base-rooting species:

- Coral Lily (*Tenuifolium*) 5 in.
- Turk's-Cap Lily (*Martagon*) 5 in.
- Elegans (*Thunbergianum*) 6 in.
- Tiger Lily (*Tigrinum*) 9 in.
- Goldband Japan Lily (*Auratum*) 9 to 12 in.
- Regal Lily (*L. Regale*) 12 in.

set well below the ground. If manure is used, it should be decayed thoroughly and worked well into the soil several months prior to planting time. Instead of manure, the soil can be enriched by working in peat or leaf mold and then adding finely ground bone meal in the proportions of about 15 lbs. per one hundred square feet, reducing this to 10 lbs. each year thereafter. You'll find this non-burning, high in phosphorus and it contains about two or three per cent

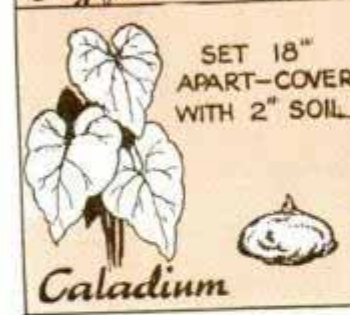

4 PLANTING CHART FOR TENDER BULBS

 <p>SET 6" APART—COVER WITH 4" SOIL</p> <p><i>Gladioli</i></p>	 <p>SET 12" APART—COVER WITH 2" SOIL</p> <p><i>Calla Lily</i></p>
 <p>SET 18" APART—COVER WITH 2" SOIL</p> <p><i>Begonia</i></p>	 <p>SET 18" APART—COVER WITH 2" SOIL</p> <p><i>Canna</i></p>
 <p>SET 18" APART—COVER WITH 2" SOIL</p> <p><i>Caladium</i></p>	 <p>SET 36" APART—COVER WITH 6" SOIL</p> <p><i>Dahlia</i></p>

of nitrogen. Supplement the bone meal with a mixture consisting of sulphate of potash, 1 lb., and slowly dissipating organic-nitrogen fertilizer, a few lbs. It has been found that fertilizer is best worked in with the first spring cultivation.

To flower, bulbs require very little aid from nature, but the energy they have ob-

tained from sunlight and nutrition must be replaced. The action of sun and light on the chlorophyl content of the leaves has much to do in replacing this stored energy. While it is frequently done, the leaves should not be cut away after flowering. Let them wither and fall off by themselves. Meanwhile, provide plant food as directed, water when necessary, and make shallow cultivations. Seed formations add a heavy drain to bulb energy. For this reason, faded blooms and seed pods should be removed at once.

When flowers are picked for use in the home, cut the stems sufficiently long enough for your purpose, yet short enough to allow the ripening bulb, corm or tuber to mature. Gladiolus spikes should be cut when the first bloom is fully opened, the remaining ones will continue to open in water and will last many days. Gladiolus corms, like all true corms, disappear each season, but the plants grow new ones. To ripen or mature this new crop, a generous fan of foliage must be left when cutting the blossoms.

In the colder regions, hardy bulbs should be mulched. The purpose of this is to prevent injury to the bulbs by the alternate freezing and thawing action of the soil. Figs. 5 and 6 show a simple frame which can be supported above the bed, using common wood lath strips to hold your mulching in place. For this, straw, hay, leaves and excelsior may be used. It is best not to mulch the ground until the first freeze. Lilies require a rather thick mulch. Narcissus, hyacinths and tulips will do with less. In early spring lift the mulch and look for emerging growth. At its first appearance, clean off the beds, regardless of weather. With the exception of lilies, which should be covered with an old sheet, most bulb growth above the ground can survive late frosts.

The chart given in Fig. 2 lists a few of the more commonly grown varieties of lilies. Generally, lilies are set too deeply. Note that the planting depth given is measured from the top of the bulb and not from the base. If you live in a northern locality, mulch the prepared beds heavily with

leaves or straw to prevent hard freezing. Medium-size bulbs are preferable. They require a cool soil and welcome a mulch of peat when the growth is well above the ground and the days are continuously warm. Some varieties, especially those of the base-rooting species, may show no growth at all the first year. This is to be expected, so do not disturb them, for you may break off growing stems.

With the exception of tulips, very little is gained and invariably harm is done by frequently moving established hardy bulbs. If necessary to transplant, delay the work until the foliage has withered completely. Tulips, however, thrive better if they are dug up several weeks after the foliage disappears. The bulbs are spread out in a warm, airy location. Within a month they should be cleaned and reset. The second-year bulbs (the offsprings) will be smaller than the parent ones, but those an inch or more in diameter will flower the next season. September is the best planting month for hyacinths. Narcissus, which multiply rapidly, will eventually begin crowding. When this occurs let the bulbs remain in the ground a few weeks after the foliage has withered. Then lift the clumps, recondition the bed and replant at once. Use only the larger bulbs that fall away from the clumps. Original planting should be made in September, at which time the bulbs are usually shipped.

Gladioli do well in a fairly rich average soil free from manure. Plant them in rows 16 in. apart when the danger of frost is past. Successive weekly plantings up to July will provide continuous blooms until frost. Thrips make heavy inroads on gladioli unless sprayed every ten days with a solution of paris green, 1 tablespoonful, brown sugar, 2 lbs., and water, 3 gals. For further control, after the corms have been cleaned, in preparation for winter storage, shake naphthalene flakes, about an ounce,

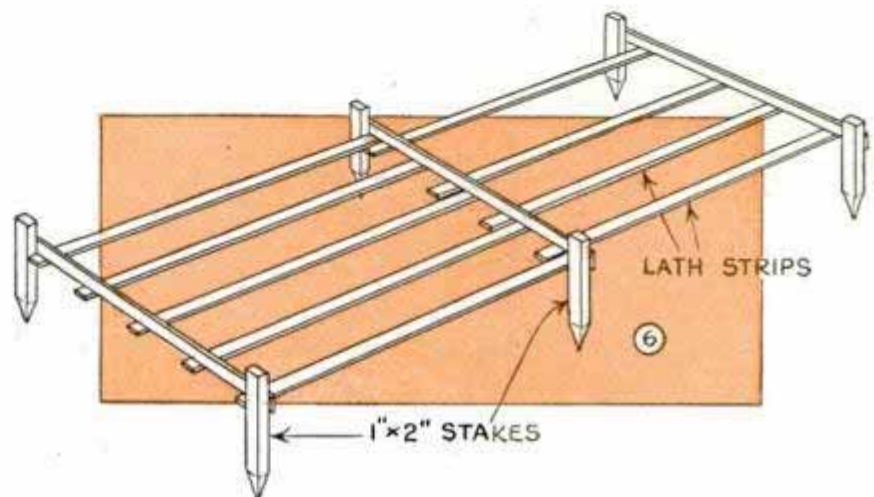

in a paper bag containing about 100 corms. Dahlias require a soil similar to that for gladioli. When planting tall varieties, provide the necessary support stake, set the tuber, cover with 2 in. of soil and fill the hole as the sprout grows. Avoid too early planting, for dahlias flower best shortly before frost. The soil requirements for calla lilies, tuberous-rooted begonias and caladiums should be well drained and contain plenty of moisture. Work in liberal quantities of peat and when the season becomes dry and warm, use it also as a mulch. Calla lilies, which bear large flowers throughout the entire summer, do well in full sun while caladiums and begonias prefer part shade.

A dry, cool cellar having a winter temperature of about 45° is an ideal location for storing tender bulbs. If your basement is too warm, a satisfactory storage space can be made by partitioning off the coolest corner with cardboard. Clumps of dahlias and cannas may be stored with the dried soil adhering to them while others should be cleaned. More expensive bulbs such as callas and begonias should be wrapped separately in newspapers. Gladioli keep well when stored in open woven baskets.

Fixture to Handle Angle Drilling Made from Old Piston

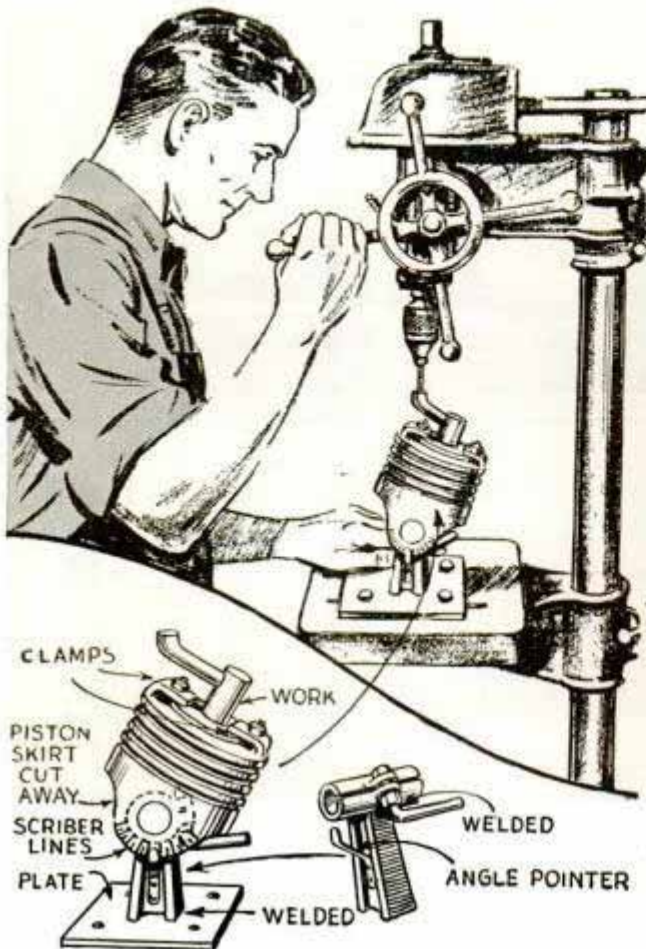

An old piston and part of a connecting rod assembled as indicated provide a handy fixture to hold work for angle drilling. The piston-and-connecting-rod assembly is welded to a steel plate, which is held on the drill-press table by bolts through the table slots. Clamps bent from flat steel hold the work to the piston top.

—F. Doughty, Yorkshire, Eng.

Panel Doors with Flooring Frames Are Easy to Make

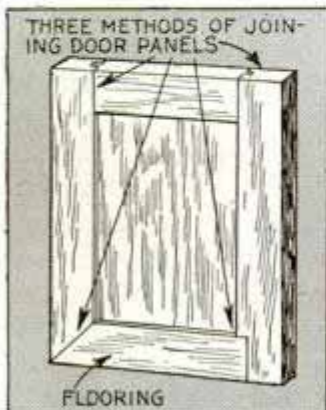

Panel doors may be made quickly by using 1-in. flooring with the tongue removed for the frame. The groove in flooring is just the right width for 1/4-in. plywood. Three alternate methods of joining are shown. The joints

should be glued and reinforced with nails, screws or dowels. Flooring comes in 2, 3,

and 4-in. widths so that it is easy to secure stock of proper dimensions.

—Maurice W. Patterson, Auburn, Wash.

Showcard Ink Bottles Sealed by Cork on Mousetrap

To keep his showcard ink bottles sealed and ready for instant use, without the usual insertion and removal of corks, a window trimmer employs ball corks, which are mounted on the jaws of small mousetraps. The traps are tacked to the wall over his worktable in such a position that the balls may be lifted to snap down over the mouths of the bottles, sealing them tightly.

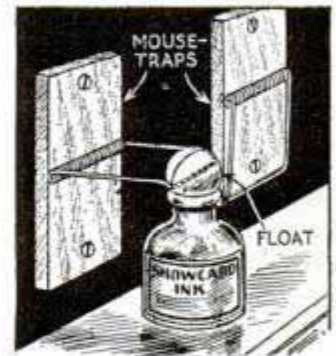

Dog Kennel in Back-Door Steps

A wooden barrel placed in the concrete back-door steps provides a place for the family dog. Less concrete is required and two jobs are accomplished for the price of

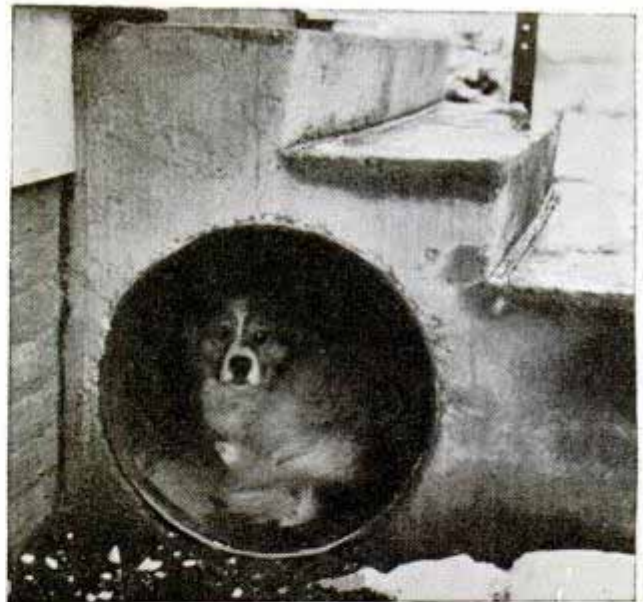

one, although a little more reinforcing of the steps will be necessary. If you do not have a dog, the extra space can be used to store rubbers, garden tools, etc.

—W. A. Junnila, Pullman, Wash.

☐ If painted walls in your home are marred with a number of hairline cracks, stippling tends to make cracks and unsightly patches less noticeable.

Cards and Bookplates from Smoke Etchings

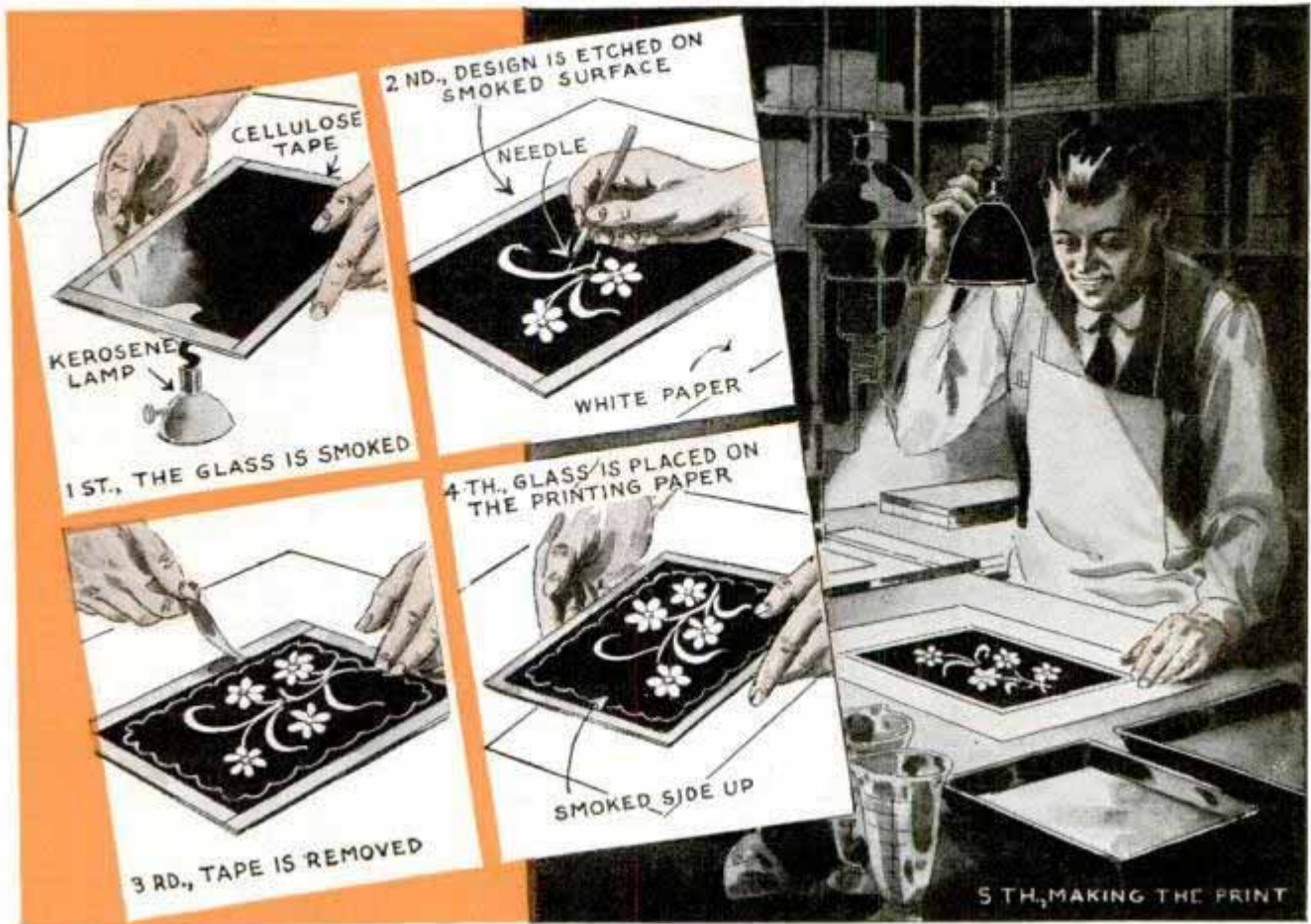

Personal cards, greeting cards, bookplates, etc., can be photo-printed from etchings scribed in smoked-glass plates, using the latter like a negative to reproduce any desired number of prints. Get a piece of clear, clean glass, bind the edges with tape for ease in handling and then move the glass over the flame of a candle or kerosene lamp until a thin layer of soot

covers the surface uniformly. For scribing fine lines on this surface you use a needle, and for heavier lines, a more blunt-pointed instrument. Be sure to wipe the soot off the point of the scriber frequently as the soot piles up on the point and causes the lines to become wider. If a black border is desired, the tape binding is removed; if no border is wanted, the tape is left on.

Hat Rack Jigsawed from Wood Folds Flat Against Door

Here is a hat rack that is especially handy for mounting on doors that have plywood panels where regular hooks cannot be attached. Four hooks to fold toward the center of the rack are jigsawed from 1-in. pine. The hooks are hinged with nails. For ease in opening, small finger-holes are rounded out as indicated at the bottom and side of each hook.

—Benj. Nielsen, Aurora, Nebr.

Be sure water does not stand around your rose plants and freeze during the winter if you want them to live. Mound the dirt up well around the plants before the ground freezes.

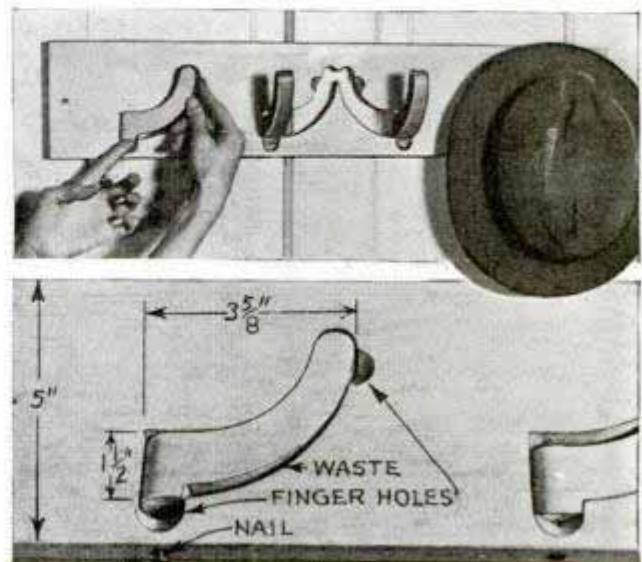

Jig Aids in Truing Bicycle Wheel When Tools Are Limited

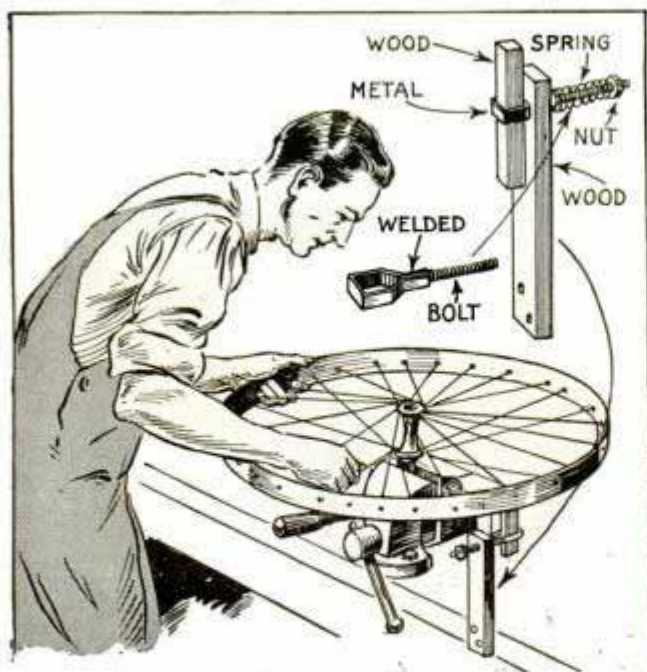

The cyclist or owner of a small shop who wants to true or stripe a bicycle wheel occasionally, but does not have the equipment, will find this little jig the solution to his problem. In use, the wheel is clamped in a bench vise by means of the spindle, and the jig is attached to the edge of the bench under the rim of the wheel. In it can be held a small hardwood block for truing the wheel, or a brush for striping it.

Wood Stain Made from Lacquer

Lacquer of either the brushing or spraying type provides a good wood stain when diluted with lacquer thinner. Use thinner, 8 parts, to lacquer, 1 part, and apply it with a brush, wiping off the excess with a cloth. If a spray gun is available, the stain can be applied evenly and the wiping omitted. Streaks and lines caused by overlapping



areas in the application can be removed by swabbing the wood with a cloth moistened with the thinner.

Shields for High-Top Shoes Protect Your Socks

Hunters and others who wear high-top shoes while walking through briars or tall weeds will find these shields handy. They cover the tops of the socks projecting from the shoes and prevent briars from catching in them. They are made by cutting sections from an old inner tube of suitable size.



Rotating Lathe Center Has Ball Thrust Bearing



There are many times when a rotating center for the lathe tailstock is a necessity, yet many home craftsmen and small shop owners are without them because they feel that the occasional jobs do not warrant the purchase of one. However, a center like the one shown can be turned out easily by anyone. It consists of a steel shank turned to the proper taper to fit in a lathe tailstock and then drilled transversely to take the center. The latter bears against a thrust ball and is grooved to engage a set screw.

Tiny Panel Saw for Modelmakers

Modelmakers who experience difficulty in cutting small pieces of wood accurately enough for a close-fitting joint will find this saw an aid in doing the job. The blade is made from a single-edge safety-razor blade of the type having a metal stiffener. The beveled edge of the

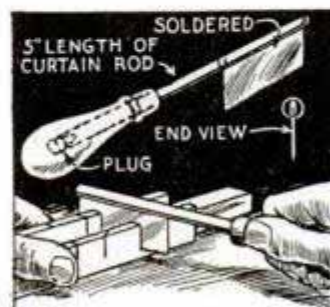

blade is ground off, after which teeth are filed in it. A handle for the saw can be made from a length of tubular curtain rod of the type having an open seam and a diameter of about $\frac{1}{4}$ in. Solder applied to both sides of the blade at the slot will hold it in place. Any wooden tool handle of suitable size slipped over the rod will do for a hand grip.—Grover G. Strother, Belington, W. Va.

Time Switch Turns on Radio or Other Appliances

A time switch to turn off or on a radio or other low-wattage electrical appliance can be assembled with an ordinary alarm clock and a small toggle switch. The latter is attached to the back of the clock by means of a bracket in a position that the alarm key will open or close the switch when the alarm goes on. Wiring of the switch is done as shown in the right-hand detail.—John L. Story, Washington, D. C.

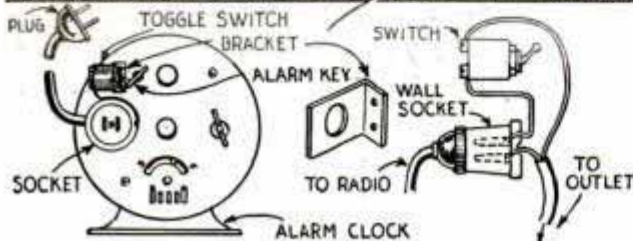

Repairing Broken Pipe Lines by Pouring Concrete Around Them

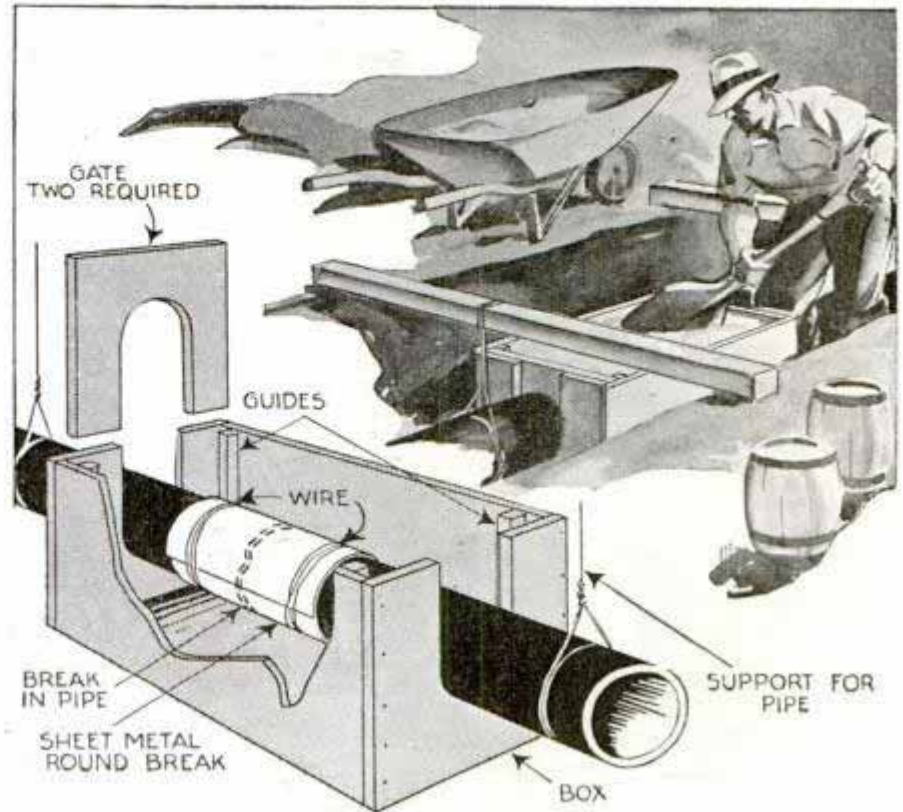

When a break or leak occurs in a pipe line, a repair often can be made as indicated. First line up the two broken sections and wrap them with sheet metal, which is then held in place with wire. A box is now fitted around the break and closed at each end with a gate. A cement mortar consisting of cement, 1 part, and clean sand, 3 parts, is poured into the box. This should be large enough to give at least a 2-in. thickness of mortar on all sides of the pipe, and more if the pipe carries high pressure. It is important that the pipe be well supported, either by props from below or by suspension from above. Small leaks are repaired similarly, except that support for the pipe usually is unnecessary.

Special Attachment for Pipe Vise

In small shops where a pipe vise is used only occasionally, it can be held in a bench vise if it is mounted on a piece of T-iron as indicated. This permits it to be stored away when not needed. If desired, two pieces of heavy angle iron placed back to back and welded together will provide a good substitute for the T-iron.

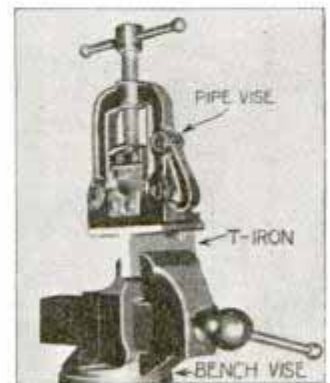

—Harold T. Quinn, Dolton, Ill.

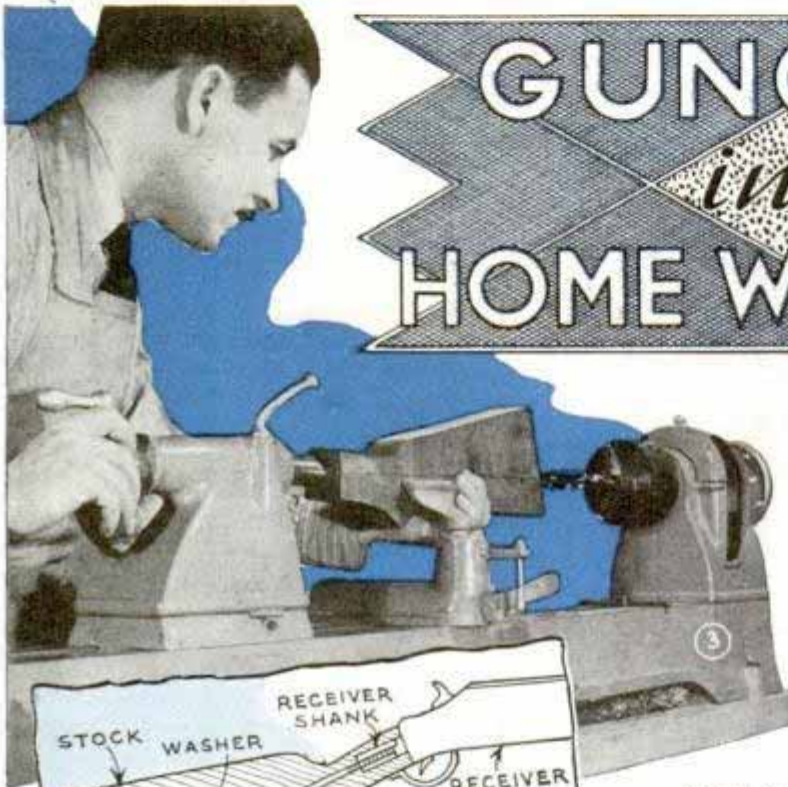
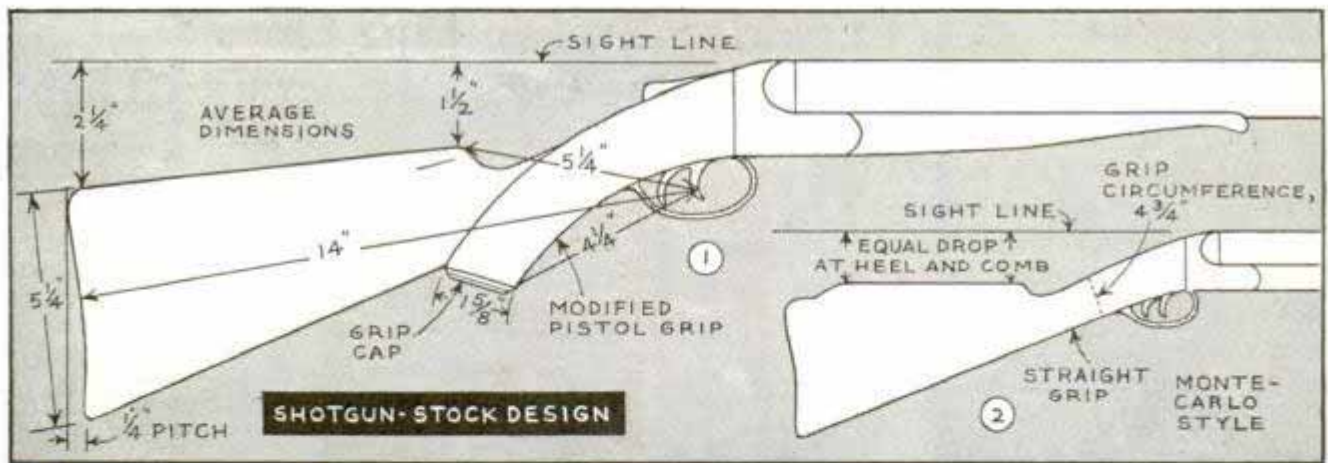

GUNCRAFT *in the* HOME WORKSHOP

PART II

THE shotgun stock is usually longer and straighter than the rifle stock, which was covered in the first installment of this story last month. Figs. 1 and 2 give average dimensions, and show the two types of stocks that anyone can make.

Shotgun actions usually are easy to inlet. In one common style, the action is attached with a long screw through the stock, as in Fig. 4. This is a lathe job. With the stock blank roughly sawed to shape, run the large hole first, Fig. 3, then follow with the smaller hole. Fig. 5 shows an action that is held to the stock by means of tangs. As in rifle work, the parts are fitted exactly by coating them with lamp-black and pressing in place. The portions of the wood that smudge from the lamp-black are then "eased off." The "press" fitting necessary for this work can be done with a regular vise, Fig. 6. A butt clamp, Fig. 7, is the usual device used by the professional worker.

Checkering: Checkering adds to the appearance of any gunstock and at the same time provides a non-slip gripping surface. The lathe does excellently for holding the work, or a simple cradle can be used as in Figs. 8 and 9. Checkering tools can be purchased or made from tool steel, Figs. 10, 11

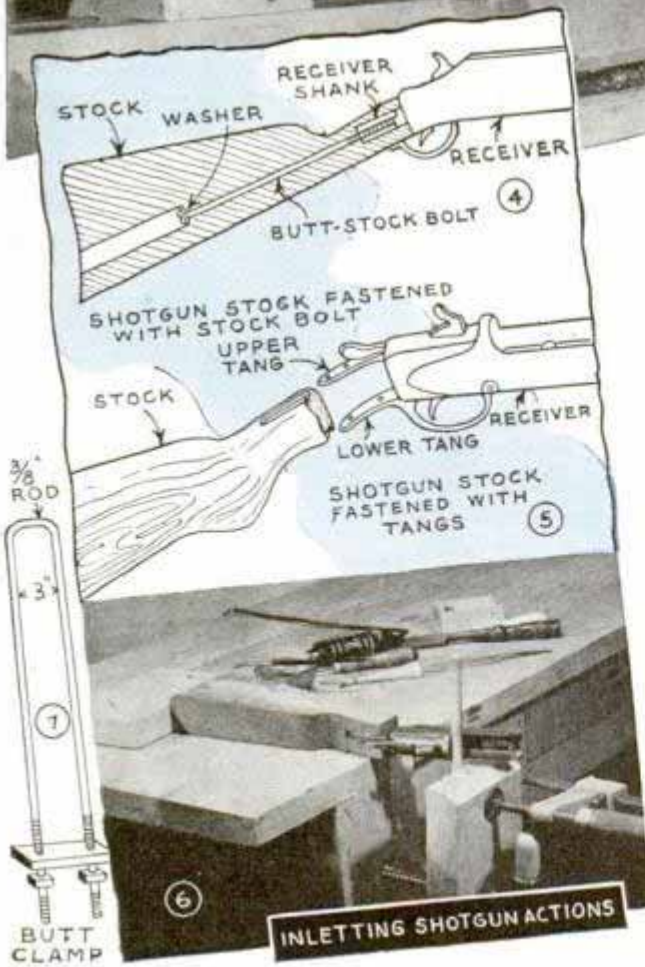

INLETING SHOTGUN ACTIONS

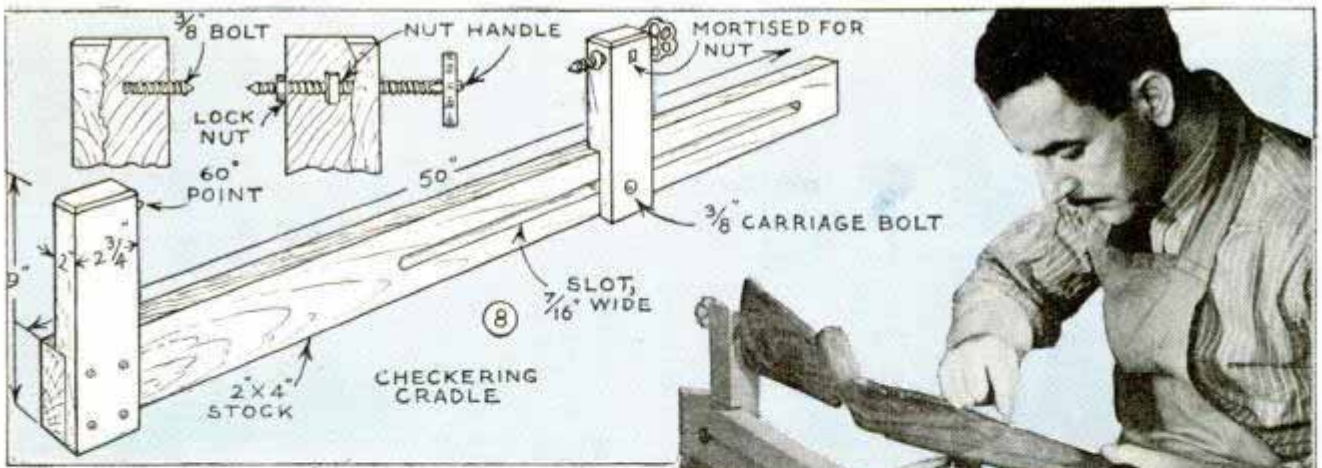

and 23. The line spacer is used to space the cuts, while the V-tool deepens them. The spacer should cut about 18 lines to the inch. The steel should be annealed so that the teeth can be filed by either of the methods given. A third tool is a three-corner file, which is used for deepening the cuts and general cleaning up.

In checkering, locate the position of the design, which should be midway between the forearm tip and magazine tang, Fig. 15. Make a paper pattern to reach within $\frac{1}{16}$ in. of the top of the stock, Fig. 12. The pattern, when laid out flat, will be slightly wedge-shaped, as in Fig. 13. For example we will use the four-point design shown at A in Fig. 22, making the diamonds two and one-half times as long as the width. Using these proportions, lay out two guide lines from the centerline of the pattern, Fig. 13. All other lines in the design will parallel these lines. Fig. 14 shows the completed pattern. Run all the point lines right across the pattern,

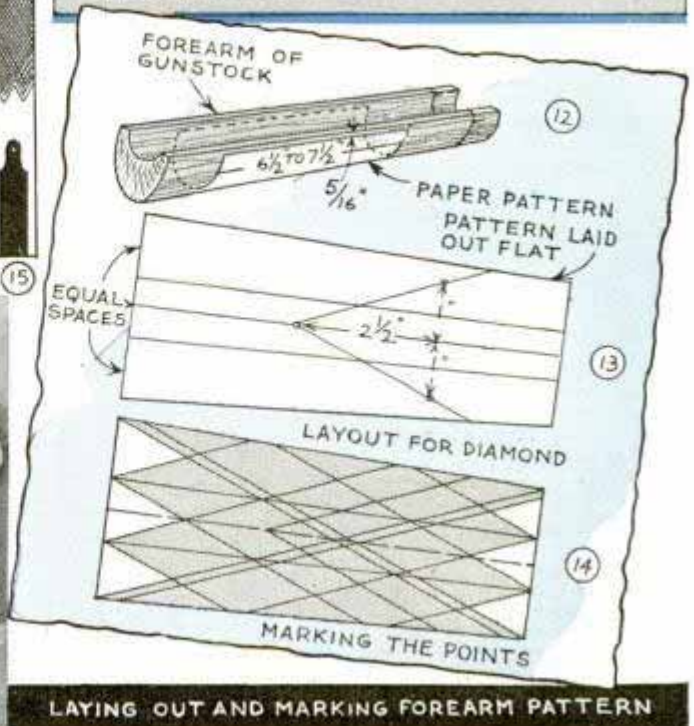
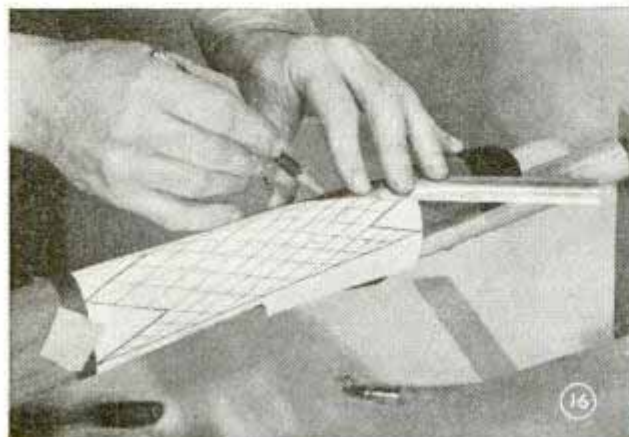
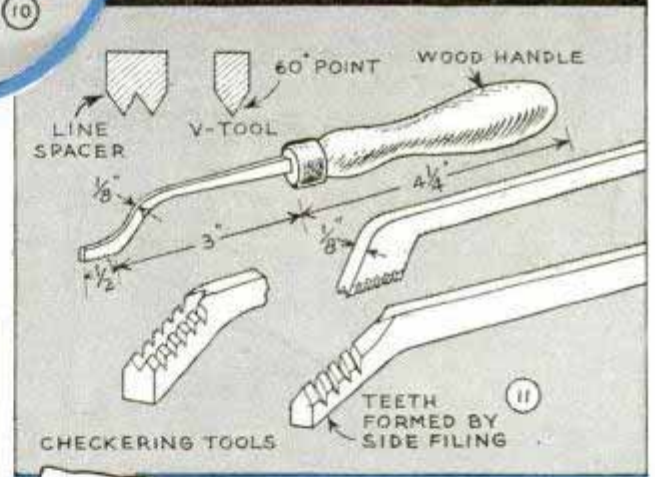

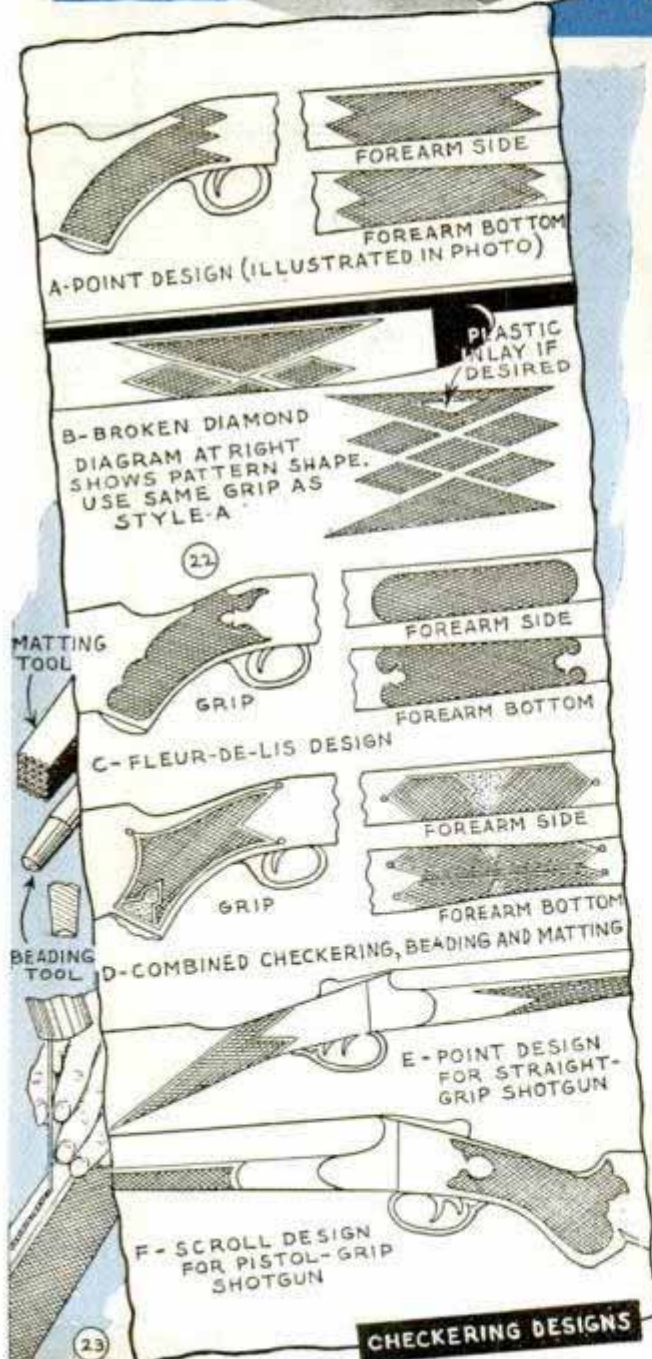
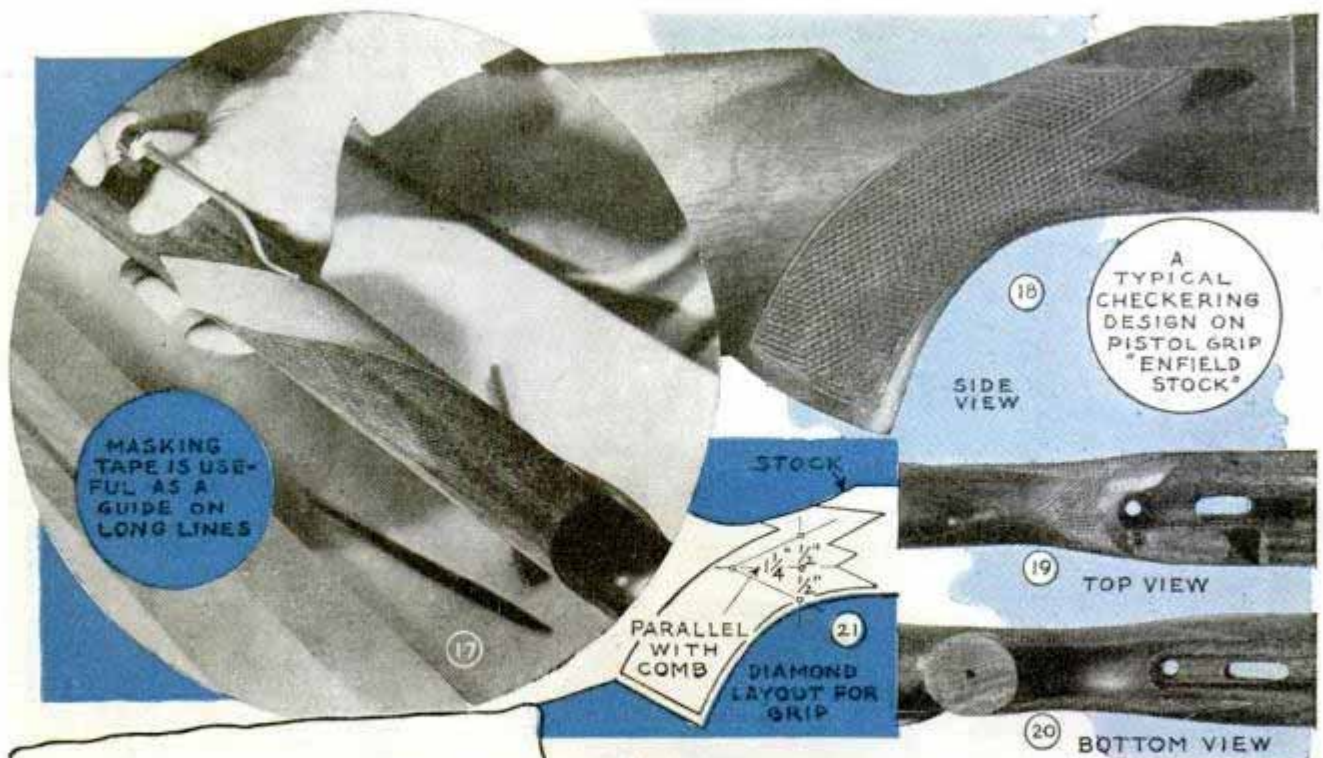

and also run in a line or two between points to serve as guides. With carbon paper, transfer the design to the wood, using a piece of flexible steel rule as a guide, Fig. 16.

Take the spacing tool and very lightly cut one of the point lines, running the cut right across the wood. Run in the corresponding line criss-crossing this. These are your two main guide lines. Work uniformly from these two lines, either to right or left. The tool is worked with a sawing motion, advancing about 1/2 in. farther on every forward stroke. One set of teeth rides in the cut already made, while the other set marks a new line. Masking tape can be used to establish a straight guide line, Fig. 17. Finishing the design is simply a matter of using the V-tool and file. Use the spacing tool to cut a border all around the design. Finish by rubbing lightly with steel wool, which will polish the diamonds and remove any fuzziness.

Checkering the grip is much the same except that a pattern is useless. Use dividers to set off the points directly on the wood. Guide lines set off as shown in Fig. 21 will give you the 2 1/2 to 1 diamond shape. All checkering lines parallel these two guide lines. The checkering should not run too far under the grip, see Fig. 20, since this is an inside curve and very difficult to work. It is a good idea to split the design on top, as shown in Fig. 19. Fig. 18 shows a side view and Fig. 22 shows typical designs. Matting and beading combined with checkering produce an attractive pattern.

Gun bluing: A simple method of bluing is to spray with blue metallic lacquer, Fig. 24. This gives an appearance equal to any other method, but has the disadvantage of chipping and peeling off. It is quite useful for touch-up work. The set-up for regular hot-solution bluing is shown in Fig. 25. A second tank for a lye solution is useful, but one tank can be made to do the whole job

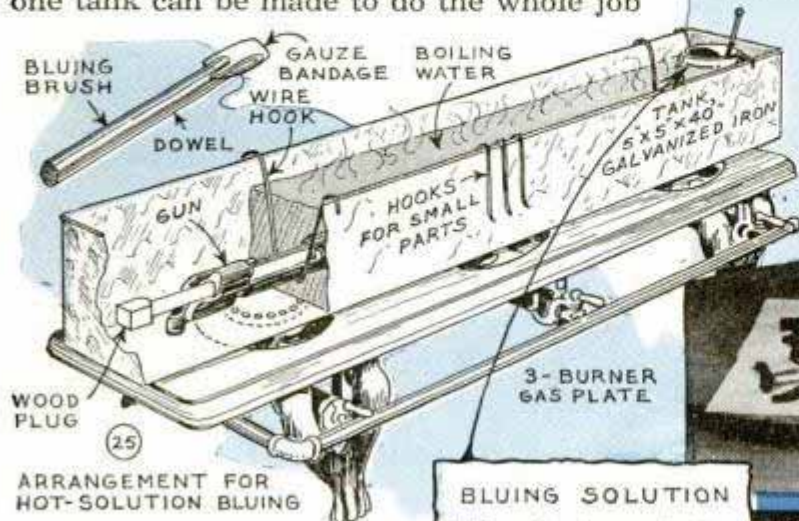

by cleaning between operations. Bluing solution can be purchased or made up according to the formula given. Start work by fitting boiled-wood plugs in both ends of the barrel. Dismount all loose parts. Scrub all parts thoroughly with gasoline. If there is old bluing on the gun, it can be removed with a 10-per-cent solution of sulphuric acid, flushing well with boiling water. Fill the tank two-thirds full of water and add a tablespoon of lye to each gallon of water. Bring to a boil. Place barrel and all parts in the tank and boil for 15 min. Flush the work with hot water and immediately after removal put it into a tank of clean, hot water. Do not touch the work with the bare hands. Wear cotton gloves or handle it by means of the wood plugs.

Now for the actual bluing. Put the bluing solution, 2 oz., in a clean glass jar and suspend in one corner of the tank. Fill the tank two-thirds full of water and bring to a hard, rolling boil. When the work is heated thoroughly, apply an etching solution made by adding nitric acid, 1/2 oz., to water, 6 1/2 oz. Let stand 5 or 6 sec. and plunge back into the water. When the work is hot, remove and swab with the



BLUING GUN BARRELS AND PARTS

BLUING SOLUTION
 Mix potassium nitrate, 1/4 oz., sodium nitrate, 1/4 oz., bichloride mercury, 1/2 oz., and potassium chlorate, 1/2 oz., in glass jar. Then stir in slowly distilled water, 10 oz., stirring constantly until almost cool, and add spirits of niter, 1/2 oz. Keep in blue or brown glass bottle with glass stopper. Label poison and let stand 24 hrs. Shake well before using



bluing solution. As soon as it is dry, get it back into the water. After a minute or so, remove the work and scour off the rust with fine steel wool, as shown in Fig. 26. Now, put the work back into the water and repeat the operation—heat, blue, card off the rust. Three to five applications will give a rich blue-black coating. After the final coat, swab the work with linseed oil. Wipe this off carefully as it starts to gum on the cooling metal, and then oil with any light oil. The whole operation takes about 1 1/2 hrs. Speed in application of bluing solution is essential. All other operations can be done at ordinary working speed.

Note: Extreme care must be exercised in handling the etching and bluing solutions as they contain chemicals that are highly corrosive and poisonous. If accidentally spilled on the hands, immediately run copious amounts of water over them.

Brush Used in Different Paints Cleaned Economically



In my work of painting models, it is often necessary to use paints of different colors on a small job. To have a brush for each type of paint would not only raise the cost of production, but would also make a lot more work in keeping them clean. To avoid all of this, I use one brush and clean it on a piece of screen wire stretched over the top of a small box. To clean the brush, I merely dip it in a can of kerosene or other solvent and then rub it back and forth across the screen. In this way, the solvent or cleaning fluid does not become colored quickly, as the brush is merely dipped in and out once or twice for each cleaning.

—C. H. Dyer, Pikeville, Ky.

Helmet Hanger Saves Space



The problem of finding storage space for helmets used by a football team was solved by one coach who used wire hangers of the type shown. These permit the helmets to be suspended from a wall or other place

instead of using shelves. Also, the hangers make it possible for the helmets to dry out quickly after a hard-played game. The

lower ends of the hanger are either taped or covered with rubber tubing to prevent damaging the helmets.

—James H. Gosch, Scotia, N. Y.

Light Bulb Serves as Float on Valves

An old light bulb serves nicely as a float on automatic float valves. A socket should be installed on the end of the float arm and the bulb screwed into it. Size of the bulb will be determined by the buoyancy required.

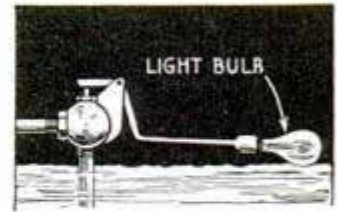

—Wit C. Casey, San Diego, Calif.

Tin-Can Stilts Are Lots of Fun



Tin-can stilts are inexpensive and are safe for children, especially the small tots who want in on the fun. The cans are held on the shoes by rubber bands cut from old inner tubes.

Rubber Ball Shields Hand When Filing Saw

A saw filer's hand can be protected easily against injury on the sharp teeth by fitting the file with a guard made from a small sponge-rubber ball. A hole punched through the center of the ball permits it to be slipped on or off the file in a jiffy.

—Howard R. Heydorf, Missoula, Mont.

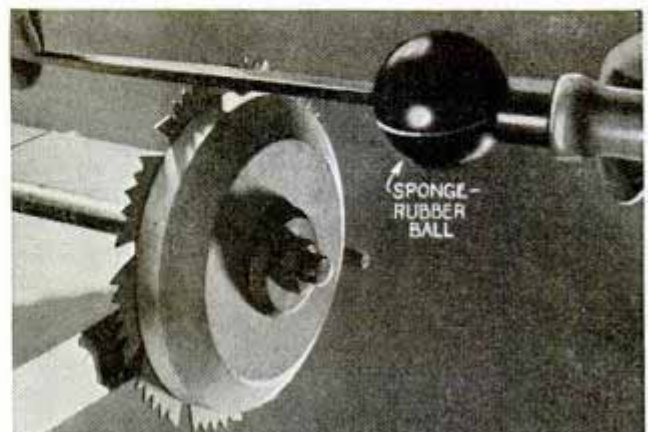

Stand and Chimney Make Hurricane Lamp

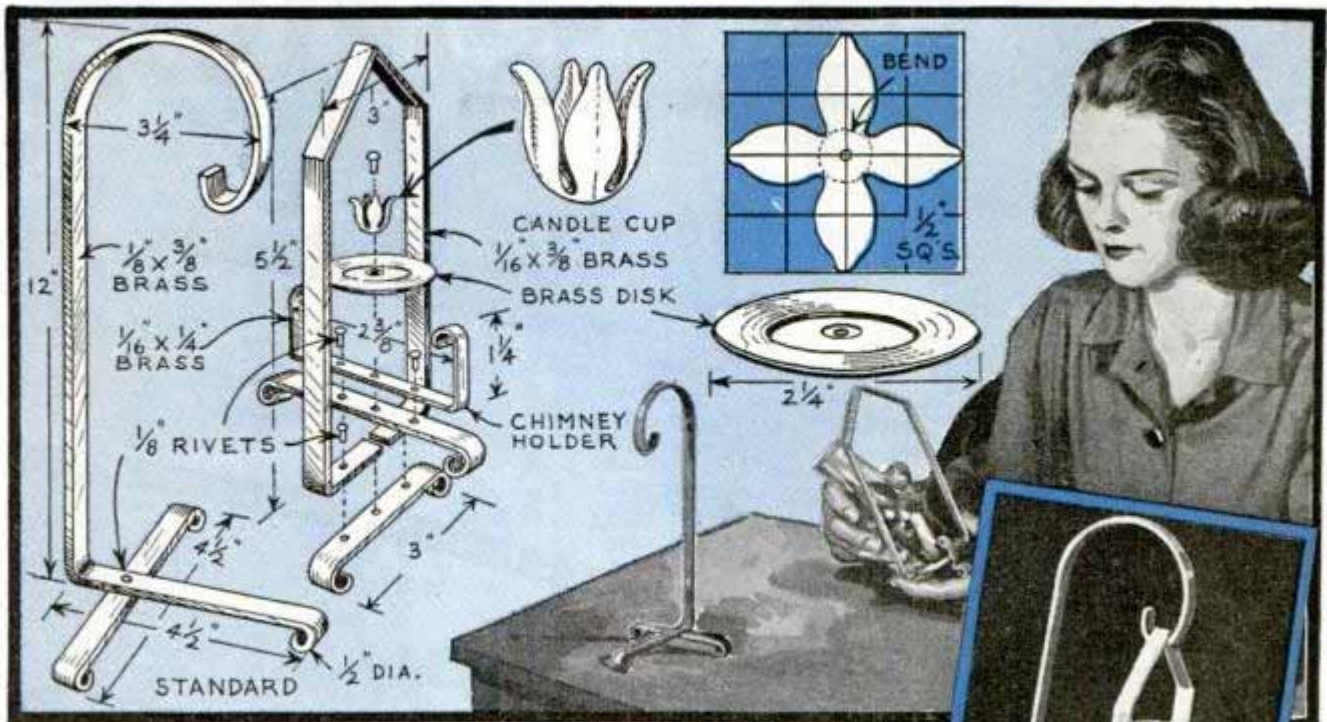

Just the thing in your colonial or knotty-pine room, a candle lamp like the one shown is made easily by anyone, and comes in handy when your electric current is cut off temporarily by a storm. A hack saw and a small vise or jig to cut and shape the brass framework, and a pair of snips to cut the sheet-brass chimney base take care of the tools. You can buy the chimney at a hardware store. The brass can be left unprotected to tarnish and give the appearance of age, or it can be polished and lacquered.

Where Does the Extra Square Come from in This Puzzle?

Does it seem possible to take a piece of heavy cardboard 8 in. square, lay it off in sixty-four 1-in. squares and then cut it

into three parts, which are then arranged in a rectangle having sixty-five squares? That is what apparently happens if you cut the cardboard as indicated in the upper detail and then arrange it as shown in the lower one. The secret is that while the three pieces appear to fit together closely, there is enough space along the three joints to equal a square inch of surface.

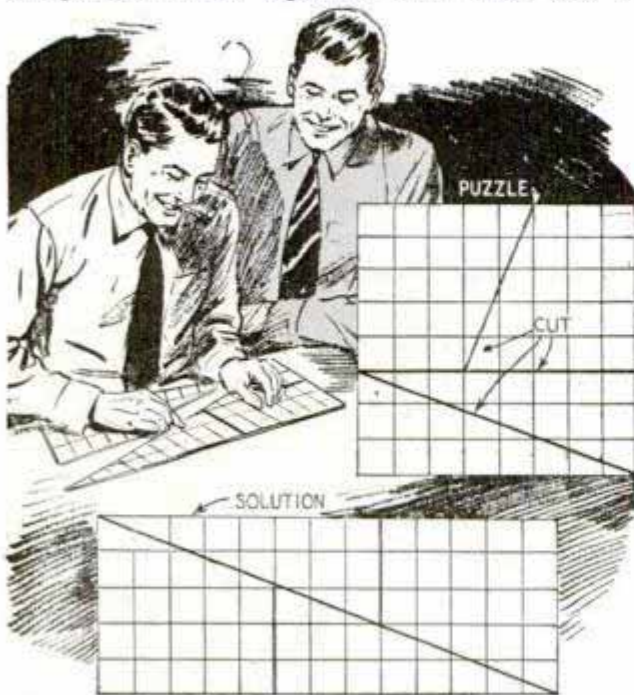

Garden Trowel Made from Spoon

A good garden trowel can be made from a large spoon, the bowl of which is cut as indicated. Such a trowel will also be handy for doing small pointing jobs on masonry.

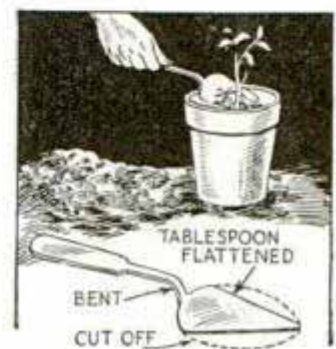

Rep 225 #42 X 306



GEM CUTTING

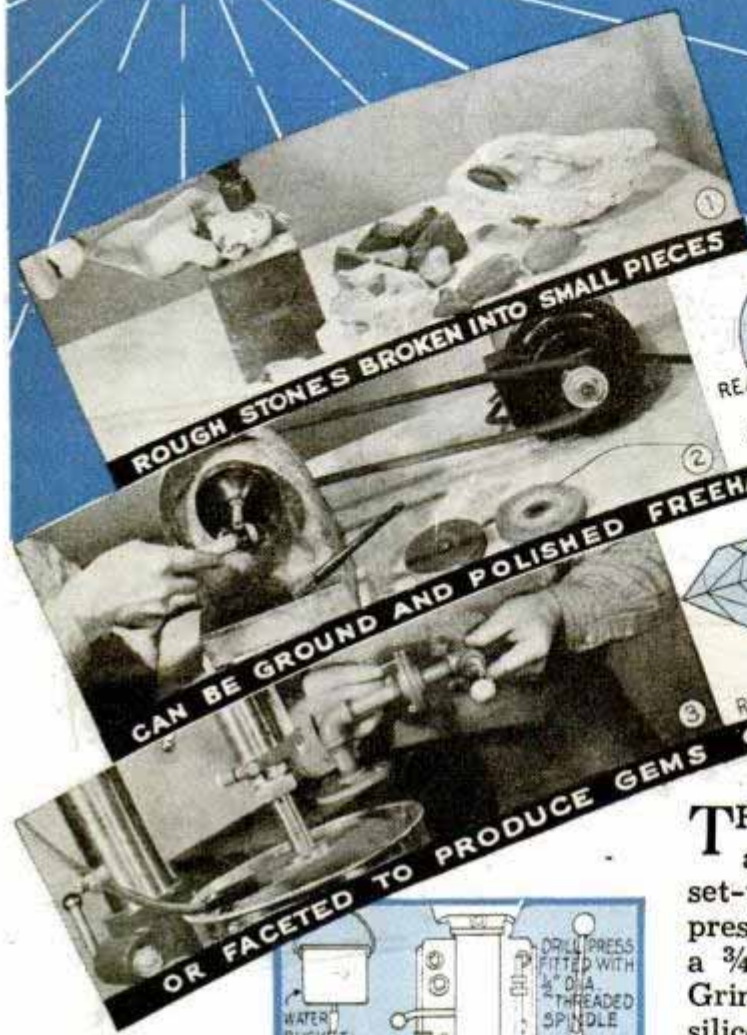

ROUGH STONES BROKEN INTO SMALL PIECES

CAN BE GROUND AND POLISHED FREEHAND TO MAKE COLORFUL CABOCHONS

OR FACETED TO PRODUCE GEMS OF SPARKLING BRILLIANCE

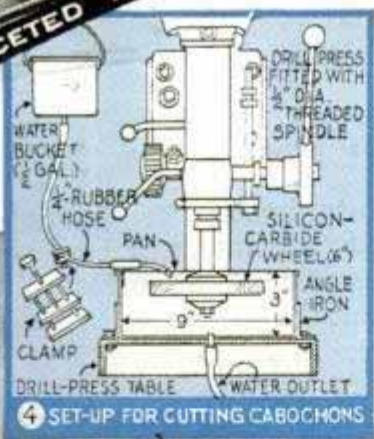
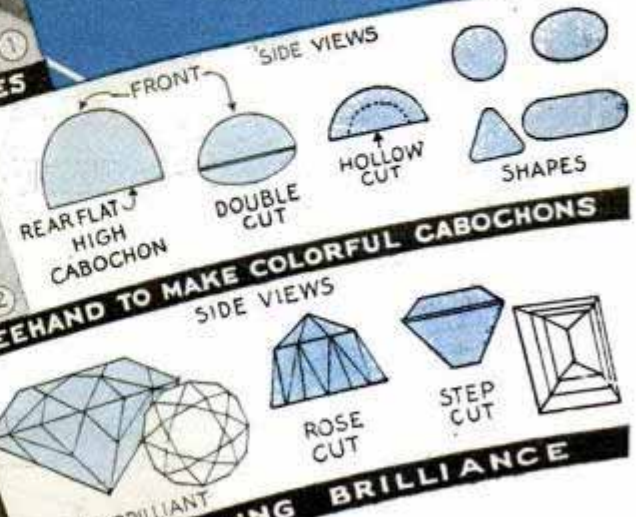

4 SET-UP FOR CUTTING CABOCHONS

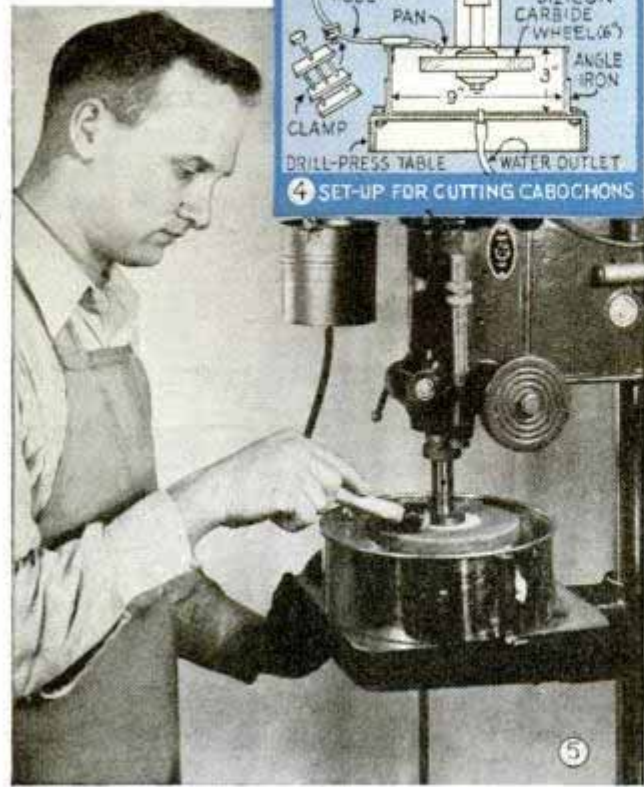

5

THERE'S a real fascination in cutting and polishing semi-precious stones. A set-up for cutting cabochons on a drill press is shown in Figs. 4 and 5. Start with a $\frac{3}{4}$ -in. round button, about $\frac{3}{8}$ in. high. Grind this roughly to shape on a 100-grit silicon-carbide wheel, running a small stream of water on the wheel. Grind one side of the stone perfectly flat, as in Fig. 8, and cement the stone to a short length of dowel rod. A cement for this can be made by mixing sealing wax, 3 parts, with flake shellac, 1 part. The mixture is made fluid by heating. Dip the end of the dowel (lap stick) into the hot cement, and, with moistened fingers, build up a ball of cement, as in Fig. 9. Pick up some cement on the flat side of the stone and press in place on the end of the stick. Have all parts warm before applying the cement, by holding the lap stick and the gem over a flame. Then proceed to grind it further, turning on the water, as the wheel will glaze in a few minutes if dry, and heat may fracture the stone. Further smoothing can be done on a 180-grit silicon-carbide wheel, or, you can jump to the next operation, done on a cast-iron lap.

The cast-iron lap wheel should be 6 in. in diameter by 1 in. thick. One side is flat and the other is hollowed out. This wheel

a double Hobby

-- takes you outdoors to find the stones and indoors to cut them

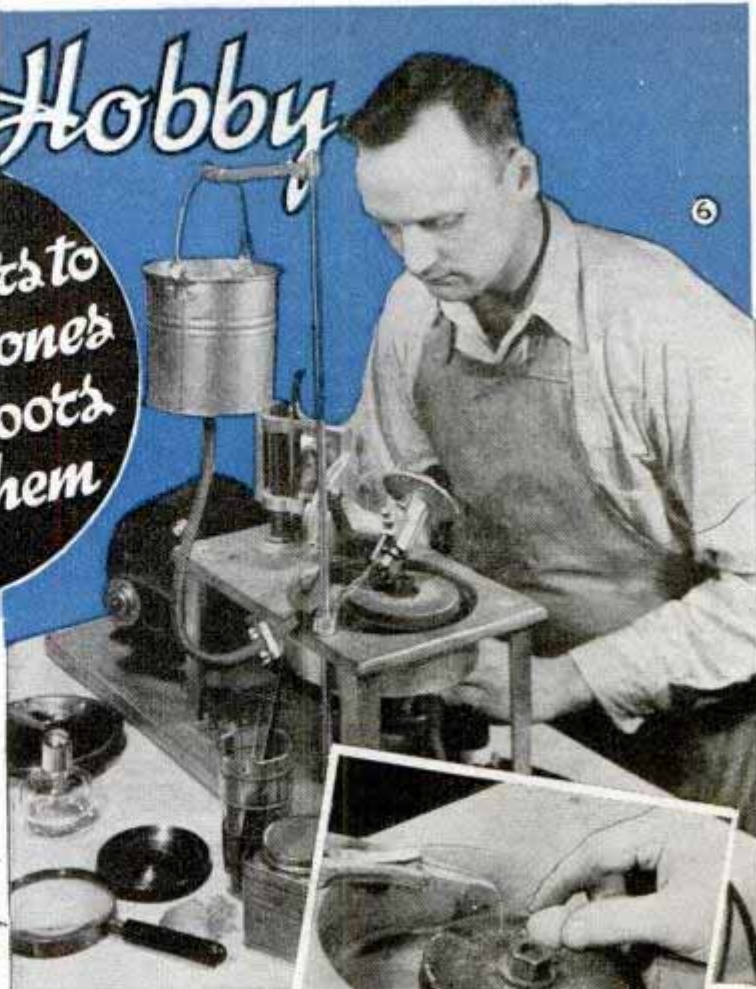
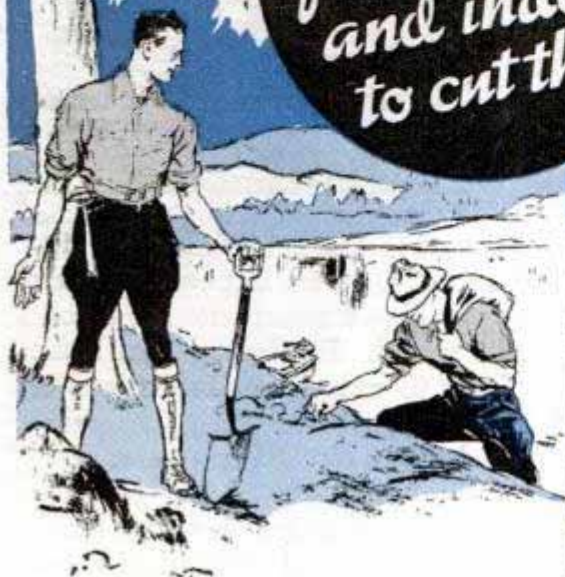

is lubricated with No. FF silicon-carbide grains mixed with water to form a paste, applied with a brush. After making the stone smooth, wash the lap with water and apply a paste of 600-grit silicon carbide. If the abrasive grains are mixed with glycerin and kept in a test tube, as in Fig. 12, the very fine grains will float near the surface, thus providing a graduated abrasive for final polishing. A further polish can be obtained by using a softer lap, as aluminum or hard maple. Final polishing is done on a hard felt wheel, lubricated with a paste made from No. FFF pumice and water as in Fig. 11. Wheels with paste abrasives should run at 600 to 1,000 r.p.m., using as much speed as possible without throwing the abrasive off the wheel. Grinding wheels can run at any speed from 1,000 to 3,600 r.p.m.

All operations can be done on an inexpensive grinding head, as shown in Figs. 13 and 14. Each wheel or lap should have a separate splash pan so that the abrasives can be kept separate. Lubrication for grinding is supplied by filling the splash pan with water or kerosene so that the wheel is immersed about 1/2 in. Sheet tin or zinc cemented to a hardwood wheel can



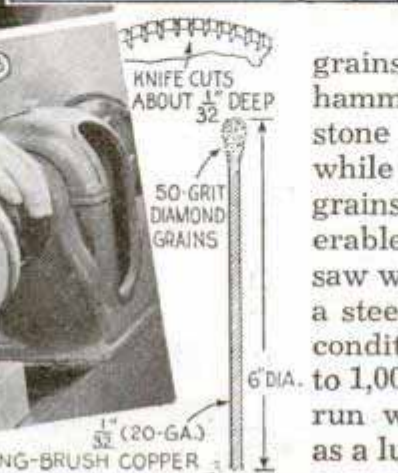
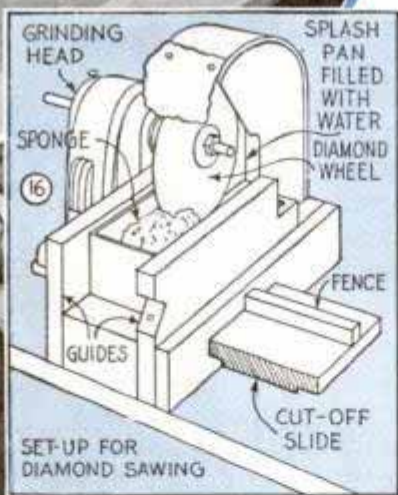
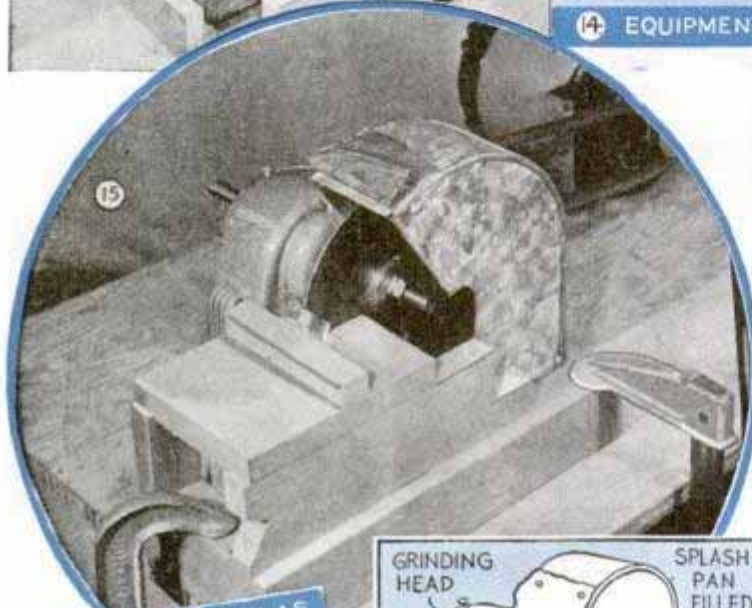
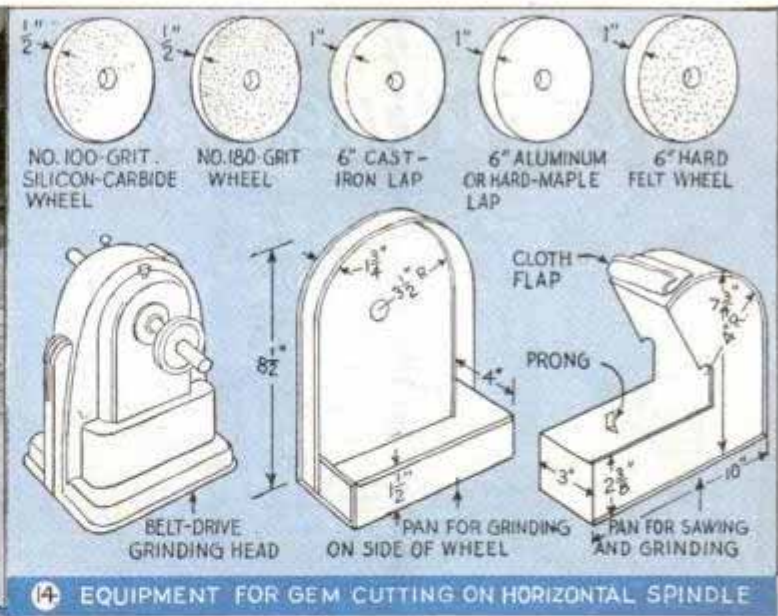
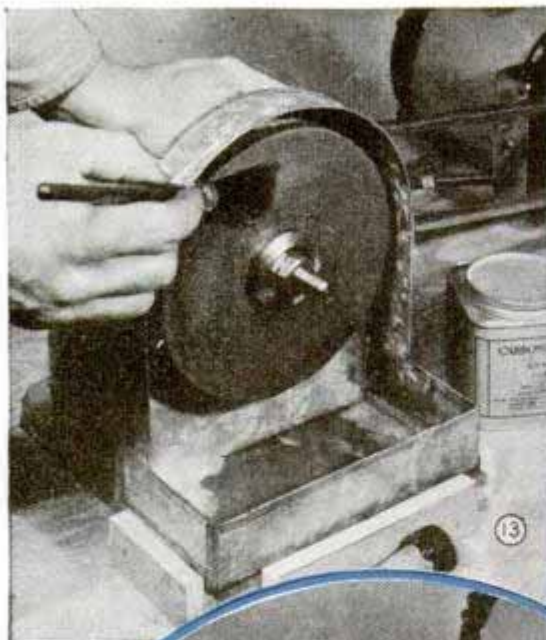

be used instead of solid metal laps. Similarly, 1/4-in. felt can be glued to wood as a substitute for a solid felt wheel. Battleship linoleum glued to wood wheels makes up nicely as a smoothing lap when used with No. FF grains. Dry sanding with 180 to 220-grit silicon-carbide paper on a disk sander is an optional method of treatment for intermediate polishing. For final polishing with muslin, leather or felt buffing wheels, a number of soft abrasives are available, including tin oxide, red rouge, green rouge, pumice stone, rottenstone, etc.

A suitable rig for sawing large stones into smaller pieces is shown in Figs. 15 and 16. The best type of wheel for sawing is a copper disk impregnated with 50-grit diamond grains (bortz), costing about \$2 per carat. About 1/4 carat will charge the 6-in. saw. Charging is done by nicking the rim of the disk with a knife, as shown in Fig. 17, after which the diamond grains, mixed with vaseline, are gently hammered into the cuts. A hard piece of stone is pressed firmly against the wheel while it is revolved by hand, bedding the grains firmly and giving the saw a considerable set. A properly charged diamond saw will cut gem stones almost as easily as a steel saw cuts wood, and, under normal conditions, should have a life of from 500 to 1,000 sq. in. of cut. The saw must always run wet, using either water or kerosene as a lubricant.

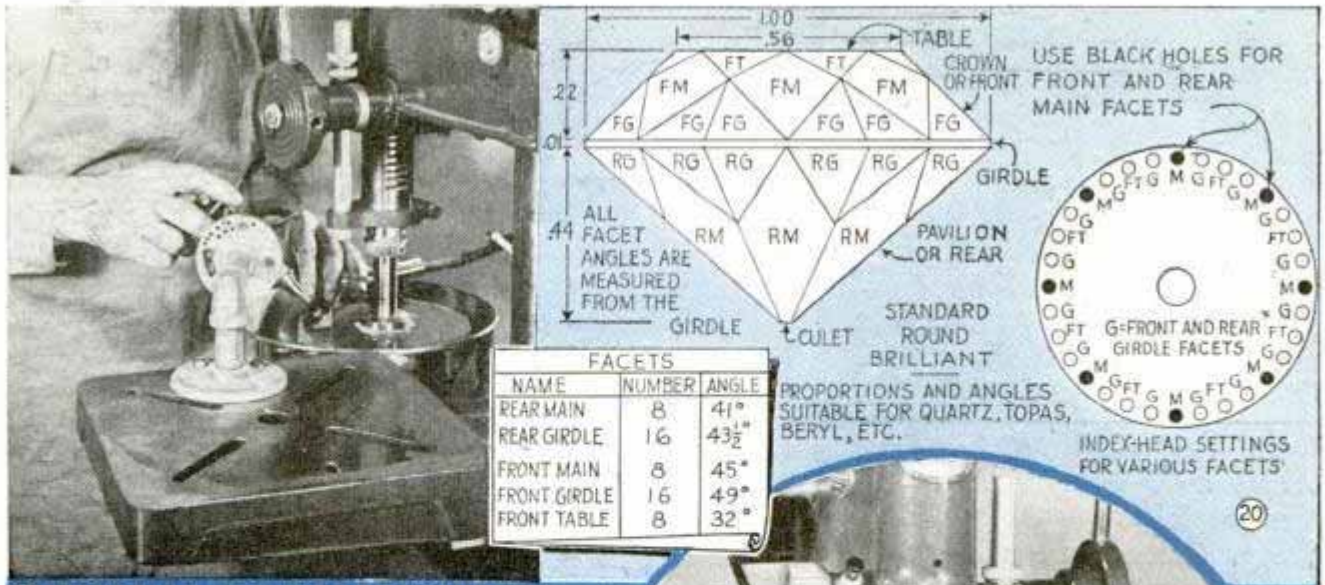

19 FACETING REQUIRES A SPECIAL JIG

Most transparent stones are faceted to obtain a better return of light, while opaque and translucent stones are cabochon cut. Fig. 20 shows the most common form of faceted gem—the standard round brilliant having 56 facets. To obtain an accurate setting for all of these various faces, a special jig is required. A small gem-cutting machine with faceting attachment, is shown in Fig. 6. Good results can also be obtained with a commercial faceting attachment worked on the drill press, Fig. 21, or with a homemade faceting device, as in Figs. 19, 22 and 23. Any faceting attachment must have four movements: (1) an indexed movement around a complete circle, (2) a 90-degree movement with settings at various intermediate positions, (3) a swing movement across the face of the stone, (4) an up-and-down movement to permit feed. The last movement is not required when the jig is worked on the drill press as the drill-press mechanism provides for feed. Figs. 22 and 23 illustrate a simple jig which embraces the first three movements mentioned. All facet angles of a gem are measured from the girdle. Hence, the angle formed by the index shaft and the grinding wheel will be the complement of the facet angle. The most common angle settings are those required for cutting the two stones shown in Fig. 20 and Fig. 24.

Your first faceted gem should be a modified round brilliant about ½ in. in diameter, as in Fig. 24. This has four banks of 8 facets, or a total of 32 facets. Rough-grind the stone by hand, flat on one side and as

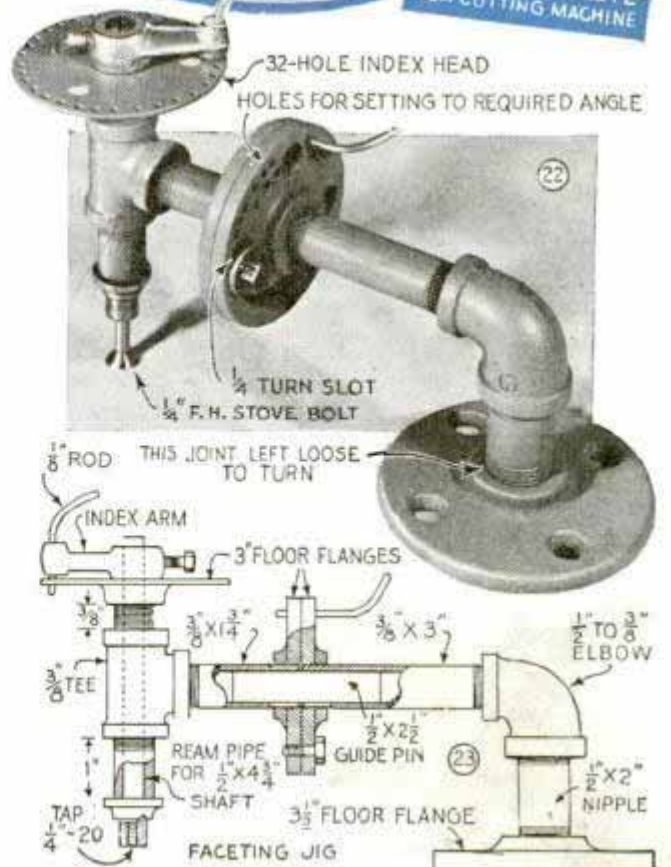
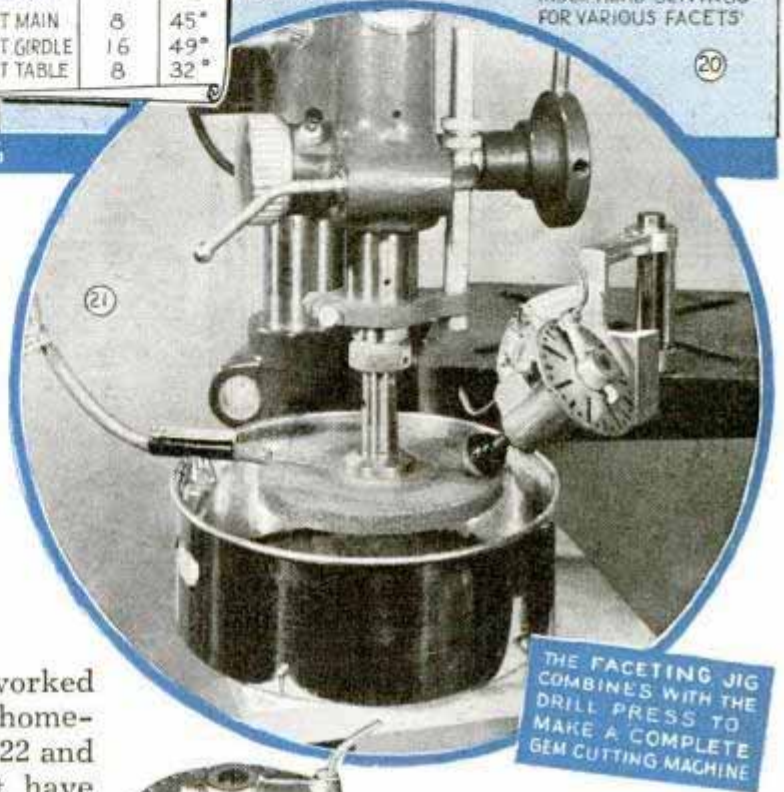

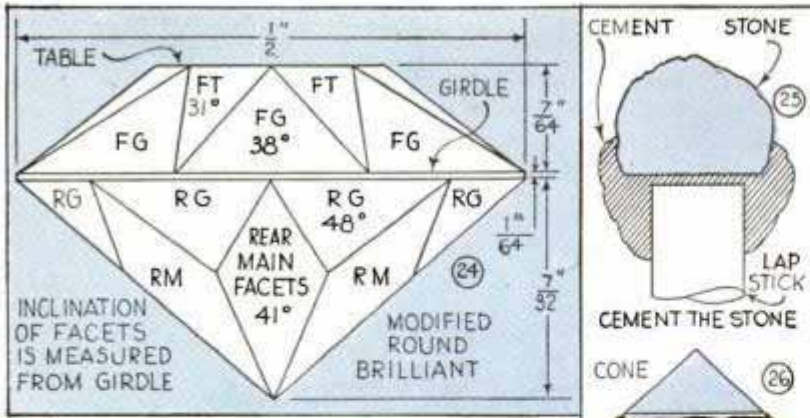

nearly a 1/2-in. cylinder as you can get it. Crystal quartz is cheap. Cement the stone to the lap stick (metal in this instance) as in Fig. 25. Set the faceting jig at 41°, this being the angle of the rear main facets. Lower the gem to the grinding wheel and spin the index arm until the stone comes to a perfect cone shape, as in Fig. 26. Now cut the eight rear main facets. Leave the angle setting as it is. Set the index head pin in any of the "M" holes (see Fig. 20). Contact the grinding wheel and grind until the facet point coincides with the point of the cone. Change the index head setting to the next "M" hole and repeat, and so on until the eight facets have been cut. The stone will now look like Fig. 27. Change the angle setting to 48° and grind the eight rear girdle facets, using the index head holes which come between the "M" holes. The stone will now look like Fig. 28, while Fig. 32 shows the operation. The photo shows the work being done dry to avoid confusion, but in actual practice the wheel would

run wet. It should be noted also that the rotation of the drill press has been reversed from that ordinarily used.

After rough grinding the rear facets, all operations are repeated, as in the cabochon cut, to bring the surfaces to a perfect polish. After this has been done, the girdle is cut on the rim of the wheel, as in Figs. 29 and 33. Then the stone is reversed. Proper alignment is important, and is best obtained by using a lap stick with a conical recess, as in Fig. 30. The table is ground and polished, as in Fig. 34, after which the front facets are cut and polished the same as described for the rear facets.

The entire operation of cutting and polishing a faceted gem requires from 4 to 6 hrs. It is important that each of the operations from coarse to fine abrasive should be carried out to the fullest extent. The gem should be dried for inspection as a wet surface appears polished when it is really quite dull. Judge the polish by reflection. When you can pick up a clearly defined image of a light bulb or a window on the surface of the stone, you can be sure it is truly polished.

SUCCESSIVE STEPS IN CUTTING A FACETED GEM

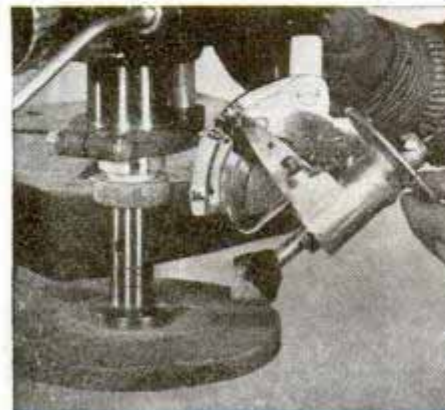

25 GRINDING REAR GIRDLE FACETS

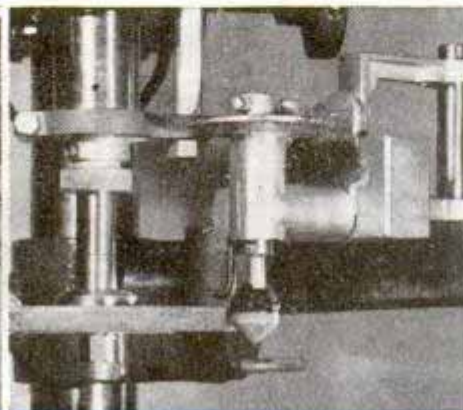

26 CUTTING THE GIRDLE

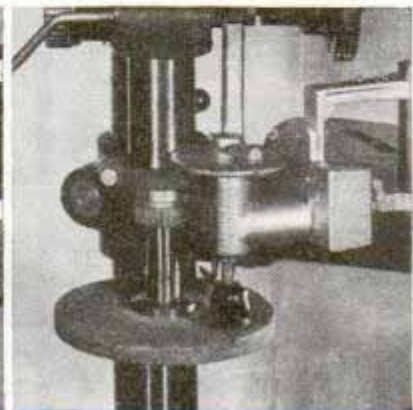

27 CUTTING THE TABLE

Direct-Drive Table Saw Has Variety of Uses

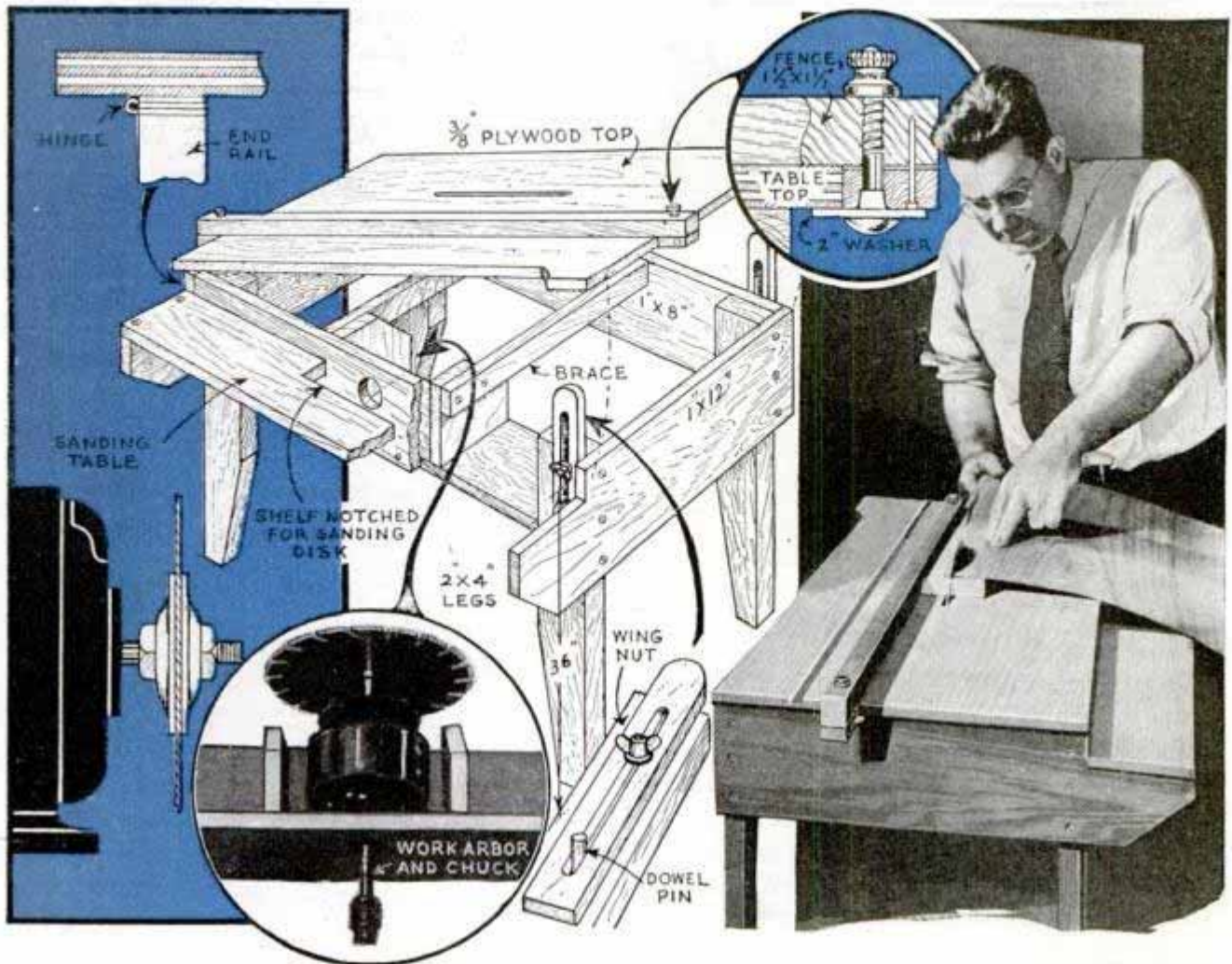

Sawing is just one of the many operations which can be done on this sturdy homemade table saw. In addition, sanding, drilling, grinding, buffing and carving are possible by equipping the motor with a standard work arbor and chuck to accommodate standard accessories. A $\frac{1}{2}$ -hp. double-shaft 1,750-r.p.m. motor, equipped with a 12-in. combination saw blade, is recommended. The motor shaft may be threaded to take the blade as shown here, or a $\frac{1}{2}$ -in. work arbor may be used. In the latter case, be sure to pin the coupling securely to the shaft to prevent the arbor from working

loose. To provide the maximum depth of cut, the hinged top is adjustable for the desired cut and to allow convenient access to the motor. The height of the motor shelf should allow the top of the motor to just touch the underside of the plywood table. While the use of a thicker panel for the top will reduce the cut, it will permit a groove to be made in its surface for a standard miter gauge. The fence is set parallel with the saw by clamping it an equal distance measured from the front and rear edges of the blade.

—Robert L. Eby, La Grange, Ill.

Broken Slats in Venetian Blind Replaced without Taking Blind Apart

Broken slats in venetian blinds may be replaced without taking the blind apart. First remove the broken slat, using a coping saw if necessary. Prepare a substitute slat of the proper dimensions and extend the cord slots all the way to one edge as shown in the photograph. Then the slat can be slipped in place easily.

—Morris Katz, Aurora, Ill.

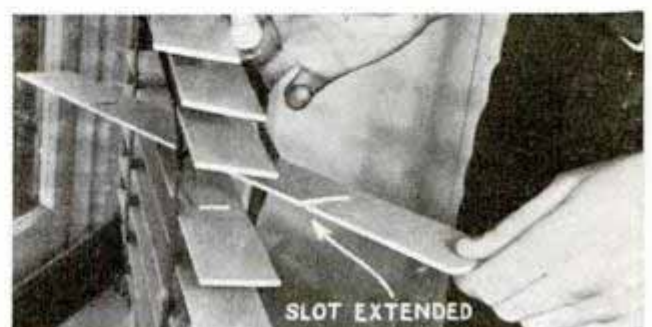

Screen-Door Pulls on Sled Protect Child's Hands

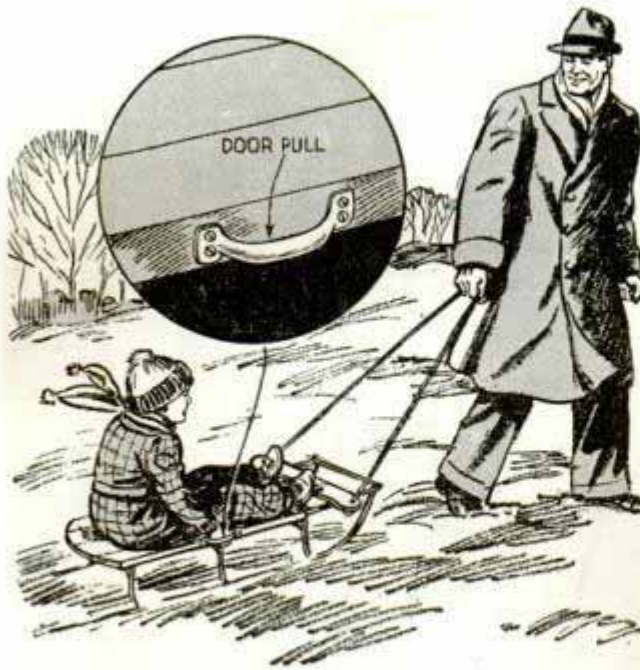

To protect a child's hands from possible injury when riding on a sled, screen-door pulls can be attached to the hand rails. These will shield the hands from contact with other sleds or stationary objects that might otherwise cause severe accidents.

—G. E. Hendrickson, Argyle, Wis.

Paper Bag Is Emergency Mitten When Cleaning Stove

A paper bag provides an emergency mitten to protect your hand and coat sleeve from soot when removing clinkers from a stove. Just punch finger holes in the bottom of the bag as shown.



Rubber Band on Desk Slide Keeps Papers in Place



To prevent papers from being brushed or blown off a desk slide, slip a rubber band over the outside corner and fasten it in place with a couple of thumb-

tacks. This will not interfere with opening or closing the slide, and the corners of the papers may be inserted under the band to hold them in place.

Spring-Type Clothespin Is Clamp for Modelmakers

Modelmakers will find this little clamp helpful in assembling tiny parts. It consists simply of a spring-type clothespin pivoted to a deep U-shaped piece of metal,

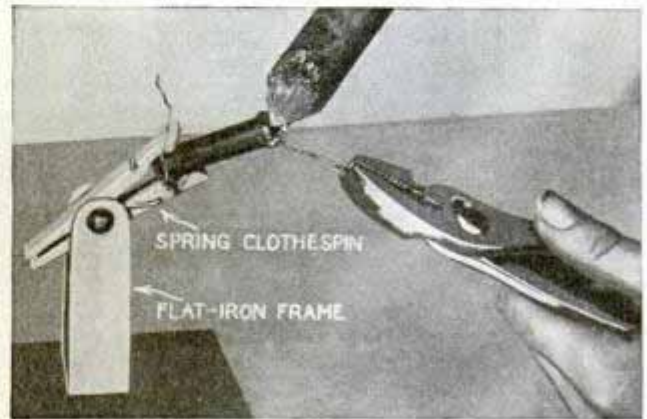

which is fastened to a small base to support it. A wing nut on the pivot bolt simplifies adjusting and locking the clamp at various angles.—W. C. Wilhite, Carlinville, Ill.

Tape Used to Make Bar Graphs

In school and scientific work where large bar graphs are often needed, the work of making them can be reduced considerably by using tape to make the lines, instead of ink. Ordinary binding tape is used when black lines are desired, while colored cellulose tape can be used when colored lines are necessary.

—Evan Wright, Topeka, Kan.

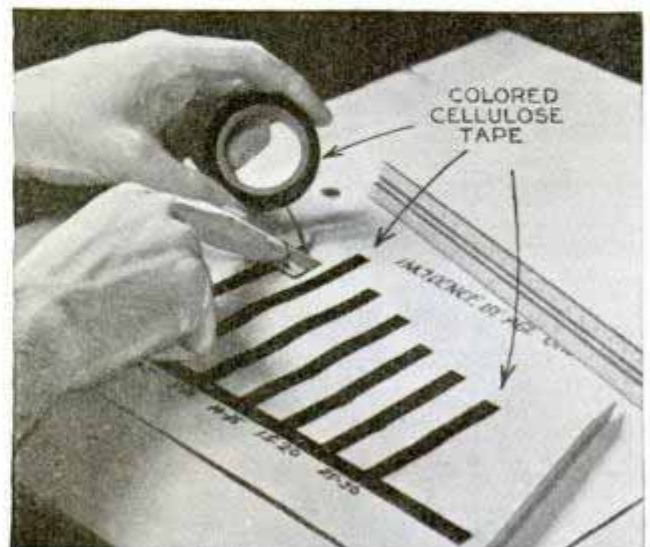

"Payload" BOBSLED

has pilot's seat at rear

Steered from the rear, this sled has more room than the conventional type of the same size, as space forward, which ordinarily would be occupied by the steering gear, is utilized for a passenger. Also, this design permits placing the sleds closer together, which makes steering easier, and the pilot has a clear view over the heads of the passengers. Construction is relatively light without sacrifice of strength. The steering gear consists of a standard auto wheel mounted on a steel-tube post having a crossarm welded on the lower end to which tie rods are bolted. The front sled turns on a ball-and-socket joint, permitting it to follow uneven contours without strain on the chassis. This joint consists of a king pin with an integral ball and collar, and a steel socket split and assembled with bolts. The ball-and-socket joint taken from the radius rods of a model-T Ford can be adapted to this purpose. The sled runners are 14 in. apart and the rear sled is connected to the chassis with a long bolt through eye bolts in the upper and lower cross members

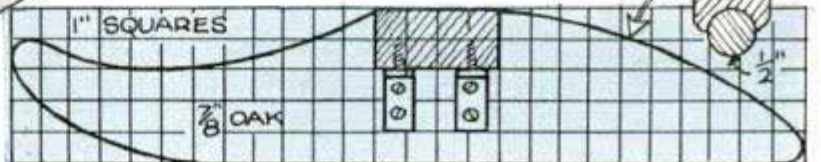
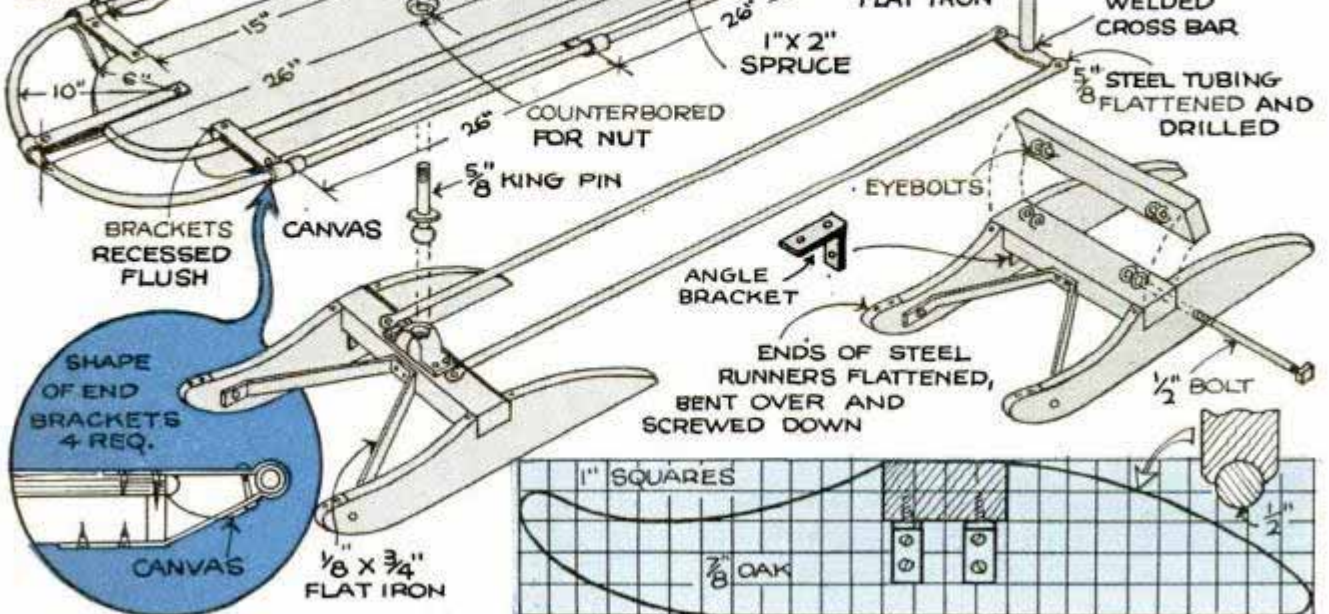
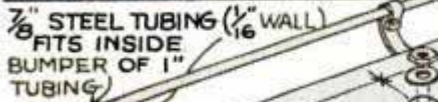
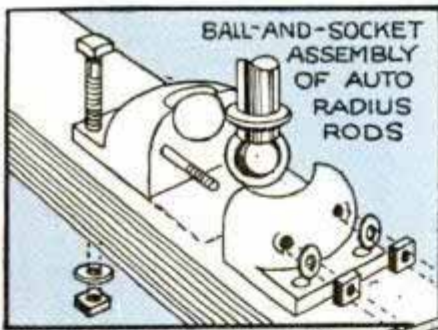
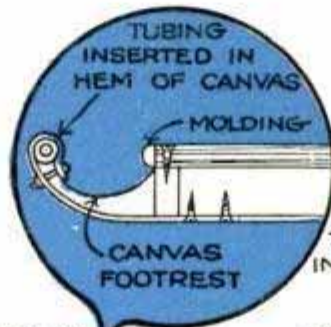
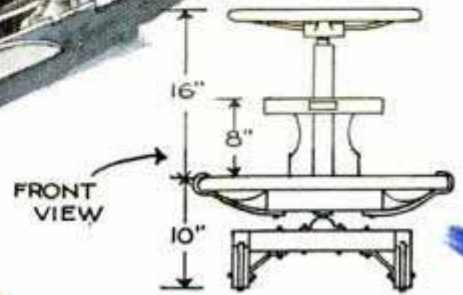

Dowels Flattened on One Side to Provide Air Vents

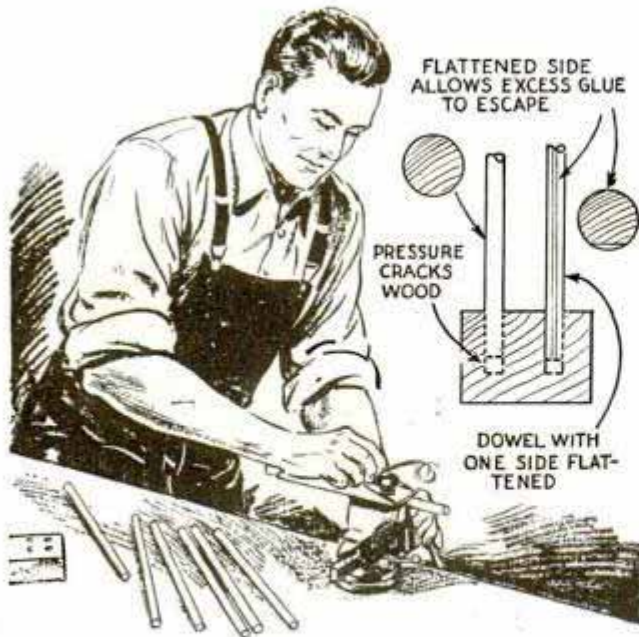

Slightly flattening one side of a dowel on a sander or with a plane takes only a few seconds, yet saves time and helps avoid damaging the work when using the dowel. The flattened surface allows air to escape from the hole when it is driven so that there is no danger of the air becoming compressed and causing the work to split.

—H. Rosenberg, Philadelphia, Pa.

Rubber Ball Protects Watch

If a watch must be kept at hand on a bench or machine where it might be damaged by acids or vibration, a holder made from a hollow rubber ball as shown will help protect it. A notch cut in the upper section of the ball to receive the stem of the watch holds it in position.

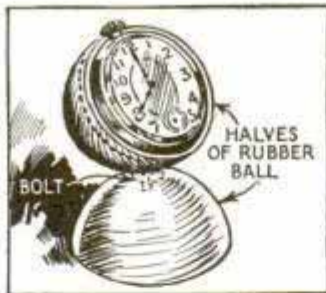

A notch cut in the upper section of the ball to receive the stem of the watch holds it in position.

Adapter to Use Tiny Drills in Standard Drill Press

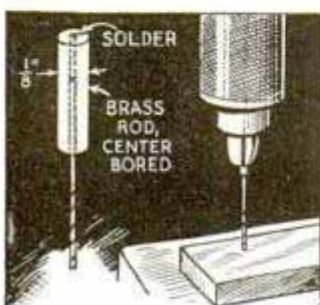

Modelmakers need not purchase an expensive auxiliary chuck to adapt pin drills for use in a standard drill press, as this simple adapter makes possible

their use for an occasional job. It is made from a length of 1-in. brass rod, which is centerbored with the size of drill you intend to use in it. The drill is held in the adapter by merely inserting it in place and then applying solder from the opposite end. The solder acts as a safety clutch, for it will pull away when a heavy load is placed on the drill, thus reducing the chances of breaking and allowing the drill to stall while the chuck continues to rotate.

Spreader from Mucilage Bottle for Sign Painting

Having a number of signs to get out in a single color, one sign painter used the fountain "brush" shown. It is made by slipping a rubber spreader from a mucilage bottle over one end of a length of steel conduit and corking the other end.

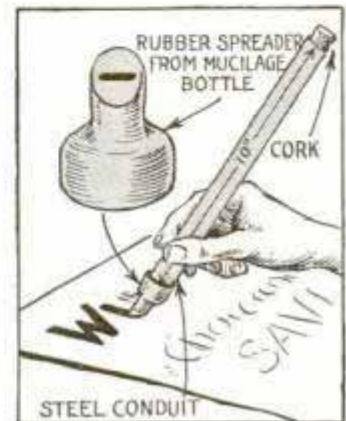

The slit in the rubber is made slightly larger to allow the paint to flow freely.

Curtain Rod Is Good Straightedge When Cutting Glass

Instead of trying to use a ruler or a yardstick in cutting glass, use flat, metal curtain rod, which is much superior for the purpose. The edge is true and does not have a tendency to impede free movement of the cutter as a ruler does. Also, with but slight pressure it will remain in position on the glass without slipping.

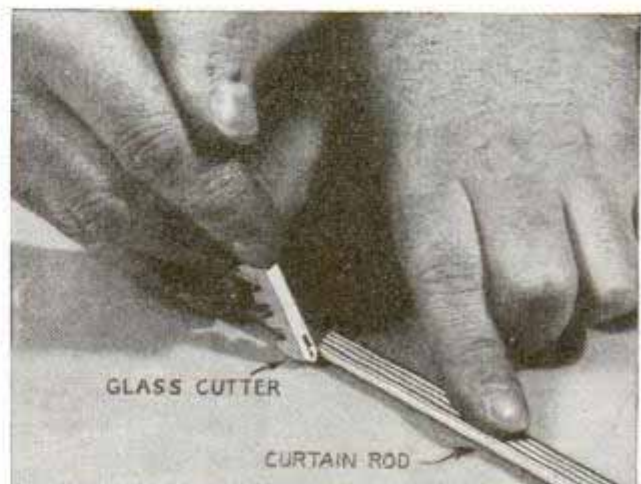

Midget Photoflash Gun Carried in Your Pocket

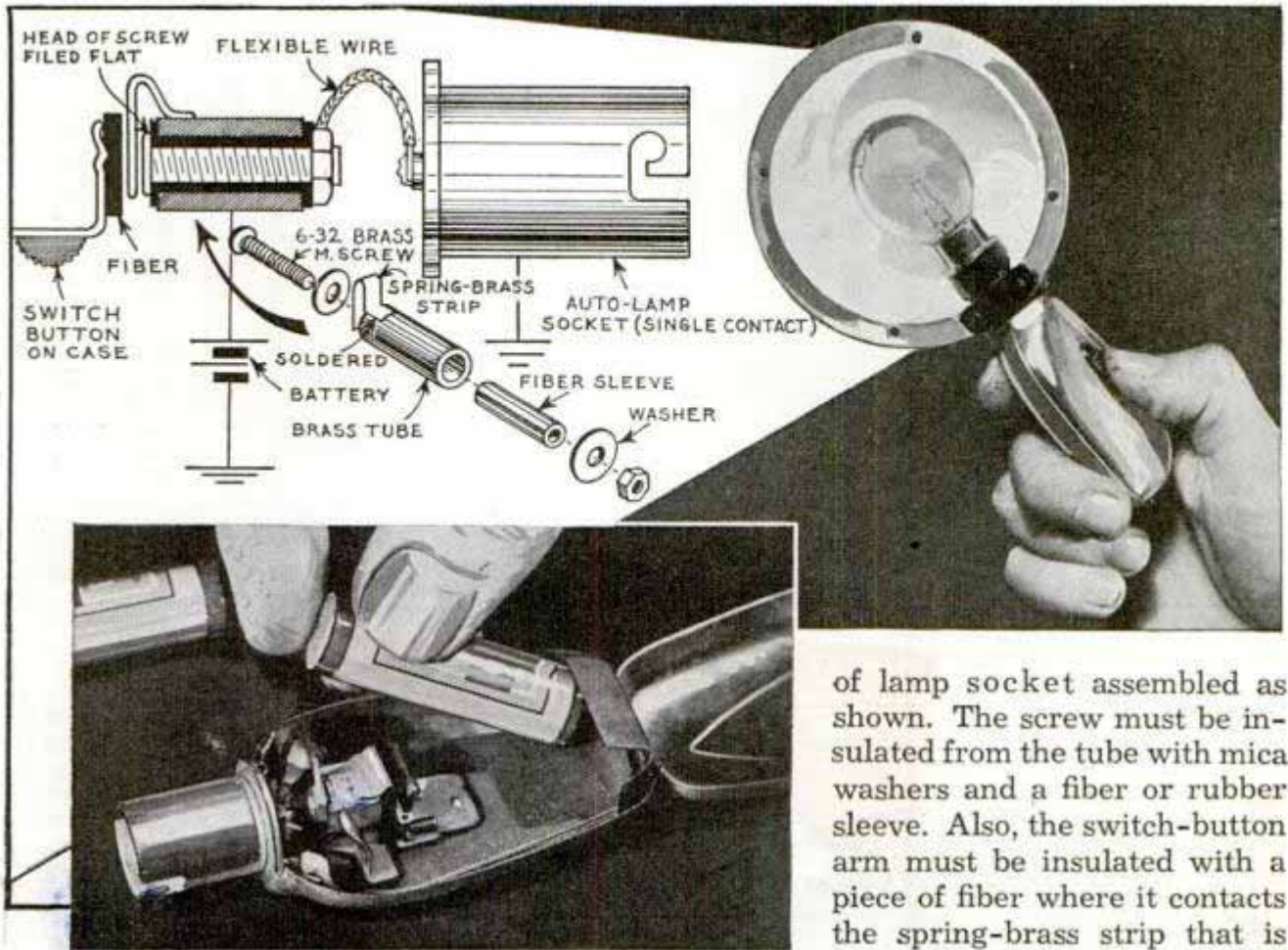

With the introduction of small photoflash lamps it is possible to make a pocket-size gun from a small flashlight by replacing the lamp and socket with the parts indicated. These consist of a brass tube, brass machine screw and an automotive-type

of lamp socket assembled as shown. The screw must be insulated from the tube with mica washers and a fiber or rubber sleeve. Also, the switch-button arm must be insulated with a piece of fiber where it contacts the spring-brass strip that is soldered to the tube. Be sure that the automotive socket is soldered to the flashlight case to make good electrical contact. The reflector was made from an egg poacher obtained at a dime store. A short brass tube attached to the reflector permits it to slip on or off the socket.

Excess Water Wiped Off Negative with Windshield Wiper

Negatives will dry more quickly if most of the excess water is removed from them before they are hung up. A handy method to do this is to tack a large piece of celluloid to the wall over the darkroom sink. Wet negatives are placed against this and wiped with a windshield-wiper blade. After one side is wiped, the celluloid is given a downward wipe so there will be no water on it to get on the dry side of the negative when it is turned over. I have found this method faster and more effective than using a sponge.

—Charlie Mihn, Hollywood, Calif.

Use only specially prepared photographic blotters to dry prints; ordinary blotters may stain a print or cause it to fade.

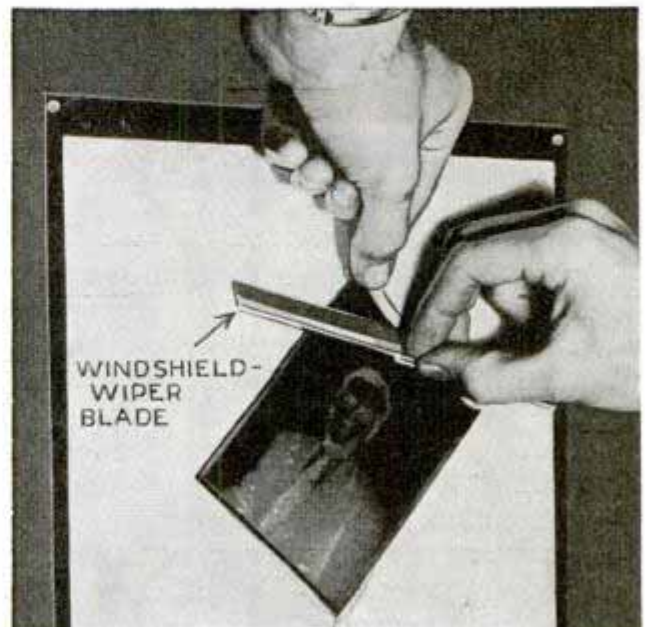

You can get those



To stop the motion of this plane as it was taking off required an exposure of one-thousandth of a second

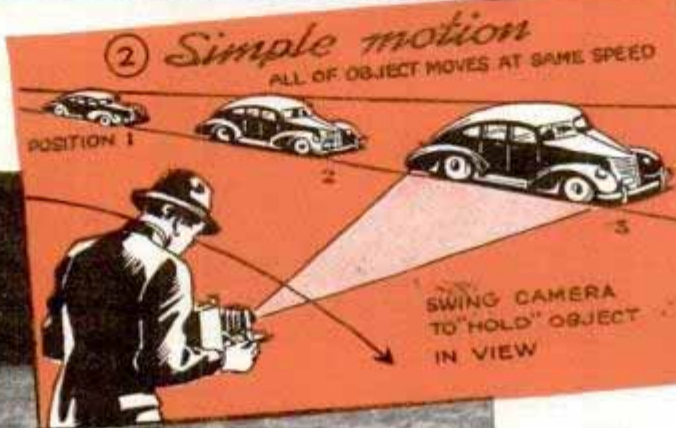

MPH	Exposure
120	1/2000
60	1/1000
30	1/500
15	1/250
12	1/200
9	1/150
6	1/100
3	1/50
1.5	1/25
0.6	1/10



When at right angles to objects of fast motion, you swing the camera to keep them in the view finder and snap the shutter when they reach the position for which the camera was focused

speeds. Figs. 1, 2, 3 and 7 illustrate simple motion, while Figs. 5 and 6 illustrate compound motion.

The table at the right of Fig. 2 gives an idea what exposure speeds are necessary to limit the movement of objects traveling at various speeds to one inch of movement during the interval of exposure. For large objects such as airplanes, several inches of movement are allowable but for small objects with fine detail even a 1-in. movement may be too much for good results. In the latter case the photographer lessens the exposure time as may be necessary in each particular case to reduce still more the space traversed by the object. It must be remembered that the exposure speeds in themselves disregard light conditions,

By THOMAS P. LAKE

CORRECT shutter speed, the use of angles to reduce apparent object speed, and "frozen action" are three important factors in getting good action photos. Without them you may often miss exciting picture possibilities.

In analyzing motion for the purpose of "stopping" it in photography, it may be simple motion, in which all parts of an object move at the same speed, or it may be compound motion, in which different parts of an object move at different and changing

"FROZEN-ACTION" SHOTS

which must be met with lens opening and proper emulsion.

In cases where you photograph objects displaying compound motion, you estimate the fastest motion and make your exposure to suit. For example, the body of the skier in Fig. 6 may be advancing at a rate of about 4 m.p.h., but, while one leg is practically at a standstill, the other one is advancing more than twice as fast as the body movement. So you estimate a 10 m.p.h. speed to arrest leg movement, and make your exposure accordingly.

When the speed of an object is too great to be photographed without excessive

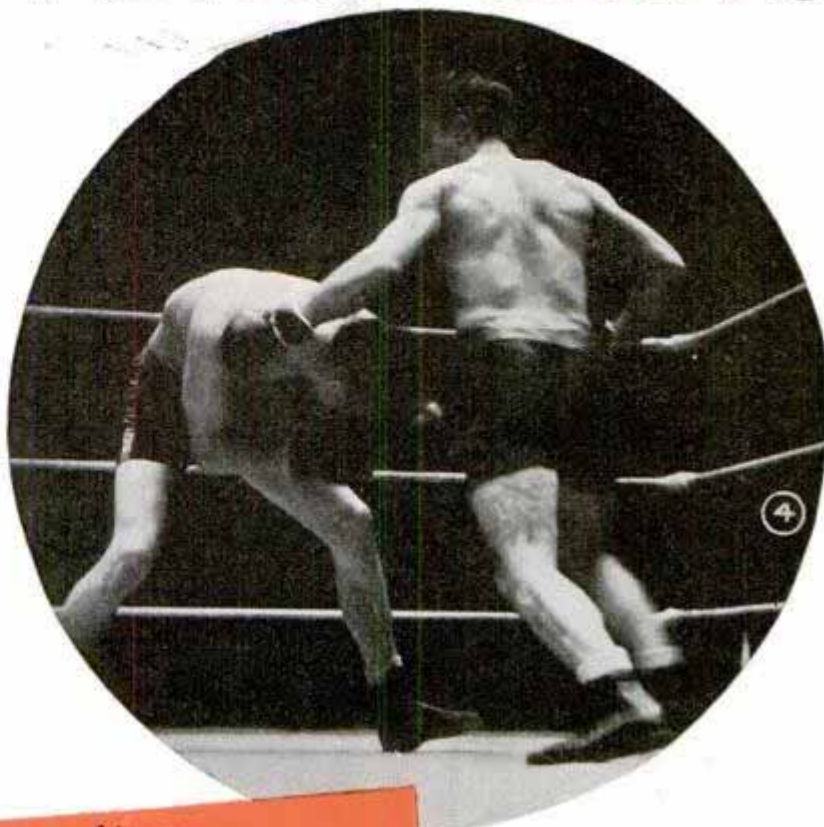

Exposure above caught the arm of the boxer the instant of impact, yet failed to stop the motion of one foot, which is slightly blurred as a result

In photographing objects displaying continuous compound motion, exposure time must be planned to arrest movement of the fastest part

blurring due to movement during exposure, it is still possible in many cases to obtain satisfactory pictures. This is accomplished, as in Fig. 7, by taking the picture at an angle less than 90° . The speed of the object is unchanged, but the movement of the image over the negative surface is reduced. An angle of 45° reduces the apparent speed to 70 per cent as compared to the speed when photographed at right angles, and image movement during exposure is reduced 30 per cent which often is sufficient to give satisfactory sharpness to pictures. When the angle

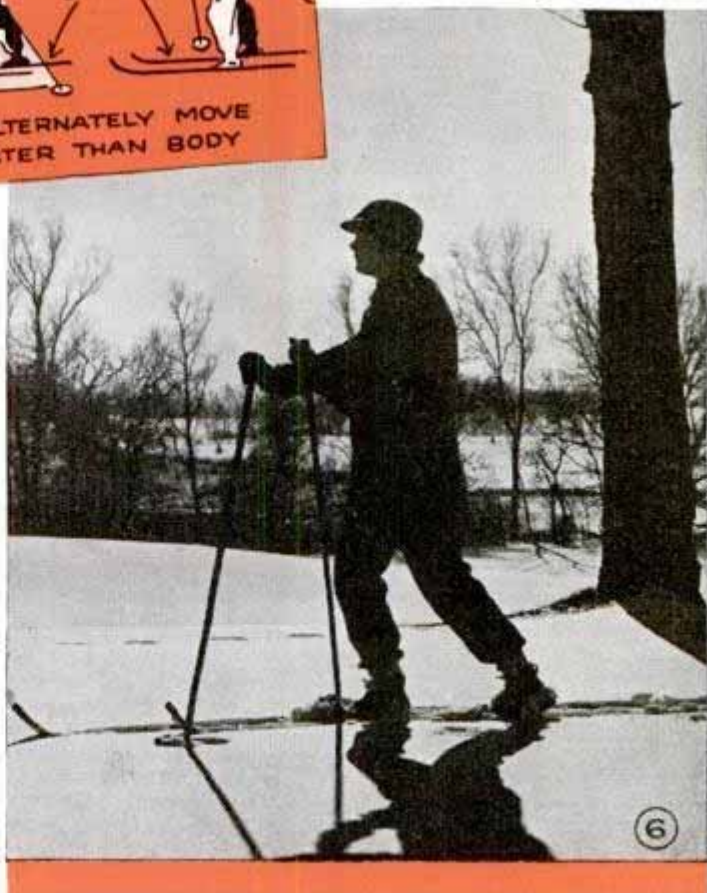

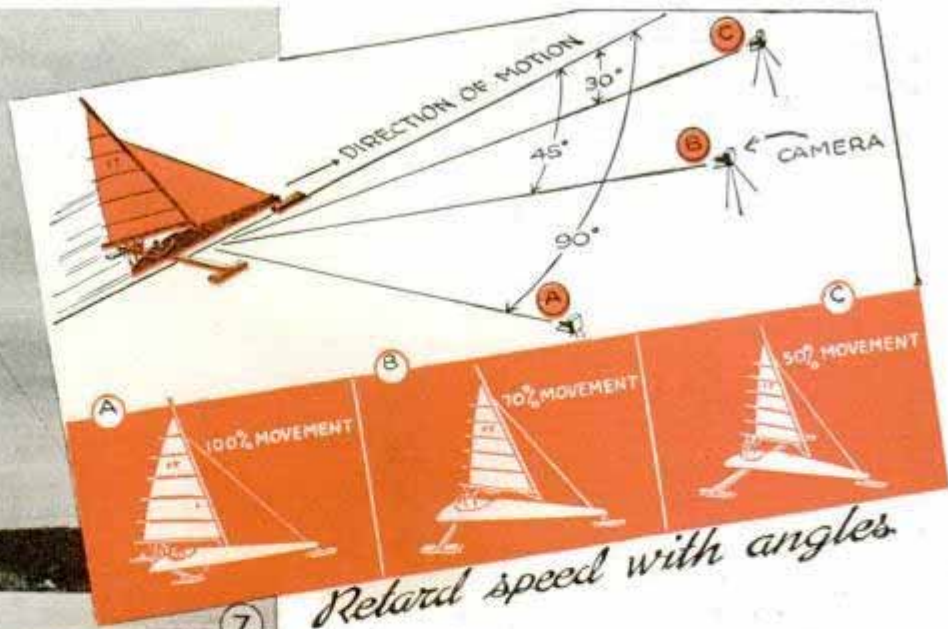
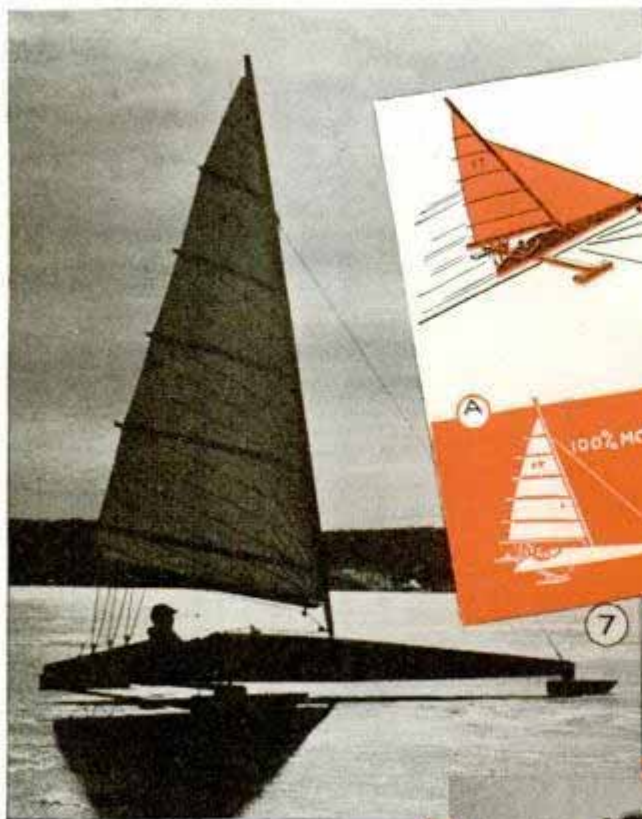

Retard speed with angles.
 An object approaching the photographer has much less apparent speed than one passing at right angles, as illustrated in the three positions shown above

is further reduced to 30° the apparent speed is only 50 per cent of that at right angles. This angle is especially valuable when dealing with higher speed, for example with airplanes and racing cars.

Another method of stopping movement of such fast objects as racing cars is to swing the camera to hold the image of the object in the view finder while making the exposure. Thus in Fig. 2, the approaching car is caught in the view finder at position one and the camera is swung toward the right of the photographer. Exposure is made at position three, for which the camera was previously focused.

In most action involving people there are moments of delayed or "frozen action." By referring to Fig. 12 you will notice that least motion takes place at positions 2 and 5. These are the instants when the arms and legs



Here are two examples of pictures taken at moments of "frozen action." The one above was taken at the end of a leg and arm swing, while the one at the right caught the boy pausing slightly to toss the ball

are fully extended and slowing to a stop preparatory to beginning the reverse action. Photographs made at such instants have only simple motion to deal with. In Fig. 4 the boxer was photographed at the instant his arm completed its swinging blow. The exposure caught the arm at the instant of impact, yet failed to stop the motion of one foot, which is slightly blurred. In Fig. 9 exposure was made during the





slight pause just before tossing the ball, and in Fig. 11 the figure was caught in the natural pause after the shovel was emptied. Sports photographers often take advantage of frozen action. These moments occur in nearly all sports, golf, tennis, basketball, baseball, etc.

It also should be remembered that there is an unavoidable natural delay in operating a shutter, both on the part of the photographer's contracting muscles and on the part of the shutter mechanism. For this reason the actual impulse to trip the shutter should precede by a fraction of a second the moment when the exposure is actually wanted. Lack of such anticipation often causes the camera shutter to click too late.



It's thrilling to captivate dynamic pictures like the fire-fighting scene or this study of a workman at a moment of retarded action



Reflector Cord Wound on Cleats Does Not Tangle or Loosen

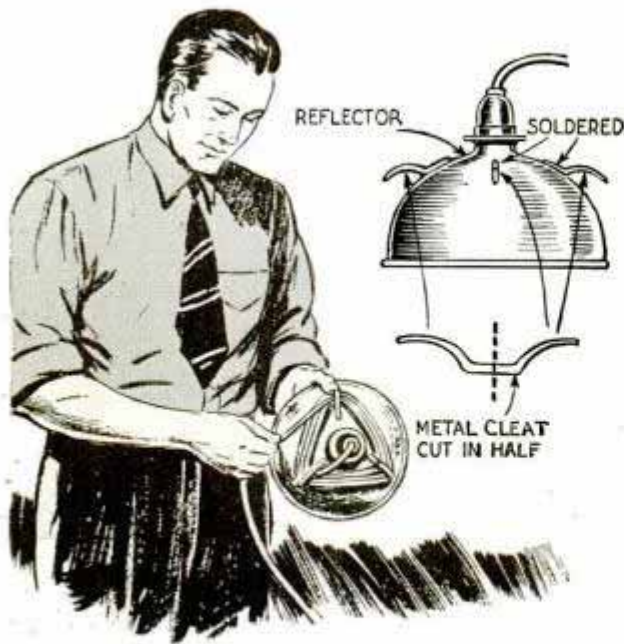

Since fitting my photoflood reflectors with cleats I have no trouble with loose and tangled light cords. Three cleats are spaced equally around the top of the reflector and the cord can be wound around

them quickly and easily and will remain in place. The cleats can be made by cutting a standard rope cleat in half.

—Robert Clark, Chicago.

Print Borders Masked with Tape Stay Clean during Coloring

Borders of tinted photographs will be neat and clean if they are covered with cellulose tape before you start the coloring and the tape will assure straight edges on the print. The tape can be removed easily when the job is finished.



A Streamlined Iceboat You Can Build

This 16-ft. skeeter-type ice yacht has a streamlined fuselage planked with $\frac{1}{2}$ -in. white pine. It carries 75 sq. ft. of sail and uses standard hardware. Our plans Nos. 1045 to 1048 inclusive, contain all necessary constructional details along with a material list, and will be sent postpaid upon receipt of \$1.00



Other Plans for Outdoor Winter Sport Devices

FRONT-STEERING ICEBOAT—786: Cockpit is 13 ft. long. Single sail of 75 sq. ft. on 18-ft. mast. 25c.

18-FT. ICEBOAT—774: Open cockpit seats four. Rear steering. Two sails. 25c.

AIR-PROPELLED ICEBOAT—785: Streamlined canvas-covered fuselage is 8 ft. long. Motorcycle engine drives a 52-in. prop. 25c.

SPEEDY BOBSLED—997: Box-type body gives rigidity and strength. Holds six passengers. Seat is 8 ft. 7 in. long. 25c.

COASTING TOBOGGAN—657: 6 $\frac{1}{2}$ ft. long by 16 in. wide. Print shows how to make form to bend bottom slats. 25c.

HOW TO MAKE SKIS—569: Print illustrates three types, 7 ft. long. Gives data on bending wood and ski sticks. 25c.

HOME-MADE SNOWSHOES—796 and 797: Prints show methods of steaming and bending frames, how to string rawhide cord, etc. Two prints 50c.

Any six of these plans (not projects) will be sent postpaid upon receipt of \$1.00

Address—Plan Service, Popular Mechanics Magazine, 200 E. Ontario St., Chicago



Vertical Antenna Installations

VERTICAL telescoping antenna systems, which receive and transmit equally well in all directions, are self-supporting and easily installed on roofs, boats and similar locations where sufficient room for a regular flat top installation is not available. Made of tubular steel, aluminum or Monel metal, all units are fully telescoping and adjustable between specified maximum and minimum lengths. Locking devices are provided at each joint.

Available in a variety of lengths up to about 35 ft., the antennas are provided with a heavy-duty footing or "Premax" base insulator of the same general construction as the large-footing insulators used on vertical towers of 800-ft. height. The Monel-metal variety shown in photo (A) is specially designed for marine installations where high strength and unusual resistance to corrosion are prime considerations; (B) is a sectional view of the locking clamp employed. A 25-ft. installation of this description is shown in photo (D). Wall bracket (C) is suggested for mounting the base insulator on side walls, or posts.

The parapet installation (F), with bracket assembly (E), is an aluminum vertical antenna for a multi-coupler receiving system which feeds up to 12 outlets installed in a large office building. Photo (G) shows a 34-ft. steel vertical on a mobile truck unit at Evansville, Ind. Tubular steel antennas of this type, suitable for home receiving systems, are heavily plated in bright cadmium to resist corrosion and are claimed to withstand high winds and all ordinary stresses in the services to which they are adapted. Guying, while not obligatory, is suggested as a reasonable precaution where possible, especially in localities where high winds are encountered frequently.

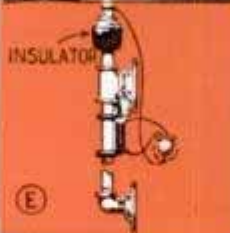

MINIATURE TUBES *in*

By L. M. Dezettel



ANY radio experimenter can build this compact and highly efficient wearable hearing-aid amplifier. Standard tiny radio tubes, with miniature sockets to match, are now available to experimenters and open up a new and interesting field for really portable homemade amplifiers and pocket-type receivers.

Smaller than the average person's little finger, these tubes, shown in photo (B), make possible the construction of a 3-tube amplifier for the hard of hearing that is compact enough to be worn on the person. The resistance-coupled amplifier circuit to be described employs three of these high-gain bantam pentodes and provides sufficient amplification to boost the output of the crystal-type microphone to several times the volume of a normal speaking voice. Housed in a small aluminum case of simple design, the completed instrument is light and compact enough to be worn suspended by means of a length of ribbon, or tape, around the neck, as shown in the photo and sketch.

Power is supplied by means of a standard combination A and B-battery which fits the pocket. This battery unit is connected by a plug at the end of a short length of 3-conductor cable.

A single crystal earphone is used as a microphone for economy and good quality; it is held in place by the pressure of the front cover and a piece of 1-in. thick sponge rubber mounted as

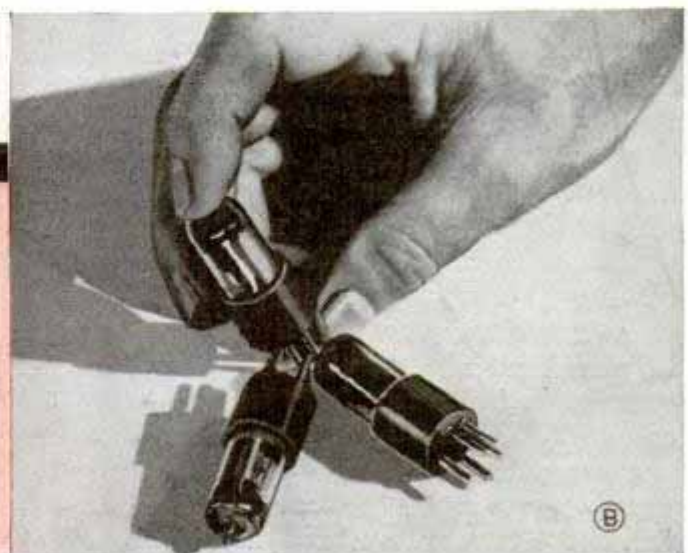
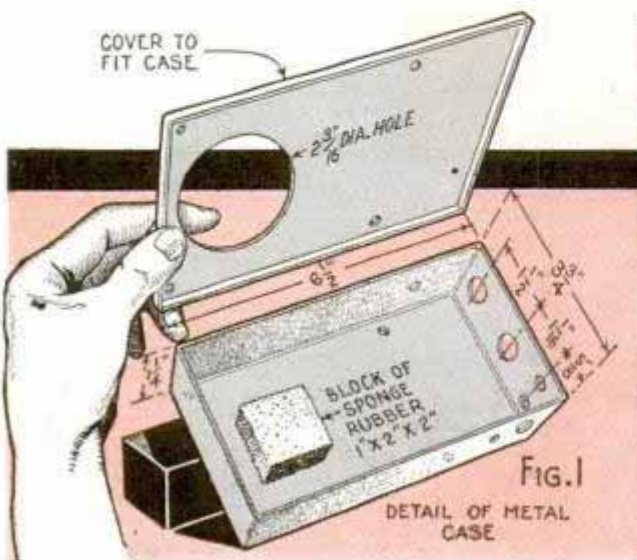
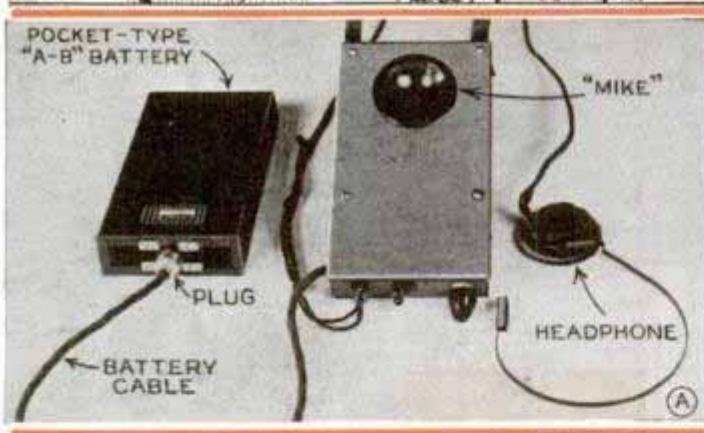

WEARABLE HEARING AID



shown in Fig. 1. This detailed sketch gives all dimensions for the aluminum case, which, when completed, may be given a coat of the new air-drying gray crackle varnish for an attractive finish.

The various radio parts are mounted on an aluminum strip $\frac{1}{8}$ by $\frac{7}{8}$ by $5\frac{1}{4}$ in., bent over $\frac{3}{8}$ in. at each end as indicated in the simplified wiring diagram Fig. 2. This diagram shows an underside view of all parts and wiring including the leads to the volume control, switch and insulated phone-tip jacks mounted in the end of the case. Please note that a shielded lead is employed to connect the microphone to the amplifier. This woven-wire shield is soldered to ground on the metal strip, and also carefully soldered to the "mike" terminal and resistor (R_1) as shown. All wiring should be done on the small chassis base strip before it is fastened in the case by means of a short machine screw at each side. One-fourth watt resistors and small mica-type condensers are used throughout to save space. Wire all resistors and condensers except the coupling condenser (C_2) connecting to the volume control. Leave 3-inch leads for wiring to the parts mounted on the case after the chassis is bolted in. Make all leads as short and direct as possible by clipping off any excess lengths of wire. Finally wire in condenser (C_2) and tuck it in behind the volume control (R_4). The 3-wire cable, just long enough to extend to a convenient pocket, is passed through a rubber grommet in the

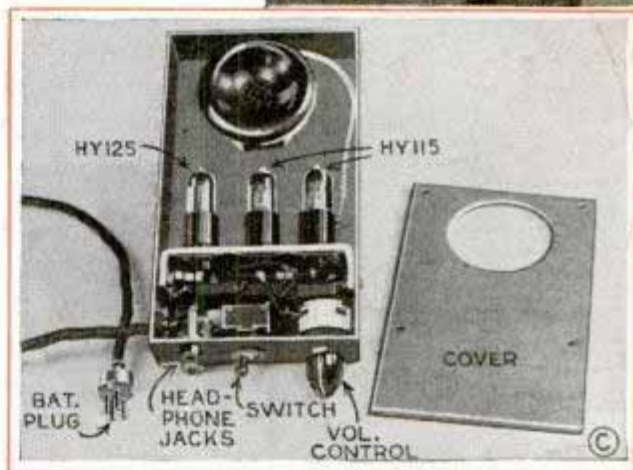

(Continued to page 130A)

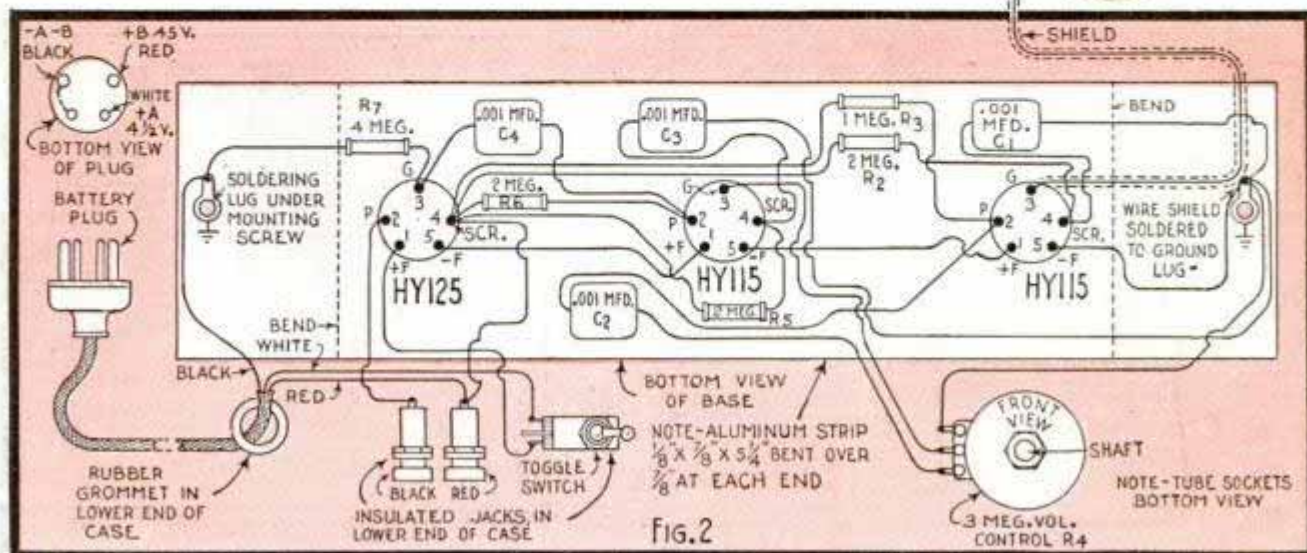

One-Tube Battery Amplifier for Beginners

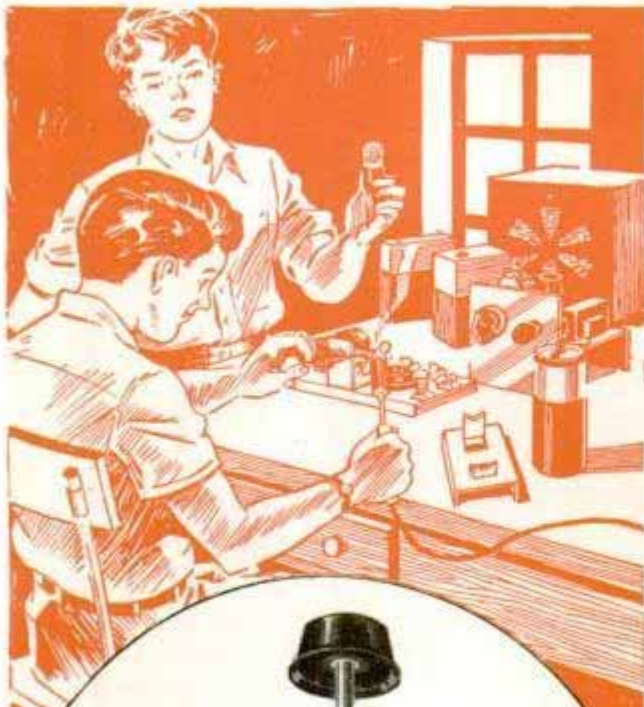

BUILD this battery-operated audio amplifier and use it to pep up the volume of any one-tube receiver. Designed at the request of experimenters and students who build and use one-tube short-wave and broadcast-band sets, this simple bread-board layout employs a type 1Q5-GT low-drain tube, 3 to 1 ratio audio transformer and a $\frac{1}{2}$ -megohm volume control. An inexpensive universal-type speaker-matching transformer is easily connected to the output clips so that a 5-in. permanent-magnet speaker may be used instead of earphones, if desired.

The amplification of this single audio stage is sufficient for use with a magnetic phonograph pick-up, and, for home entertainment a single-button carbon microphone may be employed to provide a miniature public-address system. When "mike" input is used, it is necessary to substitute a microphone transformer for the 3-1 audio transformer. Connect an additional $4\frac{1}{2}$ -volt C-battery in series with one side of the mike, the positive side being connected directly to the microphone.

A simplified wiring diagram is given in Fig. 1; this shows a top view of the tube socket and all connections clearly. The schematic circuit diagram is shown in Fig. 2; this diagram also shows the battery connections. It will be noted that the A-battery supply is ob-

(Continued to page 132A)

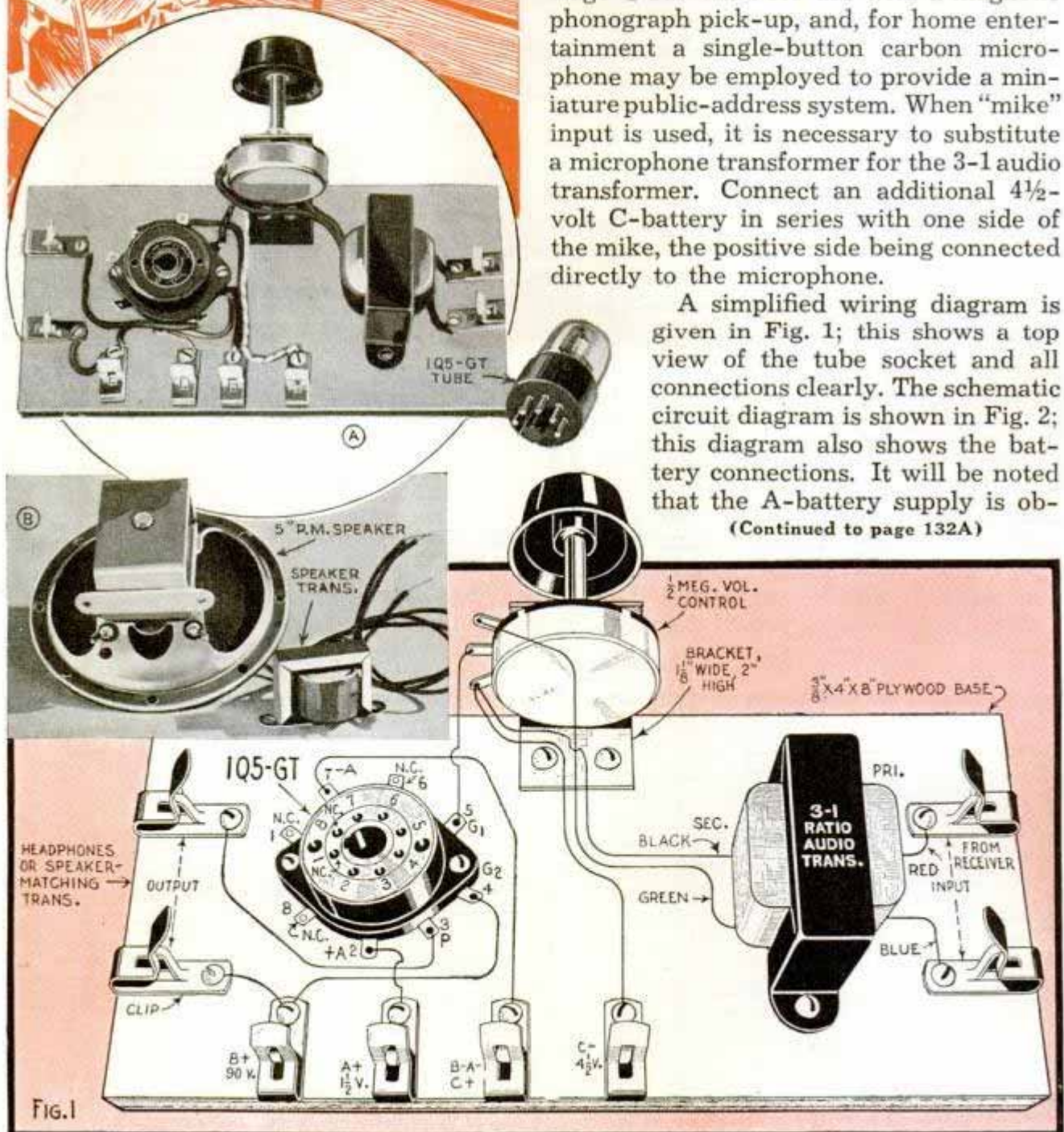
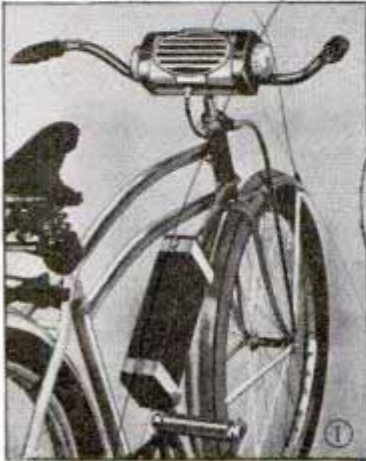

Fig. 1

Copyright © 1940 by Kenyon Transformer Co., 4545 W. Augusta, Chicago

Helpful RADIO HINTS



(1) Bicycle riders can now enjoy radio programs as they pedal along streets and country roads. Serving the owner in practically the same manner that an auto radio does a car, this "bike" set employs 3 tubes—two triple-purpose and one power tube. Batteries are housed in compact case easily mounted to frame; receiver comes complete with built-in 4-in. P.M. speaker, antenna, batteries and accessories for mounting. (2) Radio chemical kit in leatherette pocket case, contains service cement, carbon-x, grapholine, scratch polish, contact cleaner and similar materials. (3) Universal radio noise filter for use with any 110-volt a.e. or d.c. line

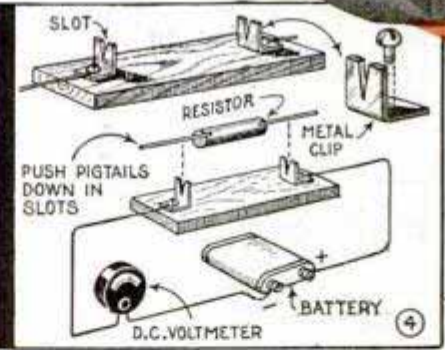
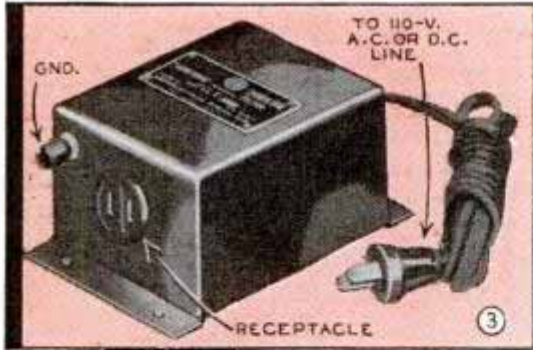

(4) Homemade resistance checker gives approximate reading where value is in doubt. By checking 5-volt voltmeter with several known values of resistance, at the same 4½-v. battery voltage, scale readings can be obtained for each value. (5) Inexpensive unit makes accurate impedance match between any type antenna and receiver for high signal gain, without tubes



(6) Collapsible ultra-high-frequency antenna system for experimenters; can be erected quickly and packs away in small space. Wood blocks should be boiled in paraffin before fastening T-hinge and eye plates. Two 4-ft. lengths of brass or copper tubing operate equally well on 56,112 or 224 megacycles. (7) Plug-in transformers for use in limited space

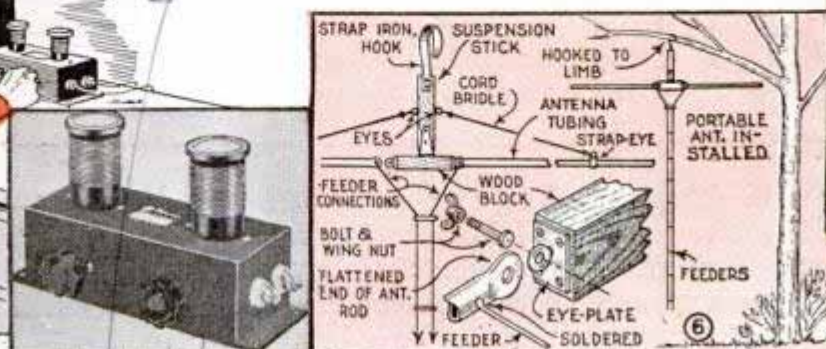

General Electric, Inc. Radio Dept. 1230 Broadway, N.Y.C.

Radio Facsimile News Printer Works at High Speed



Printing the outstanding news of the day in condensed form, this home-type receiver-recorder demonstrated at the New York World's Fair prints a miniature front page, 8½ by 12 in. per sheet, every ten minutes. This is more than twice as fast as it could be done a year ago, when similar experimental radio facsimile apparatus was exhibited.

Portable All-Wave Receiver

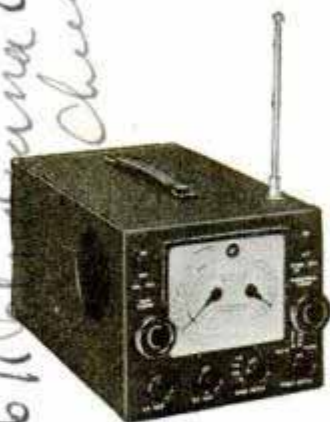

Combining the convenience features of the modern 3-in-1 portable with those of a good amateur-band receiver, this 9-tube set operates from any 110-volt a.c. or d.c. line or from batteries. One set of bat-

teries provides approximately 100 hours of service. Tuning range is continuous from 542 kc. to 30.5 megacycles.

Universal 20-Watt Amplifier

Completely self-contained in one compact case, this 20-watt amplifier may be used with any high-impedance type microphone. A built-in phono turntable adds to the operating convenience; the unit operates from 110-v. line or 6-volt battery.

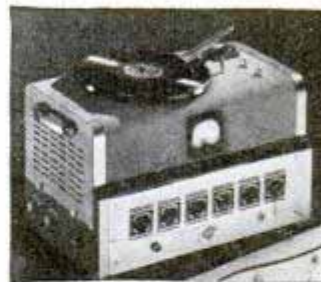

Armchair Radio-Phonograph

This 8-tube chair-side receiver covers the broadcast and foreign short-wave bands, employs a 12-in. speaker and has a built-in automatic record changer. It is also available in similar combination with single record-playing mechanism.



Blueprints covering radio construction articles in this and past issues are available for 25 cents each. Original material lists, with names of manufacturers and dealers, can be obtained from our Radio Department upon receipt of postage.

NEXT MONTH—How to Build a Two-Tube A.C.-D.C. Receiver and Phono Amplifier. Here is an easy-to-build low-cost broadcast set with dual-purpose tubes, built-in speaker and provision made for using the audio section to amplify the output of any inexpensive record player of the motor-driven turntable type



SHOP NOTES

Making GOOD CONTACTS

How to select and install silver or tungsten contacts on operating electrical devices



By C. A. CROWLEY

AS THE satisfactory operation of many electrical appliances and devices depends on the flow of electricity across a pair of closed movable contacts, as in thermostats, relays, etc., Fig. 1, it is important that they be kept clean, and that the proper type be used for the particular job. No matter what type or style contacts are used they get dirty or pitted and require occasional cleaning. Emery paper or cloth should not be used to clean contacts. Fuzz or grit is liable to be left between the faces, leaving the contacts little better, or even worse, than before. Carefully drawing a thin, flat file between the faces will remove the scale and pits. The filings and accumulated greasy dirt should be wiped off with a piece of chamois moistened in cleaning fluid. The capacity of condensers across a pair of contacts, when this method is used to prevent sparking on d.c. circuits, should not be so high as to eliminate the spark altogether. A little sparking burns away

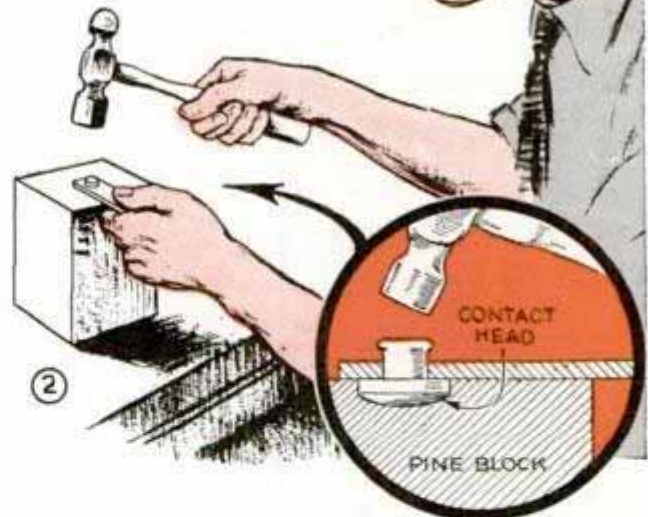

the accumulations of greasy dirt resulting in better performance. Where contacts carry a heavy load, a resistance coil of about 1 ohm per volt in the circuit should be connected in series with the condenser to prevent the contacts from overheating during the break or when they chatter slightly as often may be the case. Although many metals and alloys are used, contacts of silver or tungsten are best usually.

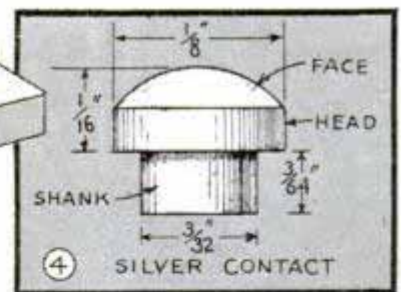
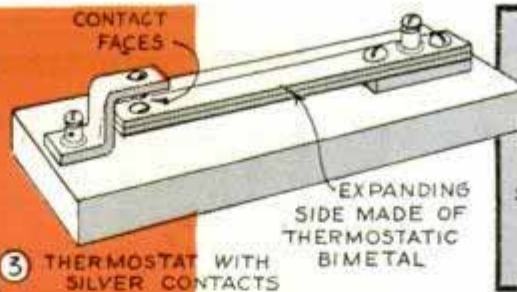

Silver contacts: Pure silver has the lowest electrical resistance of any metal, and makes the best contacts where the voltage and the mechanical pressure holding the contacts together are both low. Relays, thermostats and other devices operating with a voltage not greater than 6 volts, perform better if the contacts are of silver.

Silver rivet contacts: Silver contacts are made in the form of rivets for convenience, as the metal is soft and malleable. Due to the mechanical impossibility of perfectly aligning two flat surfaces, silver contacts are provided with radius faces as in Fig. 4. To illustrate the use of this type of contact, a thermostat of the type shown in Fig. 3 which closes and opens a low-voltage electrical circuit with a rise or fall in air temperature, is used as an example. Using a block of soft white pine as a base for the contacts, Fig. 2, will prevent deformation of the face when mounting. The mounting assembly also shows how the contact face is pressed into the soft wood by the force of the hammer blows in heading over the shank.

In those cases where a vise must be used to press-fit the contacts into a mounting thicker than the length of the contact shank, the soft pine block will protect the head from deformation by the jaws.

Silver wire contact points: Contacts for small assemblies like the relay shown in Fig. 5 can be made easily from silver wire and formed right on the mounting. Fig. 6 illustrates the method used, which is nothing more than forming the head or face of the contact with a hammer.

Tungsten contacts: In building large relays, automatic switches, buzzers,

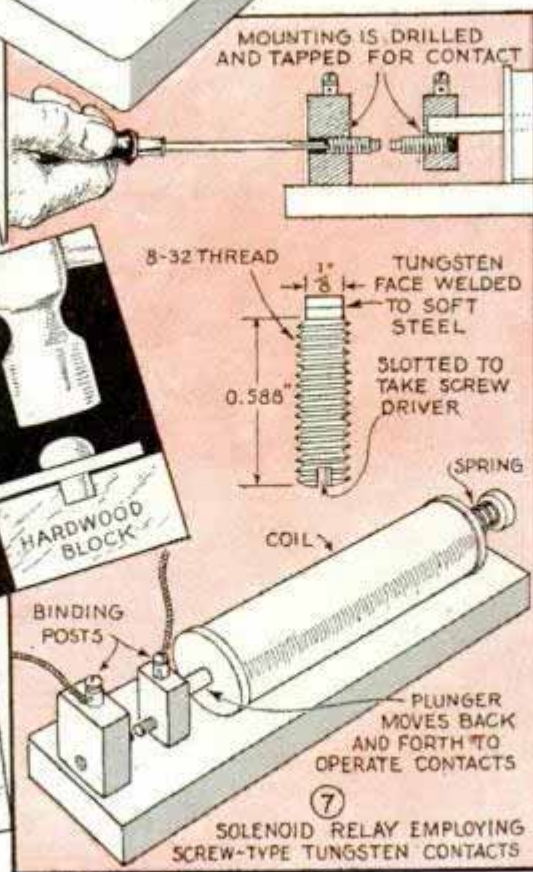
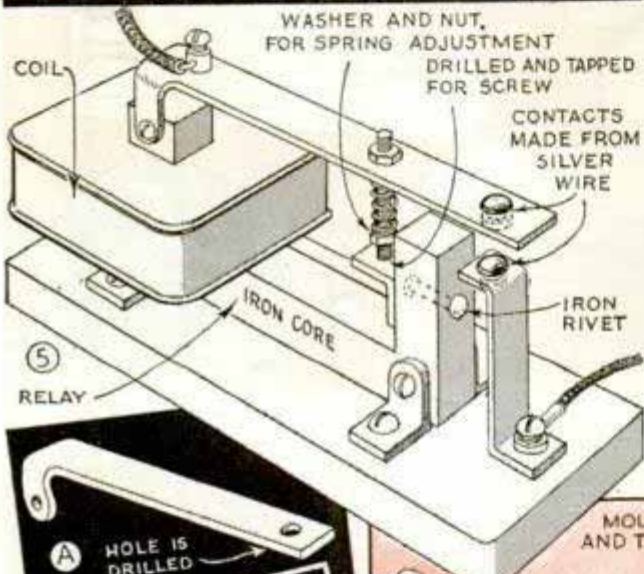

and similar devices with voltages ranging from 6 to 135 volts, it is best to use tungsten contacts. Tungsten is very hard, so contacts of this metal are always furnished welded to a soft steel base screw or rivet.

Tungsten rivet contacts: Rivet contacts like the one shown in the circular detail of Fig. 8 are the easiest to install. On devices like the switch on the photographic printing box they can be used to advantage since they need little or no adjustment. The flange on tungsten rivet contacts allow for a firm support of the head on a metal block when mounting them.

Internal adjustment contacts: The disadvantages of having to drill and tap the mounting for screw-type contacts is offset by their adjustability. They can be removed for cleaning or replacement. In mounting, two precautions must be observed. First, the tap drill used must be exactly the right size for the thread to assure a tight fit to the contacts. Second, a lock nut must be used on the contacts to tighten them in place after adjustment. The internal adjustment-screw contact shown in Fig. 10 is provided with a hexagonal flange just back of the face. This type of screw contact is used where installation and adjustment must be done from between the two mountings. The electrical overflow control for water tanks is a good example of this.

Headless contact: Useful on very thick mountings is the headless, slotted, tungsten contact screw shown in Fig. 7. It is installed from the outside of the mounting with a screwdriver. The solenoid relay is just one example of a device using heavy mountings with this type of contact.

External adjusting contact: On some devices adjustment and installation of the contacts can only be accomplished from the outside of the mountings. In Fig. 9 is shown a tungsten screw-contact unit designed to meet these conditions. The hexagonal adjustment head is on the end opposite the face. Two of these contacts, installed with lock nuts from the outside on the stationary mounting of the alarm control, oppose two rivet-type contacts installed on the movable mounting.

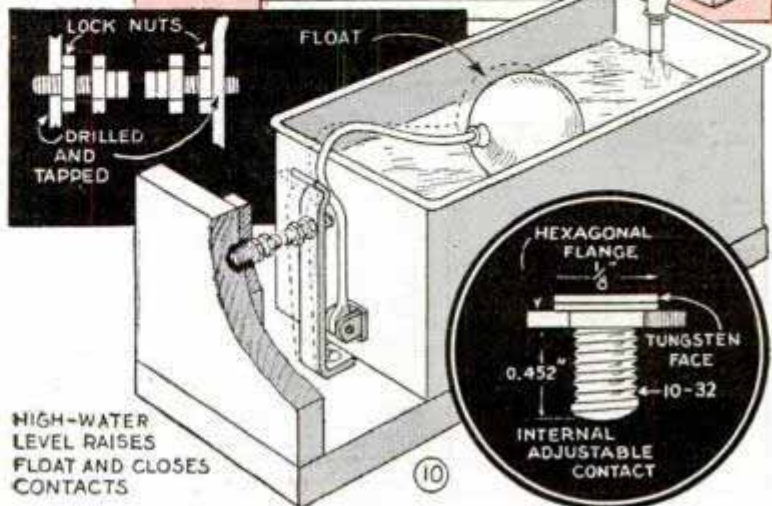
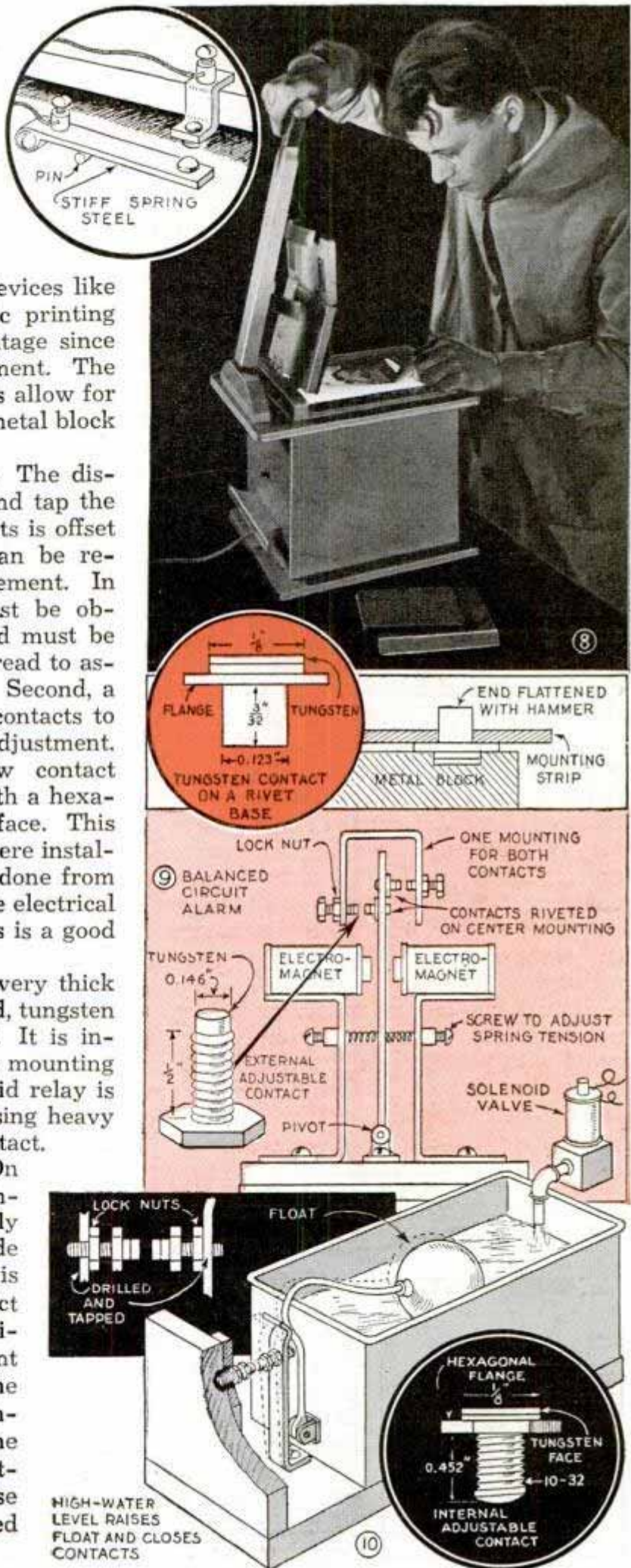

Oilcloth Having Block Pattern Aids in Cutting Glass



A hardware dealer who had much glass cutting to do in his store improvised a glass-cutting chart that saved him considerable time and labor in this work. The chart consists of a strip of oilcloth, the pattern of which is of 1-in. blocks or squares. By placing the pane of glass upon the lines and measuring off the number of inches to be cut from the sheet, the rule may be placed upon the line and the work accomplished in a jiffy. For greater convenience, the chart is attached to a window-shade roller, which is mounted at one end of the counter, and the chart is thereby rolled up out of the way when not in use. If desired, and oilcloth of this pattern cannot be obtained easily, the chart may be ruled with pencil upon any cloth window shade, but the oilcloth will prove more lasting and serviceable as it will resist the wear, and glass will not slip easily.

Receptacle Built in Workbench Extinguishes Lighted Matches

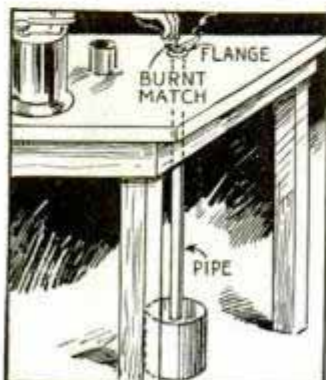

To avoid fires being started by matches thrown about his shop, after lighting gas burners and torches, one tinsmith installed this receptacle. It consists of a length of pipe run through

the bench top to end in a pail or can underneath the bench. A flange at the upper end of the pipe holds it in place. The lower end of the pipe must rest on the bottom of the pail. Matches dropped into the pipe are instantly extinguished, and when filled, the pipe is lifted to deposit the matches in the pail for disposal.

Pen Point Is Miniature Scoop for Weighing Chemicals

In handling minute quantities of various chemicals, a chemist finds that his work is made easier by using the end of a



pen point as a scoop. The pen is inserted point foremost into a penholder, which serves as a handle. The scoop makes it possible to drop one crystal or grain of a chemical at a time into the scale.

Wood Blocks Protect Door Frame When Entering with Wagon

One farmer has large blocks bolted to the lower corners of all door frames through which wagons or other wheeled implements are driven as a protection for the frames. The blocks slope from the top

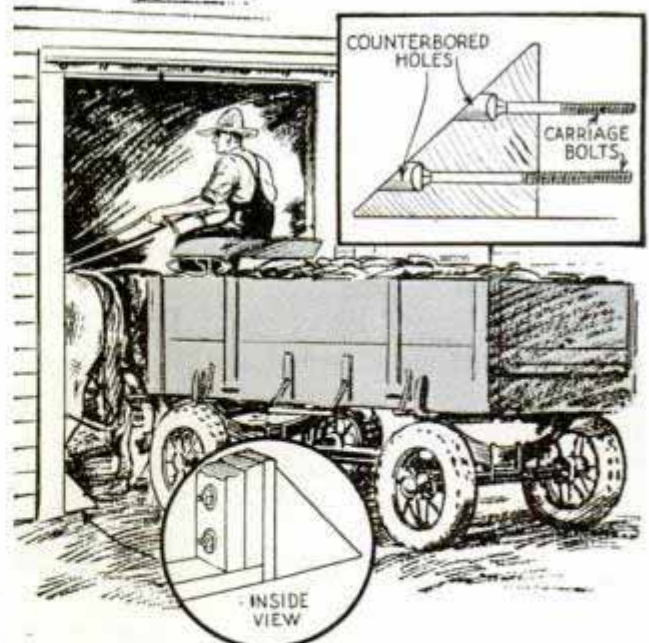

toward the bottom so that a wheel of a wagon entering is kept far enough away from the frame to prevent the tire or hub touching it. The blocks are attached to the frames with long, countersunk bolts.

Strip Moldings Cut Safely with this Shaper Jig

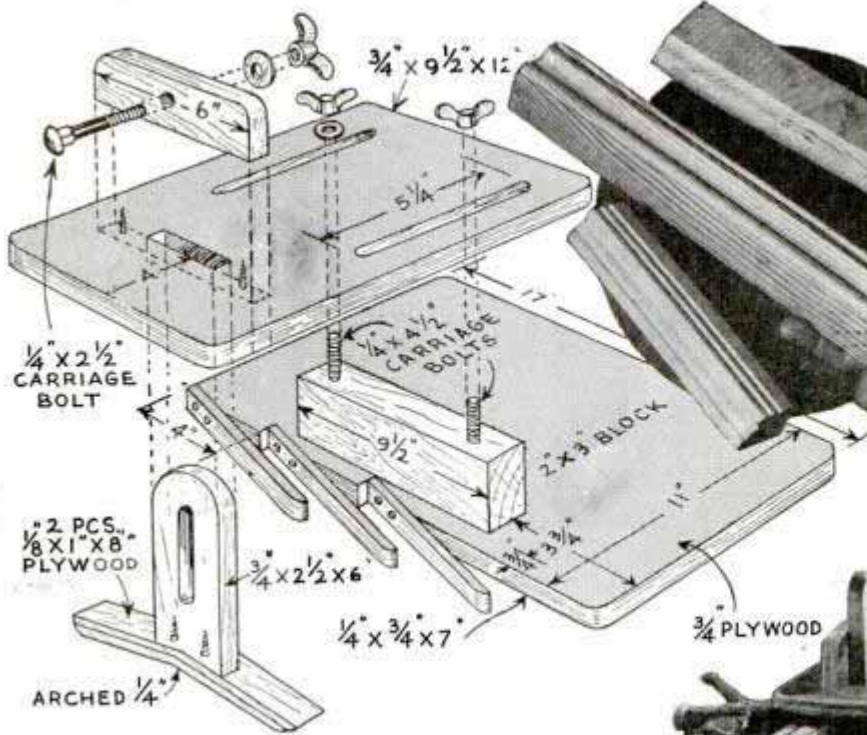

Narrow strips of expensive hardwoods can be turned easily into moldings by the use of this shaper jig which is safe to use as the cutter head is covered. The dimensions may be varied to fit the make of machine. The base of the jig holds the work against the fence. Three wooden fingers press the strip against the cutter and allow for slight irregularities in width. It can be held in any position by means of two C-clamps, and takes stock up to 5 in. in width. The heavy cleat, which supports the jig top, is of such height that the top clears the fence. The top has slots to receive the cleat bolts and to make adjustments. A rectangular hole takes the slotted hold-down slide, and a cleat behind it locks the slide by means of a bolt and wing nut. The wooden spring on the hold-down, added to give positive pressure against the table, is made of two thicknesses of $\frac{1}{8}$ -in. three-ply hardwood, curved up into the slide arch with two screws. To use the jig, loosen the

three clamp bolts and adjust the base with the fingers $\frac{1}{16}$ in. less than the strip width, from the fence. Set the top with the hold-down near the fence, and clamp. Then lock the hold-down. Feed the stock from right to left, and if it is not long enough to grasp easily on the far end, for pulling through in finishing the cut, use a long push stick.

Length of Endless Belt Measured Accurately by Rolling It on the Floor

One of the best methods of measuring an endless belt to find its length is as follows: Place the belt on a floor or other smooth surface. Then mark both the belt and floor.



Roll the belt across the floor as indicated by A*1, A*2 and A*3 until the mark comes to the

floor again, taking care that there is no slip between the belt and floor as it is rolled. The distance between A*1 and A*3 will be the exact length of the belt.

—W. F. Schaphorst, Newark, N. J.

Keep a three-minute egg timer near the phone to check long-distance calls; invert it as soon as the connection is made.

Speed Chuck Wrench Saves Time for Lathe Operators

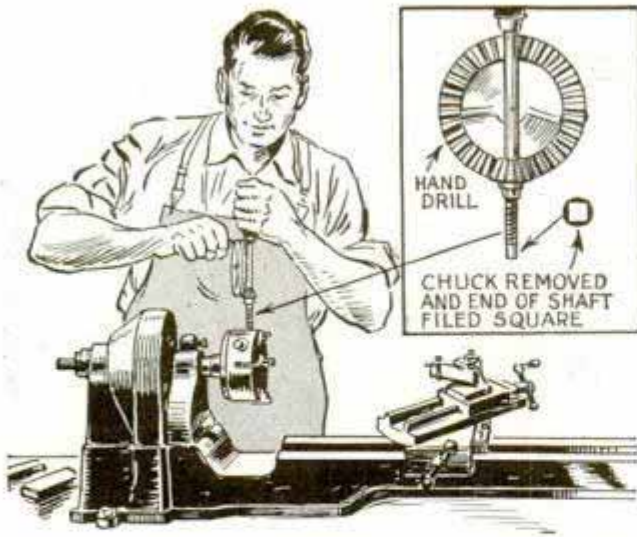

If you occasionally have a lathe job that requires resetting chucks frequently for small work, this simple speed wrench will save considerable time. It is nothing more than an ordinary hand drill with the chuck removed and the end of the shaft squared to fit the chuck screws.

Small Wire Straightened Quickly in Slotted Plank

Wishing to save wire removed from hay bales for future use, a farmer straightened it by pulling it through slots cut in the end of a hardwood plank as shown. The plank was clamped in a bench vise and the wire slipped into the slots from the top.

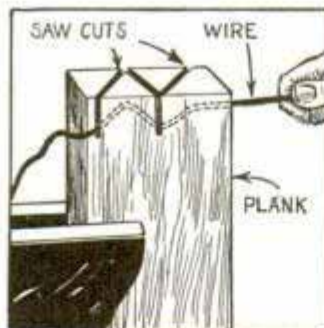

Improving Parallel Clamps

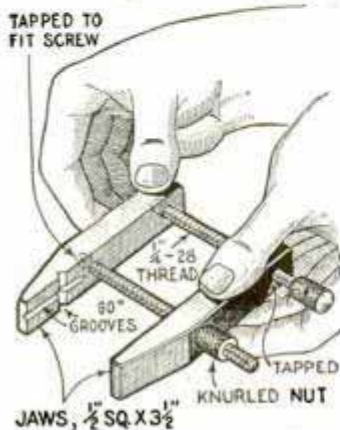

I have made several pairs of parallel clamps that I consider an improvement over the conventional type. They are similar to the usual type, and of approximately the same dimensions except that

both screws extend from the same jaw. This permits the clamps to rest flatly on the one jaw when used on a drill-press table or other plane surface. The slight V-grooves cut into the lower jaw enable one to hold small pins or parts while drilling, filing or grinding them. The forward hole in the upper jaw is drilled slightly oversize. This allows a little play in the jaw, which permits one to hold work of uneven thickness or tapered parts without slipping.—H. J. Field, Haydenville, Mass.

V-Jaw Vise to Grip Round Work

Where shafts or other round work are to be drilled or machined, a vise with V-jaws like this one will be very handy. It isn't much of a job to make it from cold-rolled steel, and it can be used on any machine having a T-slot in the table in which it is fastened.

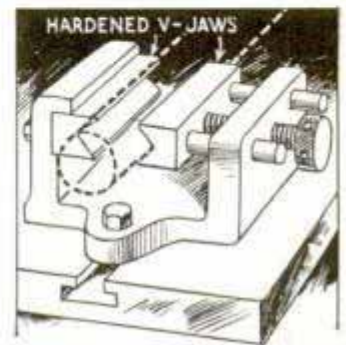

Salt Dispenser Has Cover to Keep Out Rain

To keep rock salt handy for his cattle in the pasture, and yet protected from rain, one farmer sawed the top section from a barrel, inverted the remaining section to serve as a table and suspended the smaller one over it. The hanging cover protects the salt block but is easily pushed aside by the cattle.

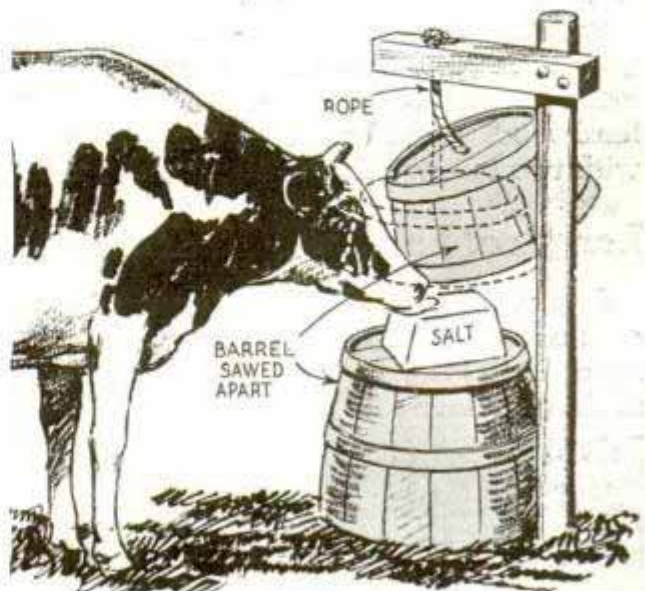

Entrance Doors Utilized as Display Windows

Confronted with the problem of limited show-window space, a merchant used the store doors to increase the space for his merchandise displays. Shallow cases or frames fitted with shelves and hinged backs were hung behind the glass in the doors and supported by means of three strong hooks of the screen-door type. The cases rest on $\frac{3}{4}$ -in. wood cleats screwed into the door near the base. This made it easy to remove the cases when desired, and the hinged backs made it easy to change or rearrange the displays. The number of shelves is optional and the interior can be illuminated with a hidden lamp mounted at the top of each case. Throughout the day when the store doors are opened and swung back inside, the case acts as an in-

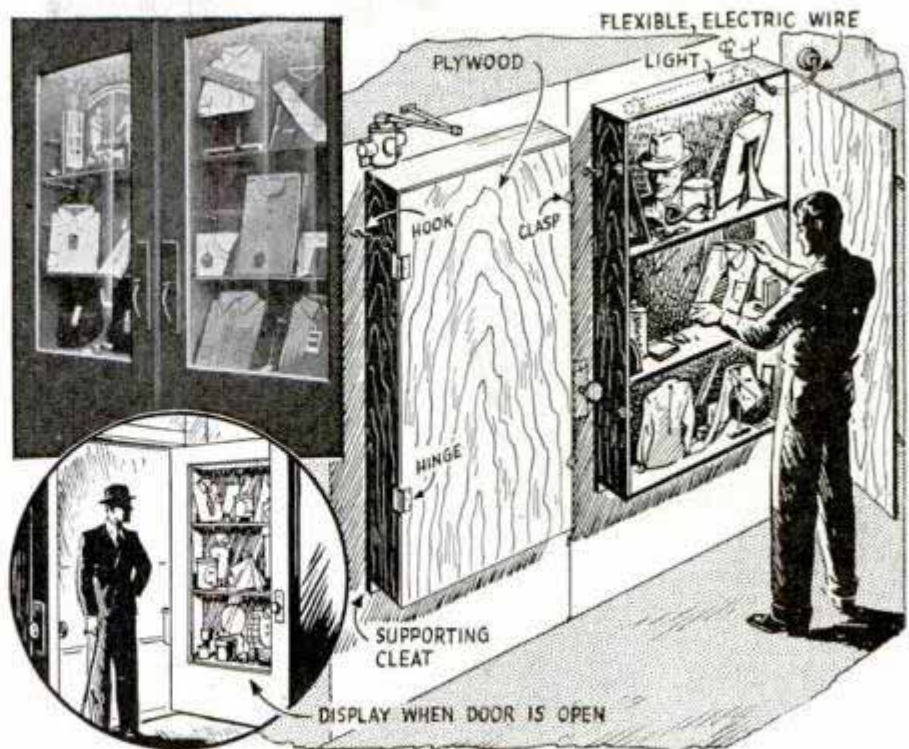

terior display, while at night when the doors are closed the cases are illuminated by merely plugging in the lamps to a convenient wall outlet.

—K. F. Keith, St. Petersburg, Fla.

Swinging Floodgate in Fence Not Easily Washed Away

One of the simplest floodgates that will swing and allow debris to flow under it and return to its normal position as the water recedes can be made as shown by

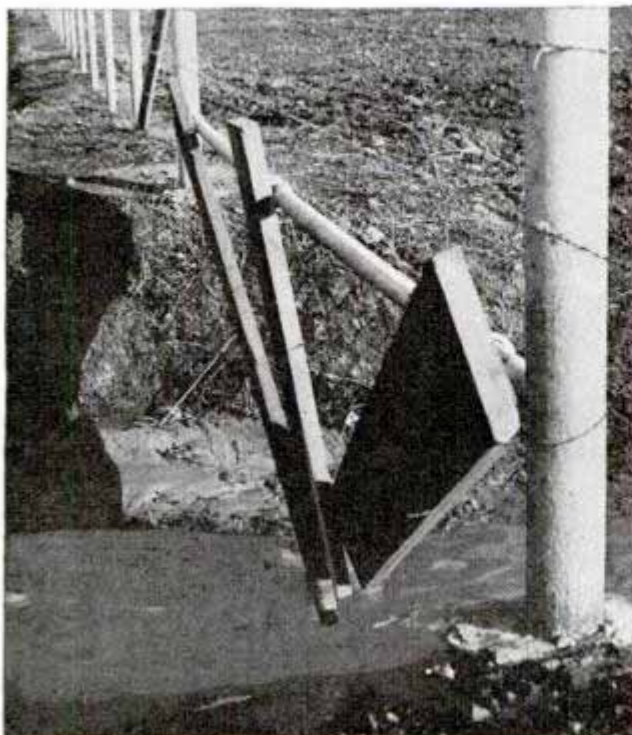

the photo. A length of large-diameter pipe is firmly attached at the proper height to posts on the banks of the stream, and from this the gate is suspended by means of U-bolts. The gate was made in a V-shape to conform to the slope of the stream banks. A heavy stake, pipe or other limiting device set firmly in the stream bed prevents opening of the guard in the wrong direction.—Elton Sterrett, Longview, Tex.

Blackboard Top on Store Scales Provides Surface for Figuring

Unable to keep scratch pads or tablets conveniently at hand for figuring weights, a merchant painted the top of his platform scales with blackboard paint. This provided a surface on which chalk could be used, and could be erased easily for repeated use.

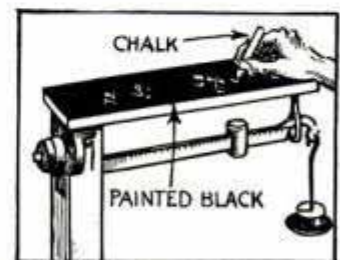

VENEERING

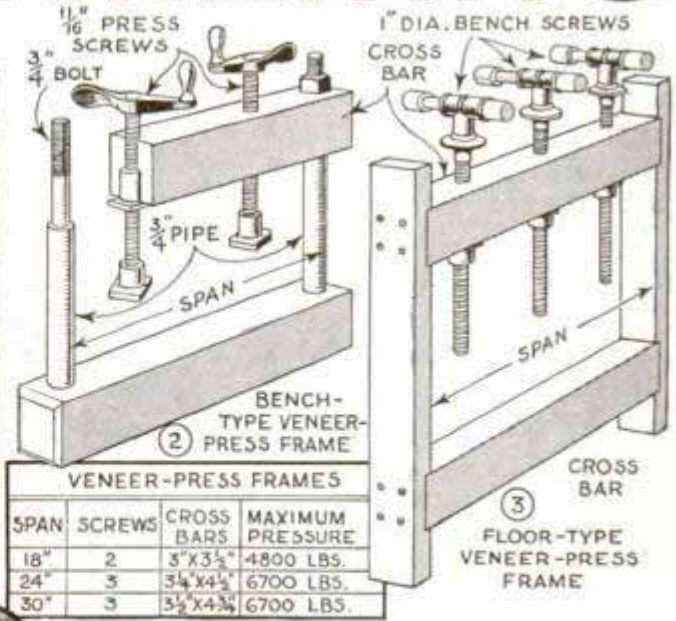
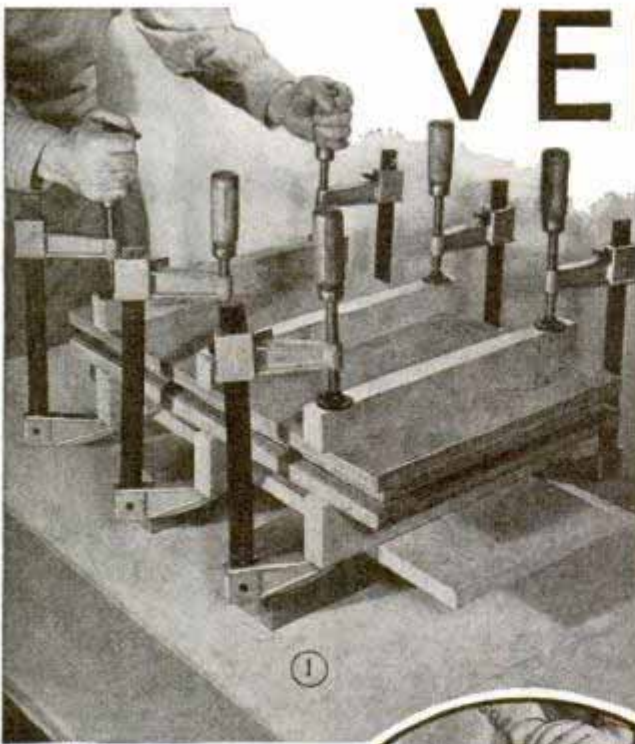

Methods of clamping

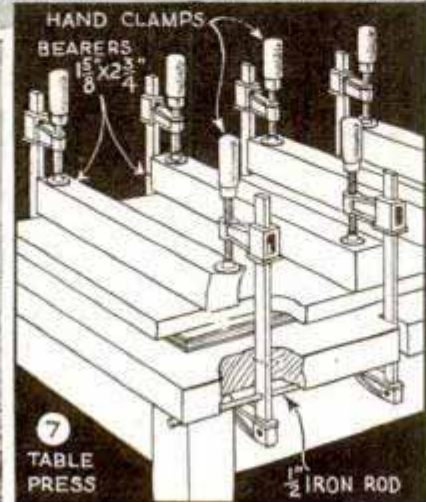
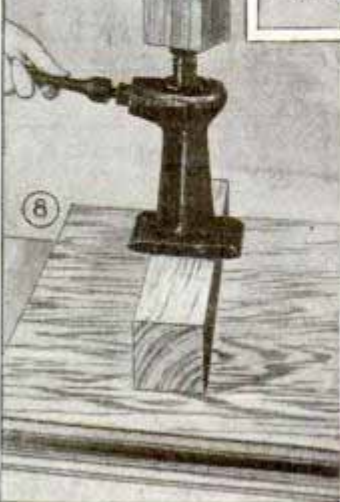
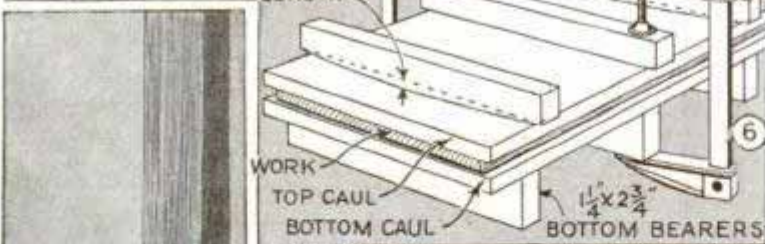
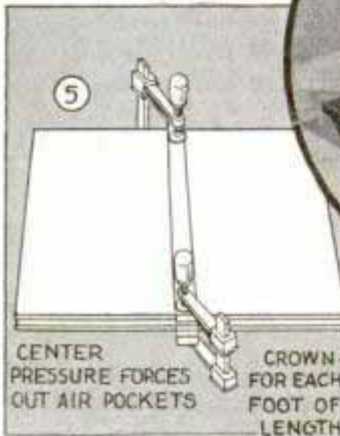
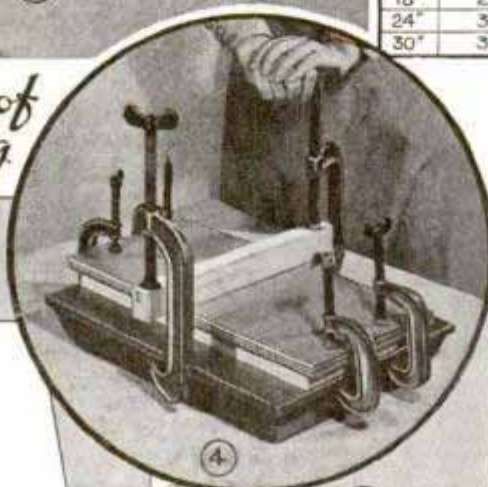

PART I

WHILE factory-made plywood is glued under pressures as much as 100 lbs. per sq. in., satisfactory work in the small shop can be done with a pressure of 20 lbs. per sq. in., which equals a weight of six tons on a 20 by 30-in. panel. Either hand clamps or press screws can be used. In Fig. 1 the work is held between 3/4-in. plywood boards or cauls and pressure is applied by means of bearers and clamps. Hand clamps of any kind can be figured at 800 lbs. each while press screws can be figured at 1,600 lbs. A safe rule to follow is to use one hand clamp for each 40 sq. in. of surface, and one press screw for each 80 sq. in. of surface.

Construction of veneer-press frames is given in the drawings, while the table shows the required dimensions of the cross bars to resist a given pressure. The wood used should be maple or yellow pine. Where a greater span is desired, the cross bars can be stiffened with iron plates. Fig. 2 shows a two-screw bench frame, while Fig. 3 shows a press of sufficient depth to be used on the floor, several of which are being used as a unit in Fig. 10. Fig. 4 shows how a surface plate or machine-table

Increases Scope of Craftwork

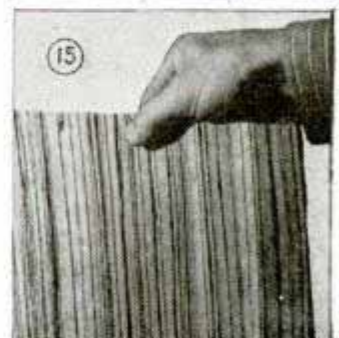
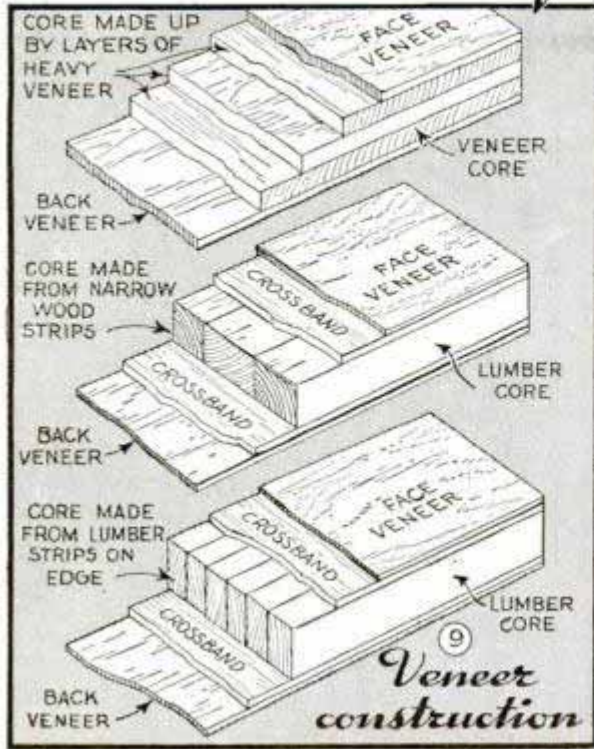

top can be used as a base for clamping. The standard set-up for clamping with bearers is given in Fig. 6. Note that the top bearers are not straight but are slightly curved on the underside. How the bearer method of clamping is used in making a permanent table press is given in Fig. 7. Excellent work can be done by using an automobile jack, Fig. 8, pushing against a heavy ceiling joist. After applying pressure in the center, the edges of the work are held by means of hand clamps. In any method of clamping, center pressure must be applied first, Fig. 5. This forces air pockets and excess glue to the edges of the work.

Veneer construction: Three of the commonest methods of constructing veneer panels are shown in Fig. 9. All are known as plywood. The center portion of the panel is the core. Lumber core plywood has a core of solid lumber strips. These are covered by a veneer called the crossband, and the crossbands are then faced with the face and back veneers. In all forms of construction, the grain of each layer is at right angles to the grain of the layer under it.

Making a lumber core: Plywood with either a veneer or lumber core can be purchased and needs only the application of face and back veneers to complete it. If the worker should wish to make his own core, the principles of core construction are illustrated in Figs. 11 to 14. Fig. 11 shows how lumber shrinks—always bowing out on the heart side. As a sheet of veneer has a tendency to pull the work hollow, it follows that where one face only of the core is to be veneered, the veneer should be applied on the heart side. This side is distinguished readily by inspecting the end grain, Fig. 12. To further eliminate warping, the lumber is usually ripped into narrow strips 3 to 4 in. wide, reversing every other piece end for end so that the heart side is alternately up and down, Fig. 13. Lumber cores always should be cross-banded, the best lumber for both cores and crossbands

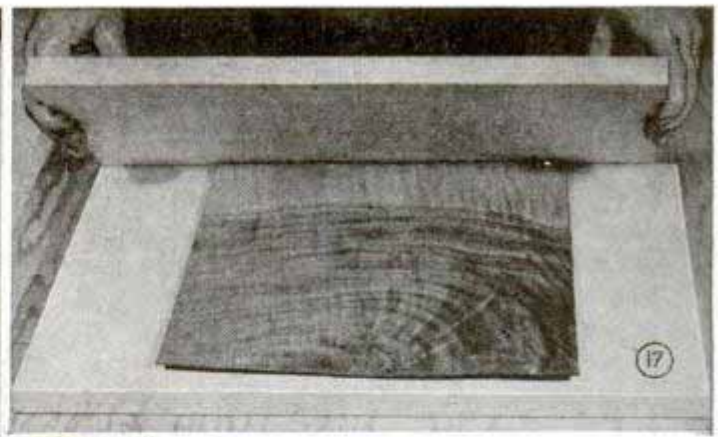

Flattening veneers

coat is essential, and is always applied to the core, not to the veneer.

Flattening veneers: Veneers are normally flat, and if kept between boards will stay that way. Intricate graining in burls and butts, however, tends to warp the veneer, and the piece must be straightened before it can be applied. Various preparations are available for this purpose, and can be applied by brush, dip, or spray, Fig. 16. When the surface wetness has dried, the veneer is placed between boards, Fig. 17, for overnight drying. A good glue size for flattening can be made by mixing, by weight, casein glue, 1 part, water, 4 parts, and then adding slowly alcohol, 2½ parts and glycerine, 1½ parts.

Assembling a panel

being poplar. Veneer cores need not be cross-banded as the top layer of veneer is itself a cross-band. Face veneers should be applied with the right side out whenever possible. The right or "tight" side can be determined by rubbing the surface of the veneer with the fingers, as in Fig. 15, the right side having a slightly smoother grain.

Concerning glue: Casein glue is used for most homecraft veneering. It is in dry powder form and requires only mixing with water to make it ready for use. Cold resin glue is also excellent. Both types should be applied with a brush having fairly stiff bristles. An even

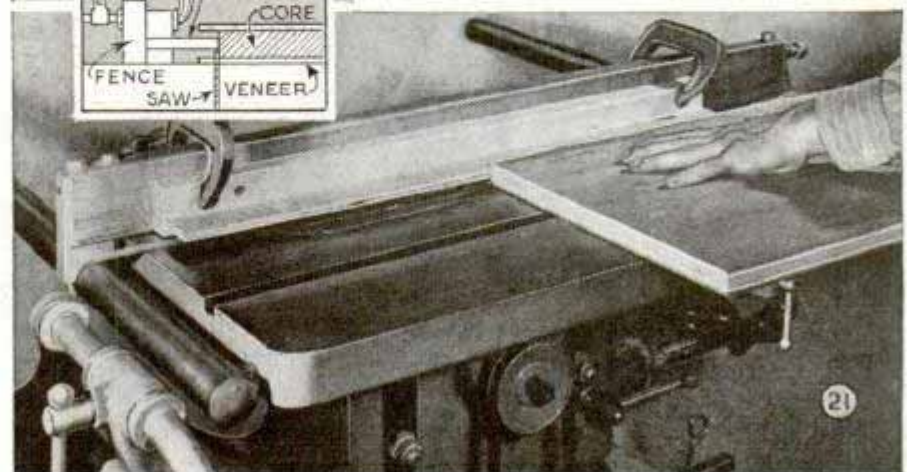
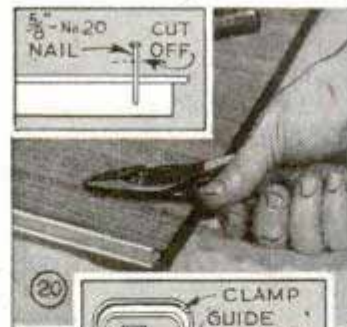
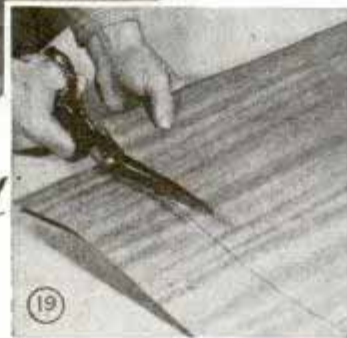

Assembling a panel: A panel with one-piece faces on a veneer core is shown in Fig. 18. The face and back veneers can be cut with a knife, saw, or heavy scissors, Fig. 19, and should be about ¼ in. larger all around than the core. Glue is brushed on one side of the

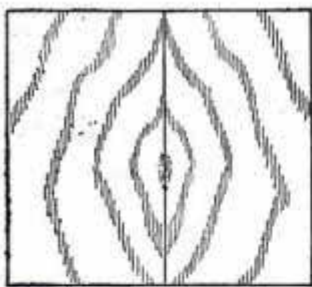

TWO-PIECE MATCH (22)

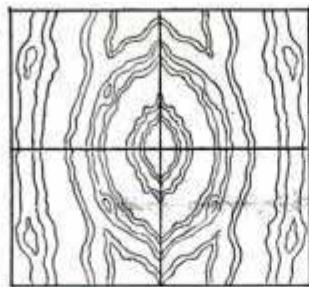

FOUR-PIECE MATCH (23)

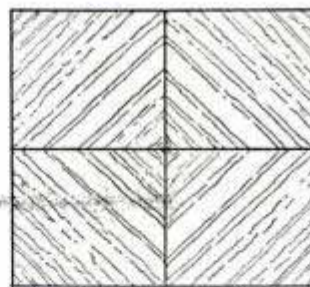

DIAMOND MATCH (24)

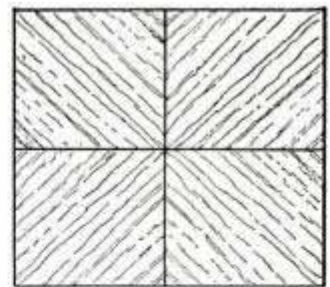

REVERSE DIAMOND (25)

core. The veneer is applied and is pressed down smoothly with the hands, stroking from the center to the edges. To prevent slippage, the veneer is held in place by small brads or nails. The heads of these are cut off about $\frac{1}{8}$ in. above the surface, as shown in Fig. 20. Then the work is turned over and the veneer applied in the same manner to the opposite side. Place a double sheet of newspaper over each side to catch any glue seepage, or, use waxed cauls. Place the work between the cauls, applying pressure by hand so that the brads enter the cauls. Then put the work in the press and apply pressure. Work should remain in the press from 3 to 6 hrs. After removal, the overhanging veneer edges can be trimmed off. The pattern method of cutting on the saw, Fig. 21, gives a very clean edge.

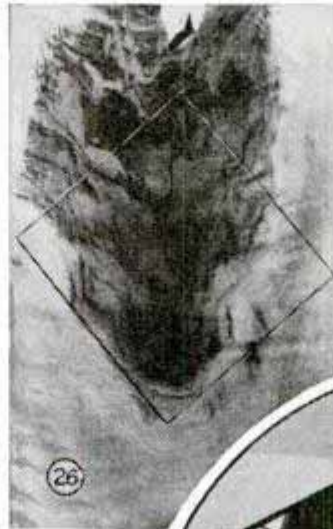

(26)

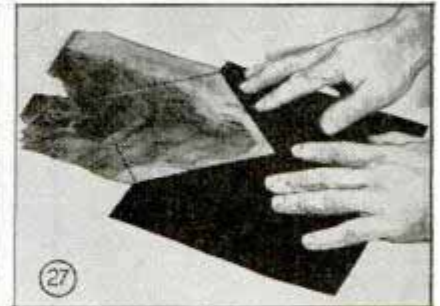

(27)

Matching

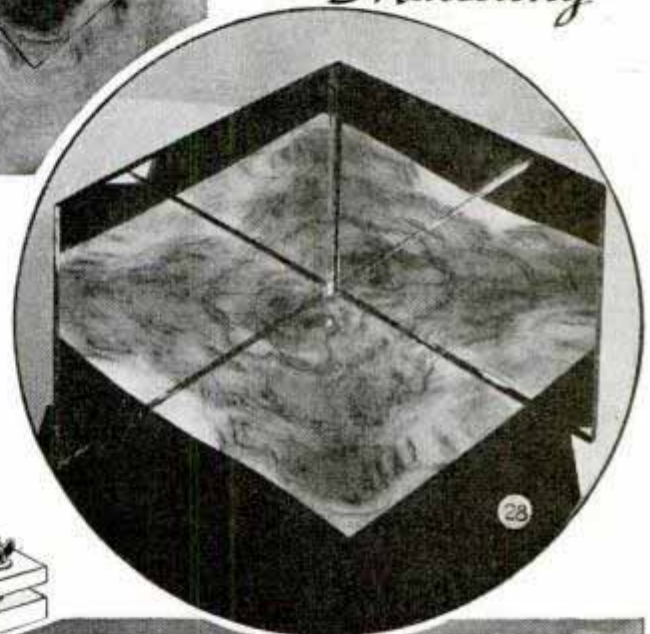

(28)

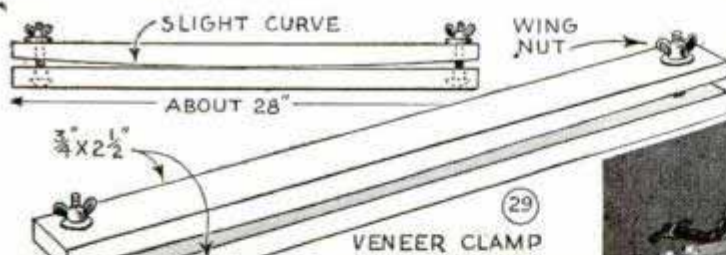

(29)

VENEER CLAMP

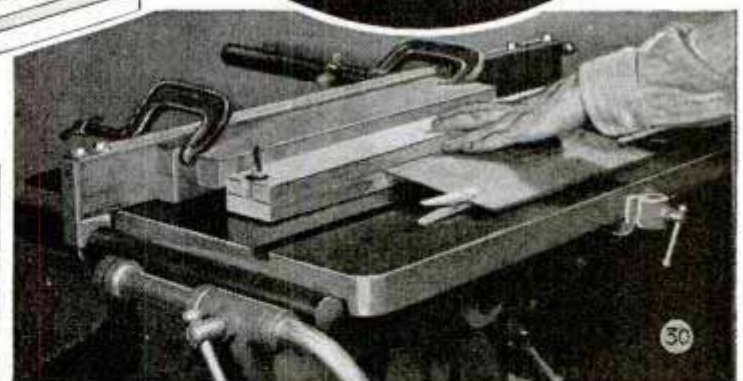

(30)

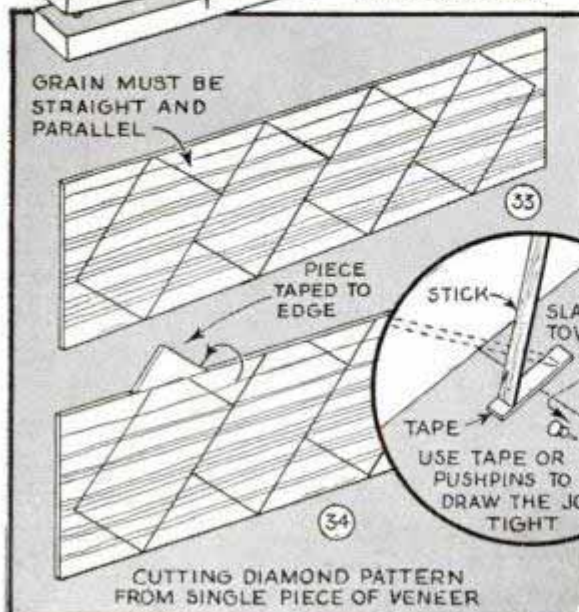

(33)

(34)

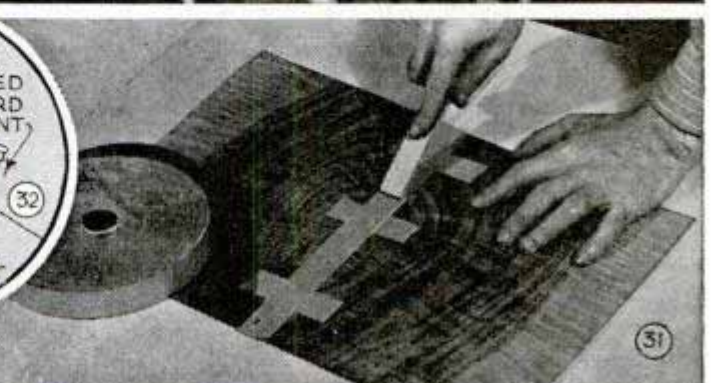

(31)

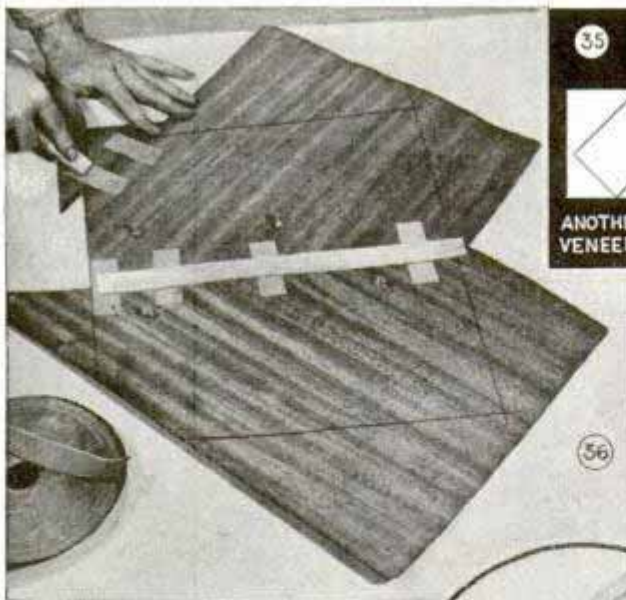

consecutive sheets. The appearance of any area on this sheet in a four-piece match can be observed by covering two edges of the area with paper, Fig. 27, and placing the mirrors on the other edges, as

shown in Fig. 28. Moving the paper and mirrors around will reveal the most pleasing figure.

In jointing veneers edge to edge, it usually is necessary to hold the two sheets of veneer in a suitable clamp, as shown in Fig. 29. About $\frac{1}{8}$ in. of veneer should overhang the edge of the clamp. Jointing can be done with a plane, a jointer, with sandpaper glued to a length of wood, or by pattern sawing. Pattern sawing, Fig. 30, is similar to the procedure used for trimming edges. After jointing, the two sheets are opened up bookwise, and assembled with gummed-paper, Figs. 31 and 32.

Forming a diamond match

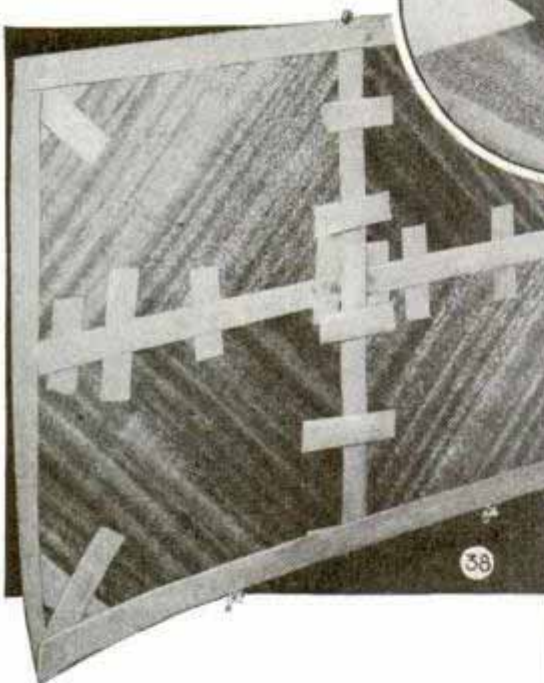
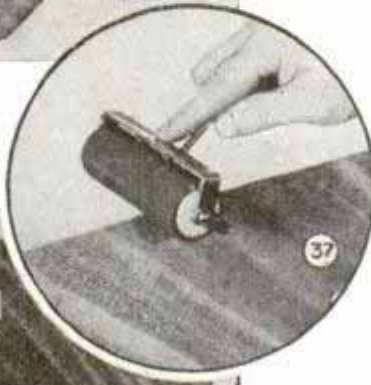

Making a diamond pattern: How the four pieces for a diamond pattern can be cut from a single sheet of veneer is given in Fig. 33. Fig. 34 shows how the length of the panel can be increased by patching. Fig. 35 shows another method of cutting, employing two consecutive sheets. The assembly of a diamond cut in this manner is shown in Fig. 36.

Matching: Veneer faces are not always in single widths but are often made up of two or more pieces. Frequently the various pieces are matched to form pleasing figures, a few examples of which are shown in Figs. 22 to 25. The two-piece match requires two identical consecutive sheets of veneer, while the four-piece match requires four identical pieces. Diamond patterns can be cut from either consecutive sheets or from a single sheet. In developing four-piece figures, a pair of small mirrors can be used to advantage. Fig. 26 shows one sheet of four

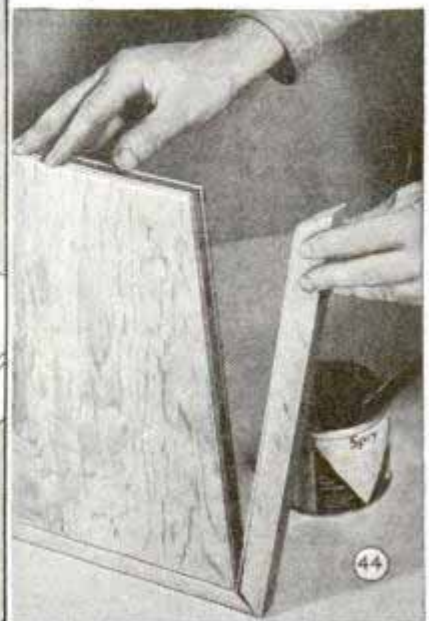
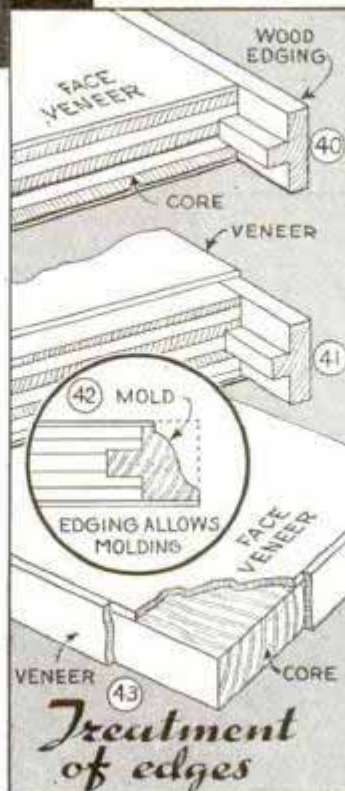

Treatment of edges

Two consecutive sheets of veneer will give a perfect match at one joint, while the other joint will be an approximate match depending on the continuity of the grain. In this respect, mahogany gives almost perfect results even when all four pieces are cut from the same sheet. After each joint has been taped, the edges can be folded back and glue applied to the veneer edges with a small roller, Fig. 37. Fig. 38 shows the completed diamond pattern, all ready for the press. The familiar herringbone pattern, Fig. 39, is made much the same as the diamond except every other piece is turned over.

Treatment of edges: The edges of a lumber-core panel require no treatment and can be molded and finished the same as a solid piece of wood. Edges of veneer cores are frequently finished dark with burnt umber to conceal the layers of veneer. A better method is to use an edging of the same wood as the face veneer, as shown in Figs. 40, 41, and 42. The edging can be applied either before or after the veneer is laid, the neatest method being to veneer over the edging. The strips should be mitered neatly at the corners, as can be seen in Fig. 44. Where the edges of the core are veneered, Fig. 43, the end grain of the core must be well sized with glue in order to secure good adhesion.

(To be continued)

Simple Cutting-Torch Guide for Flat Work

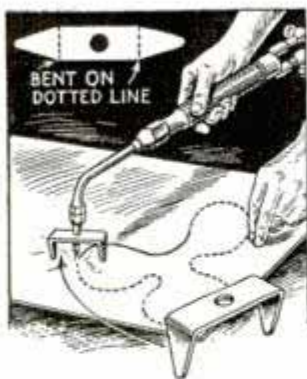

This little clip will be found an aid in cutting designs from flat work with a torch. It is made from thin steel and the ends that slide on the work are ground smooth so that they move easily over the

work. In use, the torch tip is simply rested in the hole of the guide, which helps to support it as it is moved.

☐ All painted surfaces should be washed before repainting them, to remove film of oil, grease, dirt and stains. Also less paint is required if this is done and often a coat of paint is saved.

Barbed Wire under Trough Edge Prevents Hogs Tipping It

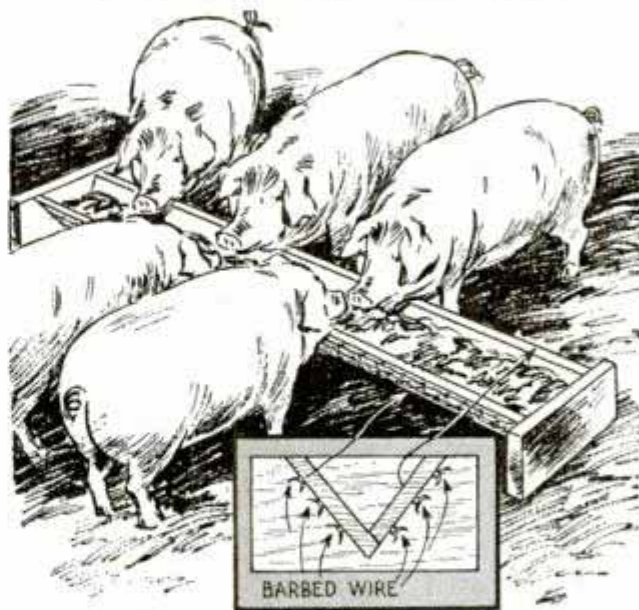

To keep his hogs from rooting and overturning the feed troughs, or from spilling the contents at feeding time, one farmer fastened lengths of barbed wire under the edges of each side. Regular staples were used to attach the wire, which was stapled at 1-ft. intervals.

Covering of Armored Cable Removed with Can Opener

Electricians and others who have to open the ends of lead cables will find that the job can be done quickly with a can opener of the type shown. Slit the rounded end with a hack saw and straighten the severed ends to act as a guide on the cable. Then sharpen the cutting edge of the blade and use it as shown.

—Herman R. Wallin, New York, N. Y.

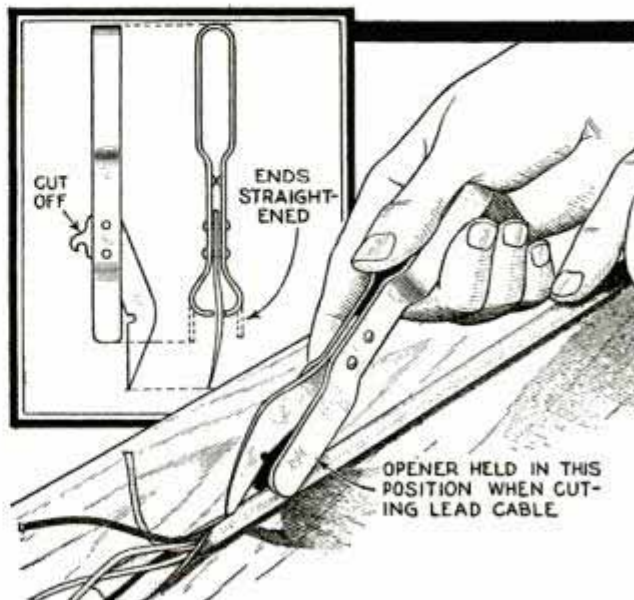

Sleeve Made from Piece of Dowel Keeps Toggle Bolt Tight

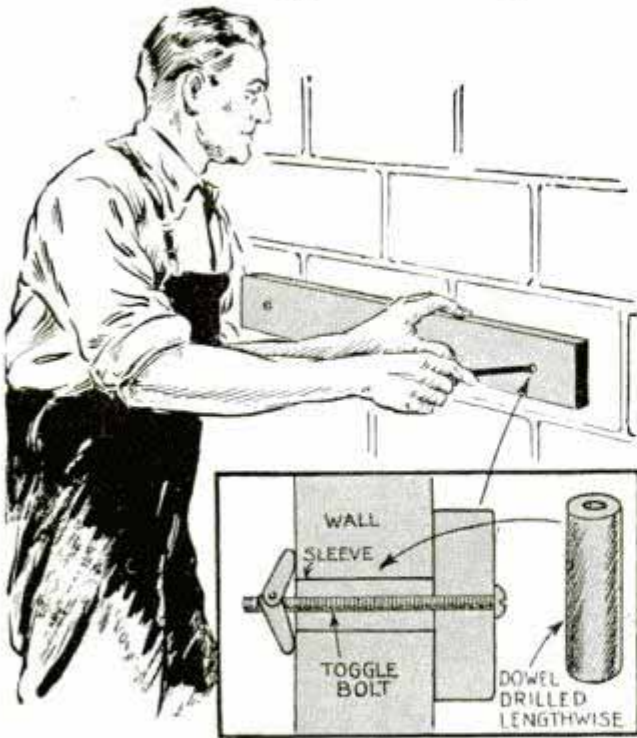

If a block of wood or other work is to be fastened to a hollow wall surface with a toggle bolt, insert a sleeve in the hole as shown to prevent the bolt from working loose. A sleeve for the purpose can be made by drilling a hole lengthwise through a dowel to take the bolt. This will fill in the space between the bolt and wall for a snug fit, besides keeping the edges of the hole from crumbling while the bolt is tightened.—A. Vena, New York, N. Y.

Increasing Capacity of Chuck

When work with slightly irregular surfaces has to be faced on one side, it can be chucked in a lathe in the manner shown. Two of the jaws on opposite sides of a four-jaw chuck were removed and stud

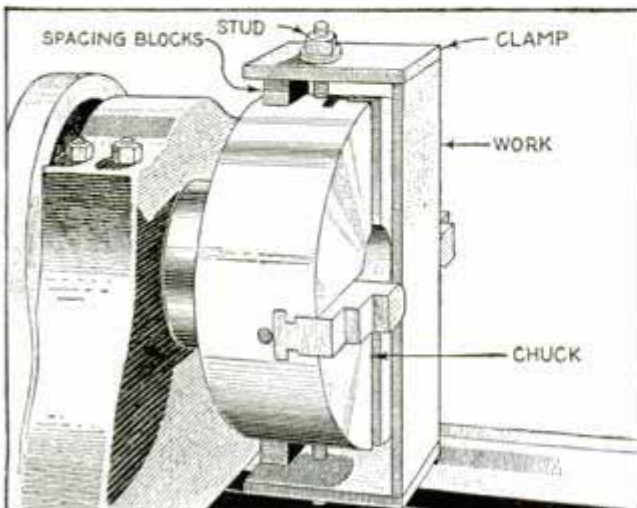

bolts were substituted for the screws. These held clamping pieces against the ends of the work as indicated, while the remaining jaws of the chuck gripped the edges of the work.

Tie Wires Cut in Equal Lengths with This Simple Jig

To cut tie wires for concrete forms quickly, a contractor made this jig. Lengths of the wires are varied as required by using blocks of different widths. Besides cutting the wires, it also shapes them.

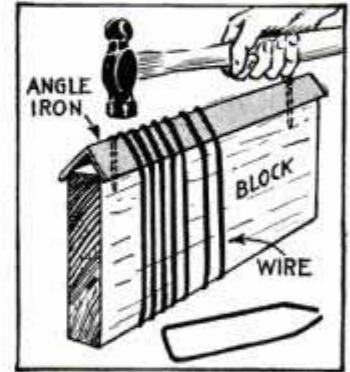

Guides Prevent Team of Horses from Crowding Gate Posts



As an aid in driving a team of horses through a narrow gateway so that the wagon or farm implement will not strike the posts at either side, fasten a couple of sections of auto-tire casing on top of the posts as shown. The horses will avoid these apparent obstructions and keep the vehicle in the center of the roadway.

☞ Late October is a good time to paint your house as there is usually less rain and fewer insects at that time than in either hot or cold weather.

Indirect WATER HEATER

connects to boiler

By J. B. MULLEN

ASSEMBLED from standard copper tubing, pipe and fittings, this domestic water heater connects to the boiler of a hot-water heating plant. It is especially advantageous on oil burners and gas furnaces where the temperature of the water is maintained automatically. Hot water from the boiler passes through the case and heats the water which circulates from the storage tank through the copper coil inside the case. A system of the type shown will have a capacity of 20 gals. of hot water per hour, which will be adequate for the average home, if the boiler-water temperature is maintained at 180° F. or higher, and a 60-gal. storage tank is used. A general layout for the system is shown in Fig. 1. The heating unit consists of a copper coil enclosed in a length of 6-in. standard pipe.

The coil is wound from a 15-ft. length of 18-gauge, soft-copper tubing having an outside diameter of $\frac{7}{8}$ in. For winding, it is filled with dry sand and the ends plugged, Figs. 3 and 4. It is best to cut the tube somewhat long and then cut off the surplus after bending. The sand-filled tube while hot is then wound around a mandrel $3\frac{1}{4}$ in. in diameter, as shown in Fig. 2, making thirteen evenly spaced coils $1\frac{3}{8}$ in. apart. After the coil has been finished, the ends are stretched out straight along the axis of the coil, plugs are removed from the tube and the sand shaken out. In shaping the coil it is essential that sharp bends be avoided. Each end is fitted with an adapter such as shown in Fig. 6, for connecting to the iron pipe. There are several types of fittings for this purpose. The one shown has a $\frac{7}{8}$ -in. socket at one end into which the copper tube should be silver-soldered, and a 1-in. pipe-threaded opening at the other end. The end of the tube and the inside of the fitting are cleaned with fine emery cloth and coated with brazing flux. The parts are then fitted together and heated. Silver solder is applied through a hole when the joint is hot enough. If you plan to use the hot-water

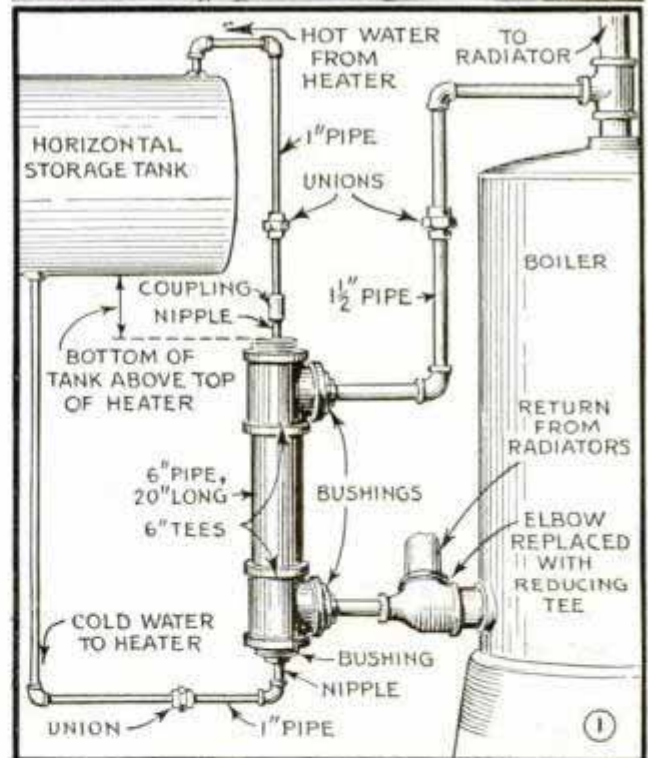
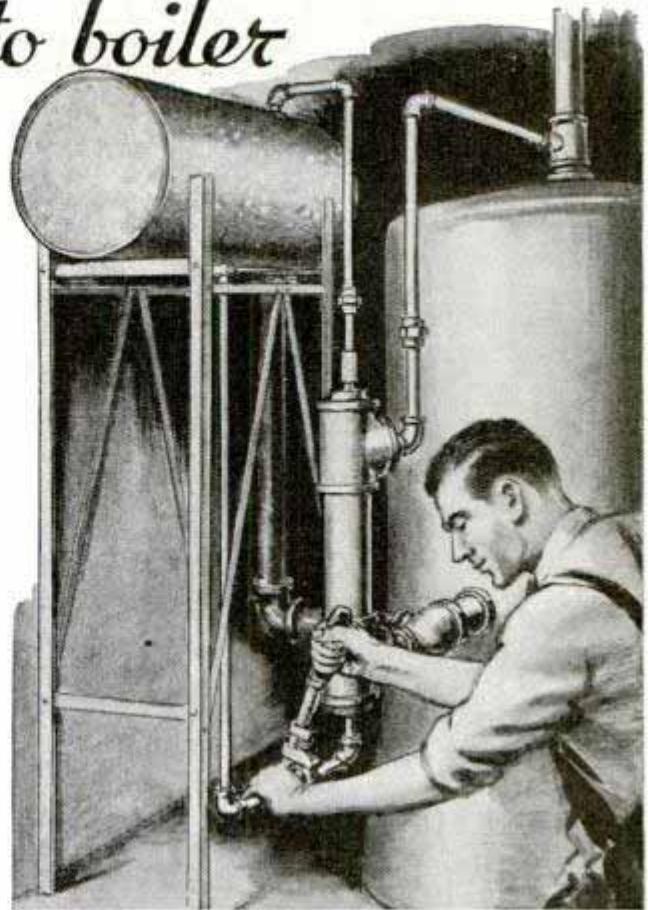

system in summer as well as in winter, a gate valve will be necessary in the line to the radiators to prevent heating them.

The heater can now be assembled as in Fig. 5. First, the bushings are installed in the lower tee and a long, 1-in. pipe nipple is run through the lower bushing. All

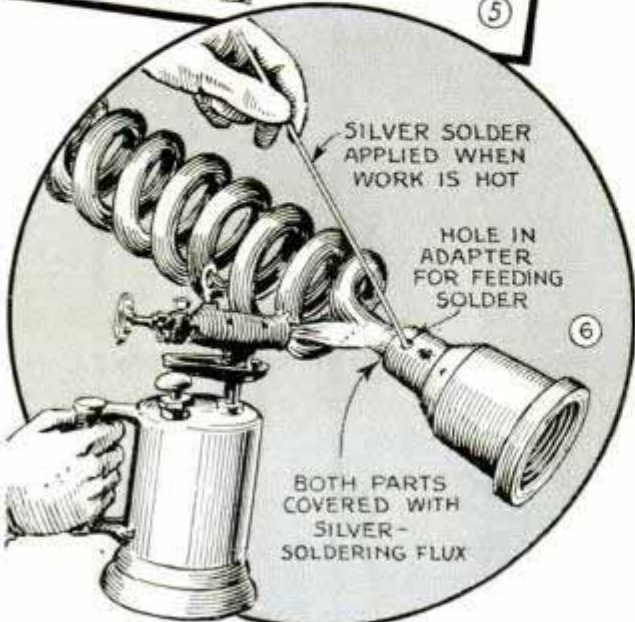
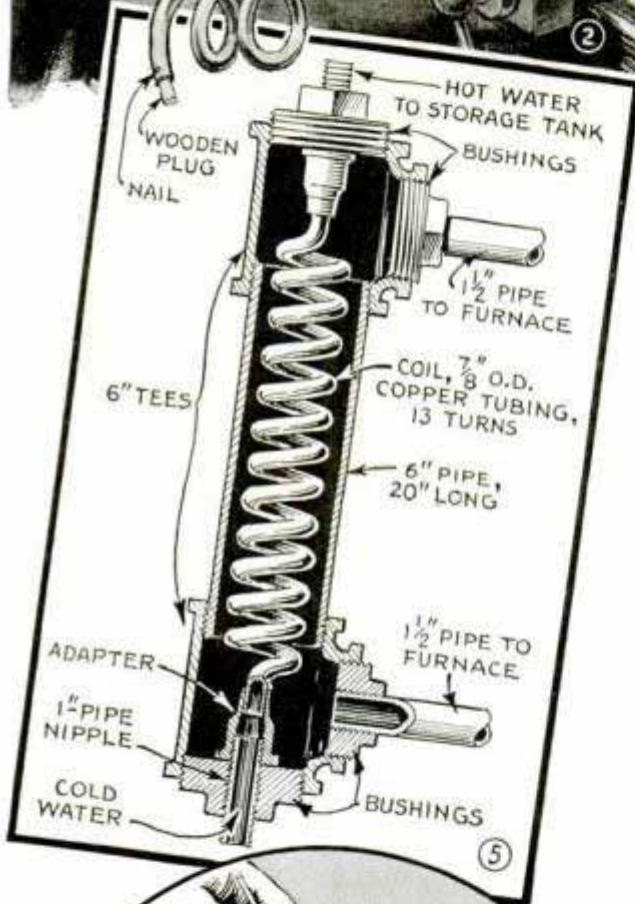
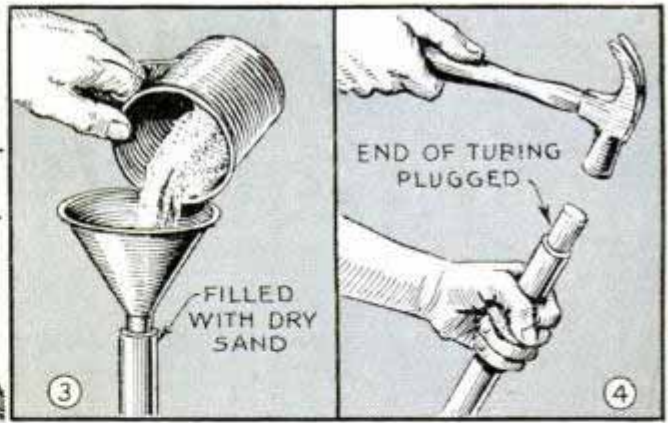
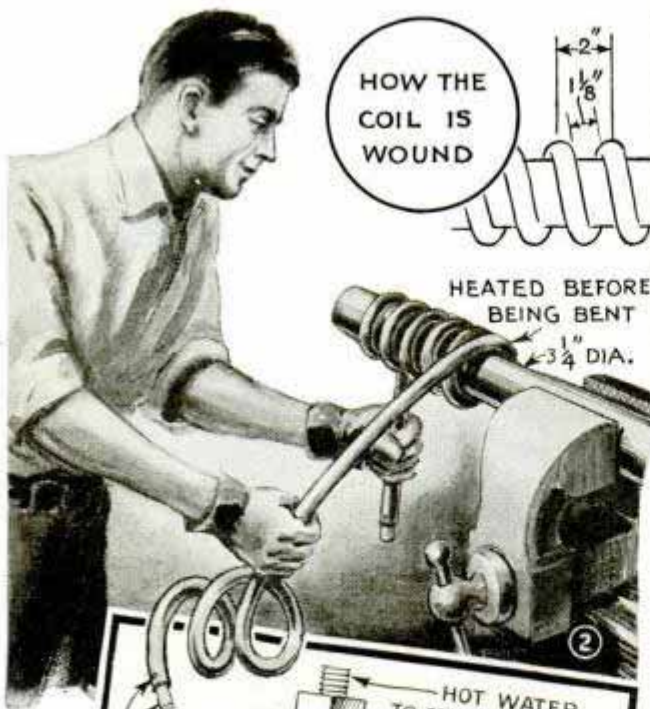

threaded joints must be calked with a good pipe-thread compound. This tee is then attached to the lower pipe from the boiler. The coil is attached to the nipple which extends through the bottom bushing, and the section of 6-in. pipe is screwed to the tee. The upper tee is next screwed to pipe and the bushing for the 1½-in. pipe inserted into its side arm. Do not, however, put the other bushing into this tee as yet.

Next, the upper connection to the boiler is made. A union will be necessary in this line. A nipple is screwed into the adapter fitting at the top of the coil and the bushing is screwed down over this nipple and into the tee. The nipples used for the upper and lower connections to the coil must be threaded for a distance of several inches in order to attach both to the bushing and to the coil. The connections to the water tank are made as shown in Fig. 1. It will be advisable to flush the tank out thoroughly to remove all sediment and scale before attaching to the new heater. A union will be needed in both lines to the tank. The tank should be horizontal and the bottom of the tank must be higher than the top of the heater.

Extinguishing Fire in Gas Main

While digging a ditch, a workman stuck his pick through a large high-pressure gas main, which quickly burst into flame. Because of the high pressure, firemen were unable to extinguish the fire with water or chemicals. A compressed-air pump and tank were run up near the fire. After a good head of air had been pumped up a pipe was attached to the air hose, and held as near the gas main as possible. A valve was opened, permitting a sudden rush of air. This carried the gas away from the flame and the fire died instantly.

Slotted Screws to Adjust Brakes Externally

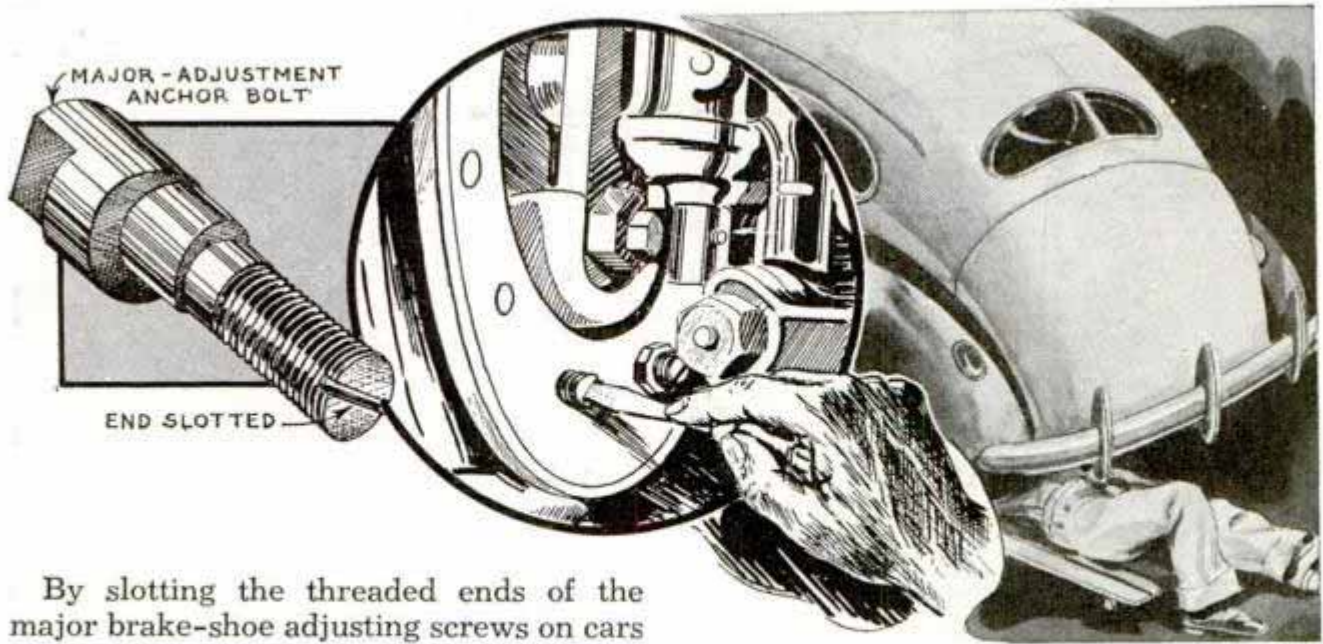

By slotting the threaded ends of the major brake-shoe adjusting screws on cars where they face inside the brake drums, you can save time when relining the brakes. The slots enable a mechanic to adjust the newly lined shoes with a screwdriver from outside the drum. Usually on brakes of this type, dummy drums have to be used in adjusting the shoes because the screws are inaccessible when the wheels

are in place. The screw ends can be slotted with a hack saw, but first they must be ground on the ends to remove the hardened surface which penetrates only a few thousandths of an inch. Use two blades in the hack saw so the slot will take a large screwdriver.—Morris Waldman, Chicago.

Badly Clogged Radiator-Core Tubes Are Cleaned by Hand

Radiators that have become so filled with rust and sediment that no amount of flushing will restore their former cooling efficiency can be cleaned without removing them from the car. First remove the two hose connections and slip off the outer shell from the tank. Drill a hole through the top of the tank above the radiator tubes,

using a No. 36 drill. Run a long piece of $\frac{1}{16}$ -in. drill rod or other stiff metal through the hole and into one of the tubes to the bottom of the radiator to remove any accumulation lodged there. All the tubes may be cleaned in this manner, but it is unnecessary to drill a hole for each tube as the rod will reach more than one tube from each hole drilled. Forcing water through the radiator from the bottom hose connection, or even running it through from the top, will aid in cleaning the tubes. After all corrosion has been removed, thread the drilled holes with a No. 6-32 tap, insert brass screws and solder over each head.

—Arthur S. Clark, Oakland, Calif.

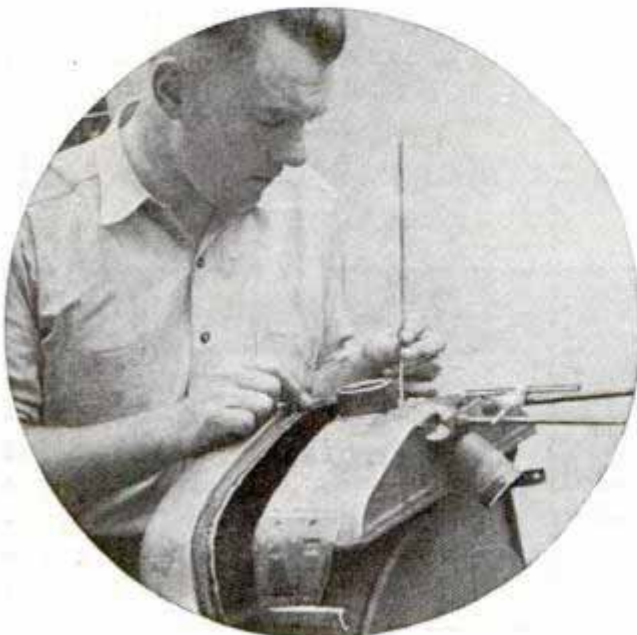

Valve Stems Easily Scraped in Drill Press

Disliking to scrape valve stems with a knife to clean them, one mechanic chucked the stems in a drill press and held a strip of fine sandpaper against them while they rotated. Only a few minutes were required to remove carbon and polish the stems.

Strap Helps Driver Close Door on Right-Hand Side



Difficulty of closing a car door on the right side from the driver's seat can be avoided to some extent by attaching a strap to the door as indicated. The strap being close to the hinged side of the door is easy to reach to pull the door shut.

Locating Punctures in Tubes

Punctures in inner tubes can be located quickly without the use of water or even the necessity of inflating them. Before the tube is removed from the tire, make a

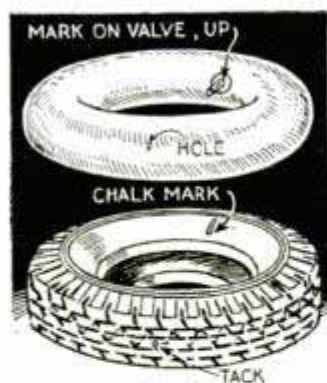

chalk mark on the side of the tire directly in line with the valve stem. Then remove the tube and locate the nail or other object that caused the puncture in the casing. Now, if the tire is laid on the floor and the tube placed over it with the valve directly over the chalk mark, the hole in the tube will be directly in line with the nail in the tire. To avoid inverting the tube with respect to the tire, a mark should be made on the side of the valve stem corresponding to that side of the tire on which the chalk mark was made. In some cases where it is possible to locate the hole in the tube and

difficult to find the nail in the tire, the above procedure may be reversed to locate the position.

—Edward Moorman, Lawrence, Kan.

Lug on Flap of Auto-Door Lock Makes Opening Easier

Pivoted flaps that cover the door locks of some cars can be opened much easier when wearing gloves if a tiny lug is soldered to the lower edge of the flap. A short piece of brass or copper wire is ideal for this purpose, a piece about $\frac{1}{8}$ in. long being sufficient.

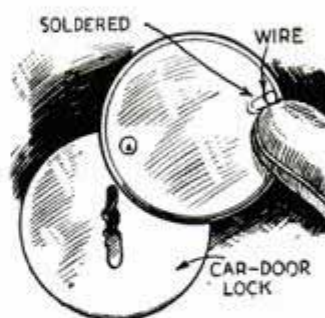

Peephole in Visor Aids Motorist When Crossing Intersections



Noticing that his sun visor restricted his view too much when approaching an intersection, one motorist cut a peephole near the right-hand end of the visor. This enabled him to take a quick look when approaching an intersection. A cover can be provided for the hole if desired.

Old Coffeepot Melts Compound for Resealing Batteries

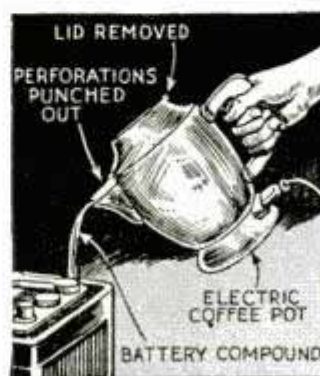

A battered, but serviceable electric coffeepot was used by a garageman to melt battery compound for resealing the tops of repaired batteries and for filling scores and other bad spots in

batteries that are to be recharged. The lid of the pot was removed entirely and the perforations between the body and the spout were punched out to make pouring easier. The shape of the spout makes it an easy matter to apply any amount of compound exactly where it is required.

Protecting Shock Absorbers Against Gravel and Rocks

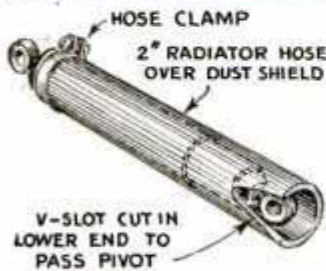

Instead of purchasing expensive shields to protect the direct-acting shock absorbers on my car, I made some from radiator hose. This was cut in sections long

enough to cover each shock absorber completely and held in place with regular radiator hose clamps.

—Emil J. Novak, Omaha, Nebr.

Unscrewing Slotted Hub Caps

If an old car of the type having wooden wheels, which have slots in the hub caps to take a tool for removing them, comes into your shop and the caps have to be removed and there is no tool at hand, try a pair of pliers. Just insert the ends of the plier handles into the slots and use a screwdriver as shown to unscrew the cap.

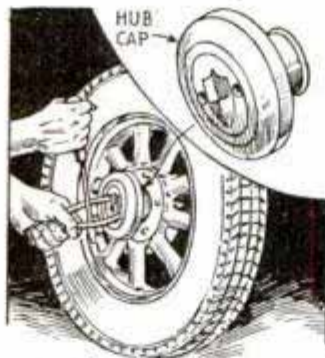

Emergency Valve-Spring Repair



When a valve spring breaks and a new one is not at hand, an emergency repair can be made by placing a large washer between the broken

ends. This prevents the ends from telescoping or twisting to one side, so that the valve will continue to function until a new one can be obtained.

Removable Step on Car Fender to Enter Rumble Seat



To facilitate entering the rumble seat of his car, especially for the lady members of his family, one motorist provided the extra step shown. It fits into a hole drilled in the regular fender step and is stored in the rumble-seat compartment when not in use.

Lock on Car Door Changed Over to Steering-Wheel Side

Tired of sliding across the front seat of his car many times during the day with a sample case, one salesman changed the lock on his car door over to the steering-wheel side for convenience. The lock, being of the type that operated in the door handle, was easily changed in a few minutes by merely switching the handles.

Hub Reflectors Safety Precaution When Crossing Highway

Have you ever had a bad scare when crossing a dark highway or street because an oncoming motorist did not see your car? If so, reflectors attached to the hub caps will help avoid this in the future. The reflectors should be attached near the edge of the cap so they will form a ring of light when the lights from an oncoming car strike them.

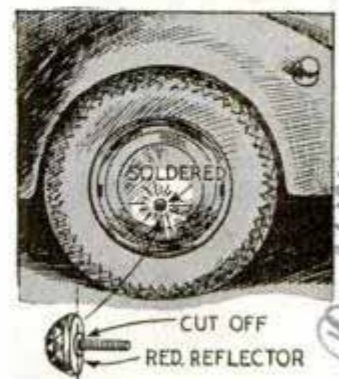

Patent. Suggest. Derrib Burner Co. and 3th St. Wash. D.C. 20001. 2/2

Door Held Open While Working on the Window Mechanism

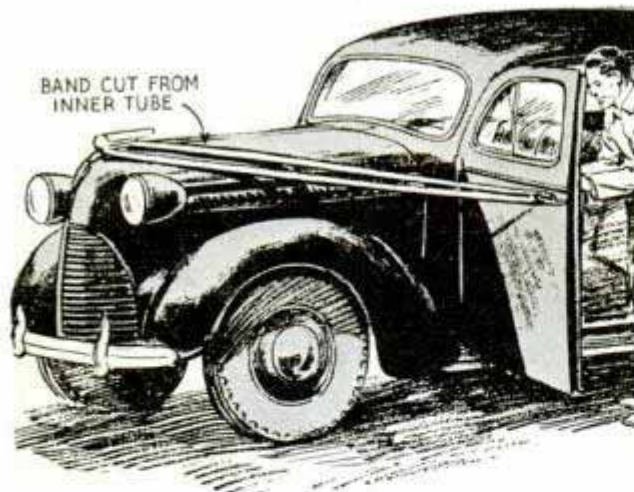

To hold car doors open while repairing the window, one mechanic uses a long rubber band slipped over the door handle and the radiator ornament. The band is cut from an old inner tube.

Multiple Posts on Car Ammeter for Connecting Accessories

All the accessories on my car, such as radio, heater, cigar lighter, etc., were connected to one post of the ammeter, and when one of them had to be disconnected, all the wires came off. I drilled several

small holes in a strip of brass and connected it to the ammeter post. Now the wire from each accessory can be fastened in one of the holes and removed without disturbing the others.—W. Waters, Alton, Ill.

Reserve of Brake Pedal Reduced by Air in Wheel Cylinder

After long use of hydraulic brakes, it is sometimes difficult to keep the proper pedal reserve for more than a few days. In some cases this is due to air getting into the rear-wheel cylinders when the hand brake is used. When this brake is set, the pressure of the fluid on the wheel cylinder is removed and if the brake-cylinder rubber cups or the walls of the cylinder are not in good condition, atmospheric pressure forces air into the cylinders, causing a loss of pedal reserve. Repairing with the necessary parts, or the replacement of the entire wheel cylinder if the walls are in bad condition, will cure the trouble.

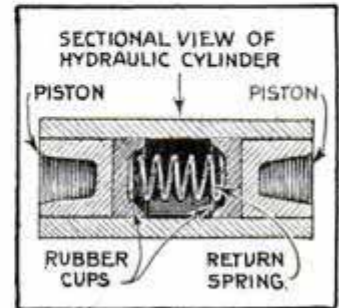

Arm Yourself with Ideas for Success By Getting This New 128-pp. Guide to Opportunities

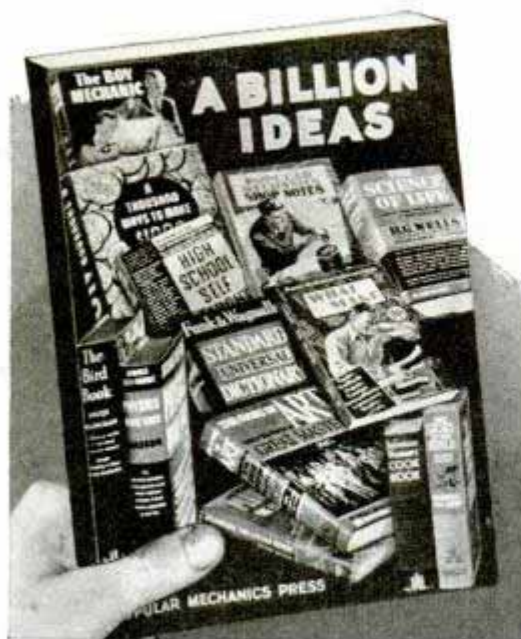

Are you looking for greater opportunities—a better position—more income—some lucrative small business or profitable hobby particularly suitable for you? Or, do you want craftwork ideas to make your spare time pay extra dividends? Then, don't fail to send for "A Billion Ideas." Your only cost is a 3-cent stamp to cover mailing expenses. This new, illustrated catalogue of ideas was especially prepared for practical-minded people who want to know about many useful books on moneymaking subjects and want shop-tested handicraft plans to make things. This book is an "eye-opener" to numerous opportunities. It's an inspiration to find out what others have done and what you too can do! Don't miss it!

Dept. 1040 — Popular Mechanics Press, 200 East Ontario Street, Chicago, Illinois

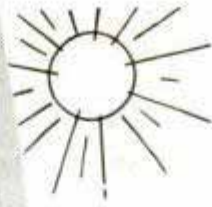

**OUTDOORS
IN SUNLIGHT**

**INDOORS
AT NIGHT**



*...either one
is a winner!*

TONIGHT make a picture-taking date with the whole family. And for surer results in your snapshots at night, under Photofloods, load with Kodak Super-XX Film . . . about four times as fast as ordinary film. You can then, from the very first, count on indoor snapshots at night that are as clear and brilliant as those you have been getting outdoors in the sun.

And your camera doesn't have to be an expensive one, either. Any camera that takes Kodak Super-XX Film will do, even a \$1 Baby Brownie.

NIGHT SNAPSHOTS
simple as A.B.C. with

**KODAK
SUPER-XX
FILM**



A . . . Load your present camera with Kodak Super-XX Film

B . . . Use a couple of inexpensive Mazda Photoflood lamps in Kodak Handy Reflectors

C . . . Follow the few simple directions in the FREE Booklet

A few minutes with this helpful booklet and you're headed for splendid nighttime snapshots. Photos, diagrams, easy-to-understand directions. At your dealer's . . . Eastman Kodak Company, Rochester, N. Y.



Above, special tool for changing tires on the Plymouth. Right, cross-section view of safety rim wheel shows how bead of flat tire is held firmly on wheel. Center, Lincoln Custom limousine. Bottom, how license plate is mounted between bumper guards on Buick

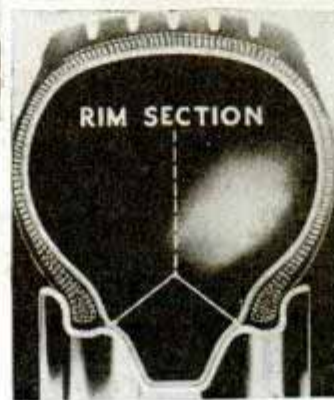

Changes in the Ford cars are more extensive than for any year in the last five. Bodies are much larger and wider, so wide, in fact, that running boards are partly concealed. Both Ford cars are powered by the eighty-five horsepower, eight-cylinder engine, the "60" being discontinued. The wheelbase is increased to 114 inches and the cars are mounted on an extremely rigid frame of new design. Springs are softer and rear springs are longer. A feature of the convertible club coupe is an automatic top operated by electric motors instead of by vacuum.

The Mercury Eight features new lines, longer wheelbase and an improved ride. The wheelbase is 118 inches. Longer rear spring, improved shock absorbers of the double-acting hydraulic type, five-inch rims and 6.50-inch tires, a perfected torsion bar and other factors contribute to a comfortable ride. Mercury bodies are wide, with running boards partly concealed. There are three distinct lines of Lincoln automobiles for

(Continued to page 116A)



The 1941 Cars

(Continued from Coloroto Section)

out shifting gears or operating the clutch. Dodge, like Plymouth, offers at extra cost a booster mechanism for helping the driver to shift gears in cars equipped with standard transmission. Other Dodge features include increased engine power, the safety rim wheel, rear windows giving forty-seven per cent more vision than did last year's windows and a counterbalanced lid for the luggage compartment.

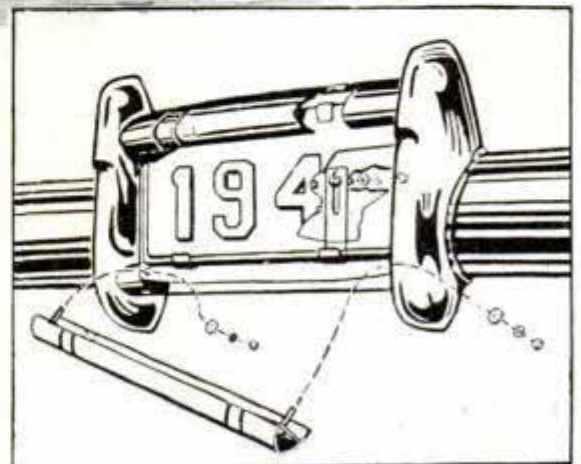

The New

DELCO ELECTRO-LEVEL

AUTOMATICALLY ELIMINATES OVERFILLING



When the electrolyte level in a battery is too high, acid is sprayed through the vent holes by the pressure inside the cell . . . pressure that is built up by the release of gases when the battery is being charged. This acid spray attacks battery connections and battery carrier. The new Delco battery is protected against these conditions by the Delco Electro-Level, which automatically prevents overfilling when water is added.

HOW THE DELCO ELECTRO-LEVEL WORKS

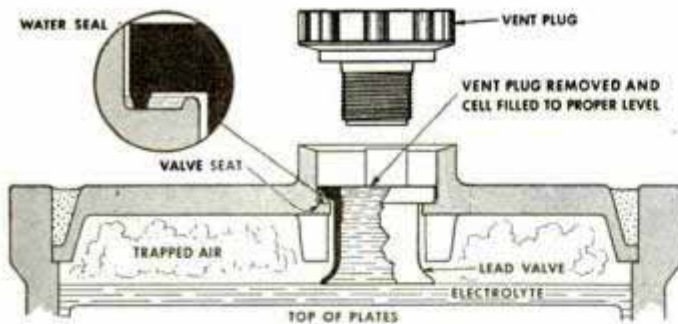

Vent plug removed for filling—valve forms air lock when electrolyte reaches proper level. Notice particularly the *water seal* formed when the edge of the valve drops into the layer of water retained by the ridge around the valve seat. This layer of water is replenished by condensation, eliminating any possibility of a leak in the air lock when the lead valve is in position for filling.

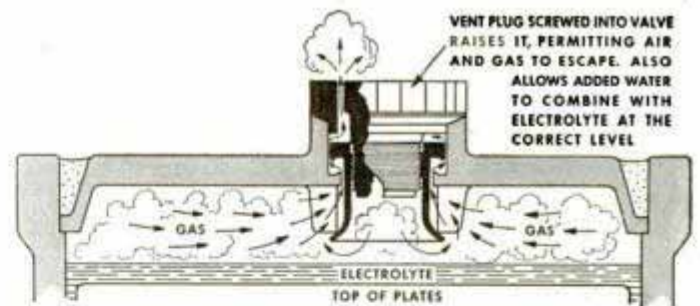

Vent plug screwed in—valve is raised to permit escape of trapped air and gases from the cell through the passage and the vent hole in the plug. Notice here the efficient baffle arrangement through which the gases must pass. This condenses moisture and breaks up the acid spray which might otherwise escape to damage the battery carrier and connections to the battery.

Stop in at your nearest Delco battery dealer's and let him check your present battery on the Battery "Life Expectancy" Chart. He has a Delco battery that is exactly the right size and type for your car.

Delco-Remy

ANDERSON, INDIANA

World's Largest Manufacturer of Automotive Electrical Equipment

1941—the Lincoln-Zephyr, the Lincoln Continental and the Lincoln Custom. All have the unit body-and-frame construction which provides great strength and safety with low weight. The Zephyr and Continental are mounted on a 125-inch chassis, while the Custom is on a 138-inch chassis. All are powered by a V-type 12-cylinder engine of 120 horsepower. The Custom features door windows which operate automatically by merely pressing buttons. Instead of door handles, the Lincolns are equipped with push-button door latches.

Studebaker's offerings for 1941 are highlighted by a slipstream Land Cruiser, a long, low, wide, sleek-looking model that already has won the approval of automotive engineers, writers and dealers. In ad-

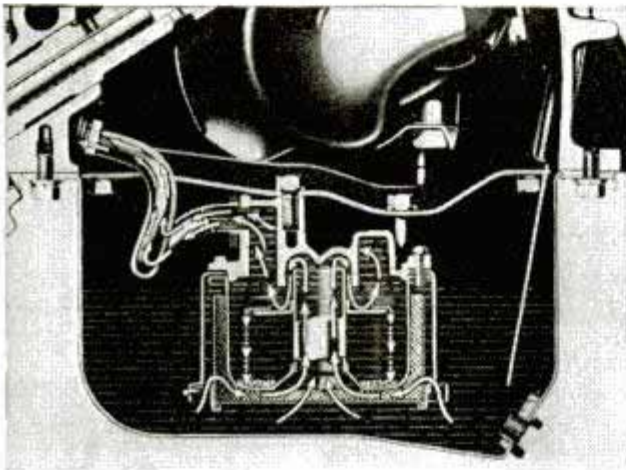

Sectional view of Pontiac engine showing oil cleaner through which all oil passes before reaching bearings. Filters, traps and baffles precipitate impurities in the oil

dition, the popular-priced Champion is continued. With its eighty-horsepower, six-cylinder engine operating at a 6.5 to 1 compression ratio, the Champion has surprising pep in traffic, as well as satisfying economy under most driving conditions. Although wider, longer and roomier, the Champion still weighs less than 2,500 pounds, thus maintaining its low weight per horsepower rating. The Studebaker Commander has a six-cylinder engine delivering ninety-four horsepower, the President an eight-cylinder motor developing 117 horsepower.

The Nash 600 is a full-size automobile, 194 inches over-all, fitted with a six-cylinder engine with the manifolds sealed into the block. Body and frame are welded into a unit to give great strength. It has no running boards. One feature is coil spring-

ing on all four wheels, a means of achieving a "soft" ride. The 600 is smartly styled, in the manner of the larger models, the Ambassador Six and the Ambassador Eight. The Nash designer makes use of the "fast back," a sloping contour from roof line to the bottom of the luggage compartment, with no bulge at the trunk level.

Willys' Americar has a wheelbase of 104 inches and an over-all length of 181 inches. Its four-cylinder engine has power increased by eight per cent from 1940, to sixty-three horsepower at 3,800 to 4,000 revolutions per minute. Helical gears are used in both high and reverse speeds and the car has a hypoid rear axle. Economy has been improved, and under defined conditions the car is capable of thirty-five miles per gallon. Steering-post gearshift is standard. The Americar is equipped with oversize hydraulic brakes, all-steel body and a frame three times stiffer torsionally than that of the 1940 Willys.

De Soto, offering the Fluid Drive at extra cost, has a 105-horsepower engine and a wheelbase of 121½ inches. Like Dodge it has the counterbalanced luggage compartment lid, the safety rim wheel, two-spoke steering wheel that gives full view of the instrument panel, new long-life bearings and the safety speedometer with indicator showing different colors at different speeds. Simplimatic Transmission, consisting of a power shifter that makes gear shifting a fingertip proposition, is optional with the standard transmission.

All models—Royal, New Yorker and Crown Imperial—in the Chrysler line have more horsepower than they had last year. Gravel deflectors are provided front and rear; the license bracket is mounted on the gravel shield. One feature is substitution of electric windshield wipers for the vacuum type common to the industry. Instead of depending upon the engine for the vacuum power to operate them, these electric wipers are operated by two electric motors, thus insuring constant speed regardless of engine speed. An automatic circuit breaker disconnects the wiper circuit when the windshield becomes covered with snow to the extent of overloading the circuit. The circuit breaker automatically resets the circuit after the overload has been removed, thus preventing fuses from blowing out. All doors are equipped with a

(Continued to page 118A)

The Inside Story of a Chemical Miracle That Cuts Motor Operating Costs



Easy to install on cars of all makes.



Cuts tractor oil bills, repair bills, too.



Saves mid-season marine oil changes.

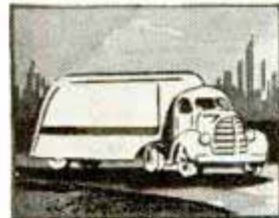

First Choice of Fleet Owners the nation over.

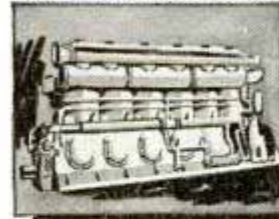

Reduces maintenance costs on Diesels and stationary engines.

Guaranteed to Save You Money on Oil Bills and Motor Repairs

Sludge and impurities in motor oil clog up pump screens, stop up oil lines, form in the ring grooves, oil ring drains and on valve stems. They cause sticking rings and valves, abrasion of moving parts, lead to big repair bills. Until the invention of the Fram Oil & Motor Cleaner, you had to change oil every thousand miles or so to keep a motor in good condition. Even then, the acids and corrosives that form in even the best oil in normal motor operation, shortened engine life and meant early loss of power and efficiency.

KEEPS BOTH OIL AND MOTOR CLEAN

But Fram has shown more than 2,000,000 motorists how to put an end to frequent oil changes—and how to cut down repair bills caused by dirty, chemically-contaminated oil. For Fram is more than an oil filter. The result of years of chemical research, Fram does more than strain out dirt, carbon, abrasives and sludge which dirty up new oil almost as soon as you put it in a motor. Fram keeps the inside of the motor clean, too. And its patented, chemically-impregnated cartridge impedes the formation of acids and corrosive chemicals. A Fram keeps oil physically, visibly and chemically clean—makes a crankcase of oil give "new oil" service for many thousands of miles without changing.

READ FRAM'S GUARANTEE

Then drive in where you see the Fram Authorized Dealer Sign shown below. Install a Fram—and put yourself on the road to savings. Or mail the coupon with 20c for your Fram patented Dip-Stick and complete information about Fram, the Miracle Oil & Motor Cleaner.

FRAM CORPORATION

Formerly Fleming Mfg. Co.

PROVIDENCE, R. I.

FACTORIES: East Providence, R. I. and Ann Arbor, Mich. CANADIAN DISTRIBUTOR: J. C. Adams Co. Ltd., Toronto. ENGLAND: Simmonds Aerocessories Ltd., London. FRANCE: Etablissements A. Guiot, Paris.



If You Had X-Ray Eyes

here's how a Fram would look to you. (1) Dirty oil goes in here; (2) Passes through chemically-impregnated cartridge as indicated by arrows; (3) comes out here clean. The patented chemically-treated cartridge removes impurities, impedes formation of acids and chemical corrosives in the oil. Cartridge is packed in metal container. Won't rupture or dump dirt into the oil stream.



Mail Coupon and 20c for Patented Fram Dip-Stick

Fram's patented Oil Condition Gauge (Dip-Stick), now available for most popular cars, ends guess-work about the condition of your motor oil. When you can't read the word "Clean" through the film of oil on the Dip-Stick, it's time to change your oil, install a Fram, and put the need for frequent and costly oil changes behind you forever. Or, if your car is already filter-equipped, it's time to replace with a genuine Fram Cartridge. Don't guess about your oil. Get your Fram Dip-Stick now. Send 20c with the coupon. We'll mail it at once—postpaid.

SEND 20c FOR SPECIAL FRAM DIP-STICK

FRAM CORPORATION, Providence, R. I.

Enclosed is 20 cents (coin or stamps) for which send one patented FRAM Dip-Stick for car checked:

- | | |
|---|---|
| <input type="checkbox"/> Buick, 1938 Model 40 | <input type="checkbox"/> Ford, 1937-40, 60 H.P. |
| <input type="checkbox"/> Buick, 1939 Model 40 | <input type="checkbox"/> Nash, 1936-38, Model 400 |
| <input type="checkbox"/> Buick, 1940 Models 40 & 50 | <input type="checkbox"/> Nash-Lafayette 1937-40 |
| <input type="checkbox"/> Buick, 1940 Models 60, 70, 80 & 90 | <input type="checkbox"/> Packard, 1940, 6 & 120 |
| <input type="checkbox"/> Chevrolet, 1935-36 | <input type="checkbox"/> Plymouth-Dodge, 1935-40 |
| <input type="checkbox"/> Chevrolet, 1937-40 | <input type="checkbox"/> Pontiac, 1935-40, 6-cyl. & |
| <input type="checkbox"/> Chrysler, 1937-40, 8-cyl. | <input type="checkbox"/> Pontiac, 1935-39, 8-cyl. |
| <input type="checkbox"/> Chrysler, 6 & DeSoto, 1937-40 | <input type="checkbox"/> Pontiac, 1940, 8-cyl. |
| <input type="checkbox"/> Ford, 1935-40, Models 85, 95 & Mercury | <input type="checkbox"/> Studebaker Com., 1939-40 |
| | <input type="checkbox"/> Studebaker Pres., 1939-40 |

Name.....
Address.....
City..... State.....

Money Back GUARANTEE
Install a Fram Oil & Motor Cleaner. If within 90 days, you feel that you can afford to drive without it, take it back to the dealer from whom you bought it, and your money will be cheerfully refunded.



stay-open check that holds them open for easy entrance or exit. Each gauge on the instrument panel has a warning signal which lights up, for instance, if oil pressure is weak, gasoline supply low, water temperature too high or the ammeter discharging too rapidly. Chrysler models also have the safety rim wheel and the two-spoke steering wheel. Running boards may be replaced by chrome-trimmed side shields.

Nineteen-forty-one will be a colorful motoring year. Hudson introduces Symphonic Styling, the application of harmonizing line and color, which makes available, at no extra cost, a wide selection of interior color combinations that harmonize with exterior colors. There are three basic color harmonies, grey, tan and green. Pontiac presents solid exterior colors such as black, Marlboro blue, Parma wine, Saratoga grey, tropic blue, Alandale green, Indiana beige and taffy tan, plus these two-tone combinations: El Paso beige with Indiana beige, paddock grey with Marlboro blue, silver French grey with Saratoga grey, Thetis green with Alandale green, French copper with taffy tan and Santone with Parma wine. Upholstery and fittings to match or contrast are available. The Plymouth is available in eleven standard colors, most of them polychromatic, including Mandarin maroon, metallique green, Jib green, West Point gold, flight grey, Plaza brown, gunmetal, Airwing grey, Eddins blue, aviator blue and black. Besides these, four different two-tone color combinations are offered. Eight solid colors and four two-tone combinations are the choices on the De Soto. When the purchaser decides on the exterior color that pleases him, he automatically gets an interior specifically designed to harmonize with that color.

Chrysler is finished this year with a liquid plastic that holds new-car appearance for years, retains luster permanently, will not fade, does not rub off and requires no expensive waxing and polishing. Before the car body receives the primer coat, it goes through twelve cleaning and rust-proofing operations. Then six coats of finishing liquid plastics are applied, each baked on in a special induction oven to insure thorough, even curing all the way through.

Six series—three six-cylinder, 100 horsepower and three eight-cylinder, 110 horse-

power—make up the Oldsmobile line. Wheelbases of all are longer than those of 1940, the smallest being 119 inches and the largest 125 inches. The Dynamic Cruiser series replaces the "70" of last year; bodies in this classification feature a long, low arching sweep from windshield to rear bumper. Automatic door switches turn the dome light on and off. One feature is a neat grouped plug-type connection which replaces the customary tangle of wires beneath the dash and behind the instrument panel. Another is the drain incorporated into the cylinder head to prevent water from accumulating around the spark plugs. Olds' Hydra-Matic Drive, which eliminates clutch, clutch pedal and which shifts gears automatically, is available, at extra cost, on all models.

In the Buick, the speedy-looking car with sloping rear end is known as the Sedanet. It is a six-passenger model set low to the ground. All Buicks are five-eighths to two and three-fourths inches lower than last year's cars. Individual steps, concealed by the lower edge of the doors, replace running boards. Sedans in the upper price brackets are equipped with dome light and courtesy lights, two at the lower edge of the front seat and two in the rear compartment, which are turned on automatically by door jamb switches.

A specially designed spark plug, patterned after insulators on power lines, is introduced by Hudson. The porcelain insulator sleeve on the plug is fluted, or ridged, by "petticoats" which minimize accumulation of grease and add to surface length of the insulator with a consequent reduction in short-circuiting tendencies.

Packard enters another year with the distinctive front end, but the straight lines appear modified. Among the features is a window-operating mechanism that rolls the glass up or down at the touch of a button. For individual operation, buttons are located on the instrument panel and in the rear compartment. Packard continues, as optional equipment, the air-conditioning plant introduced in 1940. The capacity is rated at one and one-half tons of melting ice in a twenty-four hour period at a speed of sixty miles per hour. Each Packard equipped with air conditioning has special insulation in roof, sides and floor to reduce the amount of heat leaking into the car from the outside.

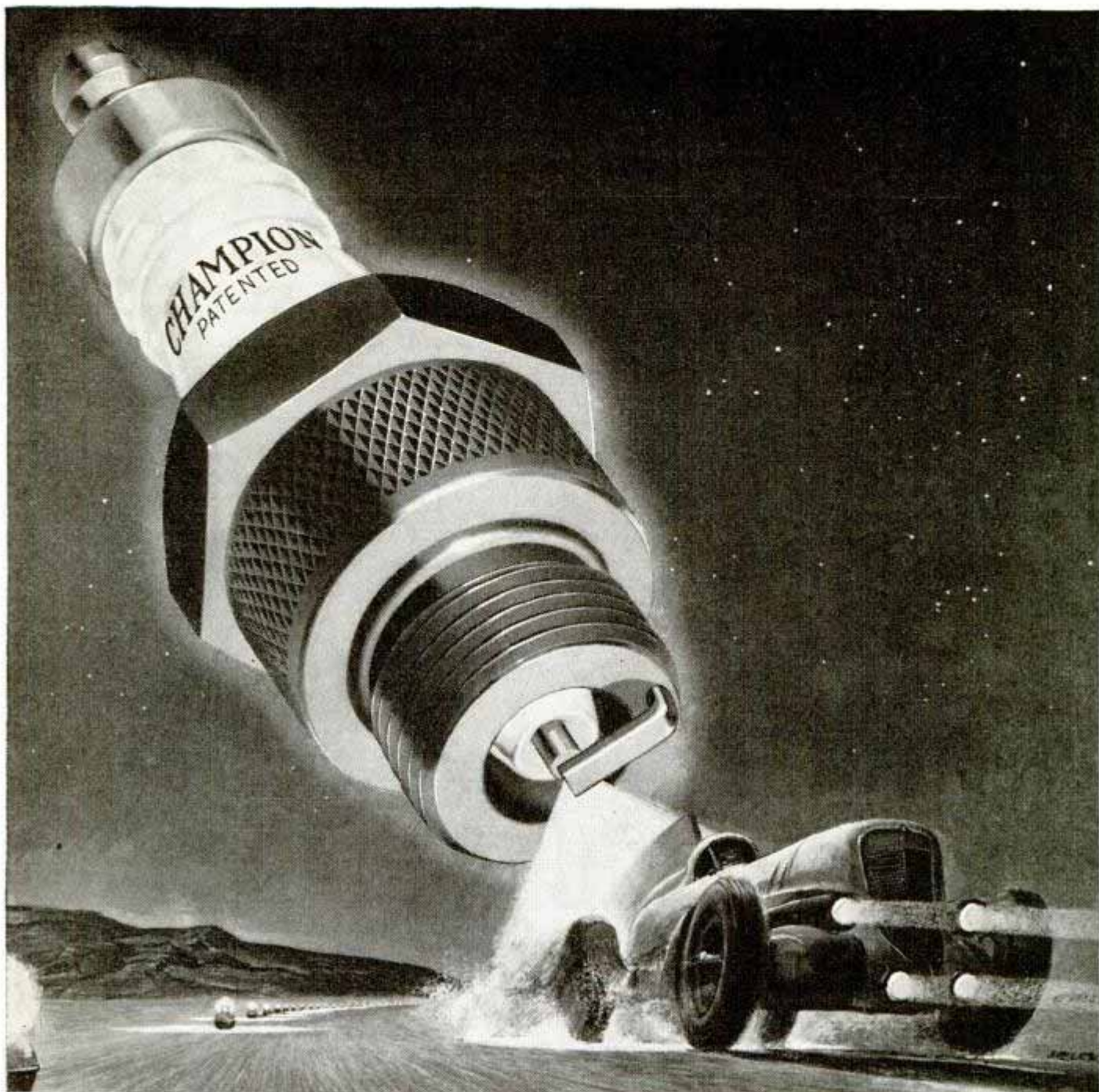

HE RODE A METEOR FOR 24 HOURS

Ab Jenkins, Speed King and Mayor of Salt Lake City, wired,

"Am happy to have broken all world's endurance records with 84 new marks. One of the things I never have to worry about is my Champion Spark Plugs. They've never let me down. Throughout entire 24 hours I never had a sputter."

Ab Jenkins

USING CHAMPION SPARK PLUGS!

RIDING HIS CHAMPION-EQUIPPED "Mormon Meteor III" over the Bonneville Salt Flats (Utah) Ab Jenkins smashed all existing records for distances from 50 kilometers to 3,000 miles and set a 24-hour record of 161.18 miles per hour.

Champion Spark Plugs are the choice of champions everywhere because they make every engine a better performing engine as strikingly demonstrated in this phenomenal event. Logically they should be your choice because your car deserves the championship performance exclusive to Champions.

Install dependable Champions now and feel the fresh surge of power, speed and acceleration they bring to every engine. You'll profit too by increased efficiency and economy.

USE THE SPARK PLUG CHAMPIONS USE

Automobiles of Tomorrow

(Continued from page 667)

Entirely practicable, such a car could be built now—and introduced along with the new 1941 motoring creations—except for one thing, and that is a part of the psychology of the car buyer, himself. While every automobilist is greatly intrigued by sweeping innovations and radical departures in motorcar designs, he has not within him the ability, or the inherent willingness, to accept great changes rapidly.

Suppose the manufacturer suddenly “transplanted” the motor from the front to the rear of the car—doing away with the hood. The driver, compelled to sit ‘way up in front of the car, would have an entirely new and, I am afraid, confusing driving outlook. In fact, he would feel as though he were exposed to all sorts of dangers. So, the car of the future, even though its engine is in the rear, must be designed so as to have some semblance of a hood. The resulting space can be made into spacious and convenient storage compartments. While his seat may be considerably nearer the front bumper, the driver will not feel that his position has been changed materially. He will feel safer and will be safer, with some construction ahead of him to take up the impact of possible collision.

The power plant will take up far less space in the “tail” of the car than the engine does now. Under the present-day hood, there is a great deal of waste space—space which the very design of the car prevents putting to good use in the interior. The trend toward elimination of the running boards is making possible far wider bodies. So, rear-end placement of the engine and utilization of former running-board space mean the car of the future can offer from twenty-five to thirty-five per cent more interior space.

This, in turn, can make possible a variety of unusual seating arrangements. One could consist of a fixed driver’s seat and a movable divan and easy chair for the passengers. Another arrangement would provide, in addition to the driver’s seat, a semi-circular lounge, extending along one side around the back of the passenger compartment to the other side.

In view of the strides in the development of plastic materials in the last few years, it is reasonable to believe that the car of the future will be of plastic materials, with

the manufacturer able to offer an almost limitless range of colors and color combinations. Because color is an inherent part of the plastic material, there will be no need for painting the new-type automobile and no danger of fading and chipping.

Use of transparent plastic materials will make possible curved, airplane-type windshields and curved windows, the contours of which can be made to “flow in” with the pleasing lines of the car, something the designer cannot achieve with ordinary flat panes of glass today. Thus, far more pleasing over-all design effects can be created. Such synthetic “glass” is available today. As clear as real glass, it will do what few forms of special glass can do—admit the healthful ultraviolet rays of sunlight, exclude the infrared. And, in addition, plastic “glass” possesses the safety factor of being well-nigh unbreakable.

By means of complete air conditioning, the driver of the car of the future will be able to create whatever type of automatic “weather” he desires, winter or summer, simply by setting a handy control dial. A thermostatic element will do the rest. Already, several well-known makes of automobiles are offering, what is in effect, winter air conditioning. Fresh, outside air is brought into the car, then filtered, heated and circulated without drafts. The car of the future, however, will provide a mechanical unit which will clean, dehumidify, cool and circulate a constant supply of new air, brought in from the outside.

With all-around air conditioning, the car of the future will not need windows of the conventional type, with levers and handles to raise, lower and adjust them. Rather, the windows—say, windows of plastic “glass”—can be installed permanently. As a matter of fact, the windows will be there purely for the important purpose of providing visibility. Of a substance thicker than ordinary glass, they will not fog or freeze or collect condensation.

The car of the future, by virtue of its greater roominess, can be made literally a luxurious “home on wheels.” Seats can be converted into comfortable berths for sleeping. In a twinkling, a portable table can be set up. There will be plenty of convenient storage places, even to little refrigerated cupboards for foods and drinks.

"MY CRIES WERE WHISPERS AS MY LIFE EBBED!"

A true experience of P. S. NICHOLLS, South Bend, Ind.



"LATE ONE NIGHT, returning from a fishing trip, I dozed at the wheel of my car while going at a fast clip," writes Mr. Nicholls. "Suddenly there was a blinding crash!"

"MY CAR HAD VEERED off the road and smashed head on into a tree. My throat was gashed and bleeding badly. I was able only to whisper—and seemed doomed to die in the inky darkness. Then ...



"...I REMEMBERED MY FLASHLIGHT! Somehow I managed to get it from my tackle box and crawl weakly back to the road. Quickly the bright beam of the flashlight, waved in my feeble grasp, stopped a motorist, who took me to a hospital just in time. There is no doubt that I owe my life to dependable 'Eveready' fresh DATED batteries!

(Signed)

P. S. Nicholls



SAFETY FIRST! Keep an EMERGENCY LIGHT in your car—for tire changing, roadside repairs, locating lost articles, if lights go out, etc. The "Eveready" Auto Flashlight, shown here, complete with "Eveready" fresh DATED batteries and steering post clamp, only \$1.25.

The word "Eveready" is a registered trade-mark of National Carbon Co., Inc.



FRESH BATTERIES LAST LONGER... Look for the DATE-LINE

NATIONAL CARBON COMPANY, INC., 30 EAST 42nd STREET, NEW YORK, N. Y.

Unit of Union Carbide and Carbon Corporation



P. W. REPAIRS FURNITURE

Plastic Wood handles like putty—hardens into lasting wood. Makes quick, yet permanent repairs to broken furniture, resets loose drawer pulls and casters. In cans or tubes at Paint, Hardware, 10¢ Stores.



PLASTIC WOOD



WASHING MACHINES NEED 3-IN-ONE

HEAVY BODY 3-IN-ONE Oil works wonders on Washing Machines and Electric Refrigerators. It instantly penetrates the tightest bearings and moving parts. Lubricates—guards against rust. Get it at Hardware, Drug, Grocery, 10¢ Stores.

Ask for

HEAVY BODY

3-IN-ONE Oil



Exploring the Heart of the Atom

(Continued from page 735)

started, intimates that similar possibilities may be found in other elements. Bismuth, lead, gold, and mercury are being bombarded with neutrons in this program.

A machine that may remove much of the atom's mystery is the proposed giant atom smasher designed by Prof. Lawrence. The huge cyclotron would weigh six million pounds and be fifteen times larger than his present cyclotron. The magnet would be thirty-four feet long, thirteen feet

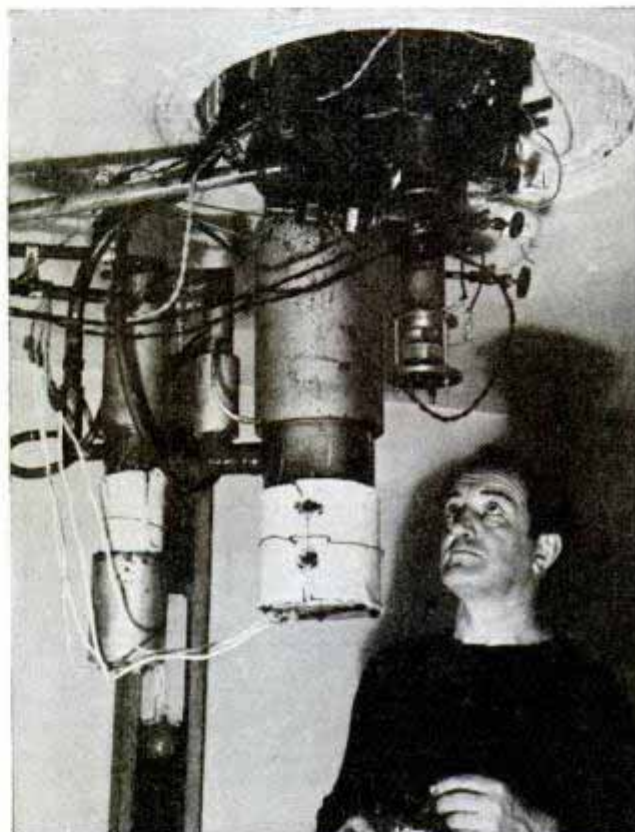

Diffusion pump at base of big vacuum tube maintains high vacuum while atomic studies are conducted

across and twenty-five feet high, and its copper windings would weigh 244 tons. The machine's control room would be at least 10,000 feet away because in some experiments the particles energized by the machine would be fifty times more potent than radium emanations.

It is suggested that such a huge cyclotron could transmute elements on a mass scale. Cosmic rays probably could be manufactured for study. Possibly most important of all, it could be used to investigate the enormous binding power that holds protons and neutrons together in atomic nuclei, the glue or gravity that prevents matter from falling apart.

The Year's Most Sensational Tool!

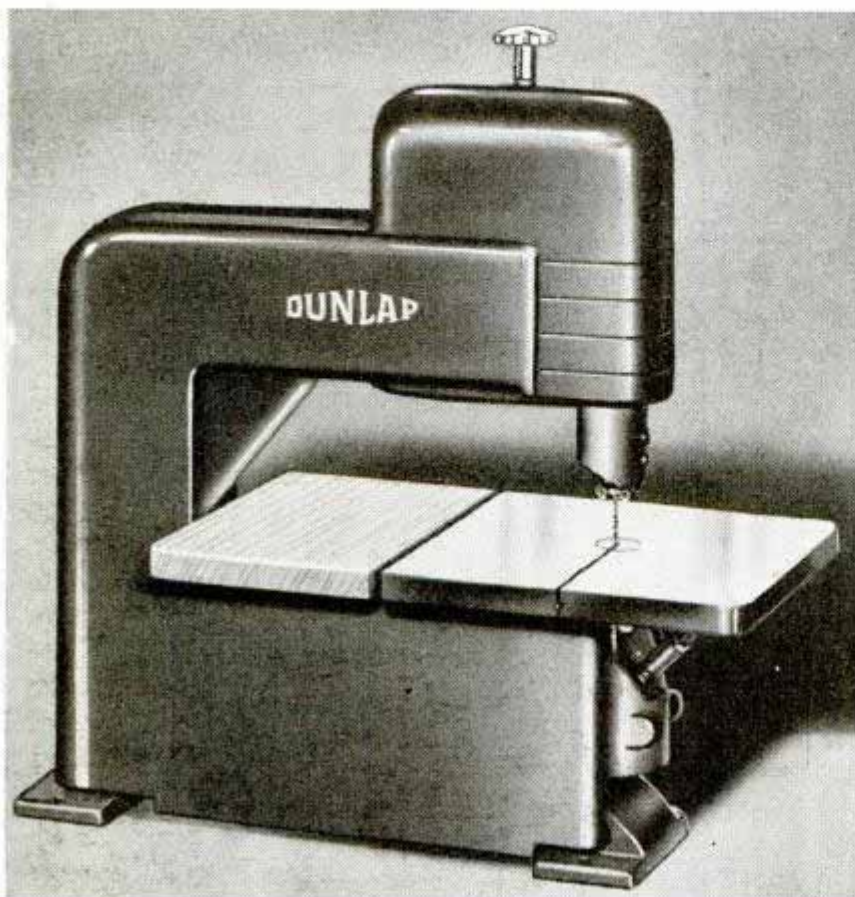

DUNLAP 3-WHEEL BAND SAW

\$16⁴⁵ EVEN LESS
IN MANY
TERRITORIES

Never before, in power tool history, a tool like this! 12-inch capacity! Cuts to the center of 24-inch circle. Exclusive Sears Chrome-manganese alloy steel blades last much longer. Auto-lubricated bronze bearings in wheels and guides for long life. Entire mechanism completely enclosed.

Full 4-inch depth of cut. Over-all height 22½ in. Over-all depth 10 in. Over-all width 22¾ in. Blade width ¼ in. Table size with wood extension 10 x 17 in.

Half the usual price of standard 12-inch capacity band saw.

See your nearest Sears store today for particulars.

On easy terms if you choose.

SEARS, ROEBUCK and CO.
Stores throughout the United States

BURN YOUR NAME ON TOOLS
WITH THE
ARKOGRAF

PROTECT YOUR TOOLS FROM THEFT
Write with electricity any name or design on the hardest and finest tools and instruments, or any metal, like writing on paper with pen or pencil.
Complete Outfit \$3.50—Prepaid Anywhere
Interesting illustrated circular free. Write today.
Agents wanted.
ARKOGRAF PEN CO., 3927 S.E. Stark St., Portland, Ore.

PUSH BUTTON CONTROLLED GAS TANK LOCK
ELECTRIC—OPERATES FROM DASH. Sold as standard accessory on the NEW GRAHAM Car. Streamline in design, low in price, year guarantee. Distributors, dealers here is the fastest selling thing out. Write now for free literature.
SNAP-UP GAS CAP CO. DEPT. 6 ASHLAND, KY.

New Adding Machine Fits Vest Pocket!..

Adds, subtracts and multiplies up to one billion. Weighs only 4 ounces. Not a toy—strong guarantee. Absolutely accurate, very fast. Sells to offices, stores, homes—wherever figures are used. Write quick for FREE sample offer and Money-Making Plan.
AGENTS
VE-PO-AD, Dept. 208, 303 W. Monroe St., Chicago

Costs only **2⁹⁵**

"MARVEL-OUS" TRAILER PARTS

(1) "Famous" Marvel Windows, (2) tail lights, (3) complete undercarriage equipment, (4) body moldings, (5) couplers. Also refrigerators, stoves, lighting fixtures, everything you need in highest quality. Largest trailer equipment stock in U. S. Immediate delivery, low prices. Send 10c coin for 40-page ill. catalog.
Marvel Trailer Parts Co., 19020 Celestine Ave., Detroit, Mich.

You Build It—Save \$ \$

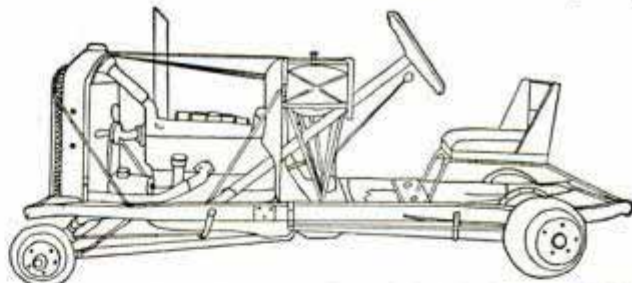

This Powerful Tractor Can Be Built By YOU!

Write for Information

NOLAN'S MACHINE SHOP
EAST WAREHAM, MASS. CAPE COD

POWERlite

AMERICA'S FINEST—MOST POWERFUL ELECTRIC LANTERN
80 to 100 HOURS LIGHT
On One 6-Volt Dry Battery

● TWO LIGHTS on a double action switch, 800 ft. spot beam from front reflector; broad floodlight from top. Handle reverses. Unbreakable lens, 6½" high. At sport, hardware, electrical dealers or write for literature.

DELTA ELECTRIC COMPANY **\$3³⁵**
300 W. 33rd ST., MARION, INDIANA **Less Battery**

Buy Only a GENUINE DELTA

SHORT CUTS FOR THE HOME CRAFTSMAN

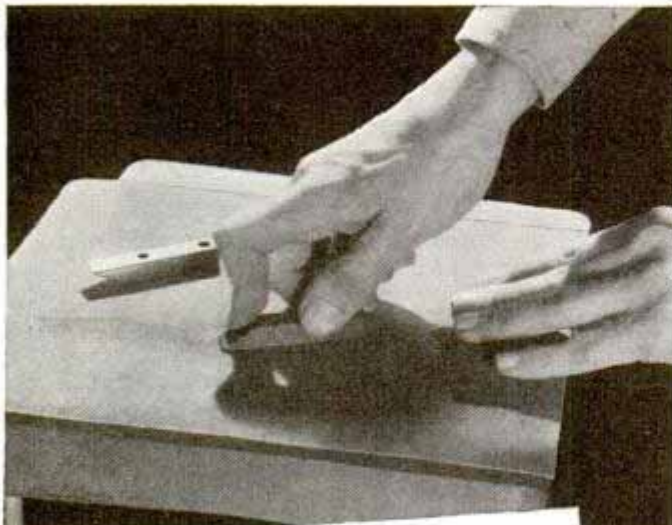

How to polish metal with cloth!

● The cloth is Aloxite Brand Aluminum Oxide Cloth. It is excellent for producing a polished surface on metal objects and for removing small amounts of metal in fitting parts. For a flat surface the cloth is laid on a flat table, as illustrated, and the work rubbed over it.

In addition to all kinds of polishing operations on metal, Aloxite Brand Cloth can be used for the removal of rust or for cleaning prior to soldering. It is available for an endless number of uses in sheet or roll form.

Ask your hardware dealer or mill supply house to show you the complete line of Carborundum-made coated abrasives, sharpening stones, grinding wheels and other abrasive products for the home craftsman. Send 10¢ coin or stamps, for souvenir sharpening stone and valuable illustrated manual on how abrasive products can save time and help you do better work.



Dept. M 110

THE CARBORUNDUM COMPANY

REG. U. S. PAT. OFF.

Niagara Falls, N. Y.

[Carborundum and Aloxite are registered trade-marks of] and indicate manufacture by The Carborundum Company

Tom Thumb Cars

(Continued from page 698)

is affixed to car and swivel so that it remains taut during a run. On an outdoor wooden track in Los Angeles, steel guide rails are used instead of a flexible line as the former make possible competitive racing of four cars at once. Designed by Russell Dooling, the track has a fifteen-degree bank on the straightaway, which increases to forty-five degrees at the center of the turns. On a mile run, the difference in the distance covered by the outside and inside cars amounts to one lap. To compensate for this, a handicapping plan has been devised. An exciting, thrill-packed finish is effected by starting the car on the outside rail first and as soon as it has traveled its "handicap" distance, an electrical mechanism catapults the second one into action and so on until the four are burning up the boards. The track's electrical timer clocks the time of each car for a given number of laps in hundredths of a second and shows on a scoreboard the number of laps traveled by each entrant.

During the hobby's brief life, the cars have undergone many refinements—refinements which might have been years in coming had not such top-flight racing-car and aeronautical designers as Bill Atwood, Harris Dooling, J. L. Lockridge, E. Alexander, and others gotten into the field early.

Atwood has been one of the foremost power-plant designers for gas-powered model airplanes and speedboats for more than a decade. His latest contribution to the field is a racer of semi-monocoque design that was engineered in a wind tunnel, with a single rear-axle suspension that gives knee-action effect on all wheels. The engine is cooled by forced draft venting.

Scores of amateurs have designed and built their own cars except for tires and motors. One of these is George C. McKee, an electrical appliance salesman, who worked for a year during spare time in fashioning his tiny car. One of its features is a combination clutch and universal joint that operates by centrifugal force. A slight push turns the drive shaft, and centrifugal force throws the clutch disk against the flywheel. It also has four semi-elliptical springs, each with seven leaves made of clock spring.

The national governing body of the sport

has done much to standardize cars into classes in accordance with the displacement of their motors. In over-all dimensions, the pee-wee cars range from ten to twenty-four inches, from six to eleven inches in width, and do not exceed ten inches in height. Likewise, wheel bases differ, but fourteen inches is the maximum allowed.

When the sport was young, the ten cubic centimeter (.62 cu. in.) airplane motors found extensive acceptance but lately the miniature-engine builders have been concentrating on power plants designed exclusively for race cars. The latest is a twin rotary valve super-ported engine with a displacement of .603 cubic inch (9.89 cubic centimeters). In recognized competition, cars are allowed one pound of weight for every one-tenth cubic-inch displacement of motor, including batteries and all running equipment.

Standard fuel is a mixture of white gasoline and No. 70 motor oil, but in their attempts to squeeze extra speed from their cars, many drivers turn to a special out-board motor fuel or a concoction of ether, castor oil and gasoline. In lieu of self-starters, a number of devices are used to turn the standard one-fifth or one-fourth horsepower engines over at high speed. One of these is simply a bicycle turned upside down. While his mechanic operates the pedals with his hands, the driver can press the car's flywheel or drive against the revolving tire. Veterans scorn such make-shift equipment in favor of motor-driven starting tables. On one of these is mounted a rubber-tired coaster wagon wheel and two discarded washing-machine rollers. The hobbyist holds the car against the tire or rollers with one hand, keeping the other free for making adjustments in the carburetor.

In order to conserve the life of the tiny dry cells that are fitted into a car, a storage battery or a pair of full size dry cells serve as a booster during starting and tune-up. Just before a car is launched, the booster battery is disconnected and the switch made to the small cells.

☐ If you will send stamped, self-addressed envelope to our Bureau of Information, you will be given the name and address of the manufacturer of or dealer in any article described in this magazine.

Champion Products Co
1104 Architects Bldg
Los Angeles Calif.

KNOW YOUR TOOLS

To keep pace with modern industry's requirements, a knowledge of filing fundamentals isn't enough. Specialization is the watchword . . . fast production and high efficiency demand special-purpose files for various metals and alloys.

Can you choose or recommend the right file for a given job? Employers will thank you if you can. And you'll be more valuable to yourself!

Nicholson makes more than 3000 kinds, sizes and cuts of files. What filing problem may we help you solve? We've Technical Bulletins that will help you. Mill supply and hardware dealers carry many special and general purpose files in Nicholson or Black Diamond quality brand.

NICHOLSON FILE CO., PROVIDENCE, R. I., U. S. A.

(Also Canadian Plant, Port Hope, Ont.)



● **ALUMINUM "A" FILES**—Special cut for fast, non-clogging filing of ductile-metal castings, sheets and bars.



● **LONG ANGLE LATHE FILES**—For clean shearing, self clearing, and smooth finishing under light pressure.

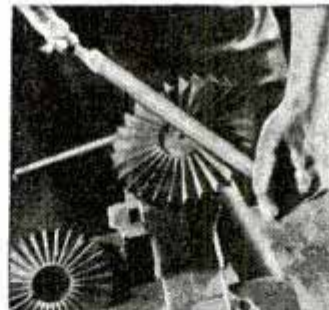

● **DIE-CAST FILES**—For finishing die castings of aluminum-alloy and similar metals.



● **BRASS FILES**—Designed to hold file to line of work, yet break up filings, keep file clear.

NICHOLSON FILES



FOR EVERY PURPOSE



NICHOLSON FILE COMPANY
 22 Acorn Street, Providence, R. I.

Send free book, "A File for Every Purpose."

Name _____

Address _____



ANTI-FREEZE must circulate freely. Otherwise you waste it, your motor overheats, you may be headed for expensive trouble. Just use 10c worth of Sani-Flush *before* you put in anti-freeze (25c for the largest truck or tractor).

Sani-Flush removes rust, scale, sediment, sludge from the radiator. It is easy to use. Or, if you prefer, have your service station do the job. Insist on Sani-Flush. It cannot injure motor or fittings. You'll find Sani-Flush in most bathrooms for cleaning toilets. *Directions on the can.* Sold by grocery, drug, hardware, and 5-and-10c stores. 10c and 25c sizes. . . . The Hygienic Products Company, Canton, Ohio.

Sani-Flush 
CLEANS OUT RADIATORS

DIRT WON'T STICK to hands covered with the greaseless cream called Du Pont **PRO-TEK**. It acts like an invisible glove—prevents grime and paint adhering to the skin. To remove, just wash the hands in running water. This dissolves the protective film, and carries away the dirt with it. Write DU PONT, Wilmington, Delaware.

STOP Itching  **GET RELIEF This Fast Way -or Money Back**

For quick relief from itching of eczema, pimples, athlete's foot, scales, scabies, rashes and other externally caused skin troubles, use world-famous, cooling, antiseptic, liquid D. D. D. Prescription. Greaseless, stainless. Soothes irritation and quickly stops the most intense itching. 35c trial bottle proves it, or money back. Ask your druggist today for **D. D. D. PRESCRIPTION**.

Foiling the Gold Swindlers

(Continued from page 725)

vary substantially, it is a danger signal. If the proportions of gold and silver run exactly the same as U. S. gold coins, or dental alloys, it is also a suspicious coincidence.

One thing a sucker needs to learn at once is to guard well his sample bags. With a hypodermic needle, a gold solution can be injected right through the sealed bags; or the solution can be dropped on them and allowed to soak through. Shrewd individuals use a sealed paper sack as an inner lining for the regular cloth bag. A needle hole or a stain reveals any tampering.

Another "must" is to be sure of your assayer. Once in a while a fake "assayer" will work with the salters. One man, his suspicions aroused by the actions of the assayer, took a piece of grindstone for test. The "expert" gave an enthusiastic report.

In a rather unlikely section, some promoters started a thriving "tin rush." It stirred up so much excitement that a government expert was dispatched to look around. After a survey of the geology of the district he sent some samples outside for analysis. The report showed them worthless. Yet he himself watched the local assayer run similar samples through the standard process and get showings of tin as high as forty per cent. Eventually he discovered the secret. Before running a sample, the assayer put powdered tin into the blower feeding the furnace. The samples were well showered with tin as they were smelted.

One salter, noticing a balcony overhanging the open workshop where an assayer's furnace was located, climbed upstairs and fed grains of gold into the samples by poking them through a knothole in the floor. An assayer became suspicious of the reports his methods were getting but his client insisted the samples couldn't have been touched before they reached the laboratory. The assayer discovered somebody had "spiked" the gasoline for the assay furnace with a gold solution.

Fortunately, such occurrences are rare. It costs too much to set up a well-equipped laboratory merely as a blind. The modern "snapshot" assayer can deliver the goods so completely that the "sucker" no longer needs take a chance. At last the salter has met his match.

NOW ONLY 4.95 REAL ENGINE VALUE



This is a miniature gasoline engine that really operates. Over 15,000 sold last year. Now is your chance to buy the *New Improved* kit for \$4.95. Absolutely complete with coil, plug, instructions, etc. Only a screw-driver needed. For boats, planes, midget cars, etc. All parts guaranteed. Send only \$1.—*Shipped Collect C.O.D. same day. Send for FREE literature or 6c for Jumbo hobby catalog.*

DEALERS WANTED. FACTORY ASSEMBLED—READY TO RUN \$6.95

GHQ MOTORS, Dept. B, 40 East 21 St., New York, N. Y.

hold it! SEND FOR MY NEW BARGAINGRAMS



They give a clear picture of the thousands of bargains in new and used Camera equipment. Send for your **FREE** copy today... Two editions... No. 242 for STILL CAMERAS... No. 245 for Movies.

Bass CAMERA CO. 179 W. MADISON ST. CHICAGO, ILL.

\$13.95 Full Set



MICROMETERS

Six piece set, in velvet lined leather case. Special price, only \$13.95. Precision machined in one thousandths, up to 4" outside and 3 3/4" inside measurements. Guaranteed accurate, easy to read and adjust. Satisfaction guaranteed or money back.

This is your opportunity to get one at a **Bargain Price** if you act now. Shipped prepaid on receipt of remittance. On C.O.D. shipments, send deposit of \$2.00.

FREE FOLDER

MICRO PRODUCTS, 529 E. Jefferson Ave., Detroit, Mich.

Do more Earn more Work less with a



Red Universal E Tractor

You plow, disc, cultivate, mow, haul, do bell work, for about 33c a day. Safe, trouble-free long life. New plow lift, new reverse. Hundreds used. Save by buying from maker. Two weeks trial. **FREE** catalog. Write today.

PIONEER MFG. COMPANY
Dept. V-110 West Allis, Wis.

DO YOU WANT a new business profession of your own, with all the trade you can attend to? Then become a foot correctionist, and in a few weeks earn big income in service fees,—not medical nor chiropody—easy terms for home training, no further capital needed, no goods to buy, no agency. Established 1894. Address Stephenson Laboratory, 1 Back Bay, Boston, Mass.

OTTAWA LOG SAW \$39



PUTS THIS OTTAWA TO work for you. MAKE MONEY! Wood is valuable. Does more than 10 men. Easily operated. Falls trees—saws limbs. Use 5-hp. engine for other work. Write for **FREE** Book.

OTTAWA MFG. CO.
3727 Wood St., Ottawa, Kans.

\$150 to \$300 PROFIT MONTHLY WITH ARC WELDING



"BUILD-YOUR-OWN" Simplified ARC WELDER

Couple this complete Hobart generator to a used auto engine and mount on chassis and get the money-making equivalent of a complete factory-built gas drive welder costing from \$300 to \$500 more.

HERE'S WHAT USERS SAY ABOUT HOBART ARC WELDERS

"I've used all popular makes in several different models, yet I believe Hobart has the edge on them all."

"I am very well pleased with my Hobart Welder. It has turned out to be the best investment I ever made."

"I certainly am satisfied with my Hobart Welder. It costs me much less to operate than I thought."

"My Hobart certainly does the work with plenty of pep. In 4 jobs I made \$48.00 for nine hours work."

HOBART BROS. CO., Box M-1140, TROY, OHIO

AMAZING VALUES IN POWER TOOLS

Lowest priced Jointer in U. S. A.

Oh, man, what buys these are!

Every one a solidly built, practical tool. Most any small electric motor supplies sufficient power. Marvelous Xmas gifts. So inexpensive you can afford several. Sold direct-by-mail only.



GREAT NEW JOINTER Only \$6.50

—and a beauty! Planes, cuts angles, etc. Weighs 8 lbs.; measures 4 1/2" x 8 1/2" x 13 3/4". Table 4 3/8" wide with two 4" tempered carbon steel knives in safety-type cylinder with automatic guard.

Drill Press: 15" high, drill table 3" in diam.; drilling to center of 4" circle. Table fully adjustable. Ball thrust bearing for long wear. The slickest ever for quick, accurate drilling.

\$1.50

JIG SAW

\$150 PRIZE CONTEST

DRILL PRESS \$2.50

Circ. Saw: Includes 12 assorted blades, blade adapters, roller saw guide and manual. 15" long, 8" high, 6 1/2" table. Cuts wood up to 2" thick.

Circular Saw: 4" combination rip and crosscut blade. Oilless bearings. 8" x 5 1/4" steel table adjustable so that by turning stock, pieces up to 2" thick may be cut. Adjustable ripping fence. Saves hours of hand sawing.

NEW! 24" WOOD LATHE \$4.90

A husky, smooth running wood lathe 32" long overall; 7" high; weighs 10 lbs.; fully adjustable; oilless bushings; long and short tool rests; two speed pulley.

"Giftmaker, Sr."

Guarantee: Satisfaction or full refund if goods returned within 5 days.

FREE CATALOG describing \$150 prize contest (1st prize \$25; 2nd, \$15; 3rd, \$10; 41 other cash and merchandise prizes). Cat. illustrates complete power tool line. Outside U.S.A., all tools 25c extra except Jointer and Lathe, 50c extra. Orders shipped C. O. D. 25c extra per package. (Postal laws permit no C. O. D.'s outside U.S.A.)

J & H Metal Products Co. 5 Commercial St. Rochester, N. Y.

NEW BENJAMIN AIR RIFLES WITH HAND PUMP

MADE IN U.S.A.



HARD ACCURATE SHOOTING WITH CHAMBERED AIR

You can use new model BENJAMIN AIR RIFLES WITH LEVER HAND PUMP anywhere, for practice firing or just plinking, around the house or camping, fishing, hunting, etc., at lowest cost. Shooting force is adjustable with amazing maximum power and accuracy—no recoil or forward lunge to disturb your aim. Bolt Action-Hammer Fire-Hair Trigger-Safety Lock-Hand Pump. Single Shot BB \$7.50; Single Shot Cal. .177 or .22 with rifled barrel \$8.50; BB 25 Shot \$9.00. Also a complete line of BENJAMIN GENUINE COMPRESSED AIR PISTOLS from dealer or factory. Write Today for details and Targets.

BENJAMIN AIR RIFLE CO., 895 Marion St., St. Louis, Mo., U. S. A.

FREE! VALUABLE BOOKLETS ON WELDING

CHECK YOURS, WRITE NAME AND ADDRESS IN MARGIN AND MAIL

30 Days Trial at our risk on "pays for itself" terms

HOBART

that's "SIMPLIFIED"

Fastest Selling Arc Welder on the Market Today

How to Build-Your-Own
New Profits in Arc Welding
New Arc Welding Catalog

Training Your Dog for the Game Trail

(Continued from page 709)

hand while in a dropped position, and deliver it to you at the command 'fetch here.' Have the dog drop; face him and hold the buck out in front of him. Give the command 'fetch' as he takes the buck from hand, back up and command 'fetch here to me.' Pull on the lead to bring him to you if necessary. He should deliver it in a sitting position."

Next, put legs on the buck so that it stands off the ground and can be picked up easily by the dog. Two short metal rods through holes drilled at each end will do. Make the dog sit and hold it at the command "fetch." Then with the same command let him take it from your hand and finally from the ground in front of him. Then put it out of his reach so that he goes over and picks it up at the command "fetch here." Gradually extend the distance to several feet and finally have him retrieve from thirty or forty feet away, using the force collar if necessary.

"Use the lead on all this work and pull him in promptly as soon as he has picked up the buck," Asmus advises. "Don't hesitate to use the force collar firmly. The dog should be perfected in each step of this training program before he is advanced to the next and if trouble develops go back several steps and work forward again. It may take two months of diligent training before the dog is ready to hunt with you."

Next step is to use the feathered buck. Tie a covering of feathers firmly around the pronged buck. Start in at the beginning once more and repeat all the first steps. This may take only a day. Then have the dog drop, throw the buck a few feet away, command him to "fetch here" and fire a cap pistol as he reaches the buck. Later on you can fire the cap pistol before the command, and after that begin using a .22 for the louder noise; but at the start it is important not to allow the dog to become gun shy. If he seems particularly timid fire the cap pistol at odd times while he is occupied and then pet him to show him that the noise is harmless.

At this stage, begin steadying the dog to command. He should always be under control and not permitted to retrieve the buck until commanded to do so. A dog that rushes in as soon as a shot is fired or a bird falls may flush up other birds and

prevent you from getting them. Drop the dog and restrain him with a force collar, throw the buck, and steady him until you finally command him to fetch it in.

Next step is to use a dead bird in the yard instead of the feathered buck. Repeat all the exercises with the bird and later take the dog out into a field and have him retrieve the bird from short distances. Then toss the bird into brush or behind bushes so that the dog has to use his nose to find it. Perfectly trained, he will quarter back and forth until he scents it, pick it up and bring it in, and sit in front of you until you take the bird from his mouth. Now you can start to hunt with your dog.

"Teaching a dog to retrieve takes time and patience and a thorough understanding of the force method," Asmus says. "Each dog is different but these basic rules should be followed in general. Once training is started, follow it through. Never give a command and then not enforce it. The dog may get the idea he doesn't need to mind you."

Daily grooming promotes health and well-being in all dogs. Brush your dog's coat with a heavy bristle brush and on long-haired dogs use a metal comb, wipe out his eyes with cotton dipped in a saturated solution of boric acid, dust dry boric acid powder down into his ears to prevent canker, and smear his nose with a little vaseline to keep it soft. All this should be done daily.

Don't overfeed a hunting dog. He should be lean and hard and if short-haired his ribs should show. Feed him the night before and not on the morning of a hunt. Carry water and offer him a drink every half hour in dry country. Brush up his training for several weeks before you hunt with him. If the dog has been lying around most of the summer he needs to be conditioned, exercised, before he is hunted. Otherwise he may get sore feet, overheat, and wear himself out. If you are to use the dog more than half a day, bring him to heel once in a while to rest him and give him a good rest at noon.

☐ Stamped, self-addressed envelope, sent to our Bureau of Information, will bring you the name and address of the maker of any article described in Popular Mechanics.



YOURS FOR MORE FUN WITH A HARLEY-DAVIDSON '41

Just out — greatest array of motorcycles ever offered in America—the 1941 Harley-Davidsons. Scores of new features and advancements. You must see them to appreciate their sensational beauty, streamlined styling and smart, new color schemes. Only by riding a 1941 model will you get the thrill of its unmatched power, supreme riding comfort and rugged dependability. See your Harley-Davidson dealer **AT ONCE**. Learn how easy it is for you to own one of these world-champion motorcycles!

HARLEY-DAVIDSON MOTOR CO.
Dept. P, Milwaukee, Wisconsin

Send FREE copy of "ENTHUSIAST"
motorcycling magazine and literature
on your new 1941 models.
Stamp is enclosed for mailing cost.

Name _____

Address _____



FREE CATALOG

196 PAGES
OF RADIO VALUES!



64
RADIO
MODELS

At amazing low prices. The famous Lafayette line of table models, portables, consoles and phonograph-combinations—for home, farm, camp and car—64 beautiful 1941 models—each tops in its class—in styling, performance and value. Consistently selected "Best Buy" by Consumer Test Laboratories. 30 day home trial.

Save real money on Lafayette sound amplifying equipment. Catalog features 3 complete lines, years ahead in engineering, streamlined in styling, matchless in performance. There's a Lafayette Sound System for every purpose. Only Lafayette offers a 30-day trial, on easy payment plan.



SAVE ON
SOUND
SYSTEMS



HAMS &
HOME-
BUILDERS

Complete lines of all nationally advertised amateur radio equipment. Remarkable savings. Also, Build-It-Yourself Kits for both radio and television experiment. Special new kits designed expressly for FM—latest development in Radio. Look to Lafayette—Headquarters for Amateurs.

All the dependable names, huge stocks, complete in everything. Catalog lists thousands of items, many hard-to-get. Lafayette rock-bottom prices save you real money on every purchase. Extra-Bargain Section of super-values in Lafayette radio parts, can't be beat anywhere.



FAMOUS
RADIO
PARTS



TEST
EQUIPMENT,
TOO

In one section, the test equipment of today's leading manufacturers. Every instrument you need—pocket and portable models, combination tube and set testers, latest all-purpose test equipment, precision panel meters. Money-saving, low Lafayette prices. Servicemen! Own up-to-the-minute equipment—easy time payments.

RUSH COUPON BELOW

You'll save time and money with this big FREE catalog. Tremendous Lafayette buying power brings the best in radio quickly to your door at lowest prices anywhere. Lafayette, remember, will never be undersold. Send for your copy of the Guide to Radio's Outstanding BUYS at once. It's FREE! Just mail this coupon.



Lafayette Radio

NEW YORK, N. Y.
100 Sixth Ave.
CHICAGO, ILL.
901 W. Jackson Blvd.
ATLANTA, GA.
265 Peachtree Street
BOSTON, MASS.
BRONX, N. Y.
NEWARK, N. J.
JAMAICA, L. I.

LAFAYETTE RADIO CORP.
DEPT. 7L—100 SIXTH AVE., NEW YORK, N. Y.
or 901 W. JACKSON BLVD., CHICAGO, ILL.
Please Rush FREE Catalog No. 82.

NAME _____
ADDRESS _____
CITY _____ STATE _____

Wearable Hearing Aid

(Continued from page 777)

side of the case. The black lead (negative-A and negative-B) is grounded and jumped in the battery plug as indicated in the bottom view of the plug. This battery plug is a 4-prong miniature "Cinch" type, and the

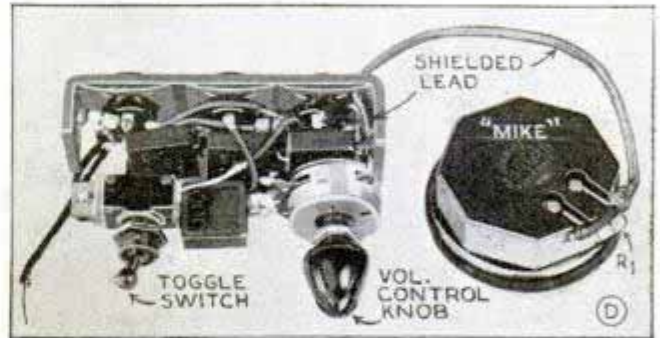

headphone may be any good 2,000-ohm lightweight variety. A detailed list of materials is available from Popular Mechanics radio department without charge. Photos A, C and D show views of the instrument in various stages of construction. Volume is easily controlled by adjusting the small knob on the 3-megohm volume control (R_4). The schematic circuit drawing is given in Fig. 3. The blueprint number of this article is R-284.

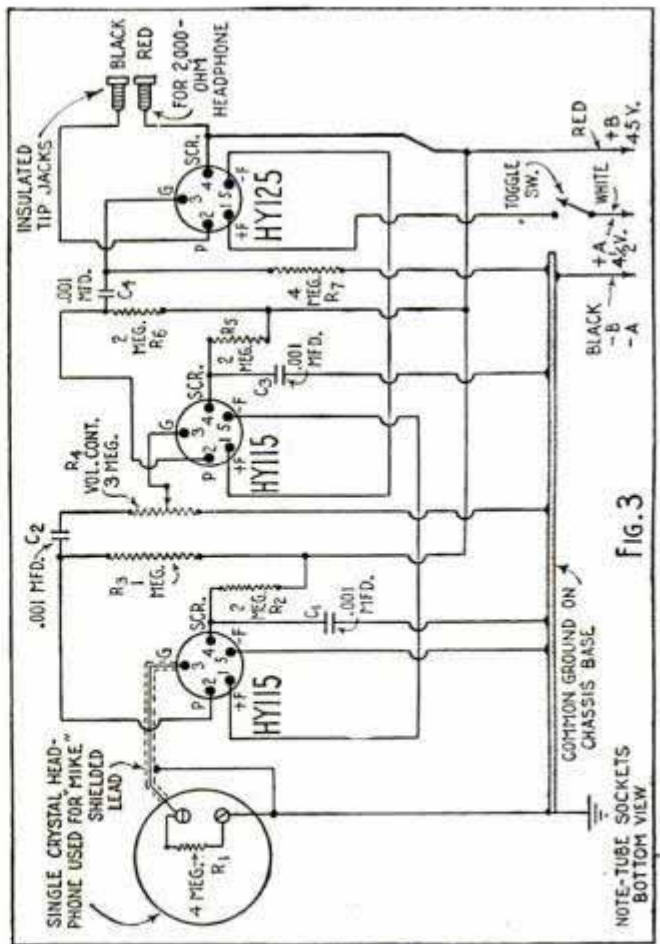

Fig. 3

New Scroll Saw of 1,000 SPEEDS



Any Speed From
650 to 1700 R. P. M.
at a turn
of your fingers

Inside Secrets of Delta Quality

"PRECISION GRINDING"

All arbors, spindles, bearing seats, etc. on Delta machines where accuracy to close limits is important, are ground to size. Turning to size is "good enough" for many manufacturers but not for Delta machines! Precision grinding to size, after turning, is an extra operation. It costs more money—and you can't see it as you can see nickel plating on the outside of the machine. But in a bearing or bearing seats, it provides a fit that is "all over" instead of only on a comparatively few high spots. This means that ball bearings do not become loose in service. Precision grinding produces a closer fit, to more exacting tolerances, which means that fits are uniformly good, and that true interchangeability is obtained.

The extra accuracy obtained by precision grinding may be visualized when it is realized that the ordinary variation or tolerance on Delta arbors and spindles is three ten-thousandths of an inch, and in many instances this tolerance is held to one ten-thousandth.

Before you buy any light machine tool, make sure all parts that vitally affect the accuracy and life of your machine, are precision ground to size!

The Most Remarkable Scroll Saw Ever Made

Now, for the first time, you can have a Scroll Saw that, at a turn of your finger, gives you the exact speed that best fits the material you are sawing—high speed for fast, fine work—low speed for heavy work—and ANY speed in between! In addition the new Delta Multi-Speed Scroll Saw gives 24" throat capacity—Timken Bearing crankshaft, shaft driven blower pump which makes air available even for sabre-cut-

ting—universal tilting table for bevel cutting as well as for straight cuts—a completely universal blade guide—high speed blade support—adjustable blade tension—splash-lubricated drive—tilting spring hold down—and many other features that have caused experts to call it "The Finest Scroll Saw Ever Made." For full description, specifications and low prices, fill out the coupon below.

Send for Latest Delta Catalog

A complete guide book to power tools which not only lists the complete line of Delta "Quality" wood and metal working tools—but shows you the important points to look for in all power tools. It illustrates and explains the advantages of the many hidden features of design and construction that make for long, better service in power tools. (Also send for Project Book No. 7 crowded with new projects, including working drawings, photographs and full instructions.)



DELTA MFG. CO.

600-634 EAST VIENNA AVENUE
MILWAUKEE, WISCONSIN

Delta Manufacturing Company
600-634 E. Vienna Ave.
Milwaukee, Wis.

Gentlemen: Send me the latest Delta Catalog listing the complete line of Delta Lathes, Circular Saws, Band Saws, Jointers, Scroll Saws, Shapers, Sanders and Drill Presses.

I enclose 10c (stamps or coin) for which please send me the new Delta Project Book No. 7.

Name.....

Address.....

City..... State.....

Check here if you are a Delta user now. A1140

**EVERYTHING IN RADIO
AT LOWEST PRICES!**

**GET ALLIED'S
GREAT 1941
RADIO CATALOG!**

FREE
212
PAGES

**DEPEND ON ALLIED—
THE WORLD'S LARGEST
EXCLUSIVE RADIO HOUSE!**

83 New Radios! Real "hits"—new plastic models; world-wide sets; "Camera" and 3-way portables; Phono and Recorder combinations, Auto Sets, Amateur Receivers—the sets you've been waiting for—all at lowest prices!

24 New Sound Systems! For every P.A. application—7 to 75 watts—exclusive new features—amazingly low-priced. Easy Time Payment Plan—15 Day Trial Offer. Also everything in P.A. in a special 35-page section.



**LEARN
RADIO**



Build your own Radio! Learn and have fun—dozens of new low-cost easy-to-build kits; new diagrams—more than 15,000 quality parts. Let ALLIED help you—just ask us—we'll help you to learn quickly, easily!

Radio Builders' Handbook—valuable beginners' book on radio; tells how to select circuits, read diagrams, build sets, etc. Illustrated; worth having. Order by coupon below. Only **10c**



ELECTRONIC LAB OFFER

1 TUBE KIT. Same as kit at right; makes all projects but builds only 1 tube set instead of 2 tube set. Shpg. wt., 7 lbs. Regular price, \$7.50. Now only **\$2.95**

A wonderful offer made by ALLIED exclusively, to Radio Builders, Beginners, Experimenters. Brand new genuine RCA kits that teach you radio by practical construction, at less than half the regular price! **2 TUBE KIT.** Build a real 2-Tube Receiver, an electronic burglar alarm, Home Broadcaster, Morse Code Practice Set, etc. Kit includes: 2 RCA tubes, sockets, condensers, resistors, coils, soldering iron and solder, wire, transformer, headphone, microphone, electric relay, telegraph key, wiring diagrams, 15-page instruction book. Shpg. wt., 7 lbs. Regular price, \$8.95. For limited time only **\$3.75**

ALLIED RADIO

833 W. Jackson Blvd. Dept. 5-L-1
Chicago, Illinois

- Rush me your FREE 1941 Fall Radio Catalog.
- Enclosed find 10c for Radio Builders' Handbook.
- Enclosed find \$3.75 (plus postage) for 2 Tube RCA Kit.
- Enclosed find \$2.95 (plus postage) for 1 Tube RCA Kit.

Name.....

Address.....

City..... State.....

**FREE
CATALOG**

One-Tube Battery Amplifier

(Continued from page 778)

tained from the receiver, and one additional 45-volt B-battery is employed. When the amplifier is used with microphone or phonograph pick-up, or, if your receiver does not use a 1½-volt A-battery, it will be necessary to connect a 1½-volt dry-cell

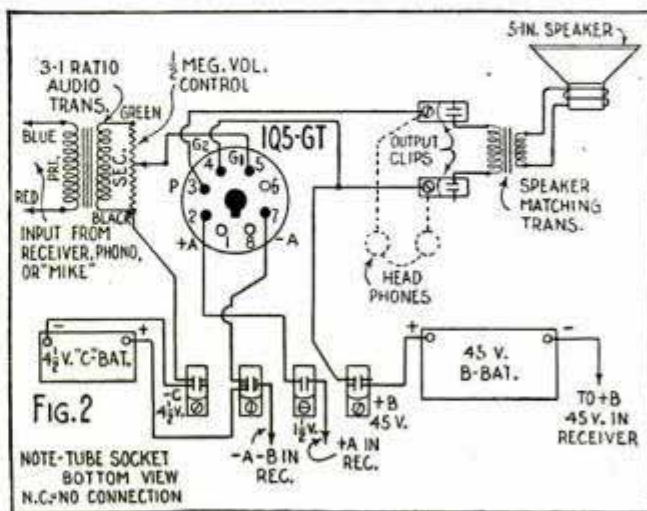

A-battery directly to the amplifier A-battery terminal clips and also include both B-batteries to furnish 90 volts for the plate of the 1Q5-GT tube.

Diagram Fig. 3 shows the method of connecting the amplifier to any standard 1-tube receiver employing a 1.4-volt battery tube. All parts for the amplifier are standard items catalogued by radio-parts mail-order houses. The speaker and its coupling transformer may be mounted on a separate base and panel arrangement

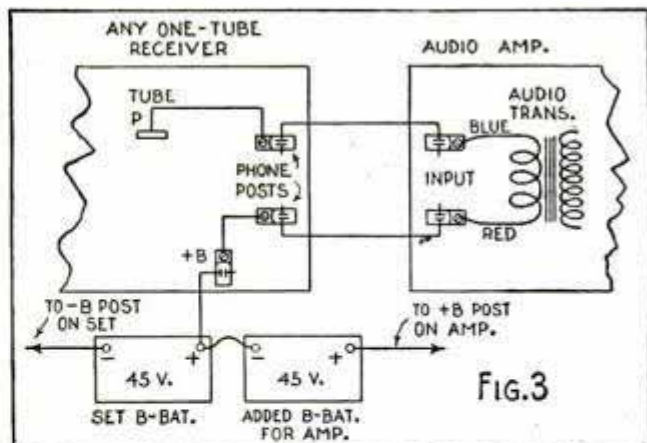

or in a small speaker cabinet, which can be made from 1/4-in. plywood. Photo A shows the completed amplifier just as wired in diagram Fig. 1. Speaker and transformer appear separately in photo B and are considered as accessories, as most experimenters prefer to use phones.

Stiff?.. NEVER! HORSEHIDE HANDS EVEN DRY SOFT! ..STAY SOFT ALWAYS



For the nearest thing to barehand freedom and firm grip, wear *Wolverine Horsehide Hands*. They're almost unbelievably soft and pliable—dry soft after soaking, too. But Man—they're **TOUGH!** They simply thrive on scuffing, scraping, and hard knocks—literally wear like iron. That's because they're tanned by the same secret process that makes Wolverine Shell Horsehide Workshoes famous for amazing extra comfort and money-saving longer wear. If your dealer doesn't have *Horsehide Hands*, send his name and 75c. We'll mail you a pair postpaid. Sizes 8 to 12... Style 8565. **WOLVERINE SHOE & TANNING CORP., DEPT. P-1148, ROCKFORD, MICHIGAN**

**TOUGH
AS NAILS**

Style No. 8565
Pony White
Driver's Pattern

**SOFT
AS KID**

WOLVERINE HORSEHIDE WORK GLOVES

DEALERS: Thousands of dealers have gained phenomenal extra work glove business by carrying *Wolverine Full Grain Horsehide Hands*. Write for catalog and tested sales plan.

Write with Electricity

NEW MODEL ELECTROGRAF

Astonishes everyone! Writes easily on the hardest tools or instruments. Identifies & protects tools against theft. Permanent writing. Requires few seconds only. Anyone can operate. Pays for itself many times.

\$1.98

Order Yours Today—Sent C. O. D. If Desired

Agents! Are you interested in \$10.00 Daily? If so write at once to

POSTPAID NATIONAL LABORATORIES, Portland, Ore.

RINGS \$1.50

PINS 30¢

FOR YOUR CLUB

Knit your group closer together and enhance pride of membership with pins or rings. Bastian's big selection, low prices, traditional clean-cut quality work has led the field for 46 years.

WRITE TODAY FOR NEW FREE CATALOG!

BASTIAN BROS. Dept. 71, Rochester, N. Y.

PISTON TYPE COMPRESSOR

EASY PROFITS IN PAINT SPRAYING

Paint walls, ceilings, screens, furniture, radiators, machinery faster, better! 1/4 H. P. motor 110 Volt 60 Cycle AC, complete with Spray Gun, 15 ft. hose. Weighs only 44 lbs. Carry anywhere. **FULLY GUARANTEED.** Complete with motor only \$31.15, or only \$25.00 less motor, f. o. b. Chicago. \$5 Deposit, Balance COD, or SEE YOUR DEALER. Circular FREE. Get started making money NOW! **\$25.00 Less Motor**

Ideal Automatic Pump Co.

Dept. PM-11, 801 Washington Blvd., Chicago, Illinois

MENDS MOST ANYTHING

Iron Glue holds tight, is extra strong. You can buy it 'most anywhere—1/4 pt. to 1 gal. cans or 10c bottles. **FREE:** Send post card for booklet, "Better Results with Glue," to: McCormick Sales Co., 402 Light St., Baltimore, Md.

IRON GLUE

AN ELEPHANT FOR STRENGTH

Big Money for Workers In Home or Shop

MONEY-MAKING PROJECTS. Make color-glazed concrete lawn, cemetery pottery without molds or cores. New patented method. \$5 equipment makes 2,500 different designs, sizes. Use only sand, cement, cheap materials. Statuary, giftware, novelties. Plastics. Imitation marble, granite gravestones, markers. Tiles, walls, floors. Guaranteed basement waterproofing. **MAKE MONEY** with these projects. Operators wanted everywhere. Send 3c stamp for illustrated booklet, colorplate, details.

NATIONAL POTTERIES COMPANY
Dept. 6 13 W. 26th St. Minneapolis, Minn.

FREE Stove Catalog



Factory Prices

New streamline designs! New features! 136 Styles and Sizes. Coal Wood Ranges; Combination Gas-Coal or Oil Ranges; Electric Ranges; Oil Ranges; Oil Heaters; Coal-Wood Heaters; Furnaces. 30 Days Trial. 24 hour shipments. 1,600,000 Satisfied Users. Stoves \$5 Down, up to 18 months to pay.

A Kalamazoo
Trade Mark
Registered
Direct to You

KALAMAZOO STOVE & FURNACE CO., Mrs.
391 Rochester Avenue
Kalamazoo Michigan

FREE BOOK OF NEW 1941 PROJECTS to build in your own workshop!



24 original designs by
★ GILBERT ROHDE
★ RUSSEL WRIGHT
★ HERMAN HJORTH

● Stop wasting good workmanship on poor design. Choose your projects from these handsome, modern pieces designed exclusively for Casco by leading professional designers. Free book illustrates tables, "unit" chests and cabinets, desks, bookcases, lamps, trays. Complete detailed working-plans are *free* with coupon found in every 25¢, or larger, can of Casco Glue.

Mail coupon today. Get the most from your efforts—with a *professionally-planned* Casco project!

CASEIN COMPANY OF AMERICA
 Dept. PM-1140
 350 Madison Ave., New York, N.Y.

Send me a copy of the new, free "CASCO PROJECTS" by return mail.

Name _____
 Address _____
 City _____ State _____

Save 2c... stick coupon on penny post card.

Pin Your Name on a Comet

(Continued from page 693)

Star clusters are globular collections of thousands of stars, so far away that individual stars can seldom be seen except on photographs taken with huge telescopes. Nebulae may be either vast clouds of gas, or whole universes of stars at an enormous distance from the earth. Both star clusters and nebulae closely resemble a comet when seen through a small telescope.

Messier had so much trouble distinguishing star clusters and nebulae from comets, that he listed them in a catalogue. Today they are still known by the numbers he gave them. Thus the globular cluster in the constellation of Hercules is Messier (M) 13; the great nebula in Orion is M 42, and so on. The first act on sighting a hazy, diffuse object should be to consult a star chart showing the positions of the star clusters and nebulae. If none appears there, it is now permissible to become a little excited, for perhaps you really have something.

One more precaution should be taken. Some telescopes have "ghosts" in them; they show a patch of light near a planet or bright star, caused by internal reflection of light among the lenses. Often they look so real that professional astronomers have made careful micrometric measures of their telescopes' ghosts.

The one sure test for a comet is motion among the stars. The stars are so distant they may be regarded as fixed landmarks. But comets are only a few million miles away, so that they seem to be moving rapidly against a background of stars. Frequently this motion can be detected in a few hours. The best method for the amateur is to make a map of the stars as he sees them in the telescope and locate the comet on it. If on the following night the object has moved into another group of stars, he has undoubtedly bagged a comet.

The next step is to establish ownership. Make a rough estimate of the comet's position by reading off its coordinates on the star map. Note the time of night and the comet's brightness. Telegraph this information to Dr. Harlow Shapley, director of the Harvard College Observatory, Cambridge, Mass. Harvard Observatory acts as a clearing house for discoveries of this



Use Casco Powdered Casein Glue—the standard for all heavy-duty wood-gluing. 10¢ to 65¢ at Hardware, Paint and Lumber Dealers'.

kind. After receiving your message, it sends out others to leading observatories of the United States and Canada. They will read somewhat as follows:

DOAKES REPORTS DISCOVERY OF SEVENTH MAGNITUDE COMET ASCENSION TWENTY ONE HOURS TWENTY MINUTES NORTH THIRTY DEGREES JANUARY TWENTY DECIMAL ZERO

This discovery position is only approximate, because the discoverer is generally in a rush to get his telegram off, before other comet hunters can send theirs in. So keen is the competition that sometimes three telegrams arrive on the same night, in which case, the comet may receive a doubly hyphenated name, such as Comet Kaho-Kozic-Lis, discovered by three individuals independently on July 17, 1936.

Professional astronomers now go to work to get a precise "fix" on the newcomer, measuring its distance from neighboring stars whose positions are known. These measures used to be made visually by means of a filar micrometer attached to the eye end of the telescope; today astronomers prefer to measure from photographs.

The comet is first centered upon the plate and held there by constant guiding during the exposure, which may be from about fifteen minutes to several hours. Telescopes are turned by clockwork at the same rate the stars move across the sky. Since the comet is moving among the stars, the direction of the telescope must be changed every few seconds, or the comet would soon drift out of view. The resulting photograph shows the comet sharply defined, but with the stars drawn out into lines.

Theoretically, the orbit of the comet can be found when its position is known at three different times. In reality, a score of positions extending over a month are needed to determine its path with any degree of accuracy. The computation of cometary orbits is a highly specialized branch of astronomy performed by experts in the use of formulae. With good luck, an expert can turn out an orbit in one afternoon. A beginner might need a month.

Most comets dash across the sky and vanish after a few weeks, never to be seen again. Others, periodic comets, return at

(Continued to page 136A)



Others *know* there's no tobacco on earth that equals this truly AROMATIC pipe mixture

Some people don't like anything *new*.

Here's such a new, *different* smoking-experience that some men don't like it. But thousands won't touch any tobacco but Bond Street.

Bond Street's like expensive custom-blends in flavor, fragrance, bite-free coolness. Contains *rare aromatic tobacco never before used in a popular price mixture*. Even women approve its aroma.

In fairness to yourself, get a 15¢ tin — today!

15¢



Today—try a tin of
BOND STREET
Pipe Tobacco

A Product of PHILIP MORRIS

I'M SO HAPPY NOW
THAT CHARLES IS
DOING SO WELL IN HIS
NEW BUSINESS



**TOOK IN \$217
in 10 DAYS
WASHING WALLS**

● Newly invented machine washes walls 6 times faster and better than by hand. Charles Stelle took in \$217 first 10 days. We want more men to go into business for themselves. Customers everywhere—homes, schools, offices, stores, churches, lodge halls, hotels all have walls that need washing. You don't have to rent a store or office. You operate this business from your home. The expense for materials is small. What you take in is practically all profit. On a \$10 job cost for materials is about 20c. Write now for complete facts on this Von Schrader Wall Deterger which washes paint beautifully and postpones repainting many years.

Harold Jones writes: "I landed a \$40 job the first day."

J. Cranston says: "I have several jobs to start on Monday, thanks to your help."

Clyde Brandt writes: "I made a demonstration in a public school and got a contract which will more than pay for my machine in the next few days."



Easy Payments

It takes only a few dollars to get started in this money-making profession. No experience necessary. The total price is so small and the payments so easy that anyone with ambition should get started NOW.

SEND FOR FREE INFORMATION

There is No Obligation

VON SCHRADER

MANUFACTURING CO.

77-N PL. Racine, Wisconsin.

Ride with a Guide



HULL Streamline AUTO COMPASS

- SAPPHIRE BEARING
- BUILT-IN COMPENSATOR
- TEAR-DROP DESIGN

Only \$2.95 AT YOUR DEALER

HULL MFG. CO., P.O. Box 246-D11, Warren, Ohio

60 POWER TELESCOPE . . . \$219

NEW! Three telescopes in one. 3 different magnifications. 20 power for ultra-bright images with 40 and 60 power for extra long range. Guaranteed to bring distant objects, people, sports events, ships, moon, stars, etc., 60 times as close.



Most powerful made for anywhere near the money. Closes to less than a foot in length. Multiple lens system. 30 mm. objective lens. 5 sections. Directions included for using as a compound 4 lens microscope. American made. Prompt shipment guaranteed. We pay the postage. Only \$2.19.

SPECIAL OFFER—64 page beautifully illustrated book on Astronomy with sky maps included **FREE** on request with each telescope. **BROWSCOPE CO., Dept. 411, 5 W. 27th St., New York, N. Y.**

New Electric Moto-Saw

Only \$4.85 POST PAID



7,200 STROKES PER MINUTE... JUST GUIDE IT!
FAST—POWERFUL—Cuts intricate designs like costly bench equipment. Averages 12" per min. thru medium hard wood up to 3/4" thick... so smoothly it eliminates sanding. **SAFE** as a hand saw. **SIMPLE—DURABLE**—Only 2 moving parts... never needs oiling. Stroke adjustable from 1/8" to 5/16". **EASY TO USE**—Wt. 17 oz. Balances in hand. Carry in coat pocket. Uses alternating current only.

10 DAYS TRIAL If your dealer can't supply you, send only \$4.85 for Moto-Saw and 3 blades, postpaid. Or send \$1.00 and pay postman balance plus postage. **MONEY BACK** if not delighted after inspection.

DREMEL MFG. CO., Dept. 110-L, RACINE, WIS.

regular intervals. Most famous of these is Halley's Comet, named after Edmund Halley, not because he discovered it, but because he was the first to predict its appearance.

From a study of old records, Halley found that bright comets had been seen in 1456, 1531, 1607, and 1682. His calculations led him to believe the same one was returning about every seventy-six years. He made a prediction, bold for that time, that the comet would appear again early in 1759. Since Halley would certainly be dead by that date, he was criticised as a common publicity seeker. But the comet returned in March, 1759, seventeen years after Halley's death. Its last visit was in 1910, its next will be about 1986.

The only reward the discoverer of a comet can expect at present is a medal and the pleasure of having it named after him. But at one time comets had a real commercial value. In 1880, H. H. Warner, a wealthy amateur astronomer, offered a prize of \$200 for every unexpected comet discovered in this country.

Soon afterward, the late E. E. Barnard, one of the most famous of recent astronomers, found a comet and collected his reward. Borrowing some more money, he built a small house. Barnard was just starting on his career, and as the date of the first payment on his note drew near, found himself without money. In desperation, he started looking for another comet, and by good luck, found one just in time. But that was only the beginning. He succeeded in finding three more comets and actually paid off the note by money derived almost entirely from comets!

Growing 'Em Bigger

(Continued from page 683)

reau of Plant Industry have developed a method of using the synthetic hormones to speed up the propagation of black locust and shipmast locust, two of our most popular farm trees. California experiments promise to develop ways to use the chemicals in speeding up the production of bushes for replanting burned-over watersheds. Soil conservation agencies are interested in developing large-scale sources of farm trees for soil defense.

(Continued to page 139A)

Atlas

1941 SHOP EQUIPMENT

WATCH NEXT MONTH!
Atlas will announce an entirely new Machine Tool

"Built the Way You Want It"

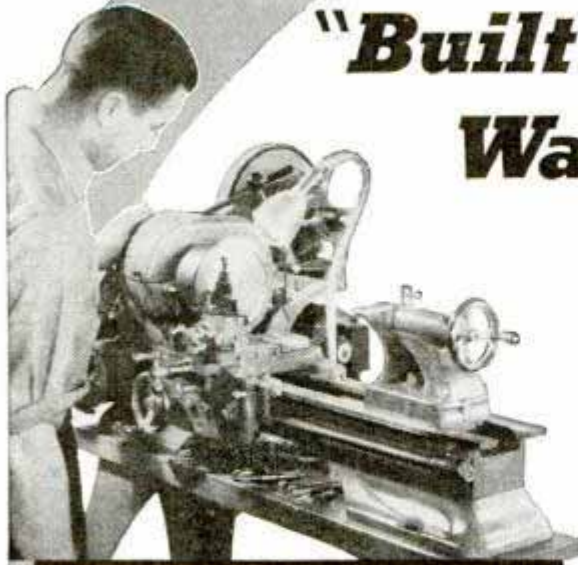

Whatever tool interests you most for your business or home shop, your Atlas dealer has a real surprise in store for you.

"Take over the controls" in his demonstration room. You will quickly see why skilled machinists in all parts of the nation are praising the Atlas Shop Equipment for 1941. Each tool has power, strength, and accuracy "built the way you want it" with typical Atlas precision and economy.

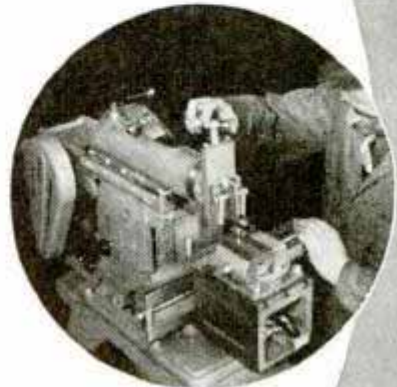

F-SERIES 10" LATHES

Power Cross Feed
Standard Equipment

Power cross feed, complete V-belt drive, precision-ground bed ways, custom-bored spindle bearings, backgeared power, wide screw-cutting range, 16 speeds—these are but a few of the many modern Atlas features. Ready-to-run models as low as \$99.75 complete less motor.

7" SHAPER

One of the Atlas machine "marvels" is this new metal shaper. All the precision and power of larger machines has been built down to scale for all work within a 7" stroke. \$245 less motor.

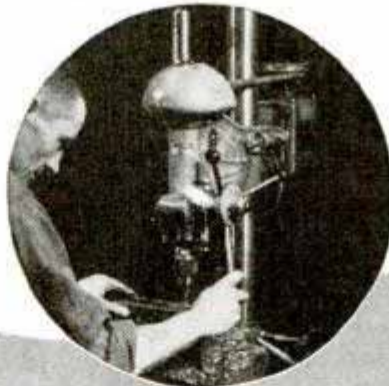

6" LATHE

These are the first popular-priced precision-built small lathes. Same modern operating features as the larger machines. Two models—12" or 18" between centers—\$61.50 and \$64.50.

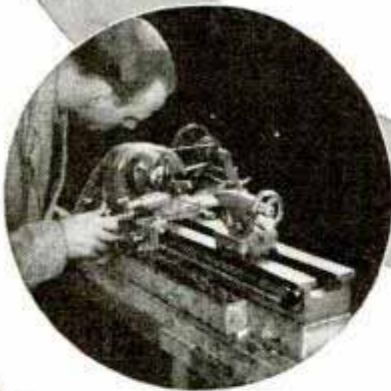

DRILL PRESSES

For smoothness and long accurate service buy an Atlas Drill Press with floating drive spindle design and SKF ball bearings. 4 models, 4 prices from \$17.25 to \$44.75.

ATLAS PRESS COMPANY

1143 N. PITCHER ST.
KALAMAZOO,
MICH.

Atlas Press Co., 1143 N. Pitcher St., Kalamazoo, Mich.

Please send me your 1941 Catalog on: 10" Metal Lathes; 6" Metal Lathes; 7" Shaper; Drill Presses; Arbor Presses; and the name of nearest Atlas Dealer.

NAME.....

ADDRESS.....

CITY AND STATE.....

FREE 1941 CATALOG

Make your reservation now for the 1941 Atlas Catalog. Has all the up-to-the-minute news about modern metal working machine tools. Ready soon.

SALES OFFICES
NEW YORK PHILADELPHIA
130 W. 42nd St. 113 N. Third St.
CHICAGO
35 E. Wacker at Wabash

IT'S FREE
THIS AMAZING

NEW BOOK

"THE WONDERS OF MODERN CHEMISTRY"

The WONDERS of MODERN CHEMISTRY

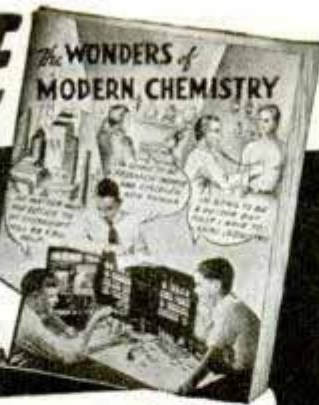

Boys! You will find Fun and Adventure in delving into the mysteries of Chemical Science and performing in your own home the thrilling chemical experiments that are described in this fascinating new book. Today is that Age of Chemistry—in devastating war or in peaceful industry. Learn about the Wonders of Modern Chemistry. Send for this book today—it's absolutely Free.

THE PORTER CHEMICAL COMPANY
26 Prospect Ave., Hagerstown, Md.

A Revelation—Our new 1941 Catalog of "HARD-TO-GET" MATERIALS

For Industrial Arts Departments in Schools, Institutions, etc., Furniture Repair Men, Cabinet Makers, Souvenir and Antique Shops, Homecrafters, etc. Send 10c cash or stamps for this new catalog.

A few of the items we sell: Chest hardware, locks, hinges, supports, tray lifts, copper trim, also mouldings, overlays, etc. Finishing materials, glue, stain, varnish, abrasive papers, sanding blocks, stick shells, etc. Upholstering supplies, coverings and tools. Electrical findings for lamp manufacture, also clusters and indirect fixtures. Chair cane, piping, rods, craft fibre cord, etc. Trays and glass liners for smoking stands. Large line electric and spring clock movements, with and without dials. Complete line Venetian Blind hardware, cord, tapes, etc. Table slides and supports. Tea wagon wheels and casters. Wood dowels, also dowel screws, dowel centers, wood screw hole buttons. Large line card table leg supports. Bed hardware of every description. Desk pens complete with funnels and fastening without base. Water transfers, inlays, small mouldings, etc. Glides and casters, office chair spiders, wood legs and K. D. chair frames. Small box hardware of every description. Large selection pulls, knobs, handles, hinges, locks, catches, etc. Perforated steel panels, chair braces, revolving chair fixtures, rocker springs, candle-stick sockets, billboard clamps, banquet table hardware, metal drawer glides, brass jack chain, drawer follower blocks, etc. Many styles corner braces, bolts, etc. Step ladder braces, plaster strips, sliding track and sheaves. Typewriter desk hardware, binoculars, mirrors, nut bowl hardware, salt and pepper inserts, music box movements, etc. Bar pins for novelties, dress clips, etc. Catalin plastics, crib hardware, swivel top table fixtures, sectional bookcase hardware, clamp nails, electric pens for burning, etc.

THURSTON SUPPLY COMPANY, ANOKA, MINNESOTA

Sensational SHOE STYLE

INCREASES HEIGHT 2 INCHES Short men look surprisingly tall in these new amazing shoe styles. Largest in direct-selling shoe line for men and women sent FREE by sales division of leading manufacturer. Good pay every day. No experience needed. Low money-saving prices. Send no money—write for "big shoe sales outfit—FREE."

CONSOLIDATED SHOE SYSTEM Dept. M-24 Chippewa Falls, Wis.

GERSTNER Tool Chests
First Choice of Machinists and Tool-makers for 34 years. Free Catalog.
GERSTNER TOOL CHESTS
440 Columbia St., Dayton, Ohio

SAW-FILING

Pays up to \$2 or \$3 an Hour

A FOLEY Automatic Saw Filer files hand, circular and band saws better than the best hand filer. Cash business, no canvassing, no eyestrain. No experience needed. Louis P. Wadonick, Ohio, says, "I have filed 764 saws in spare time and have earned \$850.00 in carpenter work due directly to my saw filing contacts." Send coupon for FREE PLAN, no obligation.



FOLEY MFG. CO., 1116-40 Foley Bldg., Minneapolis, Minn.
Send Free Plan on Saw Filing business.

Name.....
Address.....

BIG MONEY BUILDING MEAD'S NEW PORTABLE OUTBOARD BOAT



IN A FEW DAYS AT HOME!

Build this light 50 lb. tough, durable, seaworthy portable Outboard Ki-Yak! Take it anywhere by hand or car. Safe, dependable, trouble-free. More speed per horsepower, more miles per gallon. MEAD'S perfected aluminum-ribbed, cut-to-fit construction Kit guarantees successful assembly quickly, easily, economically. New 69 lb. OK-4 uses oars, sail, motors, 9 h. p. or less. Also 3 "CK" paddle-sail models from 20 lbs. to 45 lbs. Double Paddle or Oars INCLUDED with your Ki-Yak! Write for FREE lavishly-illustrated circulars, low Factory-To-You Prices!

MEAD GLIDERS, 15 S. Market St., Dept. B-110 CHICAGO, U. S. A.

WITTE ENGINES

Gas, Gasoline, Kerosene, Distillate. Size and style for every need. 2 to 10 H. P. Enclosed, Self-Oiling, Roller Bearing. Cost less to own—less to operate. Pay for themselves out of savings.



Make Real Money

WITTE LOG SAWS

Start a wood sawing business. Turn timber into cash. Write now for Engine and Saw Catalog—Low Factory Prices—Easy Terms.

WITTE ENGINE WORKS 174-B OAKLAND AVE. KANSAS CITY, MO.

SHAW "DU-ALL" GARDEN and SMALL FARM TRACTOR

Small sizes, for gardens and lawns. Larger sizes do ALL JOBS on small farm—small jobs on ALL FARMS. Walk or ride; sizes 3/4 to 8 H.P. Write for Factory prices—Free Catalog.

SHAW MFG. CO., 4511 Front St., Galesburg, Kan.; 5812-G Magnolia Ave., Chicago, Ill.; 130-G West 42nd St., New York City; 668-G North 4th St., Columbus, Ohio.

Air-cooled engine; auto-type gear shift; many fine features.

FOR BETTER WORK GET THE RIGHT SAW FOR EVERY JOB

ATKINS Silver Steel SAWS

See your hardware dealer. Send for FREE Work-At-Home Book. E. C. ATKINS AND COMPANY, 426 S. Illinois St., Indianapolis, Ind.

BIG NEW STREAMLINED LATHE AT SENSATIONAL BARGAIN PRICE

Imagine! This extra heavy wood lathe, steel bed 48" long, at low prices. Heavy duty head stock, 4-step cone pulley for V-belt. No. 2 Morse Taper Centers. Sealed ball bearings. 6" face plate screws onto spindle. Tool rest 10" long. Complete line of accessories at amazing low prices. Write today for free catalog describing Blue Star full line precision woodworking machinery. Lowest prices.

BLUE STAR PRODUCTS, 611 Lawn Ave., Fairfield, Iowa

Print Your Own

Cards, stationery, circulars, tags, labels, photo and movie titles, advertising, etc. Save money. Print for Others, Good Profit! easy rules sent. Raised Printing like Engraving, too. Junior outfit \$8, Senior outfits \$16 up. Send for free catalog and all details. KELSEY INC., 5-37, Meriden, Conn.

CATCH FISH!

minnow, tois, mink, muskrat, with our folding galvanized Steel Wire Traps. Walton's Automatic Hooks are so constructed that when a fish gives the slightest pull on the bait the upper hook reaches down and gets a hold that lands him. 3 for 50c. Write for descriptive catalog of Traps, Hooks, Lures, and other specialties. Walton Supply Co., 3567 Juniata Ave., St. Louis, Mo.

Ready Now **TRAILER** PARTS Catalog

and TRAILER BUILDERS MANUAL—25 cents

80 Illustrated Pages packed with ideas and suggestions for Trailer Builders, Buyers, and Owners. Largest and most complete line of Trailer Parts, Supplies and Equipment at America's Lowest Prices. Rush 25c (in U. S.) for this book today. Satisfaction guaranteed! TRAILER SUPPLY CO., BOX 360-A, WAUSAU, WIS.

Synthetic hormones promise many aids to fruit growers. That they can be used to assure strong-branched fruit trees was found in studies at the University of Idaho. The chemicals can't do anything for mature trees, but in new plantings a fruit grower can practically assure himself of strong trees. Application of the hormone to the seedlings influences the angles at which the new branches grow. The value of such a discovery instantly is apparent, for limb breakage is one of the most serious problems of fruit raising.

The habit of certain varieties of apples to drop before they are mature has attracted the attention of the chemical plant engineer. Department of Agriculture scientists found that certain synthetic hormones practically solved this problem. As a result commercial sprays built around these chemicals are beginning to appear. At Purdue University it was found that synthetic hormone sprays would delay the blooming of fruit trees until the period of frost danger was over.

Using synthetic chemicals which masquerade as hormones, Dr. Felix A. Gustafson, Michigan scientist, produced experimentally seedless peppers, summer squash, eggplant, cucumbers and tobacco. What science calls parthenocarpic fruits—seedless to us—are produced by substituting the chemicals for the natural pollens. Seedless watermelons also have been produced. German chemists found synthetic hormones that make pruning cuts and tree bruises heal with speed. Some companies now offer mixtures of lawn grasses and clovers in which the seed has been "hormonized" to insure speedier rooting.

Hot news among gardeners is vitamin B-1. Despite all the stirring reports of how B-1 has performed wonders in speeding up plant growth, leading research institutions say that its application on a wide scale still should be regarded as in the experimental stage. Scientists now are trying to clear up three points which surround use of this vitamin. There is need for much more knowledge on how much vitamin each plant produces itself. There is also need for more information on how much vitamin the plant may be able to get from the soil. Also, there is need for greater knowledge on how much vitamin plants can get from fertilizers.

K-76 4

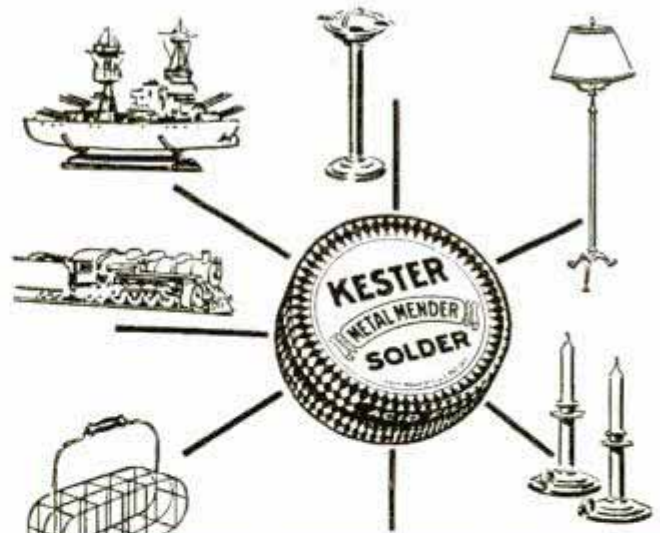

The One and Only!

FOR MENDING AND MAKING ANYTHING IN METAL

There's only one way to *do it right* when you're working in metal—use Kester Metal Mender!

This ideal home solder offers you many advantages when you have broken or leaky metal things to repair. And the same is true when you're building metal models, lamps, ornaments, equipment, and all the other endless articles your craftsmanship inspires.

Kester Metal Mender makes expert soldering a cinch. The flux in the core of the solder itself insures perfect results on anything from a door-knob to a diesel motor. And the high quality, virgin metals in this fine solder give your work real permanence. You'll be proud of it!

Hardware and other stores will supply you, or try it free by mailing the coupon now for a generous free sample of Kester Metal Mender and "How-to-Use-It" Booklet. Act at once!



KESTER METAL MENDER

Kester Solder Company, 4251 Wrightwood Ave., Chicago, Ill.
Please send me free sample of Kester Metal Mender and "How-to-Use-It" Booklet.

Name _____
Address _____
City _____ State _____
***** Mail the Coupon Now *****

R 601

Trappers of the Deep

(Continued from page 715)

made by arcs instead of a filament as in bulbs.

"Operating at high voltage, the intensity of the light may be increased or decreased," Palmer said. "Thus far, I have regulated it so that it is most effective on fish up to eight inches in length. In many instances these smaller fish have been particularly difficult to collect. Their size and shape undoubtedly have made it possible for many species to slip through the meshes of the collector's net. Once they are held prisoner in the beam of the ultraviolet ray they may be photographed. My ray is strong enough in ultraviolet to make photography possible even when there is no visible light. Even simple Super XX film is good enough to take the pictures."

Palmer believes that the ultraviolet ray light some day may be used by undersea explorers, treasure seekers and divers as a defense against vicious monsters of the deep.

"Thus far there has been no really adequate weapon for the diver," he says. "The chief obstacle to a defensive or offensive weapon has been the water itself. I could stand six feet away from the muzzle of a .22-caliber rifle fired at me underwater and not be harmed. A knife, spear or barb moves relatively slowly under water, especially when compared to the swift attack of an undersea monster moving in its own element."

"Water does not offer resistance to the ultraviolet ray light. Currents do not alter the true course of the beam. Using high voltage stepped up from a 110-volt line, the intensity of the ultraviolet ray beam might some day be strengthened to the point where it would be useful to the diver to prevent attacks."

Recently the scientific world acclaimed Palmer's feat of recording photographically the birth of a porpoise in the big tanks at Marineland, Fla. With his ultraviolet light and camera he is looking forward to "trapping" and recording for science many other strange sights and dramas far below the surface of the sea.

Send stamped, addressed envelope to our Bureau of Information for name of maker of any device described in this magazine.

★ NEW TOOLS
★ NEW FEATURES
★ NEW DESIGNS
★ NEW MODELS
★ NEW USES
★ NEW ACCESSORIES
★ NEW SIZES
★ NEW VALUES

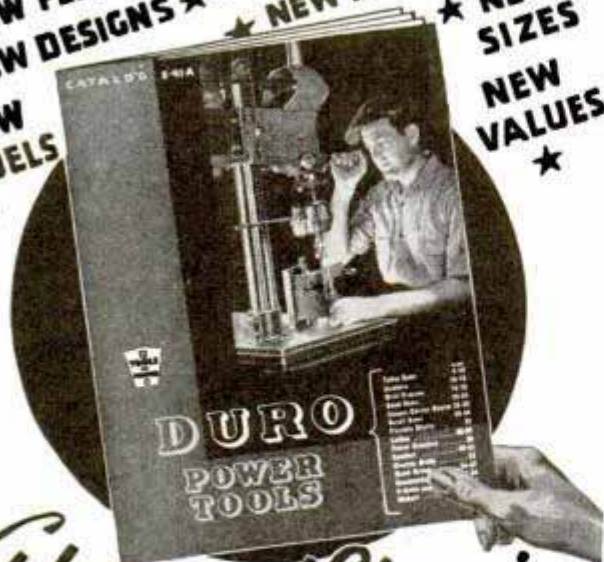

Advanced Showing of DURO's New 1941 WOODWORKING TOOLS

ASK FOR COPY OF NEW 56 PAGE CATALOG NOW READY FOR MAILING

DURO METAL PRODUCTS CO.
DEPT. PM11 2653N. KILDARE, CHICAGO, ILL.

The New MAGIC STYLUS

ELECTRIC PENCIL FOR BURNT WOOD ETCHING

GREATEST VALUE EVER OFFERED! Electric Pencil with 5 different tips, 5 ft. flexible cord and free 8 in. wood plaque—all for \$1.00! Simple, safe, durable, burns on wood, leather, velvet, etc. Not a toy—a real high grade outfit at this unheard of low price. SEND \$1.00 TODAY or write for catalog PM.



Only \$1
POSTPAID with this FREE PLAQUE

THAYER & CHANDLER, 910 W. Van Buren St., Chicago

DOES OIL WEAR OUT?

U. S. Bureau of Standards states: "Oil does NOT wear out mechanically and may be used over and over again." (After reclaiming). Thousands of car, truck and tractor owners have proven the truth of this statement with the use of 'RECLAIMO.' This revolutionary device filters and reclaims crankcase oil as you drive. Saves Time, Trouble and Money! Our 36-page illustrated booklet, "OIL FACTS," contains complete details and startling oil truths that will amaze you. Write for your copy today—It's FREE.



(Sold direct and by reliable dealers everywhere.)
RECLAIMO MFG. CO., 2306 N. Western, Dept. 51, CHICAGO

ONAN ELECTRIC PLANTS

ALTERNATING AND DIRECT CURRENT

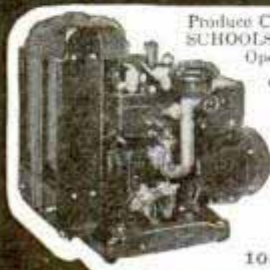

Produce Current, same as City Power Lines, for FARMS, SCHOOLS, THEATRES, PUBLIC BUILDINGS. Operate Lights, Radios, Motors, All Appliances.

Over 40 STOCK MODELS—350 to 50,000 Watts. Any Voltage—Any Frequency. Combination A. C. - D. C. Types. Manual, Full Automatic and Self-Starting. \$79 up. Shipped—COMPLETE, READY for OPERATION. THOUSANDS IN USE IN ALL PARTS OF THE WORLD

Write for Complete Details.

D. W. ONAN & SONS
1051 Fuyatston Avenue - MINNEAPOLIS, MINN.

K650

Seaplaning—Three Sports in One

(Continued from page 677)

it carries floats. Otherwise its performance and maneuverability in the air are about the same. The big difference is in taxiing. On the ground a land plane can be turned and taxied in any direction, but the seaplane pilot must be part sailor and maneuver his plane like a boat. With the motor idling or not running, a seaplane automatically swings its nose into the wind. This makes taxiing easy when heading into the wind but it makes the plane hard to control when traveling down wind on the surface. Lots of power and a hard rudder are required to turn the plane down wind, but if you use power and rudder to turn up into the wind the plane swings around so fast that it tips over. The way to head the plane into the wind is to do nothing and allow it to turn itself.

It is impossible to taxi or take off across the wind in a light seaplane. Try to taxi across wind and the leeward wing tip dips the water. You sail across instead, handling the plane like a sailboat. With the motor idling or with just enough power to prevent a backward drift, the rudder is pushed to make the plane ride at an angle with the wind. It then drifts across the wind in the direction the nose is pointed. If a green student tries to take off across wind he is apt to find that the plane stalls off the water and makes a tight turn, landing on its prop, a float and a wing tip.

Small seaplanes need protected water. A safe landing usually can be made on the ocean in bad weather but after the plane is down it is almost certain to capsize when a wave catches a wing tip. The larger seaplanes and the navy flying boats are built to withstand the punishment of rough landings, and even these planes are occasionally smashed up when a test pilot slams one into the waves in a crash landing.

Seaplanes opened up northern Canada for extensive prospecting and mining. Each of the thousands of lakes in the north is a leveled, prepared landing field for planes on floats. Seaplanes are used extensively by explorers because suitable stretches of water nearly always can be found.

In the United States seaplane activity is especially great along the Atlantic coast, in the Great Lakes region, down the Mississippi, and in the northwest.



To Bring Back Game Shoot *Western* Shells



You'll be game ahead if you shoot Western XPERT shot shells on your quail and rabbit hunts—or Western SUPER-X whenever you hunt wildfowl or pheasants. SUPER-X Short Shot String gives clean kills at long ranges. Look for the familiar red, blue and yellow boxes in your dealer's store. They're the sign of super performance. Mail the coupon now.

WESTERN CARTRIDGE COMPANY
Dept. K46, East Alton, Ill.
Mail your XPERT and SUPER-X shot shell leaflet and the 76-page Western Ammunition Handbook—free.
Name _____
Address _____
Post Office _____ State _____



MEGOW MODEL

World's largest manufacturer of Model Airplanes, Ships and Railroads. Send 10c postage for the largest and best hobbycraft catalog, just issued. 132 pages, profusely illustrated.

MEGOW Dept. PM, Howard & Oxford Sts.
Phila., Pa. or 217 N. Desplaines St., Chicago

- AIRPLANES
- SHIPS
- RAILROADS

ALL-STEEL GUN AND TACKLE CABINETS

AT NEW LOW PRICES!



10 DAYS' TRIAL Keep Sports equipment in safe, dry place. Smartest design, heavy gauge welded steel. Ample gun space, wardrobe section, spacious top shelf. Insulated, sound proof doors. Cylinder lock. 2 keys included. Factory direct to you, low prices—Guaranteed finest quality and craftsmanship. Order now.

FREE: Beautiful 24-page color catalog shows complete line of all steel, guaranteed gun and utility cabinets. Get details of our 10-day Trial Offer. Write today.

FARRELL STEEL CABINET COMPANY
2500 East 75th Street, Dept. 11 P.M., Chicago

No. 7038 (above)
Green or Brown, \$15.95
OTHER CABINETS FROM **\$9.75**
Write for Facts Today

SAVE MONEY

build your own
SMITH COMPRESSOR



We will furnish complete instructions with a Smith Compressor Head and Accessories

With a Ford Motor and shop facilities you can easily assemble a Smith Air Compressor. You'll have a smooth-performing, efficient compressor with 60 cu. ft. a minute capacity—all the power you need to operate rock drills and paving breakers. Pressure up to 175 lbs. a square inch. Head equipped with high speed compressor valves; automatic unloading and idling.

write today

GORDON SMITH & CO. Inc.
410 College Street
Bowling Green, Ky.

PRICE \$13.45

JUST WHAT YOU HAVE WANTED A BLOW TORCH FURNACE



An indispensable item for any shop. Made to operate with the flame of any blow torch. Ideal for heat treating tools and steel parts, sand drawing steel to color and temper, heating soldering coppers. Upper grid for babbit ladle or lead pot. Furnace made of heavy sheet steel, with molded fire clay lining. Inside diameter of furnace 4"x4". The torch shown is a National Pumpless Safety Torch. Featuring less fuel consumption, greater heat, pumpless, greater safety. Ask for complete literature.

National Safety Device Co.
836 W. Hubbard St.
CHICAGO ILLINOIS

PLASTICS

FOR SCHOOLS AND HOBBY CRAFTSMEN



VALUE \$1.19; ONLY \$1

postpaid

Introductory Kit—2 crosses (for pendants), 2 stars, 1 bracelet, 2 rods, 2 sheets 3x1 1/2", 2 sheets 3x1 1/4", 6 metal pin attachments, 2 rings, 2 Scotties, instructions and Catalog. all for \$1, but order today.

IN STOCK: ALL SHAPES & SIZES. CATALOG ONLY 10c

CRAFT SERVICE 333 University Ave.
Rochester, N. Y.

Calling All Cars

A
MYSTERIOUS DISCOVERY

SAVES UP TO 30% on GASOLINE or Costs Nothing to Try



FITS ALL CARS

Constructed of six parts fused into a single unit, adjusted and sealed at the factory. Easily and quickly installed by anyone in a few minutes.

Stop wasting Gas!—trim dollars off gas bills—get more power—quicker pickup—faster acceleration! **AUTO OWNERS everywhere praise VACU-MATIC!** Proven so efficient, it is guaranteed to satisfy, or the trial costs you nothing.

Automatic Supercharge Principle
Vacu-matic is entirely different! It operates on the supercharge principle by automatically adding a charge of extra oxygen, drawn free from the outer air into the heart of the gas mixture. It is entirely automatic and allows the motor to "breathe" at the correct time, opening and closing as required. Saves up to 30% on gas costs, with better motor performance.

AGENTS Get yours FREE

FOR INTRODUCING. Here's a splendid opportunity for unusual sales and profits. Every car, truck, tractor owner a prospect. Send name and address now for big money making offer and how you can get yours Free. **The Vacu-matic Co., 7617-534 W. State Street, Wauwatosa, Wis.**

CLAMPS

The biggest need in most home workshops is more good clamps—clamps for gluing, holding, drawing-up and for setting-up work. They are the extra hands for the 1-man shop. Don't spoil or delay work for want of clamps. From over 40 types of clamps we have selected these as the best for homecraft use.

ADJUSTABLE CLAMP CO.

"The Clamp Folks"

421 N. Ashland Ave., Chicago, U. S. A.



PONY Miniatures 9 types 1" to 2 1/2" cap. Not toys but fine tools with 100 uses.

PONY "50" Fittings go on ordinary 3/4" pipe. Any length. Send \$3.00 plus postage (6 lbs.) for fittings for two "50" Clamps. Also "Pony" No. 52 Fittings for 1/2" pipe—2 sets for \$2.00 plus postage.

Catalog FREE Ask your Dealer



Jorgensen Hand-screws

Genuine "Jorgensen" Hand-screws grip at all angles, never slip, split or loosen. All sizes. Send \$3.00 plus postage (7 lbs.) for 2 No. 1 Hand-screws—open 6".



WEAVE CHAIRS and STOOLS

Complete, illustrated 24 page manual on fascinating art of Seat Weaving. Learn this useful, profitable craft easily. We furnish all materials. Send ten cents for booklet and Price List.

H. H. PERKINS COMPANY, 258 SHELTON AVE., NEW HAVEN, CONN.

Fastest Sighting Combination Known



MARBLE'S Flexible Rear Sight and Sheard Gold Bead Front Sight

Look through peep to gold bead and center instantly on target. Coil spring keeps rear sight in true shooting position. Can be locked down, interchangeable discs. Price, \$4. Gold front sight that never blurs. Price, \$1.50. Give make, model and rifle cal.

Marble Arms & Mfg. Co., 578 Delta Ave., Gladstone, Mich., U.S.A.

POWELL "SETS THE PACE"



100 miles per gal. 35 miles per hour. 2 1/2 H.P. 4-cycle engine. Centri-matic clutch. Hill-climber transmission. Foot brake, foot throttle. Welded alloy steel, shock-absorbing frame. Easy riding, dependable, durable, beautiful. Many Powell Streamliners ridden over 40,000 miles a year.

Write for free folder. Powell Mfg. Co., Los Angeles, Cal., Dept. PM-7



WHY WEAR DIAMONDS?

When Diamond-Dazzling Zircons (Matura Diamonds) from the Mines of far-away, Mystic Siam are so effective and inexpensive. Stand acid; cut glass; true backs; fiery beauty; exquisite mountings. Write for FREE catalog. Address:

THE ZIRCON CO.,
Dept. 10, Wheeling, W. Va.

BUILD YOUR GRANDFATHER CLOCK

Send 25c for Simple SHOP TESTED COPY RIGHTED BLUEPRINT. The Simple Sensible Red-I-Ket way as thousands have. DIME brings PLANS and sixty picture "HOW" Book pricing many fine brass weight Westminster, tube chime, electric and battery movements showing nine beautiful colonial grandfather cases. Build now and save half. **KUEMPEL CHIME CLOCK CO., Bldg. 46, Guttenberg, Iowa.**



Sinus-Catarrh-Head Colds

TRY THIS TO CLEAN THE NASAL CONGESTION

Flood the nasal passage with SINASIPTEC. Different, it loosens and flushes out the thick, sticky, mucous secretion that often blocks drainage and causes headache pressure. Promotes easy breathing as it cools and soothes hot, irritated, swollen nasal tissue. Money back if first bottle doesn't convince you. Ask your druggist for SINASIPTEC today sure. **SPECIAL INTRODUCTORY 25c MAIL OFFER** Send only 25c coin with your name, address for demonstration size of the regularly \$1 SINASIPTEC plus a 25c value nasal applicator free of all extra charges. Write direct to American Drug Corp., Dept. X-3, 6060 Maple, St. Louis, Mo.

K659

Counting in the Next President

(Continued from page 671)

marked change in the balloting in a mill town where a strike has taken a political turn, writes a bulletin for the early editions on the failure of a candidate to carry his home precinct, or punches out a paragraph on an apparent plurality for a Democratic candidate in a district once heavily Republican.

At last spring's primary election in Illinois, automatic business machines were used for the first time to tabulate returns.



Cards punched with latest county returns are fed into machine at left to run off state election table

A dozen numbered blanks represented the various contests—presidential preference, governor and so on. For each blank there was a corresponding colored card to be punched in the tabulating machine.

Over the Morse wire from Wabash county to the AP at Chicago came an early report: BLANK ONE WABASH 13 PRECINCTS 6 REPORTING ROOSEVELT 865 GARNER 307 DEWEY 463. The Chicago operator copied this on a No. 1 white blank and sent it to the tabulator. The machine operator tapped electric keys that punched into a white card holes representing the card, or contest, number; the county; total precincts and precincts reporting; and the vote in the proper columns for Roosevelt, Garner and Dewey. This punched card was filed away according to contest and county. A later return

(Continued to page 144A)



Get "SNAPS" that sing! with G-E MAZDA MIGHTY MIDGET

PHOTOFLASH LAMPS NO. 5

Be sure of crisp, clear pictures of priceless moments indoors. No bigger than a golf ball, G-E MAZDA Photoflash lamp No. 5 lets you carry "sunlight" wherever you go.

It's grand in the new low-cost synchronized flash cameras. In press synchronizers with the new "directed flash" reflector, G-E No. 5 outperforms larger flash bulbs. It synchronizes beautifully when used in two-bulb shots like that above... with the second lamp on an extension. And convenient? It's a wow! You can put up to 30 in one coat pocket so there's no need to be out of bulbs when that "prize" shot comes along. Try Midget G-E No. 5 and get "snaps" that sing!



Now only

13¢ EACH

Movie makers: G-E MAZDA Photoflood lamps are just what you need for sparkling indoor scenes in black-and-white or color. New low prices. G-E No. 1, 15c . . . G-E No. 2, 30c

GENERAL ELECTRIC
MAZDA PHOTOFLASH LAMPS

HANDY LAMP

with built-in reflector...
for workshop and home

• Here's a handy lamp bulb for any home, especially when used in a "clamp-on" socket. Makes it easy to put plenty of light in hard-to-light spots... to make hard jobs easier. Grand for lighting horizontal boring; a big help when you have to fix the washing machine or car... or when you clean out the furnace.



150-watt
G-E MAZDA
Reflector
lamp **95¢**

G-E MAZDA LAMPS
GENERAL  **ELECTRIC**

NEW *Guild Cutter* ELECTRIC SAW



Now saves hours of slow, tiresome hand sawing... new light-weight Guild Cutter is 5 to 10 times faster—easy to use—cheap to run. Many uses in shop or home. Cuts compositions equally as well as wood. Grooves, dados. Weighs only 7 lbs., 45 degree tilting base for bevels. Depth adjustment and ripping guide. Capacity 1 1/4". 110v. AC-DC Motor. Write today.

At
Unusually Low
Price

Syracuse Guildtool Company, 1740-11C No. Solina St., Syracuse, N. Y.

MANUFACTURING OPPORTUNITIES



IN BUILDING INDUSTRY—with machine and process producing permanent construction with savings of 1/3 labor, 1/2 mortar, and 1/3 material costs—ashlar, hollow, veneer or solid walls—plain or 40 colors.

WE EQUIP YOU with Automatic Machinery—large production only one or two men. Equipment costs but fraction of other processes with equal capacity.

INVESTIGATE—let us show you why building today offers you the greatest opportunity for growth, expansion and profit in a business of your own, using raw materials available in your territory. Write today.

W. E. DUNN MFG. CO.
600 West 24th St. Holland, Mich.



HERE I AM!
To Fix That Broken Chair

Just apply Rogers Glue to broken section—place piece, joint or splinter in position—clamp... then chipped, splintered and broken articles will become, look and remain like new when repaired with Rogers Glue... *incredibly strong*—easy to apply. Sells 10c and up in tube, jar or can at hardware stores *only*, or send 10c for full size jar plus free illustrated book giving new ideas, new plans for making useful articles—New 1940 sets of free projects sheets are also available—write Dept. A-1.

ROGERS GLUE, GLOUCESTER, MASS.

OLE DOC. "GLUEKY"

ROGERS

"A TON OF STRENGTH IN EVERY DROP"

THE BEST
LIQUID
FISH GLUE

would throw the earlier card out. Then, when state totals were desired, the whole file of cards for presidential votes in 102 counties was stacked in another electric bookkeeper whose automatic brain added up the votes for each candidate as the punched cards raced past, and at the same time the machine printed a table of votes by counties—all in less than a minute.

The moment the figures show an unquestioned election, a bulletin is written. Election of a Republican congressman named Jones from the eighth district of Illinois goes on the wire to every AP newspaper thus: HOUSE—Illinois, 8th, Jones (R). At Washington an editor jots down that result on his table and watches the political color of the next Congress emerge.

Accuracy cannot be sacrificed to speed, for the press association assumes a tremendous responsibility in announcing election results. A false announcement regarding the presidency would be little short of national catastrophe. Predictions, speculation are forbidden. The AP takes the figures from the precinct election board, adds them, rechecks, then lets the figures tell their story.

There was no single organization gathering election returns throughout the United States until the Associated Press undertook the task. The AP machine had its first great test at the election of Nov. 7, 1916, when the New York Curb Exchange was quoting odds at 10 to 7 that Charles E. Hughes would defeat Woodrow Wilson.

On that election night in the midst of the world war the first returns put Hughes in the lead and by 8:00 p.m. two New York newspapers which had supported President Wilson conceded his defeat. Extras were on the street with editorials on the Democratic downfall, cables from abroad told of the reaction in Europe to the Hughes "triumph." Mrs. Hughes even embraced her husband and exclaimed "Mr. President" at Republican headquarters in New York.

Meanwhile The Associated Press had put out only figures as they materialized, had not "elected" Hughes. Member newspapers, convinced Hughes had won, bombarded the New York AP office with demands for a story of the outcome; there were even accusations that the Associated Press was pro-Wilson and too stubborn to admit his defeat.

Through election night Hughes continued his lead in the east but western returns were lacking and the Republicans had not tallied enough electoral votes to make victory a mathematical certainty. Wilson had the solid south, but the west was in the balance, and with women voting for the first time there was added uncertainty. Early on Wednesday the tide began to switch to Wilson. The count was rechecked throughout the AP system and the totals stood. At daybreak Thursday Wilson had 251 of the 266 votes needed for election; Hughes had 242. There were 38 in the doubtful column and California headed that list with 13, followed by Minnesota's 12. Hughes needed both states to win; Wilson would lose without California.

Returns were slow in California. A stage was hired in one city, messengers struggled over mountain trails and Sierra snows, men rode mules and horses to get the ballot count in rural sections. Suspense mounted.

Suddenly at 11:20 p.m. Thursday the AP wires ticked excitedly:

"FLASH — SAN FRANCISCO — WILSON CARRIES CALIFORNIA AND IS REELECTED."

The vote in California was close: Wilson 465,194, Hughes 462,224. The electoral vote stood Wilson 277, Hughes 254. Weeks later, official canvassing of the ballots confirmed the Associated Press figures.

The efficiency of the AP election system had stood its big test in the most closely contested presidential election of a generation, and after 1916 official Washington accepted AP election figures as correct and conclusive.

Four years ago there were an estimated 55,427,000 registered voters, and the popular vote for President totaled 45,646,297. Today the Associated Press is gearing up its election machine to tabulate a popular vote of fifty to fifty-five millions.

It may take but a few hours to determine the results on election night. If the vote is as close as in 1916, it may take days. But as the millions of votes flow from the tributary precincts over rivers of telegraph wires thousands of miles long, through the Associated Press tabulators to the front pages of newspapers and into the radio microphones, you can watch and hear the returns grow—returns entirely unofficial, but as dependable as the official returns that won't be known for weeks.



Power King
"TOOLS OF TESTED QUALITY"

7" TABLE SAW \$14.95

The Only Low-Priced . . . Ball Bearing SAW

It's the tool bargain of the year! A modern ball-bearing 7" Table Saw for only \$14.95 less motor! Handles rip, cross-cut, mitre, bevel, and compound cutting. Takes blades and chippers for dado work. Cuts 2 3/8" thick—6" ahead of blade. Ask your dealer to show you this Power King Saw. 8" model \$22.50. Send today for complete specifications.

TABLE SAWS
JOINTER PLANER
JIG SAW
SPINDLE SHAPER
POWER HAND SAWS
DRILL PRESSES
WOOD LATHES

POWER KING TOOL CORP.
1108 E. Market St., Warsaw, Ind.



A Midget Car or Scooter outfit is an ideal Xmas gift

BUILD YOURSELF A MIDGET CAR
WE SPECIALIZE IN WHEEL SETS, ENGINES, ETC., for building Cars, Scooters, Trucks, etc. We carry only the best at the lowest prices. Send 10c for parts catalog and plans for three Midget Racers, Scooters and other vehicles. It pays to use only reliable plans and parts—We guarantee satisfaction. **Build-Your-Own Devices**, 536 North Parkside, Dept. PM-11, Chicago

ONE DIME! 10c!

YOU CAN HAVE A 1941 REMINGTON DELUXE NOISELESS PORTABLE TYPEWRITER FOR AS LITTLE AS 10c A DAY!

Yes! Think of it! The New 1941 Remington Deluxe Noiseless Portable is yours for a small down payment and terms as low as 10c a day! Send the coupon below to learn about our 10 day FREE TRIAL OFFER!

EXTRA! Two valuable extras in this great bargain offer! From the Touch Typing book which comes with your machine, YOU can learn quickly in your spare time! And for carrying the Portable, a beautiful case! Adaptable for week-end trips, too! All in all, it's a real bargain!



CLIP AND MAIL TODAY!

Remington Rand Inc., Dept. 152-11, Buffalo, N. Y.
Send catalog on 1941 Deluxe Noiseless Portable and 10c a day plan.
Name
Street Address
City State

The **ONLY** WORKSHOP TOOL
OF ITS KIND—PLANES AND
FINISHES • PANELS •
RABBETS • ROUTS • TENONS



CONVERTS any 1/2 h.p. or larger drill press into a fast, accurate wood planer, surfacer, punter, router, rabbeter and tenoner. No blade changes or adjustments necessary. The 5-in-1 Barron Rotary Planer is safe to use—cannot possibly harm drill press mechanism—provides precision-smooth surfaces on the trickiest grains or knotty woods. No experience required. A marvelously versatile tool for any workshop. Furnishes hundreds of unusual paneled, routed and grooved effects for ingenious craftsmen. Cuts rabbets and tenon joints with uncanny speed and accuracy. Will pay for itself over and over again in time saved—improved workmanship. A new blade improvement now enables you to plane varnished or painted surfaces without difficulty. Order one today on our liberal trial offer. **FREE DESCRIPTIVE FOLDER.**

FITS ANY
DRILL PRESS
\$7.50
COMPLETE
READY TO USE

MONEY BACK FREE TRIAL GUARANTEE You risk nothing. Send check or money order for \$7.50 or order C.O.D. Postage prepaid. Use it for five days and get a full refund if not entirely satisfied.

BARRON TOOL CO., INC., 320 ARCHITECTS BLDG., DETROIT, MICH.

**THE BARRON MULTI-PURPOSE
5-IN-1 ROTARY WOOD PLANER**



**Wood
workers:**

Get Harold Hunt's 1940 Wood Catalog. 136 pages—many in natural colors. Newest ideas for wood workers—experts or amateurs.

SPECIAL BARGAINS

In Rare Woods, Veneers, Plywoods, Inlays, Bandings, Mouldings, Ornaments, Scroll Patterns. All kinds of supplies. Everything for the wood worker. Send only 10c now to

only
10c

CRAFTSMAN WOOD SERVICE CO., Dept. P-4
2729 S. Mary St., Chicago, Ill.

**NEW
TURN SIGNAL**

FLASHES from REAR WINDOW—DASH Control
AGENTS A whirlwind seller. Drivers buy on flash demonstration. Dealers buy 3 to 12. Your profit mark-up as high as 264%. Biggest sensation of year. Rush name quick for facts and Demonstrator sample plan. All Free! Rush. **WATCH-MY-TURN SIGNAL CO., Dept. W-1611, Walnut Bldg., Des Moines, Iowa**

EASIEST TOOL TO USE

BECAUSE IT HAS A Flexible SHAFT AND Pencil-Size HANDPIECE

New skill, new ease for experienced craftsmen and newcomers to the homecraft hobby. Foredom "finger-tip" control for precision work in hard-to-reach-places and for delicate jobs. Note the flexible shaft—the lightweight, pencil-size handpiece. Versatile, can use over 200 accessories. Hundreds of uses: grinding, polishing, milling, engraving, sharpening, slotting, gear-setting, sawing, carving, cleaning, sanding, glass etching, finishing dies, molds, castings, etc., etc. Only \$14.95 for the complete Portable Workshop, as illustrated.

YOURS ON 10-DAY FREE TRIAL
Order this Model 45 FOREDOM Flexible Shaft Workshop today. Enclose \$14.95 check or M.O.—or, we can ship C.O.D. Try it for 10 days. If not completely satisfied, return set—we refund money at once. **FOREDOM—has tools since 1922.**
Write for complete catalog.

FOREDOM ELECTRIC CO., Dept. 172,
27 Park Place, New York, N. Y.

ONLY \$14.95
Including 50-piece Accessory Set

MYSTERIOUS DEVICE

ENABLES ANYONE TO WELD BRAZE AND SOLDER



Now, an electric welding, brazing and soldering Torch, complete with power unit, goggles and supplies. Works instantly off ANY Light socket. Does a thousand and one repair jobs at amazingly Low Cost on aluminum, iron, steel and other metals. **Indispensable** for Auto, Fender and Body Repairs, and home repairs—shop, factory, farm, engineer, janitor, sheet metal, radio and bicycle repairs. Anyone can handle without previous experience with our simple instructions.

10-DAY HOME TRIAL
Write At Once for Special Introductory Low Price Offer. You can try 3 in 1 Electric Torch for 10 Days at our risk, or get one absolutely free by helping us to introduce it. Write **ELECTRO-TORCH CO.** 2613-LM Michigan Ave. Chicago

4000 BARGAINS

You will find illustrated, many handy articles for the small work-shop and home, also office specialties, carded goods, food products, etc., at wholesale prices, for agents, dealers, salesmen. All sold under a money back guarantee.

260 Page Wholesale Book.

Cost about 25c, yours for 10c to cover cost of mailing, packing, etc. You get your dime back with first order. Hurry your request for the catalog—today. **SPORS CO., 9-40 MAIN, LE CENTER, MINN.**

AGENTS WANTED GOLDENTONE .. 50% OFF

Deal Direct, Factory Prices
Over 60 models to choose from—4 to 12 tubes. Portable \$8.00 up. Farm sets \$8.98 up. Car sets \$8.98 up. Foreign band sets \$8.08 up. Samples 50% off. Quantity discounts.
Free 1941 Bargain catalog gives details of 10 day FREE trial, agent's proposition and discounts. No obligation. Mail postcard to **GOLDENTONE RADIO CO.** Dept. P.M., Dearborn, Mich.

FREE TRAILER PARTS CATALOG

We'll save you money on—axles, springs, wheels, couplers, windows, sinks, water pumps, brakes, refrigerators, beds, lamps, inside and out, 6V lamps, furniture, jacks—everything. Special discount to mfrs. **NATIONAL TRAILER EQUIPMENT CO.** Successors to Kar-A-Van Industries, Inc. Dept. P. 714 W. Wisconsin Ave., Milwaukee, Wis.

FREE! 240 Page handy reference book on complete line of Stanley Tools, plus helpful tables and information. Write for Catalog 34.

STANLEY TOOLS Division Of The Stanley Works
NEW BRITAIN 105 ELM ST. CONN.

A AND N SUPPLY CO.

Bargains—Military, Sport Goods, Firearms, Clothes, Shoes, etc. Send 10¢ for new catalog, to be redeemed on first order.
A & N Supply Co., 4772 Lester St., Richmond, Va.

BARBASOL FOR MODERN SHAVING

It's Like Having YOUR OWN BROADCASTING STATION

MYSTIC MIKE WIRELESS BROADCASTING OUTFIT

THOUSANDS IN USE—EVERYONE RAVES ABOUT ITS BIG-TIME PERFORMANCE
Now! This perfected Mystic Mike Wireless Broadcasting Outfit with its New Sensitive Microphone enables you to do your own broadcasting from any part of your home, office or store, with NO WIRES CONNECTED TO RADIO. Simply plug this Mystic Mike unit into an AC or DC electric socket . . . speak or play music into the microphone, and it will be picked up by ANY RADIO ANYWHERE in the same building. Has variable frequency control for easy radio dialing. Use it for entertaining, auditions, rehearsals, as a public address system . . . in fact it can serve you in hundreds of ways. Order today—**MONEY BACK GUARANTEE** Immediate delivery.

COMPLETE SET with TUBE and MICROPHONE
\$3.95
ADD 13¢ POSTAGE

Write for **OLSON MFG. CO., 362 Wooster Ave., Akron, Ohio**
Bulletin P-11

Tear out this ad, write name and address in margin. Send cash, money order, check—or order C.O.D. We will mail outfit at once.

K 722

80,000 Fledglings for Defense

(Continued from page 645)

"All applicants for the secondary flight course are required to pass the same examination required of applicants for training in the military aviation schools.

"New impetus recently was given the program by associating 1,500 experienced pilots with rated instructors who are gradually teaching pilots of the 'old school' the new methods of instruction. By this method we are greatly expanding our teaching staff. Another development contemplates a refresher course for thousands of pilots whose certificates of competency have elapsed, principally for want of practice.

"Originally we did not intend to 'refresh' more than 5,000 of the pilots formerly licensed or certified. But there have been so many applications for renewed training we have revised this figure upward. Many seek the refresher course because of the new piloting technique developed during the years since they first soloed. In this group are airmen whose training consisted of nothing more than a check pilot who accompanied them, and kept them from getting hurt, while they actually taught themselves to fly. They had no real instruction in acrobatics or other maneuvers."

For every Army and Navy pilot in the air, ten or more trained men on the ground are necessary. The Army Air Corps began training 31,000 enlisted men as mechanics and specialists last July 1. By June 30, 1941, it is estimated that the Air Corps will have 46,000 qualified enlisted specialists, trained at the three Air Corps technical schools and at seven civilian technical schools. The specialists include airplane mechanics, welders, metal workers, radiomen, parachute men, armorers, photographers, engine men, machinists, meteorologists, teletype operators, supply clerks and stenographers. Facilities of the civilian mechanics schools used by the Army Air Corps will be expanded. The Navy trains its own mechanics in its own schools.

No aeronautical engineering training is provided under the Civilian Pilot Training program. Such courses can be obtained at some of the larger colleges and to some extent at certain of the commercial aviation schools. California Institute of Technology, in cooperation with Lockheed Aircraft

(Continued to page 148A)



Motorcycle CAR... TRUCK OWNER

Let KLEANAIR Spark Plug Pump Inflate Your Tires

Just remove a spark plug and connect KLEANAIR; start your motor idling and fill that flat with clean, cool air

This amazing little device has an improved double intake valve which assures adequate clean, cool outside air for your tires.

You will find dozens of uses for KLEANAIR. It can be used with any engine of two or more cylinders, furnishing air for tires, light paint spraying, pressure tanks, air mattresses, etc. It is an indispensable accessory for any motorcycle, car, or truck. In one emergency it may prove worth many times this small cost—

KLEANAIR FOR MOTORCYCLES AND PLEASURE CARS **\$2.00**
(Without Pressure Gauge)

KLEANAIR DELUXE MODEL FOR CARS AND TRUCKS **\$3.50**
(Equipped with Gauge and Heavy Duty Hose for 60 Pounds Pressure)

Car and truck type equipped with 16-ft. hose - Motorcycle, 6-ft. hose

MAIL COUPON TODAY

THEPITT MFG. CO.,
405 Penn Avenue, PITTSBURGH, PA.

Please send me _____ KLEANAIR without pressure gauge \$ _____
post paid, (U.S.A.) _____ KLEANAIR with pressure gauge - \$ _____

Make of { car _____ Year _____
 { truck _____ Year _____
 { motorcycle _____ Year _____

Name _____
Address _____



HANDEE

Tool of 1001 Uses!

A whole tool shop in your hand—finest, fastest, most powerful tool for its weight, 12 oz. Full of thrills for everyone.

Uses 300 accessories to grind, drill, polish, cut, carve, rout, saw, sand, sharpen, engrave, etc. 25,000 r.p.m. Plugs in any socket.

Make gifts, prizes, things for the home or to sell—ship, train, plane or house models, costume jewelry, figurines, those new engraved glass book ends, mirrors, trays, etc., from any metal, alloy, plastic, glass or wood.

ORDER ON 10 DAYS' MONEY-BACK TRIAL
DeLuxe Model Handee (illustrated) with 6 Accessories, \$18.50. Standard Model, 18,000 r. p. m. with 3 Accessories, \$10.75.

FREE—64-PAGE CATALOG
Complete information on Handee Products and their wide application in crafts work and industry all over the world.

CHICAGO WHEEL & MFG. CO.
108 S. Aberdeen St., Chicago, Ill.



SPEEDY SPRAYERS

ONLY \$9.25 FOR THIS 100 % OIL-LESS PAINT SPRAYER!

New Marvel sprayer never needs oiling! Fast, smooth, better, for paint, varnish, enamels, lacquer, insecticides, moth-proofing. Special chuck inflates tires, tool Diaphragm type compressor insures clean oil-free air—only two moving parts. For the home, workshop, schools, small manufacturing. Complete as shown without motor, only \$9.25. With No. 902 gun, only \$7.85.

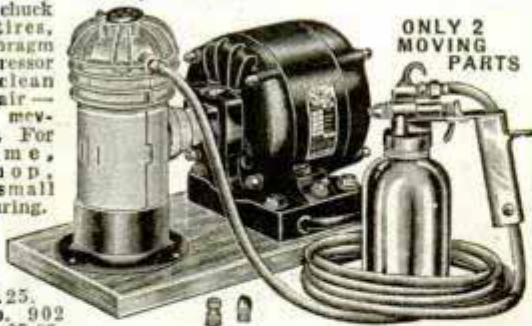

Send for FREE illustrated booklet of PORTABLE, PRACTICAL, LOW COST SPEEDY PAINT SPRAYERS

DEALERS: Send for catalog, price list and discounts on Speedy electric and auto-power paint sprayers.

W. R. BROWN CORPORATION

5726 Armitage Ave., Chicago, Ill., U. S. A.

Corporation, has a course which will prepare men for work in the industry within eight weeks. Following this college course, the men get an additional eight weeks' training in the factory before they are permitted to join the engineering department. The course is open to general engineers who have a sound background and foundation upon which aeronautical training can be based. These men are paid while they learn and are guaranteed jobs upon completion of the course.

Glenn L. Martin Company, another manufacturer of airplanes, has inaugurated a training school. Curricula include blueprint reading, drafting, engineering procedure, lettering, standard aeronautical practices and nomenclature and studies of handbooks and textbooks on Martin methods. Lectures deal with all phases of work the men will do when they are admitted as regular members of the engineering staff.

This course dovetails with a shop training course in the engineering department. The new engineers are sent into the factory for a time to learn the machine and craft operations. Transferred from one department to another, they do the actual work of building airplane parts and helping to assemble them. The students are on full pay while they attend school.

Training for aviation mechanics is available at approved commercial aviation schools and some 200 public schools in sixty-eight cities offer approved aviation ground courses.

Mantel Clock in Airplane Design Has Molded Plastic Case

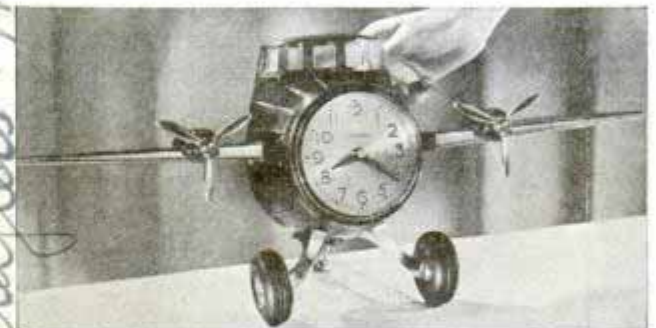

Subtly reminding you that "time flies," an electric clock is built like a model airplane. Each silvery wing houses a tiny engine and propeller. Rubber-tired wheels complete the model, aiding also in protection of polished table or mantel.

216 N. Clinton

POPULAR MECHANICS

WE WILL HELP YOU
Get this New
1000-SHOT RED RYDER CARBINE
for CHRISTMAS

Write for **FREE** CHRISTMAS "REMINDER" KIT!
Send for Free "Reminder" Kit now enclosing 3¢ stamp to cover our postage-handling charge. KIT is fun to use. It will help you get a DAISY for Christmas! Hurry. (Catalog Free on request)

DAISY AIR RIFLES \$2.95

DAISY MANUFACTURING COMPANY
5411 Union St., Plymouth, Michigan, U.S.A.

Big EARNINGS

WITH STUCCO SPRAYING MACHINE

It fuses a plastic mixture to any masonry surface. It water-proofs and fills all cracks. It can be applied in any thickness desired and in 30 colors. Fully proven by over thirteen years actual use under all conditions and every climate.

BIG EARNINGS. Operators report costs of 2c and up per sq. ft. and sell up to 7c. Machine covering capacity up to 1000 sq. ft. per hour soon pays for itself. Make money by supplying the big waiting market for renewing both old and new buildings with permanent color at low cost.

Get the facts. Send for books, "Proven Business Opportunity." Write today.

COLORCRETE INDUSTRIES, INC.
570 Ottawa Ave. Holland, Michigan

WORLD'S LOWEST PRICED ADDING MACHINE

IDEAL FOR BUSINESS OR PERSONAL USE
GUARANTEED ACCURATE. Not a toy. Operates with only a finger flick. Adds, subtracts, multiplies, divides. Counts up to ten million. Pays for itself over and over. Ideal Gift—for Business, Income Tax and School use. **MONEY BACK GUARANTEE.** Send name and address. Pay postman only \$2.50 plus postage. (Send full cash if outside U.S.) Money back in 10 days if not delighted. **AGENTS WRITE.**

ONLY \$2.50

TOTAL COST SEND NO MONEY

WORLD'S LOWEST PRICED ADDING MACHINE

ADDITION
SUBTRACTION
MULTIPLICATION
DIVISION

CALCULATOR MACHINE CO. (Mrs.) DEPT. 111, P. O. BOX 1118, CHICAGO, ILL.

**Powerful
DOUBLE-LEVER Action
LOCKS Jaws to Work
with TON-Grip!**



**WISE-GRIP
WRENCH**

Easy to Adjust

Stays Adjusted

"Double-Lever" Action Does It!

World's most powerful hand-tool! Unique "Double-Lever" Action enables the grip of one hand to close the jaws with TERRIFIC, Non-Slip Pressure! Jaws LOCK to the work—remain locked with hands removed. Adjusts exactly to size, stays adjusted. NEVER SLIPS! No lost motion. Does more things than any other hand tool, "Impossible" jobs made easy. Is perfect hand-vise to hold small work for filing, grinding, sawing, drilling. Scores other uses. Is actually a portable Vise, Clamp, Super-Plier, Pipe-Wrench, Open-End Wrench, Locking Wrench, Toggle Press—ALL IN ONE! Holds anything, round, square or otherwise. Works in close quarters, at any angle. Adjustable to ratchet-like or super-plier action. Light, trim, handsome. Finest alloy tool steel. Nickel finish. Order from your dealer. Or, send name, address and size wanted. Pay postman regular price plus few cents postage—10" size, \$1.95; 7" size, \$1.65; Money back if not pleased. Order Today. Free folder.

PETERSEN MFG. COMPANY Dept. PM-11 DeWitt, Nebr.



**ELECTRIC EYE
ANNUNCIATOR AND
BURGLAR ALARM**

STORES, Homes, Taverns, Shops, Garages—scores of others—waiting for the RAY-ALARM Burglar Alarm and Annunciator. Real protection—guards against intrusions. Invisible beam of "Black Light," when interrupted, sounds continuous alarm. Plugs in any light socket. Unfailing demonstration takes 10 seconds—makes sales on the spot.

SEND NAME Huge profits. Write AT ONCE for particulars of Distributor Plan or Agent proposition. No money. Just send name.
RAY-ALARM, 225 Fifth St., Dept. R-1611, Des Moines, Iowa

LIGHTS ITSELF

SELLS ITSELF
Quick Action (1940) Perfected Self Starting Lighter
Lights cigar, cigarette or pipe—Instantly. Never fails. IMPROVED PRINCIPLE IN IGNITION. No flint. No friction. Send 25c for sample and large can of fluid Start now. Agents report big earnings.
NEW METHOD MFG. CO.
Box PMD-95 Bradford, Pa., U.S.A.



SAVE 1/2 ON WELDING OUTFITS

Heavy-duty Welding Outfits, \$28.73 to \$63.34; Heavy-duty Welding Torches, \$11.52; Sheet Metal & Airplane Torches, \$8.08; Heavy-duty Arc Welders, \$39.90 to \$90.00; Regulators with gauges, \$8.98. Superior Machine Company, Hamilton, Ohio.

TOMBSTONES \$9 UP Freight Paid

Genuine Marble & Granite at Low Prices. Lettered. Guaranteed. Free Catalog and samples. Write Us before buying.
U. S. MARBLE & GRANITE CO., A-18, Oneco, Fla.

Choose from World's Largest Line of Power Tools!

FREE New 1940 Catalog covers Metal and Woodworking Tools, accessories, motors for every purse. Write Walker-Turner Co., Inc., 1110 South Ave., Plainfield, N. J.
DRIVER Engineered POWER TOOLS

BUILD ARC WELDER FROM OLD GENERATOR

For Light or Heavy Work. 75-200 amperes. Complete PLANS and valuable catalog 35c. Over 900 Electrical Supply Bargains. LeJay Mfg. Co., 1347 LeJay Building, Minneapolis, Minnesota

SAVE 60% OR MORE BY assembling your FLUORESCENT FIXTURES

UTILITY LIGHT COMPLETE KIT \$1.95
BULB 75c Extra plus postage
Beautiful bronze finish with white enamel reflectors
Anyone can assemble. Complete instructions furnished. All metal parts beautifully finished. Newest starter type electrical equipment fully guaranteed by us.
New shadowless, glareless light everyone is talking about, recognized as the greatest improvement in lighting since Edison discovered the electric lamp, can now be yours at a fraction of the regular cost. Your fluorescent light will give you twice the light of your incandescent bulb with less eye-strain while using only one-half the electricity. This will enable you to cut your light bill in two.
NATIONAL FLUORESCENT SALES AND SERVICE COMPANY
404 North Wells Street Chicago, Illinois

SHELDON
Back Geared Screw Cutting PRECISION LATHES \$108
F. O. B. CHICAGO

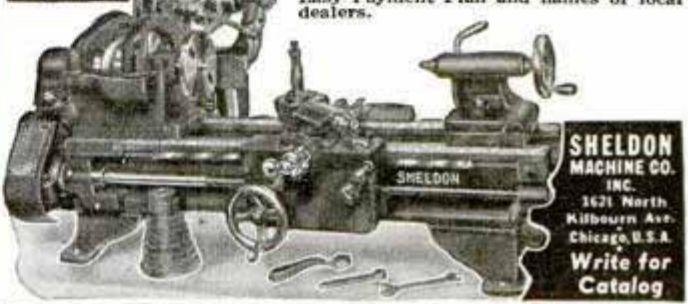

The SHELDON "METALWORKER" is a sturdy, full sized, full weight, back geared, screw cutting, 10" precision lathe, built to industrial standards with hob-cut change gears, heat treated and ground spindle, hand scraped V-way, etc., etc. 10 1/4" swing, 1 1/16" hole thru spindle, 20" center distance, 38" bed, complete with compound rest, tool post, change gears, face plate, centers and wrenches (as illustrated), less motor drive \$108.00 F. O. B. Chicago. Write for FREE Bulletin on Sheldon Lathes, drives, attachments and tools. Easy Payment Plan and names of local dealers.

SHELDON MACHINE CO. INC.
1621 North Millbourn Ave. Chicago, U.S.A.
Write for Catalog

Get a Genuine MOTO-TOOL 100 TOOLS in ONE

Grinds, polishes, sharpens, drills, engraves, etc. Saves time, cuts cost. Handiest tool in home or shop... use it daily. Same tool as used on precision jobs in factories.
OVER 25,000 R. P. M. High speed conserves Has oil-less (oil-sealed) bearings, cooling fan, balanced armature, 110 V. (AC-DC) MODEL 1 MOTO-TOOL with chuck, 1/8" collet, only \$9.85. MASTER MODEL 2, 27,000 r.p.m., heavier, more powerful, only \$16.50. 10-DAY TRIAL. See the genuine DREMEL MOTO-TOOLS at better Dealer's or order direct from factory on 10-day money-back trial. Catalog of Dremel tools, equipment and special combination offers, FREE.
Dremel Mfg. Co., Dept. 110-L, Racine, Wis.

PROJECT BOOK
Big 24-page book shows how to make 41 plastic projects. Sent postpaid for only \$1.

HOLD-E-ZEE AUTOMATIC GRIP SCREWDRIVERS

Hold, start and set-up screws in unhandy places. Gripper instantly released by spring action, sliding up out of way when not in use. Finest materials thru-out, chrome vanadium blades; many have transparent, insulating unbreakable handles. (Illustrated.)
No more expensive than ordinary screw drivers. Models for recessed-head screws. Handiest ever. Get one today. At auto-supply, hardware or electrical stores.
UPSON BROS., INC. 86 EXCHANGE ST. ROCHESTER, N. Y.

Modern wall and ceiling fixture.

Complete kit \$2.75
BULB 75 cents extra plus postage
Polished metal end caps. White enamel body. Price includes switch

3 Sizes
\$5.95
10.95
12.50



SYNCR O JIG SAWS

The Ideal Gift

Working tools to gladden the heart of any man or youth who enjoys the thrill of useful construction.

Make model boats, maps, plaques, puzzles, household novelties; any kind of scrollwork, marquetry or inlay. For model builders, cabinet workers, sign builders, hobbyists, home furniture builders. Cut fast, with smooth edges. Electro magnetic powered, requiring no motor. Is safe, efficient, economical. Delivers 7200 cutting strokes per minute. Plugs into light socket. No rotating parts. No oiling. Accidental injury practically impossible. Handles veneer, plywood, bakelite, masonite, as well as wood. Throat clearances of models 8", 13 1/2", 16". Sold by your favorite dealer.

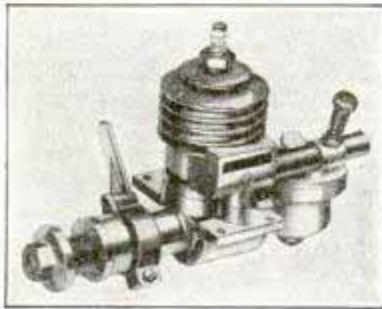

Syncro B30

SYNCR O MINIATURE GAS ENGINES

Develop 1/7-1/6 HP. 700-15000 RPMs. Bore 3/8". Stroke 3/8". Displacement .292. Weight 5 1/2 oz. Positive set carburetion. No timer points to set or adjust. 3 Piston rings. Force-feed \$6.95 lubrication....

Send for Catalog A40

SYNCR O DEVICES INC. 747 BEAUBIEN ST. DETROIT

PAINT STRIPING TOOL

As Easy to Use as a Pencil!

With this new low priced TOOL (not a brush) you can now do professional striping—on furniture, autos, models, tiled walls,



toys, boats—and all home workshop projects. Tool uses paint, enamel, lacquer, etc. Thousands of satisfied users in homes, workshops, garages, furniture stores, etc. (We also make commercial and industrial models.) Send only \$1.00 for complete tool with gravity feed container, 1/16" striping wheel, adjustable guide, operating instructions, etc. Sold on Money Back Guarantee. Narrower or wider stripe widths available. Write today for free literature.

Dealers: Write for catalog, prices and discounts.

WENDELL MFG. CO.

2500 N. Ashland Ave. Chicago, Ill.

ONLY
\$1.00
POST
PAID



8 MILE RANGE-WIDE VISION BINOCULARS

15 Days Free Trial
Postpaid or C.O.D. \$6.75

Comes complete with case and straps. Well ground powerful lens. Easily focused for all distances and eye widths. Latest features. Ideal all-weather binoculars. Guaranteed. If not satisfied after 15 days' trial money refunded. Agents Wanted, Vogue Binocular Co., 8420 S. Ashland Ave., Dept. 108, Chicago

ACE LATHE TOOL SET

\$14.50



Be permanently toolled-up
for every operation
on your Metal Cutting Lathe

The ACE Set is complete—there's nothing more to buy. Drop forged by the manufacturers of cutting tools used by 96 per cent of the plants and shops in industry, they are correctly designed, are of special steel, are finely finished, are stronger—will last a lifetime. You can cut easier, faster and more accurately with ACE TOOLS.

At your Hardware Store—Circular FREE.

ARMSTRONG BROS. TOOL CO.

"The Tool Holder People"

368 N. Francisco Ave., CHICAGO, U.S.A.

3 Turning
Tools, 2 Cutting
off Tools, Knurling
Tool, Boring Tool
Threading Tool, High
Speed Steel Cutters and
Blades, and 2 Wrenches
in Fitted Steel Case.

Fighting Forest Fires from the Air

(Continued from page 651)

and in emergencies. On any sizable blaze, when headquarters are set up, a fully equipped portable kitchen goes along, and the Forest Service has on call cooks who can handle from a dozen to a hundred men. Fire fighters, like soldiers, live on their stomachs.

This year in the Wenatchee Forest, a group of 300 ranchers, loggers and other people living in the forest have been trained in fire control. They are ready for duty at any time, in addition to special CCC crews who have been trained also and equipped to stay at least three days on the fire front without additional supplies. Sleeping bags, rations and tools for 400 men are stored in a centrally located warehouse.

Once each year, at the beginning of fire season, fire-fighting schools are conducted. Here actual fire-control methods are tested under actual conditions. Old hands and new recruits take to the brush. A camp is set up to handle a hundred men. Fires are built and men put them out by regulation methods. They load packs on backs, and tools in kits. They climb mountains and locate smokes. They carry on radio communication, and work out orientation and compass problems.

Even a small fire may spread destructively. Therefore care with fire, matches and burning tobacco is the first rule observed by every good woodsman.

One new procedure by which the effectiveness of a fire-fighting crew has been greatly speeded up is the "one-lick" method. Briefly, the method provides for three crews—clearing, digging, and patrol—which follow in that order in single file. Each man, provided with the proper tool, makes one stroke and steps on. As the crews progress, the fire line rapidly takes form and is complete when a man is dropped by the patrol crew to patrol that section of the constructed line.

By following this method, the U. S. Forest Service has been able to use its manpower and equipment more effectively on forest fires.

Send stamped, addressed envelope to our Bureau of Information for name of maker of any device described in this magazine.

R39
**Floodlight Installed over the Sink
 Throws Light Where Needed**

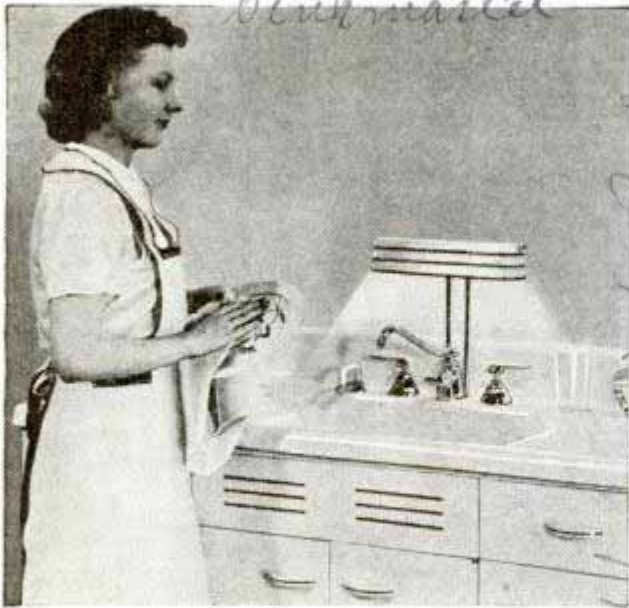

Submaster
Sumner rule info to buyers
Mounted on a pedestal at the back of the sink, this lamp sheds light downward just where it is needed

Dishwashing is easier when there is plenty of light. A new sink unit has a floodlight mounted on posts at the back, casting light downward exactly where it is needed. The sink fixtures and its cabinet have white plastic handles.

K627
**Flowers Hung in Picture Frame
 Form Living Floral "Print"**

Living floral pictures are a novel decorative idea just introduced. Inside an oval picture frame is a small vase resting on a shelf. Fresh cut flowers are placed in the vase; thus framed, they form a "floral print" that can be changed as desired. There are two types of frames, one for wall hanging and another for table use.

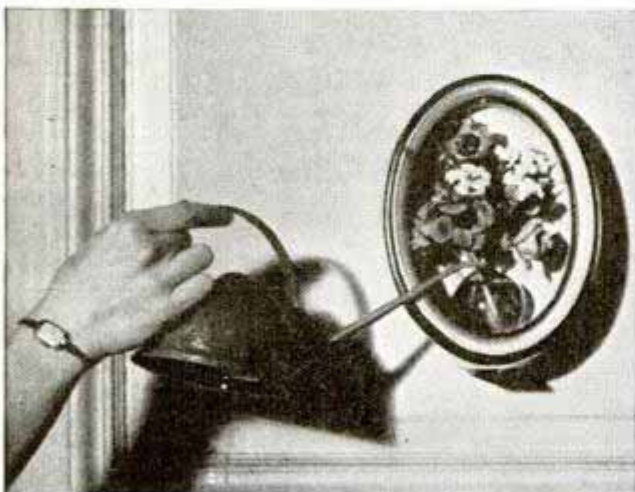

Watering a floral picture seems a bit unusual, but in this case it's all right for the flowers are real

**Greatest Hobby
 on Earth**



**Now More Exciting
 Than Ever!**

Breath-taking, new action features developed and perfected by Lionel. New, electrically operated Bascule Bridge that opens at the touch of a button. Electric Magnet Crane that loads and unloads metal scrap. New thrilling scale model Freight Cars with sprung trucks. New train combinations. New colors. New styles. New thrills and excitement for model railroaders.

SEND FOR THIS BIG, 64-PAGE COLOR CATALOG

Page after page shows cars coupling and uncoupling automatically, whistling, reversing, doing everything that real trains do. Send for your copy today! Enclose 10 cents to cover postage and handling.

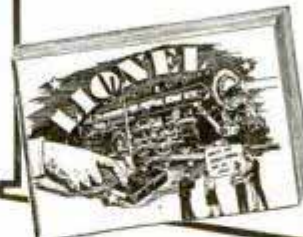

LIONEL

LIONEL, Dept. 37, 15 E. 26th St., New York, N. Y.
 Enclosed is 10 cents in coin or stamps. Please send me a copy of the new Lionel 64-Page Color Catalog.

NAME.....
 ADDRESS.....
 CITY.....STATE.....

*Lord and Taylor's Dept. Store
 5th Ave and 38th*



DOENUT WHEELS with Outside Valves

These new wheels wear longer, ride easier, prevent jolting and spillage. Developed by Musselman, the inventor of the airwheel for airplanes. No matter how carelessly tire is allowed to run under-inflated, valve cannot be cut or damaged by "creeping".

Three sizes—10" x 2.75"; 12" x 3.30"; 16" x 4.40". Unless you are a rated manufacturer, enclose 10c postage in writing for literature.

For boys wishing to build wheelbarrows, wagons, scooters or bicycle trailers, we supply blue prints at 25c each.

MUSSELMAN PRODUCTS CO.
6225-W ST. CLAIR AVE. CLEVELAND, OHIO

Biggest Photo Values!

In all photography you'll find no bigger camera or equipment values than those in the new Lafayette Camera catalog. For here all the leading, nationally-advertised names in photography combine with Lafayette astonishingly low prices to spell VALUE. Lafayette's tremendous buying power brings you your favorite-name equipment at a big saving. And you can order everything from this one complete, reliable, economical source. Send for free copy of Lafayette Catalog No. 81 today.

**FREE
Catalog**

*Lafayette
Camera*

DEPT. 7LC — 100 SIXTH AVENUE, NEW YORK, N. Y.

ARCADE POWER TOOLS



Drill Press, \$5.30; Disc Sander, \$5.00; Jig Saw, \$5.30 and \$22.50; Belt Sander, \$8.00; Shaper, \$16.50 and \$20.50; Lathe, \$9.50; Band Saw, \$18.00; Bench Saw, \$11.00 and \$22.50. In far west slightly higher. Other Tools and Model Makers. Dealer or direct. FREE CATALOG. ARCADE MFG CO., 1219 Shawnee St., Freeport, Illinois.

QUALITY AT LOW COST

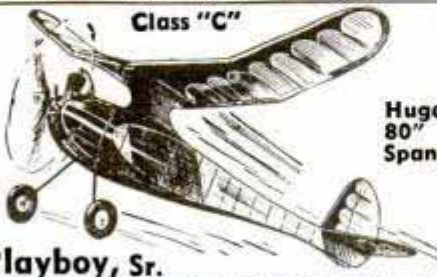

PHOTO ENLARGEMENTS

Is Photography your hobby? Do you want a profitable easy business at home? Make PHOTO ENLARGEMENTS for yourself and others. Your cost 5c each and less. The Ideal Photo Enlarger is AUTOMATIC. No experience required. Also COPIES any picture, \$5.94 COMPLETE. Interesting circular FREE. Ideal-O, 148 West 23rd St., New York City

**5¢
ANY
SIZE**

Build the
Gas Model
that "Broke
the World's Record
Twice in One Week"



Huge
80"
Span

Cleveland Playboy, Sr.

It's a real champion! Bill Schwab of Cleveland broke the world's record twice in one week with his. Others winning contests, "in the money", regularly. Get yours now. Complete Kit GP-5017 \$3.95 (except power unit) only.

Playboy Jr. Class "B". Span 46". Complete Kit GP-5006 \$2.50 (except power unit) only.

Baby Playboy. (Class A). Can be flown either gas or rubber. Span 33". Complete Kit GP-5008 (except power unit) \$1.00 only.

BIG Catalog of "America's FIRST LINE of Models"—gas, rubber, scale, Gliders, Race Cars, Engines, RRs, etc.—and all supplies. Send name, address and 10c (none free).

CLEVELAND MODEL & SUPPLY CO., 4508D115 Lorain Ave., Cleveland, Ohio

AMAZING PERFORMERS NEW MONEY-MAKERS

FIFEL-GEARED PIERRENCH KIT-7" & 8 1/2"



"Pocket Machine Shops" that do the work of \$50 worth of other tools. Amazingly Quicker, Better, Easier!

• Now of ALLOY Steel—65% Stronger! • NEW PLANT.. Quadrupled Capacity.

• Now have your Own Business in a New Selling Case. Full-time men making \$1,500 to \$4,000 Yearly.. Part-timers in proportion. We need Many More!



NEW FREE



Bottle-Cap Opener, etc.

Mail Your Address Today (on a post card will do) Get FREE—this 6-Edge End-&-Angle Screw-driver and 101-Picture Manual of Mechanics, with... User Offers: or, with... DISTRIBUTOR, Territory, Demo, and SELLING Kit Offers!

AMERICAN PIERRENCH CORP. PMY-4611 N. RAVENSWOOD AV. CHICAGO, ILL.

BRONZE FOUNDRY

Schools
Home
WORKSHOPS

Sand Casting—Forging—Heat Treating—Case Hardening

Make your own castings of aluminum, copper, bronze, silver. Foundry sets are available in three sizes including 2400 Deg. F. blas' Furnaces. \$13.50, \$19.00, \$27.50, f.o.b. Kansas City. Free Circular.

KANSAS CITY SPECIALTIES CO.

P. O. Box 6022, Dept. P-10 Kansas City, Mo.

BUILD THE DESTROYER PRESTON

CARVED HULL

Complete Kit
\$2.50
Post Paid

Makes perfect building easy



Included!
24" Super Detail Model

Catalog—10c

IDEAL AEROPLANE & SUPPLY CO., Inc., 26 W. 19 St., New York

Class Pins and Rings

Artistic pins, rings and emblems for classes and clubs. Attractive prices 30c up. Finest quality, gold plated, silver, etc. Over 300 designs.

Dept. N, METAL ARTS CO., Inc., Rochester, N. Y.

FREE CATALOG



RELIABLE MEN

Wanted to operate movie circuits in theatreless communities. Earn \$50.00 to \$100.00 weekly. No experience necessary. Everything furnished. Write Southern Visual, Dept. PM-11-2, Box 2404, Memphis, Tenn.

110-VOLT AC LIGHT PLANTS

& Generators same as city current, 110-220, 2 or 3 wire, 25, 50 or 60 cycles. Rotary converters for changing DC to AC, frequency changers, Diesel plants, DC motors with AC take-off. Write to KATOLIGHT, 12 Elm St., Mankato, Minn., U.S.A.

BUILD THESE PROJECTS

For garden or lawn. Easy to build. Easy to sell. Detailed Blueprints Model B-25 Dutch Windmill 50c; Model GM-60 Old Mill, 85c. Lawn Figure Patterns—Sunbonnet Girl, Dutch Boy, Tulip Girl, Holland Pair, 35c each, all 4—\$1.00. Catalog illustrating many models, send 10c, today.

CRAFTSMAN'S MODEL CO., Dept. P-46, 2030 N. 41st St., Milwaukee, Wis.

BRUSH PLATING OUTFITS

for autoparts, reflectors, faucets, bicycles. No tanks necessary. Free particulars. GUNMETAL CO., AVE. M, DECATUR, ILLINOIS

TRAILER BUILDERS' GUIDE & CATALOG only 10c

Build a Trailer easily in spare time with world's best line of trailer parts, axles, hitches. Complete working blue prints only 50c. Universal Draw Bar, readily attached to any car. SEND 10c TODAY FOR CATALOG.

HAMMER BLOW TOOL COMPANY, Dept. 111, Wausau, Wis.

Earn Cash at Home!

We paid M. M. \$1174 for exceptional cellar crop Snow-King mushrooms! We furnish materials; buy all crops. Big FREE picture book tells if your cellar, shed, barn, suitable. Est. 1908. Write today. United Co., 3848 Lincoln Av., Dept. 307, Chicago

RAILROAD FANS

Send for FREE 48-page illustrated book on spectacular American Flyer Scale Model Trains and Equipment. AMERICAN FLYER TRAINS, 422 Erector Square, New Haven, Conn.

When writing please mention Popular Mechanics



SAFE!

NEW DISCOVERY

**For WORMING Your Puppy or Dog
Without Danger of TOXIC POISONING!**

Thanks to the NEW Glover's *Imperial* Capsules, the danger of toxic poisoning and violent after-effects from worming your pet is at last removed. This was never before possible in a worm medicine! They not only safely expel Round Worms (Ascarids) and Hook Worms, but also Whip Worms—all THREE! Think of the ECONOMY—only 25¢!

FREE DOG BOOK—Write Glover's,
Dept. 15, 460-4th Ave., New York.

ONLY
25¢

GLOVER'S
Imperial CAPSULES

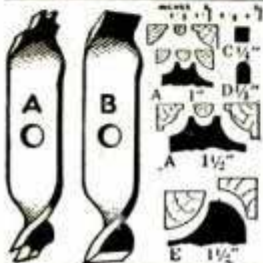

Use Your Bench Saw for Jointing
and Cutting Mouldings

ATTACH THESE SIX INCH TOOL STEEL CUTTERS IN PLACE OF SAW CUT DESIGNS SHOWN AND MANY OTHERS. Moulding Cutters A1" \$1.25, A1 1/4" \$1.50. Jointing Cutters B1" \$1.25, B1 1/2" \$1.50. Groove Cutters C or D 3/8", 1/2" or 3/4" \$1.25 Each. Cove and Quarter Cutters, E1" \$1.25, E1 1/4" (MAKES 3/4" STOCK) \$1.50.

STATE SIZE HOLE. POSTPAID
John A. Sandstrom, Box 317, Stow, N.Y.

UNBREAKABLE FLASHLIGHT

Handy as a fountain pen. Clips on pocket. Drop tools on it, step on it, let fall on cement floor. You can't break it. Solid copper case with baked bronze enamel finish—guaranteed for life. A necessity to every mechanic. Complete with battery. Your name etched on case to prevent loss, only 25c extra. Order direct. Send no money. Pay postman \$1 plus few cents postage on delivery, or \$1.25 with name. We pay postage on cash orders.



Rush
Your
Order to
**STREAMLITE
COMPANY**
3760 Main Ave.,
Dept. PM-11,
Norwood,
Ohio

Say you saw it in

POPULAR MECHANICS

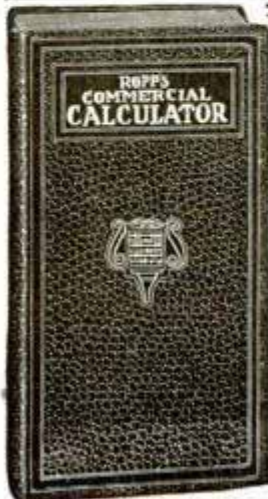

Mathematics Made Easy by
ROPP'S CALCULATOR
AND SHORT-CUT ARITHMETIC

Shows the Answer as Quickly as a Watch shows the Time to all Problems likely to occur in the Office, Store, Shop, Bank, Farm, or Factory.

Over 2,000,000 Sold
Explains and simplifies every principle in Arithmetic, Mechanics, and Mensuration.

PRICES POSTPAID
Desk Size, Flexible Keratol Binding... \$2.00
Pocket Size, Art Leather Binding... \$1.00
Pocket Size, Cloth Binding... \$0.50

POPULAR MECHANICS PRESS
Dept. 1140 200 E. Ontario St. Chicago



I'LL TAKE
THE
WHITE
ONE EVERY
TIME

WYTEFACE
EASY TO READ

Easy to read—unconditionally guaranteed. The crack-proof white surface is bonded to the steel—protects it from rust. Favorite Wyteface is easy to clean, hard to kink, durable. 25, 50, 75 and 100 ft. lengths. Mail coupon today for free sample of the line and illustrated folder

**K&E
FAVORITE WYTEFACE**
STEEL MEASURING TAPES

LOOK
FOR
THIS
DISPLAY



KEUFFEL & ESSER CO., Est. 1867
Dept. 124, Hoboken, N. J.

Name.....
Address.....
City..... State.....



WHEN DID HE
SAY TO CALL?

WHEN IS
THAT MEETING?

HOW MUCH
DID I QUOTE?

WHAT WAS THAT
NUMBER?

WHEN IS THAT
NOTE DUE?

WHEN IS HER
BIRTHDAY?

WHY DON'T I GET MORE BUSINESS?

WHY go through life forgetting the simple but important business and social details which mean the difference between success and failure . . . when for less than the cost of a couple of neckties you can have an efficient, simple method of organizing your affairs so you can't forget? If you want to be more efficient, more successful, make more money, write at once for full details of the famous



Mem Index System—the Automatic Memory on Cards that won't let you forget. Leather POCKET CASE for daily memos and temporary data—DESK UNIT for permanent records. Handy dated and otherwise indexed cards fit both—no transcribing. Used by thousands of successful business and professional people and U. S. Gov't. depts.

Free Dated Cards for the remainder of 1940 with all orders for 1941 **Mem Index**.

WILSON MEM INDEX CO., 172 St. Paul St., Rochester, N. Y.

Write for **FREE BOOKLET** "Memory on Cards"

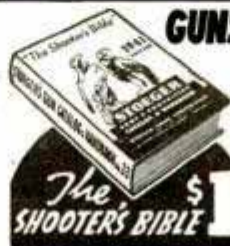

GUNSMITHING for PLEASURE or PROFIT!

WORLD'S GREATEST GUN CATALOG!
Stoeger's 1941 Edition. Only complete gun tool section for amateur and professional finest hand tools. All American—most imported Guns, Accessories, LATEST REVISIONS & PRICES. Ballistics, Restocking, Reloading All Gun Parts, Stocks, Barrels, Targets, Shooter's Articles; etc. Send a Dollar Bill, check, coin, or stamps for this 512 Page Volume

**512
PAGES
17,000
ITEMS
6,000
PICTURES**

The **SHOOTER'S BIBLE** \$1

STOEGER ARMS CORP.
507 FIFTH AVE. (at 42nd St.) NEW YORK, N. Y.

MAKE BIG MONEY

At Home! New Invention Electroplates by Brush

Plates
GOLD
SILVER
COPPER
TIN
CADMIUM
NICKEL

Easy as
painting

No Tanks, Liquids, Generators
DOES SAME WORK AS BIG OUTFITS
Millions of old auto-parts, and all kinds of old, worn articles in homes, stores, offices, factories everywhere can now be electroplated with a permanent brand-new sparkling coat of metal—by electrolysis—with the stroke of a brush. Easy as painting—no dismantling—plates right on the spot. Any electric light socket or car battery. Weighs only a few pounds. Take it anywhere—ready for instant use.

Quick, Easy Way to Start Your Own Business

MAKE BIG PROFITS AT ONCE
Amazing low price and magic-like demonstration brings you thousands of orders for plating from garages, radio shops, bicycle shops, machine shops, home work shops, factories, offices, janitors, doctors, dentists, jewelers and farmers, homes, stores, etc.—with big profits for you! List of plating charges furnished; also reports of remarkable daily earnings.

**2-MINUTE DEMONSTRATION
WITH SAMPLE AMAZES EVERYBODY**
Send today for FREE Sample and amazing profit details and bona fide reports of big steady earnings! Also, 3-way proven sure money-making plan. Get started at once on this permanent, profitable business. No competition. Simply mail name on penny post card—NOW! Be the exclusive Warner Nu-Way Electroplater in your community.

WARNER ELECTRIC COMPANY
Dept. 5-G, 360 N. Michigan Ave., Chicago, Ill.

**FREE
SAMPLE
PROVES
CLAIMS**

NEWEST TYPELESS PRINTER

\$16.95
Complete



Amazing brand new, heavier model PRINT-O-PRESS, with smoother working features. Compares with costliest stencil duplicators. Full legal size. Also other models at equally low prices. FREE Details and Samples of work. User-Agents Write.

PROFESSIONAL PRODUCTS CORP.
Dept. 1110, Silvertown, Cincinnati, O.

POWER from SMALL STREAMS

DEVELOPS UP TO 7 H.P.



Put water to work. The new No. 440 Brook Hydro-Electric Plant is amazingly simple and inexpensive. Will provide electricity for lights, pumping water, radio, etc. Most economical turbine water wheel made. Write for bulletin.

BROOK WATER WHEEL CO. WATER ST. ORANGE, MASS.

"Trolley" Holds Electric Cord Out of the Way of the Iron



Vertical arms that bend as the iron moves keep the electric cord out of the way

Spring-mounted, a "trolley arm" for the ironing board keeps the electric cord high and out of the way of the iron. The trolley slips easily onto the edge of the ironing board, and is held firm by a clamp spring. Retrieving springs let the vertical arms bend with movement of the iron.

Hydraulic Brake for Bicycles Controlled by Hand

Little effort is required to stop a bicycle equipped with a hydraulic brake patented recently. A quarter turn of the control, mounted on the handle bar at the right, stops the bike smoothly and surely, according to the inventor.

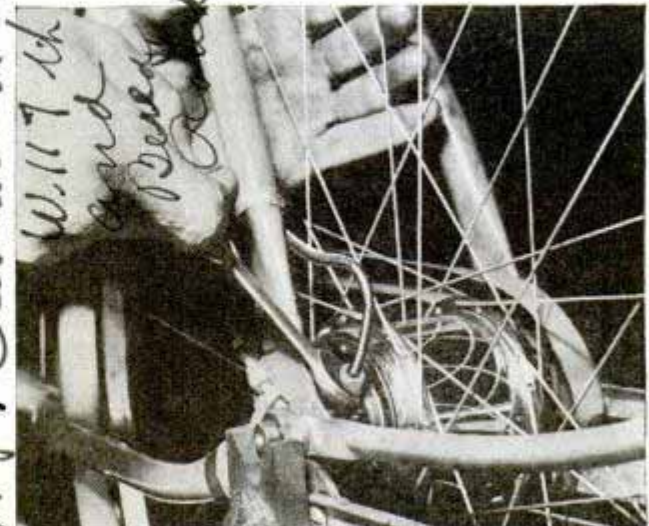

Close-up view of the brake drum and hydraulic feed line of new hydraulic brake installed on bicycle

1/3 MFRS. ORIG. PRICE

GENUINE Late Model No. 8

L.C. SMITH

was \$102.50

NOW

\$31.85
CASH

While 297 Last!

or Buy on EASIEST TERMS

Buy direct from us at 1/3 mfrs. orig. price and save over \$70.00! Beautifully rebuilt and unconditional 2 yr. guarantee. No down payment necessary—10 day Trial. *Hurry — only 297 at this price!*

only 60¢ a week



EXTRA VALUE

ROLL-A-WAY SECRETARIAL TYPEWRITER STAND

For those who have no typewriter stand or handy place to use a typewriter, I make this special offer. This attractive stand that ordinarily sells for \$4.85 can be yours for only \$2.00 extra added to your account. *Quality built. Just note all its convenient features. (See coupon)*



Mounted on casters, can be moved by touch of finger.

Big working surface, all metal, compact, strong, quiet, rigid, attractive. Two metal wings, correct working height.

FREE

COMPLETE TOUCH TYPING COURSE

We give FREE with your L. C. Smith a complete 9 lesson Home Study course of Famous Van Zandt Touch Typing system. You can now learn typing quickly and easily.

Offer for Limited Time—Send Coupon Today

Accept this wide open offer now! Send no money. Use L. C. Smith for 10 day trial in your home. Return it if you don't think it the greatest value you have ever seen. If you buy, pay on easiest terms—only \$2.50 a month. 2 yr. ironclad guarantee. Avoid disappointment—mail coupon today.

MAIL THIS COUPON

INTERNATIONAL TYPEWRITER EXCHANGE,
Dept. 1101, 231 W. Monroe St., Chicago, Ill.

Send me L. C. Smith (F.O.B. Chicago) for 10 days' trial. If I keep it I will pay \$2.50 per month until easy term price (\$35.85) is paid. If I am not satisfied I can return it express collect.
 10" carriage 14" carriage (\$3.00 extra) 18" carriage (\$5.00 extra)
 Check for typewriter stand (\$2.00 extra). Stand sent on receipt of first payment on L. C. Smith.

Name..... Age.....

Address.....

City..... State.....

CAUTION—For Quick Shipment Give Occupation and Reference

OVER 200,000 SATISFIED CUSTOMERS ALL OVER THE WORLD

**NO MONEY DOWN
10 DAYS TRIAL
Easy Terms—9c a day**

No obligation. Send no money. See before you buy on wide-open 10 day Trial. Pay on easiest terms—only 9c a day. You get this genuine late office model L. C. Smith beautifully rebuilt with all standard improvements—basket shift, standard 84 character, 4-row keyboard, shift lock key, back spacer, 2 color ribbon, ribbon reverse, stencil cutting device, tabulator, etc. Ball Bearing throughout—quiet operation. THOUSANDS PAID \$102.50—IT'S YOURS FOR ONLY \$31.85 (CASH PRICE). No risk, money back guarantee.

2 YEAR GUARANTEE

Our 2 year ironclad guarantee is your assurance of satisfaction and long service! Our 30 years of Dealing Backs This Guarantee.

IDEAL FOR HOME OR OFFICE

This late L. C. Smith with basket shift is the machine used by schools, large corporations and business houses the country over. The perfect, all-purpose typewriter for correspondence, office work, billing, manifold work, etc. Has all modern improvements you need, stands hard service—IT'S YOURS AT \$2.50 A MONTH!

WIDE CARRIAGE MODELS

Carriage L. C. Smiths for government reports, office forms, billing, etc. The 14 inch carriage takes paper 14" wide, has 12" writing line—\$3.00 extra with order. The 18" takes 18" wide has 16" writing line—only \$5.00 with order. (See coupon)

INTERNATIONAL TYPEWRITER EXCHANGE
231 West Monroe Street Dept 1101 Chicago, Illinois

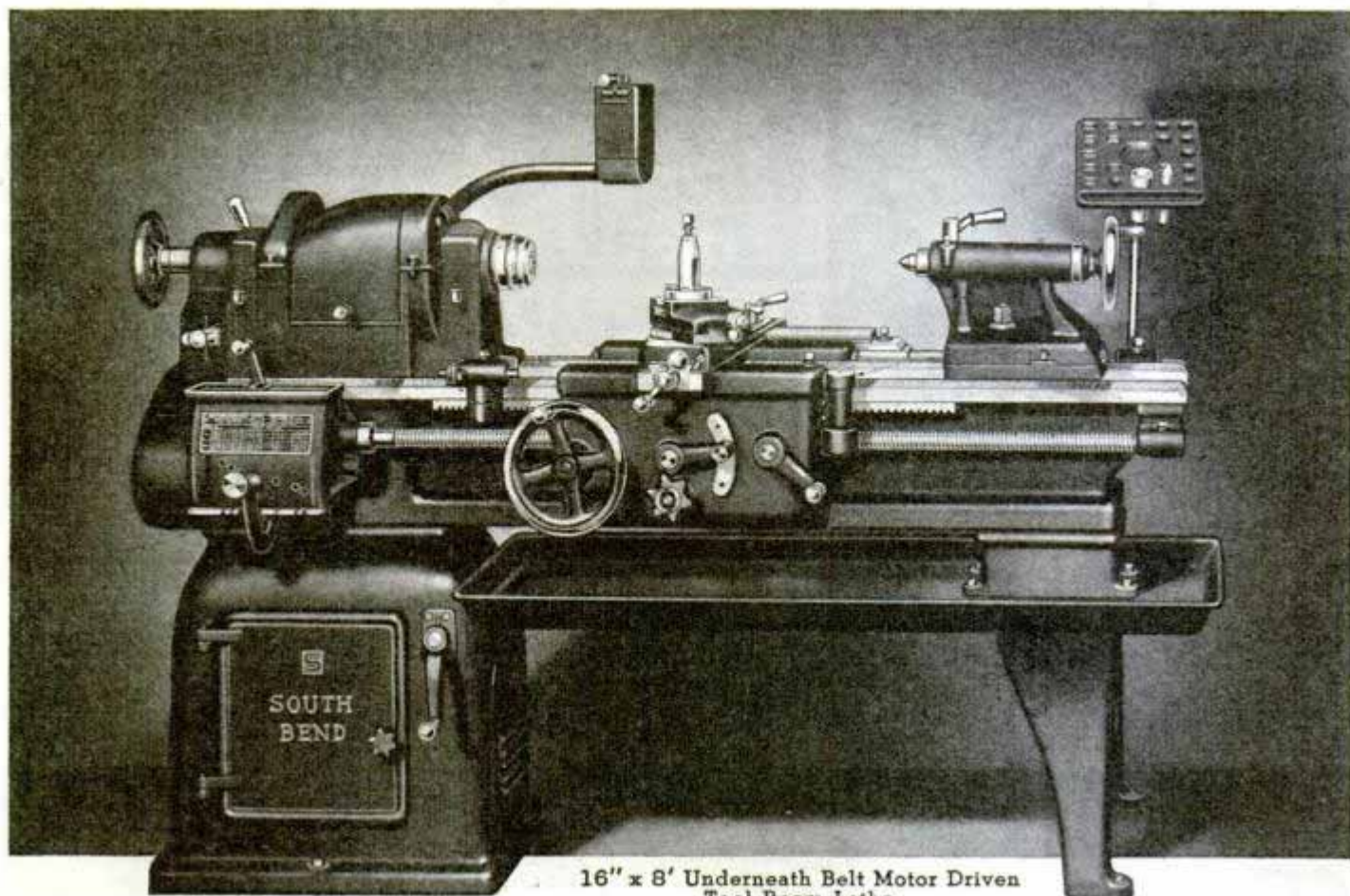

16" x 8' Underneath Belt Motor Driven
Tool Room Lathe

SOUTH BEND LATHES FOR PRECISION WORK

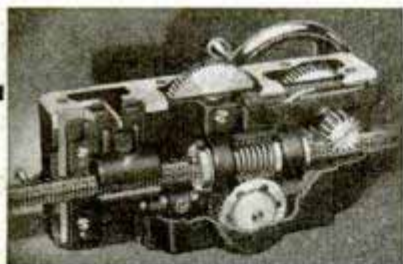

DOUBLE WALL APRON

Back view of the Double Wall Apron showing the rigid, one-piece box type construction that provides a substantial support for both ends of the gear shafts.

Gears in the apron are of steel and have a reservoir and felt wick automatic oiling system. Worm drive assures smooth operation of feeds on all classes of work.

South Bend Lathes have been giving users dependable service on the most exacting classes of precision machine work for thirty-five years.

SIZES AND TYPES

Manufactured in 9", 10", 13", 14½" and 16" swing, bed lengths 3' to 12', in Motor Drive and Countershaft Drive. Attachments are available for production, tool room and general machine work.

ON DISPLAY IN ALL PRINCIPAL CITIES

Baltimore . . . Carey Mach. & Sup.	Milwaukee . . . W. A. Voell Mach.
Boston . . . So. Bend Lathe Works*	Newark . . . J. R. Edwards Mach.
Bridgeport A. C. Bisgood	New York . . . A. C. Colby Mach.
Buffalo R. C. Neal Co.	Philadelphia . . . W. B. Rapp Co.
Chicago . . . So. Bend Lathe Works†	Providence . . . Geo. T. Reynolds
Cleveland Reynolds Mach.	Rochester Ogden R. Adams
Detroit Lee Machinery Co.	San Francisco Moore Mach.
Houston Wessendorff, Nelms	Seattle Star Machinery
Los Angeles Eccles & Davies	Toronto . . . A. R. Williams Mach.

*Boston Sales Office, 67 Broadway, Kendall, Square, Cambridge, Mass., Telephone Trowbridge 6369.
†Chicago Sales Office, Room 308 Machinery Sales Bldg; Tel., State 7283.

SOUTH BEND LATHE WORKS

LATHE BUILDERS SINCE 1906

611 E. Madison St., South Bend, Ind., U.S.A.



**"SO THEY EXPECT ME
TO CRANK THIS CAR
WITH BOTH MY ARMS
BROKEN!"**

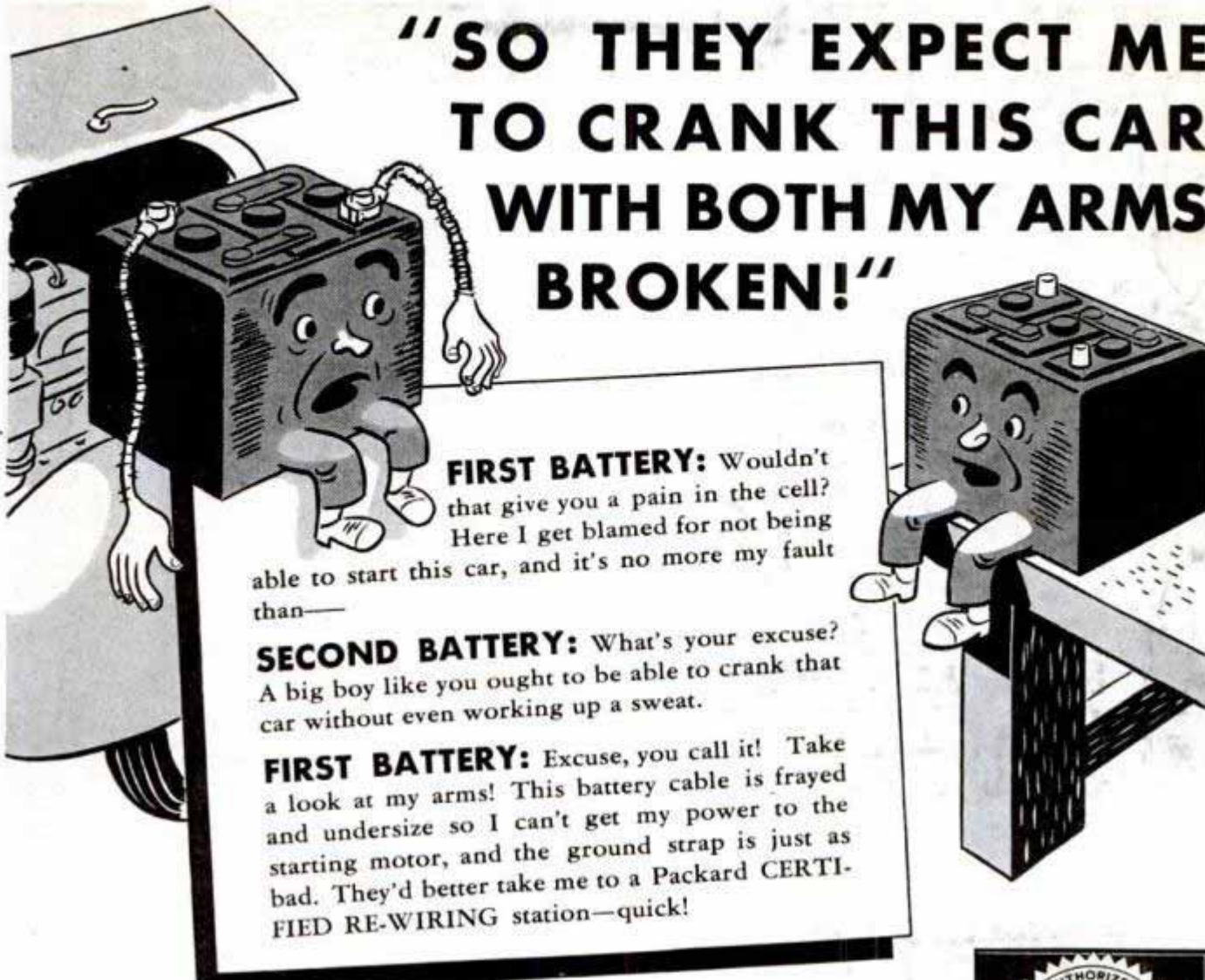

FIRST BATTERY: Wouldn't that give you a pain in the cell? Here I get blamed for not being able to start this car, and it's no more my fault than—

SECOND BATTERY: What's your excuse? A big boy like you ought to be able to crank that car without even working up a sweat.

FIRST BATTERY: Excuse, you call it! Take a look at my arms! This battery cable is frayed and undersize so I can't get my power to the starting motor, and the ground strap is just as bad. They'd better take me to a Packard CERTIFIED RE-WIRING station—quick!

GET A CERTIFIED RE-WIRING CHECK-UP TODAY

Defective cables, connections and electrical units anywhere in your car's electrical system can cause you a lot of grief—hard starting, poor pick-up, lower gasoline mileage, and unsafe lighting. Stop in today at the sign of Packard Certified Re-Wiring Service, and let an expert mechanic check your circuits with accurate instruments. All necessary cable replacements will be made with high-quality

Packard cable, and all adjustments to the electrical units made according to manufacturer's specifications, Packard Electric Division, General Motors Corporation, Warren, Ohio.

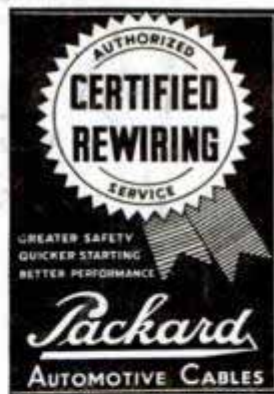

Packard
REG. U.S. PAT. OFF.
TRADE MARK

THE STANDARD WIRING EQUIPMENT OF THE AUTOMOTIVE INDUSTRY



*Double and redouble your
pleasure with the
Smoker's Cigarette*



Chesterfield

COOLER Milder BETTER-TASTING



*Do you smoke the
cigarette that
Satisfies*

