

AGE OF OPPORTUNITY

By Charles F. Kettering

★
**POPULAR
MECHANICS**

MAY

W.P.

REGD. TRADE MARK GREAT BRITAIN NO. 410428

U.S. PAT. 217

OCT.
25 CENTS
30c IN CANADA



SEE PAGE 530



WHY WATCH YOUR RADIATOR LIKE A HAWK?



**BE SAFE ALL WINTER
LONG WITH "PRESTONE"
ANTI-FREEZE!**

Put "Prestone" anti-freeze into your car now . . . and forget about freeze-up, boil-away, foaming, replacing, rust and corrosion. One shot lasts all winter. *You're safe—and you know it!*

That's why "Prestone" brand anti-freeze has been used in more cars than any other brand of winter protection . . . why it is the choice of the U. S. Army, Navy and 25 other Federal Bureaus!

"Prestone" anti-freeze is ethylene glycol *plus* exclusive inhibitors and special processing that make it America's finest anti-freeze. **GUARANTEED IN WRITING.** See your dealer today.

\$2⁶⁵
PER
GALLON

The words "Prestone" and "Eveready" are registered trade-marks of National Carbon Company, Inc.



"PRESTONE" Anti-freeze

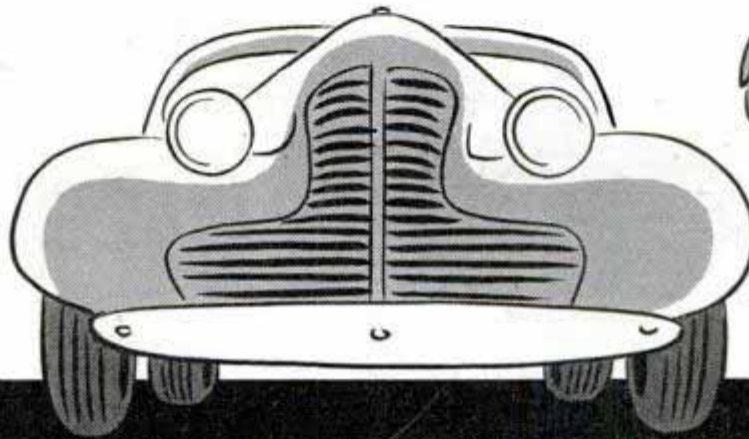
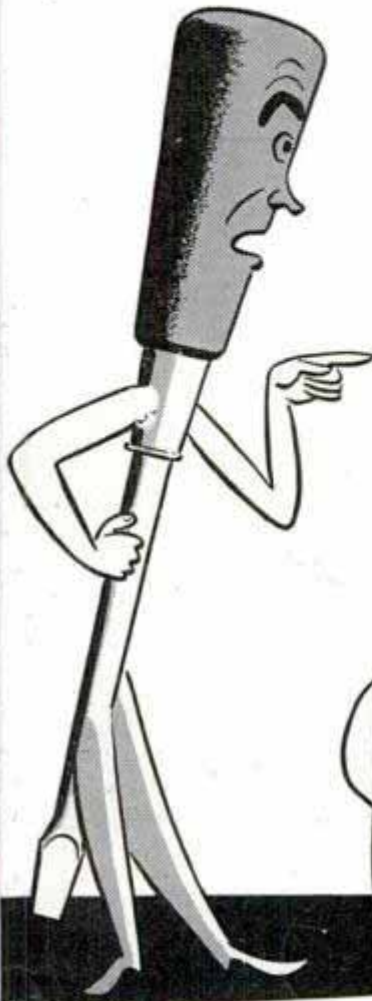
**"THERE'S NOTHING
ELSE LIKE IT"**

"As One Screwdriver to Another"

◀ "Say, mister, did you ever stop to think that there are some parts of this car that I wasn't built to fix? You'd better keep me out of the electrical system or I'll jam up the works."

"What's so tough about the electrical system? ▶ I thought you and I could take care of anything on this car, and now you're backing down on me."

◀ "We can still be pals, but when it comes to delicate adjustments of electrical units and high resistances in the wires and cables, I'm out of my class. That takes accurate instruments and special service instructions; it's a job for an Authorized Certified Re-Wiring station."



FOR EXPERT ELECTRICAL SERVICE— GET PACKARD CERTIFIED RE-WIRING SERVICE

Power, pick-up, gasoline economy and safe lighting are lost when your car's electrical system gets out of adjustment. It may be something wrong in one of the electrical units; it may be an undersize or corroded cable that makes the whole system go haywire. Whatever the trouble, a Certified Re-Wiring check-up will uncover it, and an expert Certified Re-Wiring mechanic will correct it with

proper instruments. All necessary cable replacements are made with quality Packard cable. Look for the Packard Certified Re-Wiring Service sign.

DEALERS

Have your Packard jobber show you "Copper Dollars," the new Packard film that explains Certified Re-Wiring. Packard Electric Division, General Motors Corporation, Warren, Ohio.



Packard

REG. U.S. PAT. OFF.
TRADE MARK

THE STANDARD WIRING EQUIPMENT OF THE AUTOMOTIVE INDUSTRY





**"AT THE LOWEST
POSSIBLE COST"**

Keeping rates low, in the face of rising costs, has been one of the outstanding achievements of the Bell System.

This would not have been possible without efficiency all along the line, economies resulting from centralized research and manufacture, and a sincere desire to serve the best interests of the public.

BELL TELEPHONE SYSTEM



Popular Mechanics Magazine

H. H. WINDSOR, Founder

H. H. WINDSOR, Jr., Editor and Publisher

October, 1940

Vol. 74, No. 4

Next Month

IN THIS ISSUE

The Search for War Metals	481
Riding the Water Broncs	488
The Age of Opportunity	Coloroto
Grass—Newest Food for Man	509
Winged Daredevils of Science	514
Reshaping the World	520
Adventures of the Highway Engineers	530
Speed—the Key to War	535
Get What You Pay For	541
Steeplejacks of the Mountain Peaks	546
New Tasks for War Balloons	552
Freight Trains of the Highway	562
Keeping Tab on the Sun	568
Home Was Never Like This	572

(Continued on next page)

Meet Your 1941 Car

SECRETS of next year's automobiles are guarded almost as closely as a weather report in Europe. Nevertheless we can't keep secrets forever, so next month we'll show you the 1941 cars. You'll find plenty of "torpedo" bodies in the new crop, with further advanced streamlining. You'll find gayer color than ever, inside and out. And under the hood you'll find the horsepower has been stepped up. That's all we'll say today. Watch for the November issue and see your next car for yourself.

Counting in the Next President

BACK in 1916 newspaper extras had Hughes elected. So close was the vote that not until Thursday night could The Associated Press name the winner, Woodrow Wilson. That was the first big test of the AP election tabulating system which, barring a "photo finish" like that of '16, will tell sometime election night whether it's Roosevelt or Willkie. Read next month how the AP collects the returns.

DEEP down in the sea Vincent Palmer turned on his ultra-violet lamp. Weird fish swam toward it like moths to a flame; soon they would roll over and over, as if intoxicated. And while the beam trapped them, he captured them on movie film. This was the beginning of many thrilling undersea adventures for the young scientist, described in a November feature, "Trappers of the Deep." Read how a porpoise tried to swallow his lamp, and how he escaped from an octopus.

Growing 'Em Bigger

SHOCK treatment is playing tricks on Nature. With a shock dose of colchicine, the chemical plant engineer creates giant marigolds and ten-inch dahlias. He drugs the watermelon and tomato into bearing seedless fruit, produces spearmint with a new flavor, develops fast-growing trees and hardier orchard stock. Now the chemist is hunting vitamins to be fed to plants through irrigation ditches. Next month read "Growing 'Em Bigger with Chemicals."

Seaplaning for Sport

AMERICA, air-minded these many years, is just finding out that seaplanes are fun. For a reasonable sum you can add pontoons to your little sport plane and drop in on a mountain lake or fly across the continent, sure of good landing places. Even a city reservoir will do in emergency. An article in November tells how seaplanes are sweeping the country.

Published monthly by POPULAR MECHANICS COMPANY, 200 East Ontario Street, Chicago, U. S. A. Single copy in the United States, 25 cents; subscription rates in United States and possessions, and countries of the Pan-American Postal Union including Spain, \$2.50 a year, \$4.00 for two years, \$5.00 for three years. Single copy in Canada, 30 cents; subscription rates, \$3.00 a year, \$5.00 for two years, \$6.50 for three years. To all other countries add \$1.00 a year over United States prices for overseas postage. Changes in address must be reported to us immediately to eliminate delay. Entered as Second Class Matter, Sept. 15, 1903, at the Post Office at Chicago, Illinois, under Act of March 3, 1879. Entered as Second Class Matter at the Post Office Department, Canada. Copyright 1940, by Popular Mechanics Company, in the United States, Australia, and France. Printed in the U. S. A.

Don't forget to add Pyroil



When the Gasoline Tank Is Being Serviced and the Crankcase Checked, Be Sure to Add Pyroil to Both—for the Protection of Your Car and for Its Improved Performance

Ask your service station salesman to tell you about Pyroil. About the singular value it has for protecting your car, whether new or old. Find out from him HOW Pyroil accomplishes its benefits and improves performance.

For ten years, millions of car owners have proved the merits of Pyroil to their enthusiastic satisfaction. They have formed the habit of using Pyroil regularly.

Your service station or garage salesman will add a mere few ounces of Pyroil to the gasoline tank and to the crankcase with each filling or addition. Then look for less wear on your engine. Better engine operation. Longer engine life. Less danger from contaminations such as hard carbon, sludge, gum, acid-corrosion. Fewer repairs.

Mail the coupon below for a Free Booklet which gives you many interesting facts about this famous super lubricant. Ask for Pyroil, today.

Use it regularly. Manufactured and Guaranteed by Pyroil Company, W. V. Kidder, Founder, 510 Pyroil Bldg., LaCrosse, Wisconsin, U.S.A.



ADD MERELY OUNCES TO GAS & OIL

DISTRIBUTORS:
CHECK AND MAIL
COUPON FOR FRANCHISE FACTS.

PYROIL COMPANY,
510 Pyroil Bldg., LaCrosse, Wisconsin.
I'd like to have your Free Booklet, "Questions and Answers", telling many interesting and important facts about Pyroil.
 Send Details of your plan for Distributors.
Name.....
Address.....
City or town..... State.....

AUTOMOTIVE

Snapping disk guards generator against heat..... 486
Seat robot measures for cars..... 505
Mobile service bureau helps tourists along road... 519
Rail grinder rides off track to let cars pass..... 540
Child's track-type tractor has gas engine..... 551
Glasses for the color-blind driver..... 565
Transparent top gives view of mountain scenery... 571
Fast earth-boring truck joins army..... 575

AVIATION

Air flow shown in model airplane tests..... 485
Lightweight airplane armor of rubber and steel... 487
Cartridge starter for plane on engine mount..... 493
Disk shows setting and time for 150 engines..... 496
"Ascension" chamber tests pilots in "thin" air... 539
Outdoor assembly speeds bomber production..... 545
Lens gets clear picture from three miles up..... 566
Truck uses "mitten" to spin airplane propeller... 571

BOATS AND BOATING

Barge with eight-inch guns forms floating fort... 485
Push-pull levers propel liner's lifeboats..... 496
Clamp-on running light for small boats..... 518
Boat carved into sections for shipment by rail... 525
Outboard pilot wears mask to guard face..... 529

CONSTRUCTION

"Reverse blast" anchors new road in swamp..... 492
A "haunted" house made to order..... 526
Basketwork of steel reinforces bridge pier..... 576

FARMS

Turbines pump water from sea-level farm..... 545
Dustpan wheelbarrow loads and dumps itself... 557
Tractor power digs post hole in ten seconds... 576

HOUSEHOLD

Electric "brain" puts washer through routine... 484
Shrinkless curtains hung without stretching... 496
Ball-bearing washer for faucet minimizes wear... 530
Water purifier fits on kitchen wall..... 530
Electric-outlet and switch-plant improvements... 544
Hinged "closet" on door for household supplies... 544
Feeding frame teaches baby to use spoon..... 567
Pull-cord extension arm for ceiling light..... 567

LAWN AND GARDENS

Long-arm sprinkler for garden..... 534
Long-handled lawn weeder picks up weed cut... 539
Gauge shows soil moisture around roots of plants... 551
Automatic sprayer attaches to lawn hose..... 556

MODELS

Tiny 1940 car has all operating features..... 484
Model ocean liner torpedoed for movies..... 487
Radio controls model boat carrying explosive... 561

PHOTOGRAPHY

Tall tripod gets pictures at odd angles..... 528
Lens tilter corrects distortion of picture in enlarging 534
Photos transmitted by FM radio system..... 550

RADIO AND ELECTRICITY

Phonograph plays two types of record..... 493
Television telephone sends image of speaker... 519
Germicidal lamp over doorway kills bacteria... 528
Light beams sound buzzer to guide blind... 529
"Thunder screen" for the stage..... 556
Scoop shovel "feeler" warns of hidden pipe... 560
Robot lookout watches for forest fires..... 576
Large-screen television..... 615
Compact push-button a.c. high-fidelity five... 616
Extension speaker for basement rumpus room... 618
Practical radio suggestions..... 619
Radio operated with electric-range time control... 620
Television, radio and phonograph console... 620
Two-unit push-button auto set..... 620
Wide frequency range monitor speaker..... 620

SCIENCE AND INDUSTRY

Growth of trees speeded up by ray treatments... 484
Transparent coveralls to guard chemical workers... 487
Adjustable gold stamping machine..... 493
Rotor's vibration cured by letting it sag..... 505
Rods test sunlight for ultraviolet intensity... 518
Serum made of cancer tissue aids diagnosis... 519
Sap of tree keeps lard fresh..... 529

(Continued to page 6A)



**"IMAGINE! HE SAID
MY CAR HAD NO
OOMPH!"**

**HOW A SERVICE MAN'S ADVICE GAVE
A LAZY MOTOR AMAZING NEW LIFE**



"SOUNDS BAD, MISS!" said the service man. "What sounds bad?" I retorted. "This engine," he said. "Missing—no oomph. What new Auto-Lite Plugs wouldn't do for this car?"



"AREN'T ALL SPARK PLUGS ALIKE?" I said. "No, MAM! You'd see, the minute you changed to Auto-Lites! Save gas, too." "Alright, smarty, put in your magic Spark Plugs," I said.



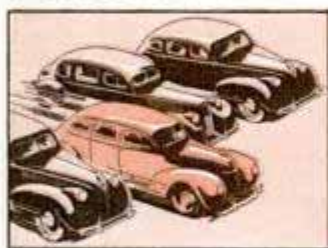
"THANKS FOR THE OOMPH!" I shouted a few days later. The motor never had such pickup, never ran so sweetly. He won a steady customer with those new Auto-Lites.

**How does this new kind of spark plug
make cars run so much better?**

NO WONDER car owners are astonished when sluggish, peepless motors suddenly take on new life! Thousands are finding new Auto-Lite Spark Plugs end starting troubles, give flashing pickup and power and restore gasoline economy.

For the new Auto-Lite Spark Plug was expressly designed to improve car performance by stepping up the efficiency of the entire ignition system. It employs a new-type Konium electrode with a new geometric gap design that produces a more effective spark with less effort. It is protected against leakage and cracking by the wonderful new "Ziramic" insulator with its triple seal.

See why owners of all makes of cars are so enthusiastic about Auto-Lite performance. Try a set of new Auto-Lites in your car today!



**ONE OUT OF EVERY FOUR
NEW CARS** is now factory-equipped with Auto-Lite Spark Plugs. They have been adopted by leading car manufacturers after the most exhaustive and convincing tests.



THE ELECTRIC AUTO-LITE COMPANY
Merchandising Division
TOLEDO, OHIO SARNIA, ONT.

Ignition Engineered by Ignition Engineers

Change to **AUTO-LITE SPARK PLUGS**

MOTORCYCLE

YOUR WAY TO FUN!

All fun spots are in "close range" — when you own a Harley-Davidson. It opens up a new world of excitement and adventure for you! Always plenty doing — good times with other riders at club rallies, gypsy tours, hillclimbs, race meets and other spine-tingling events. See your Harley-Davidson dealer — get the entire story of motorcycling — greatest of outdoor sports!

HARLEY-DAVIDSON
WORLD'S CHAMPION MOTORCYCLE

The Enthusiast
MAGAZINE

Free

Send Coupon NOW

HARLEY-DAVIDSON MOTOR CO.
Dept. P. Milwaukee, Wis.
Send FREE copy of big 24-page "Enthusiast" magazine filled with thrilling motorcycle pictures and stories. Also literature on the new Harley-Davidsons. Stamp is enclosed for mailing cost.

Name

Address

(Contents—Continued)

Vaccination prevents lockjaw from battle wounds.....	534
Low-cost radium substitutes for medical use.....	544
Gamma rays release energy from uranium atoms.....	560
Hundreds of thousands of stars for every person.....	561
Portable smelter works ore at the mine.....	566

SPORTS

Balloon-tired skis permit summer practice.....	485
Lightweight helmet to guard baseball batter.....	518
Golf bag "gocart" unburdens caddy's back.....	567

WAR

Three-way rifle converts into a machine gun.....	555
Bomber versus battleship—which will win?.....	558
How ship defends itself against air raiders.....	559

MISCELLANEOUS

Hit target or get a shower on roller coaster.....	486
Poison ivy protection mixed with vanishing cream.....	492
Tests aimed at producing dog you want.....	513
Baby's tags and footprints prevent hospital mixup.....	518
Expanding nut-and-bolt wall unit.....	524
Hand-pumped wall washer cleans and rinses.....	524
Illuminated Lucite cane for the blind.....	524
Tiny telescope on spectacles aid to weak vision.....	525
Number killed by falls and traffic accidents.....	528
Dog crate folds up like suitcase.....	530
Smoking-pipe filter gives clean, dry smoke.....	530
Non-slip ladder "shoe" gives safety and comfort.....	539
Headband flashlight carries spare batteries.....	540
"Private exchange" phone needs no operator.....	540
Self-feeding grease cup operated by spring.....	551
"Bathing beauties" offer lights to smokers.....	556
Cricket wired for sound effects chirps in museum.....	557
Three-dimension clock read from any angle.....	557
Movie screen on traveling van.....	565
Tiny bicycle trailers carry children.....	575

(Craftsman and Shop Notes)

AUTOMOTIVE

Soap carried in car for emergency.....	579
Bearing cap block retains proper sequence.....	636
Mechanic's toolbox with rollers.....	636
Paper towels handy around car.....	636
An ounce of prevention avoids winter stalling.....	637
Operating windshield wiper manually.....	639
One cause of fuel pump failure.....	640
Storage batteries moved on garage creeper.....	640

FARM

Hog trough used as form for concrete posts.....	609
Inexpensive dump truck.....	623
Holding feed basket under grain spout.....	624
Removing flies from cows before they enter barn.....	624
Patching grain sacks with cement.....	625
Hinged grain spout saves labor.....	632
Building blocks used as floor in chicken house.....	634
Planter wheel makes trough.....	634
Plow handle repaired with cow horn.....	635

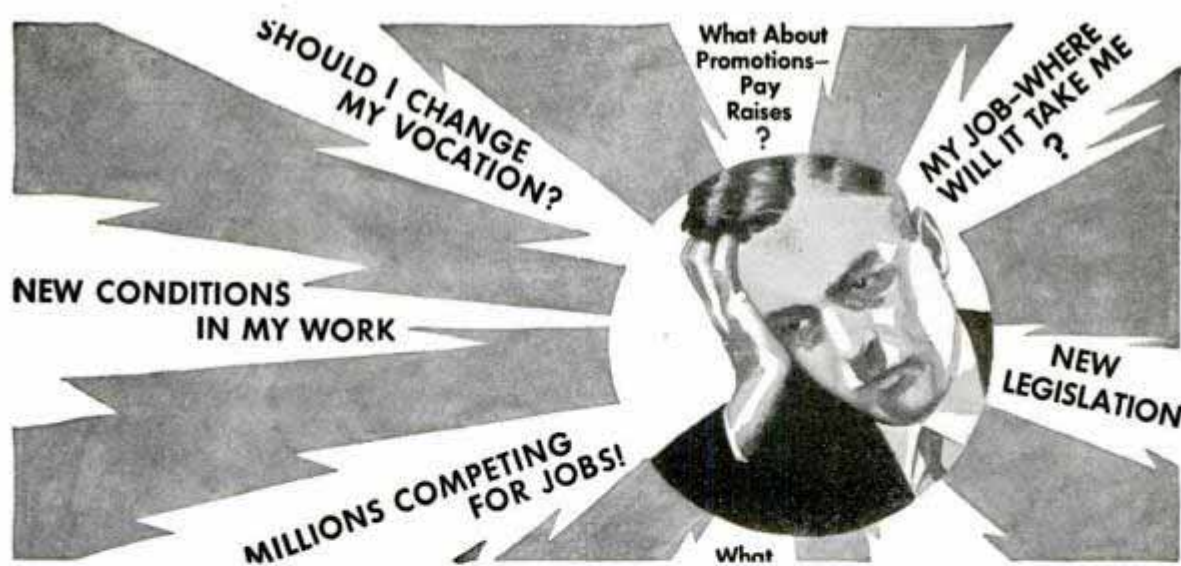
FURNITURE

Bric-a-brac shelves of dowels and plywood.....	582
Three-legged drumstick tables.....	584
Desk for the study.....	601
Portable corner shelves take minimum space.....	602
Attractive wood screen of simple design.....	603

HAND TOOLS

Simple clamp has a deep throat.....	582
Wooden pliers to loosen tight chucks.....	583
Rotating of plumb bob avoided by waxing line.....	586
Notched bar aids in sweat-soldering metal.....	592
V-block for handling large work.....	593
Hose to handle ball bearings easily.....	598
Spring wedge aids in ripping long board.....	598
Step block aids in pulling nails.....	609
High-speed hand grinder.....	621
Improvised bushing puller.....	623
Tool-post holder for small hand grinder.....	625
Cabinet for tools.....	631
Simple cut-off gauge for metal stock.....	631
Holding chain to cut link with hacksaw.....	632
Spinner on die stock aids in cleaning threads.....	632
Grinding cold chisel to suit the work.....	635

(Continued to page 8A)



WHERE DO YOU GO FROM HERE?

YOU'RE like a million other men—you're facing a big question. The depression turned business topsy-turvy and now the rebuilding period stares you in the face.

Are the things that are happening today going to help or hinder you—what will they mean in your pay check? Where will they put you five, ten, twenty years from now? How can you take full advantage of this period of opportunity?

We believe you will find the answer here—a suggestion the soundness of which can be proven to you as it has been to thousands of other men.

The whole trend today—legislation, spirit, action—is to put men back to work, raise earning and spending power, *give every man a fair chance to work out his own salvation.*

The road to success remains unchanged but, bear this in mind, *what it takes to win is radically different!*

No employer today would dare risk an important post in the hands of a man who had not learned the lesson of '29. Why should he, when right at this moment he can pick and choose and get almost any man he wants at his own price?

Business organizations are rebuilding—reorganizing for the new conditions. Before it is over every man and every method will be judged in the cold light of reason and experience—then dropped, remade or retained. This spells real opportunity for the man who can meet the test—but heaven help the man who still tries to meet today's problems from yesterday's standpoint! Out of the multitude still

jobless there are sure to be many frantically eager to prove him wrong and take his place.

Some Men Have Found the Answer

Seeing these danger signs, many aggressive men and women are quietly training at home—are wisely building themselves for more efficient service to their employers.

You naturally ask, "Has your training helped men withstand conditions of the last few years?"

Our answer is to point to a file of letters from many of our students reporting *pay raises and promotions while business was at its lowest ebb*—together with a myriad of others telling of greater success during these recent months of recovery.

Unusual evidence is ready for your investigation. We have assembled much of it in a booklet that is yours for the asking, along with a new and vitally interesting pamphlet on your business field.

This is a serious study of the possibilities and opportunities in that field. It is certain to contain an answer to vital questions bothering you today about your own work and earning power.

Send for these booklets—coupon brings them free. Be sure to check the LaSalle training that interests you most. We will tell you also how you can meet and take fullest advantage of today's situation. No cost or obligation—so why not mail the coupon now?

LASALLE EXTENSION UNIVERSITY

A Correspondence Institution

Dept. 1064-R, Chicago

Please send me—without cost or obligation—full information about how I can, through your training, equip myself for the new problems and opportunities in the business field I have checked.

- | | |
|--|--|
| <input type="checkbox"/> Higher Accountancy | <input type="checkbox"/> Business Management |
| <input type="checkbox"/> Law: Degree of LL.B. | <input type="checkbox"/> Traffic Management |
| <input type="checkbox"/> Commercial Law | <input type="checkbox"/> Business Correspondence |
| <input type="checkbox"/> Industrial Management | <input type="checkbox"/> Business English |
| <input type="checkbox"/> Stenotypy | <input type="checkbox"/> Salesmanship |
| <input type="checkbox"/> Modern Foremanship | |



Name Age.....

Position.....

Address.....

LaSalle Extension University
A CORRESPONDENCE INSTITUTION

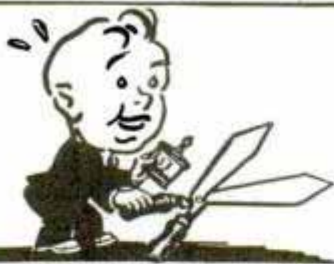


P. W. REPAIRS CRACKS and HOLES

Use Plastic Wood to fill cracks in baseboards, floors, shelving—to fill old screw holes. It handles easily as putty and quickly hardens into lasting wood. In cans or tubes at Paint, Hardware, 10¢ Stores. Try it!



PLASTIC WOOD



GOOD TOOLS NEED GOOD OIL

When you work with tools, they must be in working condition. 3-IN-ONE Oil keeps tools clean and bright. It oils the working parts; protects against harmful rust and tarnish. Get it at Hardware, Drug, Grocery, 10¢ Stores.



3-IN-ONE Oil

(Contents—Continued)

HOUSEHOLD

Adjustable pouring hole for cartons.....	579
Solving home problems.....	580
Cork holds spoon on tumbler.....	600

OFFICE

Adjustable ink-bottle holder for drawing board.....	587
Combination pencil pointer and ash tray.....	603
Shielding office trucks to protect woodwork.....	632
Hinged desk slide used for sketching board.....	635

PAINT AND PAINTING

Dew missing on aluminum painted chair.....	592
Hand grip on bucket holds bail vertically.....	598
Accessory holder helps window sign painter.....	625

PHOTOGRAPHY

Build this dual-purpose picture projector.....	594
Specimen cases made from photo film packs.....	596
Cheap darkroom thermometer.....	610
Correcting linear distortion.....	610
Extra weights for darkroom scale.....	610
Flaps on darkroom shade keep out light.....	610
Shower ring washes prints.....	610
"Frost" photos to decorate craftwork.....	611
Bobby-pin clips hold film for drying.....	612
Developing extra large prints.....	612
Fastening socket in homemade reflector.....	612
Film washed in perforated coffee can.....	612
Half-open card table holds movie screen.....	612
Camera cleaned with rubber cement.....	613
Shield stops "bellows flutter".....	613
Solution to make prints lie flat.....	613
Developing tank drains itself.....	614
Trays fitted with cheap thermometers.....	614

STORE AND SHOP

Box on shop hand truck carries small packages.....	624
Inflated sacks help clerk select proper size.....	634
Putting flypaper in show windows.....	634

WOODWORKING

Turned trinket box has secret ring cavity.....	583
Offset angles for clamping large work.....	597
Three-piece tidbit tray of unusual design.....	597
Guncraft in the home workshop.....	604
Staining wood with diluted acid.....	632
Nut makes excellent stop on round file.....	634

MISCELLANEOUS

Eli Terry mantel clock.....	577
Non-slip surface prevents tipping of ladder.....	579
Slowing hardening of plaster of paris.....	579
Tricks of cutting glass.....	582
Hammer holder for ladder.....	582
Coil spring supports test tube.....	586
Color filter for microscope is adjustable.....	586
Handy vise to tie fishing flies.....	586
Self-locking of hasp prevented by spring clip.....	586
Eyelets provide good bearings for working models.....	587
Midget trellis to hold tiny potted plants.....	587
A Great Lakes whaleback—Part II.....	588
Clamping plank between ladders to prevent tipping.....	593
Hose serves as adjuster for drop lamp.....	593
Sponge rubber keeps spectacle case in pocket.....	593
Weighted landing net opens quickly.....	593
Finger rest for automatic pencil.....	598
Hand sled stored between garage studs.....	598
Card carving with a pen point.....	599
Abrasive shoe-sole patches for icy sidewalks.....	600
Coating bolts to prevent rusting.....	600
Miter box with clamp holds work in place.....	600
Spreader for mucilage and cement in tubes.....	600
Silencing hum in oil-burner fuel lines.....	602
Tight-rope walker is fun for children.....	602
Glue made from medical capsule sticks to glass.....	603
Slingshot target for the basement.....	609
Mousetraps baited with a candle.....	624
Tane locates center of balance on crowbar.....	624
Power from small streams—Part II.....	626
Hand tapping machine helps avoid breakage.....	633
Jig to straighten small wire.....	633
Portable track to move coal truck over lawn.....	640

IMPORTANT NOTICE

It is the intention of this magazine to provide its readers with information regarding the latest developments in the mechanical arts. We take no responsibility as to whether the disclosures contained in our articles are covered by patents and advise readers to investigate this subject before making, using, or selling any of the products, machines, or processes described, in order to avoid possible liability for patent infringement.

BE A BETTER CITIZEN

WITH A BETTER JOB!

★ U. S. defense program needs **TRAINED MEN!** The demand is urgent! **Enroll NOW** for spare-time study with **International Correspondence Schools** — get **MODERN TRAINING** in a few months! **400 up-to-date I. C. S. Courses** to choose from, including vital defense subjects. **Thousands of former I. C. S. students** are leaders of **Business and Industry** today. Be a better **PATRIOT** — and **BETTER PAID!** Mail this coupon **TODAY** for complete information.

INTERNATIONAL CORRESPONDENCE SCHOOLS

BOX 5586-J, SCRANTON, PENNA.

★ Without cost or obligation, please send me a copy of your booklet, "Who Wins and Why," and full particulars about the course *before* which I have marked X: ★

TECHNICAL AND INDUSTRIAL COURSES

- | | | | | |
|---|---|---|---|--|
| <input type="checkbox"/> Agriculture | <input type="checkbox"/> Air Brake | <input type="checkbox"/> Cotton Manufacturing | <input type="checkbox"/> Mfg. of Pulp and Paper | <input type="checkbox"/> R. R. Section Foreman |
| <input type="checkbox"/> Air Conditioning | <input type="checkbox"/> Architectural Drafting | <input type="checkbox"/> Diesel Engines | <input type="checkbox"/> Marine Engines | <input type="checkbox"/> R. R. Signalmen's |
| <input type="checkbox"/> Architecture | <input type="checkbox"/> Auto Engine Tune-up | <input type="checkbox"/> Electrical Drafting | <input type="checkbox"/> Mechanical Drafting | <input type="checkbox"/> Refrigeration |
| <input type="checkbox"/> Auto Technician | <input type="checkbox"/> Aviation | <input type="checkbox"/> Electrical Engineering | <input type="checkbox"/> Mechanical Engineering | <input type="checkbox"/> Sanitary Engineering |
| <input type="checkbox"/> Boilermaking | <input type="checkbox"/> Bridge Engineering | <input type="checkbox"/> Electric Lighting | <input type="checkbox"/> Mine Foreman | <input type="checkbox"/> Sheet Metal Work |
| <input type="checkbox"/> Building Estimating | <input type="checkbox"/> Chemistry | <input type="checkbox"/> Fire Bosses | <input type="checkbox"/> Navigation | <input type="checkbox"/> Steam Electric |
| <input type="checkbox"/> Civil Engineering | <input type="checkbox"/> Coal Mining | <input type="checkbox"/> Foundry Work | <input type="checkbox"/> Patternmaking | <input type="checkbox"/> Steam Engines |
| <input type="checkbox"/> Concrete Engineering | <input type="checkbox"/> Contracting and Building | <input type="checkbox"/> Fruit Growing | <input type="checkbox"/> Pharmacy | <input type="checkbox"/> Structural Drafting |
| | | <input type="checkbox"/> Heating | <input type="checkbox"/> Plumbing | <input type="checkbox"/> Structural Engineering |
| | | <input type="checkbox"/> Heat Treatment of Metals | <input type="checkbox"/> Poultry Farming | <input type="checkbox"/> Surveying and Mapping |
| | | <input type="checkbox"/> Highway Engineering | <input type="checkbox"/> Practical Telephony | <input type="checkbox"/> Telegraph Engineering |
| | | <input type="checkbox"/> House Planning | <input type="checkbox"/> Public Works Engineering | <input type="checkbox"/> Textile Designing |
| | | <input type="checkbox"/> Locomotive Engineer | <input type="checkbox"/> Radio, General | <input type="checkbox"/> Toolmaking |
| | | <input type="checkbox"/> Machinist | <input type="checkbox"/> Radio Operating | <input type="checkbox"/> Welding, Electric and Gas |
| | | <input type="checkbox"/> Management of Inventions | <input type="checkbox"/> Radio Servicing | <input type="checkbox"/> Woolen Manufacturing |

BUSINESS COURSES

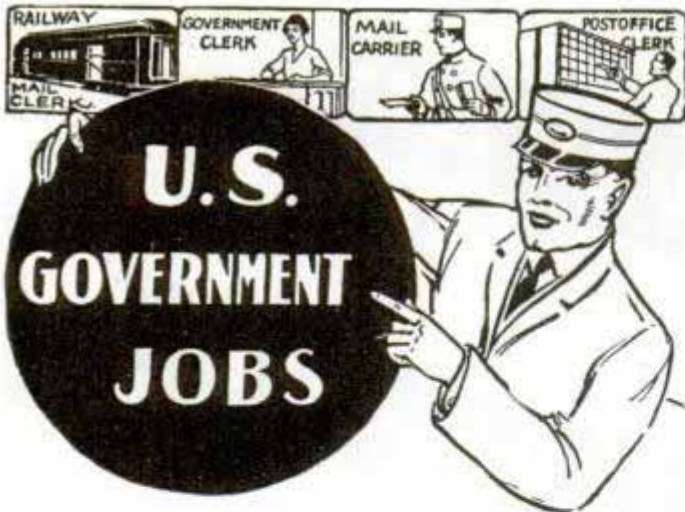
- | | | | | |
|--|--|--|---|---|
| <input type="checkbox"/> Accounting | <input type="checkbox"/> Advertising | <input type="checkbox"/> College Preparatory | <input type="checkbox"/> Foremanship | <input type="checkbox"/> Railway Postal Clerk |
| <input type="checkbox"/> Bookkeeping | <input type="checkbox"/> Business Correspondence | <input type="checkbox"/> Commercial | <input type="checkbox"/> French | <input type="checkbox"/> Salesmanship |
| <input type="checkbox"/> Business Management | <input type="checkbox"/> Business Estimating | <input type="checkbox"/> Cost Accounting | <input type="checkbox"/> Grade School | <input type="checkbox"/> Secretarial |
| <input type="checkbox"/> Cartooning | <input type="checkbox"/> Civil Service | <input type="checkbox"/> C. P. Accounting | <input type="checkbox"/> High School | <input type="checkbox"/> Sign Lettering |
| | | <input type="checkbox"/> First Year College | <input type="checkbox"/> Illustrating | <input type="checkbox"/> Traffic Management |
| | | | <input type="checkbox"/> Lettering Show Cards | <input type="checkbox"/> Spanish |
| | | | <input type="checkbox"/> Managing Men at Work | |

HOME ECONOMICS COURSES

- | | | |
|---|---|--|
| <input type="checkbox"/> Advanced Dressmaking | <input type="checkbox"/> Home Dressmaking | <input type="checkbox"/> Tea Room and Cafeteria Management, Catering |
| <input type="checkbox"/> Foods and Cookery | <input type="checkbox"/> Professional Dressmaking and Designing | |

Name..... Age..... Address.....
 City..... State..... Present Position.....

Canadian residents send coupon to International Correspondence Schools Canadian, Limited, Montreal, Canada
 British residents send coupon to I. C. S., 71 Kingsway, London, W. C. 2, England



START \$1260 to \$2100 YEAR

Thousands appointments
each year
Get ready
immediately
32 Page
Civil Service
Book
Mail Coupon
Today—
SURE

Franklin Institute
Dept. H173
Rochester, N. Y.

Gentlemen: Rush to me
FREE of charge, list of
U. S. Government big pay
jobs. Send me FREE 32-page
book describing salaries, vaca-
tions, hours and work. Tell me
how to qualify for one of these
jobs.

COUPON

Name.....

Address.....



Learn WELDING This Easy Way!

AUDELS NEW WELDERS GUIDE

Contains Important Facts and Essential Information!

- WELDING METHODS
- WELDERS
- ELECTRIC
- OXY-ACETYLENE
- THERMIT
- UNIONMELT
- SHEET METAL
- SPOT
- PIPE
- PRESSURE VESSELS
- VARIOUS METALS
- AIRPLANE
- HARDENING-FACING
- CUTTING
- EYE PROTECTION

Just Out!

\$1

Every Welder Should Own This New, Useful Book containing clear, concise, practical information, pointers and facts relating to modern practice in all Branches. Easy to read and understand—over 400 pages Fully Illustrated—flexible cover—pocket size—a Ready Reference that Answers Your Questions accurately—Money Back if not O.K. To get this assistance for yourself, order copy today.

THEO. AUDEL, Publishers, 49 W. 23rd St., New York
Please mail AUDELS WELDERS GUIDE (Price \$1). If satisfactory, I will remit \$1 on its safe arrival, otherwise I will return the book.

Name.....

Address.....

Occupation.....

Employed by..... PM

When writing please mention Popular Mechanics

Which Man's Start in Aviation Would You Like to Have?



What more could you ask for your own career than to follow the lead of these Aero ITI-trained men ... and their hundreds of fellow graduates now making good in similar jobs?

Choose an Aviation career for the ever-widening opportunities offered in the aviation industry's sweep upward to new heights of size and achievement. Choose Aero ITI training for its proven value and profitability in winning so many men an immediate start in aircraft pursuits... in equipping them with the capability to win rapid advancement ... in supplying the broad, thorough knowledge and ability for making Aviation their LIFE WORK.

Don't pass up the golden opportunities offered by Aviation and Aero ITI training. Send for details NOW.

EXECUTIVE BOARD

- +++
JOHN K. NORTHROP
President, Northrop Aircraft, Inc.
+++
ROBERT E. GROSS
President, Lockheed Aircraft Corporation
+++
C. A. VAN DUSEN
Vice-Pres., Consolidated Aircraft Corporation

AERO INDUSTRIES TECHNICAL INSTITUTE

5253 WEST SAN FERNANDO ROAD, LOS ANGELES, CALIFORNIA

Five Courses in AIRCRAFT MECHANICS and AERONAUTICAL ENGINEERING...including U. S. Civil Aeronautics Authority Approved 12 Months Aircraft Mechanics Training.

ELECTRICAL CAREERS

Become a Bliss technician in one year—ready to take advantage of increasing opportunities in the electrical field. Bliss men, today, fill key positions in many different electrical industries. All received the same course in fundamental theory and practice.

Modern laboratories. Successful placement. 48th year. Ask for free vocational chart, 120 Takoma Ave., Wash., D.C.

BLISS ELECTRICAL SCHOOL

RADIO-TELEVISION

Oldest, largest Radio-Television school in West trains you for good pay job. Complete instruction including Radio Construction and Service, Broadcast Operating, Sound, Talking Pictures, Television, Public Address, etc. Flexible plan to meet specific needs of those with or without jobs. Transportation allowed to L.A. Earn room and board while learning. Request Free Catalog.

NATIONAL SCHOOLS Dept. PMR-10
Los Angeles

LEARN WATCH REPAIRING



AT HOME You can learn by our modern and original system of instruction every part of the Watch Repairing Trade at home. You can earn money while learning and prepare yourself for a well paying position or start in business after completing our course of instruction. Good watch repairers are in demand and generally earn very good salaries. For particulars apply to the Wisconsin School of Watch Repairing 524 E. Mason St., MILWAUKEE, WIS.

FREE PRODUCTS

WRITE FOR \$6.00 ASSORTMENT OF FOODS, GROCERIES, SOAPS, ETC.

SEND NO MONEY! Rush name and address for big Assortment of FOODS, GROCERIES, SOAPS, ETC.—full size packages, worth \$6.00. Yours ABSOLUTELY FREE! Show these products to friends, neighbors. Take orders for seasonal values, more than 200 quality products used in every home. Earn big profits, full or spare time. No experience necessary. Write for FREE \$6.00 Assortment of Products NOW.



ZANOL, 1932 Monmouth, Cincinnati, Ohio

POPULAR MECHANICS

Speed Your Way to Success by *Approved* Home Study

So you dropped out of school too soon? Well, *cheer up!* Ask any representative group of Executives, Engineers or Educators and most of them will tell you: "You CAN make good through approved home study... IF you will make the effort and STICK to your course." In fact, you'll find that a number of important men in nearly every locality are former home study students themselves. They KNOW and have PROVED that home study pays.

In 40 years, home study has become an integral part of "the American way" ... a nationwide educational system especially geared to the needs of wage earners. Today, there are far more home study schools than you perhaps realize—and you may place confidence in the courses of the 46 home study schools whose advertising and catalogs carry the official seal of the National Home Study Council, shown below.

Courses complete in themselves and include basic subjects essential to proper understanding of more advanced portions.



Official catalogs and bulletins inspected and approved.

COMMERCE and Industry are tough taskmasters today—but they are *just*. The penalties of failure may be heavy—but the rewards of success are rich. If you persist in doing work that *anyone* else can do—if you carelessly leave yourself open to competition with Machinery that sooner or later may do all the "unthinking" jobs... the repetitive tasks—you are slated for final disappointment and bitterness.

To win out, today, you must THINK. You must think ON the job and AWAY from it and, *most important*, you must think AHEAD of it. And that takes study.

Join this "Promotion Parade" of Progress-Minded Men and Women

Of the approximately 2,000,000 men and women enrolled for further education in universities, colleges, institutes of technology and home study institutions, about 37½%—or 750,000—have chosen home study as most practical for their purposes. They want to win Success. You do, too! They have FAITH in themselves. Do you believe in *yourself*? They have investigated home study—decided that it offers them their way "out and up" ... out of the low pay, periodically unemployed rank and file ... up into well paid positions where they enjoy prosperity, security and respect.

Get the facts, *yourself*. On coupon, check the line of work that MOST interests you ... mail it PROMPTLY for FREE directory which lists NHSC approved schools and the courses they offer.

Come to headquarters for the information you need. NO OBLIGATION. Address your inquiry, TODAY, to

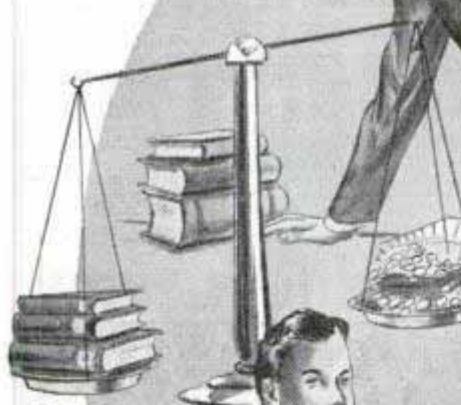
National Home Study Council
Dept. G745, Washington, D. C.

----- Mark, Clip and Mail This Coupon NOW -----

National Home Study Council, Dept. G745, Washington, D. C.
Without obligation, please send your Directory, listing names of APPROVED Home Study Schools offering instruction in the subjects checked below.

- | | | |
|---|---|---|
| <input type="checkbox"/> Air Conditioning | <input type="checkbox"/> Retail Merchandising | <input type="checkbox"/> Drafting and Design |
| <input type="checkbox"/> Elec. & Gas Refrigeration | <input type="checkbox"/> Cost Accounting | <input type="checkbox"/> Radio and Television |
| <input type="checkbox"/> Architecture and Building | <input type="checkbox"/> Practical Bookkeeping | <input type="checkbox"/> High School |
| <input type="checkbox"/> Plumbing and Steam Fitting | <input type="checkbox"/> Economics of Direct Selling | <input type="checkbox"/> Home Economics Courses |
| <input type="checkbox"/> Automotive Engineering | <input type="checkbox"/> Private Secretary | <input type="checkbox"/> Business Law |
| <input type="checkbox"/> Aviation Drafting | <input type="checkbox"/> Diesel Engineering | <input type="checkbox"/> Liberal Arts |
| <input type="checkbox"/> Aviation Engineering | <input type="checkbox"/> Surveying & Topographical Drafting | <input type="checkbox"/> Mechanical Engineering |
| <input type="checkbox"/> Business Management | <input type="checkbox"/> Sheet Metal Pattern Drafting | <input type="checkbox"/> Shop Management |
| <input type="checkbox"/> Accounting and C.P.A. | <input type="checkbox"/> Electrical Engineering | <input type="checkbox"/> Tool Making |
| <input type="checkbox"/> Salesmanship | | <input type="checkbox"/> Better Foremanship |
| | | <input type="checkbox"/> Engine and Boiler Work |

Name..... Occupation.....
Address..... Age.....
City..... State.....



Tuition fees moderate and fair.

Instruction material and methods simplify and speed up learning.

This seal protects you!



Thousands Have Made Good through HOME STUDY

THOUSANDS ENJOY THRILL OF PLAYING

Who Didn't Know a Note of Music



Over 700,000 people have studied music at home this easy way. See how quickly you can learn without a private teacher, without needless study and practice. This wonderful print and picture method shows you just what to do, makes every move clear. It starts you learning real tunes by note in first few lessons—*you learn to play by playing!*

Costs Only Few Cents A Day

Best of all, the cost is surprisingly low—averaging only a few cents a day—for whatever instrument you choose. If you would sincerely like to play a musical instrument, if you want to enjoy the pleasure and popularity that music offers, fill out and mail coupon at once for illustrated booklet and free print and picture sample.

Instruments supplied when needed, cash or credit. U. S. School of Music, 710 Brunswick Bldg., New York, N. Y. (Forty-second Year—Est. 1898).

U. S. School of Music, 710 Brunswick Bldg., New York, N. Y.

I am interested in music study, particularly in the instrument checked below. Please send me your free illustrated booklet and free print and picture sample.

- | | | | |
|---------------------------------|------------------------------------|-----------------------------------|---|
| <input type="checkbox"/> Piano | <input type="checkbox"/> Accordion | <input type="checkbox"/> Clarinet | <input type="checkbox"/> Banjo |
| <input type="checkbox"/> Violin | <input type="checkbox"/> Saxophone | <input type="checkbox"/> Trumpet | <input type="checkbox"/> Ukulele |
| <input type="checkbox"/> Guitar | <input type="checkbox"/> Mandolin | <input type="checkbox"/> Trombone | <input type="checkbox"/> Other Instrument |

Name.....

Street.....

City..... State.....

Be An ARTIST!



LEARN TO DRAW

—at home in your spare time

The fascinating field of Art offers commercial opportunities to men and women. Trained Artists are capable of earning \$30, \$50, \$75 a week. We teach you right at home for a successful career in—

COMMERCIAL ART ILLUSTRATING CARTOONING

For 25 years W. S. A. graduates have been "making good" in Art—WHY NOT YOU? No previous Art experience necessary—our instruction is practical and thorough. Write for Booklet—"Art for Pleasure and Profit," fully describes course. TWO BIG ART OUTFITS included with course. Clip coupon—mail today.



FREE BOOK gives details!

Washington School of Art, Studio 1210 P
1115—15th St., N. W., Washington, D. C.

Yes! I am interested in learning to draw. Please send me information in your Free Book, "Art for Pleasure and Profit."

Name..... Age.....

Address.....

City..... State.....



Follow This Man!

Secret Service Operator No. 38 Is On The Job!

Follow him through all the excitement of his chase after the counterfeit gang. See how a crafty operator solves a murder with tell-tale finger prints! Thrills! Mystery!

FREE! The Confidential Reports No. 38 Made to His Chief Earn a Regular Monthly Salary

Write for reports and free "Blue Book of Crime." Learn how YOU can become a Finger Print Expert, at home, in spare time, at small cost. Our graduates run 47% of all

the Identification Bureaus in America! Send for list of over 600 bureaus employing our graduates. Write today! Literature sent only to persons stating their age.

INSTITUTE OF APPLIED SCIENCE

1920 Sunnyside Avenue Dept. 1357 Chicago, Ill.



Learn Profitable Profession in 90 days at Home

Salaries of Men and Women in the fascinating profession of Swedish Massage run as high as \$40 to \$70 per week but many prefer to open their own offices. Large incomes from Doctors, hospitals, sanitariums and private patients come to those who qualify through our training. Reducing alone offers rich rewards for specialists. Write for Anatomy Charts and booklet—They're FREE.

THE COLLEGE OF SWEDISH MASSAGE
30 E. Adams St., Dept. 764, Chicago

ENGINEERING

DEGREE IN TWO YEARS

TECHNICAL AND APPLIED COURSES, Nonessentials omitted. TIME AND MONEY SAVED. Degree 2 yrs., diploma 1 yr. Electrical, Mechanical, Architectural, Structural, Civil, Aeronautical, including Air Conditioning, Refrigeration, Diesel, intensive courses, 3 and 4 months in Electricity, Power Plant, Diesel, Refrigeration, Drafting. Extensive shop equipment. LOW TUITION. Part-time work for room and board. Thousands successful graduates in U. S. and foreign lands. Approved by industry, endorsed by educators, recommended by alumni. One and two-year courses open Sept. 18 to Oct. 18, short courses start specified dates, beginning Sept. 18. 41st Year. No home study courses. Catalog free.

1001 Indiana Ave. FINLAY ENGINEERING COLLEGE Kansas City, Mo.

Learn AUTO-DIESELS

Practical, tested training. Backed by 35 years experience. Course includes Auto Mechanics, Diesel Service and Operation, Diesel Power Generation, Machine Shop Practice, Auto Electrics, etc. Flexible plan to meet specific needs of those with or without jobs. Oldest, largest trade school in West qualifies you and helps you get a good pay job. Transportation allowed to L. A. Earn room and board while learning. Request Free Catalog.

NATIONAL SCHOOLS Dept. PMA-10 Los Angeles

LEARN AVIATION IN LOS ANGELES • Nation's Aviation Capital

Huge increase in Los Angeles aviation activity has assured splendid positions for graduates. Career training offered for airline piloting, engineering, mechanics, drafting, production mechanics and instruments. Train at America's most modern, fully equipped and strategically located school, fully approved by the U. S. Government for flight, ground and mechanics courses. Write for free 64 page catalog. State are.

CALIFORNIA FLYERS
SCHOOL OF AERONAUTICS—Dept. PM-10
LOS ANGELES MUNICIPAL AIRPORT, INGLEWOOD, CALIF.

Learn Public Speaking

At home—in spare time. Many overcome "stage-fright," gain self-confidence and increase earning power, this easy way. Write for free booklet, *How to Work Wonders With Words* and requirements. North American Institute, Dept. 1357 3601 Michigan Ave., Chicago, Illinois

MONEY for MEN ALL FREE

THE PLASTEX Industry needs manufacturers on small scale and for big production of Lamp and Clock Stands, Art Goods and Novelties in Plastex and Marble imitation. Experience unnecessary. 1/2¢ material makes regular 10¢ store sellers. Rubber moulds furnished for speed production. Small investment brings big returns. WAR CAUSES GREAT SHORTAGE OF THESE GOODS. Ambitious men have chance for real prosperity. Our FREE booklet will interest and benefit you. PLASTEX INDUSTRIES, Dept. P, 1085 Washington Ave., New York, N. Y.

Be a RADIO Technician



J. E. SMITH, President, National Radio Institute
Established 25 Years

Many make **\$30 \$40 \$50** a week

I will train you at home for many Good Spare Time and Full Time Radio Jobs

If you can't see a future in your present job, feel you'll never make much more money; if you're in a seasonal field, subject to lay offs, IT'S TIME NOW to investigate Radio. Trained Radio Technicians make good money, and you don't have to give up your present job or leave home to learn Radio. I train you at home nights in your spare time.

to \$10 a week in spare time while learning. My Course includes Television too.

Here's How You Get Practical Experience While Learning

I send you special Radio equipment; show you how to conduct experiments, build circuits illustrating important principles used in modern Radio receivers, broadcast stations and loudspeaker installations. This 50-50 method of training—with printed instructions and working with Radio parts and circuits—makes learning at home interesting, fascinating, practical. YOU ALSO GET A MODERN, PROFESSIONAL, ALL-WAVE, ALL-PURPOSE SET SERVICING INSTRUMENT to help you make good money fixing Radios while learning and equip you with a professional instrument for full time jobs after graduation.

Jobs Like These Go To Men Who Know Radio

Radio broadcasting stations employ Radio Technicians as operators, maintenance men and pay well for trained men. Radio manufacturers employ testers, inspectors, servicemen in good pay jobs with opportunities for advancement. Radio jobbers and dealers employ installation and servicemen. Many Radio Technicians open their own Radio sales and repair businesses and make \$30, \$40, \$50 a week. Others hold their regular jobs and make \$5 to \$10 a week fixing Radios in spare time. Automobile, police, aviation, commercial Radio, loudspeaker systems, electronic devices, are newer fields of opportunity for which N. R. I. gives the required knowledge of Radio. And my Course includes Television which promises to open good jobs soon.

Find Out What Radio, Television Offer

Act Today. Mail the coupon for "Rich Rewards in Radio." It points out Radio's spare time and full time opportunities and those coming in Television; shows more than 100 letters from men I trained, telling what they are doing and earning. Find out what Radio, Television offer YOU! MAIL COUPON in an envelope, or paste on a postcard—NOW!



Broadcasting Stations employ operators, installation, maintenance men and Radio Technicians in other capacities and pay well.

Set Servicing pays many Radio Technicians \$30, \$40, \$50 a week. Others hold their regular jobs and make \$5 to \$10 extra a week in spare time.



Loudspeaker System building, installing, servicing and operating is another growing field for well trained Radio Technicians.



I Trained These Men



\$10 to \$20 a Week in Spare Time
I repaired some Radio Sets when I was on my tenth lesson. I really don't see how you can give so much for such a small amount of money. I made \$600 in a year and a half, and I have made an average of \$10 to \$20 a week—just spare time.—JOHN JERRY, 1529 Arapahoe St., Rm. 17, Denver, Colorado.

Makes \$50 to \$60 a Week

I am making between \$50 and \$60 a week after all expenses are paid, and I am getting all the Radio work I can take care of, thanks to N. R. I.—H. W. SPANGLER, 120 1/2 S. Gay St., Knoxville, Tenn.



Operates Public Address System
I have a position with the Los Angeles Civil Service, operating the Public Address System in the City Hall Council. My salary is \$170 a month.—H. H. ROOD, R. 136, City Hall, Los Angeles, Calif.



Why Many Radio Technicians Make \$30, \$40, \$50 a Week

Radio is already one of the country's large industries even though it is still young and growing. The arrival of Television, the use of Radio principles in industry, Frequency Modulation are but a few of the many recent Radio developments. More than 28,000,000 homes have one or more Radios. There are more Radios than telephones. Every year millions of Radios go out of date and are replaced. Millions more need new tubes, repairs, etc.—Over 5,000,000 auto Radios are in use and thousands more are being sold every day. In every branch, Radio offers opportunities for which I give you the required knowledge of Radio at home in your spare time. Yes, the few hundred \$30, \$40, \$50 a week jobs of 20 years ago have grown to thousands.

Many Make \$5 to \$10 a Week Extra in Spare Time While Learning

The day you enroll, in addition to my regular Course, I start sending you Extra Money Job Sheets—start showing you how to do actual Radio repair jobs. Throughout your course I send plans and directions which have helped many make \$5

THIS FREE BOOK HAS HELPED HUNDREDS OF MEN MAKE MORE MONEY

RICH REWARDS IN RADIO

This Coupon is Good for . . .
One FREE Copy of My Book

J. E. SMITH, President, Dept. OKP
National Radio Institute, Washington, D. C.

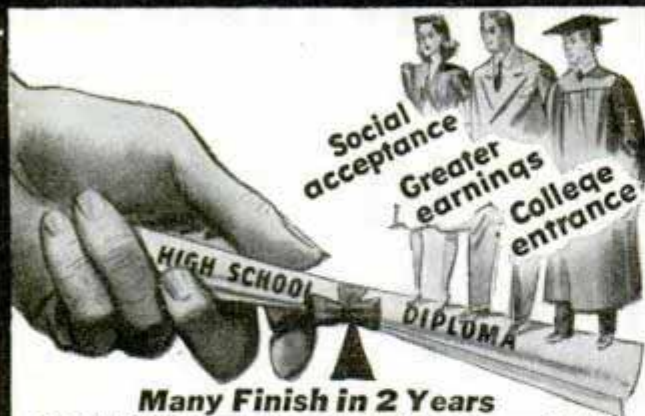
Mail me FREE, without obligation, your 64-page book "Rich Rewards in Radio." (No salesman will call. Write plainly.)

NAME.....AGE.....

ADDRESS.....

CITY.....STATE.....

High School Raises Your Standards of **LIVING TRAINING INCOME**



Many Finish in 2 Years

Finish High School at home, as FAST as time and ability permit. Equivalent to resident school work—prepares for college, pre-professional examinations, business, industry. Standard texts. Diploma. Credit for High School subjects already completed. Single subjects if desired. American School, Chicago, est. 1897. FREE Bulletin. Write TODAY!

American School, Dept. H745, Drexel Ave. at 58th St., Chicago
Send free information as checked below. No obligation.

- | | |
|----------------------------------|--------------------------|
| — HIGH SCHOOL COURSE | — Air Conditioning |
| — Accounting and Auditing | — Diesel Engineering |
| — Architecture and Building | — Drafting and Design |
| — Automotive Engineering | — Liberal Arts |
| — Business Management | — Private Secretary |
| — Aviation | — Mechanical Engineering |
| — Electrical Engineering | — Radio and Television |
| — Electric and Gas Refrigeration | — Home Economics Courses |

Name

Address

Promotion Begins at Home

WELDING

Get in Line Now for a Good Job in Welding

The national emergency program brings new opportunities in the technical fields,—especially in Welding (including Aircraft). Industry demands capable, trained welding operators, technicians, engineers and mechanics. The application of gas and electric welding in all lines of business is almost unlimited,—aircraft, automobiles, diesels, building, etc.



TWO PLANS OF TRAINING

Choose the one that suits you best.

- Day and Evening Classes at the College in Chicago. Start any Monday. Train in modern shops completely equipped. Rapid progress through short intensified courses.
- Home Training combined with shorter course at our shops in Chicago, thus permitting you to earn while learning in your spare time.

FREE BLUE BOOK Send post card today for Free Blue Book. Contains helpful information about Welding and other technical fields. Please state which training plan you favor.

CHICAGO TECHNICAL COLLEGE

N-600 Tech Bldg., 118 East 26th St., Chicago, Ill.

Say you saw it in Popular Mechanics!

PARKS AIR COLLEGE

PARKS AIRPORT

EAST ST. LOUIS, ILL.

Offers YOU COLLEGE and PROFESSIONAL TRAINING Majoring in AVIATION

Accredited by the Illinois Superintendent of Public Instruction. U.S. approved as a Commercial Ground and Flying School and Mechanics' School. Accredited by and cooperating with the United States Army Air Corps in giving flight and mechanical training. Open to high school graduates.

FOUR courses lead to B.S. degrees in Professional Piloting, Aviation Operations, Maintenance Engineering, Aeronautical Engineering.

EIGHTEEN TRAINING PLANES are used in professional flight training which prepares graduates for airline flight operations. 76,000 hours flight training given, 1800 hours being flown monthly.

FACULTY of 46 specialists in various fields of aviation. 1569 graduates. Enrollment limited to a total of 300 commercial aviation students. Total enrollment 415.

100-acre airport, 22 buildings devoted to school purposes exclusively. Dormitories and dining hall at the College.

Fall Term September 30. Send postcard for new 64-page catalog.

14th YEAR Registrar, Dept. PM-10
PARKS AIR COLLEGE, East St. Louis, Ill.

ENGINEERING DEGREE IN TWO YEARS

B. S. Degree courses in engineering: Electrical, Civil, Chem., Mechanical, Radio or Aeronautical, 1 yr. Mech. Drafting. Approved by Civil Aeronautics Authority, participation in Pilot Training Program. Large industrial center. Prep courses without extra charge. Earn board if desired. Low tuition. Enter December, March, June, September. Write for Catalog. 5100 E. Washington Blvd., Fort Wayne, Ind.

INDIANA TECHNICAL COLLEGE

LAW STUDY AT HOME

Legally trained men win higher positions and bigger success in business and public life. Greater opportunities now than ever before. Big corporations are headed by men with legal training.

More Ability: More Prestige: More Money

We guide you step by step. You can train at home during spare time. Degree of LL. B. Successful graduates in every section of the U. S. We furnish all text material, including 14-volume Law Library. Low cost, easy terms. Get our valuable 48-page "Law Training for Leadership" and "Evidence" books FREE. Send for them NOW. LaSalle Extension University, Dept. 1064-L Chicago

A Correspondence Institution

SECURITY FOR LIFE

Be an expert in an essential business. Learn Meat Cutting. Steady jobs and good pay everywhere. Quick, short course—ACTUAL PRACTICE. Learn with tools and meat—not books. Individual training. Be a fully qualified union Meat Cutter when finished. Union Card FREE. Job help after graduation. Write for catalog and complete details.

NATIONAL SCHOOL OF MEAT CUTTING, INC.
DEPT. U-11 TOLEDO, OHIO

Regain Perfect Speech, If You

STAMMER

Every stammerer should have the new 287 page book "Stammering, Its Cause and Correction." Sent free to stammerers. It describes the Bogue Unit Method for the scientific correction of stammering and stuttering. Method successfully used at Bogue Institute for 39 years—since 1901. Endorsed by physicians. Write for full information. No obligation. Benjamin N. Bogue, Dept. 1319 Circle Tower, Indianapolis, Indiana.

GET INTO THE BAKING BUSINESS!

National Baking Institute announces a new home study course in commercial baking. Baking now America's fifth industry in wages. Nearly a depression-proof business. Good field for ambitious men. Common school education sufficient. Send for free booklet "Opportunities in Commercial Baking" and requirements.

National Baking Institute
3601 Michigan Ave. Dept. 1357 Chicago, U. S. A.



Learn MECHANICAL DENTISTRY

Short course—personal, individual, instruction—best technical teachers. Profession offers unlimited opportunity—not affected by Machine Age. Meet modern and complete methods embracing every branch from plate to porcelain work. Qualifies you to work for dentists or own business. Day or night school. No books—no classes. Catalog upon request.

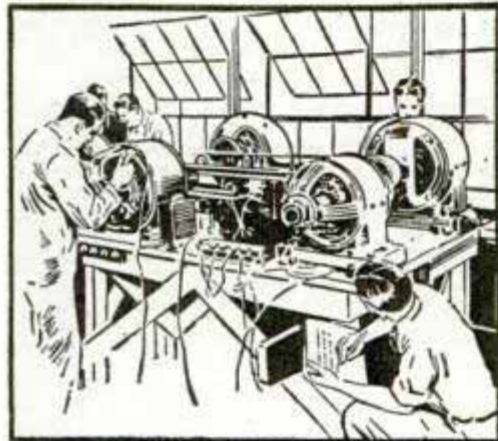
OR STUDY AT HOME. Write for information on our Home Study Course.
McCARRIE SCHOOL OF MECHANICAL DENTISTRY
207 N. Broad St. Dept. 761 Philadelphia, Pa.

TRAIN FOR A BETTER JOB IN ELECTRICITY

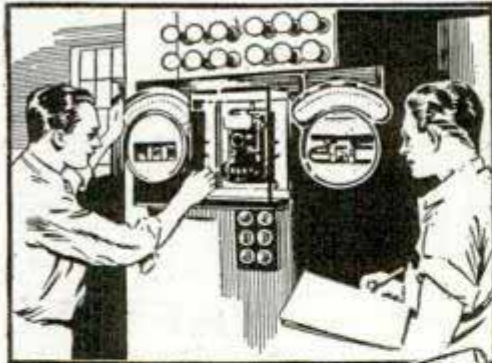
Pay Tuition After Graduation

ACTUAL WORK ON ACTUAL
ELECTRICAL MACHINERY

12 WEEKS SHOP TRAINING



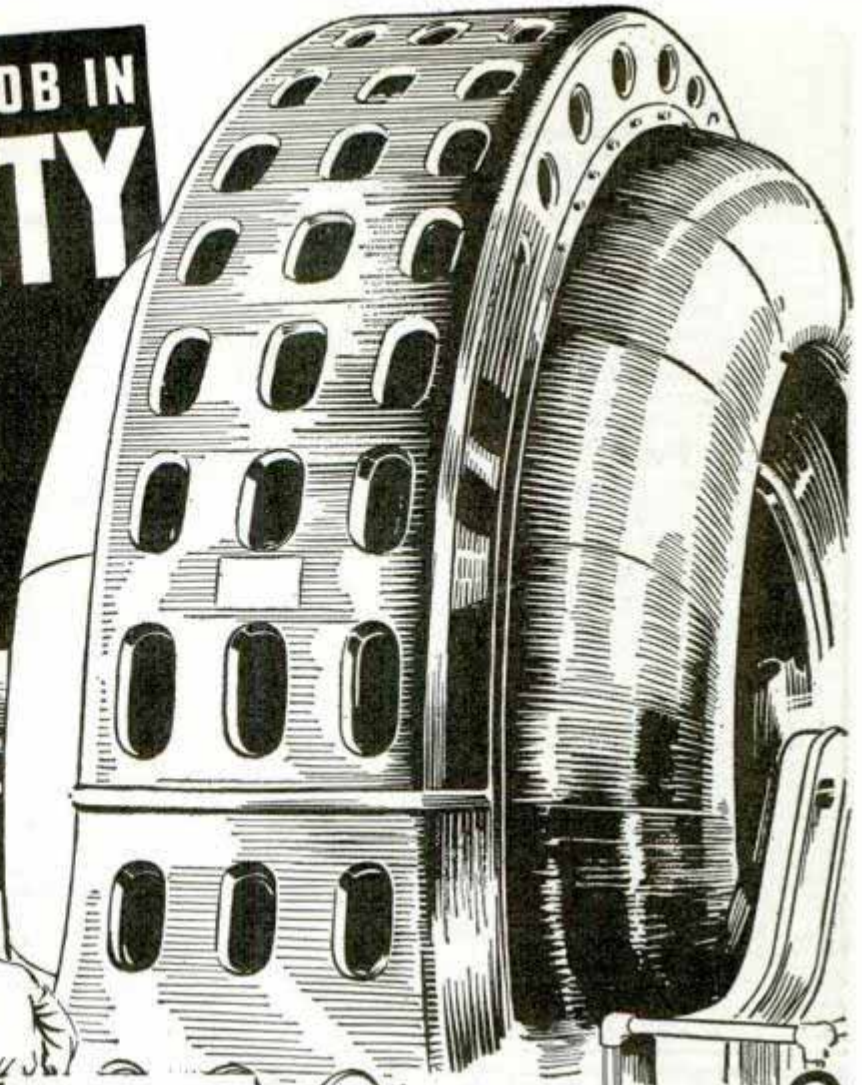
First you are told and shown what to do and how to do it. Then you do it yourself.



GET MY BIG
FREE
BOOK



Home of
Coyne
Electrical
School



LEARN TO EARN MORE?

My big free book tells you how we train you in 12 weeks for your start to a better job and better future.

Learn by Doing

You get your training not by book or lessons but on actual electrical machinery and equipment.

Get Training First— Pay Tuition Later

You can get your training first and then pay for it in 12 monthly payments starting 5 months after you start school or 60 days after your 12 weeks training period is over. Mail coupon for all the details of this plan.

Earn While Learning

Lack of money need not stop you. You can get training first and pay after graduation and if you are short of money for living expenses we will help you get a part time job while training.

Previous Experience or Advanced Education Not Necessary

You don't need any previous elec-

trical experience or advanced education to get my training.

Graduate Employment Service

After graduation every graduate is given employment help, consultation help and many other services to help him make a success of his training.

4-Weeks Extra Radio Course Included

Right now I am including an extra 4 weeks course in Radio. This training is given you at no extra tuition cost.

Get My Complete Story

Fill in and clip the coupon below. Then mail it to me. When I receive it I'll send you my big free book and all the details of the features I have outlined here.

This will not obligate you in any way and no salesman will call on you as I do not employ salesmen.

You owe it to yourself and your future to get these facts now.

So don't put it off—mail the coupon now.

COYNE ELECTRICAL SCHOOL 500 S. PAULINA ST.
Dept. 70-72, CHICAGO

MAIL THE COUPON NOW

H. C. LEWIS, President, COYNE ELECTRICAL SCHOOL,
500 S. Paulina Street, Dept. 70-72, Chicago, Ill.

I'm really in earnest. I do want to get ahead. Send me your big free catalog with full particulars about Coyne training and your plans to help a fellow, who hasn't a lot of money, to get ahead.

Name.....
Address.....
City.....State.....



MACHINE SHOP MEN

Learn to set up and run ANY kind of machine; **MAKE MORE MONEY NOW** by learning quickly **HOW TO DO THINGS** which usually take years of study and practice. The demand for **SKILLED men** is **ALREADY** ahead of the supply, then what **WILL IT BE** a month or two from now?

Needed NOW!

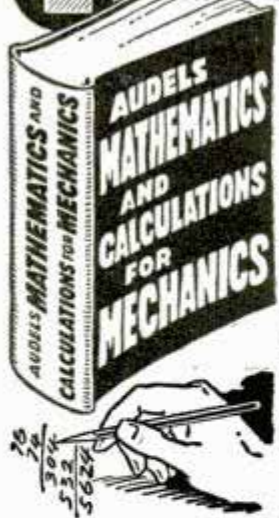
Bigger Pay Don't miss this chance to qualify for promotion, don't miss this Big Opportunity which is yours almost for the asking. Eight Big Books chockful of important mechanical facts told simply and clearly. Over 3000 pages, nearly 3000 illustrations cover every subject fully, including Tool Making, Pattern Making, Foundry Work, Mechanical Drawing, Forging, Machine Shop Practice and Management, and hundreds of other subjects.

8 Big Books (1940 Edition) Sent FREE to you for examination. Decide in your own home or place of business whether or not you want to keep them, check up on any facts you want to. Note their great **MONEY MAKING** value, then, if you want them, pay on the easiest kind of payments. Send **NOW** and we will include a year's consulting membership in the American Technical Society without extra charge—and also a **Big Binder** of nearly 800 pages with 267 original shop tickets with 1200 illustrations. Theseshow, step by step, how to set up and run almost any kind of job and are in **addition** to the 8 books. American Technical Society, Publishers—Home Study Courses.

American Technical Society, Dept. 5719, Drexel at 58th St., Chicago. You may send me the 8 big NEW books and binder of shop tickets for free examination. I will pay the delivery charges only, unless I decide to keep them in which case I will send \$2.00 in ten days and \$3.00 per month until the total price of only \$34.80 is paid. If I return them in 10 days I will owe you nothing. Because I send you you agree to give me a membership in the American Technical Society entitling me to consulting privileges with any of your experts for one year.

Name.....
 Address.....
 Please attach a letter stating age, occupation, employer's name and address and that of at least one business man as reference.

MATHEMATICS and CALCULATIONS for MECHANICS



Good News!
MATHEMATICS & CALCULATIONS for HOME STUDY & REFERENCE
PRACTICAL MATHEMATICS ILLUSTRATED. How to figure correctly. EVERY MECHANIC can use the New, Correct, Easy Methods, covering a complete review of practical arithmetic—with examples including mensuration—plane and solid geometry—trigonometry—algebra—calculus—ELECTRIC and MECHANICAL SHOP CALCULATIONS—practical tests—reference tables and data—How to use the Slide Rule—700 Pages—550 Illustrations—Pocket Size.

Highly endorsed. Let us mail you copy for free trial. Price \$2, postpaid.

● **A HANDY BOOK! ASK TO SEE IT TODAY** ●

FREE EXAMINATION COUPON

THEO. AUDEL & CO., 49 WEST 23rd ST., N.Y.C. Mail Audel's Mathematics on 7 days' free trial. If O.K. I will remit \$2, otherwise I will return it.

Name.....
 Address.....
 Occupation..... PM

When writing please mention Popular Mechanics

THIS VALUABLE BOOK

FREE



LEARN CARTOONING AT HOME IN SPARE TIME

Send for this **FREE** book containing money-making tips, cartooning charts, idea creating methods, list of cartoon buyers, and other valuable information. Read about the money-making opportunities in one of the most fascinating of all professions—**CARTOONING**. With this booklet we will include a complete portfolio describing our easy Course in Cartooning and explaining our new Marionette Method of Instruction. We will also tell you how to get the Cartoonists' Exchange Laugh Finder **FREE** of extra cost. This amazing device actually helps create and originate humorous ideas. Send name at once and mention your age.

CARTOONISTS' EXCHANGE
 Dept. 910 Pleasant Hill, Ohio

Your Place in Aviation... SPARTAN SCHOOL OF AERONAUTICS



Come to **SPARTAN** for today's finest expert training for your choice of aviation careers—Flying, Engineering, Mechanics, Radio. Approved by U. S. Civil Aeronautics Authority. 15 modern airplanes, latest aircraft engines; completely equipped shops, laboratories—private practice fields; 17 modern buildings; club-like dormitories. \$350,000 expansion program making **SPARTAN** even greater. *New semester starts Sept. 30th. Write for free catalog.*
CAPTAIN MAXWELL W. BALFOUR, Director
 Dept. PM-100 Tulsa, Oklahoma

TRI-STATE COLLEGE

B. S. Degree in 2 Years
 World famous for technical 2-year courses in Civil, Electrical, Mechanical, Chemical, Radio, Aeronautical Engineering, Business Administration and Accounting. Special preparatory department for those who lack required high school work. Short diploma courses (36 weeks) in Surveying, Drafting. Low tuition. Low living costs. Students from every state and many foreign countries. 57th year. Graduates successful. Enter September, January, March, June. Write for catalog. 4100 College Ave., **ANGOLA, IND.**

PHOTO-ENGRAVING TASOPE' SINCE 1931

FREE—a copy of the Tasope' Magazine, monthly treasure chest of photographic and photo-engraving information. Learn why Aurora, Mo., is the photo-engraving, photographic center of America . . . how hundreds of amateurs, free-lance photographers are making money with pictures. No-obligation postcard brings your copy.
TASOPE', DEPT. PM-21, AURORA, MO.



Begin today. Write for our New Free Book, "How to Become a Good Penman," it contains specimens and tells how others learned to write in spare time. Enclose 10c for a Professional Pen Point and your name beautifully written. Write today.

THE TAMBLYN SCHOOL OF PENMANSHIP
 441 Ridge Building Kansas City, Mo.

Learn PHOTOGRAPHY at Home

Splendid opportunities. Prepare in spare time. Easy plan. No previous experience needed, common school education sufficient. Send for free booklet "Opportunities in Photography", particulars and requirements.
American School of Photography
 3601 Michigan Ave., Dept. 1357, Chicago, Ill.

DRAFTING—DRAFTING

Drafting jobs pay big. Many make \$175.00-\$250.00 month. Unlimited possibilities. Learn at home in spare time. No experience needed. No text book required. Great demand now. Rapid promotion. Write today for complete information **FREE**. No obligation. No salesman.
MONROE INSTITUTE Dept. A-110, Alton, Illinois

MAKE MONEY AT HOME

RUBBER MOLDS Low as 6¢ EA.

Amazing rubber mold-making outfit makes perfect flexible molds of plaques, ash trays, book-ends, etc. Molds cost from 6c to 25c each. Each mold makes hundreds of novelties and gifts to sell up to \$1.00 apiece! No experience necessary. Quick and easy. Start profitable business in your home . . . sell to stores, gift shops, friends, resorts, road stands, by mail. Full or spare time. "Molders Handy Book" and list of buyers **FREE**. Write



SO-LO WORKS
 Dept. M-827 Cincinnati, Ohio

**I'LL TRAIN YOU AT HOME
IN SPARE TIME to MAKE GOOD
MONEY in RADIO and
TELEVISION**



Easy to Start . . . Earn While You Learn

Wake up! Get ahead! You fellows with ambition can make a wonderful success in Radio and Television through my new, practical, home training. I teach you in your spare time through interesting experiments with real equipment. Every essential phase of Radio, Television, Electronics, Facsimile, Radio Set Repair and Installation is covered. You get Personalized help. No previous experience needed. So practical—so understandable—so simplified is this training that any man with average education can grasp the money-making knowledge quickly and easily. You will be ready for a business of your own . . . or to hold down a good-paying job. My **BUSINESS BUILDERS** show you how to make profits while learning.

BIG FREE BOOK! Get complete details in new catalog "HOW TO MAKE MONEY IN RADIO". Write Sprayberry Academy of Radio, 310-K, University Place, N. W., Washington, D. C.

YOU GET

146
RADIO
PARTS

RADIO
TOOLS

ALL WAVE
ALL
PURPOSE
ANALYZER

LAW

STUDY AT HOME for Personal Success and Larger Earnings. 28 years of successful student guidance assures expert instruction. LL.B. Degree awarded. All text material furnished. Easy payment plan. Send for **FREE BOOK**—"Law and Executive Guidance," at ONCE.

AMERICAN EXTENSION SCHOOL OF LAW
Dept. PM-10, 620 N. Michigan Ave., Chicago, Ill.



Auto-Diesel

Master a real trade. Auto Mechanics, Diesel Mechanics, Arc Welding, Acetylene Welding, etc. Let us train you to be an expert Auto-Diesel Mechanic and help you get a good job. The cost to you is reasonable. Learn on modern equipment with tools under experienced instructors. Real shop work. Steam heated buildings. Room and board in our steam heated dormitory. We pay your fare to Nashville. For free catalog write

Nashville Auto-Diesel School, Dept. 75 Nashville, Tenn.

New York Established 1902
Electrical
Ask for free illustrated
booklet **School**

44 West 17th St., N. Y. C.

BE A PASSENGER TRAFFIC INSPECTOR



Ambitious Men Succeed with our Training
You can qualify as Railway and Bus Traffic Inspector in a short time by our easy, home-study course, and on completion we'll help place you at up to \$135 per month, plus expenses to start, or refund tuition. Pleasant, interesting work; travel if you like. Free Booklet describes our 21 yrs' service.
STANDARD BUSINESS TRAINING INSTITUTE,
Div. 210 Buffalo, N. Y.

TOOL & DIE MAKING DESIGNING

Machinists Trade, Machine Drafting and Design. Practical shop training in the world's industrial center. Write today for full information.

NATIONAL SCHOOL OF MECHANICAL TRADES
Dept. 22 628 W. Lake St. Chicago, Ill.

BE A LANDSCAPE ARCHITECT



Ambitious? Here's a profession for men and women. Year-round occupation—also interesting hobby! Home study course used by hundreds. Write for free booklet "Success thru Landscape Training." Write today.

AMERICAN LANDSCAPE SCHOOL
6192 Grand Avenue Des Moines, Iowa

VOICE

100% Improvement Guaranteed
We build, strengthen the vocal organs—not with singing lessons—but by fundamentally sound and scientifically correct silent exercises . . . and absolutely guarantee to improve any singing or speaking voice at least 100% . . . Write for wonderful voice book—sent free. Learn WHY you can now have the voice you want. No literature sent to anyone under 17 years unless signed by parent.
PERFECT VOICE INSTITUTE, Studio 1357
64 E. Lake St., Chicago

Prepare NOW
for **PROMOTION**



This complete drawing outfit,—everything to work with,—including drafting table, drawing board, supplies and drawing instruments,—**ALL SENT TO YOU AT NO EXTRA COST** if you are a Chicago Tech student.

MAIL COUPON
BELOW

DRAFTING

The draftman's work comes *first*. New machines,—new construction work,—new bridges,—new buildings,—*all* must *first* be laid out on paper by the draftsman. So the *first* man that must be hired is the *draftsman*.

Drafting Offers Opportunity

In the *machinery* and *building* fields,—in *aircraft*,—in *diesels* and *air conditioning*,—and in many other industries, Drafting offers real opportunities for promotion. It is one of the *steadiest* employment fields. Drafting is clean, interesting, well-paid and important work. Find out now what Drafting offers *you!*

In Spare Time,—at Home!

(or at the College in Chicago)

With our easy step-by-step lessons, (and the tools we furnish), you can learn in your spare time at home. To prove to you how easy it is to learn Drafting by the Chicago Tech Method we'll send you a Trial Lesson **FREE**. No charge for this lesson either now or later.

Send a post card or the coupon now for

FREE TRIAL LESSON
free TRIAL LESSON
Send Coupon

CHICAGO TECHNICAL COLLEGE

N-201 Tech. Bldg., 118 East 26th St., Chicago, Illinois

Please send me **FREE Trial Lesson in DRAFTING** showing how to learn at home by C. T. C. plan. No obligation of course.

Name

Address

City.....State.....

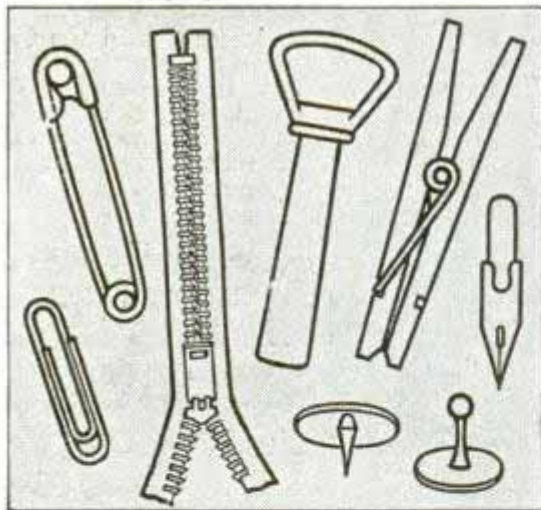
Occupation.....Age.....

INVENTORS

Act Now TO PROTECT
YOUR INVENTION WITH U.S. PATENT

Small Ideas May Have Large Commercial Possibilities

Inventions do not have to be complicated to be profitable when Patented. The 5c and 10c stores flourish on simple Patented products which are commercially successful. The zipper, safety pin, thumb tack, paper clip, collar button—all are simple yet familiar inventions—brought their inventors rich rewards. If you have a Patentable invention—act to protect it. Send for our FREE 48-Page Book that tells you how.



CLARENCE A. O'BRIEN

Dept. OK1, Adams Building, Washington, D. C.
Registered Patent Attorney before U. S. Patent Office

Free Book TELLS IMPORTANCE OF QUICK ACTION—HOW TO OBTAIN PATENT AND MARKET INVENTIONS

If you have invented something, if you're interested in inventing something, you need our new 48-page book that gives the entire Story of Patents. It tells you for the first time about new phases of invention, how others succeeded, how the patent laws protect you, how to market your invention, where to obtain finances, how to form a company, partnership, or arrange for royalties from your invention's sale.

PRACTICAL BENEFITS OF THIS BOOK

You will find 6 complete pages illustrated with simple inventions that have succeeded in six different fields of industry. Over 100 illustrations are in this book. You will read the stories of ten (illustrated) of America's most famous inventors. You will find an experienced and thorough survey of market conditions affecting the inventor—showing the possibilities for commercial invention today. Entire chapters are devoted to the value of a patent in promoting the final success of your invention. The importance of quick action in applying for patent is stressed—facts revealing danger of delay are emphasized.

If you expect to realize profits from your invention you must protect it with a U. S. Patent. Otherwise you may find that all your time and labor have been lost, because it often happens that other inventors are working on the same invention. If you have an invention, or an ambition to invent—get the information on obtaining patent AT ONCE!

FREE RECORD OF INVENTION FORM.

When you send for our FREE BOOK, we include, also Free, our specially prepared Record of Invention blank, on which you can quickly make and date a sketch and description of your invention. This "disclosure" as it is called, may be absolutely invaluable as evidence for you, should your rights ever be contested. Be sure to get it and use it.

CLARENCE

REGISTERED PATENT ATTORNEY before U. S. Patent Office

for Quick Action

GET FREE 48-PAGE BOOK
and Free Form for Recording Your Invention



MAIL COUPON NOW
TO CLARENCE A. O'BRIEN
Registered Patent Attorney
 BEFORE U. S. PATENT OFFICE

Clarence A. O'Brien, Dept. OK1, Adams Building, Washington, D. C.
 Please send me your Big, Free 48-Page Book for Inventors and your Specially Prepared Record of Invention form. This request does not obligate me.

Name.....
 Address.....
 City..... State.....
 (Please write or print plainly).

You Can Patent IMPROVEMENTS IN MACHINERY, ARTICLES, DESIGNS, FORMULAS, ETC., IF NEW

Every year thousands of Patents are granted. Very few, however, represent the discovery of entirely new principles. Most of them provide new methods of doing some every-day thing in a better way—changes for greater efficiency, usefulness, adaptability, or beauty in some previously Patented thing. These IMPROVEMENTS are patentable if new, and actually represent new inventions. These Improvement Patents offer large chances for profit if commercially useful. The business world wants improved products and services.

FINISHED DRAWINGS NOT NECESSARY

Our Big Book tells you how you can start immediately to apply for Patent Protection even if you haven't finished models or drawings available now. It will tell you how we can prepare the specifications and finished drawings necessary in the form prescribed by the Patent Office—so as to secure for you full Patent Protection. Mail Coupon for Our Big Book TODAY.

OUR SERVICES TO YOU

We are Registered Patent and Trade-Mark Attorneys, serving Inventors all over the United States and abroad. Our Organization is complete. We have Draftsmen, experienced Searchers and Attorneys to serve your interests. We can act as your legal adviser in all Patent Matters. Our complete service is described in Our Big Book. Mail Coupon for it NOW.

REASONABLE FEES—CONVENIENT TERMS

Don't worry about finances. Our fees are very reasonable—we can arrange convenient terms of payment. It is our custom to permit clients to pay for our services in installments as the application progresses in our office. See our Big Book for fees in obtaining Patent. It explains our arrangements clearly. Send for it NOW.

GET FREE BOOK—MAIL COUPON NOW

If you have an invention in the making—if you simply have the crude elements of an invention in mind—you should have our Big FREE BOOK without delay. It will guide you every step of the way—from the preliminary search stage to the issuance of the final patent grant. This book contains twenty-five chapters describing in plain man-to-man language the story of obtaining a patent and marketing an invention. This book is absolutely FREE—just tear off the above coupon or write us a letter or postcard TODAY!



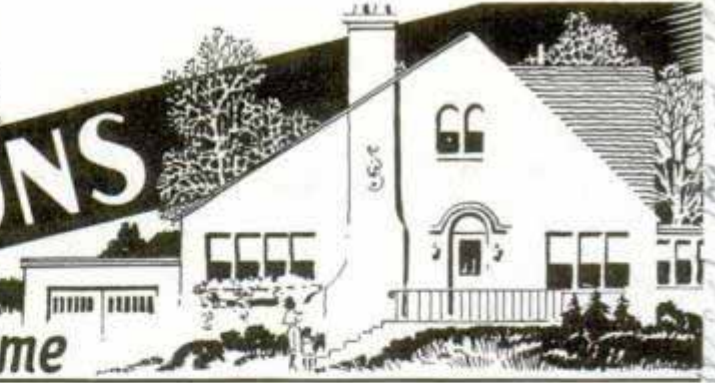
Get These Free MAIL COUPON

A. O'BRIEN

Dept. OK1, Adams Building WASHINGTON, D. C.

POPULAR INVENTIONS

For Your Home



Electric Utility Cabinet Dries Clothes and Warms Room



With a plug-in electric heating unit in its bottom compartment, a utility cabinet serves many useful purposes. It has racks for drying garments, and if left open will help warm up the bathroom.

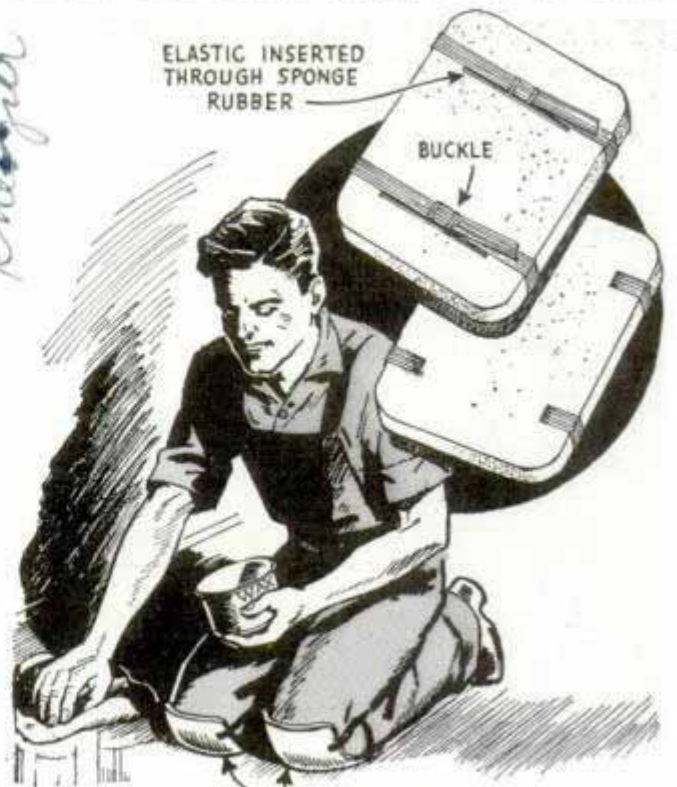
Dual Food Slicer Saves Time

A timesaver for the kitchen is a hand-cranked food slicer provided with two insets, one a cutter for turning out fruits and vegetables in thin strips for salads and cooked dishes, the other a slicer for firm foods.



Rubber Pads Protect the Knees in Garden or Floor Work

Bubble-filled rubber pads that buckle over the knees offer protection to the gardener or to the householder who has a painting or waxing job to do on the floor. Waterproof and washable, they permit work in the garden while it is still damp with dew or rain.



Flour Sifter Is Reversible



A "repeating" flour sifter just offered to housewives has accurate measuring cups for covers, so that extra bowls are unnecessary. It will sift and resift the flour as often

as desired without removing it, simply by putting covers on both ends and reversing.

The Party Car Co. West Bend, Wis. Virginia 'water' cafe. One Exchange Place Jersey City, N.J.

K 143 Kitchen Craft Co. West Bend, Wis. The Kitchen K 453 Kneeger

Reath Mfg. Co. 649 E. 61st St.

IF YOU WANT TO

EARN

ADD AN "L" AND

LEARN

You know it's a fact, and you've got to face it: The way to *earn more* in your work is to *learn more* about your work!

Start today on a definite *program* of learning and earning. Forget the years you've wasted, and start investing your leisure time in up-to-the-minute, practical *training*. That's the key to success and prosperity!

Mail this coupon right now, for *free booklet* and complete information on the International Correspondence Schools. Find out why 327 schools and universities use I. C. S. textbooks. Learn why leading educators praise I. C. S. training methods. Discover how I. C. S. training can make *you* a trained man —at a surprisingly low cost!

INTERNATIONAL CORRESPONDENCE SCHOOLS

BOX 5587-J, SCRANTON, PENNA.

★ Without cost or obligation, please send me a copy of your booklet, "Who Wins and Why," and full particulars about the course *before* which I have marked X: ★

TECHNICAL AND INDUSTRIAL COURSES

- | | | | | |
|---|---|---|---|--|
| <input type="checkbox"/> Agriculture | <input type="checkbox"/> Air Brake | <input type="checkbox"/> Cotton Manufacturing | <input type="checkbox"/> Mfg. of Pulp and Paper | <input type="checkbox"/> R. R. Section Foreman |
| <input type="checkbox"/> Air Conditioning | <input type="checkbox"/> Diesel Engines | <input type="checkbox"/> Electrical Drafting | <input type="checkbox"/> Marine Engines | <input type="checkbox"/> R. R. Signalmen's |
| <input type="checkbox"/> Architectural Drafting | <input type="checkbox"/> Electrical Engineering | <input type="checkbox"/> Electric Drafting | <input type="checkbox"/> Mechanical Drafting | <input type="checkbox"/> Refrigeration |
| <input type="checkbox"/> Architecture | <input type="checkbox"/> Electric Lighting | <input type="checkbox"/> Fire Bosses | <input type="checkbox"/> Mechanical Engineering | <input type="checkbox"/> Sheet Metal Work |
| <input type="checkbox"/> Auto Engine Tune-up | <input type="checkbox"/> Foundry Work | <input type="checkbox"/> Fruit Growing | <input type="checkbox"/> Mine Foreman | <input type="checkbox"/> Steam Electric |
| <input type="checkbox"/> Auto Technician | <input type="checkbox"/> Heating | <input type="checkbox"/> Heat Treatment of Metals | <input type="checkbox"/> Navigation | <input type="checkbox"/> Steam Engines |
| <input type="checkbox"/> Aviation | <input type="checkbox"/> Highway Engineering | <input type="checkbox"/> House Planning | <input type="checkbox"/> Patternmaking | <input type="checkbox"/> Steam Fitting |
| <input type="checkbox"/> Boilermaking | <input type="checkbox"/> Locomotive Engineer | <input type="checkbox"/> Machinist | <input type="checkbox"/> Pharmacy | <input type="checkbox"/> Structural Drafting |
| <input type="checkbox"/> Bridge Engineering | <input type="checkbox"/> Management of Inventions | <input type="checkbox"/> Management of Inventions | <input type="checkbox"/> Plumbing | <input type="checkbox"/> Structural Engineering |
| <input type="checkbox"/> Building Estimating | <input type="checkbox"/> College Preparatory | <input type="checkbox"/> Commercial | <input type="checkbox"/> Poultry Farming | <input type="checkbox"/> Surveying and Mapping |
| <input type="checkbox"/> Chemistry | <input type="checkbox"/> Cost Accounting | <input type="checkbox"/> Cost Accounting | <input type="checkbox"/> Practical Telephony | <input type="checkbox"/> Telegraph Engineering |
| <input type="checkbox"/> Civil Engineering | <input type="checkbox"/> C. P. Accounting | <input type="checkbox"/> C. P. Accounting | <input type="checkbox"/> Public Works Engineering | <input type="checkbox"/> Textile Designing |
| <input type="checkbox"/> Coal Mining | <input type="checkbox"/> First Year College | <input type="checkbox"/> First Year College | <input type="checkbox"/> Radio, General | <input type="checkbox"/> Toolmaking |
| <input type="checkbox"/> Concrete Engineering | <input type="checkbox"/> Advanced Dressmaking | <input type="checkbox"/> Home Dressmaking | <input type="checkbox"/> Radio Operating | <input type="checkbox"/> Welding, Electric and Gas |
| <input type="checkbox"/> Contracting and Building | <input type="checkbox"/> Foods and Cookery | <input type="checkbox"/> Professional Dressmaking and Designing | <input type="checkbox"/> Radio Servicing | <input type="checkbox"/> Woolen Manufacturing |

BUSINESS COURSES

- | | | | | |
|--|--|--|---|---|
| <input type="checkbox"/> Accounting | <input type="checkbox"/> Advertising | <input type="checkbox"/> College Preparatory | <input type="checkbox"/> Foremanship | <input type="checkbox"/> Railway Postal Clerk |
| <input type="checkbox"/> Bookkeeping | <input type="checkbox"/> Business Correspondence | <input type="checkbox"/> Commercial | <input type="checkbox"/> French | <input type="checkbox"/> Salesmanship |
| <input type="checkbox"/> Business Management | <input type="checkbox"/> Business Management | <input type="checkbox"/> Cost Accounting | <input type="checkbox"/> Grade School | <input type="checkbox"/> Secretarial |
| <input type="checkbox"/> Cartooning | <input type="checkbox"/> Civil Service | <input type="checkbox"/> C. P. Accounting | <input type="checkbox"/> High School | <input type="checkbox"/> Sign Lettering |
| | | <input type="checkbox"/> C. P. Accounting | <input type="checkbox"/> Illustrating | <input type="checkbox"/> Sign Lettering |
| | | <input type="checkbox"/> First Year College | <input type="checkbox"/> Lettering Show Cards | <input type="checkbox"/> Spanish |
| | | | <input type="checkbox"/> Managing Men at Work | <input type="checkbox"/> Traffic Management |

HOME ECONOMICS COURSES

- | | | |
|---|---|--|
| <input type="checkbox"/> Advanced Dressmaking | <input type="checkbox"/> Home Dressmaking | <input type="checkbox"/> Tea Room and Cafeteria Management, Catering |
| <input type="checkbox"/> Foods and Cookery | <input type="checkbox"/> Professional Dressmaking and Designing | |

Name.....Age.....Address.....
 City.....State.....Present Position.....

Canadian residents send coupon to International Correspondence Schools Canadian, Limited, Montreal, Canada
 British residents send coupon to I. C. S., 71 Kingsway, London, W. C. 2, England



HIS secret is simple. For years he has had "the MERRIAM-WEBSTER habit"—has looked up every subject that interested him in this "Supreme Authority." It contains 600,000 entries—122,000 more than in any other dictionary. Your bookdealer will be glad to show it. Write for free booklet: "The New Merriam-Webster: What It Will Do For You."

G. & C. Merriam Co., Dept. 501, Springfield, Mass.
Look for the circular trade-mark
Copyright, 1939, by G. & C. Merriam Co.



Webster's New International Dictionary
Second Edition
WEBSTER'S NEW INTERNATIONAL DICTIONARY
Second Edition



It's Easy To Be A Contractor

Learn to estimate, to plan buildings, to take contracting jobs, and make money on them. Here are 9 up-to-the-minute books on building, estimating, and contracting which cover in an interesting way, the subjects that carpenters, builders, and contractors should know to make the most out of their jobs. Roof Framing, The Steel Square, Architectural Drawing and Design, Estimating, Painting and Decorating, Heating, Air Conditioning, Building, Contracting, Concrete Forms and other subjects are all well covered.

"Boss" Carpenters in Demand NEW 1940 EDITION

Vast public works jobs, immense projects, and the rapid growth of home building, are making jobs for MEN WHO KNOW HOW. These books give you quick training. With them you shouldn't be afraid to tackle any job, for needed facts can be found in a hurry.

These books are the most up-to-date, complete we have ever published on these subjects.

Coupon Brings Nine Books FREE For Examination

AMERICAN TECHNICAL SOCIETY (Publishers—Home Study Courses)
Dept. G719, Drexel at 58th Street, Chicago, Illinois

You may ship me the new 1940 edition of your nine big books, "Building, Estimating, and Contracting" without any obligation to buy. I will pay the delivery charges only, and if fully satisfied in ten days, I will send you \$2.00, and after that only \$3.00 a month, until the total price of only \$29.80 is paid. I am not obligated in any way unless I keep the books.

Name.....
Address.....
City.....State.....

Please attach a letter stating your age, employer's name and address, and that of at least one business man as a reference.

U.S. GOV'T JOBS

SHORT HOURS-GOOD PAY -VACATIONS-PENSIONS

Stop worrying about strikes, layoffs, hard times! Get on the government payroll. No special education or experience usually required. Short hours; steady work; vacations. Open to men and women citizens, of ages 18 to 50.

SEND FOR FREE BOOK

It tells about government positions; what to do to get job you want. Mail letter or postal card now for FREE book "How to Secure a Government Position". Address **PATTERSON SCHOOL, 810 Mercantile Bldg., Rochester, N. Y.**

RAILWAY POSTAL CLERK
Start at \$1850 a year

INSPECTOR OF CUSTOMS
Start at \$2100 a year

RURAL MAIL CARRIER
Start at \$1800 a year

POST OFFICE CLERK
Start at \$1700 a year

Write and Speak **MASTERLY ENGLISH**
Learn correct English with Sherwin Cody's new invention. No rules to memorize. Like an fascinating game. Spare-time study. 15 minutes each day, quickly gives you command of English. Send for free book "How You Can Master Good English in 15 Minutes a Day." Write today. **SHERWIN CODY SCHOOL OF ENGLISH, 510 Searle Bldg., Rochester, N. Y.**

EARN A DEGREE AT HOME

From A Chartered Institution of Higher Learning
Employers Now Demand College Graduates With Degrees
88 Degree Courses in Arts; Sciences; Philosophy; Education; Public Health, Medical Jurisprudence; Psychology; Sociology; Physics; Chemistry; Geology; Pol. Science; Theology; Law; Business Training; Accounting; Statistics; Agriculture, Electrical, Civil, Mechanical, Drafting, Architectural, Automotive, Steam, Diesel, Aeronautical, Radio, Structural, Industrial, Highway, Petroleum, Mining, Marine, Refrigeration, Air Conditioning, Chemical Engineering. Founded 1908. Chartered. **McKinley-Roosevelt Graduate College, 4610-P Sheridan Road, Chicago**

EXPERT PHOTOGRAPHY MADE EASY

Successful photography as a career, for sparetime earnings or as a hobby—made easy through N.Y.L. Training! Personal coaching by leading photographers. Fascinating field. Splendid opportunities. Commercial, News, Portrait, Motion Picture, Advertising and Color Photography, Personal Attendance and Home Study Courses. Booklet FREE!
N. Y. INSTITUTE OF PHOTOGRAPHY
Dept. 49, 10 West 33rd St., New York, N. Y. (30th Year)

RADIO ENGINEERING, broadcasting, aviation and police radio, servicing, marine and Morse telegraphy taught thoroughly. 48 weeks' engineering course equivalent to three years' college radio work. School established 1874. All expenses low. Catalog free.
Dodge's Institute, Ada St., Valparaiso, Ind.

TOOL & DIE MAKING MACHINIST

Acety & Arc Welding, Body & Fender Repair, Practical Shop Training, Michigan's Oldest & Largest Trade School. Unlimited training period without extra charge.
Wolverine School of Trades, 1408 W. Fort, Detroit, Mich.

THERE'S MONEY IN CARTOONS!

RAYE BURNS will teach you HOW to CREATE ORIGINAL CARTOONS, at home, you may SELL! Cost is unusually low. Write for FREE sample lesson plates, drawing test, and addresses of successfully trained students. No obligation.
RAYE BURNS SCHOOL, Studio M, Box 2194, Cleveland, Ohio

BARGAINS IN BOOKS

A GUIDE TO SUCCESS AND ADVANCEMENT
This attractive, 128-page book will not only give you the help you need in seeking personal advancement, to get a better job, to start a small business of your own, but full information on trades, professions, opportunities, crafts and hobbies. This big catalogue, just off the press, lists more than 1,700 bargain books on popular subjects and over 400 plans. It will prove invaluable to you. Don't miss it! Send three cents today to
POPULAR MECHANICS PRESS
DEPT. 1040, 200 EAST ONTARIO STREET, CHICAGO, ILL.

Be Prepared-Get Into
DRAFTING and Industrial DESIGNING

Preparedness brings success in dollars to you. Be prepared to get into a Better Pay field with a busy and big future. Learn DRAFTING AND DESIGNING quickly from an Engineer and Designer. Get right into the Mechanized world of Success through the Drafting Office where all designs and improvements originate. Private, individual, spare time training at your home, low tuition. Drawing tools and table furnished without extra cost. Training given until competent to hold good pay positions.

BE PREPARED NOW

Drafting is a very big field. Combined with Industrial Designing is unlimited in size and opportunity for the trained men, age 16-60. Factories must continuously bring out new models, designs, and machines for new products in this field where billions of dollars are being spent. Get ready for this big money and get your share. Write today for full details on your future in "Drafting and Industrial Design."

ENGINEER DOBE

LIBERTYVILLE, ILLINOIS DIV. 3377

NEW WAY TO CHOOSE A CAREER

LET SCIENCE PICK A JOB FOR YOU!

TODAY, getting a job or choosing a career is no longer a hit-or-miss task. Science can now accurately determine for you, in advance, just what type of work or profession you are best suited for. **FREE** Send your name on a penny postcard for **FREE** booklet explaining this new proven way to greater success. Vocational Guidance Associates, Dept. 110, Tucson, Ariz.

LEARN MONEY-MAKING CARTOONING

Same simple Method that has helped train hundreds of successes. Earn while learning. Rush 10c for Picture Chart to test your ability, and full details. (State age.) THE LONDON SCHOOL, 19-O National Bldg., Cleveland, Ohio



Say you saw it in
POPULAR MECHANICS

New-TYPE Cheap OIL BURNER INVENTED
Sweeping the Country!

COOK and HEAT Without Coal or Wood

In Your Present Stove or Furnace—
HOTTER—No Drudgery, Dirt or Ashes—More Heat Quick at SMALL COST.



OVER 40,000 SOLD

Beats any cheap burner ever gotten out for low cost, perfect performance. Burns cheap oil a new way, without pre-generating or clogging up. Quick intense heat by **Simple Turn of Valve.**

GUARANTEED

30 DAYS' TRIAL

Prove its efficiency, convenience and economical operation.

Write Immediately for FREE BURNER OFFER TO AGENTS

AGENTS Salesmen BIG MONEY
 F. Silver says: "I can dispose of 250 HEAT KINGS before this year ends." Sample Burner **FREE** to producers. Write us now for agents' offer.



Slips Into Any STOVE RANGE or FURNACE
Quick HEAT At Turn of Valve!

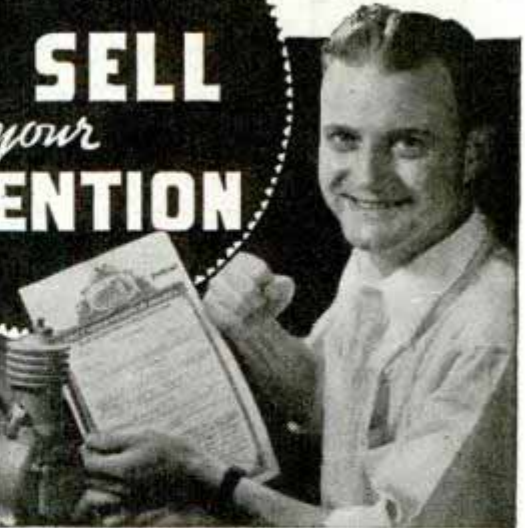
who will demonstrate and take orders. Write quick, be first to learn how to make **REAL MONEY** right now, spare or full time—mail 1c postcard today.
UNITED FACTORIES, L-751, Factory Bldg., Kansas City, Mo.

DON'T FORGET THIS:
 A little idea may have big money-making possibilities!

PATENT and SELL your INVENTION

Act now!

U. S. Patent Laws favor the first to act. Delay may be costly. Write us today.



Business today is eager for practical, new manufacturing ideas. Opportunity for men with inventive talent was never greater than it is right now. If you have an idea for a new device—no matter how simple it may be—or for the improvement of an article now in use, find out **AT ONCE** how you can protect your rights to it and proceed to commercialize it. These two advisory books offered you without cost, may prove invaluable to you. Send for them **NOW.**

68 PAGES OF FACTS FOR INVENTORS

42 years of helpful service to inventors

Plainly written, easily understood. Tell you how to apply for patent protection; give six basic methods of selling your invention. Get them **TODAY.**



VICTOR J. EVANS & Co.

One of World's Largest Firms of Registered Patent Attorneys

MAIN OFFICE: 560-L VICTOR BLDG., WASHINGTON, D. C. Pittsburgh Office: 514-N Empire Bldg.

Please send me immediately without charge or obligation, your two advisory books and your "Evidence of Invention" form.

Name

Address

City..... State.....

Say you saw it in Popular Mechanics!



DRAFTING

BOOKS SENT FREE!
ON APPROVAL

5 VOLUMES—SECOND EDITION

Only 15 minutes a day with these WONDER BOOKS can prepare you for a good drafting job. Mechanical and architectural drafting from simple straight lines to important complex plans. A step at a time! Built especially for beginners, for men with only grammar schooling. Drafting room practice, PLUS ENGINEERING, made easy and clear. Includes complete information on blue print reading for building and machine trades.

Big Field Big Demand Big Pay
Competent draftsmen are urgently needed in all building and manufacturing lines at \$30.00 to \$75.00 a week. That's just the beginning—FOR DRAFTSMEN HAVE GOOD CHANCES FOR ADVANCEMENT. Pleasant, fascinating work, easy to learn and do. Learn quickly with these books—send coupon for a set and see for yourself.

[A year's consulting membership in the American Technical Society now given to all buyers of this famous cyclopedia of drafting.]

Complete set of high grade drawing instruments if you send for these drafting books NOW. These instruments are accurate and are packed in velvet lined leatherette pocket case. Splendid value, but included with these books.

AMERICAN TECHNICAL SOCIETY
Publishers—Home Study Courses.

For Beginners or Experts

Written so you can understand every word, by well known engineers and architects. De Luxe flexible binding, nearly 2,000 pages, 1546 blueprints, charts and diagrams; prepares you for a good drafting job in mechanical or architectural lines. Sent for 10 days' free use if you mail coupon immediately.

These Instruments Included



American Technical Society, Dept. D719, Drexel at 58th St., Chicago, Ill. Send for 10 days' trial, 5 volumes set of drafting. I will pay the delivery charges only. If I wish, I may return books in 10 days and owe you nothing, but if I decide to keep them, I will send \$2.00 after 10 days, then only \$3.00 a month until \$24.80, the total price is paid. Send latest edition and include drawing instruments and consulting Membership Certificate.

Name.....

Address.....
Please attach letter stating age, occupation, employer's name and address and that of at least one business man as a reference.



Know Electricity as Experts Know It—and Get an Expert's Pay!

What about your future? Who is safe today? Surely not the man who is contented to stand still! Know your job thoroughly—prepare yourself for jobs ahead. To do just this thousands of men have used

The Croft Library of Practical Electricity

The Croft Library is a complete electrical educator. It is founded on practice—on 20 years of shirt-sleeve experience—on work as it is actually done. It is jammed from cover to cover with the kind of hard-headed facts you want. Written so that the beginner can easily understand it, yet so sound, so thorough, that it is the daily guide of 59,000 highly paid electrical workers and engineers. Croft tells you the things you need to know about motors, generators, armatures, commutators, transformers, circuits, switchboards, distribution systems—electrical machinery of every type—illumination in its every phase—the most improved methods of lighting—lamps and lamp effects, etc.—how to do a complete job, from estimating it, to completion.

6 volumes, 2155 pages—New low price
No money down—Easy payments.

Fill in and mail the coupon attached and we will send you the entire set of six volumes for ten days' Examination on approval. We take all the risk—you assume no obligation. If you decide to keep the books, send \$1.50 in ten days and the balance at the rate of \$3.00 a month. Send the coupon NOW and see the books for yourself.

EXAMINATION COUPON

McGraw-Hill Book Co., 330 W. 42nd St., New York, N. Y.

Send me for ten days' examination on approval the Croft Library of Practical Electricity. If satisfactory I will send you \$1.50 in 10 days and \$3.00 monthly until the price of \$16.50 is paid. If not wanted, I will return the books postpaid. (To insure prompt shipment write plainly and fill in all lines.)

Name.....

Home Address.....

City and State.....

Position.....

Name of Company..... PM-10-40

EXTRA MONEY

Yes, you can make extra money right at home, and have real fun doing it. We show you how, we furnish everything necessary on an easy basis.

COSTS NOTHING to learn about our plan, all details are given you free. Write today for idea book full of colored pictures telling all about our methods which have made money for so many people. Learn how easy it is to make up to \$10 to \$25 in a week in the most delightful home work you can imagine. Don't miss this opportunity—Write today for free book.

FIRESIDE INDUSTRIES, Dept. 66-P, Adrian, Mich.

AIRCRAFT WELDING ENGINEERING

Industry Offers Outstanding Opportunities to properly trained Commercial Welding Engineers (1 year), Welding Technicians (5 months), Aircraft Welders and Arc Welding Operators (3 months). Learn By Doing. Earn Part Expenses—Write for free 64-page illustrated Book—"Dawn Of A Giant Industry." Mention course desired.

MILWAUKEE SCHOOL OF ENGINEERING
PM-1040, N. BROADWAY & E. STATE, MILWAUKEE, WIS.

AVIATION APPRENTICES

AIRMINDED YOUNG MEN INTERESTED IN HOME STUDY TRAINING FOR ENTERING THE WELL PAID FIELD OF AVIATION AS APPRENTICES—Write immediately, enclosing stamp.

MECHANIX UNIVERSAL AVIATION SERVICE CO.
Wayne County Airport, Box 857, Dept. E, Detroit, Mich.

4000 BARGAINS

You will find illustrated, many handy articles for the small work-shop and home, also office specialties, carded goods, food products, etc., at wholesale prices, for agents, dealers, salesmen. All sold under a money back guarantee.

260 Page Wholesale Book.
Cost about 25c, yours for 10c to cover cost of mailing, packing, etc. You get your dime back with first order. Hurry your request for the catalog—today.

SPORS CO., 8-40 MAIN, LE CENTER, MINN.

Always write your name and full address clearly when answering advertisements.

Stop Slamming Doors

AMAZING MONEY MAKER!

Kant-Slam Door Check is an amazing invention that closes all doors silently and automatically. Closing speed easily adjusted by turning screw at top of check. Holds doors open when wanted open. Operates on hydraulic principle. Low priced. Permanent. Easily installed in ten minutes. Never needs attention.

A Real Demonstrator Furnished Every Agent.
You get orders quickly demonstrating actual sample on easy to carry miniature door. Every office, factory, store, institution, and public building needs a Kant-Slam for every door. Rush name and address for details of amazing money-making opportunity.

KANT-SLAM DOOR CHECK CO.
Demonstrator Furnished to Workers Dept. B-53, Bloomfield, Ind.

OPPORTUNITY KNOCKS

a
Thousand
Times
in a



THOUSAND HELPFUL BOOKS

SELECT FROM THIS LIST. SEND 3c FOR NEW 128-PAGE BOOK AND PLAN CATALOG

- BLUEPRINT READING**
for the Building Trades..... \$1.25
- STEEL SQUARE**
How to Figure Angles of Rafters, etc..... \$1.00
- 1000 SPARETIME MONEY-MAKING IDEAS**
Start a business of your own..... \$1.00
- COURSE IN WOOD TURNING**
Easy to follow..... \$1.50
- MECHANICAL DRAWING**
Learn Drafting; Good Salaries..... \$1.00
- METAL SPINNING**
How to become proficient..... \$1.00
- PLASTERING & STUCCO WORK**
Interior & Exterior..... \$1.25
- TURN SCRAP INTO MONEY**
Use Old Auto Parts..... \$1.00
- MAKING AMATEUR PHOTOGRAPHY PAY**
Where to submit & how to sell..... \$1.00
- AUTO BODY & FENDER REPAIRS**
New Book Covers All Details..... \$3.00
- REFRIGERATION**
Electric, Gas, Be a Service Expert..... \$5.00
- WOOD FINISHING**
Methods, Tools..... \$2.00
- CIVIL SERVICE**
Home Study Courses, Federal, State & City Positions..... \$1.00
- PROSPECTOR'S HANDBOOK**
How to Mine, Appraise, Equip..... \$3.00
- ROPP'S CALCULATOR**
Cuts Figuring to a Minimum..... \$0.50
- SOILLESS PLANT GROWTH**
Complete Directions..... \$2.75
- PHOTO ENLARGERS**
Make Your Own, Four Types..... \$0.25
- HOUSES, SMALL**
Book of, for Home Builders..... \$2.00

- PAINTING & DECORATING**
New Book..... \$1.50
- TOYS**
Build for Amusement or Profit..... \$1.50
- TRAILER BUILDING**
Four Tested Plans..... \$1.00
- UPHOLSTERY**
Always a Big Market Start Own Business..... \$2.00
- AUTO RACING**
How to Build Cars, Speed up Fords..... \$1.00
- NEW SMALL HOMES**
59 Popular Designs..... \$0.53
- MONEY-MAKING FORMULAS**
New 480 Page Book..... \$4.35
- PRACTICAL BRICKLAYING**
Step-by-step Instructions..... \$1.75
- BLUEPRINT READING**
for Machine Trades..... \$1.50
- HOUSE WIRING**
Methods, Materials..... \$2.50
- WOODWORKING POWER TOOLS**
Build Your Own..... \$0.25
- ARC WELDING**
Procedure Handbook, New Ed. Just Out..... \$1.50
- CONCRETE**
1001 Ways to Use..... \$1.98
- ELECTROPLATING**
Copper, Nickel, Chromium, etc..... \$0.25
- WHAT TO MAKE**
192 pages of Craft Projects..... \$0.50
- SHOE REPAIRING**
Modern methods..... \$1.00
- WELDERS**
Build Own Arc or Spot..... \$0.25
- KNOTS, TIES, SPLICES**
For Everyone Who Handles Rope..... \$1.00
- CARPENTRY**
Carpentry & Joinery in all Forms..... \$2.00
- SOLDERING**
New Tricks and Methods..... \$0.25

Send No Money!

Order from above list. If in U. S. or possessions, and order amounts to \$1.00 or more, pay postman on delivery plus small C.O.D. fee. We pay postage if remittance is sent with order. Ask for complete list of books on many subjects. Order today.

POPULAR MECHANICS PRESS

Room 1040 200 East Ontario St., Chicago

EVERYTHING IN RADIO AT LOWEST PRICES!

GET ALLIED'S GREAT 1941 RADIO CATALOG!

DEPEND ON ALLIED—THE WORLD'S LARGEST EXCLUSIVE RADIO HOUSE!



FREE

212 PAGES



83 New Radios! Real "hits"—new plastic models; world-wide sets; "Camera" and 3-way portables; Phono and Recorder combinations, Auto Sets, Amateur Receivers—the sets you've been waiting for—all at lowest prices!

24 New Sound Systems! For every P.A. application—7 to 75 watts—exclusive new features—amazingly low-priced. Easy Time Payment Plan—15 Day Trial Offer. Also everything in P.A. in a special 35-page section.



LEARN RADIO



Build your own Radio! Learn and have fun—Cozens of new low-cost easy-to-build kits; new diagrams—more than 15,000 quality parts. Let ALLIED help you—just ask us—we'll help you to learn quickly, easily!

Radio Builders' Handbook—valuable beginners' book on radio; tells how to select circuits, read diagrams, build sets, etc. Illustrated; worth having. Order by coupon below. Only **10c**



ELECTRONIC LAB OFFER

1 TUBE KIT. Same as kit at right; makes all projects but builds only 1 tube set instead of 2 tube set. Shpg. wt., 7 lbs. Regular price, \$7.50. Now only **\$2.95**

A wonderful offer made by ALLIED exclusively, to Radio Builders, Beginners, Experimenters. Brand new genuine RCA kits that teach you radio by practical construction, at less than half the regular price! **2 TUBE KIT.** Build a real 2-Tube Receiver, an electronic burglar alarm, Home Broadcaster, Morse Code Practice Set, etc. Kit includes: 2 RCA tubes, sockets, condensers, resistors, coils, soldering iron and solder, wire, transformer, headphone, microphone, electric relay, telegraph key, wiring diagrams, 15-page instruction book. Shpg. wt., 7 lbs. Regular price, \$8.95. For limited time only **\$3.75**

ALLIED RADIO

833 W. Jackson Blvd. Dept. 5-FK-1
Chicago, Illinois

- Rush me your FREE 1941 Fall Radio Catalog.
- Enclosed find 10c for Radio Builders' Handbook.
- Enclosed find \$3.75 (plus postage) for 2 Tube RCA Kit.
- Enclosed find \$2.95 (plus postage) for 1 Tube RCA Kit.

Name.....

Address.....

City..... State.....

FREE CATALOG



AUTO

BOOKS SENT FREE

on approval. Just mail the coupon and we'll send you a set of these remarkable auto books. Whether you are a mechanic or helper, expert or apprentice, auto owner or driver, if you're interested in knowing all about automobile mechanics, take advantage of this **FREE EXAMINATION OFFER.**

GET A BETTER JOB

A better job—in the gigantic auto industry. **BIGGER PAY**—a chance to go into business for yourself and get a share of the profits, are waiting for any man who even half tries to improve himself. Learn auto engineering with these wonder books a new way—a quick reference method. Simply use the **JIFFY INDEX** to look up the answer to any auto problem. Built by eleven of America's great automobile engineers, and written in simple language so you can understand it.

Privilege of consulting Automobile Engineers of American Technical Society for one year without cost if you mail coupon immediately.

Send promptly and we will include a **New EXTRA volume** with over 300 pages including late cars with wiring diagrams and data sheets on each.

CAN YOU FIX IT?

These wonder books tell step by step **HOW** to take out "play" in differential—to kill the shimmy in steering—to set **TIMING**—how to put your finger on engine trouble and the expert way to **FIX** it.

6 BIG VOLUMES

2500 pages, 2000 illustrations, wiring diagrams, etc., including Marine Engines, Aviation Motors, Diesel engines, etc. De Luxe edition, gold-stamped flexible binding.

AMERICAN TECHNICAL SOCIETY (Publishers—Home Study Courses), Drexel Ave. & 58th St., Dept. A719, Chicago, Illinois. I would like to see the 6-volume edition of your **AUTO BOOKS**. I will pay the delivery charges only, but if I choose to, I may return them express collect. If after 10 days use I prefer to keep them, I will send you \$2 and pay the balance at the rate of only \$3 a month, until \$24.80 is paid. Please include consulting membership and **extra Volume No. 7**, as per your offer above.

Name.....
Address.....
City.....State.....
Please attach letter stating age, occupation and name and address of employer and that of at least one business man as reference.

SECRETS ENTRUSTED TO A FEW



The Unpublished Facts of Life

THERE are some things that can not be generally told—*things you ought to know*. Great truths are dangerous to some—but factors for *personal power and accomplishment* in the hands of those who understand them. Behind the tales of the miracles and mysteries of the ancients, lie centuries of their secret probing into nature's laws—their amazing discoveries of *the hidden processes of man's mind*, and *the mastery of life's problems*. Once shrouded in mystery to avoid their destruction by mass fear and ignorance, these facts remain a useful heritage for the thousands of men and women who privately use them in their homes today.

THIS FREE BOOK

The Rosicrucians (not a religious organization), an age-old brotherhood of learning, have preserved this secret wisdom in their archives for centuries. *They now invite you to share the practical helpfulness of their teachings*. Write today for a free copy of the book, "The Secret Heritage." Within its pages may lie a new life of opportunity for you. Address Scribe F.K.B.

The Rosicrucians

(AMORC), SAN JOSE, CALIFORNIA, U. S. A.

Learn to MOUNT Birds and Animals



FUN • PROFITS

Send Today for Free Book

Old reliable school (250,000 students) will teach you **AT HOME** to Mount **BIRDS, ANIMAL HEADS, FISH and TAN SKINS and FURS**. Write now—at once.

SPORTSMEN: Save your trophies. Game is growing scarcer—every **Specimen** is valuable. Keep them—save them—mount them. Decorate your den. Fun and fascination. Profits, too.

TAN heavy and light skins and furs. Make real **HARNESS LEATHER, BUCK SOLE LACE, ETC.** Best method known, but easy and simple. Don't sell those hides cheap. Tan them for your own use. Make leather vests, belts, gloves, etc. **TAN FOR OTHERS.**

FUR-WORK for men and women. Tan and make up scarfs, capes, coats, muffs, mitts, trimmings. Quickly, easily learned.

EXTRA MONEY \$40 to \$80 a month, even more. Big demand for **TAXIDERMY, TANNING AND FUR-WORK**. A real spare-time business—good in every community. If you need extra money, **WRITE!**

FREE BOOK

45 pages, 100 beautiful pictures, tells **ALL** about Taxidermy, Tanning, Fur-Work. Write **Today**—this minute for this **STRANGE, MARVELOUS FREE BOOK**. A postal will do. State **AGE**.

N. W. School of Taxidermy, 3377 Elwood Bldg., Omaha, Neb.



Correspondence Courses in RADIO and ELECTRICAL ENGINEERING

LOW AS \$25



ELECTRICAL ENGINEERING. Get good grasp of wide electrical field. Modern. Very understandable. Theory made easy. **RADIO ENGINEERING.** Extra fine course in radio, public address, photo-electric work. Trains you to be super-service man, real vacuum tube technician. Tuition **ONLY \$25**, either course. Deferred payment plan. Experiment kits furnished. **FREE** Write for free copies of school catalog, student magazines, etc. **FREE LINCOLN ENGINEERING SCHOOL**, Box 931-P22, Lincoln, Nebr.

When writing please mention Popular Mechanics

BENNY GOODMAN

... "King of Swing"
CHOOSES GRETSCH
 ... "King of Drums"



Big-time band leaders have to be right... they can't take a chance on instruments that may not deliver the goods! Therefore, when you buy a drum, make sure you get a GRETSCH, the same drum that BENNY GOODMAN and his ace-drummer NICK FATOOL feature in GOODMAN'S world-famed "No. 1" SWING BAND. And Benny selected not only one GRETSCH OUTFIT, but TWO—a GRETSCH-GLADSTONE for full band use... a GRETSCH-BROADKASTER for the famous GOODMAN SEX-TETTE. GRETSCH, oldest drum makers in America, makes a drum for every purpose and every purse—\$5 to \$500.

NICK FATOOL
 Goodman's
 Star Drummer

**EASY
 TO
 PLAY
 *
 EASY
 TO
 PAY**

Send penny postcard for literature and FREE photograph of your favorite drummer; also full information about EASY-PAYMENT PLAN and FREE trial. Give street number; address Dept. PM 101.

The FRED. GRETSCH MFG. CO.
 Musical Instrument Makers Since 1883
 60 BROADWAY, BROOKLYN, N. Y.

GRETSCH also offers SUPER VALUES in Guitars, Saxophones, Trumpets, Trombones, Accordions. Send for FREE catalogue. Mention instrument.



LEARN AVIATION... AT LEWIS

All branches taught quickly, soundly, at Lewis School of Aeronautics. Become master airplane mechanic or pilot in 12 mos. Or, take full 4 yr. aeronautical course. School accredited, certificated by Civil Aeronautics Authority. Famed flyer instructors. Mile-wide airport. Low tuition. Write for FREE catalog.

Lewis School of Aeronautics
 Dept. M Lockport, Illinois

REAL JOBS OPEN!

**FOR TRAINED AUTO MECHANICS
 8 WEEKS' SHOP COURSE!**

AUTO, DIESEL and AVIATION Mechanics, welding, body & fender taught with real tools, on real equipment, in 2 biggest, best schools of their kind in the world. Step into Big Pay—\$35-\$60 a week. Low tuition cost! Pay for part of course later! **FREE BOOK!** Send for Big, Free Opportunity book and new low rate—write nearest school **TODAY!**

McSWEENEY SCHOOLS Dept. Detroit, Mich.
 R-7 Kansas City, Mo.

AMAZING NEW ELECTRIC ARC WELDER



Plugs Into Light Socket

Amazing new HANDI-WELD Electric Arc Welder—operates from 110 volt A.C. or D.C. same as other arc welders higher priced—generates tremendous heat to weld all kinds of metal. Not a toy welder that uses carbons, but actually uses standard coated rods—sizes 1/16" and 3/32". Generous supply furnished with welder. Guaranteed not to burn out. Repairs fenders, auto bodies, radiators, pre-heated small castings and machinery parts. Take HANDI-WELD anywhere to job, operate from light socket. Sturdily built of finest materials to last years. Fully guaranteed by Big Manufacturer.

SEND NO MONEY! You'll find a thousand uses for the HANDI-WELD around your home, garage, work shop. Also by garages, factories, repair shops, mechanics, farmers, inventors, tin shops, plumbers, etc. Order HANDI-WELD now. Send no money. We'll rush one to you, complete with rods and goggles. Pay post-man only \$2.95 plus few cents postage. If not delighted, return HANDI-WELD in 5 days from receipt and money paid for it will be refunded instantly. Rush your order now.

KUMFY PRODUCTS INC., Dept. H-203, Cincinnati, Ohio.

IMPORTANT Message To INVENTORS

I Will Send You My FREE BOOKLET

MAIL COUPON NOW

"IMPORTANT PATENT FACTS FOR INVENTORS"

and INVENTION RECORD FORM

Our laws favor the inventor who makes a dated record of his invention, and who is diligent in filing his patent application.

You owe it to yourself, if you value your invention, to make an accurate, dated, and witnessed record of your invention, and then take steps to apply for a patent just as quickly as possible.

PERSONAL SERVICE

Hence, my service can be important to you: As soon as you write me, I send, by return mail, an "Invention Record" form for you to fill out. And then, when you return it to me, my prompt and personal service begins: I personally direct the search of the Patent Office Records. Personally report to you. Personally supervise the preparation and filing of your application and the handling of your case. There is no lost motion, no lost time.

PATENT AND SELL YOUR INVENTION

I handle your case skillfully and thoroughly with a view to securing the best possible patent for you—giving you the full benefit of my training as a patent attorney and my years of experience serving hundreds of inventors. I make personal calls at the Patent Office when required. And beyond this, I will endeavor to give you useful hints and suggestions on selling your invention.

WRITE ME TODAY...

When your invention comes to me it is strictly confidential. All correspondence is handled personally by me. I take a personal interest in your success, so you can write me fully.

IMPORTANT TO GET STARTED RIGHT

Know how the laws protect you, and what steps to take, I will send you Complete FREE Booklet "Important Patent Facts for Inventors", and FREE "Invention Record" Form. Write me, or mail this coupon today—Hugh E. McMorrow, Registered Patent Attorney.

HUGH E. Mc MORROW REGISTERED PATENT ATTORNEY

135-A Barrister Building Washington, D. C.

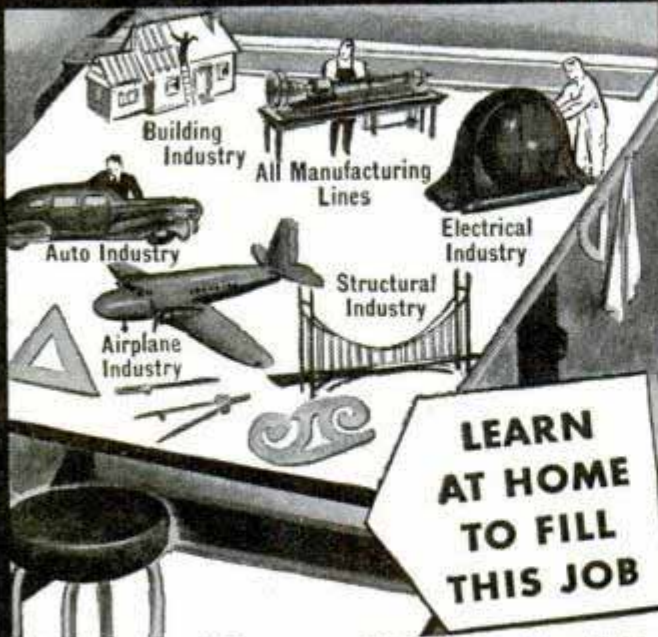
Name

Address

City..... State.....

Write or Print Name Clearly

Draftsmen Needed



Openings in all lines—pay \$40-\$50 a week and UP

For more than 40 years, our graduates have won **BIG POSITIONS**. In just 8 to 10 months, *spare time only*, you can master the beginnings of Drafting—the work done by \$60 to \$90 a month tracers. In another 10 to 12 months, you can master the lessons covering the Detailer's work—a position paying \$100 to \$175 a month. You can complete the rest of the course, dealing with Design and Engineering subjects, in 12 to 18 months and thus have the training for a \$175 to \$250 a month position. Selective Employment Service included. *No experience or artistic talent needed.* Get **FREE** Bulletin. No obligation. *Write AT ONCE.*

American School, Dept. DD-745, Drexel at 56th, Chicago, Ill.

Approved—National Home Study Council
WASHINGTON, D. C.

**Increased
production
means more**



Jobs for MACHINISTS and bigger pay for men who know their work

This home-study course gives you the practical facts on modern machines, up-to-date methods, you need to advance in machine shop work. Take advantage of the other man's experience as found in books, to solve your problems, increase your efficiency, with

The NEW AMERICAN MACHINISTS' LIBRARY

5 volumes—2014 pages—1853 illustrations
(A combined home-study course and reference library)

This library of machine shop practice was written for practical men. It gives you the best methods for every kind of machine shop work. It fully explains lathes, drills, and other machine tools and their operation, automatic screw machines, speeds and feeds, gear design and production, punch and die work, metal surfacing, etc., etc. Plainly written—completely illustrated—the best kind of help to the machine shop man who wants to advance himself.

No money down—special price—easy payments.

EXAMINATION COUPON

McGraw-Hill Book Co., 330 W. 42nd St., New York

Send me for ten days' examination the new American Machinists' Library. If satisfactory I will send you \$1.50 in 10 days and \$3.00 monthly until the price of \$16.50 is paid. If not wanted, I will return the books postpaid. (To insure prompt shipment write plainly and fill in all lines.)

Name.....
Home Address.....
City and State.....
Position.....
Name of Company..... PM-10-40

A LITTLE LIBRARY of Useful Information



A Few Sample Pages

These booklets have been carefully designed to fill a long felt demand for instructions for making things and doing the everyday jobs around the home.

Only 25c Each, or 5 for \$1

- PHOTO ENLARGERS**—Easy-to-follow instructions show you how to make four different enlargers.
- OUTBOARD RUNABOUT**—fast, V-bottom boat, 14 feet long.
- ELECTROPLATING**—Expert tells secrets of plating.
- POWER TOOLS**—Build your own power tools; every detail clearly explained.
- WELDERS**—How to build an arc welder which operates on 110-volt, 50 or 60 cycle alternating current.
- CONCRETE GARDEN FURNITURE**—Benches, pottery without molds, flower boxes, bird baths.
- BIRD HOUSES**—Easy to build homes for all kinds of birds.
- FARM AND GARDEN TRACTORS**—Two tractors you can build from old automobile parts.
- TAXIDERMY**—There's fun and profit in mounting fish and small animals. Expert tells how.
- AUTOMOBILE KINKS**—Save \$100 a year on your automobile.
- QUICK PROFIT PRODUCTS**—Sixty tested formulas for products you can make and sell.
- CHEMISTS' SECRETS**—Sixty-five beauty products you can make at home.
- TREASURE FINDERS**—Build your own treasure finder and metal locator.
- LOG CABINS AND TOURIST COTTAGES**—Two types of year-round cabins of logs.
- FOOD PRODUCTS FORMULAS**—100 formulas for making everyday necessities.
- GARDEN WOODWORK AND FURNITURE**—Gives full details for outdoor living room.
- SOLDERING AND BRAZING**—Tells how to use new fluxes and solders.
- MIRACLE PLANTS**—How you can mix your own vitamin B1 solution.
- HOME WORK OPPORTUNITIES**—Simple handicraft projects anyone can do to earn money.
- TELESCOPES**—Complete details on a reflecting telescope you can build for less than \$10.
- METAL PLATING AND COLORING**—This gives dozens of essential formulas for metal plating, coloring, etc.
- FAST ICE YACHT**—Build your own Class-E ice yacht.
- EXTRA ATTIC ROOMS**—Add to the value of your home by building an extra room in your attic.
- BASEMENT PLAYROOMS**—Build an attractive playroom in your basement.
- PHOTO PRINTER AND DRYER**—Now you can build your own printer easily.
- SAILING DINGHY**—This 14-foot boat carries 140 sq. ft. of canvas.
- TRAILERS**—Midget house and utility type trailers.
- METAL CRAFT**—Simple instructions are given for brass tapping and the making of many novelties.
- MAGIC FOR EVERYBODY**—Simple tricks to puzzle your friends.
- CANOEING**—You can easily build 16-foot Canadian type canoe.
- LOWER FUEL COST**—How to save money heating your home.

POPULAR MECHANICS PRESS
200 E. Ontario St. Dept. 1040 Chicago

Be an AIRLINE MAINTENANCE MECHANIC



Have a big-pay job with an Airline or at Airport. Earn up to \$2000 a year as Government Rated Airplane and Engine Mechanic. This **Lincoln Government Approved School** offers Government Approved Training preparing for these positions. Airlines and Airports calling on us for more of these Graduates. **BE AN AERONAUTICAL ENGINEER.** Earn up to \$4000 a year. Lincoln Engineering Students get practical experience in Airplane Design and Construction. **BE A HIGH PAID COMMERCIAL PILOT.** Learn here to fly fast modern Airplanes. Lincoln Government Approved Training prepares you for BOTH a Commercial Rating and Flight Instructor Rating. Exceptional opportunities for our Commercial Pilot Graduates.

AIRPLANE FACTORIES WANT LINCOLN TRAINED MEN. Placing our Graduates in good-pay jobs with Airplane Factories coast to coast. Lincoln Training gets you ready for one of these jobs in 8 to 12 weeks.

Mail Coupon Today for complete information about Lincoln Training and the big-pay opportunities in Aviation.

LINCOLN AERONAUTICAL INSTITUTE, (INC.)
LINCOLN AIRPLANE & FLYING SCHOOL DIVISION
 5710 Aircraft Building, Lincoln, Nebraska

LINCOLN AERONAUTICAL INSTITUTE, (INC.)
LINCOLN AIRPLANE & FLYING SCHOOL DIVISION
 5710 Aircraft Building, Lincoln, Nebraska.

I'd like to take advantage of the opportunities in Aviation. Please rush complete information about Lincoln Training.

NAME..... AGE.....
 ADDRESS.....
 CITY..... STATE.....

RUPTURED?

Get Relief This Proven Way

Why try to worry along with trusses that gouge your flesh—press heavily on hips and spine—enlarge opening—fail to hold rupture? You need the Cluthe. No leg-straps or cutting belts. Automatic adjustable pad holds at real opening—follows every body movement with instant increased support in case of strain. Cannot slip whether at work or play. Light. Waterproof. Can be worn in bath. Send for amazing **FREE** book, "Advice To Ruptured" and details of liberal truthful 60-day trial offer. Also endorsements from grateful users in your neighborhood. Write:

CLUTHE SONS, Dept. 31, Bloomfield, New Jersey

STUDY ENGINEERING AT HOME

Earn a Degree at Home

From A Chartered Institution of Higher Learning Employers Demand Degree Men For Key Positions

88 Degree Courses in Electrical, Civil, Mechanical, Drafting, Architectural, Automotive, Steam, Diesel, Aeronautical, Radio, Structural, Mining, Industrial, Highway, Petroleum, Marine, Refrigeration, Air Conditioning, Chemical Engineering, Arts, Sciences, Philosophy, Education, Public Health, Medical Jurisprudence, Psychology, Sociology, Physics, Chemistry, Geology, Pal. Science, Theology, Law, Agriculture, Business Training, Accounting, Statistics. Founded 1908. Chartered McKinley-Roosevelt Graduate College, 4610-R Sheridan Road, Chicago

MAKE MONEY

AT HOME!

Learn to color photos and miniatures in oil. No previous experience needed. Good demand. Send for free booklet, "Make Money at Home" and requirements.

NATIONAL ART SCHOOL
 3601 Michigan Ave., Dept. 1357 Chicago

Learn ADVERTISING at Home

Greater opportunities now in advertising. Learn easily and quickly in spare time. Practical work. No text books. Old established school. Low tuition—Easy terms. Send for free booklet and requirements.

Page-Davis School of Advertising
 Dept. 1357, 3601 Mich. Av., Chicago



BUCHSTEIN'S FIBRE LIMB

Soothing to stump, cool, light, strong.

Correct fit. Braces for all deformities. Fair terms.

D. BUCHSTEIN CO.

610 3rd Ave. South, Minneapolis, Minn.

SENSATIONAL BURNER IMPROVEMENT MAKES OIL BURN Just Like CITY GAS!



AT LESS THAN 1/2 THE COST

Produces **HOT, CLEAN (White-Heat) FLAME**

NOT like any oil burner you've ever seen. No noisy roar—no smoke—no soot—no clogged jets. **DORTANE** makes cheap oil burn as clean and hot as city gas, at one-third to one-half the cost. Slips into any wood or coal range—attached in few minutes—operated efficiently by anyone.

ALL THESE PROSPECTS

Will heat stoves, ranges, urns, steam tables, grills, vulcanizers, water coils, ovens, griddles, pressing machines, tanks, etc.

WIDE OPEN FOR DISTRIBUTORS AND AGENTS

A sensational seller to homes and business men. **BIG PROFITS** for **CITY DISTRIBUTORS** and agents in rural communities.

FREE Don't lose a minute. All facts are **FREE**. Rush your name quickest way for book showing and describing all models Liberty Burners. No money. Just your name and address.

LIBERTY BURNER CO.

Dept. A1610, 620 N. Michigan Ave., Chicago, Ill.

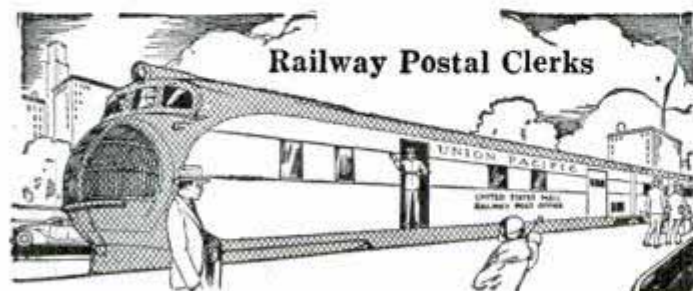
BENJAMIN AIR PISTOL WITH HAND PUMP



For Target—Small Game—Camping—Etc. Guaranteed—Accurate—Practical—Economical—Safe—Clean—Quiet—Adjustable Force—Amazing Maximum Velocity. No Smoke or Fumes. Bolt Action—Hammer Fire—Hair Trigger—Safety Lock—Hand Pump. Single Shot BB \$8.50; Single Shot cal. 177 or 22 with rifled barrel \$8.50; BB 8-Shot \$10.00; Holster \$2.00. Also a complete line of Benjamin Genuine Compressed Air Rifles for BB and cal. 177 or 22. No license required from dealer or factory. Write today for complete specifications and free targets.

BENJAMIN AIR RIFLE CO., 890 Marion St., St. Louis, Mo., U. S. A.

WANT A GOVERNMENT JOB?



Railway Postal Clerks

City and Rural Carriers—City Post Office Clerks, Clerks at Washington, Stenographers-Typists, Accountants, Messengers, etc. Many other government jobs.

Common education usually sufficient
 Mail coupon at once

FRANKLIN INSTITUTE, Dept. H195,
 Rochester, N. Y.

Sirs: Rush to me without charge—copy of 32-page book, "How to get U. S. Government Jobs," with list of dependable positions for men-women and full particulars telling how to qualify for them.

Name.....

Address.....

PATENTS

Booklet Free Highest References
 Promptness Assured Best Results

Send drawing or model.

ALL BUSINESS GIVEN PROMPT AND PROPER ATTENTION

Listed Patent Lawyer in the latest editions of the Rand-McNally Directory of Bankers and Bank-Recommended Attorneys, published by Rand-McNally & Co., Chicago, Ill.; American Lawyers Annual, Cleveland, Ohio; Bankers Service Legal Directory, published by Bankers Service Co., Boston, Mass.; and the Snow-Church Directory Co. Lawyers List, published in New York City.

WATSON E. COLEMAN,
 REGISTERED PATENT LAWYER

Victor Building, 724 Ninth Street, N. W.
WASHINGTON, D. C.

INVENTORS Get PATENT FACTS

Free Books Answer Questions—
 Tell How to Get Protection

● Your ideas may be worth money! Get facts first and save time and money. Competent advice on patent procedure is essential to good results. Our 65 years' experience enables us to explain everything you will want to know about protecting and commercializing your idea. Mail coupon today. Special "Certification of Invention" form also sent. Prompt, confidential service and results.



C. A. SNOW & CO.
 Patent Attorneys Since 1875
 1010 SNOW BLDG., WASH., D. C.

Please send me the free books illustrated without cost or obligation.

NAME.....
 ADDRESS.....

← Mail Now
 for Free Books

Inventions Wanted Patented or Unpatented

We have been successfully selling inventions, patented and unpatented, since 1924. Write us, if you have a practical, useful idea for sale.

Chartered Institute of American Inventors
 Dept. 4, Barrister Building, Washington, D. C.

PATENTS—TRADE MARKS

All cases submitted given personal attention
 Form "Evidence of Conception" with instructions
 for use and "Schedule of Government
 and Attorneys' Fees"—FREE!

LANCASTER, ALLWINE & ROMMEL
 Patent Law Offices

412 Bowen Bldg. Washington, D. C.

PATENTS

Send for FREE BOOKLET of Costs and other Useful Information about Patents, including my Special Payment Plan.

Registered Patent Attorney and Former Patent Examiner
EUGENE H. PURDY, 1506 INTERNATIONAL BLDG., WASHINGTON, D. C.

INVENTORS who derive largest profits know and heed certain simple but vital facts before applying for patents. Our book, Patent-Sense, gives those facts; sent free. Trade Marks—Copyrights.

LACEY & LACEY, Est. 1869, 635 F St., N. W., Dept. 5, WASHINGTON, D. C.

ALBERT E. DIETERICH

PATENT ATTORNEY
 Register No. 5669
 SUCCESSOR TO FRED G. DIETERICH & CO.
 Former Member Examining Corps, U. S. Patent Office
511-B COLORADO BUILDING WASHINGTON, D. C.
 Booklet on patents sent free on request.

AVIATION

DRAFTSMEN NEEDED by makers of planes, motors, equipment. Good pay. Special Aviation Drafting course trains you QUICKLY at home in spare time. FREE Bulletin. No obligation. Address **American School, Dept. A-745, Drexel at 58th, Chicago**

In answering advertisements always write name and full address clearly.

MASON, FENWICK & LAWRENCE

Registered Attorneys

PATENT AND TRADE MARK LAWYERS

Suite 725 Woodward Bldg., Washington, D. C. Financial Reference: Second Nat'l Bank
 Established 79 Years CHEMICAL, ELECTRICAL and ENGINEERING PATENT SPECIALISTS

To PROTECT YOUR INVENTION - Use this coupon, NOW

Delays are dangerous and may be very costly. My personal service assures prompt action, strict confidence, and a minimum of expense. I suggest that you send me a model or drawing, or sketch and description of your invention, and \$5.00. I will make a search and report

promptly as to its patentability and send you a copy of my 72-page booklet. Or, if you prefer to read my booklet first, mail the attached coupon at once. I will also send my "Record of Invention" form. (Over 38 years experience as a Registered Patent Attorney.)

L. F. Randolph, 302-D Victor Bldg., Washington, D.C.

Please send me at once, free of charge, your 72 page booklet and "Record of Invention" form.

Name.....

Address.....

A PERSONAL CONFIDENTIAL PATENT SERVICE

NEW models EASIER TO PLAY



Find out about these sensational new Conn Band Instruments. Many wonderful, exclusive features! Today, more than ever, Conns are the "choice of the artists." You'll advance faster and take more pride in a genuine Conn—made by the world's largest manufacturer. See your dealer or write us for Home Trial, Easy Payment offer. Mention instrument.

C. G. CONN, LTD.
1031 Conn Bldg., Elkhart, Ind.



CONN

BAND INSTRUMENTS

WRITE FOR FREE BOOK

INVENTORS PATENT YOUR IDEAS

SEND FOR FREE BOOK



HOW TO OBTAIN A PATENT

written by a Former Member of the Examining Corps (1922-24) of the U. S. Patent Office. If you want to profit by your idea, you should take steps to apply for a U. S. Patent at once. Your first step is to get this Free Book. This interesting illustrated book contains valuable information you should have. It tells you fully how to obtain a patent on your idea in the quickest way. With this Free Book you will also receive a "Record of Invention" form on which you can easily record your idea. Personal and Confidential Service: Your Case will be personally handled only by a Registered Patent Attorney who is also a Former Member of the Examining Corps of the U. S. Patent Office. All communications will be strictly confidential.

MAIL COUPON TODAY FOR FREE PATENT BOOK AND RECORD OF INVENTION FORM

CARL MILLER

REGISTERED PATENT ATTORNEY
FORMER MEMBER EXAMINING CORPS U. S. PATENT OFFICE

Woolworth Bldg., 35th Floor, Dept. 100-A, New York City
MILLER BUILDING, Dept. 100-A, WASHINGTON, D. C.
Please send me your Free Book, "How to Obtain a Patent," and your "Record of Invention" form.

NAME

ADDRESS

LEARN MECHANICAL DENTISTRY

SEND FOR FREE BOOK



Be A Dental Technician

Learn how to make Crowns, Bridges, Plates in this oldest school, licensed by the State of New York. 5,000 feet up-to-date equipment. Day and Evening Sessions. Easy terms. Write NOW for free catalog P and tool offer.

N. Y. School of Mechanical Dentistry
125-127 West 31st Street, Dept. 9, New York City



INVENTIONS MANUFACTURED AT LOW COST!

Inventions manufactured in any size, any shape, any quantity, by old established (36 years old) reputable company. (No branches anywhere). Also developing, designing, engineering, modelmaking, stampings, metal specialties, dies, models, etc. FREE estimates. FREE catalog giving "inside" information. Write today.

CRESCENT TOOL CO., DEPT. V-A, CINCINNATI, OHIO

FREE ESTIMATES

PREPARE TO FLY WITH THE U. S. ARMY

COLLEGE EDUCATION UNNECESSARY

NEW booklet gives valuable information on educational examination—with sample questions of past exams. Also, a plan which enables you to present yourself in top physical condition for the rigid physical exam. Send 25c (coin).

The Malon Co., 1900 Van Buren St., Chicago, Ill.

MYSTERIOUS DEVICE WELDS BRAZES AND SOLDERS ANYONE CAN OPERATE



Now, an electric welding, brazing and soldering Torch, complete with power unit, goggles and supplies. Works INSTANTLY off any light socket. Does a thousand and one repair jobs at amazingly LOW COST on aluminum, iron, steel and other metals. Indispensable for Auto, Body and Fender Repairs, and home repairs—shop, factory, farm, engineer, janitor, sheet metal, radio and bicycle repairs. Anyone can handle without previous experience with our simple 10-DAY HOME TRIAL instructions.

Write at once for Special Introductory Low Price Offer. Try 3 in 1 Electric Torch for 10 days at our risk, or get one free by helping to introduce it.

ELECTRO-TORCH CO., 2613-LK Michigan Ave., Chicago

Say you saw it in POPULAR MECHANICS

FREE-Inside Information

Tells you where to sell fiction, radio scripts — what material trade papers and syndicates want — how to win cash prize contests. This nationally recognized magazine has helped new and established writers for 20 years. For FREE Sample copy Address: Writers' Markets and Methods Mag., Dept. 10 W, Hollywood, Calif.

WRITERS' Markets and Methods MAGAZINE

Advice from such As:

- Ben Ames Williams
- Vicki Baum
- John Steinbeck
- Kathleen Norris

MECHANICS-WELDERS - COLLISION MEN

GOOD JOBS and MIGHTY GOOD PAY

Do you want to earn big money? If so let us know which of the following trades you prefer. You learn by doing. Practical work. Expert teachers. Low tuition. Personal attention. It will pay you to investigate AT ONCE. Just check the courses you'd like to take and mail today. You will receive full information, absolutely without cost or obligation. But don't delay.

Check the Trade You'd Like to Learn

- | | |
|---|---|
| <input type="checkbox"/> Complete Auto Mechanics (including Diesel) | <input type="checkbox"/> Electric Arc and Acetylene Welding |
| <input type="checkbox"/> Auto Collision | <input type="checkbox"/> Spray Painting |
| <input type="checkbox"/> Metal Finishing | <input type="checkbox"/> Body and Fender Bumping |

Ask about our "Pay After Graduation Plan"

Name.....

Address.....

Mail the above at once to

MICHIGAN TRADE SCHOOL

FREE 32 PAGE CATALOG

3758 Woodward Ave. Detroit, Mich.

Business Demands Accountancy

—because Accountants Command Business

ACCOUNTANTS are usually in demand—at better than average earnings.

But today—more than ever before—the competent accountant finds his services at an increasing premium.

In the depression, business tightened up the reins and is watching costs—prices—every move—striving to operate on that basis of close control so essential to profits.

Then too, progressive business is building now for future prosperity—laying plans for expansion, for new processes, new markets—getting ready for the opportunities of the next ten years.

The Home Study Way to Accountancy Success

Thousands upon thousands of men have trained for Accountancy with LaSalle—at night—at home.

Their success—their progress—is a matter of record.

Whether their goal was a C. P. A. degree or advancement in business, our files are full of letters reporting income increases far out of line with the time and cost investment.

Note for instance, these four cases chosen out of many more we might cite. (Names on request.)

F. F. A. was a railroad yard clerk at \$112 a month when he began accountancy training with LaSalle. Five years later, his income was 500% larger and he was a Certified Public Accountant and attorney. F. C. was 22 years of age and general all-around man in an Arkansas lumber yard at \$75 a month. Five months later, his firm made him manager at \$125, and ten months later promoted him to a larger yard at \$250 plus a commission on sales.

O. D. always thought stories about LaSalle training were fairy tales until the training helped him—a clerk at \$75 a month—move up in six months to \$125, and within four years to \$250. He became General Auditor of a large national organization—with his income more than seven times his starting salary.

As an assistant bookkeeper in a great Western bank, C. F. H. looked forward to slow progress. But LaSalle accountancy training speeded up his climb to Assistant Trust Officer and to a salary increase of 400 per cent.

These Men Won Success in Ordinary Times—You Will Profit By Unusual Times

Remarkable as is the success of these men—you will have an advantage over them—you will be entering accountancy when unusual business conditions work with you for success.

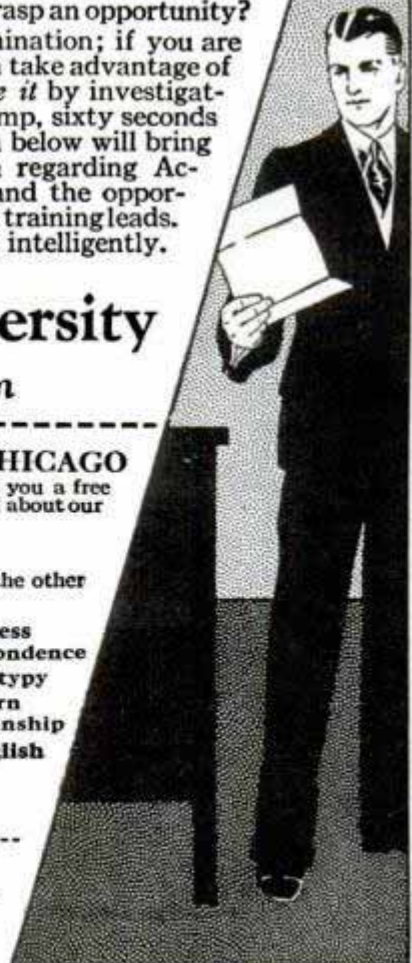
Present conditions not only call for more capable accountants—but offer unusual opportunities for both quick and permanent success. The accounting student of 1940 will face real opportunity in 1941 and the accounting leaders of 1945-50 will be largely determined in 1940-1941.

—If You Can Qualify

Ask yourself three questions:

1. Are you ambitious?
2. Have you determination?
3. Can you see and grasp an opportunity?

If you have determination; if you are ambitious; if you can take advantage of circumstances—*prove it* by investigating. A three-cent stamp, sixty seconds time, and the coupon below will bring you full information regarding Accountancy training and the opportunities to which such training leads. Then you can judge intelligently.



LaSalle Extension University

A Correspondence Institution

Dept. 1064-HR

CHICAGO

Opportunities in Accountancy—Check below and we will send you a free copy of "Accountancy, the Profession that Pays," also information about our new training in Higher Accountancy, all without obligation.

Higher Accountancy

Other LaSalle Opportunities: If more interested in one of the other fields of business indicated below, check that:

- | | | |
|--|--|--|
| <input type="checkbox"/> Business Management | <input type="checkbox"/> Law: LL.B. Degree | <input type="checkbox"/> Business Correspondence |
| <input type="checkbox"/> Expert Bookkeeping | <input type="checkbox"/> Commercial Law | <input type="checkbox"/> Stenotypy |
| <input type="checkbox"/> C. P. A. Coaching | <input type="checkbox"/> Industrial Management | <input type="checkbox"/> Modern Salesmanship |
| <input type="checkbox"/> Railway Accounting | <input type="checkbox"/> Modern Foremanship | <input type="checkbox"/> Business English |
| <input type="checkbox"/> Traffic Management | | |
| <input type="checkbox"/> Effective Speaking | | |

Name.....Age.....

Present Position.....

Address.....

**WORLD'S
BEST
WANT AD
MEDIUM**

CLASSIFIED Advertisements



Advertisements in this section, 35 cents per word, each insertion, minimum 10 words, payable in advance
To be inserted under proper classification in November issue, copy should be in our office September 8th
November issue on sale October 1st
Popular Mechanics Magazine, 200 East Ontario Street, Chicago, Illinois

YOU'LL PROFIT

By reading and answering the classified ads in this section. Hundreds of opportunities to make and save money.

Popular Mechanics Magazine,
200 E. Ontario Street,
Chicago, Illinois.

Gentlemen: You will be interested in learning that for more than a quarter of a century, we have been using the classified section of Popular Mechanics to reach those interested in magic. During this time we have received thousands of inquiries and orders from all over the world. In fact, our foreign business has really been tremendous as the result of the pulling power of Popular Mechanics. We would not think of missing an issue.

(Original letter on file in our office)

Very truly yours,
CHICAGO MAGIC COMPANY.

AUTOMOBILES—MIDGET CARS

MIDGET Autos, motorscooters. Wheels, motors, forks, axles, clutches, brakes, plans, building kits, etc. Circulars free. Catalog with plans, 10c. New lists used motors, midgets, parts, 20c. Shipps Midgets. Box 543-H, Zanesville, Ohio.

KUNS' Fifth edition Automobile Racing Book. Tells how to build dirt track bodies, frames, engines. Records, superchargers, rules, formula, plans, stock conversions, roadster racing, fast Fords. \$1.00 postpaid; \$1.15 C.O.D. Ray Kuns, Department 22, Madisonville, Cincinnati, Ohio.

PROFESSIONAL Midget racers, two-passenger roadsters. Midget motorcycles, motorscooters. Guaranteed motors, wheels, parts, plans. Handbook catalog—90 illustrations—20c. Midwest, Box 1959-CE, Chicago.

PHOTOGRAPHS. World's finest automobiles. Handbook, 10c. Automobiles, Box 534, Saint Cloud, Minnesota.

MAKE And sell motor tune-up oil. Fastest, soundest, money making proposition ever offered. Schafer, 547-A Melrose, Chicago.

AUTOMOBILE Superchargers \$3. Guaranteed mileage increase 20%; power 10%. University of Detroit test. Any car; give make, year. Wrench installs 15 minutes. John Hanley, Manufacturer, 5719 Loraine, Detroit, Mich.

AUTO SUPPLIES AND EQUIPMENT

SENSATIONAL Latest automobile novelties. Folder dime. Universal Specialties, Box 27, Aurora, Ill.

BARGAINS—Welders, compressors, battery chargers, car washers. Liberal terms. Write Hobart Equipment, Box M-10403, Troy, Ohio.

AUTO Supercharger saves up to 37% on gas. Removes carbon, saves oil, increases power, free sample offer. Multi-Matic, 2812 Gillham, Kansas City, Mo.

KNOW R.P.M. on cars, boats, machinery. use new navy tachometers, sacrificed \$4.95. Air Transport, Garden City, N. Y.

IGNITION Powerizer. Power pep economy dollar. Hahne Co., 4536 West Eighteenth, Los Angeles, California.

NO-BOLT Battery terminal. Broken posts, prying, pounding eliminated. 75c sample 25c. American-Simplex, Anderson, Indiana.

FREE Bargain catalogue auto supplies, tires, tubes, tools, garage, shop, service station equipment. For dealers only. American, 1211 Bedford Ave., Brooklyn, N. Y.

1940 IGNITION Supercharger, E. G. Sales & Mfg. Co., New York.

PISTON Rings—Multiple steel seal design. Quick seating, stops oil pumping. For all cars and trucks. Send for circular. Piston Ring Sales Co., 4022 West Lake Street, Chicago.

PLATING Outfits for auto parts. Connect to a battery. No tanks used. Free particulars and proofs. Gunmetal Co., Ave. J, Decatur, Ill.

AUTO TRAILERS

READY Now—Plans for nine new Jim Dandy Trailers including six modern house trailers. Catalog 10c. Also new edition of Trailer Builders Manual and catalog of parts, supplies and equipment. Price 25c. Both 35c postpaid. Trailer Supply Co., 5120-A Fulton St., Wausau, Wis.

MOTORCYCLES, BICYCLES, MOTOR SCOOTERS AND SUPPLIES

SAVE 70%. Thousands assembling own motorscooter! We supply parts, tires, wheels, engines. Fork-handlebar \$2.90. Literature, drawing 10c. Comet Cycle Company, Box 3032, Madison, Wisconsin.

MOTORCYCLISTS. Let's get acquainted. We can save you money on parts and accessories. List and decal free. Triangle, 1111 Washington, Chicago.

MOTORSCOOTERS. Assemble your own de luxe model. Save three-fourths! Free literature. Shipps Midgets, Box 543-H, Zanesville, Ohio.

BUILD Power scooters, midget cars. We supply tires, wheels, motors. Lowest prices. Send 10c for plans, etc. Build-Your Own Devices, Dept. 10-A, 536 North Parkside, Chicago.

MOTO-SHOOTS—Overstocked 1940 models—\$111.50 to \$189.00 list drastically reduced for clearance—50 machines—act fast. Ride to work—leave car at home for family. Write for folder. J & R Motor Supply Co., 221 E. 20th Street, Chicago, Ill.

LATEST Illustrated Pink-O-Gram describes sport, pleasure and racing motorcycles, midget cars, racing fuel, crash helmets, goggles and accessories. Full year's subscription 10c. Reggie Pink, 2077 Southern Boulevard, New York City.

ALLOY Pistons \$3.00—Harley, Indian, Henderson, Excelsior, Cleveland, Cylinder grinding, rings, bearings, gaskets, chains, sprockets, helmets, goggles, accessories, parts new and used for less. Catalogue and wings pin 10c. Ballak, 811 N. 9th, St. Louis, Mo.

MOTORSCOOTERS, Midget cars! Easily built. Complete plans and literature on wheels, tires, motors, etc., 10c. Hon-sakers, Masontown, Penna.

MOTORCYCLE. Parts, accessories. Most complete stock. New and used. We specialize on mail orders. What do you need? 35 page catalog 10c. Whitman Motorcycle & Supply Co., 405-9 Southwest Blvd., Kansas City, Mo.

MOTORCYCLES. Reconditioned. New, used, parts and accessories. All makes. Large stock. Bargains. Illustrated catalog, 15c. Indian Motorcycle Sales, Kansas City, Mo.

BICYCLE Motor. Push-a-Bike outdoor motor, complete with pneumatic tire, ready to attach. Dept. P. Richburn Company, Aurora, Missouri.

MOTOR Scooters, engines, parts. Literature 6c. Goldi Motor Scooters, Niles, Michigan.

AVIATION

ARMY Interceptor record breaking glider soars for half mile or more. Purple stamp and 25 cents. Particulars for stamp. Economy Sales Co., 2801 25th St. N. E., Washington, D. C.

AIRPLANE And engine mechanics book, 1940 edition prepares for government examinations. \$3.00 postpaid or C.O.D. Quiz System, 1435 Flower St., Glendale, Calif.

PRACTICAL Course in flying—29-chapter book only \$1.00. Aircraft Directory, Athens, Ohio.

PROPELLERS For aircraft, sleds, boats, dehydrators, etc. Sled blueprints, 25c up. Hubs, faceplates, snow sled skis. New catalog 10c. Banks Propellers, Love Field, Dallas, Texas.

100 AIRPLANES, \$50 Up. Located everywhere. Catalog 25c. Aircraft Directory, Athens, Ohio.

AVIATION Apprentices — Air-minded young men interested in home study training for entering aviation as apprentice see ad on page 24A.

AIRCRAFT Factory system training in the world's airplane manufacturing center. Ten separate specialized courses that qualify for employment. Thousands needed. Free placement. Warren School, oldest in the west. Olive at 18th, Los Angeles.

GET Into aviation! Train now at this Lincoln Aeronautical Institute for responsible position as aeronautical engineer, air transport pilot, aviation mechanic or aircraft sheet metal craftsman. Good jobs open! Big money paid! We assist graduates in locating positions. Part time employment for board and room while in training. Write today for information. Lincoln Aeronautical Institute, (Inc.), Lincoln Airplane & Flying School Division, 2007 Aircraft Building, Lincoln, Nebraska.

PROPELLERS For airplanes, sleds, Iced-sled blueprints, supplies. Catalog dime. Lorenzen Propellers, Niles, Michigan.

BATTERIES, GENERATORS, ETC.

SECRET Battery charger hook-up saves electricity 25%. Tungar bulb life 300%. Plans \$1. Schafer, 547-A Melrose, Chicago.

EDISON Lifetime storage batteries for light and power. Eliminates acid battery diseases. Long guarantee. All kinds rebuilt generating plants, motors, and miscellaneous articles at bargain prices. Free interesting literature. T. Hawley Smith Co., Croton Falls, N. Y.

1/2 HORSE. Repulsion induction, heavy duty 3400 speed motors \$9.75. Butler Electric Company, 1885 Milwaukee, Chicago.

PLUMBING AND HEATING

BUILD Inexpensive waste oil burner. \$1.00 plans by professional designers. Literature. Wayne Engineering Company, Greenville, Ohio.

ELECTRICAL SUPPLIES—EQUIPMENT

LEARN Electricity at home—growing industry, splendid opportunities. Prepare quickly in spare time. Easy demonstration method on actual equipment. No previous experience necessary. Common school education sufficient. Many earn while learning. Send for free booklet *Opportunities in Electricity* and full particulars. Ray D. Smith, President, Industrial Training Institute, 2156 Lawrence Ave., Chicago, Ill., Dept. P.

ELECTRO-SCRIBE: Electric pencil. Writes—engraves all metals \$1.00. Health Lamp: Dual ray—ultra violet, infra red. Promotes sun-tan Vitamin "D." Automatic ac-dc current. \$3.90. Details. Bever Mfg. Co., 4515-H Cottage Grove, Chicago.

ELECTRIC FENCING

BALL Bearing fence controller easily made from auto coil. No extras. Complete plans 10c. LeJay Manufacturing, 947 LeJay Building, Minneapolis, Minnesota.

WELDING—SOLDERING—PLATING

BARGAINS. Demonstrator arc welders, gasoline and electric drive. Liberal trial, easy terms. Write Hobart Welder Exchange, Box 10402, Troy, Ohio.

ARC-WELDER. 25-600 amperes, d.c., 0-75 volts, built from d.c. vehicle motors, (no rewinding). Plans \$1.00. Welders Club, AB-3432 M-Mart, Chicago. For sale: 100 assorted vehicle motors low as \$20.00 each.

BUILD 60-200 Amp. a-c welder for \$10. Illustrated plans \$1. Information dime. Hi-Point Electric Products, Bellefontaine, Ohio.

A.C. Welders, plans, material. Free literature. Holgerson's Service, Canton, Kas.

ACETYLENE Welding outfits. \$36.56; electric welders. \$66.25; easy-payment plan. Superior Oxy-Acetylene, Hamilton, Ohio.

ENGINES, MOTORS, DYNAMOS

WINDING Data 200 motors, growlers, test transformers \$1.00. Sabina Armature, Peebles, Ohio.

BARGAINS — Welders, electroplating, motor generators, guaranteed, liberal terms. Write Hobarts, Box M10404, Troy, Ohio.

AIR Compressors, twin cylinders, \$8.00. Sewing machine motors \$2.85. Electric drills \$9.50. Electric motors, 1/3 horsepower, \$5.35. 907 North Fifth, Philadelphia, Penna.

GUARANTEED Rebuilt motors. New drills, grinders, home workshop tools. Bargain pricelist. Mailorder Electric, 713 South Dearborn, Chicago.

RECLEAN Used oil without cost. Particulars. F. Gerwin, Fairview, Okla.

ELECTRIC Motors, 3/4 h.p. \$16.50, 1 h.p. \$18.50, 2 h.p. \$25.00. Others 1/4 to 50 h.p. Motors and machinery bought, sold, exchanged. Temps Brothers, 809 Myrtle Ave., Brooklyn, New York.

ALTERNATING And direct current generators, motors, converters; bargain prices. State your needs. Queen City Electric, 519 South California, Chicago.

ALTERNATING. 1/2 Horse, 110 volt, induction motors. Rebuilt, guaranteed, \$7.25. Wilmot Auto Supply, 2247 St. Paul Ave., Chicago.

BARGAIN—1/2 Hp. motors, 60 cycle, 1 phase, 110 volt, like new, guaranteed, \$7.40. Send check to Erie Electric Motor Co., 120 Church, Buffalo, N. Y.

AIR Compressors 1 1/4 x 1 3/4 \$6.00; 2 x 2 \$7.00; 2 1/2 x 3 \$8.00; electric drills 1/4 in. \$5.95. Free folder. National, 1915 S. State, Chicago.

MACHINERY, TOOLS AND SUPPLIES

MODEL Makers! Can supply compound slide rests for metal turning on your wood lathe. \$8.50. Free circular. R. Fridlund, 18637 Alcoa, Detroit, Mich.

KELLOGG Air compressors, \$6.00. Vacuum pumps, \$6.00. Taylor, 152 East 106th Street, New York.

WE Buy complete plants, lathes, shapers, milling machines, drills, presses, motors, etc. Steinberg Machinery Company, 1132 Lake Street, Chicago, Illinois.

OVER And under balance indicator beam scale attachment \$15.00 postpaid. Plan \$1.00. Schumacher, Westhampton Beach, N. Y.

WANTED: Saw filer, hand or power. Box 582, Park Ridge, N. J.

ALL-PURPOSE Lathe tool, improves accuracy, resourcefulness, sizes including 1 x 1/2 for single dollar postpaid. State dimensions hole in tool post. Tit-bit Tools, 41 East Orange, Lancaster, Penna.

6 FT. Flexible shaft mounted on 1/2 horse alternating motor \$19.50. Butler Electric Company, 1885 Milwaukee, Chicago.

BUILD Your own machine tools. Castings and blue prints at nominal cost. Send 10c for 2 color 28 page catalog. 34 prints covering 12 metal-working projects, \$1.50. 23 prints covering 6 wood-working projects, \$1.00. Lewis Machine Tool Co., Dept. M-10, 1000 Alhambra Ave., Los Angeles.

LATHES—We have a few bargains in slightly used lathes. Write for October Blue List. South Bend Lathe Works, 454 E. Madison St., South Bend, Ind.

TOOL And machinery bargain. Fascinating free catalog. Postcard. Box 200, Newfane, Vermont.

13"x5" WILLARD Lathe with gap. No. 2 Pratt & Whitney hand milling machine, four step cone drive. Write for full particulars. Cincinnati Machinery & Supply Company, 217 E. Second St., Cincinnati, Ohio.

BOATS, OUTBOARD MOTORS, ETC.

KAYAKS. Outboards, Rowboats. Weldwood ready-cut kits. Catalogs. Cre-Craft Boats, Dept. F, Millburn, New Jersey.

PLANS For fast runabout (30 to 35 miles). Approximate material cost \$150 without motor. Also any type boat designs. Advise your requirements. Tredwell Lyle, Naval Architect, Sarasota, Florida.

KAYAKS! Complete 12' kit \$10.00! Big value! Playaks, Dedham, Mass.

BUILD A boat by the Welch System. We supply ready cut parts for Welch designed boats. Everything for building and equipping boats. Send 10c for catalog, marine hardware, finishing materials, and marine motors. Welch Boat Company, Station K-1, Milwaukee, Wisconsin.

MARINE Conversion parts for all auto engines. Buy here and save. Conversion Parts Co., 278 Adams St., Boston, Mass.

12 FOOT Flat bottom rowboat—complete plans 25c. Free boat building catalog. The Rudder, 15 Murray St., New York.

EASY Built kayaks, rowboats, outboards, inboards, accessories. Complete kits. Send 10c big catalogues. 20 models, newest designs. Kayak Boat, 154-K East 129th, New York.

FULL Size, cut-to-shape boat patterns—blueprints—specifications. Big selection. Designed by naval architects. Real bargains. Send 10c (coin) for illustrated catalog. Book "How to Build Boats," \$1.00 postpaid. Cleveland Boat Blueprint Co., Station A-66, Cleveland, Ohio.

MARINE Power—Easily convert any Ford motor (domestic and foreign) with Osco parts and kits. Complete catalogue 25c (coin). Osmithson, 3644 Lawrence St., Philadelphia, Penna.

OUTBOARDS—Save 1/2. Good used parts, all makes and models. Bargains rebuilt motors. Crandall Hicks Co., 959 Commonwealth, Boston, Mass.

BOAT Designers are highly paid professionals. Complete course by mail. Catalog. Westlawn, Montville, N. J.

SPORTING GOODS, GUNS, FISHING TACKLE, ARCHERY

BYE Bye mosquito repellent. Every fisherman should have in his kit. 10 small boxes for \$1.00. B. & W. Specialties, Box 84, Auburn, N. Y.

SEND For free illustrated catalog of Lawrence leather belts, holsters, gun cases and other sporting equipment. George Lawrence Company, Portland, Oregon.

GUNSMITHING. Restocking Guide (24 pages). Free. Invaluable for amateur, professional gunsmiths, home craftsmen, shooters; exclusive, complete information, illustrations, walnut stocks, blanks, gunsmith tools, remodeling, actions, bluing, checkering tools. Limited supply. Write America's great gun house. Stoeger Arms Corp., 507 Fifth Ave., New York, N. Y.

TREASURE Finders? Read Goldak advertisement on page 138A.

GOLF Clubs. Five club matched set \$2.50. Lincoln Surplus, 123 Galena, Freeport, Ill.

ARCHERY Equipment—Catalogue free. Mid-West Archery, 2209-A East 75th, Chicago.

COMPLETE Camping, hunting, outdoor equipment, used guns. Catalog. Howe Fur Company, Coopers Mills, Maine.

ARCHERY! Complete archery instruction book, 70 pages—200 illustrations—30c. Catalogue free. Triangle Archery Company, Harrison-State Streets, Chicago.

BARGAINS! Gun catalog 5c, camera catalog 10c, archery catalog 5c, golf catalog 5c, tennis catalog 5c, medal-award catalog 10c. Warshal's, First-Madison-PM, Seattle.

FIELD GLASSES, TELESCOPES AND MICROSCOPES

LENSES—Assortment of fifteen, ground and polished. High quality. Slight imperfections as small chip on edge. Diameters 10mm. to 53mm. Various focal lengths, including negative eyepieces. Suitable for telescopes, microscopes, field glasses, etc. \$1.00 postpaid. Satisfaction guaranteed or money refunded. American Lens Company, 324 North Mayfield, Chicago.

TELESCOPES, Microscopes, binoculars; 1940 bargain catalog free. Brownscope Company, 5 West 27th Street, New York.

ANTIQUES, RELICS, INDIAN GOODS, CURIOS

WANTED—Old cigar store Indians, old guns. Dr. Pendergast, Fairbury, Illinois.

ANTIQUE Firearms, swords, daggers, Indian relics, curios, historical newspapers. Lists free. Antiques, 8 South 18th, Philadelphia, Penna.

HUNDRED Thousand Indian glacial-beauty arrows. Dan McKillop, Regina, Sask.

SWORDS, Rapiers, pistols, daggers, armor list 10c. Robert Abels, 860A Lexington Ave., New York.

INDIAN Relics, coins, bills, gems, crystals, curios, etc. Illustrated catalog 5c. 100 ancient arrowheads \$3.00. H. Daniel, Hot Springs, Ark.

INDIAN Relics, beadwork, coins, curios, minerals, old glass. Catalog 5c. Indian Museum, Osborne, Kansas.

CHINQUILLA'S Indian Craft Museum. Handwork of all Indian tribes. Jamaica, N. Y.

TAXIDERMY

NEW American made deer eyes. Patented process produces natural, lifelike Jonas-Eyes superior to best European glass. Lower in cost, too! Unbreakable. Special trial offer—Sample pair 65c. Satisfaction guaranteed or money back. Order today or write for price list of eyes and other supplies. Jonas Bros., 1049 Broadway, Denver, Colorado.

LEARN By mail to mount birds and animals, tan skins, make leather. Old reliable school teaches, easily, quickly, at low cost. Over 250,000 students. Rush postal for free 48 page book. Northwestern School of Taxidermy, 775 Elwood Bldg., Omaha, Nebr.

DOGS, PETS, BIRDS

COCKERS, Scotties, wires, Newfoundland, Airedales. Van's Dog Farm, Pella, Iowa.

PUPPIES—Scotch Collies, English Shepherds, Heelers. Sunrise Kennels, Solomon, Kansas.

NEW Low prices. Pheasants, peafowls, ducks, geese, fantails, doves, bantams, 65 varieties. Maren's Pheasantry, Wickliffe, Ohio.

EXTRAORDINARILY Attractive rustic bird feeder \$1.00; 7"x8" with porch. Box 1886, Cleveland, Ohio.

HUNTING Hounds cheap. Buy early. Beckennels, Dept. S49, Herrick, Illinois.

SPORTSMEN: 200 Pointers, setters, straight cooners, combination hunters, rabbit and fox hounds. Reasonable. List free. Ramsey Creek Kennels, Ramsey, Illinois.

PUPPIES! All breeds! Reasonable! Information free! Book 104 photos, descriptions 25c. Royal, Chazy, N. Y.

BEAUTIFUL Pure white police dogs. Ansonia Kennels, Mose, N. Dak.

TREES, SHRUBS, ROOTS, HERBS

COLORADO Blue Spruce trees, 2-year-old. Extra strong. From the bluest of the blue trees. 25 prepaid for \$1.00. Rocky Mountain Evergreen Co., Evergreen, Colo.

GINSENG. Goldenseal. Plants, seeds. Silver foxes, crosses, reeds. Raccoons. Oscar Austin, Canton, Minnesota.

JUST Out! World's greatest "Herbalist Almanac." Beautifully illustrated in natural colors. Contains over 200 old fashioned herb medicine recipes for home use. 10c (coin) postpaid. Botanicals, Box 1109, Evergreen Park, Ill.

POULTRY AND FARM SUPPLIES

MAKE Money with poultry. Read America's leading poultry magazine. Five years \$1.00; one year 25c. Poultry Tribune, Dept. E-93, Mount Morris, Illinois.

FARM MACHINERY AND SUPPLIES

GARDEN And small farm tractors, 3/4 to 8 horse-power, \$75.00 and up. Ride or walk. Catalog free. Shaw Mfg. Co., Dept. PM-10, Galesburg, Kansas.

FARMS—FARM LANDS—REAL ESTATE

IF Interested to locate good southern land at low prices with terms like rent, ask for descriptive book, furnished without obligation. Long-Bell Farm Land Corporation, 859 R A Long Bldg., Kansas City, Mo.

MORE New farm land, Washington, Minnesota, Idaho, western Montana, Oregon. Dependable crops, favorable climate. Write for impartial advice, literature and list of typical bargains. Specify state. J. W. Haw, 119 Northern Pacific Ry., St. Paul, Minn.

LEARN Startling facts about small areas, west central Missouri, heavy producing land, level to gently undulating, all tillable, alfalfa, clovers, blue-grass, all grains, low taxes. Most congenial climate in grain belt for agriculture and health. All weather roads, best rail transportation. For detailed descriptive literature, write Box 137, Carrollton, Missouri.

\$500 GETS Equipped 65 acres. Splendid low-cost start with horse, 3 cows, pig, farm tools included; 8-rm. house, barn, creek, wood; stand site on macadam, easy drive city; only \$1200, \$500 down; pg. 49 big free catalog and new supplement. Strout Realty, 255-P 4th Ave., New York City.

GOVERNMENT Land—10c acre up. Information all states 25c. Nat. Tax Service Bureau, 1037A Majestic Bldg., Detroit.

40 ACRES. Near White River, unimproved; poultry land. \$175, \$5 down, \$5 monthly. Free list and literature. Hubbard, 216 Grossman Bldg., Kansas City, Kans.

PROFITABLE OCCUPATIONS

DOMESTIC Rabbits pay. Read Small Stock Magazine—America's leading magazine devoted to commercial and fancy rabbit industry. Introductory, year 50c; sample 10c. Dept. 5, Lamoni, Iowa.

OPERATE Steady business resilvering mirrors. Making chipped glass nameplates, signs. Write Sprinkle, Plater, 288, Marion, Indiana.

M. M. Earned \$1174 in spare time for exceptional "cellar crop" Snow-King mushrooms! Free book tells if your cellar, shed suitable. We buy crows. United, 3848 Lincoln Ave., Dept. 59, Chicago.

TREASURE Finders? Read Goldak advertisement on page 138A.

PROFITABLE Evenings. Details for camp. Mid-West, 208 N. Wells, Chicago.

MAKE Copper pictures; big profits. Sample, instructions. 25c. Stelzer, 210 E. 166th, New York City.

HAND Assembled leather belts. Makem yourself. 200% profit. Samples, information, dime. Edward Carey, South Mountain, Pennsylvania.

AMAZING Transformerless neon sign just invented. Low cost reduces sales resistance. Write Warren Lamp Company, Department M, Warren, Pennsylvania.

ANNOUNCING New home study course in commercial baking. Good field for ambitious men. Nearly depression proof business. Common school education sufficient. Send for free booklet "Opportunities in the Baking Industry" and requirements. National Baking Institute, 3601 Michigan Avenue, Dept. 3434, Chicago.

RAISE Rabbits and covies for us. Full details. Catalog, contract and magazine 10c. Or send 25c for book, catalog and year's subscription to Small Stock Farmers Magazine. Stahl's, Box 10, Holmes Park, Missouri.

ANGORA Wool rabbits pay. America's fastest growing industry. Start now. Dakota Rabbitry, Oakes, North Dakota.

GAMES—ENTERTAINMENT

BINGO Games and equipment, lowest prices. Warwick Press, Conimicut, R. I.

SELL Your game! If you have devised a new game and want to market it, send 3c stamp for particulars. Also for instructions on a Mak-A-Game kit. Trend Games, Highland Park, Ill.

PLAYS, Operettas, musical comedies, complete minstrel first-parts with song programs, blackface skits, vaudeville acts, monologs, dialogs, recitations, juvenile plays and songs, musical readings, entertainments, make-up goods. Catalog free. T. S. Denison & Co., 203 N. Wabash, Dept. 11, Chicago.

TWELVE-WAY Option. Fascinating. Interesting. P. O. Box 842, Denver, Colo.

BOOKS, PERIODICALS, PICTURES, POSTCARDS

EXCELLENT Sparetime profits taking subscriptions—2500 magazines. Agents confidential catalogue, complete starting supplies free! Dept. 14, Pines, 583 Monroe, Brooklyn, N. Y.

MAGAZINES, Back numbers, list 3c. Magazine Mart, Roslyn, N. Y.

4c BUYS Back-dated magazines, mystery, detective, romance, art, hobbies, foreign, etc. 100,000 used, new books. Catalog 10c stamps, coin (refunded). Cicero's Center, 863 - 1st Avenue, New York City, N. Y.

MAGAZINES Half price. List 3c. Book-Magazine Mart, Hutchinson, Kansas.

MACHINISTS Compact shop reference book, 70 pages, \$1.00 postpaid. G. A. Knudsen, 523-48th Street, Brooklyn, N. Y.

MAGIC TRICKS, PUZZLES, JOKER NOVELTIES

HOUSE Of 1000 mysteries! Professional magic! Pocket tricks! Jokes! Puzzles! Novelties! Giant surprise catalog! Bigger-better than ever! Only 15c! Vick Lawston, Dept. J6, Queens Village, N. Y.

HOLLYWOOD Special! Magicians button, catalogue, ghost illusion and free trick for 25c. Magic House of Charles, Box 888, Hollywood, California.

WORST Of all sellers. 10c. Box 215, Redondo Beach, Calif.

BE A magician. Large professional magic catalogue of latest tricks 25c. Cash paid for complete Tarbell Magic Courses. Write, Ireland, C-109 North Dearborn, Chicago.

10 ASSORTED Tricks, puzzles, novelties. 50c postpaid. Samuels, 2653 Evergreen, Chicago.

MAGICIANS' Headquarters. 216-page catalog pocket, parlor, professional tricks, 25c. Kanter's, 1311 Walnut, Philadelphia.

AMAZE And mystify! Be popular! Magic easily learned. Illustrated catalog 500 startling tricks 10c. Lyle Douglas, Station A-5, Dallas, Texas.

EARN Money in any crowd. Call names of strangers, tell unspoken questions. Professional course mind reading, spirit writing, etc., \$1. Henderson, Box 341, San Bernardino, Calif.

WORLD'S Largest professional magic shop keeps you in touch with latest tricks. To receive mailings send 25c for 1940 catalog. Holden, 220 W. 42nd St., New York.

LEARN Ventriloquism, 3c stamp brings particulars. Smith, 801 Bigelow, Peoria, Illinois.

LARGE Magic catalog 25c. Hundreds of tricks. Chicago Magic Company, 2300 N. Mason Avenue, Chicago.

RARE COINS

COIN Packet, 100 different coins attributed, in envelopes, \$2.00 postpaid. Koepfel's Coins of World, 8th at Broadway, Los Angeles.

FREE! Foreign coin, banknote and large 36 page illustrated coin catalogue to approval service applicants. Send 3c postage. Tatham Coinco, Springfield-125, Mass.

OLD Money wanted. Will pay fifty dollars for nickel of 1913 with Liberty head (no buffalo). We pay cash premiums for all rare coins. Send 4c for large coin folder. May mean much profit to you. Numismatic Co., Dept. 20, Fort Worth, Texas.

COINS, Medals, papermoney. Lists free. Nagy, 8P South 18th, Philadelphia, Penna.

LARGE Retail coin catalogue No. 31 5c. James Randall, 37 West Van Buren, Chicago.

COIN Guide. Selling, die breaks, collecting recently circulated premium coins, etc. 25c. Lawrence, Plentywood, Montana.

WILL Pay \$10 each for certain Lincoln pennies. Indianheads \$150; dimes \$700. Catalogue 10c. Federal Coin Exchange, Columbus, Ohio.

SELL Rare coins profitably. Get inside facts from my experience. Valuable guide for beginners. 25c. Lawrence, Plentywood, Montana.

COMMEMORATIVE \$1/2. Columbus, Stone-Mountain, Cleveland, Illinois. \$1.00 ea. New catalogue 10c. Norman Shultz, Salt Lake, Utah.

I MAY Have just the scarce U. S. coins you want. Send me list. "Meet me by mail." William H. Kenworthy, Waterville, Maine.

GET Profit and pleasure in collecting old coins. Send 10c for 56 page illustrated coin catalog. You'll be delighted with it. Send for it now. B. Max Mehl, 370 Mehl Building, Fort Worth, Texas. Largest rare coin establishment in U. S. Established 40 years.

STAMP COLLECTING

WORTHWHILE Approvals sent with premiums. Foster's, Box 54, Newtonville, Massachusetts.

3c BRINGS Free premium and collectors bargain bulletin; 50 different Mexico 25c; 25 different Ecuador 15c. Klemann, Lockport, N. Y.

50 DIFFERENT U. S. to approval applicants only. 5c. Theodore Stevens, 3576 Maryland Ave., Detroit, Mich.

1c EACH. Large scale buying enables us to offer incomparable values in better-grade stamps. Large pictorials, etc. Only 1c each. Selection upon request. Adults only. Merritt Brundige, Albany, N. Y.

UNPICKED Mixture: 40c pound. U. S.; 150 different—50c. 100 revenues on documents—10c! (700—50c.) Vanvoorhis, Hyndman, Penna.

PHILIPPINES—Twenty diff. 40 Scandinavia 10c. Approvals. Sherman Shook, Nazareth, Penna.

150 U. S. 5c. Approval applicants. William Killam, 127 Hartson St., Syracuse, N. Y.

1000 DANDY Mixed stamps 25c. Monjar, 1542 Waverly, Cincinnati, Ohio.

ABYSSINIA Stamp 3c with approvals. United, 158 North Ashland, Lexington, Kentucky.

CZECHOSLOVAKIA! 50 Different! 5c to approval applicants. Cactus Junior, Box 1870, P. Tucson, Arizona.

STAMP Wallet with 25 pictorials, airmails, 10c. Approvals. Bucky, Ludlow Bldg., Dayton, Ohio.

FREE! \$1. \$5 United States. Approvals. Lucky, 745 Josephine, Glendale, Missouri.

100 DIFFERENT Portugal 25c. Approvals. Hermes Stamp Company, Box 276, Hempstead, N. Y.

FREE—Entire new United States issue of "Famous Americans." This issue consists of 35 commemorative stamps. Some have already appeared. The others will be issued at the rate of five per month. We will send absolutely free the entire issue of 35 stamps to collectors on our active approval mailing list. We'll also send for only 10c an attractive, specially prepared album for this issue, containing, besides spaces for each stamp, also the history and achievements of each of the 35 Famous Americans. Send 10c for that album today. We will send it by return mail together with a splendid approval selection. Approval Headquarters. Globus Stamp Company, 268 Fourth Ave., New York City, Dept. 201.

UNITED States—35 different beautiful commemoratives 20c. Seidenberg, Baroda, Michigan.

FREE Packet with approvals. Write C. N. Dailey, Box 1190, Charleston, W. Va.

FINE Approvals, freshly filled books and sheets. Tell me what you want and I will send them. Skinner, 306 East Fourth, Long Beach, Calif.

325 DIFFERENT Stamps (catalogue approximately \$7.00) including French, Russian pictorials, 10c to applicants for our profit sharing approvals. Official Stamp Company, Department P10, Fairlawn, New Jersey.

BARGAINS! 315 Different 15c; 515, 35c; 1015, 75c. Approvals, Star, 148 Forbell, Brooklyn, New York.

MYSTIFYING Jungland plus "hard countries" assortment. Only 3c with approvals! Saxons Company, Valley Stream, N. Y.

100 BRITISH Colonials including commemoratives, 25c with approvals, Reid, 696 Gerrard East, Toronto.

LOW Priced U. S. approvals. Postage paid both ways, Kaiser Stamp Co., 302 Hurley, St. Paul, Minn.

SEND Postage for free United States price list, Stanley Gibbons, 38-P Park Row, New York.

YOUR Name on Linotype slug 15c. Additional line 10c. Print plainly, Box 157, Williamsburg, Ohio.

NEJD (Arabland), Bolivia triangle, Caymans, Negri Sembilan, Turks Caicos, Manchukuo, Bahamas, British Solomons (Cannibal), Everything 3c with approvals, Viking, 130-Z Clinton St., Brooklyn, N. Y.

500 MIXED Stamps 10c with approvals, Guy Saulsbury, Spicer, Minn.

25 DIFFERENT U. S. and trading plan 10c. Aspen Trader, Richmond, Missouri.

POSTAGE Stamp collections bought and sold, Philatelic Headquarters, Trenton, New Jersey.

1940 WHOLESALE Catalogue free—Eighty pages, Empire Stamp, Dept. 5, Toronto, Canada.

SENSATIONAL Combination offer! Big packet 105 all different including Greenland (new country), Congo, Manchukuo, Costa Rica triangle, air-mails, commemoratives, giant diamond-shaped stamp, \$4 United States; complete set United States telegraphs, cataloging 20c, scarce set Siberia cataloging 50c. Packet British colonies including Gwalior, Hyberabad, Burma (new country), jubilee and coronations. Total catalog price over \$3.00! Everything for only 5c to approval applicants! World-Wide Stamp Company, Department 600, Camden, New York.

STAMP Book free—Forty pages. Includes stamp encyclopedia, Free. Write Empire Stamp, Dept. PM, Toronto, Can.

SCOTT'S Stamp Exchange—Send hundred different foreign stamps and dime for hundred different, Box 239, San Gabriel, Calif.

UNITED States stamps on approval. Big discounts, P. Stamp Company, Broadway, Albany, New York.

FINE Packet 250 different, 20c. Brown, 237 West Johnson, Sullivan, Indiana.

500 MIXED Stamps 50c. Hinges included. Specialties A, Carnegie, Penna.

60 DIFFERENT Airmails, commemoratives, jubilees, coronations, diamonds, triangles, etc.—10c. Approvals, McCurdy, 2505 Highland Drive, Salt Lake City, Utah.

APPROVAL Sheets, One to three cents. Frederick B. Driver, 2009 Finance Bldg., Philadelphia, Penna.

UNITED States commemoratives, 50 different 25c. Approvals. Free catalogue, Creevey, Berwick, Penna.

\$2.00 PACKET For 3c. Request approvals. Quality Stamps, Englewood, Colo.

1000 MIXED Foreign, 25c. Well worth sorting for value, Plaza Stamp Co., Santa Fe, N. Mex.

U. S. Wines, 4 different 25c. Kaye, 78 Beaumont, Springfield, Mass.

TEN So. American airmails with approvals 10c. French, Box 864, Lakeland, Fla.

100 CANADA With pictorials, 10c. No. 245, 20c. Dufort's, 4402 Chateaubriand, Montreal, Canada.

1-CENT Approvals, for general collectors, less advanced, Countway Stamp Co., 33 Wiley Road, Belmont, Mass.

DOMINICAN Republic—15 different big commemoratives—Pan-American, world fair, etc., only 25c to approval applicants. Free packet and lists included, W. Torgesen, Teaneck, N. J.

FAMOUS Americans! Any value (1c, 2c, 3c, 5c, 10c). Authors, poets, educators, scientists, composers, 1c each. Complete (25 varieties) 20c. Approvals included! Stanley Melzer, 3120 South Adams Avenue, Milwaukee, Wisconsin.

FREE! Scarce Zeppelin airmail set with approvals, Riedell, Greensburg, Penna.

WORLD'S Smallest airmail—largest map, diamond and triangle stamps, free stamp magazine, magnifier to study stamps with large packet of stamps from scarce countries, big bargain 5c with approvals, Capital Stamps, Little Rock, Ark.

15 DIFFERENT San Marino with approvals, Stamputopia, Binghamton, N. Y.

FREE! Canada royal visit complete with approvals, Chester, Box 545-P, Utica, N. Y.

3 FOR 1c Approvals. Send dime, Hewlett, 209 East 21st, New York.

10 AIRMAILS Free with approvals, Harlan, 5307 South Marshfield, Chicago.

PREGANCLES—50 Different 10c. Henderson, 962 72nd Street, Brooklyn, N. Y.

ROCKET Stamp 10c to approval applicants, Southland, 1805 Roosevelt, Los Angeles, Calif.

EXCHANGE With collectors everywhere. Free listing application for stamp, Modern, Box 995-S, New Haven, Conn.

"BULL'S EYE"—Brazilian marvel! Send 50c stamp for latest Brazil catalog—Priceless native stamps! Smith, Box 1534, Rio, Brazil.

UNITED States stamps on approval. Big discounts. Stamp Company, Albany, New York.

IRAQ 10 Different 6c with approvals, Leduc, Saint Petersburg, Florida.

600 DIFFERENT 50c; 1111, \$1; 2000, \$2.50. Fred Onken, 630 79th Street, Brooklyn.

50 BEAUTIFUL Colonials, 10c, approvals, Kravat Company, 1925-Q Quentin Road, Brooklyn, N. Y.

STAMP Collections bought. Send to N. Barcus, 3787 Longfellow, Detroit.

BRAZIL—120 Different including many fine commemoratives, \$1.00. Fernandez, Caixa 1560, Sao Paulo, Brazil.

20 U. S. commemoratives 5c with approvals, Schultze, 1155 Woodhaven, N. Y.

SCARCE Diamond airmail! Wonderful packet 115 different from strange countries. British colonies, Haiti, Tasmania, pictorials, etc. 5c to approval applicants, Reliable Co., Box 139, Dept. 3, Church Annex, New York.

SELANGOR Perak, Albania, Haiti, Bhopal, Palestine, Johore, Manchukuo, Congo, Kadah, Cochín, Kookaburra-bird and 200 different stamps only 10c with approvals, Reich Stamp Co., 4647 Kenmore, Chicago, Dept. M.

FREE—The Stamp Finder! Our new 24 page edition, fully illustrated, which will enable you to instantly identify all difficult stamps. Also fine packet of odd and unusual stamps from Bosnia-Herzegovina, Monaco, Patiala, Cyprus, etc., including maps, ships, animals and strange scenes. All free to approval applicants inclosing 3c postage, Garcelon Stamp Co., Box 900, Calais, Maine.

DESIRABLE Introductory packet 10c. Approvals, Leslie Stamp Co., Haverhill, Mass.

50 DIFFERENT, Fine U. S. including perforation gauge, 10c with approvals, The Stamp Shop, 809 Holland Bldg., St. Louis, Mo.

UNITED States; special to new approval applicants; fourteen different postage dues, 10c; twenty different revenues, 10c. Southern Stamps, Box 70M, Miami, Florida.

BELGIUM—25 Different 5c. Approvals, Tait's Stamps, 115 South Alexandria, Los Angeles, Calif.

FREE! Pony Express set (facsimiles). Postage 3c. Roberts, 406 Shearerbldg, Baycity, Michigan.

50 FREE, Approval applicants, Harford Stamp Co., 4712 Hampnett, Baltimore, Md.

19TH CENTURY U. S., battleships, civil war revenues, commemoratives, 20 different plus U. S. 1940 price list. All for 5c to U. S. approval applicants, Metropolitan Stamps, 198-J Broadway, New York City.

SEVEN Different triangles only 5c to approval applicants, Tatham Stamp Co., Springfield-30, Mass.

U. S. park set complete 19c. Better Approvals, Box 488, Minneapolis.

FOUR Star approvals! Nothing like them! Write today, 312 mixed U. S., 10c. Kessels, Tucson, Arizona.

40000 VARIETIES Available on approvals 1/4c up. Large selections, low prices. Write today, PKEigwin Stamp Company, Vineland, N. J.

SOUTH American—100 different 10c—with approvals, Davis, Silver Lake, Ind.

AIRMAILS And commemoratives, 25 different, including Columbians, Panama-Pacific, Edison, Zeppelin, etc., only 5c with exceptionally fine United States and foreign approvals, Marco Stamp Co., Box 888, San Francisco, Calif.

YOU Can now have famous Spanish Goya nude stamp, world's largest diamond stamp and world's largest triangle. These beauties sent for only 5c to collectors requesting approvals. To make this the year's biggest bargain, we will include absolutely free collection of 100 varieties containing weird scarce stamps from Transcaucasia, Georgia, Azerbaijan, etc. Cactus Junior, Box 1870-B, Tucson, Ariz.

FREE! Austria war set, Postage 3c. Williams, 606 Archerbldg, Bay City, Mich.

WEEKLY Stamp magazine, thirteen weeks, 10c. Stamp Journal, Kalamazoo, Mich.

200 DIFFERENT 10c. Big 50% approvals. Covert Stamp, 39 State, Rochester, N. Y.

CANADA 100 Different 25c—approvals all countries, Lists, Victoria Stamp Co., London, 4, Canada.

PENNY Approvals, that satisfy, Neil Gronberg, Box 5441-P, Philadelphia, Penna.

THREE Sets for 3c stamp! Jack Reed, Jr., Houtzdale, Pennsylvania.

25 UNITED States, including \$4 and \$5 stamps free to approval applicants, 3c postage, Brownie Stamp Shop, Flint, Mich.

SMOKY Mountain commemorative sheet, largest U. S. stamp issued, and 33 U. S. including commemoratives, airmail, revenues, etc. Catalogs 75c—To approval applicants for 5c. Curhan Stamp Company, Gloucester, Mass.

WHOLESALE Dealer's catalog, Illustrated, Postage 5c, Frank's, 4900 Chalmers, Baltimore, Md.

WHOLESALE Supplements to dealers for 10c postage. Hundreds of bargains, Grossman Stampco, 102 West 42nd, New York.

GIANT Packet 200 all different from Africa, South America, Asia, South Sea Islands, etc. Includes world's smallest stamp; triangle and diamond-shaped stamps; animal stamps, Nicaragua "Will Rogers" airmail; many others. Also packet 17 different United States (cataloging 50c)—all obsolete, including \$4 denomination, commemoratives, etc. Total catalogue price over \$5.00! Everything for only 5c to approval applicants! Mystic Stamp Company, Dept. 80-N, Camden, New York.

50 FREE, Catalogued \$1. Album 3c. Bullard, 13-Winter Hill, Mass.

HOBBIES AND COLLECTIONS

FIFTEEN Different cactus plants \$1.00. Grow anywhere, Eulalia Turner, Azusa, Calif.

WANTED Old cigarette cards. Write Bray, 1127 Jackson, Easton, Penna.

TRIAL (3 Month) subscription, 10c. Copy 5c. "Hobby News," Hawthorne Sta., Chicago.

KNIFE Throwing secrets exposed! Illustrated book tells all, \$1.00 postpaid, P. Dean, 1294 E. San Fernando, San Jose, Calif.

ALBUM Mounts matchbook covers without paste. Write Adams Sales, Dept. 33, State Tower, Syracuse, N. Y.

EXCHANGE Your duplicate stamps, match covers, etc., with collectors everywhere. List, swappers, dime. (Mention hobby). Secretary, Box 2166, Denver, Colo.

UNUSED Book match covers, 100 all different, \$1.00. Free list, Charles Edelman, 1311C East 84, Cleveland, Ohio.

CAMERAS, PHOTO SUPPLIES

ENLARGING Timer—Controls enlarger. Split-second accuracy. Synchronous motor driven. Price \$12.50. Write for literature, Potter & Brumfield Mfg. Co., Princeton, Ind.

TRADE In your camera or equipment. State what you have and what you desire. DeHaan Camera Co., 65th and Halsted, Chicago.

MAKE Money in photography. Learn quickly at home. Easy plan. Previous experience unnecessary. Common school education sufficient. Interesting booklet and requirements free. American School of Photography, 3601 Michigan Avenue, Dept. 3432, Chicago.

FREE Instructions. Make powerful telephoto camera. A. Jamer, Manorville, N. Y.

CAMERAS And supplies. Free illustrated catalog listing everything photographic—still and movie cameras, films, lenses—at tremendous savings. Hundreds of bargains, new and used. All guaranteed. We take your old camera or equipment in trade. Write now for your free copy of our newest money-saving bargain book—just out! Limited edition. Hurry! Central Camera Co., (Photographic Headquarters since 1899) 230 S. Wabash, Dept. J-16Z, Chicago, Ill.

TREASURE Finders? Read Goldak advertisement on page 138A.

CAMERA Repairing. Bellows made to order, shutters repaired. Bellows made to fit all standard cameras! United Camera Co., Inc., A-1515 Belmont, Chicago.

ENLARGER \$1.59. Enlarges eight times size of small negatives. Fully guaranteed. Paramount Sales Company, 89 Dudley Street, Boston, Mass.

BASS Says: Shrewd buyers, write Bass. For 30 years headquarters for everything in photography. 72-page Bargaingram No. 242 is interesting and free. Write for your copy. Don't trade until you write Bass Camera Company, Dept. AG, 179 West Madison St., Chicago, Ill.

HAVE You a camera? Send ten cents for recent number of our big magazine, showing how to make better pictures and earn money. American Photography, 116 Camera House, Boston, 17, Mass.

CAMERAS, Films, paper 25% to 35% discount. Paramount Photo Division, 327 East 92nd St., New York.

PHOTO FINISHING

EXTRA Set of prints or two double-weight enlargements with roll; prints deckle-edged. Dekelab Photo Service, Dallas, Texas.

ROLL Developed free. 8 deckled glossy prints 20c. Reprints 3c each. Eastern Photo, 55 Myrtle Ave., Danbury, Conn.

SATISFIED Customers make splendid advertisers. A trial will convince. Best possible service—quality surpassed by none. 6-8 roll, developed, 8 prints, 2-5x7 enlargements, 25c coin. Largest photo plant in North Texas. "We cover the Nation like the Sunshine." Westex Photo Laboratories, Drawer 4398, Desk 10-1, Fort Worth, Texas.

ROLL Developed, eight Velox prints, two portrait enlargements 25c. Christensen Studios, 729 Pacific, Waukegan, Illinois.

FREE—Three professional 5x7 enlargements of your own choice, two guaranteed sets of prints with your roll film developed all for 25c, original order only. Aro Studios, Dept. 12, Des Moines, Iowa.

PHOTOGRAPHY For pleasure and profit. Prepare for profitable business or fascinating hobby at home. Common school education sufficient. Write for information and requirements. American School of Photography, 3601 Michigan Avenue, Dept. 3456, Chicago.

ROLL Developed, eight beautiful professional 4x6 gloss enlargements; 25c. Crystal Studios, Box 159-F, Rushford, Minn.

OVERSIZE Prints. Your roll developed and 8 oversize prints 25c; from 116, 120, or 127 size negatives you receive 4x6 inch prints. All smaller sizes receive 3 1/4 x 4 1/2 inch prints. Reprints 3c each. Overnight service. Pacific Photo Service, Box 666, San Francisco, Calif.

ROLLS Developed, two prints each and two free enlargement coupons, 25c; reprints, 2c each; 100 or more, 1c. Summers' Studio, Unionville, Mo.

16 GUARANTEED Prints plus two free enlargements from each roll, any size, only 25c coin! Credit on bad pictures! Same-day service. Free mailers. Midland Photo Co., Dept. 236, Charles City, Iowa.

TECHNIFINISH—35mm. 36 Exposure rolls including "Mercury" fine grain developed and perfectly enlarged to 3" by 4" glossy prints, 85c. New, exclusive methods and equipment make this low price possible. Cartridge reloaded with Eastman Plus X, 30c. One day service. Satisfaction guaranteed or money back. Write for free mailing bags and information. Technifinish Laboratory, 109-K Lexington, Rochester, N. Y.

20 REPRINTS 25c, 100—\$1.00. Roll developed 16 prints 25c. 5x7 enlargements 10c, 3—25c. Nordskog, 4 Maywood, Illinois.

ENLARGEMENTS, 8x10, 50c each, four for \$1 postpaid. Send negatives. James, Box 374, Nashua, N. H.

DEVELOPING, 2 Sets prints 25c. 20 reprints 25c. Hoosier, 1353, Winamac, Ind.

OIL Coloring photographs a fascinating hobby or profitable business. Learn at home by easy simplified method. Previous experience unnecessary. Send for free information and requirements. National Art School, 3601 Michigan Avenue, Dept. 3437, Chicago.

FREE—One roll developed and printed free. Just to get acquainted, we will beautifully develop and print your first 6 to 16 exposure roll free plus 5x7 inch enlargement free, also sensational, new folding folio to frame your prints, all free with this ad. (Enclosing 10c for handling and mailing appreciated.) Dean Studios, Dept. 1039, Omaha, Nebraska.

EMBOSS Christmas cards, including envelopes, from your own negative 60c dozen. Minimum 4 for 25c. Film Capitol Service, Box 504, Rochester, New York.

AMAZING Trial offer, to get acquainted. Roll developed—any size, prints 1c each, enlarged prints, 1 1/2c each. Dick's Photo, C-1, Louisville, Ky.

EXTRAORDINARY Offer! 6-8 exposure rolls developed; 4" x 5" Kodabrom enlargements; valuable certificate, 25c. Economize! Purchase films from us! Don Lehman Enterprises, 1628-E South Compton, St. Louis, Missouri.

ENLARGEMENTS That please. 5x7, 3 for 25c; 8x10, 3 for 50c. Send negatives. Lee Photos, P.O. Box 2053, Chicago.

"MICROGRAIN 85" Development—8 exposure rolls, with Velox deckle prints—35c; 12 exposures—40c; 16—50c. Color Craft, Danbury, Iowa.

THE Modern Finishers, St. Paul, Minn., are the outstanding finishers in America for low prices, fast service, guaranteed neverfade pictures. Roll developed 8 Moderntone prints 20c. Roll developed, 16 Moderntone prints 25c. Reprints 2c each, 16 for 25c. Coupons on enlargements, 35mm, 36 exposure roll developed fine grain, 1 each enlarged \$1.00.

16 PRINTS, 2 5x7 Enlargements with roll 25 cents. Pictorial Studios, 2955 Lincoln Street, Minneapolis, Minnesota.

ROLL Developed 6 or 8 prints, including 5x7 enlargement, 25c coin; without enlargement, 20c coins. Gem Photo Service, 3355 West 63rd, Chicago, Illinois.

IMMEDIATE Service! Pictures returned same day order is received. Sixteen guaranteed deckle-edge prints from roll, 25c. One colored or two plain enlargements plus 8 deckle-edge Velox prints only 25c. Special! Coupon for 8x10 enlargement given with each 25c order. Any 36 exposure 35mm. film fine-grain developed Vaporate Treated and each good negative enlarged to 3x4 on deckle-edge Velox paper, only \$1.00! Reloads: 36 exposure, 50c; 18 exposure, 35c. 3x4 deckle-edge reprints, 4c each. 24 hour service. Details, sample and mailers free on request. American Studios, Box 51, LaCrosse, Wis.

ROLL Developed and 8 beautiful enlargements 2 to 6 times larger—high gloss—deckle edge. Any 8 exposure roll 25c coin. Reprint enlargements 3c each. Alden Photos, 94-B Astor Sta., Boston, Mass.

FREE, 2 6x4 Enlargements with 8-exposure film developed and printed, 20c. Douglas Photo Service, Tuscola, Illinois.

ROLL Developed, 16 Velox prints and 2 professional enlargements, 25c. 20 Velox prints, 25c; 100—\$1.00. Same-day service. Superior Finishers, Monroe, Wis.

ROLL Developed. Triple size pictures from every negative, 116 size enlarged 5x7, 120 enlarged 4x6, 127 enlarged 3 1/2 x 4 1/4. Inbetween sizes enlarged proportionately, triple size, 8 exposure rolls developed and 8 triple size pictures, 25c. 12 exposure rolls, 35c. 16 exposure, 50c. All reprints, 8 triple size, 25c. Tri-Plex Photo Service Co., Box 369, San Francisco.

DOUBLE Size prints. Roll developed, 8 prints all enlarged to nearly postcard size, 25c. Willard Studios, Dept. 34, Cleveland, Ohio.

BARGAINS, Speedy, eight prints, two enlargements 25c. Fotoservice, 1942-D Marlow, Toledo, Ohio.

FREE Beautiful album with cellophane envelopes plus roll developed and two sets prints, 25c. Free mailers. Same-day service. Pho-T-Pho, Box 24-F6, Highland Park, Mich.

DOUBLE-QUICK Service! Roll developed 16 Velox prints; or 8 prints, 2 enlargements 25c. Chicago Photo Lab., Box 3A, South Chicago, Illinois.

NEW! Sensational! 1940 style leader, 8 exposure roll finished, prints deckled, dated and in a neat album, plus valuable coupons, 25c. Triangle Photo Service, P.O. Box 402, Oak Park, Illinois.

8-5-7 LARJA Prints from 8ex. film 20c. 16-4x5 Larja prints from 16ex. film 48c. Abbey Camera Shop, St. Louis, Mo., 421-A.

ROLLS Developed and 16 prints or 8 prints and 2 enlargements—25c. 35mm. rolls developed and 36 3x4 enlarged prints \$1.00. 3x4 reprints from miniature negatives 4c each. Mercury Studios, Dept. M, 109 N. Dearborn, Chicago.

FREE! Best snapshot on attractive photo button with 16 prints each roll 25c. Beautiful novelty premiums. Novel-Ad Co., BM-3327 North Ave., Chicago.

FREE—To Popular Mechanics readers: Any roll developed, 16 sparkling Nu-Art neverfade enameled prints plus two beautiful Hollywood enlargements and two free Leathertone frames only 25c. Overnight service. Lifetone Studios, F-39, Des Moines, Iowa.

CANDID Developing trial—36 exposures enlarged 3x4, including free enlargement coupon—65c. Micrograin Laboratories, N-39, Des Moines, Iowa.

35MM. Rolls fine grain developed, vapo-rated and enlarged, 3 1/4" x 4 1/2" for \$1, Guaranteed minimum 25. "Electric-eye" precision. Deckled prints, Embossed margin and date. Free mailers, 8 exposure rolls beautifully finished in free album, 25c. Satisfaction guaranteed or money back. Mailbag Film Service, Box 5440 A, Chicago.

ROLL Developed and 8 lustrous, natural finish, permanent Velox glossy prints 25c—reprints 3c each. Fotoprint Service, Box I, Roanoke, Virginia.

FREE Trial—16 sparkling lifetime prints, three lovely Hollywood enlargements and free Leathertone frame with roll—25c. Overnight service. Nu-Art Studios, L-39, Des Moines, Iowa.

PROMPT Service—Quality work; 2 beautiful doubleweight gloss enlargements, 8 guaranteed neverfade prints each roll 25c. Excel Photos, Dubuque, Iowa.

ROLL Filmachine developed and your choice (1) 8 Finerfotos and 2 professional bromide enlargements; or (2) 16 guaranteed Finerfotos or (3) 8 Finerfotos and one beautiful oil colored enlargement, 25c. Order by number. Prompt service. Finerfotos, Box D-898, Minneapolis, Minn.

35MM. Fine-grain developed, 36 big 3 1/2 x 5 enlargements \$1.00. Cartridge reloaded 35c. Photoshop, Linton, Indiana.

FINER Finishing specials 25c. 6-8 exposure rolls developed, your choice—16 prints or 8 prints with 2 professional enlargements or 8 prints and one colored enlargement. Genuine nationally known Moentone superior quality. Moen Photo Service, 431 Moen Bldg., LaCrosse, Wis.

CANDID Special, 35mm. rolls enlarged to 3 1/2 x 4 1/2, \$1.00. 18mm. rolls 60c. 3 1/2 x 4 1/2 reprints 3c. Brown Photo Company, 1910-61 Emerson, Minneapolis, Minn.

ONE 6 1/2 x 8 1/2 Plate sunk enlargement or one 5x7 hand colored enlargement with each roll developed and 8 prints 25c. 36 exposure roll developed and 36-3 1/2 x 4 1/2 enlargements \$1.35. 18 exposure roll 75c. Vidor, 321-P Hennepin, Minneapolis, Minn.

BEAUTIFUL Enlargement from each picture on roll 25c. Cut Rate Photos, Dept. B-4, Janesville, Wis.

ROLL Developed, 16 Velox prints 25c. Dividend coupon, 16 Velox reprints 25c. Willard Studios, Box 3535-A, Cleveland, Ohio.

TWO Beautiful prints from each picture on roll 25c. Twenty years of satisfied customers. Quick service. Lens Photos, Dept. J-4, Janesville, Wis.

ROLL Developed—16 guaranteed prints, two coupons on enlargements, 25c. Smart Photo, Winona, Minnesota.

IDEAL Photos beautiful finished with wide border, deckle edged, 25c per roll of 8 and free enlargement. Ideal Photos, Box 2255, Paterson, N. J.

THE Photo Mill. Immediate service; No delay! Eight-exposure roll developed, carefully printed and your choice of two beautiful 5x7 double weight professional enlargements, one tinted enlargement, or eight reprints for 25c coin. Reprints two cents each. Highest quality guaranteed. The Photo Mill, Box 629-12, Minneapolis, Minn.

PROMPT Service! Rolls developed, two Velox prints each negative 25c. Hench Studios, Harrisburg, Penna.

18 LIFETIME Prints, 2 sparkling Hollywood enlargements each roll 25c. 21 reprints 25c; 100—\$1.00. Finished 3 hours. 25 other bargains. Overnight Studio, Albany, Wis.

16 PRINTS With roll 25c. 16 reprints 25c. Rex Photo, Ogden, Utah.

8 ENLARGEMENTS—Films developed plus 8 enlargements, 25c coin—116 or smaller. Enlarge Photo, Box 791, Dept. PMM, Boston, Massachusetts.

ROLLS Developed, two prints each and two free enlargement coupons, 25c; reprints, 2c each; 100 or more, 1c. Summers' Studio, Unionville, Mo.

THREE Prints each good negative in roll 25c. Reprints 3c. Fred D. Eastman, Bode, Iowa.

FOR The discriminating amateur—Rolls developed 2 prints each, 25c. Reprints 3c. Superior workmanship. Same day service. Paramount Co., 327 E. 92nd St., New York.

MOTION PICTURES AND SOUND EQUIPMENT

WRITE For new large two color 1940 catalogue nationally advertised movie cameras, projectors, films, accessories. Payments low as \$2.50 monthly. Don Elder's Home Movies, Dept. 20, 739 Boylston Street, Boston, Mass.

35MM. Silent sound. List 5c. Bedner, 5300 S. Talman, Chicago.

FILMS Rented 15c a day. Send 3c stamp for lists. Hoffman Films, 57 Broad, Albany, N. Y.

ART Film! Sample, catalogs, gift offers, dime! Venus, 2743-A Sheffield, Chicago.

LEARN Theatre management, projection. Big opportunities. Free catalog. Give age. Theatre Institute, Elmira, N. Y.

MONEYMAKER! "The World's Greatest Passion Play," 16mm. and 35mm. Specify sound or silent. Rent or purchase. Superior than Oberammergau play. Hemenway Film Co., 37F Church Street, Boston, Mass.

ART Sample, 10c; other kinds, lists free. Goodwill Company, Jackson, Tennessee.

FREE Lists projectors, cameras. Still cameras, enlargers. Sample war film dime. Discouns. Gravlee, Kennedy, Alabama.

SENSATIONAL 8-16mm. Movies "Battle of France." Thousands other subjects. Sold-exchanged. Films rented everywhere. Bargains in equipment. Trades accepted. Free illustrated catalogue (with sample art 10c.) Garden Film, 317 West 50th, New York.

HEADQUARTERS: 16-35mm. Sound, silent equipment. Large selection, low prices. B-H, Victor, R.C.A., DeVry. Trades accepted. Easy terms. Used film subjects from \$5 per 400'. 8-16mm. library serves U. S. Catalogs free. Mogull's, 64 West 48th, New York.

UNUSUAL Art catalog; sample film dime. Erwine's Laboratories, Allentown, Penna.

SENSATIONAL Films! Rare, artistic. Free list, sample film 10c. Box 1504, Hollywood, California.

NEW Reflector for motion picture projectors, guaranteed to increase screen illumination 40%. Write "All-Around" Reflector Co., 10111 Euclid, Cleveland, Ohio.

SOUND Films \$2.00 reel; silent films \$1.00 reel. Simpson, 1275 So. Broadway, Dayton, Ohio.

10 SOUND (16mm.) Projectors. Bargains. Roshon, State Theatre, Pittsburgh, Penna.

16MM. VELOTEX. Perfect outdoor film. 100 ft. rolls \$1.95 including free processing, sample free. Velotex Laboratories, 600-B, Gary, Indiana.

BASS Says: The new Revere double 8 camera at \$29.50 with F:3.5 lens is a honey. The new Revere projector at \$59.50 is great value. Both described in our new catalog No. 245, 72 pages. Write for it. New RCA Model PG-170 16mm. sound on film projector is ready. Greatest \$300.00 value. Literature on request. Write Cine Headquarters, Bass Camera Company, Dept. A, 179 West Madison St., Chicago, Ill.

OUTDOOR Film 100 ft. 16mm. \$1.98. 25 ft. double 8mm. 98c. Processing included. 8mm. camera, projector, screen \$10.00 complete. Free lists. Home Movies, Box 216, Easton, Penna.

ART Films. Sample, dime; catalog free. Cineart, 2443 Gunnison, Chicago.

MOVIE Film. Develop yourself. Univex, Eastman, etc. Chemical samples 15c. Raw film wholesale. Lake Camera Exchange, Gary, Ind.

15% TO 25% Discount on still or movie cameras. Free circular. Paramount Co., 327 E. 92nd St., New York City.

FREE—Big list of helpful books. Popular Mechanics Press, 200 E. Ontario St., Chicago.

RADIO, SUPPLIES, INSTRUCTIONS

RECORDER. Motor, turn-table, lead screw, crystal cutting head and playback, complete with \$16.50 crystal microphone. Wholesale price \$17.95. Twenty-five per cent with order. Peter Pan Radio Co., Los Angeles, California.

RADIO Kits—\$3.95 up. Single band; all wave, 5-10 tubes. Save 50%. McGee Radio, FP-10, Kansas City, Mo.

RADIO Service men and experimenters send for our giant radio catalog. Save dollars. United Radio Co., 1000 M. Newark, N. J.

ONE Tube radio kit \$1.00 postpaid. Bond, 13139 Hamilton, Detroit.

RADIOS—\$8.95 up. Save 50%. Wind-chargers, electric fencers, power plants. Home agents wanted. Catalog free. Marco-F-30, Kansas City, Mo.

COMPLETE Radio course \$1.95, full price. Write Supreme Publications, 3727 13th Street, Chicago.

AMAZING New four tube miniature portable radio. Looks and carries like camera yet everything self-contained in stunning black unbreakable case trimmed with chromium. Has four inch dynamic speaker and provision for headphones. Economical as flashlight, but powerful and sensitive. Free circular. De Luxe Radios, Box 876, Beverly Hills, Calif.

RADIO Builders, experimenters, get our free 212 page money-saving radio and parts catalog. New builder's kits: diagrams; 15,000 parts. See ads, pages 25A, 131A. Beginners—get started with an RCA electronic lab. Dept. 5-KC-1, Allied Radio Corp., 833 Jackson Blvd., Chicago, Ill.

RADIO Engineering, broadcasting, aviation and police radio, servicing, marine and Morse telegraphy taught thoroughly. All expenses low. Catalog free. Dodge's Institute, Ames St., Valparaiso, Ind.

MUSIC AND MUSICAL INSTRUMENTS

FREE Booklet "Building an Income Thru Songwriting." Write today. Songwriters Institute, 43-C Park Place, Brooklyn, N. Y.

SUCCESSFUL Songwriters make big money. Write for information. Allied Music, Box 507-N, Cincinnati, Ohio.

SONGWRITERS: Melody composed to your song poem \$1.00. Frank Jugan, Jr., Signal, Ohio.

MUSIC Composed to words. Words to music. Arrangements. Copying. Very reasonable. Universal Music Service, 1241 Broadway, 2nd Floor, New York.

WANTED! Original song poems, any subject, for immediate consideration. Richard Brothers, 24 Woods Building, Chicago.

SONG Poems wanted. Submit for consideration by professional music writers. Five Star Music Masters, (6) Beacon St., Boston.

ADULT Beginners' piano course \$1.25. Moses, 315 West 86th, New York.

LEARN To sing duets, quartets—play several instruments, or both, all at one time, in harmony, all by yourself—sensational; copyrighted booklet tells how, \$1.00. Hazelman's, 7 So. 2nd, Alhambra, Calif.

SONGS Composed, arranged, published. Special offer. Basil Ait, Ottoville, Ohio.

ORCHESTRATIONS—Popular back numbers, 10—\$1.00. Silverman, 3303 Lawrence, Chicago.

PHONOGRAPH Records 10c. Catalogue. Paramount, AH-358 East Market, Wilkes-Barre, Pennsylvania.

SONGWRITERS Outstanding proposition. Newart Song Publications, 1207 Carbon, Syracuse, N. Y.

SONGS; Songpoems; bought, composed, published, recorded, radio broadcasted. Best offer. Free advice. Metro-Melody Music Publishing Company, San Francisco.

LEARN Swing piano! Postal brings free folder. Christensen, 751 Kimball Hall, Chicago.

FREE Book to songwriters—Original poems, songs wanted. Variety, Dept. V, Salem, Indiana.

SONGWRITERS! Words, melodies! Amazing offer. Hibbler, C-5, 2157 N. Avers, Chicago.

SONG Poems wanted. Free examination. McNeil, Master of Music, 510-PM South Alexandria, Los Angeles, Calif.

MUSIC Composed to words. Wonderful proposition. Bauer Bros., Oshkosh, Wis.

MUSIC Composed to words. Rhyming pamphlet on request. Phonograph recording of completed songs. Send poem for consideration. Keenan's Studios, Dept. PM, Box 2140, Bridgeport, Conn.

WRITE Songs. Big money and reputation. Write for information. J. Gordon Pub. Co., 201 N. Hoyne Ave., Chicago.

WANTED! Lyrics, melodies for songs. We arrange, publish, sell. Superior Song Studios, Passaic, N. J.

SONG Writers. Send for publishing agreement. McKinley Music Publishers, 1501 E. 55th St., Chicago.

SONGS. Lyrics wanted by Broadway arranger. Send stamp for proposition. National Songwriters, 1674A Broadway, New York.

BUSINESS OPPORTUNITIES

MAKE Big money in new profitable business. Learn electroplating at home. Simple, easy, quick. Plate auto parts, reflectors, bicycles, bathroom fixtures, silverware, ornaments, musical instruments, tools, etc. See new, lustrous metal flow and renew old worn parts instantly. Big demand. Big profits. Earn while you learn. For full details and trial lesson merely send 10c. Warner Electric Co., Dept. FC, 360 No. Michigan Ave., Chicago, Ill.

START Photo finishing business. I'll do your work. Splendid profits. No investment. Write. Moriarty Photo Service, Box 374, Nashua, N. H.

START Home business making statuary, plaques, art goods, novelties, souvenirs, concrete pottery, garden furniture, artificial marble flooring, liquid marble. Make your own flexible molds. Amazing profits. Valuable folder free. Creative Publishers, (P10), Glencoe, Illinois.

SMALL Capital starts "route" coin operated peanut gum and amusement machines. Particulars free. Robbins Co., 1141P DeKaib Ave., Brooklyn, N. Y.

EARN Money at home making imitation diamond jewelry, bracelets, bairpins, millinery ornaments, religious medals, etc. High prices now paid on account of German and French jewelry shortage. Exceptional spare or full time opportunity. Write. United Jewelry Manufacturers, Dept. A, 1692 Boston Road, New York City.

OPPORTUNITY Knocks. Will you open the door? Get our marvelous new book, "101 Ways to Make More Money" in spare time at home. Successful, bonafide, money making plans. End your financial worries now. Order yours today. Satisfaction guaranteed. \$1.00 postpaid. Monarch Publications, 715-A Haas Bldg., Los Angeles, Calif.

START Profitable collection business your community. No capital. Very profitable. Convincing literature free. Morrison Business Service, Pontotoc, Miss.

INCREASE Your earnings in a business of your own, with all the trade you can attend to. Become a Foot Correctionist and in a few weeks earn big income in service fees—not medical or chiropody. Easy terms for home training, no further capital needed, no goods to buy, no agency. Address: Spencer System, 533 Back Bay, Boston, Mass.

"RUBBER Mold Making." Plaster Casting. Working instructions 25c. Ideal Service, RM-10, Park Ridge, Ill.

FOR Free information concerning an extremely profitable, lifetime, office business, write. Cole Associates, Syracuse, N. Y., immediately.

OPERATE Steady business resilvering mirrors. Making chipped glass nameplates, signs. Write Sprinkle, Plater, 127, Marion, Indiana.

MAIL Order business course shows you how to make money, spare or fulltime. Teaches professional mail order technique—not penny-catching schemes. Free details. Nelson Company, 500 Sherman, Dept. 404-J, Chicago.

M. M. Earned \$1174 in spare time for exceptional "cellar crop" Snow-King mushrooms! Free book tells if your cellar, shed suitable. We buy crops. United, 3848 Lincoln Ave., Dept. 69, Chicago.

POPCORN Machines, caramelcrisp crispettes, cheese coat, potato chips. Long Eakins, 2035-K High St., Springfield, Ohio.

SIGN Painting lettering patterns, samples free. Clark System, Ellwood City, Penna.

WANTED:—Opportunities, samples, etc. Remailing! Cross-section (including 35c sample) 25c. Ennis, 1363 Greenwich, Ap-ponaug, R. I.

"INDEPENDENT Operator" — Professional mailorder magazine—10c. Kraft Publications, Syracuse, New York.

"MAILMONEY Facts." Outstanding mailorder magazine. Copy, opportunity offers, 10c. Vernon Publishers, West Fairview, Penna.

FREE Literature—Profitable home opportunities. Franklin, Box 866M Hilltop Sta., Columbus, Ohio.

TURN Tin cans into money. Instructions 25c. H. Chaney, 1130 E. 16th St., Jacksonville, Fla.

NEW Scientific auto shampoo, revolutionizes car washing; harmless to paint; streakless. Rinses instantly; eliminates chamois. Does job in half time. Immense repeat field. Unique plan pays huge profit. \$1.00 brings complete informative bulletins and generous trial material. G. E. MacCoy—Moto-Foam Div., 33rd and Arch Sts., Philadelphia, Penna.

CONTROLLED Imprints give better odds. Mail order "natural"! Details, stamp. Postalfax, West Lafayette, Indiana.

HANDY Men—Earn money home operating Community "Fix-It" Shop. Stafford, Makanda, Illinois.

SEND 3c Stamp for many opportunities. Peerless Service, Long Beach, California.

DOLLARS Earned making, selling my delicious black walnut taffy, a home product. Send \$1.00 for formula and get started. A. B. McCartney, Marshalltown, Ia.

MAKE Home recording blank records and earn money. Complete forty-six page book of instructions only 35c. J. Crown-over Industries, Los Angeles, Calif.

WE Show you how to obtain capital for your business or invention. Write Enterprise Bureau, Syracuse, N. Y.

WANT Good job? Valuable tips by experienced business men (5000 words). 10c (coin). B. Bannick, Box 55, Harper Stn., Detroit.

900% PROFIT! Satisfied, "lifetime" customers. Write! McArthur, Drawer 339, (5) Butte, Montana.

"MAILORDER Directory"—300 firms listed; 51 classifications—15c. Kraft Publications, Syracuse, New York.

BIG Mail for you. Latest moneymaking offers, opportunities, catalogs, magazines. Name listed in directory 10c. Ideal Service, 110M, Park Ridge, Ill.

TREASURE Finders? Read Goldak advertisement on page 138A.

6 LEADING Mail order magazines, big mail of mail order money making opportunities. 25c. Bailey, Bethel, Ohio.

UNIQUE Service to used car dealers earns \$12 to \$18 daily. Amazing "Terginol" method cleans soiled auto interiors like new; harmless to fabric. Immense field. Three distinct plans for big paying independent business of your own. Complete instructions and trial material \$1.00. G. E. MacCoy—Terginol Div., 33rd and Arch Sts., Philadelphia, Penna.

SELL Books by mail. "Guide to Better Jobs," retail \$2. Wholesale \$4 dozen. Dealers' sample 50c. Returnable, refund. Menne, 78-14 Austin, Forest Hills, N. Y.

BUILD Big profitable dignified business introducing newest hand engraved plate glass photo frames to homes, stores, photographers. Box 71, New Albany, Ind.

MAKE Artificial marble. Novelties, floors, pottery. Cement secrets. Brilliant samples 3c. Latex postpaid—pint \$1.25; quart \$2.00. John A. Payn, 945 Grande Vista Avenue, Los Angeles, Calif.

WOW! Start photo finishing business! Develop films; make money! Details—stamp. Northern Photo Service, Dept. D, 321 W. Jefferson, Petoskey, Michigan.

START Photo-finishing business! Develop films; make money! Details—stamp. Novex, Box 1044-M, Birmingham, Ala.

OPERATE Profitable "route" four compartment vendors. Small investment. Penny King, 1233 Chouteau, St. Louis.

GLASS Cleaner made with water and standard concentrate. \$2.25 unit makes six gallons. Excellent profit. Chris Bingham, Ardmore, Pennsylvania.

RECAST Old batteries into new. Latest achievements. Battery Laboratories, St. Paul, Minnesota.

PAYING Mail order business. Write Staebler, 79-20 45th, Elmhurst, N. Y.

"FORTUNES In Formulas." Be successful manufacturer. 900 page book—10,000 authentic processes, secrets. \$1.50 postpaid. Ray Allaire, 50 Elm, Bath, Me.

CHAIR Cane jobs bring money. Details dime. Fogarty's Cane, Troy, N. Y.

150 AMAZING Money-making secrets. Free samples. Formico Novelty Service, Dayton, Ohio.

PROFITABLE Home business. Sample product. Instructions. Five money making publications. Stamp. Mail Mart, Gloucester, New Jersey.

REAL Estate, foundation of wealth, taught at home. Easy lessons. By leading experts, including expert for city of Chicago. New, reasonable, profitable. Morrison School Real Estate, 100 North LaSalle, Chicago, Ill.

START A lettershop. Splendid white-collar work in own home. Full free particulars. Tynan, Rhinebeck, N. Y.

DOLLAR Investment brings 75c profit every dollar sale. Details 3c. Goodeve, PM-940, Bergenfield, N. J.

BRING Home the bacon with Becker's Big Three mail starters. Write Box 183, Altoona, Penna.

WANTED: Distributors, manufacturers for cleaning products. Box 2363, Cleveland, Ohio.

MAKE Maple sugar apple taffies. Instructions \$1.00. Free 5 day inspection. Stamp required. Maple, 109 N. Dearborn, Chicago.

A REAL Mail order business opportunity. Everything required furnished. No experience necessary. Dollar plan, demonstration folder, book "Mail Order Selling," working details sent postpaid for quarter; (coin) 28c if stamps. No imprint proposition, but your own built to order business. You'll find this plan different. Gies Organization, 479 Autumn Ave., Brooklyn, N. Y.

EARN Extra income selling nationally-known low-priced smoking pipes to stores. Displayed on attractive self-selling counter cards. Quick repeats. Valuable territorial franchise. Smoking Pipes, Incorporated, Paterson, New Jersey.

START Photo finishing business. Develop films, make money. Details stamp. Write: Fotoprint Art Service, 194 Hebronville, Texas.

IMMEDIATE Profits in current national sentiment now! Tested plan. Send 25c for booklet containing test letters, details. Sales Institute, 177 Fort Greene Place, Brooklyn, N. Y.

MONEY Collecting coat hangers. Instructions 25c. 263 Elford Terrace, Spartanburg, S. C.

MILLIONS Made—Information (mailorder), dime! Charles Moody, 4 Spring, Salisbury, Mass.

BUSINESS Of your own. Small capital. Details 25c. Clement, 43 M. Arthur, Rochester, N. Y.

LISTS Of all United States manufacturers—10 names \$1. Stern, 6220 Ellis, Chicago.

RECEIVE Stacks of mail. Your name listed in 10,000 directories 25c. Liberty Sales Service-A, Sheboygan, Wisconsin.

PROFITABLE Mail order business, complete plan, sample, big mails 10c. Writese Enterprises, 491 West State, Columbus, O.

GOSPEL Stamps. Your picture reproduced, 3/4x1, gummed, 100 \$1.00 postpaid. Eight letters name free. Agents outfit 50c refundable. Royal Service, P.O. Box 1275, Washington, D. C.

START Profitable used magazine exchange. Send 50c for complete plan. Book-Magazine Mart, Hutchinson, Kansas.

ESTABLISH Own business. Quality products. Excellent proposition. Owens, 830-W Euclid, Detroit, Mich.

MONEY By mail, the way we do. Robert Collier's "Master" course shows you the "proven" way. Write Successful Income Builders, Hollywood, California.

MAKE Money developing films. Start photo finishing business, home, part, full-time, locally, by mail. Details stamp. Write: Fotoprint Art Service, Hebronville, Texas.

WE Help start you in business, furnishing outfits and instruction, operating "Specialty Candy Factory" home. Men-women, opportunity to earn good steady income, all or spare time. (Our 31st year.) Booklet free. Ragsdale Candies, Dept. 4, East Orange, N. J.

3c GALLON. Bleach, glass spray, cleaning fluid, type cleaner, foaming rug and upholstery cleaner, hand soap, garage floor cleaner—manufactured from Phospholene. Sample 25c. Literature free. Western, 401 Climax Bldg., Cleveland.

OPERATE Mail order business at home. Details dime. Maples, 3418 South Marshall, Chicago, Illinois.

MAKE—Biggest money duplicating leading chemical specialties. Popular branded products! Miller's Analytical Service, Tampa, Florida.

OWN A cash business? No selling. Operate "Silver King" vendors, \$3.95 up. Free instructions. Automatic, 2422-A Fullerton, Chicago.

"NEW Business" opportunities. Drop postal. Porter, Box 6346P, Pittsburgh, Penna.

WE Successfully sell inventions, patented and unpatented. Write us, if you have a practical, useful idea for sale. Chartered Institute of American Inventors, Dept. 4-C, Washington, D. C.

MOLD Making, plaster casting, tremendous profits. Foolproof rubber, 24 page instructive catalogue free. Plastic Arts, 711 Neely, Muncie, Indiana.

MAKE Color-glazed concrete pottery, gravestones, tiles, floors, walls. Basement waterproofing, etc. Booklet 3c stamp. National Potteries, Minneapolis, Minnesota.

GET Big mails—Samples galore. Your name listed in Midstates Mail Trade Directory, copy sent you, directory 500,000 articles wholesale, 10c. Eagle, 414-P W. 65th, Chicago.

INVENTION Finance Magazine, 80-G Wall Street, New York. Important particulars free.

MAIL Order business is your opportunity. Many began small, now earn thousands yearly. No personal contact. Boundless opportunities. Have had over 30 years experience; will help you succeed. Send 25c for valuable booklets, none free. B. Breniser, 257 E. 21st, Philadelphia.

A REAL Future for you with Red Comet fire control products. Low prices. Proved seven years. Splendid sales outfit free. Some good territory open. Exclusive. Write quick, 766 Red Comet Building, Littleton, Colorado.

SUCCEED With your products. Make-sell them. Formulas, Processes, Accurate analyses. Catalog free. B. Thaxly Co., Washington, D. C.

PLASTEX Industries offers industrious men an opportunity to start a business of their own, manufacturing art goods, novelties, souvenirs, etc., in Plastex and marble imitation. 5c material makes \$1 articles. Rubber moulds furnished for speed production. Small investment brings big returns. You are just in time for big wholesale season now starting. Write for interesting booklet mailed free. Plastex Industries, Dept. A, 1085 Washington Ave., New York.

GOOD Paying business silvering mirrors, plating autoparts, reflectors, bicycles, bathroom fixtures by late method. Free particulars and proofs. Gunmetal Co., Ave. H, Decatur, Ill.

ELITE Collection of business plans, contains 127 tested plans and scores of formulas. Start own business; home, office. Particulars free. Elite Co., 214 Grand St., New York.

WHERE To buy at lowest wholesale prices. Information free. Yorena, Box P-312, Bayonne, N. J.

100 PROFITABLE Mail order and local plans. Gilbert Supply, 5-P West 24th, New York.

MAKE, Sell luminous paint. Literature free. Gordon Laboratories, 1265-H Broadway, New York.

127 WAYS To make money, in home or office, business of your own. Full particulars free. Elite Co., 214 Grand St., New York.

HOW And where to obtain capital fully explained, free particulars. Star Service, Wapakoneta, Ohio.

MAKE Money by mail, the way we do. Free information. Maywood, P-1107 Broadway, New York.

MONEYMAKING OPPORTUNITIES

MAKE Money with your kodak. Sell your snapshots. Booklet describing 100 best markets 25c. L. A. Goodanough, 3323 Imperial Highway, Lynwood, Calif.

MAILORDER Opportunities, publication, plans, sell by mail. Harvey Teeple, Decatur, Indiana.

250 MONEYMAKING Plans, 40,000 words 25c coin. Janbard, Box 195, Long Beach, Calif.

"LUMINOUS Paint" shines in dark. Easily made. 300 other formulas, plans—all 25c. Ideal Service, 300P10, Park Ridge, Ill.

MAKE 20c On 25c sales. Liberty, Box 1704, Cleveland, Ohio.

UTTERLY Amazing! "Suggestions" that offer opportunity. Money-making propositions. Write—Bradley's, Box 1871, Raleigh, N. C.

M. M. Earned \$1174 in spare time for exceptional "cellar crop" Snow-King mushrooms! Free book tells if your cellar, shed suitable. We buy crops. United, 3848 Lincoln Ave., Dept. 60, Chicago.

BE Funny, make money. Learn gag writing. Stamp brings information. Don Ulsh Studios, B-518 Wrightwood, Chicago.

BOOKKEEPERS—Operate new plan public bookkeeping service. Ralph Lee, Vicksburg, Michigan.

FREE Formula. Successful lube reclaiming. Chas. Boisset, Box 483, New Orleans, La.

OPERATE Steady business resilvering mirrors. Making chipped glass nameplates, signs. Write Sprinkle, Plater, 287, Marion, Indiana.

MILLION Articles. Buy wholesale. Valuable directory 10c. Ideal Service, D-10, Park Ridge, Ill.

150 FORMULAS And trade secrets, guaranteed. 25c. Southern, Box 3303-A, Jacksonville, Fla.

BIG Appetites, big profits with old southern barbecues. Details free. Bean, B154, Mt. Kisco, N. Y.

"PORT Of Opportunities" published monthly—offering latest self employment; ideas; plans; schemes. \$1.00 year, copy 10c. Farm & Home Industries, 6 Seneca, Gardenville, N. Y.

LARGE Profits placing favorite photos on glassware from any negative. \$1.00 brings full instructions. Box 215, Buchanan, Michigan.

GENERAL Contest Bulletin. 22 big pages of contest helps. 10c. 1609 East 5th, Duluth, Minn.

LITTLE Extra money—Young, old. Buy 25c, sell \$1.50. Sample 10c. Gwynn Printing, Adrian, Michigan.

MOULDS. Guaranteed, for casting toy soldiers, Indians, trappers, warships, sinker moulds, 244 kinds. Send 5c for illustrated catalogue. Send \$1.00 for large sample mould. Henry C. Schiercke, 645 Spencer, Ghent, N. Y.

MAKE Brass signs, easy method, great money-maker. Instructions 25c. Johnson's, Box 1562, Baltimore, Maryland.

FREE—200 Clever mailorder, homework, local business, agency offers—all snappy money-makers. Lewis Co., 828-C Carpenter, Oak Park, Ill.

UNUSUAL Mailorder opportunity. Nationwide operation. Stamp. Halcot, Box 2081-P, Dallas, Texas.

TIN Cans, tons of expensive tin junked daily, can be easily detinned. Instructions 25c coin. D. Kirk, Box 930, Harrisburg, Penna.

101 FINANCIAL Opportunities—character analysis 50c. Lyon, 71, East Rockaway, N. Y.

CREATE Self employment. Two dimes brings valuable instructions. Packard's, 1578 Washington, Denver, Colorado.

MAKE Money—plan never fails, 25c silver. Hule, Vernon, Texas.

OUR Operators make money at home. So can you. Details and sample 25c coin. McIntyre, 360 Hedges St., Tiffin, Ohio.

EARN Money compiling names. We tell you how. Inexperience, location no handicap. Golliday Co., 1514 Long, Columbus, Ohio.

TREASURE Finders? Read Goldak advertisement on page 138A.

MONEY Can be made repairing scales. For information regarding instructions on repairing send stamped envelope. Ackerman Scale Repairing Instructions (Copyright 1940), Box 1653, Charlotte, N. C.

BUY Wholesale—Sell by mail or local. Wetzel, Valhalla, N. Y.

BE A professional scrapbooker. Big fees. Unlimited opportunities. Can be done at home. No competition. No capital needed. Write to Scrapbookers Guild, 59 Park Place, New York, N. Y.

"RAISE Earthworms for profit," new, interesting home business. Bureau Zoological Research, 106A Broadway, Peoria, Ill.

AMATEUR Cartoonists, earn cash at home, copying and duplicating cartoons for advertisers. Ad-Service, Argyle, Wis.

WHOLESALE Sources, 500,000 articles. Free directory. Maywoode, 1107 Broadway, New York.

GROW Plants without soil. Folder free. Gordon Laboratories, 1265-J Broadway, New York.

FORMULAS, PLANS, ETC.

MIRROR Formulas, gold, silver, gun-metal. The very best up-to-date fast working. The one minute silver formula is the fastest. How to make transparent peep mirrors. No experience necessary when you know how. All for \$10.00. Nashville Mirror Co., 427 Broad St., Nashville, Tenn.

MAKE Fast selling products. "Chemist Approved Formulas." Catalog free. Kemico, 12-M, Park Ridge, Illinois.

160 SINGLE-INGREDIENT Formulas—No manufacturing. Information free. A. Kinford, Wayne, Penna.

ANY Formula \$1.00. Assaying, analyzing. Formula Supply, 1449 Vermont, Detroit, Mich.

FREE! 10,000 Formula book. Details. Prudential, 331-D Hopkinson, Brooklyn, N. Y.

FORMULAS. Latest, best, selected sellers. Literature free. Baran, Bay City, Mich.

AUTHENTIC Formulary. Used by leading manufacturers, formula dealers. Instructions for easily making 10,000 profitable products. Supply sources. Complete book—924 pages, \$1.50, postpaid—C.O.D. Adams Brown Company, Chestnut Hill, Massachusetts.

160 FORMULAS Nationally advertised products 50c. Karp, 520 Crown St., Brooklyn, N. Y.

GUARANTEED Perfect formulas for any good product. "Just name it." Miller's Chemists, Tampa, Florida.

THAXLY Formulas, processes, for successful products. Accurate analyses. Catalog free. B. Thaxly Co., Washington, D. C.

ICELESS Ice! Colder! Cleaner! Cheaper! Instructions 25c. Duffy, Covington, Ky.

FORMULAS—All kinds. Real money-makers. Lowest prices. Catalog free. Clover Formulary, 108-P3, Niles Center, Ill.

ELITE Formulas and plans; make and sell your own products. Descriptive booklet free. Elite Co., 214 Grand St., New York.

CHEMISTRY

HANDBOOK For chemical experimenters, illustrated, hundreds of experiments 50c. Experiment booklet 15c. Chemical catalogue 5c. Reading Scientific Company, Reading, Penna.

FREE: 40 Page catalog of chemical and laboratory supplies for amateur chemists. Wollensak microscopes and supplies, scientific books at big discount. JE10 Winn, 124 West 23 Street, N. Y. C.

VITAL War minerals in demand. Find out what you have. Minerals and ores identified, \$1.00 each. Send small sample. Louis Strange, Box 613, Guthrie, Ky.

FREE Catalog: chemistry, mineralogy, telescopes, binoculars, microscopes. Tracey Laboratories, Evanston, Illinois.

JOIN American Amateur Chemists Society. Descriptive literature free. Haslett, Michigan.

FREE Chemistry catalog. Supplies at 5c! Equip complete laboratory. Kemkit Scientific Corp., 397P Bridge St., Brooklyn, N. Y.

CHEMICALS, Laboratory, glassware, apparatus. Send 3c for catalog CP1. Biological Supply Company, 1176 Mt. Hope Avenue, Rochester, N. Y.

SPECTROSCOPE For quick chemical analysis \$2.50. Kutting Sons, Campbell, California.

CHEMICALS In 5c quantities. Catalog 5c. Fleischer's Laboratories, Medford, Mass.

HELP WANTED

CALL On service stations, factories, restaurants, businesses, professions; with lettered advertising uniforms, shirts, work suits, etc. 100 styles. Exclusive features. Big advance commissions. Free outfit. Toops, Dept. N-7, Rochester, Ind.

WRITE For my big free assortment of full size packages foods, groceries, household products. Worth \$6.00. Show friends, neighbors in spare time. Take orders, earn money. Experience unnecessary. Write quick. Zanol, 2035 Monmouth, Cincinnati, Ohio.

STEADY Work—Good pay. Reliable man wanted to call on farmers. No experience or capital required. Pleasant work. Home every night. Big money every day. Wonderful new proposition. Particulars free. Write McNess Co., Dept. 446, Freeport, Illinois.

EARN Big money selling distinctive household wares. Part-full time, as our exclusive sales agent. Write Dept. B, National Products Co., 175 Fifth Avenue, New York City.

M. M. Earned \$1174 in spare time for exceptional "cellar crop" Snow-King mushrooms! Free book tells if your cellar, shed suitable. We buy crops. United, 3848 Lincoln Ave., Dept. 70, Chicago.

SELL "Nu-Glas" raincoat, our representatives make big money. Experience unnecessary. Get information, quick! Nelson's, 625 Arch, Philadelphia.

BIG Money taking orders; shirts, ties, hosiery, underwear, pants, jackets, raincoats, uniforms, etc. Sales equipment free. Experience unnecessary. Nimrod, 4922-BG Lincoln, Chicago.

GET The job you've dreamed of. We assist talented, industrious, ambitious men and women of all ages. Whether now employed or not. Job consultants that make good—not employment agency nor application-letter writers. For eye-opening booklet address Gatto Associates, Trenton, N. J.

AGENTS WANTED

MAKE Extra money easily. Sell 50 assorted personal Christmas cards for only \$1.00. 14 box assortments 30c up. Odd cards 2½c each. Send for free samples exclusive \$1 line personal cards and imprinted stationery. Request \$1 assortment on approval. New England Art Publishers, North Abington, 333, Mass.

\$1 STARTS You in business selling men's ties, boxed novelties, Slyde-On ties. Write today for descriptive wholesale catalog, free sample materials. Phillip's Neckwear, 20 West 22nd, Dept. P-5, New York.

SELL Personal Christmas cards with name, 100 exclusive designs, low as 50 for \$1. Complete line fast-selling \$1.00 box assortments. Up to 100% profit. Samples on approval. Janes Art Studios, 548 Anson Place, Rochester, New York.

15c HOUSEHOLD Specialty. Sell direct or to stores. Sample 10c. Knight Manufacturing Co., 2644 Leland, Chicago.

SELL Gabardines, reversibles, tweeds, jackets, etc. \$2.98 up. Larger commissions. Free outfit. Consumers Raincoat, 608 So. Dearborn, Dept. A, Chicago, Ill.

CHRISTMAS Cards. Sell 50 assorted folders, name imprinted \$1.00. Cost you 50c. Samples free. Dunbar, New Brunswick, N. J.

JUST Out. U. S. patented trouser-guards, prevents fraying and wear bottoms of men's pant cuffs. Nothing like it. Retail 25c. Write for free illustrated details. Samples 25c. National Trouser-Guard Company, 222 Simon Building, Shreveport, Louisiana.

FREE Water and our concentrates make 68 products. We supply labels, bottles. Enormous profits. Qualco, E-20030 Russell, Detroit.

VALUABLE Gifts—watches, cameras, etc.—in addition to doubling your money by easy selling of our 64 piece Masterpiece Box of French-fold Christmas cards and seals. Cards and seals in attractive colors by a master designer, all 64 pieces cost 25c—sell on sight at 50c. Write for free sample set, and gift plan today. Be first in your community with this quick seller. American Card Co., Box C-95, Lancaster, Penna.

ADVERTISEMENT Specialty district managers to conduct profitable business through agents under their control. Daily income. Latin American Directories, Inc., 311 O'Reilly, Havana, Cuba.

CHRISTMAS Cards—America's outstanding assortments. Big profits. Write for samples. Robinson Cards, Dept. 624, Clinton, Mass.

RAWLEIGH Men make good money. Supply everyday household necessities to Rawleigh routes of 800 family users. Ambitious men can make good earnings at start. We furnish everything but the car. Write today. Rawleigh's, Dept. J-A-PPM, Freeport, Ill.

SELL New Idea Christmas cards—21 for \$1. Can be "personalized" to relatives with free metallic gold seals. Make 100% profit. Name-imprinted Christmas cards, 50 for \$1. Samples on approval. Friendship, 895 Adams, Elmira, New York.

AGENTS! Men's suits 88c, pants 23c, top coats 50c, ladies' coats 36c, dresses 10c. Other used clothing bargains. Catalog free. Portnoy, 566-P Roosevelt, Chicago.

CHRISTMAS Card leader brings you quick cash profits. Sensational "Beauty Queen" 21-card assortment sells \$1.00. You make 100%. Ten other fast-selling assortments. Personal Christmas cards, 50 for \$1, up. Samples on approval. Chilton Greetings, 147 Essex, Dept. A-2, Boston, Mass.

EXTRA Money quick! Sell super-value personal Christmas cards, 50—with name—\$1. Finest 21-card assortment, \$1. You make 50c. Complete line. Samples on approval. Waltham Art Publishers, 160 N. Washington, Dept. 357, Boston, Mass.

SELL New, used clothing from home, auto, store. Men's suits 77c, leather jackets 29c, overcoats 54c, dresses 20c, ladies' coats 36c. Other bargains. Catalog free. National 436 East 31st, Chicago.

WEAR Fine hose I send without cost with large outfit while taking orders for amazing new hosiery. Replacement guaranteed against holes, snags, and runs. Rush name and hose size. Wilknit, Desk CO-37, Greenfield, Ohio.

CHRISTMAS Cards. Earn \$2 an hour. Take orders galore from friends. 50 exquisite folders with name \$1. Free samples 30 designs. America's fastest selling 21 Christmas folder box. Costs 50c, sells \$1. Request samples today. Sunshine Art, Dept. E-3, 154 Nassau St., New York City.

REVOLUTIONARY Window cleaning tool. Good Housekeeping approval. Only ten \$2.25 sales daily to housewives, factories, schools, stores will make you \$350.00 monthly. Carter Products Corp., 910 Front Ave., Cleveland, Ohio.

SELL 50 Personal Christmas cards—\$1.00. Amazing bargain! 50 folders with customer's name imprinted. Sells fast. Pays big profits. Free samples. Also unequalled \$1 Christmas card assortments. General Card, 400 S. Peoria St., Dept. P-71, Chicago.

OPERATE Steady business resilvering mirrors. Making chipped glass nameplates, signs. Write Sprinkle, Plater, 128, Marion, Indiana.

MAKE Extra money easy. Show smart personal Christmas cards with name, 50 for \$1, up. Outstanding values. Also 21-card assortment, \$1; others. Big profits. Samples free. Wetmore & Sugden, 749 Monroe, Dept. 76, Rochester, New York.

SELL Midget Bibles. Large profits, fast sales. 2 sample Bibles, particulars, 25c. Leon Anderson, Cadillac, Michigan.

CHEMICAL Sponge cleans cars like magic. Banishes auto-washing drudgery. New! Hot seller! Samples sent on trial. Write "Inventor," 120 Kristee Bldg., Akron, Ohio.

EASY Money selling graduation cards. 35% commission. Samples free! Printery, 226 Madison, Pittsburgh, Penna.

CHRISTMAS Card salespeople—Best sellers. You make 50c on new 21-folder \$1 assortment. Christmas cards with name, 50 for \$1. Other big-profit assortments. Experience unnecessary. 50c sample on approval. Schwer, Dept. X-4, Westfield, Mass.

CASH For your services. Opportunity, 2714 Westfield, Camden, New Jersey.

CALL On friends with greeting card assortments. Easter, birthdays, other occasions. Big demand. Big profits. Also personal stationery. Experience unnecessary. Samples free. Wallace Brown, 225 Fifth Ave., Dept. S-34, New York.

SELL 50 Christmas cards with name for \$1.00! Four complete, sensational lines! 35 sparkling designs! Amazing values! Box assortments too. Big profits. Experience unnecessary. Samples free. Noel Studios, 9 East 26th, Dept. D-27, New York City.

SELL Used clothing bargains from home, store, auto. Shoes 15c, men's suits, overcoats 75c, dresses 10c. Experience unnecessary. Free wholesale catalog. Superior Jobbing, 1250-ED Jefferson, Chicago.

SCHOOL Seniors—Earn \$25 up. Selling graduation cards. Fine opportunity. Large catalogue. Agency waiting. Craftcards, Box 235, (PM), Pittsburgh.

AGENTS. Crew managers, popular priced cosmetic items, exclusive territories. "Love Lee" Cosmetics, 20 W. 22, New York City.

ONE Reference and 25c stamps bring you sample outfit to start making money immediately with Mexican art goods. Tremendous market. Big profits. Marquez Company, Apartado 1176, Mexico City.

LIFE Of Wendel Willkie. Large illustrated book. Big money. Terms free. 400 other books and Bibles. Mead Company, Middletown, New York.

A CURE For clogged drains. Get a city, make fortune. Silent Valve Co., 3420 Fletcher Dr., Eagle Rock, Calif.

AGENTS—200% Profit on amazing new discovery. Cleans, polishes, waxes cars in 30 minutes. Magic all-purpose polish. Instant demonstration sells most skeptical auto owner and housewife. Send 25c for 75c size. Enduro, 2420-D Grand River, Detroit, Mich.

500% PROFIT. Gold and silver colored sign letters. Offices—stores. Large sizes 1c. Free samples. Modernistic, B-3000 Lincoln Ave., Chicago.

COMIC Christmas seals and cards. Sample 10c. Rogge, Grayslake, Illinois.

BRAND New! Two tremendously profitable, fast-selling automobile products. Territories open. Particulars free. Thermo-Solvo, Peoria, Ill.

AMAZING New, safety-tread, self-polishing, non-slip, waterproof liquid wax 160% profit! Big repeater. Guaranteed sales! Staminite Corporation, Dept. 55, New Haven, Conn.

CHRISTMAS Cards. New. Different. 50 name imprinted, sells \$1. Largest profits. Complete line box assortments. Special bonuses. Free samples, descriptive folder. Pen-Brush Studios, 154 Nassau Street, New York, N. Y.

MONOGRAMMING Automobiles real money maker. Write for samples. International Co., Box 9360, Philadelphia, Pa.

EVERYBODY Buys sensational "Golden Rule" assortment. 21 Christmas folders including souvenir calendar. Free Christmas motto with each box. Unparalleled value. Costs you 50c, sells on sight for \$1.00. Actual retail value \$3.00. Ten other bargain assortments. Everybody, all ages, making easy-as-pie sales. Nothing to lose. Sample "Golden Rule" assortment sent on approval, with free offer. Silver Swan Studios, 320 Fifth Avenue, Department 46, New York.

BIG Money taking orders: shirts, ties, hosiery, underwear, pants, jackets, raincoats, uniforms, etc. Sales equipment free. Experience unnecessary. Nimrod, 4922-AN Lincoln, Chicago.

WINDOW Sign letters. Penny each, large sizes. New styles. Absolutely beautiful. Free samples. Atlas, 7941 Halsted, Chicago.

MEN And women wanted, full or spare time to sell Sayman products house to house. Write T. M. Sayman Products Co., St. Louis, Mo. Dept. K3.

AGENTS. Smash go prices! Santos coffee 12c lb, 4-oz. vanilla 8½c. Razor blades 10 for 8½c. 100 sticks chewing gum 12c. Christmas cards, 21 in box, 14c. 150 other bargains. Premiums. Experience unnecessary. Carnation Company, PO, St. Louis, Mo.

AGENTS: Stamping names on pocket-key protectors. Sample check with your name, address, 25c. Stamping outfits, Emblem checks, check-fobs, name plates, Hart Mfg. Co., 303 Degraw St., Brooklyn, N. Y.

CALL On service stations. New item, necessity, big profits. Knipp, Long Beach, California.

FREE Sample—Amazing cleaner: sells homes, taverns, everywhere. Big profit—fast repeater. Betco, 5007 Irving Park, Chicago.

BIG Money applying initials on automobiles. Easiest thing today. Free samples. Also, sideline salesmen for short order decalomania name plates. "Ralco," 1305 Washington, Boston, Mass.

SUCCEED With your products. Make-sell them. Formulas, Processes. Accurate analyses. Catalog free. B. Thaxly Co., Washington, D. C.

DO You want agents for your proposition? Your ad in this space will place your message before hundreds of men seeking fast-selling products. My folder "How to Secure Agents" is filled with proof. I'll gladly send you a copy free. F. W. Johnson, Manager Classified Advertising, Popular Mechanics Magazine, 200 E. Ontario St., Chicago.

MANUFACTURE Specialties, hire agents yourself. Big money. Free literature. Gilbert Supply, 5-P West 24th, New York.

AGENTS—300% Profit selling gold leaf letters: stores and offices. Free samples. Metallic Letter Co., 438-B North Clark, Chicago.

ENGRAVED Name plates, numbers, signs, etc., easily sold, profits large. Brett Bros., Winthrop, Mass.

GOOD Paying business silvering mirrors, plating autoparts, reflectors, bicycles, bathroom fixtures by late method. Free particulars and proofs. Gunmetal Co., Ave. N. Decatur, Ill.

AGENTS—Opportunity make money; book containing 127 successful business plans; home-office; send for free introductory booklet. Elite Co., 214 Grand St., New York.

AGENTS Make big profits on food products, bargain deals. Low wholesale prices. Rush name for trial outfit offer. Ho-Ro-Co, 2810-T Dodier, St. Louis, Mo.

AGENTS—To mail our literature. Good profits. Home business. Maywood, 1105-1107 Broadway, New York.

HIGH-GRADE SALESMEN

MAKE Money selling calendars. Largest, most complete line in field. Widest price range. Newest designs—De luxe, hangers, direct on commercial, thermometer, metal, miniature, Christmas card calendars. Big commissions. Four different selling outfits sent free. Write today. Capitol Calendars, Dept. 510, Gladys at Hamilton, Station D, Chicago.

NEW Kind of man's shoe increases height two inches. Also styles that zip on and off. Pays salesmen ready cash every day. Complete sales kit, including almost 250 styles for men and women, sent free. No experience needed. Write manufacturer established 38 years. Mason Shoe Manufacturing Company, Dept. BC-22, Chipewawa Falls, Wisconsin.

SELL Business cards, stationery, book matches, gummed tape, restaurant necessities, salesbooks, advertising specialties, pencils, picture cards, straws, paper towels, napkins, ice cards. Lowest prices. 40% commission. Free deals. Sales portfolio free. Willens, 2130 Gladys, Dept. BA, Chicago.

REVOLUTIONARY New invention. Thousands prospects everywhere. Men earning high as \$100.00-\$150.00 week. Placed on free trial. Sells itself. Orders financed by factory. Protected territory available. Free demonstrator offer. Salesmanager, 2440 Lincoln Ave., Dept. R-245, Chicago.

ADVERTISING Book matches offer liberal earnings—full, spare time. Experience unnecessary. Factory direct. Low prices for fine quality, quick deliveries, help get orders; faster repeats. All business firms prospects. Free outfit, instructions. American Match & Printing Co., Dept. 610, 4822 South Trumbull Ave., Chicago.

SALESMEN! Collect \$4 profit from every service station and garage. New invention revolutionizing industry. Vernon Co., Newton, Iowa.

SENSATIONAL Quick-cash opportunity. My route building plan gives you chance for good steady income. Real future. Handle regular route local stores. Collect, deliver orders for famous 5c-10c counter display goods. Nationally advertised in 120 magazines and radio. Show merchants proven plan for beating competition and increasing sales, profits. Experience unnecessary. Use home as headquarters. Chance to operate Silver Fleet service truck. Facts free. World's Products Co., Dept. 10-D, Spencer, Indiana.

CALENDARS—Beautiful complete line, all sizes, including jumbos. Samples free. Also Christmas cards. Fleming Calendar Company, 6539 Cottage Grove, Chicago.

BIG Commissions—selling to stores celluloid pricing tickets, metal shelf moulding. To restaurants, menu covers, signs. P. Pricing Press, 124 White St., New York.

SALESMEN, Route men, distributors, cash in on new fast selling 10 cent side line that will pay all expenses. Act quick. Lovely, 1734-A Washington, St. Louis, Mo.

VISIBLE Looseleaf filing system (book form). Files present records. Undersell others. 50% commission. Visible Filing Co., Kaylor, S. D.

SELL Complete line calendars and printing at cut prices. 100 four color calendars \$1.95; 2,000 business cards \$1.50; 1,000 envelopes or statements, etc. \$1.75; 25 printed sales books \$1.50; 1,000 process embossed cards \$1.50; 2,000 two-color labels, free holder \$1.50; 2,500 printed handbills \$1.75. One-third comm. Free outfit. Bargain Prtg. Co., 189-F W. Madison, Chicago.

SELL Firex—Automatic fire extinguisher and alarm. Endorsed by fire chiefs. Prospects unlimited—good commissions. Write today. Firex Corporation, Dept. K-100, 516 South Broadway, St. Louis, Mo.

SELL Dentists, excellent line, high earnings. Write Stone, 208 W. 29th, New York City.

ADVERTISING Book matches—World's largest manufacturer of union label book matches. Fast selling line. Large sales producing kit. Sample matches, complete cut catalog. 9 color combinations makes selling easy. Commission in advance. Superior Match Co., 7530 Greenwood, Dept. M-10, Chicago.

WRITE For new free catalog fast-selling numbers, carded merchandise, razor blades, aspirin, pocket combs, etc. National Supply Company, Richmond, Virginia.

EARN Money demonstrating and selling The Winner. A new game everyone enjoys playing. Send sixty cents for sample and full particulars. National Advertising Service, Herald Bldg., Syracuse, N. Y.

MAKE Big money! Demonstrate automatic electric hot dog cooker. Sells on sight. Eating places, taverns, drug stores will about it. Write for big profit deal. Wienie Chef, 2301 W. Hubbard, Dept. X-18, Chicago.

SELL Auto finance course. Unusual opportunity. Nebraska Finance Co., Lincoln, Nebraska.

SALESMEN, Distributors; 200 items, brushes, mops, marvelous magnetic brush, excels vacuum cleaner. Highest commissions. Neway Brush Co., Hartford, Conn.

NEW! Patented! Men's self adjusting leather belt. Marvellous comfort. Wonderful demonstrator. Big commissions. Free belt offer. Self-Flex, 360 N. Michigan, Dept. PM-10, Chicago.

MAN Wanted—Trustworthy, steady worker. Manufacturer established 50 years will finance responsible man with complete stock of guaranteed food, farm and household necessities—you pay when sold. Mighty attractive proposition. Products well advertised on radio—a big help to success. Pleasant outdoor work. Experience not necessary. No slack seasons or layoffs. Write for no-investment offer. McConnon and Co., Room TK66, Winona, Minn.

NOKOROSO. One application positively cures all corrosion for life of battery. Trial tube 25c. 300% profit salesmen. Aristo, Dept. P, Plainfield, N. J.

BIG Firms need men—you. With or without experience they offer you daily cash money for your spare or full time. You can choose the company from hundreds of well established firms who are ready to help you make money working for them. No matter where you live or what your age is, here is your chance. Long established magazine tells how. Six issues sent to you free to get acquainted. No obligation now or ever. Send name on card today to "What to Sell." Box M10, 168 N. Michigan, Chicago, Ill.

WANTED: Permanent representative for Hoover uniforms—waitresses, doctors, nurses. Slack ensembles, aprons, frocks. Smartest styles. Finest quality. Exceptional commissions. Line free. Hoover, 251 W. 19th St., Dept. JK-10C, New York City.

SELL Hand made cigars, 10c brings samples. Box 84, York, Penna.

CHRISTMAS Leaders! 21 piece Flash assortment 15c; 50 imprint folders 25c; 25 religious imprints 25c; 100 piece gift wrap box 25c; samples \$1.00 postpaid. Illustrated catalog free! Elfko, 440 North Wells, Chicago.

NEW Specialty—Sells every business and professional man. Four \$15 sales daily pay \$280 weekly. Farrell cleared over \$1,000.00 monthly. Write F. E. Armstrong, President, Dept. PM, Mobile, Ala.

BLADES—Big profits. Best quality. Factory prices. Postpaid. Ace Blades, Buffalo, N. Y.

A REAL Future for you with Red Comet fire control products. Low prices. Proved seven years. Splendid sales outfit free. Some good territory open. Exclusive. Write quick. 704 Red Comet Building, Littleton, Colorado.

EXCELLENT Opportunity selling our complete line of brushes, largest commissions. Write for sales plan. Wire Grip Sanitary Brush Company, 2300 5th Ave., New York.

PLAYS, STORIES, MANUSCRIPTS

STORIES Forcefully revised, typewritten for marketing. Welton Tinney, Winnsboro, Texas.

STORIES, Articles criticized, revised, typed for market. Charbeth, Box 62, Philadelphia, Penna.

STORY Ideas built into salable short stories for you—revised, typewritten, marketed. Author's Bureau, Rhinebeck, N. Y.

STORIES, Articles, books wanted for publication. New, unknown authors invited. Manuscripts marketed, revised, criticized. Christopher Carr, 3636A Chestnut, Philadelphia, Penna.

EDUCATIONAL AND INSTRUCTION

LEARN A trade for a better job. We teach electric and gas welding by practical shop methods. Also drafting course. Exclusive farm machinery course. Correspondence and resident instruction. Free employment service. Write today stating course desired. Trades Training, 2744 Nicollet Ave., Minneapolis, Minn.

BOOKKEEPERS—Broaden your field. Pre-publication offer "Insurance Agency Accounting" in MS. form only \$1.95 postpaid. R. E. White Insurance Systems, 704 So. Spring, Los Angeles.

LEARN Electroplating at home. Make big money in new profitable business. Simple, easy, quick. Plate auto-parts, reflectors, bicycles, bathroom fixtures, silverware, ornaments, musical instruments, tools, etc. See new, lustrous metal flow and renew old worn parts instantly. Big demand. Big profits. Earn while you learn. For full details and trial lesson merely send 10c. Warner Electric Co., Dept. 5-FC, 360 No. Michigan Ave., Chicago, Ill.

BOOKS Of all publishers on advertising, art, color, photography, engraving, printing, offset, silk screen, journalism, sales management, correspondence, etc. Trade magazines. Discounts. List free. Commercial Engraving Publishing Company, 34C North Ritter Avenue, Indianapolis, Indiana.

"HOW To Break and Train Horses"—A book every farmer and horseman should have. It is free; no obligation. Simply address Beery School of Horsemanship, Dept. 11010, Pleasant Hill, Ohio.

WELDING—Electric arc. Learn profitable trade quickly through actual practice. Individual welder instruction at bare cost of materials. Full particulars free. Valuable welding lessons book 50c. Hobart Welding School, Box M-10404, Troy, Ohio.

WELDERS—In demand. Train at Healey's School of Welding, 440 South Main, Ft. Worth, Tex.

AIR Conditioning—Electric refrigeration. Rapid growth creates big demand for trained men. Earn up to \$35-\$50 weekly. Write for free facts. Utilities Engineering Institute, 1314 Belden Ave., Dept. 10X, Chicago.

WATCH Repairing is steady profitable work. Experts usually in demand. You can learn watchmaking trade at home, spare time. New original instruction system. Script engraving course included. Write for free details today! Nelson Co., 500 Sherman, Dept. J-2001, Chicago.

WORK For "Uncle Sam." \$1260-\$2100 year. Men—women. Try next examinations. Prepare immediately. List positions—particulars telling how to qualify, free. Write Franklin Institute, Dept. J3, Rochester, N. Y.

WANT Super memory? Write "Dx." Info Co., Box 1122, Chicago.

LOCKSMITH Instructions. Lock picking, key fitting, etc. \$1.00 prepaid. Locksmith, Canadian, Texas.

U. S. Government jobs. \$105-\$225, month start. Chance for advancement, security, travel, promotions, pensions. Free particulars. National Service Bureau, 610 South Broadway, Los Angeles, Calif.

READ Character from handwriting. Instructions 25c. Chapbooks, 602 Searle Bldg., Rochester, N. Y.

DRAFTING—Blue-print reading, home taught. Davison Technical School, 7 East Grand, Detroit.

U. S. Government jobs now open. New home study course. No cost until you are on government payroll. Send for free information. Civil Preparatory Service, 1702-P North LaSalle, Chicago.

LEARN Telegraphy! Opportunities now available to beginners due to new railroad retirement act. Expenses low. Catalog free. Dodge's Institute, Hiatt Ave., Valparaiso, Ind.

U. S. Gov't jobs pay up to \$40 a week to start. Get ready for next examinations: railway postal, rural carrier, mail carrier, office help and others. Free book tells how you may qualify. Write quick. Patterson School, Dept. P. M., Rochester, N. Y.

CLINICAL Laboratory technic taught in your own home. Practice equipment supplied. Bulletin free. Imperial Technical Institute, Box 494, Elkhart, Indiana.

EARN More money—Learn decorating, paperhanging, graining, marbling, pictorial and sign painting. Catalog free. Chicago Painting School, 106 West Lake Street, Chicago.

CLAIM Adjusting. Excellent pay. Investigate tragic accidents, fires; outwit fraudulent claimants. Burns School, 311 Morewood, Pittsburgh, Penna.

MASSAGE, Hydrotherapy, dietetics, drugless therapeutics, chiropraxy, taught by mail. Evans Correspondence School, Montgomery, Ala.

SECRET Investigation. Experience unnecessary. Detective particulars free. George Wagner, M-2640 Broadway, N. Y.

CARTOONING, COMMERCIAL ART, SHOWCARD WRITING, SIGN PAINTING

ART Magazine including directory art books—free! Send 10c postage. Art Headquarters, Doty Street, Madison, Wisconsin.

CHALK Talks. Laugh producing program, \$1.00. Catalog 10c. Balda, the Cartoonist, Oshkosh, Wisconsin.

CHALK Talks that really talk. Plans, patter, \$1.00 complete. Willis, 209 Wilda Building, Denver, Colorado.

TEST Your cartooning ability. Send dime for big test picture chart, full details of outstandingly successful simplified method. Landon School, 199-0 National Bldg., Cleveland, Ohio.

CARTOONING Course—30 illustrated lessons, over 500 sketches, drawing paper, pens and pencils. \$1.00 complete postpaid. Montes Studio, Box 985, Pasadena, Calif.

CARTOONING, Sketching, etc. 46 lessons. 600 illustrations, including drawing paper, pens, pencils, \$1.00 complete. Fraba Service, Cashton, Wisconsin.

PEN And ink drawings. Let us draw your advertising and catalogue illustrations, from photos, copies or objects. Best work and fair prices. Heraldic Studios, 1914P Oakdale Avenue, Chicago, Ill.

AMATEUR Cartoonists. Earn cash at home, copying advertising cartoons. Ad-Service, Argyle, Wis.

ADVERTISING AGENCIES, LETTER WRITERS, FOR ADVERTISERS

LEARN Advertising at home. Easy practical plan. No text books. Common school education sufficient. Interesting booklet and requirements free. Page-Davis School of Advertising, 3601 Michigan Avenue, Dept. 343B, Chicago.

INCH Display advertisement 30 magazines, year \$24. Wood's Popular Services, Atlantic City, (N. J.)

40 WORDS, 55 Magazines, \$2.00. Bagley Agency, Box 2522, Portland, Oregon.

ADVERTISE: 24 Words, 149 newspapers \$6.50. Lists free. Advertising Bureau, 4513-C Cottage Grove, Chicago.

26 WORDS, 169 Pulling magazines, \$5.00, inch \$7.50. Piersimone's, 1231 Spofford, New York.

SIGNS, Cloth banners, your copy, 3 colors illustrated. Low prices. Specialty Shop, Centerville, Alabama.

REACH 2,000,000 Readers with inch ad \$7.00; 24 word ad to 5,000,000 Sunday newspaper readers \$15. Ratebook free. Chicago Union Agency, 20-PR West Jackson, Chicago.

CURRENT Lists opportunity seekers—\$5 thousand. Darnell Service, Jackson, Tennessee.

ADVERTISING Placed all magazines, newspapers, radio. Lowest rates. Free service. 54 page rate book free. Baker Advertising Agency, A-189 West Madison, Chicago. Successors to Ankrum. Established 28 years.

FREE—New Advertisers Rate Guide, 44 pages. Includes everything. Lowest rates. E. H. Brown Advertising Agency, 140 S. Dearborn, Chicago.

BUSINESS SERVICE

ATTENTION Mail dealers! Original customer and agents letters \$4.00 per 1000. 15 day rentals, from the owners, and not letter brokers. Bigger sales await you at very low cost. Guaranteed fresh, legitimate. Investigate at once. Write today! Crown Mail Order Co., 164-PM Monroe St., New York City.

PERSONAL And business mail received and reforwarded. \$2.00 monthly. Dunn Mail System, 216 West 69th Street, New York, N. Y. Box 42.

HONOLULU, Hawaii, mail address and reforwarding service. Enclose stamp. Hawaii Mailing Service, Box 2017.

NOW—Only 2c daily pays for New York office under your own name. Co-operative Offices, 126 Lexington Avenue, New York.

WASHINGTON, D. C., mail address and reforwarding service. Hawkins Mail Service, 908 Fourteenth.

CHICAGO (Downtown) mail address \$1 monthly. Your mail reforwarded daily. General Business, 56 West Washington; (established 1919.)

RUBBER STAMPS AND OFFICE SUPPLIES

CUSHIONED, 3 Lines 35c. Federich Co., Box 412-B, East Pittsburgh, Penna.

SUPERIOR. Indexed, cushioned. Two lines, 25c; three 35c; four 50c. Slocum, 814 Bradley, Peoria, Illinois.

KNOB Handle, cushioned. 2 lines 25c, 3—35c. Stamp Works, Centerport, N. Y.

CUSHIONED Indexed 3 lines 35c. Pads 25c. Stamp Works, Box 402, Youngstown, Ohio.

TYPEWRITERS, DUPLICATORS, OFFICE DEVICES

STENCILS \$2.00, Duplicating ink \$1.00. Ribbon Ink Co., Cicero, Ill.

TYPEWRITERS, Adder, mimeograph, multigraph, addressograph. Send for free lists of machines that will help you at half price. Pruitt, 28 Pruitt Bldg., Chicago.

REMINGTON Portables, \$22.50. Taylor Engineering Company, 152 East 106th Street, New York.

INCREASE Business now. "Excelsior" Rotary Stencil Printer reprints thousands everything you typewrite, hand-write, draw or trace. Colors, \$19.75 to \$44. Terms. Illustrated literature free to business or professional men. Pittsburgh Typewriter Supply, Department K-2, Pittsburgh, Penna.

PRINTING, MULTIGRAPHING, MIMEOGRAPHING, GUMMED LABELS

COMBINATION Offer. 250 letterheads, 250 envelopes, 250 statements, \$2.85 postpaid. Satisfaction guaranteed. Skinner Printing, West Brownsville, Penna.

500 LETTERHEADS, Envelopes, statements, billheads \$1.00. Standard Press, 2719 Third Ave., New York City.

MIMEOGRAPH Stencils, any size, \$1.95 quire (24). Quality ink \$1.19 pound. Money back guarantee. Sterling Co., 333 No. Michigan, Chicago.

SKETCH Of home on stationery. Samples 6c. Brown's, 1437 Rugby, Schenectady.

50 SHEETS, 25 Envelopes 25c. Prepaid. George, West Burke, Vermont.

MULTIGRAPHING—500 Letters \$1.70 (20 lines). Parent Multigraphers, Ashland, Virginia.

LETTERHEADS, Envelopes, 125 each, \$1.00. Hagerman, So. 5th, Quincy, Ill.

\$1.00 POSTPAID—125 8½x11 Twenty pound bond letterheads and 125 6¾ envelopes. Benneville, 907 West Roosevelt, Philadelphia.

1000 BUSINESS Cards \$1.00, postpaid. Other bargains. Eaton Press, Gardner, Kansas.

6x9 CIRCULARS—2,500, \$3.49; 5,000, \$5.78. 50% deposit. Record Press, Lancaster, Ky.

EXTRA Special! 500 Hammermill statements, envelopes, letterheads. \$1.95 postpaid. Wood, Bedford, Penna.

MIMEOGRAPHING. Illustrated letters, circulars. Samples. Bur-Wil, 24 Louisa, Binghamton, N. Y.

3,000 BUSINESS Cards for \$2.00. Manness, 5019 Keyser, Philadelphia, Penna.

500 MIMEOGRAPHED Letters (8½x11) \$2.15. Multigraphing. Prices, samples mailed. Multitype, 487 Broadway, N. Y.

BUSINESS Cards printed, \$2.00 thousand, postpaid. Lewis-Print, Bushkill, Pennsylvania.

HARVEY Labels, Berea, Ohio. Better label values. Interesting samples free.

PRINT Anything reasonable. Samples free. Hamilton Press, 4341 P. Meade, Chicago.

250 LETTERHEADS, Envelopes. Fine colored bonds and inks \$1.00. Samples. Becker, Box 183, Altoona, Penna.

BANK, Office, factory and mine forms at wholesale prices. Southeastern Press, Inc., Daleville, Virginia.

EVERYTHING Printed, wholesale prices. Stationery, catalogs, booklets, newspapers, labels, cards. Prompt service, postpaid. Samples. Wholesale Printing Co., 318-G East McDaniel, Springfield, Missouri.

QUALITY Business cards, 1,000, \$1. Samples. Pilot, Box 22, Tulsa, Okla.

100 MATCH Books printed name, address, \$1.00. Sanderson's, Ottawa, Ill.

STANDARD Business stationery, 150 sheets and 150 envelopes \$1.00 prepaid. E. B. Brink, Printing Service, 1130 Holmes Ave., Menominee, Mich.

HAMMERMILL Letterheads, envelopes, all colors, 30 styles type. Free particulars. Woodruff's, 217A Lewis, Duluth, Minn.

PRINTING—Send stamp for lowest prices—samples. Grimson, 6325 Maxwell, Detroit, Mich.

BETTER Grade printing, free trade illustrations. Reasonable. Economic Press, Leonia, N. J.

500 ¾x2¼ FOUR Line gummed stickers, 25c. Moritz Printery, Saginaw, Mich.

PRINTING OUTFITS AND SUPPLIES

TYPE In small fonts. Send for circular showing special \$1.00 handy box fonts. Neon Type Foundry, 412 First Ave., Pittsburgh, Penna.

BARGAIN Presses, type. List 3c. Exchange, D-15, 190 Cook, Meriden, Conn.

PRINT At home, 10c will bring a complete catalog of presses, type and supplies. P. Peiffer & Company, 6 Columbia St., Newark, N. J.

COMPLETE Printing equipment bargains. Send stamp. Bradshaw, 3214-P Huron, Chicago.

ATF Foundry type, lines, sorts. Lino-type. Ornaments. Box 4464, Philadelphia.

PRESSES, Type, supplies. List free. Catalog ten cents. Model Press Co., York, Penna.

MAKE Photo-engraving outfit yourself. Particulars free. Nu-Ideas, Carrollton, Illinois.

BARGAINS — Presses, type, supplies. Send stamp, 159 Harvard, Cambridge, Mass.

PRINT Your own cards, stationery, circulars, advertising. Save money. Easy rules furnished. Print for others, big profits. Junior outfits \$8.25, senior outfits \$16.55 up. Details free. Kelsey Presses, H-11, Meriden, Conn.

USED Presses, type, supplies. Lists 3c. Turnbaugh Service, Loysville, Penna.

PATENT ATTORNEYS

PATENTS: Inventors, take first step to protect your rights to your invention—without cost. Write for free "Record of Invention" form and complete instructions for making legal disclosure of invention and establishing date. We also send, without cost, 48-page book, "Patent Guide for the Inventor" telling importance of prompt action; how to sell and market your invention; how to make application for patent; showing examples of successful inventions; explaining convenient payment plan. Write for free book and Record of Invention form. See page 18A for further information. Clarence A. O'Brien, Registered Patent Attorney, Dept. OK1B Adams Building, Washington, D. C.

PATENTS—Trade marks. Preliminary advice, book and disclosure form free. Personal service. Irving L. McCathran, 1060 International Bldg., Washington, D. C. Registered Patent Attorney.

VICTOR J. Evans & Company, 561-L Victor Building, Washington, D. C.—One of world's largest firms of Registered Patent Attorneys, established 1898—will send you free, 68 pages of facts for inventors. Two plainly written books tell you how to apply for patent—give six basic methods of selling your invention. Fees reasonable; terms arranged. Delay may be costly; write today.

INVENTORS Get my free book. Use my personal confidential patent service. Send for free facts on patenting your invention. Also suggestions on financing a patent application. Reasonable fees. Deferred payments arranged. Write Hugh E. McMorow, Registered Patent Attorney, 134-B Barrister Building, Washington, D. C.

REGISTERED Patent attorney personal service. Low fees. Preliminary advice free. Eric B. Prime, 4123 West Sixteenth Street, Chicago.

"INVENTOR'S Guide" free; full information about patenting, selling inventions. Frank W. Ledermann, 154 Nassau Street, New York.

INVENTORS—Send for free booklet "Patent-Sense." Information based on 64 years experience. Lacey & Lacey, Dept. 5A, 635 F St., Washington, D. C.

PATENTS. Booklet free. Highest references. Best results. Promptness assured. Watson E. Coleman, Patent Lawyer, 724 Ninth St., Washington, D. C.

L. F. RANDOLPH, 302-B Victor Bldg., Washington, D. C. Low cost. Book and information free.

PATENTS. Protect your idea by securing free "Proof of Invention" folder. Exceptional personal service. Established 1906. E. E. Vrooman, 871 Woodard Bldg., Washington, D. C.

FOR INVENTORS

INVENTORS—Time counts. Don't delay. Protect your idea with a patent. Get 48 page Patent Guide free. No charge for preliminary information. Write today. Clarence A. O'Brien, Registered Patent Attorney, OK1A Adams Building, Washington, D. C.

"WHEN And How to Sell an Invention"—helpful, 24 page booklet gives you preparation steps necessary to commercialize your ideas and six basic approaches to use in selling your invention. Information vital to every inventor. Get your copy free. Victor J. Evans & Co., 506-L Victor Building, Washington, D. C.

PATENT Drawings made. Portfolio of patent counsel on request. U. S. Drafting Co., 91 Wall Street, New York.

INVENTORS! Protect your invention at total cost \$1.50. Show your invention to possible buyers safeguarded against theft, and let purchaser get patent. Send \$1.00 for Inventor's Protection Sheet. Maurice Moroney, 321 - 92nd St., Brooklyn, N. Y.

DRAFTING, Designing, cost estimates, manufacturing. Westerfield, South Bound Brook, N. J.

INVENTOR'S Hand-book on Patents. New pocket edition, 1940. Invaluable guide for inventors. Mailed on receipt of 50c stamps or coin. Address—Publishers Co., B-3701 McKinley, N. W., Washington, D. C.

INVENTOR'S Universal Educator; contains 900 mechanical movements; 50 perpetual motions; instruction on procuring and selling patents and selecting an attorney, etc. Suggests new ideas. Price \$1 postpaid in U.S.A. Address Albert E. Dieterich, 511-B Colorado Bldg., Washington, D. C.

I SELL Patents. Established in 1900. Charles A. Scott, 773PM Garson Ave., Rochester, N. Y.

IF You cannot afford attorney send \$2.00 for copy of "Writing Patent Applications." Thad Goldsborough, 2714 Quarry Road, Washington, D. C.

INVENTING Taught at your home by Trofimov School of Inventive Practice, Hanna Rd., Willoughby, Ohio.

CASH For practical ideas and inventions. Mr. Ball, AB-9441 Pleasant, Chicago.

INVENTORS: Profit by your invention. A practical talk to inventors by an experienced manufacturer. Our 68 page booklet "Mind vs. Matter" mailed upon receipt of 25c. Rex Engineering Co., Cincinnati, Ohio, Dept. D.

INVENTORS: "Making Inventions Pay" our 32-page illustrated book mailed absolutely free. Crescent Tool Co., Dept. ZS, Cincinnati, Ohio.

WE Locate buyers meritorious patented, unpatented inventions. If will sell, reply immediately. Descriptive booklet, references, free. Invention Reporter, 5A-11236 South Fairfield, Chicago.

INVENTORS—Send for 72-page book on patents. Reasonable terms. Conscientious treatment to inventors. L. F. Randolph, Registered Patent Attorney, 302-E Victor Bldg., Washington, D. C.

HAVE You a sound, practical invention for sale, patented or unpatented? If so, write Chartered Institute of American Inventors, Dept. 4-A, Washington, D. C.

FREE—Big list of helpful books. Popular Mechanics Press, 200 E. Ontario St., Chicago.

INVENTIONS WANTED

PATENTS. Inventions commercialized. Plans suiting you. Booklet, details for stamp. Write fully. Inventors & Industrial Service, Roseville Station, Box 62, Newark, N. J.

CASH For inventions—Patented or unpatented. Mr. Ball, A-9441 Pleasant, Chicago.

MAKE Your inventions pay. We help you. 36 year old firm offers complete services, free estimates. Ample facilities regardless size of invention. Stampings, metal specialties, dies, models, etc. Catalog giving "inside" information free. Crescent Tool Co., Dept. W, Cincinnati, Ohio.

WANTED—Meritorious patented, unpatented inventions. Booklet, references, free. Invention Reporter, 5B11236 South Fairfield, Chicago.

INVENTION Finance Magazine, 80-G Wall Street, New York. Important particulars free.

SMALL Inventions wanted by manufacturers. I'll help you sell your invention. Write for free circular. Stanley Hull, 7829-K Euclid Avenue, Cleveland, Ohio

SIMPLE. Practical inventions wanted by manufacturers, patented or unpatented. For information write Chartered Institute of American Inventors, Dept. 4-D, Washington, D. C.

WANT Inventions suitable national distribution. Patented or unpatented. Commission or straight fee. Albert G. Burns, Box 147, Oakland, Calif.

PATENTS FOR SALE

MUST Sell. Paper fastener. Cheaply manufactured. Pasteners made fortunes. Fred Bacho, Biloxi, Miss.

ROYALTY Or outright for new fan and new design dresser and wardrobe. George W. Harding, 162 W. Cross St., Baltimore, Md.

MANUFACTURERS: For free information latest inventions your line manufacture, write: Invention Reporter, 5C-11236 So. Fairfield, Chicago.

DOMESTIC Article with considerable merit. 1530 East Kane Place, Milwaukee, Wisconsin.

WANTED Manufacturer for the most complete signal light and switch, stop, right, left pass and horn controlled from steering post of car. Husemoller, 1117 Morse N. E., Washington, D. C.

500 INVENTIONS Described with selling plan 10c. Write Patentee System, 9443 Pleasant, Chicago.

SELL Your patent through a small classified ad in Popular Mechanics. Many inventors have found buyers in this way. Ask me for proof—I'll gladly send it to you. F. W. Johnson, Manager Classified Advertising, 200 E. Ontario St., Chicago.

MANUFACTURING

DIES. Stampings, models, product engineering. Hagstrom Manufacturing Company, Kansas City, Missouri.

DIES. Models, small stampings, inventions perfected, reasonable. Weckesser Co., 1250 Fullerton, Chicago.

ENGINEERING Service—Research, design, production in mechanical, electrical, chemical; also formulas, processes. All communications confidential. Choate Engineering Co., 152 West 42nd, New York.

INVENTIONS Developed and manufactured. Send us your ideas. Model Engineering, Osgood, Ind.

INVENTIONS—Manufactured in any quantity at low cost by old-established reputable company. No branches anywhere. Stampings, metal specialties, dies, models, etc. Free estimates. Free catalog. Crescent Tool Co., Dept. XS, Cincinnati, Ohio.

MANUFACTURING. Any material, any quantity, inventions developed. Milburn, Burlington, Kentucky.

INVENTIONS Manufactured by an experienced company, in any quantity at low cost. Metal specialties, novelties, stampings, dies, and models. Free estimates. Our booklet "Mind vs. Matter" sent upon receipt of 25c. Rex Engineering Co., Cincinnati, Ohio, Dept. C.

WOODWORKING Power tools—Make them yourself. Lathe, scroll saw, saw table, drill press, portable sander, bandsaw, motorized plane. Complete details only 25c. Popular Mechanics Press, 200 E. Ontario Street, Chicago.

MODELS AND MODEL SUPPLIES

IMMENSE 52 Page Mini-Train railroad catalog. 1227 different items. Vanden Boom's, 3821 Broadway, Kansas City, Mo.

WORKING Models of anti-aircraft, naval and railroad guns. Circulars and photos 25c. William Gregory, 299 Sixth Ave., Newark, N. J.

SCALE Flying models latest army and navy planes. Big catalogue 10c. Miniature Aircraft, 83 Low Terrace, Staten Island, New York.

SHIPS Of the Pacific. New model plans. List 10c. Bon Marche, Seattle.

NEW! Midget four, 19 ounce, 4 cylinder motor. 9/16" bore. Blueprints \$5.00. Blueprints and castings \$25.00. Photographs 25c. Moody, 38 North Scott, Tucson, Arizona.

ENGINE Catalogue castings, supplies, 25c. Howardco, A-2417 North Ashland, Chicago.

DISTINGUISHED Money making hobby, making models of houses, gardens. Inexpensive courses, free information. A. Weidner, 4589 Lexington, Hollywood, Calif.

SUPPLIES. Engines, pumps. Catalogue 20c. Evraymesco, 28-P North Clinton, Chicago.

ENDURANCE 30" Contest flyer, 3 dimes. Imperial Model, Hackensack, N. J.

THOUSANDS Ship fittings, hundreds kits, catalog 10c. Polk's, 429 Seventh Ave., New York, N. Y.

GAS Motor power airplane catalog 6c. Polk's, 429 Seventh Ave., New York.

GOOD Working models with eye appeal. We have spent 36 years developing ideas into practical working models! Let us help you! Free catalog. Crescent Tool Co., Dept. Y-SA, Cincinnati, Ohio.

CARVED Hull ship model kits. Ship and yacht model fittings; model yacht sails. Illustrated catalog 20c. A. J. Fisher, 1002-M Etowah Ave., Royal Oak, Mich.

MODELS—Practical models put over your ideas. We develop models from the crude to perfect working devices. Your idea might have large commercial value. Services confidential. Bank references. Registered graduate engineers at your service. Send 25c for our 68 page booklet "Mind vs. Matter." Rex Engineering Co., Cincinnati, Ohio, Dept. B.

HOME CRAFTSMEN

WOODWORKERS—Send for valuable new data book with complete line plywood, veneers. Save up to 33% buying from direct mill representatives. See our offers. Send 10c to cover mailing (refunded on first order). S. Beck Plywood & Lumber Co., 1309 N. Halsted, Chicago.

MAKE Your own aluminum castings for model gas engines, telescope mountings, workshop tools, house hardware, etc. Manual describing pattern making, molding, melting, pouring and the finishing of aluminum castings 50c prepaid. Elden Creed, Northfield, Vermont.

BALSA Wood blocks can be furnished in any size at .0025 cubic inch. Sent C.O.D. Craftsmans Corner, 504 Capital Hill Ave., Reno, Nevada.

JOINTER Knives machine sharpened, 4" 75c. 6" \$1.00, set. Field, Box 45, Haysville, Mass.

ORIGINAL Patterns: 20 novelty, 25c. 15 lawn ornament, 20c. Wayne Gorman, Box 1272-NR, Amarillo, Texas.

KNOCKDOWN Furniture, lumber, veneers. Illustrated catalog 10c. Giles-Kendall Co., Decatur, Alabama.

GET Free leathercraft instruction pamphlets, prices of leathers, tools, projects. Make extra money. Beautiful gifts. Leather samples 5c. Wilder & Company, 1038 Crosby, Dept. 10F, Chicago, Illinois.

PATTERN Catalog finely illustrating 250 plywood novelties, silhouettes, lawn ornaments, decal transfer decorations,—and other lines. Wo-Met Shop, Ashburn, Georgia.

MEXICAN Wood novelties easily made! 20 patterns, complete instructions 25c. 20 cowboy silhouette patterns 25c. 20 lawn ornament patterns 15c. Mex-Artcrafts, Eagle Pass, Texas.

80 PATTERNS. 20 Lawn ornaments, 20 silhouette, 20 novelties, 20 lawn ornaments, 30c each set, all for \$1.00. Modern Woodcraft, Saginaw, Mich.

LEATHER Craftsmen: Send 10c for handbook and catalogue of tools and supplies. E. A. Sweet Company, Inc., Leathercraft Division, Dept. A-39, 148 State Street, Binghamton, N. Y.

22 LAWN Ornament patterns 25c. Other patterns: 15"-20" high; Dutch girl, Dutch boy, pirate, bull terrier, Mexican girl, Mexican boy, dwarf, penguin, flower girl, 10c each; 3 for 25c. 25 novelty patterns 30c. All 56 full size patterns \$1.00 postpaid. Strother, Box 383-BN, Belington, West Virginia.

LAWN Ornaments easy to make. 20 full size patterns, birds, animals, etc., 25c; Dutch boy, Dutch girl, sprinkling girl, fox terrier, scotties, bulldog, 15c each, any two 25c; Dutch windmill, 36 inches high, 25c. Entire collection, 27 patterns, \$1.00 postpaid. Wickman Co., Dept. 205, Dayton, Ohio.

LEATHER. Tooling and archery, 2 lb. \$1.00. 8 large pieces. F. Nelson, 911 Pine St., Muskegon, Mich.

PLASTICS—Bakelite, Catalin, sufficient for cigarette or powder box, four rings, two bracelets, five ornaments, five jewelers findings. Twenty pieces \$1.25 cash with order. Dependable Machy, Co., 1011 Harrison, Oakland, Calif.

1001 WAYS to Use Concrete. Send for large free illustrated folder describing new Popular Mechanics book covering every known use of concrete for the home, farm, building, business and industry. Popular Mechanics Press, Room (C40), 200 E. Ontario St., Chicago.

OLD GOLD, WATCHES, JEWELRY, PRECIOUS STONES

LEARN Watchmaking. Material, instruction for start and wholesale watch tool material catalog, all \$1.00. Refund if not OK. Stewarts 72i Olive, St. Louis, Mo.

ELGIN. Waltham watches \$3.50. Make big money. Free watch and jewelry catalog. Plymouth Jewelry Exchange, 163-A Canal St., New York.

GENUINE Mexican opals! Five assorted, ready for mounting, \$1.00. Deluxe Creations, Laredo, Texas.

REBUILT Watches, guaranteed. Pontiac Watch Co., Box 576-P, Pontiac, Mich.

WATCHES—Hamilton, Elgin, Waltham, Bulova as low as \$2.75. Diamond rings at lowest prices. Postal brings free illustrated catalog. Quaker City Jewelry Company, Wholesale Jewelers, N. W. Cor. 8th and Walnut Sts., Philadelphia, Penna. Dept. "S."

FREE. 5000 Elgin, Waltham watches. Unique plan. Particulars. William Taylor, South Mountain, Pennsylvania.

GEMS. Agates, minerals, 1/2 carat genuine cut sapphires, zircons, fireopal \$1.00 each; all 3 for \$2.50. 20 rough gemstones \$1.00. 6 polished mineral specimens \$2.00. Free catalog. Hill, Route 7, Salem, Ore.

AGATES. Fossil woods, three pounds \$1.25 postpaid. Jay Ransom, Aberdeen, Wash.

WATCHMAKERS' Materials—Tools, watches, jewelry. Bought, sold, exchanged. Best prices for old gold, diamonds. Ben Segal Company, 5 South Wabash, Chicago.

WATCHMAKERS' Tools, supplies. Watch parts. Lowest prices. Write for price list 43. Dean Company, 87 Nassau St., New York.

HIGHEST Prices for old gold—Mail your teeth, watches, jewelry. 100% full cash value mailed day shipment received. Satisfaction guaranteed or articles cheerfully returned. Information free. Chicago Gold Smelting Company, 300-P Champlain Building, Chicago.

5000 REBUILT Watches! Free catalogue—Diamonds, jewelry, (3c postage). The New York Jobbers, 74 Bowery, Dept. M, New York, N. Y.

FOR THE HOME

QUICK Furnace lighter—without kindling, \$3.50. Guaranteed. Lorain Furnace Lighter, Lorain, Ohio.

FREE—Big list of helpful books. Popular Mechanics Press, 200 E. Ontario St., Chicago.

TOBACCO

GOLDEN Leaf guaranteed, cigarette, pipe or chewing, 5 lbs. \$1.00, ten \$1.75. Pay when received. Pipe, box cigars free. Reeves Tobacco Co., Paducah, Ky.

RAZORS, BLADES, SHARPENING

BELL-O Abrasivstrop, Gardner, Massachusetts. 250,000 komfort! (Gillette months). Belloized blade; send 3c.

SURVEYING INSTRUMENTS

GUARANTEED Factory rebuilt transits and levels for rent (with purchase option) or sale (cash or terms). Order now before prices advance. We will repair, trade in, or buy your old instruments. Ship prepaid for estimate and valuation. Write for List M-510 and complete information to Warren-Knight Co., 136 N. 12th St., Philadelphia, Penna.

FOR SALE—MISCELLANEOUS

3 SLIGHTLY Used latest style silk dresses, \$1. Also 12 assorted colors, sizes, 12 for \$3. Send \$1—if balance C.O.D. Free catalog. Acme, 164-M Henry St., New York.

WANTED—MISCELLANEOUS

MERCURY (Quicksilver). \$1.00 pound remitted, promptly. Ship express. Wholesale Terminal, Norwood, Massachusetts.

CASH For used microscopes, binoculars, slide rules, drawing sets, scientific instruments, tools, cameras, transits, old gold. Satisfaction guaranteed. Elman's, 108-M South Clark, Chicago.

PERSONAL

ROSICRUCIAN Secret teachings are offered to those who seek to use them solely for the perfection of their inner faculties, and in the mastering of the daily obstacles of life; the International Organization of Rosicrucians will be happy to receive the requests of those who believe that worthiness and sincerity determine the right for one to have such wisdom; to them, a copy of "The Secret Heritage," a fascinating book, will be given without price; let this book guide you to the conservative plan whereby you may widen your scope of personal power. Simply address your letter to Scribe F.K.A., Amore Temple, Rosicrucian Park, San Jose, California.

WORRIERS: Defeat worry, gain peace of mind, relaxation through simple methods. Information free. Kenneth Weyand, 20 Hancock Street, Boston, Mass.

NERVOUSNESS, Fear, bashfulness! Afflicted? Write—describe your trouble. Receive valuable information. Free! Confidential! John Englund, Ironwood, Mich.

ANY Question answered on any subject, \$1.00. Absolute satisfaction guaranteed, or no charge. Strictly confidential. Write Dr. Smith, Box 87, Clinton, Mass.

MEXICAN Legal matters. Wm. A. Cocke, American Attorney, ElPaso, Texas.

REMOVE Your own tattoos. Write Tattoo Supply House, 651 South State, Chicago.

UNITED States \$4 and \$5 stamps free to approval buyers sending 5c for 100 different. P. Wineholt, Woodbine, Penna.

LOSING Your hair? Try Wig-On. Month's treatment \$1.00 postpaid. Wig-On, 31 Kirkland Road, Rochester, N. Y.

WIN Prize money: Booklet—"Successful Contesting"—shows how. 10c postpaid. Bulletin listing \$100,000.00 prizes included. World Publishers, 4515-B Cottage Grove, Chicago.

REAL Estate difficulties? Any question answered, \$1 each. Leslie Coyle, Box 1886, Cleveland, Ohio.

SUCCESS Or failure? Personality decides which. Learn secret of being irresistible! "Success" shows how. 60c. Doherty, 4816 46th, Woodside, N. Y.

TREASURE Finders? Read Goldak advertisement on page 138A.

WOMAN Legislator will open large farm home to a few Christian paying guests. Adults only. Refined atmosphere, modern conveniences, spacious grounds. Meals served only to resident guests. Breakfast trays if desired. No liquor. References required. Rates on request. Mrs. Bertha Hayes, Barrington, New Hampshire.

SLEEPLESSNESS — Passive concentration cured me. Details 10c. Ernest, 35A North Ninth, Columbus, Ohio.

MISCELLANEOUS

DESIGNING And developing of plastics, die castings, stampings; expert, confidential service. Mail dollar consultation fee (applicable to your order) with your problem to Industrial Designers, 2428 Glendale Avenue, Toledo, Ohio.

MEXICAN Information and Advertising Bureau. Information furnished on business, legal matters, traveling, cost of living, hunting, fishing, etc. Imports, exports. Circulars, translated, printed, mailed to one country in Americas for one cent—in English to Canada and United States. Mexican postals mailed from Mexico to your friends for 10 cents. Write—Ave. Corona 145, Guadalajara, Jalisco, Mexico.

CASH For any used scientific or optical instruments, cameras, binoculars, microscopes, slide rules, drawing sets, fine tools, transits, or what have you. Satisfaction guaranteed. Gordon Co., 162-M Madison, Chicago.

MAIL Order business course shows you how to make money, spare or fulltime. Teaches professional mail order technique—not penny-catching schemes. Free details. Nelson Company, 500 Sherman, Dept. 408-J, Chicago.

MEXICAN Jumping beans. The best curioity in the world. Joaquin Hernandez, Exporter, Alamos, Sonora, Mexico.

BUILD Your own concrete block house. 2 photos one dime. R. Edmondson, 441 E. Main St., Rochester, N. Y.

CHRIST Is coming. Get free proofs. Sheal, 263, Duluth, Minn.

HITLER Caricatured on egg. Delightfully comical. 50c postpaid. Lloyd's, 9117 82 St., Woodhaven, N. Y.

RECEIVE Gigantic mails, magazines. Your name in numerous mailing lists 10c. Howard, 396 Broadway, New York.

NEW Lettering guide makes seven sizes, innumerable styles, letters, figures, monograms. \$1.00. Drafting Devices, Box 541, Pompton Plains, N. J.

WIN Money! Prizes! Contest Magazine 10c. Butler, 473PM, Sebring, Florida.

TATTOOING And engraving machines, best, cheapest. Jensen, 412 South Main Street, Los Angeles.

GOOD Eyesight without glasses. No drugs. Use my unique home treatment. A. Jacobson, Upsala, Minnesota.

I WANT To send you proof of the wonderful pulling power of Popular Mechanics Magazine's classified pages. What's your proposition? Write me today. F. W. Johnson, Manager Classified Advertising, 200 E. Ontario St., Chicago, Ill.

FREE Photograph of national barn dance gang with 110 popular radio cowboy songs, 25c. Empire Novelities, Peterboro, Ont., Canada.

FREE Sample novelty Christmas greeting (copyrighted). Westkraft, Box 4003, South Station, Denver, Colorado.

GET Rid of your debts easily. New plan. Regent Service, Alfred Station, Detroit.

BUYERS Club. Save 25%. Radios, electric, etc. Details stamp. Urban Co-Operative, Ferndale Drive, Binghamton, N. Y.

TREASURE Finders? Read Goldak advertisement on page 138A.

TATTOOING. Engraving outfits. Illustrated list free. Percy Waters, Anniston, Ala.

BEGINNERS' Tattooing outfits. Removers. Free catalog. Tatuco, 651 South State, Chicago.

COATS Of arms and crests, correctly painted in colors or black and white, from heraldic description or furnished copy. \$10.00 and up. Highest grade work. Heraldic Studios, 1914P Oakdale Avenue, Chicago, Ill.

GET Shop Notes for 1940! May easily be best investment of your entire lifetime. Contains 384 money-making, time-saving ideas. Kinks, short cuts for mechanics, farmers, home workshop fans, handymen—for everyone who uses tools. 214 pages, and 762 illustrations. Thousands wait for this book every year. Only 50c. 1939 and 1940 Shop Notes sent postpaid for \$1.00. Popular Mechanics Press, 200 E. Ontario, Dept. C40, Chicago.



MILLERCYCLE

Ride the new fluid drive MILLERCYCLE with one control. So simple and safe a child can operate it. Strong enough to carry two full-grown men. Is not a scooter, but a light-weight motorcycle with a 2 1/2 HP motor, mounted on the front fork. Gives 75 to 100 miles to a gallon of fuel. You will be amazed at its performance.

Write for Descriptive Circular and Complete Information.
C. E. MILLER MFG. CORP.
Dept. P. Anderson, Indiana, U.S.A.



BIG PROFITS TENNIS and RESTRINGING BADMINTON RACKETS AT HOME!

It's easy—and profitable restringing Badminton, Tennis rackets at home. Write for FREE Catalog of strings, re-stringer's tools, low prices! Hurry!
H. E. WILLS CO., 1047 W. 47th St., Dept. PM-100, Chicago

Saw-Filing
Pays up to \$2 or \$3 an Hour in Spare Time

A FOLEY Automatic Saw Filer files hand, circular and band saws better than the best hand filer. Cash business, no canvassing, no eyestrain. No experience needed. Louis P. Wadowick, Ohio, says, "I have filed 764 saws in spare time and have earned \$850.00 in carpenter work due directly to my saw filing contacts." Send coupon for FREE PLAN, no obligation.



FOLEY MFG. CO., 1016A-40 Foley Bldg., Minneapolis, Minn.

Send Free Plan on Saw Filing business.
Name.....
Address.....

BROOKLYN YMCA TRADE SCHOOL



Unlimited Instruction until you have mastered every part of Course without additional charge.
Full Shop Equipment
Unexcelled Instruction
Fireproof Dormitories.
Special Privileges. **Check your interests** on coupon to receive free literature.

- Aviation Mechanic
- Machinist
- Mechanical Pre-Engineering
- Diesel Engines
- Diesel Pre-Engineering
- Aeronautical Pre-Engineering
- Auto Mechanic
- Refrigeration
- Television and Radio Mechanic
- Architectural-Mechanical Drafting
- Armature Winding
- Welding
- Tool and Die Making
- Oil Burner
- Talking Pictures
- Air Conditioning
- Electrical

MAIL COUPON
1117 Bedford Ave., Dept. P.M.
Brooklyn, New York City, N. Y.
Name.....
Address.....

ZOOM into AVIATION



AN AVIATION CAREER OFFERS YOU A GREAT FUTURE!

The greatest opportunity of your lifetime exists today. There never was such an opportunity in AVIATION for you. There may never be another. Aviation desperately needs trained men; they are at a premium and advancements for them are rapid. You can get in on the ground floor by training now, BUT you must choose the right school for your training. This is imperative, since your choice of a school in which to take your training will determine your whole future in Aviation and how much money you will make all the rest of your life. Curtiss-Wright Tech's career training is carefully designed to do just one thing—**MAKE MORE MONEY FOR YOU.** Our hundreds of successful graduates have proven that our training gets results and always pays. It has provided them with a profitable occupation and secure future, since it trained them in advance for the highest position they could ever expect to occupy. It can make you independent and self-supporting for life. Curtiss-Wright Tech is located on Grand Central Air Terminal in the heart of the Aircraft Industry. Established in 1929, this famous school is recognized as the nation's leading institution for the training of **MASTER AVIATION MECHANICS and AERONAUTICAL ENGINEERS.** (No flying involved.) We honestly believe that every student who enrolls here will be able to obtain immediate employment upon graduation. A position awaits you. **WARNING!—DON'T "MISS THE BOAT!"** Send for catalog today. Give age and course desired. Dept. PM-10.



**CURTISS WRIGHT
TECHNICAL INSTITUTE**
Glendale (Los Angeles)
California

THIS TOWER OVERLOOKS AVIATION'S MOST DISTINGUISHED SCHOOL OF AERONAUTICS

A GOOD LIVING FROM POULTRY



with a business of your own. How to start small way, spare time, grow from profits, or prepare for good job in large poultry plant. Poultry Expert, shows latest scientific methods, money making secrets in poultry raising, system of home study training used by thousands. Endorsed by many colleges and leading Poultrymen. Established 20 years. Write today for his big FREE catalogue describing courses, methods and service. Shows way to real business opportunity. Harry M. Lamon, Pres.

NATIONAL POULTRY INSTITUTE
DEPT. 50-P, ADAMS CENTER, N. Y.

Always write your name and full address clearly when answering advertisements.

LACO Oil Heater



INNER HEATING UNIT

Enjoy Automatic OIL HEAT at Amazing LOW COST!

LACO leads the field in Low Cost and Efficient Heating! "Direct-to-Dealer" selling cuts the price below others! Outstanding features produce the better heating! See at left LACO's two great heat-producing features! "Two-Stage" burner produces any desired volume of heat. From very lowest flame, down inside the burner unit—to full flame above the unit where flame contacts walls of Inner Heating Unit. These walls become intensely hot . . . air moves up through and around the hot unit . . . delivers an extra volume of slow-moving, moist heated air into the room. Very little low-priced oil is required. Outer cabinet is of heavy auto-body steel, electrically welded into a solid unit. Guaranteed. Choice of sizes.



HI-LO 2-STAGE BURNER

New Model LACO's newest "Nu-Comfort" model, only 35 inches high, delivers lots of heat, without fan, at "sitting" level—brings the heat level of the room lower. Full opening radiant doors for "oven-door" heat when wanted. Has all LACO's standard features. Typical LACO value!



For Furnace

DEALERS—LACO offers you an unusual selling opportunity! Proved the best heating unit on the market—at chain-store or mail-order house prices!

WRITE See your local LACO dealer. Or send name for free folder with full details, very Low Prices.
LACO OIL BURNER CO., 1100 Union Ave., Griswold, Iowa

LET ME PROVE I CAN MAKE YOU A NEW MAN

I changed myself from a 97-lb. weakling to winner of title "World's Most Perfectly Developed Man." Let me prove that my secret of Dynamic Tension can give you powerful muscles, smashing strength, a handsome build! All I ask is a 7 DAY TRIAL. Write for my 48-page FREE BOOK. CHARLES ATLAS, Dept. 810, 115 East 23rd Street, New York City.



SEND FOR MY FREE BOOK

EASIEST

OF INSTRUMENTS TO PLAY . . . yet Richest in Opportunity

Why be just one of the crowd? Enjoy the thrill of the spotlight, the praise of friends, the lifelong pleasure of creating your own music. It's easy with the Deagan Marimba, fastest-growing instrument in the music world today. The ideal home instrument—in demand at dances, clubs, radio stations, etc.—and yet easiest of all instruments to play. Models and terms to suit every budget. Convincing FACTS on request—write for them today!



J. C. DEAGAN, Inc., 4457 Deagan Building, CHICAGO

TOOL & DIE MAKERS

Machinists, Screw Machine Men
EARN BIG PAY Skilled metal workers earn up to \$50-\$60 a week. Learn these trades by actual work in ALLIED SHOPS. Fully equipped. State Approved. Low Fee. Enter any time. Day and Evening classes. FREE Employment Service. Write for NEW illustrated Catalog.
ALLIED SCREW MACHINE CO., (School Division)
Dept. PM-10, 609 W. Lake Street, Chicago, Illinois

ARTISTS MAKE MONEY

Find out your ability. Send name, age, occupation and address for Free Vocational Art Test.
Federal Schools, Inc., 10130 Federal Schools Bldg., Minneapolis, Minn.

SEE
The Rings
of Saturn
—
The Moons
of Jupiter



ONLY
\$395

**50 POWER
REFLECTING TELESCOPE**
Amazingly Low Priced

Study the wonders of the heavens—the mountains of the Moon, the planets, comets, stars. Strange thrills! Hours of fun—with this big powerful reflecting telescope. **EARN MONEY FOR YOURSELF.** Charge 10c for a look at the moon. **NOT A KIT.** A splendid instrument, sturdily built in three inch, heavy metal tube with machine ground, hand finished reflecting lens—48 inches long finished in black crystallized enamel. Will last lifetime. Guaranteed that you see the Moons of Jupiter. Can be used to take telescopic pictures and as a spotting scope for target practice. Complete and ready for use. Nothing else to buy. **TEN DAYS FREE TRIAL.** Rush only \$1.00 now. Pay balance of \$2.95, plus few cents postage, when postman delivers. Keep ten days. If not more than delighted, return telescope and money will be refunded.

KUMFY PRODUCTS, INC., Dept. J-500
4033 Eastern Ave. Cincinnati, Ohio

READY CASH
HOT POTATO CHIPS

Here's your chance—a money-making business of your own. Turn potatoes into newest kind of Potato Chips with my improved outfit. Makes delicious Chips at low cost. A few hours practice does it. Begin anywhere—city, village, town. Potatoes cheap and plentiful. Wholesale or retail. Steady year-round business. Groceries, markets, restaurants, taverns do the retailing for you.

Start Your Own Business. Great quantities of Chips are eaten daily. Profit large—unusually so. You can start this money-making business on a **SMALL** outlay of cash. Write for Potato Chip Booklet. **LONG-EAKINS CO.**
1028-S High St., Springfield, Ohio



**DRAFTING
&
DESIGN
ENGINEERING**

Make big-pay drafting and design engineering your career. A course for ambitious men who want thorough, complete, and comprehensive training. Personalized instruction by former Ohio State and Capital University faculty member. American methods used. Instruments furnished. **Write, Ohio Institute of Technology, Room 10-M, Greenville, Ohio.**

WELDERS WANTED!



ELECTRIC ARC—OXY-ACETYLENE
Skilled Welders earn \$8 to \$15 a day. The demand now greater than the supply. Learn this highly paid trade in 3 weeks by actual shop work. One of America's leading schools. Established 1902. 7 floors of shops. Endorsed by welding industry. Limited number of students. 3 weeks course in Electric Arc or Acetylene Welding, including room and board, only \$105. Write or wire for reservation. Ask for "Welding Facts." State age. **GREER COLLEGE, Dept. 1100, 2024 S. Wabash Ave., Chicago**

RADIO REPAIR SHORT-CUTS

Learn how to test and fix all radio sets. Hundreds of time-saving hints for all circuits. Get this new 32 page Radio Book for only a dime. **10c**
SUPREME PUBLICATIONS, 3729 W. 13th St., Chicago, Illinois



Earn Cash at Home!

We paid M. M. \$1174 for exceptional cellar crop Snow-King mushrooms! We furnish materials; buy all crops. Big **FREE** picture book tells if your cellar, shed, barn, suitable. Est. 1908. Write today. **United Co., 3848 Lincoln Av., Dept. 304, Chicago**

FACTORY-TO-YOU
Save up to 50%



EASY TERMS

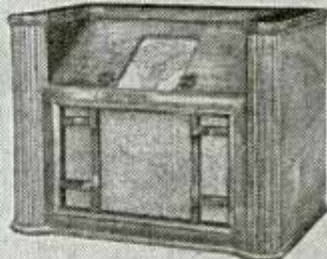
30 DAYS TRIAL PUT THIS NEW 1941 **14-TUBE CHASSIS** IN YOUR OWN CABINET

FREQUENCY MODULATION and TELEVISION PROVISION

only \$ **19.95** COMPLETE WITH TUBES AND SPEAKER

Now, you can enjoy the mighty power of a 14-tube 1941 radio at the price of an ordinary 7 or 10-tube set!

14-TUBE CABINET MODEL
\$ **29.95** COMPLETE



AMAZING FOREIGN RECEPTION

You can enjoy brilliant performance and beautifully clear tone. Now, tune in broadcasts direct from distant overseas stations. Big 1941 catalog shows how to buy at wholesale price . . . direct from factory.

Read about sensational new 14-tube cabinet model at \$29.95. Also other chassis and cabinet models from 5 to 17-tubes . . . up to 5 wave bands . . . including Radio-phonograph-combinations and Home Recorder. **Write today!**

GET MIDWEST'S ANSWER TO TRADE-INS!

FREE RADIO CATALOG
SEND 1¢ POST CARD FOR FREE 1941 CATALOG NOW!

MIDWEST RADIO CORPORATION
Cincinnati, Ohio Name _____
Dept. 15-EE
Send me your new FREE catalog, complete details of your liberal 30-day Trial Offer and factory-to-you prices. Address _____
Town _____ State _____
User-Agents Make Easy Extra Money. Check here [] for details.

As Easy as ABC

The DELCO ELECTRO-LEVEL Prevents Over-Filling

Remove the vent plug . . . and automatically the new Delco battery is protected against over-filling. Why is this protection important? When a battery is being charged, pressure is built up inside the cells by the gases which are released. These gases should pass freely through the vent holes; but when the electrolyte level is too high, acid is sprayed out. The acid corrodes the battery carrier and connections.

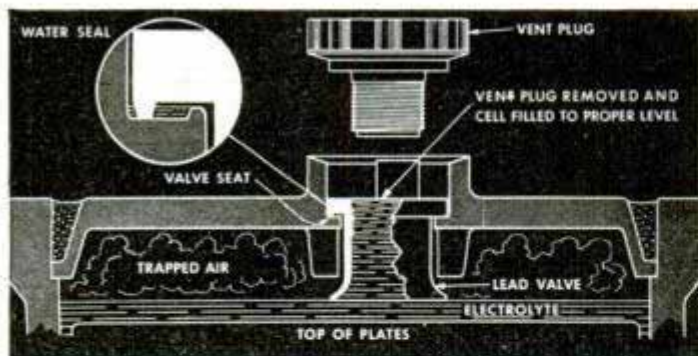
The secret of the automatic protection provided by the Delco Electro-Level is a sliding valve which drops down to form a water-sealed air lock when the proper electrolyte level is reached. When the plug is screwed in place, the valve is lifted to form an efficient



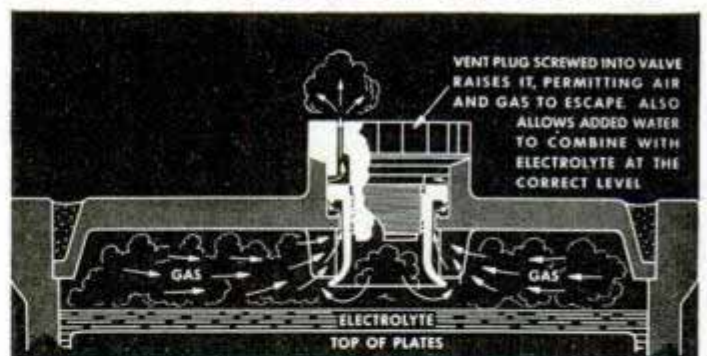
baffle arrangement that breaks up acid spray and allows only gas to escape.

Delco batteries are original equipment on 43 per cent of all new cars sold. For sure starting ability and dependability, replace with a Delco battery.

HERE'S HOW THE NEW ELECTRO-LEVEL WORKS



Vent plug removed for filling—valve forms air lock when electrolyte reaches proper level. Notice particularly the *water seal* formed when the edge of the valve drops into the layer of water retained in the ridge around the valve seat. This layer of water is replenished by condensation, eliminating any possibility of a leak in the air lock when the lead valve is in position for filling.



Vent plug screwed in—valve is raised to permit escape of trapped air and gases from the cell through the passage and the vent hole in the plug. Notice here the efficient baffle arrangement through which the gases must pass. This condenses moisture and breaks up the acid spray which might otherwise escape to damage the battery carrier and connections to the battery.

Delco-Remy

ANDERSON, INDIANA

World's Largest Manufacturer of Automotive Electrical Equipment

Popular Mechanics Magazine

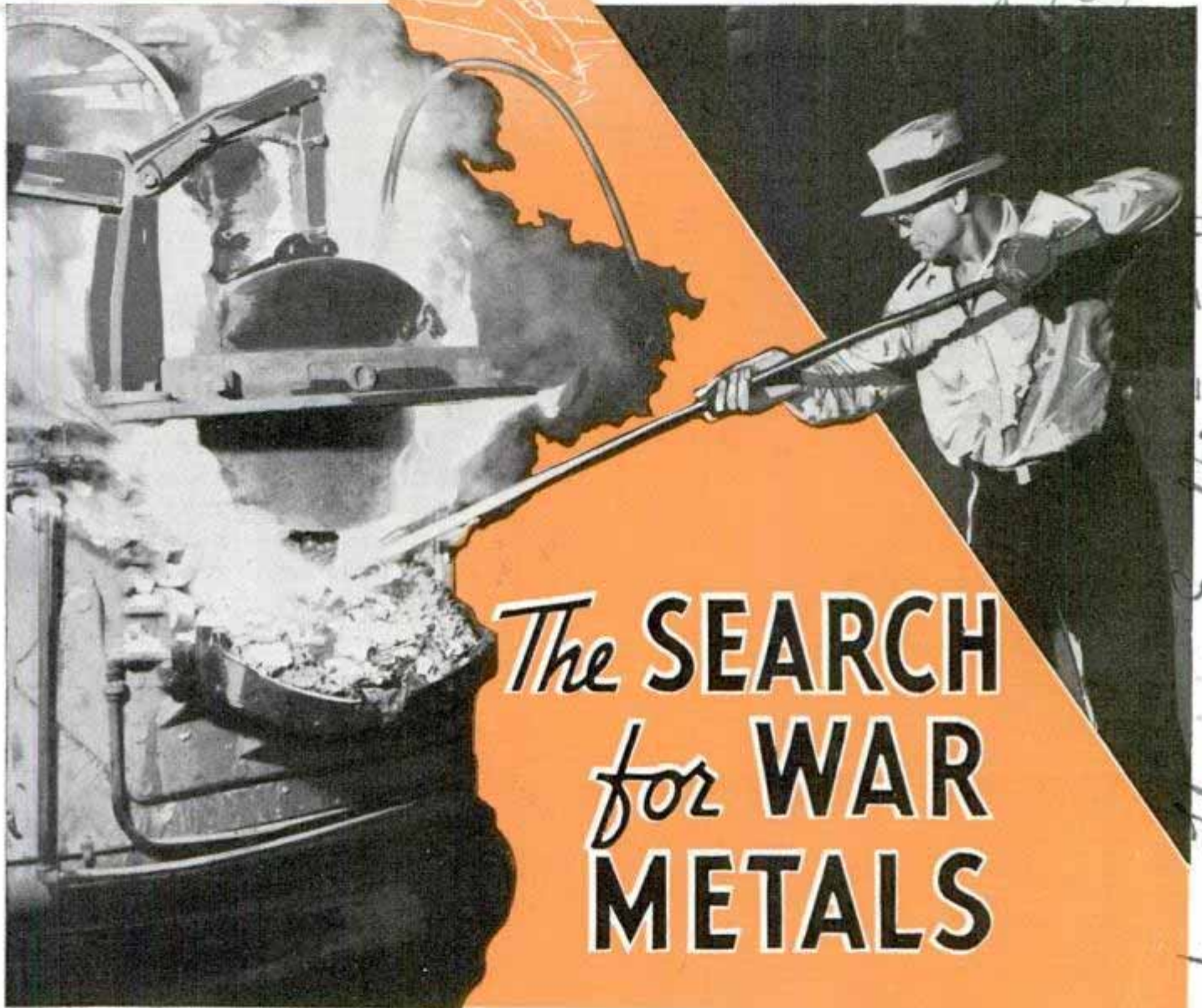
REGISTERED IN U. S. PATENT OFFICE AND CANADA

WRITTEN SO YOU CAN UNDERSTAND IT

Vol. 74

OCTOBER, 1940

No. 4



The SEARCH for WAR METALS

Skimming slag and impurities from molten steel in electric furnace. Modern mining and refining methods are helping to make the United States more nearly self sufficient

PROWLING through abandoned mines and sometimes building their own roads to reach inaccessible areas, 200 engineers of the U. S. Bureau of Mines and the Geological Survey are investigating our supplies of vital minerals.

The United States is the most self-sufficient country on earth yet it normally depends on foreign sources for most of the tin, antimony, nickel, manganese and some of the other materials required by industry. Some can be obtained cheaper abroad than here; in other cases our deposits are

inadequate. If ordinary channels of trade were disrupted the country might be cut off from materials it has to have.

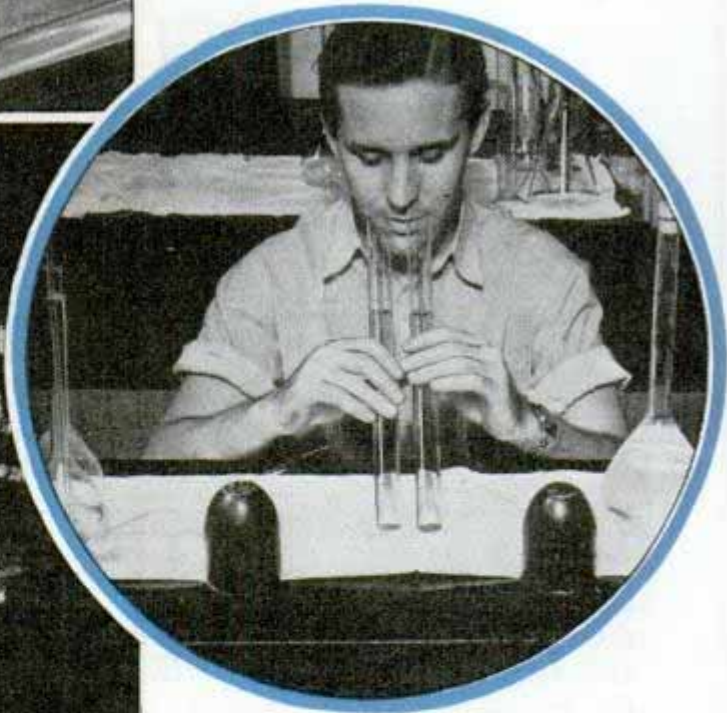
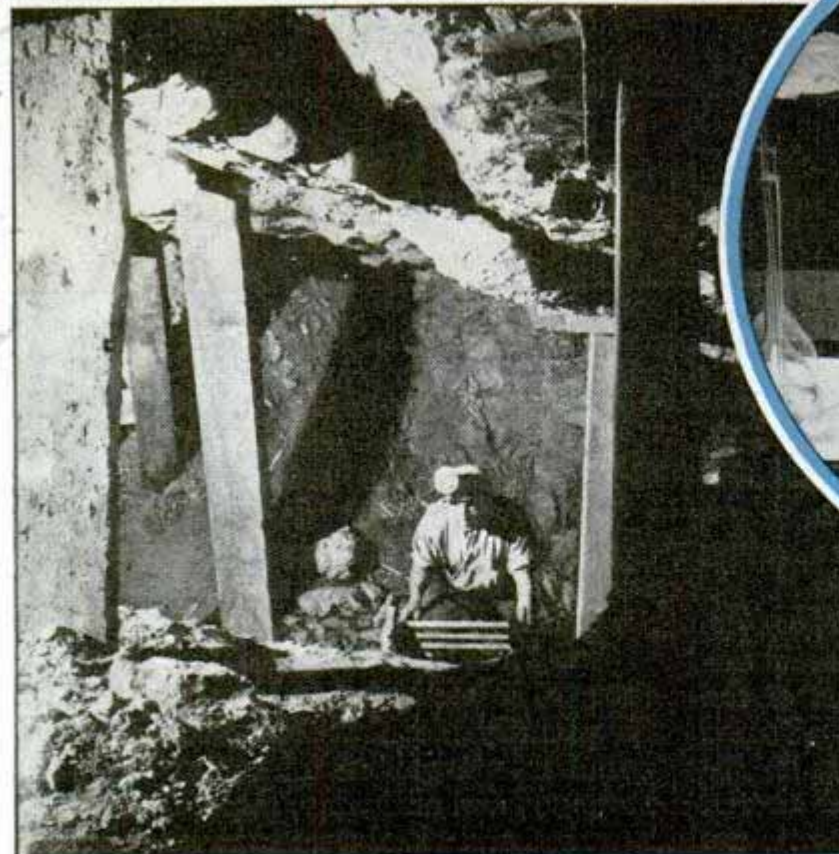
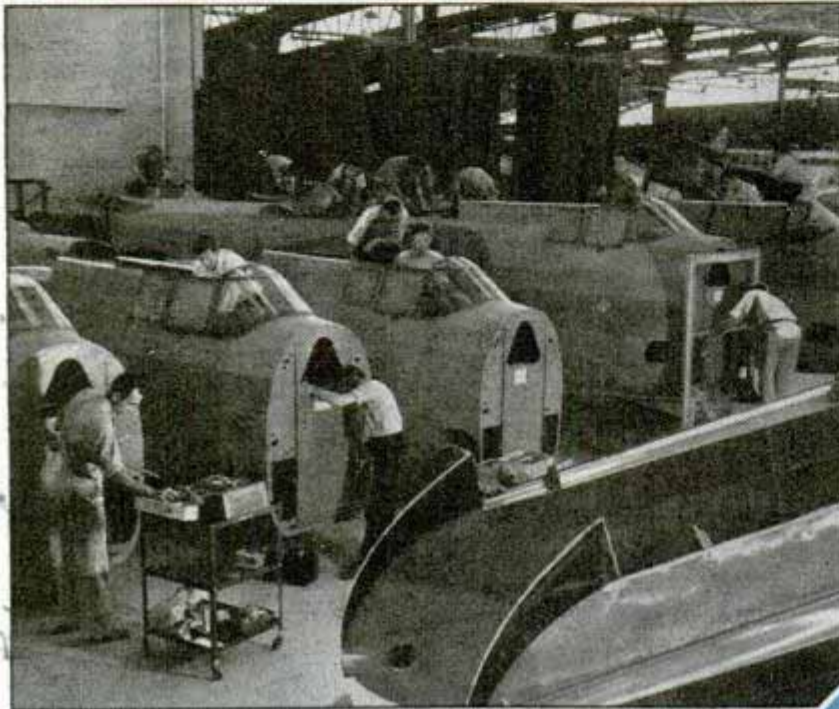
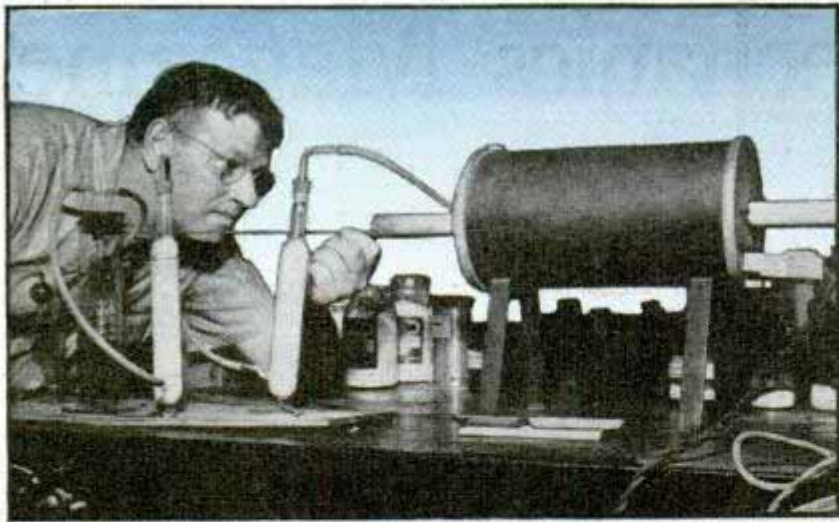
To guard against this possibility the government is spending \$10,000,000 as a starter to buy and store reserves of strategic metals. In addition a four-year search is being made to map out our own resources. Already it has been learned that the country is richer than had been supposed in manganese, chromite, tungsten, mercury, and antimony, minerals essential in peace and absolutely necessary in war.

OCTOBER, 1940

481

8767
Cont. Thomas C. Stinson, Jr. Los Angeles
10442 Webster Lane

Op. Charles E. Stinson, Jr.
Cont. E. Stinson, Jr. Los Angeles

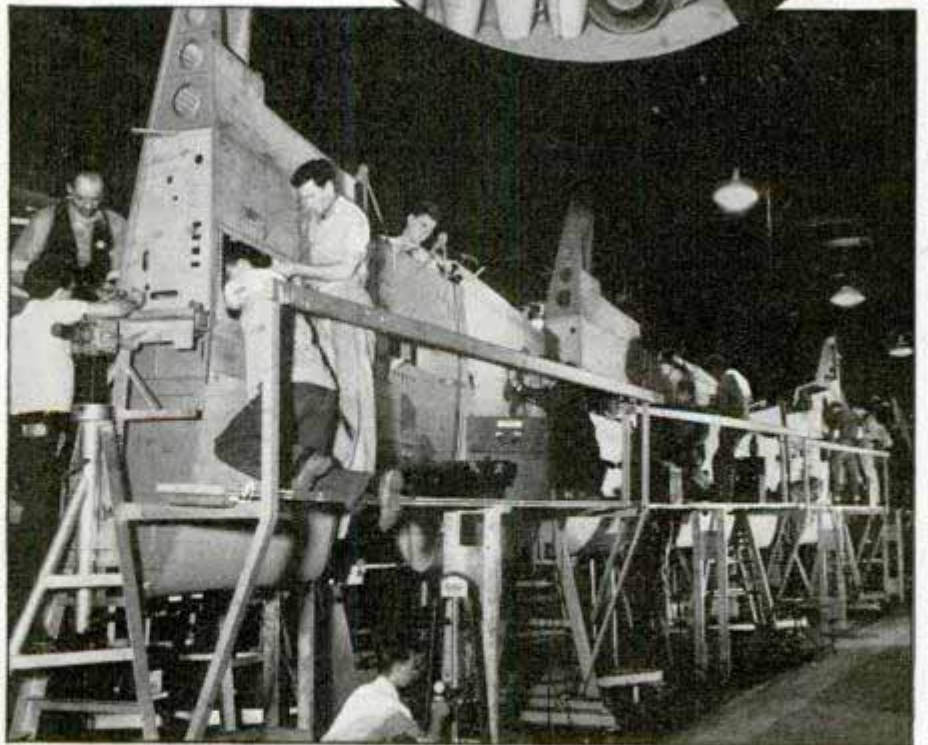
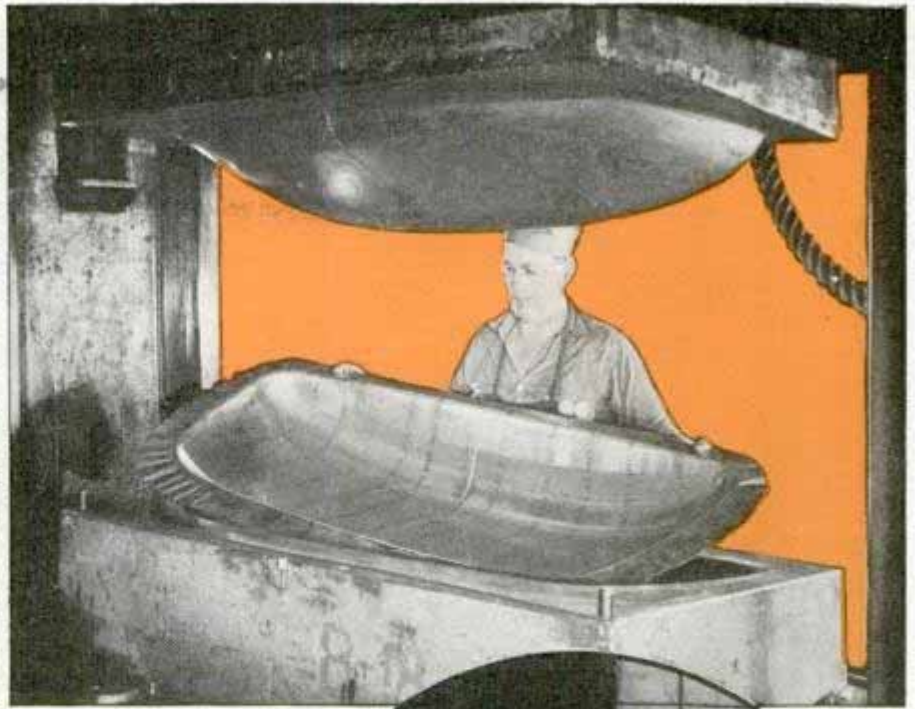


Materials on the strategic list include aluminum, antimony, chromium, coconut shell char, manila fiber, mica, nickel, optical glass, quartz crystal, mercury, quinine, rubber, silk, tin, tungsten and wool. Twenty-five other materials are only slightly less important. The United States produces only ten per cent of the antimony, five per cent of the manganese, one per cent of the chromium, and less than one per cent of the nickel and tin it uses.

Most of our manganese now comes from Russia, Africa, and Brazil. Chromium is imported from Africa, Cuba, and the Philippines. Mexico is the principal source of antimony. Nickel comes from Canada. Tin is shipped in from the other side of the Pacific. Except for tin it appears that in case of need sufficient supplies of all these metals can be obtained domestically or at least can be originated on the con-

Top, heating ore sample in electric oven. Center, assembling planes in which metal alloys play big part. Bottom, exploring mercury mine. Circle, ore sample in liquid is compared by color with liquid containing known quantity of metal

New Alameda, Calif.



continent. Placer tin in three New Mexican creeks has been traced to the sources and the lode material is being surveyed.

Strangely enough, all of the so-called war metals, with the exception of mercury, have gone down in price instead of booming as a result of the war in Europe. They are cheaper than they were a year ago. The reason seems to be that during the last decade the mining companies accumulated huge surpluses above the requirements of industry and now that the markets have become active these stocks are being sold at competitive prices.

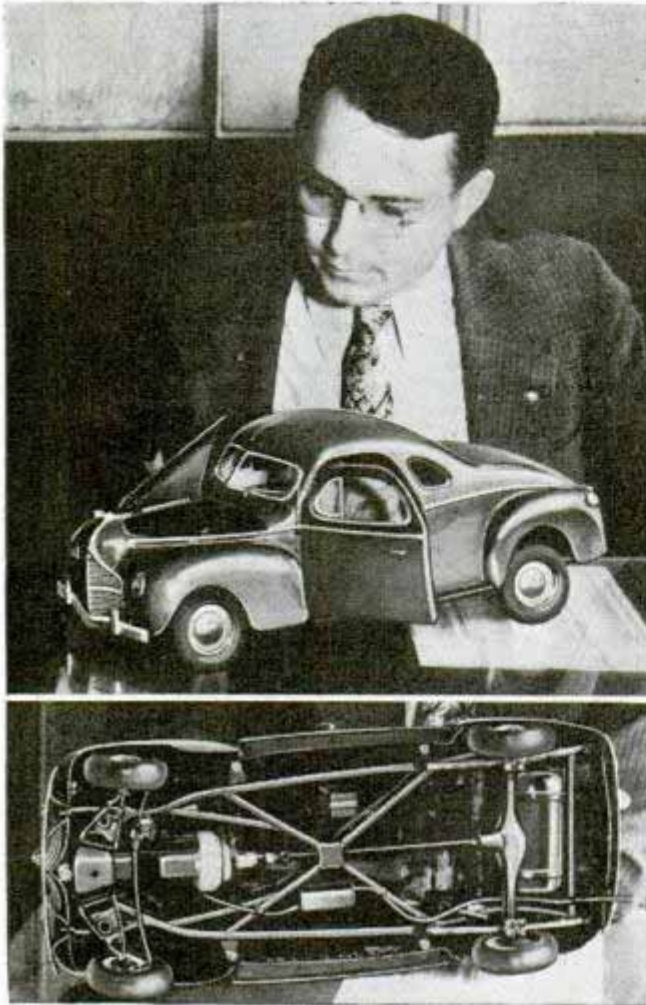
During the World War the United States was cut off from its usual sources of potash, nitrates, iodine, and molybdenum, among other materials. In each of these the country is now self sufficient. Potash is being mined from the dry lakes of the southwest, nitrate needs are supplied by nitrogen extracted from the atmosphere, and iodine is now a by-product of petroleum production. Adequate domestic molybdenum resources have been discovered.

Most people regard Spain as the source of most of the world's mer-

(Continued to page 143A)

Top, left, weighing mercury just taken from still. Right, sheet aluminum being shaped at Douglas Aircraft factory. Circle, making fire assay of crushed ores to determine metallic content. Bottom, wing assembly in aircraft plant that uses twenty-five metals and alloys in manufacture

Working Model of 1940 Car Has Adjustable Seats



A South Dakota man built this model, faithful in almost every detail to the original—his own coupe

Nearly all the operating features have been built into a model of his 1940 car by Philip Johnson of Vermillion, S. D. Copied from the original, doors, windows, hood, ventilators, windshield wipers, sun visors, glove compartment door, radio antenna, clutch, brakes, accelerator, engine fan and oil filter are made to operate. Headlamps are of the sealed-beam type, steering mechanism is complete and the small engine is suspended in floating-power mountings. The miniature has individual spiral springs in front, leaf springs at the rear, and wheels have pneumatic tires and hub caps. Its upholstered seats are adjustable.

Growth of Trees Speeded Up by Ray Treatments

A vast speed-up of tree growth, important scientifically as well as for the production of cellulose, has been achieved by the application of ultraviolet and Roentgen

rays, the Kaiser Wilhelm Plant Research Institute in Germany reports. Radiation accelerated the development of trees to such an extent that poplars were ready in two years to be cut for the manufacture of cellulose. The yield from irradiated trees was as large as from much older trees grown naturally.

Electric "Brain" Puts Washer through Automatic Routine

With a washing machine that virtually does its own thinking, you can stow a nine-pound load of clothes in the door, set the controls to regulate water temperature and number of minutes for the washing, feed it soap and then go out for a walk. The washer is connected with hot and cold water supplies. Solenoids and float valves automatically turn the water on and off, thermostats control its temperature as desired. A time-control knob controls the switch that makes contacts to change the operation of the machine; after washing the clothes for the interval you selected, it automatically gives them a shower rinse, then a slosch rinse, then a third rinse; finally a solenoid shifts gears stepping up the speed of the clothes basket and the garments are spun damp-dry.

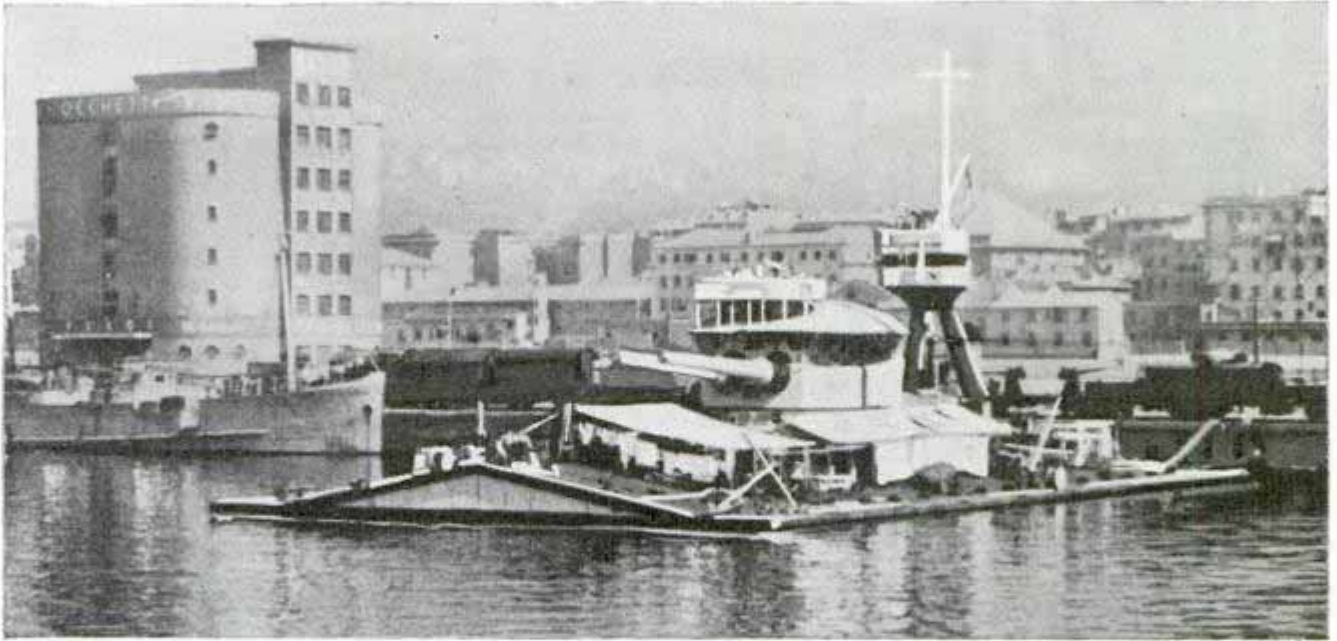


This machine washes, triple-rinses and dries clothing automatically under a time-mechanism control

Herman Railroad Company
 57th St. N.Y.C.
 110
 KR 28

Dodge Sedan
 330 of W. Sample St.
 South Dakota
 Bender Home Appliances, Inc.

Barge with Eight-Inch Guns Is Floating Fort



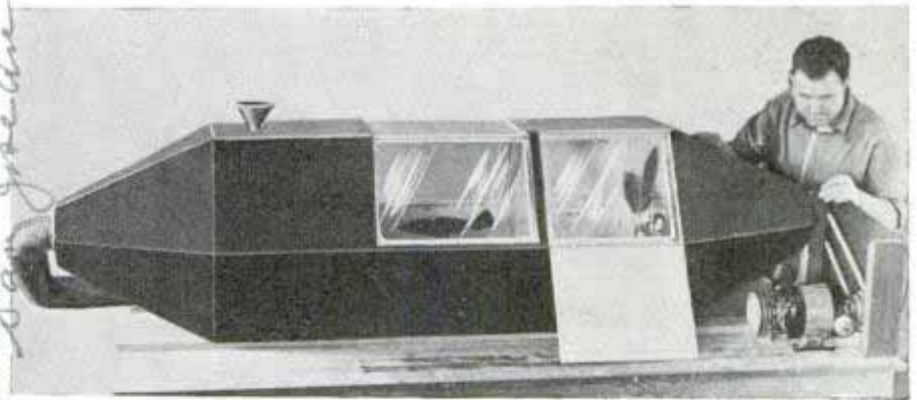
Mounted on this Italian barge are a pair of eight-inch guns and a fire-control tower, useful for training navy gunners, and a formidable weapon when towed into action by another war vessel

Offering a small target for the enemy, an Italian barge carries twin eight-inch guns capable of inflicting heavy damage on hostile shipping in the Mediterranean. The

barge was photographed in the harbor at Genoa by a member of the crew of an American ship. It is useful for gunnery practice as well as real warfare.

Plaster of Paris Shows Air Flow in Wind-Tunnel Tests

Air currents flowing over the surfaces of model airplanes undergoing tests in a wind tunnel are made visible by powdered plaster of paris circulated by a large four-blade fan. Developed at the Junior Recreation Museum in San Francisco, the wind tunnel has glass observation windows fitted in its plywood structure.



Wind tunnel made of plywood has windows for watching performance of model aircraft. The fan blows powdered plaster of paris over the model

Balloon-Tired Roller Skis Offer Summer Training for the Winter Sport



Ski enthusiasts are taking to wheels in summer to keep up training for the winter sport

Balloon-tired skis have been developed to give a skier practice in summer and autumn so he will be in good physical condition for the sport when snow comes. The wheels, ten inches in diameter, are mounted on stiff footboards sixteen inches long. Techniques required in stopping and turning are similar to those used in the snow with regular skis.

Send stamped, addressed envelope to our Bureau of Information for name of maker of any device described in this magazine.

219844th. necessary

Hit Target or Get a Shower on Roller Coaster



The lancer below had a good eye for the target and escaped a ducking. The fellow at the left was not so lucky; his spear missed the hole, tripped the target and down came a hundred gallons of water. Still, it isn't hard to take on a hot day at a carnival!

There are gallons of fun for the spectators on the barrel-sticking roller coaster ride, whether the passengers like it or not. This carnival amusement consists of an abbreviated roller coaster on which two players ride down the track and try to thrust a lance through the hole in an overhead target as they hit the bottom of the slope. If they hit the hole, all's well. But if the spear strikes the target instead, it trips a barrel and down comes a hundred-gallon cold shower.

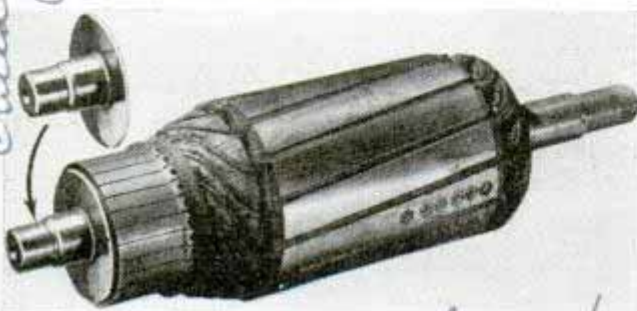


K785

Snapping Disk Stops Generator to Prevent Overheating

Damage to the armature of an automobile generator, due to excess heating, is

prevented by a dish-shaped bimetallic disk that interrupts the charging process a few degrees below the danger point. Mounted on the generator shaft, the patented disk remains inoperative in its original position, but as soon as it reaches a predetermined temperature it snaps into reverse shape so it contacts the segments of the commutator, which causes the charging to stop. When the disk has cooled about fifteen degrees it snaps back again.



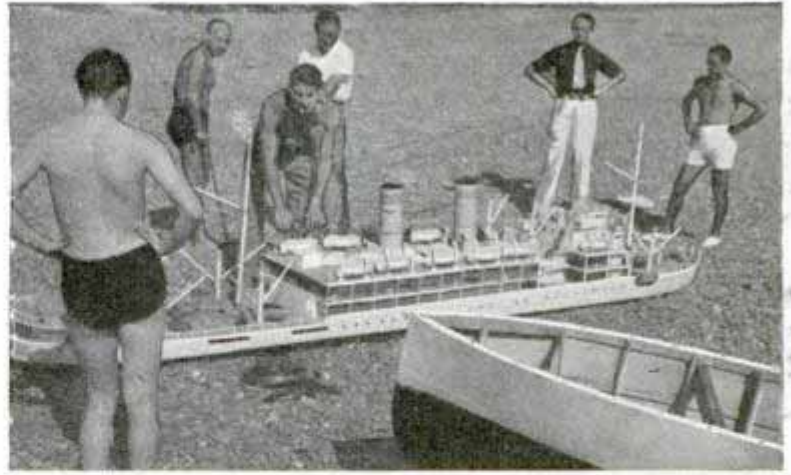
Assigned to Edw. O'Neil, Chicago

H. Beauchamp, Ave.

(22 8.42 no. New York)

Model Ocean Liner "Torpedoed" for Movies

When a cruiser or an ocean liner is torpedoed at sea, it's rare to find a movie camera posted to film the disaster; so the movies do their own torpedoing. A European government sponsored a war film for which a huge model of an ocean liner was built just to be blown up. It was constructed in two parts; first the lower hull, in which explosive was planted for the fake torpedoing, then the superstructure, done in great detail. The hull was set afloat from a seashore, the upper section was added, then as cameras ground the ship was blown up with extreme realism.



From top to bottom: the superstructure assembled on beach; the hull launched off shore; the completed liner, and the explosion simulating a torpedo attack for a war movie

#806

Synthetic Coveralls Worn as Protection for Worker

Workmen in industries using skin-irritating chemicals may soon be protected by clothing, hoods and gloves of new synthetic materials worn over their regular garments, if designs produced by United States Public Health Service scientists are put into use. Similar to transparent capes worn by women on rainy days, the proposed costumes will minimize the danger of occupational skin irritants suffered by workers employed in many kinds of manufacturing, and also protect their clothing. Of the fabrics and films tested, Pliofilm, Vinylite and Koroseal have been found most suitable for the purpose. Such garments would be light in weight and comfortable to wear.

See us Service 7/10/40
#8032

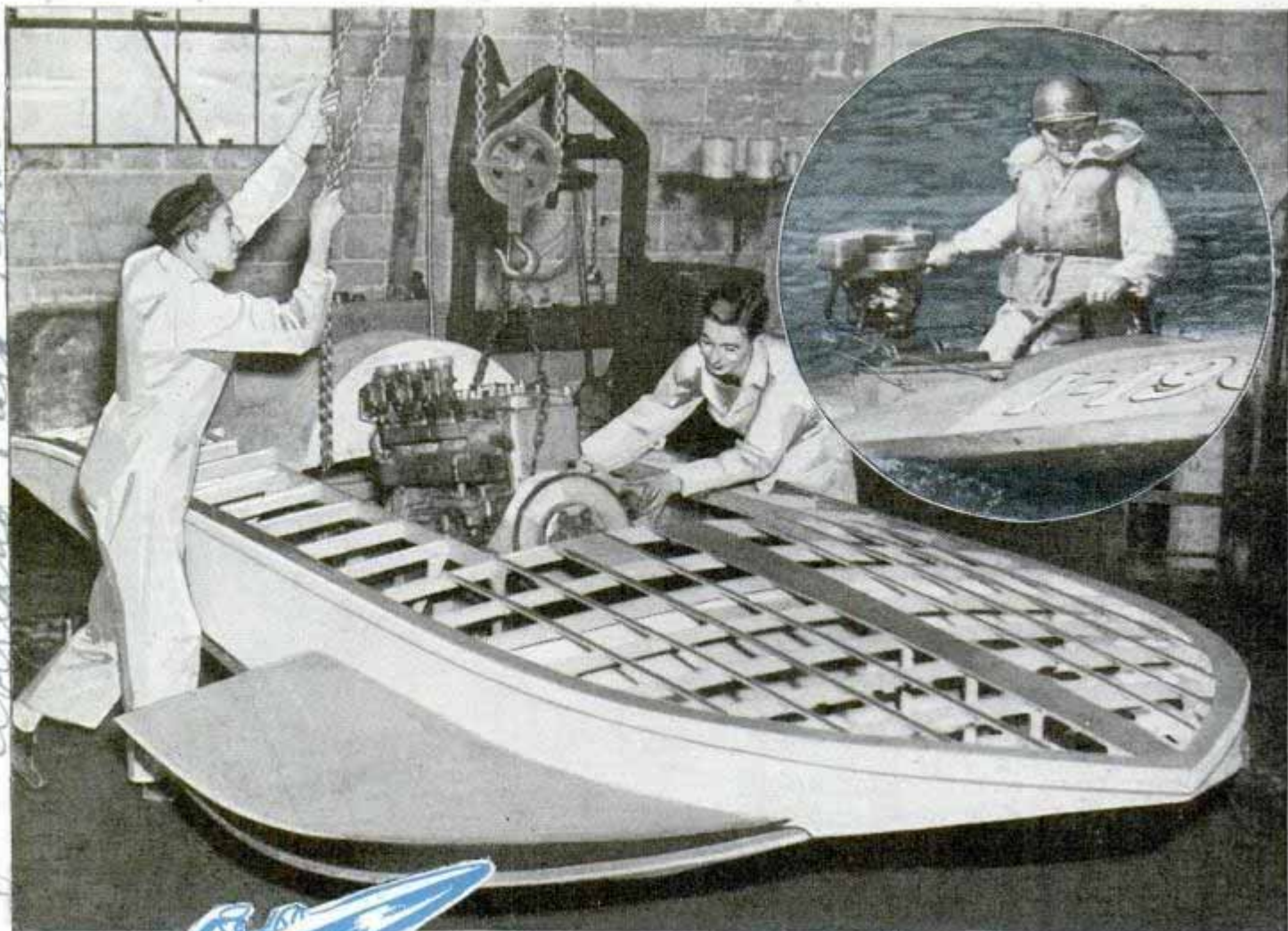
Lightweight Plane Armor Made of Rubber and Steel

Development of an armor plate of rubber and steel for airplanes was announced recently after completion of tests indicating it was equal in bullet resistance to a standard armor plate weighing twenty per cent more. The new plate makes use of a secret rubber compound.

Research conducted by Dr. Louis Schwarz, U.S. Public Health Service

States Rubber Co

Cont.: James Mc Queeny, 4600 W. 83rd Ave, Overland Park, Mo



RIDING *the*



Top, lowering \$700 motor into 225-class hydroplane hull. Circle, Jack Cooper, a 225-class record holder, in outboard. Bottom, bouncing along at fifty-eight miles an hour with only seven inches of hull touching the water.

By Thom Cooper
Outboard Racing Driver

THERE goes the five-minute gun, so slip on your life jacket and crash helmet—you're going to make your bow as an outboard racing driver.

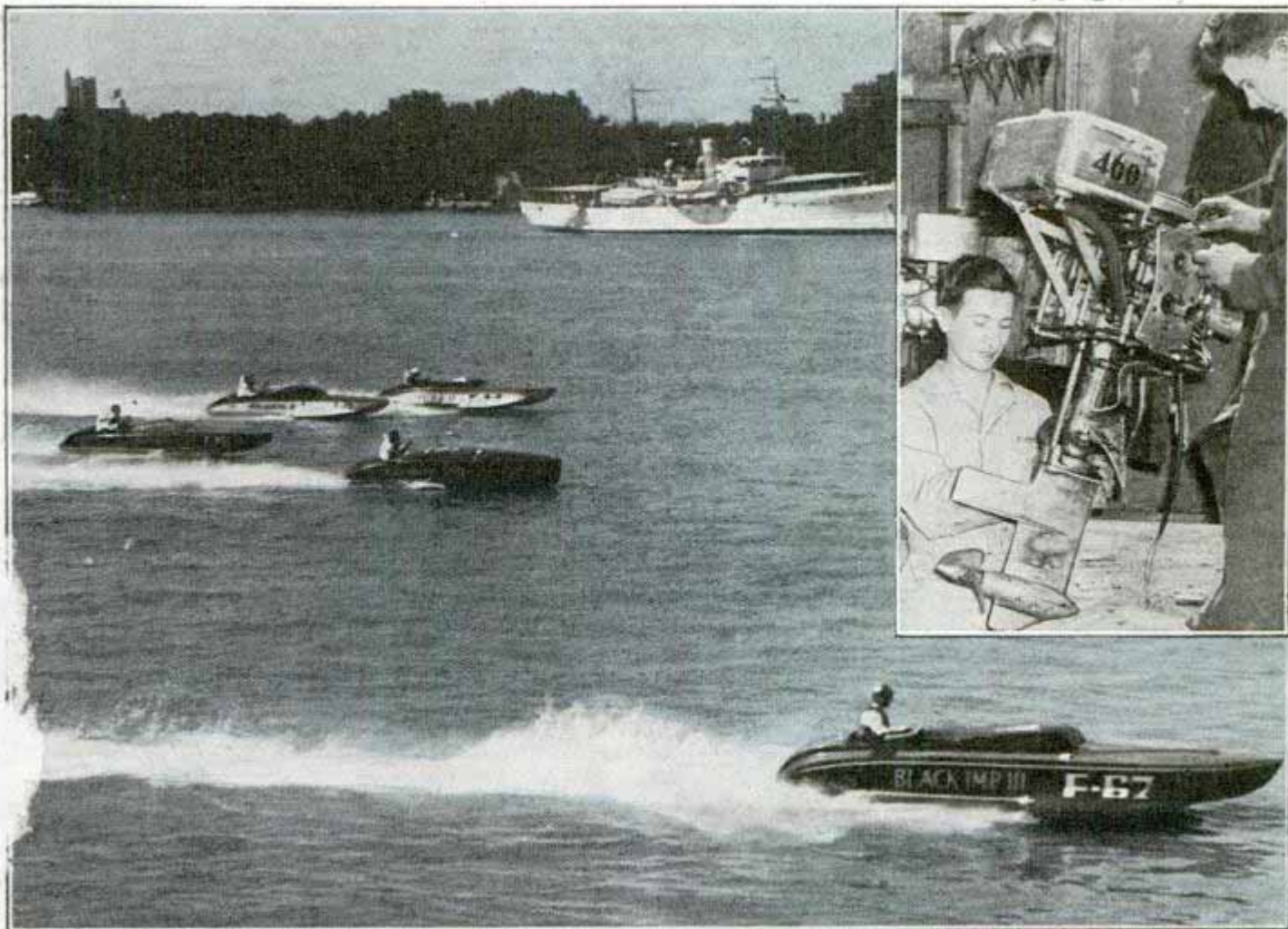
Got your motor hooked up? Give those clamps fastening it to the hull an extra twist so the power plant will be good and tight. Spark plugs okay? This is Florida, remember, you'd better coat them with

castor oil to prevent the salt spray from causing short circuits.

Now pour in the fuel, give your motor a twirl and as soon as you get the boat on a plane, reset the spark and needle valve for greatest speed. Take your time in jockeying into position for the running start.

Bang!

That's the one-minute gun, the time



WATER BRONCS

clock's starting and the white flag's going up. Pick your course but be sure you approach the starting line at the right angle or you'll be disqualified. And above all, don't jump the gun unless you want to be ruled out.

Now, go ahead—gun it!
Bang!

A beautiful start—with the throttle wide open you crossed the starting line on the nose, just as the clock hand was straight up and the flag fell. But another driver's timing was equally perfect, which means you're going to have a battle. Try and capture the inside position before he does—a four or five-yard advantage will be gained by the time the first buoy is rounded if you do.

You're bouncing along

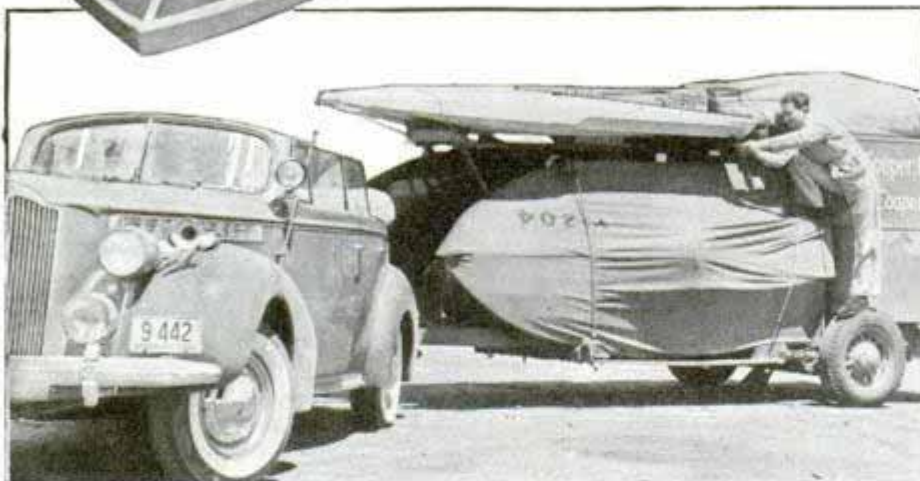
at fifty-eight miles an hour with not more than twenty inches of the seven-foot hull touching the water. Something catches in the back of your throat. A super-exhilaration grips you. The vibration is terrific and the bottom of the boat spansks you as you bob along. That wide leather belt you



Top, field of 225-hydroplanes, the popular inboard class, burning up the course. Inset, the author adjusting Class F motor in his traveling "garage." Bottom, Frank Vincent off to a good start in Class C race



Above, Jack Cooper and Tommy Chatfield battling in regatta. Left, construction of hull calls for specialized skill of racing-boat builder. Below, virtually all leading race drivers have trailers with room for several hulls and a compartment for tools, motors and parts



are wearing helps counteract the vibration.

You take a quick look over the field—and just in time to catch a glimpse of a spectacular bit of hell diving. A boat, apparently taking the first turn too sharply, skids over on her side. The driver is thrown clear, though, but hits the water

with a jolt he'll remember despite his helmet and life preserver.

Profiting from his mistake, you slow down for the next buoy, just enough to snake around it handily. Your chief rival noses up close and the rule book says you've got to give him room. Okay, give him all he wants—just so he stays on the outside. Hang on to the inside position and don't let him bluff you.

The going gets tougher as the race wears on, particularly after you've succeeded in

lapping the field. A number of the boats will be bunched together and as you head for an open spot it closes, leaving no alternative but to duck through the rooster tails and sprays to an outside lane. However, at the turn, you make up for lost ground by turning sharply in the comparatively smooth water and cutting diagonally across the course to the inside.

And so into the home stretch you and your rival thunder. The crowd tenses for a photo finish. Your competitor starts to forge ahead of you but you manage to squeeze an extra ounce or two of speed from your motor that enables you to slip across the finish line the winner.

That's only the first heat, there's another, and possibly a third, still to be run. Before the second leg of the competition starts, the gas tank must be refilled, the spark plugs changed, and minor repairs made on the motor. If your propeller was damaged by driftwood you will want to replace it—or maybe a smaller one, you feel, would give you greater speed, and the substitution is made before the race is called.

Outboards differ in size and power and the average big-time driver does not confine himself to one division but tackles as many of the seven recognized classes as his constitution and bank balance can accommodate. When he has tucked his Class F motor and hull into his trailer he girds himself for a romp with the A's or B's, or the Class X, a new field of competition in which there are no restrictions as to motor size.

Regattas spot the calendar from mid-May to September and there are a dozen or so worth-while ones on the winter circuits. Between times, a driver can occupy himself with the suicidal Albany-to-New York on the Hudson, the Canadian meets, and trying for speed marks.

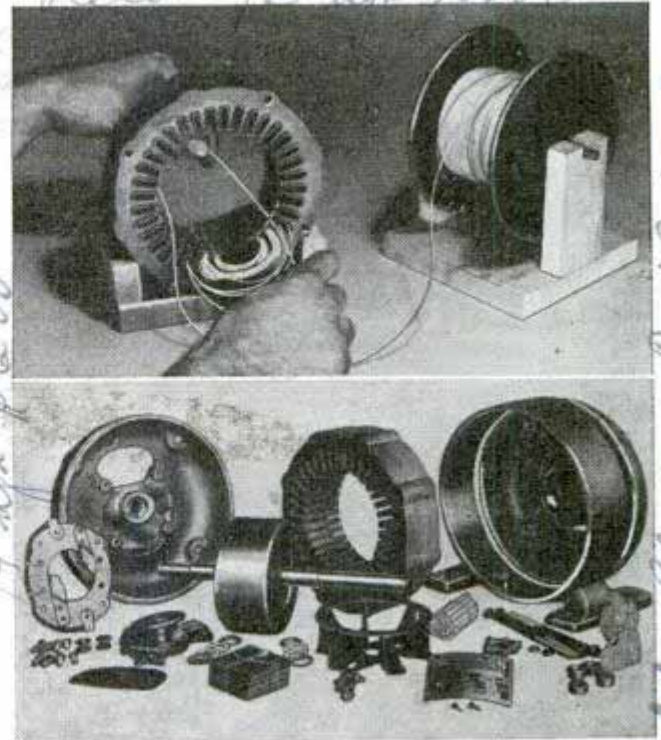
In going after a record, the water's got to be right. A still surface is not conducive to speed because there's skin friction between the water and the bottom of the boat, which has a tendency to slow it up just as rough water does. A gently rippling surface is best. That's the way the water was during one heat of a race at Lakeland, Florida, a few months back, and I had little difficulty in establishing a new competitive record of 45.135 miles per hour for five-mile distance in Class A.

With each passing season the pace grows swifter and just where the record breaking will stop under present boat and motor designs is hard to guess. In Class F, speeds up to eighty miles an hour under non-competitive conditions are likely and when drivers in the unlimited section acquaint themselves with the whims of their giant motors they're apt to be hovering around the 100-mile-an-hour mark.

The outboard's power is applied directly from the piston to the propeller, making the loss in efficiency very small. A propeller whirls at from 6,000 to 7,000 revolutions per minute and inasmuch as it's always immersed these revolutions per min-

(Continued to page 141A)

Electric Motor in Kit Form Assembled by Buyer



Winding specifications and diagrams are included with parts above for building electric motor at home

Kits for assembling various types of small electric motors in the home workshop or for classroom instruction are now available. All the necessary parts for building a useful one-fourth or one-third horsepower motor are supplied except the wire, and this can be obtained, too, at an additional cost.

Automatic Pencil That Multiplies Will Help with Home Work

Multiplication problems are simple with a new pencil. It has a movable band, which is turned until the two numbers to be multiplied are matched. Then the product is read through a hole in the band.



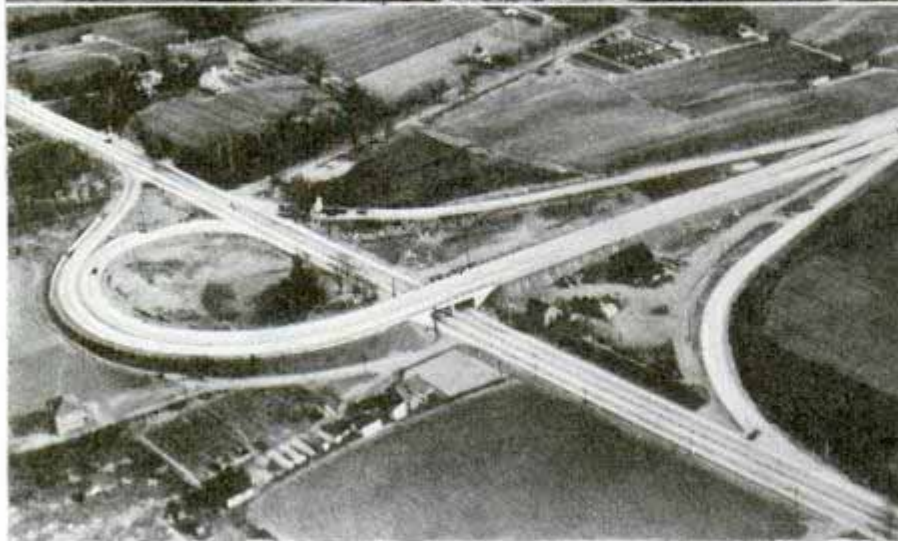
Movable band on pencil is a multiplication table

Apex Products Corp. 491
142 W. 24th St. Chicago

Rec'd. 10/15/40
142 W. 24th St. Chicago
Raynolds Electric Co. 2.650 W.
Congress. Chicago

'Reverse Blast' Anchors New Road in Swamp

Cont. Herb Foster, Daily News Bldg. Reynolds City



New methods of road construction proved both quick and effective where swamp or "muskeg" was encountered in completing certain stretches of Canada's ultra-modern four-lane express highway, the Queen Elizabeth Way. By old methods, months would have been required before the road settled sufficiently to be surfaced, but engineering ingenuity reduced the time to minutes. A layer of fill, equal in depth to the depth of the muskeg, was placed on top of the swampy ground. Engineers then placed charges of dynamite, which exploded in such a manner as to blow the muskeg out from under the road and allow the fill to settle down to solid ground, where it remains in place held by pressure of the muskeg from either side. They described the method as a reverse blast. Completed, this section of the highway provides a ninety-one-mile stretch with only twenty-three curves, none of which exceeds two degrees.

Vanishing Cream Protects Against Poison Ivy

Vanishing cream that gives protection against poison ivy, developed by scientists of the United States Public Health Service and the National Institute of Health, is made by mixing either sodium perborate or potassium periodate with the vanishing cream. To make the cream—and any

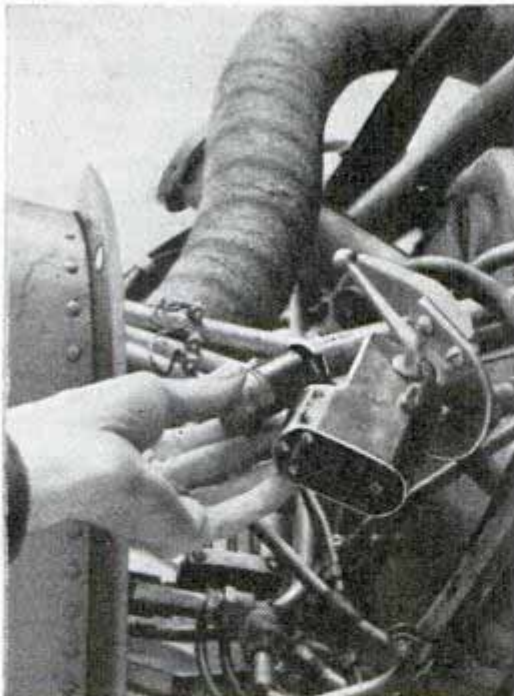
Top, exploding dynamite blows swamp muck from beneath fill; in center, placing dynamite. Below, air view of a semi-cloverleaf on the new Queen Elizabeth Way near Burlington, Ont., between Toronto and Fort Erie

K 789
 Queen's name 11610

druggist can do it—ten per cent sodium perborate is used, or two per cent potassium periodate. Either substance should be ground into powder, because in crystal form it will not mix well with the cream. The vanishing cream is prepared first and then the chemical added, else the result will be unsatisfactory. To avoid deterioration, a fresh batch should be made at least once in two weeks. Tests show that the cream protects against the leaves and stems of the plant, and also against the poison ivy extract which is many times as powerful as any poison ivy leaf. It is rubbed over the face, hands, arms and other parts of the body likely to come in contact with the plant.

K 586
Cartridge Starter for Plane Is Fixed on Engine Mount

Set up right on the engine mount, a cartridge starter for airplane motors gives sure results in "turning over" the engine. Formerly the cartridge arrangement



Inserting cartridge in the starter, which is installed right on the engine mount

was installed in the cabin of the plane, and engineers say that occasional misfires in that location are obviated by putting the starter unit on the engine mount itself.

Phonograph with a Dual Pickup Plays Two Types of Records

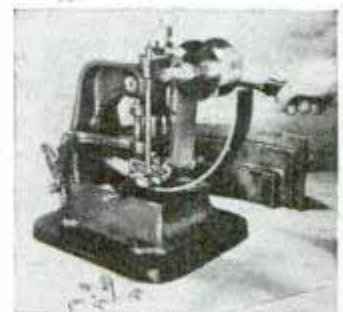


Notice the viscous disk on the stylus mount. This eliminates any high-frequency resonance due to material of the record

Both vertical and lateral "cut" records can be played with a new phonograph provided with a universal pickup. A flip of the switch converts the reproducer for either type of cut without lifting the stylus from the grooves of the record. On the stylus support is mounted a circular vane of viscous material which damps out high-frequency resonance caused by elastic properties of the record material.

K 784
Adjustable Tool Marks Products Electrically and in Color

Many colors, including gold, silver, blue, red and orange, are stamped quickly on various materials with a machine equipped with electric heat control. Designed originally to mark products up to three-fourths inch thick, the machine can now stamp four-inch articles by using a new adjustable feature. As many as twenty-five pieces can be stamped by hand per minute, depending upon the operator and the material, and excellent results are claimed in stamping fiber, wood, leather, celluloid, paper, plastics and compressed materials. The machine is furnished either with dies, interchangeable type or a numbering head.



*Western Electric Co. New York
 Broadway
 1935*

*Breeze Corps. Inc.
 3806 6th St.
 OCTOBER, 1940*

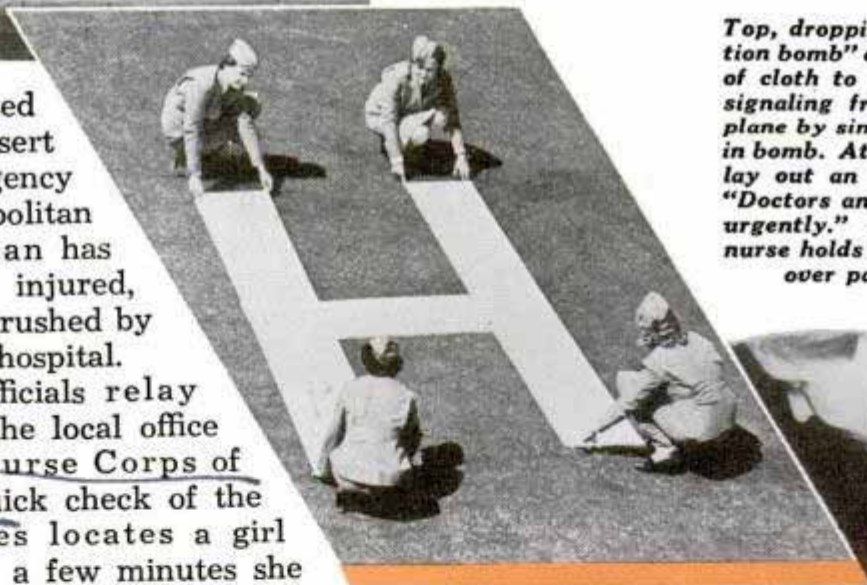
*H. O. Wates
 2510th Broadway, 2nd*

FLYING

many hours of flying ambulance experience to her credit and be able to deal with the situation quickly.

Each nurse carries a kit for emergency disaster relief and the care of patients during flight. Besides oxygen masks and tanks, the kits contain many pieces of special apparatus. One of these is an "information bomb." The purpose of this packet is to provide persons stranded in isolated districts with a means of signaling their needs to the plane overhead. The package contains strips of white cloth with which to form letters on the ground, giving information according to a code contained in the packet.

A letter "A" laid out on the ground means "First aid kits only needed." A letter "H" signifies "Doctors and nurses needed urgently," while "T" means "Water



Top, dropping an "information bomb" containing strips of cloth to form letters for signaling from ground to plane by simple code packed in bomb. At left, four nurses lay out an "H," meaning "Doctors and nurses needed urgently." Below, an aerial nurse holds an oxygen mask over patient's face



FROM an isolated town in the desert comes an emergency call to the metropolitan airport. A woman has been critically injured, and she must be rushed by plane to the city hospital.

The airport officials relay the message to the local office of the Aerial Nurse Corps of America. A quick check of the registered nurses locates a girl available, and in a few minutes she reports at the field with her special kit.

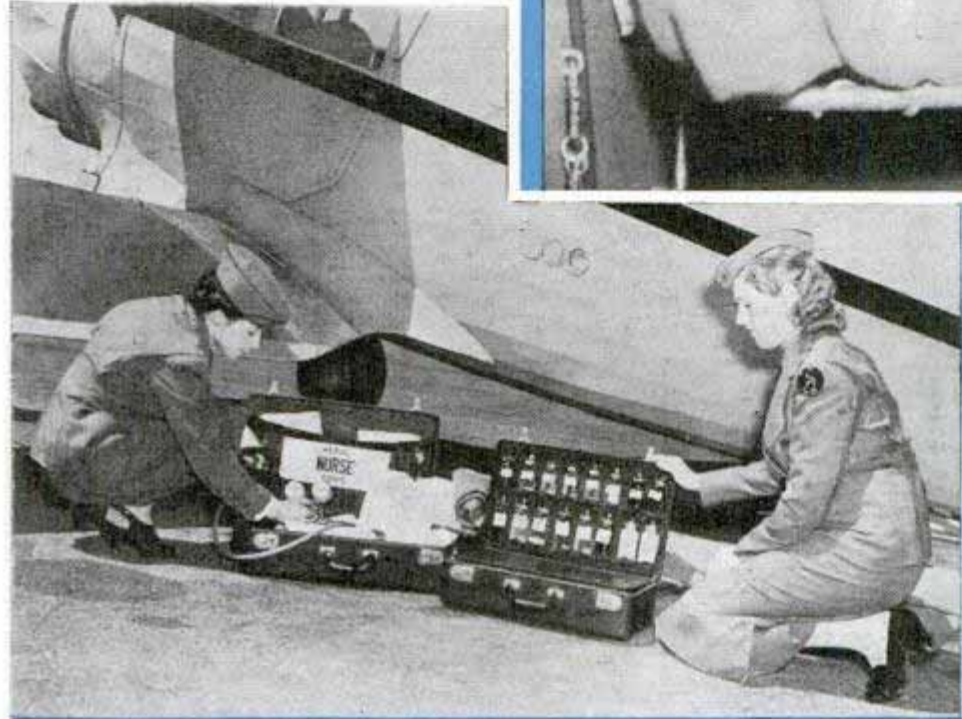
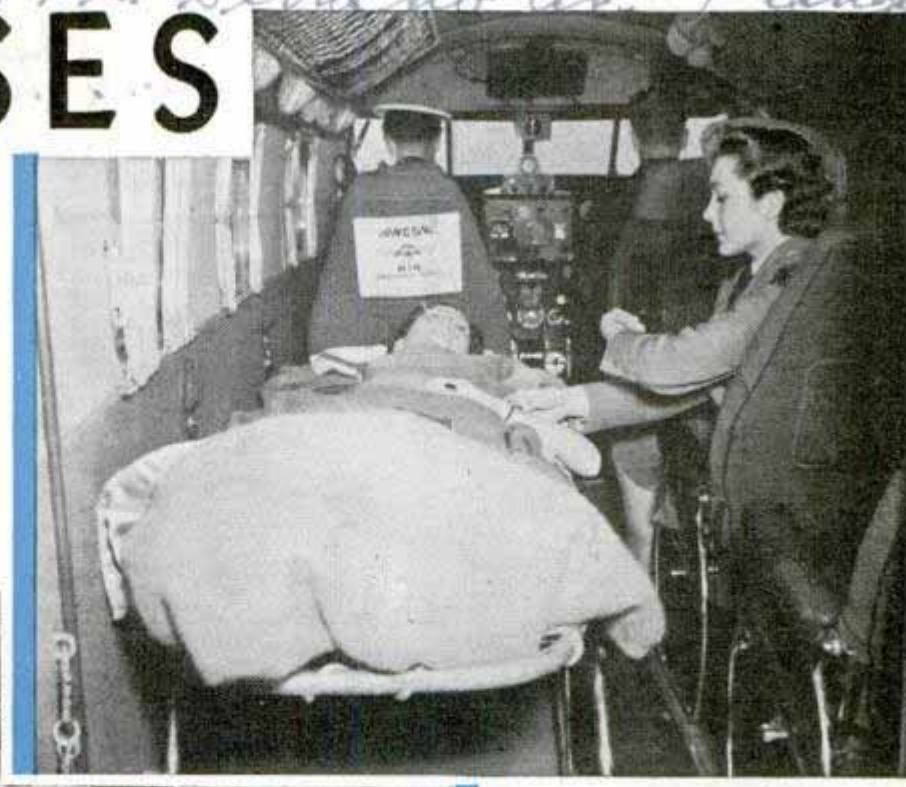
These nurses of the sky, specially trained for aerial emergency duties, have just formed a national organization to fill the need for attendants for flying ambulances and for disaster service.

Specially constructed air ambulances are few, so the Aerial Nurse must adapt the ship to the patient and sickness for which she must care. A heart case, for instance, usually requires that a patient sit up. Administration of oxygen may be necessary. If the patient must lie flat, the Aerial Nurse must make sure there is room for the stretcher. Can the seats be removed? Is the door narrow? The nurse must have

Miss Lauretta Schimmler, 2620 N. Hollywood Way, Burbank, Calif.

NURSES

At right, a cabin plane re-arranged for emergency ambulance service, with an aerial nurse attending patient. Below, nurses check contents of kits, which contain medical supplies for the care of a patient while flying, or for the injured in a disaster area. Bottom, aerial nurses learn the proper method of lifting stretcher through plane door with least discomfort to patient



needed." The code, although extremely simple, allows people on the ground to send messages of almost any type.

Another important item in the Aerial Nurse's kit is restraining straps, in case mental disease or sudden panic should cause the patient to attack nurse or pilot.

Many of the Aerial Nurses are licensed radio operators, able to take over communications, to give vital reports while a plane is in flight. Plans are now under way to organize a group of women pilots who will stand ready to fly planes of mercy and maintain a courier service in times of disaster.

Creation of the Aerial Nurse Corps was the idea of Laretta M. Schimmoler, who is herself a pilot, having studied airplane manufacturing at the Lockheed plant, worked for the weather bureau, flown her own plane for years, built and managed an airport.

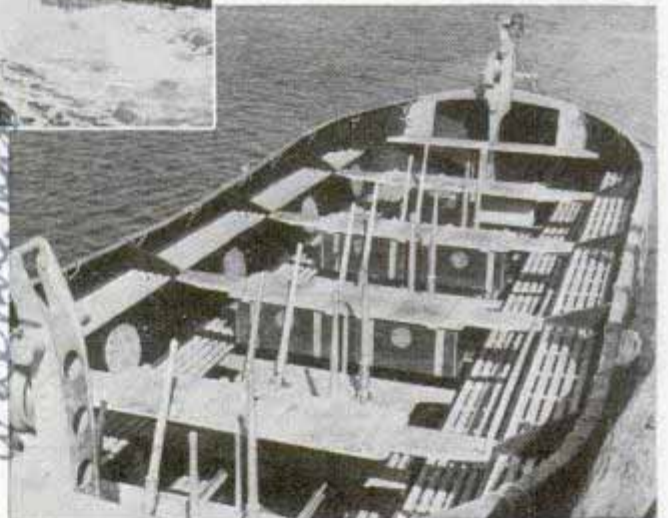
Push-Pull Levers Propel New Liner's Lifeboats

Fourteen of the lifeboats on the new U. S. liner "America" are propelled by manually operated push-pull levers instead of the conventional oars or motor.

Thus passengers unskilled at handling oars can help drive the boat; any number of crew or passengers from one to sixteen can handle the levers, and they need not work

in unison. A specially designed propeller of one-third the normal weight is required, and it is made of an aluminum alloy highly resistant to salt-water corrosion. The boat has a top speed of six miles an hour, sufficient to carry its passengers away from immediate danger. Afterward the boat can be towed by the power-driven lifeboats.

At left, one of the "America's" motorless propeller-driven lifeboats on a test run. Below, the hand levers that turn the screw



Shrinkless Fabric for Curtains Needs No Stretching

Curtains made of specially processed fabric that will not shrink more than a negligible amount will save housewives much of the usual curtain fuss and work. After they are cleaned the new-type curtains can be hung without stretching, starching, re-hemming or ironing.

You Dial an 'Information Disc' for Aircraft Engine Data

Accurate data on the timing and setting of airplane engines are available for the mechanic by simply dialing a disc, as he would a telephone. It covers 150 models of American-made engines. When the dial is turned so the base of the triangle rests at the space indicating the desired engine, various "windows" show at a glance the figures for spark timing, valve tappet adjustments for both operating and timing, correct setting for valve timing, as well as both intake and exhaust opening and closing for that particular engine.



Openings on dial show mechanical data on engines

Research Laboratory, Tokyo
 A Japanese inventor recently demonstrated a carburetor which permits the substitution of soybean oil for gasoline in ordinary gasoline engines.

The Federal. Ingot Corp. Marine Dept. 10,000 Shermans Road. K 6 87
 Aero Disc, 722 E. 24th. Minneapolis.

K 6 87
 K 6 87
 K 6 87

Aero Disc, 722 E. 24th. Minneapolis.

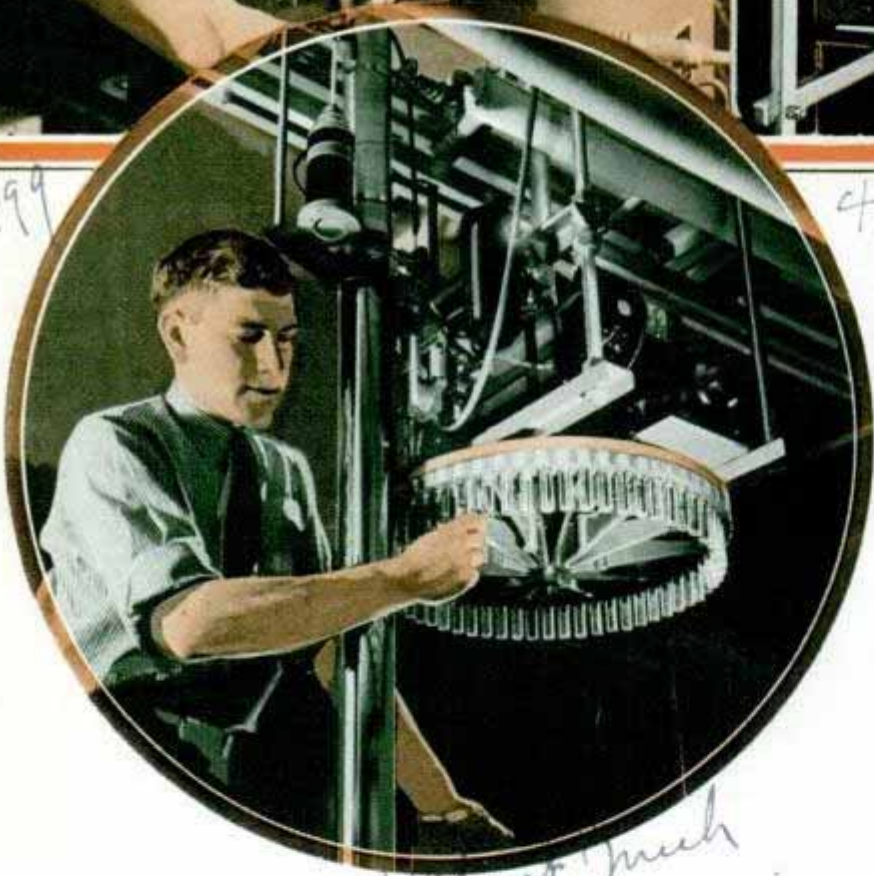
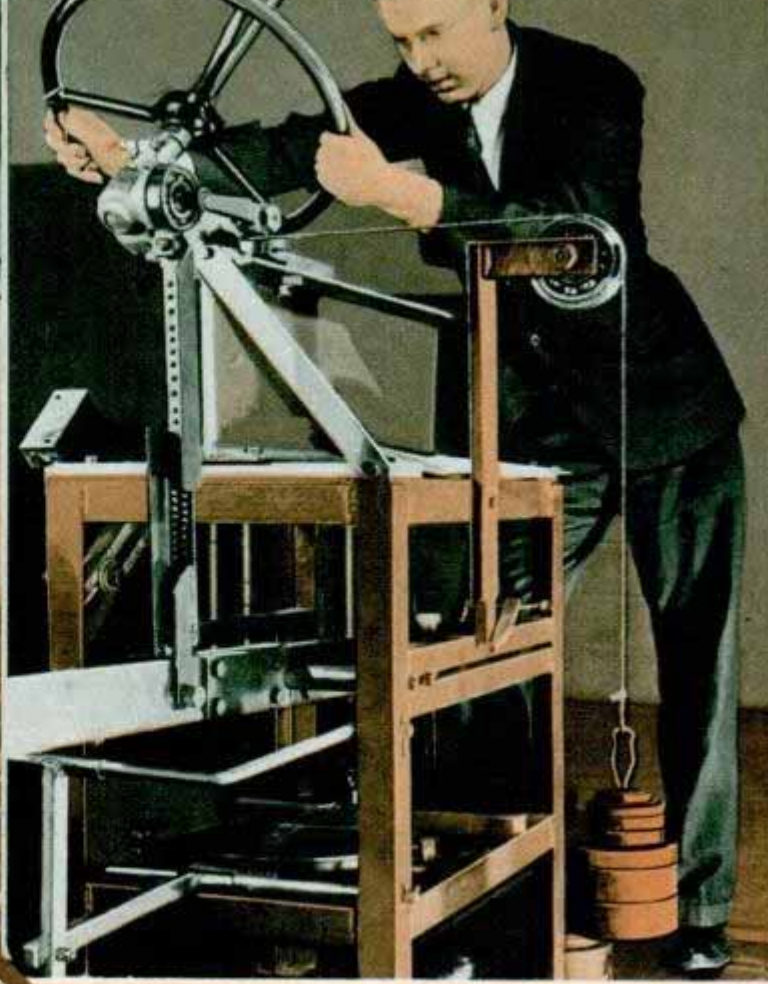
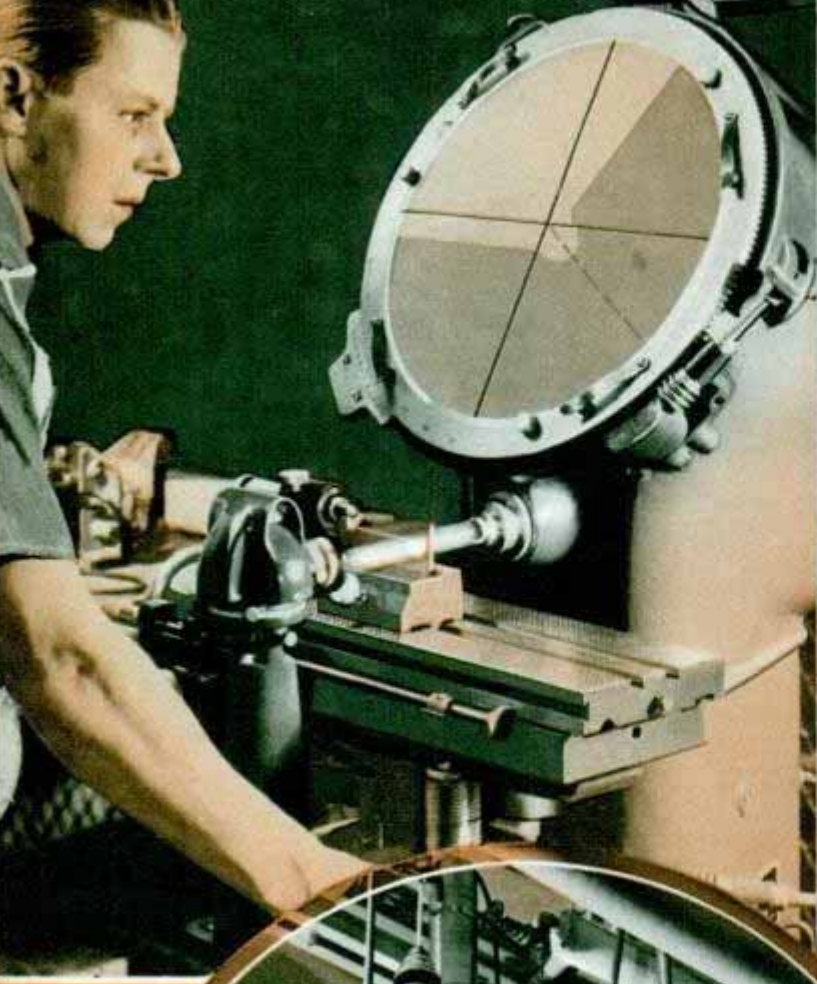
show. Invt. Abada

the AGE of OPPORTUNITY

R49
1. 2. 3. 4. 5. 6. 7. 8. 9. 10. 11. 12. 13. 14. 15. 16. 17. 18. 19. 20. 21. 22. 23. 24. 25. 26. 27. 28. 29. 30. 31. 32. 33. 34. 35. 36. 37. 38. 39. 40. 41. 42. 43. 44. 45. 46. 47. 48. 49. 50.



Accuracy of an electric clock depends upon frequency of the current, but period of this hammer, as it swings into coil at left, is affected only by length of the handle. Since the time-keeping ability of this hammer clock is independent of current frequency, the principle, with its possible applications in industry, has become a problem for research workers



K 499

498

Left, projecting enlarged image of small metal shape helps reveal accuracy of manufacturing. Right, device for testing steering gear in laboratory. Below, automatic analyzer employed for testing fuels in General Motors laboratories

By C. F. Kettering
 Vice President in Charge of Research
 General Motors Corporation

THIS world we live in today is not done—is, instead, only begun—and the builders of tomorrow's bright new world will have a host of advantages when they come to grips with the questions it will bring.

Young America is coming into a world that is only begun, a world that despite

the accumulated toil of centuries, still admits want, disease, hardship. When today's young men and their sons and grandsons of tomorrow have finished with it, we'll be a little nearer the kind of world we ought to have.

When they tell us in research that a thing can't be done, that's our cue to go ahead and do it. We don't

know how we're going to do it. We don't know what we'll need or what we'll use to do it. That isn't important. A research laboratory is not a building full of shining equipment—it's a state of mind. If you recognize a challenge when you see one, if you accept it and start to work to answer it, then you're engaged in research whether you like it or not.

We gave a young college graduate of our laboratories a little project pertain-

Detroit, Mich



K 499
 Ten great fields of research, Mr. Kettering says, hold the promise of new jobs and improvements in living. They are:

- Adequate housing.
- A modern highway system.
- Preventives and cures for man's ills.
- Communications, including television.
- Air conditioning.
- Fundamental information in the basic sciences of physics and chemistry.
- More knowledge of plant growth.
- Improved transportation systems.
- More efficient modern cities.
- Better knowledge of the properties of materials, both natural and synthetic.

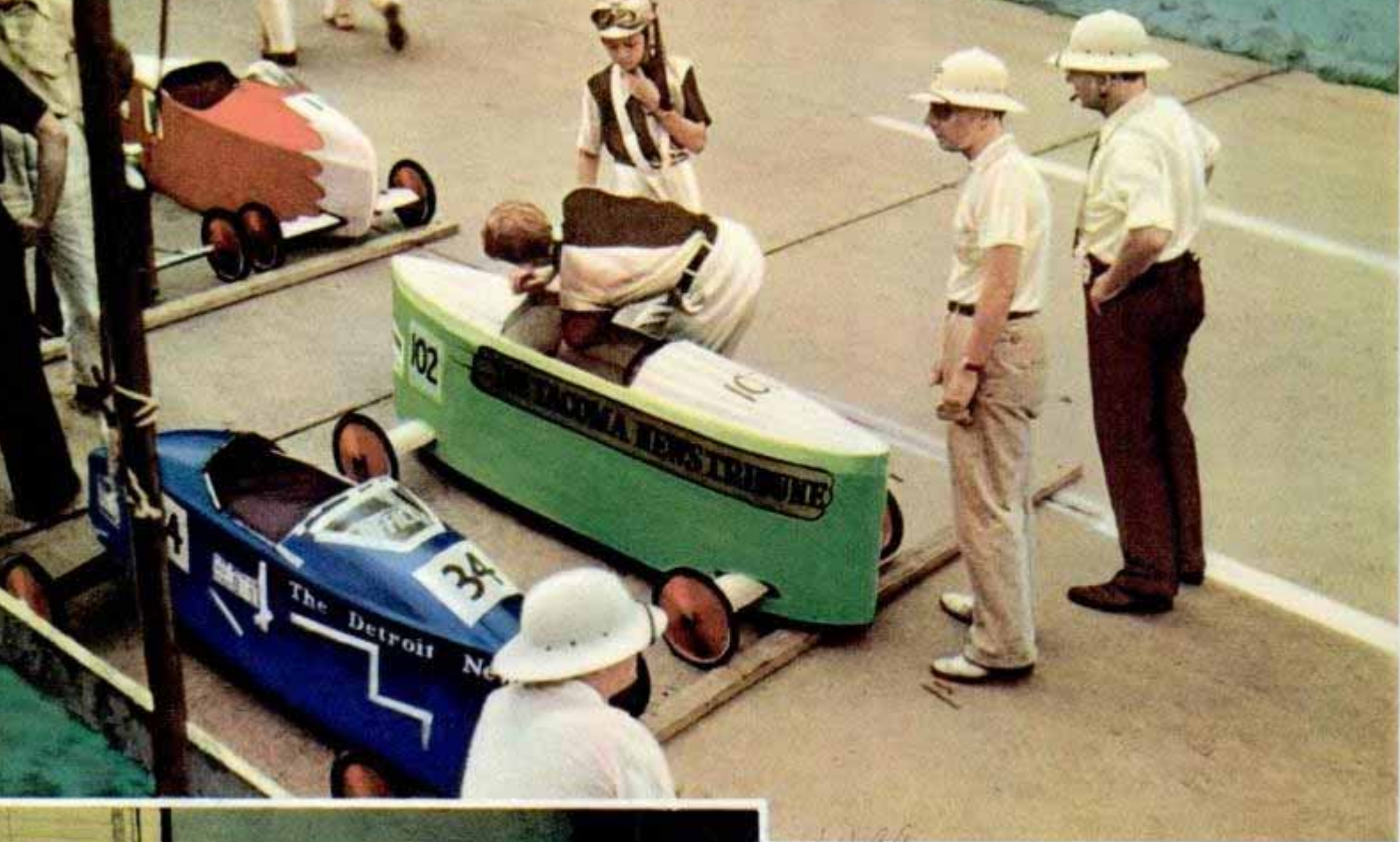
Carroll Hoff

499
 ing to lubrication and the fundamentals of friction. "Why," this young man complained, "must I spend my time rubbing two little blocks of metal together? Don't you think this job is a little below the dignity of a man with my education?" "I'm sorry," I told him, "I didn't know you had an education." "This wouldn't be so bad," he continued, "if it wasn't in all the books."

I never had seen anything like that in the books; so I offered him a substantial reward if he would find the information and bring it to me. When I saw him again two weeks later, he said, "Do you know, there is nothing in the books about this. In school they told me that everything was known about bearings

Optical system used to study air flow around a ball (top). A new device permits spraying of copper, bronze or even steel to build up surface of machine parts (bottom). Here the worker is using metallizing gun





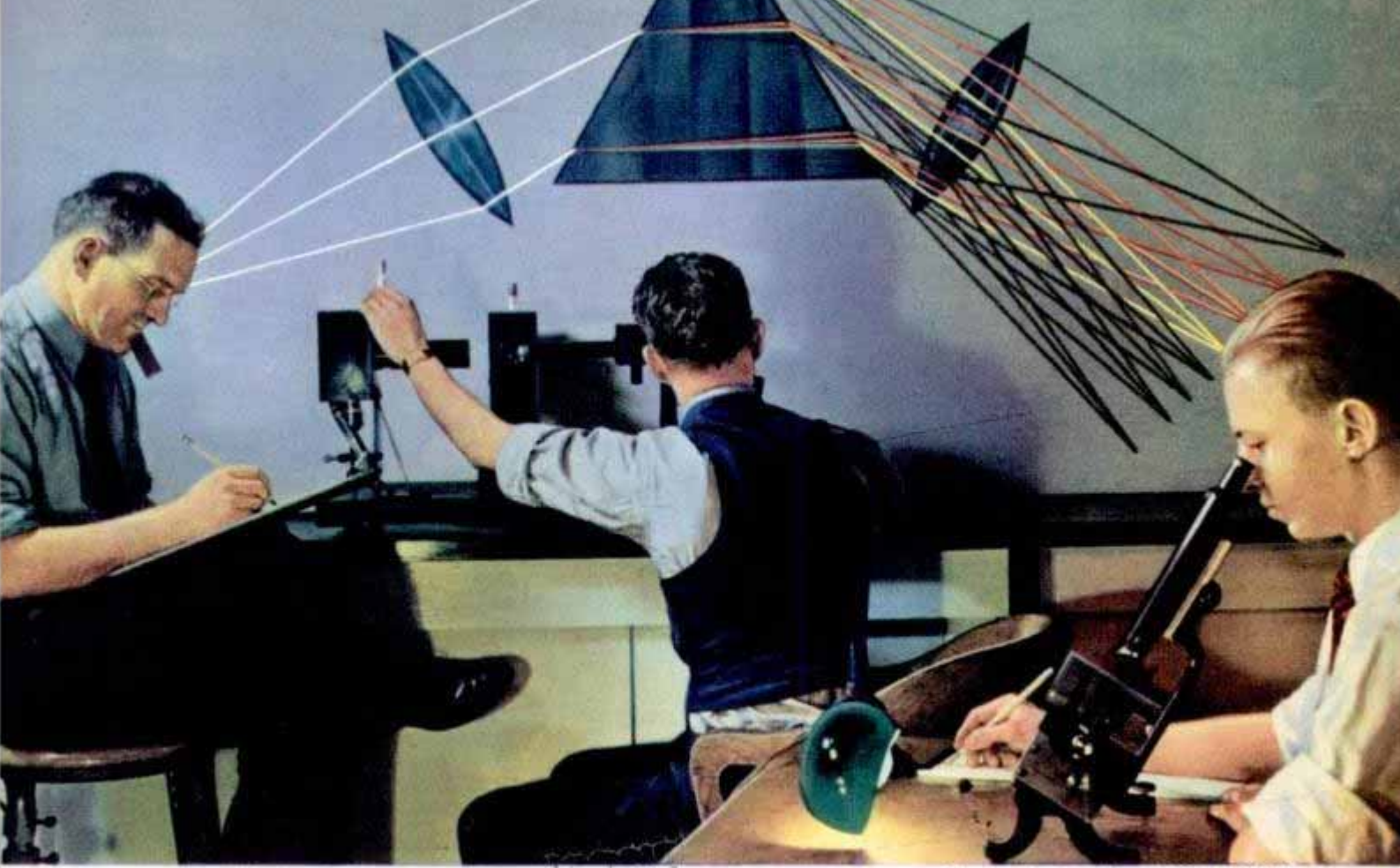
Top, full-color photograph of starting line activities in All-American Soap Box Derby at Akron, Ohio. Bottom, Mr. Kettering holding necktie made from milk. Blue cloth near it was made from glass. Fisherman's plug (foreground) is plastics product

and lubrication. This is a more important job than I thought it was."

A degree from the most highly regarded university won't guarantee that you'll invent tomorrow's greatest boon. That degree simply records the fact that you've learned the A, B, C of engineering, if that is what you happened to study. You've learned to read, but not to write, to compose. Nor will a finely equipped laboratory guarantee that you'll be able to "compose" a great invention. But give a man a purpose or a need, give him a pair of hands that have been trained to handle the instruments of a profession and a thinking mind to tackle the problem and direct the manual activity, and your "research" is under way.

For example, thousands of boys throughout the country take part in the Soap Box Derby, which Chevrolet, one of our divisions, co-sponsors with leading newspapers. Most of these youngsters are average boys, just like the kids on your block. Without something like the Derby to provide them with incentive—a purpose—

*Plastacele
Kettering Plastics Div.
Cleveland, Ohio*



Photos: Courtesy Chevrolet Motor Division

they'd probably spend the summer simply playing.

You see what I mean? When purpose is brought into their lives, when the directive influence of the Derby draws them out of themselves, they immediately become young research engineers, building, creating, developing.

These young fellows are well started. Sure, they need a push, a stimulus, because it's a softer world they live in today. And the Derby is doing a great service because it gives them something to "crystallize" around. Its directive interest brings out their mental alertness and requires finger technique. These boys can't sit around a carpenter shop and "absorb" their Derby car. They can't dream up a racer. They have to sit down and plan it out, then build it. You must think from the inside out; not from the outside in.

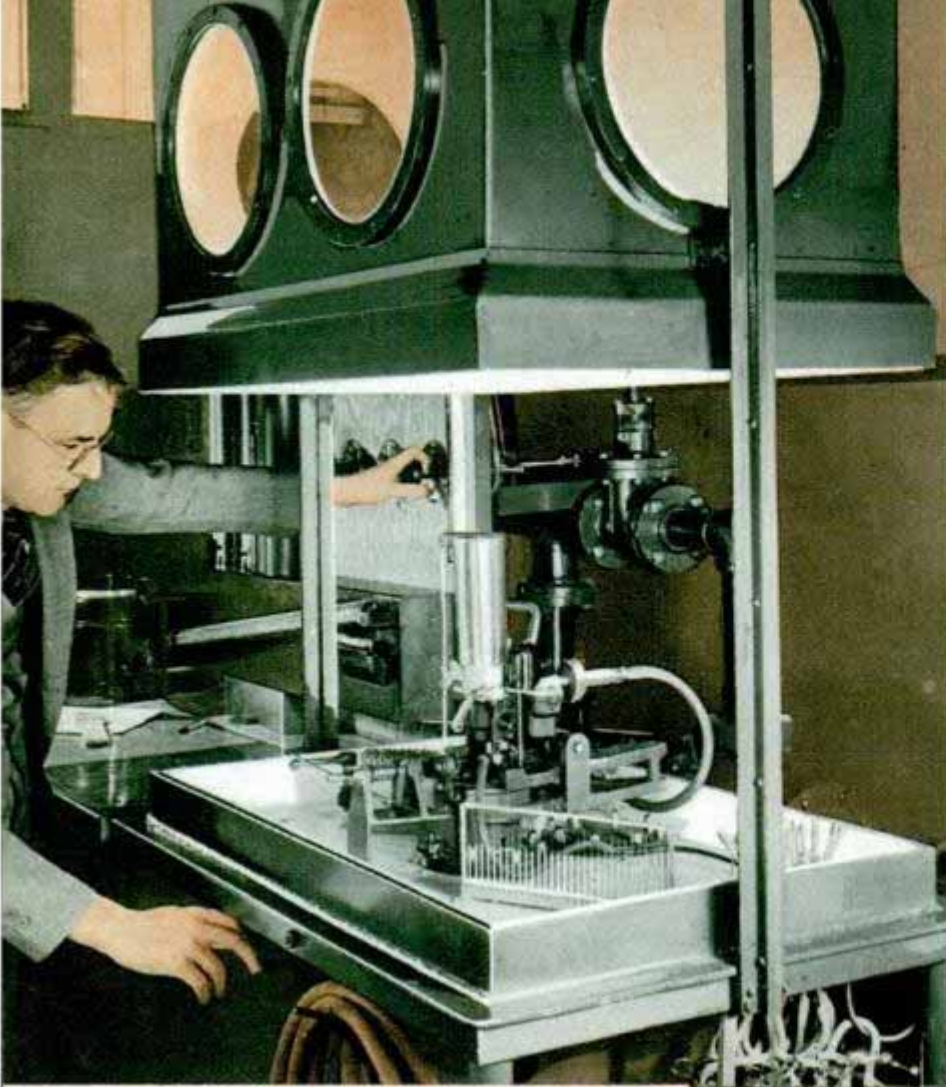
Progress doesn't come in leaps, these boys discover. It's a slow, weary, laborious process. It's the same with research. People come to me and

Above, full-color view of chart showing how light from heated mixture is sent through prism and broken into a "rainbow," revealing chemical elements present. Below, two "engineers of the future" working on plans for racing car to be entered in the Soap Box Derby

X499

501





The young people of today stand on the threshold of a world with opportunities multiplied a thousandfold over the opportunities that existed only two or three decades ago. What they don't realize, apparently, is that the threshold today is immeasurably higher than it was then. Because progress has continued, our general level of information is higher today than ten years ago—than yesterday, for that matter. So each young man who completes his school work and starts looking for a job has a better chance than his dad did. It's elementary. The young fellow knows more than his dad did—the world is doing more in scores of entirely new fields. Naturally, he'll find his place in the picture quicker.

The issue of lack of opportunity is timeless, each generation contending that it has emerged into a world where nothing re-

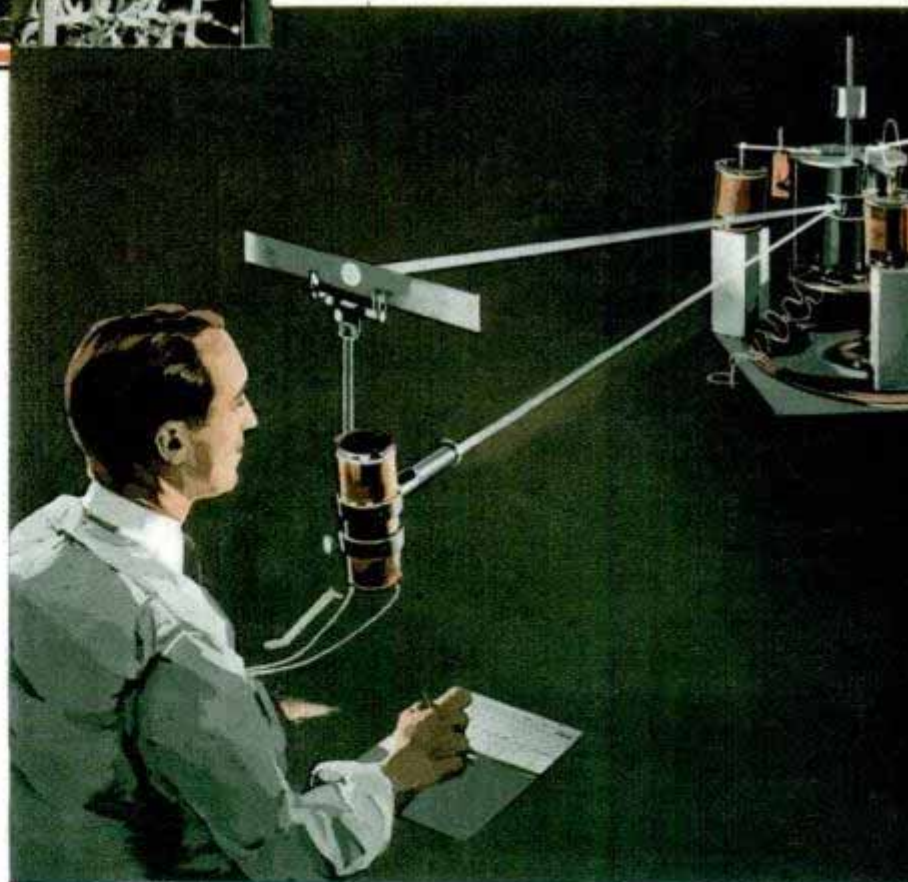
502

say, "Mr. Kettering, research must be the most thrilling sort of work in the world. It's so dramatic!"

"Yes," I answer. "Research is about as thrilling and dramatic as a fly stuck on a piece of fly-paper in a farmer's kitchen. You've watched a fly struggle to get loose. The minute he gets one foot free, another is stuck. Well, that's the way we are. We find each problem so tangled up with a score more that we simply have to plug away at all angles of a thing until eventually we lick it."

The reason people are prone to regard progress as over and done, is because man loves a show. He wants a celebration, excitement, thrills. Research just isn't done that way.

Why, every day spells progress. But since we don't keep a brass band in the laboratory to strike up a fanfare at the close of each day's work, people think we aren't getting along.



Top, testing carburetor in Chevrolet laboratory. The hood, level with operator's head, is lowered to seal in the carburetor, and air is exhausted from chamber before testing. Below, passing light from a material through prism to produce spectrum that reveals elements present and measures amount of each element

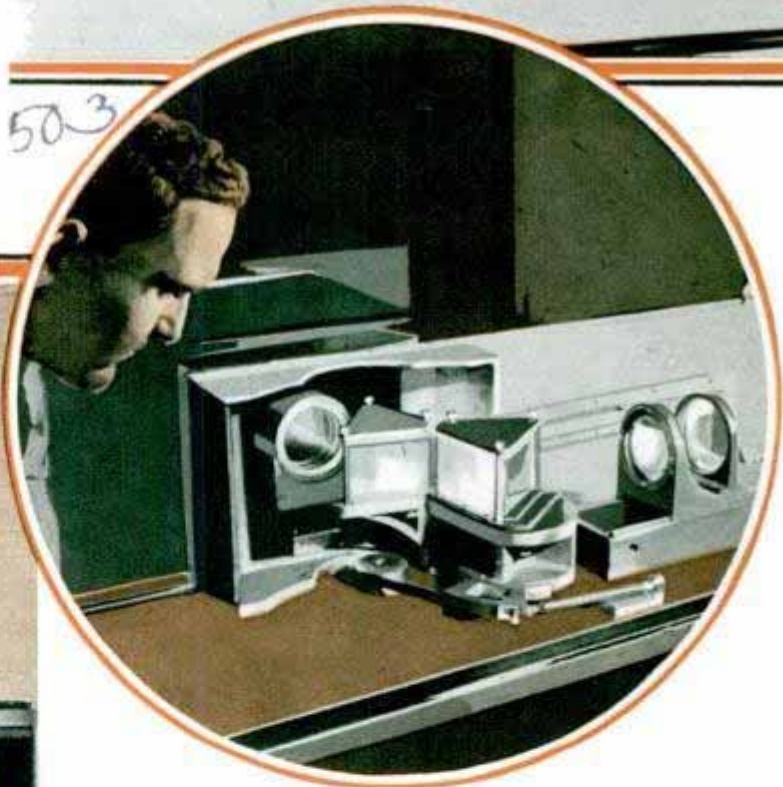
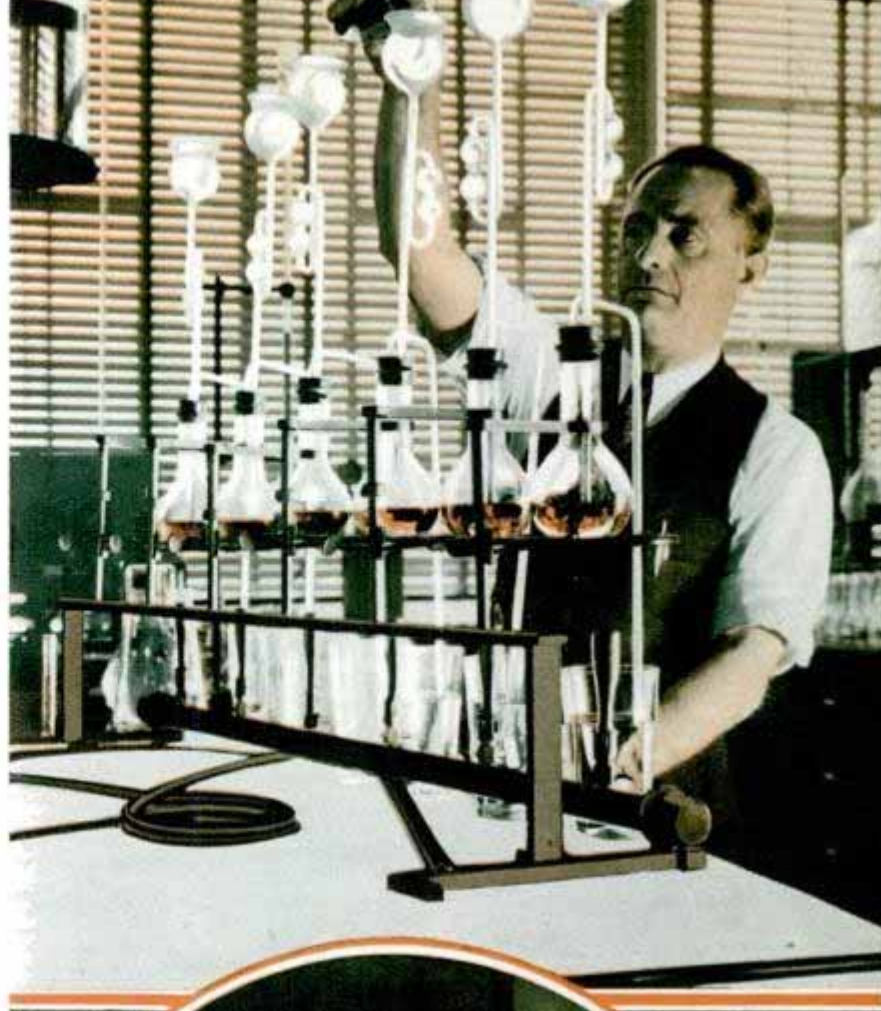
mains to be done. Several generations before I devised the self-starter for the motor car, a Patent Office official resigned, giving as his reason the fact that there was no room for further invention, consequently there would be no need for patents.

Not so long ago I was awarded an honorary degree by one of our old eastern colleges. I went east for the commencement exercises. The alumni met in ten, twenty-five, and fifty-year groups, and I happened to be thrown with the twenty-five-year group when this thing happened:

A well-dressed, successful-looking man stood up to address the twenty-five-year alumni. In his hand he held a letter, yellowed with the years. "I wrote this letter to my father on graduation day," he said, "and in it I bewailed my lot for having graduated into a world that held forth so little opportu-

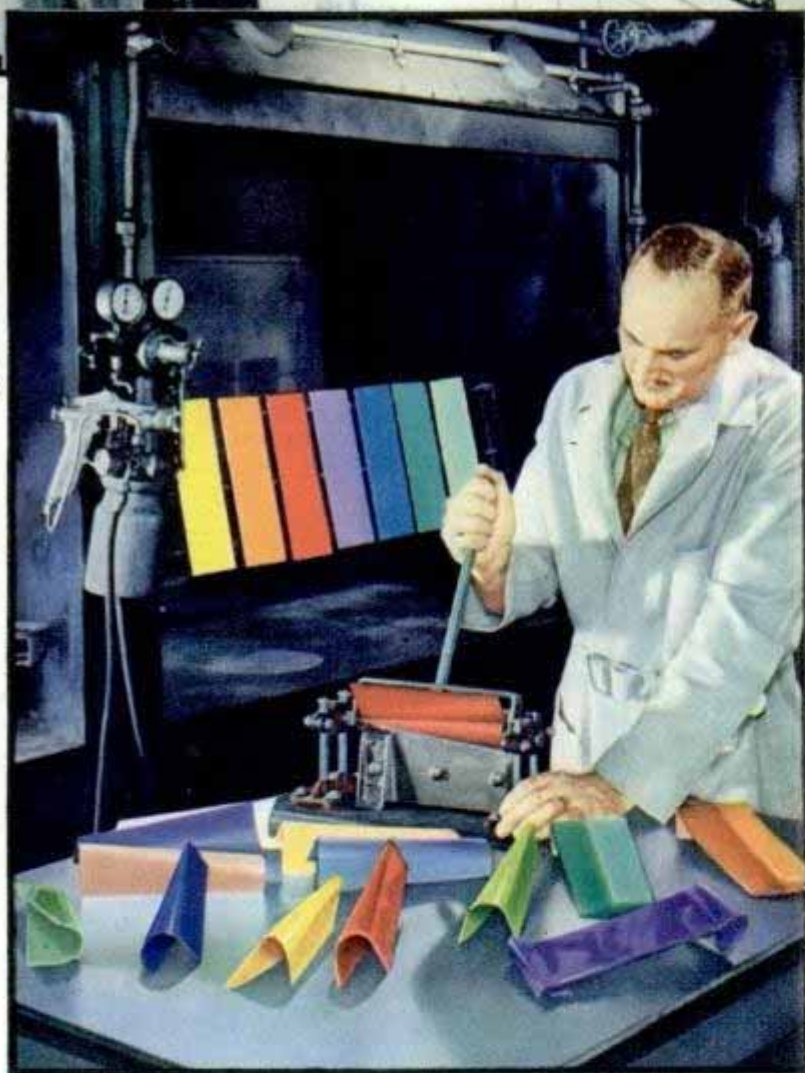
Top, working in electroplating laboratory. Circle, optical system of spectrograph which aids research men in analyzing metals, fuels, oils and other mixtures. Below, carburetor in sealed tank is subjected to speed range test with fuel and air measured accurately.

Karl Nelson



nity." When the speaker finished, the president of the college arose. He had a thick book in his hand. To the speaker he said, "In this book we have collected letters from our students over a period of 150 years. Each letter, in each succeeding year, laments the passing of opportunity, the dire plight of the student who was thrown out into such a drear world. I should like to add your letter to our collection."

So there you are. This doubt and uncertainty is ageless. And today, more than



Top, typical laboratory scene in which research man is inspecting a fluid in large tube. Below, paint and enamel test panels being subjected to bending action of a special tool. It is important that paints and enamels have no tendency to separate from sheets of metal

R 499
 ever, it is entirely groundless.

To me the great value of the Soap Box Derby is that every boy, by virtue of his having conceived and built his own race car, has selected a purpose and worked until he attained it—each boy, I say, has entered the world of competition he will live in from then on.

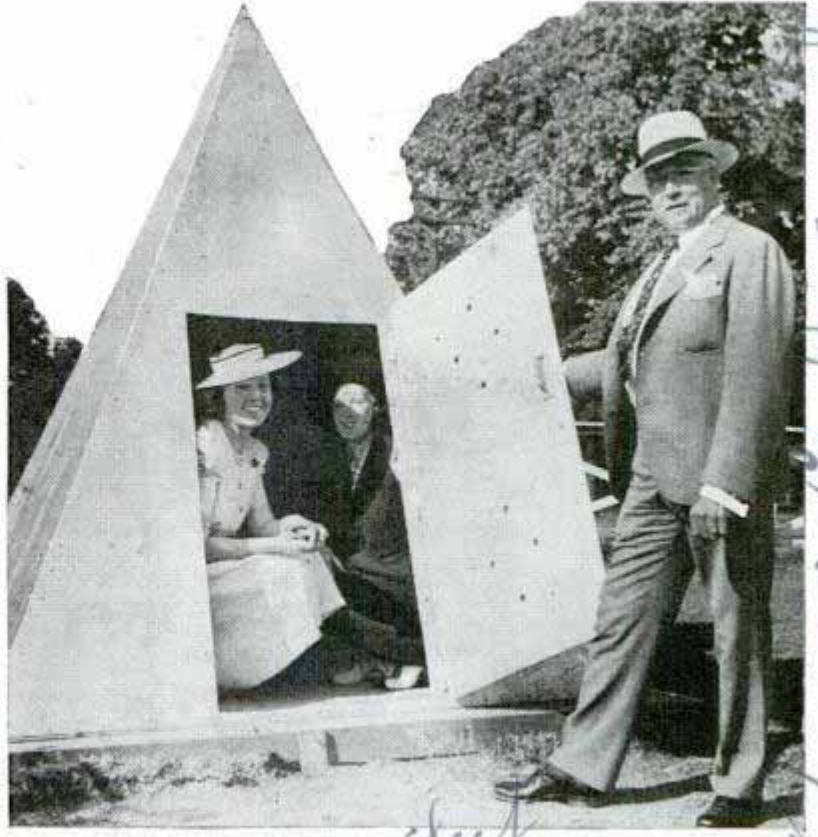
The trouble with most of us is that we seek to back into the future, like the famous bird that always flew backwards because it wasn't interested in seeing where it was going, just wanted to see where it had been.

You can't go through life on a Futurama. Too many of us just want to sit down and ride along surveying the world that is to come. Well, if many of us do that, the sights we'll see will still be those of the world of today.

Right here and now new industries are being created. I don't know what they are and neither do you. I doubt very much if any man was ever conscious of creating an industry when he set about his work. Certainly I know that Oersted didn't know he was creating an industry when he held

(Continued to page 128A)

Steel 'Tent' and Concrete 'Igloo' Resist Bombs



With death raining from the skies, the English people took every precaution for the safety of their pets as well as themselves. Above, is a gasproof dog kennel in which the pup could "ride out" an air raid in safety, barring a direct hit. In a test, a dog remained in the sealed chamber for twelve hours without suffering ill effects

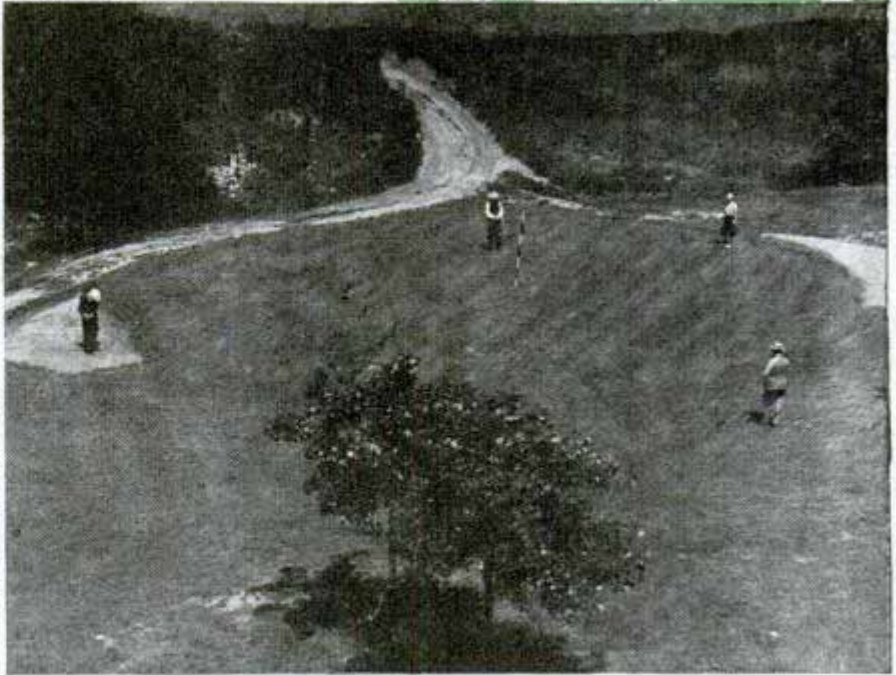
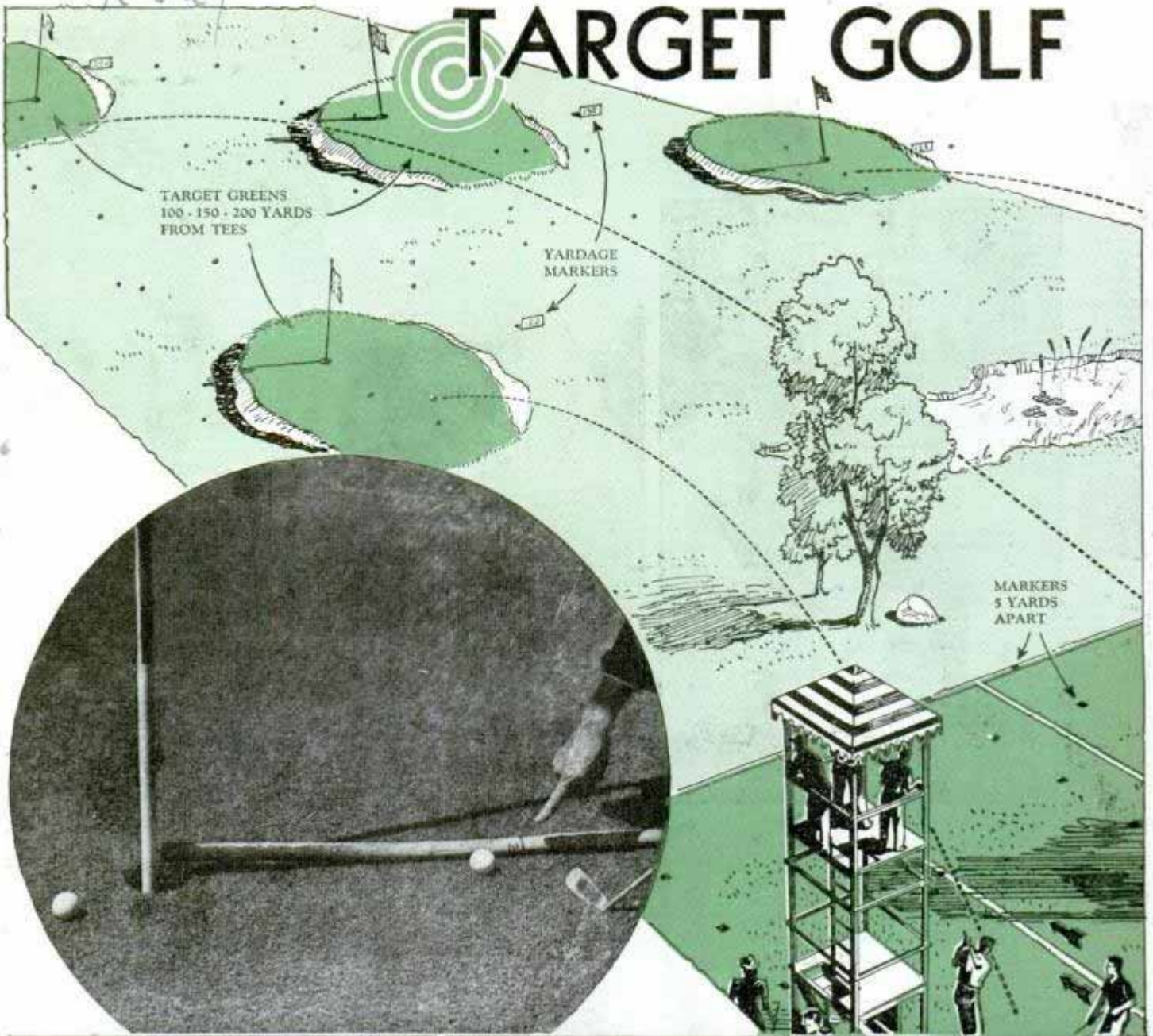


In America as overseas, preparations against possible air raids are being hastened. One manufacturer in the United States developed the steel "tent" at top, in which a family of six could take refuge. Built on a concrete base six feet square, it would resist anything but a direct bomb hit. In the center, workmen are finishing the steel-and-concrete walls of a tunnel leading to one of England's largest underground shelters, adapted from a subway. It accommodates thousands and is easily accessible. Left, a concrete "igloo" built in five hours for test purposes on the Potomac

*Exhibited by Karl
B. Pfleger, J. Pres. Vacuum
Plastics Co., Quincy, Mass.*

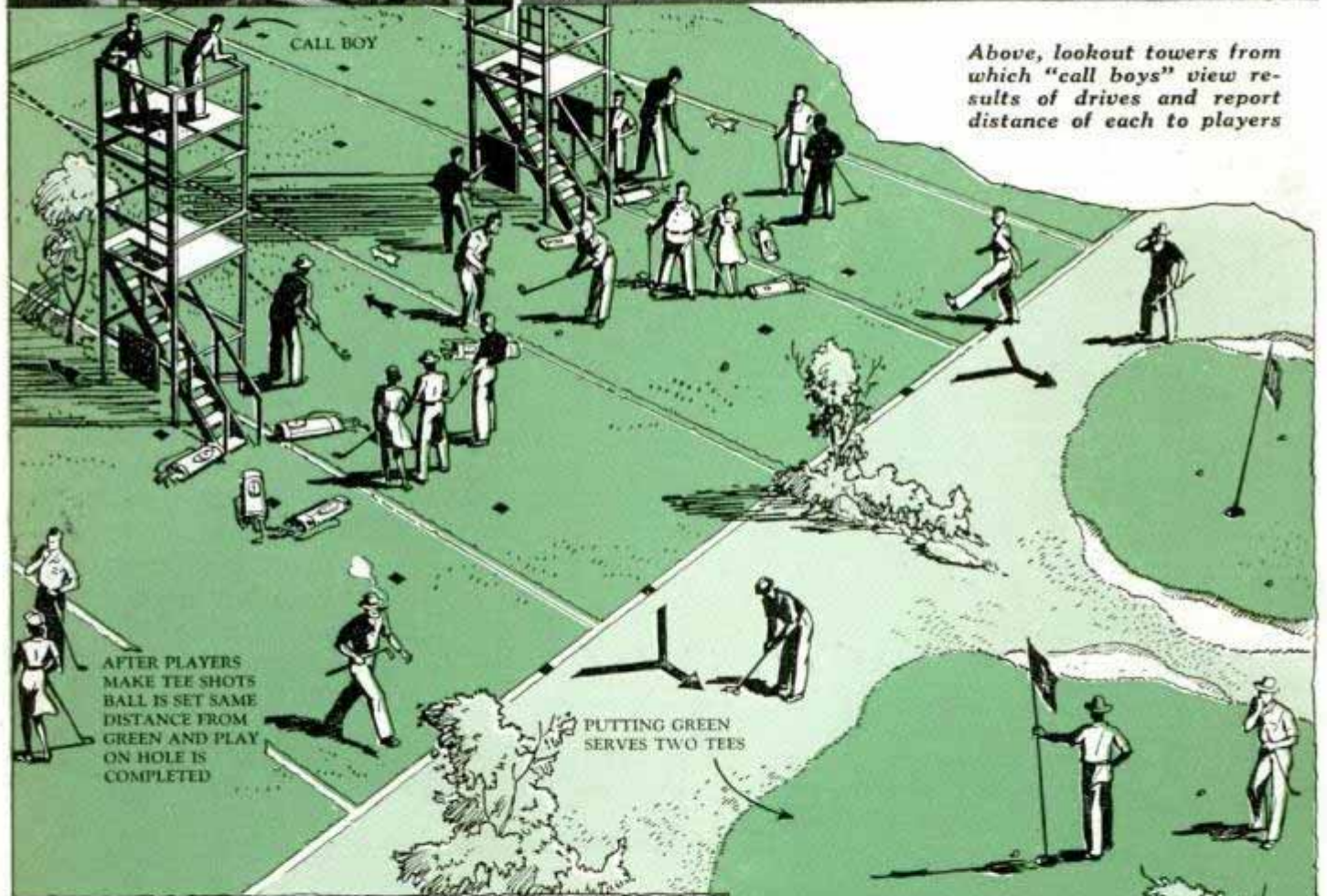
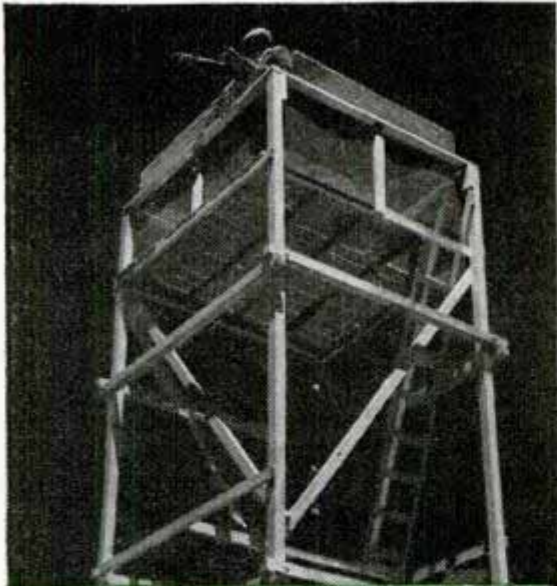
10 weeks. Pfleger Co., Quincy, Mass.

TARGET GOLF



Golf practice takes on the dignity of a real game at a new course in Chicago, where much walking is eliminated since all approach shots are made from same tee, and player does not follow his ball down the fairway. About half the usual time is needed for a game. Photo in circle, measuring a putt; bottom, left, making chip shot from twenty-five-yard marker; right, one of the greens

PLAYED like REAL GAME



Above, lookout towers from which "call boys" view results of drives and report distance of each to players

Diagonal sketch across two pages shows how patented "target" golf course may be laid out in a relatively small area. It consists mainly of tees or playing areas, main fairway, target greens, putting greens where play is finished, and "call boy" lookout towers. Each tee section is fifty yards long, marked off from the center in five-yard spaces; distance to target greens being measured from middle of tee, and the finishing green measuring fifty yards from the tee. Score cards indicate figurative length of each of the nine or eighteen holes. When a player tees off, the call boy judges the distance of drive by markers placed on fairway. Approach shots are continued from same tee until ball has been driven within seventy-five yards of the hole. Then player turns around and chips ball from tee toward putting green

Eleven Captive Parachutes Drop from 250-Foot Tower



Eleven parachutes, most of them carrying a pair of thrill seekers, take simultaneous leave from anchorage atop a 250-foot tower at world's fair

Parachutists descended en masse upon New York the other day, but they were jumping for fun rather than sabotage. Eleven parachutes were released at once from the top of the 250-foot steel tower at the world's fair, producing thrills for a score of riders as well as hundreds of fair visitors who watched the spectacle. Last year half a million persons made jumps.

Longer-Lived Engine Bearing Promises Greater Power

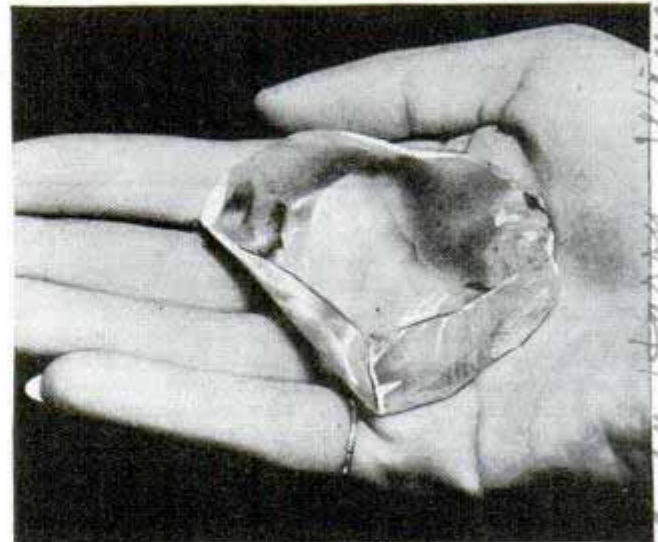
Tests of a new type of steel-back, high-lead babbitt bearing for automobile engines indicate it will increase engine bear-

508

ing life by 200 per cent. The bearing, to be introduced soon on Buick cars, was designed to withstand the high-compression ratios, increased power output, high crankshaft speeds and terrific piston pressures of modern automobiles, and automotive engineers say it will result in more miles per gallon of gasoline and greater acceleration.

Big Uncut Diamond Weighs Over Five Ounces

Said to be the largest uncut diamond in the world today, the "President Vargas" stone, weighing 726.60 carats, was shipped recently from Amsterdam to the United States as an ordinary seventy-cent registered mail package. If the gem were placed on your grocer's scale it would tip it to slightly more than five and one-quarter ounces. It is two and one-half inches long, two inches wide and one inch thick, being of blue-white color. In its uncut state the stone is valued at approximately \$750,000.



Here's a \$750,000 handful—the blue-white "President Vargas" diamond weighing 726 carats uncut

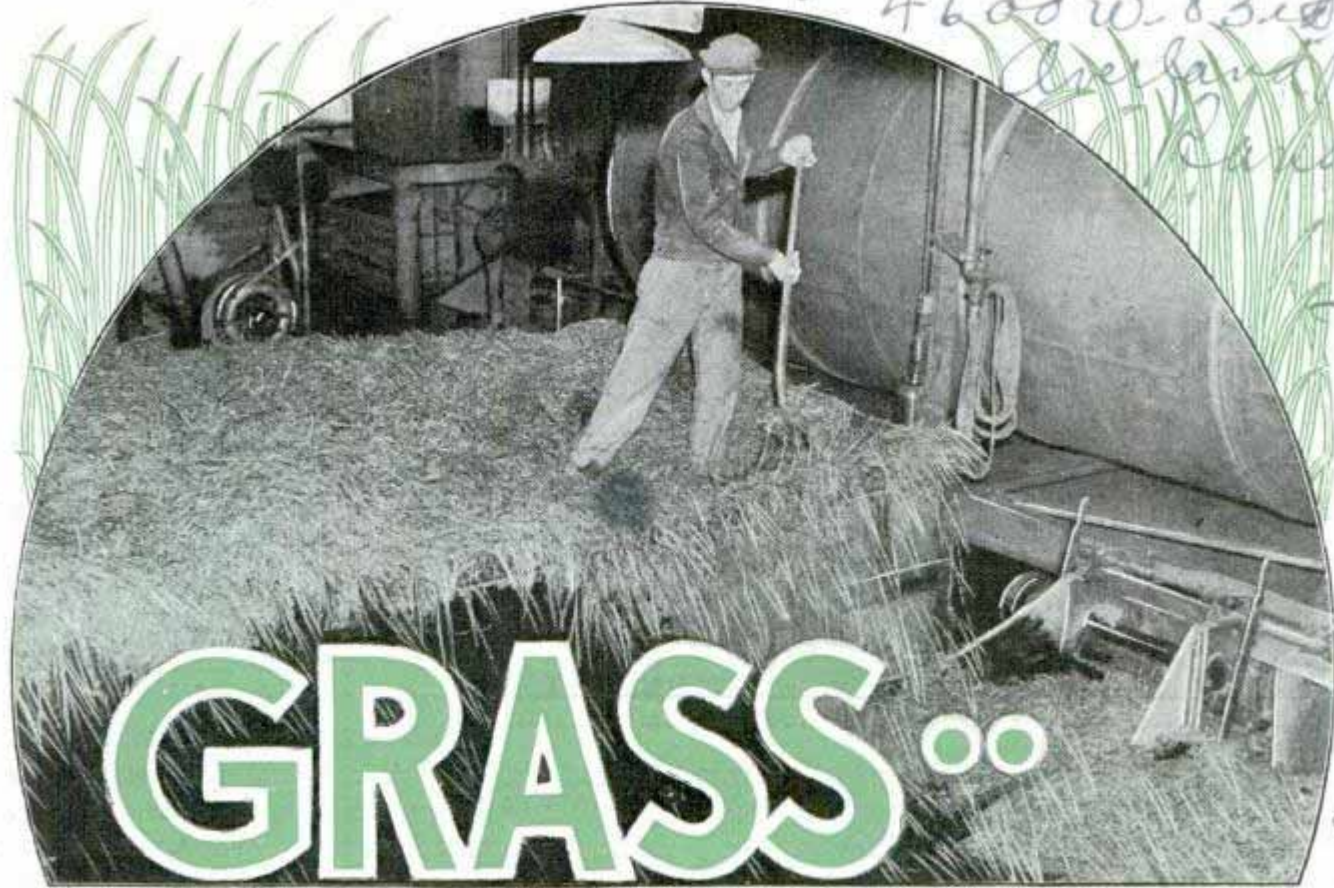
K 200
Aug 1941-51
see
Wido walk
Diamond Merchants
Clinton St. Harry Winston, Inc. New York
620-5th Av. New York

Moraine Products
Special Motors
with Buick Motor Div.

4600 W. 83rd
Overland Park
Kan.

rec July 19 40-90

Cerophyl Laboratories, 2438 Broadway, City, Mo.



GRASS..

NEWEST FOOD *for* MAN

YOU'LL soon be eating grass and liking it.

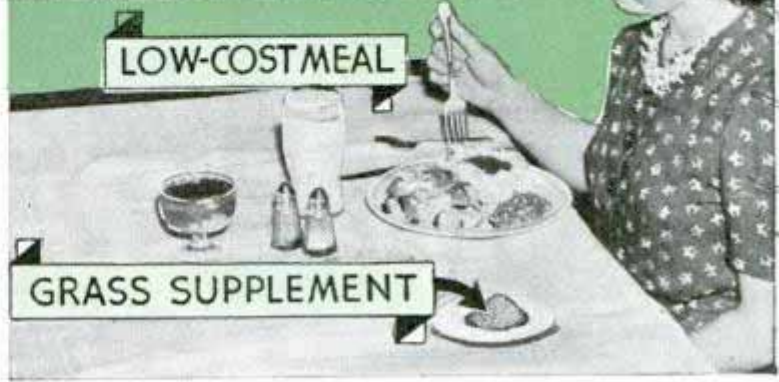
On the menus of tomorrow, you're likely to find breakfast foods, pancakes, bread, and cookies containing quantities of grass; there'll be grass in butter, milk shakes, and ice cream, perhaps even in candy bars.

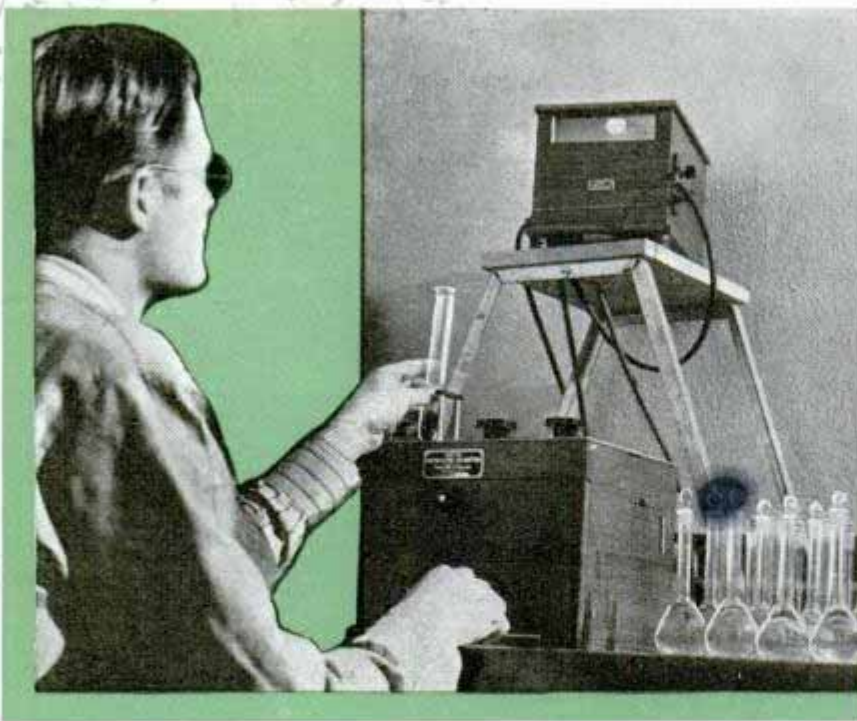
This forward step in nutrition is envisioned by a group of biochemists and scientists whose researches show the vast vitamin content in young cereal grasses can be processed into food without changing its appearance or palatability. There's a future for grass as a supplementary ration for poultry, as a pharmaceutical given on doctor's prescription, and as human food. Medical science is watching this development with interest as it gives promise of providing low-income families diets more abundant in vitamins than are now enjoyed by the wealthy.

According to Dr. W. R. Graham, Jr., an authority on cereal grasses,



Freshly cut grasses, top, are run through ensilage cutter, then quickly dehydrated by flash high temperatures in revolving drum. Left, a chemist determines Vitamin C content in a batch of grass. Below, housewives soon may add nourishing powdered grass to recipes





needs, when added to low-cost diets. In this way, a minimum adequate diet can be converted into a liberal one at no appreciable rise in cost. This doesn't mean you should join the cows in the nearest meadow; this would avail you nothing, for the crux of the development lies in cutting the young cereal grasses—oats, wheat, barley, and rye—just before jointing, usually when they're about eighteen days old.

At this stage in growth, the leaf material not only is at its peak as far as vitamins are concerned but is free from an excess of fiber that

the soundest nutritional advice is to drink more milk, eat more leafy vegetables. Government figures show a liberal diet, that is, the most healthful diet regardless of cost, calls for a yearly consumption of about 680 pounds of fruits and vegetables, exclusive of potatoes; that is just 350 pounds more than the average person eats.

If everyone could afford to eat on a liberal scale, forty-five million more pounds of fruits and vegetables would be consumed yearly and two and one-quarter billion dollars would be added to the national meal ticket.

By the use of foods now available a minimum adequate diet is estimated to cost between eighteen and twenty-eight cents per person a day, while a liberal diet runs from fifty-seven to eighty-six cents. America's food bill is around \$17,000,000,000 annually, which averages thirty-five cents per person per day. However, nearly a third of the families have an income of around \$9.00 and this, for a family of four, makes prohibitive a weekly expenditure for food of more than \$5.04—or less than half of the government's estimate for a liberal diet.

But in twelve pounds of dried grass leaves, Doctor Graham points out, can be found all the vitamins and minerals the body

would make ordinary animal forage too tough and bulky for human consumption. As the plant matures, the proportion of indigestible fiber rapidly increases and there's a corresponding decrease in the proportion of proteins, vitamins, and other digestible values.

Cut with special machinery, the grass is run through an ensilage cutter, dehydrated in a giant revolving drum by flash high temperature and then cleaned and packed according to its ultimate use. Powdered grass sold as a pharmaceutical is preserved in nitrogen and in sealed cans its vitamin



Top, measuring the carotene content of grass with a galvanometer. Bottom, supplementary rations of dried young cereal grasses are fed to chickens to study the effect on egg production

content remains unimpaired. Grass production plants are now under full steam in Kansas, near the Texas border, and in Ontario. Where growing conditions are favorable, two and three cuttings can be made before a field is allowed to stem out and produce a grain crop.

There's always skepticism regarding the practical importance of new discoveries in the nutritional field. Particularly is this the case with high sounding pronouncements on vitamins.

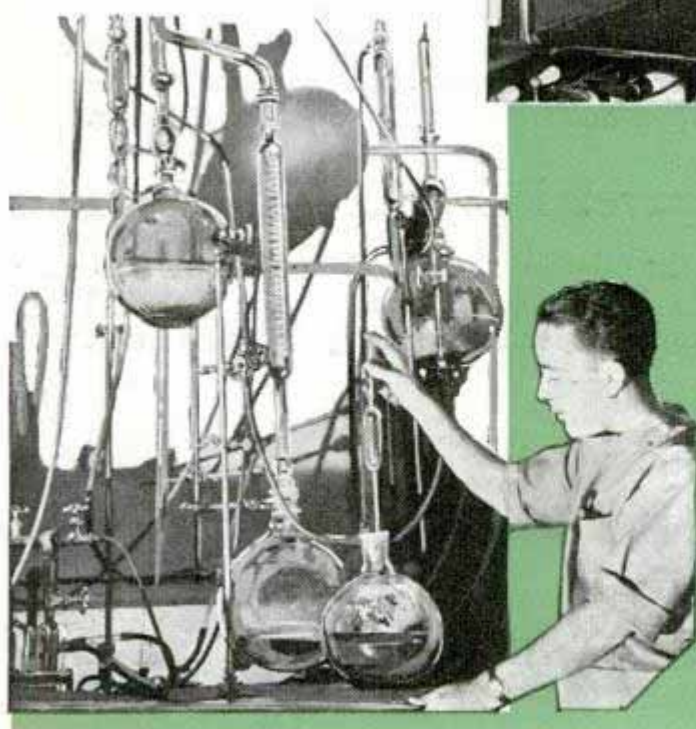
Actually, it's no trick for a person of means to get all the vitamins he needs, either at the drug store or the dinner table. But the people who need vitamins most cannot afford to have them in the quantities they should, hence the need for processing grasses into every-day foods. In this manner, all the vitamins we need with the possible exception of D will be made available to us at a price we can afford.

When the chemists first began working with the idea of putting grass into every-day foods they ran into the color problem. Bread,

(Continued to page 147A)

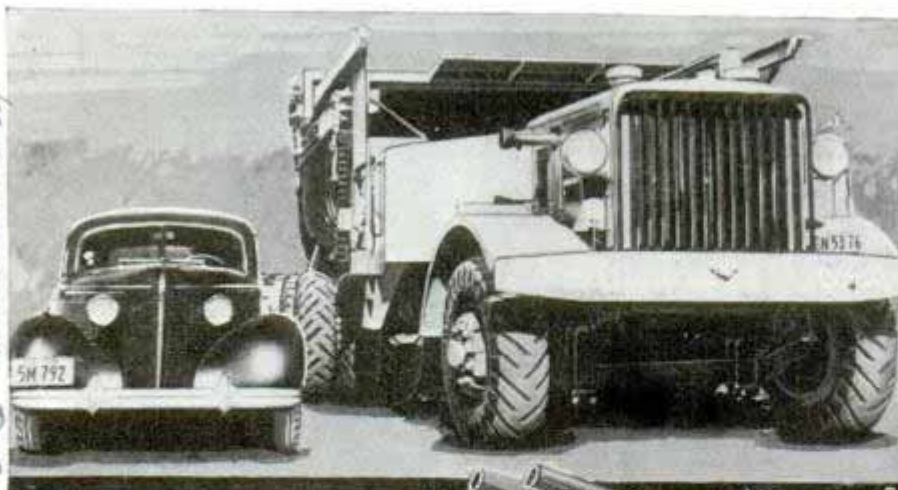


Two rats above were fed the same diet except that larger rat had supplemental feeding of dried grass. Left, powdered grass becomes yellow and imparts appetizing color to cookies and bread. Lower left, experimenting with grass for human food. Lower right, powdered grass stored in refrigerator



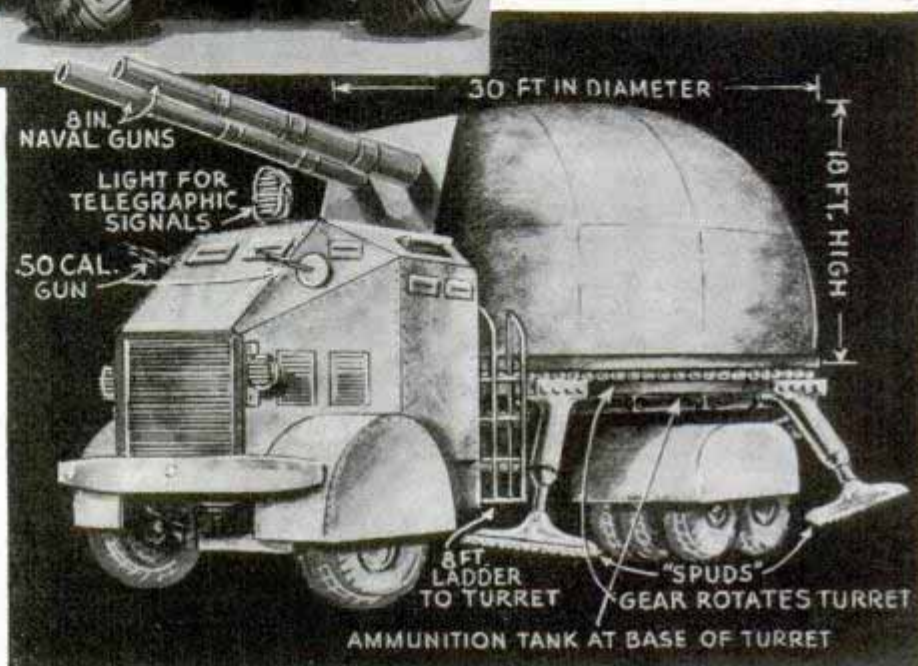
Turreted Fort Is Convertible from Dirt Truck

836.
 Los Angeles
 Trojan Truck Co.
 14 S. Vermont



The dirt-moving truck, left, used on Los Angeles river construction project, nearly spans width of highway. It is powered by a marine Diesel engine developing 190 horsepower at 1,100 revolutions per minute and is started by a small gasoline engine. Below, an artist's conception of the same truck as adapted for warfare

Plans have been completed for the conversion of a huge dirt-moving truck into a formidable "battle wagon" with two eight-inch naval guns mounted on a turret that revolves in a full circle. The armor has been patterned after that of the U. S. Navy's heavy cruisers; the turret, thirty feet in diameter and eighteen feet high, would be turned by gears on a track like a railroad turntable and it would be manned by five men under the direction of two others in the front compartment, who would handle the two fifty-caliber machine guns, the radio and a signal headlight. The plan calls for four hydraulic "spuds" to absorb the terrific recoil from the big guns. Resembling giant



vacuum sweepers, these could be released by a lever from the driver's seat and dropped to the ground at a sixty-degree angle. Hard-rubber plungers at the base of the "spuds" would grip the surface of the ground. There are twelve rear drive wheels on the truck, and it can carry ninety tons and travel sixty-five miles an hour.

K814 Glider Boat with Twin Hulls Travels Fifty Miles an Hour

Fast express glider boats have been put in service on the Black Sea between the Russian resort town of Sochi and Sukhum,

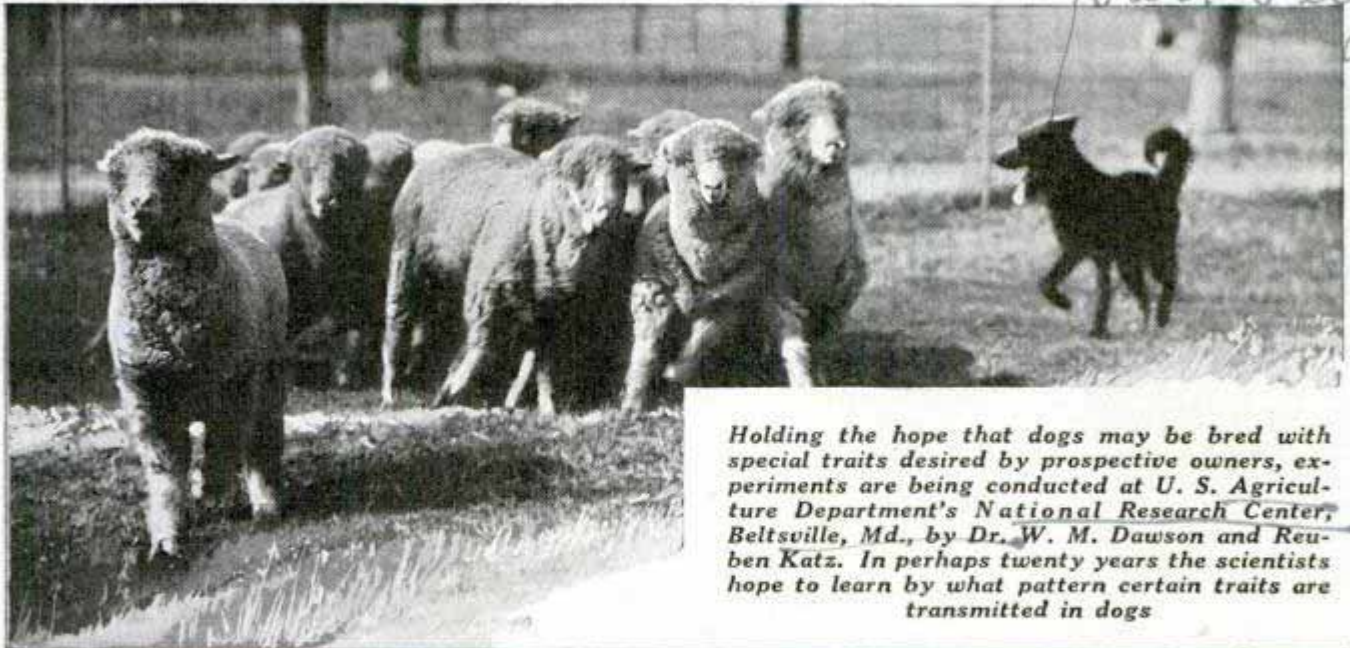
in the oil-well region. The twin-hull vessels have accommodations for 140 and cruise at speeds up to fifty miles an hour.



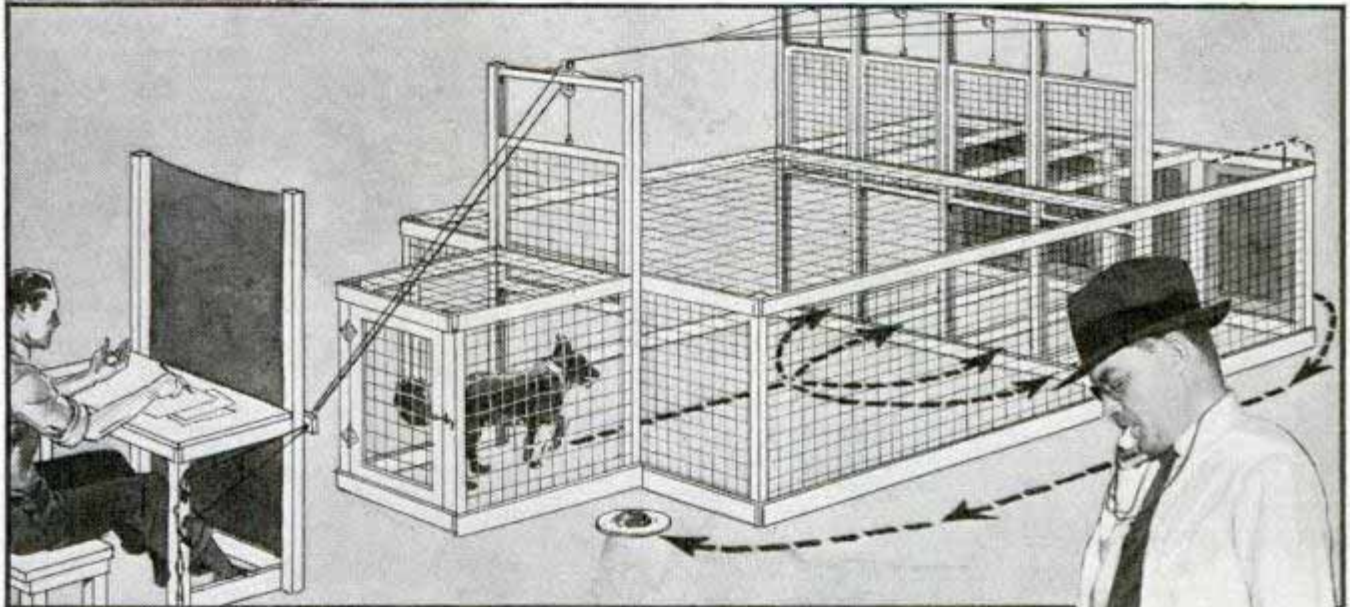
In ferry service on the Black Sea is this speedy Russian twin-hull glider boat, carrying 140 passengers

Tests Aimed at Producing the Dog You Want

(Part Puli dog)



Holding the hope that dogs may be bred with special traits desired by prospective owners, experiments are being conducted at U. S. Agriculture Department's National Research Center, Beltsville, Md., by Dr. W. M. Dawson and Reuben Katz. In perhaps twenty years the scientists hope to learn by what pattern certain traits are transmitted in dogs



Top, part-Puli dog being tested as sheep herder. Center, "reasoning" test in which dog must find way out of the cage through one of four doors. Three of the doors are locked. Meat at end of arrow path speeds up dog's work

Shepherd



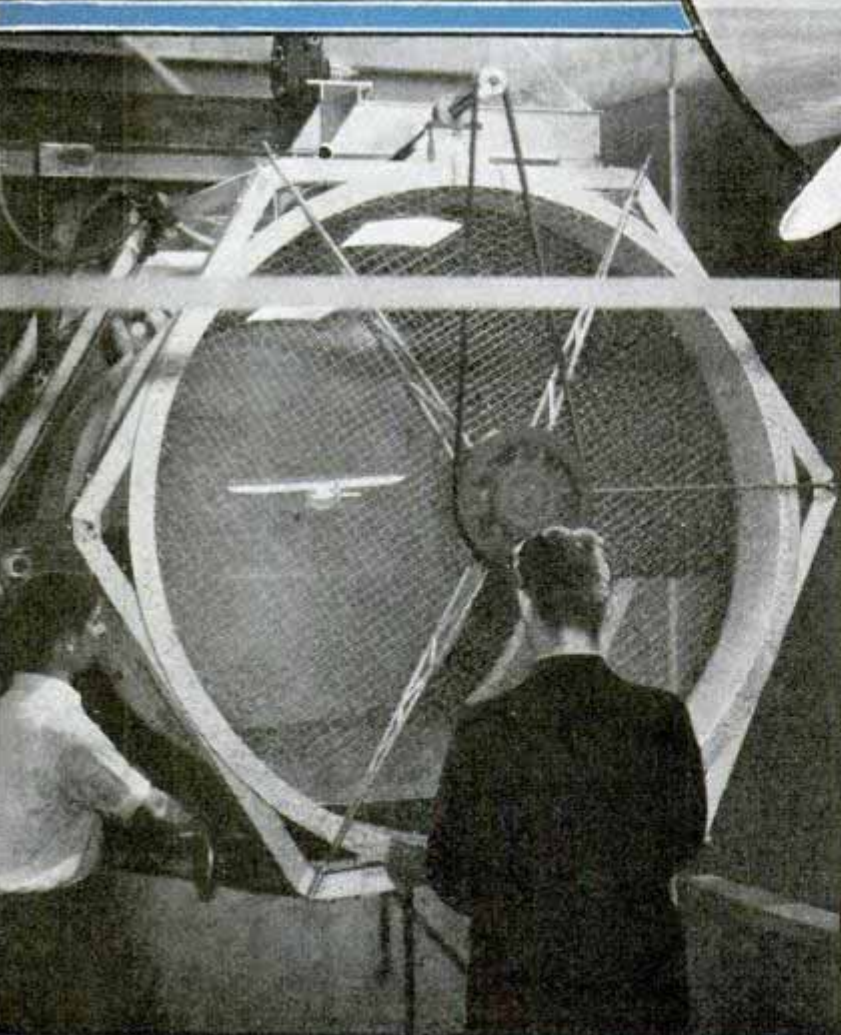
Above, black dog working on sheep in herding test with aid of trained black-and-white dog and trainer. Dr. Dawson seeks to find how to breed for intelligence, aggressiveness, friendliness and other traits

Above, using the whistle in training dog to obey commands. The dog is awaiting a second whistle signal before leaving its position

Puli or Chow

WINGED

Oxygen helmet and electrically heated goggles worn on high-altitude flights are shown at left. Below, an army "T.B.D.-1" plane. In the wind tunnel at bottom a model plane in free flight permits a new method of studying airplane stability and control characteristics

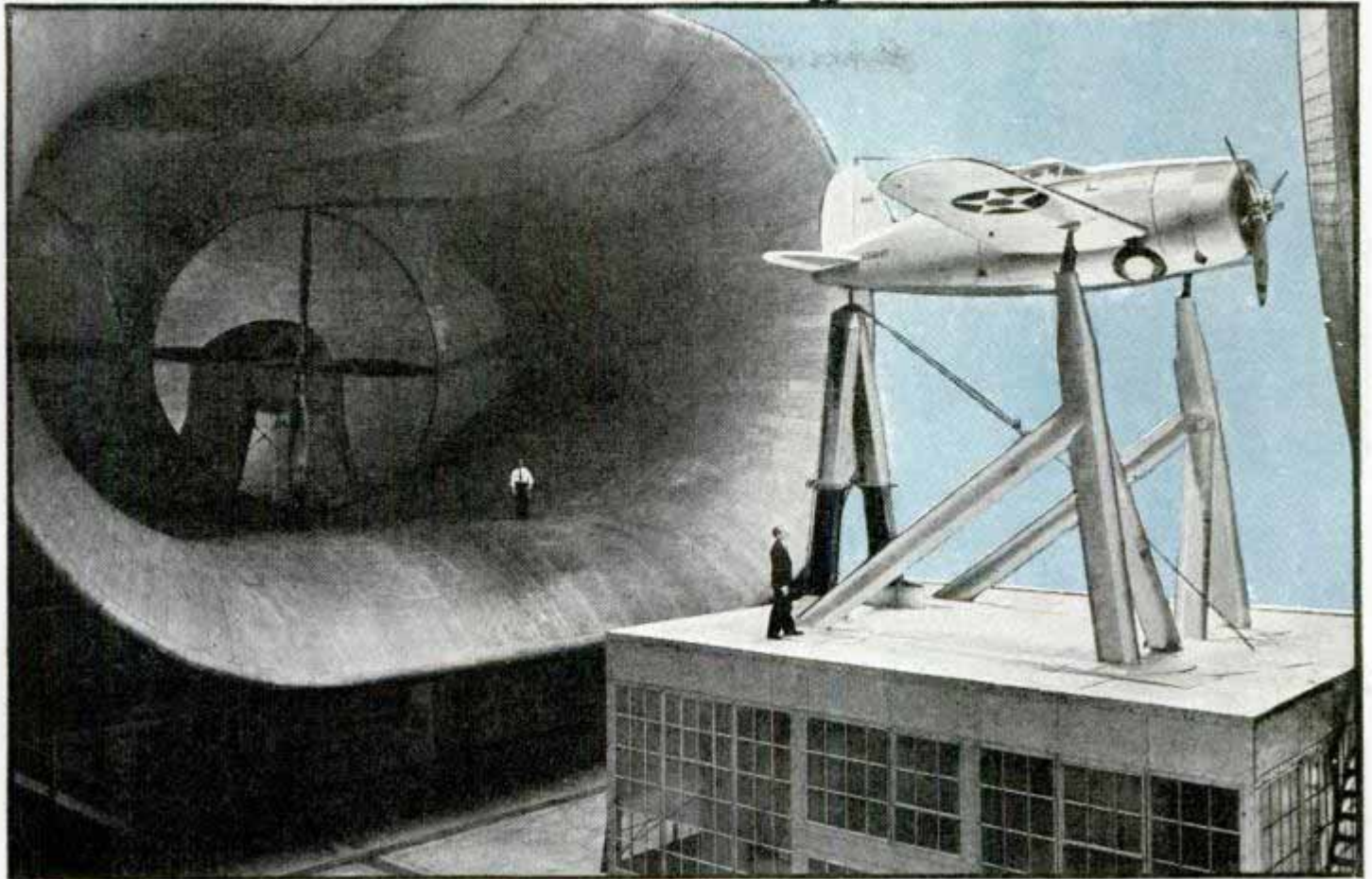


YOU'D think that skis would be fairly simple to a crack pilot of the Army Air Corps, when any co-ed can master them in a short time. Yet to say that Captain Frank G. Irvin was having difficulties would be a rank understatement.

The skis were on a new Boeing pursuit plane, being tried out for winter landings at Wright Field. In a routine test, Irvin was diving at 350 miles an hour when the front end of one ski came loose; and the wide surface, dangling broadside against the air stream, made the plane unmanageable.

It required all of Irvin's strength to hold the stick back while the ship continued its dive. To pull out was impossible. With the ground approaching at six miles a minute, an immedi-

DAREDEVILS *of* SCIENCE



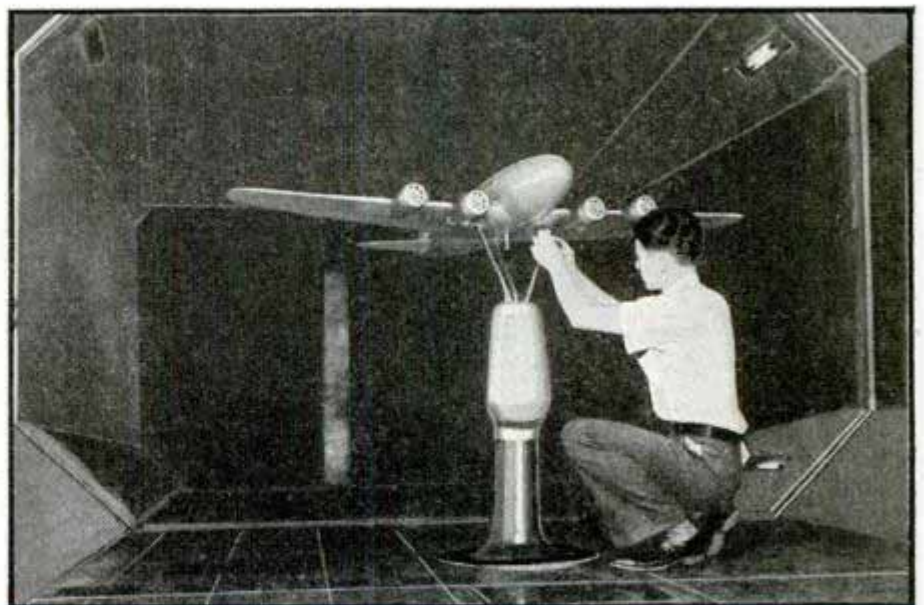
ate jump was imperative, yet Irvin doubted if he could survive exposing his head to that terrific blast of wind. There was only one way to go out—double himself into as close an imitation of a ball as is possible for a six-foot man in a cramped cockpit.

He got one leg under him. To get the other up he had to release the stick. Immediately the tail snapped forward, catapulting Irvin out in a heels-over-head spin.

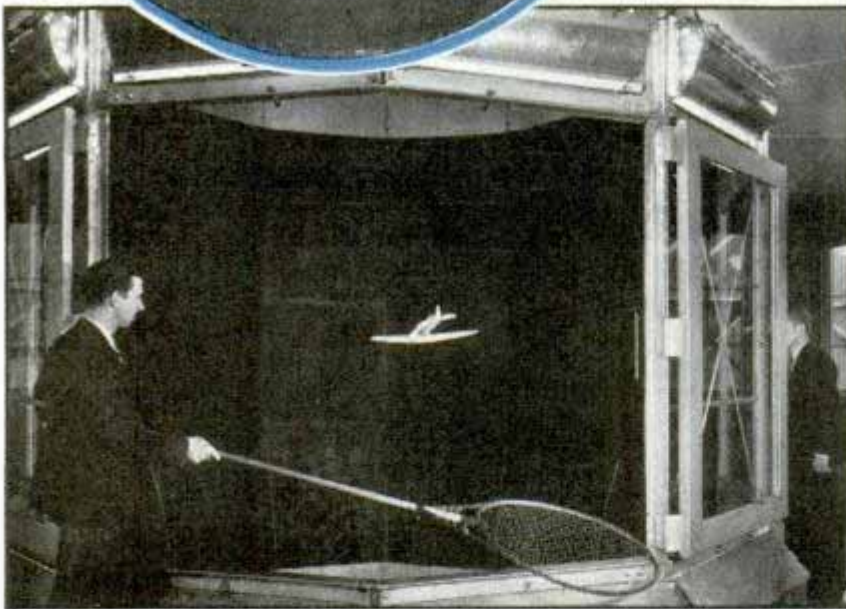
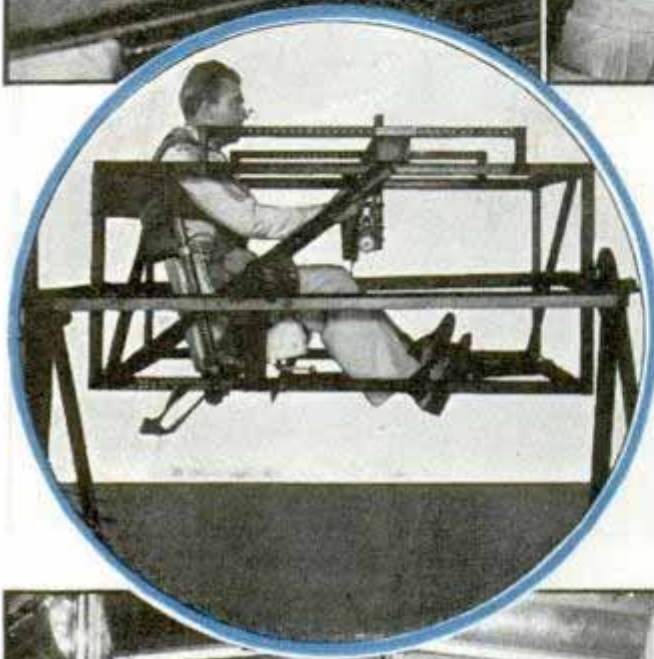
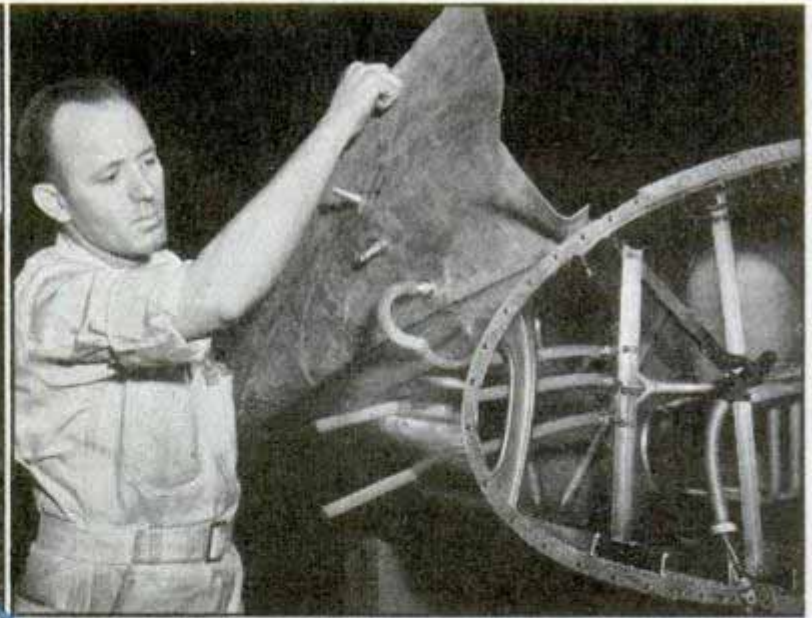
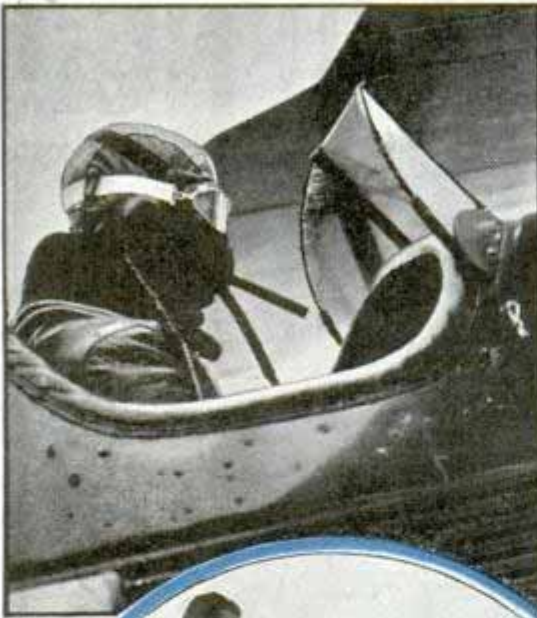
Centrifugal force and air pressure prevented him from bringing up his outflung arm to pull the rip-cord. The earth whirled about, sometimes seemingly above, sometimes below; yet always nearer. Irvin finally worked his left hand up from the elbow, close to his body, for a backhand pull. Half an hour later he was putting a dupli-

cate of the wrecked plane into another dive. And all for science.

When the army bought its first airplane, the Wright Brothers were their own test pilots, proving by repeated flights that the kite-like affair could meet army specifica-



Top, Brewster XF2A-1 plane on balance of full-scale wind tunnel at Langley Field. Bottom, one-tenth scale model of Boeing "Stratoliner" mounted for tests in University of Washington tunnel



Top, left, pilot masked for high-altitude flying; right, rubber cover on leading edge of wing of T.W.A. liner is pulsated by air to break off ice formation. Center, testing wheel-type controls. Bottom, model plane released for study of spin in wind tunnel

A service aviator with a reputation would be given the job of taking this new contraption up, to see if it would fly. His test job would be a "seat of the pants" affair from start to finish. If he liked the way the ship performed, he gave it the O.K., and others of the same design were built. If he didn't like the plane, or couldn't manage it (and lived to tell about it) the model was condemned. Test pilots' opinions then were the final authority.

Perhaps that system was unfair to inventors; but it was terribly hard on aviators too. In 1926 Lieutenant Barksdale purposely stalled a plane with a bad spinning reputation to find out what the trouble was. He didn't find out. When he jumped, the tail spun around and cut the shrouds of his 'chute. Both Barksdale and the plane had to be dug out of the ground.

Seven years ago Captains Frank O. D. Hunter and Hugh Elmendorf were testing the latest model of a two-place pursuit ship—a beautiful job and the fastest thing yet. It behaved splendidly in normal flight. But as soon as a power dive was started, the wings began

turning in a spin from which the pilot could not recover. Hunter succeeded in getting clear at only 150 feet—and lived, though terribly battered; Elmendorf spun into the ground with the ship.

turning in a spin from which the pilot could not recover. Hunter succeeded in getting clear at only 150 feet—and lived, though terribly battered; Elmendorf spun into the ground with the ship.

Lieutenant Woodring, one of the army's

outstanding pilots—a racer and stunter de luxe—took another one of these ships up to find out just what the trouble was. A giant for strength, he succeeded in pulling out of the same tight power spin, only to have the plane go to pieces around him, scattering parts over a square mile of countryside. Woodring had no chance to use his parachute.

That was the end of that. The army was through with sacrificing its best pilots to find out if inventors and engineers were right. Today organized research takes the place of "the seat of the pants." Every plane now built for the army or navy is put through severe tests at the Langley Field laboratories of the National Advisory Committee for Aeronautics before being taken into the air.

Scale models are built first, tested in the variable-density wind tunnel under conditions that simulate the actual air pressures met in flight. The free-flight wind tunnel permits the models to be tested for stability and control. The spinning characteristics of these models are then tested in the free-spinning tunnel, dangerous faults eliminated, before a full-sized plane is ever built. Then the manufacturer is required to demonstrate, with his own pilot, that the plane can be flown with safety. An army pilot, from the materiel section at Wright Field, flies alongside the ship being demonstrated, while a civilian aviator puts it through stalls, dives, and other maneuvers.

If the plane gets by this demonstration, it is taken over by the Materiel Section and subjected to a scientific analysis.

First the air-speed meter must be calibrated. A short distance from Wright Field a two-mile speed course is laid out on level ground, a highway at one end, a steep hill a short distance from the other.

The pilot must come in at top speed, without a preliminary dive, level off five or ten feet from the ground, time the two-mile run with a stop-watch as he passes the pylons at each end. Then he pulls up, notes the readings of the meter and watch, comes in again at the same indicated speed from the other direction, so he will have a course both with and against the wind.

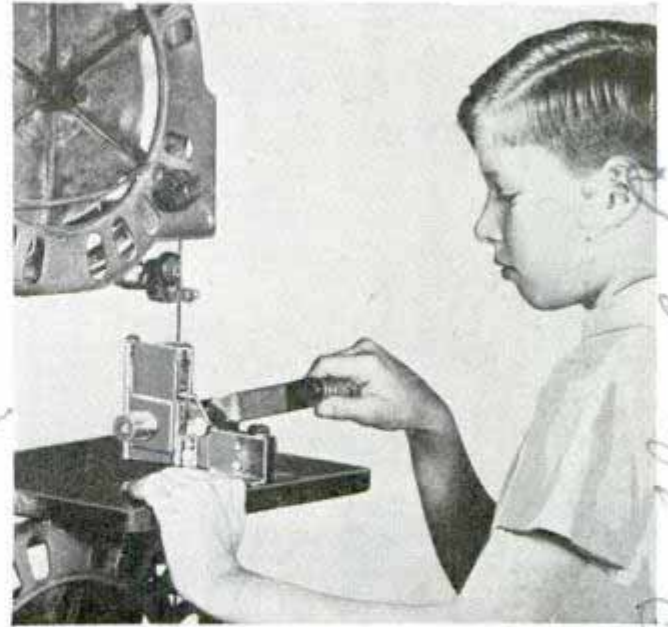
Next time he must repeat this exactly ten miles an hour slower, and so on until the stalling speed is reached.

Flying so close to the ground is always dangerous, especially with planes hitting

(Continued to page 132A)

OCTOBER, 1940

Band-Saw Teeth Set Quickly without Removing Blade



Each back-and-forth movement of the crank resets an inch of the band saw's blade

Teeth of band saws can be reset to factory specifications within three to five minutes with a tool that clamps on the blade, making it unnecessary to take the saw off the wheels. Adjustable gauges permit setting it for the width of the saw, and a back-and-forth movement of the crank resets one inch of the blade at each stroke.

Car Runs on Meager Gas Diet to Meet Wartime Rations

With the allotment of gasoline for private automobiles in England reduced nearly to "starvation" rations, new cars are



Built for economy of operation, this British car drives eighty-five miles on a gallon of gasoline

being designed to consume little fuel. One of Britain's smallest autos travels eighty-five miles to a gallon of gasoline and can make forty-five miles an hour.

no info. 1/2/47 517

Baby's Tags and Footprints Prevent Hospital Mix-up



Baby at top is thoroughly tagged; below, a new arrival signs the register with footprints

There's small chance of mistaken identities in the nursery of the modern hospital. New-born infants are virtually enveloped in tags—wristbands and ankle tags of adhesive tape bearing the name, sex, weight, date of birth, mother's room number, and other essential data. Tags are sometimes affixed also to the baby's back, and to the blanket. A further safeguard is a footprint inked upon the hospital record and on the birth certificate.

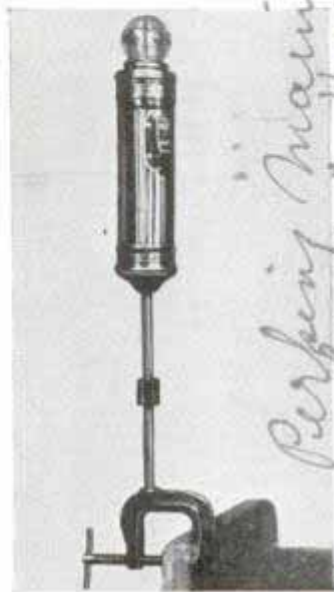
"Chameleon" Rods Test Sunlight for Ultraviolet Intensity

Glass rods that "sunburn" and change color like the chameleon are being used to measure the intensity of ultraviolet radi-

ation. Originally light green, the rods turn purple when exposed to daylight, completing the color change in about six hours of midday summer sunshine in Pennsylvania, where they were developed at Pennsylvania State College by Dr. Helmut Landsberg. In the southern states the rods indicated thirty to fifty per cent more ultraviolet than in the north.

Clamp-on Running Light for Boat Uses Flashlight Batteries

Flashlight batteries supply current for running lights now available for rowboats, canoes, dinghies and other small craft. A clamp provides a quick means for attaching the light, which may be mounted on the boat in either vertical or horizontal position.



Headgear for Baseball Batter Guards against "Bean Ball"

Various types of helmets to be worn by baseball players as they stand at bat have been designed as a result of frequent injuries resulting from players being hit by pitched balls. One of them is of tough, fibrous material and clamps a pair of conical earlaps over the skull of the batter. Sponge rubber and lightweight leather form the lining and inside rim.



Two views of headguard designed to eliminate injuries to baseball players hit by pitched balls

California Hospital Los Angeles
Hughlett
K726
Perbenz Marine
1943
K768
Acme
K923
new good
baseball
Proctor Ave. Brooklyn, N.Y.
new good
baseball
Proctor Ave. Brooklyn, N.Y.
Pres.
Ref: Ford Truck

Television Telephone Sends Image of Speaker

Teaming television with the telephone, a preview of the visual telephone of the future with which the speakers will see each other's image as they converse was presented at the General Motors exhibit at the New York world's fair. Still far from practical realization, the demonstration apparatus combined a portable television transmitter, connected with the twelve-inch receiving screen by coaxial cable, with a push-button telephone. When the receiver was lifted, the image of the person making the call flashed on the screen. Fantastic as it may appear today, engineers believe that television telephones may become commonplace within a generation, when ultra-short wave transmission is perfected. It may find its first



When the receiver is picked up in the world's fair demonstration of the "television telephone," the image of the caller appears on the screen

use in conversation between government officers or industrial heads where certainty of the identity of the speakers on confidential business is essential.

Free Road Service to Tourists Given by Mobile Office

Motorists traveling in the state of Michigan are offered free road service by a tourist information office patrolling the highways in an automobile distinctively marked, "Road Patrol—At Your Service." Any motorist who needs directions, whose

car is out of gasoline, has a flat tire, or is stalled, can get assistance by stopping one of these cars. Jacks, tow lines, tools and first-aid kit, as well as maps, folders and booklets on cities and points of interest in the state, are carried by the patrol cars.



One of the duties of patrol car attendants is to help puzzled motorist find way about state highways

Serum Made of Cancer Tissue May Aid in Diagnosis

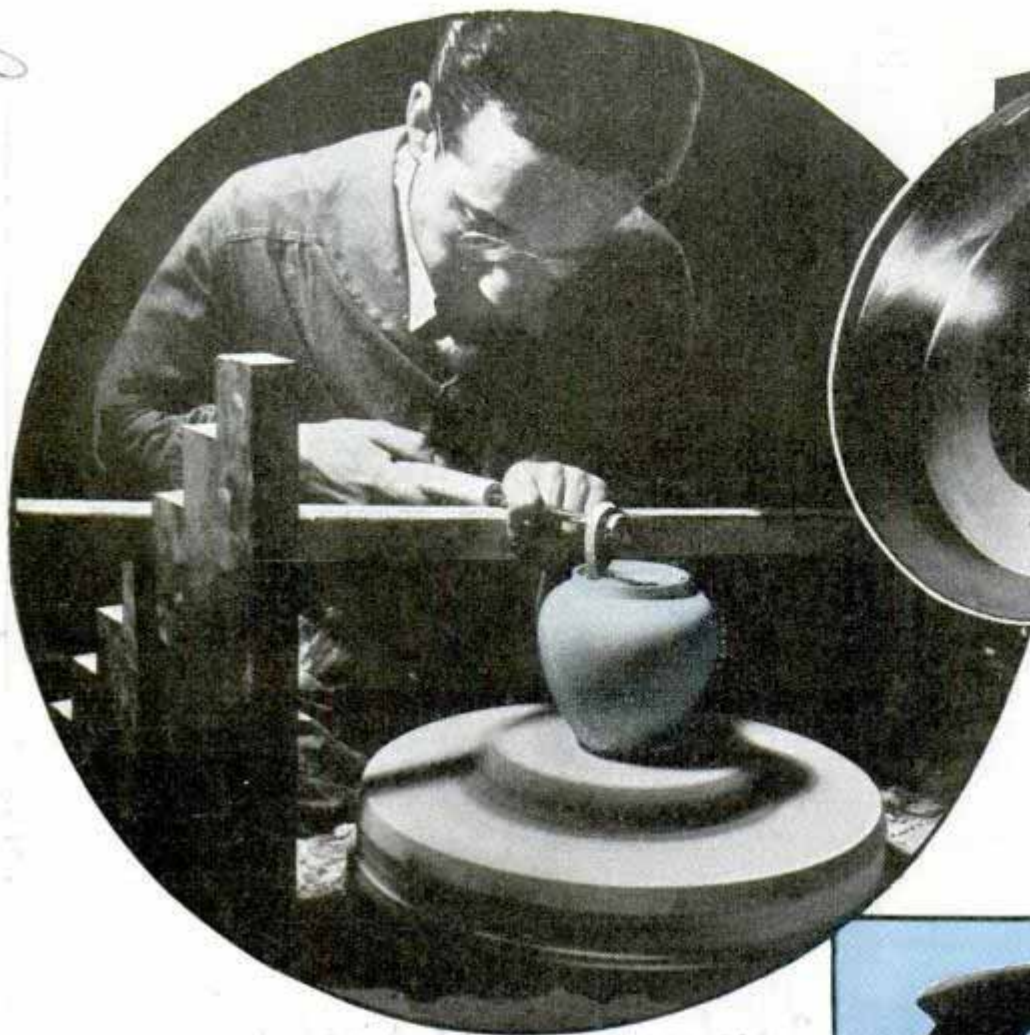
Two University of Illinois medical scientists have developed a serum which may prove helpful in the diagnosis of cancer, although no attempts to use it for cancer treatment have been made. The serum gave positive reactions with the blood of cancer patients in a high percentage of cases. It was prepared from the blood of rabbits injected with aluminum hydroxides containing ground and specially treated cancer tissue. Tests were made by stratifying blood serum from the human subject over the rabbit cancer serum; a white ring developing at the zone of contact indicated a positive reaction.

Phylomene after
Ernie D. 200
Richard H. 200
College of Medicine
Prof. W. H. Welker

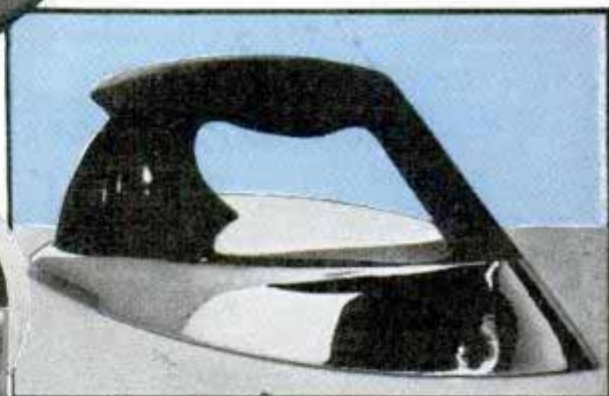
Chrysler Corp. Plymouth

RESHAPING THE

Cont: Allen Warren Elliott, 120 E. 34 St., New York



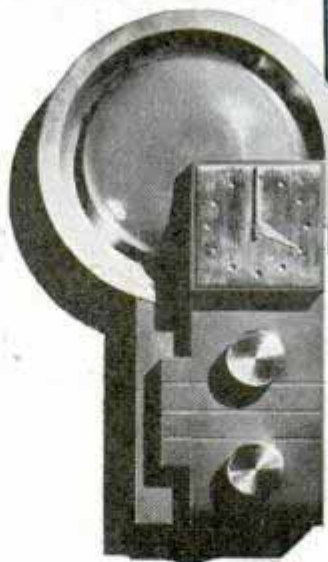
Left, design for teapot rounds into form on mold-maker's jolly. Above, small radio made to look big for living room; below, (left) kitchen radio modeled from old Dutch kitchen clock. Right, your "1941" iron



THE automobile you will ride in a year or two from now may have been conceived last week in the brain of a nineteen-year-old student.

The refrigerator that will grace your kitchen, the radio that will await the touch of your finger, the piano that will add so much dignity to your living room and the lamps that will accentuate the beauty which industrial design has given to modern furnishings—any of these may have been shaped the other day by a boy or girl in their 'teens.

To say these things may happen is to put it conservatively. They have happened already. Millions of people have ridden in a popular automobile styled by a chap in his early twenties from a theory evolved when he was younger. Some of the largest corporations in America have been turn-

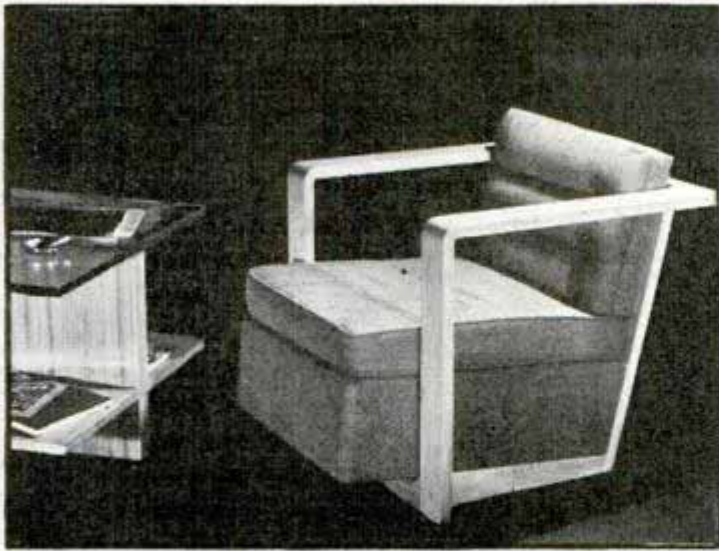


ing to students for design inspiration.

Industry has discovered that the brilliant pattern for the world of the future can be cut from the colorful desires of the youth of today. So youth is taking by storm one of the youngest professions of the machine age, industrial design.

Bending seriously over benches, molding fresh ideas from plastic minds into plastic materials, or standing alertly before electric tools, cutting the barnacles of tradition from the accessories of modern civilization, are the fledgling industrial designers of tomorrow.

WORLD

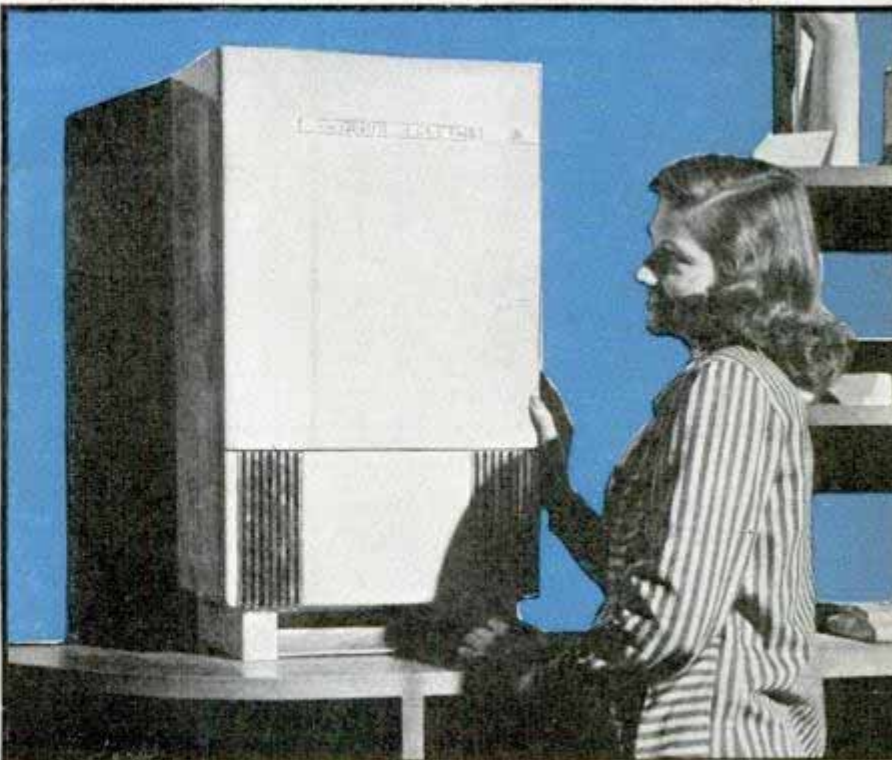
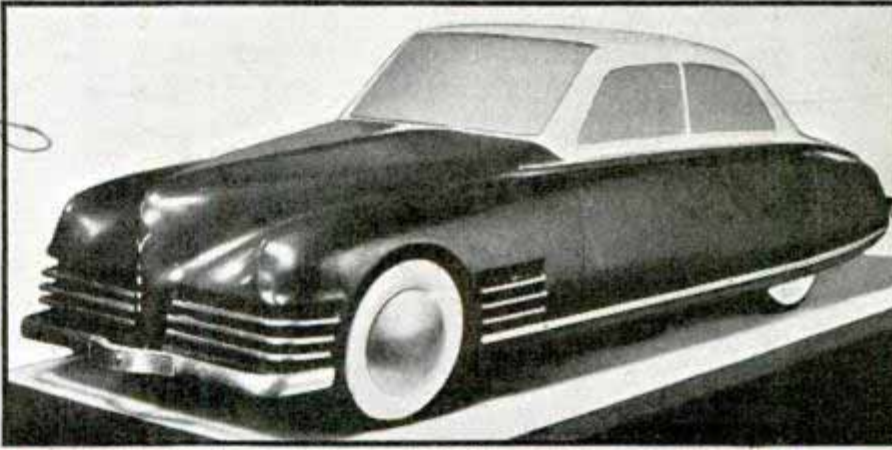


The industrial-design departments of a dozen or more advanced schools throughout the United States, notably those of Carnegie Institute of Technology in Pittsburgh, and Pratt Institute in Brooklyn, are providing wells of refreshing ideas developed by youths, and industries are dipping into these reservoirs of design inspiration to shape their products and their packages. Their requests for designs are welcomed by the schools because they provide practical problems, instead of dull theoretical examples for the youthful designers to tackle.

The designs turned out by the youngsters are welcomed by the industrial concerns because they are uninhibited, forward-looking and often brilliant forecasts of the trend of the times and the tastes of the public.

You have the explanation of young Donald R. Dohner, Supervisor of Industrial Design at Pratt Institute, for the success of the youngsters. He says:

"When we are youthful we are constantly wishing for things like automobiles, boats, airplanes, radios and fine furnishings. Never having possessed these things, we never get so familiar with them that we accept their traditional form as final.



These products of students of design combine beauty and function. Note effect of massive bulk in small apartment piano. The grill effect on refrigerator (bottom) ventilates cooling unit



as crumpled or twisted paper dipped in plaster.

By these methods, the design is kept dynamic and mobile until it takes its final shape after weeks of criticism, study and change. The purpose is not to make a product, or the model of a product. The student is always impressed with the fact that he is creating a design just as, in the old fashioned technique, he would draw, erase and correct with pencil and paper.

When the final three-dimensional sketch is finished the usual task is to complete the product in actual, practical material

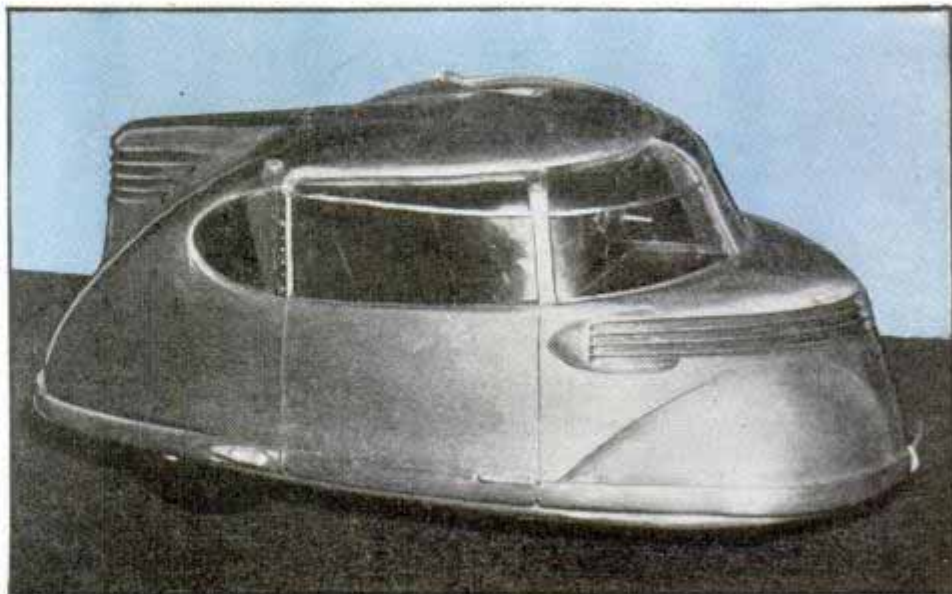
“So, when a youth tackles a problem of design, he is likely to be influenced more by what he wants than what he sees. So his desires shape his design. If these desires are practical as well as beautiful, the student is likely to catch the swift forward trend. What youth wants today is what the adult will want tomorrow.”

The practical problems presented to the students by the industries have influenced a shift to a new technique of teaching industrial design, a shift away from paper and pencil sketches and toward actual design in three dimensions. This is illustrated by the method in vogue at the Brooklyn school. Except on the most simple problems, the use of paper sketches is eliminated and the student is usually given a plastic material with which to shape his theory in three dimensions much in the same manner that a sculptor works out his preliminary forms. Pencil and paper tend to produce “frozen” designs.

If the object to be designed is too large and the plastic material is too soft, they use what is called the architectonic, or structural method, and the idea takes form in wood, Masonite, or perhaps sheet lead. Or it may be plastic material over a firm base or structure, such

so that a swanky ceramic vase is a vase, a decorative lamp is a lamp and a modern chair is a chair. Where huge machines would be required for such operations as stamping or forging, the natural effect is obtained by other means such as metallic coatings over plaster or wood. The completed plastic sketch often serves as a mold for plaster casts of the design.

Where the design can be fashioned on a moderate-size electric tool, students will find the tool in their classroom, for they are encouraged to continue their design and create ideas right at the machine as it abrades and cuts the materials to the urge of their imaginations.

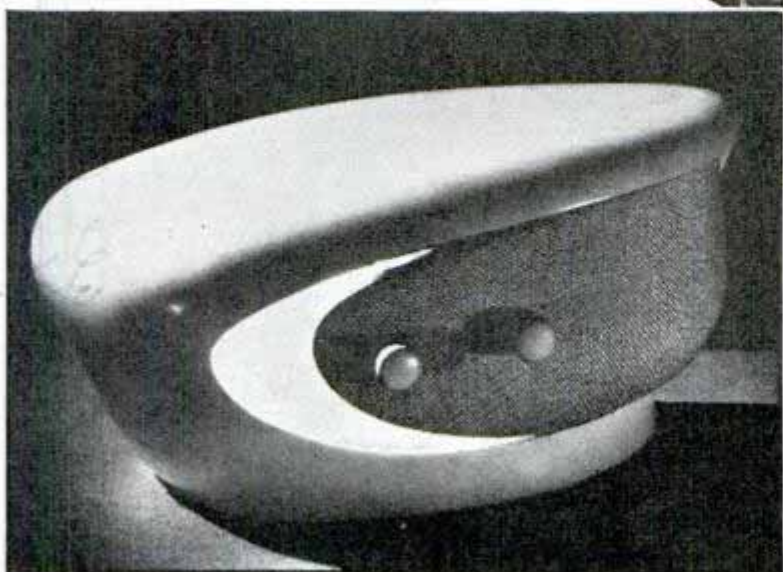


Top, modeling lamp fixtures for the wall in plastic materials, the “trial and error” method of industrial design. Below, model of a small car for crowded city use, cast in aluminum



The task of design is not so simple as it seems, however. Long before the young designers are given the plastic material with which to work, there is a series of complex problems to be solved.

For example, a radio manufacturer may ask an instructor to have a class submit designs for a modern, practical instrument with special selling points applicable to a market already flooded with radios. The



Top, Pratt Institute designers work with their fingers, not pencils. Center, modeling with balsa wood and plastics. Bottom, a tiny radio for the boudoir

student must spend days learning the history of radios from the crystal set to television and frequency modulation. Having mastered this, the student must next tackle the radio market, doing intensive research into the price structure so that the machine will find a niche in a crowded field.

Having decided on a price level, the designer must next hit upon a special

(Continued to page 139A)

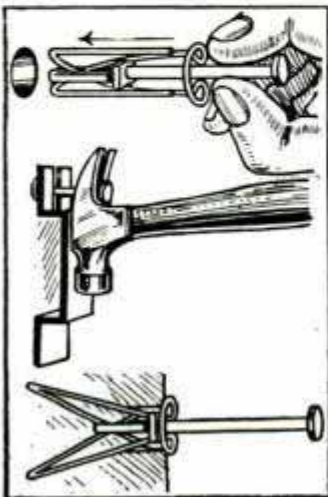
Lighted Cane for the Blind Protects User in Dark



Blind man's cane becomes glowing shaft to protect him at night. Light is supplied by bulb in handle

Easily seen by automobile drivers at night is an illuminated cane made of Lucite, designed to protect the blind as well as other pedestrians when crossing dark highways. Controlled by a switch, light from a small bulb in the handle causes the entire glasslike shaft to glow. A hole in the tip of the cane also emits a ray of light. A pencil battery is the power source.

Expanding Nut-and-Bolt Unit Grips Plaster or Wallboard



For use in fastening molding, metal cap strips or other attachments to walls that will not hold nails or screws, a nut and bolt are combined with an expanding wire frame to lock the unit behind the wall. To make it ready for insertion in the wall,

the wire frame is compressed by placing the prong ends on a hard surface and pushing against the head of the bolt. Once inside, the wire frame is expanded into locking position by pulling the bolt outward with a claw hammer. This also brings the nut forward until it rests flush against the outer flange of the wire frame. The device will hold in plastered walls, plaster board or composition wallboard.

Wall Washer Pumped by Hand Cleans and Rinses Surface

Cleaning walls is done quickly with a machine that washes and rinses, and also saves much of the cleaning material. Compressed air provided by hand pumps operates the washer which consists of two separate tanks, one containing the cleansing solution and the other clear water which are rubbed on the walls by applicators with finger-tip control. A third applicator, independent of the machine, is used as a buffer to remove streaks. The manufacturer of the wall washer claims that one man can clean from 2,500 to 3,200 square feet of walls a day. The machine can be used to clean painted walls, ceilings, washable wallpaper, marble and tile.



Washing machine for walls has separate tanks for cleaning and rinsing water applied by air pressure

Steel Ship Carved into Sections for Rail Trip

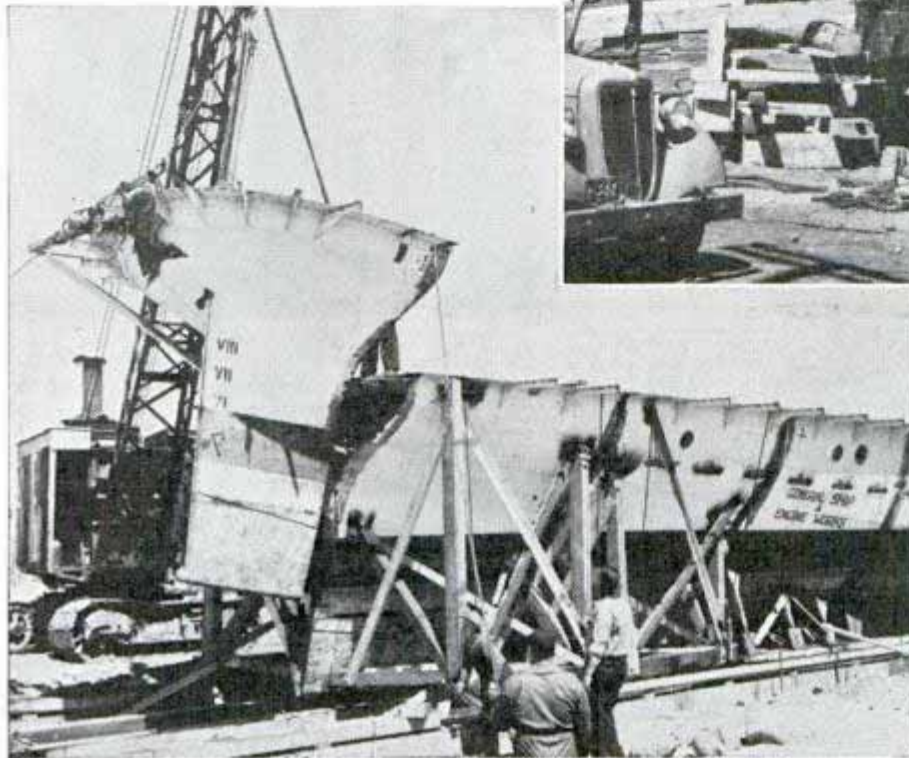
After spending more than fifty years on Lake Champlain in Vermont, the vessel "Chateaugay" has been transported 300 miles overland to a new home in the waters of New Hampshire's Lake Winnepesaukee. To make the journey in freight cars from Burlington, Vt., the steel ship was sliced into twenty-one separate

made Washng

Wade Warka

Rep. Capt. Alexander Saville

The Weis, N. H.



Above, two ten-foot "slices" of ship on flatcars. Left, stern being hoisted into place in readiness for welders to complete the assembly

ten-foot sections, which were reassembled by welders upon arrival at Lakehurst, N. H. The ship is now 205 feet long with a beam of fifty-four feet, and is powered by a 1,500-horsepower engine.

R644

Tiny Telescope on Spectacles Is an Aid to Weak Vision

For persons with eye defects which require special compensation to permit reading, a tiny telescope which is mounted on the spectacles has just been developed. Although it has a lens only six millimeters wide, it is constructed with the same precise optical technique used in the 100-inch telescope of Mt. Wilson observatory. The telescopic lens is recommended in certain cases where vision is so poor that no ordinary lens can magnify objects to sufficient size for the patient to see them clearly. The new telescope for spectacles has a Lucite cap enclosing a lens of additional magnifying power for reading.

☐ If you will send stamped, self-addressed envelope to our Bureau of Information, you will be given the name and address of the manufacturer of or dealer in any article described in this magazine.



Telescope's Lucite cap also has a magnifying lens

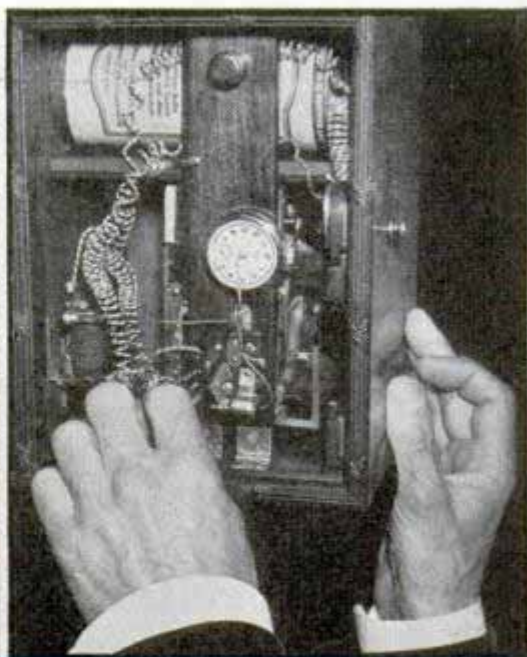
eye Jan 1940-58

The Tiny Telescope

see June 1920.04

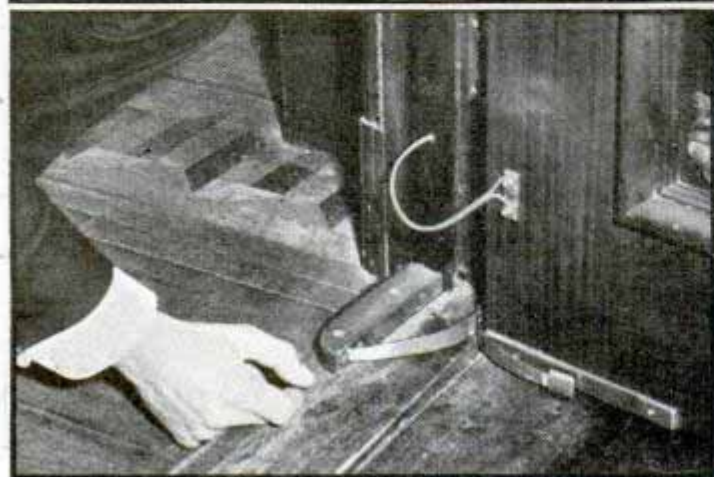
A "HAUNTED" HOUSE

*see June 1920.04
 Dr. Cecil Nixon
 1555 Broadway
 San Francisco
 Clay
 176*



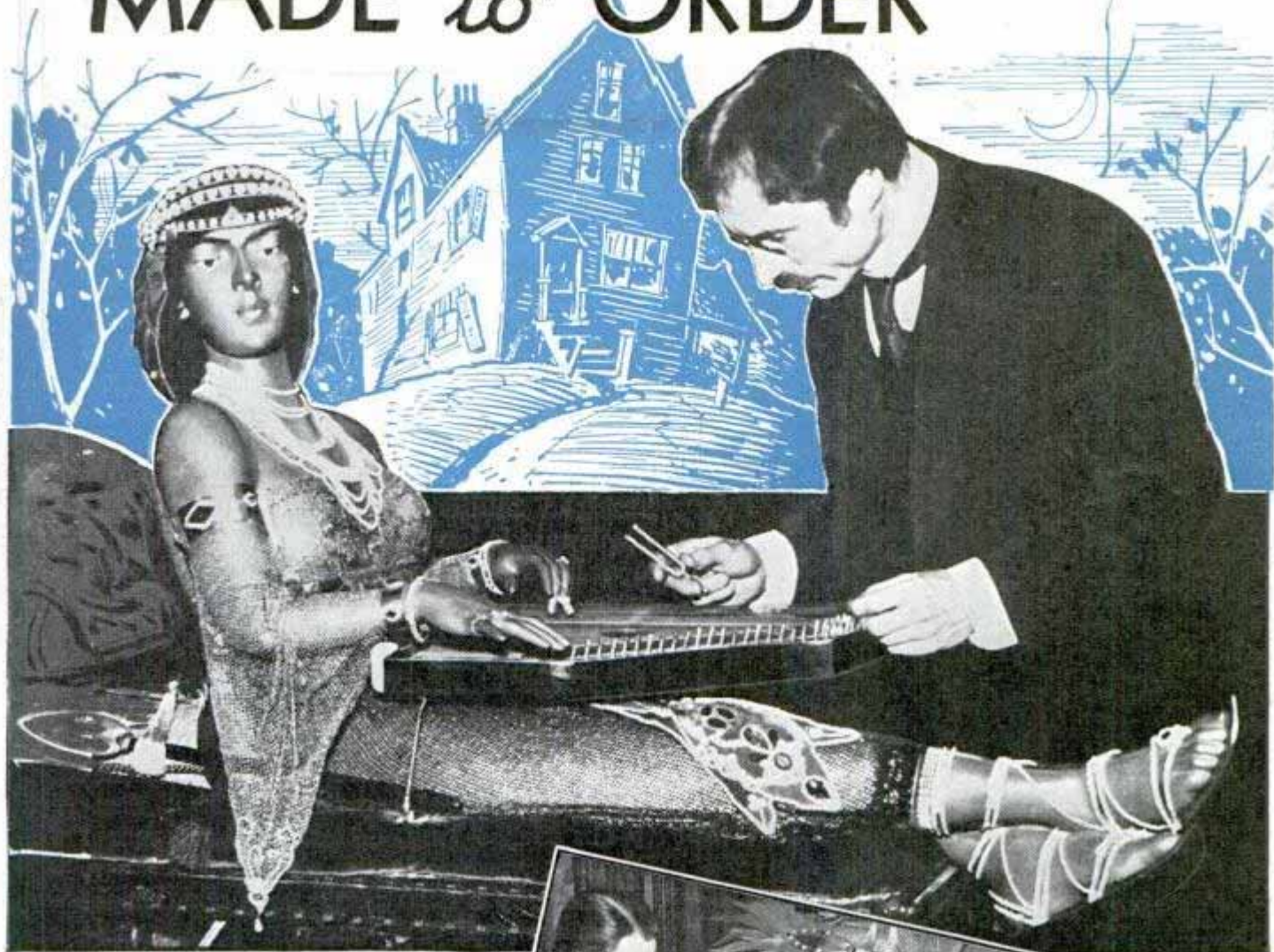
There is an old haunted house in San Francisco—haunted by mysterious music and a host of mechanical surprises contrived by its owner, Dr. Cecil Nixon. Push the doorbell and you hear taps sounded. A door (left center) opens at your command, unseen instruments play tunes. At upper left is the relay board of homemade organ; right, watch mechanism starts flutes playing melodies every half hour

1555 Broadway



Left, spring fashioned from discarded hand organ makes the door fly open when unlatched by a mechanical "ear." Above, the basement is filled with mechanisms of organ and flutes

MADE *to* ORDER



Inside the robot Isis, most famous of the inventions, are 1,187 wheels, 2,233 miles of fine wire, several hundred electromagnets, nine watches and a system of spinning disks that select the tune played at your vocal command. When Isis becomes too warm she throws off her veil; a thermometer and electric circuit in one arm accomplish this



At top, Dr. Nixon tunes the zither for Isis, who can play 3,000 tunes. The mechanism above is in the couch on which she reclines; tubes at left of instrument carry your voice to start Isis playing tune you name. At left are the bellows which furnish air continuously to play flutes in upper part of house. The tunes for the three numbers played by the flute are on paper ribbon seen at right center of picture

Tripod over Six Feet High Aids Odd-Angle Shooting



"Daddy-longlegs" tripod helps amateur photographer shoot odd-angle pictures from overhead position

Photographs can be taken from new angles by mounting your camera high on a telescoping tripod that extends six feet and ten inches. Built in four sections, it folds to twenty-three and three-fourths inches. The tripod will work at the lower levels with equal efficiency.

Nearly as Many Killed by Falls as in Traffic Accidents

Motor vehicle accidents take the largest annual toll of lives in this country, but home accidents are a close second. There were 93,000 accidental deaths in 1939, and 32,600, or thirty-five per cent, were attributed to traffic accidents, while 32,000 occurred at home. Deaths from falls numbered 25,800, twenty-eight per cent of the year's total. A fatal accident occurs every five and one-half minutes, and every sixteen minutes someone dies in an automobile accident. The toll of injuries is even more staggering; 8,800,000 injuries result-

ing in a day or more of disability were reported, someone in every four families being disabled during the year. The National Safety Council estimated that for every ten workers killed in occupational accidents, sixteen were killed in off-the-job accidents. The death total from automobile accidents was about the same as 1938, but on a basis of miles traveled the figures show great improvement since 1929. In 1929, there were 31,215 traffic deaths, with 26,501,000 cars traveling 180,000,000,000 miles in a year for an average of 17.3 deaths per hundred million miles; last year there were 32,600 deaths, and 30,615,000 American cars traveled 270,000,000,000 miles for an average of 12.1 deaths per hundred million miles. The automobile death rate is lowest numerically in February, lowest in proportion to mileage in June, rising to a peak in December.

Germicidal Lamp over Doorway Kills Air-Borne Bacteria

Forming an invisible curtain of germ-killing ultraviolet, a germicidal lamp thirty-six inches long, developed by General Electric, when mounted above a doorway, will destroy a high percentage of bacteria borne through the "curtain" by air currents. The new lamp will be used in doctors' waiting rooms, hospitals, schools, movie theaters and offices.



Three-foot glass tube being inserted over doorway emits invisible curtain of germ-killing ultraviolet

Light Beams Sound Buzzer to Guide the Blind

Blind persons are guided through a building by light beams that actuate a portable buzzer in a system demonstrated recently at the American Foundation for the Blind in New York. Entirely without escorts, sightless persons could find various offices, go up and down stairs and walk through long halls with the aid of light projected from various locations and reflected by mirrors. As long as he walks within the light beam, the small photronic-cell buzzer unit he carries continues to sound; if he strays off the beam the buzzer becomes silent and the blind person shifts the unit around until he hears the signal. The lights are placed at strategic locations and can be controlled from a central switchboard, so that a person desiring to go to a certain office can throw a switch governing a series of lights leading to that room. At corners where



Portable buzzer sounds as long as it is held in light beam projected from wall. Switches arrange beams to lead blind person to various locations

light beams overlap and confuse, a sanded strip in the floor indicates the intersection; two strips mark a doorway, three a stair.

light beams overlap and confuse, a sanded strip in the floor indicates the intersection; two strips mark a doorway, three a stair.

Mask Protects Speedboat Pilot from Injury in Racing Spill

Because luckless outboard racing pilots, catapulted from their boats at high speed, frequently suffer facial injuries and some-

times lose their glasses and even their teeth, an official of the Detroit outboard association has invented a face net to be worn for protection in case of a spill.

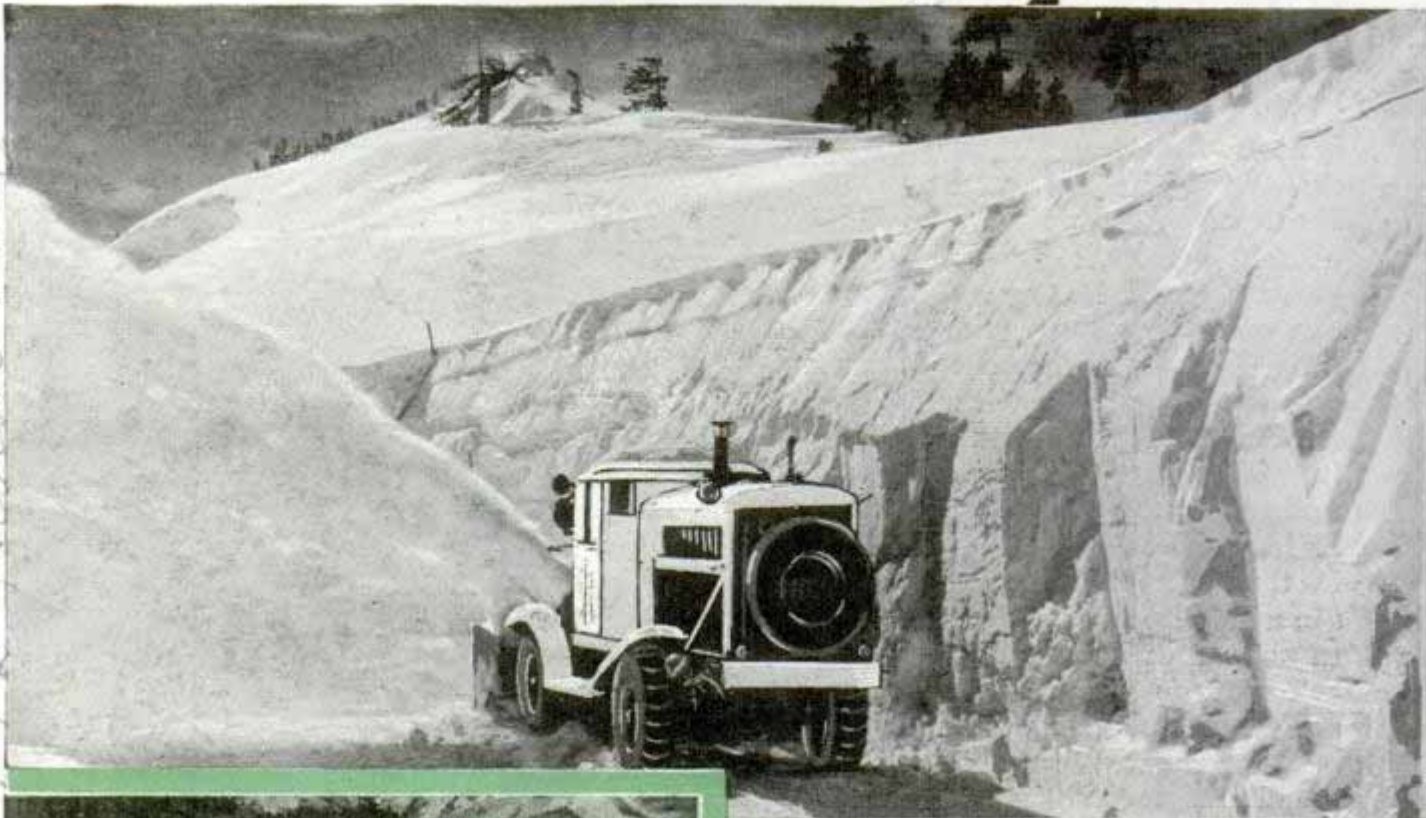


Outboard racing pilot wearing mask of heavy netting to guard his face in case of a spill at high speed

Sap of Tree Keeps Lard Fresh without Cold Storage

Small quantities of preservative material obtained from the sap of a tropical tree can be added to lard when it is processed to protect its natural qualities and to keep it fresh when exposed to air without refrigeration. The discovery followed ten years of research by chemists of a large firm. The substance is extracted from the sap of the guaiacum tree growing in Central America and the West Indies. Lard so treated is odorless and bland in flavor.

ADVENTURES *of the*



that some of them would get no sleep for thirty-six hours. Heavy rain in the lowlands was bad enough and this storm extended into the mountains. But the crews were prepared. Plans had been laid months before and emergency equipment was ready. Detours on high ground around low sections of highway had been kept up. Loaded with men, emergency signs,



LATE in the afternoon urgent telephone and teletype messages were being dispatched from Sacramento to district engineers in five counties. "Heavy general storm forecast. Put every man on emergency duty."

Even without the official order the highway engineers knew that they had a job on their hands and

Top, snowplow cleaning up drift. Center, drawing of double-deck railroad and highway bridge which will span river 500 feet above river bed. Bottom, making highway cut with hydraulic equipment

45
 Los Angeles
 Cmt. Thomas & Stinson Jr.
 10442 Del Rio Ave

Vladimir Kurka
 Cream maintenance

HIGHWAY ENGINEERS



lights, and barricades, every available highway truck was out on patrol by dark. Protection and assistance to traffic came first, then protection of the roads themselves. Flagmen were dropped off at places where flood waters were sweeping over the pavement so that traffic could be guided across until the waters became so deep that



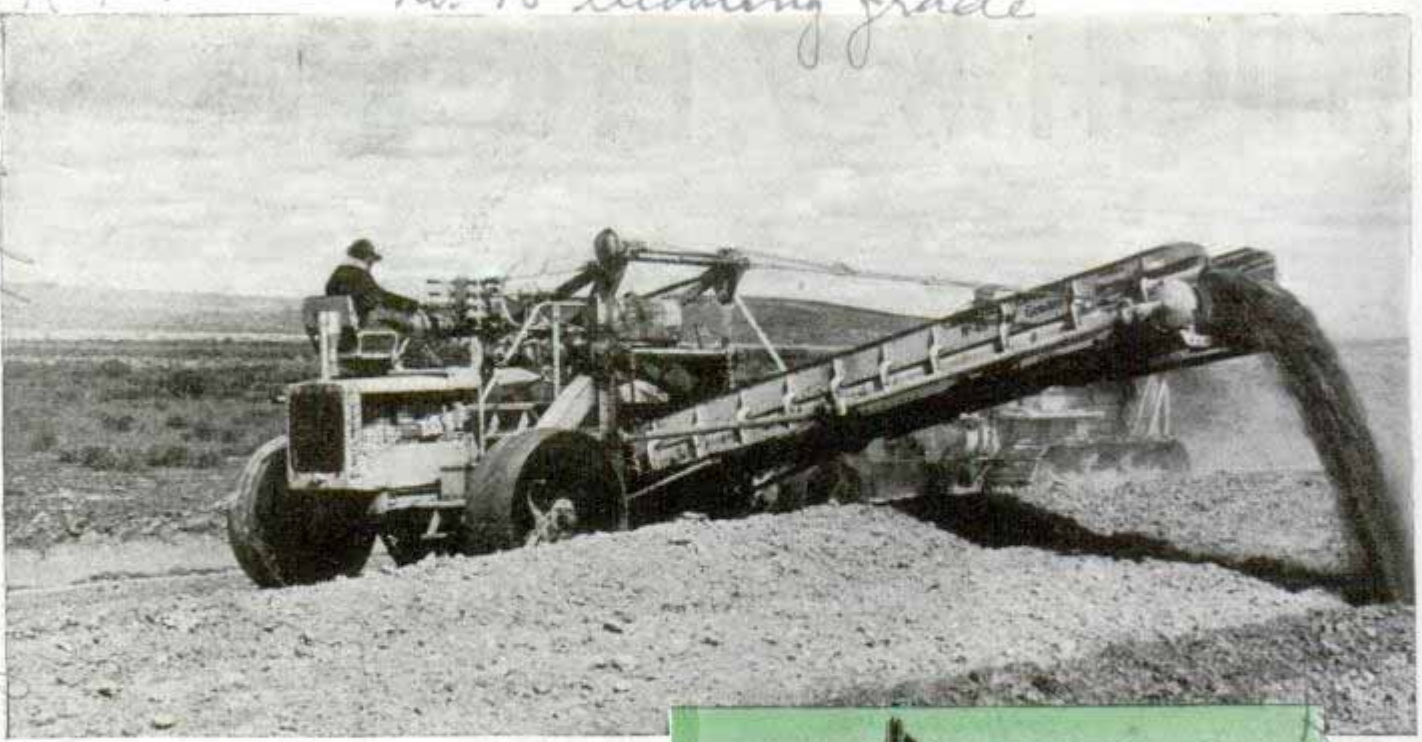
Courtesy California Division of Highways

Top, Caterpillar tractors and huge road-making machines at work. Circle, another road machine. Right, line and trucks, with equipment, building a mountain highway

Calif. Div. of Highways
 and Public Works Sacramento, Calif.

no. 48 elevating grade

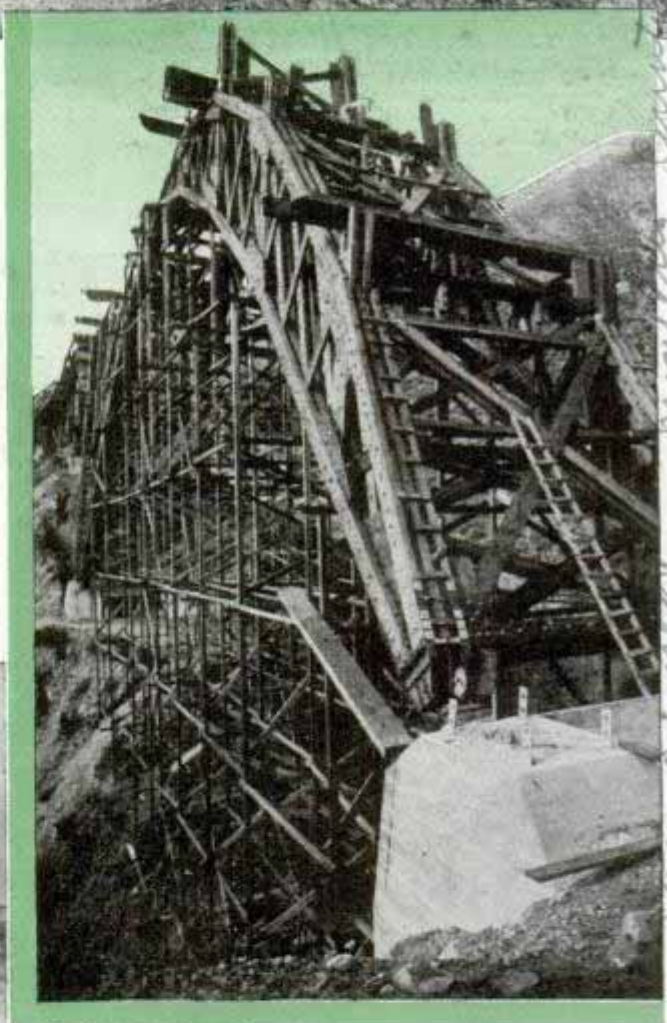
State highway between
Fitzgerald and Nohpel Wash



it was time to erect barriers. Tractors with bulldozer attachments were unloaded where slides were probable. Some of the engineers watched the banks under the roads where swollen streams were eating at the dirt. More and more sections of highway were closed. By now the maintenance men were watching their bridges with anxious eyes. Culverts that carried minor watercourses under the highways were beginning to clog with debris and brush. Road crews battled to keep them open.

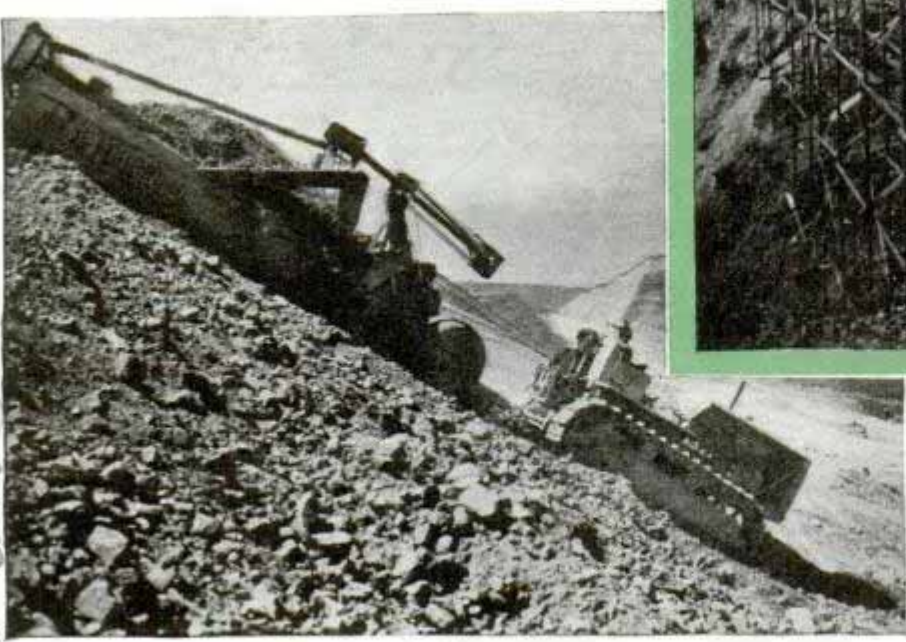
In five days the storm did one and a quarter million dollars worth of damage to

Joagum Valley



San Simon mountain

Caterpillar Model R 10 &
L-1 East Bay and San

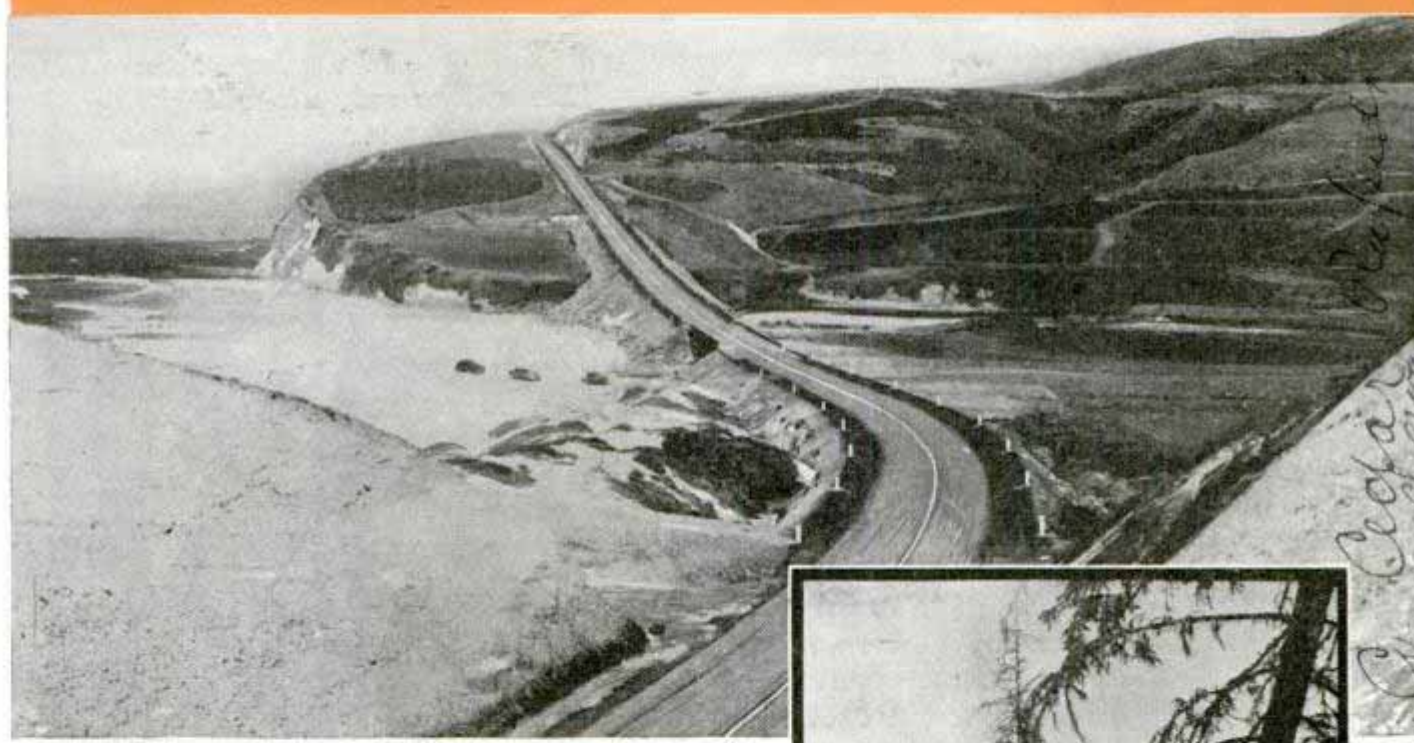


Top, building subgrade for new state highway in Washington. Right, redwood timber arch bridge in California. Bottom, earth-moving outfit at work straightening Altamont Pass

main roads of central California, but through the worst of it the engineers of the state highway department kept traffic moving over nearly every important route. Sixty thousand cubic yards of dirt slid across one busy highway south of San

California State Highway R 17-113

Below, Caterpillars helping build four-lane highway. Center, ocean shore highway stretching into distance. Bottom, tractor with stump splitter and rake blade clearing land of trees



Francisco at two in the morning yet not long after daybreak enough dirt had been moved to allow two-way passage. The Sacramento river rose three feet above its previous record, flooding half a million acres and closing a few highways for several days. Half a dozen major bridges were destroyed or damaged, one being wrecked by a dredge that had broken loose.

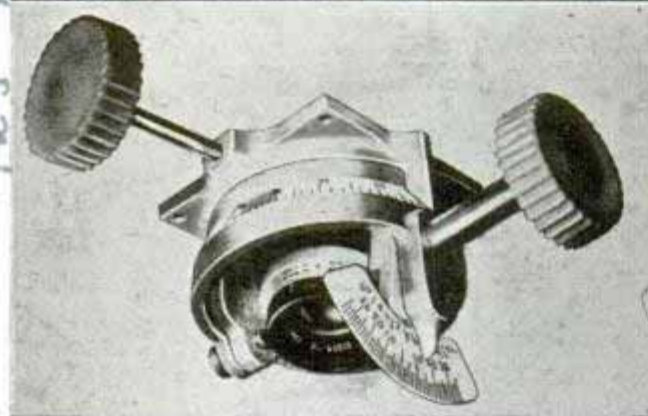
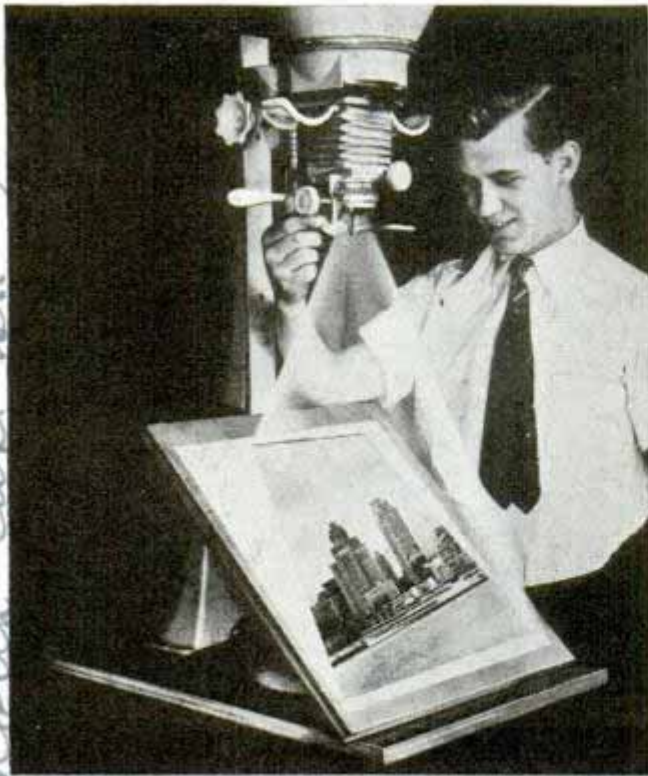
Meanwhile, the snow-removal men in the higher mountains had their hands full. This was the first big storm in which the snow crews kept in touch with headquar-

(Continued to page 134A)

La Plant. Choate Co. Cedar. Wash. D.C. Waddell. Bluffs. Stump puller

*Caterpillar Sheel
Mach. D-7*

Lens with a Tilting Mount Corrects Distortion



Scale (below) on lens mount enables operator to tilt lens exact number of degrees to correct distortion

Photographs taken at an angle can be corrected during enlarging by the use of a mount which tilts the lens to straighten out vertical and horizontal lines in exact scale measurement. The image is projected to an easel tilted to produce the desired correction. Then the lens is tilted the same number of degrees to bring the entire image in sharp focus. The device also can be used to change perspective, lengthen or shorten the image without stopping the lens to small diaphragm openings.

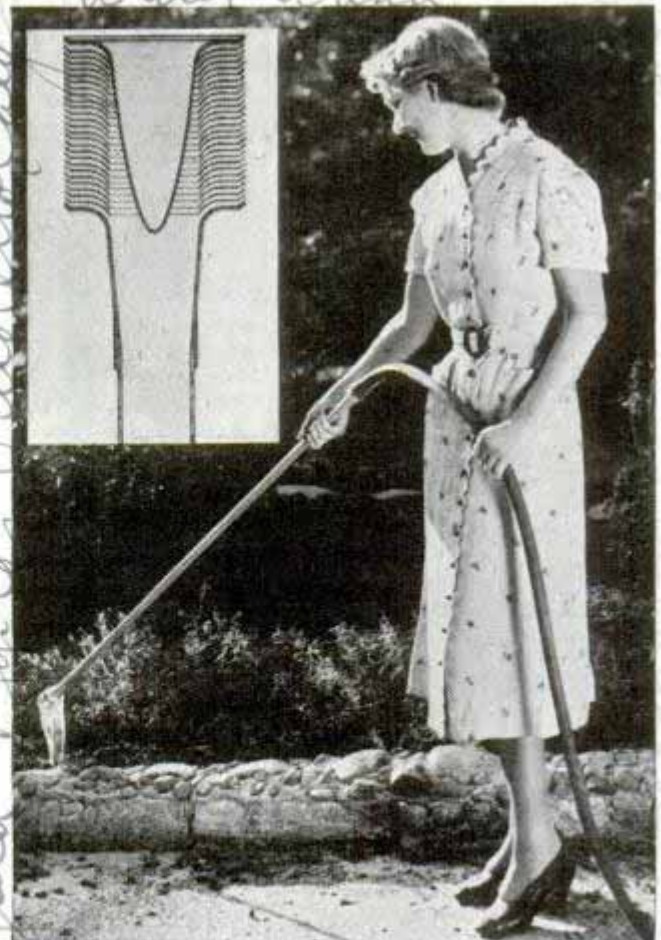
Lockjaw Vaccine Averts Death from Wounds of Battle

With a new kind of vaccination, men who go to war can be turned into walking

6/19/40
factories of lockjaw antitoxin, ready to fight off lockjaw, or tetanus, if they are wounded. Such protection has been made possible by the development of a tetanus toxoid made directly from the germs themselves, instead of from horse serum which sometimes causes so-called serum sickness. It is effective either when given at the time of injury or in advance as a protective measure, guarding likewise against danger of lockjaw from such peacetime accidents as automobile mishaps, Fourth of July burns and rusty-nail wounds.

Long-Arm Sprinkler for Garden Avoids Washing Away Soil

Provided with a long, lightweight handle that reaches back into deep flower beds, a garden sprinkler has a nozzle scientifically designed to slow down the motion of the water while still delivering full pipe volume. Its purpose is to avoid breaking down and washing away the valuable topsoil with the force of the hose stream. The sprinkler weighs only a pound. With it the gardener need not step into the soft soil of the flower bed to water plants at the rear, nor turn on the high-pressure hose.



Inset shows construction of nozzle designed to slow down force of full stream of water

220 E. 42nd St. New York

SPEED...the KEY to WAR



LEATHER COVERED STEEL HELMET

WEB PARACHUTE HARNESS

PARACHUTE PACK

RIGHT HAND ON RELEASE GRIP OF PARACHUTE

GAS MASK

OTHER MEN CARRY GRENADES, FOLDING CYCLES, ENTRENCHING TOOLS, RADIO EQUIPMENT, ETC.

SUB-CALIBRE MACHINE GUN ATTACHED TO WEB BELT

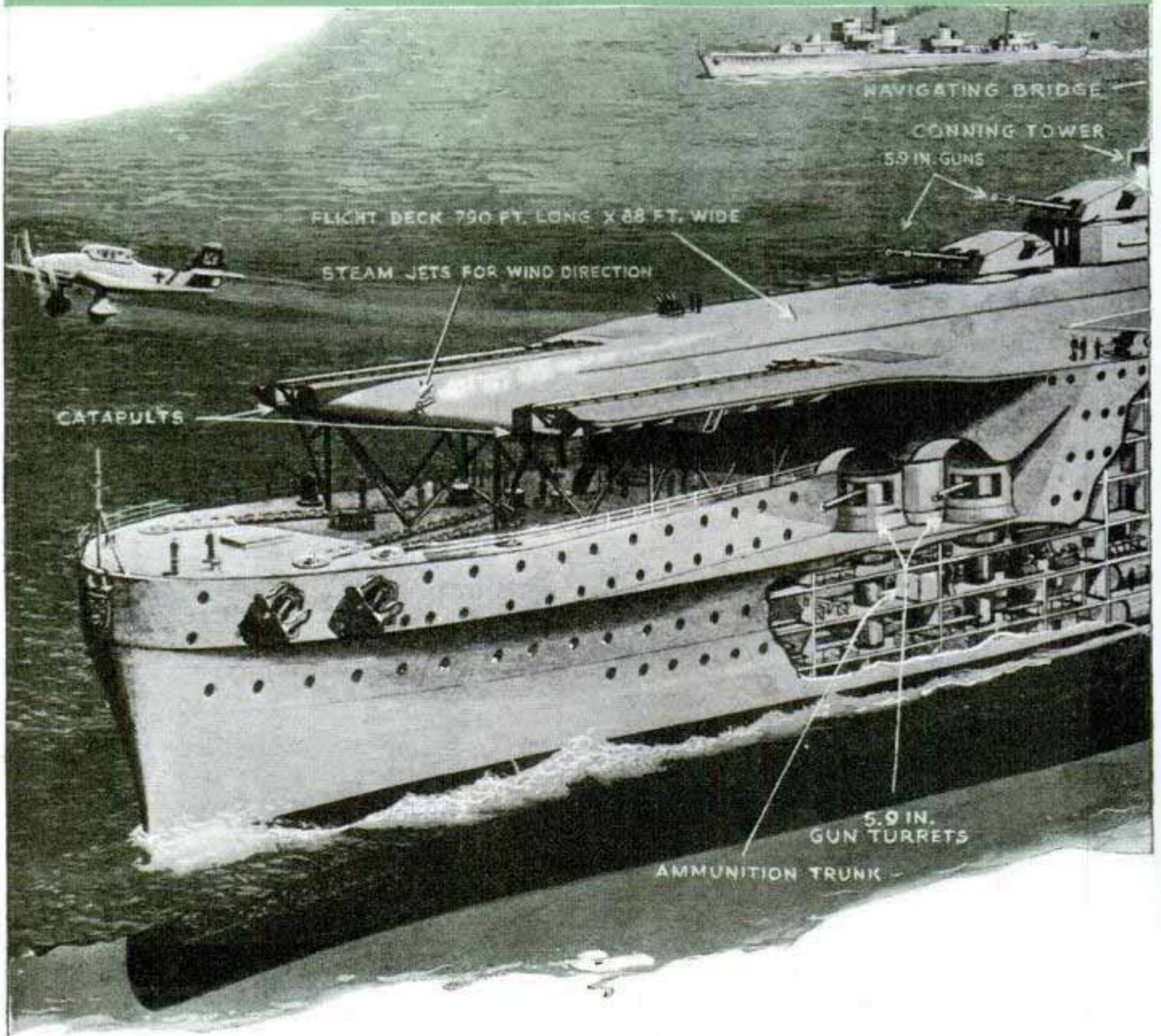
PACK

IRON RATIONS

PARACHUTE HARNESS

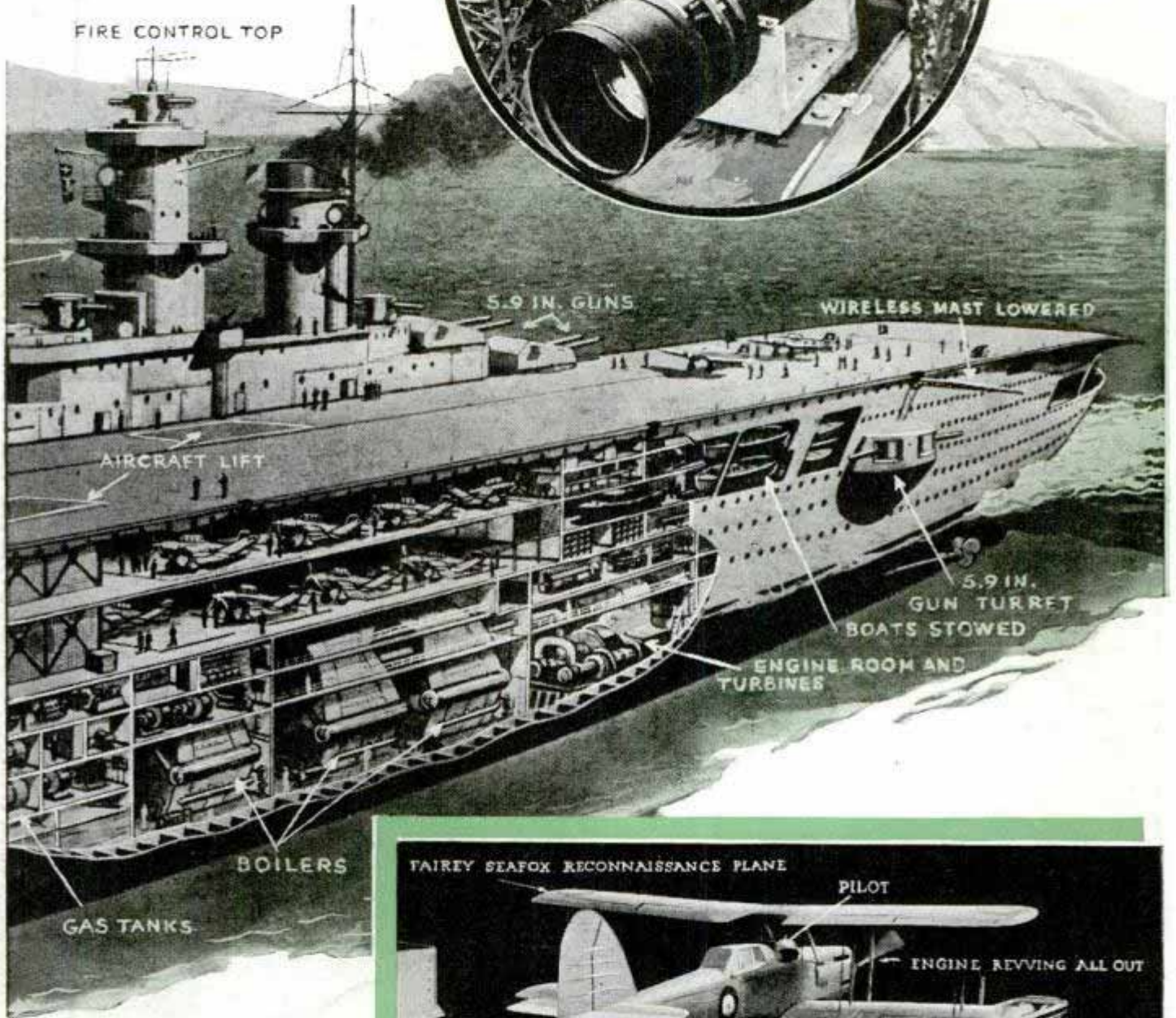
ALL GEAR IS SO ATTACHED THAT IT CANNOT WHIRL LOOSE DURING FREE FALL

By swift, stabbing thrusts the German army ended the static trench warfare typical of 1914-18, and the war of 1940 became a war of movement, with speed the key to success. The cavalry, traditional raiders, took to the air, the tank, the sea; paratroopers above are a modern version of the mounted scouts of earlier wars. Carrying quick-firing guns and bicycles, they drop behind enemy lines to seize airports, bridgeheads, even cities, or to wreck enemy communications and power lines

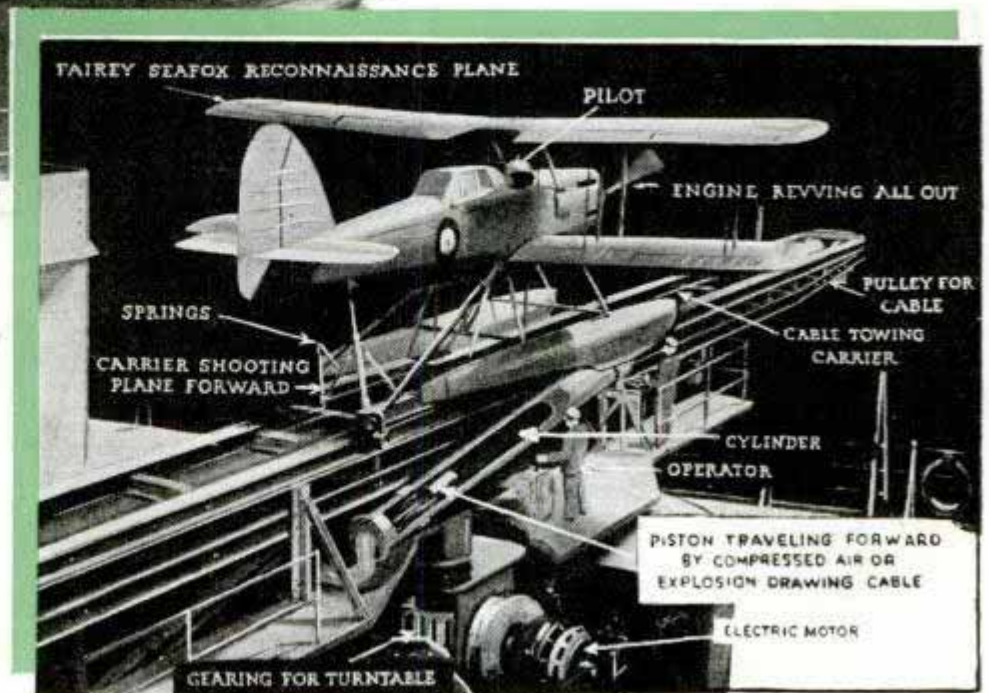


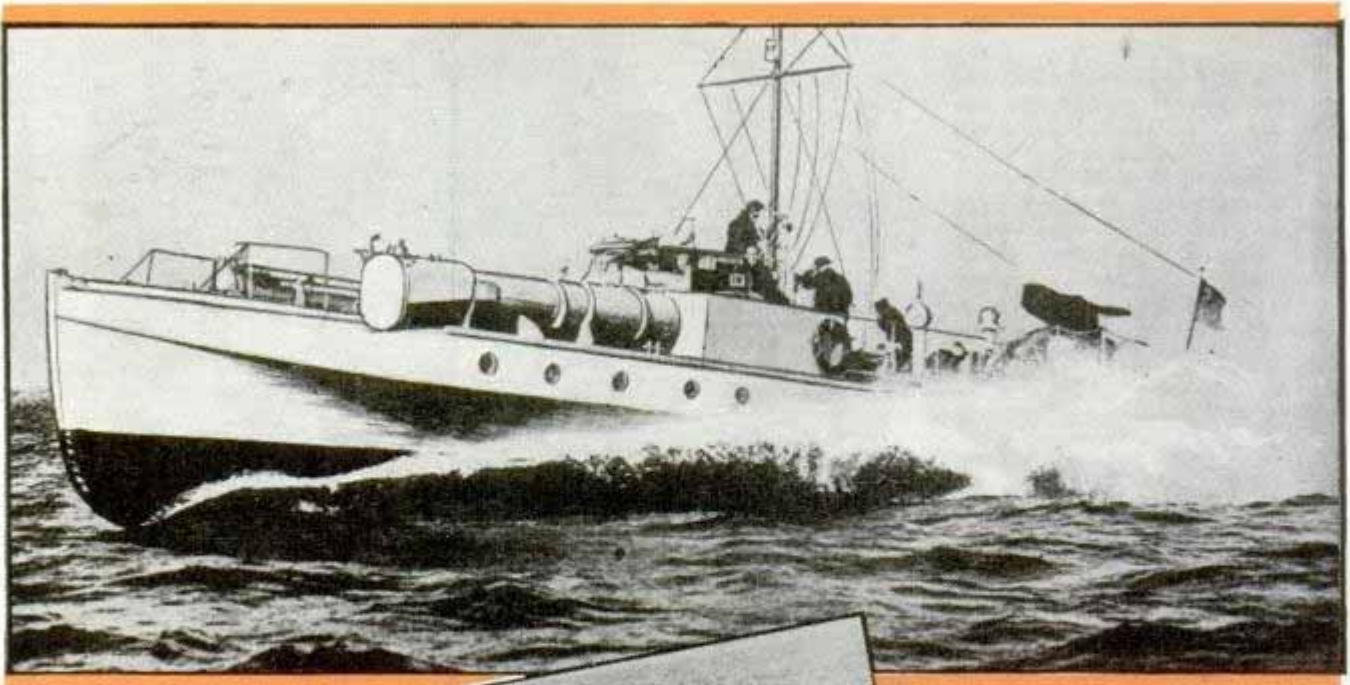
Speed disorganizes the enemy, but calls for utmost organization by the attacker. Top, a fleet of small, fast tanks used to batter holes for the supporting infantry to penetrate; this was once accomplished by the cavalry charge. American factories now are building large numbers of armored cars and tanks for mobile warfare. Across the pages is the "Graf Zeppelin," Germany's first aircraft carrier, launched nearly two years ago and presumably now in service

The big gun at the right belongs to the camera corps, not the artillery. Photographers, picking up information from the air and from front-line vantage points, speed up tremendously the work of the old-time scout who had to slip through the lines to spy out enemy fortifications and concentrations. Here the cameraman pokes his big lens through shrubbery to get a picture at the war front

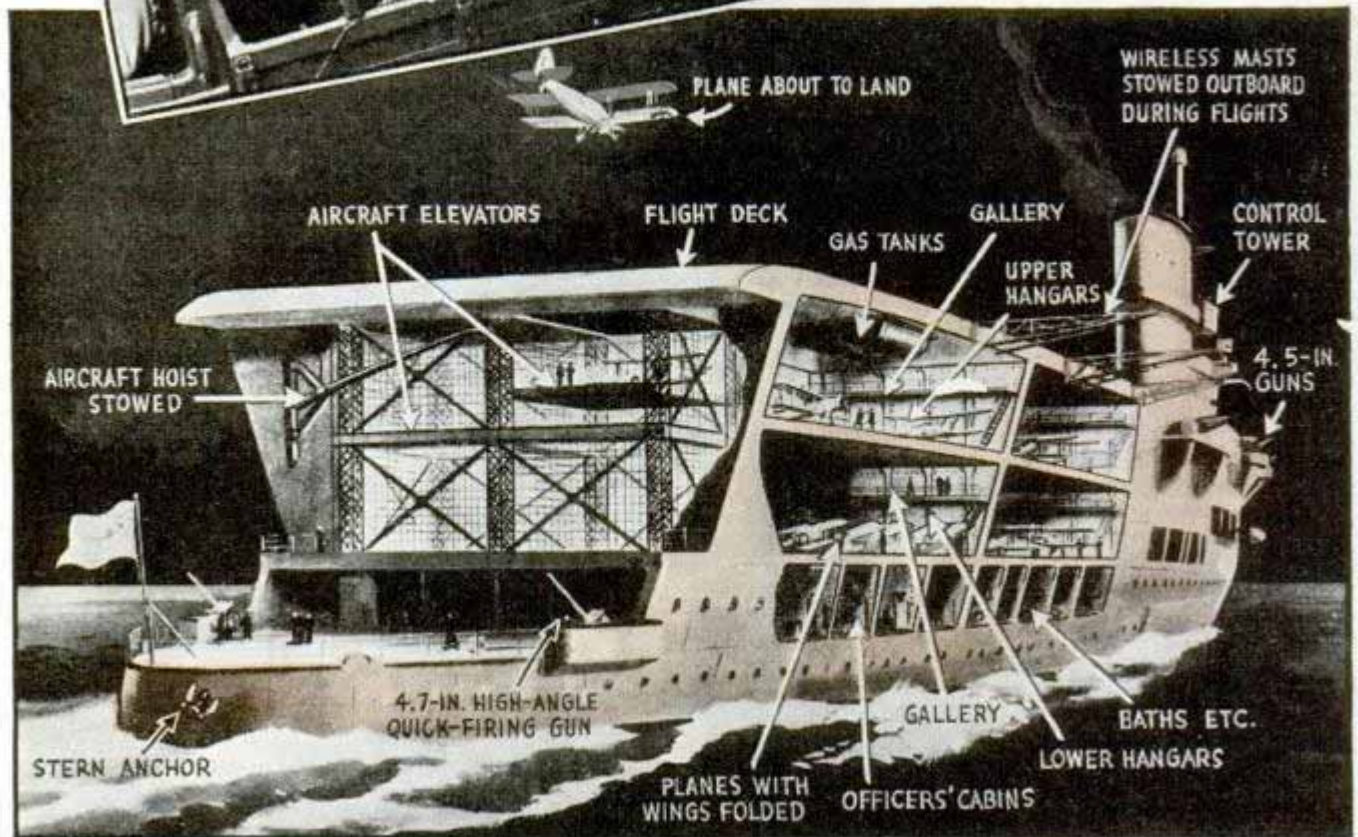


Heavily armed with sixteen 5.9-inch guns, ten 4.1-inch anti-aircraft guns and many smaller weapons, the 19,250-ton "Graf Zeppelin" above cruises at better than thirty-five miles an hour, carrying forty planes. Drawing at right shows plane taking off from British cruiser, its catapult thrust forward by cable operated by compressed air or explosion





When the English Channel became the war front, speedy torpedo boats like the German craft above were assembled on both shores for raids on enemy shipping. Darting out at forty-five to sixty miles an hour, these speedsters are so fast, maneuverable and small that they are almost impossible to hit. Gas and incendiary defense units made up of Italian civilians, left, guard desert forts and cities in Libya. Below is a cutaway drawing of Britain's "Ark Royal," showing some of its seventy aircraft



Chamber Tests Pilot for 40,000-Foot Ascent

Without leaving the ground airplane pilots can reach the equivalent of a 40,000-foot altitude in an "ascension" chamber, which permits a doctor to study their blood pressure, the effect on their ears and other physical effects to establish the individual's suitability for high-altitude flying. The pressure chamber "thins" the air corresponding to that of higher altitudes while the occupant inside is protected by an oxygen mask.

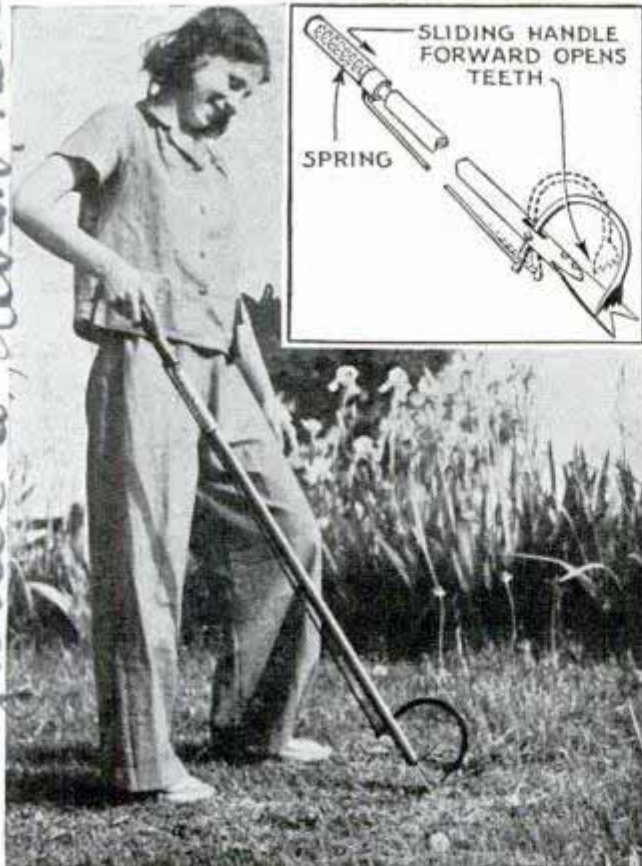
Pilot entering altitude chamber which lowers air pressure to equal that at 40,000-foot altitude in eight minutes



Long-Handled Weeder for Gardens Eliminates Stooping

Tiresome stooping when weeding is eliminated with a long-handled garden tool that severs the roots of the weeds and au-

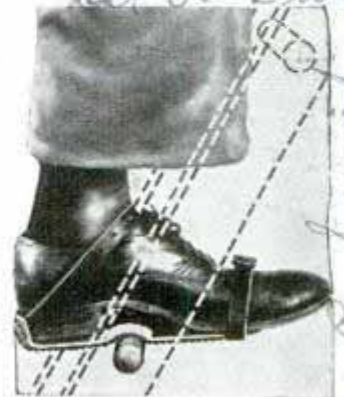
tomatically grips each plant as it is cut. When the V-shaped blade is driven into the ground to cut off a root, the sliding handle forces a pivoted arch to open so it may slip over the top of the plant. Upon release of the pressure, a spring closes the toothed end of the arch against the blade, with the severed plant held between them. Still without stooping, the gardener can remove the weed and toss it aside.



One-punch garden weeder digs weed and picks it up automatically. Inset shows how pick-up device works

Ladder "Shoe" with Non-Slip Sole Gives Safety and Comfort

Safety and comfort for workers who climb and stand on ladders is provided by a non-slip "shoe" that consists of a sturdy steel plate held on the wearer's foot with strong leather straps. Convenient to carry and easy to put on, it has a rubber slip-proof bottom and a grooved arch that grips the ladder rung securely.



Casey Ball Co., Albion, Neb.

Casey Ball Co.

Mr. Walter J. ...

Spare Flashlight Batteries Are Used in Emergency



Extra set of batteries in carrying case are always connected so flip of switch brings them into use

Light in weight so it can be worn comfortably on a headband, a flashlight outfit designed especially for forestry service holds two sets of batteries in a separate case which is worn on the belt or carried in a pocket. The two-inch headlamp uses only two batteries, and the case is equipped with a switch wired to the flashlight to permit alternating from one set of batteries to the other. Thus if one set loses its power, the extra cells are brought into service immediately by flipping the switch.

Rail Grinder "Steps" Off Track to Let Street Cars Pass

Having a gasoline engine of its own and riding on solid tired wheels independent of the rails and trolley wire, an eleven-ton track grinder is able to pick up its grind-



Track grinder moves out of street car's way under own power; grinders get power from trolley wire

ing mechanism and drive off the track to allow street cars to pass, resuming its task within one minute and twenty seconds. This "side-stepping" ability permits it to work where traffic conditions barred the old rail-riding grinder. Two grinding units, operated by separate fifteen-horsepower electric motors that connect to the overhead wire through a trolley pole, are mounted in conjunction with an elevating truck geared to one of the electric motors for power to lift the mechanism clear of the tracks when getting ready to travel.

Push-Button Telephone Serves as Private Exchange

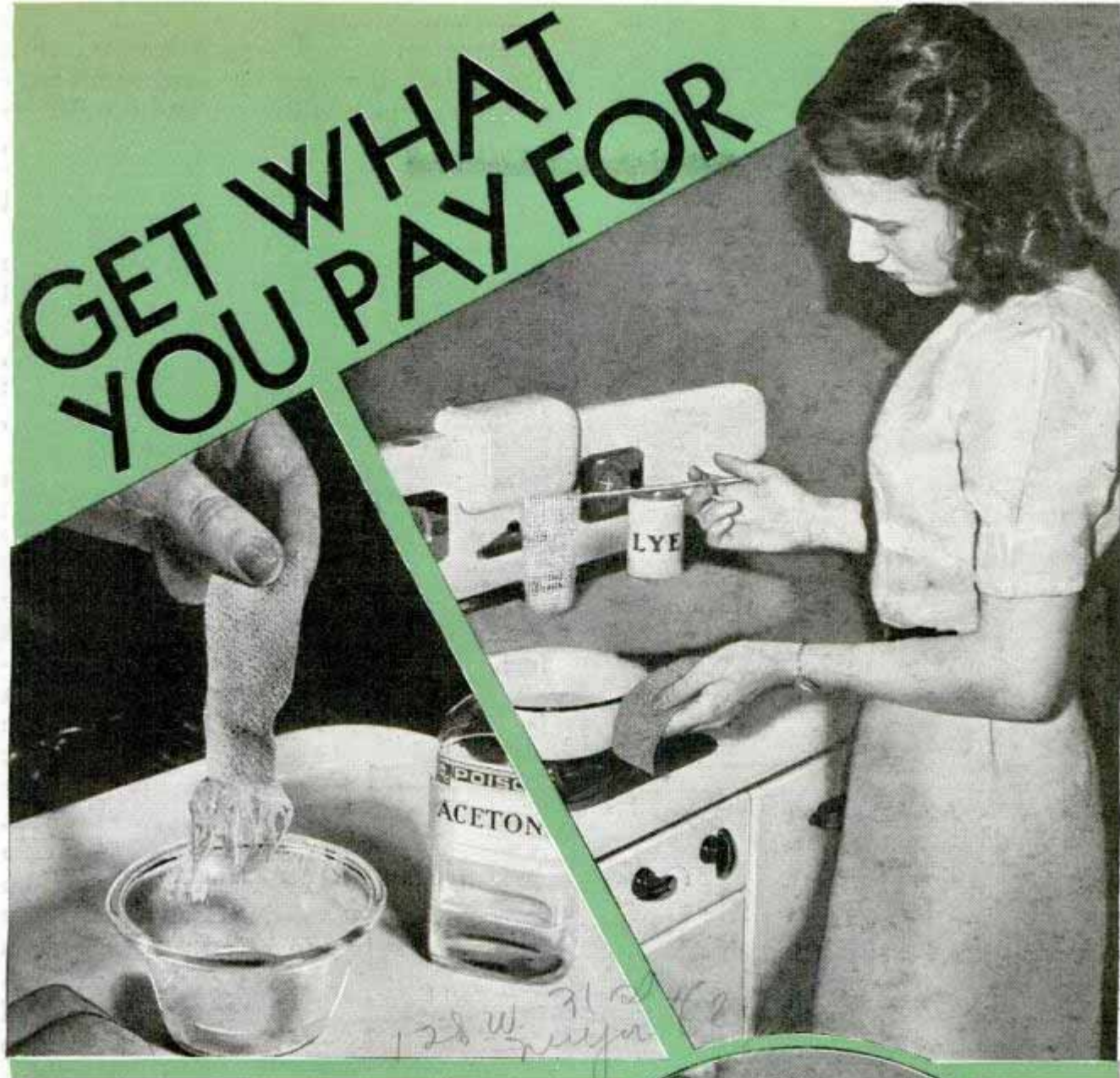


Telephone used as switchboard, inter-office or extension phone, is made private by raising tiny post

Serving as a small private exchange, a push-button telephone has been developed by Western Electric and Bell Telephone engineers. It permits a call to be answered from any phone in the line by pressing one of the selector buttons at the base of the phone. The telephones may be used for inter-office communication or as extensions on each other, but any one of the instruments can be made private by lifting up one of the posts upon which the cradle rests. Another switches off the bell when one does not wish to be disturbed.

For every gallon of gasoline burned in a modern automobile engine 9,000 gallons of air are required.

GET WHAT YOU PAY FOR

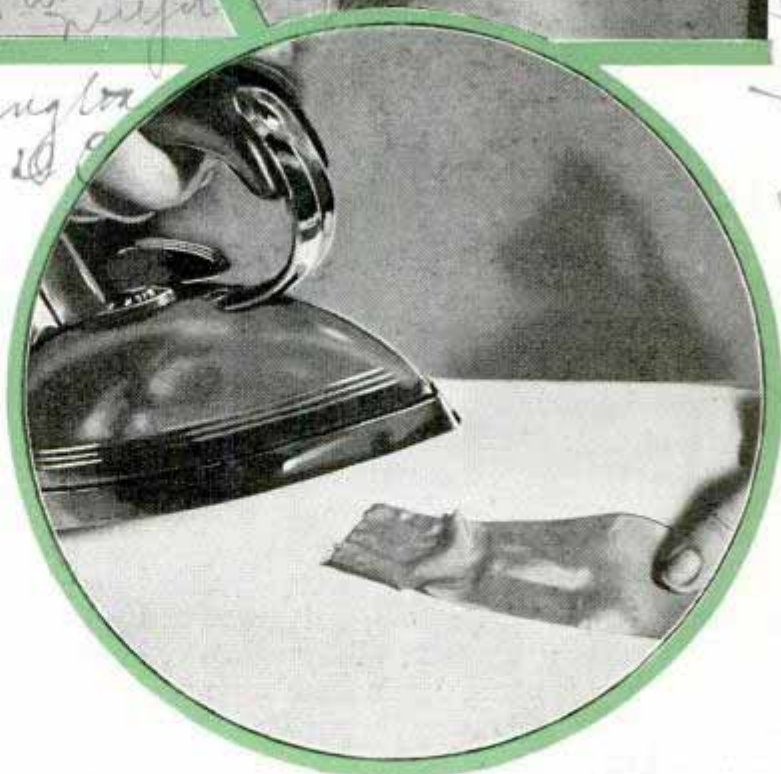


Photos courtesy The Hecht Co. and U. S. Bureau of Home Economics

THE average consumer buys largely on faith. Indeed, he must. If he attempted to acquire skill in judging everything, he would have little time for earning money to pay for anything. Fortunately, most nationally advertised products are exactly what the manufacturer claims them to be. The consumer can buy them on faith in perfect safety.

But there are certain things used by everybody that carry no manufacturer's guarantee. Often the quality can be determined by simple tests. In buying furniture, have the salesman tell you exactly what it is made of; then have him put it in writing. This protects you in case of misrepresentation.

Look first at the finish of furni-



Top, left, dipping viscose and acetate rayon fabric in acetone dissolves acetate yarns; right, coat material boiled in lye solution leaves spun rayon skeleton showing coat was only part wool. Below, viscose rayon stands hot iron, acetate rayon melts

cont. N.W. Ave., 4322 Second Road N.
Arlington, Va.

washington



reach underneath and feel. If your hand meets a lot of open space covered with cheesecloth, the piece has single-unit construction which will not stand up. If the bottom is covered with a substantial fabric, and you feel the springs supported by strong webbing, you have a hand-tied piece that will wear well.

Next, turn the piece over and read the sanitary label, required on all upholstered furniture. This tells what the filling is; and if it is new or secondhand. Horsehair, cotton felt, and moss, are the best fillings in that order. Wood wool is the cheapest, being nothing but excelsior.

You will have to use your judgment on the covering; but a fabric that looks and feels durable most likely will be; especially if the finish and construction of the rest of the piece are of good quality. Real leather can be distinguished from imitation by the feel. Leather quickly assumes the temperature of the hand, feels warm. Imitation leather feels cool. This same test may be

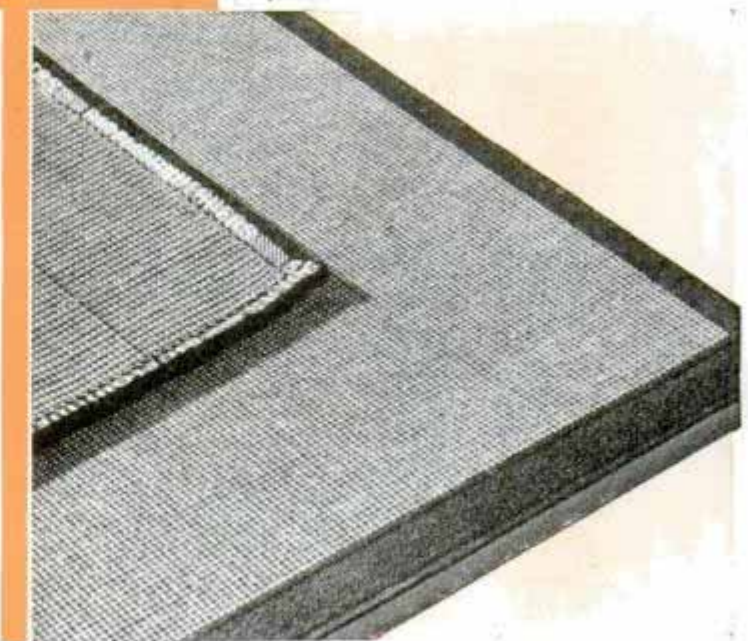
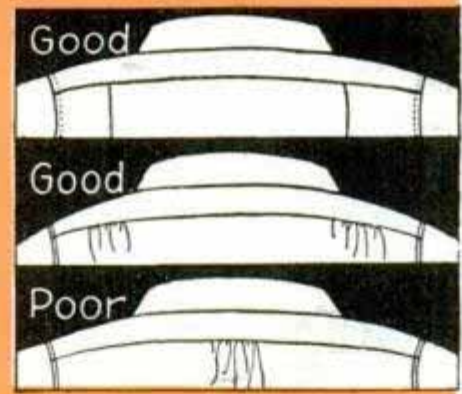
applied to luggage. But there are many qualities of leathers. Cheap split leather has the flesh side to the surface and will be rough. Good leather has the hair side up and is smooth even when artificially grained. Good canvas-covered luggage wears better than cheap

ture. If this is rough, the whole piece has been thrown together cheaply. Look at the drawers of a bureau or desk. If the dovetailing fits perfectly, the workmanship on the whole piece will be of good quality. But if you find poor joints where they may be seen, you can be sure the concealed parts will be even more poorly fitted. A cheap piece is cheap all over.

Don't insist on solid mahogany or maple or walnut on a piece having large surfaces. Even the best wood will warp or crack if wide, solid panels are used. A good veneer job is stronger, because the layers are glued together with the grain crossed. "All mahogany" or "all maple" means veneer is used, but all of the specified wood.

If you want a less expensive piece that will stand up just as well, get gumwood with your favorite wood as the surface veneer. For large panels, gum stands the gaff better than some more expensive woods. Pine and tupelo are the foundation woods of most inexpensive furniture.

In buying upholstered furniture, sit on the cushion to depress the springs, then

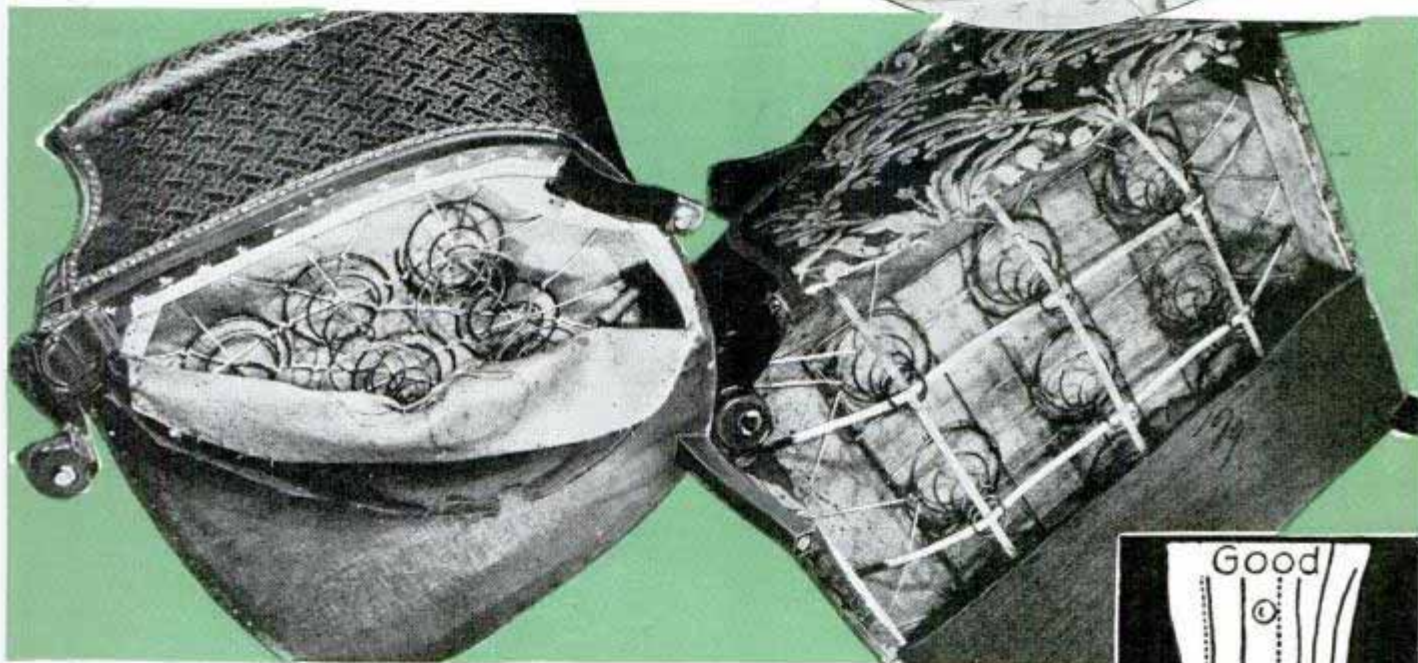


Top, weighted silk is hard to ignite, pure silk burns easily. Center, how to choose a well-fitting shirt. Bottom, note close weave and substantial binding of lower rug compared with cheaper one above it

leather. You can tell the quality of any luggage by the hardware and stitching. No manufacturer permits good materials to be botched by shoddy workmanship.

Rugs may be judged by closeness of weave and depth of pile. Fold over the edge of a rug along its width to expose the piling. The yarns should be close together, have an even dye throughout their length, and be three-eighths to one-half inch long. Now turn the corner of the rug over and count the weave, which should run six or seven warps to the inch. Cheap rugs will have fewer warps to the inch and a much shorter pile.

Modern textiles are becoming

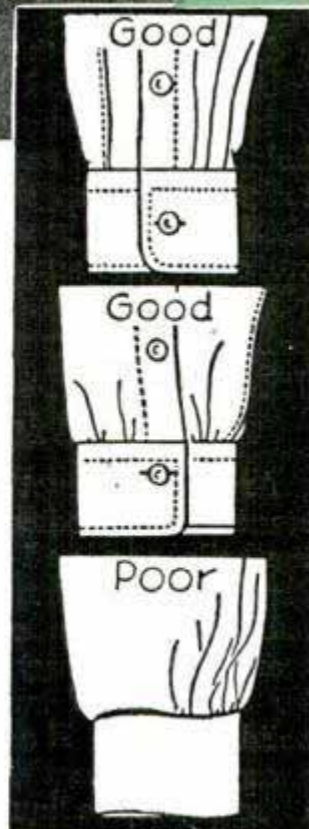


Top, materials that fray and pull out at seams need overcasting, double stitching or binding at seams. Single-unit construction of upholstered furniture is inferior to hand-tied. Right, what to look for in shirt sleeves

more and more difficult to judge. New fabrics are continually being developed; frequently two or three fibers are combined in the same fabric. Labels seldom tell the full story. "Part wool" might mean as little as five-per-cent wool. "Spun rayon and wool," or "silk and acetate" are equally misleading. If one can afford to buy for appearance only, a chance can be taken, but if wear must be considered, it is necessary to know precisely what a fabric is made of.

The U. S. Bureau of Home Economics advises simple burning tests to identify fabrics. Untreated cotton burns quickly with a yellow flame, and an odor of burning paper. Even when the flame is blown out, the edge will continue to smolder with a yellow glow that eats rapidly into the fabric, and is very difficult to put out. Practically no ash is left, and what there is is black.

(Continued to page 124A)



Hinged 'Closet' Fits on Door to Hold House Supplies



Fitted on back of the kitchen, bathroom or closet door, these shelves offer extra storage space

Extra closet space for bathroom or kitchen supplies can be added by fastening an enameled-steel cabinet on the back of a door, where it takes up no room. These cabinets, four and three-quarters inches deep, are available in various styles for holding brooms and mops, for linens and toilet articles as shown, or in an eight-shelf model for general storage. Offered in various colors and sizes, the "closets" are hinged to the door.

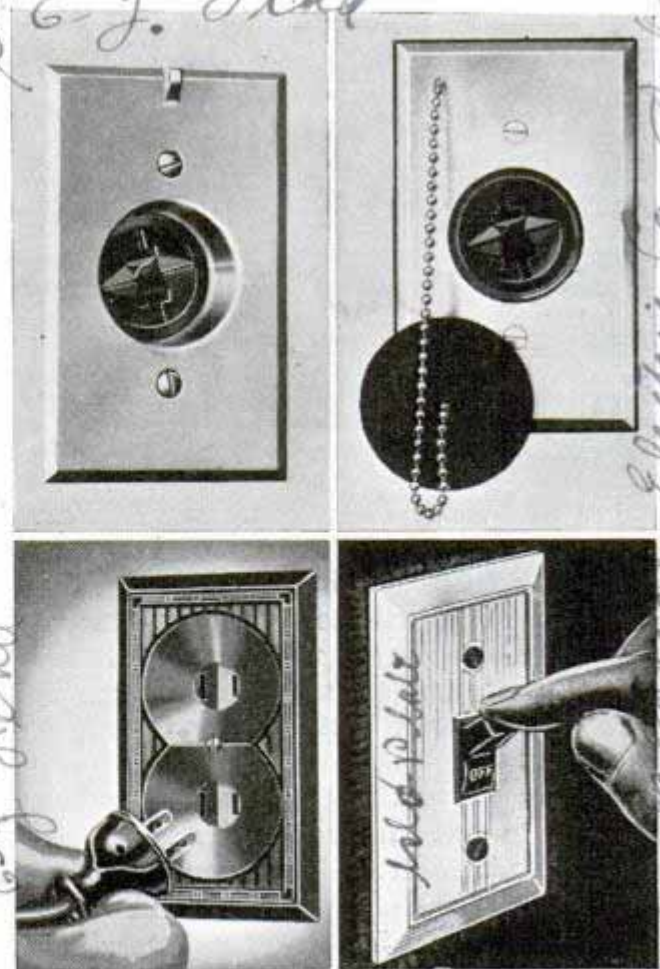
Low-Cost Radium Substitutes Produced for Medical Use

Artificial production of radium-like substances for medical use is possible by methods covered in a patent recently granted five Italian physicists. Their plan calls for bombarding materials with neutrons whose energy has been slowed down by a screen of suitable material, either solid or liquid. If a liquid is used, the material to be treated can be suspended or dissolved in the liquid itself. Sodium is one

of the most widely used elements, but platinum, gold, iodine, potassium, copper and chlorine also have been made more or less radioactive by this method, which promises artificially radioactive substances at lower cost than natural radium.

Special Purpose Electric Outlets Handy for the Home

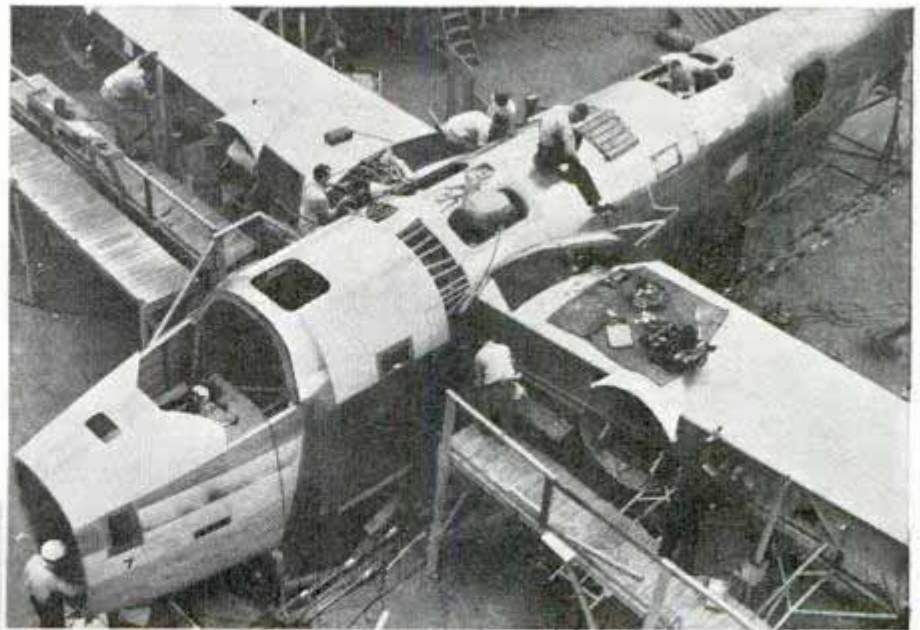
To save annoyance when plugging into a receptacle located out of sight or behind furniture, the slots of a new electric outlet are centered in a dished surface to guide the plug blades into position for quick contact. Another outlet includes a hook to hold an electric clock, while a deep recess conceals the cord and plug, thus eliminating the untidy extension cord and allowing the clock to hang flush with the wall. For damp locations and outdoor use, a weatherproof outlet contains a rubber mat under the plate to keep out moisture and is aided also by a rubber cap attached to the plate by a bead chain. A fourth innovation is a luminous wall plate for both switches and outlets which is made of plastic that glows visibly in the dark.



Left to right, top, electric clock and weatherproof outlets; bottom, "dished" outlet and luminous plate

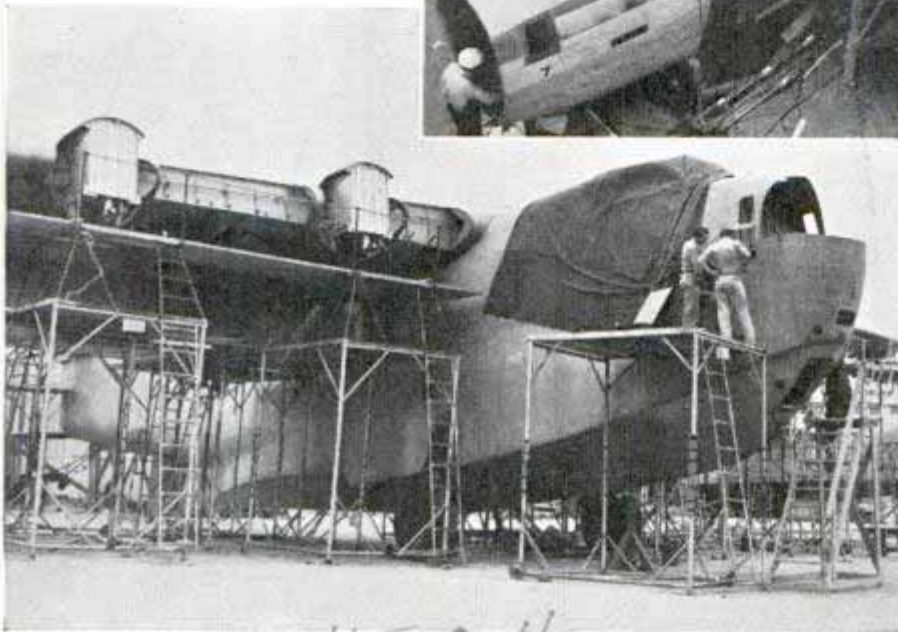
Outdoor Assembly Speeds Plane Production

To keep up with its rush of orders for military planes, the Consolidated Aircraft Corporation has moved the assembly line outdoors at its San Diego plant. This allows more room for production indoors. The company is concentrating on three types, a mammoth four-engine flying boat, a two-engine patrol bomber and



Wilds Work

Army bomber, above, and four-engined flying boat at left near completion on the outdoor assembly line at San Diego plant



K534

a four-engine bomber for the army. The engines of these huge planes are rated at 1,200 horsepower each, giving them high speed and a wide cruising range. They carry crews of six to nine men.

Pumps Drain Sea-Level Farm through Series of Canals

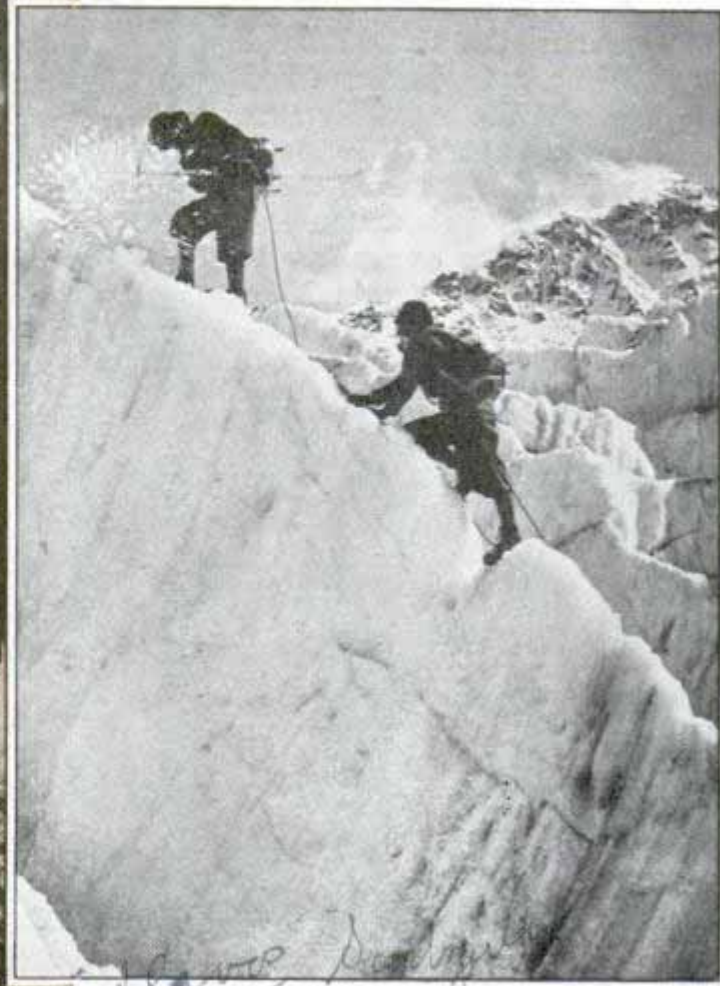
Draining a farm located at sea level was solved by pumping water through canals cut to a point three miles back from the bay. Gigantic turbines, powered with sixteen-cylinder Diesel engines and capable of pumping 6,200 gallons per minute, keep the water moving. The pumps are installed in series so that, starting at the farthest point, the first pump forces water to the next one, which gives it another push. This operation is repeated until the water empties into the bay.

Workmen installing one of the giant turbines used for draining sea-level farm. Pumps are placed in series along the level canals, some of which stretch three miles inland, to keep water flowing back into the bay



*Cond: Ted Smith of Curbass, Miami
1713 St. ...*

STEEPLEJACKS



Left, mountain climber descending by rope. Right, two climbers scaling perilous ice-coated ridge on way to conquest of a peak in Switzerland

Cont. from p. 545
Dr. 11044 Z. Debrau Kans. Cal.
July Bernina, near Pontresina, Switzerland

HIGH on the face of the cliff the young mountaineer was clinging to the vertical wall, his toes wedged in a small crack. From around his waist a thin rope trailed to an iron ring in the rock fifteen feet away and on to a companion.

As he reached for a new handhold he heard a quiet command: "All right. Jump off." For a moment he hesitated, then let go. His body plummeted down and came to a stop thirty feet below, swinging at the end of the rope. His smaller companion had checked his fall.

This hair-raising exhibition was part of the training a new climber was taking. The deliberate fall was intended to give him the confidence of knowing that in an emergency his companion could save his life. In this case the instructor weighed

less than the student, but he was a skilled climber who knew just how to absorb the sudden yank of the rope and stop the heavier weight with his hands.

Climbing mountains for the sport of it and for the thrill of accomplishing feats that seem impossible, mountaineers who use modern high-angle climbing technique are ascending to places never before reached by man. They mount sheer cliffs that apparently were never intended to be climbed, crawl out and over overhangs that have nothing but thin air for thousands of feet below, and take advantage of every tiny crack and knob to move like flies up the sides of towering peaks.

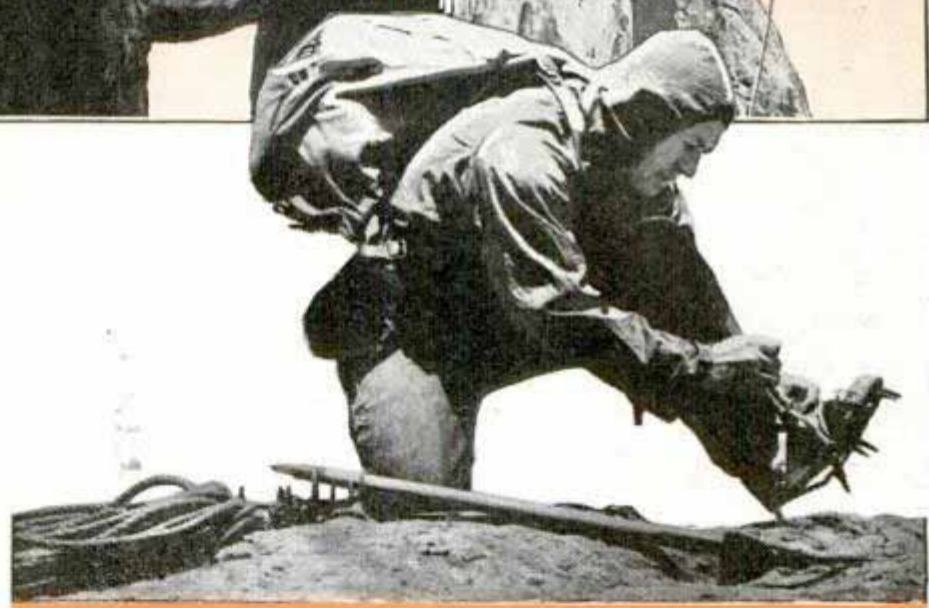
The result is that they have climbed every major mountain in the United States. Dangerous peaks once declared impossible

Sept. 1941

of the MOUNTAIN PEAKS

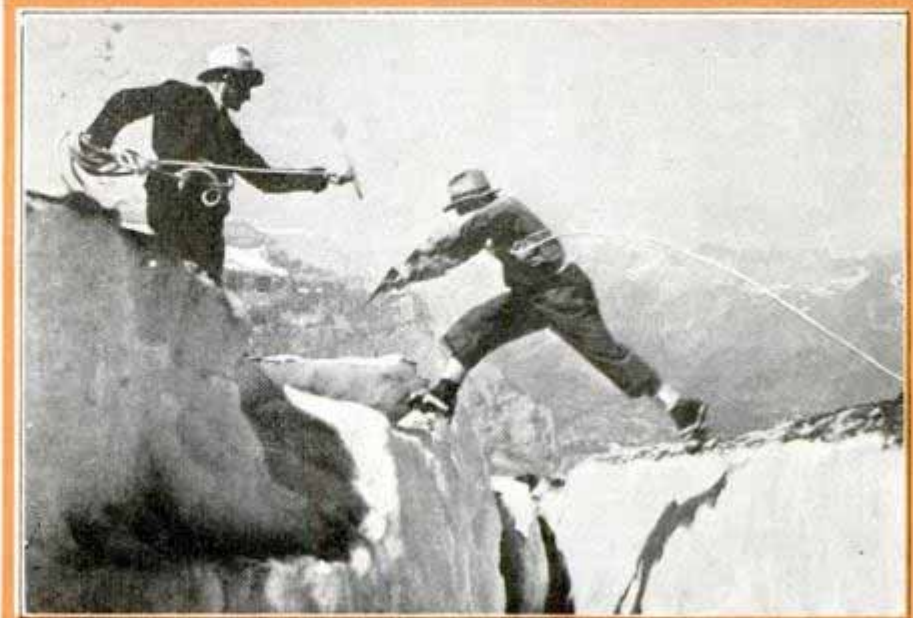


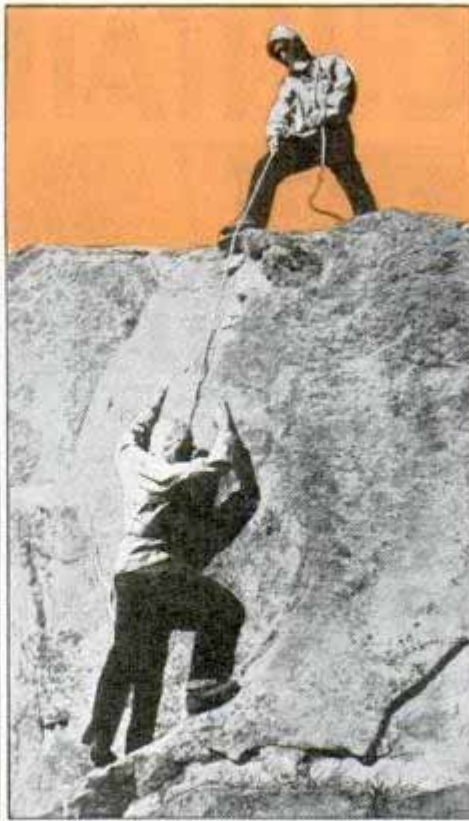
Top, left, driving piton into crack in rock wall. Center, technique of movement in vertical cracks called "chimneys." Right, climber roping down rapidly by swinging away from cliff. Center of page, strapping on crampons for ice climb. Bottom, negotiating perilous crevasse.



are being conquered one after another. Last year Shiprock in New Mexico and Monument Peak in California, two pinnacles that turned back expedition after expedition, were finally ascended by members of the Sierra Club of California.

Height alone is no handicap and 14,496-foot Mount Whitney, the highest point in the United States, is regarded simply as a training ground by skilled mountaineers. One of the worst climbs remaining is the comparatively low Lost Arrow





Peak in Yosemite Valley. The slender spire is only 1,500 feet high but its excessive steepness and smoothness and lack of holds have baffled every expedition that has tried to reach its top.

Advanced mountaineering is one of the most dangerous sports in the world when the climbers are inexperienced or over-

confident. Even though many of the risks can be overcome, such hazards as avalanches or sudden blizzards can still cause disaster. To keep their sport as safe as possible new members of the Sierra Club are taught step by step. Practice climbs are held until the students gain experience. The result is that no member of the club

has been killed while using modern technique, even though many ascents have been made that compare in technical obstacles with severe European climbs.

But many of the daring climbers have had close calls and all of them have had anxious moments. Take the climb of Monument Peak that was made by John D. Mendenhall, Mrs. Mendenhall, Arthur B. Johnson, and Paul Estes, four of the most experienced climbers in the country. As in all dangerous climbs, they were roped together. Each wore rubber-soled shoes and carried first-aid kits, flashlights, and food. In addition each wore a climbing hammer on a sling



Sierra Club Andover, Mass.

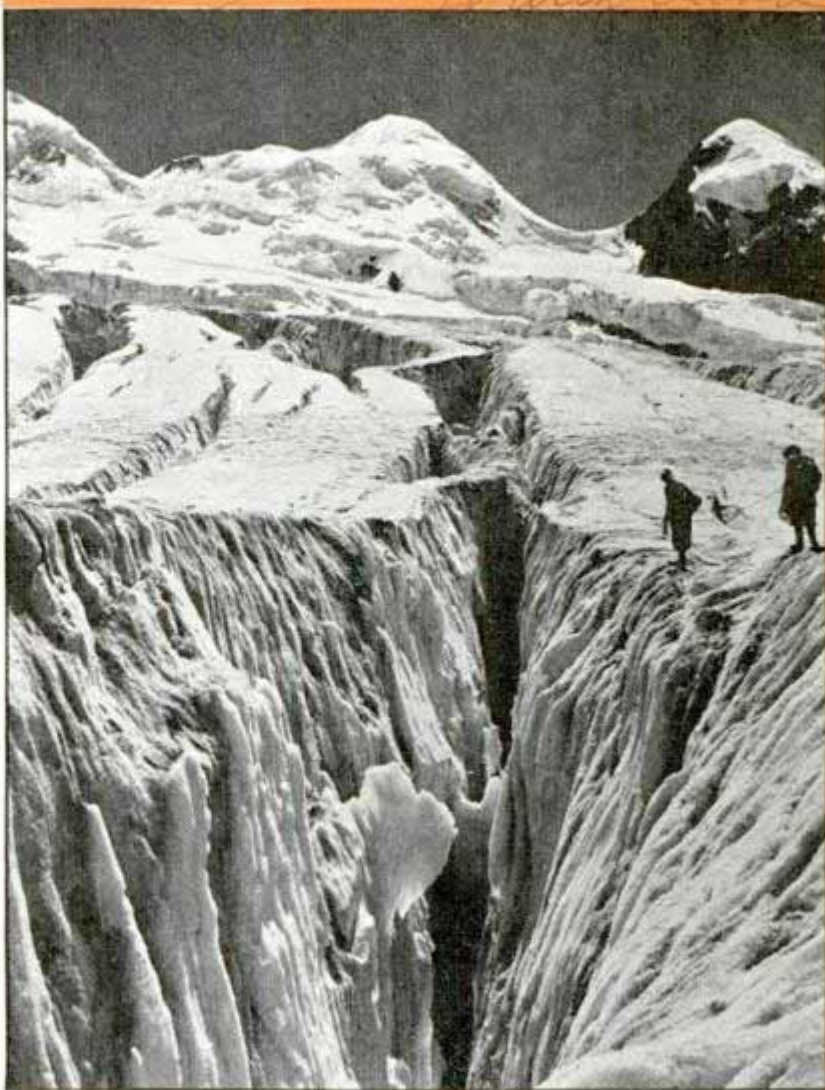
Top, left, technique employed where crack is too narrow to jam into and walls are devoid of projections. This is very strenuous. Center, standing shoulder belay aiding climber. Right, descending cliff on rope anchored above. Bottom, descending overhang, with nothing but thin air below

Poparades

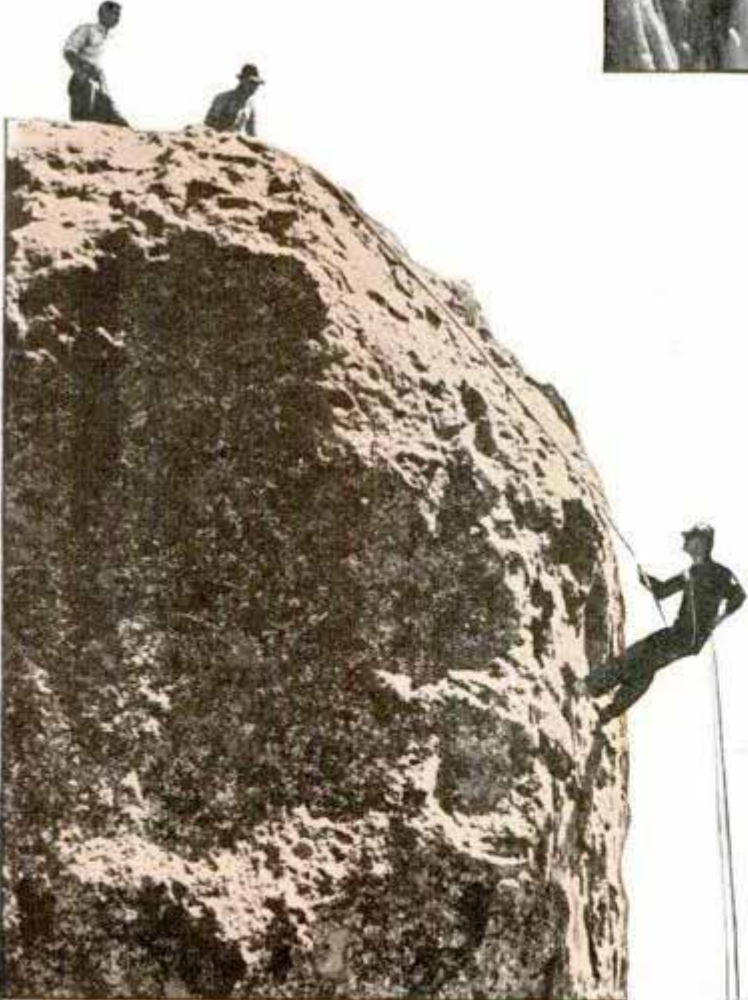
and carried pitons, short heavy spikes with an eye at the outer end that are driven into cracks in the rock, and carabiners, snap rings that can be passed around the rope and attached to the pitons. For some difficult climbs holes have to be drilled into the rock and expansion eye bolts set into the rock before the leader can move forward.

In making a dangerous pitch the leader works his way forward alone while the second man protects him by belaying the rope around his body and standing braced so as to take the strain if the leader slips and falls. When the leader can find a crack he drives in a piton and snaps his rope to it with a carabiner. Then if he slips his fall will be shorter and the strain on his companion will be less.

Reaching the end of his



Castor and Pollux Twin mountains



Top, climbers on glacier in Switzerland. Bottom, controlling descent speed by tension of left hand. Loose grasp of right hand prevents tipping backward

slack, the leader belays and protects the second man as he makes his way forward or upward. In high-angle climbing only one member at a time is on the move.

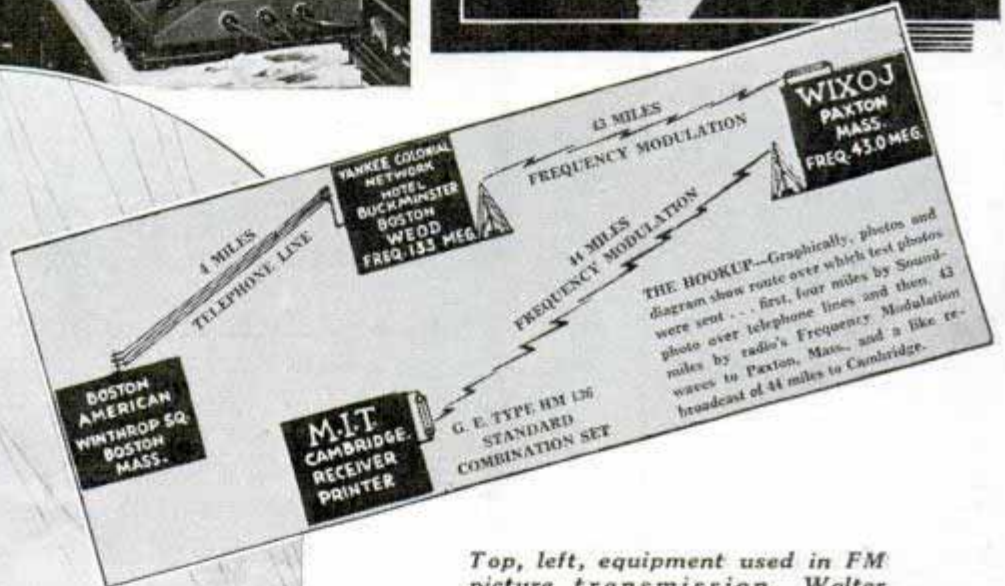
Clinging precariously to a wall, one false move can bring disaster. Smooth teamwork and immediate execution of every command are vital. If the leader is delicately balanced on a small projection the weight of too much rope alone may pull him over. Too little rope may trip his body when he moves. Occasionally the leader may lean out against the pull of the rope to reach a hold and the second man must feed the rope to him slowly and surely. On a dangerous pitch every member of the climbing crew is under a steady tension.

On the Monument Peak ascent two hours were needed to climb one difficult stretch of forty feet. Reasons why the mountain had never been climbed before are that it is composed of disintegrating volcanic breccia and the upper 360 feet of its spire are practically vertical. Every hand and foothold had to be tapped to sound out the rock. Once while Mrs. Mendenhall was

(Continued to page 126A)

Photos Are Transmitted by FM Radio System

of Record American and Advertiser
 5 Wintthrop Square, Boston, Mass.



Top, left, equipment used in FM picture transmission. Walter Howey, builder of Soundphoto system, is shown facing camera. Right, example of photo after transmission. Circle, FM station and antenna. Inset, map of picture transmitting hookup

Transmission of photographs by the Armstrong frequency modulation radio system has been accomplished, with almost perfect fidelity of reproduction. A Soundphoto system, built for International News Photos by Walter Howey, was employed in transmitting and receiving the pictures. The Howey equipment has amplitudes of carrier wave ranging from barely enough

signal to register on a sensitive voltmeter, which might correspond with black or absence of light in the photograph, to about eight-tenths volt, corresponding with the highlights or white of a picture. No more current than the load of a common telephone line is propagated. A twenty-five watt mobile transmitter is being built for International to enable reporters to telephone stories by frequency modulation radio, and photographers to transmit pictures by the same system. The mobile FM transmitter will have a range of twelve to

2358 45 th need

fifteen miles at ground level and about forty-five miles if transmitter or receiver is elevated 500 feet. Time of shooting, developing, transmitting, receiving and engraving a photo has been cut by this method to approximately forty minutes, about one-third that originally required. The test transmission by FM radio was accomplished over a four-mile telephone line to the Yankee Network's Boston station WEOD, thence by FM to WIXOJ, at Paxton, Mass., then to a receiver at Massachusetts Institute of Technology, at Cambridge—a distance of ninety-one miles, eighty-seven of which were covered by FM signals.

Small Track-Type Tractor Driven by Gasoline Engine



Young driver pauses to permit comparison of his gas-powered model with huge Diesel tractor which is driven by his father

Gauge Shows Soil Moisture around Roots of Plant

As a guide for watering house plants, window boxes and seed flats, a moisture gauge has been offered. Made of aluminum, it has a perforated prong containing a



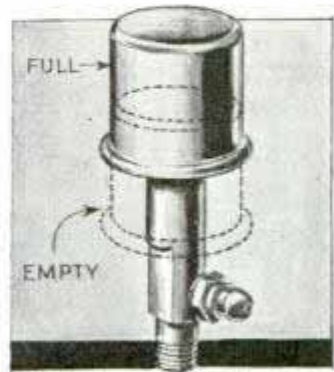
Thrust into the soil, the gauge shows whether the plants need more water

moisture-sensitive material which, contracting or expanding according to the degree of dampness, actuates an indicator showing when the plants need water and just how much they should be given.

Probably the smallest working Caterpillar track-type tractor with the youngest owner, is the one-and-one-half-horsepower model driven by a three-year-old boy of Bolivar county, Miss. More than a mere toy, the tractor is capable of doing work such as pulling his playmates' wagons, hauling him from place to place, and performing other useful jobs. It has a top speed of two miles an hour, being steered in the regular track-type manner, and having clutches to stop the flow of power from the single-cylinder gasoline engine to the tracks. The transmission, with both forward and reverse speeds, is a miscellaneous assortment of gears, the rear axle comes from a miniature automobile, and the tractor has an electric starting motor and electric lights.

Spring in Grease Cup Feeds Lubricant Loaded by a Pressure Gun

Filled through its stem by a pressure gun, a self-feeding grease cup gradually delivers the lubricant by means of a spring inside the cup. Thus it acts as its own indicator, the cup being up when filled, down when it is empty. To accommodate it to various types of greases and back pressure of various bearings, the spring can be changed easily, and there is a shut-off valve in the stem to prevent damage to the cup from a high-pressure grease gun.



Habaco Co. Inc.

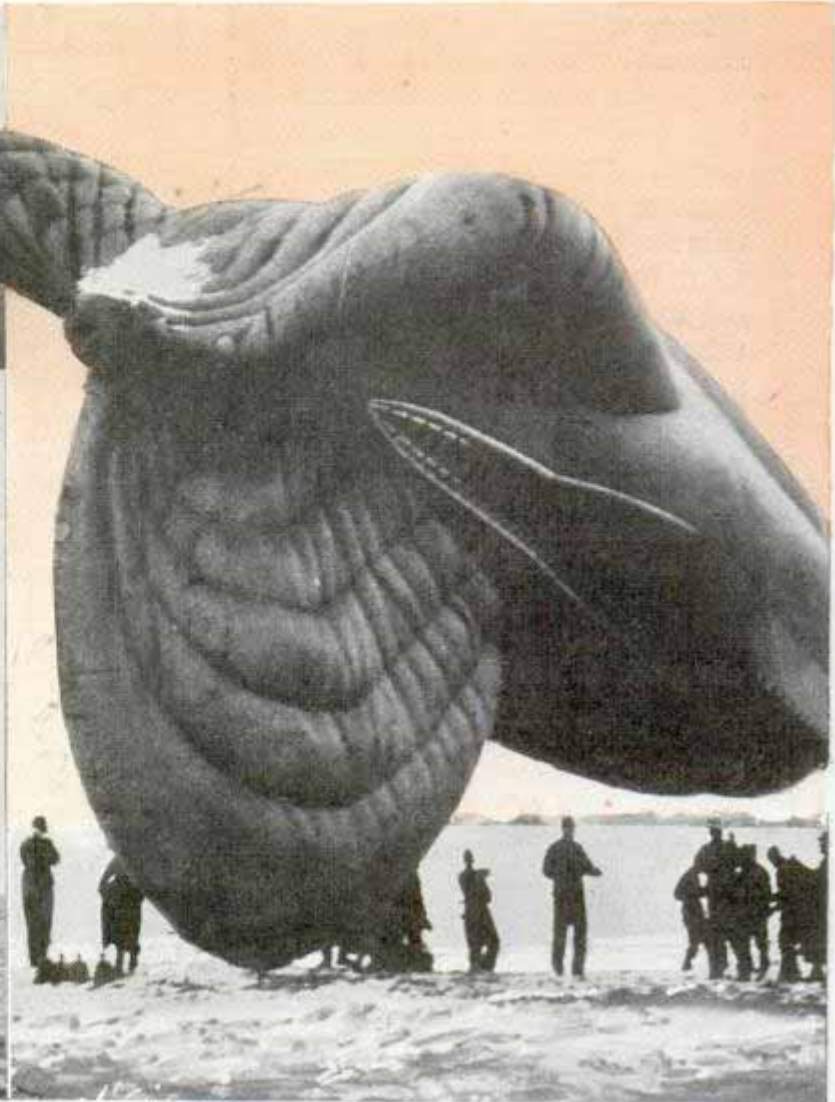
Wanted by various firms, read cub

Pavia, D. L.

Lubricating Equipment Co. 2345 W. Grand

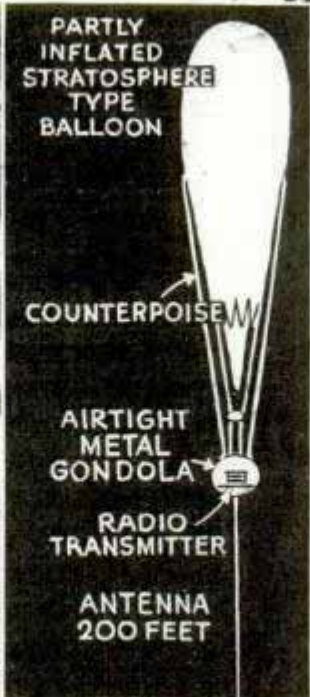
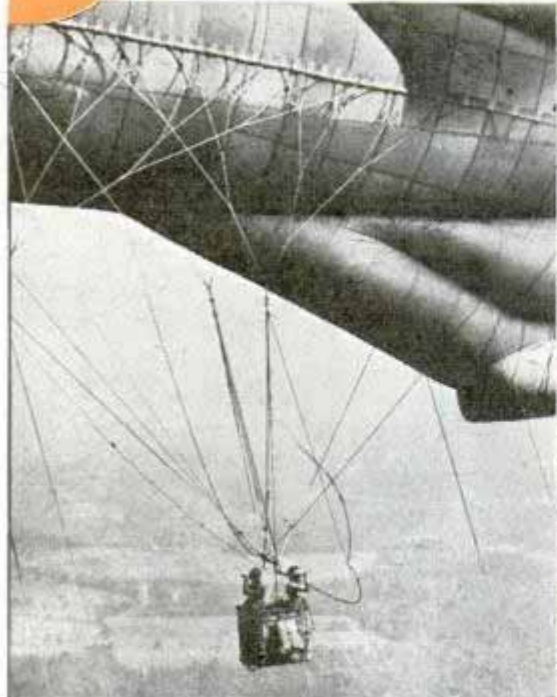
100 56

*Seaman Wesley Calhoun
Coast guard stevedore*



NEW TASKS *for* WAR

U.S.A. Air Corps

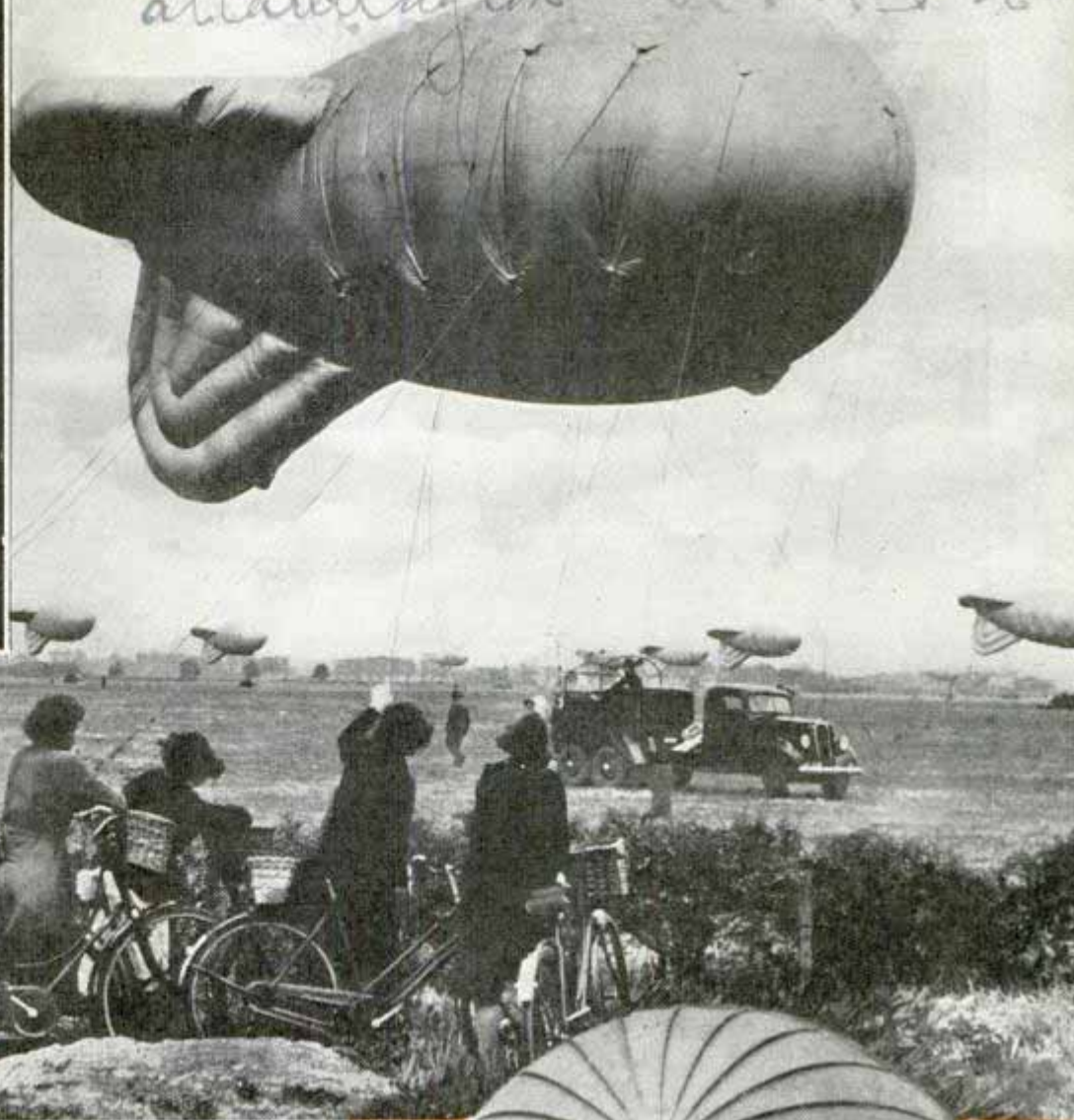
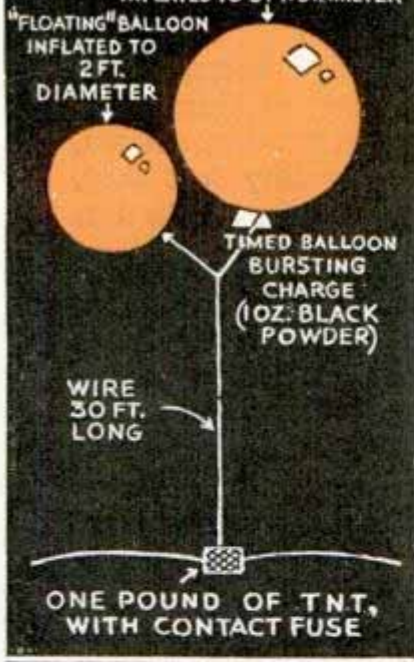


BALLOONS, lifted by hot air, coal gas, or hydrogen, manned or unmanned, captive or free, have been used in warfare for more than a hundred years.

In the first World War of 1914-18, the skies above the western front were full of large, sausage-shaped, captive kite balloons, carrying observers for long-range artillery. These balloons, hydrogen-filled and flying from a steel cable at 3,000 to 5,000 feet, were attractive but dangerous targets for the fighter-airplane pilots of those days—attractive because they would burst into great gobs of orange flame when pierced by tracer bullets, dangerous because they

Defense Co.

Top, left, U. S. Navy blimp lowering rubber boat in rescue demonstration. Right, Swiss balloon of type to be employed in forming aerial ring around nation's borders. Below, left, observers in balloon basket. Right, design for balloon to broadcast propoganda from stratosphere



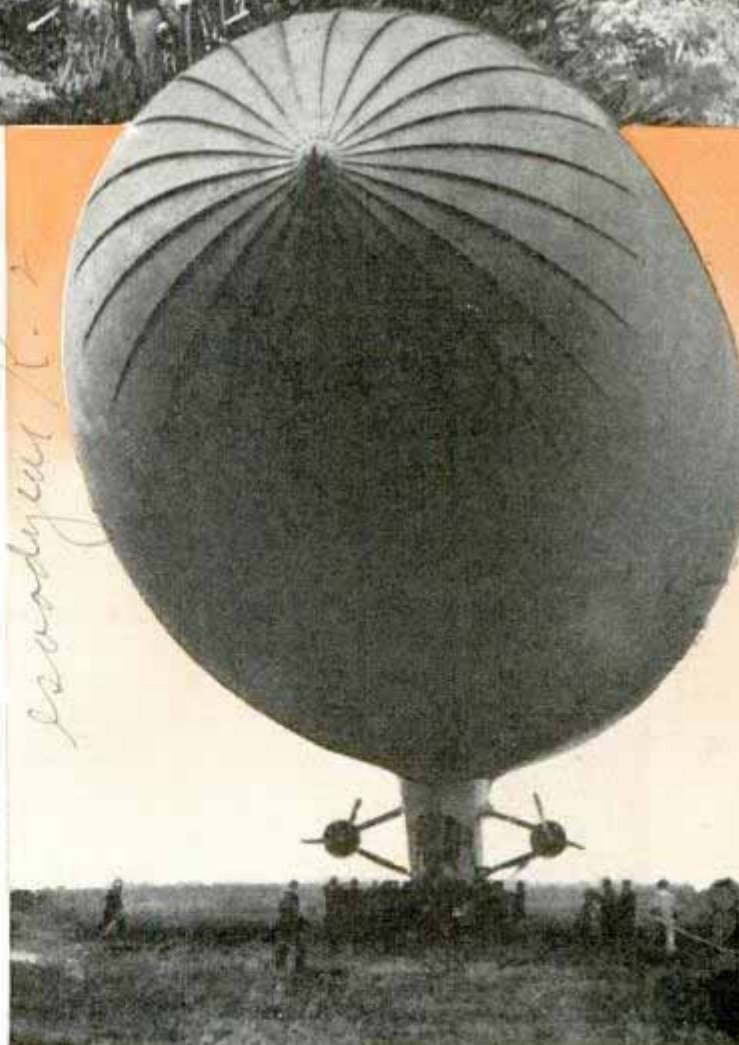
BALLOONS

By *U.S.A. Blvd*
Maj. William H. Wenstrom, M.S.

were usually protected by nests of anti-aircraft guns and interceptor fighters.

Modern American military observation balloons are, fortunately for the observers who man them, filled with non-inflammable helium. For Americans, who own most of the world's helium supply, the old-time hydrogen holocausts are a thing of the past. Nevertheless, military kite balloons are still notorious for their rough-riding qualities in a wind. Another outstanding American balloon improvement is the motorized observation balloon, which cruises like a "blimp" under its own power to the observation station. Upon arrival there, the motor gondola is replaced by the standard observation basket, and balloon and observers are let up on a cable.

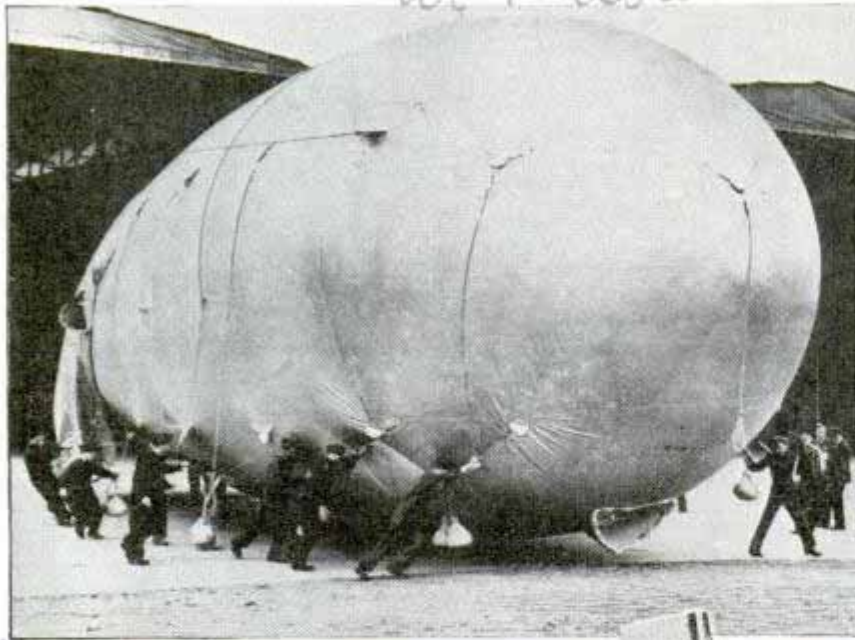
A recent development in captive kite balloons is the British balloon barrage.



Scouty
Top, one of England's barrage balloons. Inset, design for a constant altitude aerial mine. Below, U. S. Navy blimp begins trial flight

1351 Mission St. Ige Road

at Kidbrasse



Each standard barrage balloon is a bag of aluminum-painted silk, teardrop shaped, and perhaps fifty feet long, which flies from a thin but strong steel cable, heading into the wind. Ordinarily no men go aloft with the bag. Usually the balloon flies at about 3,000 feet altitude, but there is cable enough on the winch to let it up more than two miles if desired. The cable can be electrically charged, but as the wire itself would shear a wing off any high-speed bomber or attack plane striking it, or otherwise destroy the plane, the electrical feature is rather superfluous.

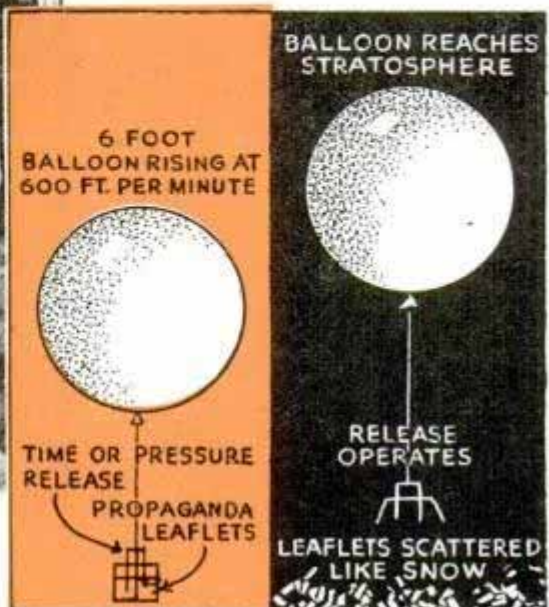
As I sailed for home from London in August, 1939, two weeks before Europe was plunged into war, more than one hundred of these barrage balloons were flying over the city. Most of them were anchored to winch trucks in the city's open parks, but a few of them flew from barges in the lower Thames river.

Five hundred steel cables stretching upward from a ten-mile square of ground constitute a formidable sky forest from an airman's viewpoint. Of course, many of the enemy bombers might well be above the balloons, but many of their accompanying,

Coastlines from Pencharban



Top, balloon used in London's defense. Center, navy blimp refuels at sea. Bottom, left, rare view of German balloon being hauled from hangar for ascent. Right, small balloon for carrying propaganda leaflets



low-flying attack planes, to say nothing of low-flying "sneak bombers," would be caught and destroyed. And in poor visibility and bad weather, when the enemy is most likely to attempt a "blind" raid, this forest of steel cables would be a terrific mental hazard for every enemy pilot.

The greatest and most spectacular free balloon ever seen was the National Geographic Society's "Explorer II," in which Captains Stevens and Anderson of the U. S. Army ascended in 1935 from the Black Hills of North Dakota. They reached an all-time world's altitude record for aeronauts of nearly fourteen miles.

Less spectacular than the great man-carrying balloons, but cheap enough and simple enough to be within experimental reach of any American free-lance inventor, are pilot balloons and sounding balloons—hydrogen-filled spheres of thin rubber, a few feet in diameter, that will carry up various small devices weighing not more than a few pounds. These smaller sounding balloons, incidentally, really hold the world's "altitude record" for man-made objects—somewhere around twenty-five miles—and probably will continue to hold it until the development of a workable sounding rocket.

The ordinary pilot balloon in universal use at most air-line terminals today is simply a thin-rubber, hydrogen-filled sphere that starts with a diameter of about two and one-half feet. By day it is released alone; by night it carries aloft a small candle lantern or electric light. The released balloon, ordinarily inflated so as to rise at about 600 feet per minute, is sighted on by two theodolites located along a measured baseline on the ground (or by only one theodolite if the rise rate is accurately known). The successive plotted positions of the balloon, from minute to minute, give an accurate determination of upper winds at all levels. Data on

(Continued to page 130A)

OCTOBER, 1940

Three-Way Semi-Automatic Rifle Converts into a Machine Gun



From top to bottom—the rifle parts ready for assembling; loading a clip of shells, and firing the rifle like a pistol

So light and well balanced that it actually can be held like a pistol, a three-way weapon devised by the inventor of the Johnson semi-automatic rifle can be used as a single-shot rifle, a semi-automatic rifle or a machine gun. It is converted simply by flipping a thumb lever. Assembling the gun takes but a few minutes. To load it, a clip of five shells at a time is inserted in the magazine, or the magazine can be loaded before being placed in the gun. It weighs only twelve and one-half pounds. Disregarding the time required for changing the magazines, the gun can fire 200 shots per minute at a muzzle velocity of 2,700 feet per second. The barrel is interchangeable.

Handwritten: #84, State St. Boston, Mass.
Signature: Charles Melvin M. Johnson, Jr.
 % Automates Trust. 555

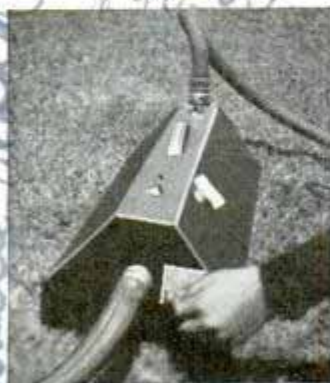
Beach Smokers Given Light by Wooden 'Bathing Girls'



Smoker getting light from attractive "seaside lighting station," erected for convenience of bathers

Electric cigarette lighters held in the mouths of wooden figures of bathing girls are stationed on an Oregon beach where water and wind combine to make it difficult for bathers to use matches. Mounted at a convenient height, the lighter is operated by batteries behind the dummy.

Automatic Garden-Spray Mixer Attaches to Lawn Hose

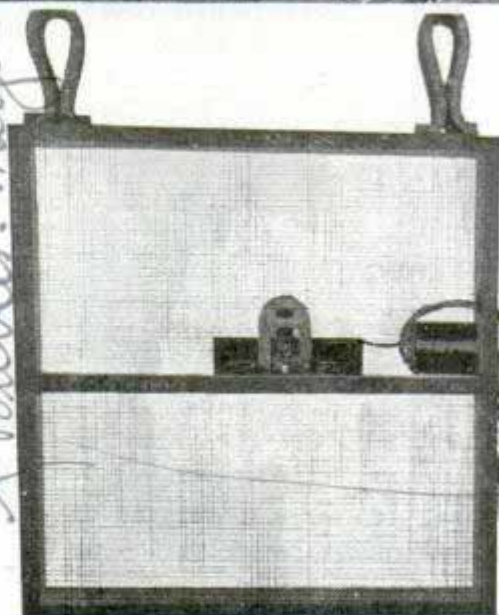
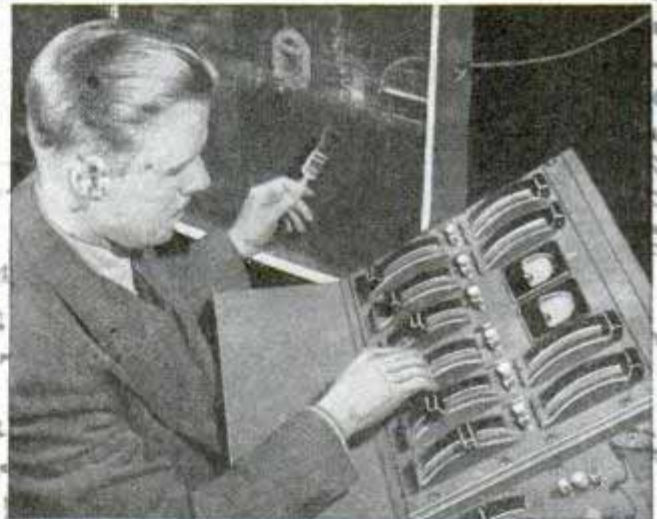


Garden and lawn sprays, either liquid or powder, are mixed uniformly with water in the desired proportion by an automatic sprayer operating through a connection with the faucet. After the tank is filled with the solution, the strength of the spray may be regulated by a dial with seven set-

tings, and an automatic shut-off stops the flow when the machine runs out of solution. The sprayer can be attached to a lawn sprinkler for beetle spraying, or used with the ordinary nozzle for disinfecting kennels, stables and other breeding places for pests, and will help in doing away with weeds on tennis courts and driveways, in addition to fighting tree and plant pests.

"Thunder Screen" for the Stage Imitates Gunfire or Crash

With an ordinary piece of window screen connected to a loud speaker and an electric sound console, engineers at Stevens Institute of Technology have produced a "thunder screen" with an amazing repertoire of sound effects for the theatrical stage. Instead of the old-fashioned rawhide thunder drums behind the scenes, the sound-effects man strikes the wire screen and then produces distant thunder by amplifying and controlling the vibrations. Sounds of ma-



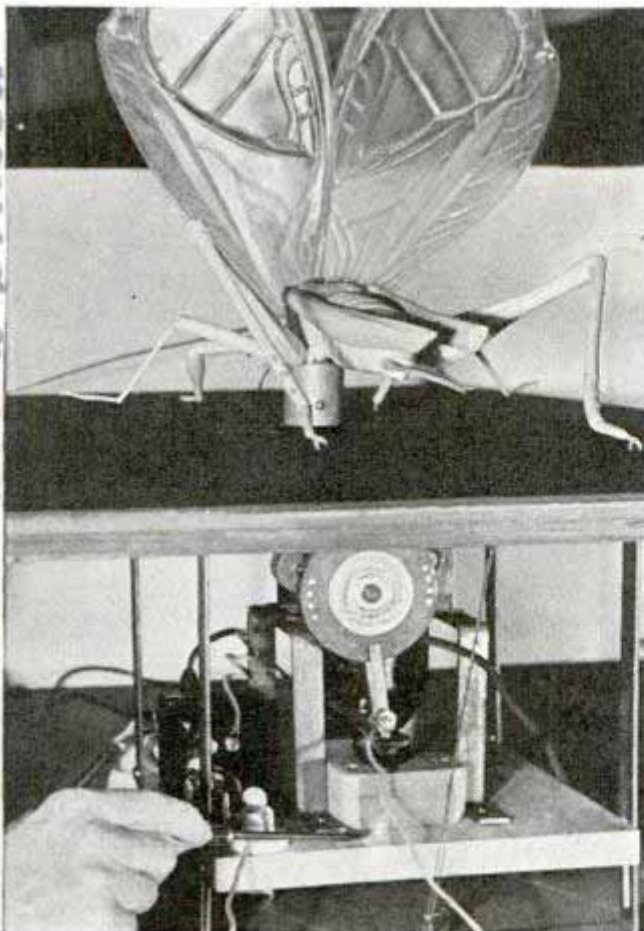
Stroking a brush on the "thunder screen," sound-effects man manipulates switch amplifying the sound

chine-gun fire are heard as a stylus is slowly drawn across the screen with the proper tempo. A quick motion of the stylus gives the effect of the tearing of a heavy fabric—an airplane wing or a sail. The tap of a covered mallet, cut off after the first contact, sounds like cannon fire. Elaborate controls in the electrical console and practice in their use enable the operator to produce a great variety of effects.

X 5 16

Cricket Wired for Sound Effects Chirps to Museum Visitors

Museums are taking a tip from the movies and adding sound effects to their animated exhibits. At the San Diego Museum of Natural History there is a singing cricket, a big mechanical fellow wired for sound. A small fan motor under the exhibit oscillates the wings exactly as they move in nature, and at the same time turns a hidden disk with contact points which actuate an electric buzzer simulating the cricket's chirp as the wing edges rub together. In another exhibit a red diamond rattlesnake shakes its rattle with realism that produces cold shivers in the visitor, who presses a button to produce the motion and sound.



Mechanical cricket oscillates wings and chirps when a museum visitor presses button to animate exhibit

"Dustpan" Wheelbarrow Loads and Dumps Itself



Stepping on bar at rear of wheelbarrow tilts the pan forward and dumps its load

Built like a dustpan on wheels, a doughnut-tired wheelbarrow does most of the work of loading and dumping itself. To pick up a load from a pile of coal, sand or rock, the pan is laid flat on the ground and shoved into the pile. At the rear is a spring-type bar which, depressed by a foot, tilts the pan forward and dumps the load.

X 7 46

"Three-Dimension" Clock Face Is Read from Any Angle

You can tell time from any angle with the "three-dimensional" clock patented recently. To save the effort of getting up out of a chair or leaving an office desk to look at a clock inconveniently located, the inventor painted numerals on protruding triangles on the face of the clock.



The hands are bent at right angles so they can be read from the side.

The Lane Photo Studio

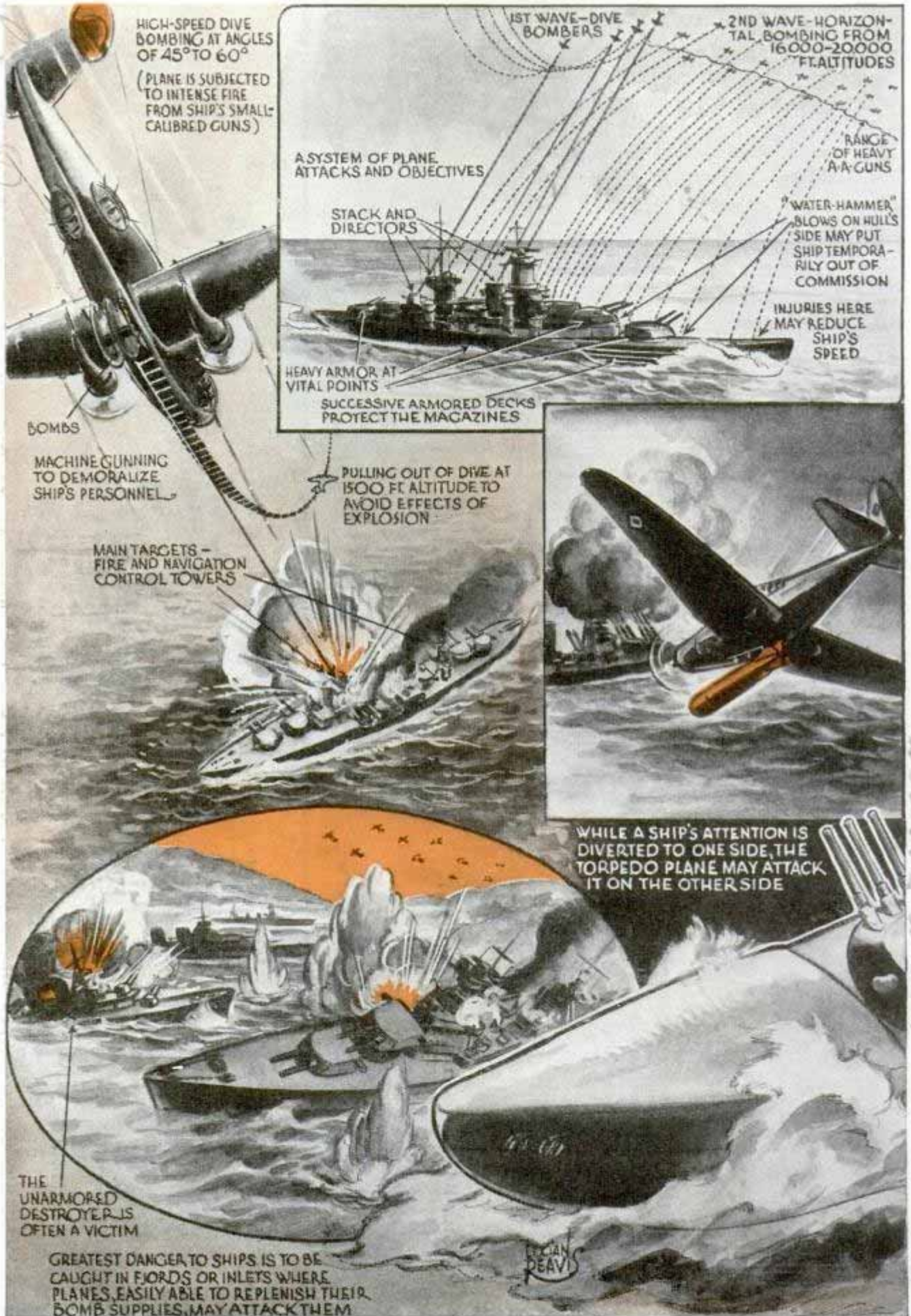
Mrs. Anthony E. Carlson (and son)

Marlinghouse, Pros. for 2476 E 16th / angled

M. Anthony E. Carlson & Co. Los Angeles, Calif.

4311 S. Vazir

Bomber versus Battleship—Which Will Win?

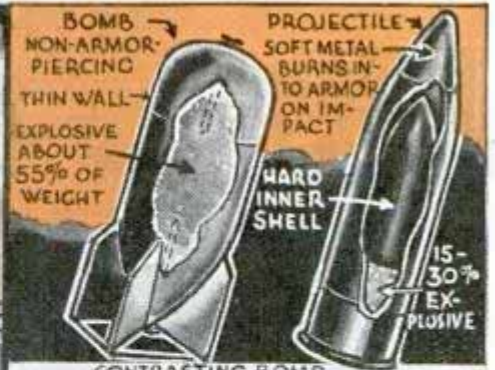


Whether the bombing plane is superior to the battleship is the question raised by reported successes of air fleets attacking surface warcraft. Air-raiding methods are pictured on this page

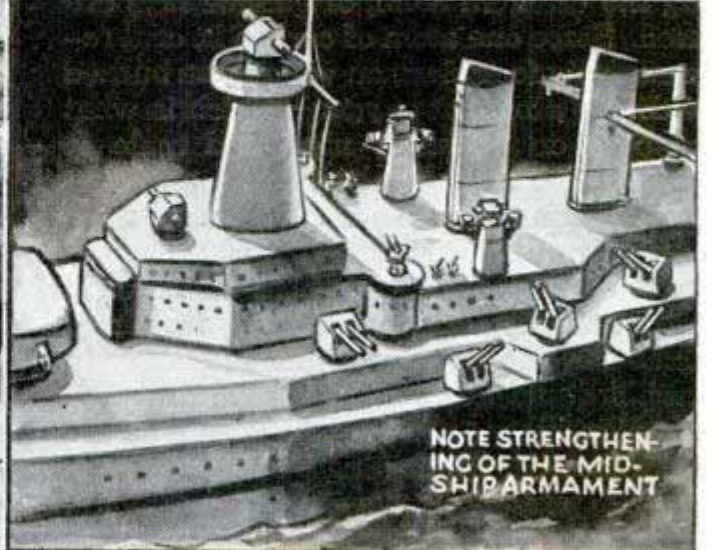
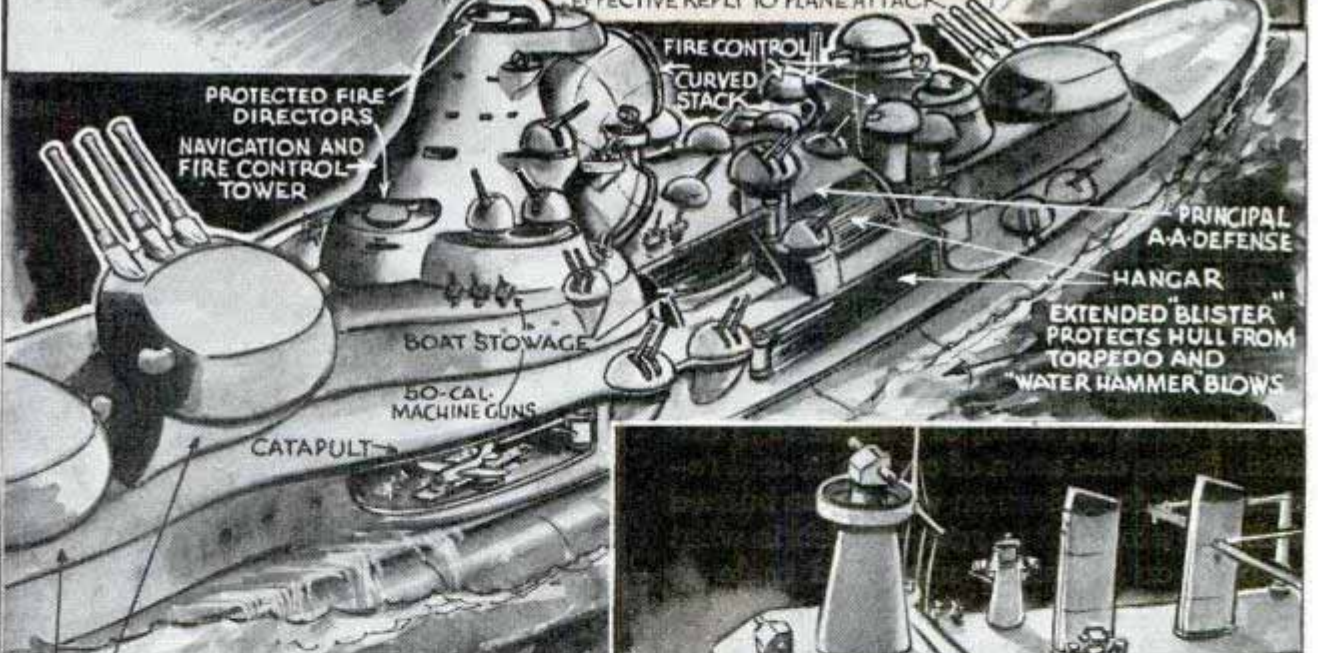
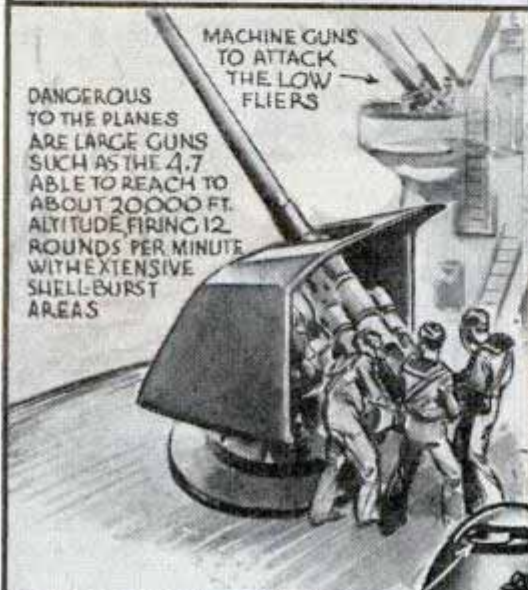
How Ship Defends Itself Against Air Raiders



THE SHIP'S OWN PLANES ARE USEFUL AS LAYERS OF SMOKE SCREENS

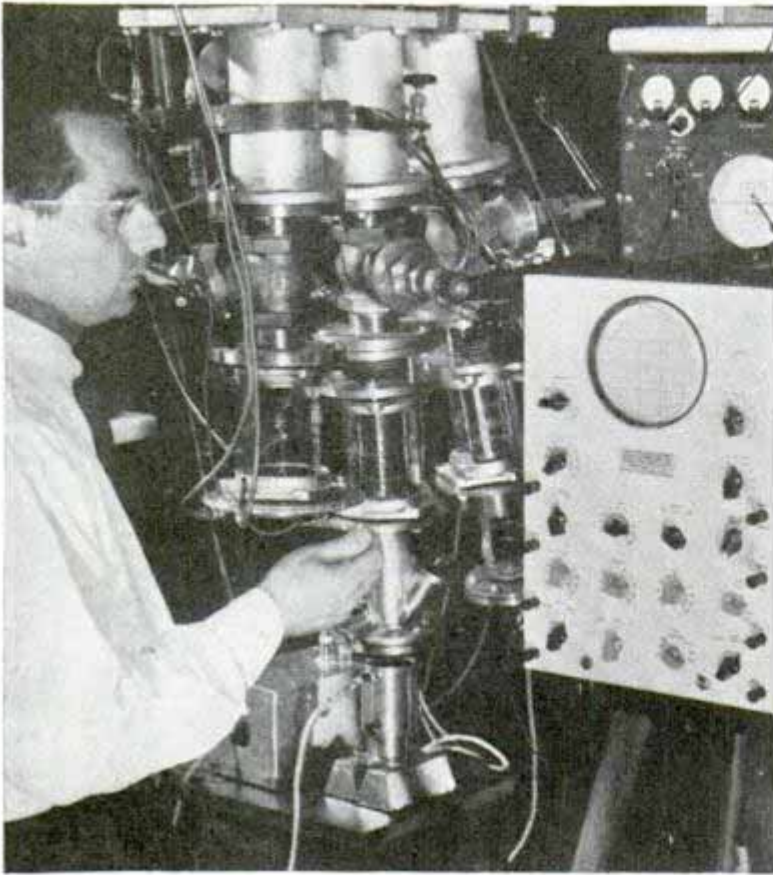


CONTRASTING BOMB AND PROJECTILE (ARMOR PIERCING)



Navy men declare the capital fighting ship can stand off the bombing plane. On this page are illustrations of how a battleship, or group of them, can combat a swarm of attacking aircraft

Gamma Rays Smash Atoms to Release Pent-Up Energy



Target end of atom smasher contains uranium in chamber below observer's hand. Oscilloscope and the screen are at the right

One more avenue for investigating atomic power has been opened by the discovery, at Westinghouse research laboratories, of the ability of gamma rays to split the heavy uranium atoms into two equal parts, thus releasing the energy that holds them together. It is said that the energy from one atom, amounting to about 200,000,000 electron volts, remains approximately the same whether neutrons, hitherto the only known means of disintegrating the uranium atom, or gamma rays are used. Since one atom of carbon in coal releases only four electron volts when burned with two atoms of oxygen—which is what happens on a greatly magnified scale in your home heating plant—it is apparent that if uranium atoms could be used their energy would be some 50,000,000 times as great as the coal and oxygen atoms. But unfortunately science is still far from achieving the release of atomic energy in usable quantities. Gamma rays are produced in the ninety-five-ton Westinghouse atom smasher by striking a target of fluorite with protons, hearts of hydrogen atoms, which are hurled down a forty-foot vacuum tube by a force of 1,000,000 to 3,000,000 volts. Some of these gamma rays enter an

ionization chamber placed four inches from the fluorite target, where they penetrate a uranium target about the size of a silver dollar. Every time a uranium atom splits, the released energy sends out an electric pulse that causes a sharp rise in an electron beam moving in an oscilloscope, a trace being made on a near-by screen which is excited by an electron beam.

K 6 62

Shovel's Electric "Feeler" Warns of Hidden Pipe

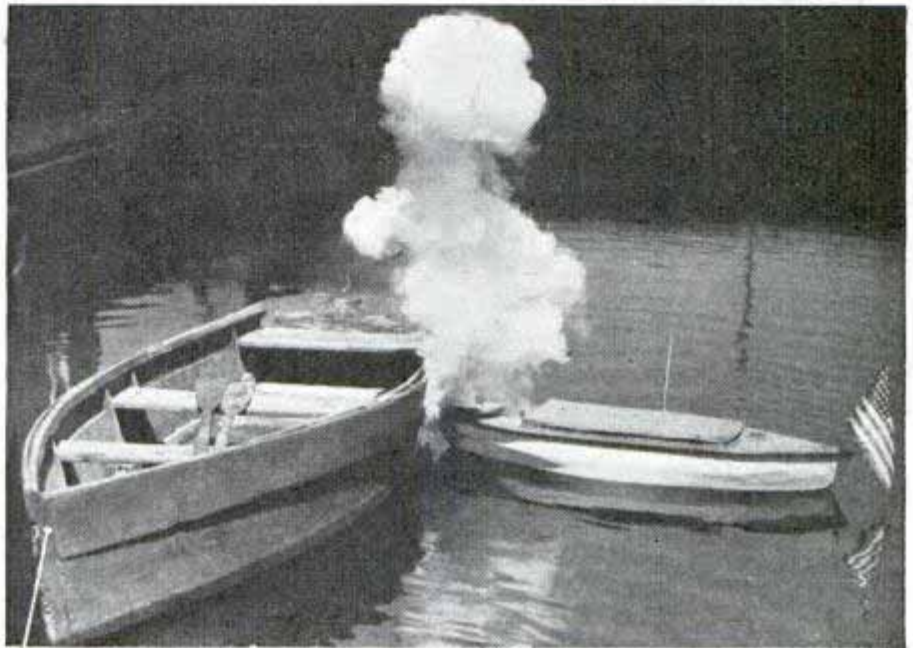
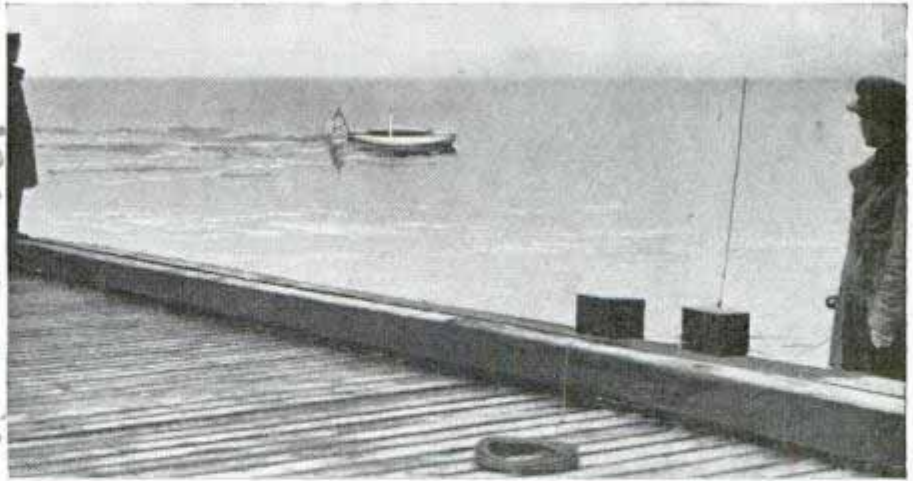
To eliminate hand digging where location of underground pipes is uncertain, an electric "feeler" signals when the scoop of an excavator approaches a hidden pipe or other metal objects. Sound comes from either a loud speaker or ear-phones operated by the excavator's own battery. To indicate that the device is in operation a sound is audible at all times, but it becomes increasingly louder as the shovel approaches the pipe. A dial adjusts the unit for different types of soil, and the feeler can be used independently as an underground metal finder.



Steam shovel operator hears loud signal from headphones or loud speaker when shovel nears metal pipe

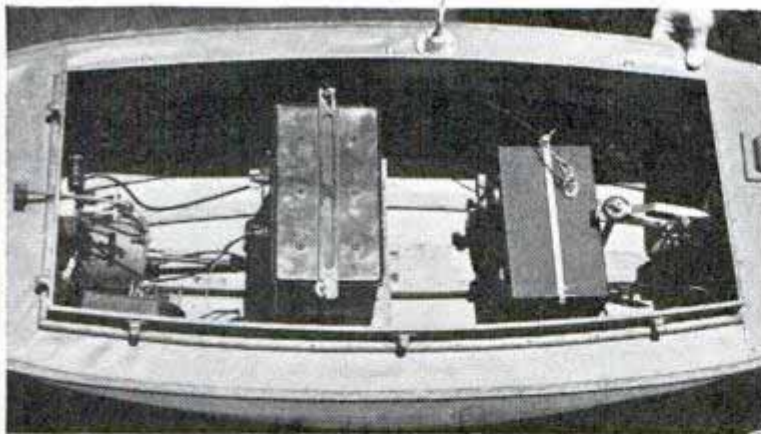
Radio Controls Model Boat Carrying Explosive

Radio-controlled torpedo boats driven silently toward enemy ships by a battery-operated propeller are suggested by a U. S. Naval Reserve officer who has built a six-foot power boat that is started, steered and stopped by high-frequency signals. A storage battery propels the boat at five miles an hour. Lieut. Henry W. Wickes, stationed at Floyd Bennett field in Brooklyn, has navigated his "crewless torpedo boat" by radio from a distance as great as eleven miles. In actual war operations a radio-controlled boat, loaded with explosives or with a torpedo at its bow, might be directed against an enemy warship, blowing it up as it collides with the hull. It could be guided by a transmitter on shore, in another ship or even in an airplane overhead.



Judy Arnold Photo

At top, the radio operator on the pier guides the tiny boat with his high-frequency radio transmitter. Below, the model simulates a wartime attack, crashing into an "enemy" vessel while carrying explosives in its bow. At left, the storage-battery "engine" and radio receiving set



100,000 Stars for Every Person within Range of Biggest Telescope

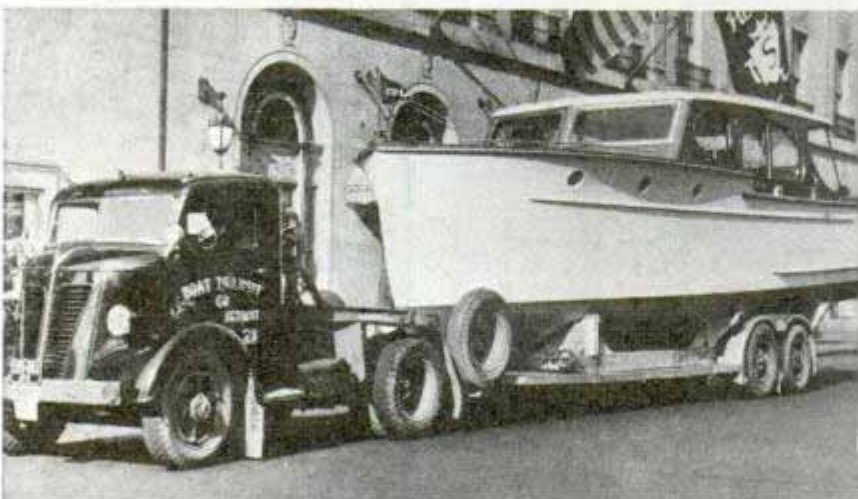
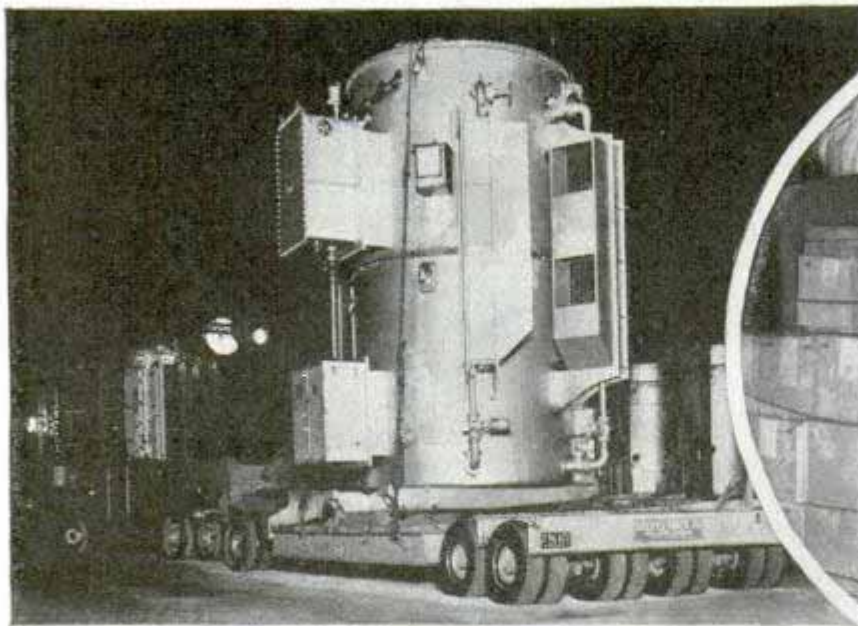
If all the stars within sight of the world's largest telescope were divided equally, there probably would be hundreds of thousands for every living person, according to an estimate given by Dr. Edwin Hubble, Carnegie Institution astronomer. He said that the equivalent of eight quadrillion suns send light from distant universes, or star groups comparable to our Milky Way,

the remotest of which are detected only faintly with the 100-inch telescope at Mt. Wilson, Calif. That would mean about 2,000,000 suns per person, but not that many stars, for the sun, which was used as a yardstick for the computation, is much smaller than many stars. Allowing for the extra size of larger stars still leaves an almost unbelievable number.

10 8 66 Al Myers

FREIGHT TRAINS *of the*

*Deluga, Type & Co
Weather Protection*



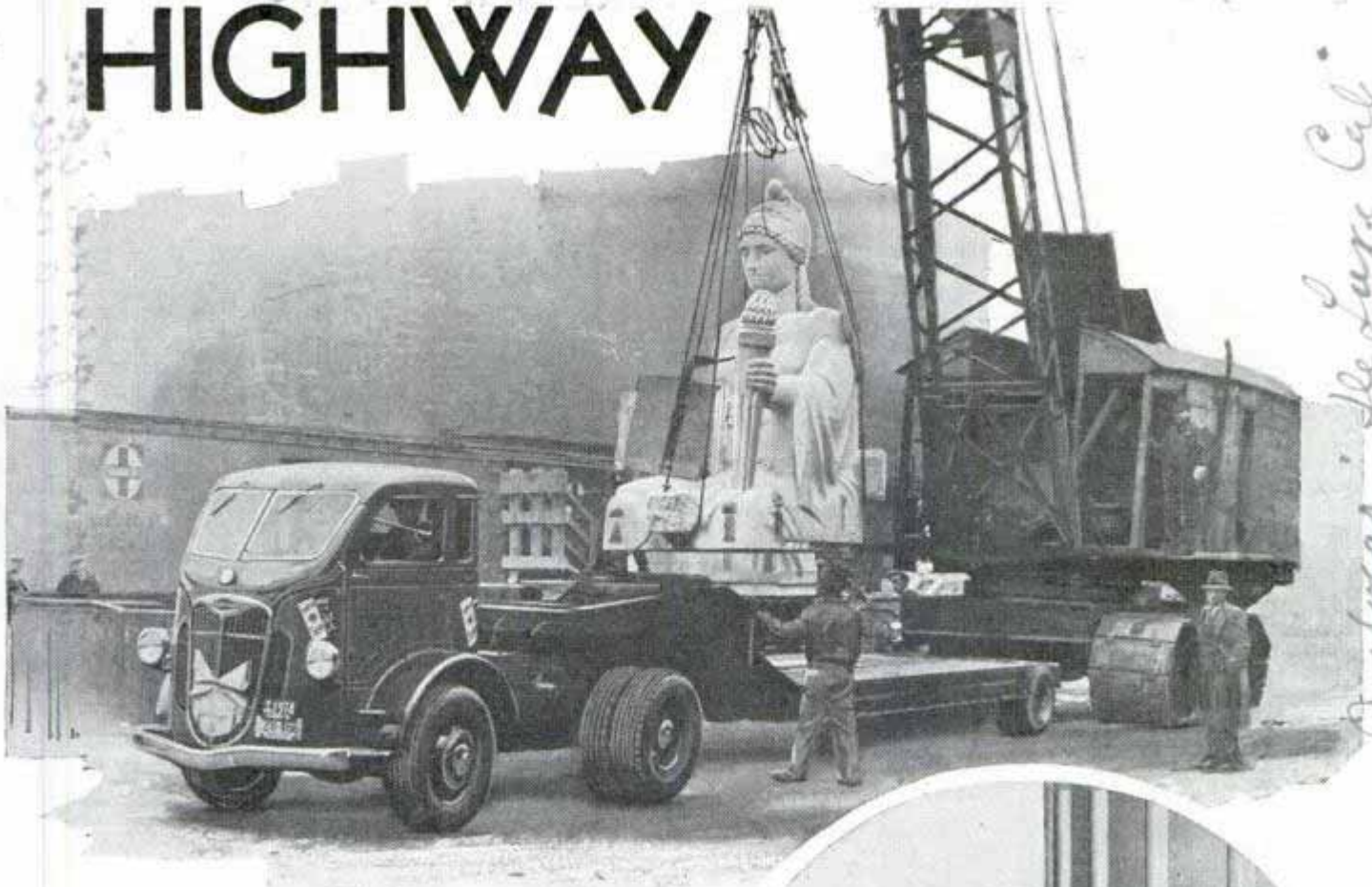
Strange cargo on the highway: Top, 100-ton transformer; bottom, a motorboat. In circle, making fast a load of merchandise. Center, experienced drivers handle big "freighters" easily in traffic like this

ROLLING southward along the broad, four-lane highway, two hours and twenty minutes out of its Hoboken terminal, tractor No. 141 pulling a twenty-two-foot trailer of mixed cargo on the fast overnight freight run to Baltimore is right on time. It is almost midnight. Across the river, clusters of street lights appear. Driver Eddie Lewis takes a look at his watch. "Philadelphia on the nose," he says. "Ten-minute lay-over for coffee."

Fifteen minutes later, the blunt, powerful nose of No. 141 is again heading south, eating up the miles. In the log book the short stopover has been dutifully recorded together with every detail of operation thus far on the trip.

This entry in the log book is significant of the careful, scientific attention to detail which goes into the operation of the modern freighter of the highways. During the past five years, research and automotive engineers, scientists and traffic experts have

HIGHWAY

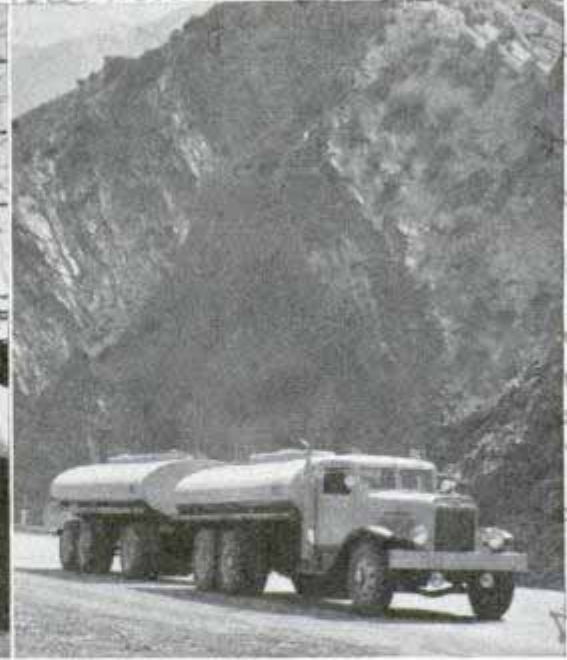


*Antique - The Sun Cal
F. Richard Fowler*

turned the old-time "trucking business" inside out. They have turned it into an efficient cargo transportation business with large fleets in every section of the country providing new opportunities for thousands of alert young men, in many specialized fields. Before driver Eddie Lewis left his Hoboken terminal, for example, nearly a dozen specialists ranging from maintenance men to loaders had been readying his tractor and trailer. And at least the same number would



Top, heavy-duty trailer takes on the first of two statues that made a thirty-five-ton load. Center, hooking up brakes between tractor and trailer. Bottom, transcontinental caravan starts from Chicago at night



*Santh (National) Camer
for angelen*

be kept busy in various ways after it reached its terminal.

Right now, seated in the warm, comfortable cab of No. 141, Lewis is occupied with the task of keeping to schedule. And in operating the powerful eight-foot tractor, pulling its heavy load, he also works more gadgets, obeys more rules and shows a great deal more road courtesy and etiquette than do millions of passenger-car drivers.

He has three mirrors mounted on his mudguard, each fitted with a different type glass so that he can keep a watch on cars at various distances behind him. He has many signal lights and must make sure that all are operating. In addition to headlights, there are three lights on top of the cab, one on each side of the top, two on the body, two red lights on the top rear of the

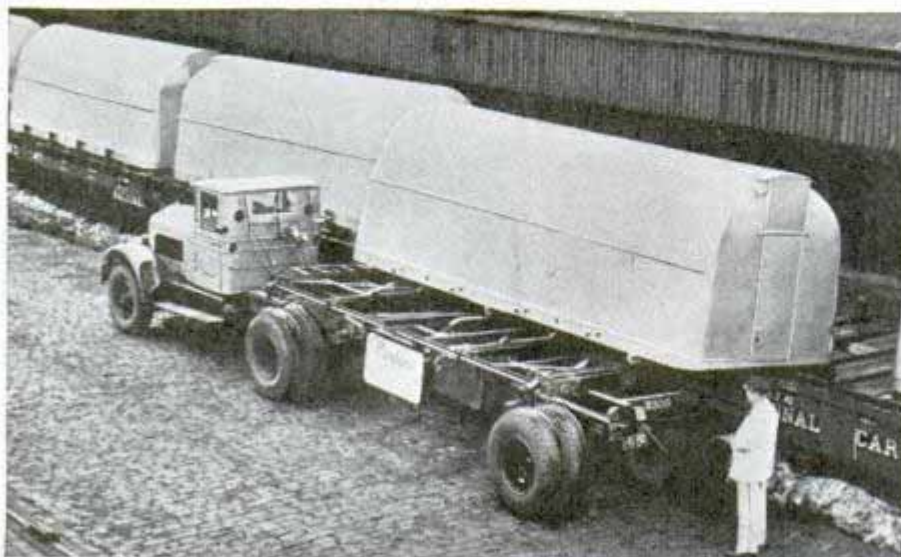
trailer, three on the bottom, a tail-light and arrow signal lights which signify his intention to turn. He watches his booster or his air brakes and with a five-speed gear shift, he carefully gauges each hill on the road, making rapid calculations as to the advisability of increasing or decreasing speed to ease the pull on the trailer.

To be an expert driver of a fast freighter, he has to do all these things in addition to steering, shifting and feeding the gasoline which, to a passenger-car operator often sums up "driving." Also he keeps "working" his headlights, giving signals to other freight drivers on the road.

"Every driver on an overnight run knows the signals and by 'breaking' our headlights we help each other out," says Lewis. "I guess that is one reason why there are so few accidents among the drivers

of the big freighters. Take this big fellow coming up on the inside lane. He's 'got his wind up' and wants to pass us. He's breaking his lights to tell us so. We almost never use a horn. The other fellow can't hear it above the roar of his motor.

"Now he's past and in the clear. I break my lights. That's an 'all clear' signal that lets him know he's far enough ahead to cut in ahead of us. Now that winking tail-light of his means 'thanks, pal.' You don't see that kind of



Upper left, a truck tilts its nose to lower rear end for loading heavy machinery; right, 2,400-gallon tankers on the road. Bottom, demountable milk tanks shift from trailer to rail car under push-button control

courtesy and helpfulness among most passenger-car drivers. If you did, there would be a lot less accidents." There are a lot of other ways in which the fast overnight freight drivers help each other. All of them have an intense pride in keeping to schedule and, like sailors obeying the rules of the sea, they will respond quickly to an SOS.

"Most of the big freighter outfits have wreckers constantly patrolling the roads," says Eddie. "My own concern among them. There's one working north to Hoboken and another south to Baltimore, right now. They report by phone to the terminals every thirty minutes.

"If anything should happen to this tractor-trailer, a punctured tire or engine trouble for example, I'd get to the side of the road as fast as possible and set out my flares. The law requires three of them, ten feet apart. Within a few minutes a freighter coming along in either direction would break his lights and I'd give him the return signal. No matter what outfit he belonged to, he'd hurry to the nearest phone and call my terminal, telling them I was in trouble. In a half hour a wrecker would be speeding toward us, or, if necessary, a new tractor."

That is one reason why, no matter what the weather, the freighters maintain their schedules. But there is a lot more to it than that according to Joseph Coughlin, operations manager of the Hoboken depot of W. T. Cowan, Inc., one of the largest freighter fleets in the East, and Eddie's chief.

"Modern manufacturing plants and businesses in cities 300 miles or more apart are so dependent upon a day-to-day exchange of material ranging from raw supplies to finished products that the fast, overnight freighter of the highway has become a vital link in making this possible," says Mr. Coughlin.

"As a result the trucking busi-

(Continued to page 116A)

OCTOBER, 1940

Movie Screen on a Traveling Van Carries Message to Public



Pedestrians in English city watch a movie on rear screen of a government cinema truck as it brings a message to the public

Taking the road throughout England to carry information to the people are fifteen big trucks equipped with movie screens. At each stop, the publicity movie concerning Britain's national savings campaign is flashed on the rear-end screen.

Glasses for the Color-Blind Driver Distinguish Traffic Lights

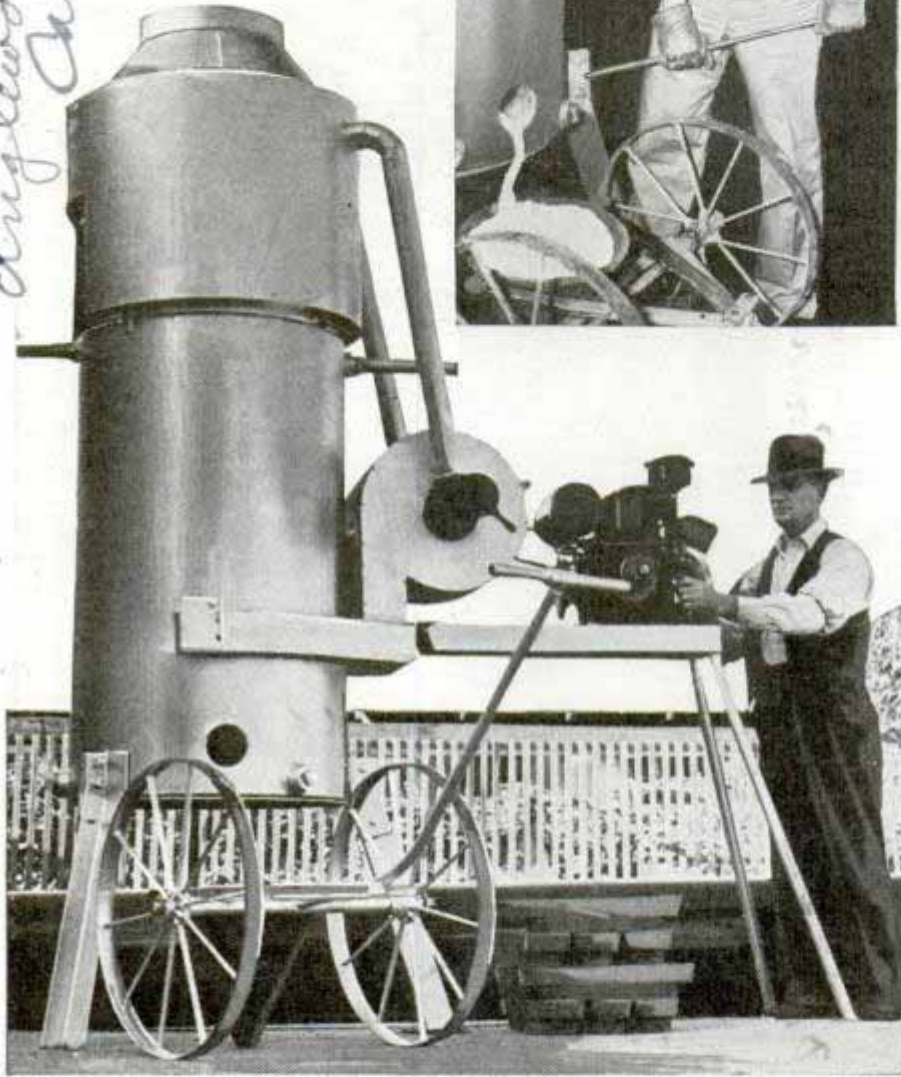
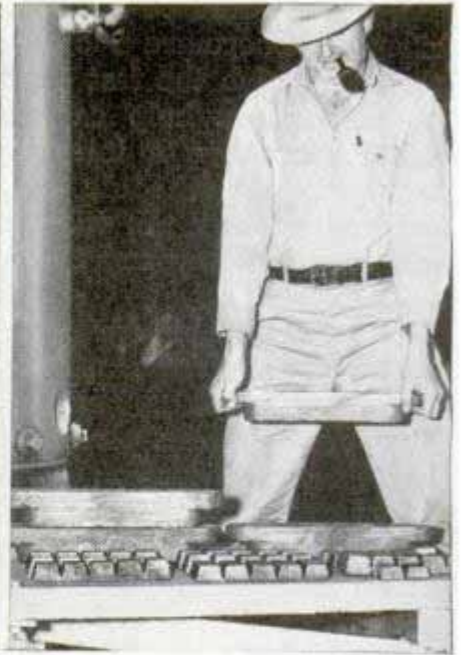


Some color-blind motorists are in constant danger due to their inability to distinguish between red and green traffic lights. To overcome this handicap a special type of glasses has been introduced, with upper segments of dark red glass to filter out the green lights. Thus the

"change" light and the red "stop" light are the only traffic signals the driver sees and if either is visible he stops. If no light is visible it means go ahead.

Portable Smelter Works Ore Right at the Mine

Below is the lightweight, portable smelter which can be set up at a mine and put in operation within an hour. At the right, drawing molten metal into bucket, and some bars of bullion produced by the smelter



ways available in the neighborhood of the mine—it is smelted on the spot and the bars of bullion shipped to the refinery. One feature of the invention is an air-circulation system that takes advantage of the earth's rotation. Gases in the northern hemisphere tend to swirl counterclockwise. By fanning air in the smelter in a clockwise direction, opposing forces are set up which cause gases heavier than air to settle to the bottom of the furnace, allowing maximum reduction of the ore.

Ore is turned into bullion right at the mine by a portable smelter that, by "cutting corners," promises to open up new sources of important minerals and save both time and labor in their recovery. The smelter weighs less than a ton and can be set up at location in an hour. Then, instead of concentrating the ore for shipment to a smelter—which requires water not al-

circulates the air. When in operation, the smelter uses only 150 gallons of water in twenty-four hours, and one ton of coke to every ten tons of ore, working a ton of ore per hour. The furnace reaches a temperature of 3,750 degrees. Any kind of ore can be smelted, the molten metal being poured into cone-shaped buckets and then dumped to cool.

Super-Sharp Camera Lens Sees Details from Altitude of Three Miles

Flying at great heights where there is less exposure to anti-aircraft fire, observation planes using a new lens announced by Bausch and Lomb Optical company are

able to photograph enemy positions with exceptional detail. From a height of three miles, it is said, the lens will take pictures so sharp that objects such as motorcycle

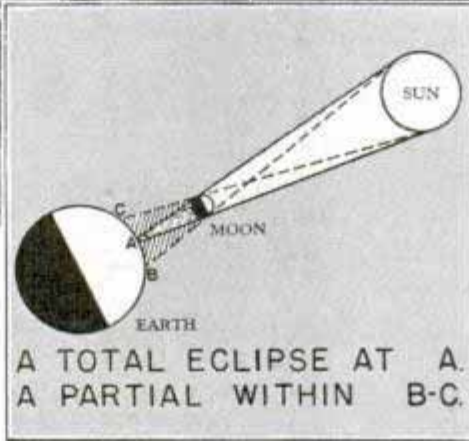
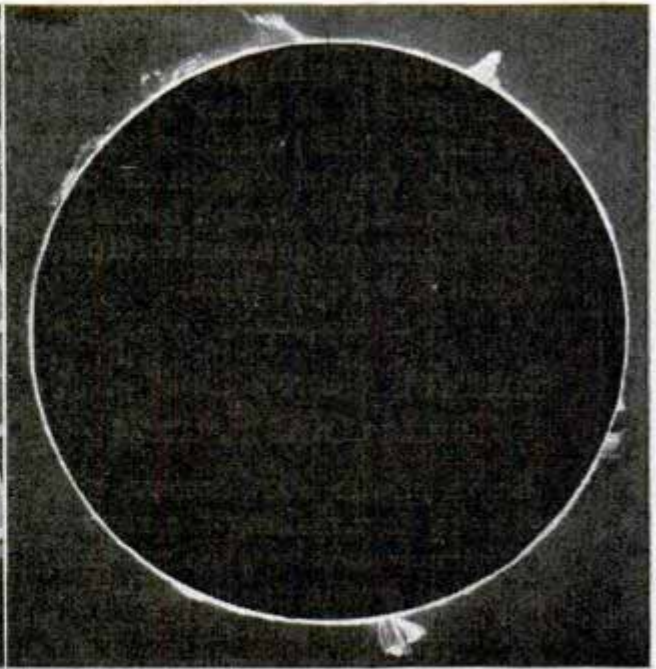
Alva Ed. Blam, 105-35 Bayard Ave
 Dingwood, Calif

K 7 49

626 St. Paul, Minn

KEEPING TAB

Cont. Thomas G. Simson, Jr. 10442 Dejean Lane Los Angeles

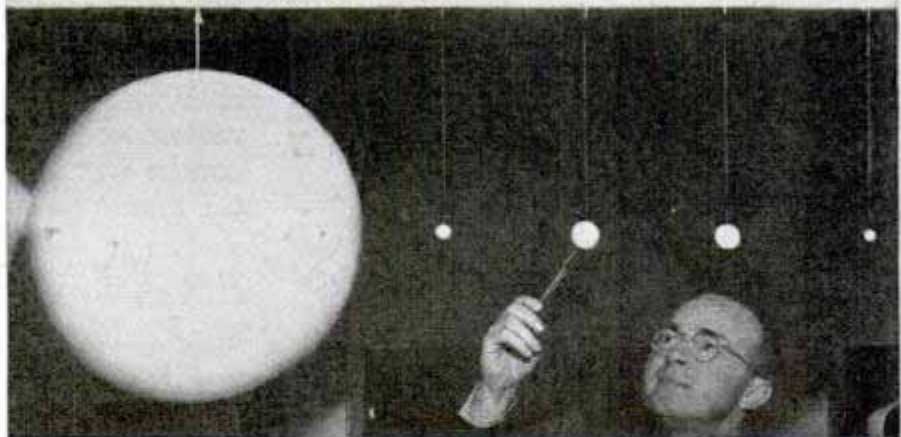


Upper left, refracting telescope at Griffith observatory, Los Angeles. Right, artificial eclipse of sun made at Mt. Wilson observatory shows prominences of incandescent gas flaming above solar atmosphere. Left, diagram of eclipse. Below, Juniper, Mars, Earth, Venus and Mercury

WHEN the sun goes on a rampage, as it did last Easter week, confusion prevails on earth. Teletype machines write meaningless chatter and telegraph and telephone lines roar with static. Long-distance radio fails. Wire photo machines draw black lines instead of pictures. Continents lose touch with each other, sometimes for hours. Even cities a thousand miles apart are apt to be isolated.

The sun is not the stately, dependable body that one might assume. "Cold," cyclonic storms called sunspots, some large enough to engulf the earth, spread and die on it. Tremendous clouds of flaming gas hover above its glowing surface. Eruptions of incandescent hydrogen burst forth. Occasionally tongues of flame spurt 100,000 miles or so beyond its atmosphere.

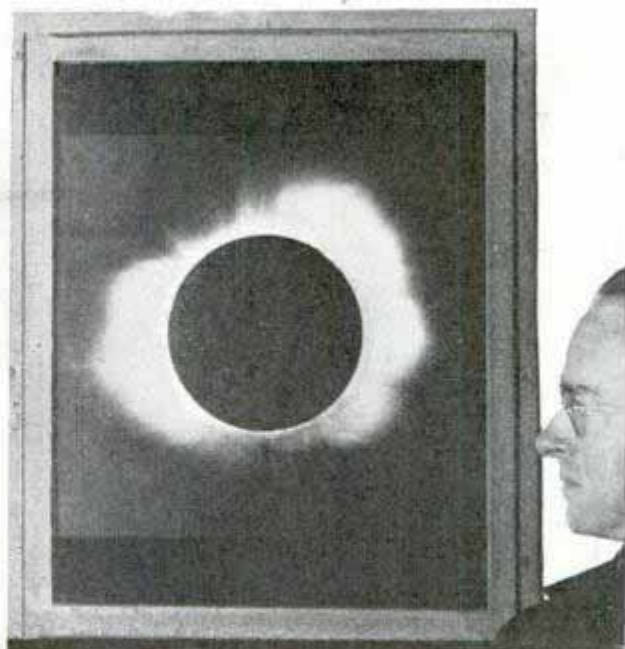
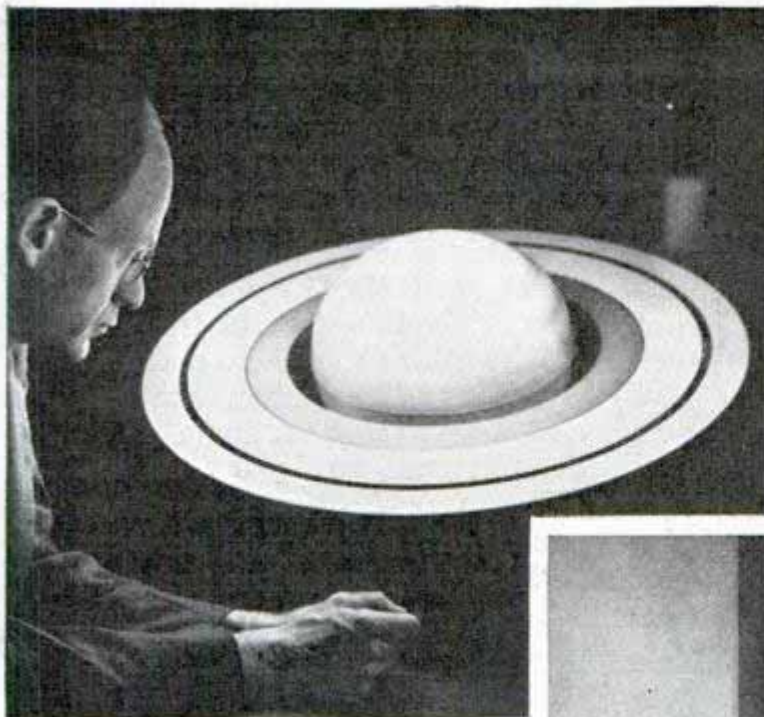
The sunspots shoot out streams of electrified particles and when the earth is in the path of one of these streams, as was the case last spring, the earth's magnetic



field is unbalanced. Brilliant auroral displays and general confusion in all kinds of long-distance communication systems follow. Earth currents up to several hundred volts surge over the lines, fusing delicate relay instruments.

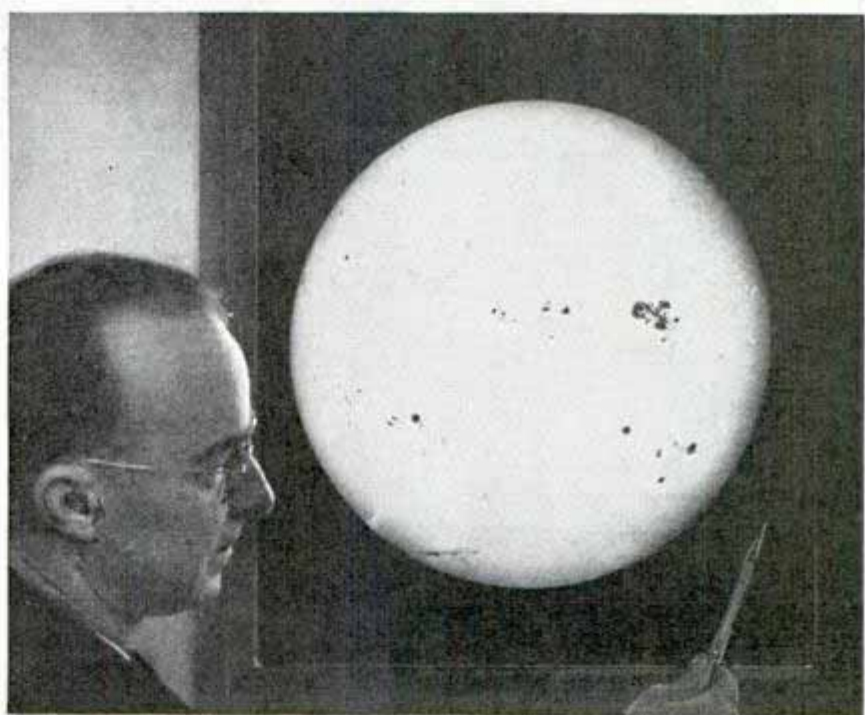
During the last decade such solar disturbances have been more troublesome

on the SUN



than previously, not because storms on the sun have increased in intensity but because our use of electrical circuits that are affected by solar activity has increased.

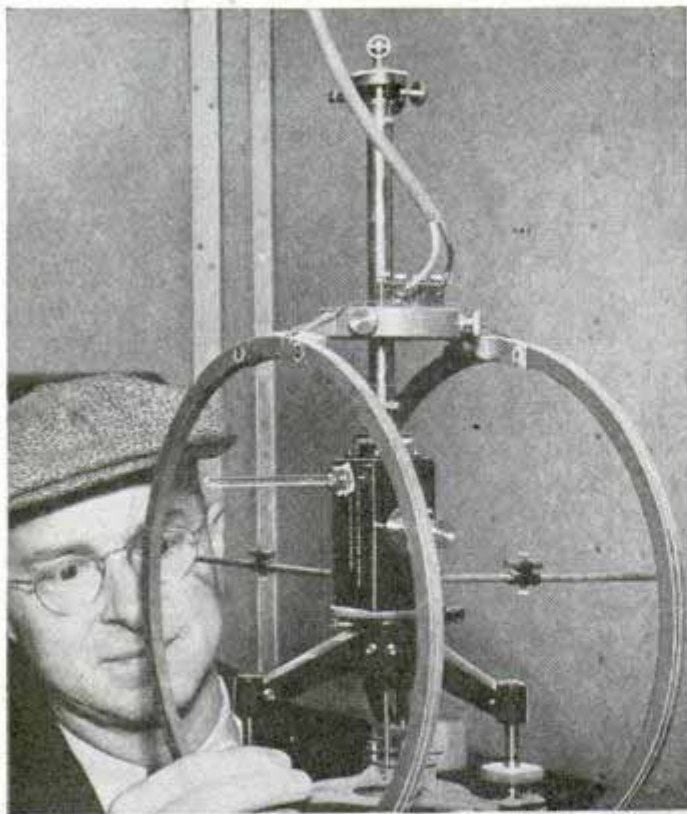
The chromospheric eruptions of hydrogen on the sun likewise affect communica-



tion. Apparently great quantities of ultraviolet light are radiated during an eruption and these rays influence the ionosphere surrounding the earth, preventing the reflection of high-frequency radio signals and making long-distance radio communication impossible. Often these eruptions are associated with sunspots. The magnetic storms caused by sunspots affect all parts of the earth, while the fading radio signals that are caused by the eruptions occur only over the lighted portion of the globe.

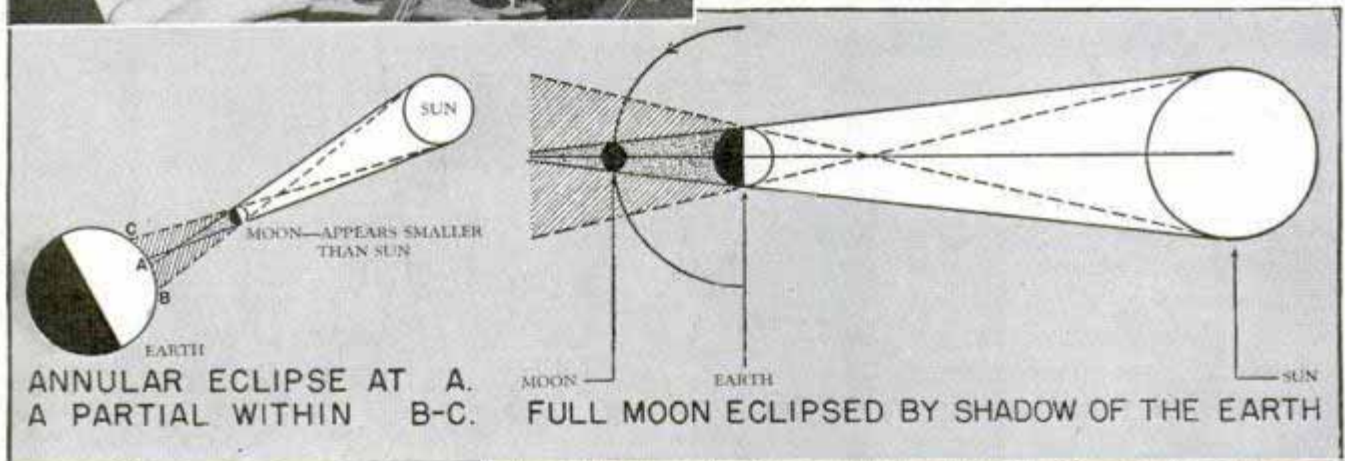
The earth's average temperature appears to be a half degree lower during maximum sunspot periods than when sunspots are at a minimum, but this has no real effect on weather or the growing of crops.

Top, left, model of Saturn; right, sun at full eclipse showing corona. Center, photo of sun showing sunspots. Below, masking sun to photograph artificial eclipse



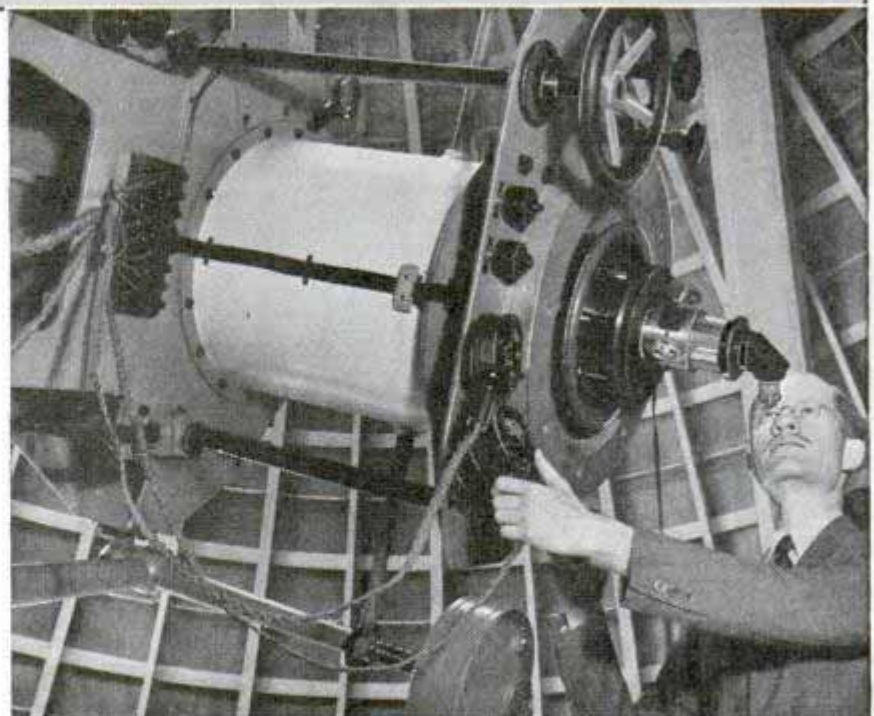
fully some of the electrical disturbances produced on the earth. Ordinarily the sun's blinding light prevents direct examination of its atmosphere and its corona. These can be studied best during a total eclipse. The total eclipse that occurs October 1, visible from a band extending across South America, the Atlantic, and the tip of Africa, will be observed by various expeditions. Photographs made during the total eclipse, it is hoped, will also help determine more accurately the state of the elements in the solar atmosphere and how they behave in the tremendous heat and electromagnetic field of the sun.

Earlier this year, on April 7, an annular eclipse was observed from points in the southern states and northern Mexico. In an annular eclipse the moon is a little too far away from the earth to



“Beliefs that sunspots indicate changes in solar radiation that in turn changes the air we breathe and influences our physiological and psychological behavior have no more scientific basis than the supposition that our lives are regulated by the conjunction of the planets,” states Dr. Seth B. Nicholson of the Mount Wilson observatory of the Carnegie Institution of Washington.

This year two eclipses of the sun are affording astronomers more opportunity than usual to study the sun's atmosphere. More knowledge about the gaseous envelope that surrounds the sun may help explain more



Top, the magnetometer: tiny magnet swings when earth's magnetic lines of force are disturbed, causing light beam to trace pattern on paper. Center, diagrams of eclipses. Bottom, astronomer watching planet keeps telescope trained by means of electric switch

Paradise, Calif.

hide the sun completely and a thin ring of sunshine around the dark moon is visible. Such an eclipse is beautiful, but even the smallest amount of direct light is too much to permit most kinds of solar eclipse observations. This year a study was made of the effects of this partial blackout on radio signals. A joint expedition comprising several groups of scientists transmitted short-wave radio signals upward to the earth's ionosphere and measured the time lag in the reflected signals to determine the shifts that took place in the reflecting layer during the eclipse and after it.

Instead of only two eclipses, astronomers are actually observing hundreds of eclipses of the sun this year. Natural eclipses are too rare to satisfy the scientists so the sun is eclipsed artificially every clear day in solar observatories. A metal disk just large enough to cover the sun's image is placed in the optical train of the solar telescope, and photographs are made of the prominences of flares projecting from the sun's atmosphere.

The universe is full of light from the myriads of stars and it is also full of shadows. Just like the moon, the earth and all the other planets cast shadows in the sunlight. Under favorable conditions it is possible to see the shadow the earth casts, low in the eastern sky during and just after sunset, where it appears as a hazy bluish arc bordered by a faint rosy hue. Shadows cast by the other planets are usually invisible because of the lack of gas and dust in interplanetary space.

The moon eclipses a great many stars in its course across the sky, and recently these occultations have been used as a means of measuring star diameters. No telescope is powerful enough to reveal any star except the sun as a disk, hence measurements of star diameters have to be made by roundabout methods. The latest way is to measure the small frac-

(Continued to page 118A)

Automobile 'Skylight' Gives View of Mountain Scenery



Driver and passenger have wide view of scenery overhead from auto equipped with transparent roof for mountain sightseeing

So that he and his friends may enjoy fully the mountain scenery in the southwest, a motorist of Pasadena, Calif., has replaced the conventional top of his automobile with a transparent one. The "skylight" is made of plates of safety glass tightly sealed in place, making the top stormproof.

Motor Truck Spins Airplane Propeller to Start Balky Engine

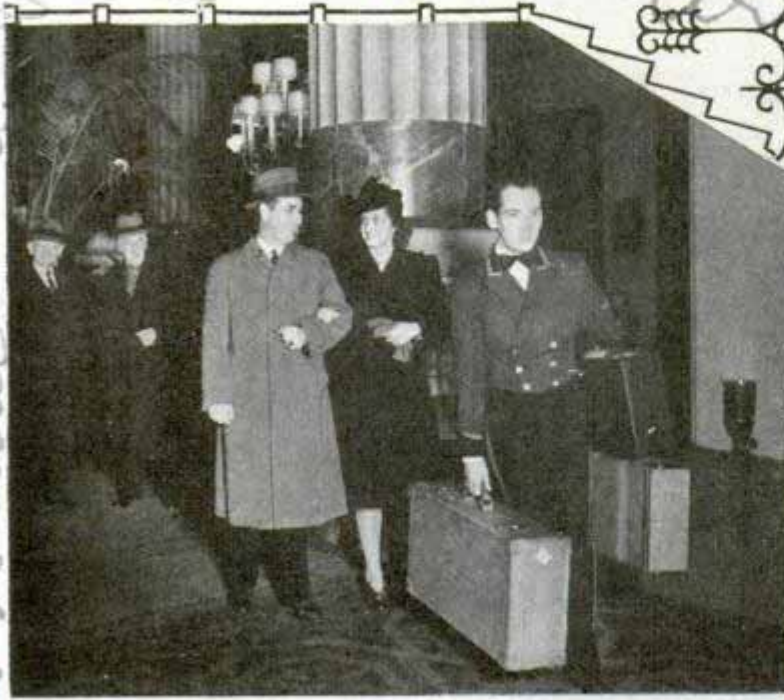
When airplane engine starters fail to work, a truck is often used as an emergency starter at the U. S. Naval Reserve aviation base at Floyd Bennett field. A twenty-five foot cable rope fastened to the



Truck helps start stubborn plane engine by turning propeller with cable attached to mitten that slips on and off blade easily

truck's rear bumper is attached to a special "mitten" that slips over the propeller blade. To spin the propeller and thus turn the engine over, the truck pulls ahead quickly and the mitten slides off the propeller tip at the end of the tug.

HOME WAS NEVER



Second Road, Arlington, Va.

THERE'S no place like home, but the place we live when away from home has its points too. A modern hotel in a large city, part-time home of a million persons a year, encounters all the problems found in the humblest cottage, multiplies them by a thousand or so, and solves them with streamlined efficiency.

Imagine being host to from 2,000 to 4,000 guests a day. There are always that many registered at any one of New York's largest hotels, with two to three thousand employes to serve them. At least 5,000 visitors drop in daily for a meal or chat. That crowd would equal the population of a good-sized little city. The biggest hotels serve 12,000 meals a day. It takes a lot of food to be ready for such a crowd, and hundreds of tons of ice daily just to keep it in a fresh condition.



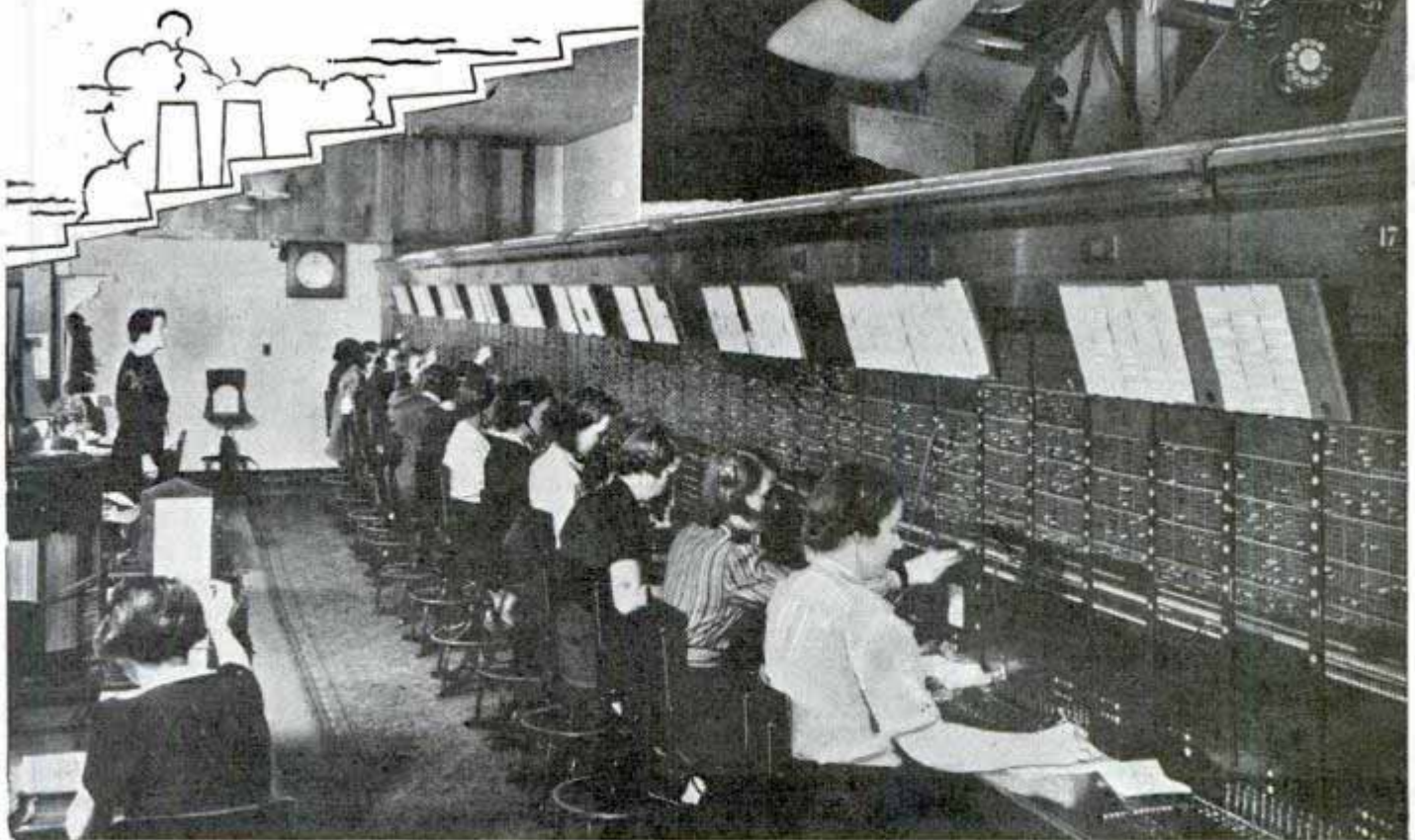
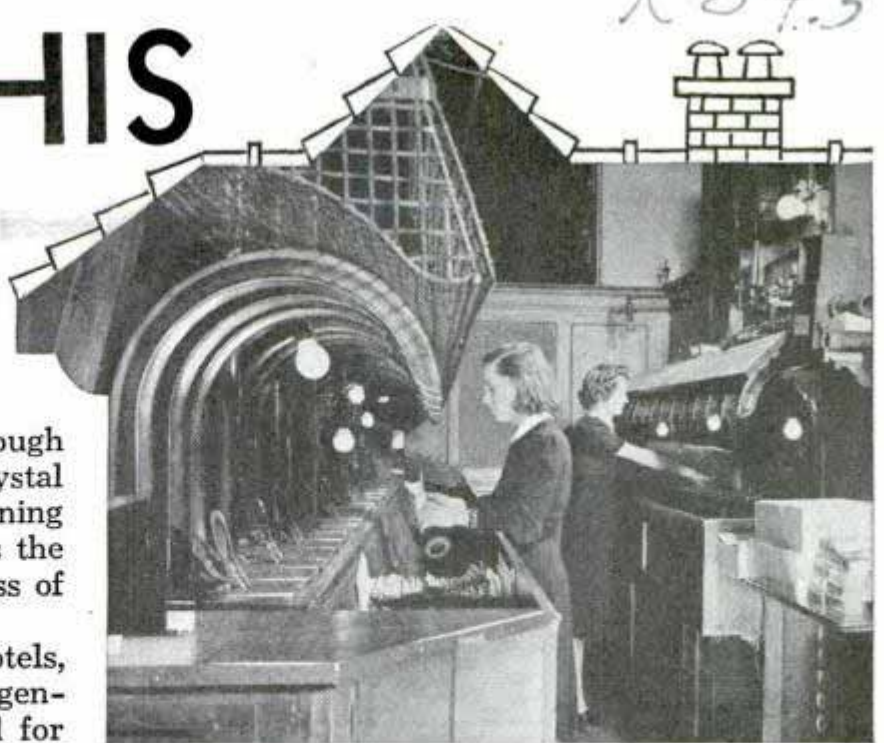
Pennsylvania State Hotel, New York

New arrivals, top, are shown to suite by bell boy. Suit to be cleaned is placed with laundry (lower left) in compartment of door. Right, information clerks tell you if the John Smiths of Dubuque are registered

LIKE THIS

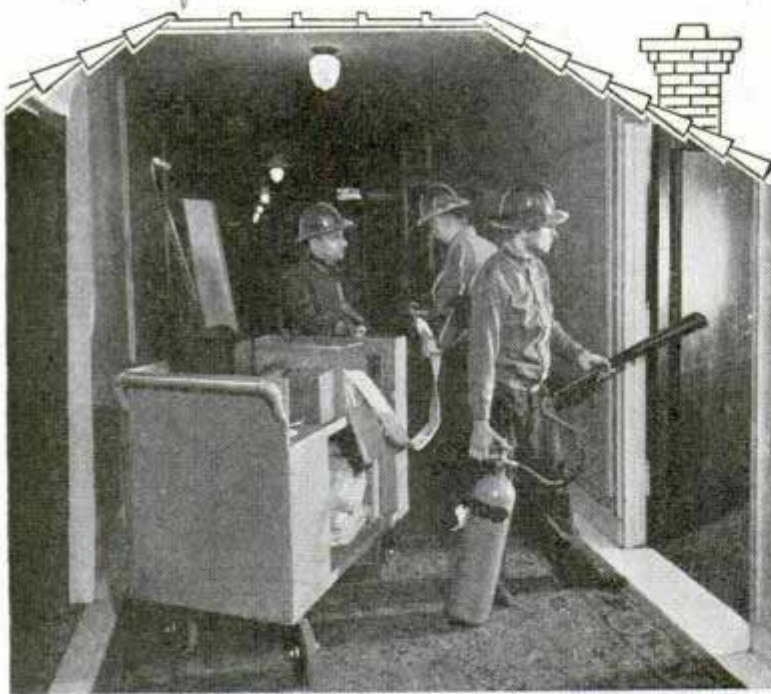
They freeze their own ice. Some of it, chopped by a machine which macerates an entire 300-pound cake at a time, is served on the table with oysters, grapefruit or wines. Air is circulated through other cakes to keep them crystal clear; then a machine containing rows of revolving saws cuts the cakes into cubes for your glass of water or iced beverage.

One of the world's largest hotels, located in New York, has four general kitchens to prepare food for its seven dining rooms, each of which has its own menu. Another kitchen specializes in preparing soup in fifty-gallon cauldrons. A bakeshop with ovens eighteen feet deep turns out 20,000 rolls, 700 loaves of bread, every day. But no pies or cakes or pastries—these are made in still another bakery. There is even an ice-cream chef with his special kitchen, turning out 400 gallons of frozen desserts.



Photos courtesy the Pennsylvania Hotel

Top, battery of pneumatic tubes in hotel's message center. In center, floor clerk's message transmitter. Bottom, a hotel telephone switchboard big enough for a small city—which a metropolitan hotel really is



There's nothing on your floor to blaze except the bedding and what you bring with you, but the hotel's own fire department (top) is ready for anything. Center, power plant for lights, machinery and elevators. Below, glasses are washed, hand-dried and polished, sterilized and wrapped in Cellophane

Washing dishes is an endless chore. Each kitchen has its own power washer which handles only china. One man does nothing but remove scraps from dishes, another stacks them on an endless belt which carries them through three spray baths in the washer. The first bath, clear water under heavy pressure, removes all food particles. The second spray is soapy. The third bath is clear, so hot it is all but steam; the dishes emerge not only clean but dry.

Glassware is handled in similar machines, but is hand-dried and polished, then sterilized, after which the drinking glasses are wrapped in Cellophane. Silver is cleaned and polished in revolving drums of sudsy shot.

This same hotel's laundry washes and irons sixty to seventy thousand pieces each day. A guest can arrive at midnight, have his clothes washed, his suit pressed, and arise at eight o'clock to find everything clean, stowed neatly in his bedroom door. The secret of speed is in drying. Water is forced from the washed clothes by centrifugal extractors, until they are just right for ironing. A battery of ironers turns out shirts two a minute. The first machine presses the collar, the next does the front. A third irons the back, while the sleeves are pressed and creased on heated metal arms. The last machine turns down the collar, irons the shoulders and cuffs, after which any missing buttons are sewed on by another machine. A woman then touches up each shirt with a hand iron. After that they are folded on a gadget that does everything but think; then a pasteboard cover is slipped on.

One woman irons all socks by slipping them over a heated metal foot. There are four feet in a line; by the time she places a sock on the fourth, the first one is ready to come off. Socks having holes are darned on a machine in the time it would take you to thread a needle.

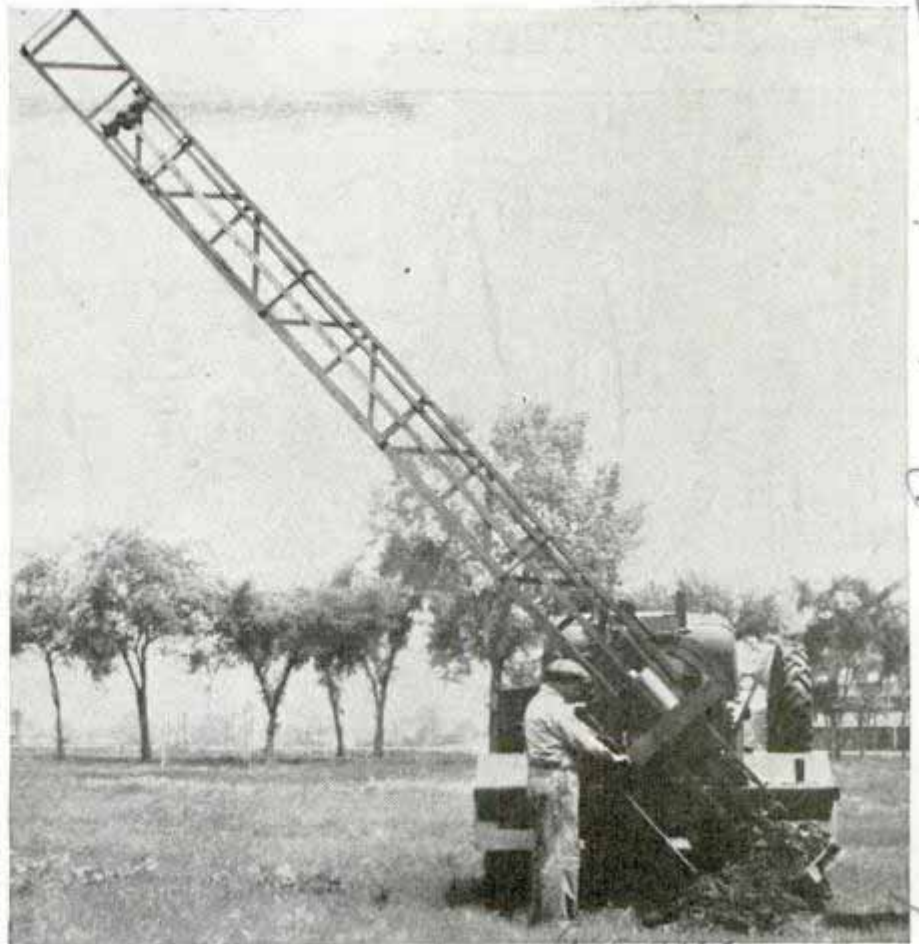
(Continued to page 120A)

POPULAR MECHANICS

Model 67-002
mac m m Co. 149 Broadway New York
Senior Square

Fast Earth-Borer Digs Tank Traps for Army

Valuable as both a defensive and offensive aid in modern blitzkrieg is the United States army's new "lightning borer" mounted at the rear of a heavy truck. It is designed to keep pace with a fast-moving army, quickly drilling holes in the earth for the placement of explosives in laying tank traps, in destroying roads, bridge foundations and railroads. Likewise it will speed up construction of temporary bridges and roads as well as foundations for artillery emplacements. An outgrowth of smaller drills used for digging holes for telephone poles, the machine can bore a hole twenty inches in diameter and six feet deep within three minutes, and the drill can go fifty feet

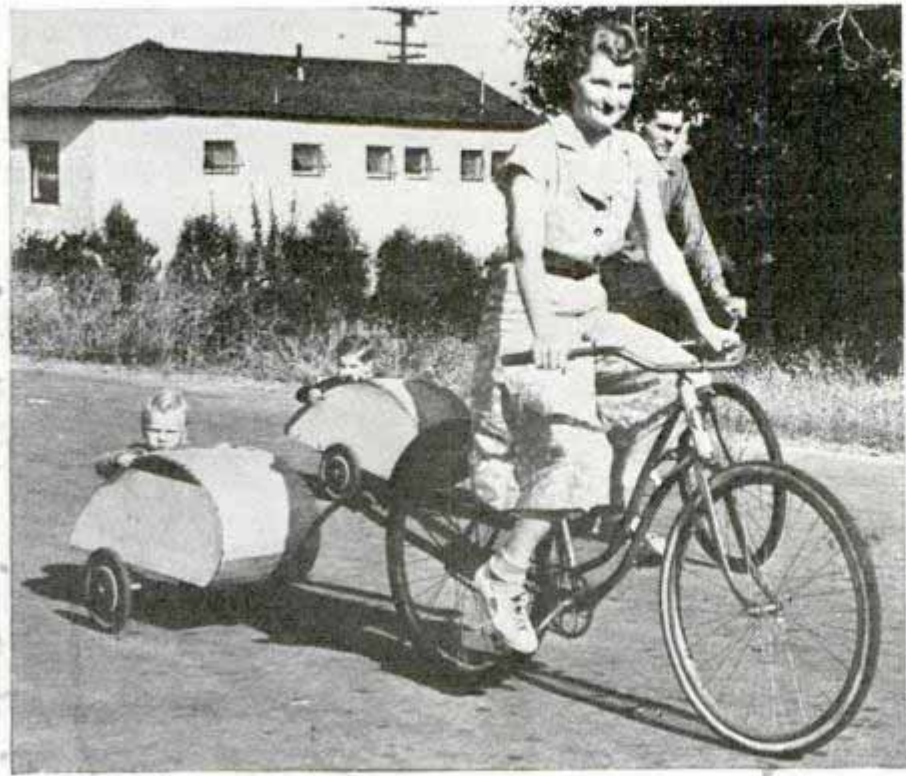


Designed to keep up with movements of army geared to high speed, earth-boring trucks like this dig holes for defensive and offensive works

deep and be adjusted to dig holes as much as forty-two inches across. The drill can be operated at any angle up to forty-five

degrees. The power plant which operates the borer is a four-cylinder, forty-horsepower, water-cooled engine.

'Kiddy Trailer' Hitched to Bike Carries Child on Outings

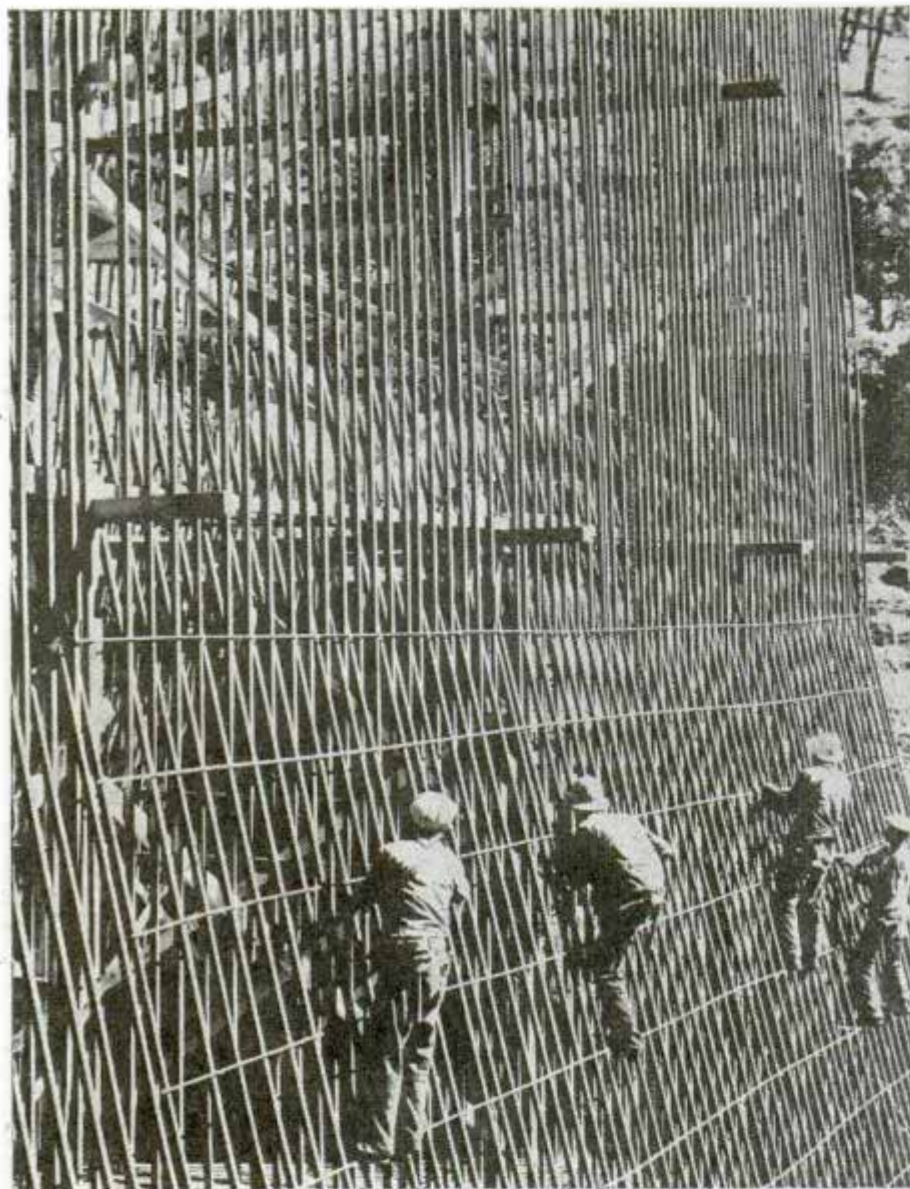


Diminutive streamline trailers are used by one couple to take along children too small to pedal their own bikes on family picnics. Each trailer is hooked to a bicycle by a gooseneck bar and towed along the road.

Children can tag along with parents to picnics in baby-size trailers that are easily towed over the highway by bicycles. A gooseneck bar between the bike and two-wheel cart makes a strong and sturdy hitch

Buda-Hubert Co.
 Harvey, Ill.
 Made by J. J. Howard
 Santa Barbara, Calif.

Basketwork of Steel Ribs Reinforces Pier for Bridge



Workmen seem to be clambering toward the top of a huge basket as they "weave" steel rods at Shasta dam in building pier for one of the bridges

Steel workers scaling the ribbed wall give the appearance of running a race to the top while they place the steel for a bridge pier that forms part of the structural work on Shasta dam. The gigantic project, undertaken on the Sacramento river in California by the U. S. bureau of reclamation, includes twelve tunnels, eight bridges and thirty miles of railroad.

Robot Lookout on Forest Tower Reports Fire and Smoke

Constant, untiring watch for fire breaking out in forests is kept by a recently patented lookout that sends signals automatically by radio or wire to distant stations only when it detects both smoke and fire in the same locality, thus avoiding many

false alarms. Rotating in a turret mounted on a tower high above the tree tops, the robot combines a photocell, or electric eye, that responds to a column of smoke rising within its range of vision, and a highly sensitive thermocouple to catch heat waves from a far-off blaze. Working together, these two "eyes" can detect and report the presence of fire and smoke, but they do not possess the ability to sense the actual location of a fire or the degree and direction of its spread.

X 673

Fast Post-Hole Drill Is Powered by a Tractor

Power from a farm tractor operates a post-hole digger that can drill a hole in ten seconds. Resembling somewhat a huge wood auger, the digger is attached easily to any tractor with a power take-off. It is attached to the rear of the tractor by a single bolt and can be set up ready for use or removed in less than one minute. The post-hole digger is the invention of an Oklahoma farmer.



Drill mounted at rear of tractor, taking power from the engine, is able to dig a post hole in ten seconds

Some since 1940
 some since 25
 X 751

and Serge N.

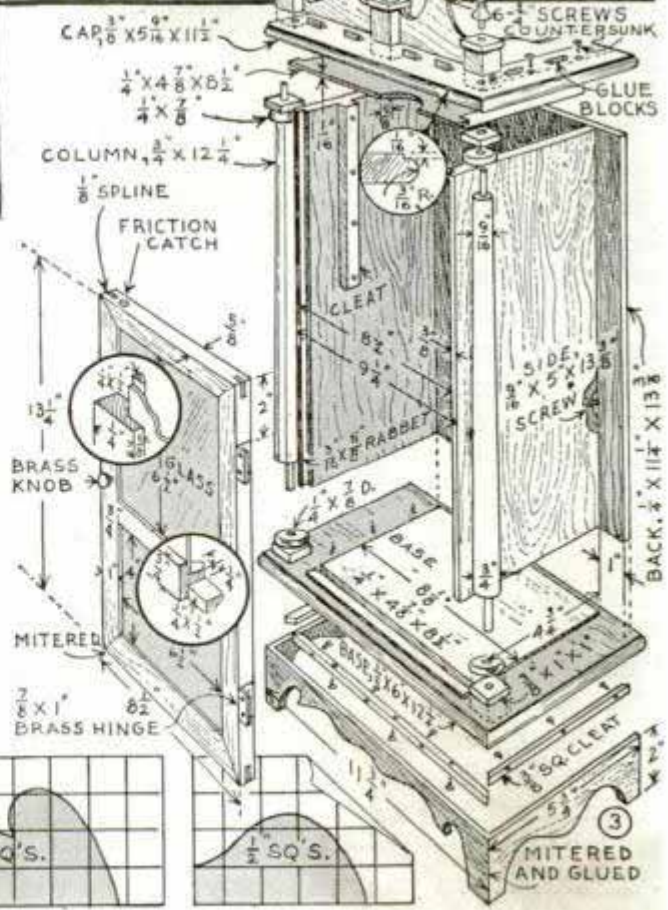
some since 25
 some since 25



The CRAFTSMAN

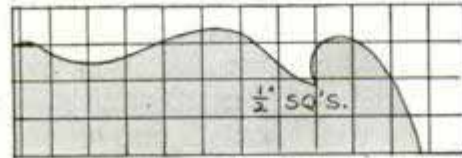
Eli Terry X180

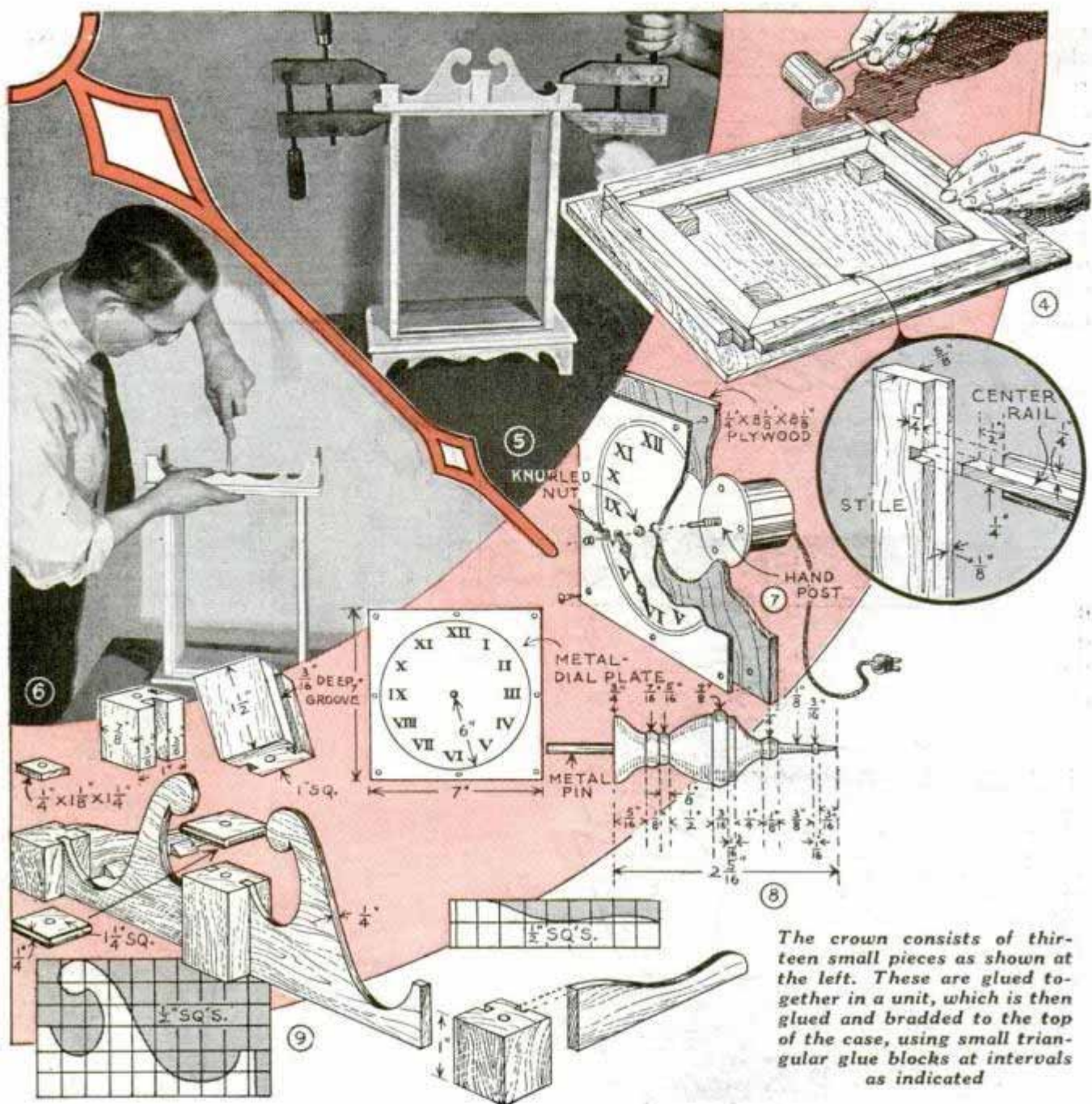
MANTEL CLOCK



THIS modern adaptation of the Terry clock is just the thing to set off the mantel in any home, regardless of the furnishings. Eight-day movements of the old clocks required a large case, but with the compact electric movements of today, the case can be constructed in a size that is more attractive and better suited to our present small rooms. Fig. 1 shows the appearance of the finished clock.

In constructing the case, start with the side panels, which have rounded edges, and rabbets along the front edges to house the door, Fig. 3. The base and cap have simple moldings worked





The crown consists of thirteen small pieces as shown at the left. These are glued together in a unit, which is then glued and bradded to the top of the case, using small triangular glue blocks at intervals as indicated

on their edges. Also, pieces having rabbeted edges are glued to the top of the base and the bottom of the cap. The framework is assembled with screws driven from the top and bottom respectively. The back butts against the rear edges of the side pieces, top and bottom, and fits under the cap and over the base piece. It also extends out 1 in. on either side.

The apron pieces are jigsawed to shape, after which cleats, drilled for screws, are glued to the backs of the apron pieces. In this manner both pieces are mitered at the same time. The apron is assembled with glue, and then screwed to the underside of the base by means of the cleats, as in Fig. 6.

The door frame is another mitring job. Splines in the corners add strength. The center rail is secured in place with a mortise-and-tenon joint of the type shown in

the circular detail of Fig. 4. Perhaps the simplest way to glue up the door, if special miter clamps are not available, is by the block-and-wedge method shown in Fig. 4. The frame is set over four blocks, and cleats and wedges are driven from all sides to put sufficient pressure on the corners. After the glue has dried, the frame should be fitted to the opening by careful planing, as in Fig. 2. Clear glass is used in the square opening over the dial, but the lower glass of the door should be decorated. Pasting a picture of some colonial scene serves very well, or a colored decalcomania may be used.

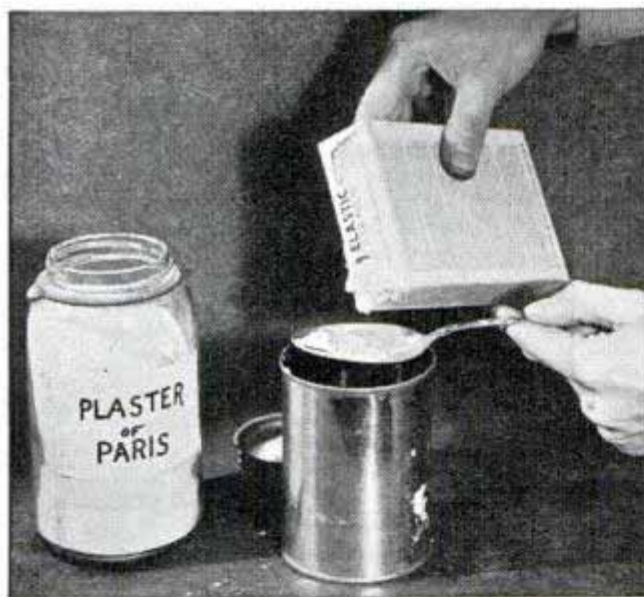
The pillars, blocks and disks are installed with dowels, which enter holes in the cap and base. The parts that make up the crown, Fig. 9, with the exception of the finials, are assembled as a unit before glu-

ing on the case. The method of clamping is shown in Fig. 5. The finials may be turned from wood or soft brass, Fig. 8. However, should you wish, finials of a suitable design may be purchased.

The electric movement should be of the self-starting, front-setting type. Replacement-type units are available that are mounted by simply running a threaded sleeve through the hand post hole of the dial and screwing on a knurled nut, as in Fig. 7. Dials may be purchased from the same source or may be made by drawing the numerals on a piece of fine white drawing paper and mounting the paper on a metal plate with cement.

Slowing Down Plaster of Paris

For jobs where the quick-setting quality of plaster of paris is objectionable, the rate of hardening can be slowed down by adding a small proportion of flour paste, paper-hanger's paste or starch. Make a thin



soup of the adhesive, and then stir it into the dry plaster until the right consistency is obtained. This is particularly helpful when patching plastered walls. Hardness of the patch is not affected materially.

—Walter E. Burton, Akron, Ohio.

Emergency Soap Carried in Car

A few pieces of soap dissolved in just enough water to form a thick solution makes an excellent cleansing fluid for the hands after engine or tire trouble on the road. When kept in a tightly sealed bottle in the car, the liquid will last indefinitely and always be at hand when needed.

Ladder Provided with Non-Slip Surface to Avoid Tipping

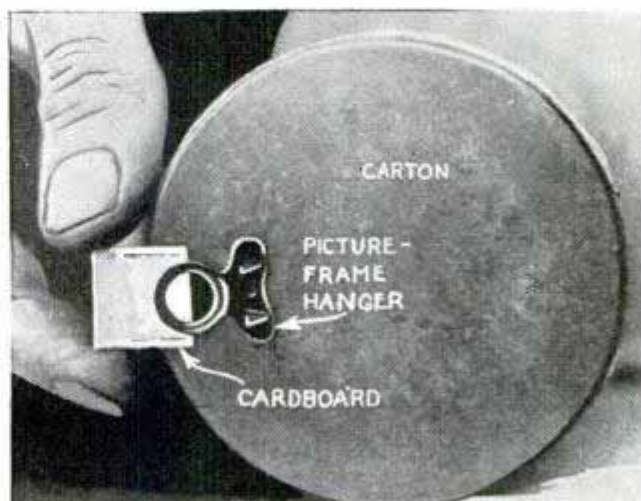


When working on a ladder that is leaned against a building or other smooth surface, a rubber-faced strip nailed to the under edge at the top will help prevent tipping. Corrugated rubber such as that used on car running boards or stair steps is ideal for the purpose.

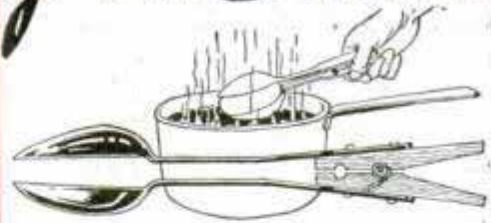
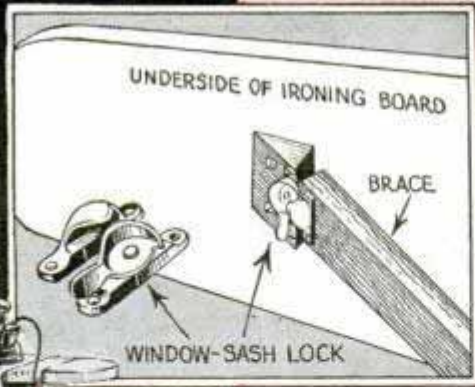
Pouring Hole in Salt Container Is Made Adjustable

The difficulty of getting just the right size pouring opening in a carton of salt, sugar and similar packaged articles can be avoided by making the opening adjustable as indicated in the photo. To do this, a picture-frame hanger of the type shown is placed over the opening, and a piece of cardboard is pushed under it over the opening. The cardboard can be adjusted to give the desired orifice.

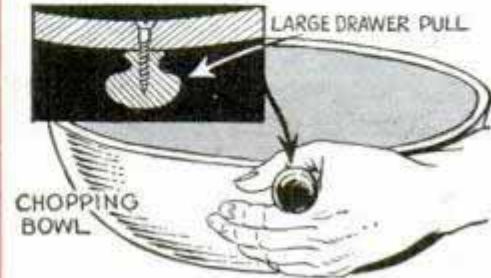
—Frank Bentley, Clinton, Ia.



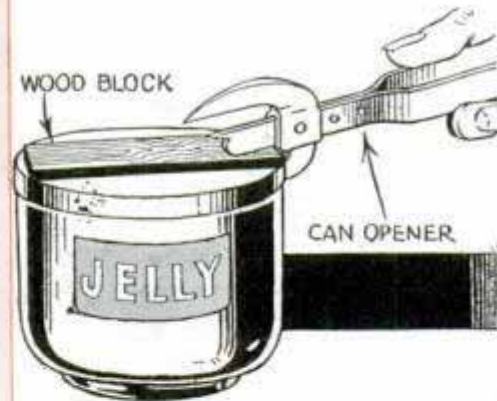
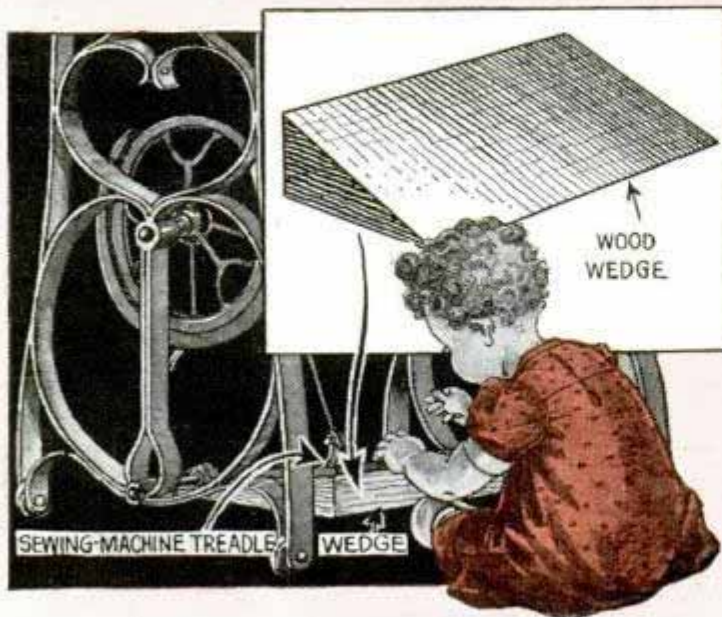
Solving HOME



Ironing boards of the type having a turnbutton on the underside to hold the slanting brace can be improved by substituting a sash lock for the turnbutton as at the left. Two teaspoons and a clothespin assembled as above provide a handy lifter for removing boiled eggs from a pan of hot water

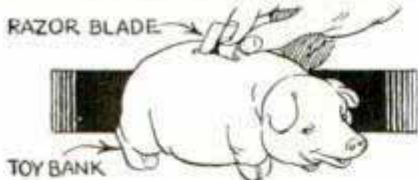


When a baby outgrows a folding play pen, the latter will serve as a gate in a doorway or at the head of an open stairway. The pen is adjustable to openings of various widths. The difficulty of holding a large wooden chopping or mixing bowl is avoided by attaching a knob or drawer pull to one side as indicated above. Use a brass wood screw for fastening the knob to avoid rust, which might contaminate the contents

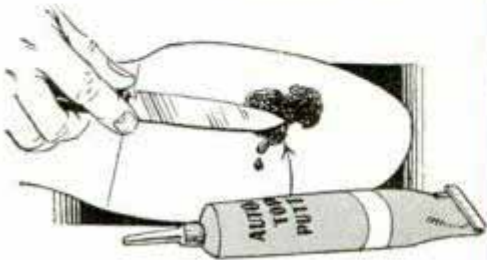


Left, there is no danger of a baby operating a foot-powered sewing machine and injuring its fingers if a wide wooden wedge is pushed tightly under the treadle when the machine is not in use. When removing a tight-fitting lid from a jelly glass with a can opener, a strip of thin wood used as shown above will prevent the lid from being bent out of shape. The wood serves as a stiffener across the top so that the opener does not press down on the center of the lid

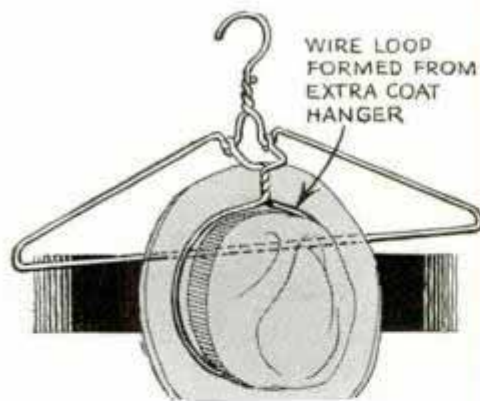
PROBLEMS



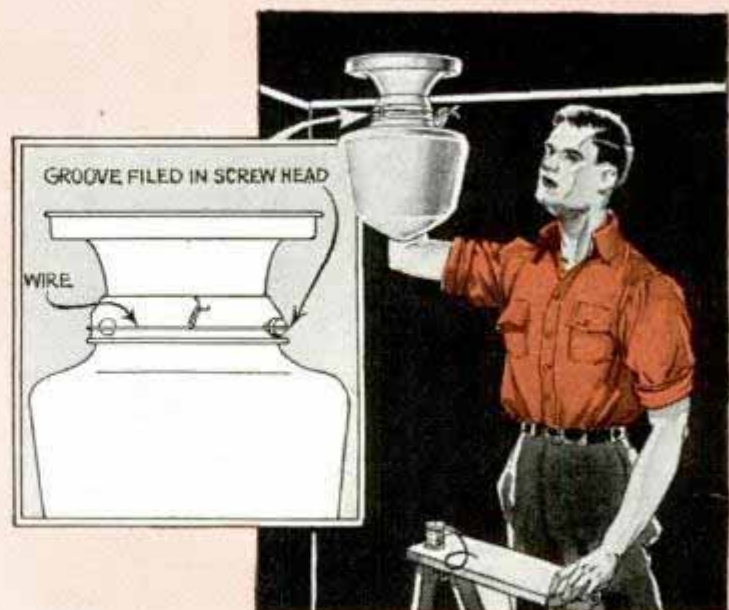
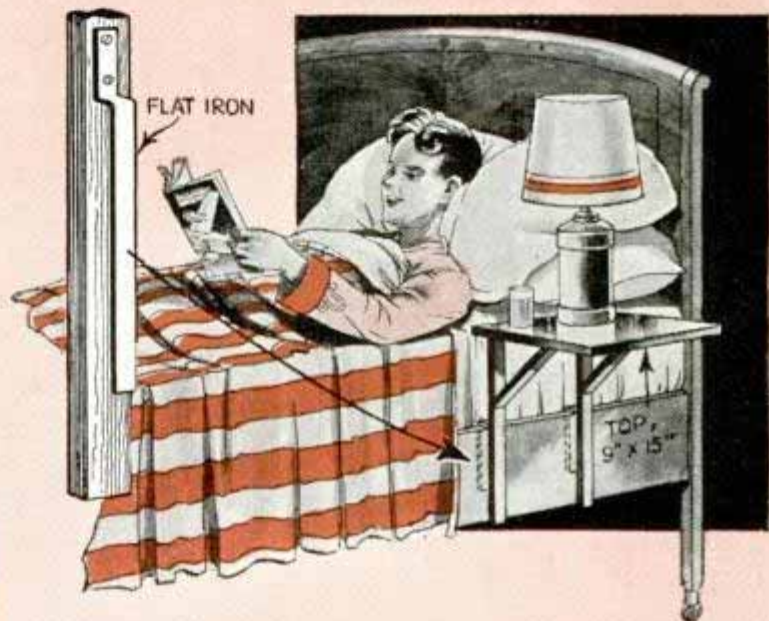
Use a box like the one shown at the right to keep a few magazines handy on a porch swing. It is made of $\frac{3}{8}$ -in. plywood and is assembled with screws. Iron brackets permit it to be attached to the underside of the swing. Above, a toy money bank provides a safe receptacle for used safety-razor blades. Being inexpensive, the bank can be disposed of when it is full.



Right, a small table that will hook over a bed rail is often a great convenience to hold things within reach. It takes no floor space and moves with the bed, or it can be set away when not in use. Also, it will serve as a lamp stand if you read in bed. Above, worn spots on shoe soles can be covered with a tough layer of rubber compound by the use of inexpensive, easy-spreading auto-top putty



To prevent a large globe on a porch light fixture from falling because vibration of a heavily traveled street has slowly loosened the screws that hold it, turn the screws so that the head slots are horizontal and place a length of iron wire around the light so that it rests in the slots, and tighten it by twisting. The combination hat-and-coat hanger shown above is handy when closet space is very limited. Also, there is no possibility of the hat being knocked down



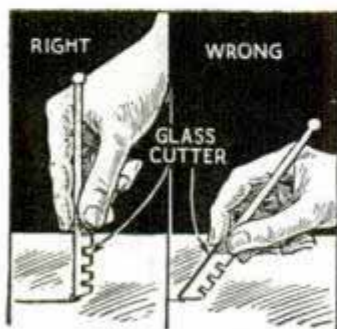
Holder Keeps Hammer Handy on Ladder for Workman



The necessity of keeping a hammer conveniently at hand when erecting eave troughs on buildings may be met by fastening a strip of stiff leather onto the side of the ladder as shown. This also precludes the dangerous possibility of a hammer, left on the roof even temporarily, falling and injuring someone below.

How to Hold Glass Cutter to Assure Clean Score

According to a skilled glass cutter, who is employed by a large glass manufacturing company to call on dealers and demonstrate successful methods of cutting and

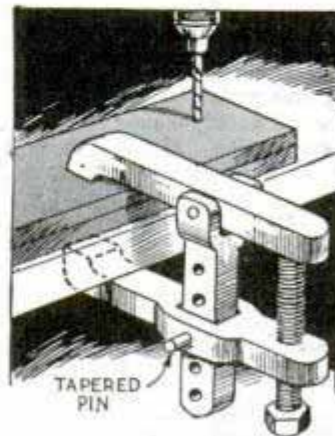


fitting glass, much of the failure and discouragement of amateurs in the art can be attributed to holding the cutter at the wrong angle. Held as shown in the right-hand detail, sufficient pressure cannot be exerted and a hollow score is the result, with a possible loss in breakage.

However, if the tool is held as nearly vertical as possible, the score will be deeper with less strain on the hand muscles and the pieces will break clean and smooth along the desired lines.

Simple Clamp Has Deep Throat

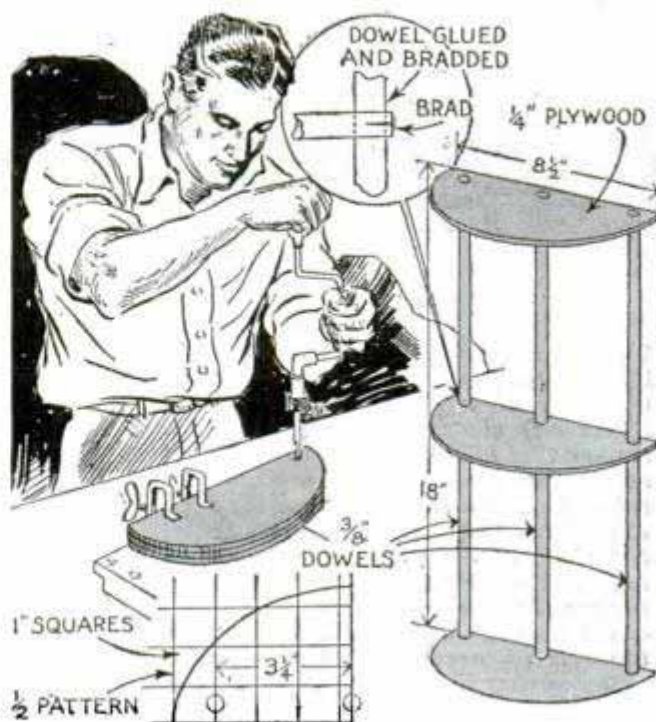
This clamp can be made any size desired and in addition to having a deep throat, it gives a strong grip. The operating screw is placed well back out of the way of the work to be clamped, something that is impossible with the conventional C-type of clamp. The adjusting pin should be a taper fit in the lower clamp jaw to keep it in place, and a free fit in the holes of the sliding arm or connecting link.



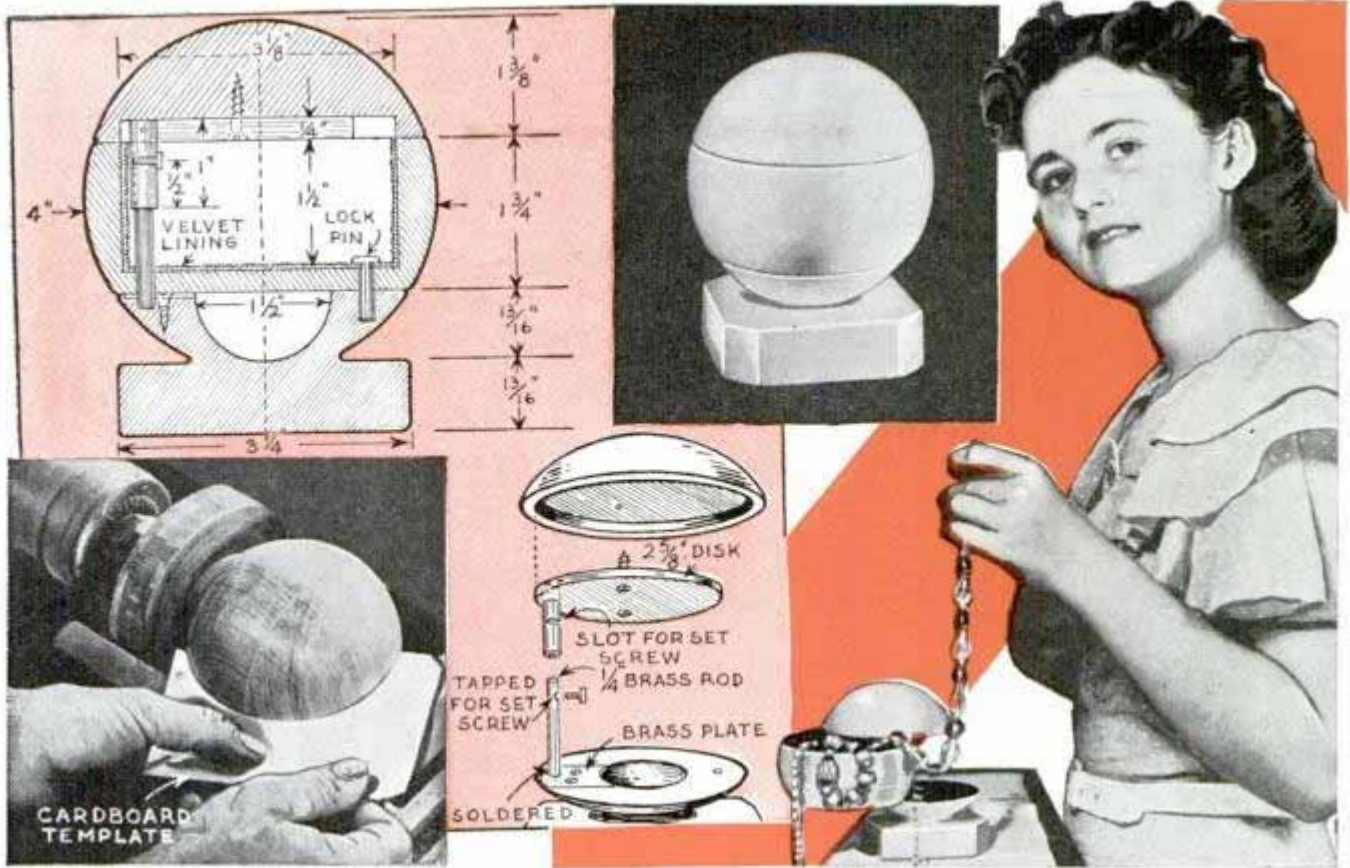
—Chas. H. Willey, Penacook, N. H.

Bric-a-Brac Shelves of Dowels and Plywood

These attractive bric-a-brac shelves can be made at a cost of a few cents. They are cut from plywood, after which they are stacked and drilled to take dowels. The shelves are glued and bradded to the latter. Finish can be enamel, varnish or wax.



Turned Trinket Box Has Secret Ring Cavity



This trinket box has a velvet-lined compartment closed by a pivoted lid, and a secret cavity in the base where rings may be hidden. First glue three pieces of 2-in. hardwood together, inserting a piece of paper in each joint so that the parts can be separated later. Then turn the unit to form a ball 4 in. in diameter. After this, remove the upper piece or lid and turn the compartment in the center piece. Next remove this and turn the cavity in the base. The lid hinge pivot is a short brass

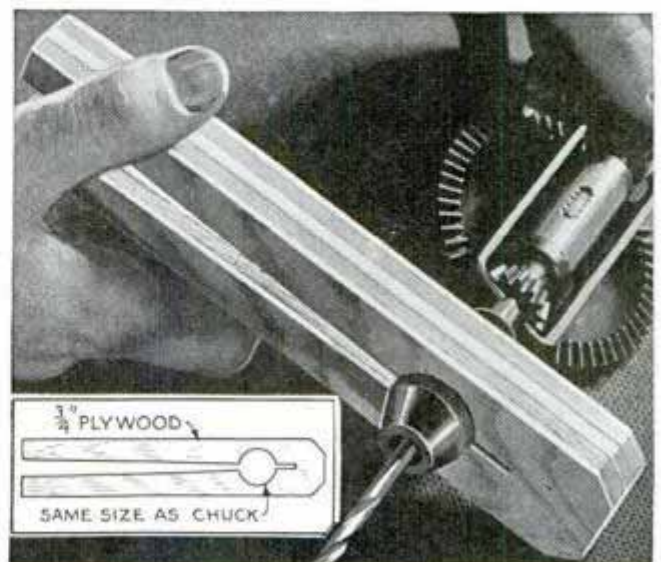
rod soldered to a small brass plate mortised into the base as indicated. A thin brass disk screwed to the underside of the lid carries a short sleeve which slips over the pivot. The sleeve is slotted for a retaining set screw. To complete the job, drill a tiny hole through the bottom of the trinket compartment into the base to take a pin for locking the ring cavity. As the lid swings rather freely, no one is likely to notice the tiny locking pin that is the secret of getting at the ring cavity.

Wooden "Pliers" Loosen Drill Chucks Without Damage

The problem of loosening small drill chucks without marring or damaging them, which may happen if a metal object is used, is solved by using these wooden "pliers." They are made of plywood, and the opening in them should fit loosely over the chuck to be removed. The pliers are used by gripping the handles tightly and turning in the right direction.

—Howard R. Heydorf, Missoula, Mont.

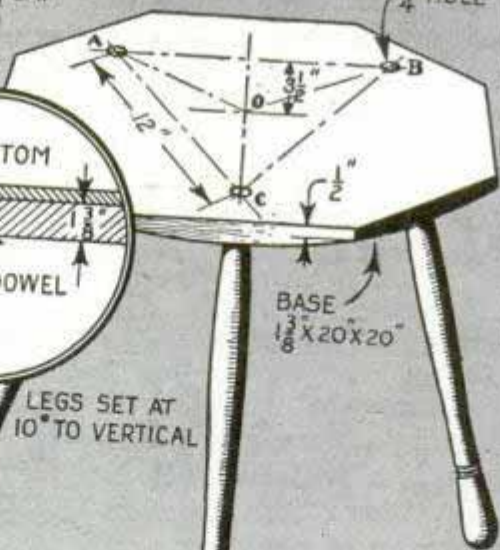
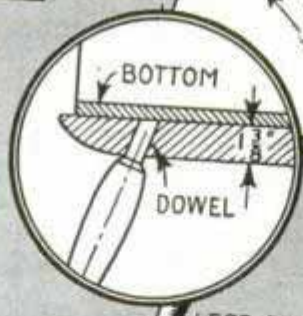
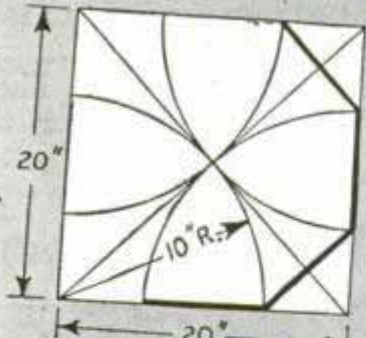
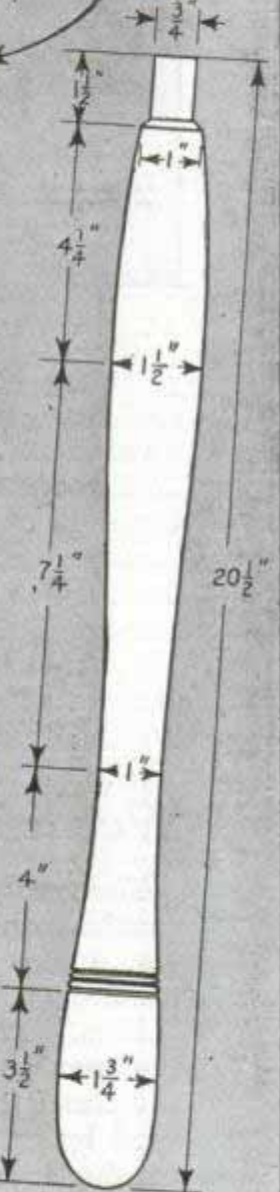
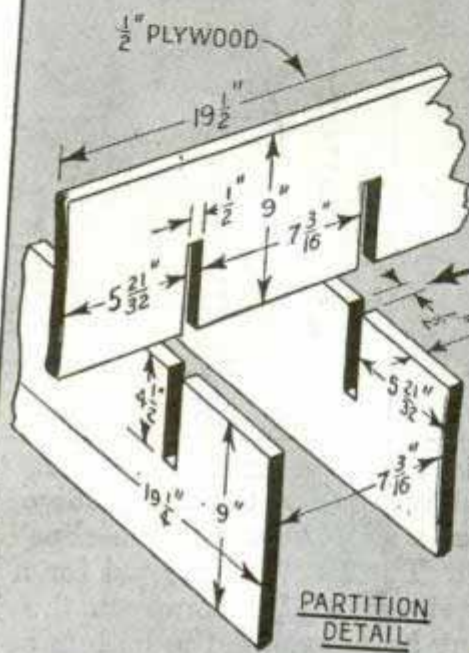
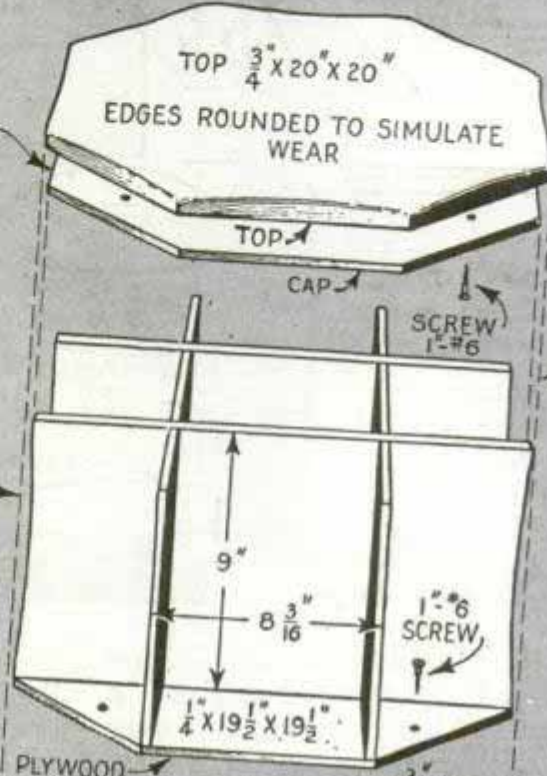
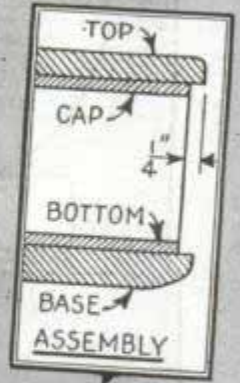
☐ If bone meal is spaded into the earth around your shrubs late in the year, the winter snows and rains will wash it into the soil and nourish the roots.



Three-Legged



TABLE PROVIDES FOUR RECTANGULAR COMPARTMENTS FOR BOOKS AND FOUR TRIANGULAR ONES FOR BRIC-A-BRAC

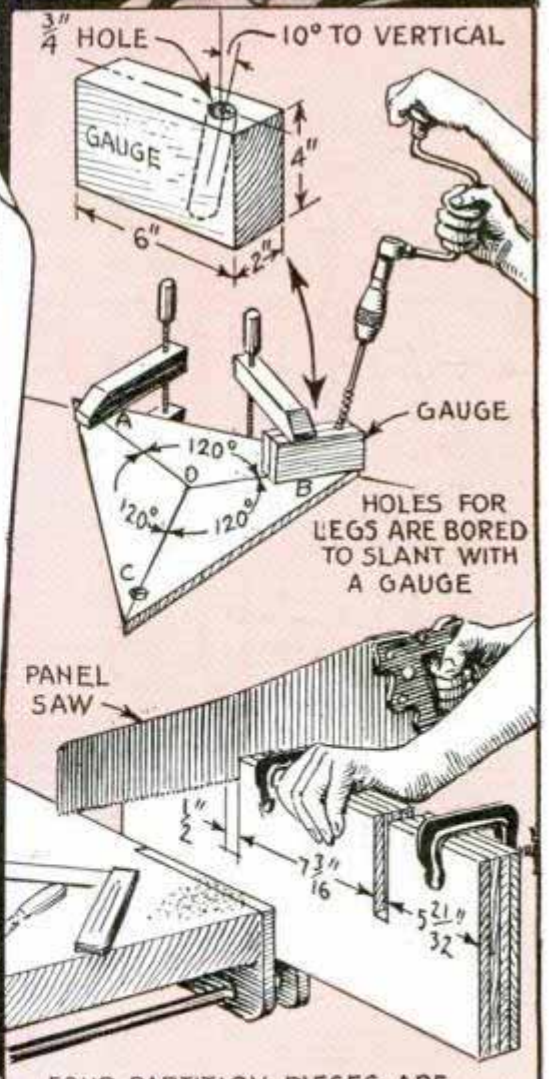
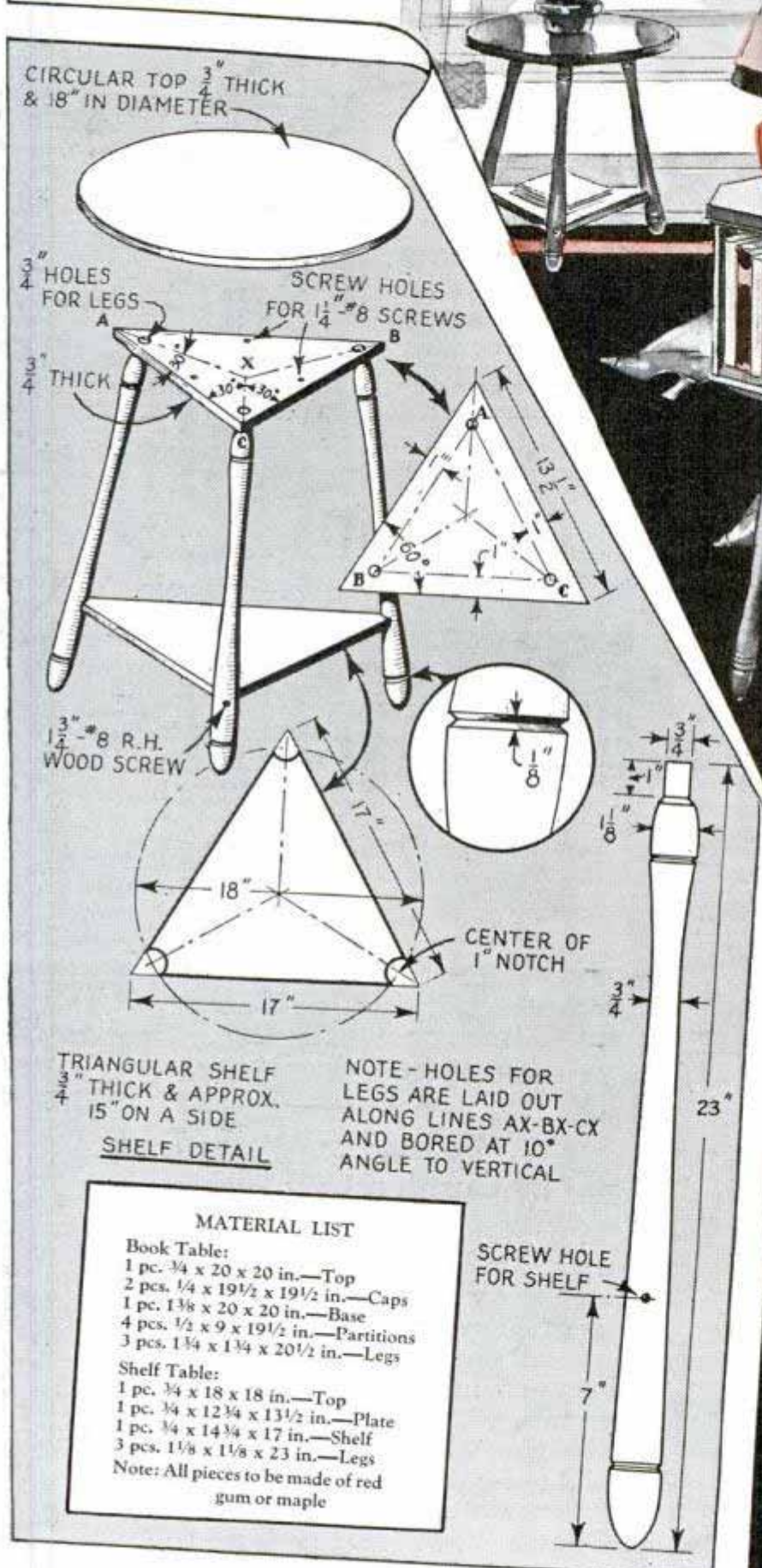


TOP & BASE ARE GLUED UP FOR WIDTH.
LEGS ARE SET AT 10° ANGLE TO VERTICAL

DOWEL HOLES ARE LAID OUT AND BORED FROM TOP - ANGLES ARE MEASURED ALONG LINES AO-BO-CO

There is a place in most homes for one or both of these neat little tables. One serves as a plant stand and the other as a combination table and book shelf. The latter will accommodate about twenty volumes of average size. Space is also provided for several pieces of bric-a-brac or smoker's articles. Construction is simple, the legs being turned or whittled to shape as desired. Boring of the leg holes is simplified by use of a jig or gauge, and the various parts are nailed or screwed together

DRUMSTICK TABLES



TRIANGULAR SHELF $\frac{3}{4}$ " THICK & APPROX. 15" ON A SIDE

SHELF DETAIL

NOTE - HOLES FOR LEGS ARE LAID OUT ALONG LINES AX-BX-CX AND BORED AT 10° ANGLE TO VERTICAL

- MATERIAL LIST**
- Book Table:**
- 1 pc. $\frac{3}{4}$ x 20 x 20 in.—Top
 - 2 pcs. $\frac{1}{4}$ x $19\frac{1}{2}$ x $19\frac{1}{2}$ in.—Caps
 - 1 pc. $1\frac{3}{8}$ x 20 x 20 in.—Base
 - 4 pcs. $\frac{1}{2}$ x 9 x $19\frac{1}{2}$ in.—Partitions
 - 3 pcs. $1\frac{3}{4}$ x $1\frac{3}{4}$ x $20\frac{1}{2}$ in.—Legs
- Shelf Table:**
- 1 pc. $\frac{3}{4}$ x 18 x 18 in.—Top
 - 1 pc. $\frac{3}{4}$ x $12\frac{3}{4}$ x $13\frac{1}{2}$ in.—Plate
 - 1 pc. $\frac{3}{4}$ x $14\frac{3}{4}$ x 17 in.—Shelf
 - 3 pcs. $1\frac{1}{8}$ x $1\frac{1}{8}$ x 23 in.—Legs
- Note: All pieces to be made of red gum or maple

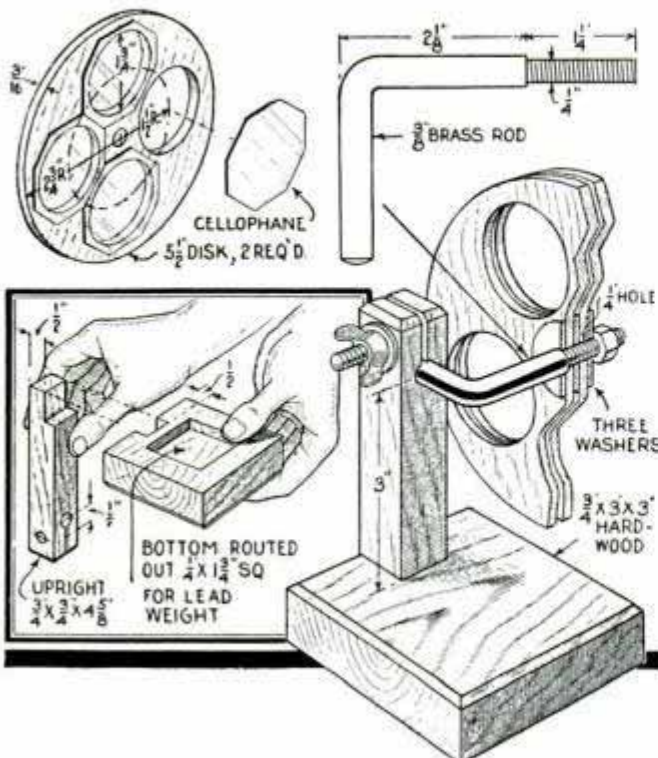
Small Tweezers Serve as Vise for Tying Fishing Flies



One of the simplest of vises for tying fishing flies may be made from a pair of pocket tweezers with pieces of rubber tubing slipped over the tips. By pushing the handle of the tweezers through a narrow slit in the top of the tackle box, the points may be made to close and hold the hook firmly in any desired position.

Color Filter for Microscope Is Adjustable

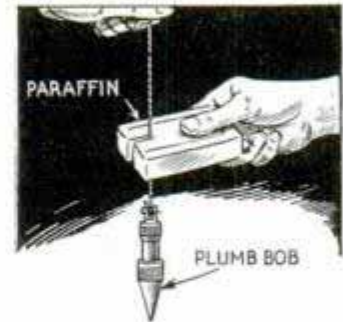
Any one of four colors or combinations of the four, for use with a microscope, is available with this filter. It consists of two $\frac{1}{8}$ -in. plywood disks, which have four corresponding openings over which pieces of



colored Cellophane are glued. The disks are pivoted to a suitable support by means of a brass rod, and are separated by a thin washer as indicated.

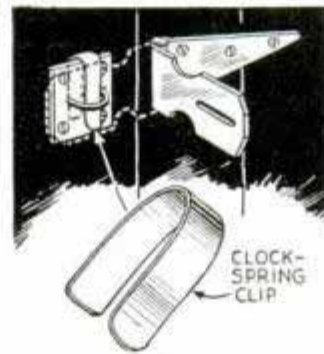
Waxed Line Prevents Plumb Bob from Rotating

Much of the trouble caused by a plumb bob that rotates when suspended with a long line can be overcome by merely applying a coating of paraffin or other wax to the line.



This will cement the strands of the line to prevent twisting without reducing the efficiency of the bob.

Self-Locking of Hasp Avoided by Spring Clip under Staple

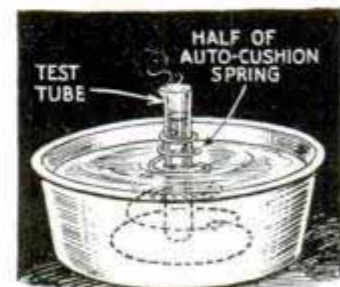


If you have had the experience of having your garage or barn door blow shut, while you were inside, and then found that the hinge had engaged the staple so that it was practically locked,

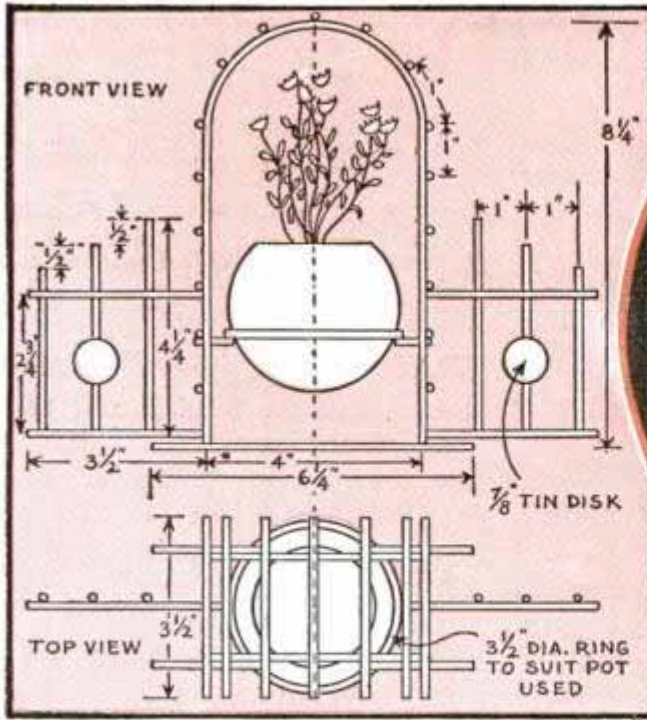
you will appreciate this little spring clip, which slips under the staple plate to prevent such accidents. The clip is shaped from a short piece of clock spring.

Test Tube held in Water Bath by Cushion Coil Spring

In performing experiments, where the working of gases or chemicals must be observed in the test tube while it is in the water bath, one-half of an auto cushion spring will serve as a convenient support. The large end of the spring is placed in the water pan and the tube is slipped through the small end.



Midget Trellis to Hold Tiny Potted Plants



An eye catcher about the house, this trellis flowerpot holder carries a brightly colored pot for small plants. The trellis work is made of $\frac{1}{8}$ -in. iron rod welded or soldered together. Fence sections are made up and joined to the trellis, then a ring to hold the pot is fastened in place.

Ink Bottle Kept Level When the Drawing Board Is Tilted

After trying many ways of holding a bottle of drawing ink on a tilted board, I made the holder shown. It consists of two wood blocks hinged together at one end, the top of a tin can being cut off and provided with

tabs to hold the bottle. The hinge pin is removed and a long slender bolt and wing nut substituted. This permits the hinge action to be made tight enough to keep the holder at any desired adjustment. A pin projecting from the underside of the lower block slips into a hole in a drawing board to keep the holder in position, yet make it removable by merely lifting it.

—L. B. Robbins, Harwich, Mass.

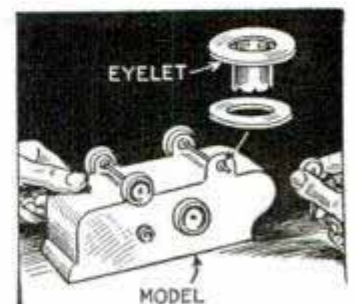


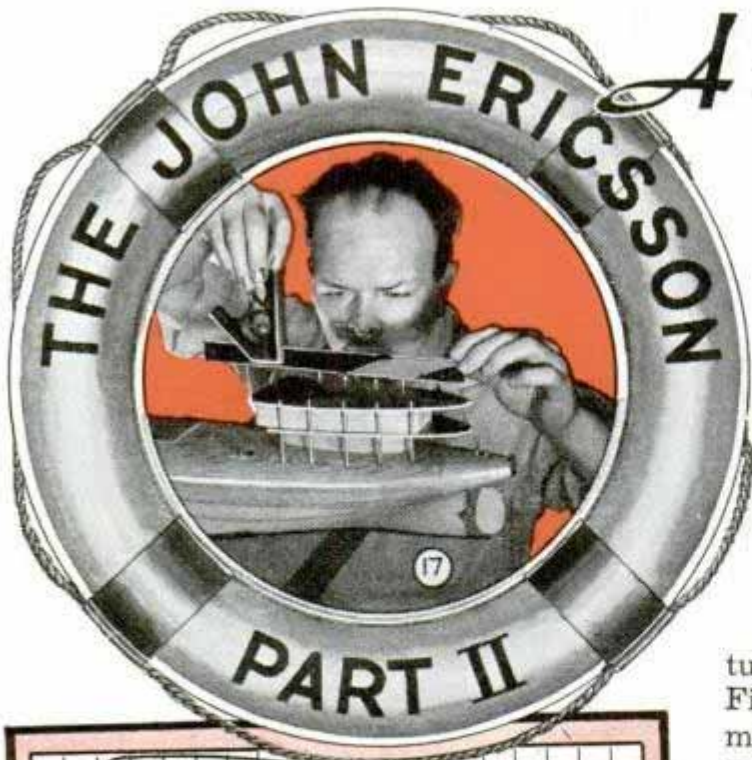
Eyelets Provide Good Bearings for Your Models

When working models of prospective machines, toys, etc., are made up of cardboard, I find that ordinary eyelets are just the thing for bearings on moving shafts.

These are obtainable in various sizes.

—A. H. Waychoff, Phoenix, Ariz.

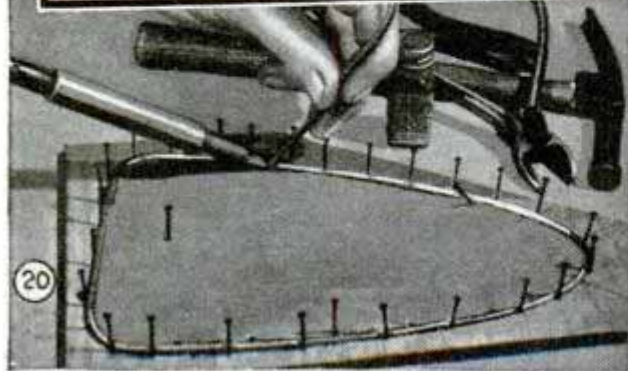
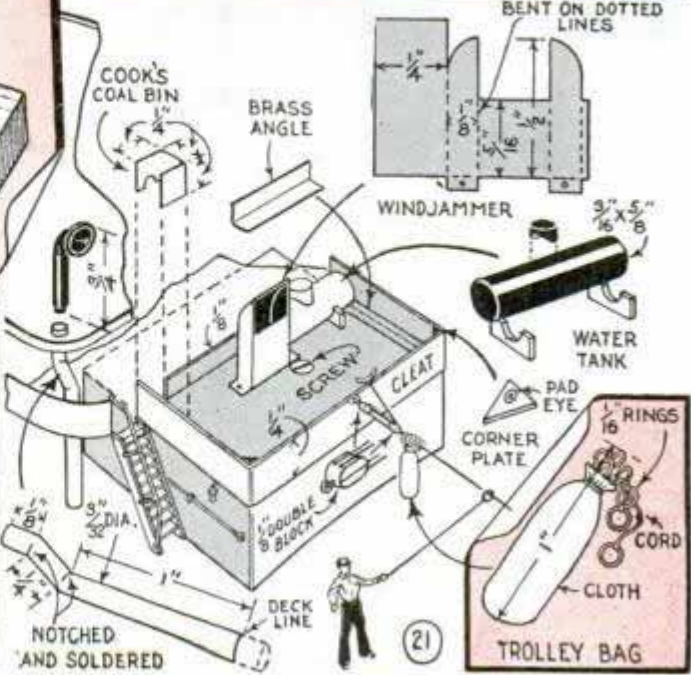
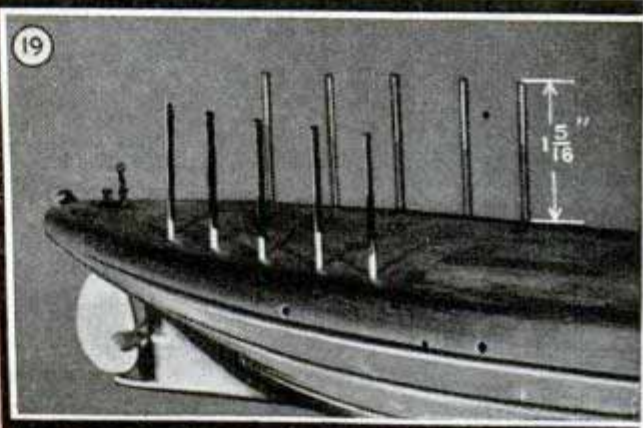
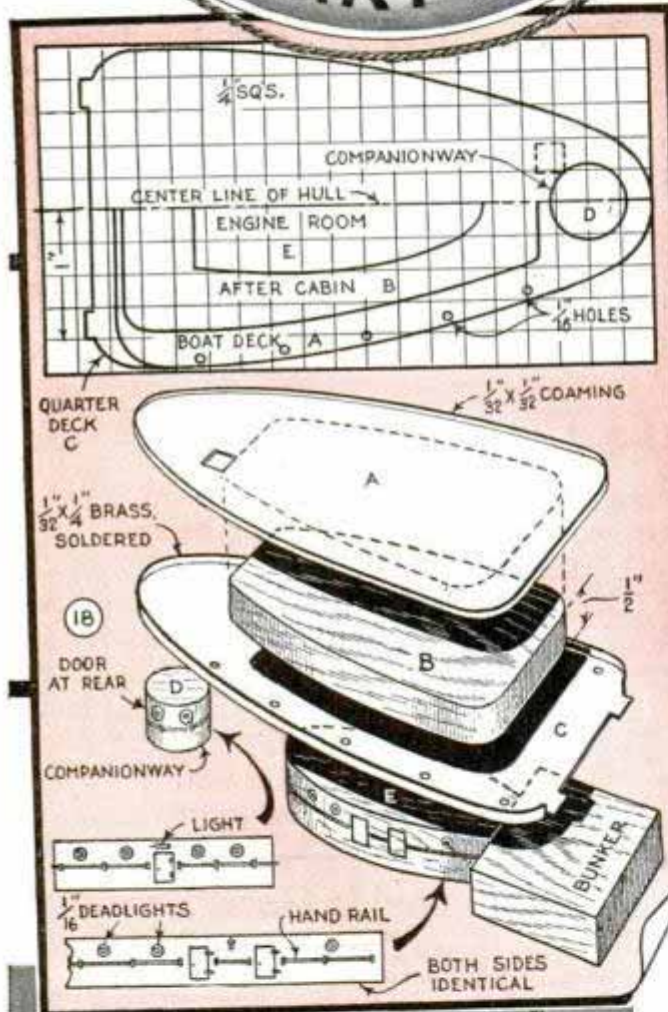




A Great Lakes

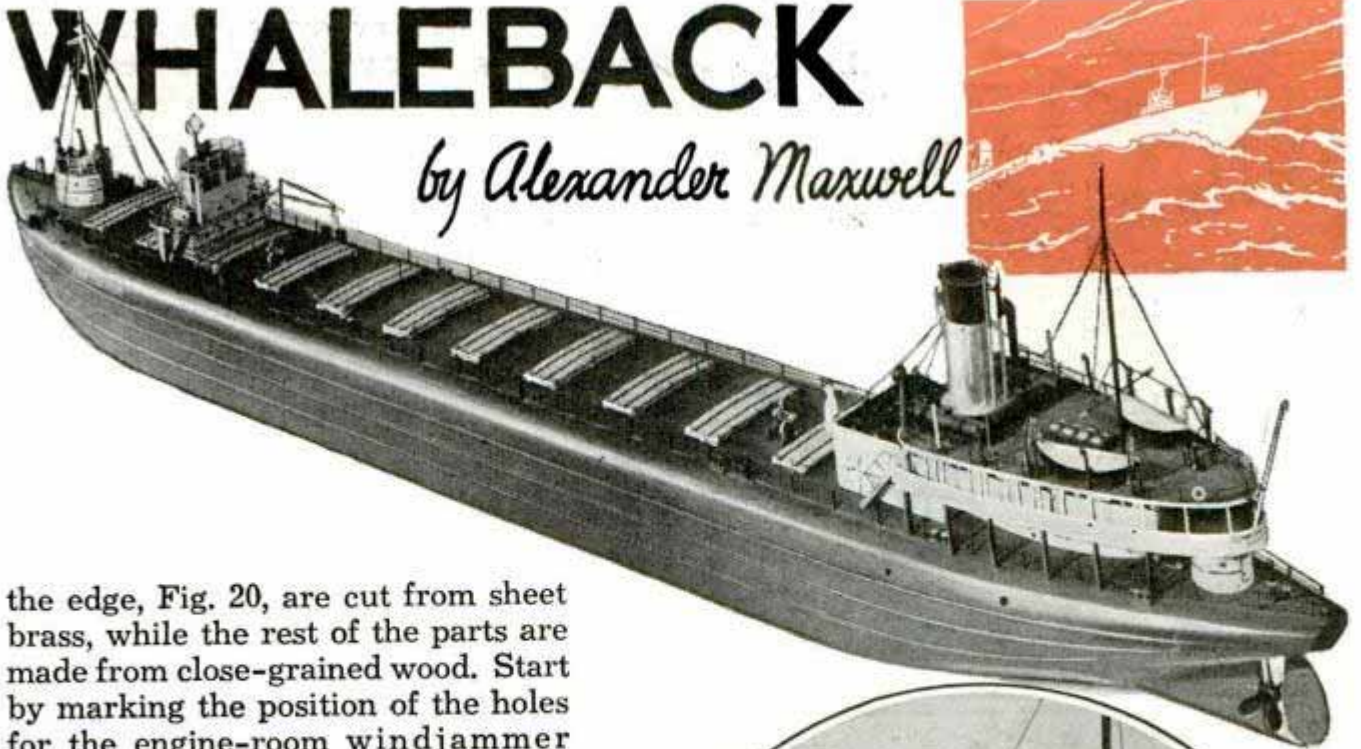
The superstructure—bunker, engine room, cabin, decks and companionway

HAVING finished the hull, forecastle and the pilot house as described in the previous installment, you may now proceed to complete your model of the "John Ericsson" by adding the superstructure, Fig. 22, located on the fantail deck. Fig. 18 gives a lettered plan to follow in making full-size paper patterns of the various parts, and also shows the order of assembly, each part being identified with a corresponding letter. The quarter and boat decks, parts A and C, which have narrow coamings soldered around



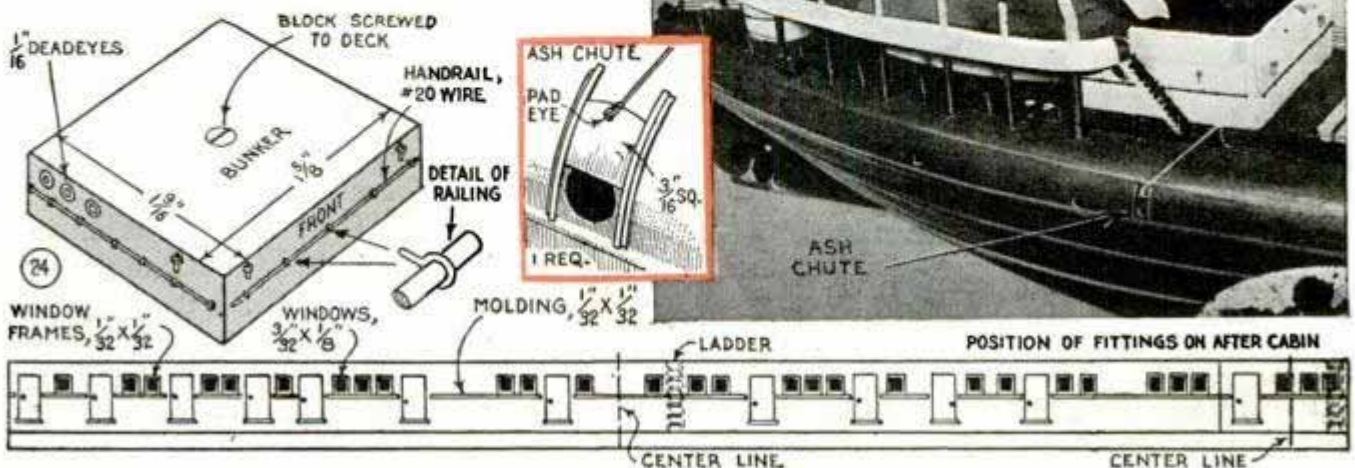
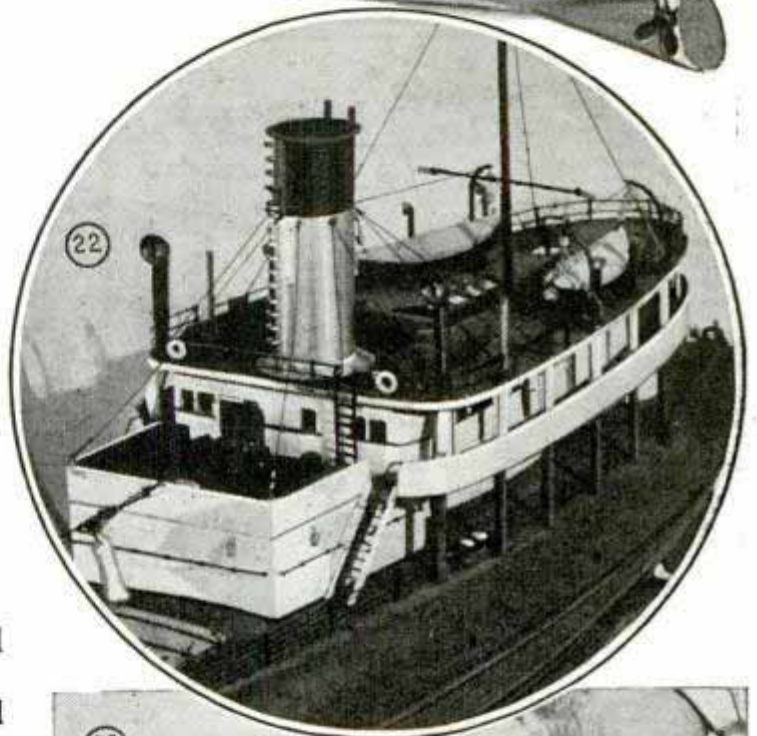
WHALEBACK

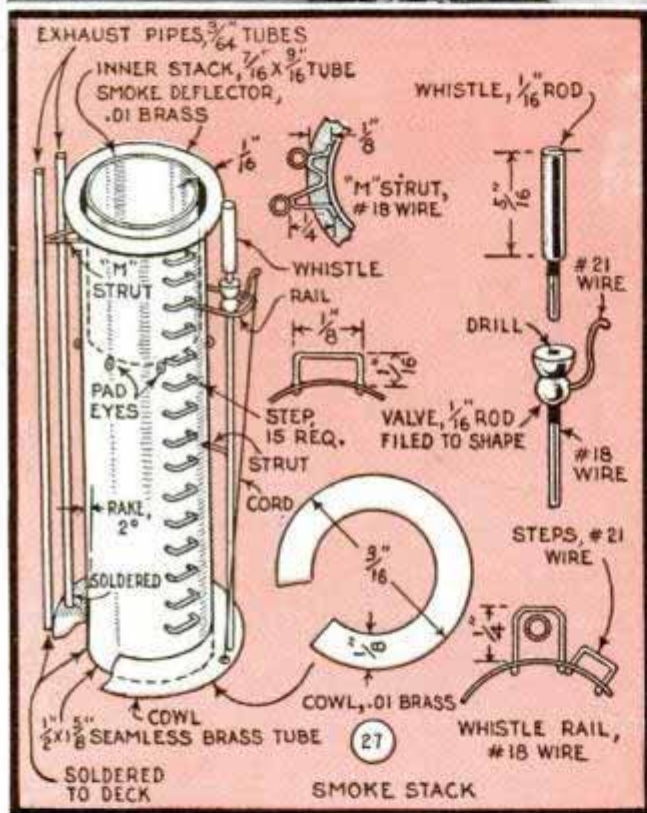
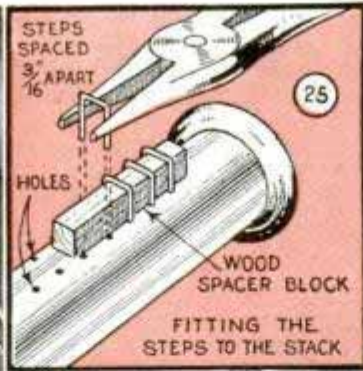
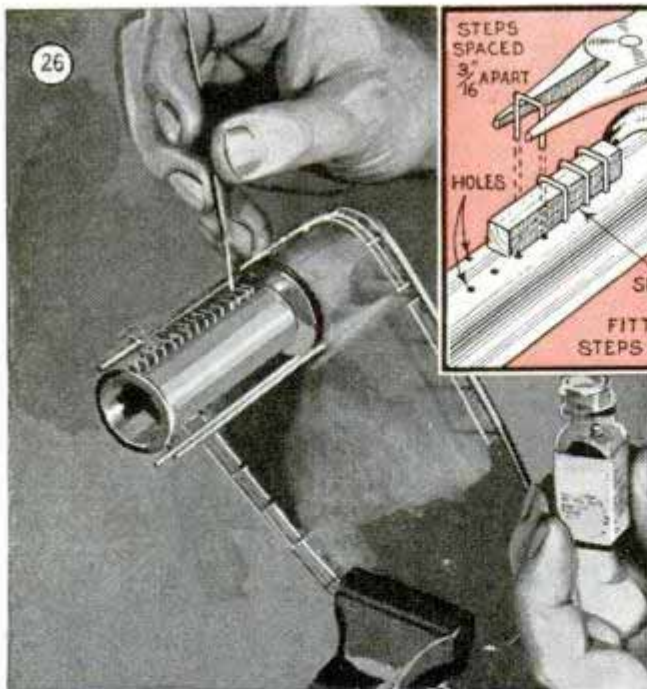
by Alexander Maxwell



the edge, Fig. 20, are cut from sheet brass, while the rest of the parts are made from close-grained wood. Start by marking the position of the holes for the engine-room windjammer pipes which are drilled along each side of the hull. As these must register with those drilled in decks A and C, it is best to use one of the latter as a guide in drilling the holes in the hull. The pipes are driven gently into slightly undersize holes to protrude $1\frac{1}{16}$ in. above the deck, Fig. 19. To assure that these are all equal height, place a straightedge across the top as in Fig. 17. You will notice that the two firehold windjammers, which are fitted in offset corner pipes (see Figs. 21 and 33), are not installed until the complete unit, exclusive of the boat deck, is attached permanently to the hull.

The bunker, detailed in Figs. 21 and 24, consists of a $\frac{1}{2}$ -in. block which is shaped to fit the deck curvature and glued to the forward end of the engine-room block, Fig. 18. A coaming of brass angle is fastened around the top edge of the bunker with small brads, allow-





ing it to overhang the edge slightly, after which corner plates and cleats are soldered to the edge as in Fig. 21. Before fastening the bunker and engine-room unit to the hull, the sides should be painted white and outlined with black India ink. This should be a dazzling white. It can be obtained by using sign-painter's zinc-white color to which a touch

of Prussian blue has been added. Apply it thinned. Figs. 18 and 24 show flat, extended layouts that can be used in locating the approximate position of the doors, windows, deadlights and handrails on the sides of the companionway, engine room and cabin. As the layout for the cabin differs on each side, you will have to work each way from a centerline marked lengthwise on the block. The thin strips of wood or cardboard applied to represent window frames, are painted a bright red.

Attach the bunker, engine room and companionway to the hull with a screw through each, Fig. 24. Next, place the quarter-deck in position and on top of this fasten the cabin with a screw down through the top. Solder the flagpole in place, and then paint the top and bottom of the quarter-deck oxide red and the railing white. You can now install the remaining fittings in the bunker which are namely: the water tank, windjammer and cook's coal bin, Fig. 21. Crushed coal is filled in around the fittings, Fig. 23, and then thin varnish is poured over the coal to keep it in place.

The trolley bag, shown in Fig. 21, contains the safety ropes used by the deck crew to keep from being washed overboard during stormy weather. The life line on which the bag hangs is a length of No. 6-0 thread and extends lengthwise of the cargo deck from a pad eye fitted in the rear of the pilot house to a block-and-tackle attached to the coal-bunker coaming.

The smokestack is a significant part of a ship. To a sailor it identifies the name of the owner, the type of power used, the age of the vessel and the living conditions aboard. The "John Ericsson's" stack was tubular in shape. Figs. 25 to 27 inclusive detail the construction of this. The fittings

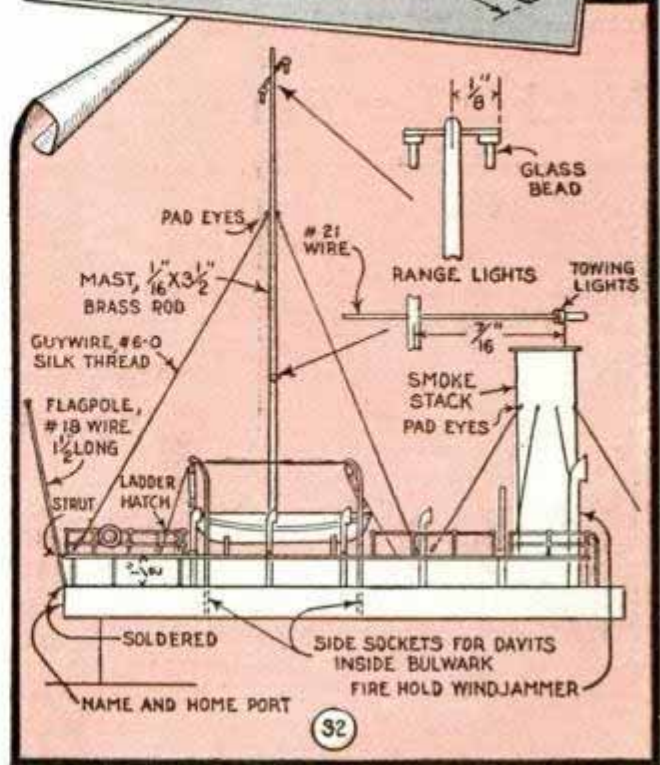
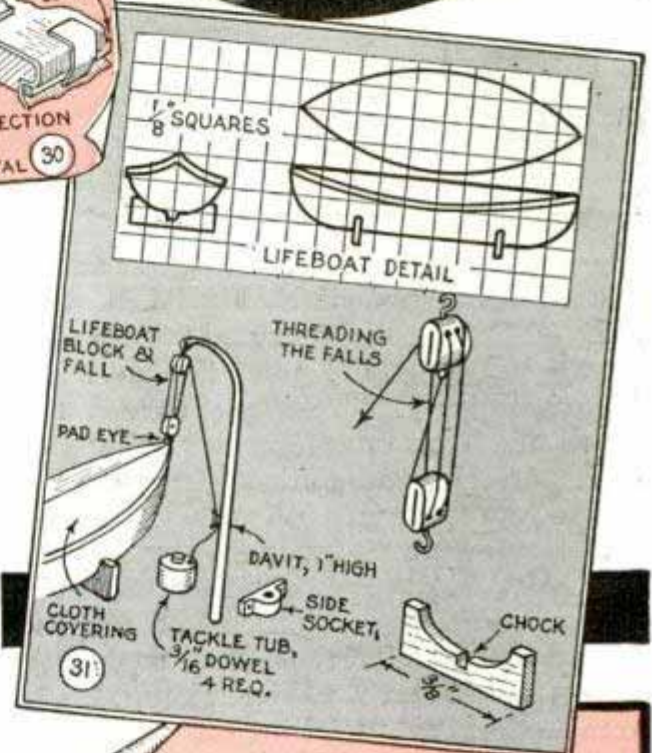
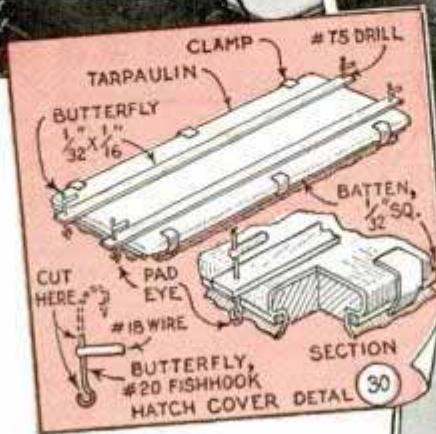
consist of a ladder, two exhaust pipes and a whistle. Made of 1/2-in. seamless tubing, it is first drilled for the fittings and then soldered to the boat deck A, using a small clamp to hold it

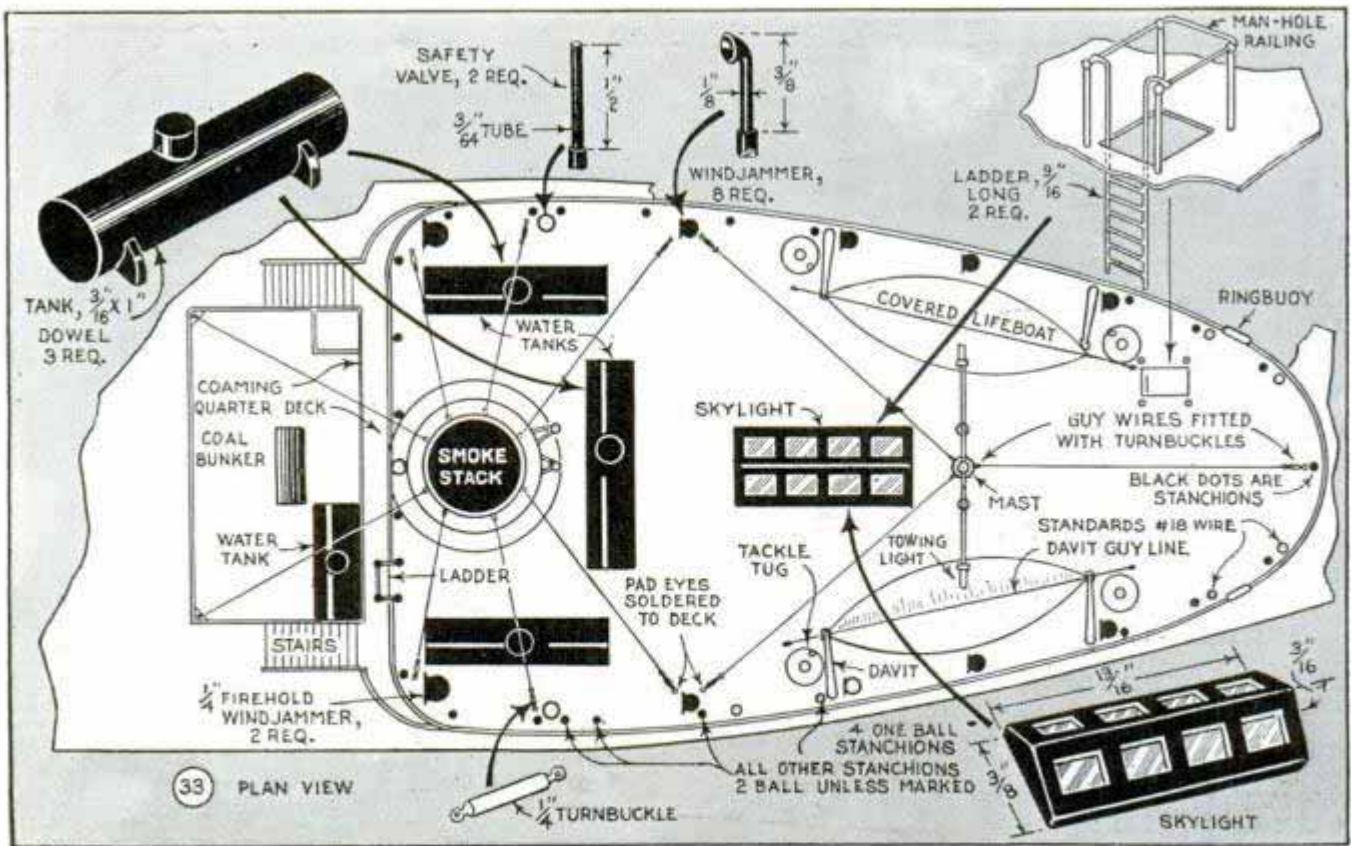


in position. The smoke deflector as well as the cowl are cut oversize and shaped after being soldered in place. The pad eyes, to which the guy wires are attached, Figs. 27 and 33, should extend inside the stack to support the inner tube. This inner stack is wrapped with adhesive tape to make a press fit inside the outer stack, letting it protrude above the latter about $\frac{1}{32}$ in. Fig. 25 shows a method for spacing the steps uniformly. The wood strip is advanced as the soldering progresses and is removed finally by whittling it away. Care must be used in soldering so as not to melt previously soldered joints. This is accomplished by sweat-soldering as in Fig. 26. Use a liquid flux and a very hot iron. A tiny drop of solder is placed in the flux and the iron is pressed carefully against it to make the weld.

At this stage the hatches may be covered with cloth to represent tarpaulins. To do this cut strips of broadcloth to the proper size, and using pins to hold the strips temporarily in place, Fig. 28, turn the cloth under the rabbeted edges of the hatch and glue with celluloid cement. The battens and clamps are then added after which strongbacks placed lengthwise over the cloth are held by butterfly screws hooked in pad eyes fitted in the deck, Fig. 30. Paint the strongbacks red.

The boat deck A which overhangs the cabin, is supported by wire standards as in Figs. 29 and 33. Holes for these are drilled through this top deck and the lower ends of the standards are soldered to the top surface of quarter deck C. Cut the standards off flush with the top of the boat deck and attach the latter with two screws,





placing one inside the smokestack and the other under the skylight, Fig. 33.

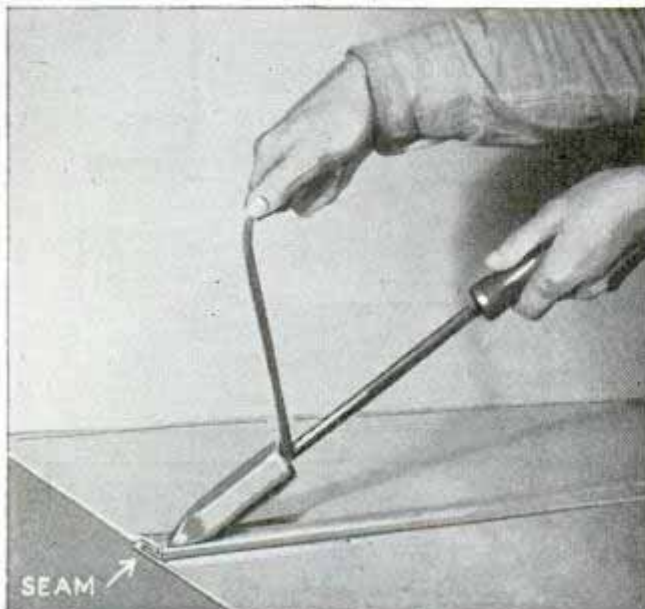
Details of the lifeboats and their position on the boat deck are given in Figs. 31 and 33 respectively. These are carved from wood, the keels and gunwales being glued on separately, and cloth is glued over the top to represent tarpaulins, Fig. 29.

Before installing the mast, skylight, water tanks, davits, etc., details of which are given in Figs. 31 to 33 inclusive, paint the boat deck and all of the fittings dark green. The name "John Ericsson" should be lettered carefully in white on the quarter

(see Part I, Fig. 2) and in black on the after rail including the word "Duluth," its home port.

Now, if you should wish to build a replica of a typical 300-ft. whaleback instead of the 404-ft. "John Ericsson," using the $\frac{1}{8}$ -in. scale, all you have to do is to make the hull distance between stations No. 9 and 10, $17\frac{1}{2}$ in. long instead of $30\frac{1}{2}$ in. when cutting the hull block. The pilot house is placed against the coal bunker. This will give you a model $37\frac{1}{2}$ in. long having eight hatches spaced evenly over the cargo deck.

Notched Bar Relieves Hand Strain When Sweat-Soldering



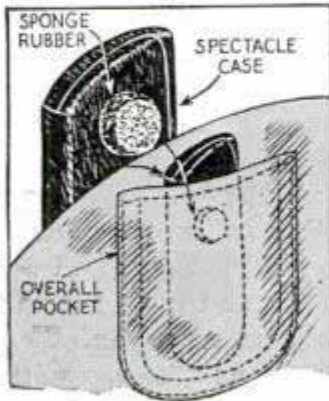
Much of the strain on the hand when sweating thin metals together with a soldering iron can be avoided by using a notched bar to help press down the soldering iron on the work. The bar is placed just back of the tip of the iron as shown.

Dew Is Found Missing on Chair Coated with Aluminum Paint

After applying a priming coat of aluminum paint to a wooden deck chair, an eastern seashore resident observed that this chair was not covered with dew although the deck railing, floor and other furniture were wet. While dew deposit depends on

the amount of moisture in the air as well as the amount of temperature drop at night, both of which are highly variable, so that the same effects might not be noticeable in all cases, other readers may be able to profit from this experience.

Spectacle Case Held in Pocket by Sponge-Rubber Disk



Workmen who are annoyed by having spectacle cases drop out of their pockets when they stoop, may avoid this trouble by gluing thick rubber disks of sponge rubber to the cases as indicated. Friction between the disk and the inside surface of the pocket keeps the case in place.

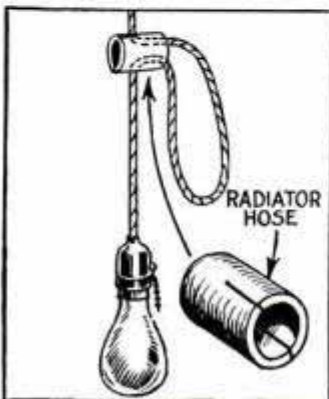
When working from a plank or scaffolding board supported between two ladders, it is a good idea to clamp the plank so that it cannot tip if you step close to the edge. While the plank may not tip enough to cause an accident, it does frighten you.

Weighted Net Opens Quickly

Having lost a large fish because his landing net had become tangled and would not open quickly, one fisherman avoided this trouble in the future by weighting the lower end of the net. A large lead sinker was used for the purpose, and when not in use, the net is stretched back along the handle where it is held by a rubber band. This is quickly rolled back with the thumb, allowing the weight to bring the net into position when needed.



Adjustable Lamp for Workshop



When you want to adjust the height of a drop lamp, use a short length of hose. Just slot one end toward the center on opposite sides and slip it over the cord of the lamp as indicated.

Plank Supported Between Ladders Is Clamped to Prevent Tipping



When working from a plank or scaffolding board supported between two ladders, it is a good idea to clamp the plank so that it cannot tip if you step close to the edge. While the plank may not tip enough to cause an accident, it does frighten you.

Handy V-Block for Large Work

A V-block for supporting work of large diameter in a drill press can be made by simply nailing or screwing four wood blocks together as indicated. Spacing of the blocks will be determined by the diameter of the work to be handled. One pair of blocks can be spaced closer than the other pair to give the V-block a wider range of usefulness.

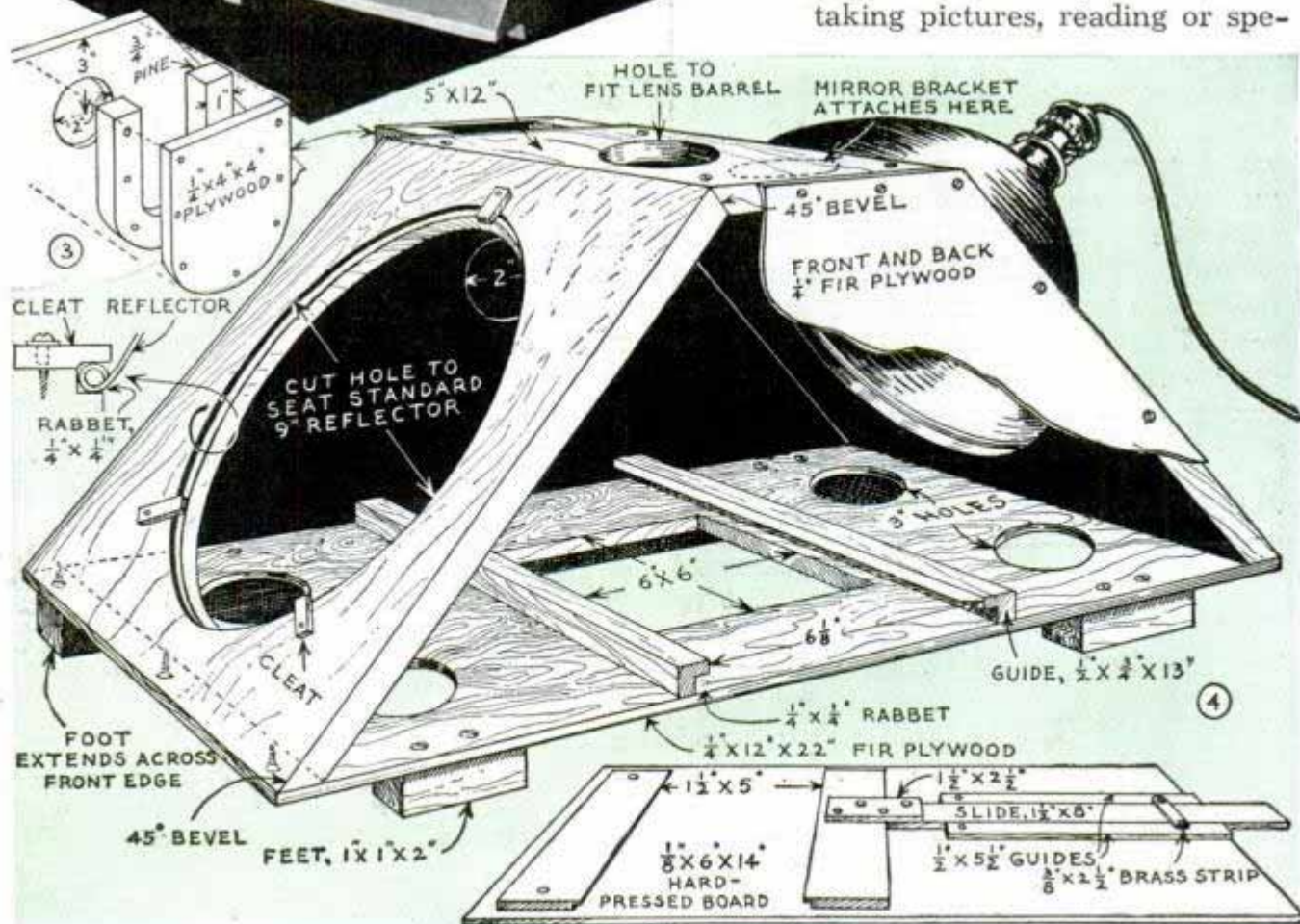


Build this dual-purpose

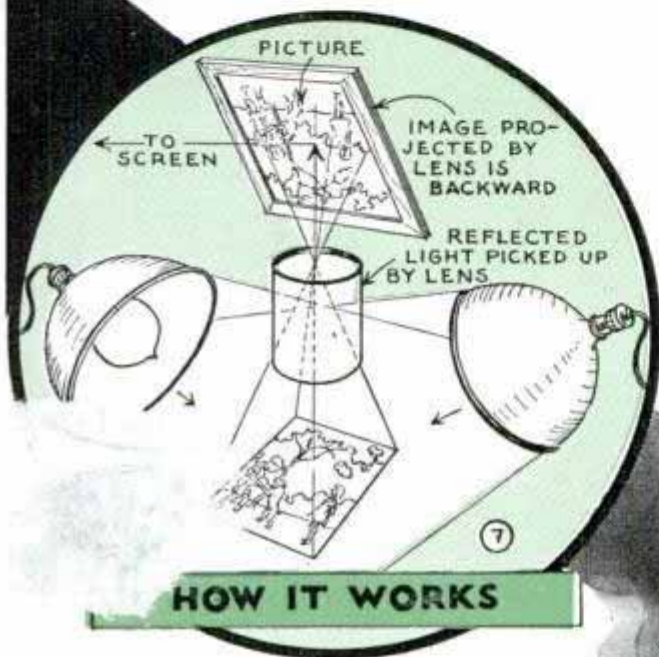


EVERY home-workshop owner will find this inexpensive projector a time-saver. It's handy when enlarging drawings from magazine pages or for doing copy work, Figs. 5 and 6. Also, children will enjoy it for putting on "picture shows" to entertain their friends, Fig. 1. The working principle is quite simple, as illustrated in Fig. 7. A strong light cast on a solid object at a 45° angle is reflected, picked up by a lens, reversed by a mirror and projected on a screen. The brilliance is not as great as with glass slides, but more light can be used. Even a pair of 300-watt lamps are none too bright for a large room.

Photoflood reflectors, Fig. 2, can be used. There is no need of using them exclusively for your projector, for by merely twisting the cleats, Fig. 4, they snap out and may be used for taking pictures, reading or spe-



PICTURE PROJECTOR



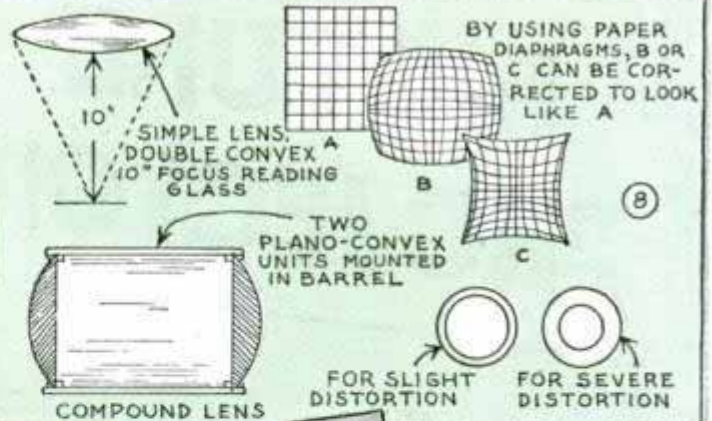
cial lighting effects. If you already have a pair, plan to use them in your projector. The lamp house must be ventilated well, Figs. 2 and 3, to take care of the heat from the powerful lamps. Cut four circular holes in the plywood bottom, and two light-trap louvers in the plywood ends. Holes both above and below the light create a draft and give maximum cooling. Use well-dried lumber and assemble with screws. The end panels are cut to fit after the rest of the housing has been assembled.

The selection of a lens is of utmost importance. An ordinary reading glass will do if the projector is to be used only for amusement. However, low-priced lenses have a tendency to distort, making a grill that looks like B and C in Fig. 8. This can be corrected to some extent by using a diaphragm made from heavy paper and laid over the lens. The quantity of light is cut down, but the picture is more normal.



Your lens should be between 3 and 5 in. in diameter. A compound lens will be necessary if the projector is to be used for critical enlarging and copying. These can be obtained for as low as \$6.00 from optical houses. A compound lens has at least five times the brilliance of a simple lens, and much less distortion.

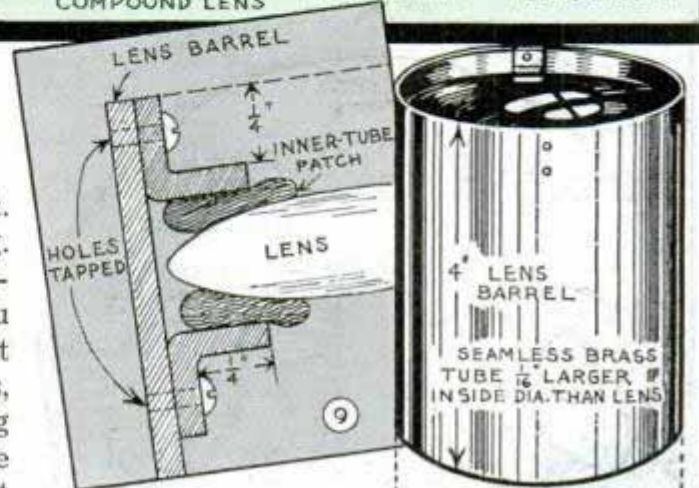
Focusing on most lenses is critical and the barrel and ring must work smoothly. Seamless brass tubing works best but is often difficult to obtain locally. It is stocked by mill and machinist supply houses. Order a size that will allow your lens to



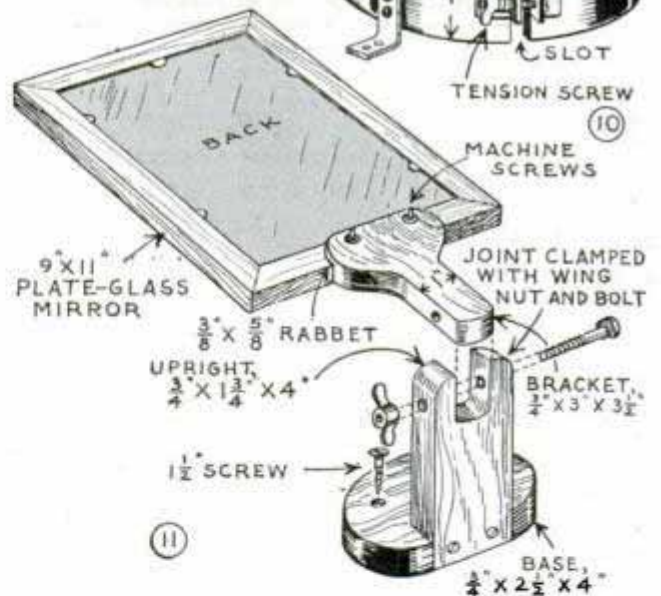
"float," so expansion will not crack it. Mount it between tiny angles of brass, Fig. 9, padded with rubber cut from an inner-tube patch. Stick these to the glass. You will have to make the angles from sheet stock. Thread the small machine screws, Fig. 10, into the barrel and focusing ring and file flush on the outside. Adjust the tension screw until the barrel will just slide when twisted.

Postcards and snapshots are clamped flat in the carriage, while books and other thick objects are slid under the square hole. The carriage slide moves back and forth between guides to accommodate any picture up to 6 in. square. Paint the carriage and base black to kill reflection.

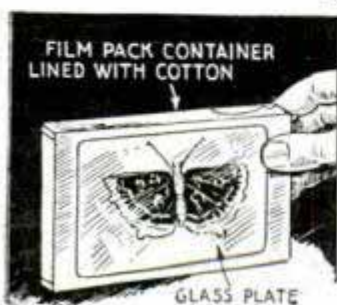
A mirror, preferably of the plate-glass type, gives the image the necessary reversal. Mount it so it may be held in any desired position by tightening the wing nut, Fig. 11. The distance you can throw a picture, and the size of it, depend largely upon your lens and the lights. Using the average magnifying glass and a pair of 100-watt bulbs, an image 3 ft. square on the screen 8 ft. away is possible. For copying on a glass-top table or ceiling projection, the mirror is not used.



SMALL SCREW
THREADED INTO
RING AND FILED
FLUSH

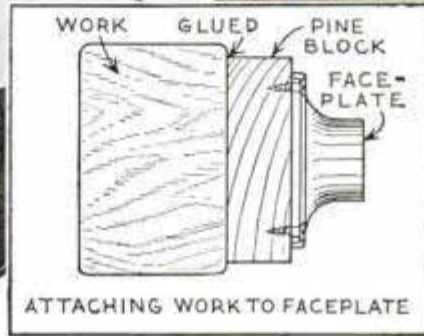
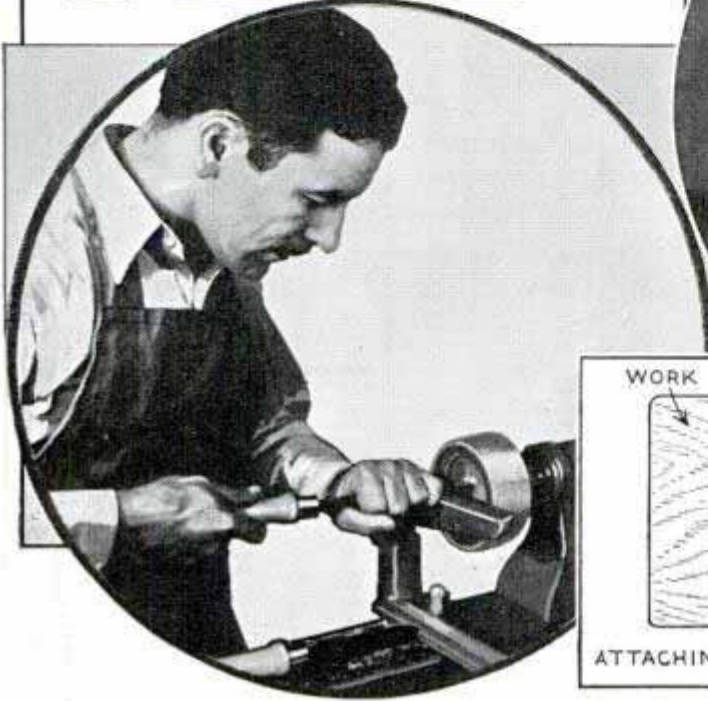
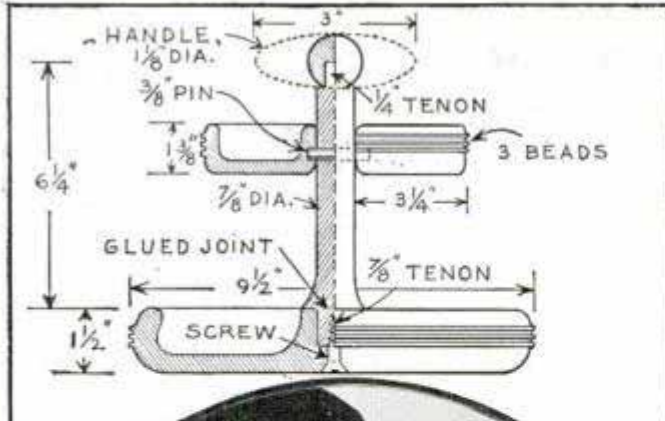


Discarded Photographic Film Packs Serve as Cases for Insect Specimens



Discarded metal film packs and photographic plates, which can be obtained from your local photographer, provide ideal specimen cases for collectors of insects. Remove all parts from the pack but the outside case and line the latter with cotton. Remove the gelatin coating from the plates with hot water, place the insect and then assemble the pack in the regular way. Before closing the pack, it is a good idea to add some moth flakes to keep out small insects that might destroy the specimen.

Three-Piece Tidbit Tray of Unusual Design



trays and an elongated handle. All parts are tenoned, doweled and glued into a unit as indicated in the upper detail. For an alternate design, use three small trays each 3 in. in diameter and group them cloverleaf fashion in a cluster on the same plane about the standard, allowing an extra 1/2 in. between the handle and cups so there will be plenty of finger space.

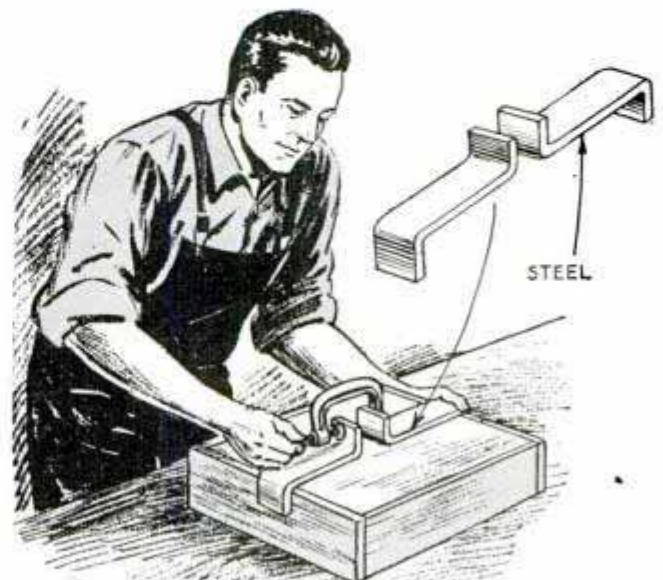
Ideal for serving cookies, nuts and after-dinner mints, this tray is not only useful but is a novel table decoration when turned from walnut, mahogany or gum. It consists of a base or large tray which supports a standard carrying two identical smaller

trays and an elongated handle. All parts are tenoned, doweled and glued into a unit as indicated in the upper detail. For an alternate design, use three small trays each 3 in. in diameter and group them cloverleaf fashion in a cluster on the same plane about the standard, allowing an extra 1/2 in. between the handle and cups so there will be plenty of finger space.

Offset Angles to Increase Working Range of C-Clamps

When used with C-clamps these offset angles enable the worker to fasten large pieces of stock together for gluing or other processing. A small clamp, when used with two offset angles as shown, will serve in place of a larger and more expensive woodworking clamp. Make the angles from cold rolled steel. Bend them cold after having set them up in a vise.

Grease spots on carpets and rugs can be removed usually by rubbing with a clean cloth dipped in hot water to which ammonia has been added. For stubborn spots, use a thin paste of fuller's earth and water. Allow to dry, then rub off with a brush.



Sled Hung Between Garage Studs Is Out of the Way



Your sled will be stored out of the way, and still be handy and convenient when wanted, if you drive a pair of screw eyes and a screw hook into the wall of your garage, between the studs, as indicated. By slipping the runner ends into the screw eyes, and one runner under the hook, the sled will be supported safely.

Spring Wedge Aids in Sawing Lengthwise of Long Board

A wedge made from a piece of spring steel as shown, will be helpful when ripping long boards. When inserted into the saw cut, the wedge maintains a constant pressure on both edges and keeps the cut



spread so that the saw does not bind. Such a wedge saves time because it does not have to be forced frequently into the cut to keep the parts of the board separated.

Ball Bearings Handled Easily with Split Hose

A short piece of small rubber hose split at one end and a short length of wire make an efficient tool for handling small ball bearings. In use, the split end of the hose is pressed down on the bearing to engage it and the wire inside the hose dislodges the bearing when desired.



Hand Grip on Paint Bucket Supports Bail Vertically

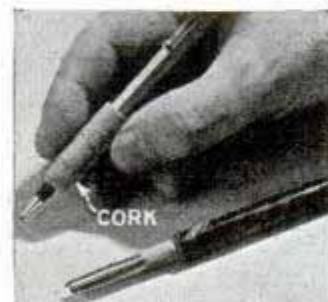


To prevent the handle of a paint bucket from dropping down against the side, where it may be smeared with paint, cut a length of garden hose, with ends tapered as shown, and slit this at one side to fit over the

bail. Dropped into the position indicated, the hose supports the bail vertically, or it may be raised to dotted-line position to make a comfortable carrying handle.

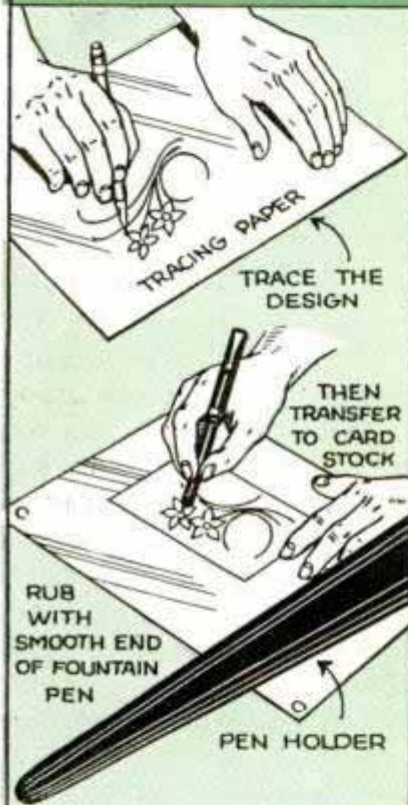
Finger Rest for Automatic Pencil

When you use an automatic pencil continually for long periods of time, the fingers are likely to become cramped and tired. As a relief, slip the cork finger rest from a penholder over the end of the pencil. This will provide a better grip and the fingers will not tire as quickly.

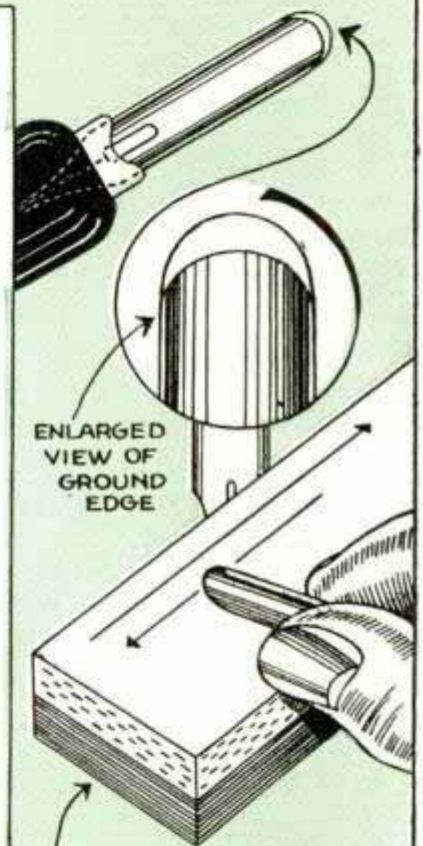


CARD CARVING

with a pen point



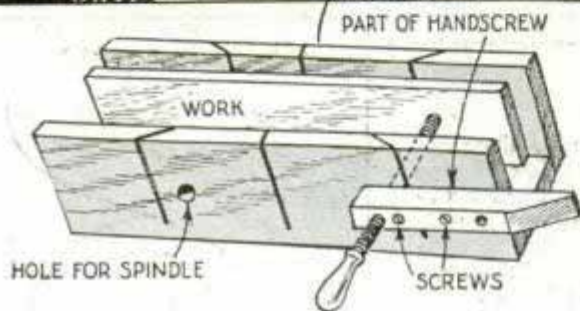
Besides enabling you to decorate greeting and calling cards and give them a personal touch, card carving offers an interesting and profitable pastime. Essentially, it consists merely of separating the upper plies of the card with a sharp tool and raising them to form a design in relief. The details show the steps in this work. While various special tools are sometimes used, the amateur carver will find that a writing pen will serve the purpose nicely. Inserted into a penholder as indicated, the pen is ground on a fine wheel and then honed to a razor edge on an oilstone. The contour of the pen is not changed. The trick in carving is to make the cutting strokes by pushing the tool toward the line or edge of the outline of the design. The corners of the pen raise the plies of the card much the same as a plow turns soil. Pictures in magazines will offer a number of suggestions for designs to be worked on the cards



RAZOR-SHARP EDGE IS GROUND BY RUBBING PEN ON OILSTONE



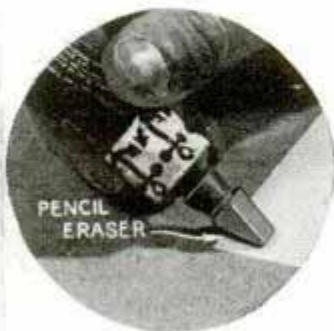
Miter Box Is Fitted with a Clamp to Hold Work in Place



Holding work in a miter box for sawing is a simple matter if the spindle and jaw of a handscrew are screwed temporarily to the side of the box, over a hole drilled for the spindle. Only a slight turn of the spindle is necessary to hold the work firmly. When not needed, the handscrew can be reassembled and used for its regular purpose. The small screw holes made in the jaw do not weaken the clamp materially.

—Robert Clark, Chicago.

Handy Spreader for Mucilage and Cements in Tubes



A convenient spreader that may be slipped over the mouth of a tube of mucilage or cement as a substitute for the cap, is made by cutting a slit in the end of an ordinary rubber slip-over eraser. Make the cut deep enough to reach the hollow core of the rubber. On squeezing the tube, the cement will be forced from the cut, ready for spreading. The tube is automatically sealed

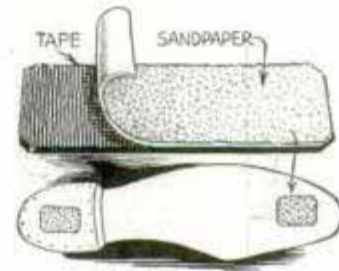
when the cement dries on the spreader. It may be used with all cements except rubber compounds using benzole, benzine or similar solvents which attack rubber.

Rusting of Exposed Bolts and Nuts Avoided with Roof Coating

Carriage or machine bolts that pass through wood exposed to the weather will soon rust in place so tightly that they are difficult to remove without damaging them. To prevent this, coat the bolt with asphalt roofing compound before putting it in place.



Abrasive Shoe-Sole Patches for Icy Sidewalks



Patches of coarse sandpaper or abrasive cloth to stick to your shoe soles will give you good footing when sidewalks are icy. The patches can

be applied by simply pressing them against the soles, or removed by stripping them off. To make the patches, just attach them to the dry side of friction tape with rubber cement, leaving the tacky side of the tape for attaching the patches to the shoes.

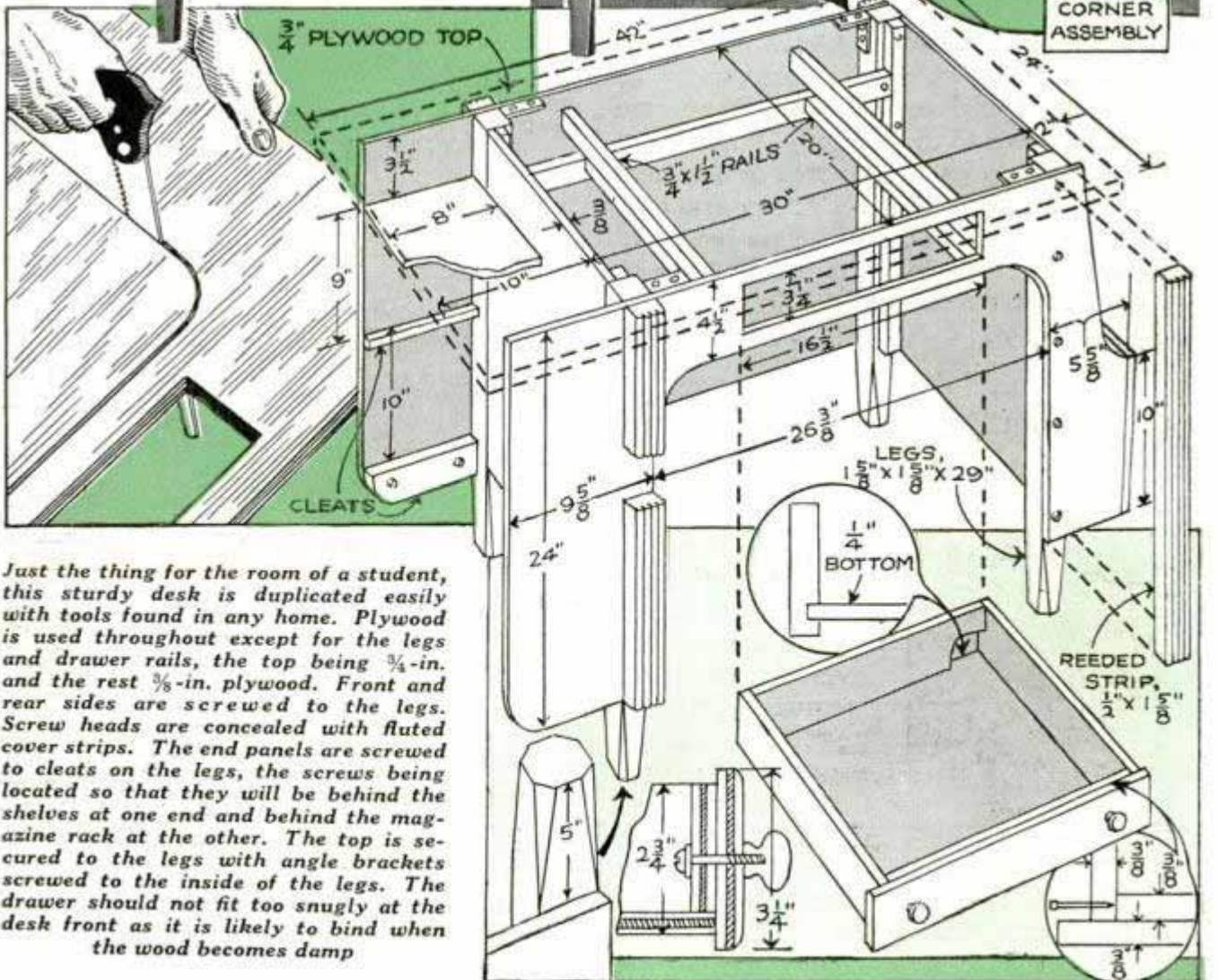
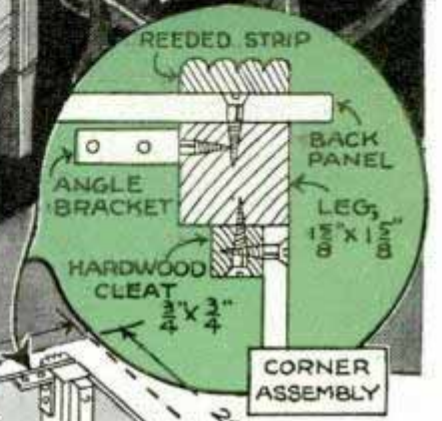
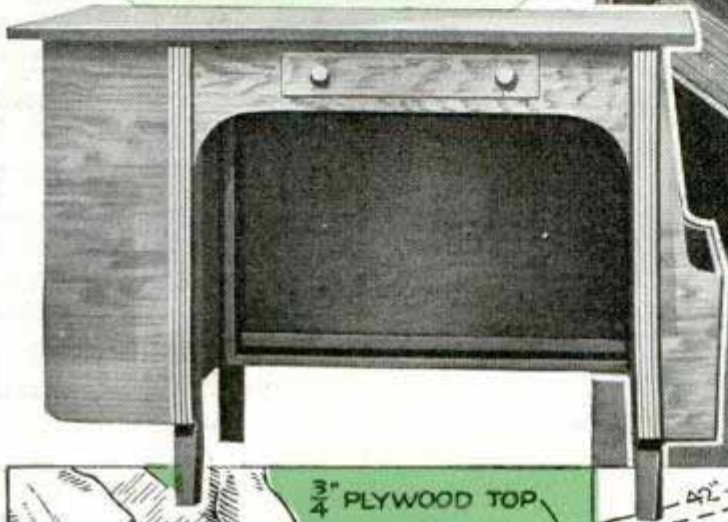
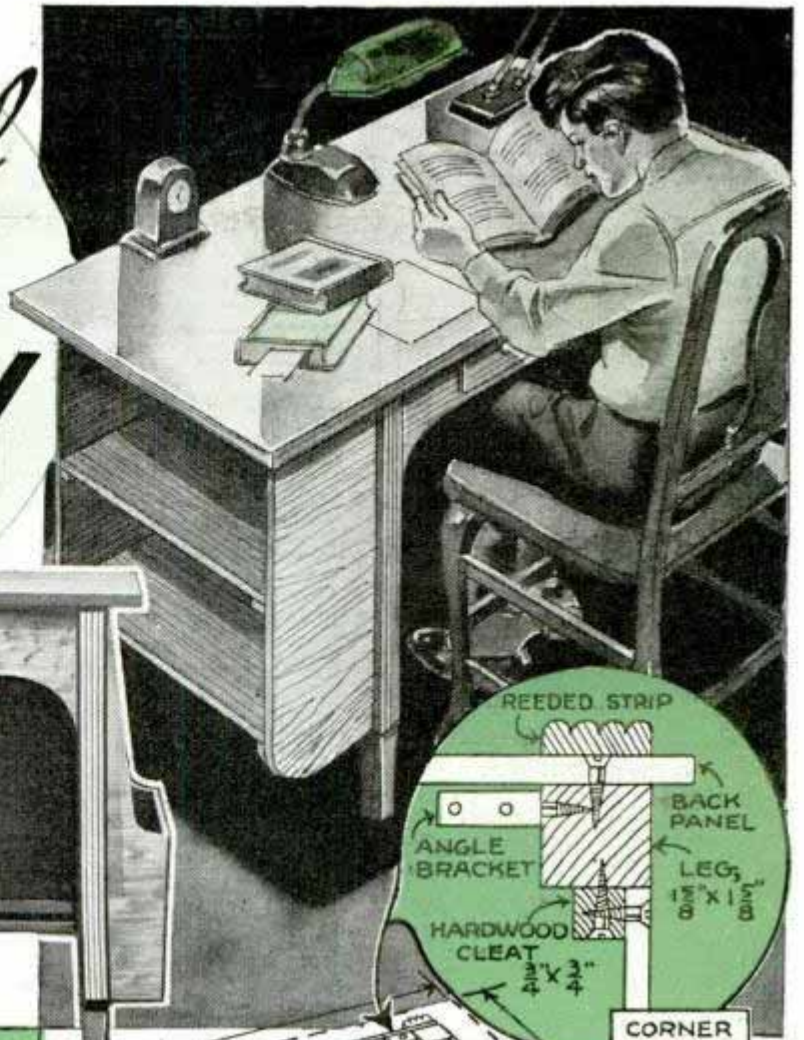
—Ray E. Kraft, Forest Park, Ill.

Cork Holds Spoon on Tumbler

To keep a spoon always at hand and avoid placing it upon the table top and causing a stain, merely saw cross notches at right angles to each other, in opposite ends of a cork. One notch in the cork fits over the edge of the tumbler and the other will engage the handle of the spoon, holding it firmly.

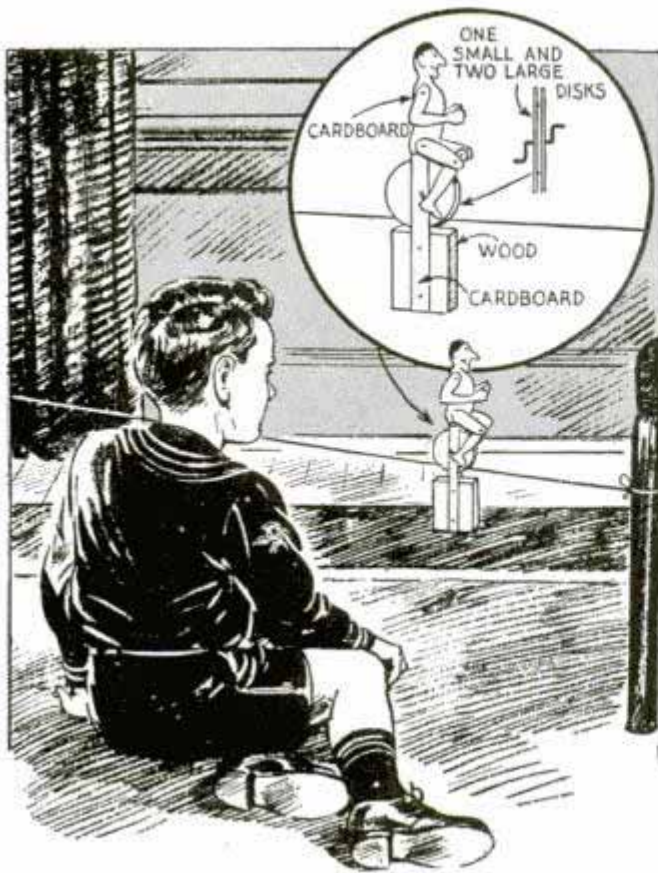


Designed for STUDY



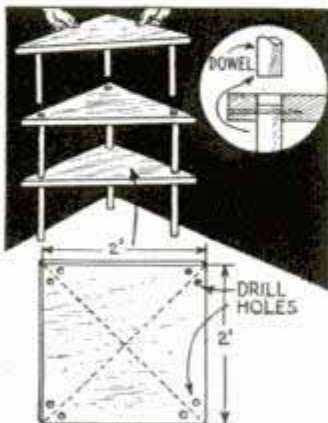
Just the thing for the room of a student, this sturdy desk is duplicated easily with tools found in any home. Plywood is used throughout except for the legs and drawer rails, the top being $\frac{3}{4}$ -in. and the rest $\frac{1}{2}$ -in. plywood. Front and rear sides are screwed to the legs. Screw heads are concealed with fluted cover strips. The end panels are screwed to cleats on the legs, the screws being located so that they will be behind the shelves at one end and behind the magazine rack at the other. The top is secured to the legs with angle brackets screwed to the inside of the legs. The drawer should not fit too snugly at the desk front as it is likely to bind when the wood becomes damp

Easily Assembled Rope Walker Amuses the Children



When you are looking for something to amuse a small child, try this tight-rope walker. It is constructed of cardboard in a few minutes. Each arm is cut in one piece and pivoted to the body, while each leg is in two pieces and pivoted at the knee and hip. The disk, which runs on a taut string, has an axle of the bicycle type, the feet being pivoted to it. A block of wood is used as a counterweight to keep the walker upright.

Portable Built-Up Corner Shelves Take Minimum Space



2-ft. piece of $\frac{3}{4}$ -in. plywood, may be used separately or stacked one upon the other

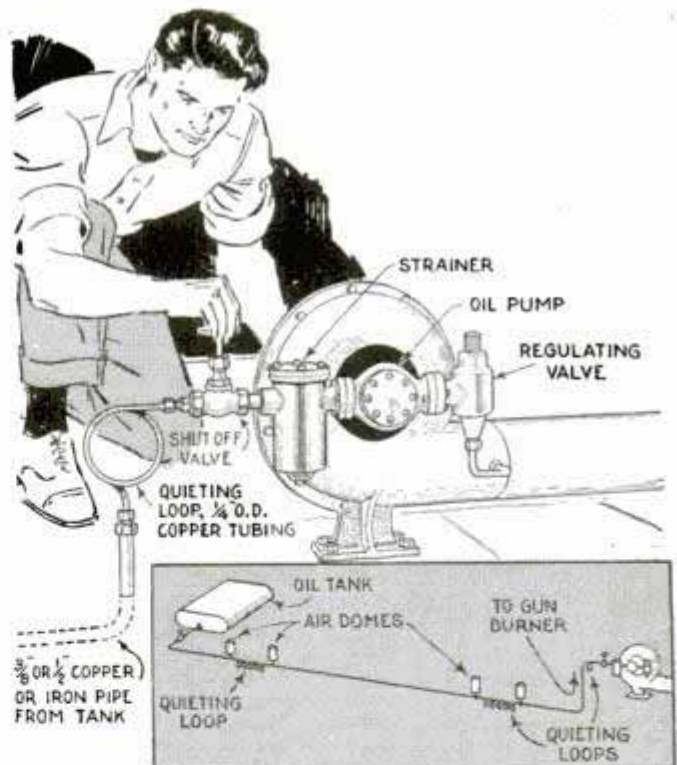
Especially useful in basement rooms where space is limited and the arrangement is changed frequently, these portable shelves may be taken down whenever desired. Each shelf, which is one quarter of a 2 by

as shown. Dowels fastened with a nail, and glued in holes drilled in the corners, form the legs and support the shelves. Where the floor is irregular, bottom shelf legs may be measured and cut to compensate for any slope.

—Dale R. Van Horn, Lincoln, Nebr.

Hum in Fuel Lines of Oil Burners Silenced by Copper-Tube Coils

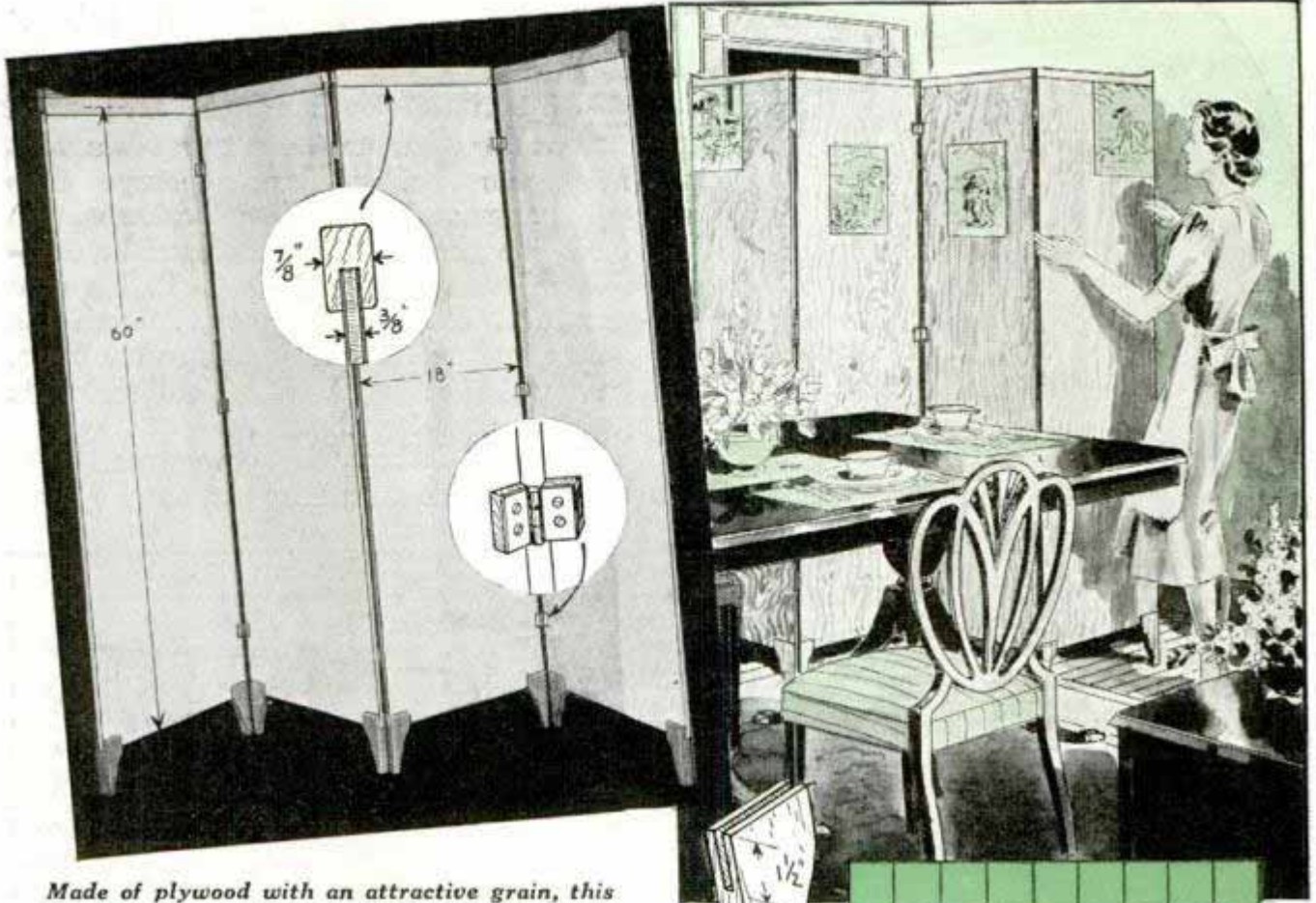
An oil-line hum that often develops in some gun-type oil burners can be silenced by coiling a 30-in. length of thick-walled $\frac{1}{4}$ -in. O.D. copper tubing and installing it in the fuel line close to the burner. The hum originates from the pulsating output of the gear-type pumps and, the oil not being compressible, the noise is carried through the lines much in the way that an iron rod carries vibration when tapped with a hammer. The effectiveness of this remedy is based on speeding the oil a short distance through the relatively small tubing. Stubborn cases of this trouble have been cured by the more effective method illustrated in the lower detail. Quieting loops are installed at the storage-tank end



of the line as well as at the burner end. In addition to these, air domes are also installed at the end of each loop. These are made of $\frac{1}{2}$ -in. pipe nipples, 6 in. long, which are capped at the upper ends and screwed into pipe tees installed in the line.

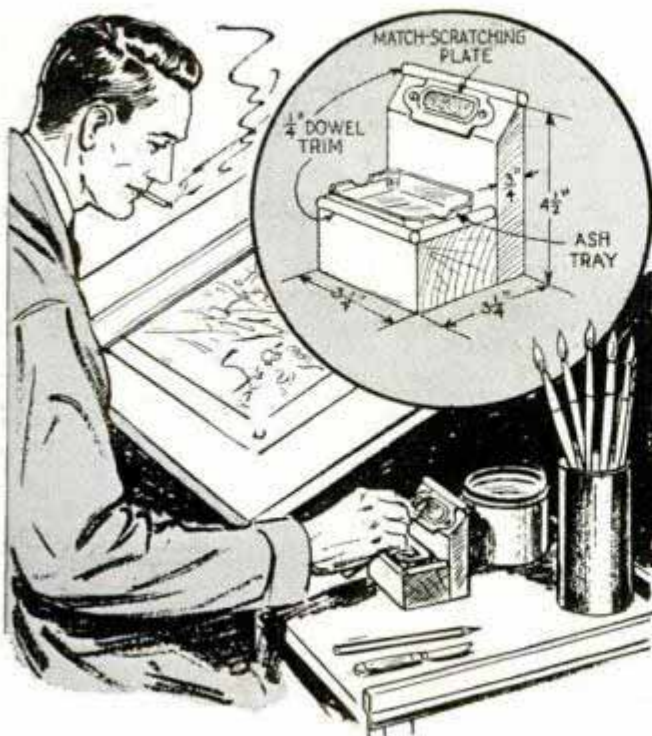
—John W. Schulz, Bay Shore, N. Y.

Plywood Screen Useful Around the Home



Made of plywood with an attractive grain, this simple folding screen is handy for placing in front of the dining-room entrance while the table is being set. Redwood or mahogany is used for the legs and cap pieces, and is finished in natural color or in Chinese red. The latter forms a pleasing contrast with the weather-stain finish of the panels. Brightly colored prints lend a striking note. Casein glue is used throughout in the assembly

Pencil Pointer and Ash Tray in One Unit for Artists



A match-scratching plate serves as a permanent abrasive surface for pointing pencil leads on this combination pencil pointer and ash tray. To promote cleanliness, the plate is tilted so that dust from the pencil lead drops into the ash tray. When necessary, abrasiveness can be restored to the corrugated surface of the plate by going over it with a discarded toothbrush.

Glue Made from Medical Capsule Sticks to Glass

A good adhesive for sticking cutout gold-paper letters or similar items to glass may be made easily by dissolving a few medical capsules in a small amount of warm water. Just enough water should be used to make a thick solution.

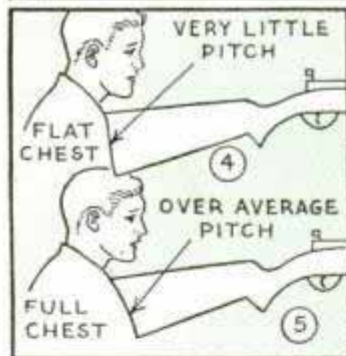
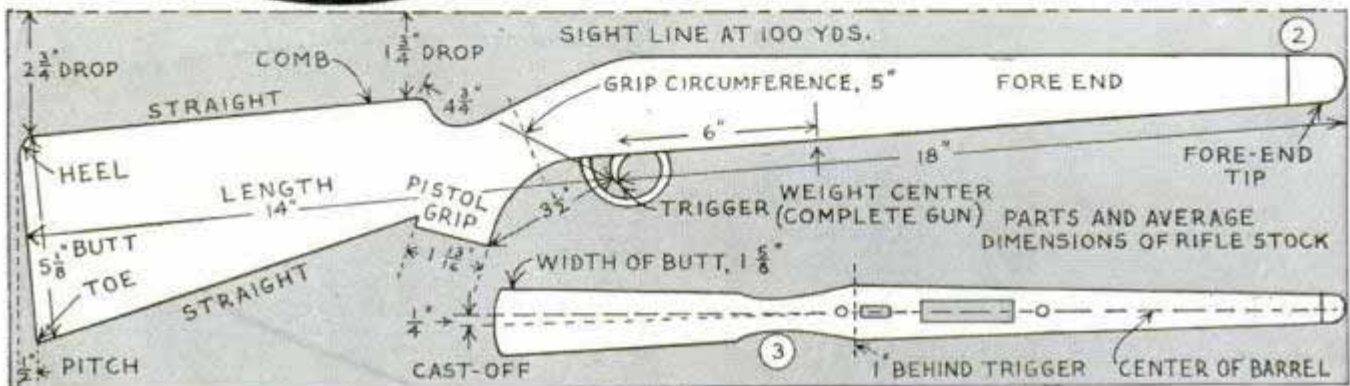


GUNCRAFT *in*

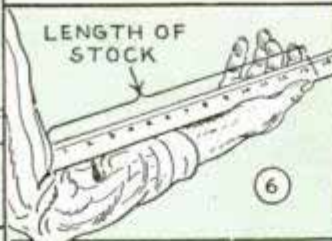
COMBINING both metal and wood working, guncraft can be made a most fascinating hobby. With average shop equipment and a few inexpensive special tools, the gun shooter can remodel a commercial or military stock to fit his own physique, checker the grip, smooth the action and spend many pleasurable hours on a host of other jobs which will make his gun look and shoot better.

PART ONE

Gunstock design: The average man takes to ready-made gunstocks just like he takes



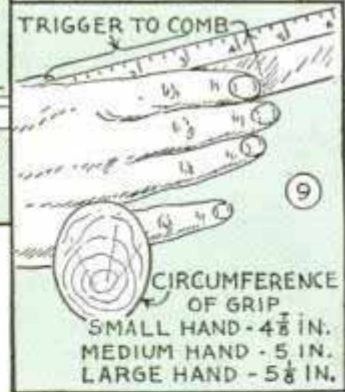
LENGTH: Measuring along a rule as shown will give the proper length of stock, or, the table below can be used



| HEIGHT | LENGTH |
|----------------------------|------------|
| UNDER 5 FT. 3 IN. | 13 1/2 IN. |
| 5 FT. 3 IN. TO 5 FT. 6 IN. | 13 1/4 IN. |
| 5 FT. 6 IN. TO 5 FT. 8 IN. | 13 1/2 IN. |
| 5 FT. 8 IN. TO 6 FT. 1 IN. | 14 IN. |
| OVER 6 FT. 1 IN. | 14 1/2 IN. |

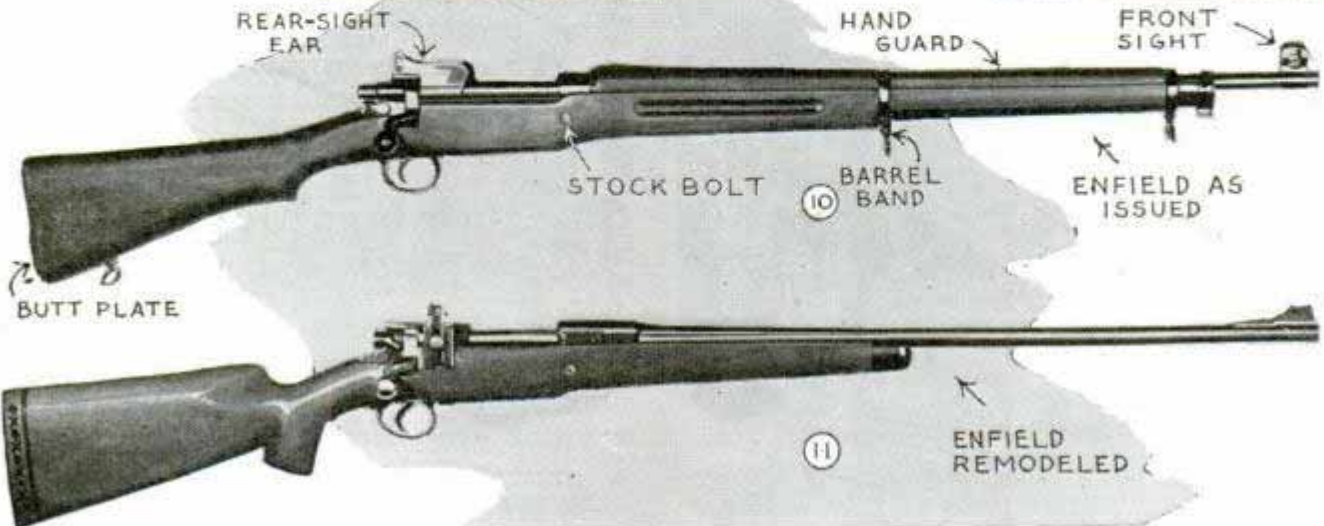


GRIP: Measure with rule as shown to determine length from trigger to comb. Make the grip circumference agree with figures given

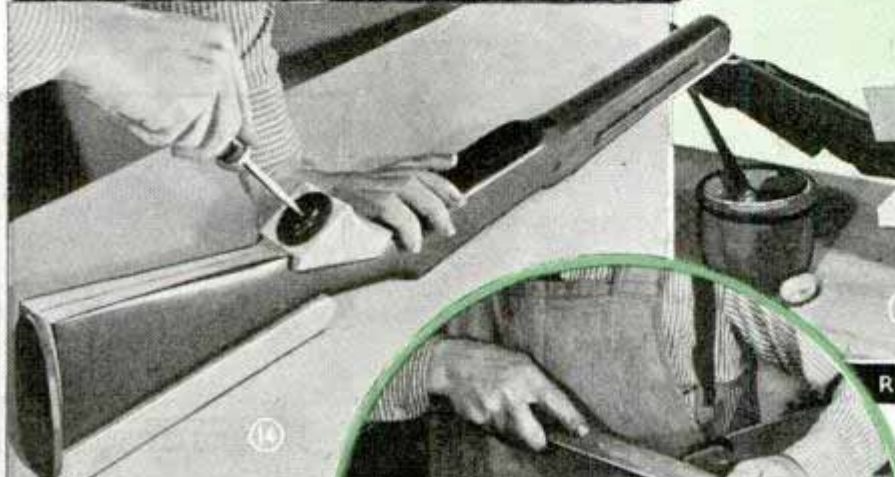
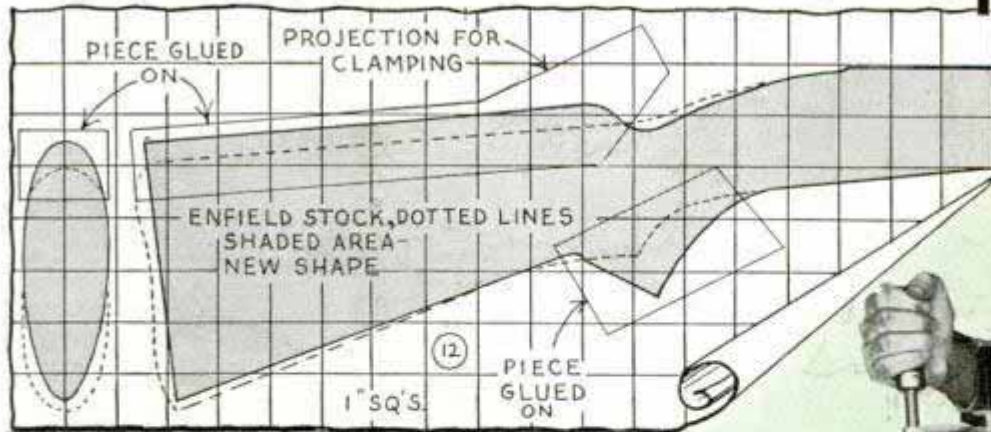


DROP: The shooter with average short neck will require average drop; a long neck takes more drop to bring eye to sight line

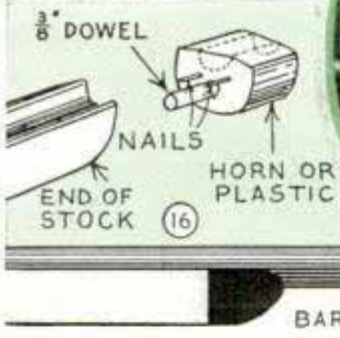
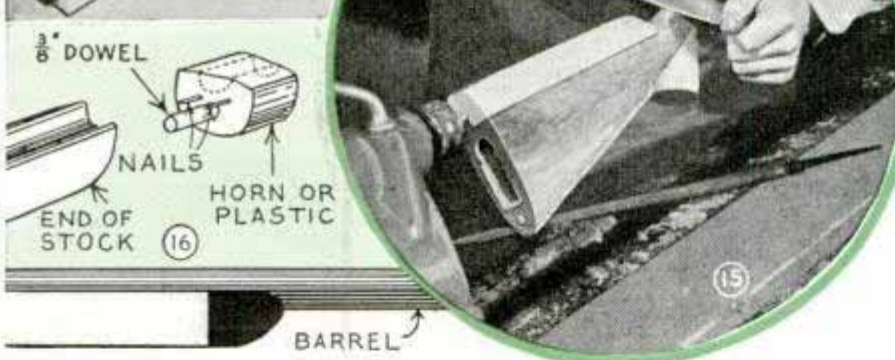
CIRCUMFERENCE OF GRIP:
SMALL HAND - 4 7/8 IN.
MEDIUM HAND - 5 IN.
LARGE HAND - 5 1/8 IN.



the Home Workshop



REMODELING THE MILITARY STOCK.



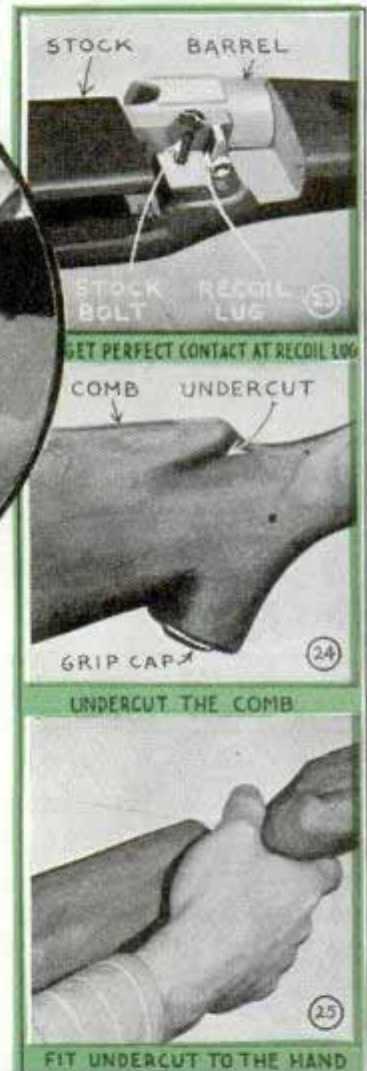
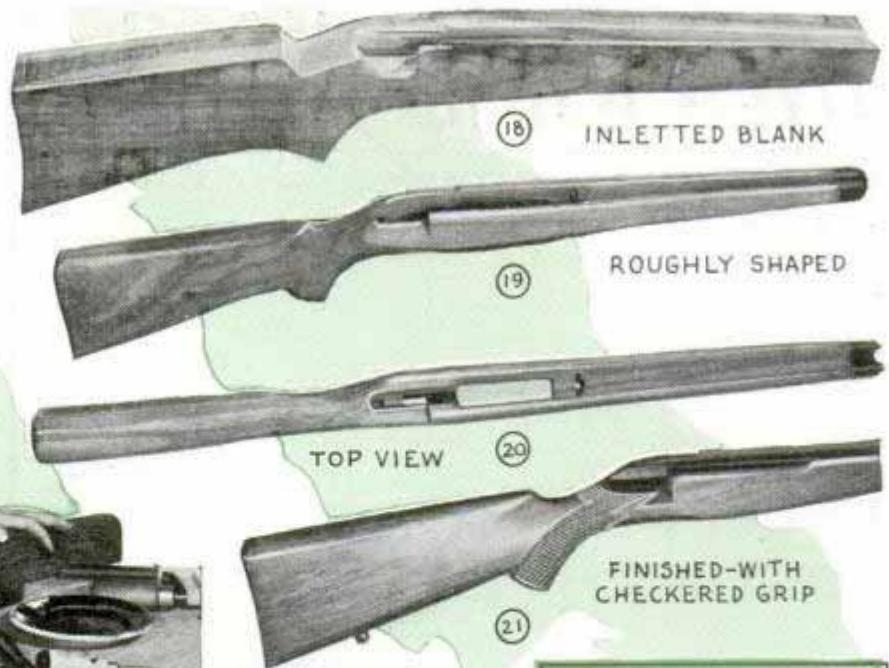
crotch of your thumb to the tip of your index finger, as shown in Fig. 9. Hand size also determines the circumference of the grip, varying according to the dimensions given.

The military rifle: The most popular job in gun-craft is the remodeling of a military rifle. Some of these can be purchased as

to ready-made clothes—the fit is fairly good but not perfect. Fig. 2 gives the dimensions of the average rifle stock. If you have a flat chest, you will want a stock with very little or no pitch; if you have a full chest, you will want more than average, Figs. 4 and 5. From bent elbow to middle of index finger measured along a rule, Fig. 6, will give you the length your stock should be from trigger to center of butt. The man with a short neck will require average drop at the heel of the stock, Fig. 7, while the man with long neck and sloping shoulders, Fig. 8, will require much more drop at this point. The distance from trigger to point of comb will average 4¾ in., but you will get a personal fit if you make this distance the same as from the

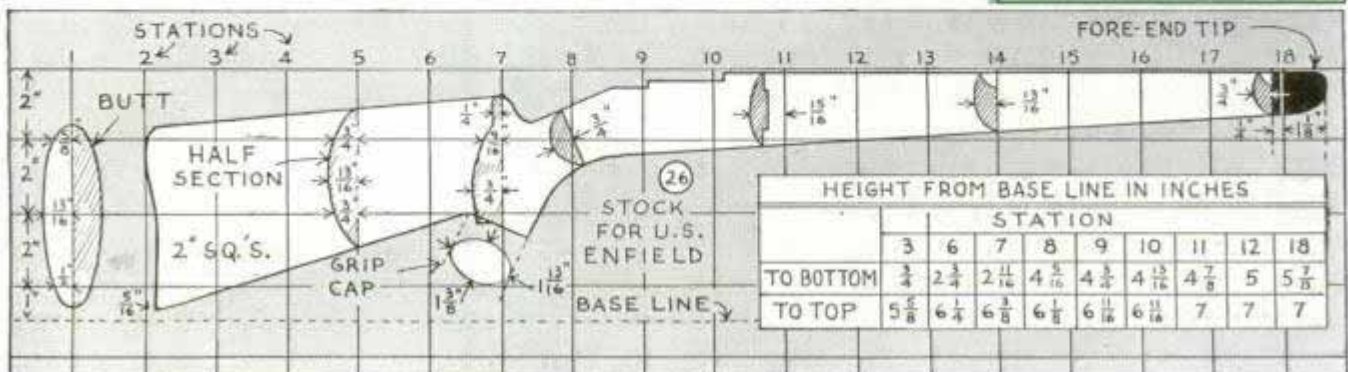
low as three dollars. One of the best of the low-priced guns is the U. S. Enfield, model of 1917, which can be obtained from the Director of Civilian Marksmanship, Washington, for less than ten dollars. This gun as issued is shown in Fig. 10, while Fig. 11 shows a typical remodeling job, making it a high-power sporting rifle. Other military rifles which usually can be found for sale include the U. S. Springfield, the Russian Nagant, the British Lee Enfield, Canadian Ross, etc. All are bolt-action rifles.

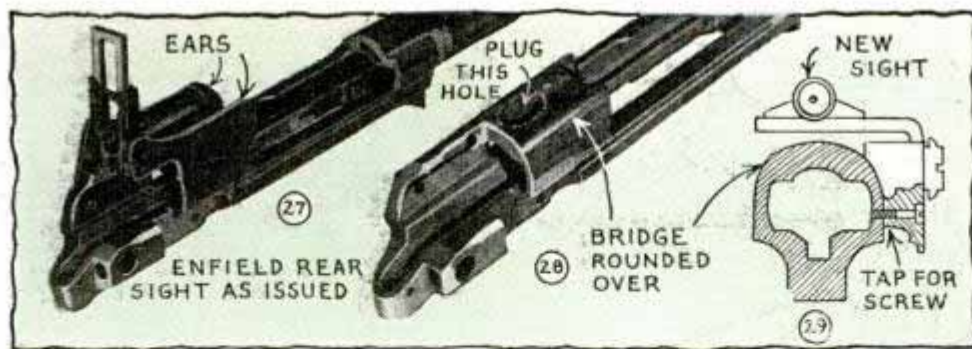
Remodeling the military stock: You can improve greatly the appearance of any military rifle such as the U. S. Enfield by revamping the stock. This is done by gluing on pieces of matched walnut, as shown in Figs. 12 and 13, and then dressing the



stock. Fig. 14 shows a new butt plate and pistol grip cap being fitted to the patched stock. Mount the stock in a lathe for rasping to shape, Fig. 15, using a dowel screwed in the barrel groove to hold the stock in the chuck. Final sanding can be done with a belt on the band saw, Fig. 1. Cut the fore end of the stock at any suitable distance and cap the end with a fore-end tip of horn or plastic, Fig. 16.

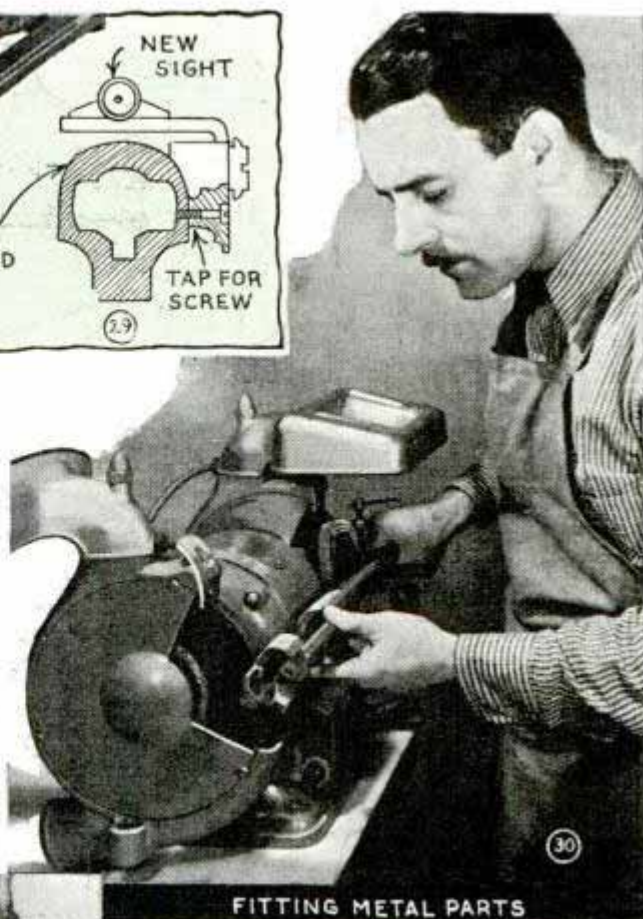
Inletting and shaping: If you want to do a really nice job on a rifle, make a completely new stock. The best way of doing this is to purchase a blank that is already inletted to take the barrel and action. Shaping this to your own dimensions takes a lot of "elbow grease," but is not at all difficult. Figs. 18 to 21 inclusive show various stages of the stock in the making. Blanks are usually cut about $\frac{1}{2}$ in. undersize and final bedding of the action and barrel is done by coating these parts with





lamp black and oil, Fig. 17, pressing the barrel and action into the wood to locate tight spots, which are then sanded down. The exterior is worked down to suitable dimensions, working from a centerline all around the edges of the blank.

You may want some cast-off in the stock, as shown in Fig. 3, in which case the centerline from immediately behind the trigger to the butt will be moved to the right. A small amount of cast-off will usually improve the hang of the gun and permit more natural sighting. The stock can be lightened and balanced by boring and routing, as in Fig. 22. The most important point in in-letting is the fitting at the recoil lug, which must bed perfectly against the wood,



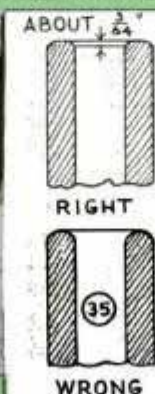
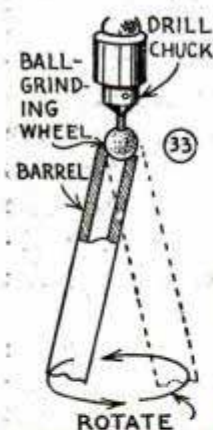
FITTING METAL PARTS

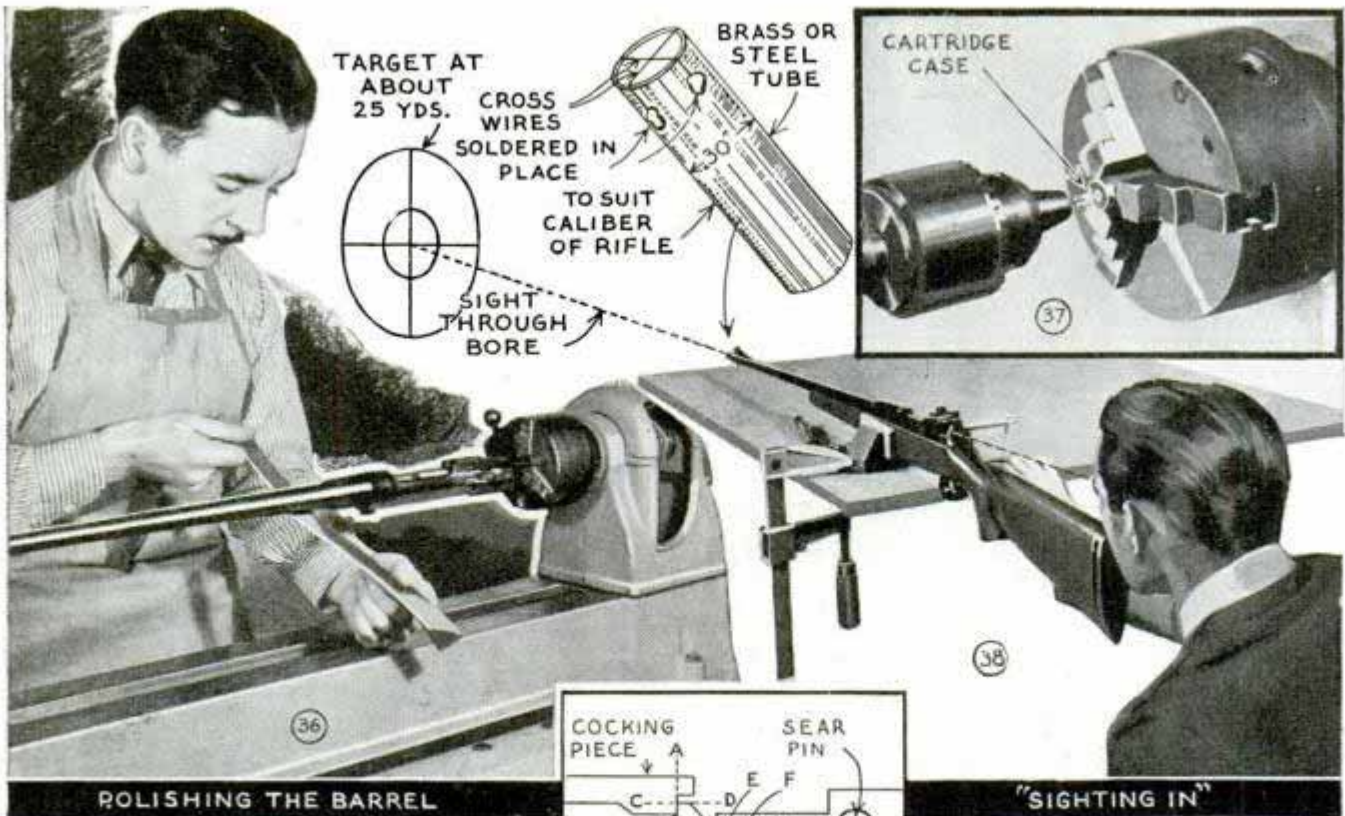


Fig. 23. The undercut at the comb, Fig. 24, should blend into the full width of the stock. Make it shallow or broad to suit the fleshy part of your thumb, as in Fig. 25. The undercut at pistol grip should not be carried up very far—just enough to get a full round where the grip cap is fitted in place. Fig. 26 shows a

typical sporting stock for the Enfield, which can be varied slightly to suit your own dimensions. The comb is higher than the patched stock previously described, and the pistol grip is of ample dimensions to negative any feeling that the little finger will slip off.

Fitting metal parts: The rear sight of the Enfield is shown in Fig. 27. This can be removed and the bridge rounded over to take any of several commercial sights made for this gun, Figs. 28 and 29. In grinding, Fig. 30, care should be taken not to draw the temper. Spot annealing for fitting screw holes for the rear sight can be done with a ball of solder which should be melted with a red-hot iron at the position required, Fig. 31. The barrel length of the Enfield is 26 in. It can be shortened to 22 or 24 in. if desired, making the cut with an abrasive wheel, Fig. 32. The muzzle then can be crowned with a ball abra-





POLISHING THE BARREL

"SIGHTING IN"

sive wheel, or various sizes of round-head bolts lapped with abrasive grains can be used, Figs. 33, 34 and 35. You will find that the follower in the magazine will prevent the bolt from working unless there is a cartridge in the magazine. This is a feature of all military rifles. For sporting use it is better to grind the follower off at an angle so that the bolt can slip over it. A bevel about $\frac{5}{8}$ in. long will give the required action. Other worth-while abrasive jobs include the polishing of the barrel, Fig. 36, and the lapping of the bolt with very fine abrasive to secure smoother action.

Sighting-in: In locating new sights it is necessary to sight the rifle. Without actually firing the gun, the best method is bore sighting, as shown in Fig. 38. To set up for this, make a hole with a No. 70 to 80 drill through the end of an empty cartridge, Fig. 37. Fit this in the usual position at the end of the barrel. Plug the muzzle end of the barrel with a steel tube to which has been fitted fine cross wires. Secure the rifle solidly in place and sight through the cartridge and tube to the center of a target at least 25 yds. away. Ad-

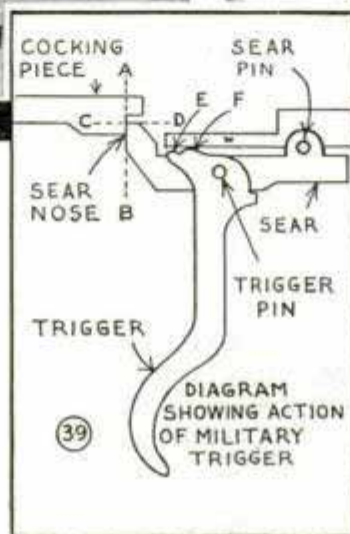
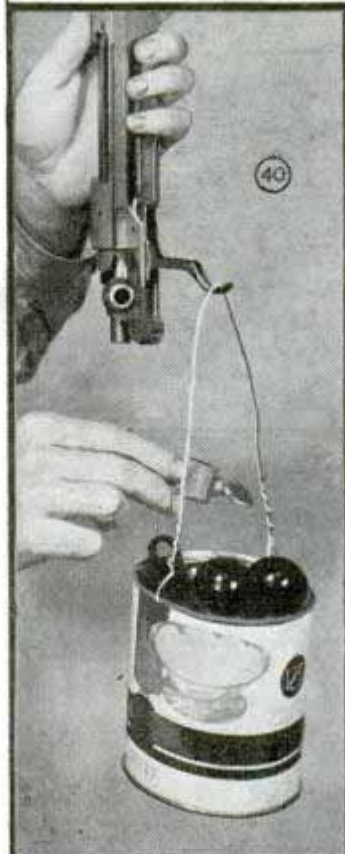


DIAGRAM SHOWING ACTION OF MILITARY TRIGGER



ADJUSTING TRIGGER PULL

just the front and rear sights until they come on the target at the same point as the sight through the bore. Temporary mounting of the sights can be done with any kind of tacky substance. Accurate bore sighting can be done through the open bore without any special set-up. Any method of bore sighting is sufficiently accurate to permit permanent mounting of the sights. Final adjustments after field shooting can be made with the adjustments provided on the rear sight.

Adjusting trigger pull: The pull of the military rifle is usually about 6 lbs. You will want it about 3 or 4 lbs. for sporting use. To get this pull, first polish the sear nose on the line AB, Fig. 39. Now, notice in the diagram that the trigger pull is really two pulls, the first or preliminary pull using the cam F as a fulcrum, while the final pull

uses point E as a fulcrum. Grind a little metal from point E to shorten the final pull, and carefully polish the metal at this point together with the surface on which it operates. When you have finished with this, test the trigger pull with weights, as shown in Fig. 40, and you will probably find it is down to about 4 lbs. Some gunsmiths reduce the pull by grinding the sear nose on line CD. However, unless you understand fully what you are doing, it is best to leave the metal alone at this point since any reduction in the shoulder length also decreases the safety factor.

(To be continued)

Hog Trough Serves as Form for Concrete Corner Posts

Confronted with the need of some substantial corner posts for his field fences, which could not be purchased in town, one farmer employed a hog trough as a form



for making the posts from concrete. If the trough available is too long, a triangular piece can be toenailed in it at the correct location without damaging the trough for its regular use.

When crystalline strontium chloride is dissolved in water, heat is absorbed and the entire solution becomes cooler. This strontium-chloride freezing mixture gives a temperature of a few degrees above zero Fahr., and can thus be used to maintain a uniformly low temperature in refrigerators.

OCTOBER, 1940

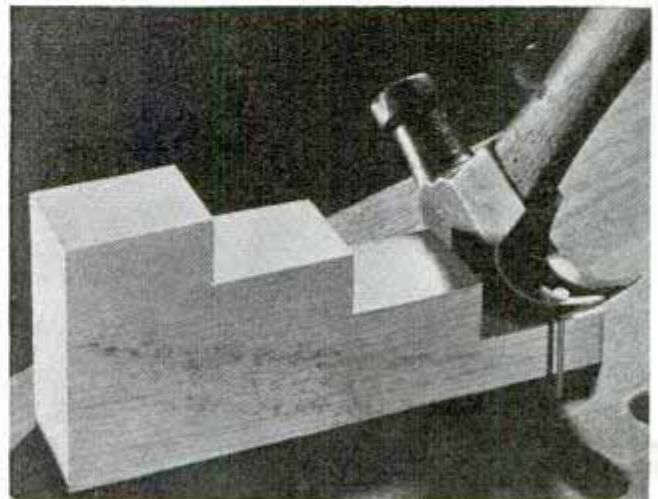
Slingshot Target Is Entertaining in the Rumpus Room



You will have a lot of fun in testing your skill with a slingshot if you use a target similar to the one shown. It is made of canvas or muslin and has a deep metal-ribbed pocket sewed over an opening in the center. This catches the steel ball, which is shot at it, and a second pocket along the lower edge catches the ball if you miss the bull's-eye. A slingshot can be made from a length of metal rod and a strong rubber band as indicated.

Step Block Aids in Pulling Nails

This step block is an improvement over the usual practice of using a scrap of wood under the hammer head when pulling nails. The block is about 6 in. long and the steps can be made any size to suit.



609

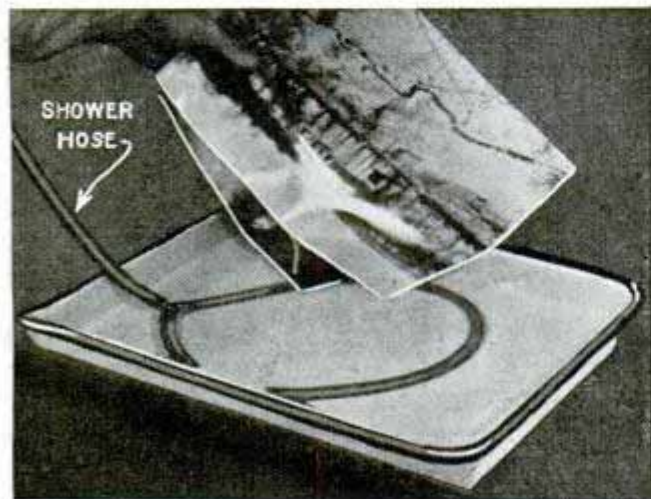
Darkroom Window Shade 'Sealed' to Keep Out the Light



Little light will leak through your darkroom window if the shade is fitted with two felt-lined metal flaps and a wooden or metal roller housing. The flaps are mounted on spring hinges so they press the drawn shade tightly against the window frame. If possible, the sill should be removed so it will not push the shade out.

Shoulder Shower Ring in Tray Washes Prints Thoroughly

A shoulder shower ring consisting of a piece of perforated rubber hose with its ends joined by a tee to the supply hose can be used effectively for washing prints. Laid in the bottom of a tray, the ring distributes water over a large area and prevents formation of stagnant pockets under the

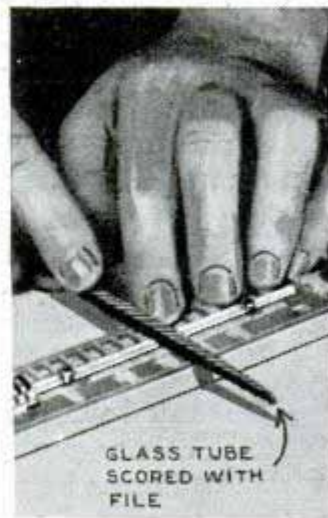


prints. These rings can be purchased complete or one could be made up from hose and a brass tee. The perforations in the circular part are about $\frac{1}{2}$ in. apart.

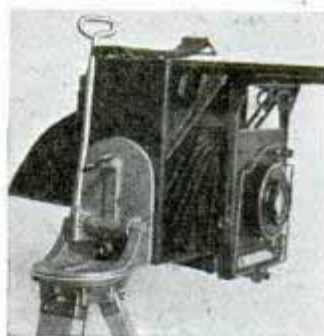
—John Modroch, Danbury, Conn.

A Thermometer for Ten Cents

Any cheap thermometer can be adapted for darkroom use by marking the glass tube with a file at the 65 and 70° points and then removing it from its wooden base. The file marks will show white against the red column.—William Swallow, Brooklyn, N. Y.



Linear Distortion Is Corrected by Inverting the Camera

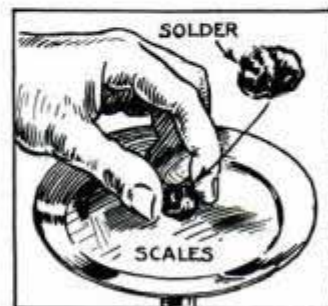


Linear distortion, often encountered when shooting downward on certain objects, can be corrected easily if your camera has a rising front and can be mounted on the tripod upside

down. With the type of camera shown, this is done by tilting the universal tripod head at a 90° angle and mounting the camera as indicated.—E. Hall, Los Angeles, Calif.

Extra Weights for Photo Scale

Lacking metric weights for my darkroom scale, I made a set from lengths of wire solder. These were trimmed carefully to the correct weight and rolled into a tight coil, after which one end was flattened and the correct weight stamped on it.—Kenneth Murray, Colon, Mich.



"FROST" PHOTOS

*to decorate
your craftwork*



GREETING CARDS

SCRAP-BOOK COVERS



PHOTO BORDERS



BOX TOPS



SMALL LAMP SHADES

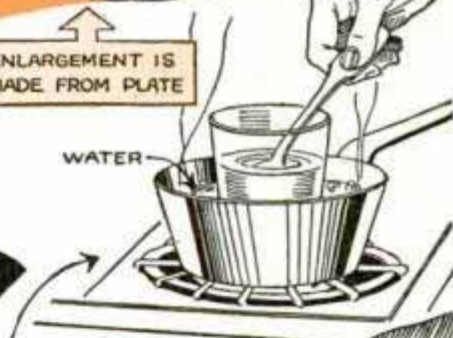


ENLARGEMENT IS MADE FROM PLATE

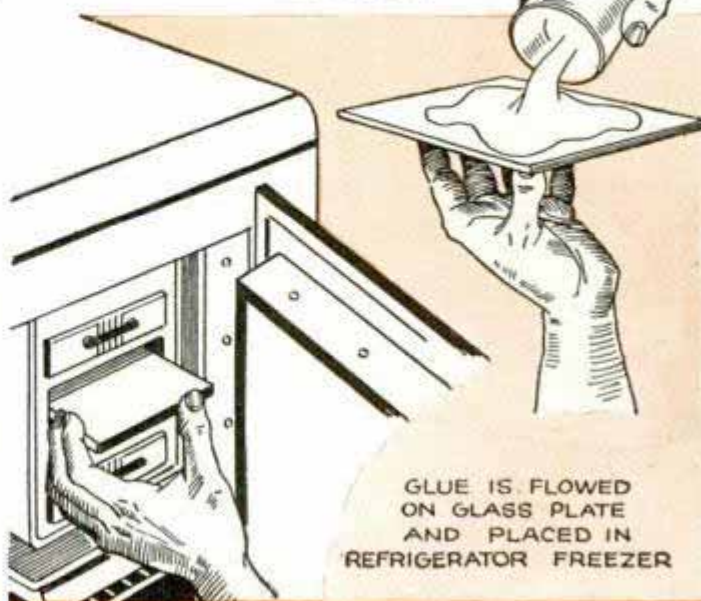
WATER
 $\frac{1}{2}$ GLASS,
DRY GLUE
1 TABLESPOONFUL



WATER



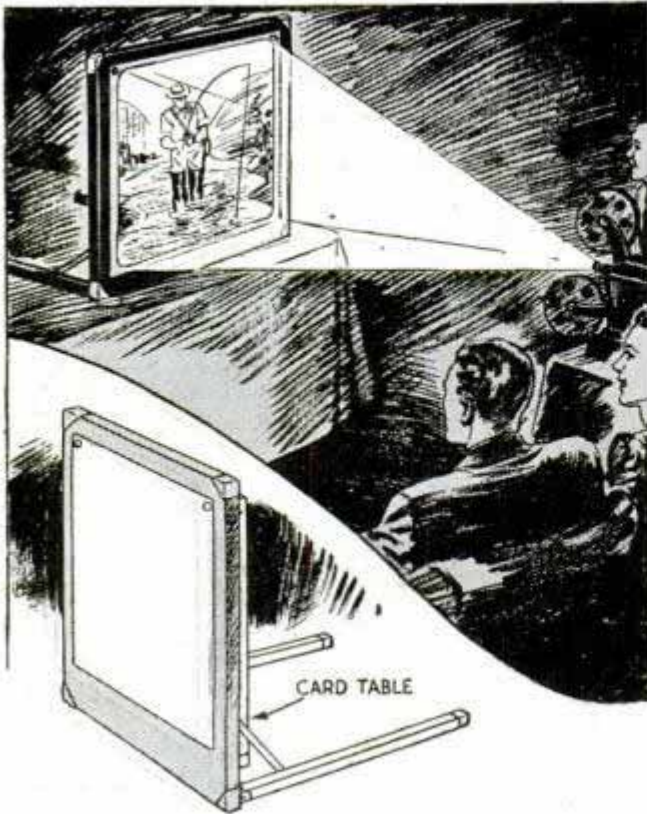
LET STAND UNTIL
GLUE SOFTENS,
THEN HEAT
TO DISSOLVE



GLUE IS FLOWED
ON GLASS PLATE
AND PLACED IN
REFRIGERATOR FREEZER

Photo borders, lamp shades, book covers and greeting cards are a few of the many uses for these "frost photos," made from glass plates on which are duplicated permanently the delicate patterns created by nature on windowpanes in cold weather. These plates can be placed in an enlarger and projected on sensitized paper, wood, metal, cloth, etc., to make attractive panels for walls or screens. Engravings made from the photos can be used for covers on books, pamphlets and other printed matter. A piece of clean glass is coated with a solution of dry glue and water and placed in the freezing compartment of a refrigerator or outside a window when the temperature is below freezing. The solution will freeze into the frost pattern, after which the water will evaporate and the glue will harden to make the design permanent on the glass. A small amount of almost any chemical salt added to the solution produces an endless variety of patterns

Folding Card Table Holds Screen for Showing Home Movies



A folding card table is convenient for mounting the screen when showing home movies. The table, with two legs open, is placed on any suitable horizontal surface and the screen is fastened on with thumb-tacks or strips of gummed tape.

Reflector Made from Bowl Screws to Light Socket

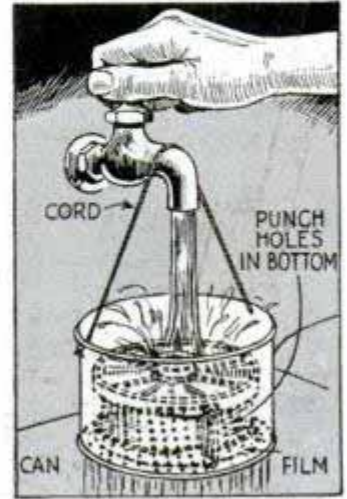
The problem of fastening a lamp socket to an aluminum bowl for use as a reflector



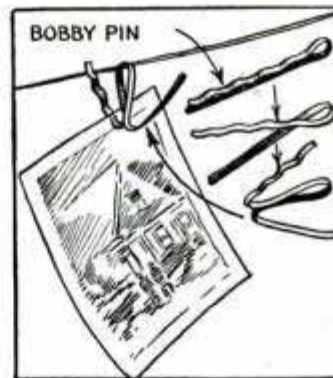
can be solved with a shade holder. Only the center part of the shade holder is used, this being cut out and riveted to the bowl so that the threaded portion projects through a hole cut to accommodate it.

Films Are Washed in Coffee Can Hung on the Sink Faucet

Placed in a perforated 1-lb. coffee can and hung on a sink faucet, film in a developing-tank reel can be washed quickly and thoroughly. Let the water run fast enough to keep the reel covered and all hypo will be washed out through the holes.



Bobby-Pin Clips Hold Negatives on Line for Drying



Sturdy clips made from bobby pins are used by one photo fan for holding his films on the line for drying. The legs of a pin are pulled into the crossed position shown and then bent

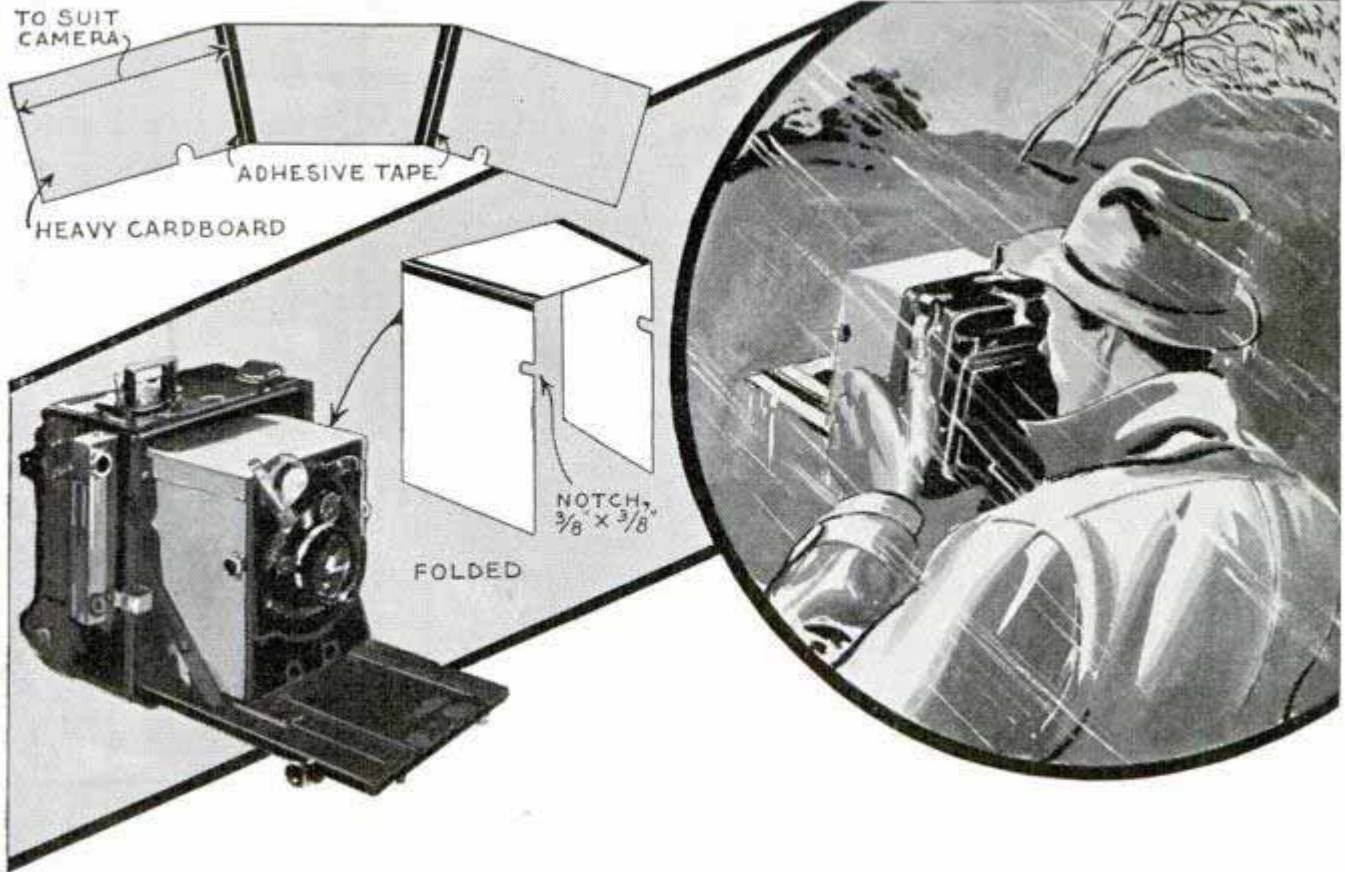
back at an angle. Pressure on the ends of the pin will open the clip which, when released, will grip the film securely.

Developing Extra Large Prints without Special Equipment

Amateur photographers who occasionally want to develop a print too large for their trays need not buy special equipment for the job. I cover a table with a piece of oilcloth, lay the exposed paper face up in the center and swab on the developer with a viscose sponge, swabbing rapidly to avoid streaks. Shortstop bath and fixing solution are applied in the same manner and the bathtub provides a convenient place for the final washing.

—John B. Cleaveland, Gladstone, N. J.

Shield Stops "Bellows Flutter" in High Wind



Everyone who has attempted to take photographs by holding an ordinary bellows-type camera outside the cockpit of an airplane has noticed fuzziness in the finished prints, even when the shots were made at high speed. This is caused by "bellows flutter" and is even evident in some photos taken on the ground in a strong wind. A shield of heavy cardboard or light sheet metal will eliminate this trouble and also protect the bellows in rain

or snow. Three pieces of cardboard, cut to fit over the top and sides of the bellows, are fastened together with adhesive tape. On some cameras the front of the shield can be notched to fit over the adjusting screws, but if this is inconvenient it can be fastened to the bed of the camera with tape. If the shield is to be used in rain or snow, it should be given a couple of coats of shellac.

—J. H. Dougherty, San Diego, Calif.

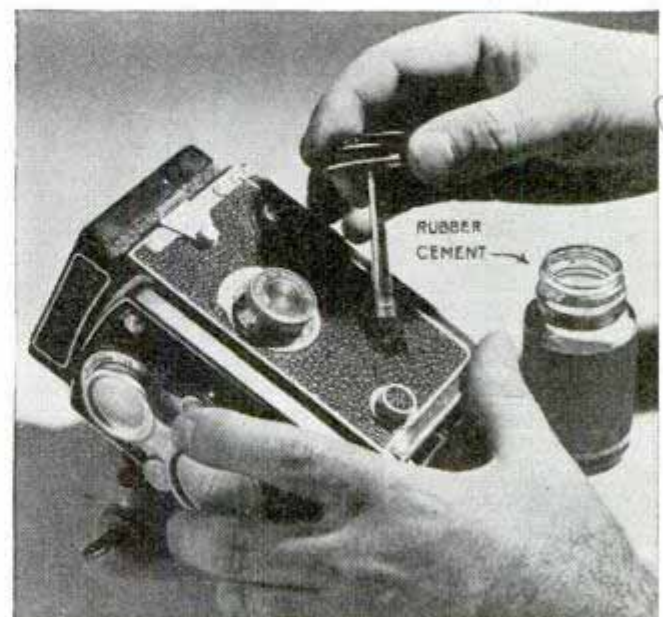
Leather Parts of a Camera Cleaned with Rubber Cement

Leather parts of a camera will continue to look like new if they are given an occasional cleaning with rubber cement. Apply a heavy coat on the leather and allow it to dry; then rub it off with a clean cloth and all particles of dirt will come with it.

Making Glossy Prints Lie Flat

The following solution is the best I have ever found for making ferrotyped prints remain flat after they dry: Glycerin, 1 part; alcohol, 1 part; water, 4 parts. The solution is brushed evenly on the backs of the prints after they have been squeegeed on the ferrotype tins.

—George W. Bucklin, Lincoln, Nebr.



James 223 W Madison Chicago
Burke

Thermometer Is Held with Wax to Bottom of Tray



I have fitted several of my trays with cheap calendar thermometers which are attached by embedding them in melted paraffin. After applying the paraffin at the ends only, the graduations are marked on the bottom of the tray, pouring in water at known temperatures and checking with an accurate thermometer. The marks are

made with a pencil, then the water is poured out and they are traced with India ink and covered with more melted paraffin.

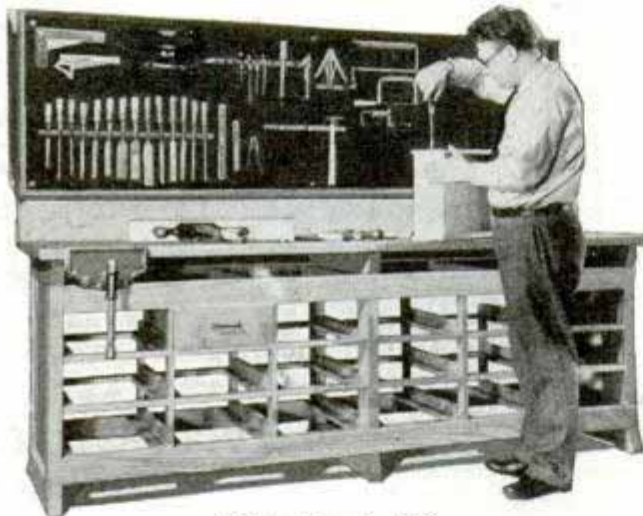
—Edwin L. Bond, Roland Park, Md.

Draining the Developing Tank

Time consumed in pouring solutions from a developing tank into a bottle can be used for other purposes if you place the tank in a glass funnel and let it drain. An average quart bottle is heavy enough not to tip when the tank is placed on it. Set the tank in the funnel carefully so the lid will not slip and admit light.



It's a Pleasure to Use Motorized Tools



Cabinet Bench—898

DRILL PRESS—895: Pipe fittings. $\frac{1}{2}$ -in. chuck and ball-bearing spindle. 28 in. high—25c.

WOODTURNING LATHE—1056: Self-contained unit, mounted on stand. 4-speed belt drive—25c.

CIRCULAR SAW TABLE—910: Angle-iron frame. 24 by 36-in. table. 10-in. blade—25c.

22-IN. SCROLL SAW—771: Pipe fittings and hardwood. Has sewing-machine drive—25c.

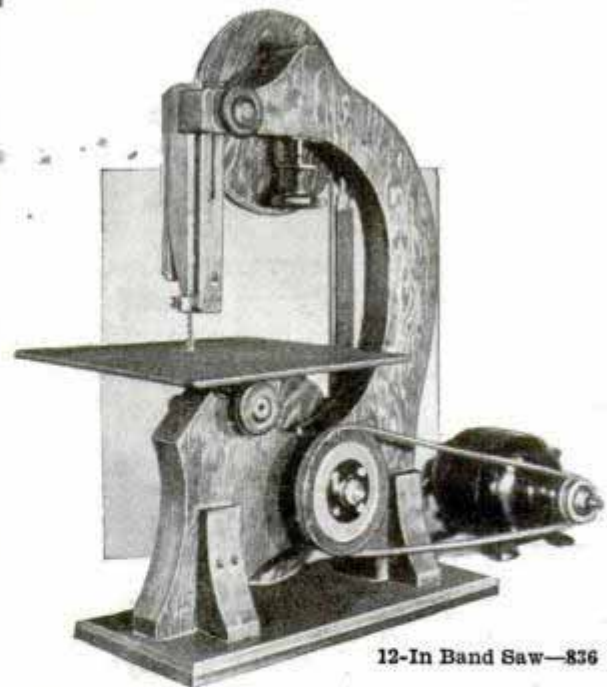
"STROKER" BELT SANDER—1057: Ideal for wide boards. Wooden framework. Table adjustable—25c.

VERTICAL SPINDLE SANDER—560: Wood table 10 by 17 in. Has $2\frac{1}{2}$ by 4-in. sanding drum—25c.

You'll save time and labor by equipping your shop with these low-cost homemade machines, and 20-drawer workbench. Whether you want a shop for pleasure or profit, our plans will give you all of the information you need

CABINET BENCH—898: Nearly 8 ft. long, 27 in. wide, 35 in. high. 20 drawers—25c.

12-IN. BANDSAW—836: Smooth running and sturdy. Cuts 2-in. stock easily—25c.



12-In Band Saw—836

Any six of these plans (not projects) will be sent postpaid upon receipt of \$1.00. Catalog listing over 400 plans included free with your order if specified, or sent separately for 3 cents to cover mailing

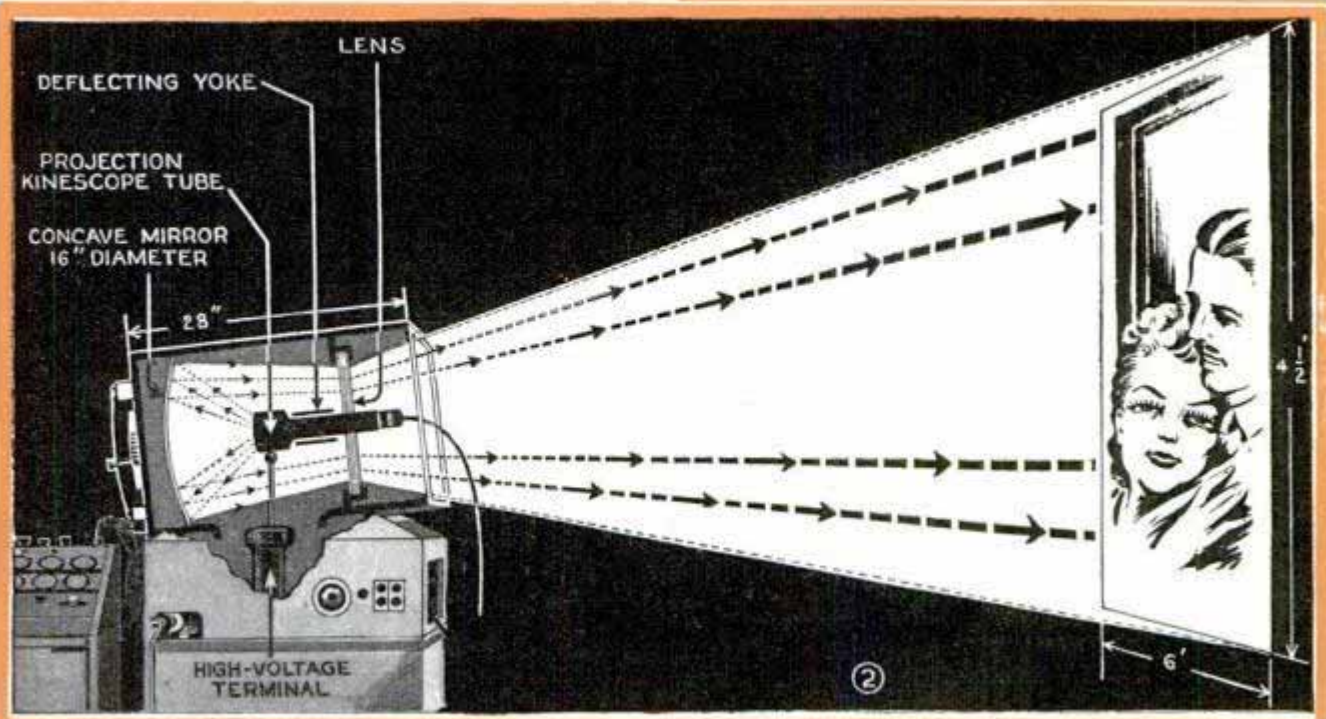
Address—Plan Service, Popular Mechanics Magazine, 200 E. Ontario St., Chicago



Large-Screen TELEVISION

AN AUDIENCE of 200 recently saw a full hour television program projected on a screen 4½ by 6 feet, with sufficient brightness and definition to be viewed in comfort from any point in the N.B.C. studio where the event took place. The apparatus was built as an intermediate step in developing units for the projection of larger images suitable for use in theaters.

The newly developed "kinescope" laboratory model projection tube shown in Photo 1, looks something like a large flashlight. This is pointed away from the screen on which the scenes appear. The images formed on the tube's fluorescent surface are only 2.4 by 3.2 in. in size. This small but very brilliant image is picked up by a 16-in. concave mirror which magnifies the pictures over 20 times before reflecting them through a glass lens and thence onto the screen placed 20 feet away, as indicated in the cross-section drawing Fig. 2.



RCA Mfg. Co. Consider. 29

COMPACT PUSH-BUTTON

By Frank M. Lund



ALTHOUGH designed primarily for the best tone quality possible in a small set, nothing has been overlooked that would add to the convenience and utility of this compact 5-tube superheterodyne table-type receiver. The outstanding feature is in the tone-control circuit. With this system of tone control it is now possible for a small set to have a bass response comparable to that of a large receiver, as this "humped" audio tone control actually amplifies and peaks the low tones without distortion. Other features include, mechanical push-button tuning, adequate filtering for hum-free reception, automatic volume control, built-in loop antenna and a 6-in. electrodynamic speaker.

All materials are available from mail-order parts houses, and have been carefully selected to produce efficient results at reasonable cost. Although the set is not designed for beginners, it is quite simple and well within the building range of the average experimenter. Cabinet and base details are given in Figs. 1 and 2 for those who wish to build their own and are equipped to do so. However, similar blank cabinets of suitable size are available and the chassis base can be obtained formed and drilled if desired.

A complete simplified wiring diagram appears in Fig. 3. This shows a bottom view of the chassis base and all wiring including the leads up to the various parts mounted on top of the base, also the loop which is to be screwed to the inside of the cabinet as indicated in photo (A). Photos B, D and E show various views of the completed chassis base; a front view of the finished set is given in photo C, and the schematic circuit diagram appears in Fig. 4.



(A)

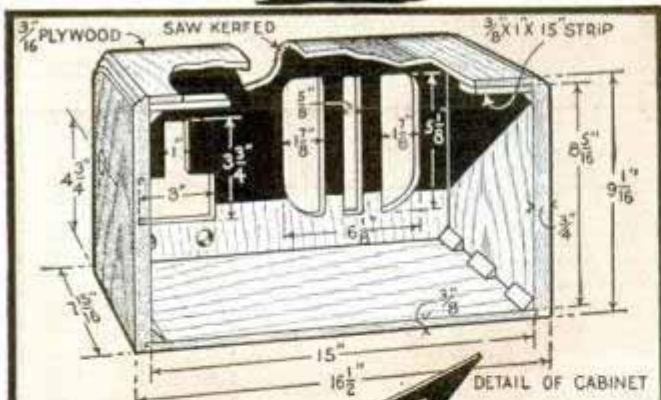


FIG. 1

ALL TUBE SOCKET HOLES ARE $\frac{1}{8}$ DIA.

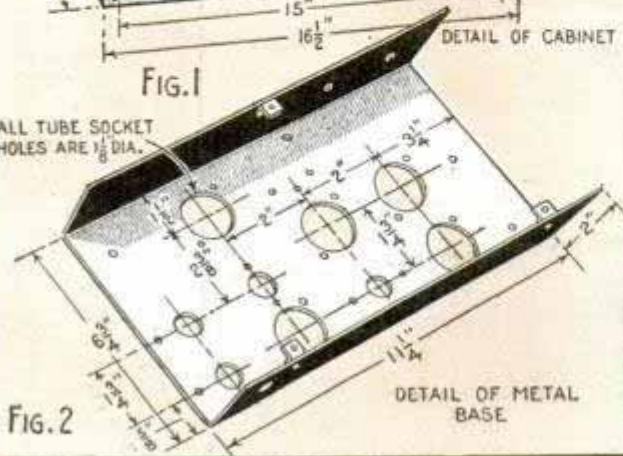
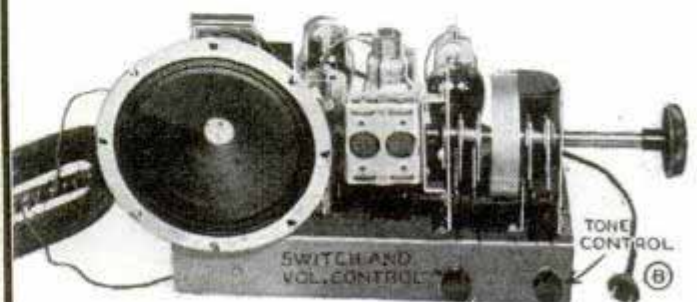


FIG. 2

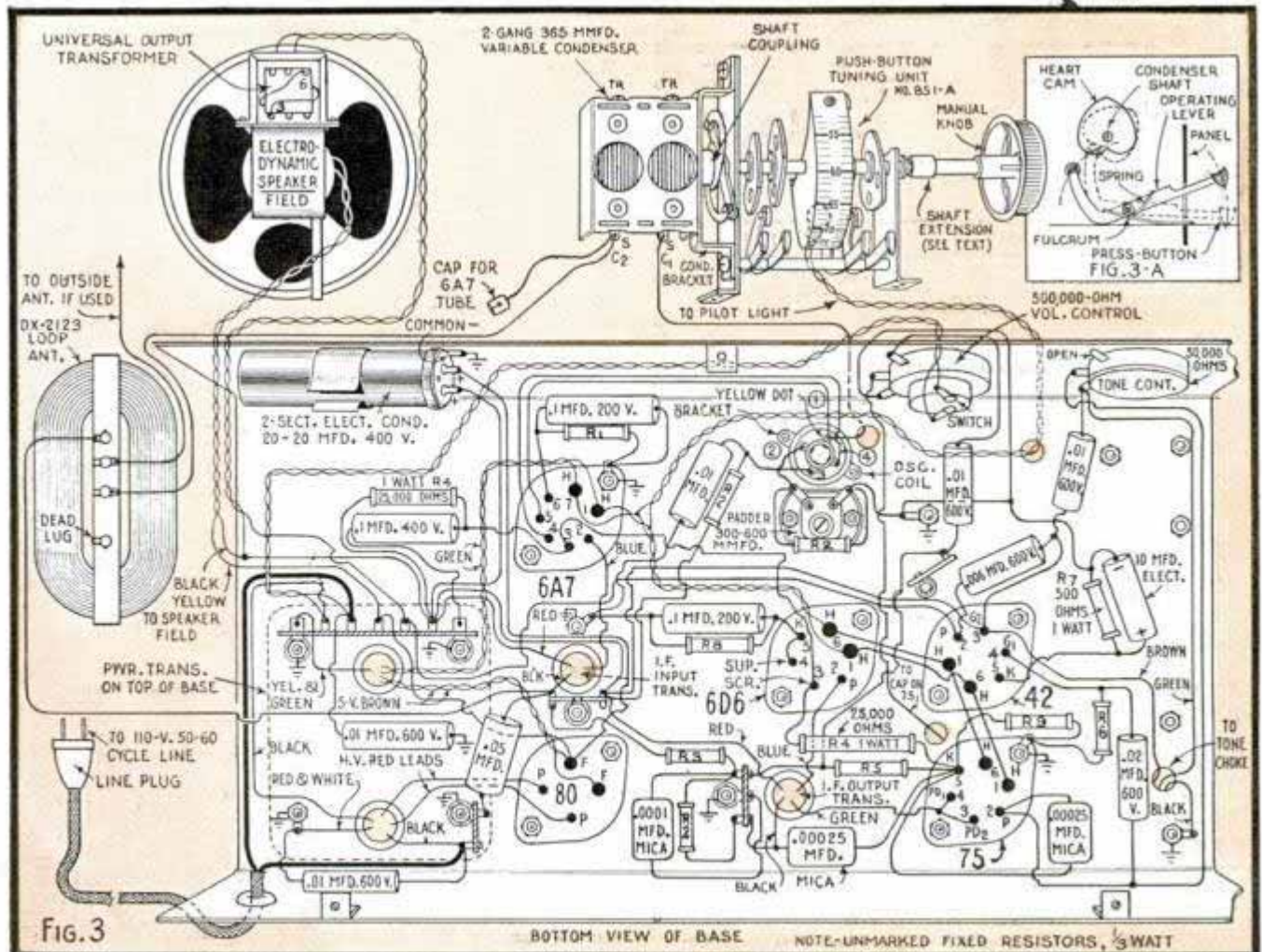
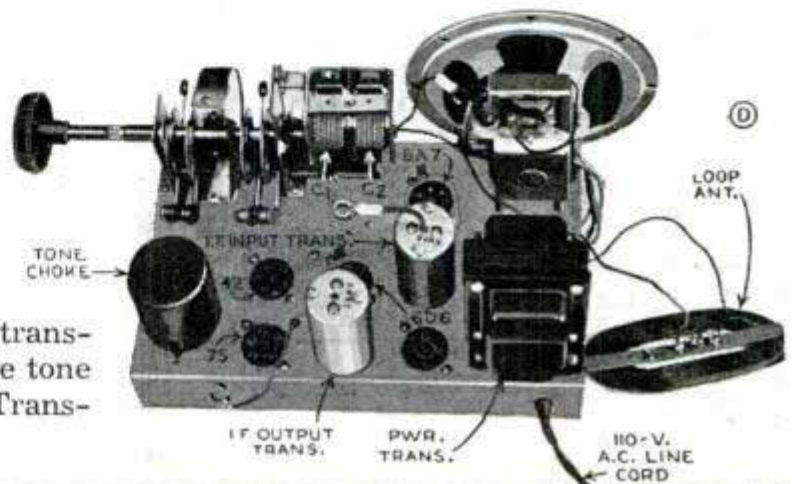


(B)

A.C. HIGH-FIDELITY FIVE

Mount all parts firmly on the base, using lock washers under all machine screw nuts, especially those under which soldering lugs are placed for the various ground connections. Make all grid and plate leads as short as possible and use rosin core solder for each soldered connection. The variable 2-gang condenser is a counterclockwise type mounted directly on the supporting bracket of the push-button tuning unit by means of a separate bracket and flexible shaft coupling. Fig. 3-A shows a sketch of the push-button tuning mechanism, which is quite simple and easy to adjust for any four favorite stations, without disturbing the usual manual tuning by means of the large knob. The power transformer is a General No. 7745, and the tone choke is also made by the General Trans-

(Continued to page 114A)



Extension Speaker for the Recreation Room

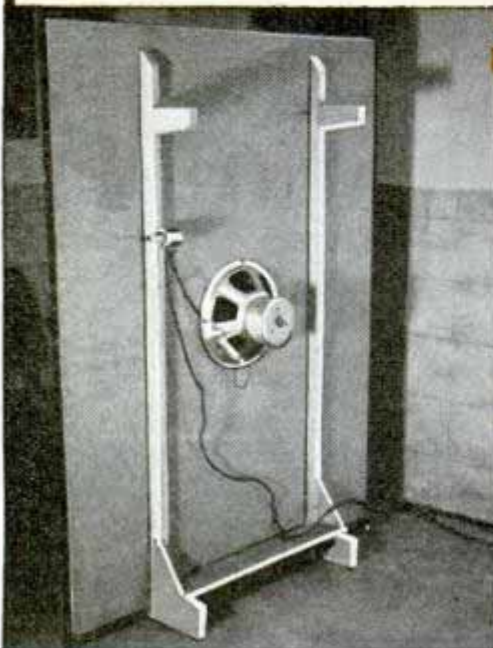
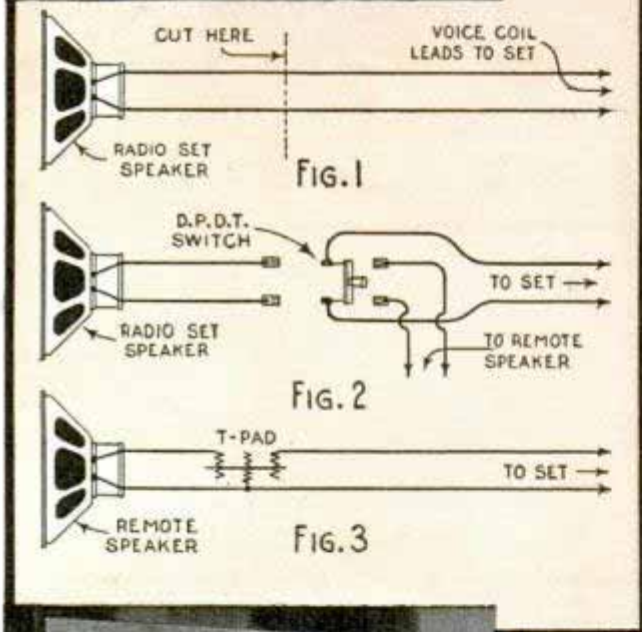


DANCE music "piped" to the basement recreation room, from a large radio-phonograph located on an upper floor, offers several distinct advantages, costs less than a separate set, and the system is easy to install. The full efficiency of the large set audio amplifier can be maintained easily at the location of the remote speaker if proper baffling is employed and careful attention given to a few important details.

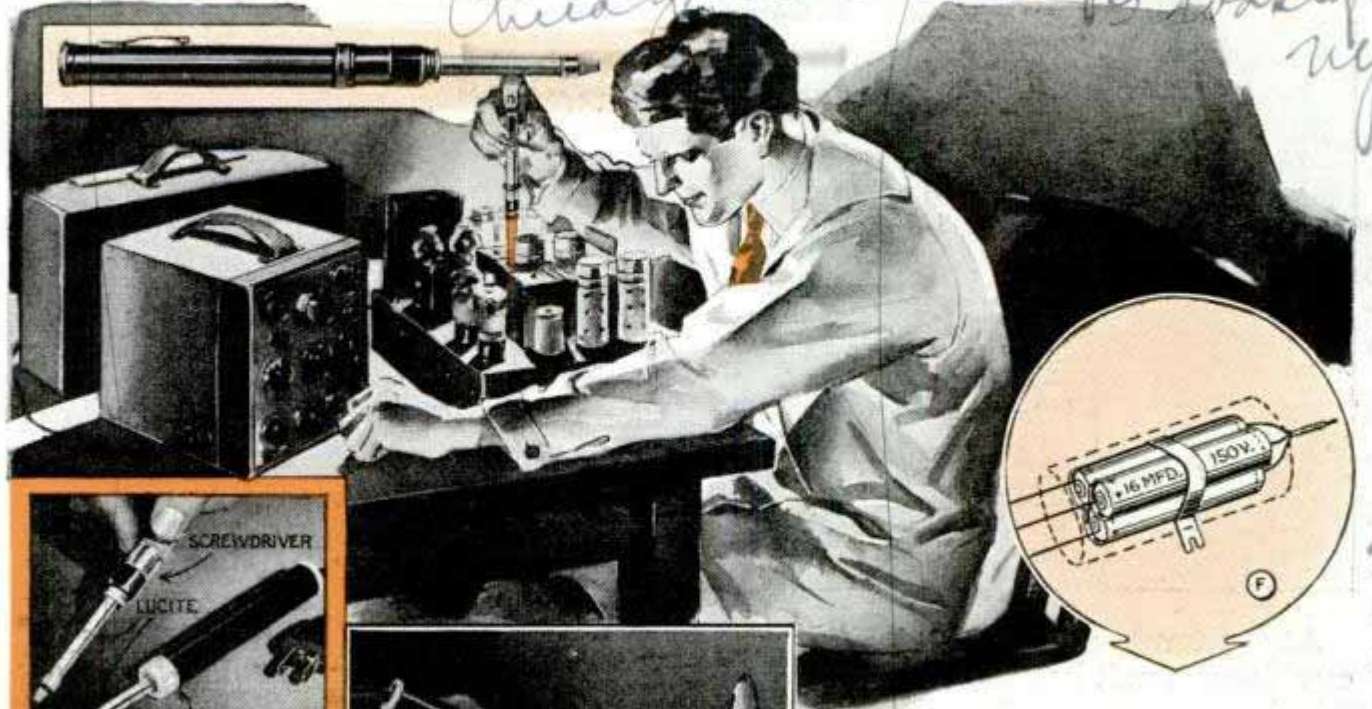
The materials used in the installation shown below cost about \$25 and include the following items: one 4 by 5-ft. sheet of 1-in. soft-pressed board; one 12-in. permanent-magnet speaker; one "T-pad"; one d.p.d.t. toggle switch, and a suitable length of 2-conductor cord. The conductor cord should not exceed 75 ft. in length and should be run in conduit as directly as possible.

Owing to the wide variety of receivers without standard coded speaker connections no specific directions can be given for locating the voice coil leads in all sets. However, this information is easily obtained from manufacturers' service sheets or your local radio serviceman. These leads are cut as shown in Fig. 1 and the d.p.d.t. switch inserted as indicated in Fig. 2. This switch can be mounted directly on the back of the radio cabinet and is used to cut in one speaker at a time as desired. When buying the remote speaker and T-pad be sure that they match the set speaker. For example, if the set speaker impedance is 8 ohms, the extension speaker and T-pad must also be 8 ohms.

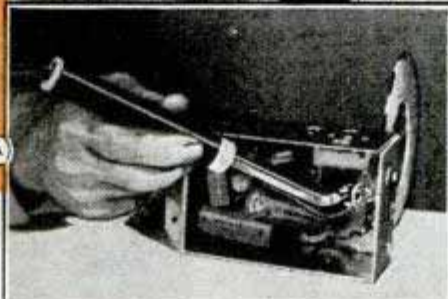
At the remote speaker the electrical hook-up is very simple. The T-pad is connected in the line as shown in Fig. 3, following the instructions that come with it. This unit acts as a volume control at the remote location and may be omitted if volume is controlled at the set.



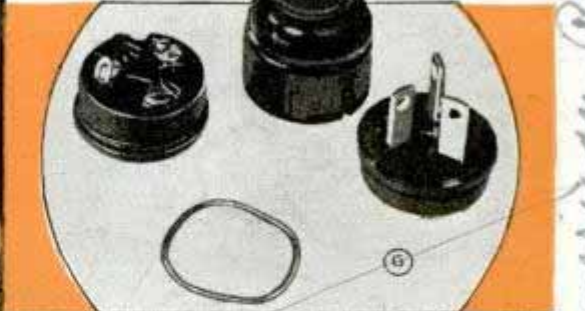
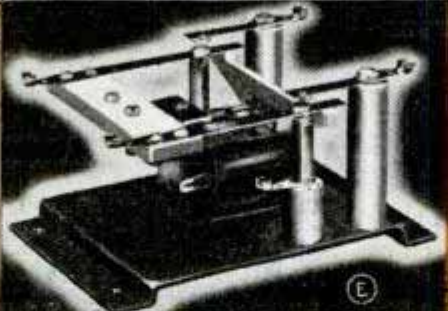
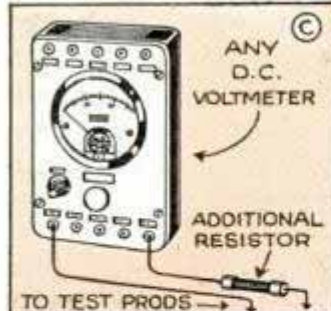
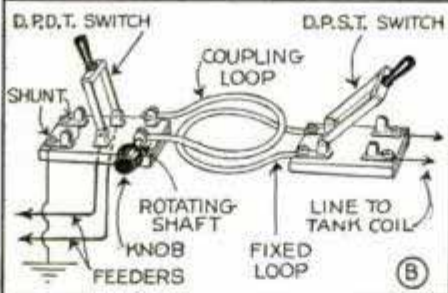
Practical RADIO SUGGESTIONS



(A) Illuminated radio tools aid experimenters and servicemen. "Lucite" shafts supply a brilliant glow for working in dark corners. Screwdriver is used to adjust I.F. transformer trimmers, and the hooker to test for loose wires. They may be used with either flashlight batteries or electric-cord attachments



(B) Simple adjustable coupling arrangement in low-power feeders for obtaining maximum feeding of antenna. Ordinary porcelain switches are mounted on a suitable base about 1 ft. apart; shunted terminals provide safety ground. (C) Semi-precision resistor connected in series with one test lead of any set-testing voltmeter converts meter to measure high voltages of value greater than its maximum scale. Set test-meter selector switch at scale nearest 10 volts and use 1,000 ohms for every volt to be measured, provided your unit has the usual sensitivity of 1,000 ohms per volt. (D) "Fiber-glass" flexible resistors operate at high temperatures without charring, burning or deterioration



(E) Antenna-switching relay suitable for any type of experimental high-frequency switching. (F) Small electrolytic condensers easily assembled in required values and strapped together to form any filter block combination. (G) Interchangeable 2 and 3-pole receptacles and plugs for serviceman's kit. (H) Rotating base acts as turntable for small standard set; permits user to turn receiver for maximum signal strength from built-in loop antenna



Handwritten notes: 3901 Arthur... Chicago, Illinois... 285 N. 6th... Solar mfg Co. RCA Victor Corp. Pasadena, Calif.

Television, Radio and Phonograph in De Luxe Combination

Woodside, N.Y.



At the touch of a switch, this versatile combination unit becomes a "sharp focus" television receiver, a high-fidelity automatic phonograph, or a radio broadcast and short-wave receiver. Thirty-three tubes, including a 12-in. picture tube, are used on television, and 10 tubes are employed on radio reception. Audio system consists of push-pull beam-power amplifier with 12-in. studio-type speaker.

Two-Unit Push-Button Auto Set

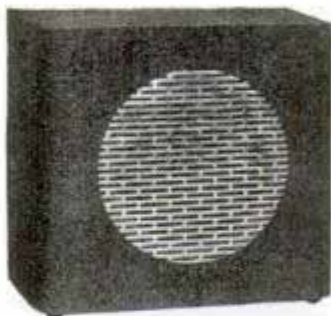
Designed with a separate 6-in. speaker provided with a bracket for mounting behind the grille opening on the dash board of the newer cars, this 6-tube push-button set is easily installed and may be trans-



ferred quickly from one car to another without difficulty. An 8-in. cabinet speaker is available for mounting on the bulkhead of any car not equipped with a grille.

Wide-Range Monitor Speaker

Although designed for broadcast-control room monitoring, this 60 to 10,000-cycle response speaker is also recommended for other applications where high quality is important.



Time Switch for Kitchen Radio



The automatic time control of this electric range is employed to turn on the kitchen radio when the young lady's favorite program is due. Normally the device provides automatic control of three cooking circuits in the range.

Blueprints covering radio construction articles in this and past issues are available for 25 cents each. Original material lists, with names of manufacturers and dealers, can be obtained from our Radio Department upon receipt of postage.

NEXT MONTH—How to Build a Wearable Hearing Aid. Three of the new miniature-type tubes are employed in this unusually compact low-cost hearing-aid amplifier which is easily concealed on the person. Also—**Simple Battery-Set Amplifier for Any One-Tube Receiver.** May also be used as amplifier for record player.

The Crowley Corp. - Components - Radio Radio Corp.



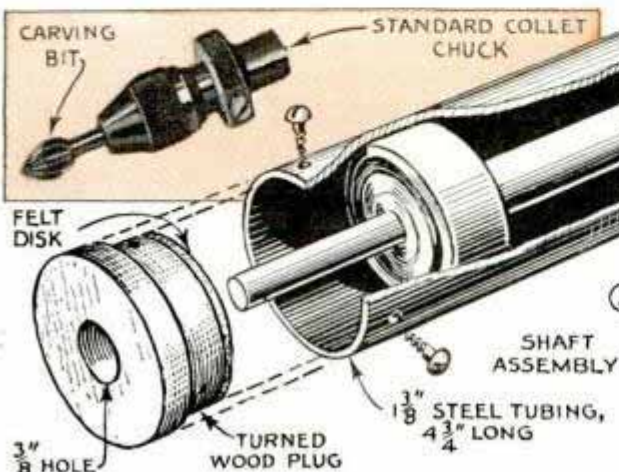
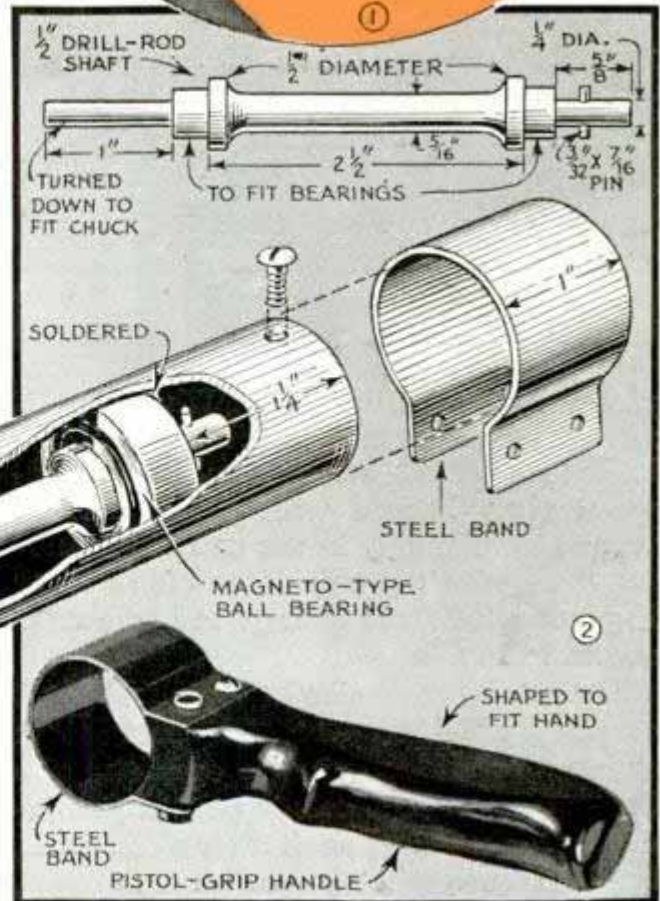
SHOP NOTES

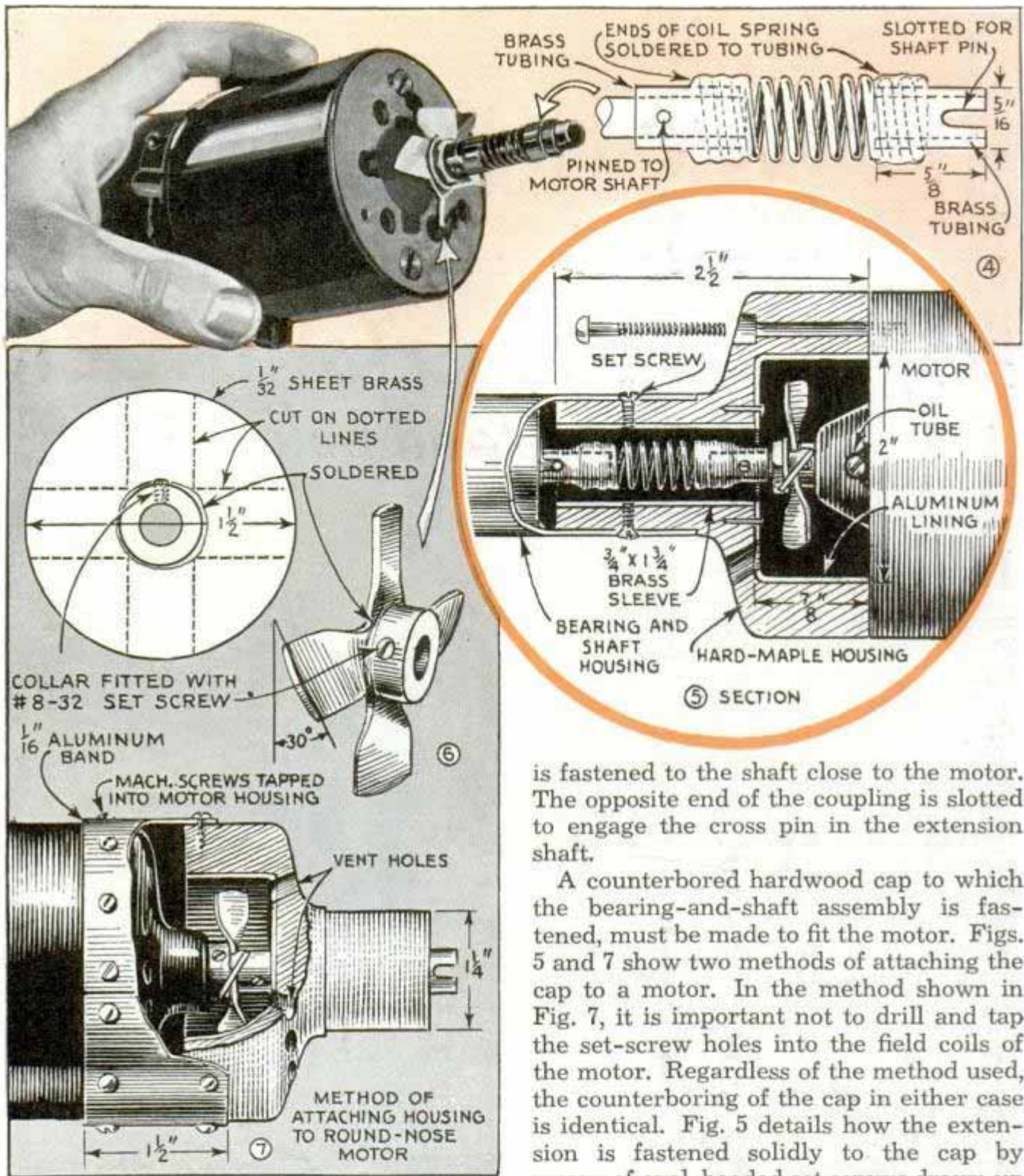
High-Speed HAND GRINDER *carves, drills and polishes*

By A. L. MILLS

BUILT around a small motor of the type used in high-speed electrical appliances, the sturdy hand grinder shown in Fig. 1, when fitted with a collet chuck to take small carving bits and accessories, makes a versatile workshop tool. Essentially, the job consists of adding an extension shaft and housing to the motor and providing a handle.

The steel shaft is machined to the size detailed in Fig. 2. One end is turned to accommodate a standard collet chuck, while the other end is fitted with a short tight-fitting pin to engage a slotted spring coupling. Standard magneto-type ball bearings are used to support the shaft inside the $1\frac{3}{8}$ -in. steel tube. The rear bearing is mounted $1\frac{1}{4}$ in. from the end and is bushed with shim brass to a press fit inside the tubing, after which the bearing is soldered permanently in place. The front bearing is likewise shimmed, but is held in place with liquid solder to make the shaft removable for future bearing re-





placement and inspection. When this is necessary the solder is loosened with a knife to free the bearing. A rabbeted hardwood plug, backed with a felt disk, is turned to fit snugly in the end of the tubing flush with the outside and is fastened in place with three short wood screws as shown in Fig. 3.

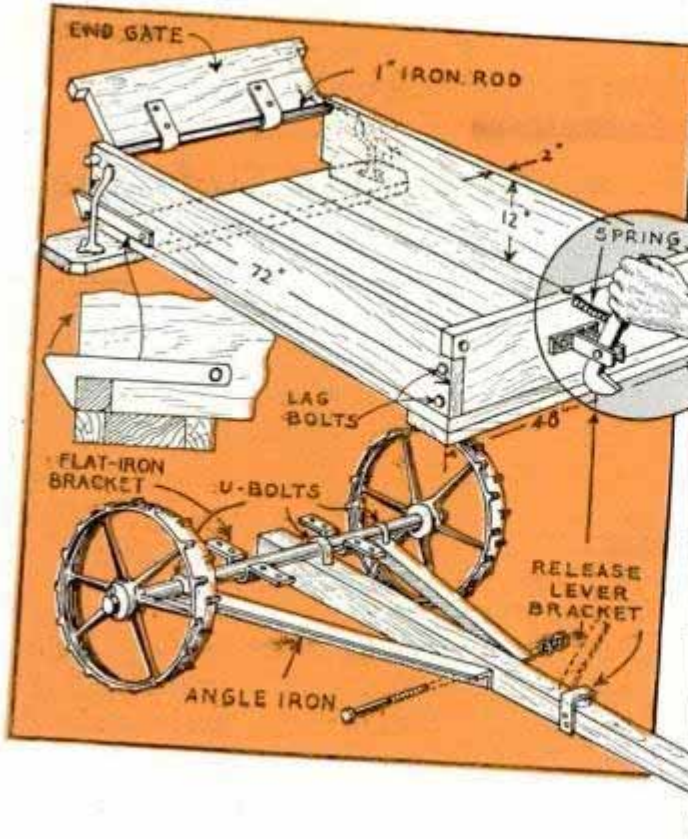
Fig. 4 shows a simple universal shaft coupling which consists of a short length of brass tubing soldered to each end of a heavy coil spring. This is pinned permanently to the motor shaft after a small fan, formed from a sheet-brass disk as in Fig. 6,

is fastened to the shaft close to the motor. The opposite end of the coupling is slotted to engage the cross pin in the extension shaft.

A counterbored hardwood cap to which the bearing-and-shaft assembly is fastened, must be made to fit the motor. Figs. 5 and 7 show two methods of attaching the cap to a motor. In the method shown in Fig. 7, it is important not to drill and tap the set-screw holes into the field coils of the motor. Regardless of the method used, the counterboring of the cap in either case is identical. Fig. 5 details how the extension is fastened solidly to the cap by means of oval-headed set screws drawn up tightly in holes tapped through the side of a brass sleeve inserted in one end. If desired, an aluminum lining, formed in the shape of a cup and held in place with short pins, can be used in the fan well as it adds strength to the wood. A series of 1/4-in. vent holes around the face of the cap are drilled through at an angle into the fan well to admit air to the motor.

The pistol-grip handle shown in Fig. 2, is shaped to fit the hand and is attached to the shaft extension at about the center of balance. It is important that the shaft turns clockwise, especially when the unit is to be used for drilling and carving.

Farm Dump Truck Saves Shoveling Off Load



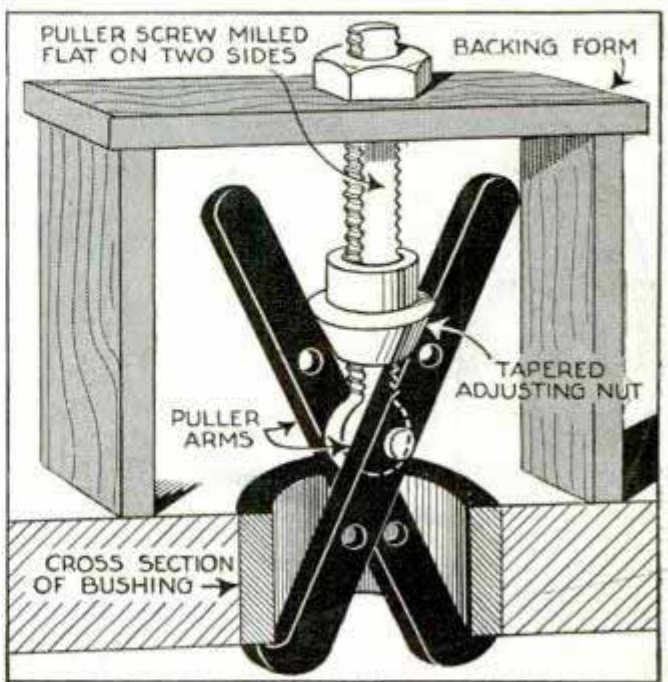
For hauling jobs around a farm, an inexpensive dump truck like the one above is just the thing. It saves wear and tear on your grain wagon, and it is handy for hauling feed into hog and cow lots where many farmers let it stand until used. In the original, a discarded mowing machine provided the wheels and axle, and boards and iron picked up here and there furnished the rest of the material. The body

is pivoted to the axle with U-shaped brackets. It should be pivoted just slightly off the center of balance so that it has a tendency to tip toward the rear. In this way, the load will dump of its own weight when the release lever at the front is pulled. Notice that a coil spring keeps a tension on the lever to prevent vibration from loosening it when the truck is in motion.

—L. S. Metford, Salmon Arm, B.C., Can.

This Improvised Bushing Puller Handles Occasional Jobs

In small shops where only an occasional job of removing a bushing or bearing does not warrant the purchase of a puller, this inexpensive one will solve the problem. Running the tapered adjusting nut up or down the puller screw spaces the jaws of the puller arm for bushings of various sizes. The backing form or support for the assembly is metal, heavy enough to stand the pressure of pulling a bushing.



EVERYBODY IS AN INVENTOR

Nearly everybody has discovered some kink or shortcut to solve one of those seemingly trivial problems encountered in every home or in a person's work, hobby and play. But the solution may have saved time, money and energy. We pay for such ideas. Submit a sketch or photo and a brief description to our Homecraft Editor. If acceptable for publication, we will send you a check promptly and if we cannot use it, the material will be returned.

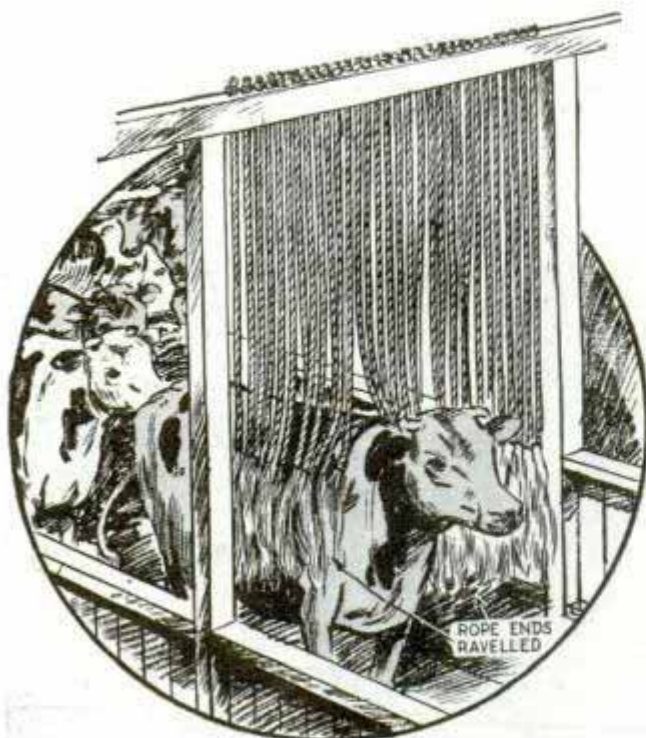
Box Fits on Shop Hand Truck for Carting Small Packages



When a number of small packages had to be moved on a hand truck, one foreman fitted the truck with a large box. Angle irons screwed to the bottom of the box straddled the cross members of the truck to hold the box in position.

Removing Flies from Dairy Cows

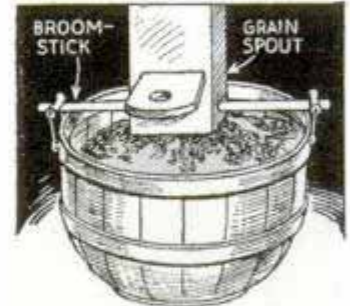
By simply building a passageway in front of his dairy-barn entrance doors and suspending ropes inside it as shown, one



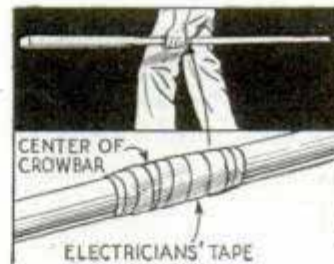
dairyman removed flies from his cows before they entered the barn. The ropes are frayed back several inches from the lower ends so that they serve as brushes when the animals walk under them.

Broomstick Holds Feed Basket under Grain Spout

To support a large basket while filling it from a grain spout, one farmer bored holes through the spout for the insertion of a length of broomstick. This is anchored securely in place to project an equal distance at each side of the spout and the basket is attached or detached by a simple movement from side to side.



Tape Marks Center of Balance on Tapered Crowbar

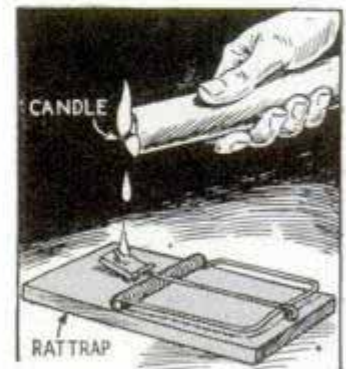


Shifting a tapered, heavy crowbar back and forth in the hand to find the center of weight or balance for carrying, is avoided by one

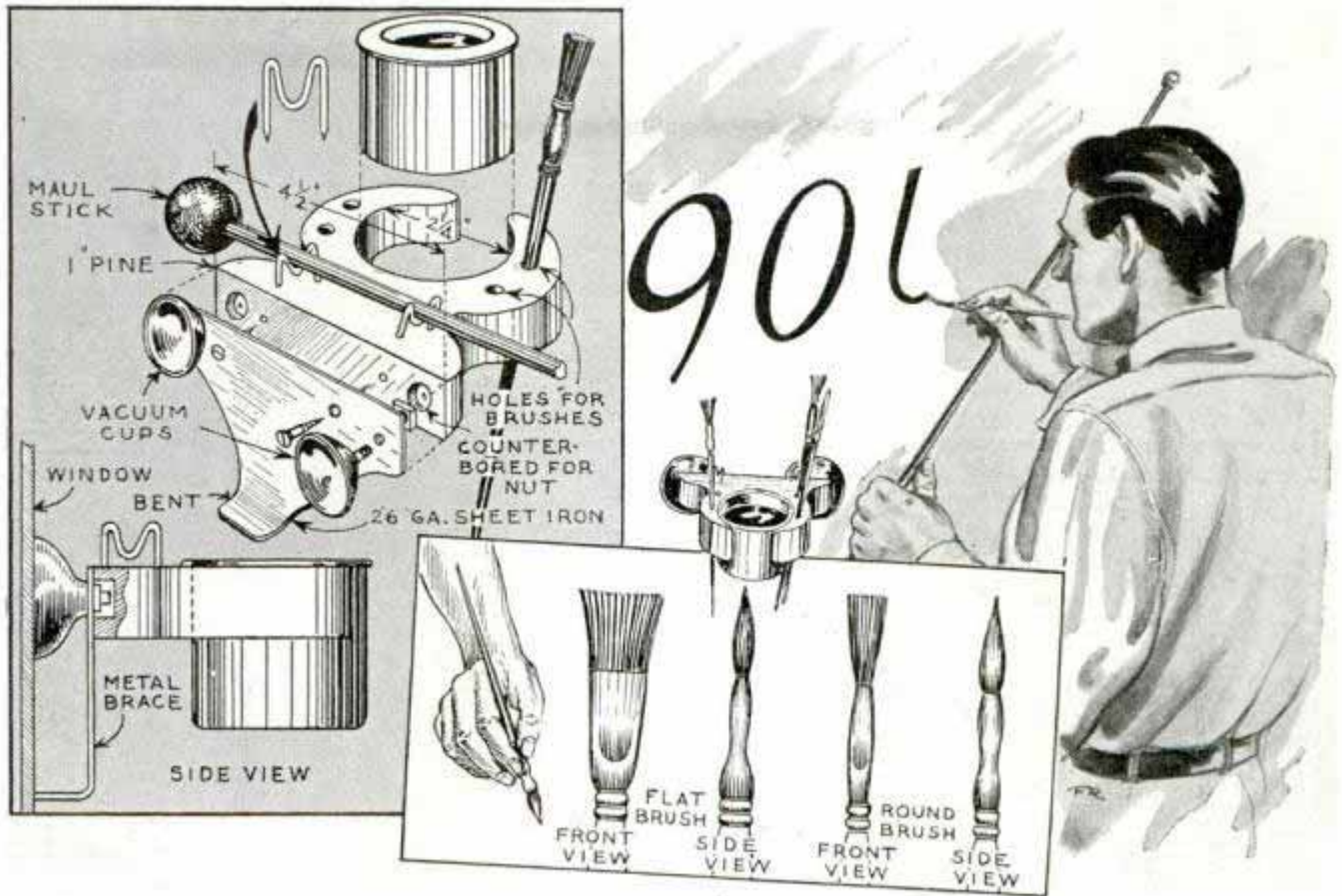
railway section boss who wrapped it with electric tape as indicated. Also, the tape protects the hands from being injured on the bar if it has been left lying in the hot sun along the roadway.

Rat Traps Baited with Candle

In places where many rat traps were set regularly every day, the task of baiting them was simplified by using a tallow candle. The lighted candle was held over the bait pans to drop a quantity of the tallow on each one, where it solidified and adhered so that a rodent could not remove it without being caught.



Accessory Holder Helps Window Sign Painter



Attached to a show window with vacuum cups, this holder keeps sign painter's accessories within easy reach. The one shown will accommodate a can of paint, maulstick and four brushes. If desired, the holder can be made to take more than one paint can. Be sure, however, to provide

vacuum cups large enough to support the weight. In addition to using the holder to simplify my work as a sign painter, I find that slight indentations made in the brush ferrules as shown in the lower detail, improve the grip and tend to eliminate tiring muscle strain.—S. Haber, Brooklyn, N. Y.

Lathe Tool-Post Holder for Grinder of the Small Hand Type

I have found that a model-A Ford connecting rod is just the thing to use as a lathe tool-post holder for one of the small, portable hand grinders of the type shown. The wristpin end of the rod was cut off and the shank ground down to slip into the tool post.—D. Fulmer, Columbus, Ohio.

Patching Sacks with Cement

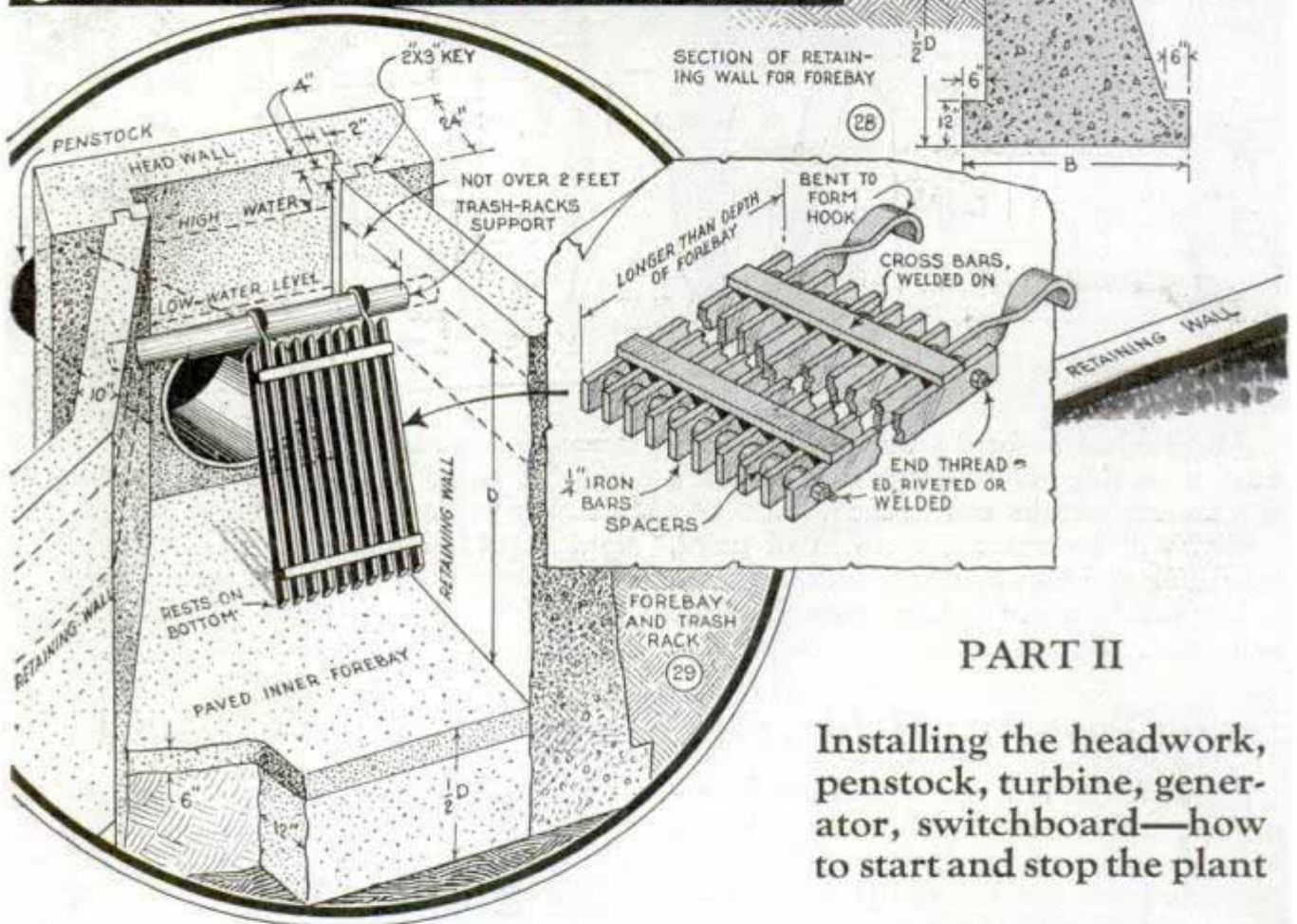
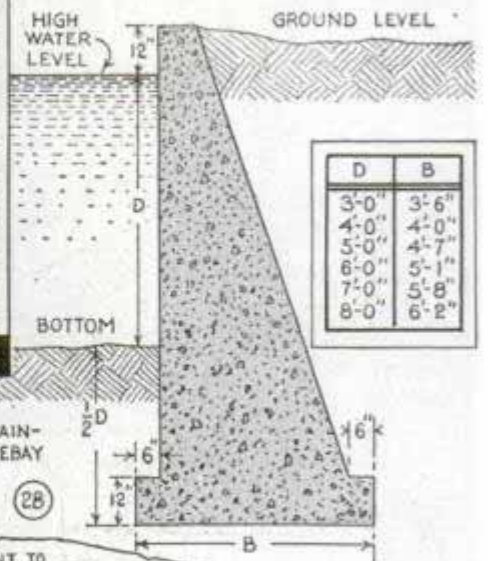
The next time you have grain sacks to repair, try applying the patches with regular tire cement. Coat the patch, and the surface of the sack around the hole, with the cement. Allow the cement to dry until it takes on a dull appearance. Then press the patch in place. Turn the sack wrong side out and apply cement around the edges of the hole, and then press the patch with a hot iron.



POWER from small streams



27 DAM PROPER COMPLETED WITHOUT RETAINING WALLS

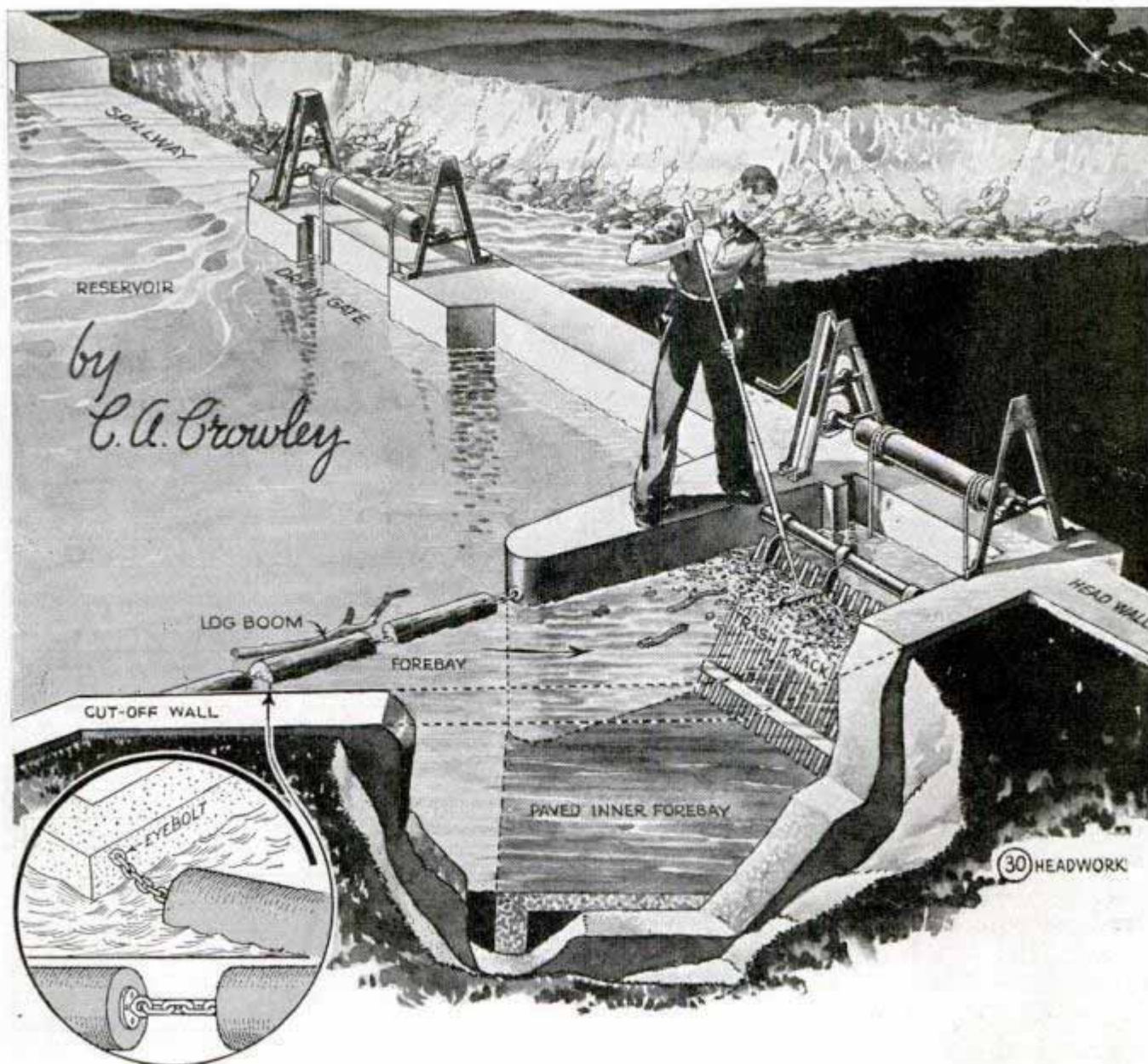


Installing the headwork, penstock, turbine, generator, switchboard—how to start and stop the plant

ASSUMING that the dam proper has been poured, you are at the stage shown in Fig. 27, which pictures a small dam from the upstream side. At this point the headwork has not yet been built. In many cases it may be convenient to build part of the forebay integral with the dam.

The headwork: In a hydroelectric plant the headwork comprises the intake for the water, gates, trash racks, etc., as illustrated in Fig. 30. The forebay, Fig. 29, serves the purpose of confining water where it is free from turbulence so that sand and dirt may settle before the water goes through the penstock to the turbine. A trash rack

prevents debris from entering the penstock, and a log boom is provided at the mouth of the forebay to keep out large floating debris and ice cakes. The forebay should be considerably larger in cross section than the penstock and widest at its mouth. Two sides are retaining walls and the third side, which has the penstock opening, is the head wall. The latter may be poured integral with the dam and should have a guide formed in the concrete to take either a gate as in Fig. 18, Part I, or stop logs so that the flow of water to the turbine can be stopped. Stop logs are heavy timbers weighted with metal and

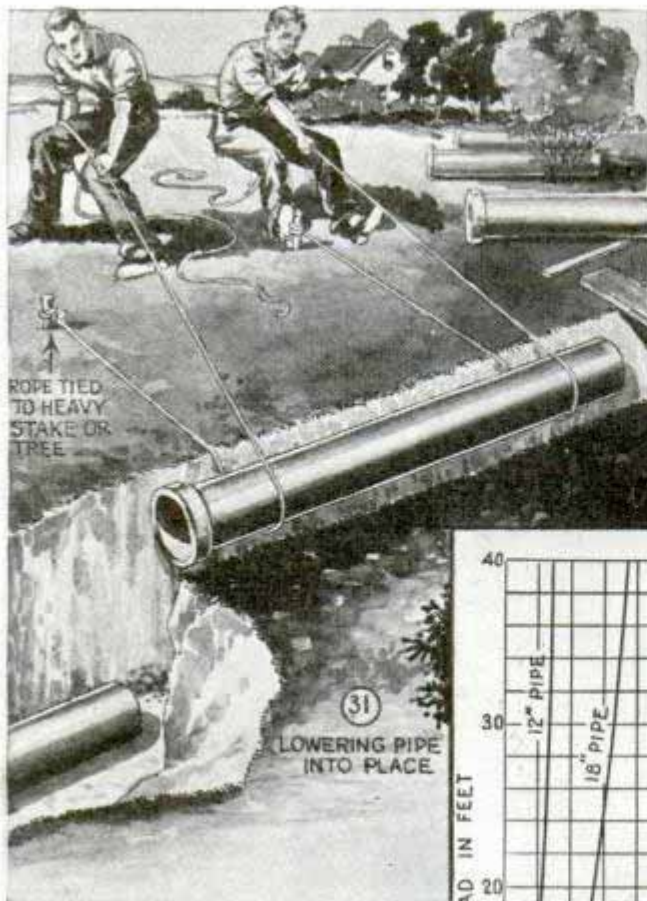


serve as a gate. Each stop log is fitted with a couple of eyebolts to facilitate handling it. The portion of the forebay nearest the head wall should have a concrete bottom. Usually the width of the paving should be twice the height of the head wall but never less than 6 ft. Length and size of the retaining walls are variable with conditions, such as the size of the reservoir, speed of water flow against the banks, etc. Construction of retaining walls is shown in Fig. 28. The width of footing B varies with the height D as indicated in the table. Retaining walls, head wall and paving should be keyed together to prevent seepage.

Size of conduit or penstock: The penstock, which extends at an angle from the forebay to the turbine, should be run as straight as possible, avoiding bends, which greatly increase friction. You can use concrete, tile or iron pipe, having bell-and-spigot type joints. After a ditch has been dug to a depth below the frost line, sec-

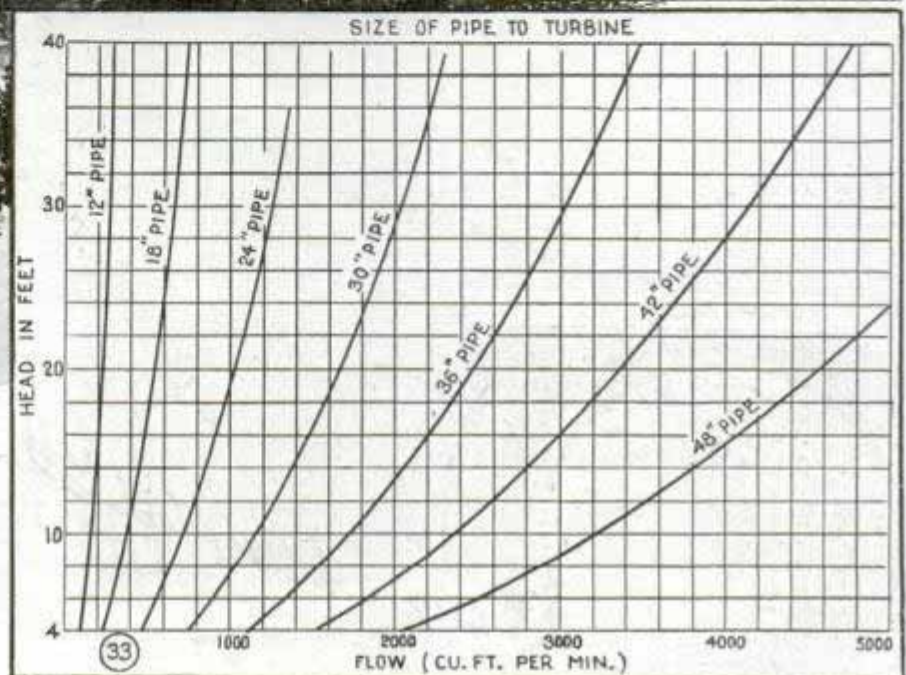
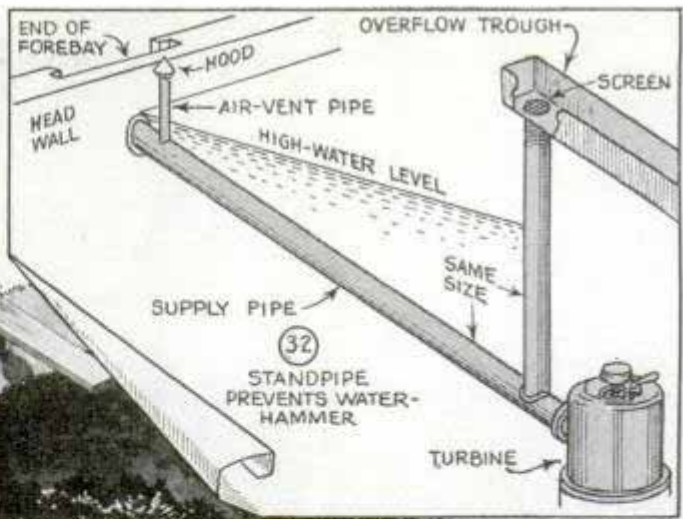
tions of pipe can be lowered into it easily as shown in Fig. 31. If the pipe line is not much longer than 100 ft., you follow the chart in Fig. 33 to select the pipe size required for your installation, which depends on the head of water and on the required flow per minute. Should your requirements be between two pipe sizes, always select the larger size. If the line is longer than 100 ft., you find the size of pipe as follows: Multiply the head in feet by 100 and divide the product by the length of the pipe. Now locate this number, instead of the head, along the left-hand margin of the chart, and find the flow at the bottom, after which the pipe size is selected.

Calking pipe joints: Pipe joints must be calked tightly. Cement mortar is used for concrete pipe, wetting the pipe thoroughly before applying the mortar. To calk tile and cast-iron pipe, you first tamp oakum or hemp tightly into the joint. Then fill up with molten lead, if the pipe is iron, or



ROPE TIED TO HEAVY STAKE OR TREE

(31) LOWERING PIPE INTO PLACE



with cement if the pipe is tile or cement. When pouring, you will have to "dam" the lead with a rag until it sets. After the lead has hardened, it is hammered down to bear tightly against both parts of the joint, to make it waterproof. After completing the pipe line it should be left uncovered for some time to see if any leaks develop.

Air vent and standpipe on penstock: Also, the pipe line should be provided with an air vent and a standpipe as in Fig. 32. The latter must be the same size pipe as the penstock, and it is connected with a T-fitting. It must extend as high as the water level at the headwork. A flume or discharge channel is also provided. Such a standpipe is essential to prevent "water hammer" which occurs when the turbine gates are closed too quickly, and has been known to wreck entire plants. The air vent at the top of the conduit is installed to prevent collapse of the wall on account of a vacuum produced when water supply from the forebay is suddenly stopped by closing the gate.

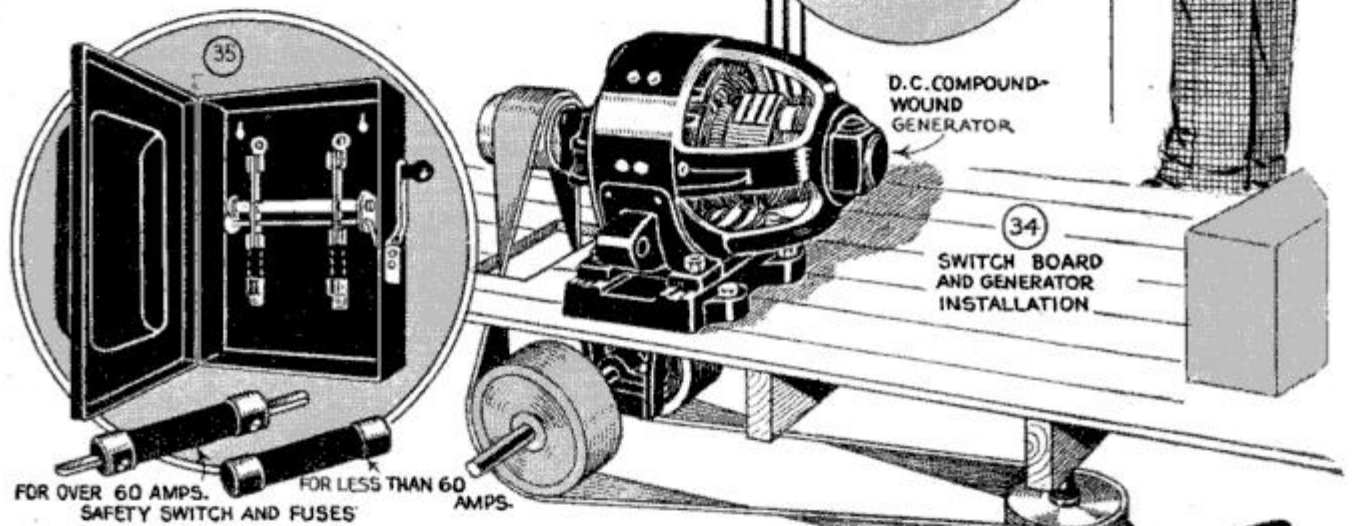
Turbine installation: Horizontal or vertical-type turbines are available. The latter type is shown in Fig. 11 of Part I. A

belt drive with a quarter turn to transmit the power to the generator is shown in Fig. 34. A horizontal type turbine can be coupled directly to the generator. The turbine is installed in the powerhouse, and is supported over a concrete tailrace, which carries away spent water. The penstock connects to the outer case (scroll case) of the turbine. Gates inside of the turbine control the flow of water to the rotating member or "runner" centered in an inner casing. Water is discharged through the draft tube into the tailrace, which should be of concrete and of adequate size to carry off all water. The walls of the tailrace may serve as the turbine support, or steel I-beams or heavy timbers may be placed across the tailrace walls to serve as a support. At this time the size of the turbine needed for the installation has already been determined by methods explained in Part I.

The generator: You can install either a d.c. or an a.c. generator, preferably one

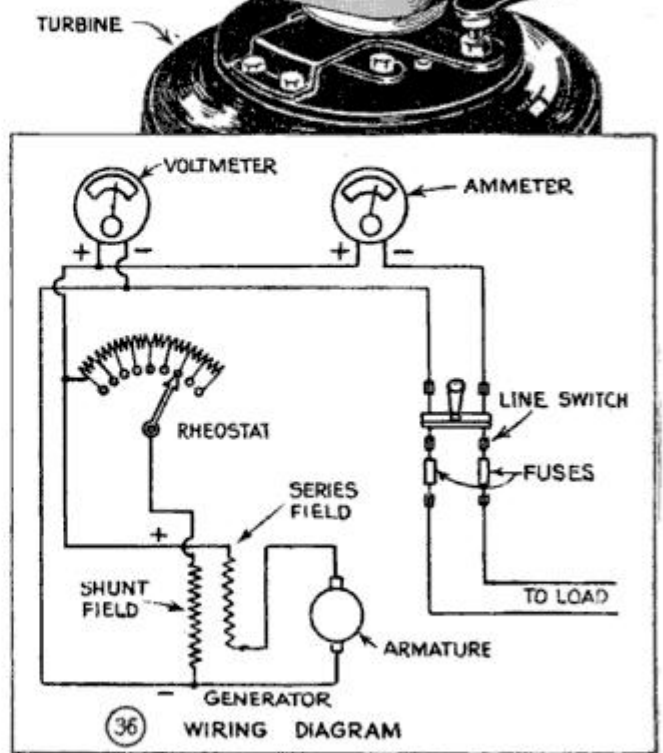
producing 110-120 volts, and of sufficient capacity for the power requirements as outlined in Part I. If an a.c. generator is used, you will have to provide a separate "exciter"—a small generator to energize the field coils of the larger generator. Appliances such as motors must be either d.c. or a.c. to correspond with the generator, and if a.c., there must be similarity of design also in respect to cycles. The capacity of a generator is given in kilowatts (a kilowatt equals 1,000 watts), and as the power demand in watts is known (see Part I), it is easy to convert watts to kilowatts. For example, in Fig. 10 of Part I, 20,000 watts are equal to 20 kilowatts.

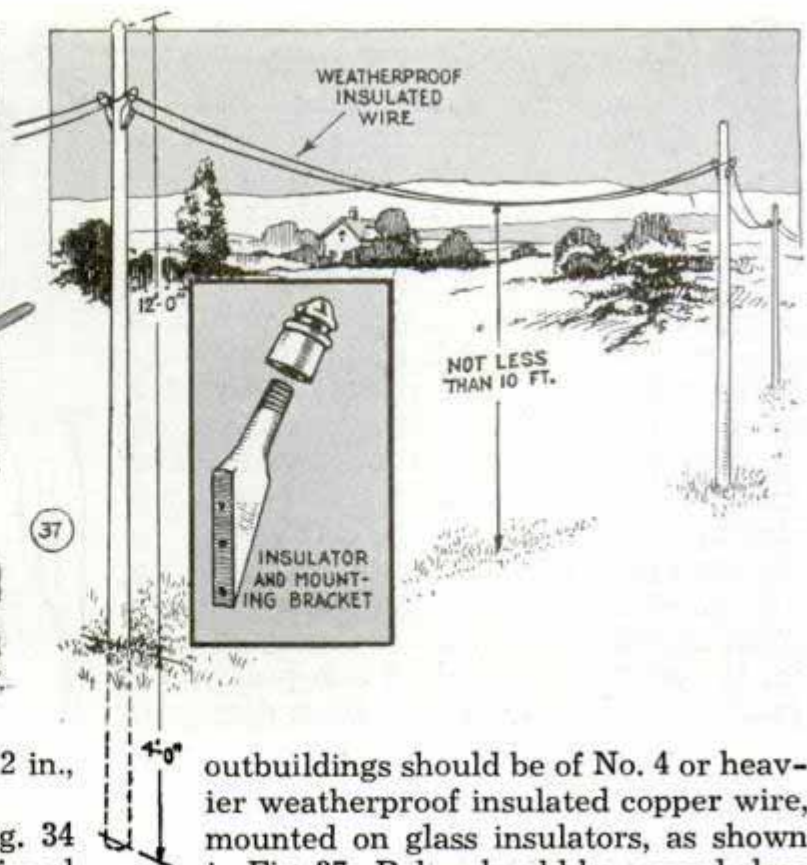
Pulley and belt sizes: To produce electricity at its rated capacity, the generator must be run at a certain speed, which is easy to control by providing the right size pulleys on generator and turbine. Usually a generator comes equipped with a pulley of suitable di-



ameter and width. Suppose that the generator is to run at 1,200 r.p.m., and has a 10-in. pulley. Then the proper size pulley for the turbine is found by multiplying 1,200 by 10 and dividing the product by the speed of the turbine. (See step H of Fig. 10, Part I.) The turbine speed is about 200 r.p.m., and the pulley on the turbine would have to be 60 in. in diameter.

Belt width is also variable and is determined by multiplying the horsepower (hp.) produced by the turbine by 3,050 and then dividing the product by the figure obtained when you multiply the generator speed by the generator pulley size. For example, to drive a generator from a 7-hp. turbine assuming that the generator runs at 1,200 r.p.m. and has a 10-in. pulley, the belt width would be 7 times 3,050, or 21,350 divided by (1,200 times 10) 12,000, which equals 1.8 in. approximately. The next





larger standard belt size, which is 2 in., should be used.

Switchboard and controls: Fig. 34 shows a switchboard fitted with a fused safety switch, a voltmeter, an ammeter and a field rheostat. These are connected as indicated in the wiring diagram, Fig. 36. If you have a d.c. generator, the meters should be d.c., but for an a.c. generator be sure to install a.c. meters. The voltmeter should have a range of from 0 to 150 volts, and the ammeter should have a range greater than the maximum current delivered by the generator. The current of the generator can be found by dividing the power of the generator in watts by the voltage. Thus, a 5-kilowatt, (kw.) or 5,000-watt, generator designed for 125 volts produces a current equal to 5,000 divided by 125, or 40 amperes. Then a 0-50 ammeter should be used. The safety switch should be the double-pole, single-throw type having cartridge fuses as shown in Fig. 35. Fuse size is determined by ampere capacity of the generator; in the above example 40-amp. fuses should be used and the switch rating should be 50-amp., 250-volt, or more, as a matter of safety.

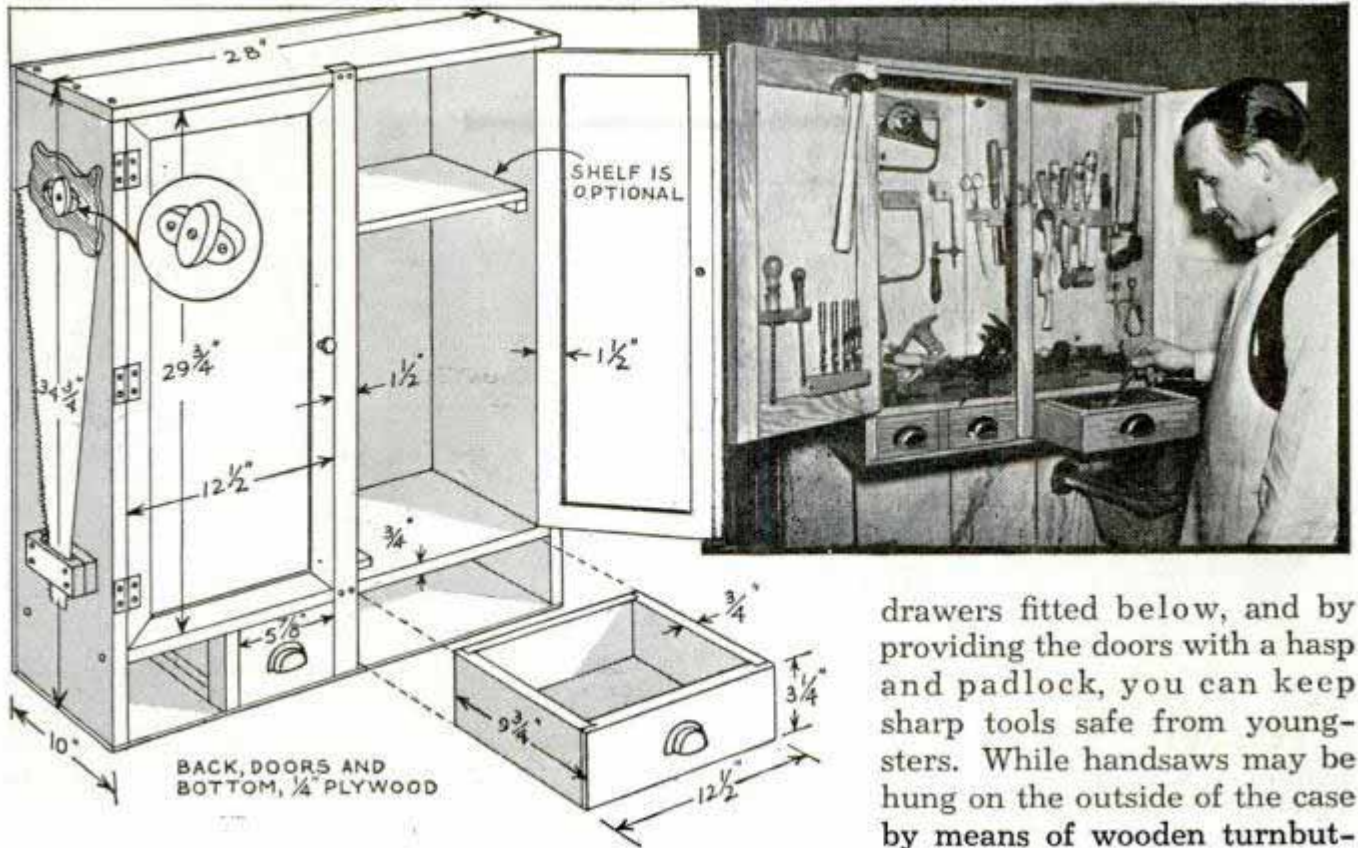
A compound-wound a.c. generator has two fields, a series field and a shunt field. See Fig. 36. To control the output, a rheostat is connected in series with the shunt field. The size of the rheostat needed can be obtained from the maker of the generator and he will also supply a diagram of the generator connections, which should be followed.

Wiring: The pole lines to the house and

outbuildings should be of No. 4 or heavier weatherproof insulated copper wire, mounted on glass insulators, as shown in Fig. 37. Poles should be spaced close enough together to prevent the wires from obstructing passage or otherwise causing a hazard. Inside house wiring should be done with No. 14 or, better, No. 12 or No. 10 standard rubber-insulated wire. It can be mounted by any standard approved methods according to underwriters' and by insurance requirements at the particular location. There are many good books available on house wiring and an article on this subject was published in the July and August, 1939, issues of Popular Mechanics Magazine.

Starting the plant: With the rheostat set at zero and with the switch open, the flow of water through the pipe is started by slowly opening the head gate, having the turbine gates wide open at this time. It is important that this be done carefully as a rush of water may do considerable damage. The gates of the turbine are adjusted so that it turns at the proper speed. Then slowly turn the field rheostat and watch the voltage build up until it reaches 120 volts, which is a very good value to use as the voltage at the plant. Then close the switch so that the current is available at the house for light and power. When necessary to shut down the plant, first open the switch to remove the electrical load. Next turn the rheostat down until the voltmeter registers almost zero. Then the gate at the headwork should be closed slowly and the turbine gates are also closed.

Protect Your Hand Tools with This Cabinet



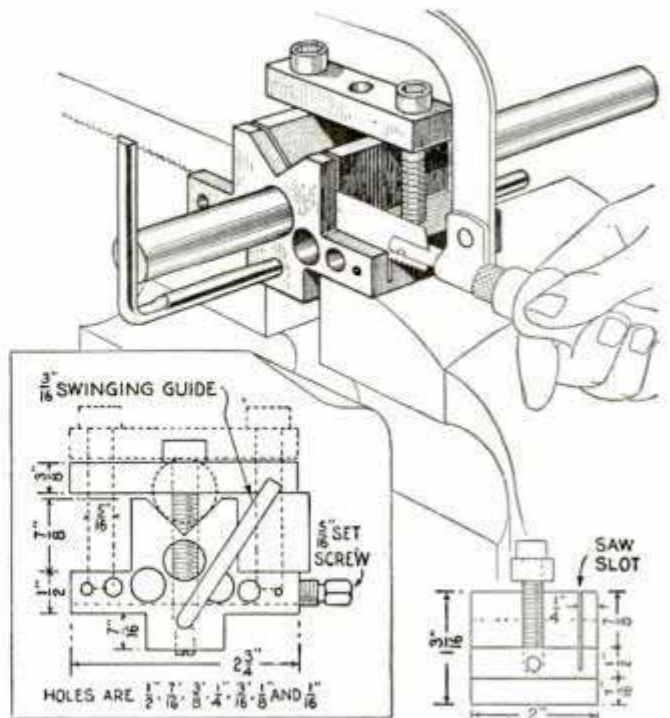
Whether you have a home workshop or possess only a few hand tools for general repair work about the home, you'll find this commodious yet compact cabinet just the thing to keep your tools neatly arranged, free of rust, and less apt to become misplaced. Items such as brads, nails and screws can be kept handy in three small

drawers fitted below, and by providing the doors with a hasp and padlock, you can keep sharp tools safe from youngsters. While handsaws may be hung on the outside of the case by means of wooden turnbut-tons as shown, space can be provided for them on the inside, if desired, by allowing the upper shelf to extend just to the center stile. Solid stock and plywood are combined in the construction, the door panels being fitted in grooved frames mitered at the corners. Use of wood screws instead of nails in the assembly tends to make the cabinet stronger.

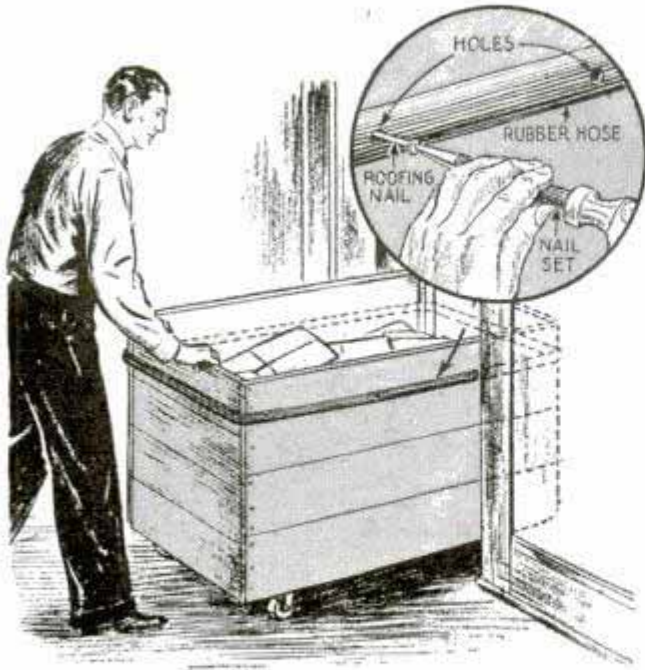
Steel Gauge Holds Metal for Cutting to Identical Lengths

Milled from a small block of cold-rolled steel to clamp between the jaws of a bench vise, this simple cut-off gauge will prove handy when cutting accurately to length short pieces of round or square bar stock. As shown, a series of holes of varying size are drilled accurately through the block lengthwise after which a slot is cut at right angles, parallel to the face, to accommodate a hacksaw blade. The work when inserted in the proper hole in the gauge, is brought to rest against a sliding L-shape stop rod which is locked in the desired position by means of a set screw tapped in the bottom. Square stock can be held securely in the rabbeted ways of the gauge by providing a clamp across the top. A short steel block held by two long screws tapped into the gauge make up the clamp.

—M. B. Birge, Hinsdale, Ill.



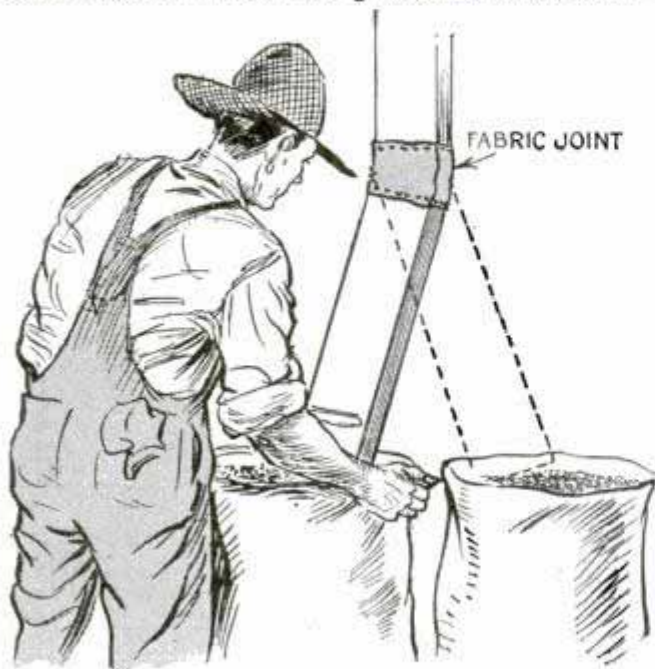
Office Trucks Rubber-Shielded to Protect Woodwork



In offices, stores, and other places where boxlike trucks of the casted type are used to move loads about the building, damage to the woodwork by the trucks can be avoided by shielding the sides and ends with rubber. A length of garden hose is ideal for this purpose, and can be attached with nails or screws. To do this, holes are punched through one side of the hose so that nails can be driven through it.

Hinged Grain Spout Saves Labor When Filling Sacks

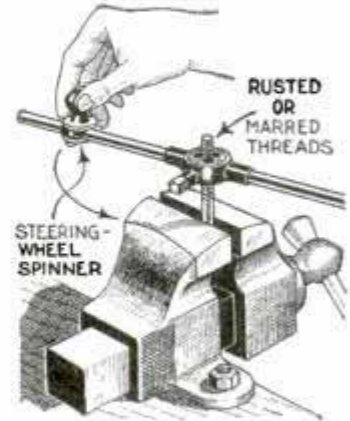
Much of the labor involved in moving sacks or baskets back and forth under a grain spout when filling them can be elim-



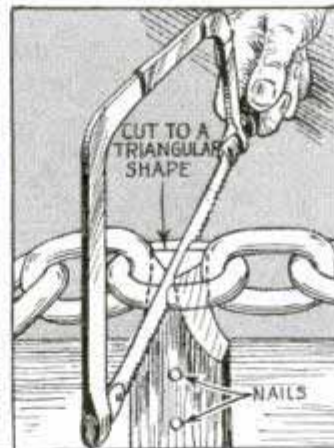
inated by hinging the spout so that it can be swung from side to side. The hinge joint is merely a piece of fabric cut from a discarded grain sack.

Steering Spinner on Die Stock Aids in Cleaning Threads

When I have a number of bolts on which the threads are to be cleaned or corrected slightly, I can save time by using a spinner from a car steering wheel on one handle of the stock. After the stock has been started on the threaded work, the spinner permits it to be rotated with ease. The spinner is also a timesaver on light threading jobs where very little torque is required.—W. C. Wilhite, Carlinville, Ill.



Chain Links Cut with Hacksaw

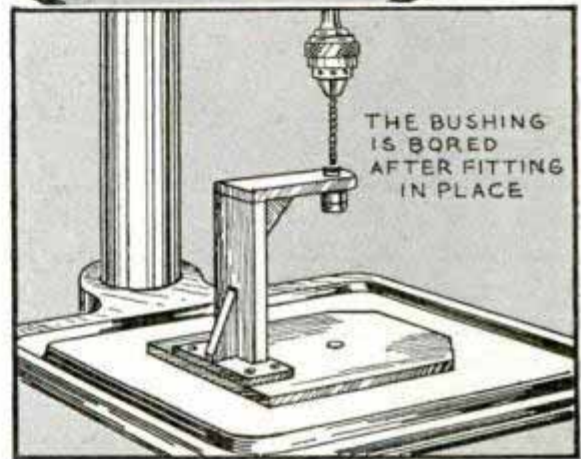
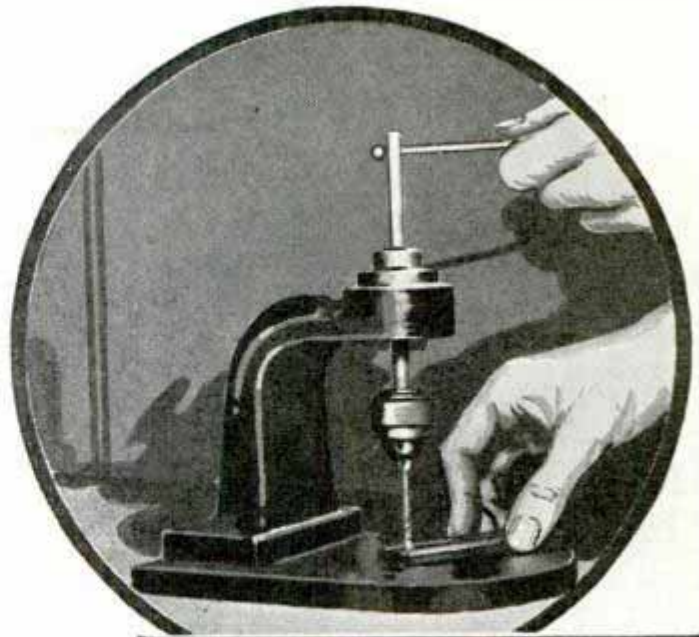
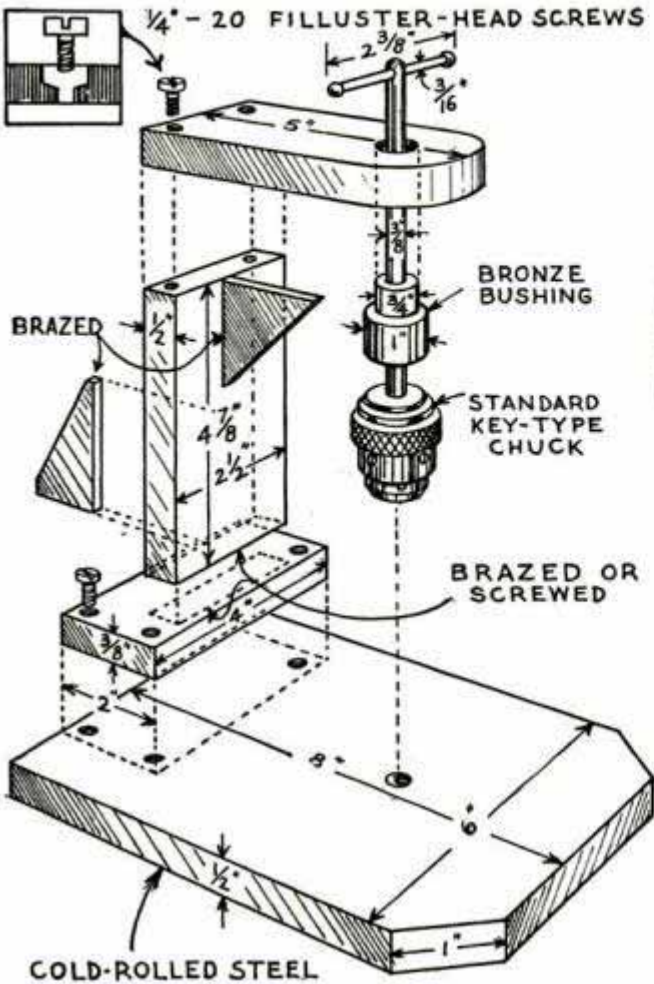


If you are out on a job where it is necessary to cut the link of a heavy chain and the only tool for the job you have at hand is a hacksaw, try the illustrated method of holding the chain. Simply whittle one end of a wood strip to a triangular shape to slip inside the link as indicated. When the strip is nailed to a table or other rigid surface and the link to be cut placed over it, you can saw right through the metal and the wood with ease.

Diluted Acid Stains Wood

A simple wood stain can be made by slowly adding sulphuric acid, 1 pt., to water, 1 gal. The diluted acid burns some of the fibers in the wood, especially pine, and brings out beautiful silver-gray tints. It will not affect the wood by warping or fading it and many floors or pieces of furniture can be given excellent stains by experimenting with different acids.

Hand Tapping Machine Helps Avoid Breakage



One of the reasons for broken taps—starting them at an angle in the holes—is avoided with this simple tapping machine. It starts the taps straight so that they follow through the holes in perfect alignment, leaving a clean-cut thread. In the original machine, the gooseneck shaped part was a junked shaft hanger anchored on a base at right angles to the chuck spindle. However, it can be built up from flat stock if desired. It's best to bore the hole for the chuck spindle on a drill press

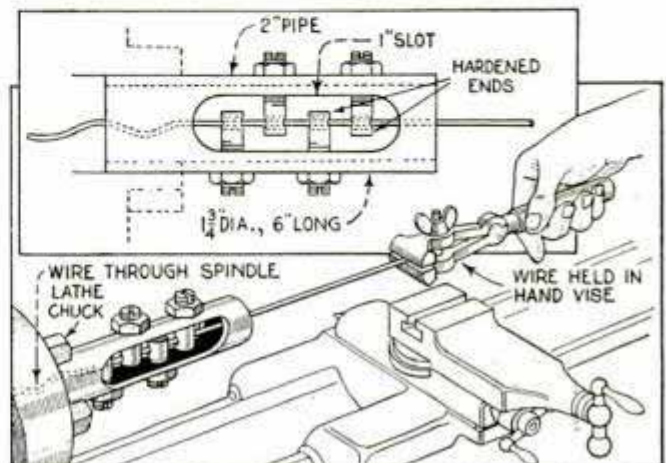
to assure that it will be at a 90° angle to the base. The hole is bushed to receive the spindle. Most any chuck can be used, but it is best to have one that can be tightened with a key or wrench to assure good gripping of the tap. Drilling the shaft near the upper end to receive a handle made from a length of steel rod completes the job.

—V. Everson, West Orange, N. J.

Jig Rotated in Lathe Straightens Lengths of Wire Quickly

Having an order to fill for a number of small pins to be made from 1/16-in. wire, a machinist straightened the wire for the purpose with the jig shown. It was assembled from a turnbuckle, although a casting or short length of pipe will do. In use, the jig is chucked in a lathe and the wire pulled through it as the lathe rotates at high speed, using a hand vise or other clamp with which to grip it to prevent turning. The wire is fed into the jig through the hollow lathe spindle.

—James MacIntyre, Hartford, Conn.

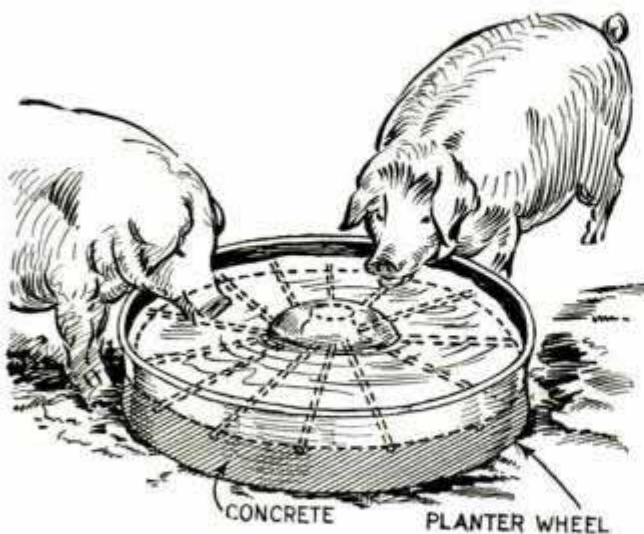


Inflated Sacks Help Store Clerk Select Proper Size of Bag



One grocer who often employed inexperienced clerks on "rush days" found that few of them could select the proper size paper bags from the hangers. Invariably they would take larger sacks than were necessary, thus adding much to the expense for these supplies over a period of time. To avoid this trouble as much as possible, he inflated one sack of each size and tied them above the racks as shown. The clerk, seeing the inflated sack, could judge the size of the one required.

Planter Wheel Provides Trough for Hogs or Poultry

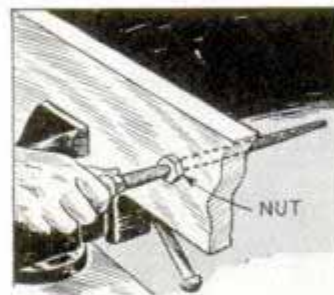


A feed trough that holds liquids for hogs or poultry can be made from an old corn-planter wheel. This is laid on a flat surface and filled up to the spokes with concrete, a

mound of the latter being brought up over the top end of the hub to fill it. Heavy enough to prevent tipping, such a trough is made easily and will last indefinitely.

Nut Acts as Stop on Round File

Reaming out a hole without the file sticking is a simple matter when this improvised stop is used. Just select a nut slightly smaller



than the hole to be enlarged, slip it on the file and tighten with a pliers. When finished, the nut may be removed easily without harming the file.

Locating Flypaper in Window to Make It Inconspicuous

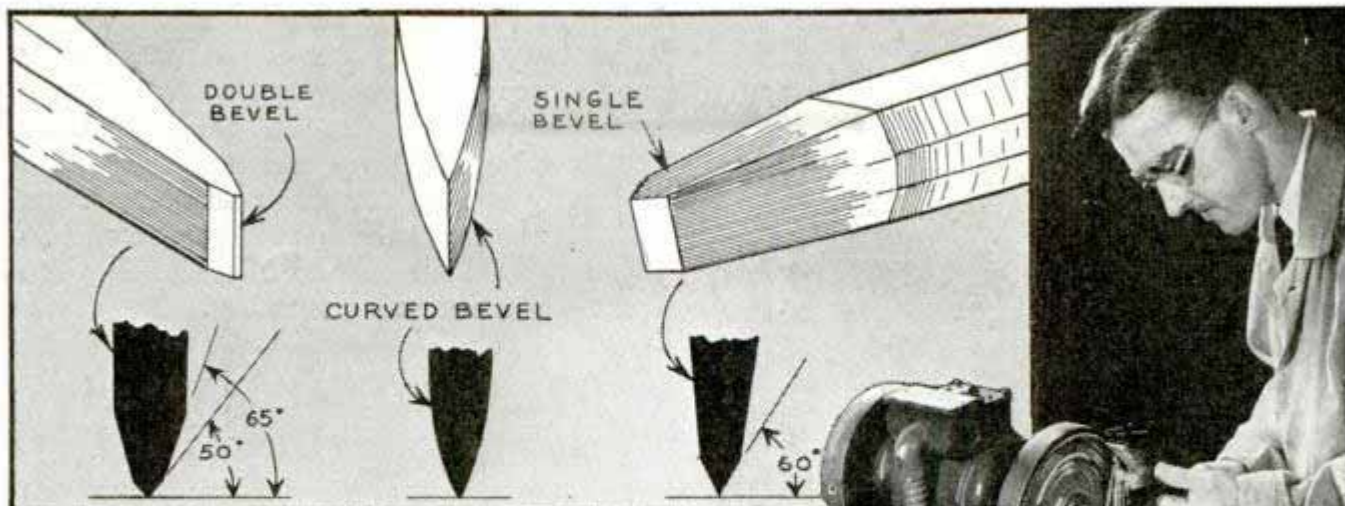


Flypaper hardly will be noticeable in show windows if it is cut into strips about 2 in. wide and cemented along the lower edges of the glass. In this position, it will catch the flies as they crawl along the lower parts of the windows.

Building Blocks Used as Floor in Chicken House

To avoid a damp floor in his chicken house, one poultryman makes the floor of building blocks. First, the ground is leveled off, then the concrete blocks are laid, after which they are covered with a layer of cheap felt roofing. On top of this, concrete is poured to a depth of 2 in. A tile at one corner takes care of drainage.

Grinding Your Cold Chisel to Suit the Work



While the general-purpose cold chisel is ground with a single-beveled edge to best suit all kinds of work, specialized jobs require that the chisel be ground for the particular work at hand. The man who has occasional jobs of the latter type can grind his chisel to suit. To do clean work on thin sheet metal or to make a deep cut in soft metals, the bevel on each side should be ground to a long curve. This type of bevel is also used in cutting off the peened ends of rivets. It will help still more if you flatten one bevel slightly for this work. For heavy work, a double bevel gives best results. The wider angle across the bevels

gives sufficient metal just above the cutting edge to prevent turning or chipping the edge. In the details above, the angles are only close approximations. The exact degree at which the bevels are cut is not so important as it is to have the bevels on both sides cut at the same angle.

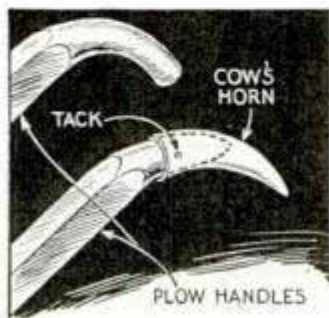
—W. C. Lammey, Naperville, Ill.

Desk Slide Used for Sketching When Hinged in Center

By hinging one of the wooden slides in his office desk as indicated, one executive converted it into a handy and convenient sketching board. Also, he found that the underside surface of the hinged end provided a suitable place to conceal confidential price lists.



Cow's Horn Repairs Handle of Walking Plow



When the curved end of one handle of his walking plow was accidentally broken off, one farmer repaired it for temporary use by slipping a cow's horn over the end. Thus

urgent work was done in the field while a new part was being ordered.

Paper Towels Kept Handy in Auto If Attached to Steering Column

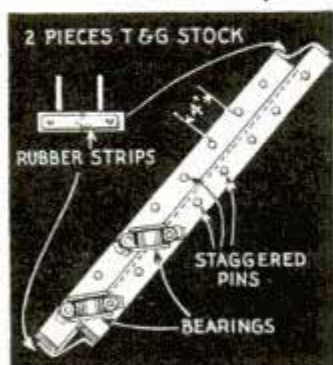


A small-size roll of paper towels will have many uses if kept handy on the steering-post housing of your car. The roll is held to the housing by means of spring clips which allow the roller to be removed easily and at the same time provide enough tension to hold the roll firmly in place.

—Everett Hanson, Argyle, Wis.

Block to Hold Bearing Caps Keeps Them in Sequence

There will be no chance of getting the bearing caps and shims replaced in the wrong positions during a bearing job if you use this sliding block to keep them



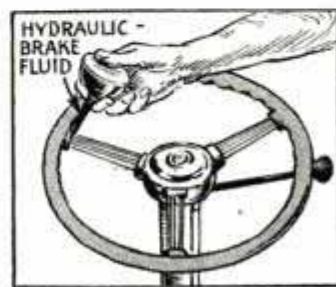
until time for re-assembly. The block consists of two 1-in. pieces of tongue-and-groove material about 2 in. wide. Provide 8 pairs of wood or metal pegs, projecting 2 in. above the surface and about 4

in. apart. The two parts are held together by two strips of inner-tube rubber, one at each end, as shown. As these are stretched tight before fastening them in place, the two parts are held firmly together. Bear-

ing caps, shims and nuts from any make of car are easily accommodated by this holder by sliding one part parallel to the other. This staggers the pairs of pins until they are the proper distance apart for the holes in the caps. When the first cap is set over the first pair of pins, the rest are automatically spaced for the remaining caps. Paint a stripe on the holder at one end so there will be no chance of mistaking the front cap when re-assembling.

Squeaks in Steering Wheel Stopped with Brake Fluid

Creaking noises that sometimes occur in the banjo or shockproof type of steering wheels can be silenced by applying a small amount of hydraulic-brake fluid at



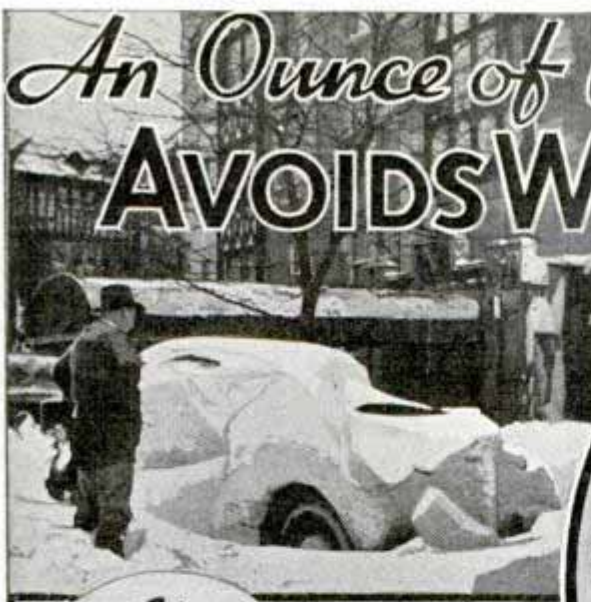
the sockets of the crossbars. Use an oilcan for the purpose, and wipe off the excess fluid.—Emil J. Novak, Omaha, Nebr.

Creeper Rollers on Tool Box Aid Mechanic under Car

The difficulty of sliding a heavy tool box about, while working underneath a car, is overcome by fitting the box with rollers or casters of the type used on creepers. In this way, the mechanic can keep his tools and supplies under the car with him and move them about to be within easy reach.



An Ounce of Prevention AVOIDS WINTER STALLING



② *Be sure about the battery*

NOT unlike your own body, which must be in good condition if you are to avoid illness during winter, your car, too, must be "healthy" if it operates efficiently in zero weather. Besides changing to lighter lubricants you also flush and clean the cooling system for which a number of commercial cleaners are available. It is equally important to check and make minor adjustments on the ignition and fuel systems, brakes and tires before winter starts. While changing lubricants, don't overlook the rear axle and transmission, Fig. 3, which should be flushed thoroughly. Also inspect the water pump, Fig. 1.

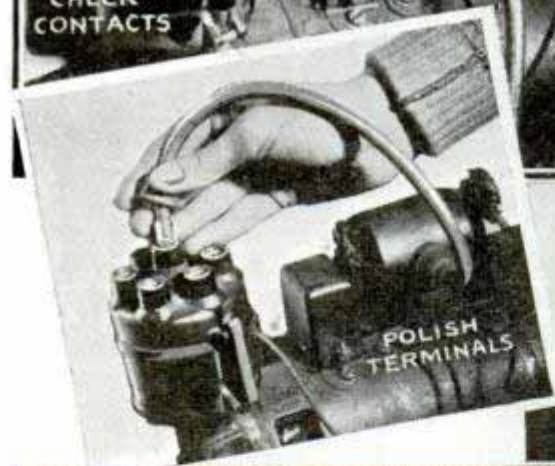
After taking care of lubrication and the cooling system, go over the ignition system, starting with the battery, which is the "heart" of the system. A battery is often damaged by overcharging and overheating on long trips during summer. If the cells vary more than 25 points as shown by the hydrometer, Fig. 2, the battery should be taken to an expert. Low gravity in one cell commonly means that the sep-



Differential cleaned thoroughly

arators are allowing the plates to "short," or that the plates have dissipated much of their active material. Under such conditions, total failure of the battery may result on the first cold morning. Be sure that the terminals are clean and tight, too. To keep the battery charged in winter when electrical requirements are likely to increase and input decrease, be sure that the generator is working efficiently. Fig. 4 illustrates the things to do. Blow out dust and clean the commutator with fine sandpaper. Also, remove accumulations of copper and carbon dust from between the segments with a hacksaw blade ground on

Three generator "musts"



⑤ Don't overlook the distributor

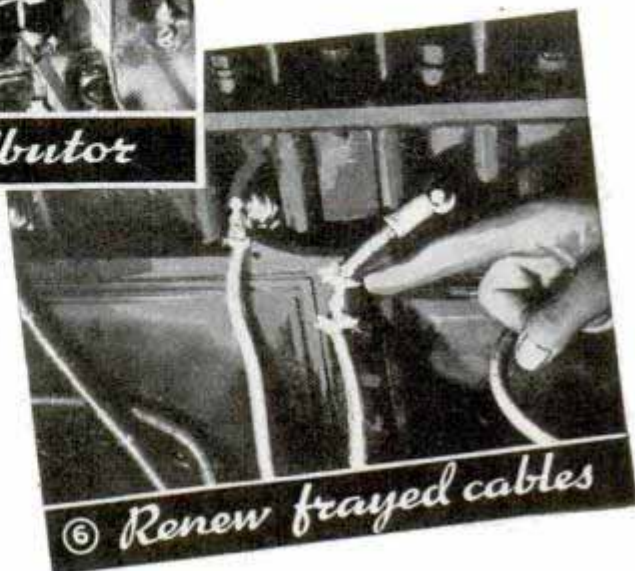
the end to form a hook shape. The presence of such material causes partial "shorts," which reduce output and increase heating. Then with the commutator smooth and clean, put in new brushes if the old ones are oily or appear worn. To be sure that the current from the generator gets to the battery without undue resistance, smooth the generator cutout points with a very fine file.

Spark plugs should be removed and in-

spected. If the points are burned, replacement will pay in easier starting and smoother running of the motor, to say nothing of better gas mileage. If the plug points are in good condition, space them correctly. If no other information is at hand, set them at .025 in. Next comes the distributor, Fig. 5. See that the faces of the breaker points are smooth and square with each other. Unless other information is at hand, space them .018 in., except Fords, which should be .0125 to .0135 in. Now examine the distributor cap for cracks and replace it if any are found. Good plugs and an efficient distributor will not help if the high-tension wires are in bad condition. If the insulation is frayed as in Fig. 6, current will leak, and it should be replaced. Also check the wires in the distributor sockets for corrosion, which sets up a high resistance to the passage of current.

Now for the starting motor. Remove and clean it and put a few drops of oil on the bearings. Most starter bearings are self-oiling, but in time a little oil helps anyway. Then wash off the shaft with gasoline. Do not lubricate the shaft as any oil or grease here may cause a gum that will prevent the pinion from moving forward to engage the gear teeth on the flywheel.

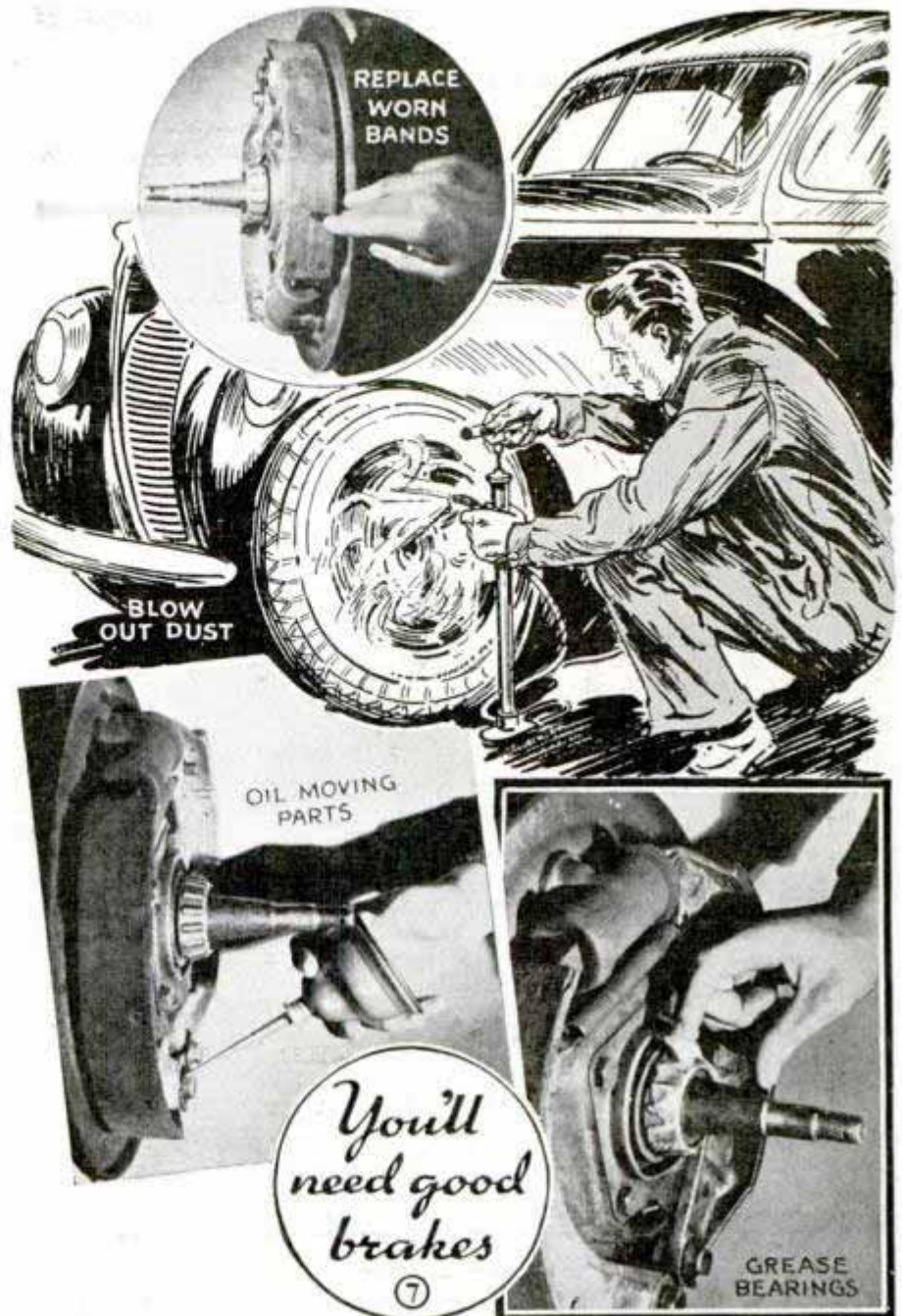
With the foregoing attended to, warm up the



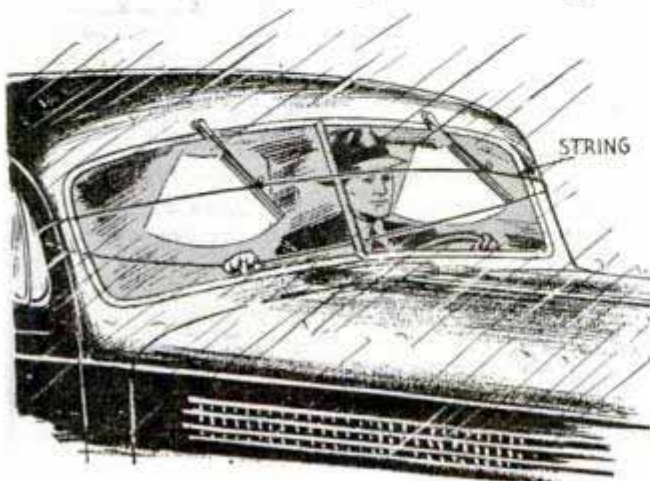
motor and adjust the carburetor so that it runs smoothly. Set the arm of the carburetor accelerating pump on the "W" position for winter operation. Clean the carburetor screens, and don't neglect the screen in the fuel pump. Replace the screen if the least bit damaged, and when reassembling the pump, it is best to use a new cork gasket at the top of the glass sediment bowl. Leakage at this point will cause the pump to fail. Next remove and wash the carburetor air cleaner as well as the one in the breather pipe of the motor. Now is a good time to disconnect the gas line from the pump and blow it out with the tire pump.

Brakes are especially vital in winter, and perfect equalization is essential due to slippery conditions of the roads. Remove the wheels and blow out dust from the drums and shoes, Fig. 7. If not removed, the dust may be wetted when driving on slushy roads and cause the brakes to fail. Inspect the shoes for high rivets. If any are rubbing on the drum, install new lining. Then, aside from the usual service of refilling the master cylinder and adjust-

ing the brakes, all points of movement, such as pins, cams and the like should get a drop of oil. Also, front-wheel bearings should be cleaned, greased and adjusted.



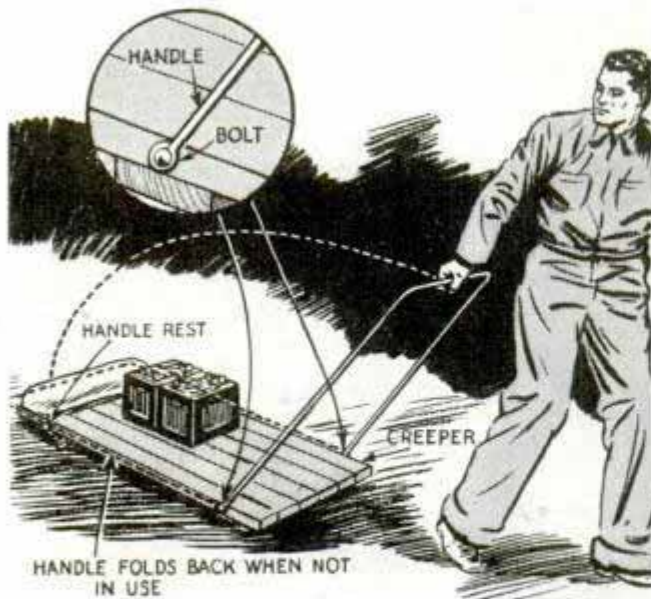
Windshield Wiper Is Operated Manually in Emergency



If you are ever caught in a storm and the windshield wiper fails to work, you can operate it manually with a string. Just run the latter through the openings of the no-draft ventilators and tie the ends to the wiper as indicated. Then by moving the string back and forth with the hand the wiper will clean the windshield.

ⓘ When checking wheel alignment drive straight across the platform. A slight shift of weight or thrust may make the test inaccurate.

Creeper Fitted with Iron Handle Hauls Batteries in Garage



Instead of carrying heavy storage batteries from the charging room to various parts of the shop, one mechanic moves them on a creeper, which he fitted with a handle. When not in use, the handle is swung over to rest on the rear end of the creeper, out of the way.

One Cause of Fuel Pump Failure

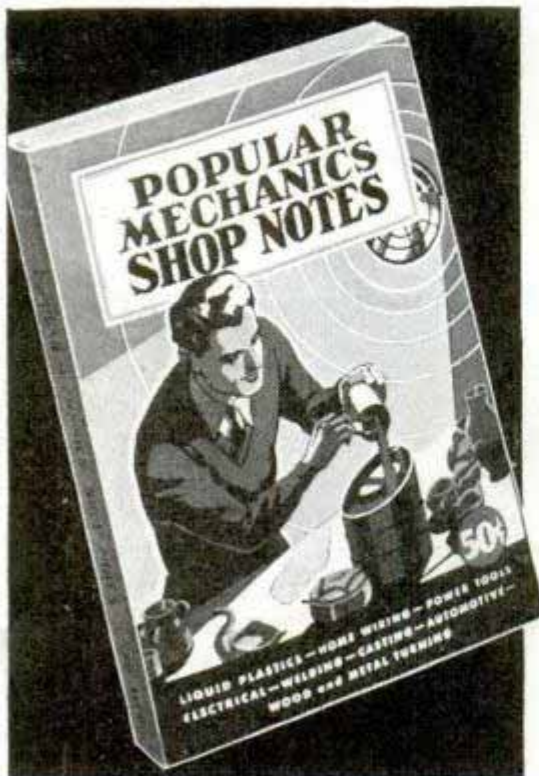
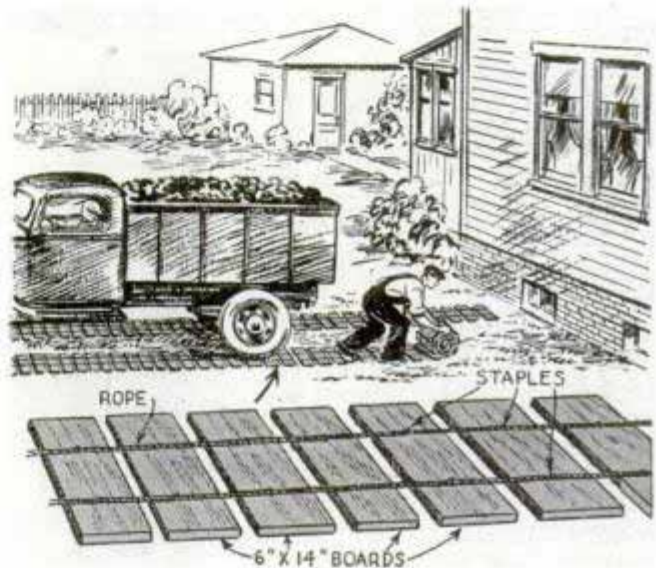
An apparent shortage of fuel at high speed and on hills with a V-type motor was traced to a short stroke in the pump.

The reduction of the stroke was caused by wear of the operating rod connecting the pump arm with the operating cam. A repair was made by welding a small amount of metal to the end of the rod.

—A. H. Vance, Linn Creek, Mo.

Folding Track Moves Coal Truck over Soft Lawns

To avoid cutting up a lawn when backing a coal truck up to deliver coal in a basement, one dealer used these portable tracks. They are made by stapling wide boards to ropes or wire cables as shown. The tracks are made in lengths suitable for easy handling when they are rolled up.



Every Mechanic Needs this Helper

This new volume contains hundreds of practical, money-making, time and labor saving ideas which you will find invaluable in your work. No man who uses tools can afford to be without this book. It contains 192 pages, 298 articles and more than 700 illustrations.

There are articles on woodworking, carpentry, metalworking, electricity, auto mechanics and plastics. Here are just a few of the other subjects covered: Wood joints, castings and molds, new waterproof finish, auto electrical testing, wallboard and how to use it, shadowless light, blast burners, brazing saw blades, building a belt sander, and sharpening joiner knives.

In addition, there are hundreds of hints and short cuts which will help you in your shop, at home or on the farm. Don't miss this new edition.

Price 50 cents

POPULAR MECHANICS PRESS
200 East Ontario Street Chicago



**RAILWAY EXPRESS - SYMBOL OF
DEPENDABLE SERVICE... USES DEPENDABLE
CHAMPION SPARK PLUGS!**

IN CITIES AND TOWNS all over the United States, the familiar Railway Express truck is a symbol of dependable, speedy, safe delivery. Over 12,000 of these trucks are constantly on the go regardless of weather. Dependability is the watchword.

This giant fleet has used Champion Spark Plugs for years. Here is just one more outstanding proof that Champions make every engine a better performing engine—one more sound reason for you to insist on dependable Champion Spark Plugs for your car.

Only Champion Spark Plugs have the Sillment seal which keeps them permanently free from troublesome leakage, common to ordinary sparkplugs. Since only one "leaker" in a set will cause rough, uneven, wasteful engine operation, it is obvious that Champion's leak-proof qualities are necessary to maximum performance and economy. Profit by the experience of the nation's largest and most efficient fleets—of the world's racing champions on land, water and in the air—by insisting on Champions for your car.

MODEL BUILDERS—ATTENTION!

**ACTUAL SIZE
V-PLUG**



65c

Champion Spark Plugs for model gas engines give the same dependable performance as the regular Champions. Sillment sealed. Sillmanite insulator. Alloy needlepoint electrodes for easy starting. One piece construction.

CHAMPION SPARK PLUG CO.
900 Upton Ave. • Toledo, Ohio

| | V | V-2 | V-3 |
|---------------|----------|------------|------------|
| Hex | 1/2" | 3/8" | 5/16" |
| Thread | 3/8"-24 | 1/4"-32 | 1/4"-32 |
| Thread Length | 7/32 | 7/32 | 5/32 |
| Weight, Grams | 8 | 3 1/2 | 2 1/2 |

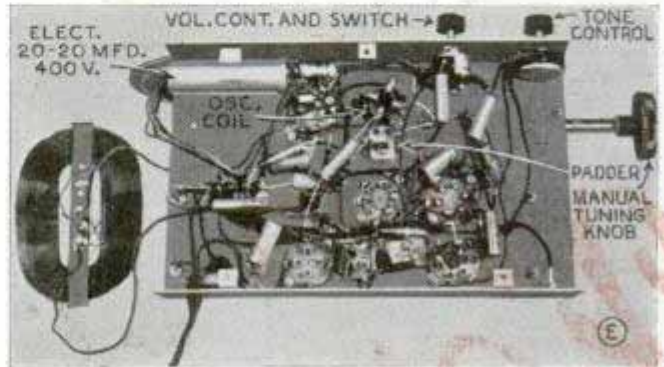
Compact Push-Button A.C. High-Fidelity Five

(Continued from page 617)

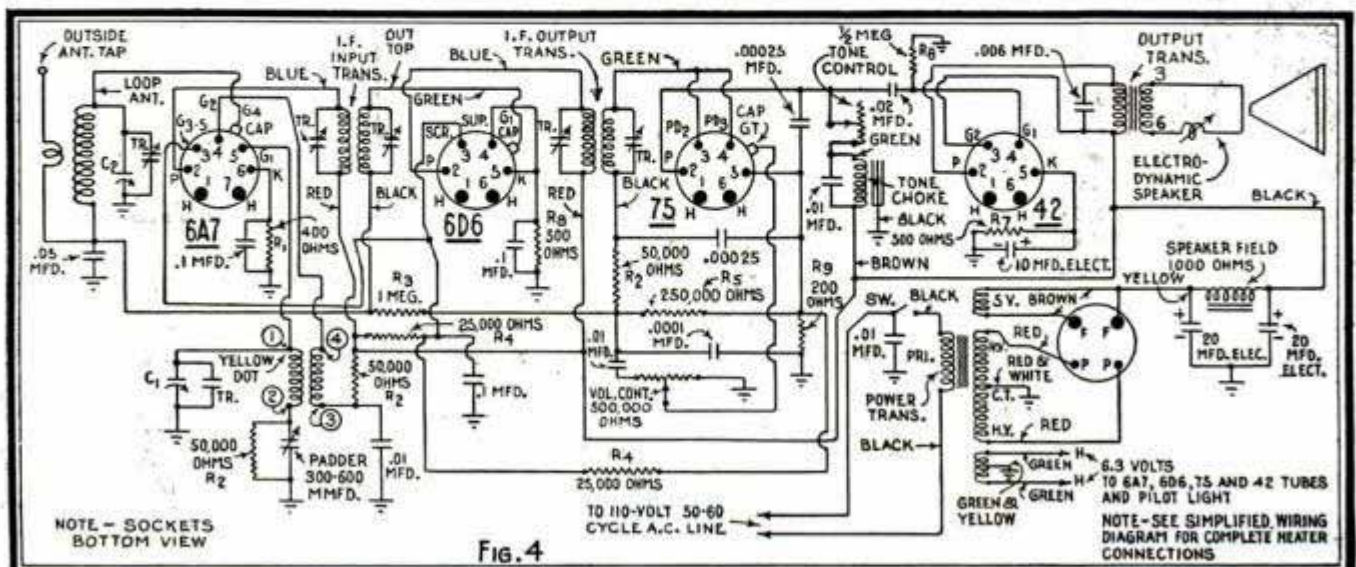
former company. DX-type input and output I.F. transformers are Nos. 5826 and 5827 respectively. The "Crowe" dial assembly and mechanical tuning mechanism is No. 851-A and must include the set of shaft extensions necessary to bring the manual tuning knob out beyond the side of the cabinet. The oscillator coil is a DX No. 2161 unshielded variety. A 2-in. machine screw with 3 half-inch bushings support the 6-in. electro-dynamic speaker directly on the base. This speaker has a 1,000-ohm field and output transformer for the type 42 tube. The volume control is a 500,000-ohm type with No. 6 curve and is provided with a switch. A GE-51 6.3-volt pilot light is used. To take down the manual tuning knob assembly, remove the large screw in the center of the knob; next slide the collar with the knurled end off the end of the shaft, and then unscrew the shaft extension. For assembling, reverse these steps; when sliding the collar on the shaft engage slot and key carefully so as to lock shaft to tuning condenser shaft. A detailed list of materials is available from Popular Mechanics radio department without charge.

To balance the set outside the cabinet: set the loop antenna in a vertical position, and tune in some station with the manual tuning knob, at about 1,500 kc., or, with the ganged condenser plates about seven-eighths out. Turn the trimmer (Tr) on the rear (C₂) section of the variable condenser with a small screwdriver until the station is heard at maximum volume. Next tune the set to a station at about 600 kc., and adjust the padder condenser screw, that

extends through a small hole in the top of the base, at the same time keeping the station tuned in with the manual tuning knob, until the station comes in at the loudest point. The oscillator section (C₁) trimmer (Tr) should be set one-eighth turn from tight. After the above operations are completed, again tune in some weak station near 600 kc. and adjust trimmers (Tr) in the tops of the I.F. transformers for maxi-



imum volume. The set now can be installed in the cabinet as shown in photo (A). Select four of your favorite local stations and set them up in their frequency order in the dial escutcheon windows. To set the automatic tuner, loosen the screw in the center of the manual tuning knob with a screwdriver. Now tune in the first station by means of the manual knob, and, while holding this knob firmly, push down the station button as far as it will go. Repeat this process for the next three station buttons. When all have been adjusted correctly, hold the tuning knob firmly and tighten the screw in the center of the knob. The blueprint number for this article is R-283.



PAUL
DERRINGER
— star pitcher
— star golfer

*2 way
Champ*

**better taste and
aroma for a pipe or
a cigarette!**

**Smoother to handle and smoother
to smoke . . . you win both ways
with Velvet. Best Kentucky Burley
that grows . . . aged for mellow
taste . . . cut for easier rolling.**



Velvet

*the Right Word for
Smooth Smoking*

**MILD and COOL
Positively NO "BITE"**

Copyright 1940, LIGGETT & MYERS TOBACCO CO.

OCTOBER, 1940

115A

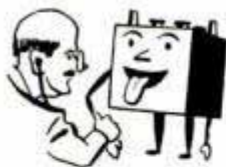
Announcing Willard DRY BATTERIES and FLASHLIGHTS

*New, Long lasting
batteries for all purposes*



● All Willard dry batteries equal or exceed U. S. Bureau of Standards specifications! Dated fresh at the factory. For your flashlights, radio or other use, ask for these new *More-for-Your-Money* Willards.

Safeguard Your Car against Starting failures



● Most starting failures are caused *not by the battery*, but by little things like worn or undersize cables, loose connections or faulty wiring that drain the life out of a perfectly good battery.

Your Willard dealer has a new Starting Service instrument that "X-rays" the entire starting system of your car—locates hidden "leaks" and flaws before they cause trouble. A Willard Starting Service check-up takes only a few minutes and will save you many a dollar—try it!

SEE OPPOSITE PAGE . . .

Willard

YOUR ASSURANCE
OF QUALITY

Freight Trains of the Highway

(Continued from page 565)

ness during the past few years has progressed rapidly. Today it is a scientific industry with many opportunities for young men, whether drivers or mechanics, traffic clerks or platform men.

"Take driver Eddie Lewis and the other skippers of the fast overnights for example. They don't look like the burly truck drivers so often pictured. Not only do they have to attain a high degree of driving skill before qualifying for their jobs, but once employed they have to obey strict rules of healthful living to remain qualified. And they must have plenty of sleep.

"They have to carry their log books right with them. Interstate Commerce Commis-



Stalled by trouble in the Holland Tunnel at New York, a truck is towed out with one "foot" on a dolly

sion men who patrol the roads, state policemen, local peace officers may stop a truck and demand to see the log book. If the log shows a driver has been behind a wheel continuously for more than eight hours he has to do plenty of explaining.

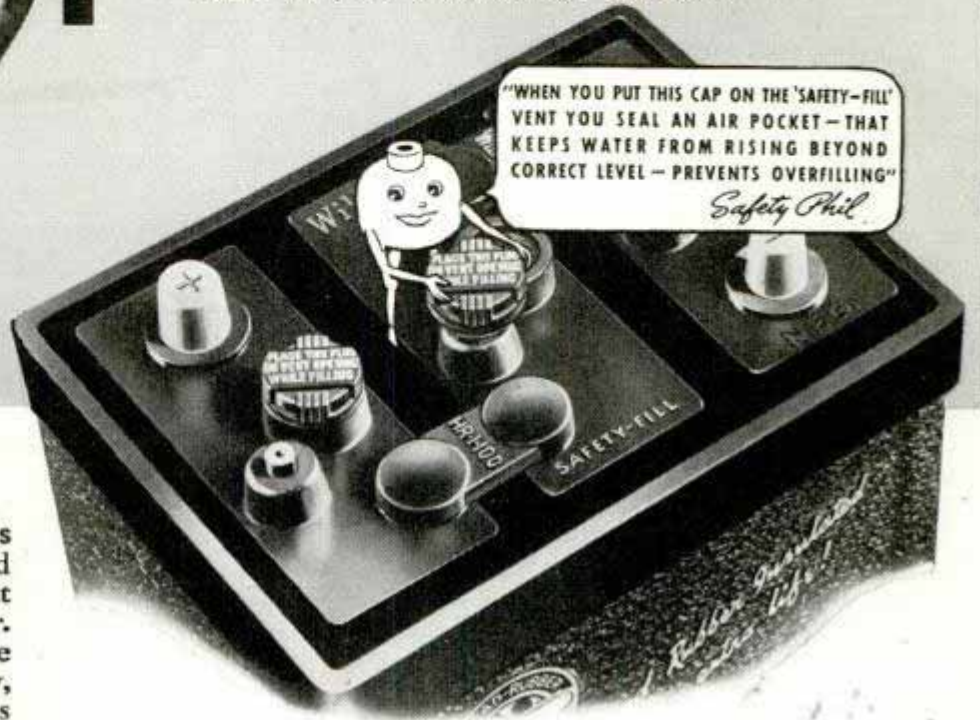
"The big freighters are constantly checked from the time they roll into a terminal until they depart on another run with a full load.

"Every man engaged in operations has a highly important part to play in the maintenance of schedules. For example, the loader has become a specialist. He may load general or mixed cargo, box, barrel, case or crate goods or a combination of all. He has to load that cargo so it won't shift, and he must skillfully compute and arrange its weight distribution. A tractor-trailer may be within the maximum weight requirements of the states it is driven through, but if the loader has not done his

(Continued to page 118A)

New improved Willards give you

4 Extra advantages at NO extra cost!



LONGER LIFE

10-15% more miles and months
—Former Willards were noted for power and long life, but these new Willards are still *better*. This year, Willard engineers have outdone themselves with a new, greatly improved line of batteries that give 10 to 15% longer average life than former Willards —and at *no* extra cost.

MORE RESERVE POWER

Plate materials increased 7-9%
—Heavier elements go into each cell of the new Willard batteries—either thicker plates, heavier plates or more plates. That means not only more life but more reserve power. These new Willards easily handle the extra current demands of modern cars—and like it.

GUARANTEED CAPACITIES

You know what you're getting
—Willard has clearly and permanently molded the guaranteed ampere hour capacity in the case of each new Willard battery. It's in plain sight. You see exactly what you are getting. And you pay *only* for what you get. It's a guarantee of *full* measure of battery value for your money.

"SAFETY-FILL" CONSTRUCTION

Stops Dangerous Corrosion

No acid spray on motor and wiring—With "Safety-Fill," your Willard battery never drinks too much. It's very simple. Very effective. This exclusive new device prevents overfilling—definitely protects your automobile against corroded cables and terminals that cause current

losses and unexpected starting failures.

Your Willard dealer has these **NEW** batteries now. Look for his red-and-white Willard sign, or the name Willard in the classified section of your phone book under "Batteries."

WILLARD STORAGE BATTERY COMPANY

Cleveland • Dallas • Los Angeles • Toronto

Willard

SAFETY-FILL BATTERIES



MORE BATTERY FOR YOUR MONEY!

work with precision, there may still be an overload on an axle or wheel."

The tractor-trailer combination seen in increasing numbers on America's vast network of roads may carry a load of "sealed freight" that was gathered from a hundred different firms in the city by pickup trucks or fliers. A large department store in New York City today may advertise a big clothing or food sale for tomorrow although the merchandise is still in a city 300 miles away. A manufacturing plant in Binghamton may need raw material from Newark by the following morning to keep up its production schedule, or a restaurant in Jersey City might require a barrel of oysters from Baltimore immediately.

At the Hoboken depot of W. T. Cowan, Inc., as in terminals of other large overnight freighters throughout the country, huge trailers are backed up against a long loading platform. On the other side of the platform speedy little fliers that gather freight locally are unloading. A continuous stream of loaders hurry the freight to the various trailers marked, "Baltimore," "Washington," and other cities, and begin stowing the cargo. When a "leaker" is

discovered—generally barrel goods which may dribble liquid—sawdust is piled around it to protect the rest of the cargo.

"While this is going on," Mr. Coughlin explains, "the tractors are being checked carefully from headlights to tires. The dual tires must be in perfect condition. So must the motor and every other mechanical detail. When the trailer has been loaded, it is sealed, the seal not to be broken until the destination is reached. Then the tractor is connected to the trailer, and the booster or air brakes are hooked up.

"The complete unit is inspected to see that everything is functioning properly. Then the driver is called. Before he gets into the cab he gets his safety box, containing flares, a red flag, fire extinguisher, fan belt and special equipment. The operations chief makes sure he's in perfect physical condition. Then only is the cargo ready to roll."

And roll it does, through the streets and onto the highways where Eddie Lewis and thousands like him are driving their big freighters on fast schedules, following the rules of the road and safety, setting an example for millions of other drivers.

Keeping Tab on the Sun

(Continued from page 571)

tion of a second that it takes for the edge of the moon to shut off the light from a star. Using a supersensitive photoelectric cell to register the fading light, the interval between the time the moon begins to cut into the light from a star and the time the star completely disappears is measured and this information, together with other data, gives a close measurement of the star's size.

The universe is full of celestial shadows because each star in the light of another casts a faint shadow. A big star, blocking off light from a smaller one, throws a shadow in the shape of an endless megaphone. Stars of equal size create pencil-like shafts of shadow that extend to infinity. Such shadows, of course, are not apparent to us because one star that hides another is constantly radiating its own light. The Milky Way, the galaxy in which the solar system is situated, contains some fifty billion stars and it is estimated that these stars cast something like five trillion shad-

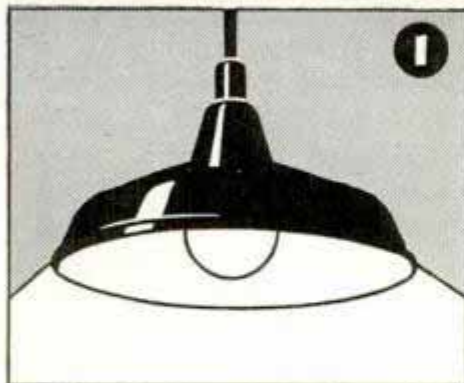
ows. Now and then, as in the case of two stars that revolve around a common center and that are called eclipsing binaries, the lack of light from one star during the time it is hidden behind the other gives astronomers information that they can't learn by studying the starlight alone.

Much as is known about stars in distant corners of the universe, the creation of our earth still remains a mystery. For a long time it was thought that the solar system was originally a whirling gaseous mass that eventually condensed into the sun and planets. The trouble with this idea is that the sun is too large and the planets are too small for the angular motion of the original gaseous cloud. More lately it has been supposed that the planets were born when another star passed close by the sun and pulled hot material out of the sun's mass. This year it was determined mathematically that such material would expand at such a rapid pace that the planets would

(Continued to page 120A)

GOOD LIGHT

the most important tool in your Home Workshop

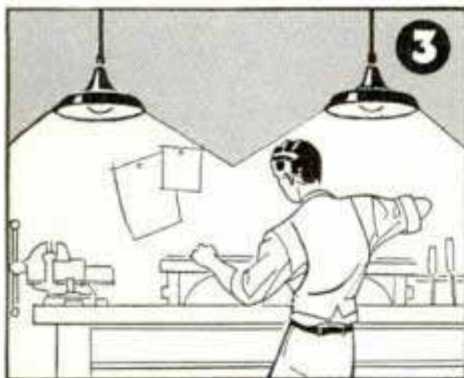


TRY THESE TIPS to get more out of it

1. In a small home workshop you need at least two 150-watt G-E MAZDA lamps in RLM reflectors. Be sure to mount units *over front edge* of bench, not halfway from front to back; you'll see pencil marks better.



2. For better light, put a 150-watt Silvered Bowl G-E MAZDA lamp in each reflector. The mirror-silvered reflector built into this bulb gives you generous, diffused light for easier seeing.



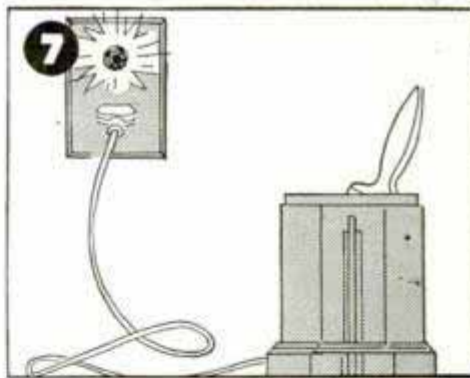
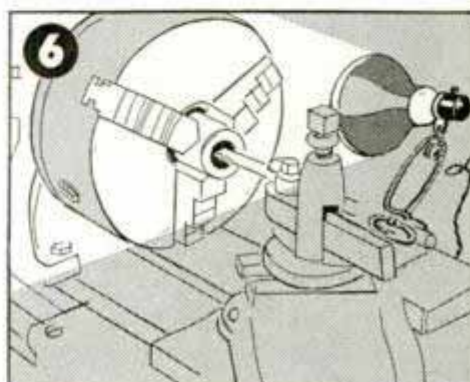
3. In a larger shop, you need more of these units. To have even lighting along the work bench, the distance between units should not be more than one and one-half times the distance from unit to bench.

4. For flexibility, some workers like this "trolley" lighting system. Lighting units glide on a "live" but protected channel... commercially available... to bring you light where you want it.



5. Need "daylight"?... for painting or other color discrimination? Look into fluorescent lighting with the new G-E MAZDA F "Daylight" lamps. It's cool, pleasing and abundant... in daylight quality.

6. Horizontal boring and many another job in workshop or home becomes easier with a handy utility light like this... a G-E MAZDA Reflector lamp in clamp-on socket, that helps you put light wherever you need it.



7. Avoid trouble, save steps and time: Use G-E MAZDA lamps (10c) to indicate "live" circuits... warning that your glue-pot is on... telling you, upstairs, that basement and bench light are "on."

8. Be sure that the lamp bulbs you use for your home workshop and *all over your house* are G-E MAZDA lamps... the kind that are *made to stay brighter longer.*

8

150-watt
20¢

150-watt
Silvered Bowl
45¢

150-watt G-E
Reflector lamp
85¢

G-E MAZDA LAMPS
GENERAL  ELECTRIC

SECRETARIES SURE COME SMART THESE DAYS

(Continued from page 118A)



YOU'RE WRONG. The gal on his lap is not his secretary. It's his wife. She's admiring that smooth, fresh-feeling Barbasol

Face his secretary told him to get. No harsh irritants in modern Barbasol to dry, tighten, coarsen the skin. Only bland ingredients that soothe the skin as well as soften the beard. Try Barbasol and see what wonders it works with your face in ten short days or so.

YOU'RE RIGHT. He does have tender skin but shaves with Barbasol—with pleasure! Here's the secret! Barbasol is modern. Soothing, cooling cream that it is, Barbasol does the job of old-fashioned preparations without raising red with your skin. Quickest, cleanest, easiest, best-feeling shave you ever had. Try Barbasol and see. Three sizes: large tube, 25¢; giant tube, 50¢; family jar, 75¢. Five Barbasol Blades, 15¢.



For Modern Shaving
No Brush · No Lather · No Rub-in

not have had a chance to form, an objection that also applies to the idea that the sun once flared up and threw off the planetary material. Today the way the earth and the other planets were formed seems to be as great a mystery as ever.

A century ago astronomers who were trying to account for discrepancies in the orbits of the known planets believed that an undiscovered planet that they named Vulcan would be found close to the sun. The belief was supported when a small black disk was sighted against the sun's surface, then disproved when the disk was revealed as a sunspot. Vulcan was sought for until 1915 when Einstein's theory of relativity, applied to the solar system, explained planetary movements without the need for an additional one close to the sun.

Recently when Mars and the earth were comparatively close to each other in their orbits around the sun, several radio stations stood guard to receive any interplanetary signals that might pierce the atmosphere. Astronomers can't decide conclusively as to whether or not there is life on Mars, but one of them suggests that if there really are Martians they may be listening for signals from us just as we have been waiting for them to signal the earth. There is no reason why we shouldn't try to initiate the conversation, he adds, since there is already evidence that under certain conditions short-wave radio signals escape through the earth's atmosphere and are reflected back again from the moon.

Home Was Never Like This

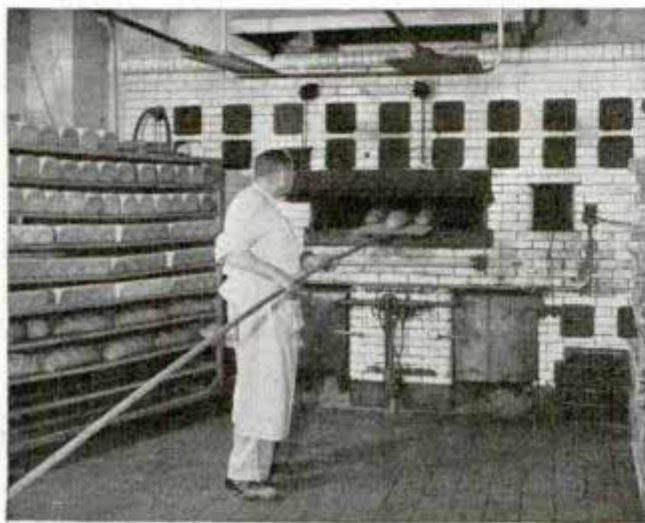
(Continued from page 574)

Dry cleaning is entirely automatic. The valet looks over the garment to determine the formula required, then selects a "record" for that formula and plays it on the machine. This mechanical formula resembles a phonograph record slotted to play on a player-piano. It really is a time switch, the punched-out parts permitting electrical contacts at predetermined times.

As the machine starts, this "record" automatically admits the correct amount of cleaning fluid, revolves the drum slowly the required time, periodically reversing the direction. Then it stops the drum, drains the fluid, then revolves the drum rapidly to extract the remaining fluid by

centrifugal force. Meanwhile it turns the heat on the still, starts water in the condenser, to clean and recover every last drop of the fluid. Finally the drum is stopped while a deodorizer is admitted, after which it whirls again to extract this fluid, which also must be run through the still. The whole process takes twenty minutes.

The hotel's electric plant in the subbasement supplies current to run the elevators, light 25,000 electric bulbs, recondition the air. The hotel itself contains 1,020 miles of electric wire, and this doesn't include wiring for the 3,340 telephones. Two huge compressors furnish air for the pneumatic tubes, the laundry presses, and to agitate the ice. A central vacuum cleaner in the subbasement has 324 outlets. There are



This isn't the entire bakery, it's merely the shop where bread and rolls for hotel patrons are baked

112 miles of plumbing pipes, carrying hot, cold, and ice water to the 2,200 rooms. In summer 15,000 gallons of ice water are cooled each day, while 45,000 gallons of hot water are used—half a barrel a second.

The hotel has its own fire department, with as large a personnel as you will find in a city of 100,000. Every male employe is a member, has his own station, his special duties to perform should the alarm be sounded. There is a fire truck in the basement, with hose, chemical extinguishers and smoke masks, yet small enough to ride the elevators.

The telephone switchboard is the largest private exchange in the world, its thirty-five operators handling 250,000 calls a month. For three hours each morning seven operators do nothing but awaken guests. Supplementing the telephones are

(Continued to page 122A)

DOES BOTH JOBS AT ONCE!



DU PONT **SPEEDY WAX** (LIQUID)

- Putting a wax polish on your car isn't the long, tough job it used to be. With Du Pont Speedy Wax, you can now *clean* the finish and give it a beautiful wax polish in one easy operation. You do *both* jobs at once. Speedy Wax, is fine for all car finishes.

WANT A SAMPLE?



**DU PONT, Chem. Spec. Div.
Dept. 6-MP, Wilmington, Del.**

Please send me a generous sample of Speedy Wax. I enclose 6¢, to help cover postage.

Name _____

Address _____

City & State _____

(Offer good in U. S. only)

SCRATCHED FENDERS can be made to look like new. Use DU PONT TOUCH-UP BLACK. Dries in 30 minutes.

W.O.O.O.O! 10¢ WORTH
OF **SANI-FLUSH**
WOULD CLEAN
OUT THAT
RADIATOR!



DON'T RISK unnecessary repair bills due to clogged radiators. Keep water circulating freely—keep motors running cool—with Sani-Flush. Cannot injure motor or fittings. Removes rust, sludge, scale, sediment. Keeps the delicate veins of a radiator clean.

Do the job yourself in a few minutes for 10c (25c for the largest truck or tractor). Or ask your service station to use Sani-Flush to do the job for you. You'll find Sani-Flush in most bathrooms for cleaning toilet bowls. *Directions are printed on the can.* Sold by grocery, drug, hardware, and 5-and-10c stores. 10c and 25c sizes. The Hygienic Products Co., Canton, Ohio.

Sani-Flush

CLEANS OUT RADIATORS



BUILD A MIDGET CAR OR SCOOTER

WE SPECIALIZE IN WHEEL SETS, ENGINES, ETC. for building Cars, Scooters, Trucks, etc. We carry only the best at the lowest prices. SEND 10c FOR PARTS CATALOG AND PLANS for three Midget Racers, Scooters and other vehicles. It pays to use only reliable plans and parts—We guarantee satisfaction. Bld-Ur-Own Devices, 536 No. Parkside, Dept. PM10, Chicago

USE BILD-UR-OWN PARTS AND SAVE MONEY

NEW BENJAMIN AIR RIFLES WITH HAND PUMP

MADE IN U.S.A.

HARD ACCURATE SHOOTING WITH CHAMBERED AIR

You can use new model BENJAMIN AIR RIFLES WITH LEVER HAND PUMP anywhere, for practice firing or just plinking, around the house or camping, fishing, hunting, etc., at lowest cost. Shooting force is adjustable with amazing maximum power and accuracy—no recoil or forward lunge to disturb your aim. Bolt Action-Hammer Fire-Hair Trigger-Safety Lock-Hand Pump. Single Shot BB \$7.50; Single Shot Cal. 17 or .22 with rifled barrel \$8.50; BB 22 Shot \$9.00. Also a complete line of BENJAMIN GENUINE COMPRESSED AIR PISTOLS from dealer or factory. Write Today for details and Targets. BENJAMIN AIR RIFLE CO., 895 Marion St., St. Louis, Mo., U. S. A.

.22
.177
BB

(Continued from page 121A)

several miles of pneumatic tubes, three telautograph systems, and a private teletype, all for the speedy transmission of messages.

Does the faucet in your room drip? You tell the operator, who writes a message on the telautograph. A woman in the message center tears off this note, places it in a tube cartridge, where it is shot by compressed air direct to the plumber in the subbasement. Does somebody call you when you're out and leave a message? The operator writes it on the telautograph, and the pneumatic tube shoots it to your floor clerk, who hands it to you when you ask for your key upon returning.

A big hotel is really a complete city under one roof. One could come to New York over any of several railroads, step directly from the station into the lobby of half a dozen of the biggest hotels. Using the subway system and underground walks, he could shop in the department stores, do business in many office buildings, attend the theater without ever stepping out of doors. He could even undergo a major operation in the hotel's own hospital.

He could have breakfast served in bed, find a newspaper under his door, have his bag packed, his dress suit laid out, his necktie tied. And everyone who served him would greet him by name.

Home was never like this.

K834

Gaseous Iron "Jackets" of Stars Tell Secrets of Metals

Atomic secrets of some important earthly metals may be learned from a study of the gaseous iron "jackets" that encase certain stars. These metallic shells are at temperatures far above the boiling point of iron, and at this intense heat the atoms give off peculiar kinds of ultraviolet light incapable of reproduction in scientific laboratories, and thus called "forbidden" radiations. The forbidden radiation usually occurs in double stars, rarely in single ones. Physicists believe they will obtain from these radiant gas jackets information concerning chromium, iron and titanium which can not be obtained on earth.

Send stamped, addressed envelope to our Bureau of Information for name of maker of any device described in this magazine.

K834
 9/16/46
 Stunt. U.S. Observatory.
 Cells
 Bell. W. W.
 Williams

Big Capacity ... Low Price ... More for Your Money

FIRST time ever offered! Notice the quality—capacity—and table size! We honestly believe you can't match it anywhere in this price range!

Important features are: sturdy new-type jaws accommodate practically all kinds of jig saw blades; coil-type spring, fully enclosed, means no blade whip. Frame is very strong, heavy and rigid with base extending entire length of the machine to give firm vibrationless support for smooth, accurate performance; has adjustable hold-down for work and guide for blade; many other features.

The large table and the large throat distinguish this machine. These and its heavy duty construction make it a real \$20 value. At Sears' low price it is an outstanding value for every home tool shop. See it at your nearest Sears' retail store; buy it on Sears' easy terms. Ask for Dunlap Jig Saw No. 99-2266. Only \$14.95 for the next 30 days.

SEARS, ROEBUCK and CO.
Stores Throughout the United States

A real \$20 Value \$14⁹⁵
30 Day Introductory Price
New 18-inch JIG SAW

Sturdy, Rigid, Extra-heavy Frame for Smooth Vibrationless Operation

Mechanism Runs in Oil Bath like the Crank Case of Your Automobile



Full 18-inch Throat for Large Work

Built-in Light for better vision.

Extra Large Ground Gray Iron Table 12 x 12 in.

CALBAR CAULKING COMPOUND

A weather proof, non-staining plastic substance that holds fast, unaffected by Heat or Cold. Seals openings around Door & Window frames for regulated Heat Control & Air Conditioned Buildings. Sold by Paint & Hardware Stores or ask your Contractor.

Calbar Paint & Varnish Co., 2614-26 N. Martha St., Phila., Pa. Manufacturers of Technical Products



SAFE!

"Prestone" anti-freeze is so safe, so completely dependable, that it has again been selected to protect the vital equipment of the U. S. Defense Forces!

See Inside Front Cover and Inside Back Cover

NEW TURN SIGNAL

FLASHES from REAR WINDOW—DASH Control

AGENTS A whirlwind seller. Drivers buy on flash demonstration. Dealers buy 3 to 12. Your profit mark-up as high as 204%. Biggest sensation of year. Rush name quick for facts and Demonstrator sample plan. All Free! Rush. WATCH-MY-TURN SIGNAL CO., Dept. W-1610, Walnut Bldg., Des Moines, Iowa

DO YOU WANT a new business profession of your own, with all the trade you can attend to? Then become a foot correctionist, and in a few weeks earn big income in service fees,—not medical nor chiropody—easy terms for home training, no further capital needed, no goods to buy, no agency. Established 1894. Address Stephenson Laboratory, 1 Back Bay, Boston, Mass.

Earn \$150 to \$300 Monthly with "Simplified" Arc Welding

30 Days Trial
Try this new "Simplified" Welder on your own work, in your own shop for 30 days at our risk. It pays for itself.



BUILD A PROFITABLE BUSINESS of your own with new 40-Volt Arc Welding. Get big pay jobs that mean real profit. Hobart welders are easier to operate, faster, do a better welding job.

FREE Welding Book. Write for it today.

NO INVESTMENT TERMS—profits pay for it. Savings make it easy to own a Hobart Welder without expense. **PAYS FOR ITSELF** in short time. Profit on single job often pays small monthly payments. Write for details. **HOBART BROS. CO., Box M1040, Troy, O.**

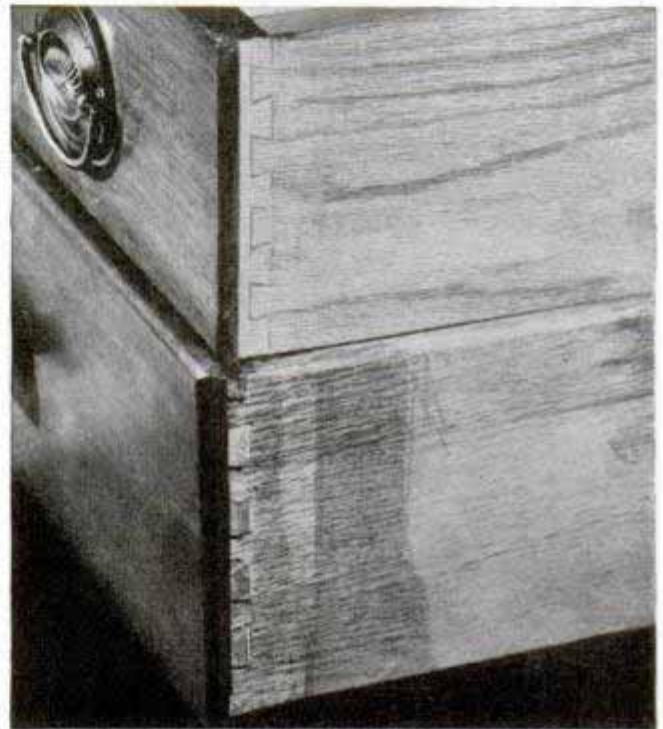


SAVE \$300 to \$500 "Build Your Own" Portable arc welder using complete Hobart generator and coupling to old motor and chassis.

(Continued from page 543)

Mercerized cotton burns less rapidly, leaves a little black ash, and does not smolder persistently when the flame is blown out. Mercerization is a chemical process that makes cotton stronger, smoother, and more resistant to soiling. Cottons with less desirable finishes flame like the untreated material; but they char rather than burn completely, and the ash retains the shape of the cloth.

Pure unweighted silk is labeled "Pure Dye Silk." Such labels as "Pure Silk," or "All Silk" are adopted for trade purposes,



Compare excellent cabinet work on dovetailing of top drawer with slipshod workmanship of lower one

and are no guarantee against weighting (and neither are they a positive indication of weighting—they are meaningless for purposes of fabric identification). Weighting is a perfectly legitimate process for making a little silk look like a lot. It improves appearance at the expense of wearing qualities. It is just the thing for relining a garment to last one more season, but not for lining a new garment that must last several seasons.

Pure dye silk burns rapidly with a blue flame, and gives off an odor of burning feathers. The ash is black, forming in shiny brittle balls at the edge of the material. Weighted silk is very difficult to ignite.

MAKE BIG MONEY

At Home! New Invention Electroplates by Brush

Plates
GOLD
SILVER
COPPER
TIN

CADMIUM
NICKEL

Easy as
painting

No Tanks, Liquids, Generators DOES SAME WORK AS BIG OUTFITS
Millions of old auto-parts, and all kinds of old, worn articles in homes, stores, offices, factories everywhere can now be electroplated with a permanent brand-new sparkling coat of metal—by electrolysis—with the stroke of a brush. Easy as painting—no dismantling—plates right on the spot. Any electric light socket or car battery. Weighs only a few pounds. Take it anywhere—ready for instant use.

Quick, Easy Way to Start Your Own Business

MAKE BIG PROFITS AT ONCE
Amazing low price and magic-like demonstration brings you thousands of orders for plating from garages, radio shops, bicycle shops, machine shops, home work shops, factories, offices, janitors, doctors, dentists, jewelers and farmers, homes, stores, etc.—with big profits for you! List of plating charges furnished; also reports of remarkable daily earnings.

2-MINUTE DEMONSTRATION WITH SAMPLE AMAZES EVERYBODY

Send today for FREE Sample and amazing profit details and bona fide reports of big steady earnings! Also, 3-way proven sure money-making plan. Get started at once on this permanent, profitable business. No competition. Simply mail name on penny post card—NOW! Be the exclusive Warner Nu-Way Electroplater in your community.

**FREE
SAMPLE
PROVES
CLAIMS**

WARNER ELECTRIC COMPANY
Dept. 5-F, 360 N. Michigan Ave., Chicago, Ill.



NOW ONLY REAL ENGINE VALUE



This is a miniature gasoline engine that really operates. Over 15,000 sold last year. Now is your chance to buy the New Improved kit for \$4.95. Absolutely complete with coil, plug, instructions, etc. Only a screw-driver needed. For boats, planes, midget cars, etc. All parts guaranteed. Send only \$1.—Shipped Collect C.O.D. same day. Send for FREE literature or 6c for Jumbo hobby catalog.

DEALERS WANTED.

FACTORY ASSEMBLED — READY TO RUN \$6.95

GHQ MOTORS, Dept. B, 40 East 21 St., New York, N. Y.

EASIEST TOOL TO USE

BECAUSE IT HAS A Flexible SHAFT AND Pencil-Size HANDPIECE

New skill, new ease for experienced craftsmen and newcomers to the homecraft hobby. Foredom "finger-tip" control for precision work in hard-to-reach-places and for delicate jobs. Note the flexible shaft—the lightweight, pencil-size handpiece. Versatile, can use over 200 accessories. Hundreds of uses: grinding, polishing, milling, engraving, sharpening, slotting, gem-setting, sawing, carving, cleaning, sanding, glass etching, finishing dies, molds, castings, etc., etc. Only \$14.95 for the complete Portable Workshop, as illustrated.

YOURS ON 10-DAY FREE TRIAL
Order this Model 45 FOREDOM Flexible Shaft Workshop today. Enclose \$14.95 check or M.O.—or, we can ship C.O.D. Try it for 10 days. If not completely satisfied, return set—we refund money at once. FOREDOM—fine tools since 1922. Write for complete catalog.

FOREDOM ELECTRIC CO., Dept. 162,
27 Park Place, New York, N. Y.

**ONLY
\$14.95**
Including
50-piece
Accessory Set



It chars rather than burns, and the ash retains the shape of the sample.

Rayon blazes rapidly. The ignited edge melts and curls into a hard brittle mass.

Wool does not flame much, but smolders, giving off a disagreeable odor of burning hair. The ash is crisp and black, with a tendency to curl up in an irregular mass.

These burning tests are inconclusive when more than one kind of fiber is used in the material. The proportion of wool or silk in a fabric can be determined by boiling a sample of the material for fifteen minutes in a pint of water, to which one tablespoonful of lye has been added. This will completely dissolve wool or silk, leaving the other fibers intact. The test, of course, will not work with silk and wool, for both fibers will be dissolved; but this is unimportant, for the two fibers are readily identified when combined, so that the proportion can be judged. The results of the lye tests with "Part Wool," "Wool and Cotton," or "Wool and Rayon" fabrics might surprise you, by showing what a small proportion of wool is actually used.

Linen burns so much like cotton that such a test is inconclusive. The break test tells you more. Ravel out a yarn from the material and pull on it steadily. Cotton will pull out gradually, leaving brush-like ends. Linen will offer more resistance, then snap suddenly, leaving pointed ends. Some linens with special finishes may break with a bushy end, like wool yarn; but the break will be sudden—the thread will not pull out gently, as does cotton made to imitate linen.

There is a vast difference in the wearing qualities of men's shirts. As with most manufactured articles, a good shirt is good all over, while a cheap one is made cheaply throughout. The Bureau of Home Economics recently laid down general rules by which the buyer may distinguish a good shirt from a poor one.

The good quality shirt will be of firmly woven, smooth fabric, with no loose threads on the surface. If colored, the color will be the same on front and back. The collar points will be well matched and sharp. There will be close, even stitching, about twenty stitches to the inch.

The buttons will be of well-shaped, well-matched pearl, with four holes, and sewn on with many stitches. A shirt with two-

(Continued to page 126A)

SHORT CUTS FOR THE HOME CRAFTSMAN



How to Spot A Metal Surface

• Here's an easy way to produce that attractive design called spotting or frosting, usually seen on the backs of watch movements or on the beds of fine lathes. You simply glue a disc of leather or felt on the end of a short piece of dowel rod, and charge it with fine Carborundum Brand Silicon Carbide or Aloxite Brand Aluminum Oxide Powders. Then place the dowel rod in the drill press chuck and revolve at slow speed. When the charged tip is brought against a polished metal surface a series of fine rings will be engraved in the metal. These rings or discs arranged in orderly rows produce the desired effect.

Ask your hardware dealer or mill supply house to show you the complete line of Carborundum-made coated abrasives, sharpening stones, grinding wheels and other abrasive products for the home craftsman. Send 10¢, coin or stamps, for souvenir sharpening stone and valuable illustrated manual on how abrasive products can save time and help you do better work.



Write Dept. M 100

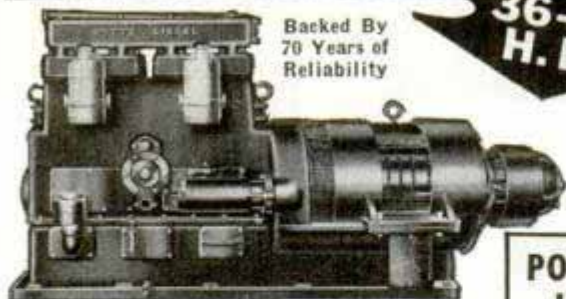
THE CARBORUNDUM COMPANY

REG. U. S. PAT. OFF.

Niagara Falls, N. Y.

[Carborundum and Aloxite are registered trade-marks of
and indicate manufacture by The Carborundum Company]

Now a New 30,000 WATT WITTE DIESELECTRIC PLANT



Backed By
70 Years of
Reliability

36-40
H.P.

More
Power
Less
Cost

This new **WITTE 30 KVA** Dieselectric Plant sets a new high standard in quality construction, compact design and low cost operation. Specially built to meet the ever-growing demand for a larger WITTE as efficient as the small WITTE Dieselectrics which have been outstanding successes!

There's a WITTE Dieselectric to meet every need—**2500 to 30000 watts**—Vertical, Horizontal, 1 to 4 cylinders. Manual Control, Electric Starting or Fully Automatic. All expertly engineered; practically no wearout.

Pay for Themselves from Savings

Rugged, compact—easy to install. Can be operated by practically anyone. **Easy to buy**—Available under F. H. A., **nothing down**, 36 months to pay! Savings on cost of electricity pays for them. \$825 and up—F.O.B., K. C. Mo

GET THE FACTS—write now for complete information—and name of dealer.

WITTE ENGINE WORKS

174-A Oakland Ave., Kansas City, Mo.

**POWER &
LIGHT
for LESS
THAN**

1¢ KWH

Make your own electricity at this amazingly low cost. WITTE Diesels operate on cheap, non-explosive fuel; assure constant low operation without supervision. Always ready—give smooth flow of current.

**Get FREE
Literature**

ACE
LATHE TOOL SET
\$14.50



Be permanently tooled-up for every operation on your Metal Cutting Lathe

The ACE Set is complete—there's nothing more to buy. Drop forged by the manufacturers of cutting tools used by 96 per cent of the plants and shops in industry they are correctly designed, are of special steel, are finely finished, are stronger—will last a lifetime. You can cut easier, faster and more accurately with ACE TOOLS.

At your Hardware Store—Circular FREE.

ARMSTRONG BROS. TOOL CO.

"The Tool Holder People"

368 N. Francisco Ave., CHICAGO, U.S.A.

3 Turning Tools, 2 Cutting Tools, 2 Boring Tools, 2 Boring Tools, 2 Threading Tools, High Speed Steel Cutters and Blades, and 2 Wrenches in Fitted Steel Case.

Be a McNess Man

**No Time Like
Now to Get In
Write for Details**

It's no trick to make good money when you use your car as a McNess "Store on Wheels." Farmers buy everything they can from McNess Men because McNess Products are tops in quality, represent extra values. Attractive business-getting prizes and premiums; also money-saving deals to customers make selling McNess daily necessities a snap.

We Supply Capital—Start Now!

There's no better work anywhere. Pays well, permanent, need no experience to start and we supply capital to help you get started quick. You begin making money first day. Write at once for McNess Dealer Book. It's FREE. Tells all—no obligation. (107)

THE McNESS CO., 908 Adams St., Freeport, Ill.



**Use Your
CAR
to Raise
Your
PAY**

hole buttons may be passed over as shoddy throughout. Buttonholes should be firm and neat; and large enough to slip over the buttons easily.

By removing a few pins, you can investigate further. The shirt will be full cut, which means the cuff will open out flat, the back will be rounded at the yoke, with pleats distributed rather than bunched in the center. The sleeves will be cut from one piece; not eked out with a V-shaped wedge and two seams that make ironing difficult.

Perhaps the salesman will not let you investigate these points. That, in itself, is a sign to be wary. The seller of good wares is proud to show their fine points.

The U. S. Department of Agriculture makes several tests of foodstuffs, that will help you get your money's worth if you know what to look for. All meat is inspected by the government, and on the edge of each carcass is stamped the quality in a blue harmless ink. This label may be read before the meat is cut up for the consumer. Ask the butcher to show it to you. The best beef, for instance, is marked U. S. Choice Steer. But cheaper cuts are perfectly safe. Inspectors allow no diseased meats to leave the packing house. The best eggs are marked U. S. Special. You can test eggs yourself by placing them in a pan of water. Those not fit for use will float, the large end up. Strictly fresh eggs will lie on their sides at the bottom of the pan.

12488

Steeplejacks of Mountain Peaks

(Continued from page 549)

moving forward both her handholds broke off simultaneously, dropping her to dangle at the end of her rope below a piton until she could find holds again.

In spite of the high places climbers have ascended, the best of them can be stopped by a sheer face that has no cracks or projections that can be reached by one man standing on the shoulders of another. When such a situation is encountered another route must be sought.

Sheer precipices, steeply inclined ice, insecure treacherous rock, fresh snow on ice—these are the principal difficulties the mountaineers encounter. Climbing down

(Continued to page 128A)

WHAT'S GOING ON BEHIND THE SCENES AT CHRYSLER?



It's an amazing new development in Fluid Drive!

Ask Your Chrysler Dealer!



SUCTION SPONGE

Cleans Cars NEW WAY!

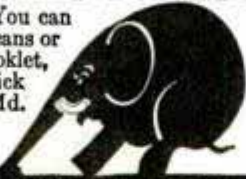
AMAZING INVENTION! Banishes auto washing drudgery. Cleans linoleum, woodwork, windows like a flash. Auto owners, housewives wild about it. **HOT SELLER FOR AGENTS AND DISTRIBUTORS.** Hustlers cleaning up Big Money.

SAMPLE OFFER Samples sent on trial to first person in each locality who writes. No obligation. Get details. *Be first—send in your name TODAY!*

KRISTEE CO. 683 Bar St. Akron, Ohio

MENDS MOST ANYTHING

Iron Glue holds tight, is extra strong. You can buy it 'most anywhere— $\frac{1}{4}$ pt. to 1 gal. cans or 10c bottles. **FREE:** Send post card for booklet, "Better Results with Glue," to: McCormick Sales Co., 402 Light St., Baltimore, Md.



IRON GLUE

AN ELEPHANT FOR STRENGTH

\$13.95 Full Set



MICROMETERS

Six piece set, in velvet lined leather case. Special price, only \$13.95. Precision machined in one thousandths, up to 4" outside and $\frac{3}{32}$ " inside measurements. Guaranteed accurate, easy to read and adjust. Satisfaction guaranteed or money back. This is your opportunity to get one at a Bargain Price if you act now. Shipped prepaid on receipt of remittance. On C.O.D. shipments, send deposit of \$2.00.

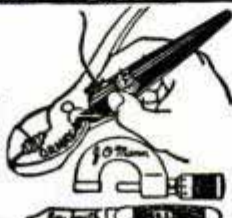
FREE FOLDER

MICRO PRODUCTS, 529 E. Jefferson Ave., Detroit, Mich.

BURN YOUR NAME ON TOOLS

WITH THE ARKOGRAF

PROTECT YOUR TOOLS FROM THEFT Write with electricity any name or design on the hardest and finest tools and instruments, or any metal, like writing on paper with pen or pencil. **Complete Outfit \$3.50—Prepaid Anywhere** Interesting illustrated circular free. Write today. Agents wanted. **ARKOGRAF PEN CO., 3927 S.E. Stark St., Portland, Ore.**



TEST-O-LITE

Tests Everything Electrical From 100 to 550 Volts



\$1.50 At Electrical Stores or Post-paid

A real necessity for electricians and home because it has 1001 uses. Equipped with a Neon light which tells instantly where trouble lies in electric circuits, fuses, cut-outs, motors, radios, all kinds of electric appliances, etc. Tells A. C. from D. C. Far superior to ordinary clumsy test bulb. Fountain pen size with clip for carrying in vest pocket. Lifetime guarantee.



PATENTED
L. S. BRACH MFG. CORP.
55 Dickerson St., Newark, N. J.

Make Big Money The American Way



Get into something for yourself where your income is practically unlimited—the **AMERICAN ELECTRIC METHOD** of floor surfacing gives you that opportunity. Large profits—work easy to get—no previous experience necessary. Start with as little as \$75 in this tried and proven money-making business. Write quickly—no cost or obligation.

The American Floor Surfacing Machine Co.
523 South St. Clair Street • Toledo, Ohio

When writing please mention Popular Mechanics

again is sometimes more difficult than climbing up. There are really two kinds of climbers, those who are best at high-angle work and those who are best on ice and snow.

Not everyone is temperamentally suited for climbing the peaks like steeplejacks. Some become frightened in the pinches and "fight the mountain." Others take too many chances. Men who have received mechanical or technical training, members of the Sierra Club have found, seem to make the best and most dependable climbers. They can study their risks and apply their mechanical knowledge coolly.

Recently Mendenhall and another experienced climber were on Mount Baldy in southern California when a hiker slipped from the Devil's Backbone. At 8,300 feet and sheeted with ice, this ridge has precipitous sides. Nine people have fallen from it and eight of them were killed. On this occasion the hiker fell and slid downward 3,000 feet before coming to a stop. No one could tell if he was still alive, but if he was he was almost sure to die of exposure during the night. Mendenhall and his companion, armed with ice axes and wearing spiked crampons on their shoes, found him after dark. He was dazed but not

badly hurt, and they carried him to safety.

The very highest mountains of the world are also the most dangerous. These are Mount Everest in the Himalayas that stands 29,141 feet above sea level, and K², Kanchanjanga, and Nanga Parbat, all of which are in the Karakorum range in northern India and all of which are more than 26,000 feet high. None of these has been climbed and each has killed members of parties striving for the tops. Deadly Nanga Parbat alone has killed twenty-seven men. The extreme altitudes, the sudden changes in weather, and the unpredictable avalanches have driven back every expedition.

There are five major climbing grounds in the United States, the Cascades in the northwest, the Tetons in Wyoming, the Colorado Rockies, the Sierras in California, and the northern Appalachians. Members of the Sierra Club have climbed in all parts of the country and have ranged into Mexico and Alaska on difficult expeditions. This year members of the club are attacking unclimbed pinnacles in the Canadian Rockies and next year one group plans to attempt the 20,300 feet of Mount McKinley in Alaska while another expedition may assault a tall peak in Argentina.

The Age of Opportunity

(Continued from Coloroto Section)

an electric wire over a compass needle and found the needle was deflected. He had searched for that a long while.

Faraday went a bit further and wound a coil. But in the simple act of winding a coil on a bar of iron the fundamental principle of the telegraph was developed, and Morse, taking that as a clue, succeeded in "inventing" the telegraph. But the distance between these elementary principles and the enormous communication system we have today represents millions of dollars of expended and invested money, hundreds of thousands of hours of toil and countless heartaches, discouragements, disappointments. Along came Bell, who in trying to improve the telegraph, gave us the telephone, and since his time thousands of unsung research workers have adapted that instrument to entirely unforeseen uses.

Each generation, in picking up what is

transmitted to it from preceding generations, has a firmer, surer footing, a better foundation upon which to base the structures it will rear in the future.

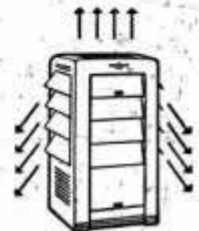
Some people like to hark back to "the age of opportunity." There never was such a thing. Or, rather, there is always an "age of opportunity." It was here yesterday, is with us now, and certainly will be here tomorrow.

I don't think there was ever a man born who wasn't born into an "age of opportunity." The main thing to remember is that opportunity is within us, is offered to rich and poor alike, is entirely democratic. But we dare not back into it, for we need to keep our eyes and our hands ahead.

Intelligent ignorance, that keeps a man dissatisfied with the wail, "It can't be done!" is a prerequisite for the research worker. And I think it holds equally true in any other field.



**Warm Floors
mean COMFORT!**



SUPERFEX is the only oil-heater with heat-directing shutters that direct heat downward to warm the floor. They're patented!

Only SUPERFEX Heater directs *Radiant* heat down for floor warmth . . . gives continuously circulating warm air, too!

Enjoy the complete comfort of oil heat with SUPERFEX! For only SUPERFEX has heat-directing shutters. With shutters closed, warm air circulates through the room and connecting rooms. With shutters on any or all three sides opened wide or directed

down, radiant heat—like sun rays—floods the room and warms the floor without draft or “blow.” And—warm air continues to circulate!

For complete, healthful comfort in your home all winter long, get a SUPERFEX in the size to suit your need.

Wide price range—easy purchase plan. Get the free, illustrated book — just send the coupon.



PERFECTION PORTABLE HEATER

For quick, comforting heat in homes and business places. 10 to 12 hours of comfort from gallon of kerosene.

**SUPERFEX
OIL HEATERS**

The Mark of Quality



PRODUCTS OF PERFECTION STOVE CO.

PERFECTION STOVE COMPANY
7262-A Platt Ave., Cleveland, Ohio

Please send me FREE booklet describing SUPERFEX Heat-Directors or PERFECTION Portable Heaters .

Name _____

St. or R. F. D. _____ Post Office _____

County _____ State _____

HERE IS ATKINS' LATEST— *The Sensational "2000"*



**LOOK—Your Own
Initials—Free—On This
Remarkable New Saw**

The new Atkins "2000" Hand Saw offers double value:

First: New scientific handle design brings the grip closer to blade—makes the saw easier and more comfortable to use—adds to its modern handsome appearance. Blade is taper ground, edge-holding Silver Steel.

Second: Free black and gold decalcomania initials furnished every purchaser. You can personalize your saw, and always identify it. Ask a nearby hardware dealer to show you this latest Atkins triumph!

ATKINS *Silver Steel* SAWS

E.C. ATKINS & COMPANY, 426 S. Illinois St., Dept. M-10, Indianapolis, Ind.

ONAN ELECTRIC PLANTS ALTERNATING AND DIRECT CURRENT



Produce Current, same as City Power Lines, for FARMS, SCHOOLS, THEATRES, PUBLIC BUILDINGS... Operate Lights, Radios, Motors, All Appliances.

Over 40 STOCK MODELS—150 to 50,000 Watts. Any Voltage—Any Frequency. Combination A. C. - D. C. Types.

Manual, Full Automatic and Self-Starting. \$99 up. Shipped—COMPLETE, READY FOR OPERATION.

THOUSANDS IN USE IN ALL PARTS OF THE WORLD.

Write for Complete Details.

D. W. ONAN & SONS
1050 Royalston Avenue - MINNEAPOLIS, MINN.

Help! Help! for the RUPTURED!

GET correct flexible pressure at exactly the right spot. That's what rupture sufferers who want genuine help should demand above all else. You can get it in the new ADJUSTO Truss because the pressure of the pad can be regulated and adjusted for the build of any body—for light or heavy work—for rest or play—for any undue stress or strain. And this pressure is instantly adjustable for easiest comfort and fullest support.

PERSONALLY FITTED

The ADJUSTO is such a precise truss that it is sold only where it can be personally fitted. No "self" or "hit or miss" fitting will get ADJUSTO results. Therefore, we have arranged with experienced trained fitters throughout the country to do the fitting. Some are near you. Write for full and complete information and name of trained fitter in your locality. Write today. Send no money. This service costs nothing extra.

ADJUSTO SURGICAL APPLIANCE CO.
Dept. K-15, 809 Walnut St., Cincinnati, Ohio

New Tasks for War Balloons

(Continued from page 555)

these upper winds are essential to modern aviation, both military and civil. They are also essential to heavy artillery in wartime.

A larger and faster-rising balloon is the "high-pilot." Inflated to perhaps forty ounces of free lift and a diameter of slightly over three feet, the balloon will carry aloft any weight up to about ten ounces at a rise rate of 1,200 feet per minute. At around 40,000 feet altitude, having expanded to a diameter of eight feet or so in the rarefied upper air, the balloon bursts. From 1935 to 1937 the U. S. Army Meteorological Service made hundreds of test ascents with these high pilots. They even burst several of the balloons at high altitudes with timed charges of black powder, foreshadowing the aerial mines of the present war.

But when fog or clouds intervene between theodolite and balloon, upper winds have been satisfactorily found so far only by very expensive methods, such as flying an airplane along a drifting line of shellbursts (above the clouds). Here is where the "raypilot" comes into its own. In principle it is only a miniature radio transmitter hanging below the rising balloon. As it rises beyond the clouds, its successive positions in space are plotted from radio bearings taken by directional receivers.

Still far from perfect, despite plenty of research attention from government laboratories, the raypilot offers many opportunities to inventors qualified in radio and surveying. Only the balloon itself and a miniature radio transmitter are necessary at the sending end—the whole combination probably costing less than three dollars.

One upper-air quality that artillery officers must know for accurate shooting is "ballistic density." The density of the air, which affects the flight of the projectile, depends mostly on its temperature, but partly also on its moisture content. Therefore heavy artillerymen are interested in the existing values of temperature and humidity of all the air levels through which their big shells will be fired.

The simplest and quickest way of finding this ballistic density, up to altitudes of less than 20,000 feet, is by means of a sounding airplane. In a streamlined aluminum case, well out from the fuselage of

the plane, are two large and easily read instruments—a thermometer and a hygrometer. As the pilot climbs steadily, the observer notes the readings of temperature and relative humidity at 500-foot intervals on his altimeter, and either notes them down or radios them to the ground.

But above 20,000 feet the time, trouble and expense of airplane sounding increase out of all proportion. Hence the "raysonde." This device is carried up to heights of ten miles or more by a rubber balloon, somewhat larger than the high-pilot, which starts at a diameter of about six feet.


Raysondes are now sent aloft by the U. S. Weather Bureau in the early morning, day in and day out, from several upper-air sounding stations scattered over the United States. These robot raysondes rise at 600 to 1,200 feet per minute, and send out a radio signal which is translated by an elaborate ground receiver into the values of upper atmospheric pressure, temperature and humidity being encountered by the balloon. This information is essential to modern, accurate, air-mass and front-analysis weather forecasting.

Still another wartime small-balloon idea, already considered by the British, involves the simultaneous release of thousands of small meteorological balloons as "aerial mines" against enemy airplanes. In the present form of the device, each balloon carries aloft, hung beneath it by a length of wire, a pound or so of TNT or other high explosive in a can fitted with sensitive contact fuses. The rising balloon, of course, drifts off to leeward with the prevailing wind, and continues to rise until it bursts. Any one of these small aerial mines would be capable of destroying any airplane hitting it, or even brushing by it.

Still another wartime job for these small balloons might be in carrying propaganda leaflets. Each little propaganda-balloon could carry, say, a pound or so of small leaflets. By some cold-proof clock or other mechanism yet to be perfected, the balloon could perhaps be made to release its leaflets in the stratosphere after two or three hours of flight. The leaflets would then be scattered over enemy territory.

Editor's note—(This article is written by the author in his capacity as a private citizen of the United States; it has no connection with his official U. S. Army position.)

EVERYTHING IN RADIO



ALLIED'S NEW 1941 RADIO AND PARTS CATALOG

212 PAGES
JUST OUT!

FREE

EVERYTHING IN RADIO
AT LOWEST PRICES!



83 NEW RADIOS SOUND SYSTEMS

The 1941 RADIO HITS you've been waiting for! Knockout values—new Plastic models, world-wide sets—new "Camera" and 3-way Portables; 1941 low-cost Phono-Radio-Recorders, Combinations, Auto Sets, Amateur receivers—40 pages of models for every purpose at new low prices!

Sensational 1941 Public Address Systems—for every P.A. application. 7 to 75 watts—new features, new ideas, new low prices. "Time Payment Plan"—15 Day Trial Offer. Complete listings of mikes, speakers, phono equipment, recorders, etc.—all in a big special 35-page P.A. section.

MORE THAN 15,000 RADIO ITEMS!
BIG MONEY-SAVING BARGAIN SECTION!



Learn
Radio

BUILD WITH
ALLIED KITS



Build your own radio set, transmitter or radio device—learn while you build! Dozens of new, low-cost easy-to-build kits; new diagrams—more than 15,000 quality parts. Free matched parts lists for building any circuit. Learn Radio quick'y, easily with ALLIED's help.

Send for this RADIO BUILDERS' HANDBOOK—a valuable beginner's book on radio; tells how to select circuits, read diagrams, build sets, etc. Easy to understand; well-illustrated; helpful. Order by coupon below. 10c
Only.....

ALLIED RADIO

833 W. Jackson Blvd. Dept. 5-BK-1
Chicago, Illinois

- RUSH me your FREE 1941 Fall Radio Catalog.
 ENCLOSED find 10c. Send me the "Radio Builders' Handbook".

NAME.....
ADDRESS.....
CITY..... STATE.....

CATALOG
FREE
Send this
Coupon!

LONG SHOT

Today's "long shot" is "Pres-tone" anti-freeze. One shot protects your car all winter long. You're safe—and you know it! See Inside Front Cover and Inside Back Cover



New Electric Moto-Saw *Only \$4.85 POST PAID*

7,200 STROKES PER MINUTE... JUST GUIDE IT!
FAST—POWERFUL—Cuts intricate designs like costly bench equipment. Averages 12" per min. thru medium hard wood up to 3/4" thick... so smoothly it eliminates sanding. **SAFE** as a hand saw. **SIMPLE—DURABLE**—Only 2 moving parts... never needs oiling. Stroke adjustable from 1/8" to 5/16". **EASY TO USE**—Wt. 17 oz. Balances in hand. Carry in coat pocket. Uses alternating current only.

10 DAYS TRIAL If your dealer can't supply you, send only \$4.85 for Moto-Saw and 3 blades, postpaid. Or, send no money, pay postman plus postage. **MONEY BACK** if not delighted after inspection.

DREMEL MFG. CO., Dept. MS110-K, RACINE, WIS.



AUTO ENGINE SPEED CONTROL GOVERNORS

Give constant speed to any make of auto or truck engine, regardless of load changes, when used as a stationary or portable power plant. No better governor can be made. Fully guaranteed. \$5.00 up. No cash down. Complete, simple instructions. Courtesies to garages and established agencies. Free circulars. 129-4 LLEWELLYN ST., LOS ANGELES.

FREE Stove Catalog



Factory Prices

New streamline designs! New features! 136 Styles and Sizes. Coal Wood Ranges; Combination Gas-Coal or Oil Ranges; Electric Ranges; Oil Ranges; Oil Heaters; Coal-Wood Heaters; Furnaces. 30 Days Trial, 24 hour shipments. 1,600,000 Satisfied Users. Stoves \$5 Down, up to 18 months to pay.

"A Kalamazoo Direct to You"

KALAMAZOO STOVE & FURNACE CO., Mfrs.
 391 Rochester Avenue
 Kalamazoo Michigan

Winged Daredevils of Science

(Continued from page 517)

400 miles an hour, stalling at close to a hundred. It is doubly dangerous when the pilot must keep his plane absolutely level, keep the air-speed indicator at a constant reading, and work a stop-watch on the split second.

"Flying the sawtooth," so called because the barograph record resembles the business edge of a saw, is used to determine at what attitude the plane will climb fastest, at different heights. The pilot will climb from 1,000 to 2,000 feet at, say 380 miles an hour. Then, back to 1,000 feet, and with the same throttle setting he will pull the stick back until the air-speed meter reads 360 miles per hour, and so on.

A plane, you will understand, does not necessarily climb fastest (vertically) while the air-speed meter shows the highest reading. Neither does the rate of climb remain the same, for the same angle of incidence, at all altitudes. And since climbing ability is so important to a fighting ship, the maximum performance at all altitudes must be determined.

This sawtooth gets to be ticklish business as the plane nears its ceiling. Lieutenant Julian Hadden dropped his pencil while flying at 34,000 feet. To reach it he had to remove the oxygen breather from his mouth. Before he could get his hand on the pencil he passed out. He came to at 9,000 feet to find his plane in a power dive, and on fire. After pulling out and battling the flames until severely burned, he had to jump at 3,000 feet.

There are dozens of other tests these pilots must make. All of them are routine, most of them are dangerous.

Yet these pilots are not chosen for their devil-may-care attitude. Quite the contrary, they are the pick of the Air Corps brains, selected for their engineering background, and willingness to follow instructions to the letter though it might mean endangering their lives. Added to these qualities of steadiness must be extraordinary flying skill, and the faculty of thinking clearly in emergencies.

These are the daredevils of science.

Send stamped, addressed envelope to our Bureau of Information for name of maker of any device described in this magazine.

Here's the perfect 10" BAND SAW for your Workshop

**Inside
Secrets
of Delta Quality**

**"PRE-LOADING
BALL BEARINGS"**

Delta ball bearings are pre-loaded to make Delta machines more accurate in operation. Here's what this means to the prospective purchaser of power tools:

In the design and manufacture of ball bearings it is practically impossible to remove all of the "play" or clearance. In other words, a perfectly close fit between the ball bearings and the races in which they run cannot be obtained. This play is not visible to the naked eye. It can only be measured by means of accurate instruments.

Yet, this extremely small variation will keep the bearing from running absolutely true. In a drillpress it will cause a fine drill to wobble from side to side. In a shaper it will make the knives rise and fall, producing an uneven cut.

Pre-loading ball bearings as practiced by Delta, eliminates all of this.

The method used in holding the bearing in all Delta tools puts a definite amount of pressure on the bearing races so that the ball bearings ride against both of the races all of the time.

Neither the inner race or the outer race can shift out of place—they are always in the same position. This means that it is impossible for the bearing or the shaft which revolves in it to run out of true. Thus you always have uniform accuracy in Delta machines.

If you want the best in power tools be sure that the bearings are "pre-loaded." Have the salesman demonstrate it to you and prove to you without a doubt that the ball bearings are pre-loaded.

Pre-loading is another superior exclusive feature of Delta tools—a feature not visible to the naked eye—a feature too often passed over lightly, yet one which is of vital importance to you.



● The massive design, advanced engineering, thoroughly studied design and accurate construction of this machine make it the finest 10" band saw ever offered to the craftsman. Its capacity under the guide makes it the equal of many machines of larger throat capacity. It has an exceptionally rugged heavy frame; double-sealed ball bearings lubricated for life; heavy cast-iron 11" x 11" table, micrometer adjustments in upper and lower guides and many other features. Some of its specifications include: Overall Dimensions: 33½" high; 11¼" wide; 23" front to back. Capacity: 10" blade to upper arm; 6" under guide. Accurate, true-running balanced wheels, carried on self-sealed New Departure ball bearings—lubricated at factory for their entire life. Heavy accurately ground main shaft. Micrometer-adjustment upper guide. Each adjustment independent of others, and each made with precision. Micrometer lower guide, with adjustments brought out to front of table. Operator's hands never come near blade. An exclusive feature. Upper wheel tilting device and tension scale similar to that used on 14" band saw. Both wheels and blade thoroughly guarded; only portion of blade actually used for cutting is ever exposed. For full details, prices on this and other Delta tools, fill out the coupon.

Send for Latest Catalog

A complete guide book to power tools which not only lists the complete line of Delta "Quality" wood and metal working tools—but shows you the important points to look for in all power tools. It illustrates and explains the advantages of the many hidden features of design and construction that make for long, better service in power tools. (Also send for Project Book No. 7 crowded with new projects, including working drawings, photographs and full instructions.)



DELTA MFG. CO.

600-634 EAST VIENNA AVENUE
MILWAUKEE, WISCONSIN

**Delta Manufacturing Company
600-634 E. Vienna Ave., Milwaukee, Wis.**

Gentlemen: Send me the latest Delta Catalog listing the complete line of Delta Lathes, Circular Saws, Band Saws, Jointers, Scroll Saws, Shapers, Sanders and Drill Presses.

I enclose 10c (stamps or coin) for which please send me the new Delta Project Book No. 7.

Name.....

Address.....

City..... State.....

Check here if you are a Delta user now. A1040

BETTER TOOLS DO BETTER WORK

LUCKY IS THE CRAFTSMAN WHO HAS A

DURO Hand Grinder



3 MODELS SIZES PRICES

Built for power, speed, precision, compactness and balance. They are the last word in Hand Grinder quality. Nowhere are there finer grinders than these, yet they are priced amazingly low. The perfect tool for routing—sanding—cleaning—grinding—polishing—drilling—cutting—carving on wood, metal, plastic, bone, etc.

Whether you need good tools for Industrial use or for your own pleasure, it will pay you to investigate Duro tools before you buy.



ASK FOR SPECIAL HAND GRINDER LITERATURE OR FOR COMPLETE CATALOG.

DURO METAL PRODUCTS CO.
DEPT. PM10 2653 N. KILDARE AVE.
CHICAGO, ILLINOIS



Woodworkers:

only **10c**

Here it is! Harold Hunt's 1940 catalog! Latest, UP-TO-DATE IDEAS for experts and amateurs; SPECIAL BARGAINS in rare woods, machines, and all kinds of supplies. Get posted! Send only 10c to CRAFTSMAN'S WOOD SERVICE CO. 2729 S. Mary Street Div. 3377 CHICAGO

TYPEWRITER 1/3 PRICE

STANDARD OFFICE MODELS
1/3 MFRS. ORIG. PRICE

Easiest Terms **60¢ A WEEK**
as low as

All late models completely rebuilt like brand new. FULLY GUARANTEED.

No Money Down - 10 Day Trial

Free price-smashing catalog shows all makes in colors. FREE COURSE IN TYPING INCLUDED. See catalog before you buy. SEND NOW.

INTERNATIONAL TYPEWRITER EXCH.
Dept. 1001 231 W. Monroe St., Chicago, Ill.



10c A DAY

ONE-MAN SAWMILL LOW AS \$59



TURN TREES INTO MONEY WITH A BELSAW

Pays for itself quickly—thousands in use. Capacity 10 to 30 ft. Mechanical feed. Write for Free Lumber Hand Book and catalog of New Improved 1941 Models.

BELSAW MCH. CO., 3542C Main St., Kansas City, Mo.

ITCH STOPPED in a Jiffy -or Money Back

For quick relief from itching of eczema, pimples, athlete's foot, scales, scabies, rashes and other externally caused skin troubles, use world-famous, cooling, antiseptic, liquid D. D. D. Prescription. Greaseless, stainless. Soothes irritation and quickly stops the most intense itching. 35c trial bottle proves it, or money back. Ask your druggist today for **D. D. D. PRESCRIPTION.**

Adventures of Highway Engineers

(Continued from page 533)

ters by radio, calling for help if they broke down or found the road blocked by fallen trees, and using their phones to advise the barriers as soon as the snow had been removed and the roads were safe.

Sitting in his enclosed cab, a snowplow driver received messages over a loud speaker and replied with the usual microphone equipment. His antenna, lying flat against the roof when not in use, is cranked to a height of twenty-three feet for communication. Day and night radio watches are kept at the central stations during storms. Five or six hundred inches of snow a season fall on some California highways and the 156 snowplows handle as much as 100,000,000 cubic yards of snow a year.

The engineers could build highways that would never be affected by bad weather but the cost is prohibitive. It is cheaper to repair damaged sections than it is to make a highway stormproof.

During one desert storm, in which three times the average annual rainfall fell in twenty-four hours, thirty-five miles of highway and the approaches to six bridges were destroyed. By turning to detours already mapped out the engineers restored normal traffic in forty-eight hours.

Imagination and the ability to improve on old methods are requisites of the engineers. Building a new road, they found that the rock of one mountain was shattered so badly that cutting into the slope for the new highway would cause dangerous slides. So they built a side-hill viaduct, literally a long bridge that wound around the mountain. They drove steel piling into the slope and erected the highway structure on top of the steel columns, with one side of the road resting against the side of the mountain.

The days are over when roads followed the easiest paths and were built the cheapest ways. A wide highway that strikes straight through the hills with few changes of direction or grade is safer and faster, carries more traffic, and lasts longer than the winding road that it replaces. Building the big highways is hard work and sometimes it's dangerous. Surveying parties may have to be lowered by ropes down cliffs to their stations. Dynamite crews

(Continued to page 137A)

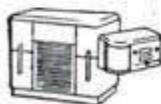
FREE!

THIS GREAT

1941 Lafayette RADIO CATALOG!

EVERYTHING
IN RADIO!

★
PRICES BED-
ROCK LOW!



64 NEW SETS

Lafayette 1941 challenge to the radio world! 64 brilliant new models—each tops in its class for style, performance and value. Portables, table models, consoles, phono-combinations — every radio type for home, farm, camp and car. 5 to 15 tube sensations. Consumer Test laboratories vote Lafayette Best Buy.



NEW SOUND EQUIPMENT

Featuring 3 complete lines. Now a Lafayette streamlined Sound System for every purse and purpose. Here's standout P. A. styling, years ahead engineering, matchless performance and value. Everything to go with the modern sound system, everything priced bedrock low.



LATEST HAM EQUIPMENT

Long "ham" headquarters, Lafayette shows the reason why in this great catalog's Amateur Radio section. See the latest receivers, plus a complete line of ham equipment—all nationally advertised and here at real money-saving prices.



THOUSANDS OF RADIO PARTS

Thousands of items, many hard-to-get today. All the famous names are in this great book that saves you money on everything you buy! Latest type tubes, test equipment (fluorescent lighting), Build-it-Yourself Kits. Tools, too, and instruction books to make radio easy and fun.



LAFAYETTE
BRANCHES
TO SERVE YOU

For one of Radio's biggest thrills, visit the Lafayette branch nearest you. See these great values in radio sets, parts, ham and P. A. equipment. Consult with the experienced men on our staff. Learn how much more Lafayette offers on everything in Radio.

196
PAGES

IT'S
ALL
NEW!



IT'S YOUR
GUIDE TO
THE BUYS

EXTRA — BUILD-IT-YOURSELF
Kits for homebuilders who want
to get the most fun out of radio,
and save money. Amazing new
FM receiving kits.

Act now

Find out how much easier it is to get what you want from the book that has EVERYTHING IN RADIO & SOUND. Find out how much you can save! Remember, we will not be undersold. Act now. Tear out the coupon and mail at once. Get your copy of the GREATEST CATALOG IN RADIO.

Lafayette Radio



NEW YORK
100 Sixth Avenue
ATLANTA
265 Peachtree St.
CHICAGO
901 W. Jackson Bld.
BOSTON • NEWARK
BRONX • JAMAICA

LAFAYETTE RADIO CORP.

DEPT. 7K—100 SIXTH AVE., NEW YORK CITY
or 901 W. JACKSON BLVD., CHICAGO, ILL.

Rush FREE 1941 Catalog No. 82

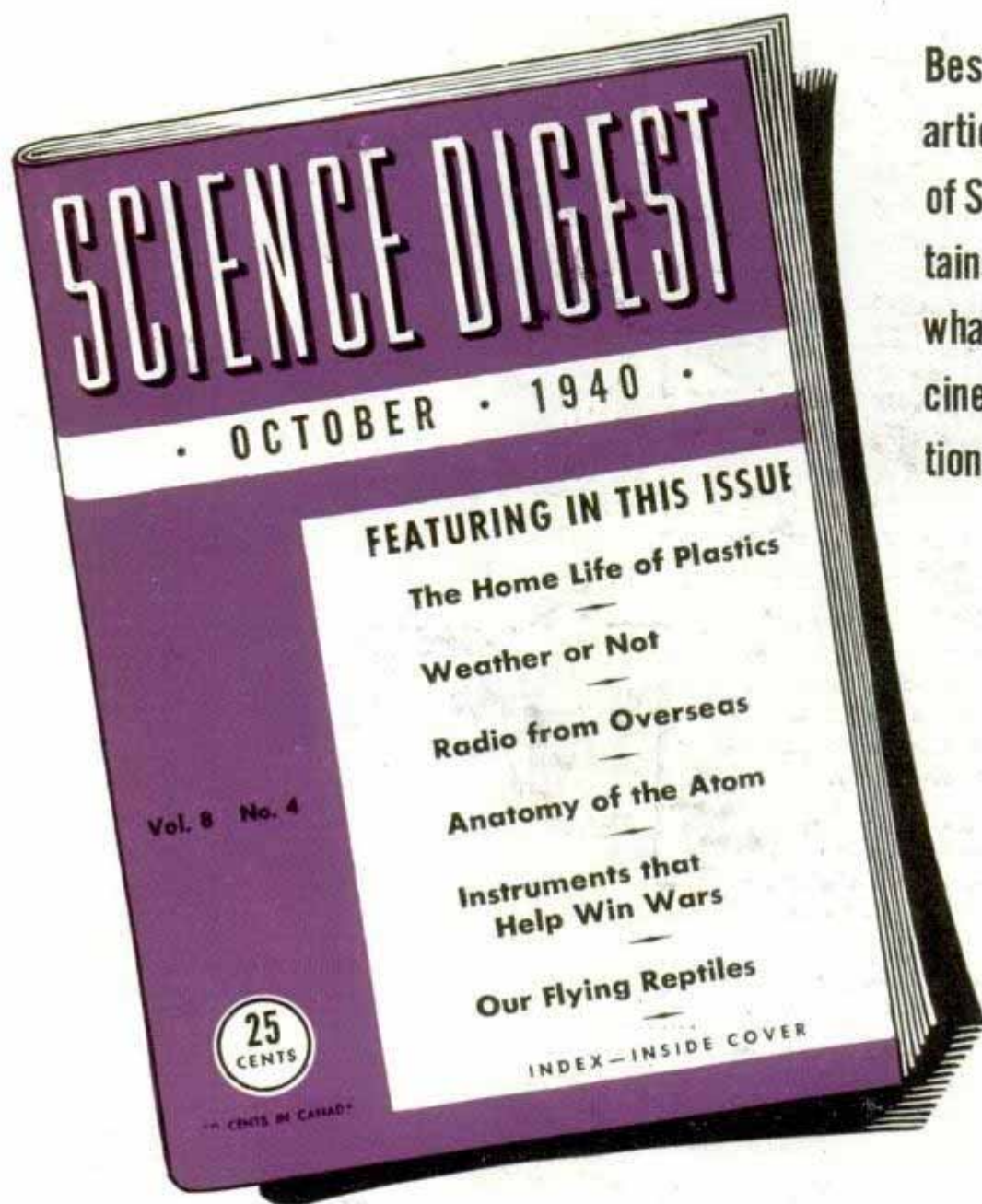
NAME _____

ADDRESS _____

CITY _____ STATE _____

it's
FREE

Plastics, Radio, Weather!



Besides its featured articles, each issue of Science Digest contains sections telling what's new in medicine, in patents, inventions and processes.

Craftsmen find new fields opened to them by new and improved plastics, some of which are now stocked, like lumber, by dealers. Designers, manufacturers, home workshop fans can read with interest and profit "The Home Life of Plastics." Radio "hams" know that messages often are more successfully received from Australia and New Zealand, or sent there, than from or to places much nearer. Why that's true is just one of the interesting things about radio that you'll find

in "Radio from Overseas." And do you have your favorite weather signs? Which of them are causes and which are only indications? Read "Weather or Not." Three hundred scientific journals and bulletins were read by the editors of Science Digest to give you these ninety-six pages on nearly forty subjects. All for only a quarter.

SCIENCE DIGEST, INC.
631-643 St. Clair St., Chicago

ON NEWSSTANDS NOW—25 CENTS

30 CENTS IN CANADA

blast the rock away in the mountains. Huge new machines pick up tons of rock and earth at a time.

Recently the engineers had the problem of replacing a narrow wooden bridge on a busy mountain road with a wide concrete structure. Usually that is easy, but in this case there was no practical way to detour traffic around the work and the highway was too busy to be closed. The highway men did it by building the deck of the new bridge on temporary supports right alongside the old one. They routed traffic over the new deck, tore down the old bridge, erected new supports, and then skidded the deck sideways into location with twenty-ton capacity screw jacks.

In building another bridge across a deep canyon they found that the side approaches were of unstable material. Under the pounding of traffic the approach roads would settle badly, leaving the new bridge up in the air. They solved that by hinging a floating span at each end of the bridge. As settlement occurs the floating spans will tilt down, keeping the road open.

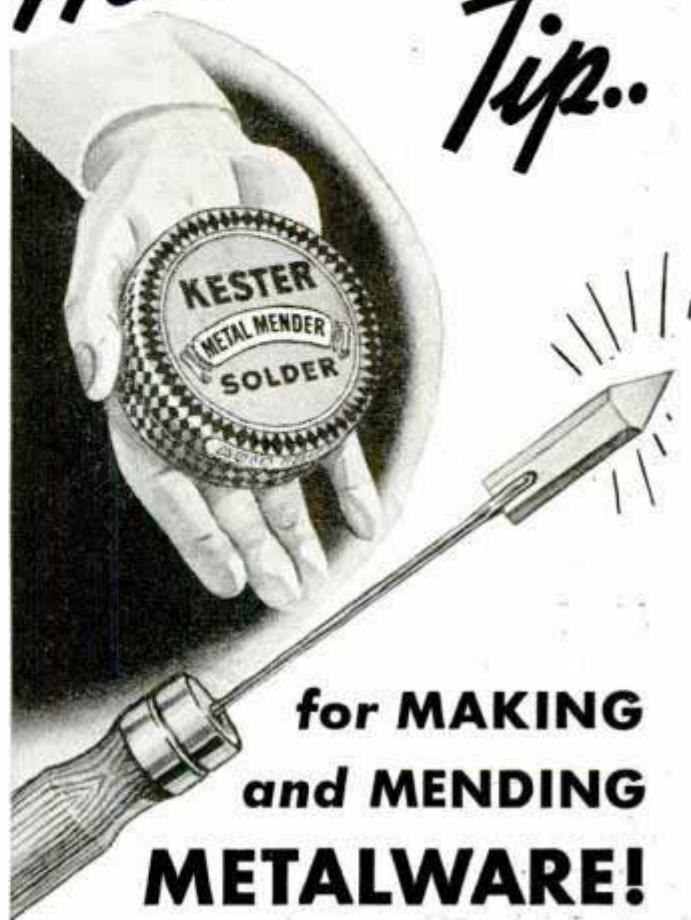
Once the highway department wanted to go through a mountain instead of over or around it. They rented hydraulic equipment from a gold mine near by. The hydraulic giants with nozzles from seven to nine inches in diameter washed the dirt away at the rate of 1,300 cubic yards an hour, some of the dirt being caught in barriers to build up the grade at one end. The cut measures 250 feet deep, 2,000 feet wide at the top, and 2,500 feet long.

When a highway follows a river, part of the construction program is to try to stabilize the stream channel so that the bank under the road won't be eaten away. Often a permanent channel for the stream is made by banking the walls with sacked concrete or laying wire and rock mattresses. One of the latest ideas is to anchor great steel shapes that resemble children's jacks to the exposed banks. The long arms of the jacks catch and retain debris brought down by the stream and this debris forms a mat that slows down the water, preventing erosion.

One unusual job that the California engineers had was to stand watch on a geyser. It was only a few hundred feet from a busy highway and occasionally spray was blown

(Continued to page 139A)

Here's a Hot Tip..



for MAKING and MENDING METALWARE!

Try this yourself: next time you start a job that calls for working in metals, use Kester Metal Mender for all metallic joints.

This famous home solder does the kind of work that adds to your skill as a craftsman... increases your pride in the products of your own design. And the things you make have *permanence* when you put them together with Kester!

In the same way, Kester Metal Mender is ideal for making quick and easy repairs for all broken or leaky metalware. The handy flux contained inside of the solder (like the lead in a pencil) insures perfect soldering results every time you put the heat to it.

Insist on genuine Kester Metal Mender at hardware and other stores. Send for a generous free sample and "How-to-Use-It" Booklet. Mail the coupon now!



KESTER METAL MENDER

..... You Can Paste this Coupon on a Postcard

Kester Solder Company, 4251 Wrightwood Ave., Chicago, Ill.
Please send me free sample of Kester Metal Mender and "How-to-Use-It" Booklet.

Name _____
Address _____
City _____ State _____

..... Mail the Coupon Now

MANUFACTURING OPPORTUNITIES



Now is the time to cash in on the growing building industry. Make a new and better building material—one that cuts building costs at every step—the kind your builders demand and are waiting for.

We equip you with a Line Production Machine—Raw materials enter at one end—finished products emerge from the other—You make them in more than 40 beautiful colors—You operate with 1 to 3 men who produce a volume selling up to \$200.00 per day.

Investigate now. Send for "4 Keys to Success." It tells how manufacturers already established are making outstanding progress from modest investments. Write today while your territory is still open.

W. E. DUNN MFG. CO.

600 W. 24th St. Holland, Mich.



Sensational SHOE STYLE

INCREASES HEIGHT 2 INCHES

Short men look surprisingly tall in these new amazing shoe styles. Largest in direct-selling shoe line for men and women sent FREE by sales division of leading manufacturer. Good pay every day. No experience needed. Low money-saving prices. Send no money—write for "big shoe sales outfit—FREE."

Salesmen Wanted! Free Sales Kit Sent!

CONSOLIDATED SHOE SYSTEM Dept. M-11

Chippewa Falls, Wis.

Calling All Cars

MYSTERIOUS DISCOVERY SAVES UP TO 30% on GASOLINE or Costs Nothing to Try

Stop wasting Gas!—trim dollars off gas bills—get more power—quicker pickup—faster acceleration! **AUTO OWNERS everywhere praise VACU-MATIC!** Proven so efficient, it is guaranteed to satisfy, or the trial costs you nothing.

Automatic Supercharge Principle Vacu-matic is entirely different! It operates on the supercharge principle by automatically adding a charge of extra oxygen, drawn free from the outer air into the heart of the gas mixture. It is entirely automatic and allows the motor to "breathe" at the correct time, opening and closing as required. Saves up to 30% on gas costs, with better motor performance.

FITS ALL CARS
Constructed of six parts fused into a single unit, adjusted and sealed at the factory. Easily and quickly installed by anyone in a few minutes.

AGENTS Get Yours FREE

FOR INTRODUCING. Here's a splendid opportunity for unusual sales and profits. Every car, truck, tractor owner a prospect. Send name and address now for big money making offer and how you can get yours Free. The Vacu-matic Co., 7617- 532 W. State Street, Wauwatosa, Wis.

JIG SAW \$150
COD or outside U.S.A. \$175

POST PAID

Including 12 assorted blades, Adapters, manual, and roller Saw Guide formerly found on expensive machines only. All metal, 15" long, 8" high, 6 1/2" table. A swift and easy cutter—best ever made for the money.

FREE CATALOG describing \$150 prize contest (1st prize, \$25; 2nd, \$15; 3rd, \$10; 4th, \$5; 5th, \$2.50; 6th, \$1.25; 7th, 50c; 8th, 25c; 9th, 12.5c; 10th, 6.25c; 11th, 3.125c; 12th, 1.5625c). Cal. illustr. complete power tool line; Shaper, Circular Saw with oilless bearings, \$3 each; Drill Press, \$2.50; Joints, \$6.50; completely equipped Lathes, \$2 and \$4.00; Sander, \$1, etc. Order today or send card for Catalog.

\$150 PRIZE CONTEST

J & R Metal Products Co. 5 Commercial St. Rochester, N. Y.

PUSH BUTTON CONTROLLED GAS TANK LOCK

ELECTRIC—OPERATES FROM DASH. Sold as standard accessory on the NEW GRAHAM Car. Streamline in design, low in price, year guarantee. Distributors, dealers here is the fastest selling thing out. Write now for free literature.

SNAP-UP GAS CAP CO. DEPT. 6 ASHLAND, KY.

FINDS BURIED TREASURE! NEW GOLDAK RADIOSCOPE

NEW PATENTED METAL LOCATOR. LATEST TYPE HIGH EFFICIENCY LOW DRAIN TUBES. NEW LOW PRICES. SENSATIONAL NEW MODELS. MONEY-BACK GUARANTEED DETECT BURIED GOLD AND SILVER. The new Radioscope is the most powerful and most sensitive metal locator ever known. Write World's Largest Manufacturer of Successful Metal Detector for free interesting information.

THE GOLDAK CO., Dept. P
1031 South Broadway, Los Angeles, Calif.

HAVE DEPENDABLE FORD BRAKES

Your Ford Car is listed in the so-called lower priced class but has more brake lining area and larger drums than the others, in fact as much or more brake area than all but the higher priced cars. You can have safe, sure, unailing mechanical brakes. Install easily yourself our Simplex Floating Wedges to center the shoes for mechanical assurance with hydraulic performance. A set of four, one for each wheel, all for \$1.75. All models 1928 to 1938—Send for circular.

SIMPLEX WEDGE EXCHANGE, Dept. PM-10, 613 Jefferson St., Ottawa, Ill.

AGENTS WANTED GOLDENTONE .. 50% OFF

Deal Direct, Factory Prices Over 60 models to choose from —4 to 12 tubes. Portables \$8.95 up. Farm sets \$8.95 up. Car sets \$8.95 up. Foreign band sets \$8.95 up. Samples 50¢ cfl. Quantity discounts.

Free 1941 Bargain catalog gives details of 10 day FREE trial, agent's proposition and discounts. No obligation. Mail postcard to **GOLDENTONE RADIO CO.** Dept. P.M., Dearborn, Mich.

10 DAY TRIAL \$4.95 E UP READY TO PLAY YEAR GUARANTEE

Free Catalog of RCA LICENSED

BRONZE FOUNDRY

Sand Casting—Forging—Heat Treating—Case Hardening

Schools Home WORKSHOPS

Make your own castings of aluminum, copper, bronze, silver. Foundry sets are available in three sizes including 2400 Deg. F. blast Furnaces, \$13.50, \$19.00, \$27.50, f.o.b. Kansas City. Free Circular.

KANSAS CITY SPECIALTIES CO.
P. O. Box 6022, Dept. P-9 Kansas City, Mo.

Get Big WELDING PROFITS! with New A.C. Arc Welding

ONLY \$1250 MONTHLY

It's easy to establish your own arc welding business! With this complete, new, speedy Hobart A.C. Arc Welder you can handle hundreds of profitable repair and construction jobs. Simple to operate, easy to get high quality welds. Very low operating cost.

For as little as \$12.50 monthly you get everything you need to start producing the big profit welding jobs. To prove how profitable it is we give you 10 days trial on your own work, at our risk. Write for your free booklet and complete details.

HOBART BROS. COMPANY, Box M-10401, TROY, OHIO

EARN \$150 to \$300 EXTRA PROFIT MONTHLY

Profit from one job alone pays the small monthly payment!

FREE!

"NEW PROFITS IN ARC WELDING" ASK FOR IT.

Check this ad and MAIL TODAY FOR COMPLETE INFORMATION

across the road. In freezing weather the pavement had to be kept sanded.

Another queer job that came under the heading of maintenance was to burn the 215-foot wooden windjammer "Minnie A. Caine." Used as a fishing barge on Santa Monica bay, the old vessel had broken loose in a gale and had grounded on the beach adjacent to U. S. 101. The ship's bulk changed the alongshore currents, building up a sandbar at one point and sending high waves ashore at another. The beach was eaten away and the highway was being undermined. Working at low tides, highway crews burned the ship down to its keel and at once the ocean began restoring the damage that had been done.

There are 14,000 miles of improved state highway in California exclusive of county and city systems. Some three million vehicles use the roads. During the 1940 fiscal year \$9,000,000 is being spent on maintenance and \$17,000,000 on the construction of new state highways.

Reshaping the World

(Continued from page 523)

appeal which will enable his product to appear more desirable than some of those already on the market. With this in mind, the student may decide, for instance, to construct a radio especially for the kitchen.

Next follows a study of the functional characteristics of the kitchen—quite a problem itself, for in the development of the modern kitchen, an instrument like a radio was not foreseen, and what might be placed nicely in one kitchen would prove a nuisance in another.

So, the new type of radio must be aimed at a spot which will suit a majority of kitchens and it is possible that the student may hit upon the idea of hanging the radio on the wall, out of the way of the busy housewife. Then the radio must look like something made especially to hang on a wall. The average radio on a kitchen wall would look out of place.

The public forms very strict habits with relation to the appearance of things in common use and if a new product is too radical in design, it is likely to excite the curiosity of the buyer, but not the desire to buy. For example, when the automobile

(Continued to page 140A)

"SEE CORONA FIRST!"



Tops in portable typewriters...Speedline Corona...three fine models. Fast, easy to operate, up-to-date. Floating Shift, Touch Selector, etc. Smart carrying case also.

Also two Corona Zephyr models...compact, light (9 lbs. and 9 3/4 lbs. in case) and amazingly complete. Standard 84-character keyboard, back spacer. Big value for students.



★ Use coupon below for free copy of color folder showing all five models and easy payment plan. Mail now. ★

CORONA

"BEST KNOWN—BEST LIKED"

L C SMITH & CORONA TYPEWRITERS INC.
Desk 10, 723 E. Washington St., Syracuse, N. Y.
I'm thinking of buying a Corona. Please send free folder describing Zephyr Speedline.

Name _____
Address _____
City _____ State _____

60 POWER TELESCOPE... \$2.19

VARIABLE EYEPIECE 20X—40X—60X
NEW! Three telescopes in one. 3 different magnifications. 20 x power for ultra-bright images with 40 and 60 power for extra long range. Guaranteed to bring distant objects, people, sports events, ships, moon, stars, etc., 60 times as close.



Most powerful made for foot in length. Multiple lens system. 30 mm. objective lens. 5 sections. Directions included for using as a compound 4 lens microscope. American made. Prompt shipment guaranteed. We pay the postage. Only \$2.19.
BROWSCOPE CO., Dept. 410, 5 W. 27th St., New York, N. Y.

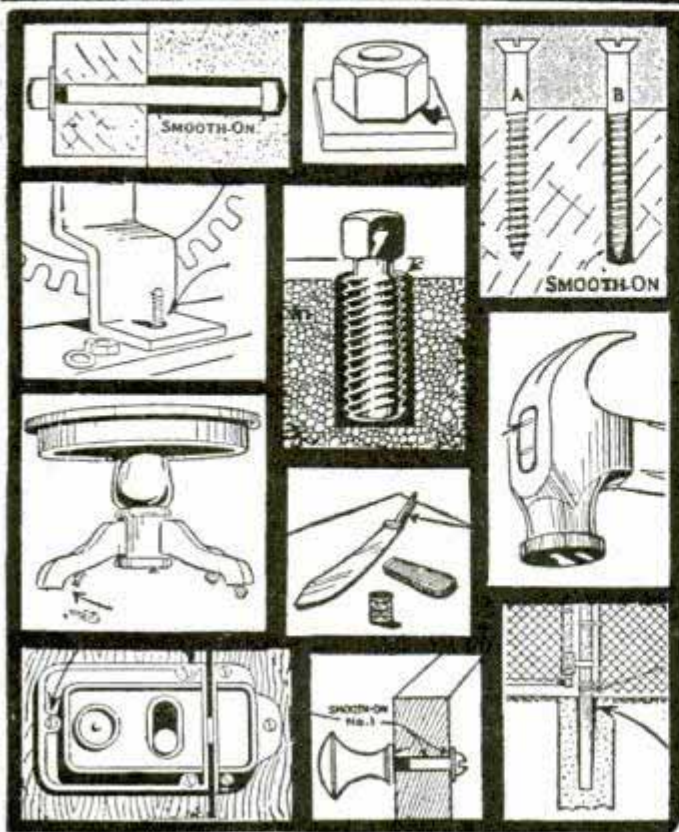
BEWARE!

Look out for anti-freeze that boils away and leaves your car unprotected. Get "Prestone" anti-freeze now — one shot lasts all winter!

See Inside Front Cover and Inside Back Cover

Loose Parts

quickly tightened with Smooth-On



With a little Smooth-On No. 1, you can easily and quickly tighten loose handles, casters, fixtures, bolts, etc., on furniture, tools and equipment all over the house.

This many-purpose iron cement is best for dozens of other household and auto repair jobs, too, such as stopping leaks on heating systems and water lines, sealing cracks in boilers, radiators, tanks, engine jackets, gear cases, etc.

Smooth-On holds securely and permanently on wood, concrete and any metal and its use does not require heat, special tools, or previous experience.

Buy Smooth-On No. 1 in 13 1/4-oz., 7-oz., 1-lb. or 5-lb. cans from your hardware store or, if necessary, from us. For your protection, insist on Smooth-On, used by mechanics and repair men since 1895.

FREE 40-Page Handbook
Describes dozens of practical, ingenious repair jobs that save time and money. 170 illustrations.



For the Motor Car and Boat, Home, Factory and Power Plant

SMOOTH-ON MFG. CO., Dept. 37
574 Communipaw Ave.,
Jersey City, N. J.
Please send Smooth-On Repair Book.
Name
Address
10-40.....

Do it with SMOOTH-ON

(Continued from page 139A)

engine replaced the horse in the early cars, the vehicles retained the appearance of buggies, even to the whip socket, in some cases, because people were accustomed to seeing their vehicles look like that.

With this customer-habit factor in mind, the student may decide to make his radio look like a clock, because clocks have hung on kitchen walls for hundreds of years. This decision makes necessary a study of clocks which are placed in kitchens.

Thus, weeks of research often come before the plastic material has been handed to the student. Does the design conform to the standard method of construction? Will the radio house the right number of tubes? Can the circuit be hooked up properly? Has an extra process been added to assembling the cabinet? Every process costs money. Is the instrument easily boxed for shipment? The radio must be considered as a package. Will it stand transportation as freight? What about net weight?

The students discover there are engineers, production managers, sales experts and advertising men to satisfy and it dawns on them why they call it industrial design.

After they have solved the industrial problems they are ready for the purely artistic—the job of satisfying the public.

Small wonder then, that when a Pratt Institute youngster produced an automobile design which attracted attention in Detroit, he was grabbed up by General Motors. He knew an automobile not only as a vehicle, but as a mechanical device, a production-line problem, a sales unit in a highly competitive field, and so on.

Graduates of the Brooklyn school's industrial design department have found their way into the design laboratories of such great corporations as General Motors, Chrysler, General Electric, Westinghouse and Libbey-Owens-Ford. Many more have placed in smaller industrial organizations.

Such leading industrial designers as Walter Dorwin Teague, Henry Dreyfuss, Raymond Loewy and Norman Bel Geddes—the men who have revolutionized the styling of trains, buses, liners, autos, telephone instruments, typewriters and vacuum cleaners in recent years—have opened their doors to Pratt graduates.

And the public welcomes the products these youngsters all over the country are shaping—through the eyes of youth.

Riding the Water Broncs

(Continued from page 491)

ute are translated into motion without great loss. One of the Gold Cup boats, which are larger, will lose as much as forty per cent of the efficiency from the slipping of the propeller in the boat's own wake.

As a hobby, outboard racing is fairly expensive, though several drivers who are professionals manage to offset at least a part of their expenses by winning cash prizes posted for different regatta events. An amateur will spend anywhere from a few dollars up to \$18,000 a year.

Supposing you decide to start out with a Class A boat. From a dealer you buy what is known as a racing stock motor that costs you \$225. A hull built by an experienced racing-boat builder will set you back \$160, two special propellers will run in the neighborhood of \$25 apiece, a water speedometer \$10 or \$15, a crash helmet and life preserver \$11, miscellaneous extras \$10.

But even with this outlay you're a long way from the starting line. Your motor must be taken apart and fixed so the factory speed guarantees are stepped up at least fifteen miles an hour. This costs from \$100 to \$200 to have it done by a specialist. The cylinders have to be chrome plated, the gas passageways opened up, and the pistons refitted so compression is as perfect as possible. All the other parts are accurately balanced, the lower unit of the motor is filed down and when it's all done your motor is rarin' to go.

Once you get going and win a few races, the speed virus gets in your blood and before long you're looking for new fields to conquer. That means more hulls, more motors. When I go to a regatta these days I take along two class A's, a B, C, and F—and there are others who have more.

From outboards some drivers graduate into the 225-hydroplanes, the country's most popular inboard racing class. The maximum horsepower of these 225-boats is around 175, and the cost of the motor alone cannot exceed \$700. Built to a minimum of fifteen and one-half feet on the water line, a hydroplane is not large as inboards go, but what some of them have done in competitive races with boats seven and eight feet longer and with twice the horsepower has been remarkable.

(Continued to page 143A)

FREE BOOKLET for CAMERA OWNERS



Here's a little booklet, especially prepared for beginners or occasional photographers, that illustrates and describes the *easy* way to get perfectly exposed pictures every time you use your still or movie camera. It's written in plain, understandable language, without confusing technicalities; and it's full of interesting, helpful illustrations. Be sure to send for your free copy... learn how *easy* it is to get every black and white or color picture you take sharply exposed with brilliant detail... how *simple* it is to avoid film losses and picture disappointments due to incorrect exposure. Write today, to Weston Electrical Instrument Corporation, 671 Frelinghuysen Avenue, Newark, New Jersey.

WESTON EXPOSURE METERS



INSURE PERFECT PICTURES WITH YOUR CAMERA

Get a *Genuine* **MOTO-TOOL**
100 TOOLS in ONE



Grinds, polishes, sharpens, drills, engraves, etc. Saves time, cuts cost. Handiest tool in home or shop... use it daily. Same tool as used on precision jobs in factories.

OVER 25,000 R. P. M. High speed conserves cutters, does finer work. Has oil-less (oil-sealed) bearings, cooling fan, balanced armature, 110 V. (AC-DC) **MODEL 1 MOTO-TOOL** with chuck, 1/8" collet, only \$9.85. **MASTER MODEL 2**, 27,000 r.p.m., heavier, more powerful, only \$16.50. **10-DAY TRIAL.** See the genuine **DREMEL MOTO-TOOLS** at better Dealer's or order direct from factory on 10-day money-back trial. Catalog of Dremel tools, equipment and special combination offers, **FREE.** **Dremel Mfg. Co., Dept. MT110-K, Racine, Wis.**

PROJECT BOOK
Big 24-page book shows how to make 41 plastic projects. Sent postpaid for only \$1.

Only \$9.85 POST PAID MASTER MODEL \$16.50

Say you saw it in *Popular Mechanics!*



SAFE!

NEW DISCOVERY

**For WORMING Your Puppy or Dog
Without Danger of TOXIC POISONING!**

Thanks to the NEW Glover's *Imperial* Capsules, the danger of toxic poisoning and violent after-effects from worming your pet is at last removed. This was never before possible in a worm medicine! They not only safely expel Round Worms (Ascarids) and Hook Worms, but also Whip Worms—all THREE! Think of the **ECONOMY**—only 25¢!

FREE DOG BOOK—Write Glover's,
Dept. 15, 460-4th Ave., New York.

**ONLY
25¢ GLOVER'S
Imperial CAPSULES**

PAINT STRIPING TOOL **ONLY**

AS EASY TO USE AS A PENCIL! **\$1.00**
POST PAID

With this new low priced TOOL (not a brush), you can now do professional striping—on furniture, autos, models, tiled walls, toys, boats—and all home workshop projects. Tool uses paint, enamel, lacquer, etc. Thousands of satisfied users in home, workshops, garages, furniture stores, etc. (We also make commercial and industrial models.) Send only \$1.00 for complete tool with gravity feed container, 1/16" striping wheel, adjustable guide, operating instructions, etc. Sold on Money Back Guarantee. Narrower or wider stripe widths available. Write today for free literature. Dealers: Write for catalog, prices and discounts.



Stripes add beauty to every painted article

WENDELL MFG. CO.

2500 N. Ashland Ave. Chicago, Ill.

**NEW MYSTERIOUS
BLACK LIGHT
ELECTRIC EYE**

FREE **BURGLAR ALARM and ANNUNCIATOR**

Send your name—no money—for free facts about the sensational sales success—RAY-ALARM—the first electric eye at a low price. Tremendous national publicity has created huge market with stores, homes, shops, factories as a burglar alarm and in gas stations and offices as an annunciator. Salesmen and distributors are now **CASHING IN** on spectacular demonstration and magical performance. If you can sell, don't lose a minute. This is the biggest profit opportunity in years. Send name today to:

RAY-ALARM, Dept. R-1610, 225 Fifth St., Des Moines, Iowa



**WORLD'S LOWEST PRICED
ADDING MACHINE** **ONLY \$250**
BEST POCKET SIZE **FREE TRIAL**

IDEAL FOR BUSINESS OR PERSONAL USE. **GUARANTEED ACCURATE.** Not a toy. Operates with only a finger flick. Adds, subtracts, multiplies, divides. Counts up to ten million. Pays for itself over and over. Ideal Gift—for Business, Income Tax and School use. **MONEY BACK GUARANTEE.** Send name and address. Pay postman only \$2.50 plus postage. (Send full cash if outside U.S.) Money back in 10 days if not delighted. **AGENTS WRITE.**
CALCULATOR MACHINE CO. (Mfrs.) DEPT. 111, P.O. BOX 1111, CHICAGO, ILL.

When writing please mention Popular Mechanics

SpeedWay DRILL \$7.95 GRINDER \$5.95

KIT \$14.95

QUALITY TOOLS
...products of SpeedWay, for 30 years leading manufacturers of electric tools. Specially wound high torque 110V universal tool motors. Improved designs, correct speeds. 1000 RPM Drill with die cast handle has 1/4" capacity in steel. 20,000 RPM Hand Grinder has speed essential for efficiency and collet for both 1/8" and 3/32" arbors. Drill and Grinder sold singly or together with 5 accessories in fitted Steel Kit. Stand takes either drill or grinder.

Router \$3.95

GRINDER \$9.85

Router Frame converts grinder into router. Bench Grinder is complete with motor. Write for Circulars. SpeedWay Mfg. Co., 1842 S. 52nd Ave., Cicero, Ill.

DOES OIL WEAR OUT?

U. S. Bureau of Standards states: "Oil does NOT wear out mechanically and may be used over and over again." (After reclaiming). Thousands of car, truck and tractor owners have proven the truth of this statement with the use of "RECLAIMO." This revolutionary device filters and reclaims crankcase oil as you drive. Saves Time, Trouble and Money! Our 36-page illustrated booklet, "OIL FACTS," contains complete details and startling oil truths that will amaze you. Write for your copy today—It's FREE. (Sold direct and by reliable dealers everywhere.)



RECLAIMS AS IT FILTERS

RECLAIMO MFG. CO., 2306 N. Western, Dept. 51, CHICAGO



SHAW GARDEN and SMALL FARM TRACTOR

Does ALL JOBS on small farm—small jobs on ALL FARMS. Three types: 2-wheel garden tractors 3/4, 2, 3, 4, 5 H.P.; 4-wheel 5 and 8 H.P. Riding Tractor; High arch models, 8 H.P. Write for FACTORY prices—FREE CATALOG.



SHAW MFG. CO., 4510 Front St., Galesburg, Kan.; 5812-G Magnolia Ave., Chicago, Ill.; 130-G West 42nd St., New York City; 668-G North 4th St., Columbus, Ohio.

Air-cooled engine; auto-type gear shift; many fine features.

Print Your Own

Cards, Stationery, Advertising, labels, paper, circulars, photo and movie titles, tags, etc. Save money. Sold direct from factory only. Junior outfit \$8.25. Senior outfits \$16.55 up. Do popular raised printing like engraving with any press. Print for Others, Big Profits Pays for itself in a short time. Easy rules sent. Write for free catalog of outfits and all details. Kelsey, Inc., L-37, Meriden, Connecticut

BUILD ARC WELDER FROM OLD GENERATOR

For Light or Heavy Work. 75-200 amperes. Complete PLANS and valuable catalog 35c. Over 900 Electrical Supply Bargains. LeJay Mfg. Co., 1347 LeJay Building Minneapolis, Minnesota

Choose from World's Largest Line of Power Tools!
FREE New 1940 Catalog covers Metal and Woodworking Tools, accessories, motors for every purse. Write Walker-Turner Co., Inc., 1100 South Ave., Plainfield, N. J.

DRIVER Engineered POWER TOOLS
TRAILER BUILDERS' GUIDE & CATALOG only 10c

Build a Trailer easily in spare time with world's best line of trailer parts, axles, hitches. Complete working blue prints only 50c. Universal Draw Bar, readily attached to any car. SEND 10c TODAY FOR CATALOG. HAMMER BLOW TOOL COMPANY, Dept. 110, Wausau, Wis.

BRUSH PLATING OUTFITS
for autoparts, reflectors, faucets, bicycles. No tanks necessary. Free particulars. GUNMETAL CO., AVE. M, DECATUR, ILLINOIS

OTTAWA Log Saw \$39 **BIG BOOK FREE**

PUTS THIS OTTAWA to work for you. MAKE MONEY! Wood is valuable. Does more than 10 men. Easily operated. Falls trees—saws limbs. Use 5-hp. engine for other work. Write for FREE BOOK. OTTAWA MFG. CO. 3627 Wood St., Ottawa, Kans.



SAW 10 TO 20 CORDS A DAY

Jack O. Cooper, my father, switched from outboards to hydroplanes four years ago and now holds three world speed marks and a half dozen Canadian and American titles.

At Picton, Ontario, last summer, he decided to try for a mile straightaway record. In these tests, two successive mile runs are made, one going one way, the other back over the same route, and then the two times are averaged. On the first mile, a cross wind interfered. Nevertheless, his official speed for the first mile was 87.379 miles an hour. On the return trip, it was clocked at 87.591 for a general average of 87.485 miles an hour—an improvement on the old record of nearly two miles an hour.

Pop, as he's known around the regattas, is not resting on his laurels. He's building a new boat with which he hopes to raise the mark to ninety miles an hour. That's the way outboard drivers are.

The Search for War Metals

(Continued from page 483)

cury and are unaware that California, with fifty-nine mercury mines, is now fulfilling the domestic demand. Mercury is a vital war metal and now that its price has risen to \$192 per seventy-six-pound flask from the average of \$80 per flask earlier in the year many of the inactive California mines have resumed production.

Instead of prospecting for new deposits, the engineers of the Bureau of Mines are simply estimating the reserves that may be available in the known mineralized areas. A large deposit of low-grade manganese, for instance, is an important national asset even though it can't be mined profitably at present prices. Mining costs would be relatively unimportant in an emergency that cut off foreign shipments. The engineers are busy in several of the western states. One group may be rushing its work at 10,000 feet to complete its survey before snow falls, while another is fighting the heat on a desert expedition. Some travel by pack train while others use tractors.

One hundred and sixty-two of the most promising mineral deposits have been given field examinations and of these thirty-three seemed promising enough to warrant more detailed study. Several hundred additional properties will be examined.

(Continued to page 144A)

I'M SO HAPPY NOW
THAT CHARLES IS
DOING SO WELL IN HIS
NEW BUSINESS



**TOOK IN \$217
in 10 DAYS
WASHING WALLS**

● Newly invented machine washes walls 6 times faster and better than by hand. Charles Stelle took in \$217 first 10 days. We want more men to go into business for themselves. Customers everywhere—homes, schools, offices, stores, churches, lodge halls, hotels all have walls that need washing. You don't have to rent a store or office. You operate this business from your home. The expense for materials is small. What you take in is practically all profit. On a \$10 job cost for materials is about 20c. Write now for complete facts on this Von Schrader Wall Deterger which washes paint beautifully and postpones repainting many years.

Harold Jones writes: "I landed a \$40 job the first day."

J. Cranston says: "I have several jobs to start on Monday, thanks to your help."

Clyde Brandt writes: "I made a demonstration in a public school and got a contract which will more than pay for my machine in the next few days."



Easy Payments

It takes only a few dollars to get started in this money-making profession. No experience necessary. The total price is so small and the payments so easy that anyone with ambition should get started NOW.

SEND FOR FREE INFORMATION

There is No Obligation

VON SCHRADER

MANUFACTURING CO.

770 Pl. Racine, Wisconsin.



HANDEE

Tool of 1001 Uses!

A whole tool shop in your hand—finest, fastest, most powerful tool for its weight, 12 oz. Full of thrills for everyone. Uses 300 accessories to grind, drill, polish, cut, carve, rout, saw, sand, sharpen, engrave, etc. 25,000 r.p.m. Plugs in any socket.

Make gifts, prizes, things for the home or to sell—ship, train, plane or house models, costume jewelry, figurines, those new engraved glass book ends, mirrors, trays, etc., from any metal, alloy, plastic, glass or wood.

ORDER ON 10 DAYS' MONEY-BACK TRIAL
DeLuxe Model Handee (illustrated) with 6 Accessories, \$18.50. Standard Model, 18,000 r. p. m. with 3 Accessories, \$10.75.

FREE—64-PAGE CATALOG
Complete information on Handee Products and their wide application in crafts work and industry all over the world.

CHICAGO WHEEL & MFG. CO.
108 S. Aberdeen St., Chicago, Ill.





GIVES YOU Accuracy Strength and Power at Low Cost

Now you can handle *any* of those precision metal lathe jobs that used to require expensive equipment—the new Atlas 6" lathe is the first precision-built small lathe at a popular price. Timken bearing equipped, 16 speeds, V-belt drive, precision-ground bed. 12" or 18" centers, \$61.50 and \$64.50 complete less motor. Send for big 1940 Atlas catalog.

See Atlas, Hall of Inventions, N. Y. World's Fair

Atlas
ATLAS PRESS CO.
1043 N. PITCHER ST.
KALAMAZOO MICHIGAN

LATHES • DRILL PRESSES • ARBOR PRESSES
METAL SHAPERS • VISES • CIRCULAR SAWS



STOPS SQUEAKS

Fight friction and friction-noise the successful way—with microscopically fine powdered Dixon's Microfyne Lubricating Flake Graphite. Lubricates better, longer, than oil or grease, cannot burn, freeze, dissolve. Will not drip, squeeze or wash out. Dixon's Graph-Air Guns make it easy to apply. See the Junior squirt-as-you-squeeze model (30c) and the rubber refillable model (75c) at your dealer's. Nothing handier, quieter, surer or better for balky locks and a thousand or more other lubricating jobs in office, store, mill, factory and home. See your dealer or write Dept. CG-26.

KILLS FRICTION

30¢
Filled with about 900 Shots

DIXON'S GRAPH-AIR GUNS

JOSEPH DIXON CRUCIBLE CO., JERSEY CITY, N. J.

He Makes a Good Living FILING SAWS

"Last Year I sharpened 2309 hand saws, for which I got \$1154.50. The Foley Saw Filer has made a good living for me!"—John Joseph, Calif. A FOLEY Automatic Saw Filer files hand, circular and band saws better than the best hand filer. Cash business, no canvassing, no eyestrain. No experience needed. Send coupon for FREE PLAN, no obligation.



FOLEY MFG. CO., 1016-40 Foley Bldg., Minneapolis, Minn.

Send Free Plan on Saw Filing Business.

Name.....
Address.....

In the hunt for antimony the engineers have explored two important areas in Idaho. Using tractors and bulldozers, the engineers built their own roads, stripped 3,000 cubic yards of earth from steep wooded hillsides, drove tunnels, and drilled into the formations to estimate their value.

In eastern Oregon one party took time out to fight a forest fire before they finished examining a chromite deposit. In Wyoming 9,000 trees had to be removed so that tractors could trench the surface of another chromite deposit. In Nevada several tungsten deposits have been explored.

Meanwhile prospectors who have been combing the west for gold and silver are turning their attention to the baser metals. A good ledge of tungsten or chromium ore may be worth more than a gold mine. Prospecting methods have changed and among other new developments is a kind of vacuum cleaner that collects heavy cuttings from holes drilled into underground formations. Such samples were formerly taken by slow, expensive core drilling.

Geologists have known for a long time that vegetation is often an indication of mineralized zones and that changes in the type or coloring of surface plants may be associated with changes in the minerals below. Prospectors who use airplanes for general studies pay special attention to ground where long lines or islands of brush differ from surrounding vegetation.

Vegetation is being analyzed for its mineral content as a way of learning whether commercial grades of ore may be found below the surface. Slight traces of many minerals are necessary parts of a healthy plant's diet and a plant absorbs minerals to the extent that each is present in the soil or the water that sustains it. A large percentage of one element in a plant suggests that a deposit exists near by.

A number of very necessary war metals, such as copper, lead, and zinc, are not regarded as strategic minerals because the United States already has tremendous quantities available. To maintain our supplies of copper one company is developing a huge body of low grade ore in Arizona. Known as the Clay ore body, it is a mile long, half a mile wide, and 800 feet deep. Half a million pounds of copper a day will be refined when the new mine is operating.

NOW! Print YOUR OWN Pictures from any negative — NO DARK ROOM NEEDED

PHOTO-PRINT

COMPLETE PHOTO-PRINTING OUTFIT

No experience required . . . No dark room needed. Here's the NEW, EASY, inexpensive way to make "professional" photographs at home from any negative.



LOOK WHAT YOU RECEIVE . . . 3 picture masks, 1 metallic top printing frame, 1 glass frame cover, 2 wood clamps, 1 bottle of Foto printer fluid, (enough for 150 pictures), supply of Hypo. Complete instructions. As an added feature, 24 Xmas folders and 24 envelopes, with cut-out picture that you can personalize with your own photograph. This is all you need to print photos (in 2 minutes) on any type of material—paper, silk, cloth, rubber, etc. It makes a permanent picture for decorating handkerchiefs, scarfs, ties, stationery, cards, etc. Order directly from this ad . . . Immediate delivery.

FREE
Write for Bulletin
PP-10

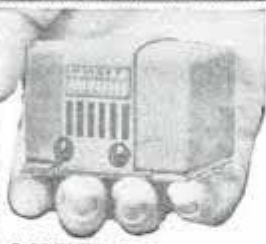
COMPLETE OUTFIT
for 150 PRINTS
Nothing More to Buy
\$1.95
POST PAID

Tear out this ad, write name and address in margin, mail \$1.95 or order C.O.D. and we will send outfit at once.

NEW! 1941 MODEL! Pocket Radio* Tubes Batteries Plug In DURABLE PLASTIC CABINETS

Dual Bands — Magictenna — Microdial

Fits your pocket or purse—Wt. 6 ozs. Small as cigarette package. Receiver standard & some short wave. PATENTED POWER CRYSTAL No tubes, batteries. Hi-ratio easy tuning slide "MICRODIAL". M. L. OF ILL. SAYS: "MIDGET RADIO WORKS FINE!"

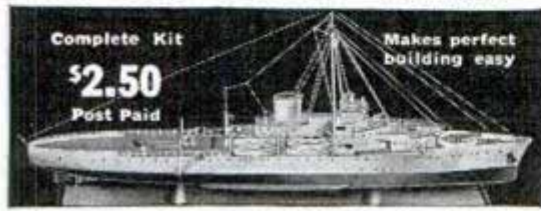


ONE YEAR GUARANTEE!

Sent complete ready to listen with instructions & tiny phone for use in homes, offices, hotels, in bed, etc. SIMPLE TO OPERATE—NO ELECTRICITY NEEDED! SEND NO MONEY! Pay postman only \$2.99 plus postage charges on arrival or send \$2.99 (Check, M. O. Cash) and yours will be sent postpaid. A MOST UNUSUAL VALUE! ORDER NOW! FREE! PLUG IN "MAGICTENNA"—ELIMINATES OUTSIDE WIRES!

MIDGET RADIO CO. Dept. P-10 Kearney, Nebr.

build this COAST GUARD CUTTER



Complete Kit
\$2.50
Post Paid

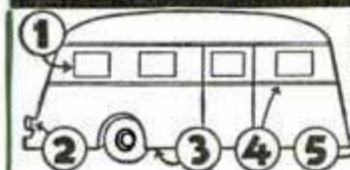
Makes perfect building easy

CARVED HULL Included!

24" Super Detail Model
Catalog—10c

IDEAL AEROPLANE & SUPPLY CO., Inc., 26 W. 19th St., New York

"MARVEL-OUS" TRAILER PARTS



(1) "Famous" Marvel Windows, (2) tail lights, (3) complete undercarriage equipment, (4) body moldings, (5) couplers. Also refrigerators, stoves, lighting fixtures, everything you need in highest quality. Largest trailer equipment stock in U. S. Immediate delivery, low prices. Send 10c coin for 40-page ill. catalog.

Marvel Trailer Parts Co., 19020 Celestine Ave., Detroit, Mich.

LIGHTS ITSELF

SELLS ITSELF
Quick Action (1940) Perfected Self Starting Lighter

Lights cigar, cigarette or pipe—Instantly. Never fails. IMPROVED PRINCIPLE IN IGNITION. No flint. No friction. Send 25c for sample and large can of fluid Start now. Agents report big earnings.

NEW METHOD MFG. CO.
Box PMD-94 Bradford, Pa., U.S.A.



Lights Easily in the Wind

Packed in DIS-PLAY BOX
25c RETAIL
Doz.....\$1.75
Gross...\$18.00

START A LETTERSHOP

Fascinating business for men or women. Operate a lettershop in your locality—secure steady profession. Send for free literature at once.
CREATIVE LETTERSHOP COMPANY RHINEBECK, N. Y.

PHOTO ENLARGEMENTS

Is Photography your hobby? Do you want a profitable easy business at home? Make **PHOTO ENLARGEMENTS** for yourself and others. Your cost 5c each and less. The Ideal Photo Enlarger is **AUTOMATIC**. No experience required. Also **COPIES** any picture. \$5.94 COMPLETE. Interesting circular FREE.

5¢ ANY SIZE

Ideal-O, 148 West 23rd St., New York City

RENEW OLD BUILDINGS WITH PLASTIC STUCCO

STUCCO SPRAYING MACHINE

It fuses a plastic mixture to any masonry surface. It water-proofs and fills all cracks. It can be applied in any thickness desired and in 30 colors. Fully proven by over thirteen years actual use under all conditions and every climate.

BIG EARNINGS. Operators report costs of 2c and up per sq. ft. and sell up to 7c. Machine covering capacity up to 1000 sq. ft. per hour soon pays for itself. Make money by supplying the big waiting market for renewing both old and new buildings with permanent color at low cost.

Get the facts. Send for books, "Proven Business Opportunity." Write today.

COLORCRETE INDUSTRIES, Inc.
570 Ottawa Ave., Holland, Michigan

SAVE \$10 to \$50 ON AN ENLARGER

Make Enlargements With Your Camera

UTICAM utilizes your camera to make enlargements and saves cost of expensive equipment. Fits any folding, miniature or box camera which opens from the back. Simply snap camera to **UTICAM**. Accommodates negatives, 35 mm. up to 3 1/4 x 5 1/4". Precision lens of your camera assures clear, sharp, accurate enlargements of any size. Only \$7.65 complete. **UTICAM** reduces as well as enlarges. Sold on 10 day trial with guarantee of satisfaction. Write for complete description, photos and diagrams of **UTICAM**. See how you can save many dollars in purchasing an enlarger. **TECHNICAL EQUIPMENT CO., 512 Keith Bldg., Dept. 610, Cincinnati, Ohio.**

SHIRT PRICES Smashed!

BONUS SHIRTS GIVEN SALESMEN . . . You get big daily earnings from following simple, easy plan of giving Bonus Shirts to customers. Sensational new 24 K. Gold Signagram Free. Prices low as 3 for \$4.38. Pays you 90c to \$1.30 each order. No delivery or collecting to do. No money or experience required. Everything sent free and without cost to men answering quickly. Send no money. Give age, occupation, race.

WILTON SHIRT COMPANY, Dept. PM-1, Milan, Tenn.

FOR THE GUNSMITH SHOOTER AND HOBBYIST

★ WORLD'S GREATEST GUN & GUNSMITH GUIDE

Stocks & Blanks, Ballistics, Barrels, Targets, Scopes, Thousands of Accessories. Latest prices and specifications. Recognized everywhere as World's Standard Gun and Gunsmithing Guide. ★ Send A DOLLAR BILL, check, M. O. or stamps for this tremendous 512 Page, new 1941 Catalog-Handbook.

512 PAGES \$1

"The Shooter's Bible" 1941 Edition
"CONTAINS ONLY COMPLETE GUNSMITHING SECTION"

STOEGER'S GUN CATALOG HANDBOOK No. 33

512 PAGES—17,000 ITEMS—6,000 PICTURES (hundreds in color). Contains only Complete Gun Tool Section for amateur & professional. Finest Hand Tools. All American Guns—Shotguns, Rifles, Revolvers, Pistols, Airguns. 100 PAGES GUN PARTS (illustrated). Restocking, Remodeling, Reloading, Walnut "The Shooter's Bible" ISSUED BY "AMERICA'S GREAT GUN-HOUSE"

— FILL OUT AND ATTACH DOLLAR BILL —

STOEGER ARMS CORP., 507 FIFTH AVE., (at 42nd St.) NEW YORK

NAME _____ ADDRESS _____ CITY _____ PM _____

DO YOUR OWN DEVELOPING

go places
IN PHOTOGRAPHY
WITH THIS
darkroom
kit



Get that "something extra" into your prints that makes a salon stand out of just another picture. Begin now to do your own developing. This 18-piece complete developing and printing outfit provides all the necessary essentials. Valued at \$3.95, here's real money-saving you won't want to miss at this low price. **\$2.49**

BE SURE YOU SEND for catalog of latest nationally advertised cameras and equipment. It's FREE! 50 pages of values to save you important money. A postcard will do. Mail at once.

Lafayette Camera

NEW YORK, N. Y.
100 Sixth Ave.
CHICAGO, ILL.
701 W. Jackson Blvd.
ATLANTA, GA.
265 Peachtree Street
BOSTON, MASS.
BRONX, N. Y.
NEWARK, N. J.
JAMAICA, L. I.

LAFAYETTE CAMERA

Dept. 7KC—100 Sixth Ave., New York, N. Y.

Rush FREE Camera Catalog No. 81.

I enclose \$..... Rush my order.

NAME

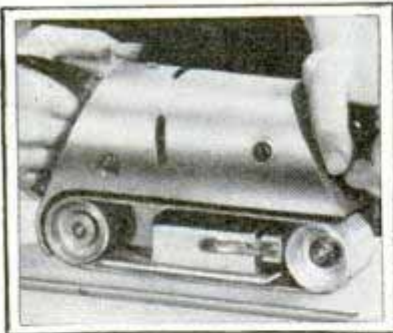
ADDRESS

CITY

STATE

SAND 10 TIMES FASTER

— get Better jobs this
Easy way!



SANDS—GRINDS
POLISHES
BUFFS—SHARPENS
REMOVES PAINTS,
VARNISHES,
LACQUERS

New Guild PORTABLE ELECTRIC Sander

Do your sanding jobs 10 times faster with this handy little portable power sander. It's easier. Ends all the drudgery of hand sanding. Anyone can use it without practice.

Driven by a powerful motor, the endless abrasive belt sands with the grain. Leaves no ugly swirls, no cross-grain scratches. Gives uniform finish on flat surfaces . . . is handier around curves. Sands wood, wall board, metal, slate, marble, bone or plastics.

GuildSANDER is a popular-priced precision tool—with a 5-year guarantee. Works from any light socket. Weighs only 9 lbs. Try it at your hardware dealer's, or write direct for details.

SYRACUSE GUILD TOOL COMPANY
1740-10C N. Salina St., Syracuse, N. Y.



AMAZING VALUE

\$15.00

LIMITED TIME ONLY

New streamlined bicycles, full size, state when ordering if you desire high pressure or balloon tires, \$5.00 deposit, balance C.O.D.

PRECISION MACHINE AND TOOL CO.

Box 228, Station D.

New York City, N. Y.



Do more
Earn more
Work less
with a

Red Universal
Tractor

You plow, disc, cultivate, mow, haul, do belt work, for about 33¢ a day. Safe, trouble-free long life. New plow lift, new reverse. Hundreds used. Save by buying from maker. Two weeks trial. FREE catalog. Write today.

PIONEER MFG. COMPANY
Dept. V-100 West Allis, Wis.

Big Money for Workers In Home or Shop



MONEY-MAKING PROJECTS. Color-glazed concrete lawn, cemetery pottery made without molds or cores. New, Patented method. Use only sand, cement, cheap materials. Tiles, walls, gravestones. Statuary, giftware. Basement waterproofing. Booklet, details 3¢ stamp.

NATIONAL POTTERIES COMPANY
Dept. 6, 13 W. 26th St. Minneapolis, Minn.

FREE

WHY WEAR DIAMONDS?

OFFER

When Diamond-Dazzling Zircons (Matura Diamonds) from the Mines of far-away, Mystic Siam are so effective and inexpensive. Stand acid; cut glass; true backs; fiery beauty; exquisite mountings. Write for FREE catalog. Address:

THE ZIRCON CO.,
Dept. 10, Wheeling, W. Va.

RELIABLE MEN
Wanted to operate movie circuits in theatreless communities. Earn \$50.00 to \$100.00 weekly. No experience necessary. Everything furnished. Write Southern Visual, Dept. PM-10-1, Box 2404, Memphis, Tenn.

do-it-with-SQUABS

Raised in ONLY 25 DAYS. Why breed for ordinary poultry trade when luxury markets want all the squabs you can ship, every day in year? Go after this profitable poultry trade now. Write postcard, get eye-opening free poultry business guide. RICE FARM, 635 H. ST., MELROSE, MASS.



GERSTNER Tool Chests

The finest Chests that money can buy. Free catalog for Machinists and Toolmakers.

GERSTNER TOOL CHESTS
440 Columbia St., Dayton, Ohio

Makes marvelous movies at everybody's price
CINÉ-KODAK EIGHT

See it at your dealer's



MONEY IN RABBITS—CAVIES

WE BUY and put you in touch with other markets. Catalog and copy of magazine 10c. Or send 25¢ for Book Catalog and Price List and Year's Subscription to the AMERICAN SMALL STOCK FARMER

OUTDOOR ENTERPRISE CO., BOX 919, NEW CITY, N. Y.



FREE TRAILER PARTS CATALOG

We'll save you money on—axles, springs, wheels, couplers, windows, sinks, water pumps, brakes, refrigerators, beds, lamps, inside and out, 8V lamps, furniture, jacks—everything. Special discount to mfrs. NATIONAL TRAILER EQUIPMENT CO., Successors to Kar-A-Van Industries, Inc. Dept. P. 714 W. Wisconsin Ave., Milwaukee, Wis.

Complete Plans and Building Instructions. 10c



Earn Cash at Home!

We paid M. M. \$1174 for exceptional cellar crop Snow-King mushrooms! We furnish materials; buy all crops. Big FREE picture book tells if your cellar, shed, barn, suitable. Est. 1908. Write today. United Co., 3848 Lincoln Av., Dept. 305, Chicago

Grass—Newest Food for Man

(Continued from page 511)

for instance, with powdered green grass added to the ingredients took on an unappetizing hue. However, by removing the chlorophyll, the green coloring matter in plant life, the powder assumed a neutral yellow color that looks and tastes like malted milk, and what's more, has an even greater vitamin potency than is otherwise the case. It gives white bread a golden color.

The story behind this development goes back a dozen years to an ill-fated commercial egg farm launched by a cereal chemist named Charles F. Schnabel and two associates. Everything was highly scientific, but once the 5,000 Leghorns and Rhode Island Reds started laying eggs they began dying. It wasn't long before the egg factory failed. Schnabel refused to call it quits until he'd gotten to the bottom of the mass deaths. The high mortality rate, he surmised, was due to lack of an adequate supply of blood-building materials. Increase the nutrients and he'd cut the death rate, possibly step up egg production.

Green leaves were a recognized source of the materials he was seeking so he turned first to alfalfa. As long as he kept the green material below ten per cent of the total ration, his chickens were in average good health but above that amount they appeared worse off.

The next couple of years found him trying some twenty different vegetables and field crops and he was on the point of junking his theory when he chanced upon a supplement of young oats, lettuce, and rape plant. His 106 hens began eating thirty pounds of the green mixture daily and during the next six months his records showed a daily average of ninety-four eggs. Another year of test feedings convinced him the record was no fluke.

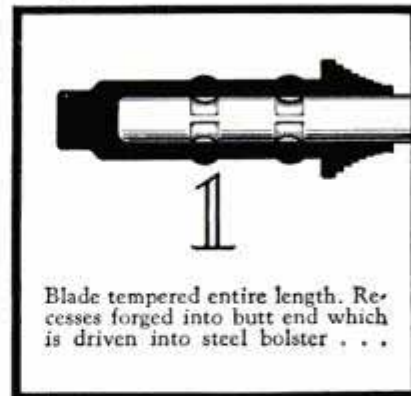
At this juncture, Schnabel found himself out of a job. He set up a budget of a dollar a day for feeding his six children, his wife, and himself. He knew his family wasn't going to get all the food values needed in such low-cost meals. The thought of the young cereal grasses popped into his mind. If they were good for poultry and livestock why wouldn't they be good for humans?

Dried cereal grasses immersed in cream

(Continued to page 148A)

Stanley Screw Driver

No. 25

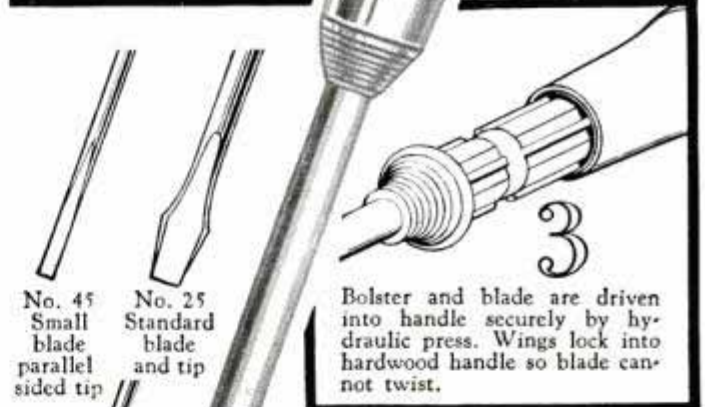


Blade tempered entire length. Recesses forged into butt end which is driven into steel bolster . . .

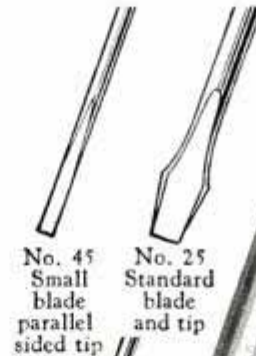


Bosses are swaged into blade recesses. Four sharp wings are swaged on outside of bolster. Blade is now locked into bolster . . .

STANLEY
Trade Mark



Bolster and blade are driven into handle securely by hydraulic press. Wings lock into hardwood handle so blade cannot twist.



No. 55 Small blade, flared tip

This patented construction makes it possible to temper the blade its entire length, providing greater strength. Stronger, better insulated, and with accurately machine cross-ground tips, the Stanley No. 25 Screw Driver is made in 8 lengths, 2½" to 12".

See them at your hardware store, or write for Catalog 34, which describes all Stanley Tools.

STANLEY TOOLS

Division of The Stanley Works, 105 Elm St., New Britain, Conn.

THE TOOL BOX OF THE WORLD

**HEAR
CLEARLY AGAIN**



**Western Electric
AUDIPHONE
Ortho-technic Model**

This product of Bell telephone research brings back the living world of sound. The Western Electric Audiphone is based on advanced technique in hearing aid design—helps the user to carry on group conversations, and widens the hearing circle. After an audiometric test, your dealer will recommend the model best suited to your needs.

Audiphone and advertisement accepted by Council on Physical Therapy, American Medical Association.

Distributed in Canada by
Northern Electric Co., Ltd., Montreal

GRAYBAR ELECTRIC CO., PM-57
Graybar Building, New York
Please send details on Western Electric Audiphone
and name of nearest dealer.

Name.....
Address.....

A SPECTACULAR MONEY MAKING OPPORTUNITY FOR A FEW MEN WITH VISION

I HAVE built and patented a form of outdoor golf that is taking the public by storm. Duffers and skilled players, alike, become so enthusiastic after their first round as to repeat play immediately.

The entire needed facilities can be set up on 10 acres of ground, the fairways and greens are full size in every respect. Player sees full flight of every shot and plays against all hazards common to golf, using every club in regular order completing each hole on grass green. Time for 9 or 18 holes greatly reduced; walking cut to one-third.

My own test installation shows possibilities for making money that should satisfy anyone.

As I will close my Chicago business in late September, I am ready now to license two or three men in southern or southwestern states under franchise of patent. I will

make the installation for you and get crowds coming as part of my contract—putting you in a clean, cash, outdoor business that will pay you substantial profits day and night (under flood lights) for years to come. If you can invest \$4,500 for equipment, I can show you real profits and a permanent future.

First come, first served. Write me quick, or telegraph your name and I will send complete description, photographs, and plans of operation. State territory in which you would be interested. Personal interview will be arranged so you can see my test plant in actual operation here in Chicago.

Address K. Huntington, 1828 W. Chase Ave., Chicago, Ill.

became a breakfast dish for his family and for three years made up for the vitamin deficiencies in the budget meals. The children apparently thrived on the dish.

Meanwhile, at the University of Wisconsin, a young graduate student, George O. Kohler, working with Professor E. B. Hart and Dr. C. A. Elvehjem, famed biochemist, had become interested in a peculiar phenomenon taking place in the university's nutritional research laboratories. The rats used in tests were on a specific diet of milk, minerals, and salts the year around, yet they grew much more rapidly in summer than in winter. Inasmuch as the milk was all from the same dairy herd, the only possible solution to the problem lay in the fact there was a difference between summer and winter milk.

Doctor Kohler's preliminary studies adduced proof milk from cows on pasture contained some growth-promoting element not present in the milk of cows foraging on hay, a factor apparently different from all other known substances. This led to the discovery of the grass juice factor, a contribution to the ever-growing list of vitamins. When the juice of growing grass was added to winter milk, the rats immediately assumed summer growing habits.

Schnabel, convinced the vitamins in young grasses tended to diminish rapidly if something weren't done to preserve them, sought a more efficient drying method. A dairy he knew of had an unused piece of equipment that would fit his need so he called on Lynwood H. Smith, its president, to see if he might borrow it.

When the need of a preserving agent for the poultry supplement was mentioned, Smith felt that by mixing the green pulp with fresh buttermilk, then condensing the mixture to a thick paste, the carotene, the precursor of Vitamin A, which ordinarily depreciates rapidly when exposed to sunshine or air, could be preserved.

The upshot of their meeting was a job for Schnabel on Smith's farm where tests were made on chickens with young grasses and buttermilk—and a new industry was born. Not only is Cerophyl, as the product is called, rich in common vitamins, A, B, C, and G but animal assays have shown the presence of many others—E, K, nicotine acid, grass juice factor, B₄, B₆, R, U, and Factor W.

TOUGH?.. I'LL SAY!

HORSEHIDE HANDS WEAR LIKE IRON

Yet They're Soft as Buckskin

There's a world of extra comfort in the amazing Kid-glove softness of WOLVERINE HORSEHIDE HANDS. But there's unbelievable toughness there too that simply defies scuffs and scrapes—saves you money in extra wear. Made by the maker of Famous Wolverine Shell Horsehide Work Shoes.



SOFT AS BUCKSKIN...
YET TOUGH AS NAILS

IF YOUR DEALER CAN'T SUPPLY YOU

Send his name and 75c. We'll mail you a pair postpaid. Sizes 8 to 12—Style No. 569. Wolverine Shoe & Tanning Corp., Dept. M-1040, Rockford, Michigan

STYLE No. 569
OLD GOLD
Driver's Pattern

DEALERS: Make your store work glove headquarters with Wolverine Full Grain Horsehide Hands. Write for catalog and tested plan.

WOLVERINE HORSEHIDE WORK GLOVES

make money with

CHET

A new, marvelous soap-cream without abrasives or caustics. Cleans greasiest hands. Keeps mechanics' hands clean and soft. Prevents "housewife's" hand-roughness and redness. Retails 25 cents 1/2 lb., 200 hand-washings. We need agents, factory representatives, charity, church and lodge workers to sell Chet. Write for this easy way to make money.

CHET, INC. • 14 E. 48 STREET • NEW YORK

SIGNS EASILY AND EXPERTLY A A

PAINTED WITH LETTER PATTERNS NO. 1 NO. 3

CAN BE USED OVER AND OVER. FIRST TRACE PATTERN WITH PENCIL THEN FILL IN WITH BRUSH. SPECIAL TRIAL OFFER: YOUR CHOICE OF 1 1/2", 2" OR 3" ALPHABET (26 LETTERS, 10 NUMBERS) WITH LETTERING BRUSH. \$1.00 POSTPAID. STATE SIZE & STYLE WANTED. WRITE FOR FOLDER A.

JOHN F. RAHN • 1330-31 CENTRAL AVE. • CHICAGO

\$5.00 starts you in a profitable SAW FILING BUSINESS. Shebel filed saws beat all competition. Experience not necessary.

Send for full information.

A. P. SHEBEL, 730 S. 2nd St., Milwaukee, Wis.

*Home Craftsmen Like **EMPIRE LEVELS!**

NEW "CIGAR SHAPED" ALUMINUM "TORPEDO" LEVEL. Won't tear pocket. Serves many uses for workmen or in homes. 9" long. Shows plumb, level, 45°, 14°, 1° pitch. Grooved bottom. Only \$1.40. **POCKET LEVEL—FOUNTAIN PEN SIZE.** Beautiful Chrome Aluminum. Clips to vest pocket. Always handy. Accurate. Level vial has pitch graduations. Great value, Only 75c.



EMPIRE LEVEL MFG. CO., Dept. P-10
717 So. Sixth St. Milwaukee, Wis.

*Order direct, or from local Dealer. Send 10c for catalog. Good Craftsmen Everywhere Use EMPIRE "Extreme Accuracy" Levels.

BE A COWBOY

Get this New 1000-SHOT

RED RYDER CARBINE

Carry this genuine Cowboy Style Carbine—Daisy's new RED RYDER CARBINE featuring: 16" Leather Saddle Thong on genuine Western CARBINE RING! Golden Bands! Red Ryder BRAND on Pistol Grip Stock! 1000-Shot Repeater! Lightning-Loader Device! \$2.95 at Dealers. If he hasn't it, send us \$2.95. We'll mail yours postpaid. (Duty added in Canada).

Write for FREE NEW CATALOG

DAISY AIR RIFLES \$2.95

DAISY MANUFACTURING COMPANY, 5410 UNION ST., PLYMOUTH, MICH. U. S. A.

DON'T DRIVE WRONG ROADS Why guess at every cross road? One wrong turn may mean wasted miles and money, worry and delay.



Know your direction of travel with a Hull Streamline Auto Compass. Attractive Bakelite case, genuine sapphire bearing, built-in compensator. Only \$2.95 at your dealer.



Write for circular
HULL MFG. CO., P. O. Box 246-D10, WARREN, OHIO



Free Fall Catalog

JUST OFF THE PRESS

Showing Hunting Footwear, Clothing and fifty other leather and canvas specialties of our own manufacture for campers and hunters.

L. L. Bean, Inc.
310 Main Street
Freeport, Maine

hold it! SEND FOR MY NEW BARGAINGRAMS

They give a clear picture of the thousands of bargains in new and used Camera equipment. Send for your FREE copy today... Two editions... No. 242 for STILL CAMERAS... No. 240 for Movies.

Dept. P

Bass CAMERA CO.

179 W. MADISON ST. CHICAGO, ILL.

NEW LIONEL CATALOG

Just Out!

64 FULL-COLOR PAGES
BRISTLING WITH NEWS
FOR MODEL RAILROADERS



FREE!
FREE!
FREE!

Packed in this great, new Lionel Catalog is the most amazing fleet of trains Lionel has ever rolled out on the rails. Get the whole story. Send for catalog today.

THE LIONEL CORPORATION, Dept. 18, 15 East 26th St., New York

Please send at once a FREE copy of the new Lionel Catalog.

NAME _____

ADDRESS _____

CITY _____

STATE _____



EASY PROFITS IN PAINT SPRAYING

Paint walls, ceilings, screens, furniture, radiators, machinery faster, better! 1/4 H. P. motor 110 Volt 60 Cycle AC, complete with Spray Gun, 15 ft. hose. Weighs only 44 lbs. Carry anywhere. FULLY GUARANTEED. Complete with motor only \$31.15, or only \$25.00 less motor, f. o. b. Chicago. \$5 Deposit, Balance COD, or SEE YOUR DEALER. Circular FREE. Get started making money NOW! \$2500 Less Motor

Dept. PM-10, 801 Washington Blvd., Chicago, Illinois

Uses No Batteries!



New!
LIFETIME
BATTERYLESS

Electric
Flashmaster
NO BATTERIES
NO TROUBLE
NO EXPENSE

NO MORE BATTERIES TO BUY! A never-failing supply of current lights standard Flash-light bulb. The FLASHMASTER is "ALWAYS THERE"—anytime—anywhere—today, tomorrow, years hence. Battery failures now banished forever. Just press the convenient finger-tip operated lever and like magic PRESTO! you have a light.

REPAYS ITS COST MANY TIMES in savings in batteries. Ideal for Autos, Airplanes, Homes, Camping, Fishing and all emergencies. A quality product made in U.S.A. A sturdily built Lite, beautifully designed. Black Tenite case with bright trim. Prepaid anywhere—\$2.00 Each.

PARKER INDUSTRIES, 100 W. North Av., Chicago, Ill.
 Send C.O.D. I will pay Postman \$2.00 plus few cents postage.
 I enclose \$2.00 send FLASHMASTER postage prepaid.

NAME _____

ADDRESS _____

PAYS FOR ITSELF IN BATTERIES IT SAVES!

MEGOW

MODEL

World's largest manufacturer of Model Airplanes, Ships and Railroads. Send 10c postage for the largest and best hobbycraft catalog, just issued. 132 pages, profusely illustrated.

MEGOW Dept. PM, Howard & Oxford Sts.
Phila., Pa. or 217 N. Desplaines St., Chicago

- AIRPLANES
- SHIPS
- RAILROADS

Ready Now

New

TRAILER

PARTS
Catalog

and TRAILER BUILDERS MANUAL—25 cents

80 Illustrated Pages packed with ideas and suggestions for Trailer Builders, Buyers, and Owners. Largest and most complete line of Trailer Parts, Supplies and Equipment at America's Lowest Prices. Rush 25c (in U. S.) for this book today. Satisfaction guaranteed! TRAILER SUPPLY CO., BOX 360-A, WAUSAU, WIS.



MECHANICS SEND NAME FOR FREE SAMPLE PISTON RINGS /

SENSATIONAL NEW KIND OF Spectacular new replacement piston ring invention—Look! Unbreakable! No breaking in! No expanders needed! Guaranteed 100,000 miles! No reboring, honing or grinding. Amazing self-locking design gives top compression, lowest oil consumption. And you buy at FACTORY DISCOUNTS—make more money on every ring job. Seeing is believing. Send your name for Absolutely Free Sample, postage prepaid. Penny postcard will do. Address TRIPLE-X ENG. CO., Dept. 1610, 3801 S. Racine Ave., Chicago, Ill.



MOTORSCOOTERS and MIDGET CARS
BUILD YOURS! Easily Constructed. We furnish highest quality parts at low prices. Assemble your own at low cost. Make extra money building for others. Send 10c for complete plans and literature on wheels, tires, motors, transmissions, clutches, etc., for building scooters, midget cars and other vehicles. HONSAKERS, Box 7500, Masontown, Pa.

SAVE 1/2 ON WELDING OUTFITS

Heavy-duty Welding Outfits, \$28.73 to \$63.34; Heavy-duty Welding Torches, \$11.52; Sheet Metal & Airplane Torches, \$8.08; Heavy-duty Arc Welders, \$59.90 to \$90.00; Regulators with gauges, \$8.98. Superior Machine Company, Hamilton, Ohio.



BUILD THESE PROJECTS

For garden or lawn. Easy to build. Easy to sell. Detailed Blueprints Model B-25 Dutch Windmill 50c; Model OM-60 Old Mill, 85c. Lawn Figure Patterns—Sunbonnet Girl, Dutch Boy, Tulip Girl, Holland Pair, 35c each, all 4—\$1.00. Catalog illustrating many models, send 10c today.

CRAFTSMAN'S MODEL CO., Dept. P-45, 2030 N. 41st St., Milwaukee, Wis.

AGENTS 300% Profit SIGN LETTERS

For Store Fronts and Office Windows. Anyone can put them on. Free Samples. Liberal Offer to general agents. METALLIC LETTER CO., 438 N. Clark St., Chicago



CATCH FISH!

minnows, eels, mink, muskrat with our folding galvanized Steel Wire Traps. Walton's Automatic Hooks are so constructed that when a fish gives the slightest pull on the bait the upper hook reaches down and gets a hold that lands him. 3 for 50c. Write for descriptive catalog of Traps, Hooks, Lures, and other specialties. Walton Supply Co., 3507 Juniata Ave., St. Louis, Mo.



A AND N SUPPLY CO.

Bargains—Military, Sport Goods, Firearms, Clothes, Shoes, etc. Send 10c for new catalog, to be redeemed on first order.

EST. 1868 A & N Supply Co., 4772 Lester St., Richmond, Va.



MONUMENT

\$900 WE PAY UP FREIGHT

Marble & Granite Memorials Low Prices, Lettered. Guaranteed. Erecting service. Free Catalog & Samples. U. S. MARBLE & GRANITE CO. Oneco, Fla.

A-18

BUILD YOUR GRANDFATHER CLOCK

Send 25c for Simple SHOP TESTED COPYRIGHTED BLUEPRINT. The Simple Sensible Red-I-Kut way as thousands have. DIME brings PLANS and sixty picture "HOW" Book pricing many fine brass weight Westminster, tube chime, electric and battery movements showing nine beautiful colonial grandfather cases. Build now and save half. KUEMPEL CHIME CLOCK CO., Bldg. 45, Guttenberg, Iowa.



CROSMAN Silent RIFLES

For Every Season, Indoors or Out, City or Country



Crosmans shoot with hair-splitting accuracy, silently, powerfully, with no recoil, using the terrific force of compressed air—instantly adjustable for long or short range. Rifled barrels, .22, .177 cal. Single Shot and Magazine Loader Models. Low Cost Ammunition. Ask Your Dealer to Show You a Crosman.

FREE BOOK

“Target and Game Shooting Facts.” 24 pages, fully illustrated. Write: CROSMAN ARMS CO., Inc., 402 St. Paul St., Rochester, N. Y.

Ammunition for all .177 and .22 cal. air guns. Heavier, longer, more perfectly formed (secret process). Harder hitting, more accurate. Folder free.

No License Required

BIG MONEY Assembling NEW BOAT!



Make big money on each 20-lb. Mead KI-YAK you easily assemble at home from complete “cut-to-fit” Kit at amazing LOW COST! Seaworthy, Fast! Snappiest thing afloat. (Complete Sailing Rig, a few dollars extra.) Also 2 other portable paddle-sail models AND 2 portable outboard motor, sail, oars models. Finished Double Blade Paddle or Oars now INCLUDED with your KI-YAK. Write for Free Circulars, Factory-to-you-prices!

WRITE for big illustrated **FREE** circulars!

MEAD GLIDERS, 15 S. Market, Dept. B-100, CHICAGO, ILL.

ARCADE POWER TOOLS



Drill Press, \$5.30; Disc Sander, \$5.00; Jig Saw, \$5.30 and \$22.50; Belt Sander, \$8.00; Shaper, \$16.50 and \$20.50; Lathe, \$9.50; Band Saw, \$18.00; Bench Saw, \$11.00 and \$22.50. In far west slightly higher. Other Tools and Model Makers. Dealer or direct. **FREE CATALOG.** ARCADE MFG CO., 1219 Shawnee St., Freeport, Illinois.

QUALITY AT LOW COST

BIG 7-FOOT GLIDER

Easily built, beautiful



Class E Complete Kit only **\$1**

CLEVELAND CONDOR

- 48" Eaglet (Baby Bowlius type) Soaring Glider, only 50c.
- Send 10c for latest catalog of Model Airplanes, Race Cars, RR's, Ships, etc.

Orders under \$1.50 add 15c packing, postage charge.

CLEVELAND MODEL & SUPPLY CO. INC., 4508D107 Lorain Ave., Cleveland, Ohio

MAKE RINGS, BRACELETS, BROOCHES, PENDANTS, PAPER KNIVES, CIGARETTE BOXES, AT HOME OF GEM-LIKE PLASTICS



In sixteen lustrous colors, translucent, or opaque. Easily sawed, carved, or turned. Durable, non-inflammable, modern. 20 page complete, illustrated instruction book, 8 page illustrated catalog, both for 18c in stamps.

FELLOWCRAFTERS, INC., 64 STANHOPE ST., BOSTON, MASS.

110-AC LIGHT PLANTS

& Generators same as city current, 110-220, 2 or 3 wire, 25, 50 or 60 cycles. Rotary converters for changing DC to AC, frequency changers. Diesel plants, DC motors with AC take-off. Write to KATOLIGHT, 12 Elm St., Mankato, Minn., U.S.A.

FREE CATALOG - PINS and RINGS



Class pins, club pins, rings and emblems. Finest quality. Reasonable prices from 30c up. Write today for our attractive, free catalog.

Dept. N, METAL ARTS CO., Inc., Rochester, N. Y.

BE THRIFTY... use ROGERS GLUE

for woodworking and household repairs... incredibly strong. Send for FREE blueprint plans for making useful articles.

ROGERS • Dept. A-1 • Gloucester, Mass.

It's Like Having YOUR OWN BROADCASTING STATION



THOUSANDS IN USE—EVERYONE RAVES ABOUT ITS BIG-TIME PERFORMANCE. Now this perfected Mystic Mike wireless outfit with its sensitive microphone and new circuit enables you to do your own broadcasting from any part of your home, office or store, with NO WIRES CONNECTED TO RADIO. Simply plug this unit into any AC or DC electric socket... speak or play music into the microphone, and it will be picked up by ANY RADIO ANYWHERE within the same building. Has variable frequency control for easy radio dialing. Use it for entertaining, auditions, rehearsals, to call Bingo games, etc. Order today—Immediate delivery.

COMPLETE SET WITH TUBE and MICROPHONE

\$3.95 ADD 35c POSTAGE

FREE Write for Bulletin P-10

MONEY BACK GUARANTEE

OLSON MFG. CO., 362 Wooster Ave., Akron, Ohio

Tear out this ad, write name and address in margin. Send cash, money order, check—or order C.O.D. We will mail outfit at once.

Your HAIR

IS IT THINNING OR FALLING OUT?

If your hair is causing you this kind of trouble and it is due to poor blood circulation in the scalp, rent a Crosley XERVAC and try home treatments with this amazing machine. It is designed to help correct just such conditions of the scalp as the lack of proper blood circulation.

Rent a CROSLLEY XERVAC



Write for free particulars, how you can rent a brand new machine, the same type now used in many barber shops and scalp clinics, for a small rental fee per month, without any obligation to buy. The Crosley XERVAC operates on the principle of alternate vacuum and pressure, known to be effective for forcing fresh, stimulating blood into the deep-rooted blood vessels. Very compact, easy to use. Now that you can rent one you can get its benefits on easiest terms. Write today for details of this new home rental plan.

THE CROSLLEY CORPORATION
Dept. K-10 Cincinnati, Ohio

The ONLY WORKSHOP TOOL OF ITS KIND—PLANES AND FINISHES • PANELS • RABBETS • ROUTS • TENONS



CONVERTS any 1/2 h.p. or larger drill press into a fast, accurate wood planer, surfacer, paneler, router, rabbetter and tenoner. No blade changes or adjustments necessary. The 5-in-1 Barron Rotary Planer is safe to use—cannot possibly harm drill press mechanism—provides precision-smooth surfaces on the trickiest grains or knotty woods. No experience required. A marvelously versatile tool for any workshop. Furnishes hundreds of unusual panelled, routed and grooved effects for ingenious craftsmen. Cuts rabbets and tenon joints with uncanny speed and accuracy. Will pay for itself over and over again in time saved—improved workmanship. A new blade improvement now enables you to plane varnished or painted surfaces without difficulty. Order one today on our liberal trial offer. **FREE DESCRIPTIVE FOLDER.**

FITS ANY DRILL PRESS \$7.50 COMPLETE READY TO USE

MONEY BACK FREE TRIAL GUARANTEE You risk nothing. Send check or money order for \$7.50 or order C.O.D. Postage prepaid. Use it for five days and get a full refund if not entirely satisfied.

BARRON TOOL CO., INC., 318 ARCHITECTS BLDG., DETROIT, MICH.

THE BARRON MULTI-PURPOSE 5-IN-1 ROTARY WOOD PLANER

NOW YOU CAN GET A HEAVY DUTY INDUSTRIAL WELDER

for Only **\$195** RETAIL



Works Off 110-Volt Light Socket

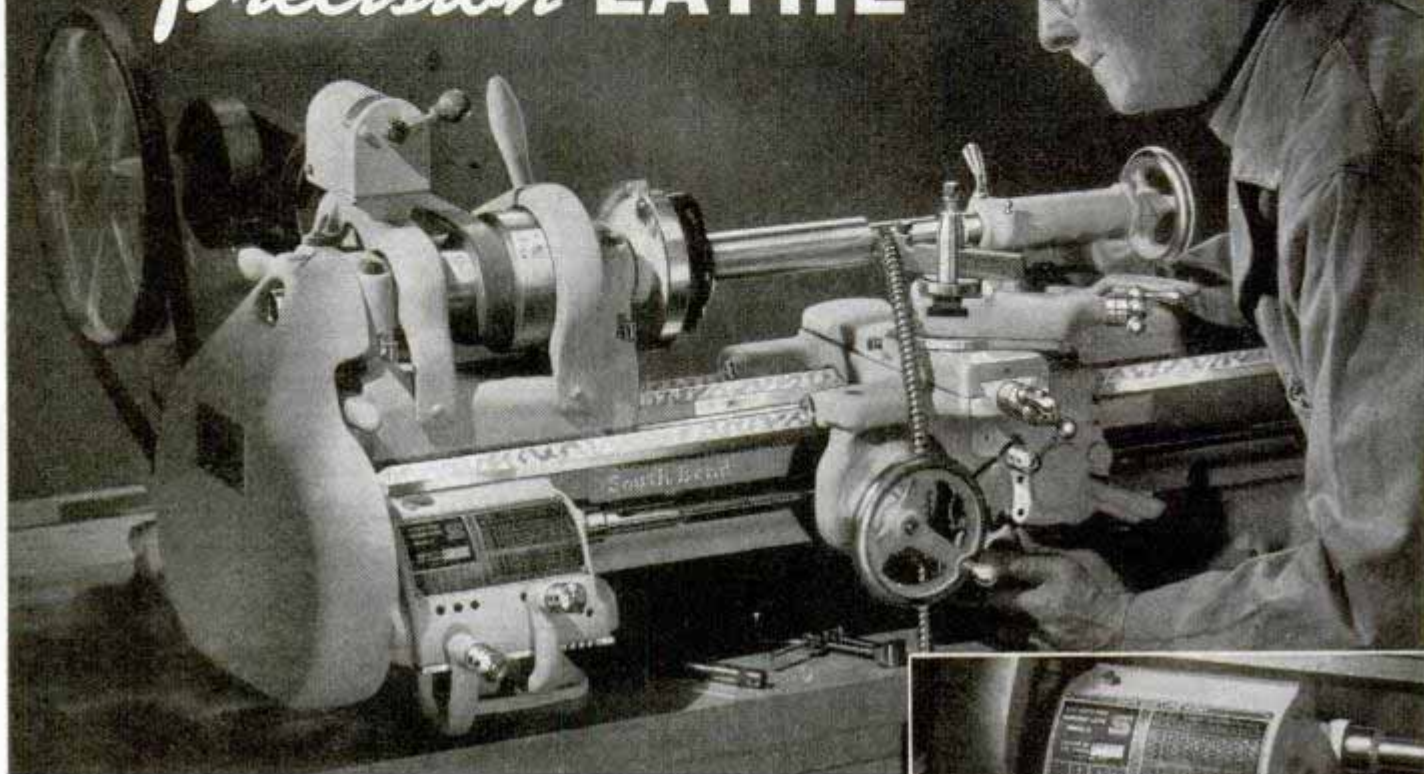
This marvelous DYNAMIC Power Welder will do the work of much higher priced types. It is easily portable. **WELDS Cylinder Blocks, Bumpers, Fenders, Tanks, Farm Machinery, and etc.** Will also solder and braze on the lightest material. Works on iron, steel, tin, brass, copper and all other metals. Men without previous experience can make as much as \$5.00 on a one hour repair job. Go into business—Open a Welding Shop NOW.

AGENTS—Make big profits selling to garages, factories, janitors and machine shops. Write TODAY for our 10-DAY TRIAL OFFER.

DYNAMIC WELDER COMPANY, 2226-NF Silverton Road, Chicago, Illinois

New!

QUICK CHANGE GEAR 9" Workshop *Precision* LATHE



MODERN FEATURES

This new Model A 9" Workshop Lathe has all the time saving features of a modern engine lathe combined with the sensitivity and accuracy of a fine precision bench lathe—yet the selling price is surprisingly low. Threads and feeds are instantly available through the quick change gear box. Power cross feeds and power longitudinal feeds are operated by a worm drive and friction clutch in the apron. Half-nuts are used only for thread cutting.

South Bend Lathes are made in six sizes, 9" to 16" swing. Prices start at \$79.50. See them demonstrated before you buy. Write for catalog and name of dealer.

Partial List of South Bend Distributors

| | |
|----------------------------------|---------------------------------|
| New York, A. C. Colby Mach. Co. | Newark, J. R. Edwards Mach. Co. |
| Philadelphia, W. B. Rapp, Mach. | Detroit, Lee Machinery Company |
| Milwaukee, W. A. Voell Mach. Co. | Buffalo, R. C. Neal Company |
| Houston, Wessendorf, Nelms & Co. | Toledo, Eno Tool & Supply Co. |
| Baltimore, Carey Mch. & Supply | Cleveland, Reynolds Mach. Co. |
| San Francisco, Moore Mach. Co. | Los Angeles, Eccles & Davies |

Chicago Sales Office—South Bend Lathe Works, Room 308, Machinery Sales Building, Telephone State 7283.

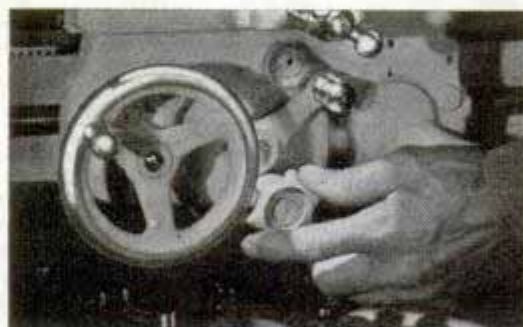
SOUTH BEND LATHE WORKS

610 EAST MADISON ST., SOUTH BEND, IND., U. S. A.

LATHE BUILDERS SINCE 1906



40 screw threads, 40 different power cross feeds and 40 different power longitudinal feeds are made instantly available by this quick change gear box.



Turning this knob engages or disengages friction clutch drive for power longitudinal carriage feeds or power cross feeds.



SOUTH BEND *Precision* LATHES

PRINTED BY POPULAR MECHANICS COMPANY, CHICAGO, ILL., U. S. A.

4 REASONS WHY "PRESTONE" ANTI-FREEZE IS 1ST IN AMERICA

1

SAFE

2

PROVED

3

GUARANTEED

4

NOTHING ELSE LIKE IT

"Prestone" anti-freeze has seen more motorists safely through more winters than any other brand.

The U. S. Army, Navy and 25 other Federal Bureaus use "Prestone" anti-freeze for the protection of vital equipment.

Behind "Prestone" brand anti-freeze is one of the most famous guarantees in motordom. It says plenty . . . in writing.

"Prestone" anti-freeze is ethylene glycol PLUS *special* processing and *exclusive* ingredients that make it America's finest anti-freeze.

One shot of "Prestone" anti-freeze lasts all winter. There's no replacing . . . no boil-away . . . no fumes . . . no foaming . . . no fire hazard. It is harmless to your cooling system . . . prevents rust and corrosion. See your dealer today.

\$2⁶⁵
PER GALLON

The words "Prestone" and "Eveready" are registered trade-marks of National Carbon Company, Inc.



"PRESTONE" ANTI-FREEZE

"There's nothing else like it"

**"IT'S THOSE EXTRA
MILES PER HOUR
THAT COUNT WITH ME"**

says **WILBUR SHAW**—

**3-Time Winner
of the 500-Mile
Speed Classic**

**"AND IT'S THOSE
EXTRAS OF SLOWER
BURNING I LIKE
ABOUT CAMEL
CIGARETTES"**



SLIPPERY TURNS at 120 miles per hour! Hub to hub duels at 150! For 500 blistering miles. Yes, it's America's most thrilling classic of auto speed. It's also a proving ground of your safer and more efficient car of tomorrow. And, three times, Wilbur Shaw (*above*) has come through with the extra degree of mechanical perfection and the extra skill that wins. He *has* the "extras"... he *appreciates* the extras... in cigarettes, too. Camels give the *extras*. Wilbur Shaw smokes Camels.

Copyright, 1940, R. J. Reynolds Tob. Co., Winston-Salem, N. C.



CAMELS BURN SLOWER AND GIVE ME THE EXTRA MILDNESS AND EXTRA FLAVOR I WANT FOR STEADY SMOKING. CAMELS EVEN GIVE ME EXTRA SMOKING

WITH WILBUR SHAW—with millions of others—the "extras" in slower-burning Camels are the difference between just smoking and smoking pleasure at its best. Light up a Camel...the *slow*-burning cigarette of costlier tobaccos... and get the "extras"—*even extra smoking* (see right).

GET THE "EXTRAS"
WITH SLOWER-BURNING
CAMELS

THE CIGARETTE OF COSTLIER TOBACCOS

EXTRA MILDNESS
EXTRA COOLNESS
EXTRA FLAVOR

In recent laboratory tests, CAMELS burned 25% slower than the average of the 15 other of the largest-selling brands tested—*slower than any of them*. That means, on the average, a smoking *plus* equal to

**5 EXTRA SMOKES
PER PACK!**

