

50,000 WAR PLANES A YEAR
By Capt. E. V. Rickenbacker

POPULAR MECHANICS MAGAZINE

WRITTEN SO YOU CAN UNDERSTAND IT

SEPT.
25 CENTS
30c IN CANADA

SEE PAGE 366



CHAMPION AGAIN!

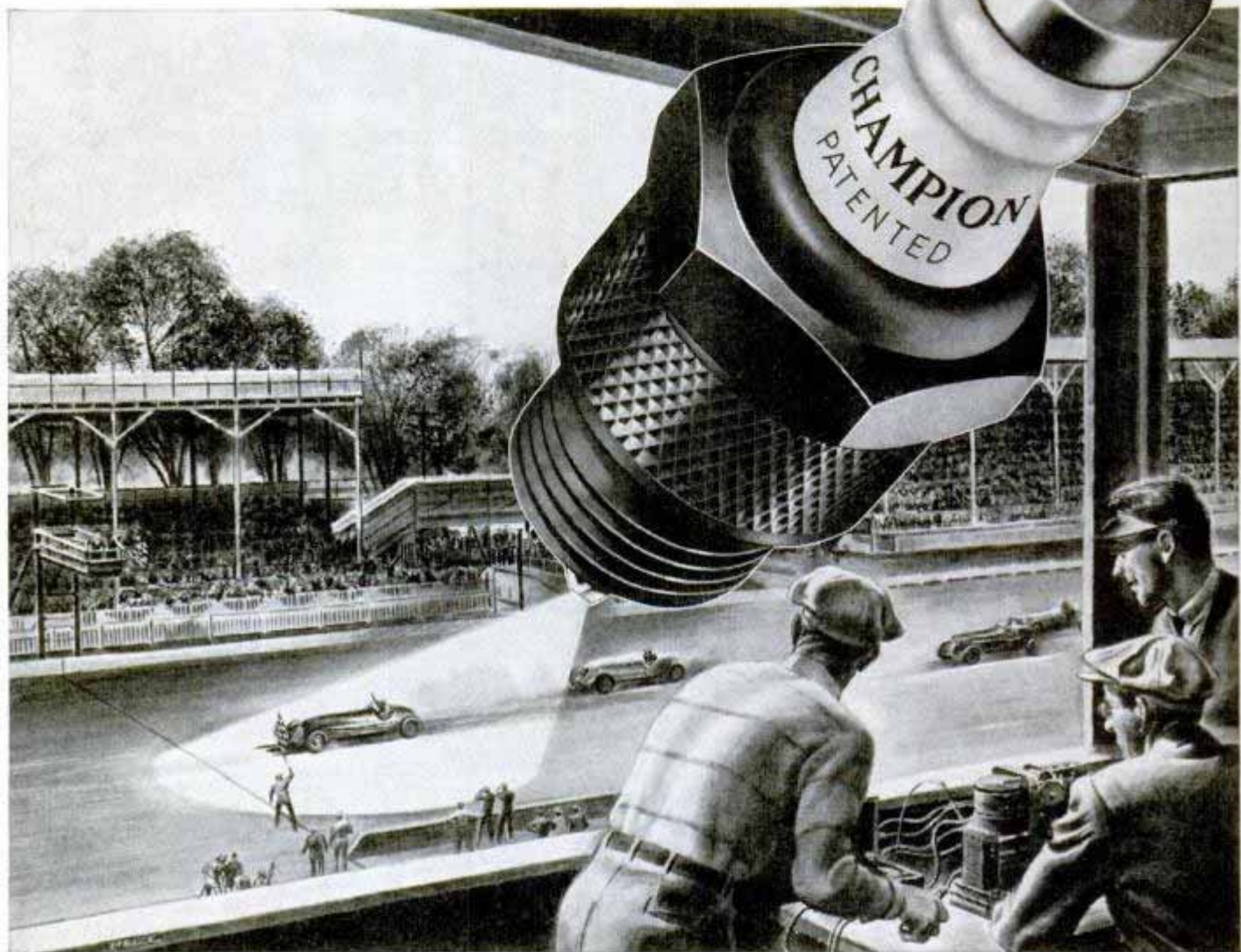

WILBUR SHAW, WINNER—9 OF FIRST 10 CARS TO FINISH—1940 INDIANAPOLIS 500-MILE RACE USED CHAMPION SPARK PLUGS



"Many thanks for the splendid performance of Champion Spark Plugs when I won the Indianapolis 500-Mile Race for the third time. The Champions functioned perfectly in my car throughout the entire race—never missed firing once."

Wilbur Shaw

CHAMPION SPARK PLUGS once again proved that they make every engine a better performing engine, with a sweeping victory in the 1940 Indianapolis 500-Mile Race. This year, as for 17 years past, Champions have proved their right to a place in the engine of every motorist who values maximum performance and dependability.

Today spark plugs more definitely determine the degree and quality of engine performance than ever before.

High speed, high-compression engines using highly developed anti-knock fuels require spark plugs that are free from leakage. The combination of Champion's exclusive Sillimanite insulators and patented Silliment seal is the perfect answer to these problems. Insist on Champion Spark Plugs for your car.

USE THE SPARK PLUG CHAMPIONS USE

"Just between us Coils"

FIRST COIL: Honestly, dear, I don't know what to do. I know I have just as much "oomph" as the next coil, but I can't seem to "give out." Only the other day I couldn't even supply enough spark to start this car.

SECOND COIL: Now don't you worry. I used to be the same way, until my boy friend took me to this Packard Certified Re-Wiring station. They found that worn-out cables and poor connections were stealing the electricity that was meant for *me*.

FIRST COIL: So that's my trouble! Just wait until this Certified Re-Wiring mechanic installs new battery, lighting and ignition cables in this car. *Then* watch me go to town... I'll show the other coils how to "spark"!



A CERTIFIED RE-WIRING CHECK-UP WILL SAVE YOU MONEY

Electrical "bottlenecks" in your wiring system cause hard starting, lower gasoline mileage, loss of power and unsafe lighting. They may even cause serious damage to the electrical units and necessitate costly repairs.

Stop in today at a Packard Certified Re-Wiring station and let a trained mechanic check your wiring circuits and electrical units with accurate instruments. All undersize, corroded and worn-out

wires will be replaced with Packard cable of the correct size. Look for the Packard Certified Re-Wiring Service sign.

DEALERS

Ask your jobber to show you the new Packard film, "Copper Dollars." Packard Electric Division, General Motors Corporation, Warren, Ohio.



Packard

REG. U. S. PAT. OFF.
TRADE MARK

THE STANDARD WIRING EQUIPMENT OF THE AUTOMOTIVE INDUSTRY

Big Load of Flavor

and never
a kick!

P. O. HARBAGE
won Amateur and Open
Clay Target Championships
with scores of
200 straight!

VELVET... just tamp
'er down and bang away...
stays cool under steady
firing. It's Kentucky's finest
Burley tobacco . . . aged
longer . . . mellowed with
real maple sugar. The mild-
est makin's for a pipe or
cigarette.

Velvet

*the Right Word for
Smooth Smoking*

MILD and COOL
Positively NO "BITE"

Copyright 1940,
LIGGETT & MYERS
TOBACCO CO.

Popular Mechanics Magazine

H. H. WINDSOR, Founder

H. H. WINDSOR, Jr., Editor and Publisher

September, 1940

Vol. 74, No. 3

IN THIS ISSUE

50,000 War Planes a Year	321
\$2,500 Home for Eight	328
Army on the Wing	Coloroto
Cashing in on Hobbies	348
Beating Robin Hood at His Own Game	354
Next Month's Weather Today . . .	360
Battleship of the Future	366
Farming Takes to the Air	371
Mechanical Monsters of the Movies	376
Mining Mud with a Biscuit Cutter .	386
The Sky's Their Limit	392
Harnessing the Atom	402
Buying Sight Unseen with Safety .	408
News—Hot Off the Grid!	412

(Continued on next page)

The Age of Opportunity

OPPORTUNITY dead? Civilization dying? Not so, says Charles F. Kettering, research genius of General Motors. To him this is an age of opportunity. Want, disease and hardship are the unfinished business challenging Young America. Mr. Kettering lists ten great fields of research which hold the promise of new jobs and better living. A research laboratory, he reminds you, is not a building full of bright equipment, but a state of mind. Read his message to American youth in the October Coloroto section, with its eight pages of pictures in color.

Steeplejacks of the Mountains

MONUMENT PEAK in California is a tough climb for the best of alpinists; a crumbling pile of rock with a 360-foot vertical spire. A party of climbers reached that peak last year, although one forty-foot stretch took two hours and one member dangled from a rope for a precarious moment. Read about this thrilling American sport in next month's issue.

Next Month

PROWLING through abandoned mine shafts, boring tunnels in mountainsides, traveling by pack train or tractor, 200 U. S. engineers are taking stock of our vital minerals. What if war cuts off our sources of tin, antimony, nickel, manganese? Most of the essential minerals are within reach, but tin comes from the East Indies. The ore hunters, however, are following a trail of placer tin up three New Mexican creeks. A feature in the October issue tells of "The Search for War Metals."

Grass for Dinner

YOU'LL eat grass and like it. Right in your front yard may be the "makings" of a variety of wholesome and tasty foods from breakfast cereals and pancakes to ice cream and candy bars—and you won't recognize in them the cuttings of the lawn mower and hay cutter. An article next month relates the discovery by scientists that grass is richly packed with vitamins and that a powdering process allows its conversion into low-cost food for man.

Don't Be Cheated

GET what you pay for. That's the title of an important article in October—important for every householder buying furniture, rugs, food, clothing. It tells you how to judge good furniture; how to identify fabrics and choose garments that will wear well. It shows you the difference between substantial and shoddy luggage. Read it—and save yourself some money.

Published monthly by POPULAR MECHANICS COMPANY, 200 East Ontario Street, Chicago, U. S. A. Single copy in the United States, 25 cents; subscription rates in United States and possessions, and countries of the Pan-American Postal Union including Spain, \$2.50 a year, \$4.00 for two years, \$5.00 for three years. Single copy in Canada, 30 cents; subscription rates, \$3.00 a year, \$5.00 for two years, \$6.50 for three years. To all other countries add \$1.00 a year over United States prices for overseas postage. Changes in address must be reported to us immediately to eliminate delay. Entered as Second Class Matter, Sept. 15, 1903, at the Post Office at Chicago, Illinois, under Act of March 3, 1879. Entered as Second Class Matter at the Post Office Department, Canada. Copyright 1940, by Popular Mechanics Company, in the United States, Australia, and France. Printed in the U. S. A.

Ask your service station salesman about Pyroil



When you drive into your favorite service station, or garage, today, ask the salesman to tell you about Pyroil. Ask him why it is that millions have used this unusual lubrication process regularly for many years.

He will tell you about the important function of Pyroil. How a mere few ounces added regularly to gasoline tank and crankcase remove the contaminations that creep into your engine while you drive. How Pyroil prevents dangerous acid-corrosion from attacking vital parts. How Pyroil protects valves, and rings and piston faces. How it aids in giving you smoother performance and dependable operation with the likelihood of less need for occasional repairs.

Ask for this information the next time you drive in for gasoline, oil, or other service. Also, mail coupon below for a Free Booklet filled with many enlightening facts.

Pyroil can save money for you in the operation of your car. You should start using it today. Manufactured and Guaranteed by Pyroil Company, W. V. Kidder, Founder, 59 Pyroil Bldg., LaCrosse, Wisconsin, U. S. A.

FREE INTERESTING BOOKLET. MAIL COUPON.



ADD MERELY OUNCES TO GAS & OIL

DISTRIBUTORS: CHECK AND MAIL COUPON FOR FRANCHISE FACTS.

PYROIL COMPANY.
59 Pyroil Bldg., LaCrosse, Wisconsin.
Please send me your Free Interesting Booklet, "Questions and Answers About Pyroil."
 Send Details of your plan for Distributors.

Name.....
Address.....
City..... State.....

(Contents—Continued)

AUTOMOTIVE

Coat of chains on huge tire saves wear.....	333
Streamline garage workbench holds specialized tools.....	333
Rearview mirror eliminates glare at night.....	368
Greenhouse trailer glazed in tough plastic.....	375
Rear-engine road scraper operated by one man.....	375
Electric brake for motorcycle.....	384
Horn plays eleven tunes.....	396
Fingertip hydraulic sleeving control guides tractor.....	397
Speedometer jammed in crash no proof of speed.....	400
Fishing rod plugs into antenna socket.....	405
Non-glare glasses have wire-screen lenses.....	411
Jack with a floating frame for uneven surfaces.....	415

AVIATION

Huge camera speeds production of airplanes.....	327
Automatic pilot on table top helps students.....	333
Ocean clipper rests in three-story drydock.....	363
Chemically treated air guards ignition of plane.....	364
Lightning no menace to planes.....	369
"Pancake" engine in wing increases speed.....	380
Wingless helicopter flies straight up.....	380
Coast to coast on four motors.....	382
British fighter mounts armed turret.....	391
Air gunners shoot clay pigeons in practice.....	401
Diesel aircraft engine has high cruising range.....	407
Land bomber swims on oil-drum "water wings".....	410

FARMS

Hybrid corn flies miles and is planted same day.....	368
Transparent "bells" guard plants from frost.....	381
Rotary tiller pulverizes soil for planting.....	400

HOUSEHOLD

Light plug released by push button.....	353
Manicure shield guards wet enamel.....	364
Sewer gun fires cartridge to clear pipe.....	375
Indoor-outdoor thermometer installed inside.....	384
Fuel saver uses waste heat to warm basement.....	396
Water evaporator cools and humidifies room.....	396
"Venetian" screen deflects sun with flat wires.....	416
Steel receptacle for dust cloths.....	128A

LAWNS AND GARDENS

Ornamental duck sprinkles the lawn.....	358
Extra knife for lawnmower cuts high growths.....	390
Seeder wheel for the garden.....	415

MODELS

"Greatest show on earth" staged in miniature.....	336
Five-foot tugboat tours under own steam.....	365
Model plane hoists wheels for launching.....	370
Models of microscopic life carved in wood.....	390

PHOTOGRAPHY

Thermometer in hose helps in photo developing.....	358
Living insignia of army division.....	365
X-ray pictures taken in millionth of second.....	398
Super-fast tube points way to X-ray movies.....	399
Odd photos made by mirror device.....	406

RADIO AND ELECTRICITY

Radio station on trailer for emergency duties.....	326
Phonograph uses photocell to reproduce sound.....	332
"Sweep circuit" ends streaks in radio photos.....	353
F. M. receiver kit for experimenters.....	455
Low-cost pack set for camp or boat.....	456
"Diversity" system employs two standard receivers.....	458
Practical radio hints.....	459
Book-size radio receiver for travelers.....	460
D.C. motor supplies 60-cycle a.c. current.....	460
Sound-on-film recorder and reproducer unit.....	460
Television camera tubes for amateurs.....	460

SCIENCE AND INDUSTRY

Robot "chemical man" eats and breathes.....	332
Uranium no longer heaviest chemical element.....	332
Sorter salvages rivets accidentally dropped.....	370
Lightweight mask filters out dust and pollen.....	374
Brain-wave irregularities help diagnose disease.....	380
Miners' barge sucks coal from bed of river.....	385
Forty-ton mass spectrograph "weighs" mass of atom.....	401
Cheap atomic power available by extraction process.....	406
Electron microscope may bring first glimpse of atom.....	410

(Continued to page 6A)

THE 500 POUND MONSTER GRABBED ME IN THE DARK!



A True Experience of Richard Kroener, Keeper of Gargantua, mighty gorilla owned by Ringling Bros. and Barnum & Bailey Circus



1. "ONE NIGHT I entered the compartment just outside Gargantua's cage on a routine check-up and forgot for a moment that Gargantua was always waiting to kill me. Suddenly, with crushing force, he grabbed my left shoulder.

2. "ALMOST PARALYZED with horror, I thought the end had come. Then I remembered the flashlight in my right hip pocket. I whipped it out and turned the bright beam full into Gargantua's cruel, glittering eyes.



3. "FOR AN INSTANT he glared into the hated light, then relaxed his grip and lumbered to the other side of the cage. Your dependable 'Eveready' fresh DATED batteries saved me from a horrible death that night. I will never be without them.

(Signed) *Richard Kroener*

The word "Eveready" is a registered trade-mark of National Carbon Co., Inc.



FRESH BATTERIES LAST LONGER... Look for the DATE-LINE

NATIONAL CARBON COMPANY, INC., 30 EAST 42nd STREET, NEW YORK, N. Y.

Unit of Union Carbide UCC and Carbon Corporation

This One



A PERFECT TEAM...

YOUR HOBBY AND YOUR Filmo



Movie Opportunity No. 407



WHATEVER your hobby, you should own a Filmo Movie Camera. For Filmos and hobbies go hand in hand. A movie record of today's hobby activities will someday be a source of priceless pleasure. You don't have to be an expert to get good movies with Filmo. Just press the button—*what you see, you get*, in black-and-white or in full, natural color, even in slow motion.

With four speeds, device for animating cartoons, and provision for adding accessories as your skill grows, Filmo is a basic camera that will meet your present and future needs. Ask your dealer

PALM-SIZE *Filmo 8*
 Makes movies at \$49.50
 snapshot cost! only
 Other models to \$1155

to show you the complete Filmo line of cameras, projectors, splicers, and accessories. Precision-built by the makers of Hollywood's professional movie equipment—Bell & Howell Company, Chicago; New York; Hollywood; London. *Established 1907.*

WRITE FOR MOVIE BOOKLET

BELL & HOWELL COMPANY
 1844 Larchmont Ave., Chicago, Ill.
 Send free, 16-page booklet about Filmo 8 mm. movie equipment.



Name

Address

City State PM 9-40

PRECISION-MADE BY

Bell & Howell

(Contents—Continued)

SPORTS

Luminous plastic fishing lure	333
Kit for tying fishing flies	368
Rifle sight aims lights at ball field targets	369
Pneumatic football trainer tests player's drive	400

MISCELLANEOUS

Bakelite base holds darkroom stop watch	326
Disk calculator helps solve mathematical problems	326
Spherical water tank on cone-shaped base	358
Folding window scaffold holds 500 pounds	359
Polaroid sun glasses control brightness	359
Portable "iron lung" worn like breastplate	359
Mechanical dog eats only electricity	364
Lightning kills three persons of each million	374
Cigarette case keeps score on number smoked	381
Fins on motor housing prevent overheating	381
Suitcase folds compactly for storage	384
Third-dimension pictures projected in color	391
Monitors would guard battleships from bombers	397
"X-ray" watch has a glass case and dial	405
Twist in church spire points spiral path	407
House painted in four minutes fourteen seconds	411
Bicycle parked on window to thwart thieves	416
Spray-gun road stripers paints three lines	416

Craftsman and Shop Notes

AUTOMOTIVE

Dash lights show if headlights are raised	475
Locking starter button to prevent theft of car	475
Oil drum forms ends for portable bench	475
Flushing radiator hydrometers with alcohol	476
Insulating car floor boards against passage of heat	476
Mirror aids in checking under hood battery	476
Rubber-cushioned wrench protects spark plugs	476
Simple repair for rusted muffler	476
Trip mileage noted on glass	476
Foot scraper folds out of way	480
"Table" in small parts washing pan	480

BOATS AND BOATING

Flexible fasteners hold loose oars in locks	424
Gas gauge for outboard motor	433
The "John Ericsson," a Great Lakes whaleback	434

CAMPING, FISHING, HUNTING

Picnic refuse impinged on sharp sticks	422
Adding hook or sinker without cutting line	430
Tin-can shelf for use in tent	433
Wire snare catches garfish	440

FURNITURE

Card table serves as fireplace screen	417
Breakfront styling in desk or china cabinet	426
Open book shelves assembled with pinned joints	447

HAND TOOLS

Paper clamp serves as soldering-iron rest	418
Iron cuttings kept out of pump cylinder	430
Wing nut used as V-block	440
Pointing small rods quickly	442
Oil stone clamped in vise leaves hands free	446
Slotted brush for cleaning rusty pipe	446
Depth gauge used as scribe	464
Shields for die-stock handles	464
Multiple stop for machine-table slots	465
Electrician's pliers serve as burr reamer	474

HOME IMPROVEMENTS

Calking window sash to avoid cracked putty	422
Repairing smoky fireplaces	422
Neat vent for kitchen stoves	442
Cement and skim milk coating for basement walls	446

HOUSEHOLD

Hat rack from coat hanger	419
Solving home problems	420
Waterproof labels for jars	422
Emergency lock for door when key is lost	424
Faded corduroy pants dyed tan	432

(Continued to page 8A)

When jobs are looking for men -that's news!



..... NOW IS THE TIME!

RIGHT now, in many lines there is a search for really good men—managers, leaders—men who can take charge of departments, businesses, branch offices, and set things humming.

As always, there are not enough ordinary jobs to go 'round—but rarely before in the history of American business, has there been so much room at the top!

Ordinarily, there would be plenty of men to fill these jobs—men in junior positions who have been studying in spare time. But most men have been letting their training slide during these dark years of depression . . . "What's the use?"—You have heard them say. Perhaps there has been some excuse for sticking to any old kind of a job one could get the past few years—but the door is wide open for the man with ambition **NOW!**

And don't let anyone tell you that "Opportunity Only Knocks Once"—that's one of the most untruthful sayings ever circulated. Opportunities flourish for every American

every day of his life.

Far more to the point is to be ready—be prepared—to make yourself interesting to the big-time employer—and, LaSalle offers you a short-cut method of qualifying for opportunity jobs in accounting, law, traffic, executive management, and kindred occupations.

LaSalle Extension is 30 years old—over 30,000 students enroll annually—60 American firms each employ 500 or more LaSalle-trained men—surveys show that average LaSalle students attain good salary increases after graduation—nearly 10% of all C. P. A.'s in the U. S. A. are LaSalle alumni.

Why not find out what LaSalle has done and is doing for men in your position? Send and get the facts; see what LaSalle can do for you personally!

There's no question about it—jobs are looking for trained men—the time has come for you to qualify for future prosperity. Mail this coupon today!

LASALLE EXTENSION UNIVERSITY, A Correspondence Institution, Dept. 964-R, Chicago

Kindly send me your free booklet on the business field I have checked—and tell me how your training in that field can help me.

- Business Management Business Correspondence Salesmanship Law Commercial Law
 Business English Traffic Management Accountancy Bookkeeping Stenotypy

Name..... Position.....

Address..... Age.....

LASALLE EXTENSION UNIVERSITY A CORRESPONDENCE INSTITUTION

Every handyman needs Smooth-On

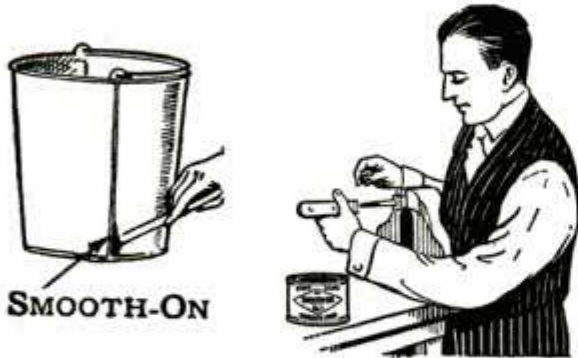

YOU'LL be surprised at the many ways in which Smooth-On No. 1 can save money in repairs around your home. Smooth-On is easy to apply, too, because it requires no heat or special tools, and the simple instructions are readily followed. The 40-page FREE Smooth-On Handbook is chock-full of time-saving and money-saving suggestions that will enable you to do perfect, lasting repair jobs that would otherwise require professional help.

Get Smooth-On No. 1 in 1½-oz., 7-oz., 1-lb. or 5-lb. can from your hardware store or, if necessary, from us. For your protection, insist on Smooth-On. Used since 1895.

FREE

40-page Smooth-On Handbook, which every handy man should have to help keep mechanical equipment in perfect order in the home, and on the motor car and boat. Your copy sent free if you return the coupon.

What you can do with SMOOTH-ON NO. 1

Tighten Loose Parts

such as screws, bolts, nuts, locks, hinges, handles, casters, etc.

Seal Leaks

in pipes, boilers, heaters, tanks, radiators, etc.

HOLDS IN METAL, WOOD OR MASONRY

(Contents—Continued)

Burning paper prevents gas forming in furnace.....	442
Electric clock hides special wall outlet.....	445
Rubber tubing on reading glass protects desk.....	448

OFFICE

Simple pencil-lead pointer.....	425
Obtaining uniform margins on typed copy.....	433
Spindle paper holder bent to protect hands.....	465
Keeping blueprints rolled.....	474

PHOTOGRAPHY

Simple beam scale made inexpensively.....	445
Flashlight photography without a camera.....	450
Identification system for movie film.....	452
Keyhole guard for darkroom door.....	452
Light-tight box for paper.....	452
Lightweight tripod is rigid and compact.....	453
Cooling solutions without dilution.....	454
Flashlight projects pictures.....	454

POWER TOOLS

Shaft hangers improvised from auto bearings.....	419
Gripping short work in a drill chuck.....	446
Sanding irregular-shaped lathe turnings.....	448

STORE AND SHOP

Stool supports cylindrical work while soldering....	430
Imitation leather pencil pocket for lady clerks....	449
Mirror attached to glass aids window trimmer....	464
Sliding support under vise saves strain on jaws....	464
Tailor's tape measure disappears through table....	465
Self-supporting price tickets.....	474
Sheet-metal triangle level indicator for eaves trough	474

TOYS AND NOVELTIES

Hand loom delights the youngsters.....	423
Mantel dolls of beads, wire and cloth.....	431
Push toy for air-minded youngsters.....	432
Let's play store.....	441
Toy cannon shoots rubber shells.....	449

WOODWORKING

Good joinery for platform railings.....	424
Support holds work on edge on sawhorse.....	425
Concave wood surfaces scraped with piston ring....	432
Wire brush roughens wood surfaces for gluing....	442
Hand chiseling.....	461

MISCELLANEOUS

Electric grindstone made from old cream separator.	419
Face crayon holder for children.....	424
Scraper for cement floors.....	424
Shoe-shine box stores accessories.....	425
Clippings cut with fountain pen.....	430
Newsboy's collection file.....	430
Waterproof sacks of plaster.....	430
Extra handle on end of suitcase.....	432
Simple handle for carrying stepladder.....	432
Draining rack for paste brush.....	440
Razor holds ice on car running board.....	440
Screw-top can holds test tube for bath.....	440
Varnishing magazine pictures to protect them....	440
Shovel used to haul cement across lawn.....	442
Laces hold shoe tongues securely in place.....	446
Adjustable spit for broiling meat outdoors.....	448
Hand drill used to mix paint.....	448
Inexpensive well-pipe lifter.....	448
Setting screws in wet concrete.....	449
Sawbuck from broken implement wheel.....	465
Power from small streams—Part I.....	466
Shelf suspended by means of vacuum cups.....	474
Simple methods identify metal of broken castings..	477

IMPORTANT NOTICE

It is the intention of this magazine to provide its readers with information regarding the latest developments in the mechanical arts. We take no responsibility as to whether the disclosures contained in our articles are covered by patents and advise readers to investigate this subject before making, using, or selling any of the products, machines, or processes described, in order to avoid possible liability for patent infringement.

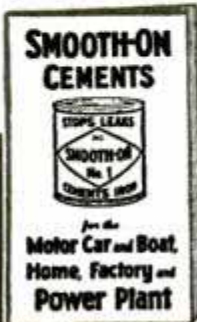

SMOOTH-ON MFG. CO., Dept. 37,
574 Communipaw Ave.,
Jersey City, N. J.

Please send Smooth-On Repair Book.

Name

Address

9-40.....

Do it with SMOOTH-ON

SURPRISE!

This young man has just got a big surprise!

He telephoned to congratulate a friend on getting a big promotion — and learned how little it costs to acquire modern *training-for-success* through the International Correspondence Schools!

You, too, will probably be surprised to discover that only a few dollars a month will pay for the sound, essential I. C. S. training you need to “get the jump” on job-competition. Compared to the cost of comparable training-courses (I. C. S. texts have been adopted by 24 State universities), I. C. S. courses in 400 business and technical subjects are amazingly inexpensive.

Mail this coupon — *today* — for complete information.



INTERNATIONAL CORRESPONDENCE SCHOOLS

BOX 5583-J, SCRANTON, PENNA.

★ Without cost or obligation, please send me a copy of your booklet, “Who Wins and Why,” and full particulars about the course *before* which I have marked X: ★

TECHNICAL AND INDUSTRIAL COURSES

- | | | | | | |
|---|---|---|--|---|--|
| <input type="checkbox"/> Agriculture | <input type="checkbox"/> Air Brake | <input type="checkbox"/> Cotton Manufacturing | <input type="checkbox"/> Manufacture of Pulp Paper | <input type="checkbox"/> R. R. Signalmen's | <input type="checkbox"/> Refrigeration |
| <input type="checkbox"/> Air Conditioning | <input type="checkbox"/> Architectural Drafting | <input type="checkbox"/> Diesel Engines | <input type="checkbox"/> Marine Engines | <input type="checkbox"/> Sanitary Engineering | <input type="checkbox"/> Sheet Metal Work |
| <input type="checkbox"/> Architecture | <input type="checkbox"/> Auto Engine Tune-up | <input type="checkbox"/> Electrical Engineering | <input type="checkbox"/> Mechanical Drafting | <input type="checkbox"/> Steam Electric | <input type="checkbox"/> Steam Engines |
| <input type="checkbox"/> Auto Technician | <input type="checkbox"/> Aviation | <input type="checkbox"/> Electric Lighting | <input type="checkbox"/> Mechanical Engineering | <input type="checkbox"/> Steam Fitting | <input type="checkbox"/> Structural Drafting |
| <input type="checkbox"/> Aviation | <input type="checkbox"/> Boiler Making | <input type="checkbox"/> Fire Bosses | <input type="checkbox"/> Mine Foreman | <input type="checkbox"/> Navigation | <input type="checkbox"/> Structural Engineering |
| <input type="checkbox"/> Bridge Engineering | <input type="checkbox"/> Foundry Practice | <input type="checkbox"/> Fruit Growing | <input type="checkbox"/> Patternmaking | <input type="checkbox"/> Plumbing | <input type="checkbox"/> Surveying and Mapping |
| <input type="checkbox"/> Building Estimating | <input type="checkbox"/> Heating | <input type="checkbox"/> Heat Treatment of Metals | <input type="checkbox"/> Pharmacy | <input type="checkbox"/> Poultry Farming | <input type="checkbox"/> Telegraph Engineering |
| <input type="checkbox"/> Chemistry | <input type="checkbox"/> Highway Engineering | <input type="checkbox"/> House Planning | <input type="checkbox"/> Practical Telephony | <input type="checkbox"/> Public Works Engineering | <input type="checkbox"/> Textile Designing |
| <input type="checkbox"/> Civil Engineering | <input type="checkbox"/> Locomotive Engineer | <input type="checkbox"/> Locomotive Engineer | <input type="checkbox"/> Radio, General | <input type="checkbox"/> Radio Operating | <input type="checkbox"/> Toolmaking |
| <input type="checkbox"/> Coal Mining | <input type="checkbox"/> Machinist | <input type="checkbox"/> Management of Inventions | <input type="checkbox"/> Radio Servicing | <input type="checkbox"/> R. R. Section Foreman | <input type="checkbox"/> Welding, Electric and Gas |
| <input type="checkbox"/> Concrete Engineering | <input type="checkbox"/> Managing Men at Work | | | | <input type="checkbox"/> Woolen Manufacturing |

BUSINESS COURSES

- | | | | | |
|--|--|--|---|---|
| <input type="checkbox"/> Accounting | <input type="checkbox"/> Advertising | <input type="checkbox"/> Civil Service | <input type="checkbox"/> First Year College | <input type="checkbox"/> Railway Postal Clerk |
| <input type="checkbox"/> Bookkeeping | <input type="checkbox"/> Business Correspondence | <input type="checkbox"/> College Preparatory | <input type="checkbox"/> Foremanship | <input type="checkbox"/> Salesmanship |
| <input type="checkbox"/> Business Management | <input type="checkbox"/> Cartooning | <input type="checkbox"/> Commercial | <input type="checkbox"/> French | <input type="checkbox"/> Secretarial |
| | | <input type="checkbox"/> Cost Accounting | <input type="checkbox"/> High School | <input type="checkbox"/> Service Station Salesmanship |
| | | <input type="checkbox"/> C. P. Accounting | <input type="checkbox"/> Illustrating | <input type="checkbox"/> Sign Lettering |
| | | | <input type="checkbox"/> Lettering Show Cards | <input type="checkbox"/> Spanish |
| | | | | <input type="checkbox"/> Traffic Management |

DOMESTIC SCIENCE COURSES

- | | | |
|---|---|--|
| <input type="checkbox"/> Advanced Dressmaking | <input type="checkbox"/> Home Dressmaking | <input type="checkbox"/> Tea Room and Cafeteria Management, Catering |
| <input type="checkbox"/> Foods and Cookery | <input type="checkbox"/> Professional Dressmaking and Designing | |

Name..... Age..... Address.....

City..... State..... Present Position.....

Canadian residents send coupon to International Correspondence Schools Canadian, Limited, Montreal, Canada
British residents send coupon to I. C. S., 71 Kingsway, London, W. C. 2, England

Step Out of Your Home prepared for a Better Job

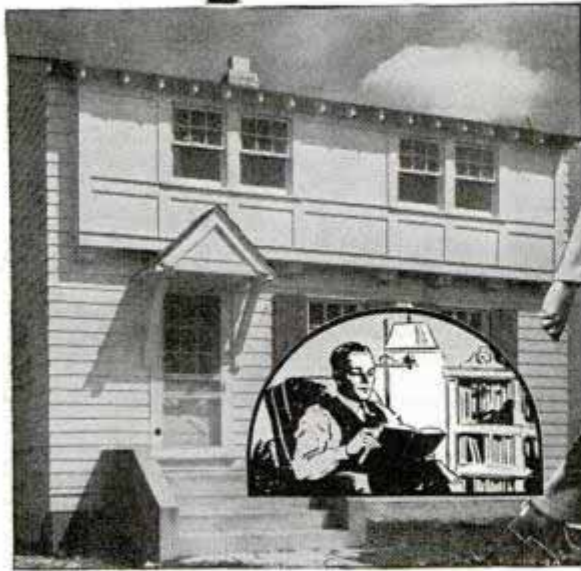

Spare Time Training Pays up to \$40 a week EXTRA* income

Home study is an accepted means of getting an education. Following the lead of pioneers like American School, many state and private universities now use this method. Home study is convenient—no interference with your present job or earnings. Home study can be quicker—you set your own pace, fast where you find "smooth sailing," more slowly and thoroughly where you feel the need. Home study costs little—write for details.



You Too Can Win through Home Study!

Students and graduates of the American School have advanced to such positions as Engineer of Buildings of a great railroad, Chief Deputy Building Commissioner of a large city, Designing Engineer with one of the largest automobile manufacturers, Architects, Plant Engineers, Office Managers, Chief Engineers, General Traffic Manager of a great telegraph system, Certified Public Accountants, and similar important positions. Would YOU like a better job? Can you GET it without more training?

Training Brings Pay Raises

It actually costs LESS—in effort as well as in money—to GET an education than to try to manage without it. Training "pays off" in CASH, as Government figures show. Graduates of American School, Chicago, have been PROVING this for over 40 years. Send for details.

What Will YOU Do About YOUR Future?

You CAN just let things drift—if you are willing to risk drifting downhill to the bottom. But ARE you? Through home study, you may win your RIGHTFUL place in life. Facts cost NOTHING—so mail coupon NOW for full information. Promptness pays premiums! Write TODAY!

American School

Drexel Ave. at 58th St.

Chicago, Illinois

The average grade school graduate earns \$16.30* a week less than high school graduates earn. The average high school graduate earns \$25.25* a week less than do men with college or vocational training.

*Figures computed from Government report. For basis of computation write American School.

Promotion Begins at HOME

Pay raises depend largely on what you do in SPARE time. Make it pay you dividends!

American School, Dept. G-645, Drexel Ave. at 58th St., Chicago, Ill.

Gentlemen: I'll sit down and consider my Promotion Problems carefully if you will send me FREE information covering special training subjects checked below. No obligation on my part.

HIGH SCHOOL COURSE

- | | |
|--|---|
| <input type="checkbox"/> Accounting and Auditing | <input type="checkbox"/> Drafting and Design |
| <input type="checkbox"/> Architecture and Building | <input type="checkbox"/> Liberal Arts |
| <input type="checkbox"/> Automotive Engineering | <input type="checkbox"/> Private Secretary |
| <input type="checkbox"/> Business Management | <input type="checkbox"/> Mechanical Engineering |
| <input type="checkbox"/> Aviation | <input type="checkbox"/> Radio and Television |
| <input type="checkbox"/> Electrical Engineering | <input type="checkbox"/> Salesmanship |
| <input type="checkbox"/> Elec. and Gas Refrigeration | <input type="checkbox"/> Home Economics Courses |
| <input type="checkbox"/> Air Conditioning | <input type="checkbox"/> Business Law |
| <input type="checkbox"/> Diesel Engineering | <input type="checkbox"/> Retail Merchandising |

Name

Address



DRAFTING

BOOKS SENT FREE!
ON APPROVAL

5 VOLUMES—SECOND EDITION

Only 15 minutes a day with these WONDER BOOKS can prepare you for a good drafting job. Mechanical and architectural drafting from simple straight lines to important complex plans. A step at a time! Built especially for beginners, for men with only grammar schooling. Drafting room practice, PLUS ENGINEERING, made easy and clear. Includes complete information on blue print reading for building and machine trades.

Big Field Big Demand Big Pay
Competent draftsmen are urgently needed in all building and manufacturing lines at \$30.00 to \$75.00 a week. That's just the beginning—FOR DRAFTSMEN HAVE GOOD CHANCES FOR ADVANCEMENT. Pleasant, fascinating work, easy to learn and do. Learn quickly with these books—send coupon for a set and see for yourself.

A year's consulting membership in the American Technical Society now given to all buyers of this famous cyclopedia of drafting.

Complete set of high grade drawing instruments if you send for these drafting books NOW. These instruments are accurate and are packed in velvet lined leatherette pocket case. Splendid value, but included with these books.

AMERICAN TECHNICAL SOCIETY
Publishers—Home Study Courses.

For Beginners or Experts

Written so you can understand every word, by well known engineers and architects. De Luxe flexible binding, nearly 2,000 pages, 1546 blueprints, charts and diagrams; prepares you for a good drafting job in mechanical or architectural lines. Sent for 10 days' free use if you mail coupon immediately.

These Instruments Included



American Technical Society, Dept. D619, Drexel at 58th St., Chicago, Ill. Send for 10 days' trial, 5 volumes set of drafting. I will pay the few cents delivery charges. If I wish, I may return books in 10 days and owe you nothing but if I decide to keep them, I will send \$2.00 after 10 days, then only \$3.00 a month until \$24.80, the total price is paid. Send latest edition and include drawing instruments and consulting Membership Certificate.

Name.....
Address.....
Please attach letter stating age, occupation, employer's name and address and that of at least one business man as a reference.

Learn this Profitable Profession



in 90 Days at Home

Hundreds of men and women of all ages 18-50 make \$10.00 to \$20.00 in a single day giving scientific Swedish Massage and Hydro-Therapy treatments. There is a big demand from Hospitals, Sanitariums, Clubs, Doctors and private patients as well as opportunities for establishing your own office. Learn this interesting money-making profession in your own home by mail, through our home study course. Same instructors as in our NATIONALLY KNOWN resident school. A diploma is awarded upon completion of the course. Course can be completed in 3 to 4 months. High School training is not necessary. Many earn big money while learning.



Anatomy Charts & Booklet FREE

Enroll now and we will include uniform coat, medical dictionary, patented reducing roller and Hydro-Therapy supplies without extra cost. The reducing course alone may be worth many times the modest tuition fee.

Send coupon now for Anatomy Charts and booklet containing photographs and letters from successful graduates. These will all be sent postpaid—FREE.

THE College of Swedish Massage (Successor to National College of Massage) Dept. 664-30 E. Adams St., Chicago. You may send me FREE and postpaid, Anatomy Charts, booklet containing photographs and letters from graduates, and complete details of your offer.

Name.....
Address.....
City..... State.....

U.S. GOV'T JOBS

**SHORT HOURS-GOOD PAY
-VACATIONS-PENSIONS**

Stop worrying about strikes, layoffs, hard times! Get on the government payroll. No special education or experience usually required. Short hours; steady work; vacations. Open to men and women citizens, of ages 18 to 50.

SEND FOR FREE BOOK

It tells about government positions; what to do to get job you want. Mail letter or postal card now for FREE book "How to Secure a Government Position". Address PATTERSON SCHOOL, 89 Mercantile Bldg., Rochester, N. Y.

RAILWAY POSTAL CLERK

Start at \$1850 a year

INSPECTOR OF CUSTOMS

Start at \$2100 a year

RURAL MAIL CARRIER

Start at \$1800 a year

POST OFFICE CLERK

Start at \$1700 a year

Your Place in Aviation... SPARTAN SCHOOL OF AERONAUTICS



Come to SPARTAN for today's finest expert training for your choice of aviation careers—Flying, Engineering, Mechanics, Radio. Approved by U. S. Civil Aeronautics Authority. 15 modern airplanes, latest aircraft engines; completely equipped shops, laboratories—private practice fields; 17 modern buildings; club-like dormitories. \$100,000 expansion program making SPARTAN even greater. New semester starts Sept. 30th. Write for free catalog. CAPTAIN MAXWELL W. BALFOUR, Director
Dept. PM90. Tulsa, Oklahoma

Operator No. 38



FOLLOW THIS MAN

Secret Service Operator No. 38 is on the job! Running down dangerous Counterfeit Gang. Tell-tale finger prints in murdered girl's room.

Free

The Confidential Report Operator No. 38 made to his chief. Write for it. Earn a Regular Monthly Salary

YOU can become a Finger Print Expert at home, in your spare time, at small cost. Write for confidential full report and details. Literature will be sent only to persons stating their age.
INSTITUTE OF APPLIED SCIENCE
1920 Sunnyside Ave.
Dept. 1356 Chicago, Ill.

BE A PASSENGER TRAFFIC INSPECTOR



We Can Help You to a GOOD JOB!
Our trained graduates are quickly placed in positions paying up to \$135 per month, plus expenses to start. You can complete this interesting, home-study course in a few months. We place you or refund tuition. Easy terms. Get Free Booklet outlining our 21 yrs. experience in this service.
STANDARD BUSINESS TRAINING INSTITUTE
Dept. 209 Buffalo, N. Y.

PHOTO-ENGRAVING TASOPE SINCE 1931

FREE—a copy of the Tasope' Magazine, monthly treasure chest of photographic and photo-engraving information. Learn why Aurora, Mo., is the photo-engraving, photographic center of America... how hundreds of amateurs, free-lance photographers are making money with pictures. No-obligation postcard brings your copy.
TASOPE', DEPT. PM-20, AURORA, MO.

NEW YORK SCHOOL OF MECHANICAL DENTISTRY

★ Learn how to make Crowns, Bridges, Plates in this OLDEST Laboratory Center. Practical training. Day, Eve. Easy terms. Ask for free Catalog P and tool offer. N. Y. SCHOOL of MECHANICAL DENTISTRY, 125 W. 31 St., N. Y. C. ★

ARTISTS MAKE MONEY

Find out your ability. Send name, age, occupation and address for Free Vocational Art Test.
Federal Schools, Inc., 9130 Federal Schools Bldg., Minneapolis, Minn.

Earn a Suit AND UP TO \$30 CASH

FOR A LITTLE SPARE TIME WORK
Sell 6 Suits to friends and you get your own suit as a bonus without cost! Cash profit on each order, besides. It's so easy when you show our fine selection of attractive woollens. UNION Made-to-Measure \$19.95 and up. Guaranteed to satisfy. Also ladies' suits. Earn extra money—build steady business, full or spare time. Big sample outfit FREE.
HERBERT A. STRONG TAILORING CO.
2300 W. Wabansia Avenue Chicago, Illinois



Be a RADIO Technician

Many make **\$30 \$40 \$50** a week

I will train you at home for many Good Spare Time and Full Time Radio Jobs



J. E. SMITH, President, National Radio Institute
Established 25 Years



Broadcasting Stations employ operators, installation, maintenance men and Radio Technicians in other capacities and pay well.

Set Servicing pays many Radio Technicians \$30, \$40, \$50 a week. Others hold their regular jobs and make \$5 to \$10 extra a week in spare time.



Loudspeaker System building, installing, servicing and operating is another growing field for well trained Radio Technicians.

I Trained These Men



\$10 to \$20 a Week in Spare Time
I repaired some Radio Sets when I was on my tenth lesson. I really don't see how you can give so much for such a small amount of money. I made \$600 in a year and a half, and I have made an average of \$10 to \$20 a week—just spare time.—JOHN JERRY, 1529 Arapahoe St., Rm. 17, Denver, Colorado.

Makes \$50 to \$60 a Week

I am making between \$50 and \$60 a week after all expenses are paid, and I am getting all the Radio work I can take care of, thanks to N. R. I.—H. W. SPANGLER, 126 1/2 St. Gay St., Knoxville, Tenn.



Operates Public Address System
I have a position with the Los Angeles Civil Service, operating the Public Address System in the City Hall Council. My salary is \$170 a month.—R. H. HOOD, City Hall, Los Angeles, Calif.

Jobs Like These Go To Men Who Know Radio

Radio broadcasting stations employ Radio Technicians as engineers, operators, maintenance men and pay well for trained men. Radio manufacturers employ testers, inspectors, servicemen in good pay jobs with opportunities for advancement. Radio jobbers and dealers employ installation and servicemen. Many Radio Technicians open their own Radio sales and repair businesses and make \$30, \$40, \$50 a week. Others hold their regular jobs and make \$5 to \$10 a week fixing Radios in spare time. Automobile, police, aviation, commercial Radio, loudspeaker systems, electronic devices are newer fields of opportunity for which N. R. I. gives the required knowledge of Radio. And my Course includes Television which promises to open good jobs soon.

Why Many Radio Technicians Make \$30, \$40, \$50 a Week

Radio is already one of the country's large industries even though it is still young and growing. The arrival of Television, the use of Radio principles in industry, frequency modulation, are but a few of the many recent Radio developments. More than 28,000,000 homes have one or more Radios. There are more Radios than telephones. Every year millions of Radios go out of date and are replaced. Millions more need new tubes, repairs, etc. Over 5,000,000 auto Radios are in use and thousands more are being sold every day. In every branch Radio offers more opportunities for which I give you the required knowledge of Radio at home in your spare time. Yes, the few hundred \$30, \$40, \$50 a week jobs of 20 years ago have grown to thousands.

Many Make \$5 to \$10 a Week Extra in Spare Time While Learning

The day you enroll, in addition to my regular Course, I start sending you Extra Money Job Sheets—start showing you how to do actual Radio repair jobs. Throughout your course I send plans and directions which have helped many make \$5

to \$10 a week in spare time while learning. My Course includes Television too.

Here's How You Get Practical Experience While Learning

I send you special Radio equipment; show you how to conduct experiments, build circuits illustrating important principles used in modern Radio receivers, broadcast stations and loudspeaker installations. This 50-50 method of training—with printed instructions and working with Radio parts and circuits—makes learning at home interesting, fascinating, practical. YOU ALSO GET A MODERN, PROFESSIONAL, ALL-WAVE, ALL-PURPOSE SET SERVICING INSTRUMENT to help you make good money fixing Radios while learning and equip you with a professional instrument for full time jobs after graduation.

Find Out What Radio and Television Offers

Act Today. Mail the coupon now for "Rich Rewards in Radio." It points out Radio's spare time and full time opportunities and those coming in Television; shows more than 100 letters from men I trained, telling what they are doing and earning. Find out what Radio, Television offer YOU! MAIL COUPON in an envelope, or paste on a postcard—NOW!

J. E. SMITH, President
Dept. OJP National Radio
Institute
Washington, D. C.

THIS
FREE BOOK
HAS HELPED
HUNDREDS OF
MEN MAKE
MORE
MONEY



This Coupon is Good for . . .
One FREE Copy of My Book

J. E. SMITH, President, Dept. OJP
National Radio Institute, Washington, D. C.

Mail me FREE, without obligation, your 64-page book "Rich Rewards in Radio." (No salesmen will call. Write plainly.)

NAME.....AGE.....

ADDRESS.....

CITY.....STATE.....

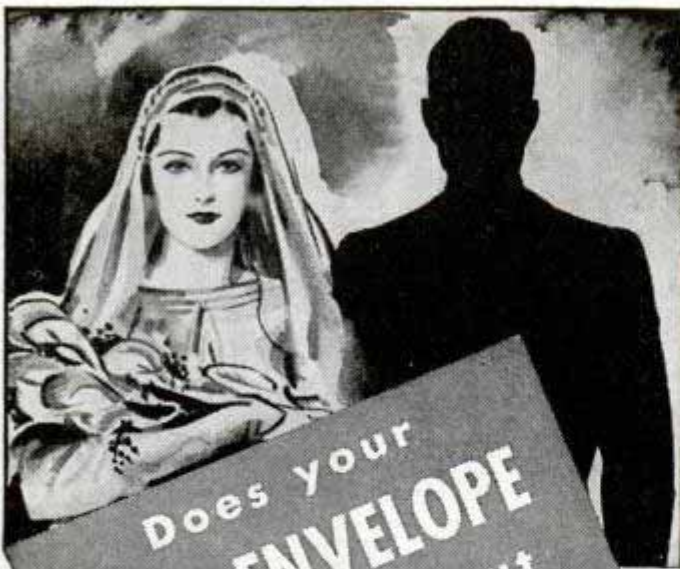

Does your
PAY ENVELOPE
keep you out
of this picture?

● If it does, do something about it! Get a raise in salary—but first get the training that will entitle you to this raise. Thousands of men in the same fix as you have gotten this training by spare-time study of an I. C. S. Course. Mail the coupon today!

INTERNATIONAL CORRESPONDENCE SCHOOLS

BOX 5585-J, SCRANTON, PENNA.

Explain fully about your course marked X:

TECHNICAL AND INDUSTRIAL COURSES

- | | | |
|---|--|--|
| <input type="checkbox"/> Agriculture | <input type="checkbox"/> Air Brake | <input type="checkbox"/> Managing Men at Work |
| <input type="checkbox"/> Air Conditioning | <input type="checkbox"/> Manufacture of Pulp and Paper | <input type="checkbox"/> Marine Engines |
| <input type="checkbox"/> Architectural Drafting | <input type="checkbox"/> Mechanical Engineering | <input type="checkbox"/> Navigation |
| <input type="checkbox"/> Architecture | <input type="checkbox"/> Patternmaking | <input type="checkbox"/> Pharmacy |
| <input type="checkbox"/> Auto Engine Tune-up | <input type="checkbox"/> Plumbing | <input type="checkbox"/> Practical Telephony |
| <input type="checkbox"/> Auto Technician | <input type="checkbox"/> Poultry Farming | <input type="checkbox"/> Public Works Engineering |
| <input type="checkbox"/> Aviation | <input type="checkbox"/> Radio Operating | <input type="checkbox"/> Radio Servicing |
| <input type="checkbox"/> Boilermaking | <input type="checkbox"/> R. R. Section Foreman | <input type="checkbox"/> R. R. Signalmen |
| <input type="checkbox"/> Bridge Engineering | <input type="checkbox"/> Refrigeration | <input type="checkbox"/> Sheet Metal Work |
| <input type="checkbox"/> Building Estimating | <input type="checkbox"/> Steam Electric | <input type="checkbox"/> Steam Engines |
| <input type="checkbox"/> Chemistry | <input type="checkbox"/> Structural Drafting | <input type="checkbox"/> Structural Engineering |
| <input type="checkbox"/> Coal Mining | <input type="checkbox"/> Surveying and Mapping | <input type="checkbox"/> Telegraph Engineering |
| <input type="checkbox"/> Concrete Engineering | <input type="checkbox"/> Textile Designing | <input type="checkbox"/> Welding, Electric and Gas |
| <input type="checkbox"/> Contracting and Building | | |
| <input type="checkbox"/> Cotton Manufacturing | | |
| <input type="checkbox"/> Diesel Engines | | |
| <input type="checkbox"/> Electrical Engineering | | |
| <input type="checkbox"/> Electric Lighting | | |
| <input type="checkbox"/> Foundry Practice | | |
| <input type="checkbox"/> Fruit Growing | | |
| <input type="checkbox"/> Heating | | |
| <input type="checkbox"/> Heat Treatment of Metals | | |
| <input type="checkbox"/> Highway Engineering | | |
| <input type="checkbox"/> Locomotive Engineer | | |
| <input type="checkbox"/> Machinist | | |
| <input type="checkbox"/> Management of Inventions | | |

BUSINESS COURSES

- | | | |
|--|--|---|
| <input type="checkbox"/> Advertising | <input type="checkbox"/> Bookkeeping | <input type="checkbox"/> Grade School |
| <input type="checkbox"/> Business Correspondence | <input type="checkbox"/> Business Management | <input type="checkbox"/> High School |
| <input type="checkbox"/> Cartooning | <input type="checkbox"/> Civil Service | <input type="checkbox"/> Illustrating |
| <input type="checkbox"/> College | <input type="checkbox"/> Cost Accounting | <input type="checkbox"/> Lettering Show Cards |
| <input type="checkbox"/> College Preparatory | <input type="checkbox"/> Foremanship | <input type="checkbox"/> Railway Postal Clerk |
| <input type="checkbox"/> Commercial | <input type="checkbox"/> French | <input type="checkbox"/> Salesmanship |
| <input type="checkbox"/> C. P. Accounting | <input type="checkbox"/> Sign Lettering | <input type="checkbox"/> Secretarial |
| | <input type="checkbox"/> Spanish | <input type="checkbox"/> Service Station Salesman |

DOMESTIC SCIENCE COURSES

- | | |
|---|--|
| <input type="checkbox"/> Advanced Dressmaking | <input type="checkbox"/> Professional Dressmaking and Designing |
| <input type="checkbox"/> Foods and Cookery | <input type="checkbox"/> Tea Room and Cafeteria Management, Catering |
| <input type="checkbox"/> Home Dressmaking | |

Name..... Age.....

Address.....

City..... State.....

Present Position.....

Canadian residents send coupon to the International Correspondence Schools Canadian, Limited, Montreal, Canada. British residents send coupon to I. C. S., 71 Kingsway, London, W. C. 2, England.

Learn To MOUNT BIRDS

Tan SKINS, Make Up FURS

Be a Taxidermist. Double your hunting fun. We teach you at Home. Mount Birds, Animals, Pets, Heads and Fish. Save your hunting trophies; decorate home and den. **MAKE MONEY.** Mount and Krome-tan for others. Big sparetime profits. **INVESTIGATE TODAY.**

FREE BOOK with 100 game pictures. 48 pages. Hunters, get yours! It's Now Free.

Send postal card TODAY—This Minute! State your AGE. NORTHWESTERN SCHOOL OF TAXIDERMISTRY: Dept. 3376, Omaha, Nebr.



TRI-STATE COLLEGE

B. S. Degree in 2 Years

World famous for technical 2-year courses in Civil, Electrical, Mechanical, Chemical, Radio, Aeronautical Engineering, Business Administration and Accounting. Special preparatory department for those who lack required high school work. Short diploma courses (36 weeks) in Surveying, Drafting. Low tuition. Low living costs. Students from every state and many foreign countries. 57th year Graduates successful. Enter September, January, March, June. Write for catalog. 490 College Ave., ANGOLA, IND.

LAW STUDY AT HOME

Legally trained men win higher positions and bigger success in business and public life. Greater opportunities now than ever before. Big corporations are headed by men with legal training.

More Ability: More Prestige: More Money

We guide you step by step. You can train at home during spare time. Degree of LL. B. Successful graduates in every section of the U. S. We furnish all text material, including 14-volume Law Library. Low cost, easy terms. Get our valuable 48-page "Law Training for Leadership" and "Evidence" books FREE. Send for them NOW.

LaSalle Extension University, Dept. 964-L

Chicago

A Correspondence Institution

SECURITY FOR LIFE

Be an expert in an essential business. Learn Meat Cutting. Steady jobs and good pay everywhere. Quick, short course—ACTUAL PRACTICE. Learn with tools and meat—not books. Individual training. Be a fully qualified union Meat Cutter when finished. Union Card FREE. Job help after graduation. Write for catalog and complete details.

NATIONAL SCHOOL OF MEAT CUTTING, INC.
DEPT. U-10 TOLEDO, OHIO



MECHANICAL DENTISTRY

Short course—personal, individual, instruction—best technical teachers. Profession offers unlimited opportunity—not affected by Machine Age. Most modern and complete methods embracing every branch from plate to porcelain work. Qualifies you to work for dentists or own business. Day or night school. No books—no classes. Catalog upon request.

OR STUDY AT HOME. Write for information on our Home Study Course.

McCARRIE SCHOOL OF MECHANICAL DENTISTRY
207 N. Broad St. Dept. 760 Philadelphia, Pa.



Begin today. Write for our New Free Book, "How to Become a Good Penman," it contains specimens and tells how others learned to write in spare time. Enclose 10c for a Professional Pen Point and your name beautifully written. Write today.

THE TAMBLYN SCHOOL OF PENMANSHIP
441 Ridge Building Kansas City, Mo.

RADIO BOOKS 10¢

Servicing Short-Cuts, tells how to fix all sets, 32 pages, 10c. Television Facts, 64 pages, 25c. Radio Mathematics, 25c. P. A. Handbook, 53 pages, 25c. Twenty interesting radio circuits 10c. Free catalog. Supreme Publications, 3727 W. 13th, Chicago, Ill.

NEW WAY TO CHOOSE A CAREER

LET SCIENCE PICK A JOB FOR YOU!

TODAY, getting a job or choosing a career is no longer a hit-or-miss task. Science can now accurately determine for you, in advance, just what type of work or profession you are best suited for. Send your name on a penny postcard for FREE booklet explaining this new proven way to greater success. Vocational Guidance Associates, Dept. 19, Tucson, Ariz.

LEARN WATCH REPAIRING



AT HOME You can learn by our modern and original system of instruction every part of the Watch Repairing Trade at home. You can earn money while learning and prepare yourself for a well paying position or start in business after completing our course of instruction. Good watch repairers are in demand and generally earn very good salaries. For particulars apply to the Wisconsin School of Watch Repairing
524 E. Mason St., MILWAUKEE, WIS.

TRAIN FOR A BETTER JOB IN ELECTRICITY

Pay Tuition After Graduation

ACTUAL WORK ON ACTUAL
ELECTRICAL MACHINERY

12 WEEKS SHOP TRAINING

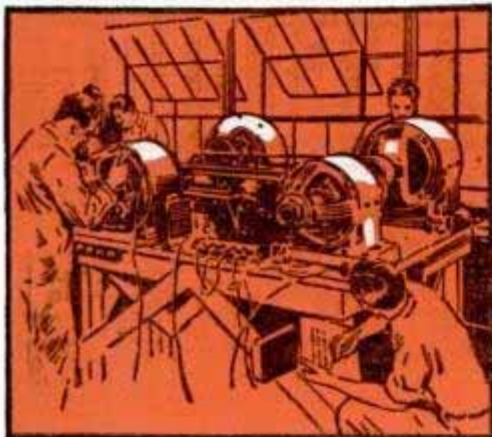

First you are told and shown what to do and how to do it. Then you do it yourself.

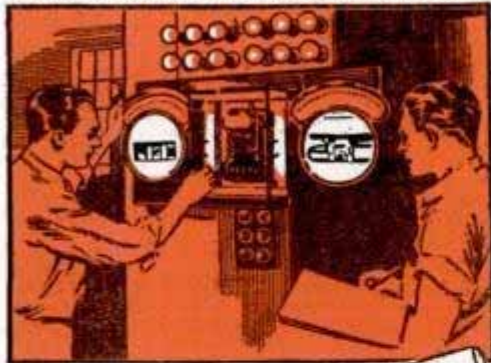

GET MY BIG
FREE
BOOK



Home of
Coyne
Electrical
School

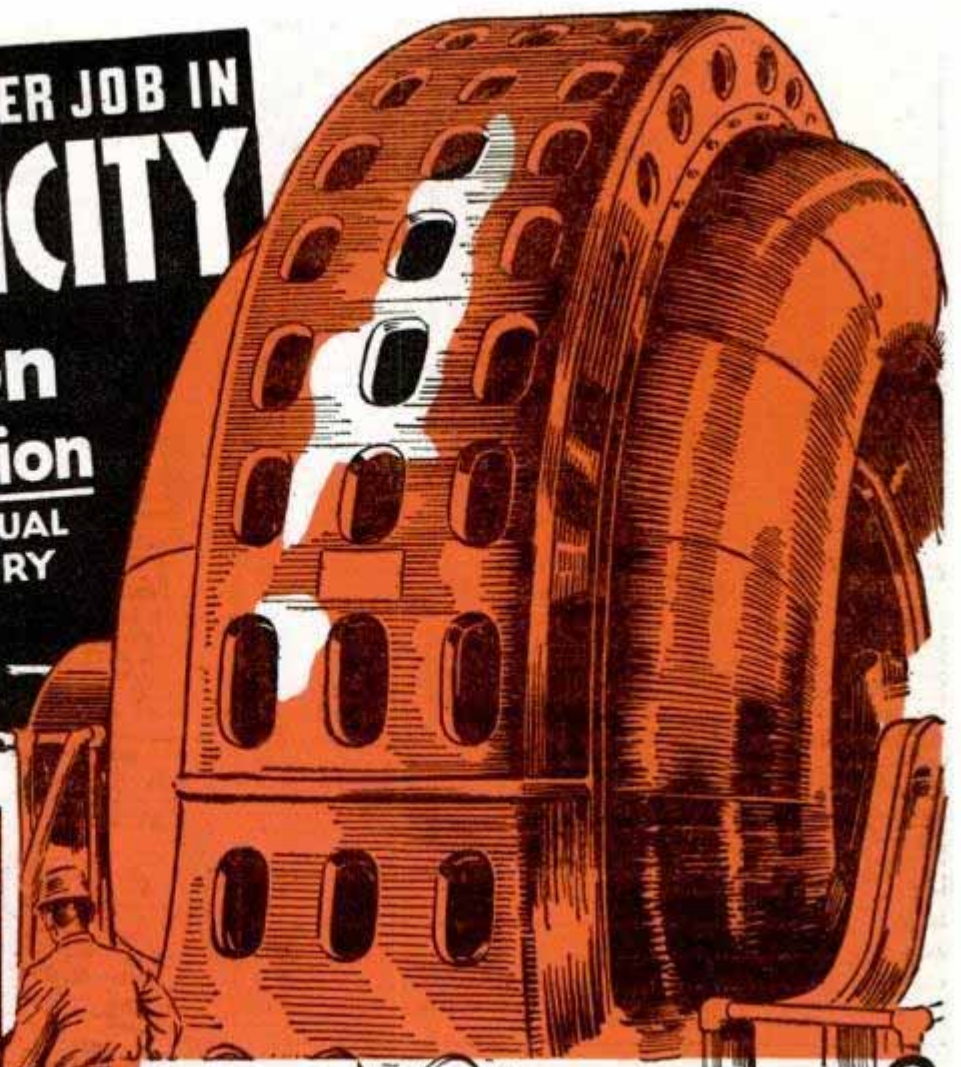

LEARN TO EARN MORE?

My big free book tells you how we train you in 12 weeks for your start to a better job and better future.

Learn by Doing

You get your training not by book or lessons but on actual electrical machinery and equipment.

Get Training First— Pay Tuition Later

You can get your training first and then pay for it in 12 monthly payments starting 5 months after you start school or 60 days after your 12 weeks training period is over. Mail coupon for all the details of this plan.

Earn While Learning

Lack of money need not stop you. You can get training first and pay after graduation and if you are short of money for living expenses we will help you get a part time job while training.

Previous Experience or Advanced Education Not Necessary

You don't need any previous elec-

trical experience or advanced education to get my training.

Graduate Employment Service

After graduation every graduate is given employment help, consultation help and many other services to help him make a success of his training.

4-Weeks Extra Radio Course Included

Right now I am including an extra 4 weeks course in Radio. This training is given you at no extra tuition cost.

Get My Complete Story

Fill in and clip the coupon below. Then mail it to me. When I receive it I'll send you my big free book and all the details of the features I have outlined here.

This will not obligate you in any way and no salesman will call on you as I do not employ salesmen.

You owe it to yourself and your future to get these facts now.

So don't put it off—mail the coupon now.

COYNE ELECTRICAL SCHOOL 500 S. PAULINA ST.
Dept. 60-72, CHICAGO

MAIL THE COUPON NOW

H. C. LEWIS, President, COYNE ELECTRICAL SCHOOL,
500 S. Paulina Street, Dept. 60-72, Chicago, Ill.

I'm really in earnest. I do want to get ahead. Send me your big free catalog with full particulars about Coyne training and your plans to help a fellow, who hasn't a lot of money, to get ahead.

Name.....

Address.....

City..... State.....

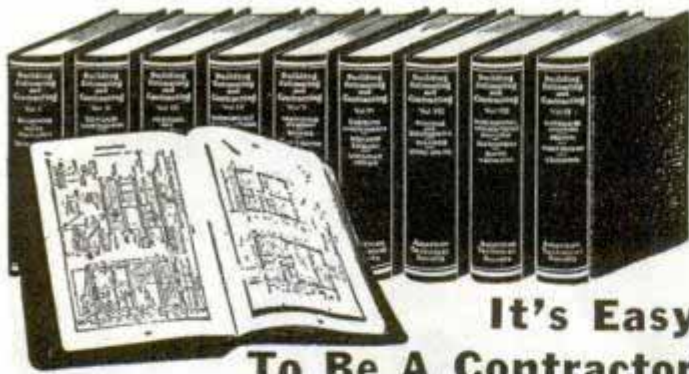

It's Easy To Be A Contractor

Learn to estimate, to plan buildings, to take contracting jobs, and make money on them. Here are 9 up-to-the-minute books on building, estimating, and contracting which cover in an interesting way, the subjects that carpenters, builders, and contractors should know to make the most out of their jobs. Roof Framing, The Steel Square, Architectural Drawing and Design, Estimating, Painting and Decorating, Heating, Air Conditioning, Building, Contracting, Concrete Forms and other subjects are all well covered.

"Boss" Carpenters in Demand **NEW 1940 EDITION**

Vast public works jobs, immense projects, and the rapid growth of home building, are making jobs for **MEN WHO KNOW HOW**. These books give you quick training. With them you shouldn't be afraid to tackle any job, for needed facts can be found in a hurry.

These books are the most up-to-date, complete we have ever published on these subjects.

Coupon Brings Nine Books FREE For Examination

AMERICAN TECHNICAL SOCIETY (Publishers—Home Study Courses)
Dept. G619, Drexel at 58th Street, Chicago, Illinois

You may ship me the new 1940 edition of your nine big books, "Building, Estimating, and Contracting" without any obligation to buy. I will pay the few cents delivery charges only, and if fully satisfied in ten days, I will send you \$2.00, and after that only \$3.00 a month, until the total price of only \$29.80 is paid. I am not obligated in any way unless I keep the books.

Name.....

Address.....

City..... State.....

Please attach a letter stating your age, employer's name and address, and that of at least one business man as a reference.

AVIATION Wants More **LINCOLN** TRAINED MEN

Airlines, Airplane Factories, Aviation Operators are calling on this **LINCOLN GOVERNMENT APPROVED SCHOOL** for more trained men. Advance employment orders exceeding our graduate supply. **TRAIN FOR PILOT'S POSITION**. Airlines calling for advanced trained Pilots. Training centers calling on us for Flight Instructors. Lincoln's Primary and Advanced Flight Training, Government Approved, prepares for Gov't. Ratings and responsible flying position. Large fleet of Training Planes. **TRAIN FOR AN AIRLINE MECHANICS POSITION**. Government Approved Training prepares for Gov't. Ratings and immediate employment as Airline Maintenance Mechanic. Short term courses prepare for job in Airplane Factory. **BE AN AERONAUTICAL ENGINEER**. Learn to design and build Airplanes. Our students getting actual experience. Big demand for Engineers. **NOW IS THE TIME TO TRAIN** for Aviation. Opportunities the best they've ever been. Good Pay! Rapid advancement. Our Placement Department assisting Graduates into fine positions. Now offering Part-time employment for board and room while in training. Act quickly. **MAIL COUPON NOW for schedule of courses.**



LINCOLN AERONAUTICAL INSTITUTE, (INC.)
LINCOLN AIRPLANE & FLYING SCHOOL DIVISION
579 Aircraft Building Lincoln, Nebraska

I'd like to get ready for a job in Aviation just as soon as I can. Please rush complete information about Lincoln Training.

NAME..... AGE.....

ADDRESS.....

CITY..... STATE.....

CAREERS IN ELECTRICITY

Become a Bliss technician in one year—ready to take advantage of opportunities in the electrical field. Bliss men, today, fill key positions in many electrical industries. All received the same course in fundamental theory and practice.

Comprehensive training; skilled instructors give personal guidance. Modern shops and laboratories. Highly successful placement record. Spacious campus. 48th year. Ask for free vocational chart. 119 Takoma Ave., Washingt'n, D.C.

BLISS ELECTRICAL SCHOOL

BE AN AD WRITER

GET into Advertising! Splendid opportunities for trained men and women. Ad writers, space buyers, mail order experts make good money. Learn quickly at home. No text books. Practical work. Old established school. Many successful graduates. Write today for free booklet "Opportunities in Advertising," and requirements.



PAGE-DAVIS SCHOOL OF ADVERTISING

3601 Michigan Ave. Dept. 1356 Chicago, U. S. A.

Free WELDING



Welding offers immediate opportunities for better pay. Practically all industry depends upon the Welder. Learn at home in spare time. Intensified shop training later. Also day and evening classes. Send for free "Blue Book" and trial lesson.

CHICAGO TECHNICAL COLLEGE
M-600 Tech Bldg., 118 E. 26th St., Chicago, Ill.

RADIO-TELEVISION

Oldest, largest Radio-Television school in West trains you for good pay job. Complete instruction including Radio Construction and Service, Broadcast Operating, Sound, Talking Pictures, Television, Public Address, etc. Flexible plan to meet specific needs of those with or without jobs. Transportation allowed to L.A. Earn room and board while learning. Request Free Catalog.

NATIONAL SCHOOLS Dept. PMR-9 Los Angeles

PROMOTE YOURSELF

Drafting Jobs Often Pay \$175.00-\$350.00 month. Trained draftsmen always in demand. Learn drafting at home in spare time. Experience unnecessary. Common education enough. Employment service FREE. Write today for complete information. No obligation. No Salesmen.
MONROE INSTITUTE, Dept. A-109, Aiton, Illinois

HEMPHILL DIESEL SCHOOLS

All communications concerning enrollment in any of the Hemphill Diesel Courses should be sent to one of the following addresses:

NEW YORK 31-26 Queens Blvd. L. I. C.
CHICAGO 2014 Larrabee Street
MEMPHIS 417 Monroe Avenue
LOS ANGELES 2120 San Fernando Road
VANCOUVER, B.C. 1363 Granville St.

HEMPHILL DIESEL SCHOOLS (use nearest address)

★ Please send data on your Diesel courses, also free copy of illustrated booklet "March of Diesel."

Name..... Age.....

Street.....

City..... State..... M-49-p

Also Diesel course in Spanish for Latin American students. Write for information and terms.

INVENTORS

Get Expert Advice on How to PROTECT and SELL Your Invention

Get
**FREE
COPY**

"Why I thought of that years ago!" How many persons have said that, when they found later that somebody else had thought of the same thing, had it patented, sold it, and were profiting from it? Too many, sad to say. These unfortunates did not know what to do about their inventions, in order to protect and profit from them. Some thought elaborate working models were necessary to secure patent—others felt their idea wasn't "worth much." They failed to realize that a good practical invention, plus prompt action in securing a Patent, and locating a buyer or a good market, have proved the secrets of success for thousands of inventors.

PATENT GUIDE SHOWS WHAT TO DO

Our "Patent Guide for the Inventor" answers many important questions concerning Patents that inventors constantly ask. It tells what facts, details, drawings, sketches, etc., are necessary to apply for a Patent; how to protect your invention through dated and witnessed disclosure; how to do this AT ONCE to safeguard your rights; how Patent Office Records can be checked to determine whether the invention is probably patentable before filing fees need be paid; discusses costs involved and a practical way these can be paid as the application progresses. It tells how some inventors secured financial backing; how many simple inventions have proved large commercial successes; how Patents covering improvements also can be profitably utilized and marketed; tells countless other facts of interest.

WHY YOU NEED EXPERT ASSISTANCE

The Patent Laws were enacted for your benefit—to give you protection for the features of your invention which are Patentable. But these features must be legally and concisely set forth in the form of "claims". This phase of the procedure is so complex that the Patent Office advises the Inventor to engage a competent Registered Patent Attorney. We maintain a large staff—carefully trained registered patent attorneys—expert draftsmen—experienced searchers—to serve you. We have been serving inventors for more than 20 years.

TAKE FIRST STEP NOW

With the Patent Guide you will receive also Free a "Record of Invention" form which will enable you at once to establish the date of your invention, before you file your Patent application. This step costs you nothing yet may be vital to your success. Remember—in Patent Matters, ACTION is IMPORTANT. Delay can be costly. Mail the coupon in an envelope, or paste it on a penny postcard—NOW!



**48
PAGES**
Over 100
Illustrations



CLARENCE A. O'BRIEN

CLARENCE A. O'BRIEN, Registered Patent Attorney
Dept. 0J1, Adams Building, Washington, D. C.

Please send me your 48-Page Patent Guide and your Specially Prepared "Record of Invention" form FREE. This request does not obligate me.

Name

Address

City State

(Please write or print plainly.)

Get This
FREE BOOK

IMMEDIATELY MAIL COUPON TODAY!

CLARENCE A. O'BRIEN
Registered Patent Attorney
Dept. 0J1 ADAMS BUILDING
WASHINGTON, D. C.

POPULAR INVENTIONS

For Your Home

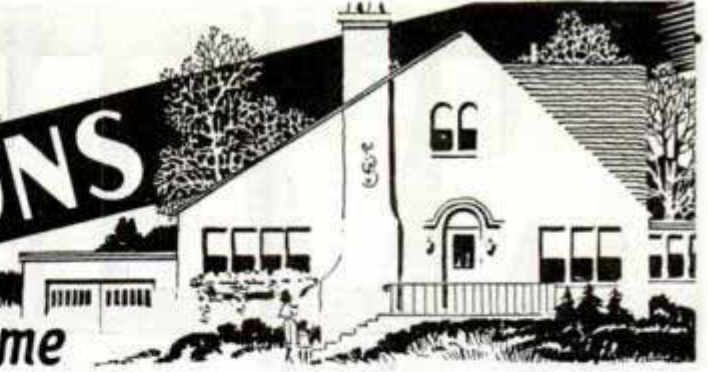

Stepladder Folds into Chair or Ironing Board

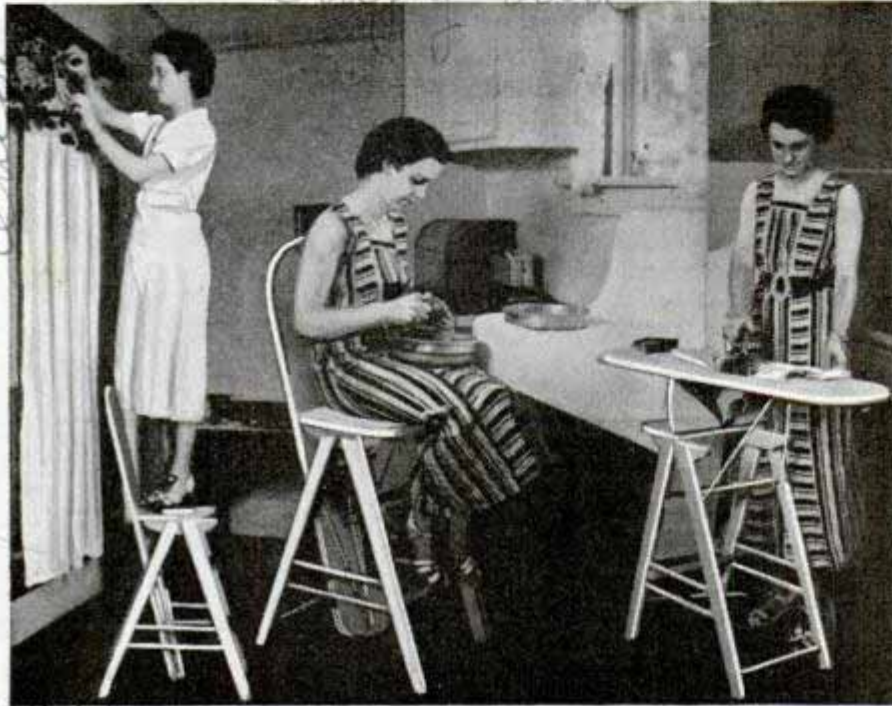

Four purposes are served by a convertible stepladder with a swinging back. It is a convenient household ladder, a chair for kitchen use, or with its back swung to horizontal position it can be used as an ironing board or a bed table. Colors to match the kitchen are available—white, ivory, maple, plain, or with red, green, blue or black decorations. When used as an ironing board it is rigidly braced; well padded and covered, it can easily be re-covered. The wide chair seat is hinged, folding back when

it is to be employed as a stepladder. The steps are provided with safety treads.

Sponge-Rubber Dirt "Eraser" Cleans Venetian Blinds

For cleaning the slats of Venetian blinds there is a sponge-rubber washer with two "legs" that straddle the slat, scrubbing each side. The washer is dipped in a liquid cleaner, and the blinds can be wiped dry afterward with another washer that is rinsed in clean water.

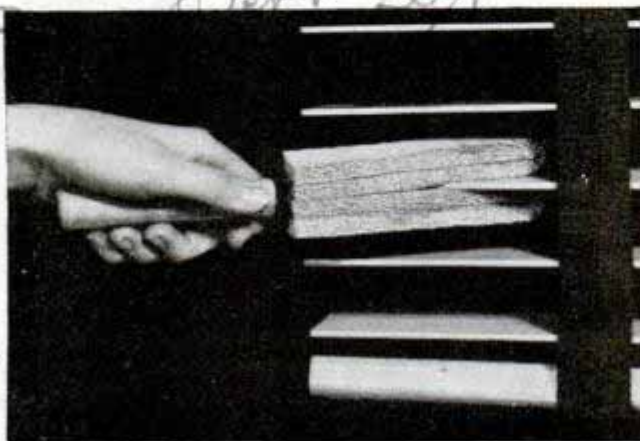

Non-Tip Rack for Garbage Can

One advantage of a wire rack for garbage cans is that it allows air to circulate underneath, and with less moisture the bottom of the can is less likely to rust. Another advantage is that the rack cannot be upset by animals. And a cup-like "moat" on its center bearing can be filled with poison to keep ants and other insects from climbing into the garbage.



Linedwood Mfg. Co Chicago
 7506 Rogers Ave
 Allending & Melrose
 Melrose Park

K 486

K 461

K 284

Amples. Call
 20

IT'S EASY TO PUT THIS *New 1941* Midwest IN YOUR OWN CABINET

FACTORY TO YOU

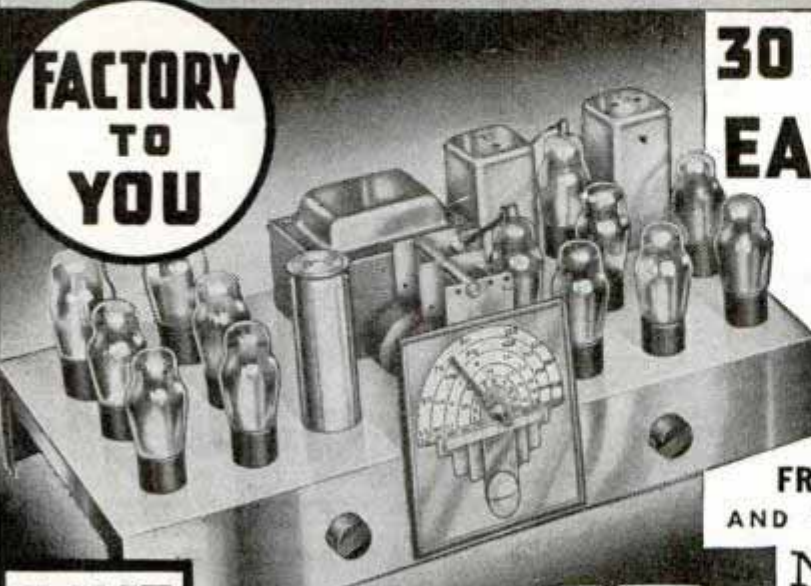

SAVE UP TO 50%

Only \$ **19.95**
COMPLETE CHASSIS WITH TUBES AND SPEAKER

30 DAYS TRIAL EASY TERMS

14-TUBES with

AMAZING FOREIGN RECEPTION

FREQUENCY MODULATION AND TELEVISION PROVISION

NOW, you can enjoy the mighty power of a 14-Tube radio, at the amazingly low, factory-to-you price of only \$19.95. Brilliant performance. Beautiful tone. Now tune in broadcasts direct from distant overseas stations. Our famous 30-day prove-it-yourself plan, fully protects you and enables you to prove Midwest's super performance in the privacy of your own home, without obligation.

USERS SAY:

"Wouldn't Trade For Any Other Radio"



Milwaukee, Wis.
—I wouldn't trade my Midwest for any other radio. It is my second Midwest and it is improved a lot, especially the foreign stations like Italy, France, Spain, England, and Germany, etc.
— S. Caplan.

"Voices and Singing Crystal Clear"



Bethlehem, Pa.
—So crystal clear and natural that one would think the person speaking or singing was right in the living room. Foreign stations come in so clear, almost like any station in the U. S. A.—Mr. and Mrs. W. Frank.

YOU BE THE JUDGE

No high pressure salesmen are needed to urge you to keep a Midwest—its performance speaks for itself. Do like thousands have done—put this new 1941 chassis in your present cabinet. Other chassis and cabinet models are fully pictured and described in our new 1941 Factory-To-You, money-saving catalog . . . from 5 to 17 Tubes, and up to 5-Wave Bands . . . including Radio-Phonograph combinations and Home Recorders.

BRINGS IN WORLD NEWS DIRECT
Tune in broadcasts direct from foreign countries. Hear history in the making before it appears in your local paper, and, before your local station announces its own version of the news! Listen direct to distant overseas stations in remotest parts of the globe.

14-TUBE CABINET MODEL
\$ **29.95**
COMPLETE



This 14-Tube radio, complete in cabinet, at a price you would ordinarily pay for a set with only 7 to 10 tubes.

FILL IN COUPON AND MAIL TODAY OR JUST SEND YOUR NAME AND ADDRESS ON 1¢ POSTCARD



RUSH COUPON
FOR **FREE CATALOG** ON COMPLETE LINE OF **5 TO 17-TUBE MODELS**

MIDWEST *Factory-to-You* **RADIOS**

MANUFACTURERS OF QUALITY RADIOS SINCE 1920

Midwest Radio Corporation
Cincinnati, Ohio, U. S. A.
Dept. 15-CC

Send me your new **FREE** Catalog, complete details of your liberal 30-day Trial offer and factory-to-you prices.

Name.....

Address.....

Town..... State.....

User-Agents Make Easy Extra Money. Check here () for details.

GET MIDWEST'S ANSWER TO TRADE-INS!

**Increased
production
means more**



**Jobs for MACHINISTS
and bigger pay for men who know their work**

This home-study course gives you the practical facts on modern machines, up-to-date methods, you need to advance in machine shop work. Take advantage of the other man's experience as found in books, to solve your problems, increase your efficiency, with

**The NEW AMERICAN
MACHINISTS' LIBRARY**

5 volumes—2014 pages—1553 illustrations
(A combined home-study course and reference library)

This library of machine shop practice was written for practical men. It gives you the best methods for every kind of machine shop work. It fully explains lathes, drills, and other machine tools and their operation, automatic screw machines, speeds and feeds, gear design and production, punch and die work, metal surfacing, etc., etc. Plainly written—completely illustrated—the best kind of help to the machine shop man who wants to advance himself.

No money down—special price—easy payments.

EXAMINATION COUPON

McGraw-Hill Book Co., 330 W. 42nd St., New York

Send me for ten days' examination the new American Machinists' Library. If satisfactory I will send you \$1.50 in 10 days and \$3.00 monthly until the price of \$16.50 is paid. If not wanted, I will return the books postpaid. (To insure prompt shipment write plainly and fill in all lines.)

Name.....
Home Address.....
City and State.....
Position.....
Name of Company..... PM-9-40

**MATHEMATICS
and CALCULATIONS
for MECHANICS**

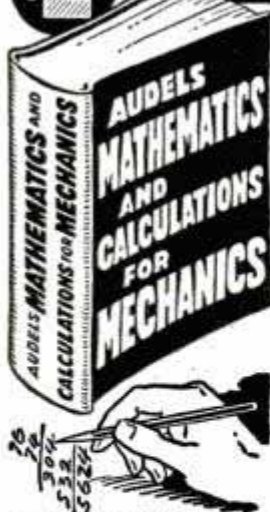

**Good News!
MATHEMATICS & CALCULATIONS
for HOME STUDY & REFERENCE**

PRACTICAL MATHEMATICS ILLUSTRATED. How to figure correctly. EVERY MECHANIC can use the New, Correct, Easy Methods, covering a complete review of practical arithmetic—with examples including mensuration—plane and solid geometry—trigonometry—algebra—calculus—ELECTRIC and MECHANICAL SHOP CALCULATIONS—practical tests—reference tables and data—How to use the Slide Rule—700 Pages—550 Illustrations—Pocket Size.

Highly endorsed. Let us mail you copy for free trial. Price \$2, postpaid.

● A HANDY BOOK! ASK TO SEE IT TODAY ●

**FREE
EXAMINATION
COUPON**

THEO. AUDEL & CO., 49 WEST 23rd ST., N.Y.C.
Mail Audel's Mathematics on 7 days' free trial. If O.K. I will remit \$2, otherwise I will return it.

Name.....
Address.....
Occupation..... PM

**For More Pay
Train To Enter
DRAFTING
INDUSTRIAL
DESIGN**

Get into a Better Pay field with a big future by learning DRAFTING and DESIGNING quickly from an Engineer and Industrial Designer. Private, individual training at your home. Drawing tools and table furnished without extra cost. Learn to draw and design new products, or to improve, re-style, streamline and modernize old products for more "eye appeal" and selling power.

Drafting is a very big field, but drafting with industrial designing is twice as big. Factories must continuously bring out new models, new products, and improved designs. You can learn both subjects right in your own home, in your spare time. You can be trained for better pay as I have trained many hundred successful students. I'll train you thoroughly by applied instruction on actual work until you are holding a good paying position. Write for complete details on "Drafting and Industrial Designing."

ENGINEER DOBE

LIBERTYVILLE, ILLINOIS

Dept. 3376

**A GOOD LIVING FROM
POULTRY**



with a business of your own. How to start small way, spare time, grow from profits, or prepare for good job in large poultry plant. Harry M. Lamon, nationally known Poultry Expert, shows latest scientific methods, money making secrets in poultry raising. His system of home study training used by thousands. Endorsed by many colleges and leading Poultrymen. Established 20 years. Write today for his big FREE catalogue describing courses, methods and service. Shows way to real business opportunity. Harry M. Lamon, Pres.

**NATIONAL POULTRY INSTITUTE
DEPT. 50-N, ADAMS CENTER, N. Y.**

**AVIATION
APPRENTICES**

AIRMINDED YOUNG MEN INTERESTED IN TRAINING FOR ENTERING THE WELL PAID FIELD OF AVIATION AS APPRENTICES—Write immediately, enclosing stamp.

**MECHANIX UNIVERSAL AVIATION SERVICE CO.
Wayne County Airport, Box 857, Dept. E, Detroit, Mich.**

EARN THE DEGREE

Doctor of Psychology (Ps.D.), Divinity—others. General Courses in science, law, business, etc. Incorporated in state of Washington. Send for 32-page FREE Bulletin at once. No Obligation. **TEMPLE BAR COLLEGE, INC., (A Correspondence Institution)** Dept. 3-R, 1411 Fourth Avenue, Seattle, Washington, U. S. A.

Earn Cash at Home!

We paid M. M. \$1174 for exceptional cellar crop Snow-King mushrooms! We furnish materials; buy all crops. Big FREE picture book tells if your cellar, shed, barn, suitable. Est. 1908. Write today. **United Co., 3848 Lincoln Av., Dept. 302, Chicago**

Get into the BAKING BUSINESS

Bakers make good money! Now 7th Industry in wages! Nearly depression-proof. New home study Baking Course qualifies you. Common school education sufficient. If you're ambitious, write for FREE BOOK, "Opportunities in Baking." **National Baking Institute, 3601 Michigan, Dept. 1356, Chicago**

**Correspondence Courses In
RADIO and ELECTRICAL ENGINEERING LOW AS \$25**

ELECTRICAL ENGINEERING. Get good grasp of wide electrical field. Modern. Very understandable. Theory made easy. **RADIO ENGINEERING.** Extra fine course in radio, public address, photo-electric work. Trains you to be super-service man, real vacuum tube technician. Tuition ONLY \$25. 60-day course. Deferred payment plan. Experiment kits furnished. **FREE LINCOLN ENGINEERING SCHOOL, Box 931-P23, Lincoln, Nebr.**

THIS TAKES
Training

AND SO DOES
THIS!

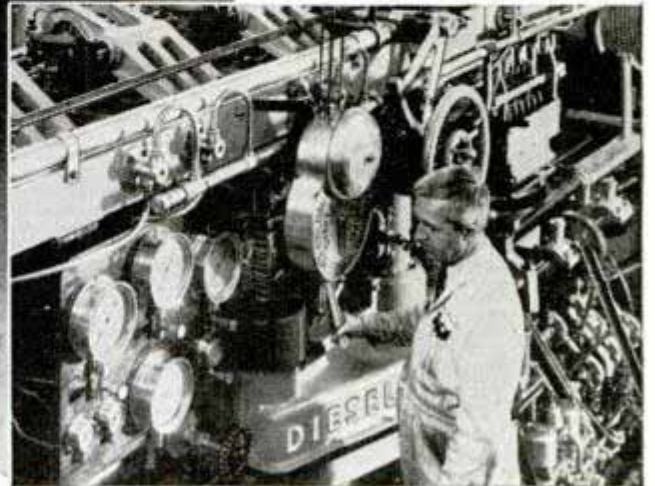

■ Training is important—whether you wish to be “tops” in skating or an expert in the Diesel field. It takes a lot of “know how” to repair, service, adjust and maintain modern Diesel engines—and they are being produced in greater numbers and varieties each year. Training is the shortcut to practical experience. Each year brings more and more activity in Diesel—but have you thought of *yourself* in connection with this great industry?

Send coupon for your free copy of “March of Diesel” and find out about it. Find out about Hemphill Diesel training. No matter where you live or what you are doing, you can start your training now, at home—and take your shop work later. Day or night resident school courses, also. Investigate—mail coupon today. No obligation.

HEMPHILL DIESEL SCHOOLS

Diesel courses in both English and Spanish for students in U. S. and Latin America. Write for information and terms.

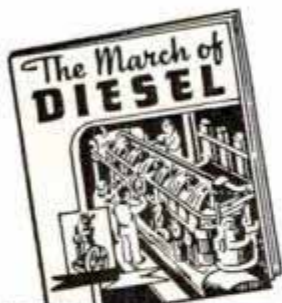

SEND COUPON TODAY!

Send coupon to the nearest
Hemphill Diesel School—

New York . . . 31-26 Queens Blvd., L. I. City
Chicago 2014 Larrabee Street
Memphis 417 Monroe Avenue
Los Angeles 2120 San Fernando Rd.
Vancouver, B.C. 1363 Granville St.

HEMPHILL DIESEL SCHOOLS

Please send my free copy of “March of Diesel” booklet and information on Hemphill Diesel training.

NAME..... AGE.....

STREET

CITY..... STATE..... m-45-p



MACHINE SHOP MEN

Learn to set up and run ANY kind of machine; MAKE MORE MONEY NOW by learning quickly HOW TO DO THINGS which usually take years of study and practice. The demand for SKILLED men is ALREADY ahead of the supply, then what WILL IT BE a month or two from now?

Needed NOW!

Bigger Pay Don't miss this chance to qualify for promotion, don't miss this Big Opportunity which is yours almost for the asking. Eight Big Books chockful of important mechanical facts told simply and clearly. Over 3000 pages, nearly 3000 illustrations cover every subject fully, including Tool Making, Pattern Making, Foundry Work, Mechanical Drawing, Forging, Machine Shop Practice and Management, and hundreds of other subjects.

8 Big Books (1940 Edition) Sent FREE

to you for examination. Decide in your own home or place of business whether or not you want to keep them, check up on any facts you want to. Note their great MONEY MAKING value, then, if you want them, pay on the easiest kind of payments. Send NOW and we will include a year's consulting membership in the American Technical Society without extra charge—and also a Big Binder of nearly 800 pages with 267 original shop tickets with 1200 illustrations. These show, step by step, how to set up and run almost any kind of job and are in addition to the 8 books. American Technical Society, Publishers—Home Study Courses.

American Technical Society, Dept. 5619, Drexel at 58th St., Chicago. You may send me the 8 big NEW books and binder of shop tickets for free examination. I will pay the few cents delivery charges only, unless I decide to keep them in which case I will send \$2.00 in ten days and \$3.00 per month until the total price of only \$34.80 is paid. If I return them in 10 days I will owe you nothing. Because I send now you agree to give me a membership in the American Technical Society entitling me to consulting privileges with any of your experts for one year.

Name.....
Address.....
Please attach a letter stating age, occupation, employer's name and address and that of at least one business man as reference.

ZOOM into AVIATION



AN AVIATION CAREER OFFERS YOU A GREAT FUTURE!

The greatest opportunity of your lifetime exists today. There never was such an opportunity in AVIATION for you. There may never be another. Aviation desperately needs trained men; they are at a premium and advancements for them are rapid. You can get in on the ground floor by training now, BUT you must choose the right school for your training. This is imperative, since your choice of a school in which to take your training will determine your whole future in Aviation and how much money you will make all the rest of your life. Curtiss-Wright Tech's career training is carefully designed to do just one thing—MAKE MORE MONEY FOR YOU. Our hundreds of successful graduates have proven that our training gets results and always pays. It has provided them with a profitable occupation and secure future, since it trained them in advance for the highest position they could ever expect to occupy. It can make you independent and self-supporting for life. Curtiss-Wright Tech is located on Grand Central Air Terminal in the heart of the Aircraft Industry. Established in 1929, this famous school is recognized as the nation's leading institution for the training of MASTER AVIATION MECHANICS and AERONAUTICAL ENGINEERS. (No flying involved.) We honestly believe that every student who enrolls here will be able to obtain immediate employment upon graduation. A position awaits you. **WARNING!—DON'T "MISS THE BOAT!"** Send for catalog today. Give age and course desired, Dept. PM-9.



CURTISS WRIGHT TECHNICAL INSTITUTE

Glendale (Los Angeles) California

THIS TOWER OVERLOOKS AVIATION'S MOST DISTINGUISHED SCHOOL OF AERONAUTICS

LET ME PROVE I CAN MAKE YOU A NEW MAN

I changed myself from a 97-lb. weakling to winner of title, "World's Most Perfectly Developed Man." Let me prove that my secret of Dynamic Tension can give you powerful muscles, smashing strength, a handsome build! All I ask is a 7 DAY TRIAL. Write for my 48-page FREE BOOK. CHARLES ATLAS, Dept. 89, 115 East 23rd Street, New York City.



SEND FOR MY FREE BOOK

REAL ESTATE IS THE FOUNDATION OF WEALTH

It is the basis of the fortunes of America's wealthiest families. BIG OPPORTUNITIES for men who really KNOW the business. LEARN from Top-Notchers in the field how to Buy, Sell, Appraise properties. Thorough, simple home-study course. Write

MORRISON SCHOOL OF REAL ESTATE, 100 N. LaSalle St., Dept. P, Chicago

ENGINEERING DEGREE IN TWO YEARS

B. S. Degree courses in engineering: Electrical, Civil, Chem., Mechanical, Radio or Aeronautical. 1 yr. Mech. Drafting. Approved by Civil Aeronautics Authority, participation in Pilot Training Program. Large industrial center. Prep courses without extra charge. Earn board if desired. Low tuition. Enter Sept. 3, December, March, June. Write for Catalog. 590 E. Washington Blvd., Fort Wayne, Ind.

INDIANA TECHNICAL COLLEGE

RADIO ENGINEERING, broadcasting, aviation and police radio, servicing, marine and Morse telegraphy taught thoroughly. 48 weeks' engineering course equivalent to three years' college radio work. School established 1874. All expenses low. Catalog free. Dodge's Institute, Ada St., Valparaiso, Ind.

MONUMENT \$9.00 UP FREIGHT PAID

Write For Catalog and Samples Of Genuine Marble & Granite. Low prices. Guaranteed satisfaction. Erecting Service. Free lettering. U. S. MARBLE & GRANITE CO., A-18, Oneco, Fla.

AMAZING NEW ELECTRIC ARC WELDER

ARC WELDER FULLY GUARANTEED RETAILS ONLY \$2.95 COMPLETE

Plugs Into Light Socket

Amazing new HANDI-WELD Electric Arc Welder—operates from 110 volt A.C. or D.C. same as other arc welders higher priced—generates tremendous heat to weld all kinds of metal. Not a toy welder that uses carbons, but actually uses standard coated rods—sizes 1/16" and 3/32". Generous supply furnished with welder. Guaranteed not to burn out. Repairs fenders, auto bodies, radiators, pre-heated small castings and machinery parts. Take HANDIWELD anywhere to job, operate from light socket. Sturdily built of finest materials to last years. Fully guaranteed by Big Manufacturer.

SEND NO MONEY! You'll find a thousand uses for the HANDIWELD around your home, garage, work shop. Also by garages, factories, repair shops, mechanics, farmers, inventors, tin shops, plumbers, etc. Order HANDIWELD now. Send no money. We'll rush one to you, complete with rods and goggles. Pay post-man only \$2.95 plus few cents postage. If not delighted, return HANDIWELD in 5 days from receipt and money paid for it will be refunded instantly. Rush your order now.

KUMFY PRODUCTS INC., Dept. H-202, Cincinnati, Ohio.



Easy

YOU'LL advance faster with an easy playing Conn. Choice of world's greatest artists. Many exclusive features yet they cost no more. Home trial. Easy payments. See your dealer or write for freebook. Mention instrument. C. G. CONN, Ltd. 931 Conn Bldg. ELKHART, IND.



CONN

BAND INSTRUMENTS

FREE TRIAL LESSON IN DRAFTING



More good jobs now in Drafting. Learn AT HOME in spare time (or at our Chicago School). Send postcard for FREE TRIAL LESSON and see how easy to learn and get a good job. CHICAGO TECHNICAL COLLEGE M-201 Tech Bldg., 118 E. 26th St., Chicago, Ill.

New York Electrical School Established 1902
Ask for free illustrated booklet
44 West 17th St., N. Y. C.

Want a Career in Photography?

Ever consider photography as a money-making career? Fascinating field. Splendid opportunities. Practical, thorough, individual training under expert personal guidance. Commercial, News, Portrait, Advertising, Motion Picture, and Color Photography. Learn for pleasure or career. Personal Attendance and Home Study courses. Booklet FREE!

NEW YORK INSTITUTE OF PHOTOGRAPHY
10 West 33rd Street (Dept. 49) New York City

Learn Public Speaking

At home—in spare time. Many overcome "stage-fright," gain self-confidence and increase earning power, this easy way. Write for free booklet, *How to Work Wonders With Words* and requirements. North American Institute, Dept. 1356 3601 Michigan Ave., Chicago, Illinois

A AND N SUPPLY CO.
Bargains—Military, Sport Goods, Firearms, Clothes, Shoes, etc. Send 10¢ for new catalog, to be redeemed on first order.
EST. 1888 A & N Supply Co., 4772 Lester St., Richmond, Va.

ELECTRIC LIGHTS AND POWER
Build Your Own Wind Plant from old generator. Dime brings complete PLANS and 1940 catalog listing over 900 Electrical Supply Bargains.
LeJay Mfg., 1447 LeJay Bldg., Minneapolis, Minn.

MONEY IN RABBITS—CAVIES
WE BUY and put you in touch with other markets. Catalog and copy of magazine 10¢. Or send 25¢ for Book Catalog and Price List and Year's Subscription to the AMERICAN SMALL STOCK FARMER
OUTDOOR ENTERPRISE CO., BOX 919, NEW CITY, N. Y.

FREE TRAILER PARTS CATALOG
We'll save you money on—axles, springs, wheels, couplers, windows, sinks, water pumps, brakes, refrigerators, beds, lamps, inside and out, 6V lamps, furniture, jacks—everything. Special discount to mfrs. NATIONAL TRAILER EQUIPMENT CO. Successors to Kar-A-Van Industries, Inc. Dept. P. 714 W. Wisconsin Ave., Milwaukee, Wis.

Complete Plans and Building Instructions. 10¢

LEARN AUTO MECHANICS

Authorities say there's greatest demand in history for TRAINED men. Good mechanics earn up to \$50 a week or more. Good practical training will fit you for a job that's waiting. Read how McSweeney-trained men make good. Hundreds of others will tell you facts equally as interesting. Don't look for a job! TRAIN for it!

8 weeks shop Course

No books, no lessons, the McSweeney practical way. First we show you, then you do the job yourself under competent instructors. You work on real equipment with real tools. Quickly you are TRAINED to hold down a permanent BIG PAY job. Any man 16 to 50 can learn. Write today for New Low Tuition Offer!

McSweeney Men Make Good!

Mesopotamia, Ohio
Dear Mac: After graduating, received job one week later in Lakewood at Willys-Knight Service. Three raises in the first year. At the end of 3 years, was assistant Service Manager. I quit at the end of 6 years to take a better job offered me in Canton, Ohio, at the Peerless Garage. Worked one year when I quit to go into business for myself. I still do most of my own service work. Your training along with practical work sure does help one in difficult problems.
—L. E. Bates.

Mt. Vernon, Ill.
Dear Mac: I am getting along fine. Have been working for the Oldsmobile dealer here in Mt. Vernon for fifteen months. I will have to give you credit for starting me out on the road to success. I feel that I owe you a debt that cannot be paid. Wishing you and all the boys the best of luck.—Loren Brown.

AVIATION & DIESEL COURSE!

Aviation is here! Each plane needs many mechanics on the ground. McSweeney's Auto Mechanical course is combined with Aviation and Diesel engine mechanical course.

LOW TUITION COST!

Learn Now and Pay for Part of Your Course Later!

In a few weeks of intensive training, actual shop work with real tools on real equipment qualify you to accept a Big Pay Job as a mechanic.

FREE! Write today for Big Free Book on AUTOS, AVIATION, DIESEL. Get the facts about jobs, and Low Tuition Offer. Mailing the coupon does NOT obligate you. It obligates ME to tell YOU how you can train for Big Money in a few weeks! WRITE TODAY!

McSWEENEY SCHOOLS

AUTO - AVIATION - DIESEL WELDING - BODY & FENDER

DETROIT, MICH. Address Your Nearest School KANSAS CITY, MO.

Mail Coupon for Free Book NOW!

McSWEENEY SCHOOLS, DEPT. N-7.

Without cost or obligation, send me your BIG FREE BOOK on Autos, Aviation, Diesel Mechanics, etc., also full information about your Low Tuition Offer.

NAME.....

STREET.....

TOWN..... STATE..... AGE.....



Know Electricity as Experts Know It—and Get an Expert's Pay!

What about your future? Who is safe today? Surely not the man who is contented to stand still! Know your job thoroughly—prepare yourself for jobs ahead. To do just this thousands of men have used

The Croft Library of Practical Electricity

The Croft Library is a complete electrical educator. It is founded on practice—on 20 years of shirt-sleeve experience—on work as it is actually done. It is jammed from cover to cover with the kind of hard-headed facts you want. Written so that the beginner can easily understand it, yet so sound, so thorough, that it is the daily guide of 59,000 highly paid electrical workers and engineers. Croft tells you the things you need to know about motors, generators, armatures, commutators, transformers, circuits, switchboards, distribution systems—electrical machinery of every type—illumination in its every phase—the most improved methods of lighting—lamps and lamp effects, etc.—how to do a complete job, from estimating it, to completion.

**6 volumes, 2155 pages—New low price
No money down—Easy payments.**

Fill in and mail the coupon attached and we will send you the entire set of six volumes for ten days' Examination on approval. We take all the risk—you assume no obligation. If you decide to keep the books, send \$1.50 in ten days and the balance at the rate of \$3.00 a month. Send the coupon NOW and see the books for yourself.

EXAMINATION COUPON

McGRAW-HILL BOOK CO., 330 W. 42nd St., New York, N. Y.

Send me for ten days' examination on approval the Croft Library of Practical Electricity. If satisfactory I will send you \$1.50 in 10 days and \$3.00 monthly until the price of \$16.50 is paid. If not wanted, I will return the books postpaid. (To insure prompt shipment write plainly and fill in all lines.)

Name.....
Home Address.....
City and State.....
Position.....
Name of Company..... PM-9-40



WHY DON'T YOU GET INTO AVIATION with these fellows?
They Are Building Famous Training Planes



What is keeping you out of Aviation? These and hundreds more Aero ITI-trained men stepped directly into aircraft work upon graduation—and found Aviation the fascinating, opportunity-laden field they had looked forward to. Aero ITI training won them a sound start and a good job. It prepared them with the broad, thorough,

intensely practical knowledge and abilities to advance along with Aviation's own swift and lasting development. Find out all about this proven Aero ITI way to an Aviation career.

EXECUTIVE BOARD

JOHN K. NORTHPROP
President, Northrop Aircraft, Inc.

ROBERT E. GROSS
President, Lockheed Aircraft Corporation

C. A. VAN DUSEN
Vice Pres., Consolidated Aircraft Corporation

AERO INDUSTRIES TECHNICAL INSTITUTE

5253 W. SAN FERNANDO ROAD, LOS ANGELES, CALIFORNIA

Five Courses in AIRCRAFT MECHANICS and AERONAUTICAL ENGINEERING...including U. S. Civil Aeronautics Authority Approved 12 Months Aircraft Mechanics Training.

FROM
A Hundred Fathoms Deep

The SECRET KNOWLEDGE of a LOST RACE



Majestic structures once stood where now is naught but the ocean's roar. Legends relate a *mysterious people* survived to reach Egypt's shore. Did they impart a *magnificent wisdom* to secret brotherhoods? Is the Great Pyramid a silent testimony to their greatness? From the land of the Nile there has descended—through the ages—a strange knowledge, truths that have guided men to the *mastery of life*. For centuries the Rosicrucians (not a religious organization) have aided in perpetuating these teachings and extended them to all who sought to vanquish fear and *dominate environment*.

THIS FREE BOOK

If you wish to receive these time-honored—yet *simple and rational*—truths of nature, write for a free copy of the "Sealed Book." It tells how you may participate in the finer benefits of life. Address: Scribe B.M.B.

The
ROSICRUCIANS
(AMORC)
SAN JOSE, CALIFORNIA

EARN A DEGREE AT HOME

From A Chartered Institution of Higher Learning
Employers Now Demand College Graduates With Degrees
55 Degree Courses in Arts; Sciences; Philosophy; Education; Public Health; Medical Jurisprudence; Psychology; Sociology; Physics; Chemistry; Geology; Pol. Science; Theology; Law; Business Training; Accounting; Statistics; Agriculture; Electrical, Civil, Mechanical, Drafting, Architectural, Automotive, Steam, Diesel, Aeronautical, Radio, Structural, Industrial, Highway, Petroleum, Mining, Marine, Refrigeration, Air Conditioning, Chemical Engineering. Founded 1908. Chartered, McKinley-Roosevelt Graduate College, 4610-P Sheridan Road, Chicago

TOOL & DIE MAKING MACHINIST

Acety & Arc Welding. Body & Fender Repair. Practical Shop Training. Michigan's Oldest & Largest Trade School. Train until Satisfied.
WOLVERINE SCHOOL OF TRADES
1400 W. Fort St. Detroit, Mich. Dept. W-3

Learn AUTO-DIESELS

Practical, tested training. Backed by 35 years experience. Course includes Auto Mechanics, Diesel Service and Operation, Diesel Power Generation, Machine Shop Practice, Auto Electrics, etc. Flexible plan to meet specific needs of those with or without jobs. Oldest, largest trade school in West qualifies you and helps you get a good pay job. Transportation allowed to L. A. Earn room and board while learning. Request Free Catalog.

NATIONAL SCHOOLS Dept. PMA-9
Los Angeles

BENNY GOODMAN
 ... "King of Swing"
CHOOSES GRETSCH
 ... "King of Drums"



NICK FATOOL
 Goodman's
 Star Drummer

Big-time band leaders have to be right ... they can't take a chance on instruments that may not deliver the goods! Therefore, when you buy a drum, make sure you get a GRETSCH, the same drum that BENNY GOODMAN and his ace-drummer NICK FATOOL feature in GOODMAN'S world-famed "No. 1" SWING BAND. And Benny selected not only one GRETSCH OUTFIT, but TWO—a GRETSCH-GLADSTONE for full band use ... a GRETSCH-BROADKASTER for the famous GOODMAN SEX-TETTE. GRETSCH, oldest drum makers in America, makes a drum for every purpose and every purse—\$5 to \$500.

Send penny postcard for literature and FREE photograph of your favorite drummer; also full information about EASY-PAYMENT PLAN and FREE trial. Give street number; address Dept. PM 91.

The FRED. GRETSCH MFG. CO.
 Musical Instrument Makers Since 1883
 60 BROADWAY, BROOKLYN, N. Y.

**EASY
 TO
 PLAY
 ★
 EASY
 TO
 PAY**

GRETSCH also offers SUPER VALUES in Guitars, Saxophones, Trumpets, Trombones, Accordions. Send for FREE catalogue. Mention instrument.

Promotion Begins at Home

Our graduates will be found in such enviable positions as Architects, C. P. A.'s, Automotive and Diesel Engineers, Business Executives, Mechanical Engineers, Private Secretaries, Air Conditioning and Radio experts, Draftsmen, Bookkeepers, Plant Engineers, Electrical Engineers. Will you trade a little of your SPARE TIME for BIGGER PAY in such a job? Our 43 years' experience helps train you QUICKLY for a REAL position. Tell us what work you like—we'll send FREE Bulletin. No obligation. American School, Dpt. P-645, Drexel at 58th, Chicago

M ECHANICS-WELDERS - COLLISION MEN

GOOD JOBS and Mighty GOOD PAY

Do you want to earn big money? If so let us know which of the following trades you prefer. You learn by doing. Practical work. Expert teachers. Low tuition. Personal attention. It will pay you to investigate AT ONCE. Just check the courses you'd like to take and mail today. You will receive full information, absolutely without cost or obligation. But don't delay.

Check the Trade You'd Like to Learn

- Complete Auto Mechanics (including Diesel)
- Auto Collision
- Metal Finishing
- Electric Arc and Acetylene Welding
- Spray Painting
- Body and Fender Bumping

Ask about our "Pay After Graduation Plan"

Name.....

Address.....

Mail the above at once to

MICHIGAN TRADE SCHOOL Write for FREE FOLDER
 3758 Woodward Ave. Detroit, Mich.

68 Pages of facts for INVENTORS

These books were prepared for men of ideas—men who have an article in mind that will make money, save money, save labor or give pleasure. Leading thinkers agree that the world of a few years from now will be radically different because of the contributions to progress that inventors will make. Now is the time—if you have an idea—to see about protecting it.

Many Little Ideas May Have Big Commercial Possibilities

Don't think that to be profitable an idea needs to be complicated. Simple articles—just a person's hunch—have often proved profitable. The crinkly hair pin, the metal tip for shoe laces, the paper clip are good examples. Also improvements on patented articles sometimes prove more profitable than the original article itself.

Don't Delay—Send for These Free Books Now

Many a man has waited until too late to protect an idea by a United States Patent. Remember someone else may be thinking along the same lines that you are, and the Patent Laws favor the man who files his application for a patent first. Delays of even a few days can sometimes mean the loss of a patent. So learn the important facts about Patent Protection at once.

42 Years of Proven Service

For forty-two years, this capable organization has served inventors from all over the country. Our large staff of patent specialists gives you expert and prompt service. Our fees are reasonable; we also help with deferred payments.



VICTOR J. EVANS & Co.

REGISTERED PATENT ATTORNEYS

MAIN OFFICE: 560-K, VICTOR BUILDING WASHINGTON, D. C.

Pittsburgh Office: 514-N, Empire Building

Send me FREE copies of your books, "Patent Protection" and "When and How to Sell an Invention."

Name.....

Street and No.....

City or Town.....State.....



Say you saw it in Popular Mechanics!

MAIL COUPON TODAY FOR YOUR COPIES

PATENTS

Booklet Free Highest References
Promptness Assured Best Results

Send drawing or model.

ALL BUSINESS GIVEN PROMPT AND PROPER ATTENTION

Listed Patent Lawyer in the latest editions of the Rand-McNally Directory of Bankers and Bank-Recommended Attorneys, published by Rand-McNally & Co., Chicago, Ill.; American Lawyers Annual, Cleveland, Ohio; Bankers Service Legal Directory, published by Bankers Service Co., Boston, Mass.; and the Snow-Church Directory Co. Lawyers List, published in New York City.

WATSON E. COLEMAN, Victor Building, 724 Ninth Street, N. W.
REGISTERED PATENT LAWYER **WASHINGTON, D. C.**

INVENTORS PATENT YOUR IDEAS SEND FOR FREE BOOK



HOW TO OBTAIN A PATENT

Written by a Former Member of the Examining Corps (1922-24) of the U. S. Patent Office. If you want to profit by your idea, you should take steps to apply for a U. S. Patent at once. Your first step is to get this Free Book. This interesting illustrated book contains valuable information you should have. It tells you fully how to obtain a patent on your idea in the quickest way. With this Free Book you will also receive a "Record of Invention" form on which you can easily record your idea. Personal and Confidential Service: Your case will be personally handled only by a Registered Patent Attorney who is also a Former Member of the Examining Corps of the U. S. Patent Office. All communications confidential.

MAIL COUPON TODAY for FREE PATENT BOOK and RECORD OF INVENTION Form.

CARL MILLER

REGISTERED PATENT ATTORNEY
FORMER MEMBER EXAMINING CORPS U. S. PATENT OFFICE

Woolworth Bldg., 35th Floor, Dept. 90-A, New York City
MILLER BUILDING, Dept. 90-A, WASHINGTON, D. C.
Please send me your Free Book, "How to Obtain a Patent," and your "Record of Invention" form.

NAME

ADDRESS

BENJAMIN AIR PISTOL WITH HAND PUMP



For Target—Small Game—Camping—Etc. Guaranteed—Accurate—Practical—Economical—Safe—Clean—Quiet—Adjustable Force—Amazing Maximum Velocity. No Smoke or Fumes. Bolt Action—Hammer Fire—Hair Trigger—Safety Lock—Hand Pump. Single Shot BB \$8.50; Single Shot cal. 177 or 22 with filled barrel \$8.50; BB 8-Shot \$10.00; Holster \$2.00. Also a complete line of Benjamin Genuine Compressed Air Rifles for BB and cal. 177 or 22. No license required from dealer or factory. Write today for complete specifications and free targets.
BENJAMIN AIR RIFLE CO., 890 Marion St., St. Louis, Mo., U. S. A.

New Ideas now Salable Before Patenting

Practical, useful inventions may now be safely marketed without patenting expense. Write us for particulars, if you have an unpatented (or patented) idea for sale.

Chartered Institute of American Inventors
Dept. 4, Barrister Building, Washington, D. C.

PATENTS—TRADE MARKS

All cases submitted given personal attention
Form "Evidence of Conception" with instructions for use and "Schedule of Government and Attorneys' Fees"—FREE!

LANCASTER, ALLWINE & ROMMEL
Patent Law Offices

412 Bowen Bldg. Washington, D. C.

INVENTORS who derive largest profits know and heed certain simple but vital facts before applying for patents. Our book, Patent-Sense, gives those facts; sent free. Trade Marks—Copyrights.
LACEY & LACEY, Est. 1869, 635 F St., N. W., Dept. 5, WASHINGTON, D. C.

DIETERICH & RUTLEY

REGISTERED PATENT LAWYERS
512 B Colorado Bldg. WASHINGTON, D. C.
Booklet on Patents sent free

INVENTIONS MANUFACTURED AT LOW COST!

Inventions manufactured in any size, any shape, any quantity, by old established (30 years old) reputable company. (No branches anywhere). Also developing, designing, engineering, modelmaking, stamping, a metal specialties, dies, models, etc. FREE estimates. FREE catalog giving "inside" information. Write today.
CRESCENT TOOL CO., DEPT. V-A, CINCINNATI, OHIO

FREE ESTIMATES

BUCHSTEIN'S FIBRE LIMB
Soothing to stump, cool, light, strong. Correct fit. Braces for all deformities. Fair terms.
D. BUCHSTEIN CO.
610 3rd Ave. South, Minneapolis, Minn.

MYSTERIOUS DEVICE WELDS BRAZES AND SOLDERS

ANYONE CAN OPERATE
Now, an electric welding, brazing and soldering Torch, complete with power unit, goggles and supplies. Works INSTANTLY off any light socket. Does a thousand and one repair jobs at amazingly LOW COST on aluminum, iron, steel and other metals. Indispensable for Auto, Body and Fender Repairs, and home repairs—shop, factory, farm, engineer, janitor, sheet metal, radio and bicycle repairs. Anyone can handle without previous experience with our simple 10-DAY HOME TRIAL instructions. Write at once for Special Introductory Low Prices Offer. Try 3 in 1 Electric Torch for 10 days at our risk, or get one free by helping to introduce it. ELECTRO-TORCH CO., 2613-LG Michigan Ave., Chicago

In answering advertisements always write name and full address clearly.

To PROTECT YOUR INVENTION—Use this coupon, NOW

Delays are dangerous and may be very costly. My personal service assures prompt action, strict confidence, and a minimum of expense. I suggest that you send me a model or drawing, or sketch and description of your invention, and \$5.00. I will make a search and report

promptly as to its patentability and send you a copy of my 72-page booklet. Or, if you prefer to read my booklet first, mail the attached coupon at once. I will also send my "Record of Invention" form. (Over 38 years experience as a Registered Patent Attorney.)

L. F. Randolph, 302-D Victor Bldg., Washington, D. C.

Please send me at once, free of charge, your 72 page booklet and "Record of Invention" form.

Name

Address

A PERSONAL CONFIDENTIAL PATENT SERVICE—



LACO New Improved Oil Burners

1ST in
Fuel Savings
...Low Cost



LACO, for 17 years, has ruled the low-priced oil-burner field in Extra Value Features! Greatest dollar-for-dollar burner in America! Priced down with the lowest, LACO offers so much more for so little (low as \$29.95 for the heater at left). Compared to burners sold at higher prices, LACO more than matches them in important features, then goes on to add new advantages not found in any burner priced so low.

LACO Oil Heater delivers up to 40% More Heat from little low-priced oil. Famous for its heavy steel "Inner Heating Unit" and Hi-Lo dual-stage burner. Self-contained fuel tank. Built extra heavy, to endure. Beautiful steel cabinet. 4 sizes.

LACO Oil Burner (right) is amazingly efficient! Priced so low it will surprise you. Approved by Underwriters' Lab. Factory-tested. Guaranteed. LACO's "Factory-to-Dealer" selling plan actually lowers selling price one-third to one-half.

FREE BOOK See your local LACO dealer, or send name for free folders and prices.



DEALERS: Write for new Dealer's Floor Plan and full details. Send at once!

LACO OIL BURNER CO., 190 Union Ave., Griswold, Iowa



RUPTURED?

Get Relief This Proven Way

Why try to worry along with trusses that gouge your flesh—press heavily on hips and spine—enlarge opening—fail to hold rupture? You need the Cluthe. No leg-straps or cutting belts. Automatic adjustable pad holds at real opening—follows every body movement with instant increased support in case of strain. Cannot slip whether at work or play. Light. Waterproof. Can be worn in bath. Send for amazing **FREE** book, "Advice To Ruptured" and details of liberal truthful 60-day trial offer. Also endorsements from grateful users in your neighborhood. Write:

CLUTHE SONS, Dept. 31, Bloomfield, New Jersey



Be a MONEY-MAKING RADIO EXPERT

I'll train you for a good job in Radio, Television, or a business of your own. My new, personalized sparetime home-study Course fits you quickly, easily. You get real Radio Equipment. I show you how to earn while you learn.

FREE: Write for complete details in new catalog "HOW TO MAKE MONEY IN RADIO" *Sprayberry Academy of Radio, 310-J University Place, N. W. Washington, D. C.*

TOOL & DIE MACHINIST TRADE Screw Machine Course

Learn these trades on actual work at ALLIED SHOPS. Fully equipped. State approved. Low fee. Day or Evening Training. Free Employment Service. Write Today for **FREE** 36-Page Illustrated Book.

ALLIED SCREW MACHINE CO., INC.
(School Div.) Dept. PM-9, 609-13 W. Lake Street, Chicago, Ill.

WELDERS WANTED!



ELECTRIC ARC-OXY-ACETYLENE
Skilled Welders earn \$8 to \$15 a day. The demand now greater than the supply. Learn this highly paid trade in 3 weeks by actual shop work. One of America's leading schools. Established 1902. 7 floors of shops. Endorsed by welding industry. Limited number of students. 3 weeks course in Electric Arc or Acetylene Welding, including room and board, only \$105. Write or wire for reservation. Ask for "Welding Facts." State age.

GREER COLLEGE, Dept. 190, 2024 S. Wabash Ave., Chicago

In answering advertisements always write name and full address clearly.

Inventors

Free Books Answer Questions—
Tell How to Get Protection

• Your ideas may be worth money! Get facts first and save time and money. Competent advice on patent procedure is essential to good results. Our 65 years' experience enables us to explain everything you need to know about protecting and commercializing your idea. Mail coupon today. Special "Certification of Invention" form also sent. Prompt, confidential service and results.



MAIL COUPON FOR FACTS ON—

- How to obtain a patent . . .
- How you can commercialize your patent . . .
- Why you need a patent . . .
- Correct way to proceed and costs . . .

C. A. SNOW & CO.

Patent Attorneys Since 1875
109 SNOW BLDG., WASH., D. C.

Please send me free books illustrated without cost or obligation.

NAME.....
ADDRESS.....



LEARN AVIATION... AT LEWIS

All branches taught quickly, soundly, at Lewis School of Aeronautics. Become master airplane mechanic or pilot in 12 mos. Or, take full 4 yr. aeronautical course. School accredited, certificated by Civil Aeronautics Authority. Famed flyer instructors. Mile-wide airport. Low tuition. Write for **FREE** catalog.

Lewis School of Aeronautics
Dept. M Lockport, Illinois

★ GET ON "UNCLE SAM'S" PAYROLL ★

Thousands Appointments Every Year

\$1260 TO \$2100 FIRST YEAR

Short Hours—Vacations With Pay

MEN—WOMEN

Mail Coupon immediately—

32 Page Civil Service Book—FREE

FRANKLIN INST., Dept. G195, Rochester, N. Y.

Gentlemen: Rush to me, without charge, 32 page book with list of U. S. Government big paid positions. Advise me also regarding salaries, hours, work, vacation, etc. Tell me how to qualify for a position.

Name.....
Address.....

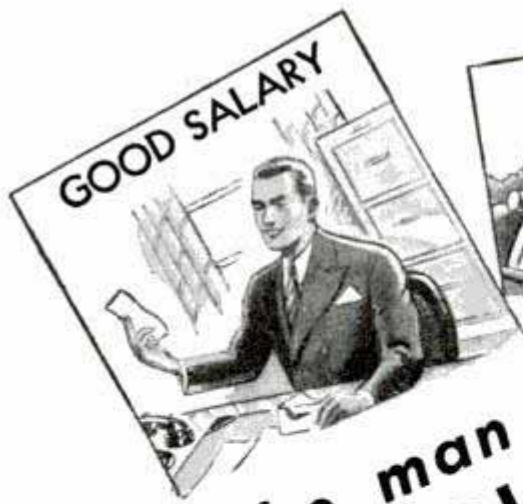

To the man who wants to enjoy
an ACCOUNTANT'S CAREER



IF you're that man, here's something that will interest you.

Not a magic formula—not a get-rich-quick scheme—but something more substantial, more practical.

Of course, you need something more than just the desire to be an accountant. You've got to pay the price—be willing to study earnestly, thoroughly.

Still, wouldn't it be worth your while to sacrifice some of your leisure in favor of interesting home study—over a comparatively brief period in your life? Always provided that the rewards were good—a salary of \$2,000 to \$10,000?

An accountant's duties are interesting, varied and of real worth to his employers. He has *standing!*

Do you feel that such things aren't for you? Well, don't be too sure. Very possibly they *can* be!

Why not, like so many before you, investigate LaSalle's modern Problem Method of training for an accountancy position?

Just suppose you were permitted to work in a large accounting house under the personal supervision of an expert accountant. Suppose, with his aid, you studied accounting principles and solved problems day by day—easy ones at first—then the more difficult ones. If you could do this—and if you could turn to him for advice as the problems became complex—soon you'd master them all.

That's the training you follow in principle under the LaSalle Problem Method.

You cover accountancy from the basic Principles right up through Accountancy Systems and Income Tax Procedure. Then you add C. P. A. Training and prepare for the C. P. A. examinations.

As you go along, you absorb the principles of Auditing, Cost Accounting, Business Law, Statistical Control, Organization, Management and Finance.

Your progress is as speedy as you care to make it—depending on your own eagerness to learn and the time you spend in study.

Will recognition come? The only answer, as you know, is that success *does* come to the man who is really *trained*. It's possible your employers will notice your improvement in a very few weeks or months. Indeed, many LaSalle graduates have paid for their training—with increased earnings—before they have completed it! For accountants, who are trained in organization and management, are the executives of the future.

Write For This Free Book

For your own good, don't put off investigation of *all* the facts. Write for our free 48-page book, "Accountancy, The Profession That Pays." It'll prove that accountancy offers brilliant futures to those who aren't afraid of serious home study. Send us the coupon *now*.

Over 1850 Certified
 Public Accountants among
 LaSalle alumni

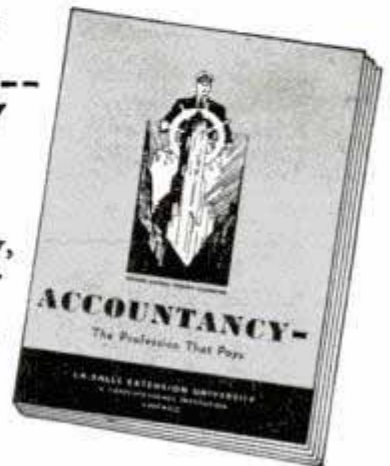

LASALLE EXTENSION UNIVERSITY

A CORRESPONDENCE INSTITUTION

4101 S. Michigan Ave., Dept. 964-HR, Chicago, Ill.

I want to be an accountant. Send me, without cost or obligation, the 48-page book, "Accountancy, The Profession That Pays," and full information about your accountancy training program.

Name.....

Address..... City.....

Position..... Age.....



CLASSIFIED Advertisements



Advertisements in this section, 35 cents per word, each insertion, minimum 10 words, payable in advance
 To be inserted under proper classification in October issue, copy should be in our office August 8th
 October issue on sale September 1st
 Popular Mechanics Magazine, 200 East Ontario Street, Chicago, Illinois

Popular Mechanics Magazine, Chicago, Ill.

Gentlemen: We have been advertising in your "classified" section during specified months for over a year and thought you might be interested in the results obtained. To date, we have received orders from twenty-one states, including Texas, California and Washington, from Canada and our most distant order came from Honolulu, Hawaii. One unusual feature: recent orders of this month, January, 1940, stated that they were ordering from the April, 1939, issue. This brings up the question "How long does a Popular Mechanics ad pull?" We are making up a new ad to appear in your April and May issues and will send it in as soon as ready.

(Original letter on file in our office)

Very truly yours,
M. B. SPOTTS MODEL AIRPLANE SHOP

YOU'LL PROFIT

By reading and answering the classified ads in this section. Hundreds of opportunities to make and save money.

AUTOMOBILES—MIDGET CARS

MIDGET And motorscooter plans, parts, building kits. Circulars free. Complete catalog. 10c. Latest list 100 used motors; midgets; parts. 20c. Shippo Midgets, Box 543-K, Zanesville, Ohio.

KUNS' Fifth edition Automobile Racing Book. Tells how to build dirt track bodies, frames, engines. Records, superchargers, rules, formula, plans, stock conversions, roadster racing, fast Fords. \$1.00 postpaid; \$1.15 C.O.D. Ray Kuns, Department 21, Madisonville, Cincinnati, Ohio.

WANTED: Old automobiles and parts, 1915 and earlier, especially Fords. Also latest Stanley Steamer. Howard Bronson, 2048 Sherman, Evanston, Ill.

SAVE Gasoline. "47 Ways to Get More Miles Per Gallon," sent postpaid. \$1.00 cash. Nelson, Box 662, Binghamton, N. Y.

AUTOMOBILE Superchargers \$3. Guaranteed mileage increase 20%; power 10%. University of Detroit test. Any car; give make, year. Wrench installs 15 minutes. John Hanley, Manufacturer, 5719 Loraine, Detroit, Mich.

PROFESSIONAL Midget racers, two-passenger roadsters. Midget motorcycles, motorscooters. Guaranteed motors, wheels, parts, plans. Handbook catalog—90 illustrations—20c. Midwest, Box 1959-CD, Chicago.

CHANGE Automobile motor into air compressor. Instructions \$1.00. Tuck, 73 Shirley, Pontiac, Mich.

AUTO SUPPLIES AND EQUIPMENT

BARGAINS—Welders, compressors, battery chargers, car washers. Liberal trial terms. Write Hobart Equipment, Box M-9403, Troy, Ohio.

TOURING Mountains? Our new altimeters indicate height. \$3.95. Air Transport, Garden City, N. Y.

FREE Bargain catalogue auto supplies, tires, tubes, tools, garage, shop, service station equipment. For dealers only. American, 1211 Bedford Ave., Brooklyn, N. Y.

PLATING Outfits for auto parts. Connect to a battery. No tanks used. Free particulars and proofs. Gunmetal Co., Ave. J, Decatur, Ill.

1940 **IGNITION** Supercharger. E. G. Sales & Mfg. Co., New York.

PISTON Rings—Multiple steel seal design. Quick seating, stops oil pumping. For all cars and trucks. Send for circular. Piston Ring Sales Co., 4022 West Lake Street, Chicago.

FREE—Big list of helpful books. Popular Mechanics Press, 200 E. Ontario St., Chicago.

AUTO TRAILERS

READY Now—Plans for nine new Jim Dandy Trailers including six modern house trailers. Catalog 10c. Also new edition of Trailer Builders Manual and catalog of parts, supplies and equipment. Price 25c. Both 35c postpaid. Trailer Supply Co., 5120-A Fulton St., Wausau, Wis.

MOTORCYCLES, BICYCLES, MOTOR SCOOTERS AND SUPPLIES

BUILD Power scooters, midget cars. We supply tires, wheels, motors. Lowest prices. Send 10c for plans, etc. Build-Ur-Own Devices, Dept. 9-A, 536 North Parkside, Chicago.

MOTORCYCLISTS. Let's get acquainted. We can save you money on parts and accessories. List and decal free. Triangle, 1111 Washington, Chicago.

SAVE 70%. Thousands assembling own motorscooter! We supply parts, tires, wheels, engines. Fork-handlebar \$2.90. Literature, drawing 10c. Comet Cycle Company, Box 3032, Madison, Wisconsin.

LATEST Illustrated Pink-O-Gram describes sport, pleasure and racing motorcycles, midget cars, racing fuel, crash helmets, goggles and accessories. Full year's subscription 10c. Reggie Pink, 2077 Southern Boulevard, New York City.

WRITE Kimley, 1271 E. Ferry, Buffalo, N. Y. Miniature storage batteries-generators.

ALLOY Pistons \$3.00—Harley, Indian, Henderson, Excelsior, Cleveland. Cylinder grinding, rings, bearings, gaskets, chains, sprockets, helmets, goggles, accessories, parts new and used for less. Catalogue and wings pin 10c. Ballak, 811 N. 9th, St. Louis, Mo.

BUILD Sensational, clutch-operated motorscooter speedster in record time with our factory finished kits. Rockbottom prices—Fork \$2.95, etc. Complete plans, literature, 10c. Zipscoot, 3622-D North Troy, Chicago.

MOTORSCOOTERS. Midget cars! Easily built. Complete plans and literature on wheels, tires, motors, etc., 10c. Hon-sakers, Masontown, Penna.

MOTORCYCLE. Parts, accessories. Most complete stock. New and used. We specialize on mail orders. What do you need? 35 page catalog 10c. Whitman Motorcycle & Supply Co., 405-9 Southwest Blvd., Kansas City, Mo.

BICYCLE Motor. Push-a-Bike outboard motor, complete with pneumatic tire, ready to attach. Dept. P, Richburn Company, Aurora, Missouri.

MOTORCYCLES. Reconditioned. New, used, parts and accessories. All makes. Large stock. Bargains. Illustrated catalogue, 15c. Indian Motorcycle Sales, Kansas City, Mo.

AVIATION

PROPELLERS. All types, unquestionable dependability, popular prices. World's largest propeller catalog. 10c. Banks Propellers, Love Field, Dallas, Texas.

PROPELLERS—True value, quick service, any size, type. Prices, descriptive literature free. Convert your motor, model A aircool, diagrams, instructions, 25c. Complete set castings going fast \$19.95. Standard Aero-Craft, Ft. Worth, Texas.

AERONAUTEXT—Certified, home study, contains best knowledge. 25c coin brings samples. Box 676, Santa Monica, Calif.

AIRCRAFT Factory system training in the world's airplane manufacturing center. Ten separate specialized courses that qualify for employment. Thousands needed. Free placement. Warren School, oldest in the west. Olive at 18th, Los Angeles.

GET Into aviation! Train now at this Lincoln Aeronautical Institute for responsible position as aeronautical engineer, air transport pilot, aviation mechanic or aircraft sheet metal craftsman. Good jobs open! Big money paid! We assist graduates in locating positions. Part time employment for board and room while in training. Write today for information. Lincoln Aeronautical Institute, (Inc.), Lincoln Airplane & Flying School Division, 2007 Aircraft Building, Lincoln, Nebraska.

PROPELLERS For airplanes, sleds. Iced sled blueprints, supplies. Catalog dime. Lorenzen Propellers, Niles, Michigan.

AVIATION Apprentices — Airminded young men interested in training for entering aviation as apprentice see ad on page 20A.

AIR CONDITIONING

REFRIGERATION — Repairing instructions, plans; postpaid, \$1.00. Appliance, 5200 Delancey, Philadelphia.

BUILD Winter and summer air conditioner. \$1.00 plans by professional designers. Literature. Wayne Engineering Co., Greenville, Ohio.

BATTERIES, GENERATORS, ETC.

WINDING Data 200 late automotive armatures \$1.00. Sabina Armature Works, Peebles, Ohio.

500 **WATT** Alternating generators \$22.50. 2 cylinder compressors with 1/2 horse repulsion induction alternating motor \$19.75. Butler Electric Co., 1885 Milwaukee, Chicago.

EDISON Storage batteries for light-power systems. Non-acid. Odorless, fifteen year life. Five year unconditional guarantee. Bargains in complete lighting systems. Low prices. Free illustrated literature. "See-Jay" Battery Co., 62 Sterling Ave., Yonkers, N. Y.

EDISON Lifetime storage batteries for light and power. Eliminates acid battery diseases. Long guarantee. All kinds re-built generating plants, motors, and miscellaneous articles at bargain prices. Free interesting literature. T. Hawley Smith Co., Croton Falls, N. Y.

PLUMBING AND HEATING

1 1/4" TOILET Seats, standard size, white and colors, \$1.35. Remittance with order. Geller, 1532 University Avenue, New York City.

ELECTRICAL SUPPLIES—EQUIPMENT

BUILD A high voltage transformer to operate Neon fluorescent from 6 volt battery. For cars, trucks, buses, airplanes, and six volt plants. Simple instructions and diagram \$1.00. Sanco, 2025 Portland, Minneapolis, Minnesota.

TRANSFORMERS Rewound, coil winding, wire, direct reading Wheatstone bridges. Free circular. Thomas Company, 321 Caroline, Neenah, Wis.

ELECTRO-SCRIBE: Electric pencil. Writes-engraves all metals \$1.00. Beyer Mfg., 4515-H Cottage Grove, Chicago.

INEXPENSIVE Fluorescent lights! "Knocked-down" fixtures; reflectors; accessories. Descriptive circulars. Dill Products, Weymouth, Mass.

EXPERIMENTERS! Make your own inexpensive photo-cells (electric eyes). Copyrighted blueprint and instructions \$1.00. Print Service, Box 105, Oak Park, Ill.

ELECTRIC FENCING

VERNON Electrical discharge fencer. No moving parts, has sealed nitrogen tube. Safe, effectual under all conditions. Write Mt. Vernon Displays, Inc., Mt. Vernon, Ohio.

HIGH-LINE Electric fencer postpaid \$5.00. Bond, 13139 Hamilton, Detroit.

WELDING—SOLDERING—PLATING

100 AMPERE Welding transformer. Operates on 110 volts \$16.50. Same transformer wound with asbestos insulated wire, burn out proof \$22.50. Transformer Supply Co., 245 Kent Avenue, Brooklyn, N. Y.

ARC-WELDER Plans \$1.00 each. Build your own from Dodge generators, vehicle motors, light plant generators. Welders Club, A9B-3432 M-Mart, Chicago. For sale: Vehicle motors, \$20.00 and up.

POWERFUL AC welder kits \$19.95 up. Plans \$1.00. Marvelweld, Box 1156, San Francisco.

BARGAINS, Demonstrator arc welders, gasoline and electric drive. Liberal trial, easy terms. Write Hobart Welder Exchange, Box 9402, Troy, Ohio.

75-200 AMPERE Welders from old generators. Complete plans 35c. Plans show single and dual welder connections. LeJay Manufacturing, 347 LeJay Building, Minneapolis, Minn.

BUILD 200A A-C welder for \$10. Others cost less—no winding. Plans \$1.00. Information dime. Hi-Point Electric Products, Bellefontaine, Ohio.

100 AMPERE Welder operates on 110 volts, asbestos wound wire, burn out proof, guaranteed two years, fully equipped, nothing else to buy \$35.00. Transformer Supply Co., 245 Kent Avenue, Brooklyn, N. Y.

FOR Sale over 100 assorted d.c. vehicle (truck) motors, convertible up to 300 amperes. Welders Club, AB-3432 M-Mart, Chicago.

BUILD A-C welder for \$10. Wind no coils. Several plans \$1.00. Information dime. Hi-Point Electric Products, Dept. W, Bellefontaine, Ohio.

A.C. Welders, plans, material. Free literature. Holgeron's Service, Canton, Kas.

ACETYLENE Welding outfits, \$36.56; electric welders, \$66.25; easy-payment plan. Superior Oxy-Acetylene, Hamilton, Ohio.

ENGINES, MOTORS, DYNAMOS

VARIABLE-SPEED A.C. reversible motors. Brand new 1/4 hp., \$13.75. Other sizes. Collins Company, 230 Bowman, South Bend, Indiana.

RECLEAN Used oil without cost. Particulars, F. Gerwin, Fairview, Okla.

BARGAINS — Welders, electroplating, motor generators, guaranteed, liberal terms. Write Hobart's, Box M-9401, Troy, Ohio.

A-1 ELECTRIC Motors. State a.c. or d.c., h.p., voltage, speed, phase, cycles. Bearings replaced. Rathbun Elec. Shop, Streator, Ill.

WINDING Data 200 motors, growlers, test transformers, \$1.00. Sabina Armature Works, Peebles, Ohio.

ELECTRIC Motors, 3/4 h.p. \$16.50, 1 h.p. \$18.50, 2 h.p. \$25.00. Others 1/4 to 50 h.p. Motors and machinery bought, sold, exchanged. Temps Brothers, 809 Myrtle Ave., Brooklyn, New York.

ALTERNATING And direct current generators, motors, converters; bargain prices. State your needs. Queen City Electric, 519 South California, Chicago.

ALTERNATING, 1/2 Horse, 110 volt, induction motors. Rebuilt, guaranteed, \$7.25. Wilmot Auto Supply, 2247 St. Paul Ave., Chicago.

BARGAIN—1/2 Hp. motors, 60 cycle, 1 phase, 110 volt, like new, guaranteed, \$7.40. Send check to Erie Electric Motor Co., 120 Church, Buffalo, N. Y.

AIR Compressors 1 3/4x1 3/4 \$6.00; 2x2 \$7.00; 2 1/2x2 \$8.00; electric drills 1/4 in. \$5.95. Free folder. National, 1915 S. State, Chicago.

MACHINERY, TOOLS AND SUPPLIES

BUILD Your own machine tools. Castings and blue prints at nominal cost. Send 10c for 2 color 28 page catalog, 34 prints covering 12 metal-working projects, \$1.50, 23 prints covering 6 wood-working projects, \$1.00. Lewis Machine Tool Co., Dept. M-9, 1000 Alhambra Ave., Los Angeles.

CONCRETE Building block machines and molds. Easy payments. Catalog free. Concrete Machine Co., 5129 South Compton Ave., St. Louis, Mo.

WE Buy complete plants, lathes, shapers, milling machines, drills, presses, motors, etc. Steinberg Machinery Company, 1132 Lake Street, Chicago, Illinois.

LONMPOWER Attachment converts any hand lawnmower into complete power lawnmower. Agents wanted. Lonmopower, 347 North Crawford, Chicago.

WANTED, Cheap used lathe chuck, 14 in. or larger. Carl Schwemle, Forestburg, S. Dakota.

LATHES—We have a few bargains in slightly used lathes, 9" to 16" swing. Write for September Blue List. South Bend Lathe Works, 454 E. Madison St., South Bend, Ind.

SACRIFICE Sale best make new machine wood bits, 1/2" dia. shank, 3" length flute. Set of 5 1/4" to 1 1/2" \$2.00. Set of 9 1/4" to 3/4" \$4.15. Set of 13 1/4" to 1" \$7.00. Sizes to 2 3/8" in stock. Send for tool bargain catalog, enclose 6c postage. Travers Tool Company, 264 Jackson Avenue, Long Island City, N. Y.

13" x 5" WILLARD Lathe with gap. No. 2 Pratt & Whitney hand milling machine, four step cone drive. Write for full particulars. Cincinnati Machinery & Supply Company, 217 E. Second St., Cincinnati, Ohio.

6 FT. Flexible shaft mounted on 1/2 horse alternating motor \$19.50. Butler Electric Company, 1885 Milwaukee, Chicago.

DRILL Grinding attachment. Price \$7.85. Used with bench grinder. Literature on request. Also dealers, salesmen wanted. Tractor-Lite Co., Sidney, Iowa.

BOATS, OUTBOARD MOTORS, ETC.

FULL Size, cut-to-shape boat patterns—blueprints—specifications. Big selection. Designed by naval architects. Real bargains. Send 10c (coin) for illustrated catalog. Book "How to Build Boats," \$1.00 postpaid. Cleveland Boat Blueprint Co., Station A-66, Cleveland, Ohio.

EASY Built kayaks, rowboats, outboards, inboards, accessories. Complete kits. Send 10c big catalogs, 20 models, newest designs. Kayak Boat, 154K East 129th, New York.

12-FOOT Flat bottom rowboat—complete plans 25c. Free boat building catalog. The Rudder, 15 Murray St., New York.

KAYAKS, Outboards, Rowboats, Weldwood ready-cut kits. Catalog. Cre-Craft Boats, Dept. F, Millburn, New Jersey.

BUILD Electric outboard from automobile generator. Smooth—quiet. Uses car battery. Complete plans 10c. LeJay Manufacturing, 547 LeJay Building, Minneapolis, Minn.

BUILD A boat by the Welch System. We supply ready cut parts for Welch designed boats. Everything for building and equipping boats. Send 10c for catalog, marine hardware, finishing materials, and marine motors. Welch Boat Company, Station K-1, Milwaukee, Wisconsin.

MONEY In selling nationally famous outboard motors. Write today for profitable dealer proposition. Power Associates, Box 501, Wilmington, Delaware.

SPEEDOMETERS For outboard boats. Two models—0-35 mph., 10-55 mph. \$6.95 each. Write for folder. Aqua Meter Co., 60 Glenwood Rd., Upper Montclair, N. J.

FORD-Mercury-Zephyr marine conversions. Catalog 10c. Lehman Engineering Company, Dept. D, Newark, N. J.

MARINE Power—Easily convert any Ford motor (domestic and foreign) with Osco parts and kits. Complete catalogue 25c (coin). Osmithson, 3644 Lawrence St., Philadelphia, Penna.

OUTBOARDS — Save 1/2. Good used parts, all makes and models. Bargains rebuilt motors. Crandall Hicks Co., 959 Commonwealth, Boston, Mass.

BOAT Designers are highly paid professionals. Complete course by mail. Catalog. Westlawn, Montville, N. J.

14-FOOT Outboard runabout. Build it yourself. Easy-to-follow instructions 25c. Popular Mechanics Press, 200 East Ontario, Chicago.

SPORTING GOODS, GUNS, FISHING TACKLE, ARCHERY

FISH, Hunting combination knife \$1.25. Gisolfi, 131 Chestnut, Scranton, Penna.

COMPLETE Camping, hunting, outdoor equipment, used guns. Catalog. Howe Fur Company, Coopers Mills, Maine.

ARCHERY! Complete archery instruction book, 70 pages—200 illustrations—30c. Catalogue free. Triangle Archery Company, Harrison-State Streets, Chicago.

GOLF Clubs, Five club matched set \$2.50. Lincoln Surplus, 123 Galena, Freeport, Ill.

ARCHERY Equipment. Catalogue free. Mid-West Archery, 2209-A East 75th, Chicago.

WORLD'S Finest fishing worms, dollar per hundred. Free instructions raising. J. B. Sandridge, Broken Bow, Okla.

GUNSMITHING, Restocking Guide (24 pages). Free. Invaluable for amateur, professional gunsmiths, home craftsmen, shooters; exclusive, complete information, illustrations, walnut stocks, blanks, gunsmith tools, remodeling, actions, blueing, checking tools. Limited supply. Write America's great gun house. Stoeger Arms Corp., 507 Fifth Ave., New York, N. Y.

ARCHERY Bows, from the heart of the yew country. W. I. King Woodworking Shop, 1958 Onyx St., Eugene, Ore.

BARGAINS! Gun catalog 5c, camera catalog 10c, archery catalog 5c, golf catalog 5c, tennis catalog 5c, medal-award catalog 10c. Warshal's, First-Madison-PM, Seattle.

FIELD GLASSES, TELESCOPES AND MICROSCOPES

FREE Instructions. Build powerful telescope. Jamer, Box 94, Manerville, N. Y.

TELESCOPES, Microscopes, binoculars; 1940 bargain catalog free. Brownscope Company, 5 West 27th Street, New York.

ANTIQUES, RELICS, INDIAN GOODS, CURIOS

FIREARMS, 50 Page list 20c. Hobby Shop, 406 Clement, San Francisco, Calif.

INDIAN Arrows, everlasting beauties, 10c. Dan McKillop, Regina, Sask.

GLASS, Books, minerals, curios, catalog 5c. Junes Antiques, Northbranch, Kansas.

SWORDS, Rapiers, pistols, daggers, armor list 10c. Robert Abels, 860A Lexington Ave., New York.

INDIAN Relics, coins, bills, gems, crystals, curios, etc. Illustrated catalog 5c. 100 ancient arrowheads \$3.00. H. Daniel, Hot Springs, Ark.

INDIAN Relics, beadwork, coins, curios, minerals, old glass. Catalog 6c. Indian Museum, Osborne, Kansas.

CHINQUILLA'S Indian Craft Museum. Handwork of all Indian tribes. Jamaica, N. Y.

POPULAR MECHANICS

TAXIDERMY

NEW American made deer eyes. Patented process produces natural, lifelike Jonas-Eyes superior to best European glass. Lower in cost, too! Unbreakable. Special trial offer—Sample pair 65c. Satisfaction guaranteed or money back. Order today or write for complete price list of all kinds of eyes. Jonas Bros., 1049 Broadway, Denver, Colo.

DOGS, PETS, BIRDS

ST. BERNARD Puppies, registered. Best on the market. Lovely pictures, details free. Manitou Kennels, Watrous, Sask., Can.

HUNTING Hounds cheap. Buy early. Beckennels, Dept. 849, Herrick, Illinois.

SPORTSMEN: 200 Pointers, setters, straight cooners, combination hunters, rabbit and fox hounds. Reasonable. List free. Ramsey Creek Kennels, Ramsey, Illinois.

PUPPIES! All breeds! Reasonable! Information free! Book 104 photos, descriptions 25c. Royal, Chazy, N. Y.

BEAUTIFUL Pure white police dogs. Ansonia Kennels, Mose, N. Dak.

TREES, SHRUBS, ROOTS, HERBS

JUST Out! World's greatest "Herbalist Almanac." Beautifully illustrated in natural colors. Contains over 200 old fashioned herb medicine recipes for home use. 10c (coin) postpaid. Botanics, Box 1109, Evergreen Park, Ill.

POULTRY AND FARM SUPPLIES

DAVIS Chicks for immediate shipment. Barred, Buff, White Rocks, Reds, Wyandottes, Orpingtons, English White, Brown, Buff Leghorns, Anconas \$5.95—100; 300—\$17.55. Also sexed chicks. We pay postage, will ship COD. Davis Poultry Farm, Route 34, Ramsey, Indiana.

NEW Low summer prices. Light cockerels \$2.25—100; straight heavy breeds \$5.95—100. Write for complete price list. Greensburg Hatchery, Box 40, Greensburg, Indiana.

BABY Chicks, cockerels \$2.45 per 100 and up. 21 different breeds. Free catalog. Write Salem Hatchery, Box 81, Salem, Ind.

MAKE Money with poultry. Read America's leading poultry magazine. Five years \$1.00; one year 25c. Poultry Tribune, Dept. E-93, Mount Morris, Illinois.

FARMS, FARM LANDS, REAL ESTATE

FARM And ranch opportunities in Minnesota, North Dakota, Montana, northern Idaho, Washington, Oregon. Write for dependable information and land lists. E. B. Duncan, Dept. 957, Great Northern Ry., St. Paul, Minn.

GOOD Farms available. Washington, Minnesota, Idaho, western Montana, Oregon. Dependable crops, favorable climate. Write for impartial advice, literature and list of typical bargains. Specify state. J. W. Haw, 119 Northern Pacific Ry., St. Paul, Minn.

FARMS For security, comfort, plenty. Catalog 1400 bargains free. Strout Realty, 255-P 4th Ave., New York City.

GOVERNMENT Land—10c acre up. Information all states 25c. Nat. Tax Service Bureau, 1037A Majestic Bldg., Detroit.

40 ACRES. Near White River, unimproved; poultry land. \$175, \$5 down, \$5 monthly. Free list and literature. Hubbard, 216 Grossman Bldg., Kansas City, Kans.

INVESTIGATE The Highlands of Southwestern Louisiana. Gently rolling, well drained, at low prices on cash rental terms. Descriptive book sent without obligation. Long-Bell Farm Land Corporation, 851 R. A. Long Building, Kansas City, Mo.

PROFITABLE OCCUPATIONS

MEN—Women, operate "Specialty Candy Factory" home. All or spare time. Opportunity for good steady income. (Our 31st year.) Ragsdale Candies, Dept. 62, East Orange, N. J.

ANGORA Wool rabbits pay. America's fastest growing industry. Start now. Dakota Rabbitry, Oakes, North Dakota.

BUSINESS Proposition resilvering mirrors, reflectors, making chipped glass nameplates, signs. Write Sprinkle, Plater, 288, Marion, Indiana.

M. M. Earned \$1174 in spare time for exceptional "cellar crop" Snow-King mushrooms! Free book tells if your cellar, shed suitable. We buy crops. United, 3848 Lincoln Ave., Dept. 67, Chicago.

WILL You give us 5% first \$600 you make? Afternoons free! Work home. \$1,000 month reported (exceptional—full-time). Expect surprise! National, Box 1240-C, San Bernardino, Calif.

WORK Projects! Starting soon throughout North and South America. Advance listings \$1 air mail. Julius, 517 East Tenth, Amarillo, Texas.

ANNOUNCING New home study course in commercial baking. Good field for ambitious men. Nearly depression proof business. Common school education sufficient. Send for free booklet "Opportunities in the Baking Industry" and requirements. National Baking Institute, 3601 Michigan Avenue, Dept. 3434, Chicago.

RAISE Rabbits and cavies for us. Full details. Catalog, contract and magazine 10c. Or send 25c for book, catalog and year's subscription to Small Stock Farmers Magazine. Stahl's, Box 10, Holmes Park, Missouri.

GAMES—ENTERTAINMENT

PLAYS, Operettas, musical comedies, complete minstrel first-parts with song programs, blackface skits, vaudeville acts, monologs, dialogs, recitations, juvenile plays and songs, musical readings, entertainments, make-up goods. Catalog free. T. S. Denison & Co., 203 N. Wabash, Dept. 11, Chicago.

TWELVE-WAY Option. Fascinating. Interesting. P.O. Box 842, Denver, Colo.

BOOKS, PERIODICALS, PICTURES, POSTCARDS

MACHINISTS Compact shop reference book, 70 pages, \$1.00 postpaid. G. A. Knudsen, 523-48th Street, Brooklyn, N. Y.

"STARDUST" Unique fantasy, science-fiction magazine. Sample 15c. 2609-P Argyle, Chicago.

MAGAZINE Back-numbers. Free list. Magazines, 35 Center Street, New Haven, Conn.

FREE Catalogue. Little Blue Books. Renseb, 30 Church, New York.

EXCELLENT Sparetime profits taking subscriptions—2500 magazines. Agents confidential catalogue, complete starting supplies free! Dept. 13, Pines, 583 Monroe, Brooklyn, N. Y.

182 THINGS You can easily make for fun or profit. 50c. Popular Mechanics Press, Room C40, 200 E. Ontario, Chicago.

MAGIC TRICKS, PUZZLES, JOKER NOVELTIES

HOUSE Of 1000 mysteries! Professional magic! Pocket tricks! Jokes! Puzzles! Novelties! Giant surprise catalog! Bigger-better than ever! Only 15c! Vick Lawston, Dept. J5, Queens Village, N. Y.

FREE Catalog tricks and jokes. Ess-Jay Novelty Sales, 5019 Winthrop, Chicago.

HOLLYWOOD Special, magicians button, catalogue, ghost illusion and trick, 25c. Magic House of Charles, Box 888, Hollywood, California.

FREE List—Stamps, coins, magic, jokes, hobby, crafts. Littlecote Hobby Shop, Utica, N. Y.

MAGICIANS' Headquarters, 216-page catalog pocket, parlor, professional tricks, 25c. Kanter's, 1311 Walnut, Philadelphia.

AMAZE And mystify! Be popular! Magic easily learned. Illustrated catalog 500 startling tricks 10c. Lyle Douglas, Station A-5, Dallas, Texas.

EARN Money in any crowd. Call names of strangers, tell unspoken questions. Professional course mind reading, spirit writing, etc., \$1. Henderson, Box 341, San Bernardino, Calif.

WORLD'S Largest professional magic shop keeps you in touch with latest tricks. To receive mailings send 25c for 1940 catalog. Holden, 220 W. 42nd St., New York.

LEARN Ventriloquism, 3c stamp brings particulars. Smith, 801 Bigelow, Peoria, Illinois.

LARGE Magic catalog 25c. Hundreds of tricks. Chicago Magic Company, 2300 N. Mason Avenue, Chicago.

FREE—Big list of helpful books. Popular Mechanics Press, 200 E. Ontario St., Chicago.

RARE COINS

LARGE Retail coin catalogue No. 30, 5c. James Randall, 37 West Van Buren, Chicago.

INDIAN Cents, 8 dates 25c. Other bargains. National, Bergenfield, N. J.

OLD Money wanted. Will pay \$100.00 for 1894 dime, S. mint, \$50.00 for 1913 Liberty head nickel (not buffalo). Big premiums paid for all rare coins. Send 4c for large coin folder. May mean much profit to you. Numismatic Co., Dept. 20, Fort Worth, Texas.

WE Pay \$10 each for certain Lincoln pennies! Indianheads \$150; dimes \$700. Catalogue 10c. Federal Coin Exchange, Columbus, Ohio.

SELL Rare coins profitably. Get inside facts from my experience. Valuable guide for beginners. 25c. Lawrence, Plentywood, Montana.

COMMEMORATIVE \$½. Columbus, Stone-Mountain, Cleveland, Illinois, \$1.00 ea. New catalogue 10c. Norman Shultz, Salt Lake, Utah.

I MAY Have just the scarce U. S. coins you want. Send me list. "Meet me by mail." William H. Kenworthy, Waterville, Maine.

FREE! Foreign coin, banknote, and large illustrated coin catalogue. Send 4c postage. Coin approvals sent. Tatham Coinco, Springfield-125, Mass.

GET Profit and pleasure in collecting old coins. Send 10c for 56 page illustrated coin catalog. You'll be delighted with it. Send for it now. B. Max Mehl, 370 Mehl Building, Fort Worth, Texas. Largest rare coin establishment in U. S. Established 40 years.

STAMP COLLECTING

GIFT Edition stamp annual free—Sixty pages with hundreds of illustrations featuring Canadians, Newfoundlanders, United States, Colonials, foreign, supplies. Sent free. Gray Stamp Company, Dept. PM, Toronto, Canada.

NEJD (Arabland), Bolivia triangle, Caymans, Negri Sembilan, Turks Caicos, Manchukuo, Bahamas, British Solomons (Cannibaland). Everything 3c with approvals. Viking, 130-Z Clinton St., Brooklyn, N. Y.

SENSATIONAL Combination offer! Big packet 105 all different including Greenland (new country), Congo, Manchukuo, Costa Rica triangle, air-mails, commemoratives, giant diamond-shaped stamp, \$4 United States; complete set United States telegraphs, cataloging 20c, scarce set Siberia cataloging 50c. Packet British colonies including Gwalior, Hyberabad, Burma (new country), jubilee and coronations. Total catalog price over \$3.00! Everything for only 5c to approval applicants! World-Wide Stamp Company, Department 600, Camden, New York.

SCARCE Diamond airmail! Wonderful packet 115 different from strange countries. British colonies, Haiti, Tasmania, pictorials, etc. 5c to approval applicants. Reliable Co., Box 139, Dept. 3, Church Annex, New York.

STUPENDOUS Offer! Selangor (mosque), Turkey (Obelisk), Malaya (ferocious tiger), Saar (dead child), Poland (swiatowit), 10 different Chile, 25 different China, 5c to approval applicants. Knopp, Box 1381, Bristol, Conn.

SELANGOR Perak, Albania, Haiti, Bhopal, Palestine, Johore, Manchukuo, Congo, Kadh, Cochín, Kookaburra-bird and 200 different stamps only 10c with approvals. Reich Stamp Co., 4647 Kenmore, Chicago, Dept. M.

325 DIFFERENT Stamps (catalogue approximately \$7.00) including French, Russian pictorials, 10c to applicants for our Profit Sharing Approvals. Official Stamp Company, Box 301-P, Fairlawn, N. J.

CANAL Zone—Panama, 25 different seldom seen stamps cataloging over \$2.00—only 50c to approval applicants. Free packet and lists included. W. Torgesen, Teaneck, N. J.

FREE—The Stamp Finder! Our new 24 page edition, fully illustrated, which will enable you to instantly identify all difficult stamps. Also fine packet of odd and unusual stamps from Bosnia-Herzegovina, Monaco, Patiala, Cyprus, etc., including maps, ships, animals and strange scenes. All free to approval applicants inclosing 3c postage. Garcelon Stamp Co., Box 900, Calais, Maine.

GRAB-BAG! Surprise yourself—5c. Approvals. Collectors Club, Box 4014, Houston.

SAMOA No. 1 to 8. catalogue \$69.75! Government re-issue only 25c to approval applicants. National Distributors, Box 408, Hollywood, California.

UNPICKED! 100 U. S. revenues on documents—10c! (700—50c). Mission mixture: pound 40c. Vanvoorhis, Hyndman, Penna.

BEGINNERS Packet, 100 different free to approval applicants. F. Lambert, Box 156, Fort William, Ont., Canada.

100 BRITISH Colonials including commemoratives, 25c with approvals. Reid, 696 Gerrard East, Toronto.

PENNY Approvals by country! M. H. Hoerning, Merriam, Kansas.

SEND 35c—Receive U. S. mint Valley Forge, Edison, Sullivan, Oglethorpe, 5c Olympic with Yorktown free. McClay, Altadena, California.

CIVIL War, battleship, Columbian, etc. 10 different U. S. 1862-1908 only 3c. Weston, Box 383, Ponca City, Okla.

ADEN, Burma, Libia, Yemen, and 25 mixed British Colonies, 10c with approvals. References. Leduc, Saint Petersburg, Fla.

1,000 BRITISH Colonials—40 colonies—rich in commemoratives, obsolete issues, big pictorials—150 to 200 varieties. Hundreds pleased. \$1. (American) George Brown, Amherstburg, Ontario.

500 DIFFERENT With hinges 55c; 1,000 \$1.25. French, Box 864, Lakeland, Fla.

1000 WORLDWIDE Stamp mixture 25c. Monjar, 1542 Waverly, Cincinnati, Ohio.

500 MIXED Stamps with prize set 25c. Countway Stamp Co., 33 Wiley Road, Belmont, Mass.

UNITED States mixtures, 3 lbs. \$1.00. Postage extra. Mission, 4512 North Racine, Chicago.

DESIRABLE Introductory packet 10c. Approvals. Leslie Stamp Co., Haverhill, Mass.

"SPAIN Goya Nudes" complete 10c. Approvals sent. Jewells, Tamaqua, Penna.

JUNGLE Wonder packet! With approvals, 5c. H. P. Wisheart Co., Dept. 10, Frankfurt, Ohio.

LOW Priced U. S. approvals. Postage paid both ways. Kaiser Stamp Co., 302 Hurley, St. Paul, Minn.

50 DIFFERENT, Fine U. S. including perforation gauge, 10c with approvals. The Stamp Shop, 809 Holland Bldg., St. Louis, Mo.

UNITED States; special to new approval applicants; fourteen different postage dues, 10c; twenty different revenues, 10c. Southern Stamps, Box 70M, Miami, Florida.

UNIQUE Island stamped envelope, addressed to you. Exceedingly rare. Pacific Union Limited, Box 28, W. Auckland, New Zealand.

BELGIUM—25 Different 5c. Approvals, Tait's Stamps, 115 South Alexandria, Los Angeles, Calif.

THREE Triangles free with approvals. Chester, Box 545-P, Utica, N. Y.

45 DIFFERENT U. S., gauge, hinges, pricelist—all for 10c. Seidenberg, Baroda, Mich.

UNITED States \$4 and \$5 stamps free to approval buyers sending 5c for 100 different. P. Wineholt, Woodbine, Penna.

FREE! Pony Express set (facsimiles), Postage 3c. Roberts, 406 Shearer Bldg., Baycity, Michigan.

50 FREE, Approval applicants. Harford Stamp Co., 4712 Hampnett, Baltimore, Md.

100 DIFFERENT Saar \$1.00, 500 British Guiana \$1.00. Gibbons, 501 Bloomfield Avenue, Montclair, New Jersey.

300 U. S. commemoratives, etc., 10c, 1000, 25c. Arden, 826 Amsterdam, New York City.

50 BEAUTIFUL Colonials, 3c. approvals, Kravat Company, 1925-Q Quentin Road, Brooklyn, N. Y.

19TH CENTURY U. S., battleships, civil war revenues, commemoratives, 20 different plus U. S. 1940 price list. All for 5c to U. S. approval applicants. Metropolitan Stamps, 198-J Broadway, New York City.

SEVEN Different triangles only 5c to approval applicants. Tatham Stamp Co., Springfield-30, Mass.

U. S. park set complete 19c. Better Approvals, Box 488, Minneapolis.

FOUR Star approvals! Nothing like them! Write today. 312 mixed U. S. 10c. Kessels, Tucson, Arizona.

OLD United States on approval. Cyril Huber, Box 9666-H, Pittsburgh, Penna.

40000 VARIETIES Available on approvals 1/4c up. Large selections, low prices. Write today. P. Keigwin Stamp Company, Vineland, N. J.

SOUTH American—100 different 10c—with approvals. Davis, Silver Lake, Ind.

AIRMAILS And commemoratives, 25 differ-ent, including Columbians, Panama-Pacific, Edison, Zeppelin, etc., only 5c with exceptionally fine United States and foreign approvals. Marco Stamp Co., Box 888, San Francisco, Calif.

FREE! Austria war set, Postage 3c. Williams, 606 Archer Bldg, Bay City, Mich.

FREE—Five beautiful airmails to approval applicants. Green and Company, Norwood, Ohio.

BIGGEST Map—odd lands—gold stamp! Our dandy packet includes all these: Giant map stamp (world's biggest), Fiume (dead country), Liberia (Bongo antelope), unique Salvador (printed in gold and 3 other colors), tiny Medellin "midget" (dwarf stamp), antique Portugal (60 years old), odd lands of Gwalior, Iraq (Arabia), Selangor, Perak, Malaya, etc.—everything only 5c to approval buyers. R. M. Stamp Co., Box 230P, Port Chester, New York.

YOU Can now have famous Spanish Goya nude stamp, world's largest diamond stamp and world's largest triangle. These beauties sent for only 5c to collectors requesting approvals. To make this the year's biggest bargain, we will include absolutely free collection of 100 varieties containing weird scarce stamps from Transcaucasia, Georgia, Azerbaijan, etc. Cactus Junior, Box 1870-B, Tucson, Ariz.

200 DIFFERENT 10c. Big 50% approvals. Covert Stamp, 39 State, Rochester, N. Y.

WEEKLY Stamp magazine, thirteen weeks, 10c. Stamp Journal, Kalamazoo, Mich.

NUDE Duchess set (2 varieties.) 5c—approvals. Shultes, Berne, N. Y.

CANADA 100 Different 25c—approvals all countries. Lists, Victoria Stamp Co., London, 4, Canada.

PENNY Approvals, that satisfy. Neil Gronberg, Box 5441-P, Philadelphia, Penna.

THREE Sets for 3c stamp! Jack Reed, Jr., Houtzdale, Pennsylvania.

25 UNITED States, including \$4 and \$5 stamps free to approval applicants, 3c postage. Brownie Stamp Shop, Flint, Mich.

SMOKY Mountain commemorative sheet, largest U. S. stamp issued, and 33 U. S. including commemoratives, airmail, revenues, etc. Catalogs 75c—To approval applicants for 5c. Curhan Stamp Company, Gloucester, Mass.

WHOLESALE Dealer's catalog, Illustrated, Postage 5c. Frank's, 4900 Chalmers, Baltimore, Md.

WHOLESALE Supplements to dealers for 10c postage. Hundreds of bargains. Grossman Stampco, 102 West 42nd, New York.

GIANT Packet 200 all different from Africa, South America, Asia, South Sea Islands, etc. Includes world's smallest stamp; triangle and diamond-shaped stamps; animal stamps. Nicaragua "Will Rogers" airmail; many others. Also packet 17 different United States (cataloging 50c)—all obsolete, including \$4 denomination, commemoratives, etc. Total catalogue price over \$5.00! Everything for only 5c to approval applicants! Mystic Stamp Company, Dept. 80-N, Camden, New York.

STAMP Dealers, your ad here will bring wonderful returns. Ask me for proof. F. W. Johnson, Manager, Classified Advertising, Popular Mechanics Magazine, 200 E. Ontario St., Chicago.

HOBBIES AND COLLECTIONS

EXCHANGE Your duplicate stamps, match covers, etc., with collectors everywhere. List, swappers, dime. (Mention hobby). Secretary, Box 2166, Denver, Colo.

UNUSED Book match covers, 100 all different. \$1.00. Free list. Charles Edelman, 1311C East 84, Cleveland, Ohio.

PHOTO FINISHING

16 GUARANTEED Prints plus two free enlargements from each roll, any size, only 25c coin! Credit on bad pictures! Same-day service. Free mailers. Midland Photo Co., Dept. 225, Charles City, Iowa.

SIX Or eight exposure rolls developed, printed 20c; or two colored enlargements and eight prints 25c. Twenty reprints 25c. Skrudland, 6444-T Diversey, Chicago.

GORGEOUS Hand colored prints—"fas-cinatingly and attractively different." Send negative and dime for sample print. Color Craft, Danbury, Iowa.

ROLL Developed, 8 beautiful prints, 15c. Dewitt Studios, Bell, Calif.

CAREFUL Workmanship. Sixteen prints from your roll 25c. Meade Photos, Meade, Kan.

TECHNIFINISH—35mm., 36 Exposure rolls including "Mercury" fine grain developed and perfectly enlarged to 3" by 4" glossy prints, 85c. New, exclusive methods and equipment make this low price possible. Cartridge reloaded with Eastman Plus X, 30c. One day service. Satisfaction guaranteed or money back. Write for free mailing bags and information. Technifinish Laboratory, 109-J, Lexington, Rochester, N. Y.

35MM. Special. Roll fine grain devel-oped, and printed on continuous strip, 40c. With Plus X cartridge reload, 75c. Grove Photo Service, Mitchell Bldg., Lafayette, Indiana.

ROLLS Developed, printed 25c. Satis-faction guaranteed. Quick service. Enterprise, Monroe, N. C.

ANY Kodak roll developed 10c. Bonnie's, 4772 Del Monte, San Diego, California.

DOUBLE Size prints. Roll developed, 8 prints all enlarged to nearly postcard size, 25c. Willard Studios, Dept. 34, Cleveland, Ohio.

EXTRA Set of prints or two double-weight enlargements with roll; prints deckle edged 25c. Dekelab Photo Service, Dallas, Texas.

FREE: Developing, five 5x7 coupons, eight prints, 15c (coin), Garrett's, Pittsburgh, Kansas.

BARGAINS, Speedy, eight prints, two enlargements 25c. Fotoservice, 1942-D Marlow, Toledo, Ohio.

8 DOUBLE Weight professional enlarge-ments 25c. From rolls up to 116, 35mm. (36 exposures) enlarged for \$1.00 on double weight paper. Enlargit, General P.O. Box 121B, New York.

FREE Beautiful album with cellophane envelopes plus roll developed and two sets prints, 25c. Free mailers. Same-day service. Pho-T-Pho, Box 24-F6, Highland Park, Mich.

PHOTOGRAPHY For pleasure and prof-it. Prepare for profitable business or fascinating hobby at home. Common school education sufficient. Write for information and requirements. American School of Photography, 3601 Michigan Avenue, Dept. 3456, Chicago.

20 VELOX Reprints 25c; 100—\$1.00. Roll developed, 16 Velox prints and 2 professional enlargements 25c. Same-day service. Superior Finishers, Monroe, Wis.

GUARANTEED, Film developed, 16 prints, 2 enlargements 25c. 20 prints 25c. Quality Photos, Hutchinson, Kansas.

DOUBLE-QUICK Service! Roll devel-oped 16 Velox prints; or 8 prints, 2 enlargements 25c. Chicago Photo Lab., Box 3A, South Chicago, Illinois.

8—5-7 LARJA Prints from 8ex. film 20c. 16—4x5 Larja prints from 16ex. film 48c. Abbey Camera Shop, St. Louis, Mo., 421-A.

CASH Prizes weekly! Any 6 or 8 expo-sure roll developed and printed, plus a beautiful, professional enlargement in a regular studio folder for only 25c. Win one of the prizes issued weekly in our cash contest. Rules of contest are that your films are developed and printed in our studio. Winner's names furnished all entrants upon request. All orders mailed same day received. Empire Photo Service, Dept. P, Ogdensburg, New York.

NEW! Sensational! 1940 style leader, 8 exposure roll finished, prints deckled, dated and in a neat album, plus valuable coupons, 25c. Triangle Photo Service, P.O. Box 402, Oak Park, Illinois.

AT Last! All your snapshots in natural colors! Roll developed, 8 natural color prints 25c. Reprints 3c. Amazingly beautiful. Natural Color Photo, Janesville, Wisconsin.

ROLLS Developed and 16 prints or 8 prints and 2 enlargements—25c. 35mm. rolls developed and 36 3x4 enlarged prints \$1.00. 3x4 reprints from miniature negatives 4c each. Mercury Studios, Dept. M, 109 N. Dearborn, Chicago.

ROLL Developed and eight glossy prints 25c; dull finish 30c. Properly washed, permanent. Wayland Photo Service, Box K-2, Wayland, New York.

FREE! Best snapshot on attractive photo button with 16 prints each roll 25c. Beautiful novelty premiums. Novel-Ad Co., BM-3327 North Ave., Chicago.

FREE—To Popular Mechanics readers: Any roll developed, 16 sparkling Nu-Art neverfade enameled prints plus two beautiful Hollywood enlargements and two free Leathertone frames only 25c. Overnight service. Lifetone Studios, F-39, Des Moines, Iowa.

CANDID Developing trial—36 exposures enlarged 3x4, including free enlargement coupon—65c. Micrograin Laboratories, N-39, Des Moines, Iowa.

35MM. Rolls fine grain developed, v. guaranteed and enlarged, 3 1/4" x 4 1/2" for \$1. Guaranteed minimum 25. "Electric-eye" precision. Deckled prints. Embossed margin and date. Free mailers. 8 exposure rolls beautifully finished in free album, 25c. Satisfaction guaranteed or money back. Mailbag Film Service, Box 5440 A, Chicago.

ROLL Developed and 8 lustrous, natural finish, permanent Velox glossy prints 25c—reprints 3c each. Fotoprint Service, Box I, Roanoke, Virginia.

FREE Trial—16 sparkling lifetime prints, three lovely Hollywood enlargements and free Leathertone frame with roll—25c. Overnight service. Nu-Art Studios, L-39, Des Moines, Iowa.

ROLL Developed and 8 beautiful enlargements 2 to 6 times larger—high gloss—deckled edge. Any 8 exposure roll 25c coin. Reprint enlargements 3c each. Alden Photos, 258-B Astor Sta., Boston, Mass.

OIL Coloring photographs a fascinating hobby or profitable business. Learn at home by easy simplified method. Previous experience unnecessary. Send for free information and requirements. National Art School, 3601 Michigan Avenue, Dept. 343B, Chicago.

TWO Beautiful professional double weight enlargements, eight lifetime prints, 25c. Prompt—careful. Film mailers free. May's Photo Shop, Box 870-AL, LaCrosse, Wis.

ENLARGED—Film developed and 8 double size prints 25c. Free mailers. Economy Lab, Box 286, Olean, N. Y.

YOUR Choice! Roll developed, 8 permanent prints and 1 5x7 hand painted enlargement or 2 5x7 unpainted enlargements, 25c. Prompt service. Individual attention to each picture! Janesville Film Service, Room 454, Janesville, Wisconsin.

FOUR Beautiful 5x7 enlargements, two sets guaranteed fadeproof glossy prints with your roll film developed only 25c. Trial offer. Reprints 16 for 25c. ARO Studios, Dept. 12, Des Moines, Iowa.

ROLL Developed, 16 artistic deckled edged permanent prints, 25c. Reprints, 3c each. 100 reprints, \$1.50. "As reliable as Uncle Sam's mail"! Midwest Photo, Room 554, Janesville, Wisconsin.

PROMPT Service—Quality work; 2 beautiful doubleweight gloss enlargements, 8 guaranteed neverfade prints each roll 25c. Excel Photos, Dubuque, Iowa.

ROLL Filmachine developed and your choice (1) 8 Finerfotos and 2 professional bromide enlargements; or (2) 16 guaranteed Finerfotos or (3) 8 Finerfotos and one beautiful oil colored enlargement, 25c. Order by number. Prompt service. Finerfotos, Box D-898, Minneapolis, Minn.

MILLIONS Now know "Hollytints Means Better Prints." Two enlargements, eight prints with trial roll developed—25c. Framed enlargement coupon free. Hollytints, P-1350 Hollywood, California.

PROMPT Service. Guaranteed work. Two beautiful portrait type doubleweight enlargements, eight neverfade gloss prints, each roll 25c. Dubuque Film Service, Dubuque, Iowa.

ROLL Developed, 16 Velox prints 25c or 8 prints and 2 enlargements. Rapid. Villa Park, Illinois.

35MM. Fine-grain developed, 36 big 3 1/2 x 5 enlargements \$1.00. Cartridge reloaded 35c. Photoshop, Linton, Indiana.

FINER Finishing specials 25c. 6—8 exposure rolls developed, your choice—16 prints or 8 prints with 2 professional enlargements or 8 prints and one colored enlargement. Genuine nationally known Moentone superior quality. Moen Photo Service, 431 Moen Bldg., La Crosse, Wis.

CANDID Special. 35mm. rolls enlarged to 3 1/4 x 4 1/2. \$1.00. 18mm. rolls 60c. 3 1/4 x 4 1/2 reprints 3c. Brown Photo Company, 1910-61 Emerson, Minneapolis, Minn.

IMMEDIATE Service! Better pictures. Sixteen guaranteed prints from roll, 25c. One colored or two plain enlargements and 8 guaranteed prints, 25c coin. Special! Coupon for 8x10 enlargement given with every 25c worth Kodak finishing. Any 36 exposure, 35 mm. film fine-grain developed and each good negative enlarged to 3x4 prints for only \$1.00. 3x4 reprints, 4c each. One day service. Details and mailers free on request. American Studios, Box 22, LaCrosse, Wis.

ROLL Developed, 8 brilliant fadeproof Velox prints and two professional enlargements 25c. Overnight service. Young Photo Service, 405-C, Albany, N. Y.

ONE 6 1/2 x 8 1/2 Plate sunk enlargement or one 5x7 hand colored enlargement with each roll developed and 8 prints 25c. 36 exposure roll developed and 36—3 1/4 x 4 1/2 enlargements \$1.35. 18 exposure roll 75c. Vidor, 321-P Hennepin, Minneapolis, Minn.

BEAUTIFUL Enlargement from each picture on roll 25c. Cut Rate Photos, Dept. B-4, Janesville, Wis.

ROLL Developed, 16 Velox prints 25c. Dividend coupon, 16 Velox reprints 25c. Willard Studios, Box 3535-A, Cleveland, Ohio.

TWO Beautiful prints from each picture on roll 25c. Twenty years of satisfied customers. Quick service. Lens Photos, Dept. J-4, Janesville, Wis.

ROLL Developed—16 guaranteed prints, two coupons on enlargements, 25c. Smart Photo, Winona, Minnesota.

IDEAL Photos beautiful finished with wide border, deckle edged, 25c per roll of 8 and free enlargement. Ideal Photos, Box 2255, Paterson, N. J.

THE Photo Mill. Immediate service; No delay! Eight-exposure roll developed, carefully printed and your choice of two beautiful 5x7 double weight professional enlargements, one tinted enlargement, or eight reprints for 25c coin. Reprints two cents each. Highest quality guaranteed. The Photo Mill, Box 629-12, Minneapolis, Minn.

PROMPT Service! Rolls developed, two Velox prints each negative 25c. Hench Studios, Harrisburg, Penna.

18 LIFETIME Prints, 2 sparkling Hollywood enlargements each roll 25c. 21 reprints 25c; 100—\$1.00. Finished 3 hours, 25 other bargains. Overnight Studio, Albany, Wis.

8 ENLARGEMENTS—Films developed plus 8 enlargements, 25c coin—116 or smaller. Enlarge Photo, Box 791, Dept. P.M.M., Boston, Massachusetts.

ROLLS Developed, two prints each and two free enlargement coupons, 25c; reprints, 2c each; 100 or more, 1c. Summers' Studio, Unionville, Mo.

THREE Prints each good negative in roll 25c. Reprints 3c. Fred D. Eastman, Bode, Iowa.

16 PRINTS With roll 25c. 16 reprints 25c. Rex Photo, Ogden, Utah.

FOR The discriminating amateur—Rolls developed 2 prints each, 25c. Reprints 3c. Superior workmanship. Same day service. Paramount Co., 327 E. 92nd St., New York.

CAMERAS, PHOTO SUPPLIES

CAMERAS And supplies. Free illustrated catalog listing everything photographic—still and movie cameras, films, lenses—at tremendous savings. Hundreds of bargains, new and used. All guaranteed. We take your old camera or equipment in trade. Write now for your free copy of our newest money-saving bargain book—just out! Limited edition. Hurry! Central Camera Co., (Photographic Headquarters since 1899) 230 S. Wabash, Dept. I-16Z, Chicago, Ill.

MAKE Your own photo prints at less than one-half cent each without dark room or extra equipment. Free information. National Service, 4105 W. Fifth Ave., Chicago.

NEW Camera catalog free. Largest discounts. Brenner, 943 Penna. Ave., Washington, D. C.

MAKE Money in photography. Learn quickly at home. Easy plan. Previous experience unnecessary. Common school education sufficient. Interesting booklet and requirements free. American School of Photography, 3601 Michigan Avenue, Dept. 3432, Chicago.

WANTED Used cameras, lenses. Cash or trade. Miller Photo Service, Avoca, N. Y.

MAKE Your own photo prints at less than one-half cent each! Complete guaranteed outfit \$1. Wallace, Box 1225, St. Petersburg, Fla.

MAKE Powerful telephoto camera, trifling cost. Jamer, 94D, Manorville, N. Y.

CAMERA Repairing. Bellows made to order, shutters repaired. Bellows made to fit all standard cameras! United Camera Co., Inc., A-1515 Belmont, Chicago.

PHOTOGRAPHERS: Earn good money advertising. Quarter brings complete instructions. Satisfaction guaranteed. Photo-Ad, Box 864, Boise, Idaho.

ENLARGER \$1.59. Enlarges eight times size of small negatives. Fully guaranteed. Paramount Sales Company, 89 Dudley Street, Boston, Mass.

BASS Says: Shrewd buyers, write Bass. For 30 years headquarters for everything in photography. 72-page Bargaingram No. 242 is interesting and free. Write for your copy. Don't trade until you write Bass Camera Company, Dept. AG, 179 West Madison St., Chicago, Ill.

HAVE You a camera? Send ten cents for recent number of our big magazine, showing how to make better pictures and earn money. American Photography, 116 Camera House, Boston, 17, Mass.

CAMERAS. Films, paper 25% to 35% discount. Paramount Photo Division, 327 East 92nd St., New York.

ENLARGE Your own photos. Make money doing work for others. Build your own enlarger. Complete details on four enlargers 25c. Popular Mechanics Press, 200 E. Ontario St., Chicago.

MOTION PICTURES AND SOUND EQUIPMENT

NEW Reflector for motion picture projectors, guaranteed to increase screen illumination 40%. Write "All-Around" Reflector Co., 10111 Euclid, Cleveland, Ohio.

WRITE For new large two color 1940 catalogue nationally advertised movie cameras, projectors, films, accessories. Payments low as \$2.50 monthly. Don Elder's Home Movies, Dept. 19, 739 Boylston Street, Boston, Mass.

GENERA Movie films. Process with powders. Bulk film list. Fromaders, Davenport, Iowa.

SOUND Films \$2.00 reel; silent films \$1.00 reel. Simpson, 1275 So. Broadway, Dayton, Ohio.

EXOTIC Movies, sample, dime. Others: sports; fairs. 8-16mm. catalog free. Cameras, projectors, bargains. Gravlee, Kennedy, Alabama.

BARGAINS! Silent 35mm. films, 95c. Demsey, 1223 Berkley, Youngstown, Ohio.

35MM. Devry, 16mm. Keystone projectors. Exchange, Box 505, Pekin, Ill.

10 SOUND (16mm.) Projectors. Bargains. Roshon, State Theatre, Pittsburgh, Penna.

ART Films—10 strips and hand viewer (magnifies 36 times) \$1.00 postpaid. We sell, exchange and buy 8mm., 16mm. films. Lists free. Fry, Box 388, Hollywood, Calif.

ART Sample, 10c; other kinds, lists free. Goodwill Company, Jackson, Tennessee.

16MM. VELOTEX. Perfect outdoor film. 100 ft. rolls \$1.95 including free processing, sample free. Velotex Laboratories, 600-B, Gary, Indiana.

SEND 3c Stamp for literature on "The World's Greatest of all Passion Plays." Silent or sound, specify which, 16mm. Hemenway Film Co., 37-F Church St., Boston, Mass.

SENSATIONAL 8-16 MM. movies "Battle of France." Thousands other subjects. Sold-exchanged. Films rented everywhere. Bargains in equipment. Trades accepted. Free illustrated catalogue (with sample art 10c). Garden Film, 317 West 50th, New York.

FREE! New fall list movie and photographic bargains; sound, silent, 33-1/3 to 50% savings. Trades accepted. Time payments. Film Library, Mogull's, 64 West 48th, New York.

BASS Says: The new Revere double 8 camera at \$29.50 with F:3.5 lens is a honey. The new Revere projector at \$59.50 is great value. Both described in our new catalog No. 245, 72 pages. Write for it. New RCA Model PG-170 16mm. sound on film projector is ready. Greatest \$300.00 value. Literature on request. Write Cine Headquarters, Bass Camera Company, Dept. A, 179 West Madison St., Chicago, Ill.

MOVIE Shop special. 100 ft. 16mm. rapid outdoor film, including processing, \$1.95. Free lists. Movie Shop, 838 Broadway, Bayonne, N. J.

OUTDOOR Film 100 ft. 16mm. \$1.98. 25 ft. double 8mm. 98c. Processing included. 8mm. camera, projector, screen \$10.00 complete. Free lists. Home Movies, Box 216, Easton, Penna.

GUARANTEED 8mm., 16mm., 24-hour reversal, processing. Eso-S, 3945 Central, Kansas City, Missouri.

ART Films. Sample, dime; catalog free. Cineart, 2443 Gunnison, Chicago.

MOVIE Film. Develop yourself. Univex, Eastman, etc. Chemical samples 15c. Raw film wholesale. Lake Camera Exchange, Gary, Ind.

15% TO 25% Discount on still or movie cameras. Free circular. Paramount Co., 327 E. 92nd St., New York City.

RADIOS, SUPPLIES, INSTRUCTION

RADIO Kits—\$3.95 up. Single band; all wave. 5-10 tubes. Save 50%. McGee Radio, EP-10, Kansas City, Mo.

RADIOS—\$8.95 up. Save 50%. Windchargers, electric fencers, power plants. Home agents wanted. Catalog free. Marco-E, Kansas City, Mo.

RADIO Engineering, broadcasting, aviation and police radio, servicing, marine and Morse telegraphy taught thoroughly. All expenses low. Catalog free. Dodge's Institute, Ames St., Valparaiso, Ind.

SEND For free giant money saving radio and phonograph record catalogue. United Radio Company, 1000-M, Newark, N. J.

MUSIC AND MUSICAL INSTRUMENTS

DUO-FLEX Reeds for clarinets, and saxophones eliminate your reed troubles. Write for circular. Duo-Flex Reeds, 1204 1st Ave., Evansville, Ind.

TWENTY Late phonograph records, \$1.00. (Small shipping charge collect.) Paul, Oswego, Illinois.

SONGWRITERS! We set music to your poems, print copies, distribute. Complete \$16.85. Melody World, 942 Market, San Francisco.

SONGS And poems wanted. No charge for melodies. Monthly awards. Hollywood Recording Studios, Box 87CW Preuss Sta., Los Angeles.

SONGWRITERS Outstanding proposition. Newark Song Publications, 1207 Carbon, Syracuse, N. Y.

PHONOGRAPH Records 10c. Catalogue. Paramount, AG-358 East Market, Wilkes-Barre, Pennsylvania.

SWISS Music box works—They operate by winding main spring. Make your novelties. Big market! Price according to size: \$1.35, \$1.70, \$2.10, \$3.90. Music Box Company, 147 West 46th Street, New York.

SONGS; Songpoems; bought, composed, published, recorded, radio broadcasted. Best offer. Free advice. Metro-Melody Music Publishing Company, San Francisco.

ADULT Beginners' piano course \$1.25. Moses, 315 West 86th, New York.

LEARN Swing piano! Postal brings free folder. Christensen, 751 Kimball Hall, Chicago.

FREE Book to songwriters—Original poems, songs wanted. Variety, Dept. V, Salem, Indiana.

SONGWRITERS! Words, melodies! Amazing offer. Hibbeler, C-5, 2157 N. Avers, Chicago.

WANTED: Original poems for musical setting. Publication, radio, recording service. Richard Brothers, 24 Woods Building, Chicago.

SONG Poems wanted. Free examination. McNeil, Master of Music, 510-PM South Alexandria, Los Angeles, Calif.

SONGWRITERS. Write for free inspiring booklet outlining new opportunities for amateur songwriters. Allied Music, Dept. 4, Box 507, Cincinnati, Ohio.

MUSIC Composed to words. Wonderful proposition. Bauer Bros., Oshkosh, Wis.

MUSIC Composed to words. Rhyming pamphlet on request. Phonograph recording of completed songs. Send poem for consideration. Keenan's Studios, Dept. PM, Box 2140, Bridgeport, Conn.

WRITE Songs. Big money and reputation. Write for information. J. Gordon Pub. Co., 201 N. Hoyne Ave., Chicago.

WANTED! Lyrics, melodies for songs. We arrange, publish, sell. Superior Song Studios, Passaic, N. J.

SONG Writers. Send for publishing agreement. McKinley Music Publishers, 1501 E. 55th St., Chicago.

BUSINESS OPPORTUNITIES

SMALL Capital starts "route" coin operated peanut, gum and amusement machines. Particulars free. Robbins Co., 1141P DeKalb Ave., Brooklyn, N. Y.

MAKE Artificial marble, glazed tiles, uncanny. Tabletops, plaques, floors, hones, novelties. Hard, fireproof, inexpensive, cement secrets. Brilliant tile and liquid rubber samples 3c. Latex postpaid—pint \$1.25; quart \$2.00; gallon \$6.00. John A. Payn, 945 Grande Vista Avenue, Los Angeles, Calif.

OPPORTUNITIES Galore! Nationwide possibilities. Stamp. Halcot, Box 2081-P, Dallas, Texas.

FREE—"Lucky 15 Golden Opportunities" vital—Reliable information about operating a mail order-mailing business including sources free circulars and free mailing of your offers, absolutely free to those sending 25c for three leading monthly moneymaking opportunities magazines. Unbelievable bargain or money refunded. Mailad Service, Mooresville, Ala.

WE Help start you in business, furnishing outfits and instruction, operating "Specialty Candy Factory" home. Men, women, opportunity to earn good steady income, all or spare time. (Our 31st year.) Booklet free. Ragsdale Candies, Dept. 4, East Orange, N. J.

AGENTS. Money in Marvex. Full size sample 25c. Marvo, 831 Ingraham St. N. W., Washington, D. C.

SIGNS And showcards easily and expertly painted with letter patterns. Many sizes and styles. Write for descriptive folder. John Rahn, A1330 Central Ave., Chicago.

MAKE Money selling advertising, 10c (coin) brings details, sample. Metcalf Advertising Service, 311 E. 61st, Chicago, Ill.

BECOME Successful realtor. Our cooperative method sells homes quickly. Saves buyer-seller hundreds dollars. Learn in one evening. Instructions \$1.00. Pring Realty, Kirkland Lake, Ontario.

MAKE Auto polish with motor oil, gallon jug and pan only equipment needed. Complete instructions quarter. Victor Grgurich, 7940 Cory Ave., Cleveland, Ohio.

HANDY Men—Earn money home operating Community "Fix-It" Shop. Stafford, Makanda, Illinois.

START Home business making statuary, plaques, art goods, novelties, souvenirs, concrete pottery, garden furniture, artificial marble flooring, liquid marble. Make your own flexible molds. Amazing profits. Valuable folder free. Creative Publishers, (P9), Glencoe, Illinois.

DEVELOP Films. outfit includes instructions, write, Johnson's, Box 1562, Baltimore.

MAKE Good durable paints and varnish about 60c a gallon. Write Emmelmann, 1425 Terrace Avenue, Indianapolis, Ind.

"RUBBER Mold Making." Plaster Casting. Working instructions 25c. Ideal Service, RM-9, Park Ridge, Ill.

GREAT Money making opportunities. Start mail order business of your own. Make money. Write, National, Argos, Indiana.

PERFUMERS Make big money. Make your own. Sample and literature 10 cts. Abell, Slavin Bldg., Pasadena, Calif.

START Profitable collection business your community. Full or spare time. No capital. Literature free. Morrison Business Service, Pontotoc, Miss.

LISTS Of all United States manufacturers—10 names \$1. Stern, 6220 Ellis, Chicago.

MONEY By mail. Tested money makers. Start your own business. 25c. C-T Sales, Box 208, White Plains, N. Y.

150 AMAZING Money making secrets. Free samples. Formico Novelty Service, Dayton, Ohio.

INCREASE Your income—Write for publication. Ready market. Simple method. Details free. Glen Donaghey, 17 Groton, Lowell, Mass.

MONEY By mail shows the way to increased income. Full and complete information. Big issue now out 25c. General Sales Bureau, Dept. 1, Agawam, Mass.

OVER 70,000 Sales were made by me of a certain article. Sample and plan showing how sold, dime and 3c stamp. Broughton, Crescent, British Columbia.

M. M. Earned \$1174 in spare time for exceptional "cellar crop" Snow-King mushrooms! Free book tells if your cellar, shed suitable. We buy crops. United, 3848 Lincoln Ave., Dept. 65, Chicago.

YOU'LL Like resilvering mirrors, reflectors, making chipped glass nameplates, signs. Write Sprinkle, Plater, 127, Marion, Indiana.

CAPITAL Not required. Exceptional opportunity. Our utilities save money and increase efficiency for merchants. Fast sellers; cost little; unlimited field; territory rights. Write now 122-5th Avenue, Dept. 500, New York.

OPERATE A lettershop. Splendid white-collar work in your own home. Write for full particulars. Tynan, Rhinebeck, N. Y.

MAIL Order business course shows you how to make money, spare or fulltime. Teaches professional mail order technique—not penny-catching schemes. Free details. Nelson Company, 500 Sherman, Dept. 404-I, Chicago.

POPCORN Machines, carmelcrisp, crispettes, cheese coat, potato chips. Long Eakins, 2035-J High St., Springfield, Ohio.

3c GALLON. Bleach, glass spray, cleaning fluid, type cleaner, foaming rug and upholstery cleaner, hand soap, garage floor cleaner—manufactured from Phospholene. Sample 25c. Literature free. Western, 401 Climax Bldg., Cleveland.

OPPORTUNITIES Everywhere for everybody 25c. Bauer's Service, Box 128, Palmerton, Penna.

OPERATE A collection agency-credit bureau. Very profitable. Permanent. Free folder. Cole Associates, Syracuse, N. Y.

GRIND Lawn mowers! Factory method, \$2.00 capital. \$800 reported. Mowers, Janesville, Wis.

MAILSALE Opportunities. Principal 70 page National Mailorder Magazine. Sample copy, big mail, 10c. 3 different 25c. Wichell Publishers, Mooresville, Ala.

MANY Secret ways to get employment. Many successful remedies. Five hundred valuable secrets-ideas. Send seventy cents to F. Bacho, Biloxi, Miss., for booklet. Thousand—one dollar. Money refunded if not satisfied.

SELL By mail, your idea, product or service, saving 50% in printing, mailing costs, with effective, tested plan, now used by reliable individuals and concerns. This merchandising plan, instructions, literature, individual consultation letter, by mail merchandising expert, 29 years experience, helps solve your mail sales problem. Sent postpaid \$1. Bank reference incorporated in plan. Shaw Service, Box 26, Jamaica, N. Y.

100 PRACTICAL Money making plans. Interesting literature free. Wallace-15, Box 1225, St. Petersburg, Fla.

SAVE Shoe soles. Home business can't fail. Information 25c coin. E. Krall, 421 Laurel Ave., Palo Alto, Calif.

MONEY Making secrets, best ever, \$1.00. Javaro, 740 Empire Blvd., Brooklyn.

WILL You give us 5% first \$600 you make? Afternoons free! Work home. \$1,000 month reported (exceptional—fulltime). Expect surprise! National, Box 1240-B, San Bernardino, Calif.

COMFORTABLE Earnings—establish a mailing business. Great possibilities for men or women, anywhere. Literature free. Lasell Business Service, Box 374, Oakland, Calif.

WANTED: Ambitious person in every locality to operate their own duplicator shop. Experience unnecessary—easy work—big earnings. Further information 10c. Daily News, Wauseon, Ohio.

RESILVER Mirrors. Amazing opportunity. Complete process, formula 25c. Ideal Service, 179M, Park Ridge, Ill.

START Plating business at home. Amazing profits. Make your own outfit. Inexpensive. Illustrated instruction booklet 25c. Popular Mechanics Press, 200 East Ontario, Chicago.

MAKE Maple sugar apple taffies. Instructions \$1.00. Sent on 5 days free inspection. Stamp required. Maple, 109 N. Dearborn, Chicago.

WANT More business! 2c daily opens individual New York branch office. Co-operative Mail Service, 126 Lexington Ave., New York.

MAIL Order opportunity. Small investment starts you. Complete instructions 25c. Morse Publishers, Box 671, Cincinnati, O.

MAKE—Biggest money duplicating leading chemical specialties. Popular branded products! Miller's Analytical Service, Tampa, Florida.

LIQUID Marble—anyone can make! Colorful, glazed! Moulded, brushed, sprayed. Rubberlastic moulds. Composition flooring. Big money in these! Particulars free. Marbleizing Service, Edwardsville, Ill.

SPARE Time profits. Work at home. Instructions, quarter. Parke, 1517 Pendleton, Columbia, S. C.

OPERATE Profitable "route" four compartment vendors. Small investment. Penny King, 1233 Chouteau, St. Louis.

OWN A cash business? No selling. Operate "Silver King" vendors, \$3.95 up. Free instructions. Automatic, 2422-A Fullerton, Chicago.

TURN Tin cans into money. Instructions 25c. H. Chaney, 1130 E. 16th St., Jacksonville, Fla.

GOING In the mail-order business? Valuable information free. Hollywood Mailers, Box 48, Hollywood.

MOLD Making, plaster casting, tremendous profits. Foolproof rubber. 24 page instructive catalogue free. Plastic Arts, 711 Neely, Muncie, Indiana.

BIG Mail for you. Latest moneymaking offers, opportunities, catalogs, magazines. Name listed in directory 10c. Ideal Service, 108M, Park Ridge, Ill.

OPERATE Mail order business at home. Details dime. Maples, 3418 South Marshfield, Chicago, Illinois.

"NEW Business" opportunities. Drop postal. Porter, Box 6346P, Pittsburgh, Penna.

WE Successfully sell inventions, patented and unpatented. Write us, if you have a practical, useful idea for sale. Chartered Institute of American Inventors, Dept. 4-C, Washington, D. C.

I WANT To send you proof of the wonderful pulling power of Popular Mechanics Magazine's classified pages. What's your proposition? Write me today. F. W. Johnson, Manager Classified Advertising, 200 E. Ontario St., Chicago, Ill.

MAKE Color-glazed concrete pottery, gravestones, tiles, floors, walls. Basement waterproofing, etc. Booklet 3c stamp. National Potteries, Minneapolis, Minnesota.

GET Big mails—Samples galore. Your name listed in Midstates Mail Trade Directory, copy sent you, directory 500,000 articles wholesale, 10c. Eagle, 414-P W. 65th, Chicago.

MAIL Order business is your opportunity. Many began small, now earn thousands yearly. No personal contact. Boundless opportunities. Have had over 30 years experience; will help you succeed. Send 25c for valuable booklets, none free. B. Breniser, 257 E. 21st, Philadelphia.

INVENTION Finance Magazine, 80-G Wall Street, New York. Important particulars free.

A REAL Future for you with Red Comet fire control products. Low prices. Proved seven years. Splendid sales outfit free. Some good territory open. Exclusive. Write quick. 766 Red Comet Building, Littleton, Colorado.

SUCCEED With your products. Make-sell them. Formulas, Processes, Accurate analyses. Catalog free. B. Thaxly Co., Washington, D. C.

PLASTEX Industries offers industrious men an opportunity to start a business of their own, manufacturing art goods, novelties, souvenirs, etc., in Plastex and marble imitation. 5c material makes \$1 articles. Rubber moulds furnished for speed production. Small investment brings big returns. You are just in time for big wholesale season now starting. Write for interesting booklet mailed free. Plastex Industries, Dept. A, 1085 Washington Ave., New York.

GOOD Paying business silvering mirrors, plating autoparts, reflectors, bicycles, bathroom fixtures by late method. Free particulars and proofs. Gunmetal Co., Ave. H, Decatur, Ill.

ELITE Collection of business plans, contains 127 tested plans and scores of formulas. Start own business; home, office. Particulars free. Elite Co., 214 Grand St., New York.

WHERE To buy at lowest wholesale prices. Information free. Yorena, Box P-312, Bayonne, N. J.

100 PROFITABLE Mail order and local plans. Gilbert Supply, 5-P West 24th, New York.

MAKE, Sell luminous paint. Literature free. Gordon Laboratories, 1265-H Broadway, New York.

EARN Money in your spare time taking subscriptions to Popular Mechanics. Unlimited possibilities, every family a prospect. Easy to sell. Bonus paid in addition to liberal commission. Send postcard for further details today. Circulation Dept., Popular Mechanics Magazine, 200 E. Ontario St., Chicago.

127 WAYS To make money, in home or office, business of your own. Full particulars free. Elite Co., 214 Grand St., New York.

HOW And where to obtain capital fully explained, free particulars. Star Service, Wapakoneta, Ohio.

MAKE Money by mail, the way we do. Free information. Maywood, P-1107 Broadway, New York.

MONEYMAKING OPPORTUNITIES

RELIABLE Men to operate movie circuits in theatreless communities. Earn \$50.00 to \$100.00 weekly. Everything furnished. Southern Visual, Dept. PM-14, Box 2404, Memphis, Tennessee.

LARGE Profits placing favorite photos on glassware or any smooth surface from any negative. \$1.00 brings full instructions. Box 215, Buchanan, Michigan.

GUIDE Book to success—Hundreds of moneymaking plans, income ideas, only 10c. Hillyer's, 618 Webster, Palo Alto, California.

"PORT Of Opportunities" published monthly—offering latest self employment; ideas; plans; schemes. \$1.00 year, copy 10c. Farm & Home Industries, 66 Seneca, Gardenville, N. Y.

MONEY Can be made repairing scales. For information regarding instructions on repairing send stamped envelope. Ackerman Scale Repairing Instructions (Copyright 1940), Box 1653, Charlotte, N. C.

"LUMINOUS Paint" shines in dark. Easily made. 300 other formulas, plans—all 25c. Ideal Service, 300P9, Park Ridge, Ill.

YOU'LL Like resilvering mirrors, reflectors, making chipped glass nameplates, signs. Write Sprinkle, Plater, 287, Marion, Indiana.

BOOKKEEPERS Make money operating new idea bookkeeping service. Ralph Lee, Vicksburg, Michigan.

M. M. Earned \$1174 in spare time for exceptional "cellar crop" Snow-King mushrooms! Free book tells if your cellar, shed suitable. We buy crops. United, 3848 Lincoln Ave., Dept. 68, Chicago.

A QUALITY Mail of money-makers. Magazines, formulas, plans. No trash. 10c. Goodeve, Bergenfield, N. J.

EARN Money with your typewriter addressing envelopes, circulars, typing. Information 10c; none free. Ace-PMI, 316 Empire, Birmingham, Ala.

250 MONEYMAKING Plans, 40,000 words, 25c coin postpaid. Janbard, Box 195, Long Beach, Calif.

PROVEN Moneymaking plans. Particulars free. Bradley's, Box 1871, Raleigh, N. C.

MILLION Articles. Buy wholesale. Valuable directory 10c. Ideal Service, D-9, Park Ridge, Ill.

BUILD Fluorescent tube lights. New economical plans 25c. McMaster Neon, 730 State, Bellingham, Washington.

LADIES! Earn money selling hosiery. No experience needed. Just write Handal, 309 East 16 Street, Brooklyn, N. Y.

MAKE \$25 A week in spare time. Stamp for reply. 212 Exchange Building, Spokane, Wash.

WILL You give us 5% first \$600 you make? Afternoons free! Work home. \$1,000 month reported (exceptional—full-time). Expect surprise. National, Box 1240-A, San Bernardino, Calif.

FREE Literature describing many money making plans. Franklin, Box 866M, Hilltop Sta., Columbus, Ohio.

YOUR Name listed—50,000 mail trade directories—50c. Receive hundreds moneymaking opportunities. International, Box F5636, Chicago.

DOLLARS For you! Be independent! Wonderful opportunity! Sensational money making secrets! \$50 week easy! No humbug! You'll never be unemployed! Particulars, complete plans \$1. Opportunity, Box 246, Hollywood, California.

Earn Money taking magazine subscriptions. Details free. New York Circulation Service, 30 Church, New York.

GET Squab checks weekly. Eye-opening poultry book free. Rice, Box 639, Melrose, Mass.

FREE Formula. Successful lube reclaiming. Boisset, Box 483, New Orleans, La.

BUY Wholesale—Sell by mail or local. Wetzel, Valhalla, N. Y.

BE A professional scrapbooker. Big fees. Unlimited opportunities. Can be done at home. No competition. No capital needed. Write to Scrapbookers Guild, 59 Park Place, New York, N. Y.

"RAISE Earthworms for profit," new, interesting home business. Bureau Zoological Research, 106A Broadway, Peoria, Ill.

AMATEUR Cartoonists, earn cash at home, copying and duplicating cartoons for advertisers. Ad-Service, Argyle, Wis.

WHOLESALE Sources, 500,000 articles. Free directory. Maywoode, 1107 Broadway, New York.

GROW Plants without soil. Folder free. Gordon Laboratories, 1265-J Broadway, New York.

SEVEN New money making wonders. Samples free. Wonder Co., 12957 Hamilton, Detroit, Mich.

FORMULAS, PLANS, ETC.

GUARANTEED. Selected formulas. Details 6c. George Barton, 86 Ditmars Street, City Island, New York.

TRUSTWORTHY Formulas, candy lessons, opportunity books. John Baran, Bay City, Mich.

70 SINGLE Ingredient formulas, everyday products. 50c. Pring, Kirkland Lake, Ontario.

MAKE Fast selling products. "Chemist Approved Formulas, Catalog free. Kemico, 12-K, Park Ridge, Illinois.

10,000 MONEY Making formulas, recipes, secrets. Make most anything. 900 page book. \$1.50 postpaid or C.O.D. (foreign \$1.85). Catalog 3c. Adams Brown Company, Chestnut Hill, Massachusetts.

FORMULAS. Analysis, literature free. Hertzstein, 330 Charles, Grand Rapids, Mich.

HUGE 900 Page book, 10,000 formulas, trade secrets, etc., \$1.50 postpaid. P. Allaire, 50 Elm, Bath, Me.

FORMULAS—Latest, best. Analysis. Literature free. Belfort, 4042 N. Keeler, Chicago.

GUARANTEED Perfect formulas for any good product. "Just name it." Miller's Chemists, Tampa, Florida.

50 AMAZING Tested formulas \$2.00. Unique service. Stamp for details. Glenco, Box 732, Indianapolis.

THAXLY Formulas, processes, for successful products. Accurate analyses. Catalog free. B. Thaxly Co., Washington, D. C.

BIGGER Profits—Less work! Single-ingredient formulas. Write A. Kinford, Wayne, Penna.

ICELESS Ice! Colder! Cleaner! Cheaper! Instructions 25c. Duffy, Covington, Ky.

FORMULAS—All kinds. Real money-makers. Lowest prices. Catalog free. Clover Formulary, 108-P3, Niles Center, Ill.

REAL Manufacturing formulas. Lists free. Cummings, Chemist, Gordon Avenue, Syracuse, N. Y.

ELITE Formulas and plans; make and sell your own products. Descriptive booklet free. Elite Co., 214 Grand St., New York.

CHEMISTRY

FREE: 40 Page catalog of chemical and laboratory supplies for amateur chemists. Wollensak microscopes and supplies, scientific books at big discount. J.E. Winn, 124 West 23 Street, N. Y. C.

JOIN—American Amateur Chemists Society. Descriptive literature free. Haslett, Michigan.

FREE, 100 Different chemical booklets, magazines. Information 25c. Nawoj, 2124 Iowa, Chicago.

FREE Chemistry catalog. Supplies at 5c! Equip complete laboratory. Kemkit Scientific Corp., 397P Bridge St., Brooklyn, N. Y.

CHEMICALS, Laboratory, glassware, apparatus. Send 3c for catalog CPI. Biological Supply Company, 1176 Mt. Hope Avenue, Rochester, N. Y.

SPECTROSCOPE For quick chemical analysis \$2.50. Kutting Sons, Campbell, California.

CHEMICALS In 5c quantities. Catalog 5c. Fleischer's Laboratories, Medford, Mass.

HELP WANTED

BIG Money taking orders: shirts, ties, hosiery, underwear, pants, jackets, raincoats, uniforms, etc. Sales equipment free. Experience unnecessary. Nimrod, 4922-BG Lincoln, Chicago.

BOYS, Girls—Earn spending money; outfit free. Vosacek, 1634 Monroe, Chicago.

APPOINT Agents to sell household products. Boness Products, Kewaunee, Wis.

M. M. Earned \$1174 in spare time for exceptional "cellar crop" Snow-King mushrooms! Free book tells if your cellar, shed suitable. We buy crops. United, 3848 Lincoln Ave., Dept. 66, Chicago.

USE Photo stamps on employment applications, personal letters, business cards. Only \$2 buys 150, gummed. Send photo to N. P. Co., Box 6, Niagara Square Sta., Buffalo, N. Y.

MEN—Women, in every city, representing us consigning "New Deal Bunk" booklet to newsstands. Research Publishers, Scranton.

GET The job you've dreamed of. We assist talented, industrious, ambitious men and women of all ages. Whether now employed or not. Job consultants that make good—not employment agency nor application-letter writers. For eye-opening booklet address Gatto Associates, Trenton, N. J.

AGENTS WANTED

CHRISTMAS Card money-makers! Sensational \$1 assortment 21 Christmas cards starts you making money now—50c profit. Other fast-selling assortments. Personal Christmas cards, 50 for \$1. 50c sample on approval. Schwer, Dept. V-4, Westfield, Mass.

NEW Kind of man's shoe that zips on and off. Also shoes that increase height two inches. Pays salesmen ready cash every day. Complete sales kit, including almost 250 styles for men and women, sent free. No experience needed. Write sales division of manufacturer established 37 years. Consolidated Shoe System, Dept. MC-1, Chippewa Falls, Wisconsin.

EVERYBODY Buys sensational "Golden Rule" assortment, 21 Christmas folders including souvenir calendar. Free Christmas motto with each box. Unparalleled value. Costs you 50c, sells on sight for \$1.00. Actual retail value \$3.00. Ten other bargain assortments. Everybody, all ages, making easy-as-pie sales. Nothing to lose. Sample "Golden Rule" assortment sent on approval, with free offer. Silver Swan Studios, 320 Fifth Avenue, Department 46, New York.

WEAR Fine hose I send without cost with large outfit while taking orders for amazing new hosiery. Replacement guaranteed against holes, snags, and runs. Rush name and hose size. Wilknit, Desk KK-37, Greenfield, Ohio.

DISTRIBUTORS Sell competitionless necessity. Territory. Information sample, 20 cents. Weidenbeck, 337A Irving, Brooklyn, N. Y.

VENETIAN Blinds—Agents! Sensational profits! Sell made-to-order blinds. Garfield Mfg. Co., 4343 Harrison, Chicago.

SELL Season's Christmas card hit! America's finest 21-card assortment, \$1. Your profit 100%. Big selection assortments. Personal Christmas cards low as 50 for \$1. Free samples. Wetmore & Sugden, 749 Monroe, Dept. 75, Rochester, New York.

STOPS Hosiery runs. Costs 5c, sells 25c. Dean's Sales, Huntington, Indiana.

MONOGRAMMING Automobiles real money maker. Write for samples. International Co., Box 9360, Philadelphia, Pa.

CHRISTMAS Cards. New. Different. 50 name imprinted, sells \$1. Largest profits. Complete line box assortments. Special bonuses. Free samples, descriptive folder. Pen-Brush Studios, 154 Nassau Street, New York, N. Y.

AGENTS: Every service station and grease rack a potential buyer; splendid profits. Details. Todds Service, 53 McGuffey, Youngstown, Ohio.

MAKE Money! Fast selling personal Christmas cards with name 50 for \$1 up, 100 designs. Also 21-card "Feature" box assortment \$1. You make 50c. Samples on approval. Janes Art Studios, 458 Anson Place, Rochester, New York.

MAGIC Polishing block—Removes scratches, mars from furniture and cars. Sample 35c, dozen \$3.00. Ducks Manufacturing Company, Freeport, Illinois.

SELL—Red, white, blue presidential photo metal auto plates. 10, \$1.00, 100, \$6.00 postpaid. Clouser Bros., Transportation Bldg., Indianapolis, Indiana.

MERCHANTS Wall signs, cost 1c, sell 10c. 3 samples 15c, refunded. Richards, 127-M. E. New York St., Indianapolis.

WE Pay you \$5 for selling ten \$1 boxes, 50 distinctive assorted name imprinted Christmas cards. Sell \$1. You make 50c. Free samples. Cheerful Card Co., 52 White Plains, N. Y.

AGENTS Wanted to sell leather sport jackets. Libbey Supply Co., 897 Washington St., Boston, Mass.

CHRISTMAS Cards. Sell 50 assorted folders, name imprinted \$1.00. Cost you 50c. Samples free. Dunbar, New Brunswick, N. J.

AMAZING Zipper clothesline. Instant demonstration. Sells on sight. Dunn Mfg., Hempstead, N. Y.

BE Rich, make 900% profit, bottle vanilla flavor. Free labels. Tharp, 914 Lexington, Cumberland, Md.

EXTRA Money—sell 21 "Personal Initial" Christmas cards for \$1. Unique metallic gold, silver initials furnished, 100% profit. Name imprinted Christmas cards 50 for \$1. Other money-makers. Samples on approval. Artistic, 450 Way, Elmira, New York.

EVERYBODY That paints needs this booklet, "The Method of Softening and Cleaning Hard Dried Up Paint Brushes." Agents and distributors wanted everywhere. Sample 35c. Harlem Brush Co., 1547 Park Ave., New York City.

HOUSEHOLD Invention, every member of family can enjoy, attractive, useful. Leonard's Novelty Mfg. Co., 4757 Sansom Street, Philadelphia, Penna.

SELL Christmas card sensation! New "Beauty Queen" 21-card assortment leads in value, appeal. Sells \$1—you make 50c. Ten other assortments. Personal Christmas cards with name 50 for \$1 up. Samples on approval. Chilton Greetings, 147 Essex, Dept. X-2, Boston, Mass.

CHRISTMAS Cards. Earn \$2 an hour. Take orders galore from friends, 50 exquisite folders with name \$1. Free samples 30 designs. America's fastest selling 21 Christmas folder box. Costs 50c, sells \$1. Request samples today. Sunshine Art, Dept. E-2, 154 Nassau St., New York City.

MEXICAN Curios sell on sight. Large profits. Free particulars. Samples 10c stamps. Marquez, PZ, Apartado 1176, Mexico City.

CHRISTMAS Card bargains. Sell 50 personal Christmas cards for \$1. All beautiful folders with customer's name inscribed. Liberal profit. Free samples. Also marvelous value \$1.00 box assortments. General Card, 400 S. Peoria St., Dept. P-71, Chicago.

AGENTS, New household necessity, no competition. Sample 25c. Hang It Co., 2612 Alcatraz Ave., Berkeley, Calif.

DON'T Be a job hunter—Start your own business on our capital. No hard times; no lay-offs; always your own boss. Hundreds average \$3,000 to \$5,000 annual sales year after year. We supply stocks, equipment on credit, 200 home necessities. Selling experience unnecessary to start. Wonderful opportunity to own pleasant, dignified, profitable business backed by world-wide industry. Write Rawleigh's, Dept. I-U-PPM, Freeport, Ill.

WORLD'S Fastest money maker. Sell 50c packs of razor blades for 5c. Tharp, 914 Lexington, Cumberland, Md.

CALL On friends with greeting card assortments. Easter, birthdays, other occasions. Big demand. Big profits. Also personal stationery. Experience unnecessary. Samples free. Wallace Brown, 225 Fifth Ave., Dept. R-34, New York.

CHRISTMAS Cards—Absolutely finest assortment. Big profits. Write for samples. Robinson Cards, Dept. 610, Clinton, Mass.

REVOLUTIONARY Window cleaning tool. Good Housekeeping approval. Only ten \$2.25 sales daily to housewives, factories, schools, stores will make you \$350.00 monthly. Carter Products Corp., 909 Front Ave., Cleveland, Ohio.

BUSINESS Proposition resilvering mirrors, reflectors, making chipped glass nameplates, signs. Write Sprinkle, Plater, 128 Marion, Indiana.

BIG Profits selling famous Waltham Christmas cards. 21-card \$1 assortment pays you 50c. Christmas cards with name, 50 for \$1. Complete line. Samples on approval. Waltham Art Publishers, 160 N. Washington, Dept. 332, Boston, Mass.

BIG Money taking orders: shirts, ties, hosiery, underwear, pants, jackets, raincoats, uniforms, etc. Sales equipment free. Experience unnecessary. Nimrod, 4922-AN Lincoln, Chicago.

WINDOW Sign letters. Penny each, large sizes. New styles. Absolutely beautiful. Free samples. Atlas, 7941 Halsted, Chicago.

RED Hot seller. Rollaway fat reducer and exerciser. \$3.50 value. Sample 50 cents. \$5.00 per dozen. Surgical Specialty Sales Co., P. O. Box 5183, Chicago, Ill.

BRAND New! Powerful Mile-Power increasing products! Million dollar market waiting. Guaranteed! Profitable! Thermo Exosolve, Peoria, Ill.

YOUR Own local shoe business. Free outfit starts you! Big commissions, bonus shoes. 208 styles, \$2.95 up. Experience unnecessary. Tanners Shoes, 226, Boston, Mass.

SALESMEN Everywhere—Make big profits. Sell tires wholesale. Save users up to 70%. Unlimited field. Details free. Sha-Mor Tire Stores, 6938-A Stony Island Ave., Chicago.

MAKE Extra money easily. Sell 50 assorted personal Christmas cards for only \$1. 14 box assortments 30c up. Odd cards 2½c each. Send for free samples exclusive \$1 line personal cards and imprinted stationery. Request \$1 assortment on approval. New England Art Publishers, North Abington, 332, Mass.

SELL Used clothing bargains from home, store, auto. Shoes 15c, men's suits, overcoats 75c, dresses 10c. Experience unnecessary. Free wholesale catalog. Superior Jobbing, 1250-DD Jefferson, Chicago.

CRACK Sellers. "Thex," the wonder hosiery treatment, doubles life of silk, rayon 50c. New blueing works in hard or soft water, richly scented with fine perfumes, 5 distinctive odors, 15c large size and economical. Ornin jewelers cream, for all fine metal surfaces, developed to top market, 25c. Sample of three 60c, refund, 150% profit. Goods are attractively packaged. "Te," 1267 Stewart St., Des Moines, Iowa.

BIG Money sell patriotic silk banners, buttons, Wilkie and Democratic badges. Tremendous demand. Unger, 567 Harrison, Chicago.

MAN And wife to introduce big line coffee, tea, spices, soaps, household necessities, etc. Good profits. Experience unnecessary. Spare time. Assortment of full size products worth \$6.00 supplied free. Zanol, 3582 Monmouth, Cincinnati, Ohio.

AGENTS Wanted—Exclusive one county franchises available on our Supercharging Air Filter. Increases acceleration—improves gas mileage. No moving parts. Pair of "supercharged" hood signs free with every air filter. Five minute installation cannot clog up with dirt—sturdily constructed of cast aluminum and iron. Two sizes to fit all popular makes of automobiles. Tremendous market. Big profits. Write for full particulars to Supercharging Air Filters, Room 922, 260 East 161 Street, New York City.

TWO Steady repeaters, prospects galore. Samples, details 5c. Daufeldt, Atalissa, Iowa.

MEN And women wanted, full or spare time to sell Sayman products house to house. Write T. M. Sayman Products Co., St. Louis, Mo. Dept. K3.

AGENTS: Smash go prices! Santos coffee 12c lb. 4-oz. vanilla 8½c. Razor blades 10 for 8½c. 100 sticks chewing gum 12c. Christmas cards, 21 in box, 14c. 150 other bargains. Premiums. Experience unnecessary. Carnation Company, P.O. St. Louis, Mo.

AGENTS: Stamping names on pocket-key protectors. Sample check with your name, address, 25c. Stamping outfits. Emblem checks, check-fobs, name plates. Hart Mfg. Co., 303 Degraw St., Brooklyn, N. Y.

DEALERS: Sensational seller. In United States, free sample. Girards, Washingtonville, Ohio.

CALL On service stations. New item, necessity, big profits. Knipp, Long Beach, California.

FREE Sample—Amazing cleaner; sells homes, taverns, everywhere. Big profit—fast repeater. Betco, 5007 Irving Park, Chicago.

BIG Money applying initials on automobiles. Easiest thing today. Free samples. Also, sideline salesmen for short order decalcomania name plates. "Ralco," 1305 Washington, Boston, Mass.

SUCCEED With your products. Make-sell them. Formulas, Processes. Accurate analyses. Catalog free. B. Thaxly Co., Washington, D. C.

DO You want agents for your proposition? Your ad in this space will place your message before hundreds of men seeking fast-selling products. My folder "How to Secure Agents," is filled with proof. I'll gladly send you a copy free. F. W. Johnson, Manager Classified Advertising, Popular Mechanics Magazine, 200 E. Ontario St., Chicago.

MANUFACTURE Specialties, hire agents yourself. Big money. Free literature. Gilbert Supply, 5-P West 24th, New York.

AGENTS—300% Profit selling gold leaf letters; stores and offices. Free samples. Metallic Letter Co., 438-B North Clark, Chicago.

GOOD Paying business silvering mirrors, plating autoparts, reflectors, bicycles, bathroom fixtures by late method. Free particulars and proofs. Gunmetal Co., Ave. N. Decatur, Ill.

AGENTS—Opportunity make money; book containing 127 successful business plans; home-office; send for free introductory booklet. Elite Co., 214 Grand St., New York.

AGENTS Make big profits on food products, bargain deals. Low wholesale prices. Rush name for trial outfit offer. Ho-Ro-Co, 2810-T Dodier, St. Louis, Mo.

AGENTS—To mail our literature. Good profits. Home business. Maywood, 1105-1107 Broadway, New York.

ENGRAVED Name plates, numbers, signs, etc., easily sold, profits large. Brett Bros., Winthrop, Mass.

HIGH-GRADE SALESMEN

AMAZING New bottle cap. Seals beverage bottles perfectly. Guaranteed to keep open beverages fresh. Easily applied—quickly removed. Greatest seller in years. Big profits await you. Magnesal Company, 3942 West Lake Street, Chicago.

SENSATIONAL Quick-cash opportunity. My route building plan gives you chance for good steady income. Real future. Handle regular route local stores. Collect, deliver orders for famous 5c—10c counter display goods. Nationally advertised in 120 magazines and radio. Show merchants proven plan for beating competition and increasing sales, profits. Experience unnecessary. Use home as headquarters. Chance to operate Silver Fleet service truck. Facts free. World's Products Co., Dept. 10-C, Spencer, Ind.

CHRISTMAS Leaders! 21 piece Flash assortment 15c; 50 imprint folders 25c; 25 religious imprints 25c; 100 piece gift wrap box 25c; samples \$1.00 postpaid. Illustrated catalog free! Elfko, 440 North Wells, Chicago.

FREE Trial to customers—Sells itself. Revolutionary Loud Speaking Inter-Communication System. Talk privately, back and forth, to one or any number of stations, even 2,000 feet away. Any station originates calls. One electrical connection. No servicing. Easily installed. Guaranteed. Technical experience unnecessary. Two-minute demonstration. Thousands prospects, factories, offices, automobile dealers, lumber yards, restaurants, etc. We carry the accounts. New low price. Men earning high as \$150 week. Protected territory available. Free demonstrator offer. John Warren, Sales Manager, Dept. FJ, 75 East Wacker, Chicago.

BIG Commissions—selling to stores celluloid pricing tickets, metal shelf moulding. To restaurants, menu covers, signs. P. Pricing Press, 124 White St., New York.

SALESMEN, Distributors, 200 items, brushes, mops, marvelous magnetic brush—excels vacuum cleaner. Big profits. Neway Brush Works, Hartford, Conn.

AMAZING New battery carrier. Tops them all. Sells rapidly. Get details at once. Safety Grip Mfg. Co., 620 N. Pine St., Bethlehem, Penna.

SELL Business cards, stationery, book matches, gummed tape, restaurant necessities, salesbooks, adv. specialties, pencils, picture cards, paper towels, ice cards. Lowest prices. 40% commission. Free deals. Sales portfolio free. David Lionel Press, 312 S. Hamilton, Dept. T, Chicago.

SOMETHING New, different, necessities. Automatic hog doors mineral feeders. Write O. Zimmerman, Fairfax, Minn.

COUNTY Distributors for the famous Blu-Glo Oil Burners for cooking range, hot air furnaces and water heaters, sells \$12.50 up. Over ½ million in use. Write General Oil Burner Co., 1214 P Spring Garden St., Philadelphia, Penna.

SELL Auto finance course. Unusual opportunity. Nebraska Finance Co., Lincoln, Nebraska.

SELL Candidates! America's largest line of political auto signs, stickers, posters, novelties. Practically no competition. Ad-Nov-Co., Newton, Iowa.

ADVERTISING Book matches—World's largest manufacturer of union label book matches. Fast selling line. Large sales producing kit. Sample matches, complete cut catalog. 9 color combinations makes selling easy. Commission in advance. Superior Match Co., 7530 Greenwood, Dept. M-9, Chicago.

SELL Printing at cut prices. 2,000 business cards \$1.50; 1,000 envelopes or statements, etc. \$1.75; 25 printed sales books \$1.50; 1,000 process embossed cards \$1.50; 2,000 two-color labels, free holder \$1.50; 2,500 printed handbills \$1.75. One-third comm. Free outfit. Bargain Prtg. Co., 189-F W. Madison, Chicago.

ADVERTISING Book matches—World's largest "direct selling" book match factory offers advance cash earnings calling on every type of business. Experience unnecessary; full, part time. Low prices for high quality; quick deliveries, help you get orders. Good repeat profits. Free kit, instructions. Match Corp. of America, 3343 West 48th Pl., Dept. E-9, Chicago.

WRITE For free sample amazing stain-proof tablecloths. Clean with damp cloth. Require no ironing. Beautiful patterns. Look like linen—cost much less. Commissions big. Also complete line of dresses. Melville Company, Dept. 1664, Cincinnati, Ohio.

REVOLUTIONARY New invention. Thousands prospects everywhere. Men earning high as \$100.00—\$150.00 week. Placed on free trial. Sells itself. Orders financed by factory. Protected territory available. Free demonstrator offer. Salesmanager, 2440 Lincoln Ave., Dept. R-219, Chicago.

COMPLETE Line everyday business necessities—Over 2000 items at big money saving prices. Experience unnecessary. Samples free. Commissions advanced daily. Northwestern, 625-BR Jackson, Chicago.

DISTRIBUTORS—District sales managers to sell neon signs. Splendid opportunity. 40% commission. Write, Neon Electric Signs, Inc., Battle Creek, Michigan.

TIRE Accessories, guaranteed 10,000 mile Tiger Grip tire patch, and fast-selling line tire accessories. Salesman-distributors over 100% profit, selling garages, service stations, etc. Protected territory. Free sample. Economy Rubber Products, 702 Burkhardt, Dayton, Ohio.

GEM Wants man in each county to sell advertising matchbooks and calendars. Liberal cash commission. Full or part time. Free outfits. Mention which. Gem Match, 82-T West Washington, Chicago.

DISTRIBUTORS, Crew managers, organizers of agents, send quick for news of amazingly-seasonable device for traveling autoists. Thirty-five cents retail or more value. Quick easy seller. Light, permanent. Immense commissions. Write or wire for details. Also can use few lone salesmen in unoccupied districts. Act promptly. Nicholas Company, 7137 Cottage St., Philadelphia, Penna.

UNITED States Constitution in booklet form! Large profits! Particulars free! Elfko, 438 North Wells, Chicago.

CALENDARS All sizes—Orders are being placed now for 1941 calendars, advertising fans and novelties. Free samples—get started now and book those early orders. Fleming Calendar Co., 6543 Cottage Grove, Chicago.

NEW Specialty—Sells every business and professional man. Four \$15 sales daily pay \$280 weekly. Farrell cleared over \$1,000.00 monthly. Write F. E. Armstrong, President, Dept. PM, Mobile, Ala.

BLADES—Big profits. Best quality. Factory prices. Postpaid. Ace Blades, Buffalo, N. Y.

A REAL Future for you with Red Comet fire control products. Low prices. Proved seven years. Splendid sales outfit free. Some good territory open. Exclusive. Write quick. 704 Red Comet Building, Littleton, Colorado.

EXCELLENT Opportunity selling our complete line of brushes, largest commissions. Write for sales plan. Wire Grip Sanitary Brush Company, 2300 5th Ave., New York.

EDUCATIONAL AND INSTRUCTION

WELDING—Electric arc. Learn profitable trade quickly through actual practice. Individual welder instruction at bare cost of materials. Full particulars free. Valuable welding lessons book 50c. Hobart Welding School, Box M-9404, Troy, Ohio.

AIR Conditioning—Electric refrigeration. Rapid growth creates big demand for trained men. Earn up to \$35-\$50 weekly. Write for free facts. Utilities Engineering Institute, 404 North Wells, Dept. 109, Chicago.

ELECTRICITY—Simplified enough for the news boy, precise enough for the engineer. No contract to sign. New method of home study. Beginners, groundmen, linemen, house wiremen, etc. Details free. Conner School of Electricity, 56 West Washington St., Chicago, Ill.

"HOW To Break and Train Horses"—A book every farmer and horseman should have. It is free; no obligation. Simply address Beery School of Horsemanship, Dept. 1109, Pleasant Hill, Ohio.

LEARN Telegraphy! Opportunities now available to beginners due to new railroad retirement act. Expenses low. Catalog free. Dodge's Institute, Hiatt Ave., Valparaiso, Ind.

DRAFTING—Mechanical, sheet metal. Home taught. Davison Technical School, 7 East Grand, Detroit.

LEARN To operate gas-diesel shovels, draglines, clamshells, cranes, at home. Get big pay checks. G. W. Sjoboen, 442 S. 96, Tacoma, Wash.

50 CODES—The only system known that can be used to write with flying hand. 10 cents coin. Wicco, St. Albans, N. Y.

LEARN Art making cast nameplate patterns. 25c. Craftspark, Willimansett, Mass.

TURN Muscles into cash. Get health that leads to wealth. Knoff, 2154ME North 52nd Street, Milwaukee, Wis.

WATCH Repairing is steady profitable work. Experts usually in demand. You can learn watchmaking trade at home, spare time. New original instruction system. Script engraving course included. Write for free details today! Nelson Co., 500 Sherman, Dept. I-2001, Chicago.

U. S. government jobs. Commence \$105-\$175 month. Men-women. Prepare now in your own home, for next examinations. Full particulars—list positions, free. Write today. Franklin Institute, Dept. H3, Rochester, N. Y.

MASTER Your mind. Conquer fear, worry, nervousness. Gain health, success. Positive results. Frank Mazur, Lorain, Ohio.

U. S. Gov't jobs pay up to \$40 a week to start. Get ready for next examinations; railway postal, rural carrier, mail carrier, office help and others. Free book tells how you may qualify. Write quick. Patterson School, Dept. P. M., Rochester, N. Y.

CLINICAL Laboratory technic taught in your own home. Practice equipment supplied. Bulletin free. Imperial Technical Institute, Box 494, Elkhart, Indiana.

EARN More money—Learn decorating, paperhanging, graining, marbling, pictorial and sign painting. Catalog free. Chicago Painting School, 106 West Lake Street, Chicago.

CLAIM Adjusting. Excellent pay. Investigate tragic accidents, fires; outwit fraudulent claimants. Burns School, 311 Morewood, Pittsburgh, Penna.

MASSAGE. Hydrotherapy, dietetics, drugless therapeutics, chiropody, taught by mail. Evans Correspondence School, Montgomery, Ala.

LEARN Auto mechanics, body, repairing, welding electricity, refrigeration. Diesel. Stevinson's, 2008A Main, Kansas City, Mo.

SECRET Investigation. Experience unnecessary. Detective particulars free. George Wagner, M-2640 Broadway, N. Y.

WELDING And hundreds of money making and money saving ideas. 762 illustrations and 214 pages in 1940 Shop Notes, 50c. Popular Mechanics Press, Room C40, 200 E. Ontario, Chicago.

PLAYS, STORIES, MANUSCRIPTS

STORIES Forcefully revised, typewritten for marketing. Welton Tinney, Winnsboro, Texas.

YOUR Story ideas built into salable short stories, novels—revised, typewritten, marketed. Free analysis. Tynan Author's Bureau, Rhinebeck, N. Y.

CARTOONING, COMMERCIAL ART, SHOWCARD WRITING, SIGN PAINTING

SIGNS Attractively painted, 20 feet long 50c. colors. "Edwards," Galena, Ill.

CARTOONING Course:—30 illustrated lessons, over 500 sketches, drawing paper, pens and pencils. \$1.00 complete postpaid. Montes Studio, Box 985, Pasadena, Calif.

MIGS School of Cartooning. Send for free details. Box 893, Springfield, Mass.

CARTOONING. Sketching, etc. 46 lessons, 600 illustrations, including drawing paper, pens, pencils. \$1.00 complete. Fraba Service, Cashton, Wisconsin.

PEN And ink drawings. Let us draw your advertising and catalogue illustrations, from photos, copies or objects. Best work and fair prices. Heraldic Studios, 1914P Oakdale Avenue, Chicago, Ill.

AMATEUR Cartoonists. Earn cash at home, copying advertising cartoons. Ad-Service, Argyle, Wis.

PORTABLE Drafting board. Will fit in briefcase. Transparent ever-true straight edge—new type paper fastener. \$2.50. Ever-Nu Products, 919 N. Lathrobe Ave., Chicago.

SURE Fire chalk-talk stunts, plans, patter. Illustrated portfolio, \$1.00 complete. Willis, 1994 So. Ogden, Denver, Colorado.

ADVERTISING AGENCIES, LETTER WRITERS, FOR ADVERTISERS

SALES Service: Correct selling plans will sell your product. Send description of your article for free analysis. Nelson Service, Dakota Bldg., St. Paul, Minn.

MAILING Lists. Specializing women buyers, teachers, ministers. 75 other classifications. \$1 hundred. Hoff Publications, 1182 Broadway, New York, N. Y.

MAIL-ORDER Ad reaching over 1,000,000 families throughout United States \$14.00 inch. Newspaper, magazine, rateguide—free. Chicago Advertising Agency, 20-P West Jackson, Chicago.

ADVERTISE: 24 Words, 149 newspapers \$6.50. Lists free. Advertising Bureau, 4515-C Cottage Grove, Chicago.

CURRENT Lists opportunity seekers—\$5 thousand. Darnell Service, Jackson, Tennessee.

FIVE Column inches display advertising in 25 newspapers for \$15 or trade. Footprints, Fountain Green, Ill.

LEARN Advertising at home. Easy practical plan. No text books. Common school education sufficient. Interesting booklet and requirements free. Page-Davis School of Advertising, 3601 Michigan Avenue, Dept. 343B, Chicago.

INCH Display advertisement 30 magazines, year \$24. Wood's Popular Services, Atlantic City, N. J.

ADVERTISING Placed all magazines, newspapers, radio. Lowest rates. Free service. 54 page rate book free. Baker Advertising Agency, A-189 West Madison, Chicago. Successors to Ankrum. Established 28 years.

FREE—New Advertisers Rate Guide, 44 pages. Includes everything. Lowest rates. E. H. Brown Advertising Agency, 140 S. Dearborn, Chicago.

BUSINESS SERVICE

WASHINGTON, D. C., mail address and forwarding service. Hawkins Mail Service, 908 Fourteenth.

CHICAGO (Downtown) mail address \$1 monthly. Your mail reforwarded daily. General Business, 56 West Washington; (established 1919.)

RUBBER STAMPS AND OFFICE SUPPLIES

HIGH Quality: indexed, cushioned, two lines 25c, three 35c. Signatures \$1.50. Sunset Stamp Works, Seattle, Wash.

3 LINE Cushioned 25c; 2 for 40c. Stamp-rite, Wauwatosa, Wis.

CUSHIONED. Indexed, 3 lines 35c. Pads 25c. Signatures \$1.50. Stamp Works, Box 402, Youngstown, Ohio.

KNOB Handle, cushioned. 2 lines 25c, 3—35c. Stamp Works, Centerport, N. Y.

SUPERIOR. Indexed, cushioned. Two lines, 25c; three 35c; four 50c. Notary seals \$4.50; signatures \$1.50. Slocum, 814 Bradley, Peoria, Illinois.

2 LINES 25c, 3 Lines 35c. Stamp Works, Auburn, Nebr.

TYPEWRITERS, DUPLICATORS, OFFICE DEVICES

INCREASE Business now. "Excellograph" Rotary Stencil Printer reprints thousands everything you typewrite, hand-write, draw or trace. Colors, \$19.75 to \$44. Terms. Illustrated literature free to business or professional men. Pittsburgh Typewriter Supply, Department K-2, Pittsburgh, Penna.

TYPEWRITERS. Adder, mimeograph, multigraph, addressograph. Send for free lists of machines that will help you at half price. Pruitt, 28 Pruitt Bldg., Chicago.

PRINTING, MULTIGRAPHING, MIMEOGRAPHING, GUMMED LABELS

STANDARD Business stationery, 150 sheets and 150 envelopes \$1.00 prepaid. E. B. Brink, Printing Service, 1130 Holmes Ave., Menominee, Mich.

HAMMERMILL Letterheads, envelopes, all colors. 30 styles type. Free particulars. Woodruff's, 217A Lewis, Duluth, Minn.

5000 ELEGANT Envelope slips, \$3.89 prepaid. All printing low prices. Samples. Goodprint, Harrisonburg, Va.

HARVEY Labels, Berea, Ohio. Better label values. Interesting samples free.

\$1.00 POSTPAID—125 8 $\frac{1}{2}$ x11 Twenty pound bond letterheads and 125 6 $\frac{3}{4}$ envelopes. Benneville, 907 West Roosevelt Blvd., Philadelphia.

1000 BUSINESS Cards, \$1.00, postpaid. Other bargains. Eaton Press, Gardner, Kansas.

\$1.85—1000; LETTERHEADS, Envelopes, statements, circulars. Samples. Midwest Printing, Minneapolis.

MIMEOGRAPH Stencils any size \$1.95 quire (24). Quality ink \$1.19 pound. Money back guarantee. Sterling Co., 333 No. Michigan, Chicago.

WESTERNERS: Cheaper, faster delivery. 1000 quality envelopes, cards, or tickets \$1.95. Felton, 19 Fremont, San Francisco.

PRINTING—Send stamp for lowest prices—samples. Grimson, 6325 Maxwell, Detroit, Mich.

100 LETTERHEADS And 100 envelopes, \$1.00 postpaid. Printshop, Linton, Ind.

STATEMENTS 90c Thousand, quantities. All printing—lowest prices. Wholesale, 318-H East McDaniel, Springfield, Missouri.

500 LETTERHEADS (8 $\frac{1}{2}$ x11) and envelopes (3 $\frac{3}{4}$ x6 $\frac{3}{4}$) both for \$2.85. Cash with order. Morton Press, 1472 Broadway, New York City.

500, TWO-COLOR Stickers 50c. Labels. Samples. Cott's, Spickard, Missouri.

MULTIGRAPHED Letters:—Guaranteed like typewritten! 300—\$1.50; 1000—\$2.25; (300 words). General Multigraphing, 108 North Dearborn, Chicago.

BETTER Grade printing, free trade illustrations. Reasonable. Economic Press, Leonia, N. J.

500 3 $\frac{1}{2}$ x2 $\frac{1}{4}$ FOUR Line gummed stickers, 25c. Moritz Printery, Saginaw, Mich.

PRINTING OUTFITS AND SUPPLIES

PRINT At home. 10c will bring a complete catalog of presses, type and supplies. P. Peiffer & Company, 6 Columbia St., Newark, N. J.

NEW Type reasonably priced. M. R. Landis Co., Richland, Penna.

STOCK Cuts 75c. Sample 25c. Novateur, Box 55, Jackson, Michigan.

INEXPENSIVE 6x9 Printing press. Details free. Novelty Shop, Downsville, Louisiana.

BARGAINS—Presses, type, supplies. Send stamp. 159 Harvard, Cambridge, Mass.

PRINT Your own cards, stationery, circulars, advertising. Save money. Easy rules furnished. Print for others, big profits. Junior outfits \$8.25, senior outfits \$16.55 up. Details free. Kelsey Presses, H-11, Meriden, Conn.

USED Presses, type, supplies. Lists 3c. Turnbaugh Service, Loysville, Penna.

PATENT ATTORNEYS

PATENTS: Inventors, take first step to protect your rights to your invention—without cost. Write for free "Record of Invention" form and complete instructions for making legal disclosure of invention and establishing date. We also send, without cost, 48-page book, "Patent Guide for the Inventor" telling importance of prompt action; how to sell and market your invention; how to make application for patent; showing examples of successful inventions; explaining convenient payment plan. Write for free book and Record of Invention form. See page 17A for further information. Clarence A. O'Brien, Registered Patent Attorney, Dept. OJ1B Adams Building, Washington, D. C.

PATENT Your idea. Write immediately for two free books, "Patent Protection" and "When and How to Sell an Invention." Fully explain many interesting points to inventors and illustrate important mechanical principles. With books we also send "Evidence of Invention" form. Prompt service, reasonable fees, forty-two years' experience. Avoid risk of delay. Address: Victor J. Evans & Co., Registered Patent Attorneys, 561-K Victor Building, Washington, D. C.

INVENTORS Get my free book. Use my personal confidential patent service. Send for free facts on patenting your invention. Also suggestions on financing a patent application. Reasonable fees. Deferred payments arranged. Write Hugh E. McMorrow, Registered Patent Attorney, 134-A Barrister Building, Washington, D. C.

"INVENTOR'S Guide" free; full information about patenting, selling inventions. Frank W. Ledermann, 154 Nassau Street, New York.

PATENTS Procured; personal service since 1904; free information. Saunders, 6430 Evans, Chicago.

PAUL M. KLEIN, M. E., 55 West 42nd St., New York. 25 years of successful service. Free information.

INVENTORS—Send for free booklet "Patent-Sense." Information based on 64 years experience. Lacey & Lacey, Dept. 5A, 635 F St., Washington, D. C.

PATENTS. Booklet free. Highest references. Best results. Promptness assured. Watson E. Coleman, Patent Lawyer, 724 Ninth St., Washington, D. C.

INVENTORS—Before disclosing your invention to anyone send for form "Evidence of Conception"; "Schedule of Government and Attorneys' Fees" and instructions. Sent free. Lancaster, Allwine & Rommel, 411 Bowen Building, Washington, D. C.

L. F. RANDOLPH, 302-B Victor Bldg., Washington, D. C. Low cost. Book and information free.

PATENTS. Protect your idea by securing free "Proof of Invention" folder. Exceptional personal service. Established 1906. E. E. Vrooman, 871 Woodard Bldg., Washington, D. C.

MEXICAN Legal matters. Wm. Cocke, Amer. Atty., El Paso, Texas.

FOR INVENTORS

INVENTING Taught at your home by Trofimov School of Inventive Practice, Hanna Rd., Willoughby, Ohio.

WE Build models which "put over" your idea. Complete engineering service, developing and designing. We market and manufacture in any quantity. Write for bulletins. R. & S. Engineering Co., Dept. AF-9, 17 East 42nd Street, New York City.

WANTED: Patent office indexes; gazettes. Standard, 65 Duane Street, New York.

INVENTORS! Protect your invention at total cost \$1.50. Show your invention safeguarded against theft, and let manufacturer get patent. Send \$1.00 for Inventor's Protection Sheet. Moroney, 321-92nd St., Brooklyn, N. Y.

"WHEN And How to Sell an Invention"—helpful, 24 page booklet gives you preparation steps necessary to commercialize your ideas and six basic approaches to use in selling your invention. Information vital to every inventor. Get your copy free. Victor J. Evans & Co., 506-K Victor Building, Washington, D. C.

PATENT Drawings made. Portfolio of patent counsel on request. U. S. Drafting Co., 91 Wall Street, New York.

LIST "50 Most Needed War Inventions" 25c. Wilbert Peterson, Godfrey, Illinois.

CASH For practical ideas and inventions. Mr. Ball, AB-9441 Pleasant, Chicago.

INVENTOR'S Universal Educator: contains 900 mechanical movements; 50 perpetual motions; instruction on procuring and selling patents and selecting an attorney, etc. Suggests new ideas. Price \$1 postpaid in U.S.A. Address Albert E. Dietrich, 511-B Colorado Bldg., Washington, D. C.

INVENTORS: Profit by your invention. A practical talk to inventors by an experienced manufacturer. Our 68 page booklet "Mind vs. Matter" mailed upon receipt of 25c. Rex Engineering Co., Cincinnati, Ohio, Dept. D.

INVENTORS: "Making Inventions Pay" our 32-page illustrated book mailed absolutely free. Crescent Tool Co., Dept. ZS, Cincinnati, Ohio.

WE Locate buyers meritorious patented, unpatented inventions. If will sell, reply immediately. Descriptive booklet, references, free. Invention Reporter, 5A-11236 South Fairfield, Chicago.

INVENTORS—Send for 72-page book on patents. Reasonable terms. Conscientious treatment to inventors. L. F. Randolph, Registered Patent Attorney, 302-E Victor Bldg., Washington, D. C.

HAVE You a sound, practical invention for sale, patented or unpatented? If so, write Chartered Institute of American Inventors, Dept. 4-A, Washington, D. C.

INVENTIONS WANTED

CASH For inventions—Patented or unpatented. Mr. Ball, A-9441 Pleasant, Chicago.

MAKE Your inventions pay. We help you. 36 year old firm offers complete services, free estimates. Ample facilities regardless size of invention. Stampings, metal specialties, dies, models, etc. Catalog giving "inside" information free. Crescent Tool Co., Dept. W, Cincinnati, Ohio.

WANTED—Meritorious patented, unpatented inventions. Booklet, references, free. Invention Reporter, 5B11236 South Fairfield, Chicago.

INVENTION Finance Magazine, 80-G Wall Street, New York. Important particulars free.

SMALL Inventions wanted by manufacturers. I'll help you sell your invention. Write for free circular. Stanley Hull, 7829-K Euclid Avenue, Cleveland, Ohio

SIMPLE, Practical inventions wanted by manufacturers, patented or unpatented. For information write Chartered Institute of American Inventors, Dept. 4-D, Washington, D. C.

ALBERT G. BURNS handles inventions. Commission basis. Box 147, Oakland, California.

PATENTS FOR SALE

ROACH Trap. New principle. Highly effective. Cheap to manufacture. Pekkala, 139 West 64 St., New York.

DENTAL Floss holder. Holds supply of floss; Tooth brush combination. Outright sale or royalty. Arthur L. Peterson, 738 Cedar Ave., Long Beach, Calif.

ROYALTY Or outright for new fan and new design dresser and wardrobe. George W. Harding, 162 W. Cross St., Baltimore, Md.

MANUFACTURERS. New hydraulic auto jack, electric controlled. F. S. Armstrong, Gen. Del., Youngwood, Penna.

PATENTS For sale. Morris, 1816-12 St., Washington, D. C.

SPEED Propeller cash, royalty. Boeing, 60 Post St., Yonkers, N. Y.

500 INVENTIONS Described with selling plan 10c. Write Patentee System, 9443 Pleasant, Chicago.

MANUFACTURERS: For free information latest inventions your line manufacture, write: Invention Reporter, 5C-11236 So. Fairfield, Chicago.

SELL Your patent through a small classified ad in Popular Mechanics. Many inventors have found buyers in this way. Ask me for proof—I'll gladly send it to you. F. W. Johnson, Manager Classified Advertising, 200 E. Ontario St., Chicago.

MANUFACTURING

MANUFACTURING. All metals, new ideas improved, models, moulds made, turnstiles, Display fixtures. Baum's Metal Specialties, Kansas City, Mo.

INVENTIONS Developed and manufactured. Send us your ideas. Model Engineering, Osgood, Ind.

MANUFACTURERS And inventors: Increase profits. Let us manufacture your product in whole or part. Accurate machine work, screw machine products, special machines, models, tools, jigs. Inventions improved and developed. Send for estimate. Wright Mfg. Co., 21 Commonwealth, Elgin, Ill.

INVENTIONS — Manufactured in any quantity at low cost by old-established reputable company. No branches anywhere. Stampings, metal specialties, dies, models, etc. Free estimates. Free catalog. Crescent Tool Co., Dept. XS, Cincinnati, Ohio.

MANUFACTURING. Any material, any quantity, inventions developed. Milburn, Burlington, Kentucky.

INVENTIONS Manufactured by an experienced company, in any quantity at low cost. Metal specialties, novelties, stampings, dies, and models. Free estimates. Our booklet "Mind vs. Matter" sent upon receipt of 25c. Rex Engineering Co., Cincinnati, Ohio, Dept. C.

MODELS AND MODEL SUPPLIES

GAS-POWERED Models: Postcard brings circulars on Blue Bird racing car, air-drive hull and speed hull for class B motors; step-hydroplane hull for class C motors; universal propeller and flywheel equipment. Morristown Boat Wks., Morristown, New Jersey.

ENGINE Catalogue castings, supplies, 25c. Howardco, A-2417 North Ashland, Chicago.

GOOD Working models with eye appeal. We have spent 36 years developing ideas into practical working models! Let us help you! Free catalog. Crescent Tool Co., Dept. Y-SA, Cincinnati, Ohio.

CARVED Hull ship model kits. Ship and yacht model fittings; model yacht sails. Illustrated catalog 20c. A. J. Fisher, 1002-M Etowah Ave., Royal Oak, Mich.

MODELS—Practical models put over your ideas. We develop models from the crude to perfect working devices. Your idea might have large commercial value. Services confidential. Bank references. Registered graduate engineers at your service. Send 25c for our 68 page booklet "Mind vs. Matter." Rex Engineering Co., Cincinnati, Ohio, Dept. B.

BLUEPRINTS AND PLANS

BUILD Your own beautiful 10x20 garage. Blue prints, complete instructions \$1.00. Clark, 218 East Lexington, Baltimore, Md.

HOME CRAFTSMEN

MEXICAN Wood novelties easily made! 20 pattern complete instructions 30c. Mexican Arts, Crafts, Eagle Pass, Texas.

BUILD Streamlined plywood kitchen cabinets. Plans 25c. Roger Underwood, 4617 Johnson Avenue, Western Springs, Illinois.

PLASTICS—Bakelite, Catalin, sufficient for cigarette or powder box, four rings, two bracelets, five ornaments, five jewelers findings. Twenty pieces \$1.25 cash with order. Dependable Machy, Co., 1011 Harrison, Oakland, Calif.

MAKE And sell new wood novelty. Old fashion farm-pump cigarette dispenser. Full size plans 50c coin. Gordon Reed, Thomaston, Maine.

20 NOVELTY Patterns, 25c. 15 lawn ornament patterns, 20c. Wayne Gorman, Box 1272-N, Amarillo, Texas.

SQUAREKNOTTERS! Make belts, handbags, etc. Quality cord samples with catalog, free. Beginners book, catalog and samples, 10c. Special! Regular \$1 book with 50c beginners outfit, all for \$1. P. C. Herwig Co., Dept. J-23, 121 Sands St., Brooklyn, N. Y.

GET Free leathercraft instruction pamphlets, prices of leathers, tools, projects. Make extra money. Beautiful gifts. Leather samples 5c. Wilder & Company, 1038 Crosby, Dept. 9F, Chicago, Illinois.

ATTENTION Craftsman! Earn extra money in your workshop—build arch files, clip boards and Vak-I-Pads. Big profits, very little work. Send \$1.00 for samples, worth \$2.50. Satisfaction guaranteed or your money refunded. Harry Bissell, 1432 Morton St., Alameda, Calif.

SPARE Time money. There's a big demand for hand tooled articles you can make with Easco Leathercraft sets. Complete outfit including tools, leather, patterns and accessories with full instructions, only \$2.00. Buy at your local department stores or order direct and pay postman upon delivery. \$2.50 outside U. S. Send 10c for latest handbook and catalog. E. A. Sweet Company, Dept. A-38, Binghamton, N. Y.

22 LAWN Ornament patterns 25c. Other patterns: 15"-20" high; Dutch girl, Dutch boy, pirate, bull terrier, Mexican girl, Mexican boy, dwarf, penguin, flower girl, 10c each; 3 for 25c. 25 novelty patterns 30c. All 56 full size patterns \$1.00 postpaid. Strother, Box 383-BL, Belington, West Virginia.

LEATHER, Tooling and archery. 2 lbs. \$1.00. P. Nelson, 911 Pine St., Muskegon, Mich.

20 LAWN Ornament patterns 30c. 20 novelty patterns 30c. Dutch boy, Dutch girl, sunbonnet girl, 2 scotties 18"-22" high 10c each, clown table 15c, 2 weather vanes 10c each. Full size patterns, entire offer, \$1.00. Modern Woodcraft, Saginaw, Mich.

PATTERN Catalog finely illustrating 250 plywood novelties, silhouettes, lawn ornaments, decal transfer decorations. Also other lines. Wo-Met Shop, Ashburn, Ga.

WOODWORKING Power tools—Make them yourself. Lathe, scroll saw, saw table, drill press, portable sander, bandsaw, motorized plane. Complete details only 25c. Popular Mechanics Press, 200 E. Ontario Street, Chicago.

GET Shop Notes for 1940! May easily be best investment of your entire lifetime. Contains 384 money-making, time-saving ideas. Kinks, short cuts for mechanics, farmers, home workshop fans, handymen—for everyone who uses tools. 214 pages, and 762 illustrations. Thousands wait for this book every year. Only 50c. 1939 and 1940 Shop Notes sent postpaid for \$1.00. Popular Mechanics Press, 200 E. Ontario, Dept. C40, Chicago.

OLD GOLD, WATCHES, JEWELRY, PRECIOUS STONES

LEARN Watchmaking. Trial material instructions, wholesale catalog watches, supplies \$1.00. Refund not O.K. Stewarts, 721 Olive, St. Louis, Mo.

WATCHES—Hamilton, Elgin, Waltham. Bulova as low as \$2.75. Diamond rings at lowest prices. Postal brings free illustrated catalog. Quaker City Jewelry Company, Wholesale Jewelers, N. W. Cor. 8th and Walnut Sts., Philadelphia, Penna. Dept. "S."

MAIL Old gold teeth, jewelry, watches—receive cash by return mail. Satisfaction guaranteed. Free information. Dr. Weisberg's Gold Refining Company, 1500-Q Hennepin, Minneapolis, Minn.

GEMS, Agates, minerals. 1/2 carat genuine cut sapphires, zircons, fireopal \$1.00 each; all 3 for \$2.50. 20 rough gemstones \$1.00. 6 polished mineral specimens \$2.00. Free catalog. Hill, Route 7, Salem, Ore.

AGATES, Fossil woods, three pounds \$1.25 postpaid. Jay Ransom, Aberdeen, Wash.

WATCHMAKERS' Materials—Tools, watches, jewelry. Bought, sold, exchanged. Best prices for old gold, diamonds. Ben Segal Company, 5 South Wabash, Chicago.

WATCHMAKERS' Tools, supplies, watch parts. Lowest prices. Write for price list 43. Dean Company, 87 Nassau St., New York.

AUSTRALIA'S Lovely opals. Illustrated catalogue free. Good selection \$5.00. Norman Seward, Melbourne, Australia.

HIGHEST Prices for old gold—Mail your teeth, watches, jewelry. 100% full cash value mailed day shipment received. Satisfaction guaranteed or articles cheerfully returned. Information free. Chicago Gold Smelting Company, 300-P Champlain Building, Chicago.

5000 REBUILT Watches! Free catalogue—Diamonds, jewelry, (3c postage). The New York Jobbers, 74 Bowery, Dept. M, New York, N. Y.

FOR THE HOME

STOVE Lining—Furnace. Iron. Fits all. Patented. Circulars free. Benjamin Co., Granite City, Ill.

RAZORS, BLADES, SHARPENING

SLIMS—Super thin blades make shaving a pleasure. See the difference. Fit all double edge razors—100, \$2.00; 200, \$3.00 or 15 cents for 5 sample blades, prepaid. Satisfaction or money refunded. Beight and Zimmerman, 2120 Hillman St., Youngstown, Ohio.

SURPLUS Stock must be removed. Genuine "Underwood" electric shavers, year factory guarantee; cream body, black rubber grip. \$8 value, \$2.10 postpaid. Dealers invited. Warehouse Manager, 120 Kingston, Rochester, New York.

FOR SALE—MISCELLANEOUS

SCOTCH Tweed topcoats, \$29.95. Tartan ties, \$1. Bridge Mill, Galashiels, Scotland, 653 Shatto Place, Los Angeles.

WANTED—MISCELLANEOUS

QUICKSILVER (Mercury). 90c pound remitted, promptly. Wholesale Terminal, Norwood, Massachusetts.

CASH For used microscopes, binoculars, slide rules, drawing sets, scientific instruments, tools, cameras, transits, old gold. Satisfaction guaranteed. Elman's, 108-M South Clark, Chicago.

WILL Buy your unused United States stamps. Small discount. What have you? Mint Sheet Brokerage Co., 418 Caxton Building, Cleveland, Ohio.

PERSONAL

STUTTERING, Stammering, speech impediments corrected. Home treatment. Practical proven method. Write for information to Correction Speech, 110 West 40th, New York.

WIN Prize money: Booklet—"Successful Contesting"—shows how. 10c postpaid. Bulletin listing \$100,000.00 prizes included. World Publishers, 4515-B Cottage Grove, Chicago.

NERVOUSNESS, Nervous fears! Afflicted? Discouraged? Free, inspiring information. Write! John Englund, Box 335, Ironwood, Mich.

MEXICAN Legal matters. Wm. A. Cocke, American Attorney, El Paso, Texas.

LOSING Your hair? Try Wig-On. Month treatment \$1. Wight, 31 Kirkland Road, Rochester, New York.

MISCELLANEOUS

NOKOROSO. One application positively eliminates all corrosion for life of battery. Trial tube 25c. 300% profit salesmen. Aristo, Dept. P, Plainfield, N. J.

UNUSUAL And beautiful. Something new. Engraved work on place cards, floral and scenic pictures, lamp shades. Took blue ribbon N. Y. world's fair. Send 25c for sample. Including your name engraved. L. Stephenson, P.O. Box 4620, Portland, Oregon.

NEW Lettering guide makes seven sizes vertical and slant letters; innumerable styles; for pen and pencil. Price only \$1.00. Drafting Devices, Box 541, Pompton Plains, N. J.

110 FORMULAS \$1.00. J. Donnelly, 181 Mill, Poughkeepsie, N. Y.

MAIL Order business course shows you how to make money, spare or fulltime. Teaches professional mail order technique—not penny-catching schemes. Free details. Nelson Company, 500 Sherman, Dept. 408-I, Chicago.

CUTS Anybody can make. Zinc etching process. Specimens, particulars, testimonials for stamp. Jiggs C. Day, Windfall, Indiana.

WIN Money! Prizes! Contest Magazine 10c. Butler, 473PM, Sebring, Florida.

DEAFNESS. Why? Good hearing without mechanical aids. No drugs. Relieving deafness. Johnston, Postal Station C, Vancouver, Canada.

TATTOOING Machines, best, cheapest. Jensen, 412 South Main Street, Los Angeles.

PROTECT Your eyes. I teach you best methods. No glasses or drugs. Arthur Jacobson, Upsala, Minnesota.

SKETCHING From photographs. People, pets, landscapes. Gags cartooned, caricatures. \$1.00 up. Entsen Studios, 1246 Spaight, Madison, Wis.

1001 WAYS to Use Concrete. Send for large free illustrated folder describing new Popular Mechanics book covering every known use of concrete for the home, farm, building, business and industry. Popular Mechanics Press, Room (C40), 200 E. Ontario St., Chicago.

DON'T Be a sucker! "Crooked Schemes, Rackets Exposed." Educational book, complete 30c. Box 43, East San Diego, Calif.

ABRASIVSTROP! 250,000! Gillette Komfort. Speed-savings. Booklet? Bell-O, Gardner, Massachusetts. (Rexalls.)

TATTOOING. Engraving outfits. Illustrated list free. Percy Waters, Anniston, Ala.

BEGINNERS' Tattooing outfits. Removers. Free catalog. Tatuco, 651 South State, Chicago.

COATS Of arms and crests, correctly painted in colors or black and white, from heraldic description or furnished copy. \$10.00 and up. Highest grade work. Heraldic Studios, 1914P Oakdale Avenue, Chicago, Ill.

I WANT To send you proof of the wonderful pulling power of Popular Mechanics Magazine's classified pages. What's your proposition? Write me today. F. W. Johnson, Manager Classified Advertising, 200 E. Ontario St., Chicago, Ill.



Be Your Own MUSIC Teacher

LEARN AT HOME by wonderful improved method. Simple as A-B-C—a child can learn it. Your lessons consist of real selections, instead of tiresome exercises. Each of these delightfully easy lessons adds a new "piece" to your list. You read real notes, too—no "numbers" or trick music. Method is so thorough that many of our 700,000 students are band and orchestra LEADERS.

Be Popular

Everything is in print and pictures. First you are told what to do. Then a picture shows you how. In a few short months you may become an excellent musician—the life of every party!

Free Book and Print and Picture Sample If interested, write at once for our illustrated Free Book and Free Print and Picture Sample. Please mention your favorite instrument. Instruments supplied when needed, cash or credit. (Forty-Second Year—Est. 1898.)

U. S. SCHOOL OF MUSIC, 79 Brunswick Bldg., New York City, N. Y.

Pick Your Course

Piano	Guitar
Violin	Saxophone
Organ	Mandolin
Cornet	Ukulele
Trombone	Harp
Piccolo	Clarinet
Flute	Cello
Hawaiian Steel Guitar	Trumpet
Piano Accordion	
Plain Accordion	
Voice and Speech Culture	
Modern Elementary Harmony	
Drums and Traps	

RENEW OLD BUILDINGS WITH PLASTIC STUCCO

STUCCO SPRAYING MACHINE

It fuses a plastic mixture to any masonry surface. It water-proofs and fills all cracks. It can be applied in any thickness desired and in 30 colors. Fully proven by over thirteen years actual use under all conditions and every climate.

BIG EARNINGS. Operators report costs of 2c and up per sq. ft. and sell up to 7c. Machine covering capacity up to 1000 sq. ft. per hour soon pays for itself. Make money by supplying the big waiting market for renewing both old and new buildings with permanent color at low cost.

Get the facts. Send for books, "Proven Business Opportunity." Write today.

COLORCRETE INDUSTRIES, Inc. 570 Ottawa Ave., Holland, Michigan



4000 BARGAINS

You will find illustrated, many handy articles for the small work-shop and home, also office specialties, carded goods, food products, etc., at wholesale prices, for agents, dealers, salesmen. All sold under a money back guarantee.

260 Page Wholesale Book.

Cost about 25c, yours for 10c to cover cost of mailing, packing, etc. You get your dime back with first order. Hurry your request for the catalog—today. SPORS CO., 7-40 MAIN, LE CENTER, MINN.

"MARVEL-OUS" TRAILER PARTS

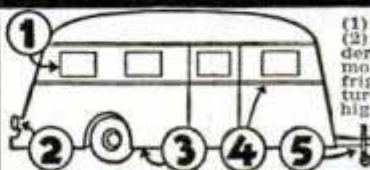

(1) "Famous" Marvel Windows, (2) tail lights, (3) complete undercarriage equipment, (4) body moldings, (5) couplers. Also refrigerators, stoves, lighting fixtures, everything you need in highest quality. Largest trailer equipment stock in U. S. Immediate delivery, low prices. Send 10c coin for 40-page ill. catalog.

Marvel Trailer Parts Co., 19020 Celestine Ave., Detroit, Mich.

When writing please mention Popular Mechanics

Amazing CHEAP OIL BURNER

Sweeping the Country!!

COOK and BAKE

Slips into Any Cook Stove

With Oil—in Your Present Stove—No Drudgery, Dirt or Ashes—Intense Heat Quick at SMALL COST—As little or as much as you want.



OVER 40,000 SOLD

Beats any cheap burner ever gotten out for low cost, perfect performance. Burns ordinary distillate or fuel oil, no clogging up. Quick, clean, intense heat by Simple Turn of Valve. **GUARANTEED.**

30 DAYS' TRIAL Prove its efficiency, convenience and economical operation without risk.

Write Immediately for SPECIAL OFFER TO AGENTS who will demonstrate and take orders. Write quick, be first to learn how to make REAL MONEY right now, spare or full time—mail 1c postcard today.

UNITED FACTORIES, 1-751, Factory Bldg., Kansas City, Mo.



MAKE MONEY

WITH NASH CUSTOM TAILORED CLOTHES

Be your own Sales Manager, take orders; earn money with this famous make of clothes. High quality men's tailoring at popular prices.

WRITE! Write in today. Territories open.

THE A. NASH COMPANY

1913 ELM STREET • CINCINNATI, OHIO

BIG 7-FOOT GLIDER

Easily built, beautiful Class E

CLEVELAND CONDOR

- 48" Eaglet (Baby Bowlius type) Soaring Glider, only 50c.
- Send 10c for latest catalog of Model Airplanes, Race Cars, RR's, Ships, etc.



Complete Kit only **\$1**

Orders under \$1.50 add 15c packing, postage charge.

CLEVELAND MODEL & SUPPLY CO. INC., 4508D95 Lorain Ave., Cleveland, Ohio

FREE! \$6.00 Full Size FOOD & HOUSEHOLD PRODUCT ASST.

SEND NO MONEY! Rush name and address for big Assortment of FOODS, GROCERIES, SOAPS, ETC.—full size packages, worth \$6.00. Yours ABSOLUTELY FREE! Show these products to friends, neighbors. Take orders for sensational values, more than 200 quality products used in every home. Earn big profits, full or spare time. No experience necessary. Write for FREE \$6.00 Assortment of Products NOW.



TOOL & DIE MAKING DESIGNING

Machinists Trade, Machine Drafting and Design. Practical shop training in the world's Industrial center. Write today for full information.

NATIONAL SCHOOL OF MECHANICAL TRADES
Dept. 21 628 W. Lake St. Chicago, Ill.

BE THRIFTY... use ROGERS GLUE

for woodworking and household repairs... incredibly strong. Send for FREE blueprint plans for making useful articles.

ROGERS • Dept. A-1 • Gloucester, Mass.

MAKE MONEY AT HOME RUBBER MOLDS

Amazing rubber mold-making outfit makes perfect flexible molds of plaques, ash trays, book-ends, etc. Molds cost from 6c to 25c each. Each mold makes hundreds of novelties and gifts to sell up to \$1.00 apiece! No experience necessary. Quick and easy. Start profitable business in your home... sell to stores, gift shops, friends, resorts, road stands, by mail. Full or spare time. "Molders Handy Book" and list of buyers FREE. Write



SO-LO WORKS
Dept. L-327 Cincinnati, Ohio

GET INTO AVIATION TODAY!

"The sky's the limit" for TRAINED MEN in the aviation industry! Get into this fast-growing, big-paying industrial field—right now, while the getting's good!

International Correspondence Schools offer courses that can lay the groundwork of PRACTICAL, MODERN TRAINING for your success in aviation. But you must act TODAY!

This coupon will bring you free booklet—and remember, I. C. S. training, famous for 50 years, costs surprisingly little! Mail the coupon RIGHT NOW!

INTERNATIONAL CORRESPONDENCE SCHOOLS

BOX 5584-J, SCRANTON, PENNA.

Explain fully about your course marked X:

TECHNICAL AND INDUSTRIAL COURSES

- | | | |
|---|---|--|
| <input type="checkbox"/> Agriculture | <input type="checkbox"/> Air Brake | <input type="checkbox"/> Managing Men at Work |
| <input type="checkbox"/> Air Conditioning | <input type="checkbox"/> Architectural Drafting | <input type="checkbox"/> Manufacture of Pulp and Paper |
| <input type="checkbox"/> Architecture | <input type="checkbox"/> Auto Engine Tune-up | <input type="checkbox"/> Marine Engines |
| <input type="checkbox"/> Auto Technician | <input type="checkbox"/> Auto Technician | <input type="checkbox"/> Mechanical Engineering |
| <input type="checkbox"/> Aviation | <input type="checkbox"/> Boiler Making | <input type="checkbox"/> Navigation |
| <input type="checkbox"/> Bridge Engineering | <input type="checkbox"/> Building Estimating | <input type="checkbox"/> Pattermaking |
| <input type="checkbox"/> Building Estimating | <input type="checkbox"/> Chemistry | <input type="checkbox"/> Pharmacy |
| <input type="checkbox"/> Civil Engineering | <input type="checkbox"/> Coal Mining | <input type="checkbox"/> Plumbing |
| <input type="checkbox"/> Concrete Engineering | <input type="checkbox"/> Contracting and Building | <input type="checkbox"/> Practical Telephony |
| <input type="checkbox"/> Cotton Manufacturing | <input type="checkbox"/> Diesel Engines | <input type="checkbox"/> Poultry Farming |
| <input type="checkbox"/> Diesel Engines | <input type="checkbox"/> Electrical Engineering | <input type="checkbox"/> Public Works Engineering |
| <input type="checkbox"/> Electrical Engineering | <input type="checkbox"/> Electric Lighting | <input type="checkbox"/> Radio Operating |
| <input type="checkbox"/> Foundry Practice | <input type="checkbox"/> Fruit Growing | <input type="checkbox"/> Radio Servicing |
| <input type="checkbox"/> Heating | <input type="checkbox"/> Heat Treatment of Metals | <input type="checkbox"/> R. R. Section Foreman |
| <input type="checkbox"/> Highway Engineering | <input type="checkbox"/> Locomotive Engineer | <input type="checkbox"/> R. R. Signalmen |
| <input type="checkbox"/> Locomotive Engineer | <input type="checkbox"/> Management of Inventions | <input type="checkbox"/> Refrigeration |
| <input type="checkbox"/> Management of Inventions | | <input type="checkbox"/> Sheet Metal Work |
| | | <input type="checkbox"/> Steam Electric |
| | | <input type="checkbox"/> Steam Engines |
| | | <input type="checkbox"/> Structural Drafting |
| | | <input type="checkbox"/> Structural Engineering |
| | | <input type="checkbox"/> Surveying and Mapping |
| | | <input type="checkbox"/> Telegraph Engineering |
| | | <input type="checkbox"/> Textile Designing |
| | | <input type="checkbox"/> Welding, Electric and Gas |

BUSINESS COURSES

- | | | |
|--|--|---|
| <input type="checkbox"/> Advertising | <input type="checkbox"/> Bookkeeping | <input type="checkbox"/> Grade School |
| <input type="checkbox"/> Business Correspondence | <input type="checkbox"/> Business Management | <input type="checkbox"/> High School |
| <input type="checkbox"/> Cartooning | <input type="checkbox"/> Civil Service | <input type="checkbox"/> Illustrating |
| <input type="checkbox"/> Cost Accounting | <input type="checkbox"/> College Preparatory | <input type="checkbox"/> Lettering Show Cards |
| <input type="checkbox"/> Commercial | <input type="checkbox"/> Foremanship | <input type="checkbox"/> Railway Postal Clerk |
| <input type="checkbox"/> C. P. Accounting | <input type="checkbox"/> French | <input type="checkbox"/> Salesmanship |
| | | <input type="checkbox"/> Secretarial |
| | | <input type="checkbox"/> Sign Lettering |
| | | <input type="checkbox"/> Spanish |
| | | <input type="checkbox"/> Traffic Management |

HOME ECONOMICS COURSES

- | | | |
|---|--|--|
| <input type="checkbox"/> Advanced Dressmaking | <input type="checkbox"/> Foods and Cookery | <input type="checkbox"/> Professional Dressmaking and Designing |
| <input type="checkbox"/> Home Dressmaking | <input type="checkbox"/> Home Dressmaking | <input type="checkbox"/> Tea Room and Cafeteria Management, Catering |

Name.....Age.....

Address.....

City.....State.....

Present Position.....

Canadian residents send coupon to the International Correspondence Schools Canadian, Limited, Montreal, Canada. British residents send coupon to I. C. S., 71 Kingsway, London, W. C. 2, England

When writing please mention Popular Mechanics

Do you want

- .. to go to College?
- .. or to enter a Profession?

(Such as Accounting, Architecture, Nursing, Dentistry, Teaching, Social Work, Osteopathy, Beauty Culture, Optometry, Embalming, Chiropody, Law, Medicine, etc.)

- .. or get an Office Position?

To get anywhere, you practically **MUST** finish High School **FIRST**. You can complete our simplified High School Course in **SPARE** time at home, as **FAST** as your time and abilities permit. Equivalent to resident school work—prepares you for college, pre-professional examinations, business, industry. Standard texts furnished. Diplomas. Credit for H.S. subjects already completed. Single subjects if desired. Low tuition, easy terms. American School, Chicago, est. 1897—endorsed by educators. Finish your high school education **NOW**. Write **TODAY!**

High School Course at Home

Many Finish in 2 Years

American School, Dept. H645, Drexel Ave. at 58th St., Chicago, Ill.

Gentlemen: Send me **FREE** information covering special training in subjects checked below. No obligation on my part.

- | | |
|--|---|
| <input type="checkbox"/> High School Course | <input type="checkbox"/> Diesel Engineering |
| <input type="checkbox"/> Accounting and Auditing | <input type="checkbox"/> Drafting and Design |
| <input type="checkbox"/> Architecture and Building | <input type="checkbox"/> Liberal Arts |
| <input type="checkbox"/> Automotive Engineering | <input type="checkbox"/> Private Secretary |
| <input type="checkbox"/> Business Management | <input type="checkbox"/> Mechanical Engineering |
| <input type="checkbox"/> Aviation | <input type="checkbox"/> Radio and Television |
| <input type="checkbox"/> Electrical Engineering | <input type="checkbox"/> Salesmanship |
| <input type="checkbox"/> Elec. and Gas Refrigeration | <input type="checkbox"/> Business Law |
| <input type="checkbox"/> Air Conditioning | <input type="checkbox"/> Retail Merchandising |

Name.....

Address.....



Be an ARTIST!

Learn at home in your spare time

Prepare for a career. Our practical method has trained men and women of all ages since 1914. **COMMERCIAL ART, CARTOONING, and DESIGNING** in one complete course. Trained Artists are capable of earning \$30, \$50, \$75 a week. No previous Art experience necessary. **FREE BOOK, "Art for Pleasure and Profit"** describes course and **TWO ART OUTFITS** included with training. Mail coupon today.

FREE BOOK gives details!

Washington School of Art, Studio 129P
1115—15th St., N.W., Washington, D.C.

Yes! I am interested in learning to draw. Please send me information in your Free Book, "Art for Pleasure and Profit."

Name..... Age.....

Address.....

City..... State.....

BROOKLYN YMCA TRADE SCHOOL



Unlimited instruction until you have mastered every part of Course without additional charge.

Full Shop Equipment
Unexcelled Instruction
Fireproof Dormitories.

Special Privileges. Check your interests on coupon to receive free literature.

- Mechanical Pre-Engineering
- Diesel Engines
- Diesel Pre-Engineering
- Aeronautical Pre-Engineering
- Aviation Mechanic
- Auto Mechanic
- Refrigeration
- Television and Radio Mechanic
- Architectural-Mechanical Drafting
- Machinist
- Armature Winding
- Oil Burner
- Welding
- Talking Pictures
- Air Conditioning
- Electrical

MAIL COUPON

1117 Bedford Ave., Dept. P.M.
Brooklyn, New York City, N. Y.

Name.....

Address.....

World's Smallest Pocket Radio
BEAUTIFUL PLASTIC COBOLTS
NO TUBES
NO BATTERIES
NO PLUG IN

Midget radio fits your pocket or purse. Wt. 6 ozs. Small as a cigarette package. Receives stations with clear tone. **PATENTED FIXED RECTIFIER.** Tubeless, Batteryless, Geared luminous color dial for easy tuning! **M. L. OF ILL. SAYS: "MIDGET RADIO WORKS FINE!"**

ONE YEAR GUARANTEE!

Sent ready to listen with instructions and tiny phone for use in homes, offices, hotels, in bed, etc. **SIMPLE TO CONNECT—NO ELECTRICITY NEEDED!** SEND NO MONEY! Pay postman only \$3.99 plus postage and charges on arrival or send \$2.99 (Check, M. O. Cash) and yours will be sent postpaid. A most unusual value. **ORDER NOW! FREE! PLUG IN "MAGICTENNA"—ELIMINATES OUTSIDE WIRES!**

MIDGET RADIO CO. Dept. P-9 Kearney, Nebr.

Auto-Diesel

Master a real trade. Auto Mechanics, Diesel Mechanics, Arc Welding, Acetylene Welding, etc. Let us train you to be an expert Auto-Diesel Mechanic and help you get a good job. The cost to you is reasonable. Learn on modern equipment with tools under experienced instructors. Real shop work. Steam heated buildings. Room and board in our steam heated dormitory. We pay your fare to Nashville. For free catalog write

Nashville Auto-Diesel School, Dept. 75 Nashville, Tenn.

LEARN AVIATION

IN LOS ANGELES - Nation's Aviation Capital

Huge increase in Los Angeles aviation activity has assured splendid positions for graduates. Career training offered for airline piloting, engineering, mechanics, drafting, production mechanics and instruments. Train at America's most modern equipped and strategically located school, fully approved by the U. S. Government for flight, ground and mechanics courses. Write for free 64 page catalog. State acc.

CALIFORNIA FLYERS

SCHOOL OF AERONAUTICS - Dept. PM-9
LOS ANGELES MUNICIPAL AIRPORT, INGLEWOOD, CALIF.

STUDY ENGINEERING AT HOME

Earn a Degree at Home
From A Chartered Institution of Higher Learning
Employers Demand Degree Men For Key Positions

88 Degree Courses in Electrical, Civil, Mechanical, Drafting, Architectural, Automotive, Steam, Diesel, Aeronautical, Radio, Structural, Mining, Industrial, Highway, Petroleum, Marine, Refrigeration, Air Conditioning, Chemical Engineering; Arts; Sciences; Philosophy; Education; Public Health; Medical Jurisprudence; Psychology; Sociology; Physics; Chemistry; Geology; Pol. Science; Theology; Law; Agriculture; Business Training; Accounting; Statistics. Founded 1908. Chartered, McKinley-Roosevelt Graduate College, 4610-R Sheridan Road, Chicago

Choose from World's Largest Line of Power Tools!

FREE New 1940 Catalog covers Metal and Woodworking Tools, accessories, motors for every purse. Write Walker-Turner Co., Inc., 190 South Ave., Plainfield, N. J.

DRIVER Engineered POWER TOOLS

SAVE 1/2 ON WELDING OUTFITS

Heavy-duty Welding Outfits, \$28.73 to \$63.34; Heavy-duty Welding Torches, \$11.52; Sheet Metal & Airplane Torches, \$8.08; Heavy-duty Arc Welders, \$59.90 to \$90.00; Regulators with gauges, \$8.98. Superior Machine Company, Hamilton, Ohio.

DIRT WON'T STICK

to hands covered with the greasless cream called Du Pont **PRO-TEK**. It acts like an invisible glove—prevents grime and paint adhering to the skin. To remove, just wash the hands in running water. This dissolves the protective film, and carries away the dirt with it. Write DU PONT, Wilmington, Delaware.

BUILD THESE PROJECTS

for garden or lawn. Easy to build. Easy to sell. Detailed Blueprints Model B-25 Dutch Windmill 50c; Model OM-60 Old Mill, 85c. Lawn Figure Patterns—Sunbonnet Girl, Dutch Boy, Tulip Girl, Holland Pair, 35c each, all 4—\$1.00. Catalog illustrating many models, send 10c today.

CRAFTSMAN'S MODEL CO., Dept. P-44, 2030 N. 41st St., Milwaukee, Wis.

FREE! 240 Page handy reference book on complete line of Stanley Tools, plus helpful tables and information. Write for Catalog 34.

STANLEY TOOLS Division Of The Stanley Works
105 ELM ST. CONN.

War, Television, Nature!

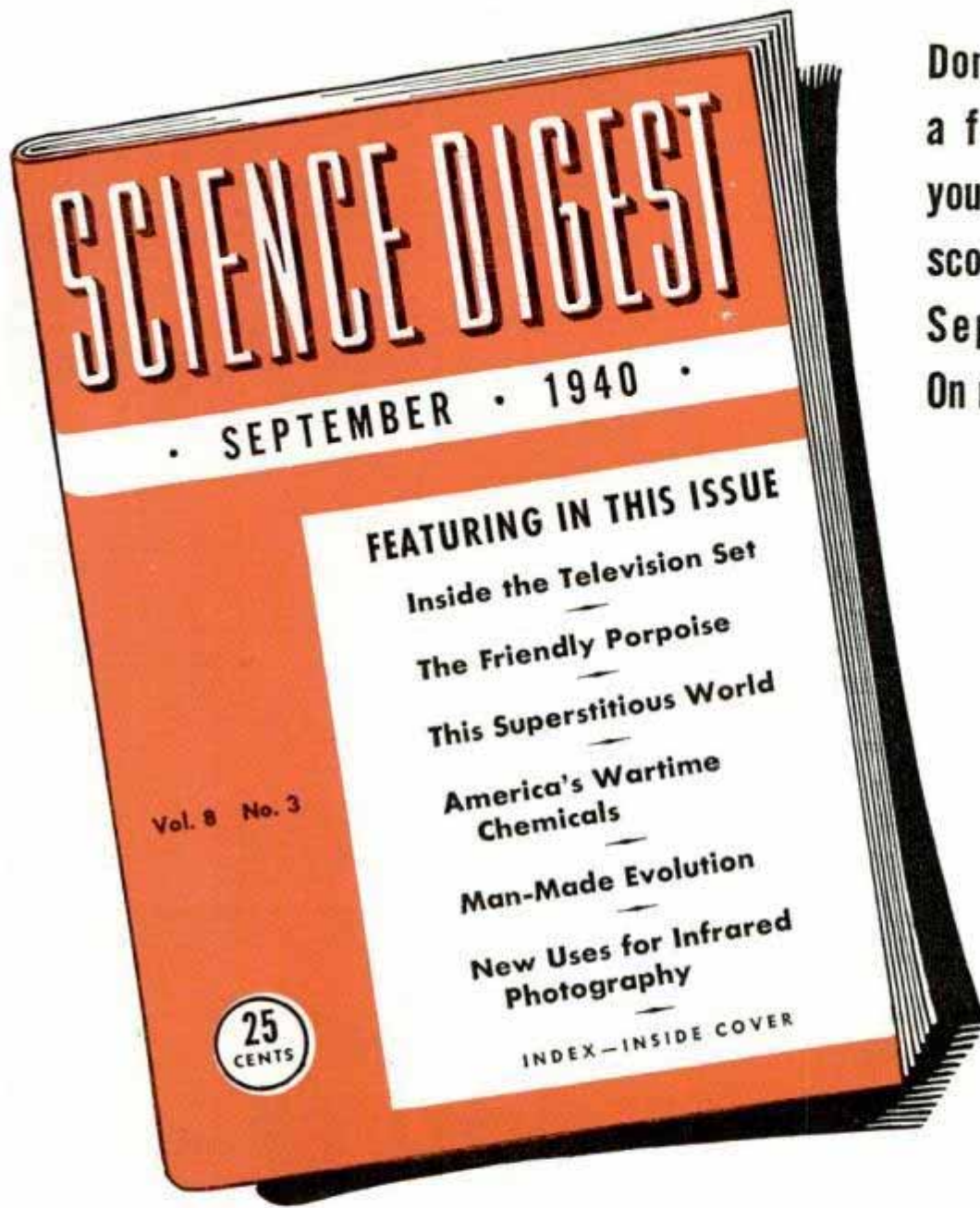

Don't these titles of a few articles whet your appetite for the score or more in the September issue? On newsstands today!

Both war and peace find uses for the same chemicals and her big peacetime chemical industry is an important factor in America's preparedness for defense. Read "America's Wartime Chemicals." There's a world of difference between television cameras and all others. And the camera was but one of television's problems. To "build" a picture, a set has to receive six million points of light a second. But get the story in "Inside The Television Set." Only since March,

1938 has man really known "The Friendly Porpoise." That was when a mother and daughter were introduced into the Marine Studios in Florida. Now much is known about its undersea life. Yes, in easy-to-read articles, Science Digest covers all fields of science for those who want to keep informed at a minimum of time and expense. Don't miss September.

SCIENCE DIGEST, INC.
631-643 St. Clair St., Chicago

ON NEWSSTANDS NOW—25 CENTS

OL' JUDGE ROBBINS



IN RECENT LABORATORY "SMOKING BOWL" TESTS, **PRINCE ALBERT BURNED 86 DEGREES COOLER** THAN THE AVERAGE OF THE 30 OTHER OF THE LARGEST-SELLING BRANDS TESTED... **COOLEST OF ALL!**



GET IN THE SWIM WITH **COOLER, MILDER SMOKING**

Copyright, 1940 R. J. Reynolds Tob. Co. Winston-Salem, N. C.

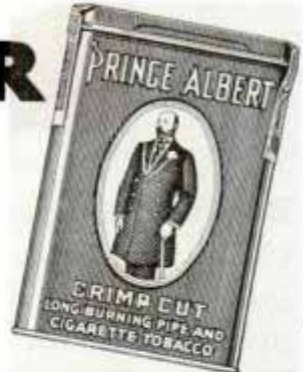

YOU BET PRINCE ALBERT IS **MILDER**— IT BURNS **COOLER**— AND IT **DRAWS EASY, EVEN!**



MEET THE **RICH BODY** AND **AROMA** OF P.A.'S **CHOICE TOBACCO!** IT'S **NO-BITE TREATED!**



ROLL-YOUR-OWNERS! P.A. IS **CRIMP CUT** FOR **FAST ROLLING, TOO**— **MILD, TASTY** FOR **'MAKIN'S SMOKES**



50 pipefuls of fragrant tobacco in every handy tin of Prince Albert

PRINCE ALBERT
THE NATIONAL JOY SMOKE

Popular Mechanics Magazine

REGISTERED IN U. S. PATENT OFFICE AND CANADA

WRITTEN SO YOU CAN UNDERSTAND IT

Vol. 74

SEPTEMBER, 1940

No. 3

50,000 WAR PLANES A YEAR

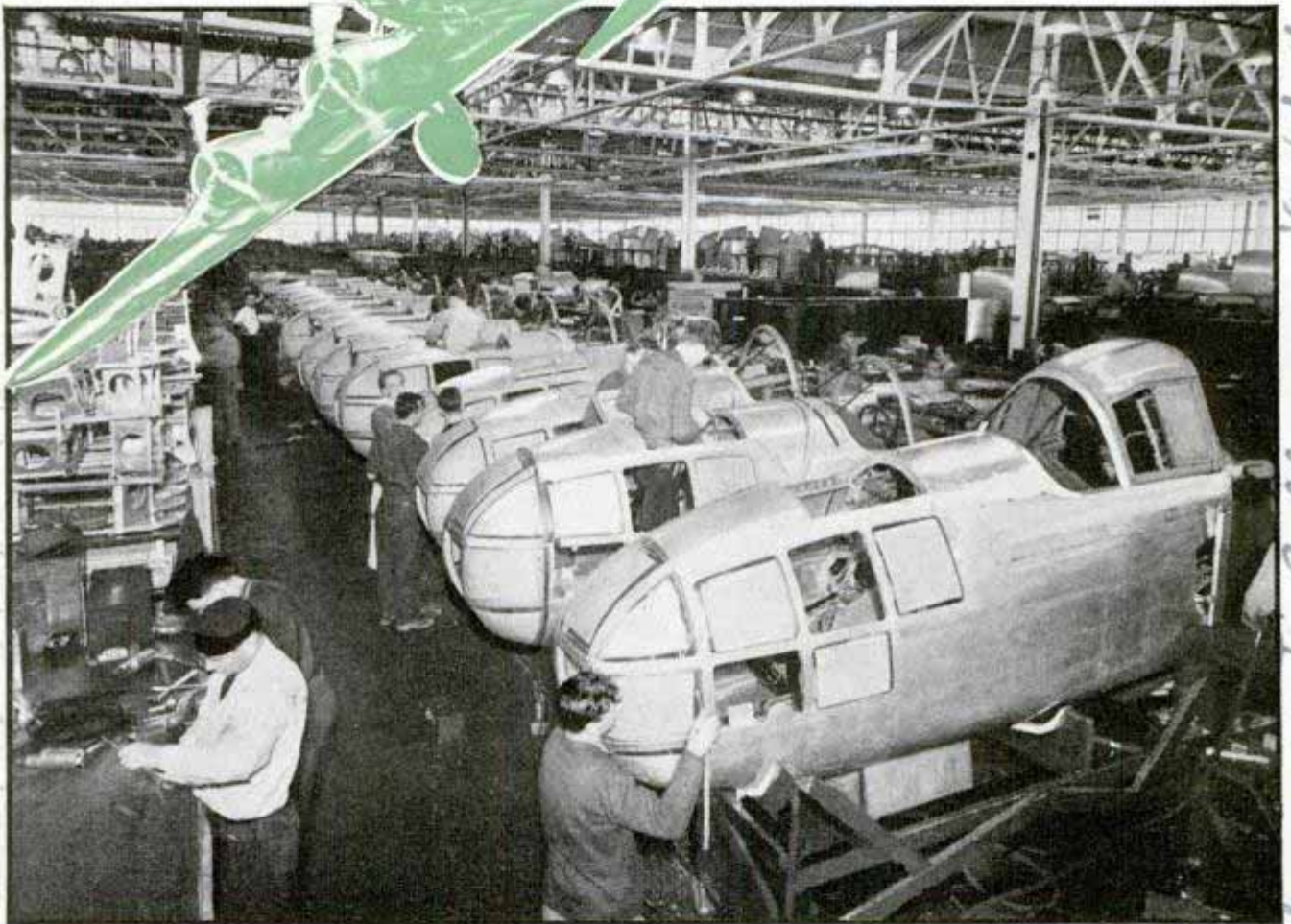

Line of nose sections moving up assembly floor in plant of Glenn L. Martin company, one of the larger military plane builders. Inset, in green, is a "flying fortress"

By Capt. E. V. Rickenbacker

President and General Manager, Eastern Air Lines

YANKEE ingenuity and talent for large-scale production should attain the goal of 50,000 fighting planes a year, in keeping with a program advanced by the government. But I do not see how even the genius of the American industrialist can reach this mark until the end of 1942, still more than two years away—and then only at an

estimated cost of more than six billion dollars for the first 50,000 planes.

According to official government reports, America had 31,264 private and commercial pilots of all classes on January 1, 1940. A total of 13,772 planes of all types (except military) were certificated and in use. The Navy had 2,863 planes and the Army 2,700.

Thomas + Colson, Dept. of Public Relations, 1775 5th Ave. N.E., Wash. D.C.

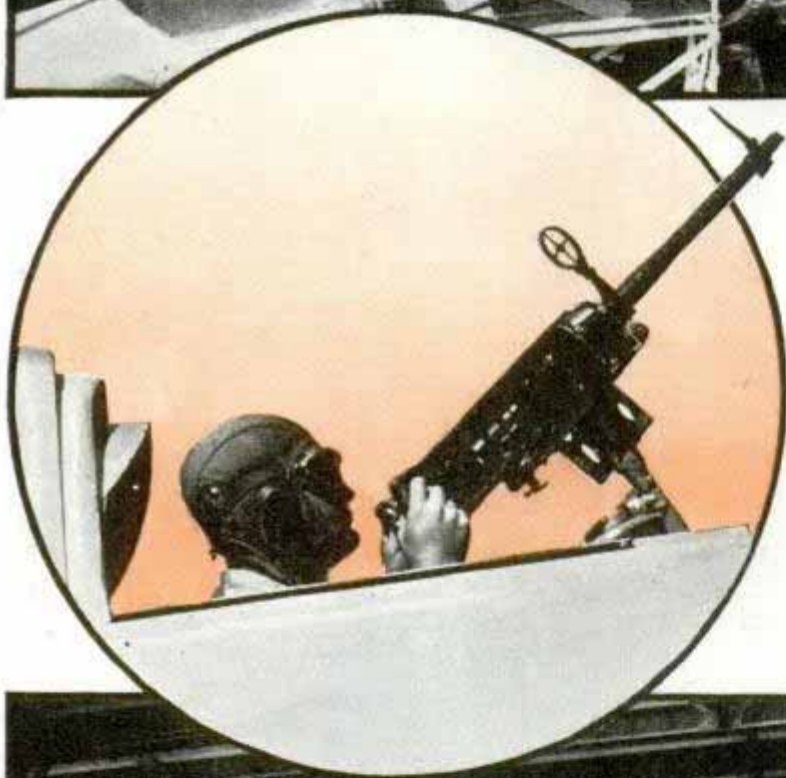
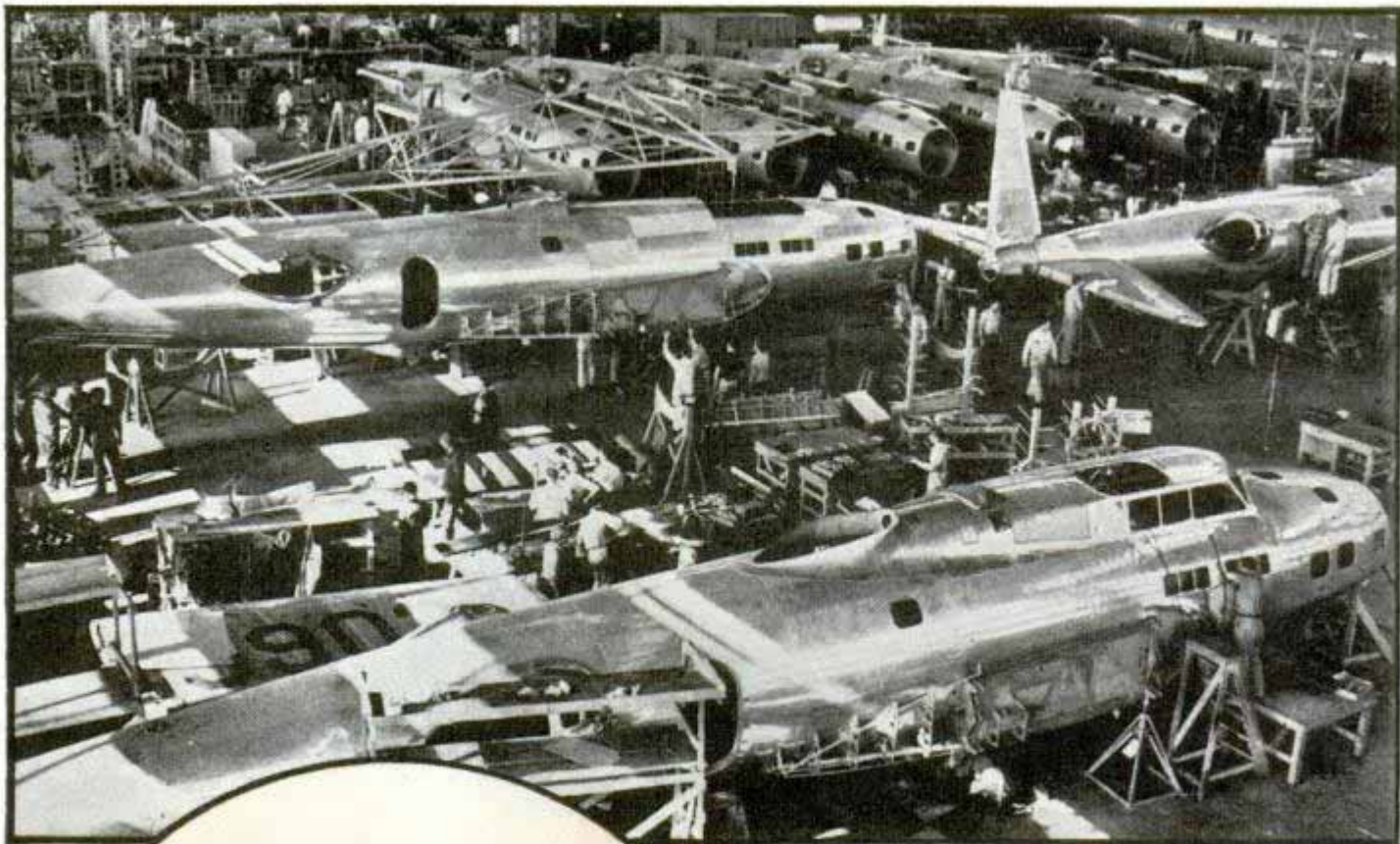

Exclusive of the latest increase in scale of production, the Army Air Corps expects to have 5,500 planes by the middle of 1941; the Navy to have 3,000. Thirty-nine four-motored bombers, the "flying fortresses," are now in operation.

It can be seen readily that this is a long way from achieving the hurry-up program which aspires to a production of 50,000 military planes per year, even if congress appropriated unlimited funds.

The cost of producing 50,000 planes a year depends on the types made. The smaller fighting planes cost about \$50,000 apiece. Bristling with guns, this type of fighting craft should be based on guard at our shores and on our north and south boundaries.

If we are learning anything from the aerial warfare in Europe it is that the advantage is on the side of the army which makes a quick and deadly thrust at the enemy before the enemy reaches his gates. It is vital, therefore, that the nation in-

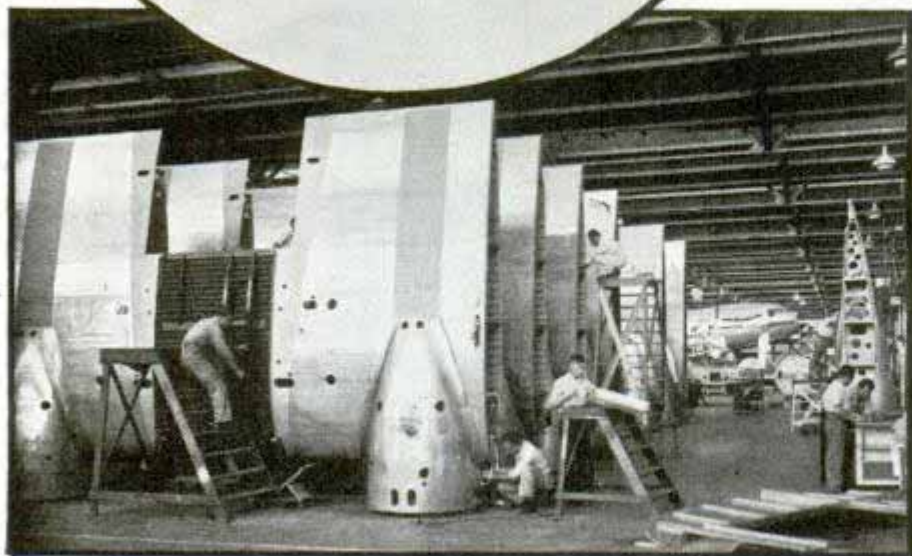

Top, bombing plane bodies in Boeing factory assembly line. Circle, gunner in rear cockpit. Bottom, wing sections in Douglas factory

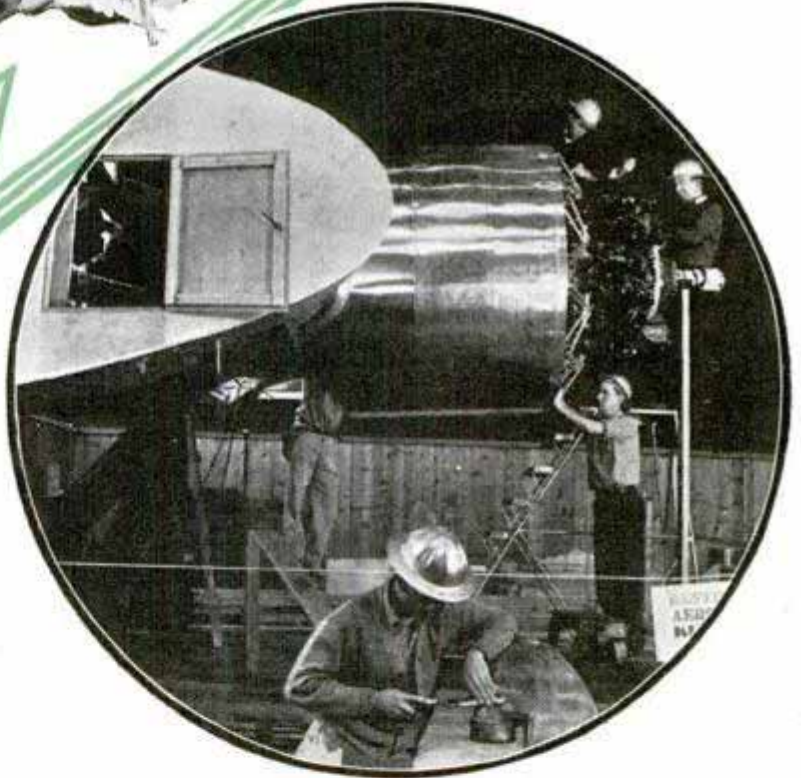
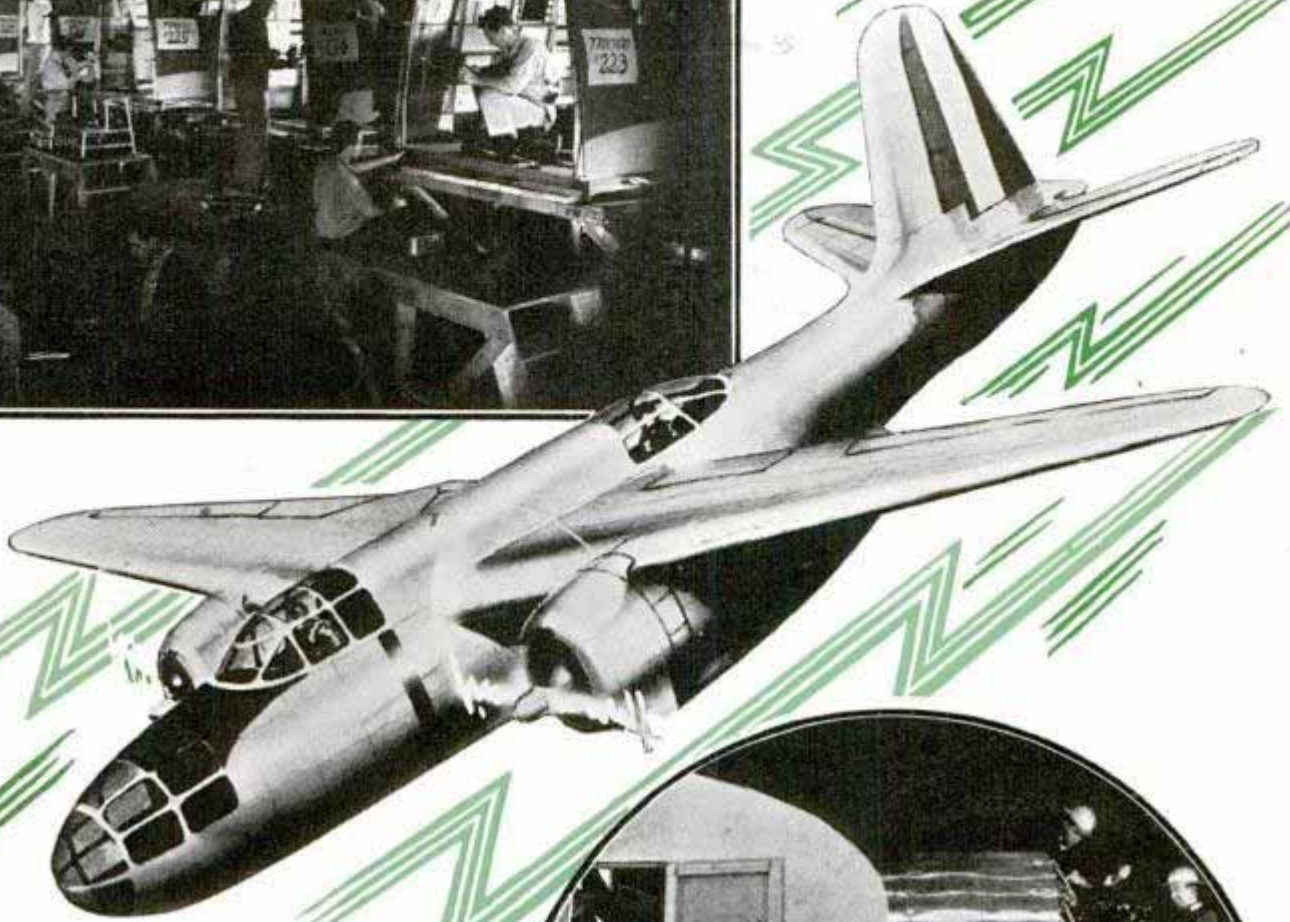
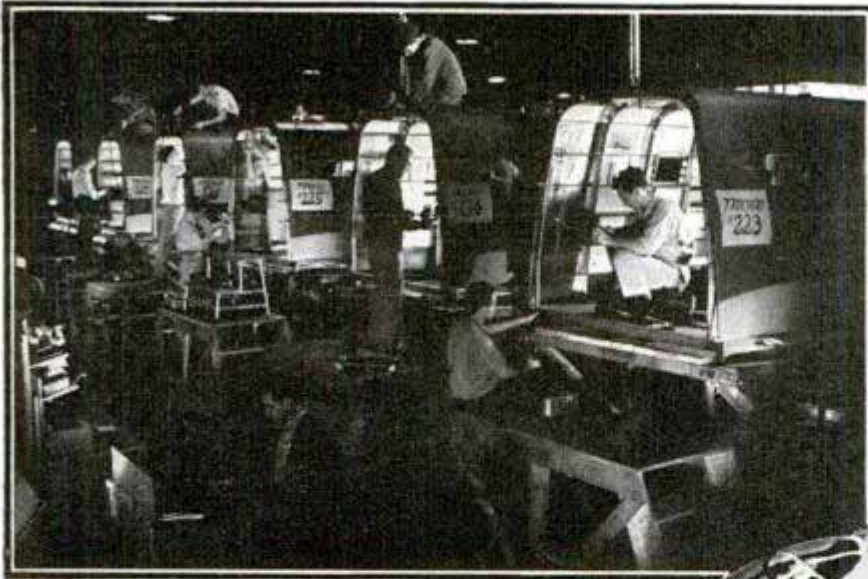

Top, expert workers assembling fuselages. Center, twin-engine light bombardment plane. Circle, one of four powerful engines powering Army's new 160,000-pound bomber built by Douglas. The craft is one of the most formidable in the world

vest heavily in long-range bombers which exceed anything we are now producing. These bombers should have a 6,000-mile range with a full load of bombs, so that they could go to Europe, Hawaii or South America and return without refueling. These deadly winged fortresses would cost \$300,000 or \$400,000 each. We should have 2,000 or 3,000 bombers of this type.

The United States should establish master air bases in New York, Miami, Brownsville, Tex., (on the international border) San Diego, Panama, Portland, Me., Alaska and at other points. From these bases lightning thrusts into the heart of the enemy would spend his power long before he arrived within striking distance of our shores.

The problem of selecting types of fight-

ing craft for an adequate air arm, and the industrial problem of producing these craft—America's vast and efficient system of manufacturing being what it is—is as nothing compared with the problem of training flying and maintenance personnel. For the task of training this personnel today is totally different from the training problem we faced in 1917-1918. At the end of the World War the Spad was the fastest plane on the western front. It had a speed



Today's fighting pilot has to be an expert and a scientist because he is either flying a meteor or a monster, a fighting plane that streaks along at 300 to 400 miles per hour or a huge bomber like our flying fortresses. A man must have at least 750 hours of flight training before he is qualified to begin on bombers and it takes one year to produce a pursuit pilot.

Here the problem assumes gigantic proportions. Let us estimate that 10,000 of the 50,000 planes planned for production go to the Navy. At least 20,000 pilots will be needed for these planes. Peak efficiency demands that we have three pilots for every plane. In the Navy an operating crew of between twenty and forty men is needed for each plane, depending on its type. If we take thirty as an average crew, this means that a trained personnel of 300,000 mechan-

(Continued to page 132A)

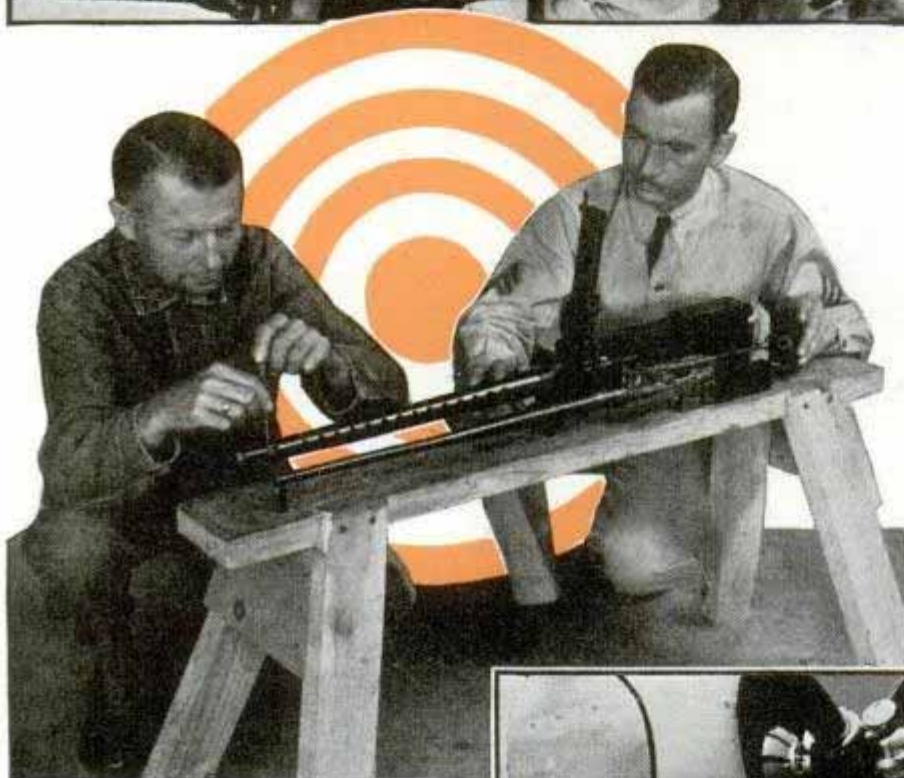

of 130 miles per hour and 220 horsepower. Today, the speed is 400 miles per hour and the horsepower 1,200 or more on the latest models. My wartime Spad had two 30-30 machine guns. Today's Spitfires and Messerschmitts have eight guns. One pursuit ship today is a literal flying barrage. Then, from forty to fifty hours was supposed to qualify a pilot for combat over the lines. The simplicity of the fighting plane of twenty-five years ago has given way today to a complexity that is enormous.

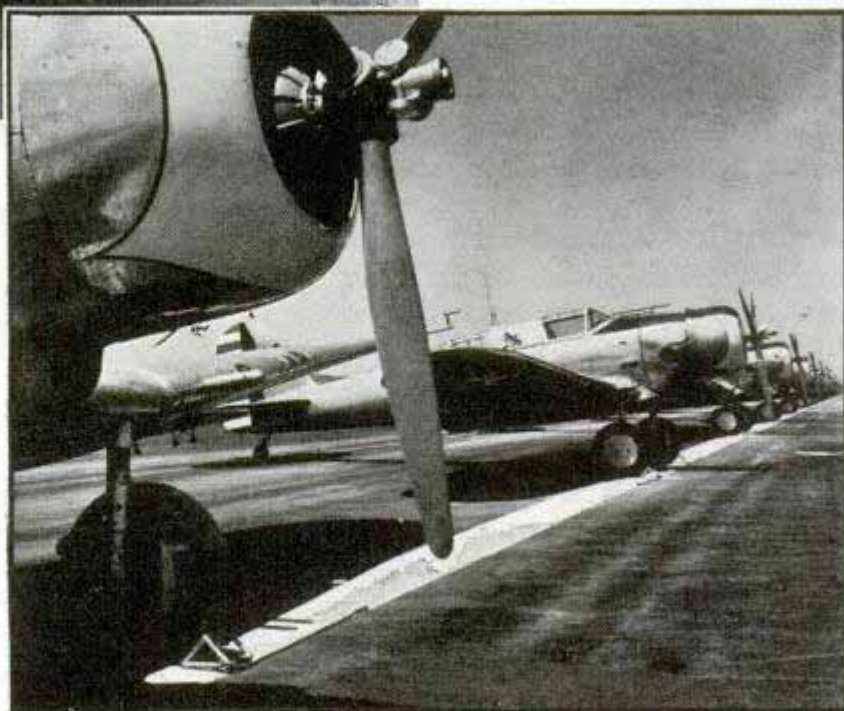

Top, students in government aviation school. Center, working on aircraft machine gun at Langley Field, Va. Bottom, attack planes at March Field, Calif.

Amphibian Tractor Inspires Giant War Tank

see Oct. 19 39. 5 74.

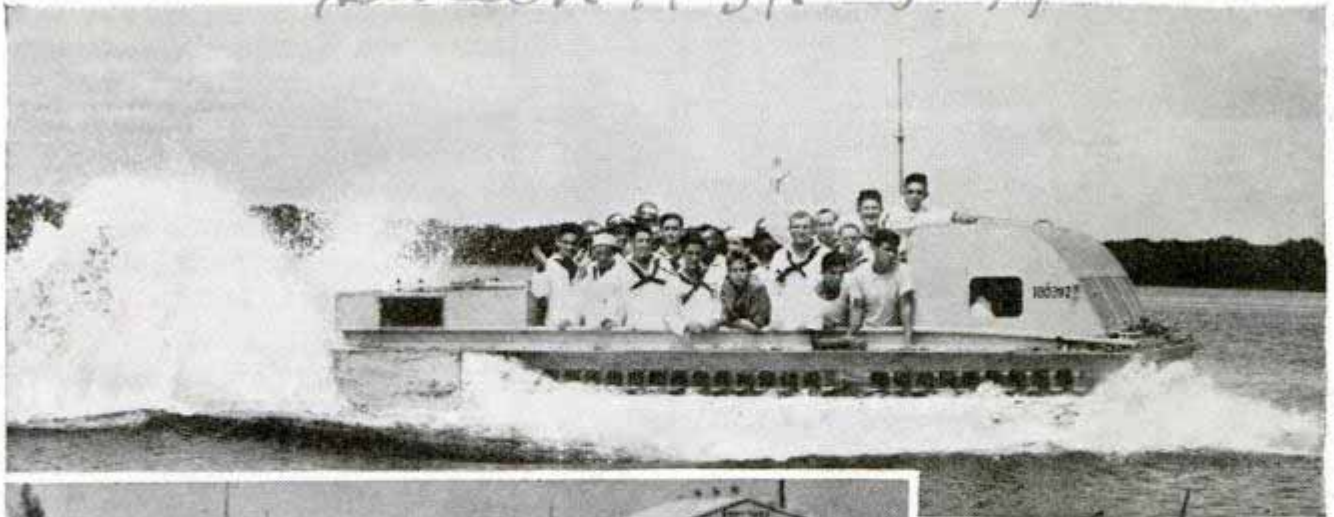

cut.

Amphibian tractor, above, carrying crew of sea scouts over body of water, supplied inspiration for design of monster land and water going war tank to be built for the United States, which will transport forty men and 7,000 pounds of equipment. Left, tractor, nicknamed "alligator," plunging into water; it was built for navigating water, swamps and land in Florida Everglades

Clearwater Florida

Inspired by achievements of an amphibian tractor of his own invention, Donald Roebing has designed a monster land-and-water war tank, a working model of which is being built for the United States at a cost of \$25,000. Plans call for a juggernaut capable of carrying forty soldiers and 7,000 pounds of equipment at twenty-five

miles an hour over land and eight and one-half miles an hour on water. One possible use for the amphibian might be the transfer of troops from ships to the shore. The "alligator" tractor was constructed for rescue work in flooded areas, for sightseeing in the Florida Everglades and for travel through swamps.

Detachable Dump Truck Body Saves Waiting for Load

K 656

Interchangeable bodies enable a dump truck to leave one body to be loaded while

it hauls the other to and from the unloading point, thus saving time that would be lost waiting to be filled. Two hydraulically operated uprights place the empty body on the ground and pick it up when full. To brace the rear end and prevent the front end from leaving the ground while lifting a loaded body, a free swinging jack may be lowered to the ground as a supporting leg. The uprights come into play again when the contents are discharged, tilting the body upward similar to other dump trucks. The uprights can lift a 2,000-pound load.

Load Lifter



Dump truck placing detachable body on ground to be loaded; when filled the body is again lifted to truck by hydraulic power

*Brooks Equipment & Supply Co.
804. Glenwood Blvd. Ocala, Fla.*

Trailer Houses Radio Station Ready for Emergency Duties



Inside the streamline trailer is an emergency short-wave radio set with seventy-five-watt transmitter and generator

Should earthquake, fire or flood strike southern California and cripple its communications, an amateur radio club's disaster unit is ready to go into action instantly. The "disaster station" is set up in a trailer and could be in operation within twenty minutes of its arrival at a focal point for transmission and receipt of messages. Eighteen San Diego county amateur radio fans own the trailer outfit, which has a seventy-five-watt-transmitter operating from 160 meters to ten meters with all amateur bands, a 600-watt gasoline-engine generator, receiver, three twenty-four-foot antenna poles, and even a kitchen sink and stove. Members of the group borrow the trailer for outings, during which they keep in touch with fellow members back home.

K 706

Bakelite Base Holds Stop Watch in Darkroom or Laboratory



Where accurate timing is essential to operations in the darkroom or scientific laboratory, a Bakelite

holder for a stop watch is a handy accessory. It eliminates handling of the watch with wet or oily hands, which might cause a costly slip, and leaves both hands of the operator free to work. The holder can be adjusted for watches of various sizes, and has an adjustable stop mechanism to suit various stem movements. To start or stop the watch or return the hand to zero, simply press the button on the base.

K 647

Disk Calculator Solves Mathematical Problems

Designed to aid in solving mathematical problems encountered in business and industry, a handy disk calculator is on the market. It consists of two circular composition plates, mounted on a common axis, with a transparent movable indicator. A ninety-six page booklet accompanying the calculator contains a large number of numerical tables and instructions for operating the calculator for finding the answer to almost any problem involving figures. Unusual accuracy is a feature of the device, which is contained in a leatherette case for protection and ease in carrying. The case fits into the pocket. It is claimed that the calculator does work as quickly and accurately as many expensive slide rules. It is useful in the home, office, factory, printing shop, carpenter shop and many other places.

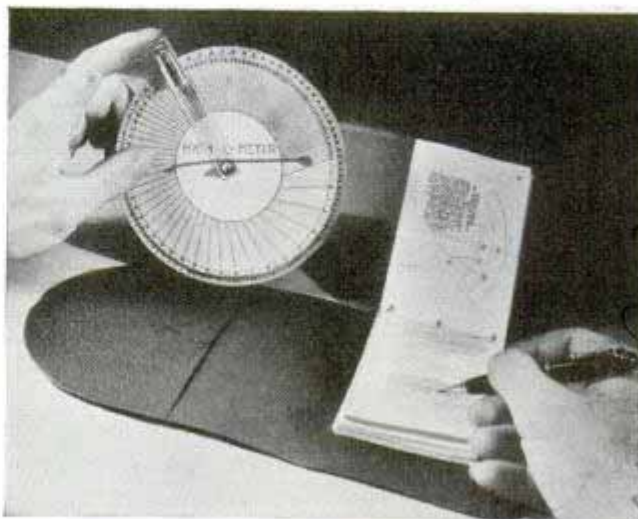

Solving problem by turning indicator to point specified by numerical guide booklet

The Chemical Rubber Co.

Delix
 Ref: Clifford C. Kemball
 4600 71st St. La Mesa, Cal.

K 647
 K 647
 Walter D. Mondschien, P.O. 1036, 176 W. Adams, Chicago

Huge Camera Speeds Production of Airplanes

Short cuts effecting an immense speedup in the mass production of airplanes are being accomplished at the Glenn L. Martin plant by a revolutionary method involving the use of a gigantic camera. This camera takes pictures on a heroic scale of the engineering drawings. The negatives are developed and the images projected on a sensitized surface which may be

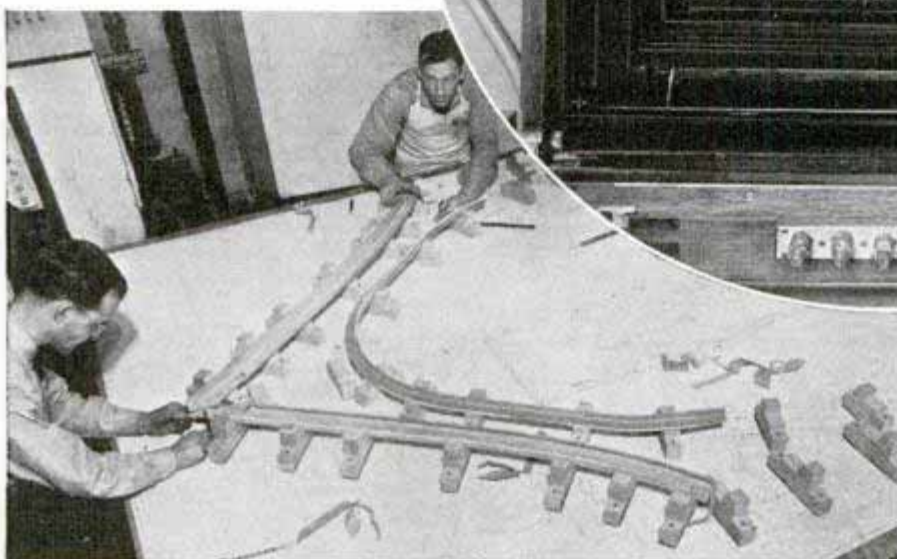
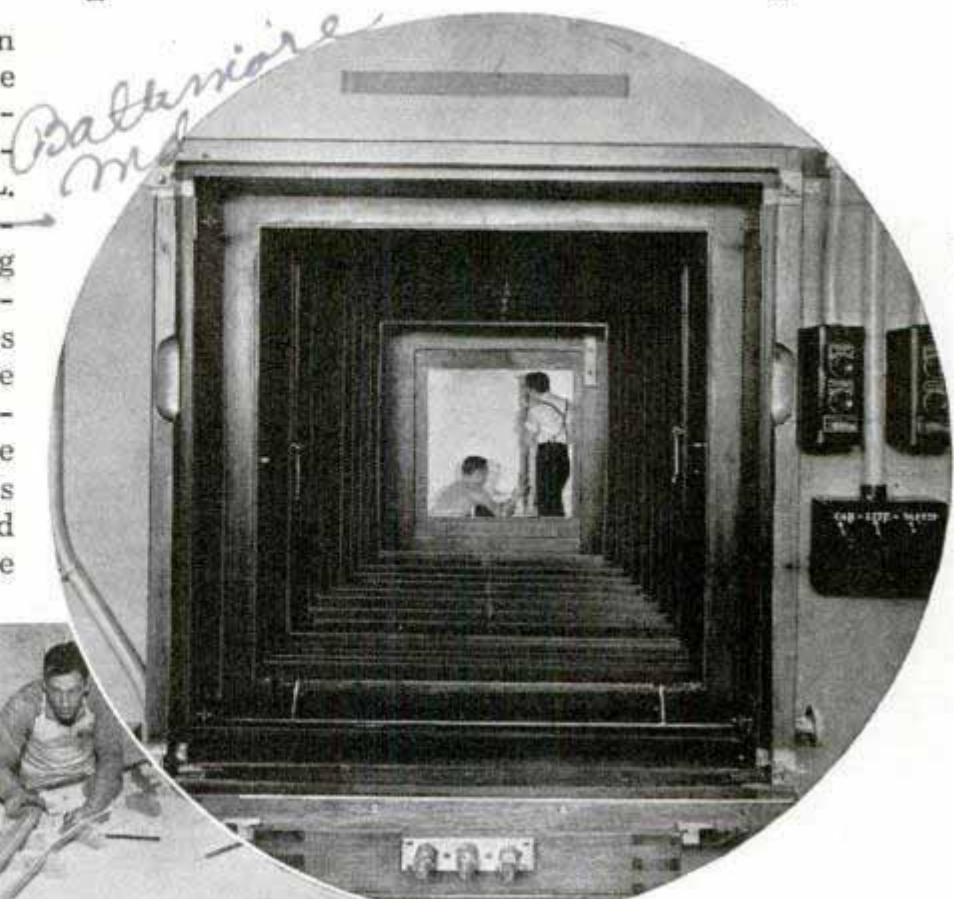

Above, looking through the big camera. Left, assembling plane parts directly on photograph in full scale. Below, laying out full-size drawing on "loft" floor

vast amount of time is saved in building full-scale mockups of new airplane types by projecting the photographed drawing directly on the wood from which the mockup is then built. In building an experimental plane, the master drawings—precise in every detail—are photographed directly on the metal and the parts are cut directly from the

metal, wood, cloth or paper; actually large sheets of aluminum alloy metal form the usual surface. Placed in a huge developing tank, the photographed drawing appears in exact scale on the sensitized aluminum sheet. Thus drawings which might have required days in redrafting are reproduced in a few minutes on metal sheets as large as five by ten feet. Multiple copies go to the tool department for tool designing, to the production department for assembly line planning, and to various engineers. A

material, itself. To build a model, the camera is used to scale down the lines to any proportion desired, a simple calibration of the camera saving perhaps weeks of redrawing. The Martin company has a "loft," a long floor raised slightly above the building floor, on which engineers draw full scale airplanes and airplane sections. Detailed drawings are made on loft layouts, sheets of aluminum alloy coated white; then the drawing is photographed and copies made on other metal sheets.

penelope cannot be purchased

A 672

Emt. Allen Warren Elcloth 120 E. 34th
New York

\$ 2,500



AFTER sixteen years of scientific research, a New York philanthropic organization has designed, patented and constructed a low-cost, five-room prefabricated house so novel that it seems almost magical when compared with an average American home.

So cleverly does it provide for human needs, it has been called "a modern machine for living." So economically is it designed that it can be sold profitably for about \$2,500, the price including the greater part of the furniture needed for eight persons, together with electric equipment not found in many high-cost dwellings.

Almost magical, too, is the manner in which the test house arose in a day or two on the Lebanon, N. J., farm of J. F. O'Brien of the John B. Pierce Foundation which is

Tops of this and page opposite: 8:10 a.m. side wall supports and floor joists being attached to concrete piers; 9:20 a.m., first row of prefabricated exterior side walls set up; 10:30 a.m., second tier of side walls almost attached and windows taking shape, and at 11:50 a.m., workman gluing top of side-wall tier so third tier may be fitted above it and nailed

conducting the research. Construction started at 8:00 a.m. with six men on the job. At 5:00 p.m. the same day, the entire structural frame, exterior walls, most of the roof and part of the flooring had been completed. When they came to work that morning, the workmen had found only twelve concrete foundation piers.

At the end of the second eight-hour day, the exterior was completed except for set-



Bottom, this page, additional stages in construction: 1:20 p.m., ceiling rafters dropped in place, and, 2:45 p.m., third side-wall tier is in and one-piece gable is being dropped into place

HOME for EIGHT

K 612

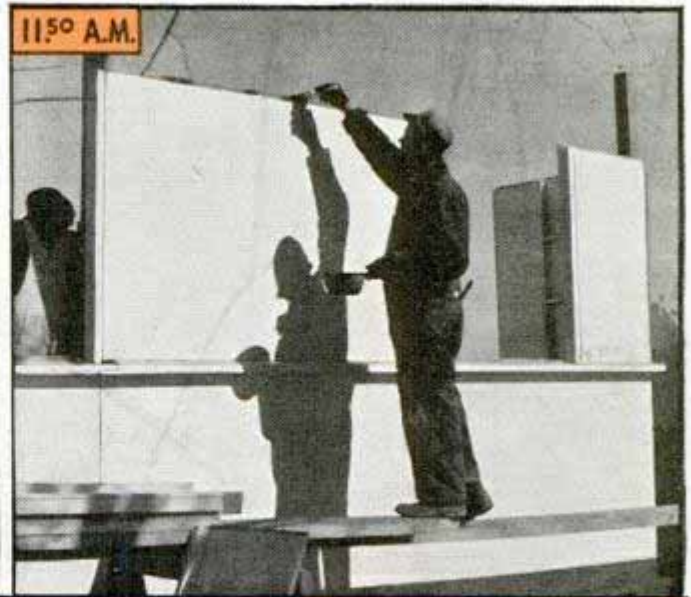
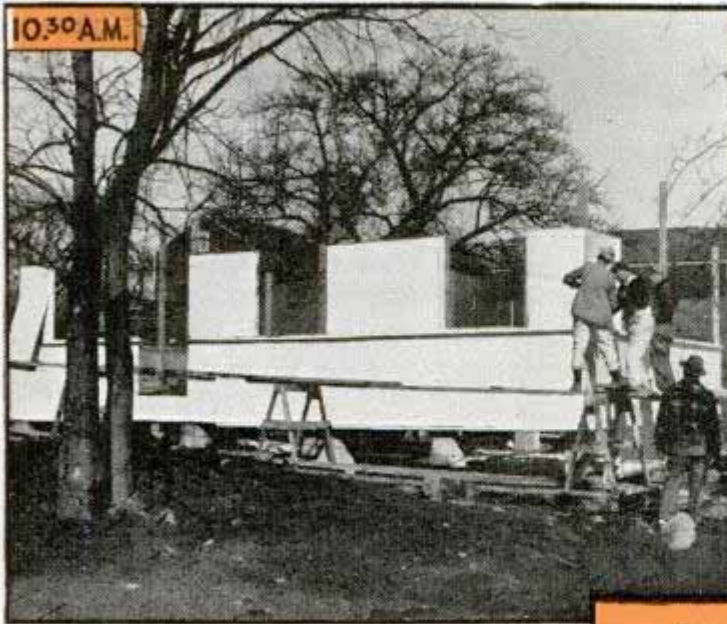

ting in the porch and landscaping, and floors and interior walls were about finished.

It can be said, therefore, that the house itself was built in two eight-hour days, although executives of the foundation estimated that a day and a half with the six men employed should have been long enough, the rest of the time being lost because of unfamiliarity with unorthodox building methods.

Nor were the foundation

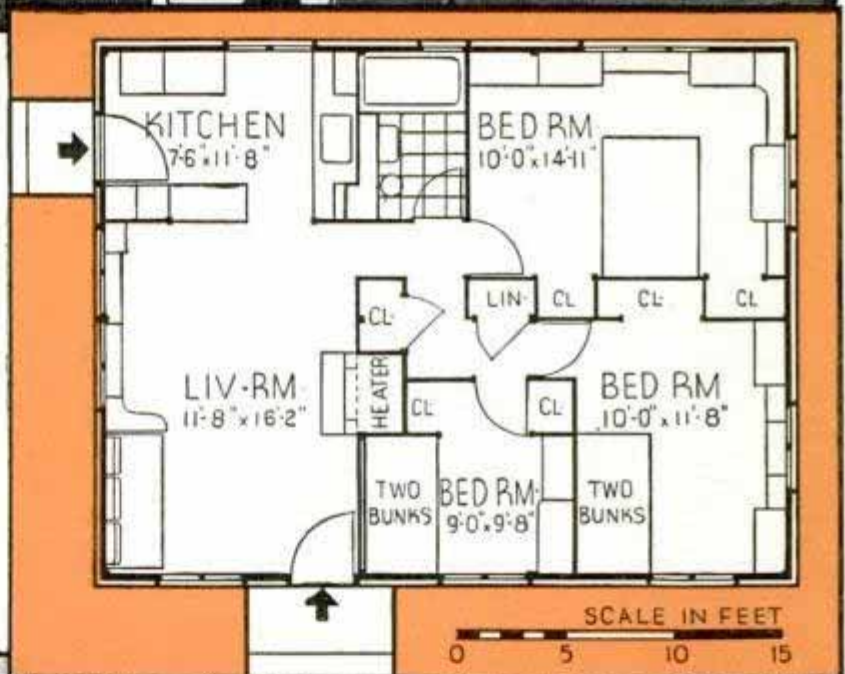

Bottom, this page, continuation of work. At 4:55 p.m., five minutes before quitting time, house is well along. Second day, the virtually completed home. Center, floor plan of the house



heater and a variety of electric gadgets intended to make living easier.

Aside from incidentals, a family of eight need bring with them only a dining table and chairs, two or three living room chairs, three bedroom chairs, and a studio couch for the living room.

What appears to be a conventional fireplace gracing the living room is an efficient hot-air furnace that can be operated by coal, oil or gas and that will whirl the indoor temperature into the nineties within a short time in

authorities satisfied with the cost of the first house, which totaled \$2,629, not including land and construction profit. This figure can be reduced to \$2,500, plus the land cost, they assert. To prove it, they plan to build a group of ten more similar dwellings.

When these dwellings, of varied design, are completed and tested, the Pierce Foundation will prepare master blueprints and probably license reputable builders throughout the country to reproduce the houses under patents the organization has obtained during the years of experiment.

By this "magic house," officials of the foundation hope to break the high-cost jam holding back the construction of an estimated 4,000,000 homes in the United States.

It then will be possible, theoretically, for a moderate-income family, able to pay twenty or twenty-five dollars a month, to select a homesite, make a modest down-payment, and move into a nearly furnished home about ten days later.

Already built in, they will find, constructed along the walls, six chests of drawers, three desks, a dressing table, two beds, a double-deck bunk with ladder, and twenty-four feet of triple shelving. Installed in the parlor they will find a heating plant; in the kitchen a refrigerator, electric stove, ten-gallon electric water

midwinter. Four tons of coal, it is estimated, will last a normal winter.

The kitchen is a veritable housewives' paradise. An electric refrigerator which opens from above so the lid may double as a table-top for the preparation of food stands in a corner. It will not produce ice cubes, but it will cool a case of bottles. The electric range has two cooking units, a broiler and an oven which is essentially a built-in roaster, large enough to handle an eighteen-pound turkey.

Underneath the sink they will find the water heater supplemented by such devices as a percolator, teakettle and scrub

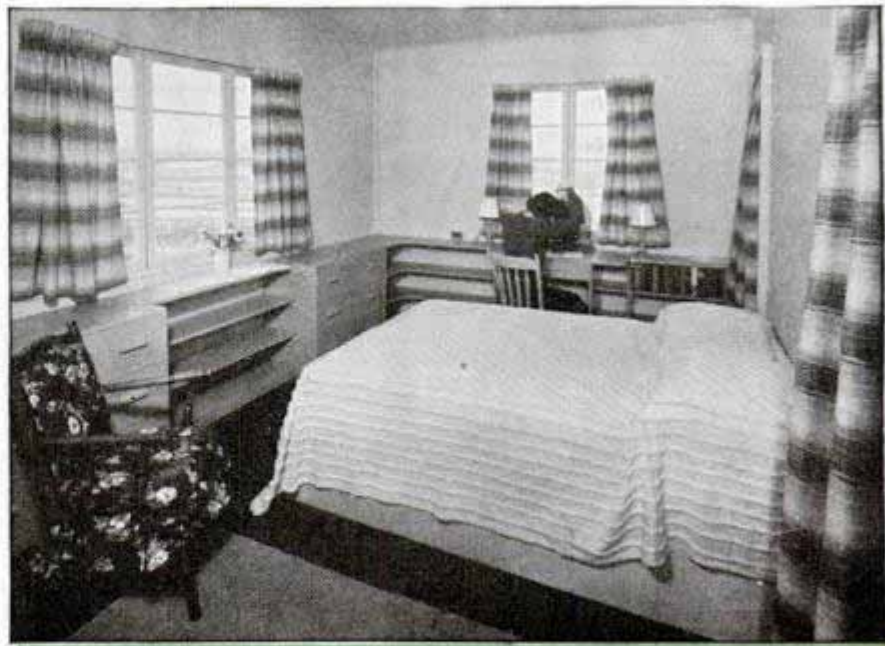

View of kitchen (top) showing housewife at refrigerator with electric stove at her right. Dining space is at left. Bottom, master bedroom with everything built in except two chairs

bucket, all electrically heated. They will also discover more electrical outlets than they have ever seen in comparable living space, because newly devised electrically wired rubber base-moldings and plastic chair rails provide electrical outlets in great numbers and at low cost, since wires are not run within walls. The average electric-light bill is estimated at ten dollars a month.

One side of a built-in cabinet in the kitchen will contain the sink; the other a large washtub so that both may be served from a single moving faucet. The arrangement provides for use of the sink as an auxiliary washtub for rinsing, bluing, etc.

Beneath the washtub, of all places, the surprised family will find the coal bin. Also they will discover that twin beds in the second bedroom are doweled so that they may be placed atop one another.

(Continued to page 131A)

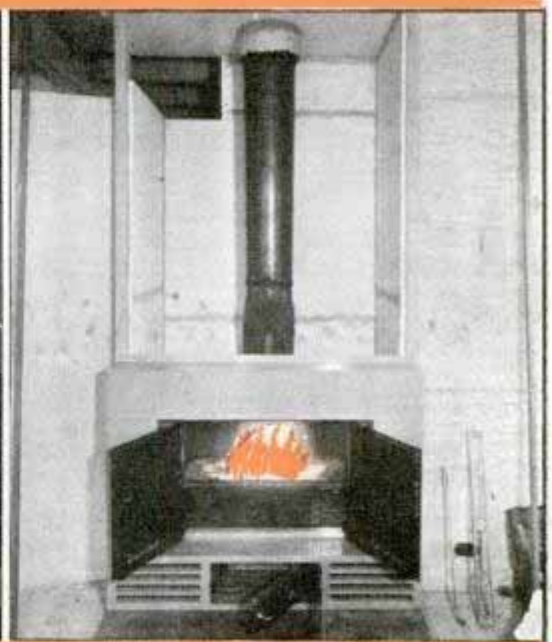
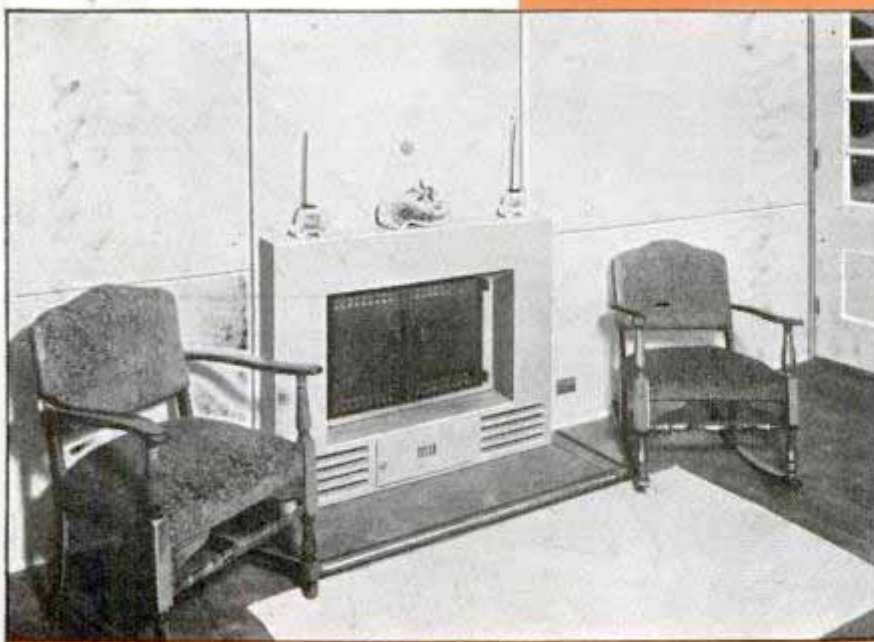
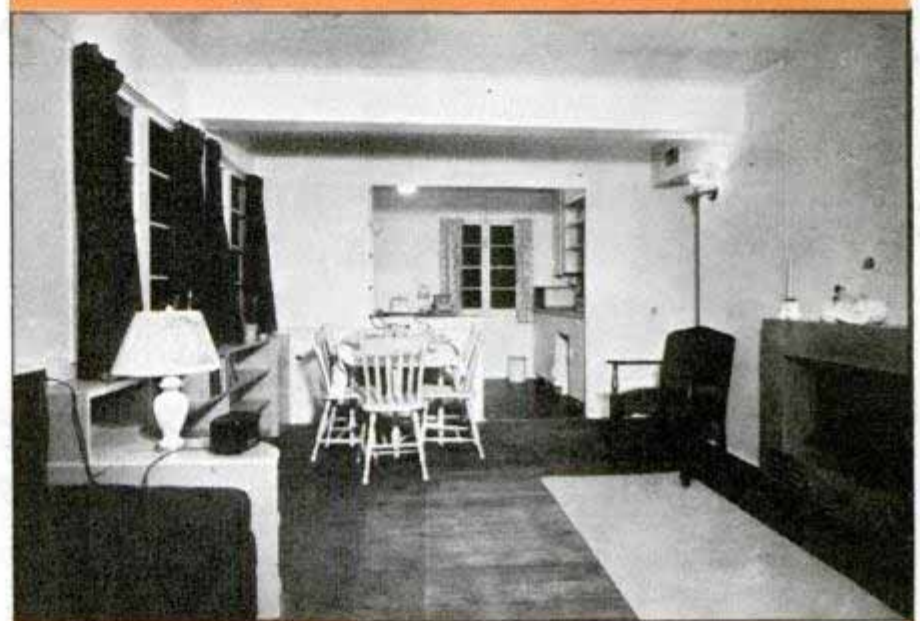

Top, No. 2 bedroom with twin beds arranged in double-decker style. Center, view of living room and kitchen. Bottom, left, hot-air heating plant built into wall. Right, plant exposed (before completion)

Robot "Chemical Man" Eats and Responds to Pain Stimuli

Elektro

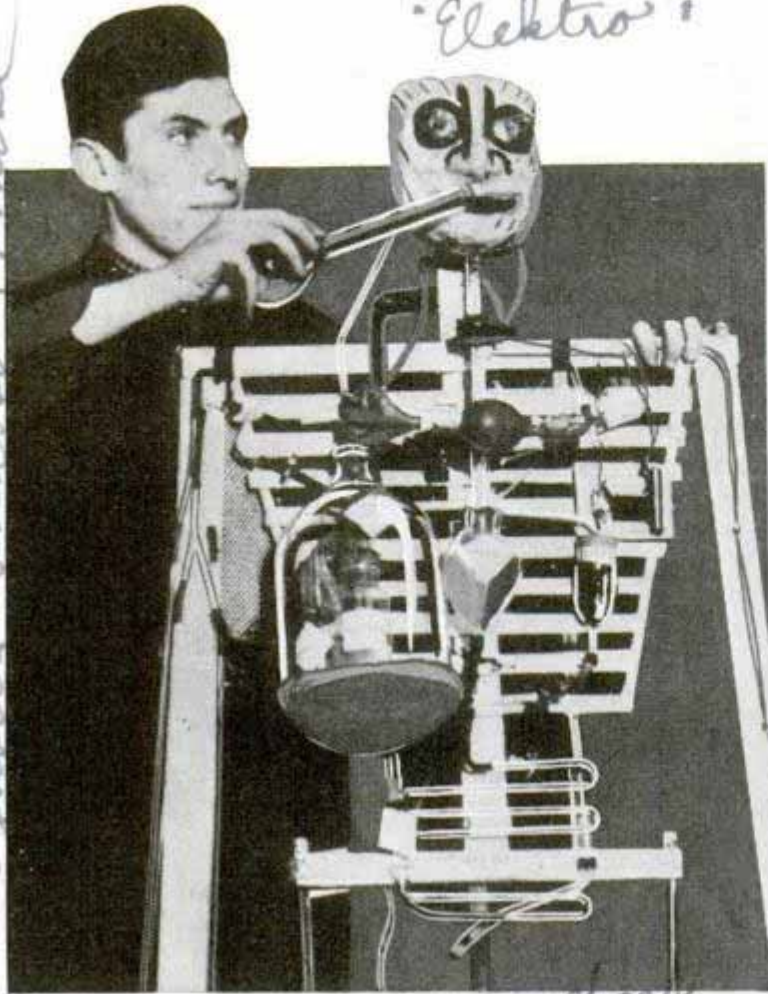

It's dinner time for the chemical robot at the world's fair. The food is actually digested in its transparent organs

Meet the "Chemical Man" who can eat and breathe, although it does him little good for he can't be brought alive. Built by sixteen-year-old Hays Gordon of Boston, the robot is a 1940 exhibit at the Westinghouse building in the New York World's Fair. It not only eats food and drinks, but digests the food while you watch, and even responds to painful stimuli.

Elements Heavier Than Uranium Revealed by Science

With the probable discovery of chemical element number ninety-four, and the positive identification of element ninety-three, which was discovered several years ago, uranium has lost by a slight margin its position as the heaviest known element in the universe. Compared with the atomic weight of 238 for uranium, or element number ninety-two, research at University of California has resulted in the production of element ninety-three of atomic

weight 239, and it is indicated that element ninety-four, also of 239 atomic weight, soon will be announced. It is said further that other heavier elements may be expected as research progresses.

Phonograph Uses Photocell to Reproduce Sound

Music travels over a light beam in a revolutionary photoelectric phonograph just announced by Philco engineers. The new method of reproducing sound was developed in a hunt for some way of eliminating wear on the needle and the record, and obtaining greater reproduction fidelity, volume and tonal range. Instead of a sharp needle, the new phonograph has a tiny floating jewel with rounded tip which flows through the record groove without injuring it. Mounted on a rotating axis over the jewel is a mirror which swings as the jewel follows the irregularities of the groove. A beam of light is directed against the mirror, reflecting from it to a photoelectric cell. Thus the swinging mirror flashes the beam of light on and off the photoelectric cell and varies the current it generates. This varying current operates the

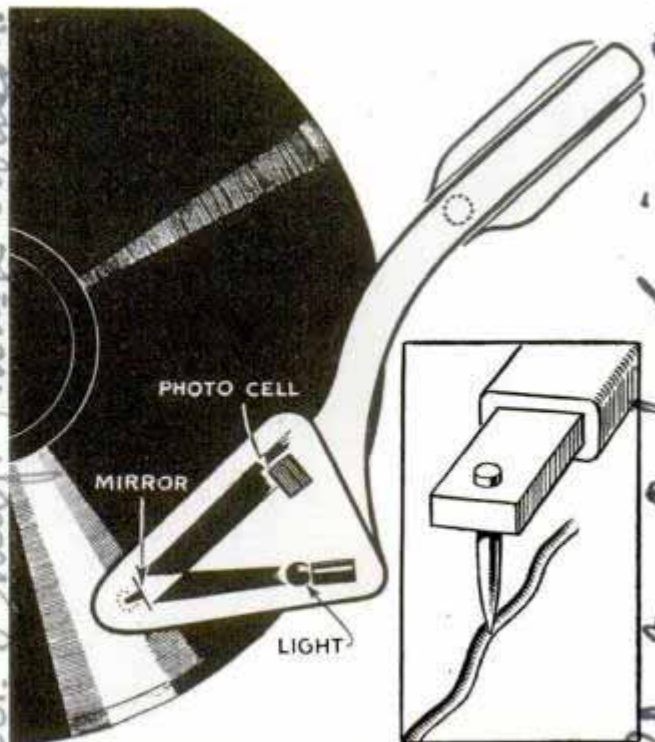

Left, diagram of photoelectric pickup; right, conventional needle in magnified groove of a record

*Science and Engineering Club
Elementary School
Carnegie Institute
Science Service
68 40
Mr. E. M. McMillan*

Philco Corp. Irving and C. Sts. Philadelphia

loud speaker, and light is translated into sound. To minimize the energy required for the jewel, floating lightly in the groove, to swing the mirror, a paper-thin mirror silvered with vaporized aluminum is used. A special light bulb was also developed, gas-filled to lengthen the life of the filament, and to eliminate flicker which would register as a hum in the loud speaker, the household alternating current must be transformed into a steady flow of light by an oscillator stepping up alternating current from sixty to 1,800,000 cycles. Filament supports are extra heavy to prevent a "howl" from the filament shaking.

X 680

Chain Coat on Huge Tire Protects Tread

In order to protect huge tires costing \$2,500 against wear and tear on unusually hard and sharp ground, a special metal web consisting of numerous chains was designed to cover the tread. The chains also provided better traction to help speed work on the construction project. Two of these gigantic tires not only are subjected to all the tractive stresses, but in addition shoulder their share of thirty-yard loads weighing about 130,000 pounds that are moved by an engine of 160 horsepower.

Journal pull



Small automobile tire is dwarfed by chain-covered giant carrying massive loads

Automatic Pilot 'Flies' Table to Teach Aviation Students



Aviation instructor using automatic pilot mounted on table to show air corps students how instrument levels tilted airplane

A table top instead of an airplane is "flown" by an automatic pilot at Curtiss-Wright Technical Institute to aid advanced students in learning operation, maintenance and repair of airplanes equipped with the instrument. The complete automatic-pilot equipment is mounted on a specially made table with a suspended top. When one corner of the table, representing the wing of an airplane, is pushed down to throw it off balance, the automatic pilot brings it back to normal "flying" position in exactly the same way it would level a plane in the air.

Luminous Fishing Lure Made of Plastic Catches the Big Ones at Night

Fishing becomes an all-night sport with a lure made of luminous plastic. When it is exposed for a few minutes to a flashlight or the sun, the bait glows for hours, attracting fish as it moves over the water.



American Chain Cable Co. of Los Angeles

Perry's magazine
 (magazine)
 (molder. Craver info. Co. 24/7 0 20 Guehen Bloss)
 estendale Los Angeles
 Island Central Air Terminal
 re seeds
 Shakespeare Co. Salamajon. Much

Ten-Mile Belt Hauls Material for Shasta Dam

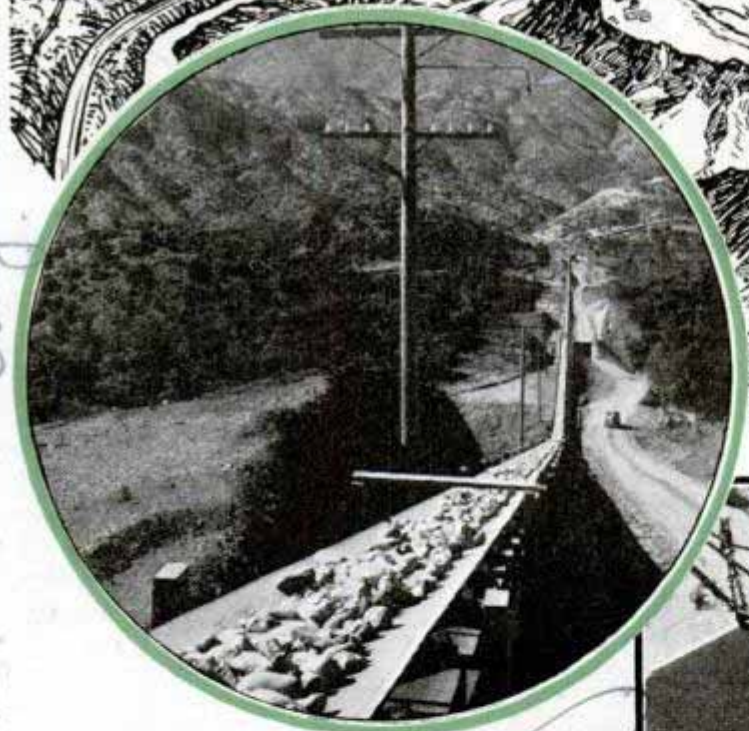
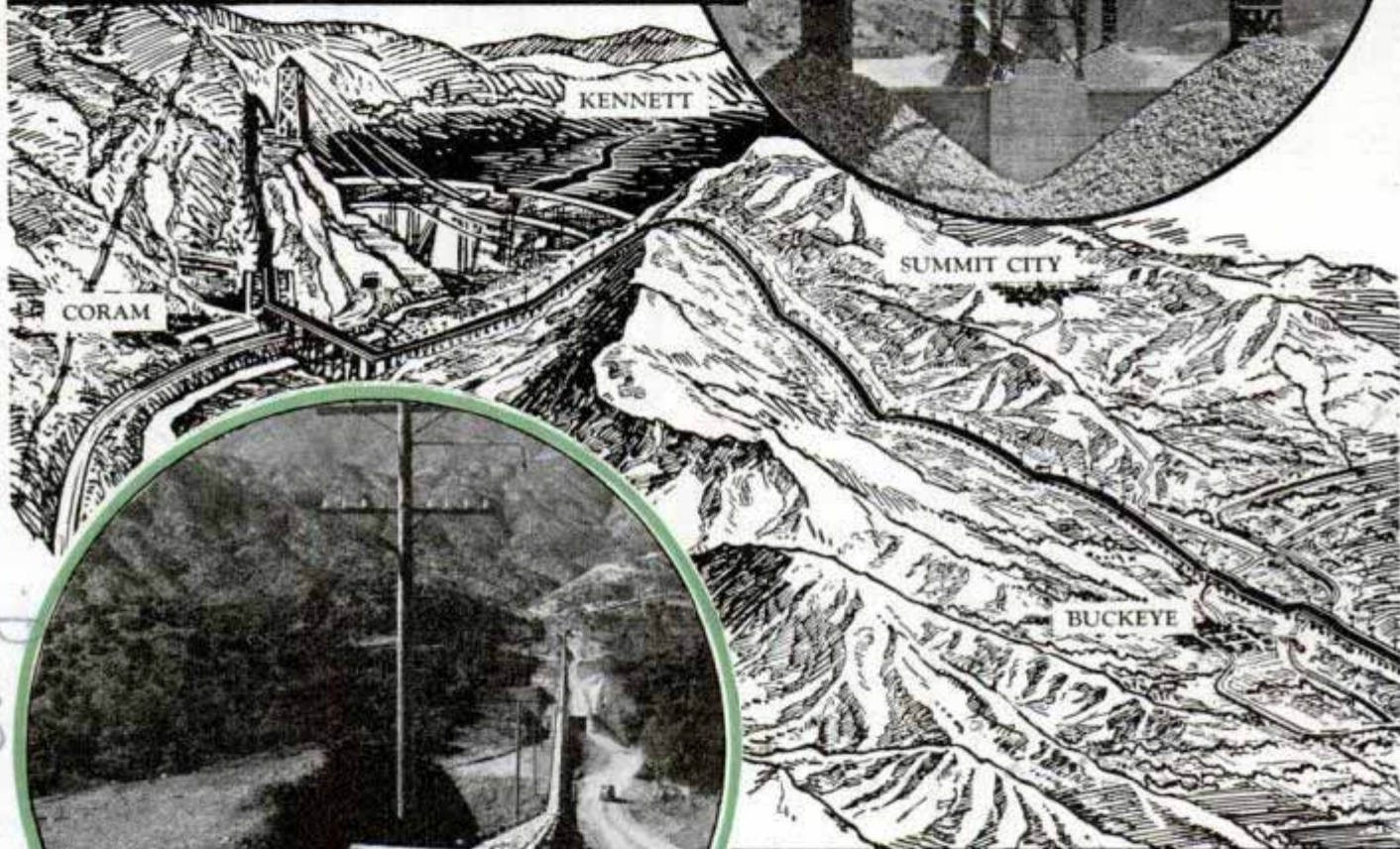
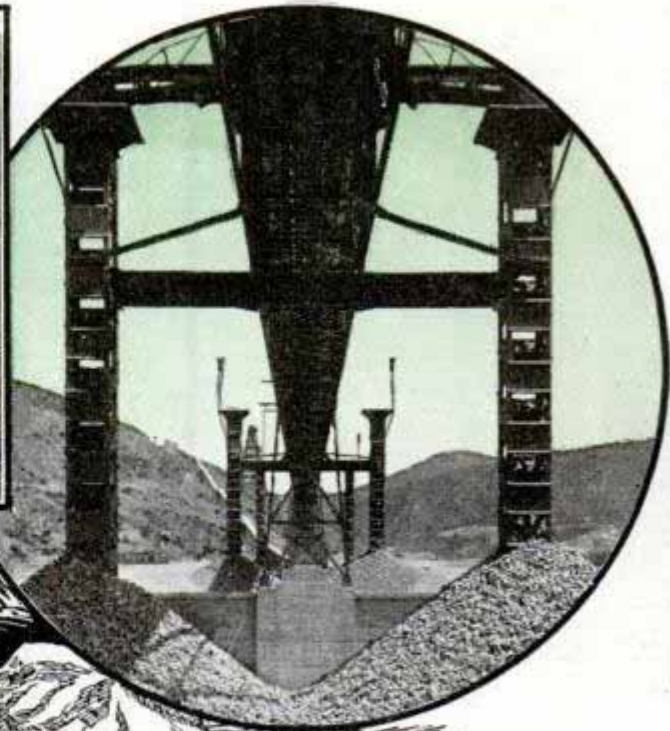

Like a giant roller coaster, a ten-mile belt hauls 22,000 tons of sand and gravel daily from Redding, Calif., to site of Shasta dam, crossing the Sacramento river twice. This conveyor system, longest in the world, consists of twenty-six relays of endless belt, each driven by 200-horsepower motor except the last three; these (circle, left) go down-grade and generate power used on other sections. Upper left, some of the 16,000 rollers on which belt travels. Upper right, gravel piling up at end of belt line. Lower right, connecting three-inch cable to bearing at top of 460-foot cableway head tower at dam site

U.S. Department of Reclamation
 Construction of Shasta Dam
 Project

Goodman Tire
 Buick Co. Akron Ohio

Alameda Calif

K 703.

Seven Cableways Hang from 460-Foot Tower

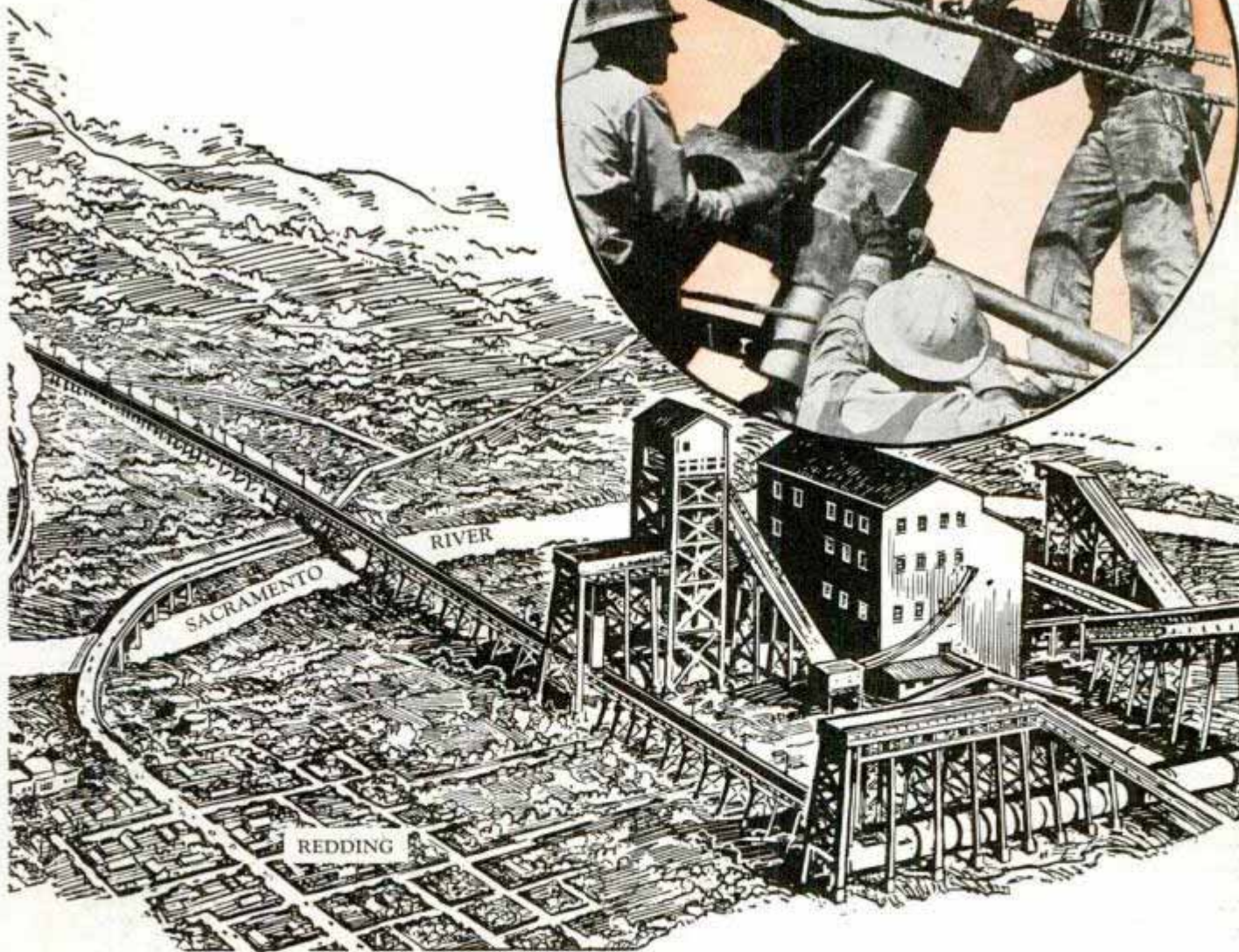
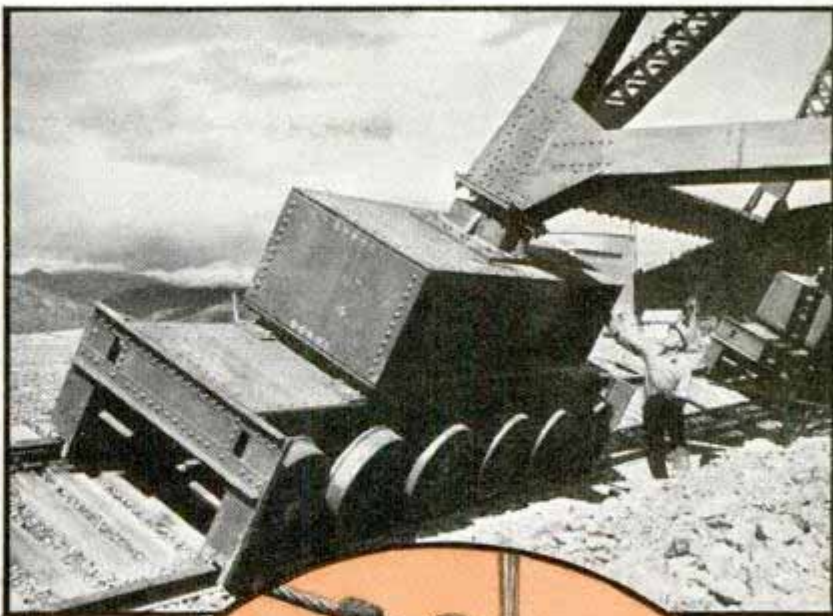
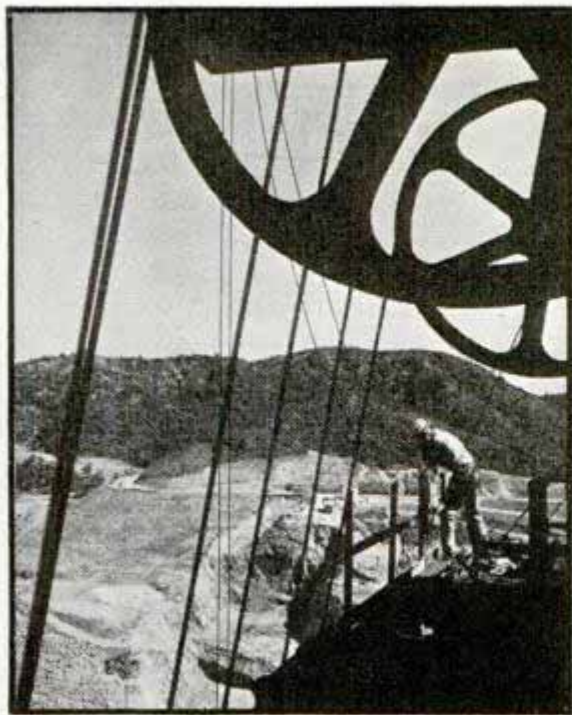

From the top of a 460-foot tower, its apex 700 feet above the Sacramento river, seven cableways radiate. Upper left, elevator hoist mechanism at top of tower; right, one of seven movable tail towers of cableways, running on curved track. In circle, rigging three-inch cable

Trunk and return belt rollers -

'Greatest Show on Earth' Staged in Miniature

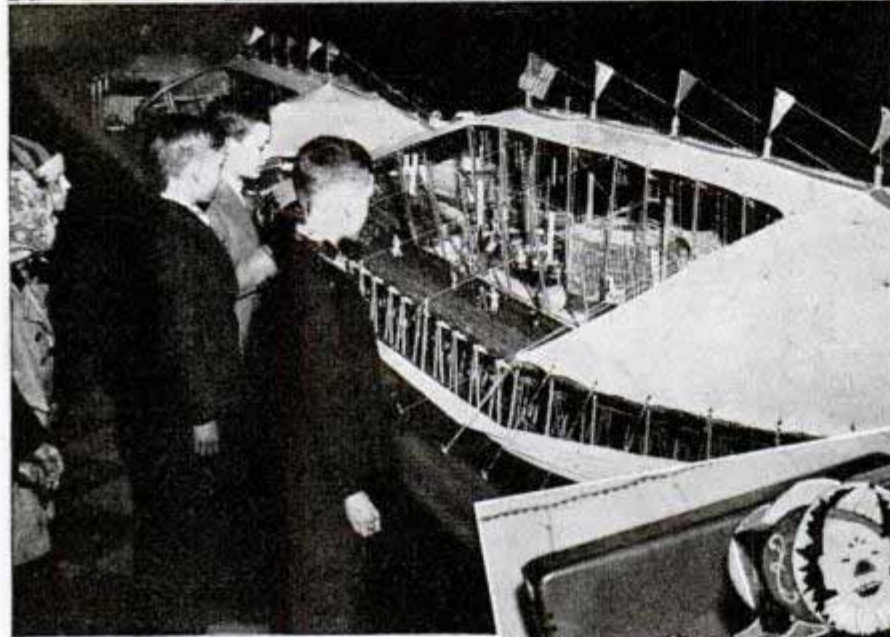
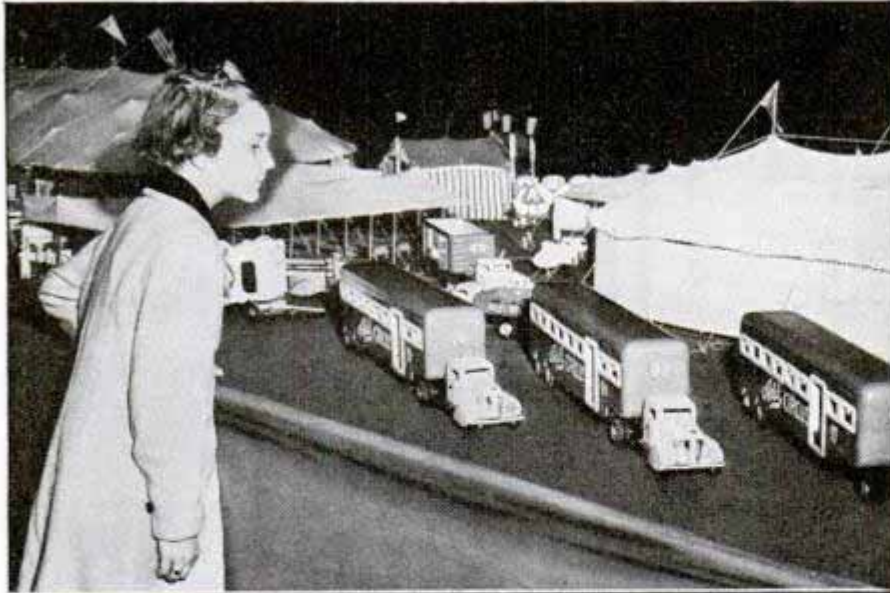

the elephants to mount. When the circus takes the road it packs aboard a miniature fleet of fifty-six tractors and semi-trailers; eleven haul the 10,000 seats, four sleeping cars carry the performers and staff. Giraffes, camels and elephants ride in private cars. There is a power plant with generators and meters, a miniature stake driver with a tractor engine furnishing power. When the circus comes to town twenty-three plumed horses lead the parade, and the seventeen-cage menagerie houses camels, giraffes, monkeys, polar bears, seals, mountain goats, black panthers, tigers, leopards, a gorilla, lion, hippopotamus, rhinoceros,

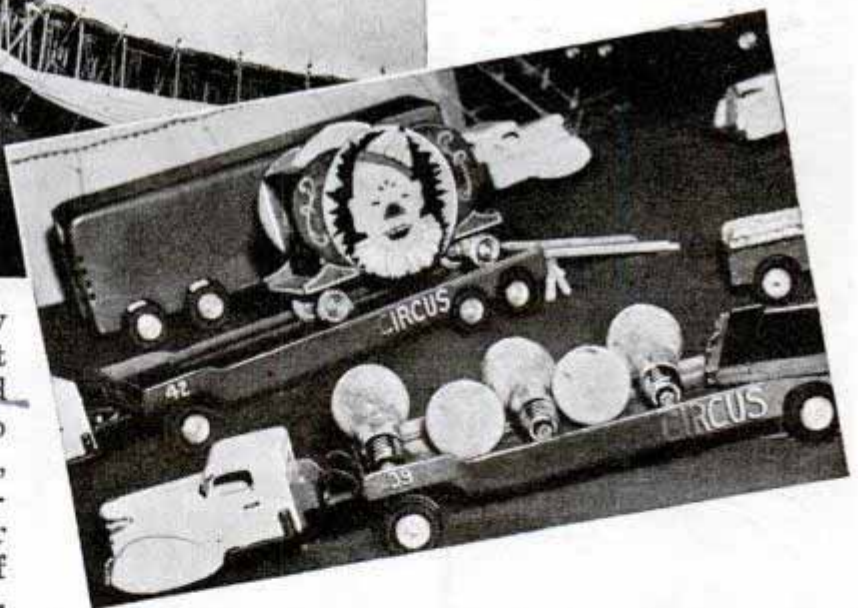

Presenting the "greatest show on earth" in miniature, Robert Krueger of Omaha has modeled a four-ring circus complete to its menagerie of plaster beasts, its glittering calliope with thirty-three brass cartridges for music pipes and its "big top" of white muslin twelve and one-half feet long and five feet wide, with six center poles twenty-two inches high. Stupendous and magnificent as the circus itself, it takes Mr. Krueger nine hours to set up for exhibition his 150,000-piece "Adel Brothers Circus," five hours to dismantle it. Supporting the model tent are 146 poles, 136 pulleys, 900 stakes and 1,000 jack pins. Under the big top are swings, trapezes, safety net, a steel cage for performing cats, an umbrella for the tight-rope walker, twelve decorated tubs for

Left, part of fleet of sleeper coaches for circus "performers," and 10,000-seat "big top." Right, trailers for parade trappings

panda, alligator, water buffalo and cinnamon bear, all made of plaster and painted in lifelike colors. A sideshow tent, made of muslin like the big top, houses the Siamese twins, midget queen, armless wonder, fat lady, snake charmer, sword swallower, hula dancer and similar attractions. The circus was built on a one-half-inch scale, taking Mr. Krueger two and a half years of spare time and less than \$400 to complete.

5222 d. 19th St



*K217 Leggett
North American BT9*

Capt Perry

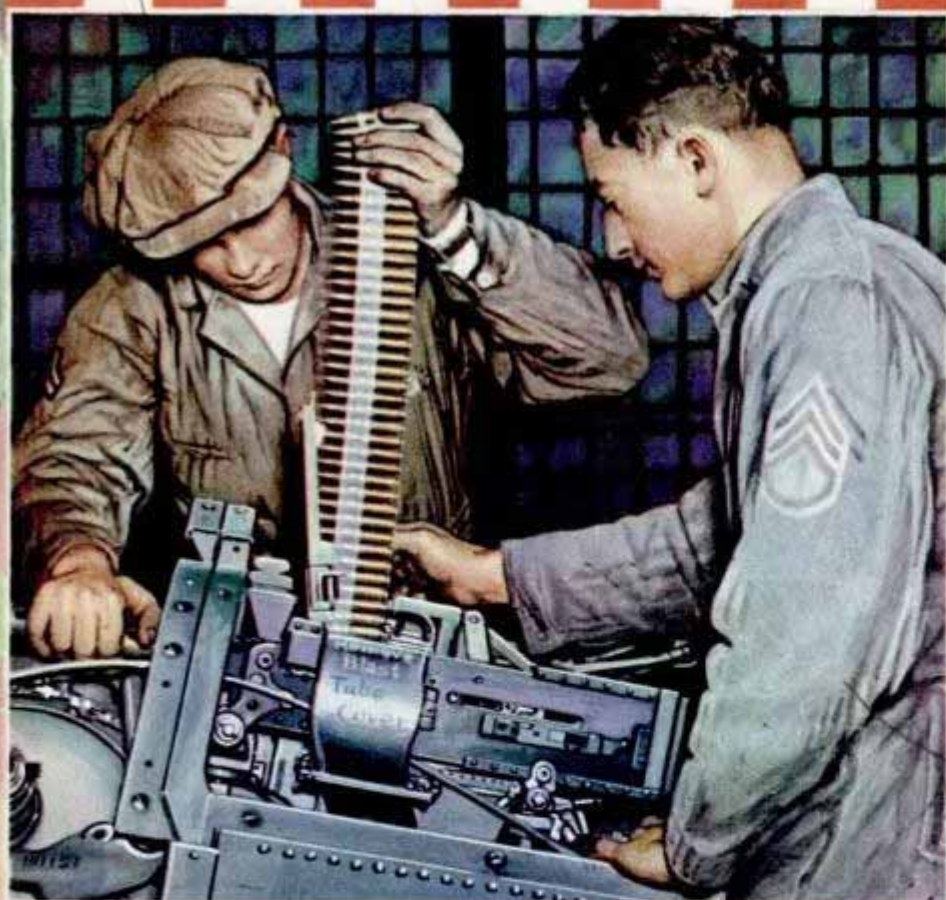

Swooping over Randolph Field (top) where students get basic training in large, moderately fast training planes. Left, testing the ammunition feed mechanism of an aircraft machine gun is another phase of instruction.

*Texas
18th Pursuit
Luffburgh, Es J.
Coalized*

337

★ ARMY on the WING ★



R217



338

11-90

Basic training students (above) trooping out to their planes at Randolph Field at start of a flight. Left, a mighty Boeing "flying fortress," powered by four great engines, soaring over the clouds on training flight.

Ref: Major General C. G. Gammis
 Hellos The Air Corps

REORGANIZED into a streamline unit, General Headquarters Air Force, U. S. Army aviators have been launched upon a program of "fly, bomb and shoot," without regard for weather, season or darkness.

Increase in strength from an original twenty-nine squadrons to forty-five, and in personnel from skeletonized organizations to full man-power is under way, so that at the end of two years the GHQ

Air Force will be nearly doubled in strength and size. Intensive training, under the same two-year plan, is in progress to prepare the force for any emergency — ready to take off on a moment's notice in defense of our homeland.

Prior to organization of this force, the training and development of military aviation were charged to the various corps area commanders. Coordination of training methods and objectives was difficult, with the result that each air unit had its own peculiar way of doing things. Finally, congress created GHQ Air Force, placing all combat aviation under one command, and attack, bombardment and pursuit squadrons were immediately formed into ho-

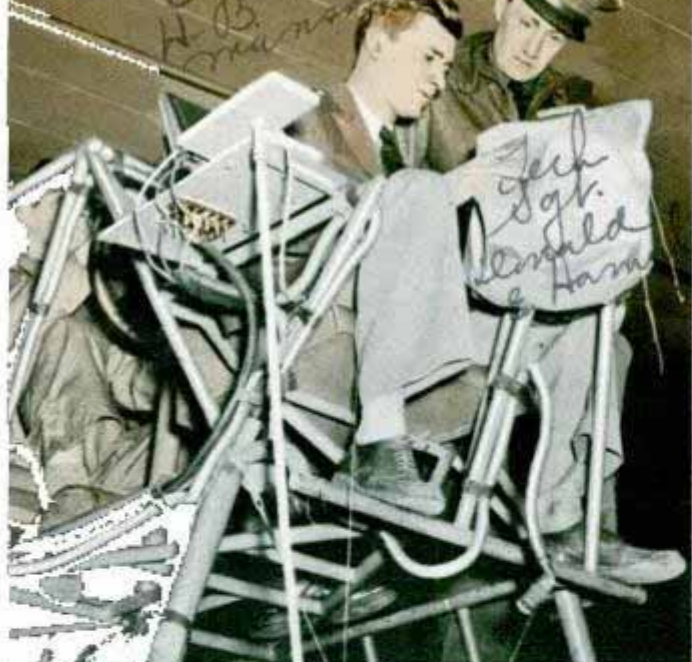

339

K217

homogeneous groups and consolidated at the army's six principal flying fields. Groups were further organized into wings, each under a brigadier general of the air corps.

Now arose the problem of developing this hitherto uncoordinated force into a highly mobile and powerful combat element of national defense. Staffs had to be organized, tactics and technique standardized and new methods of training devised. For a time all students won their wings at the training center at San Antonio, Tex., in a year's course of instruction at Randolph, Kelly and Brooks fields. The course was divided into primary, basic, advanced and specialized training.

Then, on July 1, 1939, under a vast expansion program, a new system of training was inaugurated, giving the student three months of primary training at



Using the bomb sight during instruction period (top, left); testing student's physical condition (right); parachute loft at Randolph Field (center) with 'chutes suspended from ceiling, and (bottom, left) cadets learning to read radio buzzer signals tapped out by an instructor.

Photo. etc. Polygraph.



340

Learning to fly in formation is another important phase of instruction, as above. Gunner in rear cockpit (left) simulating fire over the left tail to ward off an attack while his pilot continues on his way to the target.

bases to receive specialized training in the tactical units of the air corps. Surely, he thinks, there can't be much more to this business of flying for the army.

So it's a rude shock to the jaunty youngster when he quickly discovers that he's regarded here as only a beginner. His "grade school" course just completed, he is entering "high school" for four months to prepare for "college" work, which continues as long as he is associated with the air corps.

Instead of being a finished combat pilot, as he

civilian-operated, army-controlled flying schools, three months of basic training at Randolph Field and three months of advanced training at Kelly and Brooks fields.

Proud of his "wings" the student then reports for duty, perhaps with just a trace of cockiness, at one of the Air Force

may have fancied himself after handling the old-type planes at Kelly Field, he is merely ready to take transition training on the modern, high-speed equipment with which GHQ bases are being provided. He finds that piloting a 300-mile-an-hour pursuit ship or a giant four-engined bomber is almost as



341 R 217
 big a mystery as was the handling of that little training plane
 back at flying school.

One look at the dozens of complicated instruments, dials and levers cluttering up the pilot's compartment of the latest fighting craft sends the student, now thoroughly aware of his ignorance, scurrying back to the classroom for more ground instruction, for which he may have thought there was no further need—now that he was a pilot. And he gets it, too, 157 hours of work on such subjects as military training, signal communications, armament, instruments, meteorology, airplane and engine maintenance, navigation—dead reckoning, chemical warfare and others.

But there's something besides ground work in "high school"—there's a thrill, for the student learns to fly the service planes

Like West Pointers on parade, these Curtiss P-36 ships (above) present an unbroken formation as they roar through the air. Below, officer in cockpit of Link Trainer manipulates the controls while a group at the plotting table watches a tracing crab outline the course that he would be taking if he were in an actual plane in the air.

Lt. George B. Isreene - Laurel Isapharl Puryear.
Lt. Douglas S. Thomas & S. J. Thomas

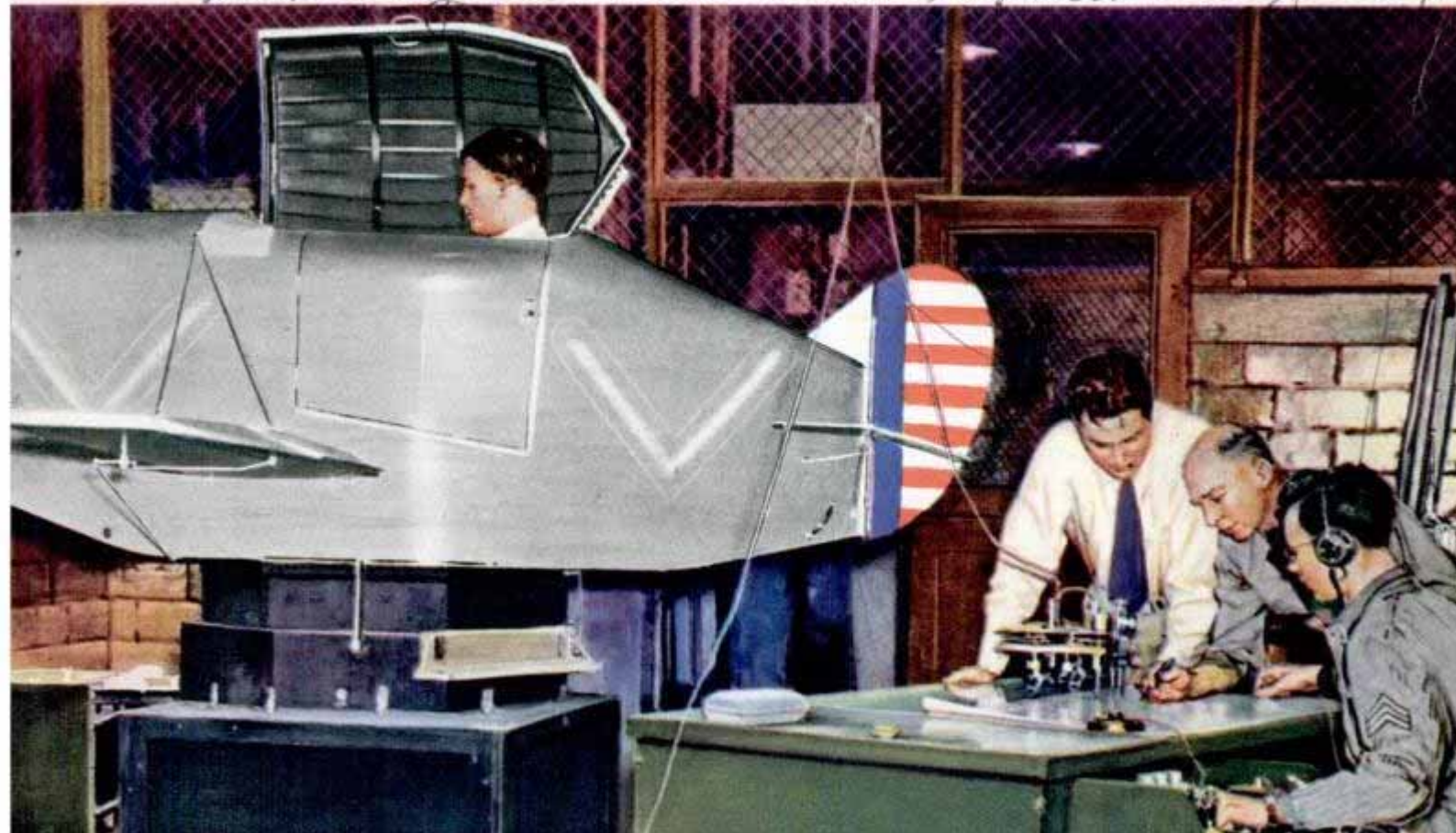



At the trigger of an aircraft machine gun (left) in a B-17 bombing plane at Langley Field, Va. Below, enlisted men learning to pack parachutes at Langley Field. Since lives depend upon these 'chutes, this work must be accomplished with the greatest precautions against mistakes.

K217

342 assigned to his organization. If he is a pursuiter, he will pilot the Curtiss P-36 for the first time—and alone, for this is a single-seater airplane; he will learn how it feels to fly straight and level, at 300 miles an hour and more, and he'll get that spine-tingling sensation that comes when first his head is forced against the headrest by the rush of a fast fighting ship taking off. More thrills are to be his when he demonstrates proficiency and is taught to handle the Bell P-39, the Aircobra, the Republic P-41 and other equipment packed with roaring power that responds in a flash to his slightest touch on the controls. Now he's learning to master a flying, fighting machine.

Twenty hours of this transition fly-

ing, and the now thoroughly subdued student graduates from "local flying" to supervised individual day navigation, making short cross-country trips on and off the civil airways system, with and without the use of radio aids. After twelve hours or more of this training, he goes on to learn the intricacies of high-speed formation flying—and here he gets an inkling of what to do, if war should come, when he gets into a "dog fight" with enemy pilots. Wing-tip to wing-tip with others in his group, he roars through the air at what once seemed blinding speed, turning and banking, climbing into the sun and swooping earthward. Then comes local night flying, later night navigation and finally instrument or "blind" flying.

If the student is a bombardment or reconnaissance man, he starts out as a



R217

co-pilot on a Douglas B-18 or a Boeing four-engine "flying fortress" and learns to play his highly essential part on the team that is prosaically called the combat crew. He learns to take off and land these huge ships and to know the significance of the dozens of dials and levers that appeared so confusing upon his arrival.

Of the specialized instruction, significant is the fact that this training begins a lifetime of such activity. The necessity for high proficiency in art that has become complicated and tech-

343



Radio signaling device (top) tests accuracy of bombardier without actual release of bombs. Bell fighter (center) in flight. Aerial gunner sighting on "enemy" plane (bottom).

Missouri National Guard Photo

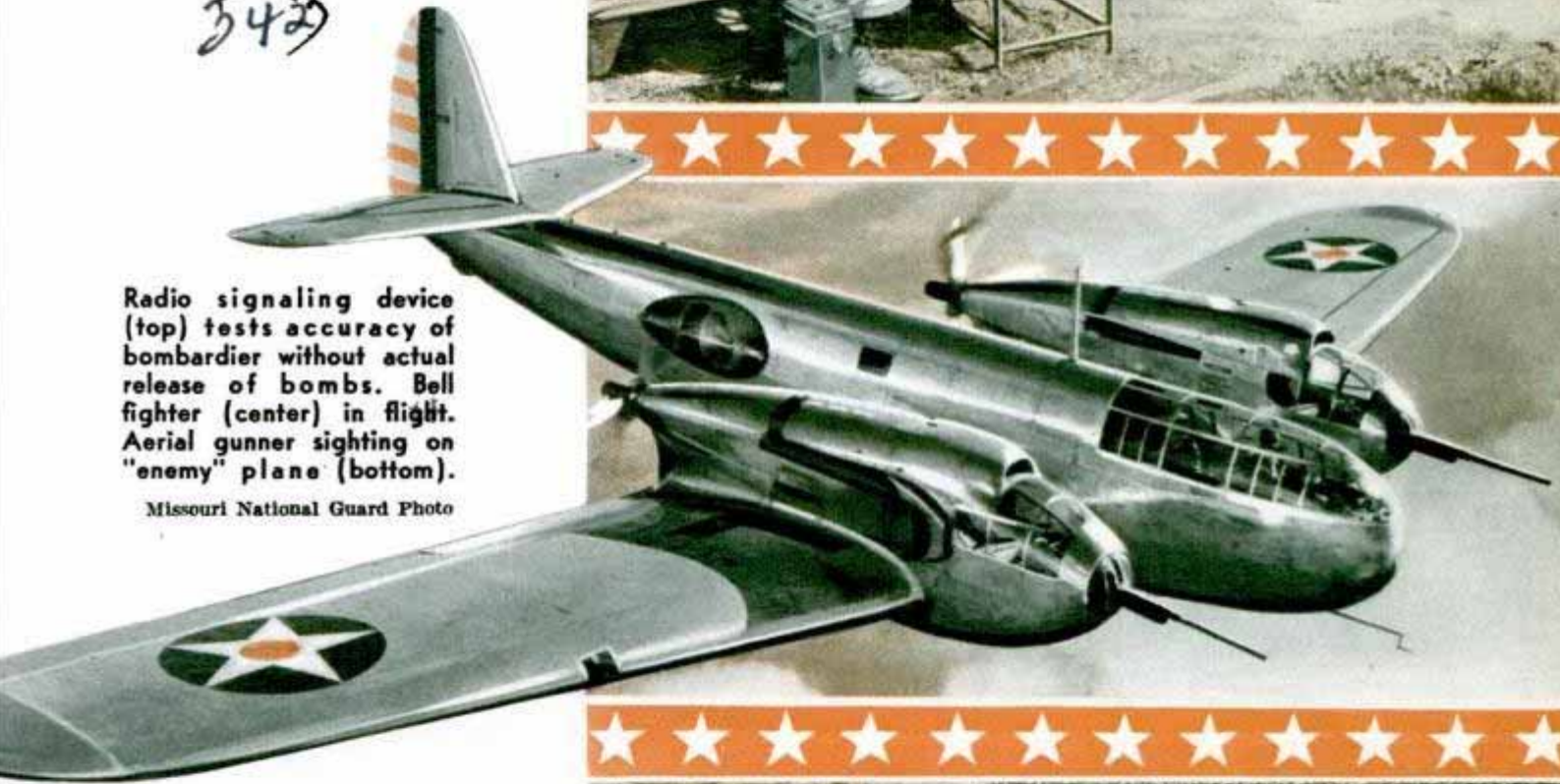

anical requires that each team, be it combat crew of a single airplane, a squadron or the entire GHQ Air Force, be thoroughly trained in an up-to-date manner at all times. Without this standard of proficiency, the unit is not an emergency force, ready to go into action instantly. Included in the "college" course on which the pilot has now embarked is every possible activity that might conceivably en-



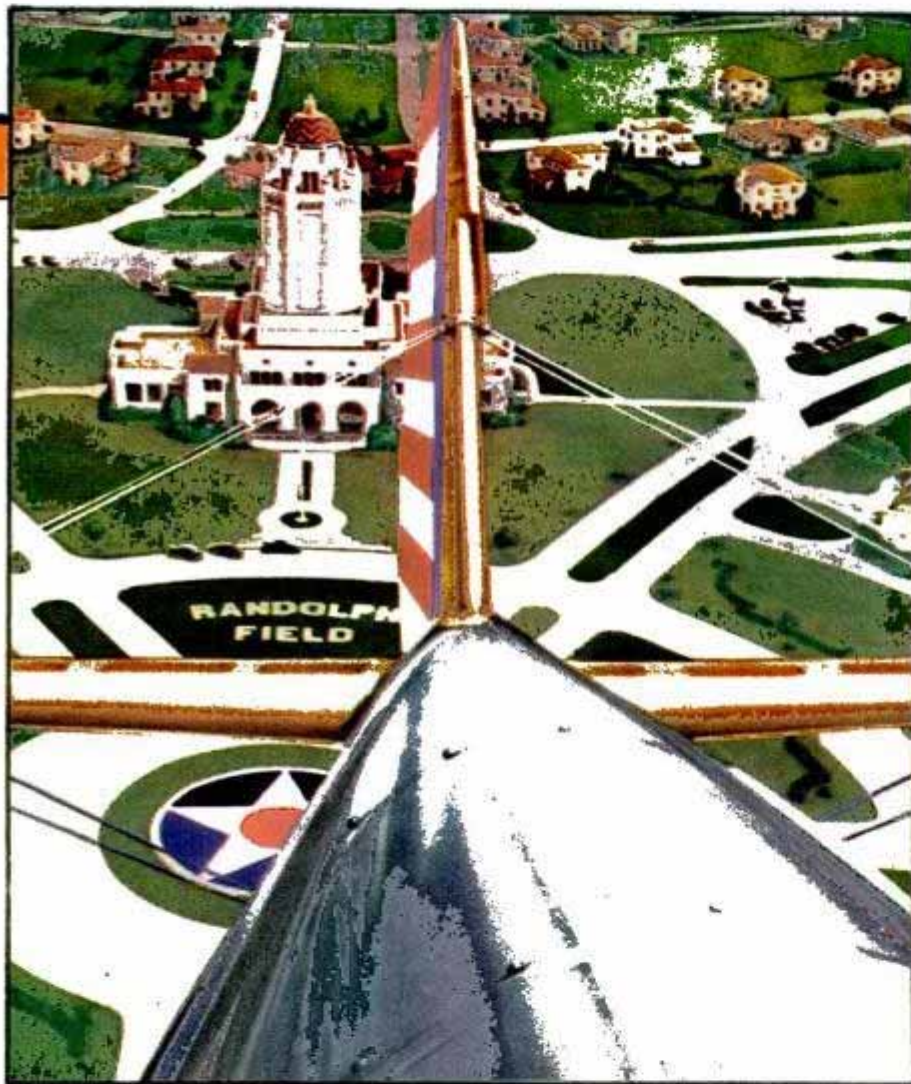

Colorful group of B-18 planes flying in formation (above). An unusual view of the administration building at Randolph Field (below) taken from the cockpit of a primary training plane with camera pointed across the tail assembly. No flashbulb was used.

344
gator, both celestial and dead reckoning. He also becomes proficient in the use of the flexible machine gun, the radio, the aerial camera and, of course, the all-important bomb sight. He has begun to learn how to "fly, bomb and shoot."

Perhaps more spectacular than the development of our tactical organization has been recent progress in the performance of military aircraft. The specifications of the first Wright airplane required, among other things, that "it carry

gage the Air Force pilot in time of war. The pursuiter continues his work on a broader scale and progresses to acrobatics, aerial combat and gunnery, in which he continues to perfect himself by constant daily practice as long as he is assigned to a tactical unit. The bombardment and reconnaissance flier "grows up" to be a first pilot and along the way learns to be an expert aerial navi-

two persons, remain aloft for a period of at least sixty minutes and have a speed of forty miles per hour in the still air." At the beginning of the World War, speeds of 100 miles per hour in level flight were yet to be reached. For many years afterward the top speed of service equipment hovered around 150 miles an hour. But about eight years ago the develop-

(Continued to page 128A)

Light Safety Plane Controlled Like an Auto

Right, Ercoupe in flight. Note tricycle landing gear and side-by-side seating. Below, cockpit of the new safety plane. It lacks the conventional rudder pedals

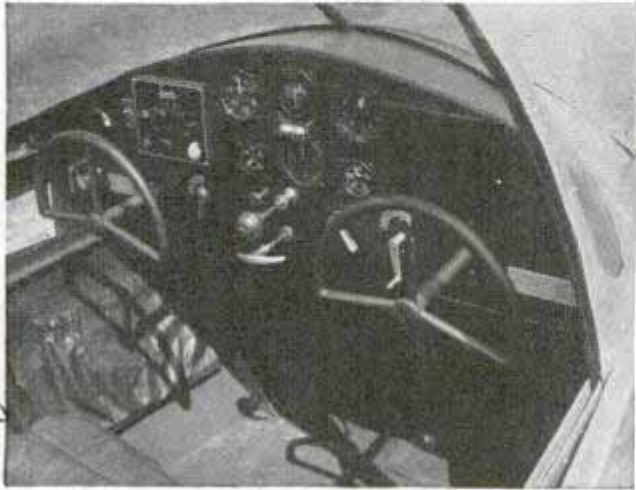

See. Oct. 1941-16 General hour. Fuel mileage is approximately twenty-six miles per gallon under normal conditions. Rudder pedals have been eliminated, the plane being flown entirely by the control wheel. Ailerons, rudder and nose wheel are all mechanically coordinated so that turning is accomplished in the air, as on the ground, by turning the wheel right or left. Proper bank is always maintained in turns at any speed. Makers of the Ercoupe claim it will not get out of control, that it will not spin. A tricycle landing gear eliminates the danger of nosing over, making landings safer. The cabin seats two comfortably side by side.

Plants Live in a Glass "Clinic" to Take a Chemical Test

Inside a "forest" of glass houses, really individual celluloid greenhouses, scientists of the U. S. Department of Agriculture are growing plants under controlled conditions to find cures for diseases and enemies for the pests that attack plants. In one experiment, the effect of boron on alfalfa plants attacked by the potato-leaf hopper is being studied. The hopper-infested alfalfa plants are grown in pure sand to which varying amounts of boron have been added, and the effect on the hopper in each individual glass "house" is watched.



Noting effects of boron in soil on hopper attacking alfalfa plants

see June 1942-72.

\$2,640 job. factory.

Engineering and Research. Cars. Riverside, Ind.

Price - \$2,590.00

R611

Continental A-65

Washington

6/17/40

Water Shrinks Huge Blades to Fit Them on Turbine Shaft

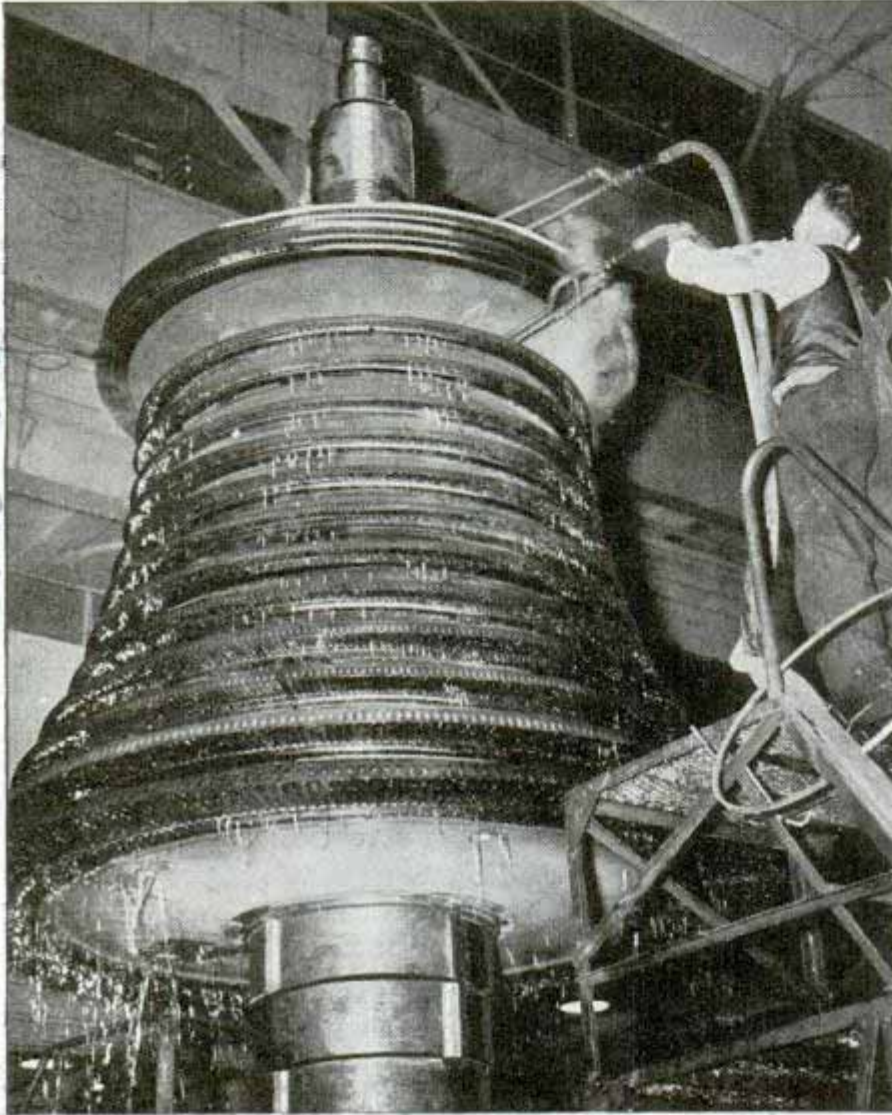

Shaft for an 80,000-kilowatt turbine being fitted with buckets which are heated to expand them and then shrunk on the shaft by applying water.

Ordinary water is used in fitting circular buckets, or blades, on the shaft of a giant turbine. After being expanded by heating in a furnace to 356 degrees Fahrenheit, the buckets are slipped rapidly over the shaft. Then water is turned on the heated disks, causing them to contract to a tight fit on the shaft.

Warm Walls Stay Clean Longer Than Cold Ones

To keep the walls of your house clean you should keep them warmer than the room, according to a Westinghouse research engineer. He explains that the molecules of oxygen and nitrogen in the air are in constant motion, their pace being quickened by higher temperatures. When the wall is warm, these molecules

move faster near this warm surface than toward the center of the room, thus keeping the dirt particles away. But when the room air is hotter than the wall, the molecules near the cool wall move slower, permitting the dirt particles to be driven against it. The effect is called "thermal precipitation."

Kitchen Ventilator Installed in Wall Runs Cheaply

Attractive in appearance and nearly noiseless in operation, a through-the-wall ventilator for the kitchen quickly exhausts smoke and cooking odors, and helps cool the room. Using less current than a twenty-five watt bulb, the fan motor runs at little expense, and can remove ninety cubic feet of air per minute. This makes it efficient for ten-by-twelve rooms with eight-foot ceilings. All parts for installing the ventilator are furnished, including the lead-out ducts, an enamel wall panel, cord and plug.

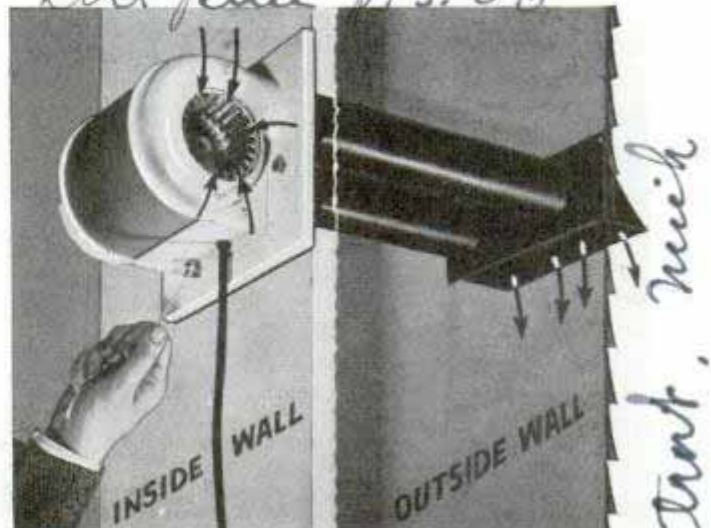

Exhaust ventilator installed through kitchen wall clears air of cooking odors and smoke at low cost

Energy Electric Co. Schenectady

Calver Service June 15, 1940

R. A. Nelson

J. L. Skuttle, Co.

contract, nich

Red pine 8/5.00

K 740

K 614

R. G. 3... British Cymrine Photo, Ltd.
271
made
need



R643
**Dogs Trained for War Duty
Give Aid to Soldiers**

Seeking the wounded, carrying telephone wire, transporting messages and food and serving as a means of getting pigeons to points from which messages and photographs may be flown back to headquarters are just a few of the duties which dogs can be trained to perform in wartime.

Circle, top, soldiers teaching a dog how to advance through smoke. The dog is equipped with a gas mask. Right, a soldier places a message in container attached to the dog's collar. Below, left, dog equipped with a first-aid outfit races to the scene of operations. Right, a soldier placing a carrier pigeon in a basket attached to the dog's back

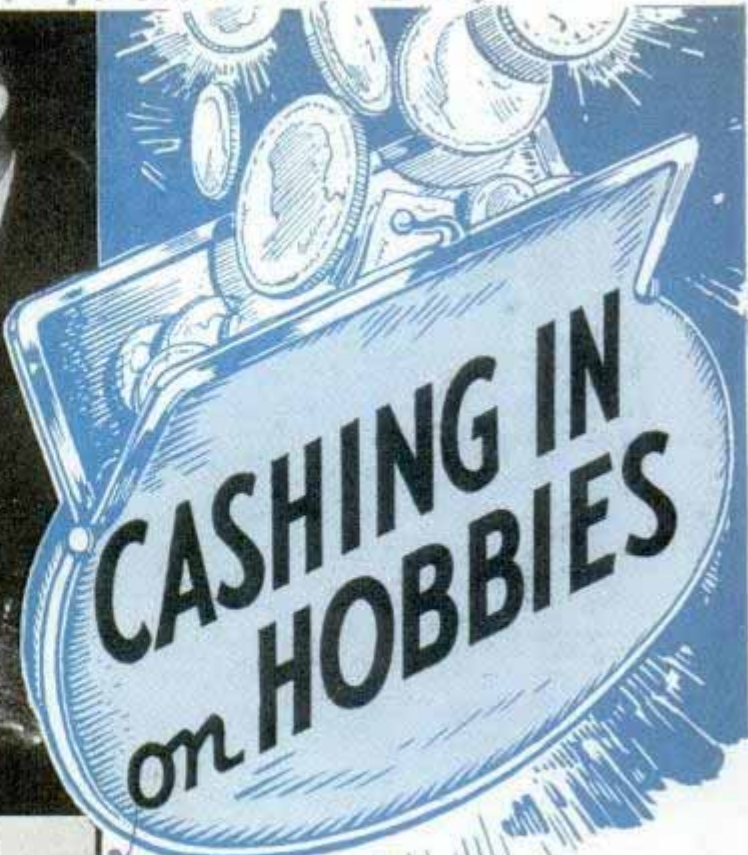
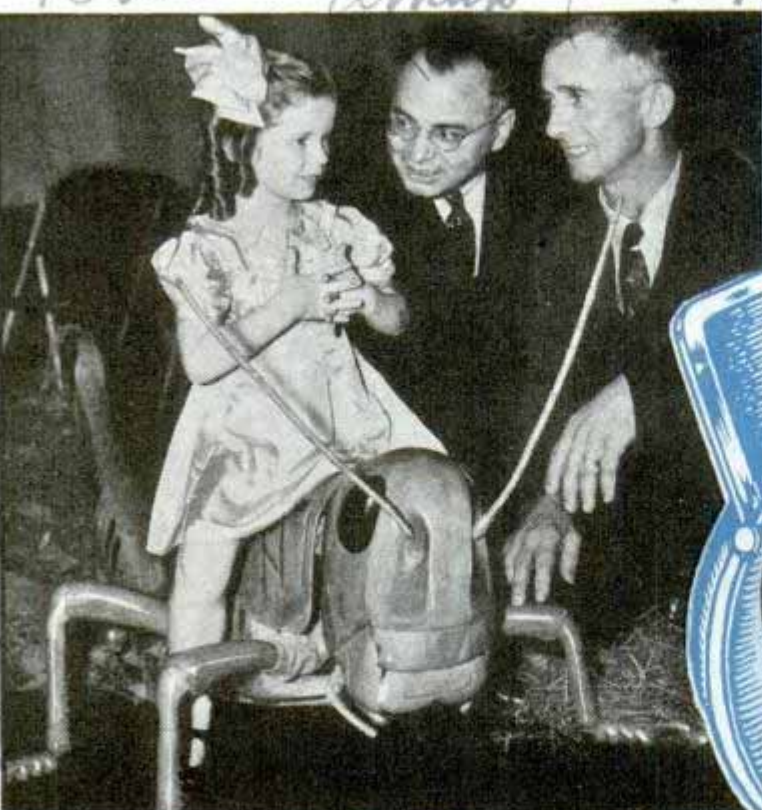

By Dave Elman

Director, "Hobby Lobby" Radio Program

OF THE millions of hobby fans in the United States, it is safe to say that not one in a thousand thought at the start of making money from his avocation, yet hobbies in countless cases have turned out to be amazingly profitable side lines. Take for example, Thomas T. Hersey, a farmer of Mitchell, S. D. In 1936 a horde of grasshoppers swept over his land, devouring his crops, stripping bare his garden and orchard.

Hersey brought a handful of the insects into the house. His anger and despair soon turned to curiosity as he studied their mechanically efficient bodies. They became his hobby.

He constructed a gigantic grasshopper—about the size of a child of eight—out of scraps, paper, wood, Cellophane, fur, wire, string and oilcloth, so anyone could see what the interesting insect really looked like.

One day, as a test, he set the finished 'hopper alongside a railroad right of way and watched. An engineer glanced, then looked, then gazed goggle-eyed. Finally

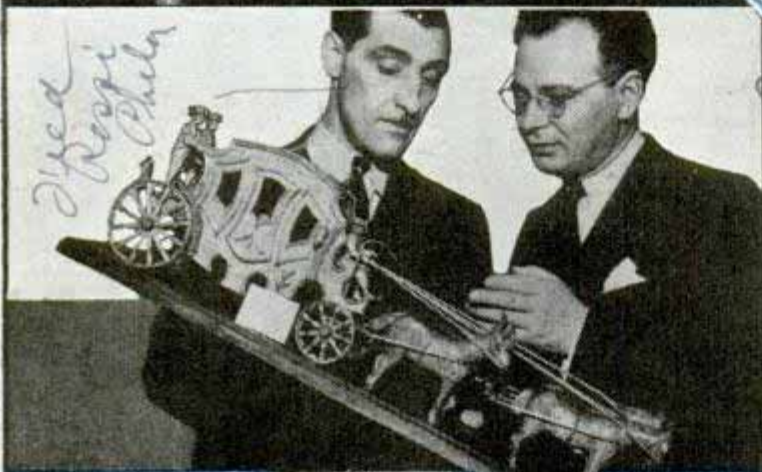

Farmer (top) earns money with animated grasshoppers. Coach was made of 8,140 matches. Homemade toy washers "clean up"

K-366 Elman Mitchell
 com. Allen Warren Elcott
 120 E. 34th Street
 Detroit
 Sam Rubin

he stopped the train and got off to examine this gargantuan insect.

If his grasshopper would stop a train, Hersey decided, he had something. So he took the 'hopper into town and sold it for enough cash to buy two cows. The purchaser was a store owner who realized it would attract trade.

Bigger and better grasshoppers,

*V. J. Shulluck
Oakland
Calif*

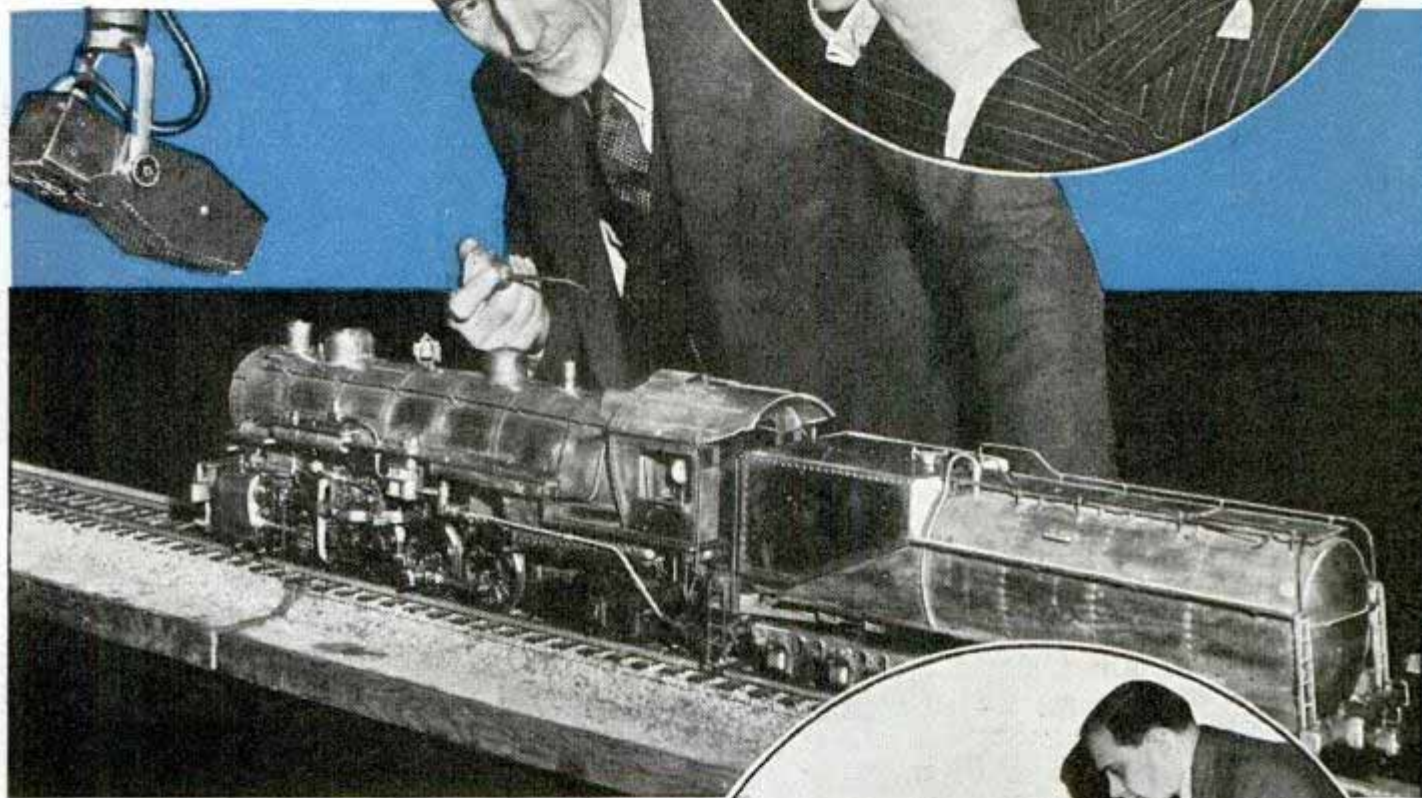

huge horseflies, black widow spiders with stomachs like basketballs, butterflies with four-foot wingspread, all lifelike and animated, followed. Now Hersey has a business which beats farming from here to the barn door. He no longer feeds insects; they feed him.

Many camera fans have made money, but there is the case of a dying boy's photographic hobby which put his brother and sister through college and his mother in comfort although the lad in his teens didn't live to make a picture.

In April, 1931, John Keaton, hopelessly ill in Munising, Mich., begged his mother, Mrs. Mildred



Sellen Camp, Akron, Ohio

Pumpkins with faces bring \$10. Model engine runs on 500-foot railway. Dog taught to play electric piano is now in vaudeville

"Ulla"

William L. Reid
White & Carter

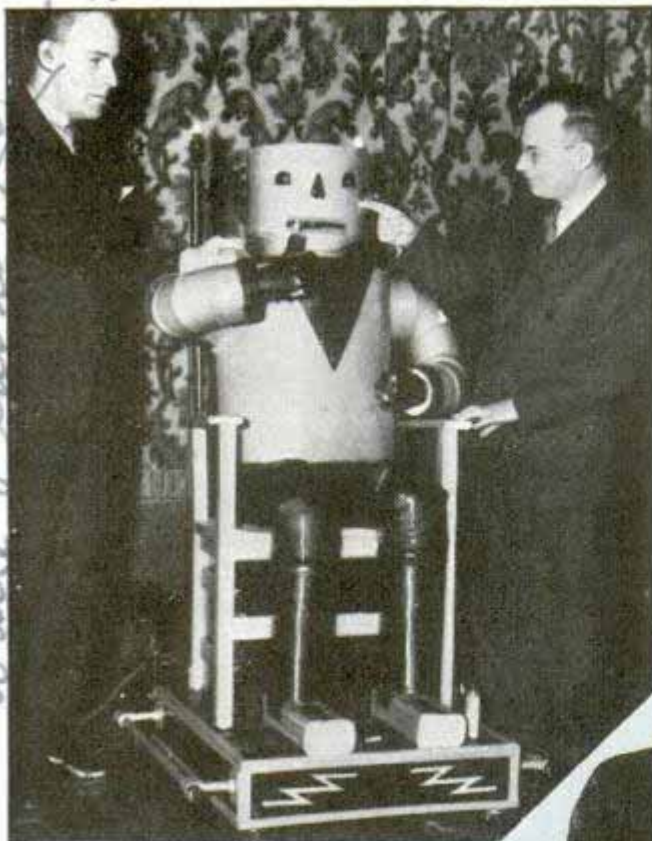

speedboats and when the orchestra disbanded, he got a 150-dollar-a-week job designing and manufacturing boats. He took up hobby Number Four, woodworking. When lack of business cost his employment in the boat yard, he used Number Four to set up a novelty woodworking factory in St. Petersburg, where he has twenty employes making buttons, buckles, bag tops, compacts, cigarette cases and even belts of wood.

Treasure hunting is the hobby of thousands, but Dr. Cyrus French Wicker, professor of international law at Miami, Fla., made it pay. Inventing a metal detector on radio principles, he visited the West

Keaton, for a camera. It seemed a waste of \$100 just when they needed the money most, but she humored the boy, knowing he had little time to live. John read books on photography and instructed his mother how to take pictures, develop negatives and print. One day they sold the picture of a smiling baby.

Soon after this, John died. His mother made their hobby her profession. She has sold hundreds of pictures for rotogravures, magazines and newspapers; her photographs have hung in many international salons.

A German dentist, Doctor Hans Sachs, selected as a hobby the collection of toothpicks, some of metal, some decorated with jeweled handles and some dating back to the days of Pompeii. He became an expert on toothpicks and sold six books and innumerable magazine articles on the subject.

When Earl Gresh of Miami was wealthy, his hobbies were fishing and the violin. One day he suddenly found himself broke. He fell back on hobby Number One, fishing, in Florida. Here he met six students from Kentucky, all musicians. He revived hobby Number Two and they organized an orchestra. Hobby Number Three was

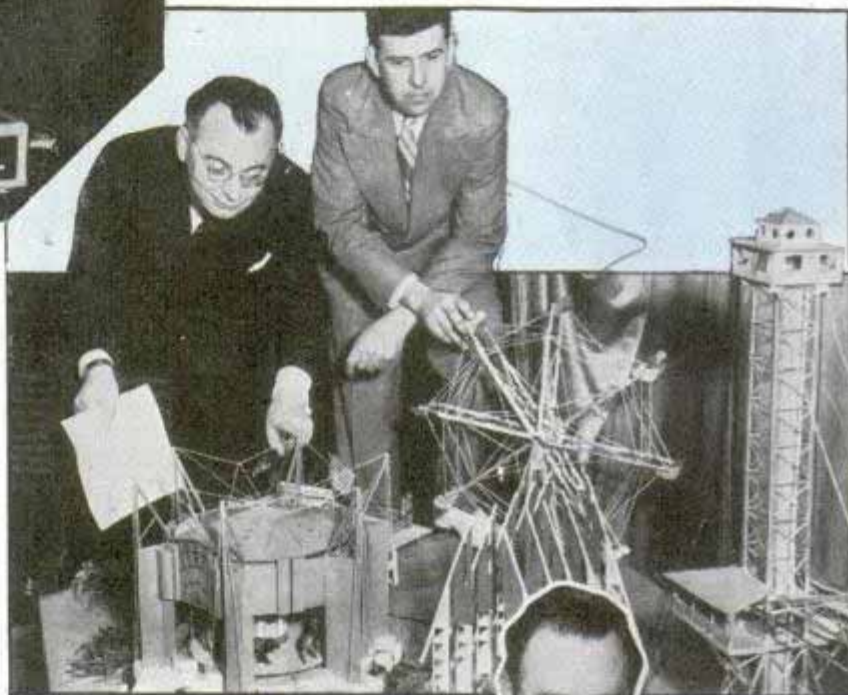

Joe Attilery, Tulsa

"Talking" robot, top, is an electrician's hobby. Below, miniature amusement park and alarm clocks played as musical instruments

Indies, and unearthed a chest of treasure containing relics believed to include antique jewels and coins worth thousands of dollars.

It is surprising how many of the younger generation find hobbies pay dividends. Bob Johnson and John McNaught, both sixteen, of Kearny, N. J., organized a juvenile motion-picture company, hired high-school students as helpers and are making pictures which they show in schools, clubs and churches. With a small movie camera, they have produced seven comedies, four travelogues, one mystery and two dramas.

Dick Fjellman, Oliver Engbretson and Stewart Sumner, of Minneapolis, all in their teens, wanted to play ocarinas but couldn't afford them. Failing to make them out of clay, they experimented with wood and discovered a process. Such well-known band organizations as Louis Prima's, Jimmy Dorsey's, the Schnickelfritz Band and the Hoosier Hot Shots are playing their instruments.

John M. Caeszczicki, landscape gardener of Madison, Ohio, discovered that if he put human masks on pumpkins when they were the size of apples, the pumpkin would retain the human features as it grew. From fifty last year to a prospective crop of 2,000 this year indicates his success. They retail for ten dollars each.

Sam Kahn, Detroit electrical appliance service man, tried to find a miniature washing machine that really washed, as a present for his niece. He couldn't, so he started making them as a hobby. Now he's in business.

Carl Seagren, of Brooklyn, a baker, made novel cakes his hobby. One day he fixed one so that when the cake was cut, a string was severed and the cake played "Happy Birthday to You." Now his orders come from all parts of the United States.

While hunting a job, Sidney B. Lubin of Atlantic City made a xylophone of plate-glass strips, and also an organ, using a vacuum cleaner, an inner tube, part of a broken sink and a few bottles. The first thing he knew he had a job, playing his contraptions on an amusement pier.

More profitable was the hobby of A. George Stern, of Washington, D. C. He liked to experiment with the reproduction of commonplace objects by using other commonplace objects. Some of the out-

(Continued to page 138A)

Hand-Operated Addresser Useful in Small Office



Portable addressing machine prints name and address on envelopes eight times faster than by hand.

Envelopes are addressed eight times faster than by hand with a portable, hand-operated addressing machine useful for the home or small business. Addresses are cut on tiny card stencils with a typewriter, each stencil being capable of printing 10,000 times, according to the manufacturer. The feed hopper holds sixty-five stencils.

Inexpensive Blocks Test Tools for Precise Measurements

Precision testing blocks for checking the accuracy of micrometers, vernier calipers, lathes and other machine tools are now available at a price within reach of the small shop and mechanic. The blocks are accurate within eight millionths of an inch.



Making a test with the low-cost precision blocks, which are accurate to 8/1,000,000 of an inch.

George Scherr Co
128 Lafayette St
Albany, N.Y.

Old "Quakes" Are Repeated to Analyze Relative Shocks

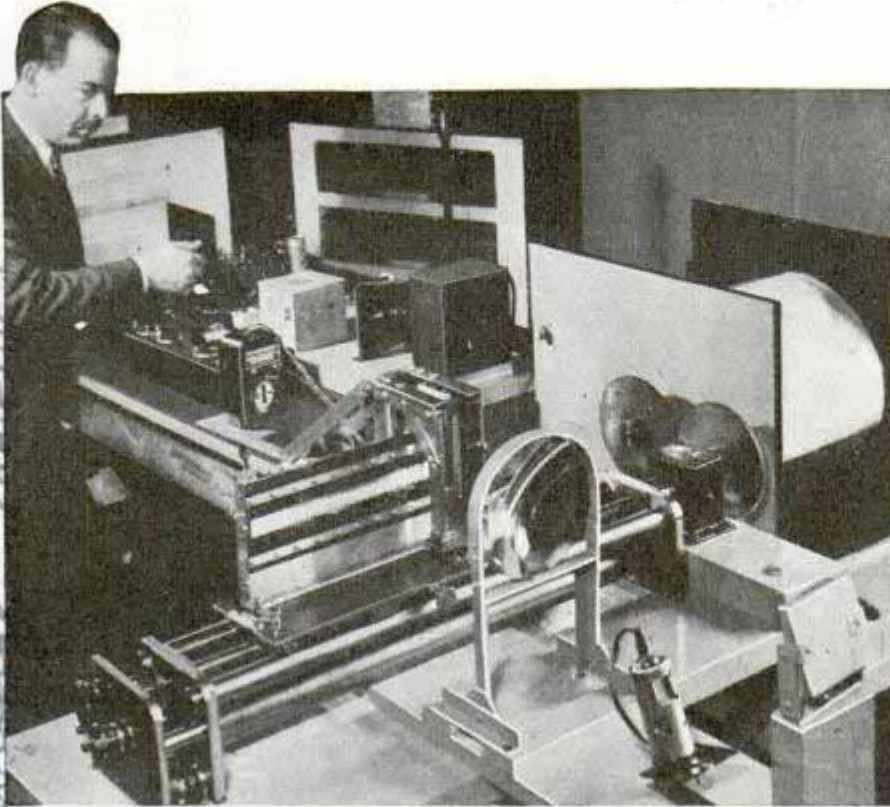

Earthquake analyzer, reproducing shocks on small scale by "scanning" film records made with seismograph, helps study effect on buildings

Few persons would want an earthquake repeated, but seismologists using an analyzing machine make them come to life again, on a miniature scale, in order to study carefully the effects of past earth shocks and classify them. "Strong motion" earthquake recorders, located in the vicinities where they occurred, have charted about forty temblors, but something better than visual examination of these complex film records was needed for comparing them scientifically. The earthquake analyzer, developed by Prof. Arthur C. Ruge of the Massachusetts Institute of Technology, is the answer. With this instrument, the wavy lines in the films are scanned by an electric eye and converted into a series of electrical impulses, which in turn set up a swinging motion in a galvanometer. A spot of light from a tiny mirror on the galvanometer is reflected onto a revolving drum covered with sensitized paper, providing a permanent record of the galvanometer's motion. This swinging motion represents the swaying of a building during

the earthquake, and it can be altered to vibrate with the characteristics of any desired structure, enabling the engineer to determine the reason for failure of buildings destroyed by severe shocks and to devise methods of construction that will be more resistant to earthquakes. The machine may also help solve vibration problems in industry.

"Packaged" Photo Darkroom Is Put Up Quickly

Completely lightproof and dustproof, a collapsible darkroom for photographers can be assembled within a room, using only a screwdriver. Erected, it measures seven by six and one-half by three and one-half feet; dismantled, it folds into a package only forty-six by twenty-six by eight and one-half inches and weighs forty-five pounds.

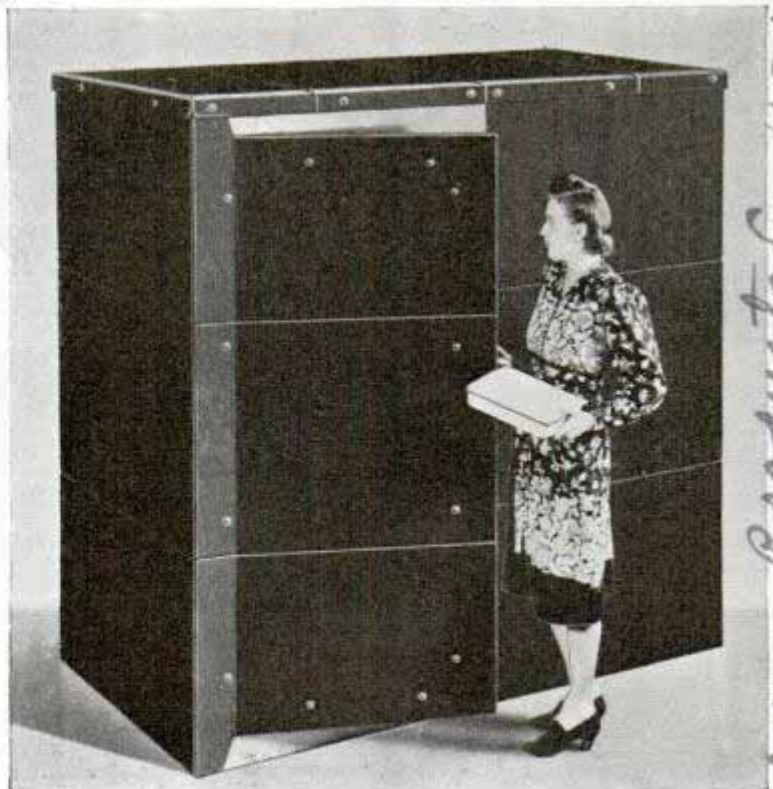

Collapsible darkroom for photographers can be assembled inside the house in a few minutes, using only a screwdriver

Prof. Engineering Technology
 1154
 Nebraska Ave.
 Almo.

X 660. Press Wireless one

'Sweep Circuit' Ends Streaks in Radio Photos

1495 00 radio news

To eliminate the characteristic streaks and blemishes appearing on photographs sent by short-wave radio, engineers for Press Wireless have developed what they call the "sweep circuit." Pictures sent by the new method are remarkably free from the black and white lines caused by fading, echo, diathermy and natural "static" during the scanning. The "sweep circuit," to be placed in operation at Paris and New York offices of the communications company which handles press stories and pictures by radio, has been likened to a fine-tooth comb which controls the modulated photo signal coming through on a

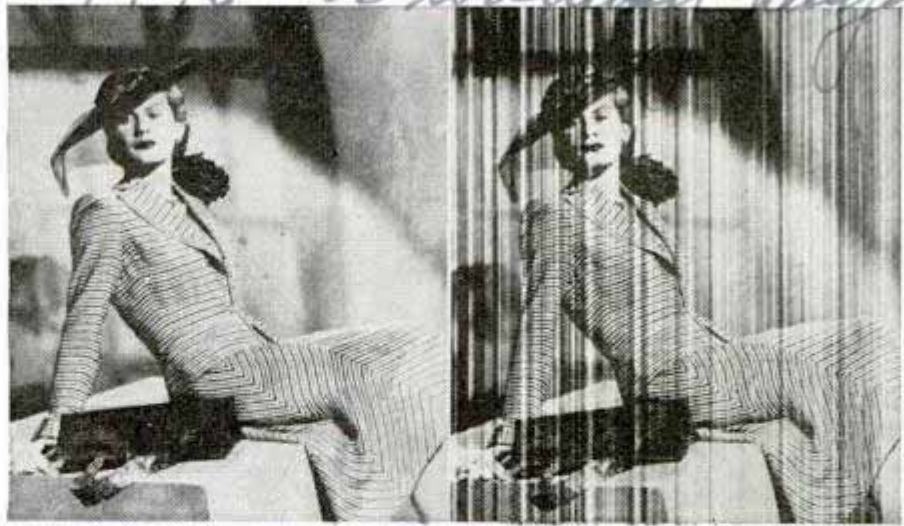

At right is a photograph transmitted by radio in the conventional way; at left, the same picture transmitted by the "sweep circuit"

radio frequency channel five to fifteen kilocycles wide. The signal jumps from one tooth to another, and since the circuit is sweeping across the channel continuously, the usual trouble is eliminated.

'Streamline' Garage Workbench Holds Specialized Tools

Master Advance



Specialized tools, supplies and working space for each section of "departmentalized" garage are centered in these "streamline" workbenches

To modernize the automotive service shop, "streamline workbenches" have been introduced, providing departmentalized working space and compartments for the specialized tools required in each department. One bench, for example, is the center for servicing wheels, brakes and steering gear; another for ignition and radio, a third for engine and carburation work, and another is an "oil bar."

Stewart Warner
Alomite Corp., 1828 W. Levee, Chicago

Light Plug That Locks in Its Socket Is Released by Pushing a Button

11518

Fitted with "L" type contact points that lock tightly when pushed into the socket, a new light plug makes a positive contact and will not slip out accidentally. To release it, a button on the surface of the plug is pressed, squeezing the points together and freeing the lock.



Pressing button on side of plug releases the contact points automatically locked in socket

4360 I van Thorson
11130 Melrose

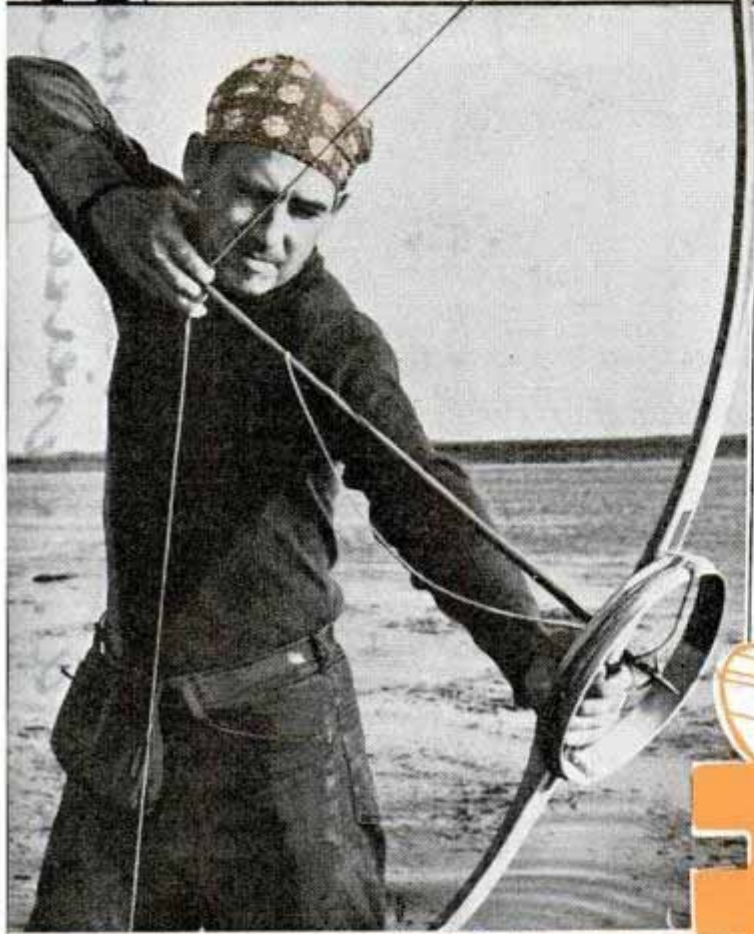
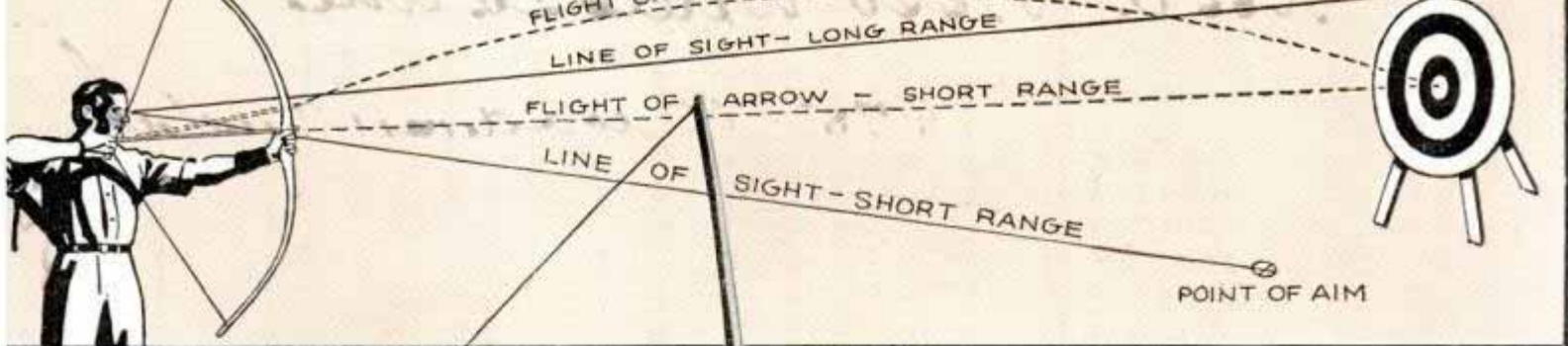

^{K112}
ROBIN HOOD is to archery what Santa Claus is to Christmas. The green knight of Sherwood Forest who robbed the rich to help the poor is supposed to have been one of the best bowmen of all times. Yet, were it possible to match him against a modern archer who uses scientific equipment and improved technique, poor Robin would make a sorry showing!

So says Howard Hill, Los Angeles bowman. Hill should know. He's the world's champion field archer and has duplicated almost all of Robin Hood's feats with bow and arrow.

"That Robin Hood shot a mile is rot!" says Hill. "That he could split one arrow with

1200 7 Satiny, north 1200 wood.

Beating ROBIN HOOD

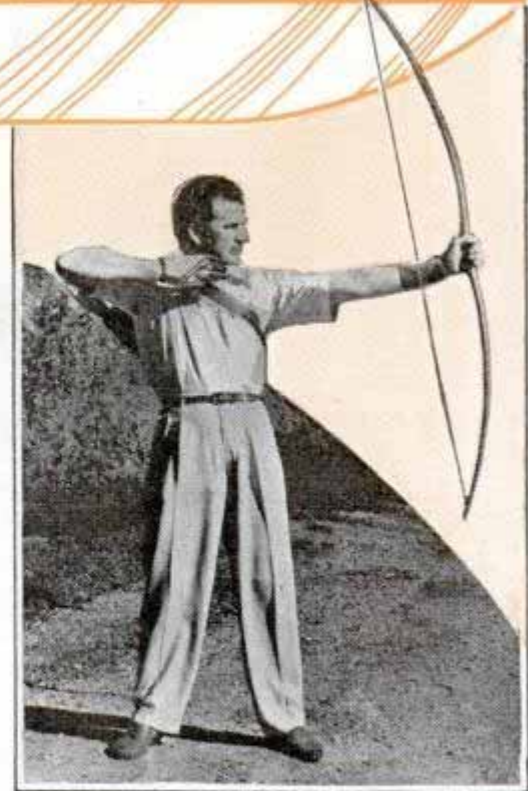
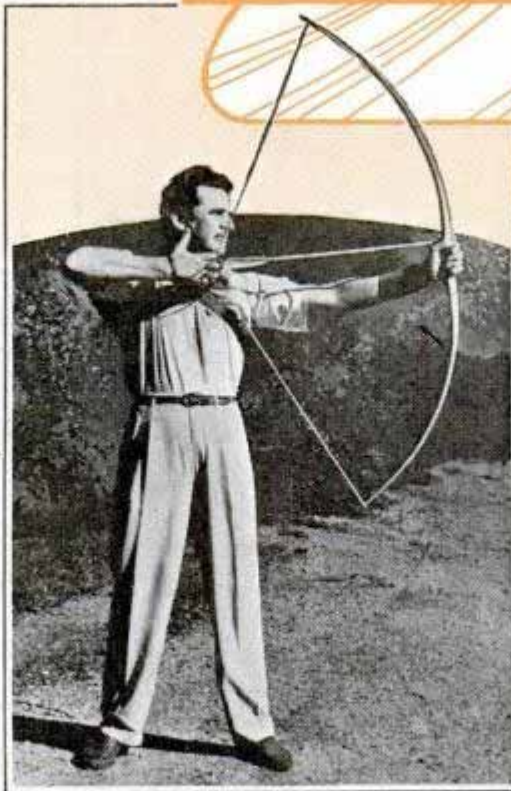
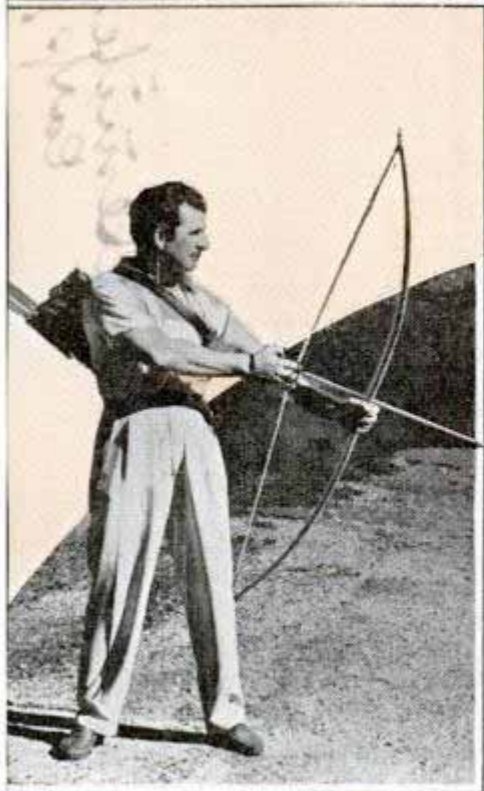

In shooting fish, above, line is rigged to arrow to play fish. Bottom, championship form; face 90 degrees from target, hold thumb at ear to anchor shaft at same place each time, hold pose until arrow hits target

Com. Andrew Hamilton R112
Enroll 1539 & Beverly Helen Blod
W. Los Angeles Calif

Howard Hill

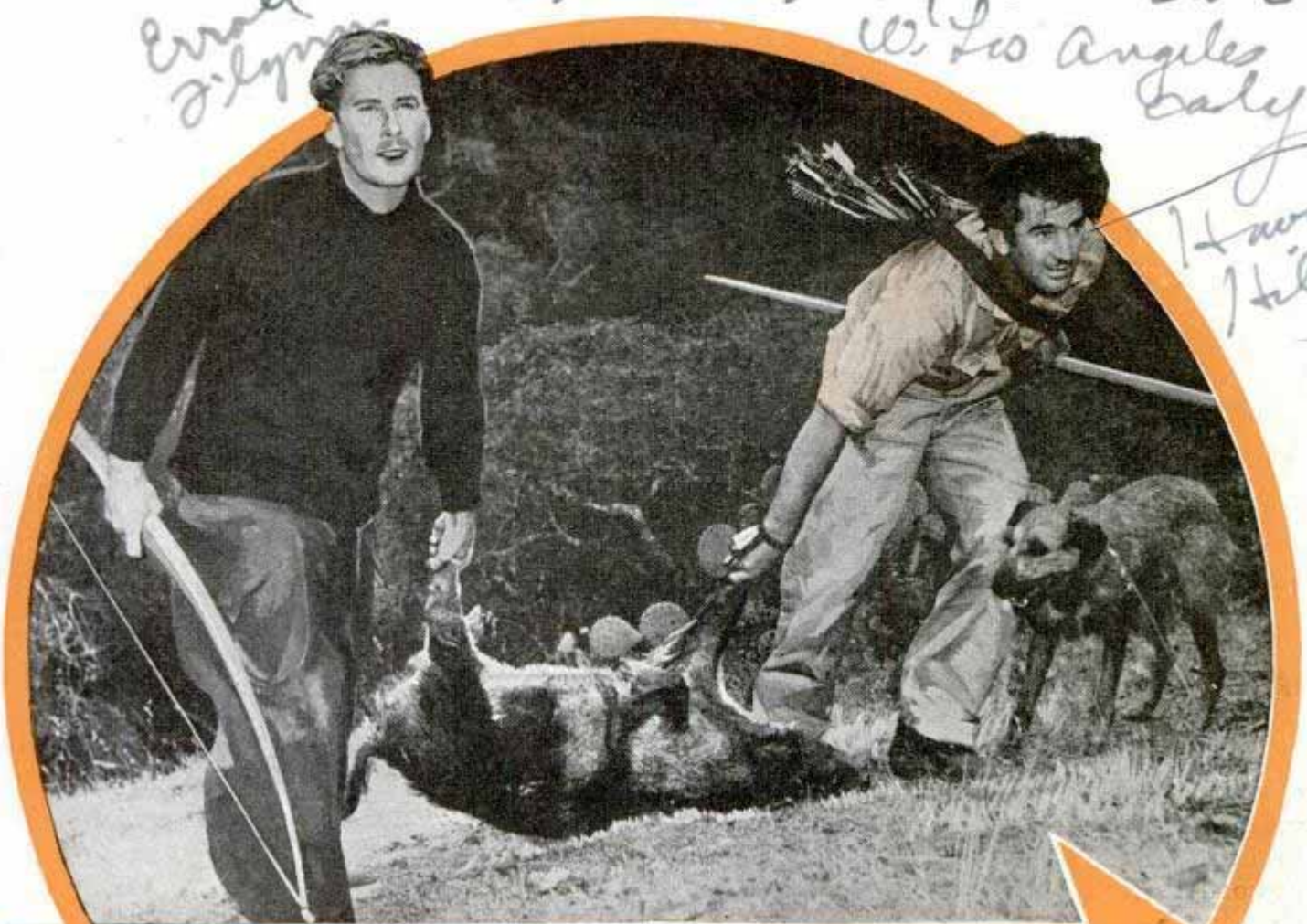

at his OWN GAME

another at 100 yards every time is equally absurd—although this has been done accidentally by many a modern archer. All in all, the modern archer probably could shoot rings around Robin Hood."

Archery is one of America's fastest-growing sports. The National Archery Association estimates 1,500,000 persons in the United States are enthusiasts. From Maine to Florida, California to Washington, they thrill to the tensed strength of the drawn bow, the swift, silent flight of the arrow and the satisfying "plunk" as it sinks in the target.

"There are three main types of archery today—each as different from the other as skeet shooting, artillery practice, and deer hunting," points out Hill. "Each requires a different kind of equipment, skill and temperament."

Target shooting, he says, claims the widest number of devotees. The "point-

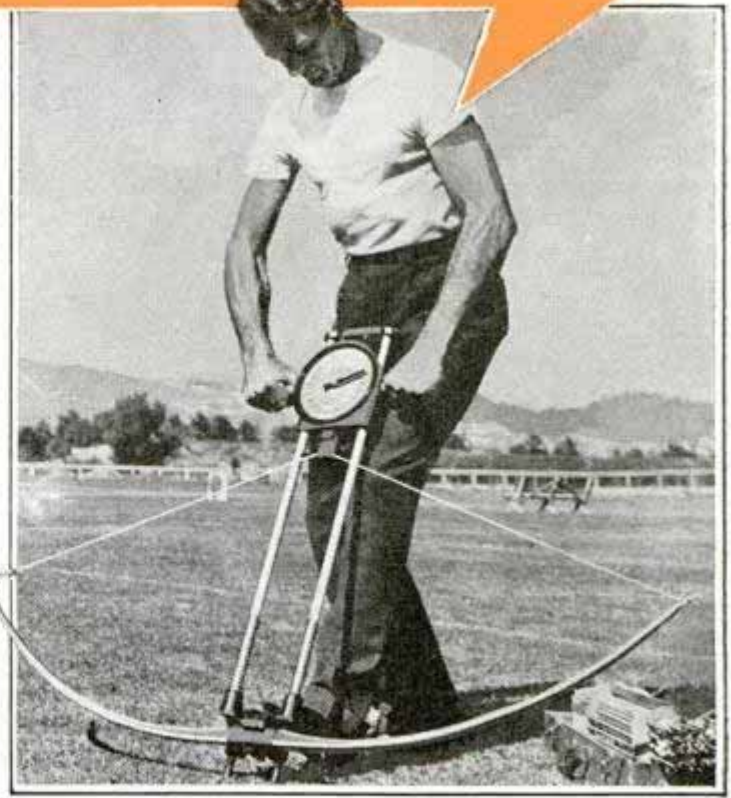

Top, bringing in a wild boar shot with bow and arrow. Below, measuring pull of a bow in pounds with a spring scale

K112.

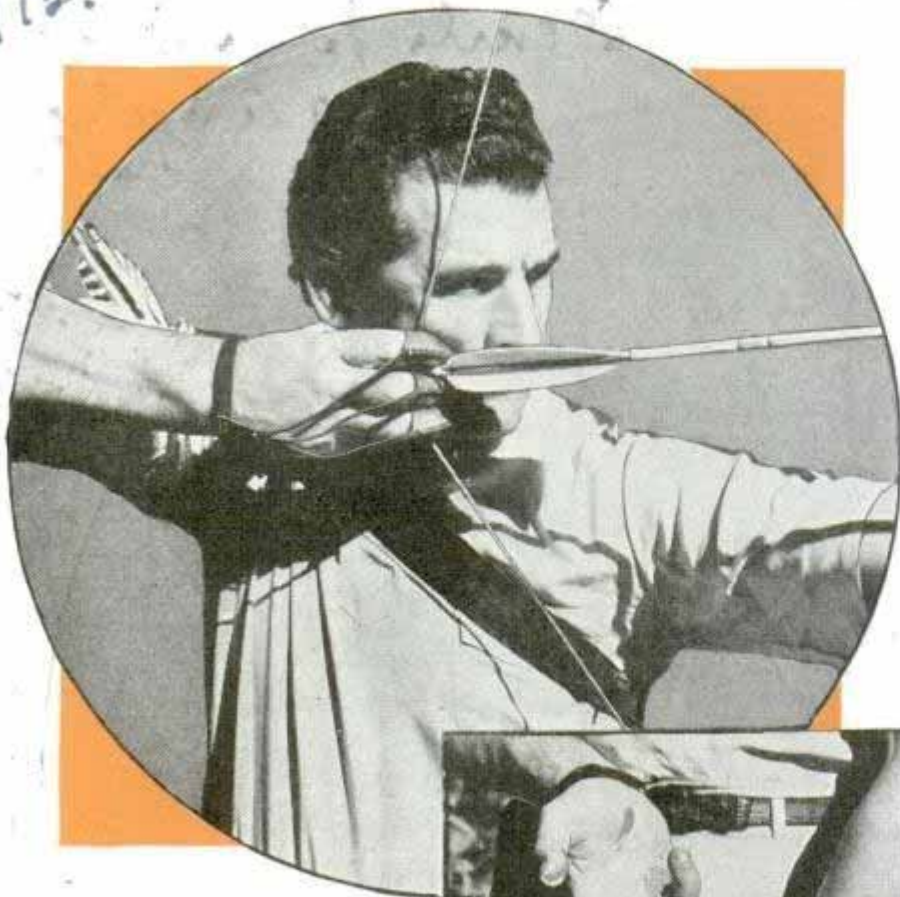

of-aim" technique—developed by Horace A. Ford in England about 1850—revolutionized target shooting.

"In a nutshell, the point-of-aim technique allows the archer to draw the arrow under his chin instead of to his eye," explains Hill. "Today's Bowman sights on a point somewhere on the field or above the target which is changed according to the distance. In Robin Hood's day the point of aim was unknown, hence modern archers are more accurate in target shooting."

According to Hill, target shooting requires constant practice and flawless technique. The secret of good shooting is to extend the bow arm, draw the arrow, freeze on the point of aim, and loose the shaft in exactly the same way each time. This requires steady nerves, stamina and perfection of detail.

Modern bows are made

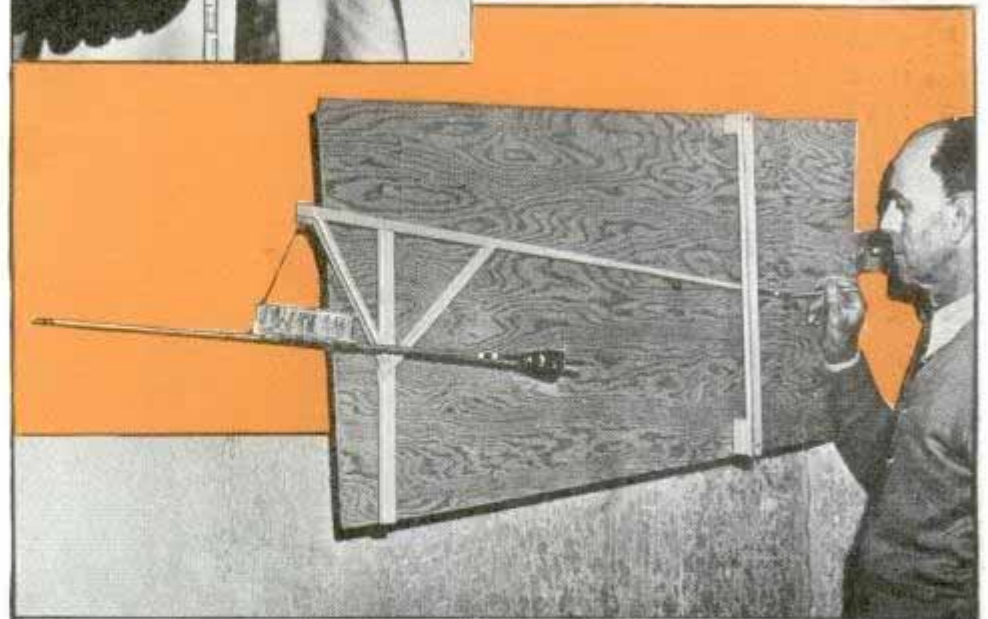
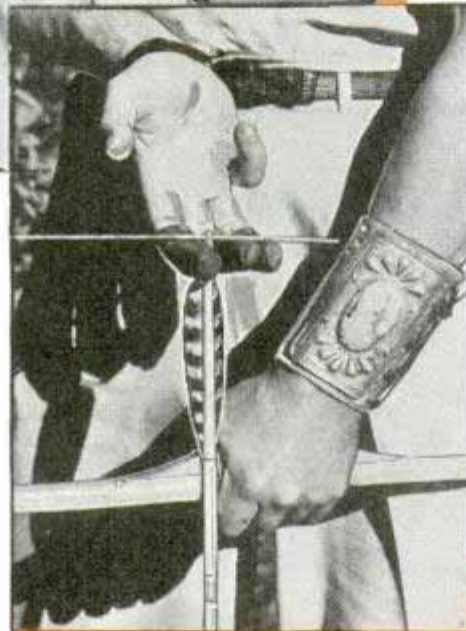

In target shooting, shaft of arrow is held to chin. In field archery (top) a flatter trajectory is acquired when arrow is held to cheek; note the standard three-finger pull. Closeup in center shows how arrow is nocked to string and how it lies across bow hand. Bottom, arrows must balance to a fraction of an ounce; this weighing machine turns out perfect arrows

scientifically so that a ninety-pound woman can handle her bow as easily as a 220-pound man. Women's bows have about a thirty-five pound pull while men's bows have a forty-five or fifty-pound pull. This means that in tournament shooting a man pulls about 21,060 pounds while a woman pulls about 8,640 pounds.

The second division of archery, flight shooting, attracts enthusiasts whose only interest is in how far they can cast their long-shafted arrows. Amazing stories of incredible long-distance shots have come down from former times—but it is hard to separate fact from fiction. The most authentic record seems to have been a 482-yard shot made in 1795 with a Turkish bow.

Today Homer Prouty holds the restricted world's record (from a standing position) with a shot of 478 yards. Corliss Hill holds the world's

foot-bow record (from a prone position) of 614 yards. This is as far as an ordinary rifle bullet travels and four times as far as Babe Ruth's longest home run clout. Longer shots have been made but not yet recognized as official.

The heaviest flight bow to be found in any museum is about ninety pounds. Today's flight shooting bows run as high as 172 pounds. The flight arrow is one-third again as long as the average target arrow.

"Robin Hood's greatest feats were in hunting the deer and wild boar in the King's private forest," declares Hill. "With Robin Hood and the American Indian, field archery was instinctive—a skill that had come down through generations of men who procured food and clothing by the bow. The bowman of today must learn field archery in the slow and painful school of experience."

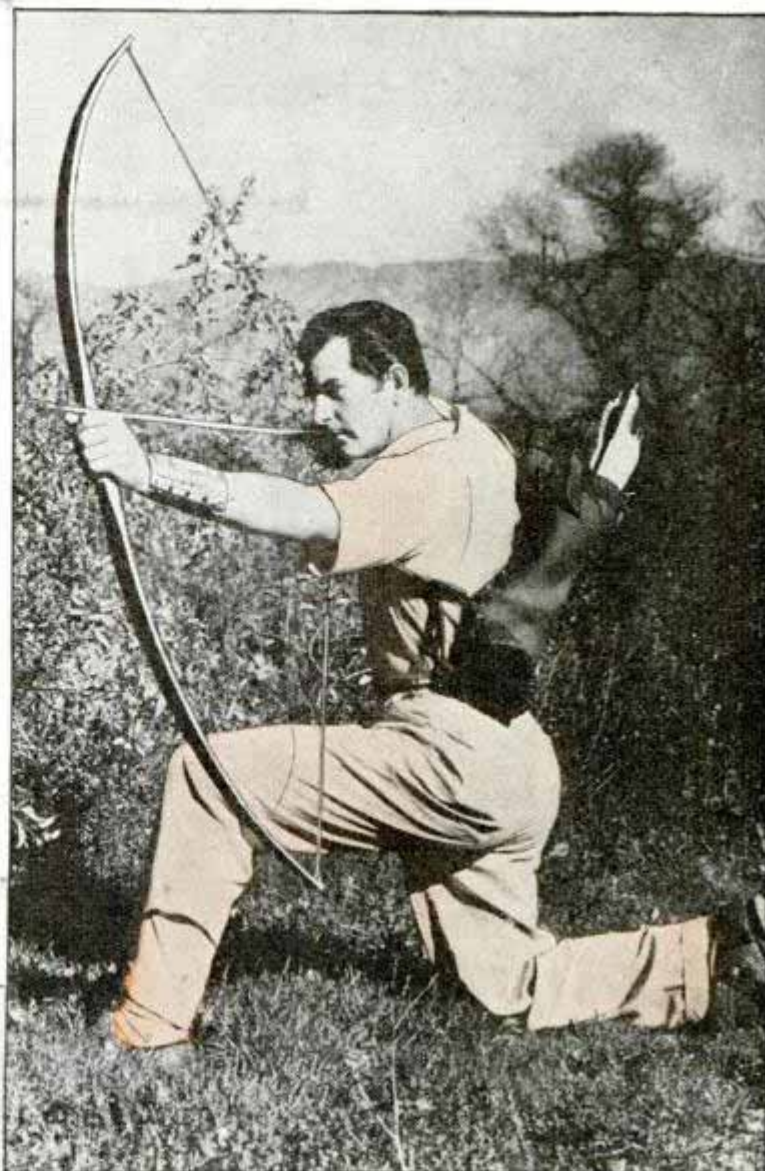

Above, the kneeling position for hunting game. Left, a shark shot with bow and arrow

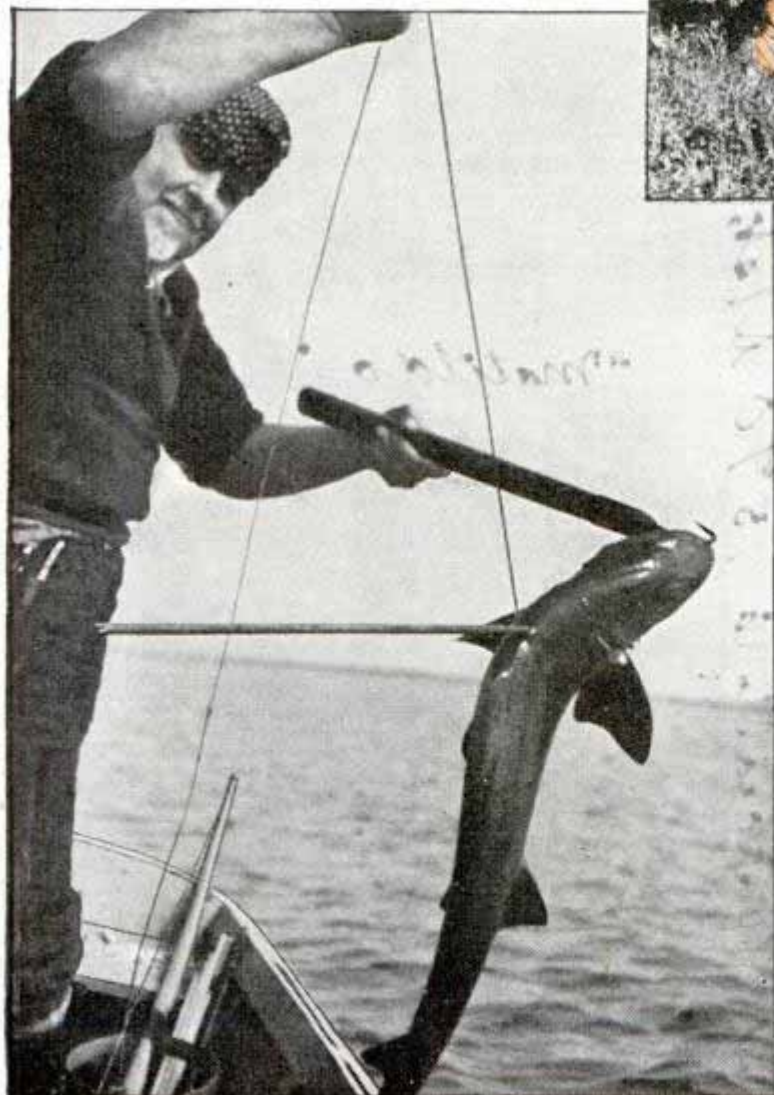

About 15,000 field archers today roam the woods, deserts and mountains with bow and feathered shaft in search of game. Wisconsin, Oregon, Utah, Pennsylvania, Ohio, Michigan, Arizona and Washington all have special hunting seasons or preserves for archers.

To be a successful field archer you have to practice year in and year out, to the exclusion of target shooting and flight shooting. You cannot expect to shoot at a target all year long and then go into the woods for two weeks in the fall and bag a deer.

Here is the advice of America's champion field archer:

"Start slowly. Go out in a field and shoot at something on the ground—long shots, short shots, fast shots, slow shots. Practice shooting in open country and in thick brush, on level ground and on

(Continued to page 114A)

K 587

Bell-Shaped Water Tower Cuts Wind Resistance

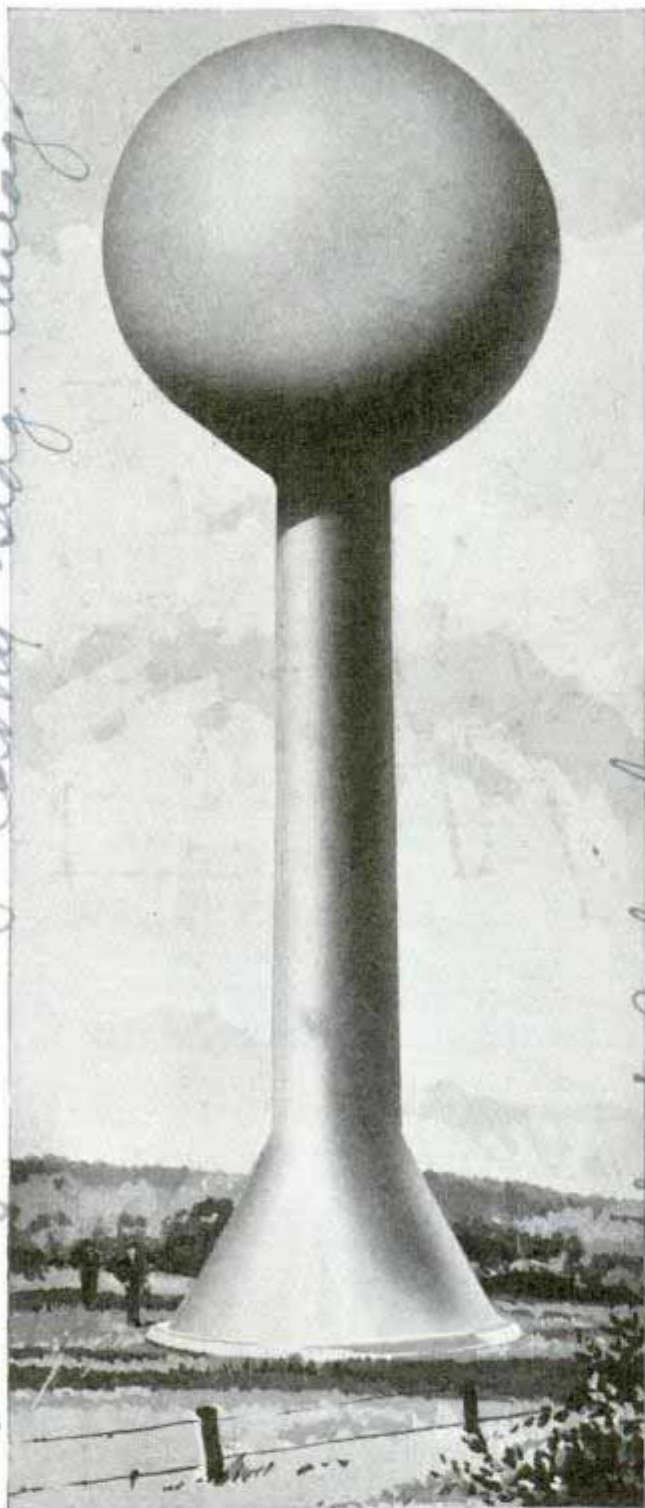

Plates made by Chicago Bridge & Iron Co. 2402 Ala. Calumet Bldg. Chicago

Presenting streamline surfaces in all directions, water tower reduces wind resistance forty per cent

Streamlining of a spherical water tank supported on a cone-shaped base has reduced wind resistance about forty per cent, according to the designers. Strength has been increased by welding the steel plates, not a rivet being used in the structure. This also reduces weight. The tower, which will be 130 feet high, is being erected near St. Paul, Minn. With a capacity of 250,000 gallons of water, the spherical tank is

89143 Search
 forty-two feet in diameter. The tank rests on a tubular base which tapers upward to about ten feet at the smallest section.

K 678 Chicago

Thermometer in the Water Line Helps in Photo Developing

\$7.50

Adjusting the tap water to the right temperature for photo developing and then keeping it running at the exact temperature is facilitated by a hose in which a thermometer is enclosed. The rubber nozzle fits over the mixer faucet, and below it is a glass tube containing the thermometer, with magnified figures.



K 603

Ornamental Duck Spins Its Head to Sprinkle the Lawn

When it's not on active duty, an enameled duck made of rustless steel is a novel lawn ornament. During "business" hours its head rotates furiously while it sprinkles the lawn from holes in its head and bill. There is a standard hose connection in the side, and the duck fills with water before it starts sprinkling, so that it is heavy enough to remain in place.

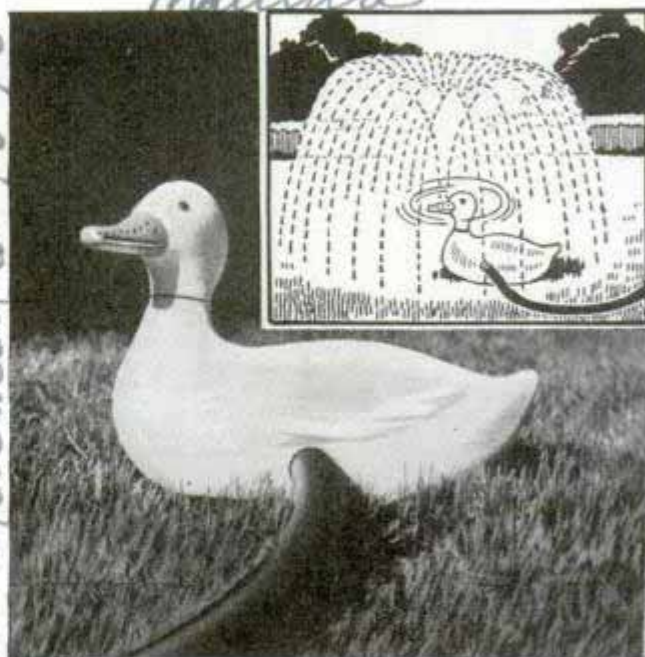

Fields garden section (P)

Filled with water, duck is heavy enough to anchor itself; then head starts spinning and sprays lawn

'Iron Lung' Jacket Releases Confined Patient

Victims of infantile paralysis who need breathing aids may find release from close confinement by wearing a newly invented portable "iron lung" that is put on like a jacket, and resembles the breast-plate of a knight's suit of armor. Bands of rubber at the waist and wrists make it airtight. It gives the wearer greater freedom of motion than is allowed by more cumbersome outfits and with its operating mechanism may be carried along while traveling.

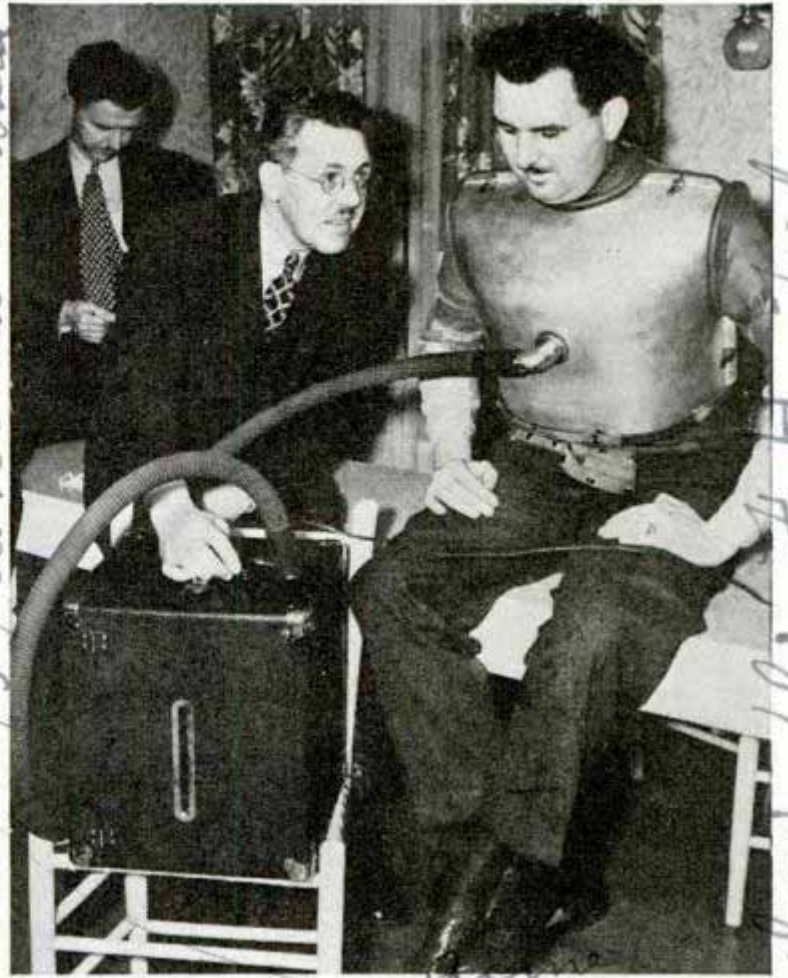

Worn like a jacket, this "iron lung" and portable apparatus permit infantile paralysis victim to travel in car or plane

Folding Window Platform Holds 500 Pounds

Useful in glazing, painting, puttying or window washing, a twenty-three-and-one-half pound scaffold safely supports a workman and material weighing up to



Workman has sure footing on sturdy platform that he can fold up to carry away

500 pounds. Rubber-padded sill clamps fasten inside the room, while braces hold the scaffold against the outside wall. It can be converted into a sling to be suspended from the roof, and may be folded for convenience in carrying.

Push Button on Glasses Darkens Vision by Turning Polaroid Lenses

You can view a daylight scene with any degree of brightness desired through a pair of sun glasses having push-button control. They are fitted with two Polaroid lenses for each eye, the outside lens being fixed and the inner one rotating. If the button is pushed to the left, the lenses admit light freely. Push it the other way and the light dims gradually until it reaches a point near blackout.



Push button changes glasses from dim to transparent

Handwritten notes:
 457 W. Santa Barbara
 8655
 H. J. St. A. Verhaar.
 Coliseum Hotel.
 8676
 Polaroid Corp. 730 Main St. Cambridge Mass.
 screen book Co.
 West American Optical Co.

NEXT MONTH'S WEATHER TODAY

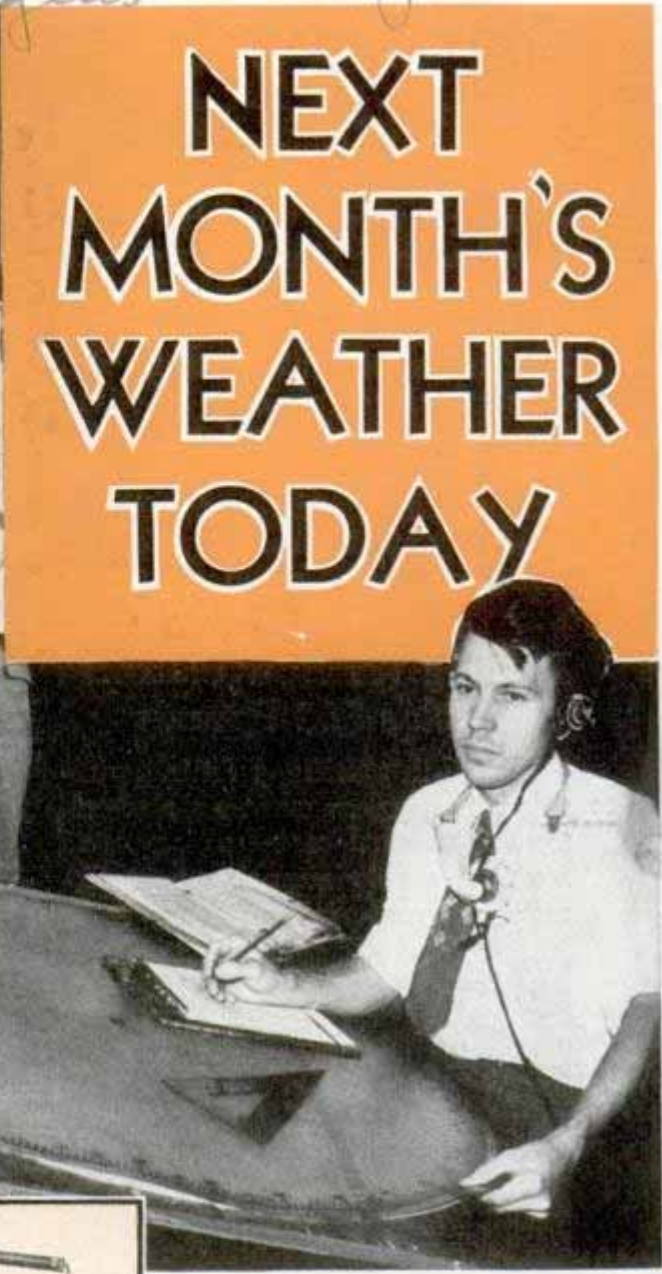

THANKS to air-mass analysis, to the radio sonde that brings to earth a continuous record of upper-air data and to a young meteorologist on the west coast, the day of long-range weather forecasting is at hand.

Accurate foreknowledge of the weather weeks before it arrives instead of the customary few hours notice is certain to prove an advantage of incalculable economic value. This may be reckoned not only in terms of preventable dollar-loss but also in the saving of human lives.

The young scientist whose study, research and enterprise contributed this boon to mankind is Dr. Irving P. Krick, associate professor of meteorology at the California

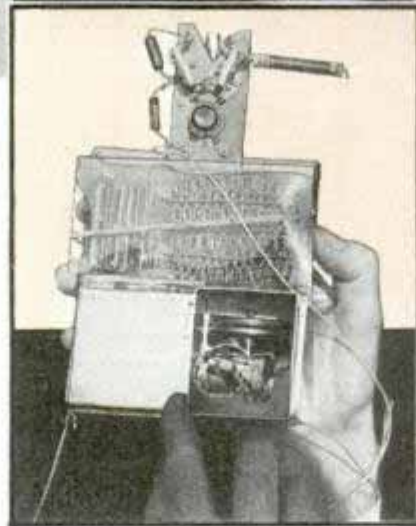

Left, Dr. Krick tunes in receiver as assistants prepare balloon and radio transmitter for flight into upper air. Right, calibrating balloon's findings to aid pilots. Below, closeup of radio sonde device which is carried aloft by balloon

Institute of Technology and proprietor of the Krick Industrial Weather Service. The latter is a business institution which publishes a monthly forecast of what the weather will be in each particular section of the United States thirty days in advance, mailing to clients all over the nation and in Canada.

This long-distance map and report, averaging better than ninety per cent accuracy, is supplemented in greater detail by a seven-day prediction mailed weekly, plus a forty-eight-hour warning of local ice storms, hail, destructive winds, thunderstorms and lightning by teletype to clients.

Pasadena, Calif

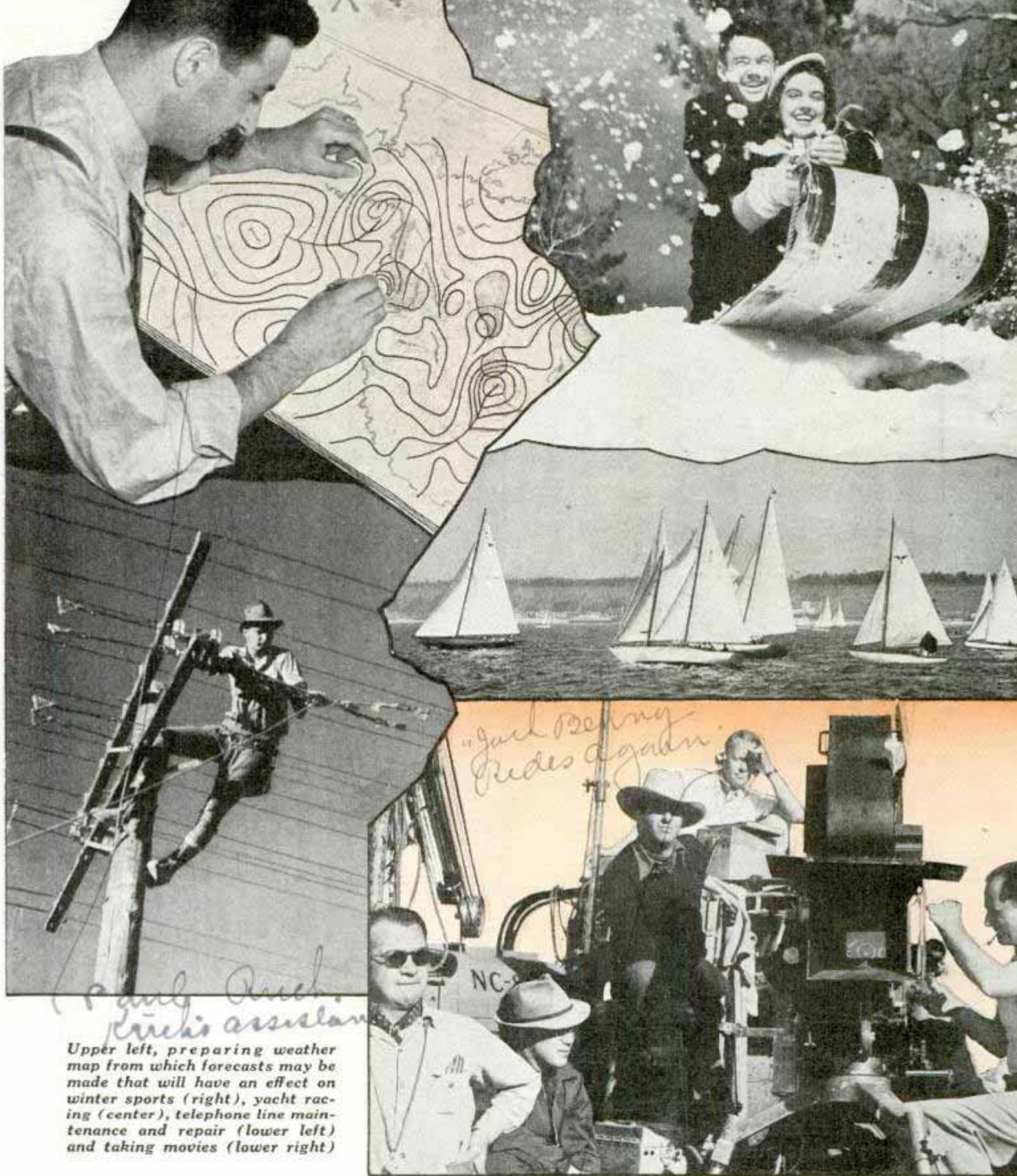

Upper left, preparing weather map from which forecasts may be made that will have an effect on winter sports (right), yacht racing (center), telephone line maintenance and repair (lower left) and taking movies (lower right)

One day recently Dr. Krick dispatched a teletyped warning to one of his utility clients on the Atlantic seaboard. It read: "Start generators two hours early today." He explained that a black thunderstorm would skirt this distant city that afternoon, bringing on darkness and city lights ahead of schedule. Since big generators require some time to build up output for peak re-

quirements, his timely tip would enable the power company to prepare for the unanticipated load.

Another day his teletype keys tapped warning to utility clients of four midwestern states that a violent electrical storm, accompanied by damaging winds, was due to sweep that area. Krick had this brewing disturbance, its probable path and oth-



fied and widely scattered clients. Such service, however, is but a minor routine compared with thirty-day predictions. For Krick is the only meteorologist to apply long-range forecasting to industry and agriculture.

The possibilities in this field began to intrigue him years ago as a young meteorologist with Western Air Express. He recognized in the Norwegian theory of air-mass analysis the key to a new science of extraordinary potentialities. For the first time it put a three-

dimensional perspective on a subject considered until then only a flat-plane basis. Applied by Krick to air-line forecasting, air-mass analysis quickly demonstrated its effectiveness by scoring 96.1 per cent accuracy. It also won Krick a national reputa-

(Continued to page 122A)



er characteristics plotted forty-eight hours in advance. Two days later that storm made headlines in the nation's press. Scores of people had been killed and injured, with property losses running high. Curiously enough, power and light, telephone and traction utilities suffered a minimum of damage and interrupted services were quickly restored, the result of the advance information that enabled these companies to mobilize trouble-shooters, linemen, other emergency personnel and equipment.

This type of weather forecasting calls for a highly developed technique. It also means that Krick and his staff must keep alert to the special interests of his diversi-



Top, setting up portable directional radio sonde equipment. Center, long-range forecasts help utility companies to combat weather disturbances. Bottom, preparing for night balloon ascent

Ocean Clipper Rests in Three-Story Drydock

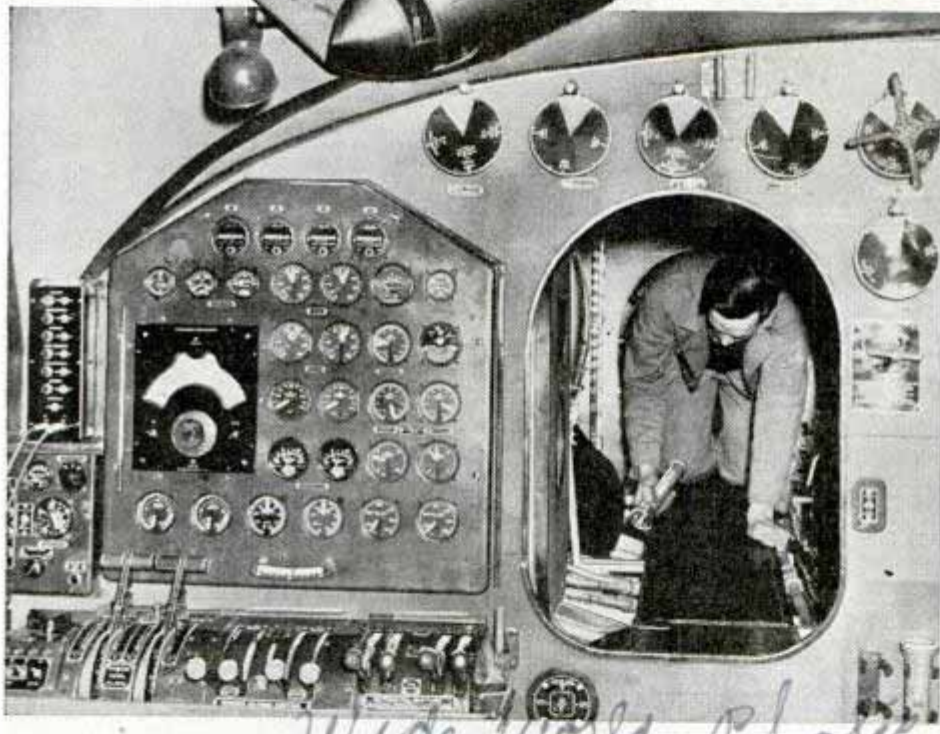
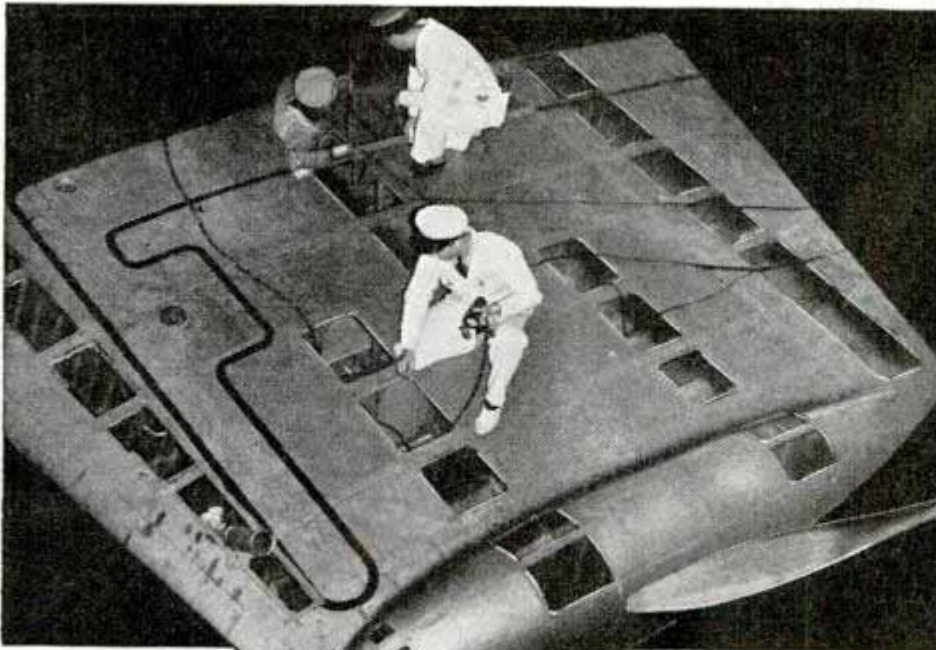

Part of the regular routine of servicing a Clipper plane is to check the tank compartments (upper left) of the hydrostabilizers, the two lower stub wings. Each of these "sea wings" holds 1,500 gallons of gasoline. Above, a three-blade propeller is checked for static balance. Each of the four propellers weighs 460 pounds

At the end of every round-trip ocean flight the Pan-American Airways Clippers are checked from nose to tail. Overhauling is done in the seaplane hangar at LaGuardia airport, New York—large enough to nest four of the big flying boats at once. Its floor space would accommodate two football fields. At the right, the Dixie Clipper is serviced in its three-story drydock. Above, the engineer's post with its controls for all four engines and a score of dual instruments. Notice the passageway at right through which mechanics can reach every foot of fuel line or make repairs on the power plants while in flight



K 480.
**Shield for Manicured Nails
 Protects Wet Enamel**



Manicure shield has four separators fitting between fingers to keep them spread while the enamel dries

While newly manicured fingers are still wet with enamel, it is often difficult to avoid touching objects, thus marring the enamel or staining the hands and clothing. To guard nails against accidental contact, an inexpensive shield can be worn that spreads the fingers and serves as a reminder that the hands must not be used. Made of cardboard, rubber or other flexible material, the guard has four separators that fit between the fingers, holding them apart.

K 729.
**Chemically Treated Air Guards
 Ignition System of Plane**

Additional and more dependable power for airplane engines is obtained by a new ignition distribution system which utilizes chemically treated, dehydrated air, pumped at high pressure through the shielding cables. Developed by a Northwest Airlines engineer, the purpose of the new system is to eliminate contamination, corrosion, moisture, injurious gases, acids, fluids, oils and other harmful influences on the efficiency of motors. The treated air rids the ignition system of these elements and also drives out any harmful fumes generated

electrically in the cables. The effect is to add power and speed to the engine and end the hazard of an engine missing due to lowered electrical insulation.

K 558.
**Mechanical Dog Sits Up for Bite
 but Eats Only Electricity**

Here's one dog that never fails to obey his master's command, provided the electricity is turned on. He was built as a companion for the mechanical man in the Westinghouse exhibit at the New York fair. The robot and his pup both have motors and wires for their organs and nerves.

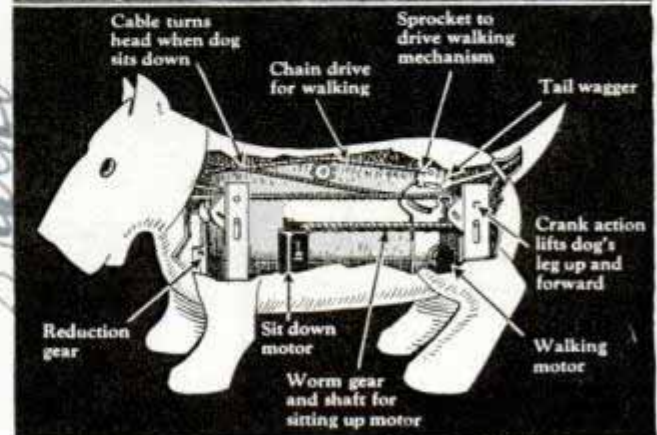
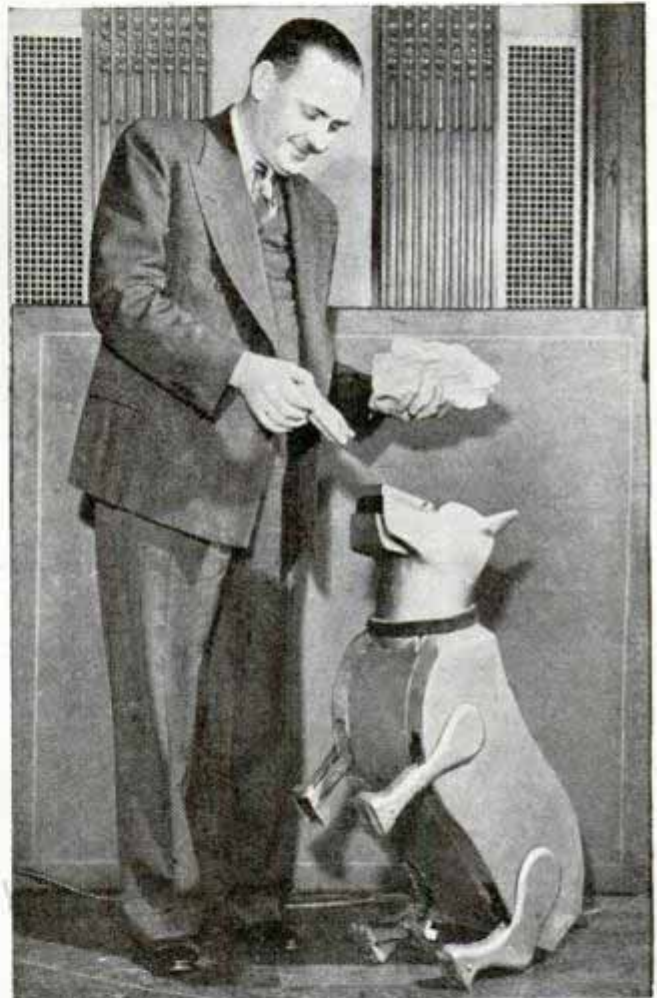

There's really no use trying to feed this obedient dog. All he eats is electric current

J. H. Warner 420 Fidelity Bldg
 Dayton Ohio
 C. E. Swanson,
 Electrical Engineer
 St. Paul, Minn.

K646

Living Insignia Formed by an Army Division

Posing for their picture recently at Fort Benning, Ga., the entire personnel of the first division of the United States army assembled in the form of living insignia. In designing the massive figure, more than thirty miles of tape and rope were needed to stake out the various sections for the assemblage of several thousand officers and enlisted men. In addition a tower ninety-five feet high was constructed from which to make the photograph.

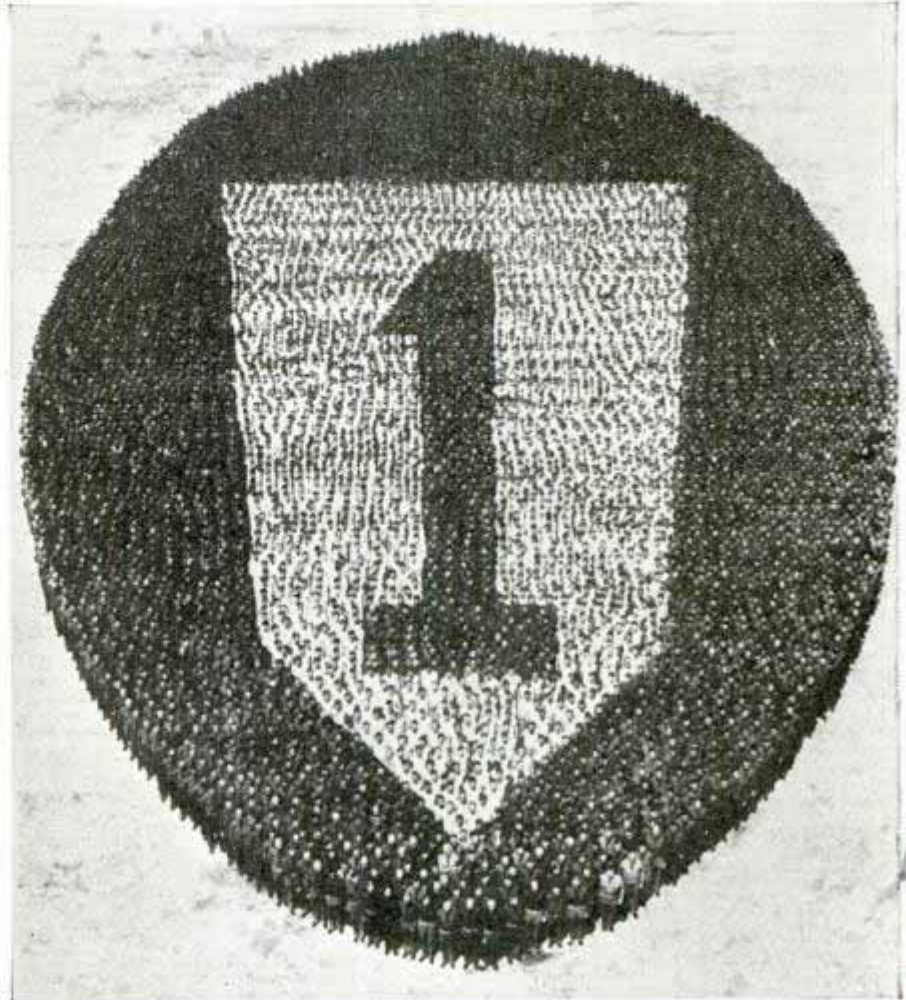

Officers and enlisted personnel of first division of the United States army, comprising several thousand men, are included in massive insignia. To get the picture, a ninety-five foot tower was built for the photographer

© National Photo & News Service—from International News Photos

K484

Miniature Sister of Big Tugboat Runs under Own Steam

Steam-powered like its big sister, the Great Lakes tugboat "Kentucky," a miniature tug, was launched recently from a raft for a tour of Buffalo harbor. Built to

scale and measuring five feet from bow to stern, the model tug has a steam engine with a piston stroke of one and one-half inches, and carries thirty-five pounds of steam. Her boiler is a three-and-one-half inch pipe eight inches long, inside a two-gallon can. Built of light sheet metal, and painted the brilliant red and green of the full-size original, the model toots a diminutive whistle and belches smoke from an eight-inch stack.



Model of tugboat "Kentucky" can chug-chug about Buffalo harbor powered by her own steam plant, in imitation of big sister plying Great Lakes

Designed by Thomas Moran
74

□ A stamped self-addressed envelope to our Bureau of Information, will bring you the name and address of the maker of any article described in Popular Mechanics.

BATTLESHIP

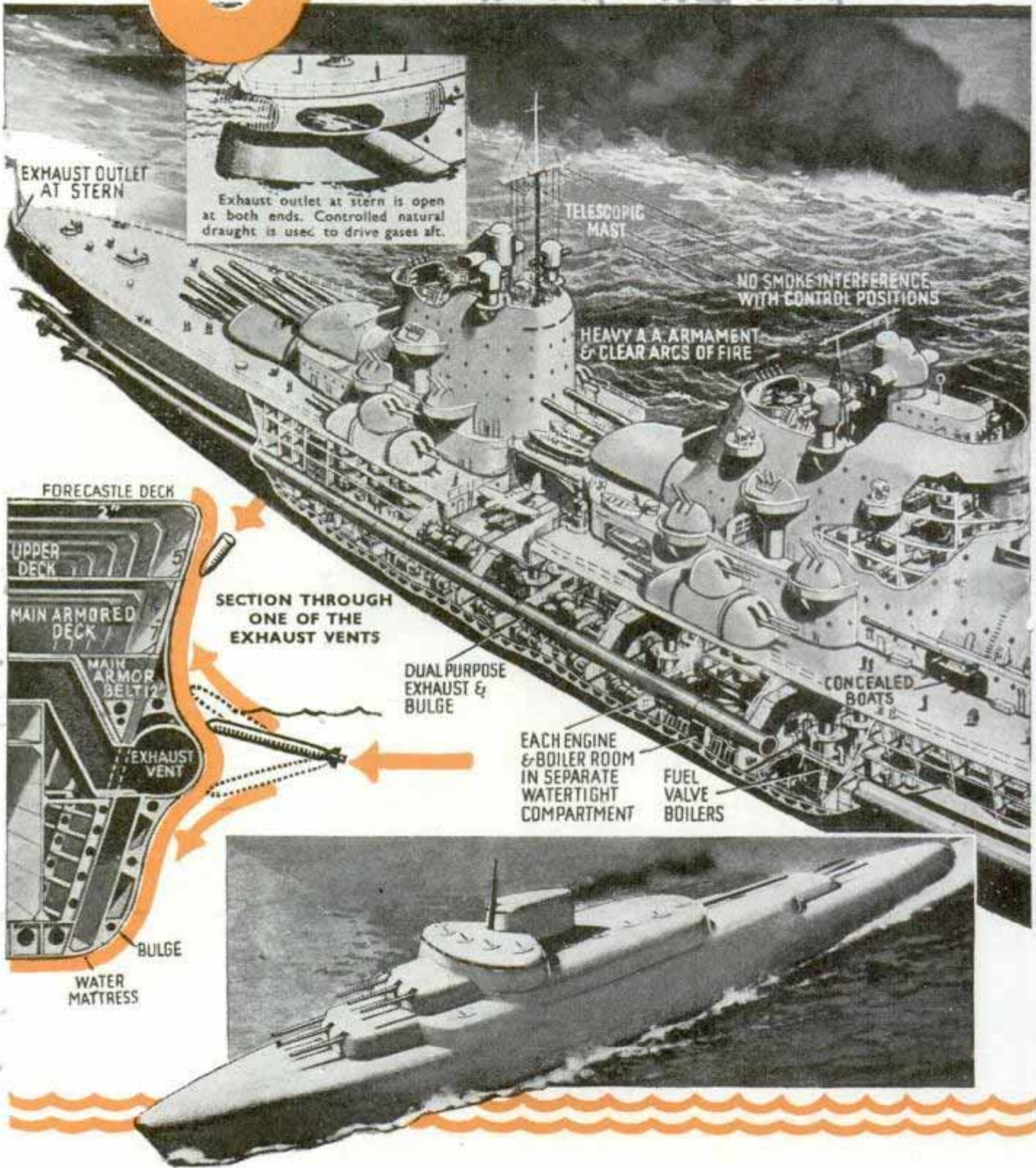

RADICAL changes in dreadnaught design are coming out of the war tests between battleship and bomber, chief among them the streamlining of decks and turrets, not for aerodynamic reasons but to fend off aerial bombs, and the multiplication of anti-aircraft batteries. Otto Kuhler, American designer, suggests the whale-

back battleship at the bottom of this page, its foredeck roofed with heavy armor plate, quantities of anti-aircraft guns over the enclosed bridge and streamlined aft turret, below which is a hangar housing bombers, fighters and reconnaissance planes launched by catapult. The larger drawing is that of an English designer, showing

of the FUTURE

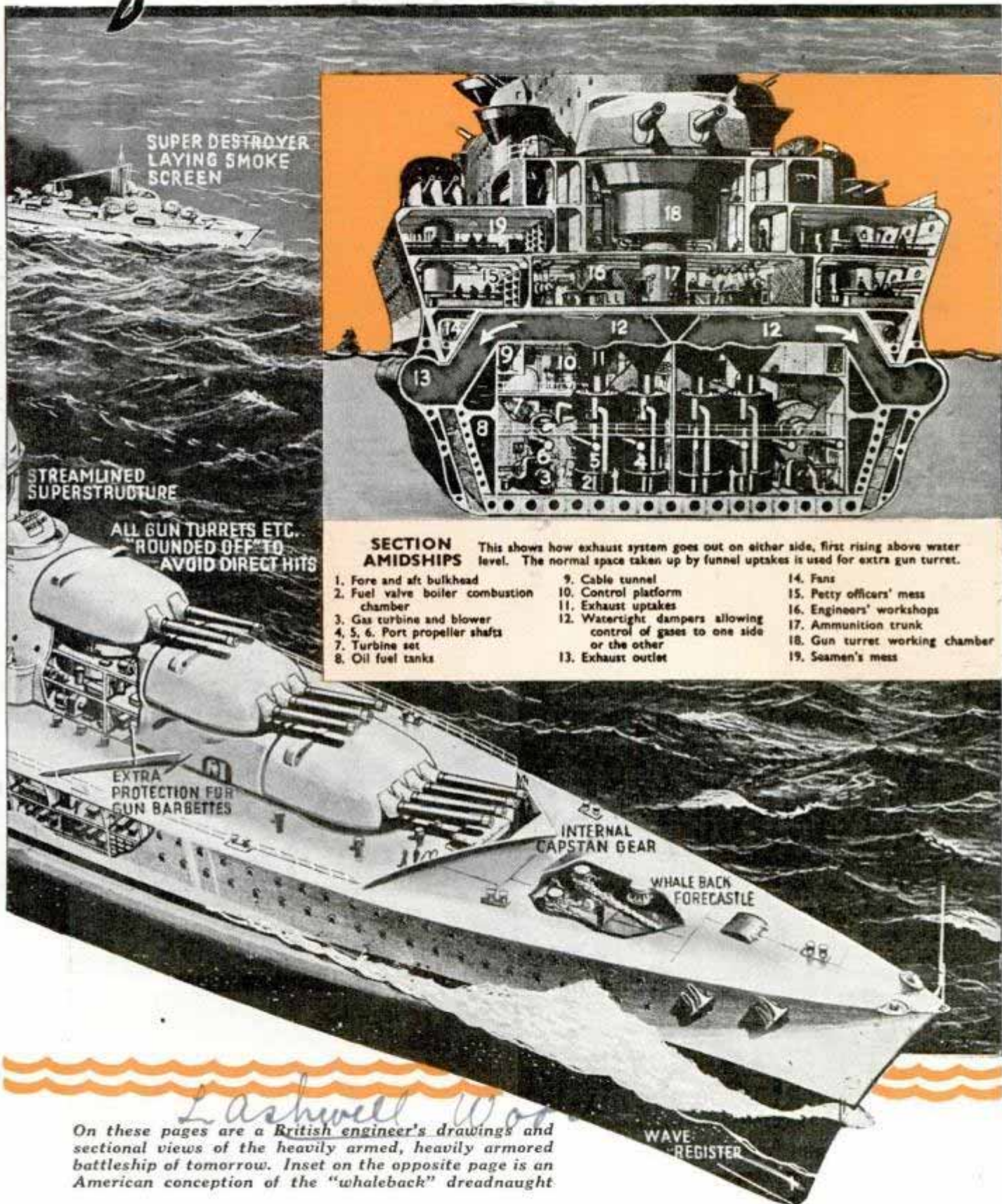

SUPER DESTROYER
LAYING SMOKE
SCREEN

STREAMLINED
SUPERSTRUCTURE

ALL GUN TURRETS ETC.
"ROUNDED OFF" TO
AVOID DIRECT HITS

EXTRA
PROTECTION FOR
GUN BARBETTES

INTERNAL
CAPSTAN GEAR

WHALE BACK
FORECASTLE

WAVE
REGISTER

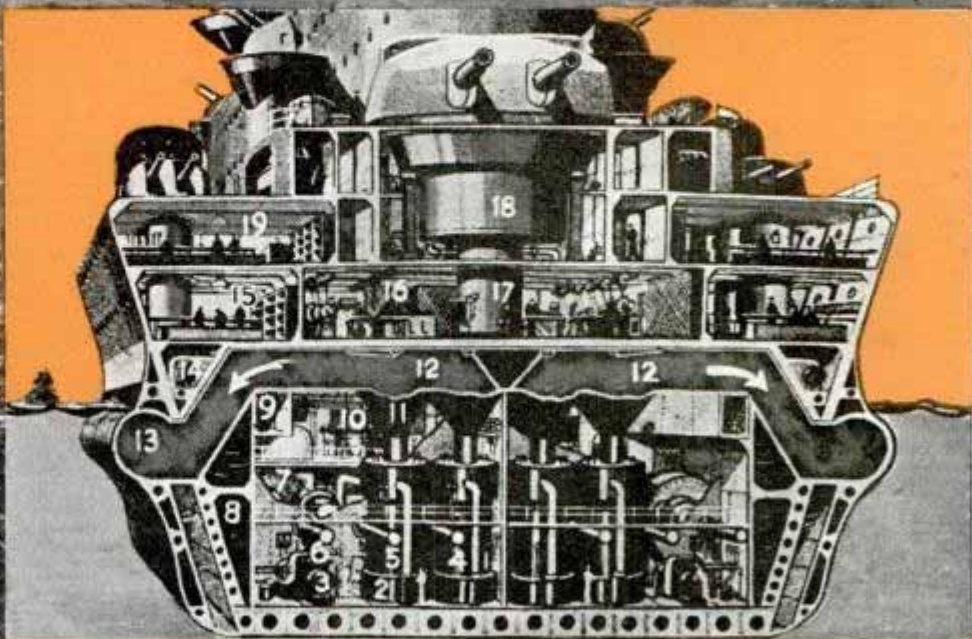

SECTION AMIDSHIPS

This shows how exhaust system goes out on either side, first rising above water level. The normal space taken up by funnel uptakes is used for extra gun turret.

- | | | |
|---|---|--------------------------------|
| 1. Fore and aft bulkhead | 9. Cable tunnel | 14. Fans |
| 2. Fuel valve boiler combustion chamber | 10. Control platform | 15. Petty officers' mess |
| 3. Gas turbine and blower | 11. Exhaust uptakes | 16. Engineers' workshops |
| 4, 5, 6. Port propeller shafts | 12. Watertight dampers allowing control of gases to one side or the other | 17. Ammunition trunk |
| 7. Turbine set | 13. Exhaust outlet | 18. Gun turret working chamber |
| 8. Oil fuel tanks | | 19. Soamen's mess |

Lashwell Wood
On these pages are a British engineer's drawings and sectional views of the heavily armed, heavily armored battleship of tomorrow. Inset on the opposite page is an American conception of the "whaleback" dreadnaught

similar arched superstructure designed to let bombs and shells ricochet off with minimum damage. This battleship would have exhaust outlets at the stern, displacing the conventional funnel, and its 70,000 tons

would call for turbines of 252,000 horsepower driving six propellers. Armament includes eighteen 14-inch guns, twenty-four 5.25-inch guns, sixteen 4.7-inch anti-aircraft guns and seven multiple pompoms.

Kit for Tying Fishing Flies Cuts Cost of Equipment

\$1.00



Here are some flies made with the kit, which includes all necessary material and directions for tying

All the essentials for making your own flies are offered in kit form for fishermen, together with instructions for tying the flies. Not only is there a saving in the cost of fishing equipment, but the tying of flies offers entertainment, and with practice the amateur can produce finished flies rivaling in appearance those of the professional. Hundreds of patterns can be made by using various colors and materials, such as feathers, quills, yarn, chenille and tinsel.

Hybrid Corn Flies 1,000 Miles to Be Planted the Same Day.

Four small sacks of hybrid seed corn were flown 1,000 miles from Texas to Chicago recently and then planted the same day on an Illinois experimental farm. The shipment represented about 200,000 kernels, irreplaceable because it represented more than fifteen years of careful breeding to obtain a corn of high yield and resistance. The parent seed had been sent to the

Rio Grande valley to save a season's time by growing during the winter in the semi-tropical south, being planted there just after New Year's day.

Rearview Mirror Shifts Glare for Driving at Night

Headlight glare reflected from a rearview mirror is sidetracked from the driver's eyes with a new-type glass, designed for Chevrolet cars, that can be tilted upward without changing the field of vision. It uses an optical principle in which both the front and back of a wedge-shaped glass, or prism, provide reflecting surfaces at slightly different angles. In daytime driving, the rearview image passes through the transparent front surface and is reflected in a normal manner from the inner surface, which is silver-plated. If left in this position at night the prism would reflect glaring headlights into the driver's eyes, just like any rearview mirror. By tilting the adjustable portion slightly, glare is thrown upward, just above the driver's head. The change in reflecting angle is not great enough, however, to prevent continued use as a rearview mirror.

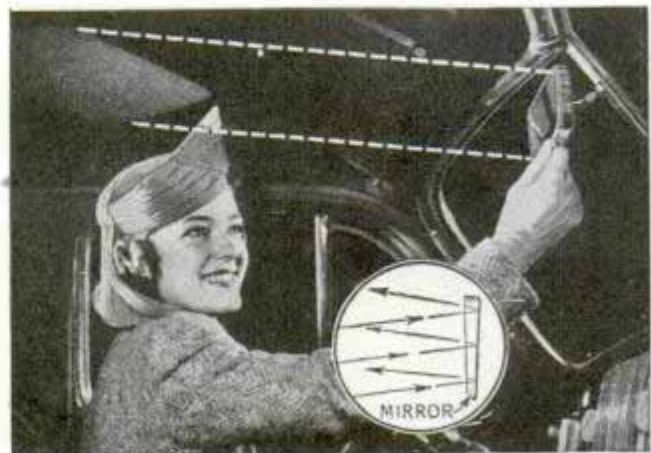
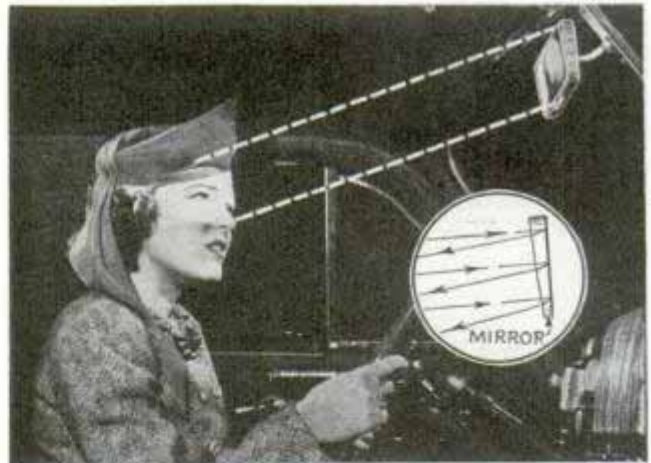

When rearview mirror throws blinding lights overhead, as shown above, driver sees glareless reflection

Stewart H. Buehler 4822
 Hamilton
 Chrusan - Duane number 6/10/48
 De Kabb Agricultural
 Pasm. De. J. S. 11

material (for...
 605

K 6 3 2 Western House

Rifle Sight Aims Lights at Ball Field Targets

Lighting engineers turned the baseball field at New York's Polo Grounds into a fielder's nightmare of hurdles when they

adjusted the floodlights, totaling 200,000,000 candlepower, for night games. To provide targets for lining up the galaxy of

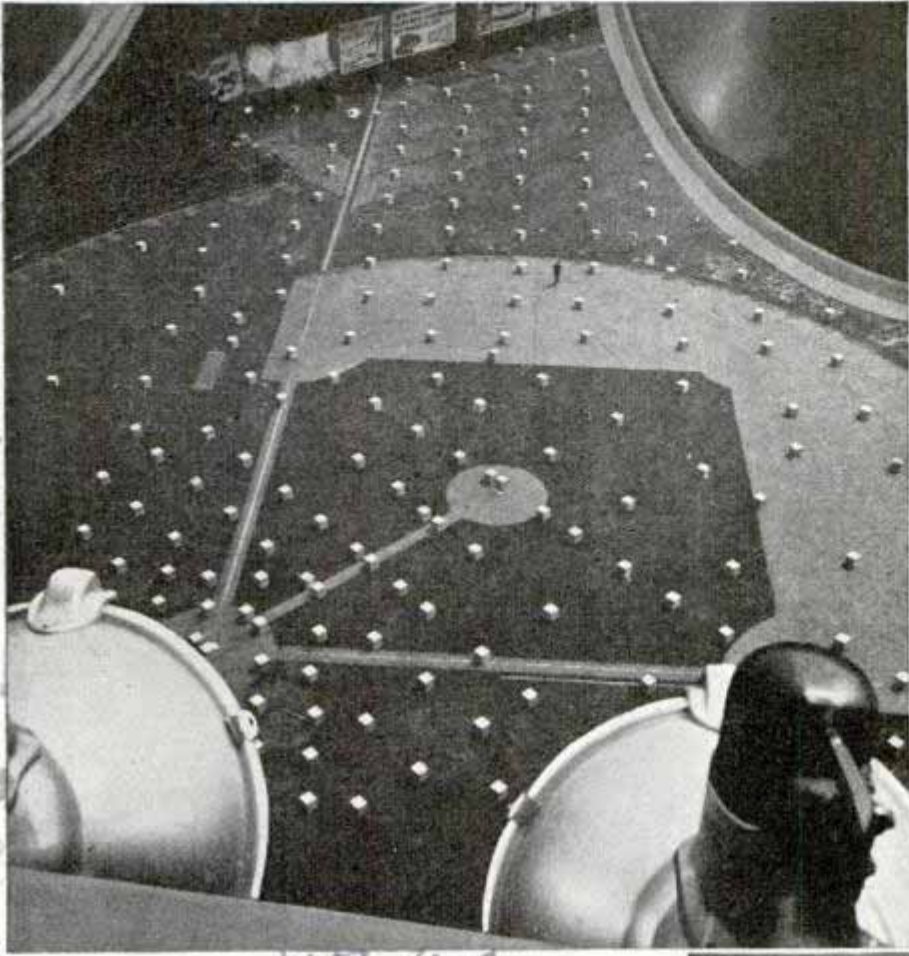

lights perched on eight steel towers, the field was studded with 836 boxes arranged in a symmetrical pattern. One floodlight of 1,740 watts was spotted at each box, the technicians using a special rifle sight to aim the lights individually. The greatest concentration of lights is on the infield, where most of the action takes place and where both the ball and players travel fastest. The pitcher's mound and batter's box each have two special floodlights trained on them to enable batters to get the best possible look at the balls pitched to them.



Lightning No Menace to Planes Pilots' Experiences Show

Lightning apparently is no menace to the modern all-metal transport plane, for at least fifty instances have been reported of lightning striking planes without doing serious damage. The General Electric company is making a study of the small holes produced by the lightning discharges, along with laboratory studies of artificial lightning. The cumulus type of cloud in temperatures around twenty-five to thirty-five degrees Fahrenheit is most likely to bring lightning discharges. Zones of positive and negative charges are built up in these clouds and as the plane passes between these zones it acts as a conductor. Pilots avoid instrument flying in cumulus formations, especially at the freezing temperature level; drop down and reduce speed when a stroke seems imminent, and turn all lights in the cockpit on to minimize temporary blindness from the flash.

Baseball field marked with 836 boxes, at top, which were used by engineers as targets for aiming the lights in making final adjustments of New York Giants' 200,000,000-candlepower lighting system. Bottom, one of the biggest of the eight steel towers, containing 120 lights, located on grandstand roof in outfield

June Bernis

September 14

Rebuilt by... D. Münster
I.W.A. to Civil Aeronautics

Robot Sorter Saves Rivets Dropped in Plane Factory

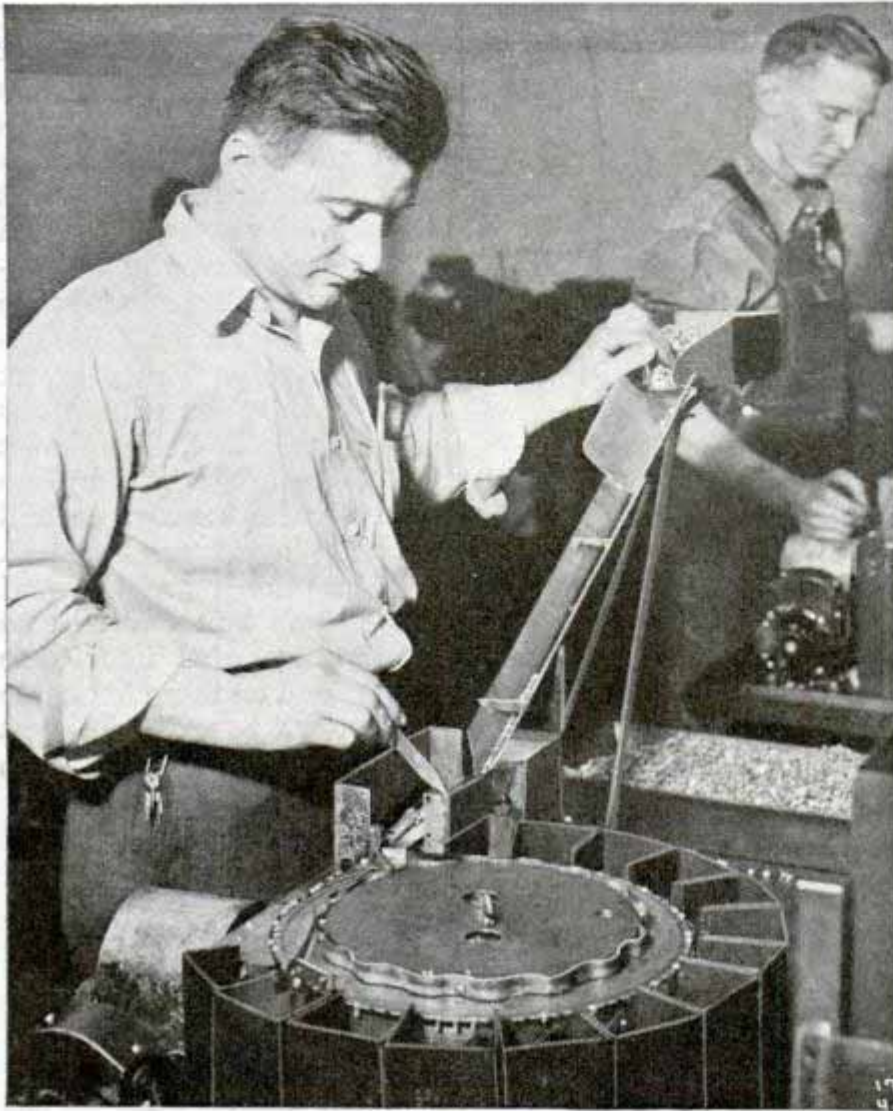

Rivets being sorted according to length. Chute carries them to wheel from which they are knocked into correct bin when shanks strike spring

Rivets dropped accidentally by airplane riveters, formerly recovered by hand sorters who could not pay their way because the process was slow, now are salvaged profitably by mechanical means. The robot separators perform the job in three stages. Reclaimed rivets swept up from the floor are shaken through a series of sifters that separate them for diameter, somewhat as gravel is graded. Then a second machine, hand-operated, divides round-head from flat-head rivets at high speed, tossing each type into its own bin. In the final step rivets are sorted into their respective lengths. With heads up and shanks down they travel around the track until their shanks strike springs below, which

knock them off the wheel into their proper bins. Here the longest fall off first, the shortest ones riding through to the last bin. Sixty pounds of rivets daily are salvaged at a fraction of their value.

Model Plane Hoists Wheels to Take Off from Water

Built from photographs of a Fleetwing L-5 amphibian, a scale model plane exhibited in a meet at Yakima, Wash., has landing gear constructed so that its wheels can be raised above the water line of the hull in a few seconds for launching from a pond or lake. A one-fifth horsepower gasoline engine is mounted above the cabin with spring-steel rods. The model weighs five pounds and one ounce ready for flight and has a main wing area of seven square feet. It was designed on a scale of two inches to the foot. The fuselage is full-planked one-eighth inch balsa wood; the motor cowling is aluminum. Remote controls permit motor adjustments without removal of the cowling.



Ready for "contact," this scale model of a Fleetwing amphibian plane is powered by a one-fifth horsepower engine

L. Martin C. Baltimore, Md.

K 636
Model Plane Hoists
Wheels to Take Off
from Water
Built by
Cox & Quiggardner, Wash.

Mr. ...
19618 Malibu Road,
Pacific Palisades
Calif



FARMING *takes to the* AIR

A BARNSTORMING pilot without the proper equipment got the job of dusting a big crop with sulphur.

"Sulphur is pretty dangerous," experienced pilots warned him. "You are apt to blow up unless you fix your exhaust stacks."

But the pilot didn't have time and he took a chance. Half an hour later it happened. A spark from the exhaust shot back into the billowing yellow cloud behind the plane and the dust exploded. Luckily the pilot still had control and was able to land straight ahead, though part of his tail surfaces and the under part of his fuselage were burned away.

To avoid such accidents experienced crop dusters like Mal Carberry of Brawley, Calif., extend the exhaust pipes of their motors up over their wings. The tail surfaces of Carberry's crop-dusting planes are metal-covered as an additional precaution. Sparks and sul-

While blowing out a cloud of insecticide (top), the crop duster wears a mask to protect himself from inhaling any poison. Open slot below hopper helps lay dust evenly

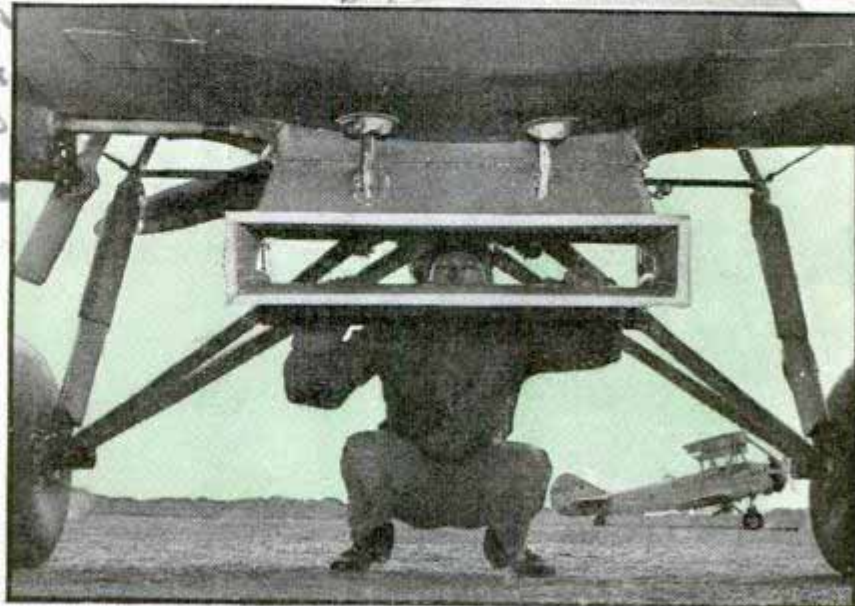

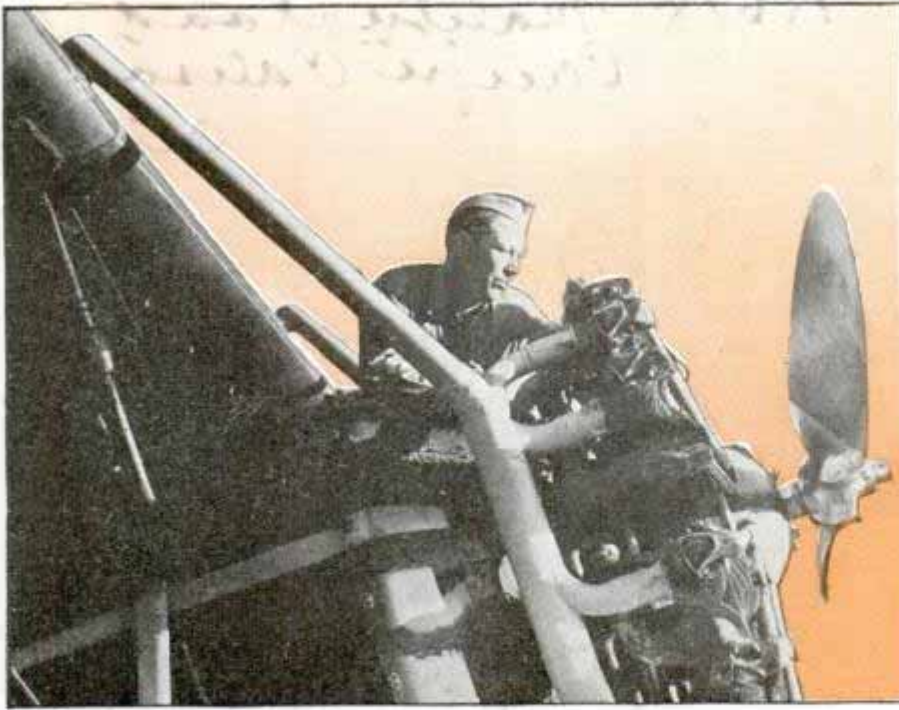

into the ground and send the plane tumbling across the field. A wrong guess when there are trees at the end of the row may hurl the plane into the branches. Stumps under the wings and phone wires above them have to be avoided.

There are plenty of hazards for the flying farmers that the average pilot wouldn't care to face yet, properly organized, the job of planting crops and dusting them from the air is a safe and sane one. None of Carberry's pilots has been injured in the eleven years he has

phur are a dangerous mixture in the air.

Most pilots would be grounded if they stunted at low altitudes, but if you are flying a crop duster you have to fly as low as you dare. Your wheels are within a foot or so of the ground much of the time. You skim along at cruising speed yet you have to pull up sharply at the end of the field to miss the trees. A hairpin turn, a dive back over the same trees, and you yank open the hopper gate and lay another cloud of insecticide over the next rows.

Dangerous? It has been and it still can be if the pilot isn't a superb flier and the equipment isn't perfect. A second's inattention or a faulty motor may dig a wheel

been dusting. Floyd H. Nolta, another of the west's leading dusters, has made 40,000 landings on farm fields for reloading his hopper without incident. Such veterans use special airplanes and employ skilled pilots. They have put crop dusting on a business basis and guarantee their work.

Carberry, like other dusters, uses biplanes because they are slower and easier to maneuver than monoplanes. Working speeds are well under 100 miles per hour. The space usually devoted to the front cockpit is converted into a large metal hopper that holds from 800 to 1,800 pounds of seed or insecticide. A small propeller on the lower wing drives an agitator at the

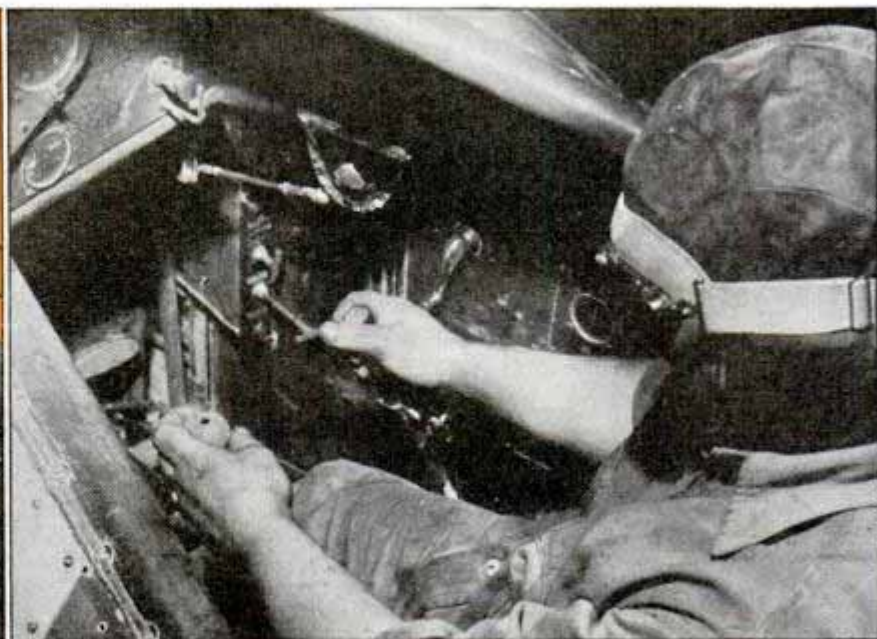

Exhaust stacks lead over the wing to keep sparks away from the trailing cloud of dust beneath plane (top). Tail (lower left) is sheathed in metal to minimize damage and assure control in case of dust explosion at rear. Pilot regulates flow of seed or dust with hopper gate lever in right hand

R 358

bottom of the hopper, and this agitator feeds the material through the discharge gate. Here the seed or dust passes into a small oblong section of wind tunnel suspended below the plane. The stream of air that is being forced through the tunnel carries the material backward and the flaring tunnel walls force the dust downward and outward at the right angle.

The planes that Carberry and his pilots fly have no windshields because dust leaking from the hoppers might coat the surfaces and blind the pilots. The fliers ride high in the cockpits for maximum visibility and many of them wear face masks as well as ordinary flying gear to protect themselves when they are dusting with a poisonous insecticide.

Motors are bare. An engine cowling might hide the first indication of an oil leak or other trouble, and in crop dusting a pilot has to know at once if engine trouble is developing.

The dusters do most of their flying early in the morning and in the evening. There is less wind at these times. Seed scatters more uniformly and insecticide isn't blown away. Too, lack of wind makes easier flying near the ground and a pilot can get down close without so much fear of bumps and turbulence. But flying

(Continued to page 120A)

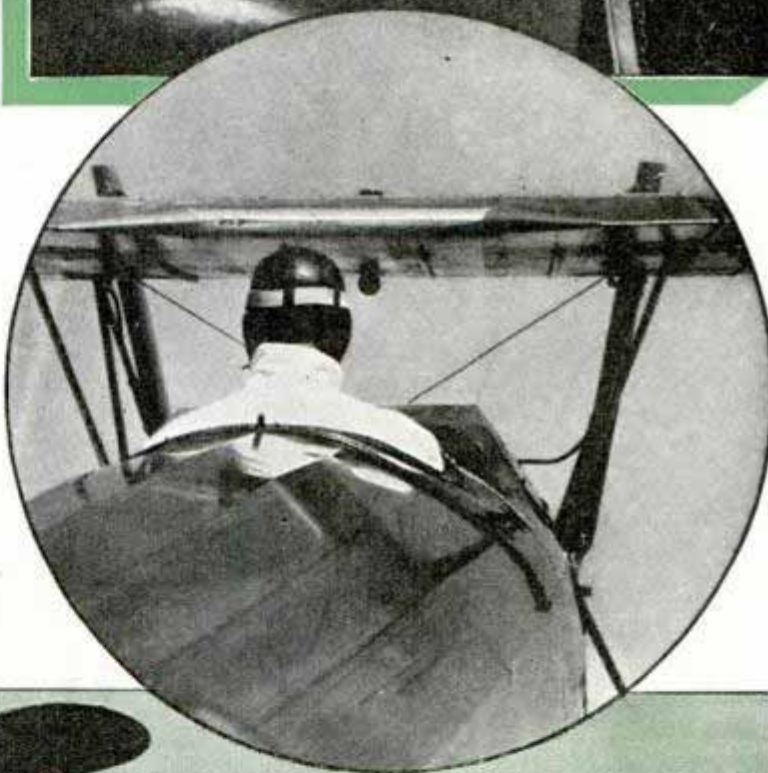
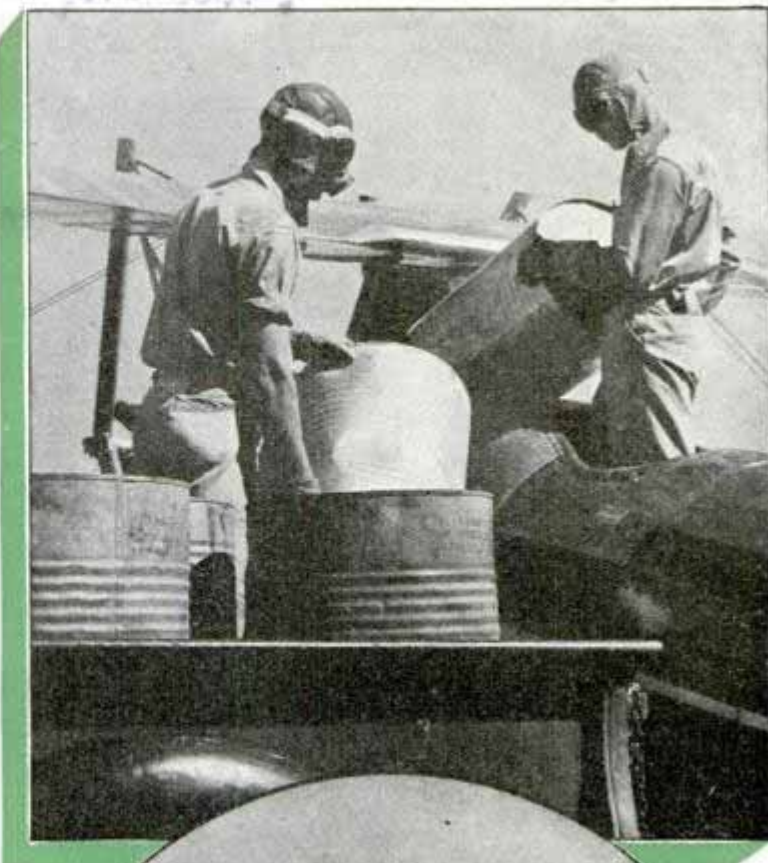

Top, filling airplane's hopper with barrels of insecticide. Center, pilot sits high for clear view of ground and hazards ahead. Bottom, flying just above ground, the pilot dusts lime over freshly planted alfalfa

Lightweight Mask Filters Out Dust and Pollen



Particles of dust and pollen as small as a micron—only 1/25,000 of an inch—are stopped by a lightweight mask developed for industrial workers, persons allergic to pollens causing hay fever and asthma, and medical workers exposed to air-borne bacteria. The mask weighs only an ounce and a half. It has been approved by the U. S. Bureau of Mines as a protector against silica and other dusts which cause silicosis and asbestosis, frequently fatal respiratory diseases. Silica dust may be five microns or less in size, pollens range from ten to 100 microns and bacteria about one micron. The effectiveness of the new mask is due to the large filter area, a new exhalation valve, and a headband and facial design that hold the mask tight yet comfortable.

Housewife and industrial worker demonstrate uses for mask, so fine it screens out pollen. Man in circle shows how well it protected eyes, nose and mouth

Chances of Death by Lightning Are Only Three in Million Population

Ranking sixteenth among causes of accidental death, lightning killed 396 persons throughout the nation in 1938, or three in each million population. This rate has varied only slightly since 1933, the first year

such figures were compiled by the Census Bureau. Of 240 lightning deaths in which the location of the accident was reported, ninety-nine occurred in the home, seventy while working, and seventy-one in public

(S.M. W. H. Lehberg)

mu. are made by mas:

made
American
made
American
made

1686

places such as the streets, parks and swimming resorts. The states reporting the largest number of deaths by lightning were Texas, thirty-four; Illinois, twenty-two; Louisiana and North Carolina, twenty-one each, and Alabama, twenty. There were 93,805 deaths from accidents in the United States during 1938, lightning being responsible for only about four-tenths per cent of them.

K608
"Sewer Gun" Fires Cartridge to Clear a Clogged Pipe

Choked plumbing can be opened up quickly with a "sewer gun" that fires a .38 blank cartridge into the drain. The gun is



equipped with a hose and rubber cup that fits over the drain; the shot sends about 100 pounds pressure with lightning speed through the hose into the clogged pipe, hammering at the obstruction. The gun has a one-inch steel chamber eight inches long to absorb the shock of the exploding shell.

K-379
Engine at Rear of Road Scraper Allows Clear View of Blade



Diesel road scraper with engine at rear can be operated by one man who is able to watch performance of the scraper blade from driver's seat

With its engine and radiator mounted at the rear, an eight and one-half ton Diesel road scraper appears to be traveling in reverse when it is going forward. The unusual design gives the driver a clear view of the twelve-foot blade, permitting one man to operate the grader.

K647
Greenhouse Built in an Auto Trailer Has Tough Plastic Windows

Flowers are traveling over the highways of New England in a rolling greenhouse that is hitched to a car. The operator has no worry about the windows breaking, since they are made of Vuepak, a non-fragile transparent plastic. Plants like it, too, as it admits more of the beneficial light rays than would ordinary glass.

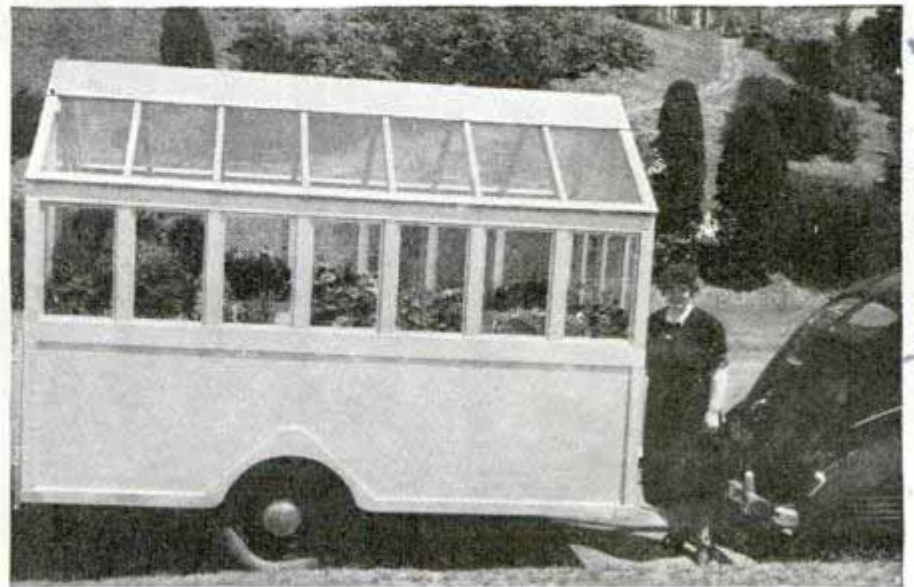

Greenhouse trailer is equipped with non-fragile windows made of plastic

The Newton Co. 1915 E. Van Buren, Phoenix, Ariz.

*W. H. Allison, Shepherd
 Los Angeles
 Macdonald & Equipment Co.
 Mrs. Edythe Bardwell
 Co. Plasticos (view).
 Chemical*

MECHANICAL

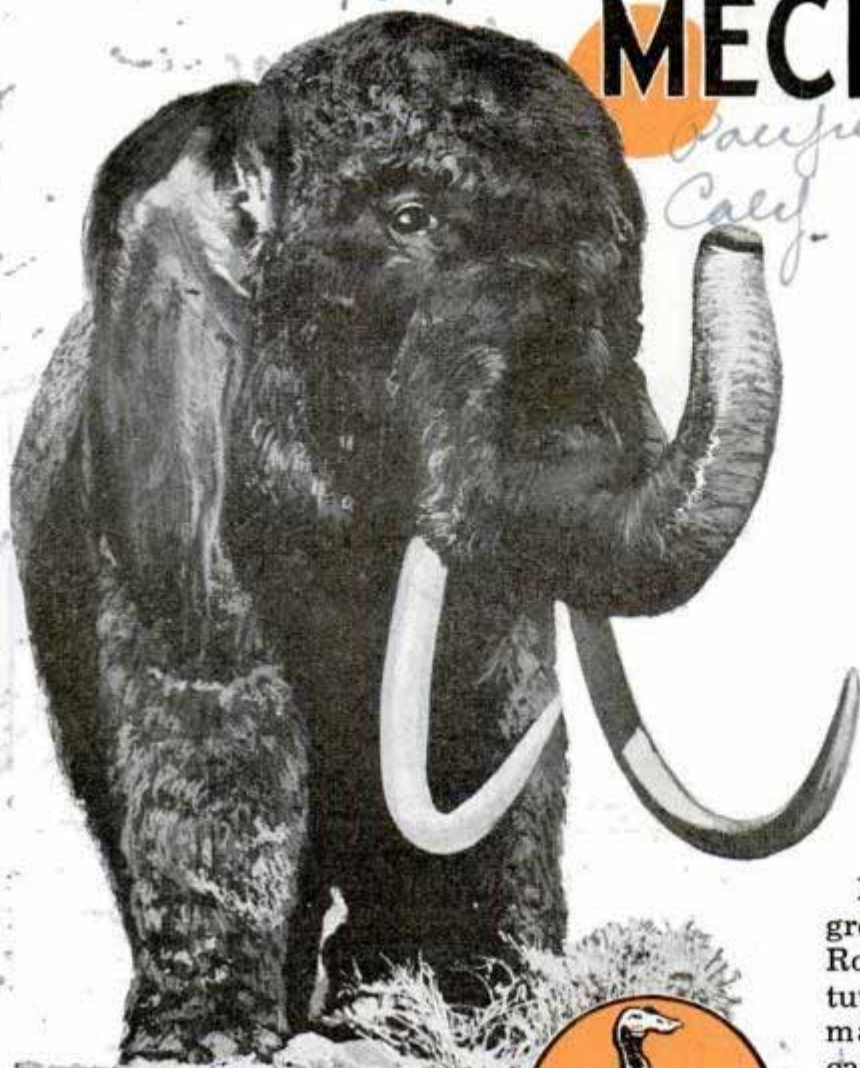

PREHISTORIC monsters battling in front of your eyes, a deadly cobra lashing at its victim, an enraged gorilla fighting a man—all this you are apt to see in the motion pictures. Common sense tells you that many scenes of this nature are impossible or too dangerous to film, yet to the geniuses behind the camera nothing is impossible.

When the Hal Roach studios decided to film "One Million B.C." the associate director, Hal Roach, Jr., was told: "We want some woolly mammoths, a musk ox, a couple of dinosaurs, and any other prehistoric animals you can get."

It's impossible to round up a group of prehistoric beasts, so Roach's job was to supply substitutes. The musk ox and woolly mammoths were comparatively easy. For the mammoths he rented two elephants. Black goat hair

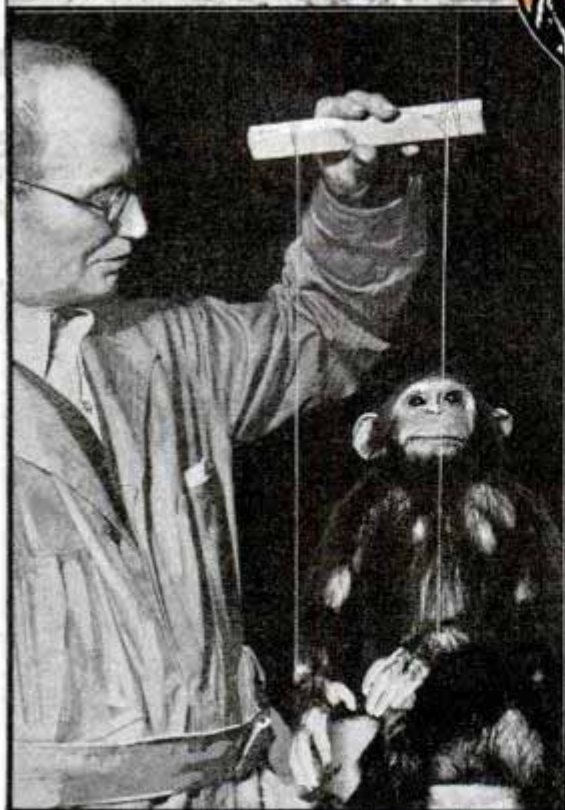

Prehistoric mammoth (top) in movie really is an elephant. Bottom, left, using strings to show how mechanical animals can be made to perform. Right, fighting monster in "One Million B.C."

MONSTERS *of the* MOVIES



by the square yard was glued to their hides, long strands of hair were draped from their ears and trunks, and long curving metal tusks were fitted over their short ones. The musk ox was created by attaching a shaggy overcoat to a Brahma steer and providing it with a pair of long metal horns.

The other prehistoric monsters were a harder problem, yet by a method that remains a studio secret these animals, some of them apparently weighing sixty or seventy tons, were recreated for the screen. All the studio will say is that the dinosaurs and others are actually living creatures that were made to look their parts by means of make-up and were mag-



Movie scene in which primitive man battles prehistoric beast (top). Right, using tiger skull as model to install teeth in papier-mache tiger head. Bottom, imitation spider animated for movie by using invisible strings

Handwritten notes:
 20
 373
 Carol Landis Co
 Los Angeles
 57 H6
 Def: Volney Wood Museum

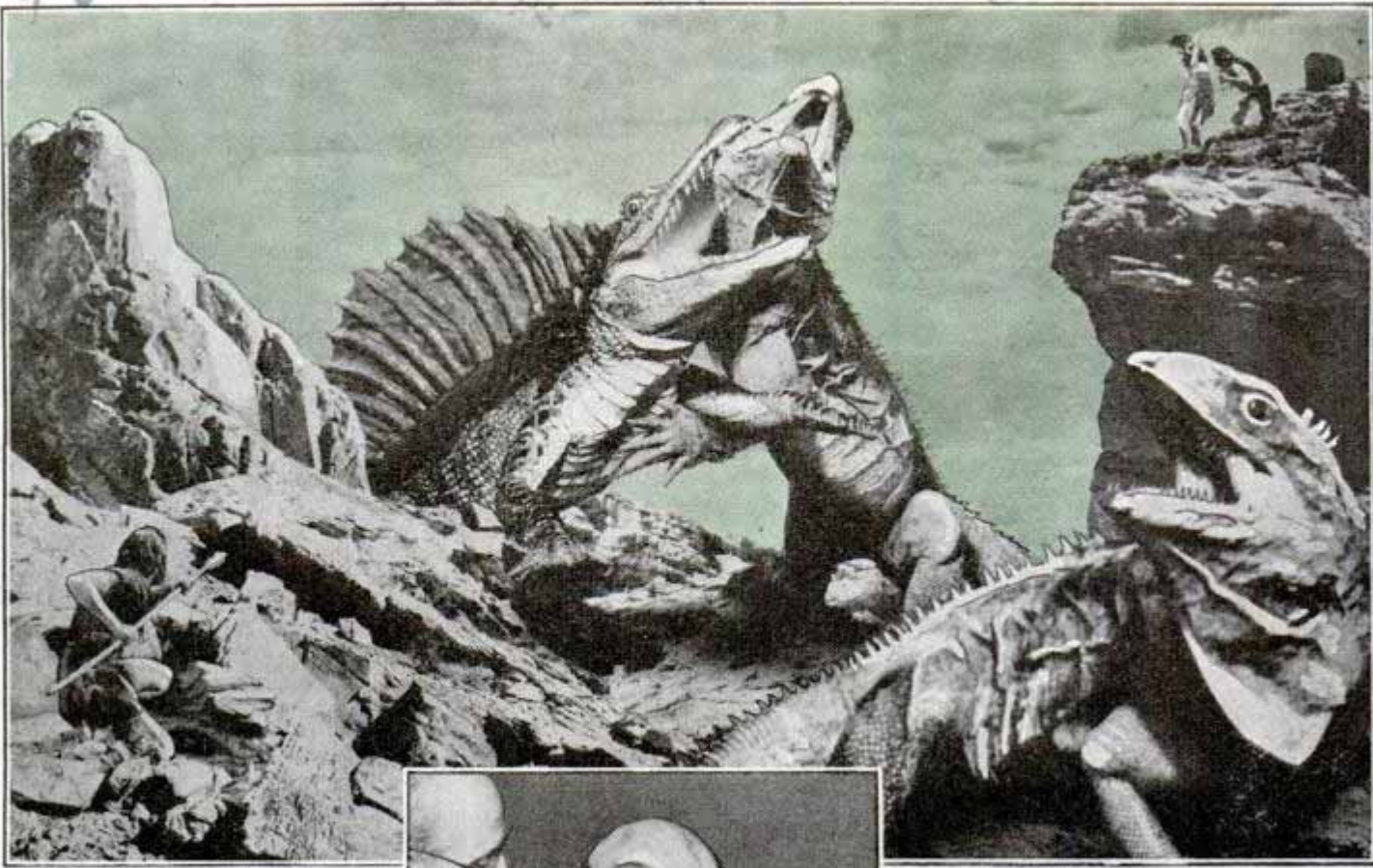

Above, monsters locked in combat, as they appear in scene of Hal Roach production. Right, measuring actor for queer bird costume. Bottom, trimming rubber on imitation ape's costume to be worn by boy actor

From his storerooms Schleisser took a large cobra skin, mounted it, and distended its head with a hollow wooden skull. Inside the skull he mounted a small clockwork. Into the snake's open mouth he inserted a long forked tongue, made of rubber, attaching it to the clockwork so that when the gears were turning the tongue darted in and out convincingly.



nified to the right scale by trick photography.

When another studio needed some prehistoric animals the problem was solved by casting the skins, complete to fins and scales, out of rubber. These costumes were placed on dogs that were trained to battle and prowl through prehistoric scenery built to the proper proportions.

Often when a studio has a problem on its hands it turns to J. M. Schleisser, head technician of the Hollywood Museum and an internationally famous sculptor and naturalist. "What we need," Schleisser was told recently, "is a cobra. The script calls for the snake to strike and poison a girl and the scene must be a close-up, so it has to be good. We want the snake by the end of the week."



Handwritten notes in the left margin: "2-2-48", "Photo by...", "George...", "Los Angeles", "California", "1948", "2-2-48", "Photo by...", "George...", "Los Angeles", "California", "1948", "2-2-48", "Photo by...", "George...", "Los Angeles", "California", "1948".

A few lengths of thin wire that were invisible to the camera completed the illusion. Handling the wires as he would operate the strings of a marionette, a technician out of camera range made the cobra raise its head, sway back and forth, and finally lash out and strike so convincingly that the audiences shuddered.

Schleisser says he can create anything from a mouse to an elephant and make it operate mechanically. During his career he has built a large menagerie of motion-picture birds and animals, ranging from hummingbirds to ostriches and from vampire bats to gorillas. This year he filled an order for a mechanical gorilla that expands its chest, opens its mouth and roars with rage. He made the

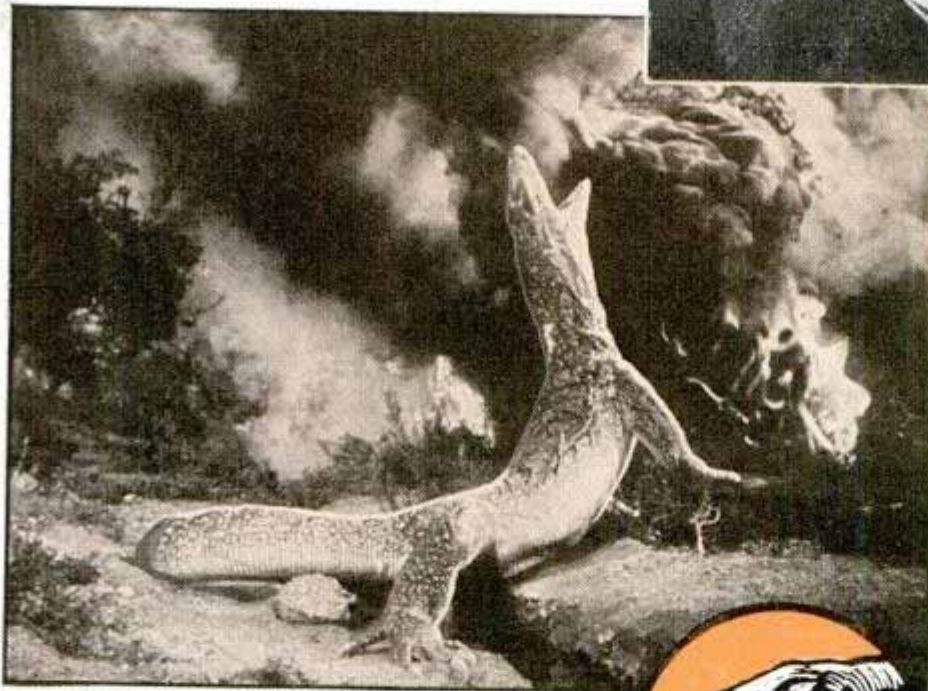
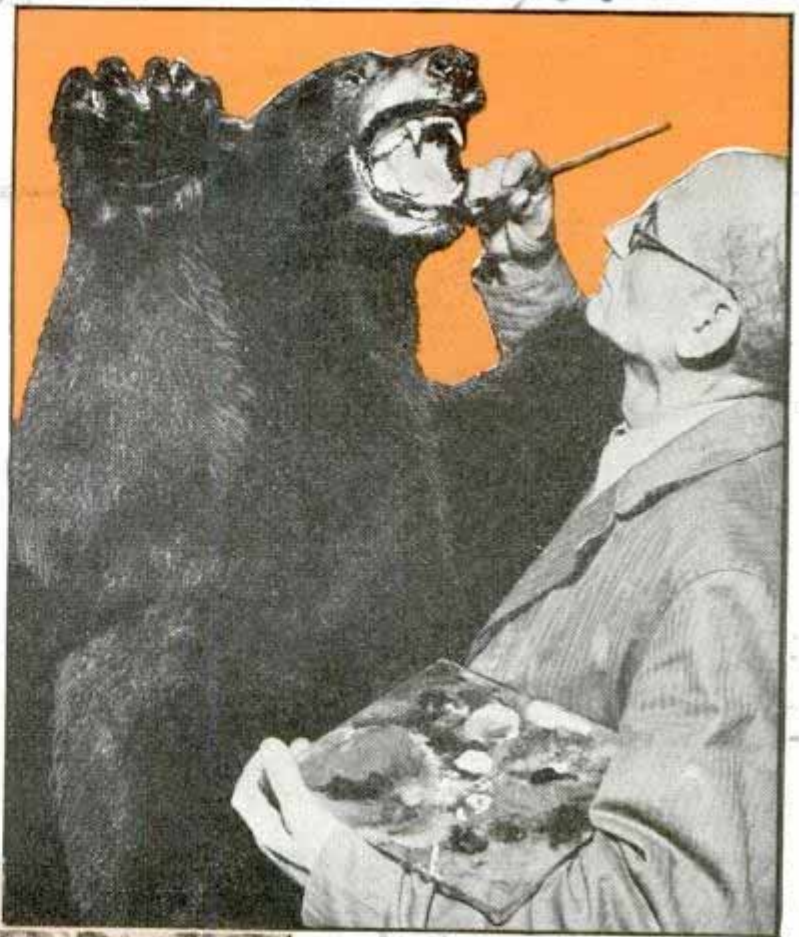

Putting finishing touches on movie bear (top) to be used in scene showing it attacking. Scene showing monster caught in crack of earth during 'quake (bottom), as taken from film "One Million B.C."



hollow body of papier-mache, covered it with fur and used a special composition for the animal's features. Inside the body are two electric motors and a complicated system of cams, chains and gears. Twelve different mechanical motions are involved in the life-like motions of the animal.

For one studio he made an elephant out of an aluminum framework and covered it

with cloth, giving it a special modeled head. Two men concealed inside the animal can make it walk, flick its tail, toss its head and even pick up peanuts with its trunk.

When he received a request for a group of apes that had to act with seemingly human intelligence in a motion picture, Schleisser made rubber suits that were exact copies of apes. A concealed zipper in the back of each allowed a small boy to get into the costume. The tight fit of the rubber head gave the boy some control over the ape's features and an aluminum clamp inside the costume fitted over the boy's chin so that he could operate the ape's mouth.

An octopus and a tiger's tail are vastly different in real life but they are close relatives in Schleisser's studio. Each is given a life-like motion by the same method. He makes up an octopus out of a rubber composition that has a natural appearance. Each hollow tentacle contains a full-length coil spring and a long wire, one end of

(Continued to page 125A)

Wingless Helicopter Flies Straight Upward

Vertical flight with full control has been achieved with a wingless helicopter built

by Igor Sikorsky, aeronautical engineer. Primitive in appearance, the ship is

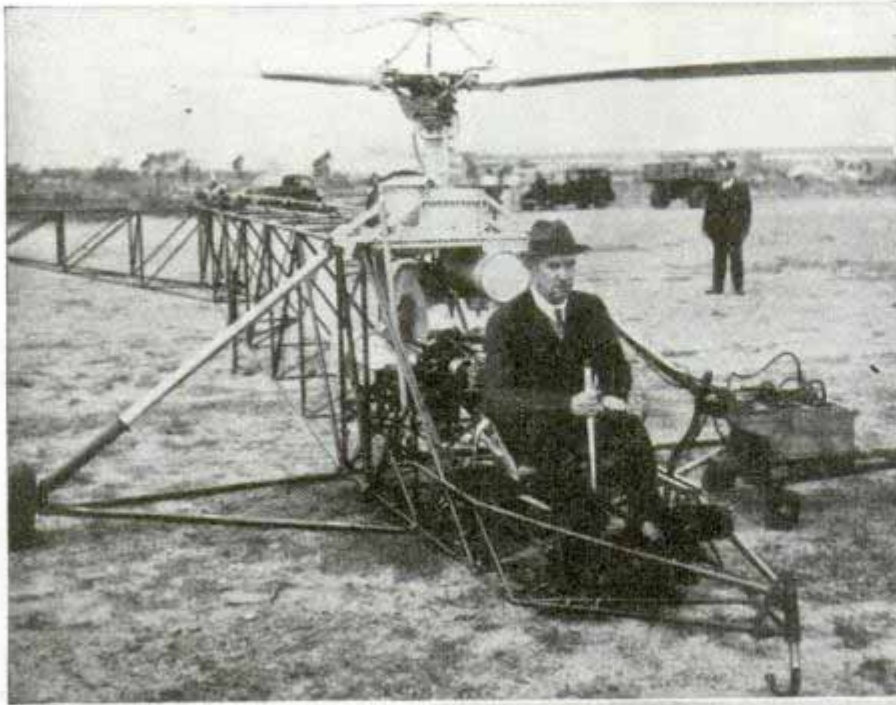

equipped with a variable pitch "windmill" rotor, two tiny rotors at the rear of the fuselage to act as elevators, and a third one serving as the rudder. Driven by a seventy-five horsepower engine, it ascended in a test flight straight up to a height of thirty feet, flew 200 feet around the field, and then came straight down to a safe landing. Further development of this type of aircraft, Mr. Sikorsky believes, may completely revolutionize flying.

acme
Above, helicopter on ground before flight and, at right, in the air. Large rotor lifts the craft straight upward, while smaller rotors serving as elevators and rudder give pilot full control. Pilot is seated far out in front as in primitive planes, and helicopter has no need of wings

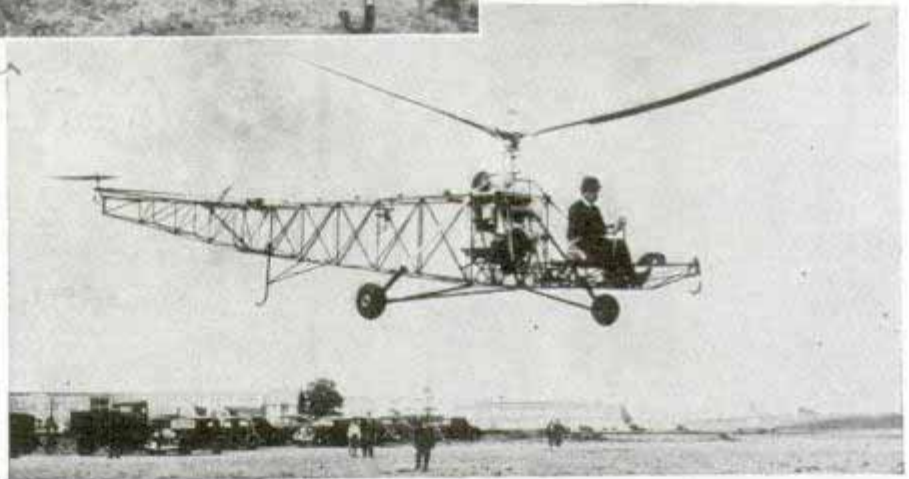

'Pancake' Engine in Plane Wing Adds Ten Per Cent Speed

Increase in speed of about ten per cent is accomplished with a 1,200-horsepower Lycoming engine designed for installation

inside airplane wings. Thirty-seven inches high and forty-four inches wide, the liquid-cooled "pancake" engine presents less frontal area and drag than either radial-type or conventional in-line engines. Power is delivered to the propeller through an extension of the crankshaft.

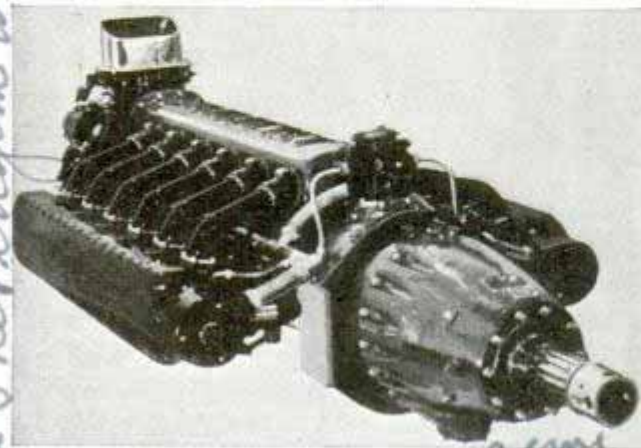

acme
Low-lying airplane engine is incased in wing to offer less frontal area and reduce amount of drag

Study of Brain-Wave Fluctuations Helps Diagnose Diseases

R 699
Tiny electrical currents continuously emitted by the brain are now being measured, making possible a direct study of the brain without disturbing its function. Detection of irregularities of these brain waves, says Dr. Ralph W. Gerard, associate

Unratige Infy. Corp. 420 Lexington Ave. New York

R 660

Bridgeport Conn

professor of physiology of the University of Chicago, aids in diagnosing and locating brain tumors and admits of the detection of epilepsy in its first stages. Research on brain waves also has revealed that the temperature of the cells increases the rate of their electrical rhythm, possibly having some bearing on the use of artificial fever in treatment of insanity. Sedative and anesthetic drugs producing sleep slow the rhythm, while caffeine steps up the waves to more than ten times their normal size. Psychologists have used the waves to tell when a sleeping person is dreaming, and have found the waves are slowed down by emotions and by lights.

K569

Cigarette Case Keeps Score on Number of Smokes

Built into a cigarette case is a meter that keeps tab on the number of cigarettes you smoke or pass out to friends. The case has two buttons, one of which merely opens the case; the other opens it and at the same time causes a ratchet wheel to turn a cog, turning up a new number in the tiny dial on the outside.



Dial of cigarette "meter" is shown in top picture; below, the inside of the case

Photos Ltd 297
 madison a newark

Transparent "Bell" for Plants

Extends the Growing Season



Individual transparent "hotbeds" permit gardener to start his plants earlier and to keep them growing until late in autumn

Bell-shaped covers that guard plants against frost are replacing hotbeds in England because of the shortage of glass and timber. These transparent cloches consist of tough acetate fabric stretched over wire frames, and play an important part in England's "grow more food" campaign by extending the growing season from early spring until Christmas. Thousands of home gardeners and farmers are able to produce a greater abundance of vegetables over the longer period.

K651

Cooling Fins on Motor Housing Help Prevent Overheating

Cast-aluminum housing that incloses small fractional-horsepower electric motors is designed with cooling fins to overcome failures caused by heat

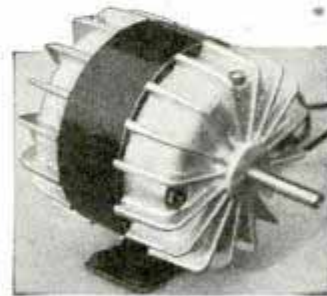

which sometimes burns out the bearing oil. Heat developed within the motor is radiated by the fins, preventing overheating.

Dorothy W. Kempers 295 madison a

J. P. Chan. Clacker. makes look

Mr. Conyers. Caled.

L. J. Ervey
 542 Kilbee

K 579

COAST *to* COAST

TWA Stratoliner



Vertical handwritten note on the right side of the card game photo.

A card game in the clouds, above; on one side of the aisle are six facing seats, on the other side, individual chairs. Left, landing flaps on the trailing edge of the wing. Below, big enough for a traffic tunnel, the sturdy circular fuselage, 11.5 feet in diameter, is sealed for supercharging at high altitudes

Boeing Aircraft Co Seattle Wash.

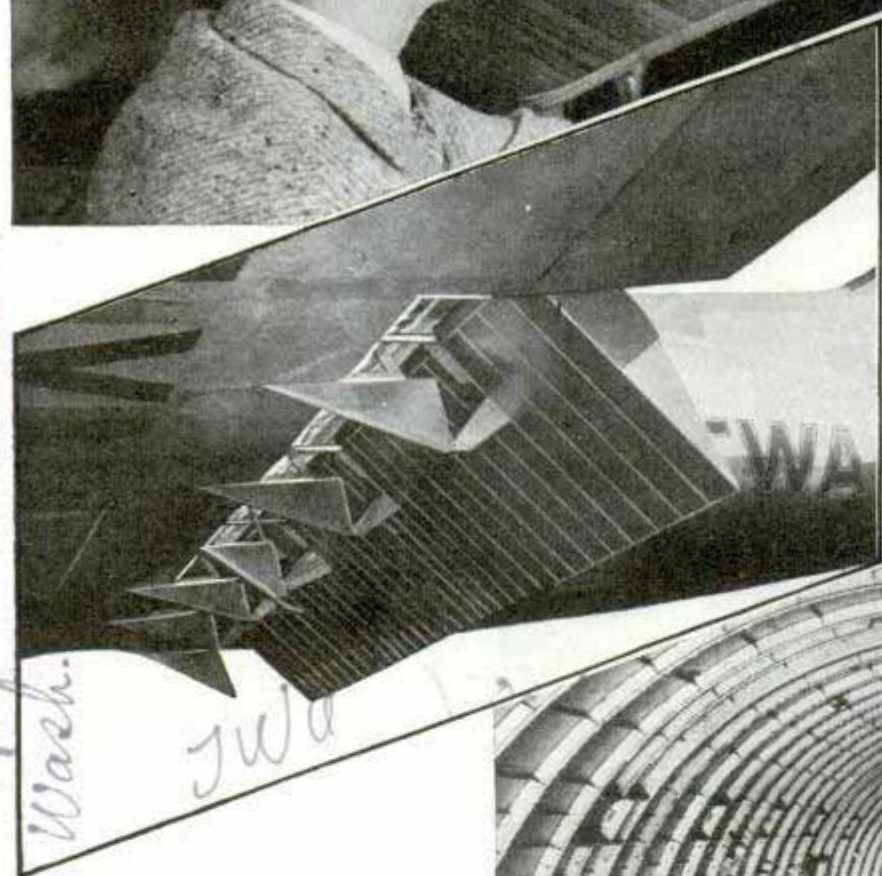

TWA

A new era of air transportation began this summer with the introduction of coast-to-coast travel by four-motored planes. With this overland link completed you can fly from Europe to New York, across the states and on to China in multi-motored craft. On these pages are views of the Boeing-built Stratoliners on the TWA transcontinental route. They accommodate thirty-three passengers by day, twenty-five as a sleeper plane at night



Vertical handwritten note on the right side of the fuselage photo.

News of the year

GN FOUR MOTORS



Largest commercial plane in domestic service, the Stratoliner (top) has 107-foot wing spread, is 74 feet long, with 240-mile top speed, cruising at 220 miles an hour. It cuts an hour and a half from the coast-to-coast schedule, bringing it to fourteen and one-half hours. Center, a glimpse of the women's "charm room." There is also a men's dressing lounge and a kitchenette

JWA



Heart of "altitude-conditioning" system is seen at lower left; air led into ventilating system from edge of wings is compressed so that oxygen content equals that at 6,000 or 8,000 feet while actually cruising in smooth air at high altitudes, where higher speeds and clear radio reception are possible. Flight engineer, below, watches dials in control cabin

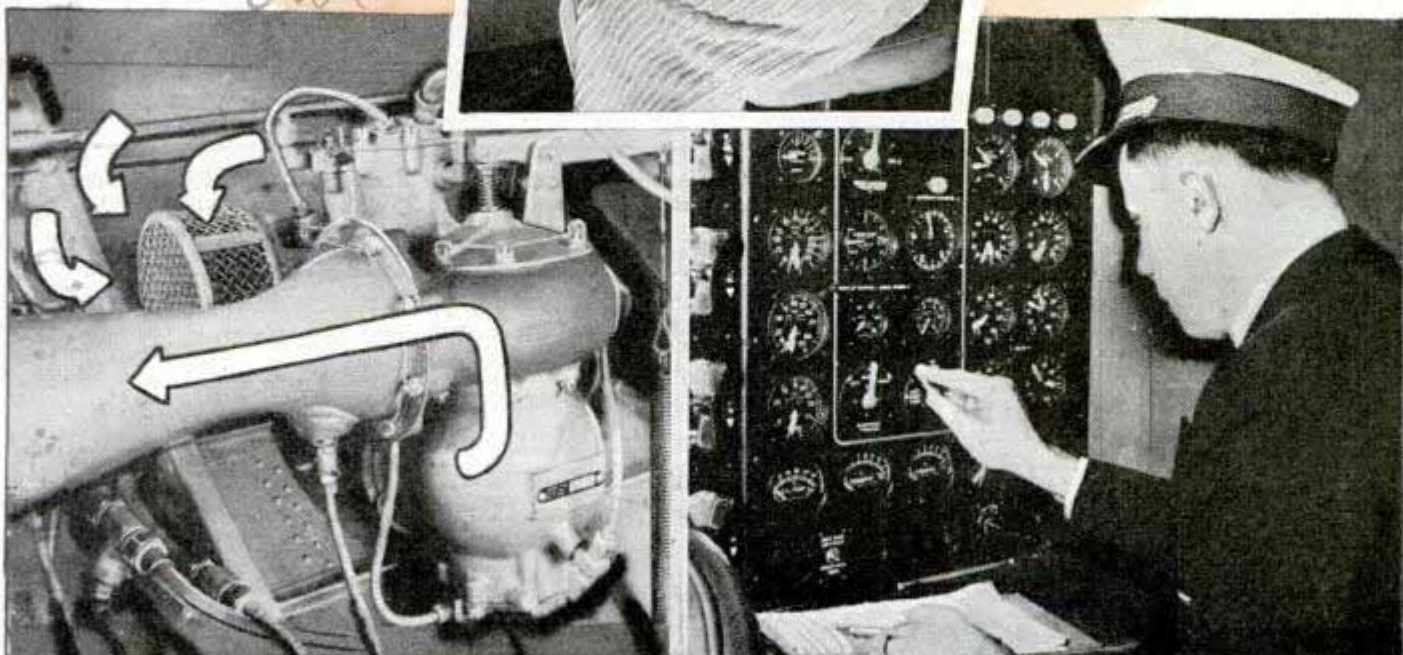

Outside Temperature Read on Indoor Thermometer

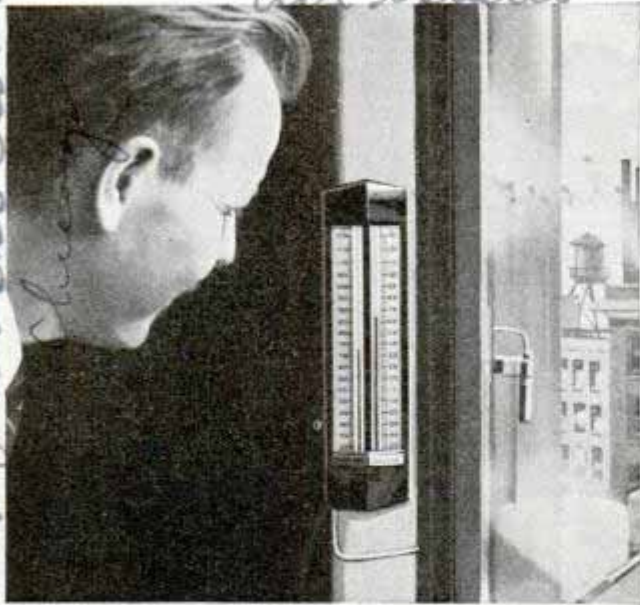

Temperature for both outdoors and indoors may be read from one instrument mounted inside of room

Located inside the house, twin thermometers combined in one instrument give both the indoor and outdoor temperature readings. The secret of recording outdoor temperature in the house is found in a metal tube located outside, which is connected with the thermometer by a piece of fine tubing. The unit is easy to install.

Lightweight Collapsible Suitcase Folds into Small Package

Folding into a small bundle when not in use, a suitcase that is sturdily built can be stored in a small space or tucked into another suitcase or a trunk. Weighing less



Suitcase has handle for carrying when folded flat

than four pounds, it is particularly convenient for air travelers. Furnished in gabardine or leather, it comes in two sizes, twenty-one and twenty-four inches long.

Electric Brake for Motorcycle Applied by Hand Controller

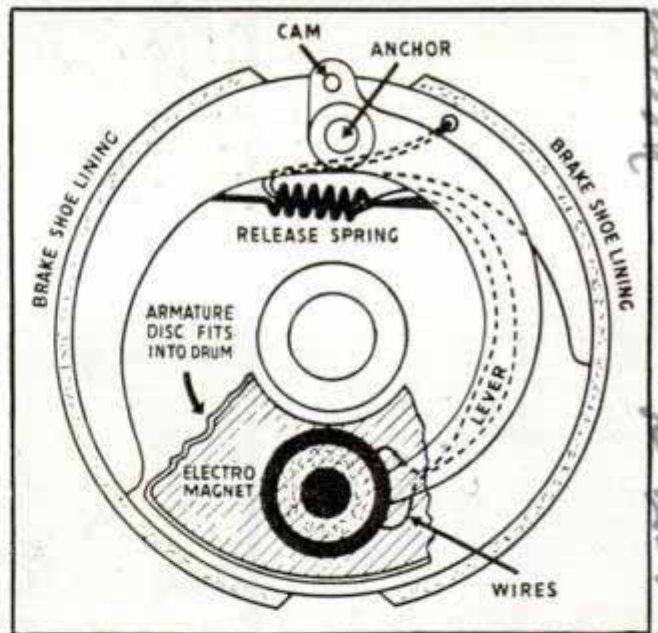
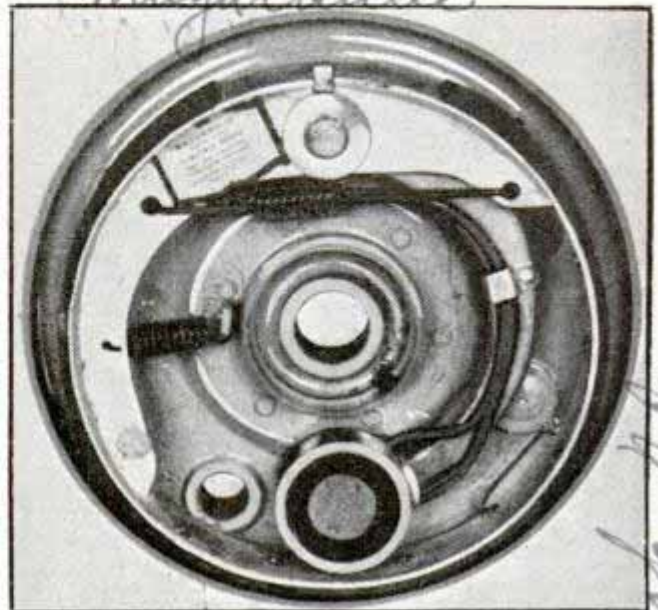

Photo and diagram of electric front-wheel brake for motorcycles, operated by a handle-bar controller

Effortless control of a front-wheel brake for motorcycles, just introduced, is provided by a rheostat controller mounted on the handle bar close to the rubber grip. The brake is electric, using less power than the horn or taillight. By braking the front wheel it lessens use of the rear-wheel foot-pedal brake, permitting quick emergency stops and freeing both legs for balancing the motorcycle when stopping. The force transmitted to the brake shoe is in proportion to the current fed by the controller.

File and the model of the
File 4949 N. Pulaski Road

K459

magdeburg

newark, N.J.
D. Wake Co 875 Broadway

mark Cross Co
657-517 Ave

Empire Electric

Miners' Barge Sucks Coal from Bed of River

*A. C. O. - Mr. ... Arnold, ... Bennett ...
Brooklyn, NY*



In circle is the "hood" that sucks coal from river bottom; above, the stream of coal, sand and water is disgorged at top of separation screen on barge. Below, "miner" pulls coal collected on screen into barge's bin; bottom, sand and water drop through screen and return to river

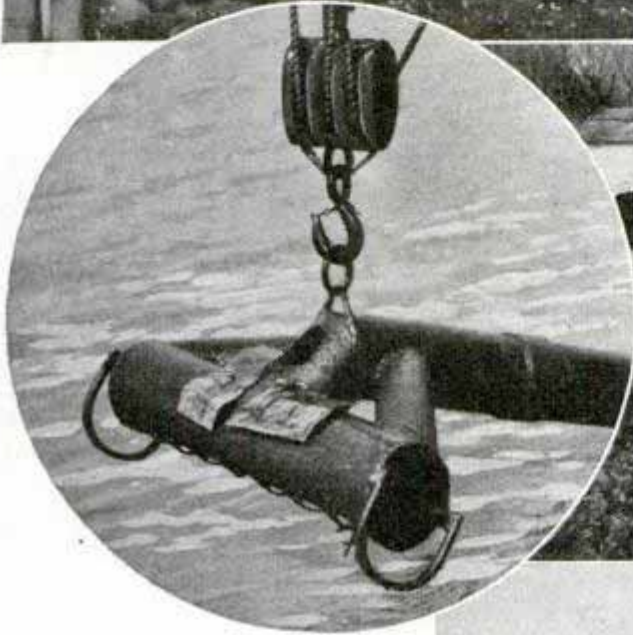

Down the Susquehanna river floats fine coal washed from the Pennsylvania anthracite fields. At Harrisburg a low dam slows the current, the coal settles to the bottom, and from these river-bed "mines" it is sucked aboard barges and taken ashore to be burned in the power plants furnishing steam heat and power for downtown Harrisburg. In front of the boiler on each mining barge is a coil of rope geared to the engine, which pulls the barge slowly toward its anchor. As it moves, a "hood" or "bonnet" creeps along the bottom. Through it sand and coal and water are sucked in an inky mixture to a separation screen. Water and sand drop through the screen and flow back to the river; coal is retained, and a "miner" pulls it with a wide "hoe" into bins in a barge which, when loaded, is

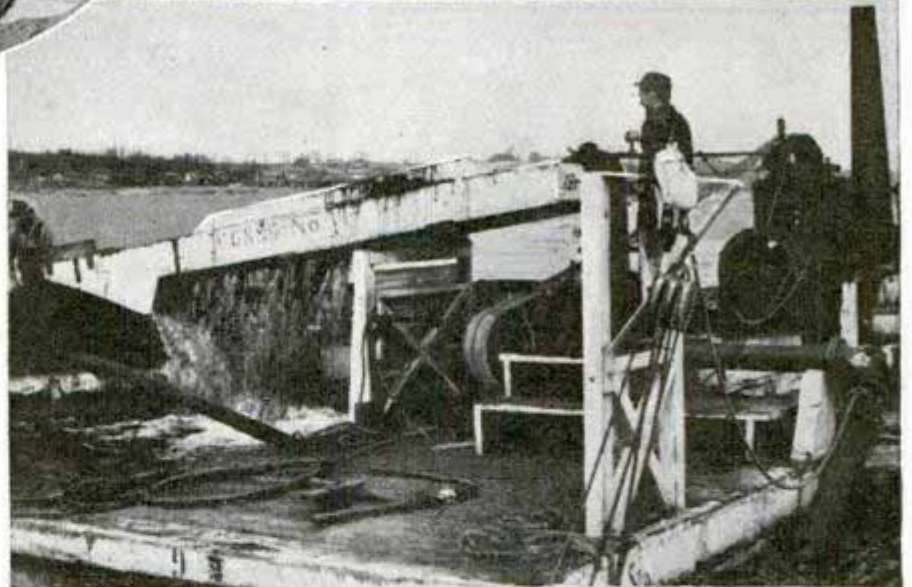

collected by a flat bottom paddle boat. The paddle boat hauls the barge ashore, where the coal is unloaded by a big crane into waiting delivery trucks. Under normal conditions one of the barges can be loaded with about twenty tons of the water-soaked river coal in an hour. Nearly all of the coal is used for industrial purposes and can be burned only in furnaces equipped with a special blower attachment.

Mining MUD

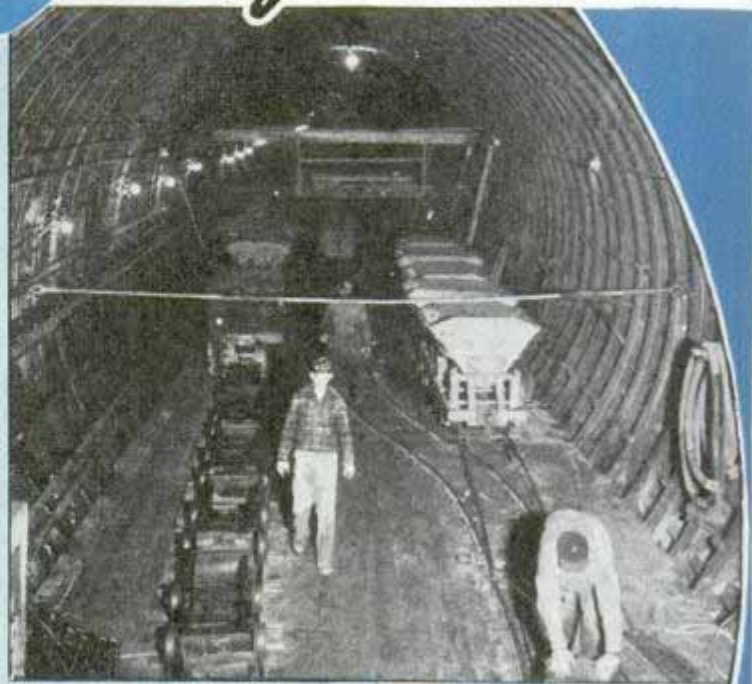
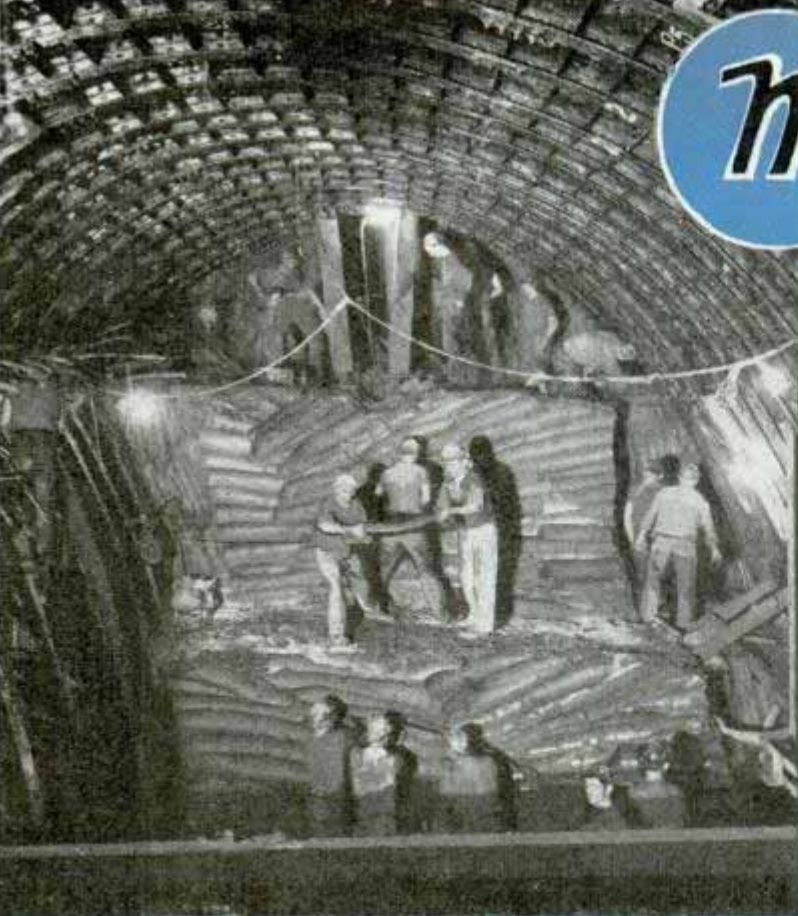

Handhogs at upper left bore tunnel by hand, peeling off clay with wire knives. Right, hauling out trainloads of muck. The tugs are escorting prefabricated section of tunnel to be sunk into river bed

By Roderick M. Grant

UNDERNEATH Chicago's skyscrapers an army of 4,000 men armed with power knives and gargantuan "biscuit cutters" is mining blue clay.

It's a \$46,000,000 mining project, but there isn't an ounce of pay dirt in the two million yards of dripping muck they're slashing and squeezing from perilously near the foundations of State street de-

partment stores and Dearborn street theaters and fifteen feet under the Chicago river bed. This heroic mining venture has just one purpose—to create an underground traffic system. For Chicago, finally is to have a subway: a little under eight miles of twin tubing that will divert part of its elevated railways underground, save some downtown commuters seven to twenty-

K 931

with a BISCUIT CUTTER

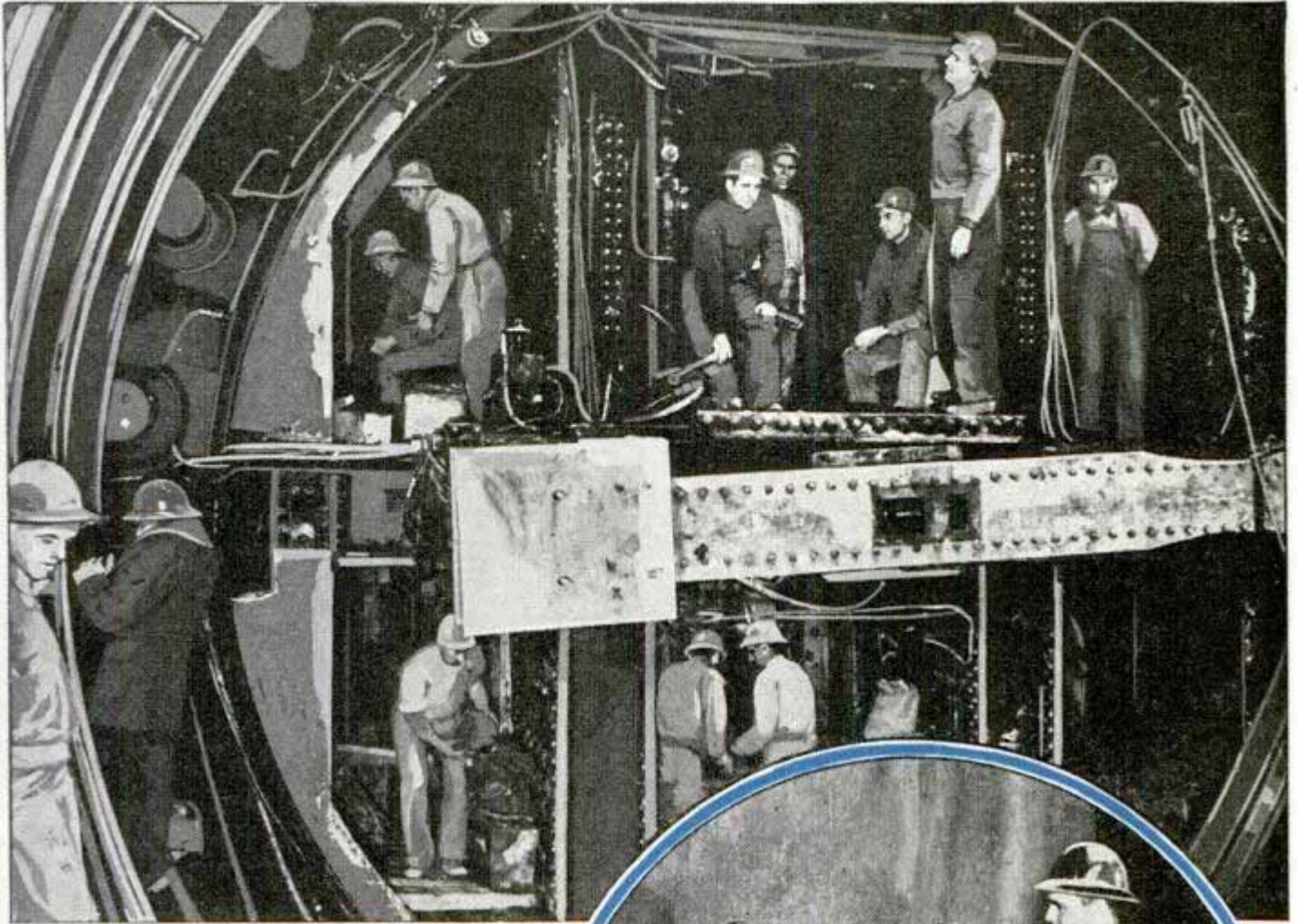

Men in left background slice off clay squeezed through openings in "biscuit cutter" as engineer (upper center) turns valve for hydraulic power. In circle, boring for a sample of clay

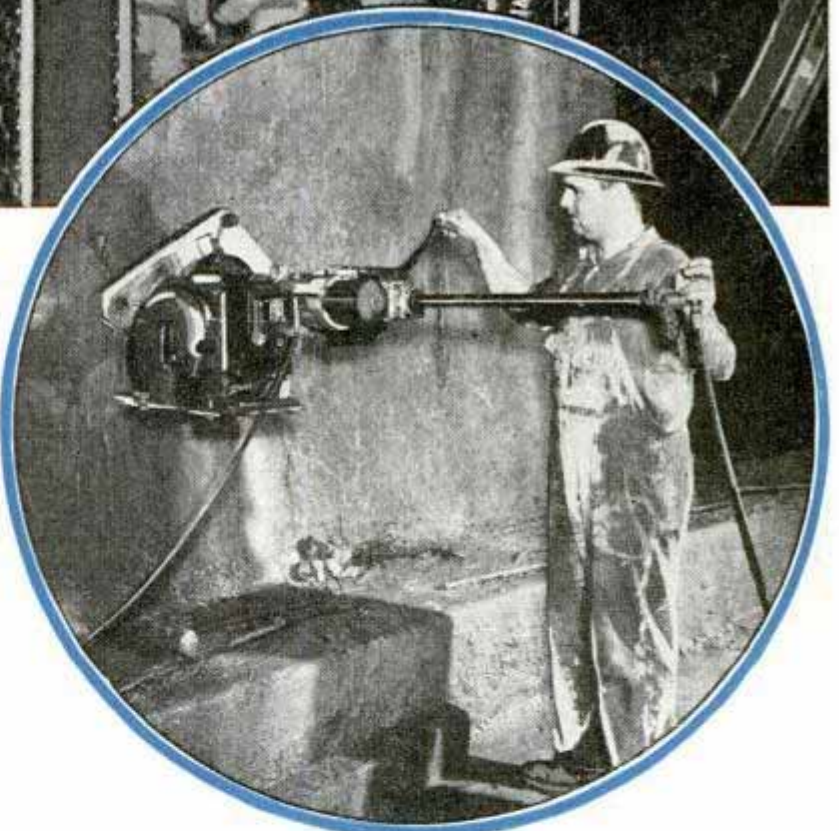

five minutes a day, and perhaps will be the beginning of the end of the historic elevated "Loop," the upstairs railway that fences in downtown Chicago.

Boring this subway is part mining, part ditch-digging, part navigation, part deep-sea diving. Three methods are being used: one, the open cut, where shovels work down from the top. Second, the "handicraft" method, where handhogs slash away at the muck with a technique reminiscent of rope-skipping, slapping their knives into the clay and letting a power-operated winch pull the wire through, curling off a long slab of mud for the muckers to heave into cars. The third

method employs the giant shield, safest in the skyscraper area where flirtations with building foundations are fraught with peril and a cave-in would be catastrophic.

Forty feet down a shaft they lower this 225-ton steel "biscuit cutter," its circular cutting edge—twenty-five feet three and

1937

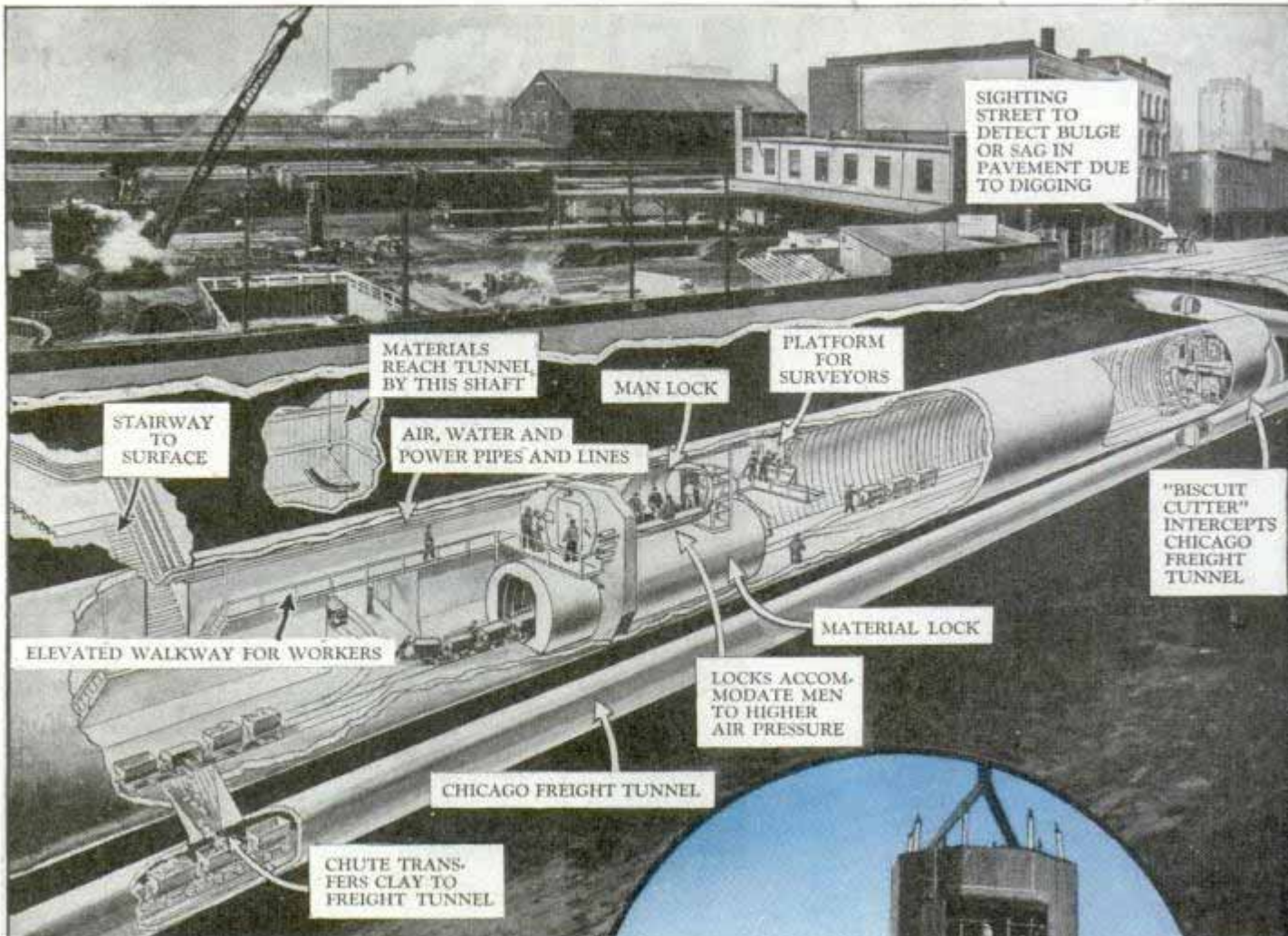

Drawing by Otto Merker for the Chicago Daily News

one-half inches in diameter—headed for town. It braces its back against the steel and concrete wall, takes a deep hydraulic breath and shoves forward irresistibly into the semi-solid clay. Four of these big steel rings are holing out four single-track tubes in the downtown area, and each is armed with twenty-four hydraulic jacks. Each jack can exert a 200-ton push—adding up to 4,800 tons pressure behind each cutting head.

As the shield thrusts forward, clay is squeezed through its windows or "muck pockets" like toothpaste from a tube. Thirty-three inches it advances at every push, while miners lop off the clay forced through six holes in the face of the shield. After a thirty-three inch push the hydraulic jacks are retracted. An erector arm hoists a steel ring consisting of six segments of liner plate that form the skeleton of the tunnel; the hydraulic jacks brace their feet against the new ring and

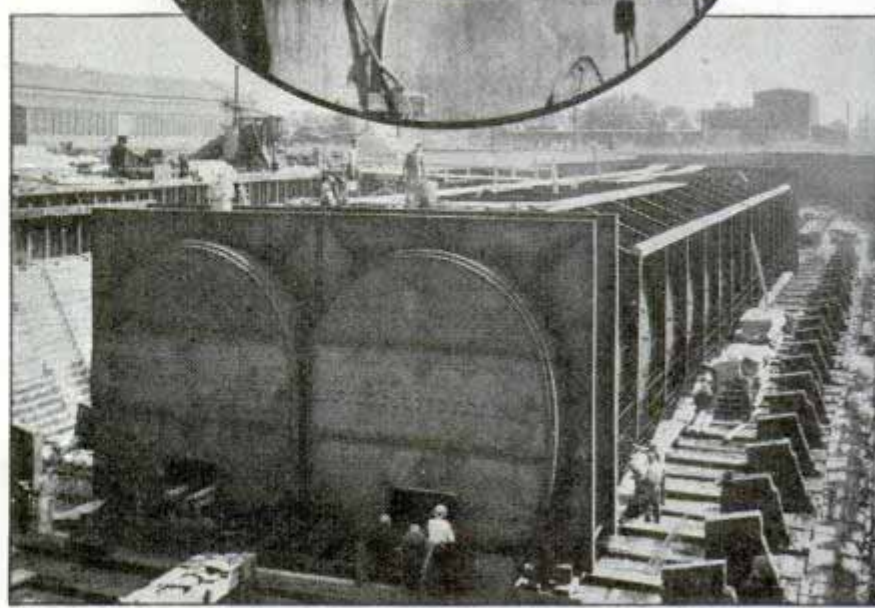
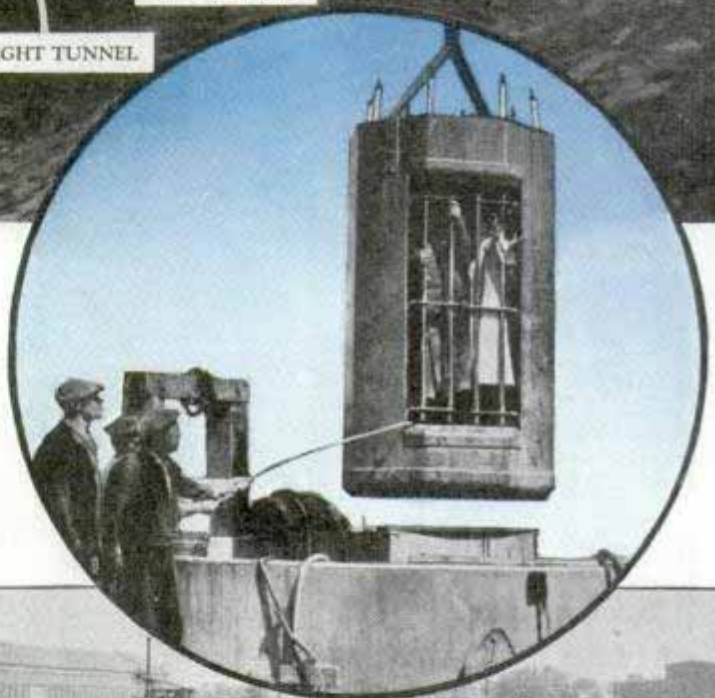

Top, sectional drawing of tunnel operations. Circle, workers' cage emerges from a shaft. Bottom, completing the twin tunnel built to carry subway under the Chicago river at State street

shove on another thirty-three inches. A foot an hour, as much as forty-six feet of tunnel on record days, creeps the mammoth cutter, funneling backward 129,000 pounds of clay for every thirty-three-inch ring. Hopper cars haul away the muck through the old Chicago freight tunnel system and dump it into scows which dispose of it in Lake Michigan. Some was used for fill in park areas. Engineers estimated it would cost around \$1,500,000 just to get rid of the 2,000,000 yards of clay.

With all its 225 tons of weight and 4,800 tons of pressure, this biscuit cutter is susceptible of extremely delicate navigation. Occasionally it will encounter resistance from a boulder that calls for a tiny dose of dynamite, or a pocket of air or sand may slacken resistance on one side. Surveyors on the subterranean "bridge" keep sights trained on the tunnel, warn the chief engineer of any variation from the straight and narrow, and by a twist of one of the valves on his control panel the engineer can adjust instantly hydraulic pressure in the individual jacks to straighten

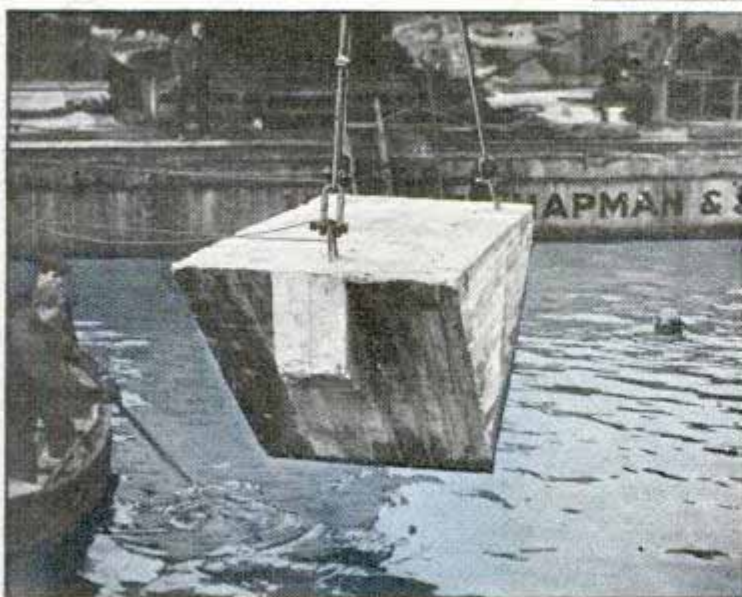
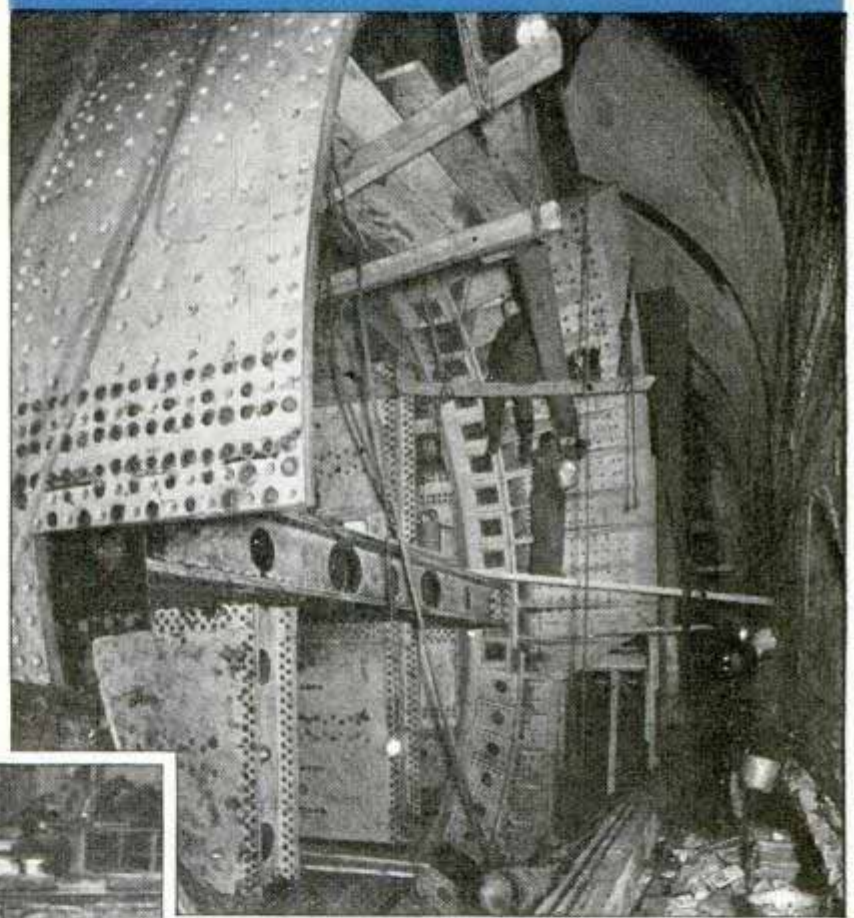

the push. One of his most ticklish navigation problems was to curve the shield around the corner where the Dearborn street tube turns into Lake street.

Down in the diggings, miners and muckers work like deep-sea divers under compression. To reach the shield they go through a compression chamber, a steel cylinder in which they pause a few minutes while the pressure is equalized with the ten or fifteen pounds of air at the shield. The one additional atmosphere does not compare with the high pressures under

(Continued to page 116A)

Top, rescue squad after battle with fire during subway construction. Center, cutting face of biscuit cutter. Bottom, dropping ballast on sub-river tunnel

505
To 32 Florida Ave. Akron Ohio

Models of Microscopic Life

Carved in Wood by Teacher

of a complete organism. A wooden model a foot long may represent a fraction of a millimeter of leaf structure. His exhibits include models of a partly dissected earthworm, a crayfish, grasshopper, frog, flower reproductive organs and leaves, a bean with its embryonic plant, and a kernel of corn showing the embryo.

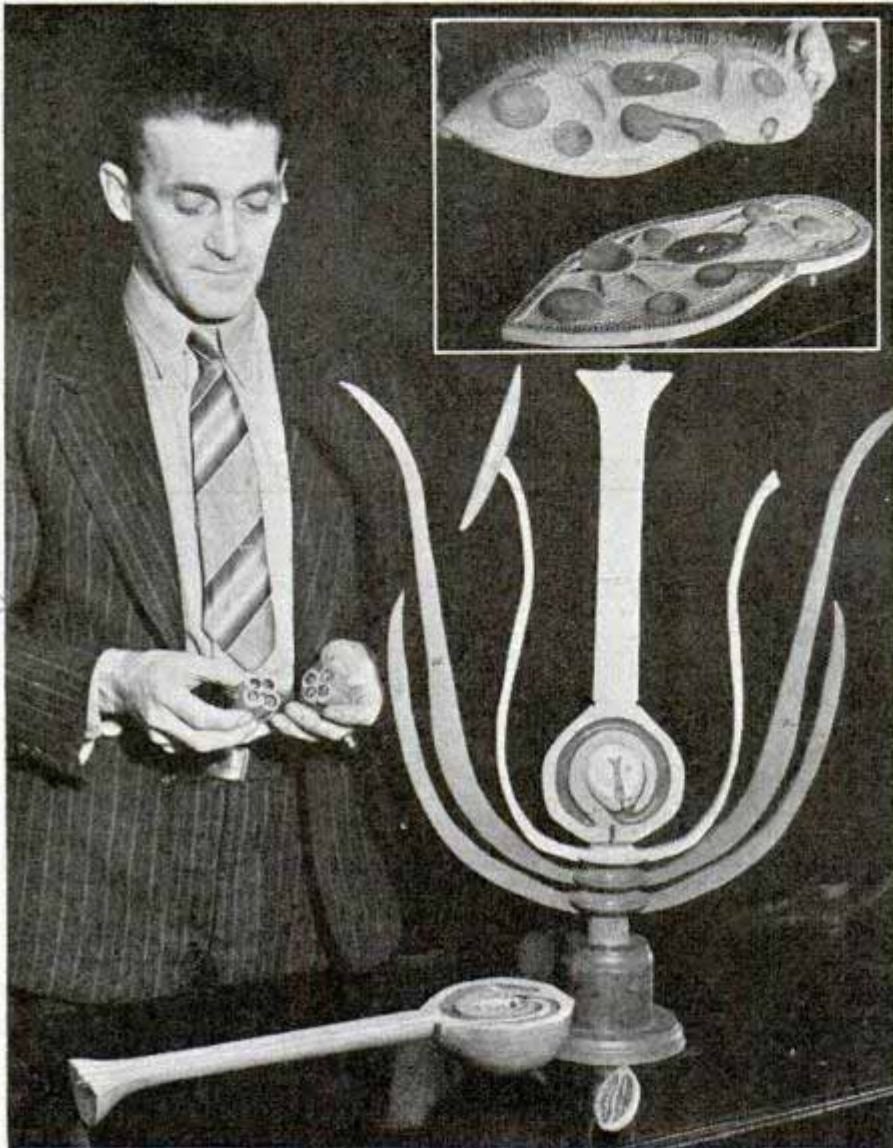

Biology teacher exhibits model of flower; he holds an anther, which comes apart to show pollen inside. Inset, two-layer model of paramecium

To show his pupils what the inside of a leaf or a flower anther looks like, a Cleveland Heights biology teacher began two years ago to carve models in wood. Today his classroom has eighteen detailed models representing in solid form what the student of plant or animal life would see under the microscope. In modeling, for example, a paramecium—a one-celled animal—he saws a rough blank from soft wood, then shapes it with carving tools and finally applies oil paints, using an actual specimen under a microscope as his guide. In the paramecium model the cilia, hair-like appendages covering the body, were represented by bristles taken from a brush and stuck into more than 1,000 tiny holes drilled in the wood. Some of his collection can be taken apart to reveal internal structure, others represent microscopic sections

4567

Rotary Mower Knife Cuts Weeds and Tall Growths

Attached at the front of a lawnmower, a rotary knife slashes weeds and other growths too high for the mower blades, thus saving the labor of hacking them with a sickle. It fits hand-pushed lawnmowers up to twenty inches. A swivel action permits it to follow the contour of both rough and smooth ground. Mounted on its own two wheels, the attachment may be lifted back out of the way and hooked in that position so it will not interfere with ordinary uses of the lawnmower. Two U-bolts and clamps fasten the attachment to the crossbar.

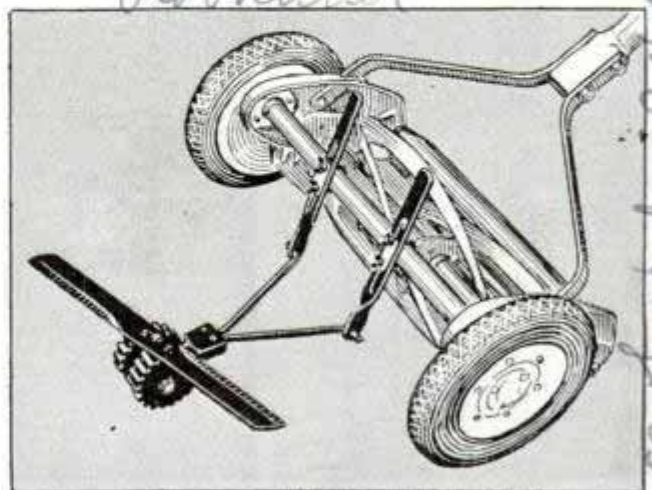

Running ahead of lawnmower, this rotary knife cuts tall-growing weeds that the mower blades would miss

Karl Christman, High School

C. C. Todd, 8406 Seaview Ave. - Cleveland

Third-Dimension Pictures Projected in Color

Color slides shown in three dimensions with the aid of a projector using Polaroid are so true to life that instead of bringing you a scene in picture form they virtually take you to the scene. Third-dimension pictures with natural perspective are obtained by projecting two slides simultaneously through Polaroid screens in the projector, one slide being for the left eye and the other for the right eye. When these two pictures are viewed through Polaroid glasses, each eye sees only the view it would if the spectator were standing where the camera was placed in making the picture. Slides are changed by remote control or by an automatic timing device.

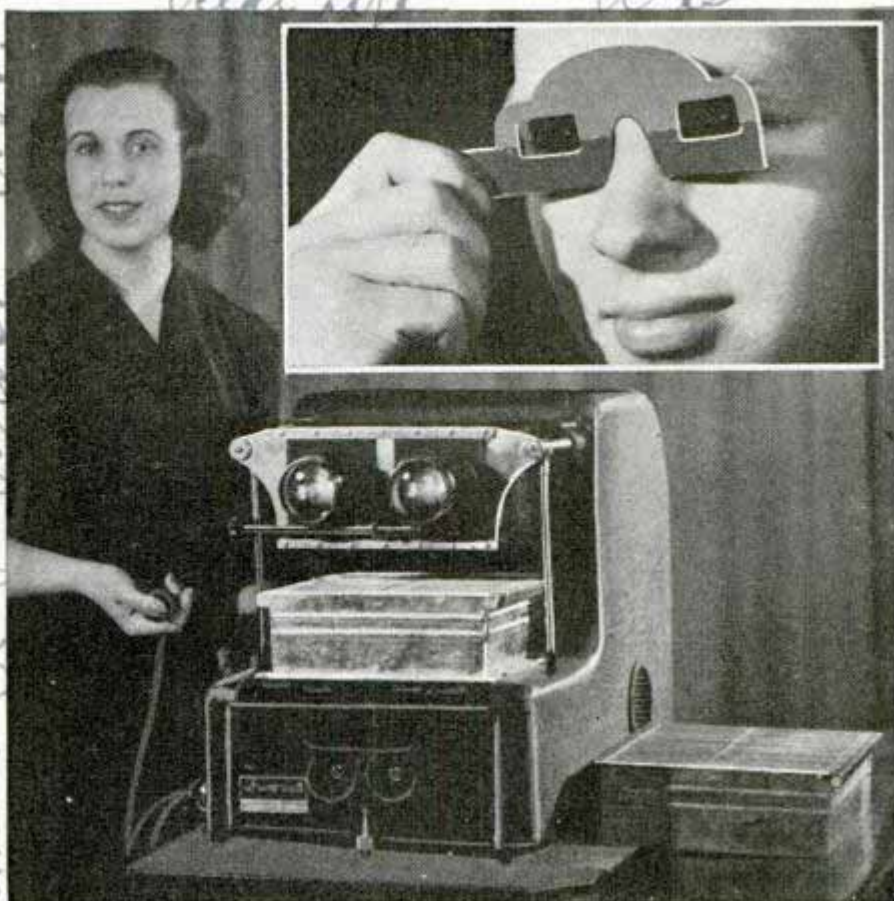

Projector shows three-dimension pictures in natural colors with the aid of Polaroid. Inset, spectator wears Polaroid glasses to view picture

K680

Twenty-One-Gun Warplane Pours Fire in All Directions



British fighter with guns in turret is more effective against bombers

One of Britain's newest aerial weapons, the two-seater "Defiant" built by the firm of Boulton Paul, fires four machine guns from a hydraulically turned turret. This enables the single-engine ship to cruise alongside an enemy bomber and pour bullets into it, a feat impossible when all guns are fixed to fire straight forward. Additional arms include fourteen machine guns in the wings close to the fuselage, two cannons synchronized with the propeller and a third cannon firing through the propeller shaft. Powered with a 1,050-horsepower Rolls-Royce Merlin engine, the fighter has a top speed of 350 miles an hour.

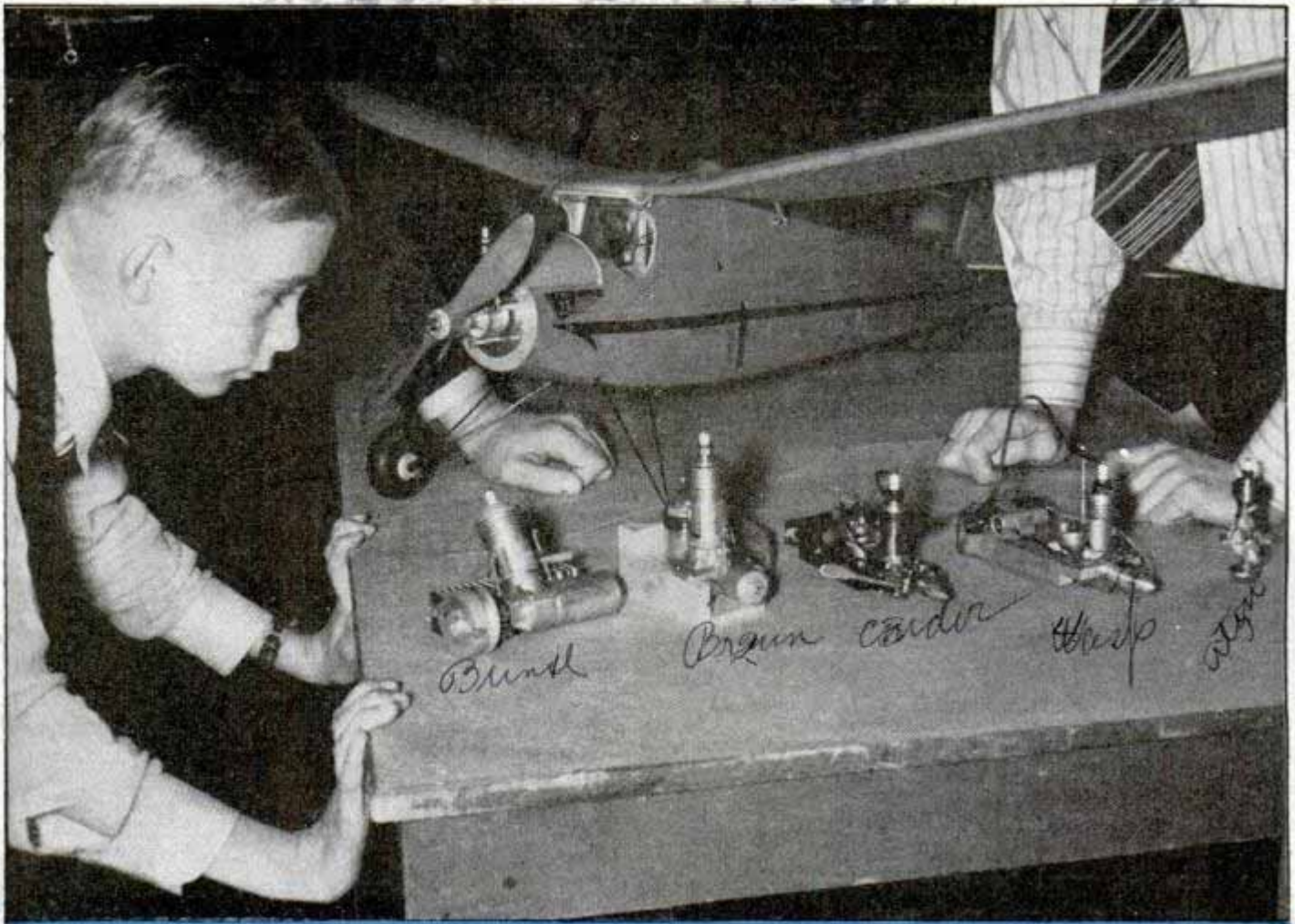

The SKY'S their



Young member of model plane club's classes (top) taking examination to qualify for "Expert" license. Bottom, all-metal seaplane

BUILDING and flying of model airplanes is a rapidly increasing hobby that already has 2,000,000 followers of every age. And there are indications that 4,000,000 more will be added to this total within a short time.

Until quite recently, construction of successful miniature planes was too complicated for average air-minded amateurs. But now practically anyone with a knack of using simple tools can produce an aircraft which in looks and ability to fly will be a credit to its maker and pilot. At any modern shop specializing in hobby-making supplies, selection can be made from a variety of ready-to-assemble model-airplane kits comprising fuselage, struts, wings and



LIMIT

wing fabric, "dope," wires, propeller and power, correctly designed and figured by factory aeronautical engineers down to the smallest details. Exactly dimensioned and easily followed working drawings, which are included, insure good results.

Prices begin with the investment of a few cents for a beginner's glider kit of diagrammed balsa-wood wings and strut which, whittled according to directions, will really glide. From this, the outfits range through the twenty-five cent, fifty cent and one dollar rubber-powered flying models. More elaborate ships of five feet and more wing spread and embodying the latest refinements of fuselage design, landing gear and variable-pitch propellers call for an outlay of around eight dollars.

Top, right, exhibiting a well-built gas-motored model. Left, misadjusted model diving in as spectators scramble out of the way. Circle, nine and one-half foot model which has made more than 300 flights

Until development of midget motors, all model planes were powered by twisted tough elastic strands. Rubber-powered ships are capable of remarkable performances in speed and endurance flying, with average time for non-stop flights of fifteen to twenty-five minutes. Their moderate

*Ref: Edward Roberts
Pres. Junior Motor Club*

Worsham, Wash. D.C. Herkimer, N.Y.



last for indoor as well as outdoor flying) which develop as much as one-third horsepower and tune up as high as 10,000 revolutions per minute.

Specially treated steel forgings of these little whirlwinds, no larger than a fair-sized paperweight, are bored with a machine which had to be invented for the purpose. Their alloy pistons, crankshafts, cams and other working parts are machined and fitted with "tolerances" held to a half-thousandth of an inch precision. Diminutive spark plugs were developed for their use. Their fuel is mixed and fed by cleverly worked out adjustable carburetors supplied by medi-

*model airplane club
Carmah 8000
Carmah 2509*

*7303
Alma engine Co. P.O. 6
Engle, Ill.
2 P.O. New York*



Courtesy Junior Motors Corp.
Top, successful autogyro model. Center, ground crew double-checking before launching miniature plane. Below, tiny gas-powered engine and propeller

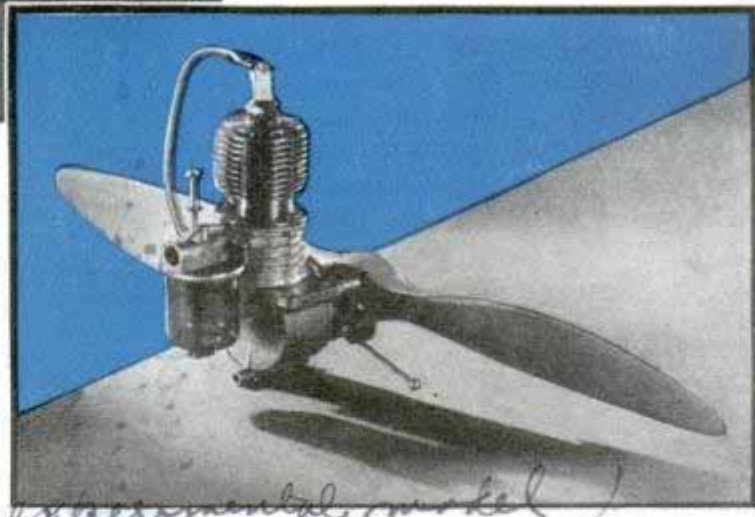

experimental model
cine-dropper-filled tanks in which ordinary low-test gasoline is combined with heavy-duty oil to insure proper lubrication. The midget motor is started by snapping over its "prop" with carburetor choked, then "thinned" to efficient flying leanness.

Rules for gas-powered endurance flights of officially sanctioned model air meets re-

quire that motors be timed for exactly twenty seconds of power with which to carry a ship to maximum altitude. This is accomplished in the newest types by a hand-set timer gear which automatically "cuts" the ignition at exactly the predetermined moment. Without the gear, the fuel tank must be measured to run dry and halt the motor at the time specified. With a pint of fuel and motor minus time control, gas-powered models have made non-stop cruises of two hours and more.

Success in flying either rubber or gas-powered models depends upon a pilot's skill in giving his ship directional control. And this is what makes model aviation such an intriguing sport. This is also why you'll find advanced model plane builders and flyers as thorough-going in their study of aerodynamics as any aviation cadet or aircraft ground-school student.

Model planes deal with almost exactly the same problems of wind velocities, drift, thermal densities and other aeronautical factors which must be solved by man-carry-

(Continued to page 130A)



Above, another model in readiness to compete for trophies awarded by A.M.A. Below, junior aviator's stable of transport, sport, commercial and military models. Bottom, boat with three-inch draft is used in launching seaplane models

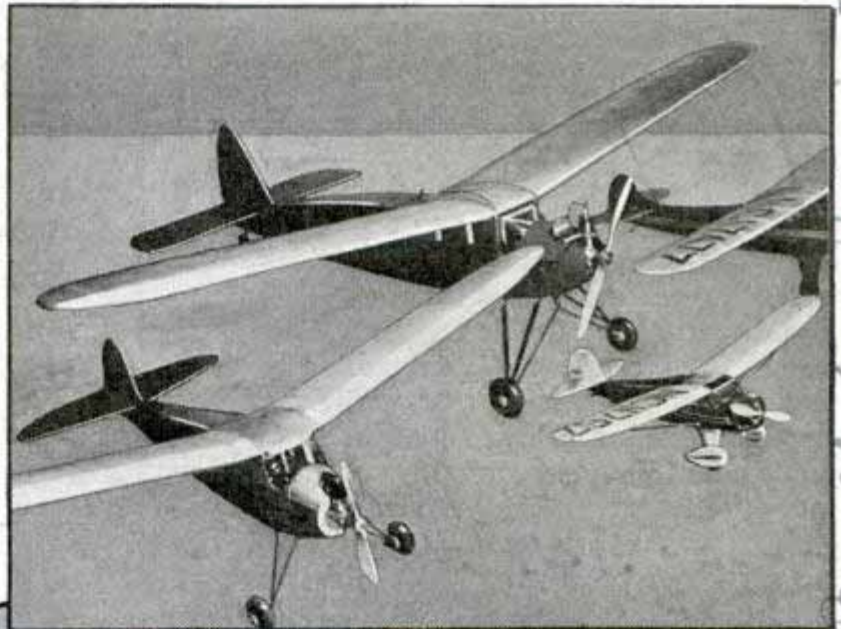

Built by Harry Ferrera, Jr. Manager, B. C. ...
 W. H. ...
 ...
 ...

Tune-Playing Horns for Car Offer Eleven Selections



Tuneful melodies instead of rude blasts issue from auto horns giving driver choice of eleven numbers

Musical strains from any one of eleven popular pieces are played automatically by an electric horn unit for automobiles. Mounted either outside the body or under the hood, the horns are controlled by the driver through a lever-type switch on the steering column. Pressing a button on the instrument panel starts relays operating to play the tune that has been selected.

Water Evaporator Cools Room and Humidifies the Air

Air current from a ten-inch electric fan is all the power needed to operate a portable "air conditioner" that humidifies the

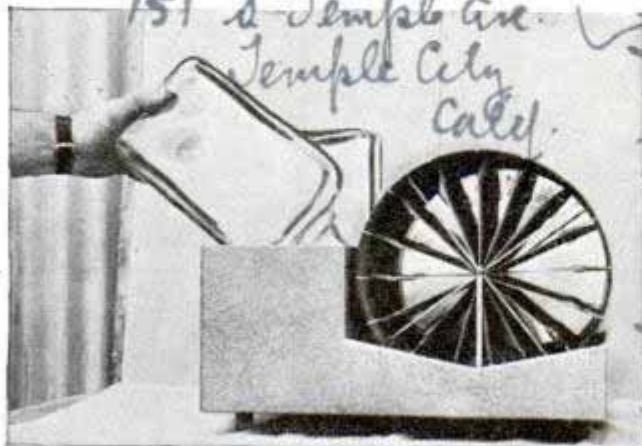

Removing jug from cooler for refilling or cleaning. Water level remains the same until jugs are empty

room by evaporation as it cools. The evaporating surface consists of numerous cloth vanes radiating from a hub like spokes inside a drum, which is rotated in a pan of water by the fan's breeze. Water from large glass containers runs the cooler ten hours on one filling. The cooler works best where the humidity is low, but if humidity becomes too high this may be offset by admitting more air into the room.

Fuel Saver Uses Waste Heat to Warm the Basement

Installed between the furnace and the chimney to utilize otherwise waste heat in the flue gases, a fuel saver will circulate hot air through the basement and raise its temperature, according to the manufacturer, from ten to twenty degrees while sav-



Above, the fuel saver is installed next to furnace to warm basement air, which passes upward through it. Diagram at right illustrates how it can be used as an auxiliary to hot-water heater

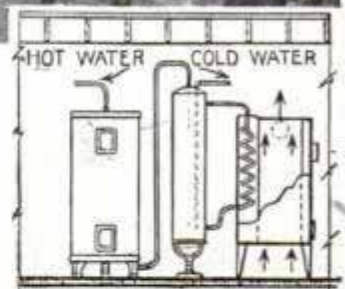

ing fifteen to twenty per cent in fuel costs. Requiring a floor space of only one by two feet, it is built of copper alloy steel and has a rectangular center flue to speed transfer of heat, induce air movement and retard cooling of the furnace. It is designed for use with oil-fired, hand-fired or stoker furnaces, hot water, warm air, steam or vapor types. Soot and dust collect in airtight cleanouts at the base for easy removal. One model can be used as an auxiliary to the hot-water heater.

Handwritten notes:
 1939-352
 K 306
 re-sept 1939-352
 Los Angeles
 54
 1285
 151
 Temple City
 Calif.
 Satterberg Bros.
 421
 151
 Temple City
 Calif.
 Satterberg Bros.
 421

Anti-Aircraft Monitors Would Guard Warship

Squads of small steel-clad monitors anchored in a protective cordon around battleships are proposed by an American naval engineer as an effective means of defending the costly dreadnaughts against the aerial bomber. Each of the little monitors would be armed with four to six anti-aircraft guns in a revolving turret. Hard to hit, themselves, they could spray a deadly barrage of shells into the sky against aircraft attacking in any direction. The monitors would be manned by crews of two or three dozen men.

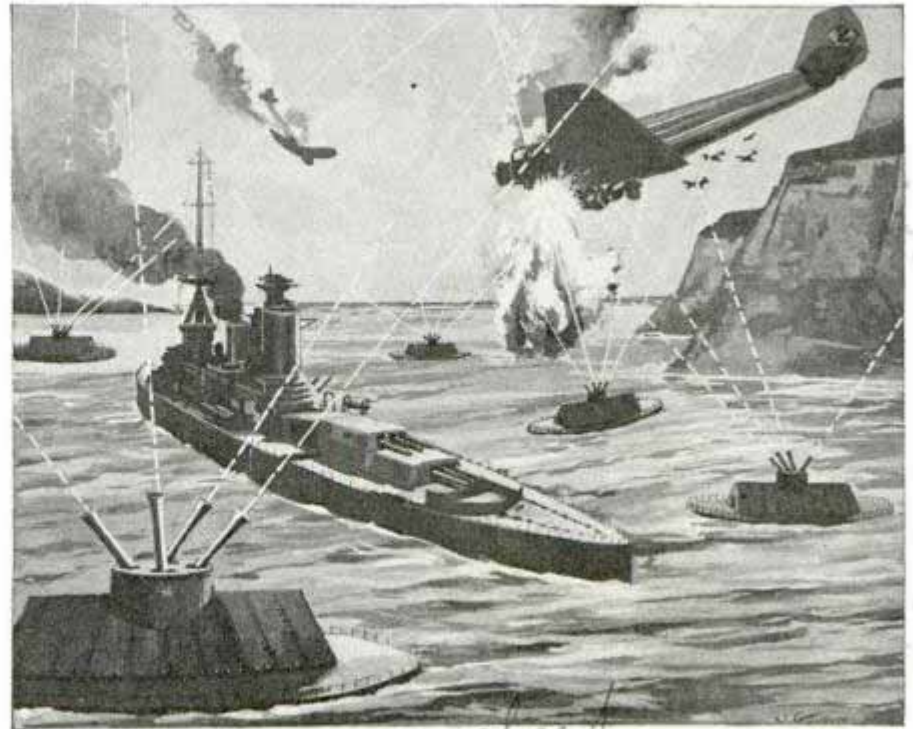

Steel-clad monitors surrounding the battleship would offer small targets for bombers while sending heavy anti-aircraft fire in all directions

Fingertip Hydraulic Steering Control Guides Big Tractor

All that it takes to steer a big seventy-five horsepower Caterpillar tractor is a slight pull on a steering lever. The tractor has no conventional wheel. Hydraulic con-

trols provide fingertip steering of the 23,500-pound Diesel-powered machine. A hydraulic pump, functioning continuously when the flywheel clutch is engaged, provides the power for releasing the steering clutches. When the clutches are engaged, oil bypasses within the unit, no pressure being built up. When the driver pulls back on the steering clutch lever, oil is pumped into a cylinder and moves a piston, which pushes against a lever arm on the end of the clutch release shaft.

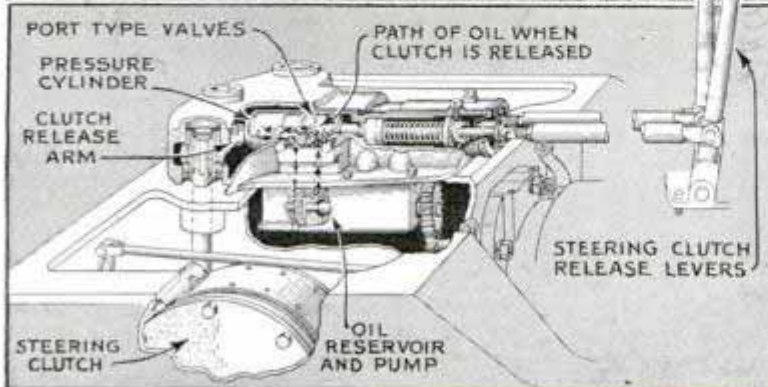

Both clutches are engaged when driving straight; a pull on one of the hydraulic levers steers tractor to right or left

Should the hydraulic mechanism fail or if the engine were not running, the clutches can be controlled manually. Driving in a straight line, both clutches are engaged; to turn left, the left clutch is released; to turn right, the right clutch is released; releasing both stops the tractor.

ⓁDiamond-impregnated wheels for cutting stone is one of the latest uses for the 10,000,000-carat annual output of the South African mines, of which two-thirds is used by industry.

Compressed Air
July 1939

X-Ray Pictures Taken in Millionth of a Second

Westinghouse Lamp Co. Bloomfield N.J.



Sept. 2, 1928 - Walter Duda, Mettling

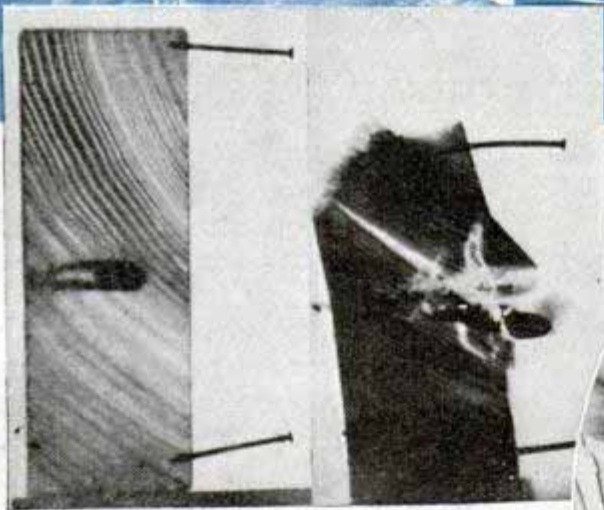

In one millionth of a second, a glass tube developed by Westinghouse scientists produces and releases a heavy surge of X-rays, resulting in still pictures of interiors of rapidly moving objects. Top, preparing to take pictures of bullet passing through block of wood. Below, left, two pictures which show bullet going through block and then emerging, literally exploding the block. Both were made with millionth of a second exposures

Galtner Pen. Genco.



Sept. 2, 1928

Merrill Sears

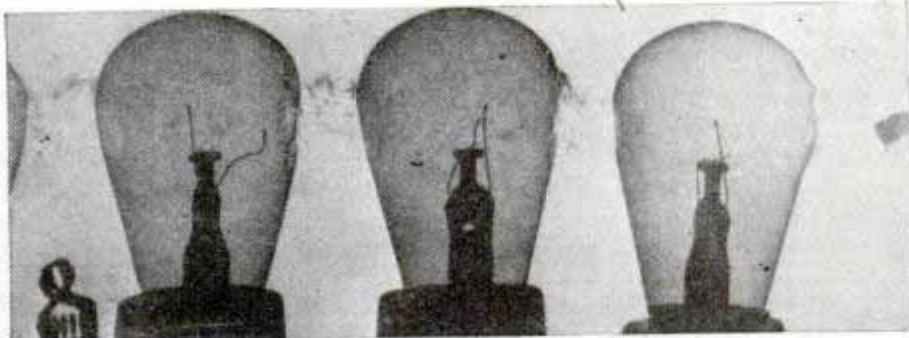

Above, Dr. H. C. Rentschler, of Westinghouse, explaining operation of ultra high-speed X-ray tube to baseball players. Bottom, twenty-two caliber bullet emerging after passing through row of electric lamps. Exposure time was so rapid that lamps, although pierced, have not had time to shatter

Super-Fast Tube Points Way to X-Ray Movies



Westinghouse engineers believe development of super-fast X-ray tubes may result in accomplishing many hitherto impossible tasks. Machine and motor builders may be able to study internal strains of rapidly moving parts. It is even possible that X-ray motion pictures may be made. Right, kicking football as millionth of a second exposure is made. Above, picture resulting from the exposure has "looked" right through both foot and ball. Note bones in kicker's foot, ankle and leg; nails in heel and sole and eyelets on top of shoe; also that although the toe has penetrated to the center of the ball, it has not started to move

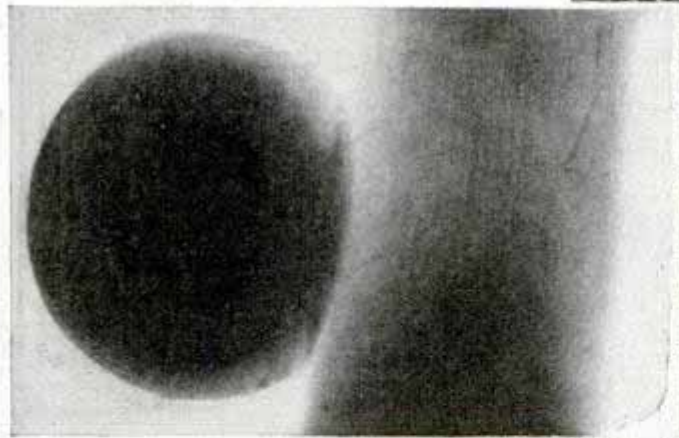
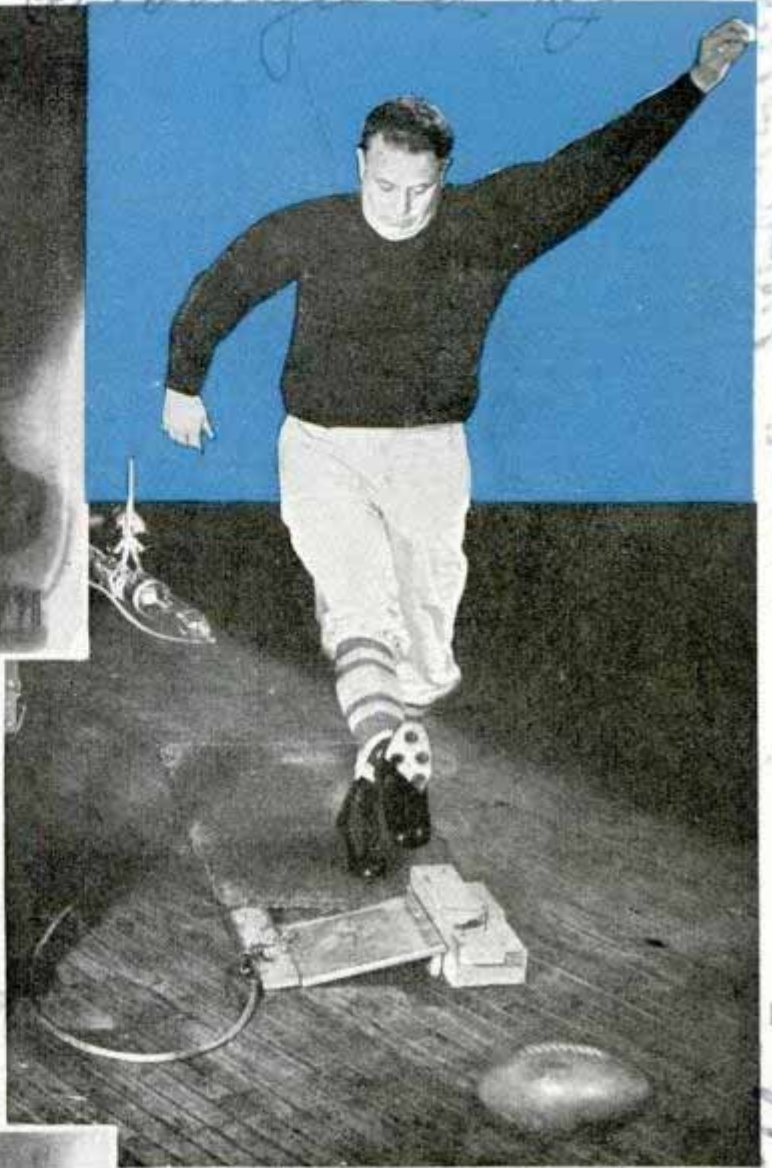

Right, player has just hit the ball as millionth of a second X-ray equipment went into action. Above, X-ray picture showing what happened when the ball and bat met. If you look closely, you'll detect distortion of black core of the ball. Apparent overlapping of ball and bat is due to fact that the ball was not hit squarely. Conventional types of high-speed X-ray equipment permit exposure times little shorter than one-hundredth of a second, amply fast for "radiographs" of the human body and of still objects

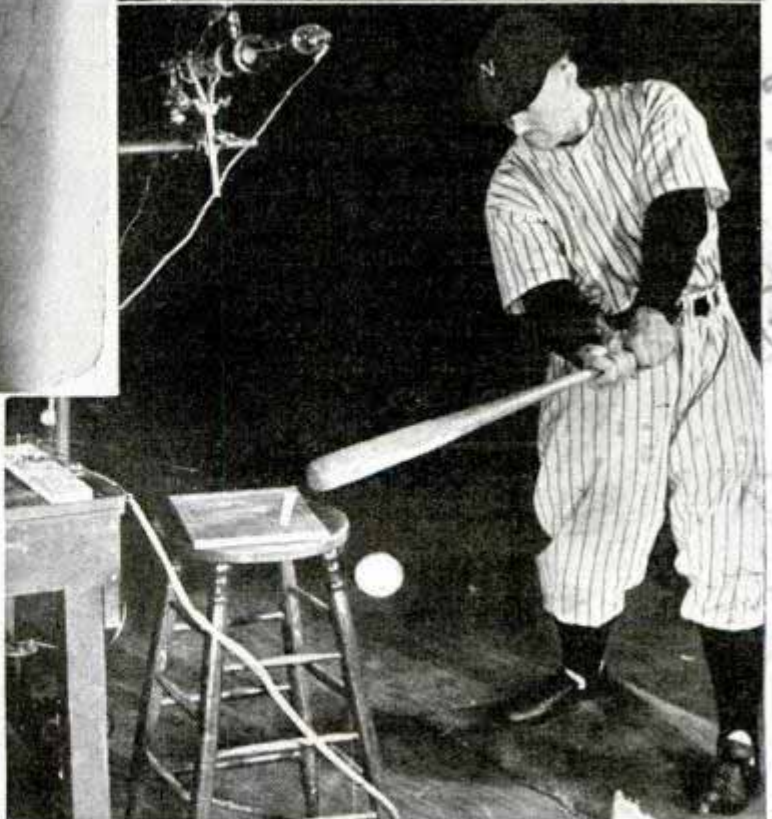

Olin: Methering

Pneumatic Football Trainer Tests Player's Drive Power



As the player charges, the dummy's movement on its overhead track is resisted by a pneumatic cylinder, and the coach reads his power on dials.

Football coaches this fall will be using a pneumatic dummy to train players in tackling and charging—and at the same time to weigh their driving power. The dummy is suspended on a trolley, traveling horizontally on an overhead track made of a structural I-beam. Movement of the dummy is resisted by a plunger moving in a pneumatic cylinder mounted above the track, and as the player charges the dummy, the power of his drive is read directly on a dial graduated up to 660 pounds pressure. The device is adapted to teaching perfect form and timing in blocking, tackling and charging, and it simulates conditions of actual play.

Jamming of Speedometer Not Proof of Speed

Speedometers found jammed after automobile collisions are not likely to indicate the speed of the car at the time of impact, according to experts. They explain that a sharp jolt may cause the indicator to turn to a high or low

speed, depending on the direction of the blow and the exact moment the instrument "freezes." Therefore, it is hardly possible for the speedometer to show how fast the car was traveling unless the indicating needle locked immediately prior to the crash, which would be a rare coincidence.

Tiller Sharpens Self as It Pulverizes the Ground

Sharp-pointed tines of a rotary tiller revolve through the ground like picks, pulverizing the soil and preparing it for seed. Mounted on springs and sharpening themselves as they work, the points break the ground into small lumps, instead of turning up large chunks as with the shovel, plow or disk. A seed bed is made in one operation, and the fineness of the tilth can be varied as the grower desires by adjusting the tines.



Rotary tiller breaks up the soil with pointed tines that are sharpened while they work. Degree of fineness is adjustable.

Rototiller, Inc.

"Bus" heavy junior
 849 Minnesota
 Coach Paul Jorgensen
 A.C. & park & lug. dist. 849
 849 Minnesota
 849 Minnesota

Troy, N.Y.

Air Gunners Shoot Clay Pigeons for Practice

Clay-pigeon shooting is part of an air gunner's course in Britain's royal air force. From a mobile gun turret similar to the one in the cockpit of his airplane, the gunner plays a machine gun on the clay pigeon, when it is released from the trap, and makes as many hits as possible. Combining fun with the serious business of target practice, the method develops the machine gunner's accuracy quickly, which is vitally important in warfare, since frequently the first shots will put an enemy plane out of action.

Clay pigeon, released from trap in foreground, makes dark spot on skyline as target for aerial gunner in mobile turret



Forty-Ton Mass Spectrograph "Weighs" Mass of Atom

Six times as powerful as similar machines built at Harvard, Princeton and at foreign universities, a mass spectrograph used for measuring masses of atoms at the University of Illinois physics laboratory is

accurate within one part in a million—one-fiftieth the mass of an electron. Built by Dr. Edward B. Jordan, it weighs forty tons. It comprises two magnets, one weighing one and one-half tons and a larger one of

six tons, which is a yard long and was constructed with such precision that its two pole faces were plane and parallel within 1/1,000 of an inch. The atoms enter through two slits 1/1,000 inch wide, and thus lined up in a straight beam they travel about ten feet in a vacuum between the magnetic poles and emerge on a photographic plate. Several hundred storage batteries maintain a constant magnetic field, for a variation of one part in 2,000 would displace the atom's tracks two feet on the photographic plate.

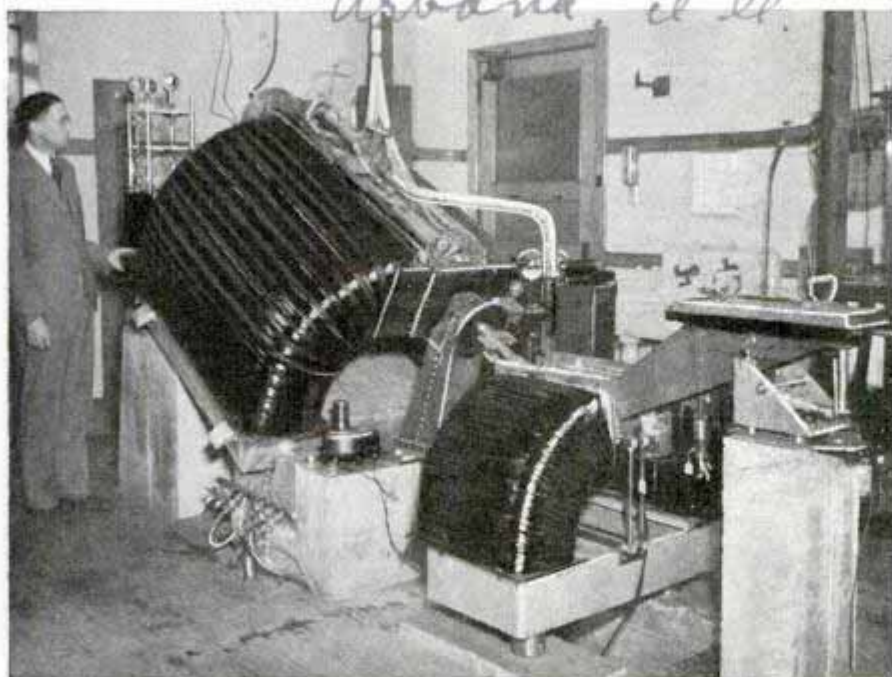

Two giant magnets, their fields kept constant by several hundred storage batteries, form the forty-ton machine for measuring masses of atoms

HARNESSING *the*

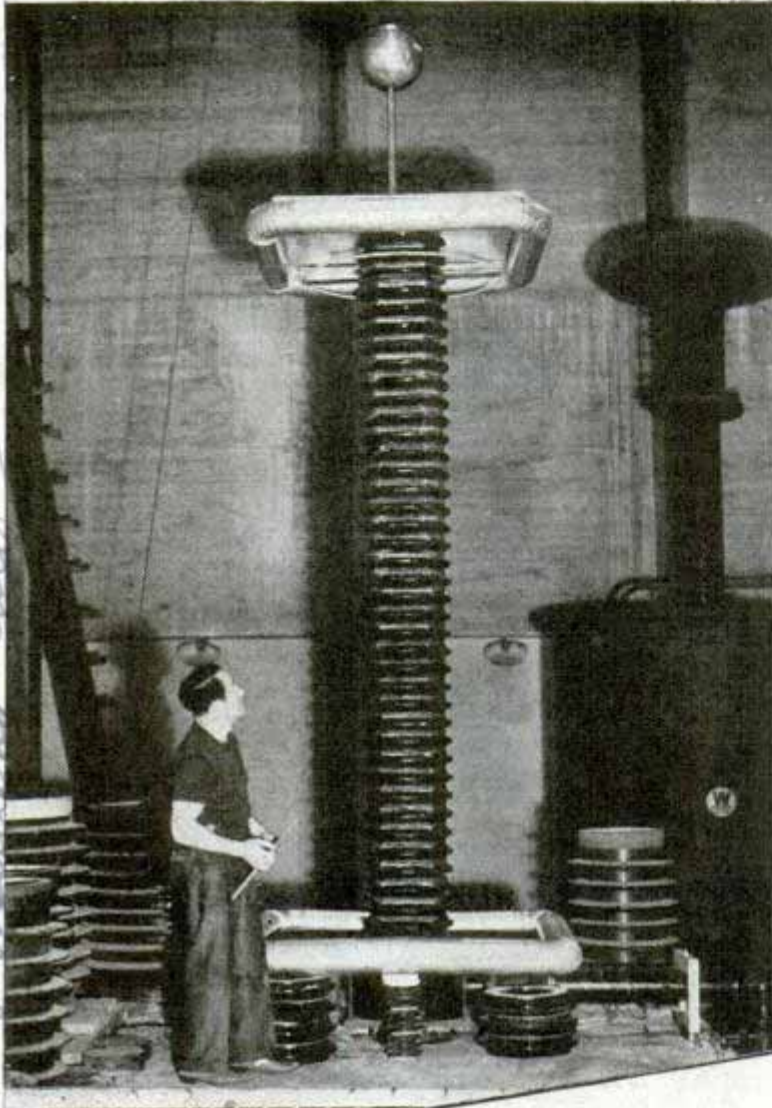

Mr. Chapman & Malibu Road
Vacuum Palace
Calif

BOILER rooms and fuel oil bunkers on an ocean liner occupy valuable space and some day a naval architect may design a ship without them, substituting instead a small room for the ship's "power package," a cubic yard in size. That would be one use for atomic power, if it is ever harnessed. Today physicists think they may have a way to make this dream come true.

What would an atomic generator be like? Quite different and a whole lot simpler than you might think. The scientists visualize a container that holds a cubic yard of uranium oxide to which 500 pounds of carbon and a pinch of cadmium have been added. Uranium oxide, refined from pitchblende, is the substance from which radium is extracted.

The "starter" of this generator would be nothing more than a small vial containing powdered beryllium and some radon gas. Place the vial alongside the ura-

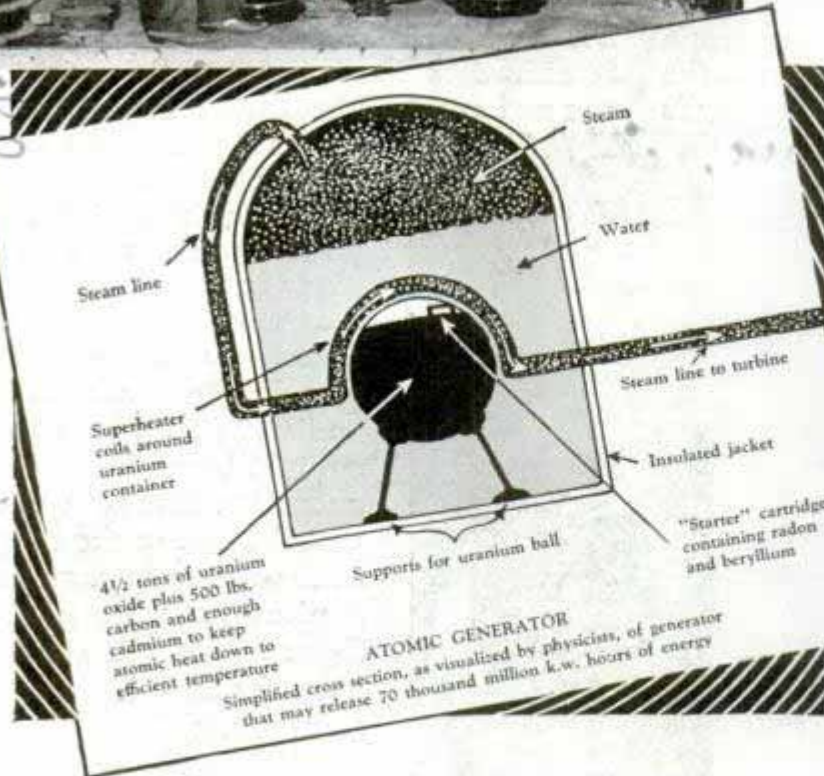

At top, upper part of giant vacuum tube down which electrons are shot to bombard sample materials in concrete vault below. Lower left, cross-sectional diagram of atomic generator that may release seventy billion kilowatt-hours of energy. Right, adjusting mirror of sun telescope

Prof: Dr. M. S. Plesset, Calif. Univ. Berkeley
of Technology Pasadena Calif

See Jan 1941-1

X 289

ATOM

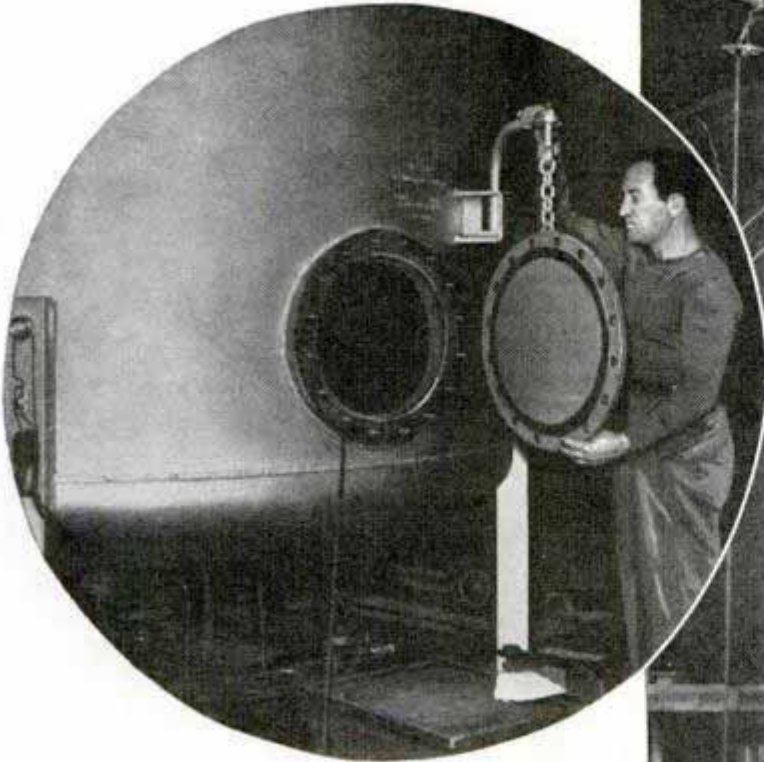

Above, steel pressure chamber housing 1,250,000-volt electrostatic generator. Right, huge vacuum tube. Below, entrance hatch of pressure chamber

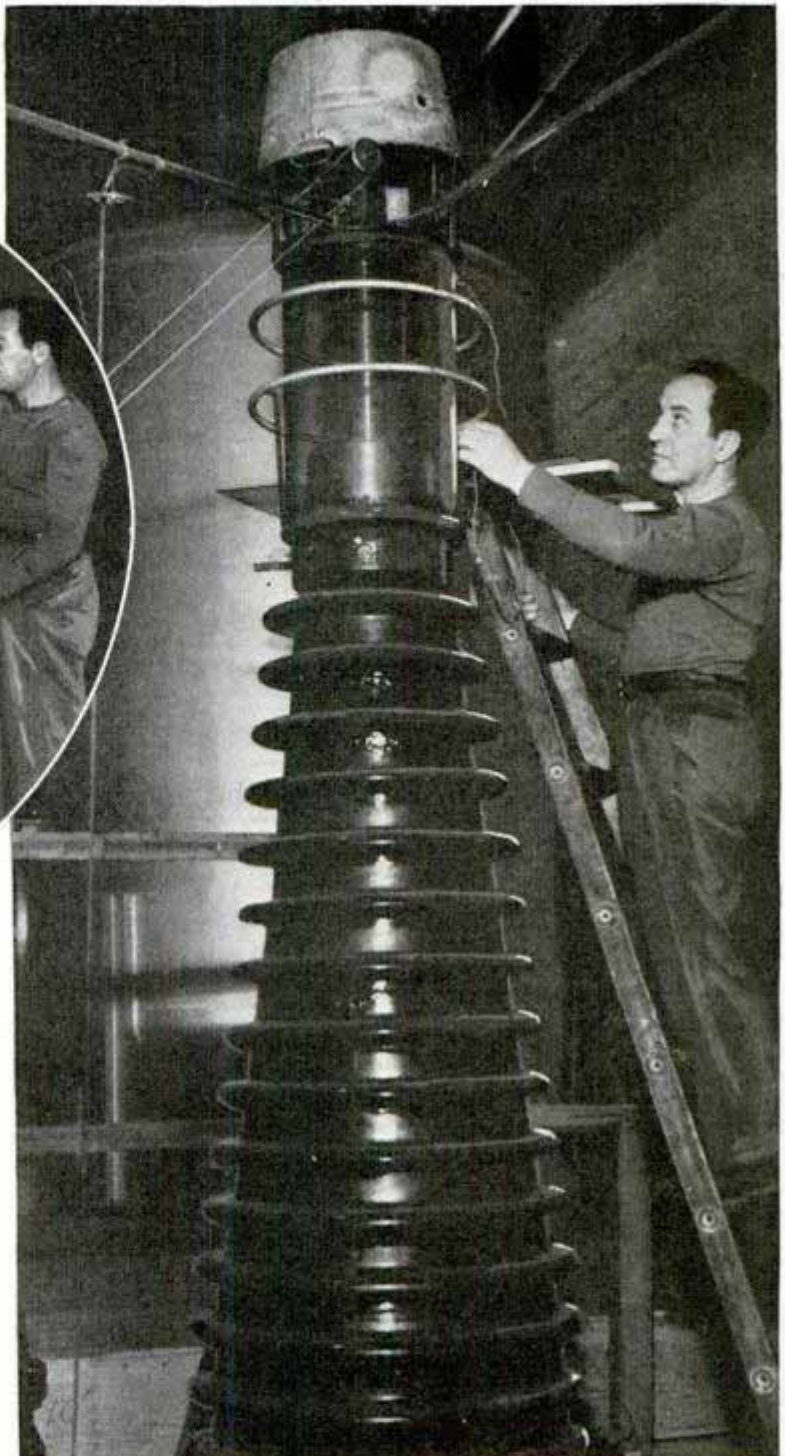

mium for a moment and at once heat would be created, at a constant temperature determined by the amount of cadmium in the mass. Place water around the hot uranium and you obtain steam to run turbines.

How much? Physicists estimate that the four and a half tons of uranium in a cubic yard contain some seventy billion kilowatt-hours of energy, about the equivalent of ten million tons of coal. Energy extracted from the small power package would equal the tremendous output of the generators at Grand Coulee Dam for a period of eight years. Released, the heat in a little more than half a pound of uranium would boil 386,000 tons of ice water. The rate of output from the atomic generator could be controlled, changed, stopped and started again at will.

If this is true, why isn't atomic power available now? Because it has been only a few months since an experiment was performed that suggests such startling possibili-

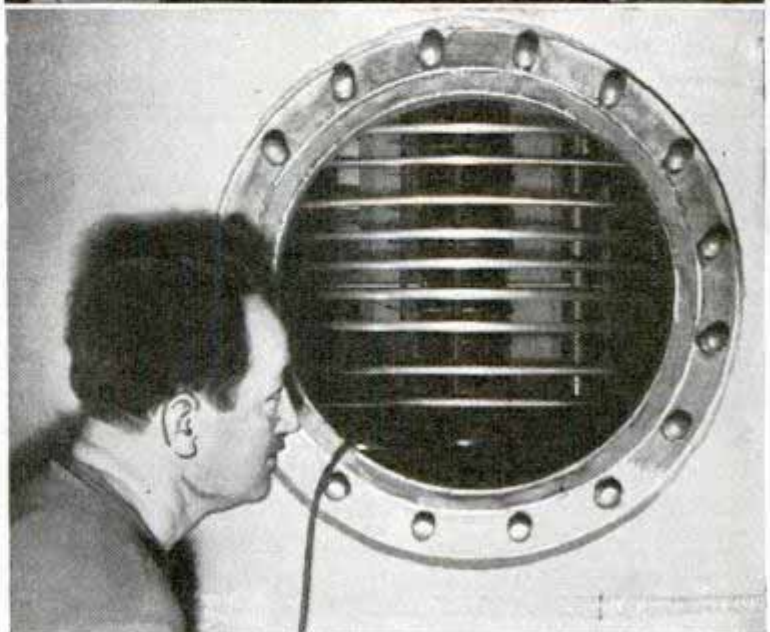

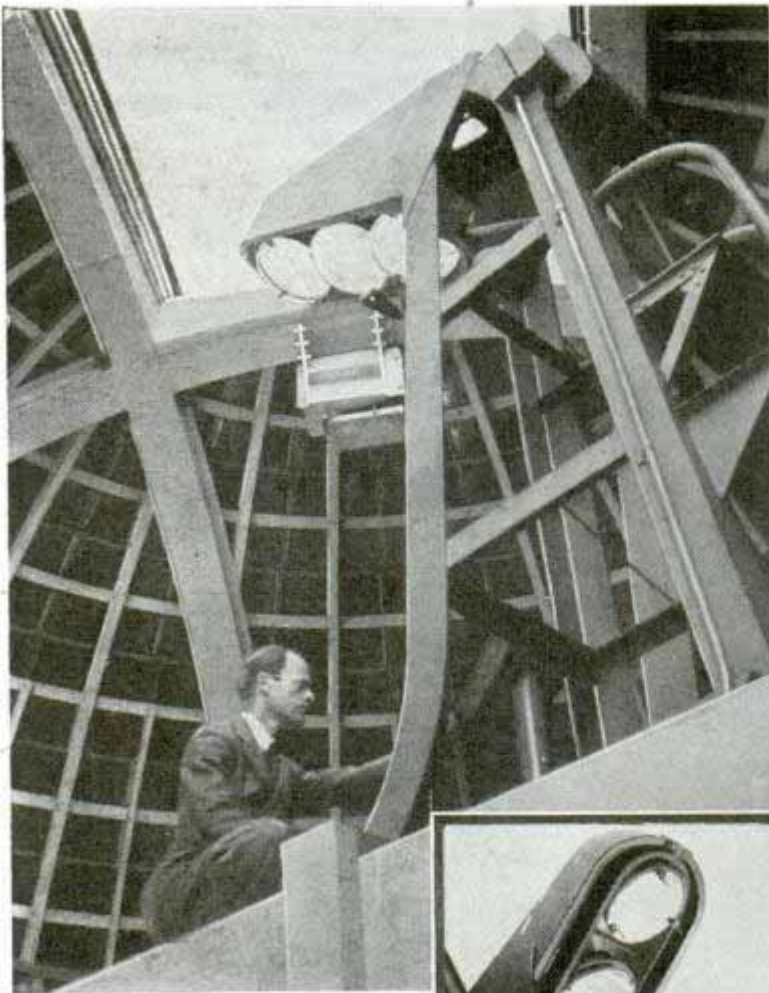

Top and center, mirrors of telescope used in study of structure of sun; solar energy is believed to be caused by nuclear reaction. Bottom, interior of an electrostatic generator

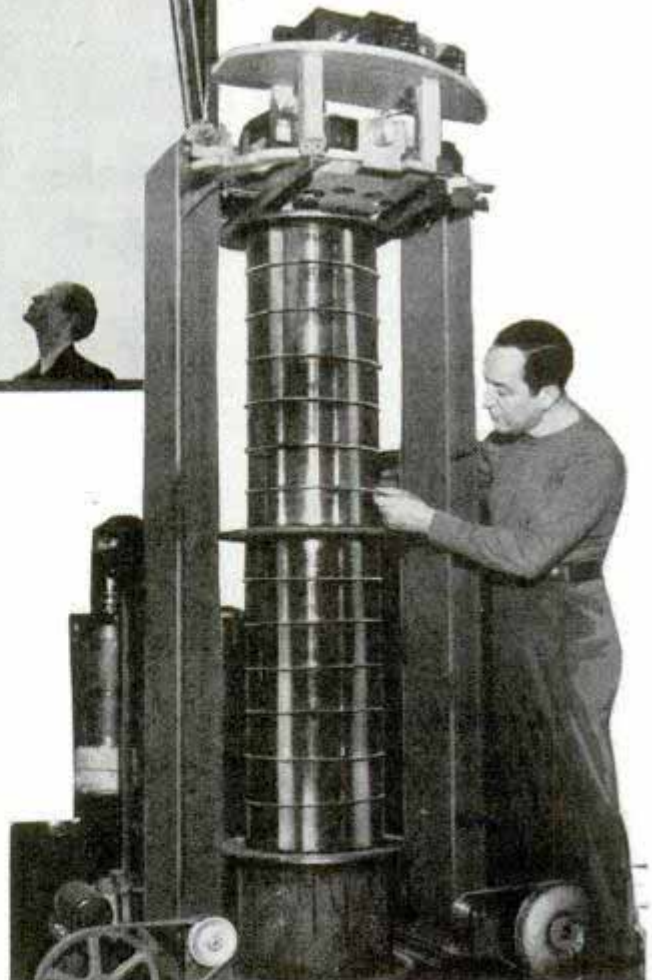
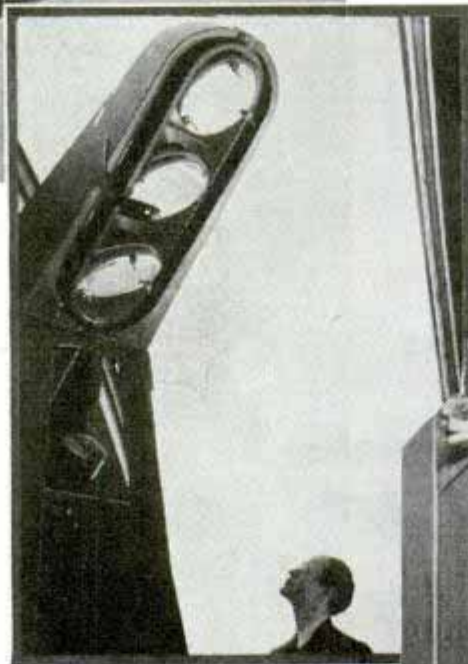

source for a large liner but probably would not be feasible for airplanes, due to the weight of the steam plant.

Scientists have been "splitting the atom" for years, creating temporarily radio-active substances that are valuable tools in biology and chemistry. They have also been releasing power from the atom, but about a million times more power is needed to crack the average atom than is released by it.

This is because the atom, minute as it is, is mostly empty space. The proportionate sizes of the nucleus and its whirling electrons compare to the spaces occupied by the sun and planets in the solar system. A nucleus is only .000,000,000,000,1 of an inch thick, about 1/10,000 of the atom's size. To release power, or heat, from the atom its nucleus must be smashed by a high-energy ray. The chance one ray that enters an atom has of hitting the nucleus is something like the chance

ties. The next step is to try it and see if it works. This may be done before the year is over.

Even if the secret of atomic power has really been discovered, the power in the atom won't supplant other sources of energy. Uranium appears to be the only substance that can be used and the world's supply wouldn't be enough to meet the demand if every factory and city power plant changed over to atomic power.

Uranium is a relatively rare element and so far has been mined mainly because it contains radium. Its radium content has nothing to do with its power possibilities. It is estimated that an atomic generator containing four and a half tons of uranium oxide would cost some \$50,000. Smaller units would be useless because at least that amount of uranium appears to be necessary for power generation. An atomic generator would make an ideal power

you would have of hitting the sun if you hurled a comet blindfold into the sky.

Tremendous numbers of energy particles or rays must be expended in order to be sure of hitting the nucleus, and this is usually done in a cyclotron, the largest of which is operated by the University of California and which shoots out an energy stream consisting of possibly 100 trillion energy particles a second at an initial velocity 25,000 times that of a rifle bullet. The cyclotron smashes atoms but the power released by the smashed atoms is only a tiny fraction of the power needed to operate the cyclotron.

Uranium, however, has the heaviest nucleus of all atoms and this nucleus gives off nearly 200,000,000 electron volts when it is split, some twenty to 200 times the energy produced by other nuclear reaction. The uranium atom was split for the first time last year. In Paris early this year research scientists who were working with uranium atoms observed what appears to be a chain reaction. They discovered that when a uranium atom is split a number of neutrons apparently are released and these energy particles in turn crack open other uranium nuclei, which in turn release other neutrons. A continuous, self-propagating explosion should have resulted but in these first experiments only tiny specimens of uranium were used, not large enough to contain enough nuclear targets to insure a succession of hits.

Physicists estimate that in a cubic yard of uranium the reaction would continue automatically once it was started. Mathematical probabilities insure steady regeneration in so large a mass.

By itself, uranium might not be efficient. Most of the neutrons released by each fission are too fast to split other nuclei. Carbon has a decelerating effect on neutron speed, hence carbon is added to the mass to slow down the neutrons and make them more competent.

Uncontrolled, the mass of uranium and carbon would attain a terrific heat and according to some guesses would explode and blow a hole in the earth 100 miles across. More likely, say the scientists, before its peak temperature of 50,000 degrees centigrade was reached, the mass would break up and the reaction would stop. To control this temperature rise and keep it at a useful level the physicists would add

(Continued to page 127A)

Fishing Rod Used as Antenna on Angler's Automobile



Fishing finished, rod is inserted in antenna socket

Having difficulty in placing his one-piece steel fishing rod in his automobile, a fisherman found it possible to plug it into the radio antenna socket. Serving to pull in radio programs while traveling, the rod is removed easily at the fishing grounds.

"X-Ray" Watch in a Glass Case

Glass windows forming the dial and back cover of a pocket watch give a view of the interior gear wheels and other working parts. The timepiece is of Swiss manufacture and is lubricated with a very light automobile oil to advertise the product of an oil company.



Handwritten notes on the right margin:
K 6 79
see notes
Thomas E. Shuman
cont)

Handwritten text at the bottom:
Shell Oil Co
1127 11 6 17

Unusual Photos Made with Camera Mirrors

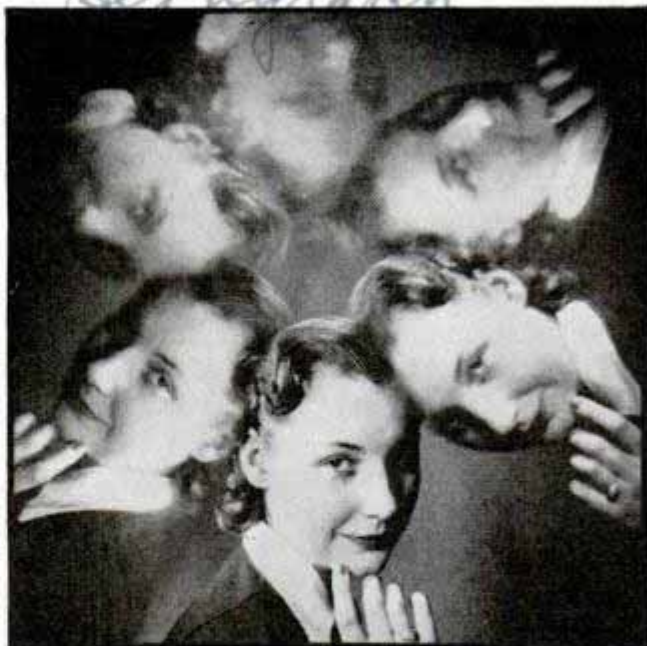
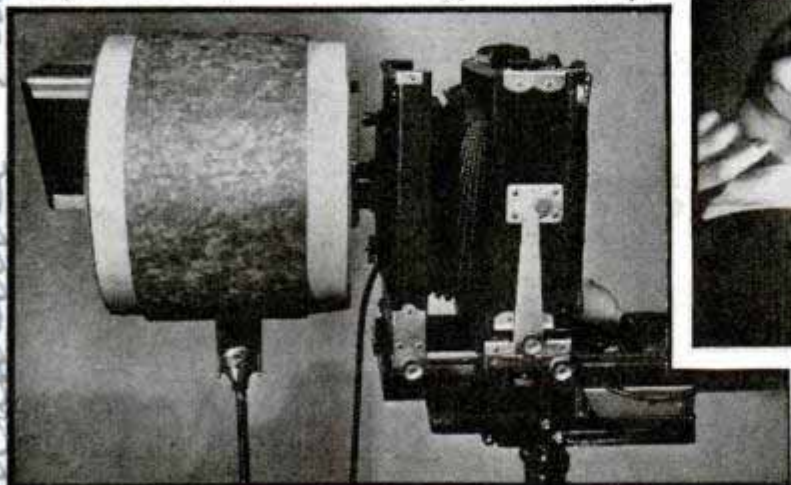
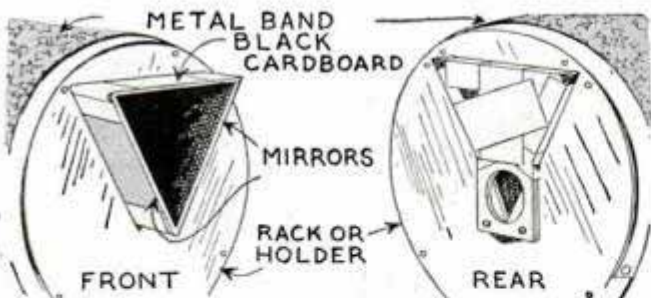

Top, right, and bottom, left, examples of multi-image photography possible with the aid of camera attachment illustrated in drawing and photo (top, left, and center). The attachment is simple and inexpensive to make



Unusual photographs showing six images of a single subject can be made with the aid of a simple homemade device attachable to your camera. It is done with mirrors. Take a mirror measuring about five by ten inches and tape its long edge to that of another of the same size. A piece of black cardboard is then taped across the top of the mirrors to form a triangle. This arrangement pitches the mirrors at about sixty degrees. The unit is mounted in any rack or holder, such as a cylindrical container, nine inches in diameter and eight inches deep, perhaps made of cardboard, encircled with a band of sheet metal. The

other end of the cylinder is masked down to form an aperture corresponding to the size of camera lens to be used. Best results may be obtained with a medium wide angle lens such as a four or five-inch lens, if used in a five-by-seven camera. Any focusing-type camera may be used. The mirrors show six images in the camera, thus giving you six on the film, or a blending of six into three is possible. Changes are accomplished by shifting or turning the cylinder housing the mirrors. The black cardboard eliminates excessive light reflections when a photo lamp is employed. If desired, the unit may be mounted on a photo lamp stand, permitting the raising or lowering of the ensemble. The mirror unit costs little or no money.

Cheap Atomic Power May Result from New Extraction Process

Large quantities of U-235, the chemical element hailed recently as a source of atomic energy, may become available as the result of an inexpensive method of extracting uranium from low-grade ores, which is described in a new patent. Since 139 pounds of ordinary uranium contain one pound of U-235, this discovery is expected to increase the supply of the new chemical by making more uranium acces-

Slavery and Chafers R. P. B. Clean

K 639
New York Times
Herman F. Flick

sible. The process, according to patent claims, gives a more complete recovery of uranium, using small amounts of cheap and abundant chemicals, such as sulphuric acid, sodium carbonate and limestone, to get rid of iron and aluminum impurities in the ores, which other processes did not accomplish. Uranium ores are found in Colorado in relatively large amounts, and the substance also is contained in carnotite ore and in pitchblende ore. In production of power, a pound of U-235 is said to equal 5,000,000 pounds of coal.

K 430
**Odd Twist in Church Spire
 Points Spiral Path**

One of the oddities of the English countryside is a church spire with a unique roof design. Deviating from the usual straight lines from the base to its point, the Chesterfield church steeple describes winding pathways in its rise heavenward.

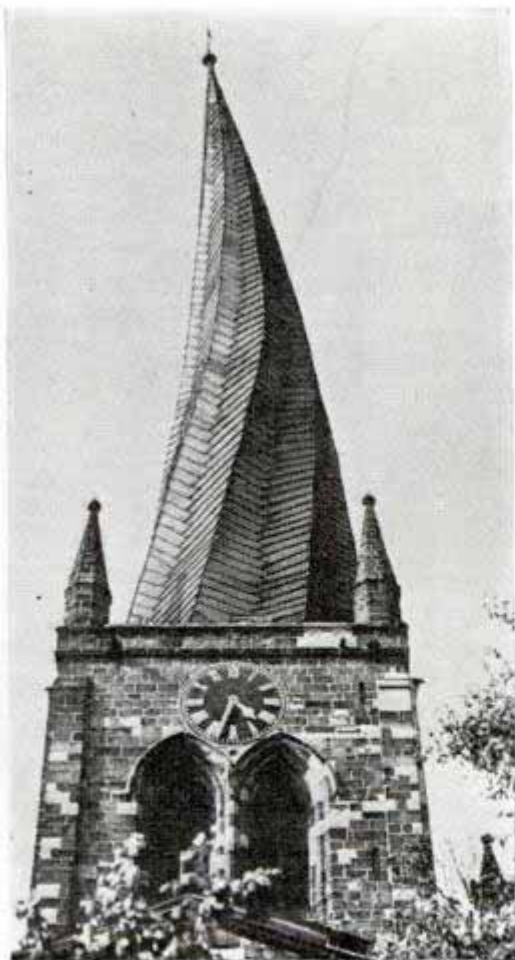

Spiral spire is oddity in church architecture seen along English countryside

K 543
**Lightweight Diesel for Airplanes
 Has High Cruising Range**

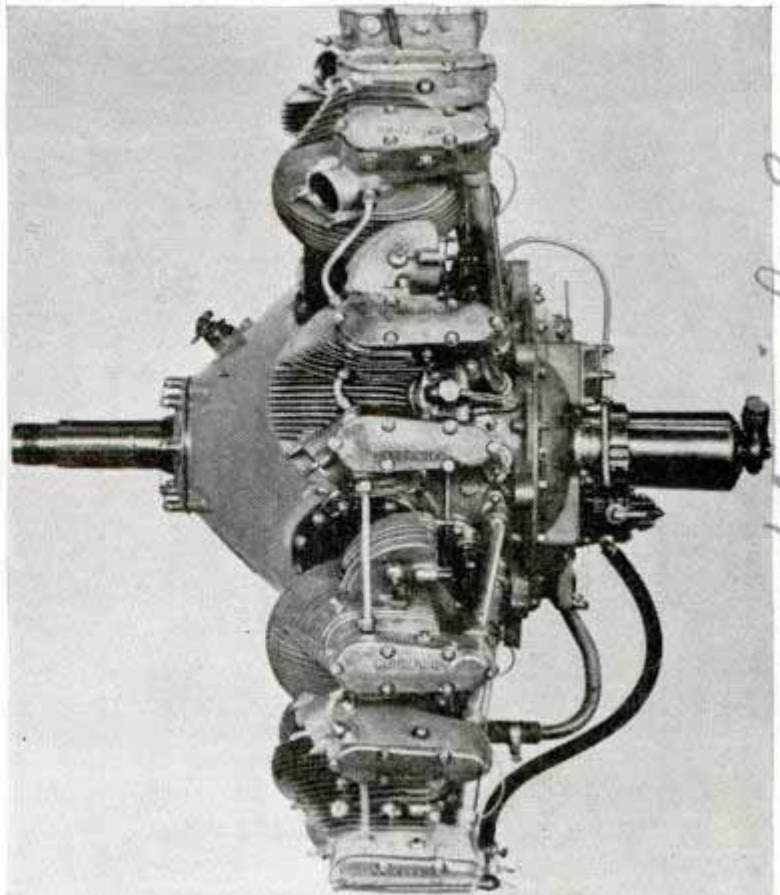

First American-made Diesel to receive a government license for aircraft use is the Guiberson engine shown above

Capable of sustaining flight over a fifty-per-cent greater range than any gasoline engine, a lightweight Diesel airplane motor was recently tested before U. S. army officials and is ready for production. Developing 310 horsepower, the nine-cylinder radial air-cooled engine weighs only 653 pounds, little more than two pounds per horsepower. It burns fuel oil costing around six cents a gallon. The engine, designed by S. A. Guiberson, Jr., of Dallas, Tex., is the only American built Diesel approved by the Civil Aeronautics Authority. A test flight indicated it could take a plane to an altitude of 21,000 feet, while the same plane had a 17,000-foot ceiling with a gasoline engine. The Diesel, however, costs about five times as much as the gas engine.

Guiberson - Dallas, Tex.

Buying SIGHT UNSEEN



nition at the seller, jotted down his initials, a few figures, at the same time nodding assent to other sellers for lots of 25,000 and 15,000 bushels. With those nods he obligated his firm for \$55,000, for goods he probably never would see. Yet he knew exactly what he was getting.

A cotton manufacturer in England gets an order for a particular fabric. He thumbs through his morning paper to the market reports from America, cables his broker an order for 10,000 bales of Strict Good Mid-

THE grain market was in a turmoil. War was raging in Europe. Lack of rain in Kansas meant a poor crop. Millers, speculators, shippers, were in a frenzy to buy.

"I bid 110 $\frac{7}{8}$ for 50,000 bushels of No. 2 Red Spring!" one exporter signaled.

A man in the rear of the crowd signaled back: "I'll take 10,000!"

The exporter flashed a glance of recog-

nition, 1 $\frac{3}{8}$ staple. That cotton must be paid for before the ship can sail, giving him no opportunity to inspect it. Yet he will get precisely what he ordered. Strict Good Middling means the same in Liverpool as in Savannah. No. 2 Red Spring is the same wheat in Bombay or Wichita. Commerce has a common language.

Standards for farm products have been

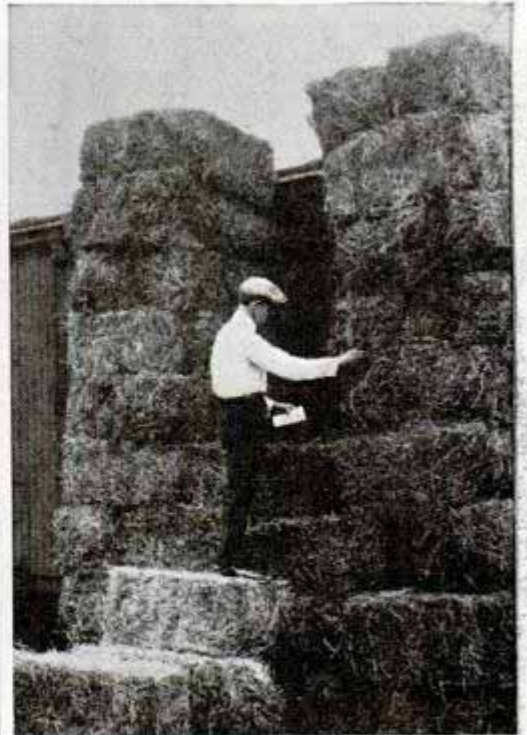
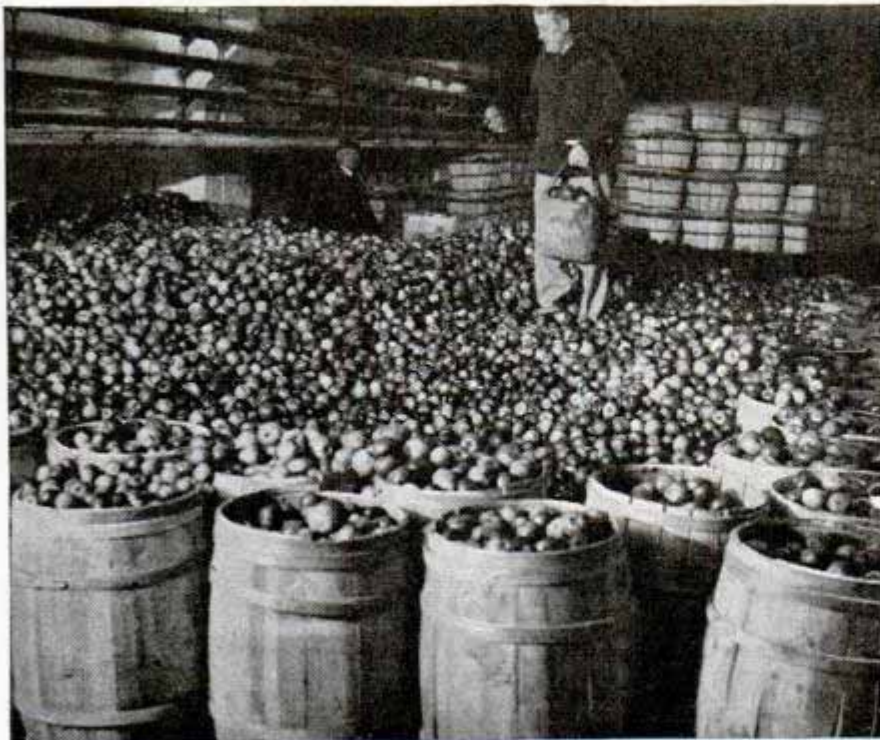

Colored models of fruit and vegetables made by Department of Agriculture artists, top, are standards for grading and inspecting produce. Below, inspectors examine apples in cold-storage plant and sample a plug of alfalfa from freight car

Cont. H. O. Webb: 4 3 2 1 10 11 12 13 14 15 16 17 18 19 20 21 22 23 24 25 26 27 28 29 30 31 32 33 34 35 36 37 38 39 40 41 42 43 44 45 46 47 48 49 50 51 52 53 54 55 56 57 58 59 60 61 62 63 64 65 66 67 68 69 70 71 72 73 74 75 76 77 78 79 80 81 82 83 84 85 86 87 88 89 90 91 92 93 94 95 96 97 98 99 100

with SAFETY



Experts examine wheat being unloaded (top) from barge at New Orleans elevator. Right, perforated tube takes sample of grain at various depths in freight car; Bureau of Agricultural Economics must certify wheat sold as a certain grade meets specifications for that grade. Below, weighing sample of cotton



developed almost entirely during the past twenty years. Before the World War there was a confusing variation in grade definitions and terminology, in different markets, even among individuals in the same market. A person who did not inspect before he bought never knew what he was getting.

The U. S. Department of Agriculture has now worked out standards for the principal farm products, and has inaugurated an inspection service to bring about uniform application of the grades and to settle disputes.

These standards vitally affect the consumer and grower, but in most cases in-

(Continued to page 118A)

Oil Drums Save Bomber Forced Down in Sea



Prudy Arnold.

With engines, instruments and portion of the tail removed, this giant bomber was floated with the aid of oil drums tied to engine mounts and towed a distance of six miles to Floyd Bennett field

Forced to land in the water off Coney Island beach, a twin-engine bomber, equipped only for land service, was floated and then towed by a Coast Guard boat to the seaplane ramp at Floyd Bennett field,

a distance of almost six miles. After engines, instruments and part of the tail were removed from the plane, oil drums were lashed to the engine mounts to act as pontoons, with life rafts helping float the tail.

Electron Microscope May Bring First Glimpse of Atom

It may be that man will have his first glimpse of the atom through the electron microscope. It may be that this scientific

wonder, which sees into a world invisible to ordinary light, will help in conquering diseases by revealing bacteria and filtrable

viruses unseen beneath the optical glass lens. For the electron microscope, now ready for work in the research laboratory, can magnify images as much as 25,000 diameters—twenty to fifty times greater than the finest optical microscope. By photographic enlargement, the image in the electronic microscope can be increased up to 100,000 diameters. In the new instrument, a beam of electrons is converged by a magnetic lens coil much as a beam of light is focused by a condenser lens in an optical instrument. Then the electron rays are focused by another series of lens coils to form the highly magnified image, which can be made visible on a fluorescent screen

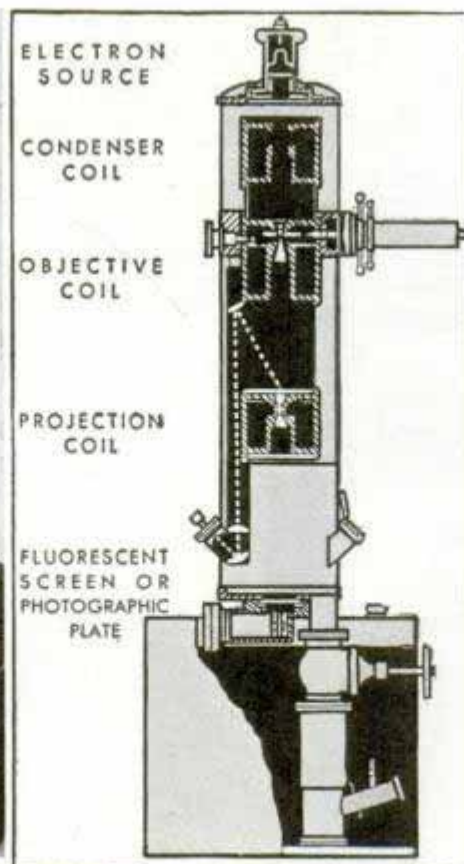

Diagram shows the system of magnetic lens coils which magnifies and focuses the object much as the glass lenses of the optical microscope do

Army Douglas B-18 a
 Em. Radio Corp. of America
 RCA a Oldy model

magnified
 by Mr. Isaac Lewis
 power

designed and constructed under

or photographed on a sensitive plate. Since the glass slides used for examining specimens under the ordinary microscope are opaque to electrons, the specimens are placed on a gelatin film one millionth of a centimeter thick. Air, too, impedes electron rays, so the interior of the microscope is evacuated with a pump. The useful magnification of the best optical lens is limited by the wave length of light itself, for many bacteria and filtrable viruses, being smaller than the wave length of light, never could be seen with light; scientists draw a parallel of a dentist probing a tooth with a railroad spike. But the wave length of the electron rays traveling at high speed under voltages of 30,000 to 100,000 is only about 1/100,000 of the wave length of light. First applications of the electron microscope are expected to be in biological and industrial research. Already it has revealed unidentified particles apparently associated with disease germs; and fine particles of materials such as rubber latex are shown to have shapes entirely different from those seen under optical lenses.

House Painted in Four Minutes and Fourteen Seconds

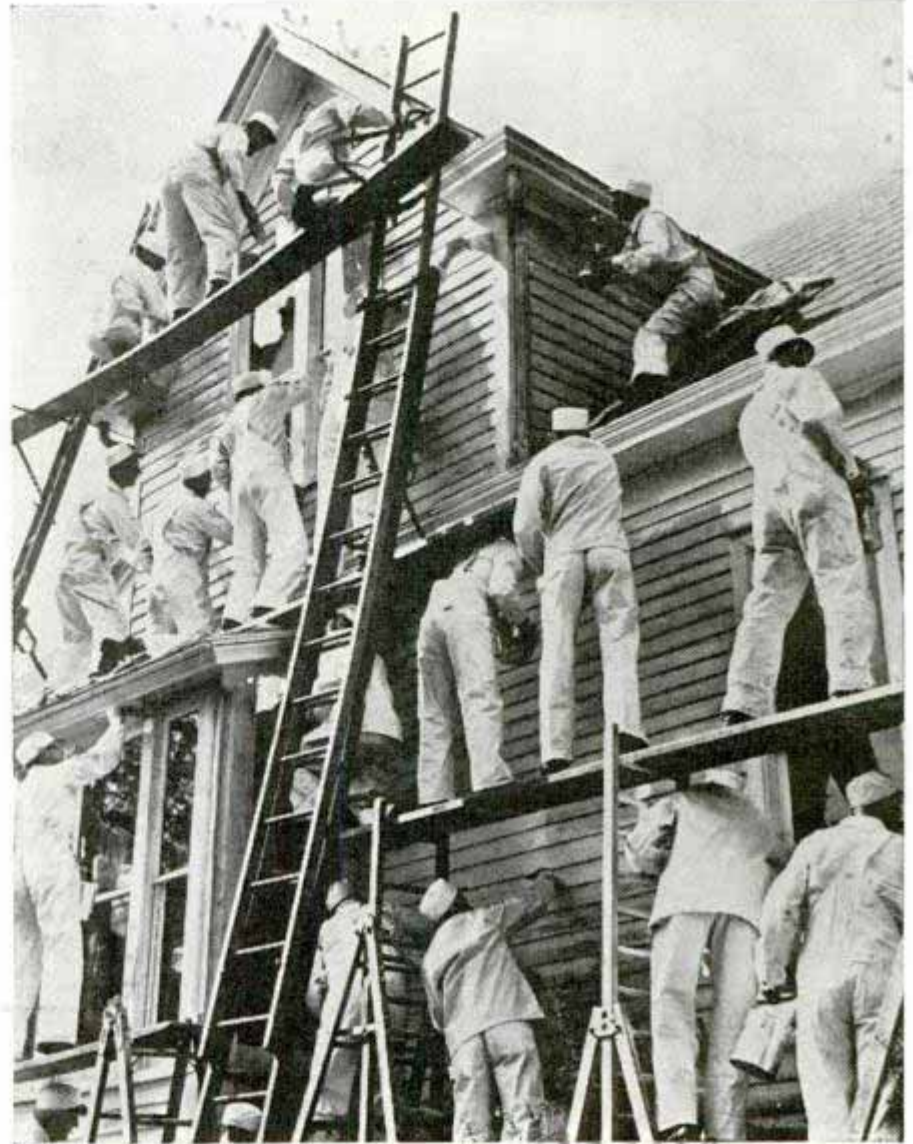

All working at top speed, 110 painters completed the painting of this house in four minutes and fourteen seconds, establishing a record

Painting a nine-room house at Omaha, Neb., within four minutes and fourteen seconds is the record set recently by a crew of 110 painters. Each carrying his own paint can, the workmen wielded brushes from the scaffolding in a combined spurt to establish the new mark for fast work.

Screen Mesh in Driving Glasses Stops Headlight Glare

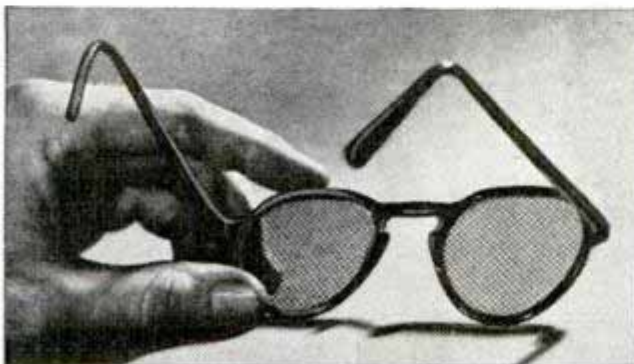

Wire screen takes the place of glass in sun glasses

Eyestrain of night driving is said to be minimized by glasses fitted with a wire screen mesh instead of colored lenses. The screen is intended to reduce the glare of bright automobile headlights without impairing the vision.

☐ Stamped, self-addressed envelope, sent to our Bureau of Information, will bring you the name and address of the maker of any article described in Popular Mechanics.

Paramount Supplies, Inc.

NEWS



Top, left, Columbia Broadcasting company's staff covers news event from special scaffolding. Right, sending bulletin to studio by pneumatic tube. Below, control panels of short-wave receiver from which signals are relayed to New York by wire

HEADED toward Viipuri, the big Russian bomber began unloading its cargo of death. William L. White, Columbia Broadcasting System's newscaster, stood knee-deep in snow in the woods with a score of Finnish villagers, watching the bombs descend. There was a terrific crash and the ground quaked with the explosion.

White glanced at his watch. In a quarter of an hour, bombs or no bombs, he was to talk into a microphone hooked up to a telephone wire in a village near Viipuri. His on-the-spot account of fighting on the Finnish front, radio's newest development in the broadcasting of hot news as it occurred, would be carried over that wire to Helsinki; thence to Stockholm, Berlin and Geneva, then shot across the Atlantic by short wave to Columbia Broadcasting System in New York. There radio engineers were waiting to put it on the air to the world.

It was an intricate and effective hookup which modern science had worked out. But as White left the scant protection of the woods, he

Cmd Emile C. Schürmermacher, 108 & 66th St NYC

Bob Truett

906 Madison Ave NYC

Handwritten notes at the bottom of the page, including the number '906' and some illegible scribbles.

John Charles Slattery

HOT OFF *the* GRID!

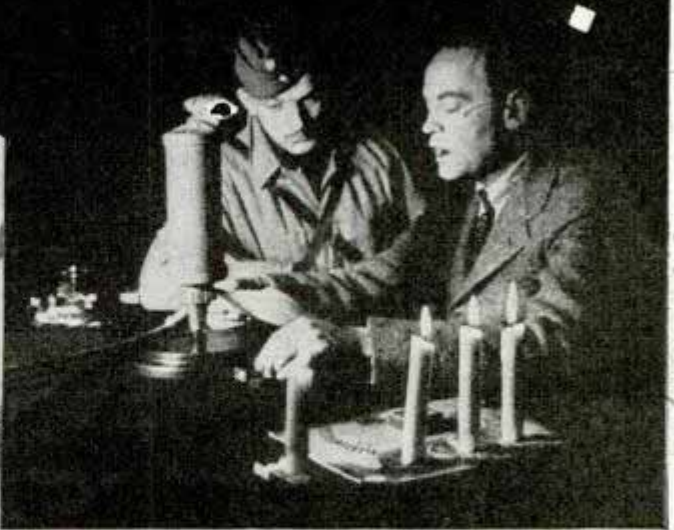

saw that a Russian bomb had landed squarely on the telephone lines, blowing them to bits.

White wasn't beaten yet.

"The lines had been cut beyond hope of immediate repair, so I tried the one alternative," said White. "Luckily the Finnish army had a field radio near by and I was given permission to use it.

"My hopes sank when I inspected it, however. Operated by a couple of Finnish youngsters, it looked as if it had been built of hairpins and rusty baling wire. I was due on the air in a few minutes and although I was sure no one in the United States would hear me through that junk pile, I had to chance it. I picked up the mike and began a running account of what I had seen on the battle front. I kept thinking I was just muttering to myself, that the broadcast wasn't going on the air at all. I was just signing off when I noticed the two young Finns grinning. Go on and laugh, I thought. It's a good joke on me!

"Then one of them took off his headset and told me that New York had just reported one of the

Charles Slattery

Top, left, covering war maneuvers in field; right, radio reporter broadcasts by candlelight from bombproof shelter in Finland. Center, interviewing the crew of a scuttled liner. Bottom, special events men at a battery of microphones

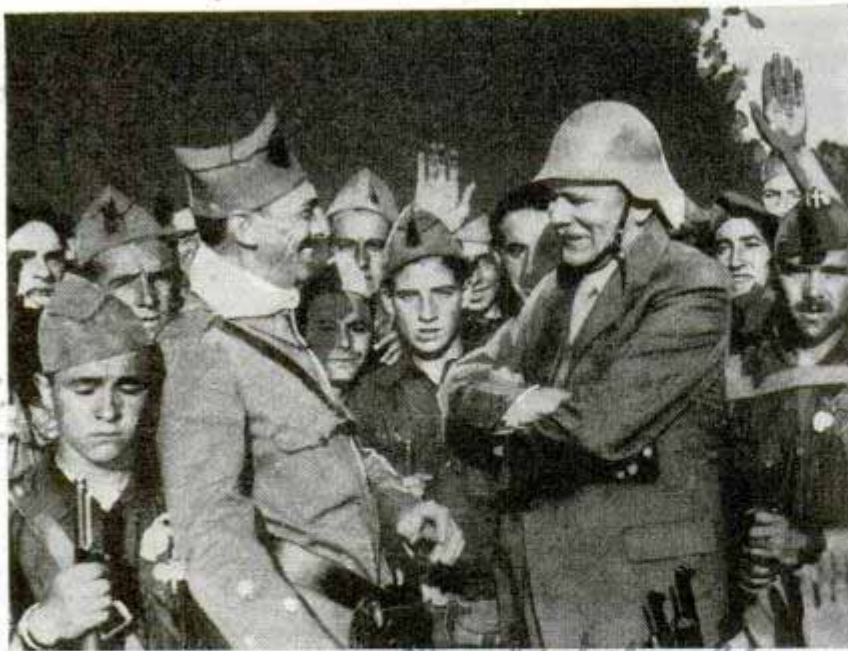

best receptions it had ever had from Finland."

While the broadcasting of news has been familiar to radio listeners for over a decade, on-the-spot broadcast of news is a new and thrilling development hastened by the anxiety of American listeners over the war crises in Europe. Previous to 1929 newscasters could go just as far afield as the end of the telephone line. Outstanding news events could only be covered if telephone lines were extended in advance; that didn't allow for broadcasting "hot" news just as it occurred. So science got busy to develop mobile units—trucks equipped with short-wave sets, pack sets and still smaller sets which could be installed in the newscaster's wearing apparel. One set had a wrist-watch microphone, a walking-stick antenna and transmitter and batteries in a binocular case.

Such devices were all right for broadcasting in America where there were many facilities obtainable. Transatlantic broadcasting was another matter. Already events in Europe were making that type of newscasting vital, and H. V. Kaltenborn, news analyst, had put on a news broadcast from Spain in 1936 which caused American radio listeners to demand more. He took microphone and equipment to the farmland outside Irun and described the Nationalist attack on that Loyalist stronghold. His talk was punctuated with the boom of cannon and the rattle of machine guns. He was the first man to broadcast directly from the battlefield.

Closeted with technicians in the Columbia offices in New York, Paul White, Di-

At top is H. V. Kaltenborn, broadcasting the news to America from a Spanish battlefield. Center, the Columbia "news desk" in New York, where bulletins come in by short wave and on press association telegraph printers. Below, hot news goes on air at the broadcasting studio

rector of Public Affairs, took stock of the war cloud last August. Details of high-speed coverage of on-the-spot news were worked out. Censorship and other conditions incidental to war were carefully considered.

"During the Austrian Anschluss we realized that in crises European governments would clamp censorship on broadcasters as well as on newspapermen," said Mr. White. "The most effective antidote would be simultaneous pick-ups from several capitals. Listeners could thus hear several points of view on the same program." It was also necessary to keep the various reporters in Europe informed of events elsewhere. The engineers worked out a four-way transatlantic radiotelephone channel which enabled reporters in London and Paris to listen in and talk to New York and Washington just as if the four were sitting together in one room. The four cities were connected by a continuous loop of telephonic short-wave and land-line facilities. The technicians were faced with a tough nut to crack in eliminating the voice of the speaker in his own earphones. If this hadn't been done, there would have been a feedback of two-fifths of a second, enough to create an impossible mixture of double talk on the air.

"Cue channels" on direct short wave between New York, London and Paris, Berlin and Rome are always available. Over these, first the traffic men, then Paul White, speak for five minutes before each news program—the traffic men to check transmission, White to bring each speaker up to date on developments elsewhere.

The next development was to try to anticipate the hot-news story and notify the man nearest the scene of possible action. This led to creation of a "listening post" at Freeport, N. Y., where radio engineers listen to short-wave broadcasts from abroad. These broadcasts are transcribed and sped to New York where translators digest them and shoot them to the news room. Here the tips they give sometimes send newscasters on the trail of hot news.

A few weeks ago the listening post picked up a cue that sent Mary Marvin Breckinridge by plane from Berlin to Bergen. There she chartered an automobile and in a blizzard took twenty-five hours to cover the eighty miles to Stavanger. There she put the captain of the German prison

(Continued to page 119A)

Jack with a Floating Frame Works on Uneven Surface

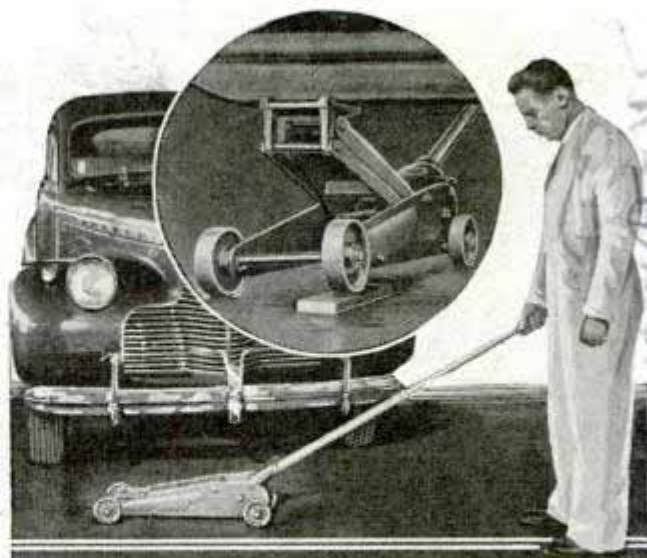

Inset reveals how jack with its free-floating frame compensates for uneven ground under the car

With its floating frame, a new hydraulic jack can be used on uneven surfaces without tipping the car. It is low-slung, and fits easily under the car. The jack is available in 2,500 and 3,000-pound capacities.

Seeder Wheel for the Garden Sows Evenly and Rapidly

Using a seeding wheel to start the garden makes one of the most tedious parts of gardening easier and quicker. A wheel mounted on a long handle is adjustable for various sized seeds and for various space intervals in the seed bed. It is made of two disks which are pulled apart to fill with seed. Holes in the rim drop the seeds as the wheel is rolled along the furrow.



Holes in rim, adjustable for proper spacing, drop seeds at regular intervals as wheel is pushed along

Flat-Wire 'Venetian' Screen Stops Sun but Admits Light

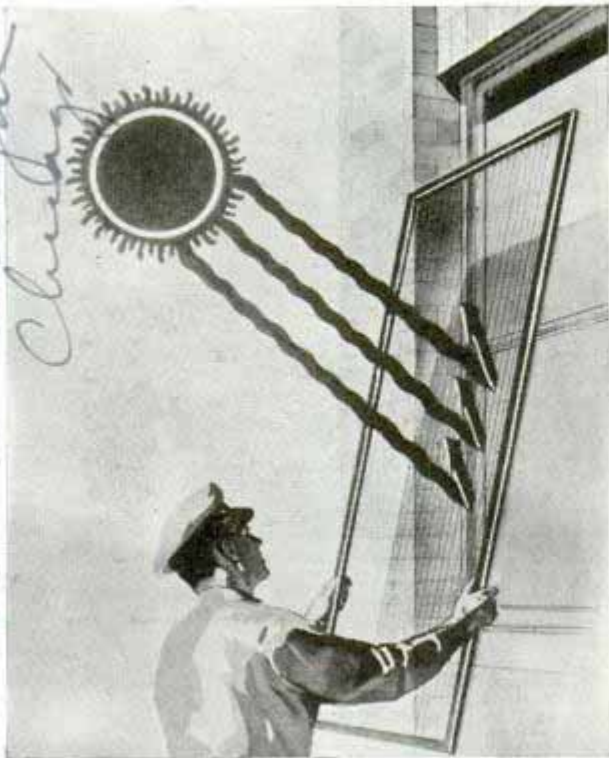

Drawing shows how sun's rays are deflected from window when they strike flattened wires in screen

Rooms are kept cooler and glaring sunlight is softened, with a "Venetian" type screen that deflects the sun's rays so they do not strike the window. Fine wires flattened to form "slats," as narrow as pencil leads, are held at a fixed angle to shut out direct sunshine, yet admit ample daylight for visibility, and keep out insects like any other screen. Windows equipped with the new screen, according to the manufacturer, do not need an awning.

Road Striper Paints Three Lines in Different Colors

Pushed at a speed of eight miles an hour by a two-and-one-half ton truck, a highway striping rig marks simultaneously one, two or three traffic lines in different colors,



Highway striper mounted on narrow-gauge chassis is pushed by cab-over-engine truck carrying paint tanks

if desired. It is designed to conform to the new system of multiple marking for "no passing" zones. Width of the lines is controlled by disks surrounding the three paint spray guns, accurate steering being accomplished by a long arm or target projecting over the pavement beyond the front wheels. The rear wheels, being hooked up with the steering mechanism, coincide while negotiating curves. In the truck are carried an air compressor, and three large paint tanks equipped with agitators to keep the paint properly mixed.

Bicycles Are "Parked" on Walls Beyond Reach of Thieves

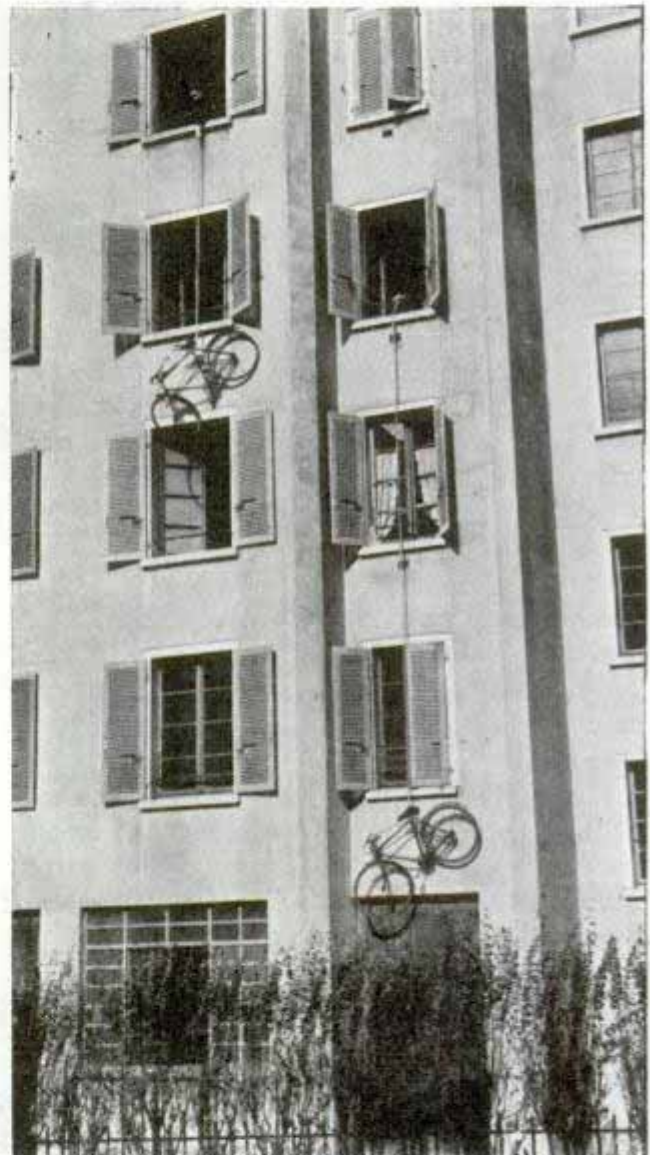

"Parked" bicycles dangle from windows high above the ground where thieves cannot reach them

Residents of Geneva, Switzerland, have devised a theftproof way to park their bicycles. Attaching a long rope to the bike, the owner pulls it up to his apartment window, where it remains suspended out of reach from the ground.

The



CRAFTSMAN

CARD TABLE

serves as

FIREPLACE SCREEN

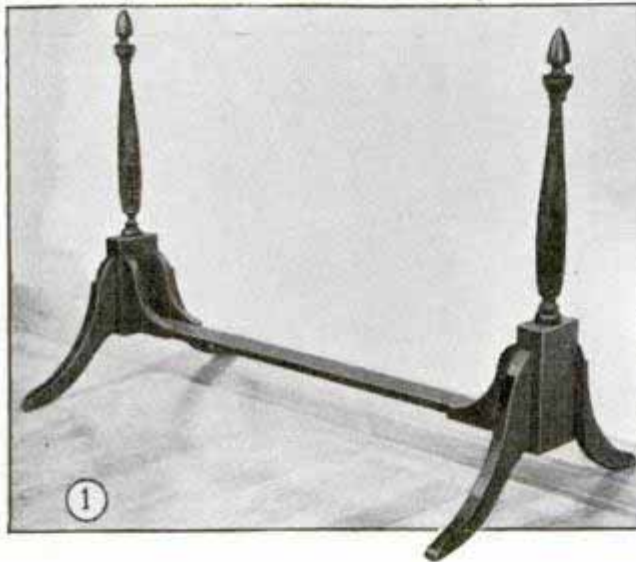
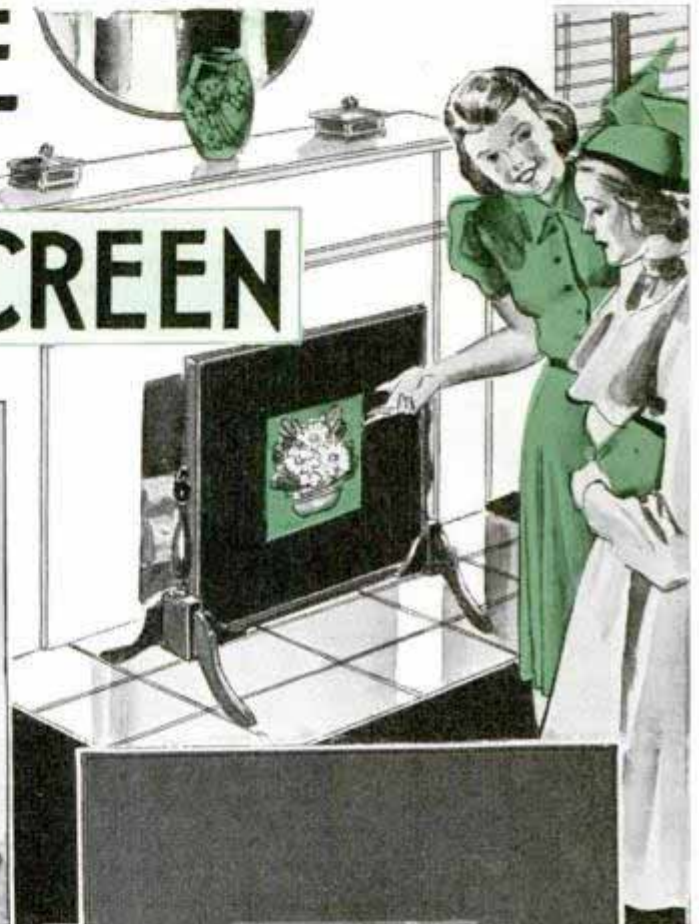

By J. BRUMFIELD

YOU may have wished for a fireplace screen of neat and graceful design, yet one that would be relatively simple to make. The one shown here, Fig. 2, was intended to fill just such a demand, and in addition to this it is also novel in that it leads a double life; you can remove the screen proper, which is a ready-made card table, and set it up for a game of poker or bridge. Such a combination helps to solve the storage-space problem in a small home.

The "chassis," Fig. 1, is all you have to make, and it is this part that gives you the pleasing lines of the assembled unit. The two turned end posts, detailed in Fig. 3, are slender, and each one is mounted on a block having two bandsawed legs attached on opposite sides. The pattern of the legs

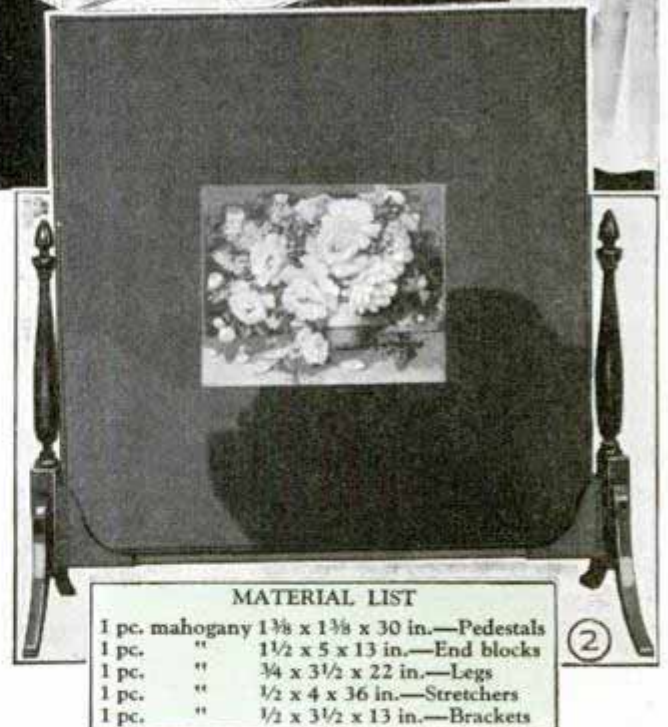

MATERIAL LIST	
1 pc. mahogany	1 3/8 x 1 3/8 x 30 in.—Pedestals
1 pc. "	1 1/2 x 5 x 13 in.—End blocks
1 pc. "	3/4 x 3 1/2 x 22 in.—Legs
1 pc. "	1/2 x 4 x 36 in.—Stretchers
1 pc. "	1/2 x 3 1/2 x 13 in.—Brackets

is given in the cross-lined detail, Fig. 4. You can rule off a 9 by 10-in. sheet of paper in 1-in. squares, and then draw in the curved outline of the leg, after which you use carbon paper to transfer the design to the wood. Three dowels, glued into match-

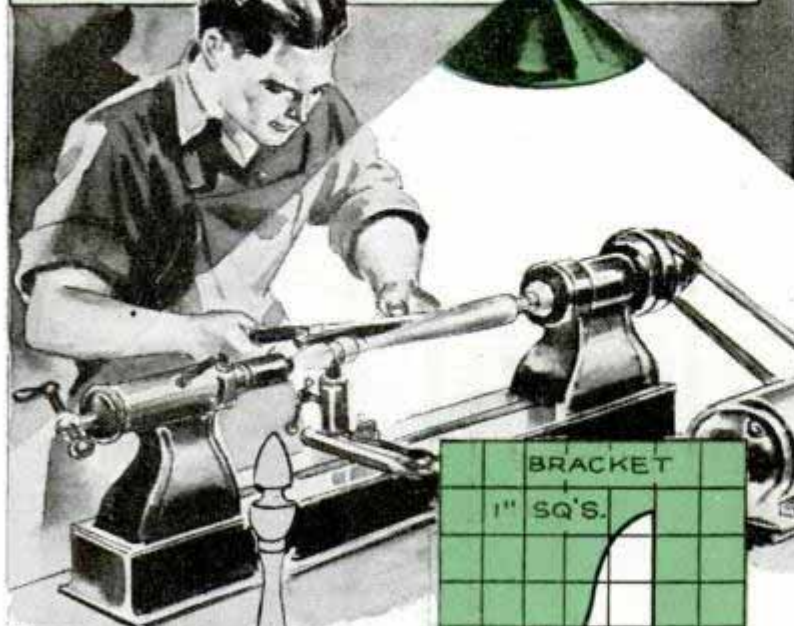
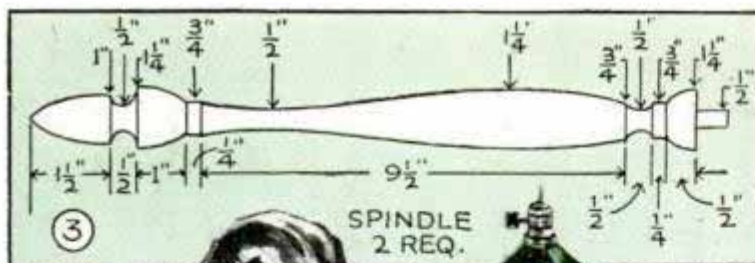

tach the brackets to the blocks you follow the same procedure as was used in attaching the legs.

The brackets are glued and nailed to the stretcher, using finishing nails, the heads of which can be sunk slightly below the surface of the wood and the resulting small holes filled before

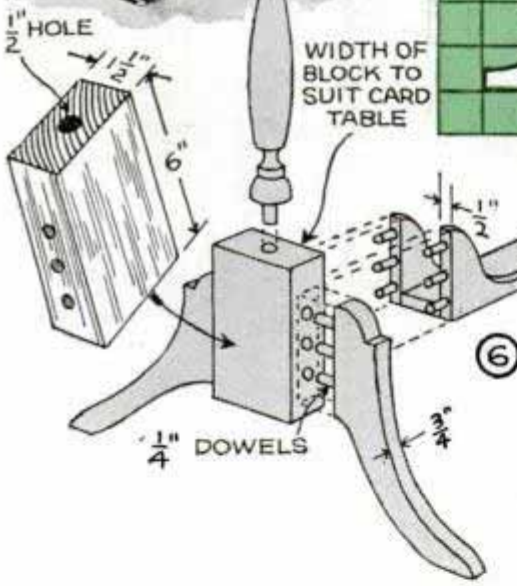
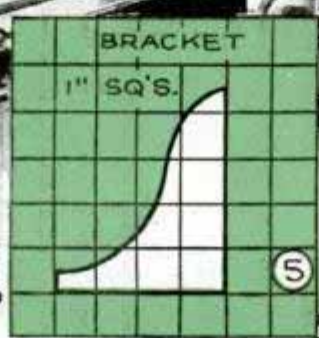
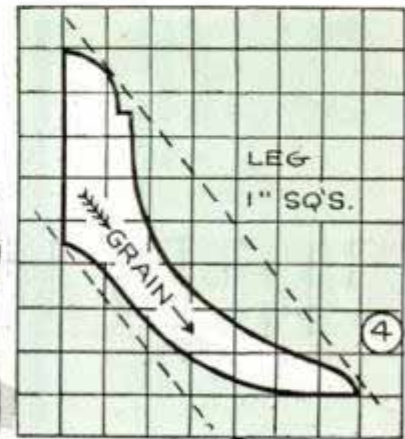

STRETCHER IS 1/2" LONGER AND 1/4" WIDER THAN CARD TABLE

ing holes in the block and each leg, provide sufficient strength and keep the assembly together securely. After each end unit has been completed you install a stretcher between them as detailed in Fig. 6. This is attached by means of small brackets, the pattern of which is given in Fig. 5. To at-

finishing. In cutting the stretcher, be sure that it is slightly longer and wider than the card table so that the latter, when folded, will fit nicely into the "nest" provided. Finishing is a matter of your own personal taste. If cheap wood is used, it may be painted attractively or enameled. Or, you may desire to use selected wood finished by staining and varnishing. Also, if you wish to alter certain parts of the design, this can be done without detracting from the main purpose. A decalcomania transfer applied to the center of the card-table top will give an extra touch or ornament on this flat expanse of surface.

Paper Clamp Serves as a Bench Rest for the Electric Soldering Iron

To permit him to lay down his electric soldering iron with safety in places where the ordinary rest or holder would be inconvenient or impossible to use, one craftsman attaches a paper clamp to it. The clamp is clipped on near the tip of the iron, as indicated, and the arms are spread so it will not tip easily. Since the clamp seldom interferes with the use of the iron it may be left in place most of the time.

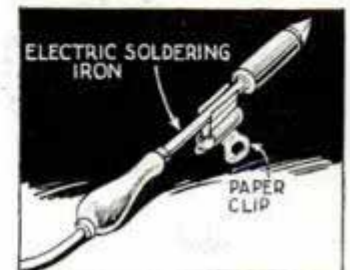

Shaft Hangers Improvised from Auto Bearings

Efficient hangers to support a line shaft for driving small bench-top machines can be made by mounting standard automobile ball bearings in flat-iron supports. The bearings, which can be purchased at an auto-parts store, are forced tightly on the 1/2-in. shaft by means of thin-brass shims. Shallow depressions are ground on the outer race of the bearings to engage four setscrews provided in the hangers for alignment. Nuts should be fitted on the setscrews to lock the adjustment.

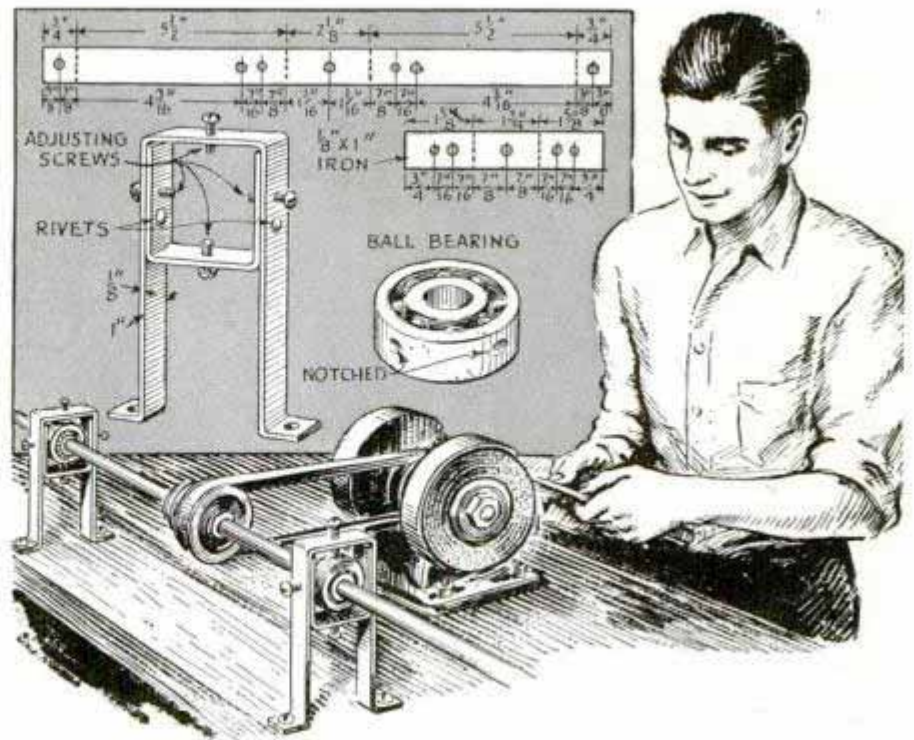

Electric Grindstone Made Easily from Old Cream Separator

With little effort an efficient electric grindstone can be built from an old electric cream separator. The only changes are to provide a water pan or trough, to saw off the support for the milk bowl and replace the shaft of the large gear wheel

with a longer one so that a Ford wheel hub will fit on it in place of the gear. The grindstone itself is then mounted on the hub and secured by a large nut. The water pan is made from 20-gauge galvanized iron and is attached to the motor mount by means of angle irons. A valve or cock should be soldered to the bottom of the pan to drain the water when the stone is not in use.—S. Morley, Clear Lake, Wis.

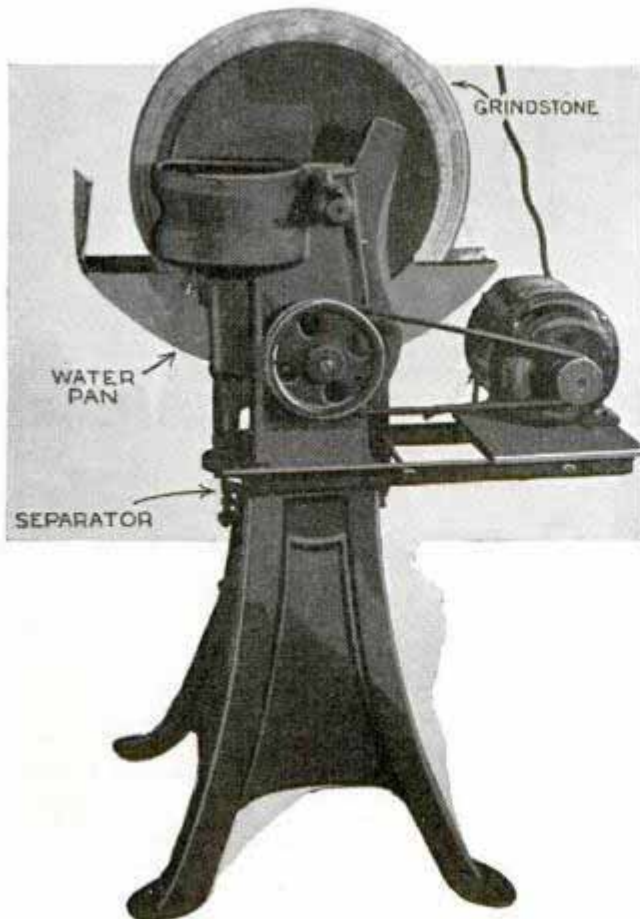

Hats Won't Fall Off This Rack

If you have limited closet space, and have to hang your hat on a hook where it is easily knocked down, make this simple rack from an old coat hanger. Just cut out the hook portion of the hanger and shape the latter to take the crown of the hat. Then solder the severed ends of the hanger wire together and bend them to fit in the eye of a half of a hinge. To insert the wire the eye will have to be spread open and then closed over it. —Mort Tenny, Denver, Colo.

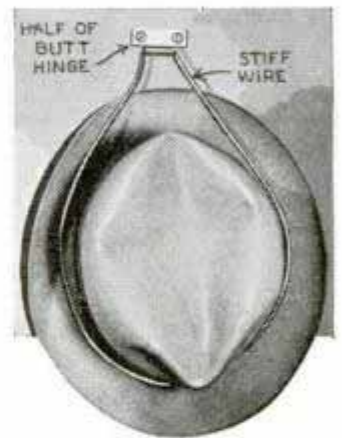

Solving HOME

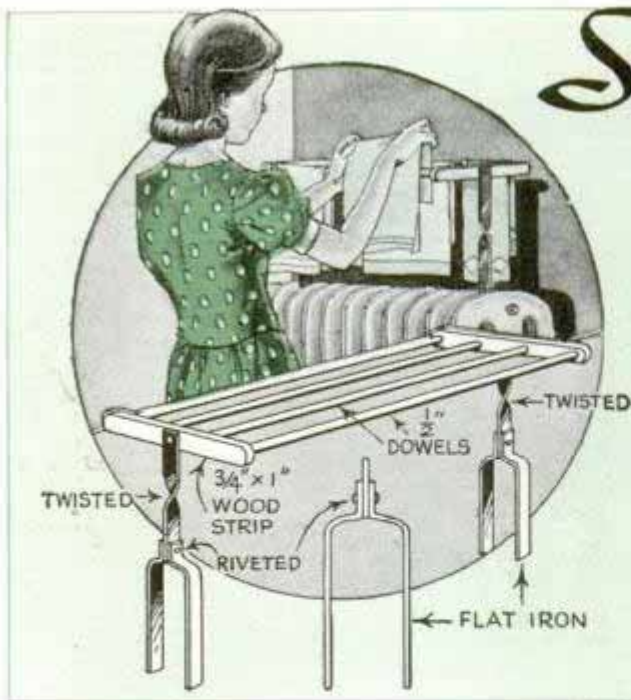

Supported by two flat-iron forks, the removable rack at the left, fits over a radiator for drying a few garments quickly

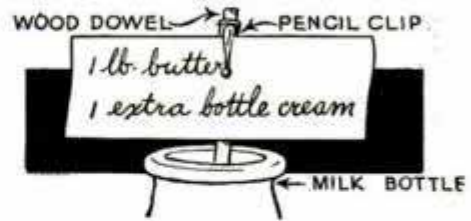

Written instructions for your milkman will "stay put" in an empty bottle if you slip the paper under a pencil clip, which has been pushed over a small wood dowel and inserted into the bottle

A "flowering" banister does much to relieve the plain appearance of an iron porch railing. Iron flower-pot brackets are attached to the railing in various locations as shown below to support potted plants of the continued-bloom variety

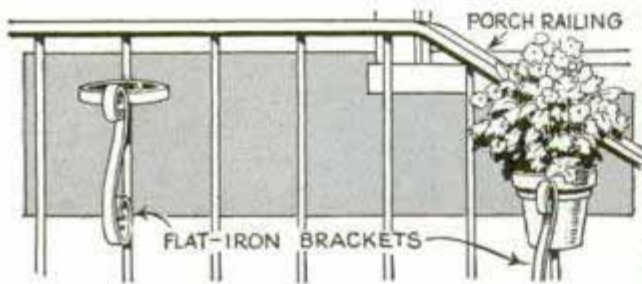

To avoid having your umbrella slip to the floor whenever you lean it against a wall, fit a slip-on pencil eraser over the tip as shown at the right. If the tip is too small to hold the eraser in place, wrap it with a few turns of adhesive tape



Flour can be sifted into a cup or other narrow-mouth container if the bottom of the sifter is provided with a funnel that will fit inside the body as indicated at the left. Punch small holes in the sifter on opposite sides near the lower end, and secure the funnel with a length of wire

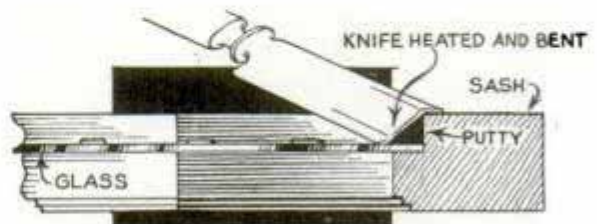

Having several windows to putty, one home owner used a table knife bent to the shape shown above. In use, the knife rides on the edge of the sash, and on the glass, spreading the putty to uniform thickness. Putty is fed ahead of the knife while it is pulled along the sash

PROBLEMS

A baseboard doorstop will also hold the door open if a friction catch of the type shown below, is used. This avoids the use of a wedge or weight on the floor, which is often rather inconvenient

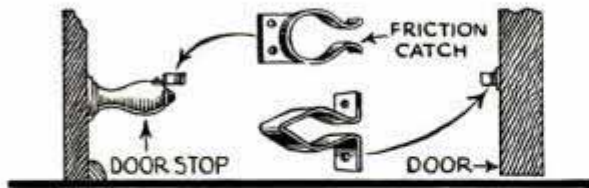

A built-in fireplace wood box that is filled from outdoors is a convenience anyone can enjoy provided the fireplace is along an outside wall. On fireplaces having cabinets on both sides, one of these can be altered to serve as a wood box by cutting an opening through the wall for access from the outside

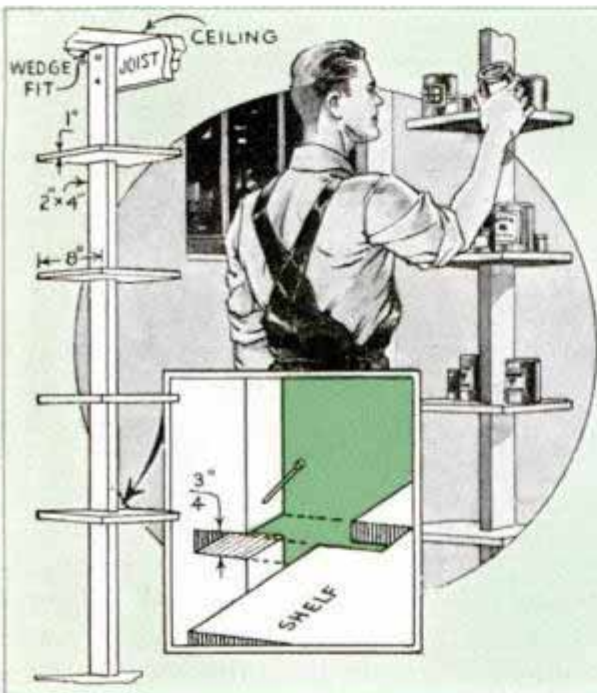
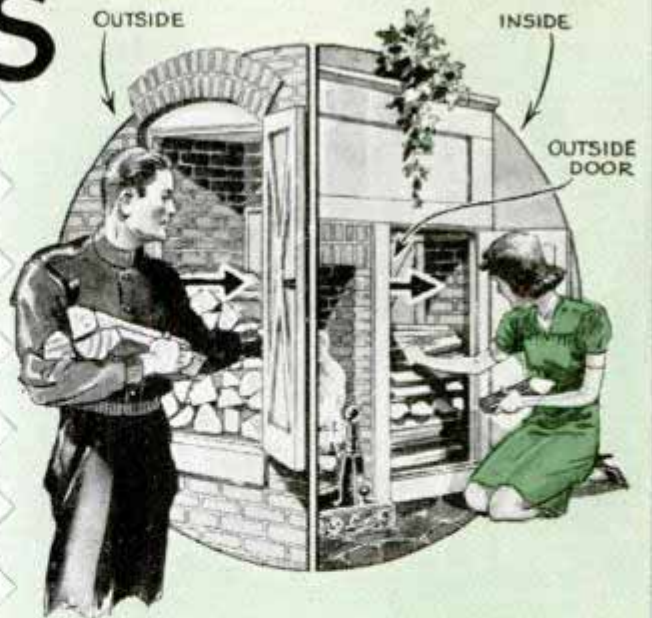

No one can enter your home by pushing the key out of a lock and inserting one from the outside if you put a wire hook through the eye of the key as shown below, to keep it in place

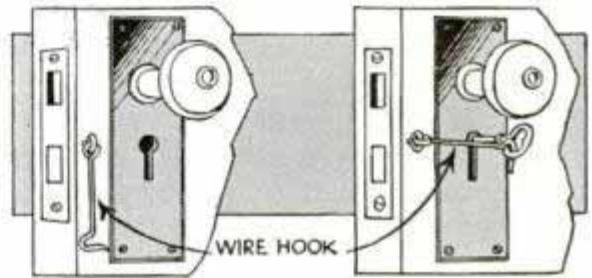

Plenty of shelf space is provided in a basement workshop, where masonry walls make it difficult to attach them, by using an upright to support the shelves. It is wedged in place tightly and spiked to a floor joist

The tendency of wax candles in a warm room to soften and bend is avoided by reinforcing them with a needle as shown below. Heat the needle first and push it into the candle from the base

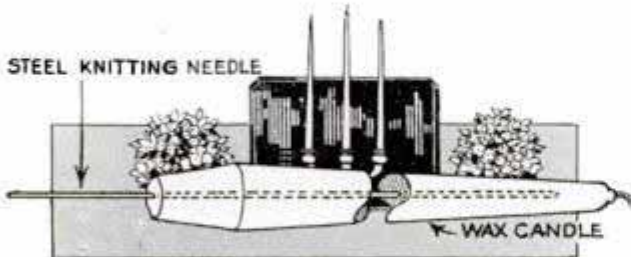

You can prevent small magazines from slipping down to the bottom of a rack out of sight by using the container at the right. It hangs inside of the rack from two flat hooks, which fit over the edge. Anyone can make such a container of 1/4-in. plywood. It is assembled with small screws and finished to match the rack



Rails of Window Sash Are Calked to Prevent Cracking Putty

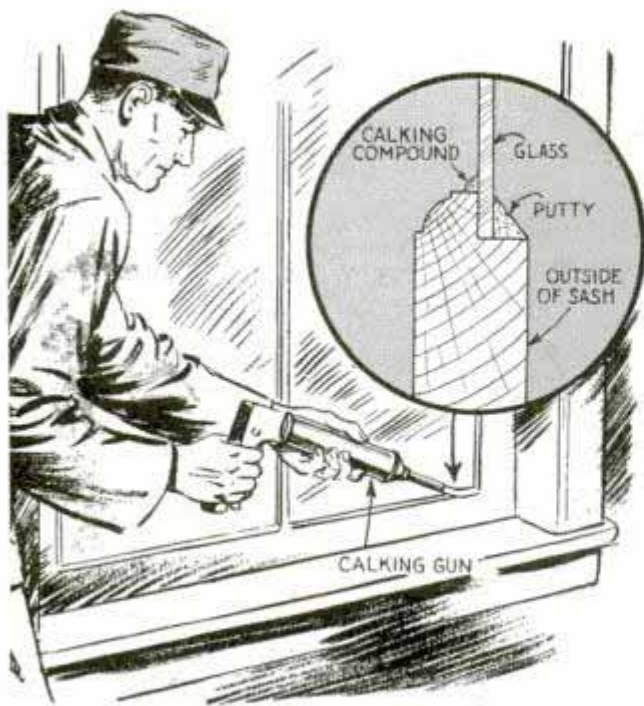

One reason glazed joints in the rails of both inner sash and storm sash loosen rapidly is because water gets between the wood and the glass on the inside of the rabbet. Moisture condenses on the inside surface of the glass in cold weather and runs down to the rails. Slight swelling of the wood forces the glass outward and cracks the putty. This trouble can be avoided by first painting the inner molded edge of the rail, allowing the paint to come up on the glass about $\frac{1}{8}$ in., and then running a narrow strip of calking compound along the joint, using a gun as shown. Only the middle and bottom rails need to be given this treatment.

Shield Repairs Smoking Fireplace

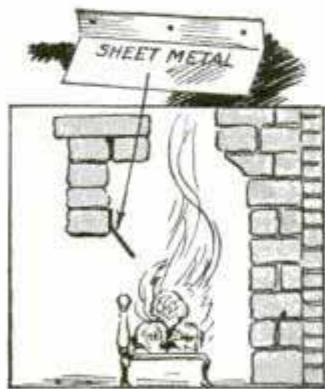

Smoking of a fireplace is sometimes caused by a downward air current which is not properly stopped by means of a shield or some form of smoke chamber. This trouble often can be stopped by placing a sheet-metal shield inside the firebox. The exact location of this must be found by experiment. The metal is set in place temporarily, then a fire is built and

the smoke eddies studied carefully for shape and location. If smoking does not stop at the first try, change the position of the shield and try again.

—Arlyn H. Vance, Linn Creek, Mo.

Waterproof Labels for Glass Jars

By a simple transfer method you can make ideal labels for jars, bottles, etc., with transparent cellulose tape. To do this, print the desired lettering on paper with a soft-lead pencil, press the tape over this firmly and then strip it off. The lettering will be transferred to the tape, which is then placed on the jar or bottle.

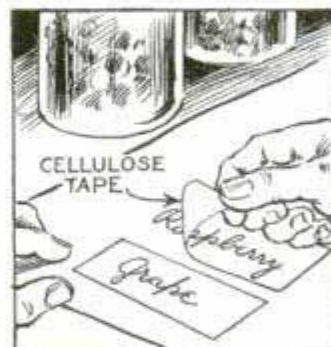

—Lincoln K. Davis, Brockton, Mass.

Refuse Impinged on Sharp Sticks Keeps Picnic Grounds Neat

Outers stopping for picnic dinners where garbage cans are not provided for disposing of refuse can do a good turn by slipping it over sharpened sticks as shown. One end of the stick is pushed in the ground while the other provides a handy place to slip on paper plates, napkins and bags of garbage. Besides improving the appearance of the grounds, refuse will be kept in one place for removal by the caretaker.



Small HAND LOOM delights the youngsters

Doll-house rugs, pot holders and dish pads of embroidery thread, yarn or ordinary cotton string, are but a few of the many practical items that one can weave on this simple hand loom. White pine is suitable for the frame, but the "heddle" cylinder, which raises the warps alternately by merely reversing the position of the handle with each pass of the shuttle, should be made from a maple or birch dowel. The cylinder, slotted as detailed below, is made to pivot in slots cut in the rabbeted edge of the frame, and grooves cut lengthwise in the dowel, in which the edge of the shuttle may be held, serve to guide it easily between the warps. The frame is strung with heavy shoemakers' thread by securing the end around pins at one corner and then spreading it in corresponding slots in the end rails and cylinder. Dowel pins inserted upright in holes drilled equidistantly apart in strips fitted along the inside of the frame, serve to keep the work uniform in width and are advanced as the weaving progresses. For the shuttle bobbin, a common metal film spool will serve

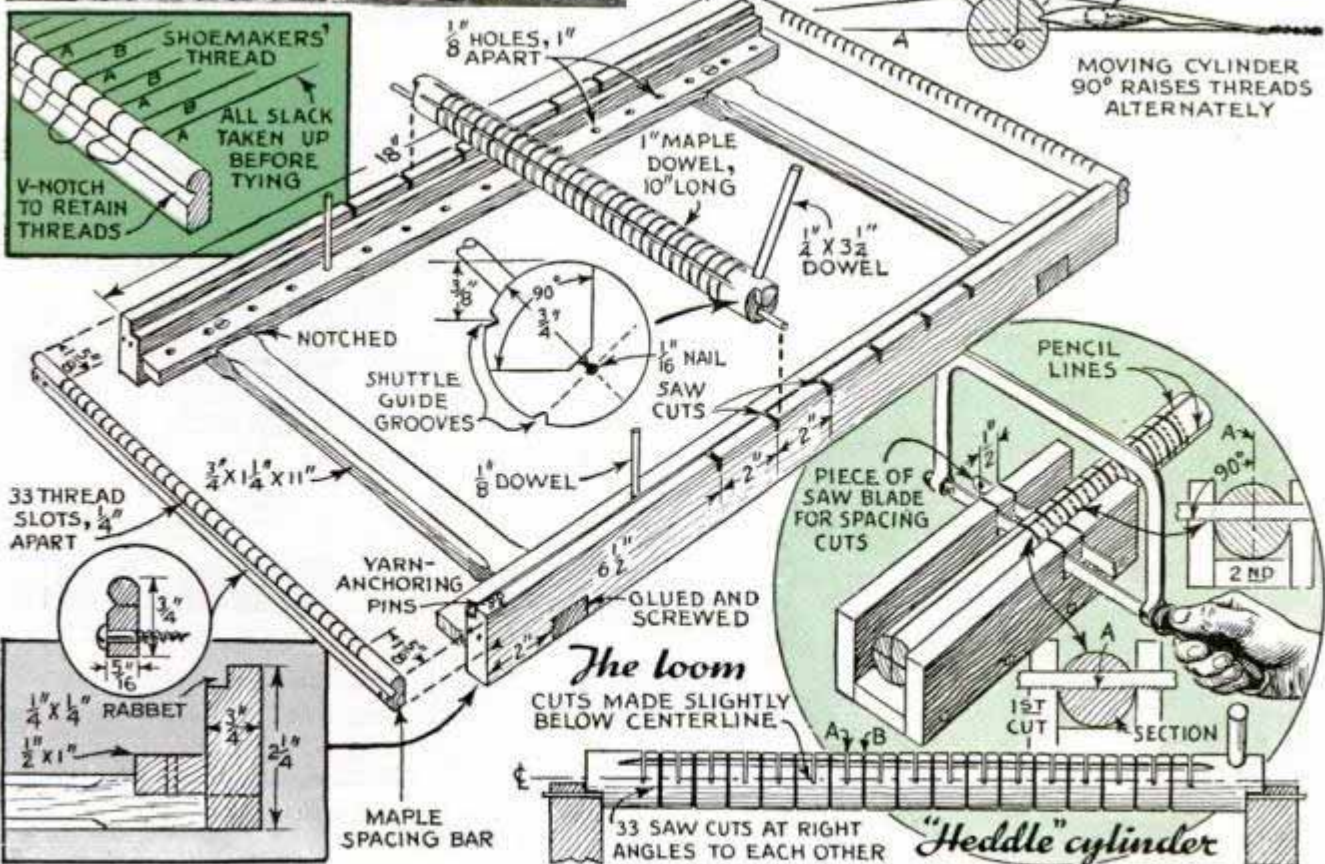
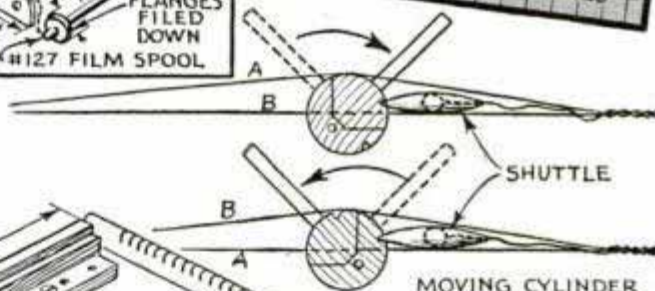
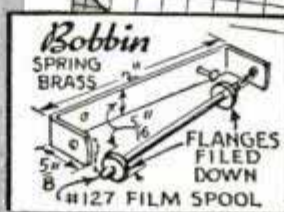

Disk Harrow Fitted with a Handle Scrapes Cement Floors



Cleaning of cement floors is done easily with this simple scraper. It is nothing more than a blade from an old disk harrow mounted on a suitable handle by means of a bolt. The handle can be made of metal or pipe bent to a shape that permits the blade to rest flatly on the concave side as it is pushed or pulled over the floor.

Loose Oars Held in Locks Securely by Flexible Fasteners

To keep loose oars from sliding back and forth in their locks, and still have them flexible so that they can be manipulated with ease, cut a couple of wide bands from

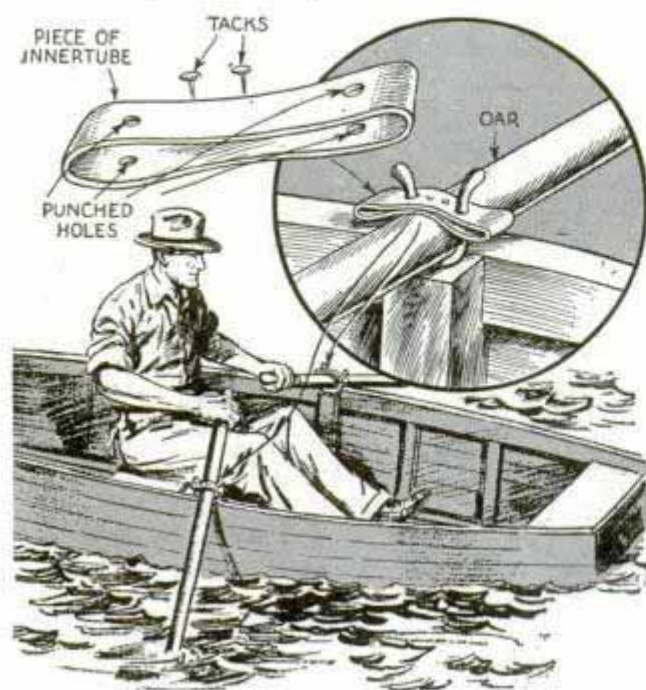

an inner tube and tack them to the oars. Then punch holes in the bands and slip them over the oar locks as indicated.

Crayon Holder Teaches Child to Keep Things in Place

Jigsawed from $\frac{1}{2}$ -in. stock and mounted on a base by means of screws, this crayon holder will be appreciated by any child. Equally spaced holes drilled in the upper edge of the head, as indicated, hold the crayons. Painting the face in a lifelike manner will add much to the realistic appearance of the holder.

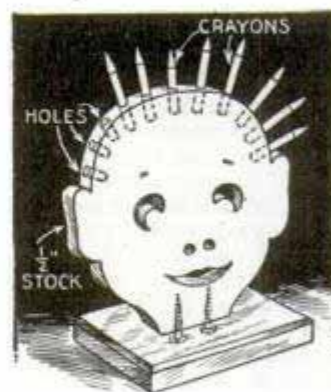

Emergency Lock for House Door When Key Is Lost

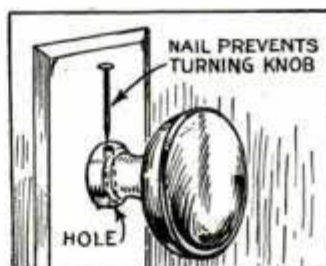

In an emergency, when your key is lost or mislaid and a door must be locked from the inside, try the arrangement shown in the drawing. All you need to do is drill a hole through the lock-plate flange and the knob shaft just large enough to take a small nail. Dropping the nail into the hole locks the knob.

Improved Joinery Adds Strength to Platform Railing

Stronger joints will result when nailing horizontal members of a platform railing to the vertical members if you notch and lap each end of the rails as indicated.

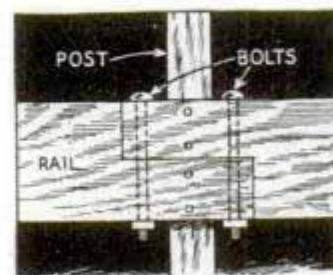

As nails can be driven not only through the center, but from the top and bottom as well, the strength of this joint is evident.

☐ A magnet kept in the sewing basket is handy to pick up spilled needles.

'Dog House' Shoe-Shine Box Stores Accessories

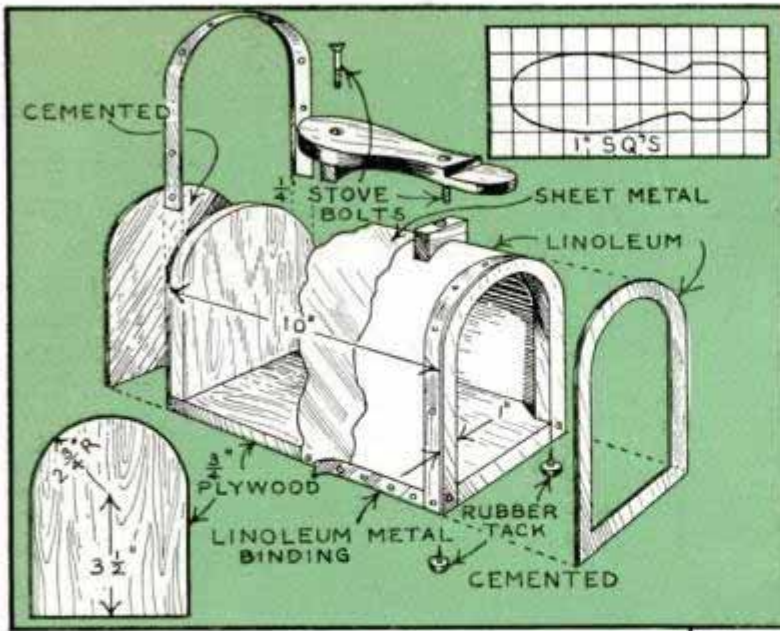

This box serves as a stand on which to rest the shoe while shining it, and has space for storing brushes, polish, etc. The base and closed end are of $\frac{3}{4}$ -in. plywood, and the top and sides are shaped from one piece of heavy sheet metal. A U-shaped piece sawed from the plywood supports the metal at the open end. The box is covered with linoleum, using metal binding

along the edges. A rubber tack at each corner keeps the box from slipping.

Sawhorse 'Clothespin' Holds Work on Edge for Planing

A support resembling a clothespin for holding boards on edge for planing on a sawhorse, is made easily from two 1 by 6-in. pieces spaced with a block so that

they straddle the rail of the horse. For most work the support will stay in place without being fastened, but may be attached rigidly by threading a thumbscrew through one side to engage the sawhorse.

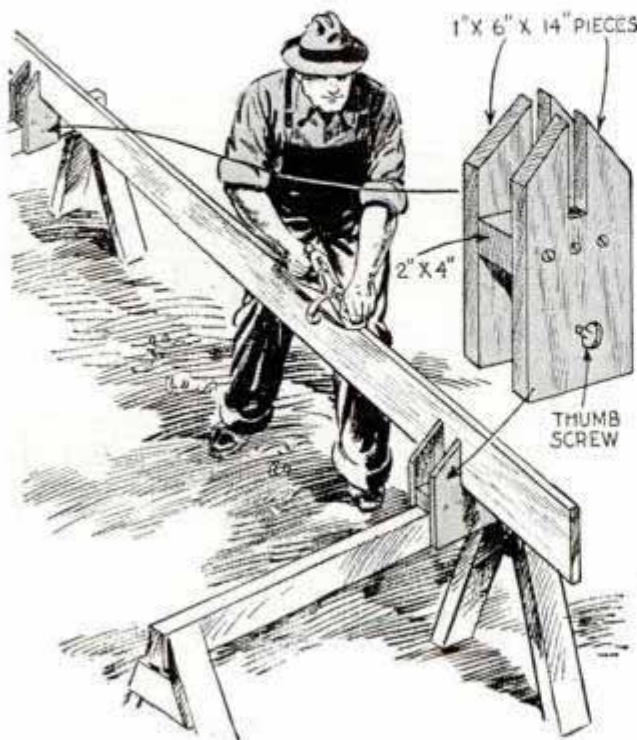

Pencil-Lead Pointer Is Assembled from Screw Bottle Cap

To point a pencil lead without scattering carbon particles over his work or on the floor, one artist employs a simple sharpener made from a deep bottle cap and a cylinder of sandpaper. The cap is fastened to one corner of the drawing board with a thumbtack. In use, the pencil is rotated within the cap, holding the lead against the sandpaper.

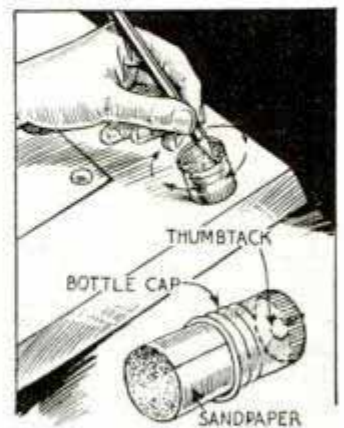

Breakfront Styling in **DESK**



THIS modern adaptation of the beautiful breakfront secretaries of years ago, which were very large and elaborate and suited only to great high-ceilinged rooms, is a project worthy of any craftsman's skill and one that he can feel justly proud of having built. While the originals were all made of mahogany, any wood, such as gum or birch, that will take a good "mahogany finish," may be used.

The cutaway drawing, Fig. 4, shows the general construction and appearance of the case. Standard moldings and fittings are used throughout. The carcass assembly is shown in Fig. 9. The side pieces run the entire height of the piece, as do the wider, center uprights. Note that the latter are cut out to house the glass doors. The horizontal pieces at the top and the cleats under the bottom shelves and drawer frame are screwed and glued into place. All

other drawer frames, shelves and counters are glued into dados run in the vertical members. The back is set into a $\frac{1}{4}$ by $\frac{1}{4}$ -in. rabbet and the plywood top is tacked on.

Start with the vertical pieces. Lay out and cut the dados, rabbets, holes

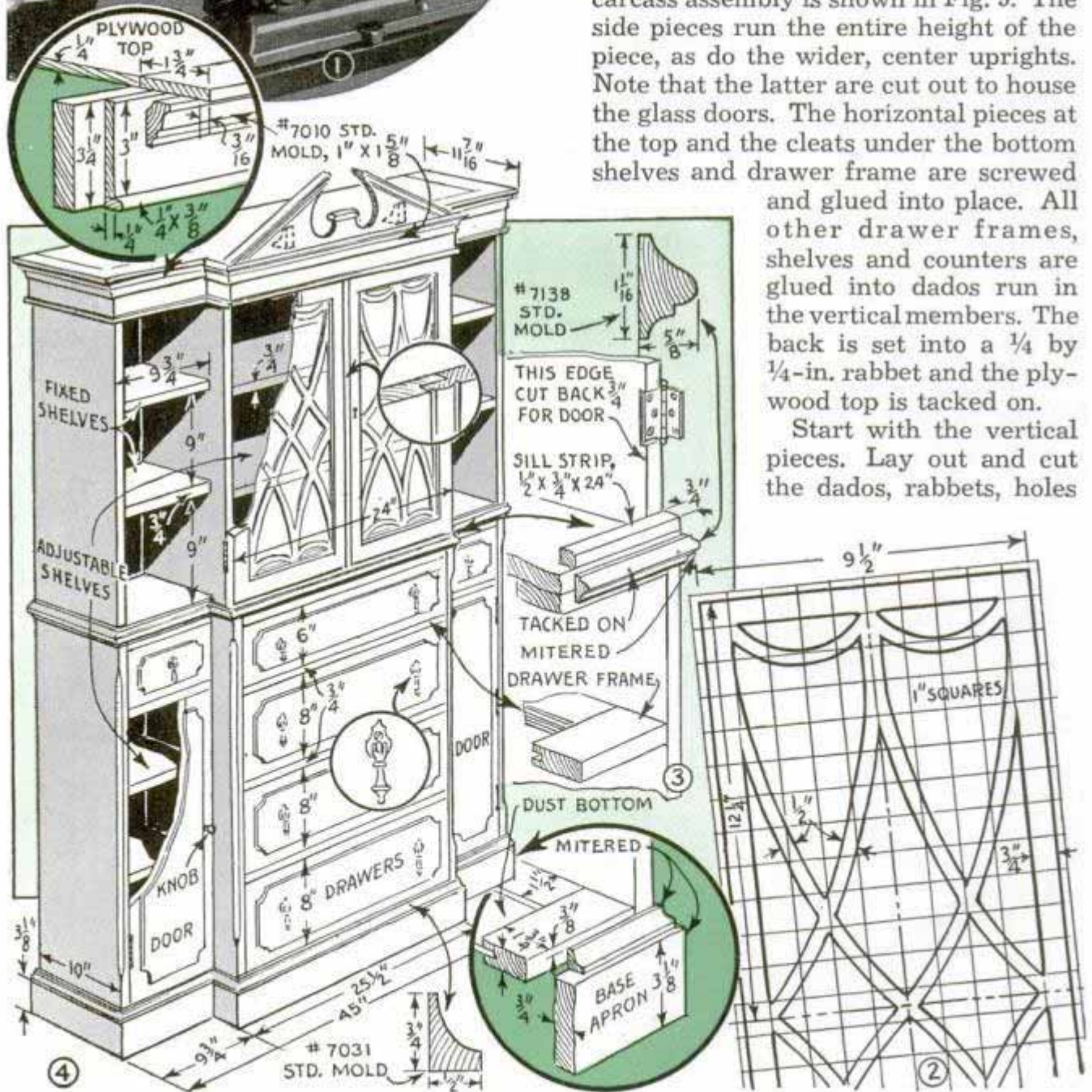

or CHINA CABINET

by R. O. Buck



for the pins which carry the adjustable shelves in the lower and upper compartments, and install the cleats that support the bottom pieces of the small compartments. To break the monotony of the long, vertical lines, a "stop chamfer" is used on the outer edges of the vertical pieces. Fig. 8 shows the details of the large drawer frames. Five frames are required, but the bottom one is made without tenons and has grooves all around to house a plywood dust bottom. The small drawer frames are shown in the circular detail of Fig. 9 and are similar in construction. Drawer design differs from the usual practice in that the bottom is housed at the back as well as sides and front, as in Fig. 11. This is done because of the shallowness of the drawers. Though plain butt joints are shown for the sake of simplicity in construction, a dove-tailed construction is preferable.

Fig. 10 shows how the overlays are glued

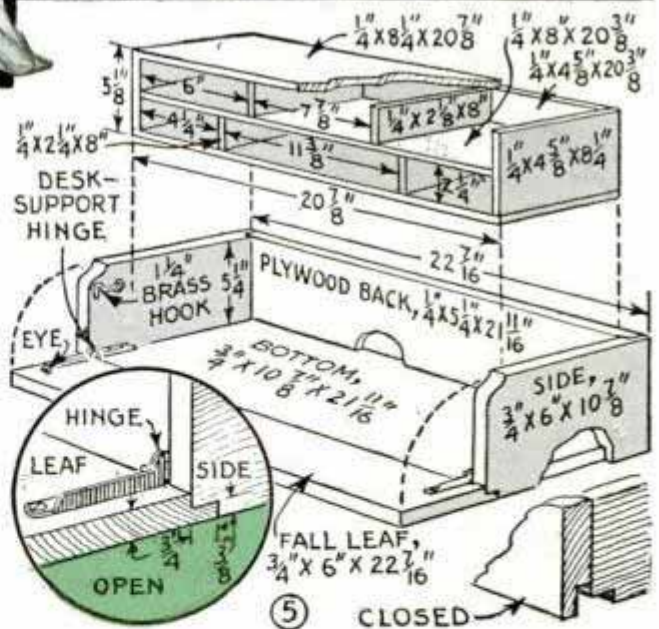

to the drawer fronts. Contrasting woods were often used for this purpose and may be used here. Or, an effect of contrast may be secured by the use of a lighter shade of stain when finishing the piece.

At this stage it is necessary to decide whether you wish to make a secretary or

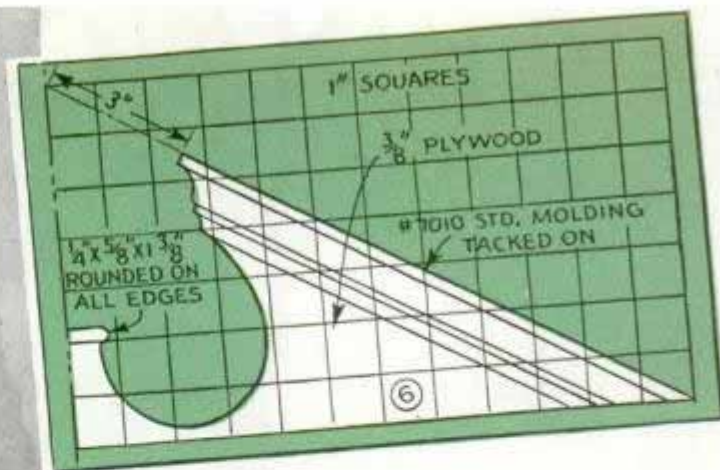
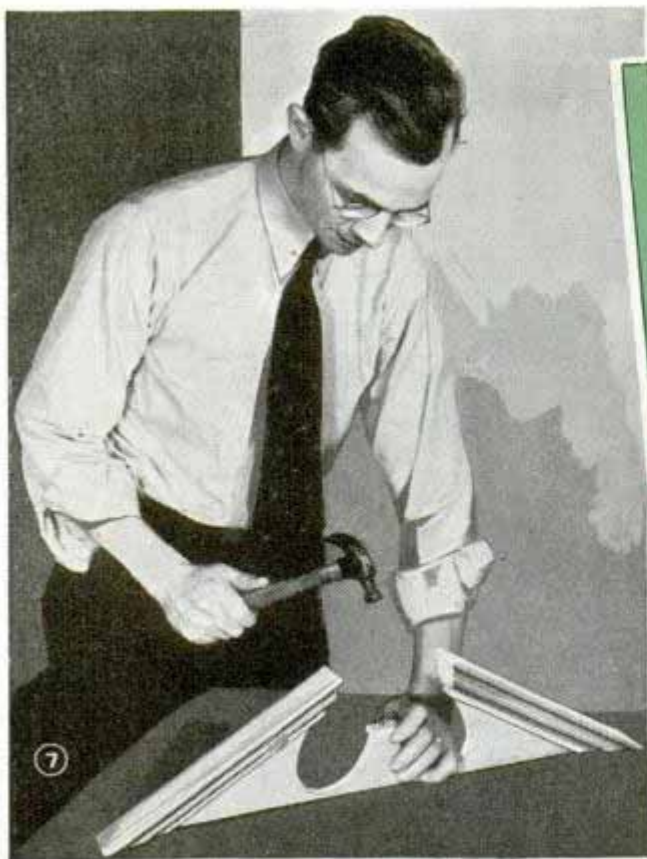

the simpler china closet. If the latter, the top or 6-in. drawer is made just like all of the others except for height. The secretary uses the top drawer for the writing bed. Fig. 5 shows the details. The front of the drawer consists of a fall leaf equipped with a pair of desk-support hinges, so that the lid is rigid. In use, the drawer is pulled about halfway out to provide a small but convenient desk. Pigeonholes are provided for papers, stationery, etc. The pigeon-hole unit is constructed separately and fastened into place with small screws. When the fall leaf is raised, two brass hooks at either side hold it in position. Note the lap-joint arrangement, which gives a drawer effect when the leaf is up and the drawer closed.

The broken pediment cap, Figs. 6 and 7, is often omitted on the larger pieces, but adds greatly to the finished appearance of the small breakfronts. Made as a complete unit, the cap is attached by means of screws driven through two back brackets, Fig. 4. Shelves in both the lower and upper closed compartments are adjustable. Inexpensive metal shelf pins or short pieces of 1/4-in. dowel rod may be used for this purpose.

Glass doors with wood grills are constructed with rebated tenon joints. Fig. 12 shows how the shoulder on the inner sides

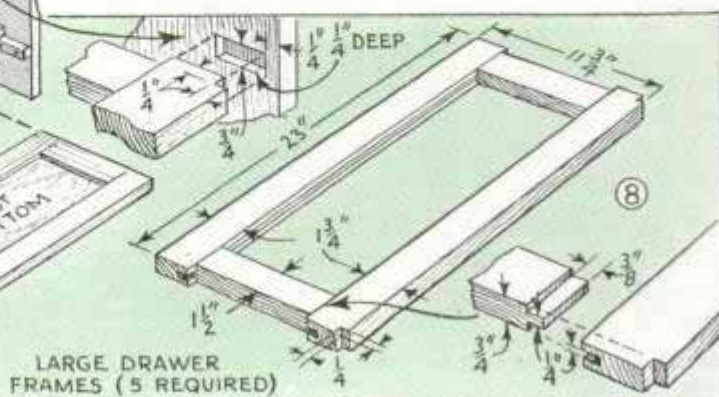
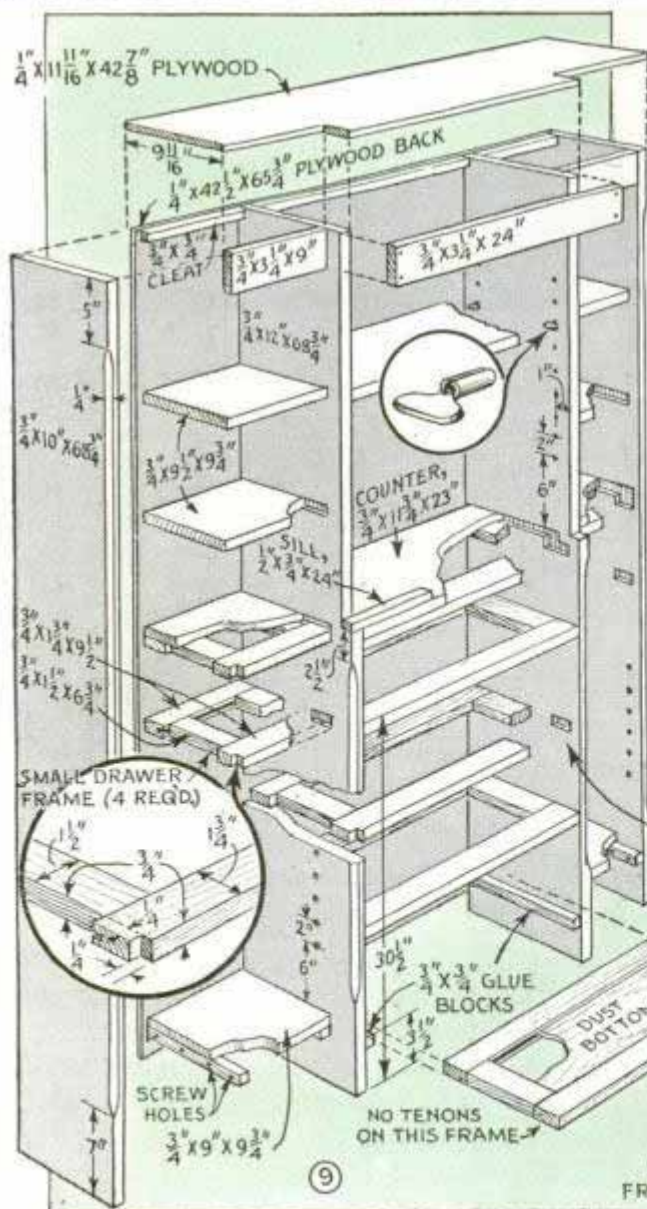

of the rails is made longer to compensate for the grooves in the stiles. Mortises for the hinges are cut only in the vertical pieces, and to the exact thickness of the barrel of the butt. See Fig. 13. The outer leaf is simply screwed to the surface of the door stile.

Grill pieces for the glass doors are cut on a jig saw, as shown in Figs. 1 and 2. The two doors are lapped $\frac{3}{8}$ in. and fitted with a brass escutcheon, key and lock, for one door and an elbow catch for the other. Glass and grill are installed in the frames by means of narrow, shaped strips, Fig. 14.

The base of the cabinet is finished with a wide apron carefully mitered at the corners and trimmed at the top with a stock cove molding, Fig. 4. A simple molding is tacked around the case at the waist to divide the upper and lower sections, Fig. 3. The top is finished with a $\frac{1}{4}$ -in. fascia, half-round nosing, standard molding and a $\frac{1}{4}$ -in. cap strip, all carefully mitered at the corners. The drawer pulls suggested in this figure are fastened with wood screws from the front rather than the usual bolt arrangement. After all surfaces have been sanded, the sharp edges should be rounded slightly so that the finish will not be cut through when rubbing down.

In finishing mahogany or walnut stock it is necessary to first fill the open pores of the wood with a paste filler of the proper color. If birch, maple or gum have been used, this step may be omitted.

After the filler has been brushed on, it is allowed to set until it begins to flatten, at which time it is rubbed off across the grain with a piece of burlap or coarse excelsior and allowed to dry for 24 hrs. The surface is sanded lightly with the grain, using fine sandpaper, before applying a coat of oil stain. The oil stain is followed with one coat of shellac. When this is thoroughly dry, two coats of high-grade rubbing varnish are applied.

If a dull finish is desired, rub the final coat with powdered pumice and paraffin oil. The use of rottenstone and oil will give a high-gloss finish.

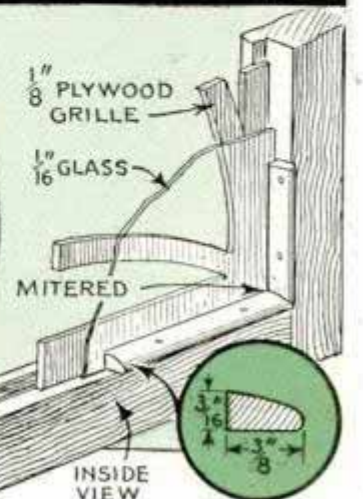
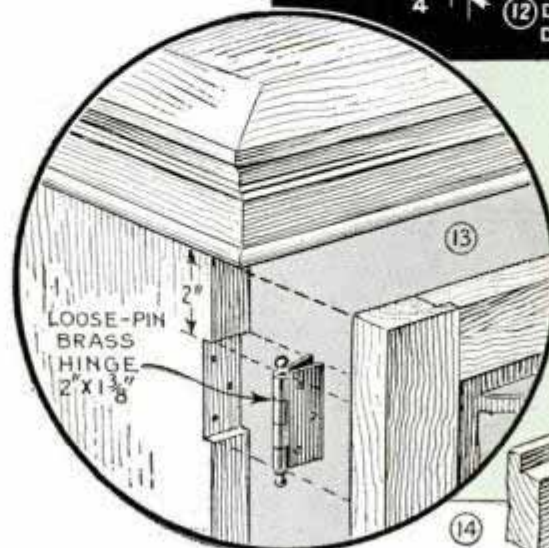
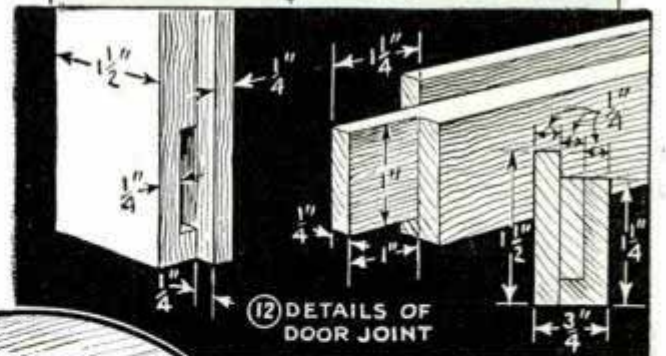
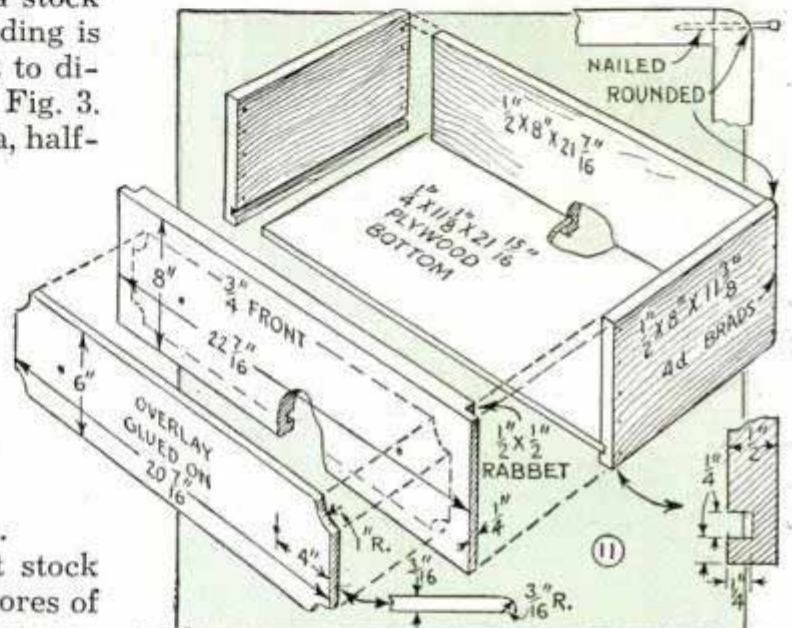
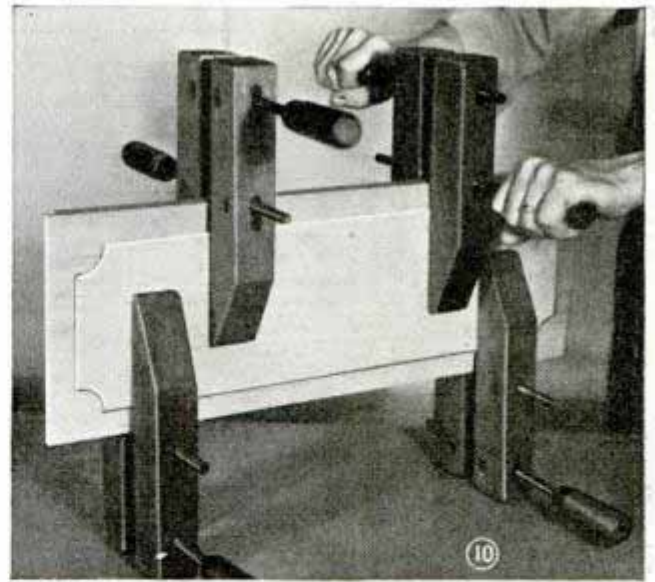

Shop Stool Holds Cylindrical Can While Soldering Seams



Having a number of large milk cans with seams which had to be soldered, I found that a shop stool placed upside down on the floor formed a good support for them so that they could be turned during the soldering operation. Also, I have used a stool to support large tanks while brazing the seams, or while applying patches.

—W. C. Wilhite, Carlinville, Ill.

Adding a Hook or Extra Sinker Without Cutting Fishline

When tying a hook to your fishline, do it as shown in the lower detail and you can remove it easily when necessary. Also, if



moving from one fishing spot to another makes it necessary to add another sinker, you can do it, as shown in the upper detail, without cutting the line.

Iron Filings Kept Out of Pump by Half of Rubber Ball

A workman who repairs well pumps and frequently has to cut or renew pump rods while they are projecting from the well pipe, keeps the iron cuttings from getting into the pipe and damaging the cylinder valve leathers by using a hollow rubber ball. This is cut in two, and one half is slipped over the end of the rod as shown.



Varnish Waterproofs Plaster Sacks

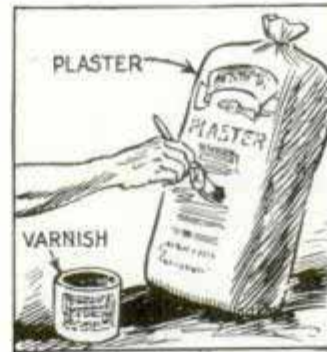

Next time you use only part of a sack of patching plaster, try brushing a coat of varnish on the sack before setting it away. The varnish puts a moisture-proof coating on the sack and helps

to protect the plaster left over. Of course, it is necessary to tie the mouth of the sack securely to avoid entrance of moisture at this point as much as possible.

Clippings Cut with Fountain Pen

When you are reading a soft-paper magazine or a newspaper and want to clip something from it, use your fountain pen. Outline the clipping with ink and then go over it repeatedly until the ink has softened the paper. Then push up from one corner until the paper gives away, after which the clipping can be removed easily.



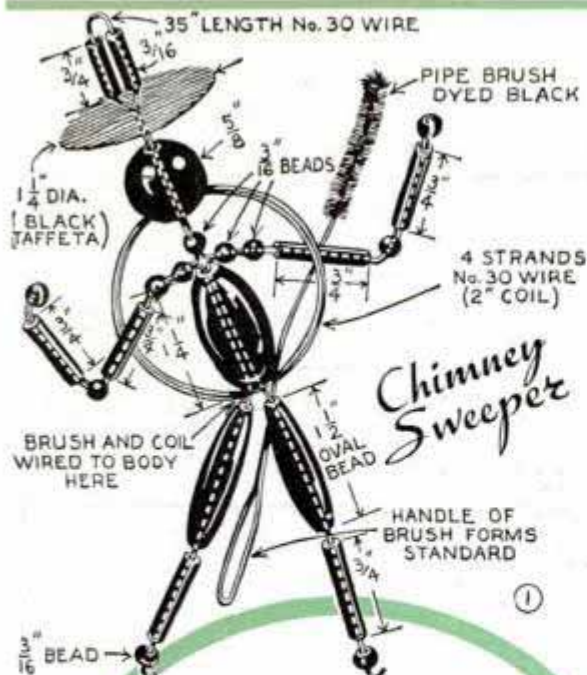

MANTEL DOLLS

of beads, wire and cloth

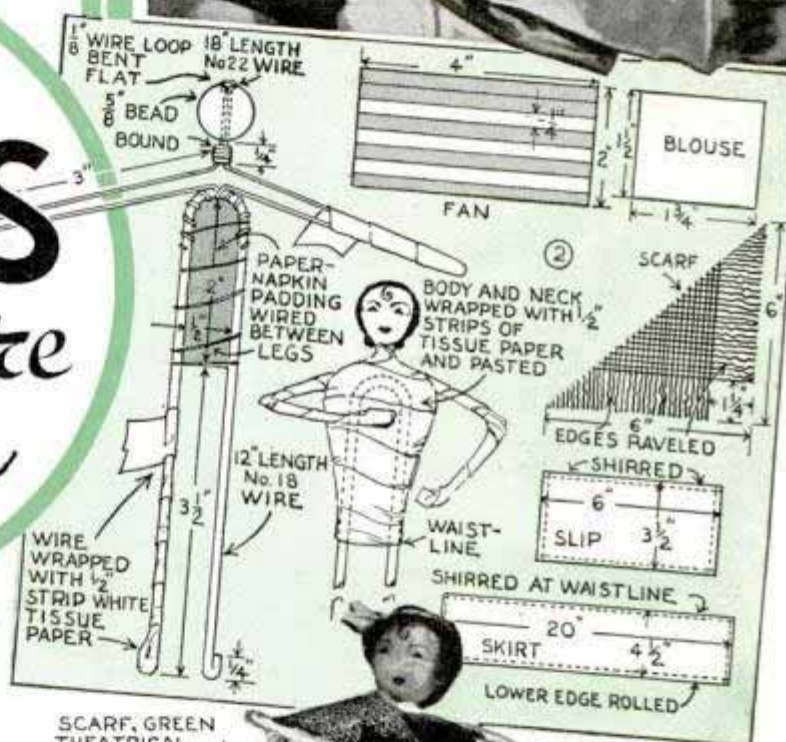

Purely decorative, these dolls which anyone can make from a few standard black wooden beads and odd scraps of colorful cloth, can be used for bridge prizes, table favors and party gifts. Round, oval and tubular-shaped beads strung on a length of soft-iron wire make up the chimney sweeper shown in Fig. 1. The wire is doubled at the center, threaded singly through the beads forming the hat, double through those comprising the head, arms and body and then singly through each leg. A coil of fine wire simulating a rope, and a pipe brush to form a standard for the figure, are wired to the body at the point indicated. The gay Spanish dancer, Fig. 3, is formed over a wire framework which is bent and wrapped with paper, as shown in Fig. 2, and padded at the center to form the body. The doll is dressed as follows: The crepe-paper slip is drawn together around the waistline first, over which the cloth skirt is fitted. The blouse, scarf and feathers are attached to the figure with glue. A fan and a cluster of straw flowers, wired to the wrists, and a small red feather glued to the back of the head complete it



An Extra Grip on End of Suitcase for Easy Removal from Trunk



Salesmen and others who travel with several suitcases in their car trunks and have to remove all or part of them frequently, will find that a handle on the front end of each case is helpful. The handles can be purchased, or made from leather, and can be attached by riveting.

Concave Wood Surfaces Scraped with a Piston Ring

One of the best scrapers I have ever found for scraping the concave surface of wood, such as the inside surface of wood chopping bowls, is an old piston ring. A

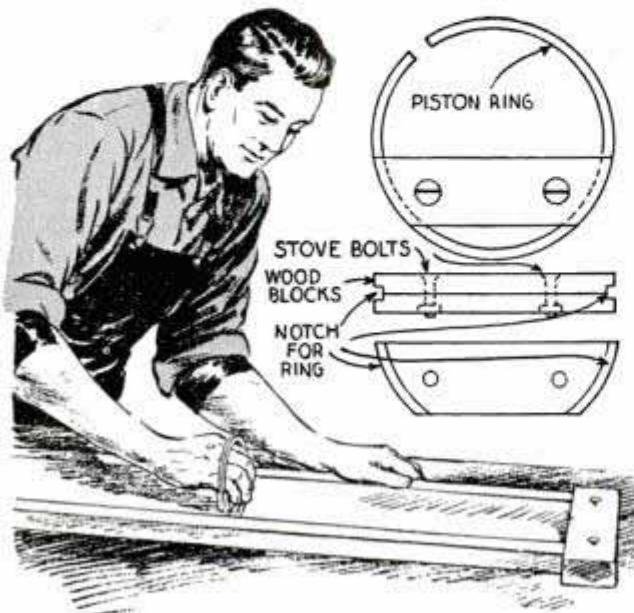

hand grip is fitted to the ring by clamping wood blocks on each side of it with small stove bolts, as indicated. These rings are very hard and will hold their scraping edge indefinitely. Once the edge does become dull, a new one can be provided by loosening the stove bolts and fastening the hand grip to bring a new surface in contact with the wood.

—H. D. Ross, Salinas, Calif.

Spools and Propeller Make Toy for Air-Minded Youngster

This simple toy will afford a small child many hours of entertainment, and it is easy to make. All you need is a tin propeller, a couple of spools and a length of wire, which is bent as indicated to provide axles for the spools. The propeller is attached to the upper spool and both are belted together by means of a rubber band.

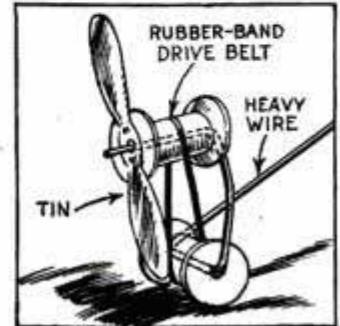

Cross Link from Old Auto Chain Serves as Stepladder Handle

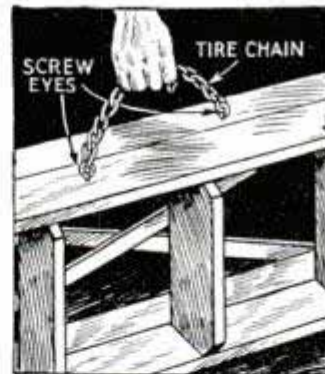

Carrying a large stepladder from place to place on a job can be simplified by providing it with a handle. A cross link from an old auto skid chain is good for this purpose. Screw eyes are

driven into opposite legs of the ladder and one end of the link is fastened permanently to one of the screw eyes. The other end is fitted with a hook for fastening to the remaining eye when the ladder is folded.

Dye Your Faded Corduroys Tan

If your corduroy pants have lost their original color from being washed so many times, they can be dyed tan at a cost of only 10 cents by spending this amount for permanganate of potash. Dissolve this in water, 1 qt. Then get a vessel large enough

to hold the pants, fill it with water and add the permanganate solution. Before dipping the pants, try a scrap piece of cotton to determine the right shade. Pants should be dipped wrong side out and then be allowed to remain in the solution only a few seconds at a time until the desired shade is obtained. Wring them out thoroughly, rinse in clear water and hang in a shady place to dry.—Walter Meinke, Santa Ana, Calif.

Can on Tent Pole Is Handy Shelf for Campers

A handy shelf for a lighted candle, lantern, lamp or other objects inside a tent can be made by cutting triangular holes in the side of a tin can. Two screw eyes or round-head screws driven into the tent pole one above the other to correspond with the holes in the can will serve to support it.

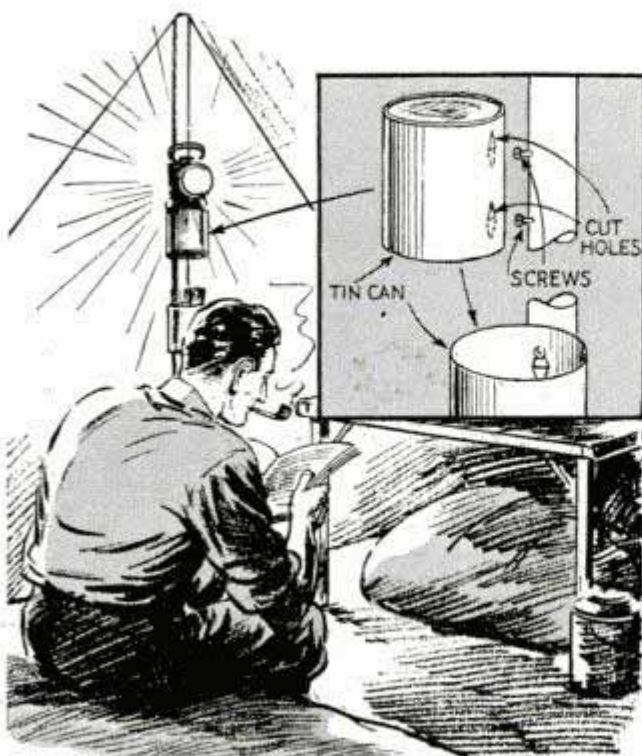

Typed Copy Given Uniform Margins by Double Spacing Between Words

When scraping paint from a boat or other place where the work is above the head, this simple mask will keep dust and paint particles from getting into the eyes, nose and throat. The mask is nothing more than a piece of muslin or other cloth sewed sack fashion to fit closely

When/scraping/paint/from/a boat or/other///// place where/the work is/above/the/head, this///// simple/mask will/keep dust and paint particles// from/getting into/the eyes, nose/and/throat.//// The mask is nothing more,/than a piece of muslin/ or other cloth sewed sack fashion to fit closely

When scraping paint from a boat or other place where the work is above the head, this simple mask will keep dust and paint particles from getting into the eyes, nose and throat. The mask is nothing more, than a piece of muslin or other cloth sewed sack fashion to fit closely



In preparing typewritten material where a number of copies are to be reproduced, the appearance of the final copy can be improved if precautions are taken to assure that the right-hand margin of the type will line up as accurately as the left-hand margin. This can be done by first making a rough copy and extending the ends of the lines to a predetermined length with some character that does not normally appear in the typescript. The characters at the end of each line are then counted, the carriage returned and an equal number of characters placed between words of that line. This is to indicate to the typist that one extra space is to be put between the words where the character appears.

Stagger the positions of the double spaces as much as possible. If they are located one below the other, there will appear to be white streaks running through the copy.
—William E. Smith, Newark, N. J.

Gas Gauge for Outboard Motor

There is no guesswork about the amount of gasoline in the tank of an outboard motor if you install this gauge. This particular

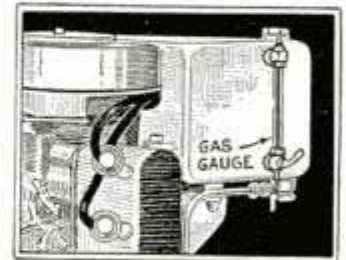

one was an old oil gauge adapted for the purpose. Almost any glass boiler gauge could be used, however, by merely shortening the glass tube to the desired length and fitting it on the tank as shown.

—M. L. Harmon, South Bend, Ind.

THE "JOHN ERICSSON" *A Great Lakes*



can steel industry of fifty years ago. But like all pioneers, its era was short and today the 404-ft. "John Ericsson," still in service and unchanged in design, alone carries on the tradition. It was the largest and finest and is the last of the Great Lakes whalebacks.

You can reproduce the "John Ericsson" in either of two sizes, choosing between the scale of $\frac{1}{16}$ in. or $\frac{1}{8}$ in. per foot. The first gives you a model $25\frac{1}{4}$ in. long, while the second produces a model $50\frac{1}{2}$ in. long. As the

By ALEXANDER MAXWELL

PART I

DISTINCTLY different from the average run of model ships, the "whaleback" is unique yet simple in design, has the color of adventurous background and considerable historical significance. A fleet of 138 of these picturesque whalebacks plied thousands of miles of uncharted waters in the Great Lakes, pioneering iron-ore shipments and being the largest single factor in the spectacular rise of the Ameri-

smaller size is more acceptable to most model builders, the dimensions given in this article are based on the $\frac{1}{16}$ -in. scale, except for parts that would be too difficult to reproduce so small—such as the stanchions, rails, turnbuckles, deadlights and hatch clamps. In the $\frac{1}{8}$ -in. scale these parts would still be oversize so the dimensions pertaining to these small parts, as

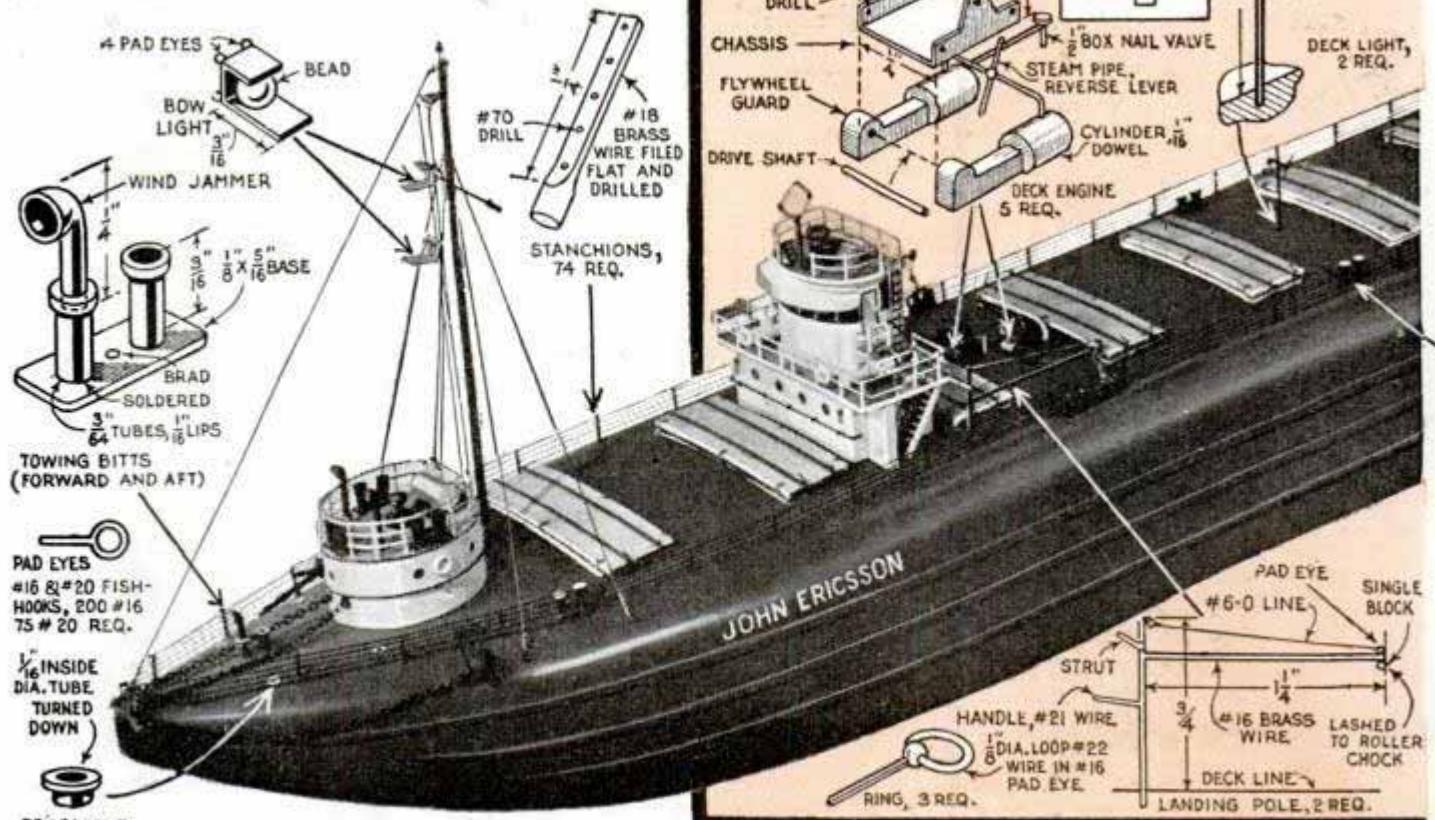

Whaleback

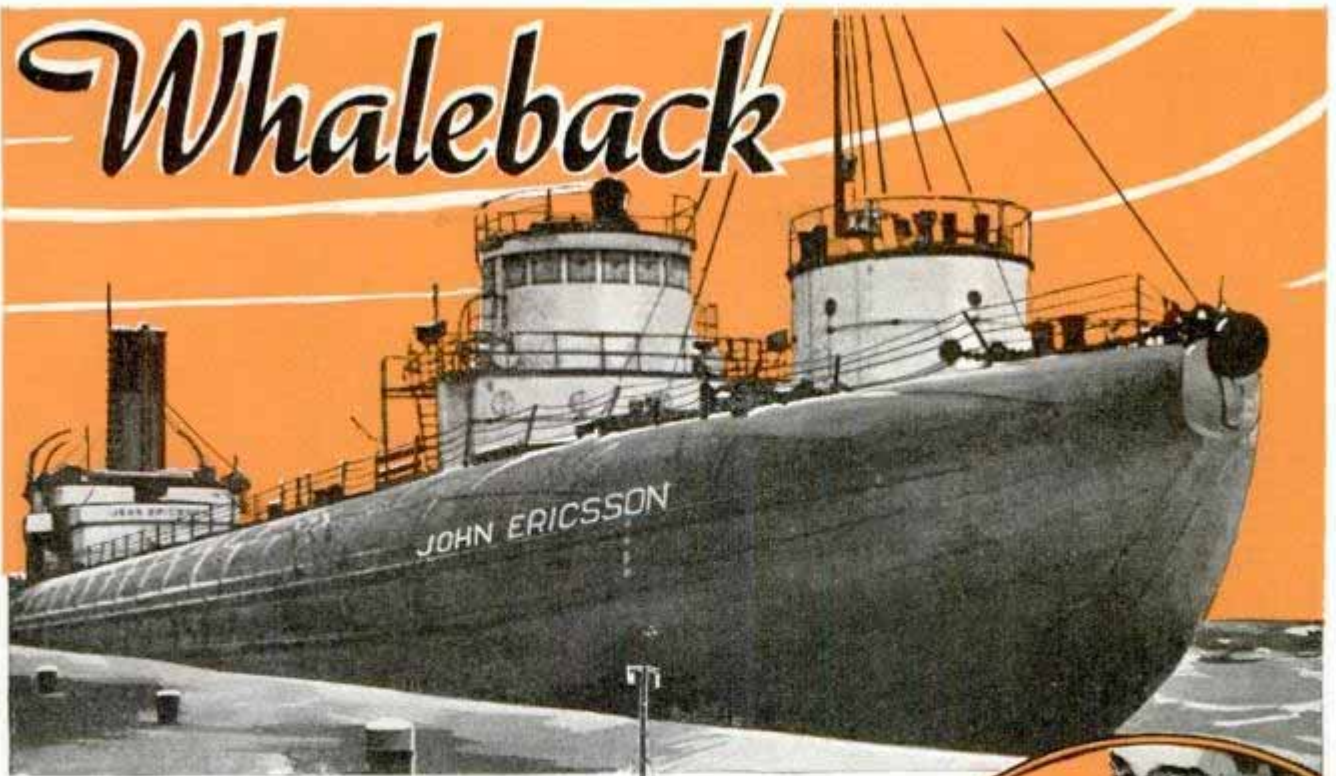

Streamlined in a day when the word was unknown, the sleek Great Lakes whalebacks of fifty years ago are of especial interest to the modelmaker; the type is unique, the design simple yet graceful and the background is both colorful and historically important

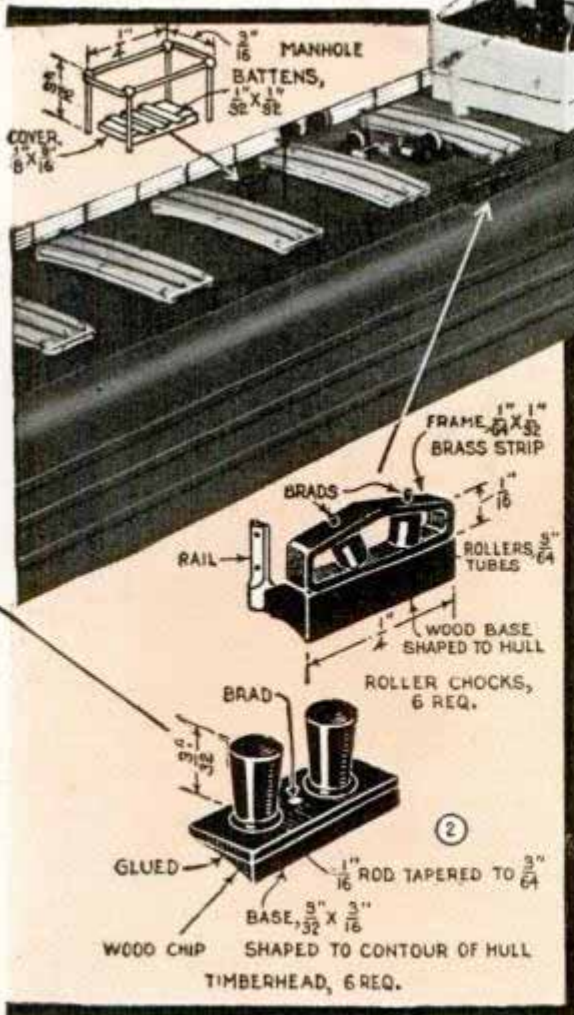
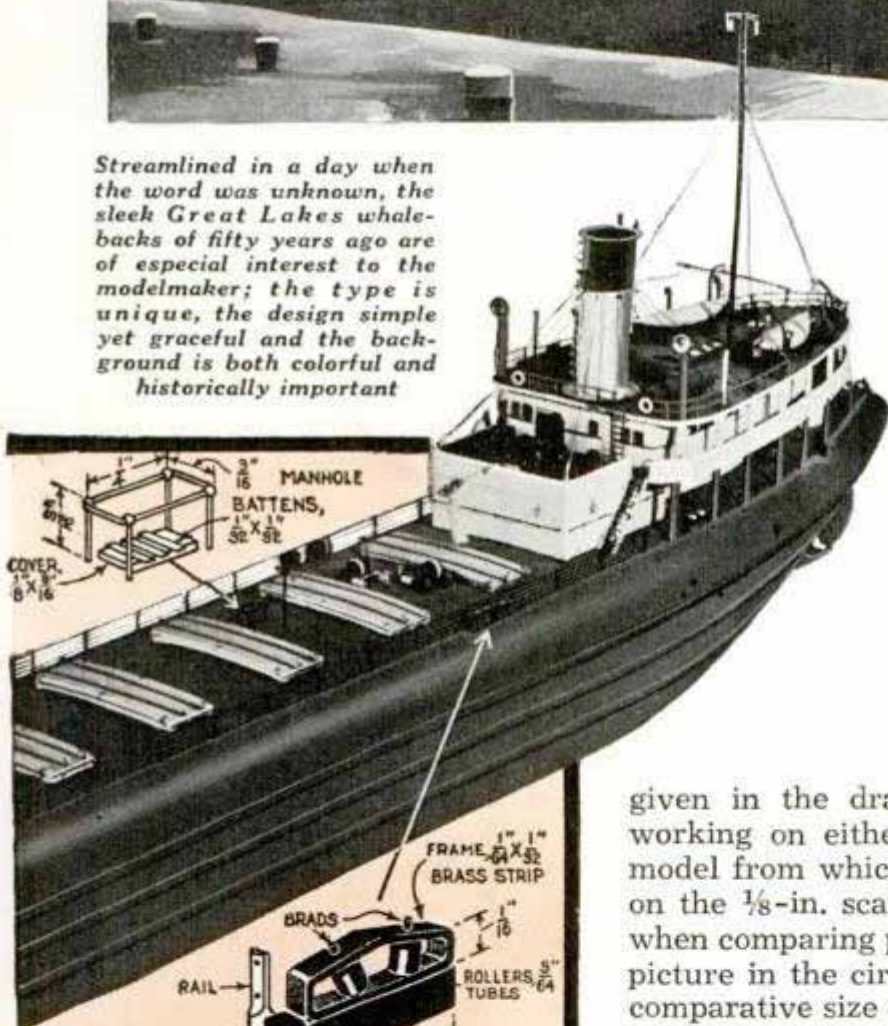

given in the drawings, should be followed when working on either a $\frac{1}{16}$ -in. or a $\frac{1}{8}$ -in. scale. The model from which the photos were taken was built on the $\frac{1}{8}$ -in. scale and this should be remembered when comparing photos and drawings. However, the picture in the circular insert at the right shows the comparative size of a model built on the $\frac{1}{16}$ -in. scale. Then, there is still another choice for those who like to work on the $\frac{1}{8}$ -in. scale but do not desire a model over 4 ft. long. As other whalebacks were very similar but shorter, and most of them had the pilot house located aft, you can produce a replica of a typical 300-ft. whaleback on the $\frac{1}{8}$ -in. scale, reducing the distance between stations 9 and 10, and transferring the pilot house aft as will be explained in Part II. The completed model will be $37\frac{1}{2}$ in. long and will have eight hatches instead of eleven.

The original model of the "John Ericsson" is shown in Fig. 2. In building this model on the $\frac{1}{16}$ -in. scale,

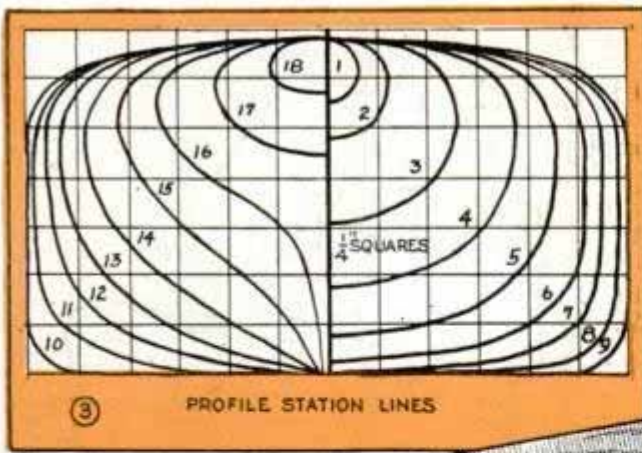

you make the hull from a piece of well-seasoned white pine, Fig. 4. To assure thorough seasoning, set the block in a warm, dry place for two or three weeks before shaping it. Shaping is done as shown in Fig. 1, the model being held in a vise. Make cardboard templates of the station lines, Fig. 3. These templates give the exact curvature of the hull at the various stations, from 1 to 9 at the stern and from 10 to 18 at the bow, Fig. 5. The curvature does not vary between stations 9 and 10. Hold each template in place and mark the areas on the

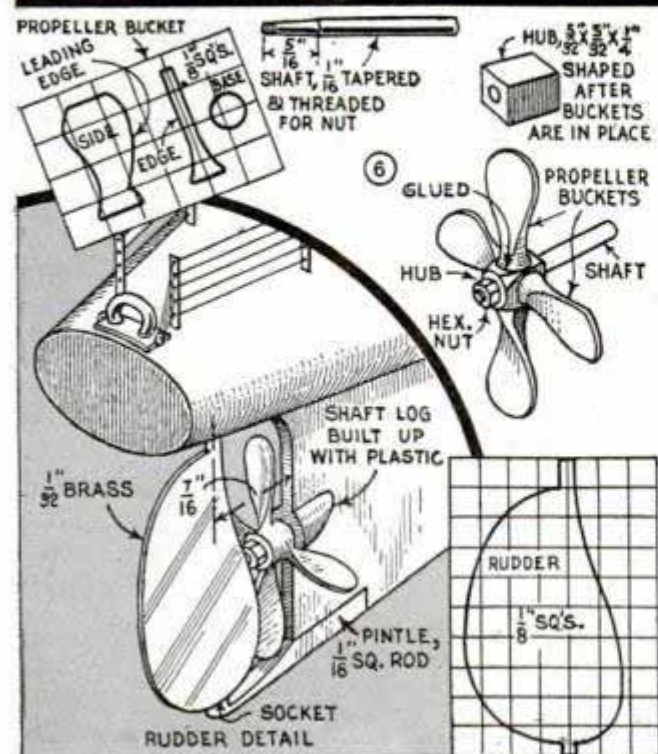
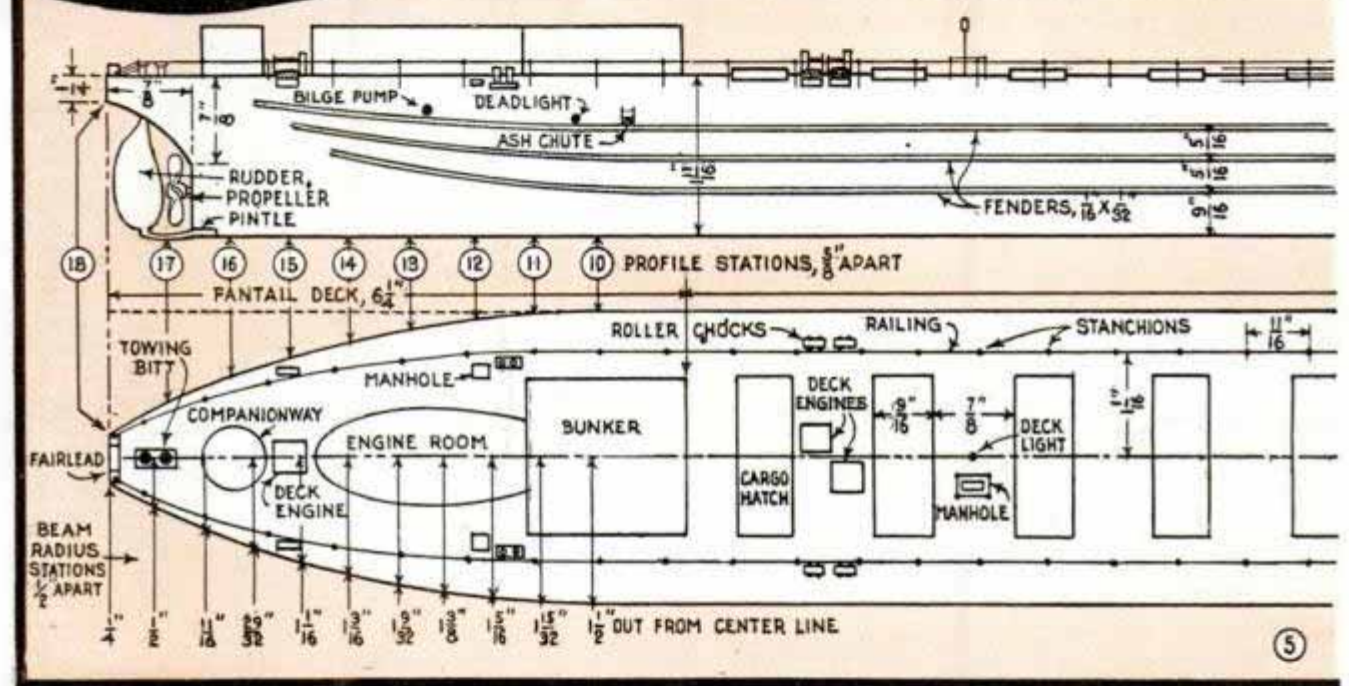
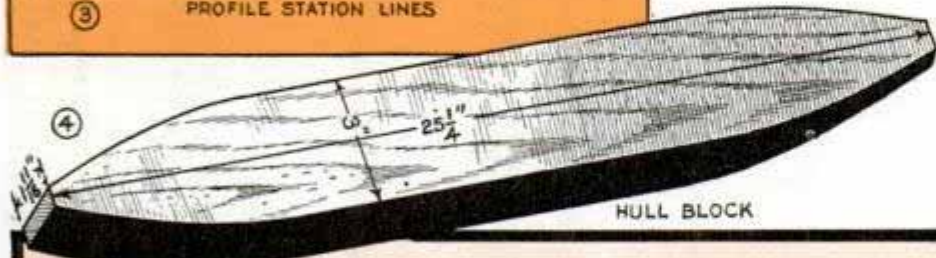

hull where the template touches. After the entire hull has been so marked, plane away the shaded areas and repeat the process until no light shows between the hull and the templates, when the latter are held in correct position. Then finish to a smooth surface with sandpaper. After the hull has been completed, three fenders on each side (strips of birch) are glued in place as in Fig. 5, using celluloid cement.

Great Lakes vessels use different names for fittings than ocean vessels. For example, bollards are called timberheads, ventilators are windjammers and port holes are deadlights. The fittings of the "John Ericsson" will be called by the names familiar to lake sailors. The rudder, Fig. 6, has its upper bearing in the hull and the lower one in the brass pintle. Details of the propeller and blades or "buckets,"

which originally were removable, are also shown in Fig. 6. The only hull openings large enough to reproduce on a small model are the two bilge-discharge ports, the two deadlights for the fire hold and the ash-discharge syphon. These are $\frac{1}{8}$, $\frac{3}{64}$ and $\frac{3}{32}$ in. in size respectively. The ash-chute cover slides in channels. This cover was opened by a rope leading to a rail stanchion. Distinctly a whaleback fitting, the bow fairlead, Fig. 8, served as a hawsepipe and chock for the towing cable when a tug was used. On the

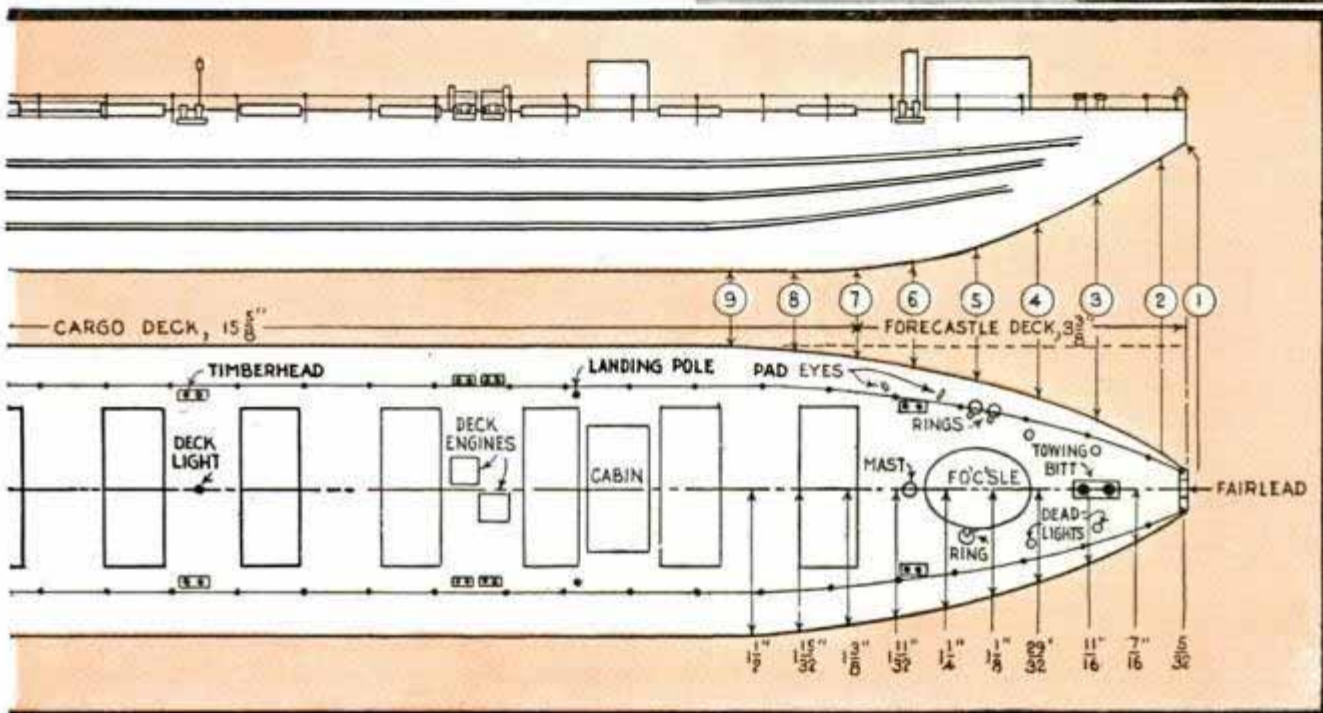
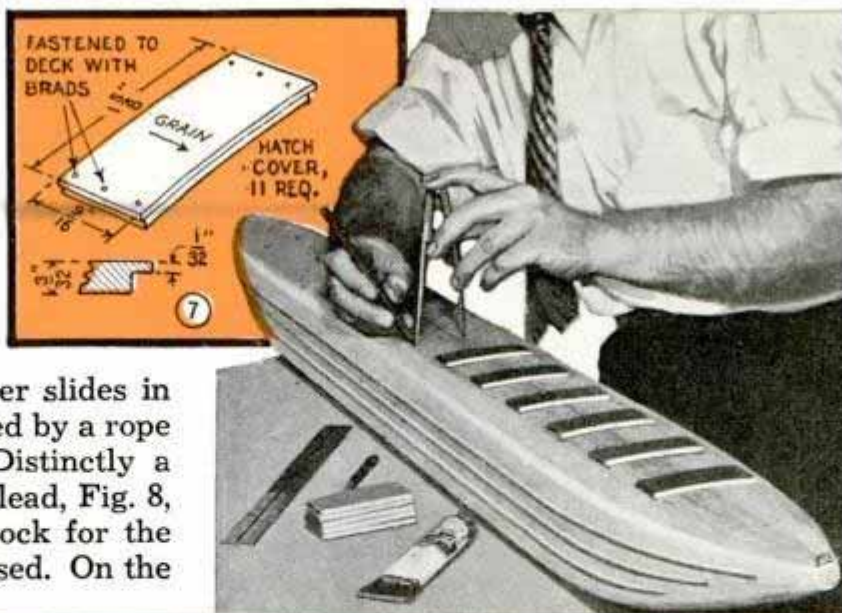

model this as well as the stern fairlead is made of sheet-brass and tubing. Towing bitts (see extreme left-hand detail of Fig. 2) not only provided an anchorage for the towing hawser, but they were hollow to serve as ventilating pipes. Windjammers, shown in the same detail, carried fresh air into the crew's quarters. There are 74 railing stanchions. These can be drilled as detailed at the extreme left of Fig. 2, to take a 5 or 3-wire railing. Instead of drilling, however, the stanchions may be notched. For the railing you can use No. 6-0 fishline, gluing it in place. The railing should be strung after painting and after the deck structures and all other fittings have been installed. Hatch covers are mahogany, the grain running lengthwise of the hull so they can be bent to conform to the deck curvature. They are bradded and

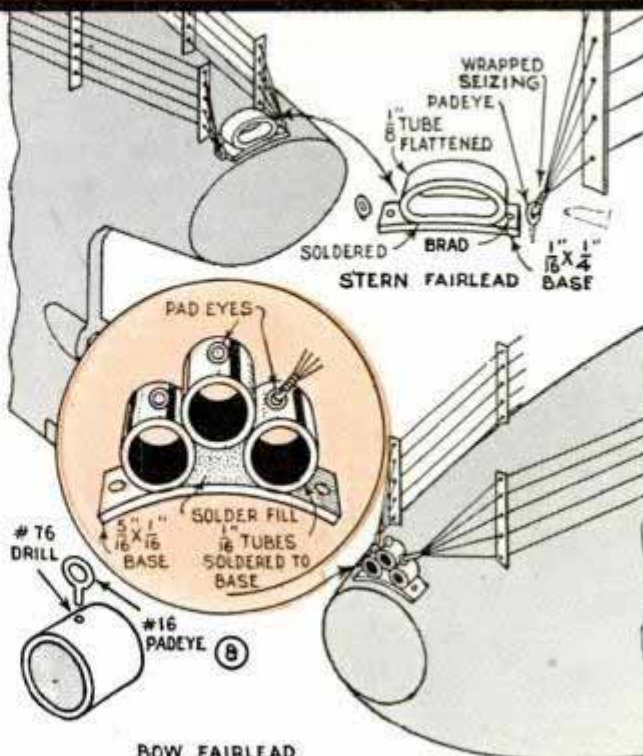

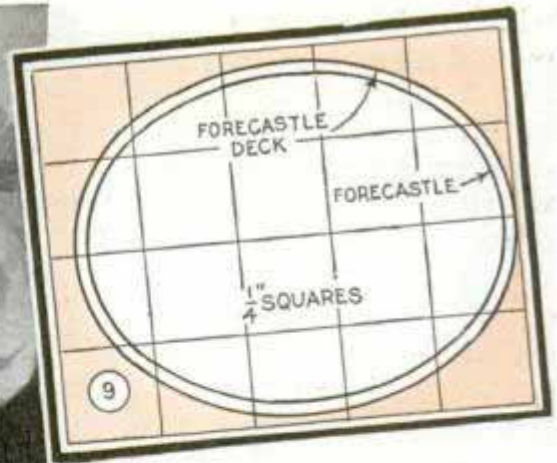
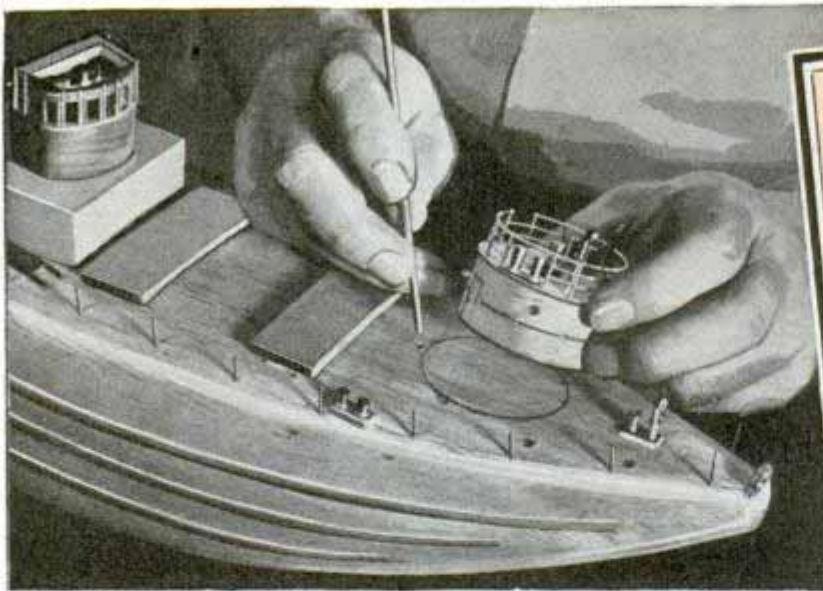

glued in place. See Fig. 7.

At this stage the hull should be painted. All fittings applied later are painted separately. However, as the deck structures such as the fore-castle, pilot house, etc., are to be glued to the deck, their location and the exact area they are to cover is marked off on

the deck, after which removable tape is used to cover these areas while painting. To give the hull an appearance of steel, use flake aluminum. You get this in the form of an asphalt paint to which the aluminum is added. Apply a thin coat and rub well into the wood, wiping away all that is not imbedded, and polish with cheesecloth. Then give the hull a coat of oxide red, using japan coach colors thinned with boiled linseed oil and turpentine. Oxide red is made by mixing Venetian red, 9 parts, and black, 1 part. Put on three coats, 48 hrs. apart. The propeller is black

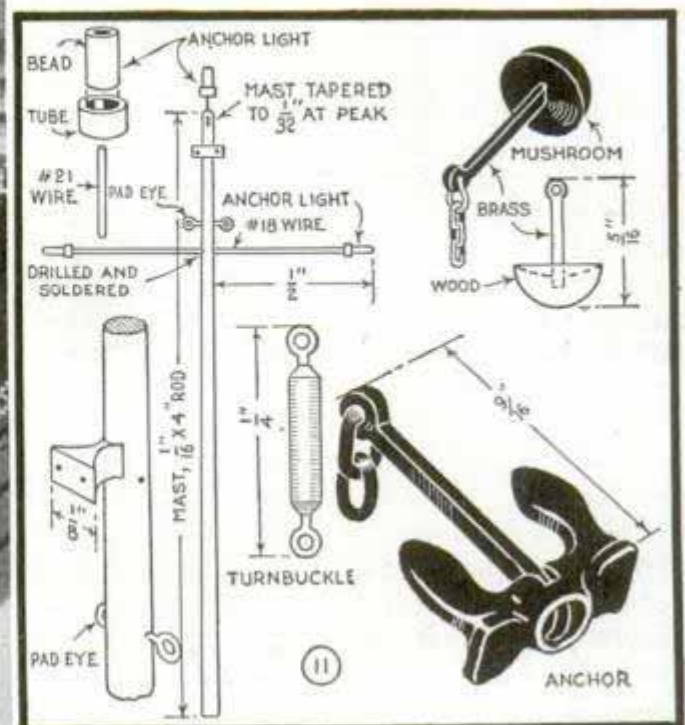
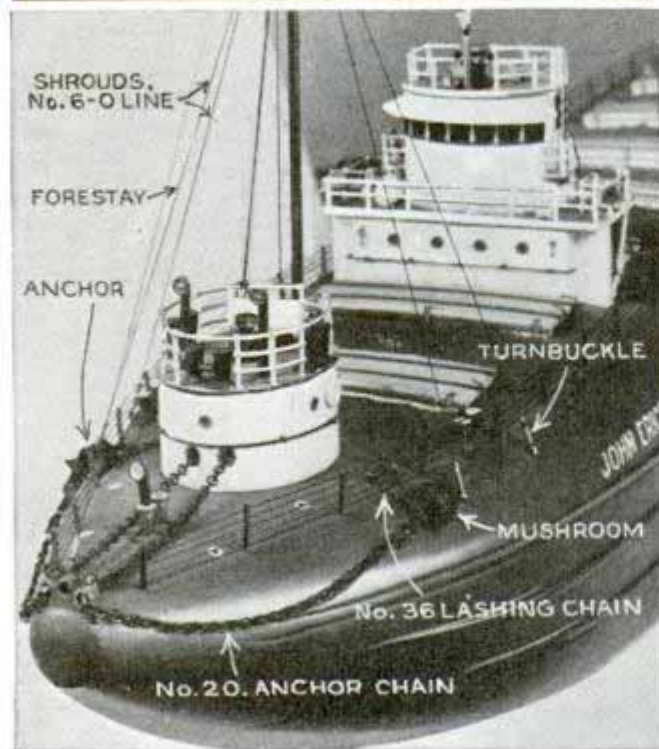
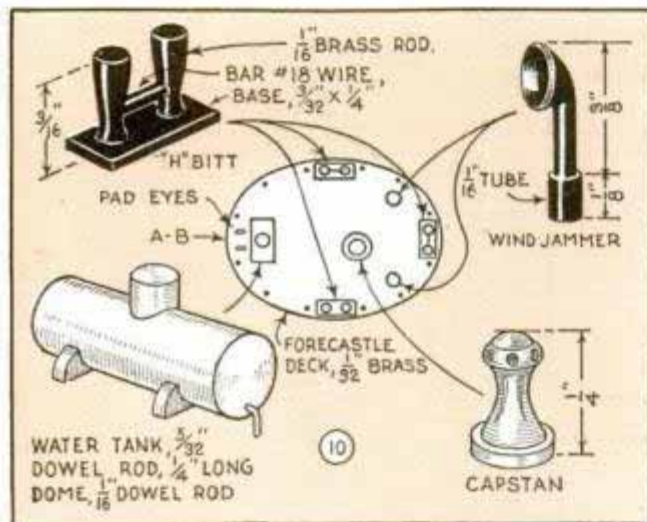
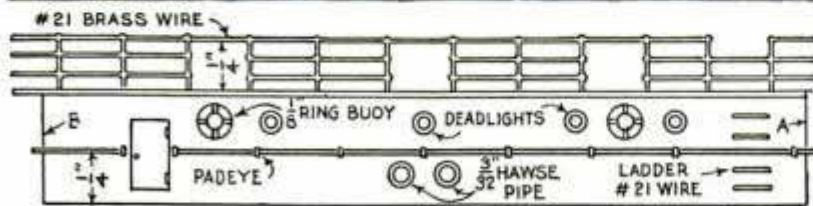

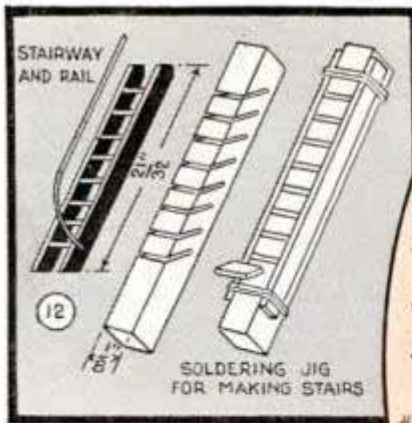

and all deck fittings that might be stumbled over are tipped with white. The windjammers are dark green.

Deck fittings such as timberheads, roller chocks, manhole, deck lights, deck engines, landing poles, bow lights and the rings for lashing the anchor and mushroom in place, are detailed in Fig. 2 and their location is given in Fig. 5. Fig. 11 and the photo on its left, show the mushroom and anchor and the foremast.

The deck structures are built separately and are glued to the hull. Fig. 5 shows their position on the deck. They are made of close-grained hardwood and brass. In this installment the forecabin (fo'c's'le) and the combination captain's cabin and pilot house are detailed. See Figs. 9, 10 and 12 to 16 inclusive. Structures on the after deck will be detailed in Part II. Decks on the cabins are of sheet brass just heavy

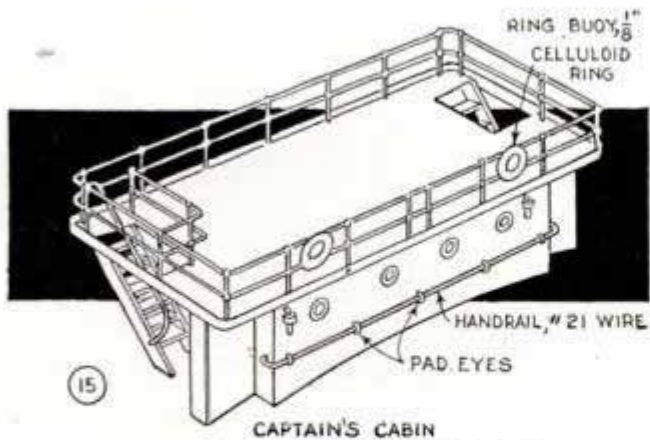
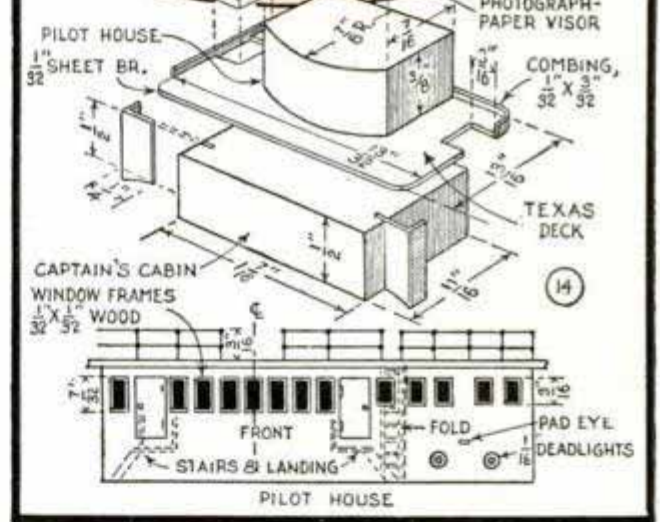
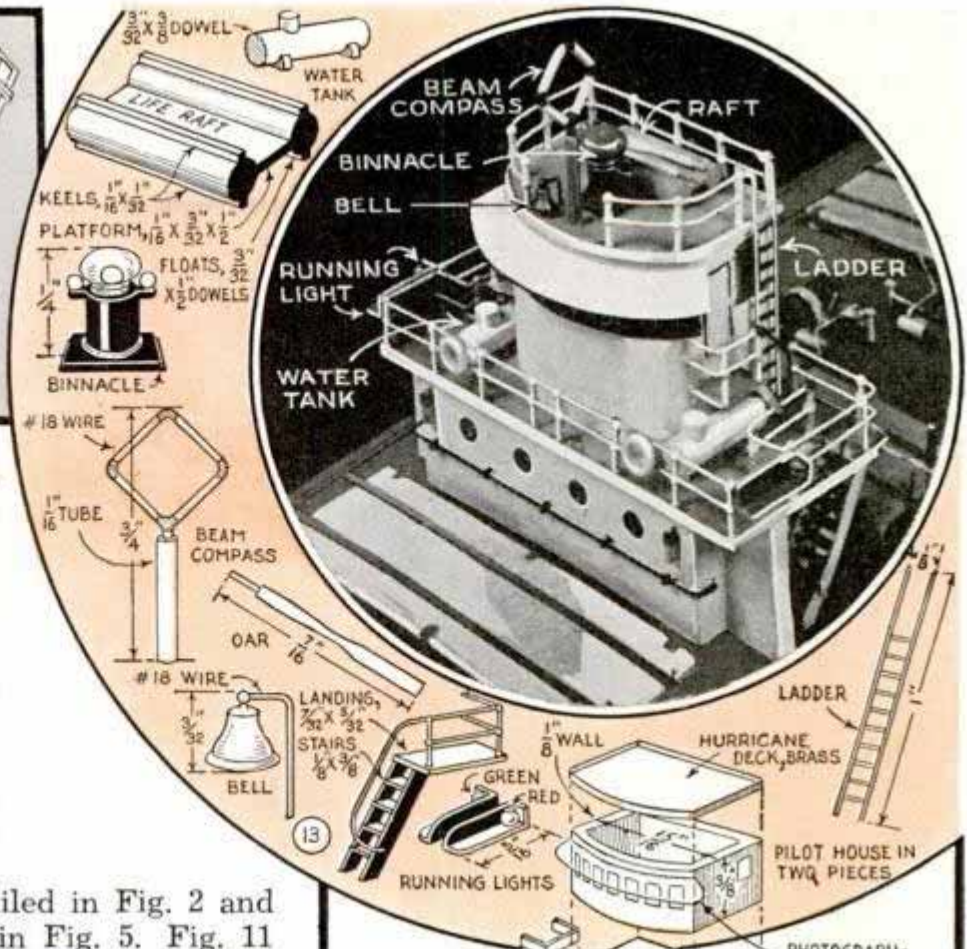

enough to remain stiff and flat. Sandwich the brass between two pieces of 1/8-in. plywood and cut with a jewelers' saw. Dimensions on these parts can be obtained from the drawings. The detail above Fig. 10 shows a flat, extended layout of the forecabin side, while Fig. 16 gives the same for the captain's cabin. The layout can be made on paper and transferred.

(To be continued)

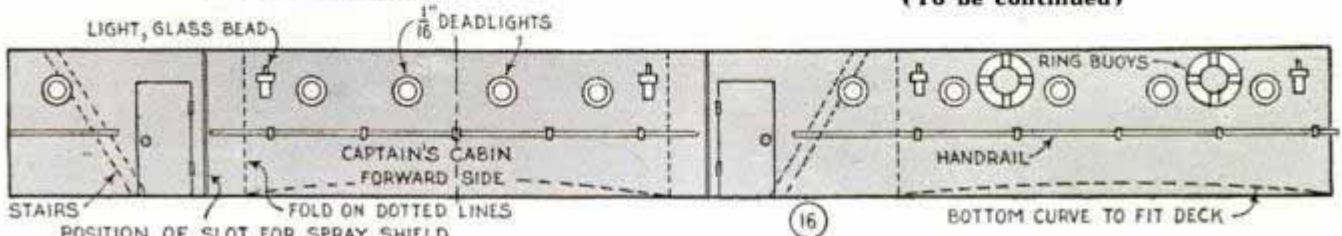

Draining Rack for Paste Brush When Hanging Wallpaper



A large pie tin makes a good draining rack for use on the paste bucket when hanging wallpaper. A heavy plate should be cut as shown, so that a little more than half of it remains to fit on the bucket.

Screw-Top Can Holds Test Tube for Water Bath

If the contents of a test tube must be subjected to a hot-water bath, the tube may be held upright by placing it in a screw-top can as shown. The can is partly filled with water and heat applied at the bottom.

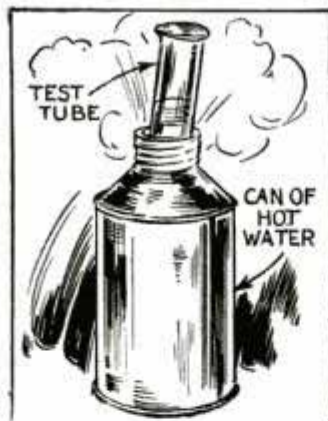

Razor Frame Anchors Cake of Ice on Car Running Board

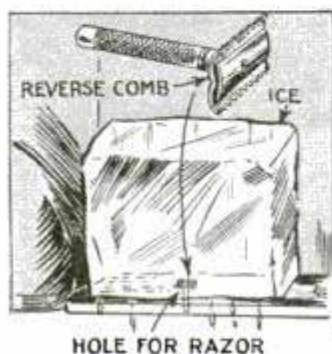

Having to make frequent trips after ice for use at his summer camp, one man used an old safety-razor frame to keep the ice from slipping off the running board of his car. The

comb of the razor was reversed, after which the handle was inserted into a hole drilled through the running board. When a chunk of ice was placed over the comb, it melted quickly, so that the comb projected into the ice to serve as a stop.

Thumbnut Serves as V-Block

When away from the shop where it is sometimes necessary to true up with a file threads, dents and other defects in small round pieces, you can avoid carrying V-blocks to support the work by simply using a thumb or wing nut of the type used on bolts for fastening auto license plates in place. These nuts have deeply flared wings to take the work, and when screwed to a block or other convenient location are ideal for the purpose.



Boxes Decorated with Pictures Varnished for Protection

Brushed over the surfaces of boxes or panels when decorating them with magazine pictures, thin glue will seal the pores of the paper and prevent any printing on the reverse side from showing through. When dry, the glaze is transparent and the pictures then can be varnished for protection without soaking through the paper.

Garfish Caught with Wire Snare

Anglers who like to help exterminate garfish, which are hard to catch with a hook and line, will find that this snare will do the trick. Made of fine copper wire, it should be baited with a piece of raw meat which hangs at the bottom of the loop. When the fish takes the bait, the snare closes on the upper snout and the fish's sharp teeth prevent the noose from slipping off.

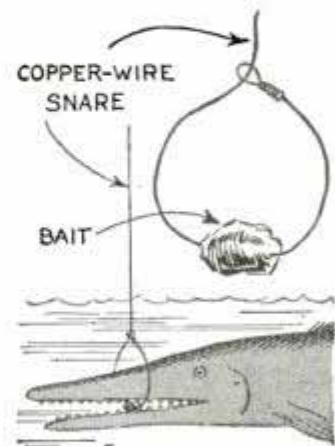

Child's Play STORE



Open for business



Closed for the day

Requiring little space when not in use, as the counter nests compactly over the shelves of the cabinet, this clever play store, when stocked with empty cans and cartons and provided with a toy cash register, will be found just the thing for keeping restless youngsters entertained indoors in inclement weather. Except for the back of the cabinet, which is covered with $\frac{1}{4}$ -in. material, $\frac{1}{2}$ -in. fir plywood is used throughout. The lower portion of the cabinet should be made first. To this the shelving is fastened with screws or nails driven up through the top. The counter is open across the back to allow it to fit over the shelves. A small paper holder, made to accommodate standard rolls of narrow wrapping paper, is attached to one end of the counter with screws

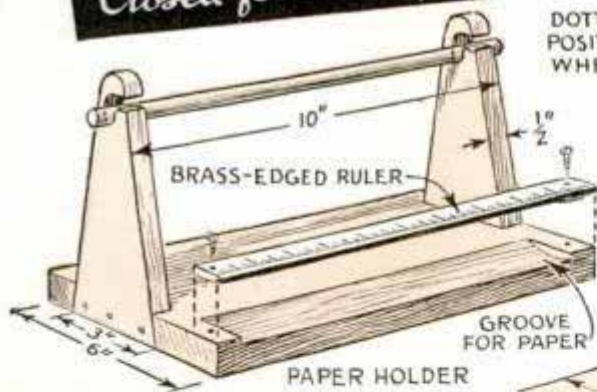

DOTTED LINES SHOW POSITION OF COUNTER WHEN NOT IN USE

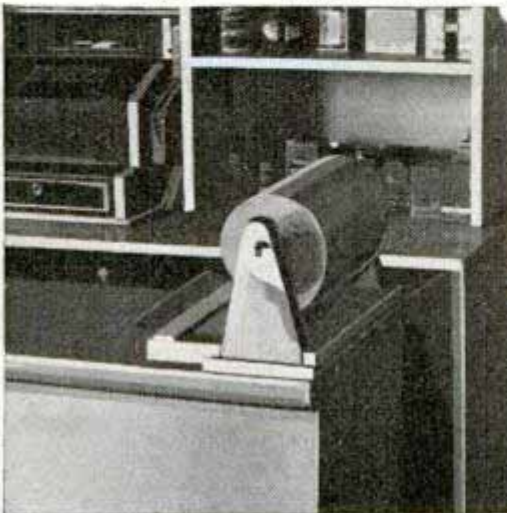
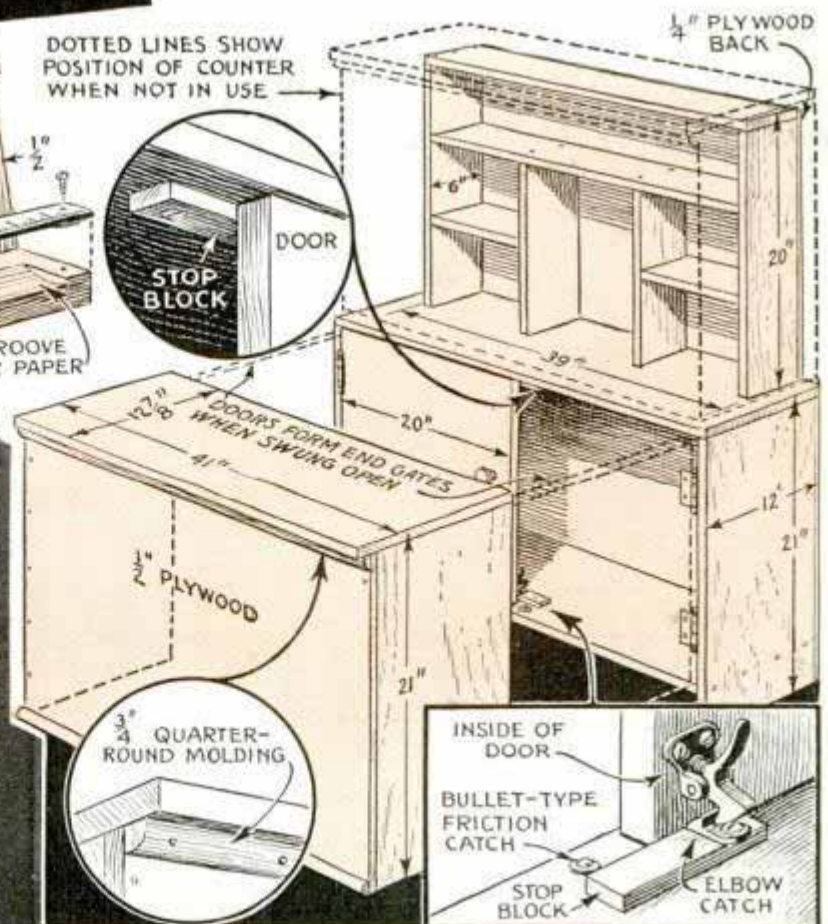
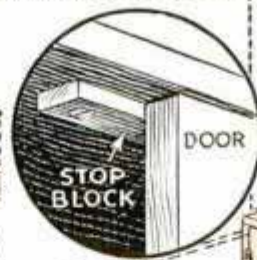

Wire Brush Roughens Surfaces to Be Glued Together



When gluing smooth wood surfaces together, I find that the glue will adhere better if the adjoining surfaces first are roughened slightly. For this job, a stiff-bristled wire brush pounded against the surfaces makes numerous small indentations that give the glue a good "tooth."

—Wayne Woodward, Racine, Wis.

Shovel Is Conveyance for Cement in House or Garden Work

Obliged to build a cement walk at the back of my yard, I was at a loss for some means of transporting cement and rock from the curb to the job, as there was no wheelbarrow to be found in the neighbor-



hood. As a substitute, I employed a shovel as shown. The work was done in short order without damage to the lawn or walks.

—G. E. Hendrickson, Argyle, Wis.

Neat Vents for Kitchen Stoves Where Wall Faces Street

If it is necessary to put a vent over the kitchen stove and the outside wall faces the street, the job can be done neatly as shown. Made of tin, the top of the vent is curved and riveted in place, after which the vent is painted the same color as the brick facing. In many cases, the outlet tube can be made to fit the space occupied by one brick.

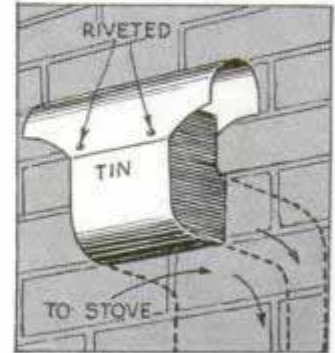

Rods Held Easily for Pointing by Vise and Rubber Band

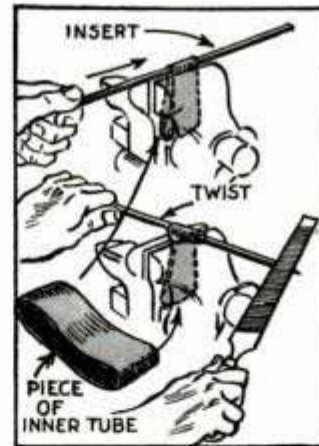

Having a number of small rods to point with a file, a Wisconsin mechanic clamped a rubber band in the jaws of his vise, leaving a loop above into which the rod could be inserted. By merely twisting the rod to the position indicated, it was gripped and held securely, but could be released and replaced with another in an instant.

Burning Paper Prevents Gas Forming in Furnace

In the morning after I have shaken the furnace down and added fresh coal, the fire is sometimes slow to burn. Gas will accumulate and the furnace will blow out filling the basement with gas and ash dust. When I notice that the fire is not coming up as it should, I ignite a crumpled newspaper and throw it in on the coal and close the door. This burns up the gas and starts the draft.

—A. M. LaBrant, Watford City, N. D.

SCULPTURING *in* WOOD

simplified for beginners

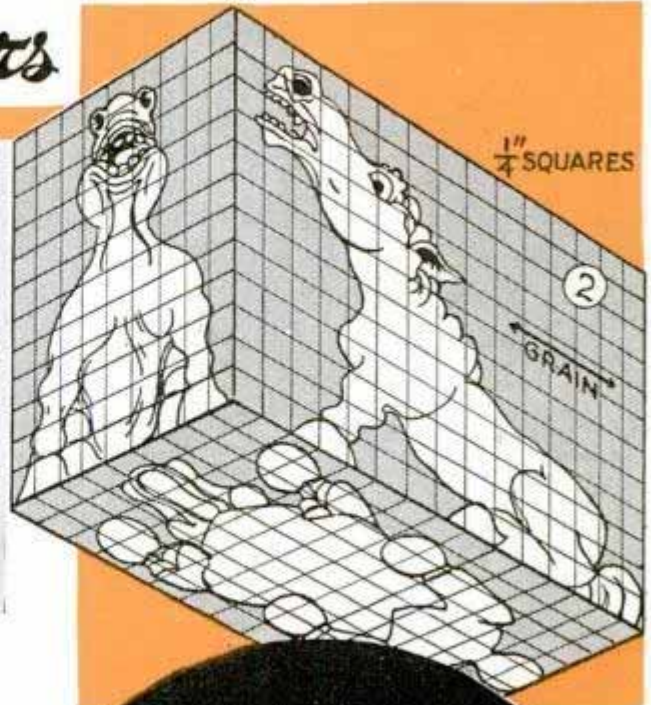

By E. J. TANGERMAN

WHITTLING caricatures in wood with a jackknife is a fascinating hobby that costs practically nothing and it may be a source of worth-while revenue, as small hand-carved pieces, especially of characterized animals, have become a popular fancy. Fig. 1 shows seven poses of a little stallion, which were carved from softwood. You can use white pine, sugar pine or basswood, or, if desired you can practice by carving in soap. To reproduce these poses in wood, first make full-size paper patterns of the front and profile views shown in the squared drawings in

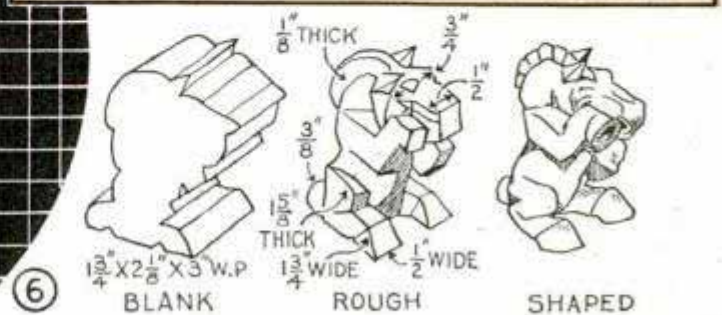
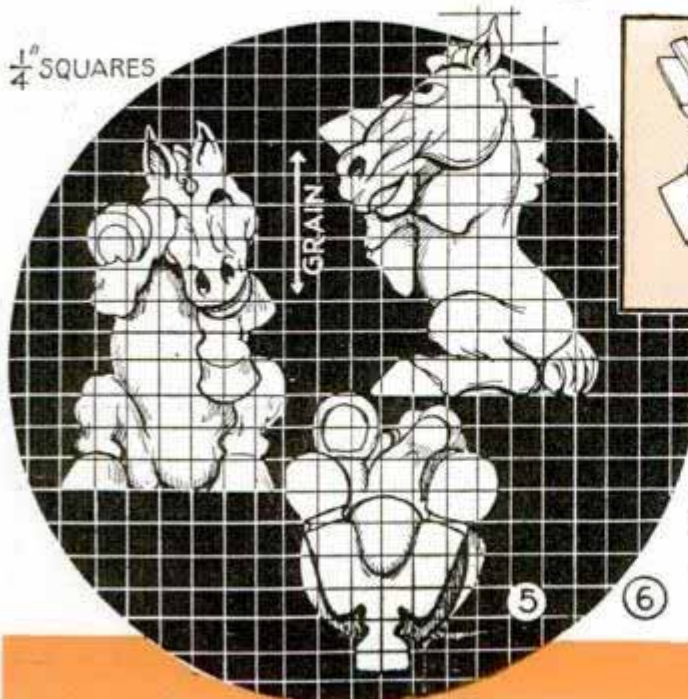

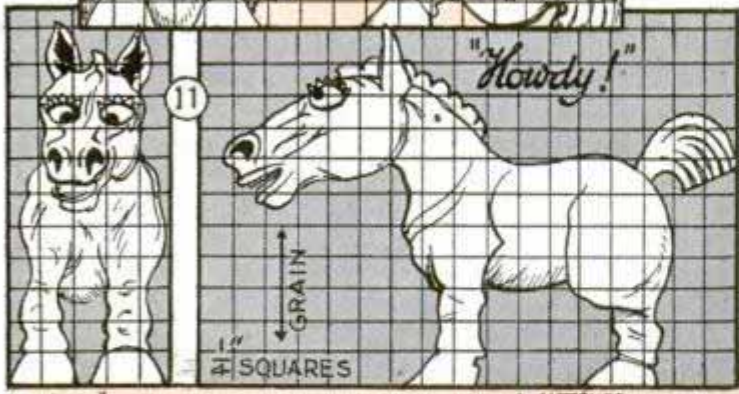
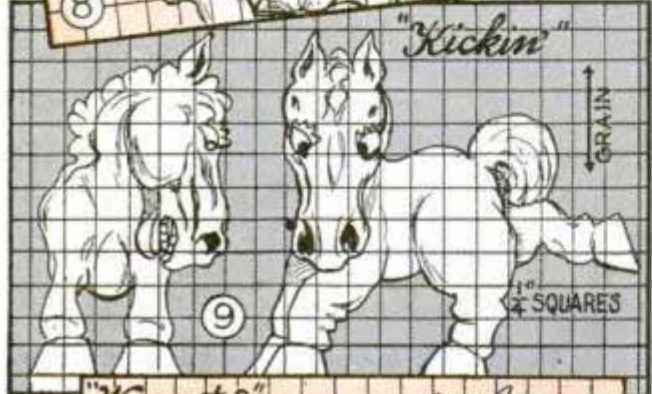
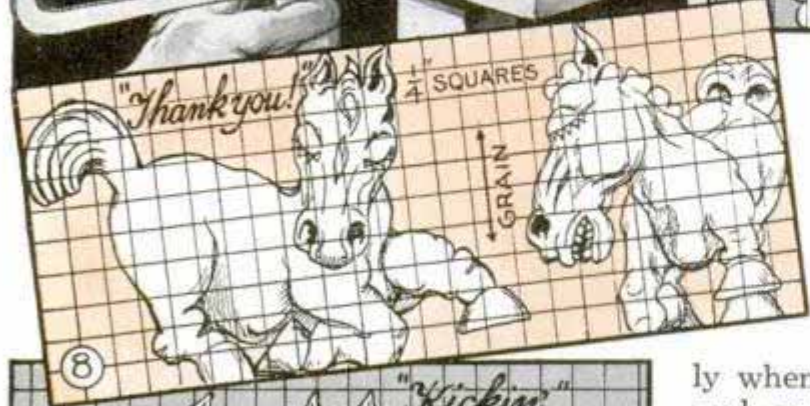
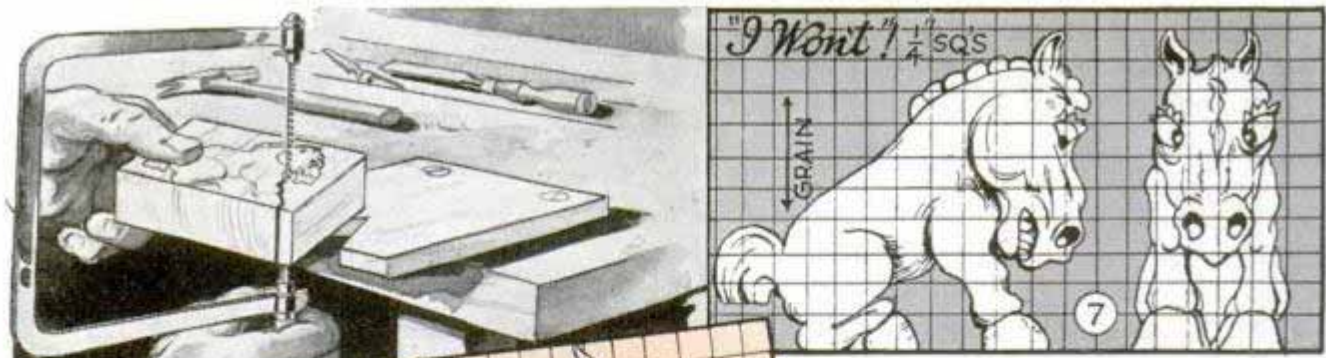

Figs. 2, 5 and 7 to 11 inclusive. Then using carbon paper, trace each pattern on respective, adjacent faces of a squared block of wood. Place the pattern to correspond with the direction of the grain indicated in each pattern. This is important especially when carving in wood, as small parts such as the ears are otherwise likely to break off before the carving is completed. For this reason it is best to carve the ears last. The approximate shape of the horse is obtained by first sawing out the rough blank. This can be jigsawed or cut by hand, using a coping saw as shown at the top of the page. Here you will find that a V-notched board, screwed to the top of a bench to allow it to overhang the edge, will be helpful in supporting the work while sawing. Saw the profile first, then temporarily tack the waste pieces back on the block to provide a flat surface, and saw out the front view. Figs. 4 and 6 show two poses in blank, rough and finished form, with dimensions for thickness at various points. If made of wood, the figure looks best when carved rather roughly as in Fig. 3, while a smoother finish is more desirable on soap or plastics. For the beginner, Fig. 12 suggests a simplified head which is less difficult to carve than the one shown for the advanced whittler. You can finish your model with either stain or paint, applying a darker color to the hoofs, mane, tail and nostrils to give contrast to a light body.

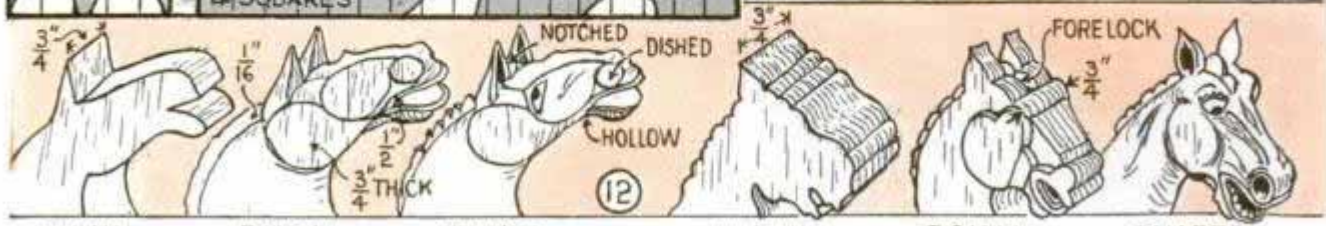

SIMPLE HEAD

ELABORATE HEAD

This Simple Beam Scale Made Inexpensively

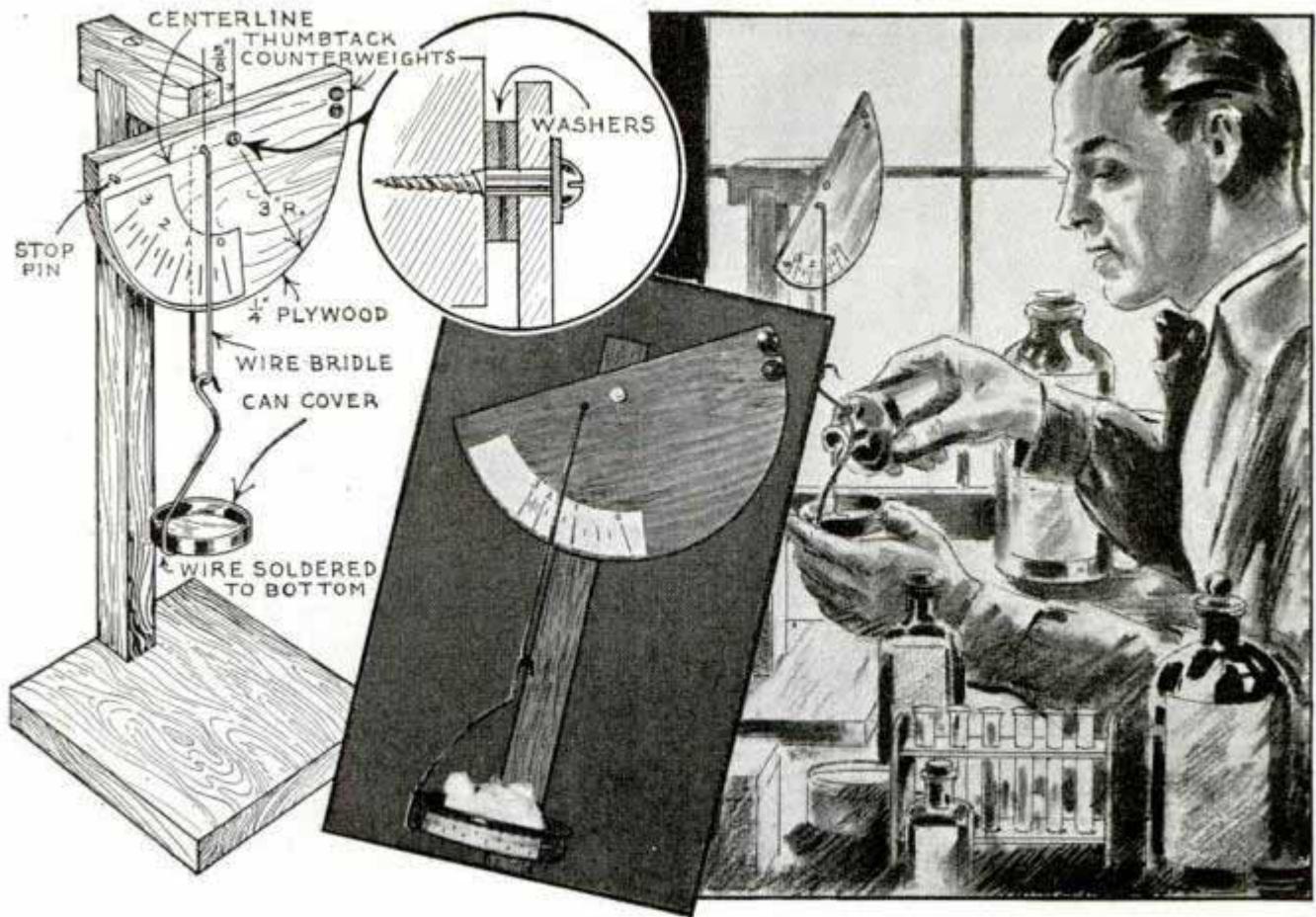

Amateur chemists and photographers who desire a beam scale for weighing chemicals but feel they cannot afford it, will find that this one solves the problem where weights are not too critical. The beam is made of plywood and is pivoted to a wood support with a screw, using spacer washers behind it. The beam must swing with the least possible amount of friction. A wire bridle to carry the weighing pan,

which is a can cover, swings from a hole near the upper edge of the beam as indicated. After assembling the scale, the beam is counterweighted with thumbtacks at the right-hand corner so that the upper edge swings horizontally. Then a mark is made on the beam directly behind the bridle, which serves as a pointer. With known weights in the pan, similar marks for 1, 2 and 3 oz. are made.

Sunken Receptacle in Wall Outlet Permits Clock to Hide It

By using a wall outlet with the receptacle recessed like the one shown, for your electric wall clock, you can hide the outlet and all wires by hanging the clock over it. Recessing of the receptacle is done as in-

dicated. A hook bent from heavy sheet metal and slipped over the upper edge of the outlet cover supports the clock.

—R. Boettinger, Englewood, N. J.

TELL YOUR FRIENDS

through the medium of Popular Mechanics just how you solved that little tricky problem encountered in your home, work or hobby. Money and labor-saving ideas, shortcuts to do things quickly and more efficiently, wrinkles that others will appreciate knowing—that is the kind of information we try to pass along on these pages. Just send us a clear sketch or photo with a brief description giving the essentials. For those ideas that are suitable we will send you a check and return those we cannot use.

Address Homecraft Editor

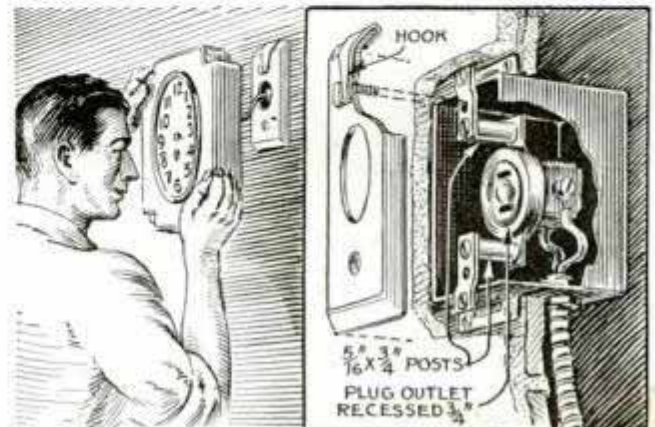

Paint for Interior Basement Walls Made from Cement and Milk



If you would like to clean up your basement walls and give them an inexpensive white coating, try a mixture of white cement and skim milk. In mixing, pour the cement into the milk, stirring it constantly until the mixture has reached a consistency that can be applied to the walls with a brush. Proportions are not critical. A paint of this type will adhere and will withstand vigorous scrubbing and abrasions.—Don W. Sigler, Lincoln, Nebr.

Plug Aids in Gripping Short Work in a Lathe Drill Chuck

When it is necessary to put a small piece of work in a drill chuck and only a short portion will project into the jaws, first in-

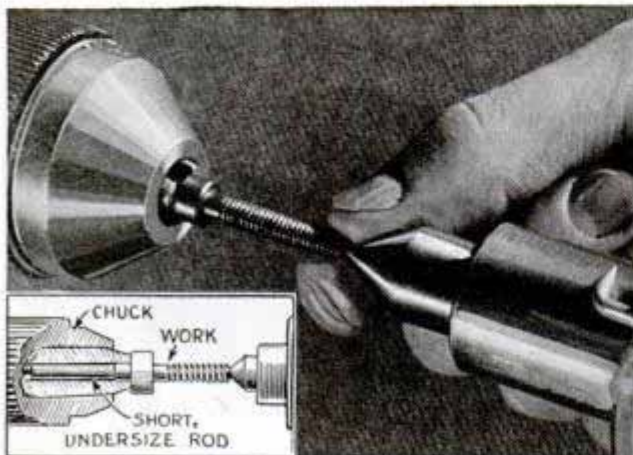

sert a short, undersize rod into the chuck. The rod will prevent the jaws from being forced together at the rear ends and will provide a good grip on the work.

Oil Stone Clamped in Vise Leaves Both Hands Free

When sharpening tools on an oil stone, clamp it at an angle in the vise. This will leave both hands free for manipulating the tool and in many cases enable you to do a better job than if you have to use one hand to hold it in place. Care must be taken not to clamp the vise too tightly as there is danger of breaking the stone.

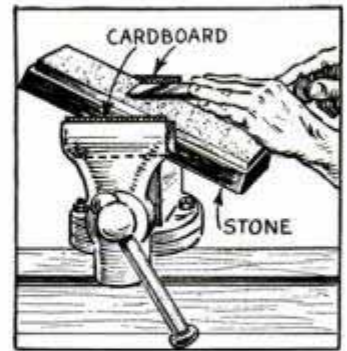

Rusty Pipe Cleaned Easily with Slotted Brush

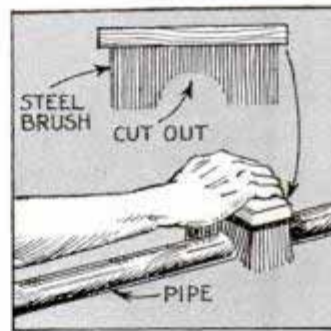

Given the unpleasant task of cleaning old paint and rust scale from several lengths of pipe, one workman made the job easier by altering a wire brush for the purpose. A circular portion of the bristles was cut out to fit over the pipe as indicated. This made it possible to cover a larger area with each stroke and kept the brush from slipping off the pipe.—Jas. Vick, Church Road, Va.

Tongues in Roller-Skate Shoes Held Securely in Place

To prevent the tongues of your skate shoes from wrinkling and causing discomfort, simply punch four holes near the top of each tongue and pass the laces through them as shown at the right.

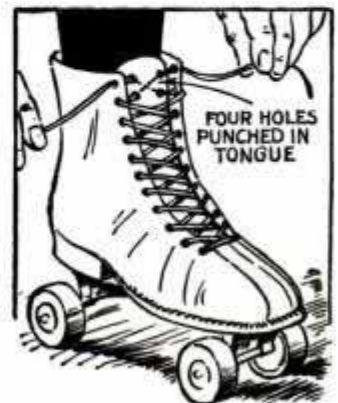

OPEN BOOK SHELVES

assembled with pinned joints

There are no nails, screws or glued joints in these book shelves, and the whole assembly comes apart quickly for moving. Construction is simple and only a few hand tools are needed. Instead of horizontal shelves of the usual type there are four troughs, the lower one being set at a different angle than the rest for small-size books and "digest-form" magazines. The other shelves are especially suited for medium-size books. Large and especially thick volumes always should be set on horizontal shelves rather than in troughs as the backs of the volumes are likely to sag when the volumes are left in a trough for any length of time.

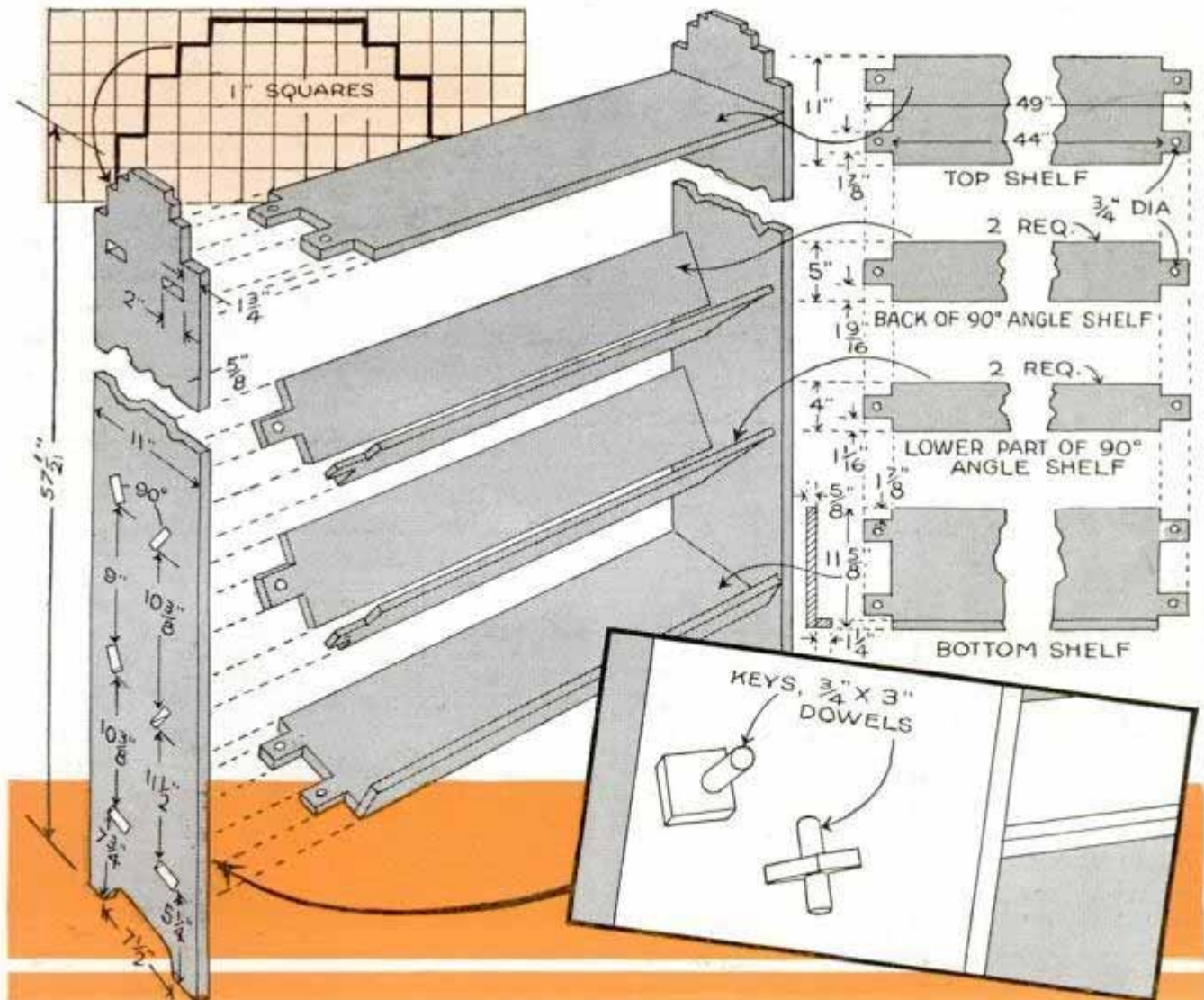

Well-Pipe Holder Is Made Easily from Hinge and Wood Block

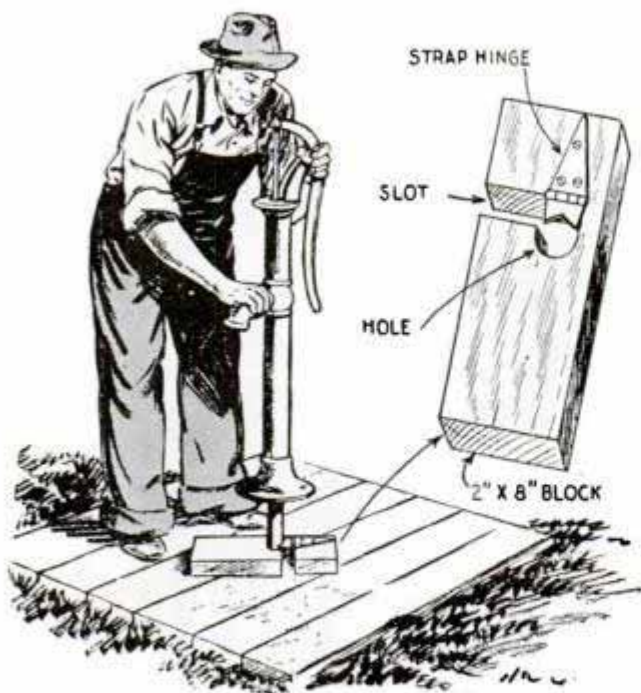

When you have to pull the pump and pipe from a well to repair the cylinder, this holder to support the pipe at any desired height can be made inexpensively from a strap hinge and wood block, the latter being slotted as indicated. One end of the hinge is cut to a wide, shallow V-shape and mounted on the block in the position shown. If the pipe assembly to be lifted is quite heavy, the hinge should be strong and it should be fastened to the block with heavy screws.

Paint Mixed Quickly with Drill

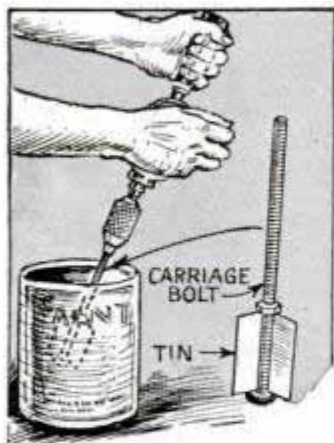

You will find that a small hand drill is much handier for mixing small quantities of paint than a paddle or other hand tool. To use a drill, fit it with a bolt about 6 or 8 in. long on the head end of which has been fastened a flat piece of metal to serve as a beater. The metal can be held between the head and a nut, which is tightened up against it securely. In use, rotate the drill and in a few minutes the paint will be smooth and evenly mixed. If high-speed mixing is desired, make a hole in the paint-can cover

and mix by inserting the drill through it. In this way, the paint will not spill. Also, it is a good idea to make the beater smaller if it is to be rotated at high speed.

Slit Sandpaper Smooths Turnings of Irregular Shape Neatly

To sand irregular-shaped lathe turnings, such as furniture legs, use a strip of sandpaper that has several slits made in it as shown. The slits permit the paper to adjust itself to the different diameters on turnings of this type.



—Joseph D. Amorose, Washington, D. C.

Tubing on Rim of Reading Glass Protects Desk Top

To prevent the rim of a reading glass from scratching highly polished tables or desk tops around the home, cover both edges of the rim with rubber tubing. After the tubing has been slit and cut to fit the rim of the glass, it may be secured with liquid solder which can be obtained from almost any ten-cent store.

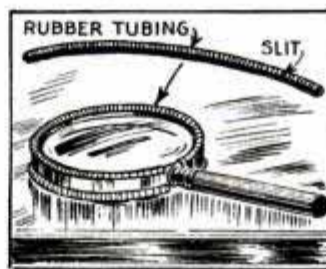

Spit for Broiling Meat Outdoors

For picnics and other outings when you want to broil meat over a bed of hot coals, this spit is just the thing. It is easy to

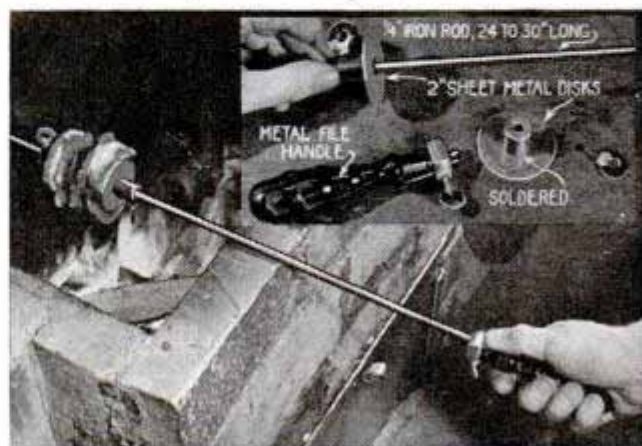

carry or store in a small space. It consists of a steel rod pointed at one end and fitted with a metal file handle at the other. Two disks slide on the rod and can be spaced any width to hold the meat. These are cut from sheet metal and are soldered to two metal sleeves, which are fitted with set screws for locking the disks on the rod at the desired adjustment.

—W. E. Burton, Akron, O.

Holder for Pencils on Clerk's Dress Is Removable

Women clerks who dislike carrying pencils in their hair, will find this neat, detachable pocket just the thing to help prevent mislaying them. It is made of imitation leather and attached to the dress with a pin. If desired, the pocket can be made of material to match the dress.



Toy Cannon Shoots Rubber "Shells" for Junior's Lead-Soldier Army

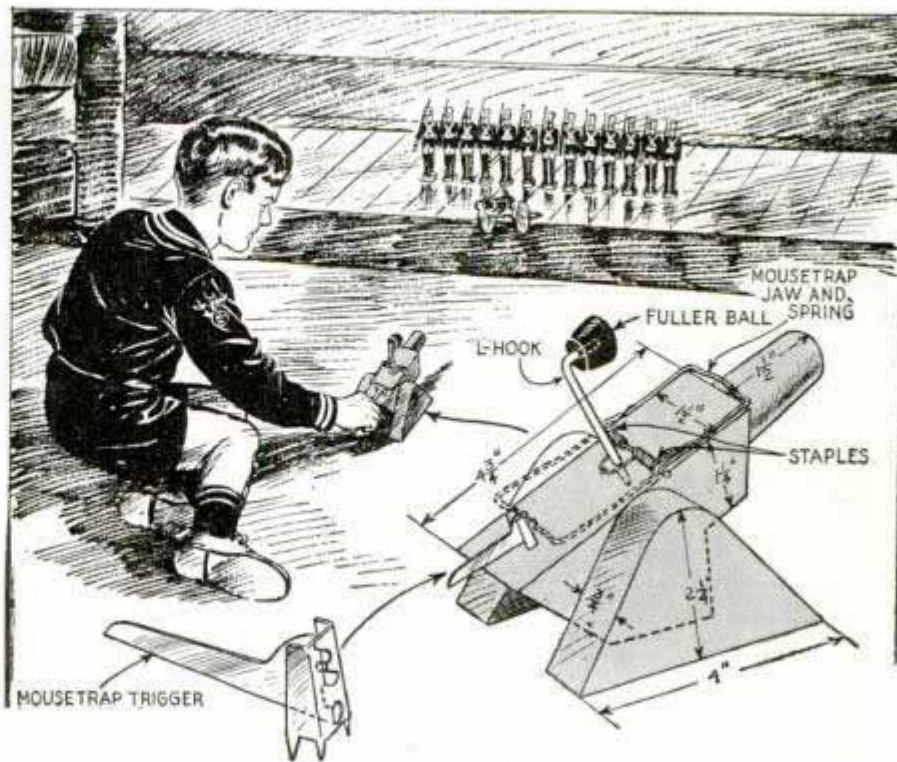

Firing point blank at an advancing army of lead soldiers, this cannon will provide endless fun for any small boy playing at army maneuvers. The cannon is harmless because all it does is toss a fuller ball across the room when the trigger is pulled. It is made of pine and the operating mechanism is the jaw, spring and trigger of an ordinary five-cent mousetrap which are assembled on the cannon as shown. In firing the cannon, the jaw is pulled back and held by the trigger, after which the fuller ball is slipped over the L-hook. Then the trigger is pulled and the jaw swings forward, pushing the ball from the hook and throwing it out in front.—R. W. Madden, Palatine, Ill.

Setting Screws in Wet Concrete

Sometimes it is desirable to set a screw in concrete so that it can be driven or removed. This can be done if the screw is set while the concrete is wet. First dip it in melted paraffin and then put it in place. The paraffin coating will prevent the concrete from adhering to the screw, which can be turned out after the concrete has hardened, leaving a permanently threaded hole. It is best to use a brass screw to avoid rusting and sticking.

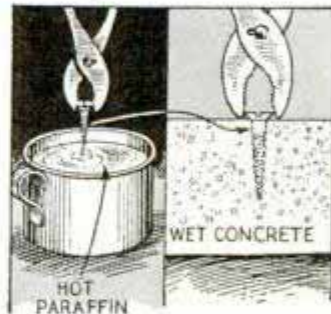

Flashlight PHOTOGRAPHY

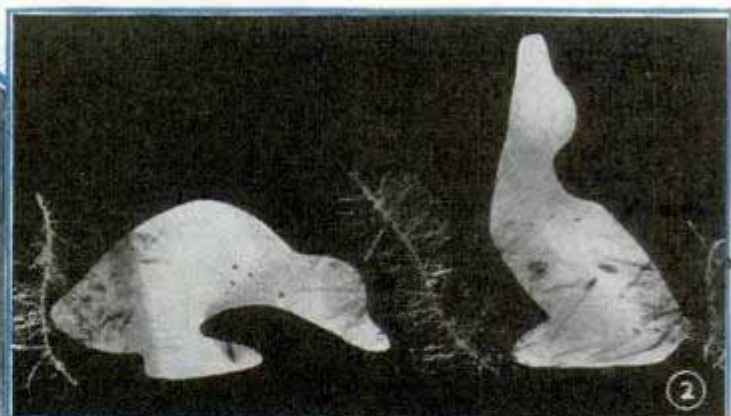

Simple props consisting of cardboard cutouts, pipe-stem cleaners and toothpicks cast distorted shadows to form these clever silhouette photos

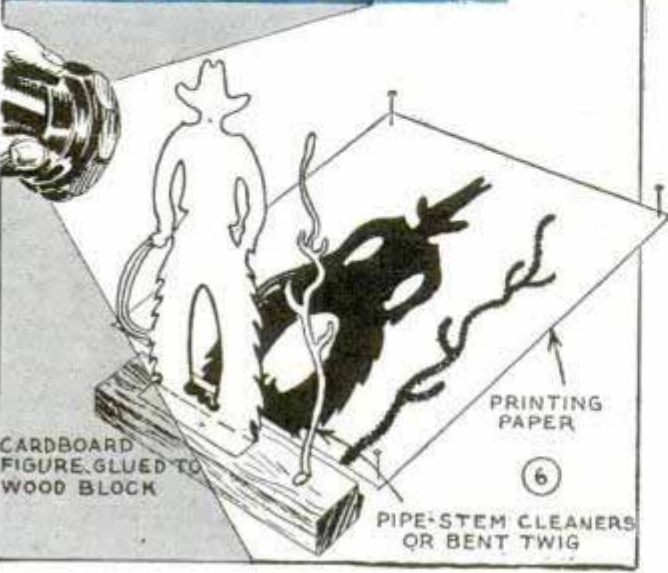
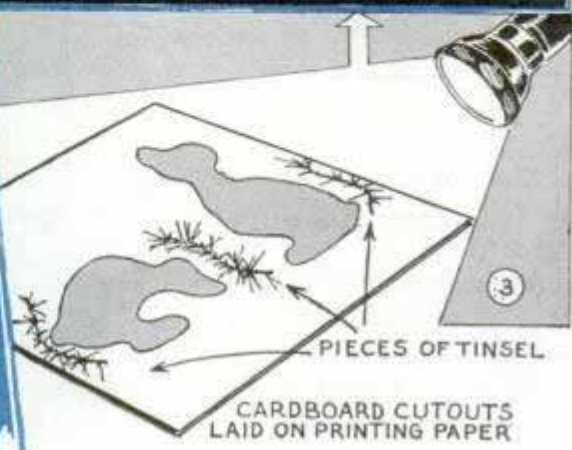

By
E. C. SCHNURMACHER

A PACKAGE of sensitized printing paper, three trays containing developer, water and hypo respectively, a few simple props and a flashlight are all the items needed to make these interesting and unusual "shots" which simulate closely photos taken with a camera. Essentially the effects are obtained by placing objects, either translucent or opaque, between the printing paper and a spot of light which exposes it as in Fig. 1. These objects may be almost anything available, such as cardboard cutouts, tumblers and numerous complementary props. When opaque objects are used the results are black-and-white silhouettes, but when translucent objects are used, the results are designs in various tones of grey. The work must be done in a subdued light such as provided by a dark-room safelamp. Usually the flashlight is held about 2 ft. from the work at an angle that gives an unusual, perhaps distorted effect, as may be desired. Of course, for sharp shadow effects the flashlight must be

without a CAMERA

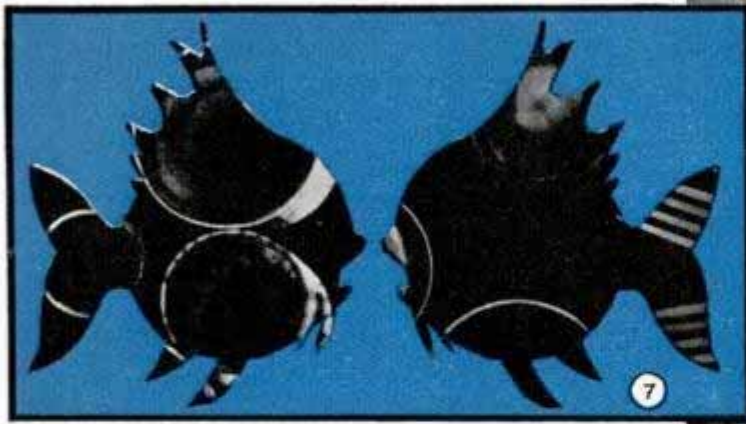

held immovably while making the exposure. Correct timing is determined by making test exposures on scraps of paper.

Reverse silhouettes, where the subject is white and the background is dark, are illustrated in Figs. 2 to 6 inclusive. The picture shown in Fig. 2 was produced by laying cardboard cutouts and pieces of tinsel directly on the paper as in Fig. 3, and then exposing with a flashlight. The silhouettes shown in Figs. 4 and 5, are distorted shadows secured by setting the cardboard cutout upright, near the edge of the paper, and then making the exposure as in Fig. 6. In these pictures, props such as toothpicks, pipe-stem cleaners, small twigs, etc., were used for obtaining the added effects.

Silhouettes in which the subject appears in black or grey on a white background, are made by providing masks that cover the background. After selecting a picture which will provide the kind of silhouette you want, you trace the design on a piece of light cardboard and cut it out carefully with a razor blade as in Fig. 9, after which the mask is placed over the paper, Fig. 10, and the exposure made. A picture which incorporates both a simple silhouette and a pleasing design in contrasting tones of grey is shown in Fig. 7. This result is obtained by placing several items of glassware over the center of the mask and directing the light from above as in Fig. 8.

Interesting background effects may be given to the picture by using additional props. To do this, remove the glasses and mask and lay the props on the paper. Hold the light at an angle and make another short exposure. In this way marine flora can be put behind the silhouette of a fish, or leaf effects in trees behind a bird.



After arranging the props under a darkroom safe-light, a flashlight is used to make the exposure



A CARDBOARD MASK IS CUT FIRST



THEN PLACED OVER A SHEET OF SENSITIZED PAPER

ENLARGING PAPER

Light-Tight Box for Sensitized Paper Has a Compartment for Each Grade

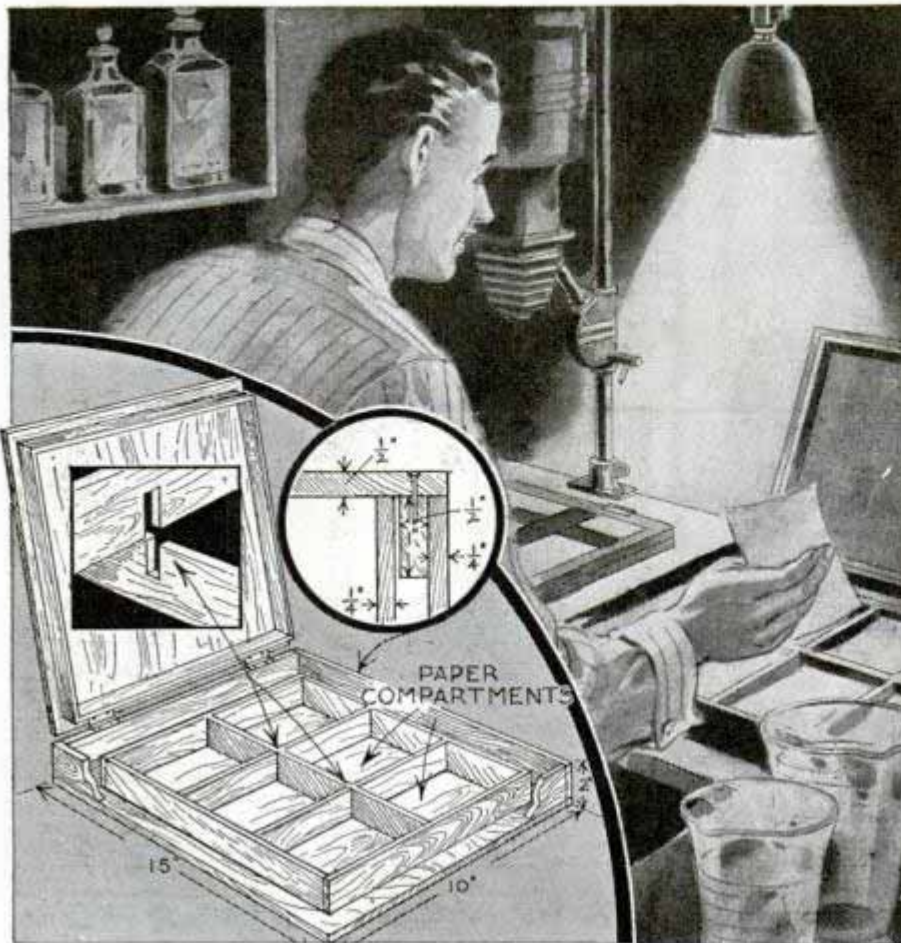

This box does away with the inconvenience of unwrapping and wrapping a package of photographic paper each time a piece is used. Its triple walls keep all light away from the paper and the compartments separate the different grades. As you see from the detail, a strip of $\frac{1}{4}$ -in. wood, nailed to the underside of the lid, fits between two similar strips on the bottom, forming an effective light trap if all corners fit snugly. Spacing between the two strips on the bottom should be wider at the back than elsewhere as the upper piece on the lid swings into place at this point. Paper in the compartments can be identified by labels or marks on the dividing strips. As the boxes are inexpensive and easy to make, one can be made for each size of paper commonly used and the partitions arranged accordingly.

Keyhole Cover on Darkroom Door Keeps Out Stray Light

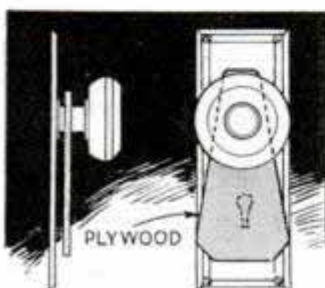

Made in a few moments, this wooden guard keeps light from coming into the darkroom through a keyhole, yet allows the door to

be locked or unlocked easily. It is merely a piece of plywood having a hole at the top to fit loosely on the shank of the door-knob. Another method is to glue the upper edge of a rubber flap to the lock plate so that it covers the keyhole, yet can be lifted for insertion of the key. Such a flap can be cut from a piece of inner tube.

Identification and Data Are Shown on Film Can

Quick identification and complete film data are supplied by this system of filing home-movie film. A sheet of paper that fits on the lid of the can has the data typed on it, and is protected by a piece of thin celluloid held in place with transparent tape. To keep each reel in its proper can, corresponding numbers are marked on the cans and the films. Cans are identified without removing them from the cabinet by a brief title on a narrow strip of paper which is held on the edge of the can with a piece of Cellophane tape.—M. G. Winterton, Fort Lewis, Wash.



Lightweight TRIPOD

is rigid and compact

IF YOU'VE been looking for an easy-to-make tripod—one that will support your camera rigidly at eye level, yet can be folded compactly for carrying and weighs very little—this one should fill your need. Except for the head which consists of a plywood disk fitted with three tenoned studs to which the legs are pivoted, all the parts are of metal. Standard duralumin angle stock, owing to its lightness, is recommended for the legs, but brass, while somewhat heavier, will do for a second choice. The flared upper ends of the legs are formed by slitting the angle along the back and bending the metal outward sufficient to fit over the studs. Each of the clamps for locking the two sections together as shown in detail (A) at the right, is filed to shape from a $\frac{1}{2}$ by $\frac{3}{4}$ by $\frac{3}{4}$ -in. block of metal. Detail (B) shows how each guide band is bent around the lower end of the upper section and fastened to the outside with a setscrew to allow the inner angle to slide between freely. Bending over the upper end of the inner angle after it has been slipped through the band, prevents the extension from being pulled out completely.

—Walter F. Debold, Alameda, Calif.

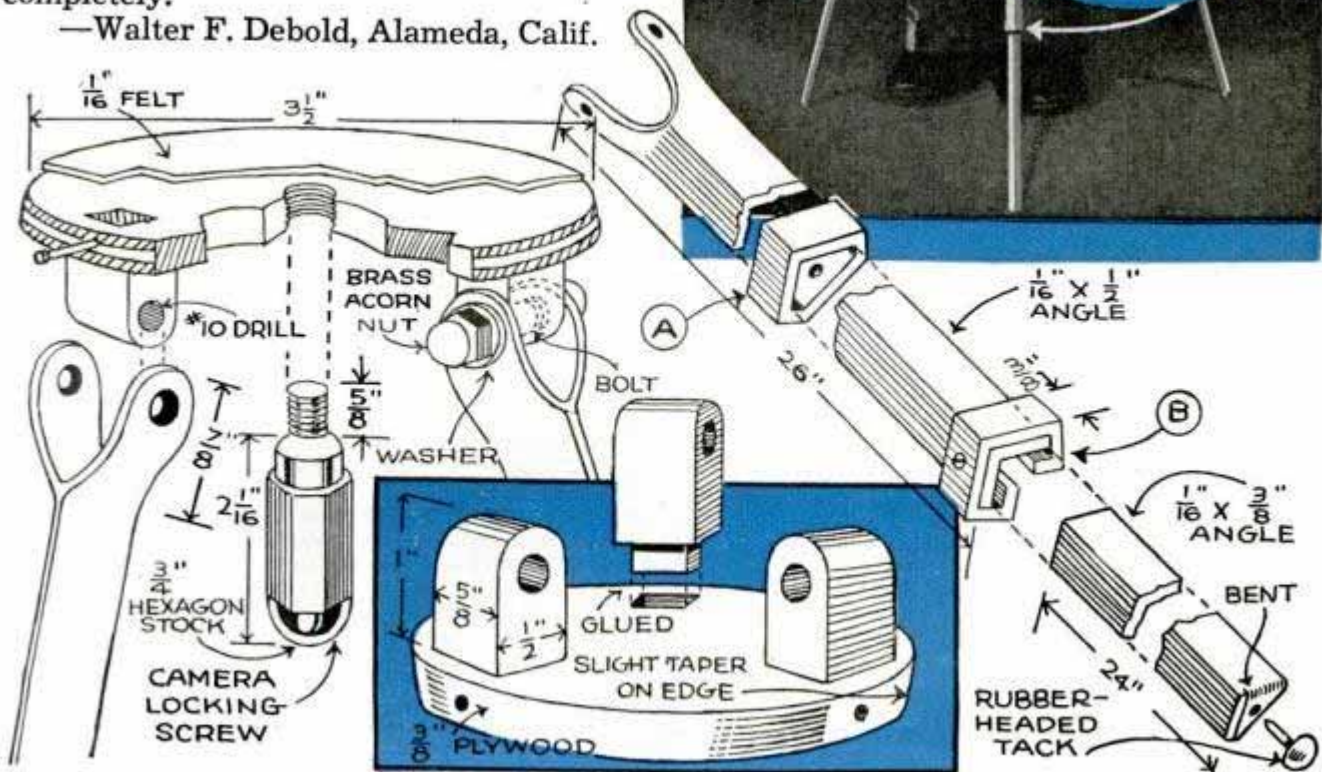
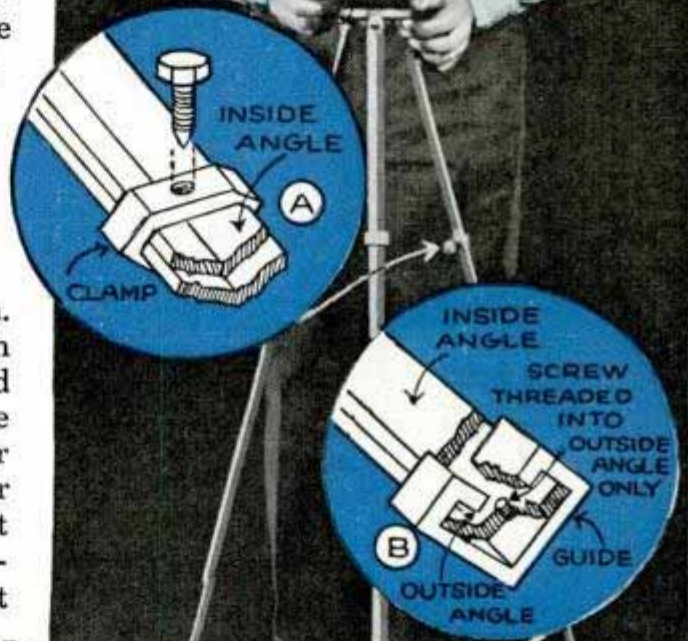
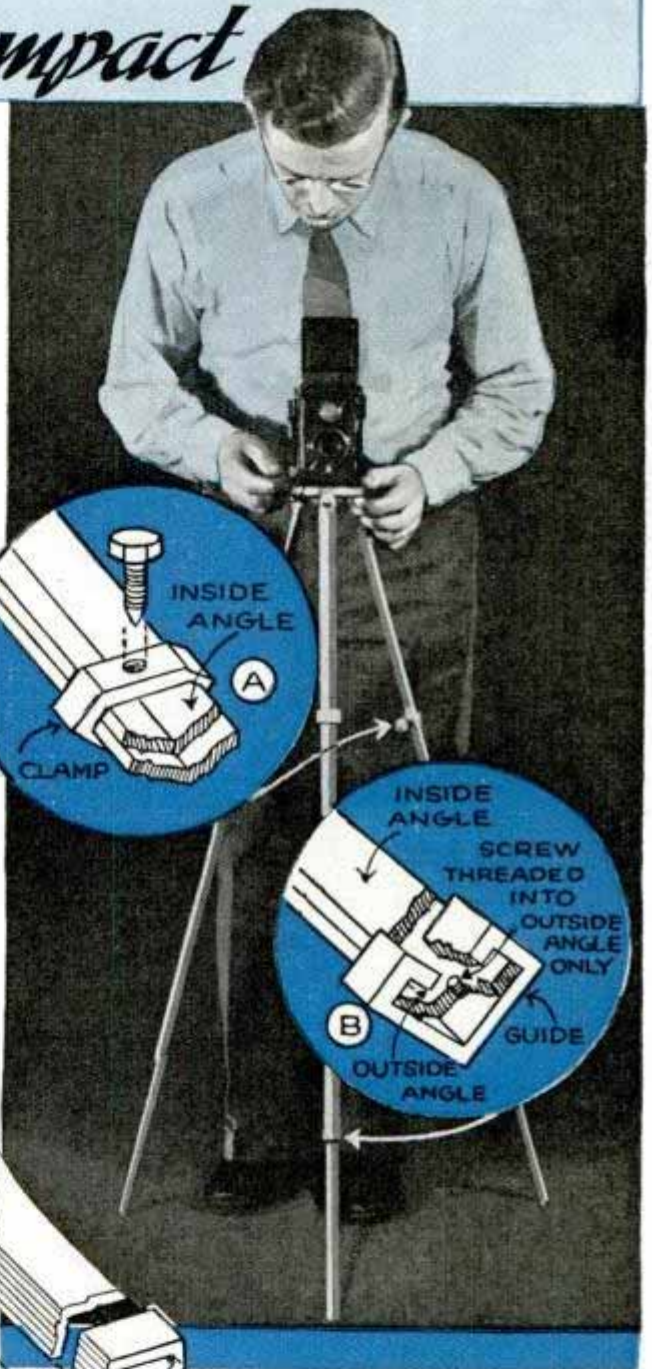

Compact Projector Has Flashlight as Source of Illumination

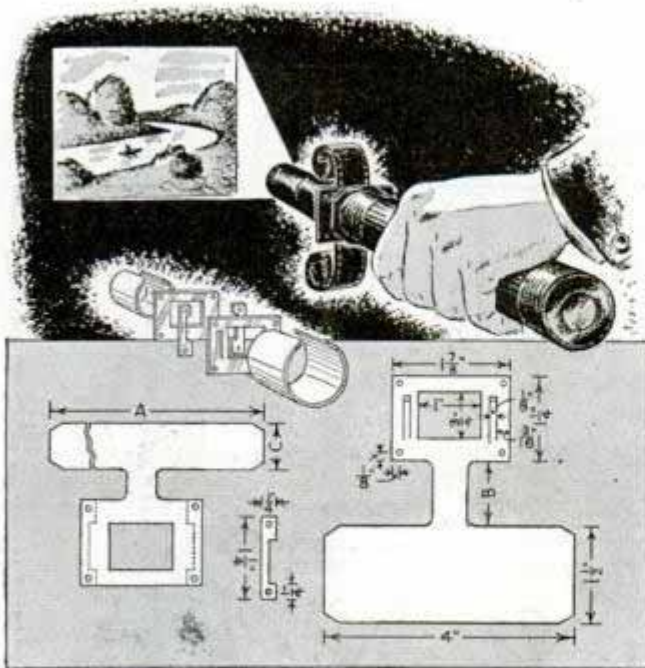

Thirty-five millimeter movie film or positive films made from miniature negatives can be flashed on a blank wall with this simple projector. A three-cell flashlight with a fixed-focus lens furnishes the illumination. Sheet brass is used for all parts. Dimensions A, B and C vary with the type

of projection lens used. Dotted lines in the drawing show the positions of the spacers which serve also as guides to keep the film aligned. In the original model, a lens salvaged from an old toy projector was used and gave surprisingly good results.

—Earle T. Orchard, Providence, R. I.

Developing and Fixing Solutions Cooled without Dilution

You can use either a tumbler or a rubber glove partly filled with cracked ice to keep photo solutions cool without diluting them. Just swish the glove or tumbler around in the solution until it has been cooled to the proper temperature. If it should be necessary to let the glove remain in the solution for a short time, be sure to close the wrist end with a rubber band.



DO IT YOURSELF and SAVE MONEY



The following booklets are practical and fully illustrated gold mines of useful information on the subjects listed. They cost only twenty-five cents each, or five for a dollar. They give complete and authoritative details

Everyman's Library of Practical Information

OUTBOARD RUNABOUT—V-bottom, 14-ft. boat for small motors which will carry entire family.
SAILING DINGHY—This 14-ft. boat carries 140 sq. ft. of canvas and weighs about 350 pounds.
CANOE—A 14-ft. Canadian type of craft for fun or sport.
AUTO KINKS—Little things that will easily save you up to \$100 a year on your car.
BIRD HOUSES—Easy to build homes for all kinds of birds.
LOG CABINS AND COTTAGES—Attractive and inexpensive types for all purposes.
MIRACLE PLANTS—Latest in vitamin and soil-less plant culture.
PHOTO ENLARGERS—How to build your own vertical or horizontal enlargers.

PHOTO PRINTER AND DRIER—Printer takes negatives up to 6½ by 8½ in. Also split-second timer and miniature printer.
GARDEN FURNITURE—Made of attractive colored concrete.
GARDEN WOODWORK—Will improve appearance of your home.
TRACTORS—For farm and garden made from old auto parts.
TREASURE FINDERS—Large and small metal locators which have many uses.
TELESCOPES—Complete details on a reflecting telescope you can build for less than \$10.
CLEANING FORMULAS—How you can make your own cleaning preparations for woodwork, wallpaper, autos, etc.

POPULAR MECHANICS PRESS, Dept. 940 - - - 200 E. Ontario, Chicago



Radio

F.M. RECEIVER for Experimenters

EXPERIENCED set builders located within the range of a station broadcasting programs by means of the recently introduced "F.M.," frequency modulation system, can assemble this 10-tube kit "receptor" which is a complete F.M. receiving unit with the exception of the audio amplifier. It may be used with any external amplifier, or the audio system of a good standard broadcast receiver, generally without disturbing the wiring of the receiver.

Designed to give the experimenter an early opportunity to try out this new high-fidelity, interference-free reception provided by frequency modulated transmitters, its frequency range is from 39 to 44 megacycles,

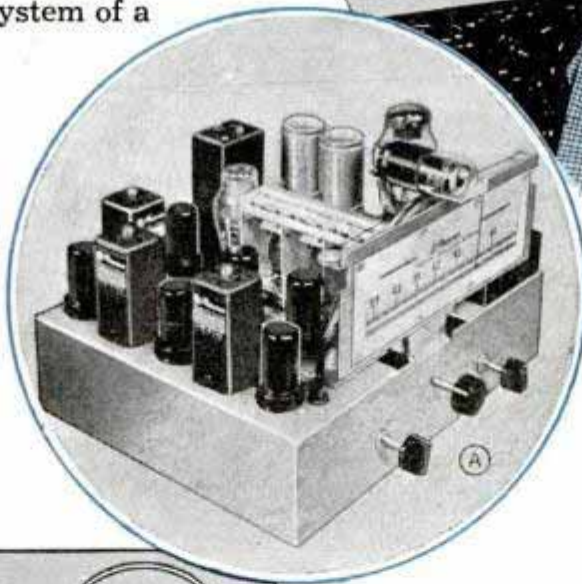

including only the band in which such broadcasts are available. Photo A shows the completed receptor, which looks very much like an ordinary receiver; connection of the output to the regular phono terminals in a standard broadcast receiver is all that is required.

Provision is also made for a built-in audio system on the same chassis, if desired. The complete tube layout is clearly indicated in Fig. 1, the 6L6 and 6C5 being the audio tubes referred to. A standard doublet television-type antenna is recommended. Each half of the doublet should be 65 in. long; twisted-pair lead-in runs to the receptor. Because of the short wavelength employed in F.M. broadcasting (7.0 to 7.5 meters) reception of distant stations should not be expected.

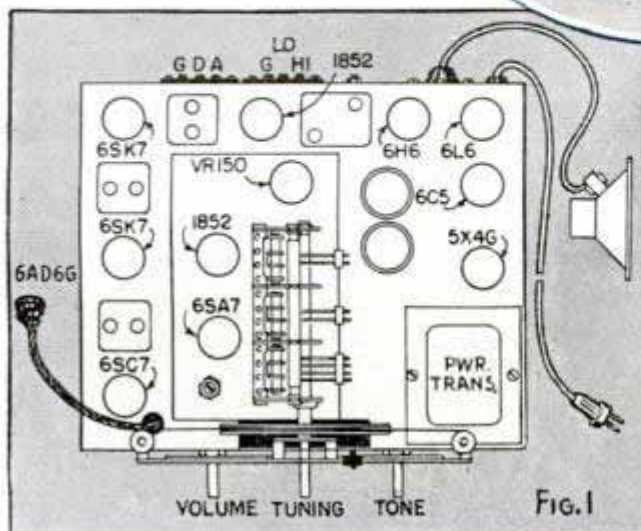

LOW-COST PACK SET



ENTIRELY self-powered, this "over-the-shoulder" portable battery-operated receiver is built into a revamped 49-cent overnight bag of the type available in chain stores. All radio parts are standard and easily obtained. An excellent knock-about set, it will play anywhere in camps or boats, and has all of the sensitivity necessary to pull in stations on a built-in loop antenna.

Only three of the new 1.4-volt low-drain tubes are required for the simplified superheterodyne circuit which employs a large hand-wound loop installed in the lid of the case. The set operates on two 45-volt portable-type B-batteries, and four 1½-volt flashlight cells for the A-battery supply. Connected in parallel for long life, these flashlight cells furnish the necessary 1½ volts for the tube filaments and are easily renewed at low cost; the B-batteries should last for nine or ten months. There is plenty of space in the case for these batteries and a full-size 5-in. speaker. The 1A7-GT tube is used as a mixer; a type 1A5-GT operates as the I.F. amplifier and the 1D8-GT multi-unit tube is employed as a combined second detector, first audio and power output stage, which accounts

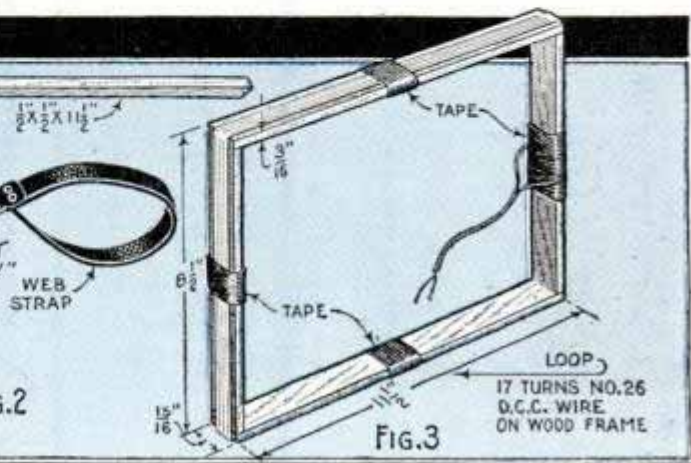
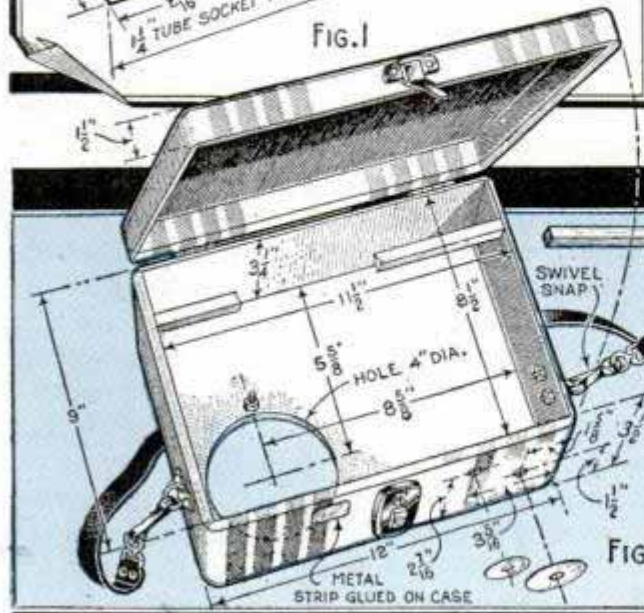
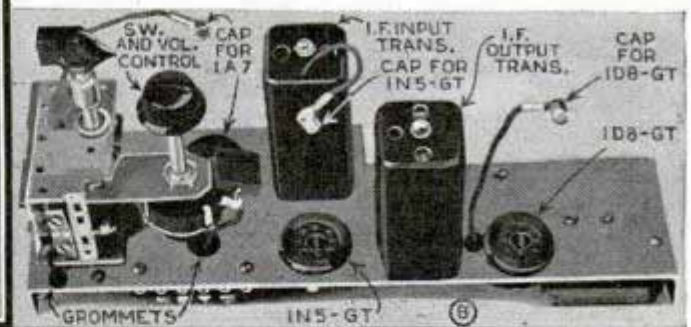
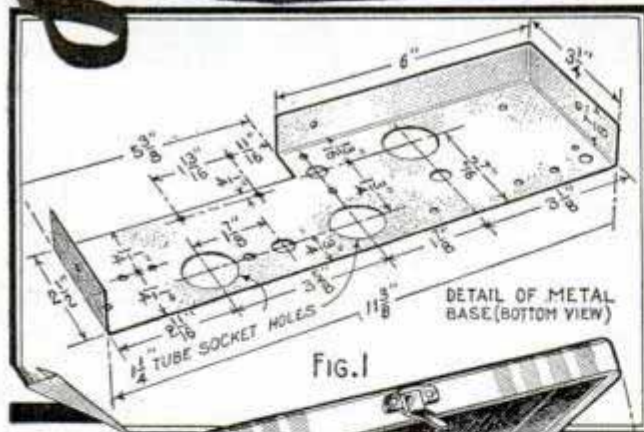

For camp or boat

for the high efficiency and satisfactory volume of the 3-tube circuit.

The dimensions of the overnight bag used for the original model are given in Fig. 2 for those who may wish to build a similar plywood canvas-covered case, and also as a guide for those who purchase one in their local stores. These cases vary slightly in size and such variations should be taken into consideration as it may be necessary to change the length of the galvanized-iron base detailed in Fig. 1 and also the size of the loop frame detailed in Fig. 3. Slight differences in the dimensions of the loop and metal base will in no way affect the operation of the set. When buying one of these cases be sure that you get one with good hinges as some are better than others. Please note that the 2-gang variable condenser is mounted on end by means of machine screws and two hex nuts which are used as bushings. The volume control is mounted on a metal bracket fastened to the frame of the condenser as shown in the simplified wiring diagram and photo (B). Photos A, B, C and D give various views of the chassis and completed set.

A small soft-metal angle bracket is used to support the padder condenser (C11)

(Continued to page 135A)

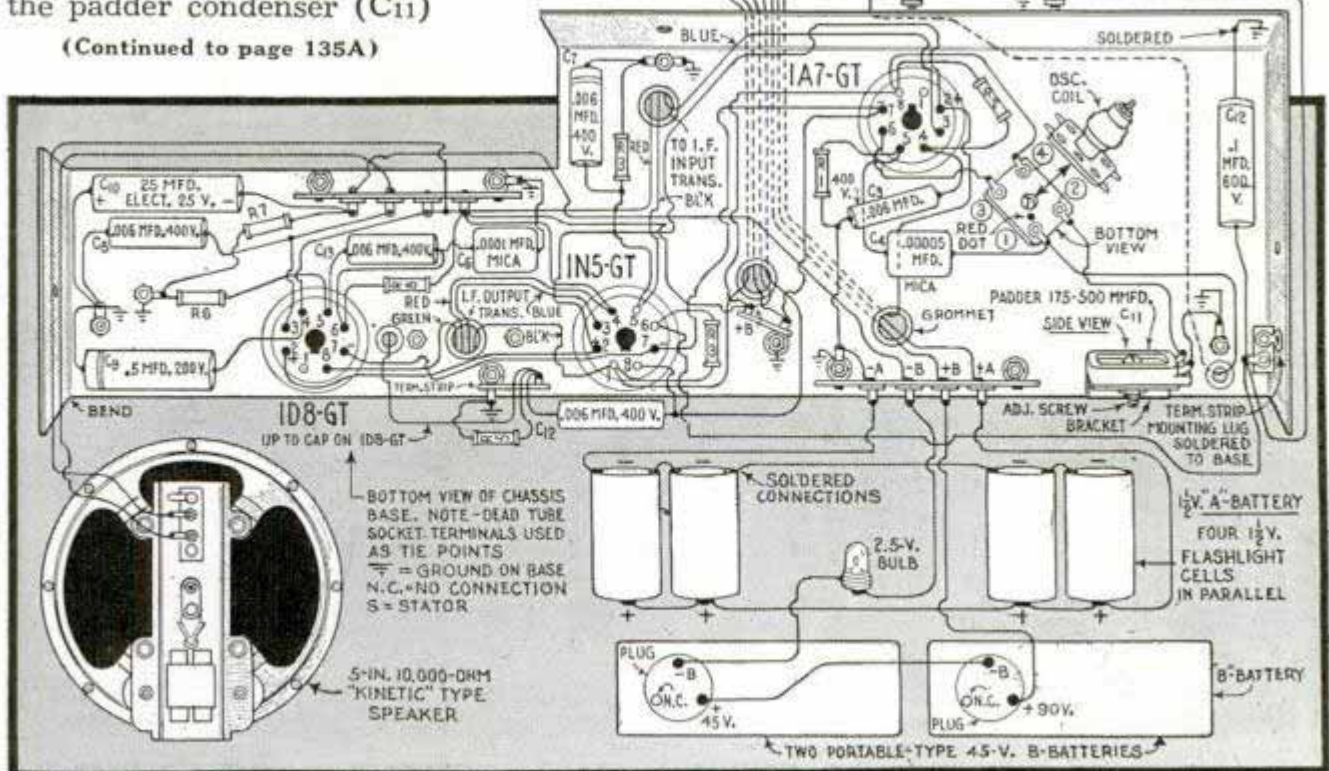
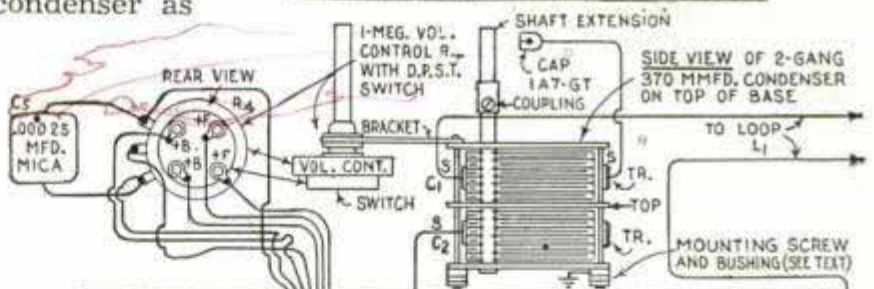

"Diversity" System Employs Two Receivers

By S. Gordon Taylor

IF YOU have two short-wave superheterodyne receivers it is a simple matter to hook them up for "diversity" reception. This system provides a marked reduction in the fading of distant short-wave signals.

The receiver requirements for a diversity installation are fundamentally no different than for any single-receiver installation except that there must be a reasonable difference between the intermediate frequencies so that there will be no interaction. In the SX-17 and SX-25 Hallicrafters receivers shown, the I.F. frequency of one was 465 kc. and of the other 455 kc. If your sets are also of the shielded variety in metal cabinets this difference in frequencies will be sufficient, if not, a greater difference may be required. So far as the antennas are concerned, they need not be special but they should be erected at an angle of 90 degrees or more to one another, and preferably equipped with balanced down leads to confine signal pickup to the antenna proper. When arranged as shown in Fig. 1, the output of the two headphones will always be additive and at any instant that the signal is heard will be that of the sum of the two individual receiving systems. The use of "split" headphones is advised rather than loud speakers, one cord going to the headphone jack of each receiver. In this way the ears function as in ordinary conversation, and a slight fade in one is compensated for in the other.

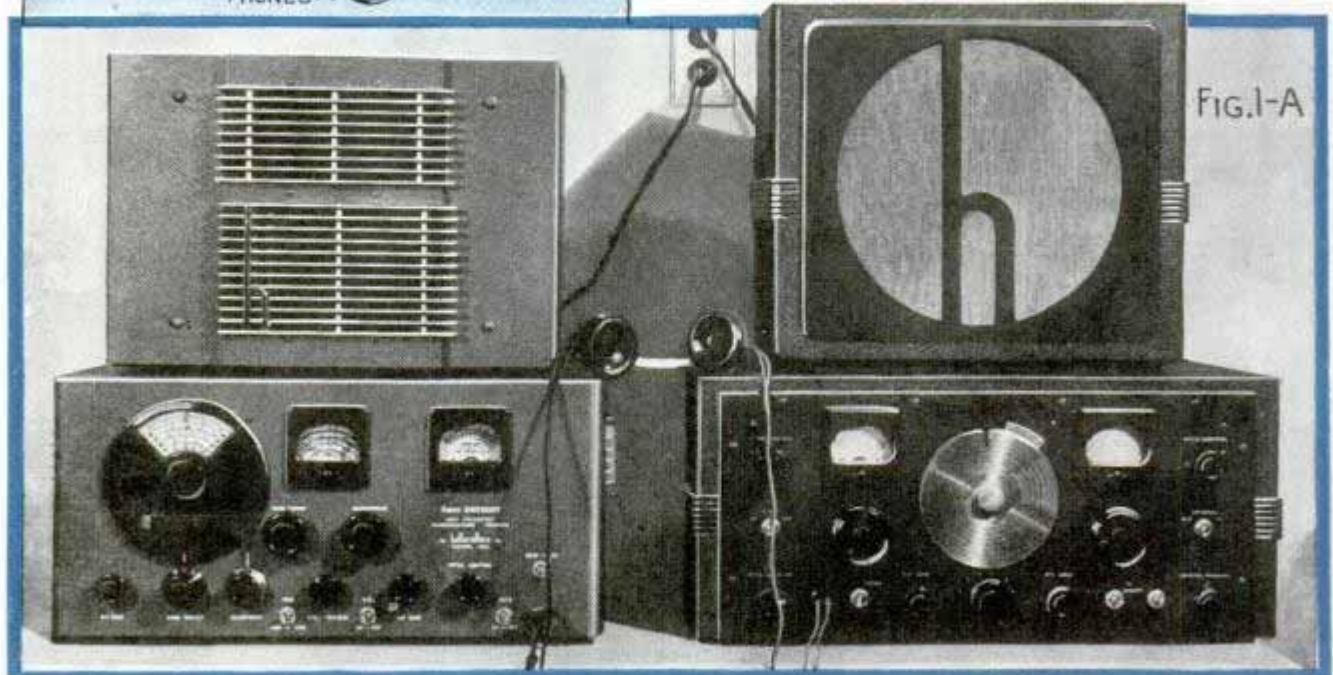
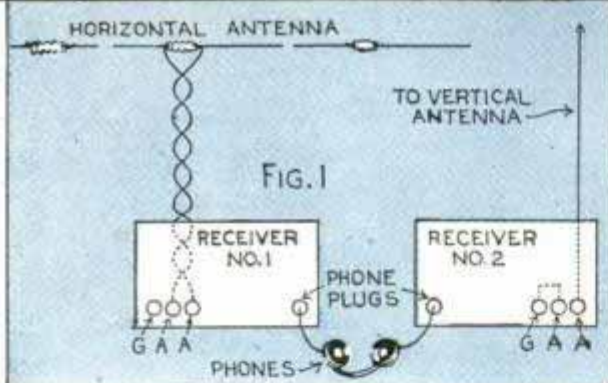
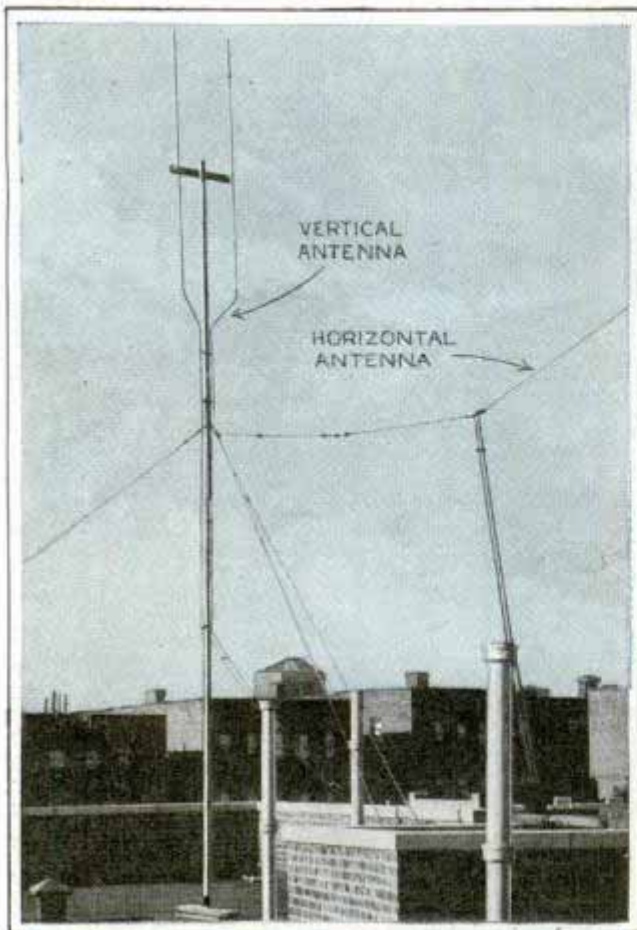

Practical RADIO HINTS

(1) Inexpensive power-line filter reduces line noises picked up from electrically operated devices in the home or shop. It consists of a small plug unit that is inserted between the wall outlet and the radio receiver, or between the outlet and motor or other appliance that is causing the noise

(2) Small porcelain stand-off insulator, and drilled terminal clip, make rugged mounting for wire-wound tubular-type resistors when located under metal chassis bases

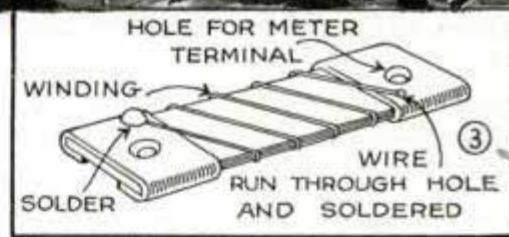
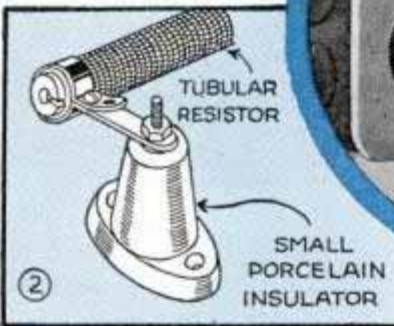
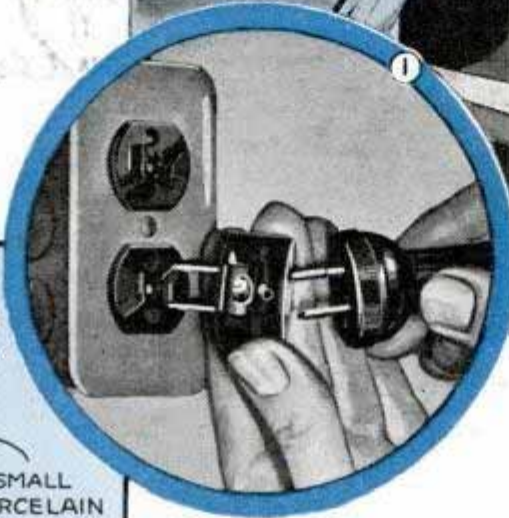

(3) Homemade shunt resistor for experimenters' test meter; ends of thin Bakelite or fiber strip terminate in sheet-brass ferrules drilled to fit over meter terminals. Small holes drilled in ferrules permit resistance wire to be drawn through and soldered when correct value of resistance is found

(4) Low-drain miniature battery tubes now available to experimenters for use in hearing aids and pocket-type receivers. Based type is 1 3/4 in. by 9/16 in.



(5) Variable voltage transformer enables user to adjust line voltage in one-volt steps from 0 to 256 volts, and, in 1/2-volt steps from 0 to 128 volts for set servicing. (6) Extra station tabs for push-button receivers may be lettered on thin white paper and used as photo negative; prints are made on No. 5 glossy paper. (7) Push-pull beam-power amplifier tube for ultra-high frequencies

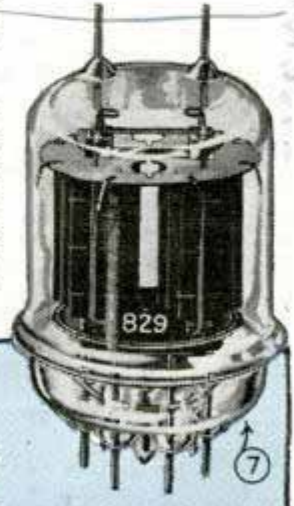

The Halvorsen Co. 459

Master Radio Sales. Blecher Huffer. 9500 of no. 1. Day the m. Production Corp. Chap. 55. New York. Man.

mills Reproducer Co. Radio Engineering
**Compact Sound-on-Film Recorder
 and Reproducer Unit**



Complete portable unit for schools, dictation or home movies

Recording and reproducing sound-on-film mechanically in the same manner that a sound track is cut in an ordinary wax record, this device is claimed to reduce materially the cost of amateur recording for schools and home movies; it also serves a wide field in sales promotion and voice training. The unit is available complete with amplifier, speaker, microphone, cables and control panel. Forty sound tracks may be recorded side by side across the width of inexpensive 16 mm. safety film, permitting high-fidelity reproduction. Recordings may be made and played back immediately.

Book-Size Radio for Travelers

This thin "edition" of a radio can be slipped easily into a traveling case. Made of

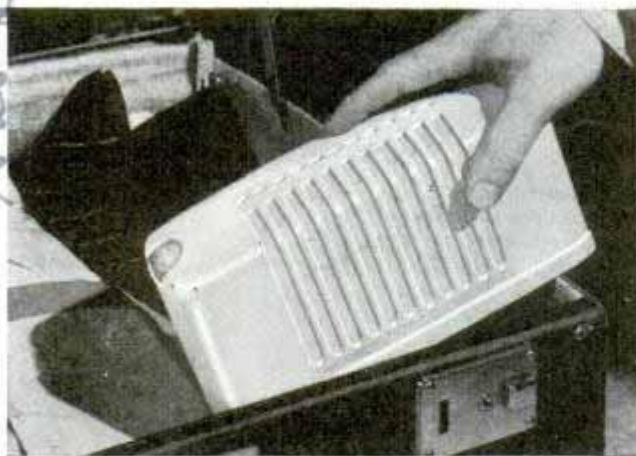

durable plastic material, it can withstand the hard knocks of travel without marring the surface. Control is recessed on the end.

Co. Marshall, Miss
A.C. Current from a D.C. Motor

Solving a perplexing problem for experimenters and shop workers located in d.c. powered areas, this motor is designed so that in addition to driving a piece of d.c. equipment it also furnishes 60-cycle a.c. current for the operation of spot welding transformers, relays, radio power packs and synchronous motors.

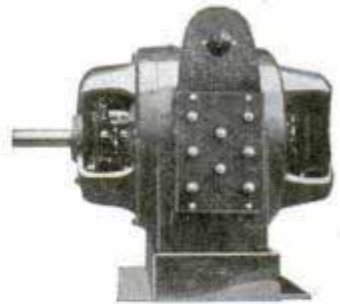

RCA mfg Co. Camden, N.J.
Television for the Amateur



To encourage amateur interest in television, and cooperating with experimenters in that field, a simplified version of the "iconoscope" television camera tube is now available for about \$25. Amateurs equipped with 2½-meter ultra-high frequency apparatus will find it relatively simple to adapt it for sending television signals alternately with sound broadcasts.

Blueprints covering radio construction articles in this and past issues are available for 25 cents each. Original material lists, with names of manufacturers and dealers, can be obtained from our Radio Department upon receipt of postage.

NEXT MONTH—How to Build a Compact Push-Button A.C. High-Fidelity Five. This comparatively small and inexpensive table-model receiver employs a tone-control circuit of advanced design which amplifies and peaks the bass response to give the effect of a large console. Also—**An Extension Speaker for Recreation Room**



SHOP NOTES

HAND CHISELING

Little tricks that simplify working with wood chisels

By W. CLYDE LAMMEY

WITH a little practice anyone can use a wood chisel skillfully by keeping a few suggestions in mind. The three common types of wood chisels in varying blade widths, shown in Fig. 7, will take care of most work. Socket-butt and the socket-firmer chisels are generally used for heavy jobs, under a mallet. The tang-firmer chisel is the one for the more delicate paring work.

A marking gauge, Fig. 2, always should be used for laying out the work. The important thing is to score the gauge lines deeply. This not only makes it easier to locate the chisel edge when following the line, Fig. 3, but aids in chipping out the waste, for the wood ahead

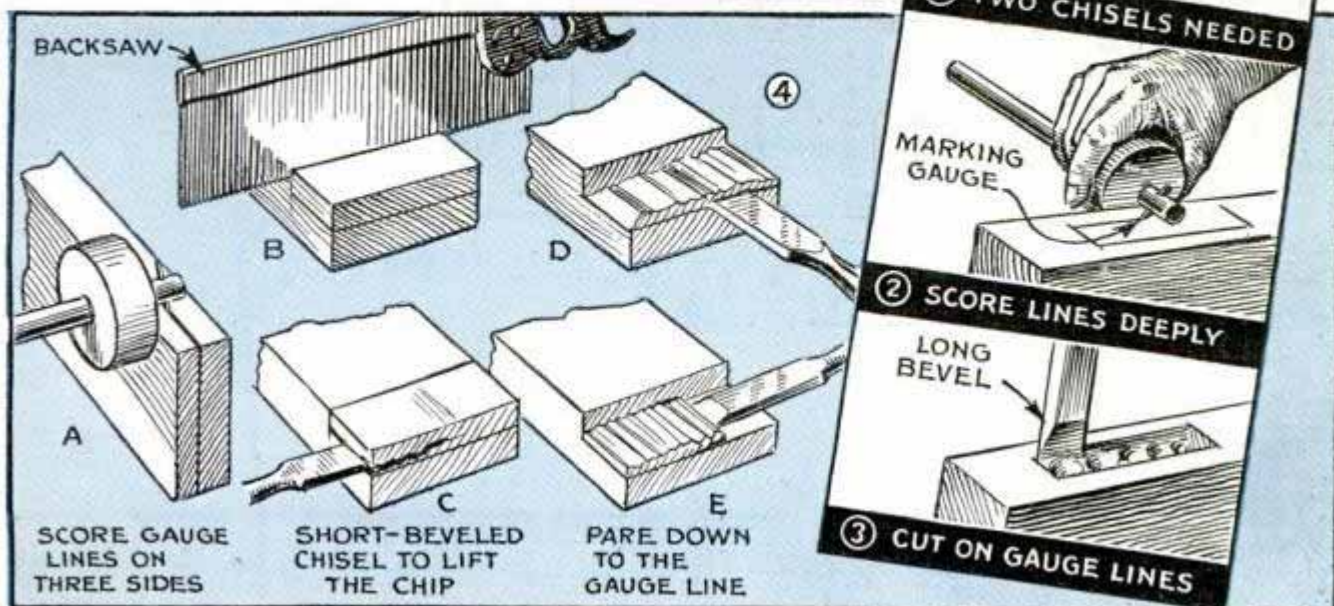

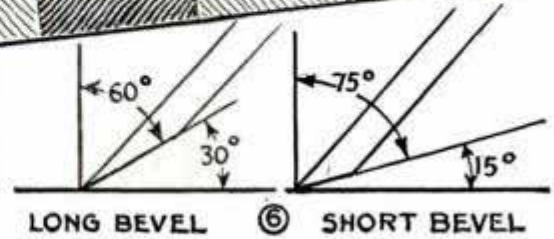
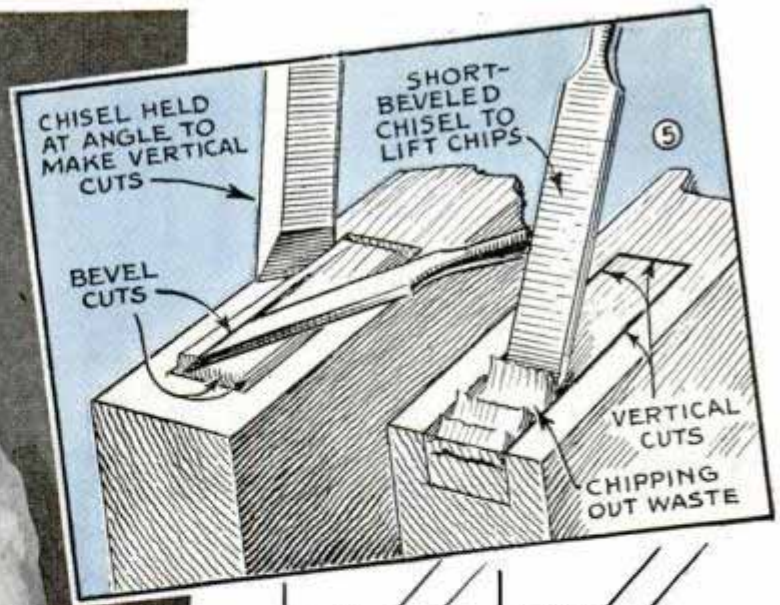
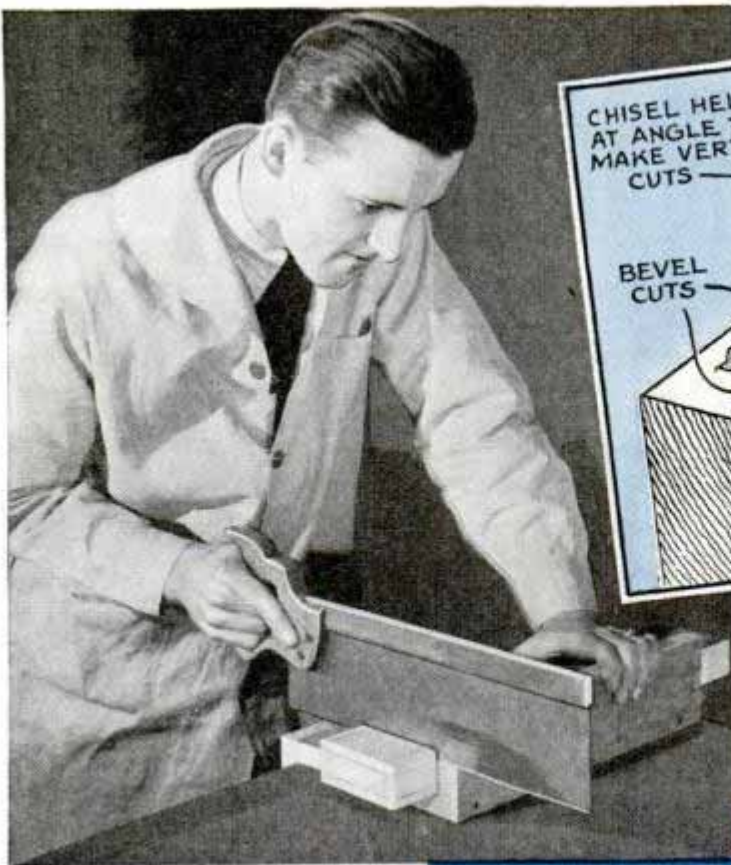

A bench hook or a miter box, which can be made quickly from a few scrap boards, is required to guide a backsaw vertically for making the final shoulder cuts in forming a tenon. The rough tenon is pared down to fit the mortise accurately

of the chisel will not split off below the scored line unless you have taken too big a "bite." If you do a variety of hand-chisel work it will help to have one chisel blade ground with a fairly long bevel and the other with a short bevel to give a blunt edge, Figs. 1 and 6. The degree of the bevels indicated is merely an approximation. The short bevel is a definite help to accurate and quick work when you need to lift a series of chips as in Fig. 5, or when a fairly large section of waste wood is to be split out as at C in Fig. 4. The short bevel greatly increases the wedging effect of the blade and, at the same time, prevents the cut from opening too far ahead of the cutting edge. The long-beveled edge makes it easier to run a series of deep parallel cuts along a scored line. Also, when you use the chisel without a mallet for paring and shearing



cuts, the long-beveled blade works its way through the wood easily and leaves a smooth surface. Unless you follow a regular procedure you're likely to have some trouble clearing the waste from one member of an end half-lap joint, as indicated in the details of Fig. 4. First, there's the essential deeply scored gauge lines on three sides as at A, and the cheek cut, which is made with a backsaw as at B. Then comes the tricky step indicated at C. On $\frac{3}{4}$ -in. stock you can place the edge of the chisel on the gauge line and drive it in until the chip splits up as shown. Repeat the same thing from the opposite side and, on fairly straight-grained stock, all of the waste you'll have left is a small triangular piece. This can be lifted out easily. Finally, the rough surface is smoothed up with light paring cuts to bring it uniformly to the gauge lines as at E. If one uses care in this procedure, end half laps with good gluing surfaces can be cut almost as quickly as you could set up and do the same job on a circular saw.

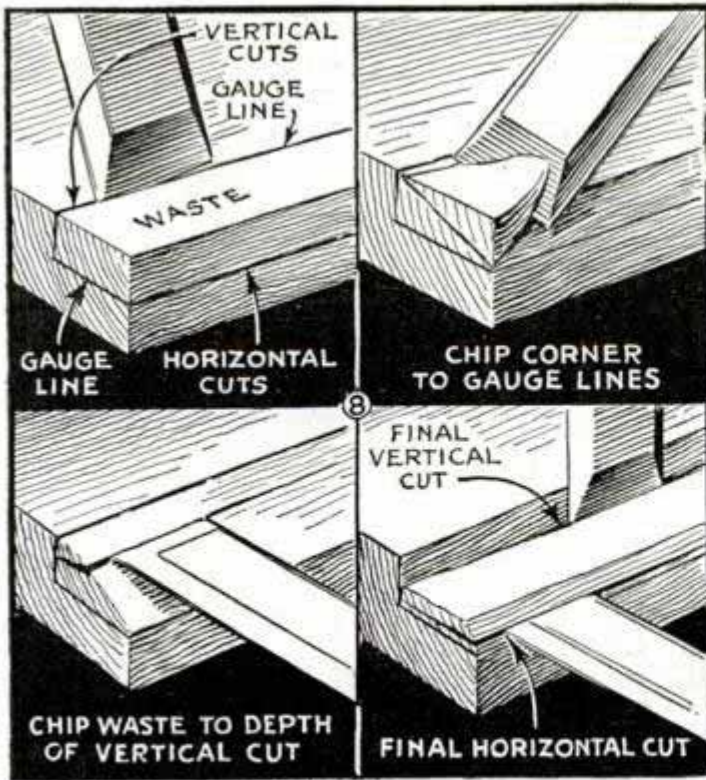

Should you find it necessary to recess a block to a given depth, the left-hand detail in Fig. 5 shows how. Score deep gauge lines and then make them still deeper with vertical cuts. Bevel one end of portion that will be waste stock. Working alternately from both sides, you can chip out the waste to the depth of the vertical cuts and smooth up the bottom.

Now suppose you have to cut or enlarge a rabbet. At first glance this may look like a tough one, but if you follow the procedure detailed in Fig. 8 you'll find it very easy. First come the gauge lines and the vertical or checking cuts. Then you chip off the corner to the scored lines. As a third step, the waste is chipped to the depth of the first checking cuts. Then you repeat to remove the last sliver of waste. Figs. 9 to 12 inclusive show the important refinements in making paring cuts. Note especially how the blade is rocked from side to side when making a paring cut with the grain in a mortise. This sideward movement to the blade gives a fast shearing cut and makes it easier to control the cutting edge in paring down to a guide line than is otherwise true when straight vertical strokes are used. Notice also, how the chisel is held for paring end grain, Fig. 12. Here just one corner of the cutting edge is engaged to remove only a very thin shaving with each stroke of the blade. The back of the blade should bear slightly against the work to restrict the depth of cut.

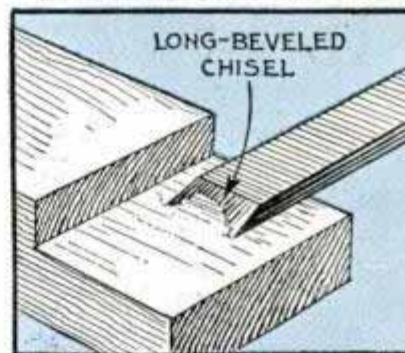

⑨ FLAT PARING CUT

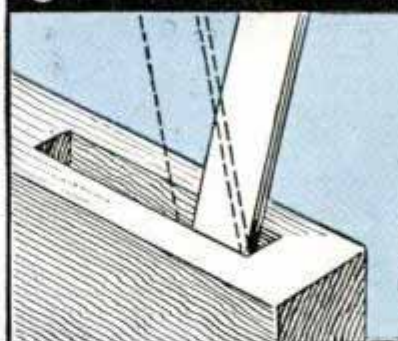

⑩ ROCKING BLADE SIDEWISE

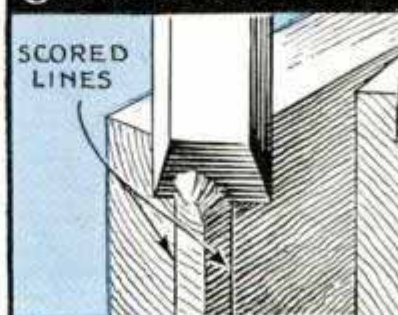

⑪ CHAMFERING



⑫

Mirror on Glass of Show Window Aids Window Trimmer



When working in a narrow show window where there isn't room to stand in front of the displays to get the general effect as the work of trimming progresses, one workman uses a large mirror which he attaches to the inside of the window glass with vacuum cups. The cups permit the mirror to be located in any position desired on the glass. Thus when trimming a window of a clothing store where various garments are displayed, the workman can stand behind the model while fitting the clothing without going out to the sidewalk to see the appearance of his work.

Depth Gauge Used as Scriber for Soft Metals

A stainless-steel rule of the type that is fitted with a depth gauge is handy for the sheet-metal worker. The tool can be ob-

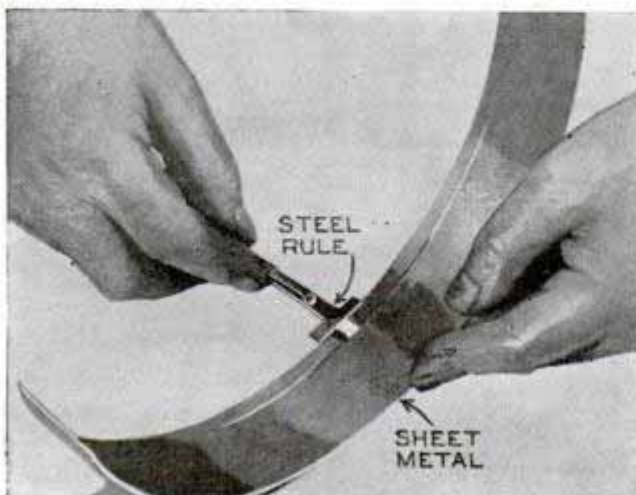

tained in most department stores, and provides an excellent scriber if the depth attachment is slid along the edge of a sheet of metal and the rule tilted slightly so that a corner of the end leaves a scratch mark.

Handles of Die Stock Shielded to Avoid Injuring Worker

After one of his helpers had been painfully injured when struck by the end of a large die stock, which had been rotated rapidly to back it off the work, one plumber slipped large rubber cane or crutch tips over the ends of the handles. These tips come in various sizes which makes it easy to find some that will fit the die stock.



Bench Extension under Vise Is Rest for Vertical Work

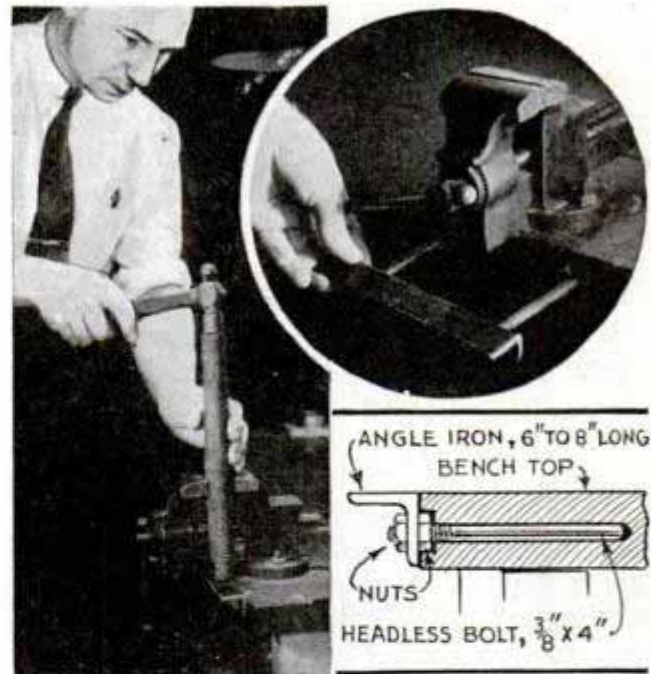

When a machinist's vise is mounted on a bench with the jaws overhanging the edge so that long work can be supported in a vertical position, it is a good idea to provide a sliding extension under the vise as indicated. The extension can be moved in under the vise to support the end of short vertical work that is held in the vise when

it is necessary to pound on the end. If such a support is not provided, the work must be gripped tighter than necessary, and the pounding throws excessive strain on the vise jaws, especially the front one.

Spindle Paper Holder Bent at End Will Not Injure Hands



Spindle-type paper holders, often used in stores, shops and sometimes in homes, can be rendered much safer to have sitting around if the pointed end of the spindle is bent as indicated. This

makes it almost impossible to strike the point with the hands accidentally, and also provides a handle for lifting the holder.

Finger Holes in Small Patterns Prevent Slipping on Work

Annoyed by frequent slipping of small sheet-metal patterns when marking duplicate cutouts, one tin-smith overcame the trouble by punching finger holes in them. The tips of the fingers pressing against the pattern and the work beneath it, served to hold the pattern.

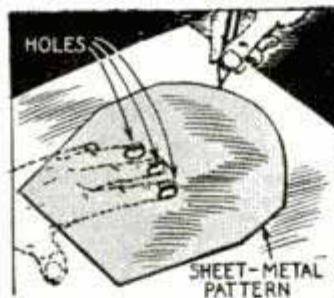

Tailor's Tape Measure Disappears Through the Worktable



To keep his tape measure out of the way, yet have it always at hand when needed, a tailor attached it to his worktable so that it would automatically disappear when not in use. To do this, a small slot was cut in the table top and one end of the tape was tacked to the side of the slot. Then the tape was folded and a small counterweight fastened to it as indicated.

Sawbuck Made from Wheel Supports Light Logs

A sturdy sawbuck may be made from an old farm implement wheel from which two spokes and a section of the rim have been

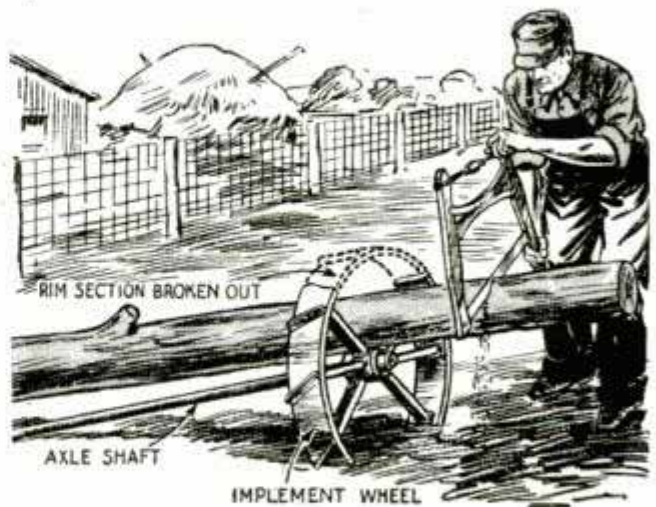

Machine-Table Stop Fits Slots of Various Widths

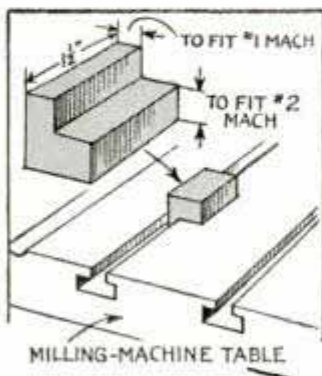

As most machine shops are equipped with planers and milling machines that have table slots of various widths, this stop will make it unnecessary to have a number of them. Machined

from cold-rolled steel, it has two sides of different widths, thus making it usable on more than one machine.

broken. The wheel is set in a shallow depression and an axle or shaft inserted in the hub with one end resting on the ground helps to hold it in an upright position.

POWER

By C. A. CROWLEY

PART I

Estimating power demand, measuring capacity of the stream, determining "head" of water, turbine size, and building a dam

Requirements

ROOM	LIGHTS OR APPLIANCES	WATTS
Kitchen	1 ceiling light	100
	1 side light	40
	refrigerator	375
Dining Room	Toaster	600
Living Room	ceiling fixture - 3 light (60)	180
Bed Room #1	Radio (100) + 3-60 watt lamps	280
Bed Room #2	1 ceiling light (60) - outlet (60)	120
Bath	" " "	120
	2 side lights	80
	Total	1895

① *Power demand*

THOUSANDS of small streams have sufficient power to produce electrical energy for light and power. Also, where it is desired to have reservoirs for irrigation purposes, the construction of a dam is of vital interest. Either one or both of these purposes can be achieved by following the information contained in this article. Except for the initial expense of the equipment, there is very little cost in obtaining electricity in this way. A typical small installation is shown in Fig. 5. It consists essentially of a dam to provide a reservoir and "head" or drop of water, which is led to a turbine at a lower level. The rotating turbine drives an electric generator, and a transmission line carries the electric current to the house.

Estimating power requirements: Before deciding on the

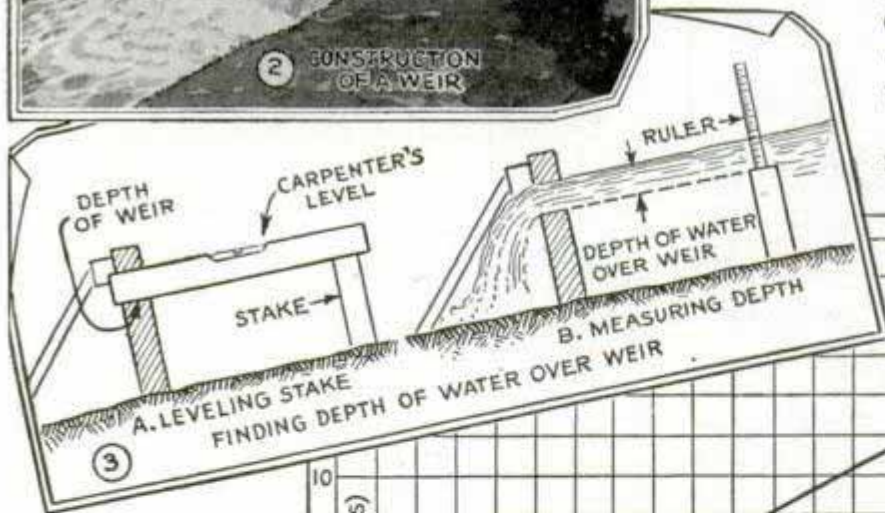

Measuring capacity of stream

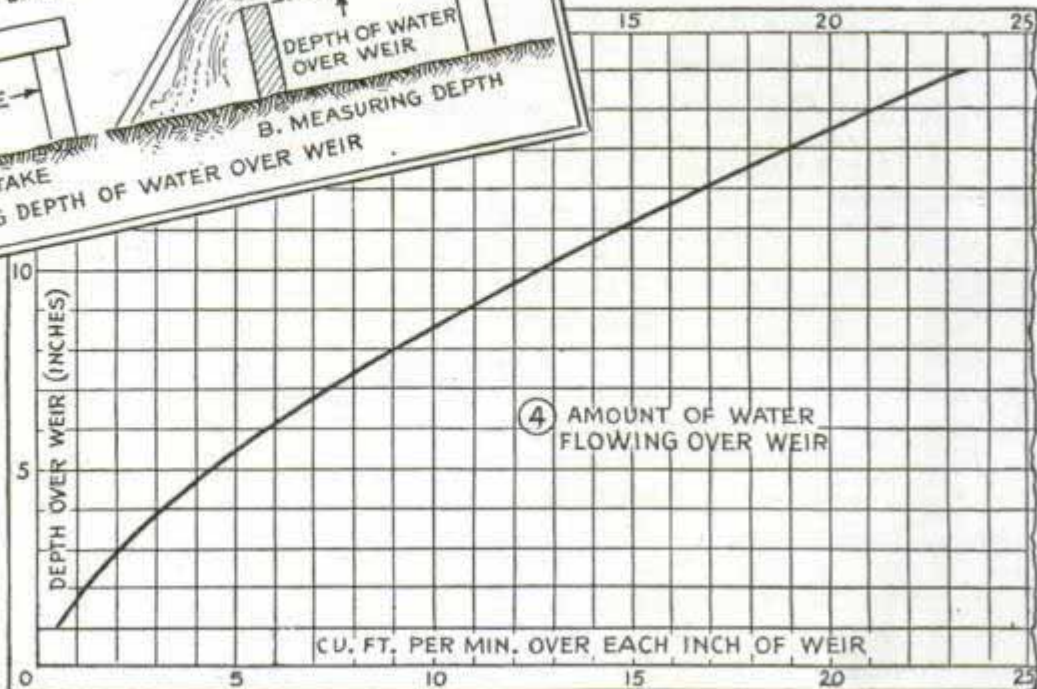



size and location of a power plant, it will be necessary to estimate how much power will be needed—the power demand. This is done by adding together the watts consumed by each lamp and appliance as in Fig. 1. Watts consumed are marked on the lamps and appliances, and often are given in catalogues listing electrical appliances. Next, the total electrical consumption in watts is translated into horsepower. See Fig. 10 step A. If the plant is designed to accommodate the total, an ample reserve of power will be available for future appliances. However, it is not necessary to build an installation to take care of the total load, but only enough to carry the highest peak load that can be expected at any one time.

Finding capacity of stream: After determining the power demand, the next step is to measure the stream to find the capacity or flow of water available in cu. ft. per

min., and also the “head” or distance that the water drops. Measuring the capacity of a stream should be done at the time of normal or minimum flow, as measurements based on swollen, fast-moving creeks after a period of rainfall or during early spring after the snow melts, will be greatly exaggerated over measurements based on normalcy. For a small stream the “weir” method is most accurate. A temporary dam of planks, shown in Fig. 2, is erected. The rectangular opening should be perfectly horizontal and the flow of water over the weir should be smooth and free from turbulence. All the water should flow through the opening and none around or under the sides and bottom. A stake is driven into the stream bed a few feet upstream from the weir, its top level with the surface of the weir. See detail A of Fig. 3. Next, the depth of the water above the stake is measured as in detail B, Fig. 3.

How to find "head" of water

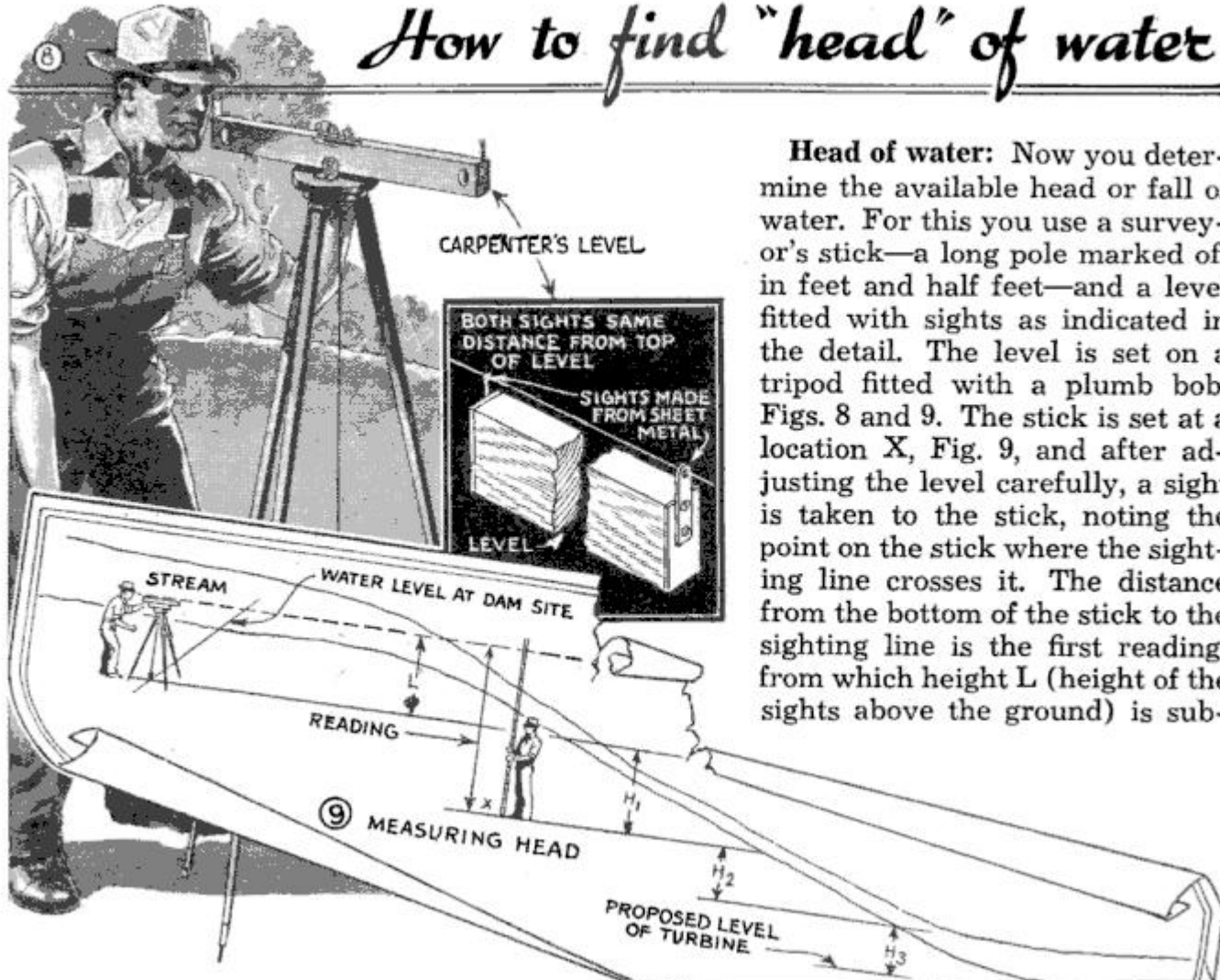

Head of water: Now you determine the available head or fall of water. For this you use a surveyor's stick—a long pole marked off in feet and half feet—and a level fitted with sights as indicated in the detail. The level is set on a tripod fitted with a plumb bob, Figs. 8 and 9. The stick is set at a location X, Fig. 9, and after adjusting the level carefully, a sight is taken to the stick, noting the point on the stick where the sighting line crosses it. The distance from the bottom of the stick to the sighting line is the first reading, from which height L (height of the sights above the ground) is sub-

Then by referring to the chart, Fig. 4, you can determine the amount of water flowing over each inch of the weir in cu. ft. per min., which is multiplied by the width of the weir in inches in order to get total flow.

An alternate method of estimating the approximate capacity of a stream, which is simpler than the weir method but not as accurate, is shown in Figs. 6 and 7. The first step is to find the velocity of the stream by timing how long it takes a chip to float a certain distance, say 50 ft., as in Fig. 6, taking the average time of a number of trials. Suppose that the average speed is 7.8 seconds. You convert this to ft. per minute by dividing the average time into 2,400, which takes into account the varying speed of the stream at the center and at the banks. Dividing 2,400 by 7.8 gives 308 ft. per minute as the average velocity of the stream. Also, see step B of Fig. 10. The average depth of the stream is measured as shown in Fig. 7. Supposing that this is 1.67 ft., the flow of the stream in cu. ft. per min. is found by multiplying the average depth by the width and multiplying this product by the average velocity—see steps C and D of Fig. 10.

10 PROCEDURE	EXAMPLE
A. Estimate power demand in watts. Horsepower (hp.) required = watts ÷ 746	Peak demand is 20,000 watts. Hp. = 20,000 ÷ 746 or about 27 hp.
B. Average velocity of stream = 2400 ÷ average time chips float 50 ft. (Fig. 6)	Chips take 7, 8, 9, 8 and 7 sec. to float 50 ft. Average time = 7.8 sec. Average velocity = 2400 ÷ 7.8 or 308 ft. per min.
C. Measure width and average depth (Fig. 7)	Width = 6.5 ft. Depths at 1-ft. intervals are 10, 18, 22, 28, 26 and 16 in. Average depth = 20 in. or 1.67 ft.
D. Volume of flow = depth × width × velocity. (Weir method may be used)	Volume of flow = 1.67 × 6.5 × 308, or 3350 cu. ft. per minute
E. Measure head (Fig. 9) Theoretical hp. = .00189 × head × flow	Head = 15 ft. Hp. = .00189 × 15 × 3350 or 95
F. Flow needed to give required hp. equals 662 × hp. ÷ head	Flow needed = 662 × 27 ÷ 15, or about 1190 cu. ft. per min.
G. Determine wheel size needed (Fig. 12)	15 ft. head and 1190 cu. ft. per min. comes between 15 and 18-in. wheels. Select latter
H. Wheel speed = flow through wheel × speed factor for wheel (Fig. 13)	Speed factor for 18-in. wheel = 0.174. Wheel speed = 1190 × 0.174 or 209 r.p.m.

You purchase the turbine

tracted. The difference H_1 will be the difference in elevation between the base of the stick and the base of the tripod. Now set the tripod with the plumb bob at X and move the stick to a lower point, where another sight is taken. Proceed in this way until the entire distance between the water level at the proposed dam site and the proposed level for the turbine has been covered. It is not necessary to move in a straight line between the starting and finishing points. All distances H_1 , H_2 , etc., are added, which gives you the head.

Power: It is now an easy job to find how much theoretical horsepower is available

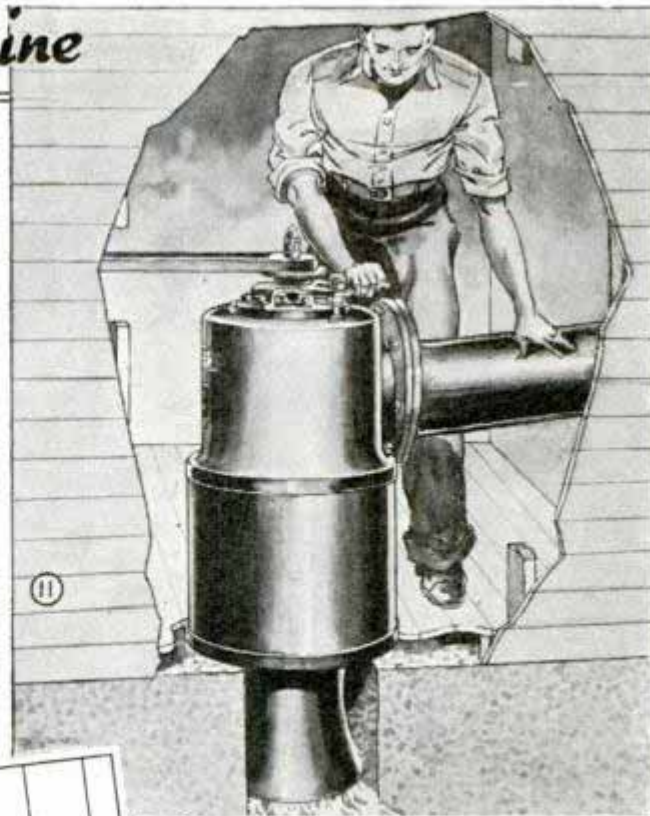

Determining turbine size

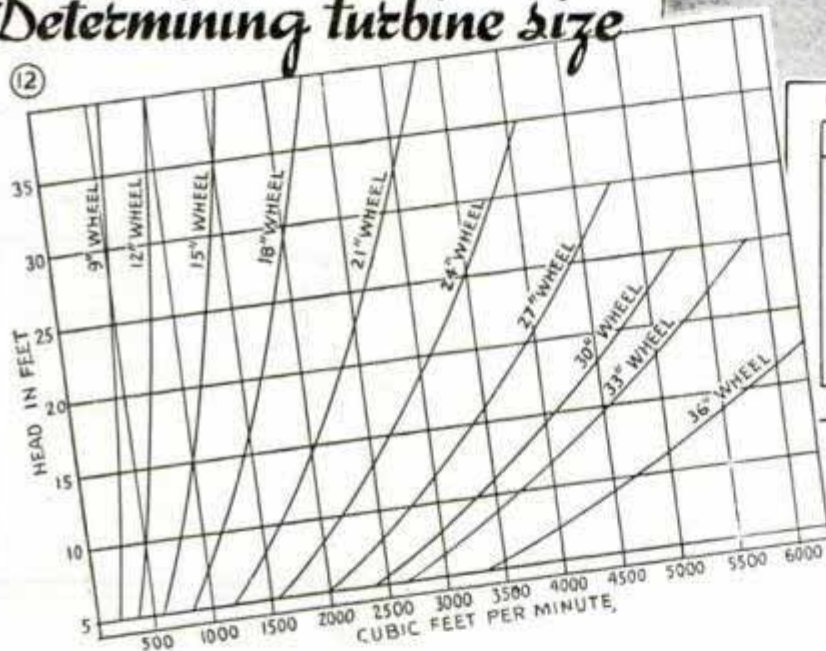

13 SPEED FACTOR OF TURBINES

DIA. OF WHEEL, INCH	SPEED FACTOR
9	1.46
12	.628
15	.315
18	.174
21	.117
24	.0731
27	.0539
30	.0394
33	.0307
36	.0238

from the stream by multiplying the flow in cu. ft. per min. by the head in ft. and multiplying the product by .00189. See step E of Fig. 10. It should be remembered, however, that all of this cannot be transformed into electrical energy as there are a number of unavoidable losses of energy from the time water leaves the reservoir until the electric current is produced by the generator, due to such factors as length and size of conduits, bends in conduits, efficiency of the turbine and generator.

Turbines and water wheels: A turbine, Fig. 11, is a much more efficient means of getting power from a stream than undershot and overshot water wheels. For a low head of water, which is generally the case, the American type of turbine is best. These turbines are available at moderate cost in

sizes as small as 9 in. in diameter. While the theoretical horsepower available already has been determined, it is now necessary to find how much of the available water flow will actually be needed to run a turbine which will produce the power required. Taking for example 27 hp. as the power required, as mentioned in step A of Fig. 10, you follow step F to arrive at the water flow needed. Then the size of the turbine is determined by referring to step G and the chart in Fig. 12. In the example given, the proposed plant should use a turbine between 15 and 18 in. in diameter. But, as only standard sizes are available, always select the larger size wheel, which in this case would be 18 in. Then the best operating speed for the turbine is found by multiplying the flow by the speed factor for the wheel. See step H of Fig. 10 and also the table of Fig. 13.

State specifications on dams: Before building a dam, find out just what restric-

Concrete dam for power or irrigation

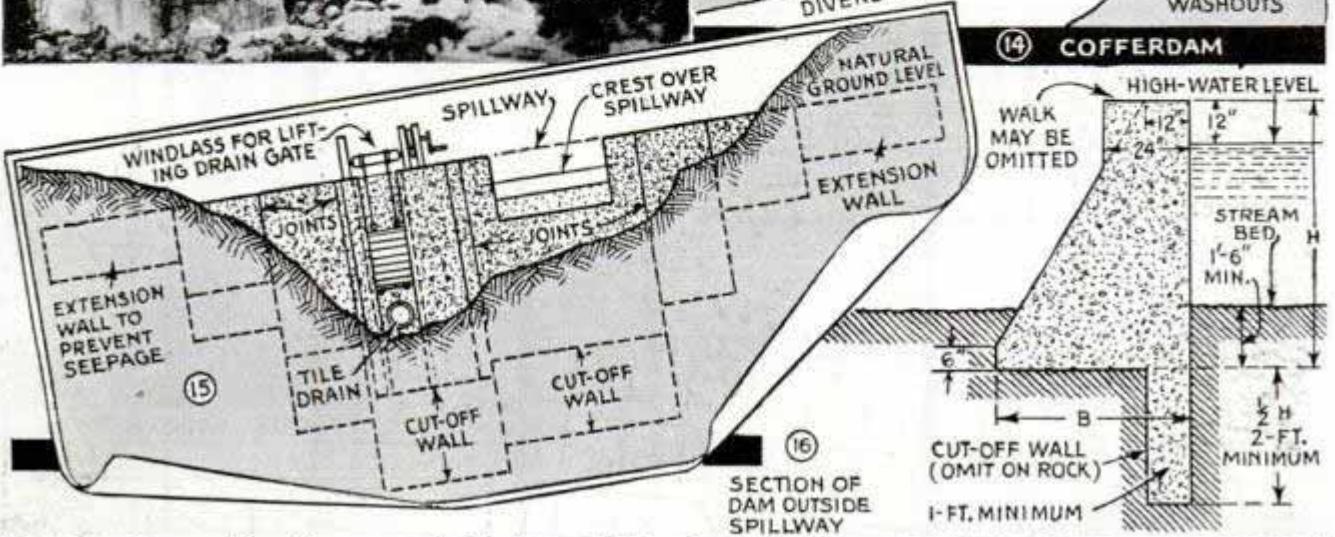
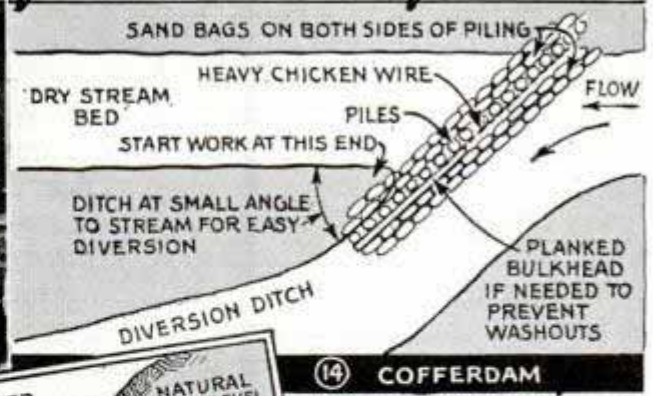

tions and specifications are laid down by your state in respect to dam construction, and abide by them. Where a dam will be of considerable size, obtain the services of an experienced engineer to supervise its design and construction. In some states this is required for all dams over a certain size. Small dams can be made of concrete, masonry, rock-fill or earth-fill construction. Concrete construction is best and will be followed in this article.

Erecting a cofferdam: To divert a stream from its usual channel while the permanent dam is being built, a temporary dam—cofferdam—is erected. Also, a diversion ditch will be needed to carry the water around the dam site. A typical cofferdam is shown in Fig. 14. The diversion ditch is dug at an angle to the stream proper and the work is begun by driving a row of piles across the stream in line with the bank of the diversion ditch. It may be necessary to build a bulkhead—a face of 1-in. planks nailed to the piling. Then, heavy wire mesh or fencing is stretched across the rest of the piling and sandbags are placed on both sides. Sometimes it is necessary to build another cofferdam below the dam site to prevent water from backing up in the original stream bed.

Concrete dam construction: A typical concrete dam is detailed in Figs. 15 to 21

HEIGHT (H)	BASE (B)		DEPTH OF CORE WALL		DEPTH OF WATER AT HEAD OF DAM		CUBIC YARDS OF CONCRETE PER FOOT LENGTH OF DAM
	FT.	IN.	FT.	IN.	FT.	IN.	
5	4	4 1/2	2	6	2	6	0.62
6	5	5 1/2	3	6	3	6	0.83
7	5	6 1/2	3	6	4	6	1.06
8	6	7 1/2	4	6	5	6	1.33
9	7	8 1/2	4	6	6	6	1.62
10	8	9 1/2	5	6	7	6	1.94

inclusive. The upstream wall is vertical and the downstream face is sloped so that the base is considerably thicker than the top. A cut-off wall extends into the ground to prevent seepage underneath, and extension walls in the banks prevent seepage around the ends. See Figs. 15 and 16. Dams should be built in firm and substantial foundations. Excavations for a concrete dam should be at least 18 in. deep and more if necessary to reach a firm foundation. Solid rock provides the best foundation. In this case the dam must be keyed to the rock as in Fig. 19. Sand and gravel do not make good foundations and should be avoided if at all possible.

Dimensions of the dam: To find the height of a section of the dam (height indicated by letter H in Fig. 16), add together the maximum depth of water at the dam

(high-water level) plus 2½ ft. The latter figure includes 1 ft. for the height of the dam above high water and 1½ ft., which is the minimum excavation for the dam. Other dimensions including the base width B, vary with dimension H as given in the table Fig. 17. Dams should be equipped with drainage outlets as shown in Fig. 18. The size of pipe for the drain may be deter-

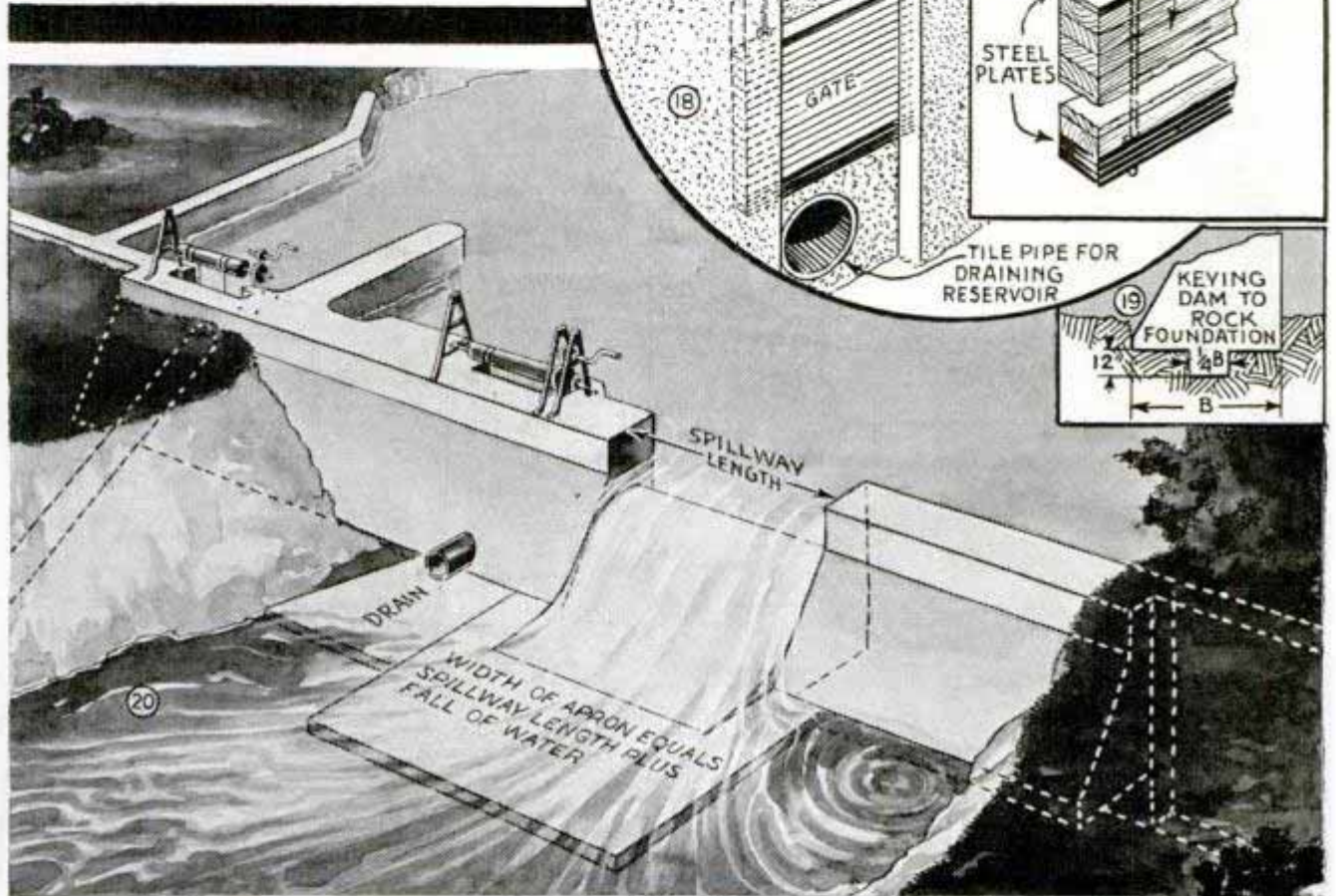

mined with the aid of the chart in Fig. 24. The nearest larger pipe size as shown by the curves should be used. A concrete apron always should be provided under the drain on the downstream side of the dam to prevent washing away of earth.

The spillway: The spillway,—the portion of the dam through which excess water flows—should be large enough to carry off the maximum overflow of water without allowing the water level above the dam to rise within a foot of the top. Any overflow except through the spillway would cause serious erosion below the dam, which might undermine the structure. To find the dimensions for a spillway, Figs. 20 and 21, first estimate the maximum flow of the stream as previously

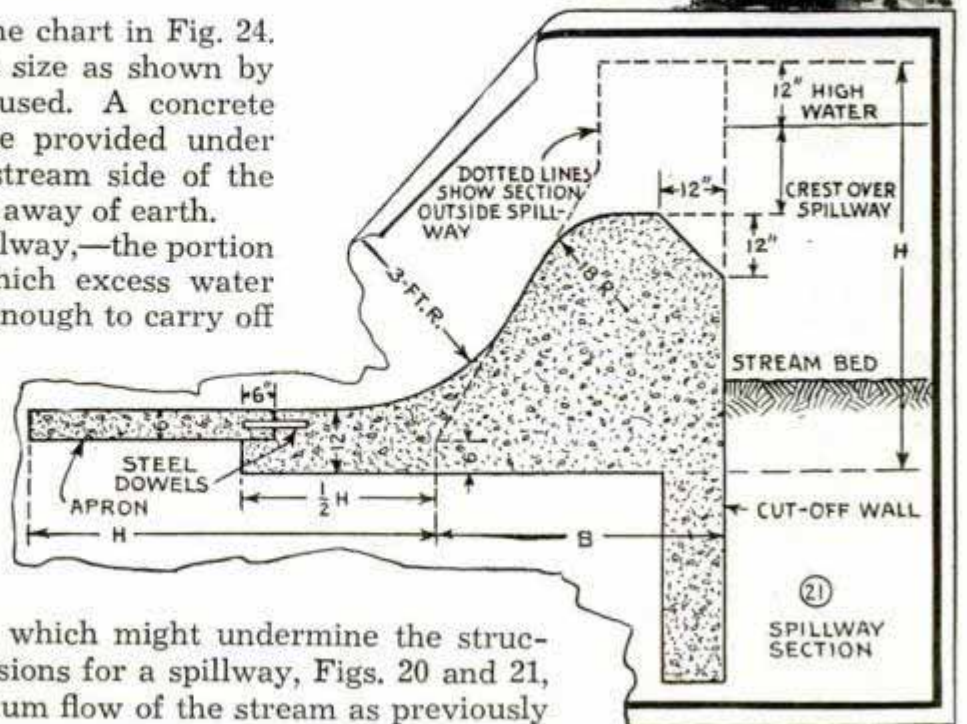

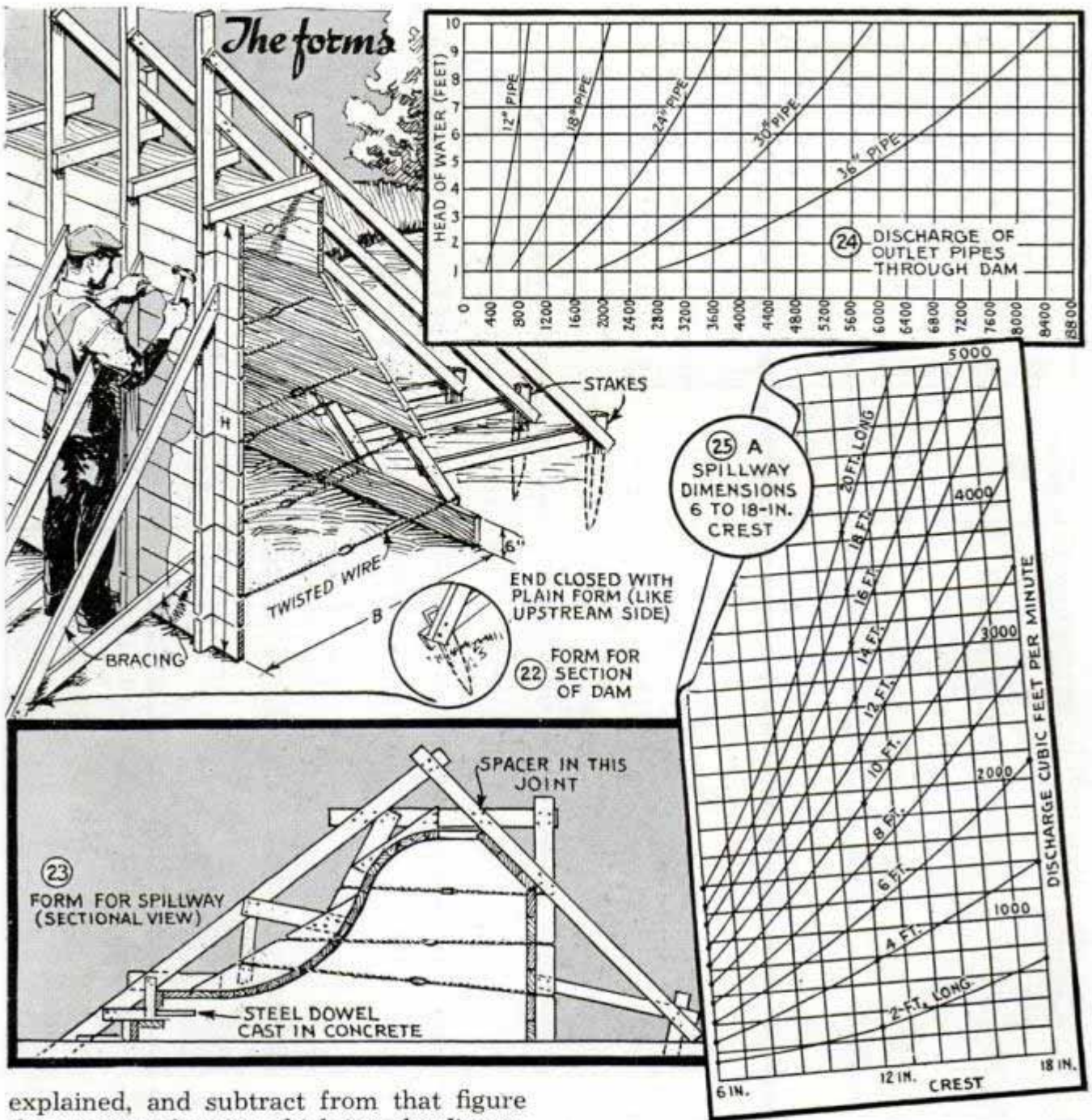

explained, and subtract from that figure the amount of water which is to be diverted for the turbine. The difference is the amount which must be discharged through the spillway. Then refer to the graphs shown in Figs. 25A and 25B to find the dimensions. The crest is the depth of the spillway, represented by the vertical lines of the graphs. The curved lines represent different widths of spillways, and the horizontal lines indicate the discharge of water in cu. ft. per min. In examining these graphs, you will notice that a 10-ft. spillway that must discharge 5,000 cu. ft. of water per min. should have a crest of a little more than 1 ft. 6 in., while a 4-ft. spillway, discharging the same amount of water, should have a crest of almost 3 ft., and a 6-ft. spillway, also discharging the same amount of water, should have a crest of 2 ft. 3 in. Similarly, other lengths require

other crests. In each particular case, the spillway dimensions must be suitable to the width and depth of each stream. Wide, shallow streams should have proportionally long, shallow spillways, but on deep and narrow streams shorter and deeper spillways are often necessary. Generally a wide spillway is preferred, as it can carry off an unexpected overload more easily than a small one. If the fall is fairly high or if the channel is narrow, it may not be wide enough to accommodate an apron of the full width. See Fig. 20. In this case it will be necessary to pave the sides of the channel below the dam to prevent erosion. A concrete paving or revetment not less than 4 in. thick should be used.

Concrete forms: Methods of constructing forms for concrete work are shown in

Figs. 22, 23 and 26. Adequate bracing is necessary so that pressure of the concrete will not make the forms bulge or burst. The bracing should be arranged to form a series of triangles, which give great strength and rigidity. The mix of the concrete should be in the proportion of cement, 1 sack, sand, 3 cu. ft., and gravel or coarse stone, 4 cu. ft.

Dams built in sections: The upstream view of a large dam,

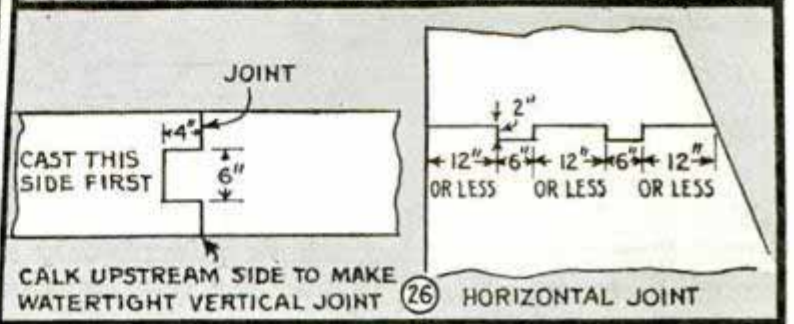
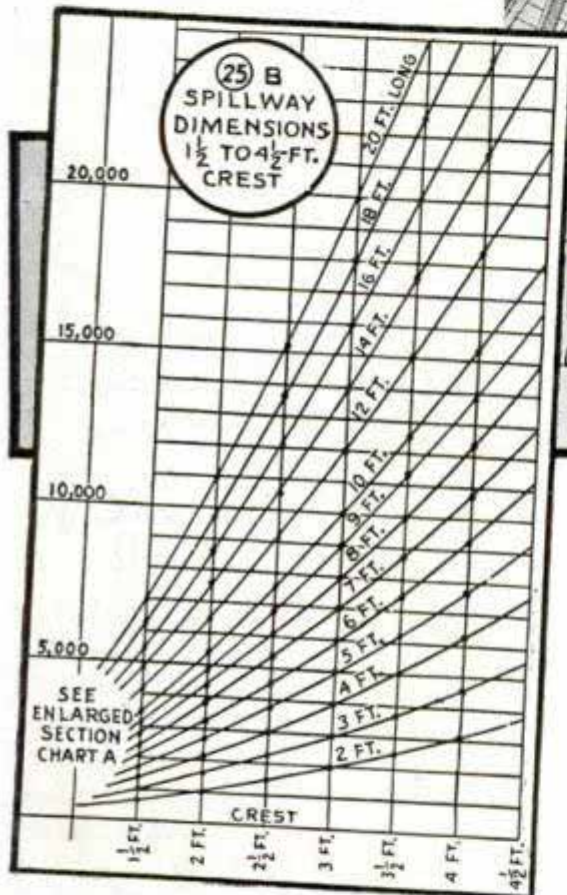
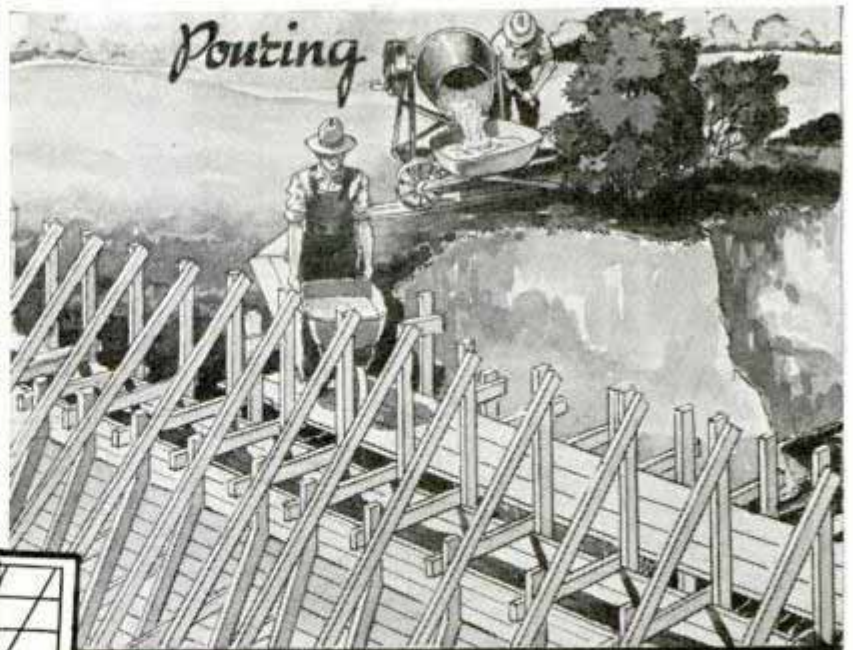

Fig. 15, shows a number of sections, each being of suitable depth for the stream at that point. Construction in sections is not necessary in narrow streams where it can be avoided, as every joint is an invitation to seepage. But in larger streams it would be too costly to build the whole dam to the same depth, and such a large block of concrete would be likely to crack. To avoid seepage, the joints on sections of a large dam are keyed together as shown in Fig. 26. In bonding a new section to one already poured, the old concrete should be brushed well to remove any dusty particles and it is wetted thoroughly to assure a good bond. After the forms have been removed, the upstream end of all joints should be calked with pitch and tar. Be-

fore the concrete is poured, be sure that the inside of the form is free from loose pieces of wood and other debris. Such foreign material should be kept out of the mix in order to avoid formation of any weak spots in the finished wall. It is also advisable to wet the forms thoroughly before pouring.

Curing the concrete: After concrete has been poured its surface must be kept moist for seven days. This can be done by covering the surface of the concrete with wet sand, burlap or canvas, which is kept wet by constant sprinkling. If the concrete is poured during cold weather, the materials should be heated before they are mixed. The concrete when poured, should have a temperature of between 70 and 100° F., and it must be protected from freezing for at least three days. This is generally accomplished by covering it with straw and manure.

Before starting: While you can do some preliminary work on the basis of the information contained in this article, actual work on building the dam should be postponed until complete data on the installation of the penstock, forebay, etc., are available, which will be contained in the next and final article.

Burrs on Conduit End Removed with Electrician's Pliers

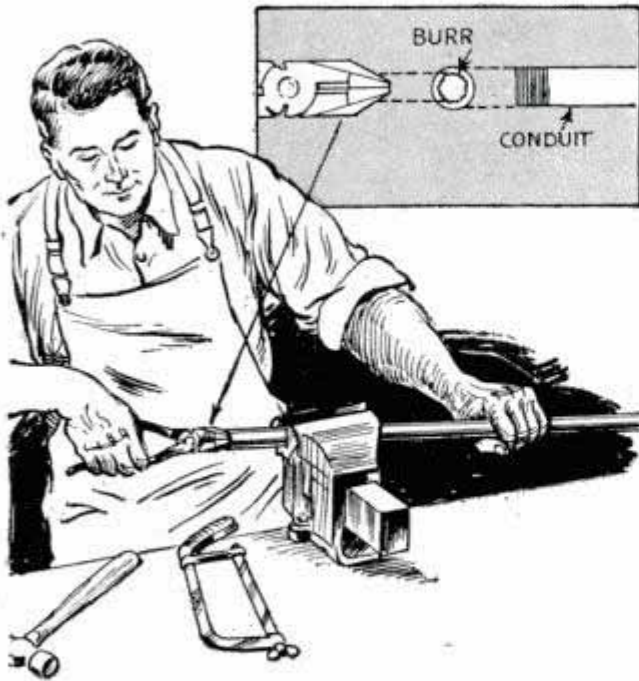

While installing some electrical conduit which had been cut with a hack saw, I found that a pair of electrician's pliers served as an emergency reamer for removing burrs at the end of the conduit. Used as shown, the pliers sheared off the burrs quickly to provide a smooth surface.—Edward E. Lucas, New Brunswick, N. J.

Sheet-Metal Triangle Is Level Indicator for Eaves Trough

In order to avoid carrying a level for determining the pitch of long sections of eaves trough, one tinsmith cut a triangle from a piece of sheet metal, punched a hole at the point indicated for the suspension of

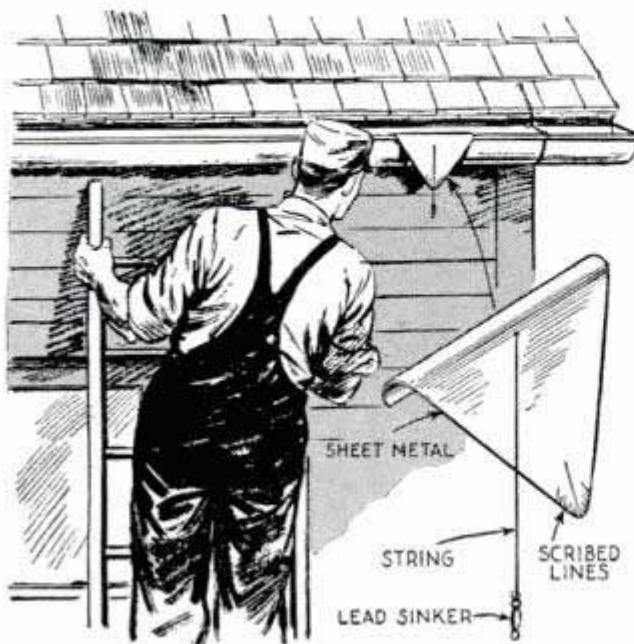

a plumb line and attached a lead sinker to this to complete the assembly. The triangle was bent to hook over the rim of the trough and scribed lines at the lower angle were figured to indicate the degree of pitch. When attached to the trough, the suspended line against the marks shows the direction and degree of the pitch.

Blueprints Kept Rolled by Clips Permanently Attached to Them

To keep blueprints and maps rolled and yet always ready for use without rubber bands, one artist inserts brass paper clips through the upper corners as indicated. When the sheet is rolled, it is only necessary to bend up the clip and spread the legs to secure the roll.

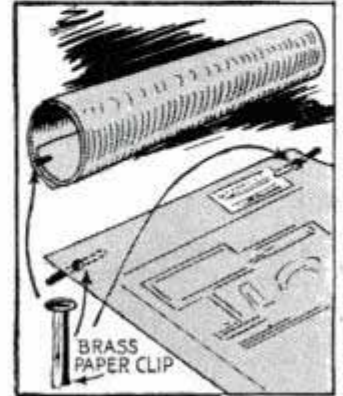

Sign Painter Uses Vacuum Cups to Hang Portable Shelf

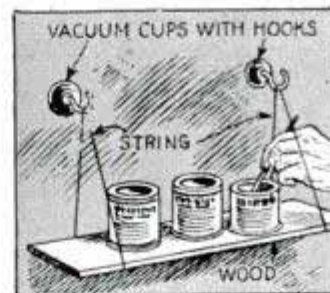

A sign painter uses a portable shelf to keep his accessories close at hand when working on large windows and attaches it to the glass with a couple of small

vacuum cups. These are of the type fitted with hooks, from which the shelf is suspended by means of fine wire or string as indicated.—Dale Van Horn, Lincoln, Nebr.

Price Tags Are Self-Supporting

Annoyed by the lack of enough clips to support price tickets, one showcard writer made them self-supporting. The tickets are lettered as indicated, after which they are folded and the ends stapled together so that they will hold their shape.

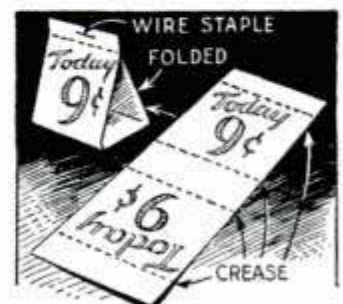

Oil Drum Forms Ends for This Portable Bench

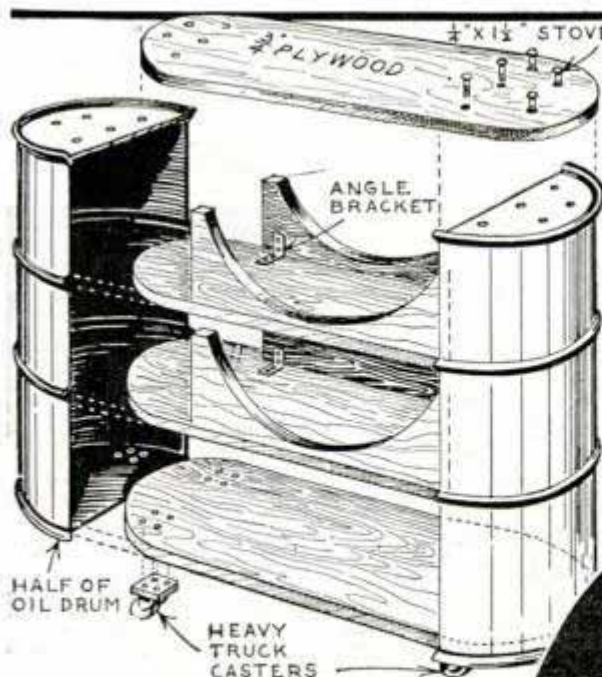

Highly convenient in the garage as it can be rolled beside a car so that tools can be reached quickly, this portable tool bench will save the garage mechanic many steps. As you can see, it is made by cutting a discarded oil drum in half and fitting four plywood shelves between the two halves. The rounded ends of the center shelves are beveled to fit in the V-grooves of the drum and are held in place by the top and bottom shelves. Sides may be added to the upper shelves to keep small tools and parts from rolling off

Dash Lights Show If Headlights Are Raised or Depressed

With two pilot lights on the instrument panel, you can tell at a glance whether your headlights are turned on the high or on the depressed beam when another car is approaching. Radio panel lights can be used for this purpose. The wiring diagram shows just how to make the connections so a red light will show when the headlight beam is raised, and a green light when it is depressed. If desired, the green light can be eliminated, the driver depending on whether the red light is on or off.



Padlock Around Starter Button Helps Avoid Theft

If the starter-switch button of your car is on the floor boards, you can make it pretty hard for anybody to start the motor by simply clipping the hasp of a small padlock under the button. This prevents the latter from being pressed down far enough to close the starter switch.

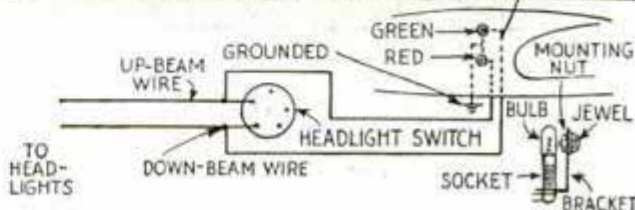

Mirror Aids in Checking Battery Installed under Car Hood



When the battery is located underneath the hood of the car and it is difficult to see into the cells, a small mirror held at an angle above the cell openings will enable you easily to determine the height of the electrolyte. This is especially handy where the hood of the car makes it almost impossible to hold your head so that you can see inside the cells.

Cleaning Radiator Hydrometers

Radiator hydrometers that have a greasy coating inside so they are difficult to read can be cleaned by flushing them with alcohol that contains an anti-rust solution. Improved reading of the instrument makes the few minutes required to do this worthwhile.—Emil J. Novak, Omaha, Nebr.

Trip Mileage Noted on Glass Beside Speedometer

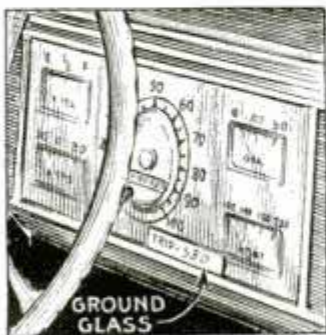

Missing the trip-mileage portion of the speedometer on my new car, I used a piece of ground glass on which to note the mileage of various trips taken. The glass is cemented to the instrument panel close to the speedometer. Before starting on a trip, the speedometer reading is copied on the glass with a pencil. Then,

Missing the trip-mileage portion of the speedometer on my new car, I used a piece of ground glass on which to note the mileage of various trips taken. The glass is cemented to the instrument

at the end of the trip, a simple problem in subtraction shows the exact mileage traveled.—K. M. Becker, Sparks, Nev.

Hose in Spark-Plug Wrench Protects Porcelains

If you have had a spark-plug wrench break a porcelain on a plug when removing it, slip a piece of hose inside the socket portion of the wrench as shown in the drawing. The

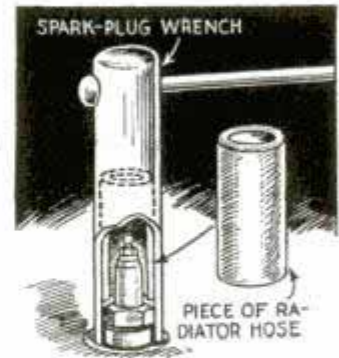

hose tends to cushion the inner surface of the socket and protect the fragile porcelain.

Easy Repair for Broken Muffler

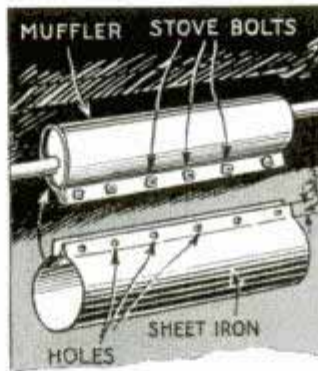

it is clamped in place. If the sheet metal is cut and fitted carefully, all leakage of exhaust gases will be stopped.

—J. E. Chapman, Cincinnati, Ohio.

Holes that have rusted in the outer shell of an exhaust muffler can be repaired by clamping sheet metal around them. The metal is shaped as indicated and drilled for stove bolts with which

Insulating Floor Boards Assures Foot Comfort on Long Drives

Passengers in the front seat of a car are often discomforted by heat from the exhaust pipe being transferred through the floor boards to their feet. A simple way of eliminating this trouble is to insulate the floor with a sponge-rubber kneeling pad.

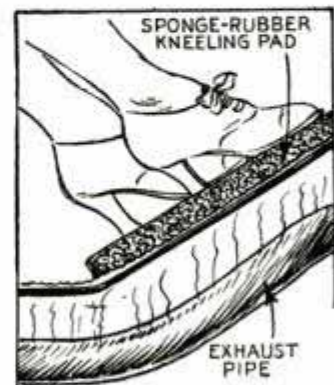

Also, the rubber provides a pleasant cushioning action under the feet.

Simple Methods Identify METAL of BROKEN CASTINGS

STAINLESS Alloys: Stainless steel and Monel metal usually present no identification problem as the maker will generally call attention to the fact that these metals were used. In addition, their bright stainless surface distinguishes them from other metals although it is important not to confuse these metals with chromium plate. Monel metal can be distinguished from stainless steel by the difference between their specific gravities. See Figs. 4 and 5.

Copper Alloys: Bronze, brass and aluminum bronze are reddish or yellow in color, and can be distinguished from other metals if surface coatings of paint, dirt and corrosion, and plating are filed or ground off to expose the base metal. The other commonly used metals are white or gray in color. Bronze is definitely reddish in color and most brasses are yellow. Red brass is difficult to distinguish from bronze, but both are repaired by the same methods. Aluminum bronze is a yellow-gold color but can be distinguished from brass by the specific-gravity test.

Identifying Iron and Steel: Various grades of iron and steel can be distinguished most easily by the kind of sparks given off in grinding, as shown in Fig. 1. The chip test, Fig. 2, is another means of identification. Malleable iron differs from cast iron in its extreme hardness, as a file will hardly touch malleable iron. The fractured surface often gives a clue as to the kind of iron or steel; cast iron shows a very dark gray fracture while the fractures in wrought-iron and low-carbon steel castings are bright gray and those of high-

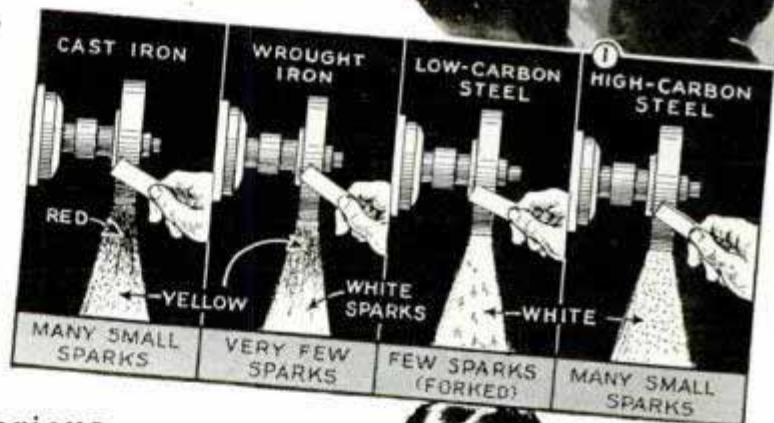

Chip test

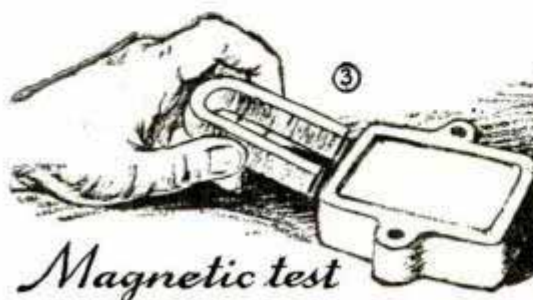

Magnetic test

CAST IRON	WROUGHT IRON	LOW-CARBON STEEL CASTINGS	HIGH-CARBON STEEL
Chips break into small pieces, leaving fairly smooth surface	Soft and easy to chip; chips usually break in large pieces. Chipped surface quite smooth	Easily cut, leaving smooth surface. Chips are long, and have little tendency to break under chisel	Difficult to chip due to hardness. Chips are large. Chipped surface very light gray

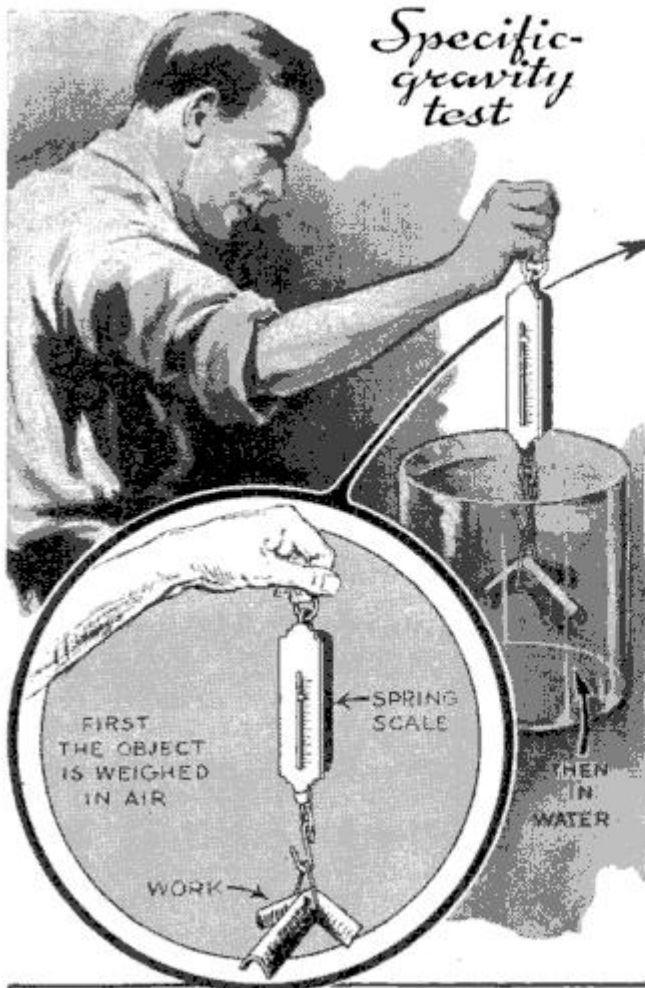

Specific-gravity test

EXAMPLE	
WEIGHT IN AIR	= 6.50 LBS.
WEIGHT IN WATER	= 5.75 LBS.
LOSS OF WEIGHT	= 0.75 L.B.
SPECIFIC GRAVITY	$\frac{\text{WEIGHT IN AIR}}{\text{LOSS OF WEIGHT}} = \frac{6.50}{.75} = 8.7$
If metal is white and non-magnetic, it is nickel silver (see table)	
If metal is yellow or reddish and non-magnetic, it is brass (see table)	

suspend the article from an ordinary spring scale by a light wire or string to get the weight in air. Then suspend the article in water, using the same scale, and subtract this weight from the weight of the article in air to find the loss of weight. Then the specific gravity is found by dividing the weight in air by the loss of weight. White non-magnetic alloys vary in specific gravity from about 1.7 to 8.8.

Repair Methods for Iron and Steel: The best repair methods depend primarily on the alloy, but in some cases there is a choice of methods, depending on whether the casting is or is not subject to severe strain. Cast iron is best repaired by bronze-welding, using the oxyacetylene torch. Bronze-welding also should be used

on malleable iron. The crack should be "veed" out as shown in Fig. 7, and the surfaces should be freed thoroughly from rust and scale by grinding, and then cleaned. The same procedure is necessary before any brazing or welding operation. Heat is applied with the torch, using a neutral or slightly oxidizing flame as shown in Fig. 6, heating the metal to a dull red heat, which will just permit the bronze welding rod to flow. The metal must not be overheated, and an excess-acetylene flame must not be used. The rod is dipped in flux and applied to the hot surfaces to tin them, and then more welding rod is applied to fill the gap, using flux as needed to remove oxide. The weld

⑤ PROPERTIES OF ALLOYS				
Specific Gravity	Color	Magnetic Properties	Name of Alloy	Repair Methods
8.9	White (stainless)	Non-mag.	Monel metal	Gas-weld; braze or silver-solder
8.8 to 9.0	Reddish-yellow	Non-mag.	Bronze	Bronze-weld (fusion); silver-solder or soft solder
8.7 to 8.8	White	Non-mag.	Nickel-silver	Silver-solder or soft solder
8.4 to 8.8	Yellow or reddish	Non-mag.	Brass	Braze; silver-solder or soft solder
7.5 to 8.2	Yellow-gold	Non-mag.	Aluminum-Bronze	Braze; silver-solder or soft solder
7.6 to 7.8	White (stainless)	Non-mag.	Stainless steel	Gas-weld; arc-weld; silver solder or soft solder
7.6 to 7.8	White	Magnetic	Steel	Bronze-weld; gas or arc-fusion weld
Ab. 7.6	White	Magnetic	Malleable iron	Bronze-weld
7.0 to 7.6	White	Magnetic	Cast iron	Bronze-weld
7.0 to 7.6	White	Non-mag.	Pewter	Soft solder
6.7 to 6.8	White	Non-mag.	Zinc alloys	No satisfactory methods
2.7 to 3.0	White	Non-mag.	Aluminum alloys	Gas-weld or soft solder with special flux
2.0 to 2.5	White	Non-mag.	Aluminum-magnesium alloys	Solder with aluminum solder and flux
1.7 to 1.8	White	Non-mag.	Downmetal	Gas-weld with special rod and flux

carbon steel are light gray. Iron and steel are the only metals appreciably affected by an ordinary magnet and can be identified readily in this way, as shown in Fig. 3.

Other White Metals: To distinguish other white or gray alloys commonly met with, it is only necessary to determine their specific gravity (specific gravity is the weight of an object divided by the weight of an equal volume of water). Measuring specific gravity is shown in Fig. 4. First

should be made a couple of inches at a time, first tinning the metal for about 2 in., then filling.

Steel castings can be repaired by bronze-welding in the same manner as described for cast iron. However, the strength will be materially less than the strength of the steel proper. If strength is essential in the casting being repaired, it will be better to make a fusion weld, using regular steel welding rod according to the usual pro-

Oxy-acetylene flames

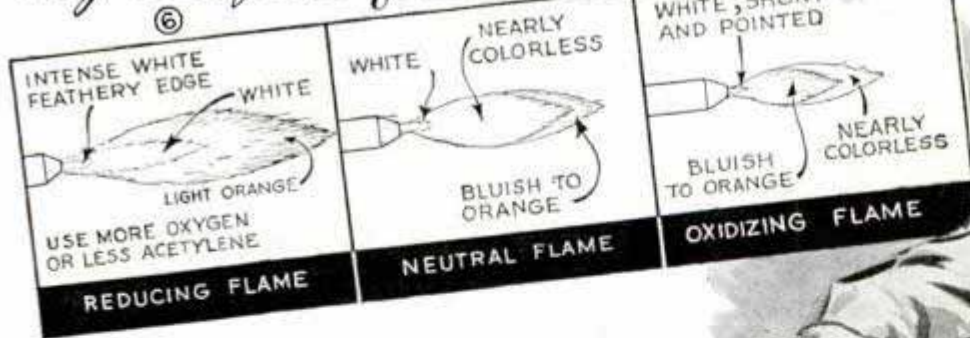

cedure. If preferred, arc-welding equipment can be used for this purpose.

Stainless steel can be welded with a flame either neutral or slightly excess in acetylene, as shown in Fig. 6. If arc welding is done, shielded-arc electrodes must be used, and the electrode is made positive, the work negative. Stainless-steel welding electrodes having approximately the same composition as the stainless steel itself should be used. Stainless steel also can be brazed or silver-soldered, and if strength is not needed, it can be soldered with ordinary solder, using hydrochloric acid as a flux. Monel metal should be welded using Monel welding rod, or silver-soldering may be applied.

Aluminum Alloys: Aluminum alloys and magnesium-aluminum alloys can be soldered by using commercial aluminum solders and flux, and a blowtorch or similar heat source to heat the metal. However, the work is somewhat exacting and frequently gas welding is a better solution. The flame used should be neutral or slightly reducing (excess acetylene). An active flux designed for use on aluminum also should be used liberally. Aluminum is very weak at its melting point and so the work must be well supported. The welding rod used preferably should be of about the same composition as the alloy used in the casting; and the work should be preheated to save on gas in welding. Dowmetal should be welded with a special welding rod and flux made for acetylene-welding Dowmetal, which are available from the manufacturer of the metal. The flux should be removed from the metal after welding to prevent corrosion.

Copper Alloys: Brass castings can be bronze-welded by a technique very similar to that used in bronze-welding cast iron. However, the melting point of brass is only slightly higher than that of the bronze welding rod, and care is needed to prevent

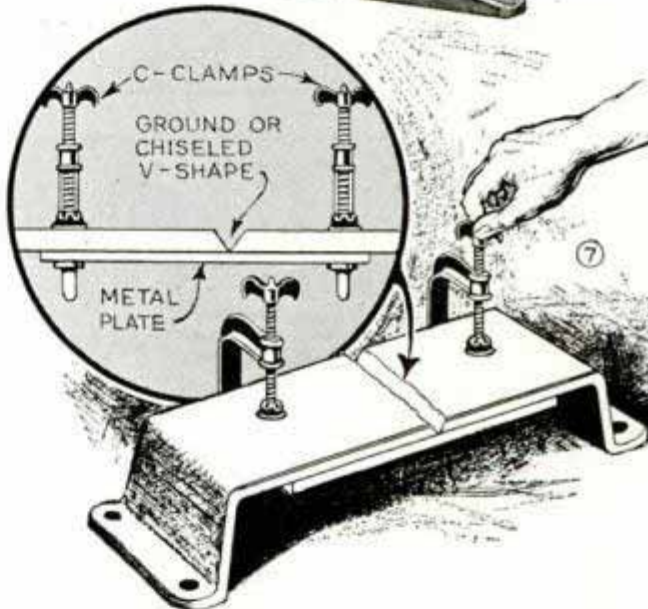

overheating and melting the base metal. Brass also can be soldered very readily, using zinc-chloride flux, if great strength is not required. Brazing or silver-soldering will give considerably greater strength, and in many cases these are the most satisfactory methods to use on brass castings. Bronze also can be welded with bronze welding rod, but the technique is different. The melting point of bronze is about the same as that of the bronze welding rod, and so the base metal is melted and fused with the welding rod to make the joint. Welding flux is used as usual to remove oxide. Silver solder or ordinary soft solder also can be used on bronze. Aluminum bronze and nickel silver can be brazed, silver-soldered, or soldered.

Foot Scraper on Running Board Folds Out of the Way

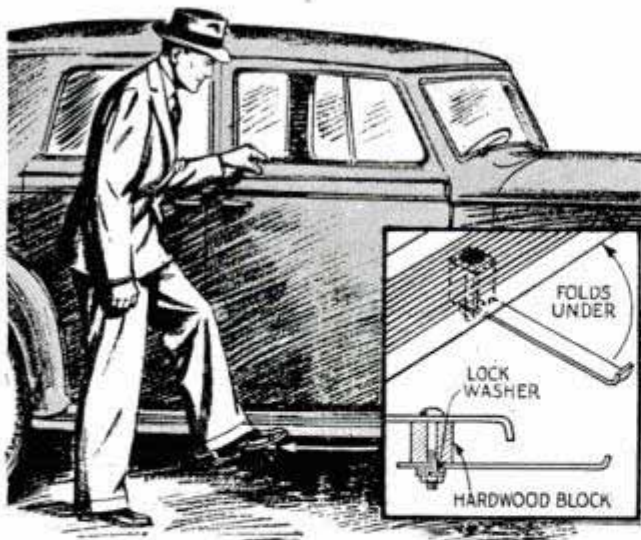

Motorists who sometimes have to get out of their cars where their shoes are likely to get muddy, will find this foot scraper just the thing to help avoid getting the interior of their cars dirty. The scraper is nothing more than a short length of flat iron pivot-

ed to the underside of the running board by means of a bolt and a hardwood block, as shown in the detail. It's best to use a carriage bolt on a metal running board as the head will have to project. On running boards of the wood type it is countersunk.

Brake Drum in Small Parts Pan Keeps Work Within Reach

An old brake drum inverted in a pan of gasoline used for cleaning small parts in a garage, provides a table on which the work can be placed so that it is easily found when needed. The drum is especially handy when cleaning exceptionally small parts such as nuts, screws, etc. The cleaning brush is inserted into the gasoline through the hub opening of the drum.

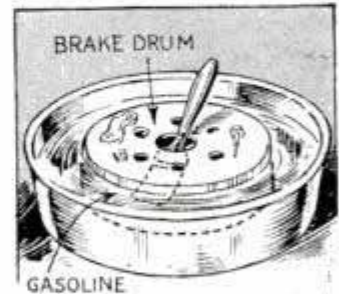

Low-Cost Tractor Built from Old Car Parts

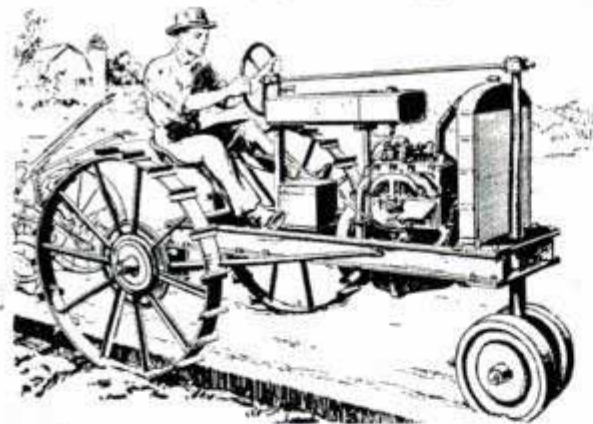

This sturdy, efficient tractor has plenty of power to pull a two-bottom plow and other implements! Built from old car parts, it includes a Ford model-A motor and twin transmissions so that you can get six speeds forward. Wrenches, hacksaw and drill are about the only tools needed to make it—welding can be done at your local machine shop at a nominal cost. Our set of three 17 by 22-in. plans, Nos. 1024 to 1026 incl., provides easy-to-understand assembly details, gives instructions how to proceed step by step, and contains a complete list of materials needed. This set will be sent postpaid upon receipt of 75c.

OTHER BUILD-IT-YOURSELF PLANS

STREAMLINE FAMILY TRAILER—937 to 942: Includes all the conveniences of home with sleeping accommodations for four. Trailer is 15 ft. long and weighs approximately 1,400 lbs. Six prints \$1.00.

UTILITY TRAILERS—986 and 987: Built of old auto parts and lumber. Adaptations of body to suit various purposes. Two prints 50c.

ELECTRIC SPOT WELDER—891 and 892: Works on 110-volt, 60-cycle alternating current. For small work up to 1/8 in. in thickness. Two prints 50c.

ELECTRIC ARC TORCH—1006: Carbon electrodes 1/8 in. dia. produce arc for soldering, brazing, light welding. For 110-v. 60-cycle a.c. 25c.

SINGLE-CAR FRAME GARAGE—621 to 623: 14 by 18 ft. Has space on sides for workbench, shelves, etc. Three prints 75c.

WOODWORKERS' JOINTS—544 and 545: How to cut and assemble all kinds of joints. Every shop should have these reference sheets. Two prints 50c.

CARPENTERS' TOOLBOX—824: 8 1/2 by 13 3/8 by 31 1/4 in. Carries large planes, saws and many other tools. Special rack for auger bits. 25c.

NOVELTY FOOT SCRAPERS—1009: Unusual scrapers that lend distinction to doorsteps. 25c.

METAL WEATHER VANES—520: Scroll-sawed from sheet aluminum. Three designs. 25c.

Any six of these plans (not sets of plans) will be sent upon receipt of \$1

Catalog listing 400 plans included free with your order if specified, or sent separately for 3 cents to cover mailing

Address—Plan Service, Popular Mechanics Magazine, 200 E. Ontario St., Chicago

KODAK VIGILANTS



"First family" of the moderate-price camera clan... eight models

\$14⁵⁰ to \$42⁵⁰

PICTURES ARE BIG . . . 2½ x 4¼ inches with the Six-16's, 2¼ x 3¼ inches with the Six-20's. **FEATURES ARE MODERN . . .** Single push button for opening and closing. Waist-level and eye-level view finders. Retracting body shutter release. Extra-rigid lens support. **LENSES** are genuine Kodak Anastigmats. And the **SHUTTERS**, all highly accurate and reliable, include Eastman's new nine-speed Supermatic.

See these finest of moderate-

price folding cameras at your Kodak dealer's. Go over them "with a fine-tooth comb," and you will agree that rarely has so little money bought so much picture-taking ability.

. . .

PRICES: Kodak Vigilant Six-16, f/8.8 lens, \$16; f/6.3 lens, \$19.50; f/4.5 lens, \$29; f/4.5 Special lens, \$42.50. Kodak Vigilant Six-20, f/8.8 lens, \$14.50; f/6.3 lens, \$17; f/4.5 lens, \$25; f/4.5 Special lens, Supermatic shutter (illustrated), \$37.50 . . . Eastman Kodak Company, Rochester, N. Y.

GOING TO THE NEW YORK WORLD'S FAIR?—Take your Kodak—visit the Kodak Building—see the Greatest Photographic Show on Earth.

Only EASTMAN makes the KODAK

Beating Robin Hood at His Own Game

(Continued from page 357)

slopes. Then try your luck at rabbits, birds, squirrels until you think you are proficient enough to tackle a deer.

"A field archer must be in good physical condition—his reactions trigger-quick. He must know the flora of the woods, the different types of terrain and the habits of animals he is stalking. He must be able to shoot from any position—sitting, standing, kneeling, crouching.

"When hunting, a field archer should use a bow that is as heavy as he can draw. The reason for this is obvious. The field archer does not use the point-of-aim technique but draws the arrow under his eye so that he may sight along the shaft. A sixty-pound bow will cast an arrow about forty yards in a flat trajectory while a 100-pound bow will throw it seventy or eighty yards. Thus, a stronger bow is more accurate for longer distances."

Hunting bows, says Hill, are usually made of Osage orange wood because it is tougher and stronger than yew wood commonly used for target bows. Better yet, however, is bamboo—faster, more durable, and tough as steel. Hunting arrows are longer and heavier than target arrows and are tipped with barbed-steel heads.

When stalking an animal, the field archer should carry his arrow notched on the string of his bow. From this position he can shoot at the first flicker of movement. When he knows that game is near by, he may have his bow half drawn. The target archer draws his bow in two movements—the thrusting out of the arm that holds the bow and the drawing of the arrow; the hunting archer, however, performs both movements at the same time in the "spread" draw. Hill has learned the best shot is to aim for the chest cavity of an animal. Such a shot brings death quicker and more mercifully than a bullet.

"The man who says he would face any animal in the world with bow and arrow is either crazy or a liar," declares Hill.

"I have shot moose in Canada, Big Horn sheep in the Rocky Mountains, alligators in Florida and wild boar in California, but not without certain precautions. I wouldn't shoot a charging animal unless I were certain I could get out of its way. I have put an arrow clear through a charging Grizzly bear and it didn't stop coming. It's always

common sense to have a tree or rock near by to get to when big game charges at you."

Shooting fish with arrows is becoming popular, says Hill. Here are several tips:

"Refraction of light in water makes fish appear to be where they aren't. Clearness of the water, light conditions, depth of the fish, etc., all affect refraction. I always take a wooden fish with me, anchor it on the bottom and take a few practice shots so as to gauge the refraction.

"A bullet will penetrate water only a couple of feet but an arrow will penetrate five or six feet. To kill a fish, shoot for its head or gills. If you want to play it on a line, aim for its tail. Your fishing arrows should carry a light silk or wire line—otherwise your quarry will be lost."

Howard Hill, as well as being the top-flight field archer in America, also makes archery tackle.

"Science," he says, "has provided American archers with the best tackle in the world. With a Yankee love of invention and improvement—whether it be archery tackle, radio, or airplanes—we have developed ways of making bows and arrows that are far superior to those of olden times.

"Although many archery champions do make their own tackle, if you're a beginner you'll have more success if you purchase your bows and arrows. There are about 300 bowyers in the United States today—all expert craftsmen.

"Bows are still made without the use of machinery, but the modern bowyer has a scientific knowledge of woods, grains, seasoning, strength, etc. While the bow is being shaped carefully from the raw wood it is subjected to continual tests and measurements. Both top and bottom must bend equally along their whole length, and the maximum spring must be developed.

"Arrows are even more important than bows. It is possible to be a good shot with a poor bow, but not with poor arrows. The arrows of today's archers are made from straight-grained cedar, machine-tooled to absolute straightness, fletched with feathers from the same wing of the same bird, and balanced to the fraction of a grain."

Archery is a sport for men and women of all ages, popular around the world. In a hurrying, mechanical age, archery's primitive appeal is a strong one.

You may worry about the plumbing



but here is one worry you can avoid

With proper care you might have avoided the worry of that leaky pipe. That's true about chassis lubrication too.

A haphazard job with ordinary grease means early repair bills. That's why it is important to remember one word: "MARFAK," which means our 40-point Chassis Lubrication Service. We are trained in a special Texaco lubrication school. We work from a special Texaco "Lubrication Guide," so we don't miss a point on *your* car. We use Marfak lubricants. They last twice as long as ordinary grease.

Look for the bright red sign, "Let us Marfak your car," at Texaco and other

good dealers' stations and leave your chassis lubrication worries with an expert.

TEXACO DEALERS INVITE YOU TO tune in the TEXACO STAR THEATRE—Starring Kenny Baker and Frances Langford—Every Wednesday Night—Columbia Network—9:00 E.D.T., 8:00 E.S.T., 8:00 C.D.T., 7:00 C.S.T., 6:00 M.S.T., 5:00 P.S.T.

Let us
MARFAK
your car



Copyright 1940
The Texas Company

TEXACO'S 40-POINT CHASSIS LUBRICATION SERVICE AT ALL TEXACO AND OTHER GOOD DEALERS

Mining Mud with a Biscuit Cutter

(Continued from page 389)

which caisson men and divers work; but it is enough to send about fifteen men a day up for first aid with cracking ears, nosebleed or sinus pains. And it is enough to protect against cave-ins. On several occasions the air has burst through sand pockets and escaped, lowering pressure in the tunnel and letting the street sag slightly, halting traffic temporarily. But on the whole the subway builders are proud of

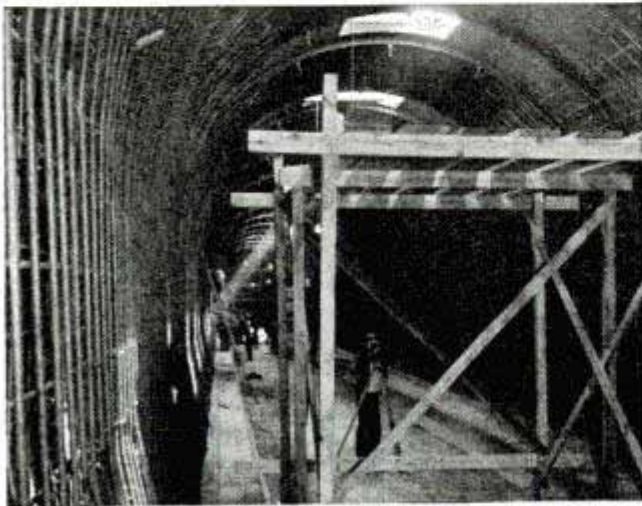

Engineer takes sights in the steel tube that was later floated to its site under river

their safety record. With thousands of men at work underground, in the first year there were three casualties—two men killed by a live wire, one by an elevator.

Rescue squads practice daily in gas masks, but they have had little work to do. Once they were called to fight fire and carbon monoxide when sparks from a torch lit straw in a tunnel under ten pounds of air. For sixteen hours they fought the blaze and smoke. Seven were overcome.

Up on the street scouts are on guard constantly, watching for any bulge or sag of the pavement as the biscuit cutter inches ahead. Twenty-five feet in advance of the shield a level is set on the sidewalk, sighted on a rod atop the streetcar tracks. The instant a change as little as an eighth of an inch is seen in the street level, the man on the surface presses a button and a siren shrieks warning down at the shield. All work stops at once until shield work or air pressure is adjusted to prevent further variation of the street level. At one time, early in the project, a section of North State street settled down four or five

inches; excavation had been going faster than the concreting of the tunnel, air pressure was not enough to compensate for street pressure, and digging had to be halted until the concrete lining could catch up to the handhogs.

The layman might think it far easier to bore through clay than through rock, yet one Chicago subway contractor called boring through rock "a cinch compared to a job like this." Chicago's bed of clay is eighty feet deep; beneath that, bed rock. Some of the sticky stuff squeezed through the biscuit cutter has "assayed" fifty-eight per cent water. From the top of the tunnel to the street is just twenty feet of blue clay and paving, and in places the cutter misses skyscraper foundations by just five feet. But one thing can be said in favor of the clay—when subway trains start roaring through the tube in a year or so, the clay will absorb vibrations as if the tunnel were mounted in rubber.

The twin tunnel that crosses beneath the Chicago river on State street, near the site of old Fort Dearborn, was prefabricated and floated to its bed. Built of steel and concrete, the tubes were towed by tug from the factory to site, weighted with concrete and sunk into the bed prepared by dredges. Divers guided the tubes into the exact channels to meet the handhogs burrowing from North State street and the biscuit cutter advancing from the Loop.

Eighty years ago the first horse car ventured out into the bog that was State street then. Sixty years ago the cable car ushered in the eighties. The first electric trolley arrived with the Gay Nineties, and two years later, in 1892, Chicago's first elevated—then a steam railway on stilts—was strung up to ferry the crowds out to the glittering Midway at the World's Columbian Exposition. Now, at last, Chicago is to have a subway. Fifteen other cities got there first, from London in 1863 to Moscow in 1935, and it can't be predicted yet when the escalators will start rolling the crowds down to subway stations under the Chicago Loop. But contracts call for "substantial completion" of the tunnels by December 31, and it won't be many months before the green lights of the automatic control system show the way to Chicago's first passenger subway train.

There is
a Goldmine
in Your Own
Backyard

A goldmine of Health, Pleasure, Better Living and Profit lies right in your own home-yard. That little plot of ground will grow all the fresh fruit your family can eat—enough to put up—and give you a tidy Profit every year besides.

Slash Living Costs with Stark YOUNG-BEARING Fruits

Think of the pride and enjoyment of bringing your own trees to fruiting—in spring sweet-smelling blossoms, apple, peach, cherry, plum—the grateful shade during summer—and the ripening of delicious red, gold and purple fruits—STARK and BURBANK EXCLUSIVE Prize Fruits—health-giving—adding zest to your meals; fresh fruit in season—tasty preserves to enrich the winter diet—and a surplus to sell at TOP PRICES.

FREE—Stark's BIG JUBILEE PRIZE FRUIT Book

Shows all STARK and BURBANK U. S. Pat. Prize Fruits—young-and-heavy-bearing—scores of varieties—with astounding records as Profit Producers: the famous GOLDEN DELICIOUS and STARKING Apples—the gigantic delicious HAL-BERTA and Burbank JULY ELBERTA Peaches, Red and Gold Plums, Berries and Grapes—the most magnificent collection ever gathered in the pages of one Book—send for your FREE copy.

Also FREE—"Home Orchard Profit Guide" With PLANTING PLANS

Don't let lack of experience worry you—along with the Big JUBILEE Book we will also send you FREE, the HOME ORCHARD PROFIT GUIDE—it brings the benefit of 125 years experience in fruit-growing—tells you how and when to plant—gives planting plans, simple

diagrams and complete information that make it EASY to grow these wonderful Prize Fruits. Ask for this Helpful Book.

FREE BOOK—"How You Can Landscape Your Own Home Grounds"

In addition to World's Prize Fruits the Big JUBILEE Book also shows marvelous Stark & Burbank Ornamental Beauties—Shade Trees, Shrubs and Roses. Be sure to check Coupon also to get your FREE copy of the New Landscaping Book, an invaluable aid in landscaping and beautifying home grounds.

Plant NOW and Gain a Year

Plant fruit trees NOW—and gain a year in bringing them to fruit. Stark Berries and Grapes often bear 1 yr. after planting—peaches in 2 yrs.—GOLDEN DELICIOUS apples bore in many states when only 2 years old. Send in the Coupon TODAY—get these Helpful Books and Information—plant NOW and gain a year.



MADE \$319.23 in 2 MONTHS



SELLING STARK TREES

{ If you would like to engage in a Profitable, Dignified occupation, read the message below }

A. F. Klawe of Michigan is one of many men from all walks of life who add FINE EARNINGS to their incomes by selling STARK Prize Trees—Shrubs & Roses in Spare Time. In just 2 recent months he made \$319.23 CASH.

This pleasant, healthful, PROFITABLE occupation requires no investment. No experience is necessary to start—we supply everything you need—and STARK High-Quality Trees make it EASY to take orders. Check space to right to receive our Liberal Weekly Cash Income Plan.

FINE SELLING OUTFIT Free CLIP COUPON

P. M. 9-40

STARK Nurseries
Box Y-00
Louisiana, Mo.

Send me FREE Big New JUBILEE FRUIT BOOK, also FREE STARK HOME ORCHARD PROFIT GUIDE with PLANTING PLANS.

Check here for FREE Book "HOW YOU CAN LANDSCAPE YOUR OWN HOME GROUNDS."

I may plant ----- Trees, Shrubs, Roses
(Number)

Name -----

Address -----

Town ----- State -----

If you are interested in selling, check here for FREE details of our NEW Liberal Weekly INCOME-PLAN for Salesmen

Free SEND COUPON For These 3 Helpful Books



Luther Burbank

STARK-BURBANK INSTITUTE OF HORTICULTURE is carrying forward the great scientific work of Luther Burbank. Stark Bro's, successor to Luther

Burbank, have exclusive Propagation, Control and Sale of Burbank's New Creations.

STARK Bro's Nurseries

Box Y-00 Town of Louisiana, MISSOURI

Largest in the World—Oldest in America
A Branch Nurseries—Coast to Coast

K932

Buying Sight Unseen

(Continued from page 409)

directly; for they are generally applied only to wholesale transactions. A farmer, for instance, can haul his eggs to market, sell them with no inspection. But the large poultry raisers in California could not possibly sell all their eggs locally. Most of them are shipped to New York, Chicago, and other large cities, where buyers insist on graded goods carrying the government stamp.

No one would buy a carload of eggs from 3,000 miles away, without knowing exactly what he was getting. But by calling in a government inspector to candle those eggs, the shipper can sell them as "U. S. Specials," and the buyer will know he is getting only fresh, clean eggs, of uniform size.

Lettuce is even more perishable than eggs. If picked a day late, most of the heads will be burst. If a few days early, the heads will be under size. Yet practically all the iceberg lettuce consumed in this country is bought by telegraph while the cars are speeding eastward. A government inspector has checked random boxes from each car for count and quality.

There is nothing compulsory about this. The packer requests the inspection, pays the government five dollars a car. But that government stamp more than pays for itself; it enables the shipper to get top prices.

Grain inspection, and the use of officially recognized designations in selling, are compulsory. Every lot of wheat sold must meet the official specifications for that grade. In all the marketing centers, government men enter each car, take samples throughout its depth, certify it as to class, moisture, foreign material, weight per bushel, and condition.

Cotton grading, also compulsory, is the hardest task of all. Each inspector has a box containing samples representing the nine grades into which cotton is divided and classification is made by comparing lint taken from the bale with fibers from these official forms.

The cotton spinner no longer finds it necessary to order 5,000 bales of cotton to insure receiving 2,000 bales of the right quality and staple. Waste is thus eliminated, distribution costs are cut.

A common language in commerce means money in our pockets.



P. W. RESETS BATHROOM FIXTURES

You can quickly and easily reset loose bathroom fixtures, loose tiles, seal unsightly cracks around bathtubs and sinks with water-proof Plastic Wood. At Paint, Hardware, 10c Stores. Try it!



PLASTIC WOOD



3-IN-ONE QUIETS SMALL MOTORS

Regular use of HEAVY BODY 3-IN-ONE Oil will add to the life of small electric motors. It lubricates and cleans, prevents rust and tarnish. Shop equipment needs it. At Hardware, Drug, Grocery, 10¢ Stores. Try it!

Ask for

HEAVY BODY



3-IN-ONE Oil

News—Hot Off the Grid!

(Continued from page 415)

ship "Altmark" on the air in a thrilling interview which gave the first details of how the British had driven the "Altmark" ashore and rescued the seamen confined aboard.

Somehow, despite the obstacles of censorship, red tape and the hazards of war conditions, the newscasters manage to meet their radio deadlines and broadcast red-hot news. Miss Breckinridge tells of traveling "by plane, train, boat, tug, bicycle, bus, ice skates, taxi, horse, cab and shanks' mare," broadcasting from "a London sub-basement, the attic of a post office in Dublin, a small house in Stavanger, a derelict, unfinished building in the fortified zone in Berlin."

All the newscasters are confronted with the problem of censorship, some of which doesn't seem to make rhyme or reason. One unusual instance occurred when White was under fire at Viipuri.

"A Russian long-range gun was dropping a shell into town nearly every forty seconds," he said, "at such regular intervals that while trying to get from the hotel to the improvised studio where I was to broadcast, I could make thirty-second dashes and then seek cover before the next one landed.

"When I went on the air a shell landed so near it jarred the microphone. Luckily it was a dud but I couldn't tell the radio audience that. I started to, but the censors stopped me. Later they explained the Russians might be listening, and if they found their artillery was firing duds they'd do something mighty fast about substituting live shells."

Newscasters with censors beside them at the microphone have resorted to ingenious means to evade censorship. One is to put the banned news in American slang. Another is to accent certain words and hope the audience draws a true inference.

The technique of modern newscasting has gone a long way. Radio engineers, technicians and the newscasters themselves are constantly devising new methods of getting hot news on the air. Whatever lies ahead, wherever the big stories break, the newscasters will speed to them despite all obstacles, and somehow put them on the air for radio listeners.



...and **GUESSWORK** makes a mess of motor repair jobs, too. Be safe. Get piston rings that are specifically *Engineered* for your particular model of car.

Insist on

McQUAY-NORRIS ALTINIZED *Engineered Set* PISTON RINGS



EACH Engineered Set is specially made for one particular make and model of car and *precision installed* according to blueprint instructions. Guesswork is eliminated. That's why these rings will stop oil waste and prevent blow-by in *your car*. And McQuay-Norris Engineered Set Piston Rings are the only rings that are *Altinized* to lengthen life and reduce wear.

McQUAY-NORRIS MFG. CO.

St. Louis, Mo.

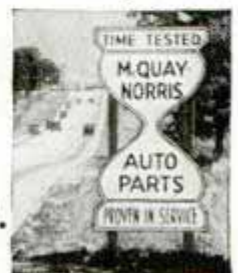

Farming Takes to the Air

(Continued from page 373)

in the half-light cuts down his vision and when he faces the horizontal rays of the rising or setting sun he may have to fly partly blind.

Sometimes, depending on the crop and the dust he is scattering, a pilot has to stay down within one or two feet of the ground. For other work he can climb to eight or ten feet. For general broadcasting where uniformity is unnecessary he may fly as high as fifty feet. Diving down over a line of trees into a field, he opens his gate and gives the engine a burst to blow the material back so that it covers the ground right up to the edge of the field.

A crop-dusting outfit uses a ground crew of several men and a truck or two for hauling supplies. Landing fields are nothing more than level stretches of farm land handy to the work. The crews load the planes by portable lamps before daybreak. For some kinds of seeding one or two members of the ground crew stand out in the field to show the pilot the successive strips that he has covered and the strip that he is to cover next. Carberry's dusting jobs take him all over California and Arizona and occasionally into Mexico. His pilots fly to the scene and the ground crew follows by truck.

Crop dusting and planting by airplane is an established business today and ranchers who used to think of it as a stunt now casually phone the airport and order dusters when they need them. Using an airplane over large acreages is faster, cheaper, and more efficient than doing the work from the ground. Every leaf gets its quota of insecticide when an airplane does the work because the dust particles, hurled from the plane, take on positive charges of static electricity and are repellent to each other, while the crop below, in contact with the ground, has a negative charge and attracts the particles.

Cotton needs a lot of protection from pests and a good proportion of the dusting planes specialize in cotton. One company alone in the south uses twenty planes. A large plantation has dusted 15,000 acres of cotton by air annually for the last twelve years. Working only when the dew is on the crop, at dawn and dusk, an airplane can dust nearly 1,000 acres of cotton a day.



• Of course you'll be comfortable at Hotel Cleveland; you'll be convenient to train and business . . . but—in addition—you'll enjoy your stay.

You might as well have a pleasant trip. You will at Hotel Cleveland.

Rooms from \$3

At the heart of Cleveland, and directly connected with Union Passenger Terminal and Terminal Garage.

HOTEL CLEVELAND
Cleveland

STOP
SEND to Bass for this **DOUBLE 8 REVERE**

LOOK! Light weight — automatic film loop — 5 speeds — 5 ft. spring motor — speed control — 12.5 mm. Wollensak Universal focus F.3.5 lens — Turret model . . . \$68.00 — 500 Watt Revere Projector . . . \$89.00 — write Dept. P.

Only 29.50

Bass CAMERA CO. CHICAGO, ILL.
179 W. MADISON ST.

STOP BACKTRACKING

Don't let confused directions put you on the wrong road. Drive by compass and avoid backtracking.

The Hull Streamline Auto Compass is a positive guide at all times. Attractive Bakelite case, genuine sapphire bearing, built-in compensator. Only \$2.95 at your dealer.

Write for information.

HULL MFG. CO., P. O. Box 246-D9, WARREN, OHIO



DURO

Shipped on ten-day trial money back guarantee. Send your order today or ask us for completely illustrated circular.

Hand Grinders AND ACCESSORIES

DURO METAL PRODUCTS CO.
DEPT. PM-9 2653 N. KILDARE AVE., CHICAGO ILLINOIS

\$6.45 LESS GRINDER

\$5.15 LESS GRINDER

A man on the ground can dust only eight acres in the same time and most power machines dust less than 100 acres a day. Leafy vegetables are dusted with non-poisonous insecticides and root crops get treatments of calcium arsenate and other poisons. Crops to a total of more than 100,000 acres are dusted annually in California. A similar acreage of California rice is planted by airplane at a rate of from forty to sixty acres per hour, depending on the kinds of hazards that the pilots have to dodge at low altitudes. Carberry's airplanes are busy six months of the year.

One of the advantages of aerial planting is that an entire ranch can be seeded in a day instead of over a period of weeks, insuring a crop that matures simultaneously and that allows rapid power harvesting.

Besides planting and protecting commercial crops there are numerous allied uses to which airplanes are being put. One of the strangest of these is scaring ducks. An average sized flock of ducks can ruin hundreds of dollars worth of rice planting a day if left unmolested. The birds are protected by law so the pilots are hired to fly low across the fields and scare them away.

Sowing the open range by airplane to augment the natural sparse grasses and increase the supply of cattle food has been a success in many parts of the west. In Idaho an airplane seeded 8,000 acres in half a day at less than the cost of seeding 600 acres by horseback and in a tiny fraction of the time. Airplanes have been used for distributing fertilizer over large fields, for scattering weed killer, and for shooting coyotes and other predators. Two hunters alone got 500 coyotes in two seasons, shooting from low-flying planes.

It takes weeks or months to poison a vast swamp against mosquitoes, a job that the airplane does in a few hours. Orchards and bogs are both dusted efficiently against pests from the air. Vetch and similar crops that return nitrogen to the soil can be planted from the air while soil-exhausting crops are still standing in the fields.

☐ If you will send stamped, self-addressed envelope to our Bureau of Information, you will be given the name and address of the manufacturer of or dealer in any article described in this magazine.

**TRAVEL!
THRILLS!
ADVENTURE!**



on a
HARLEY-DAVIDSON

Pack your vacation with action — good times—excitement! Explore distant places —see new sights—visit pleasure spots—all at little cost! Pal with fun-loving riders on club runs and gypsy tours. Take in rallies, hillclimbs, race meets and other thrilling events! See your Harley-Davidson dealer — learn why motorcycling is the king of all outdoor sports!

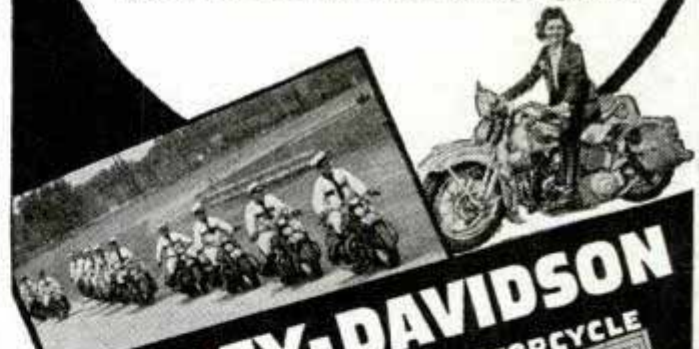

HARLEY-DAVIDSON
WORLD'S CHAMPION MOTORCYCLE

Free

Send Coupon NOW

HARLEY-DAVIDSON MOTOR CO.
Dept. F, Milwaukee, Wis.

Send FREE copy of big 24-page "Enthusiast" magazine filled with thrilling motorcycle pictures and stories. Also literature on the new Harley-Davidsons. Stamp is enclosed for mailing cost.

Name

Address

MAKE BIG MONEY

At Home! New Invention Electroplates by Brush

Plates
GOLD
SILVER
COPPER
TIN
CADMIUM
NICKEL
Easy as
painting

No Tanks, Liquids, Generators DOES SAME WORK AS BIG OUTFITS
Millions of old auto-parts, and all kinds of old, worn articles in homes, stores, offices, factories everywhere can now be electroplated with a permanent brand-new sparkling coat of metal—by electrolysis—with the stroke of a brush. Easy as painting—no dismantling—plates right on the spot. Any electric light socket or car battery. Weighs only a few pounds. Take it anywhere—ready for instant use.

Quick, Easy Way to Start Your Own Business

MAKE BIG PROFITS AT ONCE
Amazing low price and magic-like demonstration brings you thousands of orders for plating from garages, radio shops, bicycle shops, machine shops, home work shops, factories, offices, janitors, doctors, dentists, jewelers and farmers, homes, stores, etc.—with big profits for you! List of plating charges furnished; also report of remarkable daily earnings.

2-MINUTE DEMONSTRATION WITH SAMPLE AMAZES EVERYBODY

Send today for FREE Sample and amazing profit details and bona fide reports of big steady earnings! Also, 3-way proven sure money-making plan. Get started at once on this permanent, profitable business. No competition. Simply mail name on penny post card—NOW! Be the exclusive Warner Nu-Way Electroplater in your community.

WARNER ELECTRIC COMPANY
Dept. 5-E, 360 N. Michigan Ave., Chicago, Ill.

**FREE
SAMPLE
PROVES
CLAIMS**

60 POWER TELESCOPE . . . \$219

VARIABLE EYEPIECE 20X—40X—60X
NEW! Three telescopes in one. 3 different magnifications. 20 power for ultra-bright images with 40 and 60 power for extra long range. Guaranteed to bring distant objects, people, sports events, ships, moon, stars, etc., 60 times as close.

Most powerful made for anywhere near the money. Closes to less than a foot in length. Multiple lens system. 30 mm. objective lens. 5 sections. Directions included for using as a compound 4 lens microscope. American made. Prompt shipment guaranteed. We pay the postage. Only \$219.
BROWSCOPE CO., Dept. 45, 5 W. 27th St., New York, N. Y.

*He Makes a
Good Living*

FILING SAWS

"Last year I sharpened 2309 hand saws, for which I got \$1154.50. The Foley Saw Filer has made a good living for me"—John Joseph, Calif. A FOLEY Automatic Saw Filer files hand, circular and band saws better than the best hand filer. Cash business, no canvassing, no eyestrain. No experience needed. Send coupon for FREE PLAN, no obligation.



FOLEY MFG. CO., 916-40 Foley Bldg. Minneapolis, Minn.
Send Free Plan on Saw Filing Business.

Name.....
Address.....

Next Month's Weather Today

(Continued from page 362)

tion and a faculty job at California Tech.

About three years ago, Krick decided that meteorology had progressed to a point where it could be applied to commerce. After a year of test predictions in which his long-range technique was carefully developed and proved, he launched the Krick Industrial Weather Service. He picked the motion-picture industry for his first customer. A three-month trial demonstrated the service so successfully that



Teletype speeds Krick's weather warnings to clients of forecast service

in 1938 Krick filled 6,000 studio requests for special weather forecasts. His predictions have saved producers literally millions of dollars, since a day lost through unanticipated weather conditions might well run into fabulous money where, say, 1,000 extras, high-priced stars, directors and technicians on location are involved.

Today Krick's clientele has expanded to scores of other businesses, continent-wide. Last spring he advised a Chicago ice-cream manufacturer three weeks in advance of an unseasonable hot spell coming, giving his client a big advantage over unprepared competitors. Krick foretold the arrival of the Rio Grande valley's first killing frost in twenty years a full week in advance and a tomato-growing California client realized \$300 extra profit per carload by holding up shipments east until the market had soared on word of the southern freeze.

Krick tells fruit and produce growers

(Continued to page 124A)

NEW!

Now It's Easy To Cut Long Pieces Of Lumber!

CRAFTSMAN BUILDER'S SAW

No Other Saw In **\$39⁹⁵**
The World Like It! **LESS MOTOR**

Now, for the first time, a moderately priced saw for cutting long, heavy lumber. Work remains stationary—*movable blade* cuts quickly and accurately. Will do 90% of the work done by many \$200 radial type saws.

Ideal for carpenters for framing lumber; for concrete men for form lumber; for factories for crating lumber; and for all contractors and builders.

Easily portable. Legs and motor removable for transportation. Depth of cut adjustable, and is shown by gauge. Has miter bar for angle cuts. Rip fence locks at both ends. Heavy steel table has removable insert for dadoing. Blade can be locked as in usual type table saw and work moved into it if desired.

Extra large table — 34½ x 22 in. To get a table size like this you normally would have to buy expensive extensions.

Now on display at Sears stores. Stop in today and see this amazing new CRAFTSMAN Builder's Saw that will save you work and money. Price: \$39.95 without motor, even less in some territories. Can be bought on Easy Terms.

SEARS, ROEBUCK and CO.
Stores Throughout the United States



SPECIFICATIONS

Over-all Height.....	40 in.	Distance in front of blade (at miter bar) 19 in.
Over-all Width.....	25 in.	Table size.....
Over-all Length.....	40 in.	34½ x 22 in.
Combination blade.....	8 in. dia.	Two ball bearings on spindle.
Maximum depth of cut.....	2¼ in.	Motor recommended, ¾ H.P.—3450 R.P.M.
		Max. carriage travel.....
		19¼ in.

OTTAWA LOG SAW \$39 BIG BOOK FREE



PUTS THIS OTTAWA to work for you. **MAKE MONEY!** Wood is valuable. Does more than 10 men. Easily operated. Falls trees—saws limbs. Use 5-hp. engine for other work. Write for **FREE Book.**
OTTAWA MFG. CO.
3527 Wood St., Ottawa, Kans.

SAW 10 TO 20 CORDS A DAY



Do more Earn more Work less with a

Red Universal E Tractor

You plow, disc, cultivate, mow, haul, do belt work, for about 33¢ a day. Safe, trouble-free long life. New plow lift, new reverse. Hundreds used. Save by buying from maker. Two weeks trial. **FREE** catalog. Write today.

PIONEER MFG. COMPANY
Dept. V-90 West Allis, Wis.



EASY PROFITS IN PAINT SPRAYING

Paint walls, ceilings, screens, furniture, radiators, machinery faster, better! ¼ H. P. motor 110 Volt 60 Cycle AC, complete with Spray Gun, 15 ft. hose. Weighs only 44 lbs. Carry anywhere. **FULLY GUARANTEED.** Complete with motor only \$31.15, or only \$25.00 less motor, f. o. b. Chicago. \$5 Deposit, Balance COD, or **SEE YOUR DEALER.** Circular **FREE.** Get started making money NOW! **\$25⁰⁰ Less Motor**
Ideal Automatic Pump Co.

Dept. PM-9, 801 Washington Blvd., Chicago, Illinois



PUSH BUTTON CONTROLLED GAS TANK LOCK

ELECTRIC—OPERATES FROM DASH. Sold as standard accessory on the **NEW GRAHAM Car.** Streamline in design, low in price, year guarantee. Distributors, dealers here is the fastest selling thing out. Write now for free literature.
SNAP-UP GAS CAP CO. DEPT. 6 ASHLAND, KY.



Own A Printing Business

Spare time or full time. Print Cards, Tickets, Stationery, Advertising, Labels, tags, circulars, etc. Good profits. Easy rules supplied. **Print Your Own** greeting cards, movie titles, church work, etc. Save money. **Junior Press \$8, Senior Outfits \$16 up.** Have home shop. Raised printing like engraving too. Sold direct from factory only. Write for free details.

KELSEY, INC., B-37, Meriden, Conn.

Ready Now **New TRAILER PARTS** Catalog

and **TRAILER BUILDERS MANUAL—25 cents**
80 Illustrated Pages packed with ideas and suggestions for Trailer Builders, Buyers, and Owners. Largest and most complete line of Trailer Parts, Supplies and Equipment at America's Lowest Prices. Rush 25¢ (in U. S.) for this book today. Satisfaction guaranteed!
TRAILER SUPPLY CO., BOX 360-A, WAUSAU, WIS.



FREE Stove Catalog



Factory Prices

New streamline designs! New features! 136 Styles and Sizes. Coal Wood Ranges; Combination Gas-Coal or Oil Ranges; Electric Ranges; Oil Ranges; Oil Heaters; Coal-Wood Heaters; Furnaces. 30 Days Trial. 24 hour shipments. 1,600,000 Satisfied Users. Stores \$5 Down, up to 18 months to pay.

"A Kalamazoo Direct to You"
KALAMAZOO STOVE & FURNACE CO., Mfrs.
391 Rochester Avenue
Kalamazoo Michigan

When writing please mention Popular Mechanics

EASY TO READ

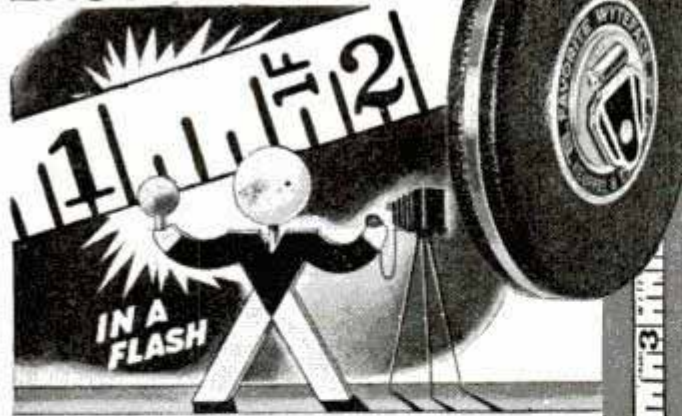

Black-on-white markings! *In a flash* you read this steel tape—even in poor light. The crack-proof white surface—bonded to the steel—protects it from rust. Favorite Wyteface is easy to clean, hard to kink, tough and durable. *Unconditionally guaranteed.* Mail coupon today for free sample of line and illustrated folder.

K&E FAVORITE WYTEFACE
STEEL MEASURING TAPES

LOOK FOR THIS DISPLAY

KEUFFEL & ESSER CO. . . . Est. 1867
Dept. 119, Hoboken, N. J.

Name

Address

City.....State.....

BIG MONEY Assembling
NEW MEAD KI-YAK
at Home!

WRITE for big illustrated **FREE** Circulars!

or profit! Portable, Seaworthy . . . Light . . . Fast. Highest quality. Low cost. 3 models 20 lbs. to 45 open a new world of sport for you both in sailing, paddling. Also 2 portable Outboard Models. Finished double-blade paddle or Oars now INCLUDED with your KI-YAK. Write now for illustrated circulars, low Factory-to-You prices!

MEAD'S complete cut-to-fit **KI-YAK** Kiteasily assembled for pleasure

MEAD GLIDERS, 15 S. Market, Dept. B-90, Chicago

SELL AMERICANISM!

NOW is the time to put one of these sparkling American Flags on the lapel of every person you meet. They'll want to show they're Americans! An exact replica, 48 stars, 13 stripes, silver-plated, with red and blue enamel—an actual piece of jewelry. See how fast you can make real money. Be first in your community to cash in on this patriotic emblem. Send 25c in coin for your sample and full particulars of selling offer.

SPIES BROTHERS, INC.
1140-B Cornelia Ave. Chicago, Ill.

MANUFACTURING OPPORTUNITIES

IN BUILDING INDUSTRY—with machine and process producing permanent construction with savings of 1/3 labor, 1/2 mortar, and 1/3 material costs—ashlar, hollow, veneer or solid walls—plain or 40 colors.

WE EQUIP YOU with Automatic Machinery—large production only one or two men. Equipment costs but fraction of other processes with equal capacity.

INVESTIGATE—let us show you why building today offers you the greatest opportunity for growth, expansion and profit in a business of your own, using raw materials available in your territory. Write today.

W. E. DUNN MFG. CO.
600 West 24th St. Holland, Michigan

how, when and where to ice cars for trans-continental shipment. Department stores know when to advertise and dress their windows for rainy-day appeal, when to put on extra clerks, when to curtail sales forces. Wheat growers in western Canada plant and market at his direction. He forecasts for sporting events of all kinds, plotted the winning course of favorable winds for Honolulu-bound yachtsmen last year. Santa Anita race track subscribes to his service. So does Coach Howard Jones of the University of Southern California. Jones knows a full week in advance whether his football team will encounter a wet or dry field.

Restaurants, hotels and food purveyors regulate the menu by his prognostications. Other long-distance predictions are made for automobile wash-rack people, for automobile club information bureaus, resort areas at mountain or shore, for aircraft test-hops, experimental flights and deliveries. Chain grocery stores subscribe so that perishables may be shifted from a location of unfavorable weather to one where marketing is assured.

Special rain forecasts are issued for the U. S. Army Engineering Corps, the Los Angeles County Flood Control and for hydroelectric utilities all over the country. Knowing when water replacements are due is of great value in regulating the flow from dams and reservoirs.

Citrus growers utilize his predictions in the preparation of irrigation schedules, for timing application of sprays and insecticides, as notice of coming frost, when to pick fruit and in routing shipments to points of weather-anticipated demand.

Municipalities consult him about street cleaning, maintenance, construction, to mobilize snow-clearing crews and equipment; for gauging possible consumption of water and for labor and employment estimates. Some other clients are golf courses, bakeries, gas companies, produce markets and building contractors.

How Krick does it is his own secret. His forecasts are made from the identical data made available by the government's vast collection network to air-line meteorologists and their own twenty-four-hour forecasters. From this basic material he simply projects his analysis several critical steps beyond his contemporaries.

Mechanical Monsters

(Continued from page 379)

which is fastened inside the tentacle's tip. When the free end of the wire is pulled the tentacle coils and writhes just like the arm of a real octopus. Schleisser uses similar apparatus to make the tail of a mechanical tiger sway back and forth in a picture.

For some of the common animals such as a bull or a horse, when the required action is either too difficult for a real animal to perform or dangerous to the other actors, Schleisser builds up an imitation, using a natural tanned hide. Sometimes one or two men inside the mechanical beast operate it; other times a complex system of levers and springs concealed inside the body and leading to a point outside of camera range is used to stamp the legs, heave the sides, or operate the head and jaws.

When Schleisser was asked to create a large bat that could slowly wing its way into a scene and hover in the air he made the wings, of 100-foot span, from mouse-colored leathery looking cloth and modeled the head and beak from plastic composition. The body was attached by a long thin wire to a tall springy bamboo pole that was held up outside of camera range. Two other wires attached to the wings led up to the tip of the pole and down along it to an eccentric on a variable-speed geared-down electric motor. One man at the motor operating the wings and one man at the pole practiced until they could give an eerie exhibition of the bat in flight.

When a butterfly is needed, say, to fly in through an open window and perch on some flowers, Schleisser takes a dead butterfly from his collection, removes the wings, and re-attaches them to the body by tiny hair springs taken from a couple of small wrist watches. The butterfly is suspended by an invisible wire from overhead and the slightest shaking of the wire causes the springs to beat the wings up and down in exact imitation of an alive insect. To make a hunting falcon stay perched on an actor's wrist and turn its head and eyes, Schleisser takes a stuffed falcon and uses levers and wires inside the body to obtain the desired actions.

Send stamped, addressed envelope to our Bureau of Information for name of maker of any device described in this magazine.

DON'T WAIT FOR TOMORROW

TRY

Fluid-Driving

NOW

WHY SHIFT GEARS?

THE greatest thrill in motoring... the biggest thrill of tomorrow... is *Fluid-Driving*... and you can enjoy it right now!

Why shift gears? Why make work of driving? Just touch the throttle to go... touch the brake to stop!

Fluid Drive is the smoothest, easiest, quietest drive ever put in a motor car. See your Chrysler dealer and enjoy tomorrow's biggest thrill *today!*

*Tune in on Major Bowes, CBS., Thurs., 9 to 10 P.M., E. D. S. T.

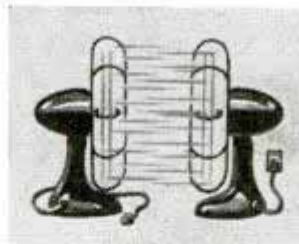

SIMPLE AS THIS!

Air from a running fan will set an idle fan in motion, as a breeze turns a windmill. That's the principle of *Fluid Drive*.



SMOOTH AS OIL!

One fan-like wheel drives another by forcing a current of oil against it. Smooth as oil, because it *is* oil. No rigid metal connections. Can't jerk.



A CHRYSLER
First
THEY'LL ALL FOLLOW!

be modern **BUY CHRYSLER!**

A bargain in FILTERS



ONLY THE FINEST dyed-in-the-mass

optical glass is used in Lafayette Filters. The filters are ground to insure faces absolutely flat and parallel. Colors are spectroscopically accurate. Here's great value! Use coupon to order.

COLOR	25 MM.	32 MM.	39 MM.
Light Yellow	84¢ each	98¢ each	\$1.19 each
Medium Yellow			
Light Green			
Medium Green			
Red			
Orange			

FREE Filter Manual with purchase of 2 or more filters. FIFTY PAGES of values await the photographer in Lafayette's new Camera Catalog No. 81. Mail the coupon at once for your copy. It's FREE!

Lafayette Camera

NEW YORK • CHICAGO
ATLANTA • BOSTON
NEWARK • BRONX
JAMAICA, L. I.

LAFAYETTE CAMERA

DEPT. 7JC — 100 SIXTH AVE., NEW YORK, N. Y.

- I Enclose \$..... Please Rush my order.
 Rush FREE Camera Catalog No. 81.

NAME

ADDRESS

CITY

STATE

FOR BETTER WORK GET THE RIGHT SAW FOR EVERY JOB

ATKINS Silver Steel SAWS

See your hardware dealer. Send for FREE Work-At-Home Book. E. C. ATKINS AND COMPANY, 426 S. Illinois St., Indianapolis, Ind.

BURN YOUR NAME ON TOOLS

WITH THE ARKOGRAF

PROTECT YOUR TOOLS FROM THEFT Write with electricity any name or design on the hardest and finest tools and instruments, or any metal, like writing on paper with pen or pencil. Complete Outfit \$3.50—Prepaid Anywhere. Interesting illustrated circular free. Write today. Agents wanted. ARKOGRAF PEN CO., 3927 S.E. Stark St., Portland, Ore.



NOW ONLY 4⁹⁵ REAL ENGINE VALUE

Over 7,000 GHQ Gas Engine Kits were sold at \$8.50. Over 15,000 sold last year. Now is your chance to buy the New Improved kit for \$4.95. Absolutely complete with coil, plug, etc. Only a screwdriver needed. For boats, planes, midget cars, etc. All parts guaranteed. Send only \$1.—Shipped Express Collect C.O.D. same day. Send for FREE literature or 6c for Jumbo hobby catalog.

DEALERS WANTED. FACTORY ASSEMBLED — READY TO RUN \$6.95

GHQ MOTORS, 40B East 21 St., New York, N. Y.

Big Money for Workers In Home or Shop

MONEY-MAKING PROJECTS. Color-glazed concrete lawn, cemetery pottery made without molds or cores. New, Patented method. Use only sand, cement, cheap materials. Tiles, walls, gravestones. Statuary, giftware. Basement waterproofing. Booklet, details 3c stamp.

NATIONAL POTTERIES COMPANY
Dept. 6, 13 W. 26th St. Minneapolis, Minn.

SEAW GARDEN and SMALL FARM TRACTOR

Does ALL JOBS on small farm—small jobs on ALL FARMS. Three types: 2-wheel garden tractors 2, 3, 4, 5 H.P.; 4-wheel 5 and 8 H.P. Riding Tractor: High arch models, 8 H.P. Write for FACTORY prices—FREE CATALOG.

SHAW MFG. CO., 4509 Front St., Galesburg, Kan.; 5812-G Magnolia Ave., Chicago, Ill.; 130-G West 42nd St., New York City; 668-G North 4th St., Columbus, Ohio.

RE-STRING RACKETS AT HOME

EARN MONEY WITH THE WONDER VISE

It's pleasant, profitable work. No experience or skill required. Easy to learn. Full line of guaranteed Stringing Tools, Frames, Gut and Silk Strings. Every item high quality.

W. A. BICKEL & CO.
137 N. Marion, Dept. A-90, Oak Park, Ill.

DO YOU WANT a new business profession of your own, with all the trade you can attend to? Then become a foot correctionist, and in a few weeks earn big income in service fees,—not medical nor chiropody—easy terms for home training, no further capital needed, no goods to buy, no agency. Established 1894. Address Stephenson Laboratory, 1 Back Bay, Boston, Mass.

AGENTS 300% Profit SIGN LETTERS

For Store Fronts and Office Windows. Anyone can put them on. Free Samples. Liberal Offer to general agents.

METALLIC LETTER CO., 438 N. Clark St., Chicago

BRUSH PLATING OUTFITS

for autoparts, reflectors, faucets, bicycles. No tanks necessary. Free particulars.

GUNMETAL CO., AVE. M, DECATUR, ILLINOIS

Earn \$150 to \$300 PROFIT monthly with new Arc Welding

30 DAYS TRIAL at Hobart's risk and easy "Pays for itself" Terms

"BUILD YOUR OWN" Arc Welder

Couple your own engine to this unit on a used auto chassis and you have the money-making advantages of a portable welder at a saving of \$300 to \$500.

Now you can start a profitable welding business and easily clear \$150 to \$300 every month. With present low prices arc welding is now made available to you at little cost, and with this equipment it's easy to get the profitable big pay jobs. Hobart Arc Welders are simple to operate, faster welding with that extra capacity and guaranteed to bring quality welding business.

LET YOUR WELDER PAY FOR ITSELF

You can own your welder with practically no expense to you. The extra profit on a single job is usually more than enough to take care of the small monthly payments. You can even rent a new Hobart and later purchase it without loss.

FREE! BOOKS ON ARC WELDING Check Coupon

How to "Build-Your-Own"
 New Profits in Arc Welding
 New Arc Welding Cat.

HOBART
The Fastest Selling Arc Welder on the Market Today

Gas Engine Drive
Electric Drive

HOBART BROS., BOX M-940, TROY, OHIO

Send me information without obligation on Build Your Own Welder
 Electric Drive Welder Gas Drive Welder 30 Days Trial, Easy Terms.
Send me free books I've checked.

Name

Address

Harnessing the Atom

(Continued from page 405)

cadmium to the mass of uranium and carbon. Cadmium absorbs neutrons.

An atomic generator such as this would be extremely dangerous if left unprotected. Not even a lead wall three feet thick is dense enough to stop stray neutrons that would shoot out from the generator. Neutrons are extremely destructive to human tissue. However, the hydrogen in water absorbs neutrons and the water jacket used to convert the atomic heat to steam power would also be an effective shield.

The generator's starter is itself a small energy machine. Radon, a radio-active gas, emanates from radium and gives off high-speed alpha particles of energy. In the presence of beryllium these alpha particles knock slow neutrons out of the beryllium nuclei and these neutrons start the action in the uranium mass when the vial is placed close to it.

Not all uranium atoms, but only one isotope of uranium seems to be the kind that splits. There are three isotopes or physical classifications of uranium, the first of which is the heaviest and most abundant, the second of which is 139 times as rare, and the third of which occurs only once in 17,000 times. It is the atoms of the second group that split and release their power in the form of heat when bombarded by neutrons.

Astronomers have decided that the heat and light given off by the stars are caused by some similar nuclear reaction instead of by a simple burning or oxidation process. The sun is our closest example of this release of atomic energy and it may be, eventually, that the power from various other kinds of atoms can be harnessed by additional studies of the sun.

When uranium atoms are split up they break down into atoms of different substances, including barium and krypton, rhodium and silver, and iodine and yttrium. But since it is only the second rare isotope of uranium that breaks up, this transmutation has no practical value.

"No one is certain yet that even the power of the uranium atom can really be harnessed," says one of the physicists. "But the possibilities are so promising that for the first time science is apt to express a hope of extracting power from the atom."

FALSE ALARM! IT'S
JUST A MOTORIST
WHO HASN'T HEARD
ABOUT **SANI-FLUSH!**

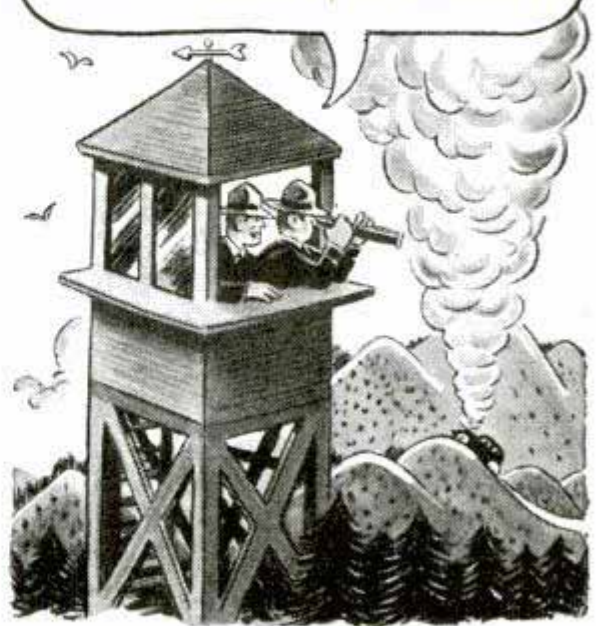

TRUE, Sani-Flush was made originally to clean toilet bowls. And today you'll find it in almost every bathroom. Sani-Flush is also the best way many motorists have found to keep a radiator free of rust, scale and sludge.

It only costs 10c to clean out a car radiator with Sani-Flush (25c for the largest truck or tractor). You can do it yourself in a few minutes (*directions on the can*). If you prefer, have the job done at the service station—insist on Sani-Flush. It cannot injure motor or fittings. Sold by grocery, drug, hardware, and 5-and-10c stores. 10c and 25c sizes. The Hygienic Products Company, Canton, Ohio.

Sani-Flush
CLEANS OUT RADIATORS

Safe
NOT
CAUSTIC

TRAILER BUILDERS' GUIDE & CATALOG only 10¢

Build a Trailer easily in spare time with world's best line of trailer parts, axles, hitches. Complete working blue prints only 50c. Universal Draw Bar, readily attached to any car. SEND 10c TODAY FOR CATALOG.

HAMMER BLOW TOOL COMPANY,

Dept. 109,

Wausau, Wis.

NEW *Guild Cutter* ELECTRIC SAW



Now saves hours of slow, tiresome hand sawing... new light-weight GuildCutter is 5 to 10 times faster—easy to use—cheap to run. Many uses in shop or home. Cuts compositions equally as well as wood. Grooves, dados. Weighs only 7 lbs., 45 degree tilting base for bevels. Depth adjustment and ripping guide. Capacity 1 1/4". 110v. AC-DC Motor. Write today.

At
Unusually Low
Price

Syracuse Guildtool Company, 1740-9C No. Solino St., Syracuse, N. Y.

Army on the Wing

(Continued from Coloroto Section)

ment of the monoplane design began and with it the performance of military aircraft increased by leaps and bounds.

Present types of pursuit planes are capable of speeds in excess of 300 miles per hour. Not so long ago the first of a new lot of Boeing "flying fortresses" crossed the continent non-stop at an average rate of 268 miles per hour to establish a new world's record for military aircraft. All service planes are now capable of operating at altitudes hitherto deemed impracticable, and the development of the first pressure-cabin stratosphere plane has passed the experimental stage. Today there are being manufactured for use in the GHQ Air Force, pursuit and bombardment airplanes that far surpass the performance of existing service equipment in speed, altitude, range and load characteristics. Even now the army is experimenting with a seventy-ton super-bomber. What tomorrow will bring in the way of fast, huge and high-flying military airplanes is difficult to foresee.

Five years ago night flying played but a small part in the routine training of the average officer. Non-stop flights of over 500 miles were rare, and flights under adverse weather conditions were so fraught with hazard as to be considered prohibitively dangerous. Bombing and machine-gun training was a brief seasonal affair, resulting in rather low standards of proficiency.

Since inauguration of the "fly, bomb and shoot" program, instrument flying and night flying have been emphasized, with the result that the combat efficiency of the Air Force has so improved that units are able to operate in almost any kind of weather, night or day. Thus today we have a highly trained force of experts admirably qualified to supervise the training of the hundreds of young men who will come into the expanding air corps.

To provide strategically located bases from which to operate this enlarged GHQ Air Force, several new air bases are being established throughout the country. Upon completion of the two-year plan the headquarters will be centrally located at Scott Field, Ill. To the First Wing will be added a new base at McChord Field in Washington. The Second Wing will be increased

by another base at Chicopee, Mass., and the Third Wing by the Southeast Air Base at Tampa, Fla. Up to now the First Wing had three bases, March Field, Hamilton Field and Moffett Field, all in California; the Second Wing, with headquarters at Langley Field, Va., had other bases at Mitchel Field, N. Y., and Selfridge Field, Mich., and the Third Wing had its base at Barksdale Field, La.

Completion of this air expansion program will provide the United States with an air force organized, trained and equipped to take its place, along with land and sea forces of the nation, in defending American soil against foreign aggression.

Steel Receptacle for Dust Cloths Fits on Back of Door

Dust cloths can be kept handy and safe in a metal container easily installed on the wall or the back of a door. Made of fire-retardant steel, it removes the hazard of



There's no danger of spontaneous combustion if oily rags are kept in a handy metal container like this

spontaneous combustion in oily or greasy rags. The containers are available in ivory, black, green or blue enamel finish to match the kitchen scheme.



"My! How Handy!"

"A pump right in the kitchen! What'll they think of next? You're a lucky woman, Josephine."

LUCKY? Yes—compared with toting heavy pails of water from an outside well. But if Josephine was lucky, what about her granddaughter of today?

With electric lights, Josephine's granddaughter doesn't have to fill and clean lamps. With her electric refrigerator, she doesn't have to keep the butter and milk in the cellar in warm weather. Her electric cleaner makes it unnecessary to lug the carpets out and beat them. With her electric range, she doesn't have to cook over a hot stove. And the furnace keeps the house at the right temperature without her going near the cellar.

Even if electricity's contributions to better living had stopped here, we'd still recognize it as one of the greatest benefits of our century. But electricity goes much further. In every branch of industry it helps to make manufactured articles available at such low prices and in such quantity and variety that more millions can enjoy them.

For more than 60 years General Electric scientists, engineers, and workmen have been making electricity more useful—creating for all of us hundreds of comforts unknown to any former generation. Their efforts today are producing More Goods for More People at Less Cost.

G-E research and engineering have saved the public from ten to one hundred dollars for every dollar they have earned for General Electric

GENERAL  **ELECTRIC**

952-1E4



**GIVES YOU Accuracy
Strength and Power at Low Cost**

Now you can handle any of those precision metal lathe jobs that used to require expensive equipment—the new Atlas 6" lathe is the first precision-built small lathe at a popular price. Timken bearing equipped, 16 speeds, V-belt drive, precision-ground bed. 12" or 18" centers, \$61.50 and \$64.50 complete less motor. Send for big 1940 Atlas catalog.

ATLAS PRESS CO.

943 N. PITCHER ST

KALAMAZOO
MICHIGAN

Atlas

LATHES • DRILL PRESSES • ARBOR PRESSES
METAL SHAPERS • VISES • CIRCULAR SAWS

**CALBAR
CAULKING
COMPOUND**

A weather proof, non-staining plastic substance that holds fast, unaffected by Heat or Cold. Seals openings around Door & Window frames for regulated Heat Control & Air Conditioned Buildings. Sold by Paint & Hardware Stores or ask your Contractor.

Calbar Paint & Varnish Co., 2614-26 N. Martha St., Phila., Pa. Manufacturers of Technical Products



BUILD A MIDGET CAR OR SCOOTER

WE SPECIALIZE IN WHEEL SETS, ENGINES, ETC. for building Cars, Scooters, Trucks, etc. We carry only the best at the lowest prices. SEND 10¢ FOR PARTS CATALOG AND PLANS for three Midget Racers, Scooters and other vehicles. It pays to use only reliable plans and parts—We guarantee satisfaction.

Build-Ur-Own Devices, 536 North Parkside, Dept. 49, Chicago



SENSATIONAL Flexible SHAFT TOOL

The FOREDOM FLEXIBLE SHAFT TOOL brings new skill, new ease for home and master craftsmen. Uses over 200 accessories. Grinds, polishes, drills, mills, engraves, sharpens, slots, sands, carves, etc., etc. Every hobbyist should own one. Send for free illustrated catalog.

SEND FOR
FREE
CATALOG

FOREDOM ELECTRIC CO., Dept. 158, 27 Park Pl., New York, N.Y.

READY *New* 1000 SHOT *Only \$2.95*
DUTY ADDED IN CANADA

RED RYDER 16 INCH LEATHER SADDLE THONG
Cowboy **CARBINE**

Featuring: Golden Bandal Western Carbine Ring! Red Ryder BRAND on stock! Lightning-Loader Device! \$2.95 at Dealers. If he hasn't it, send us \$2.95... we'll mail yours postpaid! Write for FREE Daisy Air Rifle Catalog!

DAISY MANUFACTURING COMPANY
PLYMOUTH, MICHIGAN, U.S.A.

549 Union St.,

The Sky's Their Limit

(Continued from page 395)

ing aircraft. The one exception is "inherent stability" or self-righting properties which designers have worked out for miniature planes. Too much inherent stability in a full-size airplane would be a serious handicap to pilot control, but with the model plane it is indispensable in providing automatic adjustment to unpredictable conditions aloft with which the ground pilot could not possibly cope as they arise.

The prize-winning model pilot is the one whose understanding of aeronautics reliably informs him, after a survey of the ceiling in which his ship is about to fly, of conditions to be met by the proper set of elevators and rudders, the pitch and rate of propeller turn-over and the manner in which his ship should be launched.

Sponsorship by the American Aeronautical Association has added tremendous impetus to organized model plane building and flying. The N.A.A., America's oldest and most influential non-profit organization for the advancement of aviation and aeronautical research, has established a division devoted solely to promotion and coordination of model aircraft activities. This, the Academy of Model Aeronautics, now has chapters in every part of the United States. Through these are issued "Expert" licenses to modelmakers and flyers who qualify for membership. The Academy also functions as a research body, and from its N.A.A. headquarters in Washington, D. C., distributes instructive bulletins and other literature.

The A.M.A. grants charters to local model plane clubs organized in accordance with its rules and regulations, issues the schedules of, and furnishes officials for, its sponsored local, sectional, state, interstate, and national model meets.

For these competitions models of every size and type are entered in classes which specify definite structural requirements. Trophies are awarded to the winners of precision, endurance, stunt, weight-flying, radio ground control, and other events planned to cover the entire gamut of model plane performance.

Send stamped, addressed envelope to our Bureau of Information for name of maker of any device described in this magazine.

17th and Pennsylvania Washington D.C. 20004

8612
\$2,500 Home for Eight

(Continued from page 331)

other, or side by side as desired. The windows do not open outward, or lift upward, but merely slide back into the wall.

Although the outer dimensions of the house are only thirty-two by twenty-four feet and five rooms and bath are included, the planners have been able to include no less than eight closets.

The plumbing has been so simplified that only one hole in the floor is needed for installation. In the bathroom, water closet and washstand are suspended from porcelain enamel steel panels which also contain a medicine cabinet and conceal water and drain pipes. Around the corner, extending from a similar panel, are bathtub faucet, shower head and necessary valves.

Since the panels and their concealed pipes are placed between bathroom and kitchen, it is only necessary to extend pipes and drains to sink, washtub and water heater to complete all plumbing connections.

No less novel were the methods of construction of the house itself which, together with the use of scientific building materials, explain how the dwelling was built so economically and quickly.

Each important part was pre-cut, numbered and keyed to construction drawings. Within ten minutes after their arrival on the job, the six workmen were able to raise twelve two-by-four-inch columns fitted with angle irons slipped over anchor bolts on the concrete foundation piers.

These columns and connecting wooden girders extending around the house, established a frame which supported the two-by-ten-inch floor joists, the phenolic plywood exterior and interior walls, and the roof.

The five-eighths-inch exterior plywood walls below the windows were attached in sections four feet deep and as wide as twelve feet. Between the exterior walls and the interior quarter-inch plywood panels, a one-inch air space was provided for and a one-inch blanket of spun-glass insulation was installed.

A continuous sill extending around the house, except for door apertures, supported pre-manufactured window frames. Between the windows and doors, the second

(Continued to page 132A)



*Make More Things
at Home with*
**KESTER
METAL MENDER**

You'll get a real kick out of increasing your skill as a craftsman with Kester Metal Mender. You can build more things and make them better when you have a can of this handy home solder on your work bench. Time and again you'll find that the easiest way to make it is to *solder it!*

And the same thing goes for repairing anything made of metal. Kester Metal Mender contains its own flux and makes perfect, money-saving repairs every time. All you do is apply heat and the job's done.

Buy it at your hardware or other stores.

For a sizable free sample of Kester Metal Mender and "How-to-Use-It" Booklet — *mail coupon now.*



**KESTER
METAL MENDER**

***** You Can Paste this Coupon on a Postcard *****

Kester Solder Company, 4251 Wrightwood Ave., Chicago, Ill.

Please send me free sample of Kester Metal Mender and "How-to-Use-It" Booklet.

Name _____

Address _____

City _____ State _____

***** Mail the Coupon Now *****

tier of plywood walls was attached, with insulation omitted beside the windows so as to form a wall recess for the two-by-four-foot sashes when slid open. Metal weatherstripping sealed this recess and also guided the movement of the sash.

Roof construction was more conventional except that five rafters, four feet longer than the others, were extended outside the building line to form a hood over the door.

No attempt was made to disguise the plywood constructed on either exterior or interior. In fact, because of the horizontal manner in which the house was designed, the exterior has a smooth, smart, modern look. On the interior, the edges of the ply-

wood sections on walls and ceiling were beveled, producing a pleasing effect.

These innovations were not the result of quick theorizing. Years of design, trial and modification brought the "magic" house to its present state of excellence.

Many thousands of dollars have been expended in research by the foundation to promote research in the field of heating, ventilation and sanitation and "to the increase of knowledge to the end that the general hygiene and comfort of human beings and their habitations may be advanced."

The "magic" house is a step in that direction.

50,000 War Planes a Year

(Continued from page 324)

ics will be needed by the Navy alone. In addition, the aircraft factories will need a minimum of 250,000 more trained men to produce these planes.

Translate these figures into the Army's task of training pilots to fly and mechanics to maintain 40,000 planes, and you have some idea of the magnitude of the job facing the nation if this vast program is to be achieved.

The snail's pace of 200 pilots emerging every six weeks from the advanced Army training school and 100 from the Navy school every month, will have to be stepped up miraculously if America's fighting arm is to become the threat to the potential invader that is desired.

There are important considerations to be given the relation between the production of aircraft and the training of men expected to fly and maintain them. One aspect of the problem cannot be studied intelligently without giving equal consideration to the other.

For example, it would not be smart to produce large numbers of planes which would become obsolete by the time enough men could be trained to fly them. Modern combat planes become valueless in two years. It is important, therefore, not to let assembly-line production become a Frankenstein to the program as a whole.

We know of only one way to train a pilot: that is, teach him how to fly and keep him flying. Any civilian effort such as the proposed "Plattsburg" flight training bases,

must be closely synchronized with the real objective of shaping, ultimately, the student pilot into a well-trained military flier.

It is well to remember that replacement facilities—both of men and machines—is the real key to supremacy in the air. The only thing that can really beat off an airplane attack is a better airplane.

Germany has exceeded us in quantity of planes and pilots through a program of government ownership of all aircraft and compulsory military service. The United States is not ready to stand for either of these things. Our problem is to get ahead of them without government ownership of aircraft and without compulsory military service. I think it's a problem we can solve. In Germany, every youngster starts his study of aviation at the age of ten. In America, a few months ago, only 500 out of 26,000 high schools had any aviation activities. Let's teach aviation in our schools and in our everyday life.

Let's carry by air all first-class mail dispatched distances of 100 miles or more. Let's use the vast facilities already built up in our commercial air lines, to make us into an air-conscious and air-skilled people. Let's use these strategic factors that no other nation in the world can equal, to develop more airplanes and more pilots, more maintenance personnel.

Consider what this one step would do. At no cost to the government, our peacetime aviation industry would be increased

(Continued to page 134A)

12" All 'Round Lathe for Wood and Light Metal Turning



**Swings 12" Over Bed
37" Between Centers**

• This No. 1465 Delta 12" Ball Bearing Lathe is designed to give you the biggest amount of **real lathe** for the least money! It has many splendid features including: Rigid, fine-grained cast iron bed with accurately machined ways; improved, convenient Self-Indexing device; Lubricated-for-life sealed ball bearings; Universal Tool Support, rigid yet easily adjustable; Full 1 1/4" spindle with 5/8" hole; 4 speeds for wood turning or 16 speeds for metal work (with simple counter shaft arrangement); Inboard and outboard spindles threaded to take face plates; Efficient, powerful V-Belt drive; Safety headstock with covered belt and pulley. For the complete story of this outstanding lathe, including specifications and prices, fill out coupon below.

**Inside
Secrets
of Delta Quality**

"DIAMOND BORING"

• All holes on Delta machines, where precision must be maintained, are "diamond bored." Here's why: It is physically impossible to produce a perfectly round hole by drilling and reaming alone. A drilled hole may actually be oval in shape, slightly larger at one end, rough in surface and not true to size. Reaming corrects some of these troubles, but, as the reamer follows the drilled hole, the reamed hole will be "off" if the original hole is not true.

Diamond boring as performed on special machines in the Delta plant, is the finest method known in modern machine shop practice for producing perfectly accurate round holes and precision fits. All ball bearing seats in Delta tools, for example, are diamond-bored to size. Since the diamond-bored hole is perfectly round, perfect in size and mirror-like in surface, the fit of the bearing is held to close tolerance and is absolutely uniform and snug. Contrast this with the fit of a bearing in a drilled hole, or a rough bored hole, where the bearing is held only by the "high points" of the metal in the hole, and consequently frequently becomes loose in service.

"Diamond-boring" is but one of the many precision operations that make Delta machines the finest you can buy.

Send for Latest Delta Catalog

A complete guide book to power tools which not only lists the complete line of Delta "Quality" wood and metal working tools—but shows you the important points to look for in all power tools. It illustrates and explains the advantages of the many hidden features of design and construction that make for long, better service in power tools. (Also send for Project Book No. 7 crowded with new projects, including working drawings, photographs and full instructions.)



Delta Manufacturing Company
600-634 E. Vienna Ave.
Milwaukee, Wis.

Gentlemen: Send me the latest Delta Catalog listing the complete line of Delta Lathes, Circular Saws, Band Saws, Jointers, Scroll Saws, Shapers, Sanders and Drill Presses.
 I enclose 10c (stamps or coin) for which please send me the new Delta Project Book No. 7.

Name

Address

City State

Check here if you are a Delta user now. (Dept. A940)

Delta MFG.
CO.
600-634 EAST VIENNA AVENUE
MILWAUKEE, WISCONSIN

SPEEDY SPRAYERS

ONLY \$9.25 FOR THIS 100% OIL-LESS PAINT SPRAYER!

New Marvel sprayer never needs oiling! Fast, smooth, better, for paint, varnish, enamels, lacquer, insecticides, moth-proofing. Special chuck inflates tires, too! Diaphragm type compressor insures clean oil-free air—only two moving parts. For the home, workshop, schools, small manufacturing. Complete as shown without motor, only \$9.25. With No. 962 gun, only \$7.85.

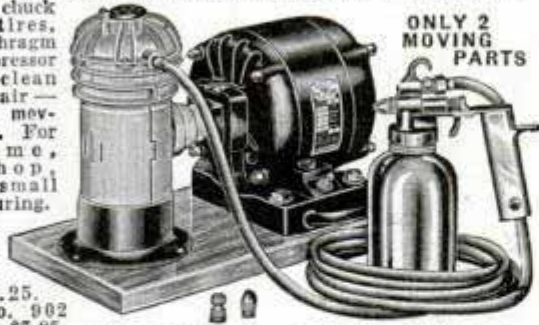

ONLY 2 MOVING PARTS

Send for **FREE** illustrated booklet of **PORTABLE, PRACTICAL, LOW COST SPEEDY PAINT SPRAYERS**

DEALERS: Send for catalog, price list and discounts on Speedy electric and auto-power paint sprayers.

W. R. BROWN CORPORATION

5726 Armitage Ave., Chicago, Ill., U. S. A.

SAVE MONEY

build your own
SMITH COMPRESSOR



We will furnish complete instructions with a **Smith Compressor Head and Accessories**

With a Ford Motor and shop facilities you can easily assemble a Smith Air Compressor. You'll have a smooth-performing, efficient compressor with 60 cu. ft. a minute capacity—all the power you need to operate rock drills and paving breakers. Pressure up to 175 lbs. a square inch. Head equipped with high speed compressor valves; automatic unloading and idling.

write today

GORDON SMITH & CO. Inc.
410 College Street
Bowling Green, Ky.

MECHANICS FREE SAMPLE

SEND NAME FOR
PISTON RINGS

SENSATIONAL NEW KIND OF Spectacular new replacement piston ring invention—Look! Unbreakable! No breaking in! No expanders needed! Guaranteed 100,000 miles! No rebor-ing, honing or grinding! Amazing self-locking design gives top compression, lowest oil consumption. And you buy at **FACTORY DISCOUNTS**—make money on every ring job. Seeing is believing. Send your name for Absolutely Free Sample, postage prepaid. Penny postcard will do. Address **TRIPLE-X ENG. CO., Dept. 169, 3801 S. Racine Ave., Chicago, Ill.**

HANDEE

Tool of 1001 Uses

A WHOLE TOOL SHOP IN YOUR HAND

Smooth, steady power at your finger tips. Uses 300 accessories to grind, drill, polish, rout, cut, carve, sand, saw, sharpen, engrave, etc. Plugs in any AC or DC socket.

10 Days' Money-Back Trial Order today. Standard Model (illustrated) 18,000 r.p.m., 16 oz. \$10.75 postpaid with 3 Accessories . . . DeLuxe Model 25,000 r.p.m., 12 oz. \$18.50 postpaid with 6 Accessories.

Chicago Wheel & Mfg. Co., 108 S. Aberdeen St., Chicago, Ill.



Save Hours of Hand Work

FREE 64-PAGE CATALOG Complete information on Handee Products and their wide application in crafts work and industry all over the world.

K683

(Continued from page 132A)

200 times,—not 200 per cent—200 times. The aviation industry would jump at the chance to carry mail at the existing three-cent rate.

By thus expanding the peaceful work of aviation, pilots and technicians would spring up as a natural consequence of supply and demand. It would gear industry to a steady, to-be-counted-upon production.

This policy would make aviation a mass industry that would absorb millions of young men eager to get into it. This program would give work for a peacetime air "army" but withal an "army" so formidable in numbers and so experienced in the air, that it would give any enemy pause.

This is not the first time the United States has been faced with the necessity of arming quickly. All of the discussions now current are strongly reminiscent of 1917-1918 when America hurried into a well-meant but ill-considered air offense training and construction program which cost \$750,000,000 and resulted in the construction of 18,000 fighting planes—all of them so obsolete that no plane of American design was in combat on the western front at the end of hostilities in November, 1918.

build this COAST GUARD CUTTER



Complete Kit
\$2.50
Post Paid

Makes perfect building easy

CARVED HULL Included!

24" Super Detail Model
Catalog—10c

IDEAL AEROPLANE & SUPPLY CO., Inc., 26 W. 19th St., New York

POWELL

"SETS THE PACE"

100 miles per gal. 35 miles per hour. 2 1/2 H.P. 4-cycle engine. Centri-matic clutch. Hill-climber transmission. Foot brake, foot throttle. Welded alloy steel, shock-absorbing frame. Easy riding, dependable, durable, beautiful. Many Powell Streamliners ridden over 40,000 miles a year.

Write for free folder, Powell Mfg. Co., Los Angeles, Cal., Dept. PM-6

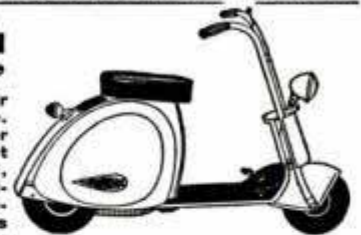

it's here!

The Syncro b30, the latest and best of all engineering developments in the miniature motor field. A new timer design without troublesome contact points, positive set carburetion, forced feed lubrication, moulded alloy cylinder & 3 piston rings.

Complete
\$6.95
with
coil and
condenser

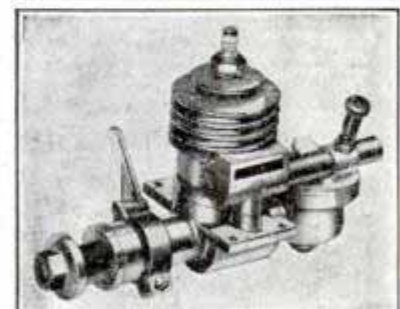

These features with plenty of speed, power, and light weight make Syncro b30 the head of the B Class. A truly great motor. Send for catalog A40 for complete details and specifications. No better motor can be bought at any price. Your dealer has b30 in stock.

SYNCR0 DEVICES INC. 747 BEAUBIEN ST. DETROIT

Low-Cost Pack Set

(Continued from page 457)

under the base in a position where the set-screw is easily accessible for adjustment. The I.F. transformers are Meissner iron-core types for 456 kc. and the oscillator coil is an unshielded type to match. Note that one side of the padder condenser is grounded through the mounting bracket, therefore the lead to the condenser must be made to

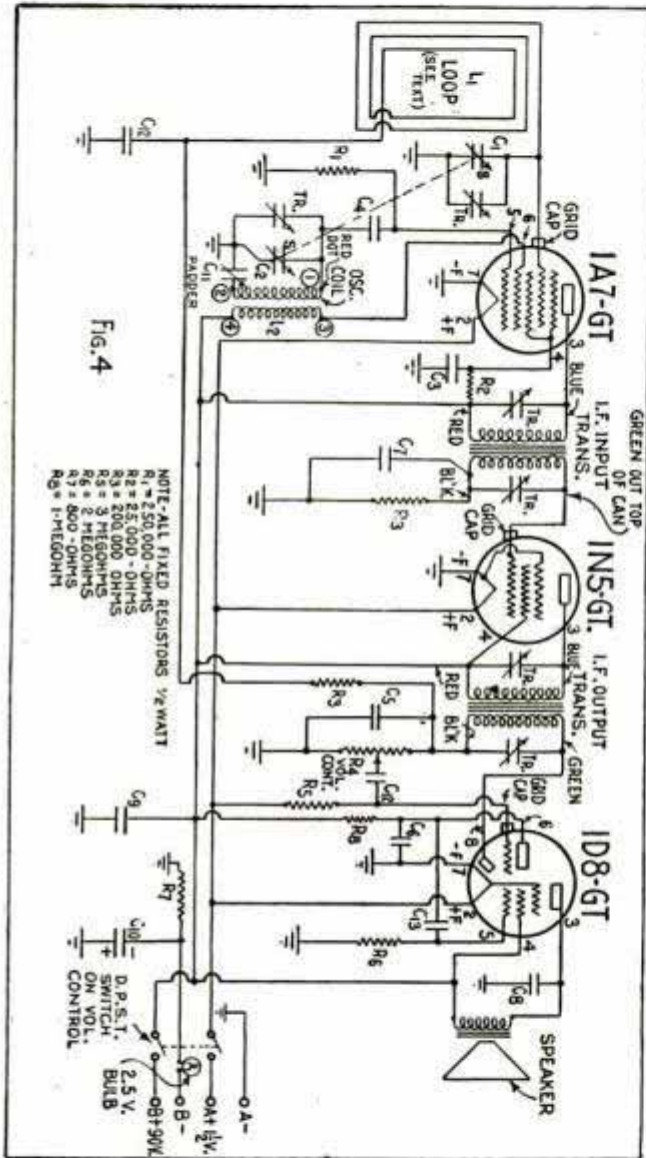

the ungrounded side. Check the A and B-battery leads that run to the double-pole, single-throw switch carefully, and if in doubt as to the terminals on your switch, check them with a flashlight bulb in series with a 1½-volt dry cell before making the connections. This switch cuts off both the A and B-battery supply when the set is not in use. After wiring is completed mount the chassis and install the batteries in the case as shown in photo (C). All details for the loop are clearly indicated in

(Continued to page 137A)

COMING **50,000 BARGAINS**

FREE

LAFAYETTE'S GREATEST RADIO CATALOG

RESERVE YOUR COPY NOW!

Never before a catalog like this. Tops every effort we've ever seen at catalog completeness, wide selection and value-giving. Here, literally, is everything in radio arranged for quick, easy reference. Take a tip—this book's a smash-hit—reserve your copy at once!

LOOK WHAT'S IN IT!

Radios—over sixty brilliant models—with every last-minute feature, beautiful new styling and power galore. Includes portables, table models, radio-phonographs, farm and auto receivers. Build-it-Yourself Radio Kits, complete nationally advertised parts, tubes, equipment and handy tools. Amateur radio and sound amplifying equipment—196 pages, and every page talks big value!

196 PAGES OF VALUES

SEE HOW MUCH YOU SAVE!

Prices in this catalog are all bed-rock low. You save on everything you buy. And deliveries to your door—no matter what the size of the order—is an added saving, in time as well as money. Here's a catalog you will certainly want.

HOW TO GET IT!

So great is the expected demand for this new, "last-word" edition of the greatest catalog in radio that we are asking you to reserve your copy in advance. All you need do is mail the coupon. A copy of Catalog No. 82 will be sent to you. Don't delay. Act now.

NEW YORK • CHICAGO • ATLANTA • BOSTON, MASS.
 BRONX, N. Y. • JAMAICA, L. I. • NEWARK, N. J.

Lafayette Radio 20th Year of Radio Leadership

RUSH COUPON NOW

■ LAFAYETTE RADIO — DEPT. 7J
 ■ 901 W. JACKSON BLVD., CHICAGO, ILL.
 ■ or 100 SIXTH AVENUE, NEW YORK, N. Y.

I don't want to miss this great catalog. Please reserve my FREE copy.

■ NAME

■ ADDRESS

■ CITY STATE

■ PASTE COUPON ON PENNY POSTCARD

**SENSATIONAL
BURNER
INVENTION**

MAKES KEROSENE BURN JUST LIKE CITY GAS

Produces HOT, CLEAN (White-Heat) FLAME!

SLIPS into any coal or wood range or stove—burns gas just like any gas stove—No noise, No smoke, No soot, No ashes. New cast pottery burners can't stop up or clog. Gives high or low heat as needed. No experience needed to operate. Astonishing generator invention makes endless supply of Clean-Burning DORTANE Gas as it is needed. Not like any oil burner you ever saw. Already in use in homes and shops in place of coal—in factories and some of the biggest plants in the country in place of city gas. DORTANE Gas costs only 27c per thousand cubic feet.

**AT
LESS
THAN
1/2
THE
COST**

WIDE OPEN for DISTRIBUTORS and AGENTS

A sensational seller in small towns—a surprising success in cities. Models for all purposes open wide field for distributors. Time payment plan for homes makes sales easy. Open account sales to rated concerns enable our men to handle big orders. Absolute customer satisfaction brings amazing repeat and referred sales.

FREE Don't lose a minute. All facts are free. Rush your name quickest way for book that tells all about DORTANE Gas, Liberty Burners, and shows huge market and big profits for right man. No money. Just rush name and address for complete information on one of the biggest opportunities of the day.

LIBERTY BURNER CO., Dept. A169, 620 N. Michigan, Chicago, Ill.

**ALL THESE
PROSPECTS**

Will heat stoves, ranges, urns, steam tables, grills, vulcanizers, water coils, ovens, griddles, pressing machines, tanks, etc.

**3 Models
Fit All
Stoves**

SAFE

**NO-GASOLINE
EXPLOSIVE OILS**

ONAN ELECTRIC PLANTS ALTERNATING AND DIRECT CURRENT

Produce Current, same as City Power Lines, for FARMs, SCHOOLS, THEATRES, PUBLIC BUILDINGS . . . Operate Lights, Radios, Motors, All Appliances.

Over 40 STOCK MODELS—350 to 50,000 Watts. Any Voltage—Any Frequency. Combination A. C. - D. C. Types. Manual, Full Automatic and Self-Starting, \$99 up. Shipped—COMPLETE, READY FOR OPERATION. THOUSANDS IN USE IN ALL PARTS OF THE WORLD.

Write for Complete Details.

D. W. ONAN & SONS
1049 Royalston Avenue - MINNEAPOLIS, MINN.



**\$13.95
Full
Set**



MICROMETERS

Six piece set, in velvet lined leather case. Special price, only \$13.95. Precision machined in one thousandths, up to 4" outside and 3/8" inside measurements. Guaranteed accurate, easy to read and adjust. Satisfaction guaranteed or money back. This is your opportunity to get one at a Bargain Price if you act now. Shipped prepaid on receipt of remittance. On C.O.D. shipments, send deposit of \$2.00.

**FREE
FOLDER**

MICRO PRODUCTS, 529 E. Jefferson Ave., Detroit, Mich.

NEW BENJAMIN AIR RIFLES WITH HAND PUMP

MADE IN U.S.A.



**HARD
ACCURATE SHOOTING
WITH CHAMBERED AIR**

You can use new model BENJAMIN AIR RIFLES WITH LEVER HAND PUMP anywhere, for practice firing or just plinking, around the house or camping, fishing, hunting, etc., at lowest cost. Shooting force is adjustable with amazing maximum power and accuracy—no recoil or forward lunge to disturb your aim. Bolt Action-Hammer Fire-Hair Trigger-Safety Lock-Hand Pump. Single Shot BB \$7.50; Single Shot Cal. 177 or .22 with rifled barrel \$8.50; BB 25 Shot \$9.00. Also a complete line of BENJAMIN GENUINE COMPRESSED AIR PISTOLS from dealer or factory. Write Today for details and Targets. BENJAMIN AIR RIFLE CO., 895 Marion St., St. Louis, Mo., U. S. A.

NATIONAL MOWER CO.

832 Cromwell St. Paul, Minn.

Sickle mower, power driven, rubber tired, pulls self, cuts high grass, hay, weeds, on level or rough. Moderate price.

WRITE FOR CATALOG.



SIX TIMES AS FAST AS A SCYTHE

NOW a DYNAMIC HEAVY DUTY INDUSTRIAL WELDER

Works OFF 110-Volt Light Socket. This marvelous Dynamic Power Welder does the work of much higher priced types. It is easily portable. WELDS Cylinder Blocks, Bumpers, Fenders, Tanks, Farm Machinery, etc. Will also solder and braze on the lightest material. Works on iron, steel, tin, brass, copper and all other metals. Men without previous experience can make as much as \$5.00 on a one hour repair job. In a year's time a Dynamic Welder Costs You LESS THAN 6 CENTS A DAY. Instructions Free—Open a welding shop now. AGENTS—Make big profits selling to garages, factories, janitors and machine shops. Write today for our 10-DAY TRIAL OFFER. **DYNAMIC WELDER CO.** 2226-ND Silverton Road Chicago, Illinois

for Only **\$19.75**



WITTE DIESELECTRIC PLANTS

Power and Light for 1c a Kilowatt

Make your own electricity at this amazingly low cost. Quality built, dependable, efficient WITTE Diesels operate on cheap, non-explosive fuel. Rugged, compact, easy to install, simple to operate. 1500 to 8000 Watts; vertical, horizontal. Easy to buy. Pay for themselves out of savings. WRITE now for literature and name of dealer.

WITTE ENGINE WORKS

1749 OAKLAND AVE. KANSAS CITY, MO.

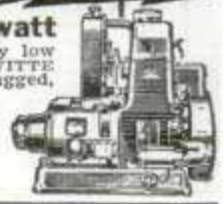

NEW PATENTED SHOES

PAY UP TO \$3.00 PROFIT! No experience needed. Be successful from the start taking orders for amazing new comfort invention in men's shoe styles. Nationwide SALES SENSATION! Demonstrator and everything needed for a mighty good cash income every day sent FREE. Get the largest and most complete sales outfit in the direct-selling shoe business ABSOLUTELY FREE from manufacturer established 37 years. Line includes 250 styles of dress, sport, work shoes. For men and women. Prices as low as \$1.98. WRITE TODAY! **MASON SHOE MANUFACTURING CO.** Dept. B-11 Chippewa Falls, Wis.



**FREE
SALES
OUTFIT**

Earn Cash at Home!



We paid M. M. \$1174 for exceptional cellar crop Snow-King mushrooms! We furnish materials; buy all crops. Big FREE picture book tells if your cellar, shed, barn, suitable. Est. 1908. Write today. United Co., 3848 Lincoln Av., Dept. 303, Chicago



CATCH FISH!

minnows, eels, mink, muskrat, with our folding galvanneal Steel Wire Traps. Walton's Automatic Hooks are so constructed that when a fish gives the slightest pull on the bait the upper hook reaches down and gets a hold that lands him. 3 for 50c. Write for descriptive catalog of Traps, Hooks, Lures, and other specialties. **Walton Supply Co., 3507 Juniata Ave., St. Louis, Mo.**

MEGOW MODEL

World's largest manufacturer of Model Airplanes, Ships and Railroads. Send 5c postage for 100-page, profusely illustrated catalog.

- AIRPLANES
- SHIPS
- RAILROADS

MEGOW Dept. PM, Howard & Oxford Sts. Phila., Pa. or 217 N. Desplaines St., Chicago

Say you saw it in Popular Mechanics!

(Continued from page 135A)

Fig. 3. Wind the loop in a single close-wound layer, using 17 turns of No. 26 d.c.c. wire, as close to the outer edge of the frame as possible to keep it away from the chassis. A detailed material list is available from Popular Mechanics radio department without charge.

It will be noted that resistor R_5 is shown connected to ground in the simplified wiring diagram, and to positive "A" in the schematic circuit diagram. Either connection may be used without apparent difference in results. The 2.5-volt bulb in the B-negative lead acts as a safety fuse. The tuning dial is a round 0 to 100 clockwise scale. This dial plate and the one for the

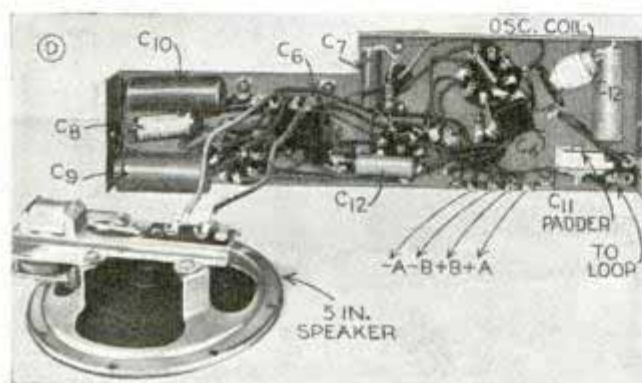

combination switch and volume control are glued to the top of the case, the hole left by the removal of the case handle being employed for its shaft. The other handle hole is covered by a thin sheet of metal tacked or glued over it, see photo (A); speaker cutout is backed with a piece of silk cloth.

To line up the set, tune in a station and reduce the volume until the signal is rather weak. It may be necessary to readjust the trimmers in the tops of the I.F. transformers slightly for maximum volume; however, they are aligned at the factory and should not be very much out of line. The next step is to adjust the padder condenser. Tune in a station as near 550 kc. as possible and then adjust the padder condenser screw until the station is tuned in with the variable condenser plates almost closed. Now tune in a station at about 1,500 kc. at the high-frequency end and adjust the trimmers (Tr.) on the top of the ganged condenser for maximum volume. Like any loop set this one is strongly directional, therefore rotate the case when tuning weak distant stations. The blueprint number of this article is R-282.



ALLIED'S NEW
1941 RADIO
AND PARTS CATALOG

212 PAGES
JUST OUT!

FREE

EVERYTHING IN RADIO
AT LOWEST PRICES!





65 NEW RADIOS SOUND SYSTEMS

The 1941 RADIO HITS you've been waiting for! Knockout values — new Plastic models, world-wide sets—new "Camera" and 3-way Portables; 1941 low-cost Phono-Radio-Recorders, Combinations, Auto Sets, Amateur receivers—48 pages of models for every purpose at new low prices!

Sensational 1941 Public Address Systems—for every P.A. application. 7 to 75 watts—new features, new ideas, new low prices. Time Payment Plan—15 Day Trial Offer. Complete listings of mikes, speakers, phono equipment, recorders, etc.—all in a big special 35-page P.A. section.

MORE THAN 15,000 RADIO ITEMS!
BIG MONEY-SAVING BARGAIN SECTION!



Learn
Radio

BUILD WITH
ALLIED KITS



Build your own radio set, transmitter or radio device—learn while you build! Dozens of new, low-cost easy-to-build kits; new diagrams—more than 15,000 quality parts. Free matched parts lists for building any circuit. Learn Radio quickly, easily with ALLIED's help.

Send for this RADIO BUILDERS' HANDBOOK—a valuable beginner's book on radio; tells how to select circuits, read diagrams, build sets, etc. Easy to understand; well-illustrated; helpful. Order by coupon below. 10c

Only.....

ALLIED RADIO

833 W. Jackson Blvd. Dept. 5-J-1
Chicago, Illinois

RUSH me your FREE 1941 Fall Radio Catalog.

ENCLOSED find 10c. Send me the "Radio Builders' Handbook".

NAME.....

ADDRESS.....

CITY..... STATE.....

CATALOG
FREE
Send this
Coupon!

Cashing in on Hobbies

(Continued from page 351)

growths of his hobby are extremely valuable to the motion-picture industry. They include cornflake snow and ice cream made of mashed potatoes, dyed to resemble the various flavors, so that the "ice cream" will not melt under the studio lights and yet may be eaten by the actors during the shooting of a scene. Another result of his hobby is the synthetic spiderwebs used in the movies. These are manufactured by dripping rubber cement in front of an electric fan.

Grace Olive Wiley of Minneapolis was afraid of reptiles until she made them her

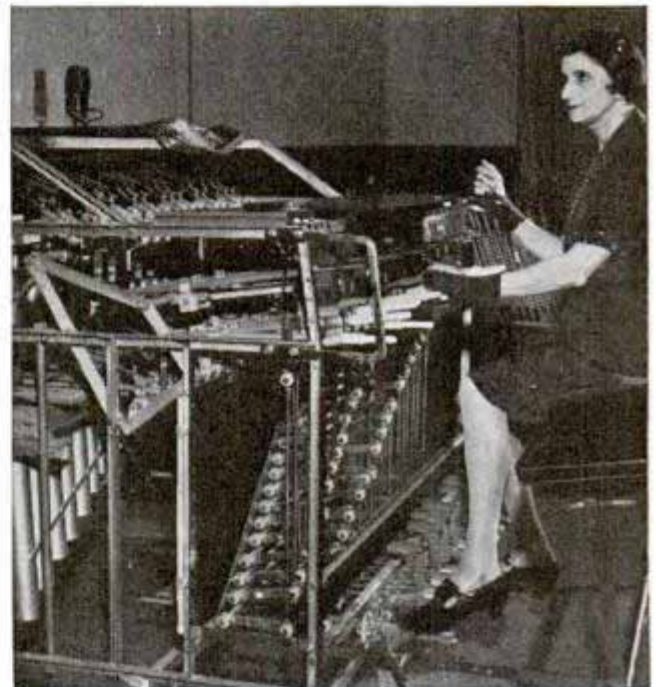

Keys of this miniature carillon, now on tour of states, are played with padded gloves

hobby. She learned they could be handled with impunity if they were understood. There was a place for her rattlesnakes, fer-de-lances, moccasins and cobras in the movies and she moved to Long Beach, Calif., after studio executives found she could tame a cobra, whose bite would kill a horse, by stroking it gently with a stick, much as one would scratch a purring kitten. Her pets are used in the picture "Trade Winds" and other films.

Lee Sims, popular radio pianist, never took a piano lesson. He used to tinker on the keys of a piano after finishing his day's toil as a plumber.

Paul Kuhlthau, of Milltown, N. J., "Professor Coleslaw" on the radio, was just an-



DOENUT WHEELS with Outside Valves

These new wheels wear longer, ride easier, prevent jolting and spillage. Developed by Musselman, the inventor of the airwheel for airplanes. No matter how carelessly tire is allowed to run under-inflated, valve cannot be cut or damaged by "creeping".

Three sizes—10" x 2.75"; 12" x 3.30"; 16" x 4.40". Unless you are a rated manufacturer, enclose 10c postage in writing for literature.

For boys wishing to build wheelbarrows, wagons, scooters or bicycle trailers, we supply blue prints at 25c each.

MUSSELMAN PRODUCTS CO.
6225-V ST. CLAIR AVE. CLEVELAND, OHIO

900 Shots of Powdered Lubricant

30¢



One lubricant that cannot drip, gum or freeze, that cannot wash out, squeeze out or burn out—Dixon's Microfyne Lubricating Graphite prevents wear, saves power, stops friction noises. The Dixon "Junior" Graph-Air Gun makes it easy to use. Just squeeze and the powder goes to the seat of trouble.

At most dealers, or write Dept. CG 26 for list of hundreds of uses.

JOSEPH DIXON CRUCIBLE CO., JERSEY CITY, N. J.

PHOTO ENLARGEMENTS

Is Photography your hobby? Do you want a profitable easy business at home? Make **PHOTO ENLARGEMENTS** for yourself and others. Your cost 5c each and less. The Ideal Photo Enlarger is **AUTOMATIC**. No experience required. Also **COPIES** any picture, **\$5.94 COMPLETE**. Interesting circular **FREE**.

5¢ ANY SIZE

Ideal-O, 148 West 23rd St., New York City

HI-SPEED-INDICATOR

0-30,000 R.P.M. SENSITIVE

checks low-power, high speed units; surface speeds, etc.; easy direct reading dial; indispensable to laboratories, machinists, experimenters, etc.; accurate, substantial. Guaranteed. **ODOMETER, 2349 Cambridge Ave., Chicago, Ill.**



GERSTNER Tool Chests

Built for longer service, therefore the choice of Toolmakers and Machinists. Free Catalog.

GERSTNER TOOL CHESTS
440 Columbia St., Dayton, Ohio

BUILD YOUR GRANDFATHER CLOCK

Send 25c for Simple SHOP TESTED COPYRIGHTED BLUEPRINT. The Simple Sensible Red-i-Kut way as thousands have. **DIME** brings PLANS and sixty picture "HOW" Book pricing many fine brass weight Westminster, tube chime, electric and battery movements showing nine beautiful colonial grandfather cases. Build now and save half.

KUEMPEL CHIME CLOCK CO., Bldg. 44, Guttenberg, Iowa.

WORLD'S LOWEST PRICED ADDING MACHINE

IDEAL FOR BUSINESS OR PERSONAL USE GUARANTEED ACCURATE. Not a toy. Operates with only a finger flick. Adds, subtracts, multiplies, divides. Counts up to a million. Pays for itself over and over. Ideal Gift—for Business, Income Tax and School use. **MONEY BACK GUARANTEE.** Send name and address. Pay postman only \$2.50 plus postage. (Send full cash if outside U.S.) Money back in 10 days if not delighted. **AGENTS WRITE.**

ONLY \$2.50

TOTAL COST SEND NO MONEY

FREE TRIAL

ADDITION SUBTRACTION MULTIPLICATION DIVISION

CALCULATOR MACHINE CO., (Mfrs.) DEPT. 109, P. O. BOX 1118, CHICAGO, ILL.

other good pianist until he took up the hobby of finding toy pianos on department store counters which were accurate in tune, sometimes testing 300 to select one. One day he played one of his ninety-eight-cent toys over the air and it was a hit.

White bull frogs with pink eyes are the especial hobby of C. C. Moler, electrical engineer of Hagerstown, Md. They are so rare that museums, including the American Museum of Natural History in New York, have taken a pair from him and zoos have put them on display.

Moler once heard that a white tadpole had been seen in a goldfish pond in Maryland. Waiting until the pond was being drained, he picked among thousands of tadpoles until he found not one, but three white ones. He put the albino froglets in his own pond and nature took over the job of superintendent of production.

What started as a hobby turned out to be a valuable asset for J. P. Rosenbaum of Denver, Colo. He collected water from famous rivers until he found people were especially desirous of being baptized with water from the river Jordan. Now he sells Jordan water in flasks with affidavits of a priest and a protestant minister who have seen the water taken from the Jordan before it is shipped in barrels to Denver.

Gold strikes by those who collect things for a hobby are inevitable. Ben Albertson, of Lewes, Del., fancier of old guns, bought five for a few dollars. Four were junk; the fifth was worth \$9,000 as a collector's item. Oliver Steel, Birmingham, Ala., grain and flour broker, picked up cameos. One he bought for \$1.50 in a pawn shop proved to be worth hundreds of dollars. Adolph Bruner, watch salesman, collected spoons from jewelers' scrap heaps as he made his rounds. A twenty-cent spoon made by a forgotten Russian art process by which the handle takes on the appearance of stained cathedral glass when held up to the light, was worth thousands of times what it cost.

There are many pots of gold awaiting hobby fans at the end of their rainbows, but along the trail there is also the spiritual wealth that happiness brings. This reward is waiting for everyone.

☐ Stamped, self-addressed envelope, sent to our Bureau of Information, will bring you the name and address of the maker of any article described in Popular Mechanics.

The ONLY WORKSHOP TOOL OF ITS KIND—
PLANES and FINISHES
PANELS • RABBETS
ROUTS • TENONS



FITS ANY DRILL PRESS \$7.50 COMPLETE READY TO USE

• A precision safety tool . . . does five distinct operations . . . saves time, money, labor . . . planes and finishes to precision smoothness all woods, tricky grains and knots . . . provides intricate, beautiful paneling effects with ease and speed . . . rabbets, grooves and routs . . . fashions tenons with uncanny accuracy and lightning speed. No blade adjustments required for any or all operations. Fits any 1/4 h.p. or larger drill press.

MONEY BACK FREE TRIAL GUARANTEE. You risk nothing. Send check or money order for \$7.50 or order C.O.D. Postage prepaid. Use it for five days and get full refund if not satisfied.

BARRON TOOL CO., INC., 315 Architects Bldg., Detroit, Mich.

THE BARRON MULTI-PURPOSE
5-IN-1 ROTARY WOOD PLANER

Wood workers: Here it is! Harold Hunt's 1940 catalog!



only 10c

Latest, **UP-TO-DATE IDEAS** for experts and amateurs; **SPECIAL BARGAINS** in rare woods, machines, and all kinds of supplies. Get posted! Send only **10c** to **CRAFTSMAN'S WOOD SERVICE CO.** 2729 S. Mary Street Div. 3376 CHICAGO

15 MODELS! EARN BIG MONEY!

Solo, Tandem, Delivery, Side-car—all featuring **ALL STEEL** frame, Automatic Gear Shift, clutch. **WRITE!**

Ride, Sell or Rent the **NEW Ranger SCOOTER**



120 Miles Per Gallon 30 M.P.H.

Big money selling Mead's new power SCOOTER to stores needing quick, cheap, delivery—renting or selling to persons! Good territory still open but hurry! Write for **EASY TERMS, Free Circular now!**

Mead CYCLE CO. DEPT. N-1 CHICAGO

Save on **TENNIS** **SAVE on our** **NEW LOW PRICES**

BADMINTON STRINGS



Earn money—save money re-stringing rackets! Buy Gut tennis strings direct from factory. Silk strings; Re-stringer's vices, equipment, instructions. Catalog **FREE.**

H. E. WILLS CO., 1047 W. 47th St., Dept. PM-90, Chicago

Calling All Cars

MYSTERIOUS DISCOVERY
SAVES UP TO 30%
on GASOLINE
or Costs Nothing to Try



Stop wasting Gas!—trim dollars off gas bills—get more power—quicker pickup—faster acceleration! **AUTO OWNERS everywhere** praise **VACU-MATIC!** Proven so efficient, it is guaranteed to satisfy, or the trial costs you nothing.

Automatic Supercharge Principle
Vacu-matic is entirely different! It operates on the supercharge principle by automatically adding a charge of extra oxygen, drawn free from the outer air into the heart of the gas mixture. It is entirely automatic and allows the motor to "breathe" at the correct time, opening and closing as required. Saves up to 30% on gas costs, with better motor performance.

FITS ALL CARS
 Constructed of six parts fused into a single unit, adjusted and sealed at the factory. Easily and quickly installed by anyone in a few minutes.

AGENTS *Get yours FREE*

FOR INTRODUCING. Here's a splendid opportunity for unusual sales and profits. Every car, truck, tractor owner a prospect. Send name and address now for big money making offer and how you can get yours Free.

The Vacu-matic Co., 7617-531 W. State Street, Wauwatosa, Wis.

SOUTH BEND LATHES

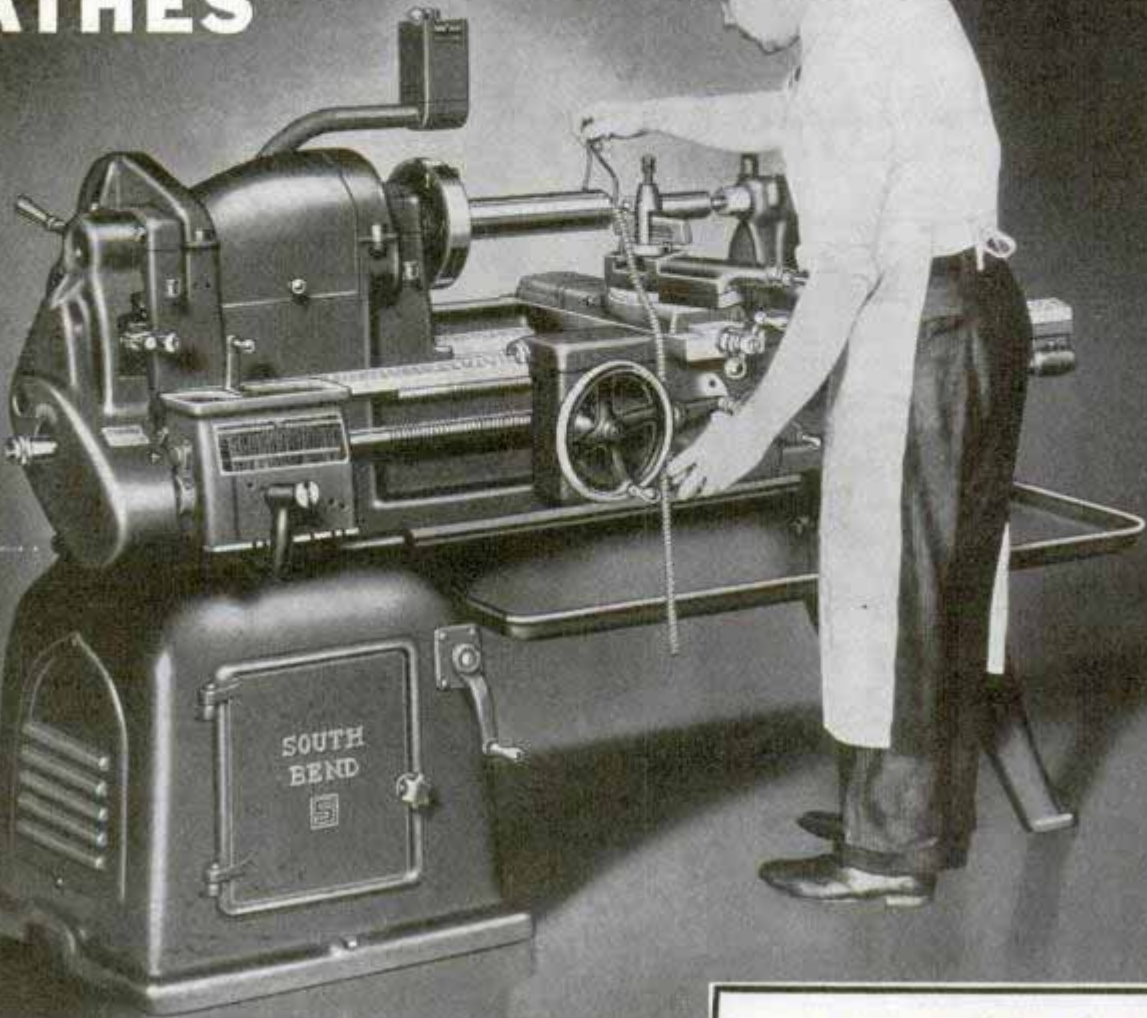

16" x 6' South Bend Underneath Motor Driven Lathe

For thirty-three years South Bend Lathes have been giving efficient, dependable service in the tool rooms and production shops of America's leading industries. Throughout the world, their practical design and fine workmanship have made them the popular choice of men who know machinery. South Bend Lathes have ample power, extreme accuracy, and an unusually wide range of spindle speeds.

SIZES OF SOUTH BEND LATHES

Swing Size	Bed Lengths	Dist. Between Centers
9"—Workshop Lathes	3' to 4 1/2'	17" to 35"
10"—Lathes	3' to 4 1/2'	16 3/4" to 34 3/8"
10"—1" Collet Lathes	3' to 4 1/2'	16 3/8" to 34 3/8"
13"—Lathes	4' to 7'	16" to 52"
14 1/2"—Lathes	5' to 10'	24 1/2" to 84 1/4"
16"—Lathes	6' to 12'	34" to 106"

SOUTH BEND LATHE WORKS

609 E. Madison St., South Bend, Ind., U. S. A.

Lathe Builders Since 1906

ON DISPLAY In all Principal Cities

See a South Bend Lathe before you buy. Write today for free catalog and name of nearest dealer.

Partial List of Dealers

Baltimore, Md.—Carey Machinery Co.
 Boston, Mass.—MacKenzie Mach. Co.
 Bridgeport, Conn.—A. C. Bisgood
 Buffalo, N. Y.—R. C. Neal Company
 Cleveland, Ohio—Reynolds Mach. Co.
 Dayton, Ohio—C. H. Gosiger Mach. Co.
 Detroit, Mich.—Lee Machinery Co.
 Houston, Texas—Wessendorf, Nelms
 Los Angeles, Cal.—Eccles & Davies Co.
 Milwaukee, Wis.—W. A. Voell Mach.
 Newark, N. J.—J. R. Edwards Mach. Co.
 New York, N. Y.—A. C. Colby Mach.
 Philadelphia, Pa.—W. B. Rapp, Mach.
 Pittsburgh, Pa.—Tranter Mfg. Company
 Portland, Ore.—Portland Machinery Co.
 Providence, R. I.—G. T. Reynolds & Son
 Rochester, N. Y.—Ogden R. Adams
 Rockford, Ill.—Factory Supplies Co.
 San Francisco, Cal.—Moore Mach. Co.
 Seattle, Wash.—Star Mach'ry Company
 St. Louis, Mo.—Colcord-Wright Mch.
 St. Paul, Minn.—Robinson Cary & Sands
 Toledo, Ohio—Eno Tool & Supply Co.
 York, Pa.—York Mach. & Supply Co.





DOWN WENT MCGINTY

—but he's out of the dog house now!



"SURE AND IT'S good riddance to an ugly-smellin' pipe!" snapped Mrs. McGinty, dropping the pipe into the water. Quick as an Irish temper, down went McGinty after it!



"NICE WORK, MISTER!" said a young lad on the dock. "But you better smoke a *milder* tobacco to stay out of the 'dog house'. Try the world's best-smelling blend of burleys!"

New! Cellophane tape around lid seals flavor in, brings you tobacco 100% factory-fresh!



SIR WALTER RALEIGH



SMOKING TOBACCO FOR PIPE AND CIGARETTES

UNION MADE

Tune in... **UNCLE WALTER'S DOG HOUSE**
 EVERY TUESDAY NIGHT ★ NBC ★ PRIZES FOR YOUR "DOG HOUSE" EXPERIENCE

HE'S GOT THOSE EXTRAS THAT WIN BALL GAMES

Yes, it's the extras that carried "Bucky" Walters to the top. The extras of slower burning won him to Camel cigarettes



"BUCKY" WALTERS
He won more games
in 1939 than any other
pitcher in the majors

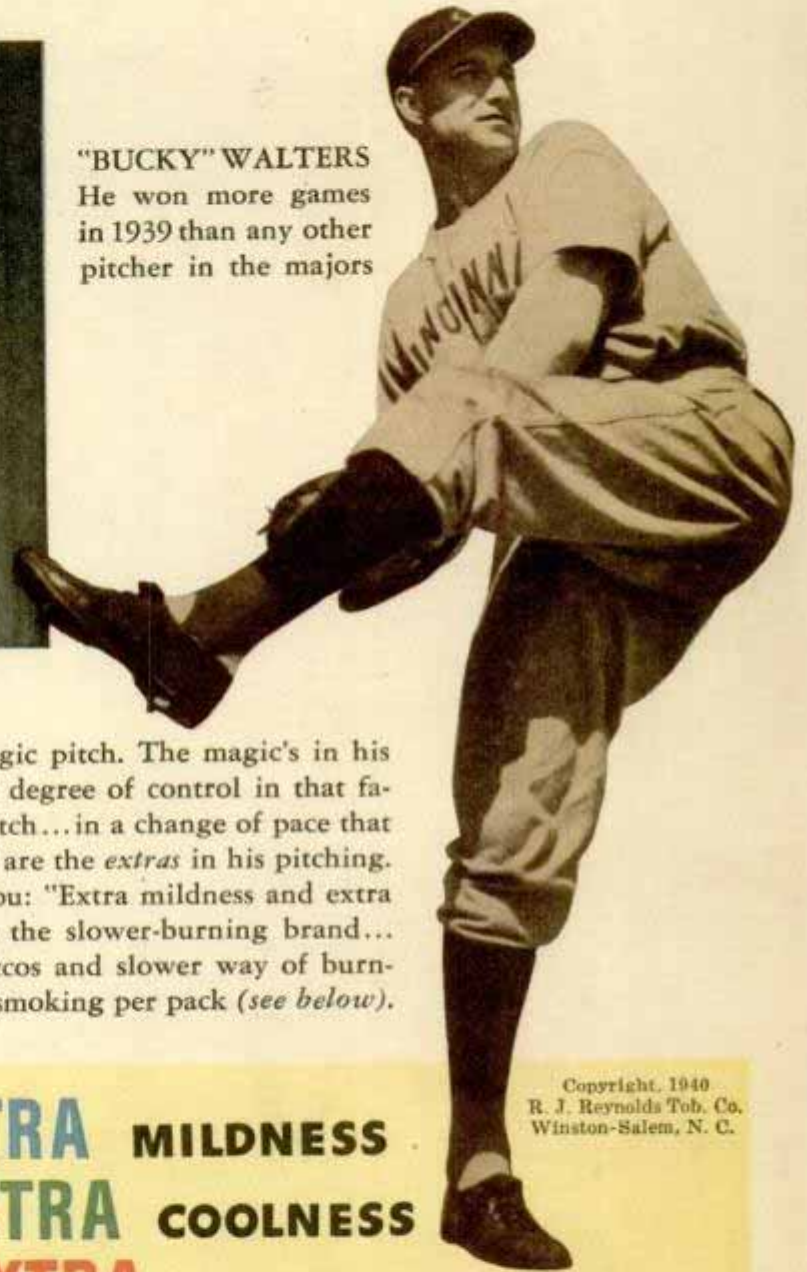

NO, "Bucky" Walters has no magic pitch. The magic's in his extra pitching sense—the extra degree of control in that famous right arm. It shows in every pitch...in a change of pace that shackles the mightiest of bats. Those are the *extras* in his pitching. In his cigarette, "Bucky" will tell you: "Extra mildness and extra coolness win with me. So I smoke the slower-burning brand... Camels." Yes, Camel's costlier tobaccos and slower way of burning mean extra pleasure—and extra smoking per pack (*see below*).



EXTRA MILDNESS
EXTRA COOLNESS
EXTRA FLAVOR

In recent laboratory tests, Camels burned 25% slower than the average of the 15 other of the largest-selling brands tested—slower than *any* of them. That means, on the average, a smoking *plus* equal to

5 EXTRA SMOKES PER PACK!

GET THE "EXTRAS"—WITH SLOWER-BURNING CAMELS

THE CIGARETTE OF COSTLIER TOBACCOS

Copyright, 1940
R. J. Reynolds Tob. Co.
Winston-Salem, N. C.