

**BLITZKRIEG!**

# POPULAR MECHANICS

**MAG**

WRITTEN SC



REG'D. TRADE MARK, GREAT BRITAIN, No. 410426

**AUG.  
25 CENTS**

**SEE PAGE 210**





## "DON'T TELL ME ABOUT WIRING!" barks Mr. Johnson

"I do all my own wiring around the house, and I know that actual 'shorts' are the only things to worry about. As long as there's insulation on wire, everything's OK."

"That may be true in a house," says Fred, "but car wiring is different. Every cable's got to be built to carry a particular load and to meet particular conditions. If a cable is undersize, poorly constructed, or has corroded connections, it 'chokes off' the 'juice'—and the electrical system goes haywire."



"I suppose you're telling me I should replace every wire in this car!" grins Mr. Johnson. "Not at all," says Fred. "This is a Certified Re-Wiring station, and our check-up will spot electrical 'bottle-necks' anywhere in the system. Where we *do* find a defective cable, we replace with Packard cable—best there is."

## FOR BETTER PERFORMANCE . . . SAFER HEADLIGHTS . . . GET A CERTIFIED RE-WIRING CHECK-UP TODAY

For more pep, power and economy from your motor—more light from your headlamps—drive into a Packard Certified Re-Wiring station today. Let a trained mechanic check your electrical system with

accurate instruments . . . clean dirty connections and replace "bottle-neck" wiring. Look for the blue-and-gold Packard Certified Re-Wiring sign—your assurance that the job will be done right.

**DEALERS:** Ask your Packard jobber to arrange a showing of the new Packard Certified Re-Wiring film, "Copper Dollars," explaining the Certified Re-Wiring program. Packard Electric Division, General Motors Corporation, Warren, Ohio.

**Packard**  
REG. U.S. PAT. OFF.  
TRADE MARK

THE STANDARD WIRING EQUIPMENT OF THE AUTOMOTIVE INDUSTRY

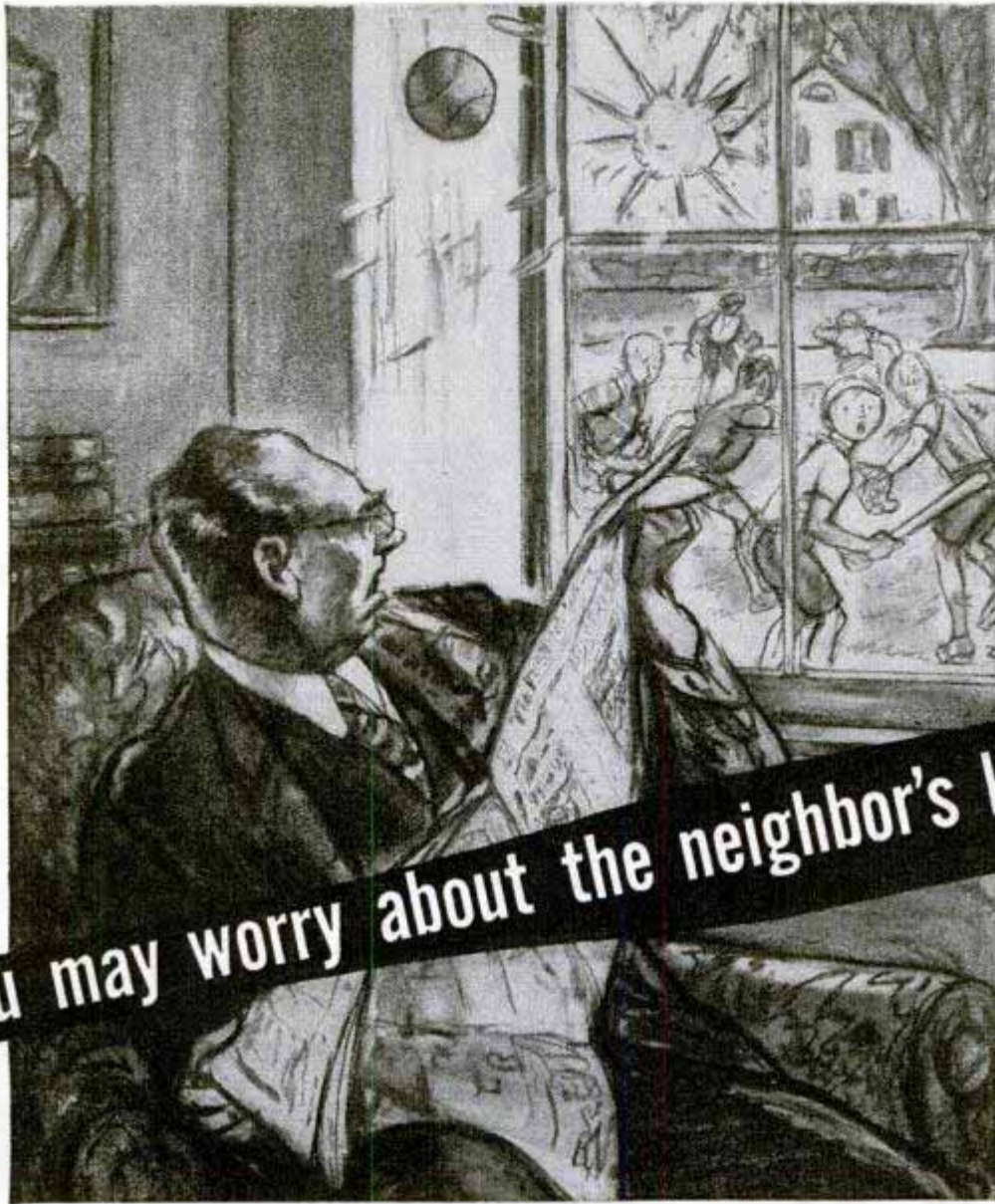

You may worry about the neighbor's kids

but here is one worry you can avoid

If those little rascals next door get your goat, there's not much you can do about it except change your address.

But you don't have to move to get Peace Of Mind about your chassis lubrication.

Let us Marfak your car every 1,000 miles, and be sure it is in perfect running condition.

For Marfak is Texaco's standardized 40-Point Lubrication Service. Every detail is checked. Nothing missed.

And at every vital friction point, a special lubricant goes on duty—a lubricant so tough it lasts twice as long as ordinary grease.

This lubricant is Marfak, from which the full service takes its name.

To keep your car in smooth-as-velvet condition, drive in and we'll do the rest.

TEXACO DEALERS INVITE YOU TO tune in the TEXACO STAR THEATRE—Starring Kenny Baker and Frances Langford—Every Wednesday Night—Columbia Network—9:00 E.D.T., 8:00 E.S.T., 8:00 C.D.T., 7:00 C.S.T., 6:00 M.S.T., 5:00 P.S.T.

Let us  
**MARFAK**  
your car



Copyright 1940  
The Texas Company

TEXACO'S 40-POINT LUBRICATION SERVICE AT ALL TEXACO AND OTHER GOOD DEALERS



"IS IT FOR ME?"



You kind of hope it is — for a lot of good news and good times come your way by telephone.

Maybe it's a date for Sister Sue. Or a golf call for Dad. Or Bill asking if Jimmie can go to the movies. Or Grandma calling Mother to find out if things are all right.

And everything is more likely to be all right when there's a telephone in the home. In many, many ways, it is a real friend of the family.

*The Bell System cordially invites you to visit its exhibits at the New York World's Fair and the Golden Gate International Exposition, San Francisco.*

**BELL TELEPHONE SYSTEM**



# Popular Mechanics Magazine

H. H. WINDSOR, Founder

H. H. WINDSOR, Jr., Editor and Publisher

August, 1940

Vol. 74, No. 2

## IN THIS ISSUE

<b>Blitzkrieg</b> . . . . .	<b>161</b>
<b>Quicker than a Wink—and then Some</b>	<b>168</b>
<b>Sea Giants on Parade</b> . . . . .	<b>Coloroto</b>
<b>Super-Speed Roads of Tomorrow</b> . . . . .	<b>188</b>
<b>Why Not Try the Easy Way?</b> . . . . .	<b>194</b>
<b>Get into the Swim</b> . . . . .	<b>200</b>
<b>Seeking Power for Space Rockets</b> . . . . .	<b>210</b>
<b>Dress Rehearsals for Danger Aloft</b> . . . . .	<b>216</b>
<b>Tuning in the Next President</b> . . . . .	<b>221</b>
<b>Miracle Men of the Corn Belt</b> . . . . .	<b>226</b>
<b>Keeping the Midget Racers Rolling</b> . . . . .	<b>232</b>
<b>Minutes That Mean Eternity</b> . . . . .	<b>242</b>
<b>Homing Pigeons on the Night Shift</b> . . . . .	<b>248</b>
<b>Trappers of Lightning</b> . . . . .	<b>252</b>

(Continued on next page)

## 50,000 Planes a Year

**Y**ANKEE ingenuity and talent for mass production, says Capt. E. V. Rickenbacker, should be able to turn out 50,000 planes a year by the end of 1942. But the first 50,000 will cost over \$6,000,000,000, and training pilots and mechanics is more difficult than manufacturing planes. Ten thousand planes for the Navy alone would require 20,000 pilots and 300,000 mechanics, and it wouldn't be smart to build planes that would be obsolete before pilots were trained to fly them. Read Capt. Rickenbacker's analysis of the air defense situation in the September issue.

## \$2,500 Home for Eight

**T**HEY call it a magic house and in many ways it is. Its cost is only \$2,500, plus the land. It was built in two days, has five rooms, living quarters for a family of eight. No prairie shack, it is a modern machine for living, efficient, economical, comfortable, designed after years of research by a philanthropic foundation. A September article tells of this new American home.

## Next Month

**B**ARNSTORMING pilots of the new generation are the fliers who go up at dawn and dusk to hop over trees and duck under power lines to sow crops from the air or dust them with insect poison. It's risky work and takes superb flying. One pilot lost part of his fuselage and tail when the cloud of sulphur blew up behind him but he got down all right. Those fellows know how to fly. They have to. Read about them in the September story, "Farming Takes to the Air."

## Big Biscuit Cutter

**S**ANDHOGS are mining blue clay between the toes of Chicago skyscrapers with big "biscuit cutters," giant rings of steel that exert a 4,800-ton push into the muck and squeeze it out like toothpaste. They're burrowing under the river with only a few feet of mud separating them from tons of water. Theirs is the business of boring Chicago's first passenger subway, a \$46,000,000 project. An article next month takes you down in the diggings.

## Army on the Wing

**N**INE months of training at the army air schools prove to be just "grade school" when the graduate moves on to an air base. There, learning to "fly, bomb and shoot" in 300-mile-an-hour fighters and four-engined bombers, he finds college never ends. The September Coloroto section, with eight pages of color photographs, puts you in the school that's really high.

Published monthly by POPULAR MECHANICS CO., 200 East Ontario Street, Chicago, U. S. A. Single copy in United States, 25 cents; \$2.50 a year, \$4.00 for two years, \$5.00 for three years in United States and possessions, Canada, Newfoundland, Labrador and countries of the Pan-American Postal Union including Spain. To all other countries add \$1.00 a year extra for overseas postage. Changes in address must be reported to us immediately to eliminate delay. Entered as Second Class Matter, Sept. 15, 1903, at the Post Office at Chicago, Illinois, under Act of March 3, 1879. Entered as Second Class Matter at the Post Office Department, Canada. Copyright 1940, by Popular Mechanics Co. in the United States, Australia and France. Printed in the United States of America.

**"PYROIL** was a great help in my fuel to win First Place in this year's Indianapolis 500 Mile Auto Race"

*Wilbur Shaw*



**WILBUR SHAW**—daring and dashing three-time winner of the annual 500 Mile Memorial Day Auto Classic at Indianapolis. Shaw won this hazardous, punishing, 117 mile-an-hour speed event in 1937, 1939 and again this year, 1940.

## 8 of the PRIZE WINNERS Use PYROIL

**MAURI ROSE, 3rd**                      **BOB SWANSON, 6th**  
**TED HORN, 4th**                     **FRANK WEARNE, 7th**  
**JOE THORNE, 5th**                 **MEL HANSEN, 8th**  
**FRANK BRISKO, 9th**

Again the great 500 mile Memorial Day automobile race at Indianapolis has been run. And again as in many years past, Pyroil has been a favored product of the winners.

The fact that Pyroil has been proved time and again on many speedways by the foremost of auto racing pilots, tells you that it must be a good product for your car. Ask your garage or service station salesman to tell you all about Pyroil, today. Or mail coupon, below. Manufactured and Guaranteed by Pyroil Company, W. V. Kidder, Founder, 58 Pyroil Bldg., Main St., LaCrosse, Wisconsin, U. S. A.



*Want to Know How Pyroil Works and All That It Does? Send Coupon Below.*

**DISTRIBUTORS:**  
**CHECK AND MAIL COUPON FOR FRANCHISE FACTS.**

ADD MERELY OUNCES TO GAS & OIL

**PYROIL COMPANY,**  
 58 Pyroil Bldg., LaCrosse, Wisconsin  
 Please send me Free Booklet and full information about how Pyroil improves engine performance and provides important protection to vital parts.  
 Send Details of your plan for Distributors.  
 Name.....  
 Address.....  
 City..... State.....

## (Contents—Continued)

### AUTOMOTIVE

Mirrors for auto show side and rear views.....176  
 Motorcycle with retractable outrigger wheels.....205  
 Army trucks "go over the top" in tests.....208  
 Globular road map magnified for easy reading.....214  
 New car model displayed on horizontal bar.....215  
 Independent wheel springing for trailers.....220  
 Air speed indicator on door-type mirror.....230  
 Auto assembly of mechanisms developed century ago 230  
 Hot plate vaporizes turpentine used as motor fuel...237  
 One-man towing bar attached without tools.....237  
 Motorized chair for invalid.....247  
 Air-powered vacuum cleaner for service stations...251  
 Auto clinic on wheels diagnoses car ills.....256

### AVIATION

Flying nurses "bail out" with first-aid kits.....199  
 Hydraulic starter designed for light planes.....224  
 Three-dimension map shows scheduled flights....224  
 Luminous signal hails navy seaplanes to port.....231  
 Fall with parachute has little effect on man.....240  
 Radio headlight to guard planes from collision....241

### FARM

Plant marker in glass tube is weatherproof.....172  
 Uniform fertilizer spreader can sow seeds.....204  
 Cultivator helps England "dig" for victory.....245

### HOUSEHOLD

Stainless steel wallboard resists corrosion.....215  
 Water heater with table top.....224  
 "One-way peephole" in door reveals caller.....246

### MODELS

Village has lighted homes and street lamps.....204  
 Building a city to order.....206  
 Engine weighing half an ounce.....220  
 Electric model of element shows nuclear changes...240  
 Tin soldier and gun advertise gas station.....245  
 Life size "Last Supper" sculptured in plastics.....256

### PHOTOGRAPHY

Portable miniature enlarger packs in small case...176  
 Four lights for darkroom in single fixture.....198  
 High-speed portrait of a sneeze.....198  
 Photofloods worn as headgear.....220

### RADIO AND ELECTRICITY

Ultra-compact marine radiotelephone for small craft 295  
 Capacity-operated vacuum-tube switch.....296  
 Two-tube "phantom" record player uses a loop....298  
 Hints for radio experimenters.....299  
 Built-in vertical loop proposed for television.....300  
 Miniature camera-type set for hikers.....300  
 Portable receiver has detachable loop antenna.....300

### SCIENCE AND INDUSTRY

Electric brain plays Chinese game of Nim.....166  
 Six auto engines team as power plant.....193  
 Iron mines in lake charted through ice.....209  
 Melting pills tell temperature of heated metals...214  
 100,000,000-volt atom smasher.....236

### SPORTS

Straps hold runner until starter fires gun.....167  
 Grooved rack trains football place kickers.....193  
 Football blocking indicator for each player.....205

### TOOLS

Offset ratchet screwdriver for close quarters.....173  
 Portable wrench cabinet has workbench top.....176  
 Drill attachment cuts rivets from plane "skin"....231  
 Pliers cut flexible cable and strip wires.....241  
 Foot-powered saw clamps to bench.....246  
 Powered chain saw is efficient under water.....251

### WAR

Four-gun-man in a "blister" guards bomber.....237  
 Fire-control tower is the battleship's "brain".....238  
 Training big guns of a floating fortress.....239

### MISCELLANEOUS

Navy torpedo boats fight warship or submarine...166  
 Light bulb with reflector inside.....167  
 Water boiled in fireproof paper.....167

(Continued to page 6A)

# TEST YOUR

# B.K.\*



## IN THIS BATTERY QUIZ

\*BATTERY KNOWLEDGE

**QUESTION:** What are the three major functions of a storage battery in a car?

**ANSWER:** (1) To provide a source of current for starting and ignition; (2) to control the voltage of the electrical system; (3) to furnish current when the electrical demands exceed the output of the generator.

**QUESTION:** Does a battery store up electricity?

**ANSWER:** No, a battery can store only chemical energy which is produced from the electrical energy of the generator and is caused by the reaction between the sulphuric acid in the electrolyte and the active materials in the plates.

**QUESTION:** How does the battery produce electrical energy?

**ANSWER:** The stored-up chemical energy of the plates produces electrical energy when the battery is discharged. This reaction produces lead sulphate and water, which reduces the concentration of acid in the electrolyte.

**QUESTION:** What is meant by "self-discharge"?

**ANSWER:** When a battery stands idle, it loses chemical energy. This is "self-discharge," and it is very dependent on temperature. It amounts to one point loss of capacity per day at 70° F., and to nearly three points per day at 100° F. The loss is negligible at 0° F. Therefore, batteries should be stored in a cool place.

**QUESTION:** In what ways is summer harder on a battery than winter is?

**ANSWER:** In hot weather evaporation is very high, and unless water is added regularly the electrolyte level will get so low that it does not cover the top of the plates. Another danger is excessive output of the generator. This is more serious in summer because a battery stores up chemical energy faster in hot weather than in cold, with the result that it is more likely to gas and overheat.

**QUESTION:** What are the dangers of an over-charged battery?

**ANSWER:** If the generator charging rate is not properly controlled, the generator output may become excessively high, resulting in unnecessary wearing out of the plates. It is, of course, obvious that too low a charging rate will result eventually in a discharged battery.

**QUESTION:** What make of battery is original equipment in 40 per cent of American cars?

**ANSWER:** Delco batteries are used as original equipment by the manufacturers of nearly half the cars sold in America. This expression of confidence by leading car manufacturers is based on the fact that Delco batteries have proved their dependability in millions of cars. When a new battery is needed, replace with a Delco—available for all makes of cars.

# Delco-Remy

World's Largest Manufacturer of Automotive Electrical Equipment

# SHE DIDN'T MARRY HIM FOR HIS MONEY



IT'S NOT HOW OLD you are, but how young you look that counts! If you'd like to smooth a couple of years off your chin and jowls, get yourself a Barbasol Face. Modern Barbasol is more than kind to your skin. Containing soothing, beneficial oils, it protects against razor irritation while you shave—and leaves your face feeling soft as satin, after you've shaved!

**HEY, BROTHER!** If you're trying to improve your appearance, we've got a better idea. Try shaving with Barbasol for ten days and see how much younger you look. It's 25¢, 50¢, and 75¢ at all drugstores. Barbasol Blades, 5 for 15¢.



For Modern Shaving  
No Brush · No Lather · No Rub-in

## (Contents—Continued)

Rail sleeper has three-story berth.....	172
Balloon warns pilot movie is being filmed.....	173
Cup-shaped sun shades fit like glasses.....	198
Life span gains twenty years since 1870.....	205
Metal clip for brace work strengthens house.....	208
Coin-in-slot movie machine shows seventy-foot film.....	214
Heroic ten-ton plaque cast in steel.....	225
Perisphere dwarfs painters crawling over it.....	230
"Strongback" moves boardwalk to new location.....	236
Elephant feet form legs of table.....	240
"Stop-and-go" halts long-winded speakers.....	246
4,000,000 pound test rack crushes concrete.....	247

## Craftsman and Shop Notes

### AUTOMOTIVE

Preventing shifting of ice load in truck.....	304
Auto shortcuts.....	317
Anchoring temporary boot on tire.....	318
Combination brush and leaf wedge.....	318
Handle on truck tailboard serves as step.....	318
Hole in instrument panel holds your pipe.....	318
Creepers improved by shifting the casters.....	319
Holding inner tubes under water for testing.....	319
Water short-circuits generator cutout.....	319
Weight sounds horn while testing.....	319
Clogged line to gasoline gauge cleaned with wire.....	320
Device to locate compression leaks.....	320
Guards on creeper casters allow free action.....	320

### CAMPING, HUNTING, FISHING

Keeping rain out of tent-pole openings.....	259
Minnow-trow keeps bait alive.....	263
Simple fire starter.....	264
Camp stove improvised from pail.....	268
Avoiding loss of tackle when fishline snags.....	269
Rubber-hose hanger for fishing rod.....	272
Copper wire replaces winding on fishing rods.....	278
Self-closing pocket for fishhooks.....	283

### FARM

Furrow chain aids in steering tractor.....	306
Orchard ladder clamps to limb.....	306
Rotating hook assembly for use in barn.....	306
Rake tooth makes humane tether spring.....	313
Fishpole tether for mother hen.....	314
Seeder for replanting hill crops.....	314
Brake drums serve as farm signal gong.....	316
Rim prevents clogging of tractor lugs.....	316
Rugged hand truck for farm use.....	316

### HAND TOOLS

T-square cut out shows lines on work.....	262
Make your hand chucks and pin vises.....	301
Hand router from vacuum motor.....	303
V-block clamps that do not mar work.....	311
Adjustable pipe-flange spanner wrench.....	312
Handle for threading-tool gauge.....	312
Beveled square checks angle of welded joints.....	314
Jig for driving stakes for concrete-walk forms.....	314

### HOME IMPROVEMENTS

Bookcase hides chimney in attic.....	273
Braces steady eave troughs.....	289
Putty knife beveled to simplify glazing windows.....	289

### HOUSEHOLD

Care of iron kettles.....	259
Solving home problems.....	260
Scrubbing brush silks corn.....	262
Paper towel rack to hang under shelf.....	264
Extra coil improves gas hot-water heater.....	268
Flowerpot rack hooks on window.....	272
Pattern helps fit linoleum around fixed objects.....	279
Vacuum cup prevents window shade flapping.....	282

### LAWN AND GARDEN

Hinged sides on wheelbarrow make dumping easy.....	259
Spring holds bed knife of lawnmower down.....	264
Gauge aids in cutting hedge uniformly.....	268
Belt acts as compass to circle around tree.....	269

(Continued to page 8A)



# HOW SAFE IS



# YOUR JOB?

## CAN YOU CLASS YOURSELF AMONG THE "OK-MUST KEEP!" EMPLOYEES?

**NO** USE dodging facts! At times—in every company's history—the pay-roll goes onto the operating table for major surgery. And when such times come, certain employees are amputated—sometimes a few, sometimes many.

Yet a certain few are always marked "OK-Must Keep!" And the many who are let out envy them—call them "lucky."

### What's Behind Job-Holding "Luck"?

It can be *proved*, however, that there's almost always something more than luck involved.

Even the fellow who seems to "have a drag" may actually have a lot more on the ball than is apparent to his fellow workers.

He may have hidden values that only his superiors see or know about.

After all, the "I-Gotta-Drag-Club" has taken a bad licking. In fact, it rather completely disbanded in 1932-1933.

Yet why is it that some employees hold their jobs at the very time when others of seemingly *equal* ability lose theirs?

If it's not luck, there *must* be some explanation. And there *is* one!

### How to Insure Your Job

The secret of holding your job in hard times is to be invaluable to your employer. And a man or woman who is invaluable is usually a well-trained one.

Training is of many kinds—stems from many sources. But the LaSalle kind has been unusually successful. Nearly a million members, in a score of subjects, over a thirty year period can testify to that—and many can prove it by their pay envelopes!

They have cause to agree with us that the real secret of both promotion and job security is just this: "On your present job, make sure you are doing it well, then *train* for the job ahead!"

### Why It Works

Put yourself at your own president's desk for a moment.

You are faced with cutting the pay-roll. First of all, you certainly are going to do your best to hold on to those employees who really know their present jobs.

But among them—the very last to go will be those

few who are also wholly or partly trained for the job ahead—even for the job *ahead* of the job ahead!

### What You Should Do About It—

But true as these facts are, you probably will tend to do nothing about them.

"My job is safe," you think. "My company won't cut down—and even if it does, *I* won't suffer."

But doesn't the very fact that you have read this far indicate that there's some small doubt—a trifle of uneasiness in your mind?

Wouldn't you be more comfortable if right now *your* boss knew that *you* were taking LaSalle training—a piece of knowledge that upon request we take pains to bring to the personal attention of every LaSalle enrollee's superior?

What you *should* do about it is, therefore, as obvious as the coupon below.

### — If You've Got What It Takes!

That coupon, you know, has helped increase the pay envelopes, brighten the lives, and secure the future for many men and women who saw what they *should* do — **AND THEN DID IT!**

It isn't easy. It will cost you hours of serious study, of leisure with friends, your radio, and the movies. And, even on our very liberal payment plan, it will also cost you some money.

But any worthwhile insurance does cost money. And since this is the nearest thing to job-certainty that we know about—it is *worth* money!

Why not at least investigate? *That* costs not a cent! The coupon will bring a quick response—may help start you on the way toward the future that's *due* you!

Better mail it now—and play safe!

**FREE!** Any of these booklets — or similar ones on your own field.

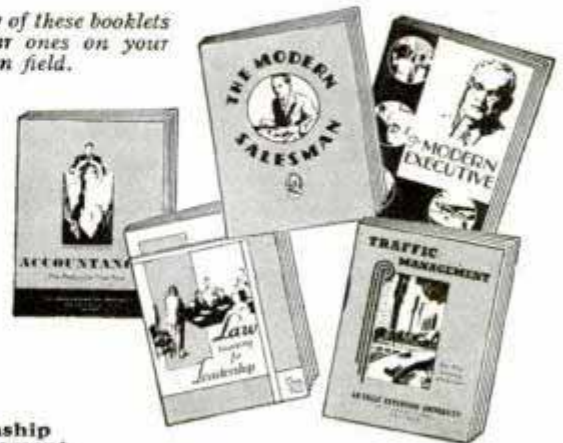

## LASALLE EXTENSION UNIVERSITY

### A CORRESPONDENCE INSTITUTION

Dept. 864-R, CHICAGO

I'd like to know what you can do to help me better my job. Send me your free booklet and full details about the training I have checked below:

- |   |   |  |
|---|---|--|
| <input type="checkbox"/> Higher Accountancy | <input type="checkbox"/> Traffic Management   | <input type="checkbox"/> Modern Salesmanship   |
| <input type="checkbox"/> Law: LL.B. Degree  | <input type="checkbox"/> Executive Management | <input type="checkbox"/> Industrial Management |

Name.....Age.....

Address.....Present Position.....

# How to save money on home repairs

Sealing a crack in a heating boiler—one of the hundreds of economical home repairs that can be made with Smooth-On No. 1.

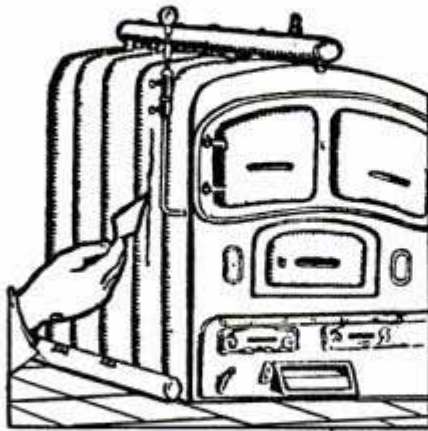

Leaks, and loose appliances—the bane of every household—need not be tolerated or expensively corrected when you have a can of SMOOTH-ON No. 1 on hand.

This many-purpose iron cement quickly remedies such nuisances and possible dangers at a cost of a few pennies for each application.

A can of SMOOTH-ON is as essential to a householder or shop as a hammer or screw driver. Once you have tried it and found how easily it can be applied, how positively it works, and how many jobs it can be used for, you will join the huge army of SMOOTH-ON boosters.

The free Smooth-On Handbook gives simple instructions with diagrams for ingenious, practical, money-saving repairs to mechanical equipment around the home and on the motor car and boat. Every householder and mechanic should have a copy of this useful manual.

Get Smooth-On No. 1 in 1 $\frac{1}{4}$ -oz., 7-oz., 1-lb. or 5-lb. can from your hardware store, or if necessary, from us. For your protection, insist on Smooth-On, used since 1895.

**FREE** The Smooth-On Handbook — 40 pages — 170 diagrams—sent free if you return the coupon.

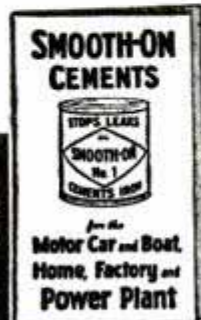

SMOOTH-ON MFG. CO., Dept. 37  
574 Communipaw Ave.,  
Jersey City, N. J.  
Please send Smooth-On Repair Book.  
Name .....  
Address .....  
8-40 .....

Do it with **SMOOTH-ON**

## (Contents—Continued)

Net has gas chamber to kill insects.....	272
Stakes help position croquet arches easily.....	272
Care of lilac bushes.....	273
Stakes in flower bed keep dogs out.....	279

### OFFICE

Freezing pen to assemble it.....	267
Inkstand holds two bottles and has pivoted cover.....	278
Headrest for cradle telephone.....	305
Eraser held on typewriter by vacuum cup.....	311

### PHOTOGRAPHY

Suitcase-type "darkroom" carried with you.....	290
Mark on jug to measure hypo.....	292
Notebooks as photo albums.....	292
Punch mark photo film for identification.....	292
Rockers on tank to agitate developer.....	292
Tape on lens checks focus.....	292
Drying line from paper clips and spring.....	293
Flashlight on camera aids in focusing.....	293
Plate scraper used as a squeegee.....	293
Rubber bands show age of developer.....	294
Slot in bench catches paper scraps.....	294

### POWER TOOLS

Holders for your drill-press accessories.....	262
Five toy motors convey basic ideas.....	274
Clamp holds cord out of way of sander.....	278
Avoiding chatter in slender lathe boring tools.....	305
Cutting accurate miters on a circular saw.....	311
Sliding motor mount serves bench-top machines.....	315

### STORE AND SHOP

Dividing butter prints accurately.....	304
Padlocked front on cabinet keeps contents safe.....	304
Brake system for shop hand trucks.....	305
Removing hat-box cover easily.....	306
Cardboard trough assures even borders on tickets.....	312
Position of stovepipe damper located accurately.....	312
Tailor carries pins on wrist.....	316

### TOYS AND NOVELTIES

Tree house for little tots.....	278
Motor-driven merry-go-round seats six.....	280
Electric-train lights stay on all the time.....	282
"Barrel bronco" gives a thrilling ride.....	283
Container for marbles of Chinese checker game.....	283
Amusing animal toy can change its face.....	289

### WOODWORKING

Snack and beverage tray cut from plywood.....	257
Magazine rack of plywood.....	269
Building jack serves as veneer press.....	273

### MISCELLANEOUS

Sealing knots and stains against bleeding.....	258
Improvised holder for crocheting materials.....	259
Anchoring brace or guy wires in the ground.....	262
Bumper for coaster wagon.....	262
Paper-plate spools store pieces of wire.....	264
A rowboat goes sailing.....	265
Beach umbrella has folding table.....	267
Spider-web house numbers and wall ornaments.....	267
Tennis-table apron keeps ball from rolling under it.....	268
Twin pier cabinets.....	270
Tension spring protects guy ropes.....	278
An aid in docking a boat single handed.....	279
Pencil electrode for arc-soldering outfits.....	282
Stepping stones made light by reinforcing them.....	282
Bookbinding for fun or profit.....	284
Two alterations that improve arc-soldering outfits.....	303
Frayed cable repaired with copper-wire wrapping.....	304
Chromium plating simplified.....	307
Adjustable rail on sawhorse has many uses.....	312
Gas-torch "compass" to cut metal disks.....	313
Emergency repair for copper tubing.....	318

### IMPORTANT NOTICE

It is the intention of this magazine to provide its readers with information regarding the latest developments in the mechanical arts. We take no responsibility as to whether the disclosures contained in our articles are covered by patents and advise readers to investigate this subject before making, using, or selling any of the products, machines, or processes described, in order to avoid possible liability for patent infringement.



# "THE RUDDER'S GONE, SIR!"

● Fateful moment — when a ship loses its rudder! Then a great hulk drifts helplessly — and unless aid comes, that ship goes "on the rocks."

There are *men* who drift all their lives. Is it surprising that these rudderless souls end up "on the rocks"?

I. C. S. students are men who fashion their own "rudders" — out of common sense, determination, and *sound, essential training!* If you want to come into the Port of Prosperity and Security, then you must get the training you need. Get it "the I. C. S. way" — from textbooks that have been adopted by 25 State Universities — through methods that are *individualized* to fit your own *personal* requirements. Send the coupon — *today* — for complete information.

## INTERNATIONAL CORRESPONDENCE SCHOOLS

BOX 5582-J, SCRANTON, PENNA.



Without cost or obligation, please send me a copy of your booklet, "Who Wins and Why," and full particulars about the course *before* which I have marked X:



### TECHNICAL AND INDUSTRIAL COURSES

- |   |  |   |   |  |  |
|---|--|---|---|--|--|
| <input type="checkbox"/> Agriculture              | <input type="checkbox"/> Air Brake                 | <input type="checkbox"/> Cotton Manufacturing     | <input type="checkbox"/> Marine Engines         | <input type="checkbox"/> R. R. Signalmen's         | <input type="checkbox"/> Refrigeration |
| <input type="checkbox"/> Air Conditioning         | <input type="checkbox"/> Diesel Engines            | <input type="checkbox"/> Electrical Engineering   | <input type="checkbox"/> Mechanical Drafting    | <input type="checkbox"/> Sanitary Engineering      |  |
| <input type="checkbox"/> Architectural Drafting   | <input type="checkbox"/> Electric Lighting         | <input type="checkbox"/> Fire Bosses              | <input type="checkbox"/> Mechanical Engineering | <input type="checkbox"/> Sheet Metal Work          |  |
| <input type="checkbox"/> Architecture             | <input type="checkbox"/> Fruit Growing             | <input type="checkbox"/> Heating                  | <input type="checkbox"/> Mine Foreman           | <input type="checkbox"/> Steam Electric            |  |
| <input type="checkbox"/> Auto Engine Tune-up      | <input type="checkbox"/> Heat Treatment of Metals  | <input type="checkbox"/> Navigation               | <input type="checkbox"/> Patternmaking          | <input type="checkbox"/> Steam Engines             |  |
| <input type="checkbox"/> Auto Technician          | <input type="checkbox"/> Highway Engineering       | <input type="checkbox"/> Pharmacy                 | <input type="checkbox"/> Plumbing               | <input type="checkbox"/> Steam Fitting             |  |
| <input type="checkbox"/> Aviation                 | <input type="checkbox"/> House Planning            | <input type="checkbox"/> Poultry Farming          |   | <input type="checkbox"/> Structural Drafting       |  |
| <input type="checkbox"/> Boilermaking             | <input type="checkbox"/> Locomotive Engineer       | <input type="checkbox"/> Practical Telephony      |   | <input type="checkbox"/> Structural Engineering    |  |
| <input type="checkbox"/> Bridge Engineering       | <input type="checkbox"/> Machinist                 | <input type="checkbox"/> Public Works Engineering |   | <input type="checkbox"/> Surveying and Mapping     |  |
| <input type="checkbox"/> Building Estimating      | <input type="checkbox"/> Management of Inventions  | <input type="checkbox"/> Radio, General           |   | <input type="checkbox"/> Telegraph Engineering     |  |
| <input type="checkbox"/> Chemistry                | <input type="checkbox"/> Managing Men at Work      | <input type="checkbox"/> Radio Operating          |   | <input type="checkbox"/> Textile Designing         |  |
| <input type="checkbox"/> Civil Engineering        | <input type="checkbox"/> Manufacture of Pulp Paper | <input type="checkbox"/> Radio Servicing          |   | <input type="checkbox"/> Toolmaking                |  |
| <input type="checkbox"/> Coal Mining              |  | <input type="checkbox"/> R. R. Section Foreman    |   | <input type="checkbox"/> Welding, Electric and Gas |  |
| <input type="checkbox"/> Concrete Engineering     |  |   |   | <input type="checkbox"/> Woolen Manufacturing      |  |
| <input type="checkbox"/> Contracting and Building |  |   |   |  |  |

### BUSINESS COURSES

- |  |   |  |   |   |                                      |
|--|---|--|---|---|--------------------------------------|
| <input type="checkbox"/> Accounting          | <input type="checkbox"/> Advertising                            | <input type="checkbox"/> Civil Service       | <input type="checkbox"/> First Year College   | <input type="checkbox"/> Railway Postal Clerk         |                                      |
| <input type="checkbox"/> Bookkeeping         | <input type="checkbox"/> Business Correspondence                | <input type="checkbox"/> College Preparatory | <input type="checkbox"/> Foremanship          | <input type="checkbox"/> Salesmanship                 | <input type="checkbox"/> Secretarial |
| <input type="checkbox"/> Business Management | <input type="checkbox"/> Business Correspondence                | <input type="checkbox"/> Commercial          | <input type="checkbox"/> French               | <input type="checkbox"/> Service Station Salesmanship |                                      |
| <input type="checkbox"/> Cartooning          | <input type="checkbox"/> Cost Accounting                        | <input type="checkbox"/> C. P. Accounting    | <input type="checkbox"/> Grade School         | <input type="checkbox"/> Sign Lettering               | <input type="checkbox"/> Spanish     |
|  | <input type="checkbox"/> Home Dressmaking                       |  | <input type="checkbox"/> High School          | <input type="checkbox"/> Illustrating                 |                                      |
|  | <input type="checkbox"/> Professional Dressmaking and Designing |  | <input type="checkbox"/> Lettering Show Cards | <input type="checkbox"/> Traffic Management           |                                      |

### DOMESTIC SCIENCE COURSES

- |   |   |  |
|---|---|--|
| <input type="checkbox"/> Advanced Dressmaking | <input type="checkbox"/> Home Dressmaking | <input type="checkbox"/> Tea Room and Cafeteria Management, Catering |
| <input type="checkbox"/> Foods and Cookery    |   |  |

Name..... Age..... Address.....

City..... State..... Present Position.....

Canadian residents send coupon to International Correspondence Schools Canadian, Limited, Montreal, Canada  
British residents send coupon to I. C. S., 71 Kingsway, London, W. C. 2, England

This One





**WOULD YOU LIKE TO HELP KEEP  
GIANT AIR LINERS IN FLYING TRIM?  
...That's what these fellows are doing!**



As maintenance men with the nation's great air lines, these fellows are only four out of hundreds of Aero ITI-trained men now making good in all branches of Aviation.

The same training that won them a "flying start" is open to you. Even MORE important, Aero ITI training gives you the broad, thorough technical knowledge and practical ability to make Aviation your LIFE WORK—whether you make your start in aircraft manufacturing, air line operations, or aeronautical engineering.

Aviation is a permanent, fast-growing industry. Success in it demands the RIGHT training. Investigate the PROVEN Aero ITI way to an Aviation career. Write NOW.

**AERO INDUSTRIES TECHNICAL INSTITUTE**  
5253 WEST SAN FERNANDO ROAD  
LOS ANGELES, CALIFORNIA

Five Courses in AIRCRAFT MECHANICS and AERONAUTICAL ENGINEERING... Including U. S. Civil Aeronautics Authority Approved 12 Months Aircraft Mechanics Training

**EXECUTIVE BOARD**

**JOHN K. NORTHROP**  
President, Northrop Aircraft, Inc.  
**ROBERT E. GROSS**  
President, Lockheed Aircraft Corporation  
**C. A. VAN DUSEN**  
Vice-Pres., Consolidated Aircraft Corporation



**U. S. Government Jobs**

**START \$1260 TO \$2100 A YEAR MEN—WOMEN**

Many appointments each year  
32 Page Civil Service Book FREE  
Mail Coupon Today—SURE

COUPON

**FRANKLIN INSTITUTE**  
Dept. F 173  
Rochester, New York

Gentlemen: Rush to me, FREE of charge, list of U. S. Government big pay positions. Send me FREE 32-page book describing salaries, hours, work, vacation, and giving full particulars on how to qualify for examinations.

Name.....

Address.....

**LEARN MUSIC**  
in Your Own Home  
This *EASY* Way

Yes, you can actually learn to play your favorite instrument right in your own home this amazing short-cut way! No expensive teacher—no tiresome scales and exercises—no confusing theories. You learn at home, in your spare time, at a cost of only a few cents a day. Every step is as clear as A B C—and before you know it, you are playing real tunes by note.



**FREE BOOK** If interested, send for free booklet and Print and Picture Sample. These explain our wonderful home study course fully. Mention instrument preferred. Instruments supplied when needed, cash or credit.

**U. S. SCHOOL OF MUSIC, 78 Brunswick Bldg., New York City, N. Y.**

**AUTO-MECHANICS & WELDERS**

Auto Mechanics and Welders are in big demand. Complete courses in arc and acetylene welding, body and fender bumping, spray painting and metal finishing. Pay after graduation plan. Special low rates. Write today.

**MICHIGAN TRADE SCHOOL**  
3758 Woodward Ave., Detroit, Mich.

Write for FREE CIRCULAR

**LEARN WATCH REPAIRING**



**AT HOME** You can learn by our modern and original system of instruction every part of the Watch Repairing Trade at home. You can earn money while learning and prepare yourself for a well paying position or start in business after completing our course of instruction. Good watch repairers are in demand and generally earn very good salaries. For particulars apply to the Wisconsin School of Watch Repairing 524 E. Mason St., MILWAUKEE, WIS.

**BE A PASSENGER TRAFFIC INSPECTOR**



**A Good-Paying Job is Ready for You**  
Complete our simple home-study course in a few months and we will place you as a Railway and Bus Traffic Inspector at up to \$135 per month, plus expenses to start, or refund your tuition. You'll like the work. Ask about our 21 yrs' experience in this service. Free Booklet on request.

**STANDARD BUSINESS TRAINING INSTITUTE,**  
Div. 208 Buffalo, N. Y.



**CASH PAID** for insects — butterflies, moths, I buy them for collections. Good cash prices paid. There are some kinds on the large price list in my instructions and pictures worth \$1 to \$7 each. Beginners get ready now. Send 10c (not stamps) for **Illustrated Prospectus**, before sending any insects.

**MR. SINCLAIR, DEALER IN INSECTS**  
Dept. 6, Box 1839. San Diego, Calif.



Begin today. Write for our New Free Book, "How to Become a Good Penman," it contains specimens and tells how others learned to write in spare time. Enclose 10c for a Professional Pen Point and your name beautifully written. Write today.

**THE TAMBLYN SCHOOL OF PENMANSHIP**  
441 Ridge Building Kansas City, Mo.

**NEW YORK SCHOOL OF MECHANICAL DENTISTRY**

Learn how to make Crowns, Bridges, Plates in this OLDEST Laboratory Center. Practical training. Day, Eve. Easy terms. Ask for free Catalog P and tool offer.

**N. Y. SCHOOL OF MECHANICAL DENTISTRY, 125 W. 31 St., N. Y. C.**

**MONEY for MEN ALL DATA FREE**

THE PLASTEX Industry needs manufacturers on small scale and for big production of Lamp and Clock Stands, Art Goods and Novelties in Plastex and Marble imitation. Experience unnecessary. 1/2c material makes regular 10c store sellers. Rubber moulds furnished for speed production. Small investment brings big returns. **WAR CAUSES GREAT SHORTAGE OF THESE GOODS.** Ambitious men have chance for real prosperity. Our FREE booklet will interest and benefit you. **PLASTEX INDUSTRIES, Dept. P, 1085 Washington Ave., New York, N. Y.**

# TRAIN FOR A BETTER JOB IN ELECTRICITY 12 WEEKS TRAINING ACTUAL WORK ON ELECTRICAL MACHINERY

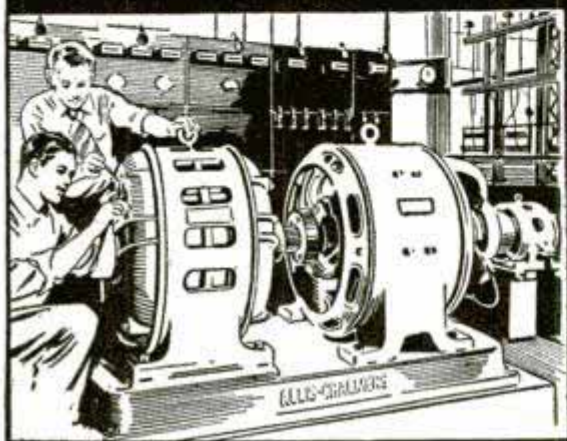

First you are told and shown what to do and how to do it. Then you do it yourself.



**EXTRA  
4 WEEKS  
COURSE IN  
RADIO  
INCLUDED**

## EASY TO LEARN — EASY TO PAY

Don't let lack of money hold you back. If you need part-time work to help out with living expenses while you train, my employment department will help you find it. We also give you valuable **lifetime employment** service after you graduate. And remember this: If you are short of money you can get this training first and pay for it beginning 60 days after you graduate—in 12 monthly payments.

### "LEARN BY DOING" Not a Correspondence Course

In my shops you "Learn by Doing" on real electrical equipment, wind armatures, do house-wiring, work on real dynamos, generators, etc.

Home of  
Coyne  
Electrical  
School



## Send Today For Details of My "PAY-AFTER-GRADUATION" PLAN!

Are you out of a job? Are you working long hours at low pay in a job you don't like? Are you wondering where you can find a job that will give you steady, interesting work with better pay? If this applies to you and you are between 16 and 40 then you owe it to yourself to read every word of this message. Here at Coyne you have an opportunity to get 12 weeks of practical shop training in ELECTRICITY—training that can help fit you for your start towards a better job and better pay—and you can get this training first and pay for it after you graduate. My school is not the usual kind of school. It's more like a shop—a place where a fellow who likes to get his hands on machinery feels right at home. For that's exactly how you train, and because you "Learn by Doing" right here in my shops you don't need previous experience or advanced education. You do real work on real motors, generators and dynamos. You operate big, factory-type switchboards, wind armatures and do house wiring. You train in these and other branches of electricity—all with capable instructors to tell you and show you how. And right now I'm including valuable instruction in Diesel, Electric Refrigeration and Air Conditioning at no extra tuition cost.

### Mail Coupon for FREE BOOK

Get my big free book. It's filled with facts and pictures which tell the whole fascinating story. I'll also tell you about part-time employment while training, today's electrical opportunities, and my "Pay After Graduation" plan, and the 4 weeks extra Radio Course I'm now including. Mail the coupon for this big free book today.

H. C. LEWIS, President  
COYNE ELECTRICAL SCHOOL  
500 S. Paulina St., Dept. CO-72, Chicago, Ill.

Please send me your big free Opportunity Book and all the facts about Coyne training, and the plans to help a fellow who wants to get ahead.

NAME.....  
ADDRESS.....  
CITY.....STATE.....

# This MACHINISTS' Home-Study Course



## helps men get ahead

Newly assembled—specially priced—these five recent books give you the practical facts on modern machines, up-to-date methods, you need to advance in machine shop work. Take advantage of the other man's experience as found in books, to solve your problems, increase your efficiency, with

## The NEW AMERICAN MACHINISTS' LIBRARY

5 volumes—2014 pages—1853 illustrations

(A combined home-study course and reference library)

This library of machine shop practice was written for practical men. It gives you the best methods for every kind of machine shop work. It fully explains lathes, drills, and other machine tools and their operation, automatic screw machines, speeds and feeds, gear design and production, punch and die work, metal surfacing, etc., etc. Plainly written—completely illustrated—the best kind of help to the machine shop man who wants to advance himself.

No money down—special price—easy payments.

### EXAMINATION COUPON

McGRAW-HILL BOOK CO., 330 W. 42nd St., New York

Send me for ten days' examination the new American Machinists' Library. If satisfactory I will send you \$1.50 in 10 days and \$3.00 monthly until the price of \$16.50 is paid. If not wanted, I will return the books postpaid. (To insure prompt shipment write plainly and fill in all lines.)

Name.....  
Home Address.....  
City and State.....  
Position.....  
Name of Company..... PM-8-40

# AUDELS Carpenters and Builders Guides 4 vols. \$6



Inside Trade Information for Carpenters, Builders, Joiners, Building Mechanics and all Woodworkers. These Guides give you the short-cut instructions that you want—including new methods, ideas, solutions, plans, systems and money saving suggestions. An easy progressive course for the apprentice and student. A practical daily helper and Quick Reference for the master worker. Carpenters everywhere are using these Guides as a Helping Hand to Easier Work, Better Work and Better Pay. To get this assistance for yourself, simply fill in and mail the FREE COUPON below.

### Inside Trade Information On:

How to use the steel square—How to file and set saws—How to build furniture—How to use a mitre box—How to use the chalk line—How to use rules and scales—How to make joints—Carpenters arithmetic—Solving mensuration problems—Estimating strength of timbers—How to set girders and sills—How to frame houses and roofs—How to estimate costs—How to build houses, barns, garages, bungalows, etc.—How to read and draw plans—Drawing up specifications—How to excavate—How to use settings 12, 13 and 17 on the steel square—How to build hoists and scaffolds—skylights—How to build stairs—How to put on interior trim—How to hang doors—How to lath—lay floors—How to paint.



THEO. AUDEL & CO., 49 W. 23rd St., New York City

Mail Audels Carpenters and Builders Guides, 4 vols., on 7 days' free trial. If O.K. I will remit \$1 in 7 days, and \$1 monthly until \$6 is paid. Otherwise I will return them. No obligation unless I am satisfied.

Name.....  
Address.....  
Occupation.....  
Reference..... P.M.

# PARKS AIR COLLEGE

PARKS AIRPORT EAST ST. LOUIS, ILL.

## Offers YOU COLLEGE and PROFESSIONAL TRAINING Majoring in AVIATION

Accredited by the Illinois Superintendent of Public Instruction. U.S. approved as a Commercial Ground and Flying School and Mechanics' School. Accredited by and cooperating with the United States Army Air Corps in giving flight and mechanical training. Open to high school graduates.

FOUR courses lead to B.S. degrees in Professional Piloting, Aviation Operations, Maintenance Engineering, Aeronautical Engineering. EIGHTEEN TRAINING PLANES are used in professional flight training which prepares graduates for airline flight operations. 76,000 hours flight training given, 1800 hours being flown monthly. FACULTY of 46 specialists in various fields of aviation. 1569 graduates. Enrollment limited to a total of 300 commercial aviation students. Total enrollment 415. 100-acre airport, 18 buildings devoted to school purposes exclusively. Dormitories and dining hall at the College. Fall Term September 30. Send postcard for new 64-page catalog.

14th YEAR Registrar, Dept. PM-8 PARKS AIR COLLEGE, East St. Louis, Ill.

## BE AN AD WRITER

GET into Advertising! Splendid opportunities for trained men and women. Ad writers, space buyers, mail order experts make good money. Learn quickly at home. No text books. Practical work. Old established school. Many successful graduates. Write today for free booklet "Opportunities in Advertising," and requirements.



### PAGE-DAVIS SCHOOL OF ADVERTISING

3601 Michigan Ave. Dept. 135C Chicago, U. S. A.

## Learn Profitable Profession in 90 days at Home



Salaries of Men and Women in the fascinating profession of Swedish Massage run as high as \$40 to \$70 per week but many prefer to open their own offices. Large incomes from Doctors, hospitals, sanitariums and private patients come to those who qualify through our training. Reducing alone offers rich rewards for specialists. Write for Anatomy Charts and booklet—They're FREE.

The College of Swedish Massage 30 E. Adams St., Dept. C64, Chicago (Successor to National College of Massage)

## ENGINEERING

DEGREE IN TWO YEARS

TECHNICAL AND APPLIED COURSES. Nonessentials omitted. TIME AND MONEY SAVED. Degree 2 yrs., diploma 1 yr. Electrical, Mechanical, Architectural, Structural, Civil, Aeronautical, including Air Conditioning, Refrigeration, Diesel. Intensive courses, 3 and 4 months in Electricity, Power Plant, Diesel, Refrigeration, Drafting. Extensive shop equipment. LOW TUITION. Part-time work for room and board. Thousands successful graduates in U. S. and foreign lands. Approved by industry, endorsed by educators, recommended by alumni. One and two-year courses open Sept. 18 to Oct. 18, short courses start specified dates, beginning Sept. 18, 41st Year. No home study courses. Catalog free.

1001 Indiana Ave. FINLAY ENGINEERING COLLEGE Kansas City, Mo.

**RADIO ENGINEERING**, broadcasting, aviation and police radio, servicing, marine and Morse telegraphy taught thoroughly. 48 weeks' engineering course equivalent to three years' college radio work. School established 1874. All expenses low. Catalog free. Dodge's Institute, Ada St., Valparaiso, Ind.

## HEMPHILL DIESEL SCHOOLS

All communications concerning enrollment in any of the Hemphill Diesel Courses should be sent to one of the following addresses:

NEW YORK . . . . . 31-26 Queens Blvd., L. I. C.  
CHICAGO . . . . . 2014 Larrabee Street  
MEMPHIS . . . . . 417 Monroe Avenue  
LOS ANGELES . . . . . 2120 San Fernando Road  
VANCOUVER, B.C. . . . . 1363 Granville St.

HEMPHILL DIESEL SCHOOLS (use nearest address)  
★ Please send data on your Diesel courses, also free copy of illustrated booklet "March of Diesel."

Name..... Age.....  
Street.....  
City..... State..... M-48-p

Also Diesel course in Spanish for Latin American students. Write for information and terms.

# NEW YORK ELECTRICAL SCHOOL

Established 1902

FOR MEN 16 to 60

The unique school—known the world over for its distinctive method of combining "Why & How"—theory with all electrical-trades practices.

Free descriptive booklet

NEW YORK ELECTRICAL SCHOOL

44 West 17th St. New York City

## FREE TRIAL LESSON IN DRAFTING



More good jobs now in Drafting. Learn AT HOME in spare time (or at our Chicago School). Send postcard for FREE TRIAL LESSON and see how easy to learn and get a good job.

CHICAGO TECHNICAL COLLEGE  
K-201 Tech Bldg., 118 E. 26th St., Chicago, Ill.

## LAW STUDY AT HOME

Legally trained men win higher positions and bigger success in business and public life. Greater opportunities now than ever before. Big corporations are headed by men with legal training.

More Ability: More Prestige: More Money

We guide you step by step. You can train at home during spare time. Degree of LL. B. Successful graduates in every section of the U. S. We furnish all text material, including 14-volume Law Library. Low cost, easy terms. Get our valuable 48-page "Law Training for Leadership" and "Evidence" books FREE. Send for them NOW.

LaSalle Extension University, Dept. 864-L Chicago  
A Correspondence Institution



## VOICE

100% Improvement Guaranteed

We build, strengthen the vocal organs—not with singing lessons—but by fundamentally sound and scientifically correct silent exercises... and absolutely guarantee to improve any singing or speaking voice at least 100%... Write for wonderful voice book—sent free. Learn WHY you can now have the voice you want. No literature sent to anyone under 17 years unless signed by parent.

PERFECT VOICE INSTITUTE, Studio C-135  
64 E. Lake St., Chicago

## LEARN PHOTOGRAPHY

Practical training under personal direction of leading authorities. Commercial, News, Portrait, Advertising, Motion Picture, and Color photography. Learn for pleasure or career. Big money-making opportunities. Personal Attendance and Home Study courses. 30th year. Free Booklet.

from Experts

NEW YORK INSTITUTE OF PHOTOGRAPHY  
10 West 33 Street. (Dept. 49) New York City

## ARTISTS MAKE MONEY

Find out your ability. Send name, age, occupation and address for Free Vocational Art Test.  
Federal Schools, Inc., 8130 Federal Schools Bldg., Minneapolis, Minn.



## WILL YOU WEAR THIS SUIT

and Make up to \$12 in a Day!

Let me send you a fine all-wool union tailored suit FREE OF ONE PENNY COST. Just follow my easy plan and show the suit to your friends. Make up to \$12 in a day easily. Partial Payment Plan. No experience—no house-to-house canvassing necessary.

SEND FOR SAMPLES—FREE OF COST  
Write today for FREE details. ACTUAL SAMPLES and "sure-fire" money-getting plans. Send no money.  
H. J. COLLIN, PROGRESS TAILORING COMPANY  
500 So. Throop Street, Dept. H-216, Chicago, Illinois

## You Ask Me...

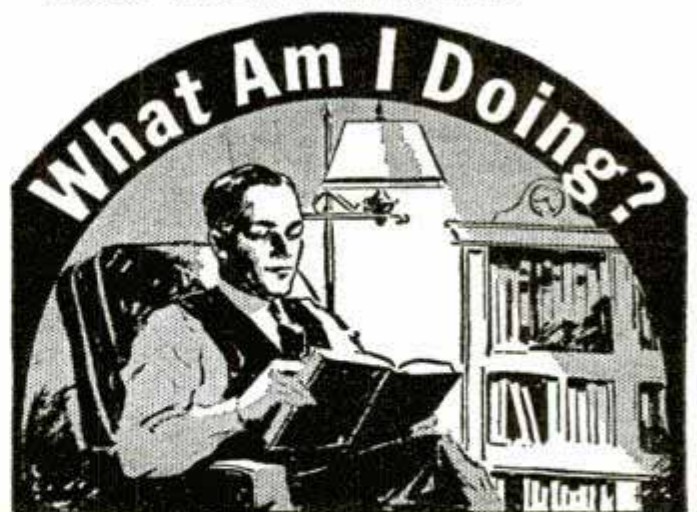

## I'm Getting Ready to Earn More ... Preparing for a Bigger Job

I am a student of the American School, Chicago. A little more than half way through my course—already my increased knowledge has brought me promotion as a result of the hour or so a day I have been spending getting acquainted with the principles of the work I enjoy. I use only part of my spare time, so it doesn't interfere with my home and social life, and certainly helps me on the job.

## And I Like It, Too

I have been surprised at the practical manner in which even advanced work is explained. It is a lot easier than I had expected. I only wish I had started this plan of getting ahead a few years earlier. But when I was 18 to 20 I felt pretty sure of myself. I didn't take enough stock in what more experienced people told me about the importance of being thoroughly trained for the job I wanted.

## Success Through Home Study

There's no magic to home study. It takes "backbone"—but it is worth the effort because it helps you overcome the handicap of having left school too soon. It helps free you from low wage slavery—enables you to compete to better advantage in this NEW world of college trained men and women.

In 1900, only ONE person in 800 was a high school graduate. Today, one in every 837 is college trained. That's why you need so much more "on the ball" today than ever before. That's why American School has stepped up all its complete courses to include so much work of college level. You NEED it, to win out today! Mail coupon NOW.

## Promotion Begins at HOME

Pay raises depend largely on what you do in SPARE time. Make it pay you dividends!

American School, Dept. GC-45, Drexel Ave. at 58th St., Chicago, Ill.

Gentlemen: I'll sit down and consider my Promotion Problems carefully if you will send me FREE information covering special training subjects checked below. No obligation on my part.

- |  |   |
|--|---|
| <input type="checkbox"/> Accounting and Auditing     | <input type="checkbox"/> Drafting and Design    |
| <input type="checkbox"/> Architecture and Building   | <input type="checkbox"/> Liberal Arts           |
| <input type="checkbox"/> Automotive Engineering      | <input type="checkbox"/> Private Secretary      |
| <input type="checkbox"/> Business Management         | <input type="checkbox"/> Mechanical Engineering |
| <input type="checkbox"/> Aviation                    | <input type="checkbox"/> Radio and Television   |
| <input type="checkbox"/> Electrical Engineering      | <input type="checkbox"/> Salesmanship           |
| <input type="checkbox"/> Elec. and Gas Refrigeration | <input type="checkbox"/> Home Economics Courses |
| <input type="checkbox"/> Air Conditioning            | <input type="checkbox"/> Business Law           |
| <input type="checkbox"/> Diesel Engineering          | <input type="checkbox"/> Retail Merchandising   |

Name.....  
Address.....



## MACHINE SHOP MEN

Learn to set up and run ANY kind of machine; MAKE MORE MONEY NOW by learning quickly HOW TO DO THINGS which usually take years of study and practice. The demand for SKILLED men is ALREADY ahead of the supply, then what WILL IT BE a month or two from now?

**Needed NOW!**

**Bigger Pay** Don't miss this chance to qualify for promotion, don't miss this Big Opportunity which is yours almost for the asking. Eight Big Books chockful of important mechanical facts told simply and clearly. Over 3000 pages, nearly 3000 illustrations cover every subject fully, including Tool Making, Pattern Making, Foundry Work, Mechanical Drawing, Forging, Machine Shop Practice and Management, and hundreds of other subjects.

**8 Big Books (1940 Edition) Sent FREE**

to you for examination. Decide in your own home or place of business whether or not you want to keep them, check up on any facts you want to. Note their great MONEY MAKING value, then, if you want them, pay on the easiest kind of payments. Send NOW and we will include a year's consulting membership in the American Technical Society without extra charge—and also a Big Binder of nearly 800 pages with 267 original shop tickets with 1200 illustrations. These show, step by step, how to set up and run almost any kind of job and are in addition to the 8 books.

American Technical Society, Publishers—Home Study Courses.

American Technical Society, Dept. SC19, Drexel at 58th St., Chicago. You may send me the 8 big NEW books and binder of shop tickets for free examination. I will pay the few cents delivery charges only, unless I decide to keep them in which case I will send \$2.00 in ten days and \$3.00 per month until the total price of only \$34.80 is paid. If I return them in 10 days I will owe you nothing. Because I send now you agree to give me a membership in the American Technical Society entitling me to consulting privileges with any of your experts for one year.

Name.....

Address.....

Please attach a letter stating age, occupation, employer's name and address and that of at least one business man as reference.

## ZOOM into AVIATION



### AN AVIATION CAREER OFFERS YOU A GREAT FUTURE!

The greatest opportunity of your lifetime exists today. There never was such an opportunity in AVIATION for you. There may never be another. Aviation desperately needs trained men; they are at a premium and advancements for them are rapid. You can get in on the ground floor by training now, BUT you must choose the right school for your training. This is imperative, since your choice of a school in which to take your training will determine your whole future in Aviation and how much money you will make all the rest of your life. Curtiss-Wright Tech's career training is carefully designed to do just one thing—MAKE MORE MONEY FOR YOU. Our hundreds of successful graduates have proven that our training gets results and always pays. It has provided them with a profitable occupation and secure future, since it trained them in advance for the highest position they could ever expect to occupy. It can make you independent and self-supporting for life. Curtiss-Wright Tech is located on Grand Central Air Terminal in the heart of the Aircraft Industry. Established in 1929, this famous school is recognized as the nation's leading institution for the training of MASTER AVIATION MECHANICS and AERONAUTICAL ENGINEERS. (No flying involved.) We honestly believe that every student who enrolls here will be able to obtain immediate employment upon graduation. A position awaits you. **WARNING!—DON'T "MISS THE BOAT!"** Send for catalog today. Give age and course desired. Dept. PM-8.



**CURTISS WRIGHT TECHNICAL INSTITUTE**  
Glendale (Los Angeles) California

THIS TOWER OVERLOOKS AVIATION'S MOST DISTINGUISHED SCHOOL OF AERONAUTICS

## ARREST HIM, OFFICER! I'LL HAVE COMPLETE FACTS ON THE OTHER

FELLOW TONIGHT!

Secret Service Operator No. 38 is on the job... FOLLOW HIM through all the excitement of his chase after the counterfeit gang. Write NOW for

**FREE Confidential Reports No. 38 Made to His Chief!**

It may open your eyes to the great opportunity for YOU as a well paid Finger Print Expert. The kind of work you'd like. Excitement! Travel! Thrills! A REGULAR MONTHLY salary. REWARD MONEY. Graduates of this school HEAD 47% of all



Identification Bureaus in U. S.! Write for Free Reports, Finger Print Book, low prices. Easy Terms Offer.

Literature will be sent only to persons stating their age.

**INSTITUTE OF APPLIED SCIENCE**

1920 Sunnyside Ave., Dept. 135-C Chicago, Illinois

Regain Perfect Speech, If You

## STAMMER

Every stammerer should have the new 287 page book "Stammering, Its Cause and Correction." Sent free to stammerers. It describes the Bogue Unit Method for the scientific correction of stammering and stuttering. Method successfully used at Bogue Institute for 39 years—since 1901. Endorsed by physicians. Write for full information. No obligation. Benjamin N. Bogue, Dept. 1317 Circle Tower, Indianapolis, Indiana.

## ENGINEERING DEGREE IN TWO YEARS

B. S. Degree courses in engineering: Electrical, Civil, Chem., Mechanical, Radio or Aeronautical. 1 yr. Mech. Drafting. Approved by Civil Aeronautics Authority, participation in Pilot Training Program. Large industrial center. Prep courses without extra charge. Earn board if desired. Low tuition. Enter Sept. 3, December, March, June. Write for Catalog.

580 E. Washington Blvd., Fort Wayne, Ind.

**INDIANA TECHNICAL COLLEGE**

## SECURITY FOR LIFE

Be an expert in an essential business. Learn Meat Cutting. Steady jobs and good pay everywhere. Quick, short course—ACTUAL PRACTICE. Learn with tools and meat—not book. Individual training. Be a fully qualified union Meat Cutter when finished. Union Card FREE. Job help after graduation. Write for catalog and complete details.

**NATIONAL SCHOOL OF MEAT CUTTING, INC.**  
DEPT. U-9 TOLEDO, OHIO

## PHOTO-ENGRAVING TASOPE' SINCE 1931

FREE—a copy of the Tasope' Magazine, monthly treasure chest of photographic and photo-engraving information. Learn why Aurora, Mo., is the photo-engraving, photographic center of America... how hundreds of amateurs, free-lance photographers are making money with pictures. No-obligation postcard brings your copy.

**TASOPE', DEPT. PM-19, AURORA, MO.**



## Learn DIESELS

ALSO AUTO MECHANICS; MACHINE SHOP WORK

No matter where you are or what you do, National has a training plan for you. Unnecessary to give up present employment. Write for FREE literature.

**NATIONAL SCHOOLS**

Dept. PMA-8, 4000 S. Figueroa St., Los Angeles, California

NAME..... AGE.....

ADDRESS.....

CITY..... STATE.....





# CAREERS IN ELECTRICITY

Become a Bliss technician in one year—ready to take advantage of opportunities in the electrical field. Bliss men, today, fill key positions in many electrical industries. All received the same course in fundamental theory and practice.

Comprehensive training; skilled instructors give personal guidance. Modern shops and laboratories. Highly successful placement record. Spacious campus, 48th year. Ask for free vocational chart, 118 Takoma Ave., Washingt'n, D.C.

**BLISS** ELECTRICAL SCHOOL

# Free WELDING

FREE TRIAL LESSON

Welding offers immediate opportunities for better pay. Practically all industry depends upon the Welder. Learn at home in spare time. Intensified shop training later. Also day and evening classes. Send for free "Blue Book" and trial lesson.

CHICAGO TECHNICAL COLLEGE  
K-600 Tech Bldg., 118 E. 26th St., Chicago, Ill.

# CARTOON YOUR WAY TO SUCCESS!

RAYE BURNS will teach you HOW to CREATE ORIGINAL CARTOONS, at home, you may SELL! Cost is unusually low. Write for FREE sample lesson plates, drawing test, and addresses of successfully trained students. No obligation.

RAYE BURNS SCHOOL, Dept. M, Box 2194, CLEVELAND, OHIO

# NEW WAY TO CHOOSE A CAREER

LET SCIENCE PICK A JOB FOR YOU! TODAY, getting a job or choosing a career is no longer a hit-or-miss task. Science can now accurately determine for you, in advance, just what type of work or profession you are best suited for. Send your name on a penny postcard for FREE booklet explaining this new proven way to greater success. Vocational Guidance Associates, Dept. 18, Tucson, Ariz.

# Get into the BAKING BUSINESS

Bakers make good money! Now 7th Industry in wages! Nearly depression-proof. New home study Baking Course qualifies you. Common school education sufficient. If you're ambitious, write for FREE BOOK, "Opportunities in Baking." National Baking Institute, 3601 Michigan, Dept. 135C, Chicago

**\$5, \$10, \$15 FOR ONE DRAWING**

**LEARN TO DRAW**  
—at home in your spare time

Train to be an Artist and become your "own boss." Our practical method has trained men and women of all ages since 1914. COMMERCIAL ART, CARTOONING, and DESIGNING all in one complete course. Trained Artists are capable of earning \$30, \$50, \$75 a week. No previous Art experience necessary. FREE BOOK, "Art for Pleasure and Profit" describes course, opportunities and TWO ART OUTFITS included with training. Mail coupon today.

**FREE BOOK gives details!**

Washington School of Art, Studio 128P  
1115—15th St., N. W., Washington, D. C.

Yes! I am interested in learning to draw. Please send me your Free Book, "Art for Pleasure and Profit."

Name.....Age.....  
Address.....  
City.....State.....

# Be a Radio Technician



**Learn at Home to Make \$30, \$40, \$50 a WEEK**



**Chief Operator Broadcasting Station**  
When I completed 30 lessons, I obtained my Radio Broadcast Operator's license and immediately joined Station WJPC where I am now Chief Operator.—**HOLLIS F. HAYES**, 327 Madison St., Lapeer, Michigan.

**\$200 to \$300 a Month in Own Business**  
For the last two years I have been in business for myself making between \$200 to \$300 a month. Business has steadily increased. I have N. R. I. to thank for my start in this field.—**ARLIE J. PROEHNER**, 300 W. Texas Ave., Goose Creek, Texas.



**\$15 a Week Extra in Spare Time**  
I am doing spare time Radio work, and I am averaging from \$700 to \$850 a year. Those extra dollars mean so much—the difference between just barely getting by and living comfortably.—**JOHN WASHKO**, 97 New Cranberry, Hazleton, Penna.



**Find Out What Radio, Television Offer Act Today!** Mail the coupon for my 64-page Book, "Rich Rewards in Radio." It points out Radio's spare time and full time opportunities and those coming in Television; tells about my Course in Radio and Television; shows more than 100 letters from men I have trained, telling what they are doing and earning. Read my money back agreement. MAIL COUPON in an envelope, or paste on a penny postcard—NOW!

Radio broadcasting stations employ Radio Technicians as engineers, operators, maintenance men. Radio manufacturers employ testers, inspectors, foremen, servicemen in good-pay jobs. Radio jobbers and dealers employ installation and servicemen. Many Radio Technicians open their own Radio sales and repair businesses and make \$30, \$40, \$50 a week. Others hold their regular jobs and make \$5 to \$10 a week fixing Radios in spare time. Automobile, police, aviation, commercial Radio, loudspeaker systems, electronic devices are other fields offering opportunities for which N. R. I. gives the required knowledge of Radio. Television promises to open good jobs soon.

## Many Make \$5 to \$10 a Week Extra in Spare Time While Learning

The day you enroll, in addition to my regular Course, I start sending you Extra Money Job Sheets—start showing you how to do Radio repair jobs. Throughout your course I send plans and directions which have helped many make \$5 to \$10 a week in spare time while learning. I send special Radio equipment to conduct experiments and build circuits. This 50-50 training method makes learning at home interesting, fascinating, practical. I also give you a MODERN PROFESSIONAL ALL-WAVE, ALL-PURPOSE SET SERVICING INSTRUMENT to help you make money fixing Radios while learning and equip you for full time work after you graduate.

**Find Out What Radio, Television Offer Act Today!** Mail the coupon for my 64-page Book, "Rich Rewards in Radio." It points out Radio's spare time and full time opportunities and those coming in Television; tells about my Course in Radio and Television; shows more than 100 letters from men I have trained, telling what they are doing and earning. Read my money back agreement. MAIL COUPON in an envelope, or paste on a penny postcard—NOW!

J. E. SMITH, President, Dept. OHP  
National Radio Institute, Washington, D. C.

**Mail this Now FREE**  
Get 64-page Book **FREE**

**J. E. SMITH, President, Dept. OHP**  
National Radio Institute,  
Washington, D. C.

Mail me FREE without obligation, your 64-page book "Rich Rewards in Radio" which points out Radio's opportunities and tells how you train men at home to be Radio Technicians. (No salesman will call. Write Plainly.)

AGE.....  
NAME.....  
ADDRESS.....  
CITY.....STATE.....

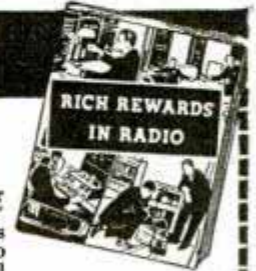

Say you saw it in Popular Mechanics!

# High School Raises Your Standards of LIVING TRAINING INCOME

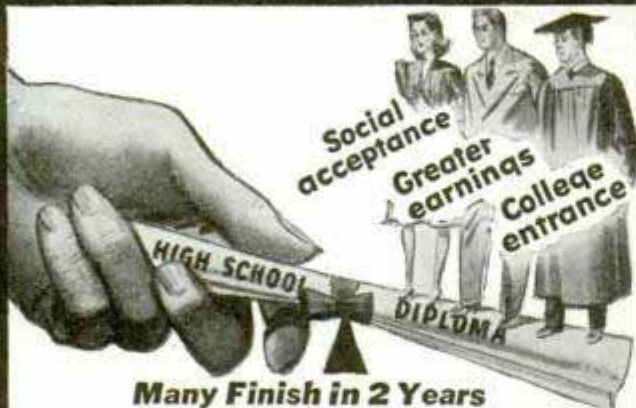

## Many Finish in 2 Years

Finish High School at home, as FAST as time and ability permit. Equivalent to resident school work—prepares for college, pre-professional examinations, business, industry. Standard texts. Diploma. Credit for High School subjects already completed. Single subjects if desired. American School, Chicago, est. 1897. FREE Bulletin. Write TODAY!

American School, Dept. HC-45, Drexel Ave. at 58th St., Chicago

- Send free information as checked below. No obligation.
- |   |   |
|---|---|
| <input type="checkbox"/> HIGH SCHOOL COURSE             | <input type="checkbox"/> Air Conditioning       |
| <input type="checkbox"/> Accounting and Auditing        | <input type="checkbox"/> Diesel Engineering     |
| <input type="checkbox"/> Architecture and Building      | <input type="checkbox"/> Drafting and Design    |
| <input type="checkbox"/> Automotive Engineering         | <input type="checkbox"/> Liberal Arts           |
| <input type="checkbox"/> Business Management            | <input type="checkbox"/> Private Secretary      |
| <input type="checkbox"/> Aviation                       | <input type="checkbox"/> Mechanical Engineering |
| <input type="checkbox"/> Electrical Engineering         | <input type="checkbox"/> Radio and Television   |
| <input type="checkbox"/> Electric and Gas Refrigeration | <input type="checkbox"/> Home Economics Courses |

Name .....

Address .....

## Promotion Begins at Home



## Know Electricity as Experts Know It—and Get an Expert's Pay!

What about your future? Who is safe today? Surely not the man who is contented to stand still! Know your job thoroughly—prepare yourself for jobs ahead. To do just this thousands of men have used

## The Croft Library of Practical Electricity

The Croft Library is a complete electrical educator. It is founded on practice—on 20 years of shirt-sleeve experience—on work as it is actually done. It is jammed from cover to cover with the kind of hard-headed facts you want. Written so that the beginner can easily understand it, yet so sound, so thorough, that it is the daily guide of 50,000 highly paid electrical workers and engineers. Croft tells you the things you need to know about motors, generators, armatures, commutators, transformers, circuits, switchboards, distribution systems—electrical machinery of every type—illumination in its every phase—the most improved methods of lighting—lamps and lamp effects, etc.—how to do a complete job, from estimating it, to completion.

**6 volumes, 2155 pages—New low price  
No money down—Easy payments.**

Fill in and mail the coupon attached and we will send you the entire set of six volumes for ten days' Examination on approval. We take all the risk—you assume no obligation. If you decide to keep the books, send \$1.50 in ten days and the balance at the rate of \$3.00 a month. Send the coupon NOW and see the books for yourself.

### EXAMINATION COUPON

McGRAW-HILL BOOK CO., 330 W. 42nd St., New York, N. Y.

Send me for ten days' examination on approval the Croft Library of Practical Electricity. If satisfactory I will send you \$1.50 in 10 days and \$3.00 monthly until the price of \$16.50 is paid. If not wanted, I will return the books postpaid. (To insure prompt shipment write plainly and fill in all lines.)

Name.....  
Home Address.....  
City and State.....  
Position.....  
Name of Company..... PM-8-40

## For More Pay Train To Enter

# DRAFTING INDUSTRIAL DESIGN

Get into a Better Pay field with a big future by learning DRAFTING and DESIGNING quickly from an Engineer and Industrial Designer. Private, individual training at your home. Drawing tools and table furnished without extra cost. Learn to draw and design new products, or to improve, re-style, streamline and modernize old products for more "eye appeal" and selling power.

Drafting is a very big field, but drafting with industrial designing is twice as big. Factories must continuously bring out new models, new products, and improved designs. You can learn both subjects right in your own home, in your spare time. You can be trained for better pay as I have trained many hundred successful students. I'll train you thoroughly by applied instruction on actual work until you are holding a good paying position. Write for complete details on "Drafting and Industrial Designing."

## ENGINEER DOBE

LIBERTYVILLE, ILLINOIS

Dept. C-337

## A GOOD LIVING FROM POULTRY



with a business of your own. How to start small way, spare time, grow from profits, or prepare for good job in large poultry plant. Harry M. Lamon, nationally known Poultry Expert, shows latest scientific methods, money making secrets in poultry raising. His system of home study training used by thousands. Endorsed by many colleges and leading Poultrymen. Established 20 years. Write today for his big FREE catalogue describing courses, methods and service. Shows way to real business opportunity. Harry M. Lamon, Pres.

**NATIONAL POULTRY INSTITUTE**  
DEPT. 50-M ADAMS CENTER, N. Y.

## LEARN AVIATION



IN LOS ANGELES - Nation's Aviation Capital

Huge increase in Los Angeles aviation activity has assured splendid positions for graduates. Career training offered for airline piloting, engineering, mechanics, drafting, production mechanics and instruments. Trains at America's most modern equipped and strategically located school, fully approved by the U. S. Government for flight and mechanics courses. Write for free 64 page catalog. State are

**CALIFORNIA FLYERS**  
SCHOOL OF AERONAUTICS - Dept. PM-8  
LOS ANGELES MUNICIPAL AIRPORT, INGLEWOOD, CALIF.

## REAL JOBS OPEN FOR TRAINED AUTO MECHANICS

Learn QUICK! In As Little As  
8 WEEKS REAL SHOP TRAINING

AUTO, DIESEL and AVIATION Mechanics, welding, body & fender taught with real tools, on real equipment, in 2 biggest, best schools of their kind in the world. Step into Big Pay—\$35-\$60 a week. Low tuition cost! Pay for part of course later! FREE BOOK! Send for Big, Free Opportunity book and new low rate—write nearest school TODAY!

**McSWEENEY SCHOOLS** Dept. Kansas City, Mo.  
M-7 Detroit, Michigan

## Learn PHOTOGRAPHY at Home

Splendid opportunities. Prepare in spare time. Easy plan. No previous experience needed, common school education sufficient. Send for free booklet "Opportunities in Photography", particulars and requirements.

American School of Photography  
3601 Michigan Ave., Dept. 135C, Chicago, Ill.

## Correspondence Courses in RADIO and ELECTRICAL ENGINEERING

LOW AS  
\$25



ELECTRICAL ENGINEERING. Get good grasp of wide electrical field. Modern. Very understandable. Theory made easy. RADIO ENGINEERING. Extra fine course in radio, public address, photo-electric work. Trains you to be super-service man, real vacuum tube technician. Tuition ONLY \$25, either course. Deferred payment plan. Experiment kits furnished. FREE Write for free copies of school catalogs, student magazines, etc. **FREE LINCOLN ENGINEERING SCHOOL, Box 931-P20, Lincoln, Nebr.**

# How to PROTECT YOUR INVENTION

*Guard Your Right to Sell, Market and Profit From it!*



## With a U.S. PATENT

**1 Record Your Invention** A model is usually unnecessary. Your first step is to make a sketch and description of your invention and have it dated and witnessed by a friend. Mail the coupon for FREE "Record of Invention" form on which to do this.



**2 Patent Your Invention** Mail the Coupon for our Free Book, "Patent Guide for the Inventor"—48 fascinating pages of facts you should know about securing a U. S. Patent. We stand ready to give you prompt, efficient service in all Patent matters.



**Free**

Mail the Coupon today, for 48-page "Patent Guide" and "Record of Invention" form.

The U. S. Patent Laws give you the exclusive right to make, use and sell your invention. But to secure these benefits, it is important to **APPLY FOR YOUR PATENT PROMPTLY**—because millions of persons have the opportunity to develop an invention similar to yours. The law favors the one **WHO FILES HIS PATENT APPLICATION FIRST.**

### How We Serve You Before The Patent Office

Those features of your invention which are patentable must be legally and concisely set forth in the form of "Claims"—a phase of procedure so complex that the Patent Office advises the inventor to engage a competent Registered Patent Attorney. We have a large and competent staff—carefully trained registered patent attorneys—expert draftsmen—experienced searchers—to serve you every step of the way.

### The First Steps You Should Take

Obtain the services of a Registered Patent Attorney and establish the date of your invention. Our Book tells you how to do this, and our Free Record of Invention form helps you do it quickly. The next step is to have a search made of the Patent Office records to determine whether or not your invention is probably patentable. We do this for you—**BEFORE FILING YOUR APPLICATION.** This time and money-saving step is fully explained in our Book. Mail the coupon for your Free Copy.

### Simple Inventions, Improvements Often Big Commercial Successes

Inventions need not be complicated to be successful. The zipper, thumb-tack, collar-button, safety pin, paper clip, etc.—and methods of making them—have proved profitable to their inventors. Remember, too, that patents are granted on improvements over already-existing inventions. You can secure a Patent for such an improvement, even though you do not hold the patent on the original invention.

### SEND NOW FOR FACTS

NOW is the time for you to get and read our FREE BOOK—to get and use our Record of Invention form. The book—cramped with vital facts and fascinating illustrations—shows you every step to take. The Record of Invention form—especially prepared for the inventor—makes it EASY for you to take the first step, without cost or obligation. Mail the coupon now—on a penny postcard or in an envelope.



**3 Sell Your Patent** Once your rights are defined by your United States Patent, we can give you sound advice and guidance. We analyze patent claims, prepare assignments, agreements, etc.; review them to protect your interests if prepared by others. Details in our Free Book. Mail Coupon.

## Mail Coupon Now for FREE Book

**CLARENCE A. O'BRIEN, Registered Patent Attorney**  
Dept. OH1, Adams Building, Washington, D. C.

Please send me your 48-Page Patent Guide and your Specially Prepared "Record of Invention" form FREE. This request does not obligate me.

Name.....

Address.....

City..... State.....

(Please write or print plainly.)

**CLARENCE  
A. O'BRIEN**  
REGISTERED PATENT ATTORNEY  
WASHINGTON, D.C.

**WRITE DEPT. OH1**  
ADAMS BUILDING

# "WIN YOUR WINGS"

BY COL. ROSCOE TURNER AND JEAN DUBUQUE



COL. ROSCOE TURNER

Col. Eddie Rickenbacker says, study of Win Your Wings should give a "thorough education in fundamentals of aviation."

2 Volumes—cloth bound—over 1000 pages—600 illustrations—\$3.50 per volume—Sold separately.

### SEND NO MONEY

Order today. Shipment C.O.D. Sent prepaid if cash with order. Money back guarantee.

**ORDER NOW!**

# LATEST, MOST PRACTICAL BOOKS ON AVIATION TRAINING!

## NEW APPROACH—FOLLOW C. A. A. REQUIREMENTS

Written by world famous authorities. Everything needed to prepare for private, commercial and instructor's certificate covered in comprehensive, non-technical manner. The reader feels as though actually in the cockpit, making take-offs, turns, landings. A unique approach doubling instructive value of the book.

## FOR STUDENT—PILOT—INSTRUCTOR

Much C.A.A. program material taken from Dubuque's writings. Vol. 1 gives complete instruction for private pilot's certificate. Vol. 2, for commercial certificate. Both books for instructor rating. Subjects segregated into progressive steps—vital points clearly illustrated. **Write for FREE descriptive folder.**

**FREDK. J. DRAKE & CO., 608 W. Van Buren Street, Chicago, Ill.**

# DRAFTING

**BOOKS SENT FREE!**  
ON APPROVAL

## 5 VOLUMES—SECOND EDITION

Only 15 minutes a day with these WONDER BOOKS can prepare you for a good drafting job. Mechanical and architectural drafting from simple straight lines to important complex plans. A step at a time! Built especially for beginners, for men with only grammar schooling. Drafting room practice, **PLUS ENGINEERING**, made easy and clear. **Includes complete information on blue print reading for building and machine trades.**

## Big Field Big Demand Big Pay

Competent draftsmen are urgently needed in all building and manufacturing lines at \$30.00 to \$75.00 a week. That's just the beginning—**FOR DRAFTSMEN HAVE GOOD CHANCES FOR ADVANCEMENT.** Pleasant, fascinating work, easy to learn and do. Learn quickly with these books—send coupon for a set and see for yourself.

[A year's consulting membership in the American Technical Society now given to all buyers of this famous cyclopaedia of drafting.]

Complete set of high grade drawing instruments if you send for these drafting books **NOW.** These instruments are accurate and are packed in velvet lined leatherette pocket case. Splendid value, but included with these books.

**AMERICAN TECHNICAL SOCIETY**  
Publishers—Home Study Courses.

American Technical Society, Dept. DC19, Drexel at 58th St., Chicago, Ill.  
Send for 10 days' trial, 5 volumes set of drafting. I will pay the few cents delivery charges. If I wish, I may return books in 10 days and owe you nothing but if I decide to keep them, I will send \$2.00 after 10 days, then only \$3.00 a month until \$24.80, the total price is paid. Send latest edition and include drawing instruments and consulting Membership Certificate.

Name.....

Address.....

Please attach letter stating age, occupation, employer's name and address and that of at least one business man as a reference.



## Be a MONEY-MAKING RADIO EXPERT

I'll train you for a good job in Radio, Television, or a **business of your own.** My new, personalized sparetime home-study Course fits you quickly, easily. You get real Radio Equipment. I show you how to earn while you learn.

**FREE:** Write for complete details in new catalog "HOW TO MAKE MONEY IN RADIO" Sprayberry Academy of Radio, 310-H University Place, N. W. Washington, D. C.

In answering advertisements always write name and full address clearly.

# BROOKLYN YMCA TRADE SCHOOL



Unlimited instruction until you have mastered every part of Course without additional charge.

Full Shop Equipment  
Unexcelled Instruction  
Fireproof Dormitories.

Special Privileges. **Check your interests on coupon to receive free literature.**

- Mechanical Pre-Engineering
- Diesel Engines  Oil Burner
- Diesel Pre-Engineering
- Aeronautical Pre-Engineering
- Aviation Mechanic  Welding
- Auto Mechanic  Talking Pictures
- Refrigeration  Air Conditioning
- Television and Radio Mechanic
- Architectural-Mechanical Drafting
- Machinist  Tool and Die Making
- Armature Winding  Electrical

## MAIL COUPON

1117 Bedford Ave., Dept. P.M.  
Brooklyn, New York City, N. Y.

Name.....

Address.....

# FACTORY-TO-YOU SAVES YOU UP TO 50%

EASY TERMS



30 DAYS TRIAL

FOREIGN RECEPTION

Other models from 5 to 17 Tubes, and up to 5 Wave Bands.

● Write for FREE 1940 catalog, showing complete line. (User-agents make extra money!) See **MIDWEST'S Answer to TRADE-INS!**

PUT THIS NEW  
**4-TUBE**  
CHASSIS IN YOUR PRESENT CABINET  
only \$19.95 COMPLETE

**MIDWEST RADIO CORPORATION**  
Dept. 15-BB Cincinnati, Ohio



# MECHANICAL DENTISTRY

Short course—personal, individual, instruction—best technical teachers. Profession offers unlimited opportunity—not affected by Machine Age. Most modern and complete methods embracing every branch from plate to porcelain work. Qualifies you to work for dentists or own business. Day or night school. No books—no classes. Catalog upon request.

OR STUDY AT HOME. Write for information on our Home Study Course.  
**MCCARRIE SCHOOL OF MECHANICAL DENTISTRY**  
207 N. Broad St. Dept. 753 Philadelphia, Pa.

Say you saw it in

# POPULAR MECHANICS



**AERONAUTICAL ENGINEERING** (Founded by Curtiss-Wright)  
2 year B. S. Degree. Certified Mechanics, Administrative Courses, Radio, etc. Accredited.  
Write for Free Illustrated Catalog.

**AERONAUTICAL UNIVERSITY**  
1342 S. Michigan Ave., Dept. A, Chicago, Illinois.

## AIRCRAFT WELDING ENGINEERING

Industry Offers Outstanding Opportunities to properly trained Commercial Welding Engineers (1 year), Welding Technicians (3 months), Aircraft Welders and Arc Welding Operators (3 months). Learn By Doing. Earn Part Expenses—Write for free 64-page illustrated Book—"Days Of A Giant Industry." Mention course desired.



MILWAUKEE SCHOOL OF ENGINEERING  
840PM—N. BROADWAY & E. STATE, MILWAUKEE, WIS.

**ENGINEERS**  
**CARPENTERS,**  
**Other Construction Men, or Ambitious Beginners**

### FIT YOURSELF QUICKLY AT HOME FOR BETTER-PAYING CONSTRUCTION JOBS

as Superintendent, Foreman, Estimator, etc., on Public Works, Sewer-Water—Gas Pipe Lines, Buildings, Bridges, and other construction activities now demanding trained men. Practical course that fits engineer or beginner for actual work out on a job. . . Level-Transit Instrument Furnished Students. Certificate Awarded Graduates.

Write for Free Booklet.  
**CONSTRUCTION ENGINEERS SERVICE**  
Box 2192-PA. Atlanta, Georgia

## Auto-Diesel

Master a real trade. Auto Mechanics, Diesel Mechanics, Arc Welding, Acetylene Welding, etc. Let us train you to be an expert Auto-Diesel Mechanic and help you get a good job. The cost to you is reasonable. Learn on modern equipment with tools under experienced instructors. Real shop work. Steam heated buildings. Room and board in our steam heated dormitory. We pay your fare to Nashville. For free catalog write

Nashville Auto-Diesel School, Dept. 75 Nashville, Tenn.

**Be a CARTOONIST** *Only \$1.00*  
you can learn at home  
**MAKE MONEY! HAVE FUN!**  
35 complete easy lessons, hundreds of illustrations, the best out for beginners. Helps you draw good cartoons simply, tells how to originate. \$1.00 postpaid.  
**PROFESSIONAL PUBLISHERS, Inc.**  
98 AVENUE L NEWARK, N. J. Dept. PM-207

## TOOL & DIE MAKING MACHINIST

Acety & Arc Welding. Body & Fender Repair. Practical Shop Training. Michigan's Oldest & Largest Trade School. Train until Satisfied.  
**WOLVERINE SCHOOL OF TRADES**  
1400 W. Fort St. Detroit, Mich. Dept. W-3

## 5c TIRE MAKES \$2.00 MAT

Make springy, long-wearing Rubber Mats out of old auto tires. Any length or width. BIG sale to schools, factories, stores, homes. Think of the profit. Brand new business. Field untouched. Reasonable investment and simple hand machine starts your local plant. Write quick for free information. Don't lose a minute—this is BIG!  
**FABRIX, INC.** Dept. 78 620 No. Michigan Ave., Chicago, Ill.

**Your Place in Aviation**  
**SPARTAN**  
**SCHOOL OF AERONAUTICS**  
Come to SPARTAN for today's finest expert training for your choice of aviation careers—Flying, Engineering, Mechanics, Radio. Approved by U. S. Civil Aeronautics Authority. 15 modern airplanes, latest aircraft engines; completely equipped shops, laboratories—private practice fields; 17 modern buildings; club-like dormitories. \$100,000 expansion program making SPARTAN even greater. *New semester starts Sept. 30th.* Write for free catalog.  
**CAPTAIN MAXWELL W. BALFOUR, Director**  
Dept. PM80. Tulsa, Oklahoma

## MAKE MONEY AT HOME

**RUBBER MOLDS** *Low as 6¢ EA.*  
Amazing rubber mold-making outfit makes perfect flexible molds of plaques, ash trays, book-ends, etc. Molds cost from 6c to 25c each. Each mold makes hundreds of novelties and gifts to sell up to \$1.00 apiece! No experience necessary. Quick and easy. Start profitable business in your home . . . sell to stores, gift shops, friends, resorts, road stands, by mail. Full or spare time. "Molders Handy Book" and list of buyers FREE. Write  
**SO-LO WORKS**  
Dept. K-827 Cincinnati, Ohio

**COSTS** **PROFITS**  
**APPROPRIATIONS** **TAXES**  
**POLICIES** **AUDITS**  
**PLANS FOR FINANCING**

## Become an Expert Accountant

*The Profession That Pays*

The demand for skilled accountants—*men who really know their business*—is increasing. The new national and state legislation is requiring of business—both big and small—much more in matters relating to Auditing, Cost Accounting, Business Law, Organization, Management, Finance. Men who prove their qualifications in this important field are promoted to responsible executive positions—given an opportunity to earn real salaries. The range is from \$2,000 to \$10,000 a year—even to higher income figures.

Send for Free Book—  
"Accountancy, the Profession that Pays"

Why let the other fellow walk away with the better job, when right in your own home you may equip yourself for a splendid future in this profitable growing profession?

Preliminary knowledge of bookkeeping is unnecessary. Our free book on accountancy fully explains how we train you from the ground up, or from where you now are, according to your individual needs. Low cost; easy terms.

The facts about the new LaSalle training in Accountancy and the opportunities in this highly profitable field are clearly outlined in a 48-page book which LaSalle will send you free.

The man in earnest to get ahead will find this coupon a most profitable aid to progress. If you have the urge and the will to increase your income, clip and mail the coupon NOW.

### LASALLE EXTENSION UNIVERSITY

A CORRESPONDENCE INSTITUTION

Dept. 864-HR Chicago  
I would welcome details of the new opportunities in accounting, together with copy of "Accountancy, the Profession that Pays," without obligation.



- Higher Accountancy  
**Other LaSalle Opportunities:**  
LaSalle opens the way to success in every important field of business. If interested in one of the fields below, check and mail.
- Business Management
  - Law—Degree of LL.B.
  - Modern Salesmanship
  - Commercial Law
  - Traffic Management
  - Modern Business Correspondence
  - Railway Accounting
  - Expert Bookkeeping
  - Industrial Management
  - Stenography-Stenotypy
  - C.P.A. Coaching
  - Credit and Collection Correspondence

Name.....  
Present Position.....  
Address.....

# PATENTS

Booklet Free      Highest References  
 Promptness Assured      Best Results

Send drawing or model.

## ALL BUSINESS GIVEN PROMPT AND PROPER ATTENTION

Listed Patent Lawyer in the latest editions of the Rand-McNally Directory of Bankers and Bank-Recommended Attorneys, published by Rand-McNally & Co., Chicago, Ill.; American Lawyers Annual, Cleveland, Ohio; Bankers Service Legal Directory, published by Bankers Service Co., Boston, Mass.; and the Snow-Church Directory Co. Lawyers List, published in New York City.

**WATSON E. COLEMAN,** Victor Building, 724 Ninth Street, N. W.  
**REGISTERED PATENT LAWYER**      **WASHINGTON, D. C.**

### INVENTORS PATENT YOUR IDEAS SEND FOR FREE BOOK



#### HOW TO OBTAIN A PATENT

Written by a Former Member of the Examining Corps (1922-24) of the U. S. Patent Office. If you want to profit by your idea, you should take steps to apply for a U. S. Patent at once. Your first step is to get this Free Book. This interesting illustrated book contains valuable information you should have. It tells you fully how to obtain a patent on your idea in the quickest way. With this Free Book you will also receive a "Record of Invention" form on which you can easily record your idea. Personal and Confidential Service: Your case will be personally handled only by a Registered Patent Attorney who is also a Former Member of the Examining Corps of the U. S. Patent Office. All communications confidential.

MAIL COUPON TODAY for FREE PATENT BOOK and RECORD OF INVENTION Form.

**CARL MILLER**  
 REGISTERED PATENT ATTORNEY  
 FORMER MEMBER EXAMINING CORPS U. S. PATENT OFFICE

Woolworth Bldg., 35th Floor, Dept. 80-A, New York City  
**MILLER BUILDING, Dept. 80-A, WASHINGTON, D. C.**  
 Please send me your Free Book, "How to Obtain a Patent," and your "Record of Invention" form.

NAME .....

ADDRESS .....

Practical Facts You Will Want to Know About

## PATENTS      TRADE MARKS COPYRIGHTS

**INVENTORS!** This old-established firm assures prompt, confidential advice concerning patent procedure based on 65 years experience in serving thousands of people. You can save time and money now by sending for our free booklets. They explain steps necessary to obtain a patent and opportunities for capitalizing on your idea. All inquiries confidential and answered immediately. Write for free books right now.

● **C. A. SNOW & CO.**  
 Registered Patent Attorneys Since 1875  
 108 Snow Building      Washington, D. C.

### PATENTS—TRADE MARKS

All cases submitted given personal attention  
 Form "Evidence of Conception" with instructions  
 for use and "Schedule of Government  
 and Attorneys' Fees"—FREE!

**LANCASTER, ALLWINE & ROMMEL**  
 Patent Law Offices

412 Bowen Bldg.      Washington, D. C.

### Inventions Wanted Patented or Unpatented

We have been successfully selling inventions, patented and unpatented, since 1924. Write us, if you have a practical, useful idea for sale.

**Chartered Institute of American Inventors**  
 Dept. 4, Barrister Building, Washington, D. C.

### INVENTORS who derive largest profits know and heed certain simple but vital facts before applying for patents.

Our book, Patent-Sense, gives those facts; sent free. Trade Marks—Copyrights.  
**LACEY & LACEY, Est. 1869, 635 F St., N. W., Dept. 5, WASHINGTON, D. C.**

### INVENTIONS MANUFACTURED AT LOW COST!

Inventions manufactured in any size, any shape, any quantity, by old established (36 years old) reputable company. (No branches anywhere). Also developing, designing, engineering, modelmaking, stampings, metal specialties, dies, models, etc. **FREE** estimates. **FREE** catalog giving "inside" information. Write today.  
**CRESCENT TOOL CO., DEPT. V-A, CINCINNATI, OHIO**



**BUCHSTEIN'S FIBRE LIMB**  
 Soothing to stump, cool, light, strong. Correct fit. Braces for all deformities. Fair terms.  
**D. BUCHSTEIN CO.**  
 610 3rd Ave. South, Minneapolis, Minn.

FOR COMFORT

**Learn Public Speaking**  
 At home—in spare time. Many overcome "stage-fright," gain self-confidence and increase earning power, this easy way. Write for free booklet, *How to Work Wonders With Words* and requirements.  
**North American Institute, Dept. 135C**  
 3601 Michigan Ave., Chicago, Illinois

**Earn Cash at Home!**  
 We paid M. M. \$1174 for exceptional cellar crop Snow-King mushrooms! We furnish materials; buy all crops. Big **FREE** picture book tells if your cellar, shed, barn, suitable. Est. 1908. Write today.  
**United Co., 3848 Lincoln Av., Dept. 300, Chicago**

M.M. EARNED \$1174 at Home!

## To PROTECT YOUR INVENTION—Use this coupon, NOW

Delays are dangerous and may be very costly. My personal service assures prompt action, strict confidence, and a minimum of expense. I suggest that you send me a model or drawing, or sketch and description of your invention, and \$5.00. I will make a search and report

promptly as to its patentability and send you a copy of my 72-page booklet. Or, if you prefer to read my booklet first, mail the attached coupon at once. I will also send my "Record of Invention" form. (Over 38 years experience as a Registered Patent Attorney.)

### A PERSONAL CONFIDENTIAL PATENT SERVICE—

**L. F. Randolph,** 302-D Victor Bldg., Washington, D. C.

Please send me at once, free of charge, your 72 page booklet and "Record of Invention" form.

Name .....

Address .....

# Learn To MOUNT BIRDS



## Tan SKINS, Make Up FURS

Be a Taxidermist. Double your hunting fun. We teach you at Home. Mount Birds, Animals, Pets, Heads and Fish. Save your hunting trophies; decorate home and den. **MAKE MONEY.** Mount and Krome-tan for others. Big sparetime profits. **INVESTIGATE TODAY.** **FREE BOOK** with 100 game pictures. 48 pages. Hunters, get yours! It's Now Free. Send postal card TODAY. This Minute! State your AGE. **NORTHWESTERN SCHOOL OF TAXIDERMISTRY: Dept. 337C, Omaha, Nebr.**

## STUDY ENGINEERING AT HOME

Earn a Degree at Home From A Chartered Institution of Higher Learning Employers Demand Degree Men For Key Positions 23 Degree Courses in Electrical, Civil, Mechanical, Drafting, Architectural, Automotive, Steam, Diesel, Aeronautical, Radio, Structural, Mining, Industrial, Highway, Petroleum, Marine, Refrigeration, Air Conditioning, Chemical Engineering; Arts, Sciences; Philosophy; Education; Public Health; Medical Jurisprudence; Psychology; Sociology; Physics; Chemistry; Geology; Pol. Science; Theology; Law; Agriculture; Business Training; Accounting; Statistics. Founded 1908. Chartered. **McKinley-Roosevelt Graduate College, 4750-R Sheridan Road, Chicago**

## EARN MORE MONEY

Drafting Jobs Often Pay \$175.00-\$350.00 month. Trained draftsmen always in demand. Learn easily at home in spare time. Experience unnecessary. Common education enough. Employment service FREE. Write today for complete information. No obligation. No Salesmen. **MONROE INSTITUTE, Dept. A-108, Alton, Illinois**

## RUPTURED?

### Get Relief This Proven Way

Why try to worry along with trusses that gouge your flesh—press heavily on hips and spine—enlarge opening—fail to hold rupture? You need the Cluthe. No leg-straps or cutting belts. Automatic adjustable pad holds at real opening—follows every body movement with instant increased support in case of strain. Cannot slip whether at work or play. Light. Waterproof. Can be worn in bath. Send for amazing **FREE** book, "Advice To Ruptured" and details of liberal truthful 60-day trial offer. Also endorsements from grateful users in your neighborhood. Write: **CLUTHE SONS, Dept. 31, Bloomfield, New Jersey**

## AGENTS SURE-FIRE WAY to MAKE MONEY

Start making money at once in simple, pleasant business, full or part time. Distribute over 200 home necessities. Earnings start first day. Sure-fire premium plans and big valuable outfit with full-size packages sent on trial plan. Write: **E. J. MILLS, 1847 Monmouth Ave., Cincinnati, O.**



## AMAZING NEW ELECTRIC ARC WELDER

**RETAILS ONLY \$2.95 COMPLETE**

**FULLY GUARANTEED**

**Plugs Into Light Socket**

Amazing new **HANDIWELD** Electric Arc Welder—operates from 110 volt A.C. or D.C. same as other arc welders higher priced—generates tremendous heat to weld all kinds of metal. Not a toy welder that uses carbons, but actually uses standard coated rods—sizes 1/16" and 3/32". Generous supply furnished with welder. Guaranteed not to burn out. Repairs fenders, auto bodies, radiators, preheated small castings and machinery parts. Take **HANDIWELD** anywhere to job, operate from light socket. Sturdily built of finest materials to last years. Fully guaranteed by Big Manufacturer.

**SEND NO MONEY!** You'll find a thousand uses for the **HANDIWELD** around your home, garage, work shop. Also by garages, factories, repair shops, mechanics, farmers, inventors, tin shops, plumbers, etc. Order **HANDIWELD** now. Send no money. We'll rush one to you, complete with rods and goggles. Pay post-weld in 5 days from receipt and money paid for it will be refunded instantly. Rush your order now.

**KUMFY PRODUCTS CO., Dept. G-202, Cincinnati, Ohio.**

## 68 PAGES OF FACTS FOR INVENTORS!

If you have an idea that will save time, labor or give pleasure, you owe it to your future to find out **QUICKLY** how you can protect your rights to it! Some of the world's biggest fortunes came from inventions conceived by Mr. Average Man. The books shown below may prove invaluable to you... send for them **RIGHT NOW!**

### FREE TO MEN WITH IDEAS!

Books tell you simple steps to take to claim your rights; kind of sketch or model needed; 115 different mechanical movements; how to sell your invention, etc.

*Act now!*

USE COUPON BELOW



### YOUR FIRST STEP

Find out how U. S. Government Patent Laws protect YOU! We've been helping inventors for more than 42 years right here in Washington. Fees are reasonable. Write us frankly... what you say will be held in strictest secrecy!

## VICTOR J. EVANS & Co.

REGISTERED PATENT ATTYS. Main Office, 560-J Victor Bldg. WASHINGTON, D. C.

Please send me your books, "Patent Protection" and "How to Sell an Invention" without cost or obligation.

NAME.....  
 ADDRESS.....  
 PLACE AND STATE.....

## AVIATION Wants More LINCOLN TRAINED MEN

Airlines, Airplane Factories, Aviation Operators are calling on this **LINCOLN GOVERNMENT APPROVED SCHOOL** for more trained men. 225 Graduates recently placed. Opportunities for many more. **TRAIN FOR PILOT'S POSITION.** Airlines calling for advanced trained Pilots. Training centers calling on us for Flight Instructors. Lincoln's Primary and Advanced Flight Training, Government Approved, prepares for Gov't. Ratings and responsible flying position. Large fleet of Training Planes. **TRAIN FOR AN AIRLINE MECHANICS POSITION.** Government Approved Training prepares for Gov't. Ratings and immediate employment as Airline Maintenance Mechanic. Short term courses prepare for job in Airplane Factory. **BE AN AERONAUTICAL ENGINEER.** Learn to design and build Airplanes. Our students getting actual experience. Big demand for Engineers. **NOW IS THE TIME TO TRAIN** for Aviation. Opportunities the best they've ever been. Good Pay! Rapid advancement. Our Placement Department assisting Graduates into fine positions. Now offering Part-time employment for board and room while in training. Act quickly. **MAIL COUPON NOW for information.**



### LINCOLN AERONAUTICAL INSTITUTE, (INC.) LINCOLN AIRPLANE & FLYING SCHOOL DIVISION 578 Aircraft Building Lincoln, Nebraska

I'd like to get ready for a job in Aviation just as soon as I can. Please rush complete information about Lincoln Training.

NAME..... AGE.....  
 ADDRESS.....  
 CITY..... STATE.....

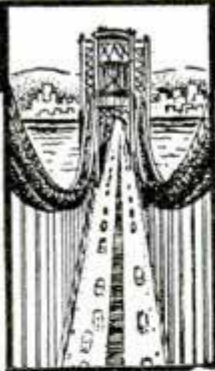

# TRI-STATE COLLEGE

**57th  
YEAR**

## ENGINEERING DEGREE IN 2 YEARS

Courses in Civil, Electrical, Mechanical, Chemical, Aeronautical, Radio Engineering. The Mechanical course includes Diesel Engineering, Air Conditioning and Refrigeration. Essentials of engineering training included and non-essentials eliminated. Tri-State graduates in Radio Engineering can complete the Electrical course in 24 weeks. B. S. Degree granted upon completion of course. For ambitious, earnest students. Special Preparatory Department for those who lack required high school work. Graduates compete successfully with those of 4-year schools.

Technical instruction at lowest cost and in least time consistent with thorough training. Intensive instruction in accord with individual ability. Courses also in Business Administration and Accounting. Also short diploma courses (36 weeks) in Surveying, Drafting. Students from all parts of the world. Tri-State graduates make good. Tuition, living costs low. Enter September, January, March, June. Write for catalog. 480 College Ave., Angola, Ind.

## REFRIGERATION TEXTBOOK FOR HOME STUDY



### HOW TO FIX ANY REFRIGERATOR

Learn quickly to expertly service all types of refrigerators. Get into high-paying, interesting, money-making work. This new remarkably complete book, prepared for practical men, will give you all the training needed. Page after page of useful, easy to understand facts, charts, illustrations, and actual repair hints. A complete "course" in modern refrigeration. 1940 edition.

### REDUCED PRICE—2 BOOKS FOR \$1.00

Order today and get besides a 160 page AIR CONDITIONING MANUAL free. (8 1/2 x 11 in.) Both books for only \$1.00. Great bargain for you. Satisfaction guaranteed or money back.

### AMAZING LIMITED OFFER—WRITE TODAY

Send only \$1.00 as complete payment for both large books. Weight, 3 lbs. No other payment besides a few cents for postage. Answer now.

**SUPREME PUBLICATIONS** 3727 W. 13th Street  
Room 221, Chicago, Ill.



## AVIATION NEEDS YOU

Prepare yourself with a license as airplane mechanic, engine mechanic, pilot, or engineer. Live and study with a fine group of men, at a great government-approved college, on a mile-wide airport. Benefit by single, low tuition and pleasant, inexpensive accommodations.

**WRITE TODAY FOR YOUR FREE CATALOG.**  
**LEWIS SCHOOL OF AERONAUTICS**  
DEPT. J LOCKPORT, ILL.

## EARN A DEGREE AT HOME

From A Chartered Institution of Higher Learning  
Employers Now Demand College Graduates With Degrees  
58 Degree Courses in Arts; Sciences; Philosophy; Education; Public Health; Medical Jurisprudence; Psychology; Sociology; Physics; Chemistry; Geology; Pol. Science; Theology; Law; Business Training; Accounting; Statistics; Agriculture; Electrical, Civil, Mechanical, Drafting, Architectural, Automotive, Steam, Diesel, Aeronautical, Radio, Structural, Industrial, Highway, Petroleum, Mining, Marine, Refrigeration, Air Conditioning, Chemical Engineering. Founded 1908. Chartered. McKinley-Roosevelt Graduate College, 4750-P Sheridan Road, Chicago

## FORGE AHEAD

with the Thinking Alphabet. New "exactly how" short cut to self advancement through self-discovery, originality, personality and mind training. Free booklet.

**SELF ADVANCEMENT INSTITUTE.** 99J Fern St., Philadelphia

## TOOL & DIE MAKING DESIGNING

Machinists Trade, Machine Drafting and Design. Practical shop training in the world's industrial center. Write today for full information.  
Dept. 20 **NATIONAL SCHOOL OF MECHANICAL TRADES**  
628 W. Lake St. Chicago, Ill.

# MECHANICS

**KNOW  
YOUR  
CAR**

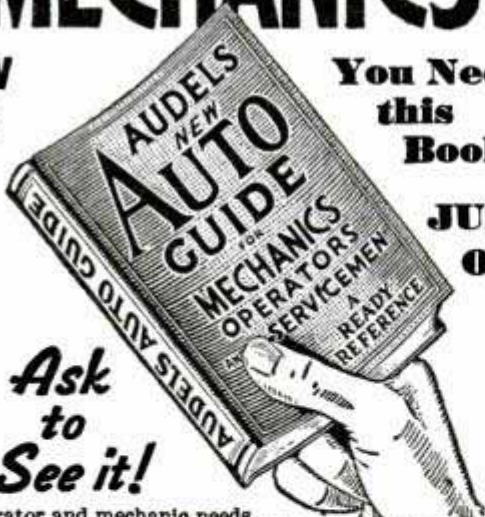

**You Need  
this  
Book  
JUST  
OUT!**

**Ask  
to  
See it!**

Every operator and mechanic needs **AUDELS NEW AUTO GUIDE**. This book saves time, money and worry. Highly endorsed. It presents the whole subject of auto mechanics: 1—Basic principles, 2—Construction, 3—Operation, 4—Service, 5—Repair. Easily understood. Over 1500 pages—1540 illustrations showing inside views of modern cars, trucks and buses with instructions for all service jobs. Diesel Engines fully treated; \$4 fully illustrated. To Get This Assistance for Yourself Simply **4** Fill In and Mail Coupon Today.

**COMPLETE • PAY ONLY \$1. A MONTH** ←  
**THEO. AUDEL & CO., 49 WEST 23rd STREET, NEW YORK**  
Please send me postpaid AUDELS NEW AUTOMOBILE GUIDE (\$4) for free examination. If I decide to keep it, I will send you \$1 within 7 days; then remit \$1 monthly until purchase price of \$4 is paid. Otherwise, I will return it to you promptly.

Name \_\_\_\_\_  
Address \_\_\_\_\_  
Occupation \_\_\_\_\_  
Reference \_\_\_\_\_ PM

## SUPPRESSED KNOWLEDGE OF THE AGES

What strange powers did the ancients possess? Where was the source of knowledge that made it possible for them to perform miracles? Were these profound secrets burned with ancient libraries, or are they buried beneath crumbling Temple walls? These wise men of the past knew the mysteries of life, and personal power. This wisdom is not lost—it is withheld from the mass. It is offered freely TO YOU if, with an open mind, you wish to step out of the rut of monotonous existence and MASTER YOUR LIFE.

### THIS FREE BOOK

Man's intolerance has at times swept his achievements from the face of the earth, yet secret brotherhoods have preserved this sacred wisdom of the ages. The Rosicrucians, one of these ancient brotherhoods, INVITE YOU to write and secure a free copy of "The Secret Heritage." It will point out how you may receive age-old truths. You can learn to MAKE YOUR LIFE ANEW—the fulfillment of your ideals awaits you. Address:

Scribe C.M.B.

**The Rosicrucians**  
— AMORC —  
**SAN JOSE, CALIFORNIA**  
The Rosicrucians are NOT a religious organization



**WORLD'S  
BEST  
WANT AD  
MEDIUM**

# CLASSIFIED Advertisements



Advertisements in this section, 35 cents per word, each insertion, minimum 10 words, payable in advance

To be inserted under proper classification in September issue, copy should be in our office July 8th

September issue on sale August 1st

Popular Mechanics Magazine, 200 East Ontario Street, Chicago, Illinois

## YOU'LL PROFIT

By reading and answering the classified ads in this section. Hundreds of opportunities to make and save money.

Popular Mechanics, Chicago, Ill.

Gentlemen: For two years I have constantly used your Classified Section with an ad costing \$7.00 a month. The returns from this ad nets the company a little better than \$1,300.00 a year. I believe this to be a remarkable record, and should appeal to anyone interested in a material gain, whether it be reading these columns or advertising therein. We have also made a study of the individuals who read your magazine, and have found people in all walks of life who are mainly interested in advancement, and are restricted to a very high clientele.

(Original letter on file in our office)

Sincerely yours,  
**BEGLEY SPECIALTY COMPANY**

### AUTOMOBILES—MIDGET CARS

**MIDGET** And motorscooter wheels, axles, forks, motors, clutches, brakes, plans, building kits, etc. Circulars free. Catalog with plans, 10c. New list used motors, midgets, parts, 20c. Shipp's Midgets, Box 543-H, Zanesville, Ohio.

**NEW Fifth edition Automobile Racing Book.** Tells how to build dirt track bodies, frames, engines. Records, superchargers, rules, formula, plans, stock conversions, roadster racing, fast Fords. \$1.00 postpaid; \$1.15 C.O.D. Ray Kuns, Department 20, Madisonville, Cincinnati, Ohio.

**DON'T "Go wrong"** on used cars. 20 genuine tips—tests that never fail \$1.00. Satisfactory or money refunded. Tony Gorski, 189 Semel Ave., Garfield, N. J.

**PROFESSIONAL** Midget racers, two-passenger roadsters, midget motorcycles, motorscooters. Guaranteed motors, wheels, parts, plans. Handbook catalog—90 illustrations—20c. Midwest, Box 1959-CC, Chicago.

**ONE Man** tows and steers two cars with Schaap Tow-Er. No connection to steering. Uncanny demonstration. Distributors wanted. Schaap Company, Brooklyn, New York.

**ALUMINUM** Alloy pistons, automotive, aviation, diesel, industrial, marine, midget, model, motorcycle, outboard. Finished or semi. Judson Mfg. Co., Hedge and Gillingham, Philadelphia, Penna.

**AUTOMOBILE Superchargers** \$3. Guaranteed mileage increase 20%; power 10%. University of Detroit test. Any car; give make, year. Wrench installs 15 minutes. John Hanley, Manufacturer, 5719 Loraine, Detroit, Mich.

### AUTO SUPPLIES AND EQUIPMENT

**TOURING** Mountains? Our new altimeters indicate height, \$3.95. Air Transpond, Garden City, N. Y.

**FREE** Bargain catalogue auto supplies, tires, tubes, tools, garage, shop, service station equipment. For dealers only. American, 1211 Bedford Ave., Brooklyn, N. Y.

**BARGAINS**—Welders, compressors, battery chargers, car washers. Liberal trial terms. Write Hobart Equipment, Box M-8403, Troy, Ohio.

**MANUFACTURE** My motor tune up oil under your label. Real proposition. Schafer, 547 Melrose, Chicago.

**NEW** Invention, re-uses unburned gases, increases mileage, power and acceleration. Removes carbon, saves oil. 30 day trial offer. Salesmen wanted. Multi-Matic, 2812-B Gillham, Kansas City, Mo.

**1940 IGNITION Supercharger.** E. G. Sales & Mfg. Co., New York.

**PLATING** Outfits for auto parts. Connect to a battery. No tanks used. Free particulars and proofs. Gunmetal Co., Ave. J, Decatur, Ill.

**PISTON Rings**—Multiple steel seal design. Quick seating, stops oil pumping. For all cars and trucks. Send for circular. Piston Ring Sales Co., 4022 West Lake Street, Chicago.

**"PUNCTURESEAL"** Automobile tires 15c. Selfsealing. Particulars, O. Gerwin, Fairview, Oklahoma.

### AUTO TRAILERS

**READY Now**—Plans for nine new Jim Dandy Trailers including 6 modern house trailers, sports, tent and utility trailers. The most complete line ever announced. All have latest features of construction, easy and economical to build. Send for circular quick. Jim Dandy, Box 125-A, Wausau, Wis.

**JUST Off** the press. "New Edition of Trailer Builders Manual and Catalog of Parts, Supplies and Equipment." Rush 25c coin for this big value book that tells all about trailer building and shows you America's largest line of trailer parts at the lowest prices. Trailer Supply Co., 512-A Fulton St., Wausau, Wis.

### MOTORCYCLES, BICYCLES, MOTOR SCOOTERS AND SUPPLIES

**ALLOY** Pistons \$3.00—Harley, Indian, Henderson, Excelsior, Cleveland. Cylinder grinding, rings, bearings, gaskets, chains, sprockets, helmets, goggles, accessories, parts new and used for less. Catalogue and wings pin 10c. Ballak, 811 N. 9th, St. Louis, Mo.

**BUILD** Power scooters, midget cars. We supply tires, wheels, motors. Lowest prices. Send 10c for plans, etc. Build-Own Devices, Dept. 8-A, 536 North Parkside, Chicago.

**"WHIZZER"** Bicycle motor. Quiet, dependable, 4-cycle, 1 $\frac{3}{4}$  h.p., motorcycle type crankcase. Bicycle structure not weakened. Center of gravity unchanged. Spring motor suspension eliminates vibration. Anyone can install one hour. Further information and nearest place to see, write Breene-Taylor Engineering Corporation, 6800 McKinley, Los Angeles, California.

**MOTORCYCLISTS.** Let's get acquainted. We can save you money on parts and accessories. List and details free. Triangle, 1111 Washington, Chicago.

**BUILD** Sensational, clutch-operated, motorscooter speedster in record time with our factory finished kits. Rockbottom prices—fork \$2.95, etc. Complete plans, literature, 10c. Zipscoot, 3622-C North Troy, Chicago.

**MOTORSCOOTERS.** Now is the time to buy, low cost, free literature. Star Put Put Co., Bremen, Indiana.

**MOTORIZED** Vehicles. Build scooters, sport plane, conversion, midgets, etc. Big book \$1.00. Circular, Kamm Metal Products, 105 Boyd, Oshkosh, Wis.

**MOTORSCOOTERS.** Midget cars! Easily built. Complete plans and literature on wheels, tires, motors, etc., 10c. Hon-sakers, Masontown, Penna.

**SAVE 70%.** Thousands assembling own Comet motorscooter! We supply parts, tires, engines. Literature, drawing 10c. Comet Cycle Company, Box 3032, Madison, Wisconsin.

**MOTORCYCLE.** Parts, accessories. Most complete stock. New and used. We specialize on mail orders. What do you need? 35 page catalog 10c. Whitman Motorcycle & Supply Co., 405-9 Southwest Blvd., Kansas City, Mo.

**MOTORCYCLE** Bargains, lowest prices, bargain sheets for stamp. Motorcycle accessories. Rochester Harley Davidson Corp., 129 W. Main St., Rochester, N. Y.

**BICYCLE** Motor. Push-a-Bike outboard motor, complete with pneumatic tire, ready to attach. Dept. P, Richburn Company, Aurora, Missouri.

**MOTORCYCLES.** Reconditioned. New, used, parts and accessories. All makes. Large stock. Bargains. Illustrated catalog, 15c. Indian Motorcycle Sales, Kansas City, Mo.

### AVIATION

**PROPELLER** Special limited, all types, save 50%, price list free. Aircooled Ford A conversion diagrams, instructions, illustrated light plane literature, including flying manual, 25c. Standard Aero-craft, Ft. Worth, Texas.

**PROPELLERS**—All types, world's largest propeller catalog 10c. Banks Propellers, Love Field, Dallas, Texas.

**100 AIRPLANES** \$45 Up. Terms. Located everywhere. New summer directory 25c. Used Aircraft Directory, Athens, O.

**AERONAUTEXT**—Certified, home study, contains best knowledge. 25c coin brings samples. Box 676, Santa Monica, Calif.

**PROPELLERS.** An oil cooled conversion parts \$22.50. Makers of famous American Flea Ship. Descriptive literature 25c. Universal Aircraft Co., Ft. Worth, Texas.

**AIRCRAFT** Factory system training in the world's airplane manufacturing center. Ten separate specialized courses that qualify for employment. Thousands needed. Free placement. Warren School, oldest in the west. Olive at 18th, Los Angeles.

**GET** Into aviation! Train now at this Lincoln Aeronautical Institute for responsible position as aeronautical engineer, air transport pilot, aviation mechanic or aircraft sheet metal craftsman. Good jobs open! Big money paid! We assist graduates in locating positions. Part time employment for board and room while in training. Write today for information. Lincoln Aeronautical Institute, (Inc.), Lincoln Airplane & Flying School Division, 2007 Aircraft Building, Lincoln, Nebraska.

**PROPELLERS** For airplanes, sleds. Iced blueprints, supplies. Catalog dime. Lorenzen Propellers, Niles, Michigan.

**LEARN** To fly free. Folder, dime. Ohmeyer, Box 391, Hempstead, N. Y.

**AVIATION** Apprentices — Airminded young men interested in training for entering aviation as apprentice see ad on page 35A.

### AIR CONDITIONING

**DEALERS** Build air conditioning attic ventilating outfits. Send 10c for wholesale catalog electric motors, attic fan blades, bearing sets, vari-speed pulleys. Evaporative cooler pumps 75c. 10 inch 110 a.c. motor, fan blade combination \$1.75. Other bargains. CMCO, 1111 Washington, Chicago.

**AIR** Condition your home yourself! Low cost. Our complete blueprints, plans and specifications for warm air furnaces shows how. Sent postpaid \$1.00. Satisfaction guaranteed or money back. Emsee Engineering Co., Monroe, Michigan.

### BATTERIES, GENERATORS, ETC.

**WRITE** Kimley, 1271 E. Ferry, Buffalo, N. Y. Miniature storage batteries-generators.

**AC** Electricity with Katolight plants and generators, \$44.50 upwards. Katolight, Inc., Mankato, Minnesota.

**WINDING** Data 200 late automotive armatures \$1.00. Sabina Armature Works, Peebles, Ohio.

**EDISON** Lifetime storage batteries for light and power. Eliminates acid battery diseases. Long guarantee. All kinds rebuilt generating plants, motors, and miscellaneous articles at bargain prices. Free interesting literature. T. Hawley Smith Co., Croton Falls, N. Y.

**500 WATT** Alternating generators \$22.50. 2 cylinder compressors with 1/2 horse repulsion induction alternating motor \$19.75. Butler Electric Co., 1885 Milwaukee, Chicago.

**EDISON** Storage batteries for light-power systems. Non-acid. Odorless. Fifteen year life. Five year unconditional guarantee. Bargains in complete lighting systems. Low prices. Free illustrated literature. "See-Jay" Battery Co., 82 Sterling Ave., Yonkers, N. Y.

### PLUMBING AND HEATING

**ONE** Look! It's all figured out. Amount of steam or hot water heating required for any room or building. Plan 50c. Kramer Mfg. Co., Box 1916, Tulsa, Oklahoma.

**STOKERS** — Your automatic fireman. Lowest prices. Terms, Vanderpool, Springfield, Ohio.

### ELECTRICAL SUPPLIES—EQUIPMENT

**ELECTRO-SCRIBE:** Electric pencil. Writes-engraves all metals \$1.00. Beyer Mfg., 4515-H Cottage Grove, Chicago.

**PRICELIST** Motors; grinders; drills; fans; home workshop tools; paint sprayers; portable workshop. Rebuilt motors. Write for copy. Mailorder Electric, 713 South Dearborn, Chicago.

**DEALERS**—Lowest prices—Blowers, controls, cooling coils, coolers, motors, gas and oil burners, furnaces. Biggs Supply, Lincoln, Nebr.

**BANKRUPT** Public address apparatus, speakers, amplifiers, at salvage sale. 70% discount. Send for list. Electrical Salvage Company, Lincoln, Nebraska.

**FLUORESCENT** AC daylight lighting for desk; office; windows; home. Latest sensation. 50% discount. Literature free. McGee Radio, E-20, Kansas City, Mo.

**ELECTRIC** Engraver, engraves hardest steel, deeply. \$1.00. Hudson Engravers, East Syracuse, N. Y.

### WELDING—SOLDERING—PLATING

**BUILD** 200A A-C welder for \$10. Others cost less—no winding. Plans \$1.00. Information dime. Hi-Point Electric Products, Bellefontaine, Ohio.

**We** Nickel plate pistols, telephone parts, etc. Globe Company, Fitzgerald, Ga.

**100 AMPERE** A.C. arc welder wound with asbestos covered wire and asbestos insulation. burn-out proof. Fully guaranteed. Complete all accessories—Operates 110 volts. \$35.00 f.o.b. New York. Transformer Supply Co., 245 Kent Ave., Brooklyn, N. Y.

**BARGAINS.** Demonstrator arc welders, gasoline and electric drive. Liberal trial, easy terms. Write Hobart Welder Exchange, Box 8402, Troy, Ohio.

**ARC-WELDER** Plans \$1.00 each. Build your own from Dodge generators, vehicle motors, light plant generators. Welders Club, A8B-3432 M-Mart, Chicago. For sale: Vehicle motors, \$20.00 and up.

**ACETYLENE** Welding outfits, \$36.56; electric welders, \$66.25; easy-payment plan. Superior Oxy-Acetylene, Hamilton, Ohio.

**WELDERS,** New and used. Write Lincoln Electric Company, Cleveland, Ohio.

**A.C. Welders,** plans, material. Free literature. Holgerson's Service, Canton, Kas.

### ENGINES, MOTORS, DYNAMOS

**ELECTRIC** Motors, 3/4 h.p. \$16.50, 1 h.p. \$18.50, 2 h.p. \$25.00. Others 1/4 to 50 h.p. Motors and machinery bought, sold, exchanged. Temps Brothers, 809 Myrtle Ave., Brooklyn, New York.

**BARGAINS** — Welders, electroplating, motor generators, guaranteed, liberal terms. Write Hobart's, Box M-8401, Troy, Ohio.

**ALTERNATING** And direct current generators, motors, converters; bargain prices. State your needs. Queen City Electric, 519 South California, Chicago.

**WINDING** Data 200 motors, growlers, test transformers, \$1.00. Sabina Armature Works, Peebles, Ohio.

**ALTERNATING,** 1/2 Horse, 110 volt, induction motors. Rebuilt, guaranteed. \$7.25. Wilnot Auto Supply, 2247 St. Paul Ave., Chicago.

**SMALL** Elect. motors, with flexible shafts \$3.25 postpaid. McConnell, 1619 Edgewood, Racine, Wis.

**BARGAIN**—1/2 Hp. motors, 60 cycle, 1 phase, 110 volt, like new, guaranteed. \$7.40. Send check to Erie Electric Motor Co., 120 Church, Buffalo, N. Y.

**AIR** Compressors 1 3/4x1 3/4 \$6.00; 2x2 \$7.00; 2 1/2x2 \$8.00; electric drills 1/4 in. \$5.95. Free folder. National, 1915 S. State, Chicago.

### MACHINERY, TOOLS AND SUPPLIES

**LAWN** Mower sharpener. Patented efficient hand tool designed for one purpose only. Sharpens both stationary and rotary blades. Mailed prepaid, with full directions \$1.00. McKittrick Mfg. Co., Sandusky, Ohio.

**LATHES**—We have a few bargains in slightly used lathes, 9" to 16" swing. Write for August Blue List. South Bend Lathe Works, 454 E. Madison St., South Bend, Ind.

**BUILD** Your own machine tools. Castings and blue prints at nominal cost. Send 10c for 2 color 28 page catalog, 34 prints covering 12 metal-working projects, \$1.50. 23 prints covering 6 wood-working projects, \$1.00. Lewis Machine Tool Co., Dept. M-8, 1000 Alhambra Ave., Los Angeles.

**VENEER** Presses. All metal. Folder. Unklee Presses, Rock Hill, S. C.

**WE** Pay cash for precision machine tools, gauges, micrometers, instruments. Arcade Electric, Freeport, N. Y.

**SACRIFICE** Sale best make new machine wood bits, 1/2" dia. shank, 3" length flute. Set of 5 1/2" to 1 1/2" \$2.00. Set of 9 1/4" to 3/4" \$4.15. Set of 13 1/4" to 1" \$7.00. Sizes to 2 3/8" in stock. Send for tool bargain catalog, enclose 6c postage. Travers Tool Company, 264 Jackson Avenue, Long Island City, N. Y.

**13"x5" WILLARD** Lathe with gap. No. 2 Pratt & Whitney hand milling machine, four step cone drive. Write for full particulars. Cincinnati Machinery & Supply Company, 217 E. Second St., Cincinnati, Ohio.

**6 FT.** Flexible shaft mounted on 1/2 horse alternating motor \$19.50. Butler Electric Company, 1885 Milwaukee, Chicago.

**DRILL** Grinding attachment. Price \$7.85. Used with bench grinder. Literature on request. Also dealers, salesmen wanted. Tractor-Lite Co., Sidney, Iowa.

### BOATS, OUTBOARD MOTORS, ETC.

**NEW** Johnson outboard parts. Discount. Give motor number. Indian Motors, 622 East Grand, Des Moines, Iowa.

**EASY** Built kayaks—inboards—outboards—rowboats. Complete kits. Free catalog. Kayak Boat, 154-K East 129th, New York.

**KAYAKS!** Complete 12' kit \$10.00! Big value! Playaks, Dedham, Mass.

**BOAT** Pumps, cadmium plated, 10 gal. per minute \$1.25. Brass, 14 gal. per minute \$2.50. H. & R. Manufacturing Company, Fort Wayne, Indiana.

**KAYAKS,** Outboards, Rowboats, Weldwood ready-cut kits. Catalog. Cre-Craft Boats, Dept. F, Millburn, New Jersey.

**13' PLYWOOD** One design fast outboard plans, June Rudder 35c. Free catalog boat-building plans. Rudder, 15 Murray St., New York.

**BUILD** Electric outboard from automobile generator. Smooth—quiet. Uses car battery. Complete plans 10c. LeJay Manufacturing, 547 LeJay Building, Minneapolis, Minn.

**GREATEST** Values ever offered in rebuilt and new outboard motors, boats, marine equipment. Chicago's oldest, largest dealer guarantees satisfaction. 5c stamp brings bargain list. Masters & Son, 808 North Clark, Chicago.

**BUILD** A boat by the Welch System. Use Welch Ready Cut Parts. Send 10c for America's finest boat catalog. Boats of many types. Everything for building, equipping or repairing boats. Welch Boat Company, Station K-1, Milwaukee, Wis.

**SEE** The Cleveland Boat Blueprint Company display ad, page 126A.

**SELL** Nationally-famous outboard motors. Write today for money-making dealer proposition. Power Associates, Box 501x, Wilmington, Del.

**SPEEDOMETERS** For outboard boats. Two models—0-35 mph., 10-55 mph. \$6.95 each. Write for folder. Aqua Meter Co., 60 Glenwood Rd., Upper Montclair, N. J.

**FORD-Mercury-Zephyr** marine conversions. Catalog 10c. Lehman Engineering Company, Dept. D, Newark, N. J.

**MARINE** Power—Easily convert any Ford motor (domestic and foreign) with Osco parts and kits. Complete catalogue 25c (coin). Osmithson, 3644 Lawrence St., Philadelphia, Penna.

**OUTBOARDS** — Save 1/2. Good used parts, all makes and models. Bargains rebuilt motors. Crandall Hicks Co., 959 Commonwealth, Boston, Mass.

**BOAT** Designers are highly paid professionals. Complete course by mail. Catalog. Westlawn, Montville, N. J.

### SPORTING GOODS, GUNS, FISHING TACKLE, ARCHERY

**GUNSMITHING.** Restocking Guide (24 pages). Free. Invaluable for amateur, professional gunsmiths, home craftsmen, shooters; exclusive, complete information, illustrations, walnut stocks, blanks, gunsmith tools, remodeling, actions, bluing, checkering tools. Limited supply. Write America's great gun house, Stoeger Arms Corp., 507 Fifth Ave., New York, N. Y.

**LIVE** Bait fishermen. We have a minnow trap that's plenty good. It's tops. Send a card and let us tell you about it. Doan Trap Co., Miami, Oklahoma.

**FISHERMAN**—Looking for something sensational? "When Fish Bites — Bob Lights," \$1.00 postpaid. Box 497, Greensburg, Penna.

**KRAG** Owner! My \$5.00 speed action job eliminates Krag's sloppy trigger and sluggish action. Two magazines containing descriptions, 10c. K. Clark, Madera, Calif.

**ATTENTION** Fishermen. New patent fish hook disgorger. Very efficient. Positively new principle. Only 25c, five \$1.00. Locke Brothers, Mt. Pleasant, Tenn.

**BOWS,** Arrows, raw material. Lowest prices. Morrison, Waldport, Oregon.

**ARCHERY** Headquarters, 617 South State, Chicago. Illustrated catalogue free. 75 page archery book, 200 illustrations 50c.

**ARCHERY** Bows, from the heart of the yew country. W. I. King Woodworking Shop, 1958 Onyx St., Eugene, Ore.

**RIFLES,** Shotguns, Colts, target pistols, holsters, police goods, etc. Catalog 5c. Wineholt Co., Box C-5, Woodbine, Penna.

**ARCHERY** Equipment. Catalogue free. Mid-West Archery, 2209-A East 75th, Chicago.

**BARGAINS!** Gun catalog 5c, camera catalog 10c, archery catalog 5c, golf catalog 5c, tennis catalog 5c, medal-award catalog 10c. Warshal's, First-Madison-PM, Seattle.

**SAVE** 40% On sleeping bags. Duck down filled. Mothproofed. Regular \$38.25 value, by mail \$22.95. \$17.50 wool bags only \$10.95. Guaranteed. Write for circular. Alaska Sleeping Bag Co., 1414 S. W. Harrison St., Portland, Oregon.

ARCHERY Kits complete, also finished equipment, catalog. Krons-Noble Co., 910 - 43rd St., Kenosha, Wis.

### FIELD GLASSES, TELESCOPES AND MICROSCOPES

TELESCOPES, Microscopes, binoculars; 1940 bargain catalog free. Brownscope Company, 5 West 27th Street, New York.

### ANTIQUES, RELICS, INDIAN GOODS, CURIOS

THE Gun Collectors' Handbook of Values, 220 pages plus 32 full page plates and frontispiece, illustrating 500 valuable firearms, 2,000 firearms described with prices collectors are now paying. Clothbound, autographed, \$3. Paperbound, not autographed, \$2. Charles Edward Chapel, 1195 Begier Avenue San Leandro, California.

TOURISTS! Visit myriads rainbow Indian arrows. Dan McKillop, Regina, Sask.

SWORDS, Rapiers, pistols, daggers, armor list 10c. Robert Abels, 860A Lexington Ave., New York.

INDIAN Relics, coins, bills, gems, crystals, curios, etc. Illustrated catalog 5c. 100 ancient arrowheads \$3.00. H. Daniel, Hot Springs, Ark.

30 GENUINE Indian arrowheads, \$1.00. Catalog. Geo. Holder, Glenwood, Ark.

INDIAN Relics, beadwork, coins, curios, minerals, old glass. Catalog 6c. Indian Museum, Osborne, Kansas.

CHINQUILLA'S Indian Craft Museum. Handwork of all Indian tribes. Jamaica, N. Y.

### DOGS, PETS, BIRDS

SPORTSMEN: 200 Pointers, setters, straight cooners, combination hunters, rabbit and fox hounds. Reasonable. List free. Ramsey Creek Kennels, Ramsey, Illinois.

PUPPIES! All breeds! Reasonable! Information free! Book 104 photos, descriptions 25c. Royal, Chazy, N. Y.

BEAUTIFUL Pure white police dogs. Ansonia Kennels, Mose, N. Dak.

### TAXIDERMISTRY

TAXIDERMISTRY Supplies—Quality artificial eyes, teeth, genuine Jonas head forms. Tools, materials, etc. Everything for the progressive taxidermist. Send 10c for big illustrated catalogue. Jonas Bros., 1049 Broadway, Denver, Colo.

### POULTRY AND FARM SUPPLIES

DEPENDABLE Baby chicks on easy payments. \$3.95 per 100 up. Year-round delivery. Chestnut Hatchery, Box 40, Chestnut, Ill.

DAVIS Chicks for immediate shipment. Barred, Buff, White Rocks, Reds, Wyandottes, Orpingtons, English White, Brown, Buff Leghorns, Anconas \$5.95—100; 300—\$17.95. Also sexed chicks. We pay postage, will ship COD. Davis Poultry Farm, Route 34, Ramsey, Indiana.

NEW Low summer prices. Light cockerels \$2.25—100; straight heavy breeds \$5.95—100. Write for complete price list. Greensburg Hatchery, Box 40, Greensburg, Indiana.

BABY Chicks, cockerels \$2.45 per 100 and up. 21 different breeds. Free catalog. Write Salem Hatchery, Box 81, Salem, Ind.

MAKE Money with poultry. Read America's leading poultry magazine. Five years \$1.00; one year 25c. Poultry Tribune, Dept. E-93, Mount Morris, Illinois.

### TREES, SHRUBS, ROOTS, HERBS

JUST Out! World's greatest "Herbalist Almanac." Beautifully illustrated in natural colors. Contains over 200 old fashioned herb medicine recipes for home use. 10c (coin) postpaid. Botanicus, Box 1109, Evergreen Park, Ill.

### FARMS—FARM LANDS—REAL ESTATE

MORE New farm land. Washington, Minnesota, Idaho, western Montana, Oregon. Dependable crops, favorable climate. Write for impartial advice, literature and list of typical bargains. Specify state. J. W. Haw, 119 Northern Pacific Ry., St. Paul, Minn.

WILL Buy California property. No commission. Eugene Morrison, Reseda, Calif.

129 AC. Equipment, neat bldgs. Owner lived well here for 22 yrs., includes team, cattle, machinery, hay, etc.; 9 rms. and hardwood floors, 40x60 barn, handy village and lake; half cost at \$2000, terms arranged; pg. 6 free catalog 1400 bargains. Strout Realty, 255-P 4th Ave., New York City.

FLORIDA Lakefront tracts \$50.00. Five acre highway fronts \$50.00. \$5.00 down. \$5.00 monthly. Grazing lands \$2.00 per acre. Easy terms. R. W. Stewart, Inverness, Fla.

GOVERNMENT Land—10c acre up. Information all states 25c. Nat. Tax Service Bureau, 1037A Majestic Bldg., Detroit.

40 ACRES. Near White River, unimproved; poultry land, \$175, \$5 down, \$5 monthly. Free list and literature. Hubbard, 216 Grossman Bldg., Kansas City, Kans.

INVESTIGATE The Highlands of Southwestern Louisiana. Gently rolling, well drained, at low prices on cash rental terms. Descriptive book sent without obligation. Long-Bell Farm Land Corporation, 851 R. A. Long Building, Kansas City, Mo.

### PROFITABLE OCCUPATIONS

SILK Screen stenciling. New profession. Paint any design on any surface. Outfit and lessons \$5.00. Signart Studios, Fremont, Ohio.

DOMESTIC Rabbits pay. Read Small Stock Magazine—America's leading magazine devoted to commercial and fancy rabbit industry. Introductory, year 50c; sample 10c. Dept. 5, Lamoni, Iowa.

ANGORA Wool rabbits pay. America's fastest growing industry. Start now. Dakota Rabbitry, Oakes, North Dakota.

RAISE Minks: Profitable, interesting. Excellent stock available. Ralph Gentry, Marshall, Illinois.

MAKE Money, others do, collecting reptiles, toads, frogs. Easy! Profitable! Sure! We buy all varieties. Particulars dime. Biological Research Laboratories, Dept. 2E, Little Rock, Arkansas.

BUSINESS Proposition resilvering mirrors, reflectors, making chipped glass nameplates, signs. Write Sprinkle, Plater, 288, Marion, Indiana.

M. M. Earned \$1174 in spare time for exceptional "cellar crop" Snow-King mushrooms! Free book tells if your cellar, shed suitable. We buy crops. United, 3848 Lincoln Ave., Dept. 64, Chicago.

\$50 A WEEK With a camera. Booklet describing 100 best markets with addresses, 25c coin. Atlas, Box 113, Woodside, N. Y.

WORK Projects! Starting soon throughout North and South America. Advance listings \$1 air mail. Julius, 517 East Tenth, Amarillo, Texas.

AFTERNOONS Free! Work home! \$1,000 month reported (exceptional case—full-time). Expect surprise! National, BX 1240-E, San Bernardino, Calif.

ANNOUNCING New home study course in commercial baking. Good field for ambitious men. Nearly depression proof business. Common school education sufficient. Send for free booklet "Opportunities in the Baking Industry" and requirements. National Baking Institute, 3601 Michigan Avenue, Dept. 3434, Chicago.

RAISE Rabbits and cavies for us. Full details. Catalog, contract and magazine 10c. Or send 25c for book, catalog and year's subscription to Small Stock Farmers Magazine. Stahl's, Box 10, Holmes Park, Missouri.

### GAMES—ENTERTAINMENT

PLAYS, Operettas, musical comedies, complete minstrel first-parts with song programs, blackface skits, vaudeville acts, monologs, dialogs, recitations, juvenile plays and songs, musical readings, entertainments, make-up goods. Catalog free. T. S. Denison & Co., 203 N. Wabash, Dept. 11, Chicago.

### BOOKS, PERIODICALS, PICTURES, POSTCARDS

EXCELLENT Sparetime profits taking subscriptions—2500 magazines. Agents confidential catalogue, complete starting supplies free! Dept. 12, Pines, 583 Monroe, Brooklyn, N. Y.

BACK Dated magazines 4c domestic, foreign, art. Catalog 10c (refunded first order). Cicerones Magazines, 863 (M) 1st Ave., New York.

PACIFIC Fancier—Illustrated monthly for fancier and breeder. Departments for bantams, pigeons, turkeys, waterfowl, ornamental fowl, rabbits, cavies. One dollar year; ten cents copy. Pacific Fancier, Desk M. Shafter, California.

182 THINGS You can easily make for fun or profit, 50c. Popular Mechanics Press, Room C40, 200 E. Ontario, Chicago.

### MAGIC TRICKS, PUZZLES, JOKER NOVELTIES

TAKITAPART—New puzzle sensation. Get penny out—35c. List free. Littlecote Stamp Shop, Utica, N. Y.

JOIN Magicians' Fraternity! Monthly magazine, sample 10c. Tricks free! International Magicians, Mt. Morris, Ill.

MAGICIANS' Headquarters, 216-page catalog pocket, parlor, professional tricks, 25c. Kanter's, 1311 Walnut, Philadelphia.

A THOUSAND Laughs—Unique lackass cigarette dispenser. Holds 10 cigarettes. Simply press donkey's head down, tall rises—presto—out slips cigarette. Satisfaction guaranteed. Shipped C.O.D. for 98c plus small money order fee or \$1.00 with order. Sanimo Industries, Dept. C-1, Spencer, Ind.

BE A hand-cuff king. You can defy anyone to confine you with their own hand-cuffs. Presto, and you are free. Revealed for the first time. Seven other feats, vault and trunk escape included. Book complete \$1.00. Box 43, East San Diego, Calif.

FREE Catalog tricks and jokes. Ess-Jay Nov. Sales, 5019 Winthrop, Chicago.

AMAZE And mystify! Be popular! Magic easily learned. Illustrated catalog 500 startling tricks 10c. Lyle Douglas, Station A-5, Dallas, Texas.

HOLLYWOOD Special! Magicians button, new 1940 catalogue and free trick. All for 25c. Magic House of Charles, Box 888, Hollywood, California.

EARN Money in any crowd. Call names of strangers, tell unspoken questions. Professional course mind reading, spirit writing, etc., \$1. Henderson, Box 341, San Bernardino, Calif.

WORLD'S Largest professional magic shop keeps you in touch with latest tricks. To receive mailings send 25c for 1940 catalog. Holden, 220 W. 42nd St., New York.

LEARN Ventriloquism, 3c stamp brings particulars. Smith, 801 Bigelow, Peoria, Illinois.

LARGE Magic catalog 25c. Hundreds of tricks. Chicago Magic Company, 2300 N. Mason Avenue, Chicago.

### RARE COINS

OLD Money wanted. Do you know that coin collectors pay up to \$100.00 for certain U. S. cents? And high premiums for all rare coins? We buy all kinds. Send 4c for large coin folder. May mean much profit to you. Numismatic Co., Dept. 20, Fort Worth, Texas.

COINS. Send stamp and want list. Box 338, Brighton, Colo.

FOR Sale. All dates Indian and Lincoln head pennies. Guy Saulsbury, Spicer, Minn.

INDIAN Cents, 25 dates, \$1.00. Hansen's, 1326 Main, Kansas City, Missouri.

RETAIL Coin catalogue 3c. 28 large pages. James Randall, 37 West Van Buren, Chicago.

COIN Packet, 100 all different coins, copper, nickel, silver, some over 100 years old, \$2.00, postpaid. Koepfel Coin-Shop, 8th at Broadway, Los Angeles.

COMMEMORATIVE \$1/2. Columbus, Stone-Mountain, Cleveland, Illinois, \$1.00 ea. New catalogue 10c. Norman Shultz, Salt Lake, Utah.

I MAY Have just the scarce U. S. coins you want. Send me list. "Meet me by mail." William H. Kenworthy, Waterville, Maine.

FREE! Foreign coin, banknote, and large illustrated coin catalogue. Send 4c postage. Coin approvals sent. Tatham Coinco, Springfield-125, Mass.

GET Profit and pleasure in collecting old coins. Send 10c for 56 page illustrated coin catalog. You'll be delighted with it. Send for it now. B. Max Mehl, 370 Mehl Building, Fort Worth, Texas. Largest rare coin establishment in U. S. Established 40 years.

## STAMP COLLECTING

FREE Extraordinary combination! Large beautiful pictorials (Martinique, Guadeloupe, Madagascar), national heroes pictorial issue, Constant, Cabral, Wandewolk (Brazil), 60 years old classics (Philippines, Turkey-Eastern Roumelia), Malta (King George pictorial), Selangor (Mosque), Sembilan (coat of arms), Mozambique (Lusiads). Everything offered approval applicants only 3c postage. Imperial Stamps, Department 130, G.P.O., New York.

STUPENDOUS Offer! Selangor (mosque), Turkey (Obelisk), Malaya (ferocious tiger), Saar (dead country), Poland (swiatowit), 10 different Chile, 25 different China, 5c to approval applicants. Knopp, Box 1381, Bristol, Conn.

STAMP Magazine free—Breezy, authoritative articles on new issues, questions and answers, philatelic subjects. Sample copy Philatelic Monthly free. Empire Stamp, Dept. P.M., Toronto, Canada.

UNITED States stamps on approval. Over 1500 varieties in stock. Send for a selection and be convinced that we offer an outstanding service. Reasonable prices, high quality. Southern Stamps, Drawer 70, Miami, Florida.

100 DIFFERENT U. S. only 37c. Stamp Agency, Box 283, Rochester, Minn.

BEST American mixtures 65c lb. Anna Measley, 215 Washington St., Hammonton, New Jersey.

SENSATIONAL Combination offer! Big packet 105 all different including Greenland (new country), Congo, Manchukuo, Costa Rica triangle, air-mails, commemoratives, giant diamond-shaped stamp, \$4 United States; complete set United States telegraphs, cataloging 20c, scarce set Siberia cataloging 50c. Packet British colonies including Gwalior, Hyderabad, Burma (new country), jubilee and coronations. Total catalog price over \$3.00! Everything for only 5c to approval applicants! World-Wide Stamp Company, Department 600, Camden, New York.

STAMP Wallet with perforation gauge. Watermark detector. Set 12 Montenegro, 5c to approval applicants. Gordon Stamp Co., 875 Mariborough, Detroit, Mich.

UNPICKED! 100 U. S. revenues on documents—10c! (700—50c). Mission mixture; pound 40c! 750 Canada—25c. Vanvoorhis, Hyndman, Penna.

42 DIFFERENT Unused Russia 3c with approvals. Stamputopia, Binghamton, N. Y.

72 DIFFERENT U. S. 10c. Album Service, Route 57-13, Sioux City, Iowa.

10 CANADIAN Commemoratives, 3c. Bowes, 1148 Clifton Avenue, Moose Jaw, Sask., Canada.

500 MIXED, Including 50 different U. S. 10c! Approvals, Paul Baringer, Defiance, Ohio.

U. S. Approvals, Postage 3c. Wamsutta Company, Box 1065, Providence, R. I.

FOUR Star approvals! Nothing like them! Write today, 312 mixed U. S. 10c. Kessels, Tucson, Arizona.

OLD United States on approval. Cyril Huber, Box 9686-H, Pittsburgh, Penna.

UNITED States stamps on approval—Big discounts, Stamp Company, Broadway, Albany, New York.

WOODEN Soldiers issue 3c with approvals. Robert Fuller, Lander, Wyoming.

1940 WHOLESALE Catalogue free. Eighty pages. Empire Stamp, Dept. 5, Toronto, Canada.

NEJD (Arabland), Bolivia triangle, Caymans, Negri Sembilan, Turks Caicos, Manchukuo Bahamas, British Solomons (Cannibaland). Everything 3c with approvals. Viking, 130-Z Clinton St., Brooklyn, N. Y.

40000 VARIETIES Available on approvals 1/4c up. Large selections, low prices. Write today, PKelgwin Stamp Company, Vineland, N. J.

ALL Africans, valuable sets \$1. Malutizicht, Generaalsnek, Dist. Ficksburg, South Africa.

1000 WORLDWIDE Stamp mixture 25c. Monjar, 1542 Waverly, Cincinnati, Ohio.

25 FINE U. S. 1861-1908, 10c. Weston, Box 383, Ponca City, Okla.

SOUTH American—100 different 10c—with approvals. Davis, Silver Lake, Ind.

UNITED States 100 face different 50c. Poole, Merritt Building, Los Angeles, Calif.

PHILIPPINES Pictorials, commemoratives, on approval. Send references. Afran Stamp, Manila, Philippines.

UNUSED Danzig to approval applicants 3c postage. National, Needham, Mass.

FINE Approvals, freshly filled books and sheets. Tell me what you want and I will send them. Skinner, 306 East Fourth, Long Beach, Calif.

BRITISH Morocco—complete Edward VIII issue only 30c to approval applicants. Free penny lists. W. Torgesen, Teaneck, N. J.

100 DIFFERENT 15c; 1000, 75c; approvals. Jeannette Stamp Co., Milford, Mich.

AIRMAILS And commemoratives, 25 different, including Columbians, Panama-Pacific, Edison, Zeppelin, etc., only 5c with exceptionally fine United States and foreign approvals. Marco Stamp Co., Box 888, San Francisco, Calif.

FREE—World's only octagonal (eight-sided) set and 25 different Japanese pictorials to approval applicants. Charles Cleaveland, 806 North Humphrey, Oak Park, Illinois.

FREE! Austria war set. Postage 3c. Williams, 606 Archerbldg, Bay City, Mich.

U. S. and foreign penny approvals. Lenott Stamp Company, Oxford, Maryland.

100 DIFFERENT, Gauge, hinges, catalogue, 10c. Anderson, Box 137, Morristown, N. J.

FREE! Scarce zeppelin airmail set with approvals. Riedell, Greensburg, Penna.

FREE—Five beautiful airmails to approval applicants. Green and Company, Norwood, Ohio.

FREE! Royal visit packet. Postage 3c. Roberts, 312P Shearerbig, Bay City, Mich.

QUALITY Packet 100 different United States 15c to approval applicants. Wineholt, 207, Woodbine, Penna.

FREE! Dime packet to approval applicants sending postage. Brady, Cheswick, Penna.

U. S. park set complete 19c. Approval Service, Box 488, Minneapolis.

PENNY Approvals by country. M. H. Hoerning, Merriam, Kansas.

UNSORTED Mixtures; 50c pound. Mission, 857 South 89th, Wauwatosa, Wis.

10 COMPLETE Sets 10c with approvals. Midwest, 2241 East 71st, Chicago.

SELANGOR Perak, Albania, Haiti, Bhopal, Palestine, Johore, Manchukuo, Congo, Kadh, Cochin, Kookaburra-bird and 200 different stamps only 10c with approvals. Reich Stamp Co., 4647 Kenmore, Chicago, Dept. M.

175 U. S. commemoratives, etc., 10c. 600 25c. P.O. Box 457, Newark, N. J.

STAMP Collections bought. Send to N. Barcus, 3787 Longfellow, Detroit.

SEND Postage for free United States price list, precancel list. Stanley Gibbons, 38-P Park Row, New York.

50 LARGE French Colonials, 3c, approvals. Kravat Company, 1925-Q Quentin Road, Brooklyn, N. Y.

BIGGEST Map—odd lands—gold stamp! Our dandy packet includes all these: Giant map stamp (world's biggest), Piume (dead country), Liberia (Bongo antelope), unique Salvador (printed in gold and 3 other colors), tiny Medellin "midget" (dwarf stamp), antique Portugal (60 years old), odd lands of Gwalior, Iraq (Arabia), Selangor, Perak, Malaya, etc.—everything only 5c to approval buyers. R. M. Stamp Co., Box 230P, Port Chester, New York.

YOU Can now have famous Spanish Goya nude stamp, world's largest diamond stamp and world's largest triangle. These beauties sent for only 5c to collectors requesting approvals. To make this the year's biggest bargain, we will include absolutely free collection of 100 varieties containing weird scarce stamps from Transcaucasia, Georgia, Azerbaijan, etc. Cactus Junior, Box 1870-B, Tucson, Ariz.

200 DIFFERENT 10c. Big 50% approvals. Covert Stamp, 39 State, Rochester, N. Y.

WEEKLY Stamp magazine, thirteen weeks, 10c. Stamp Journal, Kalamazoo, Mich.

NUDE Duchess set (2 varieties.) 5c—approvals. Shultes, Berne, N. Y.

CANADA 100 Different 25c—approvals all countries. Lists. Victoria Stamp Co., London, 4, Canada.

PENNY Approvals, that satisfy. Neil Gronberg, Box 5441-P, Philadelphia, Penna.

600 DIFFERENT 50c; 1111, \$1; 2000, \$2.50. Fred Onken, 630 79th Street, Brooklyn.

THREE Sets for 3c stamp! Jack Reed, Jr., Houtzdale, Pennsylvania.

45 DIFFERENT United States, gauge, hinges, pricelist—all for 10c. Seidenberg, Baroda, Mich.

SCARCE Diamond airmail! Wonderful packet 115 different from strange countries, British Colonies, Haiti, Tasmania, pictorials, etc. 5c to approval applicants. Reliable Co., Box 139, Dept. 3, Church Annex, New York.

25 UNITED States, including \$4 and \$5 stamps free to approval applicants, 3c postage. Brownie Stamp Shop, Flint, Mich.

SMOKY Mountain commemorative sheet, largest U. S. stamp issued, and 33 U. S. including commemoratives, airmail, revenues, etc. Catalogs 75c—To approval applicants for 5c. Curhan Stamp Company, Gloucester, Mass.

WHOLESALE Dealer's catalog. Illustrated. Postage 5c. Frank's, 4900 Chalmers, Baltimore, Md.

SIX Dollars for 9c! 300 different stamps (cat. price \$6) only 9c with approvals. Tatham Stamp Co., Springfield-30, Mass.

WHOLESALE Supplements to dealers for 10c postage. Hundreds of bargains. Grossman Stampco, 102 West 42nd, New York.

GIANT Packet 200 all different from Africa, South America, Asia, South Sea Islands, etc. Includes world's smallest stamp; triangle and diamond-shaped stamps; animal stamps, Nicaragua "Will Rogers" airmail; many others. Also packet 17 different United States (cataloging 50c)—all obsolete, including \$4 denomination, commemoratives, etc. Total catalogue price over \$5.00! Everything for only 5c to approval applicants! Mystic Stamp Company, Dept. 80-N, Camden, New York.

STAMP Dealers, your ad here will bring wonderful returns. Ask me for proof. F. W. Johnson, Manager, Classified Advertising, Popular Mechanics Magazine, 200 E. Ontario St., Chicago.

## HOBBIES AND COLLECTIONS

WANTED Old cigarette cards. Write Bray, 1127 Jackson, Easton, Penna.

EXCHANGE Your duplicate stamps, match covers, etc., with collectors everywhere. List, swappers, dime (Mention hobby). Secretary, Box 2166, Denver, Colo.

UNUSED Book match covers, 100 all different, \$1.00. Free list. Charles Edelman, 1311C East 84, Cleveland, Ohio.

## PHOTO FINISHING

NEW! Sensational! 1940 style leader, 8 exposure roll finished, prints deckled, dated and in a neat album, plus valuable coupons, 25c. Triangle Photo Service, P.O. Box 402, Oak Park, Illinois.

20 REPRINTS 25c. 100—\$1.00. Roll developed 16 prints 25c. 5x7 enlargements 10c. 3—25c. Nordskog, 4 Maywood, Illinois.

AT Last! All your snapshots in natural colors! Roll developed, 8 natural color prints 25c. Reprints 3c. Amazingly beautiful. Natural Color Photo, Janesville, Wisconsin.

ROLLS Developed and printed new electric eye way, 8 beautiful, guaranteed never-fade, dated, deckled edged enlargements. Any 8 exposure roll. All for 35c coin each roll. Extra enlargement coupon free. Bonus certificate free. 2-day service guaranteed. Send rolls now to Bostonian Photo Laboratories, 403 Uphams Corner, Boston, Mass.

SPECIAL Miniature service, 35mm. rolls, fine grain development, 36 enlargements 3 1/2 x 5, \$1.00. Cartridge reloaded 35c. Osborne, Box 114, Dorchester Center, Mass.

ROLLS Developed and 16 prints or 8 prints and 2 enlargements—25c. 35mm. rolls developed and 36 3x4 enlarged prints \$1.00. 3x4 reprints from miniature negatives 4c each. Mercury Studios, Dept. M, 109 N. Dearborn, Chicago.

TECHNIFINISH—35mm., 36 Exposure rolls including "Mercury" fine grain developed and perfectly enlarged to 3" by 4" glossy prints, 85c. New, exclusive methods and equipment make this low price possible. Cartridge reloaded with Eastman Plus X, 25c. One day service. Satisfaction guaranteed or money back. Write for free mailing bags and information. Technifinish Laboratory, 109-I, Lexington, Rochester, N. Y.

ROLLS Developed, 16 Velox prints 25c. Liberty Photo, 403 Eighteenth, Pottsville, Penna.

ROLL Developed 6 or 8 prints including 5x7 enlargement 25c coin, without enlargement 20c coins. Gem Photo Service, 3355 West 63rd, Chicago, Illinois.

**FILMS** Developed and enlarged, sizes 127, 120, 620, 116 and 616. 8 exposure rolls developed and enlarged to post card size, 25c; 12 exposure rolls, 35c; 16 exposure rolls, 45c. Same-day service. Knickerbocker Photo Service, General P.O. Box 546L, New York City, N. Y.

**CASH Weekly.** You do not have to be a professional, any simple picture may be a winner. During the campaign cash prizes awarded for best pictures submitted. Weekly prizes: First \$5.00; second \$3.00; third \$2.00. Requirements are that your pictures must be finished in our studio. The judges' decisions shall be final. In case of tie duplicate prizes awarded. Send in as many rolls of film as you choose. Any six or eight exposure roll developed and printed for 25c. Free enlargement coupon with all roll orders. Notice the quality of our work. The winners of the previous week furnished all entrants upon request. Empire Photo Finishers, Box 297, Dept. P, Oedensburg, New York.

**HIGHEST Class photo finishing.** We use fine grain developer. Any size roll developed and printed and two enlargements 25c. One dozen reprints and two enlargements 36c. Try us once. Helen Art Photo Service, Albany, New York.

**FREE Beautiful album with cellophane envelopes plus roll developed and two sets prints, 25c.** Free mailers. Same-day service. Pho-T-Pho, Box 24-F5, Highland Park, Mich.

**ROLL Developed and eight glossy prints 25c; dull finish 30c.** Properly washed, permanent. Wayland Photo Service, Box K-2, Wayland, New York.

**FREE! Best snapshot on attractive photo button with 16 prints each roll 25c.** Beautiful novelty premiums. Novel-Ad Co., BM-3327 North Ave., Chicago.

**PHOTOGRAPHY** For pleasure and profit. Prepare for profitable business or fascinating hobby at home. Common school education sufficient. Write for information and requirements. American School of Photography, 3601 Michigan Avenue, Dept. 3454, Chicago.

**24 PRINTS** From roll, enlargement coupon, photograph wild duck scene. Half dollar. Fotocraft, Stuttgart, Ark.

**A PROFESSIONAL 4x6 enlargement of each exposure.** Eight exposure rolls. Coin 25c. Hi-Tone, Box 2426, E. Cleveland, O.

**5x7 ENLARGEMENTS 10c** From your negative. Rolls developed 20c. Catlin Films, Catlin, Ill.

**ROLL Developed and printed, two enlargements, one in colors, all for 25c coin.** Photo Finisher, Station E, Box 42K, Columbus, Ohio.

**ANY Photo, negative enlarged to life-like 5x7—15c.** Quick service. Rolls developed and 8 prints plus one colored 5x7—25c. Promenade Photos, 30 East 20th, New York.

**ROLL Developed, 8 lifetime prints, 5x7 enlargement 25c.** V & R Photofinishing, Devon, Conn.

**20 VELOX Reprints 25c; 100—\$1.00.** Roll developed, 16 Velox prints and 2 professional enlargements 25c. Same-day service. Superior Finishers, Monroe, Wis.

**LIFE Photo finishing lasts a life time.** Film developed, 16 prints, 2 enlargements 25c. 20 prints 25c. Life Photos, Hutchinson, Kansas.

**ONE Print and one free 4x8 enlargement of each of all six or eight negatives on a roll, 25c.** Jumbo Laboratories, Box 426, Lincoln, Nebraska.

**FREE—To Popular Mechanics readers:** Any roll developed, 16 sparkling Nu-Art neverfade enameled prints plus two beautiful Hollywood enlargements and two free Leathertone frames only 25c. Overnight service. Lifetone Studios, F-39, Des Moines, Iowa.

**CANDID Developing trial—36 exposures enlarged 3x4, including free enlargement coupon—65c.** Micrograin Laboratories, N-39, Des Moines, Iowa.

**35MM.** Rolls fine grain developed, vapo-rated and enlarged, 3 1/4"x4 1/2" for \$1. Guaranteed minimum 25. "Electric-eye" precision. Deckled prints. Embossed margin and date. Free mailers. 8 exposure rolls beautifully finished in free album, 25c. Satisfaction guaranteed or money back. Mailbag Film Service, Box 5440 A, Chicago.

**SNAPSHOTS, Roll finished (16 pictures 25c).** Speedy Service, Box 64, Wilkes-Barre, Penna.

**ROLL Developed and 8 lustrous, natural finish, permanent Velox glossy prints 25c—reprints 3c each.** Fotoprint Service, Box I, Roanoke, Virginia.

**FREE Trial—16 sparkling lifetime prints, three lovely Hollywood enlargements and free Leathertone frame with roll—25c.** Overnight service. Nu-Art Studios, L-39, Des Moines, Iowa.

**ROLL Developed and 8 beautiful enlargements 2 to 6 times larger—high gloss—deckled edge.** Any 8 exposure roll 25c coin. Reprint enlargements 3c each. Alden Photos, 258-B Astor Sta., Boston, Mass.

**OIL Coloring photographs a fascinating hobby or profitable business.** Learn at home by easy simplified method. Previous experience unnecessary. Send for free information and requirements. National Art School, 3601 Michigan Avenue, Dept. 343B, Chicago.

**TWO Beautiful professional double weight enlargements, eight lifetime prints, 25c.** Prompt—careful. Film mailers free. May's Photo Shop, Box 870-AL, LaCrosse, Wis.

**CLIK-TIK Is sensational.** 25c brings 16 prints. Reprints 2c. Clik-Tik, Sioux Falls, S. Dak.

**ROLL Developed, eight beautiful professional 4x6 gloss enlargements; 25c.** Crystal Studios, Box 159-F, Rushford, Minn.

**ENLARGED—Film developed and 8 double size prints 25c.** Free mailers. Economy Lab, Box 286, Olean, N. Y.

**YOUR Choice! Roll developed, 8 permanent prints and 1 5x7 hand painted enlargement or 2 5x7 unpainted enlargements, 25c.** Prompt service. Individual attention to each picture! Janesville Film Service, Room 454, Janesville, Wisconsin.

**ENLARGEMENTS On beautiful portrait paper—Four 8x10 \$1.00. Six 5x7 \$1.00. Ten 4x6 \$1.00.** Miniservice, Dept. PMS7, Box 318, General P.O., New York.

**PROFESSIONAL, Overnight, eight prints, two enlargements, 25c.** Fotoservice, 1942-D Marlow, Toledo, Ohio.

**FOUR Beautiful 5x7 enlargements, two sets guaranteed fadeproof glossy prints with your roll film developed only 25c.** Trial offer. Reprints 16 for 25c. ARO Studios, Dept. 12, Des Moines, Iowa.

**ROLL Developed—Beautiful enlargement and 16 neverfade prints, 25c.** Reprints, 3c. Finest quality. Fastest service guaranteed. Dick's Photo, B-1A, Louisville, Ky.

**ROLL Developed, 16 artistic deckled edged permanent prints, 25c.** Reprints, 3c each. 100 reprints, \$1.50. "As reliable as Uncle Sam's mail"! Midwest Photo, Room 554, Janesville, Wisconsin.

**PROMPT Service—Quality work; 2 beautiful doubleweight gloss enlargements, 8 guaranteed neverfade prints each roll 25c.** Excel Photos, Dubuque, Iowa.

**YOU Get one 5"x7" silk enlargement.** Send negative—10c—P.D.Q., Elmhurst, Ill.

**FREE Snapshot magazine, mailing equipment and price list.** H.F.H. Co., Jamaica Plain, Mass.

**ROLL Filmachine developed and your choice (1) 8 Finerfotos and 2 professional bromide enlargements; or (2) 16 guaranteed Finerfotos or (3) 8 Finerfotos and one beautiful oil colored enlargement, 25c.** Order by number. Prompt service. Finerfotos, Box D-898, Minneapolis, Minn.

**MILLIONS Now know "Hollytints Means Better Prints."** Two enlargements, eight prints with trial roll developed—25c. Framed enlargement coupon free. Hollytints, P-1350 Hollywood, California.

**PROMPT Service, Guaranteed work.** Two beautiful portrait type doubleweight enlargements, eight neverfade gloss prints, each roll 25c. Dubuque Film Service, Dubuque, Iowa.

**ROLL Developed, 16 Velox prints 25c or 8 prints and 2 enlargements.** Rapid, Villa Park, Illinois.

**THE Modern Finishers, St. Paul, Minn., are the outstanding finishers in America for low prices, fast service, guaranteed neverfade pictures.** Roll developed 8 Moderntone prints 20c. Roll developed, 16 Moderntone prints 25c. Reprints 2c each, 16 for 25c. Coupons on enlargements, 35mm. 36 exposure roll developed fine grain, 1 each enlarged \$1.00.

**35MM. Fine-grain developed, 36 big 3 1/2"x5 enlargements \$1.00.** Cartridge reloaded 35c. Photoshop, Linton, Indiana.

**FINER Finishing specials 25c.** 6—8 exposure rolls developed, your choice—16 prints or 8 prints with 2 professional enlargements or 8 prints and one colored enlargement. Genuine nationally known Moentone superior quality. Moen Photo Service, 431 Moen Bldg., La Crosse, Wis.

**CANDID Special, 35mm. rolls enlarged to 3 1/4"x4 1/2", \$1.00.** 18mm. rolls 60c. 3 1/4"x4 1/2" reprints 3c. Brown Photo Company, 1910-61 Emerson, Minneapolis, Minn.

**IMMEDIATE Service! Better pictures.** Sixteen guaranteed prints from roll, 25c. One colored or two plain enlargements and 8 guaranteed prints, 25c coin. Special! Coupon for 8x10 enlargement given with every 25c worth Kodak finishing. Any 36 exposure, 35 mm. film fine-grain developed and each good negative enlarged to 3x4 prints for only \$1.00. 3x4 reprints, 4c each. One day service. Details and mailers free on request. American Studios, Box 22, LaCrosse, Wis.

**ROLL Developed, 8 brilliant fadeproof Velox prints and two professional enlargements 25c.** Overnight service. Young Photo Service, 405-C, Albany, N. Y.

**ONE 6 1/2"x8 1/2" Plate sunk enlargement or one 5x7 hand colored enlargement with each roll developed and 8 prints 25c.** 36 exposure roll developed and 36—3 1/4"x4 1/2" enlargements \$1.35. 18 exposure roll 75c. Vidor, 321-P Hennepin, Minneapolis, Minn.

**BEAUTIFUL Enlargement from each picture on roll 25c.** Cut Rate Photos, Dept. B-4, Janesville, Wis.

**PROFESSIONAL Service, any 6 or 8 exposure roll, including two 5x7 enlargements 25c.** Film Capital Service, Box 504, Rochester, N. Y.

**ROLLS Developed, Two 5x7 and 8 prints, 25c.** Reprints 2c. Photolab, 1806-CA Wabash, Chicago.

**ROLL Developed, 16 Velox prints 25c.** Dividend coupon, 16 Velox reprints 25c. Willard Studios, Box 3535-A, Cleveland, Ohio.

**TWO Beautiful prints from each picture on roll 25c.** Twenty years of satisfied customers. Quick service. Lens Photos, Dept. J-4, Janesville, Wis.

**ROLL Developed—16 guaranteed prints, two coupons on enlargements, 25c.** Smart Photo, Winona, Minnesota.

**IDEAL Photos beautiful finished with wide border, deckle edged, 25c per roll of 8 and free enlargement.** Ideal Photos, Box 2255, Paterson, N. J.

**THE Photo Mill, Immediate service; No delay! Eight-exposure roll developed, carefully printed and your choice of two beautiful 5x7 double weight professional enlargements, one tinted enlargement, or eight reprints for 25c coin.** Reprints two cents each. Highest quality guaranteed. The Photo Mill, Box 629-12, Minneapolis, Minn.

**PROMPT Service! Rolls developed, two Velox prints each negative 25c.** Hensch Studios, Harrisburg, Penna.

**18 LIFETIME Prints, 2 sparkling Hollywood enlargements each roll 25c.** 21 reprints 25c; 100—\$1.00. Finished 3 hours. 25 other bargains. Overnight Studio, Albany, Wis.

**8 ENLARGEMENTS—Films developed plus 8 enlargements, 25c coin—116 or smaller.** Enlarge Photo, Box 791, Dept. PMM, Boston, Massachusetts.

**ROLLS Developed, two prints each and two free enlargement coupons, 25c; reprints, 2c each; 100 or more, 1c.** Summers' Studio, Unionville, Mo.

**THREE Prints each good negative in roll 25c.** Reprints 3c. Fred D. Eastman, Bode, Iowa.

**16 PRINTS With roll 25c.** 16 reprints 25c. Rex Photo, Ogden, Utah.

**FOR The discriminating amateur—Rolls developed 2 prints each, 25c.** Reprints 3c. Superior workmanship. Same day service. Paramount Co., 327 E. 92nd St., New York.

**ROLLS Developed, 16 guaranteed prints, 25c, reprints 2c.** Photolab, 1806-C Wabash, Chicago.

#### CAMERAS, PHOTO SUPPLIES

**CAMERA Repairing.** Bellows made to order, shutters repaired. Bellows made to fit all standard cameras! United Camera Co., Inc., A-1515 Belmont, Chicago.

**CAMERAS And supplies.** Free illustrated catalog listing everything photographic—still and movie cameras, films, lenses—at tremendous savings. Hundreds of bargains, new and used. All guaranteed. We take your old camera or equipment in trade. Write now for your free copy of our newest money-saving bargain book—just out! Limited edition. Hurry! Central Camera Co., (Photographic Headquarters since 1899) 230 S. Wabash, Dept. H-16Z, Chicago, Ill.

**MAKE Money in photography.** Learn quickly at home. Easy plan. Previous experience unnecessary. Common school education sufficient. Interesting booklet and requirements free. American School of Photography, 3601 Michigan Avenue, Dept. 3432, Chicago.

**HIGH Allowance for your camera on Perflex, Graflex, Leica, etc.** Enlargers cheaper. Gravlee, Kennedy, Alabama.

**AERIAL Cameras—How to make and use them.** Complete 72-page book only \$1.00. Aircraft Directory, Athens, Ohio.

**PHOTOGRAPHERS:** Earn good money advertising. Quarter brings complete instructions. Satisfaction guaranteed. Photo-Ad, Box 864, Boise, Idaho.

**ENLARGER \$1.59.** Enlarges eight times size of small negatives. Fully guaranteed. Paramount Sales Company, 89 Dudley Street, Boston, Mass.

**FREE Camera catalog PM5.** Largest discounts. Cameras, movie equipment, binoculars. Trade-ins. Brenner, 943 Penna. Ave., Washington, D. C.

**CANDID Midret F4.5—\$9.00.** Bargain lists free. Debski, 1554 East 17th, Brooklyn.

**BASS Says:** Shrewd buyers, write Bass. For 30 years headquarters for everything in photography. 72-page Bargainingram No. 242 is interesting and free. Write for your copy. Don't trade until you write Bass Camera Company, Dept. AG, 179 West Madison St., Chicago, Ill.

**HAVE You a camera?** Send ten cents for recent number of our big magazine, showing how to make better pictures and earn money. American Photography, 116 Camera House, Boston, 17, Mass.

**CAMERAS, Films, paper 25% to 35% discount.** Paramount Photo Division, 327 East 92nd St., New York.

### MOTION PICTURES AND SOUND EQUIPMENT

**BASS Says:** The new Revere double 8 camera at \$29.50 with F:3.5 lens is a honey. The new Revere projector at \$59.50 is great value. Both described in our new catalog No. 245, 72 pages. Write for it. New RCA Model PG-170 16mm. sound on film projector is ready. Greatest \$300.00 value. Literature on request. Write Cine Headquarters, Bass Camera Company, Dept. A, 179 West Madison St., Chicago, Ill.

**USE Peerless "Plus+Violet" reversible movie films for better movies at less cost.** Weston 12—daylight loading spools—free processing. Univex, 60c each, two rolls for \$1.00; 25 ft. double 8mm., \$1.00, four rolls for \$3.50; 100 ft. 16mm. \$2.35, four rolls for \$8.00. (Also bulk). Details free. Peerless, Box 1310P, Hollywood, California.

**WRITE For new large two color 1940 catalogue nationally advertised movie cameras, projectors, films, accessories.** Payments low as \$2.50 monthly. Don Elder's Home Movies, Dept. 18, 739 Boylston Street, Boston, Mass.

**35 MILLIMETER Sound film and equipment to exchange for 16 millimeter sound film and equipment.** Mertz, Virginia, Ill.

**COMPLETE 16MM. silent library for sale.** 50 features, 75 reels comedies, cartoons, \$5.00 per reel. Remington Pictures, Cincinnati.

**SILENT 35MM. films.** Lowest prices! Demsey, 1223 Berkley, Youngstown, Ohio.

**8MM. AND 16MM. art films.** Lists free. Catalog 10c. Box 108, Lefferts, Brooklyn, N. Y.

**"LEMOINE Process" titles!** Film catalog! Stamp. LeMoine Films, Nevada, Missouri.

**MOVIE Shop special.** 100 ft. 16mm. rapid outdoor film, including processing, \$1.95. Free lists. Movie Shop, 838 Broadway, Bayonne, N. J.

**NEW Sateen screens, 9'x12' \$15.00.** Pathe \$55.00 hand generator, special \$9.50. Drying drum complete for 1000' 16mm., 500' 35mm. \$27.00. Acme portable 35mm. projector, 1000' motor driven, complete \$25.00. Powers heads, also complete outfits, \$10.00 up. Universal camera, less lens, 2-400' internal magazines \$33.00. Victor "25" sof 16mm. projector, complete \$149.50. Odd 400' silent 16mm. films, \$1.95; sound film, \$2.95. Pathex 9 1/2 mm. \$18.00 camera, f:3.5, special \$2.99; film \$1.49 with processing. Trades accepted, bought. Mogull's, 64 West 48th, New York.

**MOVIE Film processing outfit \$2.95.** Roycraft, Box 1810, Milwaukee, Wis.

**ART Sample, 10c; other kinds, lists free.** Goodwill Company, Jackson, Tennessee.

**OUTDOOR Film 100 ft. 16mm. \$1.98.** 25 ft. double 8mm. 98c. Processing included. 8mm. camera, projector, screen \$10.00 complete. Free lists. Home Movies, Box 216, Easton, Penna.

**EXOTIC Movies, sample, dime.** Catalog 8-16mm. free. Cameras, projectors, \$6.00 up. Gravlee, Kennedy, Alabama.

**100 FEET 16mm.** including processing now \$1.50. 8mm., 16mm. from 1c foot. Cameras and projectors, low priced, easy terms. Morrison's, Province St., Boston, Mass.

**RENT 8-16MM. programs, 7 reels \$2.** Free catalogue (with sample film 10c). Parkway Exchange, 1040 Eastern Parkway, Brooklyn.

**SENSATIONAL 8-16MM. movies "Bombs Over Europe."** Thousands other subjects. Sold-exchanged. Films rented everywhere. Bargains in equipment. Trades accepted. Free illustrated catalogue (with sample art 10c). Garden Film, 317 West 50th, New York.

**SHOW Movies outdoors! 35mm. bargains.** Calderara, 5119 South St. Louis, Chicago.

**MOVIE Cameras, projectors, films, etc., bought—sold—exchanged.** Lists free. Art samples 25c. Peerless, Box 1310-P, Hollywood, Calif.

**GUARANTEED 8mm., 16mm., 24-hour reversal, processing.** Eso-S, 3945 Central, Kansas City, Missouri.

**ART Films, Sample, dime; catalog free.** Cineart, 2443 Gunnison, Chicago.

**MOVIE Film.** Develop yourself. Univex, Eastman, etc. Chemical samples 15c. Raw film wholesale. Lake Camera Exchange, Gary, Ind.

**15% TO 25% Discount on still or movie cameras.** Free circular. Paramount Co., 327 E. 92nd St., New York City.

### RADIOS, SUPPLIES, INSTRUCTION

**RADIO Kits—\$3.95 up.** Single band; all wave, 5-10 tubes. Save 50%. McGee Radio, EP-10, Kansas City, Mo.

**RADIOS—\$8.95 Up.** Save 50%. Wind-chargers, electric fencers, power plants. Home agents wanted. Catalog free. Marco-E, Kansas City, Mo.

**RADIO Engineering, broadcasting, aviation and police radio, servicing, marine and Morse telegraphy taught thoroughly.** All expenses low. Catalog free. Dodge's Institute, Ames St., Valparaiso, Ind.

**SEND For free giant money saving radio and phonograph record catalogue.** United Radio Company, 1000-M, Newark, N. J.

**HOME-BUILT Radio receivers that provide factory-built performance.** Anyone can assemble and wire high-grade receivers from Meissner kits. Big 168-page instruction manual contains complete constructional information on 30 models, one to seventeen tubes. Includes television and frequency modulation receivers with latest data. Send 50c to Dept. PM-8, Meissner, Mt. Carmel, Illinois.

### MUSIC AND MUSICAL INSTRUMENTS

**SWISS Music box works—They operate by winding main spring.** Make your novelties. Big market! Price according to size: \$1.35, \$1.70, \$2.10, \$3.90. Music Box Company, 147 West 46th Street, New York.

**SONGS: Songpoems; bought, composed, published, recorded, radio broadcasted.** Best offer. Free advice. Metro-Melody Music Publishing Company, San Francisco.

**SPECIAL \$3.85 Postage prepaid piano tuning tools, with book of instructions.** Hall Music Co., Waco, Texas.

**MUSIC Arranged to poems.** (Sample 10c). Frank Wildt, Lancaster, Penna.

**STUDY Guitar, instrument free.** Rodenius, 75th Ave. West, Duluth, Minn.

**ADULT Beginners' piano course \$1.25.** Moses, 315 West 86th, New York.

**LEARN Swing piano! Postal brings free folder.** Christensen, 751 Kimball Hall, Chicago.

**ORIGINAL Song poems wanted.** Free examination by professional music writers. Five Star Music Masters, 6 Beacon St., Boston.

**PHONOGRAPH Records 10c.** Catalogue. Paramount, AF-358 East Market, Wilkes-Barre, Pennsylvania.

**TWENTY Late phonograph records, only \$1.00.** (Shipping charges collect.) Paul, Oswego, Illinois.

**FREE Book to songwriters—Original poems, songs wanted.** Variety, Dept. V, Salem, Indiana.

**MANUTYPE:** A small instrument that prints music fast, neat, easy to read. Price \$2.00 postpaid. Manutype Company, Ft. Wayne, Indiana.

**SONGWRITERS—Agents, new sales plan.** National Music-D, 532 Sixteenth, Oakland, Calif.

**SONGWRITERS! Words, melodies!** Amazing offer. Hibbeler, C-5, 2157 N. Avers, Chicago.

**WANTED: Original poems for musical setting.** Publication, radio, recording service. Richard Brothers, 24 Woods Building, Chicago.

**SONGWRITERS—Splendid proposition.** Newark Song Publications, 1207 Carbon, Syracuse, N. Y.

**MUSIC Printed.** Fifty copies your song, "Stylostyle" artist prints, \$6.00. Sample sent. Orchestra, brass band, choral. Gil Friar, 401 Kambach, (II), Pittsburgh, Penna.

**SONG Poems wanted.** Free examination. McNeil, Master of Music, 510-PM South Alexandria, Los Angeles, Calif.

**SONGWRITERS.** Write for free inspiring booklet outlining new opportunities for amateur songwriters. Allied Music, Dept. 4, Box 507, Cincinnati, Ohio.

**MUSIC Composed to words.** Wonderful proposition. Bauer Bros., Oshkosh, Wis.

**MUSIC Composed to words.** Rhyming pamphlet on request. Phonograph recording of completed songs. Send poem for consideration. Keenan's Studios, Dept. PM, Box 2140, Bridgeport, Conn.

**WRITE Songs.** Big money and reputation. Write for information. J. Gordon Pub. Co., 201 N. Hoyne Ave., Chicago.

**WANTED! Lyrics, melodies for songs.** We arrange, publish, sell. Superior Song Studios, Passaic, N. J.

**SONG Writers.** Send for publishing agreement. McKinley Music Publishers, 1501 E. 55th St., Chicago.

### BUSINESS OPPORTUNITIES

**AMAZING Lawn mowers.** Gasoline or electric power. Whirling rotary blades, \$50.00 and up. Distributors wanted. Rotary Mower Company, Omaha, Nebraska.

**INCREASE Your earnings in a business of your own.** with all the trade you can attend to. Become a Foot Correctionist and in a few weeks earn big income in service fees—not medical or chiropody. Easy terms for home training, no further capital needed, no goods to buy, no agency. Address: Spencer System, 533 Back Bay, Boston, Mass.

**MONEY Can be made repairing scales.** For information regarding instructions on repairing, send stamped envelope. Ackerman Scale Repairing Instructions (Copyright 1940), Box 1653, Charlotte, N. C.

**START Home business making statuary, plaques, art goods, novelties, souvenirs, concrete pottery, garden furniture, artificial marble flooring, liquid marble.** Make your own flexible molds. Amazing profits. Valuable folder free. Creative Publishers, (P8), Glencoe, Illinois.

**MONEY By mail.** Tested money makers. Start your own business. 25c. C-T Sales, Box 208, White Plains, N. Y.

**150 AMAZING Money making secrets.** Free samples. Formico Novelty Service, Dayton, Ohio.

**RECAST Old batteries into new.** Latest achievements. Battery Laboratories, St. Paul, Minnesota.

**PERFUMERS Make big money.** Start small, grow large. Small capital—profits large. Write quick for free folder explaining all. Dr. Abell, Slavin Bldg., Pasadena, Calif.

**CONVERT Tin cans into steel scrap and valuable tin by chemistry.** Cash markets. Write today for process, 50 cents. Harry Cater, 1601 East 14th Avenue, Denver, Colorado.

**START Home Mailorder Business.** "25 Lesson Course 25c." Ideal Service, 98, Park Ridge, Ill.

**CUBAN Information Bureau.** Everything relative to, or about Cuba, reliably investigated and conscientiously done at moderate fees, backed by legal or official evidence. No charge for the first inquiry. Confidential, commercial, industrial, mineralogical, political, historical, legal statistical or personal information furnished. References exchanged. Information Department, Cuban American Brokerage Company, Apartado 566, Havana, Cuba.

**TURN Tin cans into money.** Instructions 25c. H. Chaney, 1130 E. 16th St., Jacksonville, Fla.

**REFLEX** Lawn mower blade keeps mower always sharp. Give size. Sample 50c. Reflex Blade Co., 420 Cherry St., Scranton, Penna.

**FREE**—"Lucky 15 Golden Opportunities." Vital, reliable information about operating a mail order—mailing business including sources, free circulars and free mailing of your offers. Absolutely free to those sending 25c for three leading monthly moneymaking opportunities magazines. Unbelievable bargain or money refunded. Mailad Service, Mooresville, Ala.

**POPCORN** Machines, caramelcrisp, crispettes, cheese coat, potato chips. Long Eakins, 2035-H High St., Springfield, Ohio.

**MAIL** Order business course shows you how to make money, spare or fulltime. Teaches professional mail order technique—not penny-catching schemes. Free details. Nelson Company, 500 Sherman, Dept. 404-H, Chicago.

**MAILMONEY** Facts. Outstanding mail-order magazine. Sample copy, big mail, 10c. Vernon Specialty Co., West Fairview, Penna.

**ST. CLOUD** Granite samples, red or gray. 2" square, initials engraved 50c. Box 553, St. Cloud, Minn.

**A LITTLE** Gold mine. Repair, refinish, upholster broken or discarded furniture. Very small capital needed. Complete information and working instructions \$1.00. Monarch Upholstery Shop, 2517 La Salle, Los Angeles, Calif.

**"RUBBER** Mold Making." Plaster Casting. Working instructions 25c. Ideal Service, RM-8, Park Ridge, Ill.

**COMPLETE** Used brass moulding outfit, only \$200.00. Write for list of equipment included. Youngs & Co., Newburgh, N. Y.

**START** Mail order book business new way. I've made thousands yearly by it. Complete particulars free. Economy Publishers, 15-P Park Row, New York.

**OPERATE** Legitimate amusement machines. Investment required. Box 1591, Rockford, Illinois.

**YOU'LL** Like resilvering mirrors, reflectors, making chipped glass nameplates, signs. Write Sprinkle, Plater, 127, Marion, Indiana.

**M. M.** Earned \$1174 in spare time for exceptional "cellar crop" Snow-King mushrooms! Free book tells if your cellar is ched suitable. We buy crops. United, 3848 Lincoln Ave., Dept. 62, Chicago.

**GRIND** Lawn Mowers! Factory method. \$2.00 capital. \$800.00 reported. De Lambert, Janesville, Wis.

**OPERATE** A collection-credit bureau. Very profitable. Permanent. Free folder. Cole Associates, Syracuse, N. Y.

**START** Potato chip business in your kitchen. There's money in potato chips for everyone; also Krispy cheese chips, golden corn chips; 3 formulas. 50 cents; guaranteed. Joe Syc, 2712 Geimer, Detroit, Mich.

**GOING** in the mail-order business? Valuable information free. Hollywood Makers, Box 48, Hollywood.

**UP** To \$25,000 reported using schemes, tips, opportunities, formulas from "Schemer" Magazine, Alliance, Ohio. Copy, 10c; trial six months, 30c.

**LEARN** To mottle furniture, walls, woodwork. Imitate parquet floors. Quickly taught with our formula, minute drying paint. Instructions 50c cash. Kay Laboratories, 1064 E. 14th St., Brooklyn, N. Y.

**CLEVER** Publishing proposition. Make money, spare time. Bulletin 10c. E. De Witt, Orchard Park, N. Y.

**MOLD** Making, plaster casting, tremendous profits. Foolproof rubber, 24 page instructive catalogue free. Plastic Arts, 711 Neely, Muncie, Indiana.

**BIG** Mail for you. Latest moneymaking offers opportunities, catalogs, magazines. Name listed in directory 10c. Ideal Service, 108M, Park Ridge, Ill.

**HANDY** Men—Earn money home operating Community "Fix-It" Shop. Stafford, Makanda, Illinois.

**MAIL** Order opportunity. Small investment starts you. Complete instructions 25c. Morse Publishers, Box 671, Cincinnati, O.

**MAKE** Artificial marble. Novelties, floors, pottery. Cement secrets. Brilliant sample 3c. John A. Payn, 945 Grande Vista Avenue, Los Angeles, Calif.

**CASH** Paid for insects. See Sinclair display advertisement on page 10A.

**SMALL** Capital starts "route" coin operated peanut, gum and amusement machines. Particulars free. Robbins Co., 1141P DeKalb Ave., Brooklyn, N. Y.

**MAKE** Money developing films, prints, outfits include instructions, write for prices. Johnson's, Box 1562, Baltimore.

**START** Own business. New collection tested plans. Real moneymakers. Particulars free. Enterprise, Hillburn, New York.

**NEED** Money? Do you have a worthwhile idea or business in mind but lack capital? Our complete course of instructions—"How to Control and Operate a Business Without Your Own Capital"—should solve your problem. Only \$1 postpaid. A. Shaw, P.O. Box 26, Jamaica, N. Y.

**OPERATE** Mail order business at home. Details dime. Maples, 3418 South Marshfield, Chicago, Illinois.

**AFTERNOONS** Free! Work home! \$1,000 month reported (exceptional case—fulltime). Also wartime plan! Expect surprise! National, BX 1240-Z, San Bernardino, California.

**RAISE** Angora rabbits—Safe home business, easy, reasonable care. Wool sales guaranteed. Small capital. Authentic information. Maurice B. Sixby (Pioneer Breeder), 94 Melrose, Buffalo, New York.

**YOU'LL** Like the candy business—we help start you, furnishing outfits and instruction. Operate "Specialty Candy Factory" home. Men-women, opportunity for good steady income. All or spare time. (Our 31st year.) Booklet free. Ragsdale Candies, Drawer 4, East Orange, N. J.

**MANUFACTURER'S** Exclusive formulas; specialties-merchandise information, duplicating latest popular branded products! Miller's Laboratories, Tampa, Florida.

**WANT** More business! 2c daily opens individual New York branch office. Co-operative Mail Service, 126 Lexington Ave., New York.

**A SHORT-CUT** To continuous profits through new, permanent business. No competition. Small investment and thereafter a lifetime business of your own with extraordinary profits. Skeptical? Good! Write for eye-opening details. A chance of a lifetime. Kenneth Fleck Company, 300 Wallace Avenue, Columbia City, Ind.

**RUBBER** Mold bargains brings Xmas business. Colonial Arts, Derry, N. H.

**WIN** Money! Prizes! Contest Magazine 10c. Butler, 473PM, Sebring, Florida.

**SIGNS** And showcards easily and expertly painted with letter patterns. Many sizes and styles. Write for descriptive folder. John Rahn, A1330 Central Ave., Chicago.

**MEN—Women**, operate "specialty candy factory" home, all or spare time. Opportunity for good steady income. (Our 31st year.) Ragsdale Candies, Drawer 62, East Orange, N. J.

**GRAPHITONE** A super lubricant relieves sticky valves, reduces friction, and ends carbon. Used in gasoline and oil. Be independent, make big money, sold in quart cans. Formula with state rights and territory. Wire or write Arthur Oils, Maywood, California.

**MAKE** Money with personal service bureaus! No investment needed. Twenty different ways to begin immediate financial independence. Simple, smart, practical. 25c. Berton Strickland, Box 427, Longmont, Colorado.

**135 SINGLE-INGREDIENT** Formulas, \$1.00 postpaid. B. Kinford, Wayne, Penna.

**"NEW Business"** opportunities. Drop postal. Porter, Box 6346P, Pittsburgh, Penna.

**WE** Successfully sell inventions, patented and unpatented. Write us, if you have a practical, useful idea for sale. Chartered Institute of American Inventors, Dept. 4-C, Washington, D. C.

**I WANT** to send you proof of the wonderful pulling power of Popular Mechanics Magazine's classified pages. What's your proposition? Write me today. F. W. Johnson, Manager Classified Advertising, 200 E. Ontario St., Chicago, Ill.

**MAKE** Color-glazed concrete pottery, gravestones, tiles, floors, walls. Basement waterproofing, etc. Booklet 3c stamp. National Potteries, Minneapolis, Minnesota.

**GET** Big mails—Samples galore. Your name listed in Midstates Mail Trade Directory, copy sent you, directory 500,000 articles wholesale, 10c. Eagle, 414-P W. 65th, Chicago.

**MAIL** Order business is your opportunity. Many began small, now earn thousands yearly. No personal contact. Boundless opportunities. Have had over 30 years experience; will help you succeed. Send 25c for valuable booklets, none free. B. Breniser, 257 E. 21st, Philadelphia.

**INVENTION** Finance Magazine, 80-G Wall Street, New York. Important particulars free.

**A REAL** Future for you with Red Comet fire control products. Low prices. Proved seven years. Splendid sales outfit free. Some good territory open. Exclusive. Write quick. 766 Red Comet Building, Littleton, Colorado.

**MANUFACTURE** From Phospholene. Bleach 2c gallon; glass spray 1c gallon; hand soap 2c pound; and ten fast sellers. Sample 25c. Details free. Western 401 Climax Bldg., Cleveland, Ohio.

**SUCCEED** With your products. Make-sell them. Formulas. Processes. Accurate analyses. Catalog free. B. Thaxly Co., Washington, D. C.

**PLASTEX** Industries offers industrious men an opportunity to start a business of their own, manufacturing art goods, novelties, souvenirs, etc., in Plastex and marble imitation. 5c material makes \$1 articles. Rubber moulds furnished for speed production. Small investment brings big returns. You are just in time for big wholesale season now starting. Write for interesting booklet mailed free. Plastex Industries, Dept. A, 1085 Washington Ave., New York.

**GOOD** Paying business silvering mirrors, plating autoparts, reflectors, bicycles, bathroom fixtures by late method. Free particulars and proofs. Gunmetal Co., Ave. H, Decatur, Ill.

**ELITE** Collection of business plans, contains 127 tested plans and scores of formulas. Start own business; home, office. Particulars free. Elite Co., 214 Grand St., New York.

**WHERE** To buy at lowest wholesale prices. Information free. Yorena, Box P-312, Bayonne, N. J.

**100 PROFITABLE** Mail order and local plans. Gilbert Supply, 5-P West 24th, New York.

**MAKE** Sell luminous paint. Literature free. Gordon Laboratories, 1265-H Broadway, New York.

**EARN** Money in your spare time taking subscriptions to Popular Mechanics. Unlimited possibilities, every family a prospect. Easy to sell. Bonus paid in addition to liberal commission. Send postcard for further details today. Circulation Dept., Popular Mechanics Magazine, 200 E. Ontario St., Chicago.

**127 WAYS** To make money, in home or office, business of your own. Full particulars free. Elite Co., 214 Grand St., New York.

**HOW** And where to obtain capital fully explained, free particulars. Star Service, Wapakoneta, Ohio.

**MAKE** Money by mail, the way we do. Free information. Maywood, P-1107 Broadway, New York.

**SECURE** Financial independence by placing coin operated merchandise vending machines, out on percentage basis, no experience required, little capital needed, write for free details. Torr, 2047 1/2 South 68th St., Philadelphia, Pennsylvania.

#### MONEYMAKING OPPORTUNITIES

**RELIABLE** Men to operate movie circuits in theatreless communities. Earn \$50.00 to \$100.00 weekly. Everything furnished. Southern Visual, Dept. PM-13, Box 2404, Memphis, Tennessee.

**GET** Squab checks weekly. Eye-opening poultry book free. Rice, Box 639, Melrose, Mass.

**PROFITABLE** Proposition; real money getter; local, agents, mail order. Write Bruso, 703 Robinson, St. Clair, Michigan.

**PROVEN** Moneymaking plans. Particulars free. Bradley's, Box 1871, Raleigh, North Carolina.

**3 NATIONAL** Mailorder magazines crammed with moneymaking information—25c. Single copies 10c. International, Box 5636, Chicago.

**MONEY** Making ideas. Samples and particulars free. Tobiasen, Ree Heights, S. D.

**"LUMINOUS** Paint" shines in dark. Easily made. 300 other formulas, plans—all 25c. Ideal Service, 300P8, Park Ridge, Ill.

**YOU'LL** Like resilvering mirrors, reflectors, making chipped glass nameplates, signs. Write Sprinkle, Plater, 287, Marion, Indiana.

**EXTRAORDINARY** Moneymaking ideas! Worldwide propositions; stamp appreciated. Worldwide Service, Box 5450, Metropolitan Station, Los Angeles, California.

**BOOKKEEPERS** Make money operating new copyrighted bookkeeping service. Ralph Lee, Vicksburg, Michigan.

**FREE Formula.** Successful lube reclaiming. Boisset, Box 483, New Orleans, La.

**MAKE Money,** others do, collecting reptiles, toads, frogs. Easy! Profitable! Sure! We buy all varieties. Particulars dime. Biological Research Laboratories, Dept. 3E, Little Rock, Arkansas.

**BUY Wholesale—Sell** by mail or local. Wetzel, Valhalla, N. Y.

**MAKE 600%.** Plan 25c. Nubia Company, 770 Columbia Road, Washington, D. C.

**CONTEST Bulletin.** Sample copy 10c. 1609 East Fifth, Duluth, Minnesota.

**1,000,000 ARTICLES Wholesale.** Directory 10c. Herbert Masser, 201 Ocean Parkway, Brooklyn, New York.

**CASH Paid** for insects. See Sinclair display advertisement on page 10A.

**A QUALITY Mail** of money-makers. Magazines, formulas, plans. No trash. 10c. Goodeve, Bergenfield, N. J.

**FREE Literature** describing many money making plans. Franklin, Box 866M Hilltop Sta., Columbus, Ohio.

**HOME Built mailorder business.** Like mine. Start you. Information. Stamp. Frank H. Battles, Ann Arbor, Michigan.

**EARN Money** taking magazine subscriptions. Details free. New York Circulation Service, 30 Church, New York.

**QUICK Money.** 2 way proposition. Write today. Kahn, 506 W. 45th, Chicago.

**TYPISTS!** Earn money addressing envelopes, circulars, typing. Information 10c; none free. Ace-PMH, 316 Empire, Birmingham, Ala.

**AFTERNOONS Free!** Work home! \$1,000 month reported (exceptional case—fulltime). Expect surprise. National, BX 1240-M, San Bernardino, Calif.

**LEARN Making** perfect models of buildings, landscapes. Profitable business, hobby. Unique courses, inexpensive. Free particulars. Alfred Weidler, 4589 Lexington, Hollywood, California.

**BE A professional scrapbooker.** Big fees. Unlimited opportunities. Can be done at home. No competition. No capital needed. Write to Scrapbookers Guild, 59 Park Place, New York, N. Y.

**"RAISE Earthworms for profit."** new, interesting home business. Bureau Zoological Research, 106A Broadway, Peoria, Ill.

**AMATEUR Cartoonists,** earn cash at home, copying and duplicating cartoons for advertisers. Ad-Service, Argyle, Wis.

**WHOLESALE Sources,** 500,000 articles. Free directory. Maywoode, 1107 Broadway, New York.

**GROW Plants** without soil. Folder free. Gordon Laboratories, 1265-J Broadway, New York.

**PROFITS Day-night,** year around. No selling. Operate "Silver King"—"King Jr." vendors. \$3.95 up. Free instructions. Automatic, 2425-A Fullerton, Chicago.

### FORMULAS, PLANS, ETC.

**THAXLY Formulas,** processes, for successful products. Accurate analyses. Catalog free. B. Thaxly Co., Washington, D. C.

**FORMULAS: — "Chemist Approved."** None better. Lowest prices. Catalog free. Kemico, 12-8, Park Ridge, Ill.

**FORMULA Guaranteed** to kill all ringworm, athlete's foot. 25c. Agnes Luzader, Winnfield, La.

**BIGGER Profits—Less work!** Single-ingredient formulas. Write A. Kinford, Wayne, Penna.

**SPECIAL Course** on manufacturing of shoe polishes, by a French specialist, \$25.00. Write, Jules Janelle, 1420 Blvd. Mt. Royal W., Outremont, Montreal, Can.

**FORMULAS, Candy lessons,** opportunity books. Literature free. Baran, Bay City, Mich.

**MEATLESS Roast beef—Six meatless meat formulas** 25c. NuWay Foods, 139<sup>1</sup>/<sub>2</sub> Chandler, Jamestown, New York.

**DISTRIBUTORS Sell** competitionless necessity. Territory. Information, sample, 20 cents. Weidenbeck, 337A Irving, Brooklyn, N. Y.

**AFTERNOONS Free!** Work home! Expect surprise! National BX 1240-K, San Bernardino, Calif.

**MANUFACTURE Motor** tune up oil. Formula. Schafer, 547 Melrose, Chicago.

**ANALYSIS.** Guaranteed duplication. Formula Messengers, free! Miller's Chemists, Tampa, Florida.

**ICELESS Ice! Colder! Cleaner! Cheaper!** Instructions 25c. Duffy, Covington, Ky.

**FORMULAS—All kinds.** Real money-makers. Lowest prices. Catalog free. Clover Formulary, 108-P3, Niles Center, Ill.

**REAL Manufacturing formulas.** Lists free. Cummings, Chemist, Gordon Avenue, Syracuse, N. Y.

**ELITE Formulas and plans;** make and sell your own products. Descriptive booklet free. Elite Co., 214 Grand St., New York.

### CHEMISTRY

**FREE: 40 Page catalog** of chemical and laboratory supplies for amateur chemists. Wollensak microscopes and supplies. Scientific books at big discount. JES Winn, 124 West 23 Street, N. Y. C.

**COMPLETE Chemical laboratory.** Priced low. Herman G. Perkins, Madison, Maine.

**FREE Catalog;** chemistry, mineralogy, telescopes, binoculars, microscopes. Tracey Laboratories, Evanston, Illinois.

**FREE Chemistry catalog.** Supplies at 5c! Equip complete laboratory. Kemkit Scientific Corp., 397P Bridge St., Brooklyn, N. Y.

**CHEMICALS, Laboratory, glassware,** apparatus. Send 3c for catalog CP1. Biological Supply Company, 1176 Mt. Hope Avenue, Rochester, N. Y.

**SPECTROSCOPE** For quick chemical analysis \$2.50. Kutting Sons, Campbell, California.

**CHEMICALS In 5c quantities.** Catalog 5c. Fleischer's Laboratories, Medford, Mass.

### HELP WANTED

**LOCAL Agents** wanted to wear and demonstrate suits to friends. No canvassers. Partial payment plan. Up to \$12 in a day. Experience unnecessary. Valuable demonstrating equipment, actual samples free. Stonefield Corp., 1300 Harrison, Dept. H-817, Chicago.

**USE Photo stamps** on employment applications, personal letters, business cards. \$2 buys 150, gummed. Send photo to N. P. Co., Box 6, Niagara Square Sta., Buffalo, N. Y.

**M. M. Earned \$1174** in spare time for exceptional "cellar crop" Snow-King mushrooms! Free book tells if your cellar, shed suitable. We buy crops. United, 3848 Lincoln Ave., Dept. 63, Chicago.

**MEN, Women.** Full or spare time. Finn, 2602-A Gerritsen Avenue, Brooklyn, N. Y.

**GET The job** you've dreamed of. We assist talented, industrious, ambitious men and women of all ages. Whether now employed or not. Job consultants that make good—not employment agency nor application-letter writers. For eye-opening booklet address Gatto Associates, Trenton, N. J.

### AGENTS WANTED

**WONDERFUL Invention** brings joy to women who iron; beats electric; proven seller; good profits up \$100 weekly. Write Finn, 330 Mt. Prospect, Newark, New Jersey.

**MAKE Extra money** easily. Sell 50 assorted personal Christmas cards for only \$1. 14 box assortments 30c up. Odd cards 2<sup>1</sup>/<sub>2</sub>c each. Send for free samples exclusive \$1 line personal cards and imprinted stationery. Request \$1 assortment on approval. New England Art Publishers, North Abington, 331, Mass.

**INSTANT Sales.** New patented room perfumer. Snaps on any light bulb. Uses solid perfume. Lasts for hours. Constant repeat sales on refills. Send 25c for complete sample. Lyndon Products, Norwalk, Conn.

**CALL On friends** with sensational lowest-priced personal Christmas cards and stationery. Names imprinted. Also big-value 21 card \$1.00 assortment. Profit, 50c. Experience unnecessary. Samples free. Wallace Brown, 225 Fifth Ave., Dept. P-34, New York.

**NOVELTY Jewelry.** Fast sellers. Send dime for sample. Transposter, 729 Boylston, Boston, Mass.

**SILVERWARE Cleaned** instantly. Simply dip and dry. Amazing demonstrations. 566% profits. NuProcess, Dept. 68, Aurora, Ill.

**"I GUARANTEE You can sell"** my new automatic floor waxer, cleaner, polisher—all in one. Retail \$1.95. Your profits 100%. Write J. H. Smith Manufacturing Co., Dept. P-7, Springfield, Mass.

**CHRISTMAS Cards.** Earn \$2 an hour. Take orders galore from friends. 50 exquisite folders with name \$1. Free samples 30 designs. America's fastest selling 21 Christmas folder box. Costs 50c, sells \$1. Request samples today. Sunshine Art, Dept. E-1, 154 Nassau St., New York City.

**LONMPOWER Attachment** converts any hand lawnmower into complete power lawnmower economically. Agents wanted. Lonmopower, 347 North Crawford, Chicago.

**CHRISTMAS Card leader** brings you quick cash profits. Sensational "Beauty Queen" 21-card assortment sells \$1.00. You make 100%. Ten other fast-selling assortments. Personal Christmas cards, 50 for \$1. up. Samples on approval. Chil-ton Greetings, 147 Essex, Dept. T-2, Boston, Mass.

**SELL San-Blen signs.** Big profits. Sample free. Rister Signs, Abilene, Texas.

**HUSTLERS—Easy pitch—Clean deal.** For restaurants, taverns, up to 300% profit. Investigate. M. Sheridan, 624 S. Michigan, Chicago.

**MILLION Articles.** Buy wholesale. Valuable directory 10c. Ideal Service, D-8, Park Ridge, Ill.

**EXTRA Cash!** Sell Christmas cards—50 for \$1 with name imprinted. New raised colored printing. 21-card assortment \$1—you make 100%. Complete line. Samples on approval. Colonial Studios, 395 Dwight St., Dept. B-11, Springfield, Mass.

**FASTEST Selling** polishing cloths. Sample, 15c. Matz Products, Reading, Penna.

**TWO Steady repeaters,** prospects galore. Samples, details 5c. Daufeldt, Atalissa, Iowa.

**EXTRA Money quick!** Sell super-value personal Christmas cards. 50—with name—\$1. Finest 21-card assortment \$1. You make 50c. Complete line. Samples on approval. Waltham Art Publishers, 160 N. Washington, Dept. 309, Boston, Mass.

**AGENTS—Your own** hose sent free with big outfit. Amazing guarantee. Silk or nylon. Rush name and hose size. Wilknit, Desk HH-37, Greenfield, Ohio.

**SELL 50 Personal Christmas cards—\$1.00.** Amazing bargain! 50 folders with customer's name imprinted. Sells fast. Pays big profits. Free samples. Also unequaled \$1 Christmas card assortments. General Card, 400 S. Peoria St., Dept. P-71, Chicago.

**CHRISTMAS Cards.** Absolutely finest assortment. Season starting. Write for samples. Robinson Cards, Dept. 600, Clinton, Mass.

**MAKE Extra money** easy. Show smart personal Christmas cards with name. 50 for \$1. up. Outstanding values. Also 21-card assortment, \$1; others. Big profits. Samples free. Wetmore & Sugden, 749 Monroe, Dept. 74, Rochester, New York.

**FREE Water** and our concentrates make 68 products. Labels, bottles, everything supplied. Qualco, E-20030 Russell, Detroit.

**UP To 500% profit** with new perfected 1940 quick action, no flint, automatic gas lighter. Retail \$25c. Sample 10c. New Method Company, Box PMG-93, Bradford, Penna.

**SELL Food.** Everybody needs food. Own profitable neighborhood business. Complete outfit sent on trial plan. Write for particulars. Ed. Mills, 3571 Monmouth, Cincinnati, Ohio.

**BUSINESS Proposition** resilvering mirrors, reflectors, making chipped glass nameplates, signs. Write Sprinkle, Plater, 128, Marion, Indiana.

**IF You are ambitious** you can make good money with a Rawleigh route. We help you get started. No experience needed to start. Steady work for right man. Write Rawleigh's, Box H-2-PPM, Freeport, Ill.

**UP To 100% profit** in new perfected 1940 quick action self-starting cigar lighter. No flint or friction. Lights easily in the wind. Retail \$25c. Costs you \$1.75 dozen. Sample and can fluid 25c. New Method Company, Box PM-92, Bradford, Penna.

**AT Home,** your own manufacturing business, making popular \$1 novelties. Cost you 3c to 15c. Everything supplied. Write So-Lo Works, Dept. K-842, Cincinnati, Ohio.

**MEN And women** wanted, full or spare time to sell Sayman products house to house. Write T. M. Sayman Products Co., St. Louis, Mo. Dept. K3.



500% PROFIT Selling new "20-in-1" kitchen utensil. Retail 25c. Costs you \$1.00 a dozen or \$7.20 a gross. Sample 10c. New Method Co. PMM-92, Bradford, Penna.

CHRISTMAS Card salespeople—Best sellers. You make 50c on new 21-folder \$1 assortment. Christmas cards with name, 50 for \$1. Other big-profit assortments. Experience unnecessary. 50c sample on approval. Schwer, Dept. T-4, Westfield, Mass.

SELL Different Christmas cards—21 for \$1. Free metallic gold seals can be used to "personalize" cards. Make 100% profit. Christmas cards with name imprinted 50 for \$1. Samples on approval. Friendship, 811 Adams, Elmira, New York.

MEXICAN Curios sell on sight. Large profits. Free particulars. Samples 10c stamps. Marquez, PY, Apartado 1176, Mexico City.

MAKE And sell your own products. No machinery needed. Amazing profits. Guaranteed "Chemist Approved" formulas. Catalog free. Kemico, 10-G, Park Ridge, Ill.

REVOLUTIONARY Window cleaning tool. Good Housekeeping approval. Only ten \$2.25 sales daily to housewives, factories, schools, stores will make you \$350.00 monthly. Carter Products Corp., 908 Front Ave., Cleveland, Ohio.

CALL On friends with greeting card assortments. Easter, birthdays, other occasions. Big demand. Big profits. Also personal stationery. Experience unnecessary. Samples free. Wallace Brown, 225 Fifth Ave., Dept. K-34, New York.

MEN; Women; full or part time. \$10.00 daily is easy with our sure fire 25c pocket novelty. Everybody needs it. \$1.00 starts you. Refunded if not satisfied. Winton Mfg. Co., 510 Orange St., Newark, N. J.

AGENTS Wanted—Exclusive one county franchises available on our Supercharging Air Filter. Increases acceleration—improves gas mileage. No moving parts. Pair of "supercharged" hood signs free with every air filter. Five minute installation cannot clog up with dirt—sturdily constructed of cast aluminum and iron. Two sizes to fit all popular makes of automobiles. Tremendous market. Big profits. Write for full particulars to Supercharging Air Filters, Room 922, 260 East 161 Street, New York City.

MERCHANTS Wall signs, cost 1c, sell 12c. 3 samples 15c, refunded. Richards, 127-M E. New York St., Indianapolis.

TIP It, knock it over, turn it upside down. The Kant-Spill inkwell does not spill. Sold in combination with beautiful long-life fountain feed pen, writing over 200 words with one dip. Fast selling, profitable item. Sample 60 cents prepaid. Full information return mail. Haarer & Company, Box 389 MO, Lansing, Michigan.

CHRISTMAS Cards. Sell 50 assorted folders, name imprinted \$1.00—Cost you 50c. Samples free. Dunbar, New Brunswick, N. J.

WE Pay you \$5 for selling ten \$1 boxes, 50 distinctive assorted name imprinted Christmas cards. Sell \$1. You make 50c. Free samples. Cheerful Card Co., 51 White Plains, N. Y.

AFTERNOONS Free! Work home! \$1,000 month reported (exceptional case)—fulltime. Expect Surprise! National, BX 1240-N, San Bernardino, Calif.

SELL To building trades. New article; easy sell. Send 25c for sample. Mason and Parrish, Engineers, 2105 N. Burdick Street, Kalamazoo, Michigan.

HOUSEHOLD Necessity costs 2c, sells 25c. Linnell, 14006 Coit, Cleveland.

AGENTS Wanted for window cleaner. Details, Ward, 97B, Saybrook, Connecticut.

EARN Big money. Part-full time, as our exclusive sales agent. Write Dept. G, National Products Company, 175 5th Ave., New York City.

BIG Manufacturer wants housewives with spare time to wear free sample dresses, and show to friends. Give size, age. Harford, Dept. H-55, Cincinnati, O.

AGENTS: Smash go prices! Santos coffee 12c lb. 4-oz. vanilla 8½c. Razor blades 10 for 8½c. 100 sticks chewing gum 12c. Christmas cards, 21 in box, 14c. 150 other bargains. Premiums. Experience unnecessary. Carnation Company, PO, St. Louis, Mo.

AGENTS: Stamping names on pocket-key protectors. Sample check with your name, address, 25c. Stamping outfits. Emblem checks, check-fobs, name plates. Hart Mfg. Co., 303 Degraw St., Brooklyn, N. Y.

DEALERS: Sensational seller. In United States, free sample. Girards, Washingtonville, Ohio.

CALL On service stations. New item, necessity, big profits. Knipp, Long Beach, California.

FREE Sample—Amazing cleaner; sells homes, taverns, everywhere. Big profit—fast repeater. Betco, 5007 Irving Park, Chicago.

BIG Money applying initials on automobiles. Easiest thing today. Free samples. Also, sideline salesmen for short order decalcomania name plates. "Ralco," 1305 Washington, Boston, Mass.

SUCCEED With your products. Make-sell them. Formulas. Processes. Accurate analyses. Catalog free. B. Thaxly Co., Washington, D. C.

DO You want agents for your proposition? Your ad in this space will place your message before hundreds of men seeking fast-selling products. My folder "How to Secure Agents," is filled with proof. I'll gladly send you a copy free. F. W. Johnson, Manager Classified Advertising, Popular Mechanics Magazine, 200 E. Ontario St., Chicago.

MANUFACTURE Specialties, hire agents yourself. Big money. Free literature. Gilbert Supply, 5-P West 24th, New York.

AGENTS—300% Profit selling gold leaf letters; stores and offices. Free samples. Metallic Letter Co., 438-B North Clark, Chicago.

GOOD Paying business silvering mirrors, plating autoparts, reflectors, bicycles, bathroom fixtures by late method. Free particulars and proofs. Gunmetal Co., Ave. N. Decatur, Ill.

AGENTS — Opportunity make money; book containing 127 successful business plans; home-office; send for free introductory booklet. Elite Co., 214 Grand St., New York.

AGENTS Make big profits on food products, bargain deals. Low wholesale prices. Rush name for trial outfit offer. Ho-Ro-Co, 2810-T Dodier, St. Louis, Mo.

AGENTS—To mail our literature. Good profits. Home business. Maywood, 1105-1107 Broadway, New York.

ENGRAVED Name plates, numbers, signs, etc., easily sold, profits large. Brett Bros., Winthrop, Mass.

SALESMEN, District managers, state representatives wanted for marvelous new automatic grease cup. Indicates when cup is full or empty. Mammoth sales outlet. See our ad on page 129A. Ace Lubricating Equipment Co., 2345 West Grand Boulevard, Detroit, Michigan.

#### HIGH-GRADE SALESMEN

SALESMEN: America's finest sideline. 40% comm. daily. 725 fast selling repeat items. Every business uses and must buy. No investment. Sales portfolio free. David Lionel Press, 312 So. Hamilton, Dept. F, Chicago.

FREE Trial to customers. Sells itself! Revolutionary loud speaking inter-communication system. Talk privately, back and forth, to one or any number of stations, even 2,000 feet away. Any station originates calls. One electrical connection. No servicing. Easily installed. Guaranteed. Technical experience unnecessary. Two-minute demonstration. Thousands prospects, factories, offices, automobile dealers, lumber yards, restaurants, etc. We carry the accounts. New low price. Men earning high as \$150 week. Protected territory available. Free demonstrator offer. Inter Communication System of America, 2440 Lincoln Ave., Dept. 309, Chicago.

SENSATIONAL Quick-cash opportunity. My route building plan gives you chance for good steady income. Real future. Handle regular route local stores. Collect, deliver orders for famous 5c—10c counter display goods. Nationally advertised in 120 magazines and radio. Show merchants proven plan for beating competition and increasing sales, profits. Experience unnecessary. Use home as headquarters. Chance to operate Silver Fleet service truck. Facts free. World's Products Co., Dept. 10-B, Spencer, Ind.

WRITE For free sample amazing stain-proof tablecloths. Clean with damp cloth. Require no ironing. Beautiful patterns. Look like linen—cost much less. Commissions big. Also complete line of dresses. Melville Company, Dept. 1629, Cincinnati, Ohio.

UNITED States Constitution in booklet form! Large profits! Particulars free! Elfco, 438 North Wells, Chicago.

ADVERTISING Book matches—World's largest manufacturer of union label book matches. Fast selling line. Large sales producing kit. Sample matches complete cut catalog. 9 color combinations makes selling easy. Commission in advance. Superior Match Co., 7530 Greenwood, Dept. M-8, Chicago.

CALL On service stations factories, restaurants, businesses, professions; with lettered advertising uniforms, shirts, work suits, etc. 100 styles. Exclusive features. Also soft-ball uniforms. Big advance commissions. Free outfit. Topps, Dept. L-7, Rochester, Indiana.

SALESMEN, Distributors, 200 items. Brushes, mops, marvelous magnetic brush—exceeds vacuum cleaner. Big profits. Neway Brush Works, Hartford, Conn.

SELL Printing at cut prices. 2,000 business cards \$1.50; 1,000 envelopes or statements, etc. \$1.75; 25 printed sales books \$1.50; 1,000 process embossed cards \$1.50; 2,000 two-color labels, free holder \$1.50; 2,500 printed handbills \$1.75. One-third comm. Free outfit. Bargain Prtg. Co., 189-F W. Madison, Chicago.

SELL Candidates! America's largest line of political auto signs, stickers, posters, novelties. Very little competition. Ad-Nov-Co., Newton, Iowa.

COMPLETE Line everyday business necessities—Over 2000 items at big money saving prices. Experience unnecessary. Samples free. Commissions advanced daily. Northwestern, 625-BK Jackson, Chicago.

IT'S Hot! Big repeater with plenty immediate and repeat commissions. No investment. Sells to every type retail dealer and service station. Sales kit free. Hurry! Universal, 2222 Diversey, Dept. C58, Chicago.

ADVERTISING Book matches offer liberal earnings—full, spare time. Experience unnecessary. Factory direct. Low prices for fine quality, quick deliveries, help get orders; faster repeats. All business firms prospects. Free outfit, instructions. American Match & Printing Co., Dept. 68, 4822 South Trumbull Ave., Chicago.

ONLY Two sales per day makes over \$1200.00 monthly profits. Auto tools. Every mechanic a prospect. 95% virgin. \$50.00 sales makes \$36.00 profits. New. Proven. Protected territory to producers. Year around demand. Mesco, Beaver City, Neb.

BIG Commissions—selling to stores celluloid pricing tickets, metal shelf moulding. To restaurants, menu covers, signs. P. Pricing Press, 124 White St., New York.

TIRE Accessories. Guaranteed 10,000 mile Tiger Grip tire patch, and fast-selling line tire accessories. Salesmen-distributors easily earn up to \$60 weekly, selling garages, service stations, etc. Protected territory. Economy Rubber Products, 701 Burkhardt, Dayton, Ohio.

\$300 PROFIT Next month on \$425 sales. America's finest automatic fire protection. Largest commissions. Complete line. Territories. PyroTecTor, Bradley Beach, N. J.

DISTRIBUTORS, Crew managers, organizers of agents, send quick for news of amazingly-seasonable device for traveling autoists. Thirty-five cents retail or more value. Quick easy seller. Light, permanent. Immense commissions. Write or wire for details. Also can use few lone salesmen in unoccupied districts. Act promptly. Nicholas Company, 7137 Cottage St., Philadelphia, Penna.

SELL Songs, postcards, calendars. Commission. Write G. Mayer, Lake Mary, Florida.

CALENDARS All sizes—Orders are being placed now for 1941 calendars, advertising fans and novelties. Free samples—get started now and book those early orders. Fleming Calendar Co., 6543 Cottage Grove, Chicago.

NEW Specialty—Sells every business and professional man. Four \$15 sales daily pay \$280 weekly. Farrell cleared over \$1,000.00 monthly. Write F. E. Armstrong, President, Dept. PM, Mobile, Ala.

BLADES—Big profits. Best quality. Factory prices. Postpaid. Ace Blades, Buffalo, N. Y.

A REAL Future for you with Red Comet fire control products. Low prices. Proved seven years. Splendid sales outfit free. Some good territory open. Exclusive. Write quick. 704 Red Comet Building, Littleton, Colorado.

EXCELLENT Opportunity selling our complete line of brushes, largest commissions. Write for sales plan. Wire Grip Sanitary Brush Company, 2300 5th Ave., New York.

## EDUCATIONAL AND INSTRUCTION

"HOW To Break and Train Horses"—A book every farmer and horseman should have. It is free; no obligation. Simply address Beery School of Horsemanship, Dept. 1108, Pleasant Hill, Ohio.

U. S. Gov't jobs pay up to \$40 a week to start. Get ready for next examinations; railway postal, rural carrier, mail carrier, office help and others. Free book tells how you may qualify. Write quick. Patterson School, Dept. P. M., Rochester, N. Y.

AIR Conditioning—Electric refrigeration. Rapid growth creates big demand for trained men. Earn up to \$35-\$50 weekly. Write for free facts. Utilities Engineering Institute, 404 North Wicks, Dept. 108, Chicago.

WATCH Repairing is steady profitable work. Experts usually in demand. You can learn watchmaking trade at home, spare time. New original instruction system. Script engraving course included. Write for free details today! Nelson Co., 500 Sherman, Dept. H-2001, Chicago.

LEARN Auto finance business. Complete course \$5.00. Free particulars. Nebraska Finance Co., Lincoln, Nebraska.

YOUNG Men—Learn linotype (typesetting). Booklet "X" free. Mergenthaler School, 244 West 23rd, New York.

TELEPATHY. Productive, distinguishing study. Dr. Green, Box 1177-p.m., San Francisco, California.

TURN Muscles into cash. Get health that leads to wealth. Knoff, 2154 M. D. North 52nd Street, Milwaukee, Wisconsin.

HOME Study for degree. Psychology, Metaphysics, Philosophy, Bible. Free information. College of Universal Truth, 20-B East Jackson, Chicago.

MEN—Women. Get U. S. government jobs. Commence \$105-\$175 month. Prepare immediately for examinations. Experience usually unnecessary. Full particulars—list positions, free. Write today. Franklin Institute, Dept. G3, Rochester, N. Y.

ACQUIRE Emotional stability! Nervousness, fear, bashfulness—afflicted? Free, inspiring information. Write! John Englund, Ironwood, Mich.

BECOME Practical scientific investigator. Modern illustrated course. Thorough training by former agent U. S. secret service. Particulars free. International Secret Service Institute, PM-80, Hoboken, N. J.

CLINICAL Laboratory technic taught in your own home. Practice equipment supplied. Bulletin free. Imperial Technical Institute, Box 494, Elkhart, Indiana.

WELDING—Electric arc. Learn quickly by actual practice at Hobart Welding School. Individual instruction at bare cost of materials used. 50c in stamps brings valuable welding lessons post paid and full particulars. Hobart Welding School, Box M-8404, Troy, Ohio.

GOOD Eyesight without glasses or apparatus. Complete illustrated course \$1.00. Satisfaction guaranteed. Eyesight Improvement, Hamilton, Ohio.

FIRST. You must learn how to think. Your mental mechanics. Then success is easy. Ten confidential mail lessons. Free outline. Write 100% Effective Thinking, Hollywood.

DRAFTING—Layout—blueprint reading. Home taught. Davison Technical School, East Grand Avenue, Detroit.

EARN More money—Learn decorating, paperhanging, graining, marbling, pictorial and sign painting. Catalog free. Chicago Painting School, 102 West Lake Street, Chicago.

PHOTO Engraving. Unusual results. No expensive equipment. Imagic, Bristol, Tenn.

CLAIM Adjusting. Excellent pay. Investigate tragic accidents, fires; outwit fraudulent claimants. Burns School, 311 Morewood, Pittsburgh, Penna.

TELEGRAPHY Taught thoroughly. Railroad retirement act creating opportunities for new operators. Expenses low. Catalog free. Dodge's Institute, Hiatt Ave., Valparaiso, Ind.

MASSAGE. Hydrotherapy, dietetics, drugless therapeutics, chiropody, taught by mail. Evans Correspondence School, Montgomery, Ala.

LEARN Auto mechanics, body, repairing, welding electricity, refrigeration, Diesel. Stevenson's, 2008A Main, Kansas City, Mo.

SECRET Investigation. Experience unnecessary. Detective particulars free. George Wagner, M-2640 Broadway, N. Y.

## PLAYS, STORIES, MANUSCRIPTS

FREE Test for writers! Send for our free Market Propensity Test. Designed to show for which of 2,500 paying markets for free-lance writing you are best fitted. Write today. Comfort Writer's Service, Dept. 490, St. Louis, Mo.

STORIES Revised, typewritten; placed on market. Hursh, Box P-1013, Harrisburg, Penna.

## CARTOONING COMMERCIAL ART, SHOWCARD WRITING, SIGN PAINTING

CARTOONING Course—30 illustrated lessons, over 500 sketches, drawing paper, pens and pencils. \$1.00 complete postpaid. Montes Studio, Box 445, Pasadena, Calif.

CARTOONING. Sketching, etc. 46 lessons, 600 illustrations, including drawing paper, pens, pencils. \$1.00 complete. Fraba Service, Cashton, Wisconsin.

LEARN Lettering! Fascinating hobby, profitable vocation. Send \$1.00 for series of beautiful charts, plus instructions. Studiocrats, Box 207, Times Square Station, New York.

PEN And ink drawings. Let us draw your advertising and catalogue illustrations, from photos, copies or objects. Best work and fair prices. Heraldic Studios, 1914P Oakdale Avenue, Chicago, Ill.

AMATEUR Cartoonists. Earn cash at home, copying advertising cartoons. Ad-Service, Argyle, Wis.

## ADVERTISING AGENCIES, LETTER WRITERS, FOR ADVERTISERS

CURRENT Lists opportunity seekers—\$5 thousand. Darnell Service, Jackson, Tennessee.

LEARN Advertising at home. Easy practical plan. No text books. Common school education sufficient. Interesting booklet and requirements free. Page-Davis School of Advertising, 3601 Michigan Avenue, Dept. 343B, Chicago.

ADVERTISE: 24 Words, 149 newspapers \$6.50. Lists free. Advertising Bureau, 4515-C Cottage Grove, Chicago.

ADVERTISING Placed all magazines, newspapers, radio. Lowest rates. Free service. 54 page rate book free. Baker Advertising Agency, A-189 West Madison, Chicago. Successors to Ankrum. Established 28 years.

FREE—New Advertisers Rate Guide, 44 pages. Includes everything. Lowest rates. E. H. Brown Advertising Agency, 140 S. Dearborn, Chicago.

## BUSINESS SERVICE

YOUR Broadway address. Only \$1.00 monthly. Particulars free. Karavan, 1241 Broadway, New York.

STENOGRAPHER—Typist. 20 years experience desires position. Carl A. Jonas, 27 Church Street, Lowville, New York.

WASHINGTON, D. C., mail address and reforwarding service. Hawkins Mail Service, 908 Fourteenth.

CHICAGO (Downtown) mail address \$1 monthly. Your mail reforwarded daily. General Business, 56 West Washington; (established 1919.)

## ADVISORY SERVICE

YOUR Problem, business or vocational, will be thoroughly analyzed by a group of successful executives. Following intensive study a solution will be submitted together with comments and suggestions. The combined ability, experience and vision of this organization should bring you greater profit and success. Such an analysis may be the turning point of your career. Confidential, individual attention. Write, stating your problem clearly. No obligation. Particulars and analysis chart will be forwarded. Executive Research Foundation, 30 Kilby St., Boston, Mass.

## RUBBER STAMPS AND OFFICE SUPPLIES

KNOB Handle, cushioned. 2 lines 25c, 3—35c. Stamp Works, Centerport, N. Y.

SUPERIOR. Indexed, cushioned. Two lines. 25c; three 35c; four 50c. Notary seals \$4.50; signatures \$1.50. Slocum, 814 Bradley, Peoria, Illinois.

CUSHIONED Indexed 3 lines 35c. Stamp Works, Box 402, Youngstown, Ohio.

SELFINKING Pocket stamps. 2 lines 50c, 3 lines 60c. Manufacturers of visible cushioned rubber stamps. Write for catalog. Time & Energy, 208 W. Monroe, Chicago, Illinois.

2 LINES 25c, 3 Lines 35c. Stamp Works, Auburn, Nebr.

## TYPEWRITERS, DUPLICATORS, OFFICE DEVICES

INCREASE Business now. "Excelligraph" Rotary Stencil Printer reprints thousands everything you typewrite, hand-write, draw or trace. Colors, \$19.75 to \$44. Terms. Illustrated literature free to business or professional men. Pittsburgh Typewriter Supply, Department K-2, Pittsburgh, Penna.

TYPEWRITERS. Adder, mimeograph, multigraph, addressograph. Send for free lists of machines that will help you at half price. Pruitt, 28 Pruitt Bldg., Chicago.

## PRINTING, MULTIGRAPHING, MIMEOGRAPHING, GUMMED LABELS

500 HAMMERMILL Letterheads \$1.75 postpaid. Multigraphing reasonable. Irving Letter Service, 4123 N. Kildare, Chicago.

125 8½x11 TWENTY Pound bond letterheads, 125 6¾ envelopes. Both printed \$1.00 postpaid. Benneville, 907 West Roosevelt, Philadelphia.

1000 6¾ HEAVY Bond envelopes \$2.00. Felton, 19 Fremont, San Francisco, Calif.

500 ENVELOPES 95c. No. 10 \$1.25. Wood, 246 Main, Brockton, Mass.

CIRCULARS. Folders, letters, blanks, cards, stationery, labels—all printing—lowest prices. Modern plant—Best workmanship—Immediate service. Samples. Goodprint, Harrisonburg, Va.

THOUSAND: Two color shipping labels, 4x2½—\$1.75; large envelopes—\$2.95; 3x6 circulars—\$1.50; advertising cards—\$2.45; quantities much cheaper. Okayprint, Martins Ferry, Ohio, Samples.

WEDDING Invitations, 100, \$4.50. Embossed! Postpaid. Andy's, Cleveland Ave., Amsterdam, N. Y.

250 LETTERHEADS. Envelopes, billheads, \$1.00. Guaranteed. Johnson's, 939P Windsor, Chicago.

500 ENVELOPES. Statements, billheads \$1.00. Barron, 22 Fox, Worcester, Mass.

LETTERHEADS. Envelopes, billheads, statements, \$1.75 thousand. 2000 business cards \$1.50. Everything printed. Free estimates, samples. Wholesale Printing Co., 318-Y East McDaniel, Springfield, Mo.

1000 NEATLY Printed letterheads, envelopes, billheads or statements \$2.50 postpaid. 5000—\$9.00. Bob's Press, Janesville, Wisconsin.

50 SHEETS, 25 Envelopes 25c. Prepaid. George, West Burke, Vermont.

500 LETTERHEADS (8½x11) and envelopes (3¼x6¾) both for \$2.85. Cash with order. Morton Press, 1472 Broadway, New York City.

100 ENVELOPES And 100 letterheads for \$1.00. Wimmer, Wilcox, Nebr.

100 EACH, Letterheads, envelopes, full size, full count, \$1.00 postpaid. Continental, Dept. R-7, Springfield, Missouri.

HAMMERMILL Letterheads, any color, envelopes matching; 30 styles type. Free particulars. Woodruff's, 217A Lewis, Duluth, Minn.

BUSINESS Cards \$2.00 per thousand printed. Good quality. Stanton, 344 E. 65 St., New York City.

500, TWO-COLOR Stickers 50c. Labels. Samples. Cott's, Spickard, Missouri.

MERCHANT'S Drawings tickets, Flat. Tested. Plan free. 50,000—\$18.95. Merchant's Press, Lamoni, Iowa.

MULTIGRAPHED Letters—Guaranteed like typewritten! 300—\$1.50; 1000—\$2.25; (300 words). General Multigraphing, 108 North Dearborn, Chicago.

HAMMERMILL 8½x11 Letterheads 1000 \$2.75. Samples. Lackawanna Printing, Lackawanna, New York.

BETTER Grade printing, free trade illustrations. Reasonable. Economic Press, Leonia, N. J.

500 ¾x2¼ FOUR Line gummed stickers, 25c. Moritz Printery, Saginaw, Mich.

## PRINTING OUTFITS AND SUPPLIES

**INEXPENSIVE** 6x9 Printing press. Details free. Novelty Shop, Downsville, Louisiana.

**BARGAINS**, Presses, type, List 3c. Exchange, D-15, 222 Columbus, Meriden, Conn.

**MAKE** Photo-engraving outfit yourself. Particulars free. Nu-Ideas, Carrollton, Illinois.

**NON** Skin quick setting, jet black inks (book, job, bond, halftone) saves wash-up. Will not dry on press. rollers 72 hours. Try pound all-around job black, \$1.00 prepaid (\$1.10 west Mississippi) or send 10c for sample. Ask for copy of Efficiency "Line" Type Service, enclose stamp. Webster's, 307 Fifth Avenue, New York.

**HAND** Presses, type and complete printers supplies. Send stamp for new 52-page catalog. P. Peiffer & Company, 6 Columbia St., Newark, N. J.

**STOCK** Cuts to illustrate advertising and printer matter. Catalog free. Cobb Shinn, 721 Union Street, Indianapolis, Ind.

**BARGAINS** — Presses, type, supplies. Send stamp, 159 Harvard, Cambridge, Mass.

**PRINT** Your own cards, stationery, circulars, advertising. Save money. Easy rules furnished. Print for others, big profits. Junior outfits \$8.25, senior outfits \$16.55 up. Details free. Kelsey Presses, H-11, Meriden, Conn.

**USED** Presses, type, supplies. Lists 3c. Turnbaugh Service, Loysville, Penna.

## PATENT ATTORNEYS

**PATENT** Your idea. Write immediately for two free books, "Patent Protection" and "When and How to Sell an Invention." Fully explain many interesting points to inventors and illustrate important mechanical principles. With books we also send "Evidence of Invention" form. Prompt service, reasonable fees, forty-two years' experience. Avoid risk of delay. Address: Victor J. Evans & Co., Registered Patent Attorneys, 561-J Victor Building, Washington, D. C.

**ALBERT G. BURNS**, "The Nation's Gadget Chief" handles inventions on commission or straight fee. Patented or unpatented. Three offices. Write today, Box 147, Oakland, California; 80 East Jackson, Chicago, Illinois; or 135 Broadway, New York City.

**PATENTS**: Inventors, take first step to protect your rights to your invention—without cost. Write for free "Record of Invention" form and complete instructions for making legal disclosure of invention and establishing date. We also send, without cost, 48-page book, "Patent Guide for the Inventor" telling importance of prompt action; how to sell and market your invention; how to make application for patent; showing examples of successful inventions; explaining convenient payment plan. Write for free book and Record of Invention form. See page 17A for further information. Clarence A. O'Brien, Registered Patent Attorney, Dept. OH1B Adams Building, Washington, D. C.

**ERIC B. PRIME**, Registered Patent Attorney, 4123 West Sixteenth Street, Chicago. Personal service. Low fees. Preliminary advice free.

**PAUL M. KLEIN**, M. E., 55 West 42nd St., New York. 25 years of successful service. Free information.

"**INVENTOR'S** Guidebook," full information about patenting, selling inventions, free. Patent Attorney-Engineer Frank W. Ledermann, 154 Nassau Street, New York.

**INVENTORS**—Send for free booklet "Patent-Sense." Information based on 64 years experience. Lacey & Lacey, Dept. 5A, 635 F St., Washington, D. C.

**PATENTS**, Booklet free. Highest references. Best results. Promptness assured. Watson E. Coleman, Patent Lawyer, 724 Ninth St., Washington, D. C.

**INVENTORS**—Before disclosing your invention to anyone send for form "Evidence of Conception"; "Schedule of Government and Attorneys' Fees" and instructions. Sent free. Lancaster, Allwine & Rommel, 411 Bowen Building, Washington, D. C.

**L. F. RANDOLPH**, 302-B Victor Bldg., Washington, D. C. Low cost. Book and information free.

**PATENTS**, Protect your idea by securing free "Proof of Invention" folder. Exceptional personal service. Established 1906. E. E. Vrooman, 871 Woodard Bldg., Washington, D. C.

**MEXICAN** Legal matters. Wm. Cocke, Amer. Atty., El Paso, Texas.

## FOR INVENTORS

**INVENTORS** Co-operative. Manufacturers, inventors, financiers get together. 1719 Lexington Avenue, New York City. Lehigh 4-9883. Write for information.

**CASH** For practical ideas and inventions. Mr. Ball, AB-9441 Pleasant, Chicago.

**SHOW** Us something good, patented or unpatented. New ideas wanted. Allied Engineering, Box 1445, St. Louis, Mo.

**INTERESTED** In inventions. Will finance, market. Phillips Co., 2027 No. Prospect, Milwaukee.

**INVENTORS**: Protect your invention at total cost \$1.50. Sell your invention with safety and let buyer get patent. Send \$1.00 for instruction sheet. Moroney, 321 92nd St., Brooklyn, N. Y.

**CASH** For your invention—whether patented or unpatented. Quick, inexpensive action; literature free. Mason, 1035 East Eleventh Street, Oakland, California.

**ATTENTION** Inventors! Old established patent licensing company doing national business is willing to finance the exploitation of worthwhile patents. Our fee is fair compensation from proceeds only. Address International Industrial Consultants Corporation, Fidelity Building, Baltimore, Maryland.

**INVENTOR'S** Universal Educator: contains 900 mechanical movements; 50 perpetual motions; instruction on procuring and selling patents and selecting an attorney, etc. Suggests new ideas. Price \$1 postpaid in U.S.A. Address Albert E. Dietrich, 511-B Colorado Bldg., Washington, D. C.

**SEVERAL** New inventions, we recently developed, have been successfully placed by us on the market through department and chain stores. Items manufactured on cooperative basis. Submit your item for free estimate and details. Patented or unpatented items handled, proof of disclosure furnished. We obtain patents through our associated attorney. We specialize in plastics. We design your inventions and build models to "put over" your ideas. Tools, dies, stampings. Especially interested in chain store items. Write for "4-Points of Service" bulletin. R. & S. Engineering Co., (Dept. AF-8), 17 East 42nd Street, New York City.

**INVENTORS**—Registered patent engineer offers a complete patent and sales service. Est. 1916. Starck, 332 Wells Building, Milwaukee.

**INVENTORS**: Profit by your invention. A practical talk to inventors by an experienced manufacturer. Our 68 page booklet "Mind vs. Matter" mailed upon receipt of 25c. Rex Engineering Co., Cincinnati, Ohio, Dept. D.

**INVENTORS**: "Making Inventions Pay" our 32-page illustrated book mailed absolutely free. Crescent Tool Co., Dept. ZS, Cincinnati, Ohio.

**SELL** Your invention, get results. Write Walter Kreuzer, Edwardsville, Illinois.

**WE** Locate buyers meritorious patented, unpatented inventions. If will sell, reply immediately. Descriptive booklet, references, free. Invention Reporter, 5A-11236 South Fairfield, Chicago.

**INVENTORS**—Send for 72-page book on patents. Reasonable terms. Conscientious treatment to inventors. L. F. Randolph, Registered Patent Attorney, 302-E Victor Bldg., Washington, D. C.

**I** SELL Patents. Established in 1900. Charles A. Scott, 773PM Garson Ave., Rochester, N. Y.

**HAVE** You a sound, practical invention for sale, patented or unpatented? If so, write Chartered Institute of American Inventors, Dept. 4-A, Washington, D. C.

## INVENTIONS WANTED

**CASH** For inventions—Patented or unpatented. Mr. Ball, A-9441 Pleasant, Chicago.

**MAKE** Your inventions pay. We help you. 36 year old firm offers complete services, free estimates. Ample facilities regardless size of invention. Stampings, metal specialties, dies, models, etc. Catalog giving "inside" information free. Crescent Tool Co., Dept. W, Cincinnati, Ohio.

**WANTED**—Meritorious patented, unpatented inventions. Booklet, references, free. Invention Reporter, 5B11236 South Fairfield, Chicago.

**INVENTION** Finance Magazine, 80-G Wall Street, New York. Important particulars free.

**SMALL** Inventions wanted by manufacturers. I'll help you sell your invention. Write for free circular. Stanley Hull, 7829-K Euclid Avenue, Cleveland, Ohio

**SIMPLE**, Practical inventions wanted by manufacturers, patented or unpatented. For information write Chartered Institute of American Inventors, Dept. 4-D, Washington, D. C.

## PATENTS FOR SALE

**BASIS** For sale outright or on royalty patents 2185084 and 2185085, two unique auto license holders. Also improved typewriter eraser embracing patents 2107209 and 2189649. Also duck decoying outfit, patent 2174211. And water and feed device for bird cages 2174725, and a cigarette case and dispenser, patent 2168214, and paddle game, patent 2194761. Design patent of bunny hop. Toy rabbit design, patent 119597, and trademark on name Bunny Hop, number 359716. Write for photoline prints or further information if interested in any of above patents. G. H. Hutaft, Jr., P.O. Box 716, Wilmington, North Carolina.

**NEW** Type wire stretcher outright preferred. Louis Bock, 1429 Mississippi, Flint, Mich.

**FOLDING** Grocery basket: mounted on wheels and chassis. Easily folds up when basket is carried to store. William Kim-mich, Medina, Ohio.

**HAIR** Dyeing applicator. Hollow handle brush holds bottle and comb. Pat. pending. Mrs. Lillie M. Hillsberry, Sterling, Kans.

**500** INVENTIONS Described with selling plan 10c. Write Patentee System, 9443 Pleasant, Chicago.

**NON-SKID** Device for icy roads. Patent No. 2,203,459. M. Espelta, Franklinville, N. J.

**MANUFACTURERS**: For free information latest inventions your line manufacture, write: Invention Reporter, 5C-11236 So. Fairfield, Chicago.

**GASOLINE** Filter. Automobile accessory. Sam Schiff, 1937 Gladstone, Detroit, Michigan.

**SELL** Your patent through a small classified ad in Popular Mechanics. Many inventors have found buyers in this way. Ask me for proof—I'll gladly send it to you. F. W. Johnson, Manager Classified Advertising, 200 E. Ontario St., Chicago.

## MANUFACTURING

**DIES**, Stampings, models, product engineering. Hagstrom Manufacturing Company, Kansas City, Missouri.

**DIES**, Stampings, special machinery manufactured. Catalog of model supplies 10c. Pierce Model Works, Tinley Park, Ill.

**INVENTIONS** Developed and manufactured. Send us your ideas. Model Engineering, Osgood, Indiana.

**INVENTIONS** — Manufactured in any quantity at low cost by old-established reputable company. No branches anywhere. Stampings, metal specialties, dies, models, etc. Free estimates. Free catalog. Crescent Tool Co., Dept. XS, Cincinnati, Ohio.

**MANUFACTURING**, Any material, any quantity, inventions developed. Milburn, Burlington, Kentucky.

**INVENTIONS** Manufactured by an experienced company, in any quantity at low cost. Metal specialties, novelties, stampings, dies, and models. Free estimates. Our booklet "Mind vs. Matter" sent upon receipt of 25c. Rex Engineering Co., Cincinnati, Ohio, Dept. C.

## MODELS AND MODEL SUPPLIES

**WORKING** Models of anti-aircraft, naval and railroad guns. Circulars and photos 25c. William Gregory, 9 North 11th Street, Newark, N. J.

**LATHE**, Screw cutting, bench, easily constructed. Blue prints \$2.00. Spirco, P.O. Box 1444, San Antonio, Texas.

**ENGINE** Catalogue castings, supplies, 25c. Howardco, A-2417 North Ashland, Chicago.

**GOOD** Working models with eye appeal. We have spent 36 years developing ideas into practical working models! Let us help you! Free catalog. Crescent Tool Co., Dept. Y-Sa, Cincinnati, Ohio.

**CARVED** Hull ship model kits. Ship and yacht model fittings; model yacht sails. Illustrated catalog 20c. A. J. Fisher, 1002-M Etowah Ave., Royal Oak, Mich.

**MODELS**—Practical models put over your ideas. We develop models from the crude to perfect working devices. Your idea might have large commercial value. Services confidential. Bank references. Registered graduate engineers at your service. Send 25c for our 68 page booklet "Mind vs. Matter." Rex Engineering Co., Cincinnati, Ohio, Dept. B.

#### BLUEPRINTS AND PLANS

**BUILD** Your own beautiful 10x20 garage. Blue prints, complete instructions \$1.00. Clark, 218 East Lexington, Baltimore, Md.

#### HOME CRAFTSMEN

**SPARE** Time money. There's a big demand for hand tooled articles you can make with Easco Leathercraft sets. Complete outfit including tools, leather, patterns and accessories with full instructions, only \$2.00. Buy at your local department stores or order direct and pay postman upon delivery. \$2.50 outside U. S. Send 10c for latest handbook and catalog. E. A. Sweet Company, Dept. A-37, Binghamton, N. Y.

**20 NOVELTY** Patterns, 25c. 15 lawn ornament patterns, 20c. Wayne Gorman, Box 1272-N, Amarillo, Texas.

**GET** Free leathercraft instruction pamphlets, prices of leathers, tools, projects. Make extra money. Beautiful gifts. Leather samples 5c. Wilder & Company, 1038 Crosby, Dept. 8F, Chicago, Illinois.

**22 LAWN** Ornament patterns 25c. Other patterns: 15"-20" high; Dutch girl, Dutch boy, pirate, bull terrier, Mexican girl, Mexican boy, dwarf, penguin, flower girl, 10c each; 3 for 25c. 25 novelty patterns 30c. All 56 full size patterns \$1.00 postpaid. Strother, Box 383-BJ, Belington, West Virginia.

**MAKE** Typical Mexican wood plaques! 20 patterns, complete instructions 30c. Mexican Arts, Crafts, Eagle Pass, Texas.

**20 LAWN** Ornament patterns 30c. 20 novelty patterns 30c. Dutch boy, Dutch girl, sunbonnet girl, 2 scotties 18"-22" high 10c each, clown table 15c. 2 weather vanes 10c each. Full size patterns, entire offer, \$1.00. Modern Woodcraft, Saginaw, Mich.

**PATTERN** Catalog finely illustrating 250 plywood novelties, silhouettes, lawn ornaments, decal transfer decorations. Also other lines. Wo-Met Shop, Ashburn, Ga.

**MODERN** Plastics—sheets, rods, tubes. Walter Fratesi, P.O.B. 3625, Washington, D. C.

**LEATHER** Tooling and archery. 2 lbs. \$1.00. F. Nelson, 911 Pine St., Muskegon, Mich.

**NEW** Profitable wood novelty. Old fashion farm-pump and trough cigarette dispenser. Embodies action, utility and attractiveness. Plans 50c coin. Gordon Reed, Thomaston, Maine.

**PLANS** For 10 different wood novelties 25c. Jepson, 95 Liberty Ave., Belleville, N. J.

**WOODWORKING** Power tools—Make them yourself. Lathe, scroll saw, saw table, drill press, portable sander, bandsaw, motorized plane. Complete details only 25c. Popular Mechanics Press, 200 E. Ontario Street, Chicago.

#### OLD GOLD, WATCHES, JEWELRY, PRECIOUS STONES

**GEMS**, Agates, minerals, 1/2 carat genuine cut sapphires, zircons, fireopal \$1.00 each; all 3 for \$2.50. 20 rough gemstones \$1.00. 6 polished mineral specimens \$2.00. Free catalog. Hill, Route 7, Salem, Ore.

**WATCHES**—Hamilton, Elgin, Waltham, Bulova as low as \$2.75. Postal brings free illustrated catalog. Quaker City Jewelry Company, Wholesale Jewelers, N. W. Cor. 8th and Walnut Sts., Philadelphia, Penna. Dept. "S."

**ELGIN**, Waltham watches from \$3.50. Make big money. Send for free watch and jewelry catalog. Plymouth Jewelry Exchange, 163-M Canal St., New York.

**AGATES**, Fossil woods, three pounds \$1.25 postpaid. Jay Ransom, Aberdeen, Wash.

**WATCHMAKERS'** Materials—Tools, watches, jewelry. Bought, sold, exchanged. Best prices for old gold, diamonds. Ben Segal Company, 5 South Wabash, Chicago.

**WATCHMAKERS'** Tools, supplies. Watch parts. Lowest prices. Write for price list 43. Dean Company, 87 Nassau St., New York.

**BULOVA**, Gruen, Hamilton, Elgin, Waltham wrist and pocket watches for ladies and gents. Positively lowest wholesale prices. 1941 styles now available. Write for free money making wholesale catalogue. Norman Rosen, Wholesale Jeweler, Dept. P.M., 801 Sansom Street, Philadelphia, Penna.

**5000 REBUILT** Watches! Free catalogue—Diamonds, jewelry, (3c postage). The New York Jobbers, 74 Bowery, Dept. M, New York, N. Y.

**AUSTRALIA'S** Lovely opals. Illustrated catalogue free. Good selection \$5.00. Norman Seward, Melbourne, Australia.

**HIGHEST** Prices for old gold—Mail your teeth, watches, jewelry. 100% full cash value mailed day shipment received. Satisfaction guaranteed or articles cheerfully returned. Information free. Chicago Gold Smelting Company, 300-P Champlain Building, Chicago.

**GOLD \$35** Ounce. Ship old gold teeth, crowns, jewelry, watches—receive cash by return mail. Satisfaction guaranteed. Free information. Dr. Weisberg's Gold Refining Co., 1500-Q Hennepin, Minneapolis, Minn.

#### FOR THE HOME

**STOVE** Lining—Furnace. Iron. Fits all. Patented. Circulars free. Benjamin Co., Granite City, Ill.

#### TOBACCO

**GUARANTEED:** Cigarette, pipe or chewing 5 lbs. \$1.00, ten, \$1.75. Pay when received. Pipe and box cigars free. Reeves Tobacco Co., Paducah, Ky.

#### RAZORS, BLADES, SHARPENING

**LIFETIME** Underwood electric shaver, ac.-dc., equals performance of \$15.00 razor; money-back guarantee; complete \$2.00 prepaid. George Lerner, 356 W. 34th St., New York City.

#### SURVEYING INSTRUMENTS

**GUARANTEED** Factory rebuilt transits and levels for rent (with purchase option) or sale (cash or terms). Order now before prices advance. We will repair, trade in, or buy your old instruments. Ship prepaid for estimate and valuation. Write for List M-58 and complete information to Warren-Knight Co., 136 N. 12th St., Philadelphia, Penna.

#### WANTED—MISCELLANEOUS

**GOLF** Balls, used. Any kind; any amount. Lake or white balls. Smiley Bell Ball Co., 75th St. and Mission Rd., R. R. No. 7, Kansas City, Missouri.

**QUICKSILVER** (Mercury), 90c pound paid immediately. Wholesale Terminal, Norwood, Massachusetts.

**AGGRESSIVE** Sales organization wants worthwhile products; wholesale distribution only. Gotham Distributors, 521 Fifth Avenue, New York.

**CASH** For used microscopes, binoculars, slide rules, drawing sets, scientific instruments, tools, cameras. Satisfaction guaranteed or shipment returned. Elman's, 108-M South Clark, Chicago.

#### PERSONAL

**FEET** Hurt? You can get quick, continuous relief—without expensive braces! Send stamp to Box 1144, Fuller Publications, Kalamazoo, Michigan.

**SELF-CONSCIOUSNESS**, Inferiority complex, public enemies number one. Do you blush easily? Self-conscious when meeting people? Bashful, uneasy in company? At loss for words when on a date with the opposite sex, etc. If so, then get "How to Overcome Self-Consciousness." Banish this evil, enjoy life. Book complete \$1.00. Send before August 1st, and receive free book "Instantaneous Personal Magnetism." Box 43, East San Diego, Calif.

**WIN** Prize money: Booklet—"Successful Contesting"—shows how. 10c postpaid. Bulletin listing \$100,000.00 prizes included. World Publishers, 4515-B Cottage Grove, Chicago.

**GOOD** Eyesight without glasses or apparatus. Complete illustrated course \$1.00. Satisfaction guaranteed. Eyesight Improvement, Hamilton, Ohio.

**HAY-FEVER** Quick relief. New discovery effectively prevents suffering without medicine or injections. Details 3c. Prove it yourself. Clarke Research, 363 North-east 76th Street, Miami, Fla.

#### MISCELLANEOUS

**MEN**—Save money on shoes. Buy direct from factory. New corrective-arch feature. Send size and width from old shoe. \$3.50 pair. Churchill-Alden Company, Brockton, Mass.

**NEW** Super-Air purifier and odor destroyer. Refreshes sick rooms. Benefits many with asthma, sinus, hay fever, head colds. A. C. table model \$16.45. Air Purification System, 2526 West Grand Avenue, Detroit, Michigan.

**ENLARGED** Portrait drawing \$1.00. Send best photograph. Hally Barebo, 323 Jersey, Quincy, Ill.

**MONOGRAMMED** Book matches. 150 with your initials in silver on solid black stock, black stems, red heads. Send three initials desired with \$1.00. Chicago Match Co., 4014 Parker Ave., Chicago, Ill.

**BURGLAR** Alarm! Guards home, barn, garage, poultry, etc. Satisfaction guaranteed. \$1.00. Box 5908, Kansas City, Mo.

**NEW** Kind of gun kills flies. Harmless sport for everybody. Free circular. Kahler Fly Gun, St. F., Kankakee, Ill.

**TATTOOING**, Engraving outfits. Illustrated list free. Percy Waters, Anniston, Ala.

**ROACHES**, Sure kill. Sample 25 cents. Shasta, 3721 Lake Park Ave., Chicago, Ill.

**MAIL** Order business course shows you how to make money, spare or fulltime. Teaches professional mail order technique—not penny-catching schemes. Free details. Nelson Company, 500 Sherman, Dept. 408-H, Chicago.

**GOOD** Hearing without mechanical aids. No drugs. Relieving Deafness, 108 West 18th, Vancouver, Canada.

**TATTOOING** And engraving machines. Jensen, 412 South Main Street, Los Angeles.

**FEATHERWEIGHT** Crutches are the lightest, most comfortable, finest and strongest crutch built. Write. Featherweight Products Mfg. Co., Custer, Wis.

**AMMUNITION** And arms manufacturers list \$7.50; airplane manufacturers \$5.00; other lists—stamp. Wade, 20 West Jackson, Chicago.

**BREAK** Your glasses? Mail them with broken pieces Box 427, Mt. Vernon, Ill., for repairs. We make new bifocal lens low as \$1.00. Dr. John W. Williams, Optometrist, Eye Sight Specialist.

**REVOLUTIONARY!** New pencil writes four colors simultaneously—10c. Encyclopedia of Sex—10c. 100 shaves per blade—outfit 25c. Prudential, 331-D Hopkinson, Brooklyn, New York.

**ABRASIVSTROP!** Gillette Komfort; speed; savings. 250,000! Booklet? Bell-O, Gardner, Massachusetts. (Rexalls.)

**BEGINNERS'** Tattooing outfits. Removers. Free catalog. Tatuco, 651 South State, Chicago.

**LAW** Blanks protect you. Contracts, wills, partnership agreements. \$1.00 each. Walter Traylor, Box 182, Perth Amboy, New Jersey.

**NEW** 1 1/4" Toilet seats, standard size, white and colors, \$1.65. Remittance with order. M. Geller, 1532 University Avenue, New York City.

**SWAP** Anything. We have everything. Itemized lists, instructions for dime. Economy, 32 N. Division, Grand Rapids, Mich.

**ELECTRIC** Lawn mowers. 18" cut G.E. motors—belt drive to reel—non traction—90% less effort \$25.00. Box 305, Michigan City, Ind.

**STANDARD** Electric lamp insect killer. \$2.00 up. Literature free. Sauer Bros., San Leandro, Calif.

**COATS** Of arms and crests, correctly painted in colors or black and white, from heraldic description or furnished copy. \$10.00 and up. Highest grade work. Heraldic Studios, 1914P Oakdale Avenue, Chicago, Ill.

**I WANT** To send you proof of the wonderful pulling power of Popular Mechanics Magazine's classified pages. What's your proposition? Write me today. F. W. Johnson, Manager Classified Advertising, 200 E. Ontario St., Chicago, Ill.

# "UNCLE SAM" JOBS

## RAILWAY POSTAL CLERKS

\$1900 First year regular

## MANY OTHER GOVERNMENT JOBS

File Clerks—Mail Carriers—Stenographers—Typists, etc.

32 Page Civil Service Book—FREE.

MEN—WOMEN

Mail Coupon immediately—today sure.

\$1260 to \$2100

FIRST  
YEAR

### COUPON

FRANKLIN INST., Dept. F195, Rochester, N. Y.

Gentlemen: Rush to me, without charge, 32 page book with list of U. S. Government big paid positions. Advise me also regarding salaries, hours, work, vacation, etc. Tell me how to qualify for a position.

Name.....

Address.....

## TOOL & DIE MACHINIST TRADE Screw Machine Course

Learn these trades on actual work at ALLIED SHOPS. Fully equipped. State approved. Low fee. Day or Evening Training. Free Employment Service. Write Today for FREE 36-Page Illustrated Book. ALLIED SCREW MACHINE CO., INC. (School Div.) Dept. PM-8, 609-13 W. Lake Street, Chicago, Ill.

## AVIATION APPRENTICES

AIRMINDED YOUNG MEN INTERESTED IN TRAINING FOR ENTERING THE WELL PAID FIELD OF AVIATION AS APPRENTICES—Write immediately, enclosing stamp.

MECHANIX UNIVERSAL AVIATION SERVICE CO.

Wayne County Airport, Box 857, Dept. E. Detroit, Mich.

## WELDERS WANTED!

ELECTRIC ARC—OXY-ACETYLENE. Skilled Welders earn \$8 to \$15 a day. The demand now greater than the supply. Learn this highly paid trade in 3 weeks by actual shop work. One of America's leading schools. Established 1902 7 floors of shops. Endorsed by welding industry. Limited number of students. 3 weeks course in Electric Arc or Acetylene Welding, including room and board, only \$105. Write or wire for reservation. Ask for "Welding Facts." State age. GREER COLLEGE, Dept. 180, 2024 S. Wabash Ave., Chicago

## EARN THE DEGREE

Doctor of Psychology (Ps.D.), Divinity—others. General Courses in Science, law, business, etc. Incorporated in state of Washington. Send for 32-page FREE Bulletin at once. No Obligation. TEMPLE BAR COLLEGE, INC. (A Correspondence Institution) Dept. 3-R, 1411 Fourth Avenue, Seattle, Washington, U. S. A.

## LACO Delivers Lots of HEAT!

### SAVE 25% FUEL COST!

Improved features of LACO Oil-Burning Heater convert low-priced oil into clean, constant, big-volume heat! Thoroughly warms your home on coldest days! Special "Inner Heating Unit" utilizes utmost of the heat developed by famous "Oil-Saver" Burner—delivering 25% to 40% More Heat! Simple heat adjustment. Self-contained fuel tank. Quiet. Safe. Beautiful life-time steel cabinet. 4 sizes.

Factory-to-Dealer selling plan saves you 1/3 to 1/2.

### GUN-TYPE BURNER

All that's best and new at an Amazing Low Price!

Low as \$29.95 F.O.B. Fcty.

FREE BOOK See your LACO dealer or send for free illustrated folder.

DEALERS: Write for new Dealer's Floor-Plan and full details!

LACO OIL BURNER CO., 180 Union Ave., Griswold, Iowa

In answering advertisements always write name and full address clearly.

## LET ME PROVE I CAN MAKE YOU A NEW MAN

I changed myself from a 97-lb. weakling to winner of title, "World's Most Perfectly Developed Man." Let me prove that my secret of Dynamic Tension can give you powerful muscles, smashing strength, a handsome build! All I ask is a 7 DAY TRIAL. Write for my 48-page FREE BOOK. CHARLES ATLAS, Dept. 88, 115 East 23rd Street, New York City.

SEND FOR MY FREE BOOK

## AUTO BOOKS SENT FREE

on approval. Just mail-the coupon and we'll send you a set of these remarkable auto books. Whether you are a mechanic or helper, expert or apprentice, auto owner or driver, if you're interested in knowing all about automobile mechanics, take advantage of this FREE EXAMINATION OFFER.

### GET A BETTER JOB

A better job—in the gigantic auto industry. BIGGER PAY—a chance to go into business for yourself and get a share of the profits, are waiting for any man who even half tries to improve himself. Learn auto engineering with these wonder books a new way—a quick reference method. Simply use the JIFFY INDEX to look up the answer to any auto problem. Built by eleven of America's great automobile engineers, and written in simple language so you can understand it.

Privilege of consulting Automobile Engineers of American Technical Society for one year without cost if you mail coupon immediately.

Send promptly and we will include a New EXTRA volume with over 300 pages including late cars with wiring diagrams and data sheets on each.

### CAN YOU FIX IT?

These wonder books tell step by step HOW to take out "play" in differential—to kill the shimmy in steering—to set TIMING—how to put your finger on engine trouble and the expert way to FIX it.

### 6 BIG VOLUMES

2500 pages, 2000 illustrations, wiring diagrams, etc., including Marine Engines, Aviation Motors, Diesel engines, etc. De Luxe edition, gold-stamped flexible binding.

AMERICAN TECHNICAL SOCIETY (Publishers—Home Study Courses), Drexel Ave. & 58th St., Dept. AC19, Chicago, Illinois. I would like to see the 6-volume edition of your AUTO BOOKS. I will pay the few cents delivery charges only, but if I choose to, I may return them express collect. If after 10 days use I prefer to keep them, I will send you \$2 and pay the balance at the rate of only \$3 a month, until \$24.80 is paid. Please include consulting membership and extra Volume No. 7, as per your offer above.

Name.....

Address.....

City.....

State.....

Please attach letter stating age, occupation and name and address of employer and that of at least one business man as reference.

# OL' JUDGE ROBBINS

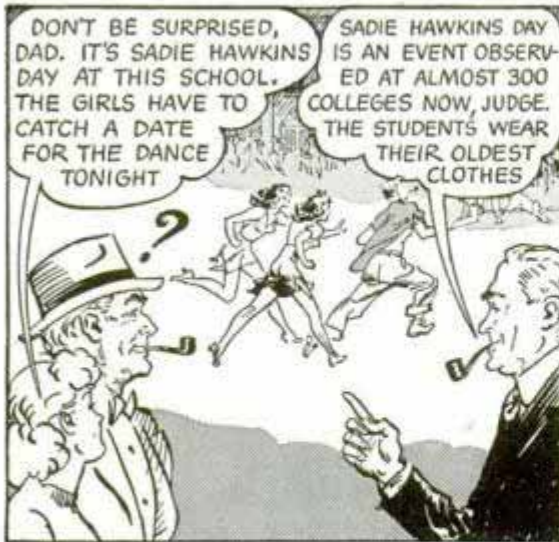

IN RECENT LABORATORY "SMOKING BOWL" TESTS, PRINCE ALBERT BURNED

**86 DEGREES COOLER**

THAN THE AVERAGE OF THE 30 OTHER OF THE LARGEST-SELLING BRANDS TESTED—*COOLEST OF ALL!*



**GRADUATE TO THE CIRCLE OF SMOKING JOY!**

TRY PRINCE ALBERT FOR A NEW DEGREE OF BITE-FREE, EASY-DRAWING SMOKING!

GREET THE WORLD WITH THAT P.A. SMILE. P.A. PACKS RIGHT—HELPS A PIPE CAKE UP BETTER

PRINCE ALBERT GETS HIGH HONORS FROM ROLL-YOUR-OWNERS, TOO. SPINS UP FASTER, EASIER, SMOOTHER!

**50** pipefuls of fragrant tobacco in every handy tin of Prince Albert

**PRINCE ALBERT**  
THE NATIONAL JOY SMOKE

Copyright, 1940  
R. J. Reynolds Tob. Co.  
Winston-Salem, N. C.

# Popular Mechanics Magazine

REGISTERED IN U. S. PATENT OFFICE AND CANADA

WRITTEN SO YOU CAN UNDERSTAND IT

Vol. 74

AUGUST, 1940

No. 2

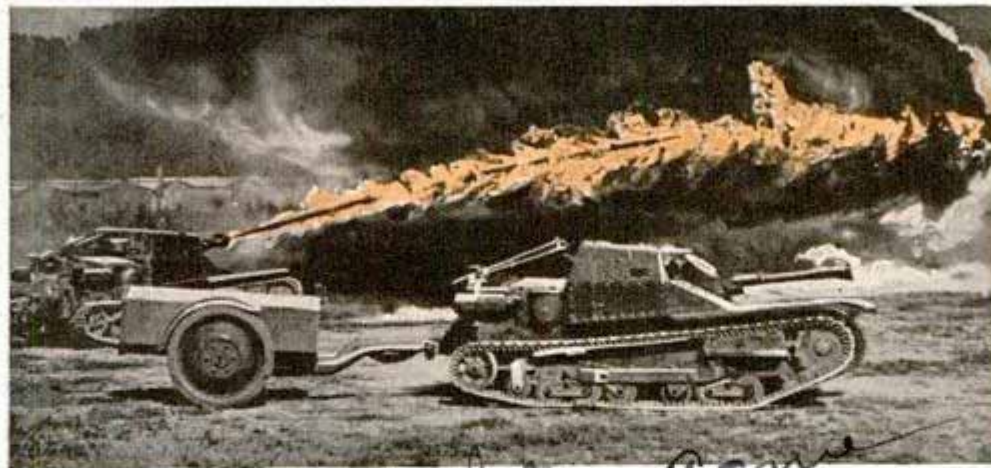

German dive bombers of the type pictured above played a big part in forcing Dutch and Belgian capitulation and in fighting Allied navies. German tanks that threw a stream of flames seventy yards were used in the march to the channel; at left is an Italian army flame thrower

By R. Ernest Dupuy  
Major, U. S. Field Artillery

LESS than a year ago a siren voice was heard: "Stay on the defensive—modern weapons are so murderous that whoever takes the offensive is doomed." A part of the world believed; another part—professional soldiers these—disbelieving, found themselves without an audience.

Distrust history, sang the siren. Forget Genghis Khan, Frederick the Great, Washington's sweep to Yorktown, Napoleon's 1805 campaign to Austerlitz, Robert E. Lee in the Shenandoah Valley, Grant before Vicksburg and again at Appomattox, Allenby in Palestine. Forget that surprise, speed and striking power offensively used have won every previous campaign. Today that siren is silent. An amazed world prates

AUGUST, 1940

Public Relations Office,  
Headquarters United States Military Academy

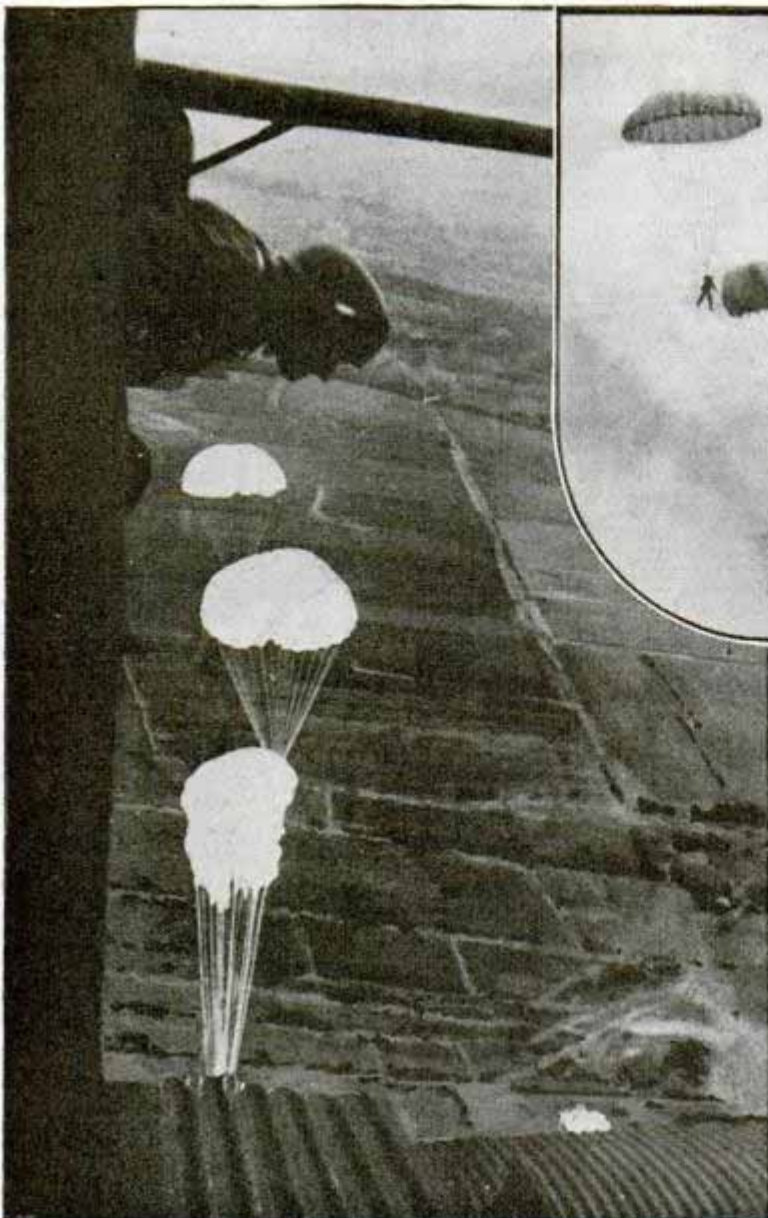

same; an offensive plan which chooses the terrain to fight on, which takes advantage of every opportunity, and which has the punch to crash through.

Here, of course, an aggressor has initial advantage, unless a peacefully inclined nation be fully prepared for every eventuality. For only if prepared in theory, fact and training, can a peacefully inclined nation parry the thrust and launch a counterattack, the return blow which means so much,

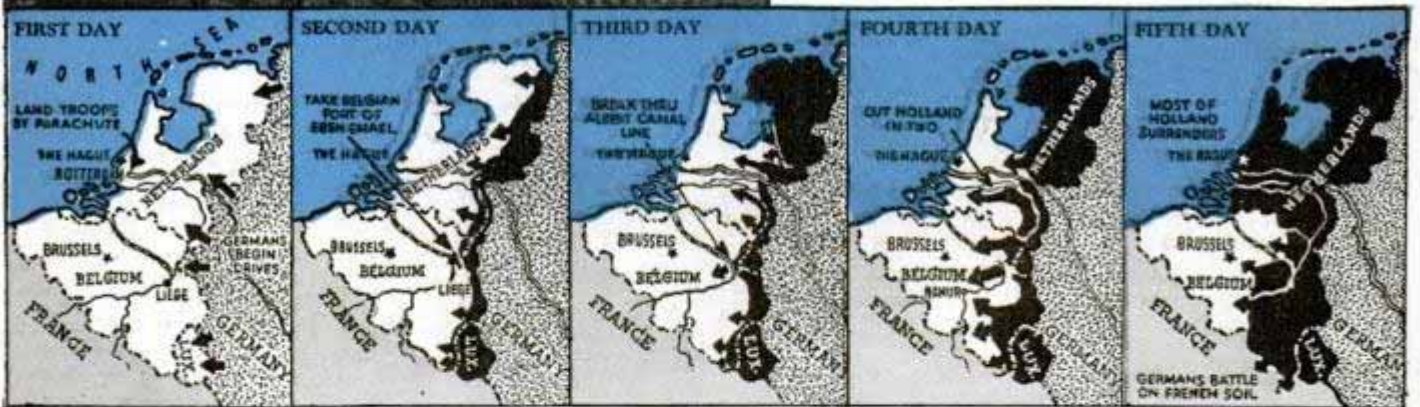

*In warfare of old the spy and the cavalry worked behind enemy lines and made forays into enemy country. Today parachute troops (top) bail out of big transports with guns, supplies, even bicycles to sabotage and prepare the way for the army. Below, timetable of German blitzkrieg*

of blitzkrieg, the lightning war, as something new under the sun.

This is an error. What is new is the technique, the utilization of scientific advances—mainly the internal-combustion engine and everything it made possible—which has geared warfare to a heretofore unthinkable rapidity of movement. The basic elements of success in war remain the

whether in the boxing arena or in war. To realize this, one must see just what this blitzkrieg amounts to, and what are the parries by which the attacked can check the blow, in order to strike back.

There are several essential ingredients to the successful blitzkrieg. First, you must be prepared. Second, you must know where you want to go. Then you must





know not only the hostile strength and where it may be expected, but also every hill and valley, every road, river, bridge, every village in the area. You must know how the enemy gets his food and water, all his vital necessities, so that he can be throttled by their disruption. This knowledge is obtained by map study, by travel in his country, by careful check of all his resources of supply and manufacture. Only then will you be prepared, in striking, to disrupt all enemy efforts to resist.

The next step is study of the enemy terrain. Relief maps of the area are prepared, over which officers pore to thrash out every possible angle of opposition. Far in the interior of your own country maneuvers are carried out simulating all the difficulties which must be hurdled. These include incessant drilling of the combat teams—tanks, airplanes, infantry and artillery—until, so far as is humanly possible, each man knows exactly where to go and what to do. This must be done on terrain closely resembling the scene of action. The enemy language must be studied, in elementary form at least.

If an overseas expedition is planned, the advance ground elements must be drilled in loading and unloading the transports. Into each vessel

must go an equal distribution of men and materials. What good dumping a battalion of infantry on the beach if it does not have the necessary ammunition, rations, machine guns and supporting artillery? The naval forces must plan and rehearse their part; the air troops—combat, reconnaissance and transport planes—must be picked and rehearsed; the parachutists must go



*Parachute riflemen (top) rush for a container of supplies dropped to them; they carry gas masks and full fighting equipment (right) on their aerial invasion. Below, parachutists form into fighting unit*



through their maneuvers. Warfare today is so complicated by mechanization that nothing can be left to chance.

The dress rehearsals completed, you launch the blitzkrieg. Rolling on every highway leading into enemy country come the juggernauts—tanks, led by armored cars and closely followed by motorized infantry and artillery. Overhead the bombers have already laid their eggs on hostile airdromes and vital centers. The enemy's covering forces give what battle they may against the flaming chariots. But hedge-hopping over the trees come the whirling dive bombers to blister with bomb and machine guns and light cannon every spot of resistance.

Does the road-net cross a river? Then the 400-mile-per-hour dive bombers must sow death and destruction about it, to stun its defenders, while out of speedy transport planes bail the parachute troops which, on landing, rush to the key point—the bridgehead, the powerhouse, the dike control—to fight off opposition until the tanks catch up. The "fifth column," your own agents and sympathizers, assist in this preliminary, seizing telephone centrals, spreading false alarms, giving contradictory orders, sabotaging waterworks, light plants, broadcasting stations and railway switches.

Knowing the location of every air field in the hostile terrain, you may, at the same time, actually land transport planes where necessary, to aid the "fifth column" and the parachutists in capturing key points. And by judicious bombing of centers of population, hordes of terror stricken refugees will be driven out to clog the roads leading toward the interior of the enemy's country. Their presence will impede the advance of reinforcements, and may delay

*Top, inflated rubber boats carry troops across rivers and take them ashore from seaplane transports alighting in enemy country. Below, light tanks on the march; heavily armored, the German tanks and cars resisted ordinary anti-tank shells*

2607 near Ahr Germany



Above, motor launch pulls string of rubber boats carrying a battalion. Right, U. S. anti-aircraft guns roll beneath big bombers; below, glimpse inside a French seventy-ton tank; bottom, U. S. army tanks

his demolition squads in blowing up bridges, tunnels and causeways, for it is but natural to suppose that he will hesitate to cut off his own citizens from safety.

Should the bridges be blown up, that will of course impede your swift-rolling columns. But, remember, you are proceeding with a definite plan, and on a wide swath of roads. The momentary halting of a column does not hinder its neighbors on other roads—whether the halt be due to hostile resistance or to obstacles. Like the tide which swirls around the rocks, the advance continues. The reconnaissance planes hovering over the head of your columns are carrying back word of all such hindrance. Dive bombers will harry the islands of resistance, the engineer detachments making up part of the mechanized columns soon will make temporary repairs to bridges or lay ponton bridges.

Collapsible rubber boats carrying four or more men may be carried by transport planes or by trucks, to be put to quick use. Or they may be carried by the big flying boats with which you make a lightning swoop on a harbor or wide river, to enable the first detachments to paddle ashore and seize the key points.

The essence of the first move, then, is surprise. Surprise brings uncertainty and disorder in its wake, disrupts all the normal life of the invaded country. To be stronger than the attacked, particularly in the air, is essential. You don't make a blitzkrieg unless this is reasonably certain. The strongest body is powerless if its nerve-centers be cut. Successful blitzkrieg does just this.

How long you can keep up this lightning war is dependent upon fuel, ammunition

(Continued to page 141A)



Printa Bouringuey G. D.

# Electric Brain Plays Game with Fair Visitors

Offering a challenge to all comers in the ancient Chinese game of Nim, or fan-tan, a one-ton electric brain, called the "Nimatron," matches its wits with visitors at New York world's fair. As the game is usually played, each player alternately picks up a number of match sticks or counters from a single pile until one of them has picked up the last match and won. But the Nimatron substitutes rows of electric lamps for stacks of matches. The machine's opponent pushes a button to turn out as many lights as he chooses, and the mechanical brain, consisting of two miles of copper wire and 116 relays, then makes its selection and turns out more of the lamps, which is continued until the last one is turned out. Research men at the Westinghouse laboratories, where the machine was built, explain that the visitor must be able to think in powers of "two" of the binary system of numbers, if he expects to be a consistent winner.

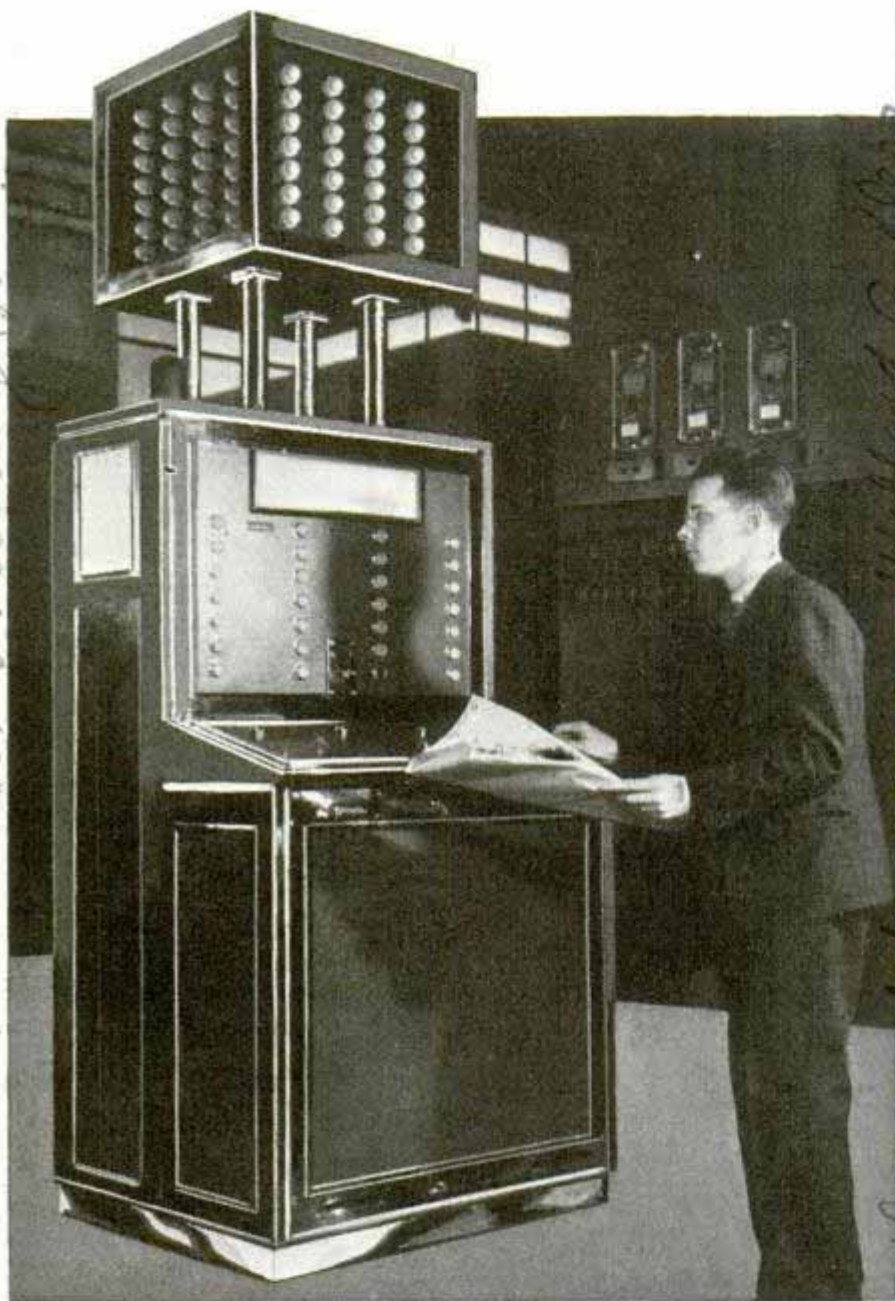

Rows of lamps above "Nimatron" show the status of game being played as visitors at New York fair pit their wits against one-ton electric brain

# Fast Navy Torpedo Boats Fight Warship or Submarine

Thirty-one fast torpedo boats are being completed as an experimental patrol fleet for the United States Navy. Ranging from fifty-nine to eighty-one feet long, the boats are to be armed with torpedo tubes, machine guns, depth charges and apparatus for laying smoke screens, so they will be capable of fighting enemy surface ships or submarines.



First of the Navy's experimental fleet of coast-patrol torpedo boats, the "PT-3" hit forty-six miles an hour in its test run on Detroit river

*15 & 69th New York City*

# Non-Inflammable Paper Resists Oil and Water

Folding pots and pans made of non-inflammable paper, in which water may be boiled, are some of the possibilities offered by a recent invention. To show that fire and water do not harm his fire-proof paper, an inventor boiled water in a single sheet which he held over a burning candle. Being resistant likewise to oil, and easy to disinfect, the paper is said to be well suited for use in Braille books, since perspiration from fingers of the blind will not damage the raised characters. Perhaps even more important, according to the inventor, would be its military applications.

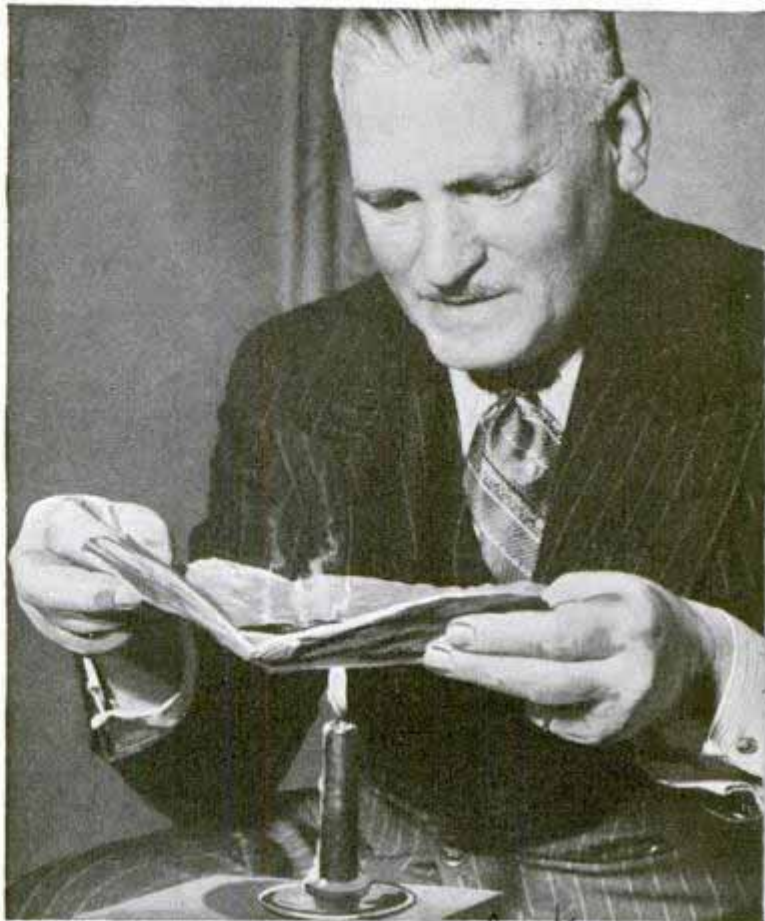

*Water being boiled over candle flame in sheet of fireproof and waterproof paper in order to demonstrate its qualities. The paper also resists damage by oil, and the inventor offers it for military use*

*K 593.*

# Straps Hold Runner on the Mark until Starter Fires Gun



*Temple University Phila*

*Dr. Coach Ben Ogden*

*Club photo*

*Renata Linn*

*This athlete cannot start his dash until straps release him, which occurs when starting gun is fired*

Runners who attempt to jump the gun are held in check by a new starting gate invented by a university athletic coach. Straps, serving as barriers to prevent false starts, are released automatically when the starting gun is fired.

*K 589*

# Light Bulb with Reflector Inside Is Economical in Wattage

Blown in a parabolic shape to direct all its light upon the working area, a new type of electric-light bulb has its own self-contained reflector. The silver plating is on the inside of the bulb where it is untouched by dirt or fumes. It is especially useful where concentrated light is required. With its parabolic shape and built-in reflector, lower wattages can be used.



*Solar*

*Warren Lamp Co. Pa. Warren*

982. ...  
120 E. 54th, New York City

# QUICKER *than a* WINK..

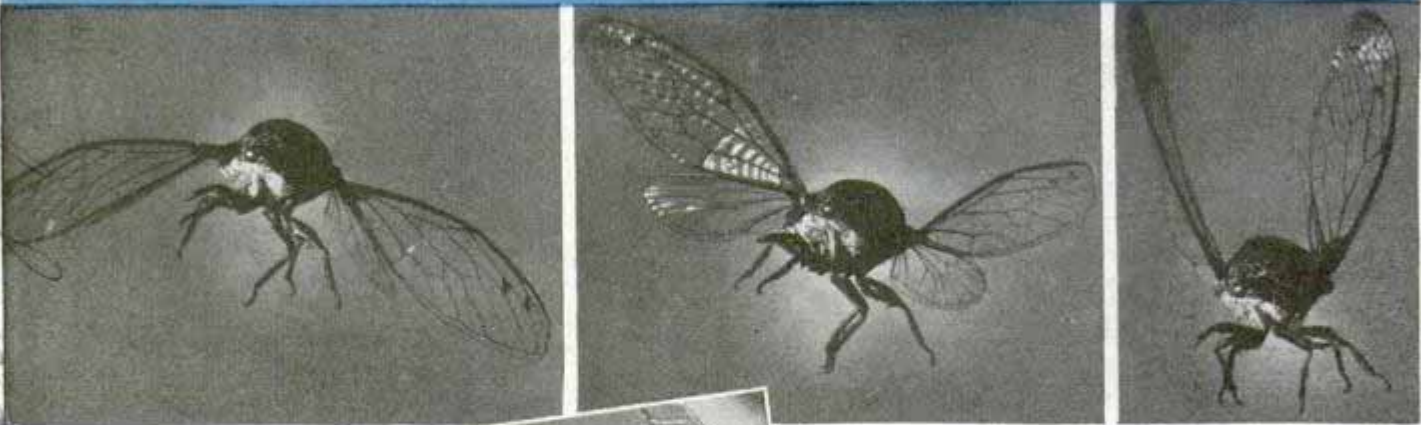

Courtesy Hale, Cushman & Flint, publishers of "FLASH!  
—Seeing the Unseen by Ultra High-Speed Photography,"  
by Harold E. Edgerton and James R. Killian, Jr.

*Aviation designers may learn from insect's flight; top, high-speed photographs catch locust's wings on upstroke, half-way and start of downstroke. Left, kicker's toe "stopped" as it drives deep into football*

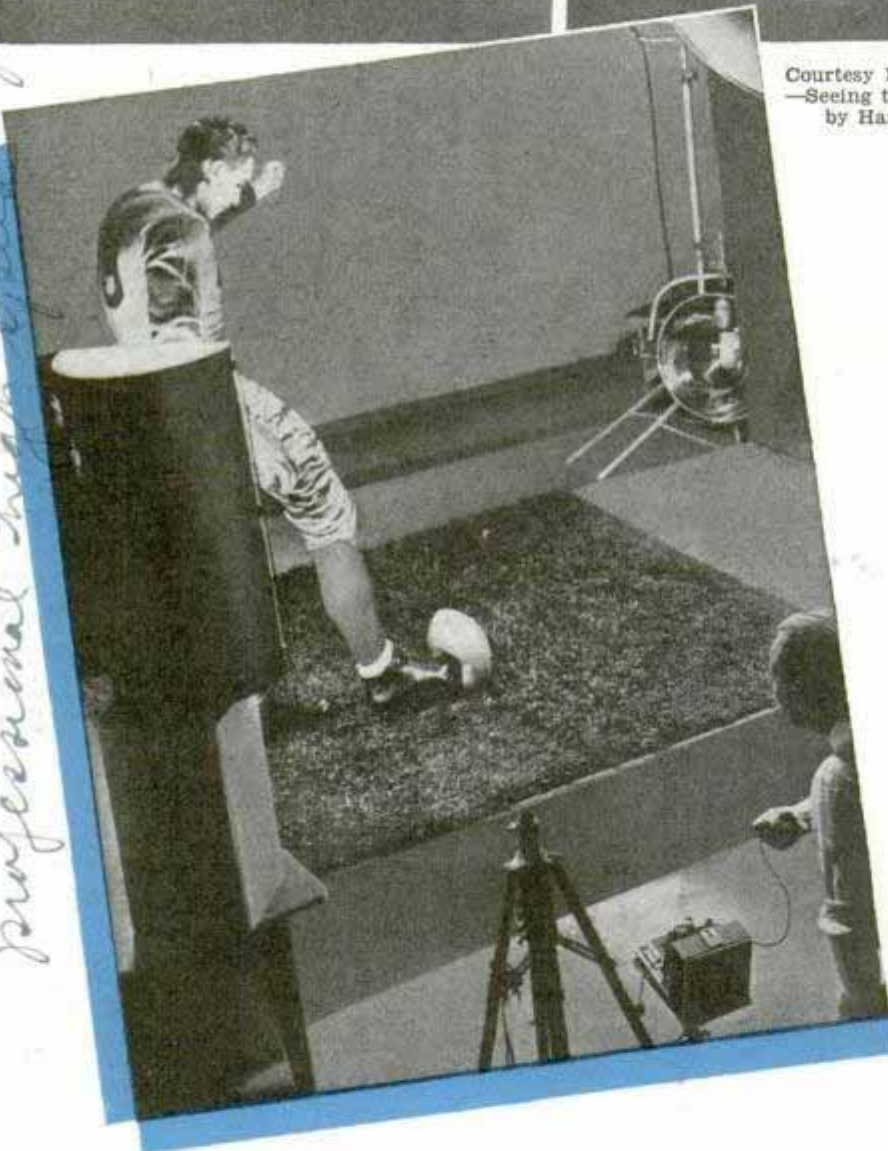

where Dr. Harold E. Edgerton and a group of scientists have been experimenting in ultra high-speed photography, they often use the phrase "slow as a wink"; half in fun, of course, though it does give them a valuable commonplace standard of comparison to explain the wonders they have achieved.

To these research men, who have been dealing with velocities too great for the mind to encompass, the "batting of an eye" is slow motion. A wink, they have found, by counting the frames of film exposed in a high-speed motion-picture

*Judges of 2.5-jour mile professional high speed*

**T**HAT time-worn phrase, "quick as a wink," has always meant incredible speed to man. Indeed, the involuntary operation of the eyelid—the shutter on that human camera called the eye—seems very fast when measured by the antiquated standards of the eye itself.

But in the laboratories of the Massachusetts Institute of Technology in Boston,

camera, usually lasts one-fortieth of a second. They have taken pictures with an exposure of 1/3,000,000 of a second. The use of a light flash accurately timed to last 1/1,000,000 of a second to take photographs is as commonplace to them as dishwashing to a housewife.

You will probably continue to say "quick as a wink" after you have noticed some of

# and then **SOME!**

*Leakage of powder (below) revealed by photo taken at 1/1,000,000th of second exposure. Right, showing bat actually bends in striking ball. Inset, punishment taken by ball. Bottom, left, bullet before striking steel plate. Right, lead bullet splattering like a liquid upon hitting plate*

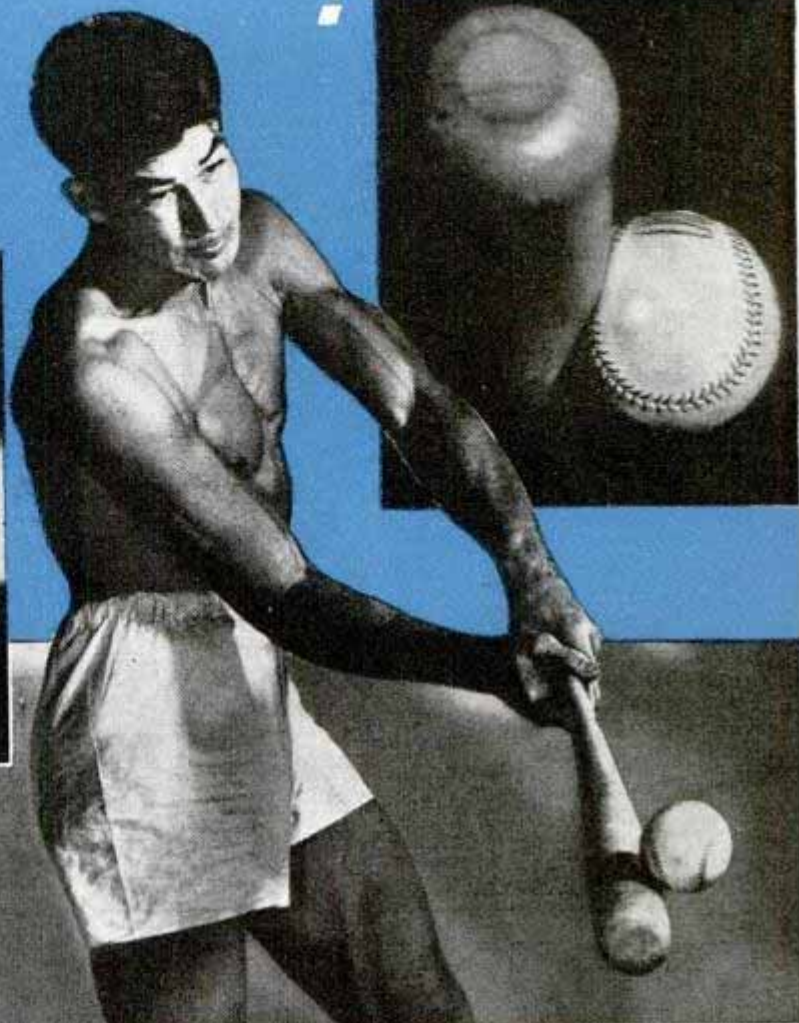
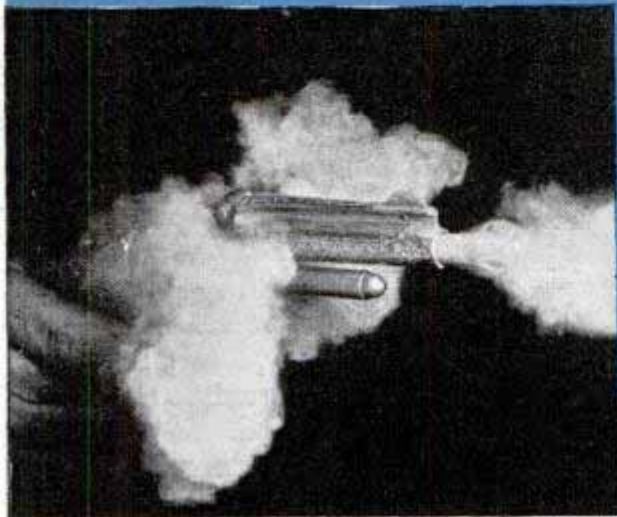

the "frozen motion" photographs a major newspaper picture syndicate is beginning to produce by the Speedray process, an adaptation of the professor's experiments.

But you will realize what an absurdly laggard mechanism the eye really is after you have seen pictures of diving swimmers suspended as if in flight, leaping basketball players who appear to be hanging in midair and actual action prize-fight scenes which are so much like stills from Hollywood studios that they appear posed.

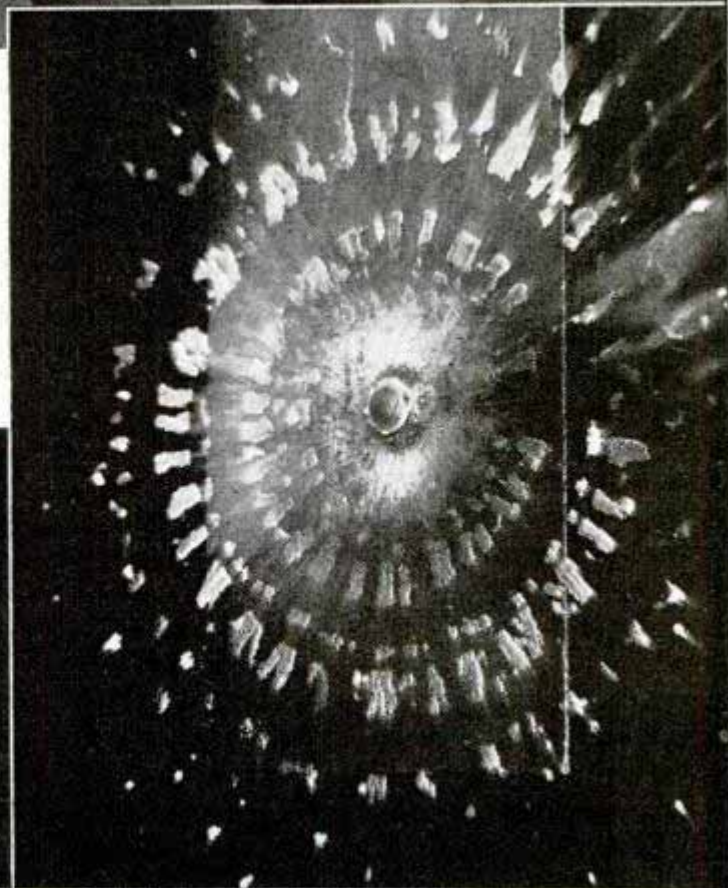

Defeated Long Island at Madison Square Garden

Interquarling New Speed Ray Lamp

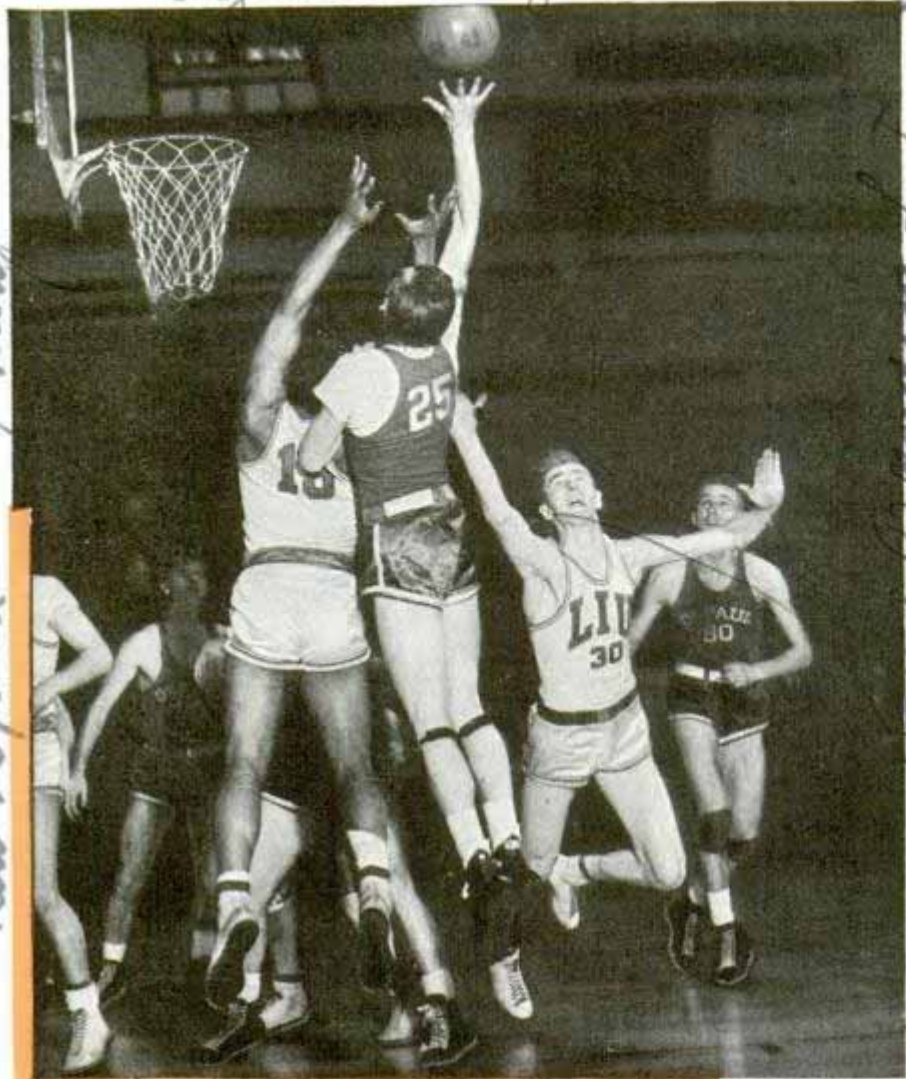

and ship propellers, spindles and looms of textile plants, fans, guns and moving automatic machinery of many kinds by matching the rapidity of their motion with the rapidity of his camera. Thus they produce "stop motion" pictures which can be analyzed at leisure.

The manner in which glass breaks, metals cool, liquids flow and air impedes had never been demonstrated accurately until Dr. Edgerton used his portable stroboscopic camera — stroboscopic meaning, roughly, "whirling watcher"—to make motion pictures at the incomprehensible rate of 6,000 a second.

Words like "incomprehensible" and "incredible" are often uttered by

Delly King Jim Parker  
These are produced by what Dr. Edgerton considers a moderately fast exposure of 1/100,000 of a second.

Just as these pictures will show you details of sporting events your eyes would have missed if you attended, Dr. Edgerton's experiments in his laboratory have opened a whole world of unseen rapid motion which is certain to affect the manufacture of the food you eat, the clothes you wear, the household utensils you use, the vehicles you ride in, the dwellings you occupy and the equipment you use for recreation and sports.

Industrial research men are learning to solve some of the mysteries of the machine which the human eye could not fathom, nor could mathematics unravel.

By coupling incredible speed of exposure with intense light developed in his still photography and inventing a motion-picture camera fast enough to use both, Dr. Edgerton and his assistants have enabled the scientists of industry ultimately to disclose mass-production secrets. They are probing the automobile motor, airplane

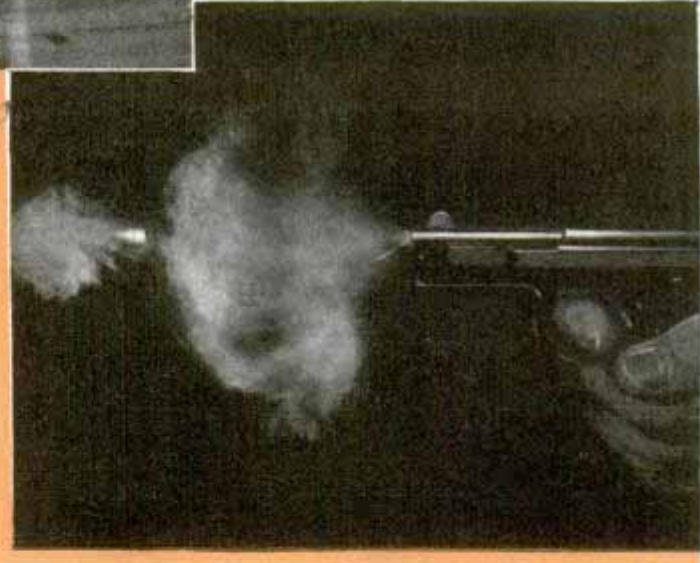

Press photographer caught fast action in basketball game at 1/100,000 second. Muzzle velocity of a bullet, below, was determined accurately by calculating the distances and times with speed photography

bewildered visitors in the institute's ultra high-speed photography laboratories. So James R. Killian, Jr., an associate and co-author with Dr. Edgerton of the fascinating book "Flash!" which the Boston publishers, Hale, Cushman and Flint, have recently issued, has figured out a few comparisons, like that of the wink, to simplify matters. If you know enough about a



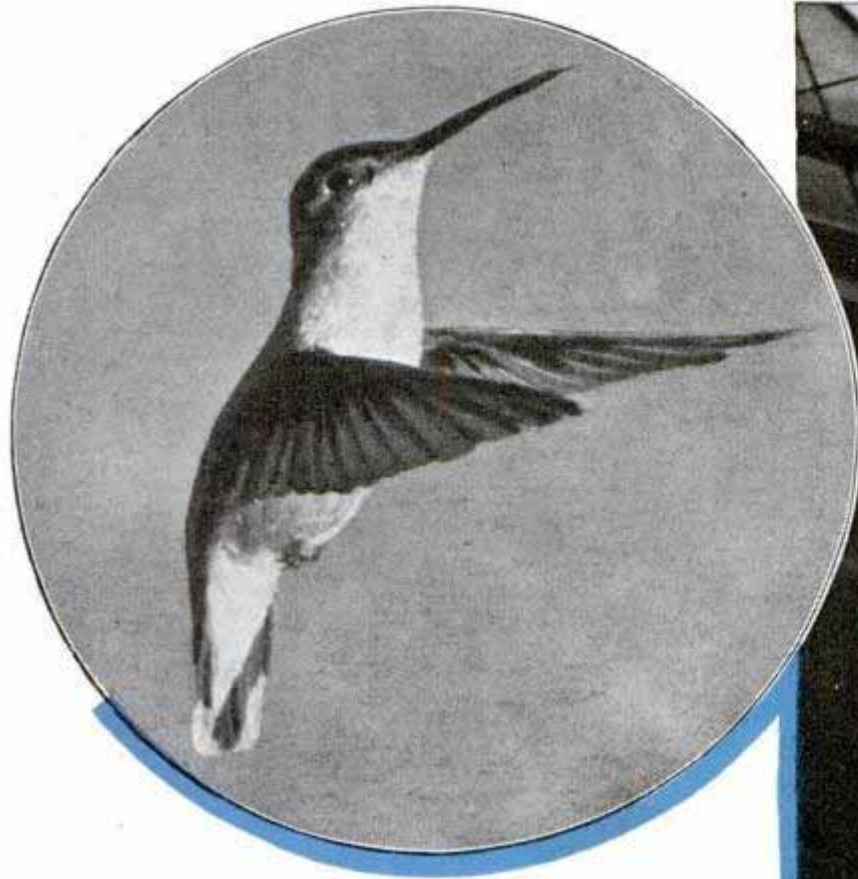

standard camera to realize that it is essentially a box containing a film sensitive to light, that the picture is taken by the admission of a certain amount of light which strikes the film and that the amount of light is regulated by a shutter which opens and closes at a desired rate, you can readily grasp author Killian's explanatory comparisons.

First, Dr. Edgerton uses a standard camera but he eliminates the regular operation of the shutter because it is much too slow. Instead, electrical control of the illumination replaces the shutter. The light is turned on only when a picture is to be exposed, in a fashion similar to taking photographs with photoflash bulbs except that the duration of the flash in a flash bulb is about 2,500 times longer than the 1/100,000 of a second necessary to "stop" a ball in flight.

To grasp what an exposure of 1/1,000,000 second means, think of the length of the exposure as the distance across an ordinary room, while the length of a second is the distance between New York and San Francisco.

Next, to get enough light into the camera in such a short time, the illumination must be strong; and so it is, for Dr. Edgerton's flash is brighter than the light of 40,000 ordinary fifty-watt bulbs. Brighter

(Continued to page 132A)



Did you notice the hummingbird stuck out its tongue at the photographer? At upper right, a fast shot over the parallel bars. Below, a speed flash just as the glass crashes on the floor makes the spattering milk seem to flow as slow as molasses

Clapp, West Point

Mass: d inst: of Technology

# Low-Cost Rail Sleeper Has Three-Story Berth

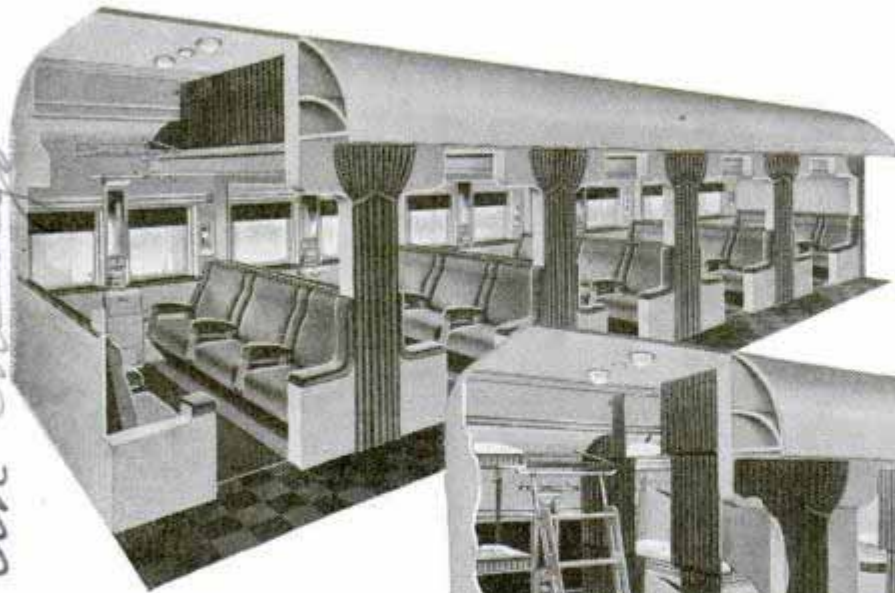

Sectional view at left shows six-seat section of coach-sleeper during day travel; notice that uppermost berth is curtained off but not folded away. Below, the same section at night, with facing tiers of three-deck berths made up. Middle berth extends downward from upper

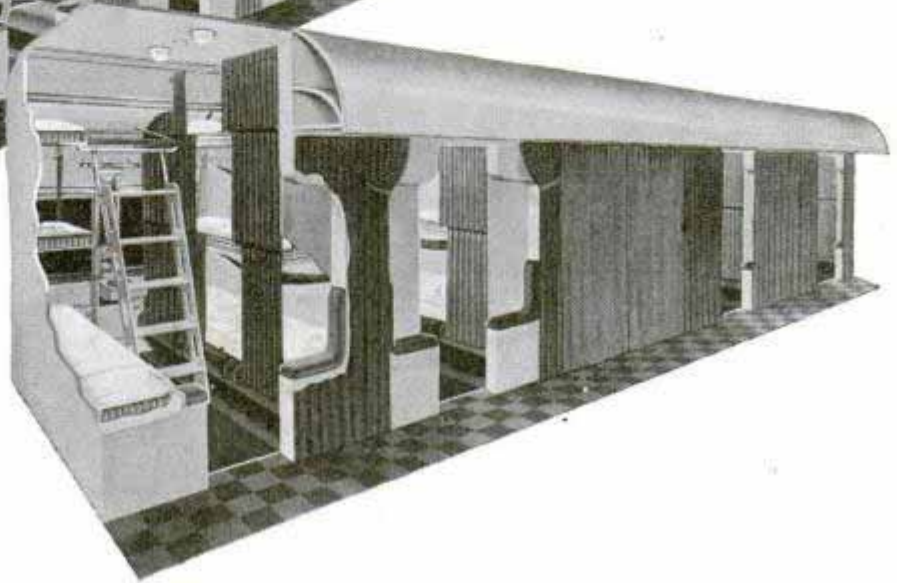

Midsummer travel finds an entirely new type of sleeping car on the rails—the coach-sleeper. Built experimentally to offer low-cost sleeping accommodations for the traveler who has been patronizing the bottom-rate day coach, the coach-sleeper introduces a three-story berth arrangement. On one side of the car is an aisle from which ten compartments are entered. Five of the compartments seat and sleep three persons each; the other five accommodate six persons. In daytime the rooms have three adjustable seats side by side, with arm and foot rests for comfort; the six-seat compartments have three additional seats facing the others. At night the lower berth is formed by the seat back; the other berth is

stationary, its bottom well above the height of a tall man; between these is the new intermediate berth, which is raised against the upper during the day. Each berth has individual curtains, shelf and hammock for belongings, and a ladder allows easy access to the higher berths. The Pullman coach-sleepers, only two of which have thus far been completed, are air conditioned and every berth has a fresh-air inlet individually controlled. The modern lighting system includes a reading lamp in each berth.

## Garden Label in a Glass Tube Is Unaffected by Weather



To help identify plants, an outdoor garden label enclosed in a glass tube provides an easily readable marker unaffected by weather. The gardener prints the name of his plant on the paper insert, rolls it up and places it in the tube which then is sealed with corks at both ends. A metal supporting rod is pushed through one of the corks until the end is embedded in the other cork, leaving three inches extending outside for sticking into the ground or bending into shape to hang on bush or tree.

Glass tube sealed at both ends with corks keeps water from damaging the garden label

K 50-1  
 The Pullman Co. Adams and Michigan Ave Chicago  
 555  
 W. Patten  
 406 Leeward Blvd  
 Honolulu, Hawaii

*20th Century Fox Studio  
Hollywood, Calif*

# Balloon Guards Movie from Airplane Noises

Airplane pilots give a wide berth to a movie studio above which floats an orange-colored balloon, studded with silver reflectors, because in their language it means "quiet, please." Sound in the wrong places ruins a talking picture sequence, and the unexpected roar of airplanes has caused losses of \$250,000 to \$500,000 annually. The captive-balloon idea was agreed upon between the film and aviation industries as a solution to the problem, and it is used whenever a picture is being "shot," either on special outdoor locations or at the studio, to establish a zone of quiet warning pilots not to fly within three miles of the set.

*Sending up captive balloon at movie studio as warning to pilots that talking picture is in the making. As unwanted airplane noise would spoil the movie sound effect, aviators steer a course at least three miles distant from any point where the balloon is floating*

*14566*

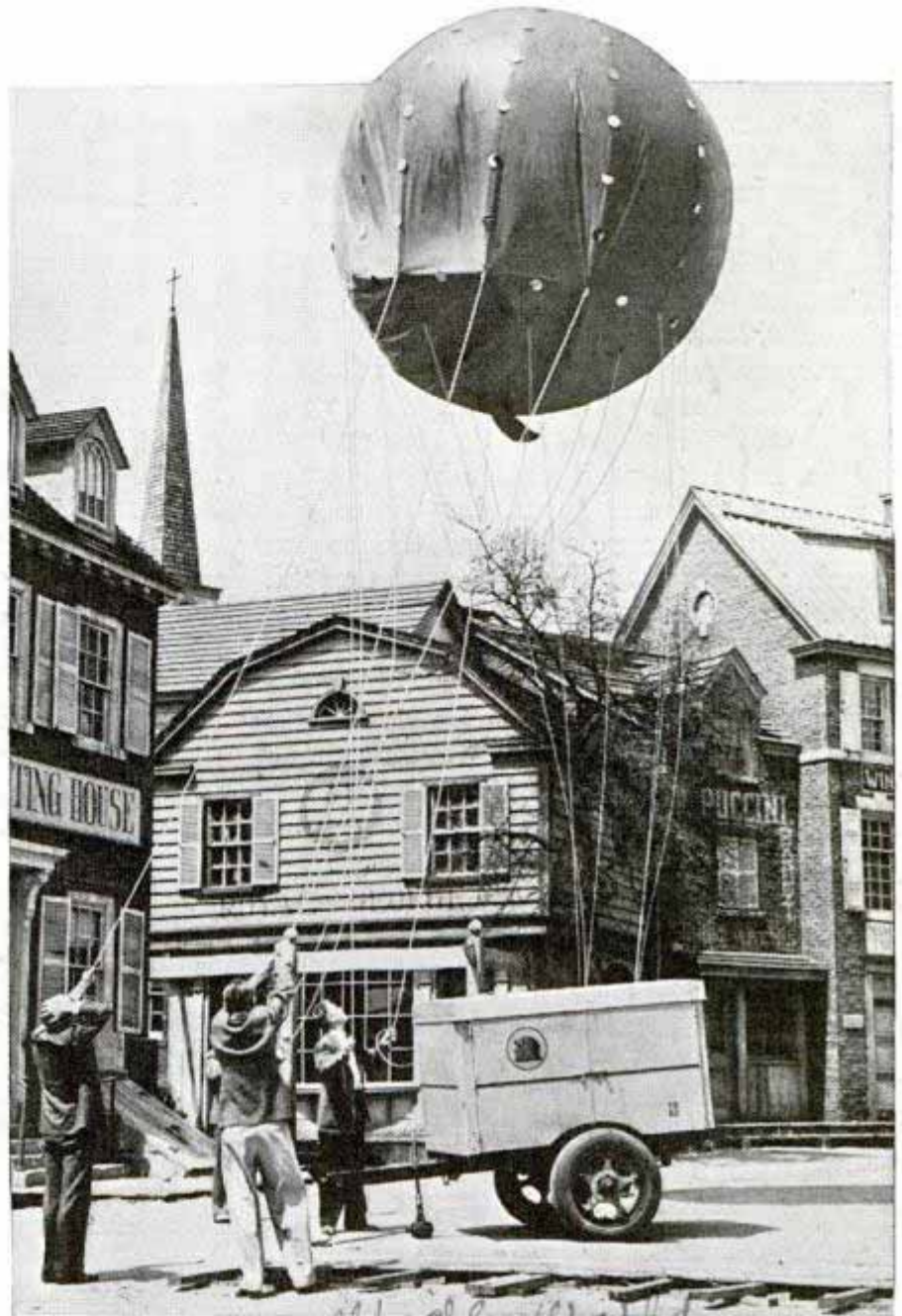

*Wide World*

## Offset Ratchet Screwdriver for Work in Close Quarters



For driving screws in close quarters there is an offset ratchet screwdriver that will reach into narrow slots and similar places difficult of access. There is a fixed blade at one end and two ratchet-operated blades at the other end, the ratchet being reversible. Made of tough steel, these tools are offered in various sizes and with interchangeable adapters for use on the various types of screws.

*Smaller than your finger, the ratchet-type screwdrivers at left have adapters for use with various types of screw heads*

*North Bros. Mfg Co  
Chicago, Ill.*

K519

# FLOATING WALL *of*

**R**UMANIA has girded herself, like a medieval castle, with a vast moat stretching for 750 miles along its northern and western borders which, at the moment of invasion, can be turned into a river of flaming oil. For more than a year 150,000 Rumanians worked to construct the system of canals, locks to regulate the flow of water at various points, storage tanks for oil, and valves from which the oil can be released on the surface of the water and set ablaze, raising a wall of fire between the defenders and the invaders. There are three main sections of the moat, the longest running about 400 miles from Hotin on the River Dniester to Cetatea Alba on the Black Sea. The canals are fifty feet wide and twelve feet deep, connected with the Dniester and three of its tributaries to use their water and to form a continuous channel to the sea. This section divides the Rumanian province of Bessarabia from

Soviet Russia. A second section runs from Hotin to Vijnita, connecting the Dniester and the River Prut, about 100 miles long. This part forms a barrier against what formerly was Polish territory, at a point from which either Germany or Soviet Russia might strike south into Rumania. Western Rumania is guarded naturally by the Carpathian mountains, but south of them the moat resumes in a 250-mile series of canals along the Hungarian frontier from Satu-Mare to Arad, using the waters of the Szamos, Crisul and Maros rivers. In addition to the moat of fire, the outbreak of war would be a signal for closing the steel gates which form tank barriers at the highways from Hungary into Rumania. Back of the canal system are trenches, fortifications and "pill boxes" connected with underground corridors. One section of the canal system was tested not long ago in a realistic rehearsal of a large-scale invasion at



Edwards Press Ltd. 93 Longacre St. New York 17  
London W.1 England

# FIRE GUARDS NATION

the Hungarian frontier. Crude oil was turned into the moat and set ablaze, while the fortifications were pounded heavily with artillery. The defenses fulfilled the expectations of the military experts. One especial advantage of the use of oil is that it freezes at much lower temperature than water and therefore could be used in the moat even during rigorous winters characteristic of southeastern Europe.



Right, map and plans of the flaming-oil moat. Below, across the pages, a battle scene with section of moat set afire as invaders storm the border

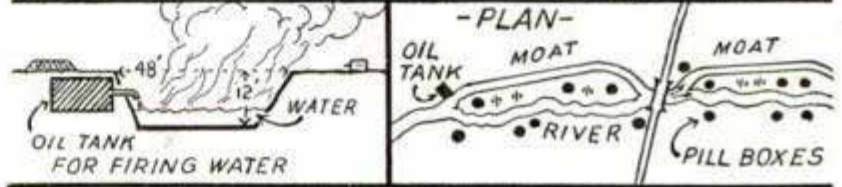

K 528

## Mobile Cabinet and Bench Wired for Light and Tools



Drawers in top part of portable chest hold socket wrench set. Note electric outlets at base of lamp

For convenience of mechanics, a wrench set consisting of fifty-three pieces is furnished in an easily portable cabinet that may be used as a worktable. Equipped with electric outlets and a built-in light, the cabinet has a roomy compartment at the bottom for bulky tools such as electric drills. A special feature of the socket wrenches is a "lock-on" patent which prevents sockets from falling off the handle.

K 545

## Panorama Mirrors for the Car Show Side and Rear Views

Dual mirrors above the windshield offer the motorist an additional safety factor



The small mirror is flat; the broad convex mirror gives full view of sides and rear

through a panorama view of the road to both sides and the rear. The upper mirror is flat, giving the best judgment of distance. The lower one is a sixteen-inch convex mirror reflecting a wide panorama.

K 530

## Portable Miniature Enlarger Packs in a Small Case

With the compactness of the miniature camera itself, a portable enlarger for miniature films dismantles and packs in a convenient carrying case only thirteen and one-half inches square and six and one-half inches wide. There are only two assembling screws, no tools being required, and the enlarger thus can be set up in a few minutes. Enlargements from two and one-half to nine diameters can be project-



Inset shows how the enlarger packs in a small carrying case which also holds developing material

ed on its baseboard, which packs away in the lid of the case; greater dimensions can be obtained by projecting against the floor or wall, the enlarger head rotating ninety degrees to right or left for projecting against a vertical surface. The case has ample room for a camera, developing tank, chemicals and other essentials.

Send stamped, addressed envelope to our Bureau of Information for name of maker of any device described in this magazine.

Blackhawk Mfg. Co.  
5325 W. Project.  
Cloverdale  
2335  
Caston Hwy.  
Los Angeles, Calif.

\$27.50 without case or lens

Case \$10.00  
Rochester, N.Y.  
Eastman Kodak Co.

# SEA GIANTS *on* PARADE

*Marine Land*  
400-pound turtle being fed by hand  
beneath the surface in Marine  
Studios. Note wire "dinner pail"  
which diver carries.

*Shanghaier*  
*Ilora*



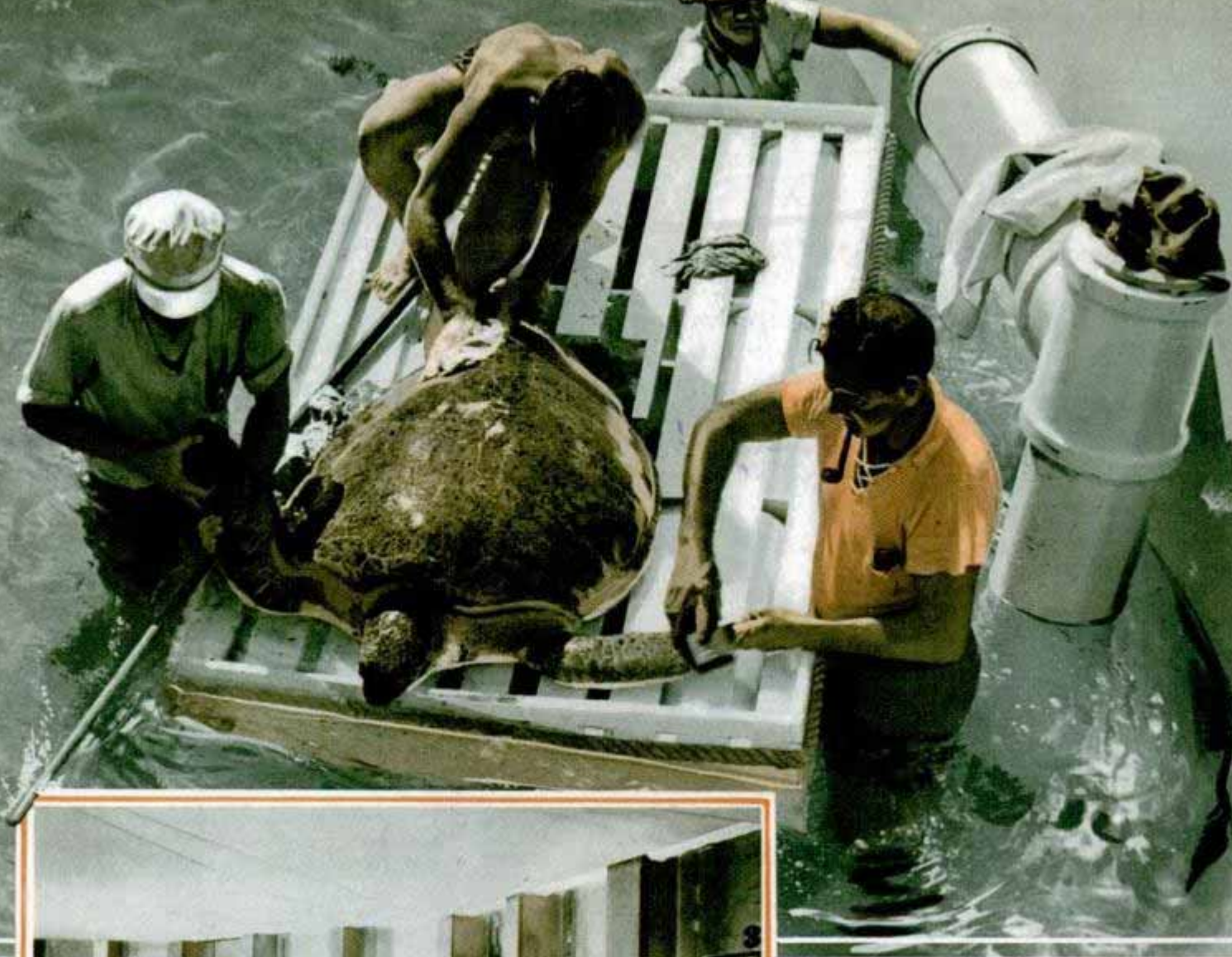

Attendants giving 250-pound green turtle its spring cleaning (above), and visitors watching the fish through some of the 200 portholes (left). Only still pictures may be taken by visitors.

By Julian P. Leggett

**C**AN fish communicate with each other? If so, how? Can a shark bite without turning over? Is it true that a porpoise will push the body of a drowned person ashore? How long may a porpoise, which breathes air like land animals, stay under water without drowning?

Scientists know the answers to innumerable questions like these, entailing long, patient study of marine life as it

exists in the open sea, because an outpost at which they may carefully observe and photograph the private lives of fish, both large and small, has been established. Two hundred glass portholes in the sides and bottom of two huge tanks comprising this outpost—the Marine Studios on Florida's east coast—permit scientist or layman to watch sea giants living a normal existence—feeding, courting, mating, reproducing and even playing tricks on each other.

Different from all other forms of the aquarium, because here marine life is not segregated in small tanks but is placed together, the studios are literally a cross section of the ocean, a constantly changing picture—gaily colored little tropical

*W. Donald Burden, President.*

*St. Augustine, Fla.*

F35  
78

F35





179 K351  
 fish scurrying into hiding from predatory enemies perhaps weighing hundreds of pounds, playful porpoises rising to the surface to expel and take in air through curious blowholes on top of their heads, a 1,000-pound sea cow nursing a 300-pound "youngster," a twelve-foot shark ignoring a school of silvery bumper fish, clumsy 300-pound turtles lumbering lazily along, huge rays flapping their way past a 400-pound jewfish standing guard over its "home."

Into this wonderland, housed in a circular tank seventy-five feet in diameter and a rectangular tank 100 feet long, scientists and staff members of the studios already have peered and emerged with the answers to several interesting ques-

Diver feeding porpoises by hand eighteen feet below surface (above). Interior view of rectangular tank (below) with attendants at work. The two tanks hold 800,000 gallons of sea water and 5,000,000 gallons are circulated by pump through the tanks every day. Note the observation portholes.





tions. Among other things, they have found:

That the porpoise communicates with another by a whistle emitted when air is ejected through the blowhole on its head; that, contrary to popular belief, the shark can bite without turning over; that if a porpoise ever rolled a drowning victim ashore, it was simply because of the porpoise's playfulness and not because it was aware of any intentional accomplishment—in other words, the porpoise would do the same with any flotsam that might appeal to its curiosity; and that the porpoise, which can take in sufficient air to supply oxygen necessary for about two minutes of submergence, may prolong its stay under water because of an internal adjustment that provides for utilization of the oxygen mainly by tissues most sensitive to the lack of oxygen.

One of the first discoveries

180  
K 351  
Porpoise, almost with a smile, takes a mullet from the "table" floating on surface (above). Capture of a shark by fishing vessel's crew (bottom, left). Note trap door in stern through which specimens are taken aboard. Shark in well-stern of fishing craft (bottom, right) where anesthetic is administered which incapacitates the monster for two hours or longer, insuring safe transportation to Studios.

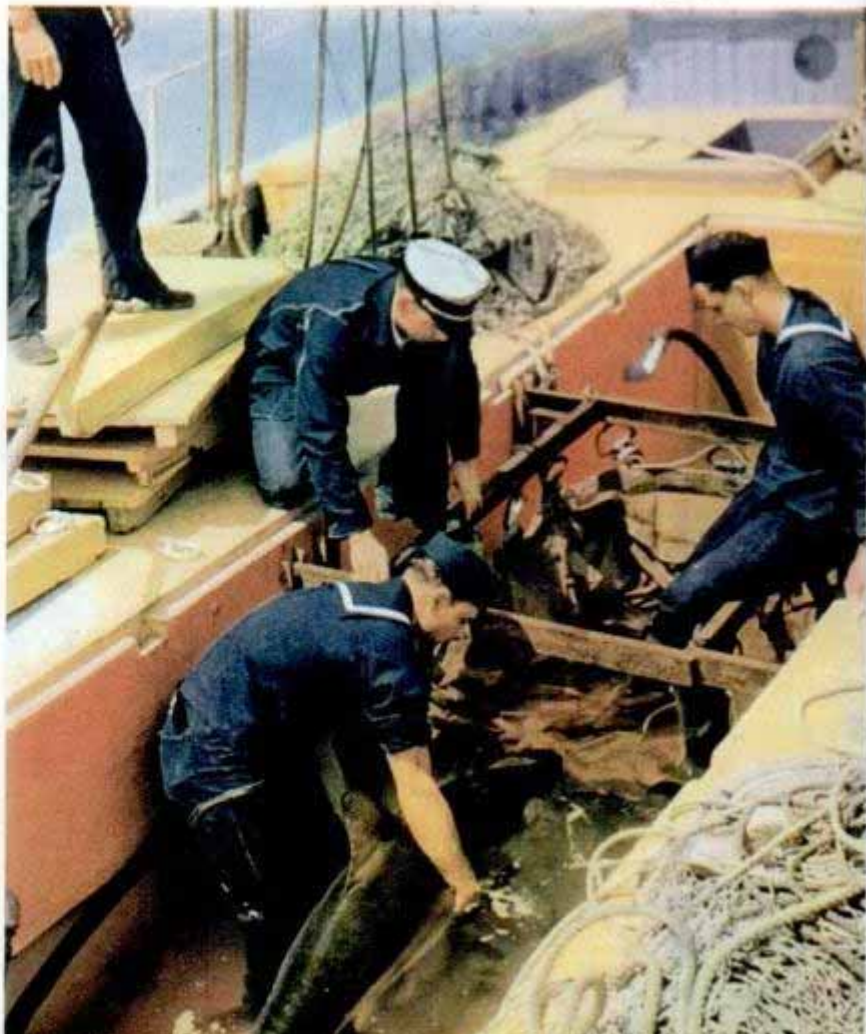

at the Marine Studios, which has the only porpoises in captivity, was that the porpoise, which is a mammal, was capable of making sounds. During the first week or two of captivity all specimens whistled constantly and swam about the tank nervously. After they became accustomed to the tank, however, the whistling was heard less frequently and the sound apparently served as a method of communication. The porpoises seemed to use variations in the whistling to indicate different emotional states. Usually when one or several would chase a live fish, all would be whistling excitedly. When any disturbing object, such as a net, was present, this was true.

187  
Porpoise literally stands on end (right) to take a mullet. Big fish arriving at studios (bottom, left) in canvas hammock is deposited in tank by a boom. Releasing specimen (right) in receiving tank.

K. 351

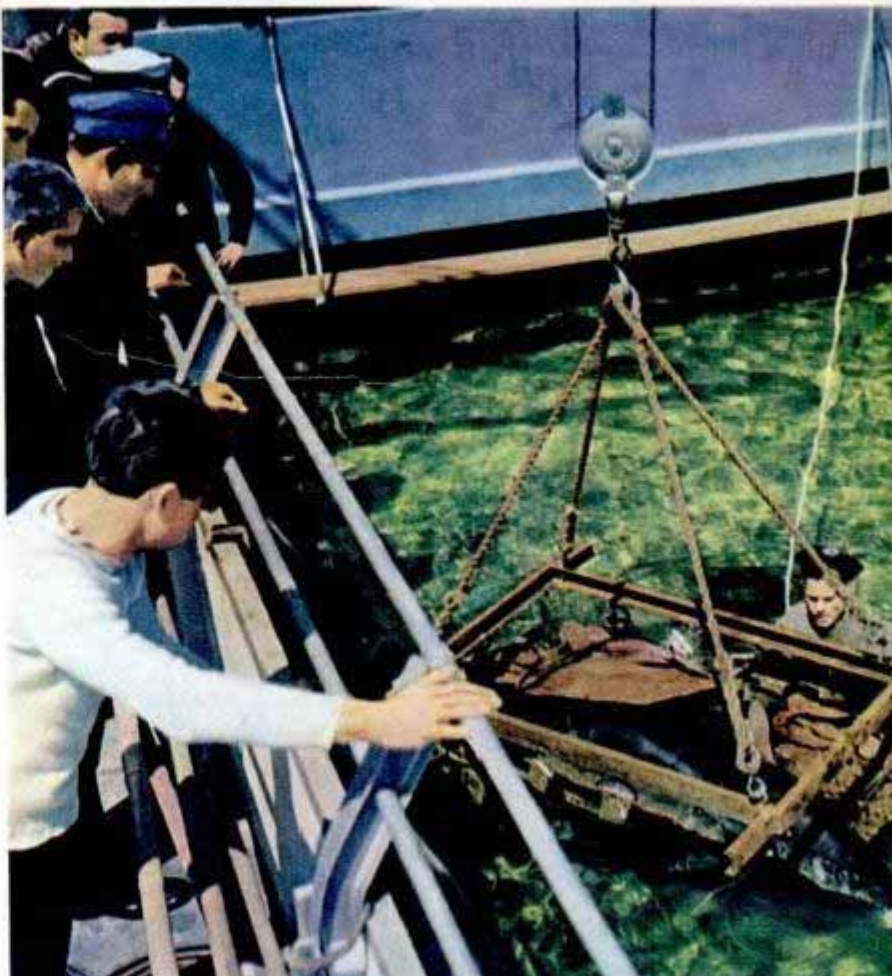



K351

Once it was necessary to move a mother and a daughter porpoise from the rectangular tank into the circular one through a shallow connecting tank. The parent was netted and moved through the shallow connecting tank. The water level was then lowered in order to catch the youngster. The two remained in their respective tanks, close to the wire-mesh gates that separated them from each other, the young one whistling madly and the parent answering frequently. As soon as the water level in the two tanks dropped low enough, so the connecting tank was dry and the watery, and therefore sound-conducting, connection between the two tanks was severed, the parent left its position at the gate and swam about, even chasing live fish. The young one persistently whistled as loudly as ever, but the parent never whistled again after it was unable to hear the young one.



The shark, which has a bad reputation, doesn't always turn over to bite its prey, but only when it happens to approach from below—and that's the only position in which it can snap its ugly looking teeth on the prospective meal. In addition, the studios' staff has found that while the shark is extremely treacherous, it isn't as black as it is painted. Frequently the shark goes a week without feeding, never bothering other fish although many times some of the 50,000 specimens in the two tanks could be snapped up without effort. Attendants have noticed, too, that smaller fish seem to sense feeding time for the big fellow, scurrying for cover before he begins foraging. Sometimes, however, a shark breaks his fast unexpectedly, as one did not so long ago. Before attendants could do anything to save the victim, the shark had snapped up a spotted ray about five feet long. One reason for



Porpoise picking dainty morsel off bottom (top); a big turtle comes close to porthole to scrutinize cameraman (center), and diver using vacuum cleaner on tank bottom. One of the hardest problems the builders encountered was that of filtering the water sufficiently to remove debris without also taking out tiny animals and plants necessary to feed some specimens.

K 35 /  
the shark's decorous behavior probably springs from the fact that all the fish are kept well fed, thus lessening the inclination, and necessity, for gobbling up the other fellow.

Satisfying the hunger of the studios' big family is no small job, either, because an adult porpoise consumes twenty pounds of mullet per day and others of the larger species eat proportionate amounts; thus it is no surprise to learn that the management keeps 50,000 pounds of mullet, frozen in blocks of ice, and 25,000 pounds of shrimp in the Marineland "pantry." A diver, who descends into the tanks frequently, plays the role of waiter, feeding mullet by hand to some of the big fellows, such as the porpoises, jewfish and the huge turtles. The diver carries the mullet in a wire-mesh "dinner pail," and, in case one of the sharks should become an uninvited guest at the party, he also carries a circular wire shield to protect himself. That didn't prevent a shark ripping the trouser leg off the diver upon one occasion, however.

An old tale about porpoises purposely helping to bring a drowned person ashore was exploded at the studios, as well as in Virginia Capes waters where photographs were obtained of two porpoises working for dear life pushing a water-soaked ship's mattress a quarter of a mile from deep water to the beach. It is not unusual at the studios to see a 400-pound porpoise playing a practical joke on the other specimens, such as rooting a 200-pound turtle from its place among the rocks and shoving it up and down the length of the tank. A porpoise will amuse itself for long periods by playing

Maneuvering a big fellow into well-stern of fishing boat (top); air view of Marine Studios with the Atlantic surf visible at upper left (center), and diver feeding a porpoise (bottom). In aerial photo, note the rectangular tank and the circular tank, separated by receiving tank in which specimens remain until found healthy.

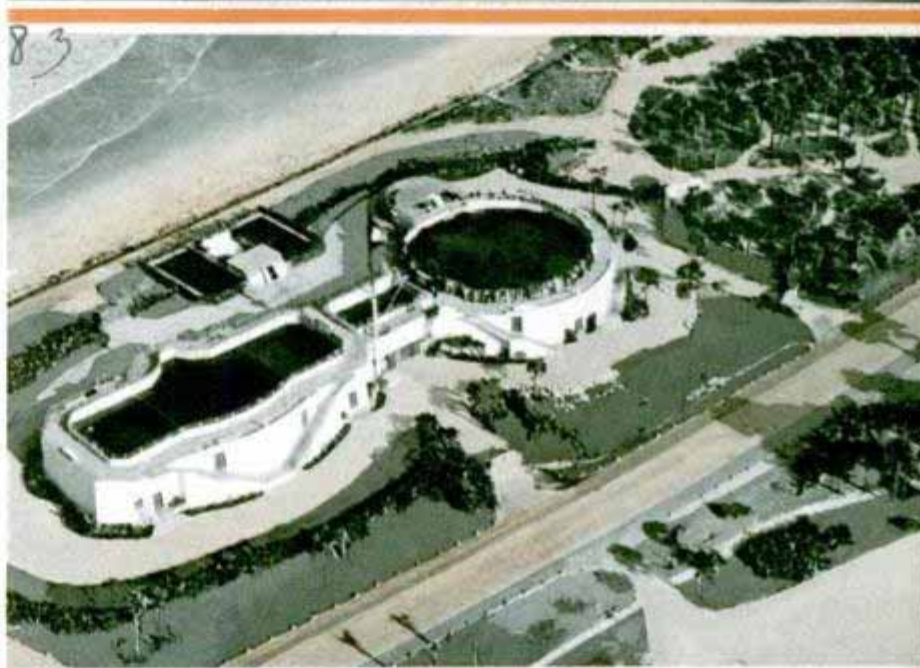
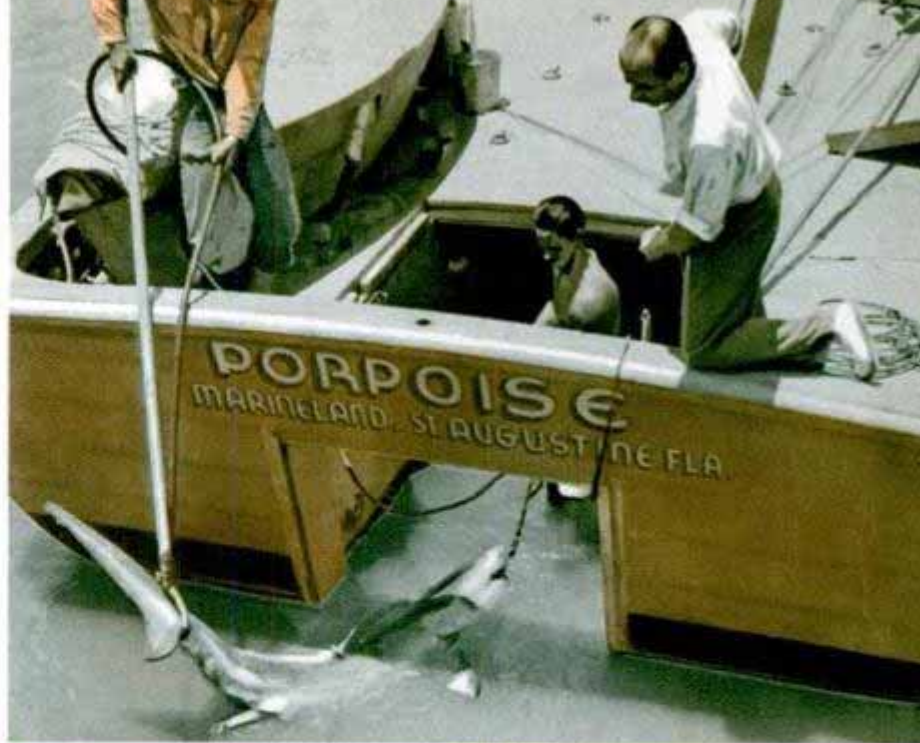



7357  
184.  
Remarkable photo of 500-pound jewfish and diver (above).  
Closeup of seven-ton coral reef in one of the tanks (below).  
Note the octopus in foreground. Small fish seek protection  
from enemies in this giant reef.

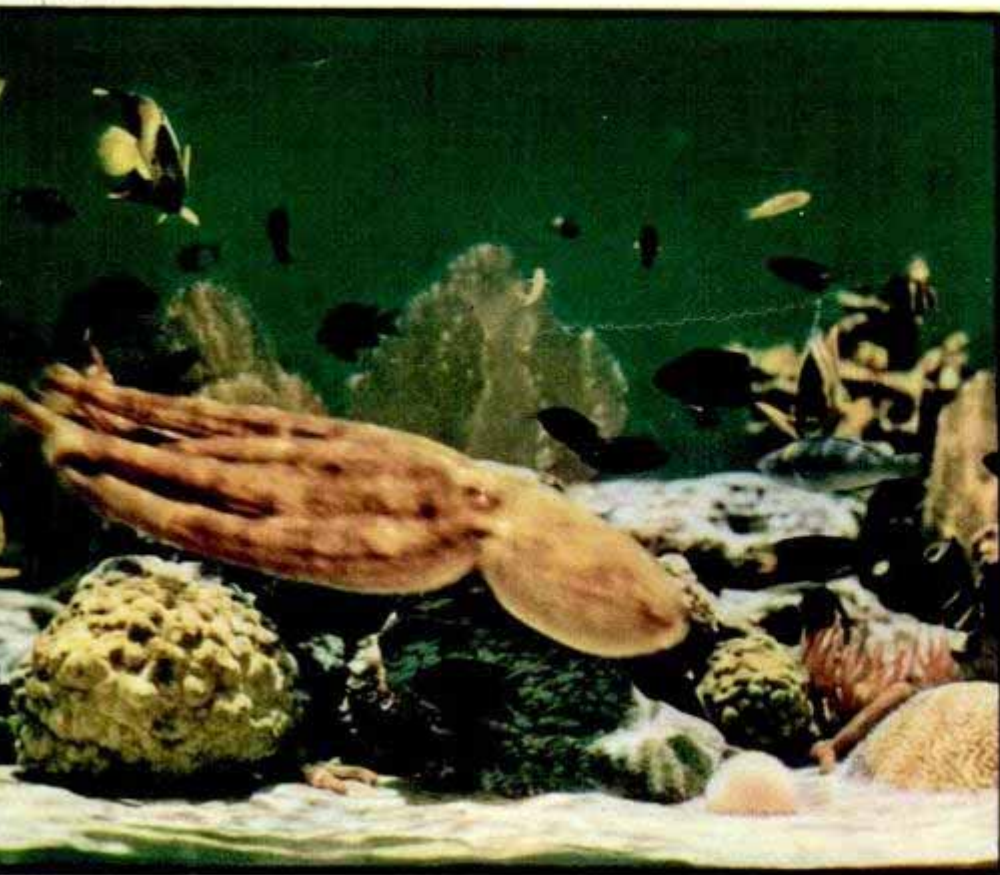

with large rubber balls, carrying a ball to the bottom in its mouth, releasing it and racing the ball to the surface.

It requires only two weeks to tame a porpoise so that it will accept food from the hand of attendants. If the food is held above the water, the porpoise will leap higher and higher, occasionally clearing the surface with its tail. It does not take a running start for a leap; instead it starts from the surface and drives itself steadily upward with powerful sweeps of the tail, enabling it to maintain a vertical position, standing on its tail, for several seconds.

Professor Laurence Irving of Swarthmore College is among scientists who have visited the studios to study denizens of the tanks. (Continued to page 128A)

# Airplane Fuselage Woven of Plywood Strips

Thin strips of plywood woven like a basket form the fuselage of a small airplane which may be the forerunner of a line of low-cost aircraft. The wood built into this two-seat monoplane cost exactly \$23. Materials for the jigs and forms cost \$10.20. Each plywood strip stresses the other until every inch of the fuselage and wing offers full cantilever construction. Wooden planes are more easily designed and built, there is more wood than metal available, and weight for weight, wooden ships provide a stiffer wing and smoother surface for aircraft up to 60,000 pounds gross, the in-

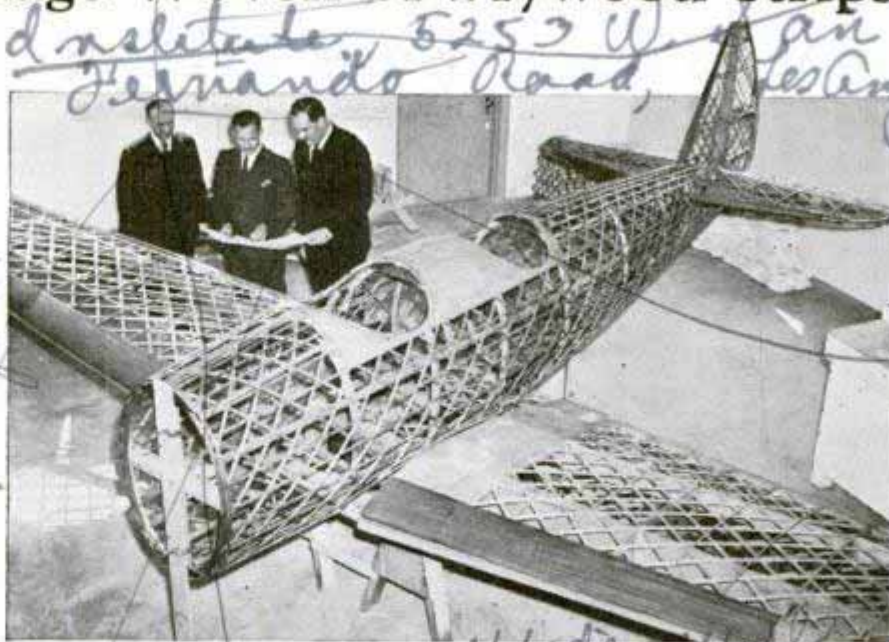

Here is the basket-weave airplane, woven of plywood strips; the wood in the plane cost twenty-three dollars. Any woodworker could build it

Curtis L. Bates Chief Engineer  
 vendor asserts. Further, the labor market is unlimited since any woodworker could be taught to build plywood planes.

# U. S. S. 'Indianapolis' Model Built to Scale by Craftsman

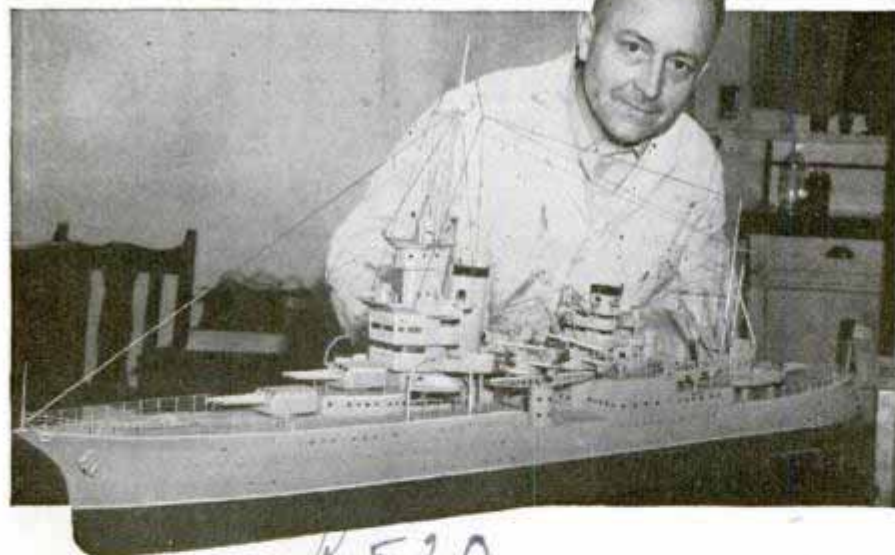

While the cruiser U.S.S. "Indianapolis" was at anchor with the fleet in Los Angeles harbor, Claude A. Lehman completed a model of the ship on a scale of three-sixteenths of an inch to the foot. An instructor in metal arts at Long Beach, Calif., Mr. Lehman has constructed as a hobby many miniatures of the United States Navy's fighting ships.

Ship model builder's latest achievement, a scale miniature of the cruiser "Indianapolis"

# Screwdriver Has Replaceable Bits to Fit Screws of Five Different Sizes

Screwdriver bits of five different sizes fit into a tool holder developed for the home or shop worker. Since the bits are replaceable, the tool is especially valuable for driving case-hardened screws where there is considerable wear on the driver.



Fitting a new screwdriver bit into standard holder

Send stamped, addressed envelope to our Bureau of Information for name of maker of any device described in this magazine.

X 606

# 'Self-Healing' Gasoline Tank Seals Holes Made by Bullets

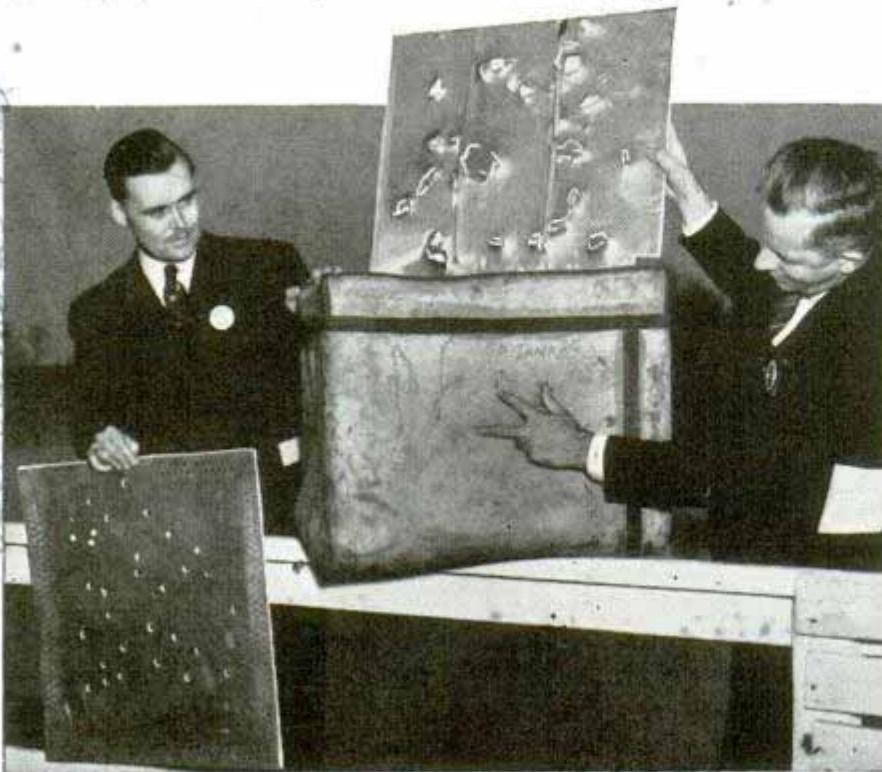

Examining bullet-pierced aluminum alloy shielding and the self-sealing gasoline tank which lost little gas when fired on thirty-two times

Able to seal itself when punctured, a gasoline tank intended for war airplanes automatically stops gasoline leaks through bullet holes. In a recent test the self-sealing tank, filled with forty-four gallons of gasoline, remained tight and lost very little gas after being penetrated thirty-two times by thirty-caliber armor-piercing bullets fired into the tank, although gaping holes were riddled in its aluminum alloy shielding.

## Universe You See Is Flat with Shape of a Watch

Virtually all the stars visible to the unaided eye are spread out in a space shaped somewhat like a huge watch, having a diameter of about 50,000 light-years and being about 10,000 light-years thick, according to Better Vision Institute. It is pointed out that this watch-like shape of the visible universe is what makes stars in the Milky Way appear closely packed together, since we are looking at that region edgewise toward the remotest stars in the group. Reaching beyond this immediate system of stars, telescopes

observe more than ninety globular clusters, each comprised of about 100,000 stars, and located 100,000 or more light-years distant. Still farther out in space are thousands of spiral nebulae, some being 150,000,000 light-years away, which means that the beam of light striking the earth today started on its journey 150,000,000 years ago.

## Giant Bomber Tires Carry Weight of Seventy Tons

Taller than many light planes, pneumatic tires, built for a seventy-ton bomber, stand ninety-six inches high. Two such tires form part of the tri-cycle landing gear, each taking its share of the landing impact and starting to rotate instantly on hitting the ground at 100 miles an hour or faster.



Eight-foot tire being examined by William Broughton, of Barberton, O., whose model airplane won national racing honors

Valent D. Martin, Baltimore, Md.  
K 573  
K 657  
630 7th Ave  
New York City  
Freestone Tire & Rubber Co.



*Isodorian Mfg Co.*

# Expanding Tube Breaks Coal from Vein Safely

*4934 S Halsted Chicago*

*Consolidated Coal Co New Mineral Mine Hebron, Ill.*

Much of the hazard of coal mining is removed by a new hydraulic mining process that applies a "squeeze play" to the coal vein. An expansible tube is placed in a hole drilled in the wall of the mine; an electrically driven hydraulic pump forces a low-inflammable oil through a hose into the tube, and its expansion under pressure breaks the coal along its natural parting lines. Around the tube is a cable braid that prevents expansion beyond a fixed maximum diameter. One of the principal advantages of this method, announced by E. I. du Pont de Nemours & Co., is its safe-

*explodes itself.*



At right, miners insert the tube into hole drilled in wall of mine; left, hydraulic pressure expands tube and will shortly break coal loose along natural lines of cleavage. Cable braid around tube prevents over-expansion



*National Standard Co Niles, Mich*

*National Standard Co. Niles, Mich.*

ty. There is no flame or dangerous gas, and no explosives are used. There is no flying rock or coal. The danger of cave-ins is minimized, since the expansion tube has practically no effect on the mine roof. Another advantage is the large percentage of big lumps of coal produced by the expansion method, a feature desirable to the coal industry. The tubes, five inches in diam-

eter and three to seven feet long, break the coal loose within thirty to forty-five seconds after being put in position.

Gasoline tax revenues of the forty-eight states reached a record of \$816,433,000 in 1939, topped by New York's \$69,693,000, Pennsylvania's \$59,584,000, Ohio's \$50,466,000 and California's \$49,795,000.

*No data*

120-334th, New York

# Super-Speed

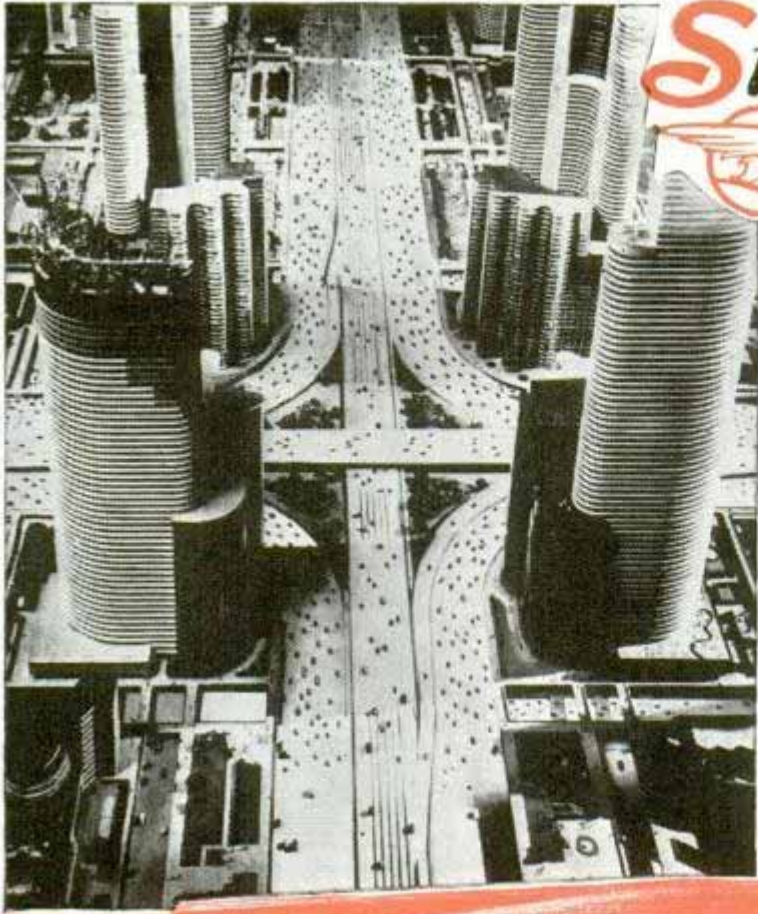

IT IS 4:15 o'clock on the afternoon of a pleasant June day in 1960. You, the wife and the children in your modest home on the outskirts of Washington, D. C., are planning to drive over for a day with Aunt Lillian in San Francisco.

You promised Aunt Lillian over the short-wave telephone that you would surely drop in for supper tomorrow night and it was good to see the happy smile on her face as she talked across the states.

With more than twenty-four hours to span the continent in 1960 at the wheel of your little old teardrop model, aluminum-alloy sedan you shouldn't be late, in the



Future highway pictures and sketches copyrighted 1940 by Norman Bel Geddes; photographs by Richard Garrison

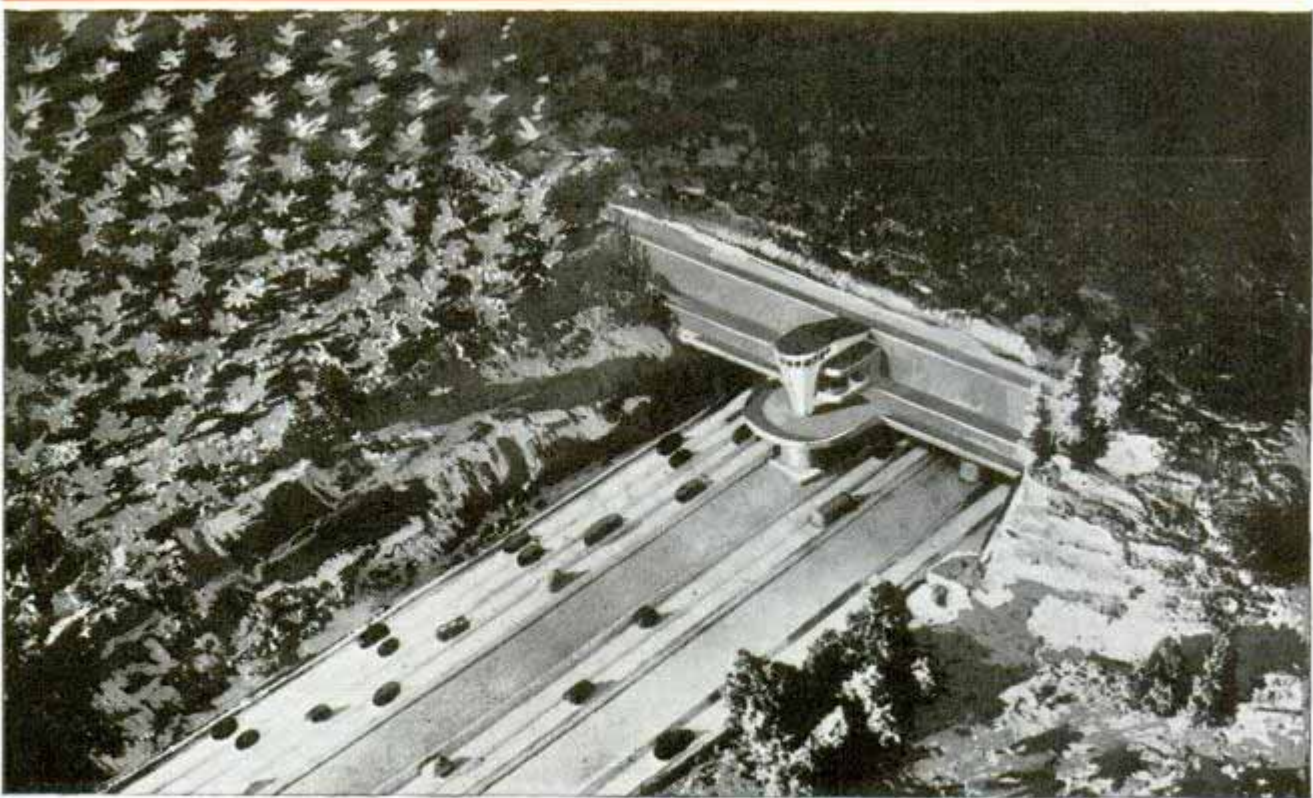

*Boulevards in the air (top), with no meeting of cross traffic or pedestrians, would permit fifty-miles-an-hour driving in heart of cities. Center, the teardrop car of 1960. Below, future transcontinental motorway enters mountain tunnel, with fifty, seventy-five and hundred-miles-an-hour lanes shown left to right*

# ROADS of TOMORROW

*50 Rockefeller Plaza*

opinion of Norman Bel Geddes, noted industrial designer and author of the book "Magic Motorways." Not if progress in highway improvement and traffic control keeps pace with the possibilities science has already envisioned.

Designing the huge General Motors Futurama traffic spectacle at the New York World's Fair, with the cooperation of scientists, highway engineers and research men from the laboratories of leading automobile companies, necessitated several years of study by Geddes into the past, present and future of automobile traffic. Boiling the mass of information down, he asserts, it is likely that by 1960—a date set arbitrarily—100 miles an hour will seem no faster than the motor speeds we now take for granted. And travel certainly will be much more safe and comfortable.

So, with the help of Designer Geddes' research, you are able to pick up the story of what is likely to come—subject to modifica-

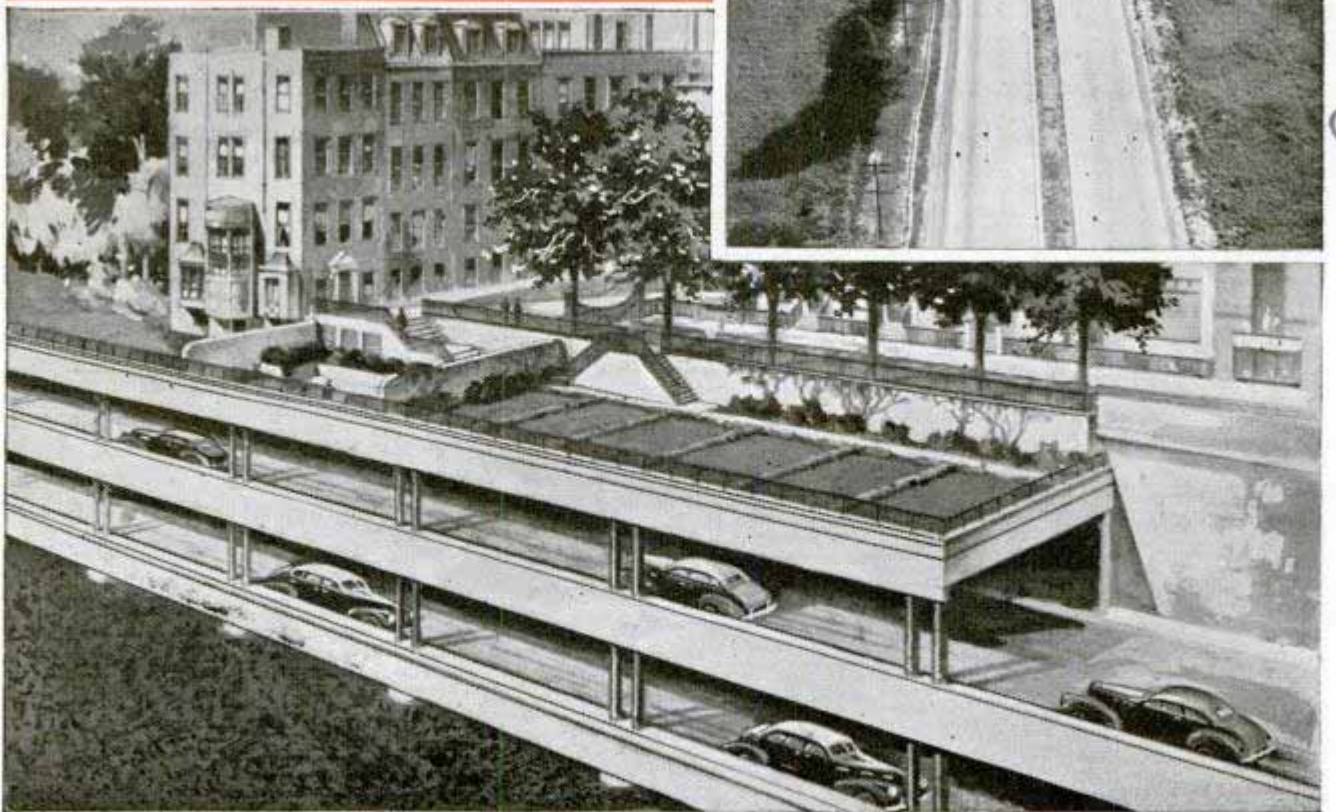
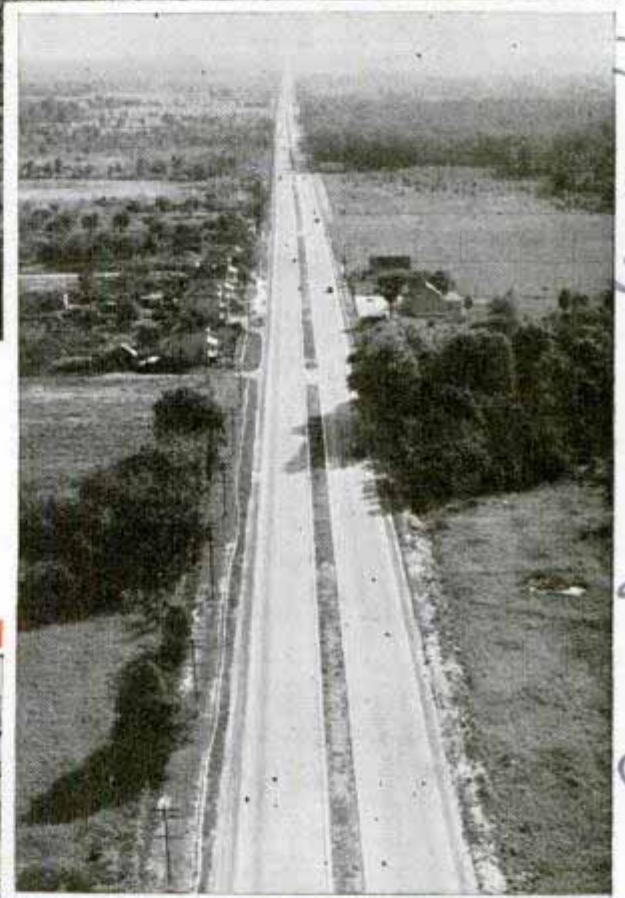
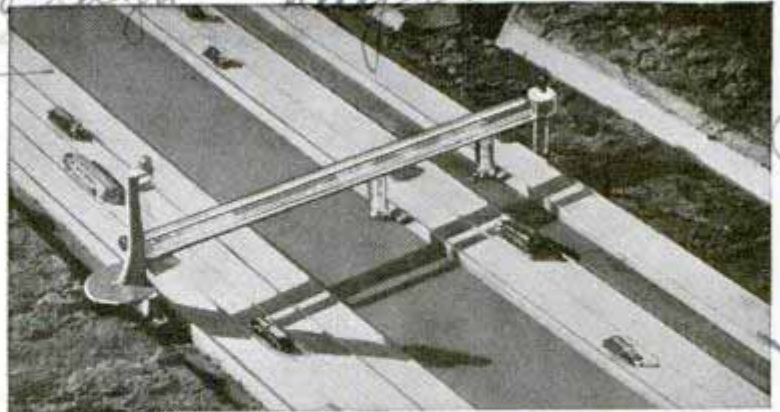

*26  
New Jersey State Highway Route  
Baltimore Pike. Princeton. New Jersey*

Top, transparent plastic control bridges at five-mile intervals would automatically control your motor and speed by short-wave beams. Two-lane New Jersey highway, center, runs twenty-seven miles in almost straight line. Bottom, two-deck East River Drive in Manhattan is to have third deck landscaped

*Dalton Square*



This beam control is simple, but important; it will regulate the velocity of your car, guide you into the traffic lane corresponding to your desired speed and keep a margin of safety between your automobile and those in front or behind all the way to California.

The family climbs in, the motor at the rear is running sweetly, and in a few minutes you are off for the motorway feeder lanes. As you bear to the

tion by developments which cannot be foreseen—and drive across the United States at a speed which leaves you breathless in contemplation right now.

While the wife and children are gathering up the few things they need for the trip, you go downstairs to the garage. The old bus is a bit dirty around the vertical fin and the right rear tail-plane surface has a small dent, but that won't matter. You examine the eight tires which have become necessary on these no-chassis models because loss of weight has reduced traction. You inspect the Diesel-electric power plant. All okay.

Now you climb into the centrally located driving seat, flick over the air-conditioning key and switch on and off the automatic beam control for a test.

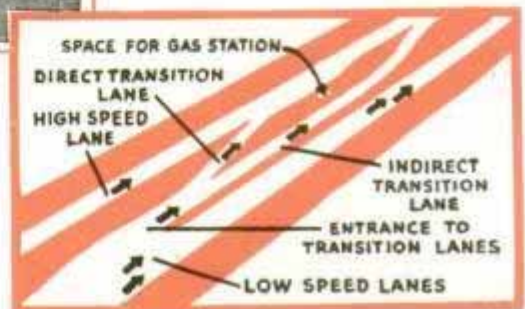

Above, scheme for transition from one speed lane to another. Below, uniform surface illumination from center curb

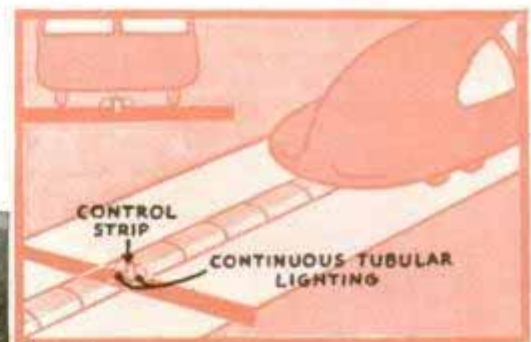

Top, traffic circle at Camden airport. Bottom, complex traffic distribution system west of George Washington bridge; note three-level crossing

right from the secondary highway at the transcontinental motorway feeder point and enter the feeder lane, you switch on the beam device and feel the automatic car control take effect. Approaching the motorway on a long, sweeping curve, the car automatically accelerates to a steady fifty miles an hour, ready to merge with the flow of traffic on the through lane.

For a moment you parallel the motorway on the feeder lane and then au-

to automatically slip into a gap in the spaced line of cars heading west. You are lucky to find a vacant space, or the speed control would have stopped you in response to the beams emanating from the transparent plastic control bridges you are continually passing under.

As darkness falls, you wonder how folks ever managed to drive, back in 1940, blinded by stabbing lamps. Ahead the motor-

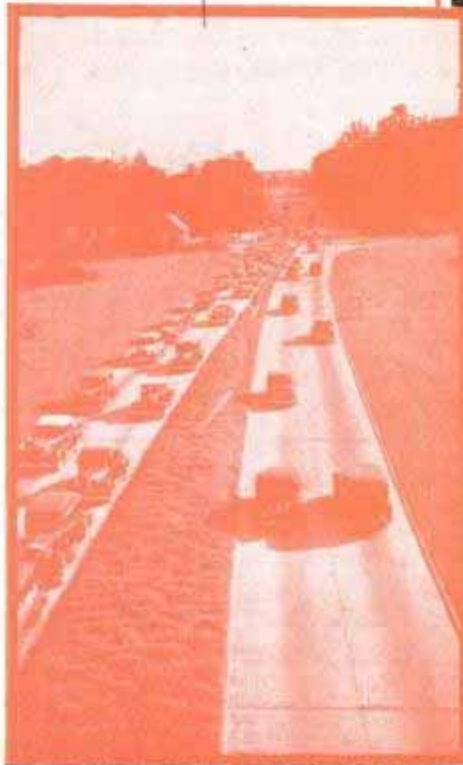

way is bathed with an even glow of light from a continuous tubular fixture raised slightly above the roadway center. A banner of illumination extends for a distance in front of your car, lighted by an electric-eye device and extinguished behind you in the same manner, so that the road is lighted only when it is being used. There is no glare; no unsightly poles or distracting flashes of light as you pass.

Your control device broadcast tells you that you are whizzing through the Blue Ridge mountains. On the left, beyond a plot of grass is the 75-mile-an-hour

(Continued to page 138A)



**Top, junction of two major arteries in the future. At left, modern divided highway in New York is jammed because of cars turning left in front of heavy traffic at grade intersection. Below, each traffic lane, divided according to speed, has a separate approach and deck on suspension bridge of the future**

## Small Wheel within Wheel Eases Maneuvering of Car



Small wheel at top of steering wheel offers an easy grip when turning sharp corners or parking the car

Parking your car and maneuvering in traffic are made easier by a new wheel within a wheel. Turning freely on its ball-bearing mount within the steering wheel proper, the small wheel offers a convenient hand grip for swinging the car around corners or backing into the curb.

## Safety Fuse in Electric Wall Plug Guards House Lights

Embedded in an electric wall plug now available is a tiny fuse that will keep your lights from going out when a defective lamp cord or appliance short-circuits. The



Tiny fuse inserted in wall plug at contact point prevents short circuit from overloading main fuse

little safeguard burns out before the main fuse becomes overloaded, saving you a trip to the basement or attic to replace it. The fuse is held in the plug by two clips.

## Lie-Awake Detector Tells You How You Tossed Last Night

Those who believe they do not sleep a wink all night can learn exactly how restless they are with an instrument the inventor calls a motilograph, popularly known as a lie-awake detector. A leg of the bed is fitted into a stirrup which transmits to the recording part of the apparatus every movement made by the sleeper. Next morning he will know how much tossing he did during the night and, on the other hand, what part of the night was spent in sound sleep. The average sleeper, the inventor has found, changes position from twenty to sixty times a night. The first half of the night is usually quieter than the last half, although there is a pre-sleep period of settling down, with a fair degree of restlessness, which lasts from a few minutes to a half hour.

## Double Bucket for Anglerworms Keeps Them Alive and Active



Worm can immersed in cold-water jacket keeps life in the wrigglers by condensing moisture within can

Built like a double boiler but serving as a cooler, a fisherman's bucket keeps worms lively over a long period. The worm container is built into a large bucket, or water jacket, that is kept filled with cold water. This causes condensation inside the worm container, bringing in fresh supplies of oxygen and producing moisture.

College of Engineering,  
Lexington, Ky.

# Six Auto Engines Team as Single Power Plant

By harnessing six automobile engines as a radial unit driving an eccentric central shaft, engineers in the machine shop of the University of Kentucky have produced a multiple power unit at a cost of about \$1,500, with the efficiency of an engine selling for \$12,000. Six Plymouth motors were used, their collective horsepower being transmitted to the central shaft by means of a "spider." The six crankshafts extend to the inner side of a plate to which the engines are fastened, and are connected by the spider. At 3,600 revolutions per minute each motor produced eighty horsepower, but to reduce wear the speed was cut to 1,800 and horsepower thus to forty. With all motors working, the plant has 240 horsepower.

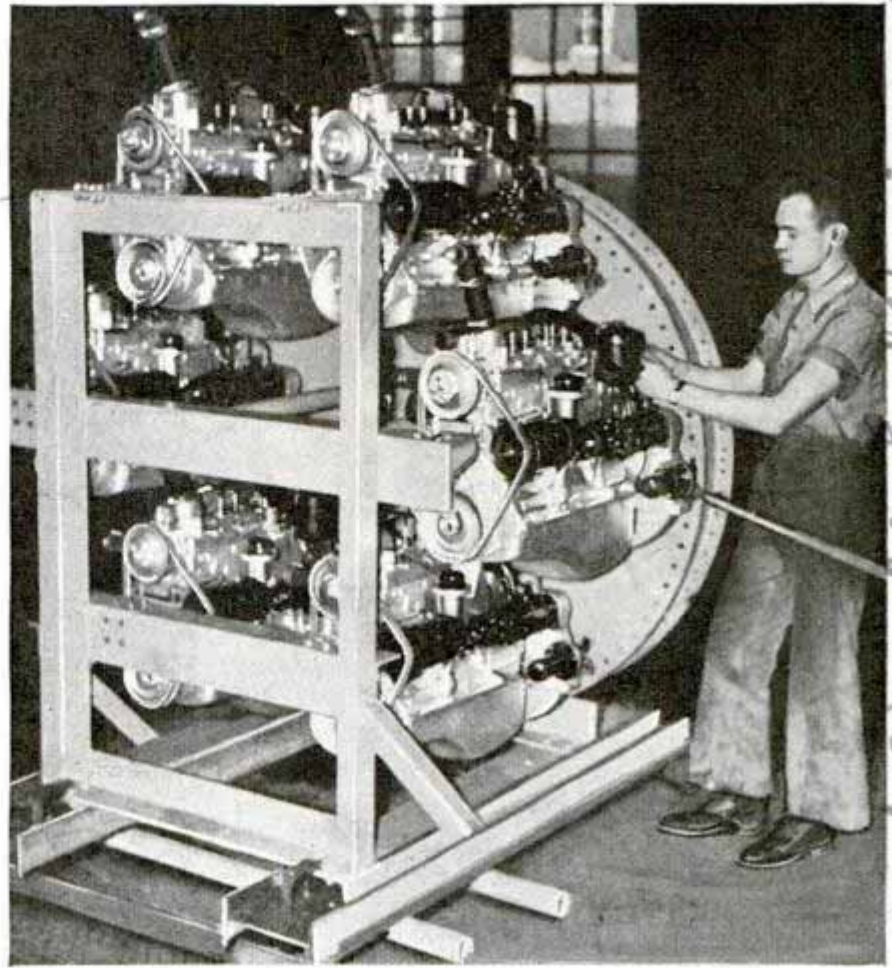

Six automobile engines fastened to a plate pool their horsepower in a central eccentric drive shaft, thus forming a multiple radial engine

Crnk Harold E. Wayne  
Box 2995, U.S. Kentucky

# Football Players Practice Kicking in Grooved Runway

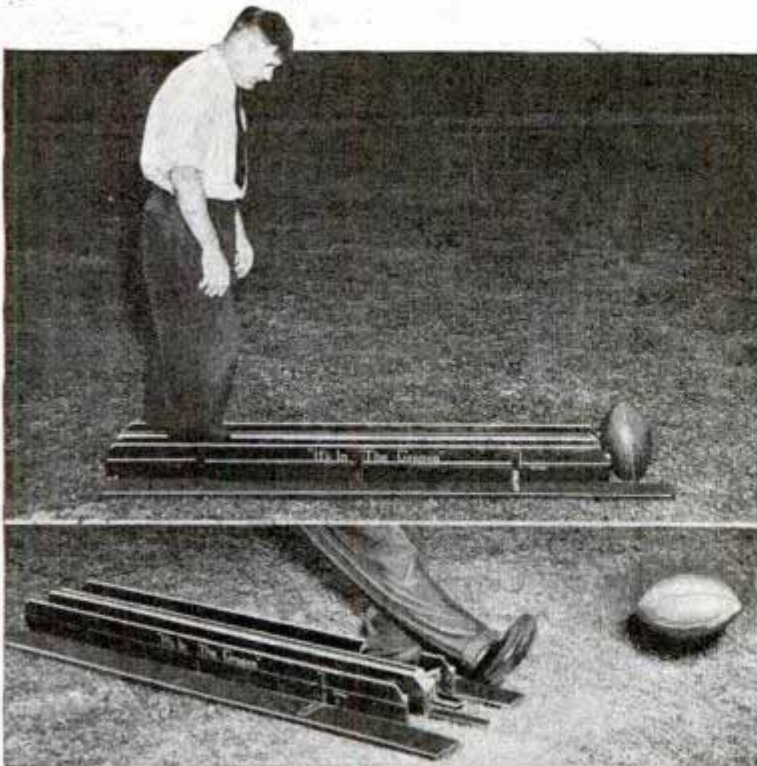

Keeping both feet in grooves, football player runs forward in practice rack and kicks the ball, as shown in bottom picture

Football place kickers are improving their accuracy with the aid of a frame that forces them to abide by the old axiom, that they should kick as though their feet were in grooves. It consists of two grooves, one for each foot, teaching the player to step straight ahead and to time his steps so he will kick at the right moment and in the correct standing position. At the end of one groove a football is set at the desired angle for place kicking, and a block is used in the opposite groove as a stop for the other foot. The ball and the block may be placed in either channel to accommodate right or left-footed kickers. Inexperienced men have attained ninety per cent accuracy in actual play by training their feet to stay in the groove naturally.

Willard W. Peterson,  
W. Lee and Co. 28 Muladwin St.

# WHY NOT

ARE you wearing yourself out doing things the wrong way?

On scores of everyday tasks, lugging trunks, sweeping the basement, shoveling snow, do you expend energy needlessly and fatigue your body out of proportion to the work you've done?

If you do, take a tip from Wallace Rosenbauer, noted sculptor, and acquaint yourself with the mechanics of the body, its functions as a weight-bearing, weight-lifting structure, and you won't waste so much time and energy doing simple jobs the hard way. A working knowledge of the engineering principles governing the human body is the key to conserving energy and eliminating muscular strains.

Were it possible, through the eyes of an engineer, to look beneath our skins, Rosenbauer explains, we'd see how inept

many of us are in handling this, the most functionally varied machine ever conceived. We would be able to see how a mechanical

*Below, the hard way to move a trunk, its weight on knees hampering movement. Top, the professional way, started from kneeling position, one hand holding burlap strip. Lower left, easy way using back and leg muscles*



*Wallace Rosenbauer*



9 E. 46 St. Kansas City, Mo. 8/2/40

# TRY *the* EASY WAY ?

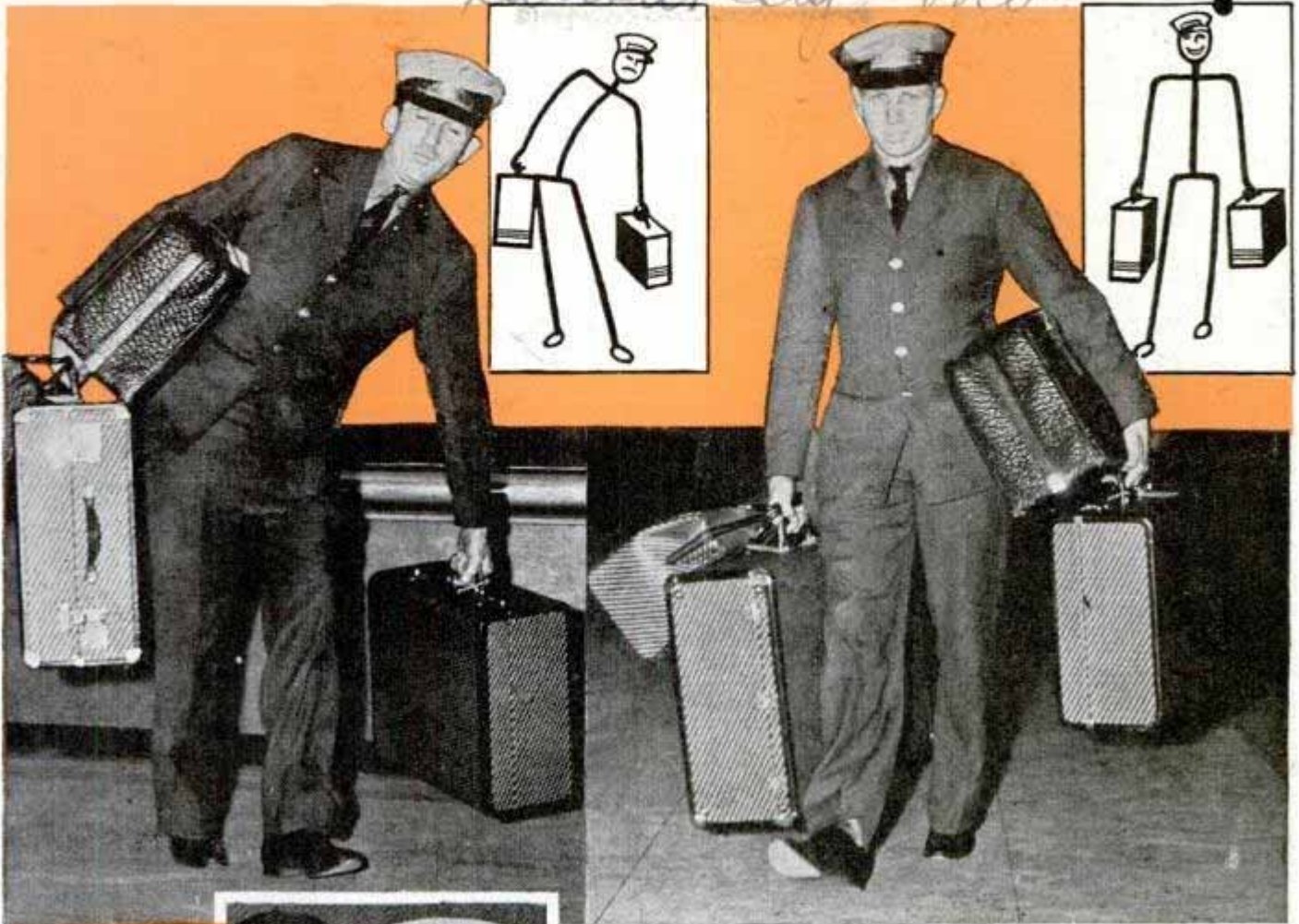

*Above (left), with load unbalanced the body must work harder; (right) movement is free and natural with heavy load properly balanced. Practice balance by putting on socks while standing (bottom). Diagram of foot shows how arch distributes weight*

force operates on the body the same way it does on any other arrangement of weights, levers, and supports; how by slumping instead of sitting in a chair we tax our strength more than if we were walking, and how by using our arms instead of our backs in lifting a heavy object, we're sending a boy to do a man's work.

Getting out of balance is our chief difficulty, the anatomical authority says. The shop worker who miscues in hammering a nail is guilty of the same error as the golfer who slices his drive; he's out of balance, so the full impact of the blow hits at a point off dead center with lamentable results.

The most telling blow in a fight is the one a boxer gets across when he has his weight perfectly balanced. On the other hand, the shock from a hit made from an unbalanced position, as from the heels, shoots through the fighter's body at angles, whereas a properly delivered punch is continuous from fist to feet.

The reason Rosenbauer gives for this is that all

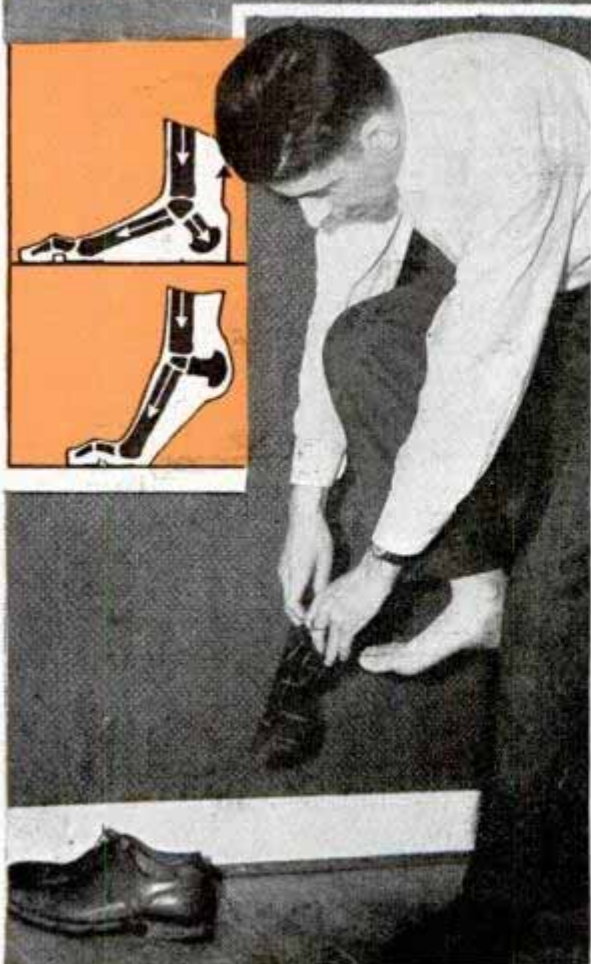

*4511 1/2 W. 46th Blvd. - Kansas City, Mo.*

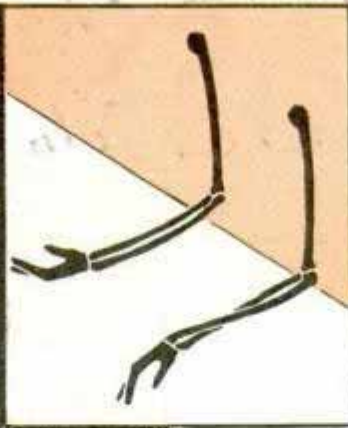
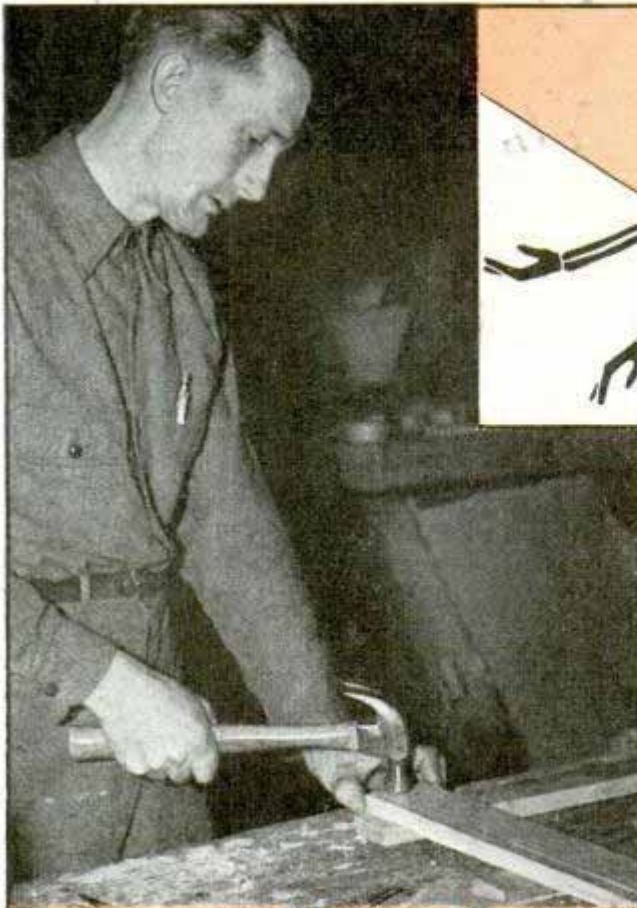

the bones and actions of the body are curved. "Your arm," he states, "if left to itself will assume a curved pattern from hand to shoulder even with the elbow flex. The design of the bones is such that there is a continuous curve directly through them. There's one position where that curve is best adapted to a given job and in any other position there will be not only extra

muscular tension but a corresponding loss of power."

A defective posture can be a constant drain on our energy because lack of balance in any structural part of the body results in habitually strained muscles. Standing perfectly still without straining is a difficult job, Rosenbauer points out, because inertia and gravity tend to unbalance the various weights of the body and we have to set up a counter tension to offset them. Strictly speaking, however, this

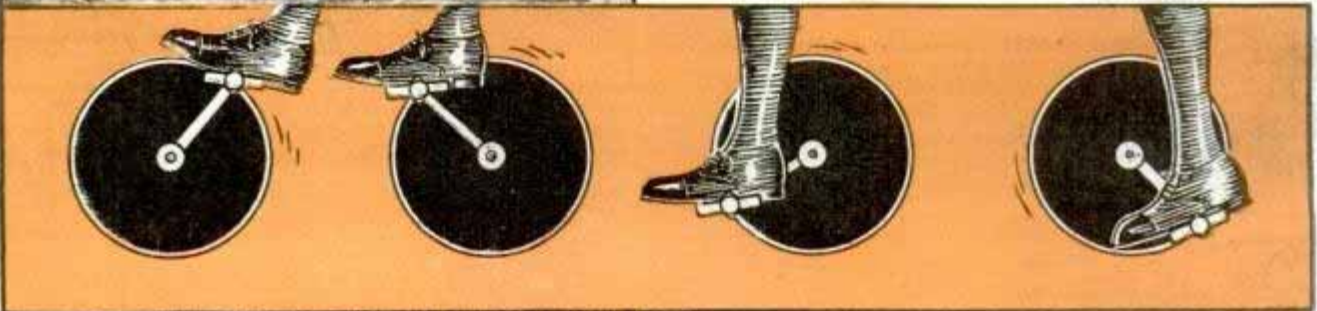

*As in golf, the carpenter (top) must let body move easily; with body rigid (bottom) hammer is out of control. Drawing shows how curve of arm changes for leverage in lifting or setting down an object. Center, proper anking is key to effortless pedaling*

rigidity is unnatural to the body, for muscles cannot be held contracted for long without tiring.

The human body is built on a slightly curved, upright column with accumulated load concentrated on a narrow base (pelvis), whence it is distributed through only two supports to the ground. The head, chest, and pelvis—the bone on which the spine rests—are the three heaviest weights and by standing incorrectly, carrying the head or chest in a manner not in keeping with the design of the body, these bony structures will be thrown out of balance at their joints, and the muscles must carry these weights off center, placing unnecessary strain on them. Muscles are for moving bones, not supporting body weights, which is the skeleton's job.

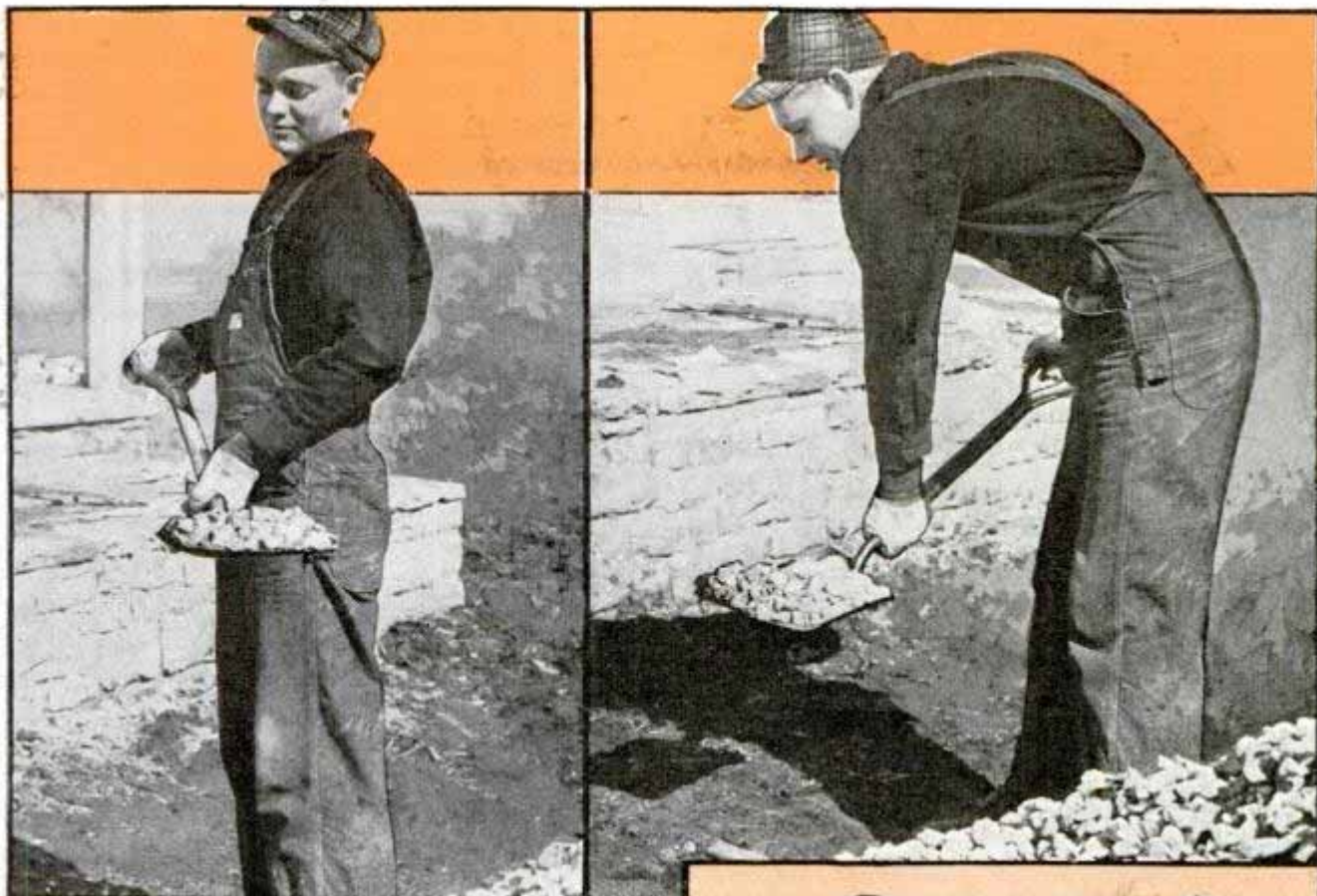

*Shoveling with arms alone (above), straightening the back each time, tires the worker quickly. It's better to balance the body and use arms pendulum fashion (upper right). Diagram shows mechanical forces in body, lines representing the pull of muscles*

Apart from resisting gravity and providing a framework for the body weights, bones serve as joints of leverage for the muscles. The sculptor likens a muscle to the spring on a screen door: It can only pull two ends together by contracting. When you crook your arm, for instance, here's what happens: the bicep, tied to the shoulder bone at one end and a tendon at the other, receives the impulse from the spinal cord via the nerve, and contracts. Contraction causes a pull on the tendon, which moves the bone in the forearm called the radius. To straighten the arm out, a second muscle, the tricep, gets the assignment. So it is with the two hundred other movable joints in the body; two or more muscles work at each of them.

"The body," Rosenbauer explains, "stays together and operates by opposing muscular tensions. From the front (or back) the body is bisymmetric on its vertical axis. The spine can curve slightly and the legs (with the feet) can rotate outward and bend at the knee and ankle, but the body is not well adapted to side movement without twisting, which brings the long curved forms of the side into play.

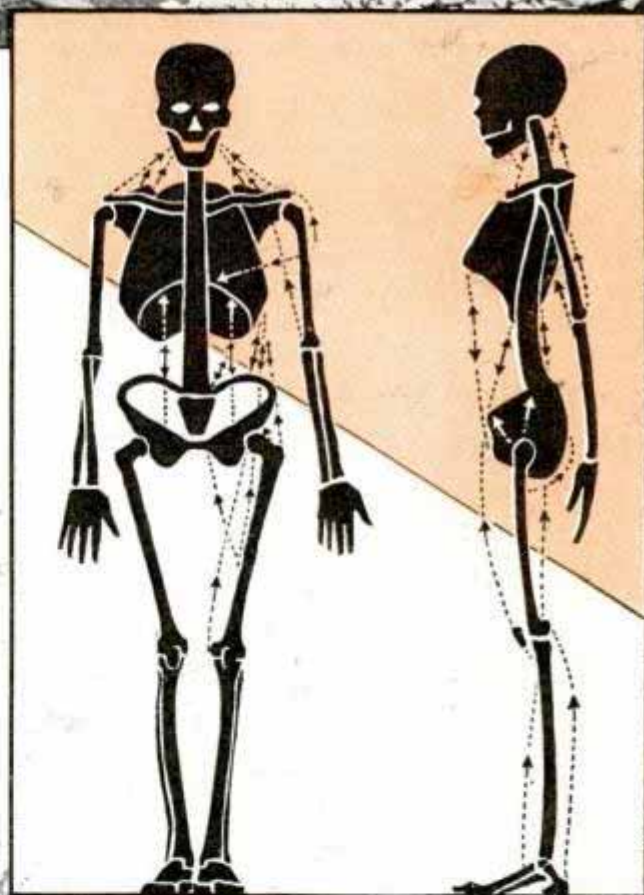

"From the side, the forms of the body are two long component equal curves, one for the legs, one for the torso. If you bear in mind the extreme flexibility of the smooth-working hinges and ball-and-socket joints by which the rigid forms of the body are joined, you realize the im-

(Continued to page 125A)

K 524

### Four Lights for the Darkroom Provided in Single Fixture



To change colors of this darkroom light, boxlike insert slides out and is turned to another "window"

Four different lights for the photographic darkroom are provided in a safelight just brought out. Box-shaped, an insert which slides in and out of the lamp chamber has four unbreakable plastic filters; one red, one green, a third orange-green and the fourth shedding a diffused white light for examining negatives.

Alfred S. Green, Chicago

Cambridge

tute of Technology scientist that it's a mile-a-minute spasm spraying minute droplets from the nose and mouth at "muzzle" velocities as high as 150 feet a second, or nearly two miles a minute. Prof. Marshall W. Jennison found this out by taking ultra-high speed photographs stopping a sneeze at its climax. The pictures showed thousands of droplets varying in size down to a diameter of 1/250 inch. Scientists are studying the responsibility of the sneeze in spreading germs of respiratory diseases.

Public Health

### Plastic Sun Shields for the Eyes Are Safe for Sport or Driving

Protection from glaring sun and bright lights is provided by eye shades, worn like glasses, which are made of lightweight and non-breakable Tenite plastic and contain no glass. They may be adjusted to shield the eyes against glare from any angle, the



Eyeshades made of plastic have up and down adjustment to shut out glare, yet permit desired vision

Eye shade Corp. of America 3746 Prospect Ave. Cleveland Ohio

### High-Speed Portrait of a Sneeze Stops Mile-a-Minute Spasm

If you've never "clocked" a sneeze, consider the report of a Massachusetts Insti-



This is how a sneeze appears to high-speed camera

nosepiece being of soft rubber and comfortable to wear. Made in many attractive colors, they permit unrestricted vision and are particularly suitable for driving and participating in sports.

An artificial display of the colorful Aurora Borealis was produced at Hayden Planetarium in New York by shooting a 15,000-volt current through a four-foot glass tube from which most of the air had been withdrawn.

new York Times 2/3/40 POPULAR MECHANICS

1228 92 no. neyab

# Flying Nurses "Bail Out" with First-Aid Kits

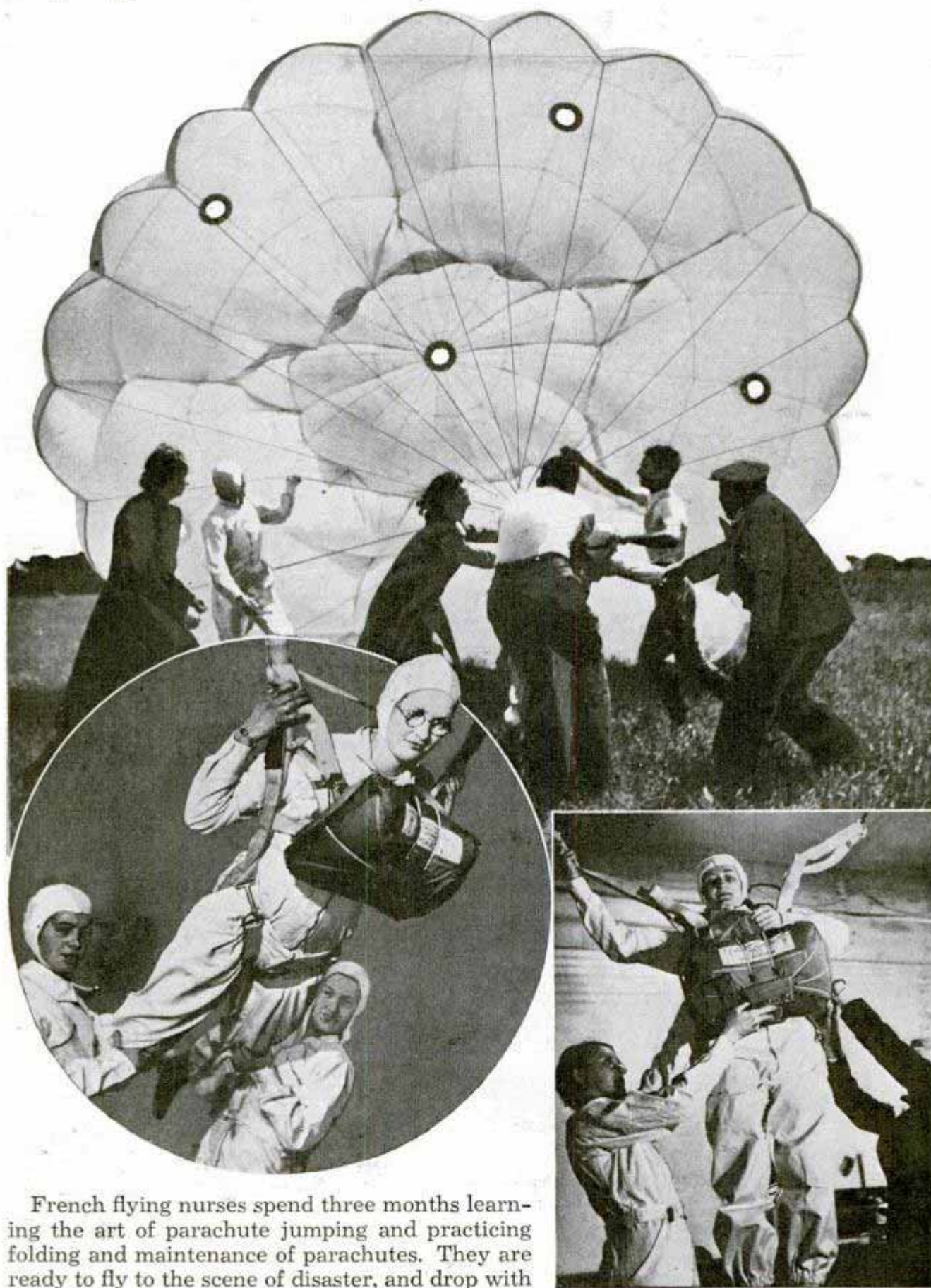

French flying nurses spend three months learning the art of parachute jumping and practicing folding and maintenance of parachutes. They are ready to fly to the scene of disaster, and drop with first-aid kits and medical supplies if no landing field is near by. Before the girls are allowed to make practice jumps from a parachute tower they are suspended from the ceiling of a parachute factory and trained in maintaining balance in the air.

*Top, learning to release parachute after landing will save the flying nurse broken bones when the emergency comes. Below, indoor practice with the 'chute. The kit, carried on the nurse's back while descending, includes part of portable operating table*

K 374

see Aug 1941 - 57  
diving

# GET INTO THE



Top, Steve Forsyth teaching proper breathing, and timing it with the kick. At the left the coach starts a pupil out on the correct stroking of the crawl



Flamingo Hotel  
Medicine Beach Fla.

## By Steve Forsyth

Associate Olympics Swimming Coach

**T**HERE is no excuse for being a poor swimmer. If you've tried in vain to become proficient, your failure probably is due to fear of the water or ignorance of how to breathe properly.

You could not swim the first time you

entered the water because you, unlike animals which swim with no difficulty on their first plunge, had an inherent fear of the water. And, although you may be able to paddle slowly in deep water, you still may be afraid. You must conquer that fear before you can become a good swimmer. One way to do that is to remain in shallow water and practice strokes and breathing until you gain complete confidence. With the increased poise and

ease will come relaxation of the muscles, which is one of the essentials in smooth, powerful swimming.

When you are ready for the next step, and I believe the most important one, toward proficiency, try this: turn your head to the left as you count one-two, at the same time taking a quick, deep breath through your mouth; then exhale through

# SWIM



*Above you see a champion in action—Adolph "Sonny" Kiefer, holder of a flock of back-stroke records. The sequence at the right illustrates the "butterfly" breast stroke, latest swimming development*

your nose as your head returns to normal position, counting one-two-three-four with the same regularity as you used in timing the intake of air.

Sounds easy—and it is easy, out of the water. But try it in the pool and you'll find it is a little more difficult than it sounds. The deep breath is taken just as your head reaches a point where the mouth is clear of the water and is expelled with the face in the water, blowing bubbles. You have to use some force to get the air out of your lungs, thus contracting the muscles of your diaphragm and getting them ready to expand for taking the next deep breath. You can't do this exercise too much because you must learn to time your respirations so that you'll be able to breathe normally while swimming. And that's more difficult than learning the mechanics of a stroke. Even after you've become profi-

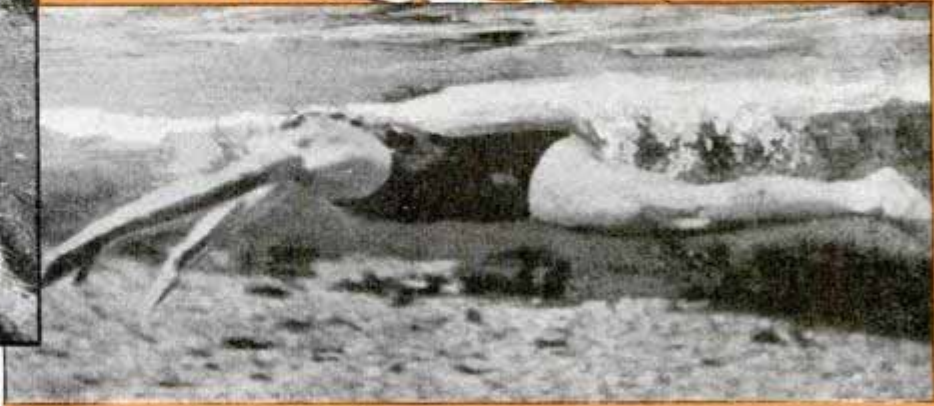

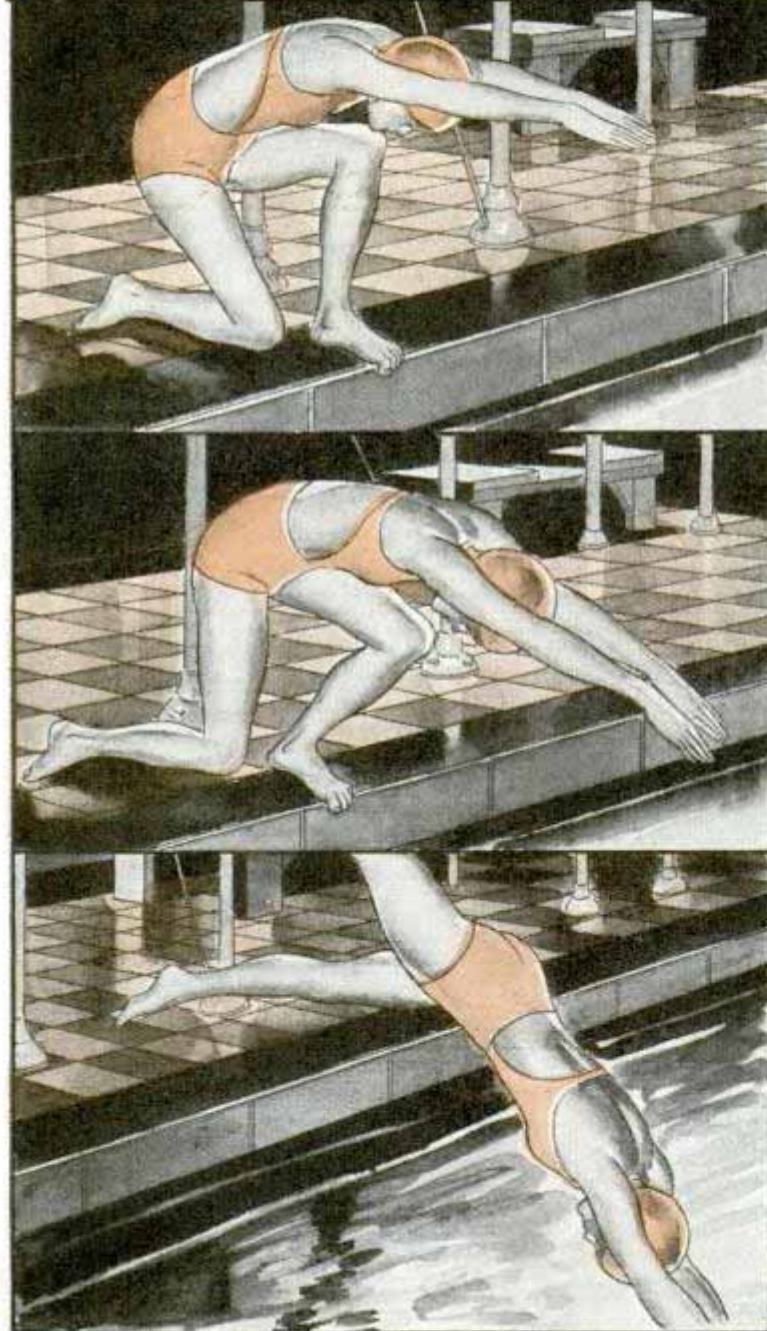

At top, Ralph Flanagan gives a demonstration of rhythmic breathing and the crawl stroke. At twenty-one Flanagan held more American swimming records than anyone else and he is one of the greatest stylists. The drawings show a simple way for beginners to dive, starting from a crouch on one knee

cient it is wise to continue the bubble blowing, practicing with several complete breaths before starting to swim.

When breathing is faulty the swimmer's muscles tighten up, due to accumulation of excessive carbon dioxide in the lungs, and the strokes are jerky. When normal breathing is resumed, the muscles relax and function at top efficiency, resulting in smooth, powerful stroking. Most swimmers do not utilize one-third of their lung capacity, and therefore their diaphragms, which might be called motors, do not function properly; every muscle is subjected to a harder pull, and endurance is minimized. That is why I maintain that proper breathing is the key to swimming.

Once you have developed lung capacity, and normal breathing comes easily in the water, you may go into your lessons, doing any one of several styles, perhaps the American crawl because it is easy to learn and is the most efficient and fastest of all styles. We learn the kick first, using an easy, free up-and-down motion of the legs from the hips, similar to swinging of a pendulum. The foot goes down about twelve inches and then back to the surface in a series of short, whiplash motions until you can make two complete kicks per second. One kick is the motion of one foot going down at the same time the other comes up. Next comes the arm stroke. Assume a position in waist-deep water, one foot forward and the other back, to brace the body and retain balance. Your right arm is placed in position, straight out in front of the right eye; the left beside your left side. Now you pull the right arm back through the water, at the same time raising the slightly crooked left arm out of the water and bringing it forward. Keep your head motionless, looking



down and slightly ahead. The right arm is pulled straight down and back under the center line of the body with the hand taking the lead and a slight bend in the elbow, as the left arm comes forward. When the right arm pull nears the surface the left arm enters the water in front of the left eye and begins the pull in a similar manner. At this point the shoulders should be virtually level, which is highly important. Practice until you can coordinate the pull and the recovery strokes with the shoulders.

Now try to swim, starting the kick and then the arm stroke and getting three kicks on each arm pull. Thus as the right foot comes down on the count of one, the pull begins and finishes on the third kick. The body should remain floating, head motionless, eyes open looking straight down at the bottom. The arms enter the water close to the head. After you've learned to combine the kick and arm stroke while holding your breath, you may try breathing. With the right arm straight ahead, the left to the rear, the head should be pivoted to the left on the one-two count, air being inhaled through the open mouth. If you find it easy to take the breath from the right side, simply have the left arm ahead and the right one back.

After the breath is taken in, the exhaling position is assumed, with face straight down in the water. The air is expelled evenly through the nose to the counts of one-two-three-four. Thus you have a complete respiration in six counts. Practice until you can exhale with ease at least twenty breaths in the water without stopping.

Now comes the important point of timing your breathing with the

(Continued to page 122A)

*Here Ralph Flanagan—whom Forsyth began developing at the age of seven—demonstrates the American crawl arm stroke. One of his secrets is his manner of maintaining shoulder balance while continuing to breathe normally*

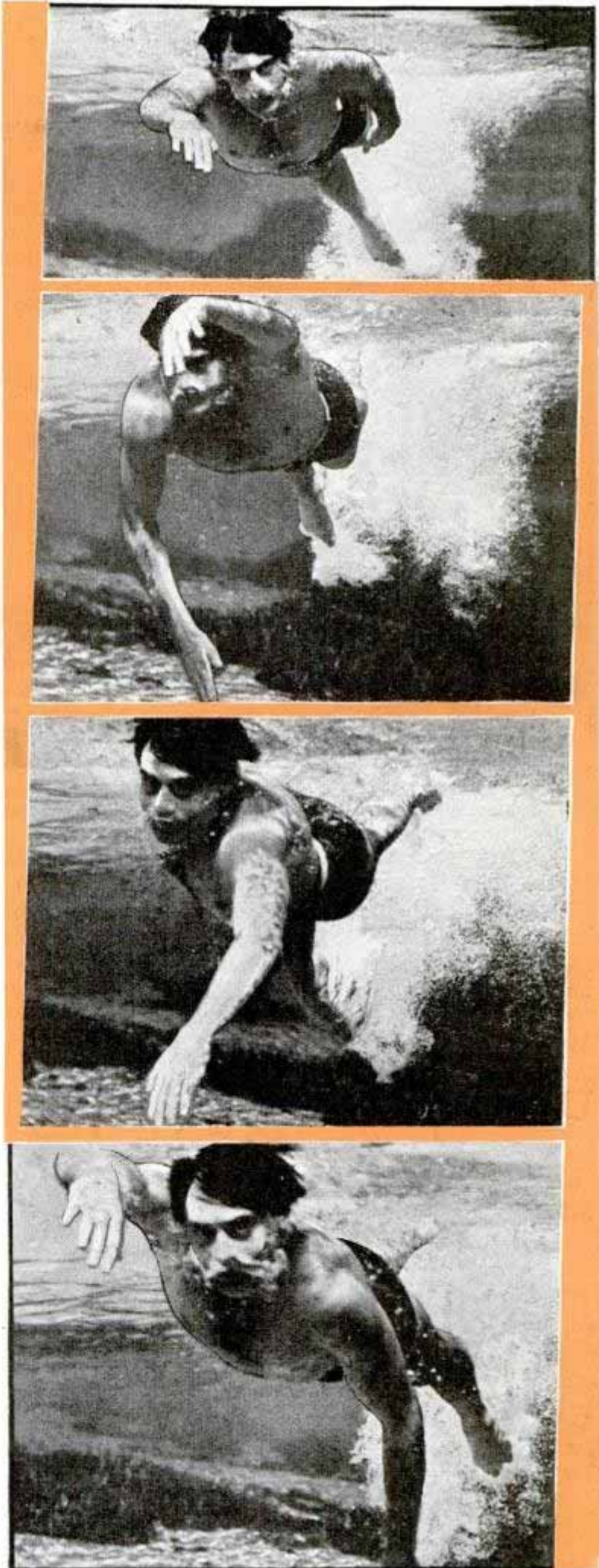

# Copy of Village Has Lights in the Tiny Homes

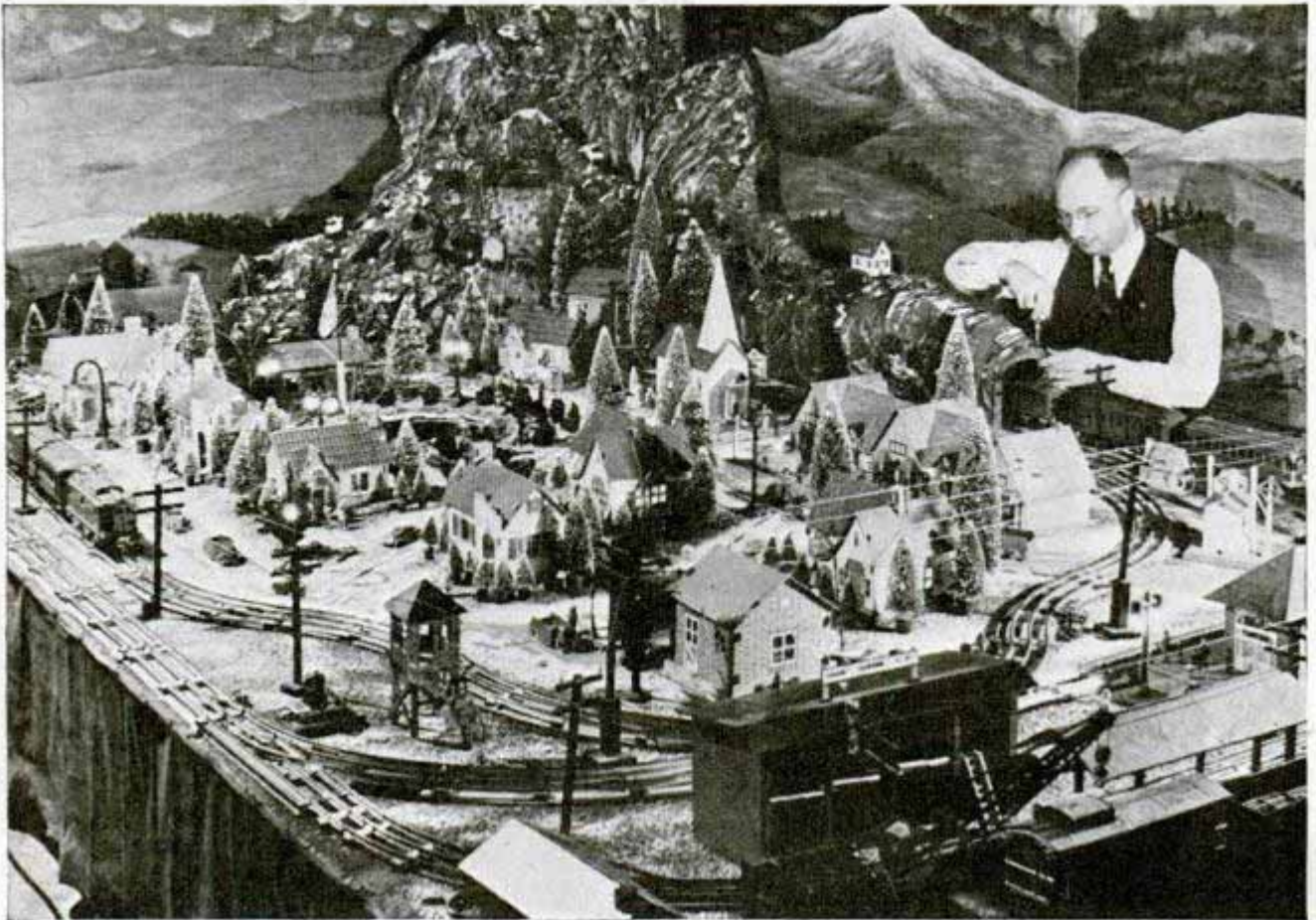

*Builder turned his model village into a reproduction of his own neighborhood by constructing miniatures of his neighbors' homes and substituting them for the tiny houses originally used for the setting*

Starting with tiny houses he purchased in the dime store, Russell L. Snyder, of Millburn, N. J., is rebuilding his neighborhood on a scale of three-fourths inch to one foot. As he completes models of his neighbors' homes, each is inserted in its rightful place and the "store" model is removed. Measuring eight by sixteen feet, the "town"

is given local color by trees and shrubbery made from sponges, streets with realistic lamps, policeman on the corner, and shoppers, mailman and delivery boy on the sidewalks and streets. From a waterfall with concealed pump, water flows to an old mill and turns a water wheel. At night the streets and midget houses are lighted.

## Uniform Spreader for Fertilizer Is Useful Also as Seeder

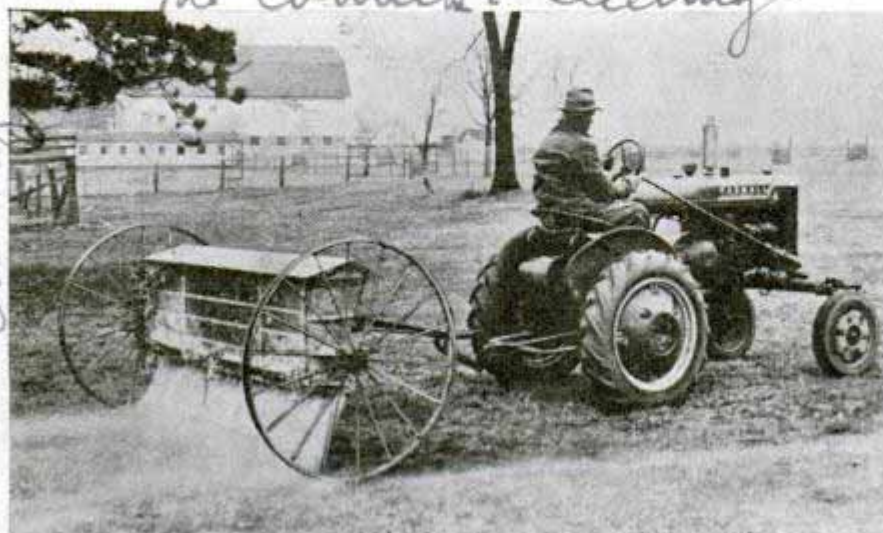

*Tractor-drawn fertilizer spreader may be used for sowing grass and clover*

Fertilizer can be spread evenly, in amounts from twenty to 2,350 pounds per acre, with a distributor having the hopper at a convenient height for filling. The quantity to be scattered may be regulated while moving. The adjustments are accurate enough for sowing grain and clover seed. A force feed assures uniform spreading of fertilizers that become damp and sticky, and a special at-

39  
 Journal of Mechanical Hardware  
 Co. 180 N. Michigan  
 Chicago

tachment helps strew ammonium sulphate. For lime, the capacity is ten to 2,350 pounds to the acre. The implement is said to be especially suited for applying top dressings to pastures, meadows and orchards.

**Life Span Gains Twenty Years Since 1870**

Babies born in 1940 can expect to live to the age of sixty-two years. Life insurance company statistics show a steady lengthening of the life span in this country, due to the better standard of living and medical and sanitary advances. The babies of 1870 had a life expectancy of only forty-one and one-half years, according to mortality rates then prevailing, but even during their lives conditions improved to such an extent that the average person born in 1870 actually lived forty-six and one-half years.

**Automobile's 'Missing Link' Is Four-Wheel Motorcycle**

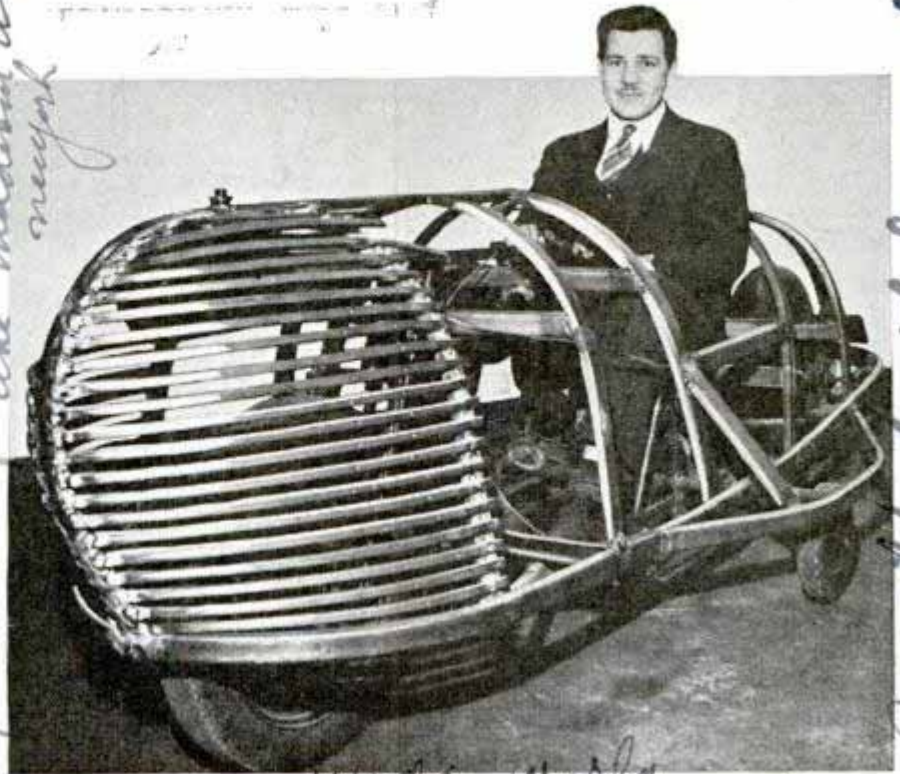

Strange vehicle on eight-foot wheelbase includes two retractable wheels to give balance when needed. The welded frame has room for driver only

What might be classed a link between a motorcycle and automobile is a vehicle consisting of a welded frame built on two motorcycle wheels and powered with a motorcycle engine. Having room for only the driver, the "quadracycle" includes two extra wheels mounted in outrigger fashion which may be retracted like airplane landing gear when not needed for balance. It travels at a forty-five mile clip.

**Football Blocking Indicator Shows Work of Each Player**

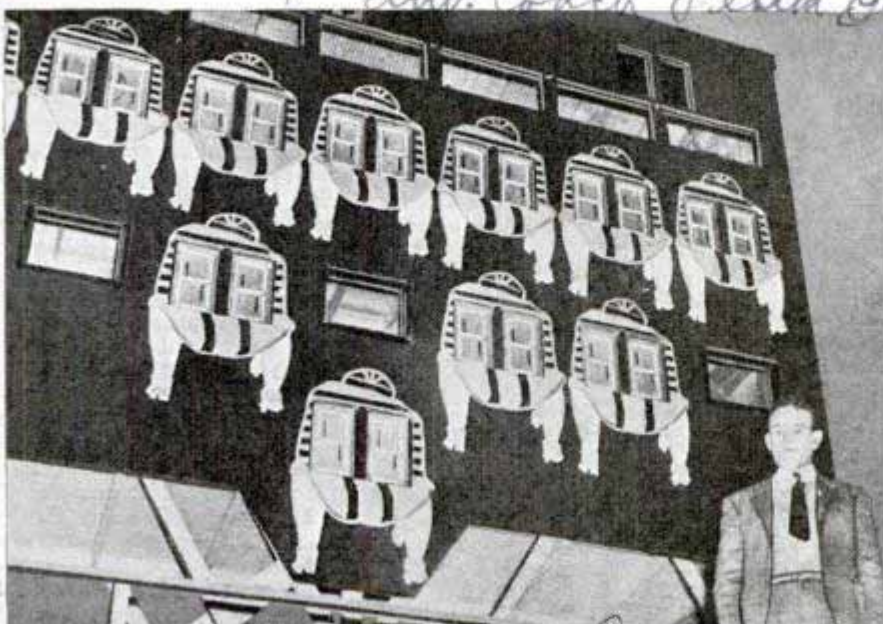

Each football player is represented by a figure in "blocking indicator"; green lights flash for those who get their man, red for those who do not

Blocking performance of each football player on the offensive side is indicated on an illuminated board after each play. The board was designed as an incentive for players to block more efficiently as well as to help spectators keep check on individual effort. Figures of eleven men are shown in team formation. If a player blocks his opponent successfully, a green light flashes on the board in his position; if he fails to get his man, the light is red.

Mr. L. L. Leubner, D.P.

K635

K529

Coach Fielder & Wright

Coach Helton I. C. Pouch

Built by J. James Sturgeon, Cleveland, Ohio

Callinger, Texas

120 6. 3 4 Feb 1934 -

# BUILDING a



*15.0.51*

Buildings located in most of the principal cities of the world are represented in miniature in two cities made to order for the New York and San Francisco fairs. The dioramas show how widespread are the branches of a large manufacturing concern. They include 326 models built from photographs, sketches and blueprints of the company's buildings in various cities



Photos courtesy Diorama Corporation  
Top, left, when completed, each tiny structure was sprayed with paint and glue and then turned over to artists who performed the final painting and touching-up before it took its place in the setting; right, at work in one corner of studio. Workman, center, is guided by photographs and topographical sketch as he assembles a country clubhouse. Lower left, steel wool is used in making trees; light trees are of swamp moss, and darker ones of rubber; note tree to right consists of twisted wire to form trunk, spreading out into branches. Variations in architectural style and size of buildings required careful planning to group them harmoniously

# CITY *to* ORDER



Composition walls are glued to building frames made of wood, above; ordinary clothespins holding them together until glue sets. Below, a study in proportions; model builder, squatting near tiny street being built for another diorama, paints dwarf buildings that form part of city built to order. X-marks on windows protect glass from breakage

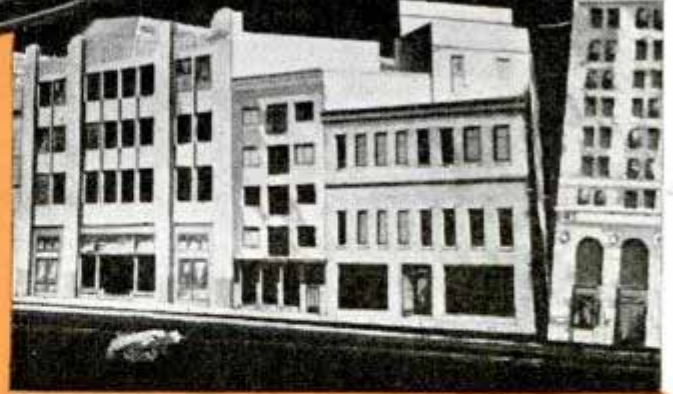
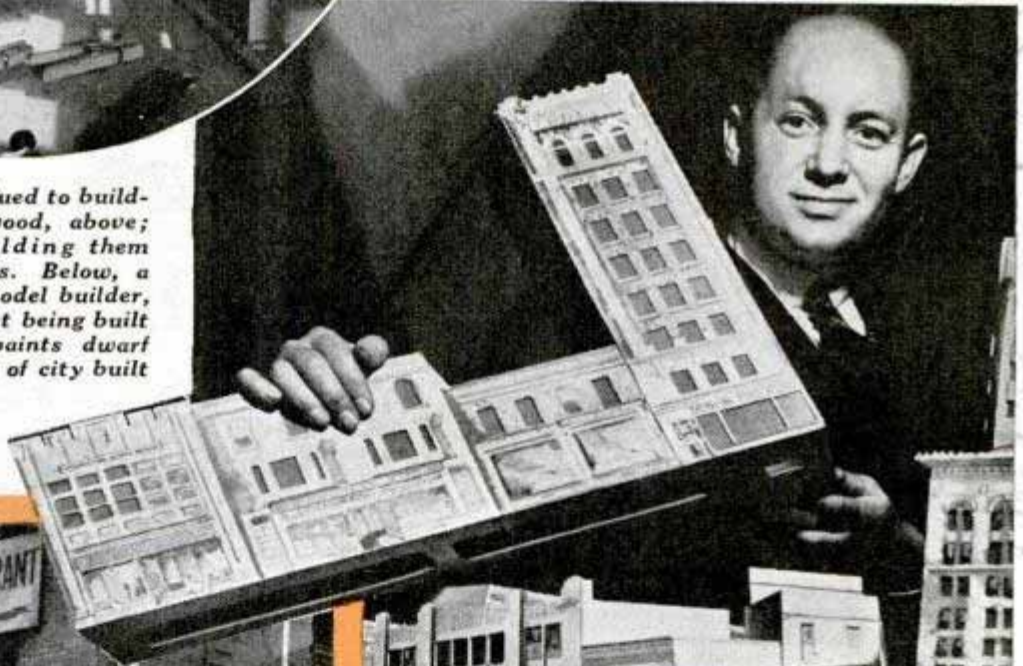
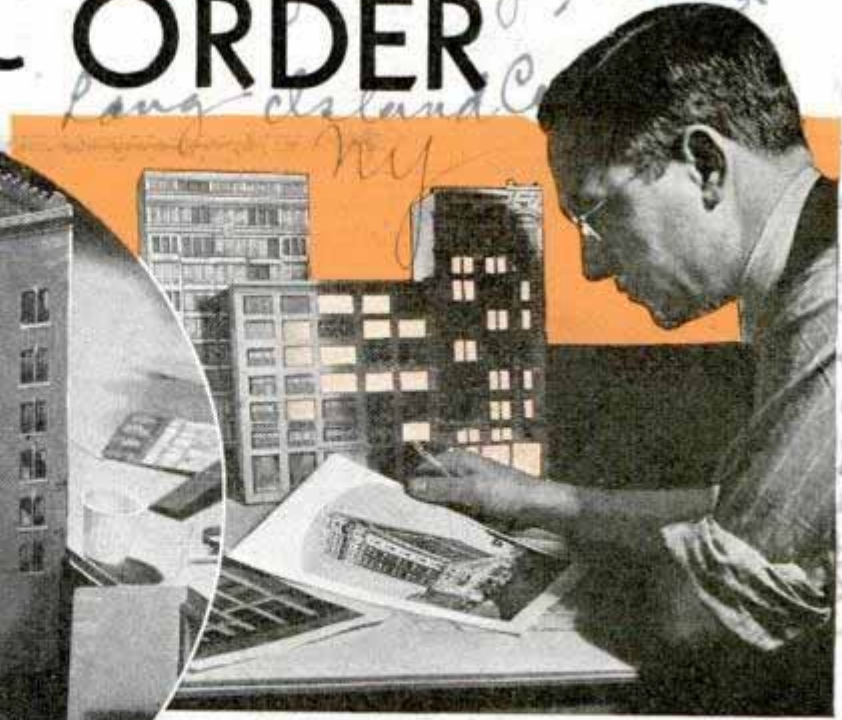

Right, top, three stages in constructing city include, first, photograph of building; second, sketch made on cardboard; third, completed likeness ready for painter. Bottom, Edward H. Burdick, creator of city built to order, shows how models are built out-of-plumb to blend into tricky perspective of scene when in place

# Army Trucks 'Go over the Top' in Stiff Tests

Reconnaissance trucks, designed for the United States army, run the gauntlet of grueling tests to prove themselves fit for field service. The olive drab vehicles have four-wheel drives, must maintain a top

speed of forty-five miles an hour on the level, and the fuel systems cannot falter on steep slopes or roughest terrain. To meet rigid army requirements, the light half-ton trucks, loaded with one thousand pounds, must be able to climb a sixty per cent grade in low gear, a seven per cent grade in high gear, and a five per cent grade—towing an extra thousand-pound load—in high gear. Carrying three thousand pounds, the one and one-half ton trucks must go up the sixty per cent grade in low, a five per cent grade in high, and, with an additional four-thousand-pound tow-load, climb a three and one-half per cent grade in high.

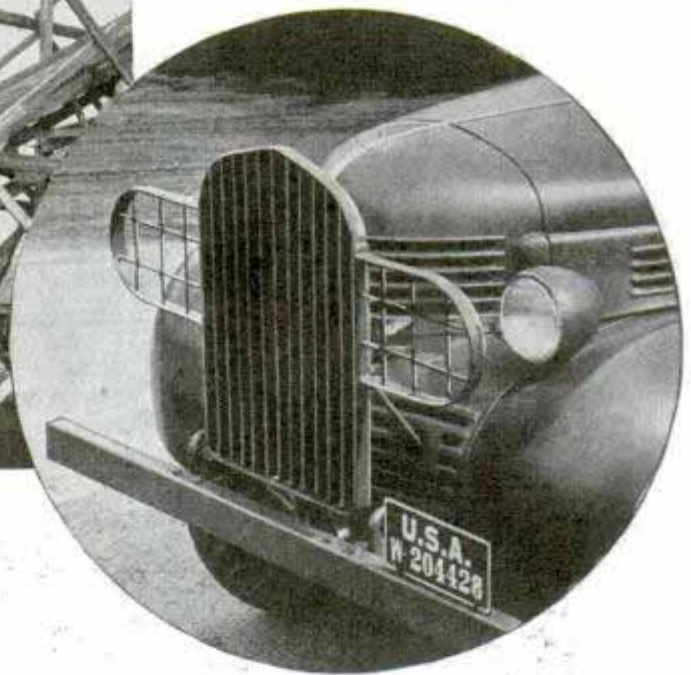

Above, one and one-half ton army truck bouncing up steep six-foot incline in test; below, light trucks must be able to ascend grades like this in low gear, carting a thousand-pound load. At the front ends (right) truck radiators and headlights are guarded by heavy metal grill

## Metal Clip for Brace Block Strengthens Frame of House

Saw-toothed metal clips, just introduced in the building industry, are being used as

a brace block to produce a stronger wooden frame. The clip is installed simply by hammering its teeth into the vertical stud just under the cross brace, nailing one end of the clip to the stud and bending the other end to be nailed to the cross brace. This saves two saw cuts and three nails from each bracing assembly. In an engineering test, metal-clipped braces stood a weight of 19,060 pounds while a wooden brace block stood only 7,510 pounds.

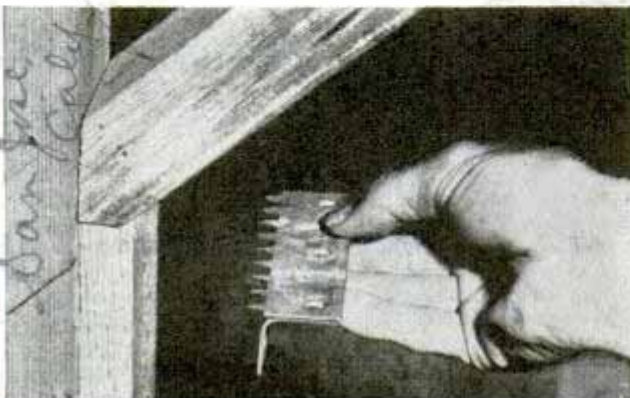

Clip is driven into vertical stud under cross brace

Send stamped, addressed envelope to our Bureau of Information for name of maker of any device described in this magazine.

K 448  
 Dodge Bros. 7900 So. Cambridge Ave.  
 Charles City, 341 Massachusetts St.  
 K 568  
 Paterno mfg Co  
 1st Natl Bank Bldg  
 San Jose, Calif.

# Iron Mines Charted by 'Fishing' through Ice

517 Harbour Commission  
Wldg Toronto, Ont.



Lugging one of the portable huts on toboggans over ice, left, top, in search for ore deposits; and, bottom, engineer in hut reading meters. Right, magnet attraction of ore being measured from surface

Ice two feet thick on Steep Rock lake in northern Ontario helped Canadian geophysicists in mapping four distinct iron deposits far under water, which are estimated to contain 300,000,000 tons of ore. After the contour of the lake bottom had been charted from boats, a survey was made through the ice with a torsion balance to determine the shape of the bedrock beneath the clay bottom. Portable electric plant, meters and other instruments were housed in an insulated shack mounted on toboggans which were moved from place to place, the electrical readings being taken by machinery in a box which the surveyors term a "torture chamber," "doodle-bug," or "count jeep." Three ten-foot electric rods were lowered through holes drilled in the ice, one rod being 1,000 yards from the other two. Gradually moving the two rods nearer the third one, the geophysicists could compute the quantity of

ore present, basing their calculation on the fact that the electric currents passing between the rods would vary with the amount of iron encountered. A third survey consisted of magnetic readings to learn the nature of the rock contents under the lake bottom. With the results of all three studies plotted on a large map, drillers took their four-ton rigs onto the lake ice and plumbed their casings and diamond drills through the ice, 150 feet of water, and another 150 feet of clay and bedrock, striking hematite iron ore which in some places proved even richer in iron content than that in the rich fields of Minnesota. On shore a shaft 800 feet deep has been sunk, with tunnels branching under the lake to hit the deposits, and a daily output of 2,000 tons is predicted, which will be brought to the surface from the underwater mine and shipped to blast furnaces for Canada's growing war industries.

Ref: University of Toronto  
Toronto Ont Canada

# SEEKING POWER

Ref: John W. Parsons, California Institute of Technology, Pasadena, Calif.

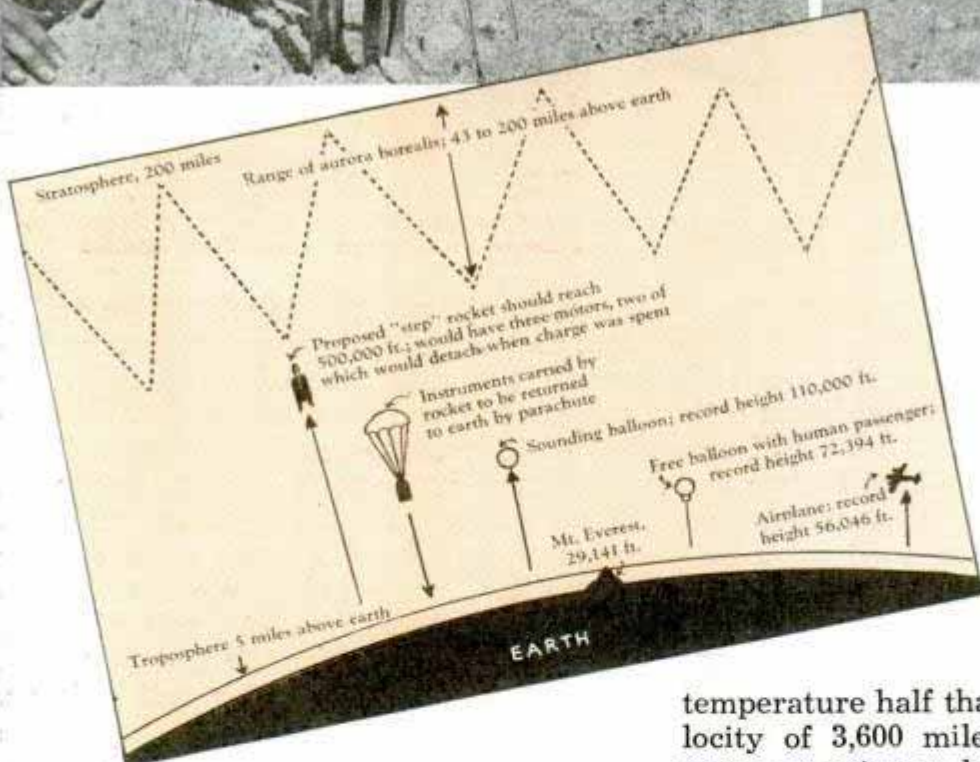
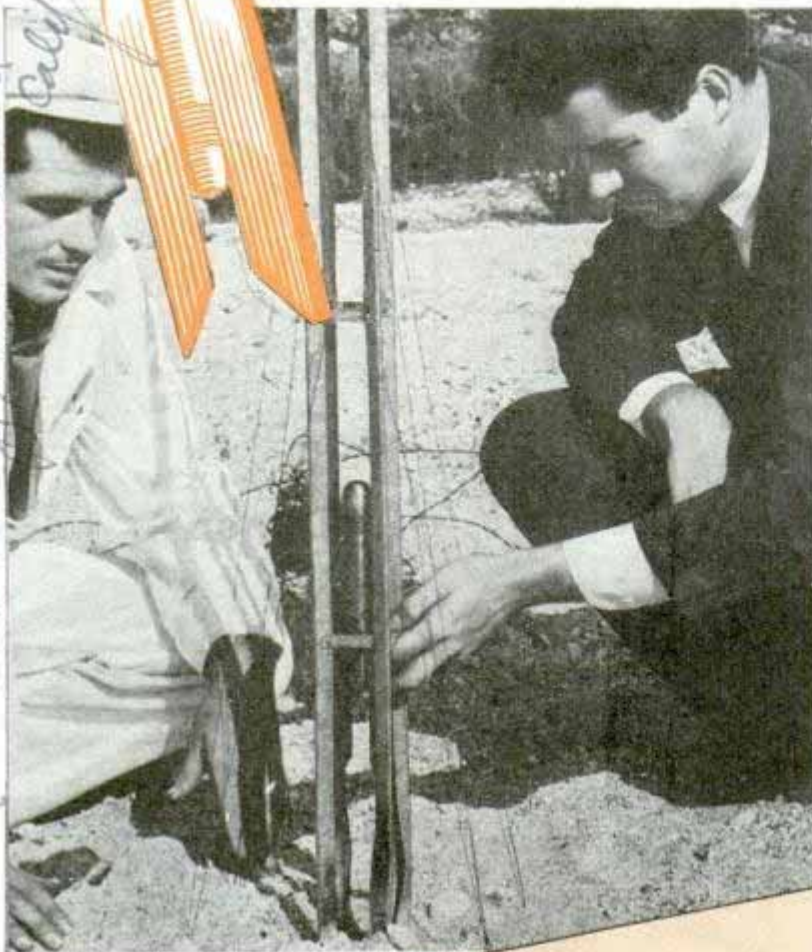

Small test rocket is loaded into firing stand, upper left, to trace its characteristic path. Above, putting powder charge in rocket. Diagram shows man's altitude records and his hopes for the rocket

most unimportant. Yet in those few seconds all the fires of hell have been raging in the little cylinder behind the sandbags. Terrifically explosive gases have just reached a

**G**UARDED by sandbags, a man sits before a panel on which are rows of gauges. As he turns valves, needles of the gauges spin and gyrate. From behind the sandbags comes a hiss, a puff of smoke.

The man relaxes, the gauges come to rest. If it were not for the tiers of protecting sandbags, it would seem undramatic, al-

temperature half that of the sun and a velocity of 3,600 miles per hour—and one more experiment has been added to the long list by which men have sought to gain knowledge which will enable them to conquer outer space.

Scientists are hard-headed men. They do not speculate on traveling to the moon every time they see a sky rocket. They say simply:

"We are experimenting with fuels for



457 Serrano Ave K490  
Los Angeles

# for SPACE ROCKETS

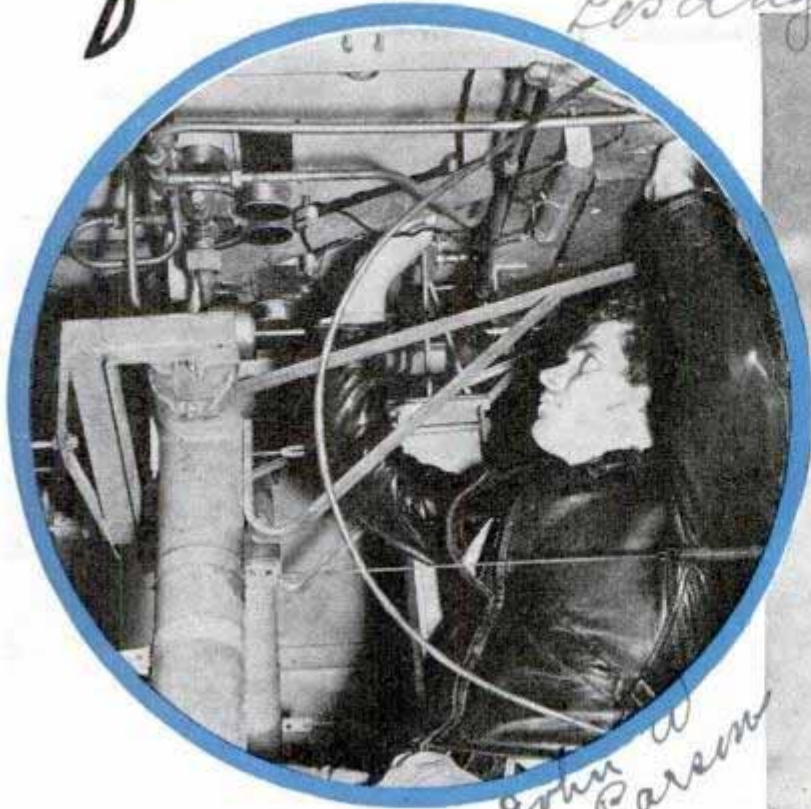

John A. Parsons

rockets. We've found out a few things. It may be that in the reasonably near future science will succeed in sending a rocket higher than any man-made contrivance ever traveled before. Perhaps such a rocket might reach an altitude of 500,000 feet.

"If a rocket could be shot that high, it could carry recording instruments which would gather information of the greatest importance. A rocket to the moon. . . Men still dream of that. But science deals with facts. Still, the dream is perhaps a little bit nearer realization."

Behind that simple statement is another chapter in man's struggle to escape the chains of gravity which bind him to one planet.

Three years ago it was decided to study rocket motors at California Institute of Technology. Although many rocket experiments had been conducted throughout the world, no complete and systematic investigation of motors has been available. Yet it is just those

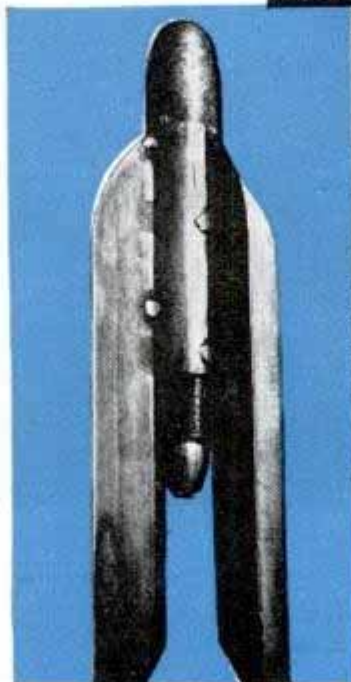

Test apparatus for rocket motors, in circle, records temperatures of motor and exhaust gases, speed of intake gases, amount of gas used, etc. Right, a rocket starts up fired by remote control. Below, test rocket used at California Tech

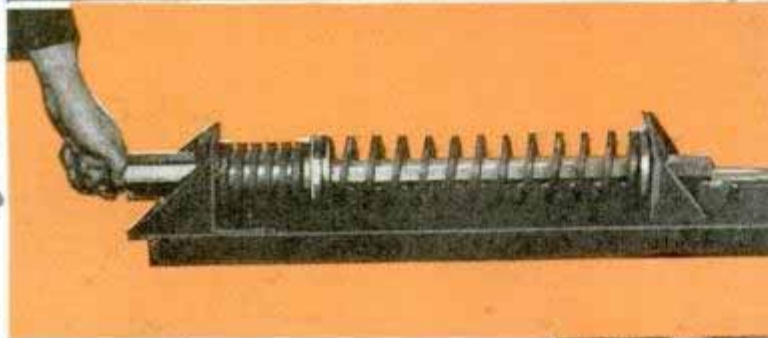

very problems of a powerful enough fuel and a long-life combustion chamber that are the stumbling blocks which are holding back rocket flights.

So three experimenters at California Tech., Frank J. Malina, John W. Parsons, and Edward Forman, decided to build a rocket which did not fly, a rocket which moved but a few fractions of an inch, but which told those vital facts about what goes on when a charge is fired.

As a background for their work, they had the long history of rocket experimentation, going back to the days of early Chinese culture when rockets were first used for fireworks displays. The western world did not begin to construct rockets until about the fourteenth

century. Immediately, the question of their possible military importance arose. But no one devised a successful military rocket until 1805, when William Congreve perfected one—and in so doing helped write the American national anthem.

For it was the Congreve rockets fired by the British forces attacking Fort Mchenry that inspired Francis Scott Key to write the lines of the Star Spangled Banner, "and the rockets' red glare." Congreve rockets were also used with telling effect against Napoleon at Waterloo. Both incendiary and explosive charges were carried by these rockets. Not until modern artillery was developed did interest in military rockets wane.

However, the military potentialities of rockets have again come under serious consideration. With nations searching for new weapons, rockets were bound to have their day once more.

Major James R. Randolph of the U. S. Army recently set forth the advantages of military rockets. They are cheap, as no elaborate gun barrel or firing mechanism is needed. Rockets are fired from



To determine stability, a flying model is fired with powder by remote control, top. Center, recoil of spring gauges strength of powder fuels. Behind the sandbags (bottom) California Institute of Technology scientists test rocket motors and explosive fuel—mixture of oxygen and ethylene—developing 5,000-degree heat and gas velocities of 3,600 miles per hour



simple tubes. They are easy to transport. The tubes may be set up in a few moments, and a terrific fire concentration achieved suddenly, without the elaborate preparations which make artillery concentrations obvious to the foe.

But whatever the military significance of the rocket, its most dramatic and intriguing potentiality is that of conquering space. Although many older writers of fantasy speculated on space rockets, the first really practical experimentation in America was done by Prof. R. H. Goddard, beginning in 1909.

In 1918 Goddard published a set of calculations which he believed established the possibility of a rocket flight to the moon. If such a rocket could be constructed, he proposed that a small charge of flash powder be carried, and exploded when the rocket struck the moon. The flash would be visible to the earth's large telescopes.

Ten years later Goddard fired some experimental altitude rockets which attained a height of about two miles and a vertical

(Continued to page 118A)

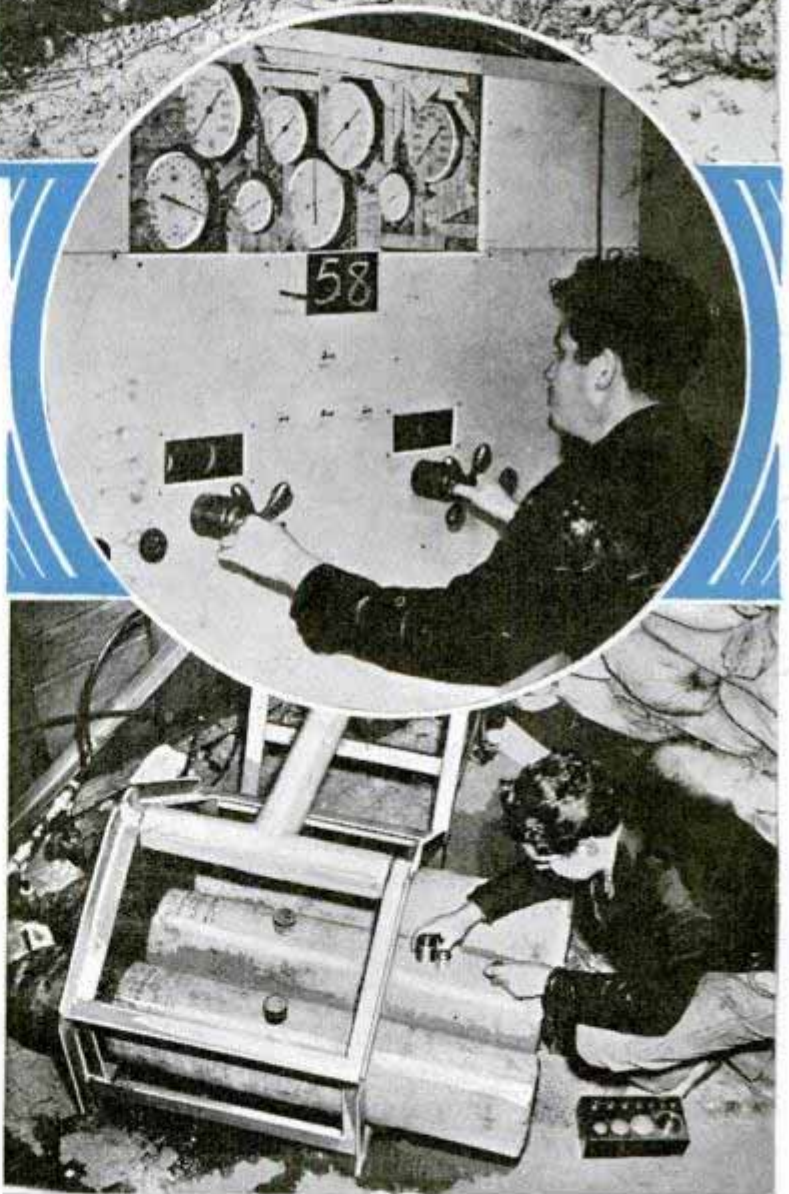

Heavy barricade of stones is laid to protect operators before firing a rocket with its highly explosive charge (top). Dials in center show the fury of the thrust of a rocket motor in operation, its fuel consumption, temperature of motor and exhaust, and intake velocity. Three tanks of ethylene gas, shown at bottom, are on a delicate balance accurate to one-tenth ounce

K521  
522 N. La Brea,  
Hollywood  
Calif

## Coin-in-Slot Movie Machine Shows Seventy-Foot Film



At the drop of a coin this machine shows a two and one-half minute movie on its ground-glass screen

Youngest member of the slot-machine family is a vendor of motion pictures. Drop a coin in the slot and the machine projects on its ground-glass screen for your entertainment a film lasting two and one-half minutes. Intended for cafes, stations, drug-stores and the like, each machine holds five seventy-foot film subjects. The 350-foot roll of film, changeable each week, lies flat on a series of rollers and goes through the projector endlessly.

K626

## Melting Pills Tell Temperature of Heated Metals

Tiny pellets that look like medicinal pills are being used in place of costly heat-measuring instruments to take the temperature of hot metals in industrial operations. Various pills melt at definitely known temperatures from 200 to 1,500 degrees Fahrenheit and are accurate within three per cent. They are used to prevent

cracks in metal processing, to make stronger welds, and to indicate the approach of safe-temperature limits when making costly castings, forging and machine equipment. Simple to use, the pellets will not corrode or pit the metal.

K561

## Auto Road Map in Small 'Bomb' Magnified for Easy Reading

Despite its small size, a globular map clamped to the auto steering post shows highway routes for a large area of the United States. Inclosed in a bomblike case fitted with magnifying lens and light bulb, the map's minute details are enlarged so the driver can read them easily. The map is rotated north and south by raising and lowering a knob; east and west by twisting the knob. By combining these two motions a diagonal course can be traced. The globular map inserts are interchangeable.

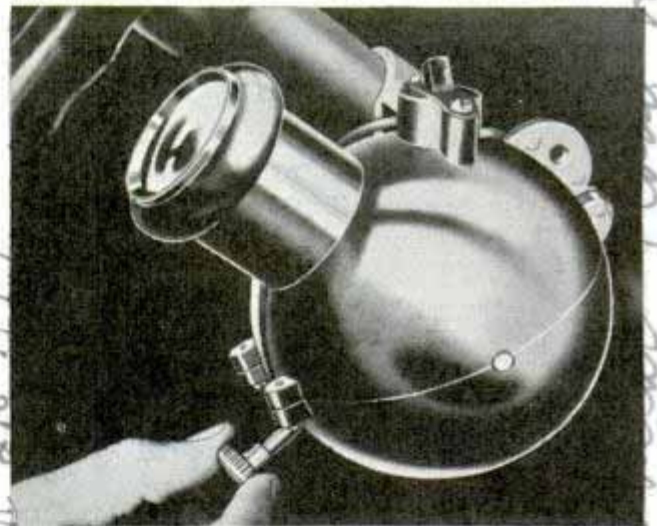

Road map mounted on steering column has light inside and a magnifying glass to enlarge markings

*The Temple Corp. 132 W. 22nd Street New York City*  
*April 1939*  
*marks all major roads*  
*Edwards and*

# Animated Displays Show How an Auto 'Ticks'

Full-weight automobile chassis, at right, balanced between pylons, swings gently end-over-end, in display trick at New York world's fair. Below, assembling engine that opens and closes like pages of a book and is illuminated so various parts are seen in action.

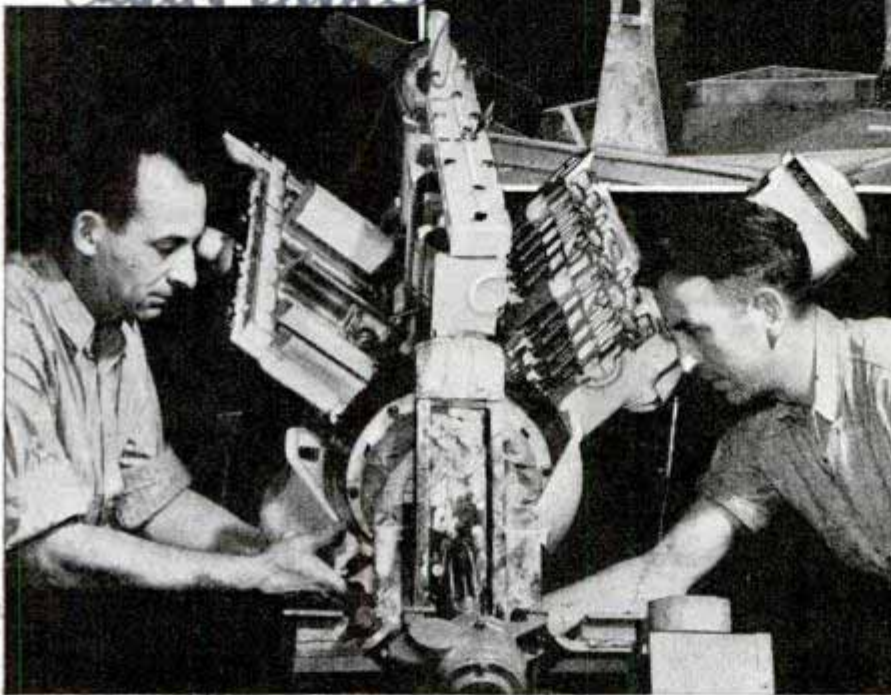
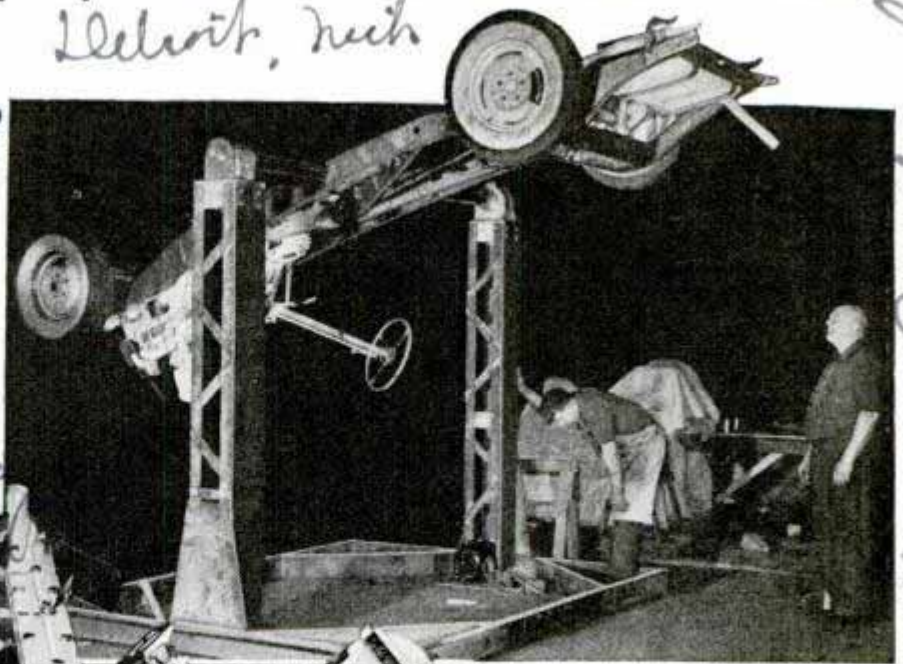

a pair of pylons. Near by is an animated engine that opens and closes, section by section, like the leaves of a book. With every part wired for lights and operated by separate switches, it is possible to illuminate any part of the engine in action. Flow of gasoline and exhaust is indicated by crumpled Cellophane in the cut-out manifolds, aided by flashing lights, synchronized to the speed of the engine. Colorless Cellophane is used for the intake and red for the exhaust. While the engine is running, you can peer inside such parts as cylinders, crankshaft, pistons and water pump through Pyralin windows fitted into openings in the curved surfaces.

Automobiles performing acrobatic stunts and magic tricks attract spectators to General Motors' exhibits of their latest models at New York world's fair and the automobile shows. In one display a full-size chassis appears to be balanced on a horizontal bar, swinging slowly end over end between

ing lights, synchronized to the speed of the engine. Colorless Cellophane is used for the intake and red for the exhaust. While the engine is running, you can peer inside such parts as cylinders, crankshaft, pistons and water pump through Pyralin windows fitted into openings in the curved surfaces.

## Stainless Steel Wallboard Resists Rust and Corrosion

Wallboard surfaced with a thin sheet of stainless steel is unaffected by acids or chemicals and will not corrode, tarnish nor rust. It has a backing of plaster composition. Furnished in satin or pebble finish, the wall covering has many uses such as for shower stalls, sink coverings and hearth.

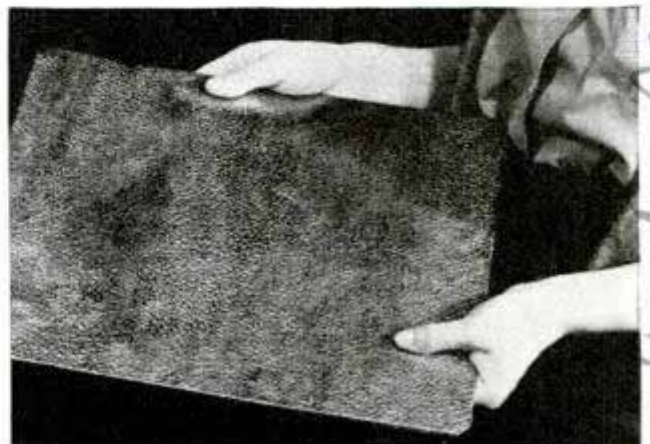

☐The human population of the earth has doubled since 1860, but scientists regard it as doubtful that the present population of 2,000,000,000 will ever be doubled.

*X 499. General Motors Corp. Detroit, Mich. John H. Baker*

*Dr. U. Bathrick, Director of Science, State manager*

*Scientific Monthly*

# DRESS REHEARSALS

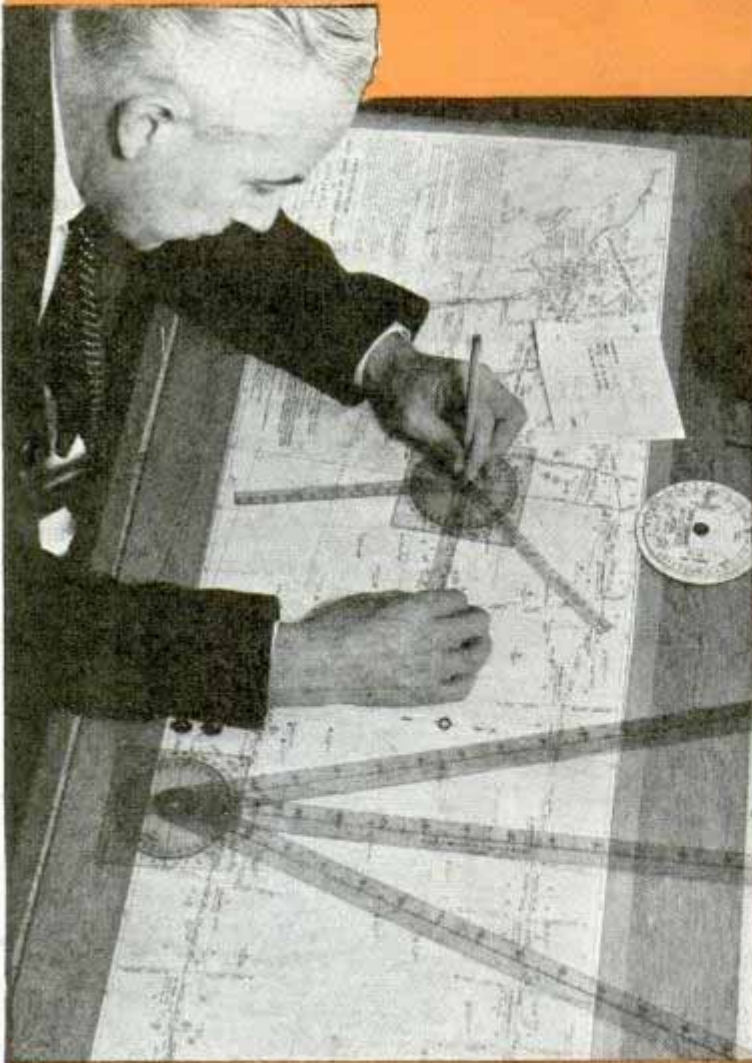

Night flying is almost all by instruments even in good weather (top); below, plotting plane's position from radio bearings

THERE was silence in the air line's operations office as the flight superintendent hastily scribbled out a dispatch and passed it to the radio desk.

"Mayday message. Chicago to Trip Ten. Your midnight position report not received. If you are in trouble your best out is to fly northwest for twenty minutes. That puts you in the clear south of Omaha. Weather to the west and south is zero zero."

"Mayday"—from the French "m'aidez," help me—is the "SOS" of the air lines, yet this emergency message was never broadcast. Like scores of others it was just a rehearsal to test the efficiency of the men on the ground.

America's impressive record of safety in the air rests on the elaborate precautions that are taken to avoid hazards, and on the ability of flight and ground crews to

*J.A. Schmidt  
American Air Lines  
Chicago  
56 N. Dearborn*

*Chicago  
American Air Lines  
Chicago  
56 N. Dearborn*

for

# DANGER ALOFT

Thomas G. Thomson, Jr.  
868 Malibu Road  
Pacific Palisades, Calif.

American Air Line  
Meteorologist Sandy  
Hoyle



handle the one chance in millions when something might happen. Daily the air-line staffs discuss combinations of circumstances that might cause a pilot trouble and decide on the best plan to follow in case of such an emergency.

Suppose that strong static is preventing a pilot from following his radio beam and a bad side wind is drifting him off the airway. What can the air line do to help him? Of course, the pilot has his radio loop and he can tune through the static to take bearings on several radio stations, then plot his position from the bearings. But time may be pressing and it's easier to do this paper work on the ground than in the cockpit. So the ground station,



Meteorologist plots upper winds by watching rising balloon through theodolite, top. Below, American Airlines radio room

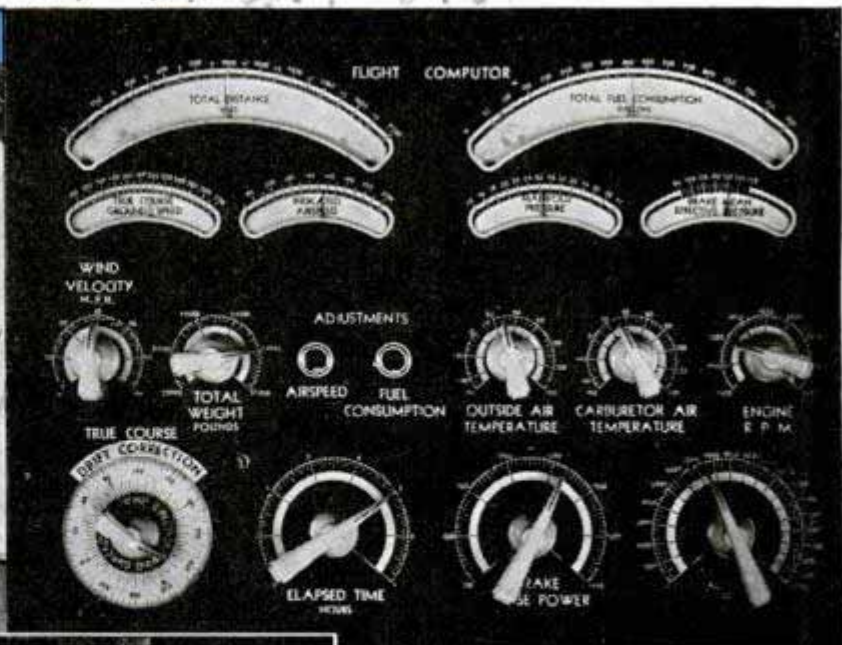

possibly 500 miles away, helps the pilot out by telling him where he is. The pilot takes the radio bearings with his loop, relays the information to the ground, and the ground does the rest. If necessary, the ground staff can even tell the pilot how fast he is traveling.

Accurate? Practice makes perfect and positions are plotted every day, just for practice. In good weather the pilot can check up visually on how well the ground crew locates him.

A westbound American flagship pilot radios a practice position request to Burbank: "Compass 255, March Field 0, Daggett 75, San Diego 300. Position please?" When the message reaches the flight superintendent he calculates the variation of the compass bearings and picks up an avigation protractor. One arm of the protractor is moved to the bearing of March Field, a second to the bearing of Daggett, and a third to the bearing of the Long Beach radio. Then he lays the protractor on the airway chart, turning the instrument so that each arm is over its own station. The intersection of the arms marks the location of the airplane at the time the bearings were taken. Allowing nine miles of on-course progress for the three minutes that will elapse before

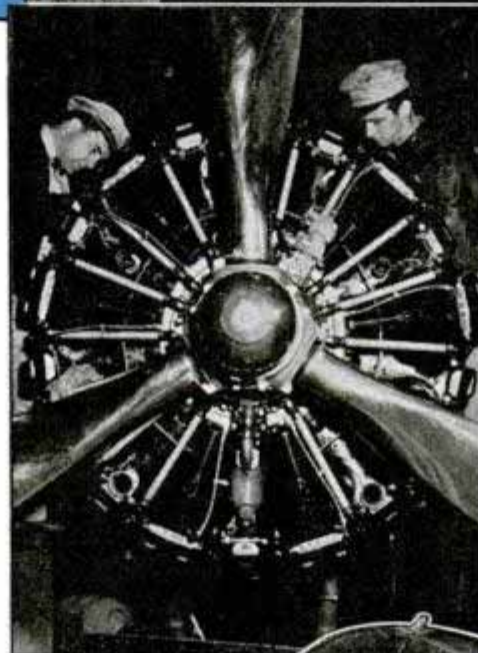

the answer reaches the pilot, the flight superintendent makes a hasty calculation and writes out the message: "You are four miles northwest of the Palm Springs airport." At once by radio comes back the reply. "That's right."

A second "fix" plotted ten minutes later by the ground staff from a second set of bearings taken by the pilot is used to

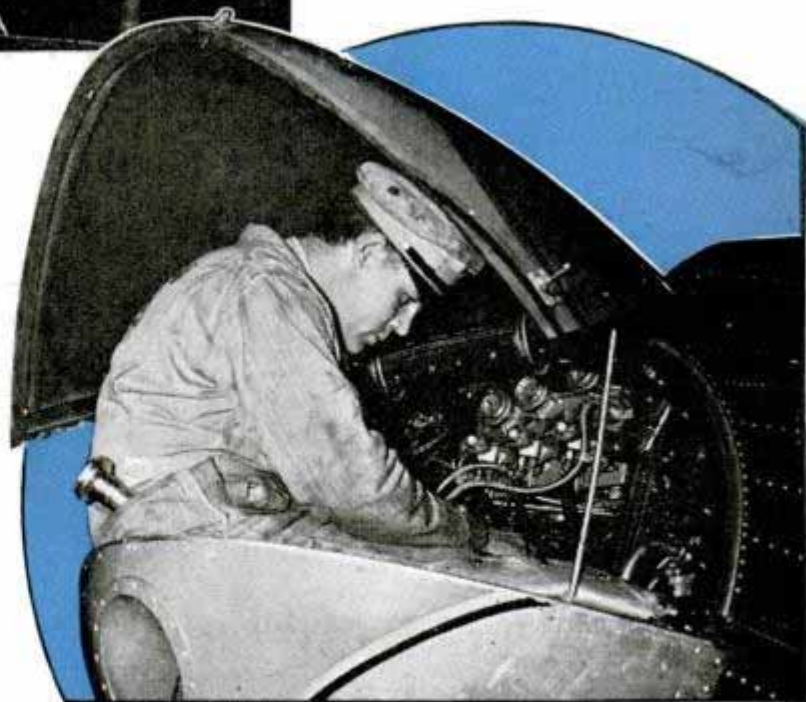

Top, left, TWA men distribute load properly with balance computer; right, automatic computer lays efficient flight plan. Center, engine inspection; bottom, checking maze of instrument cables in nose



figure the miles per hour the plane is traveling over the ground and shows the direction in which the plane has been flying, information that helps the pilot check on the direction and velocity of the wind.

An improvement on which the air lines are working jointly is a proposed system of ground radio-compass stations. By listening to an airplane's transmitter, two or more of the ground stations could swing their loops to tune the signals to peak intensity. The intersection of these bearings, plotted on a map, gives the exact location of the plane and the pilot can be notified at once.

Suppose an air liner's radio transmitter fails and the pilot isn't able to make his regular half-hour position report. Weather conditions are unexpectedly getting worse and it's imperative to reach the pilot. What's the best thing to do? Just because the plane's transmitter is out of order doesn't imply a real emergency. The pilot may be continuing on schedule, flying the beam, although unable to report his progress. But the ground staff takes no chances and supplies him with the latest weather information and comprehensive advice based on it.

Suggested circumstances like these were responsible for the practice "may-day" message outlined above. Before the message was prepared some fast work was done. First the location of the plane had to be determined and then the best course for the pilot had to be de-

(Continued to page 114A)

On the line for night takeoff, top. Center, "fog eye" being developed to utilize infrared rays and photoelectric cell to produce picture of ground on pilot's television screen. Lower right, cockpit of liner testing ing automatic direction finder. Left, United Air Lines' "flying laboratory"

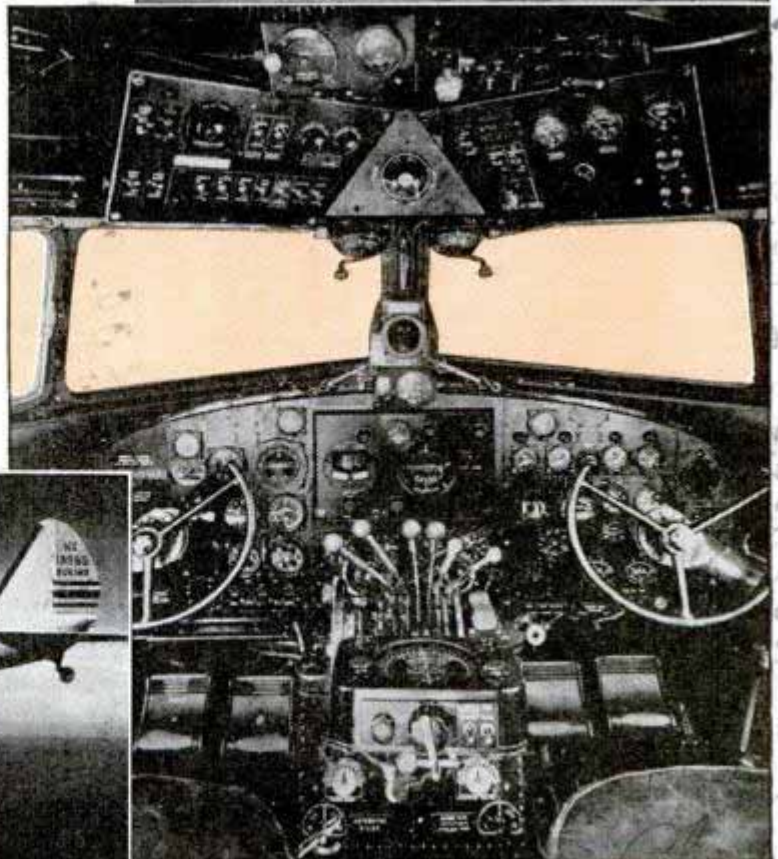
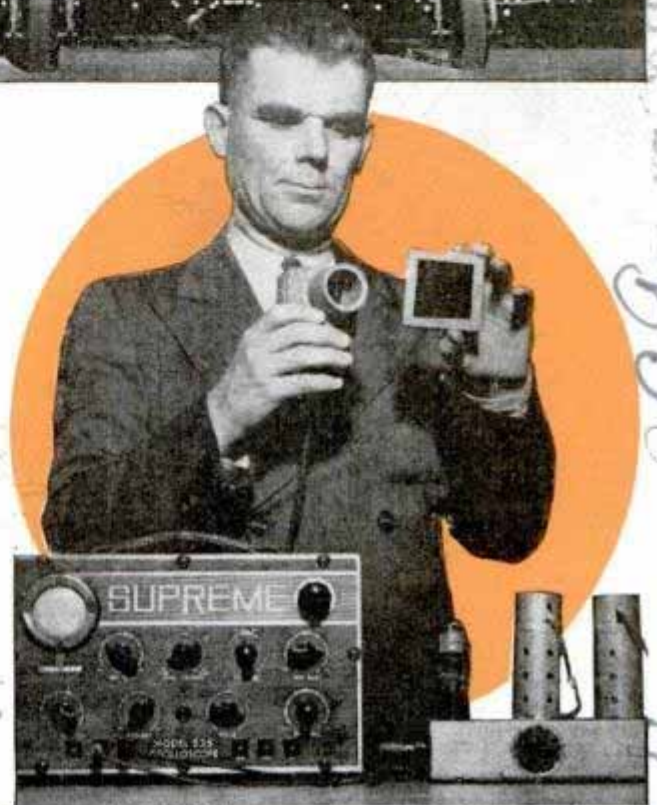
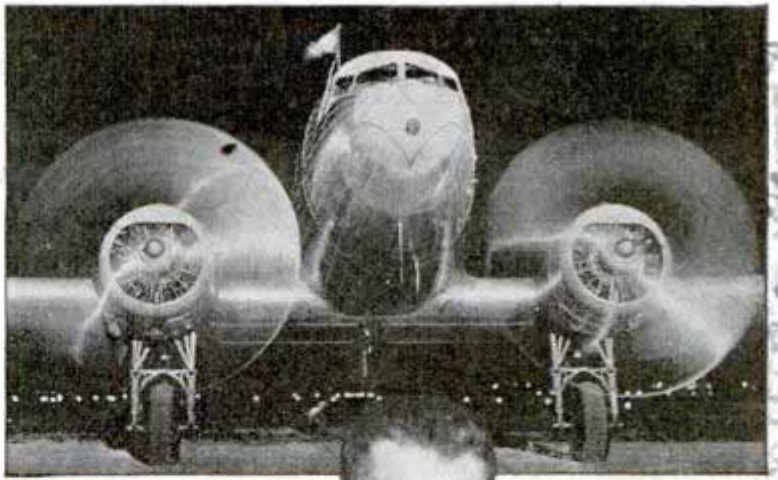

P.C.A. Automatic Direction Finder  
 Sperry Gyroscopic Instrument Co.  
 United Air Lines  
 flying laboratory

## Helmet Carries Photofloods Leaving Both Hands Free



Two reflectors clamped to another which is worn helmet fashion free hands for manipulating the camera

Difficulty experienced in juggling lights and camera at the same time led one camera enthusiast to devise headgear for holding the photofloods. After the photofloods are adjusted both hands are left free for operating the camera. The unit consists of three reflectors, one being worn as a helmet, with the others clamped to it.

## Engine Weighing Half an Ounce Has a Four-Drop Gas Tank

Already producing a miniature two-cycle gasoline engine for midget race cars, airplanes and power-boat hobbyists, Ray

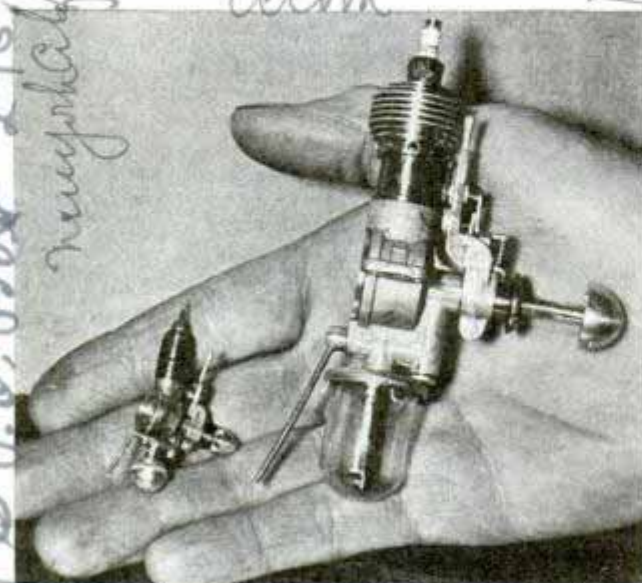

At right is the miniature gasoline engine for model planes and cars; at left, the tiny model

Arden of Baldwin, N. Y., has now built a tiny model of his model engine. The new "baby" has a bore and stroke of five-sixteenths inch, spins a propeller at 15,000 revolutions per minute and complete with a propeller it weighs only 215 grains—about three-eighths of an ounce. The spark plug weighs only four and one-half grains and took him 100 hours to make. The gas tank holds four drops of fuel, and is filled with a medicine dropper; the jet through which the gasoline enters the cylinder can be seen only with a magnifying glass. Measuring  $1\frac{1}{16}$  inches high and  $\frac{7}{16}$  inch wide, the engine runs four minutes on a full gas tank, developing unusually high power for its displacement. The larger engine of which it is a copy weighs one and three-fourths ounces.

## All-Wheel Springs for Trailers Ease Ride in Touring Home

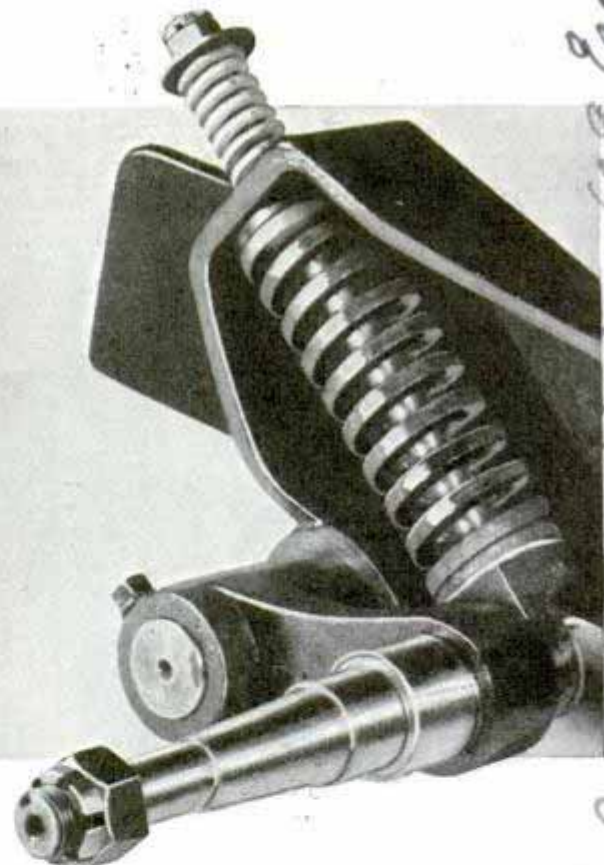

Trailer axle assembly provides individual spring for each wheel, resulting in a restful, easy ride

By giving each wheel of the house trailer an independent spring, riding action becomes so smooth, it is claimed, that a person can sleep comfortably while the trailer is in motion. Main springs of the new axle assembly may be varied for trailers of different types and weights to obtain the best riding quality.

# TUNING IN *the* NEXT PRESIDENT



FOR the first time, television has joined hands with radio to portray by sight and sound a national political convention choosing a nominee for President.

Owners of sets from Massachusetts to Pennsylvania, an audience of approximately 40,000, are the privileged few to whom the picture story of the Republican convention has just been unfolded. Lack of telecasting stations, receivers and a means of piping the programs to all sections of the United States necessarily limited the audience.

Bringing all the exciting sounds of the two conventions to the millions of Americans who own standard broadcast receivers, is the gigantic task of the big networks—National Broadcasting Company, Columbia Broadcasting System and Mutual Broadcasting System. For months before the first convention, executives carefully planned for complete coverage and engineers designed new equipment, or improved old, so that reception might

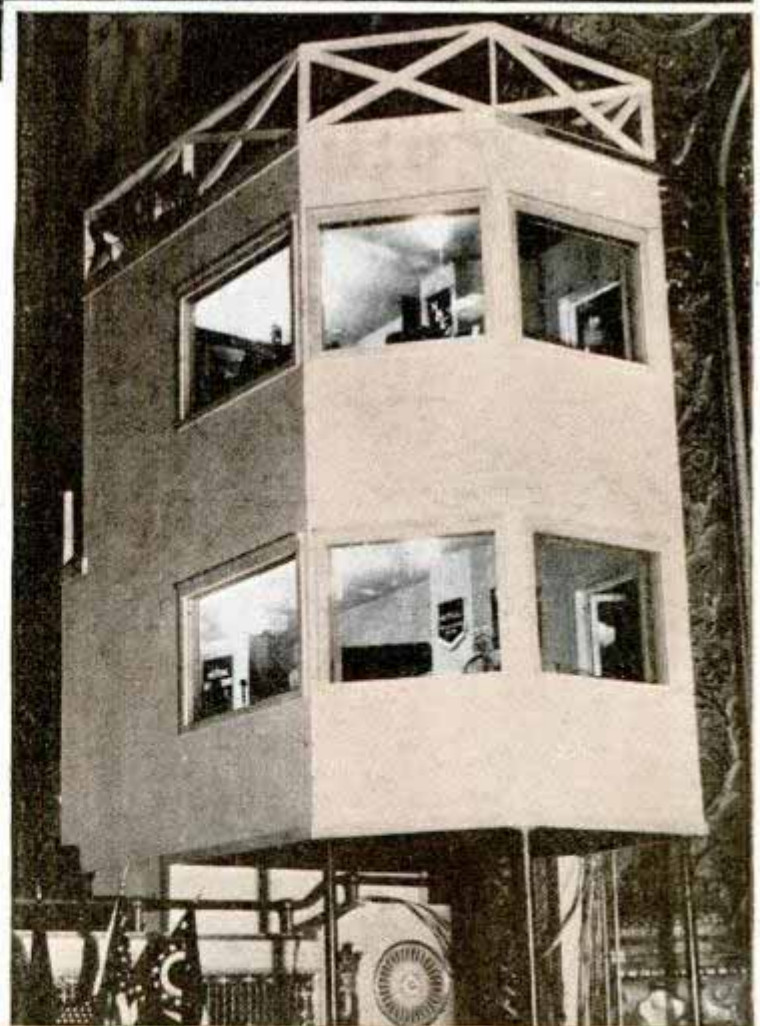

At top, NBC mobile "pickup" equipment. Bottom, a radio booth erected to cover one of the national party conventions



activity into a coherent picture for the radio audience and devising ways for explaining what that picture means. Next to him sits an ace reporter of the network. The booth is strategically placed to command a view of every part of the huge auditorium. With great floodlights directed at the stage, over which the booth is hung, both men must wear dark glasses.

As we look out of the window, a hundred things seem to be happening; on the main floor where the delegates sit; in the balconies where spectators hang on the rails to see the floor; on the speakers' platform, almost directly below, and in the press gallery, with a radio section for the first time in history. Also in the booth are the network's chief technical aide and an assistant, both wearing telephone headsets and in constant contact with the control room of the local network point. Through this point pass all of the network's programs, and at a nod from the director the engineers flash the local station, cut off the running program and tune in the convention.

be as near perfect as possible.

Let's imagine ourselves in one of the big network booths at the Chicago Stadium where the Democratic convention meets. Below us the hall is crammed with delegates. Beside us sits a man who heads the job of translating their



Top, the CBS "walking" short-wave transmitter covers convention floor. Center, parabolic "mike" tuned on convention hall. Below, left, switchboard with buttons controlling fifty-four microphones among delegations; right, mobile television units



From a small rostrum directly below the booth, the principal speeches are picked up. Here stands the permanent chairman of the convention; the raps of his gavel are heard over a battery of four microphones wired to the control booths of the major networks, and to a control booth for the public-address system of the hall, so that any activity on the rostrum is heard simultaneously through the auditorium and in the homes of

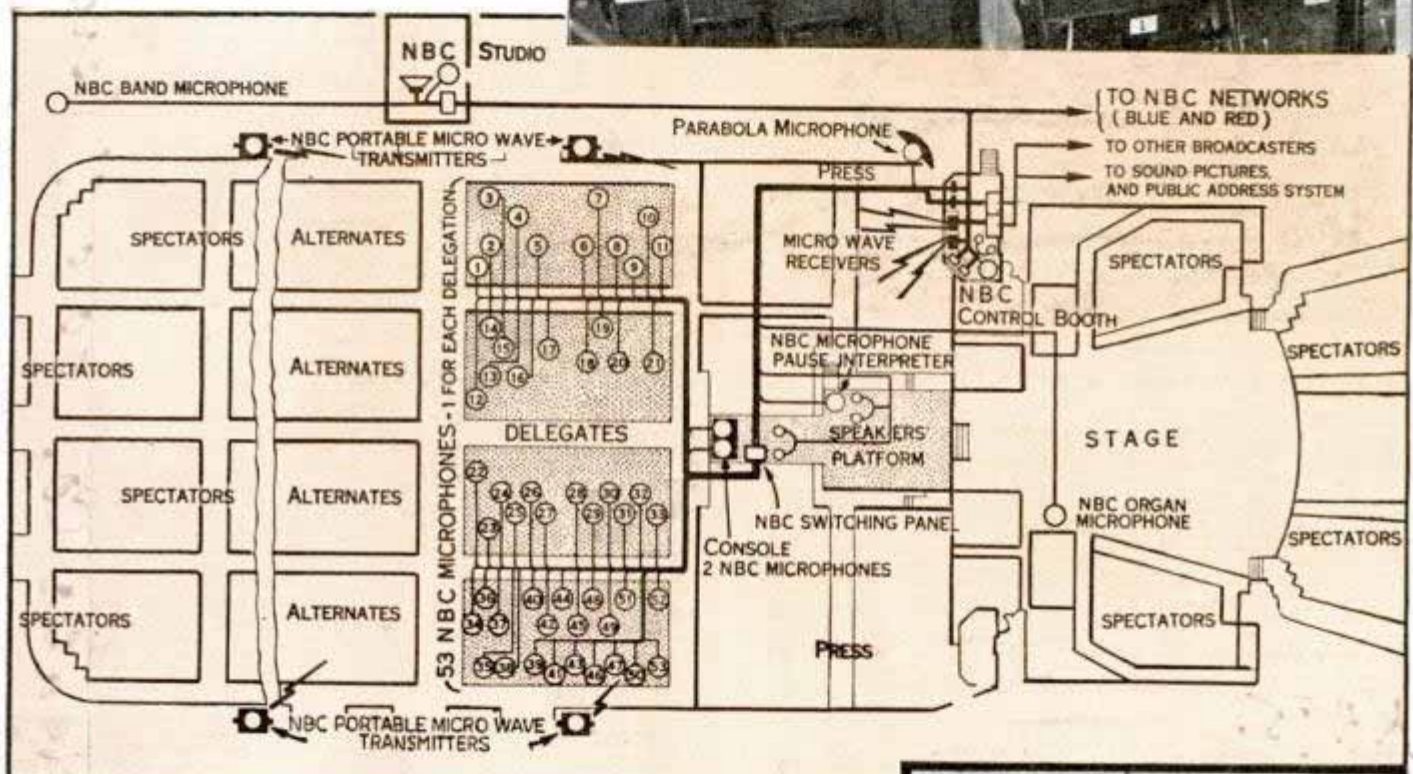

Each delegation has its microphone, top. Diagram shows how NBC covers a convention. Below, "beer mug" transmitter

the nation. The rostrum is at the front center of the speakers' platform, an enormous stage seating all the national committeemen of the party, and the important speakers and guests. Sitting at a small table near the front of the platform is a radio news analyst, or commentator, with a microphone. His job is to cover all activity on the platform.

In front of the speakers' stand is the big press gallery and beyond, stretching to the far end of the auditorium, is the delegates' floor. The floor is served by more than fifty separate studio-type microphones wired into one of the most complex circuits ever arranged. These microphones, one for each state delegation, were set up by the three major networks. All the microphones are wired to

(Continued to page 140A)



K 5 2 6

*Criley Aircraft, Indianapolis. Mechanical Airpart. Kansas City, Mo.*

## Starter for Light Airplanes Uses Hydraulic Power

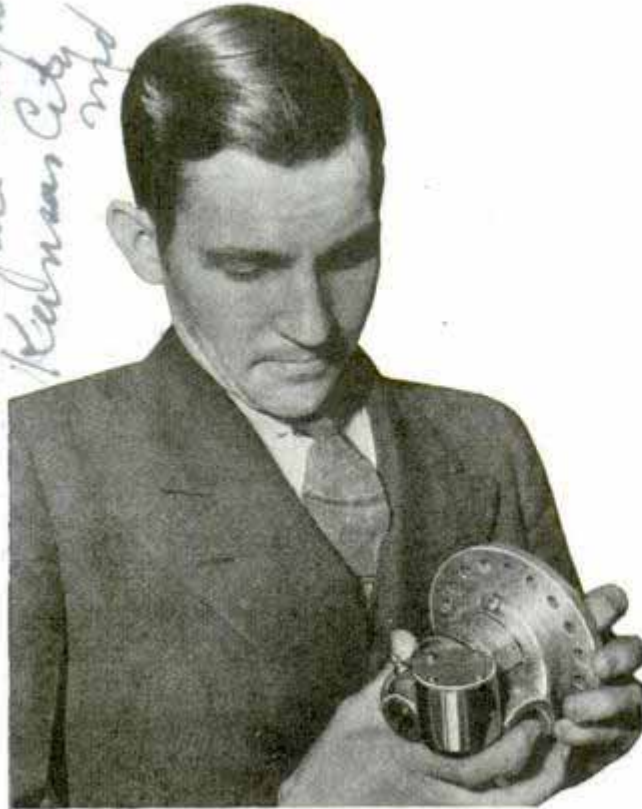

*Hydraulic starter for light airplanes, needing no battery to operate it, weighs only fifteen pounds*

Doing away with the necessity for a battery, which makes conventional starters too heavy for light airplanes, a fifteen-pound hydraulic starter has been designed specially for the smaller craft. It is operated by turning a handle at the instrument panel, and when the starter runs down, it can be pumped from inside the ship.

K 4 9 5.

## Three-Dimension Air-Line Map Charts Routes of All Planes

Scheduled flights of every airplane in the service of American Airlines are shown at a glance with a mechanical toy-like device

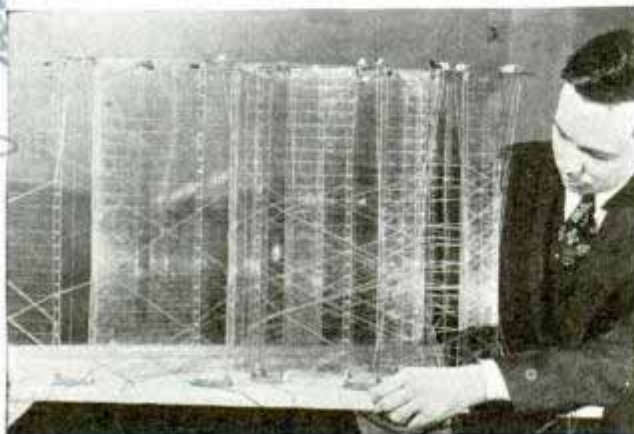

*Air map showing flight schedules in third dimension*

having bright-colored strings attached to it. Made of transparent Pyralin, it resembles a chart of the Airline's system at the top, and down the sides are lettered the hours of the day. Strings of various colors denoting types of airplanes—red for twenty-one passenger DC-3's, blue for Flagship skysleepers, and green for fourteen-passenger day planes—are fastened at the top at points where the planes are based, and each string traces the route of the plane from the base station to its destination, and indicates also turn-arounds at destinations. The three-dimensional map replaces charts which have been used in routing the big air transports.

K 1 7 6

## Water Heater with Table Top Adds Handy Work Space



*This enclosed gas-operated water heater serves the additional purpose of furnishing a working table*

Taking up little space in the kitchen and adding a convenient working place, a gas-operated water heater has a table top of regulation height. It is automatic and available in twenty or thirty-gallon sizes.

*New York Imperial Airpart. The Hotstream Heater Co. 800 7 Grand Ave. Chicago.*

# Heroic Ten-Ton Plaque Cast in Stainless Steel

First heroic sculpture ever cast in stainless steel, a ten-ton plaque just installed over the entrance to the Associated Press building in New York's Rockefeller Center symbolizes America's free press. Measuring twenty-four by eighteen feet, it was made of an alloy of chromium, nickel and iron and was poured in nine sections weighing more than a ton each, at a temperature of 3,000 degrees Fahrenheit. At this terrific heat special techniques had to be worked out to keep the metal from destroying the sand molds. The problem was solved by rigging up "bathtub" arrangements on top of the mold, then building into each mold a

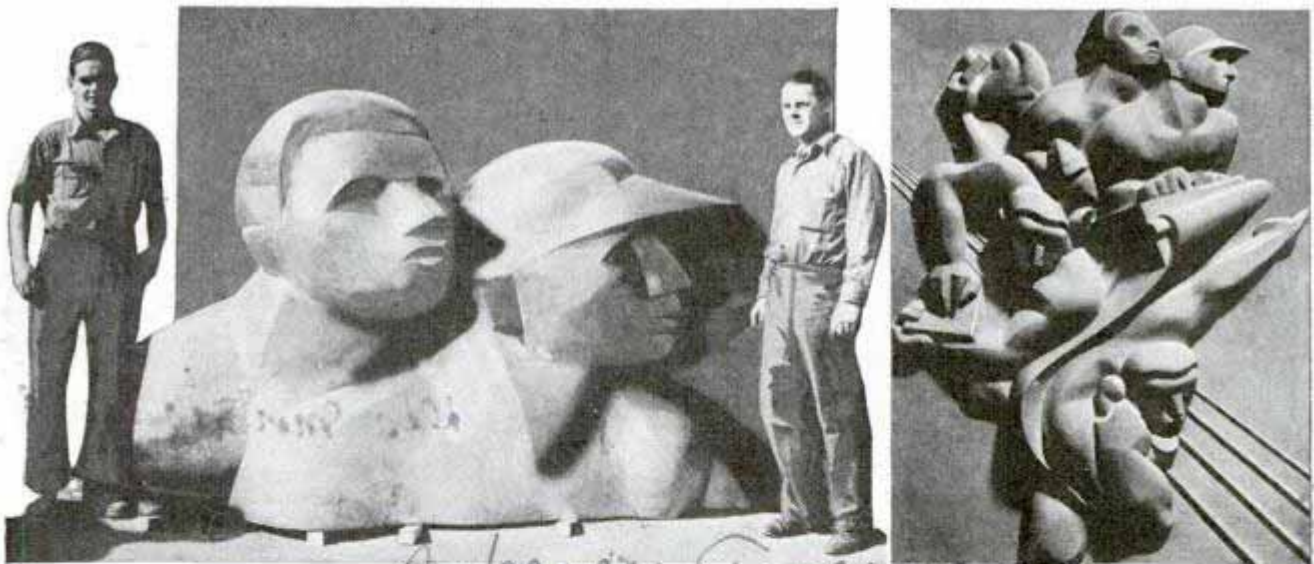
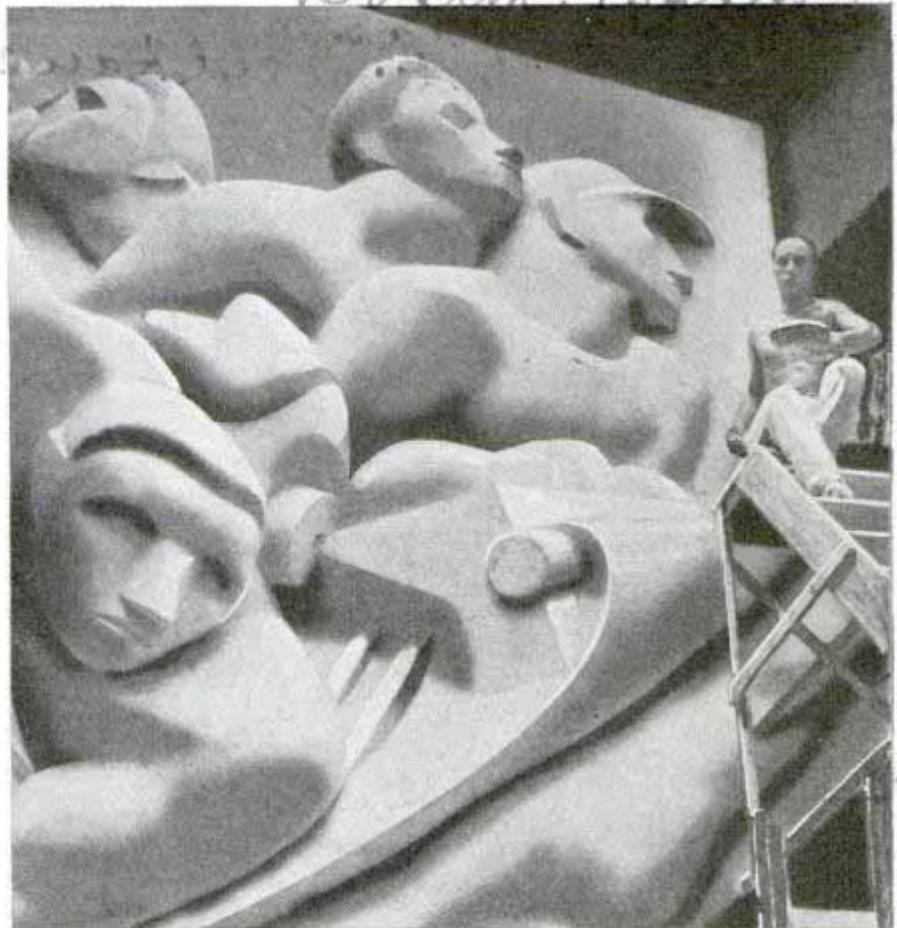

At top, Sculptor Isamu Noguchi finishes full-scale, eighteen-by-twenty-four foot plaster model of the Associated Press plaque. Below, top section of the plaque, the first piece cast; right, assembled plaque

whole network of channels that would carry the molten metal quickly and evenly over the whole surface. The "bathtubs" were fitted with big plugs that could be pulled out simultaneously, and thus the casting of each section actually was accomplished in a second or less. Weeks of preparation were required before the casting, the sand molds being packed hard under pressures as high as a thousand pounds.

The sections afterward were polished, trimmed and fitted together to an exactness of 1/1,000 inch. The figures in the sculpture represent newspaper men armed with pad and pencil, camera, telephone, Teletype and Wirephoto.

Send stamped, addressed envelope to our Bureau of Information for name of maker of any device described in this magazine.

# MIRACLE MEN

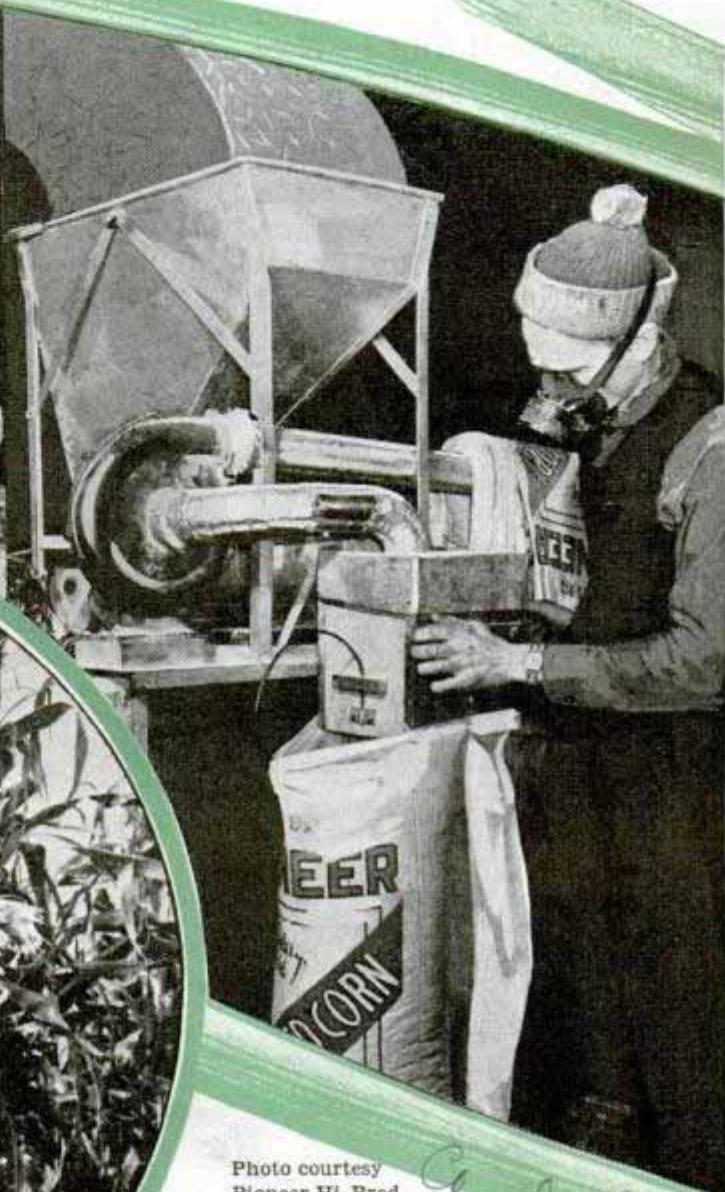

Photo courtesy  
Pioneer Hi-Bred.

*Les Jones, Iowa*

Top, left, sorting ears of hybrid corn; right, seed-treating machine which adds mercury dust to corn, destroying mold and assuring high germination. In circle, five men stand on platform supported only by four hills of sturdy hybrid corn

Ref: *Gnech Peppard, Peppard, Iowa 8th grade*  
*Kansas*  
*celin*  
*m*

**T**HEY called a farmer a wonder man five years ago if he could raise 100 bushels of corn to an acre. Today, he'd be lucky to make the championship flight in a county growing event.

Up and down the Corn Belt, yields have shot upward. An Illinois farmer last fall reported 171 bushels to an acre on a test patch of eight acres. The winner of a ten-

*Frank Blount*  
*Bloomington, Ill*

acre yield contest of a farm group raised 137.96 bushels to an acre while the crops of 268 county corn-growing champions averaged 114 bushels.

This is only the beginning. With the full mastery of new corn-breeding methods and with more efficient cultivating and planting, agronomists predict harvests may reach 200 bushels to the acre.



# of the **CORN BELT**

*Right, corn plant is inoculated with fungus organisms to determine susceptibility to disease. Machine below speeds detasseling, saving thousands of dollars worth of corn which might be polluted if work was done by hand, a slow process*

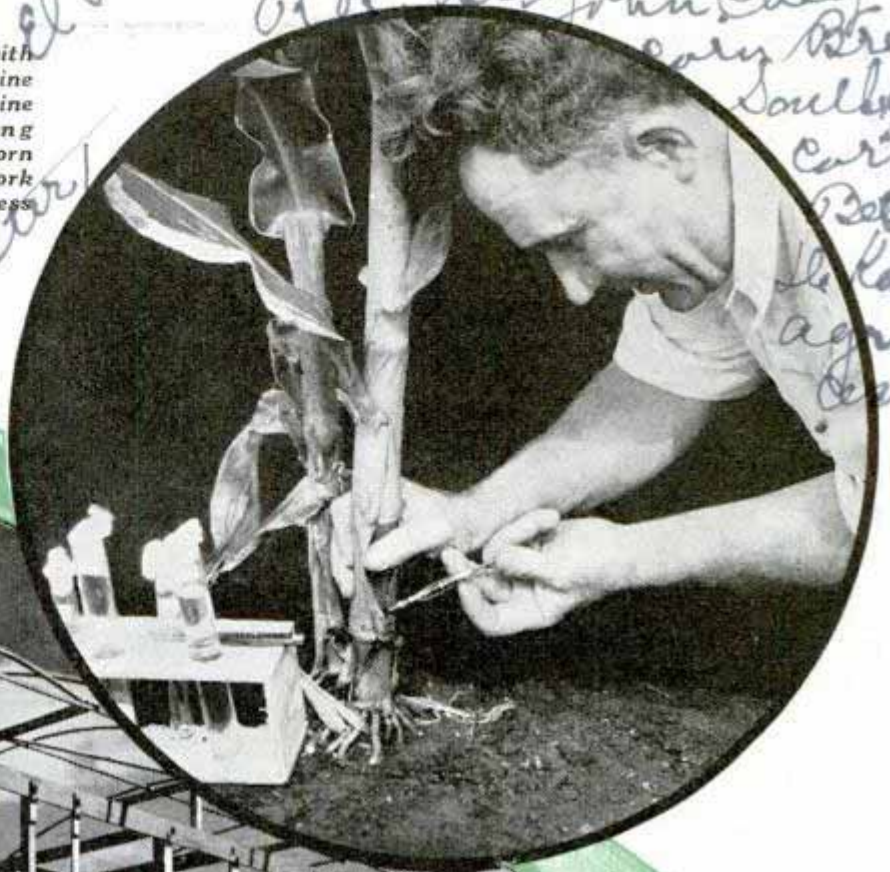

Back of this development stands the scientist in straw hat and overalls who's taken the laws of evolution and reproduction into his own hands to develop a hand-tailored corn. He's literally taken apart the established varieties, chucked out their weaknesses, reassembled their superior traits in new corns.

The inbred corns that survive look as if they've been through a hard summer in the Dust Bowl. The stalks are small, the

ears inferior looking. But by crossing these nubbins with another strain that's been put through the same procedure, a highly productive, uniform corn results. In fact, hybrid corns, as they're called, look as if they came off an assembly line. Yield and uniformity are only half the story. They mature earlier, which is important, because a crop that's already "made" a few days ahead of a long, dry spell will probably make the grade where a crop that's

K 222  
Lester Pfister  
P. J. J. J. J. J.

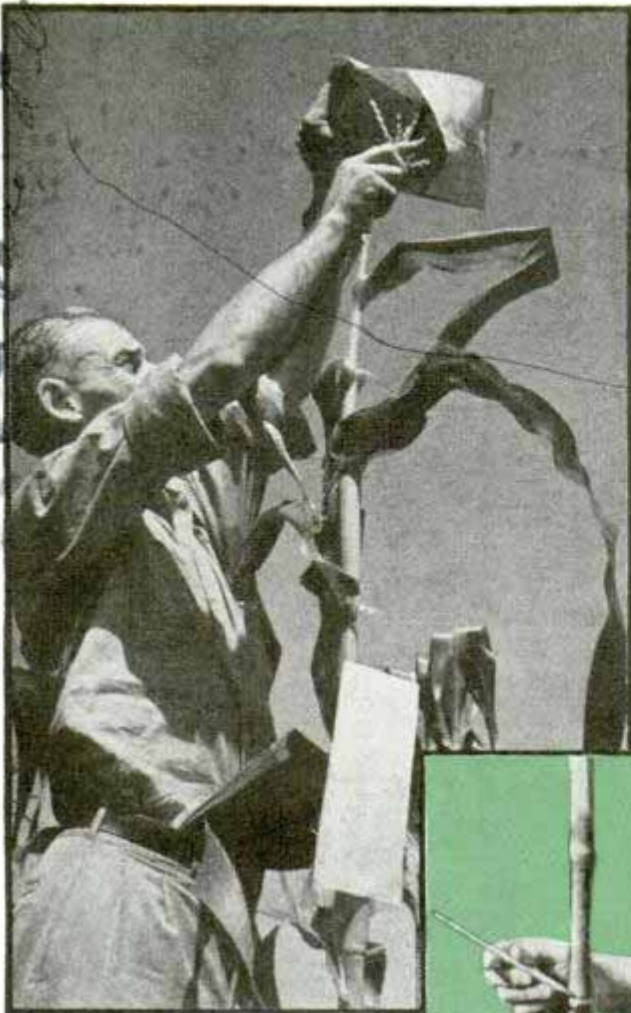

The first important excursions into corn genetics were made more than three decades ago. Years passed before experiment stations and private breeders began to make headway. One of the first breeders was an Iowa editor named Henry Wallace, now secretary of agriculture. For years he preached the gospel of hybrid corn, and one interested listener was an Illinois seed grower, Lester Pfister. His experiences are as rich in drama as Pasteur's probings in bacteriology or Madame Curie's in radium.

On the tassel, he learned, was the pollen and when one of the tiny particles lodged in the silk of an ear, a kernel was started. In the child of that kernel would appear the traits of both the mother stalk and the one that bore the pollen. Pfister decided to try controlling this indiscriminate breeding to produce a superior corn.

The following spring he planted the seeds from 388 select ears of a standard variety in a shielded patch. When the corn began to put out shoots he tied paper bags around each tassel and every ear as soon as they appeared. When he calculated each bag was filled with pollen, usually around three weeks, he inverted it over the silk of the same stalk and snapped off the tassel. He was fertilizing the ear silks with the pollen

just maturing will not.

The corn-seed breeders are "building" hybrids suitable for different soils and climates; hybrids that expedite the use of mechanical corn pickers by dropping only a small percentage of ears from the stalks; hybrids the searing winds, grasshoppers, or disease can't lick, and lastly, new corns particularly suited for livestock feeding and industrial uses.

A government expert, Frederick D. Richey, likens hybrid corn to a mule. The latter is a first-generation hybrid between the mare and the ass, with the mother's size, the father's stamina. A mule does not reproduce. The miracle corn is a first-generation cross involving two or more inbred strains of corn. A good hybrid will produce more and better corn than any standard variety. But the resulting corn is useless as seed for the next crop.



Top, bagging a tassel; center, inbred type throwing out roots from stalk; below, uniform hybrid kernels give accurate drop

produced on the same stalk and no other. This was inbreeding.

For the next few years, the procedure was followed. Thousands of bags were used but the crops lacked any uniformity. There were stalks the size of saplings, others too frail to stand a hard blow. A few stalks produced big ears but no kernels, and others were discarded for poor root growth. The open-pollinated Krug corn was, under the strain of inbreeding, breaking down into the traits of scores of ancestors. Here was plant evolution in reverse. Only the best specimens were saved from each generation and replanted the following year. Year by year the plants grew more uniform but their yield and vigor diminished. Some varieties couldn't stand repeated inbreeding and had to be thrown away.

Five years found Pfister down to four puny ears, inbred so long their good qualities had become fixed. He proceeded with the second step, that of making crosses.

In his field laboratory the next year were eight test plots, each containing three short rows. The middle row he designated as the pollinator or sire, and left the tassels growing; but from the stalks in the rows on either side he

(Continued to page 120A)

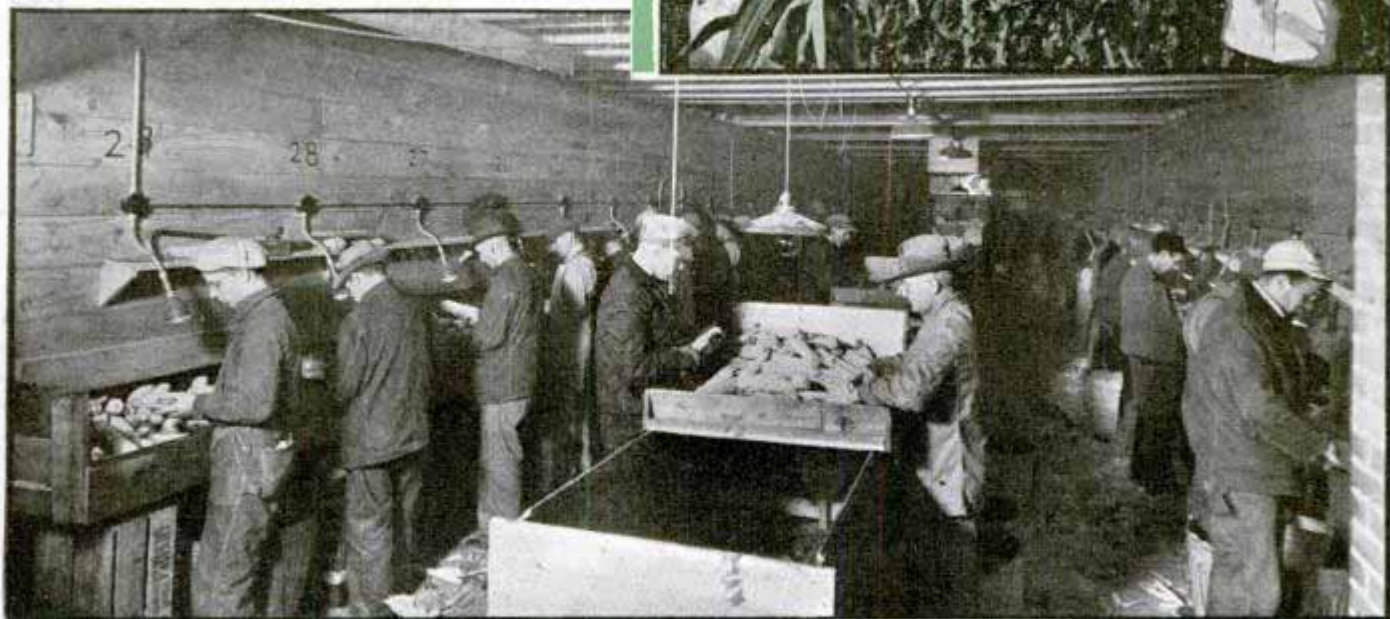
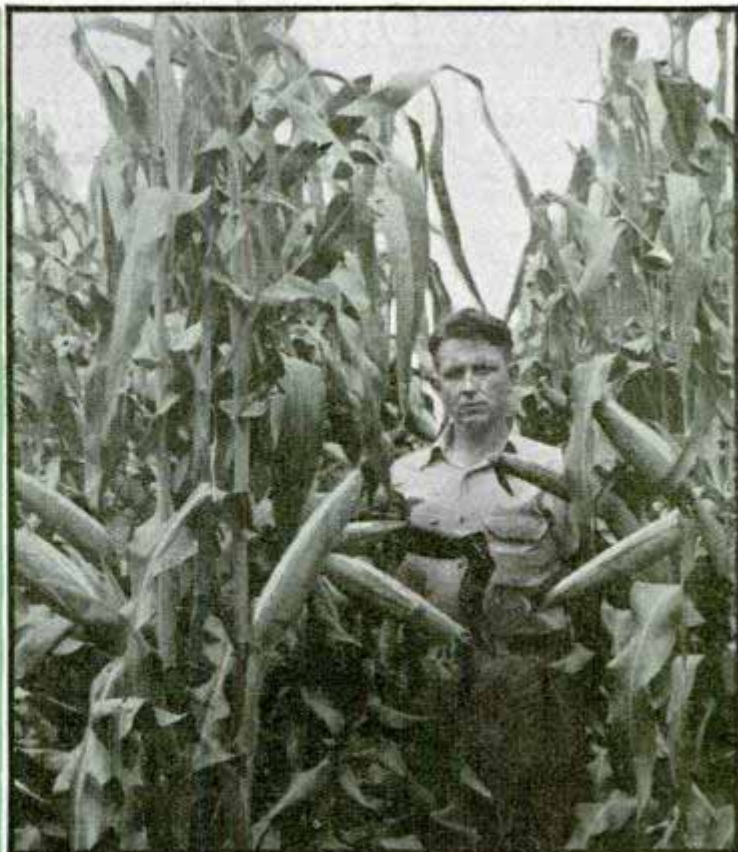

Notice sturdy structure of stalks and ears at top. Center, strong-rooted hybrid contrasts with inferior-rooted strain at right. Bottom, hand sorting to winnow out damaged ears before grading

*Frank B. Seed Co. Bloomington, Ill.*

*... and ...*

X 520

Director, Fuel Laboratories

# Perisphere Dwarfs Painters Crawling over It Like Flies

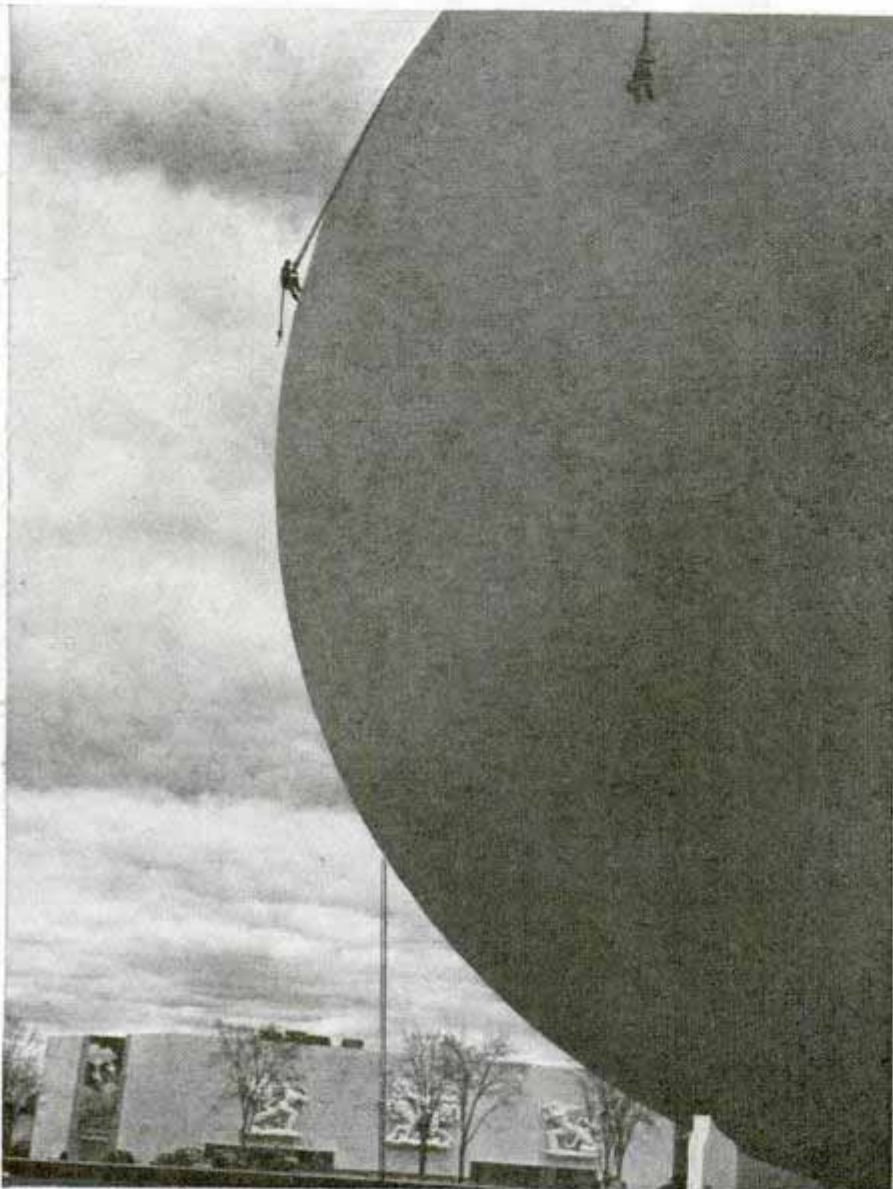

Down the face of the globe crawls the spring clean-up squad, busy at the vast job of painting the Perisphere for the 1940 New York world's fair

One of the world's biggest decorating jobs this spring was the repainting of the Perisphere at the New York world's fair. Swinging down from the "top of the world" on long ropes, the painters looked like tiny flies crawling over its vast surface.

X 617

## Auto Might Be 100 Years Old but It Waited for Gasoline

Most of the principles built into the modern automobile were known long ago. The sliding-gear transmission is almost 140 years old. The differential gear is over 100. Rubber tires were patented almost a century back. The first crude internal-combustion engine chugged before Benjamin Franklin was born. Self-moving road

carriages of a sort ran on English roads more than 100 years ago. The automobile is an assembly of mechanisms developed a century or more ago, but the gasoline automobile itself lagged because gasoline and oil were so long in coming. It was not long after gasoline arrived in the 'sixties that gasoline cars began to be built.

X 553

## Air-Speed Indicator for Auto Mounted in Door Mirror

You can keep a constant check of the air speed of your car, and compare it with the land speed, by installing an outside mirror equipped with an air-speed indicator. Wind velocity is shown on a dial marked from ten to 125 miles per hour in brightly colored figures easy to read, the dial being turned by a three-vane rotor at the back of the mirror. The unit is designed for mounting on the outside of the left front door. Exposed parts are chrome plated and the Bakelite rotor is treated to resist weather. A rigid die-cast swivel allows the mirror to be adjusted to any angle.

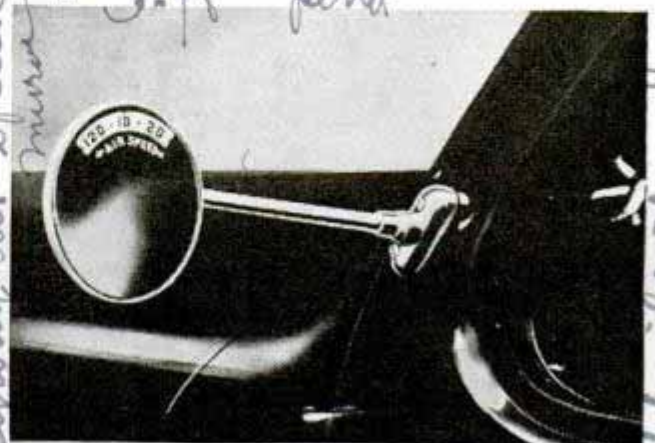

As car travels, numbered dial indicates air speed. Wind rotor, not in picture, is other side of mirror

Scene scene  
May 11, 1940

up on car with self used.  
1/7/42

X 592.

122 E. 42, New York.

# Luminous Signal Hails Navy Seaplanes to Port

Guarding the French "life line" across the Mediterranean to its colonies in north Africa is a new naval air base at Aspretto, on the Gulf of Ajaccio in Corsica. A dike protects the landing basin for seaplanes from the open sea, and, once on the water, the planes taxi

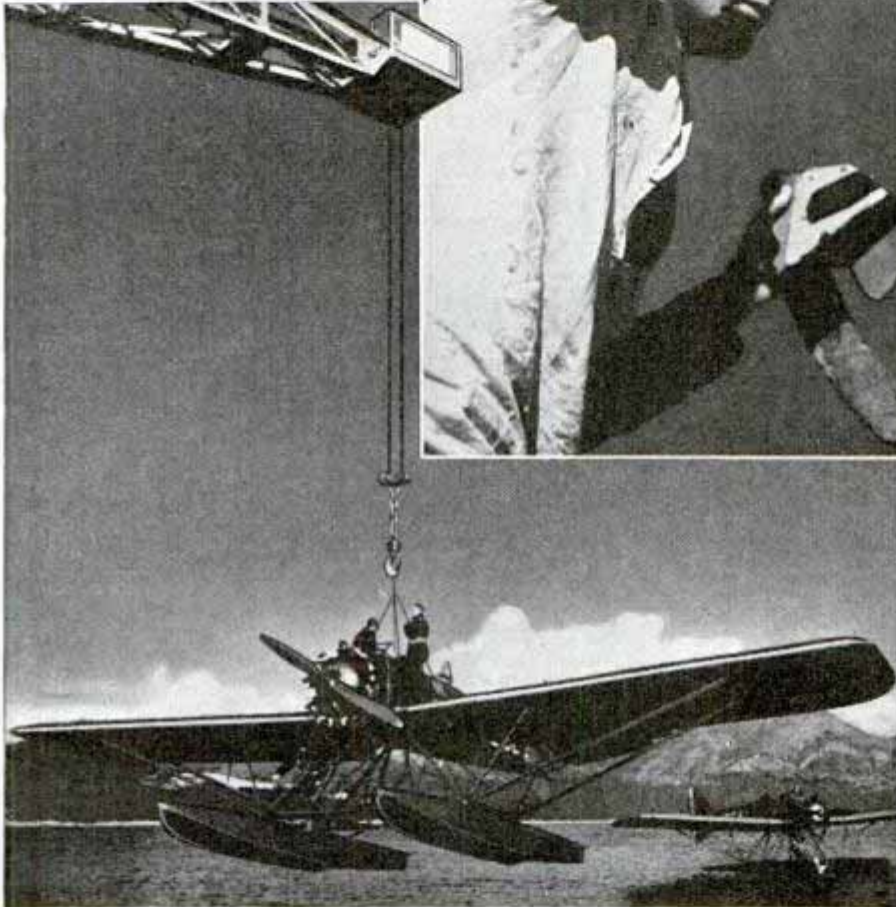

At top, operator at French air base in Corsica signals plane down with light beam. Below, hoisting a big seaplane ashore with a powerful crane

within reach of a powerful crane which hoists them ashore. Vast sheds have been built for refueling and repairing the aircraft and spacious quarters are provided for the crews. At the air base there is a powerful luminous signal with which the base headquarters and seaplanes in flight exchange messages.

## Drill Cuts Rivet from Plane Skin without Enlarging Hole

It often becomes necessary to drill out rivets in an airplane's "skin," and when this is done with ordinary tools it usually makes the hole larger, requiring a larger rivet. As a remedy, an airplane mechanic invented a drill attachment that fits at the end of the drill chuck, enabling the workman to drill straight through the center of the head of the faulty rivet without affecting the "skin," so the rivet will fall out easily. This permits a rivet of the same size to be used, thus avoiding the irregularity resulting from unequal rivets.

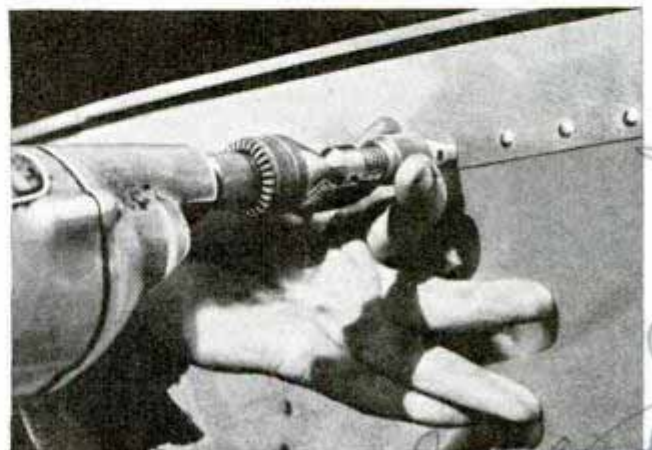

Removing rivet with special drill attachment

Mayland Owens  
212 E. 42nd St. New York

Vertical handwritten notes on the right margin, including "Brooklyn, N.Y." and other illegible text.

R 191  
Cmd. Thos. E. Stinson, Jr. 18618  
Malibu Road, Pacific Palisades, Calif.  
4182 S. Vermont

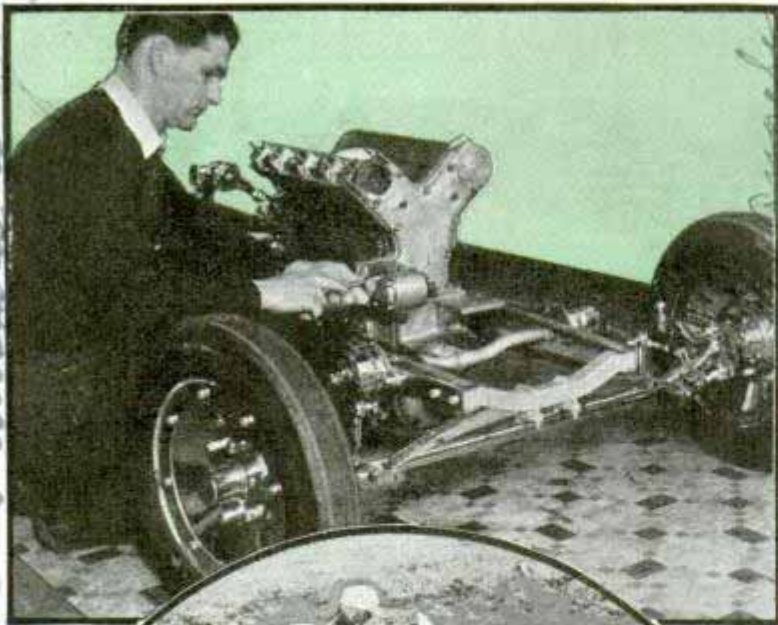

**M**IDGET auto racing is so popular this year that good drivers can race every night in the week with a couple of matinees thrown in, if they wish. During the summer season a busy driver follows a timetable packed with action and there's hardly an hour when he is not racing, working on his car, sleeping, or traveling to the next track.

Leading drivers such as Ronnie Householder, who won last year's championship race at Chicago, may schedule 100 or more races between May and October. A broken shoulder laid Householder up when he went through the fence last season after sixty races, of which he won thirty-five and placed among the first three for the balance except for half a dozen times when his engine "blew up."

To keep abreast of a grueling schedule like that calls for careful planning. Householder makes his headquarters at Pontiac, Mich., accessible to the tracks at Detroit, Toledo, Cleveland,

## KEEPING *the*

Chassis and engine are torn down completely every week in race season, top. Circle, attempting to pass car on rail at turn. Bottom, midget car assembled from stock parts ready for race

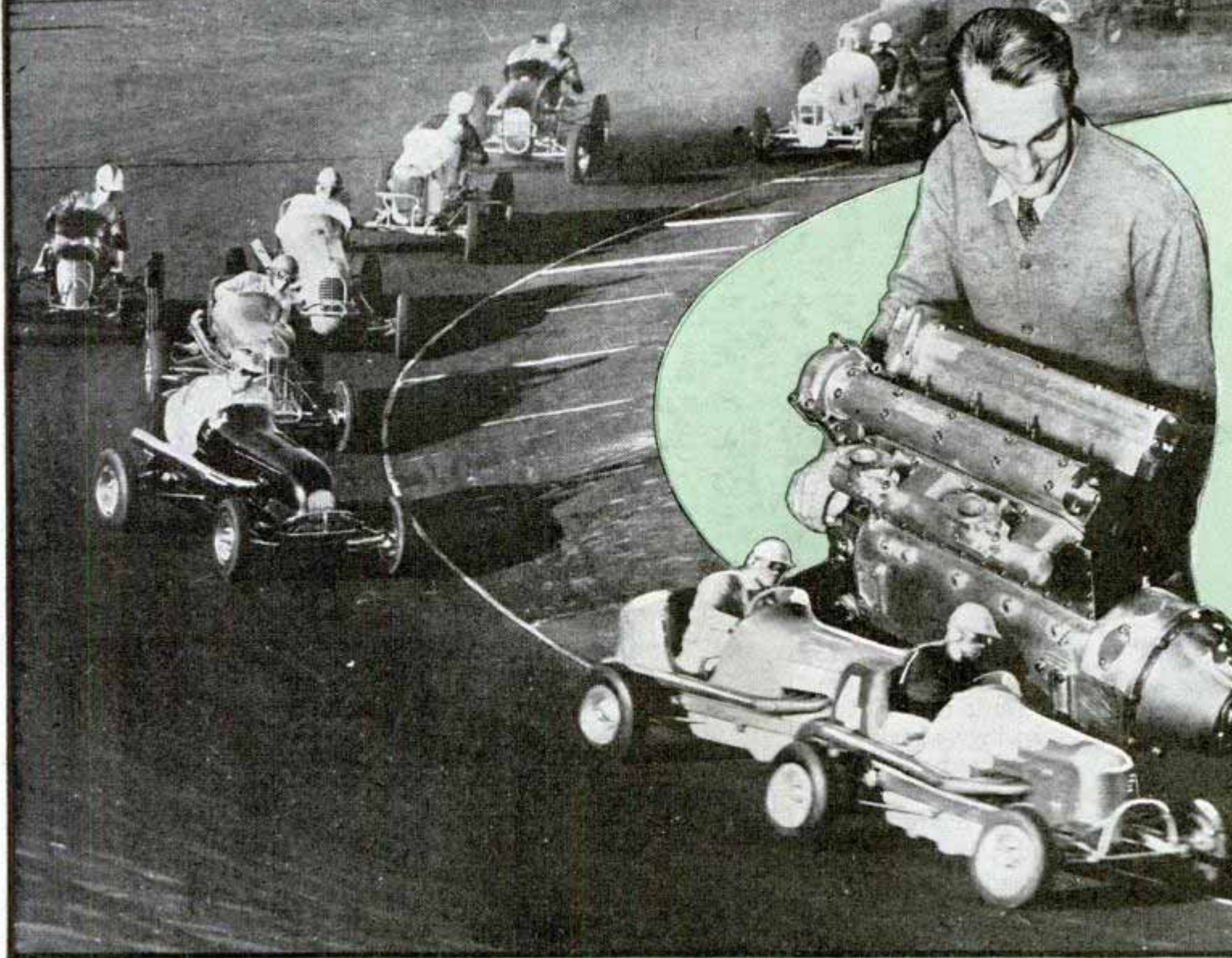

## MIDGET RACERS *Rolling*

Grand Rapids, and Kalamazoo. This year, with two race cars, he travels in a station wagon and tows a double-deck trailer on which the cars are carried. Johnny Wolfiel is the other driver of the team. After each race the pair travel several hundred miles to the next track, catch a few hours of sleep, and get up in time to begin preparing their cars for the race that night.

First the body is washed and the chassis inspected for cracks. If the motor wasn't quite right the night before, it is tuned up. Tires and the rear-end gear ratio may be changed to fit the conditions of the coming race. Once a week each engine is torn down and new rings fitted. The valves may need grinding at the same time. After twenty or more races, depending on the amount of dust that has filtered into the engine, it is rebored and rebabbitted.

A well-equipped car has plenty of spare parts. Shafts and motor parts are most apt

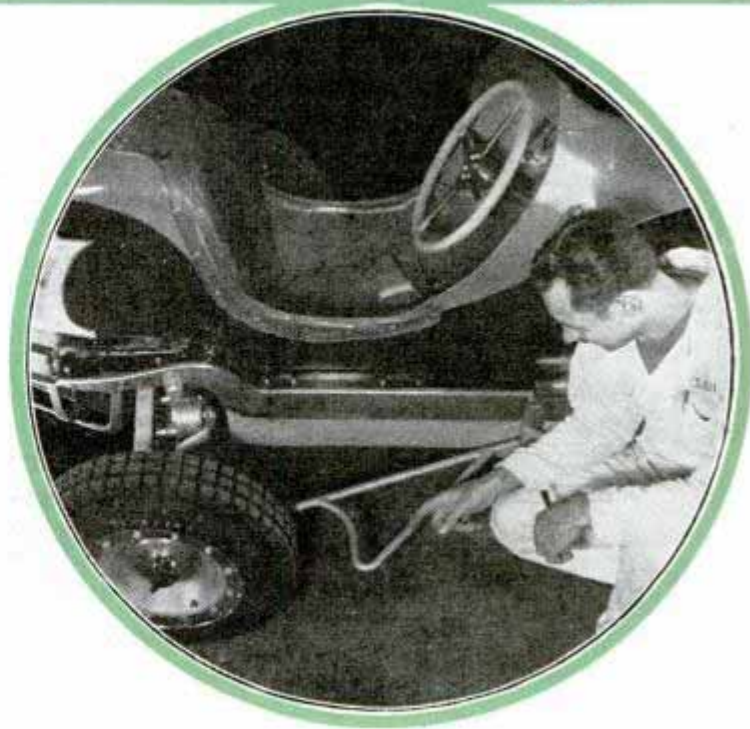

*Top, sliding the turn, and a 200-pound, 100-horsepower motor; below, "nerfing" bar for safety in collisions*

R198

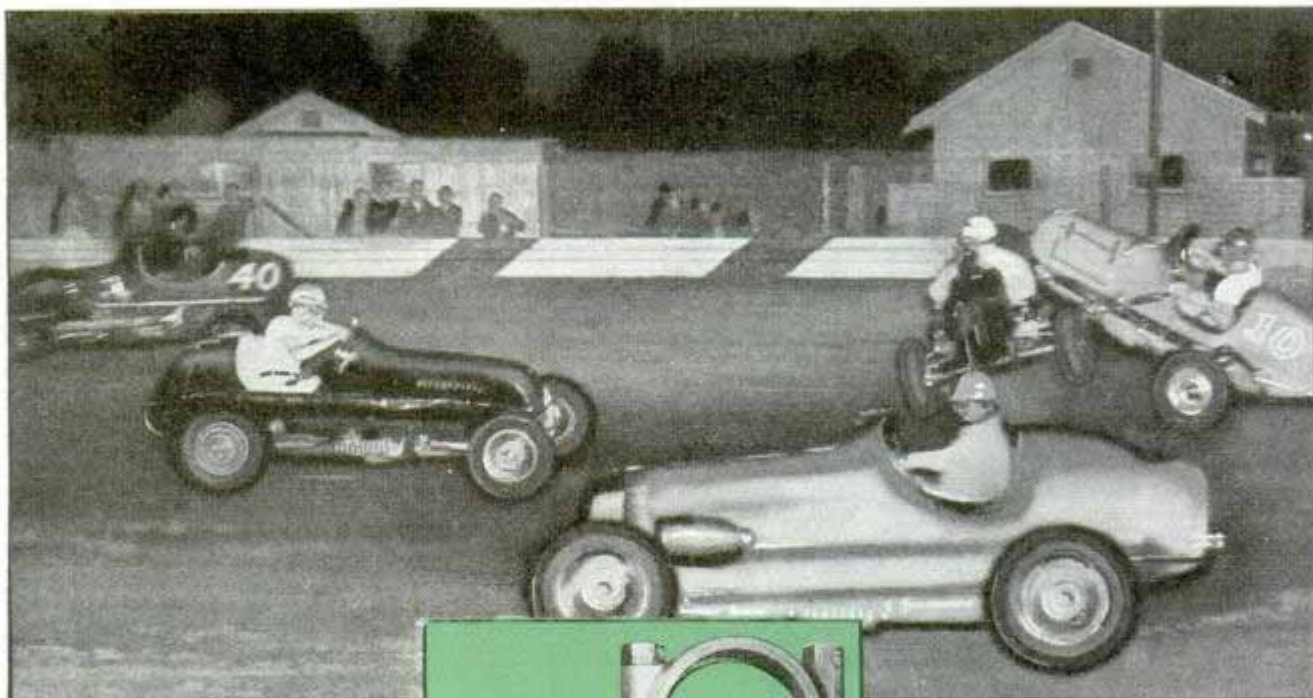

to fail in racing. Axle shafts, crank and clutch shafts, springs, shock absorbers, spare gears, boxes of spark plugs, and as many as eight spare tires and wheels of different treads and sizes to suit different tracks are part of the equipment. Some drivers carry a spare block, with pistons and valves fitted, ready to mount on the crankcase.

Preparations for a race aren't finished until just before the race begins. A change in the weather may necessitate a change of fuel and spark plugs. The qualifying trials are usually made with a high gear ratio, after which the ratio is changed for the race itself. On a damp night the burned gases from the exhausts may hang over the track and the carburetor will need a last-minute adjustment. If the trial dashes dry out the track's surface, tires may be changed in a hurry to take advantage of the new conditions.

Being a consistent winner takes more than superb driving. Competition is so intense that a leading driver must constantly improve his car to keep in the lead. The trend in engineering is to develop lighter cars that ride the tracks more perfectly, transforming more of the available engine power into speed. Cars that bounce around and toss their wheels off the ground in the turns are beaten by cars easier to control.

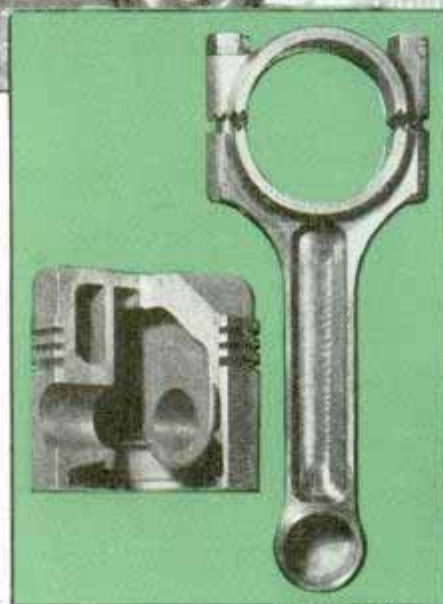

*Above, three drivers try desperately to miss pair that have collided at high speed in night race. Left, cut-away piston of midget engine showing interior construction, and new type of midget connecting rod. Below, installing main bearings of new Sampson midget racing engine.*

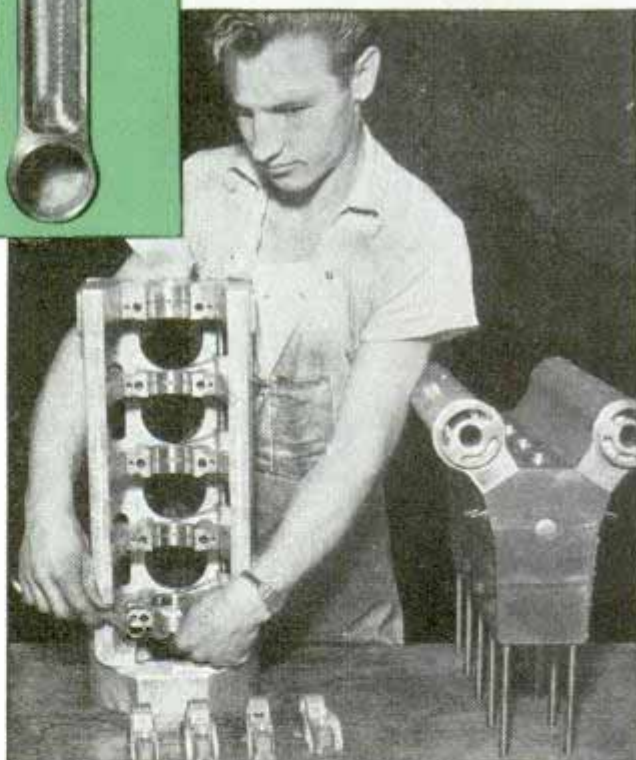

Householder's new car has a total weight of 690 pounds as against an average weight of 850 pounds. Weight was saved at every possible point. There are no housings on the rear axles. The frame is of light channel steel, the steering box is an aluminum casting, and special shock absorbers that weigh fourteen ounces instead of five and



6117 S. Vermont Pl.,  
Los Angeles

Los Angeles, Calif

one-half pounds each are used. The shocks have the additional advantage of delivering immediate and positive action, helping to keep all four wheels on the track. The car is powered with a new Sampson motor.

Fred Offenhauser, builder of stock racing engines for midget cars, is experimenting with a new chassis that has a novel independent wheel suspension in front while between the rear wheels is a cross spring hinged in the middle. The purpose is to keep all four wheels vertical and in contact with the track at all times, the body being permitted to roll in the turns. Each front wheel is attached to a coil spring housed horizontally inside the hollow front cross bar of the frame.

Alden Sampson, race car owner who has entered the field with a new stock lightweight 100-horsepower engine, is also building an experimental chassis for a car that is expected to weigh only 600 pounds. Suspension of this car is to be about the opposite of the new Offenhauser, with one cross spring in front while each of the rear wheels is independently sprung by means of a twenty-four-inch alloy steel torsion bar, the rear end of which is connected to the wheel and the front of which is anchored to the frame.

Sampson's new engine runs counter-clockwise like an aircraft engine, the purpose being to transfer engine torque to the left side of the car to prevent the left wheels from rising in the turns.

The four-cylinder engine weighs 200 pounds complete with transmission, and develops 100 horsepower at 6,500 revolutions per minute. Bore is three and one-eighth inches and stroke is three and one-fourth inches. There are four valves per cylinder, overhead camshafts, and two carburetors designed to use leaded gasoline instead of expensive alcohol. The counterbalanced crankshaft is supported by five main bearings. Connecting-rod bearings are of the shell type, the bearing caps making a saw-toothed fit with the rods to prevent side twist. Bearings can be replaced rapidly and at slight cost. The new engine is thirty-four inches long, fourteen and one-half inches wide, and twenty-one and one-half inches high. The design permits use of supercharging equipment. Both Sampson and Offenhauser are manufacturing quick-change transmission assemblies that permit changing gear ra-

(Continued to page 140A)

## Children's Homebuilt Swing Has Interchangeable Seats



Safe swing for children, top, fitted with closed-in seat; bottom, bicycle-type seat for older children

To provide new thrills for his children, one father built a swing which can be used safely. It may be fitted with seats suitable for either small or large children. An airplane body, in which the smaller ones sit fully protected, is propelled by pushing and pulling on a bar at the front. For larger children, a body with bicycle seats and handle bars can be substituted.

When their home is flooded, the vicious driver ants of Liberia—inch-long blind ants—form a ball which rotates as it floats in the water, keeping them from drowning by remaining under water too long.

Charles J. Eckley  
1617 N. 39th, Seattle, Wash

W. H. Stone  
W. H. Stone

W. H. Stone  
W. H. Stone

# Steel "Strongback" Lifts a Five-Ton Sidewalk

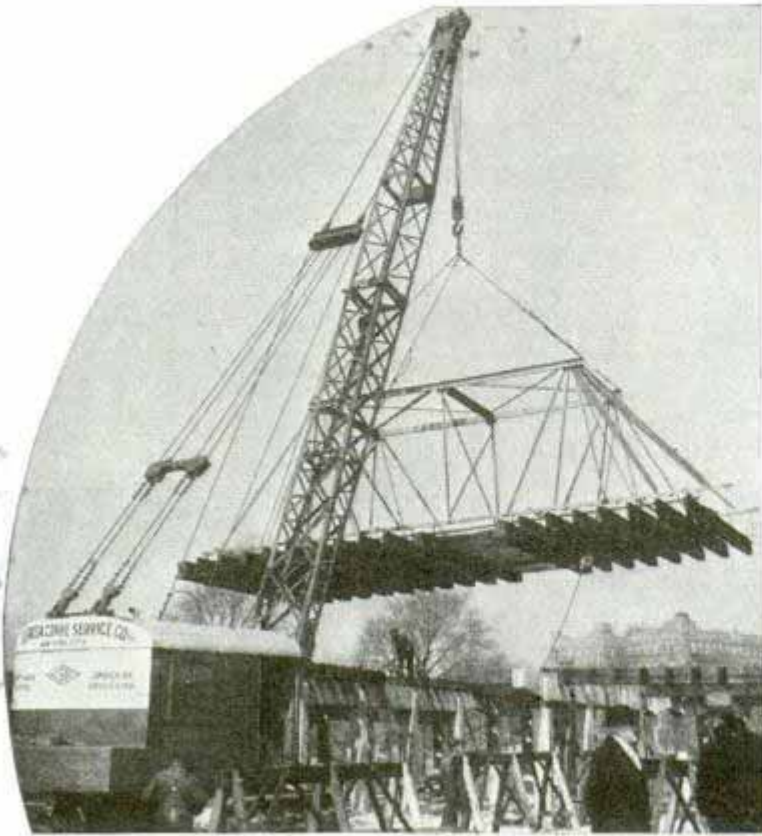

Whole sections of the boardwalk at Coney Island were picked up bodily and transplanted to a new location with the help of a steel frame, nicknamed "strongback" by the contractors. The bridgelike carrier, which weighs two tons, was designed to distribute evenly the strain of lifting the five-ton sections and moving them by crane as far as 350 feet. It proved a real time-saver in "straightening" a 4,000-foot length of the boardwalk to enlarge the beach front area.

Five-ton sections of boardwalk, above, are picked up and carried by crane to new location, sometimes 350 feet away. Right, note bridge-like structure of "strongback" with forty hooks swinging from 'tracks' at sides

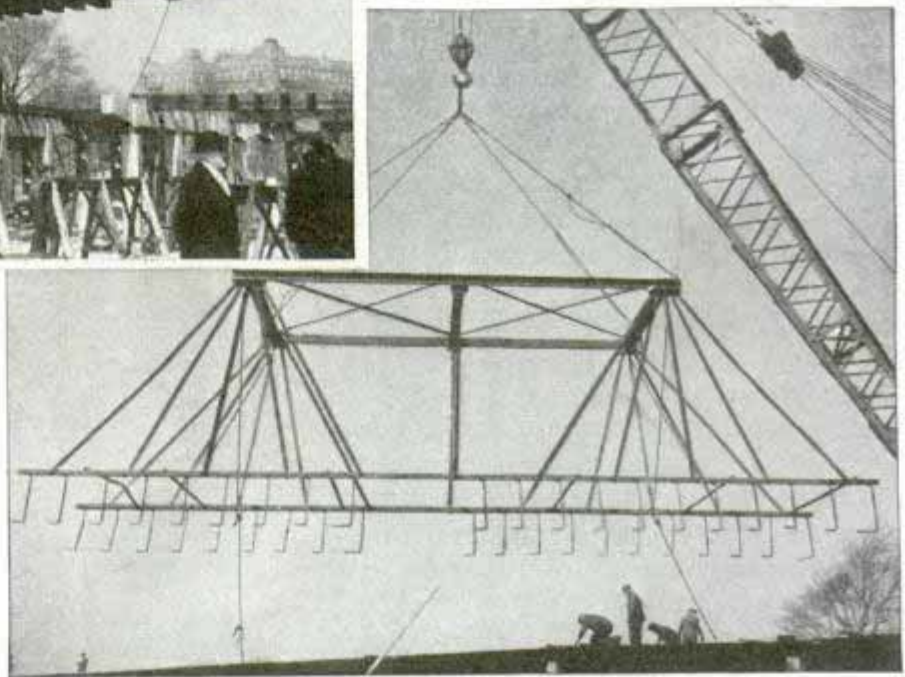

# 100,000,000-Volt Atom Smasher to Probe Matter's Secrets

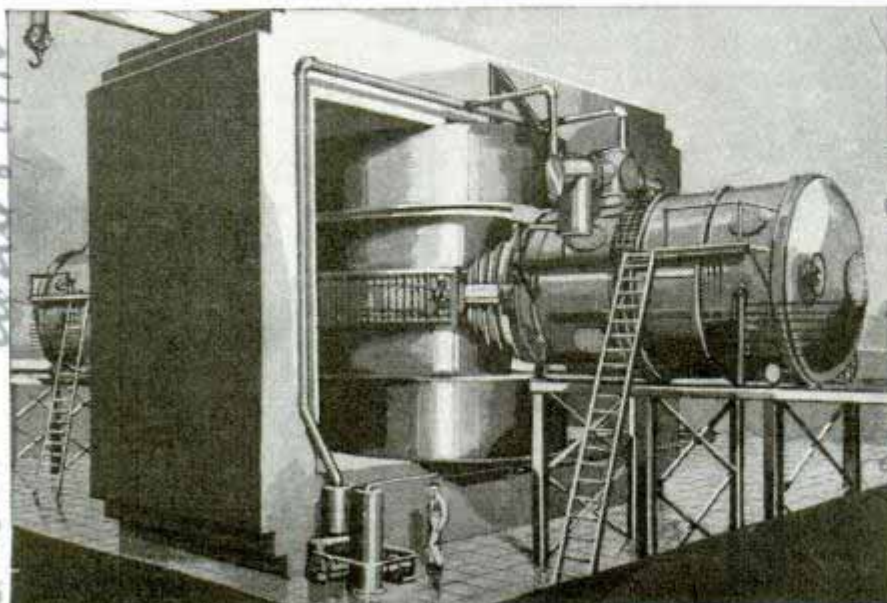

New attacks will be directed against the atom to unlock its pent-up secrets when the giant of all atom smashers is completed at University of California. The cyclotron will produce energies in excess of 100,000,000 volts, about triple the voltage of the university's present atom smasher, and will weigh 4,900 tons, which is more than twenty times heavier. As compared with the sixty-inch magnet of the present instrument, the

Drawing shows how 100,000,000-volt cyclotron will appear when finished

new one will measure 184 inches. The structure will be fifty-eight feet long and fifteen feet wide, with a height of 36.8 feet, of which 11.8 feet will be underground. Its control room will be located underground, 150 feet from the cyclotron. While nothing is known about the possibilities with such enormous energies, the primary objective is to open a way to study new regions of the atom, an infinitesimal planetary system that is the "building block" of material substances.

*Hannover. Lüderi*  
*esperance*  
**Four-Gun Man in a 'Blister'**  
**Guards Tail of Air Bomber**

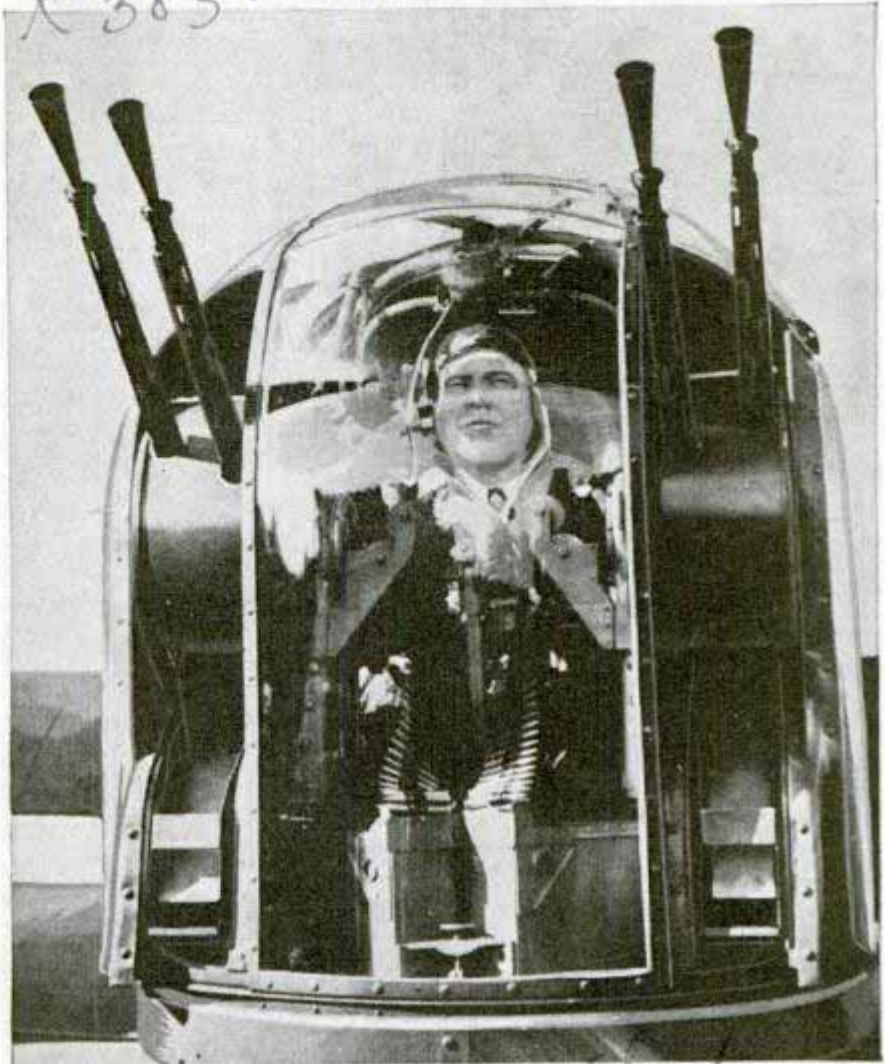

*and*  
Guarding the tail of a British bombing plane, the machine gunner in his glassed turret can maneuver his multiple guns in all directions

Flanked by a brace of machine guns on each side, a "four-gun man" in a "blister" guards the British bombing planes from enemies attacking the tail. His glassed-in turret affords a wide enough view to prevent any surprise attack.

*Automotive Engineer*  
*5/1/40*

R 588.  
**Hot Plate Vaporizes Turpentine Used as Motor Fuel**

*sponsor*  
Crude turpentine was used successfully as a motor fuel in a recent demonstration in Sweden. In the experiment, a copper plate with a hole of smaller diameter than the cylinder was placed between the cylinder head and engine block, so that heat retained by the copper would help vaporize the turpentine. The method was tried only on overhead-valve engines.

R 439  
**One-Man Towing Bar for Auto Is Attached without Tools**

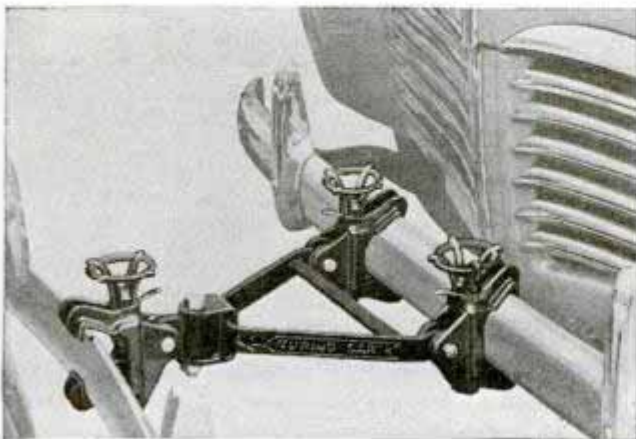

Jointed bar adjusts itself to meet bumper heights

Only one driver is needed to handle two cars with a new towing bar that attaches to the bumpers without the use of tools. Adjusting itself automatically to bumper heights, the bar is fastened easily by turning hand wheels to tighten the clamps, and it can be released quickly by pressing a thumb lever. The clamp jaws are lined with special fabric so they will not mar the bumper finish.

Send stamped, addressed envelope to our Bureau of Information for name of maker of any device described in this magazine.

*The Fulton Co*

K476  
 S. W. Clatworthy, 84, Lewin Road, London S.W. 16 England

# Fire-Control Tower Is the Battleship's 'Brain'

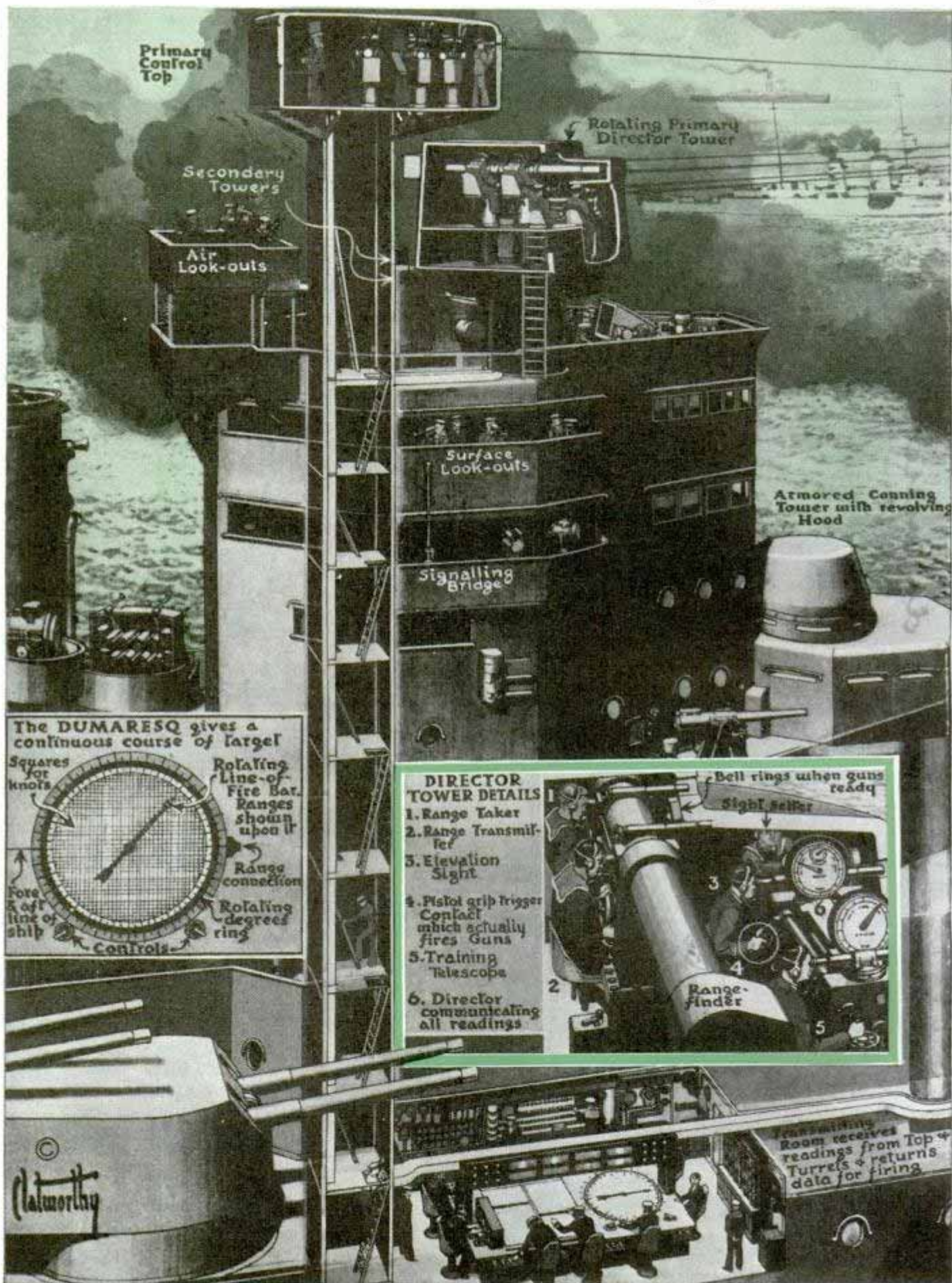

Here is a glimpse of the fire-control tower of the latest British battleships, representing equipment costing about \$1,000,000. The transmitting room, "brain center," is beneath the thickest deck and behind the heaviest side armor. The "Dumaresq" is a mathematical marvel for aiming at moving target

# Training the Big Guns of a Floating Fortress

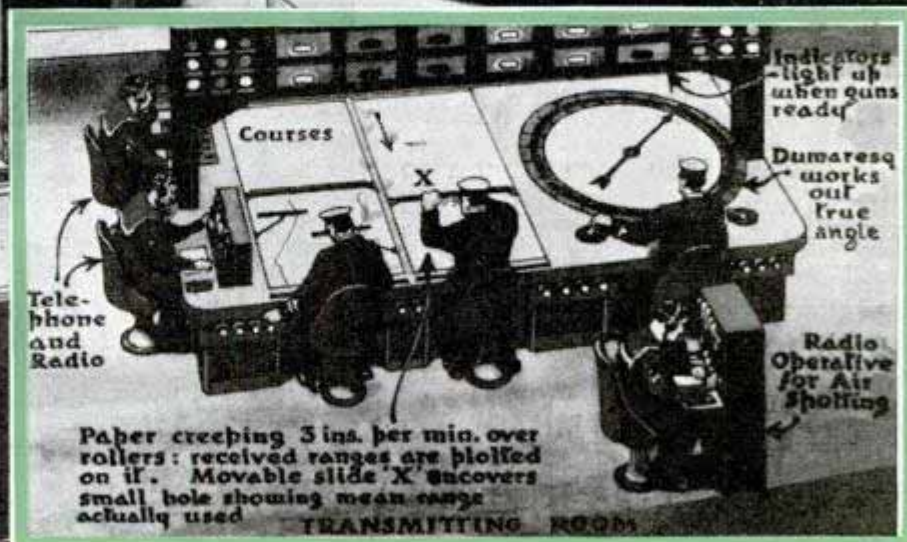
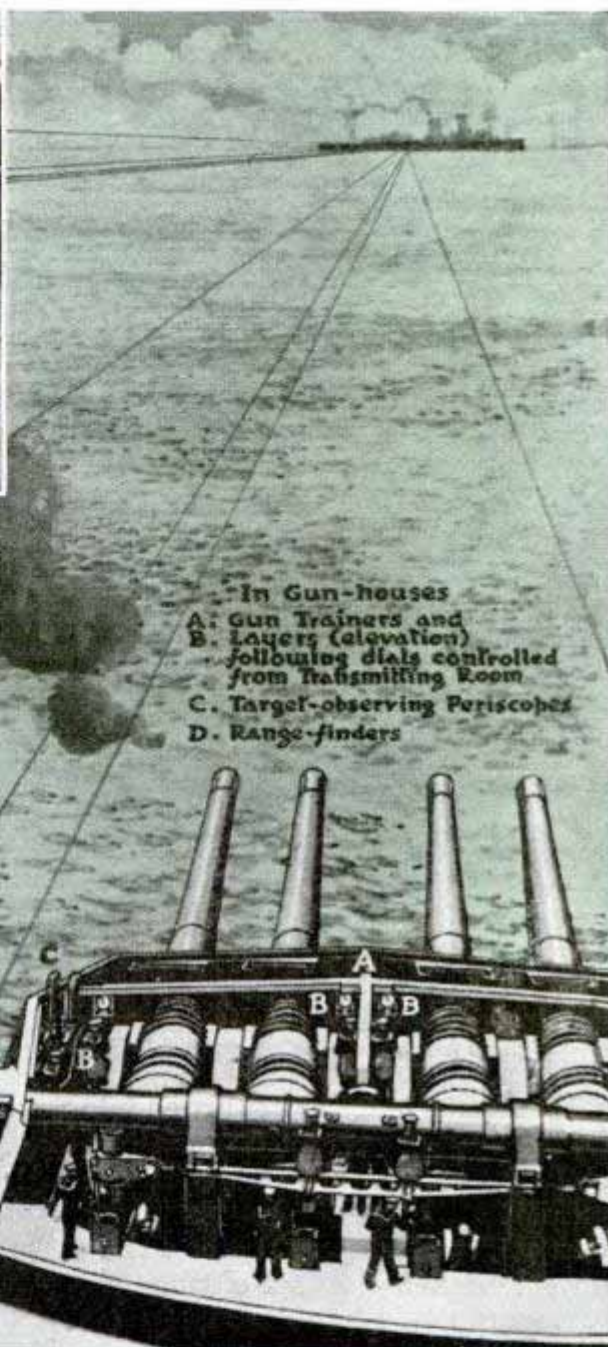
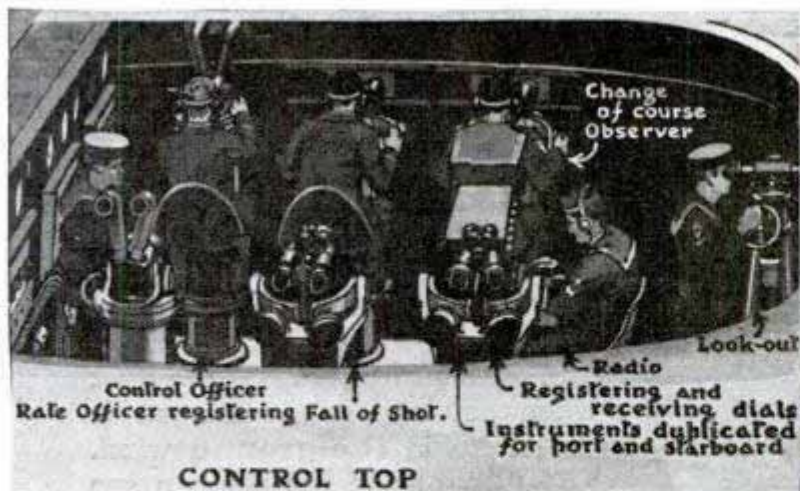

Gun turrets of a dreadnaught are trained on but one target at a time, and gun crews do not see enemy nor even fire their own guns. This is done by electric pistol in director tower after data on range and elevation are worked out in transmitting room. Entire fire-control system is duplicated aft

## Elephant Feet Form the Legs of a Sportsman's Novel Table



At left is a wastebasket made of hollowed leg of an elephant, at right a heavy table is supported by two elephant legs

Elephants' feet can be turned into novel furniture for the big game hunter's home or the sportsmen's club. Two huge feet were used as pedestals for a table, and another was hollowed out and mounted as a wastebasket. Smaller elephants' feet were made into decanters.

## Rapid Fall with a Parachute Has Little Effect on Man

It doesn't take a superman to jump from a plane, fall through space at 119 miles an hour and land conscious and ready to fight. Aviation physicians have found that a free fall damages neither body nor mind. At high altitudes the sensation is one of floating, gravity-free, in the air rather than plunging downward. There is no terrific strain on heart, blood vessels, breathing, nor on the eyes and ears. The principal annoyance is the increasing pressure on the

ear drums which is compensated by holding the nose and blowing into it. The two real hazards are the two stops—first when the ripcord is pulled and the parachute gives a stiff jerk which, opened at 325 miles an hour, would exert 6,000 pounds pressure on the chute and the man in harness; and secondly, when the jumper hits the ground. The trick is to come down ready for a forward somersault, but many jumpers are hurt when they land, or are dragged by the chute in the ground wind. The parachute jumper can see clearly even when his eyes are unprotected by goggles, and breathing is normal—why, science has not yet decided.

## Electric Model of Element Shows Nuclear Changes

To illustrate the transmutation of elements, eighteen-year-old Robert Tedeschi, science student in a Long Island high school, worked out an electrical model using light bulbs for an illuminated diagram. When he presses buttons, relays of bulbs are lighted, showing what nuclear changes take place as gases change form.

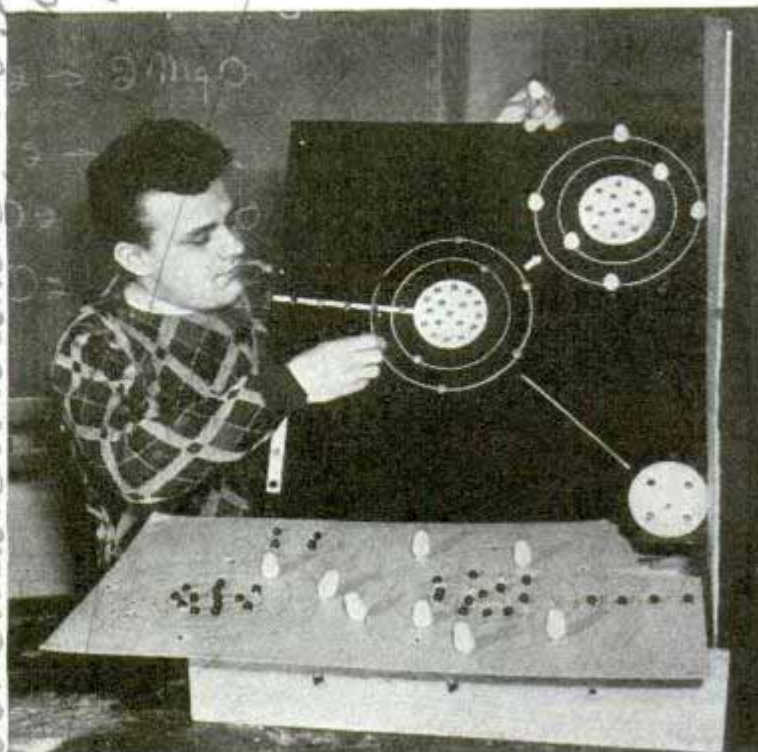

Planting lights in model showing transmutation of elements

James L. Clark Studios  
 172 nd and Jerome Ave.  
 Scene Service  
 May 17, 1940  
 K 383  
 K 633  
 American Institute 60 8470  
 Newtown High School

*12 E. Esmond Ave Chicago*

# Radio Headlight to Prevent Collisions in Air

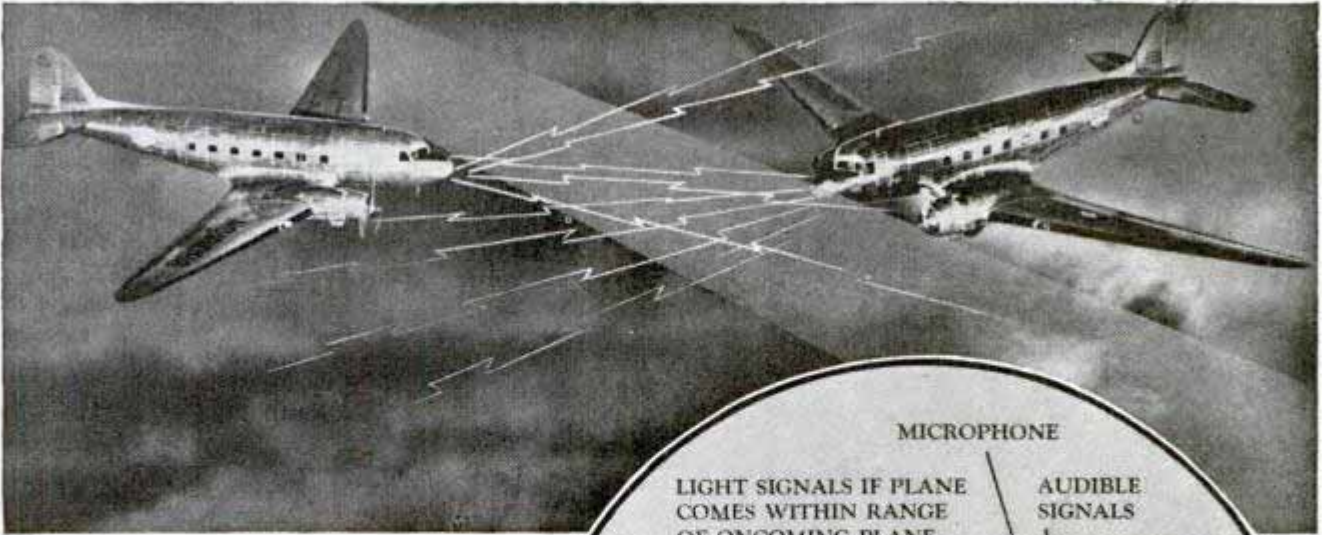

Aeronautical engineers are developing a radio "headlight," a directional signal projected from an airplane which will permit the pilots to "see" each other at night and in thick weather. Whenever another plane comes within range, a signal on the instrument board will show a warning light and the flier can then communicate with the other ship and avert a collision. There is no immediate need for such a detector, but with air traffic rapidly thickening and around thirty transports flying each way daily between Chicago and New York, a radio headlight may soon become an essential safety device. Air-line pilots today can talk to ground stations, but not to each other in the air. The first step toward an anti-collision beam is expected to be standardization of equipment for inter-plane conversation over fifty to sixty miles. The next step would be an oscillator giving out a

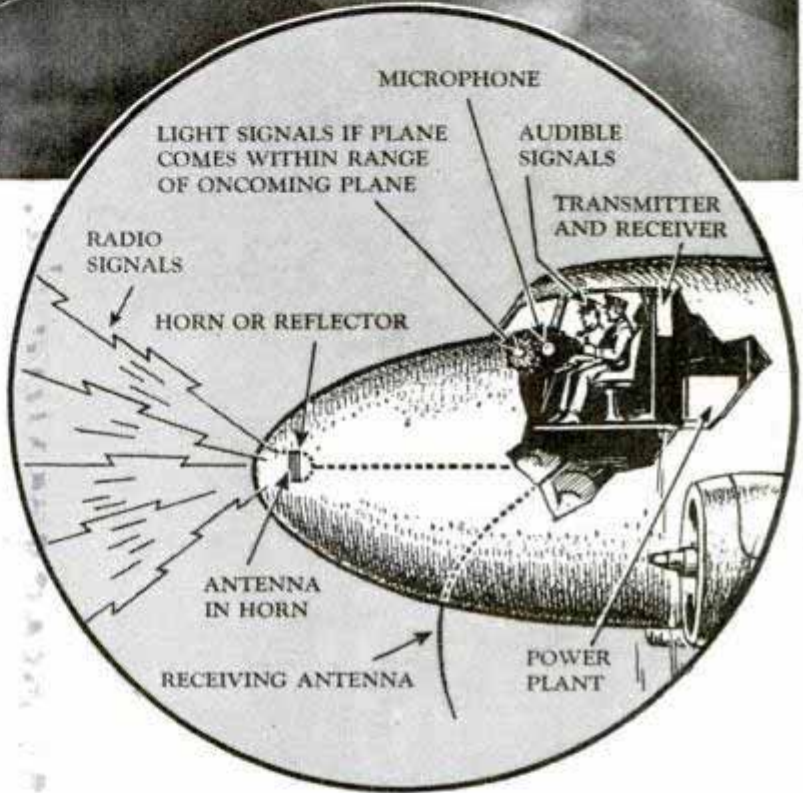
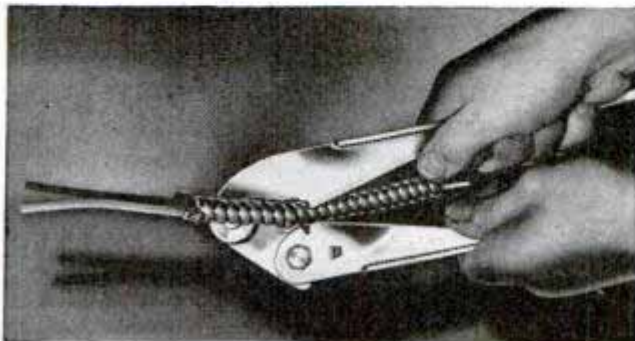

*Photo-drawing indicates how planes fifty or sixty miles apart could detect each other; below, diagram of radio "headlight"*

signal at intervals, and a visual signal in the cockpit to indicate approach of another plane. Eventually the engineers expect to build a small reflector in the nose of the plane to project a directional, flattened radio beam, divorcing the interphone system from the anti-collision device.

*K 483*

## Pliers Cut Metal Armor from Cable and Strip Insulation Off Wires



*Pliers cut flexible cable without damaging wires*

Flexible electric cable is severed quickly with a pocket-size cutting tool that also strips insulation from the wires. The twelve-ounce pliers will not cause shorts by nicking or bending the wires, according to the manufacturer, and they can be used to cut into the cable anywhere along its length to make openings for outlets, switches or boxes. The blade is removable for sharpening or replacement.

*deal Commutator, Messer Co. 57 E 3 Park Ave. Syracuse N.Y.*

# MINUTES

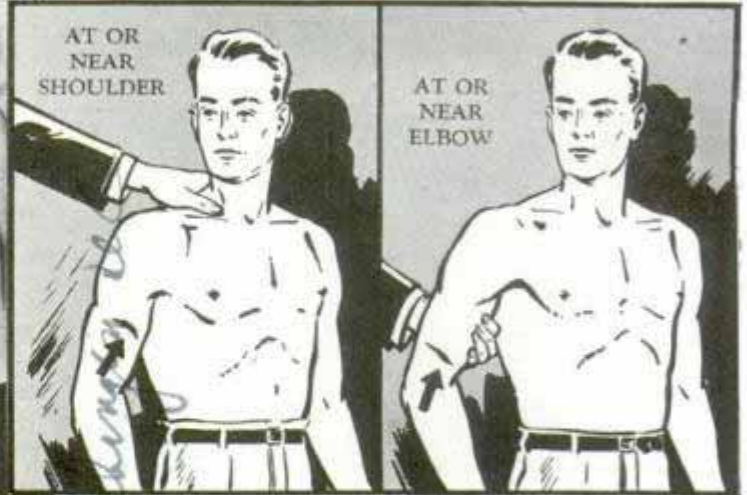

By **Laurance M. Thompson, M. D.**  
 Assistant Director of First Aid and  
 Life Saving, American Red Cross

**A**CCIDENTS happen too swiftly to do anything about them. After they have happened, after a person has been injured, the first few minutes are important. What we do then, or fail to do, often spells the difference between life and death.

Invariably the first thing to do is call a doctor or ambulance. But even in a city, where professional help is never far away, several minutes must elapse before it can arrive. In those few minutes a person can suffocate, bleed to death, die of poisoning or shock. These are the minutes that mean eternity.

In case of an auto accident or fall, where serious injury is apparent or suspected, never under any circumstances move the victim, nor permit anyone not skilled in first aid to do so. He may have a serious fracture. Let him lie in the middle of a busy street if that is where he happens to be, and resist all efforts of ignorant bystanders to bundle him into a car.

The victim might have a broken back or neck. You have no way of knowing. Such injuries, serious as they are, are not necessarily fatal; but easily can be made so by unskilled efforts.

Other fractures may result in

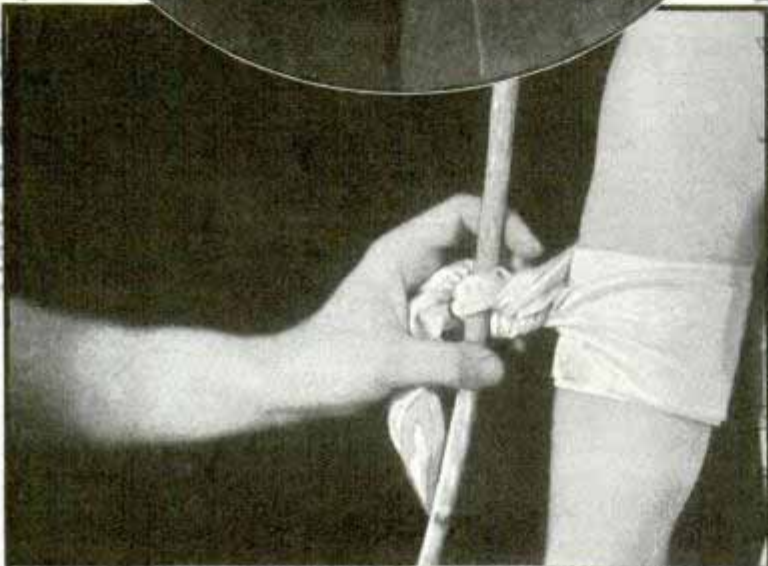

Here are some methods of stopping loss of blood in emergency. At top, using forearm to apply pressure to arm; center, tourniquet applied without pad; bottom, pressing fingers into arm. Drawings across top indicate pressure points for arteries

K154  
 Capt. Herbert V. Webb, 4322 Second Road North, Arlington, Va.



K 154

# that mean ETERNITY

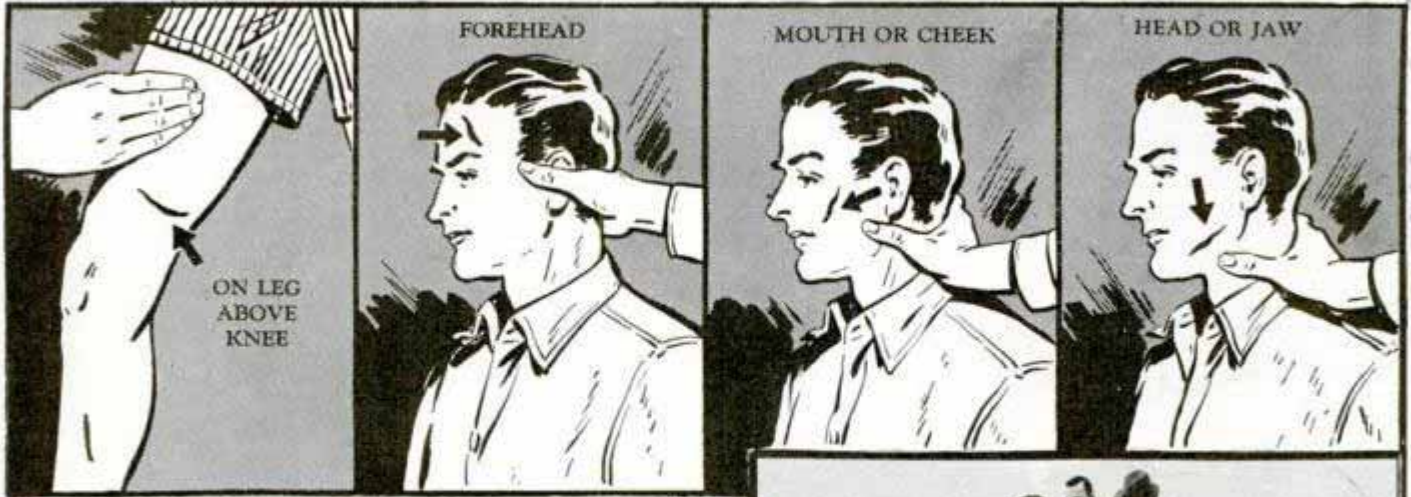

death or permanent crippling if not handled properly. Sharp ends of the broken bone have a nasty habit of cutting through blood vessels, or piercing the skin so that infection results and amputation becomes necessary. Broken ribs can puncture the lungs easily and cause death. If in doubt as to whether bones have been fractured, always assume that they have. Make the victim comfortable, treat for any shock that may be present, but do not move the person until the fracture is splinted.

But one who applies splints must know how. He cannot know without proper training. Such training is available to all,

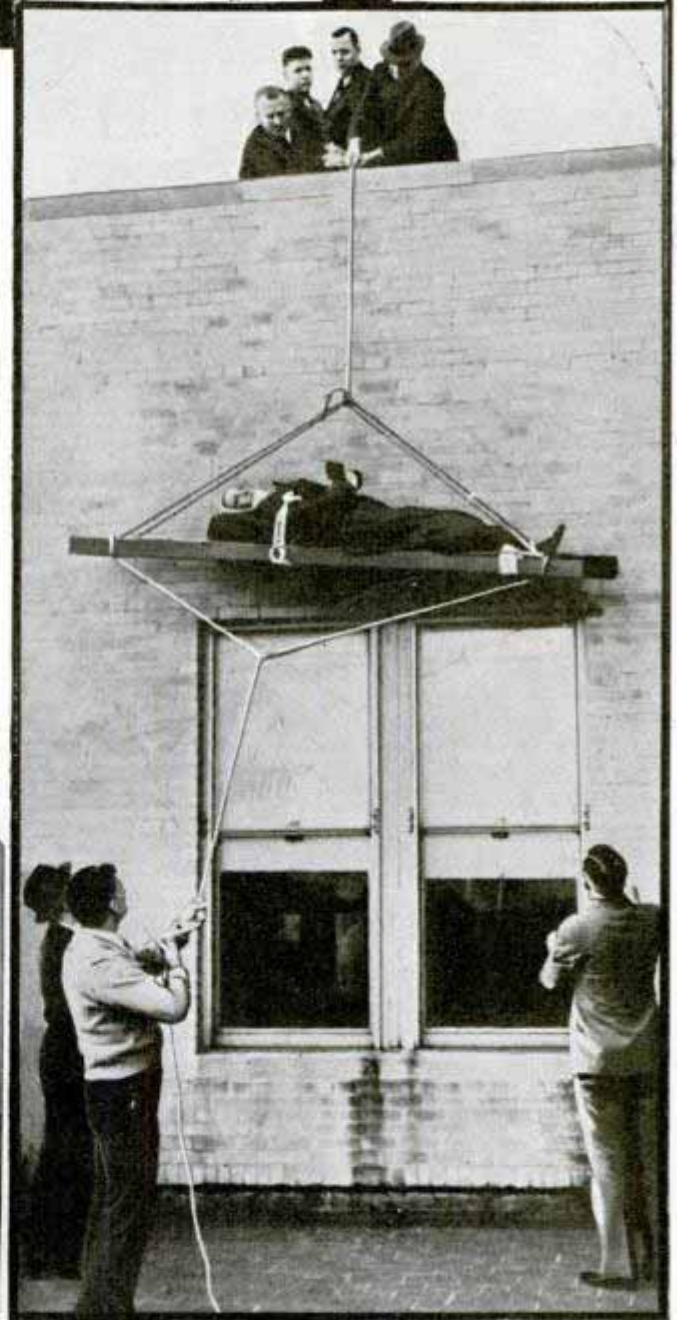

Above, lowering an injured person from roof. He is strapped to a ladder and his hands are tied to prevent struggle which might cause a fall. At left, the "chair carry," a method which helps avoid dangerous tension on victim's body

Ferguson F. Thelmer  
Chelie ob  
Ferguson  
W maffel

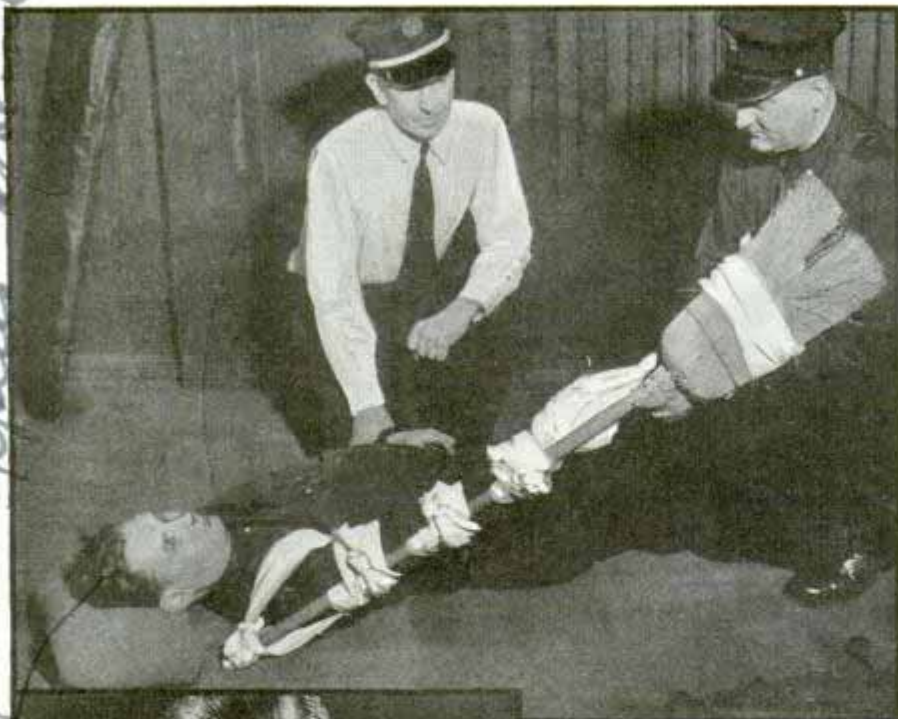

and heart until the flow of blood stops. There are certain places where the arteries cross bones near the surface. Once one has learned the location of these, he can immediately control bleeding from an injury to any part of the body. These places are known as pressure points. In the excitement following an accident, these pressure points may be hard to find in a hurry. You can learn definitely where they are at your Red Cross first-aid class, then practice until you can apply this pressure instantly. You may save a life, perhaps the life of a loved one.

Severe bleeding can be controlled by a tourniquet, leaving the hands free to help otherwise; but

a tourniquet is such a dangerous device in the hands of an untrained man that its use is not recommended except in extreme cases. If one must be applied, let it be a stocking, scarf, or some other wide, soft material. Loosen it gently every fifteen minutes to permit blood to flow to the limb, and stand by to inform the doctor of its presence. Never conceal it with a splint or bandage. Im-



*Top, applying a broom splint to arm. A folded magazine may serve well as an emergency splint, center. Bottom, a wife finds husband in garage filled with smoke and fumes; what she does in next few minutes may mean life or death to him*

properly applied tourniquets have too often caused unnecessary amputations.

Shock is always more or less present in cases of severe bleeding or extreme pain; and since this condition often causes death even when the injury is not otherwise serious, it should receive prompt attention as soon as the bleeding is controlled.

The symptoms of shock are paleness with an anxious expression. A cold perspiration appears on forehead and palms, the pulse is rapid and weak. The breathing is irregular. Sometimes a severe chill develops; nausea and vomiting are frequent. The victim, though conscious, is mentally dull, and sometimes has to be asked how he feels two or three times, then often replies that he is cold or very tired.

The most important thing in treating shock is to keep the victim warm. Wrap him in blankets, coats, or whatever is handy, under him as well as over. If possible, apply external heat such as hot-water bottles, heated bricks wrapped to prevent burning, or anything that is available. Rubbing the limbs is of little value, since it requires uncovering the patient.

Since the cause of shock is insufficient supply of blood to the brain and heart, the position of the patient is of next importance. He should be made to lie down without a pillow under his head, while the feet, legs, and thighs are elevated. Do not permit him to sit up, except in cases of chest injuries where breathing becomes difficult when lying down. If there are head injuries, have him lie flat but do not raise his feet.

Stimulants may be given, though they are of less importance than heat and position. The best stimulant is a teaspoonful of aromatic spirits of ammonia in half a glass of water. Hot coffee and tea are also good. Give these with a spoon, or have the victim drink a sip at a time, with a few seconds between each to swallow. Alcoholic drinks are depressants, not stimulants, and should not be given. No stimulant should be administered until bleeding has been checked; and an unconscious person should never be given anything to drink, for he cannot swallow.

When a person has taken poison, immediate action is demanded. The treatment is to dilute the poison and wash it from the stomach. Both may be accomplished at the same time by having the victim swallow

(Continued to page 134A)

AUGUST, 1940

## Cultivator Turns the Lawn into a Vegetable Bed

*"Walking" cultivator used in England to convert private lawns into gardens for raising vegetables in war campaign*



Many lawns in England are being dug up and vegetables now grow in place of grass, as part of the home front's drive to win the war. In cooperation with its citizens, the city of Wimbledon owns a small-size power cultivator which is loaned to anyone who wants to help in the campaign to "dig for victory."

## Soldier "Sculptured" in Oil Cans Stops Motorists for Gas

In front of a filling station stands a tin soldier with his hand upraised in a silent command for passing motorists to stop. Close by is a "field gun" trained on the road. The entire display, modeled from discarded oil containers, is an advertising stunt to attract customers.



Tin soldier alongside cannon helps sell gas and oil

K 396

## Jig Saw Run by Foot Power Clamps on Bench or Table

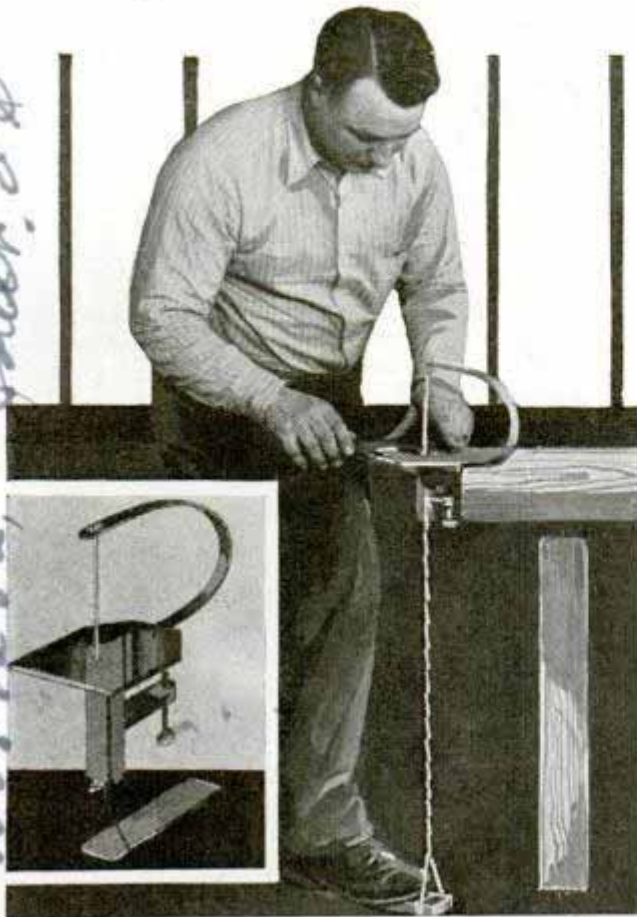

Jig-saw craftsman supplies own power by pressing treadle to pull blade downward; spring draws it up

Where no electric power is available, a foot-operated jig saw can be clamped easily to the edge of a table or workbench. Pressure on the treadle delivers power directly to the saw, which is sturdily constructed of cast iron and steel.

K 409

## 'Stop-and-Go' Lights for Speakers Halt Long-Winded Talks

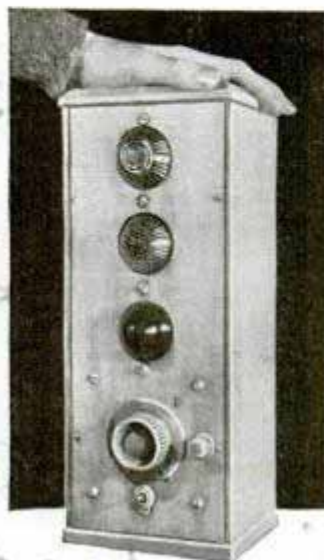

Enforcing a six-minute time limit upon long-winded after-dinner speakers was solved at one club by installing warning lights. Placed at the back of the room, where only the speaker sees it, the signal consists of a buzzer and three colored lights—green, orange and red. At

14008 Bessemer St  
the beginning of a speech a member turns the big dial to start the timer. The green light at the top shows for five minutes, followed by the orange light for one minute, to complete the allotted six minutes. Then the red light comes on, warning the speaker that his time is up, but allowing him thirty seconds of grace. If this still does not stop him, a loud buzzer goes into action, hindering further attempts of the speaker to make himself heard.

K 373

## Secret "Peephole" Reveals Caller before Door Is Opened

For protection against intruders who ring the doorbell and force their way into the home when the door is opened, the housewife can have a "one-way" glass window installed in the door panel to permit a secret view of visitors before deciding to admit them. It consists of a bull's-eye mounted in the center of an innocent appearing door knocker. You can look through it from within to scrutinize the stranger knocking at your door, but the person outside is unable to peer in and so would be unaware of the inspection.



Housewife gets close view of stranger through "one-way" glass in knocker (inset) before opening door

*White*  
*Box 47*  
*Alameda*

# 4,000,000-Pound Test Rack Crushes Concrete

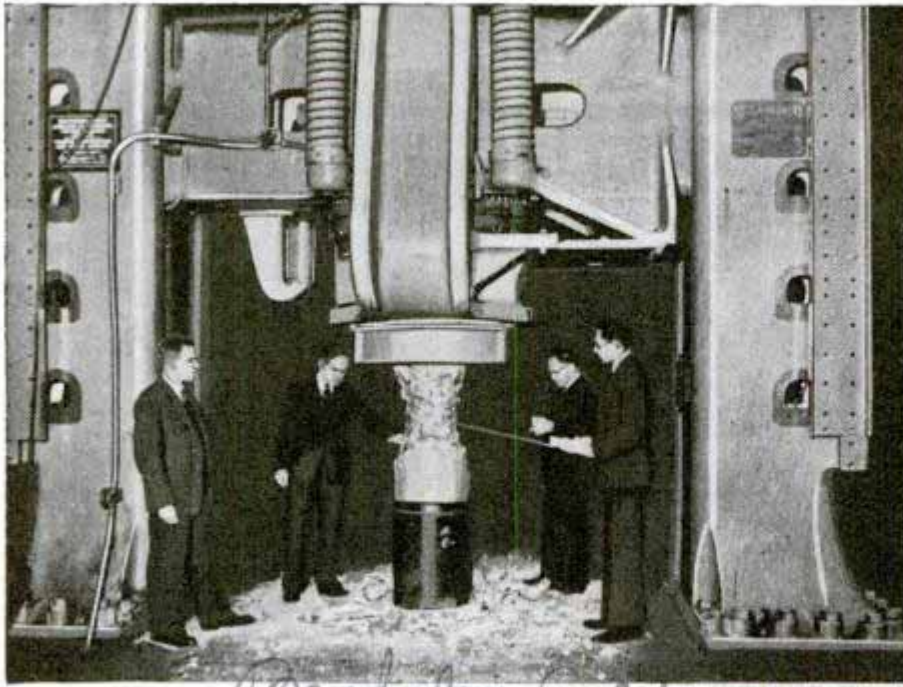

*Calif*  
At the left, a concrete column is crumbling under the pressure of the hydraulic tester which can exert a 4,000,000-pound thrust. Below, a view of the twin sixty-foot steel pillars, between them the hydraulic steel blocks which put building materials to breakdown test

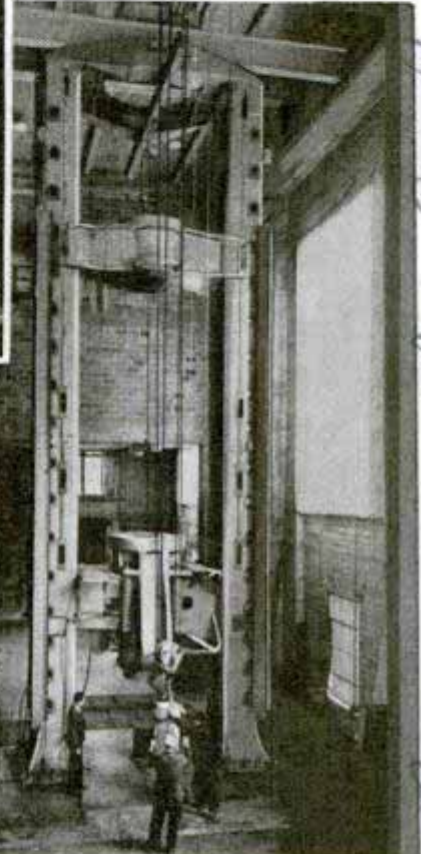

*Berkeley, Calif*  
Huge steel girders buckle and tear apart, solid concrete crumbles under the power of a giant machine at the University of California which puts building materials to the breakdown test before they can be used in dam or bridge or skyscraper. The shoulders of this 240-ton tester consist of two perpendicular steel pillars sixty feet high; between them are two hydraulic steel blocks with 4,000,000 pounds compressive power or 3,000,000 pounds pull. They can tear apart a solid steel bar eight inches thick. Samples of concrete going into Boulder, Bonneville and other dams are compressed until they disintegrate while engineers watch the fracture point. Some of the heaviest steel sections ever used in



construction, like those supporting the San Francisco-Oakland bay bridge, have been pulled and compressed to determine what load they can carry.

*K 346*

# Gas-Driven Chair for Invalid Runs Twenty Miles an Hour

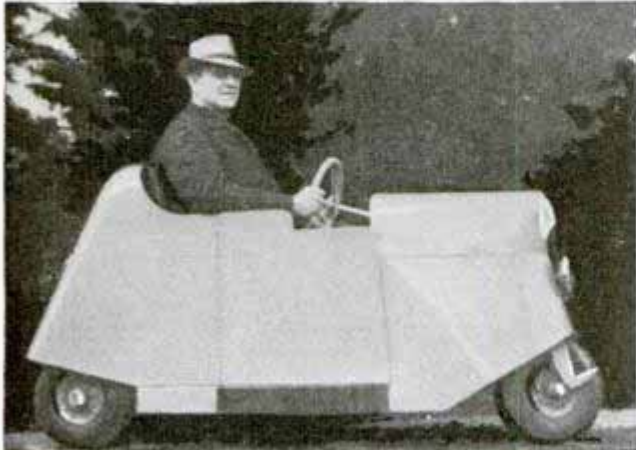

Automobile chair for invalids has speed of twenty miles an hour and runs 100 miles on a gallon of gas

One of the latest aids for invalids and aged people is a motorized chair easy to operate. Its two-horsepower engine runs 100 miles on a gallon of gasoline and can drive the car at twenty miles per hour. Equipment includes an electric starter, electric lights and a horn.

☛ First new species of bird discovered in the United States since 1919, a small warbler with an olive yellow patch on its back and raw sienna tinge on the throat was found in West Virginia recently by Karl W. Haller of Bethany college, and named Sutton's Warbler.

*Electric Gas Motor Co Santa Clara Ave Long Beach Calif*

*W. J. O. Smithsonian Institution*

# HOMING PIGEONS



FROM the darkness surrounding the pigeon lofts at Fort Monmouth, N. J., a bell tinkles. An attendant hurries with a flashlight to remove from the leg capsule of a newly arrived bird a message highly important to the U. S. Army Signal Corps. It reveals that the pigeon was released sixty miles away less than two hours ago.

In quick succession, six other pigeons swoop out of the night sky to the lofts, concluding the same trip. And the Signal Corps has completed another successful experiment in an almost revolutionary effort to develop night-flying birds.

Pigeons have been used since ancient times as message carriers, but only in daylight hours, because it is unnatural for them to fly at night. Daytime use of pigeons has always been undesirable, from a military standpoint, because the birds frequently were brought down or wounded by enemy sharpshooters, and messages fell into the wrong hands or were lost. Too, pigeons were subject to attack by natural enemies, such as hawks, increasing the

Photos courtesy U. S. Army Signal Corps

Top, left, removing message from pigeon's leg. Right, releasing bird for night flight. Bottom, kind treatment is important in training the pigeons

# *on the* NIGHT SHIFT

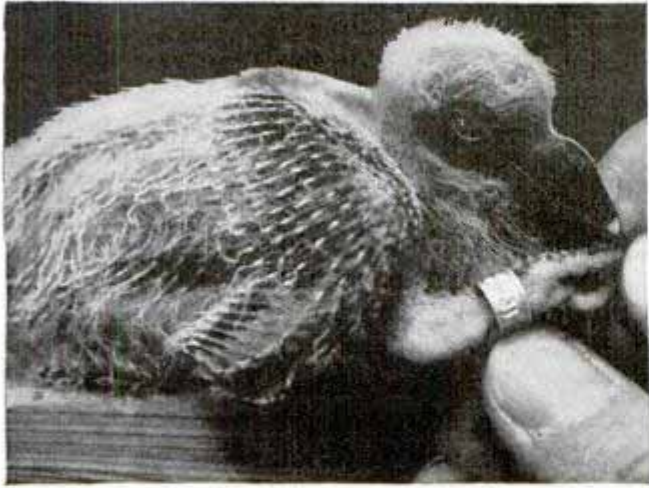

chances against messages reaching destination.

Just recently the Signal Corps began trying to invert the habits and instincts of pigeons by training them to fly at night. One of the first discoveries was that not all pigeons are adaptable to this work. Hating night flying naturally, the average bird will not get into the air, but will land as soon as he sees an opening. Of course, birds that will not get into the air are never of value, for eventually they are certain to fly into wires or trees and injure themselves. Therefore, it has been necessary to select birds of superior intelligence and courage for night work.

Long hours and plenty of patience are requisites for the trainer. Flying at night is a quality that may be developed

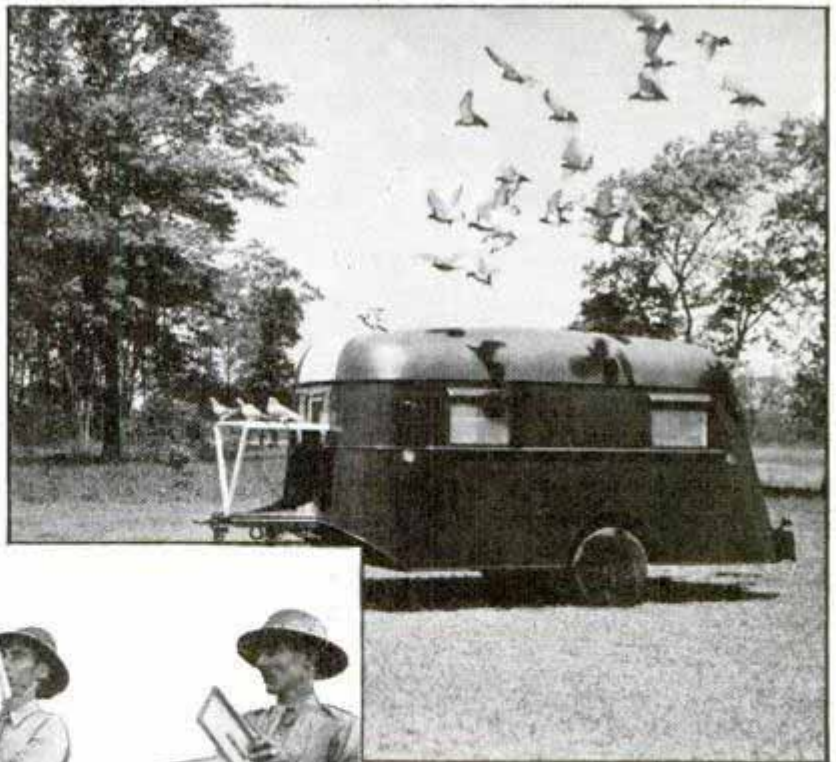

*Top, left, placing metal band on six-day-old bird. Right, inserting message into harness-type tube. Below, pigeons homing to mobile loft after a move. Left, releasing winged messengers*

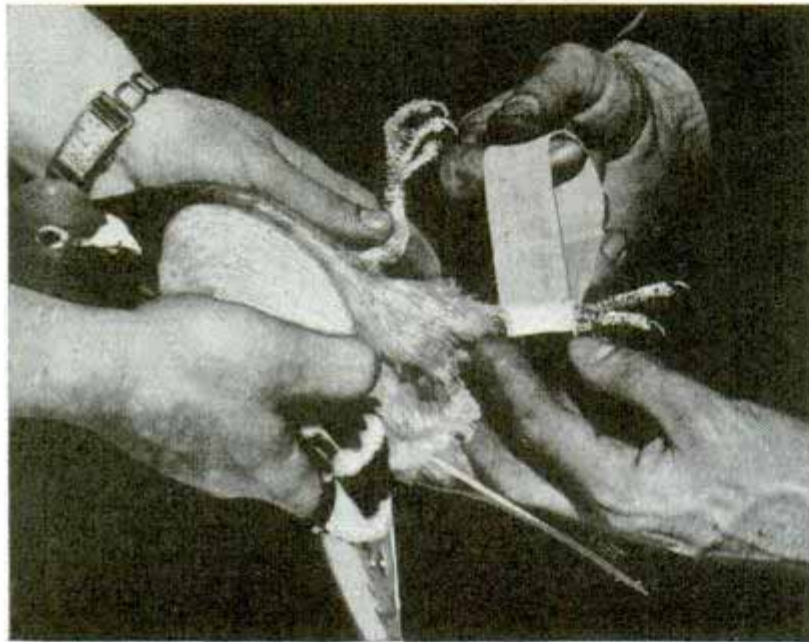

becoming lost or injuring themselves. On that, the longest night flight attempted, the pigeons were released at 11:55 p.m., on a dark night, in a slight drizzle of rain.

Another discovery made during the Signal Corps experiments is that the birds, because they do not like to fly at night, even though they have had years of training, always fly much faster than they would during the day. As a result, it is not uncommon to get speeds far in excess of a mile a minute at night. Average daylight speed is about thirty-five miles per hour, although speeds about twice that have been recorded under favorable conditions.

Training methods have changed greatly in the past few years. Where previously the birds were controlled by use of their instinctive return to the mate, and by starvation—forcing them to return to the loft for food—now they are trained through kindness. Believing that the homing pigeon was intelligent enough to do anything required of it, if it were shown

in an individual pigeon, but it is not transmitted to the youngsters, so each bird must be trained.

When the Signal Corps experiments began, the loft was brightly illuminated. Later, colored lights were tried and finally all lights were removed. The birds, it was found, fly as well to a dark loft as they did to one well lighted. Numerous attempts were necessary before the pigeons started returning to the loft from the point of release, a short distance away. Gradually the distance was increased until today the workable average is about twenty miles. However, the successful experiment covering nearly sixty miles is regarded as evidence that the birds soon will be able to fly reasonably long distances without



*Top, on their way with important messages. Center, bandaging leg of injured bird. Bottom, returning to home loft after a practice flight in Hawaii*



what was wanted, a training method was inaugurated to make the bird perfectly contented in the loft and to impress on it what was expected of it outside the loft. Results have been surprising. It is now possible to move a loft mounted on wheels into new positions, many miles away, and break the birds to a new location within twenty-four hours without having any of them fly back to the old location. It takes little imagination to recognize the value of this training to an army in the field.

In the Fort Monmouth lofts 500 of the finest pigeons in the United States are housed. Here are bred replacement stock for the other army lofts and for the mobile lofts. When the youngsters are six days old a seamless metal band is placed on their legs. This band shows where the bird belongs, when it was hatched and gives the bird a permanent serial number.

Young birds are taken from their parents when four weeks old and placed in lofts by themselves. Their first training consists of being placed on the loft landing board for a look at the country. As the birds grow stronger, they are taken from the loft, starting at only a few feet, and forced to fly back. At this time they are also trained to enter the loft when called. This is done by repeating a sound at feeding time until the birds associate that sound with "mess call" and will dash into the loft whenever they hear it.

Later the pigeons are equipped with leg or back capsule. All are trained to carry these tiny tubes so that they will not fight them when taken into the field for use. The tube on the leg is very light and the messages are written on thin paper so there is very little weight. The back capsule, designed for carrying maps and photographs, is held in place by a harness. Each bird has to be fitted for this harness, to insure that it will fit properly and that the capsule is balanced on the bird's back. Loads of as much as three ounces have been carried successfully in this manner.

The mobile loft, converted from a standard house trailer, becomes the permanent home of the birds placed in it. They are allowed to mate and breed in this loft. It is moved by being attached to a truck and towed. During preliminary training the loft is moved every day so that the birds become accustomed to looking for it, and no difficulty is experienced in making

(Continued to page 127A)

AUGUST, 1940

## Vacuum Cleaner Run by Air Handy at Service Station



Handy vacuum cleaner for service stations operates on compressed air and produces a strong suction

Producing a stronger suction than many electric-motor vacuum cleaners, a new machine operated by compressed air is designed for use at service stations. Its suction increases as air pressure is applied.

## Powered Lightweight Chain Saw Can Operate under Water

Working efficiently both above and below water, a chain saw is adaptable for use with gasoline engine, electric motor or pneumatic power units. Lightweight and portable, the amphibious saw cuts off piles under water, fells trees on land, and saves labor in cutting up large logs or lumber.

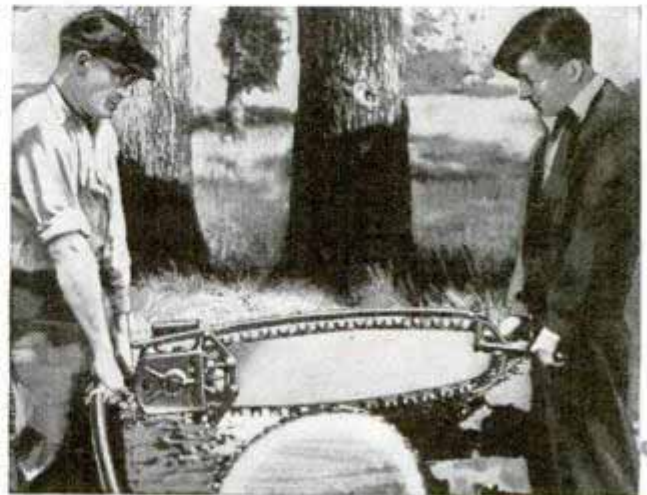

Cutting a log with the power driven chain saw

Mail Tool Co  
7740  
Chicago, Ill.  
251

Mr. Vac. drive. Los Angeles Calif. 2177

W. E. Berkeley

# TRAPPERS

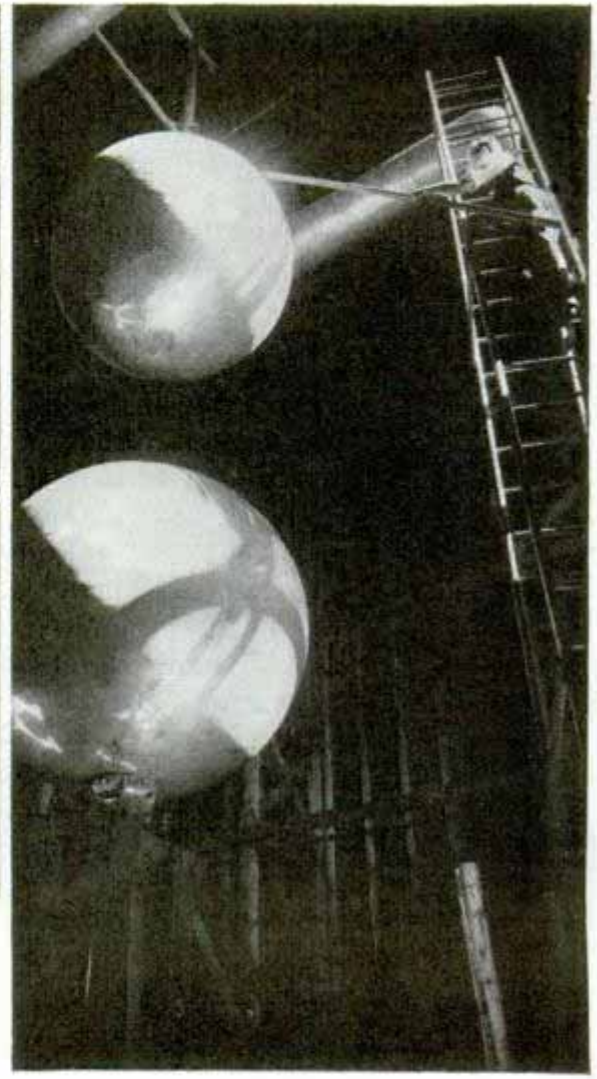

Peering into a cathode-ray oscillograph, engineer above watches path of sixty-kilovolt artificial lightning stroke through lightning arrester. Lightning flashes up to 3,000,000 volts surge between spheres at right

Emile C. Schmittmacher, 1008 E. 6th St. New York City

**H**URLED with the terrific energy of a thirty-pound shell fired from a cannon at a muzzle velocity of 2,200 feet a second, a bolt of lightning strikes a power line carrying electric current to a near-by house. Within a split second five, six or more destructive lightning "shells" have scored direct hits upon the pole supporting the power line. Strangely enough, nothing happens. Because the modern trappers of lightning have done their work well, lights in the house do not even flicker.

With from ten to fifty million lightning bolts bombarding the earth every year, the average thunderstorm up to a short time ago meant possible trouble if not danger for communities throughout the country. A housewife working in her kitchen, a factory hand bending over his lathe, a surgeon performing an emergency operation—in fact millions of people in all walks of life were likely to have their activities

halted, sometimes under hazardous circumstances, by a bolt of lightning disabling an exposed line and depriving them of needed light and power.

Today scientists have taken many of the risks out of nature's fireworks by actually trapping wild lightning bolts, the biggest and most treacherous of all big game. Research engineers learned to duplicate them in laboratories with man-made apparatus, study their characteristics and devise safeguards against their menace. They have even put up lightning bolts in "packages" for use in testing safety devices.

"A strange phenomenon is natural lightning, and stranger still is the modern research engineer's efforts to duplicate and study it," says Peter L. Bellaschi, research engineer of the Westinghouse Lightning Laboratories, Sharon, Pa., one of the greatest lightning trappers.

"Not only is lightning the most awesome

# of LIGHTNING

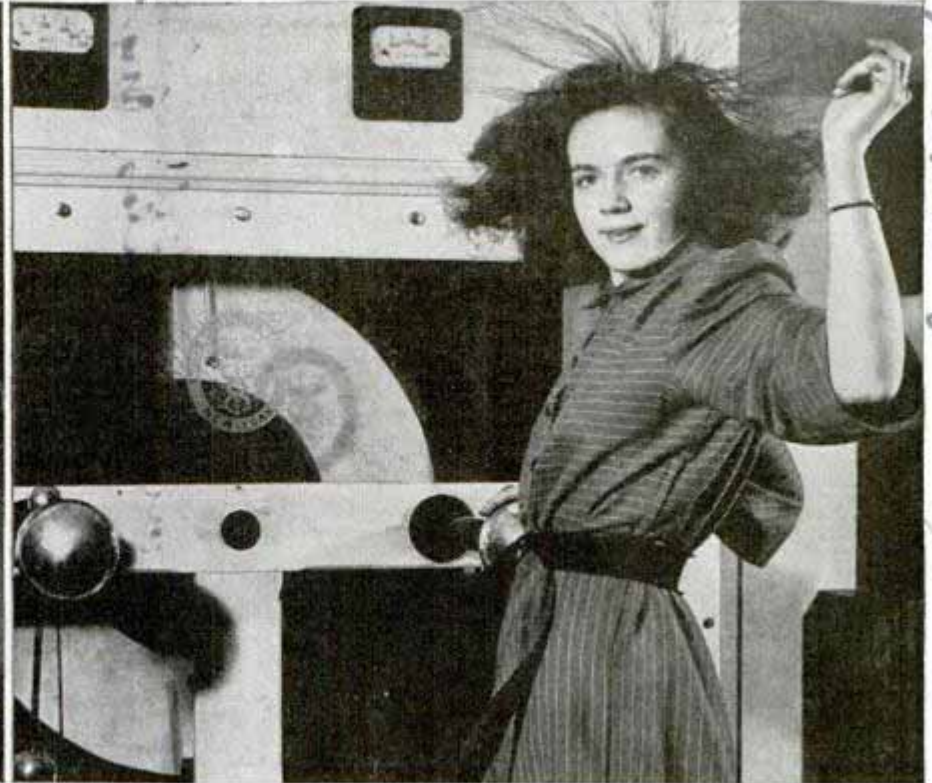

Engineers say natural lightning (top) hits earth ten to fifty million times a year. Right, half-million-volt static charge stands girl's hair on end. Below, lights stay on in toy house as 3,000,000-volt stroke detours from transformer to ground

of nature's spectacles but it is also one of the most variable. There are countless stories regarding the unpredictability of lightning and where and how it will distribute its four destructive characteristics—explosion, burning, paralyzing and contortion.

"The pressure and heat of a lightning bolt shatter trees, poles and metal pipes by converting their particles of matter into gases in a few millionths of a second. Expansion of gas does the rest.

"Contortion of tin roofs on barns, for instance, is due to the magnetic force of the lightning. The metal is twisted and curled by the magnetic field set up by the high-current concentration through the metal conductor.

"Innumerable stories of lightning burns and paralysis, frequently fatal, are reported every year. Animals need not be struck by lightning to be killed by it.



Why the hair  
stands on end  
is because of  
the high voltage  
charge from the  
generator  
Crossed out

Developed by Westinghouse High Voltage Laboratory



work which Westinghouse began thirteen years ago—this meant being lucky enough to be in the right place at the right time to observe the bolts. What science needed was some small apparatus which could be spotted throughout the country to record lightning automatically.

It came in 1939, a development by Charles F. Wagner, Westinghouse consulting engineer at East Pittsburgh, Pa. Mr. Wagner, in charge of Westinghouse investigations of natural lightning, explains:

"The device is called the fulchronograph (lightning-time-write). A small motor drives a recording disk at constant speed. Fixed to the rim of the disk are several hundred flat strips of magnetic material. At one point the rim of the wheel passes through a field of a coil. A lightning surge is led through this coil to ground, creating a magnetic field across

Whole herds of cattle are known to have been killed while grazing thirty feet from a tree struck by lightning. The lightning current flowed radially out from the tree, producing high-voltage bolts between points on the ground which were bridged by the bodies of cows."

To devise safeguards against lightning, scientists needed as much data as possible about its characteristics. But while it was possible to study lightning by photographing it and by measuring its strokes and effects with an expensive apparatus known as the cathode-ray oscillograph—research

Cathode-ray oscillograph, top, uses beam of electrons as pencil moving 1,000 miles a second to trace electric voltages on photo film. Lower left, engineer presses button to release lightning from surge generator. Right, porcelain lightning arrester that discharged 21,000-ampere current of direct stroke

Edward Beck

the recorder rim whose magnitude varies with the change in current during the life of the stroke. Each tiny magnet thereupon receives a magnetic charge, proportional to the current in the surge at the time that magnet is swung through the lightning-produced field.

"By measuring the strength of the magnets thus formed, and knowing the speed of the disk, a current-time curve of the lightning stroke can be plotted. Such records show current magnitude, polarity—and very important, the full duration of the current.

"By the onset of the 1939 lightning season about fifty of these 'traps' had been set on all sorts of lightning-exposed structures—radio towers, tall buildings and transmission lines scattered from the Gulf coast to New York. Many

(Continued to page 116A)

*Hubert D. McCann*

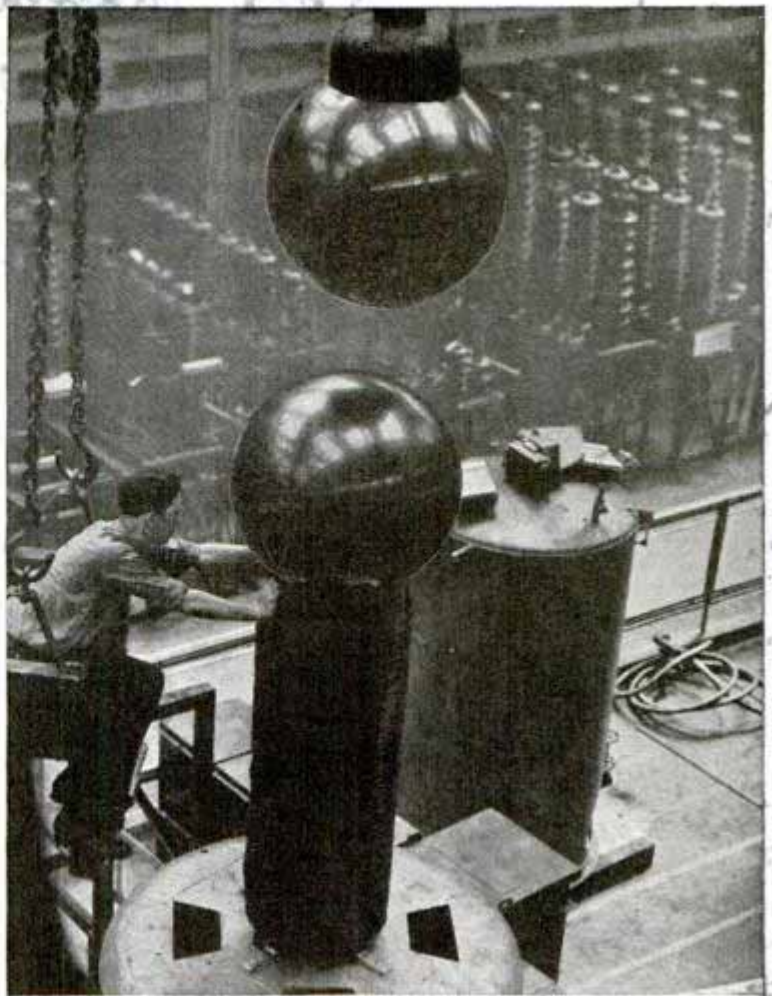

*Westinghouse*  
Fulchronograph, left, measured current in bolt striking a skyscraper. Right, (top) space between spheres is adjusted to regulate voltages up to 750,000 in circuit-breaker test; (bottom) checking magnetism in recording wheel of fulchronograph

*Lightning Engineer*  
*Cathedral of Learning*

K 420. 18618 *Walter Rosa Jr.*  
**Life-Size "Last Supper" Sculptured in Plastics**



Plastic materials of his own composition, instead of wax, were used by a Hollywood sculptor in creating a life-size reproduction of Leonardo da Vinci's famous painting, "The Last Supper," with amazing fidelity to the color and form portrayed in the original. The features of the sculptured figures are reproduced according to the artist's conception of each character, and such details as clothing and tableware have been copied closely.

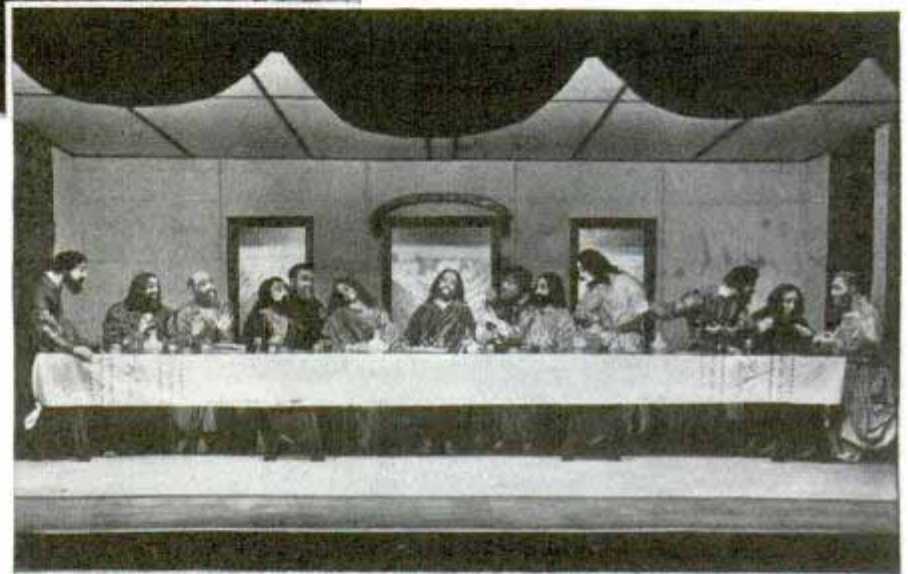

*Los Angeles*  
**"Last Supper" reproduced in plastic figures, right, now being exhibited to accompaniment of descriptive lecture and appropriate music, required ten years to complete and is valued at \$150,000. Above, fastening garments in place on the life-size figure of Jesus**

K 312  
**Traveling "Auto Doctor" Diagnoses the Ills of Your Car**

Believing that automobiles need an impartial doctor to investigate their ill and prescribe a remedy, a Los Angeles expert operates an auto clinic on wheels. For a nominal fee he drives to the garage, home

or parking lot of his patient, and with his carload of instruments will analyze the car's ailments, feeling its "pulse" for tell-tale vibrations, and taking its temperature and pressures in search for symptoms.



**Automobile "doctor," left, applying stethoscope to ailing engine. Right, mobile laboratory carries instruments for diagnosing car's troubles**

The motorist receives a diagnosis as well as a prescription for adjustments and repairs, which he takes to his own repairman or service station. The "doctor" does no repairing himself and will not even recommend anyone to do the work, assuring his customers of an unbiased examination and report. A special service offered to prospective purchasers consists of an accurate appraisal of the value of a used car.



# The CRAFTSMAN

## SNACK and BEVERAGE

# Tray

cut from plywood

LIGHT lunches at the bridge table can be served conveniently with this little double-deck tray. Cutouts in the upper deck hold beverage glasses securely while carrying the tray. Tidbits and small napkins are placed below. As you see from Fig. 1, nearly all straight lines have been eliminated in the design. The decks are oval in shape and the upright piece which incorporates a handhold, is also pleasingly curved. While a scroll saw is best for the job, the cutting can be done with an ordinary coping saw.

Due to the design of the handle and the cutouts for the glasses, the wood should be  $\frac{1}{4}$ -in. plywood. Sizes of all parts are given in Fig. 3 and the method of drawing an ellipse is indicated in Fig. 2, which is done as follows: First divide the length and width of the desired ellipse with centerlines A-B and C-D, which cross at right angles at the center X. Points 1 and 2 where brads or pins are driven are located by striking arcs across the line C-D, using points A or B as a center for the compass and adjusting it so that the radius of the arc scribed will be exactly equal to the distance D-X. Then a loop of string is slipped over the brads and should just reach to

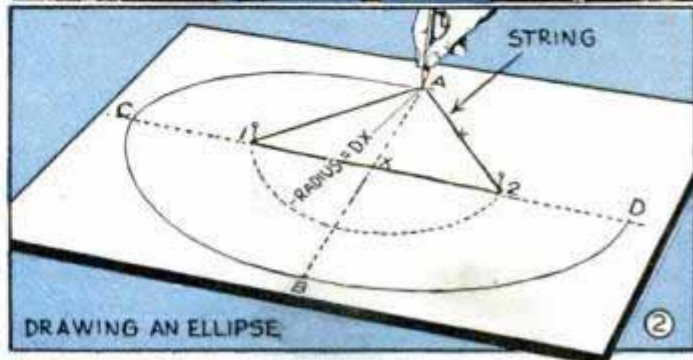



point A or B when stretched to triangular shape by means of a pencil as shown. Then it is a simple matter to draw the ellipse by sliding the pencil point along inside the taut string up to points C and D, and repeating the process on the other side.

The portions of the plywood on which the ellipses are drawn should be separated roughly with a fine hand saw and then the curves are cut with a scroll or coping saw, after which the edges should be sanded carefully, rounding the corners slightly. The design for the handhold is laid out on paper and traced to the wood. A small hole is first bored in the waste portion of the stock to insert the saw blade. After cutting slots at the ends of the elliptical pieces to fit the handle portion snugly, small blocks are glued in the corners as indicated, clamps being used to hold them in position until the glue has dried thoroughly.

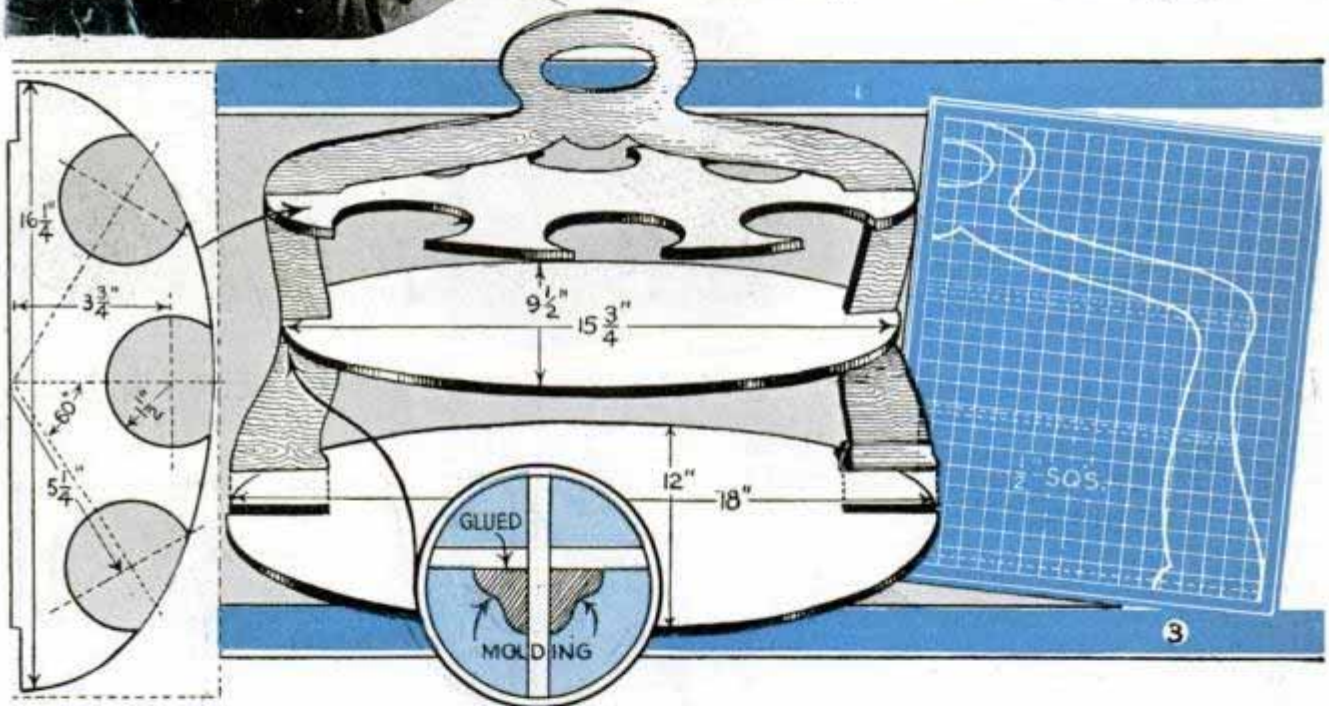

## Sealing Knots and Stains in Wood to Prevent Bleeding

If knots and resinous or sappy spots, in wood to be painted, are not sealed against bleeding, the paint job is likely to be ruined. For small, smooth knots and resinous spots, two coats of shellac or aluminum paint are usually effective. On large knots where the latter treatment is insufficient, it has been found that Cellophane glued over them will often do the trick. Also, Cellophane is good for tar and other stains in wood or plaster, and for hiding hair cracks and lath marks in plaster that is to be painted or papered. Use a piece of Cellophane larger than the surface to be

covered, dip it in cold water and place it between two pieces of newspaper to absorb surplus water. When applying it to wood, coat the knot or stain with thin glue, place the Cellophane on the tacky surface and smooth it with a piece of cloth, rubbing from the center outward. For applying Cellophane to plaster or painted surfaces, coat the surface with a glue size made by mixing brown sugar, 1 spoonful, and glue, 1 pt. It is not advisable to repair a stain requiring a piece of Cellophane larger than 2 ft. square.—C. A. Graham, Scarborough Bluffs, Ont., Can.



# Improvised Holder for Crocheting Materials

Whether you prefer to crochet while riding in the car or sitting in your favorite easy chair, this improvised box will be found ideal for holding your materials. All you need is a couple of lead pencils and a corrugated-cardboard box. Sharpening the pencils will allow them to be punched through the sides of the box easily.

## Care of Iron Kettles

Iron kettles should be primed before they are used for cooking. To do this, fill kettle with cold water and let it boil a short time. Then wash and scour it thoroughly, rinse, dry well, and grease it with sweet lard. Next heat it very hot, and wipe off what lard has not been absorbed. Do this a few times before using and you will not be annoyed by rust or a strange taste, provided you keep the kettle perfectly clean and dry when not in use.

—A. W. Scheib, Arlington, Mass.

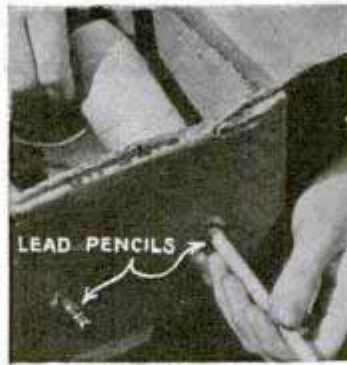

# Load Dumped Easily from Wheelbarrow with Hinged Sides



Fit your garden wheelbarrow with sides like the ones shown and you can lower them to make dumping sideways easy, or you can dip them at an angle to increase the load size when hauling light material. The side pieces are mounted on heavy strap hinges and strong hooks engage screw eyes in the end piece of the wheelbarrow to hold them either in a vertical or flared position.—S. A. Camp, Riggins, Ida.

## Keeping Rain Out of Tent

During long, steady rains, water sometimes enters the ridge-pole openings of a tent. To avoid this, cut disks from an inner tube and impale them on the steel spikes that project through the holes.

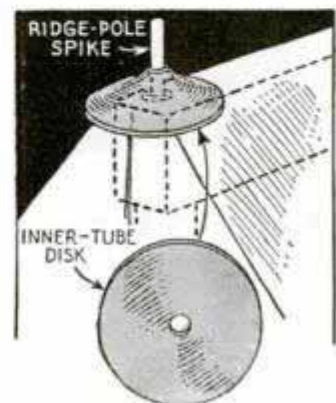

# Solving HOME

Mayer Mrs Cook  
 1436 W. Randolph  
 Chicago



Fitted to the front legs of a high chair as above, two vacuum cups will help prevent a small child from pushing itself over backward. The cups are attached by drilling tiny holes into the ends of the chair legs and screwing the cup bolts into them



Soiling of the pages of a cookbook when it is opened on your worktable can be avoided by setting a glass-bottom serving tray, or even a clear-glass baking dish over it as above. The weight of the tray will keep the pages flat. Inserting or removing a pie from an oven is simplified if it is put in a tray made from a cake tin, shown below

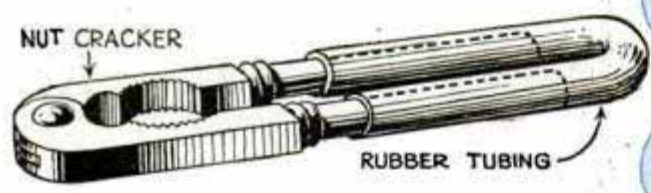

You will find a nutcracker much easier to use if a length of rubber tubing is slipped over the handles as above. The tubing will tend to spread the handles so that they can be operated with one hand. Be sure to allow the tubing to form a loop at the fold so that the handles can be opened wide enough to receive a nut



The next time you have to repair a finger in a glove, try using a sewing thimble as a darning egg as indicated below. Slip the thimble on one of your fingers and push it into the glove, pulling the latter down snugly over the thimble



A shelf to hold soap, brushes and other articles is attached easily to your scrubbing pail. A wide board is cut out as indicated at the left, to take a band made from heavy sheet metal, the band being screwed to the board. Small lugs straddle the ears of the pail where the bail is attached. It will be necessary to remove one side of the bail to slip the shelf in place

# PROBLEMS

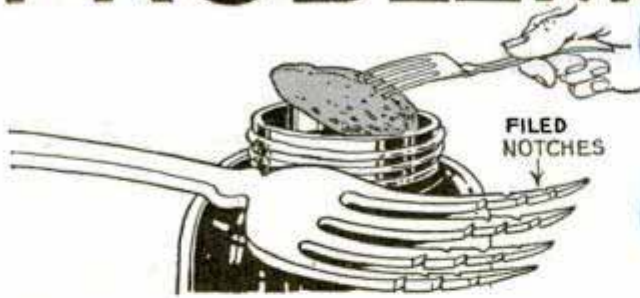

An ordinary table fork with notches filed in the tines to provide barbs as above, will remove pickles from a jar without them falling off. If you have small children in your home, you can prevent them from getting at poisons by keeping the latter in the top shelf of the bathroom cabinet and fitting it with a hinged cover that can be closed with a small padlock as at the right

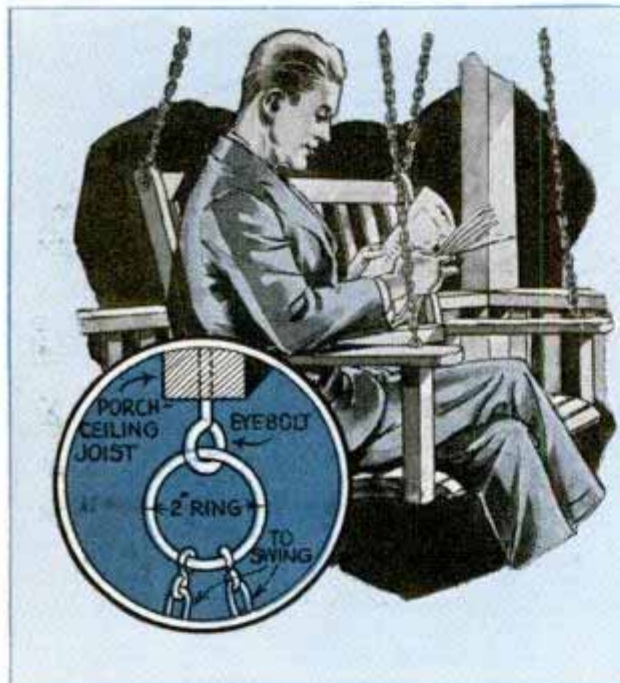

Suspend your porch swing with large eyebolts and rings as shown at the left and it will not squeak. The swing chains are attached to the ring with large S-hooks, which can be obtained at any hardware store

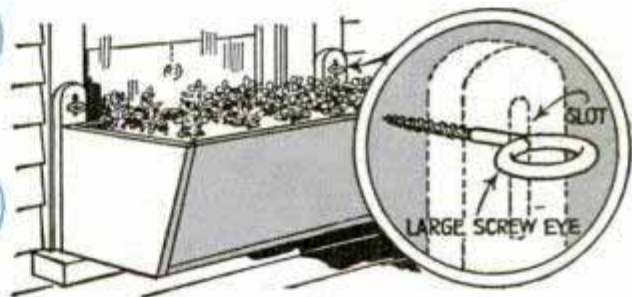

To anchor a window box on the sill so that it is easy to remove, slot a couple of wood cleats to take the heads of screw eyes in the window frame. Nail the cleats to the box, slip the screw heads through the slots and turn them as above

Suspended from the corner of a porch railing, the seat below provides a handy extra "chair" that utilizes waste space. If desired, it can be removed, and set away when not needed. Heavy flat-iron brackets support the seat

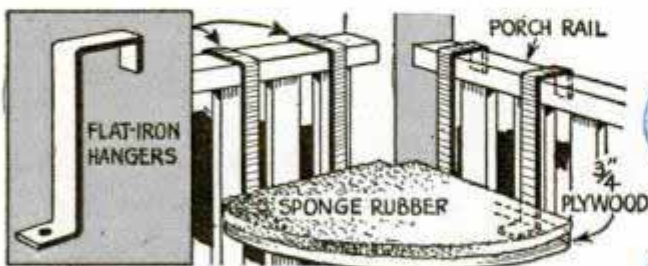

The removable shelf at the right permits potted plants to be set on a porch rail to get air and sunlight without any possibility of them being blown or knocked off. The shelf is made from a 10-in. board and is held on the rail by clamps shaped from heavy flat iron. The clamps are bolted to the board so that they slip under the rail

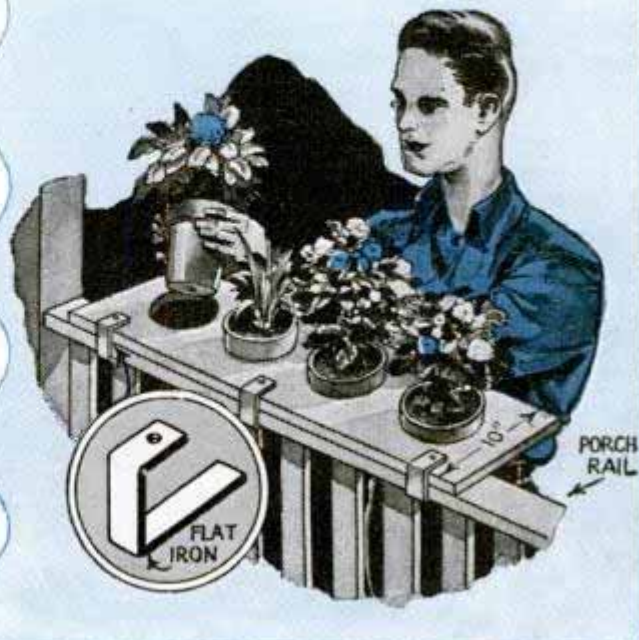

## Safety Added to Coaster Wagon by Use of Rubber Bumper



To avoid injuring anyone if he accidentally bumped into them with his coaster wagon, and to cushion the shock if he ran into a solid object, one boy put a rubber bumper on his coaster wagon. This was merely a section of auto tire nailed to the wagon tongue in the position indicated.

## Tool Holders on the Drill Press Keep Accessories Handy

The chuck key and oilcan for use in connection with a drill press will always be at hand if you use a couple of holders like the ones shown. A piece of flat iron bent in the center at right angles and screwed to a

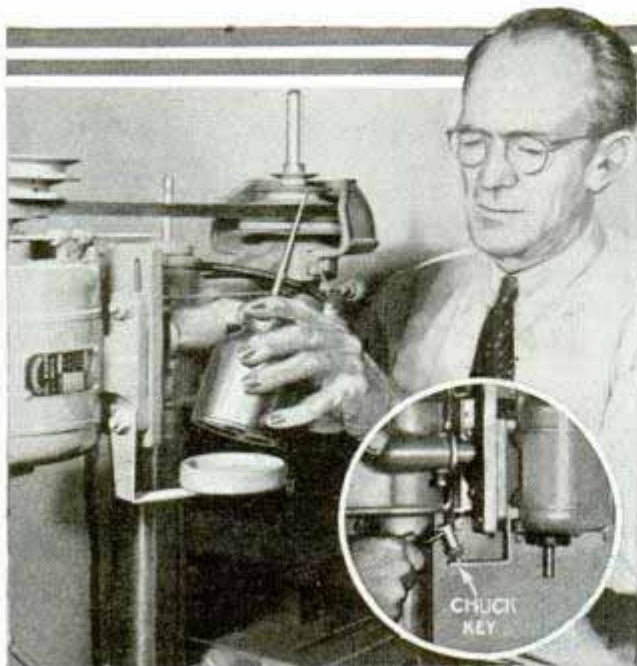

saucer-shaped wood disk will hold the oilcan when attached under a nut on the drill press. The chuck key can be kept in another piece of iron drilled at the end and similarly bent. It is attached under a bolt head on the opposite side.

—Frank Hegemeyer, Monterey Park, Calif.

## Notches in T-Square Head Make Work Lines Visible

When squaring a board or block on two or more sides, a T-square with semicircular sections cut out of the head, as indicated, will make the guide lines on the work easily visible for comparison.

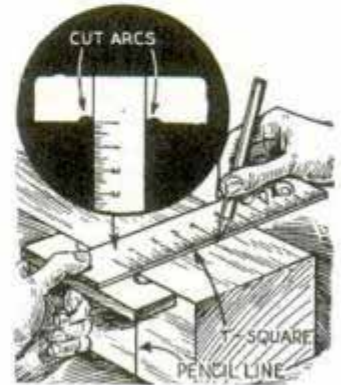

## Method of Rigidly Anchoring Brace and Guy Wires

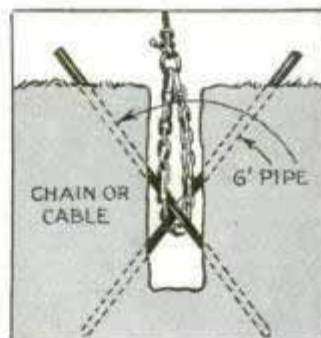

Whenever you have to anchor a brace or guy wire in the ground, here is a method of doing it that is strong and rigid. Just drill a hole into the ground.

Then, using either a chain or cable to form a loop on the end of the wire, suspend it into the hole and drive iron pipe or rods into the ground at a tangent so that they pass through the loop inside the hole as indicated.

—Chester Jasin, Chicago.

## Scrubbing Brush Silks Corn

The tedious job of removing silks and bits of husk from an ear of sweet corn can be done quickly by using a brush. One having stiff fiber bristles, such as used for cleaning pots, is best, and is passed back and forth over the ear parallel with the rows of kernels.

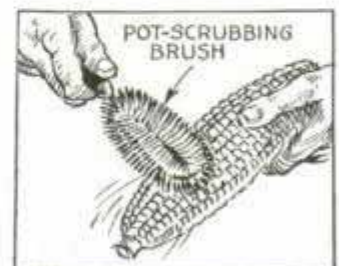

—Ivan J. Stretten, Detroit, Mich.

# MINNOW TROW

*keeps bait alive*

Sheet metal and wire mesh are soldered together to form this handy little minnow trow, which will keep the fisherman's bait alive on the hottest day, when the usual minnow bucket, kept in the boat, would fail. In use, it is towed behind or alongside the boat and causes very little resistance because of its shape, and thus it does not make rowing inconvenient due to drag. The wire-mesh sides permit a constant change of fresh, cool lake or river water, which is the reason for its success. While the details given here were taken from a model that proved entirely satisfactory in actual use, you can make a larger one of similar proportions if desired. Airtight chambers keep it afloat even in rough weather, and as sheet metal is used for construction, the trow should last indefinitely

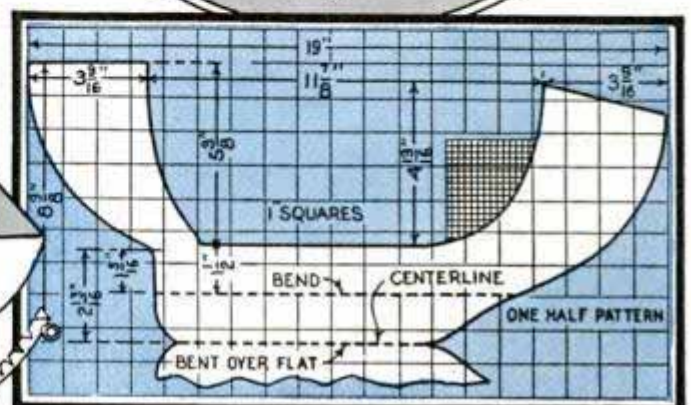
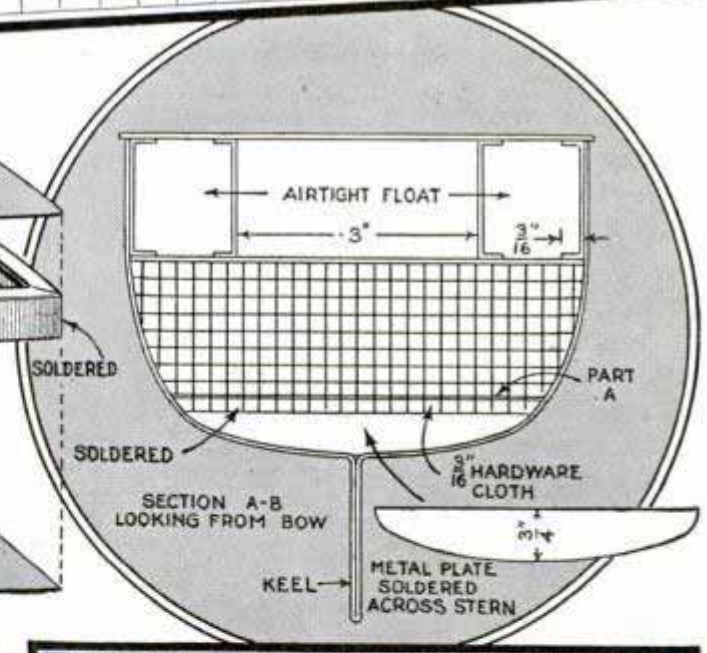
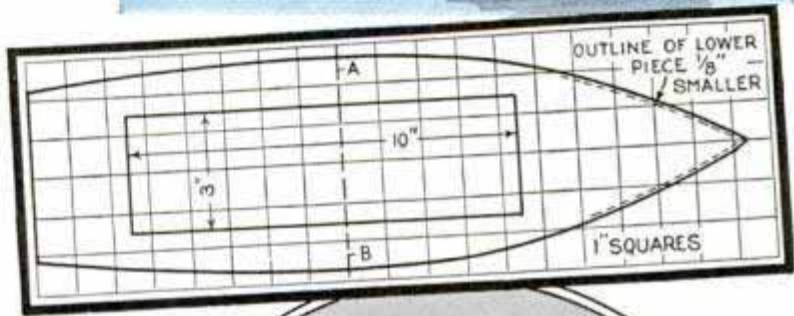
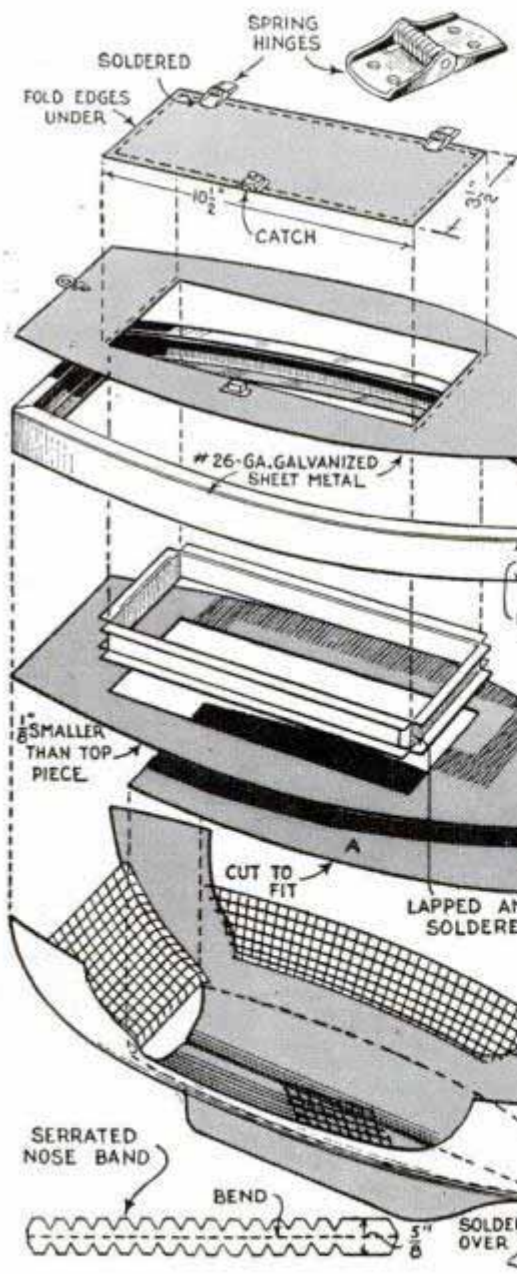

## Bed Knife of Mower Held Down While Cutting Tough Grass

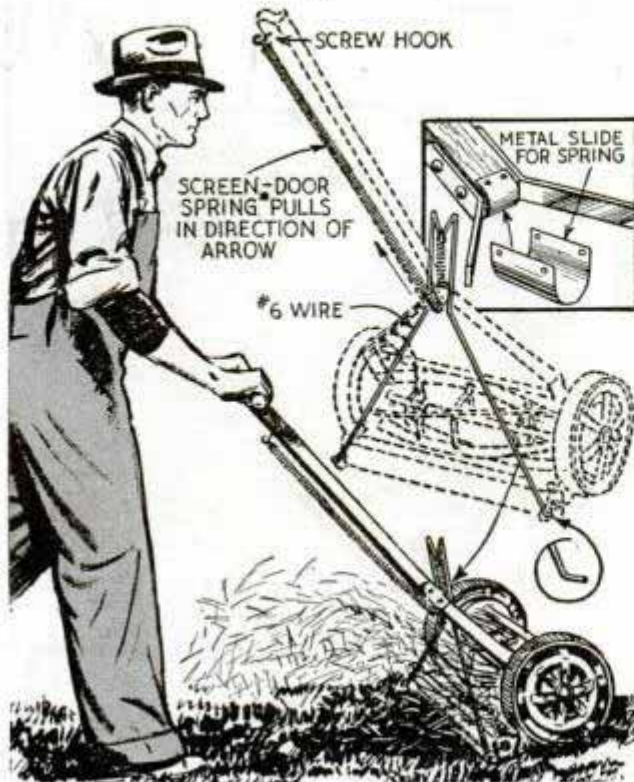

A simple arrangement to hold the roller and bed knife of your lawnmower to the ground when cutting tough grass can be made with a length of No. 6 wire and a screen-door spring. Hook each end of the wire into a hole in the castings that support the roller and extend it upward behind the handle brackets so that it forms a triangle with its upper corner 6 in. directly above the lower end of the handle. Now attach one end of the spring to this upper corner, which has been indented for the purpose, and extend it downward over the end and along the underside of the handle. Stretch the spring reasonably tight and fasten the end to the handle with a small screw eye.—W. F. Allen, Callao, Mo.

## Storing Odd Pieces of Wire

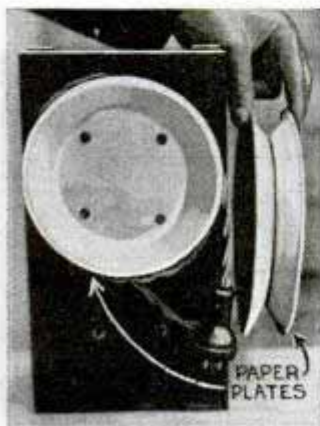

Most of us keep various lengths of insulated wire of all sizes around our homes or workshops, and usually throw them into a box or hang them on nails. Instead of having to untangle the wire every time

a piece is needed, as when it is stored in a box, make spools or reels from paper plates. Place them bottom to bottom and nail them to a wall or cabinet as shown.

## Inexpensive Fire Kindler

Filled with paraffin, a used shotgun shell makes a handy device for starting a fire when wood is damp. To start a fire, slit the sides of the shell with a knife and ignite the paraffin.



## Making a Paper-Towel Rack to Match Other Fixtures

I wanted a paper-towel rack to match other wall fixtures in the room, and as one could not be located in local stores, I made this one. A regular hand-towel rack with a removable rod, like the ones already on the walls of the room, was purchased. The brackets from this were used, and a telescoping rod for easy insertion of the paper roll was assembled from two short pieces of metal tubing, a coil spring and a large wood dowel, as shown in the detail.

—Merle J. Lucas, Chicago.

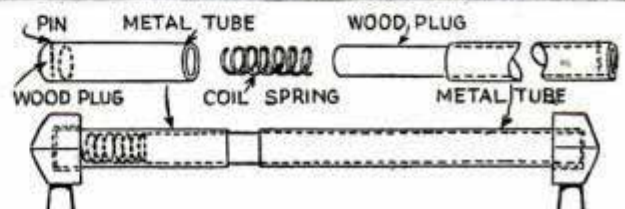
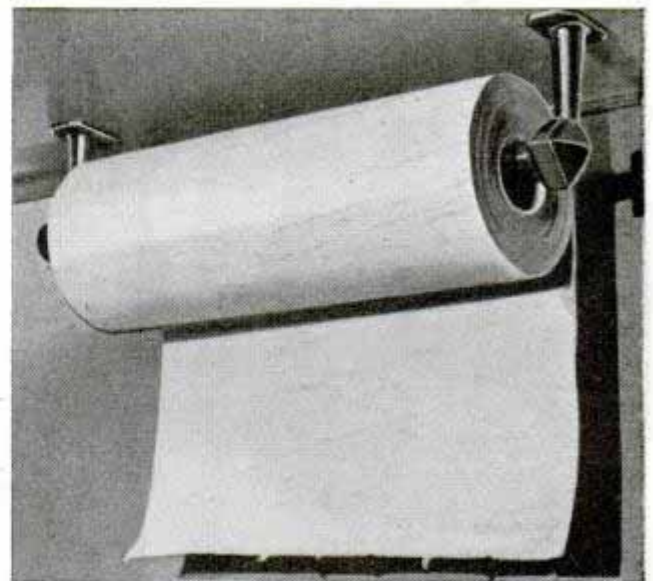

# A ROWBOAT goes Sailing

By David Swartwout

EQUIPPED with this inexpensive portable sail rig any rowboat becomes a sailboat. While dimensions given in Fig. 2 are for a small boat having a beam of 4 ft., the length of the thwart may be varied to suit the boat at hand. With the exception of the rudder and tiller, which should be made of oak,  $\frac{3}{4}$ -in. pine will do for the leeboards and thwart. Begin by making the thwart. Two pieces of 6-in. stock, cut to the proper length and mitered  $22\frac{1}{2}$  degrees, are held together with a notched cleat fastened to the underside with  $1\frac{1}{4}$ -in. brass screws as in Fig. 1. The forward piece which rests on the breast hook, is attached to the thwart with a large T-hinge. The barrel of the hinge should be fitted with a removable pin so that the assembly may be taken apart easily for storing. Two bolts passing through

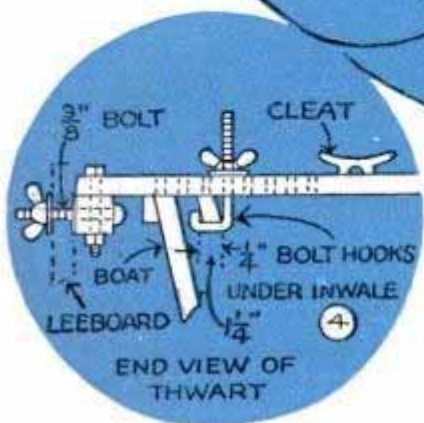
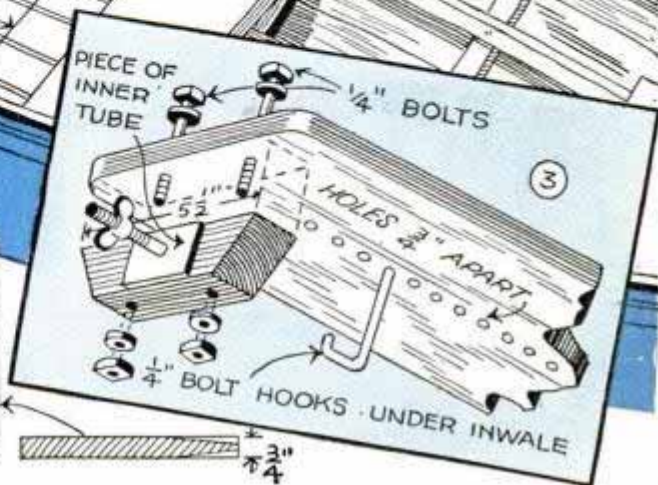
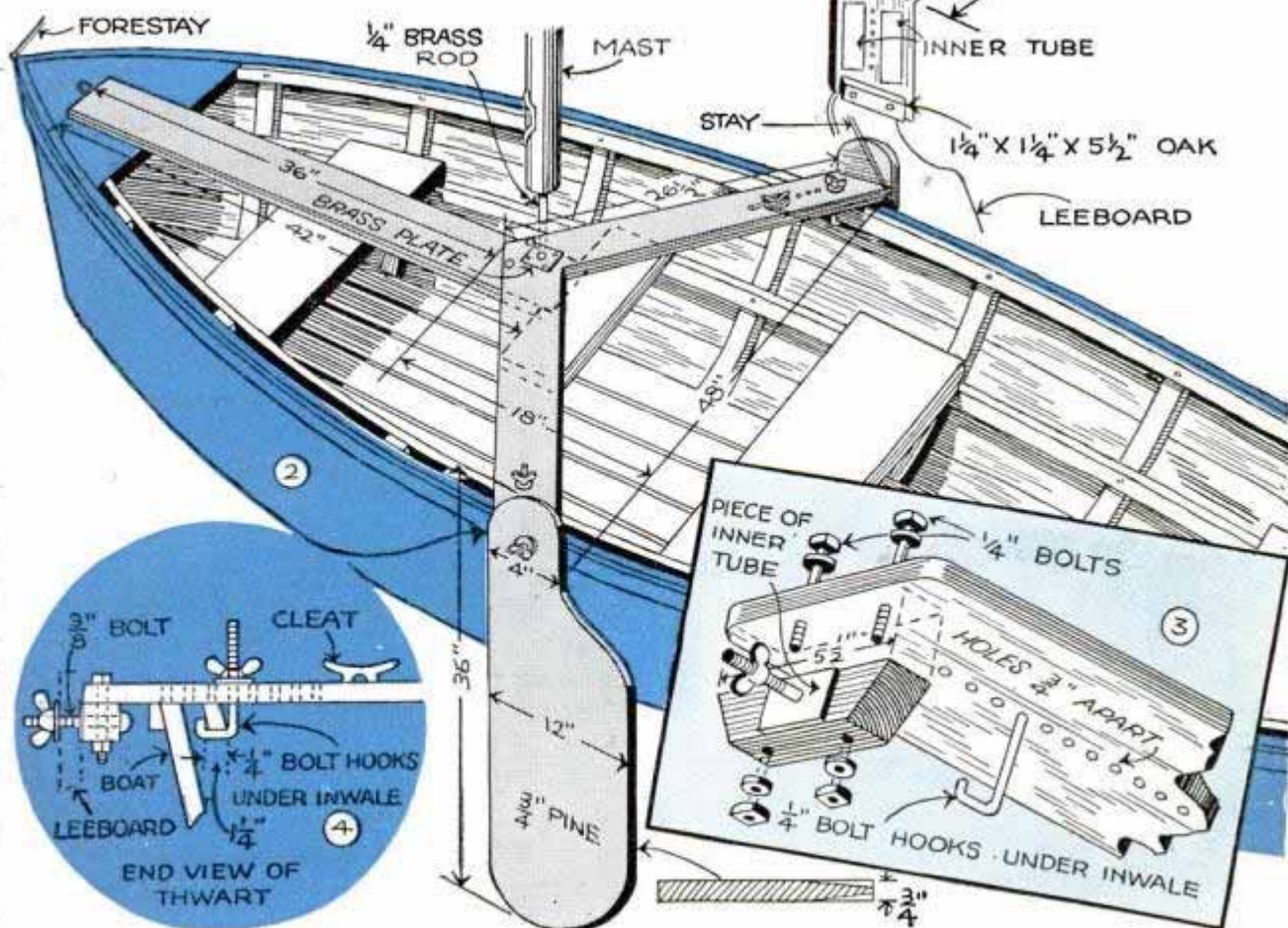
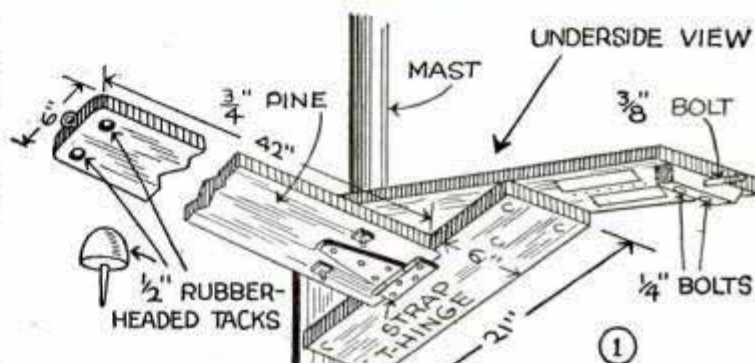

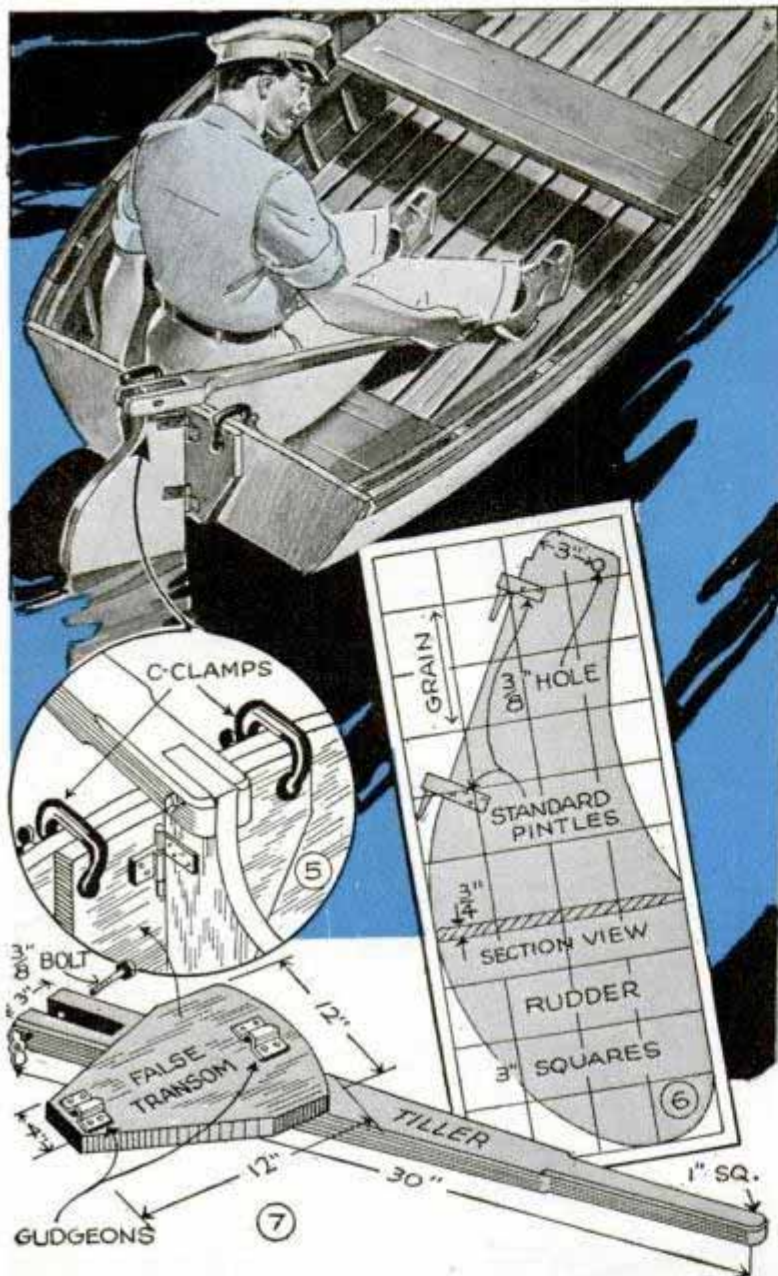

from a 1/4-in. brass rod, threaded and fitted with wing nuts as in Fig. 3. Fig. 4 shows how these bolts hook over the boat inwales. Oak blocks are next bolted to the extreme ends of the thwart and are fitted with 3/8-in. bolts for attaching the leeboards as in Fig. 3. Pieces of inner tube slipped over the bolts serve as rubber washers to keep the leeboards vertical. Strips of rubber as well as rubber-headed tacks are also fitted to the underside of the thwart to protect the finish of the boat. Next, the leeboards which provide lateral balance to the boat when under sail, are cut from 12-in. pine stock, following the design given in Fig. 2. The after edge of the board is tapered as shown in the sectional detail. A 1/16 by 3 by 3-in. brass plate with a 1/4-in. hole made in the center to receive a brass pin driven up into the end of the mast, is screwed to the top side of the thwart at the center. The mast is held upright by two shrouds and a forestay, the shrouds being brought through holes in the side of the boat just below the gunwale and belayed to cleats attached to the thwart. See Fig. 2.

Details of the rudder, tiller and false transom, and the method of clamping the assembly to the stern with a pair of C-clamps are shown in Figs. 5, 6 and 7. Standard pintles and gudgeons are used to hinge the rudder, after which the tiller is pivoted at the top by a single bolt fitted with a wingnut. A small lanteen sail, similar to a canoe or kayak sail, of 50 or 60 sq. ft. area, is recommended.

holes in the peak of the thwart securely clamp the forward member in place. To make the rig adaptable for use on several boats whose beam may vary slightly, a series of 1/4-in. holes spaced 3/4 in. apart, is provided at each end of the thwart for adjusting the two hook bolts which are bent

## Jaws of Wire Nippers Are Altered to Strip Off Insulation

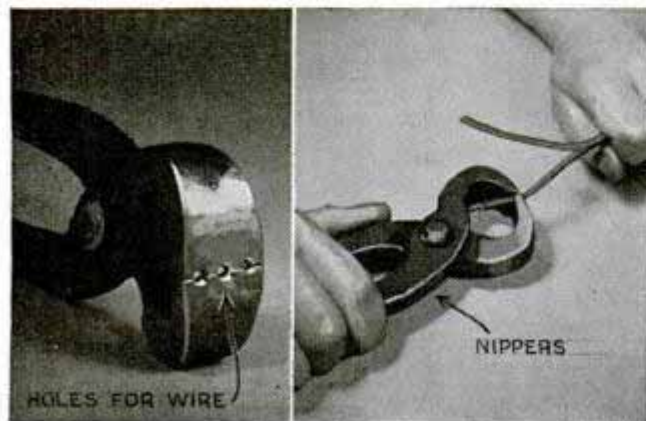

By drilling three holes through the jaws of a pair of wire nippers as shown, I found that they were handy for stripping insulation from wire. The holes should vary in size so that the nippers can be used for different sizes of wire. Each hole should be just a trifle larger than the wire it is intended to strip. It is a good idea to countersink the holes, thus reducing the thickness of the cutting edges so that they will cut through the insulation easily.

—Arthur Trauffer, Davenport, Ia.



# Spider-Web House Numbers and Ornaments

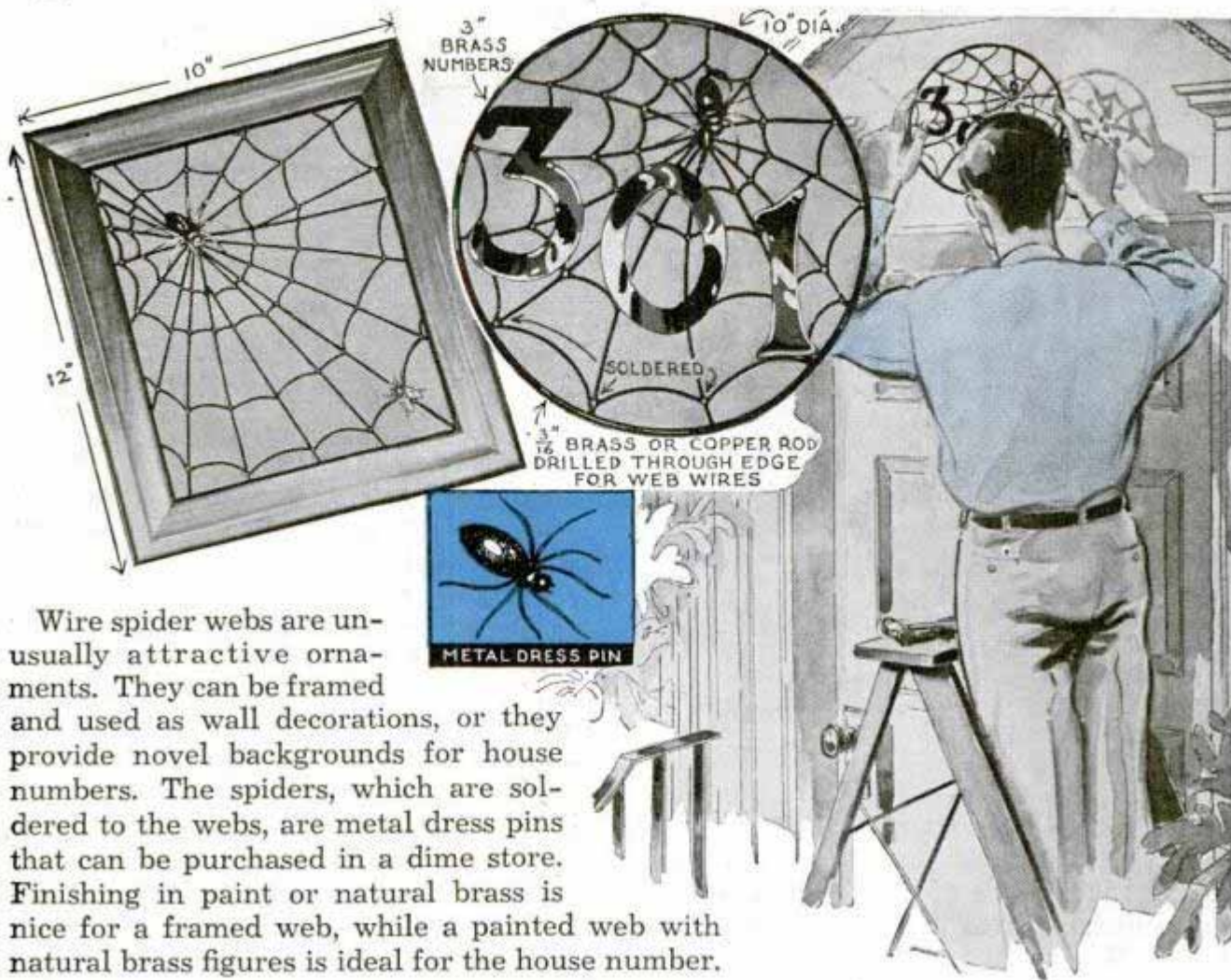

Wire spider webs are unusually attractive ornaments. They can be framed and used as wall decorations, or they provide novel backgrounds for house numbers. The spiders, which are soldered to the webs, are metal dress pins that can be purchased in a dime store. Finishing in paint or natural brass is nice for a framed web, while a painted web with natural brass figures is ideal for the house number.

## Folding Card Table and Umbrella for Picnics at the Beach



An old card table slotted through the top from one side to the center so that it will slip around the standard of a beach umbrella is handy for days spent at a beach where shade and picnic tables are unavailable. The table provides a good place to spread a lunch or play cards in the shade. Also, it will keep clothes and other articles out of the sand. As the table folds, both it and the umbrella can be carried easily.

### Freezing Pen to Assemble It

Putting a fountain pen together can sometimes be an annoying problem, as the ink sack usually refuses to go back into place. I solved the problem by filling the sack with water and then freezing it solid in the ice-cube compartment of the refrigerator, after which it went together without difficulty. When the ice melted the pen was emptied in the usual manner.

—Philip La Point, Ottumwa, Ia.

## Gauge Aids in Cutting Your Hedge at a Uniform Height

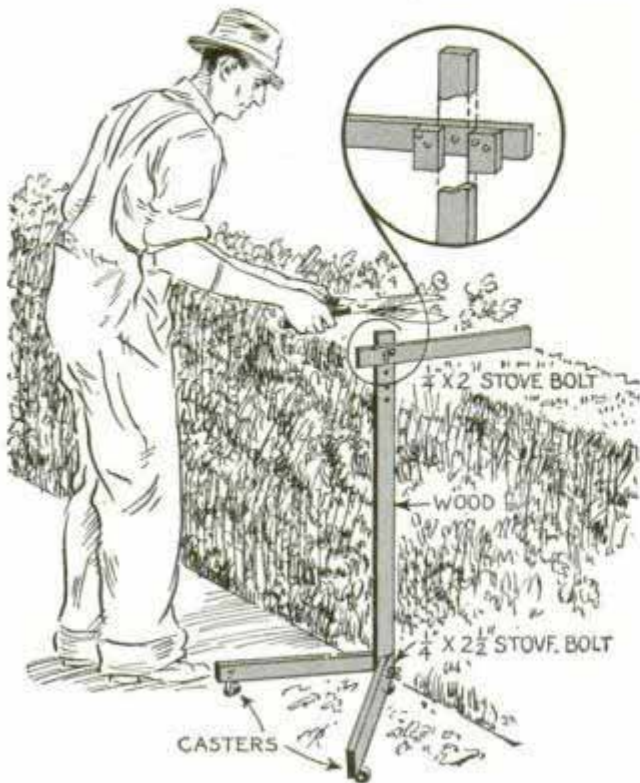

I find that this simple gauge helps in trimming my lawn hedge at the same height. It is made of  $\frac{3}{4}$ -in. wood and has an adjustable arm that projects over the hedge. Cheap furniture casters permit it to be moved along as the trimming progresses. Of course, the ground or sidewalk along the hedge must be fairly uniform, otherwise you are likely to trim the hedge to the same contour as the ground when using the gauge as a guide.

—George W. Peterson, Miami, Fla.

## Improving Gas Hot-Water Heater

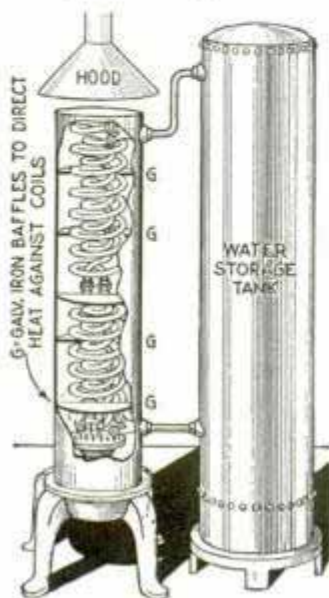

By simply attaching an extra coil to my gas hot-water heater, I was able to reduce gas consumption considerably in heating a given amount of water. The job was done as indicated, sheet-iron baffles being attached to the sides of the housing around the coils to deflect the heat against them. This

arrangement doubles the coil surface exposed to the heat, much of which is absorbed by the upper coil before passing out of the flue.

—A. J. Bruyere, Milwaukee, Wis.

## Camp Stove Improved from Pail

You need only a 5-lb. lard pail and an empty can to make a good outdoor stove. Punch a number of holes in the pail, then put a few pebbles in the small can to weight it down. Fill it with either gasoline or wood alcohol and set it inside the pail. Ignite the fuel and place your cooking utensils on top of the pail, which acts both as a holder for the utensils, and a windbreak for the fire.

—G. E. Valentine, Summerland, B. C., Can.



## Cloth Apron around Tennis Table Prevents Ball Rolling under It

Table-tennis players who wish to avoid crawling under the table to retrieve a ball can do so by tacking a cloth apron to the table so that it extends to the floor. The cloth should be placed about 10 in. in from the table edge to prevent the players from stepping on it.

—Robert Scott, Saltsburg, Pa.

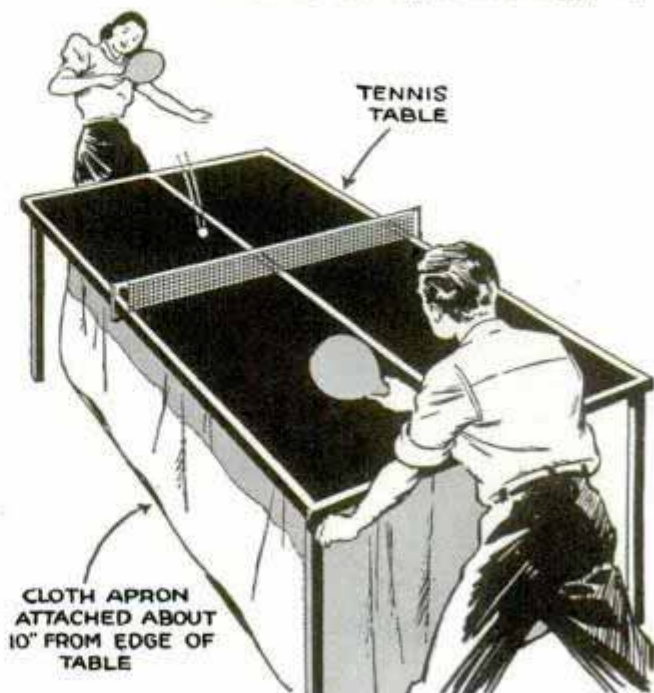

# This Magazine Rack Is a One-Evening Job

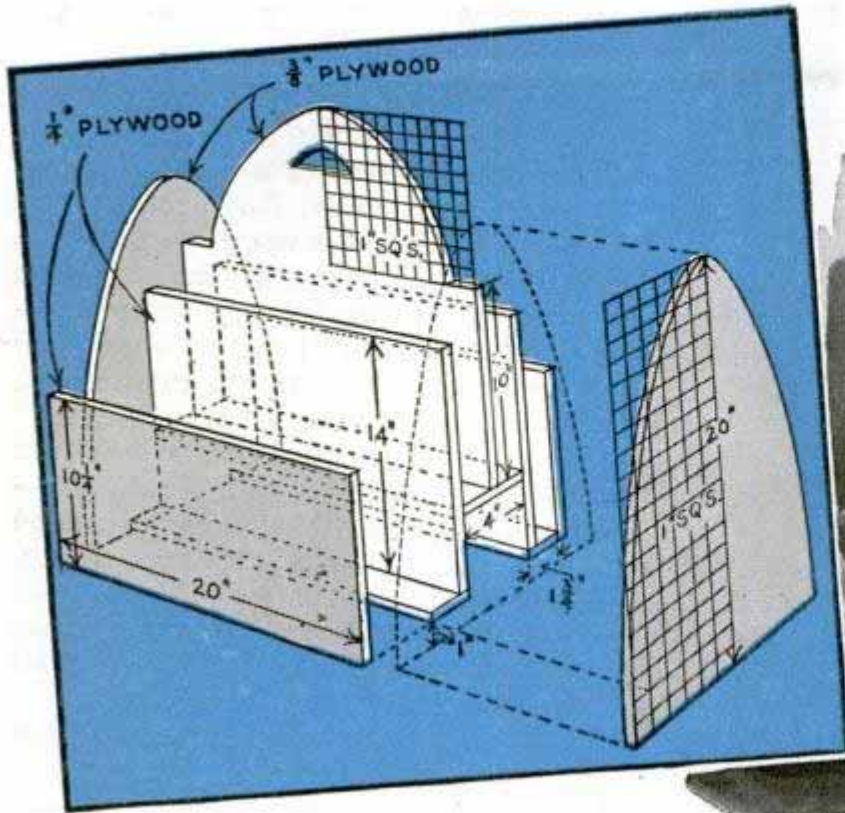

Here is an attractive magazine rack that anyone can cut out with a scroll saw and assemble with a screwdriver. The ends and the center partition are  $\frac{3}{8}$ -in. plywood, and the other partitions and sides are  $\frac{1}{4}$ -in. plywood. Notice that the bot-

toms of the two center compartments are raised above the outer ones so small magazines can be seen. If desired, the edges of the plywood can be filled with a mixture of sawdust and glue, which is allowed to harden and is then sandpapered.

## Belt Acts as Compass to Cut Circle in Sod Around Tree



When you want to cut sod around a tree or shrub, just use a belt, rope or heavy cord and a spade as a compass. Be sure to hold the spade vertically and snugly against the belt when making the cuts in the sod.

## Avoiding Loss of Fishhooks When Line Snags

If you are fishing in water where the bottom is rocky, or there are other obstructions that may snag your tackle, try the method shown. Partly sever the line between the sinker and the hooks. Then if the sinker catches on something, a jerk will break the line so that only the sinker is lost.



—Henry Gifford, New York, N. Y.

# TWIN



A PAIR of these graceful pier cabinets is just the thing to liven up dull places on each side of a wide doorway. Or, used individually, they are ideal for vacant corners where nothing else seems to fit in well. While the original was made of knotty pine, Fig. 1, sycamore, mahogany or walnut are attractive woods for the job. Side members are cut from  $\frac{3}{4}$  by  $9\frac{1}{2}$ -in. pieces, and have "stopped" grooves for the shelves, which are screwed in place as shown in Fig. 2. Stopping the grooves in this manner gives the front of the cabinet a neat appearance. Making the cabinet is an easy job with hand tools. If, however, the grooves are to be run on a dado head and finished with a chisel, Fig. 3, this work should be done before cutting the steps on the front edges of the side members. This leaves a straight surface to rest against the saw miter gauge while cutting the grooves, which must be started from the rear edges of the boards. The scroll work near the upper ends of the sides, Fig. 6, can be cut with a coping saw and smoothed with a wood rasp, Fig. 5. Cutting tenons on the upper ends of these members to fit mortises in the top piece finishes the sides. Fig. 7 gives all dimensions and shows the assembly.

Reinforcing blocks are screwed in place under the bottom as indicated in Fig. 4, and holes are drilled in them for feet, which are located at each corner of the

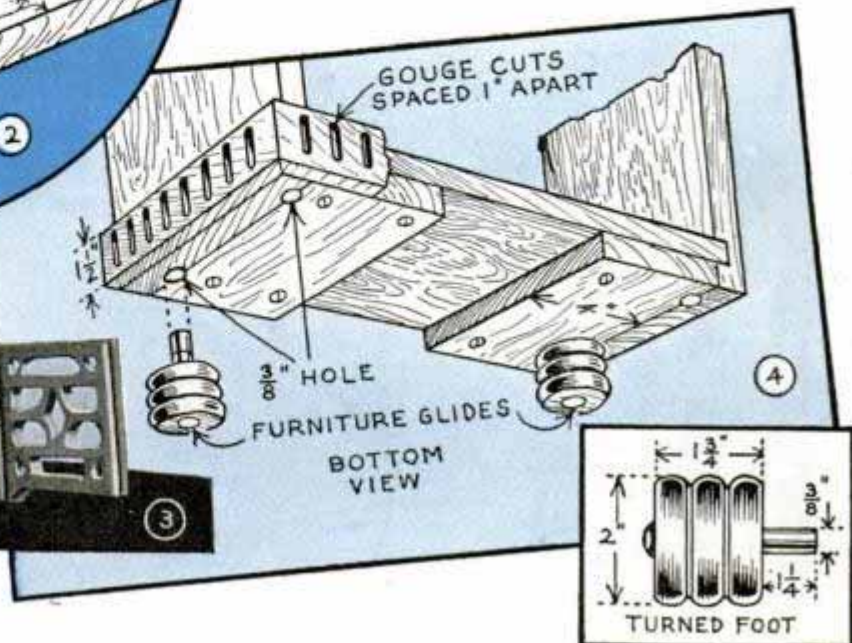
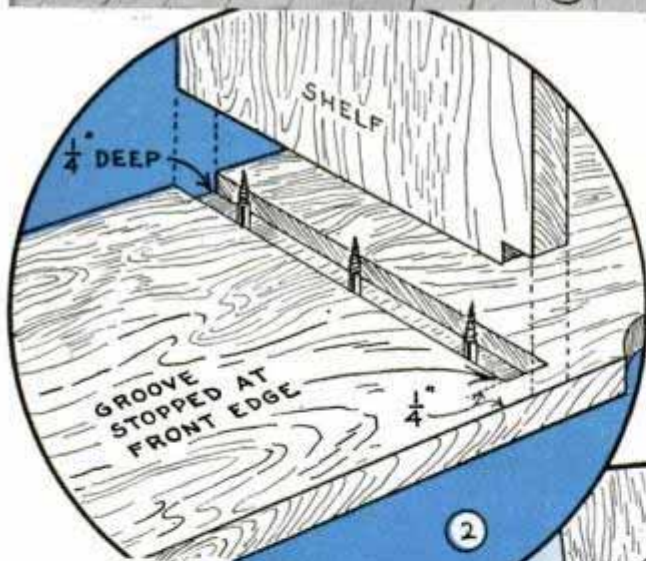

# PIER CABINETS

*balance wide doorway*

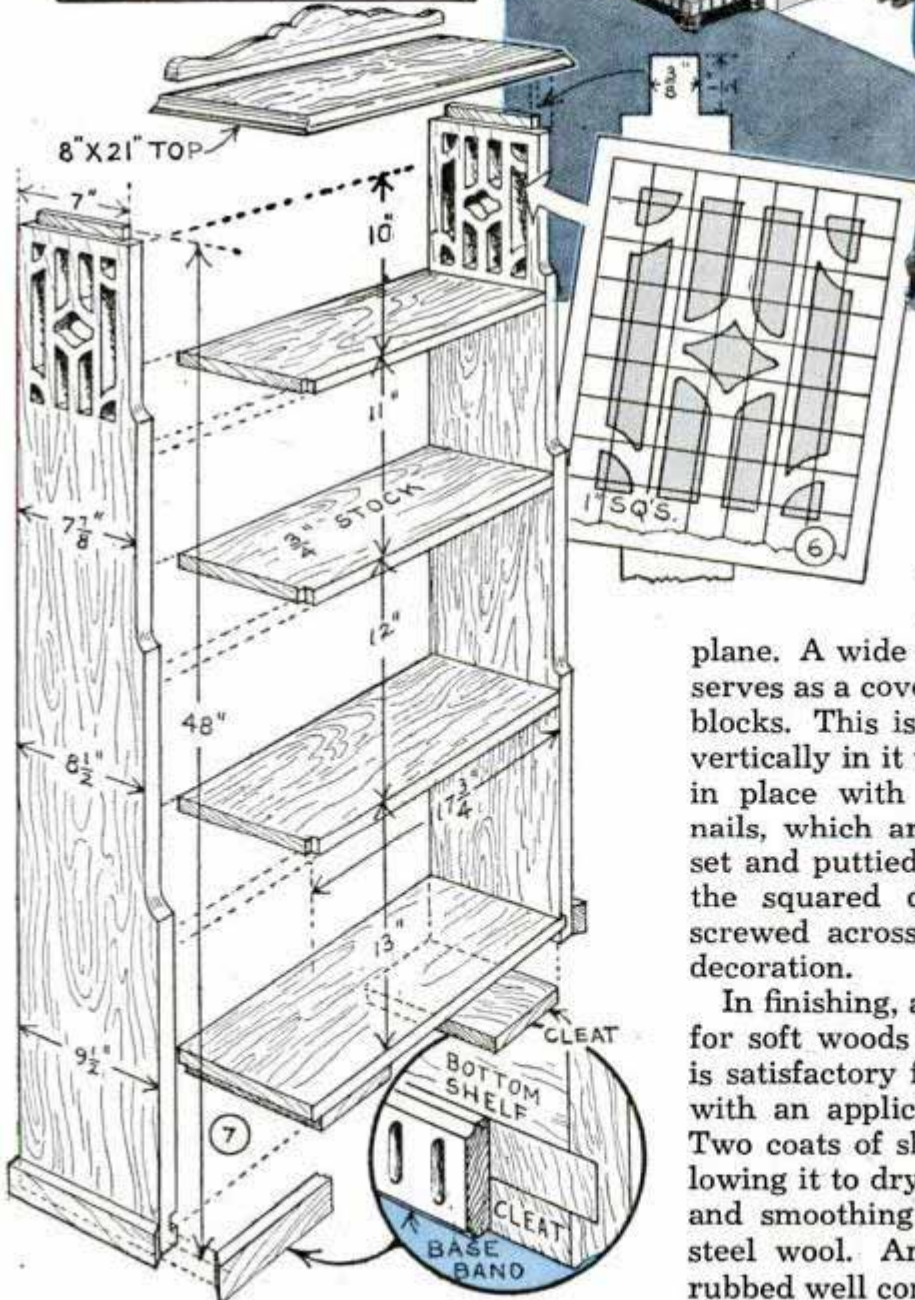
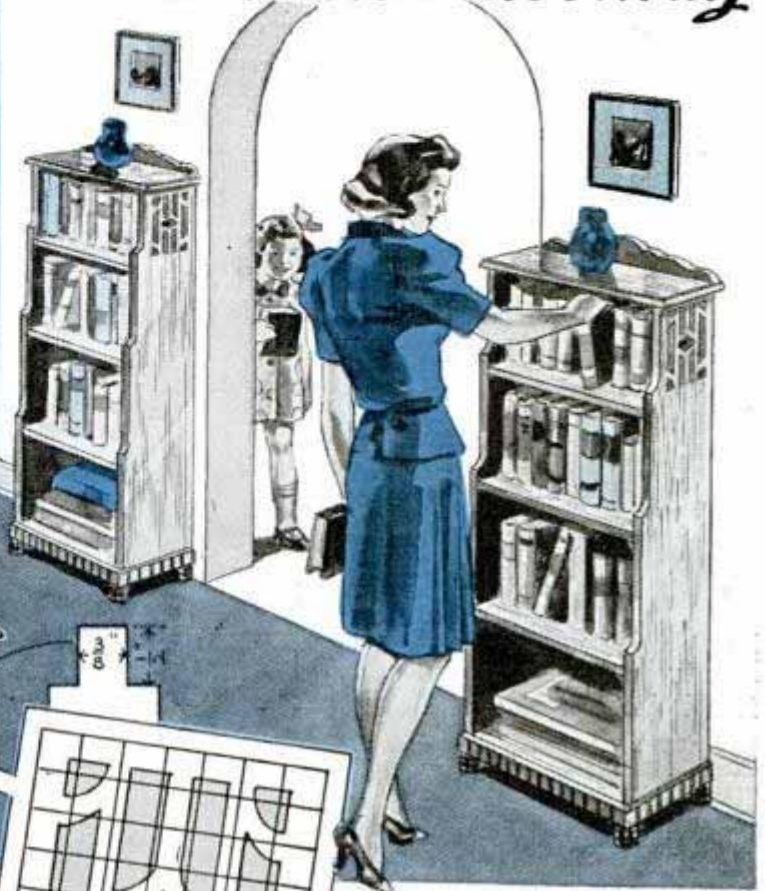
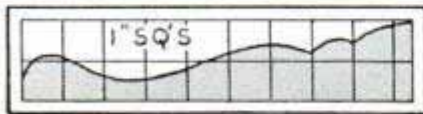

cabinet. The feet are turned on a lathe from the same material as the rest of the cabinet, dowels being formed on the ends to fit in the holes. If a lathe is unavailable, the feet can be short blocks shaped with a

plane. A wide molding around the bottom serves as a cover strip over the reinforcing blocks. This is decorated by making cuts vertically in it with a gouge. It is fastened in place with casein glue and finishing nails, which are countersunk with a nail set and puttied. A scrolled rail, cut as in the squared drawing under Fig. 5, is screwed across the top at the rear as a decoration.

In finishing, an oil stain is recommended for soft woods such as pine. Water stain is satisfactory for walnut, mahogany, etc., with an application of wood grain filler. Two coats of shellac are then applied, allowing it to dry thoroughly between coats, and smoothing after each coat with fine steel wool. An application of floor wax rubbed well completes the job.

## Croquet Arches Located Easily by Stakes in Lawn

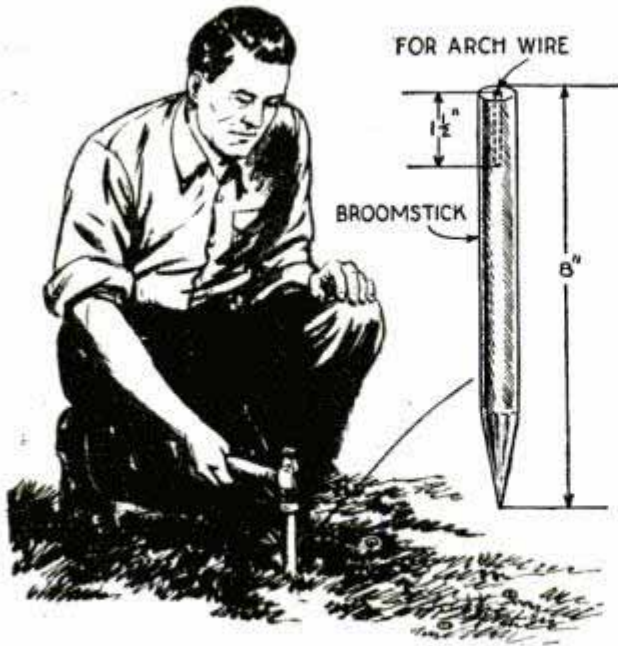

To avoid the trouble of relocating the proper positions for croquet arches, which had to be removed each time we quit playing, I drove stakes into the ground in the proper locations to take the arches. The stakes were made from lengths of broomstick and were drilled in the upper ends to receive the ends of the arches. Being flush with the top of the ground, the stakes did not interfere with use of the lawnmower, and there was no possibility of anyone tripping over them.

—Frederic Chenot, Louisville, Ohio.

## Butterfly Net Has Gas Chamber to Kill Insects

Instead of carrying a bottle of carbonated ammonia or other liquid for killing insects that have been caught in a net, why not provide a poisonous gas chamber right in the handle? If the handle is bamboo,

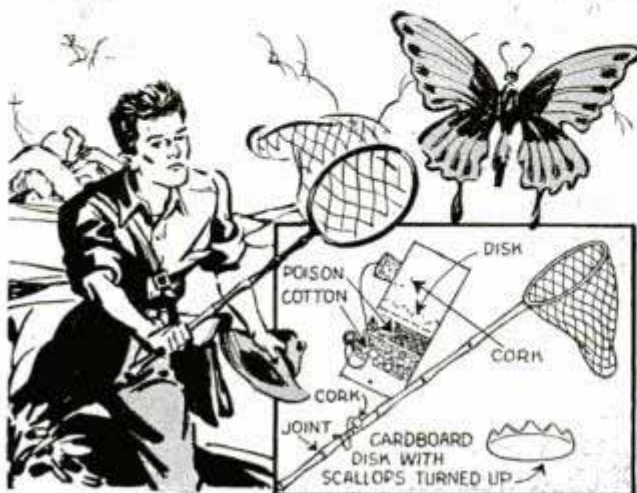

this is done easily. Drill a hole between two of the joints and fill the hollow portion almost to the hole with the poison. On top of this, place some cotton and hold it in position with a cardboard disk, which has been serrated around the edge as indicated. A cork in the hole prevents the escape of fumes. In use, just remove the cork and insert the insect to be killed.

## Rubber Hanger for Fishing Rod

A good hanger for a fishing rod can be made by simply tacking a short length of rubber hose to a wall at an angle. The rod is inserted into the hose, and its tendency to hang vertically causes the tip to bind at

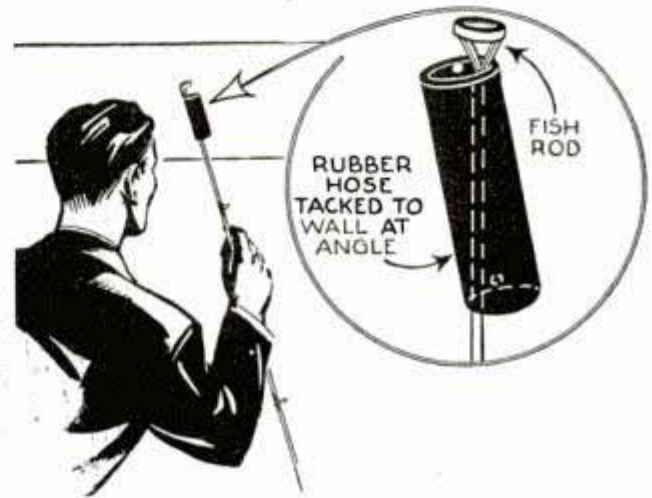

the top and keep it from slipping out of the hose. Such a hanger has the advantage of not injuring the agate tip no matter how carelessly the rod is inserted into it.

## Flowerpot Rack Hooks to Window

Finished to match the window trim, this neat rack will hold potted plants in a window without detracting too much from its appearance. The sides or brackets are made of hardwood and are joined at the bottom by lengths of dowel stock, which serve as a shelf. Thin, metal clips at the upper ends of the sides slip between the two window sash.



It is easy to break up nut meats if you will place them in a paper bag and go over them several times with a rolling pin.

# Open Bookcase Hides Chimney in Attic Room

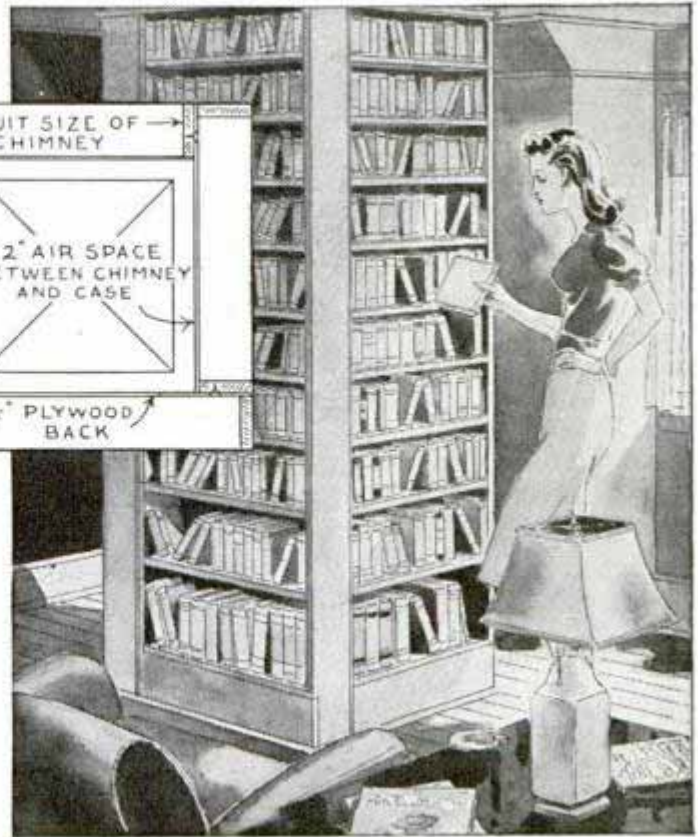
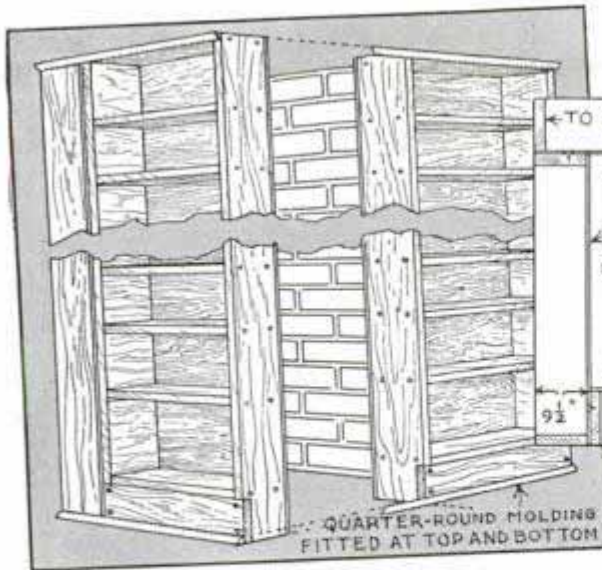

If an unsightly chimney mars the appearance of an attic room, build a bookcase around it and "kill two birds with one stone" by hiding it and providing additional book storage space. Allow at least a 2-in. air space between the case and the chimney. The case is made in four sections, and if this gives more space than is needed for books, fit doors to some of the sections and use them as cabinets. Or, you can build an upholstered

seat around the lower part and put shelves in the upper part for books.

—Chester W. Colburn, North Weare, N. H.

## Building Jack under House Beam Used as Veneer Press



In an emergency, a screw-type car or building jack can be used as a veneer press if the total area of the work surface is small enough for pressure to be applied uniformly to it by a piece of  $\frac{3}{4}$ -in. plywood, which is used as a pressure plate. Assemble the work and plate on a smooth place of your basement floor directly under a floor beam. Generous use of newspapers under the work will help compensate for any unevenness in either the work or the floor. Then set the jack on three short pieces of 2 by 4-in. stock assembled as shown, and use a long piece between the jack and the beam.

—Edw. J. Hobert, Hempstead, N. Y.

### Care of Lilac Bushes

Lilac bushes require plenty of room, good drainage and cultivation. Every spring add a top dressing of well-rotted manure, and a little bone meal occasionally. Lilacs require little pruning aside from the usual gathering of bouquets.

# 5 TOY

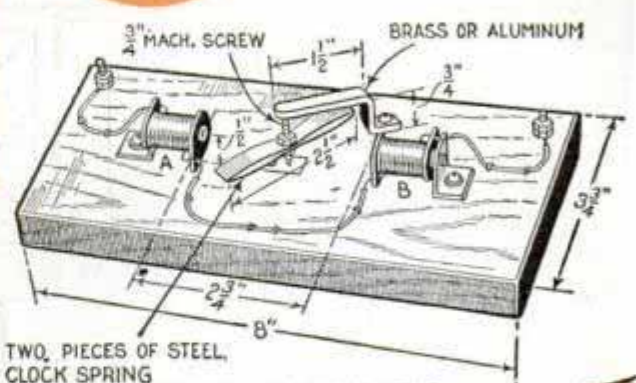

TWO PIECES OF STEEL, CLOCK SPRING  
 ① MAGNETS A & B FROM BUZZER CONNECTED IN SERIES  
 SYNCHRONOUS MOTOR

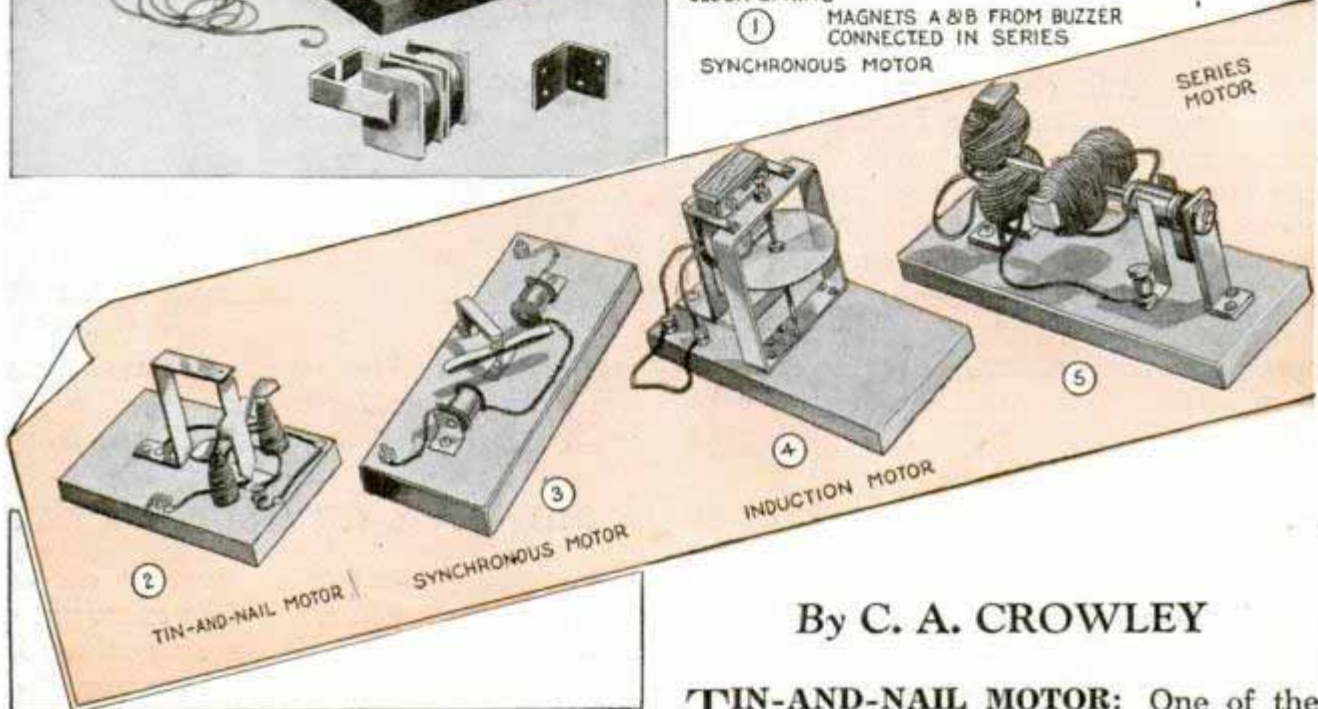

By C. A. CROWLEY

**TIN-AND-NAIL MOTOR:** One of the simplest forms of an electric motor where small electromagnets cause a tin rotor to spin, is shown in Figs. 2 and 6. This motor runs on a couple of dry cells or will operate on 6 volts a.c. provided by a transformer. The rotor acts like a tiny switch as it wipes against a brush lightly, turning on current momentarily just before its arms pass over the electromagnets. This current impulse, which occurs at each half rotation, is just enough to keep the rotor going. The rotor is cut from tin to the cross shape shown and the side arms are twisted at right angles. The electromagnets or field coils are wound in series on two nails, both windings being in the same direction. The nails are 2 in. apart. One end of the wire is scraped bare and twisted to form a tight coil which serves as a binding post, it being tacked down to

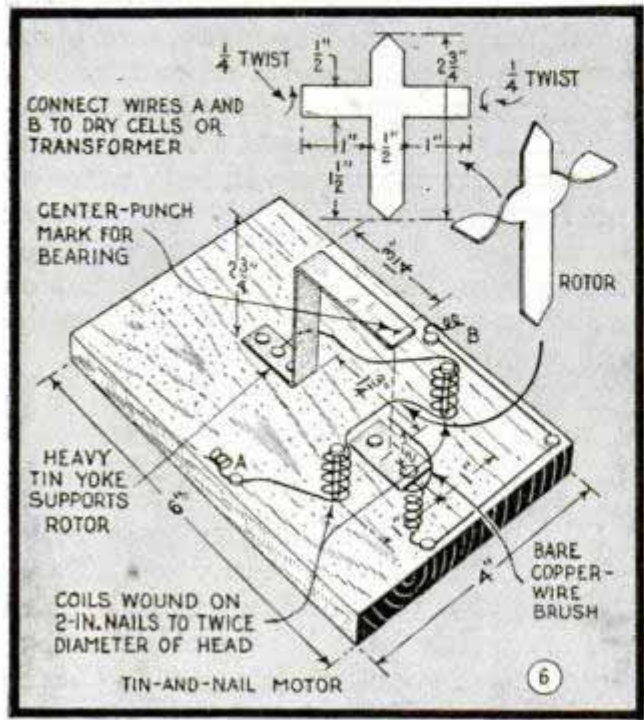



# MOTORS

*convey basic ideas*

These simple electric motors, which run on low-voltage a.c. or d.c. as specified, are constructed from nails, wire and scraps of iron and tin. All of them have been built and made to operate; one provides ample power to drive small toys

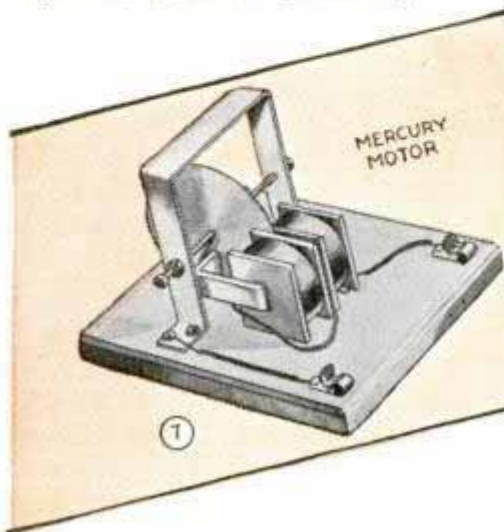

the baseboard at point A, Fig. 6. At this point connections to a transformer or battery are made. The other end of the wire is tacked to the yoke that supports the upper end of the rotor. A length of bare copper wire is used as a brush, rubbing lightly against the edges of the rotor about  $\frac{1}{2}$  in. above the base. It is formed to a coil to provide flexibility. The other end of the brush wire is bared and formed into a binding-post coil at point B to which the other side of the transformer or battery is connected. Center-punch marks are made in the yoke and in a small tin base plate, halfway between the two nails. Then the rotor is set in place so that the arms are about  $\frac{1}{8}$  in. above the tops of the nails. The brush is adjusted so that it touches the edges of the rotor and also releases before the arms pass over the nail heads. After connecting the motor to the current supply, give the rotor a start by turning it and the motor should run.

**Synchronous Motor:** A synchronous motor is one that operates at a constant speed, which is equal to or a submultiple of the frequency of the alternating current supplied to it. A simple synchronous motor

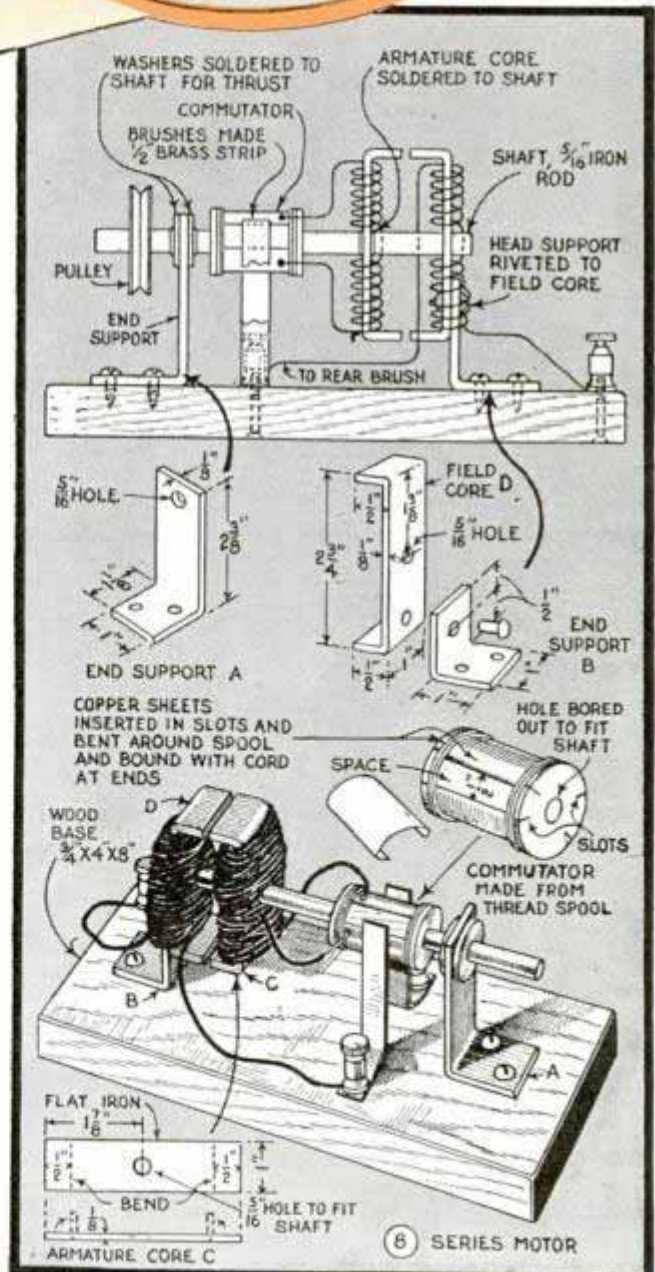

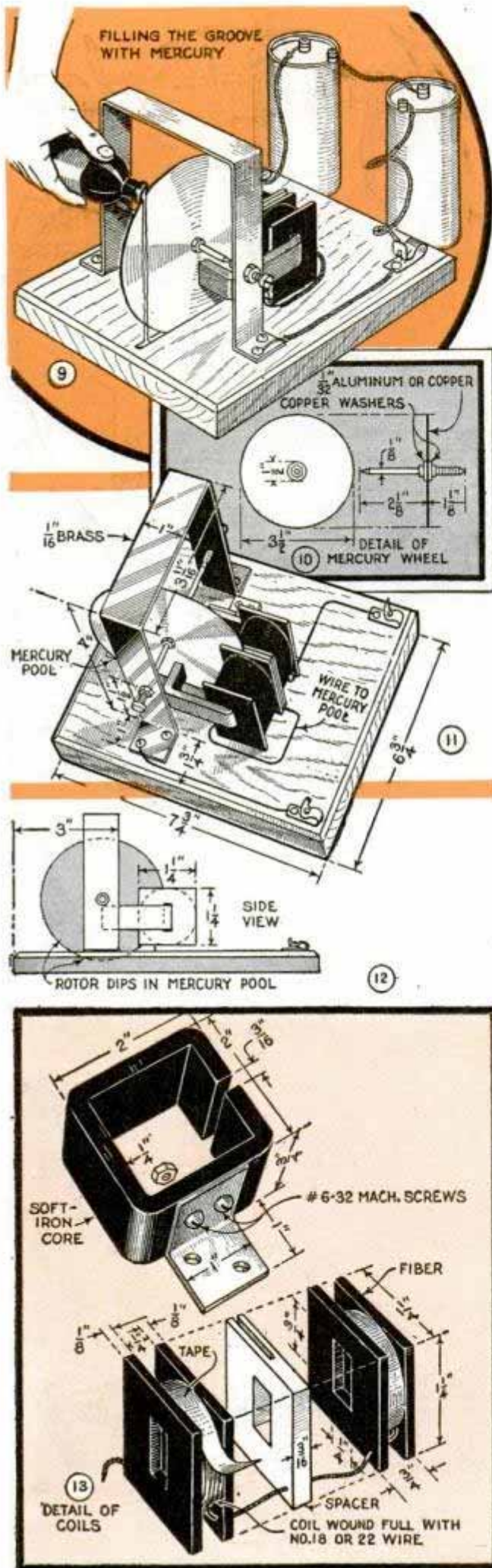

operating on low-voltage a.c. from a bell transformer is shown in Figs. 1 and 3. The field coils A and B are two magnets from a buzzer or doorbell placed so that the windings run in the same direction. These are connected in series. The rotor consists of two pieces of steel clock spring and the shaft is a No. 6-32 machine screw filed to a point at each end. Two nuts hold the springs to the shaft as shown. The shaft is pivoted between center-punched marks in the base plate and the supporting arm. There is no electrical connection to the rotor of this motor. The motor will continue to operate at about the speed at which it is started.

**Series Motor:** The motor shown in Fig. 5 runs on 6 volts d.c. or 8 to 12 volts a.c. from a toy transformer, and it can be fitted with a pulley to operate small models or other devices, delivering considerable power for its size. Details of construction are shown in Fig. 8. The armature and field cores C and D, as well as the end supports A and B, are made of  $\frac{1}{8}$ -in. strap iron. Armature and field coils are wound with bell wire which approximately should fill the space. The armature is slipped on the shaft and is held in place by peening or with a drop of solder. The commutator is made from a thread spool and two strips of copper. Slots are sawed in opposite sides of the spool, the edges of the copper strips are inserted into the slots, and the strips are bent around the spools. There should be about  $\frac{1}{4}$  to  $\frac{3}{8}$ -in. clearance between the two copper segments. The edges of the commutator should be wrapped securely with strong cord. The leads from the armature coil are soldered to the two copper segments of the commutator, and the armature is put in place. Two washers are soldered to the shaft on either side of the end support to limit end play. The brushes are made of spring brass,  $\frac{1}{2}$  in. wide. It may be necessary to give the motor a start by hand. If it does not run as first assembled, turn the commutator on the shaft to a position which will cause the motor to take hold.

**Mercury-Pool Motor:** The mercury-pool motor shown in Figs. 7 and 9 is a type used in d.c. watt-hour meters and other meters. It operates on two or three dry cells connected in series. It will not operate on a.c. Details of construction are shown in Figs. 9 to 13 inclusive. The rotor is a disk of  $\frac{1}{32}$ -in. aluminum or copper mounted on a

small shaft which is placed between two machine screws which are center-punched at one end to serve as bearings and are locked to the frame with nuts. The mercury pool is cut in the wooden base, directly under the rotor. Next, an electromagnet is made. The core is  $\frac{1}{4}$ -in. flat iron bent as shown in Fig. 13 and the two coils are wound full of No. 18 or No. 22 magnet wire, a spacer being placed between them. Both coils must be wound in the same direction. The electromagnet is mounted so that the rotor revolves freely between the coils, and the poles of the magnet are directly below the shaft of the rotor. Electrical connections are shown in Fig. 11. One terminal is connected to the coil, and the other side of the coil is connected to a wire dipping into the mercury pool. The rotor also dips into the pool. The second terminal is connected to the frame of the motor.

**Induction Motor:** Operated on low-voltage a.c. from a toy transformer, the disk-type induction motor shown in Fig. 4 exemplifies a principle used in meters of various types. It will not operate on d.c. Details of parts are given in Figs. 14 to 17 inclusive. The laminations used are approximately of the dimensions shown in Fig. 17 and can be obtained from an old audio transformer used in radio. Two stacks of laminations, each  $\frac{9}{16}$  in. thick, are required for the lower and upper coil. The upper coil is wound with No. 28 d.c.c. wire, enough wire being wound on the coil to fill the winding space on the core. The lower coil is wound with No. 18 wire. The leads from each coil are brought out to a pair of binding posts on opposite sides of the motor. The core of the upper coil is drilled directly below the coil and a single turn of No. 8 bare copper wire is inserted as shown in Fig. 15. The ends of this wire should be lapped carefully and soldered together. The frame is made of No. 16-ga. sheet brass. The rotor is a disk of sheet copper or aluminum. It is moved up or down on the shaft until it is in the proper position between the two cores. The upper coil terminals are connected to a radio rheostat and the lower coil is connected to the transformer supplying 6 volts. It will be necessary to shift the upper coil slightly to one side or the other in order to get the motor to operate properly. Once the proper position has been found, the speed can be controlled by adjusting the rheostat.

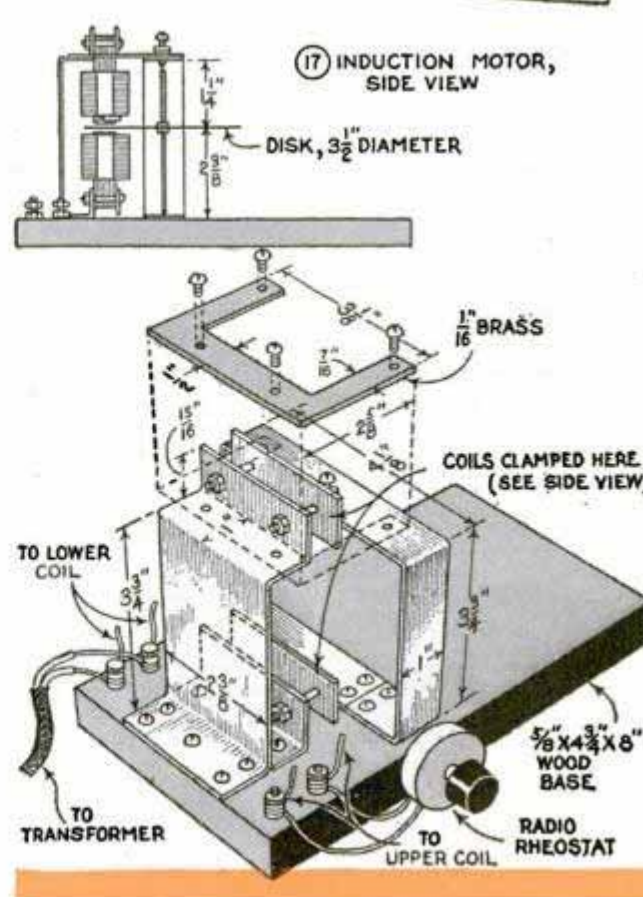
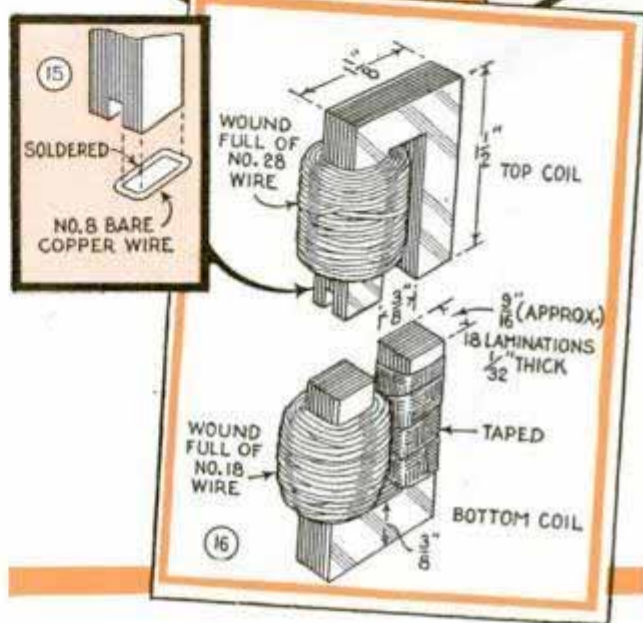
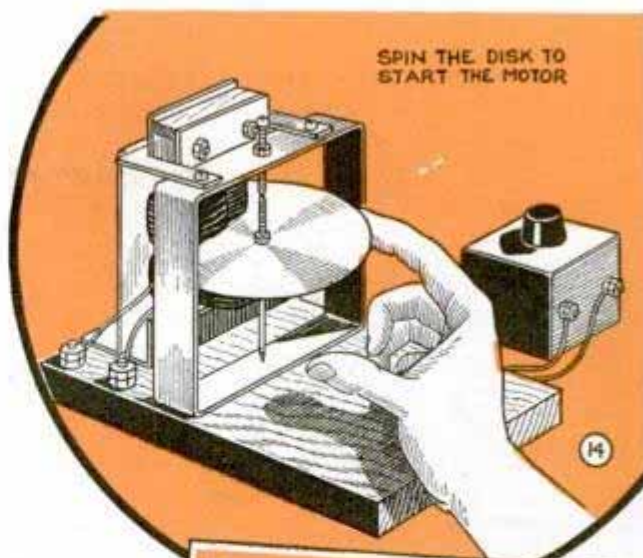

## Spring Clamp Holds Sander Cord Out of Operator's Way

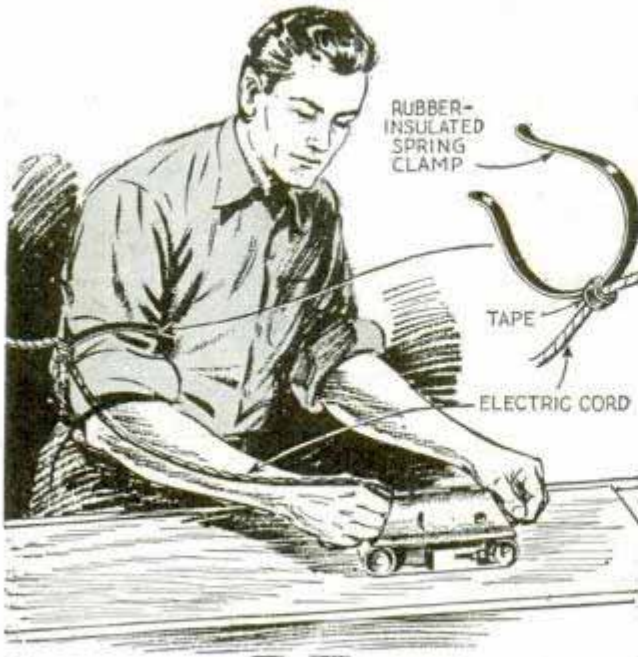

To keep the electric cord out of the way when operating his portable electric sander, a carpenter uses a spring clamp, which holds the cord to his arm. The clamp is insulated with a covering of rubber tubing.

## Fine Wire Replaces Silk Winding on Fishing Rods

The next time you have to replace the winding on your fishing rod, try fine copper wire instead of silk thread. The wire will last longer and produces a neat appearance when carefully wrapped. A drop of solder melted over the windings and smoothed out with a hot iron prevents the ends from coming loose.

## Dipping of Pen in Wrong Ink Avoided by This Stand

Holding bottles of red and black ink, this stand has a pivoted cover that is

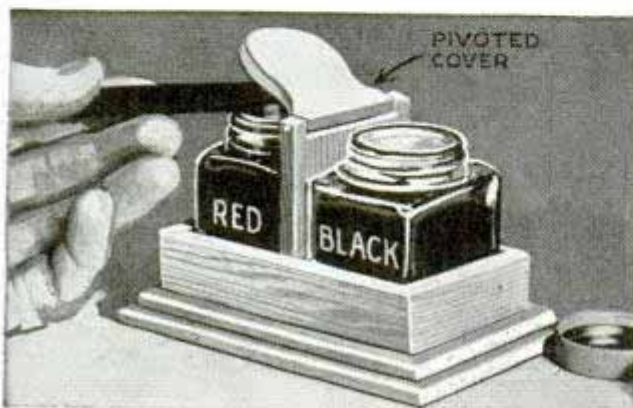

turned over the bottle not being used so that there is no possibility of accidentally inserting the pen in the wrong one. Both inks cannot be exposed at the same time, and the cover is so loosely pivoted that it will not remain in a vertical position.

## Tension Spring in Guy Rope Helps Prevent Breakage

Springs of the desired strength inserted in guy ropes and lines of tents and other objects will provide some give in the ropes and help prevent breakage of the lines in sudden gusts of wind. The detail shows how the springs are installed close to the anchoring stakes.

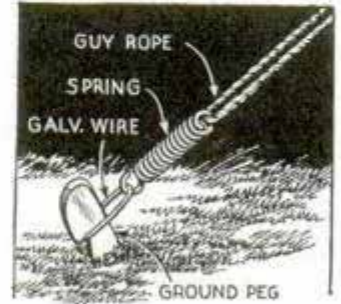

## Tree "House" for Little Tots



Built around the trunk of a tree, this house is nothing more than a platform with a strong railing along all four sides. It is 3 or 4 ft. above the ground, and the impression of height is increased by a small ladder from the ground to an opening in the railing.

Tennis players whose racket handles get smooth and slippery and turn in their hand while playing, should keep a small piece of rosin at hand and rub it on the racket handle as often as is needed.

# Pattern Fits Linoleum Around Fixed Objects

Difficulty often experienced in laying linoleum around fixed objects on the floor can be overcome by making up a pattern as follows: Take a piece of heavy wrapping paper and make a slit part way through the center. Then make cuts radiating in all directions from the slit toward the edges of the paper. Slip this around the object and press down the paper tabs around the object as shown in the upper photo, creasing each tab where it contacts the object. Then remove the paper and cut off the tabs at the folds. This will give you the outline of the object. Now measure

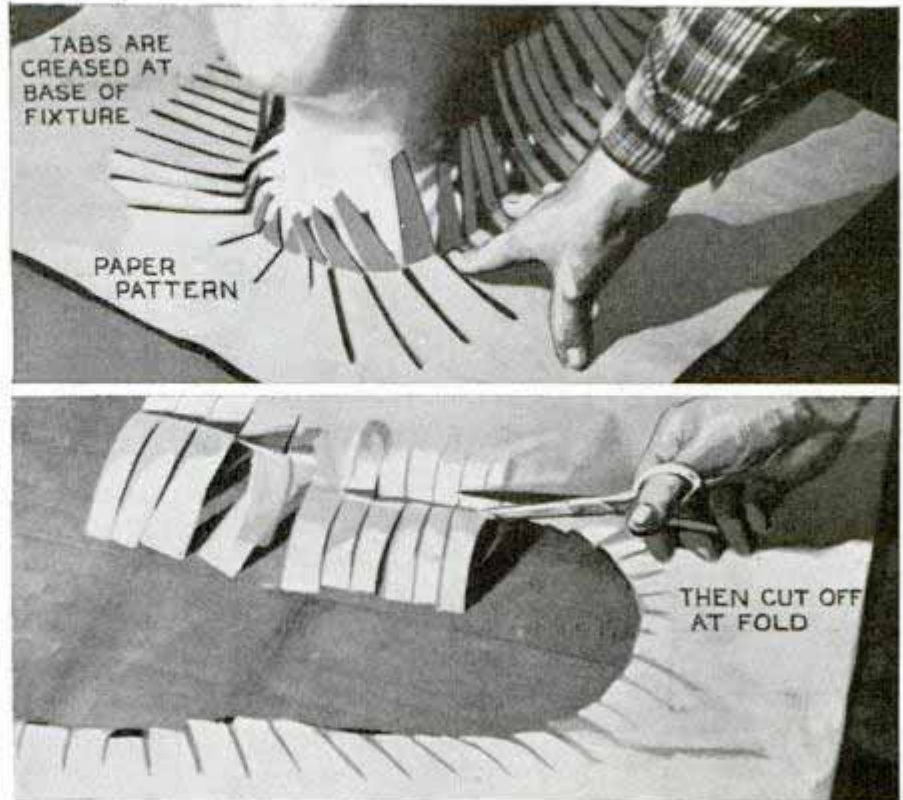

measure the exact distance from two walls to the object. Then transfer this distance to the linoleum, measuring from the two edges of the linoleum that will be laid

along the walls from which the measurements were taken. Use the pattern to cut the opening in the linoleum at this point and it will fit accurately around the object.

## An Easy Method of Docking Boat Against Adverse Currents

To simplify docking my boat when alone and the tides are adverse, I nailed a heavy

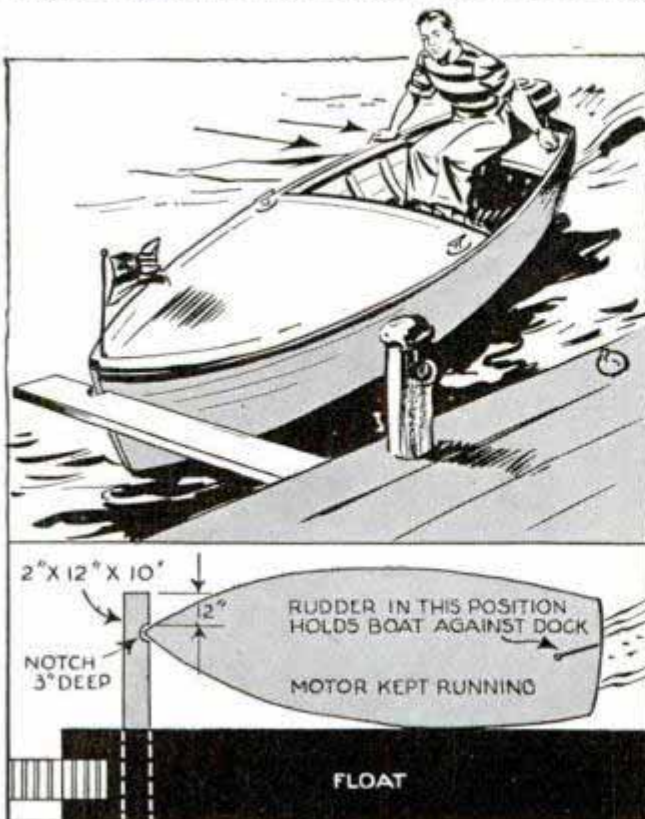

plank to the dock as indicated, and cut a large notch near the outer end to take the bow of the boat. In docking, I ease the stem into the notch and leave the propeller going with the rudder turned to move the boat against the dock while I make the lines fast. Also, the plank is handy for backing out the boat when the current tends to hold it against the dock, because I can swing the stern to the desired angle and then back straight out into the clear.

—Arne O. Salonen, South Bend, Wash.

## Keeping Dogs Out of Flower Bed

If your dog has a habit of lying in the flower bed, drive a few stakes in the ground at his favorite spots. The stakes, which should project above the ground about 2 in., will be hidden by the flowers.

Use bottles with screw-on medicine droppers in the kitchen. Fill with flavoring extracts, fruit coloring or any liquid you might wish dropped in small quantities.

# Motor-driven

YOUR small children will have good reason to stay in their backyard to play if they have this merry-go-round. Outside of a  $\frac{1}{4}$ -hp. electric motor and a reduction gear, it is assembled chiefly from pipe and old car parts. To begin, make a cross of heavy planks for the base as in Fig. 1 and on this, mount the left half of a car axle housing and differential, including the ring gear, axle and drive pinion complete as in Fig. 7. Use J-bolts to lock the spider gears of the differential as shown in the circular detail of Fig. 8, so that the axle will rotate when the ring gear is turned. Next mount the motor and reduction gear on a base and connect it to the differential drive shaft by means of a piece of hose and clamps as in Fig. 2. Now you are ready for the platform and its supporting members. First ream an outer wheel-hub flange to a turning fit over the axle housing and then put a complete wheel hub on the end of the axle as in Fig. 6. Assemble these two parts into a unit by means of vertical pieces of flat iron. The platform is carried on six horizontal lengths of

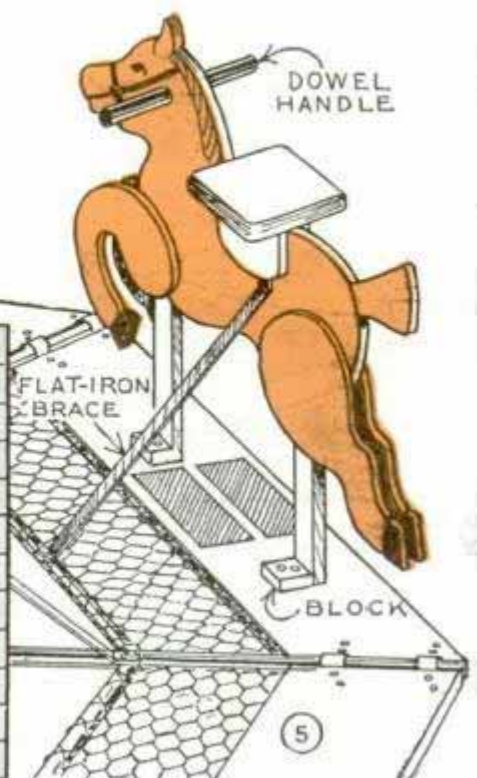
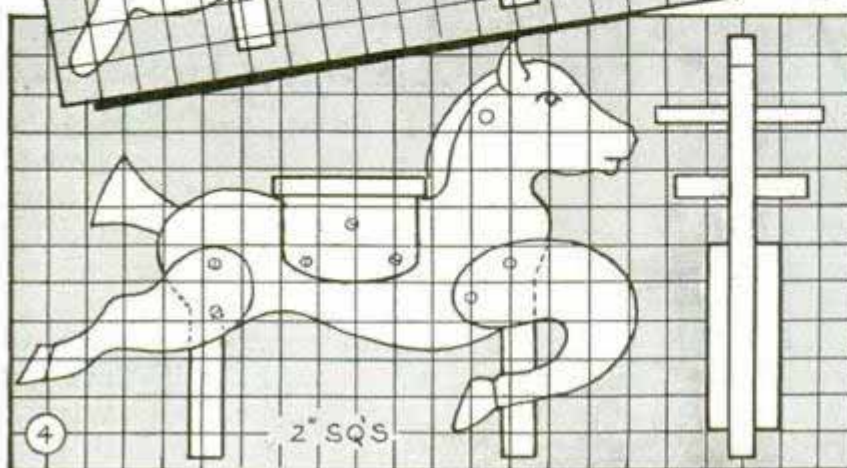
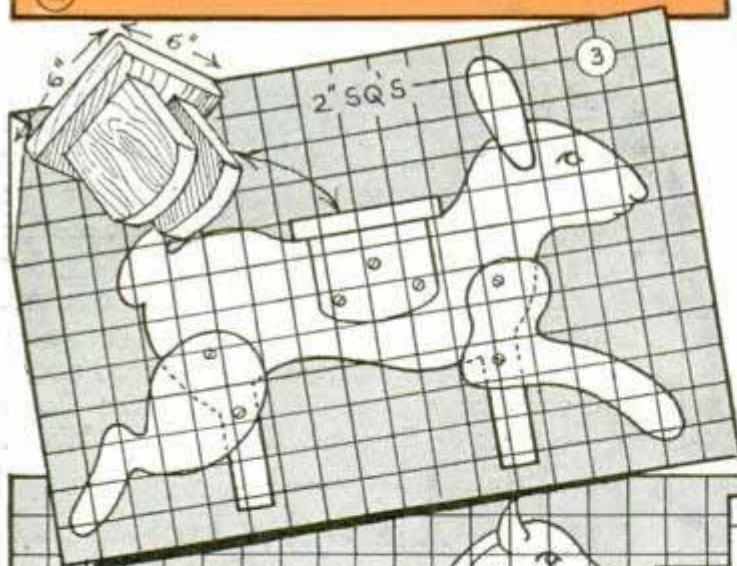
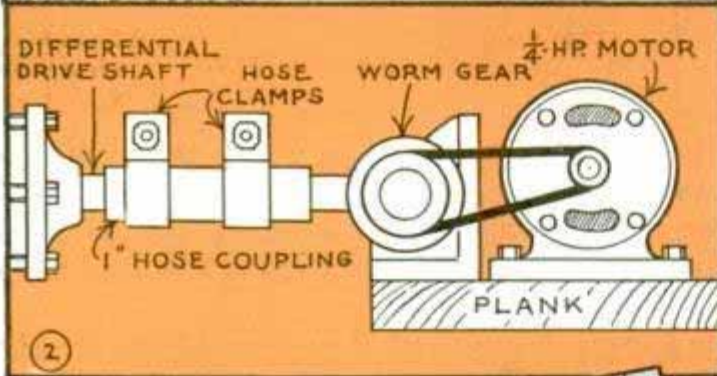
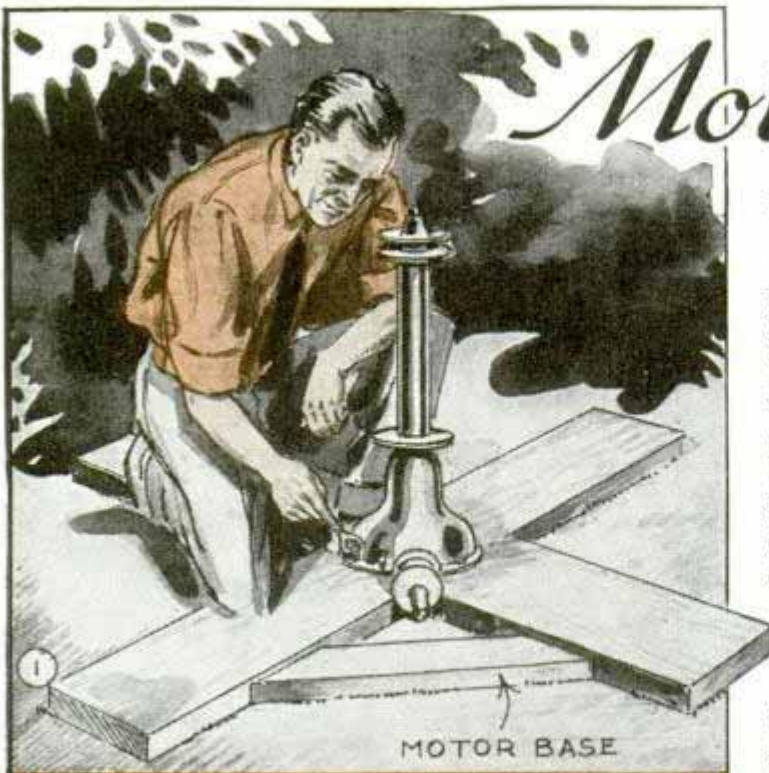

# MERRY-GO-ROUND

*Seats Six*

1-in. pipe, which are attached to the reamed flange with awning fittings, and spaced equally by means of horizontal braces of  $\frac{3}{4}$ -in. pipe. Flat-iron braces running from the wheel hub on the axle to the horizontal members complete the supporting assembly. Iron brackets bent to fit over the horizontal pipes are used to join the platform boards. Animals can be mounted on the merry-go-round if desired. A horse and rabbit are shown in Figs. 3 and 4. Fig. 3 also shows how a seat or saddle is made and attached, while Fig. 5 gives the method of mounting and anchoring the animals.

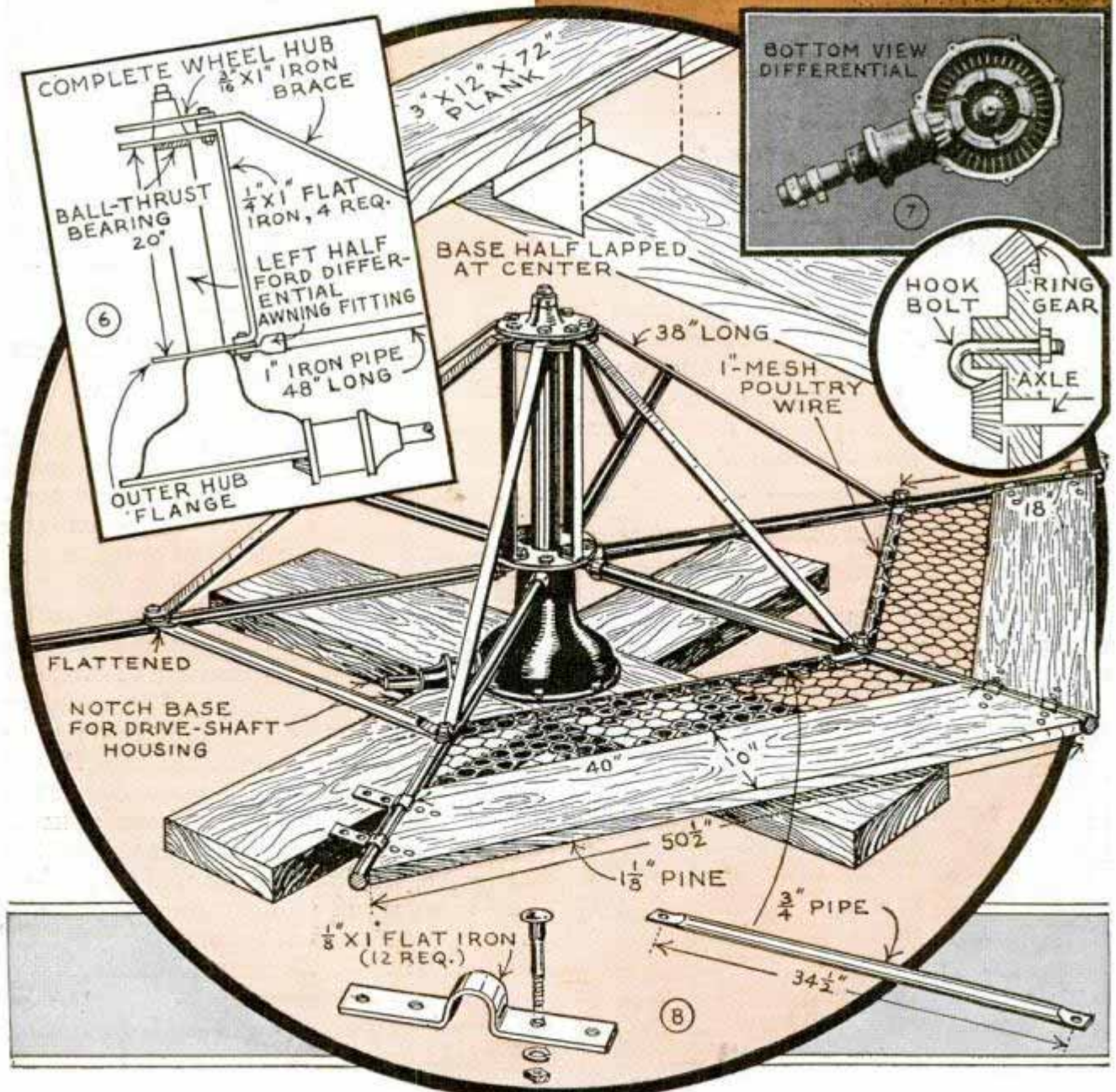

## Train Lights Wired to Stay On over Dead-Track Section

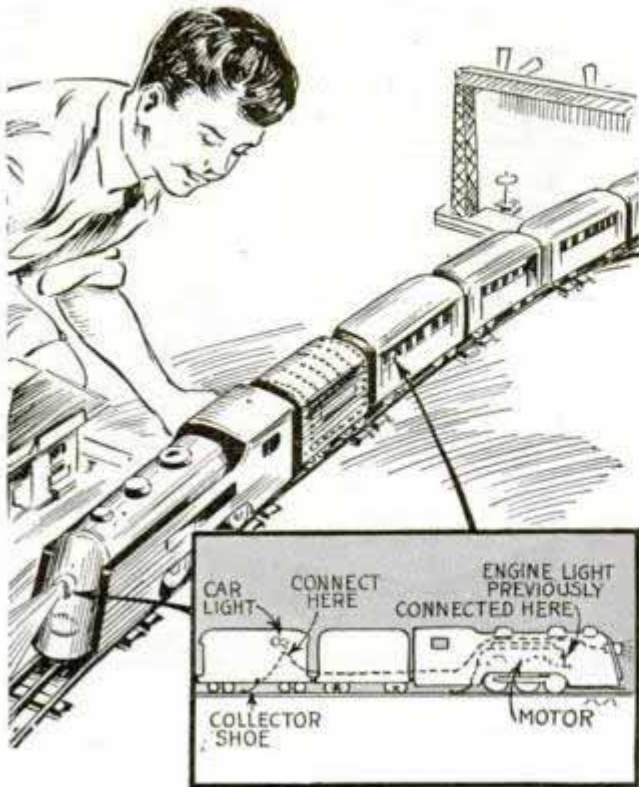

Much of the realistic effect of a lighted toy train is lost if the lights go out when the engine passes over or stops on a section of the track that has been made "dead" temporarily by the automatic controls. To avoid this, add an extra collector shoe to the rear car of the train and connect it to the light circuit. In this way the train will always be lighted as long as either the engine or rear coach is on a "live" portion of the track.—Wm. Naken, Chicago.

## Pencil Provides Small Electrode for Arc-Soldering Outfits

Owners of small carbon-soldering outfits can increase their utility by using a cheap mechanical pencil as an auxiliary electrode

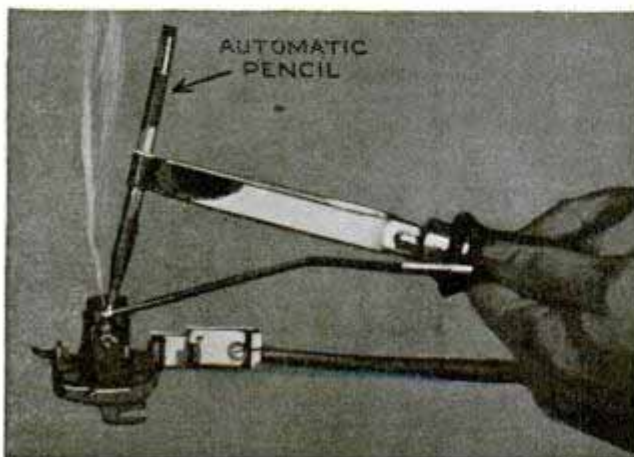

for fine and delicate work. If the pencil barrel is enameled, scrape off enough for the electrode clamp to make good electrical contact. The pencil is used just as the regular carbon, the lead being run out for a distance of  $\frac{1}{2}$  in. or more. The thin lead offers considerable resistance to the passage of current and will instantly become white hot up to where it enters the pencil. The small point permits use of the outfit in places where the larger carbon cannot be inserted, and the metal barrel of the pencil offers protection against breakage of the lead.

—W. C. Wilhite, Carlinville, Ill.

## Vacuum Cup Holds Shade to Avoid Flapping

A vacuum cup attached to the center of a window-shade slat can be stuck to the windowpane to keep the shade from flapping in the wind when the upper sash is lowered at night.

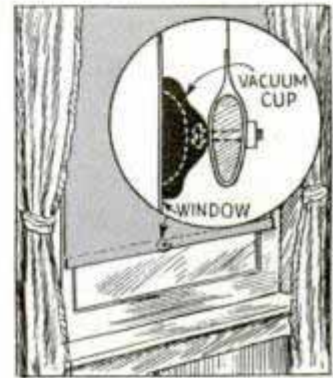

## Reinforce Your Stepping Stones When You Cast Them

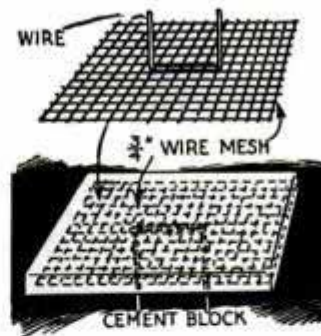

If you are going to make stepping stones out of concrete, reinforce them with heavy wire mesh and they can be made lighter and at a saving in materials. When you lay

in the mesh, bend a length of heavy wire to a U-shape and insert it so that it will project 3 or 4 in. from the underside of the stone after the latter has been poured. Then when the stones are placed on the lawn, the projecting wires will be pushed into the ground to help keep the stones from being moved about easily.

—Dale R. Van Horn, Lincoln, Nebr.

☐ An old whisk broom is ideal for watering tiny seedlings; dip the broom in tepid water and shake over the plants.



# "Barrel Bronco" Gives a Fast Sidewalk Ride

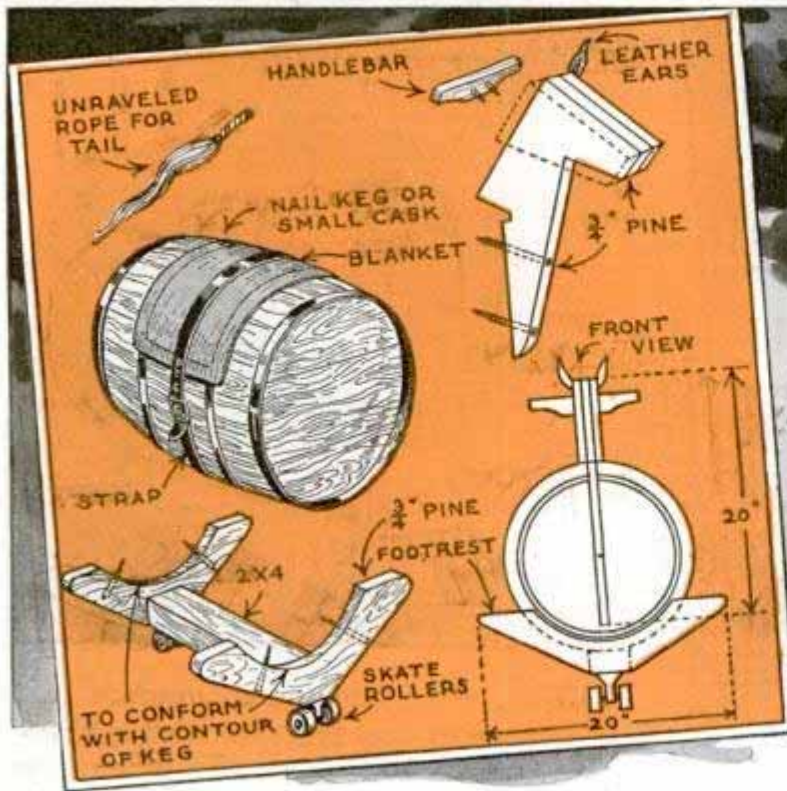

Why not dress up a simple roller-skate scooter to resemble a bronco which you can mount? A small, strong keg is attached securely to a cradle and a scroll-sawed head is screwed to the front end of the keg. A cleat on the head serves as a han-

dlebar. Mane and tail are simulated by unraveling lengths of rope, which are attached, while the ears are cut from leather, and a piece of rug or a doubled blanket is strapped to the keg to form a saddle.

## Marbles for Chinese Checkers Kept in This Wood Case

Instead of keeping marbles for your Chinese checker game in a bag you will find this simple container much handier and the marbles can be separated as to color. It is made from a wood block, holes being bored lengthwise to receive the marbles. Sliding covers at the ends have beveled edges, which fit in grooves. Peepholes enable you to select the desired marbles.



## Self-Closing Pocket for Fishhooks

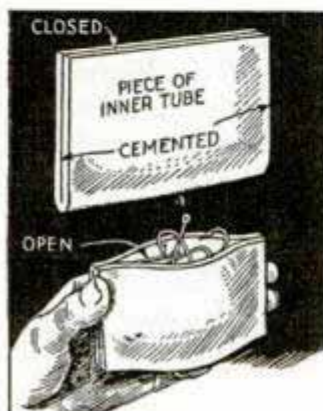

By folding a piece of inner-tube rubber and cementing the ends together, you have a practical case for fishhooks. The case will remain closed until the ends are pressed toward each other.

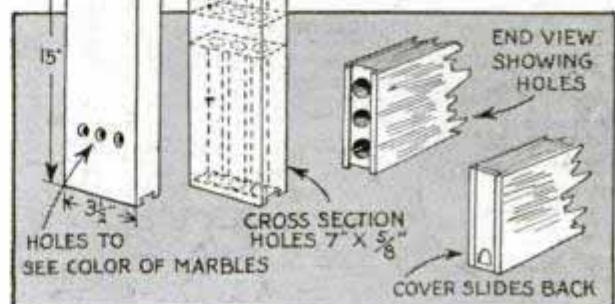

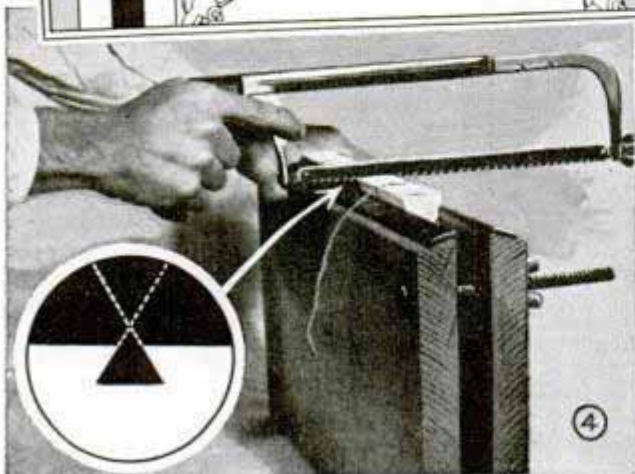
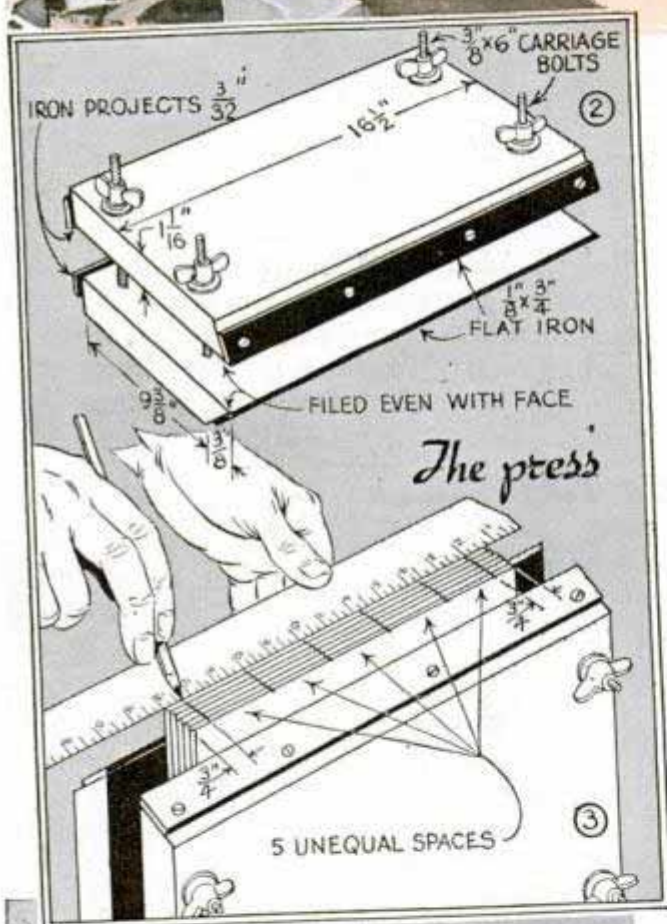

**TORN**, worn and faded volumes that detract greatly from the neat appearance of your library can be given new covers of leather or cloth and even improved beyond their original appearance when new. Such rebinding can be done at home by anyone. Also, when an accumulating stack of old magazines becomes a problem, why not separate the portions of them you wish to save and bind these together in yearly volumes?

Only a few simple pieces of equipment are required, namely: a press, sewing table and trimming board which are detailed in Figs. 2, 6 and 15. To bind magazines, begin by tearing off the covers and pulling out the staples as in Fig. 1. Separate the sections, being careful not to tear the backs, especially if glued. Align the edges by "jogging" the sections on the table until the back is flat and then clamp the stack in the press. Next mark lines across the back  $\frac{3}{4}$  in. from the head and tail, as in Fig. 3, and divide the remaining distance into five spaces. With a fine-toothed saw make two end cuts to a depth of  $\frac{1}{16}$  in. to provide openings for inserting the needle when sewing. The other marks are undercut as shown in the circular detail of Fig. 4, to imbed heavy cords. If tapes, available at dry-goods stores, are used instead of cords, all cuts are made  $\frac{1}{16}$  in. deep, a cut being made on each side of each tape.

Now for sewing: Place the first section face downward on the bed of the sewing table. Using the saw marks as guides,

*... \$3.00*

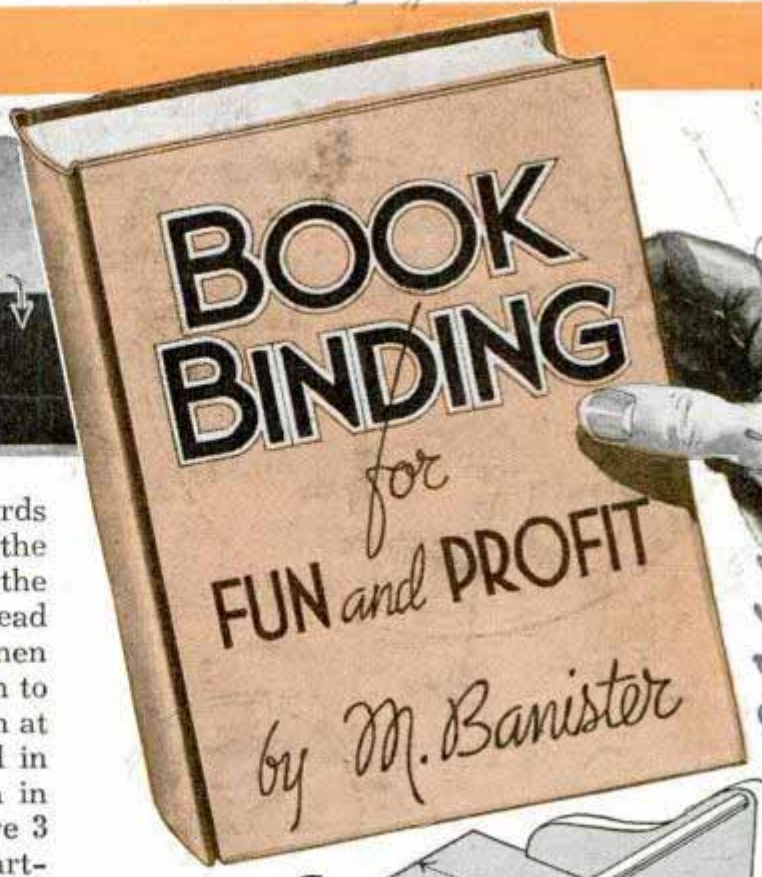
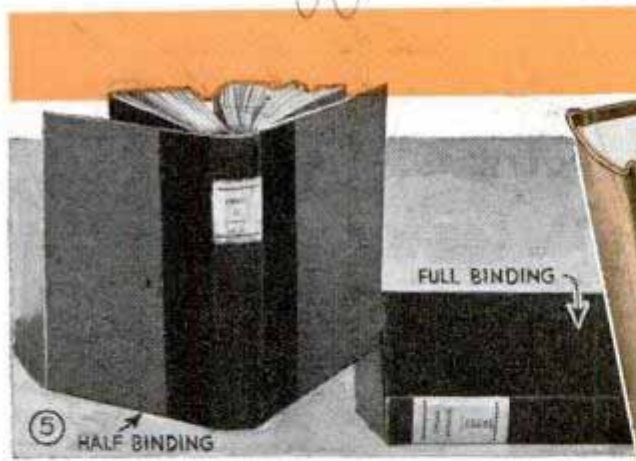

string the table with four vertical cords or tapes, fastening one end beneath the table with thumb tacks and tying the other end to the frame, Fig. 10. Thread a darning needle with No. 25 linen thread and begin sewing each section to the cords by holding the section open at the division and running the thread in and out around the cords as shown in the insert detail of Fig. No. 9. Leave 3 or 4 in. of thread extending at the starting hole. Then the second section is set in place and sewed from left to right with the same length of thread, after which the two ends are tied together. When the thread emerges at the left, or

*2069 Wall Park Ave  
P. M. Lund*

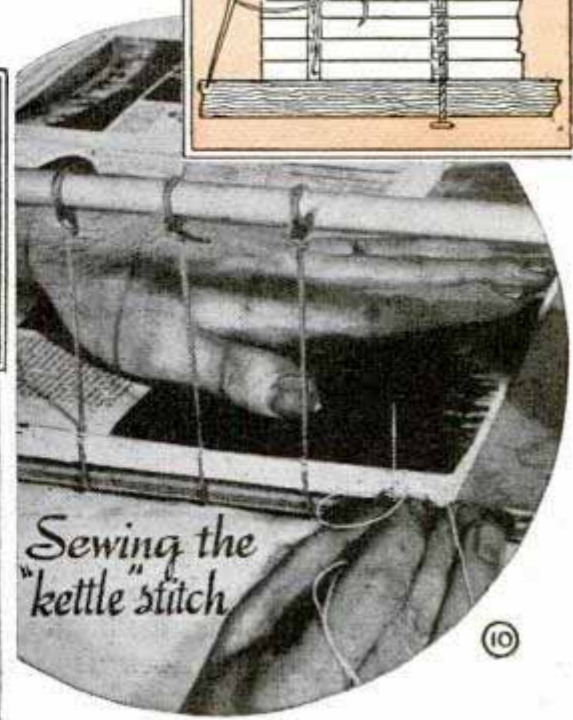
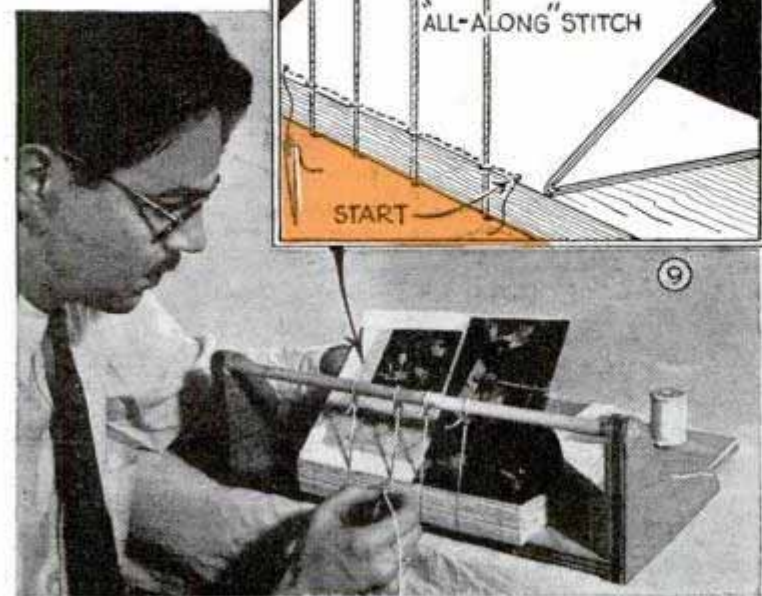
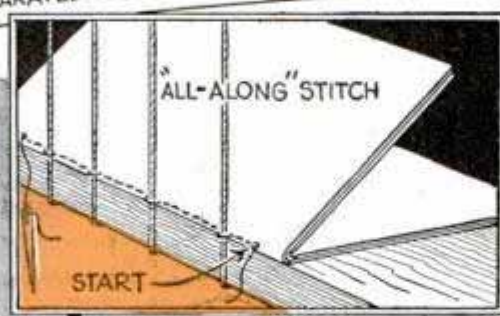
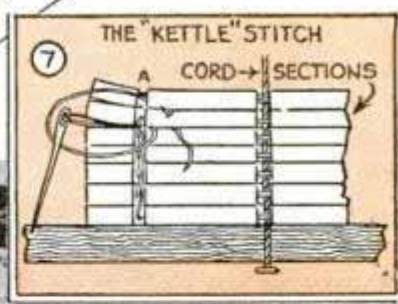
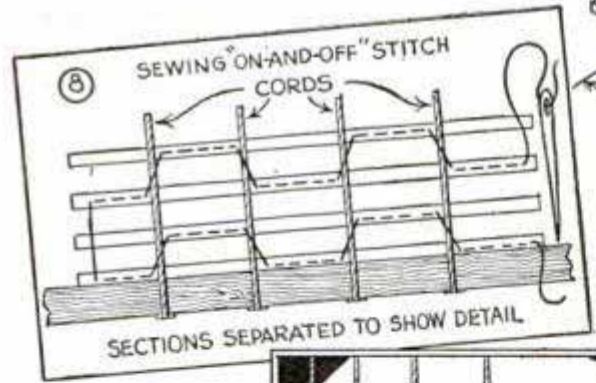
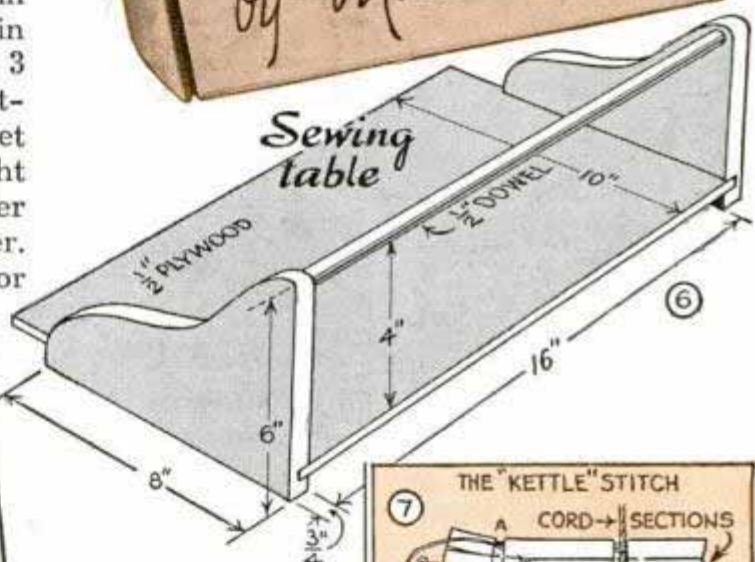

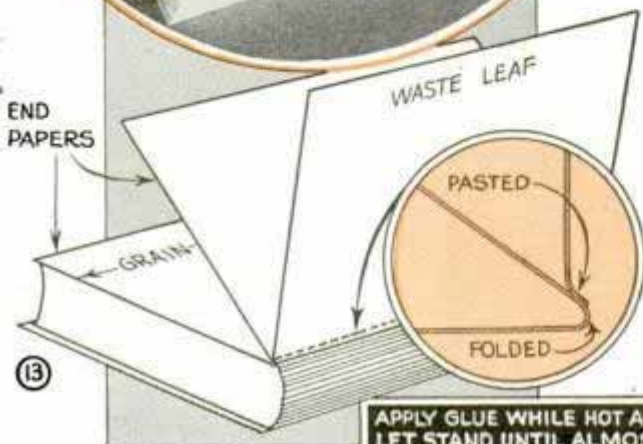
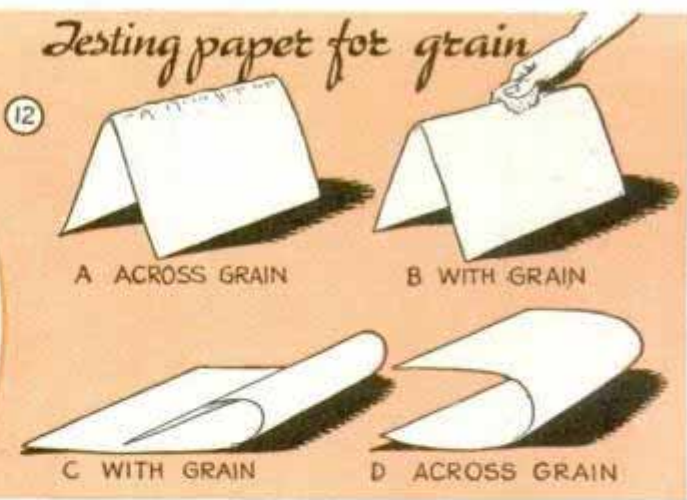
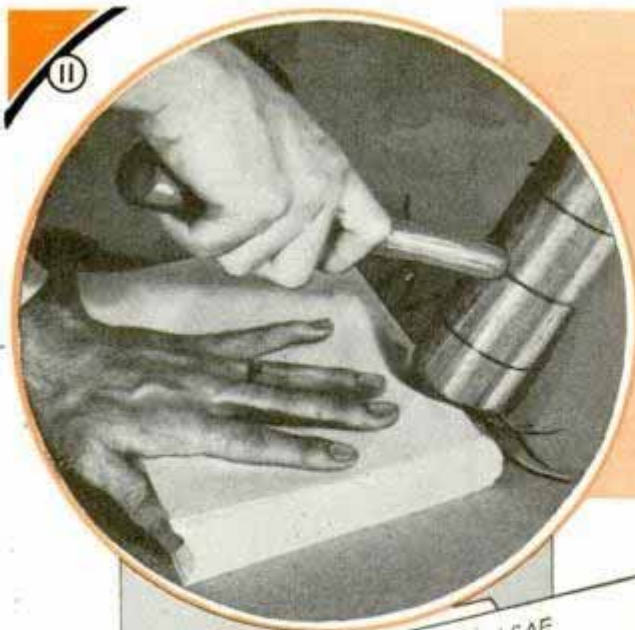

It is important that the grain of both end papers and cardboard run vertically. Fig. 12 shows how to determine this for folding the paper with the grain. The waste leaf is pasted to the outside of the folded end paper, Fig. 13. Open the book and fasten together each of the first and last three sections with a 1/4-in.-wide strip of paste down the back. Paste the end papers in the same manner and place under a heavy weight to dry for 1/2 hr.

You can make your own paste by mixing powdered alum, 1/2 oz., with flour, 1/2 cup, adding enough water to make a thin paste. Stir to a

tail end of the third section, the "kettle" stitch is made, Figs. 7 and 10, to tie the three together. This is done by passing the needle behind the cord and again through the loop thus formed. The kettle stitch is made at the end of each section. Sew four sections using the "all along" stitch, Fig. 9, and then change to the "off-and-on" method, Fig. 8, for sewing the center sections of the book, finally reverting to the former stitch for sewing the last four sections. Use a square knot in joining a new length of thread so that the knot will come on the inside of the book. Where tapes are used, the threads passing across each tape are tied together by passing the needle vertically beneath them and knotting together. When the sewing is completed cut the vertical cords, hold the book firmly on the table with the back flat and strike heavy blows with a mallet along the back edge at the front and end to knock down the swelling and imbed the threads.

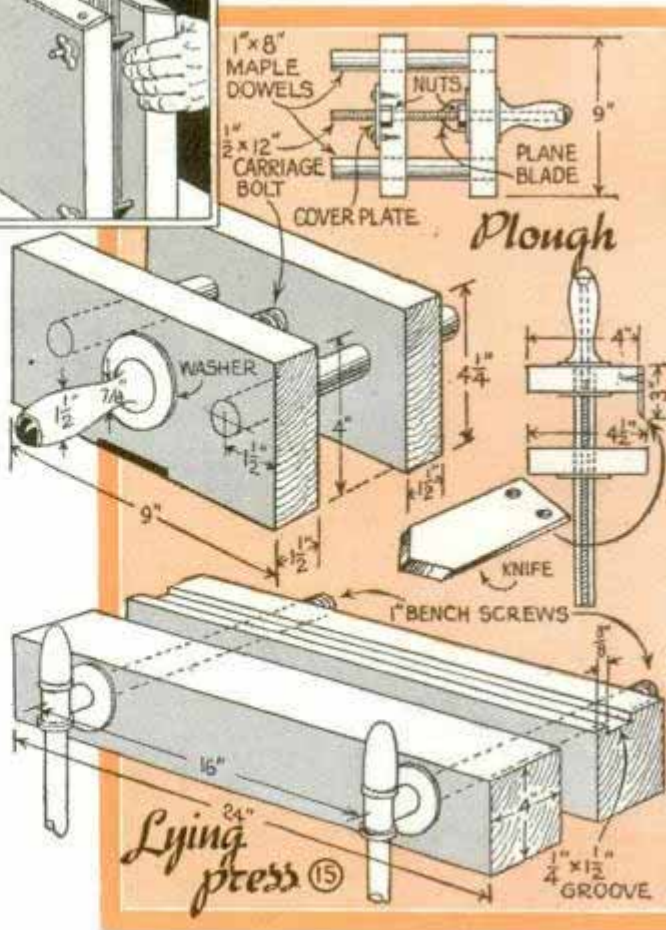
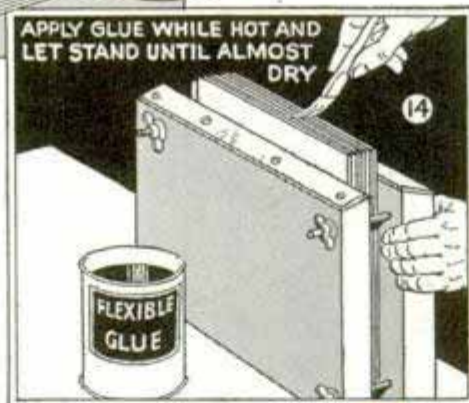

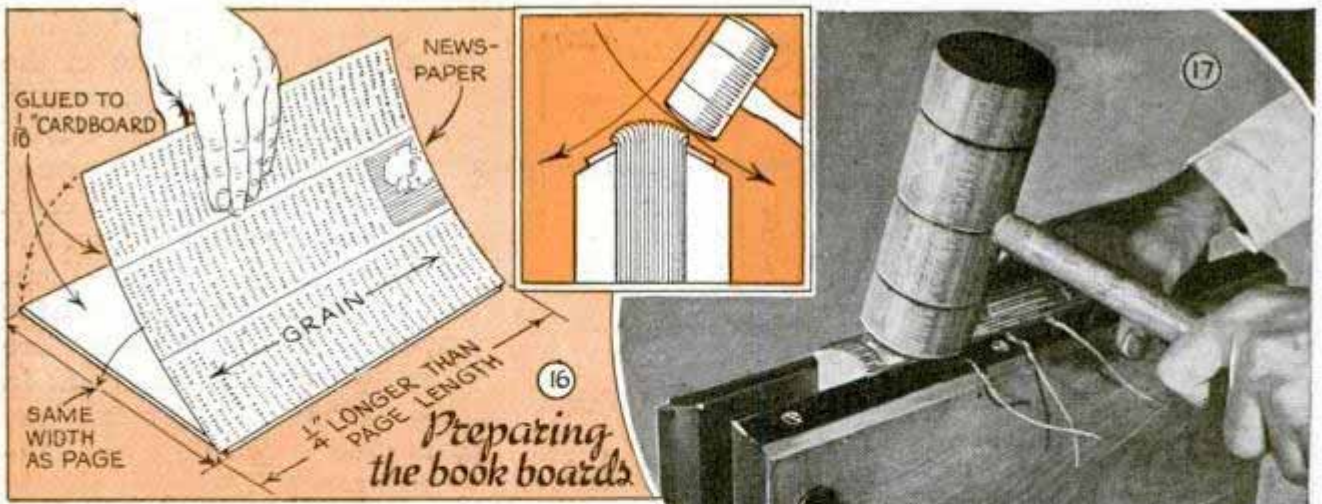

smooth consistency, add two cups of water and boil for five minutes, after which a few drops of oil of cloves are added before setting aside to cool.

Jog the book on the table to flatten the back and again clamp it in the press. Using thin "flexible" glue, which is made by adding glycerin, 1 tablespoonful, to dry glue, 4 oz., while cooking, coat the back of the book, working it in the sections well as in Fig. 14. When still tacky, the book is trimmed. Mark a straight line across the front waste leaf about 1/8 in. from the head. Insert the book in the cutting press, placing it between heavy cardboards, Fig. 21, and line up the guide mark with the edge of the press. The paper is trimmed evenly by

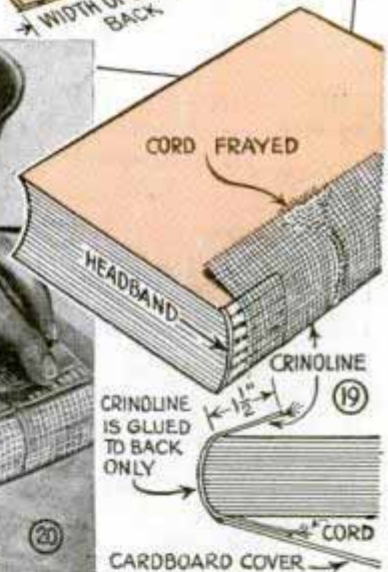
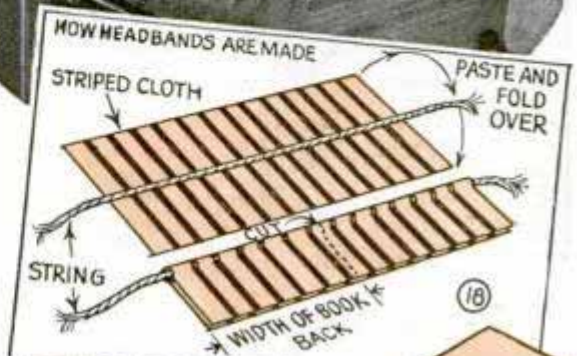
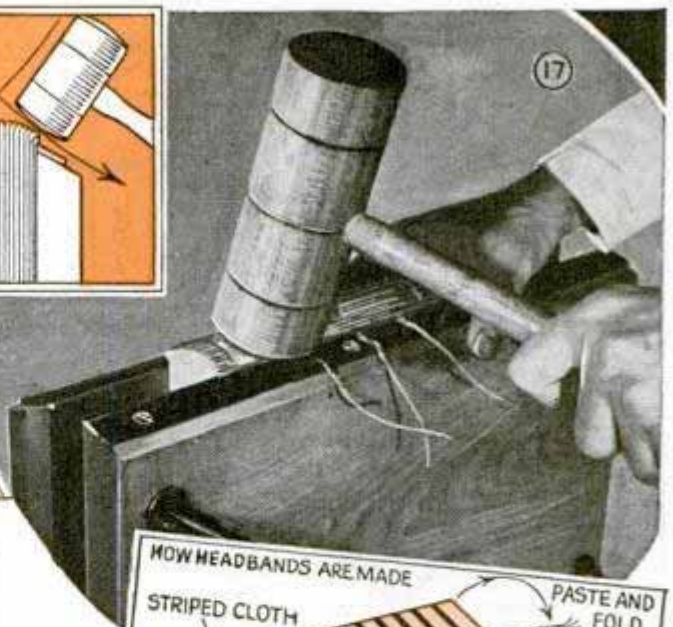

moving the plough back and forth as the feedscrew is gradually advanced with each forward thrust. Feed the knife slowly to prevent jamming and tearing the sections.

Cut the book boards from heavy cardboard to the size given in Fig. 16. Paste a piece of newspaper to one side of each and dry under a weight. The grain of both must run vertically. Rounding and backing the book is done by first pushing in the fore edge with the thumb at the same time a drawing force is exerted with the fingers, as in Fig. 11, and then striking the back with a mallet to form "ears" along each side as in Fig. 17. Headbands of striped cloth are made as in Fig. 18 and are glued to the back at the tail and head. Apply

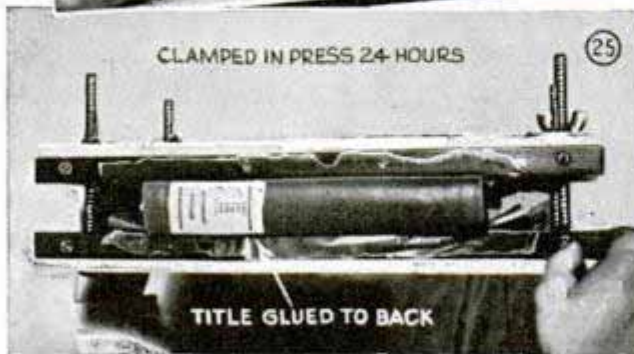
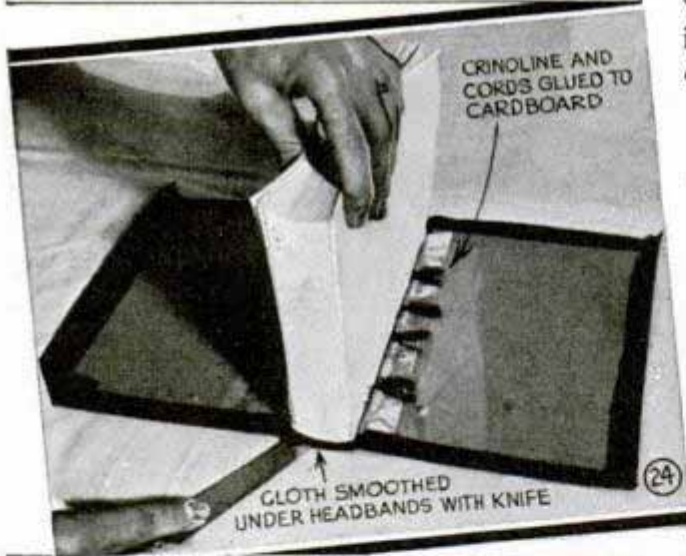
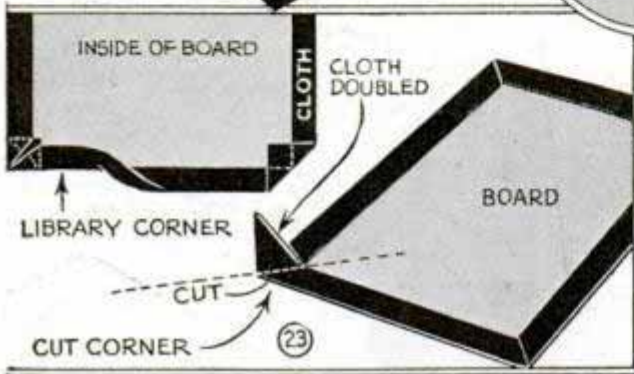
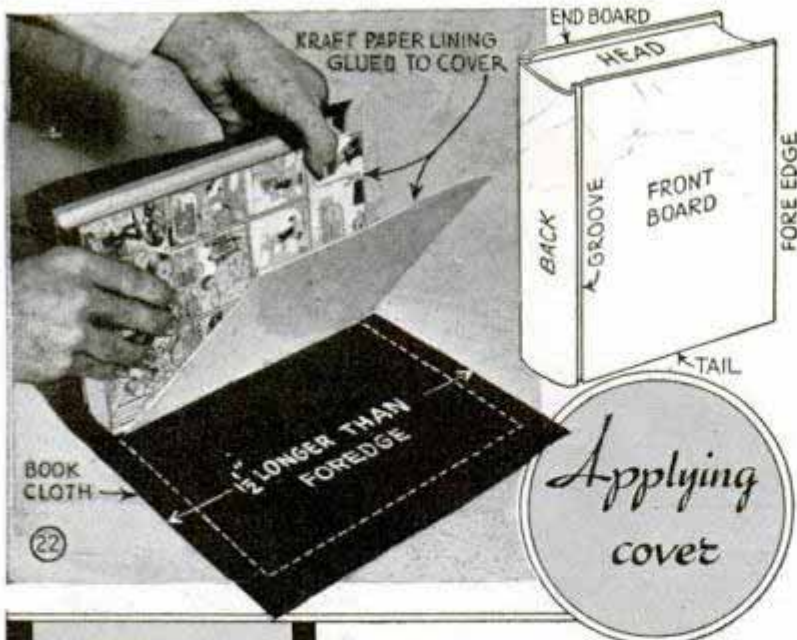

The title, listing name, month and year, may be typed neatly on white or colored paper and glued to the back of the book as shown above, or if you prefer, it can be lettered by hand directly on the binding, using gold or silver paint applied with a pen or small brush and followed with a coat of clear shellac to keep the lettering from rubbing off

"flexible" glue to the back and lay a piece of crinoline in the glue to overhang  $1\frac{1}{2}$  in. on each side as shown in Fig. 19. Cut off the cords even with the crinoline backing and fray the ends. Several thicknesses of wax paper are placed over the front and back waste sheets and the frayed cords and crinoline are glued to the book covers as in Figs. 20 and 24. For this use plain glue which does not contain glycerin. The cover should project  $\frac{1}{8}$  in. at the head and tail, leaving a groove  $\frac{1}{8}$  in. wide along the back edge. Allow the book to dry thoroughly clamped in the press.

To cover the book, a piece of book cloth, which may be of buckram, paper or leather, is cut to reach completely around the book, allowing sufficient material for turning under. Make a mark down the center of the cloth on the inside and then, straddling this centerline, glue to the cloth a piece of kraft paper which is the same width and length of the book-back, including the headbands. A second piece of paper of the same width, but shorter, is glued to the back over the crinoline. Additional pieces of paper may be glued to both covers to serve as a lining as in Fig. 22. Glue the cover material first to the front board and then to the end board, and turn the cloth in over the edges of the cardboard as in Fig. 23. The sides and edges of the book are rubbed down with the rounded edge of a ruler, after which the book is covered with wax paper and clamped in the grooving end of the press where it is left for at least 12 hrs. After drying, excess cover material is trimmed away with a razor blade, leaving about  $\frac{1}{2}$  in. margin around the edges. The waste leaf is then torn out and the end paper thus exposed is glued down. Wax paper is placed between the covers, and the book is once again placed in the press and clamped tightly, Fig. 25. Fig. 5 shows the completed book and an example of half binding. This process is similar as described, except that the back cover material is applied first. When dry, the material is trimmed down the sides evenly, being careful not to cut the cardboard too deeply, and completed by covering the remaining portion with cloth or paper.

# Amusing Animal Toy Can Change Its Face

Wagged from side to side by a pendulum, the head of this toy has interchangeable eyes, mouth, nose and ears, which can be used in various combinations to produce unusual facial expressions. Variations of these facial parts are shown in the squared detail. All parts have dowels attached for anchoring them in place, and they all fit in holes in the face except the ears, which slip into staples on the back of the head. The base for the head is a box with the front side painted to resemble the bars of a cage. As shown in the lower left-hand detail, the head is attached off center to a dowel, which turns in a hole through the side of the box. Washers are used as spacers between the head, box and pendulum, which is fastened rigidly to the end of the dowel

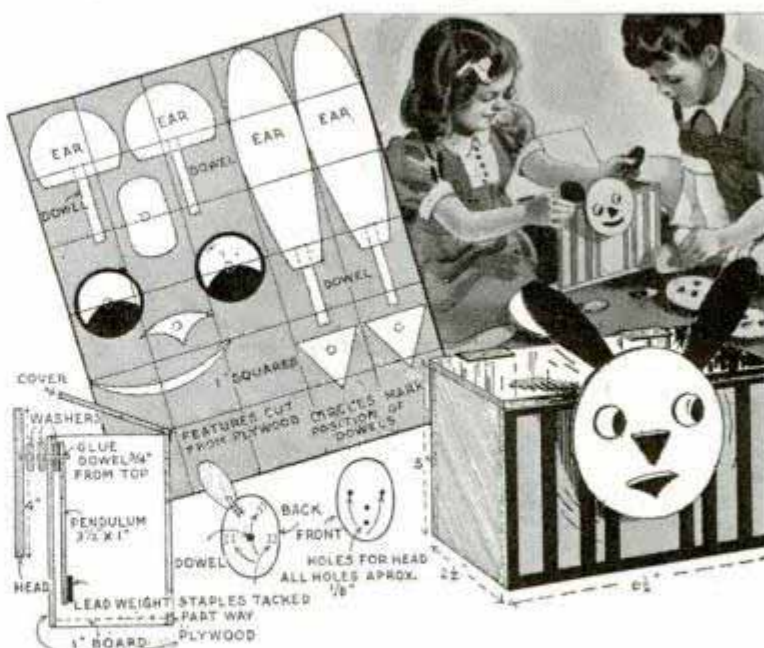

inside the box. The box is painted yellow, bars black and the face white with black features.—R. L. Fairall, Los Angeles, Calif.

## Glazing of Window Is Simplified with Beveled Putty Knife

To speed up the work of putting window sash, one glazier found that grinding the blade of his putty knife at an angle enabled him to do a better job in less time. Such a blade is especially helpful in shap-

ing the putty strip into a neat joint at the corners. On the long spaces between the sash rails, the angle of the blade helps to force the loose strip into place with one stroke.—W. C. Lammey, Naperville, Ill.



## Braces Steady Eave Troughs in High Winds

Eave troughs supported on wire hangers sometimes flap or vibrate in high winds, and occasionally are even torn away from the eaves. To prevent this, one home owner provided braces at intervals along the full length of the gutters. The braces are simply 1-in. strips cut from heavy galvanized iron. One end is soldered to the bottom of the trough and the other is screwed or nailed to the underside of the cornice. One brace to each 10-ft. section of trough is sufficient.

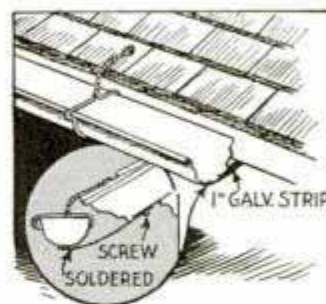

☞ Covers of recipe books may be cleaned with a damp cloth without damage if they have been given a coat of thin shellac.

# Suitcase-Type

By W. E. STEPHENS



THIS compact portable cabinet which houses all necessary items for complete developing and printing, is particularly of value to the person residing in an apartment where limited space forbids a regular darkroom. Besides providing space for storing quantities of developing powders, and such standard items as a developing tank, print tongs and roller, stirring rod, thermometer, pans, etc., as shown in the photos at the right, the cabinet will also accommodate several items which can be made, namely: a printer, washer, file, winder and a holder for dispensing roll-type printing paper.

While designed expressly to care for equipment required in finishing 35-mm. film, the dimensions given for the case may be altered to suit your particular needs. A notched rack is handy for keeping film cans arranged orderly, while two flat-iron L-hooks attached to the end of the shelf will permit several developing pans to be hung vertically alongside the printer. Following the circuit diagram, the case is wired for a white bulb which is controlled with a switch mounted on the top, and a socket for a safelight is attached to the door

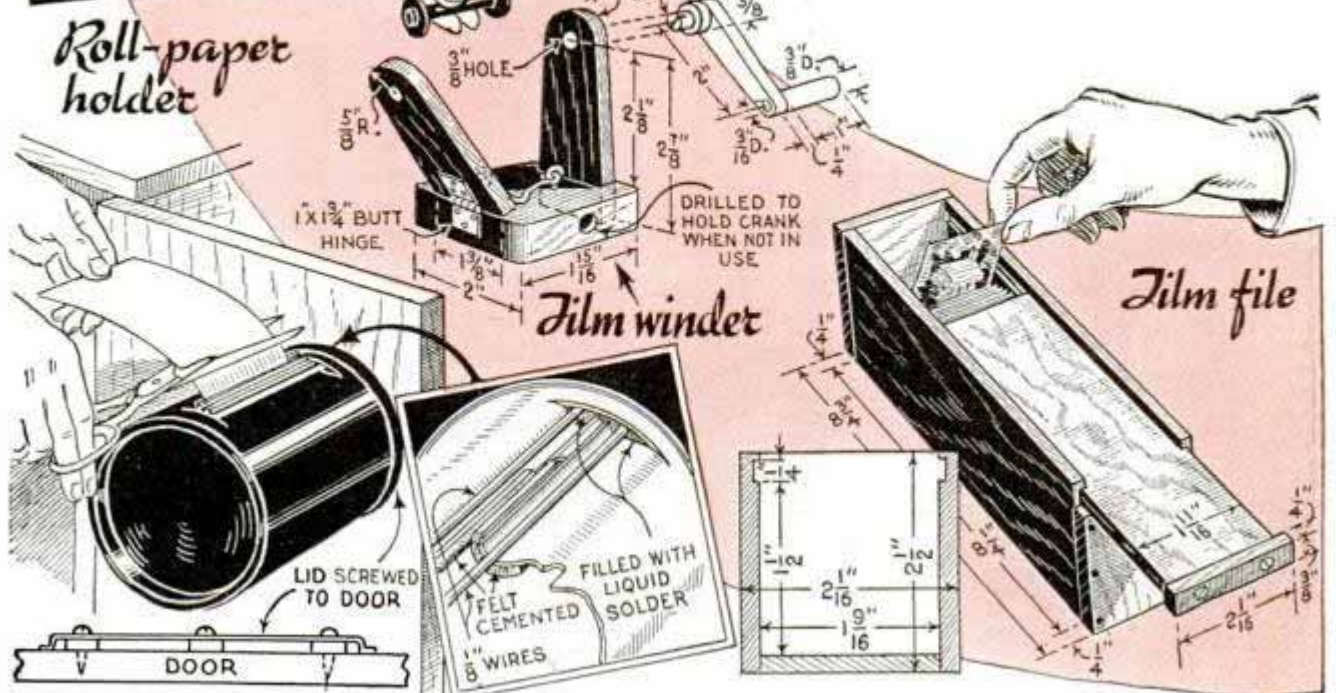
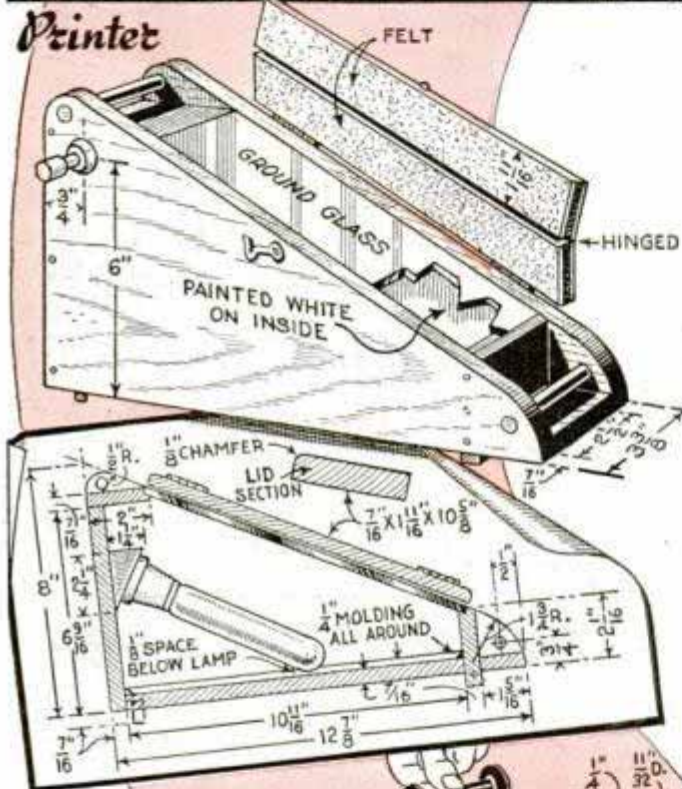



# "DARKROOM" carried with you

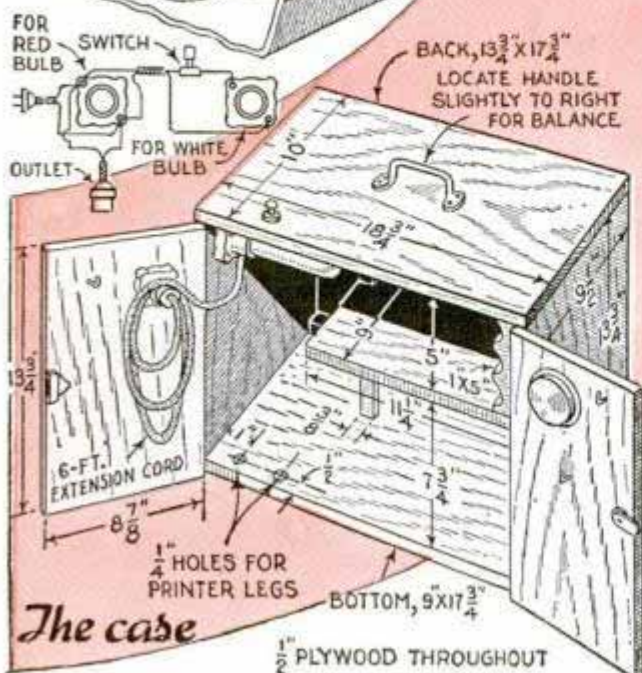
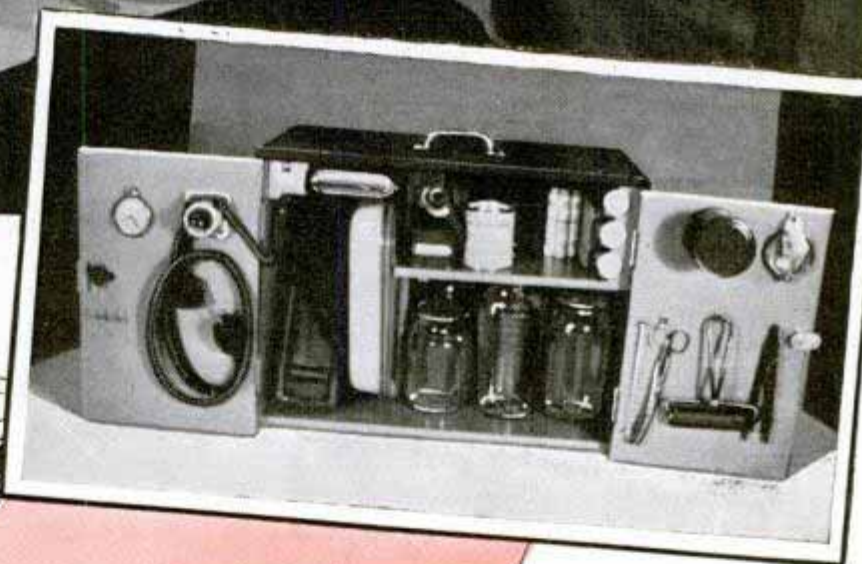

in a position to clear the former when the door is closed.

The printer, which will take film as large as No. 120, is clearly detailed in the drawing at the extreme left. The film winder, which is handy for loading cartridge reels with bulk film, and the file are dimensioned to take 35-mm. film. The roll-paper holder, consisting of a press-lid can with a felt-lined opening made in the side through which the paper can be pulled as it is needed, is held to the inside of the right-hand door by means of the can cover which is attached near the top with small screws as shown. A tin baffle soldered behind the water inlet of the film washer produces a swirling motion to remove all hypo.

## 'Rocking Chair' Developing Tank Keeps Solution Agitated

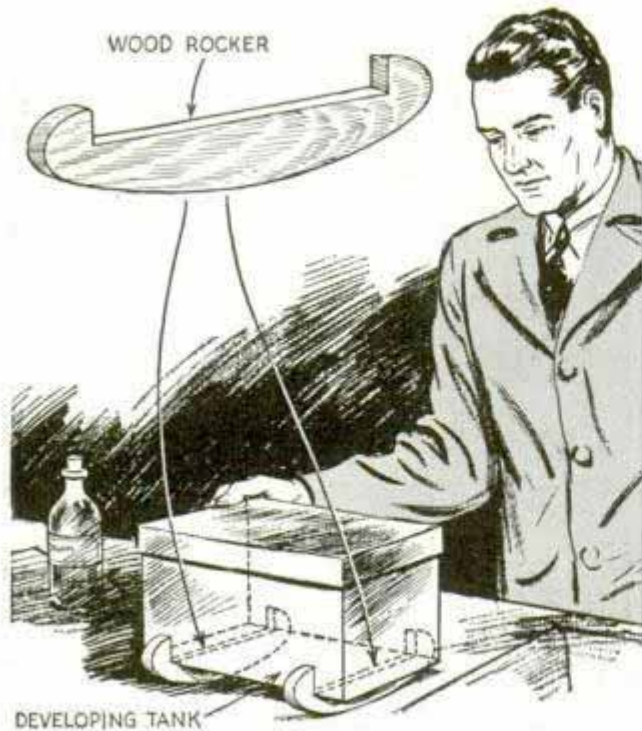

DEVELOPING TANK

Slipped under a cut-film developing tank, a couple of rockers provide a convenient means for keeping the developer agitated. They are sawed from 1-in. stock and should fit snugly on the tank. A gentle push now and then will keep the tank rocking during the developing period.

## Notebooks Used as Photo Albums

Groups of related snapshots can be kept together in small looseleaf notebooks. The prints can be punched to match the rings in the book or pasted on the leaves with rubber cement. In this way you can select the album you wish to show and there's

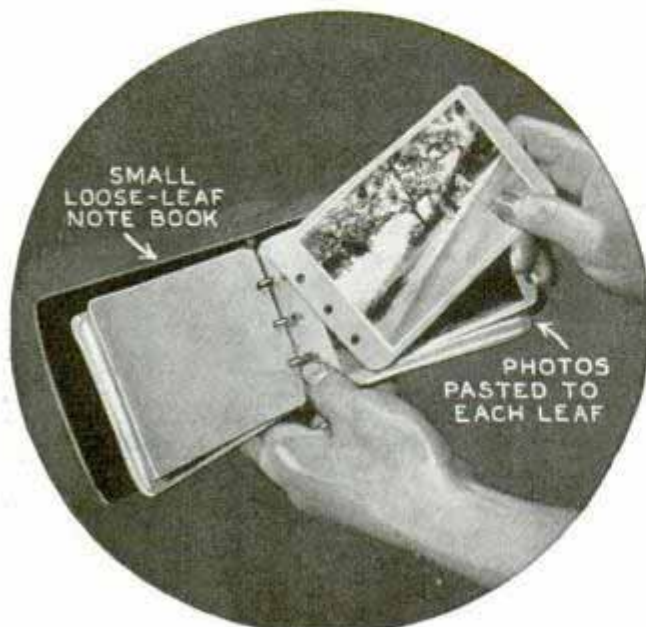

much less handling of the undesired prints. Also, they are protected much better in this way than when kept loosely in a box.

## Hypo Poured to Tape Line on Jug Assures Correct Solution

Time can be saved when mixing fixing solution if the jug is marked to indicate how much dry hypo to use. For a gallon jug, place a strip of adhesive tape to show the space required by 2 lbs. of hypo. Pour dry hypo into the jug up to the mark, then add water. The same idea can be applied to jugs or bottles of any size.



## Notches Cut in Edge of Film for Quick Identification

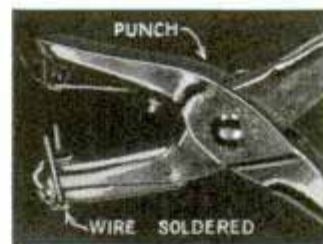

Making half-circular notches in the edges of photo films to identify them, especially in three-color separation negatives,

can be done with a ten-cent paper punch. A U-shaped piece of wire soldered to one jaw of the punch, serves as a stop for the edge of the film so that a half-circular notch is made when the jaws are closed.

## Strip of Scotch Tape over Lens Aids in Getting Sharp Focus

When you wish to focus your camera sharply at a certain distance, for checking the footage scale or similar test, try this method: Place a narrow strip of tape over the center of the lens and focus on an elec-



tric-light bulb. Two images of the bulb will appear on the ground glass. Rack the bellows in or out to bring the images together and when they are in exact register the bulb is in perfect focus. A clear glass bulb of low power is best for this purpose because the filament is easy to focus on.  
—L. Ryan, Quincy, Mass.

### Clips on Door Spring Hold Films Apart While Drying

Cut-film negatives cannot rub together and become scratched while drying on this line. Paper clamps of the type shown are threaded on a screen-door spring that has been pulled out until the loops are about 1/2 in. apart. The spring is fastened between two supports and the clamps are spaced every three or four loops. The negatives will not come in contact with each other even when a strong breeze from a fan is turned on them.



## Flashlight Clipped to the Camera 'Spots' Photograph to Be Taken

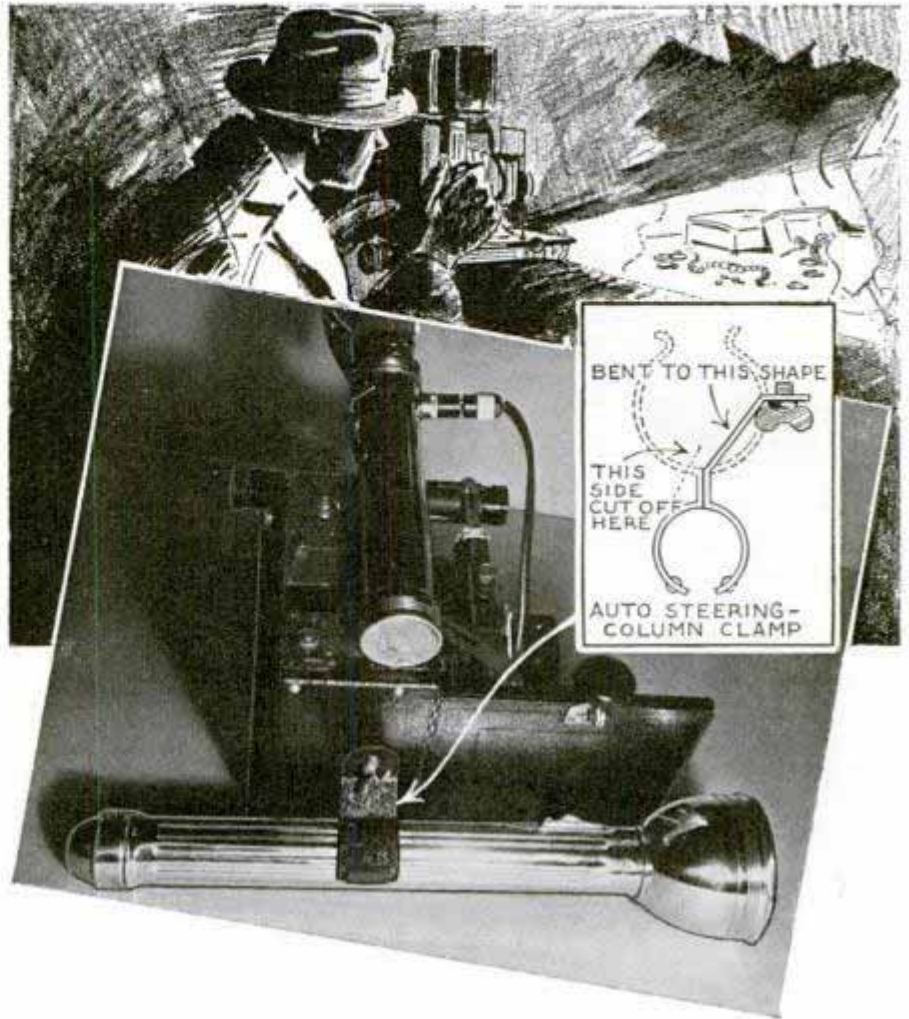

Police and news photographers, and others who have had trouble focusing on objects in the dark, can overcome the difficulty by clipping a flashlight to the camera. The clip used is one for holding a flashlight on the steering column of an automobile. One side of the clip is cut off and the other side bent as indicated and drilled for the wing screw that fits the tripod socket on the camera. A focusing type of flashlight should be used as it can be adjusted to cover approximately the same field as the camera.

### Small Squeegee for Strip Prints

A ten-cent rubber plate scraper is a handy squeegee for applying 35-mm. strip prints to a ferrotype tin. Using the small scraper on each strip separately usually will produce a better job than using a large squeegee on several strips at once.



## Slot Cut in Bench under Trimmer Swallows Paper Scraps



Paper cuttings will not pile up in your way if a slot is cut in the bench top under the trimmer. I have my trimmer screwed

to the bench so the knife is always over the hole. A waste basket on a shelf under the table catches the scraps.

—Mel Ivory, Ann Arbor, Mich.

## Rubber Bands on Developer Bottle Indicate Age of Solution

By using rubber bands you can keep a simple and accurate record of the number of times a bottle of developer has been used. Slip several bands around the bottle near the top and each time a roll is developed push one of the bands down toward the bottom.



## Ride Fifty Miles on a Gallon of Gas!



Run by a  $\frac{1}{2}$ -hp. gas engine of the washing-machine type, this homemade motor scooter gives you plenty of fun at a safe speed and costs little to operate. Levers on handle bars control brake and throttle. Has standard ball-bearing wheels with 12 by 3-in. pneumatic tires. Complete details on making this simple scooter are given in a set of plans, Nos. 989 and 990, which will be sent to you, postpaid, upon receipt of 50 cents.

### ADDITIONAL PLANS ON POPULAR SUMMER PROJECTS

**OUTDOOR FIREPLACES—917:** Several simple, but practical types, to match other items in rock garden. 25c.

**LAWN CHAIR—529:** Plain sawed from  $\frac{3}{4}$ -in. stock. Easily made with hand tools. 25c.

**ORNAMENTAL WOOD FENCES—640:** Five artistic designs for standard wood stock. 25c.

**CIRCULAR ARBOR AND GATE—637:** Popular style anyone can build. 25c.

**LAWN AND GARDEN FURNITURE—920 to 922 incl.:** Collection of designs for arbor-and-seat combinations and swings. 3 prints 75c.

**TRELLIS SUGGESTIONS—639:** Six types that will help beautify your home. 25c.

**BARROW CHAIRS—924:** Two styles. Built for comfort. Simple construction. 25c.

**DUTCH WINDMILL AND WATER WHEEL—911:** Mill, 40 in. high. Small water wheel. 25c.

**LOG-CABIN CONSTRUCTION—916:** Two floor plans. Shows how to make corner joints. 25c.

**"ZIP," MODEL RACING YACHT—880 to 883:** Marblehead Class, 50 in. long, 800 sq. in. of sail. Bread-and-butter hull construction. Plans include full-size lift templates. 4 prints \$1.00.

**SPEEDY MODEL BOAT—965 to 968:** 32-in. boat powered by midget gas engine develops 20 to 25 m.p.h. on circular course. 4 prints \$1.

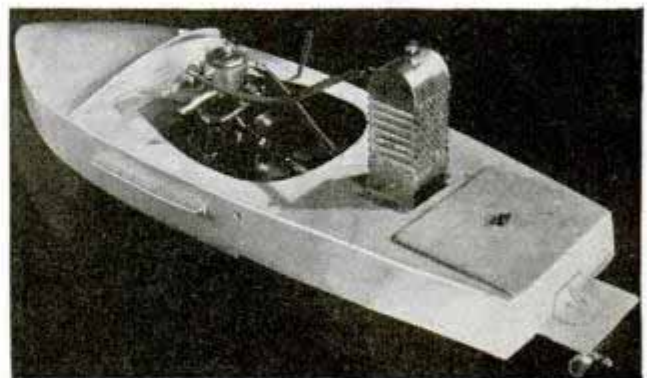

*Any six individual plans (not sets of plans) will be sent upon receipt of \$1.00*

Also, be sure to get our handy reference catalog listing 400 plans. This will be included free with your order if specified, or sent separately for 3 cents to cover mailing

**Address—Popular Mechanics Plan Service, 200 East Ontario Street, Chicago, Ill.**



# ULTRA-COMPACT *Marine* RADIOPHONE

COMPLETE in one sturdy seaworthy unit, and weighing only twenty-nine pounds fully equipped, this efficient portable radio station includes a 3-channel crystal-controlled marine-band transmitter, broadcast and marine-band receiver and a power supply, developed especially for two-way marine radiotelephone service.

Photo (1) shows transmitter band-switching control and all receiver tuning controls arranged conveniently on the front panel. Easily installed for operation on a wall or bulkhead as indicated in photo (2), and economical on battery drain, this ultra-compact



marine phone is ideal for small craft where all available space is at a premium. A single-button carbon microphone, of the press-to-talk type, mounts on the side of the cabinet. The lower photo shows rear view with door

opened, which permits easy access to all stages when inspection or adjustments are required. The following metal-type tubes are employed in the transmitter: one 6V6 oscillator, one 6L6 R.F. power amplifier and one 6L6 modulator; the receiver uses one each 6K8, first detector and oscillator; 6SK7, I.F. amp.; 6SQ7, second detector-avc and audio; 6V6 output.

High voltage is provided by a synchronous vibrator-type of rectifier; a carefully designed filter is built into this power unit, which operates on a 12-volt storage battery. Similar models are available for 6-volt battery operation.

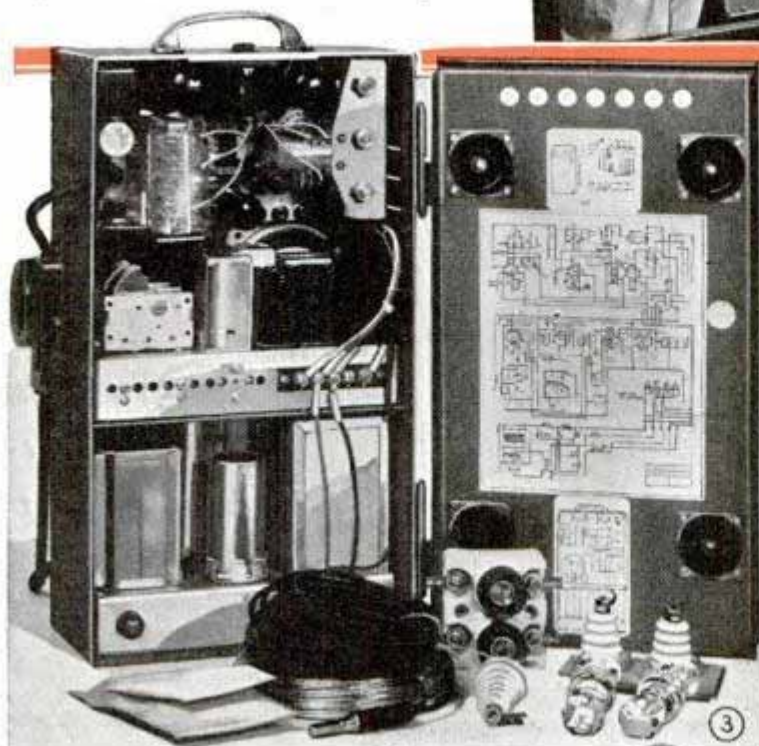

# CAPACITY-OPERATED

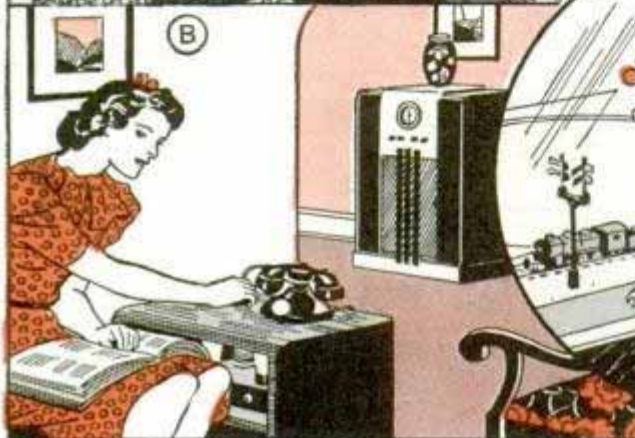

THIS sensitive capacity-operated vacuum-tube relay is easy to construct from ordinary inexpensive radio parts. Capacity added to, or removed from, the immediate vicinity of a short alarm wire operates the relay either in broad daylight or darkness. The capacity effect takes place at the approach or withdrawal of a person or passing object, therefore this versatile instrument can be connected to ring alarm bells, light floodlights, switch on electrically driven door-opening devices, window displays, or cut off radio while phoning, as illustrated in sketches A, B, C, and D, and for many other useful applications. Furthermore, this unit is provided with binding posts wired to supply 110-volts

for operating any electrical device which the vacuum-tube switch controls.

The relay unit is adjusted with a single control and may be operated from any 110-volt a.c. outlet. A type-77 tube is used as an oscillator with the alarm wire forming a part of the tuned circuit; this tube in turn controls the type-43 power output, or "trigger" tube, which is connected directly to the relay.

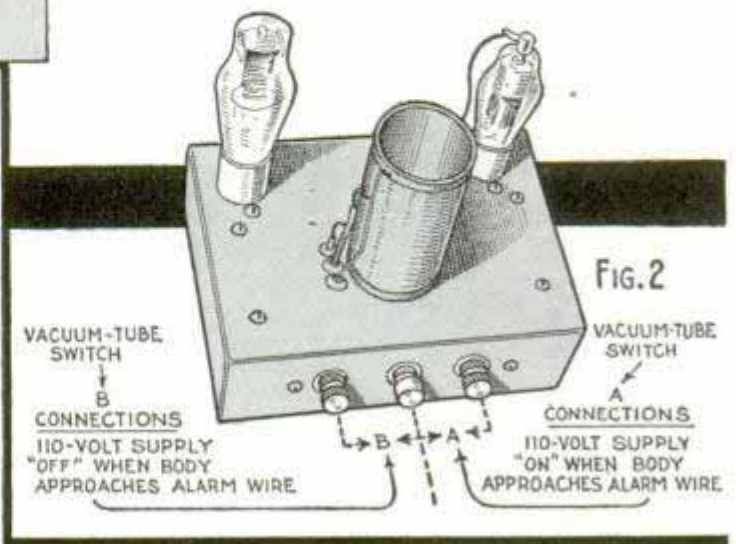
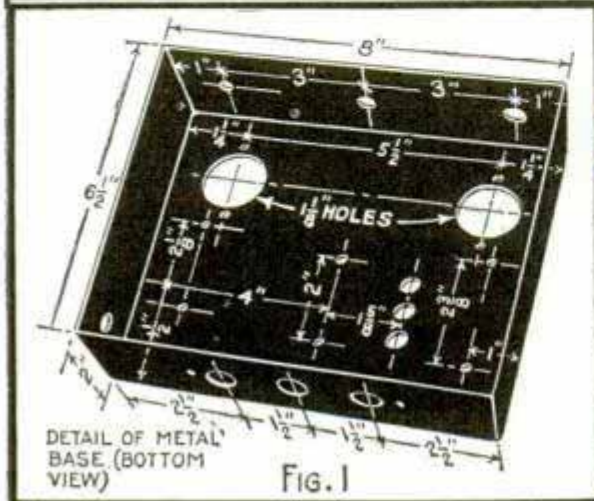
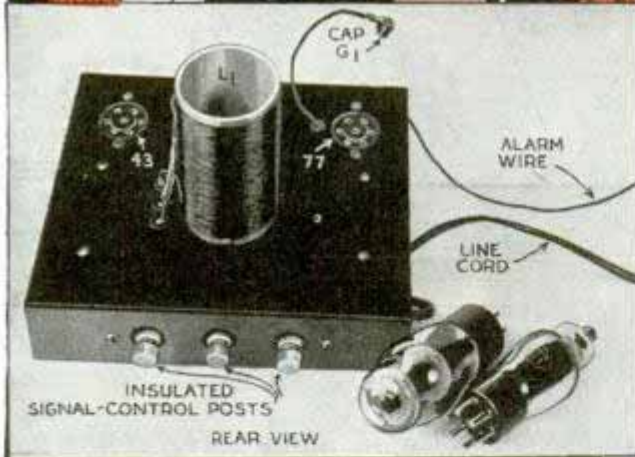

# VACUUM-TUBE SWITCH

Complete details for the simple sheet-metal base are given in Fig. 1. The relay is a standard inexpensive 2,500-ohm coil s.p.d.t. type with silver contacts to carry 5 amp. of non-inductive a.c. at 115 volts.

A simplified wiring diagram is shown in Fig. 3 and the schematic circuit diagram appears in Fig. 4. The coil ( $L_1$ ) is close-wound, as detailed in Fig. 3, on a 2-in. Bakelite tube, 4 in. long. Two small holes,  $\frac{1}{4}$  in. apart and  $\frac{1}{4}$  in. away from the edge, should be drilled at each end for fastening the beginning and end turns. After 50 turns have been wound, tightly twist a loop of about 6 in. to make the center-tap lead and then continue winding another 50 turns in the same clockwise direction; the completed coil may be varnished, or lacquered if desired. When wiring the circuit keep all wires as short as practical and use "spaghetti" insulating tubing on the coil leads that go down through the base; also carefully insulate the binding posts, and tuning condenser ( $C_1$ ), from the metal base. Two fiber shouldered-type washers

(Continued to page 135A)

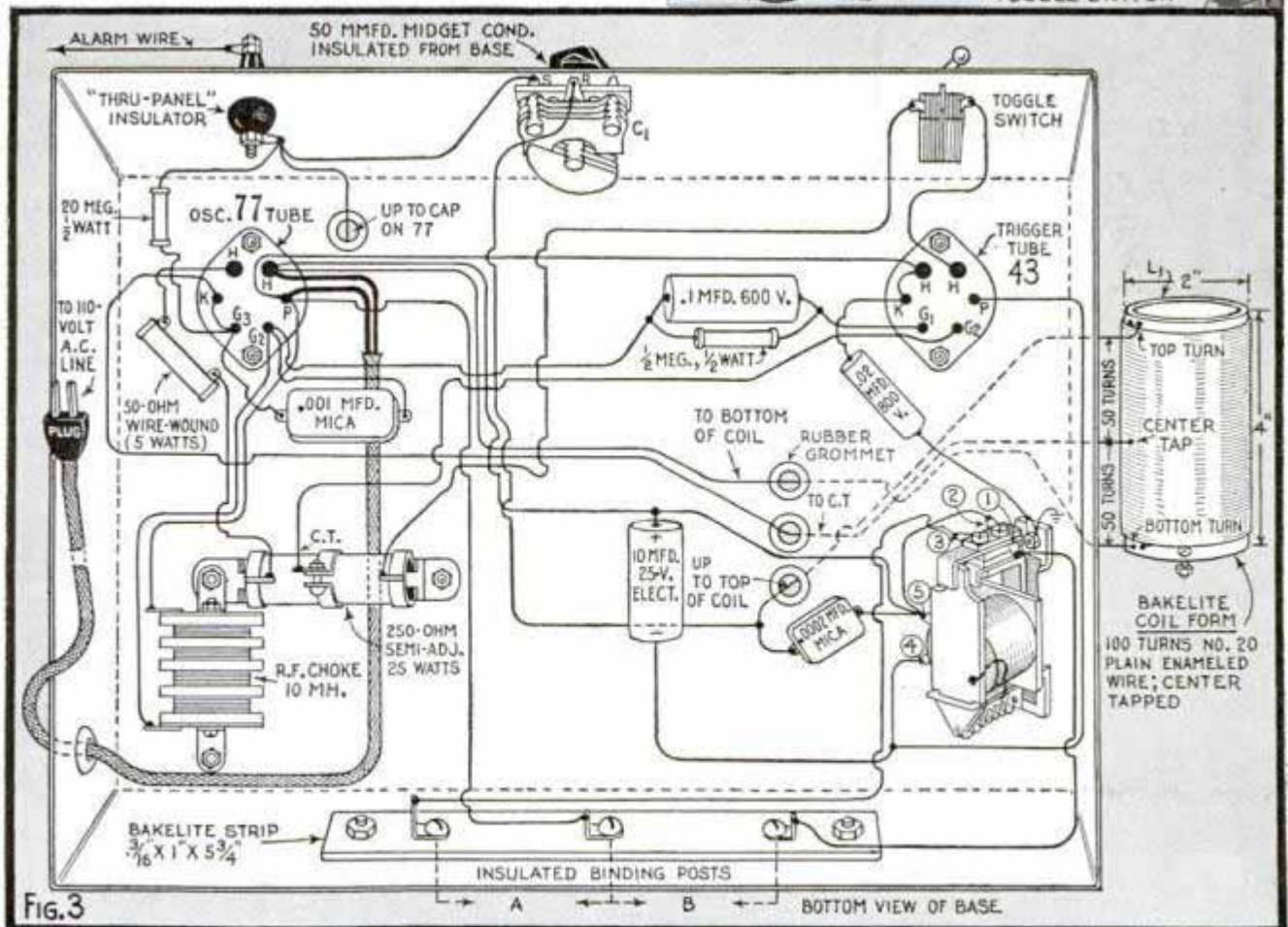
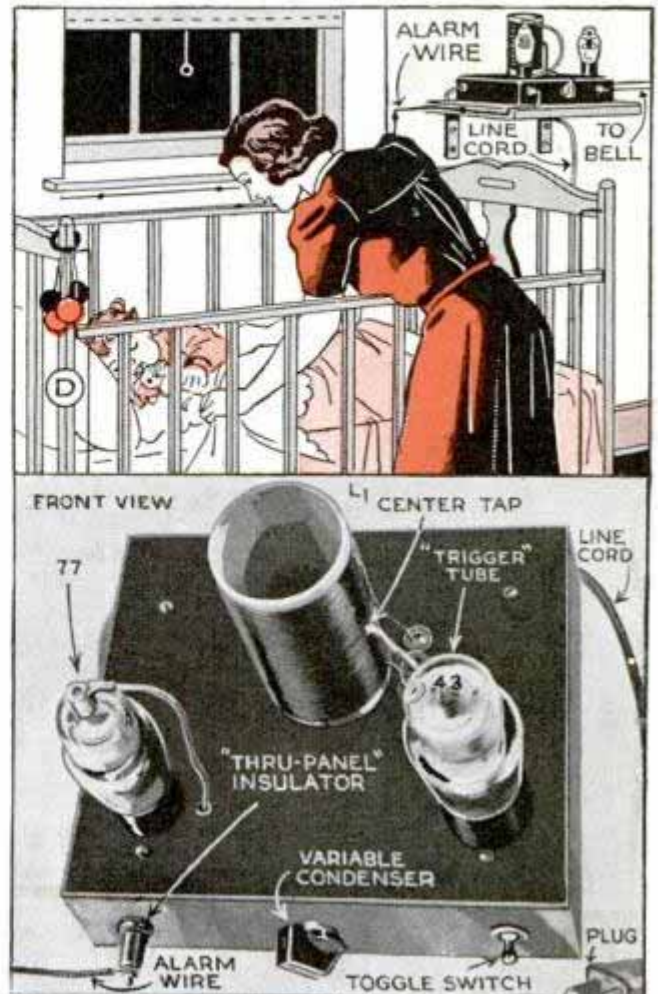

# Loop-Operated "Phantom" Record Player



ONLY a few radio parts are required to build this improved model of the popular 2-tube "phantom" record player R-270 which appeared in the September, 1939, issue. A marked directional effect and greater efficiency obtained by using the phono-loop are helpful with the newer receivers.

Those who built the original model can change over to loop operation easily by making a few minor adjustments in the circuit and substituting the loop for the oscillator coil. Complete details of the metal base are shown in Fig. 1; except for several additional holes the base is unchanged. Photos (A) and (B), and simplified wiring diagram, Fig. 2, clearly illustrate construction details, and the schematic circuit diagram is given in Fig. 3. All parts are available from radio mail-order firms and the parts values are given in the diagrams. The DX Products company type phono-loop and dual trimmer condenser, plus the extra toggle switch No. 2, are the only parts required not previously specified in R-270. It will be noted that the only original fixed condensers not

(Continued to page 137A)

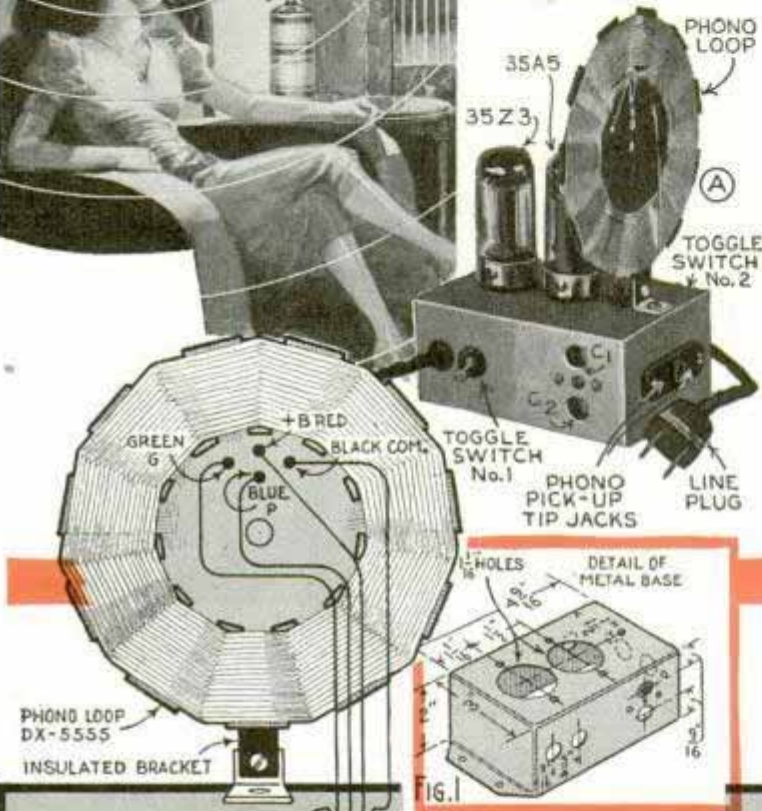

FIG. 1

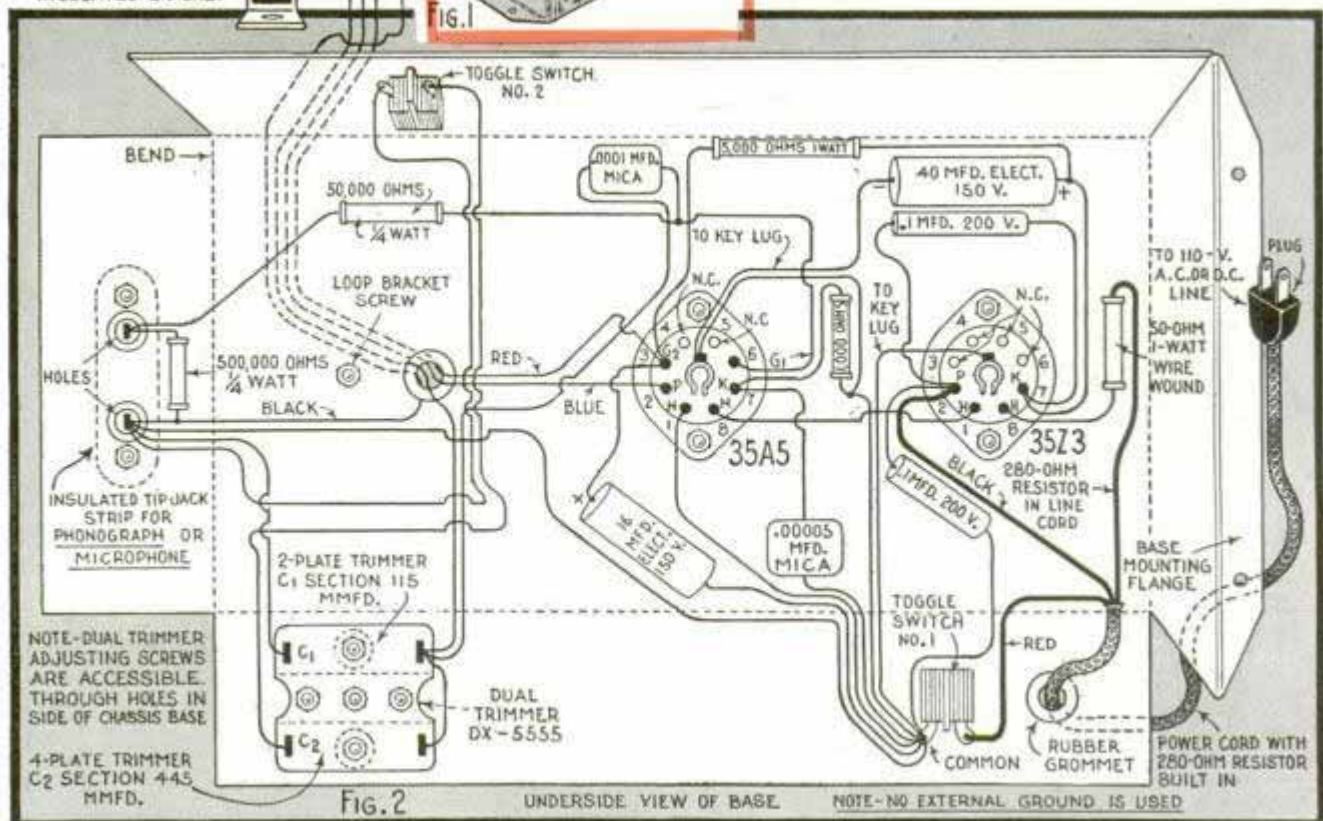

FIG. 2

UNDERSIDE VIEW OF BASE

NOTE-NO EXTERNAL GROUND IS USED



# Hints for RADIO EXPERIMENTERS



(1) You can use this compact power unit to operate any portable battery receiver from a 6-volt "hot shot" battery, or the storage battery in your car, by clipping one terminal on ammeter and grounding the other. In auto, a pole-type antenna would be employed. Power unit supplies all voltages at low drain

(2) Ultra-low-loss polysterene crystal holder in horizontal-mounting type

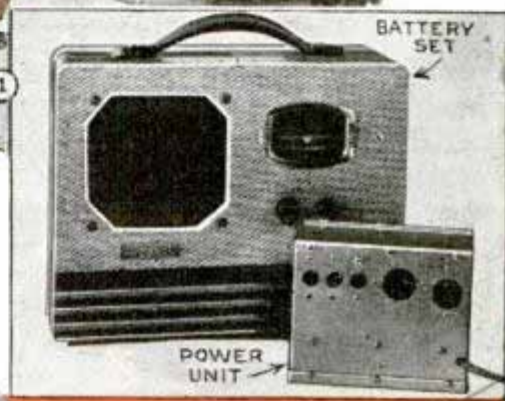

(6) Compact panel-mounting type heavy-duty relays in s.p.s.t. and s.p.d.t. varieties for radio amateurs and experimenters. (7) Old hot-water tank sunk vertically as shown, and kept filled with water, makes excellent radio ground even in dry sandy locations



(3) Uni-directional microphone reduces background noise; the four-side call-letter plate is optional. (4) Piece of corrugated sheet metal makes handy screw tray for workbench. (5) Simple method for holding small machine or wood screws to shorten by filing

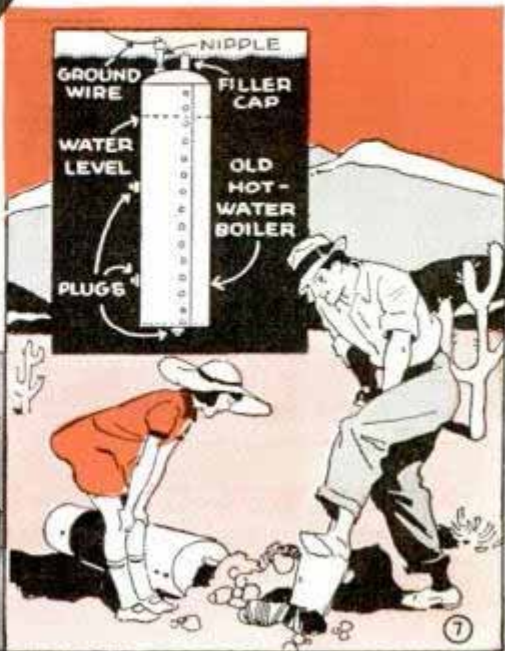
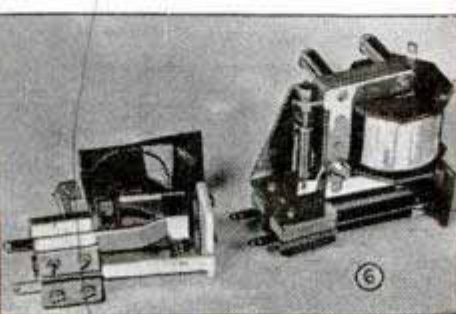
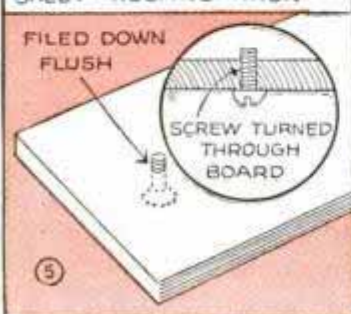

*Shure Bros 225  
211-1st St. Chicago*

## "Camera" Radio Set for Hikers



Available either with carrying handle or shoulder strap, this tiny radio receiver has built-in batteries, antenna and dynamic speaker. It employs the new miniature tubes in a superheterodyne circuit, and tunes the standard broadcast band.

## Portable Has Detachable Antenna

This universal portable radio receiver employs a detachable loop antenna that may be fastened to the window of an auto-



mobile, steel building, airplane or train where steel construction reduces signal strength. Set works on 110-volt a.c. or d.c. current or on a self-contained battery pack.

## Vertical Loop for Television

Built-in vertical loop television receiving antenna is made possible by a recently proposed system of vertical wave transmission. This system is claimed to reduce diathermy and noise interference, trouble-

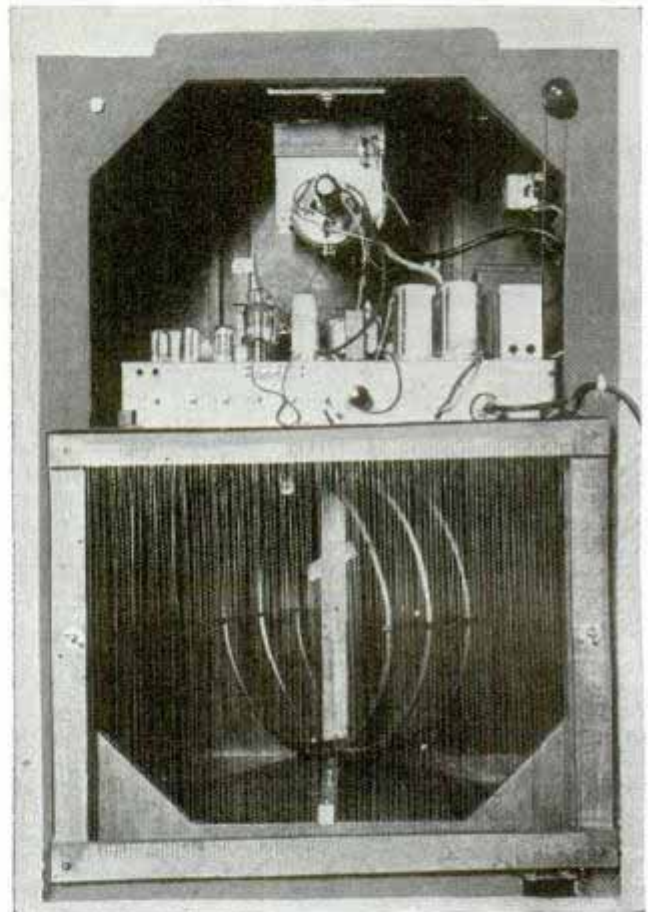

some in the reception of horizontally polarized television signals now being received on dipole antennas installed on roofs. The directional property of the loop is under the control of the operator.

Blueprints covering radio construction articles in this and past issues are available for 25 cents each. Original material lists, with names of manufacturers and dealers, can be obtained from our Radio Department upon receipt of postage.

**NEXT MONTH—How to Build a Pack Set for Camp or Boat.** A low-cost 3-tube battery-operated "knockabout" super built into a revamped 49-cent overnight bag. This case is fitted with a shoulder strap and hand-wound loop antenna. Uses standard I.F. transformers; operates on two 45-volt B-batteries and four flashlight cells.



# SHOP NOTES

## Make your own

By J. B. MULLEN

**E**SPECIALLY useful in model-making and in other intricate work, a hand chuck for tiny twist drills, and a pin vise to grip extremely small parts while working on them, are two handy tools which can be made from a few pieces of cold-rolled steel.

While the use of a metal-turning lathe will simplify the work considerably, successive steps in making a hand chuck without a lathe are given in Fig. 1. Beginning with a steel rod, center one end with a scribe, center punch and then drill a hole in

## HAND CHUCKS and PIN VISES

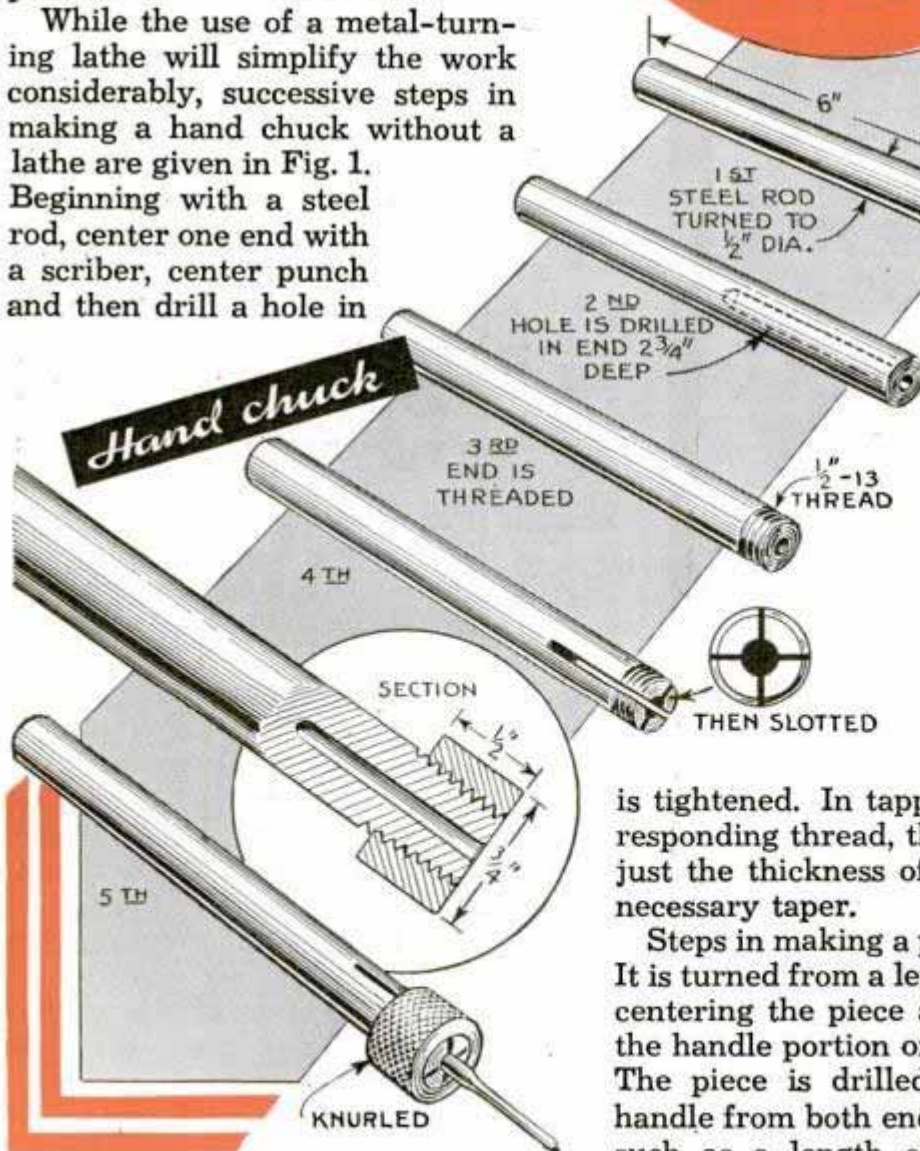

the end, using a drill the same size as the tool which the chuck is to hold. Threads are cut on the end for a distance equal to the thickness of the die, after which the rod is slotted. Do not cut threads beyond the thickness of the die as the taper of the thread provides the clamping action of the chuck when the knurled collet

is tightened. In tapping the collet with a corresponding thread, the tap likewise must enter just the thickness of the collet to provide the necessary taper.

Steps in making a pin vise are given in Fig. 4. It is turned from a length of square steel. After centering the piece as shown in the first step, the handle portion of the vise is turned to size. The piece is drilled lengthwise through the handle from both ends. The hole permits work such as a length of wire or rod to extend

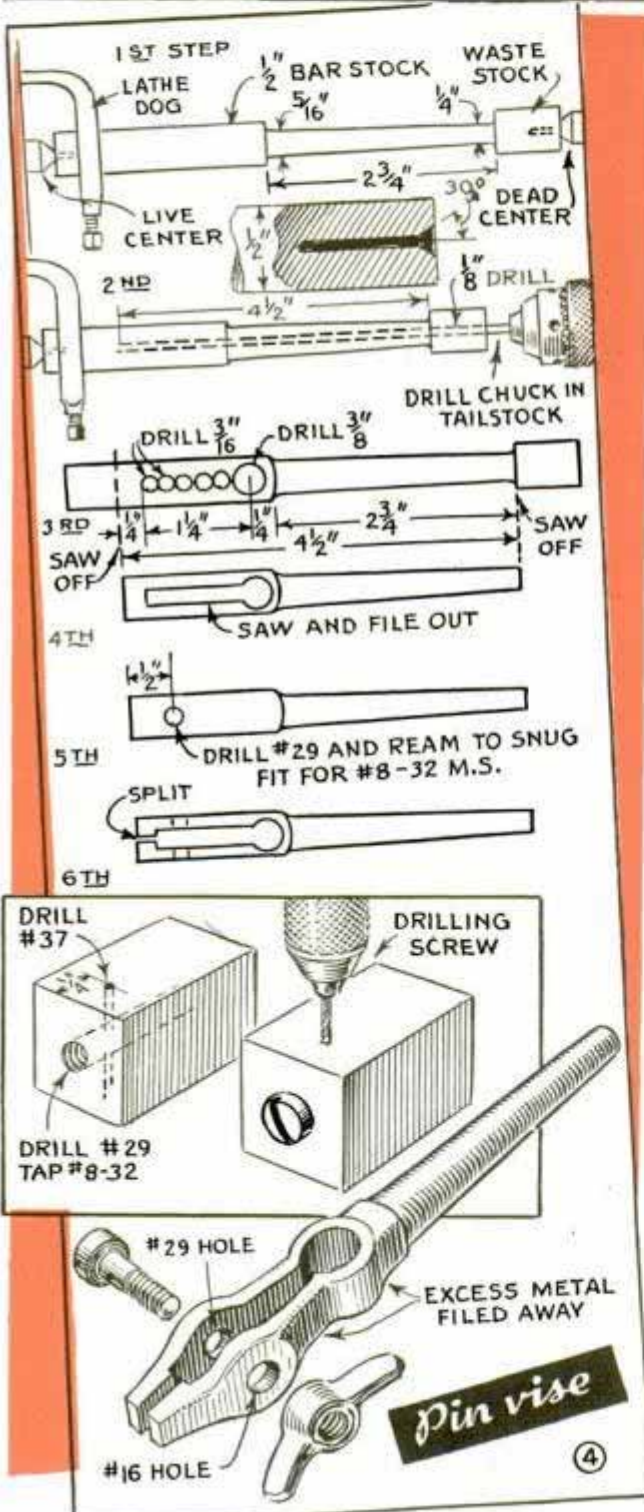
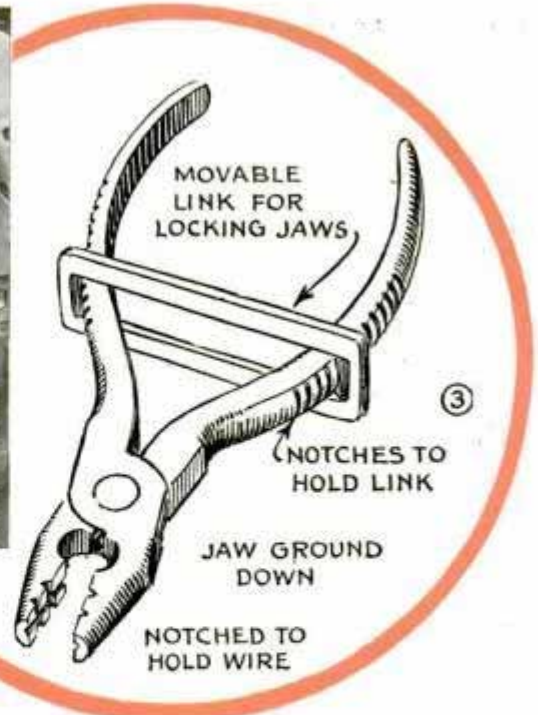
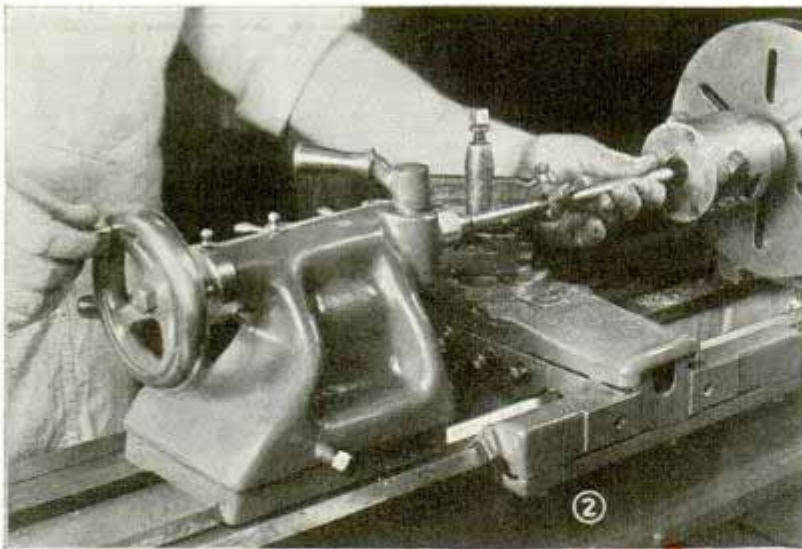

through the handle. While drilling, the piece is held in a chuck or supported with a steadyrest as in Fig. 2. Then it is removed from the lathe and a series of holes are drilled as shown in the third step, after which the opening is filed square and the waste is cut from the ends. At right angles to this slot, holes are drilled through the side for a machine screw which is fitted with a wing nut. The shoulder of the screw fits snugly while the threaded end passes through a hole in the opposite side. This is shown clearly in the completed view of the vise. The insert detail in Fig. 4 shows a jig for drilling a small hole through the shoulder of the adjusting screw accurately. The jig is merely a small steel block drilled and tapped to receive the screw after which it is an easy matter to drill a small hole at right angles to pass through the screw. The pin vise is completed by splitting the jaws apart with a hacksaw and filing smooth.

Another serviceable pin vise can be improvised quickly from a pair of inexpensive side-cutting, flat-jaw pliers as in Fig. 3. A link to engage in notches filed in the handles provides a means of clamping the jaws. The link is cut from a piece of steel after which it is slotted to slip only part way over the handles. The cutting edges are ground away, of course, and a hole is drilled through the rivet of the pliers to permit long work to be clamped lengthwise, while V-shaped notches, filed crosswise in the jaws, allow small work to be held vertically.

# Hand Router Carves Intricate Designs in Relief



This router will handle regular grooving jobs with ease, and after a little practice in manipulating the tool, you will be able to carve intricate designs similar to the two examples given. To make the router, all you need is an old vacuum-cleaner motor, a standard chuck and some wood to make the mounting or base for the motor. The projecting end of the motor shaft is threaded to take the chuck, and the fan is left on so that it produces a blast of air to blow away wood dust made by the router bit. Height of the vertical pieces of the base will depend on the combined

length of the motor shaft and the chuck. A couple of wooden doorstops provide hand grips for manipulating the router. Cutting depth of the router bit is adjusted by the depth to which it is inserted into the chuck.

## Two Alterations That Will Improve Arc-Soldering Outfits

If you have an electric arc-soldering outfit, try using a wedge-shaped end on the carbon. It will last longer than a point and is easier to shape. Also, on outfits of this type a single wrapping of tin or thin copper around the carbon where the holder contacts it helps to assure good electrical contact.

—W. C. Wilhite, Carlinville, Ill.

☞As most acids are measured out in small quantities, in some cases it will pay to keep concentrated acids in small bottles having medicine droppers in the caps.

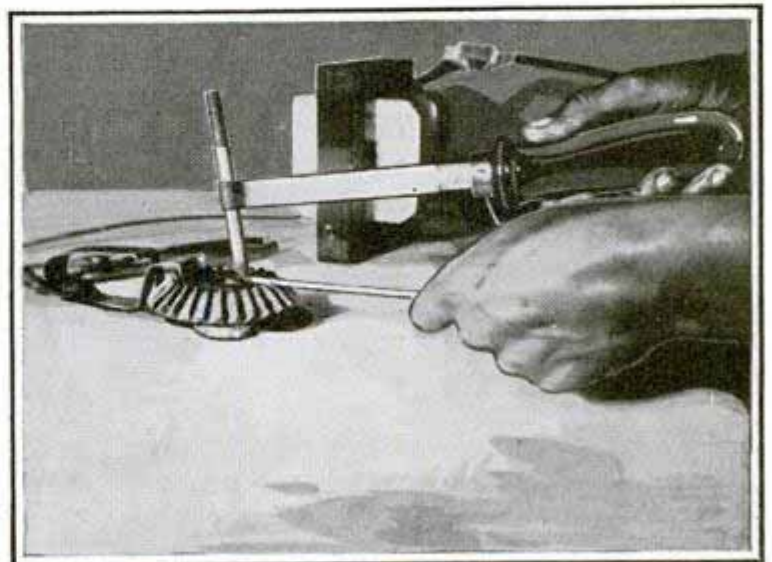

## Locked Panel on Parts Cabinet Keeps Contents Safe

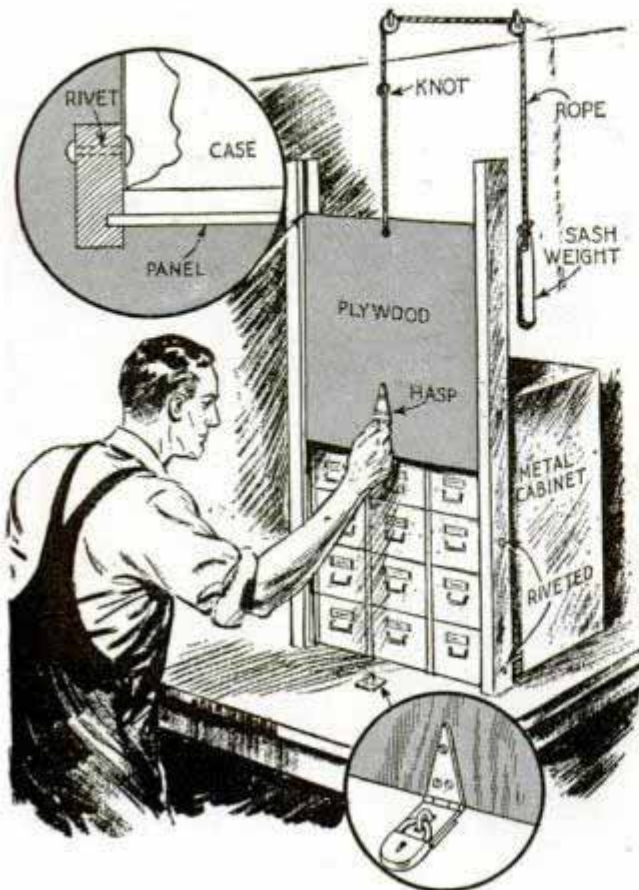

To protect the contents of a small-parts cabinet against petty thieves, one shop worker provided his cabinet with a sliding panel front which could be padlocked to the top of the bench. Grooved uprights to take a plywood panel were riveted to the sides of the cabinet, which was screwed firmly to the bench. A window-sash weight was then attached to the panel to raise it automatically when released.

## Frayed Cable Is Easy to Repair with Copper-Wire Wrapping

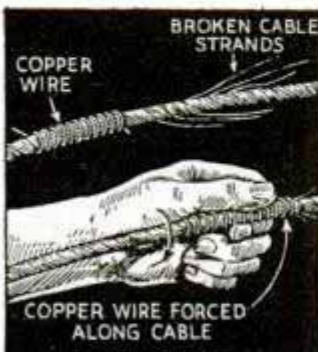

Where flexible wire cables, which are not subjected to heavy strain, have a few broken strands, and the flexibility must be maintained by any repair method, try a sleeve of copper wire. The wire is

wrapped tightly around the cable above the portion where the strands are broken, after which it is "screwed" down over this portion, and both ends of the wire are sol-

dered to hold it in position. This repair adds a slight thickness to the cable but holds the frayed edges down and prevents them from being bent out, which might cause them to jam inside of a housing or sheathed pulley through which it runs. Cables subjected to considerable strain, especially if weighted, should be renewed when the strands start to break.

## Diagonal Cuts Divide Butter Print into Four Equal Parts

A grocer who did not stock butter prints in less than 1-lb. size found that he could fill an occasional order for ¼-lb. prints by dividing the larger ones. This was done by making two diagonal cuts as indicated. When done carefully, the four pieces obtained will be almost identical in weight.

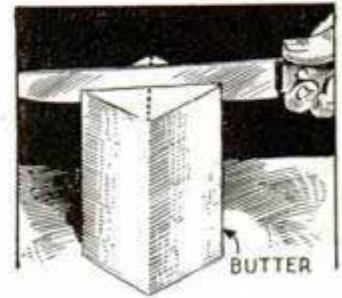

## Ice Kept from Shifting in Truck by Angle Irons on Floor

After a large ice truck had overturned on a sharp curve because heavy ice cakes shifted to one side, the owner put lengths of angle iron on the bottom of the truck body. The ice cakes were centered in loading so that the slight melting would anchor them against sidesway.

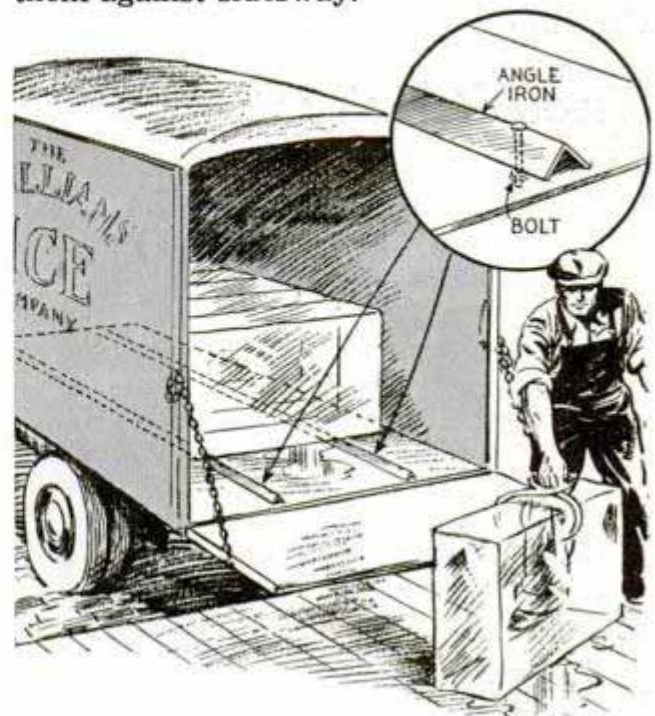

# Brake Holds Shop Truck When Unattended

Shop hand trucks fitted with brake systems similar to the one shown do not have to be blocked when loaded and left, and there is no possibility of forgetting to put on the brakes as they are always set. The brakes are released by a small lever, which is located conveniently on the handle or push rail and held in the depressed position while pushing the truck. The circular detail shows how the brake system is assembled, using a spring and a linkage to the operating lever.—W. K. Crosson, Detroit, Mich.

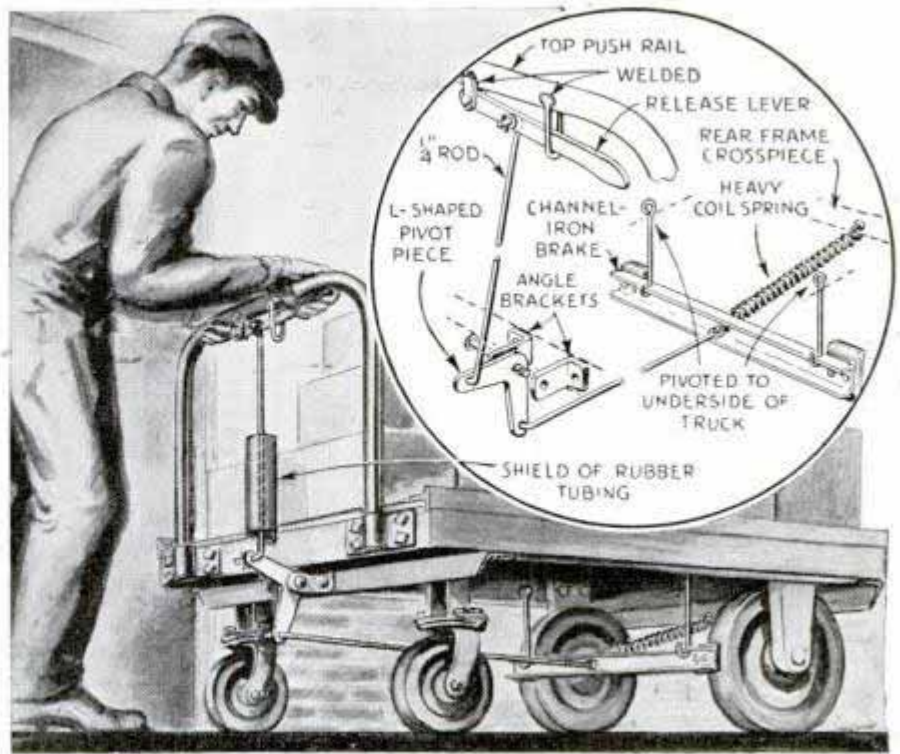

# Headset for Cradle Telephone Leaves Both Hands Free



Having to take down notes and memos while using a cradle-type telephone, one office worker rigged up a headset for it so that he could have the use of both hands. A pair of old radio headphones were used, one of the phones being removed and the bracket that held it slipped into holes in the cradle-phone receiver. Not being connected, the other phone of the headset tended to balance the weight of the receiver and, at the same time, served to cover the ear and help keep out outside disturbances.

—Fred Delavan, Philadelphia, Pa.

# Chattering of Slender Boring Bar Is Avoided by Encasing It in a Tube

Chatter that is usually present when boring small deep holes can be avoided by encasing the bar in a copper tube. If necessary, the tube is crimped around the bar to give a tight fit, then the assembly is clamped in the lathe tool holder. The tube must extend as close as possible to the cutting edge. This arrangement gives the tool the advantage of a large bar with the size of a small cutting tip.

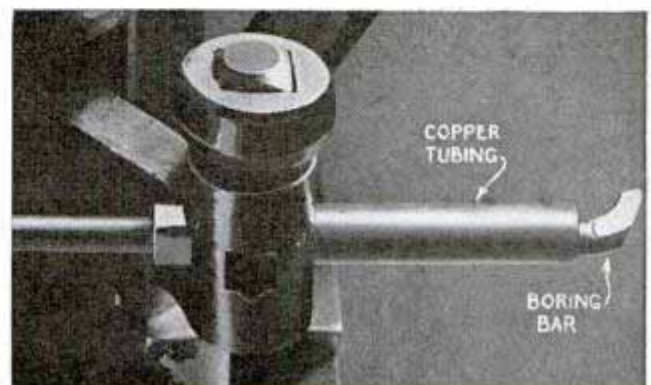

## Orchard Ladder Clamps to Limb of a Fruit Tree

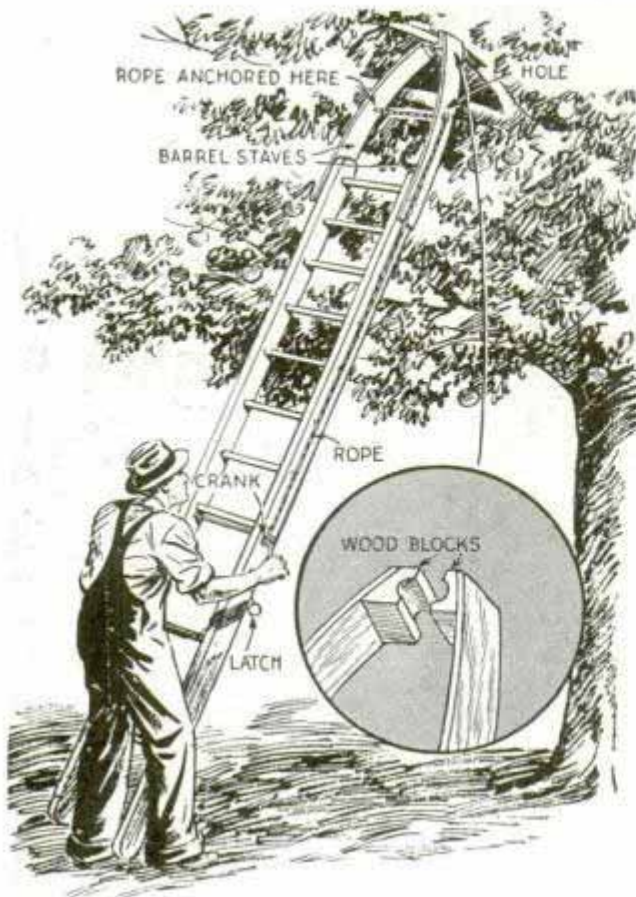

To assure safety in using a ladder in an orchard, one fruit grower attached a pair of heavy barrel staves to the top and arranged them so that they could be operated like a pair of pincers by means of a rope and crank. The rope was anchored to the center of one stave, drawn through a hole in the center of the other and then wrapped around a crank rod inserted through holes in the lower portion of the ladder. In use, the staves were made to engage a limb of the tree and the crank rod turned to draw up the rope. An anchored loop or ring near the crank handle served to hold it at the desired tension.

## Handy Hook Assembly for Barn from Rimless Wheel

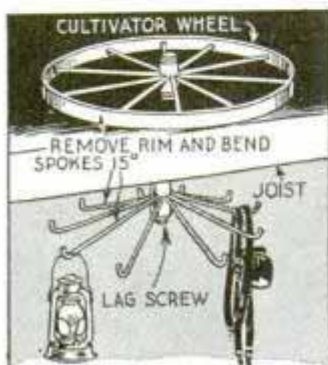

An old cultivator wheel with the rim removed and the spokes bent upward at the ends as shown, provides a handy rotating assembly of hooks for use in a barn. The assembly is

pivoted to a ceiling joist with a long lag screw. To do this, drive a hardwood plug in the hub and fasten it in place with a wood screw running through the oil hole in the hub. Then drill through the plug to take the lag screw.

## Ribbon Stapled in Hat Box Lifts Cover Easily

Annoyed by the difficulty of removing lids from round hat boxes, a merchant stapled a strip of cheap ribbon to each box so it hangs over the edge when the cover is replaced. To remove the lid quickly, the ribbon is pulled upward.

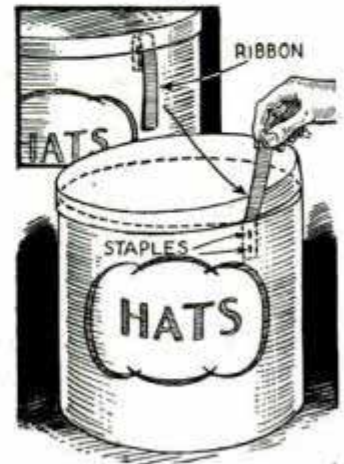

## Furrow Chain Aids in Steering Tractor When Plowing

Here is a simple guide for your general-purpose tractor that eases the tension of constantly watching the furrow wheel when plowing. It consists of a bar of wood or iron bolted to the forward end of the tractor frame and projecting at right angles to a distance slightly more than half the normal rear-wheel tread. Drill several small holes near the outer end so you can attach the chain at just the right point.

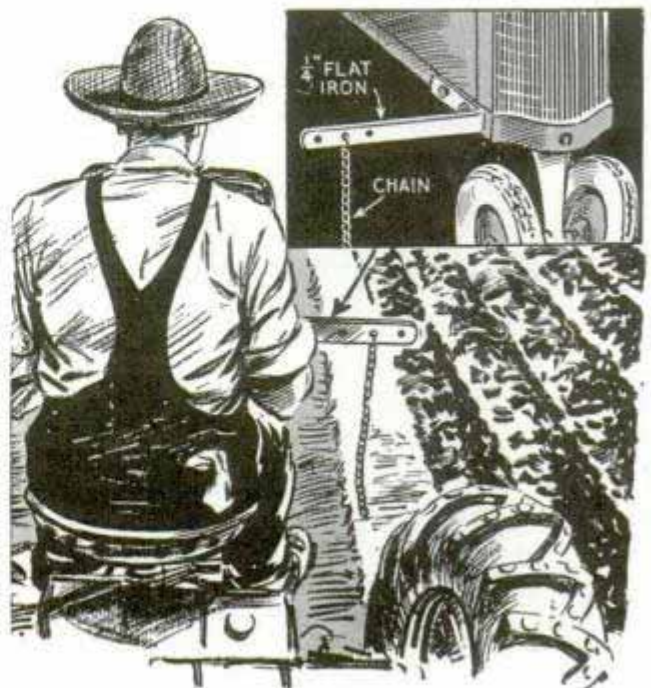



# CHROMIUM PLATING

## *Simplified*

Lever to immerse anode in the plating solution gives accurate current control

By Alexander Maxwell

WHERE an exceptionally hard surface is needed for wear-resisting quality, such as cutting edges of tools, chromium plating with subsequent honing has been found highly successful. Compared to a diamond, which for the sake of comparison we will rate at a hardness of ten, and tool steel, which ranges from four to seven, chromium is about nine. Applied directly to steel, it enables a tool to be used about four times as long as normally possible before sharpening.

A convenient chromium-plating arrangement for small work is shown in Figs. 1 and 2. A wood or metal framework on a wood base holds a gas or electric plate for heating a pan or pail of water in which a glass or stone container is set. The latter contains the plating solution, which is kept at uniform temperature by the hot water. Spacing blocks are provided under the jar to avoid direct contact with the pan. The framework also supports an anode holder, which is pivoted so that the anode can be immersed slowly into the plating solution until the correct current flow is registered on a 0-50 ammeter. When the anode, which is lead, has been immersed as far as required, the anode handle is locked in position by turning a wing nut on the frame until plating has been completed. Where considerable plating is done, a switch controlled by a thermostat in the water bath has been found helpful in turning the electric plate on and off to maintain uniform temperature automatically. While plating,



CHROMIUM-PLATING SOLUTION  
CHROMIC ACID, 9 OZ.  
SULPHURIC ACID, .07OZ.  
WATER, 1 PT.

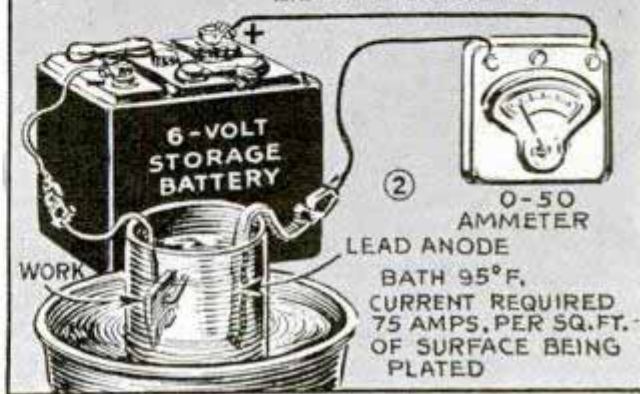
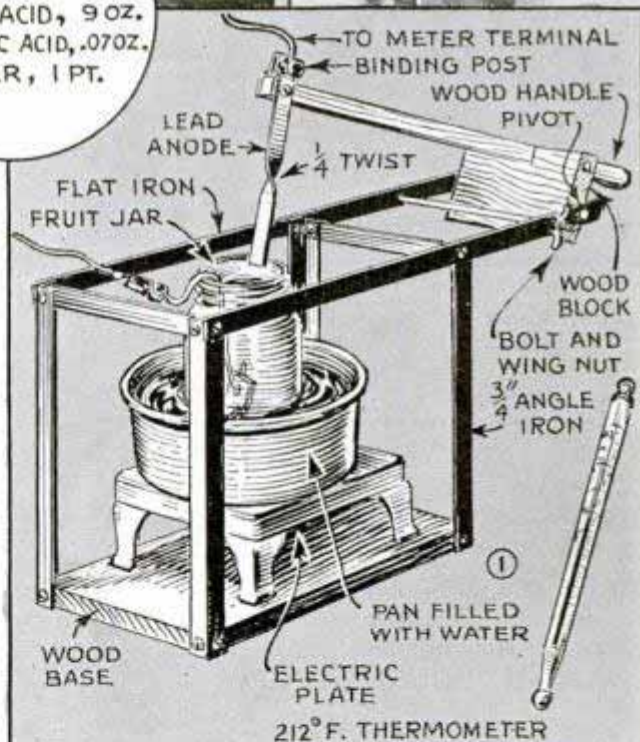

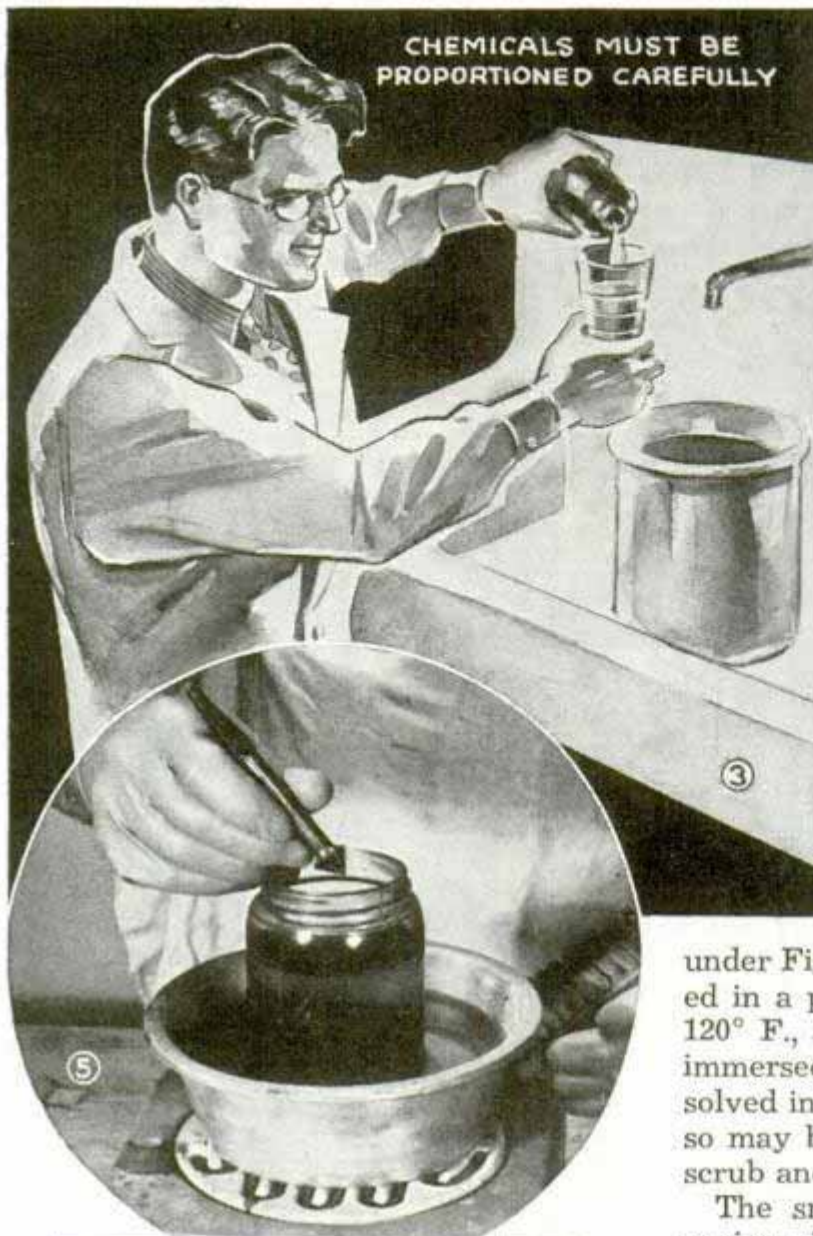

**CURRENT REQUIREMENTS FOR SURFACE AREA**  
(at 75 amps. per sq. ft.)

1 sq. in.	requires	0.52 amp.
2 "	"	1.04 "
3 "	"	1.56 "
4 "	"	2.08 "
5 "	"	2.6 "
6 "	"	3.12 "
7 "	"	3.64 "
8 "	"	4.16 "
9 "	"	4.68 "
10 "	"	5.2 "
20 "	"	10.4 "
30 "	"	15.6 "
40 "	"	20.8 "
50 "	"	26.0 "
60 "	"	31.2 "
70 "	"	36.4 "
80 "	"	41.6 "
90 "	"	46.8 "
100 "	"	50.2 "

④

**RUST-REMOVING FORMULA**  
HYDROCHLORIC ACID, 1 OZ.  
WATER, 10 OZ. (HEAT TO 120°)

the solution gasses violently and the fumes produced should not be inhaled as they are injurious to the nose and throat lining. To avoid this, a fan is placed between the operator and the tank to blow the fumes away through an open window. Fan-equipped exhaust hoods are also used. An additional precaution to prevent injury from breathing the fumes is to rub vaseline inside the nose, especially on lengthy plating jobs. Rubber gloves are worn when handling the work or any other time when there is a possibility of getting the plating or rust-removing solution on the hands. However, if the worker accidentally gets some on his hands, immediate rinsing in running water will prevent any harm.

Rust on the work to be plated should be removed, although scrupulous cleaning

procedure necessary with most plating baths is not essential with chromium, as the acid itself is better than any soap or solvent available. For rust removal a bath of hydrochloric acid and water (see formula

under Fig. 5) is prepared, and this is heated in a pan of water to a temperature of 120° F., after which the rusty objects are immersed. Light coatings of rust are dissolved in about 10 minutes, but an hour or so may be necessary for bad cases. Then scrub and rinse well with water.

The smoothness of the plated surface varies with that of the surface underneath as shown in Fig. 6. Therefore surface irregularities of the work are removed before plating it. Preliminary smoothing of a rough surface is accomplished by grinding with suitable stones. This is followed by a thorough buffing, Fig. 8, using a cotton buff charged with fine silicon carbide in lard, then tripoli. For final polish a high-speed flannel buff charged with rottenstone is used. Holes, such as those in a pair of pliers or scissors, resist plating because the hydrogen generated is sufficient to drive chromium away from surrounding surfaces. These holes are plugged with wax, plastic clay or cork as in Fig. 7.

Successful chromium plating depends on keeping the sulphate percentage of the solution within bonds, keeping the temperature of the solution constant at 95° F., and applying the proper amount of current, which is 75 amps. per square foot of surface being plated. An effective plating solution is given at the left of Fig. 1. The

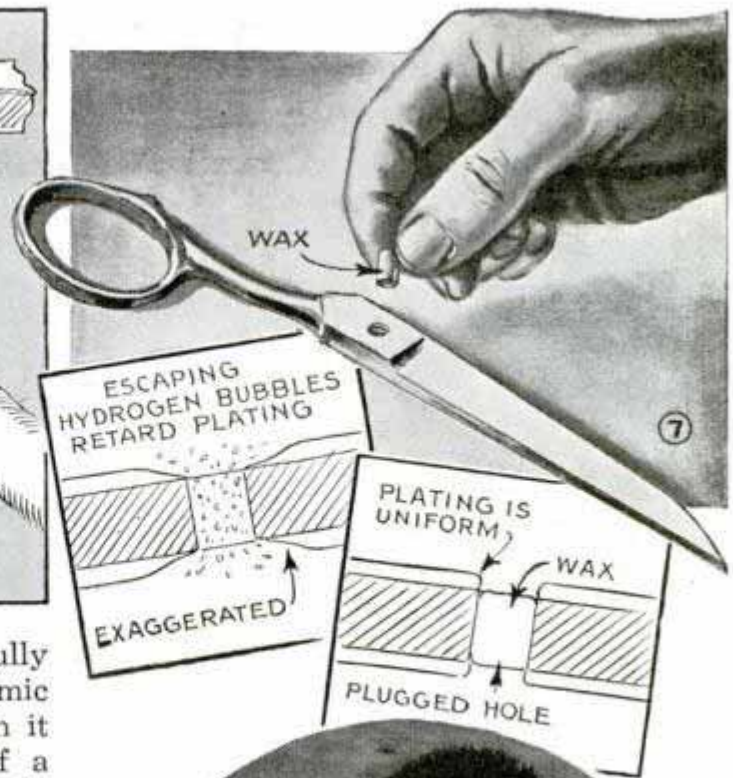
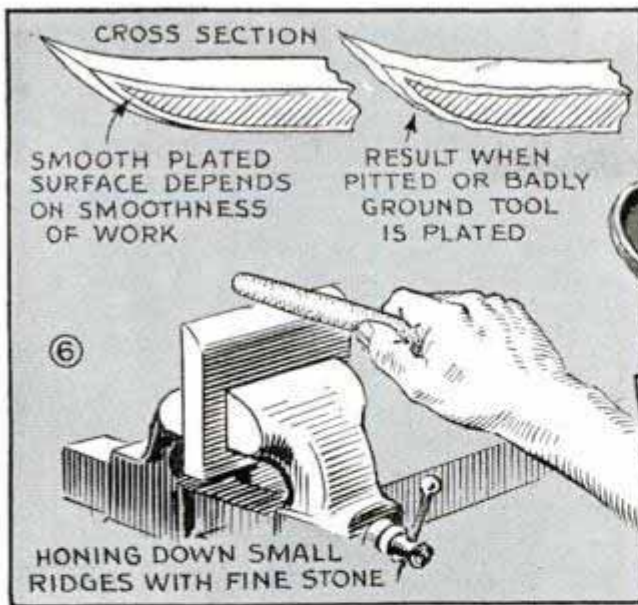

chemicals must be proportioned carefully as indicated in Fig. 3. Commercial chromic acid has a light amount of sulphate in it and usually requires the addition of a small amount of sulphuric acid with a medicine dropper. When the correct amount of sulphate is present, a bright deposit of chromium will be produced at a temperature of 95°, provided the correct amperage is applied. To test, add sulphuric acid drop by drop while plating a sample piece. The table given in Fig. 4 shows exact current requirements for various areas from 1 to 100 sq. in. Current is supplied by a 6-volt, heavy-duty storage battery. The negative side is connected to the work and the positive side runs through the ammeter to the anode, as shown in Figs. 1 and 2. Use heavy rubber-covered wire or flexible cable of large enough size so that it will not heat excessively when a large current is passed. If any one or more of the three factors controlling the success of the work are at fault, the plate deposited will be

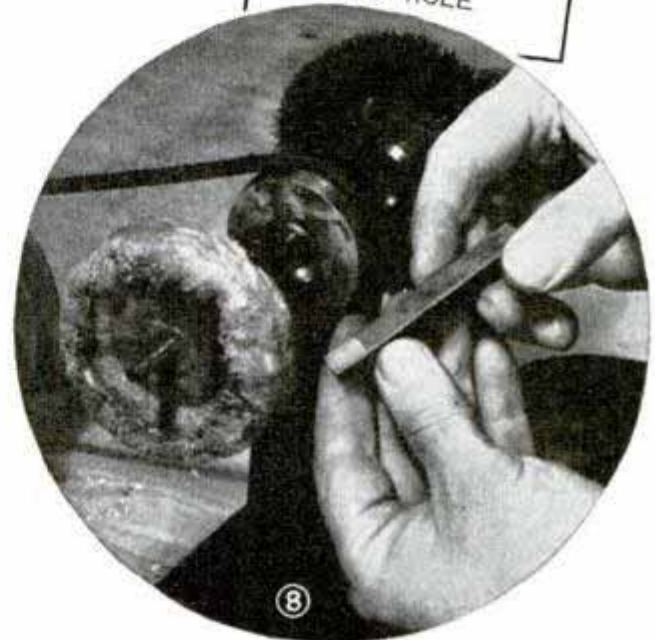

*Tools to be plated must be free from rust, pits and scratches if a smooth coating of chromium is expected. If necessary, grind down the tool and polish to a mirror-like surface*

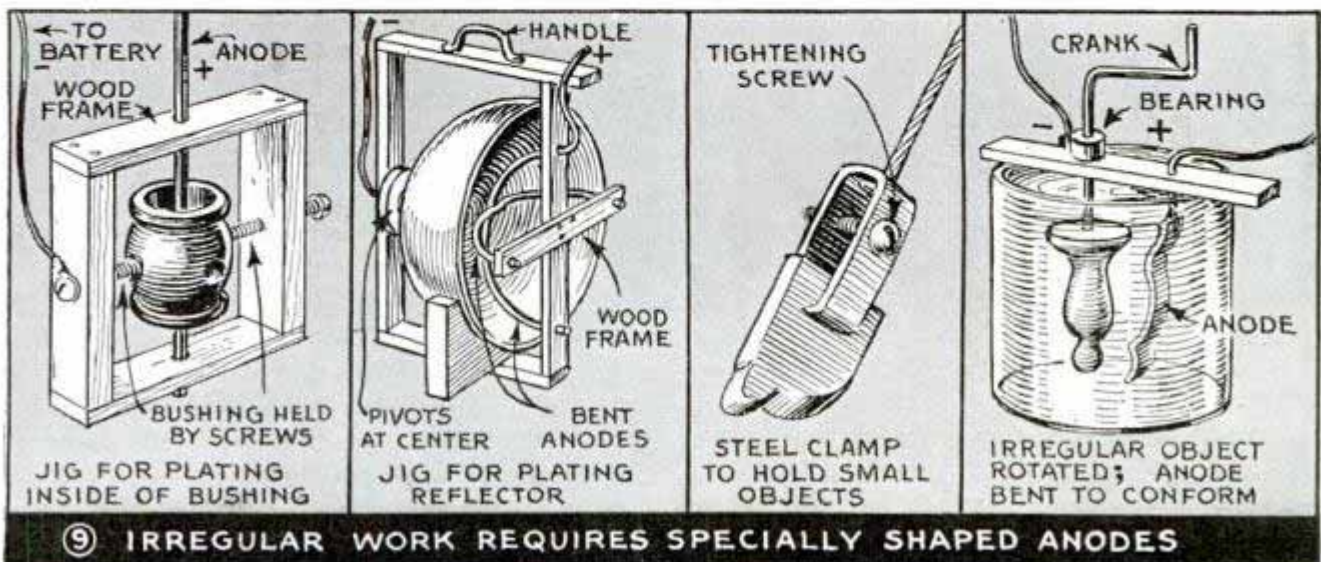

**9 IRREGULAR WORK REQUIRES SPECIALLY SHAPED ANODES**



milky, flaky or muddy. The first 5 seconds determines the type of deposit, but it usually takes about 20 minutes to build it up to satisfactory thickness. If the deposit at first is not right, it can be removed from the work by immersing in the warm rust-removing solution.

Odd-shaped pieces of work require specially shaped anodes because the chromium is deposited first and most on parts of the work closest to the anode, and may skip those farthest away. A number of methods for spacing the surface of the anode equidistantly from the surface of the work, are given in Fig. 9. Uniformly curved surfaces such as reflectors are rotated a few degrees every minute to obtain uniform plating. In lining a bronze or steel bearing, the anode is a lead rod located in the exact center of the bearing. The entire jig is dipped into the solution and is kept in constant motion while plating. The current flow is determined by the area of lead immersed, and experiments are first made in order to determine the proper diameter needed for giving the correct amperage for the area of work. When large surfaces are to be plated, the heavy current required makes it necessary to have good contacts between the work and wire from the battery. Wherever possible the wire is soldered to the work; otherwise a strong spring-type clip is used, which is shifted in position during plating to avoid unplated spots. The area of the clip should be added to that of the work to get correct

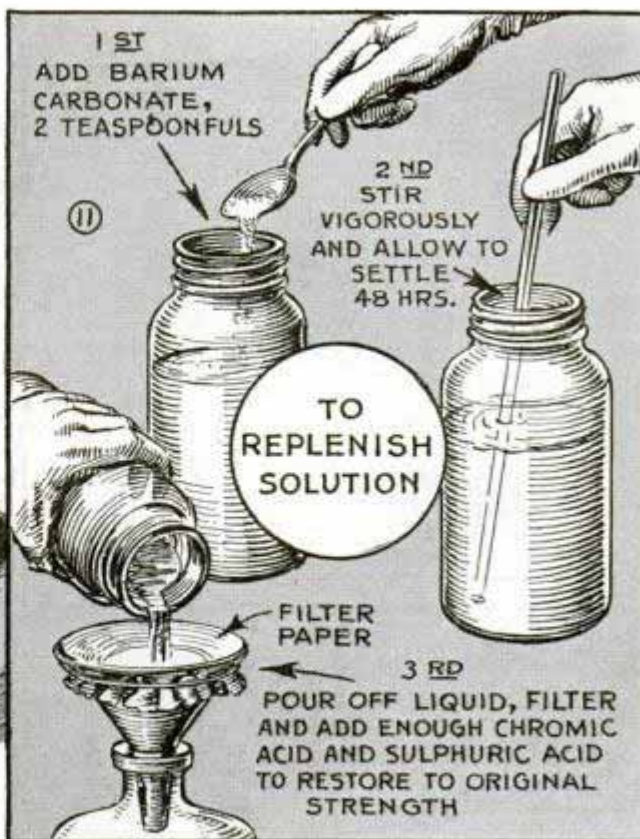
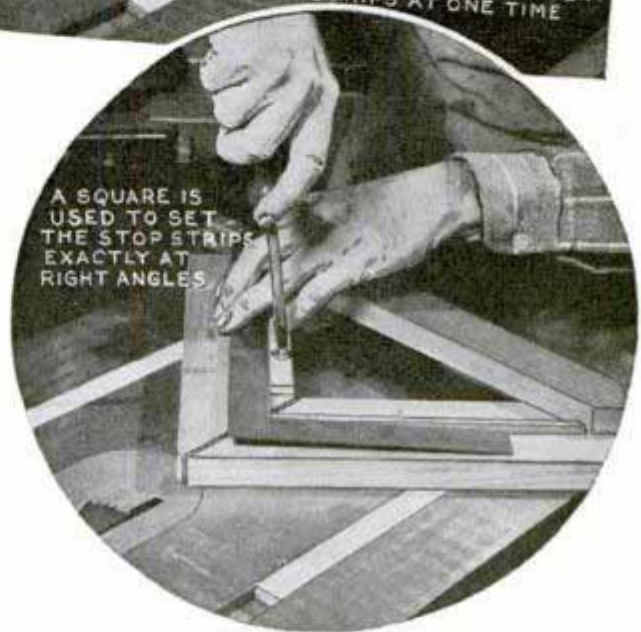
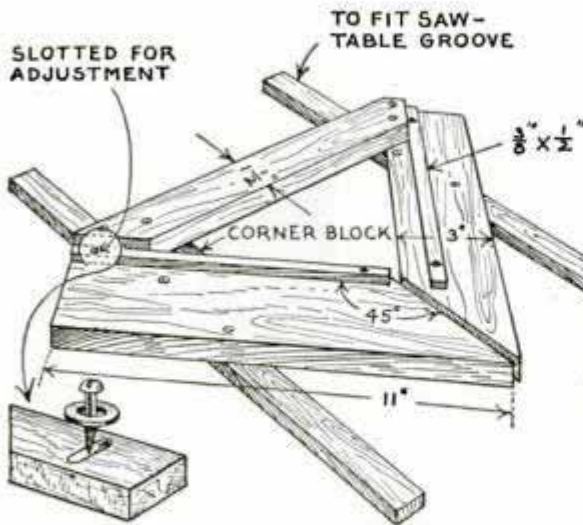

figure for current. Statuettes and ornaments are best plated in a dilute plating solution. Start them at lower current than the maximum given in the table and increase the current gradually to maximum as the plating progresses. Objects having irregular surfaces not sufficiently pronounced to require specially shaped anodes should be kept moving constantly in the plating bath to assure an even coating of chromium all around. In order to plate metals other than steel, copper or nickel, they must be copper or nickel plated before applying chromium. For cutting and abrasion resistance on tools, a .005-in. plate is sufficient. When plating tools, allowance is made for grinding down the surface to a keen edge, and for this reason an extra thick deposit is made. When work has been given a plate of sufficient thickness, it is washed in running water and is buried in maple sawdust, which dries it and prevents the formation of water spots. See Fig. 10. After using chromium-plating solution, its sulphate content increases and the quality of the work decreases correspondingly, but the addition of barium carbonate to the solution, as shown in Fig. 11, neutralizes the sulphate. This is stirred in and allowed to settle, after which the clear liquid is poured off and filtered. More chromic and a slight amount of sulphuric acid are added to restore the solution to original strength.

# Cutting Accurate Miters on a Circular Saw



Work mitered on a circular saw with the aid of this jig will fit accurately when joined because the two cuts are made at the same time. In this way, there is no possibility of slight variation in the angle at which the work is fed into the saw as sometimes happens when the cuts are made separately. Wood strips slide in the miter-gauge grooves of the saw table to keep the jig in alignment. The jig can be built to accommodate any width of material by varying the width of the diagonal pieces and the spacing of the adjustable strips.—Walter E. Burton, Akron, Ohio.

## Double V-Block Clamp Grips Work without Marring It

In my work as a machinist, I often have to use screw-type V-blocks and find that the screws sometimes mar the work badly. To avoid this, I fitted small V-blocks to the ends of the screws as shown. The small blocks were drilled in the centers to take the screws, which were turned down at

the ends to fit the holes. The blocks were held in place by small pins, which passed through the blocks and fitted in grooves turned near the screw ends. This arrangement allows the blocks to turn freely.

—L. Malecki, Chicago.

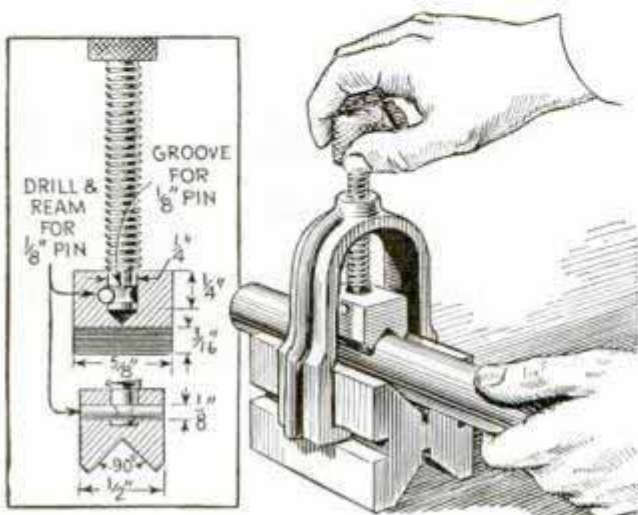

## Vacuum Cup Holds Eraser on Typewriter

Attach your typewriter eraser to a small vacuum cup as indicated, and you can stick it on the typewriter so that it will always be at hand when you want it.

A vacuum cup with a small bolt molded in it can be obtained at a dime store.

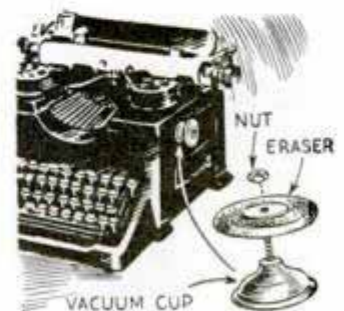

## Adjustable Rail for a Sawhorse Has Many Uses

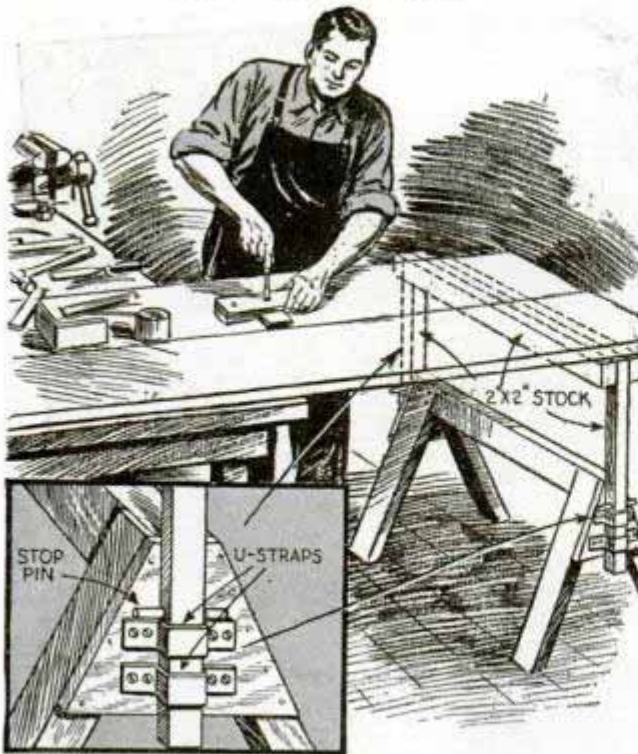

An extra rail on a sawhorse that can be adjusted to various heights is handy around the shop. It can be used to support a plywood panel to add additional working space on a bench, or to support extra long work on a bench, or on your circular saw.

## Fuller Ball Used as Handle on Threading-Tool Gauge

Small threading-tool gauges are easy to use if you fit them with this simple handle. It is nothing more than a fuller ball slit part way through to slip over the end of the gauge as indicated. Besides providing

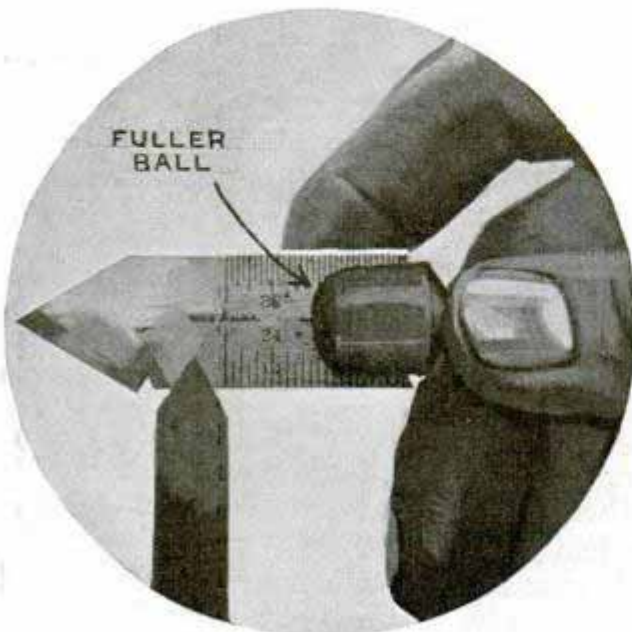

a good grip for the fingers, the handle makes the tool easier to pick up, and it can be slipped off in a jiffy when the large end of the tool has to be used.

## Position of Stovepipe Damper Located Accurately

To assure accurate location of stovepipe dampers, one Wisconsin hardware dealer employs an arc of sheet metal, which fits snugly over the standard 6-in. stovepipe. Notches in the ends of the arc are spaced exactly one half the circumference of the pipe so that the metal may be punched at the indicated points to install the damper.

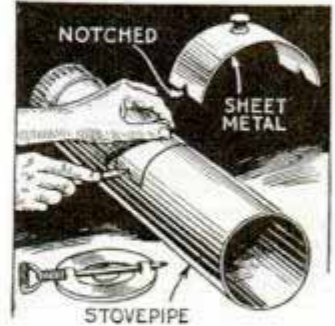

## Even Borders on Price Tickets Assured by Using This Guide

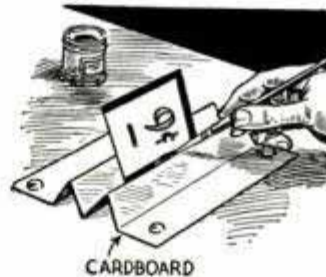

Having a large number of price tickets to prepare for a special sale, and desiring to paint a neat border on each one, a showcard artist facilitated the

work by means of a trough made from a folded strip of cardboard. This was attached to his desk with thumbtacks, and each ticket was inserted at the angle indicated so that the trough would serve as a gauge for the brush.

## Large Pipe Flanges Turned Easily with This Spanner Wrench

For the factory-maintenance crew, this spanner wrench is better for turning large pipe flanges than the usual method of putting two bolts through the holes and using a bar. The wrench consists of a steel notched bar and a separate link that is adjusted to various sizes.

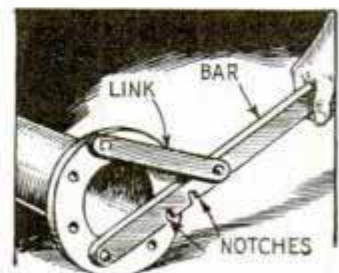

# Gas-Torch 'Compass' to Cut Out Metal Disks

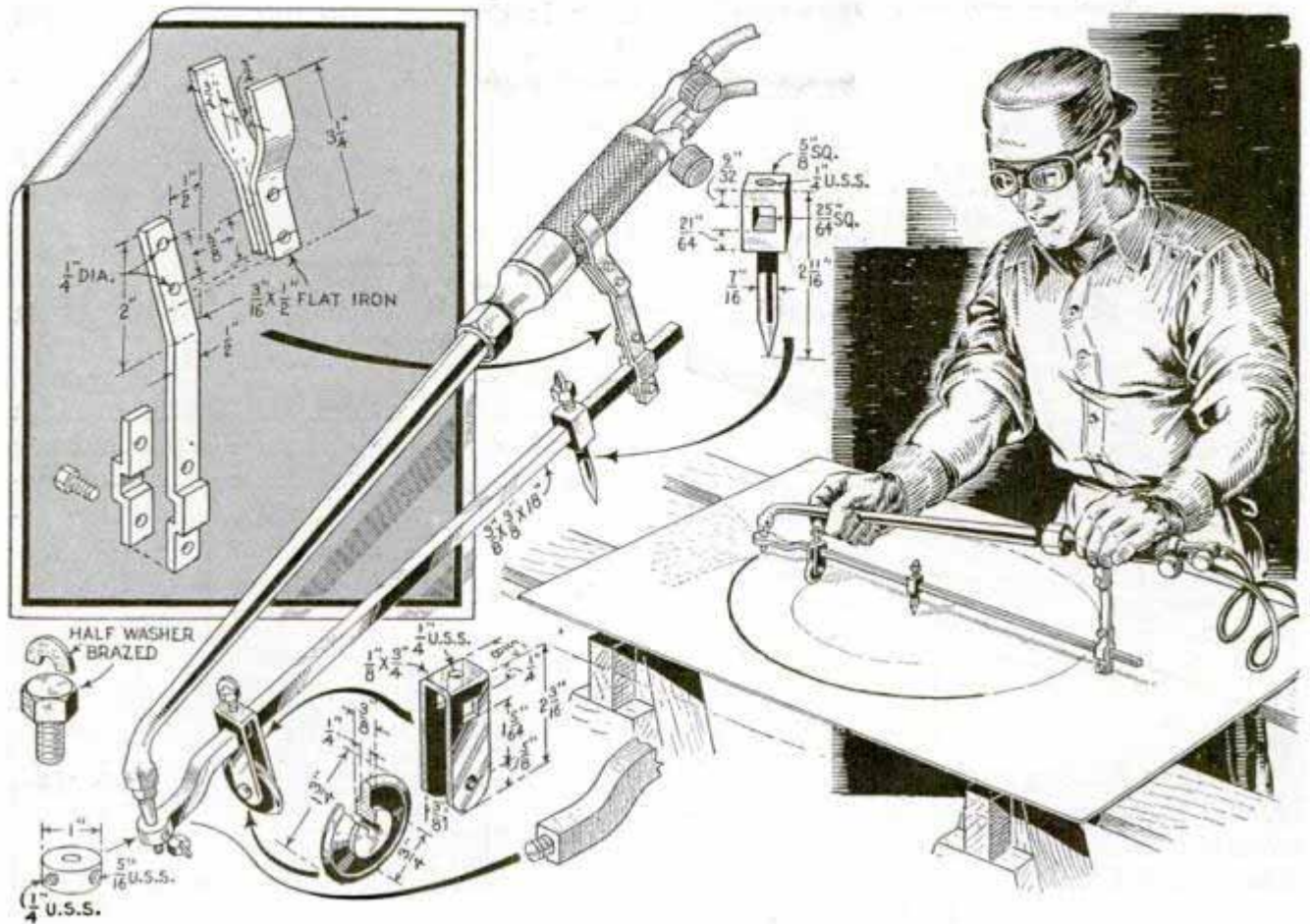

Owners of small shops who do not have equipment for cutting circles or disks in steel plates, will find this inexpensive attachment for a gas-cutting torch just the thing for the job. When the work is done free hand, it is almost impossible to avoid ragged edges that require considerable machining to finish them. With the attachment anyone can cut circles having smooth edges and ranging in size from a few inches to nearly 3 ft. in diameter. If the small

wheel near the torch tip interferes with moving the adjustable pivot close enough toward the end of the torch for a very small radius, it is a simple matter to remove the wheel and put the pivot in its place. When a number of duplicate disks are to be cut from stock up to  $\frac{1}{2}$  in. in thickness, several pieces of the metal can be stacked and cut in one operation, and thus save considerable time.

—A. L. Havens, Rutland, Vt.

## Tooth from Hay Rake Serves as Shock Absorber in Tether

To provide a spring in a tether that would tend to absorb shock on an animal's neck when it stretched the tether suddenly, and at the same time allow it to rotate on the stake without winding up, a farmer used a hay-rake tooth. This was annealed at the pointed end and an eye was formed to attach the tether. The tether stake was driven into the ground through the coiled portion of the tooth near the other end.

☐ A tool box is more efficient if the partitions are cut a few inches lower than the top of the box to leave room for carrying wide, flat tools on the trays.

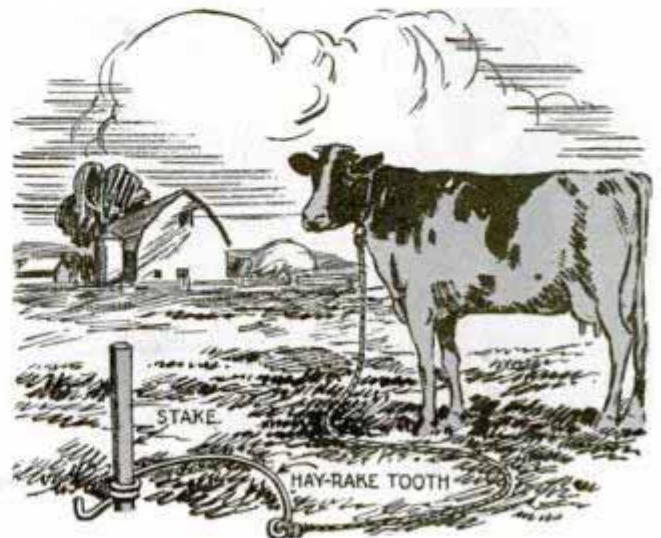

## Concrete-Form Stakes Driven with Aid of Jig

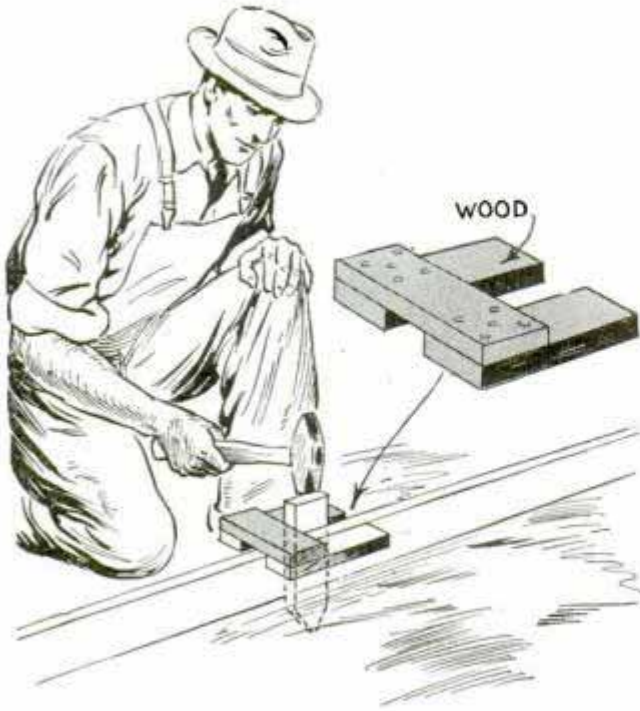

To aid in driving anchor stakes vertically, and firmly against the form boards for concrete walks, one contractor employs this simple jig. It consists of three wood blocks nailed together as indicated.

## Simple Tool Replants Corn and Beans

Going over a large corn or bean field, to replant the hills that failed to grow, is a tiresome task especially if each hill must be dug with a hoe to receive the new seeds. If a funnel is attached to the end of a

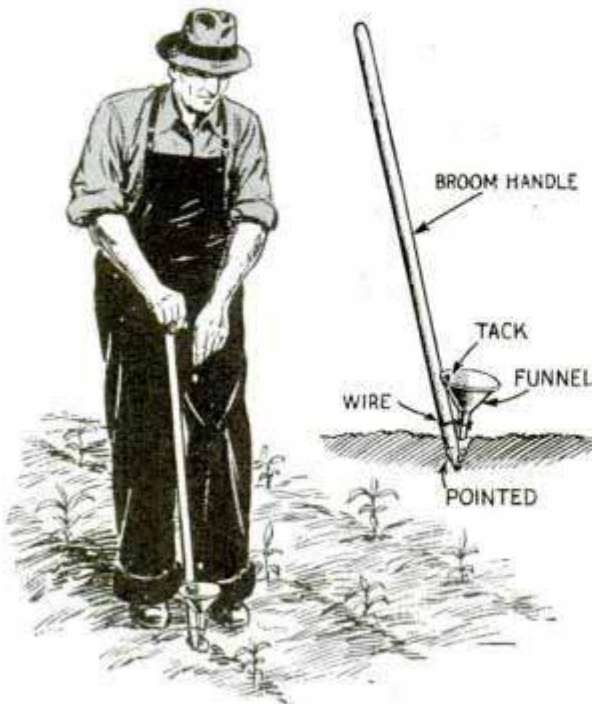

sharpened broomstick, this tool may be employed to do the work. The point of the stick is inserted into the soil at a slight angle, then pushed forward to make an opening of the desired depth directly below the funnel spout. The required number of seeds are then dropped into the funnel, the tool removed, and the seeds covered by pressing the soil down with the foot.

## 'Fishpole' Tether for Mother Hen Cannot Tangle

When a mother hen must be tethered on the lawn or in the barnyard to prevent her from wandering away, the usual annoyance of a tangled tether line may be avoid-



ed by using a fishpole for the tether stake. Any pole will do just so it is longer than the line. The hen may walk comfortably about in the restricted circle and with no danger of the line being caught.

## Corner of Square Beveled to Check Angle of Welded Work

The difficulty of checking a joint that has been welded at a 90° angle can be overcome by using a small square that has been beveled at the corner as indicated. The bevel allows the square to bridge the weld metal so that it butts accurately against the two sides of the work.

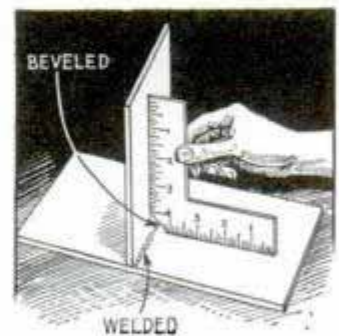

—E. D. Biggerstaff, Jr., Macon, Ga.



# Sliding MOTOR MOUNT

*Serves bench-top machines*

By H. O. BUMANN

**M**OVABLE longitudinally on two angle-iron rails running down the center of your bench top so that it can be slid into position quickly, to operate any one of several small power machines mounted on each side as in Fig. 1, this quick-change motor "carriage" is adjustable laterally as well, for tensioning the belt of each machine as shown in Fig. 2. The lower block of the "carriage" is slotted to slide freely on 1 by 1-in. rails spaced about 5 in. apart. The center piece of the upper assembly to which the motor is bolted, slides on two grooved members screwed to the lower block, and is made adjustable crosswise by means of a bolt passing through a flat-iron brace and into a nut embedded into the wood as shown in Fig. 3. Machines which may be operated either clockwise or counterclockwise, such as a jigsaw, disk sander, etc., should be mounted along the rear side of the bench so that other machines, which must run clockwise, can be driven without twisting the belt.

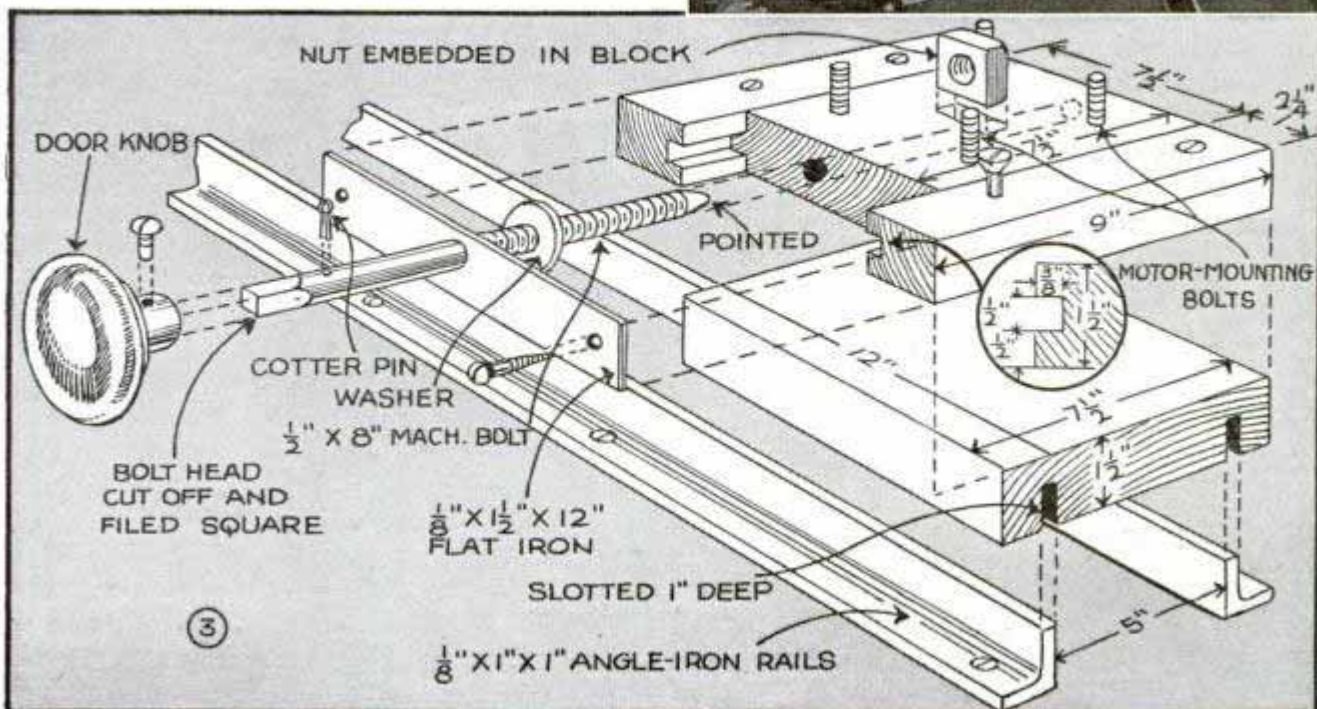
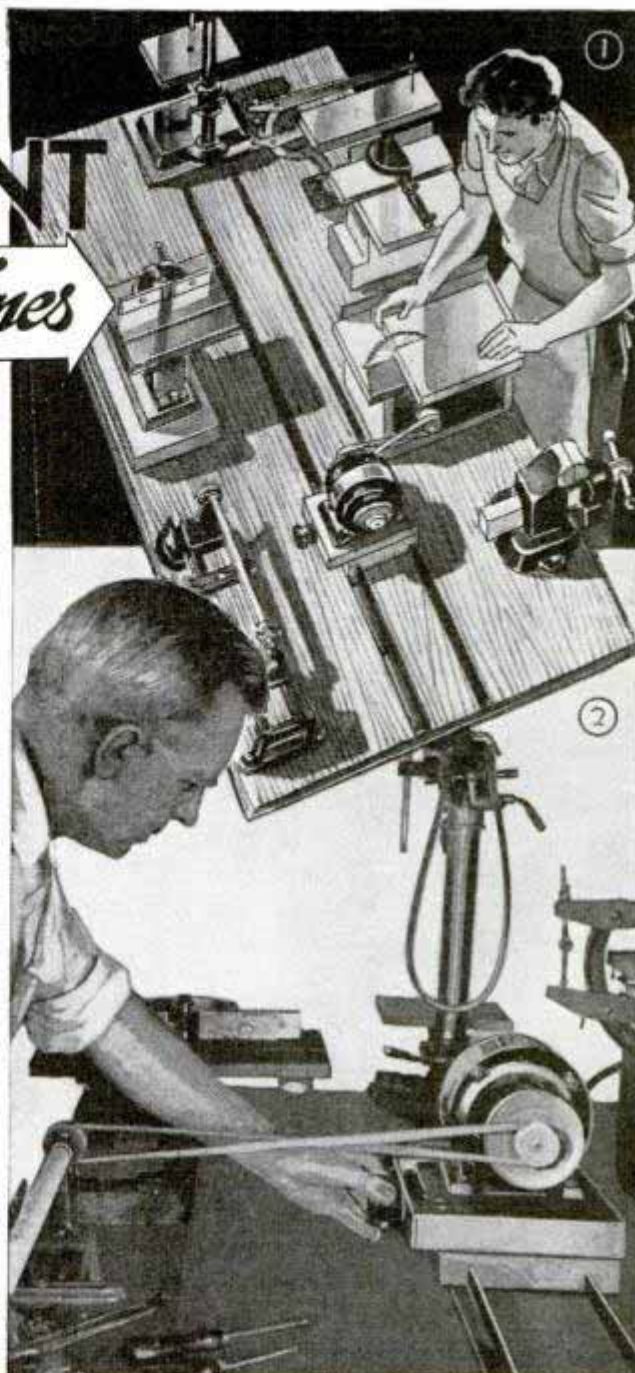

## Brake Drums Serve as Signal Gong for Farm Home

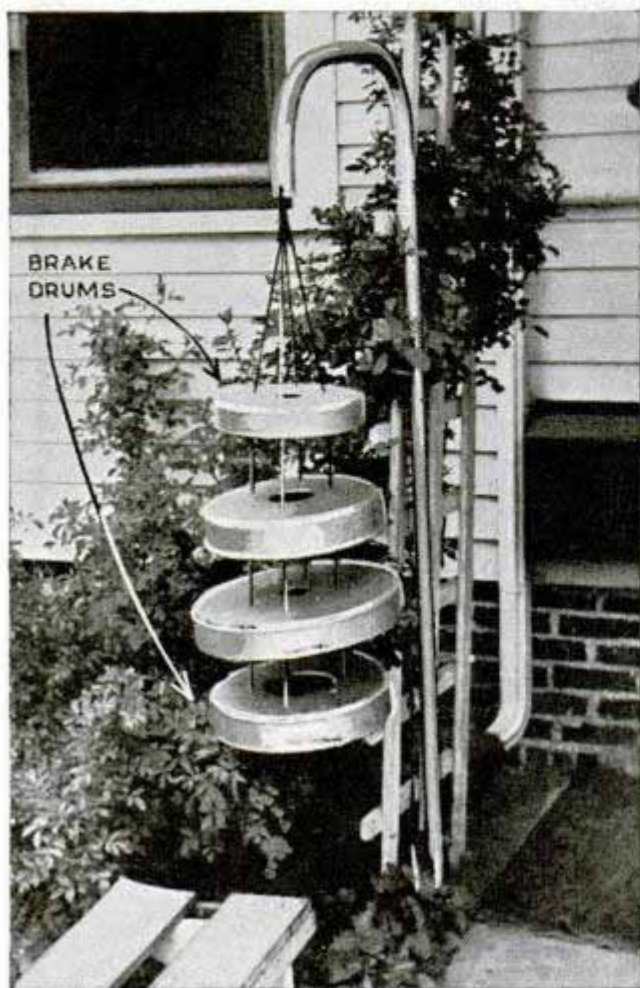

Replacing the antiquated farm dinner bell, four old brake drums of various sizes, suspended from a pipe standard by small chains, will provide a pleasantly toned signal gong for use at the farm or suburban home. If care is taken in selecting the drums, you can assemble four of them that will produce tones closely simulating the notes of a chord. The supporting chains are threaded through bolt holes in the drums, which are coated with aluminum paint. A wood mallet is best for striking the drums, which will produce a sound that will carry a considerable distance.

## Loose "Tire" Prevents Clogging of Tractor-Wheel Lugs



Under certain conditions, impacted soil and trash "bridges" across tractor-wheel lugs to such an extent that the machine loses

headway due to slippage. One farmer overcame this trouble by placing a loose iron band over the tire between the two rows of lugs. For tractors with small-diameter wheels an old wagon tire is just the thing. In any case, the band should be of  $\frac{1}{4}$ -in. iron, and the ends should be welded to form a ring, the inside diameter of which is about  $1\frac{1}{4}$  in. larger than the outside diameter of the tractor wheel.

## Tailor Carries Pins on Wrist

Tailors and others who use many pins can save time and always have them at hand if the pins are carried on the wrist. A good way to do this is to cut a paper of pins in strips as indicated, and fasten one of the strips to the wrist of the garment they are wearing.

—G. E. Hendrickson, Argyle, Wis.

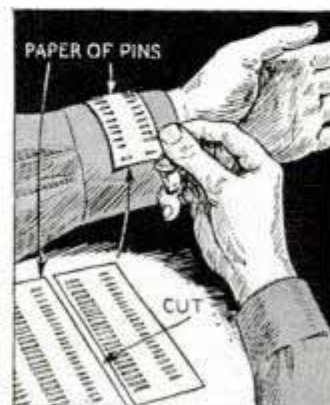

## All-Metal Utility Hand Truck Can Stand Hard Use

Here's an all-metal hand truck that will come in handy for hauling heavy loads around the farm buildings. The axle is a length of pipe to which iron wheels from the scrap pile are keyed. A second length of pipe welded to the axle forms the handle. The box or rack is made of angle iron riveted together, the bottom of the rack being pieces of flat iron riveted in place.

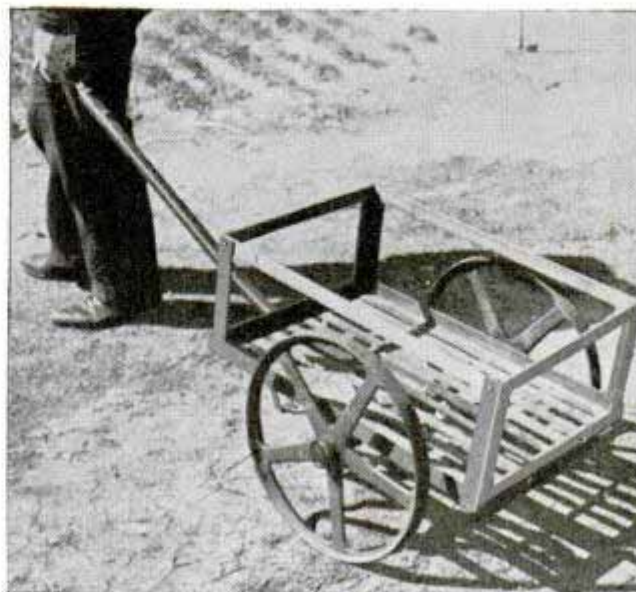

# AUTO SHORTCUTS

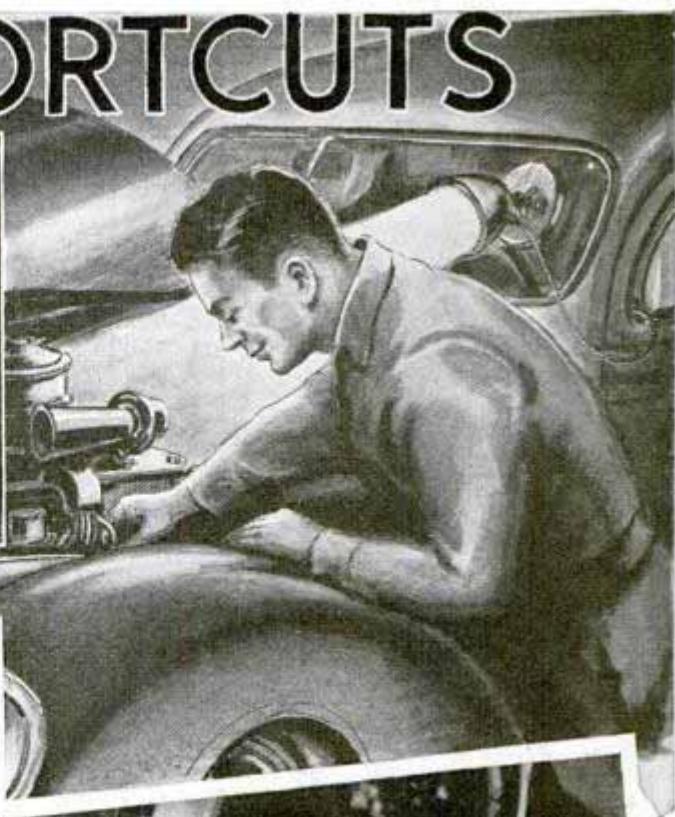
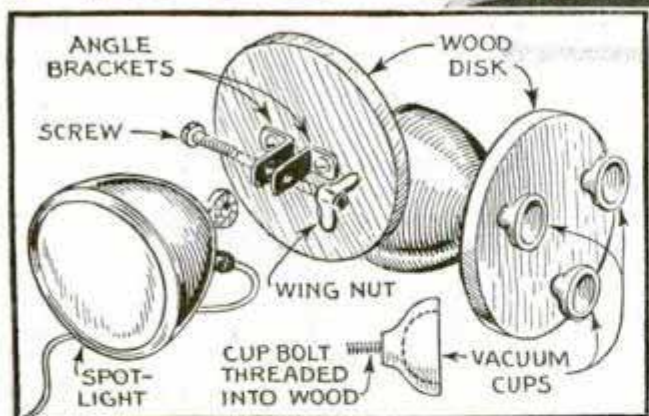

Plenty of light directed right where you want it when working on a car is possible with the portable spotlight above, which can be stuck on the windshield, windows or any part of the body. When a number of small cracks started to radiate from a large one in the corner of a safety-glass windshield, the cracking was confined to the corner by scoring a line in the glass as at right

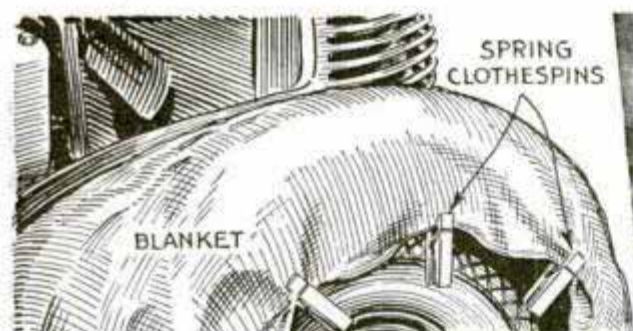

When a cloth is laid over a fender to prevent marring the finish while leaning over it to work on the motor, spring-type clothespins clipped over the cloth and fender as above will prevent the fabric from shifting out of place

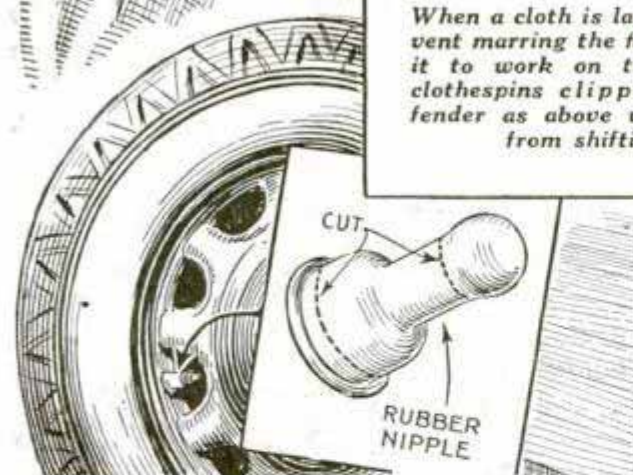

Gravel and water can be kept from working into a tire around a rubber valve stem by cutting a nursing-bottle nipple as above and slipping it over the stem. To prevent the body stakes of his truck from jumping out, and yet have them easy to remove, one driver notched the lower ends as at the right and then tacked strips of heavy rubber belting on the underside of the truck floor to engage the notches when the stakes were inserted in their sockets

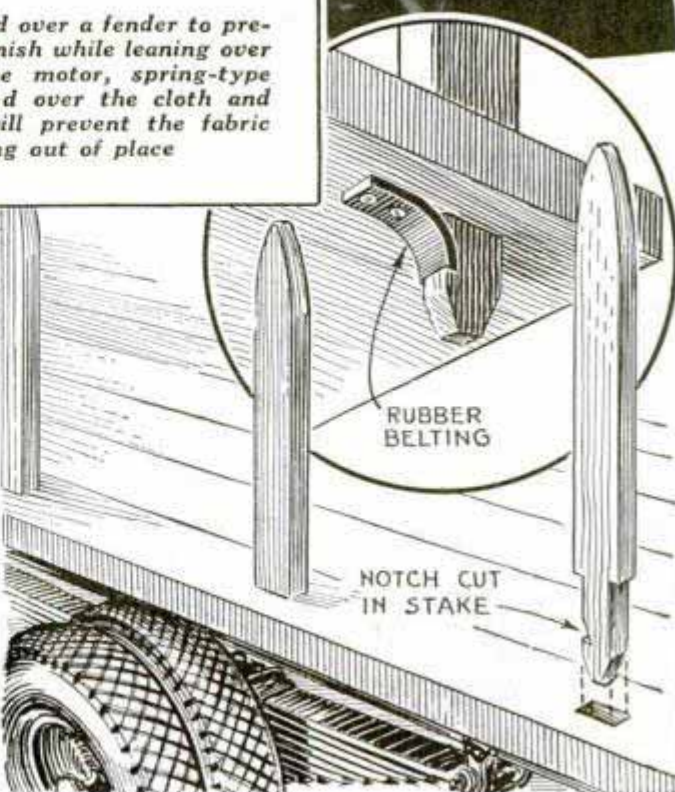

## Handle on Tailboard of Truck Serves as Step

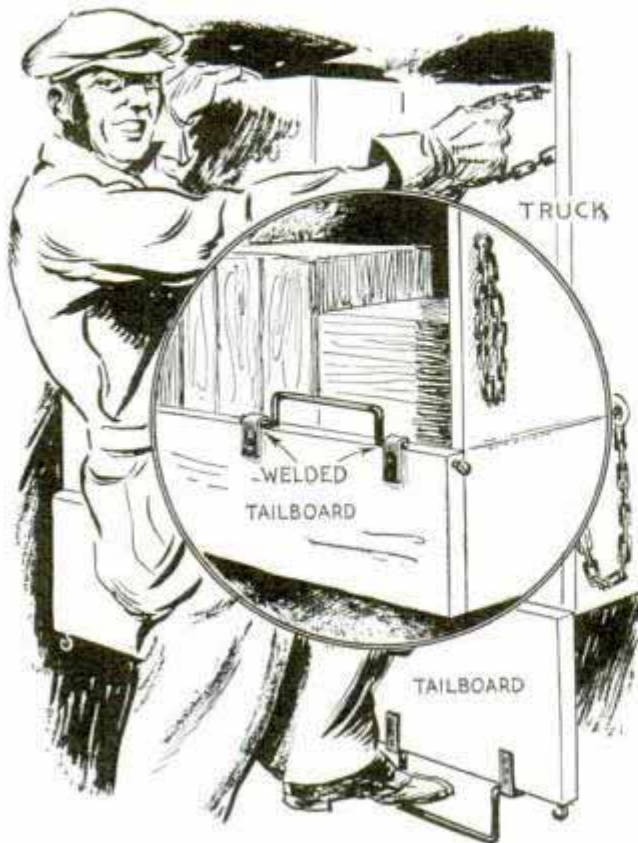

One truck driver who had to climb into the rear end of the truck many times when unloading, put a handle on the tailboard that helped in raising and lowering it. Also, when the board was in the down position, the handle served as a step.

## Combined Brush and Leaf Wedge to Lubricate Car Springs

You can clean and spread your car springs for lubricating them with this homemade device. Simply snip off a couple rows of bristles from a scrub brush, and screw on a 1-in. angle iron, sharpened along the projecting edge. Hammer lightly

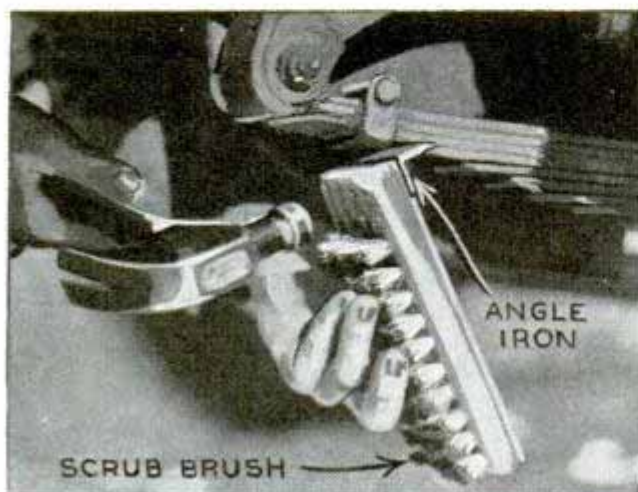

against the brush, and even the tightest spring leaf will spread sufficiently for the insertion of a lubricant.

—Ormal I. Sprungman, Minneapolis, Minn.

## Adhesive Tape Anchors Boot in Auto Casing

When you are obliged to place a temporary boot in an auto casing, especially in making repairs on the road where no cementing or vulcanizing facilities are at hand, you can anchor the patch with a couple of strips of tape. Bits of the tape will also serve to keep moisture out of a nail puncture until the casing can be repaired properly in a garage.



## Hole in Car Instrument Panel Holds Your Pipe

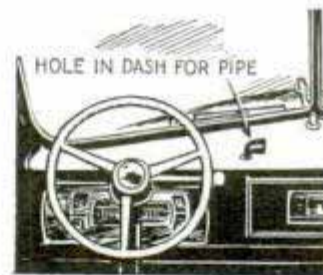

As there is no place on a car where a driver can lay his pipe temporarily, one motorist drilled a hole through the upper part of the instrument panel. This provided a safe place for inserting the stem of the pipe within easy reach of the steering wheel.

—Everett Hanson, Argyle, Wis.

## Emergency Repair for Tubing

When repairing copper tubing using compression fittings and none of the brass sleeves used on this type of fittings are available, the following method will help. Polish the end of the tubing with steel wool and plug it with a small wooden plug, allowing it to project enough so that it may be removed after repair is complete. Place the nut over end of tube and wrap the end

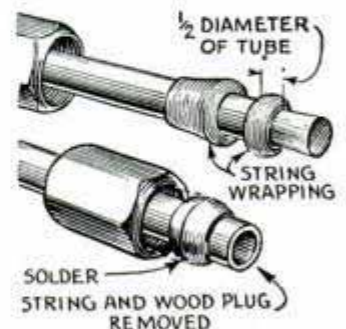

with string. Apply soldering flux to the space between the wrappings, and dip in molten solder. A small ring of solder will adhere to the tube, taking the place of the brass sleeve necessary in compression fittings. After dressing off any irregularities with a file, the tube may be installed as usual.—R. J. Higman, Seattle, Wash.

## Weight Sounds Horn for Testing

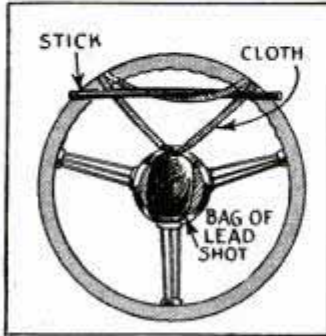

A cloth bag of shot is handy to depress the horn button while testing the circuit. This makes it unnecessary to have an assistant sound the horn, and enables the mechanic

to make the test without waiting for someone to be free to help him. A strip of cloth sewed to the bag permits it to be fastened to the steering wheel with a stick as indicated in the drawing.

## Moving Casters Toward Center Improves Creeper

One mechanic took the casters from one end of his creeper and placed them in the center as shown. To move about, he allows his weight to rest on the fore part of the

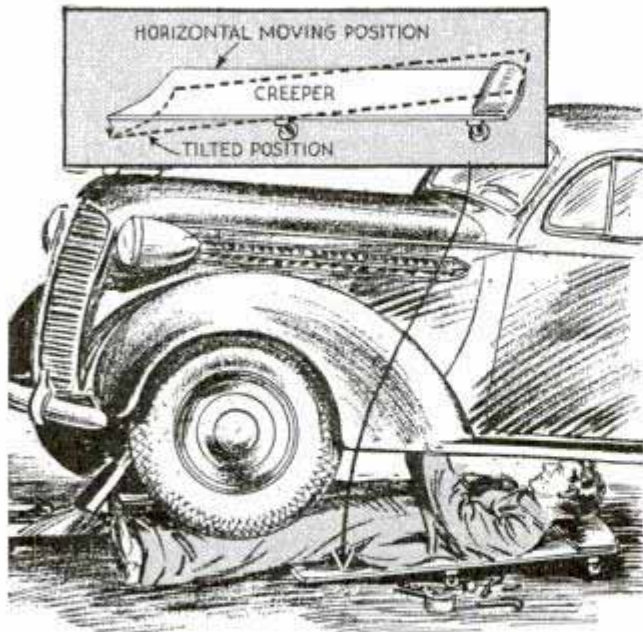

creeper, and while working he rests his weight at the other end. In this way the creeper does not move about while he is working under a car.

## Pressure Stick Holds Inner Tube in Tub of Water



Seeking a handy method of holding inner tubes under water for testing them, a garage mechanic slipped two short pieces of hose over the ends of a broomstick. The over-all length of the stick and hose combined was a little greater than the diameter of the water tub. In use, a tube to be tested was submerged in the tub and the stick pushed down on it, thus binding the projecting ends of the hose against the sides of the tub to hold the tube in place.

## Water on Generator Cutout Short-Circuits Battery

A mysterious short circuit in the electrical circuit of a truck was found to be caused by a drop of water that collected between the generator cutout and the small lug to which the wire was connected.

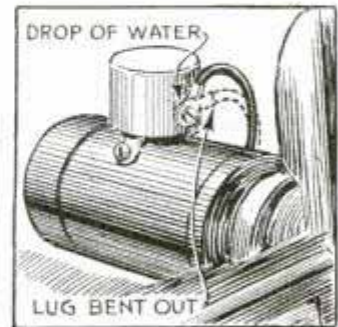

The "short" appeared only during wet weather, and would run down the battery overnight. To prevent the trouble, the lug was bent outward to increase the space between it and the cutout.—H. B. Linn, Coronado, Calif.

## 'Cowcatchers' on Garage Creeper Allow Free Action of Casters

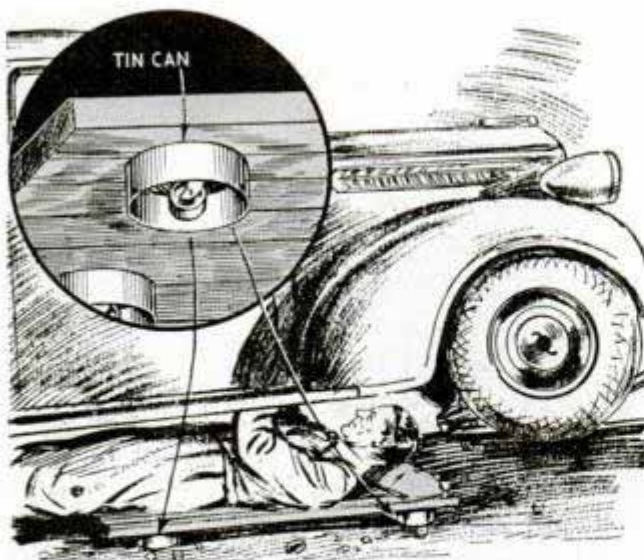

To keep bolts, nuts and other small obstacles from hindering the operation of the casters on his creeper, one mechanic put tin cans over them. These were cut to a height to just clear the floor when nailed in place, and served to brush all small articles out of the way of the casters.

## Clogged Line to Gasoline Gauge Cleaned with Wire

When a hydrostatic gasoline gauge does not register, I disconnect the line at the gauge end and clean it with a piece of piano wire about 8 in. in length. One end

of this is ground flat like a chisel, and the other end is put in a small electric drill. With this tool I drill out the corrosion in the line, which is usually within a few inches of the gauge end.

—T. E. Bordner, Willard, Ohio.

## Locating Compression Leaks

Here is a simple device by which you can locate compression leaks. It consists of the base of an old spark plug and a tire valve assembled as shown. In use, the plug is removed from the cylinder suspected of losing compression and the device is screwed into the spark-plug hole. Then the motor is cranked to bring the piston to the top dead-center firing position, after which compressed air is admitted through the device at a pressure of 100 to 135 lbs. Any air leaking past the piston and rings will blow out of the crankcase filler tube. An intake valve that is not seating properly will allow air to escape through the carburetor inlet, while air blowing out of the muffler indicates a bad exhaust valve.

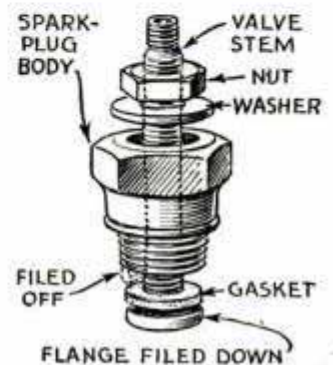

the device at a pressure of 100 to 135 lbs. Any air leaking past the piston and rings will blow out of the crankcase filler tube. An intake valve that is not seating properly will allow air to escape through the carburetor inlet, while air blowing out of the muffler indicates a bad exhaust valve.

—Edward N. Avery, Dunmore, Pa.



## There's Both Fun and Profit in Outdoor Living Room

**N**OTHING will contribute more to the value and enjoyment of your home than outside furnishings. And it is surprisingly easy to make your yard so attractive that it will arouse the envy of all your friends and neighbors. You can do it yourself—in your spare time. This little booklet, "How to Build Your Own Garden Woodwork and Furniture," will give you fully illustrated plans and simple details for trelliswork, beautiful pergolas and several types of easy-to-make pieces of furniture. Just a few shrubs and a little "fixin'" will not only add to the value of your property, but will provide enjoyment for your friends and family. Just send 25 cents for this booklet to **Popular Mechanics Press, 200 East Ontario Street, Chicago**

Lens mount  
extended—ready  
for pictures

Lens mount  
turned back—in  
carrying position



## Announcing **KODAK DUEX—\$5<sup>75</sup>**

- ☛ Takes 16 album-size pictures (1 $\frac{5}{8}$  x 2 $\frac{1}{4}$  inches) at one loading, on Kodak Film No. 620
- ☛ Spiral-threaded lens tube makes it compact as a folding camera

Keeping in mind the price . . . \$5.75 with neck cord . . . consider the features . . . **Album-size pictures** 1 $\frac{5}{8}$  x 2 $\frac{1}{4}$  inches—16 of them at a clip. And note particularly, that through modern photofinishing methods, the Kodak Duex leads to standard enlarged prints about 2 $\frac{3}{4}$  x 3 $\frac{3}{4}$  inches. **Spiral-threaded lens tube** provides compactness of a folding camera. See illustration above. **Doublet lens**—fixed focus, 73 mm.; carefully ground and polished. **Improved new-design shutter** operates with unusual smoothness, precision, uniformity.

See the Kodak Duex, and get the rest of the story, in a demonstration at your dealer's. You'll find this handsome little instrument a major star in the low-priced miniature field . . . Eastman Kodak Co., Rochester, N. Y.

### KODAK'S NEW COLOR SHOW—AGAIN THE HIT OF THE NEW YORK WORLD'S FAIR

 Millions of people have marveled at the beauty and drama of Kodachrome full-color pictures projected on a 187-foot screen, longest in the world . . . Also at the Kodak Building—expert advice on picture taking at the Fair. Don't forget your Kodak.

**ONLY EASTMAN MAKES THE KODAK**

# Dress Rehearsals for Danger Aloft

(Continued from page 219)

1178  
cided. The pilot's flight plan, made out before the flight, was checked to learn where he expected to be by now. The earlier position reports received from the plane were checked against the flight plan to confirm it. Changes in the wind since the last position report were used to help determine exactly where the plane had to be.

Fuel gallonage remaining in the plane was determined by computing consumption and time, to learn the plane's cruising radius that remained. The picture was completed by studying the map of the

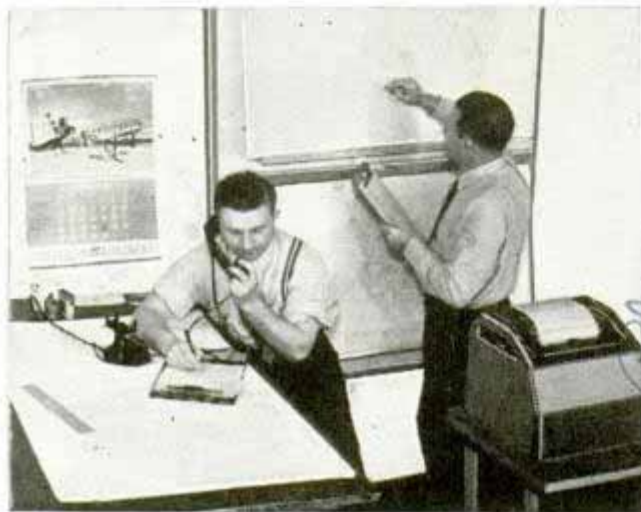

Air line weather room where reports are gathered and airway weather for next few hours is forecast

present weather. That showed the flight superintendent the route that would take the plane to clear weather, and this information was prepared so that it could be broadcast to the plane.

The campaign for perfect safety in the air has resulted in many improvements to airplane instruments. The latest to appear on the instrument board is the radio height indicator, a device that shows the plane's true altitude above the ground instead of measuring its height above sea level. A different adaptation of the same principle may be worked out to indicate the presence of mountains ahead or to one side of the plane.

Radio is the pilot's best friend and today it is being put to more and more uses. The radio direction finder has been trained to keep its needle pointed toward the ground station to which it is tuned, no matter in what direction the airplane is turned. The next step is to couple the direction finder, tuned to the airway radio-beam frequency,

to the automatic pilot so that the plane will steer itself along the airway as well as fly itself without help.

One of the latest projects in instrument flying is the suggestion that a television receiver coupled to a special photoelectric cell can be made to penetrate clouds and fog. The result would be that a pilot, flying blind, could watch the ground below and in front of him by glancing at the television screen. Progress has already been made in developing a photoelectric cell that is sensitive to infrared rays, which pass through fog easily.

The more efficiently an airplane is flown the safer it is. Fuel, passengers and cargo must be balanced scientifically to preserve the plane's normal center of gravity. Throttle settings and revolutions per minute must be regulated to the most efficient engine performance, considering load and altitude. Any of half a dozen factors, wrongly estimated, is apt to increase fuel consumption and thus reduce the time an airplane can remain aloft. In the past pilots and dispatchers have spent hours over calculations, but now mechanical brains do this thinking for them.

One instrument, called the Librascope balance computer, is a sort of electrical slide rule that shows the total weight of the airplane's load and its center of gravity after the dials marked "cargo," "passengers" and "fuel" have been turned to the proper settings. If the center of balance is wrong, fuel and cargo dials may be re-set for different loading arrangements until the right balance is achieved.

A power computer that works on the same principle tells the horsepower, fuel consumption and effective pressures for a given set of operating conditions. A flight computer solves fourteen problems concerning optimum engine settings after its dials are adjusted to the weight of the airplane, altitude, wind velocity, and other flight conditions. The inventor of these instruments, Lewis W. Imm, of Glendale, Calif., is perfecting two other computers, one to forecast local weather after meteorological reports are fed into it; the other will automatically predict speed, rate of climb, and other characteristics of a proposed design of airplane when the machine is supplied with engineering data.



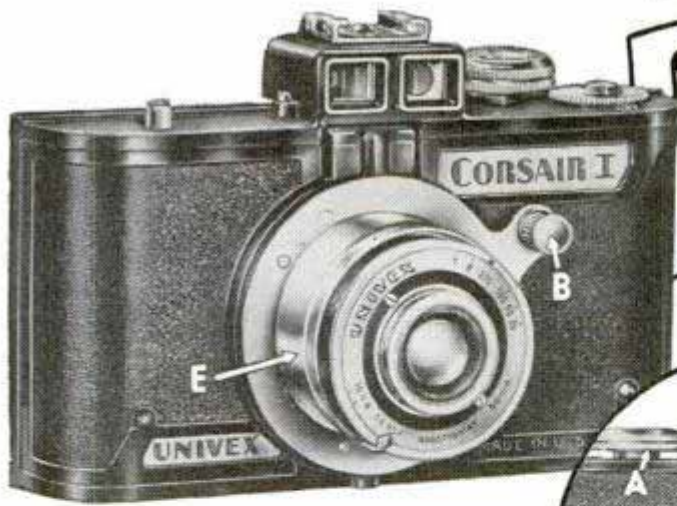

**NEW**  
**35mm. CORSAIR I Camera**  
*"Thinks For Itself!"*

*Only*  
**\$16.75**

with 50mm. UNIVAR f4.5 Lens

Here's the sensational new camera everybody's talking about. Its "mistake-proof" features eliminate wasted film—poor picture results. Uses economical double-frame 35mm. UniveX film, as well as any make bulk film. Accessory film cartridge for daylight-loading available.

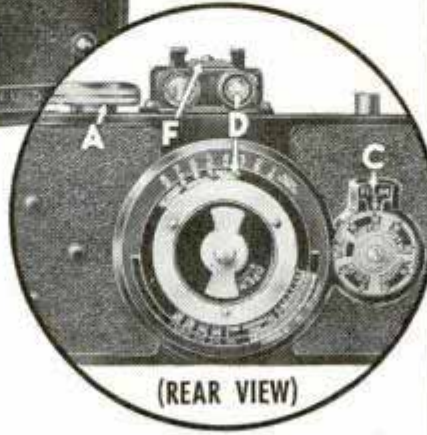

(REAR VIEW)

Check These "Mistake-Proof" Features!

- A. No More Double Exposures!**  
AUTOMATIC FILM TRANSPORT
- B. No Forgetting To Extend Lens!** RETRACTABLE LENS MOUNT LOCKS SHUTTER
- C. EXCLUSIVE "FILMINDER" Indicates Type Of Film And Number Of Exposures!**
- D. Correct Exposure—No Guessing!**  
BUILT-IN EXPOSURE METER
- E. Velvet-Smooth Focusing!**  
PRECISION FOCUSING MOUNT
- F. Bad Light Can't Stop You!**  
BUILT-IN FLASH SYNCHRONIZER

Six Shutter Settings—Time—Bulb—200th—100th—50th—25th • Five Diaphragm Openings—f4.5 to f16 • Picture Size Standard 35mm. Double Frame • 10 and 20 Exposures to the Roll.

**FREE!** Write for booklet describing New Corsair I. Dept. A-4, Universal Camera Corp., N. Y. C.

**UniveX CORSAIR I**

\$13.95  
 Full Set



**MICROMETERS**

Six piece set, in velvet lined leather case. Special price, only \$13.95. Precision machined in one thousandths, up to 4" outside and 3 3/4" inside measurements. Guaranteed accurate, easy to read and adjust. Satisfaction guaranteed or money back. This is your opportunity to get one at a Bargain Price if you act now. Shipped prepaid on receipt of remittance. On C.O.D. shipments, send deposit of \$2.00.

**FREE FOLDER**

**MICRO PRODUCTS, 529 E. Jefferson Ave., Detroit, Mich.**

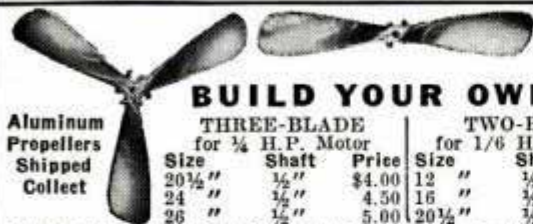

**SAVE MONEY**

**BUILD YOUR OWN FAN**

Aluminum Propellers Shipped Collect	THREE-BLADE for 3/4 H.P. Motor			TWO-BLADE for 1/6 H.P. Motor		
	Size	Shaft	Price	Size	Shaft	Price
20 1/2"	1/2"	\$4.00	12"	1/2"	\$2.25	
24"	1/2"	4.50	16"	1/2"	2.50	
26"	1/2"	5.00	20 1/2"	1/2"	3.00	

**MICHAEL ELECTRIC COMPANY, Dept. F., Fort Worth, Texas**

**DO YOU** WANT a new business profession of your own, with all the trade you can attend to? Then become a foot correctionist, and in a few weeks earn big income in service fees,—not medical nor chiropody—easy terms for home training, no further capital needed, no goods to buy, no agency. Established 1894. Address Stephenson Laboratory, 1 Back Bay, Boston, Mass.

**MEGOW MODEL**

World's largest manufacturer of Model Airplanes, Ships and Railroads. Send 5c postage for 100-page, profusely illustrated catalog.

- AIRPLANES
- SHIPS
- RAILROADS

**MEGOW** Dept. PM, Howard & Oxford Sts. Phila., Pa. or 217 N. Desplaines St., Chicago

**ACTUAL SIZE V-PLUG**



**MODEL BUILDERS—ATTENTION!**

Champion has designed 3 spark plugs for model gas engines which give the same dependable performance as the regular spark plugs. Sillmanite insulator. Alloy needlepoint electrodes for easy starting. One piece construction.

	V	V-2	V-3
Hex	1/2"	3/8"	5/16"
Thread	3/8"-24	1/4"-32	1/4"-32
Thread Length	7/32	7/32	5/32
Weight, Grams	8	3 1/2	2 1/2

**CHAMPION SPARK PLUG CO.**

900 Upton Ave. Toledo • Ohio



**ANYONE CAN DO THIS IF**

**THEY HAVE OUR CHART**

Blue Print 27" x 36" shows how to find length of any rafter, find any angle in degrees, frame any polygon 3 to 16 sides, read board foot and brace tables, octagon scale, rafter tables and many other uses. Can be scaled down for model work as well as full scale framing.

Send 35c in coin for one chart or \$1.00 for three—No stamps—Print name and address plainly.

**MASON and PARRISH**  
 Engineers

2105 N. Burdicks Street Kalamazoo, Michigan



# SAFE!

## NEW DISCOVERY

**For WORMING Your Puppy or Dog  
Without Danger of TOXIC POISONING!**

Thanks to the NEW Glover's *Imperial* Capsules, the danger of toxic poisoning and violent after-effects from worming your pet is at last removed. This was never before possible in a worm medicine! They not only safely expel Round Worms (Ascarids) and Hook Worms, but also Whip Worms—all THREE! Think of the ECONOMY—only 25¢!

FREE DOG BOOK—Write Glover's, Dept. 15, 460-4th Ave., New York.

ONLY  
**25¢** GLOVER'S  
*Imperial* CAPSULES

Ready Now **New TRAILER** PARTS **Catalog**

and TRAILER BUILDERS MANUAL—25 cents

80 Illustrated Pages packed with ideas and suggestions for Trailer Builders, Buyers, and Owners. Largest and most complete line of Trailer Parts, Supplies and Equipment at America's Lowest Prices. Rush 25c (in U. S.) for this book today. Satisfaction guaranteed! TRAILER SUPPLY CO., BOX 438-A, WAUSAU, WIS.



**STOP** SEND to Bass **LOOK!** -for this **DOUBLE 8 REVERSE**

Only **29<sup>50</sup>**

**Bass CAMERA CO. CHICAGO, ILL.**

Light weight — automatic film loop — 5 speeds — 5 ft. spring motor — speed control — 12.5 mm. Wollensak Universal focus F:3.5 lens — Turret model . . . \$69.00 — 500 Watt Reverse Projector . . . \$99.00 — write Dept. P. 179 W. MADISON ST.

### RE-STRING RACKETS AT HOME



● **EARN MONEY** ●  
**WITH THE WONDER VISE**

It's pleasant, profitable work. No experience or skill required. Easy to learn. Full line of guaranteed Stringing Tools, Frames, Gut and Silk Strings. Every item high quality.

**W. A. BICKEL & CO.**  
137 N. Marion, Dept. A-80, Oak Park, Ill.

## FREE Stove Catalog



### Factory Prices

New streamline designs! New features! 136 Styles and Sizes. Coal Wood Ranges; Combination Gas-Coal-Wood Ranges; Electric Ranges; Oil Ranges; Oil Heaters; Coal-Wood Heaters; Furnaces. 30 Days Trial, 24 hour shipments. 1,500,000 Satisfied Users. Stoves \$5 Down, up to 18 months to pay.

**"A Kalamazoo Direct to You"**  
KALAMAZOO STOVE & FURNACE CO., Mfrs.  
391 Rochester Avenue  
Kalamazoo Michigan

## Trappers of Lightning

(Continued from page 255)

records have been obtained from the lightning thus trapped."

The lightning hunters staked out one trap on a fifty-foot steel mast on top of the 535-foot Cathedral of Learning in Pittsburgh, then patiently awaited their prey. They didn't wait long. In mid-July a terrific bolt of lightning scored a direct hit and was "caught" in the trap. Lasting approximately one-sixtieth of a second and with a maximum crest of 21,000 amperes, the bolt was conducted through a new auto-valve lightning arrester no larger than a quart fruit jar. At its peak, the flow of power was equivalent to the current drawn by some 40,000 light bulbs.

The lightning trappers were elated. Not only had they discovered a method of inspecting natural lightning at close quarters but they had also developed an arrester which would permit them to do so safely and which could safeguard power lines and other objects exposed to lightning. Throughout the country other lightning traps added to scientific knowledge.

Investigators have discovered that the average natural lightning stroke consists of a core about the size of a man's finger which, upon the completion of the initial discharge to the ground from the cloud, explodes in a column of sponge-like fire about four inches in diameter. This explosion causes thunder. They learned that lightning consists of two essentially distinct parts. First, a leader stroke traveling under tremendous voltages, often as high as 20,000,000. This leader stroke breaks down the air insulation between cloud and earth and establishes a lightning path.

When the leader stroke hits the ground it causes a heavy surge of high current to flash through the path, thus producing the lightning channel. The leader travels about 1/1,000 as fast as light, but the current discharge races along the path at about one-fifth the speed of light or more than 37,000 miles a second. The lightning surges, which are the electric charges introduced into a power line by a stroke, are equivalent to electric bullets which rip through anything in their path.

The scientists now conclude that the first rush of heavy current through the channel of a natural lightning stroke might be

compared with the heavy stream of water that spurts from a sponge as it is squeezed quickly. But just as a continued squeezing of the sponge produces a small but steadier stream of water, so a steady seepage of charges from the cloud into the main lightning channel sets up a lower current but longer-duration discharge which carries fiery destruction.

In a laboratory at the Westinghouse transformer works in Sharon, Pa., the lightning investigators built a three-story stairway of thirty-six banks of condensers, each charged with 100,000 volts of direct current with a combined output of 3,600,000 volts, comparable to the high applied voltage rise of a lightning stroke after it has struck a power line or a tree.

Another shorter stairway was built to carry eight banks of eight condensers, each condenser representing so many cubic feet of a thunder cloud, and acting together to produce 150,000 amperes of current for a period as great as 200 millionths of a second.

Key to this apparatus is a tiny microsecond switch invented by Mr. Bellaschi. It can act in a millionth of a second and it stands just so much electrical pressure or voltage; when the pressure reaches a critical point, the plug melts, setting free the high current. It synchronizes the two stairways of power and releases their combined output of pressure and current in proper sequence as a genuine reproduction of real lightning, duplicating every one of its physical effects from the crash of thunder to the shattering of poles and steel-covered electrical apparatus.

Today it is no longer necessary to install a lightning arrester or distribution transformer, for example, and "hope" it will stand up if struck by lightning. Instead, as each piece of equipment is completed, Westinghouse engineers take it into the laboratory and bombard it with a bolt of lightning so like nature's that if it emerges unscathed, the possibilities are ninety-nine to one that it will protect life and property when exposed to actual thunderstorms.

☐ If you will send stamped, self-addressed envelope to our Bureau of Information, you will be given the name and address of the manufacturer of or dealer in any article described in this magazine.

# Fluid-Driving

**...TOMORROW'S NECESSITY  
...TODAY'S BIGGEST THRILL!**



TOUCH the throttle to go...touch the brake to stop!  
That's *Fluid-Driving*...today's biggest motoring thrill...tomorrow's necessity.

For people will never go back to shifting gears...once they've tried *Fluid-Driving*.

See your Chrysler dealer and enjoy motoring's biggest thrill.

## WHY SHIFT GEARS?

### AS SIMPLE AS THIS

Air from the running fan will set the idle fan in motion, as a breeze turns a windmill. That's the principle of *Fluid Drive*.

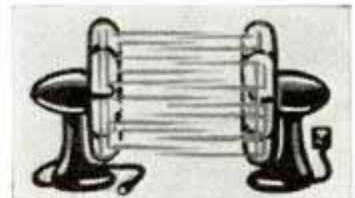

### ONLY TWO MOVING PARTS

One fan-like wheel drives the other by directing a current of oil against it, fast or slow as governed by engine speed.



### MIRACLE HAPPENS HERE

Driving wheel fastened to engine, driven wheel to transmission system. Power transmitted through oil cushion.

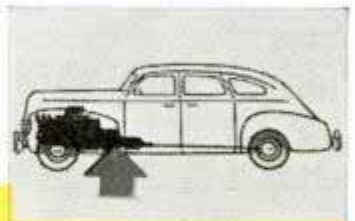

*Be Modern*

**BUY CHRYSLER!**

★Tune in Major Bowes, CBS, Thurs., 9 to 10 P. M., E. D. S. T.

Can You Equal This Home for **875**

Shipped Direct from Our Mill

Save 30% to 40% on Your New Home..

WE PAY FREIGHT



Don't pay several hundred dollars more than necessary when you build a home! Buy it direct from our mill at our low factory price. We ship you the materials—lumber cut-to-fit, ready to erect. Paint, glass, hardware, nails, etc., all included in the price—no extra charges. We pay the freight. Plans furnished—also complete building instructions. No wonder our customers write us that we saved them 30% to 40%, compared with builders' prices. Easy terms—monthly payments.

Send for FREE BOOK of Liberty Homes

Handsome Big CATALOGUE **FREE**

Pictures wonderful homes in colors at money-saving prices. Designs to suit everyone. Write for your catalogue today. LEWIS MANUFACTURING CO. Dept. 1208 Bay City, Michigan



only 10c

**Woodworkers:** Here it is!

Harold Hunt's 1940 catalog! Latest, UP-TO-DATE IDEAS for experts and amateurs; SPECIAL BARGAINS in rare woods, machines, and all kinds of supplies. Get posted! Send only 10c to CRAFTSMAN'S WOOD SERVICE CO. 2729 S. Mary Street Div. 337C CHICAGO



**PUSH BUTTON CONTROLLED GAS TANK LOCK**

ELECTRIC—OPERATES FROM DASH. Sold as standard accessory on the NEW GRAHAM Car. Streamline in design, low in price, year guarantee. Distributors, dealers here is the fastest selling thing out. Write now for free literature. SNAP-UP GAS CAP CO. DEPT. 6 ASHLAND, KY.

**BURN YOUR NAME ON TOOLS WITH THE ARKOGRAF**

PROTECT YOUR TOOLS FROM THEFT Write with electricity any name or design on the hardest and finest tools and instruments, or any metal, like writing on paper with pen or pencil. Complete Outfit \$3.50—Fragile Anywhere. Interesting illustrated circular free. Write today. Agents wanted. ARKOGRAF PEN CO., 3927 S.E. Stark St., Portland, Ore.

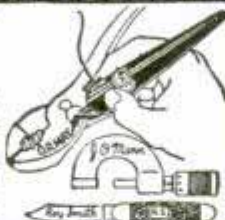

**BRUSH PLATING OUTFITS**

for autoparts, reflectors, faucets, bicycles. No tanks necessary. Free particulars.

GUNMETAL CO., AVE. M., DECATUR, ILLINOIS

**STOP the ITCH** of Insect Bites—Heat Rash

For quick relief from itching of insect bites, heat rash, athlete's foot, hives, eczema and other externally caused skin troubles, use world-famous, cooling, antiseptic, liquid D.D.D. Prescription. Greaseless, stainless. Soothes irritation and quickly stops the most intense itching. 35c trial bottle proves it, or money back. Ask your druggist today for **D. D. D. PRESCRIPTION.**

## Seeking Power for Space Rockets

(Continued from page 213)

climbing speed of 700 miles per hour, far greater than the fastest airplane. Since that time, Goddard has continued his experiments in perfecting rocket design. Recently he incorporated a gyroscope to stabilize his rockets during flight.

However, the old problem of a sufficiently powerful fuel and a sufficiently durable firing chamber still remained. Certain experiments seem to favor the use of powder explosives, but in general, liquid fuels seem to offer the best prospects. A combination of liquid oxygen and gasoline has proved very efficient.

Rockets powered by such fuels have been used by the American and German rocket societies. A British society has made speculative plans for space travel should the day ever arrive when fuel and construction problems are licked. This society has designed space suits, and has even made tentative arrangements to secure human beings who would be willing to take the terrific gamble should the conquest of space ever be technically possible.

These problems of fuel and combustion chamber the California Tech. scientists have set out to study—and they have made such advancement that they talk of a sounding rocket which might reach a height of half a million feet.

The first problem faced was to design a highly accurate testing machine. Such a device must be able to register thrust, temperature, pressure of gases, amount of fuel used, and the efficiency of the combustion.

For experimental purposes gaseous combustibles are used instead of liquid. The propellant now being experimented with is a mixture of ethylene and oxygen. These gases are kept under pressures of 1,200 and 2,000 pounds to the square inch. Operators control the flow of gas by means of valves. The gauges which record the performance of the rocket motor are photographed to give a permanent record.

The rocket motor is a single steel cylinder about eighteen inches long and six in diameter. It is lined with carbon to guard against the terrific heat when the motor is operated. A temperature of 5,000 degrees Fahrenheit is sometimes reached—almost half that of the sun's corona.

Rocket motor, tanks of ethylene and

oxygen, and connecting tubes are mounted on a torsion balance so delicate that it will register forces of only one-tenth of an ounce. When the motor is fired, motor, lines, and braces move as a single unit. The thrust is then registered by a dial on the control panel.

Because of the terrifically explosive character of all fuels used, the control panel and operator are protected from the firing chamber by sandbags. Once a nozzle blew out during a test, and the resulting roar was heard for blocks.

Nozzles for the rocket motor are made from such substances as pure carbon, stainless steel, and copper alloys. Experiments have shown that few substances will stand the extreme heat and pressure of the exhaust gases. Velocities of 6,000 feet per second, or better than 3,600 miles per hour, have been recorded. Often after one minute in the firing chamber, a nozzle, which a moment before was a beautifully machined piece of metal, will be charred, distorted, and blacked, looking as if it had been subjected to the eternal fires.

Rocket scientists have calculated that a velocity of seven miles per second, or approximately 25,000 miles per hour, would be necessary for a rocket to escape the earth's gravity. They further believe that 6,000 tons of fuel would be necessary to carry ten tons of pay load. The California men do not speculate on space travel. However, they do say that their experiments indicate that with a "step" rocket (one having three motors, two of which would be released during flight), a velocity of 11,000 feet per second might be reached. This would carry the rocket to a height of 500,000 feet, five times the record height for a sounding balloon. Physical information gathered by such a rocket would be of incalculable value.

Meanwhile, the motor behind the sandbags hisses and thrusts and the needles on the dials continue to write their record of vital facts. And another significant step is being taken in man's struggle to conquer space.

☐ If you will send stamped, self-addressed envelope to our Bureau of Information, you will be given the name and address of the manufacturer of or dealer in any article described in this magazine.



It's a well-known fact that Sani-Flush is found in most bathrooms for cleaning toilet bowls. More and more car owners are saving money, saving power, saving repair bills by cleaning out radiators regularly with this same Sani-Flush. It's harmless. Cannot injure motor or fittings. It cleans out rust, sludge and scale. It costs 10c (25c for the largest truck or tractor).

Do the job yourself (*directions on the can*), or ask your service station to do it for you. Insist on Sani-Flush. Sold by grocery, drug, hardware, and 5-and-10c stores. 10c and 25c sizes. The Hygienic Products Co., Canton, Ohio.

## Sani-Flush Safe NOT CAUSTIC

CLEANS OUT RADIATORS

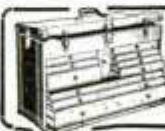

### GERSTNER Tool Chests

Always please particular men. Free catalog for machinists and toolmakers.

GERSTNER TOOL CHESTS  
440 Columbia St. Dayton, Ohio



Do more  
Earn more  
Work less  
with a

### Red Universal Tractor

You plow, disc, cultivate, mow, haul, do belt work, for about 33c a day. Safe, trouble-free long life. New plow lift, new reverse. Hundreds used. Save by buying from maker. Two weeks trial. FREE catalog. Write today.

PIONEER MFG. COMPANY  
Dept. V-80 West Allis, Wis.

# Miracle Men of the Corn Belt

(Continued from page 229)

snapped them off. Thus, the tassels remaining could shed their pollen on the silks of the ears in the other two rows. The summer proved a scorcher. The sun began to fire the stalks in the regular fields and not long afterwards the plants in the test patch began to droop. Pfister would not baby them; he was striving to develop a breed of corn that could "take it," no matter what the weather.

His regular corn at harvest time was little more than withered husks but the hybrid stalks were straight as fence posts with ears filled with deep, even rows of yellow kernels. He had made a good start, but still wasn't satisfied. He decided to secure some of the government's pure inbreds to cross with his own. That meant more years of testing—and sacrifice. He wasn't a research worker of a richly endowed foundation; he was just a seed grower of limited means, staking everything on an idea. He was hard pressed for money and his farm was beginning to look run-over-at-the-heels. He knew he was taking a long chance but he didn't weaken on his experimental program. For a time, success was elusive. Then one spring he produced the finest crop of corn ever seen in his county. His troubles were at an end and at present he directs a million-dollar hybrid seed organization.

Several kinds of hybrids are possible, depending on the number of inbred lines involved. The simplest is the crossing of two inbred lines, but most commercial hybrids are double crosses, produced by crossing two single crosses. Commercial seed production is effected by planting alternate blocks of two parents or inbreds in a field isolated from other corn and removing tassels from all of one kind by special machinery before the pollen has been shed. The seed picked from these detasseled rows is hybrid seed.

James R. Holbert, who has bred and produced more commercial hybrid strains than any other man, says nature doesn't like to be regimented, and without constant attention, undesirable variations and mutations, as well as the occasional out-cross, which are more or less "freaks," can soon multiply to quantities that greatly reduce their value for hybrid combinations. The foundation seed lines are hand-

pollinated and selected each year in order to maintain their purity.

To improve the inbred strains, corn scientists have gone to Mexico and South America for new breeding materials. Although these foreign corns do not measure up to ours they do have greater vigor and disease resistance. Transferring of desirable qualities from one inbred line to another was a problem until it was found this could be done by taking a hybrid, backcrossing once or twice to the desired parent, then inbreeding for six to eight years.

To speed up research, the DeKalb Agricultural Association and Funk, two of the larger hybrid seed groups, carry on breeding work in Florida in the winter months as well as in the Corn Belt during the regular growing season. Likewise, Pioneer company since 1934 has had as its winter base the growing fields of Argentina.

Inasmuch as ninety per cent of our annual crop of three billion bushels of corn is used for feed on the farms where it's grown, the work being done to develop a hybrid for this use is significant. No corn has a complete protein content, so supplementary proteins such as tankage, cotton seed, or linseed meal are also fed to livestock to obtain a balanced ration. By breeding, the seed men believe they will be able to control the composition of the corn, even breed more protein or oil into it to give a higher feeding value.

The rise of hybrid corn—23,000,000 acres were planted last year—has spurred experiments in planting and cultivating methods, the most important being the drilling of twenty-inch rows, the hills only eighteen inches apart with a single kernel of corn planted four inches deep in each hill. This system, a departure from the ordinary check-row method, wherein the hills are thirty-six inches apart in each direction, was tested last year by Pfister and a farm-machinery company, and is said to permit planting more kernels per acre, and gives each stalk more room to produce perfect ears. There is no standard row cultivation, as commonly practiced. The early and frequent use of wide tools in the seed-bed preparation, Pfister explains, insures freedom from weeds and makes their control easier in later weeks.

(Continued to page 122A)

# The new triumph in the fine-camera field!

Agfa Speedex . . . \$27.50

Takes 12 pictures 2¼ x 2¼

**P**RODUCING the Agfa Speedex for only \$27.50 is a new triumph for American manufacturing ingenuity and skill.

For in this modern example of compact camera efficiency, you get all these fine-camera features:

1. An f 4.5 anastigmat lens, fully corrected.
2. A precision shutter, with speeds of ½ to 1/250 seconds, Time and Bulb.
3. Focusing ability, 3½ feet to infinity, with focusing ring in lens mount.
4. Clear, optical, eye-level view finder.
5. Pre-set shutter, with convenient button release built into camera body.

In addition, the Speedex has a new type of self-erecting platform. A finger-touch brings the lens and shutter assembly into rigid, picture-taking position with smooth precision.



At this price, there's no further need to wait for the fine camera your increased ability demands. See the Speedex—and other Agfa Cameras from \$2.10—at your dealer's today. **Agfa Ansco, Binghamton, New York. Made in U. S. A.**

**AGFA**  **CAMERAS**

**NOW ONLY** **REAL ENGINE VALUE**

**4.95**

Over 7,000 GHQ Gas Engine Kits were sold at \$8.50. Over 15,000 sold last year. Now is your chance to buy the *New Improved* kit for \$4.95. Absolutely complete with coil, plug, etc. Only a screwdriver needed. For boats, planes, midget cars, etc. All parts guaranteed. Send only \$1.—Shipped Express Collect for balance same day. Send 6c for new 20-page illus. catalog.

**DEALERS WANTED. FACTORY ASSEMBLED—READY TO RUN \$6.95**

**GHQ MOTORS, 40B East 21 St., New York, N. Y.**

**PISTON TYPE COMPRESSOR**

**EASY PROFITS IN PAINT SPRAYING**

Paint walls, ceilings, screens, furniture, radiators, machinery faster, better! ¼ H. P. motor 110 Volt 60 Cycle AC, complete with Spray Gun, 15 ft. hose. Weighs only 4 ½ lbs. Carry anywhere. **FULLY GUARANTEED.** Complete with motor only \$31.15, or only \$25.00 less motor. f. o. b. Chicago. \$5 Deposit, Balance COD, or SEE YOUR DEALER. Circular FREE. Get started making money NOW! **\$25.00** Less Motor

**Ideal Automatic Pump Co.**

Dept. PM-8, 801 Washington Blvd., Chicago, Illinois

**"MARVEL-OUS" TRAILER PARTS**

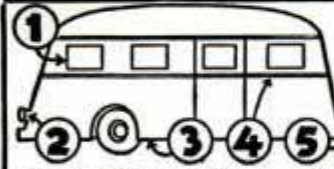

(1) "Famous" Marvel Windows, (2) tail lights, (3) complete undercarriage equipment, (4) body moldings, (5) couplers. Also refrigerators, stoves, lighting fixtures, everything you need in highest quality. Largest trailer equipment stock in U. S. Immediate delivery, low prices. Send 10c coin for 40-page ill. catalog.

**Marvel Trailer Parts Co., 19020 Celestine Ave., Detroit, Mich.**

**OTTAWA LOG SAW \$39** **BIG BOOK FREE**



**PUTS THIS OTTAWA** to work for you. **MAKE MONEY!** Wood is valuable. Does more than 10 men. Easily operated. Falls trees—saws limbs. Use 5-hp. engine for other work. Write for **FREE Book.**

**OTTAWA MFG. CO.**  
3427 Wood St., Ottawa, Kans.

SAW 10 TO 20 CORDS A DAY

**TEST-O-LITE**

**Tests Everything Electrical From 100 to 550 Volts**

**APPLIANCES**  
**MOTORS**  
**FUSES**

A real necessity for electricians and home because it has 1001 uses. Equipped with a Neon light which tells instantly where trouble lies in electric circuits, fuses, cut-outs, motors, radios, all kinds of electric appliances, etc. Tells A. C. from D. C. Far superior to ordinary clumsy test bulb. Fountain pen size with clip for carrying in vest pocket. Lifetime guarantee.

**PATENTED**

**L. S. BRACH MFG. CORP.**  
55 Dickerson St., Newark, N. J.

\$1.50 At Electrical Stores or Post-paid

**Big Money for Workers In Home or Shop**

**MONEY-MAKING PROJECTS.** Color-glazed concrete pottery, garden novelties, statuary, giftware, cemetery products, gravestones, tiles, walls, floors, etc. Basement waterproofing. New, patented method makes concrete pottery without molds, cores or costly tools. Use only sand, cement, cheap materials. No experience needed. Get the facts about these new money-making projects NOW. Send 3c stamp TODAY for booklet, colorplate, details.



**NATIONAL POTTERIES COMPANY**  
Dept. 6, 13 W. 26th St. Minneapolis, Minn.

K 2 2 2

(Continued from page 120A)

The ground is plowed once in the fall and "worked" twice before planting with a heavy twenty-four-foot rotary hoe. After planting, the field is dragged four times with a twenty-seven-foot cultivator, a "finger weeder." This covers as many as fifteen acres per hour.

Although results of the test will be withheld until a three-year test is completed, it's believed this system will show an additional increase of fifteen per cent over conventionally grown hybrids. If this is true, the corn grower will be within hailing distance of the agricultural millennium—200 bushels to an acre.

K 2 7 4

### Get into the Swim

(Continued from page 203)

arm stroke. The head is turned to the natural breathing side and as the arm on that side is recovered—brought from the rear and forward—the air is inhaled to a one-two count. Return the face to exhaling position before the arm enters the water and exhale for the counts of one-two-three-four while the arm is being pulled down and back, completing the pull as you complete the exhalation. The right arm pull, of course, began just as the air was taken in and was completed as you began to exhale.

The best way to time a six-beat kick with the arms in the crawl is to time the breathing with the kick; thus, the breath is taken in on the right as the right foot goes down, and the left goes up on the first kick, on the count of one. When the right foot comes up, completing the second kick, return your face to exhaling position. Begin exhaling as soon as the face is returned to the water. At that point the right foot is down on the completion of the third kick. Continue exhaling as you make the fourth and fifth kicks and complete the respiration on the sixth kick. This will take lots of practice, but when you become proficient in the timing you'll have mastered the six-beat American Crawl.

Ralph Flanagan, whom I began developing when he was only seven years old, has effectively employed the crawl to become one of the greatest middle-distance swimmers in history. At twenty-one years of age he held more American swimming rec-

(Continued to page 124A)

**GET NEXT TO THIS NEW**  
*Atlas* **LATHE**



**POWER CROSS FEED** Now Standard Equipment

**FREE CATALOG**

It's the sweetest running lathe you've ever seen. Includes all modern features for precision work. 10" swing, \$99.75 and up complete less motor on easy terms through your dealer. Send for new 72 pg. catalog showing other Atlas backgeared, screw-cutting lathes from \$61.50 up.

See Atlas at Hall of Inventions, N. Y. World's Fair

**ATLAS PRESS CO.**  
843 N. Pitcher St.  
Kalamazoo, Mich.

**LATHES · DRILL PRESSES**  
**ARBOR PRESSES · SHAPERS**

**POWELL**  
**"SETS THE PACE"**

100 miles per gal. 35 miles per hour. 2 1/2 H.P. 4-cycle engine. Centri-matic clutch. Hill-climber transmission. Foot brake, foot throttle. Welded alloy steel, shock-absorbing frame. Easy riding, dependable, durable, beautiful. Many Powell Streamliners ridden over 40,000 miles a year. Write for free folder. Powell Mfg. Co., Los Angeles, Cal., Dept. PM-5



**STOP BACKTRACKING**

Don't let confused directions put you on the wrong road. Drive by compass and avoid backtracking. The Hull Streamline Auto Compass is a positive guide at all times. Attractive Bakelite case, genuine sapphire bearing, built-in compensator. Only \$2.95 at your dealer.

Write for information.  
**HULL MFG. CO., P. O. Box 246-D8, WARREN, OHIO**



**TENNIS**  
**SAVE ON OUR NEW LOW PRICES**

Earn money—save money re-stringing rackets! Buy Gut tennis strings direct from factory. Silk strings; Restringer's vice, equipment, instructions. Catalog FREE H. E. WILLS CO., 1047 W. 47th ST., DEPT. PM-80, CHICAGO



**EARN SPARE-TIME MONEY**  
**with Light Power Tools**

Learn how you can build up a profitable spare or full-time business in your own home. This new book "How to Make Money in Woodworking" is crammed with practical tested ideas, plans, and suggestions. Tells you exactly what to make, how to make it and how to sell it. Describes plans that have worked for others. Woodworking, the new way, is light, pleasant, and profitable. Send only 10c and complete book will be mailed postpaid. Satisfaction guaranteed or money refunded. Write to

**DELTA MFG. CO. (Dept. A 840)**  
600-634 E. Vienna Ave., Milwaukee, Wis.





# Popular Mechanics Announces A LITTLE LIBRARY of Useful Information



A Few Sample Pages

These booklets have been carefully designed to fill a long felt demand for instructions for making things and doing the everyday jobs around the home.

**PHOTO ENLARGERS**—Easy-to-follow instructions show you how to make four different enlargers.

**OUTBOARD RUNABOUT**—fast, V-bottom boat, 14 feet long.

**ELECTROPLATING**—Expert tells secrets of plating.

**POWER TOOLS**—Build your own power tools; every detail clearly explained.

**WELDERS**—How to build an arc welder which operates on 110-volt, 50 or 60 cycle alternating current.

**CONCRETE GARDEN FURNITURE**—Benches, pottery without molds, flower boxes, bird baths.

**BIRD HOUSES**—Easy to build homes for all kinds of birds.

**FARM AND GARDEN TRACTORS**—Two tractors you can build from old automobile parts.

**TAXIDERMY**—It's fun to mount your own birds, fish and small animals.

**AUTOMOBILE KINKS**—Save \$100 a year on your automobile.

**CLEANING FORMULAS**—How you can make your own cleaning preparations.

**COSMETIC FORMULAS**—Make your own hand lotions, cold creams, etc.

**TREASURE FINDERS**—Build your own treasure finder and metal locator.

**LOG CABINS AND TOURIST COTTAGES**—Two types of year-round cabins of logs.

**FOOD PRODUCTS FORMULAS**—100 formulas for making everyday necessities.

**GARDEN WOODWORK AND FURNITURE**—Gives full details for outdoor living room.

**SOLDERING AND BRAZING**—Tells how to use new fluxes and solders.

**MIRACLE PLANTS**—How you can mix your own vitamin B1 solution.

**HOME WORK OPPORTUNITIES**—Simple handicraft projects anyone can do to earn money.

**TELESCOPES**—Complete details on a reflecting telescope you can build for less than \$10.

**METAL PLATING AND COLORING**—This gives dozens of essential formulas for metal plating, coloring, etc.

**FAST ICE YACHT**—Build your own Class-E ice yacht.

**EXTRA ATTIC ROOMS**—Add to the value of your home by building an extra room in your attic.

**BASEMENT PLAYROOMS**—Build an attractive playroom in your basement.

**PHOTO PRINTER AND DRYER**—Now you can build your own printer easily.

**SAILING DINGHY**—This 14-foot boat carries 140 sq. ft. of canvas.

**TRAILERS**—Midget house and utility type trailers.

**METAL CRAFT**—Simple instructions are given for brass tapping and the making of many novelties.

**MAGIC FOR EVERYBODY**—Simple tricks to puzzle your friends.

**CANOEING**—You can easily build 16-foot Canadian type canoe.

**LOWER FUEL COST**—How to save money heating your home.

Only 25c Each, or 5 for \$1

**POPULAR MECHANICS PRESS**  
200 E. Ontario St. Dept. 840 Chicago

# OPPORTUNITY

## Surfacing Business



• Make new or old buildings more attractive outside or inside with waterproofed plastic Colorcrete. It fuses with any masonry surface—can be sprayed in any thickness and in 30 colors. Proven by over 13 years use in all climatic conditions.

Big earnings. Operators report costs of 2c and up per sq. ft. and sell up to 7c. Some have paid for their equipment from first few jobs. Machine capacity up to 1000 sq. ft. per hour.

Get the facts. Send for book "Proven Business Opportunity". Write today.

**COLORCRETE INDUSTRIES, INC.**  
570 Ottawa Ave., Holland, Mich.

## Print Your Own

Cards, Stationery, Advertising, labels, paper, circulars, photo and movie titles, tags, etc. Save money. Sold direct from factory only. **Junior outfit \$8.25**, Senior outfits \$16.55 up. Do popular raised printing like engraving with any press. **Print for Others, Big Profits** Pays for itself in a short time. Easy rules sent. Write for free catalog of outfits and all details. Kelsey, Inc., L-37, Meriden, Connecticut

**EXCELSIOR**

## build this COAST GUARD CUTTER

Complete Kit \$2.50 Post Paid

Makes perfect building easy

**CARVED HULL Included!**

24" Super Detail Model

Catalog—10c

**IDEAL AEROPLANE & SUPPLY CO., Inc., 26 W. 19th St., New York**

## New ELECTRIC SANDER... Many Uses

Portable GuildSander sands the roughest surface and leaves it smooth and clean. Saves time, energy and money. Useful wherever sanding, planing and finishing is done. Removes paint and rust. Works on many different materials. Runs on either AC or DC. Popular price. See your hardware dealer or write direct for FREE folder on many uses.

**SYRACUSE GUILD TOOL COMPANY**  
1740-8C N. Salina St., Syracuse, N. Y.

**Saves TIME and TOIL**

## ELECTRIC EYE ANNUNCIATOR AND BURGLAR ALARM

**STORES, Homes, Taverns, Shops, Garages—scores of others—waiting for the RAY-ALARM Burglar Alarm and Annunciator. Real protection—guards invisible beam of "Black Light," when interrupted, sounds continuous alarm. Plugs in any light socket. Unfailing demonstration takes 10 seconds—makes sales on the spot.**

**SEND NAME** Huge profits. Write AT ONCE for particulars of Distributor Plan or Agent proposition. No money. Just send name.

**RAY-ALARM, 225 Fifth St., Dept. R-168, Des Moines, Iowa**

K 374

(Continued from page 122A)

ords than any one else, in addition to a number of world records. He is regarded as one of the greatest stylists of all time.

Adolph "Sonny" Kiefer, undoubtedly the greatest backstroke swimmer ever developed, also is an example of what perfect shoulder balance can do for the water athlete. His right arm, starting a stroke, and his left arm, recovering, work like a double-bladed paddle with a windmill action, resulting in tremendous power that gives him such flashing speed. Another of Kiefer's secrets is a whiplash motion of the foot—much like the snapping of a whip—that is a big factor in his drive through the water. Whereas most swimmers depend on their arms to get speed, Kiefer depends on perfect coordination of his shoulders and a follow-through of his windmilling arms.

The latest development in aquatic sports is the butterfly breast stroke, which is still in a state of experiment. In the conventional breast stroke the hands, which must work in unison, are pulled only half way back, which cuts the power of the stroke almost in half. In the butterfly the hands are pulled downward and all the way back, very similar to the crawl except that the hands are working together. On the recovery both arms come up out of the water and forward together, again in the manner of the crawl. The kick is not much different from that employed in the conventional breast stroke, both legs working together with a froglike motion, being drawn up at either side with the knees bent and then thrust backward in a powerful kick. Immediately after the kick the arm pull begins, without pausing for a glide.

The butterfly already has been found much faster than the old breast stroke, some of its exponents being able to swim 100 yards in not much more than a minute—fast time for a crawl a few years ago.

Training for swimming should be gradual to keep the muscles from tightening up. If you try to rush the process, you'll find you're sluggish in the water—the result of uncoordinated stroking. Because swimming requires long, smooth and pliable muscles, you should avoid exercises that tend to develop hard and tense muscles.

Swimming is ninety-five per cent confidence, five per cent effort. Getting confidence is largely up to the individual; the coach can teach the mechanics.

**THIS GRINDER DOES MANY JOBS EASIER FASTER-BETTER**



**DURO** Easier because it is streamlined to fit the hand and balanced for vibration-free performance which reduces "hand fatigue" to a minimum.  
Faster and better because 42 watts output and 24,000 R.P.M. insures surplus power and speed for smooth cutting on all operations.  
To become acquainted with a most interesting hobby, write for circular describing the full line of Duro Grinders and Model Making Accessories.

**DURO METAL PRODUCTS CO.**  
Dept. PM8, 2653 N. Kildare Ave., Chicago, Ill.

**60 POWER TELESCOPE . . . \$219**  
VARIABLE EYEPIECE 20X—40X—60X  
**NEW!** Three telescopes in one. 3 different magnifications. 20 power for ultra-bright images with 40 and 60 power for extra long range. Guaranteed to bring distant objects, people, sports events, ships, moon, stars, etc., 60 times as close.



Most powerful made for anywhere near the money. Closes to less than a foot in length. Multiple lens system. 30 mm. objective lens. 5 sections. Directions included for using as a compound 4 lens microscope. American made. Prompt shipment guaranteed. We pay the postage. Only \$2.19.

**BROWSCOPE CO., Dept. 48, 5 W. 27th St., New York, N. Y.**

**ONAN ELECTRIC PLANTS**  
ALTERNATING AND DIRECT CURRENT



Produce Current, same as City Power Lines, for FARMS, SCHOOLS, THEATRES, PUBLIC BUILDINGS . . . Operate Lights, Radios, Motors, All Appliances.

Over 40 STOCK MODELS—350 to 50,000 Watts. Any Voltage—Any Frequency. Combination A. C. - D. C. Types. Manual, Full Automatic and Self-Starting. \$99 up. Shipped—COMPLETE, READY FOR OPERATION. THOUSANDS IN USE IN ALL PARTS OF THE WORLD. Write for Complete Details.

**D. W. ONAN & SONS**  
1048 Royalston Avenue - MINNEAPOLIS, MINN.

**\*Home Craftsmen Like EMPIRE LEVELS!**

**NEW "CIGAR SHAPED" ALUMINUM "TORPEDO" LEVEL.** Won't tear pocket. Serves many uses for workmen or in homes. 9" long. Shows plumb, level, 45°, 30°, 15° pitch. Grooved bottom. Only \$1.40.

**POCKET LEVEL—FOUNTAIN PEN SIZE.** Beautiful Chrome Aluminum. Clips to vest pocket. Always handy. Accurate. Level vial has pitch graduations. Great value, Only 75c.

**EMPIRE LEVEL MFG. CO., Dept. P-9**  
717 So. Sixth St. Milwaukee, Wis.

★Order direct, or from local Dealer. Send 1c for catalog. Good Craftsmen Everywhere Use EMPIRE "Extreme Accuracy" Levels.



**BE THRIFTY . . . use ROGERS GLUE**  
for woodworking and household repairs . . . incredibly strong. Send for FREE blueprint plans for making useful articles.

**ROGERS • Dept. A-1 • Gloucester, Mass.**

**MAKE BIG MONEY at HOME!**  
NEW INVENTION  
*Electroplates by Brush*



New, patented invention makes possible big earnings AT HOME. Replate auto-parts—worn articles in homes, stores, hotels, restaurants, etc., with durable, sparkling, new coat of metal—with stroke of brush. Easy, simple, quick. Genuine Gold, Silver, Nickel, Cadmium, etc. Everything furnished. Outfit complete, ready for use. No shop required. Clear from \$2 to \$5 an hour in lifetime business. Small investment starts you in business. Steady repeat. Machine can pay for itself in week. Send TODAY for FREE SAMPLE and illustrated BOOKLET how you can have a life income from a business of YOUR OWN built upon satisfied customers. Act at once!

**WARNER ELECTRIC COMPANY**  
360 N. Michigan Ave., Chicago, Ill., Dept. 5-D

**FREE SAMPLE and BOOKLET EXPLAINS ALL**

## Why Not Try the Easy Way?

(Continued from page 197)

portance of keeping the forms in balance."

Watch how a major league pitcher throws with his back as well as his arms, how the golfer gets his back into his tee shots. Rosenbauer suggests we follow their example when lifting, carrying, or pulling. The secret of putting the power of the entire body into any action is primarily a matter of poise and balance. The feet are the bases of operation from which most actions begin. The body weight is distributed between the heel and the ball of the foot. The arch is an unequal one, the heel being almost underneath the ankle tends to stay where it is put. The tendency of the long front of the arch to slip is arrested by the toes, particularly the big one. Only as the weight of the body is forward does it get the benefit of the springy arch.

"The power required to drive a golf ball 300 yards down the fairway," states the sculptor, "actually operates between the ball and that part of the earth occupied by the golfer's feet. There must be an even and direct flow of energy from the ground through the completed action. You can't get your back into action unless it's evenly geared, so to speak, to both the hands and feet. If the body is off balance, violent muscular action simply upsets the figure."

So, whether you're pushing a stalled motor car or a broom; shoveling coal or carrying a trunk, get in balance, put your back to work—and the job will be accomplished quickly and with a minimum expenditure of energy. To move a trunk properly, the trunk is tipped over on the right knee, the left hand grasps the far corner, and the trunk rolls onto the leg so that it can be lifted easily with the muscles of the legs and back. The most effective way of packing a trunk for any distance, however, is with a strip of burlap. Start in a kneeling position and pull the load over as you rise. Only one hand is necessary to hold the twisted burlap, leaving one hand free to assist in rising and guiding.

Any train usher will tell you it's harder to carry a fifty-pound traveling bag in one hand than a seventy-five-pound one in each hand. In order that he may be able to wrestle with bags for hours at a time, a red cap distributes the load equally in each

(Continued to page 126A)

*"But, madame—I am  
an artiste!"*



"Who, me?" said I, when this housewife asked me to polish her car for my victuals, "A retired impresario?" Whereupon she just handed me a can of polish and said, "No work, no food . . . get busy!" Which I did, for just then I smelled steak sizzling.



Imagine my joy! Why, this polish imparted a dazzling shine with scarcely more effort for me than when I wielded the baton for the Hoboken Philharmonic! "Ah, No. 7," I said, examining the can . . . "my favorite number!" Then I saw that it was "made by Du Pont."

"That No. 7 Polish," I confided, as I topped off my steak with a slab of pie, "is made by the same people who made the 'Duco' finish for my last three town cars. No wonder it bestows such a lustre! And using it left me so full of vigor I'd be charmed to chop some wood for you, Madame."



## DU PONT No 7 POLISH

made by the makers of DUCO\* and DULUX\*  
\*Reg. U. S. Pat. Off.

### WANT A SAMPLE?



Du Pont, Dept. 5-MP, Wilmington, Del.

Send me a sample of No. 7 Polish—  
enough for hood and fenders. I enclose 6¢  
to help cover mailing costs.

Name \_\_\_\_\_

Address \_\_\_\_\_

City & State \_\_\_\_\_

(Offer good in U. S. only)

**CLEAN AUTO UPHOLSTERY** with DU PONT "TRI-CLENE,"  
the non-inflammable cleaning fluid which leaves no odor.



### Get Into Motorcycling NOW!

Your fun hits a "new high" the very day you get a Harley-Davidson. New friendships grow like magic as you pal with other riders. Thrills come thick and fast on vacation tours, club runs — at hillclimbs, races and other exciting events. Get into motorcycling NOW. It's king of sports. See your Harley-Davidson dealer — and send the coupon.

**HARLEY-DAVIDSON**  
WORLD'S CHAMPION MOTORCYCLE

**HARLEY-DAVIDSON MOTOR CO.**  
Dept. P., Milwaukee, Wis.

Send FREE copy of big 24-page "ENTHUSIAST" motorcycling magazine. Stamp enclosed for mailing cost.

Name \_\_\_\_\_

Address \_\_\_\_\_

**ROBERTSON "HORSESHOE MAGNET" HAMMER**  
Reg. U. S. Pat. Office

SPECIAL FORGED STEEL, STRONG, PERMANENT MAGNET

**\$1.00 Postpaid**

**GIBSON GOOD TOOLS, INC.,** Box 26, Orange, Mass.

**BOAT PATTERNS**  
14 FOOT CRUISER

full size, cut-to-shape; and blueprints. Big selection. Low prices. Send 10c (coin) for illust. catalog. "HOW TO BUILD BOATS" book, \$1.00 postpaid

**Cleveland Boat Blueprint Co.**  
Station A-6 Cleveland, Ohio

**FREE! "FISHING DIGEST"**—a collection of the year's best fishing articles in digest form. Facts, fiction, thrills! Includes chart of world's record catches. Sent free.

Write **JOHNSON MOTORS**, 400 Pershing Road, Waukegan, Ill.

**HANDEE**  
*Tool of 1001 Uses*

**A WHOLE TOOL SHOP IN YOUR HAND**

Smooth, steady power at your finger tips. Uses 300 accessories to grind, drill, polish, rout, cut, carve, sand, saw, sharpen, engrave, etc. Plugs in any AC or DC socket.

**10 Days' Money-Back Trial**  
Order today. Standard Model (illustrated) 18,000 r.p.m. 16 oz. \$10.75 postpaid with 3 Accessories . . . DeLuxe Model 25,000 r.p.m. 12 oz. \$18.50 postpaid with 6 Accessories.

**Chicago Wheel & Mfg. Co., 108 S. Aberdeen St., Chicago, Ill. 126A**

Save Hours of Hand Work

**FREE 64-PAGE CATALOG**  
Complete information on Handee Products and their wide application in crafts work and industry all over the world.

hand. He knows enough about anatomy to realize the bones of the shoulder operate in much the same manner as a yoke by which European peasants carry their water pails so the loads tend to balance each other. And when he picks up a set of suitcases, he bends his knees, not his back.

Sitting in a chair isn't regarded as hard work, yet it exhausts many people, Rosenbauer believes, particularly when the chair of their choice isn't conducive to correct posture. By sitting easily and naturally erect we are relieving the muscles, but if we sprawl on the end of the spine or in some other grotesque position the strain is readily apparent.

Knowledge of body mechanics will help even in bicycling. A top-notch rider, whether a professional in a six-day event, or an amateur enthusiast, never throws his knees out away from the frame. He knows the knee is a hinge and should flex straight forward. Ankling is the key to correct, effortless pedaling; the ball of the foot is placed on the pedal and flexed at top and bottom of the stroke. This keeps the power constant throughout the revolution of the sprocket. Pedaling is done from the hip and ankle. Body motion only tires the rider.

There's no correct posture or stance for doing tasks that applies to everyone, concludes the Missouri sculptor, owing to the differences in physiques. The masses and leverages vary considerably in individuals and the only way a correct position can be learned is to set about discovering one's self. The person who trips easily is probably carrying his weight too far forward, he opines, and should practice walking so he can stop quickly without falling forward or jerking—a matter of carriage and correctly placing the feet. A good way to attain balance is to put your socks on in the morning while standing—and without hopping or irregular breathing.

No baseball batter ever hits the ball into the right field bleachers when his muscles are over-tense. There's a certain ease about a home run, a prize-winning shot put, or any other great sport feat. Bear this in mind when you're confronted with some heavy lifting job in your daily work. Tense muscles are slower to respond and lack power in action, so follow the advice of the sports headliner, relax and get in balance before you swing into action.

# Homing Pigeons on the Night Shift

(Continued from page 251)

short moves while the birds are away from the loft, or in settling them in an entirely new location. On one occasion a loft was moved from Fort Monmouth to Cleveland, Ohio, and all birds flown to the loft within twenty-four hours after arriving.

Probably the most famous pigeon in U.S. Army history was "Cher Ami," which, according to records, carried the message that saved the Lost Battalion in the World War. When the bird reached its loft it was found that one leg was shattered and a machine-gun bullet had pierced its breast. The bird has been mounted and is now preserved in the National Museum. Another World War pigeon, captured from the German army in 1918, still lives in the Fort Monmouth lofts. Twenty-three years old, it is the last living World War bird.

Just what causes the homing pigeon to return to its loft from distances as great as 1,000 miles? Experts say that it is the homing instinct, the result of certain faculties, partly innate, partly acquired, which have been developed, modified and exploited by man for practical purposes. This is the instinct of orientation, which has been the subject of contradictory explanations. The remarkable improvements in the race since 1914, by means of intensive training, have undoubtedly proved that it cannot be explained as some special, mysterious and unchanging instinct, but as greater acuteness of certain senses and faculties. The ensemble of the bird's intellectual faculties constitutes its intelligence. The principal faculties manifested by the pigeon's return are attention, observation, memory, will, sense of direction and physical fitness.

The ear seems to play an important part in the pigeon's sense of direction. It is regarded as possible that the sensitiveness of certain parts of the inner ear enables the bird to perceive magnetic and atmospheric impressions.

A mature pigeon, if properly trained and in good health, is capable of covering distances up to 600 miles in a single day. However, weather conditions are an important factor and absolute reliability cannot be expected for distances over 200 miles. Normal military requirements for use within divisions generally range from three to twenty-five miles.

FROM A WHOLE BOOK OF VALUES

## LAFAYETTE'S NEW FREE CAMERA CATALOG



### TRIPOD

3 section, all metal and all quality. Designed especially for portable use. Reversible head with stud for both American and European type cameras. Head constructed to precision standards, chrome finished. Each leg section fitted with retractable pins to lock sections in position. Sturdy, compact, American made. Closed, 16 1/2"; extends to 42 1/2". Unusual value at this low price..... **\$1.89**  
 4 section model closed 15 1/2"; extends to 48 1/2"..... **\$2.19**  
 Case for either of above..... **98c**

3 SECTION  
**\$1.89**

4 SECTION  
**\$2.19**

### LAFAYETTE COMBINATION SUNSHADE AND FILTER MOUNTS

Scientifically designed and precisely machined from selected duraluminum. Inside surface of shade is "flocked"—not painted.



### LAFAYETTE DURAL FILTER MOUNTS

Same as above but without shade feature. Fits 3 sizes of optical glass filters.



Lens Diam.	Sunshade	Plain Type	Lens Diam.	Sunshade	Plain Type
21 mm.		75c	A 30 mm.	1.98	95c B
23 mm.	\$1.69	75c	A 32 mm.	1.98	95c B
24 mm.	1.69	75c	A 33 mm.	1.98	95c B
25.5 mm.	1.69	75c	A 36 mm.	2.49	95c C
27 mm.	1.98	95c	B 37 mm.	2.49	95c C
28.5 mm.	1.98	95c	B 39 mm.	2.49	95c C
29.1 mm.	1.98	95c	B 42 mm.	2.49	95c C

USE COUPON WHEN ORDERING

Note: Type "A" mounts take 25 mm. Filters; Type "B" 32 mm. and Type "C" 39 mm.

### LAFAYETTE OPTICAL GLASS FILTERS

Finest dyed-in-the-mass optical glass. Colors are spectroscopically accurate. Ground to assure absolutely flat and parallel faces. All fit mounts and sunshades above.



COLOR	25 MM.	32 MM.	39 MM.
Light Yellow	<b>84¢</b>	<b>98¢</b>	<b>\$1.19</b>
Medium Yellow			
Light Green			
Medium Green			
Red			
Orange	<b>EACH</b>	<b>EACH</b>	<b>EACH</b>

### ORDER TODAY!

Save valuable time and money by buying this easy way. OUR COMPLETE STOCK INCLUDES ALL NATIONALLY ADVERTISED CAMERAS AND PHOTO SUPPLIES.

FREE book on how to use filters with purchase of 2 or more filters.

NEW YORK • CHICAGO  
ATLANTA • BOSTON  
NEWARK • BRONX  
JAMAICA, L. I.

## LAFAYETTE CAMERA

LAFAYETTE CAMERA  
DEPT. 7HC—100 SIXTH AVE., NEW YORK, N. Y.

- Rush FREE Camera Catalog No. 81
- I enclose \$..... Rush my order.

NAME.....  
 ADDRESS.....  
 CITY..... STATE.....

K 351

## Sea Giants on Parade

(Continued from Coloroto Section)

With his associates, Prof. Irving sought to learn why the porpoise, an air-breather, can be comfortable in the water where its need for frequent breathing is a handicap in the pursuit of food beneath the water's surface. The scientists, with the aid of the studios' staff, found that a porpoise weighing 400 pounds consumes approximately one liter of oxygen per minute while resting in the water. Oxygen is secured from air which is breathed at the rate of two or three times a minute. The porpoise, at the end of an expiration, takes in about ten liters, about two and one-half gallons of air, at each breath. By measuring the actual rate of utilization of oxygen the scientists found that oxygen stores of the mammal are virtually depleted after two minutes under water.

Suspecting an internal arrangement for sidetracking some tissues and utilizing the oxygen mainly for tissues most sensitive to its lack, Prof. Irving found that the heart-beat of the porpoise at rest in a tank is about eighty to ninety, immediately after breathing. An electrocardiograph was employed in this work. Going further, it was learned that during a dive, the porpoise's heart slows down to about thirty beats a minute, thus showing that less blood is circulating and that probably most of it is being directed to the brain, which is perhaps the most sensitive organ.

In a general way, Prof. Irving concludes, one may say that the whole respiratory process in the porpoise is carried on by lungs, blood and heart, which are quite similar to those same systems in a land animal. The porpoise has learned to apply them to a habit of respiration which is rather different and which enables it to swim freely below the surface. In contrast, the human respiratory system does not seem to be organized for this type of work. The difference is, however, one of degree, Prof. Irving points out, and human beings and other land animals frequently hold out for a short interval during which they can go without breathing. The adjustment of their respiration to these short intervals appears to be accomplished in the same manner as in the porpoise, which is, however, more competent at enduring interrupted breathing. Thus, differences and



**World's Finest Clarinet**  
ENDORSED BY

"PEE WEE" RUSSELL  
CHESTER HAZLETT

● The new clarinet sensation. For the first time an American-made clarinet acknowledged to excel all others in intonation and perfection of scale. Amazing new bridge key protector, adjustable pivot screws, post lock plates. Other exclusive features; yet they cost no more. See your dealer or write us today for free book on clarinets or any other band instrument.

C. G. CONN, Ltd., 831 Conn Bldg., Elkhart, Ind.

Write FOR FREE BOOK

CONN  
BAND INSTRUMENTS

**Sell UNION MADE! BOOK MATCHES!**

America's Largest Manufacturer of Union Label Book Matches

FREE Complete line with free inside printing at prices that insure sales. Big repeat business. FREE cuts, catalog, including political cuts and big sales producing kit. Free inside printing—BASEBALL SCHEDULES all leagues, fishing laws, etc. Big cash commission in advance.

Big Sales Kit—Zipper Case and 500 Books of matches with your own name. Send for details.

**SUPERIOR MATCH COMPANY**  
7520 S. GREENWOOD AVE. Dept. G-8 CHICAGO, ILL.

WHEN YOU BUY FLASHLIGHT BATTERIES DEMAND "EVEREADY" FRESH DATED BATTERIES

The word "Eveready" is the registered trade-mark of National Carbon Co., Inc.



World's Smallest Pocket Radio

BEAUTIFUL PLASTIC COINSETS

NO TUBES NO BATTERIES NO PLUG IN

Midget Radio fits your pocket or purse. Weighs only 6 ozs. Small as cigarette package. Receives stations with clear tone. "PATENTED FIXED CRYSTAL"—NO UPKEEP—only one moving part. TUBELESS, BATTERYLESS NEW PATENTED DESIGN. Has enclosed geared luminous rotor dial for easy tuning. MANY OWNERS PLEASSED WITH RECEPTION

AND DISTANCE OBTAINED WITH THIS NOVEL RADIO.

**ONE YEAR GUARANTEE**

Sent ready to listen with instructions and tiny phone for use in hotels, offices, homes, boats, in bed, etc. **SIMPLE TO CONNECT—NO ELECTRICITY NEEDED. SEND NO MONEY!** Pay postman only \$2.99 plus postage and charges on arrival or send \$2.99 (Check, M. O., Cash) and yours will be sent postpaid. A most unusual value. **ORDER NOW!** MIDGET RADIO CO. Dept. P-8, Kearney, Nebr.

**Amazing CHEAP OIL BURNER**  
*Sweeping the Country!!*

**COOK and BAKE** Slips Into Any Cook Stove

With Oil—in Your Present Stove—No Drudgery, Dirt or Ashes—Intense Heat Quick at SMALL COST—As little or as much as you want.

**OVER 40,000 SOLD**

Beats any cheap burner ever gotten out for low cost, perfect performance. Burns ordinary distillate or fuel oil, no clogging up. Quick, clean, intense heat by Simple Turn of Valve. **GUARANTEED.**

**30 DAYS' TRIAL** Prove its efficiency, convenience and economical operation without risk.

**Write Immediately for SPECIAL OFFER TO AGENTS** who will demonstrate and take orders. Write quick, be first to learn how to make REAL MONEY right now, spare or full time—mail 1c postcard today.

**UNITED FACTORIES, H-751, Factory Bldg., Kansas City, Mo.**

similarities between man's respiratory system and that of the porpoise may be studied with the aid of the tanks.

Another type of work made possible is the observation of births in the giant "fish bowl." Just recently scientists were able to study and photograph, for the first time in history, the birth of a porpoise under normal conditions. The baby, perfectly formed, was believed to have drowned when it sank to the bottom of the tank immediately after being born. The mother made frantic efforts to raise the twenty-five pound baby to the surface by balancing it on her snout, but in vain. Staff members at once began assembling all data in an effort to determine the cause of death, hoping to derive information that may help to save other porpoises born in the tanks, information that may throw more light on the entire subject of mammal births.

It is for just such work, as well as for the study of other marine mysteries that a modern laboratory is employed at the Marine Studios. A staff of biologists keeps busy constantly cataloguing newly deciphered knowledge garnered from the lives of the fish. For instance, the known ability of jewfish to change their color so as to blend with their immediate background was demonstrated when a 500-pound jewfish which became blind turned black.

When one of the specimens becomes ill, the staff sets about to determine what medical treatment is necessary. In the case of a baby porpoise, consultations resulted in a decision that a dose of castor oil should be given. After the baby was netted, its mouth was forced open and almost a pint of the oil poured in. After being held a minute or two, to make sure the medicine had been swallowed, the porpoise was released and it swam away, attendants said, with a wry look on its face.

A fishing fleet operated by the studios is in constant search for new specimens for observation and for replacement of species that become extinct in the tanks, either through natural death or violent death caused by predatory enemies. Besides a full stock of nets ranging from four-foot hand nets to 1,000-yard shark nets, this department maintains live-specimen cars, cranes, canvas hammocks and harpoons for handling all kinds and sizes of fish. A spe-

(Continued to page 130A)

TO

# HEAR

**AGAIN IS  
TO LIVE AGAIN!**

Hear at greater distances, carry on group conversation. Hear clearly with this Audiphone based on advanced design technique and on 58 years of experience in making Bell telephones. Consult an authorized dealer. After an audiometric test, he'll show you the Audiphone that will best meet your needs.

Accepted by American Medical Association

**Western Electric  
AUDIPHONE  
Ortho-technic Model**

GRAYBAR ELECTRIC CO., PM-56  
Graybar Building, New York

Please send details on Western Electric Audiphone (Ortho-technic Model) and name of nearest dealer.

Name .....

Address .....

City ..... State .....

**Mechanically-Minded MEN WANTED**



To Introduce the Sensational

**New ACE**

Automatic  
**GREASE CUP**



**Takes the Guessing Out of Greasing**

Nothing else like it. Forces lubrication constantly. Shows at a glance whether cup needs refilling. Saves labor, grease and machinery repairs. Thousands sold on sight in factories, fleets, etc.; in fact, every place grease and oil are used. Biggest money-maker in years. Send 50 cents for sample and attractive offer. Write quick!

**ACE LUBRICATING EQUIPMENT CO.**

2345 W. GRAND BOULEVARD,

DETROIT, MICHIGAN.

**NOW a DYNAMIC  
HEAVY DUTY  
INDUSTRIAL WELDER**

for Only  
**\$195**

Works Off 110-Volt Light Socket. This marvelous Dynamic Power Welder does the work of much higher priced types. It is easily portable. **WELDS Cylinder Blocks, Bumpers, Fenders, Tanks, Farm Machinery, etc.** Will also solder and braze on the lightest material. Works on iron, steel, tin, brass, copper and all other metals. Men without previous experience can make as much as \$5.00 on a one hour repair job. In a year's time a Dynamic Welder Costs You **LESS THAN 6 CENTS A DAY.** Instructions Free—Open a welding shop now. **AGENTS**—Make big profits selling to garages, factories, janitors and machine shops. Write today for our 10-DAY TRIAL OFFER. **DYNAMIC WELDER CO.** 2226-NB Silverton Road Chicago, Illinois



# NEW BOAT READY!

Write for lavishly-illustrated FREE Circulars!



**BUILD OK-4 at Home in a Few Evenings!**

Ready!—Mead's sensational 14 foot portable Outboard KI-YAK! OK-4 carries 4 adults and duff—takes motors up to 9 H.P., oars and sail. Seaworthy. Leakproof. Biggest, lightest, strongest of its kind! You can build yours easily, quickly, perfectly at home in a few evenings from our patented, complete construction kit and save nearly HALF! Big money assembling, selling to others. (3 other paddle-sail KI-YAKS from 18 to 45 lbs., . . . also OK-2 for motor, sail, oars . . . weighs 50 lbs.) Double paddle or oars now included with your KI-YAK Kit! Write for FREE illustrated circulars, amazing low Factory Prices!

**MEAD GLIDERS, 15 So. Market, Dept. B-80, CHICAGO**

## NEW BENJAMIN AIR RIFLES WITH HAND PUMP

MADE IN U.S.A.



**HARD ACCURATE SHOOTING WITH CHAMBERED AIR**

You can use new model BENJAMIN AIR RIFLES WITH LEVER HAND PUMP anywhere, for practice firing or just plinking, around the house or camping, fishing, hunting, etc., at lowest cost. Shooting force is adjustable with amazing maximum power and accuracy—no recoil or forward lunge to disturb your aim. Bolt Action—Hammer Fire—Hair Trigger—Safety Lock—Hand Pump. Single Shot BB \$7.50; Single Shot Cal. 177 or .22 with rifled barrel \$8.50; BB 25 Shot \$9.00. Also a complete line of BENJAMIN GENUINE COMPRESSED AIR PISTOLS from dealer or factory. Write Today. BENJAMIN AIR RIFLE CO., 695 Marion St., St. Louis, Mo., U. S. A.



## HAVE DEPENDABLE FORD BRAKES

Your Ford Car is listed in the so-called lower priced class but has more brake lining area and larger drums than the others, in fact as much or more brake area than all but the higher priced cars. You can have safe, sure, unflinching mechanical brakes. Install easily yourself our Simplex Floating Wedges to center the shoes for



mechanical assurance with hydraulic performance. A set of four, one for each wheel, all for \$1.75. All models 1928 to 1938—Send for circular. SIMPLEX WEDGE EXCHANGE, Dept. PM-8, 613 Jefferson St., Ottawa, Ill.

## BUILD A MIDGET CAR OR SCOOTER

WE SPECIALIZE IN WHEEL SETS, ENGINES, ETC. for building Cars, Scooters, Trucks, etc. We carry only the best at the lowest prices. SEND 10c FOR PARTS CATALOG AND PLANS for three Midget Racers, Scooters and other vehicles. It pays to use only reliable plans and parts—We guarantee satisfaction. Build-ur-Own Devices, 536 North Parkside, Dept. 48, Chicago

USE BILD-UR-OWN PARTS AND SAVE MONEY



## BUILD ARC WELDER FROM OLD GENERATOR

For Light or Heavy Work. 75-200 amperes. Complete PLANS and valuable catalog 35c. Over 900 Electrical Supply Bargains. LeJay Mfg. Co., 1347 LeJay Building, Minneapolis, Minnesota



## SENSATIONAL Flexible SHAFT TOOL



The FOREDOM FLEXIBLE SHAFT TOOL SEND FOR brings new skill, new ease for home and master craftsmen. Uses over 200 accessories. Grinds, polishes, drills, mills, engraves, sharpens, slots, sands, carves, etc., etc. Every hobbyist should own one. Send for free illustrated catalog. FOREDOM ELECTRIC CO., Dept. 156, 27 Park Place, New York, N. Y. FREE CATALOG

## NEW TRAILER BUILDERS' GUIDE AND CATALOG



WORLD'S BEST LINE OF TRAILER AXLES, HITCHES AND PARTS including New Universal Trailer Draw Bar, readily attached to any late model car. Complete house trailer working blue prints only 50c. SEND 10c TODAY FOR THIS NEW CATALOG.

HAMMER BLOW TOOL COMPANY. DEPT. 108, WAUSAU, WIS.

## MANUFACTURING OPPORTUNITIES

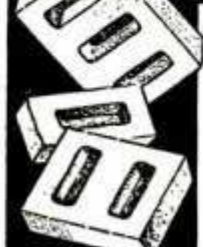

IN BUILDING INDUSTRY—with machine and process producing permanent construction with savings of 1/3 labor, 1/2 mortar, and 1/3 material costs—ashlar, hollow, veneer or solid walls—plain or 40 colors. WE EQUIP YOU with Automatic Machinery—large production only one or two men. Equipment costs but fraction of other processes with equal capacity. INVESTIGATE—let us show you why building today offers you the greatest opportunity for growth, expansion and profit in a business of your own, using raw materials available in your territory. Write today. W. E. DUNN MFG. CO. 600 West 24th St. Holland, Michigan

(Continued from page 128A)

cially designed hypodermic harpoon is capable of injecting a drug that in sixty seconds stuns and incapacitates a huge shark for two hours or longer. The staff has perfected a secret invention which will make it possible to capture porpoises and sharks without hooks, harpoon or nets.

What possibilities does this giant "fish bowl" hold for scientific research of the future? First, plans in regard to the porpoise entail the acquiring of information which will ultimately uncover the complete life history of at least one species. Already studies with slow-motion cameras have been launched in attempt to analyze critically the function of various parts of the body in swimming. Then feeding habits of fish will be observed and tests conducted, in the hope that hitherto unknown habits and secrets of fish feedings may be divulged—a subject of tremendous interest to anglers throughout the world.

Dr. G. Kingsley Noble of the American Museum of Natural History, points still further into the future, saying: "Many groups of fishes, such as the giant sharks, start off at certain seasons and unerringly migrate to particular parts of Florida. The problem of what directs the migrations of birds is baffling but the mechanisms which regulate these shark migrations are infinitely more mysterious. A special study may result in an answer to this riddle.

"Marine Studios afford unique opportunities for study of the mental life of fishes. What regulates the formation or the breaking up of schools? Why do some fish seek retreats which they defend against intruders? What is the hormonal and nervous basis of fish personality? The studios have been making an extensive collection of fish brains with the idea of correlating habits with brain structure. It is usually assumed that fish do not have a very emotional life, but in the tanks when the fish are breeding or defending their young, they are found to be as active in the defense of their homes as many birds are. Many fish pair off and recognize their mates as well as do birds. All this means a much higher mental life than the average person realizes. The findings being made today on the relation of brain structure to the social behavior of fishes may be found to have the widest application to other back-boned animals, including man."





**\$2.00**

224 PAGES

**IT'S LOTS of FUN**  
to make  
things that move

## Read How This Father Won Back His Son

**E**VEN if that boy of yours is to go to college, a father writes, let him spend some time making things. Hand training is an essential part of brain training. His letter follows in part:

"The hours spent with my boy and dog while building a boat have been very much worth while in the feeling of companionship and understanding that have come to us both as a result."

"The busy professional man like myself, I advise that he take his boy and his tools and go down to his workshop and learn many worthy things. It will teach him patience, perseverance—and his boy."

"That alone is pay enough, indeed, but that is not all, for we both enjoyed every minute we spent with our tools."

Why not do as much for your boy? All you need is this fascinating book and a few simple tools. All boys are creative. Give them tools and the idea and they will be building useful things.

Send no money, just your name and address on a postcard, and we will mail this book anywhere in the United States or its possessions. You can pay the postman. Money back if not pleased.

**POPULAR MECHANICS PRESS**

200 East Ontario Dept. 840 Chicago, Ill.

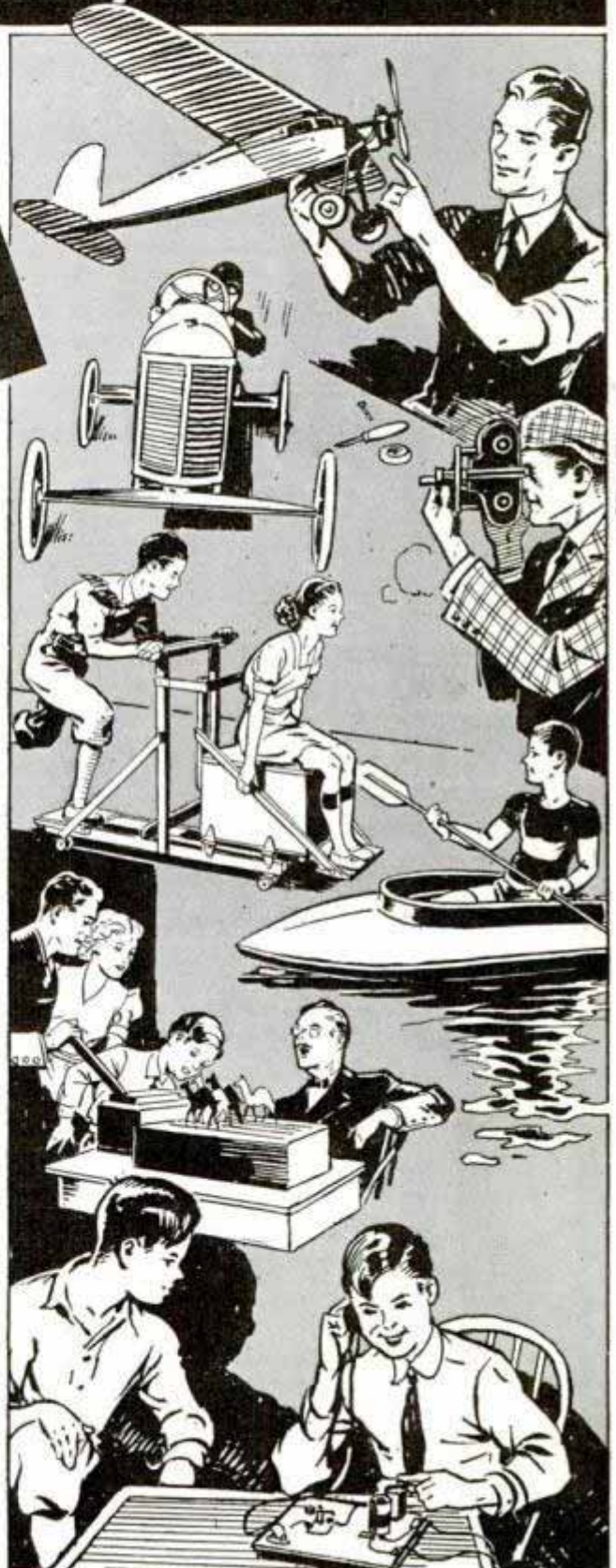

# AGENTS and DEALERS WANTED

To Sell or Rent the NEW

**Mead Ranger SCOOTER**

**120 MILES**  
Per Gallon

**30**  
m. p. h.



**PAY AS YOU RIDE!**  
**EASY TERMS**  
Available in Most States

These sensational, new, improved Ranger Scooters sell like hot cakes all over the country! Order your demonstrator while territory is still open—there's big money selling to all stores needing quick, cheap delivery . . . sell to messengers, mechanics, garages, canvassers, friends; or rent for easy hourly profits at beaches, resorts, etc. World's CHEAPEST transportation! New low prices! ALL STEEL frame, automatic gear shift, clutch, starter, generator, spring fork. 15 models for 1940—solo, tandem, delivery, sidecar, etc. — 1 1/2 or 2 1/2 h.p. Write for FREE circular. HURRY!

Send for FREE CIRCULARS.

CYCLE CO.

**Mead**

Dept. Y-1, CHICAGO, USA

*Ranger Bicycles*  
for 50 Years!

## WITTE DIESELECTRIC PLANTS

**Power and Light for 1c a Kilowatt**

Make your own electricity at this amazingly low cost. Quality built, dependable, efficient WITTE Diesels operate on cheap, non-explosive fuel. Rugged, compact, easy to install, simple to operate. 1500 to 8000 Watts; vertical, horizontal. Easy to buy. Pay for themselves out of savings. WRITE now for literature and name of dealer.

**WITTE ENGINE WORKS**  
1748 OAKLAND AVE. KANSAS CITY, MO.

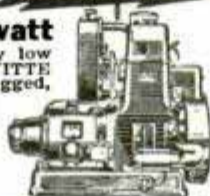

**MAKE MONEY in new Kind of CONCRETE Business**

**START YOUR OWN SPARE TIME OR FULL TIME BUSINESS**

Here's a world beating opportunity to start a profitable business right at home, making salable articles of all kinds from concrete. Make garden furniture—bird baths—statuary—vases and hundreds of other products from both the conventional and the new colored concretes. All these things are in big demand. Little or no capital needed.

**256 PAGE BOOK TELLS HOW**

Get "1001 Ways to Use Concrete" the amazing new book that covers the whole field of making money in concrete work. Explains all methods and materials, trade secrets, simple equipment you can make—gives 148 short cuts to extra profits. Hundreds of pictures and sixteen full-colored plates. It's the key to a new and growing industry, that you can use now.

**SEND NO MONEY. Pay Postman**

Price, complete \$1.98. Postpaid upon receipt of remittance. If you live in the U. S. or possessions you may pay postman on delivery, plus few cents charges. Money back if not satisfactory. Order now and get started at once.

**POPULAR MECHANICS PRESS**  
Dept. 840, 200 E. Ontario Street, Chicago



## Quicker than a Wink

(Continued from page 171)

than sunlight. This light is produced by an electric spark—miniature lightning—inside a gas-filled lamp. Electricity flows into a kind of reservoir known as a condenser and when the reservoir is full, it overflows at the desired moment to produce a brilliant flash within the lamp.

Electrical controls make it possible to govern very accurately the duration of the flash, the time between flashes and the exact instant of flash. That's how Dr. Edgerton can tell the difference between 1/1,000,000 and 1/2,000,000 of the tick of a clock.

When years of experiment perfected methods and machines to work with, Dr. Edgerton set out to remedy the one great limitation of the human eye, its inability to see rapidly moving objects. The unaided eye cannot see the way a falling cat turns to land on its feet, how rain drops, how a bird moves its wings, let alone how a bullet travels at the speed of 1,800 miles an hour.

Since the eye, the ear and the hand were all too clumsy to time the camera exposure, he found it necessary to work out a method of using electrical contacts, microphones or photoelectric cells to trip the flash and catch the objects at the right instant.

Then he began delving in an unknown world of speed which exists right under our noses. He soon solved the mystery of the flight of birds, photographing purple finches, homing pigeons, hummingbirds and tumbling pigeons. Bats, which are flying mammals, were next investigated and every detail of their muscular and bony structures was revealed in actual flight. Insects were also "stopped" in midair and the pictures provided more food for thought in airplane research laboratories.

The tongue of the cat was the subject of another test and it was shown that the action of this remarkable lapping instrument raised a column of milk in the form we are accustomed to see in an ordinary drinking fountain.

Dealing with projectiles, he proved that ordnance experts were wrong in their belief that a bullet continues to gain speed for some considerable time after it leaves a weapon because of the pushing effect of gases. He also showed that the kick of a

gun occurs after the bullet is clear so that the tilt does not affect aim.

He revealed unsuspected power leakages in pistols, and his pictures of bullets even disclosed the sound and heat waves set up by their flight through the air. Manufacturers of automatic pistols are now able to see the recoil of their weapons in slow-motion pictures. Makers of shotgun cartridges can follow the pattern by which the pellets spread after being fired.

Sporting-goods manufacturers are vitally interested in his stills showing how concussion affects baseballs, tennis balls, golf balls, footballs, as well as the bats, rackets, clubs and shoes which propel them.

Managers of baseball and football clubs and university athletic directors are poring over his pictures of athletes in action, studying form. Fencing, archery, lacrosse are being taught with the use of his speed-flash photographs.

Surface tensions of liquids and their reaction to force under many circumstances are important to manufacturers and scientists. The formation and life of a drop were revealed in detail. The pear-shape theory of streamlining was muddled by the discovery that a drop flattens out and slips sideways when falling at high speed. It looks more like a corn-flake than a pear.

In the field of glass, photographs were taken at 1/3,000,000 of a second to show what happens when plate glass cracks.

Science has long known that quenching molten steels in different liquids produces various effects, depending upon the liquids. Using the ultra high-speed technique, I. N. Zavarine, a scientist, found out why this was true. The bubbles formed by certain liquids tended to insulate the steel and the result was changed.

Into the mills and factories wherever high-speed operations are used, the flash method of photography is going, always with the purpose of improving operations and cutting the cost of products you buy.

The effect on your pocketbook is certain to continue for years to come and, being human, that is where you are likely to notice most quickly the benefits of Dr. Edgerton's discoveries—you might say—quick as a wink.

☐ Send stamped, addressed envelope to our Bureau of Information for name of maker of any device described in this magazine.

**PHOTO-FANS! SAVE \$1.40**  
**ON YOUR NEXT 3 ROLLS OF FILM!**



**3 GIANT-SIZE Photographs FREE!**

**\$15-\$10-\$5 AWARDED MONTHLY FOR BEST SNAPSHOTS**

**BIGGEST PHOTO BARGAIN EVER OFFERED.** THREE rolls any 6- or 8-exposure film developed. 24 deckled Salon-type prints made from good negatives. 3 Enlargements (8" x 10") as bonus. Regularly \$2.40 — now only \$1.00. You save \$1.40.

**Send No Money UNLESS YOU WISH TO—**

Just mail coupon below with any 6- or 8-exposure roll and by return mail you will receive your developed negatives—8 embossed panel prints—2 Credit Slips (entitling you to 2 more rolls developed and printed at no further cost)—and 3 Enlargement Coupons worth 45c each. Pay Postman \$1.00 plus postage—or send \$1.00 with coupon and we pay postage. Enjoy better pictures and cut photo costs. Mail coupon now with \$1.00 and 1, 2 or 3 rolls. Twenty-two years of satisfied customers.

**'30 MONTHLY FOR BEST PHOTOS**

**ROYALTONE, DEPT. 130**  
 37 West 57th Street, New York, N. Y.

Check here if \$1.00 enclosed for 3 rolls and Enlargements prepaid. Money back if not delighted.

Check here if C.O.D. plus postage.

Name.....  
 Address.....  
 City & State.....

*Helps You* **SAVE MONEY**



- This book contains 480 pages of up-to-the-minute formulas.
- It tells how to package your products and how to market them.
- Gives important information on patents; trade-marks and copyrights.
- Tells where all required equipment and supplies can be obtained.
- It explains how to test formulas and start manufacturing.
- Practical information on small plant equipment.

**PARTIAL TABLE OF CONTENTS**

Adhesives	Varnish Drier	Gelatine Powders
Fireproof Cement	Removing Paint	Ginger Extract
Exterminators	Shellac Troubles	Icing Powder
Insecticides	Soap Making	Vanilla Extract
Moth Paper	Disinfectants	Inks
Plant Fertilizers	Dry Cleaning	Carbon Paper
Poultry Tonics	Grease Spot Removers	Metal Plating

**Money-Back Guarantee**

This wonderful book which will answer your questions as to how things are made will be sent C.O.D. anywhere in the U. S. A. with a money back guarantee. Just drop us a postcard and pay the postman \$4.00 plus few cents charges when the book is delivered. We prepay postage if money is sent with order.

**POPULAR MECHANICS PRESS**  
 200 E. Ontario St. Dept. 840, Chicago

X 254

## Minutes That Mean Eternity

(Continued from page 245)

large quantities of soapy water, salt water, or any harmless fluid such as milk, coffee, or soup. But if none of these is handy, give him plain water. Tickling the back of the throat with the finger will help induce vomiting. When this occurs, give more liquids, reinduce vomiting, repeatedly. Meanwhile, have someone send for a doctor.

Suffocation is the inability of the lungs to pump oxygen for the body. Whether caused by hanging, choking, drowning, lightning, electric shock, or the inhalation of noxious fumes, the treatment is always the same—artificial respiration. This should be started immediately, and should

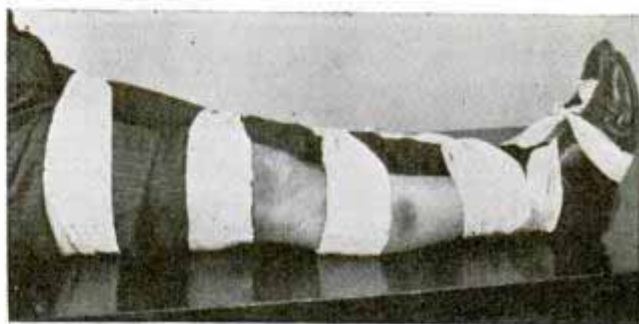

An example of emergency splinting—the broken leg is fastened securely to the uninjured one

be continued until normal breathing is resumed, or until a physician declares it is useless to go on. There are many cases on record where persons have recovered after four hours of continuous treatment; so don't be too ready to give up.

Artificial respiration cannot be learned by reading about it; but it is such an important factor in first aid that everyone should know how to administer it. In practically every community the Red Cross conducts classes in this work, and these classes are open to everyone. Yet every year hundreds die for want of air, while crowds stand by and look on. All because nobody has taken the trouble to learn.

This by no means exhausts the possibilities of first aid. The things described here are those things that need to be done in the great majority of accidents, and need to be done at once—that cannot await the arrival of a doctor. These are the things that save lives in minutes that mean eternity.

Send stamped, addressed envelope to our Bureau of Information for name of maker of any device described in this magazine.

## SELL BIG OUTDOOR NEON SIGNS

It's easy to sell beautiful big neon signs on these terms. Imagine! Your customer pays us only 15¢ per day—and we supply the big sign—all complete, ready to be connected to his store wires.

ONLY ONE SALE EACH DAY PAYS YOU MINIMUM EARNINGS **\$57 PER WEEK**

We furnish all sales help—colored illustrations—catalogs—and sales manual, "How To Sell Neon Signs". Learn how to sell signs in one day. COMMISSIONS PAID DAILY.

CHICAGO SIGN SALES CORP., Dept. 30, Charlotte, N. C.



SOLD ON TERMS OF ONLY **\$1.25 PER WEEK**

WRITE FOR FREE CATALOGS



## New! P.D.Q. AUTOMATIC PHOTO MACHINE! Today's Big Money Maker!

Takes and finishes Black and White or Sepia photos in one minute. No film or dark room. Easy to operate. Simple instructions. Take photos everywhere—friends, neighbors, picnics, parks, beaches, etc. Travel and make money. About \$60 starts you. WRITE TODAY.

P. D. Q. CAMERA CO.

109 E. 35th., Dept. 25, Chicago

**FREE!**

240 Page handy reference book on complete line of Stanley Tools, plus helpful tables and information. Write for Catalog 34.

NEW BRITAIN

STANLEY TOOLS Division Of The Stanley Works 105 ELM ST. CONN.

## Make Your Hobby and Spare Time Pay You EXTRA MONEY



Here are selected books to help you cash in on your hobby, earn extra money or establish a profitable business of your own. Pay postman or remit with order for pre-paid delivery. Money refunded if not satisfactory, if returned in 3 days.

### ORDER UNDER MONEY-BACK PLAN

**A SMALL BUSINESS OF YOUR OWN.** Gives 1000 ways for a man with little or no capital to build a modest dependable business. \$1.00.

**MAKING AMATEUR PHOTOGRAPHY PAY.** Turn your prints into extra money. Tells what to take, where to submit and how to sell pictures. \$1.00.

**TURN SCRAP INTO MONEY.** Shows how to build power plants, 110 volt motors and generators, wind power plants and other electrical apparatus from old auto parts. \$1.00.

**HOME AND WORKSHOP FORMULAS (HENLEY).** 10,000 opportunities to make and save money through the use of these tested recipes, formulas and processes, etc. Tells how to make salable preparations of all kinds. 883 Pages. \$4.00.

**A LIVING FROM THE LAND.** The information that thousands of people have, who are seeking security and productive uses for their leisure time, want and need. \$1.50.

**SHOE REPAIRING.** Practical and simplified instruction on modern

shoe repair methods. Helps you save money on your own work and make money repairing for others. \$1.00.

**AUTOMOBILE BODY AND FENDER REPAIRS.** Covers thoroughly, the best paying end of the auto repair business. Prepares for regular job or good source of extra, spare time money. \$3.00.

**PAINTING AND DECORATING.** Use this book for complete study or to pick up extra money on spare time jobs. Includes estimating and cost figuring. \$1.50.

**HIGH SCHOOL SELF TAUGHT.** Complete four year high school course in one volume. Broaden your knowledge and increase your income with high school subjects. 1000 Pages. \$2.39.

**BUSINESS COLLEGE SELF TAUGHT:** Here's your practical training for business all in one handy volume. 15 courses covering all essential subjects taught in a modern business college. Over 1000 pages. Cloth. \$2.39.

## POPULAR MECHANICS PRESS

Dept. 840. 200 E. Ontario Street Chicago

# Capacity-Operated Switch

(Continued from page 297)

insulate (C<sub>1</sub>). A list of the materials is available from Popular Mechanics radio department without charge, if desired.

To test the relay, connect up to 10 ft. of ordinary insulated hook-up wire to act as

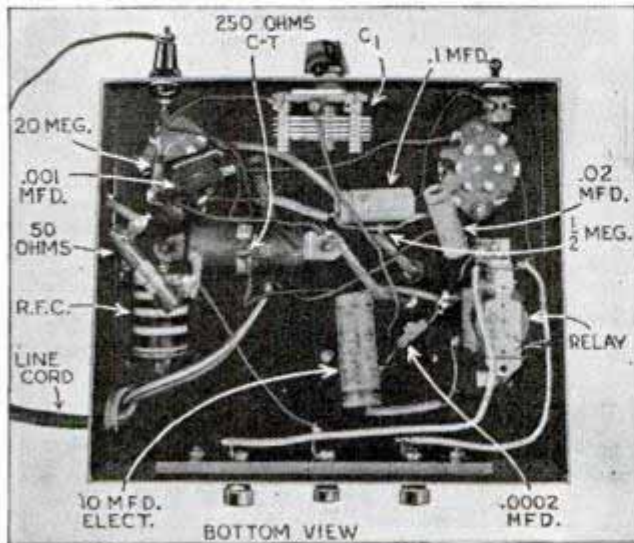

the alarm wire. Now open the variable condenser until you hear a click indicating that the relay has closed. Next back off condenser slightly until the relay just opens. Approaching the alarm wire closely after this adjustment will close the relay. The adjustment may also be made so that the relay will open when someone leaves the vicinity of the alarm wire. Now

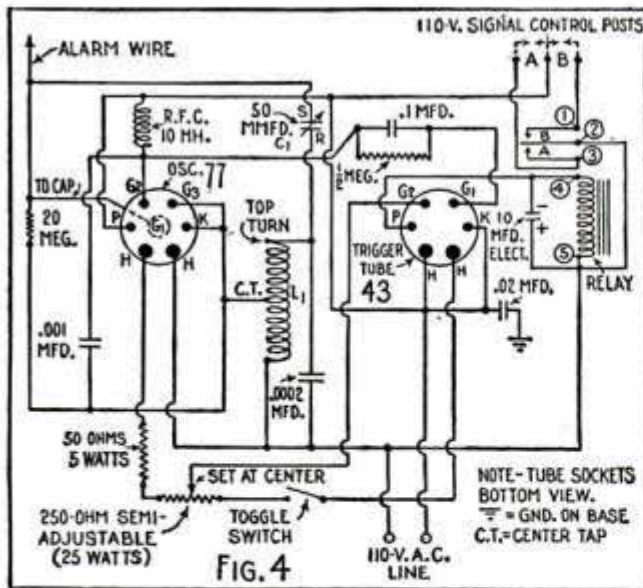

the binding posts can be connected for (A) or (B) operation on either side of the center post, as indicated in Fig. 2, directly to the electrical appliance, alarm bell or lamp to be controlled. The blueprint number for this article is R-281.

## GET AHEAD FASTER in Radio

Is it the time or expense that's holding you back? Hundreds once in the same fix are radio experts today—enjoying life, many holding big pay jobs. Lafayette Radio helped these men realize their ambitions—and Lafayette can help you—quickly. Everything you need—money-saving prices. And you

in radio is in stock at Lafayette—at low, money-saving prices. And you have your choice of all the nationally advertised radio parts, tubes, tools and equipment—all guaranteed. What's more, you can order at home from Lafayette's big, complete FREE catalog, and save valuable time. Three great warehouses and four additional Lafayette branches (there is one near you) handle orders with speed. No need now to waste spare hours shopping for parts. No need to pay regular prices. Deal with one of Radio's oldest, most successful firms, 20 years in business and still growing. Save time and money! Send at once for your FREE catalog.

### Watch for this

Coming in September—Lafayette's new, bigger-than-ever Fall Radio Catalog. Complete, up-to-the-minute—all that's new as well as old in radio. Watch for announcement in these pages. It's FREE. And it's money-saving!

## LAFAYETTE RADIO

NEW YORK • CHICAGO  
ATLANTA • BOSTON  
NEWARK • BRONX  
JAMAICA, L. I.

LAFAYETTE RADIO

DEPT. 7H—100 SIXTH AVE., NEW YORK, N. Y.

Rush FREE Radio Catalog No. 80 **RUSH**

NAME.....  
ADDRESS.....  
CITY..... STATE.....

**THIS COUPON  
NOW FOR  
FREE  
CATALOG**

## MEN WORLD'S LARGEST "DIRECT-SELLING" ADVERTISING BOOK MATCH FACTORY

Offers a money-making connection in a year 'round business. Experience unnecessary to start. Full, spare time. Every type of business a prospect, also Political Candidates. Big line of brand new designs PRINTED IN FIVE AND SIX COLORS OF INK, giving up to TEN COLOR effects! FREE INSIDE PRINTING. Proven advertising value, low prices for high quality and quick deliveries help get orders. Profitable repeats. Sales Kit, Instructions, FREE. Write TODAY!

MATCH CORPORATION OF AMERICA  
3433-43 W. 48th Pl., Dept. M-840 CHICAGO, U.S.A.

Say you saw it in  
**POPULAR MECHANICS**

## TURN HOME WORKSHOP HOURS into EXTRA MONEY



Get the New 188 Page Book  
**WHAT TO MAKE**

Get this new book and turn happy home workshop hours into extra cash. 188 pages packed with instructions, plans, valuable data and pictures showing what to make and how to make it. Anyone who can use simple tools can work from this book and make it pay him a profit. Order today. Tells how to make—Breakfast Nook—Humidifier—Knee-hole Desk—Night Table—Twin Deck Beds—Modern Bedroom Furniture—Clocks—Plastic Candlesticks—Bob Sled—and more than a hundred other useful and saleable articles.

POPULAR MECHANICS PRESS  
Dept. 840, 200 E. Ontario St., Chicago



# Jobs, Gardens, I. Q. Tests!

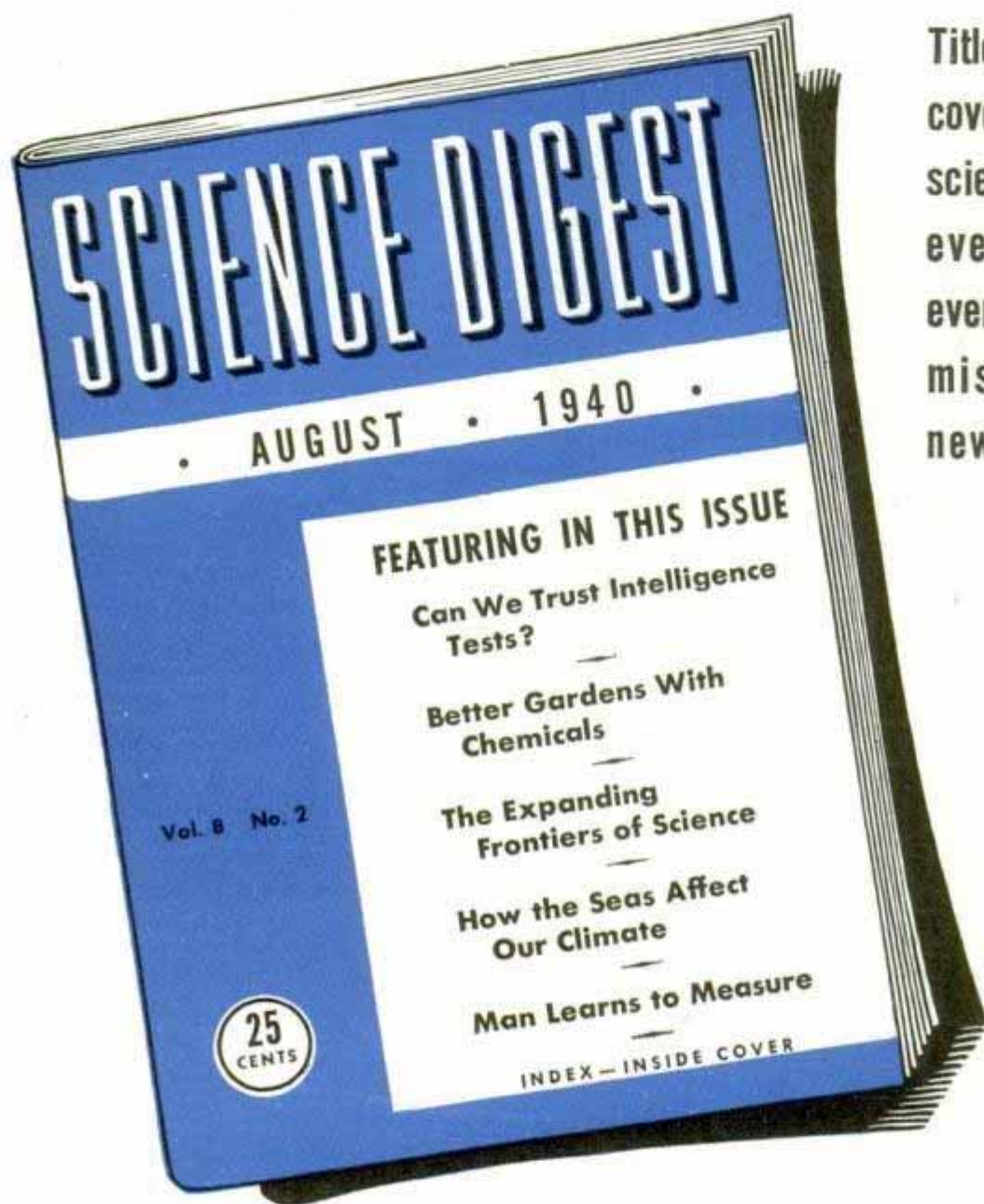

Titles on this August cover show how close science comes to the everyday lives of everyday people. Don't miss August—on newsstands today!

How science replaces old jobs with new is the real meat of "The Expanding Frontiers of Science". Interesting to any man who works. "Man Learns to Measure" goes back even beyond the king who decreed that three grains of barley end to end made one inch. Why do age limits in infancy and in maturity affect intelligence tests as guides in rating human aptitudes? And an interesting contrast appears in the articles on

gardening with chemicals and the effect of the seas upon climate. You have to take climate as you find it but the results of gardening are largely in your hands. A score of easy-to-read digests of scientific articles from all over the world make this August issue of Science Digest one that you will want to read—and keep.

SCIENCE DIGEST, INC.  
631-643 St. Clair St., Chicago, Ill.

## ON NEWSSTANDS NOW—25 CENTS

# Improved Record Player

(Continued from page 298)

employed in this improved model are: one .1 mfd. 200-volt and one .0001 mfd. mica type.

The chassis "floats," which is common practice with a.c.-d.c. sets; no external

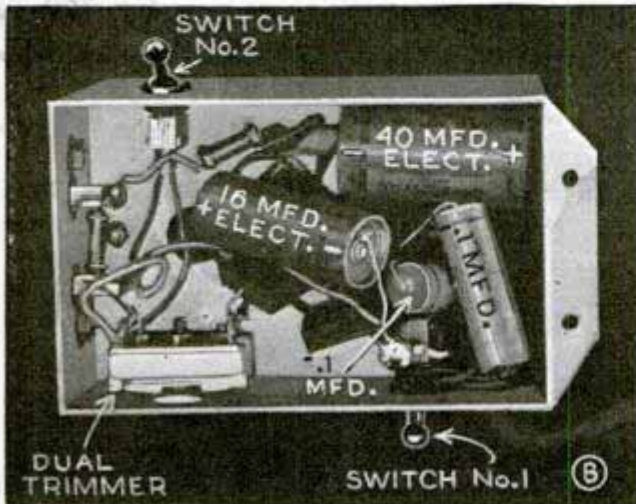

ground should be used. If you are changing over the original model merely cut off the antenna wire which extends beyond the line plug as it is no longer required. Mount the unit on the wood case of your record player, or on a separate wooden base. To operate, turn on your receiver

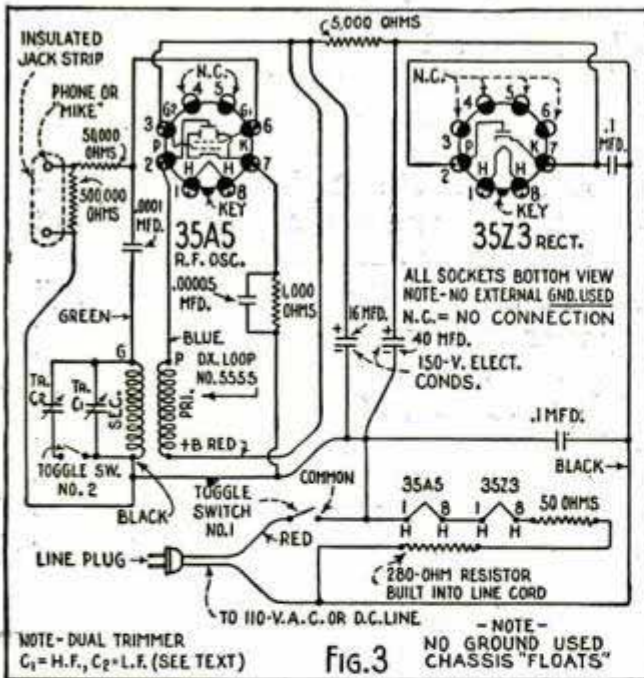

NOTE - DUAL TRIMMER C<sub>1</sub> = H.F., C<sub>2</sub> = L.F. (SEE TEXT) **FIG. 3** - NOTE - NO GROUND USED CHASSIS "FLOATS"

and tune it to about 1,700 kc. or some adjacent quiet spot on the dial, and adjust trimmer screws for operation at that point. Toggle switch No. 2 cuts out trimmer condenser (C<sub>2</sub>) for the high-frequency end of the broadcast band.

**EVERYTHING IN RADIO**  
at *Lowest Prices!*

Get this Big FREE Book of everything that's new in Radio. See the new Miniature and 3-way Portables, new Home Recorders and Phonographs, new Home and Auto Radios—more than 60 new models; latest 7-75 watt Sound Systems; new Radio Builders' Kits—easy and inexpensive to build; testers, tools, books—more than 15,000 quality radio items at lowest prices! Get this Free Catalog now!

**FREE 172 PAGE CATALOG**

**ALLIED RADIO CORP.**

833 WEST JACKSON DEPT. 5-H-0 CHICAGO

Radio Builders' Handbook. Explains radio fundamentals; shows how to read diagrams, build popular circuits, etc. Only 10c

**PHOTO ENLARGEMENTS**

Is Photography your hobby? Do you want a profitable easy business at home? Make **PHOTO ENLARGEMENTS** for yourself and others. Your cost 5c each and less. The Ideal Photo Enlarger is **AUTOMATIC**. No experience required. Also **COPIES** any picture. \$5.94 **COMPLETE**. Interesting circular **FREE**.

**5¢ ANY SIZE**

833 West 23rd St., New York City

**NATIONAL MOWER CO.**  
832 Cromwell St. Paul, Minn.

Sickle mower, power driven, rubber tired, pulls self, cuts high grass, hay, weeds, on level or rough. Moderate price.

**WRITE FOR CATALOG.**

SIX TIMES AS FAST AS A SCYTHE

**CATCH FISH!**

minnows, eels, mink, muskrat, with our folding galvanized Steel Wire Traps. Walton's Automatic Hooks are so constructed that when a fish gives the slightest pull on the bait the upper hook reaches down and gets a hold that lands him. 3 for 50c. Write for descriptive catalog of Traps, Hooks, Lures, and other specialties. **Walton Supply Co., 3507 Junata Ave., St. Louis, Mo.**

**Choose from World's Largest Line of Power Tools!**

**FREE** New 1940 Catalog covers Metal and Woodworking Tools, accessories, motors for every purse. Write **Walker-Turner Co., Inc., 180 South Ave., Plainfield, N. J.**

**DRIVER Engineered POWER TOOLS**

**BUILD THESE PROJECTS**

For garden or lawn. Easy to build. Easy to sell. Detailed Blueprints Model B-25 Dutch Windmill 50c; Model OSM-60 Old Mill, 85c. Lawn Figure Patterns—Sunbunnet Girl, Dutch Boy, Tulip Girl, Holland Pair, 35c each, all 4—\$1.00. Catalog illustrating many models, send 10c, today.

**CRAFTSMAN'S MODEL CO., Dept. P-43, 2038 N. 41st St., Milwaukee, Wis.**

**TOMBSTONES \$9 UP** Freight Paid

Genuine Marble & Granite At Low Prices. Lettered. Guaranteed. Free Catalog and samples. Write Us before buying.

**U. S. MARBLE & GRANITE CO., A-18, Oneco, Fla.**

**FREE WHOLESALE CATALOG**

260 pages chock-full of tested fast sellers, for salesmen, dealers and operators. Big 1940 issue, off the press. Describes many plans for boosting sales one of which may add \$3 to \$15 a day to your earnings. It illustrates carded goods, automobile accessories, household necessities, office specialties, wearing apparel—over 4000 first quality items at low wholesale prices. Cost about 35c, **FREE**, while stock lasts. Get your copy by mailing your request for it, now.

**SPORS COMPANY**  
6-40 Main St. Le Center, Minn.

**4000 BARGAINS**

**Calling All Cars**

**MYSTERIOUS DISCOVERY**  
**SAVES UP TO 30%**  
**on GASOLINE**  
*or Costs Nothing to Try*



**FITS ALL CARS**  
Constructed of six parts fused into a single unit, a just and sealed at the factory. Easily and quickly installed by anyone in a few minutes.

**Stop wasting Gas!**—trim dollars off gas bills—get more power—quicker pickup—faster acceleration! **AUTO OWNERS everywhere** praise **VACU-MATIC!** Proven so efficient, it is guaranteed to satisfy, or the trial costs you nothing.

**Automatic Supercharge Principle**  
Vacu-matic is entirely different! It operates on the supercharge principle by automatically adding a charge of extra oxygen, drawn free from the outer air into the heart of the gas mixture. It is entirely automatic and allows the motor to "breathe" at the correct time, opening and closing as required. Saves up to 30% on gas costs, with better motor performance.

**AGENTS** *Get Yours FREE*

**FOR INTRODUCING.** Here's a splendid opportunity for unusual sales and profits. Every car, truck, tractor owner a prospect. Send name and address now for big money making offer and how you can get yours Free. **The Vacu-matic Co., 7617- 529 W. State Street, Wauwatosa, Wis.**

**SHAW DU-ALL GARDEN and SMALL FARM TRACTOR**



Does **ALL JOBS** on small farm—small jobs on **ALL FARMS**. Three types: 2-wheel garden tractors 2, 3, 4, 5 H.P.; 4-wheel 5 and 8 H.P. Riding Tractor: High arch models, 8 H.P. Write for **FACTORY prices—FREE CATALOG.**



**SHAW MFG. CO., 4508 Front St., Galesburg, Kan.; 5812-G Magnolia Ave., Chicago, Ill.; 130-G West 42nd St., New York City; 668-G North 4th St., Columbus, Ohio.**

Air-cooled engines; auto-type gear shift; many fine features.

**Build a BOAT**  
*for PLEASURE or PROFIT*



**EASY—LOW COST with POPULAR MECHANICS BOAT BOOK**

**Shows EXACTLY HOW TO BUILD 15 DIFFERENT BOATS**

This is the new edition with 42 added pages, 6 new books, and conversion of Ford motor for marine use. Full directions and details for cabin cruiser, racing, hydroplane, outboard runabout, sail boats, kayak, sled type—15 boats in all. Also sectional boat to carry on car.

**These Are the Boats:**

"Roamer"	16 ft. Cruiser
"Popular Flyer"	12 ft. Hydroplane
"Crack"	16 ft. Runabout
"Rambler"	16 ft. Inboard
"Flash"	14 ft. Runabout
"Sauterer"	12 ft. Rowboat
"Chum"	12 ft. Sailing Boat
"Sailing Skiff"	12 ft. Sailing Boat
"Sea Saucer"	9 ft. Sailing Boat
"Skip"	8 ft. Dinghy
"Half Pint"	12 ft. Sea Sled
"Rowboat"	15 ft. Flat Bottom
"Kayak"	17 1/2 ft.
"Racing Shell"	17 1/2 ft.
"Sectional Rowboat"	12 ft.

**POPULAR MECHANICS PRESS**  
200 E. Ontario St. Dept. 840 Chicago

K 372

## Super-Speed Roads of Tomorrow

(Continued from page 191)

lane. Beyond, the 100-mile-an-hour lane with large and small passenger cars, trailer-truck-trains of several cars and small farm trucks carrying produce.

A flick of the switch to the "75" dial swings you into the next lane. Another flick and soon your car enters the 100-mile-an-hour section of the transcontinental motorway. Here you stay except for fuel stops.

The wife and children have fallen asleep on their adjustable couch-like seats. You pass Pittsburgh and Fort Wayne without seeing them and at 1:30 a.m. a voice from the box tells you Chicago is forty-seven miles north. You are thankful that highway planning has reduced the jump from 697 miles to 625 by "straight-shot" motorways and has cut the time to nine hours.

Over the Mississippi on a two-mile bridge and into the west until dawn catches up with you in Nebraska. You switch to "75," then "50" and pull into a combination fuel station, emergency stop, restaurant and hotel. After breakfast, the wife takes the wheel and you tilt your seat back for a snooze which lasts until Salt Lake City. Here the fifty-mile lane swings around the lake, but the higher speed roadways draw together and the "100" rises on top of the "75" forming a two-deck bridge. Beyond the lake the climb soon begins in earnest and the lanes no longer parallel each other, each requiring a different grade and curve radius. The "100" and "75" lanes climb a much straighter route than the "50," using cuts, fills, grades and tunnels.

As the altitude signs read "7,000 feet," your tires sing over the now unused snow slots. The road surface is composed of metal with gratings that allow the snow to fall through into receptacles where chemicals melt it. In other sections, a chemical is automatically sprayed over the surface from hydrants which also flush the resultant slush away.

After the short run along "the top of the world," the 75-mile-an-hour route joins up again. Likewise the "50" which has used triple the mileage, but is preferred by sightseeing tourists who have no dinner appointments tonight in San Francisco.

At 4:45 the radio signals the car's approach to a transition point and before



long you dial "75," then "50," soon turning off into the feeder leading to San Francisco.

Jogging along at fifty on a wide express boulevard, a bit tired, but anticipating one of Aunt Lillian's apple pies after the snacks at fuel stops, you wonder why all this wasn't done long ago. Airplanes were making blind landings on radio beams as far back as 1940. Years before that the railroads were operated by automatic signals and controls.

San Francisco, you find, is beginning to look more and more like New York and Chicago as the modern sections crowd out the old. The new blocks are made up of low five-storied structures, every tenth block consisting of one huge skyscraper—a steel and glass shaft set back with garden terraces. Buildings are restricted to seven different heights. Adjacent to the buildings are recreational and rest facilities. Parks cover one-third of the total land area. Pedestrians and automobiles are kept entirely apart. Shoppers walk on sidewalks at the second-story height of buildings. At intersections, the sidewalks bridge the streets.

The lower motor level is no wider than was the 1940 street together with its sidewalk; but its traffic capacity is double that of 1940. Its traffic lanes extend from building line to building line, not from curb to curb. Cars are parked indoors.

The streets themselves are all one way and of only two widths—100 feet and eighty feet. There are no breaks in the flow of traffic. At intervals of ten blocks each way streets are crossed by a grid of express boulevards, 100 feet wide, designed to ramp alternately above and below the cross streets in a basket-weave pattern, and thus permit an uninterrupted, sustained speed of fifty miles an hour through the heart of the city.

In 1940, street speed in the great city averaged about fifteen miles an hour. Boulevard speed averaged about twenty-five miles. By 1960 both speeds have been exactly doubled.

For which you are mighty thankful, since it is supper time and Aunt Lillian and her delicious apple pies are still three blocks ahead and ten blocks to the right.

You are sorry you loafed at those fuel stops in the mountains, although the scenery was beautiful. Next time you'll hurry.

## Mows and Trims Lawns

in One Simple, Easy Operation



Save Time and Labor with a

## MONTAMOWER

Tired backs and aching arms just don't happen to users of Montamower. All the drudgery and noise of lawn mowing is done away with. No dead weight to push and pull. Instead, just 7 pounds of live mechanism that first gathers then cuts the grass closely, smoothly, and to the correct height; no matting; no streaking; no clatter; no rattles. Cuts a 16" swath through long grass, dandelions, spike grass and weeds. Cuts right up to walls, fences, trees or posts; leaves no fringes to be trimmed by hand. Cutters are self-sharpening. Built to last many years. Guaranteed. Thousands in use. Sold direct from factory. Costs little. Write at once for guarantee information and literature.

### MONTAMOWER DISTRIBUTING CO.

329 Houseman Bldg. GRAND RAPIDS, MICHIGAN

**ANNOUNCING**  
New Daisy 1000-SHOT  
**RED RYDER CARBINE**

New Daisy COWBOY CARBINE features:  
16" Leather Saddle Thong on genuine Western CARBINE RING!  
Golden Bands! Red Ryder BRAND on Pistol Grip Stock! 1000-Shot Repeater! Lightning-Loader Device! \$2.95 at Dealers. If he hasn't it, send us \$2.95. We'll mail yours postpaid.

Write for FREE New Catalog **DAISY**

**DAISY AIR RIFLES** IT'S REALLY YOURS for only \$2.95 DUTY ADDED IN CANADA

DAISY MANUFACTURING COMPANY  
548 Union St., PLYMOUTH, MICH., U.S.A.

**BIG 7-FOOT GLIDER**  
Easily built, beautiful

Class E Complete Kit only **\$1**

**CLEVELAND CONDOR**

- 48" Eaglet (Baby Bowlius type) Soaring Glider, only 50c.
- Send 10c for latest catalog of Model Airplanes, Race Cars, RR's, Ships, etc.

Orders under \$1.50 add 15c packing, postage charge.

**CLEVELAND MODEL & SUPPLY CO. INC., 4508D85 Lorain Ave., Cleveland, Ohio**

**S AGENTS 300% Profit SIGN LETTERS**

For Store Fronts and Office Windows. Anyone can put them on. Free Samples. Liberal Offer to general agents.

**METALLIC LETTER CO., 428 N. Clark St., Chicago**

**Earn Cash at Home!**

**M.M. EARNED \$1174 at Home!**

We paid M. M. \$1174 for exceptional cellar crop Snow-King mushrooms! We furnish materials; buy all crops. Big FREE picture book tells if your cellar, shed, barn, suitable. Est. 1908. Write today. United Co., 3848 Lincoln Av., Dept. 301, Chicago

**A AND N SUPPLY CO.**

Bargains—Military, Sport Goods, Firearms, Clothes, Shoes, etc. Send 10¢ for new catalog, to be redeemed on first order.

EST. 1868 A & N Supply Co., 4772 Lester St., Richmond, Va.

**MONEY IN RABBITS—CAVIES**

**WE BUY** and put you in touch with other markets. Catalog and copy of magazine 10c. Or send 25c for Book Catalog and Price List and Year's Subscription to the AMERICAN SMALL STOCK FARMER.

**OUTDOOR ENTERPRISE CO., BOX 919, NEW CITY, N. Y.**

# OPPORTUNITY KNOCKS

*a  
Thousand  
Times  
in a*



## THOUSAND HELPFUL BOOKS

**SELECT FROM THIS LIST. ASK ALSO FOR FREE LIST ON MANY SUBJECTS**

- BLUEPRINT READING**  
for the Building Trades.....\$1.25
- STEEL SQUARE**  
How to Figure Angles of Rafters, etc.....\$1.00
- 1000 SPARE TIME MONEY-MAKING IDEAS**  
Start a business of your own.....\$1.00
- COURSE IN WOOD TURNING**  
Easy to follow.....\$1.50
- MECHANICAL DRAWING**  
Learn Drafting: Good Salaries.....\$1.00
- METAL SPINNING**  
How to become proficient.....\$1.00
- PLASTERING & STUCCO WORK**  
Interior & Exterior.....\$1.25
- TURN SCRAP INTO MONEY**  
Use Old Auto Parts.....\$1.00
- MAKING AMATEUR PHOTOGRAPHY PAY**  
Where to submit & how to sell.....\$1.00
- AUTO BODY & FENDER REPAIRS**  
New Book Covers All Details.....\$3.00
- REFRIGERATION**  
Electric, Gas. Be a Service Expert.....\$5.00
- WOOD FINISHING**  
Methods, Tools.....\$2.00
- CIVIL SERVICE**  
Home Study Courses, Federal, State & City Positions.....\$1.00
- PROSPECTOR'S HANDBOOK**  
How to Mine, Appraise, Equip.....\$3.00
- ROPP'S CALCULATOR**  
Cuts Figuring to a Minimum.....\$0.50
- SOILLESS PLANT GROWTH**  
Complete Directions.....\$2.75
- PHOTO ENLARGERS**  
Make Your Own, Four Types.....\$0.25
- HOUSES, SMALL**  
Book of, for Home Builders.....\$2.00

- PAINTING & DECORATING**  
New Book.....\$1.50
- TOYS**  
Build for Amusement or Profit.....\$1.50
- TRAILER BUILDING**  
Four Tested Plans.....\$1.00
- UPHOLSTERY**  
Always a Big Market Start Own Business.....\$2.00
- AUTO RACING**  
How to Build Cars, Speed up Fords.....\$1.00
- NEW SMALL HOMES**  
59 Popular Designs.....\$0.50
- MONEY-MAKING FORMULAS**  
New 480 Page Book.....\$4.35
- PRACTICAL BRICKLAYING**  
Step-by-step Instructions.....\$1.75
- BLUEPRINT READING**  
for Machine Trades.....\$1.50
- HOUSE WIRING**  
Methods, Materials.....\$2.50
- WOODWORKING POWER TOOLS**  
Build Your Own.....\$0.25
- ARC WELDING**  
Procedure Handbook, New Ed. Just Out.....\$1.50
- CONCRETE**  
1001 Ways to Use.....\$1.98
- ELECTROPLATING**  
Copper, Nickel, Chromium, etc.....\$0.25
- WHAT TO MAKE**  
192 pages of Craft Projects.....\$0.50
- SHOE REPAIRING**  
Modern methods.....\$1.00
- WELDERS**  
Build Own Arc or Spot.....\$0.25
- KNOTS, TIES, SPLICES**  
For Everyone Who Handles Rope.....\$1.00
- CARPENTRY**  
Carpentry & Joinery in all Forms.....\$2.00
- SOLDERING**  
New Tricks and Methods.....\$0.25

## Send No Money!

Order from above list. If in U. S. or possessions, and order amounts to \$1.00 or more, pay postman on delivery plus small C.O.D. fee. We pay postage if remittance is sent with order. Ask for complete list of books on many subjects. Order today.

**POPULAR MECHANICS PRESS**

Room 840

200 East Ontario St., Chicago

## Keeping Midget Racers Rolling

(Continued from page 235)

tios in a few minutes. Most modern midget cars have abandoned the usual clutch and use a positive in-and-out shift. Two wheel brakes, either hydraulic or friction, are satisfactory because of the decelerating effect of the engine when the accelerator is released.

Midget cars average only about sixty-five miles per hour on the quarter-mile tracks yet many enthusiasts would like to see the rules changed so that a midget car could compete against its big brothers in the annual 500-mile Indianapolis race. They think a supercharged midget would have a good chance of placing up among the leaders. A midget has a top speed of about 125 miles per hour as compared to an average top of 175 miles per hour for a big race car, yet one reason why a midget might make a good showing is that the driver probably would be able to drive through turns wide open, the car's lightness and ease of control permitting the driver to make a good average speed around the track. The average midget weighs 850 pounds, half as much as a big car, has up to 100 horsepower as against 200 to 300 horsepower, a tread of forty-five inches as against sixty inches, and a wheel base of seventy inches as against an average for the big cars of 104 inches.

## Tuning in the Next President

(Continued from page 223)

a large switching panel standing alongside the speakers' stand and controlled by three technicians. As the chairman of the convention polls a delegation the technicians switch its microphone into circuit and the voice of the delegation's leader is carried into each of the control booths. Any of the networks can cut in or out of the panel, and while the polling continues on the floor, the loud-speaker system alone may be connected with the switchboard, while the networks are bringing in other interesting activity for their listeners.

As the vote is recorded, and its result becomes apparent, the noise of the crowd increases. To enable radio listeners to hear this, technicians switch on the parabolic microphones, which are regular microphone units collared by large curved metal

disks, to permit focusing on distant sounds.

When the band strikes up, a touch of a switch in the control booth brings a close-up of the music by means of microphones in front of the bandstand. If a great demonstration for a favorite son starts, all its exciting sounds are broadcast by a battery-operated short-wave transmitter carried on the back of an announcer on the floor. Its signals are picked up on a short-wave receiving set inside the hall and then broadcast to the nation. The announcer gets his cue by means of a very light short-wave receiver which he also carries.

Televising the Republican convention constituted probably the most elaborate television coverage ever given to a single event. Two mobile television units were used for daily program relays from Philadelphia to NBC's New York City transmitter. Special television camera stands and an interview studio were provided.

The relay from Philadelphia to New York was made over a coaxial cable. Capable of transmitting several hundred telephone messages simultaneously, the cable handled only a single television program.

## Blitzkrieg!

(Continued from page 165)

and food. The mechanized units, which can go 200 miles or more a day when unimpeded, carry two days' rations for man and motor. If the first bound carries you through the covering forces and fortifications, the further you go and the faster you move, the easier the going is along that particular line. It is quite possible that, since the roads and resources along those roads are known, fuel and food may be seized. If that be impossible, you must arrange for fast-shuttling motor supply convoys to bring up fuel, ammunition and food daily, while the spearheads of the advance may also be replaced by fresh reinforcing tanks and combat cars which will leapfrog tomorrow the squadrons which started the drive today.

Lest hostile planes take the air from dromes you have not found and bombed, squadrons of pursuit planes cover the advance, to protect both the mechanized units and their following motorized infantry, and also your own attack aviation; that is your anti-aircraft artillery, motor-

(Continued to page 142A)

## The ONLY WORKSHOP TOOL OF ITS KIND—



PLANES and FINISHES  
PANELS • RABBETS  
ROUTS • TENONS

FITS ANY  
DRILL PRESS  
\$7.50  
COMPLETE  
READY TO USE

• A precision safety tool . . . does five distinct operations . . . saves time, money, labor . . . planes and finishes to precision smoothness . . . all woods, tricky grains and knots . . . provides intricate, beautiful paneling effects with ease and speed . . . rabbets, grooves and routs . . . fashions tenons with uncanny accuracy and lightning speed. No blade adjustments required for any or all operations. Fits any 1/4 h.p. or larger drill press.  
**MONEY BACK FREE TRIAL GUARANTEE.** You risk nothing. Send check or money order for \$7.50 or order C.O.D. Postage prepaid. Use it for five days and get full refund if not satisfied.  
**BARRON TOOL CO., INC., 311 Architects Bldg., Detroit, Mich.**

## THE BARRON MULTI-PURPOSE 5-IN-1 ROTARY WOOD PLANER



## 10 LESS STROKES

Two-thirds of the game is played on or near the green. *The Short Game*, by P. A. Vaile, easy to read and follow, has helped many golfers cut scores 10 to 15 strokes. Sent for 10c . . . Worth its weight in gold.

**BECKLEY-RALSTON CO.**  
40 W. Cermak Rd. Chicago

## EASY TO BUILD KAYAKS IN & OUTBOARDS



**ROWBOATS** Complete Cut-to-Fit "Double Processed" Home Assembly Kits. No Experience Necessary. Detailed Illustrated Instructions. Save Money — Build Your Own —

More than 1001 Satisfied Builders. Write today for FREE COMPLETE CATALOG illustrating 20 models.

**KAYAK BOAT CO.**  
154-P. East 129 St., N. Y.



## MECHANICS SEND NAME FOR FREE SAMPLE

**SENSATIONAL NEW KIND OF PISTON RINGS!**  
Spectacular new replacement piston ring invention—Look! Unbreakable! No breaking in! No expanders needed! Guaranteed 100,000 miles! No reboring, honing or grinding. Amazing self-locking design gives top compression, lowest oil consumption. And you buy at FACTORY DISCOUNTS—make money on every ring job. Seeing is believing. Send your name for Absolutely Free Sample, postage prepaid. Penny postcard will do. Address **TRIPLE-X ENG. CO., Dept. 168, 3801 S. Racine Ave., Chicago, Ill.**

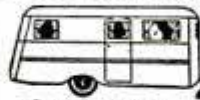

Complex Plans and Building Instructions. 10c

## FREE TRAILER PARTS CATALOG

We'll save you money on—axles, springs, wheels, couplers, windows, sinks, water pumps, brakes, refrigerators, beds, lamps, inside and out, 6V lamps, furniture, jacks—everything. Special discount to mfrs. **NATIONAL TRAILER EQUIPMENT CO. Successors to Kar-A-Van Industries, Inc. Dept. P. 714 W. Wisconsin Ave., Milwaukee, Wis.**

He Makes a  
Good Living

**FILING  
SAWS**

"Last year I sharpened 2309 hand saws, for which I got \$1154.50. The Foley Saw Filer has made a good living for me"—John Joseph, Calif. A FOLEY Automatic Saw Filer files hand, circular and band saws better than the best hand filer. Cash business, no canvassing, no eyestrain. No experience needed. Send coupon for FREE PLAN, no obligation.



**FOLEY MFG. CO., 816-40 Foley Bldg., Minneapolis, Minn.**  
Send Free Plan on Saw Filing Business.

Name . . . . .  
Address . . . . .

ized of course, is rolling with your own columns to furnish additional protection to them and to the bridges and tunnels you have seized.

It all sounds diabolical, fantastic and terrifying. It is. But never has man developed any weapon or technique for harassing his fellowman that antidotes have not been found. The backbone of defense is discipline: training that holds men together in stress, together with a planned organization. Airdrome runways sown with concrete blocks prevent hostile landings. These blocks must be movable, else we hinder our own air power from action, and ground crews must be trained to scatter them and replace them. Runways may be split by traps—counterparts of the drawbridges of old—to be tripped or replaced at a signal. Highways, too, may be so safeguarded. Bridges must be mined, under the control of men who will, without hesitation, blow them up, when necessary. Waterworks, power plants, telephone and telegraph centrals, radio stations, supply dumps and factories, must be guarded from the "fifth column."

The covering forces—outpost troops—must be trained soldiers. They must be equipped with anti-aircraft and anti-tank guns to cripple and slow down the first rush. Behind them garrisoned where they can be rushed to the place we decide to launch our counterattack, must be the mobile main body, also trained troops. They must be protected by anti-aircraft and anti-tank artillery. Their own spearheads must be mechanized, that they may shoot into the area into which the enemy has swept and in turn disrupt his communications.

Stone-wall defense is impossible, since we cannot be strong in all places at the same time. Once a stone wall is pierced, the path is free for the invader. But our own fortifications must be so arranged that we may use them to protect a flank of the counterattack. Modern war differs from the past only in that we must think in terms of hundred-mile bounds instead of miles, of minutes instead of days. The world has done this in its peacetime traffic systems. It must do it in war.

Our air force must be prepared to leap into action—to harass, to strafe, to get information. This it must do in close coordination with the ground troops and the

navy. Alone, the air force is as useless as a battery of artillery without support. Combined with the other members of the combat team, it becomes a vital force.

Anti-aircraft warning systems, by which all the communications resources of the nation will be linked to spread the alarm of approaching aircraft, are essential. Part of this defense net must consist of locally organized bodies of home-defense forces prepared to shoot down the parachutists. The parachute technique is to drop armed men. These reach the ground scattered over comparatively wide space. They must rally into fighting units, must retrieve the machine guns and extra ammunition dropped at the same time. It is not as individuals but as groups that they are dangerous. On the highways, road-building equipment in the hands of trained men may be transformed into road-breaking equipment. Any and every means which will slow down the mechanized forces puts the brakes on blitzkrieg, paves the way for the decisive counterblow. But it cannot be done by theory alone, it cannot be left to untrained individual initiative. It must be planned, it must be organized.

The success of a blitzkrieg is definitely dependent upon ability to follow up the mechanized spearheads with the main body of troops which will organize the ground swept over in the first rush, open the way for unimpeded supply and reinforcement, and mop up the remaining enemy troops. Once the other fellow has time to draw breath, the initiative has been yielded by the attacker. And the essence of it all is time. A counterattack cannot be launched until the direction and extent of the blow be definitely known. One must first parry, get set, then return the blow.

Better still, and certainly less nerve racking, is not only to match the other fellow ship for ship, gun for gun, trained man for trained man, in the air, on the land and on the sea, but also to raise the ante. The pleasant thing about that is that then there probably won't be any blitzkrieg. Or at least the "blitz" won't be on our home folks.

(Note—The foregoing is the opinion and view of an individual, and should not be construed as necessarily reflecting official War Department opinion, nor that of the services in general.)



*Capture those  
"SPLIT SECOND"  
Action Shots!*

Now you too can experience the thrills of taking those "hard-to-get" split-second action shots—night or day! The 1/1000th Second UniveX Mercury answers your every picture need! **\$1000 Mercury Contest!** Get details from your dealer. Or, write Universal Camera Corp., Dept. M-13, New York, N. Y.

On Easy Terms **\$29.75**  
At Many Dealers

With Tricolor  
f3.5 Lens



**COMPARE WITH ANY \$50 CANDID!**

- 1/1000th second focal plane shutter
- Tricolor deep-focus f3.5 lens • Built-in photoflash synchronizer • Quick-action controls • Interchangeable lens equipment • Automatic film transport—makes double exposures impossible.
- NEW!** Accessory Cartridge for day-time loading all types of 35mm. film.

**1/1000th SECOND**  
*UniveX* **MERCURY**  
AMERICA'S CHALLENGE TO WORLD'S FINEST CAMERAS!

Start a Profitable Business of Your Own  
Get the New Book • Just Published

**MONEY Formulas MAKING**



Here is the book you need to put yourself into a good paying spare time or full time business of your own. Shows how to make, package, and sell saleable articles of all kinds. Gives practical and tested formulas for household, auto and shop products. Tells how to make cleaning products, polishes, soaps, rubber, glass adhesives, cement, lacquers, pharmaceuticals, food products, cosmetics, photography accessories, and hundreds of other products. Order today. Pay postman on delivery or sent postpaid for \$4.35. Money back if not satisfied.

**GIVES EVERY FACT YOU NEED**

Hundreds of good paying businesses have been built on products made from simple recipes. Opportunities in this field exist everywhere.

**POPULAR MECHANICS PRESS**

Dept. 840, 200 E. Ontario St., Chicago

**BUILD YOUR GRANDFATHER CLOCK**

Send 25c for Simple SHOP TESTED COPYRIGHTED BLUEPRINT. The Simple Sensible Rod-Kit way no thousands have. DIME brings PLANS and sixty picture "HOW" Book giving many fine brass weight Westminster, tube chime, electric and battery movements showing nine beautiful colonial grandfather cases. Build now and save half. **KUEMPEL CHIME CLOCK CO., Bldg. 43, Guttenberg, Iowa.**

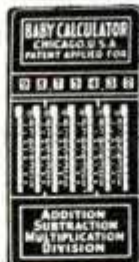

**WORLD'S LOWEST PRICED ADDING MACHINE**

IDEAL FOR BUSINESS OR PERSONAL USE GUARANTEED ACCURATE. Not a toy. Operates with only a finger flick. Adds, subtracts, multiplies, divides. Counts up to a million. Pays for itself over and over. Ideal Gift—for Business, Income Tax and School use. **MONEY BACK GUARANTEE.** Send name and address. Pay postman only \$2.50 plus postage. (Send full cash if outside U.S.) Money back in 10 days if not delighted. **AGENTS WRITE.**

**CALCULATOR MACHINE CO., (Mrs.) DEPT. 108, P.O. BOX 1118, CHICAGO, ILL.**

In answering advertisements always write name and full address clearly.

**Earn \$150 to \$300 PROFIT monthly with New Arc Welding**



**Save \$300**  
**"Build Your Own" Hobart Arc Welder**  
With this Hobart welding generator, a reconditioned auto motor and used auto chassis you can build your own arc welder and save.

Establish a welding business for yourself and you'll earn big money every month. "Simplified" Arc Welding is easier, faster, more economical... and brings in the big pay jobs carrying real profit.

**30 DAYS TRIAL.** Try a Hobart welder for 30 days on your work, at our risk, to prove it's profitable **ONLY \$20 MONTHLY.** The extra profit from a single job will often take care of your small payments... so own your own welder with practically no outlay on your part.



**PROFITS PAY FOR IT**

Ask about HOBART'S liberal "No Investment terms"

**HOBART**

**FASTEST SELLING ARC WELDER ON THE MARKET TODAY**

**FREE!** VALUABLE BOOKLETS ON ARC WELDING—CHECK AND MAIL COUPON TODAY!

- How to "Build Your Own"
- New Profits in Arc Welding
- New Arc Welding Cat.

**HOBART BROS., BOX M-840, TROY, OHIO**

Send me information on  Build Your Own Portable Welder  
 Electric Drive Welder  30 Days Trial  Easy Terms  
 Rental Plan. Also send free books I've checked.

Name \_\_\_\_\_ Address \_\_\_\_\_

# Prices Reduced!

ON ALL SOUTH BEND  
9" WORKSHOP LATHES

Model C Bench Lathes

Now Only

**\$79<sup>50</sup>** LESS  
MOTOR DRIVE

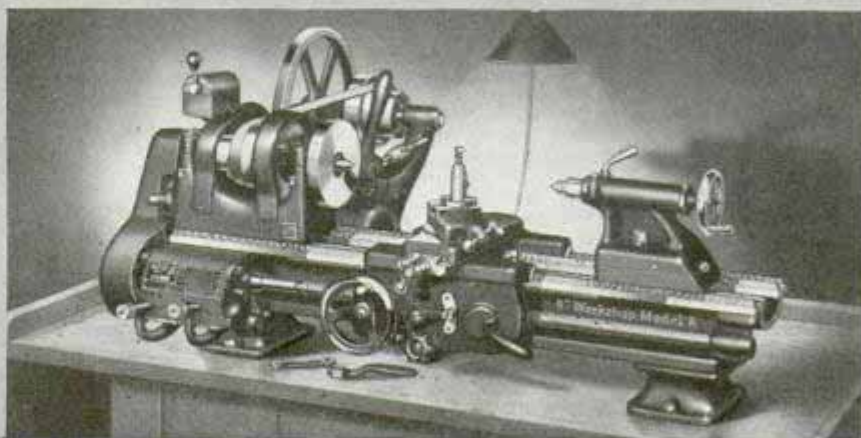

**Model A** 9" x 3' Workshop Quick Change Gear Bench Lathe with Power Cross Feed, Horizontal Motor Drive, Reversing Motor, and Reversing Switch. Ship. Wt. 340 lbs... **\$199.50**

**S**AVINGS that result from the efficiency of our quantity production are passed along to you in lower prices, giving you even more for your money than formerly. This is the same high quality South Bend 9-inch Workshop Precision Lathe that has become known the world over as the best lathe value per dollar of cost. It has the same quality construction, the same fine design, the same features.

**SOUTH BEND LATHE WORKS**  
608 E. Madison St., South Bend, Ind., U.S.A.

**ON DISPLAY IN ALL  
PRINCIPAL CITIES**

Baltimore, Md.—Carey Machinery Co.  
Boston, Mass.—MacKenzie Machinery Co.  
Bridgeport, Conn.—A. C. Bisgood  
Cleveland, Ohio—Reynolds Machinery Co.  
Dayton, Ohio—C. H. Gosiger Mach. Co.  
Detroit, Mich.—Lee Machinery Company  
Houston, Texas—Wessendorff, Nelms & Co.  
Los Angeles, Cal.—Eccles & Davies  
Milwaukee, Wis.—W. A. Voell Mach. Co.  
Newark, N. J.—J. R. Edwards Machinery Co.  
New York, N. Y.—A. C. Colby Mach. Co.  
Philadelphia, Pa.—W. B. Rapp, Machinery  
Pittsburgh, Pa.—Tranter Manufacturing Co.  
Portland, Ore.—Portland Machinery Co.  
Providence, R. I.—Geo. T. Reynolds & Son  
Rochester, N. Y.—Ogden R. Adams  
San Francisco, Cal.—Moore Machinery Co.  
York, Pa.—York Machinery & Supply Co.

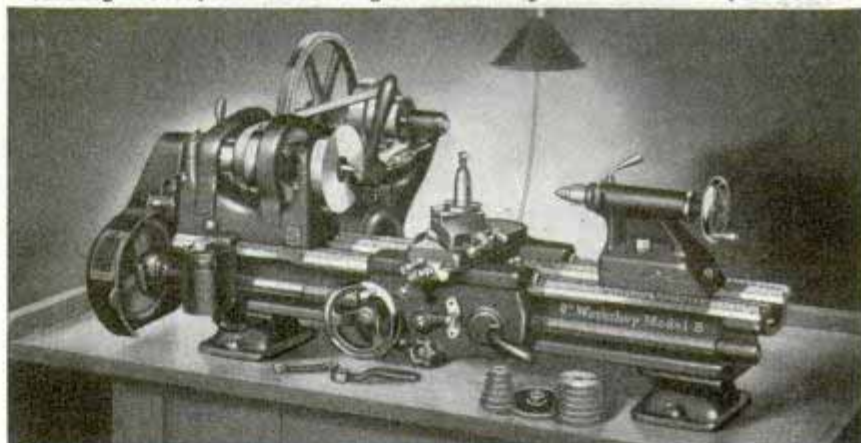

**Model B** 9" x 3' Workshop Bench Lathe with Power Cross Feed, Horizontal Motor Drive, Reversing Motor, and Reversing Switch. Ship. Wt. 330 lbs... **\$149.50**

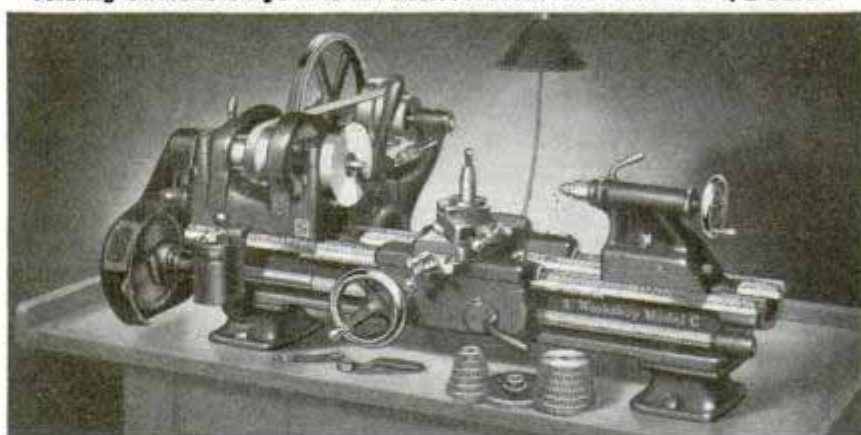

**Model C** 9" x 3' Workshop Bench Lathe with Hand Cross Feed, Horizontal Motor Drive, Reversing Motor, and Reversing Switch. Ship. Wt. 320 lbs... **\$109.50**

**SOUTH BEND**  
*Precision* LATHES

YOU CAN TALK  
ALL YOU WANT TO  
ABOUT BLOW-OUTS  
... I STILL SAY *SKIDS*  
ARE WORSE

BUT LISTEN  
A *BLOW-OUT*  
GIVES NO WARNING  
... YOU CAN'T STOP  
... YOU CAN'T STEER

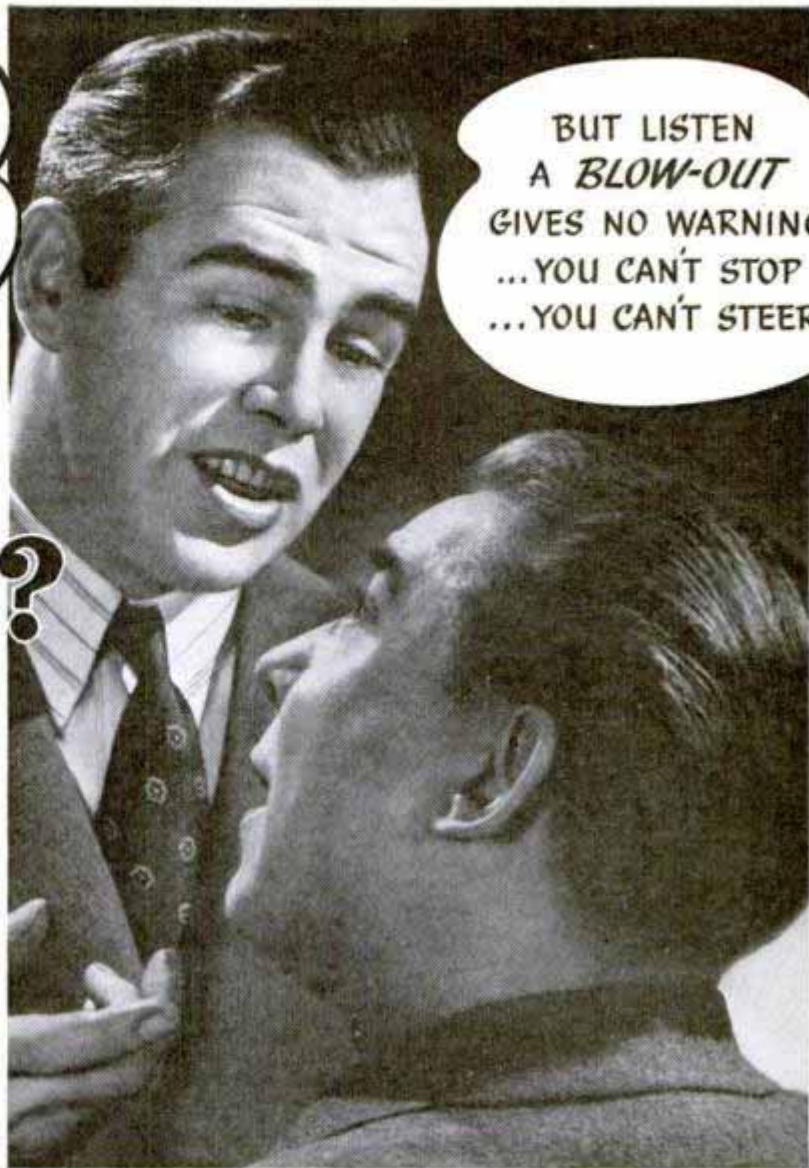

## Why Argue?

**New Goodrich Tire  
protects you against  
both skids and  
blow-outs**

READING TIME: 50 SECONDS

**W**HAT do you think? Are blow-outs worse than skids?—or skids worse than blow-outs? No matter what side of the fence you're on you're bound to admit that *both* are dangerous.

Yes, the figures prove it, too! Thousands are actually killed or injured in skid and blow-out accidents every year. And it's figures like these that demonstrate all too clearly why you need the extra protection of Goodrich Safety Silvertown tires. For, remember—Silvertowns are the *only* tires with the famous Life-Saver Tread that gives you the quickest non-skid stops you've ever had—and the new improved Golden Ply that offers maximum protection against dangerous high-speed blow-outs.

Why waste your breath arguing about skids and blow-outs when you may be risking your life riding on tires that do not give you protection?

Get Silvertowns now. You'll find you can get them easily, if you wish on the liberal Budget Plan available at Goodrich Silvertown Stores and many Goodrich Dealers.

### Miniature Reproduction of Your License Plate on a Key Chain

ONLY 10 CENTS for this smart handy reproduction of your own license plate on a key chain. Drive in to your nearest Goodrich Dealer or Goodrich Silvertown Store and ask them to get one for you. There's no obligation. Just 10 cents to cover cost of handling.



**The new Goodrich SAFETY Silvertown**

DON'T MISS JIMMIE LYNCH'S DEATH DODGERS AT THE GOODRICH ARENA . . . N. Y. WORLD'S FAIR



*and Milder*  
*and Better-Tasting*



There you have it... good reasons why Chesterfield gives so much smoking pleasure to so many people.

Treat yourself to a package today and every day... you'll see at once the refreshing difference in Chesterfield's right combination of the world's best cigarette tobaccos.

**CHESTERFIELD**  
*America's Busiest Cigarette*