

OUR FLYING NAVY

POPULAR MECHANICS



MAGAZINE

WRITTEN BY AMERICAN ENGINEERS

ISSN: 0097-0310 (U.S.)



JUNE
25 CENTS

SEE PAGE 861



**"GET THAT JALOPPY
OFF THE ROAD!
SEZ THE COP"**

**Read how this new kind of spark plug
peps up lazy, spark-weary motors**

"IT'S amazing, the difference in the way my car runs since I put in those new Auto-Lite Spark Plugs!" That's what owners of all makes of cars are saying as increasing thousands change to this sensational new kind of spark plug.

Often this one simple change holds the secret of quick, sure starting for sluggish motors—of flashing pickup and power—of smooth, even engine performance at all speeds—of substantial savings due to elimination of gas waste.

The performance of any car depends upon the efficiency of its ignition system. And Auto-Lite Spark Plugs have been expressly developed by ignition engineers to increase the efficiency of the ignition system by working in balanced harmony with it. They fire with less electrical strain—and that means a smooth, uniform flow of power, with faster pickup and livelier engine performance.

Next time you see the Auto-Lite sign, why not stop for a free inspection of your spark plugs? Cleaning and proper setting of the electrodes costs only a few cents; and you will save money by replacing worn-out plugs with new Auto-Lites—they cost no more.



**LISTENING TO AN
ENGINE'S HEART-BEAT**

Using a sensitive stethoscope, Auto-Lite engineers test the performance of Auto-Lite Spark Plugs under actual operating conditions. No guess work here.

**A TAXI DRIVER TELLS HOW HE PUT
NEW LIFE INTO HIS SLUGGISH CAR**



"YE'RE HOLDIN' UP TRAFFIC," the cop sez. "Get that jaloppy off the road!" I step on the gas but nothing happens. The old bus acts like she's glued to the spot.



"THIS BUS IS READY TO JUNK," I beef to the service guy. "Put in Auto-Lite Spark Plugs," he says. "She'll take your hat off when you give her the gas."



"HI, PAL!" I yells, next time I pass that cop. His eyes nearly pop out at how the old car shoots ahead with new Auto-Lites on the job.

THE ELECTRIC AUTO-LITE COMPANY
Merchandising Division
TOLEDO, OHIO • SARNIA, ONTARIO

**IGNITION ENGINEERED
BY IGNITION ENGINEERS**



Change to **AUTO-LITE SPARK PLUGS**

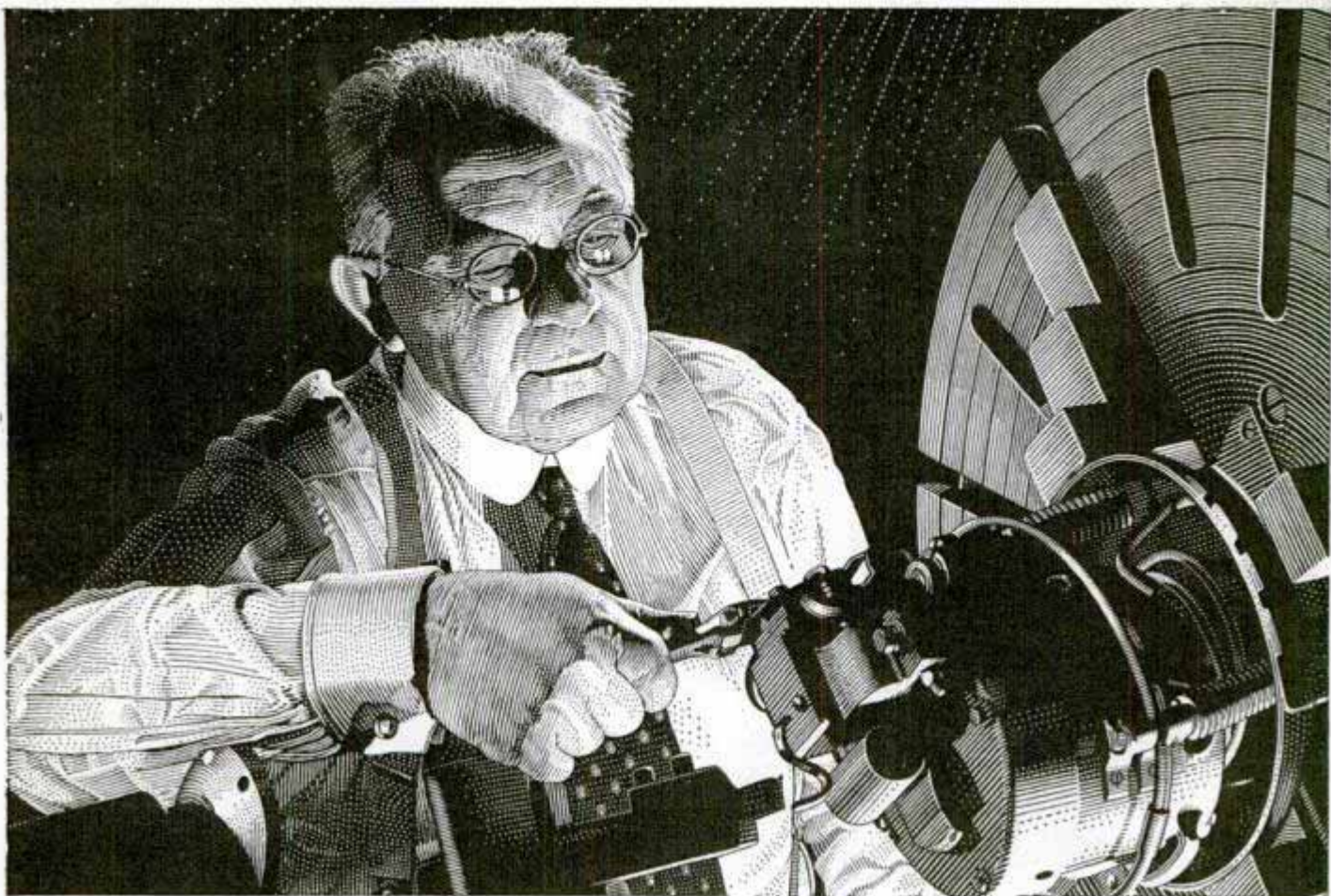

THE STORY OF STEENSTRUP

IN 1901 a young Danish toolmaker began work in the General Electric shops in Schenectady. One day he hit on an idea for making a machine safer and more efficient. The boss had his doubts, but Chris Steenstrup proved his idea would work. Today, beloved by his fellow engineers, with 110 patents to his credit, Chris is still looking for ways to improve things.

Chris welcomes tough engineering assignments. For instance, he solved one of the toughest problems in the building of Dr. Alexanderson's great radio alternators which made possible radio communication with Europe during the World War. Back when there were very few domestic electric refrigerators in the country, Chris got the job of devising a long-lived

and efficient refrigerator. After months of work he designed a mechanism that ushered in a new era in American living. For from it General Electric developed the first sealed-in-steel refrigerator mechanism—the principle that has helped bring the comforts of electric refrigeration to 14 million American families.

Chris Steenstrup's contributions to more comfortable living are typical of the hundreds made by General Electric men and women. For years they have been putting electricity to work in the home and in industry, helping to make all manufactured products more plentiful and less expensive, enriching our lives—providing More Goods for More People at Less Cost.

G-E research and engineering have saved the public from ten to one hundred dollars for every dollar they have earned for General Electric

GENERAL  **ELECTRIC**

90-236E1

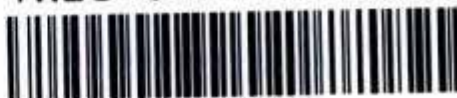



**"GIVE MY BEST
TO THE FOLKS"**

"Hope to be seeing you soon." . . . "Gee, it's swell to hear your voice." . . . "We're all well here."

No great words of business or state are these — just the homey, every-day conversations that are America. The thoughts and hopes and remembrances that bind families and friends together. The flow of understanding that helps to make this a united nation.

Always the Bell System stands ready to help . . . to do its part quickly, cheaply, courteously, in the manner of a friend.

**BELL TELEPHONE
SYSTEM**



Popular Mechanics Magazine

H. H. WINDSOR, Founder

H. H. WINDSOR, Jr., Editor and Publisher

June, 1940

Vol. 73, No. 6

IN THIS ISSUE

New Wonders of Agriculture	801
Sky-High Without a Motor	808
Our Flying Navy—Part I	Coloroto
Job Hunting in Test Tubes	828
500 Miles to Go!	834
Tapping Neptune's Treasure Chest	840
Battling Bugs with Bacteria	851
Solving Crime with the Camera	856
Science Rules the Cinders	866
20,000 Feet Down for Oil	872
Weighing Weather to Combat Fires	878
Making Your Voice Do Tricks	882
Keeping the Diesels Moving	888
The World's Shock Absorber	892

(Continued on next page)

Billion-Bushel Market Place

VENTURING for the first time, unenlightened, into that vast hall at the foot of LaSalle street in Chicago, you'd wonder what was the bitter argument among those shouting, gesticulating men. Fists and fingers fly, but there are no casualties; for this apparent disorder is in reality the orderly trading of unharvested grain crops in the world's largest commodity market place—the Chicago Board of Trade, where five billion bushels of wheat alone were bought and sold last year. One of those flying fists may be signaling a \$10,000 sale. A feature in the July issue takes you behind the scenes on the Board.

Masters of Destruction

RACING a four-horse team in front of the movie camera, the stunt driver closes a switch, leaps, and the wagon dissolves in the roar of a dynamite bomb, wheels flying high. Shells burst five feet from soldiers in war scenes, Atlanta burns safely in jets from an oil pipe line. Read next month about these Hollywood destroyers who play with powder.

Next Month

BIG fires were once little, and the difference between a flicker and a conflagration is a matter of minutes. In the July issue Chief Peter Kiernan of the Newark Fire Department offers sound advice for emergencies—what's the first thing to do with an electrical fire, with blazing grease in the kitchen, with burning clothes? Here's one tip in advance: if you smell smoke, feel the door before you open it to investigate; if it's hot, don't open. Death's on the other side.

Earth Goes to Sea

HOW deep is a farm? Skin off the six to eighteen inches of topsoil and you have no farm, only a sterile wedge of earth. Yet that's what's happening; every year three billion tons of fertile soil are eroded from American farms, flowing to sea in muddy rivers, darkening the sky with dust storms. But Uncle Sam has begun to fight back. An article in July tells of the war against erosion with soil-stopping furrows, dams, trees and crop rotation.

Secrets of Slugging

FEW baseball thrills compare with hitting a homer with the bases full. It should be easy; batting is merely an application of mechanical principles. But the best sluggers disagree on how to bat, and Babe Ruth didn't follow the rule of hitting level. Next month Harry Danning, New York Giants' catcher, offers you some "Secrets of Big League Batting."

Published monthly by POPULAR MECHANICS CO., 200 East Ontario Street, Chicago, U. S. A. Single copy in United States, 25 cents; \$2.50 a year, \$4.00 for two years, \$5.00 for three years in United States and possessions, Canada, Newfoundland, Labrador and countries of the Pan-American Postal Union including Spain. To all other countries add \$1.00 a year extra for overseas postage. Changes in address must be reported to us immediately to eliminate delay. Entered as Second Class Matter, Sept. 15, 1903, at the Post Office at Chicago, Illinois, under Act of March 3, 1879. Entered as Second Class Matter at the Post Office Department, Canada. Copyright 1940, by Popular Mechanics Co. in the United States, Australia and France. Printed in the United States of America.

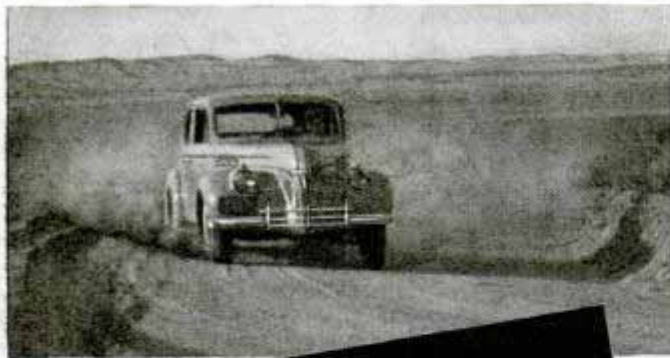

**Test Driver
TED ELLIS thanks
Pyroil for its
sturdy protection**

1345 miles over lofty mountains in freezing cold, through scorching heat in the Mojave Desert, battling roads of all kinds, averaging almost 22 miles to the gallon of gasoline and using only one quart, eight ounces of motor oil—that's the vivid story of test driver Ted Ellis' sensational run that brought forth high praise for Pyroil.



Ted Ellis is one of those courageous fellows who risk their necks testing automobiles in a dangerous way. "Recently," says Ellis, "I completed a 1345 mile test run using a car which I completely serviced with Pyroil prior to and throughout the entire run.

"The motor was sealed and the car driven through mountains, desert, heat, cold, over all kinds of roads. The excellent results secured bear out to me that the continued use of Pyroil will give a motorist protection to his engine and a more economical and better running car."

Top drivers of the world, and millions of car owners, use Pyroil. It safeguards against acid attack on metal parts. Removes hard carbon, gum and sludge contaminations. Improves operation. Offsets many common, often costly, repairs. Only a few ounces needed at merely a few cents cost.

Ask your favorite service station or garage for a trial Pyroil service, today. Manufactured and guaranteed by Pyroil Company, W. V. Kidder, Founder, 56 Pyroil Bldg., LaCrosse, Wisconsin, U. S. A.

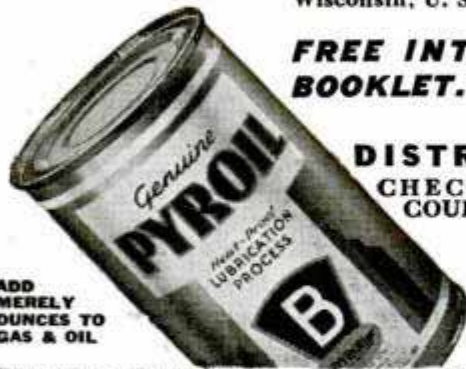

**FREE INTERESTING
BOOKLET. Mail Coupon**

**DISTRIBUTORS:
CHECK AND MAIL
COUPON FOR FRAN-
CHISE FACTS.**

ADD
MERELY
OUNCES TO
GAS & OIL

PYROIL COMPANY,
 56 Pyroil Bldg., LaCrosse, Wisconsin
 Please send me your Free Interesting Booklet about
 Pyroil.
 Send Details of Your Plan for Distributors:
 Name.....
 Address.....
 City..... State.....

(Contents—Continued)

AUTOMOTIVE

Road map unrolls as car travels.....833
 Black is favorite auto finish.....862
 Movie shows how wind affects auto steering.....865
 Front seat adjuster gives forty-five positions.....869
 Auto inclosed in transparent body.....890
 1924 car costing \$1,685 sells for \$40.....896

AVIATION

Landing gear studied in army air school.....804
 Plane muffler has "safety exit" for backfire.....843
 School for airline stewardesses.....845
 Pocket oxygen supply for high-altitude leap.....850
 Electric "stratoliner" model tested in wind tunnel.....854
 Motorcycle "fire wagon" fights plane blaze.....860
 "Ski Slide" proposed to launch heavy planes.....861
 U. S. plans plane with 11,000-mile range.....864
 Small three-cylinder engine.....881
 Engine set afire to test safety devices.....886
 Ice survey "bombs" river to find ship lanes.....887

BOATS AND BOATING

World's largest liners at same dock in U. S.....825
 Boat engine built of old auto parts.....838
 Speedboat with V-6 engine to seek record.....862
 "Crash boat" has four-bed hospital.....871

FARMS

Newspaper carrier shoots paper to rural box.....855
 Chute brushes cattle and kills flies.....881
 Two crops grown together in soilless garden.....890

HOUSEHOLD

Fast-working pressure cooker saves fuel.....806
 Non-collapsing ironing board fits in wall.....849
 Storage water heater fits under kitchen sink.....850
 Wall rack folds out of way.....850
 Convertible bridge table has an extra top.....863
 Recipe books on shelf tilt to reveal index.....865
 Hose washer can't get lost.....869
 Cake divider cuts equal pieces.....875
 Sawtoothed cutter trims lawn edge.....885
 Electric stove fits travel case.....895

MODELS

Welder sculptures tiny figures with a torch.....804
 Cinderella's carriage made from pipe cleaners.....839
 Battleship model trains young seamen.....855
 Tiny planes on tracks illustrate formation flight.....860
 Tiny four-cycle engine has overhead valves.....870
 Model trains test men for drivers.....886

PHOTOGRAPHY

High-speed flash "freezes" swimmers in air.....838
 Plastic cover makes safelight of darkroom lamp.....864
 Infrared drying lamps imitate sun.....876

RADIO AND ELECTRICITY

Curved reflectors put new angles on light.....847
 Directional "mike" adjusted by switch.....850
 Policeman's pocket radio receives orders on beat.....859
 Blast of air blows out electric arc.....863
 Television set in plane broadcasts view of city.....880
 Wireless magnetic telephones aid mine-rescue work.....886
 Band-switching "25-watter" for phone and CW.....935
 Portable battery-operated vacation receiver.....936
 How to improve tone of console receivers.....938
 Practical radio hints.....939
 Marine radiophone operates on battery or a.c. line.....940
 Special-purpose television transmitting tubes.....940
 Table-type and console sets for FM programs.....940
 Wide range signal generator for servicemen.....940

SCIENCE AND INDUSTRY

Speeding up the ancient art of rug making.....816
 Insects preserved in glasslike block.....844
 Synthetic silk and wool made from soybean.....844
 Bacteria alive after million-year sleep.....848
 Camera sees inside a high-pressure turbine.....849
 Magnetic "brain" to guide giant telescope.....870
 Million-pound "nutcracker" thrust splits oak.....871
 Radium exposure meter warns of danger.....885
 Eighth vitamin is synthesized as Pantothenic acid.....887
 Sheet metal stretched to form airplane "skin".....890
 Foot-controlled coil winder has even tension.....896

SPORTS

Floodlights for three major league ball parks.....833
 Coin-operated duckpin alley is automatic.....846
 Hollow plastic chessmen are ballasted by buyer.....877
 Table-tennis top fits card table.....895

(Continued to page 6A)



Alone and penniless, armed only with the ideas that filled his brain, he challenges the world—determined to wrest success from the grasp of the great city.



Romance enters his life when he meets lovely Mary Stillwell... but instead of interfering with his work, it helps him forge ahead... with a new will to succeed.



Soon he invents the stock ticker. For it he receives \$40,000, though he would have taken \$2,000! His first success—his first step toward fame and fortune!

With a Dime and a Dream... HE CHANGED THE WORLD!

HIS LIFE was a wild adventure... though he spent most of it in a littered laboratory. Never did a man work so hard—fail so often—and succeed so brilliantly!

The whole astounding story is told by Metro-Goldwyn-Mayer in "Edison the Man"—the drama of an adventurous, inventive mind eager to grapple with any untried idea—and the human story of a warm-hearted man, his love, his kindness, his wit, his jolly, genial delight in his friends.

Spencer Tracy plays the role of Edison magnificently. Again this gifted artist presents a fine and true screen characterization—the most demanding of his career. This is one of the important pictures of our time—don't miss it!



Spencer
TRACY
AS
EDISON
THE MAN

A CLARENCE BROWN Production
with RITA JOHNSON • LYNNE OVERMAN
CHARLES COBURN • GENE LOCKHART
Henry Travers • Felix Bressart

Directed by CLARENCE BROWN

Produced by John W. Considine, Jr.
Screenplay by Talbot Jennings and
Bradbury Foote



A Metro-Goldwyn-Mayer Picture



9,000 failures! They called him a fake—a charlatan. But he believed in his dreams! He knew that he could grapple with the mystery of the electric light—and win!



The dynamo explodes! Five hours left to light the city—or be branded a failure forever! "We can change the world in five hours!" shouted Edison—and he did!

See America on a HARLEY-DAVIDSON

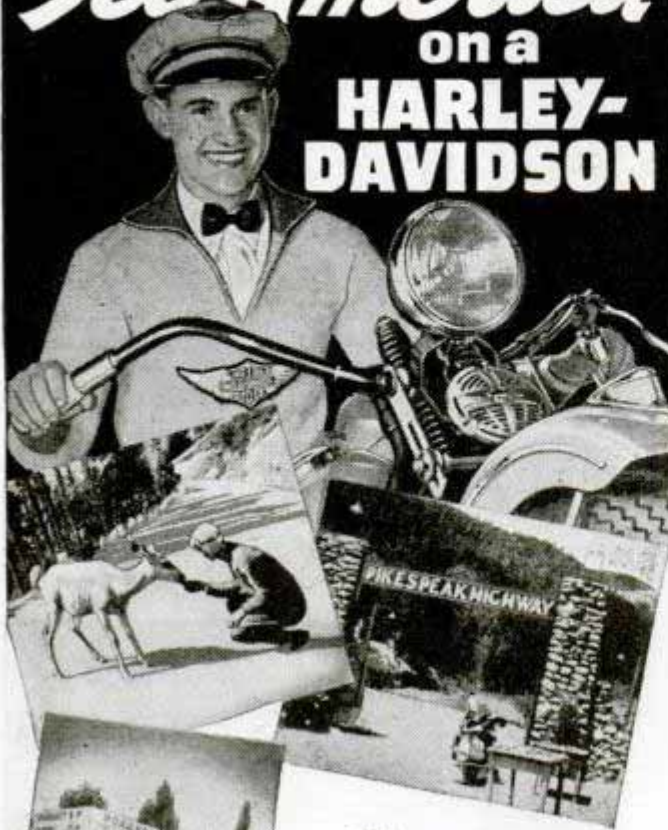

VISIT famous places and beauty spots! See glorious America — go on thrilling vacation trips. Niagara Falls! Miami! San Antonio! New England! Hollywood! National Parks! No spot too far away when you own a Harley-Davidson! Always plenty doing near home, too — fun with other riders at club rallies, gypsy tours, tourist trophy races, hill-climbs! See your Harley-Davidson dealer NOW!

HARLEY-DAVIDSON WORLD'S CHAMPION MOTORCYCLE

FREE



HARLEY-DAVIDSON MOTOR CO.
Dept. P, Milwaukee, Wis.
Send FREE copy of big 24-page "Enthusiast" motorcycling magazine filled with pictures and stories of exciting motorcycle doings. Also literature on the sensational 1940 Harley-Davidsons. Stamp enclosed for mailing cost.

Name

Address

SEND COUPON NOW

(Contents—Continued)

MISCELLANEOUS

Metal stairway assembled at factory.....	804
Furniture hangs from walls of upside-down room.....	839
Automatic fire-fighting "bomb" thrown like grenade.....	843
Double bicycle for family in wartime.....	846
Portable floodlight tower generates own power.....	848
Waterproof trouser legs keep entire suit dry.....	848
Gas detectives guard subways from gas leaks.....	854
Rubber "jung" restores breathing.....	864
Wafer-thin pencil used as bookmark.....	864
Squeegee steers self by twisting handle.....	875
Oil-well drilling rig on semitrailer.....	877
Pistol-grip spotlight throws beam a quarter mile.....	880
"Blotter" for drying concrete forms smooth surface.....	891
"Bobsled" tests waxed floor to eliminate skid.....	891
Bomb shelters in Paris to aid gas victims.....	891
Fluorescent carpet for dark theater aisles.....	896

Craftsman and Shop Notes

AUTOMOTIVE

Tires deflated to soften ride.....	920
Auto shortcuts.....	957
Battery charged while making minor car repairs.....	958
Flashlight illuminates ground when leaving car.....	958
Removing broken speedometer chain.....	958
Repairing sockets in reflectors of headlamps.....	958
Spoon holder holds memo on truck door.....	958
Tool rack for outside work.....	958
Adhesive tape repairs sun visor.....	959
Doorbell locates short circuit in car wiring.....	959
Handle aids in removing spare tire.....	959
Shielding side of car in crowded garage.....	959
Stopping squeaks in composition shackles.....	959
Hood fasteners hold washing pan on workbench.....	960
Tow truck's exhaust heat starts stalled motor.....	960

BOATS AND BOATING

Shock absorber mounting for outboard motor.....	900
Automatic holder for boat-anchor rope.....	904
Car vacuum tank serves as bilge pump.....	913
"Zephyr"—a sailing dinghy—Part III.....	923

FARM

Flies killed with poisoned grasshopper bait.....	921
Mower-sickle guards cleaned with wire.....	944
Pail over tether peg protects animal.....	944
Slotless mailbox.....	952
Twine prevents chickens from flying over fence.....	954
Reflector protects rural mailbox.....	956

HAND TOOLS

Holder for soldering iron and accessories.....	900
Bench stop swings out of way.....	921
C-clamp shielded to protect work.....	928
Small drills carried in spectacle case.....	928
Slotted punch to drive tacks.....	930
Pipe wrench serves as pipe-threading vise.....	943
Rubber tube shields dividers.....	943
Screw aids in setting dividers and calipers.....	946
Small clamp aids in measuring long work.....	952
Handle for long chisel or drill.....	954

HOUSEHOLD

Solving home problems.....	902
Baby carriage held on porch by broom clamp.....	904
Grinder dust supplies iron for potted plants.....	904
Double-deck chairside table.....	905
Doorstop made from flat spring.....	916
Rack for collapsible tubes.....	916
Starch removed from iron with salt.....	916
Making candles fit the holders.....	918
Neckties cleaned in fruit jar.....	918
Coffee table has plate-glass top.....	919
Weighting mosquito net on baby's crib.....	920
Shielding hooks to protect clothing.....	928

HUNTING, FISHING, CAMPING

Wrapping split-bamboo fishing rods.....	901
Fishhooks sharpened on match book.....	904
Repairing worn ferrules on fishing rods.....	906
Fishing-tackle box held on boat seat.....	910
Carrying case for fishing rod.....	912
Loop in end of line to change fishhooks.....	916
Mirror held on tent pole with rubber strip.....	916
Flypaper keeps ants off camp cot.....	918
Windlass supplies camp with water from lake.....	921
Safe catch on pole for fishhook.....	922
Tent pole hinged for easy storing.....	930

(Continued to page 8A)



Plan Your Future

Choose Your Field NOW For Success

Will you master fate or will fate master you? That's a question deserving your honest answer... right now! Actually it is largely up to you. You can do with Life almost what you will. LaSalle will help you establish yourself for real success by providing you with the comprehensive, specialized training for which it is so famous. Choose your field... now! Check the coupon below for the free booklet you want us to send you. It can be your first step toward assured success.

Opportunities in Traffic Management

The field of Traffic Management offers real opportunity only to the man who knows. Spare time study and the will to succeed have pushed scores of Traffic employees up the ladder to financial success. Many LaSalle-trained traffic managers—both in the railroad and industrial field—now command salaries of \$3,000.00 to \$5,000.00 a year—and better. Investigate. Find out how you can qualify for these higher positions through LaSalle home-study and guidance.

Law for Business Success

And it isn't necessary to practice law to get this Success. In fact probably most of the men who study law today have no idea of taking the bar examination or becoming lawyers—they want law training to give them mastery of men and situations in business. You know that—

- (1) the man with legal training is a leader—not a follower.
- (2) legal training keeps your mind—clears away the problems that stump the ordinary fellow and makes you master instead of man.
- (3) knowledge of law simplifies the complications of executive work.
- (4) Many top executive places are filled by men who have studied law.

No matter whether you are in a big corporation or a small business—in a great city or a little town—a practical knowledge of law cannot fail to be of real and vital help to you in making a more successful career.

In every state in the union you'll find law-trained men who came up through LaSalle. What others have done, you can do.

And LaSalle offers either a full law course leading to LL. B. or a shorter business law training—whichever you prefer. All text material, including valuable 14-volume Law Library. Training comprises the most effective features of modern law instruction.

Executive Training

Executives who are efficient managers command responsible positions and good incomes. And the need for

trained executives is growing rapidly. We train you thoroughly at home in your spare time for every type of executive work—teach you the principles and practices used by our most successful business leaders and help you develop your management capacity—by a training built with the aid of outstanding executives.

Become an Expert Accountant The Profession That Pays

The demand for skilled accountants—men who really know their business—is increasing rapidly. New state and federal legislation requires much more, and more efficient accounting from business—big and small. Corporations are in constant need of expert counsel in matters relating to Auditing, Cost Accounting, Business Law, Organization, Management, Finance. Men who prove their qualifications in this important branch of business are rapidly promoted to responsible executive positions—given an opportunity to earn real salaries. The range is from \$2,000.00 to \$10,000.00 a year—even to higher income figures.

Under the LaSalle Problem Method you can at home acquire a thoro understanding of Higher Accountancy, master its fundamental principles, become expert in the practical application of these principles—this without losing an hour of work or a dollar of pay.

Your training will be under the direct supervision of a staff of legal, organization and management specialists, business efficiency engineers and Certified Public Accountants.

Preliminary knowledge of bookkeeping is unnecessary. We train you from the ground up, or from where you now are, according to your individual needs.

Mr. Salesman: What's Wrong?

Why aren't you making more sales—more money? Is it you—or your proposition? Check up first on yourself. Other men—no better than you—have found their earnings jump and stay up when they trained with LaSalle. Literally thousands of men—many of them years at the game—have increased their sales volume and earnings through home study with LaSalle guidance. Sound—practical—usable—right from field experience. Train for top-notch production with LaSalle.

LASALLE EXTENSION UNIVERSITY A CORRESPONDENCE INSTITUTION Dept. 664-R CHICAGO

I would like to have your special booklet—without any cost or obligation to me—about my opportunities and your success training in the business field I have checked.

- | | | |
|--|--|--|
| <input type="checkbox"/> Higher Accountancy | <input type="checkbox"/> Commercial Law | <input type="checkbox"/> Business English |
| <input type="checkbox"/> Law: Degree of LL. B. | <input type="checkbox"/> Expert Bookkeeping | <input type="checkbox"/> Business Correspondence |
| <input type="checkbox"/> Traffic Management | <input type="checkbox"/> C. P. A. Coaching | <input type="checkbox"/> Effective Speaking |
| <input type="checkbox"/> Modern Salesmanship | <input type="checkbox"/> Industrial Management | <input type="checkbox"/> Stenotypy |
| <input type="checkbox"/> Business Management | <input type="checkbox"/> Modern Foremanship | |

Name..... Age.....

Position..... Address.....



For Quick Repairs

that cost little and are permanent

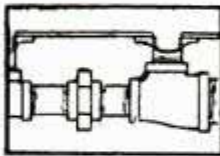

Pipe Leaks



Boiler Leaks



Anchoring in masonry

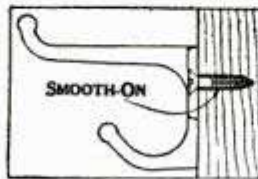

Tightening loose or stripped screws

WHEN boiler or tank seams or pipe joints start to leak, or when screws, bolts, handles or fixtures become loose, these are the times that SMOOTH-ON No. 1 comes in handy. With a few cents worth of SMOOTH-ON and a few minutes of time, you can do as perfect and lasting a repair job as a skilled mechanic, and avoid the expense of new parts.

SMOOTH-ON repairs require no heat, no special tools, and no previous experience. Just mix and apply in accordance with simple instructions, and the job is finished. There are dozens of places, in every home and shop, where SMOOTH-ON can be advantageously used.

Get SMOOTH-ON in 1 $\frac{3}{4}$ -oz., 7-oz., 1-lb. or 5-lb. can from your hardware store or from us. For your protection, insist on Smooth-On—used since 1895.

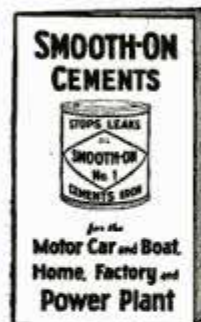

FREE

40-Page SMOOTH-ON Handbook containing dozens of suggestions unobtainable elsewhere for saving time and money in repair jobs all around the house, in the shop, and on the car. Send the coupon for your copy.

Write for
FREE BOOK

SMOOTH-ON MFG. CO., Dept. 37
574 Communipaw Ave.,
Jersey City, N. J.

Please send Smooth-On Repair Book.

Name

Address

6-40



Do it with **SMOOTH-ON**

(Contents—Continued)

LAWN AND GARDEN

Swan cutouts enhance your fish pool.....	901
Grass shears always at hand on lawnmower.....	910
Notched picket makes good vine trellis.....	918
Lawn hose used as a hydrant wrench.....	922
Stakes to support wire around the lawn.....	922
Fishpool kept cool by evaporation of water.....	927
Spray of water aerates fish pool.....	929
Cold frame cover controls temperature.....	954

OFFICE

Blotting paper aids in locking type forms.....	922
Desk penholder with calendar.....	944
Spacing parallel lines.....	952
Eraser attached to magnet clings to typewriter.....	955

PHOTOGRAPHY

"Swing" photos stop racing cars.....	931
One filter used on several cameras.....	933
Prints and films dried in dish rack.....	933
Small pictures with big camera.....	933
Colored paper identifies film in holder.....	934
Cork keeps tongs from slipping.....	934
Developing cut films in tray.....	934
Diffuser slips on and off reflector.....	934
Reel for cord on photo light.....	934

POWER TOOLS

Linoleum cement attaches abrasive to disk sander.....	900
Circulating pumps of flat metal.....	941
Jig to support round work in drill press.....	945
Non-chatter tool for grooving metal disks.....	945
Changing lathe gears in pairs saves time.....	956

STORE AND SHOP

Cushioning jerk on pull chain of electric light.....	944
Roller jig aids welder.....	946
Spring hook prevents blowtorch from tipping.....	946
Threading belts on pulleys on newspaper folders.....	946
Drill blocks aid in setting up irregular work.....	952
Guard on spindle holder protects workers.....	954
Dispensing of fruit from barrel simplified with tray.....	956

WOODWORKING

Re-gluing loose patches of veneer.....	904
Bolt improves lathe tool rest.....	910
Useful things made from the woodpile.....	917
Hooks on stepladder support plywood for swing.....	946

MISCELLANEOUS

Modeling in sheet metal.....	897
Two-size hole in stopper protects glassware.....	900
Matches attached to cigarette package.....	906
Nuts started in hard-to-reach places.....	906
T-square serves as armrest for artist.....	906
Tripod head does double duty in laboratory.....	906
Decorating with thin plastics.....	907
Artist wears two-finger glove to protect work.....	910
Bucket bail held vertically by rubber ball.....	910
Game-fish ash tray.....	911
Inexpensive portfolio has adjustable ends.....	913
Colonial corner dish shelf.....	914
Simple filter for acids.....	916
Cistern cover made from car-wheel rim.....	918
Finger-ring measurement taken with a cork.....	918
Silencing rattle in lawnmower.....	922
Spilled mercury salvaged with medicine dropper.....	922
Cutting irregular pieces of glass.....	928
Door knocker holds caller's card.....	928
Reversible dividing board in mortar box.....	928
Turned Swedish top sings while it spins.....	929
Birdhouse of wood and composition roofing.....	930
Watering new trees and shrubs.....	930
Changing valve in tank without draining it.....	943
Saddlebag holds lineman's tools conveniently at hand.....	944
"Split-second" soldering.....	947
Mixture to clean greasy goggles.....	952
Chef and cowboy hold restaurant menus.....	953
Pipe bushings made from regular pipe.....	953
Rubber pad on plasterer's hawk protects the hand.....	954
Jigsaw stand has drawers for accessories.....	955
Safety on high scaffolds.....	955

IMPORTANT NOTICE

It is the intention of this magazine to provide its readers with information regarding the latest developments in the mechanical arts. We take no responsibility as to whether the disclosures contained in our articles are covered by patents and advise readers to investigate this subject before making, using, or selling any of the products, machines, or processes described, in order to avoid possible liability for patent infringement.

can you find
5 ERRORS in this print

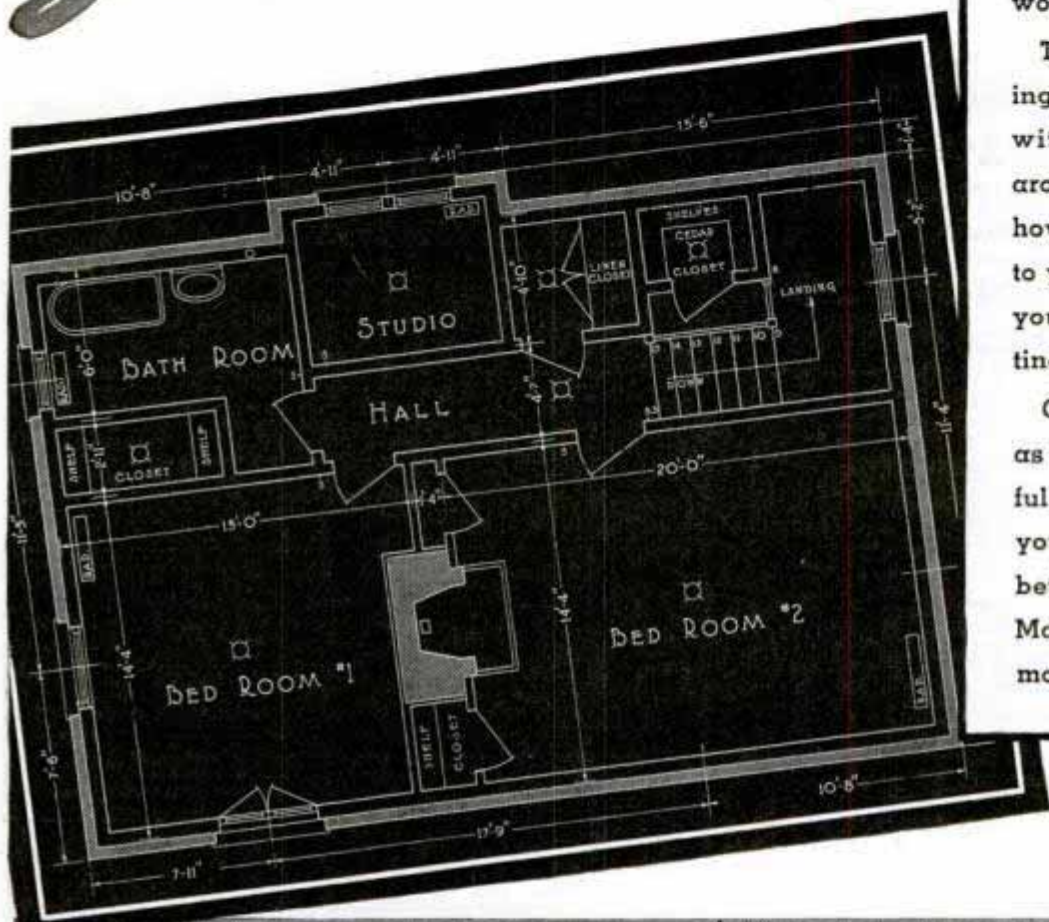

SOME of the errors in this print are obvious. But it takes a trained man to read blueprints satisfactorily—or to get ahead in a complex, specialized world such as ours!

The man without training is usually the man without money. Look around, and you'll see how true that is. It's up to you to get the training you need, while the getting's good!

Get it "the I.C.S. way," as thousands of successful men have done. Fit yourself for a bigger, better paying position. Mail this coupon—not tomorrow, but now!

INTERNATIONAL CORRESPONDENCE SCHOOLS
 BOX 5578-J, SCRANTON, PENNA.

★ Without cost or obligation, please send me a copy of your booklet, "Who Wins and Why," and full particulars about the course *before* which I have marked X: ★

TECHNICAL AND INDUSTRIAL COURSES

- | | | | | | |
|---|---|--|---|--|--|
| <input type="checkbox"/> Agriculture | <input type="checkbox"/> Air Brake | <input type="checkbox"/> Cotton Manufacturing | <input type="checkbox"/> Marine Engines | <input type="checkbox"/> R. R. Signalmen's | <input type="checkbox"/> Refrigeration |
| <input type="checkbox"/> Air Conditioning | <input type="checkbox"/> Diesel Engines | <input type="checkbox"/> Electrical Engineering | <input type="checkbox"/> Mechanical Drafting | <input type="checkbox"/> Sanitary Engineering | |
| <input type="checkbox"/> Architectural Drafting | <input type="checkbox"/> Electric Lighting | <input type="checkbox"/> Fire Bosses | <input type="checkbox"/> Mechanical Engineering | <input type="checkbox"/> Sheet Metal Work | |
| <input type="checkbox"/> Architecture | <input type="checkbox"/> Fruit Growing | <input type="checkbox"/> Heating | <input type="checkbox"/> Mine Foreman | <input type="checkbox"/> Steam Electric | |
| <input type="checkbox"/> Auto Engine Tune-up | <input type="checkbox"/> Heat Treatment of Metals | <input type="checkbox"/> Highway Engineering | <input type="checkbox"/> Navigation | <input type="checkbox"/> Steam Engines | |
| <input type="checkbox"/> Auto Technician | <input type="checkbox"/> House Planning | <input type="checkbox"/> Locomotive Engineer | <input type="checkbox"/> Patternmaking | <input type="checkbox"/> Steam Fitting | |
| <input type="checkbox"/> Aviation | <input type="checkbox"/> Machinist | <input type="checkbox"/> Management of Inventions | <input type="checkbox"/> Pharmacy | <input type="checkbox"/> Structural Drafting | |
| <input type="checkbox"/> Boilermaking | <input type="checkbox"/> Managing Men at Work | <input type="checkbox"/> Manufacture of Pulp Paper | <input type="checkbox"/> Plumbing | <input type="checkbox"/> Structural Engineering | |
| <input type="checkbox"/> Bridge Engineering | | | <input type="checkbox"/> Poultry Farming | <input type="checkbox"/> Surveying and Mapping | |
| <input type="checkbox"/> Building Estimating | | | <input type="checkbox"/> Practical Telephony | <input type="checkbox"/> Telegraph Engineering | |
| <input type="checkbox"/> Chemistry | | | <input type="checkbox"/> Public Works Engineering | <input type="checkbox"/> Textile Designing | |
| <input type="checkbox"/> Civil Engineering | | | <input type="checkbox"/> Radio, General | <input type="checkbox"/> Toolmaking | |
| <input type="checkbox"/> Coal Mining | | | <input type="checkbox"/> Radio Operating | <input type="checkbox"/> Welding, Electric and Gas | |
| <input type="checkbox"/> Concrete Engineering | | | <input type="checkbox"/> Radio Servicing | <input type="checkbox"/> Woolen Manufacturing | |
| <input type="checkbox"/> Contracting and Building | | | <input type="checkbox"/> R. R. Section Foreman | | |

BUSINESS COURSES

- | | | | | |
|--|---|--|---|---|
| <input type="checkbox"/> Accounting | <input type="checkbox"/> Advertising | <input type="checkbox"/> Civil Service | <input type="checkbox"/> First Year College | <input type="checkbox"/> Railway Postal Clerk |
| <input type="checkbox"/> Bookkeeping | <input type="checkbox"/> Commercial | <input type="checkbox"/> College Preparatory | <input type="checkbox"/> Foremanship | <input type="checkbox"/> Salesmanship |
| <input type="checkbox"/> Business Correspondence | <input type="checkbox"/> Cost Accounting | <input type="checkbox"/> C. P. Accounting | <input type="checkbox"/> French | <input type="checkbox"/> Secretarial |
| <input type="checkbox"/> Business Management | <input type="checkbox"/> C. P. Accounting | | <input type="checkbox"/> Grade School | <input type="checkbox"/> Service Station Salesmanship |
| <input type="checkbox"/> Cartooning | | | <input type="checkbox"/> High School | <input type="checkbox"/> Sign Lettering |
| | | | <input type="checkbox"/> Lettering Show Cards | <input type="checkbox"/> Spanish |
| | | | | <input type="checkbox"/> Traffic Management |

DOMESTIC SCIENCE COURSES

- | | | |
|---|---|--|
| <input type="checkbox"/> Advanced Dressmaking | <input type="checkbox"/> Home Dressmaking | <input type="checkbox"/> Tea Room and Cafeteria Management, Catering |
| <input type="checkbox"/> Foods and Cookery | <input type="checkbox"/> Professional Dressmaking and Designing | |

Name..... Age..... Address.....
 City..... State..... Present Position.....

Canadian residents send coupon to International Correspondence Schools Canadian, Limited, Montreal, Canada
 British residents send coupon to I. C. S., 71 Kingsway, London, W. C. 2, England



U.S. GOVERNMENT JOBS

START \$1260 to \$2100 Year
OVER 52,000 APPOINTMENTS IN 1939 GOV'T YEAR.

THOUSANDS APPOINTMENTS EACH YEAR.

Railway Postal Clerks

Railway Postal Clerks get \$1,900 the first year regular, being paid on the first and fifteenth of each month. (\$79.17 each pay day.) Their pay is automatically increased yearly to \$2,450. Advance may be had to Chief Clerk at \$2,700 a year. (\$112.50 each pay day.)



3 Days On — 3 Days Off — Full Pay

Railway Postal Clerks on long runs usually work 3 days and have 3 days off duty or in the same proportion. During this off duty their pay continues just as though they were working. They travel on a pass when on business. When they grow old, they are retired with a pension.

City Mail Carriers, Post Office Clerks

Clerks and Carriers now get \$1,700 the first year on regular and automatically increase \$100 a year to \$2,100 and \$2,300.

File Clerk — Clerk

Open to Men — Women 18 to 50. Entrance salary \$1,260 — \$1,440 year. Appointments as File Clerks and Clerks in the Departments at Washington, D. C., are made from this examination.



Many Other Positions

Many other positions are obtainable. Those wishing these positions should qualify at once.

Get Free List of Positions

Fill out the following coupon. Tear it off and mail it today—now, at once. This investment may result in your getting a big-paid government job.

FRANKLIN INSTITUTE, Dept. D-173, Rochester, N. Y.
 Rush to me, entirely free of charge (1) a full description of U. S. Government Jobs; (2) Free copy of illustrated 32-page book, "U. S. Government Positions and How to Get Them"; (3) List of U. S. Government Jobs; (4) Tell me how to qualify for one of these jobs.

Name.....
 Address.....
 Use This Coupon Before You Mislays it. Write or Print Plainly.

GET IN THE SWING with Slingerland RADIO KING DRUMS GUITARS



GENE KRUPA—And Three Out of Four of the World's Greatest Drummers Use Slingerland Radio King Drums.

Wonder Value Easy Payments

Compare the value — tone and power in Slingerland "Radio King" drums, banjos, guitars, mandolins—before you buy. Guaranteed the tops in smooth tone, easy playing, rich power by world's leading musicians. Easy payments. 5-days free trial. See at your dealers.



Free special information on how to organize drum and bugle corps. Free catalog—mention instrument wanted.

SLINGERLAND DRUM CO.
 1330 Belden Avenue Chicago, Illinois

LEARN WATCH REPAIRING



AT HOME You can learn by our modern and original system of instruction every part of the Watch Repairing Trade at home. You can earn money while learning and prepare yourself for a well paying position or start in business after completing our course of instruction. Good watch repairers are in demand and generally earn very good salaries. For particulars apply to the Wisconsin School of Watch Repairing 524 E. Mason St., MILWAUKEE, WIS.

ELECTRICAL CAREERS

Become a Bliss technician in one year—ready to take advantage of increasing opportunities in the electrical field. Bliss men, today, fill key positions in many different electrical industries. All received the same course in fundamental theory and practice. Modern laboratories. Successful placement. 48th year. Ask for free vocational chart, 116 Takoma Ave., Wash., D. C.

BLISS ELECTRICAL SCHOOL

AVIATION APPRENTICES



AIRMINDED YOUNG MEN INTERESTED IN TRAINING FOR ENTERING THE WELL PAID FIELD OF AVIATION AS APPRENTICES—Write immediately, enclosing stamp.

MECHANIC UNIVERSAL AVIATION SERVICE CO.
 Wayne County Airport, Box 857. Dept. E. Detroit, Mich.



Learn to Write

Begin today. Write for our New Free Book, "How to Become a Good Penman," it contains specimens and tells how others learned to write in spare time. Enclose 10c for a Professional Pen Point and your name beautifully written. Write today. **THE TAMBLYN SCHOOL OF PENMANSHIP** Kansas City, Mo. 441 Ridge Building



CASH PAID for insects — butterflies, moths, I buy them for collections. Good cash prices paid. There are some kinds on the large price list in my Instructions and pictures worth \$1 to \$7 each. Beginners get ready now. Send 10c (not stamps) for **Illustrated Prospectus**, before sending any insects.

MR. SINCLAIR, DEALER IN INSECTS
 Dept. 6, Box 1830, San Diego, Calif.

PHOTO-ENGRAVING TASOPE SINCE 1931

FREE—a copy of the Tasope Magazine, monthly treasure chest of photographic and photo-engraving information. Learn why Aurora, Mo., is the photo-engraving, photographic center of America . . . how hundreds of amateurs, free-lance photographers are making money with pictures. No-obligation postcard brings your copy. **TASOPE, DEPT. PM17, AURORA, MO.**

Promotion Begins at Home

If you are an average grade school graduate, the average man with High School training earns \$16.30 a week MORE than you.

To Get Ahead Today You MUST Finish High School

Alice in Wonderland learned: "You must run as fast as you can in order to stay where you are. To get anywhere, you must run TWICE that fast."

Your own life, today, is like that. During the day, you must try as hard as you can—as well as you can—in order to be sure of holding what you already have. To get anywhere in commerce, industry or socially—to win a better job—bigger pay—greater success in your social activities—you must make EXTRA effort in your SPARE time to meet the competition of better educated people.

YESTERDAY—	TODAY—
<p>In 1900 . . . Many doctors then practicing were not even high school graduates. High School had not been required at the time they entered medical school.</p> 	<p>In 1940 . . . Schools of nursing require high school graduation because most of them are conducted at college level. Progress has made modern nurses' training equal or superior to that available to many old time doctors.</p> 
<p>The Wright brothers, long months after they actually had accomplished flight, still were baffled by the problem of how to turn a plane while it was flying. (1904)</p> 	<p>Thousands of schoolboys 14-16 years of age know more today about airplane design than the Wrights knew at Kitty Hawk.</p> 
<p>In 1900 . . . The High School Graduate was a person of distinction. Only one person in 800 had finished high school.</p> 	<p>In 1940 . . . More than a MILLION boys and girls completed high school. Graduates now are commonplace. High school is minimum educational requirement in most lines.</p> 
<p>In 1900 . . . Very few even thought of going to college, unless to enter one of "the learned professions." The number of college graduates in business and industry was so few that they formed practically NO COMPETITION in the average job.</p> 	<p>In 1940 . . . Almost exactly as many are being graduated from college, today, as from high school 40 years ago. Everywhere—in everything you do—in commerce, industry, personal affairs, you are up against the competition of COLLEGE GRADUATES.</p> 

Do you want

- ➔ .. to go to College?
- ➔ .. or to enter a Profession?
(Such as Accounting, Architecture, Nursing, Dentistry, Teaching, Social Work, Osteopathy, Beauty Culture, Optometry, Embalming, Chiropody, Law, Medicine, etc.)
- ➔ .. or get an Office Position?

To get anywhere, you practically MUST finish High School FIRST. You can complete our simplified High School Course in SPARE time at home, as FAST as your time and abilities permit. **MANY FINISH IN 2 YEARS.** Equivalent to resident school work—prepares you for college, pre-professional examinations, business, industry. Standard texts furnished. Diploma. Credit for H. S. subjects already completed. Single subjects if desired. Low tuition, easy terms. American School, Chicago, est. 1897—endorsed by educators. Finish your high school education NOW. Write TODAY!

In 1900 . . . The "little red school-house" did a pretty fair job of equipping men and women to make their way in the world.



American School, Dept. HA 45, Drexel Ave. at 58th St., Chicago, Illinois

Gentlemen: I'll sit down and consider my Promotion Problems carefully if you will send me FREE information covering subject checked. No obligation.

- | | | |
|---|--|---|
| <input type="checkbox"/> HIGH SCHOOL COURSE | <input type="checkbox"/> Radio and Television | <input type="checkbox"/> Business Management |
| <input type="checkbox"/> Diesel Engineering | <input type="checkbox"/> Salesmanship | <input type="checkbox"/> Aviation |
| <input type="checkbox"/> Drafting and Design | <input type="checkbox"/> Air Conditioning | <input type="checkbox"/> Electrical Engineering |
| <input type="checkbox"/> Liberal Arts | <input type="checkbox"/> Accounting and Auditing | <input type="checkbox"/> Electrical Refrigeration |
| <input type="checkbox"/> Private Secretary | <input type="checkbox"/> Architecture and Building | <input type="checkbox"/> Business Law |
| <input type="checkbox"/> Mechanical Engineering | <input type="checkbox"/> Automotive Engineering | <input type="checkbox"/> Retail Merchandising |

Name

Address

Spare Time Training Can Help You in Your Work—and Socially

ZOOM into AVIATION



AN AVIATION CAREER OFFERS YOU A GREAT FUTURE!

The greatest opportunity of your lifetime exists today. There never was such an opportunity in AVIATION for you. There may never be another. Aviation desperately needs trained men; they are at a premium and advancements for them are rapid. You can get in on the ground floor by training now, BUT you must choose the right school for your training. This is imperative, since your choice of a school in which to take your training will determine your whole future in Aviation and how much money you will make all the rest of your life. Curtiss-Wright Tech's career training is carefully designed to do just one thing—**MAKE MORE MONEY FOR YOU.** Our hundreds of successful graduates have proven that our training gets results and always pays. It has provided them with a profitable occupation and secure future, since it trained them in advance for the highest position they could ever expect to occupy. It can make you independent and self-supporting for life. Curtiss-Wright Tech is located on Grand Central Air Terminal in the heart of the Aircraft Industry. Established in 1929, this famous school is recognized as the nation's leading institution for the training of **MASTER AVIATION MECHANICS and AERONAUTICAL ENGINEERS.** (No flying involved.) We honestly believe that every student who enrolls here will be able to obtain immediate employment upon graduation. A position awaits you. **WARNING!—DON'T "MISS THE BOAT!"** Send for catalog today. Give age and course desired. Dept. PM-6.



**CURTISS WRIGHT
TECHNICAL INSTITUTE**
Glendale (Los Angeles)
California

THIS TOWER OVERLOOKS AVIATION'S MOST DISTINGUISHED SCHOOL OF AERONAUTICS

AUDELS Carpenters and Builders Guides 4 vols. \$6



Inside Trade Information for Carpenters, Builders, Joiners, Building Mechanics and all Woodworkers. These Guides give you the short-cut instructions that you want—including new methods, ideas, solutions, plans, systems and money saving suggestions. An easy progressive course for the apprentice and student. A practical daily helper and Quick Reference for the master worker. Carpenters everywhere are using these Guides as a Helping Hand to Easier Work, Better Work and Better Pay. To get this assistance for yourself, simply fill in and mail the FREE COUPON below.

Inside Trade Information On:

How to use the steel square—How to file and set saws—How to build furniture—How to use a mitre box—How to use the chalk line—How to use rules and scales—How to make joints—Carpenters arithmetic—Solving mensuration problems—Estimating strength of timbers—How to set girders and sills—How to frame houses and roofs—How to estimate costs—How to build houses, barns, garages, bungalows, etc.—How to read and draw plans—Drawing up specifications—How to excavate—How to use settings 12, 13 and 17 on the steel square—How to build hoists and scaffolds—skylights—How to build stairs—How to put on interior trim—How to hang doors—How to lath—lay floors—How to paint.



THEO. AUDEL & CO., 49 W. 23rd St., New York City

Mail Audels Carpenters and Builders Guides, 4 vols., on 7 days' free trial. If O.K. I will remit \$1 in 7 days, and \$1 monthly until \$6 is paid. Otherwise I will return them. No obligation unless I am satisfied.

Name

Address

Occupation

Reference P.M.

ARREST HIM, OFFICER! I'LL HAVE COMPLETE FACTS ON THE OTHER FELLOW TONIGHT!



Secret Service Operator No. 38 is on the job . . . FOLLOW HIM through all the excitement of his chase after the counterfeit gang. Write NOW for

FREE Confidential Reports No. 38 Made to His Chief!

It may open your eyes to the great opportunity for YOU as a well paid Finger Print Expert. The kind of work you'd like. Excitement! Travel! Thrills! A REGULAR MONTHLY salary. REWARD MONEY. Graduates of this school HEAD 47% of all

Identification Bureaus in U. S. I Write for Free Reports, Finger Print Book, low prices. Easy Terms Offer.

Literature will be sent only to persons stating their age.

INSTITUTE OF APPLIED SCIENCE
1920 Sunnyside Ave., Dept. A-135 Chicago, Illinois

ENGINEERING DEGREE IN TWO YEARS

B. S. Degree courses in engineering: Electrical, Civil, Chem., Mechanical, Radio or Aeronautical. 1 yr. Mech. Drafting. Approved by Civil Aeronautics Authority, participation in Pilot Training Program. Large industrial center. Prep courses without extra charge. Earn board if desired. Low tuition. Enter June, September, December, March. Write for Catalog.
560 E. Washington Blvd., Fort Wayne, Ind.

INDIANA TECHNICAL COLLEGE

SECURITY FOR LIFE

Be an expert in an essential business. Learn Meat Cutting. Steady jobs and good pay everywhere. Quick, short course—ACTUAL PRACTICE. Learn with tools and meat—not books. Individual training. Be a fully qualified union Meat Cutter when finished. Union Card FREE. Job help after graduation. Write for catalog and complete details.

NATIONAL SCHOOL OF MEAT CUTTING, INC.
DEPT. U-7 TOLEDO, OHIO



VOICE

100% Improvement Guaranteed

We build, strengthen the vocal organs—not with singing lessons—but by fundamentally sound and scientifically correct silent exercises . . . and absolutely guarantee to improve any singing or speaking voice at least 100% . . . Write for wonderful voice book—sent free. Learn WHY you can now have the voice you want. No literature sent to anyone under 17 years unless signed by parent.

PERFECT VOICE INSTITUTE, Studio A-135
64 E. Lake St., Chicago

BE A PASSENGER TRAFFIC INSPECTOR



Qualify for this Job in your Sparetime Complete our simple, home-study course in a few months and we will help place you as a Railway and Bus Traffic Inspector at up to \$135 per month, plus expenses to start, or refund your tuition. You'll like the work. Ask about our 2 1/2 yrs' experience in this service. Free Booklet on request.
STANDARD BUSINESS TRAINING INSTITUTE,
Div. 206 Buffalo, N. Y.

EARN THE DEGREE

Doctor of Psychology (Ph.D.), Philosophy, Divinity, Science. General Courses—Arts, Law, Business, etc. A Chartered Correspondence Institution. Send for 32-page FREE Bulletin at once. No Obligation.
Temple Bar College Inc., Dept. 2-R, 1411 Fourth Avenue
Seattle, Washington, U.S.A.

MAKE MONEY AT HOME

RUBBER MOLDS Low as 6¢ EA.

Amazing rubber mold-making outfit makes perfect flexible molds of plaques, ash trays, book-ends, etc. Molds cost from 6c to 25c each. Each mold makes hundreds of novelties and gifts to sell up to \$1.00 apiece! No experience necessary. Quick and easy. Start profitable business in your home . . . sell to stores, gift shops, friends, resorts, road stands, by mail. Full or spare time. "Molders Handy Book" and list of buyers FREE. Write

SO-LO WORKS
Dept. H-827 Cincinnati, Ohio





Let me show you how we
 can train you here in my
shops for a better job and
 a better future in—
ELECTRICITY
12-WEEKS SHOP TRAINING.
"LEARN BY DOING"
H. C. Lewis

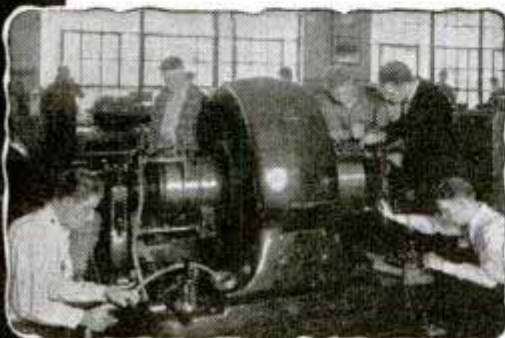

Students in our School, connecting and testing a large convertor, which is large enough to supply a small town with electricity for light and power.



Students repairing motor generator set, and operating one of our power switchboards.



Students working on many well-known makes of Electric Refrigerators.

GET THE DETAILS OF MY "PAY AFTER GRADUATION" PLAN

Send coupon today and get my big free book and all details of my quick easy way to train for your start for a better job and a real future. Here in my shops you are trained on real motors, generators, dynamos—you do house wiring, wind armatures and work on the actual equipment and machinery in many other branches of electricity. My method is simple and easy. First you are told how to do a thing—then you are shown how to do it—Then you do the work yourself. I not only show you how we train our students but when I get the coupon I'll tell you how you can get this training first—then pay for most of it in easy monthly payments starting 60 days after your training period is over.

YOU DON'T NEED Previous Experience or A Lot of Education

Because my training is on actual equipment and because the necessary theory is given you in a practical way you don't need previous experience or a lot of education. I have made it possible by my method of training for the fellow who hasn't been born with a silver spoon in his mouth to get a training that he can apply to earn a living—and by my "Pay after Graduation" plan I've made it possible for him to get this training without a large outlay of money. Send the coupon today for all details.

Low Cost Living Expenses

Board and room rates are very low and many students do part time work to help out with their living expenses.

Free Employment Service After Graduation

After graduation you will get employment service as well as free consultation service as often as you want it.

4 WEEKS EXTRA RADIO COURSE

For a limited time I am including an extra 4 weeks Radio Course at no extra tuition charge—my regular electrical course also includes training in Electric Refrigeration and Air Conditioning.

SEND COUPON NOW

for particulars of this offer and the present low tuition offer.

Coyne trains you for success, then helps you to hold success. When you enroll at Coyne you receive a life membership which permits you to come back at any time to review any subject or to take up any new subject which has been added to our course.

SEND FOR FREE BOOK

The Coyne Electrical School is 41 years old. Many hundreds of young men have become successful through Coyne training. My free book tells you how you, too, can get a training that will give you your start to a better job and a real future.

H. C. LEWIS, President

COYNE ELECTRICAL SCHOOL

500 S. Paulina Street, Dept. BO-72, Chicago, Illinois

MAIL COUPON TODAY for my big free book. It tells you all about my "Pay-Tuition-After-Graduation" Plan—part time work while learning and many other things you will want to know about if you are interested in a better job at better pay.

H. C. LEWIS, President, Coyne Electrical School, 500 S. Paulina Street, Dept. BO-72, Chicago, Ill.

Dear Sir: Please send me free your big catalog and full particulars of your offer, also your "Pay-Tuition-After-Graduation" Plan and all other features.

Name.....

Address.....

City.....State.....

Mail in envelope or paste on postcard

Be Your Own MUSIC Teacher

LEARN AT HOME

by wonderful improved method. Simple as A. B. C.—a child can learn it. Your lessons consist of real selections instead of tiresome exercises. When you finish one of these delightfully easy lessons, you've added a new "piece" to your list. You read real notes, too—no "numbers" or trick music. Method is so thorough that many of our 700,000 students are band and orchestra LEADERS. Everything is in print and pictures. First you are told what to do. Then a picture shows you how to do it. Then you do it yourself and hear it. In a few short months you become an excellent musician—the life of every party.



Free Print & Picture Sample

You may quickly become a fine player through the U. S. School home study method. If interested, mail coupon today for Free Book and Print and Picture Sample, which explain all. Please mention your favorite instrument. Instruments supplied when needed, cash or credit.

U. S. School of Music, 76 Brunswick Bldg., N. Y. C., N. Y.

U. S. School of Music, 76 Brunswick Bldg., N. Y. C.

I am interested in music study, particularly in the instrument checked below. Please send me your free illustrated booklet and free Print and Picture Sample.

Piano	Accordion	Clarinet	Banjo
Violin	Saxophone	Trumpet	Ukulele
Guitar	Mandolin	Trombone	Other Instrument

Name

Street

City..... State.....

**This
MACHINISTS'
Home-Study
Course
helps men get ahead**



Newly assembled—specially priced—these five recent books give you the practical facts on modern machines, up-to-date methods, you need to advance in machine shop work. Take advantage of the other man's experience as found in books, to solve your problems, increase your efficiency, with

The NEW AMERICAN MACHINISTS' LIBRARY

5 volumes—2014 pages—1853 illustrations

(A combined home-study course and reference library)

This library of machine shop practice was written for practical men. It gives you the best methods for every kind of machine shop work. It fully explains lathes, drills, and other machine tools and their operation, automatic screw machines, speeds and feeds, gear design and production, punch and die work, metal surfacing, etc., etc. Plainly written—completely illustrated—the best kind of help to the machine shop man who wants to advance himself.

No money down—special price—easy payments.

EXAMINATION COUPON

McGRAW-HILL BOOK CO., 330 W. 42nd St., New York

Send me for ten days' examination the new American Machinists' Library. If satisfactory I will send you \$1.50 in 10 days and \$3.00 monthly until the price of \$16.50 is paid. If not wanted, I will return the books postpaid. (To insure prompt shipment write plainly and fill in all lines.)

Name

Home Address

City and State

Position

Name of Company

PM-6-40

PARKS AIR COLLEGE

PARKS AIRPORT

EAST ST. LOUIS, ILL.

Offers YOU COLLEGE and PROFESSIONAL TRAINING Majoring in AVIATION

Accredited by the Illinois Superintendent of Public Instruction, U.S. approved as a Commercial Ground and Flying School and Mechanics' School. Accredited by and cooperating with the United States Army Air Corps in giving flight and mechanical training. Open to high school graduates.

FOUR courses lead to B.S. degrees in Professional Piloting, Aviation Operations, Maintenance Engineering, Aeronautical Engineering. SEVENTEEN TRAINING PLANES are used in professional flight training which prepares graduates for airline flight operations. 74% of graduates enter air transportation in North and South America. 76,000 hours flight training given, 1800 hours being flown monthly. FACULTY of 48 specialists in various fields of aviation. 1569 graduates. Enrollment limited to a total of 300 commercial aviation students. Total enrollment 415. 100-acre airport, 18 buildings devoted to school purposes exclusively. Dormitories and dining hall at the College.

Summer Term July 8. Send postcard for new 64-page catalog.
13th YEAR Registrar, Dept. PM-6
PARKS AIR COLLEGE, East St. Louis, Ill.

Free WELDING

FREE TRIAL LESSON

Welding offers immediate opportunities for better pay. Practically all industry depends upon the Welder. Learn at home in spare time. Intensified shop training later. Also day and evening classes. Send for free "Blue Book" and trial lesson.

CHICAGO TECHNICAL COLLEGE
G-600 Tech Bldg., 113 E. 26th St., Chicago, Ill.

Regain Perfect Speech, If You STAMMER

Every stammerer should have the new 287 page book "Stammering, Its Cause and Correction." Sent free to stammerers. It describes the Bogue Unit Method for the scientific correction of stammering and stuttering. Method successfully used at Bogue Institute for 39 years—since 1901. Endorsed by physicians. Write for full information. No obligation. Benjamin N. Bogue, Dept. 1315 Circle Tower, Indianapolis, Indiana.

AUTO-MECHANICS & WELDERS

Auto Mechanics and Welders are in big demand. Complete courses in arc and acetylene welding, body and fender bumping, spray painting and metal finishing. Pay after graduation plan. Special low rates. Write today.

MICHIGAN TRADE SCHOOL
3758 Woodward Ave., Detroit, Mich.

Write for FREE CIRCULAR

ARTISTS MAKE MONEY

Find out your ability. Send name, age, occupation and address for Free Vocational Art Test.

Federal Schools, Inc., 6130 Federal Schosis Bldg., Minneapolis, Minn.

Learn PHOTOGRAPHY at Home

Splendid opportunities. Prepare in spare time. Easy plan. No previous experience needed, common school education sufficient. Send for free booklet "Opportunities in Photography", particulars and requirements.

American School of Photography
3601 Michigan Ave., Dept. 135A, Chicago, Ill.

SUCCEED IN LANDSCAPING

Send for FREE book with full details about landscape training. Study at home, earn while learning. Profitable, healthful career; interesting hobby; men, women. Give age, occupation.

AMERICAN LANDSCAPE SCHOOL
6186 Grand Avenue Des Moines, Iowa

FIREWORKS FREE Oh Boy!

THINK OF IT! An assortment of over 605 pieces of fireworks worth \$6.15, for \$2.95 cash with order. We have the famous "ZEBRA" flashlight crackers. World's loudest. You get more for your money at BANNER. 100 FREE salutes with every order. Write for free catalog.

BANNER FIREWORKS
3916 1/2 Detroit Ave. Toledo, Ohio

BENNY GOODMAN
 ... "King of Swing"
CHOOSES GRETSCH
 ... "King of Drums"



Big-time band leaders have to be right ... they can't take a chance on instruments that may not deliver the goods! Therefore, when you buy a drum, make sure you get a GRETSCH, the same drum that BENNY GOODMAN and his ace-drummer NICK FATOOL feature in GOODMAN'S world-famed "No. 1" SWING BAND. And Benny selected not only one GRETSCH outfit, but TWO—a GRETSCH-GLADSTONE for full band use ... a GRETSCH-BROADCASTER for the famous GOODMAN SEXTETTE. GRETSCH, oldest drum makers in America, makes a drum for every purpose and every purse—\$5 to \$500.

NICK FATOOL
 Goodman's
 Star Drummer

**EASY
 TO
 PLAY
 *
 EASY
 TO
 PAY**

Send penny postcard for **FREE DRUM CATALOGUE** and full information about **EASY-PAYMENT Plan** and **FREE TRIAL**. Please give street address and send to Dept. PM-61.

The FRED. GRETSCH MFG. CO.
 Musical Instrument Makers Since 1883
60 BROADWAY, BROOKLYN, N. Y.

GRETSCH also offers SUPER VALUES in Guitars, Saxophones, Trumpets, Trombones, Accordions. Send for FREE catalogue. Mention instrument.

**A GOOD LIVING FROM
 POULTRY**



with a business of your own. How to start small way, spare time, grow from profits, or prepare for good job in large poultry plant. Harry M. Lamson, nationally known money making secrets in poultry raising. His system of home study training used by thousands. Endorsed by many colleges and leading Poultrymen. Established 20 years. Write today for his big **FREE** catalogue describing courses, methods and service. Shows way to real business opportunity. Harry M. Lamson, Pres.

NATIONAL POULTRY INSTITUTE
 DEPT. 50-K ADAMS CENTER, N. Y.

LAW STUDY AT HOME

Legally trained men win higher positions and bigger success in business and public life. Greater opportunities now than ever before. Big corporations are headed by men with legal training.

More Ability: More Prestige: More Money

We guide you step by step. You can train at home during spare time. Degree of LL. B. Successful graduates in every section of the U. S. We furnish all text material, including 14-volume Law Library. Low cost, easy terms. Get our valuable 48-page "Law Training for Leadership" and "Evidence" books **FREE**. Send for them **NOW**.

LaSalle Extension University, Dept. 664-L Chicago
 A Correspondence Institution

TOOL & DIE MAKING DESIGNING

Machinists Trade, Machine Drafting and Design. Practical shop training in the world's Industrial center. Write today for full information.
NATIONAL SCHOOL OF MECHANICAL TRADES
 Dept. 18 628 W. Lake St. Chicago, Ill.

Get into the BAKING BUSINESS

Bakers make good money! Now 7th Industry in wages! Nearly depression-proof. New home study Baking Course qualifies you. Common school education sufficient. If you're ambitious, write for **FREE BOOK** "Opportunities in Baking."
National Baking Institute, 3601 Michigan, Dept. 135A, Chicago



**WILL YOU WEAR THIS SUIT
 and Make up to \$12 in a Day!**

Let me send you a fine all-wool union tailored suit **FREE OF ONE PENNY COST**. Just follow my easy plan and show the suit to your friends. Make up to \$12 in a day easily. **Partial Payment Plan**. No experience — no house-to-house canvassing necessary.

Send for Samples—FREE OF COST
 Write today for **FREE** details. **ACTUAL SAMPLES** and "sure-fire" money-getting plans. Send no money.
H. J. Collin, PROGRESS TAILORING CO.
 500 S. Throop St., Dept. F-216, Chicago, Ill.



Partial Payment Plan Pays BIG!



**SAMPLE
 LESSON
 AND 64-PAGE BOOK
 FREE**

**I WANT TO PROVE
 I Can Train You
 at Home for
 GOOD RADIO JOBS**



Makes \$50 to \$60 a Week

Get my sample lesson Free. Examine it — see how clear it is, how easy to understand. Find out how I train you at home in spare time to be a Radio Technician. Do it now. Mail the coupon.

Many Radio Technicians Make \$30, \$50, \$75 a Week

Radio Broadcasting stations employ engineers, operators, technicians. Radio manufacturers employ testers, inspectors, foremen, servicemen in good-pay jobs. Radio jobbers, dealers, employ installation and service men. Many Radio Technicians open their own Radio sales and repair businesses and make \$30, \$40, \$50 a week. Others hold their regular jobs and make \$5, to \$10 a week fixing Radios in spare time. Automobile, Police, Aviation, Commercial Radio; Loudspeaker systems, Electronic Devices are other fields offering opportunities for which N. R. I. gives the required knowledge of Radio. Television promises to open good jobs soon.

\$10 to \$25 a Week in Spare Time



"I am now making from \$10 to \$25 a week in spare time while still holding my regular job as a machinist. I owe my success to N. R. I." WM. F. RUPP, 611 Green Street, Bridgeport, Pa.

Many Make \$5, \$10, \$15 a Week Extra in Spare Time While Learning

The day you enroll, I start sending Extra Money Job Sheets; show you how to do Radio repair jobs. Throughout your Course, I send plans and directions that have helped many make \$200 to \$500 a year in spare time while learning. I send you special Radio equipment to conduct experiments and build circuits. This 50-50 method of training makes learning at home interesting, fascinating, practical.



Operates Public Address System

"I have a position with the Los Angeles Civil Service operating the Public Address System in the City Hall Council. My salary is \$170 a month." R. H. ROOD, R. 136, City Hall, Los Angeles, Calif.

Find Out What Radio Offers You

Act Today. Mail the coupon now for sample lesson and 64-page book. They point out Radio's spare time and full time opportunities and those coming in Television; tell about my training in Radio and Television; show more than 100 letters from men I trained, telling what they are doing and earning. Find out what Radio offers YOU! **MAIL COUPON** in an envelope, or paste on a postcard—**NOW!**

J. E. Smith, President
 Dept. OFF, National Radio Institute
 Washington, D. C.

MAIL NOW FOR BIG BOOK Free



Mr. J. E. Smith, President, Dept. OFF, National Radio Institute, Washington, D. C.

Without obligating me, mail "Rich Rewards in Radio" which points out opportunities in Radio and explains how you train men at home to be Radio Technicians. No salesman will call. (Write plainly.)

Name.....Age.....
 Address.....
 City.....State.....



It's Easy To Be A Contractor

Learn to estimate, to plan buildings, to take contracting jobs, and make money on them. Here are 9 up-to-the-minute books on building, estimating, and contracting which cover in an interesting way, the subjects that carpenters, builders, and contractors should know to make the most out of their jobs. The Steel Square, Architectural Drawing and Design, Estimating, Painting and Decorating, Heating, Air Conditioning, Building, Contracting, and other subjects are all well covered.

"Boss" Carpenters in Demand NEW 1940 EDITION

Vast public works jobs, immense projects, and the rapid growth of home building, are making jobs for MEN WHO KNOW HOW. These books give you quick training. With them you shouldn't be afraid to tackle any job, for needed facts can be found in a hurry.

These books are the most up-to-date, complete we have ever published on these subjects.

Coupon Brings Nine Books FREE For Examination

AMERICAN TECHNICAL SOCIETY (Publishers—Home Study Courses)
Dept. GA19, Drexel at 58th Street, Chicago, Illinois

You may skip me the new 1940 edition of your nine big books, "Building, Estimating, and Contracting" without any obligation to buy. I will pay the few cents delivery charges only, and if fully satisfied in ten days, I will send you \$2.00, and after that only \$3.00 a month, until the total price of only \$29.80 is paid. I am not obligated in any way unless I keep the books.

Name.....
Address.....
City..... State.....

Please attach a letter stating your age, employer's name and address, and that of at least one business man as a reference.

Learn this Profitable Profession



in 90 Days at Home

Hundreds of men and women of all ages 18-50 make \$10.00 to \$20.00 in a single day giving scientific Swedish Massage and Hydro-Therapy treatments. There is a big demand from Hospitals, Sanitariums, Clubs, Doctors and private patients as well as opportunities for establishing your own office.

Learn this interesting money-making profession in your own home by mail, through our home study course. Same instructors as in our **NATIONALLY KNOWN** resident school. A diploma is awarded upon completion of the course. Course can be completed in 3 to 4 months. High School training is not necessary. Many earn big money while learning.



Anatomy Charts & Booklet FREE

Enroll now and we will include uniform coat, medical dictionary, patented reducing roller and Hydro-Therapy supplies without extra cost. The reducing course alone may be worth many times the modest tuition fee.

Send coupon now for Anatomy Charts and booklet containing photographs and letters from successful graduates. These will all be sent postpaid—FREE.

The College of Swedish Massage (Successor to National College of Massage)
Dept. A64—30 E. Adams St., Chicago.

You may send me FREE and postpaid, Anatomy Charts, booklet containing photographs and letters from graduates, and complete details of your offer.

Name.....
Address.....
City..... State.....

I'LL TRAIN YOU AT HOME IN SPARE TIME TO MAKE GOOD MONEY in RADIO and TELEVISION



Easy to Start . . . Earn While You Learn

Wake up! Get ahead! You fellows with ambition can make a wonderful success in Radio and Television through my new, practical, home training. I teach you in your spare time through interesting experiments with real equipment. Every essential phase of Radio, Television, Electronics, Facsimile, Radio Set Repair and Installation is covered. You get Personalized help. No previous experience needed. So practical—so understandable—so simplified is this training that any man with average education can grasp the money-making knowledge quickly and easily. You will be ready for a business of your own . . . or to hold down a good-paying job. My **BUSINESS BUILDERS** show you how to make profits while learning.

BIG FREE BOOK! Get complete details in new catalog "HOW TO MAKE MONEY IN RADIO". Write Sprayberry Academy of Radio, 310-F, University Place, N. W., Washington, D. C.

YOU GET
146 RADIO PARTS
•
RADIO TOOLS
•
ALL WAVE ALL PURPOSE ANALYZER

FREE TRIAL LESSON IN DRAFTING



More good jobs now in Drafting. Learn AT HOME in spare time (or at our Chicago School). Send postcard for FREE TRIAL LESSON and see how easy to learn and get a good job.

CHICAGO TECHNICAL COLLEGE
G-201 Tech Bldg., 118 E. 26th St., Chicago, Ill.

WANT A GOOD PAY JOB?

Learn Tool and Die Making, Machinist Trade, Screw Machine work. Earn as much as \$50-\$60 per week. Learn by actual work in one of America's best equipped shops. Training supervised by experts. State certified. Day-Evening classes. Enter any time. Low tuition fee, employment help. Write **FREE** NOW for booklet "Practical Machine Shop Training."

ALLIED SCREW MACHINE CO., Inc.
School Division
Dept PM-6 603-9 W. Lake Street, Chicago, Ill.



Learn to play

Easy lessons at home. Inexpensive. 132-page Music Dictionary FREE when you enroll. Over 1000 satisfied customers. Write for free catalog. **Hamann Music Studios**, 3016 N. 24th Place, Dept. R-18, Milwaukee, Wis.

Hawaiian Steel Guitar
Spanish Guitar
Piano • Violin
Piano Accordion
Drums and Traps

Correspondence Courses in RADIO and ELECTRICAL ENGINEERING LOW AS \$25

ELECTRICAL ENGINEERING. Get good grasp of wide electrical field. Modern. Very understandable. Theory made easy.
RADIO ENGINEERING. Extra fine course in radio, public address, photo-electric work. Trains you to be super-service man, real vacuum tube technician. Tuition ONLY \$25, either course. Deferred payment plan. Experiment kits furnished.

FREE LINCOLN ENGINEERING SCHOOL, Box 931-P18, Lincoln, Nebr.

NEW WAY TO CHOOSE A CAREER

LET SCIENCE PICK A JOB FOR YOU!

TODAY, getting a job or choosing a career is no longer a hit-or-miss task. Science can now accurately determine for you, in advance, just what type of work or profession you are best suited for. **FREE** Send your name on a penny postcard for FREE booklet explaining this new proven way to greater success. Vocational Guidance Associates, Dept. 16, Greenway Sta., Tucson, Ariz.



Earn Cash at Home!

We paid M. M. \$1174 for exceptional cellar crop Snow-King mushrooms! We furnish materials; buy all crops. Big FREE picture book tells if your cellar, shed, barn, suitable. Est. 1908. Write today. **United Co., 3848 Lincoln Av., Dept. 309, Chicago**

MONEY for MEN ALL FREE

THE PLASTEX Industry needs manufacturers on small scale and for big production of Lamp and Clock Stands, Art Goods and Novelties in Plastex and Marble Imitation. Experience unnecessary. 1/2c material makes regular 10c store sellers. Rubber moulds furnished for speed production. Small investment brings big returns. **BIG CHAIN STORE** orders now being placed. Ambitious men have chance for real prosperity. Our FREE booklet will interest and benefit you. **PLASTEX INDUSTRIES, Dept. P, 1085 Washington Ave., New York, N. Y.**



Say you saw it in Popular Mechanics!



Easy

YOU'LL advance faster with an easy playing Conn. Choice of world's greatest artists. Many exclusive features yet they cost no more. Home trial. Easy payments. See your dealer or write for free book. Mention instrument.

C. G. CONN, Ltd, 631 Conn Bldg. ELKHART, IND.

CONN

BAND INSTRUMENTS

SHE KNOWS HOW



AND SO DOES HE

LEARN PHOTOGRAPHY

Practical training under personal direction of leading authorities. Commercial, News, Portrait, Advertising, Motion Picture, and Color photography. Learn for pleasure or career. Big money-making opportunities. Personal Attendance and Home Study courses. 30th year. Free booklet.

from Experts

NEW YORK INSTITUTE OF PHOTOGRAPHY
10 West 33 Street. (Dept. 49) New York City

ENGINEERING

DEGREE IN TWO YEARS

TECHNICAL AND APPLIED COURSES. Nonessentials omitted. TIME AND MONEY SAVED. Degree 2 yrs., diploma 1 yr. Electrical, Mechanical, Architectural, Structural, Civil, Aeronautical, including Air Conditioning, Refrigeration, Diesel, Intensive courses, 3 and 4 months in Electricity, Power Plant, Diesel, Refrigeration, Drafting. Extensive shop equipment. LOW TUITION. Part-time work for room and board. Thousands successful graduates in U. S. and foreign lands. Approved by industry, endorsed by educators, recommended by alumni. One and two-year courses open Sept. 18 to Oct. 18, short courses start specified dates, beginning Sept. 18, 41st Year. No home study courses. Catalog free.

1001 Indiana Ave. **FINLAY ENGINEERING COLLEGE** Kansas City, Mo.



CARTOONING

FREE TRIAL LESSON! Cash in on your sense of humor—AT HOME—BY MAIL. Have fun! Make money! No experience needed to start. Write today for FREE LESSON, mailed postpaid. No obligation. Moon Gag-Cartoon School, Dept. M, Fall Creek, Wis.

DRAFTING PAYS BIG

Drafting Jobs Often Pay \$175.00-\$350.00 month. Trained draftsmen always in demand. Learn easily at home in spare time. Experience unnecessary. Common education enough. Employment service FREE. Write today for complete information. No obligation. No Salesmen. **MONROE INSTITUTE, Dept. A-106, Alton, Illinois**

NEW YORK SCHOOL of MECHANICAL DENTISTRY

Learn how to make Crowns, Bridges, Plates in this OLDEST Laboratory Center. Practical training. Day, Evn. Easy terms. Ask for free Catalog P and tool offer.

N. Y. SCHOOL of MECHANICAL DENTISTRY, 125 W. 31 St., N. Y. C.

MONEY IN RABBITS—CAVIES

WE BUY and put you in touch with other markets. Catalog and copy of magazine 10c. Or send 25c for Book Catalog and Price List and Year's Subscription to the **AMERICAN SMALL STOCK FARMER**

OUTDOOR ENTERPRISE CO., BOX 919, NEW CITY, N. Y.

WHAT STRANGE POWERS

Did The Ancients Possess?

WHERE was the source of knowledge that made it possible for the ancients to perform miracles? These wise men of the past knew the mysteries of life and personal power. This wisdom is not lost—it is withheld from the masses. It is offered freely TO YOU, if you have an open mind. Write for free sealed book. Address: Scribe P.R.B.

The ROSICRUCIANS
San Jose (AMORC) California

Diving champions and Diesel engine experts are "tops" in their field because they know how—have been trained.

Unless you know how you cannot be a champion in your chosen field. The DIESEL INDUSTRY hit a record high in 1939. It takes training—either intensive schooling or long experience—to get the "know how" of today's intricate Diesels, in industry, ships, trains, busses, trucks. *Hemphill Diesel* training is a short-cut to practical experience. FIND OUT ABOUT IT.

Modern Diesel engines are masterpieces of engineering. Hemphill training has equipped many men to service, adjust, repair, operate, and maintain them. No matter where you live or what you are doing, you can start your training NOW, at home—take shop work later. Also day or night courses. Send coupon today. No obligation. Get your free copy of "March of Diesel."

HEMPHILL DIESEL SCHOOLS

All communications concerning enrollment in any of the Hemphill Diesel Courses should be sent to one of the following addresses:

NEW YORK . . . 31-26 Queens Blvd., L. I. C.
CHICAGO . . . 2014 Larrabee Street
MEMPHIS . . . 417 Monroe Avenue
LOS ANGELES . . . 2120 San Fernando Road
VANCOUVER, B.C. . . . 1363 Granville St.

HEMPHILL DIESEL SCHOOLS (use nearest address)

★ Please send data on your Diesel courses, also free copy of illustrated booklet "March of Diesel."

Name _____ Age _____

Street _____

City _____ State _____ m-47-p

Also Diesel course in Spanish for Latin American students. Write for information and terms.

**PICK THE JOB
YOU WANT**



**TRAIN TO QUALIFY FOR
RADIO-TELEVISION**

Have you a job or do you seek one? In either case, National Schools can definitely help you. Without giving up present employment you can get practical preliminary training; then receive intensive shop instruction at school at no extra cost. Every branch taught—Radio, Television, Broadcasting, Sound, etc. Oldest trade school in West.

Get the facts. No misstatements. Learn about this flexible plan to fit your needs.

NATIONAL SCHOOLS

FREE

MAIL COUPON FOR DETAILS LITERATURE POSTPAID

NATIONAL SCHOOLS, Dept. PMR-6
4000 South Figueroa Street, Los Angeles, Calif.
Request for Free Literature on Radio and Television.

NAME _____ AGE _____
ADDRESS _____
CITY _____ STATE _____



**Know Electricity as Experts
Know It—and Get an Expert's Pay!**

What about your future? Who is safe today? Surely not the man who is contented to stand still! Know your job thoroughly—prepare yourself for jobs ahead. To do just this thousands of men have used

**The Croft Library of
Practical Electricity**

The Croft Library is a complete electrical educator. It is founded on practice—on 20 years of shirt-sleeve experience—on work as it is actually done. It is jammed from cover to cover with the kind of hard-headed facts you want. Written so that the beginner can easily understand it, yet so sound, so thorough, that it is the daily guide of 50,000 highly paid electrical workers and engineers. Croft tells you the things you need to know about motors, generators, armatures, commutators, transformers, circuits, switchboards, distribution systems—electrical machinery of every type—illumination in its every phase—the most improved methods of lighting—lamps and lamp effects, etc.—how to do a complete job, from estimating it, to completion.

**6 volumes, 2155 pages—New low price
No money down—Easy payments.**

Fill in and mail the coupon attached and we will send you the entire set of six volumes for ten days' Examination on approval. We take all the risk—you assume no obligation. If you decide to keep the books, send \$1.50 in ten days and the balance at the rate of \$3.00 a month. Send the coupon NOW and see the books for yourself.

EXAMINATION COUPON

McGraw-Hill Book Co., 330 W. 42nd St., New York, N. Y.

Send me for ten days' examination on approval the Croft Library of Practical Electricity. If satisfactory I will send you \$1.50 in 10 days and \$3.00 monthly until the price of \$16.50 is paid. If not wanted, I will return the books postpaid (To insure prompt shipment write plainly and fill in all lines.)

Name _____
Home Address _____
City and State _____
Position _____
Name of Company _____ PM-6-40

**Your Place in Aviation
SPARTAN
SCHOOL OF AERONAUTICS**



Come to SPARTAN for today's finest expert training for your choice of aviation careers—Flying, Engineering, Mechanics, Radio. Approved by U. S. Civil Aeronautics Authority. 15 modern airplanes, latest aircraft engines; completely equipped shops, laboratories—private practice fields; 17 modern buildings; club-like dormitories. \$100,000 expansion program making SPARTAN even greater. New semester starts July 8th. Write for free catalog. **CAPTAIN MAXWELL W. BALFOUR, Director**
Dept. PM60. Tulsa, Oklahoma



**LEARN HOW TO DRAW
GAG CARTOONS**

New special, up-to-date instruction.

E. C. SEGAR, creator of "POPEYE," CHESTER GOULD, who draws "DICK TRACY," "LANKY," LEONARD—"MICKY FINN" and many other famous cartoonists and comic strip artists learned how to draw during their spare time by following CARTOONIST EVANS' SIMPLE, EASY, INEXPENSIVE COURSE. Send 6c in stamps for full details. **THE W. L. EVANS SCHOOL OF CARTOONING**
521 Premier Bldg. Cleveland, Ohio



LACO Oil-Heat Books FREE!

Send your name for Free Booklets describing newest oil-heating methods—all about LACO's improved models for room or furnace! America's lowest priced! Tremendous heat for low cost! Save work, dirt, money. No attention required. Thousands of delighted users. See your local LACO dealer. Or, write for free folders and low prices!



LACO OIL BURNER CO., 160 Union Ave., Griswold, Iowa

**TOOL & DIE MAKING
MACHINIST**

Acety. & Arc Welding, Body & Fender Repair. Practical Shop Training. Michigan's Oldest & Largest Trade School. Train until Satisfied.
WOLVERINE SCHOOL OF TRADES
1400 W. Fort St. Detroit, Mich. Day—Night School Dept. K-3

THRILL AND MYSTIFY YOUR FRIENDS

by showing front page of newspaper with headline including yours or friend's name. Send words for headline with 25c (stamps or coin). We will print, mail postpaid. 3 for 50c.
HEADLINES, Uninc., 1411-B South Michigan Ave., CHICAGO

In answering advertisements always write name and full address clearly.

AMAZING NEW ELECTRIC

ARC WELDER

RETAILS ONLY
\$2.95
COMPLETE



Plugs Into
110 Volt
Light Socket

New design patent applied for! Amazing new HANDIWELD Electric Arc Welder—operates from 110 volt light socket, A.C. or D.C. current, same as other arc welders higher priced—generates tremendous heat to weld all kinds of metal. Not a toy welder that uses carbons, but actually uses standard coated rods—sizes 1/16" and 3/32"—Generous supply furnished with welder. Guaranteed not to burn out. Repairs fenders, auto bodies, galvanized cans, radiators, pre-heated small castings and machinery parts. Take HANDIWELD anywhere to the job, operate right from light socket. Sturdily built of finest materials to last years. Fully guaranteed by Big Manufacturer.

SEND NO MONEY! You'll find a thousand uses for the HANDIWELD around your home, garage, and work shop. Thousands of garages need the HANDIWELD Welder. Also factories, repair shops, mechanics, farmers, inventors, tin shops, plumbers, etc. Order a HANDIWELD now. Send no money. We'll rush one to you, complete with rods and goggles. Pay postman only \$2.95 plus few cents postage. If not delighted, return HANDIWELD in 5 days from receipt and money paid for it will be refunded instantly. Rush your order now.

KUMFY PRODUCTS CO., Dept. E-202, Cincinnati, O.

When writing please mention Popular Mechanics

INVENTORS

Get Expert Advice on How to PROTECT and SELL Your Invention

Get
FREE COPY

"Why I thought of that years ago!" How many persons have said that, when they found later that somebody else had thought of the same thing, had it patented, sold it, and were profiting from it? Too many, sad to say. These unfortunates did not know what to do about their inventions, in order to protect and profit from them. Some thought elaborate working models were necessary to secure patent—others felt their idea wasn't "worth much." They failed to realize that a good practical invention, plus prompt action in securing a Patent, and locating a buyer or a good market, have proved the secrets of success for thousands of inventors.

PATENT GUIDE SHOWS WHAT TO DO

Our "Patent Guide for the Inventor" answers many important questions concerning Patents that inventors constantly ask. It tells what facts, details, drawings, sketches, etc., are necessary to apply for a Patent; how to protect your invention through dated and witnessed disclosure; how to do this AT ONCE to safeguard your rights; how Patent Office Records can be checked to determine whether the invention is probably patentable before filing fees need be paid; discusses costs involved and a practical way these can be paid as the application progresses. It tells how some inventors secured financial backing; how many simple inventions have proved large commercial successes; how Patents covering improvements also can be profitably utilized and marketed; tells countless other facts of interest.

WHY YOU NEED EXPERT ASSISTANCE

The Patent Laws were enacted for your benefit—to give you protection for the features of your invention which are Patentable. But these features must be legally and concisely set forth in the form of "claims". This phase of the procedure is so complex that the Patent Office advises the Inventor to engage a competent Registered Patent Attorney. We maintain a large staff—carefully trained registered patent attorneys—expert draftsmen—experienced searchers—to serve you. We have been serving inventors for more than 20 years.

TAKE FIRST STEP NOW

With the Patent Guide you will receive also Free a "Record of Invention" form which will enable you at once to establish the date of your invention, before you file your Patent application. This step costs you nothing yet may be vital to your success. Remember—in Patent Matters, ACTION is IMPORTANT. Delay can be costly. Mail the coupon in an envelope, or paste it on a penny postcard—NOW!

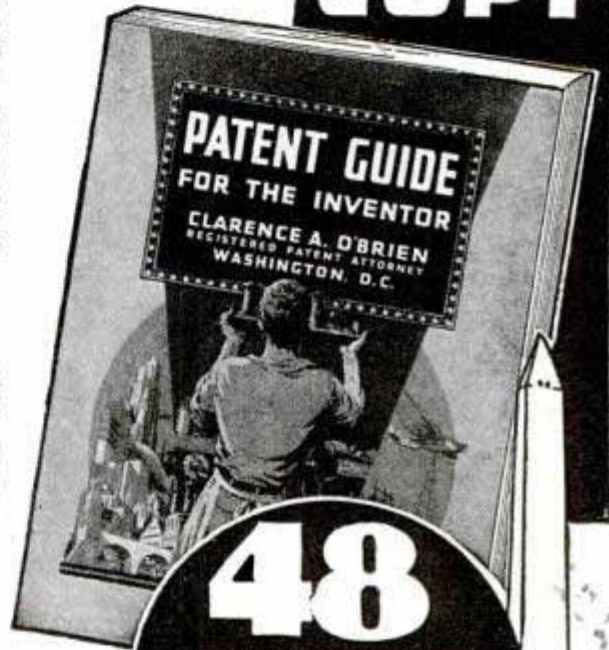

48 PAGES
Over 100
Illustrations

CLARENCE A. O'BRIEN

CLARENCE A. O'BRIEN, Registered Patent Attorney
Dept. QF1, Adams Building, Washington, D. C.

Please send me your 48-Page Patent Guide and your Specially Prepared "Record of Invention" form FREE. This request does not obligate me.

Name

Address

City State

(Please write or print plainly.)

Get This
FREE BOOK
IMMEDIATELY MAIL COUPON TODAY!

CLARENCE A. O'BRIEN
Registered Patent Attorney
Dept. QF1 ADAMS BUILDING
WASHINGTON, D. C.

POPULAR INVENTIONS

For Your Home

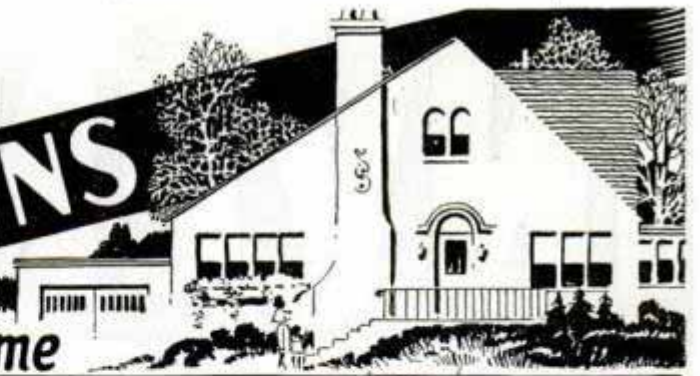

K296

Outdoor Furniture of Woven Plastic Is Weatherproof

Unharmd by sun or rain, the newest thing in outdoor furniture is woven of an extruded plastic that can be molded in continuous lengths of any desired shape. Beautiful effects are obtained by weaving translucent, transparent or colored plastics like reed or rattan. Washing with soap and water restores its luster. Plastic furniture, having low heat conductivity and low moisture absorption, is weather resistant.

K202

Rack for Steaming Vegetables Prevents Waterlogging

Vegetables such as broccoli and asparagus can be steamed without waterlogging by placing them in a wire rack that holds them out of the boiling water and eliminates the need of tying them in bunches. The rack is placed in the bottom half of a one and one-half or two-quart double boiler, then the top part is inverted over it to hold in the steam.

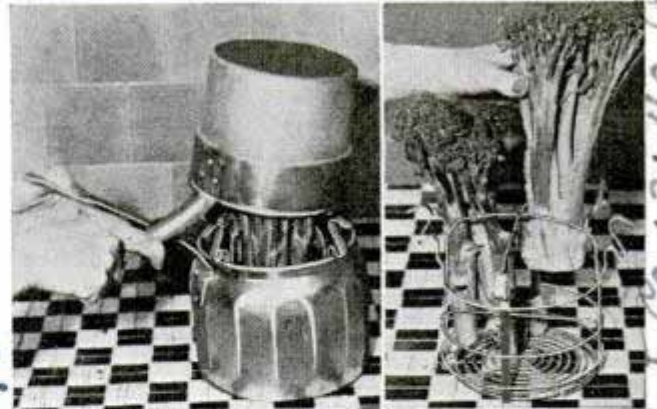

K220

Sharpener for Knives and Tools Has Reversible Blades

Adjustable blades of a new sharpener make it possible to put a keen edge on any knife, cleaver, tool, ice skates or even a lawnmower. When the sharpener blades become dull they are moved to a new position or reversed to use the opposite edge.

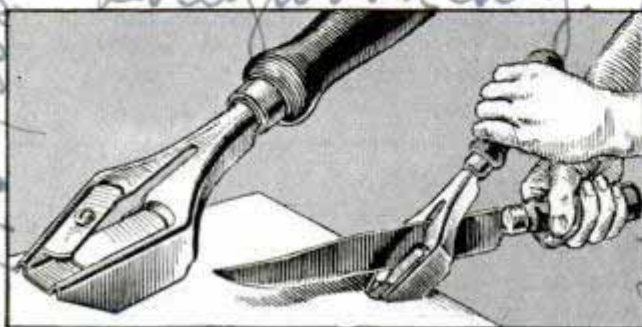

(More Popular Inventions on page 22A)

The Vita-Rope Corp
 7169 Sunset Blvd
 Hollywood Calif
 K202
 12040 Cloverdale Ave
 Detroit Mich
 K296
 K220

Cherry Lane St, Detroit, Mich
 K296
 K220

\$ AGENTS \$

DAILY SELLERS! DAILY PROFITS!

Special advertising plan gives you opportunity for daily profits with over 200 nationally famous household needs used daily in the home. Plan makes profits possible the day you start. Builds you exclusive route with regular customers.

Outfit Sent on Trial Plan

Sample outfit of full-size packages sent on trial plan. We supply everything you need to establish a permanent business. Just rush your name and address—a postal will do—no money necessary for complete Free details. Write quick!

E. J. MILLS, 1794 Monmouth Ave.
CINCINNATI, O.



CARTOON YOUR WAY TO SUCCESS!



DON'T COPY - LEARN TO ORIGINATE!

RAYE BURNS will teach you HOW to CREATE ORIGINAL CARTOONS at home that you can SELL! Course has 26 lessons and 600 illustrations. **\$285**

Send name and address for free details. Only....

RAYE BURNS SCHOOL, Dept. M, Box 2194, CLEVELAND, OHIO

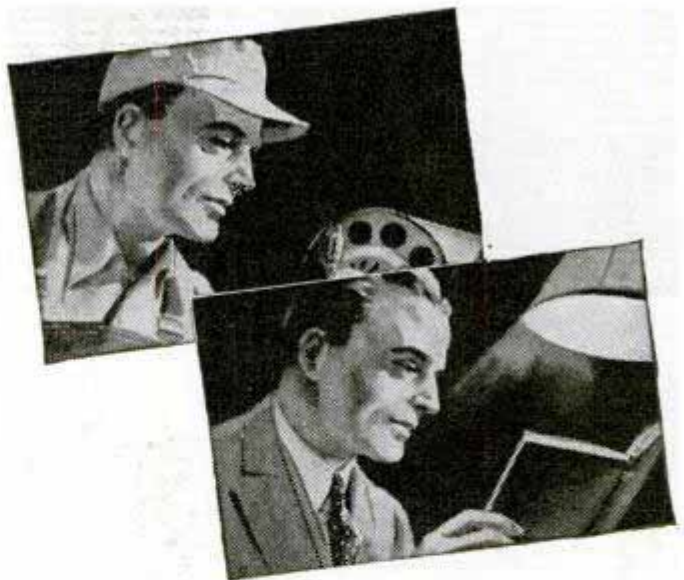

"SHOP PRACTICE & HOME STUDY-brother, they go together!"

"I work in the shop every day. And a couple of hours every evening, I study. Study what? I don't mind telling you — an I. C. S. Course! Take it from me, shop practice and home study go together. When you combine them, you're headed for more pay and a brighter future!"

The International Correspondence Schools are proud that over 500 American schools, colleges and universities use textbooks prepared by the I. C. S.! And I. C. S. instruction is a *personal* relationship between student and instructor. The coupon will bring you detailed information.

INTERNATIONAL CORRESPONDENCE SCHOOLS

Box 5579-J, Scranton, Penna.

Without cost to me, please send full particulars about the course marked X:

- | | |
|--|---|
| <input type="checkbox"/> Accounting | <input type="checkbox"/> Commercial |
| <input type="checkbox"/> Advertising | <input type="checkbox"/> Diesel Engines |
| <input type="checkbox"/> Architecture | <input type="checkbox"/> Electrical Engineering |
| <input type="checkbox"/> Aviation | <input type="checkbox"/> High School |
| <input type="checkbox"/> Business Management | <input type="checkbox"/> Radio |
| <input type="checkbox"/> Chemistry | <input type="checkbox"/> Salesmanship |
| <input type="checkbox"/> Civil Engineering | <input type="checkbox"/> Welding |

Name..... Age.....

Address.....

City..... State.....

Present Position.....

Canadian residents send coupon to the International Correspondence Schools Canadian, Limited, Montreal, Canada. British residents send coupon to I. C. S., 71 Kingsway, London, W. C. 2, England.

REAL JOBS OPEN FOR TRAINED AUTO MECHANICS

Learn QUICK! In As Little As 8 WEEKS REAL SHOP TRAINING

AUTO, DIESEL and AVIATION Mechanics, welding, body & fender-taught with real tools, on real equipment, in 2 biggest, best schools of their kind in the world. Step into Big Pay—\$35-\$60 a week. Low tuition cost! Pay for part of course later! FREE BOOK! Send for Big, Free Opportunity book and new low rate—write nearest school TODAY! **McSWEENEY SCHOOLS** Dept. Detroit, Michigan K-7 Kansas City, Mo.

AVIATION WANTS MORE LINCOLN TRAINED MEN



This Lincoln School of Aviation, APPROVED by the U. S. Civil Aeronautics Authority, wants to immediately get in touch with men interested in preparing NOW for employment opportunities as Pilots, Mechanics, Aeronautical Engineers.

BE AN AIR TRANSPORT PILOT

Prepare here to earn your Gov't. Pilot Rating to qualify you for a responsible flying position. APPROVED C.A.A. Training for Private or Commercial Pilot. Large fleet of Training Planes.

BE AN AERONAUTICAL ENGINEER Learn Airplane Design and Construction. Training includes wide practical experience. Excellent opportunities for Engineers. High Pay!

BE AN AVIATION MECHANIC

Lincoln's APPROVED Mechanics Training prepares for Gov't. Rating and immediate employment as Airplane and Engine Mechanic with Airline. Other Mechanics Courses prepare for Airplane Factory employment.

NOW IS THE TIME. Opportunities in Aviation the best they've ever been. 150 Graduates recently placed. Opportunities for many more. Act NOW!

MAIL COUPON for complete information.



LINCOLN AERONAUTICAL INSTITUTE, (INC.)
LINCOLN AIRPLANE & FLYING SCHOOL DIVISION
576 Aircraft Building Lincoln, Nebraska

I'd like to prepare myself for a place in Aviation. Please send complete information about Lincoln Training.

NAME..... AGE.....

ADDRESS.....

CITY..... STATE.....

Car No. 155 2442



DRAFTING

BOOKS SENT FREE!
ON APPROVAL

5 VOLUMES—SECOND EDITION

Only 15 minutes a day with these WONDER BOOKS can prepare you for a good drafting job. Mechanical and architectural drafting from simple straight lines to important complex plans. A step at a time! Built especially for beginners, for men with only grammar schooling. Drafting room practice, PLUS ENGINEERING, made easy and clear. Includes complete information on blue print reading for building and machine trades.

Big Field Big Demand Big Pay
Competent draftsmen are urgently needed in all building and manufacturing lines at \$30.00 to \$75.00 a week. That's just the beginning—FOR DRAFTSMEN HAVE GOOD CHANCES FOR ADVANCEMENT. Pleasant, fascinating work, easy to learn and do. Learn quickly with these books—send coupon for a set and see for yourself.

[A year's consulting membership in the American Technical Society now given to all buyers of this famous cyclopedia of drafting.]

Complete set of high grade drawing instruments if you send for these drafting books NOW. These instruments are accurate and are packed in velvet lined leatherette pocket case. Splendid value, but included with these books.

AMERICAN TECHNICAL SOCIETY
Publishers — Home Study Courses.

For Beginners or Experts

Written so you can understand every word, by well known engineers and architects. De Luxe flexible binding, nearly 2,000 pages, 1546 blueprints, charts and diagrams; prepares you for a good drafting job in mechanical or architectural lines. Sent for 10 days' free use if you mail coupon immediately.

These Instruments Included



American Technical Society, Dept. DA19, Drexel at 58th St., Chicago, Ill.
Send for 10 days' trial, 5 volume set of drafting. I will pay the few cents delivery charges. If I wish, I may return books in 10 days and owe you nothing but if I decide to keep them, I will send \$2.00 after 10 days, then only \$3.00 a month until \$24.80, the total price is paid. Send latest edition and include drawing instruments and consulting Membership Certificate.

Name.....

Address.....
Please attach letter stating age, occupation, employer's name and address and that of at least one business man as a reference.



DIESELS

—including
AUTO MECHANICS & MACHINE SHOP PRACTICE

No matter where you are or what you do, National Schools now offers immediate training to meet your specific needs. It's a tested, flexible plan to fit your circumstances—a plan for those seeking immediate shop training as well as for those who cannot give up their present employment and income. Investigate.

PRE-TESTED TRAINING FOR YOU. SEND TODAY FOR FULL DETAILS.

Amazing facts are yours for the asking. Simply mail the coupon for free literature.

NATIONAL SCHOOLS
LOS ANGELES

TRAINED MEN get TOP PAY Jobs
Diesel Industry
Diesel Servicing
Auto Industries
Power Plants
Machine Shops
Aircraft Plants
Mining and Marine
Mechanical Depts.



Request for FREE LITERATURE

NATIONAL SCHOOLS
Dept. PMA-6, 4000 So. Figueroa St., Los Angeles, Calif.

NAME..... AGE.....
ADDRESS.....
CITY..... STATE.....

POPULAR INVENTIONS

For Your Home

(Continued from page 20A)

K244. Fiber Milk Bottle Has a Spout for Sanitary Pouring

Fiber milk containers with a sanitary, non-spill spout and an airtight "clip" seal are being turned out at the rate of fifty per minute by a "production line" machine just developed. This machine shapes a spruce



or pine "blank" into a round container with spouted top, sterilizes it with hot paraffin, chills it, fills it with milk, seals the cap, stamps the date and dispatches the bottle to the cold-storage room—all in one continuous operation. To open it, the householder lifts the clip, presses the edges and the spout opens.

K296 Switch Shield Guards Wallpaper

Wallpaper can be protected from smudges around the electric-light switch by a decorative shield easy to install. Made of an ivory-hued composition material, it is fastened by screwing the switchplate over it.

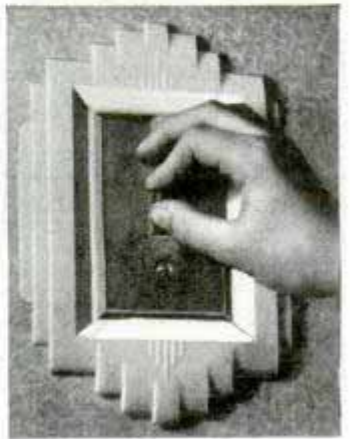

made in mechanical machine.

Send for an... free literature.

Bits molding Corp 4600 W. Hesperon Street

Sanncraft Co 1007 E. Washington Ave

POPULAR INVENTIONS

For Your Home

K268. Madison Wis

Electric Sterilizer for Bottles Has Automatic Shutoff

Seven baby bottles and nipples fit in the tray of an electric sterilizer that shuts off automatically after live steam has thor-



oughly sterilized the contents. A metal cover fits over the tray of bottles. The sterilizer plugs in on any alternating-current outlet.

K223

Saucepan with a "Window" Lid



Cooking with a saucepan that has a Pyrex lid, you can watch the food through the transparent cover and avoid the loss of heat in lifting the lid for inspection.

Send your inquiry, with a stamped, self-addressed envelope, to our Bureau of Information to learn the name of the maker of any article described in this department.

You Should Get Into DRAFTING and Industrial DESIGNING



Get into a Better Pay field with a big future by learning DRAFTING and DESIGNING quickly from an Engineer and Industrial Designer. Private, individual training at your home. Drawing tools and table furnished without extra cost. Learn to draw and design new products, or to improve, re-style, streamline and modernize old products for more "eye appeal" and selling power.

Drafting is a very big field, but drafting with industrial designing is twice as big. Factories must continuously bring out new models, new products, and improved designs. You can learn both subjects right in your own home, in your spare time. You can be trained for better pay as I

have trained many hundred successful students. I'll train you thoroughly by applied instruction on actual work until you are holding a good paying position. Send coupon for full facts on "Drafting and Industrial Designing." ENGINEER DOBE, Libertyville, Illinois.

Engineer Dobe, Div. A337 Libertyville, Illinois. **SEND FOR FULL FACTS**

Please send me full facts on "Drafting and Industrial Designing." Also please explain how you assist your graduates to good positions in these fields.

Name..... Age.....
 Address.....
 Town..... State.....

MECHANICS

KNOW YOUR CAR

You Need this Book

JUST OUT!



Ask to See it!

Every operator and mechanic needs AUDELS NEW AUTO GUIDE. This book saves time, money and worry. Highly endorsed. It presents the whole subject of auto mechanics: 1—Basic principles, 2—Construction, 3—Operation, 4—Service, 5—Repair. Easily understood. Over 1500 pages—1540 illustrations showing inside views of modern cars, trucks and buses with instructions for all service jobs. Diesel Engines fully treated, fully illustrated. To Get This Assistance for Yourself Simply **4 COMPLETE • PAY ONLY \$1. A MONTH**

THEO. AUDEL & CO., 49 WEST 23rd STREET, NEW YORK
 Please send me postpaid AUDELS NEW AUTOMOBILE GUIDE (\$4) for free examination. If I decide to keep it, I will send you \$1 within 7 days; then remit \$1 monthly until purchase price of \$4 is paid. Otherwise, I will return it to you promptly.

Name.....
 Address.....
 Occupation.....
 Reference.....

PM

Will You Let Me PROVE I Can Make YOU a New Man?

By Charles Atlas

Do you want a powerful body of might and muscle—deep, husky chest—biceps like iron—arms and legs that never tire?

7-DAY TRIAL OFFER

Just give me a week! Make me prove—in even that short time—that continuing with my **Dynamic Tension** method will make a **New Man** of you—put you in magnificent physical condition which wins the envy and respect of everyone.

FREE BOOK

I myself was once a 97-pound weakling—sickly, half-alive. Then I discovered **Dynamic Tension**. And I twice won the title, "The World's Most Perfectly Developed Man!"

But I am not making any claims which I am not willing to have you prove for yourself. If **Dynamic Tension** can't show enough results in a 7-day trial period—**results you can see, feel, measure with a tape**—then don't go ahead with it—and it won't cost you one cent!

Make me PROVE it! Gamble a postage stamp. Send for my **FREE BOOK AT ONCE!** Address me personally: Charles Atlas, Dept. 86, 115 East 23rd Street, New York, N. Y.



JUST OUT! **PROFESSIONAL CARTOONING**

Beautiful new book containing 35 complete lessons on this profitable field of work. Excellent help for student or professional. Text and illustrations easy to follow for home or spare time study. Prepare for your future with these pleasant lessons. Get into Professional Cartooning for fame and fortune. Order your copy TODAY. Send →

1 COMPLETE COURSE

PROFESSIONAL PUBLISHERS, Inc.
24 WILLIAM ST. • NEWARK, N. J.

STUDY CHEMISTRY AT HOME

Earn a Degree at Home
From A Chartered Institution Of Higher Learning
Employers Demand Degree Men For Key Positions

88 Degree Courses in Electrical, Mechanical, Civil, Structural, Diesel, Architectural, Drafting, Automotive, Aeronautical, Radio, Refrigeration, Air Conditioning, Highway, Mining, Geology, Petroleum, Marine, Industrial, Chemical Engineering; Arts; Sciences; Philosophy; Psychology; Chemistry; Education; Business Training; Law; etc.
McKinley-Roosevelt Graduate College, 4750-K Sheridan Road, Chicago

Established 1902

New York Electrical School

Ask for free illustrated booklet

44 West 17th St., N. Y. C.

Auto-Diesel

Master a real trade. Auto Mechanics, Diesel Mechanics, Arc Welding, Acetylene Welding, etc. Let us train you to be an expert Auto-Diesel Mechanic and help you get a good job. The cost to you is reasonable. Learn on modern equipment with tools under experienced instructors. Real shop work. Steam heated buildings. Room and board in our steam heated dormitory. We pay your fare to Nashville. For free catalog write

Nashville Auto-Diesel School, Dept. 75 Nashville, Tenn.

To make money on your idea

Some of the world's biggest fortunes came from inventions evolved by the "LITTLE MAN" . . . who didn't consider himself an inventor at all. The telegraph was invented by a painter; the typewriter by a farmer; the stock ticker by a dentist; the crinkly hair pin by an observant husband. If YOU have an idea that will save time, save labor or give pleasure, you owe it to your future to find out QUICKLY how you can protect your rights to it! The books shown below may prove invaluable to you . . . send for them NOW!

PATENT

and

SELL

your

INVENTION

DON'T FORGET THIS!
A little idea may have
BIG commercial possibilities!

Act now!

DELAY MAY BE COSTLY!
Someone else a thousand miles away may be thinking along the same lines as you
REMEMBER . . . the U. S. Patent Laws favor the first to ACT!



42 YEARS OF HELPFUL SERVICE

VICTOR J. EVANS & Co.

REGISTERED PATENT ATTYS.
Main Office, 560-G Victor Bldg.
WASHINGTON, D. C.

Please send me your books, "Patent Protection" and "How to Sell an Invention" without cost or obligation.

NAME

ADDRESS

PLACE AND STATE

YOUR FIRST STEP — Learn how U. S. Government Patent Laws Protect YOU!

These FREE books tell you simple steps to take, promptly, without cost, to claim your rights to your own idea; kind of sketch or model needed; how you can go about selling your invention, etc., etc. They're packed with facts you want to know . . . and should know . . . to make money on your idea!

SEND NO MONEY

THIS COUPON BRINGS YOU FREE-

68 PAGES OF FACTS FOR INVENTORS!

If You could have stepped into this picture



EXECUTIVE BOARD
JOHN K. NORTHROP
 President, Northrop Aircraft, Inc.
ROBERT E. GROSS **C. A. VAN DUSEN**
 President, Lockheed Vice-Pres., Consolidated
 Aircraft Corporation Aircraft Corporation

...You would be building giant transports NOW

If you could have stepped into this picture you would have joined a group of Aero ITI-trained men requested by one of the world's largest aircraft builders. These fellows saw the great future in Aviation—and trained at a school whose graduates are IN DEMAND. In the last year alone over 840 Aero ITI-trained men started their careers in aircraft design, engineering, maintenance and production. You too, can take this proven training that has equipped so many men for permanent, profitable careers in the ever-expanding Aviation industry. Send for details NOW.

AERO INDUSTRIES TECHNICAL INSTITUTE

5253 W. SAN FERNANDO ROAD, LOS ANGELES, CALIFORNIA
 Five Courses In AIRCRAFT MECHANICS and AERONAUTICAL ENGINEERING...including U. S. Civil Aeronautics Authority Approved 12 Months Aircraft Mechanics Training.

TENNIS
SAVE on our NEW LOW PRICES



Earn money—save money re-stringing rackets! Buy Gut tennis strings direct from factory. Silk strings; Restringing's vice, equipment, instructions. Catalog FREE H. E. WILLS CO., 1047 W. 47th ST., DEPT. PM-660, CHICAGO

LEARN TO SKETCH

DIRECT FROM NATURE, easy with this 62-page book, 50 illustrations. No drawing ability necessary. Simplified instructions, no technical terms. Send \$1 for "Sketching from Nature" by C. P. Zaner. Postage paid.

FREE: 3 issues of THE EDUCATOR magazine of penmanship with order, **EXTRA**, while supply lasts, 40-sheet sketch pad **FREE**.

The Zaner-Bloser Co., 612 N. Park, Columbus, Ohio

FORGE AHEAD

with the Thinking Alphabet. New "exactly how" short cut to self advancement, through originality, personality and mind-training. **FREE BOOKLET.**

SELF ADVANCEMENT INSTITUTE, 99J Fern St. Philadelphia.

FIREWORKS FREE SALUTES Oh Boy!



THINK OF IT! An assortment of over 605 pieces of fireworks worth \$6.15, for \$2.95 cash with order. We have the famous "ZEBRA" flashlight crackers. World's loudest. You get more for your money at BANNER. 100 FREE salutes with every order. Write for free catalog.

BANNER FIREWORKS
 3916 1/2 Detroit Ave. Toledo, Ohio

Money Making Pay Raising BOOKS Catalog FREE

Send Name and Address Today

Selected books covering all trades, office helps, home workshop, spare time work, hobbies, etc. Learn how to earn more. Write today.



Popular Mechanics Press
 DEPT. 640
 200 E. Ontario Street
 CHICAGO

There's MONEY IN ARC WELDING!



U. S. Manufacturers desire men to learn Electric Arc Welding and get practical experience under actual production conditions in the laboratories of the School of Engineering. Moderate training fee. Accepted applicants will be fully trained until ready to pass rigid test and assisted in securing employment.

AIRCRAFT WELDING

"We want more planes!" That's the demand on every side. No wonder there is a shortage of aircraft welders. Other industries need welders, too. There's almost no limit to what Milwaukee School of Engineering trained welders can do. They get good pay because they know the "how and why" of Welding, Metallurgy, Drawing, Blueprint Reading, Set-up Work and Fabrication—and they enable manufacturers to cut production costs. Remember—industries need practical trained Aircraft Welders, Arc Welding Operators, Technicians and Welding Engineers, and Air Conditioning and Refrigeration Technicians. Don't be satisfied to struggle along on ordinary, hit-or-miss jobs with poor pay—when in a short time you can become a trained specialist. Send coupon today—classes begin within a month.

MILWAUKEE SCHOOL of ENGINEERING

Institute of Electrotechnics

P.M. 640 North Broadway and E. State, Milwaukee, Wis.

Without obligation send Free Booklet "The Dawn of a Gigantic Industry and its Outstanding Opportunity." Also tell me How to Become an Arc Welding Operator (3 mo.)... Air Conditioning & Refrig. Tech. (4 mo.)... Air Craft Welder (6 wks.)... Radio Serviceman (6 mo.)... Welding Technician (6 mo.)... Commercial Electrical Engineer (1 yr.)... Welding Engineer (1 yr.)... Commercial Radio Engineer (1 yr.)... Electrical Engineer Student Loan Plan B. S. Degree (4 yrs.)... Earn Part Expense Plan

Name..... Address.....
 City & State..... Age..... P.M. 640

QUICK-WAY to make money in RADIO

Modern receivers demand men with modern training for service work. New training method and service equipment offer starts you earning almost at once. Up to \$3 an hour easy in a short time. Write today for FREE book of details.

Radio Training Ass'n of America, Dept. PM-60, 4525 Ravenswood Ave., Chicago

TRI-STATE COLLEGE **57th YEAR**

ENGINEERING DEGREE IN 2 YEARS

Courses in Civil, Electrical, Mechanical, Chemical, Aeronautical, Radio Engineering. The Mechanical course includes Diesel Engineering, Air Conditioning and Refrigeration. Essentials of engineering training included and non-essentials eliminated. Tri-State graduates in Radio Engineering can complete the Electrical course in 24 weeks. B. S. Degree granted upon completion of course. For ambitious, earnest students. Special Preparatory Department for those who lack required high school work. Graduates compete successfully with those of 4-year schools.

Technical instruction at lowest cost and in least time consistent with thorough training. Intensive instruction in accord with individual ability. Courses also in Business Administration and Accounting. Also short diploma courses (36 weeks) in Surveying, Drafting. Students from all parts of the world. Tri-State graduates make good. Tuition, living costs low. Enter September, January, March, June. **Write for catalog. 460 College Ave., Angola, Ind.**



PATENTS

Booklet Free Highest References
Promptness Assured Best Results

Send drawing or model.

ALL BUSINESS GIVEN PROMPT AND PROPER ATTENTION

Listed Patent Lawyer in the latest editions of the Rand-McNally Directory of Bankers and Bank-Recommended Attorneys, published by Rand-McNally & Co., Chicago, Ill.; American Lawyers Annual, Cleveland, Ohio; Bankers Service Legal Directory, published by Bankers Service Co., Boston, Mass.; and the Snow-Church Directory Co. Lawyers List, published in New York City.

WATSON E. COLEMAN, Victor Building, 724 Ninth Street, N. W.
REGISTERED PATENT LAWYER **WASHINGTON, D. C.**

INVENTORS PATENT YOUR IDEAS SEND FOR FREE BOOK



HOW TO OBTAIN A PATENT

Written by a Former Member of the Examining Corps (1922-24) of the U. S. Patent Office. If you want to profit by your ideas, you should take steps to apply for a U. S. Patent at once. Your first step is to get this Free Book. This interesting illustrated book contains valuable information you should have. It tells you fully how to obtain a patent on your idea in the quickest way. With this Free Book you will also receive a "Record of Invention" form on which you can easily record your idea. Personal and Confidential Service: Your case will be personally handled only by a Registered Patent Attorney who is also a Former Member of the Examining Corps of the U. S. Patent Office. All communications confidential.

MAIL COUPON TODAY for FREE PATENT BOOK and RECORD OF INVENTION Form.

CARL MILLER

REGISTERED PATENT ATTORNEY
FORMER MEMBER EXAMINING CORPS U. S. PATENT OFFICE

Woolworth Bldg., 35th Floor, Dept. 60-A, New York City
MILLER BUILDING, Dept. 60-A, WASHINGTON, D. C.

Please send me your Free Book, "How to Obtain a Patent," and your "Record of Invention" form.

NAME.....

ADDRESS.....

Inventions Wanted Patented or Unpatented

We have been successfully selling inventions, patented and unpatented, since 1924. Write for proof, and tell us what you have for sale.

Chartered Institute of American Inventors
Dept. 4, Barrister Building, Washington, D. C.

BENJAMIN AIR PISTOL WITH HAND PUMP



For Target—Small Game—Camping—Etc. Guaranteed—Accurate—Practical—Economical—Safe—Clean—Quiet. Adjustable Force—Amazing Maximum Velocity. No Smoke or Fumes. Bolt Action—Hammer Fire—Hair Trigger—Safety Lock—Hand Pump. Single Shot BB \$8.50; Single Shot cal. 177 or 22 with rifled barrel \$8.50; BB \$10.00; Holster \$2.00. Also a complete line of Benjamin Genuine Compressed Air Rifles for BB and cal. 177 or 22. No license required from dealer or factory. Write today for complete specifications and free targets.
BENJAMIN AIR RIFLE CO., 890 Marion St., St. Louis, Mo., U. S. A.

PATENTS—TRADE MARKS

All cases submitted given personal attention
Form "Evidence of Conception" with instructions for use and "Schedule of Government and Attorneys' Fees"—FREE!

LANCASTER, ALLWINE & ROMMEL

Patent Law Offices

412 Bowen Bldg.

Washington, D. C.

INVENTORS PROTECT & SELL

Your unpatented invention can be sold with positive safeguards under patent laws. New, low-cost procedure. Complete details, free.
AMERICAN PATENTS CORPORATION
Dept. 4-E Washington, D. C.

INVENTORS who derive largest profits know and heed certain simple but vital facts before applying for patents. Our book, Patent-Sense, gives those facts; sent free. Trade Marks—Copyrights.
LACEY & LACEY, Est. 1869, 635 F St., N. W., Dept. 5, WASHINGTON, D. C.

MAKE YOUR INVENTIONS PAY!
Make BIG profits from your invention! We help you, 36 year old firm offers complete services, free estimates. Ample facilities regardless of size of invention. Stamping, metal specialties, dies, models, etc. Catalog giving "inside" information FREE. Write TODAY!
CRESCENT TOOL CO., Dept. V, Cincinnati, Ohio

FREE ESTIMATES

PATENTS Write for free booklet of costs and other information
EUGENE H. PURDY
Registered Patent Attorney and former examiner in Patent Office
808 International Bldg. Wash., D. C.

BUCHSTEIN'S FIBRE LIMB
Soothing to stump, cool, light, strong. Correct fit. Braces for all deformities. Fair terms.
D. BUCHSTEIN CO.
110 3rd Ave. South, Minneapolis, Minn.

FOR COMFORT

MONUMENT \$9.00 UP
FREIGHT PAID
Write For Catalog and Samples Of Genuine Marble & Granite. Low prices. Guaranteed satisfaction. Erecting Service. Free lettering.
U. S. MARBLE & GRANITE CO., A-18, Oneco, Fla.

To PROTECT YOUR INVENTION Use this coupon, NOW

Delays are dangerous and may be very costly. My personal service assures prompt action, strict confidence, and a minimum of expense. I suggest that you send me a model or drawing, or sketch and description of your invention, and \$5.00. I will make a search and report

promptly as to its patentability and send you a copy of my 72-page booklet. Or, if you prefer to read my booklet first, mail the attached coupon at once. I will also send my "Record of Invention" form. (Over 38 years experience as a Registered Patent Attorney.)

L. F. Randolph, 302-D Victor Bldg., Washington, D.C.

Please send me at once, free of charge, your 72 page booklet and "Record of Invention" form.

Name.....

Address.....

A PERSONAL CONFIDENTIAL PATENT SERVICE

RUPTURED?

Get Relief This Proven Way

Why try to worry along with trusses that gouge your flesh—press heavily on hips and spine—enlarge opening—fail to hold rupture? You need the Cluthe. No leg-straps or cutting belts. Automatic adjustable pad holds at real opening—follows every body movement with instant increased support in case of strain. Cannot slip whether at work or play. Light. Waterproof. Can be worn in bath. Send for amazing FREE book, "Advice To Ruptured" and details of liberal truthful 60-day trial offer. Also endorsements from grateful users in your neighborhood. Write:

CLUTHE SONS, Dept. 31, Bloomfield, New Jersey

AVIATION Needs RADIO TECHNICIANS

Trained radio operators, service, maintenance men in demand in aviation. SPARTAN'S Air Transport Communications Course prepares you for these good positions. Finest modern Aviation Radio Laboratory and equipment; accredited instructors. SPARTAN aviation radio graduates now holding responsible positions with leading aviation concerns. Write for complete facts.

SPARTAN SCHOOL OF AERONAUTICS

Capt. Maxwell W. Balfour, Director, Dept. PMR60, Tulsa, Okla.

PROFESSIONAL ENGINEER — Long Experience
Will develop your
Inventions and Technical Problems
Development Engineering • 11 WEST 42nd ST.
NEW YORK, N. Y.

EARN A DEGREE AT HOME

From A Chartered Institution Of Higher Learning
Employers Now Demand College Graduates With Degrees

55 Degree Courses in Art; Sciences; Philosophy; Education; Psychology; Public Health; Medical Jurisprudence; Sociology; Physics; Chemistry; Pol. Science; Theology; Law; Business Training; Accounting; Statistics; Agriculture. Electrical, Mechanical, Civil, Structural, Diesel, Architectural, Mining, Drafting, Automotive, Aeronautical, Radio, Refrigeration, Highway, Marine, Air Conditioning, Geology, Petroleum. Industrial, Chemical Engineering. Founded 1908.

McKinley-Roosevelt Graduate College, 4750-F Sheridan Road, Chicago

WELDERS WANTED!



ELECTRIC ARC-OXY-ACETYLENE

Skilled Welders earn \$8 to \$15 a day. The demand now greater than the supply. Learn this highly paid trade in 3 weeks by actual shop work. One of America's leading schools. Established 1902. 7 floors of shops. Endorsed by welding industry. Limited number of students. 3 weeks course in Electric Arc or Acetylene Welding, including room and board, only \$105. Write or wire for reservation. Ask for "Welding Facts." State age.

GREER COLLEGE, Dept. 160, 2024 S. Wabash Ave., Chicago

LEARN AVIATION IN LOS ANGELES

• Nation's Aviation Capital

Huge increase in Los Angeles aviation activity has assured splendid positions for graduates. Career training offered for airline piloting, engineering, mechanics, drafting, production mechanics and instruments. Train at America's most modern and strategically located school, fully approved by the U. S. Government for flight, ground and mechanics courses. Write for free new 64 page catalog.

CALIFORNIA FLYERS

SCHOOL OF AERONAUTICS — Dept. PM-6
LOS ANGELES MUNICIPAL AIRPORT, INGLEWOOD, CALIF.

LEARN MONEY-MAKING CARTOONING

by America's most famous method. Hundreds of successes! Start today—soon draw for pay. Rush 10c for details and big Picture Chart to test your ability (state age).

THE LONDON SCHOOL, 1039 National Bldg., Cleveland, Ohio



In answering advertisements always write name and full address clearly.

BROOKLYN YMCA TRADE SCHOOL



Unlimited instruction until you have mastered every part of Course without additional charge.

Full Shop Equipment
Unexcelled Instruction
Fireproof Dormitories.

Special Privileges. Check your interests on coupon to receive free literature.

- Mechanical Pre-Engineering
- Diesel Engines Oil Burner
- Diesel Pre-Engineering
- Aeronautical Pre-Engineering
- Aviation Mechanic Welding
- Auto Mechanic Talking Pictures
- Refrigeration Air Conditioning
- Television and Radio Mechanic
- Architectural-Mechanical Drafting
- Machinist Tool and Die Making
- Armature Winding Electrical

INVENTORS Get PATENT FACTS

Free Books Answer Questions—
Tell How to Get Protection

• Your ideas may be worth money! Get facts first and save time and money. Competent advice on patent procedure is essential to good results. Our 65 years' experience enables us to explain everything you need to know about protecting and commercializing your idea. Mail coupon today. Special "Certification of Invention" form also sent. Prompt service and results.

C. A. SNOW & CO.

Patent Attorneys Since 1875

106 SNOW BLDG., WASH., D. C.

Please send me free books illustrated without cost or obligation.

NAME.....

ADDRESS.....



← MAIL NOW

FOR FREE BOOKS



on approval. Just mail the coupon and we'll send you a set of these remarkable auto books. Whether you are a mechanic or helper, expert or apprentice, auto owner or driver, if you're interested in knowing all about automobile mechanics, take advantage of this FREE EXAMINATION OFFER.

GET A BETTER JOB

A better job—in the gigantic auto industry. BIGGER PAY—a chance to go into business for yourself and get a share of the profits, are waiting for any man who even half tries to improve himself. Learn auto engineering with these wonder books a new way—a quick reference method. Simply use the JIFFY INDEX to look up the answer to any auto problem. Built by eleven of America's great automobile engineers, and written in simple language so you can understand it.

Privilege of consulting Automobile Engineers of American Technical Society for one year without cost if you mail coupon immediately.

Send promptly and we will include a New EXTRA volume with over 300 pages including late cars with wiring diagrams and data sheets on each.

CAN YOU FIX IT?

These wonder books tell step by step HOW to take out "play" in differential—to kill the shimmy in steering—to set TIMING—how to put your finger on engine trouble and the expert way to FIX it.

6 BIG VOLUMES

2500 pages, 2000 illustrations, wiring diagrams, etc., including Marine Engines, Aviation Motors, Diesel engines, etc. De Luxe edition, gold-stamped flexible binding.

AMERICAN TECHNICAL SOCIETY (Publishers—Home Study Courses), Drexel Ave. & 58th St., Dept. AA19, Chicago, Illinois. I would like to see the 6-volume edition of your AUTO BOOKS. I will pay the few cents delivery charges only, but if I choose to, I may return them express collect. If after 10 days use I prefer to keep them, I will send you \$2 and pay the balance at the rate of only \$3 a month, until \$24.80 is paid. Please include consulting membership and extra Volume No. 7, as per your offer above.

Name.....
Address.....
City..... State.....
Please attach letter stating age, occupation and name and address of employer and that of at least one business man as reference.

MAIL COUPON

1117 Bedford Ave., Dept. P.M.
Brooklyn, New York City, N. Y.

Name.....

Address.....

Business Demands Accountancy

—because Accountants Command Business

ACCOUNTANTS are usually in demand—at better than average earnings.

But today—more than ever before—the competent accountant finds his services at an increasing premium.

In the depression, business tightened up the reins and is watching costs—prices—every move—striving to operate on that basis of close control so essential to profits.

Then too, progressive business is building now for future prosperity—laying plans for expansion, for new processes, new markets—getting ready for the opportunities of the next ten years.

The Home Study Way to Accountancy Success

Thousands upon thousands of men have trained for Accountancy with LaSalle—at night—at home.

Their success—their progress—is a matter of record.

Whether their goal was a C. P. A. degree or advancement in business, our files are full of letters reporting income increases far out of line with the time and cost investment.

Note for instance, these four cases chosen out of many more we might cite. (Names on request.)

F. F. A. was a railroad yard clerk at \$112 a month when he began accountancy training with LaSalle. Five years later, his income was 500% larger and he was a Certified Public Accountant and attorney. F. C. was 22 years of age and general all-around man in an Arkansas lumber yard at \$75 a month. Five months later, his firm made him manager at \$125, and ten months later promoted him to a larger yard at \$250 plus a commission on sales.

O. D. always thought stories about LaSalle training were fairy tales until the training helped him—a clerk at \$75 a month—move up in six months to \$125, and within four years to \$250. He became General Auditor of a large national organization—with his income more than seven times his starting salary.

As an assistant bookkeeper in a great Western bank, C. F. H. looked forward to slow progress. But LaSalle accountancy training speeded up his climb to Assistant Trust Officer and to a salary increase of 400 per cent.

These Men Won Success in Ordinary Times—You Will Profit By Unusual Times

Remarkable as is the success of these men—you will have an advantage over them—you will be entering accountancy when unusual business conditions work with you for success.

Present conditions not only call for more capable accountants—but offer unusual opportunities for both quick and permanent success. The accounting student of 1940 will face real opportunity in 1941 and the accounting leaders of 1945-50 will be largely determined in 1940-1941.

—If You Can Qualify

Ask yourself three questions:

1. Are you ambitious?
2. Have you determination?
3. Can you see and grasp an opportunity?

If you have determination; if you are ambitious; if you can take advantage of circumstances—*prone it* by investigating. A three-cent stamp, sixty seconds time, and the coupon below will bring you full information regarding Accountancy training and the opportunities to which such training leads. Then you can judge intelligently.

LaSalle Extension University

A Correspondence Institution

Dept. 664-HR

CHICAGO

Opportunities in Accountancy—Check below and we will send you a free copy of "Accountancy, the Profession that Pays," also information about our new training in Higher Accountancy, all without obligation.

Higher Accountancy

Other LaSalle Opportunities: If more interested in one of the other fields of business indicated below, check that:

- | | | |
|--|--|--|
| <input type="checkbox"/> Business Management | <input type="checkbox"/> Law: LL.B. Degree | <input type="checkbox"/> Business Correspondence |
| <input type="checkbox"/> Expert Bookkeeping | <input type="checkbox"/> Commercial Law | <input type="checkbox"/> Stenotypy |
| <input type="checkbox"/> C. P. A. Coaching | <input type="checkbox"/> Industrial Management | <input type="checkbox"/> Modern Foreman- |
| <input type="checkbox"/> Railway Accounting | <input type="checkbox"/> Modern Foreman- | <input type="checkbox"/> Salesmanship |
| <input type="checkbox"/> Traffic Management | <input type="checkbox"/> ship | <input type="checkbox"/> Business English |
| <input type="checkbox"/> Effective Speaking | | |

Name.....Age.....

Present Position.....

Address.....

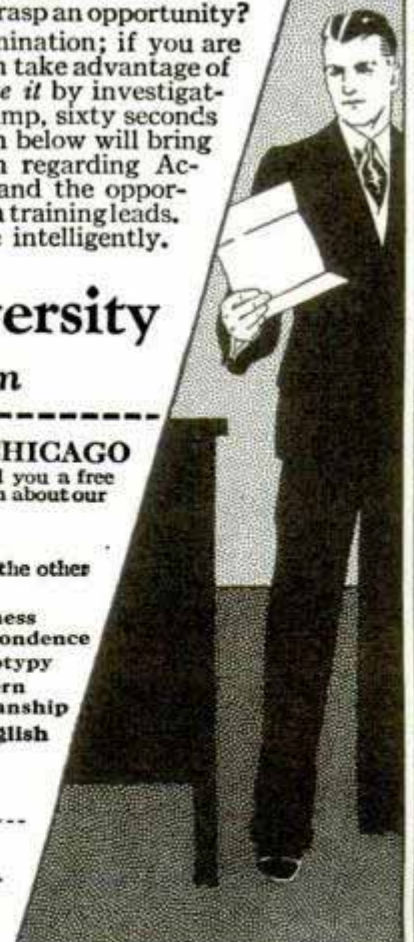

**WORLD'S
BEST
WANT AD
MEDIUM**

CLASSIFIED Advertisements



Advertisements in this section, 35 cents per word, each insertion, minimum 10 words, payable in advance

To be inserted under proper classification in July issue, copy should be in our office May 8th

July issue on sale June 1st

Popular Mechanics Magazine, 200 East Ontario Street, Chicago, Illinois

YOU'LL PROFIT

By reading and answering the classified ads in this section. Hundreds of opportunities to make and save money.

Mr. F. W. Johnson,
Popular Mechanics Magazine,
Chicago, Ill.

Dear Mr. Johnson: I am enclosing copy of ad I want run in your classified column of the June issue of Popular Mechanics. The last ad I carried with you (16 words) brought more than 500 replies, inquiries and cash, which I consider very splendid. Looking for some good business from the enclosed, I am

(Original letter on file in our office)

Cordially yours,
H. S. THOMASSON.

AUTOMOBILES—MIDGET CARS

GARAGE Owners and mechanics only purchase direct at full factory discount Triple-X Alloy Self-locking Piston Rings. Nationally distributed. Guaranteed performance. Stops oil pumping. Saves gasoline. Re-boring unnecessary. Write for sample and details. Triple-X Co., 3801 S. Racine, Dept. 106, Chicago.

MIDGET Axles, wheels, motors, clutches, brakes, plans, kits, etc. Request circulars 40-H. Shippo Midgets, Zanesville, Ohio.

AMATEUR Racers: Convert your Model A Ford easily, inexpensively, into Jallopy Racer, or fastest buggy in town. Full, easy instructions, \$1.00. Benny Hiltz, 134 Ross Avenue, Buffalo, New York.

CHANGE Ford motor into air compressor. Instructions \$1.00. Tuck, 73 Shirley, Pontiac, Mich.

MIDGET Motors, \$5.00 up. Used equipment—80 motors, 30 cars, many parts. Lists, 20c. Midgets, Box 543-H, Zanesville, Ohio.

PROFESSIONAL Midget racers, two-passenger roadsters, midget motorcycles, motorscooters, guaranteed motors, wheels, parts, plans. Handbook catalog—90 illustrations—20c. Midwest, Box 1959-CA, Chicago.

COMPLETE Auto painting instruction booklet 50c. Melco Co., Woodstock, Ill.

NEW Fifth edition Automobile Racing Book. Tells how to build dirt track bodies, frames, engines, Records, superchargers, rules, formula, plans, stock conversions, roadster racing, fast Fords. \$1.00 postpaid; \$1.15 C.O.D. Ray Kuns, Department 17, Madisonville, Cincinnati, Ohio.

AUTOMOBILE Superchargers \$3. Guaranteed mileage increase 20%; power 10%. University of Detroit test. Any car; give make, year. Wrench installs 15 minutes. John Hanley, Manufacturer, 5719 Loraine, Detroit, Mich.

AUTO SUPPLIES AND EQUIPMENT

WORLD Famous invention battery terminal, tremendous weekly repeats. 875 million used yearly, prevents 90% electrical troubles. Child installs easily with pliers. 50c postpaid, distributors, 200% profit. Pontus Manufacturing, 978 Broadway, East Providence, R. I.

AUTOMOBILE Initials—Black on gold shields—6 for 10c. Water transferring. Master Decalomania, Ardsley, Penna.

AUTO Supercharger saves up to 37% on gas. Removes carbon, saves oil, renews power. Free sample offer. Agents wanted. Multi-Matic, 2812-A Gillham, Kansas City, Mo.

FREE Bargain catalogue, auto supplies, tires, tubes, tools, garage, service station, and shop equipment. For dealers only. American, 1211 Bedford Ave., Brooklyn, N. Y.

1940 **IGNITION** Supercharger. E. G. Sales & Mfg. Co., New York.

PLATING Outfits for auto parts. Connect to a battery. No tanks used. Free particulars and proofs. Gunmetal Co., Ave. J. Decatur, Ill.

PISTON Rings—Multiple steel seal design. Quick seating, stops oil pumping. For all cars and trucks. Send for circular. Piston Ring Sales Co., 4022 West Lake Street, Chicago.

RECLEAN Used oil. Complete instructions \$1.00. Hutchison, 2742 Hennepin, Minneapolis, Minn.

SUPER-X Spark plugs, guaranteed unconditionally 20,000 miles, 25c each. Write for dealer offer. Spartan Automotive Sales, 141 W. Main, Spartanburg, S. C.

BARGAINS—Welders, compressors, battery chargers, car washers. Liberal terms. Write Hobart Equipment, Box M-6403, Troy, Ohio.

RE-FINE Crankcase drainings, request information. Zeiball, Mount Holly, N. J.

ANTI-KNOCK Gasoline formula 35c. Devereaux, Box 212, Battle Creek, Mich.

MOTOR Oil free—Reclaim used oil by original costless method, complete instructions \$1.00. Technical Laboratories, East Haven, Conn.

AUTO TRAILERS

READY Now—Plans for nine new Jim Dandy Trailers including 6 modern house trailers, sports, tent and utility trailers. The most complete line ever announced. All have latest features of construction, easy and economical to build. Send for circular quick. Jim Dandy, Box 125-A, Wausau, Wis.

MAKE Big money building, selling \$49.95 trailers. Cost about \$25. Construction data one dollar. Pal-Boats, Marblehead, Mass.

JUST Off the press. "New Edition of Trailer Builders Manual and Catalog of Parts, Supplies and Equipment." Rush 25c coin for this big value book that tells all about trailer building and shows you America's largest line of trailer parts at the lowest prices. Trailer Supply Co., 512-A Fulton St., Wausau, Wis.

ALL About trailers, construction, parts, supplies, etc. 64 pages vital information for anyone interested in home trailers. Send 25c. Stephe Co., 2800 14th, Kansas City, Mo.

MOTORCYCLES, BICYCLES, MOTOR SCOOTERS AND SUPPLIES

MOTORCYCLE, Parts, accessories. Most complete stock. New and used. We specialize on mail orders. What do you need? 35 page catalog 10c. Whitman Motorcycle & Supply Co., 405-9 Southwest Blvd., Kansas City, Mo.

MOTORCYCLISTS. Let's get acquainted. We can save you money on parts and accessories. List and details free. Triangle, 1111 Washington, Chicago.

SEND 10c For new 1940 Handbook of Information. Lists new and used parts, accessories for Harley, Indian, Hen-Ex, Bootz, 622 East Grand, Des Moines, Iowa.

MOTORSCOOTERS. Now is the time to buy, low cost, free literature. Star Put Put Co., Bremen, Indiana.

DEALERS Wanted: Big profits selling sensational Keen Motorscooters. Superpower engine, clutch. Climb hills. Best mechanically. Terms cash. Keen Manufacturing Co., Madison, Wisconsin.

SAVE 70%. Thousands assembling own Comet Motorscooter! We supply parts, tires, engines. Literature, drawing 10c. Comet Cycle Company, Box 3032, Madison, Wisconsin.

MOTORSCOOTER Motors, \$5.00 up. Used motors, midgets, scooters, parts. Complete lists, 20c. Shippo Midgets, Box 543-H, Zanesville, Ohio.

BUILD Power scooters, midget cars. We supply tires, wheels, motors. Lowest prices. Send 10c for plans, etc. Build-Ur-Own Devices, Dept. 6-A, 536 North Parkside, Chicago.

MOTORCYCLE Bargains, lowest prices, bargain sheets for stamp. Motorcycle accessories. Rochester Harley Davidson Corp., 129 W. Main St., Rochester, N. Y.

ALLOY Pistons \$3.00—Harley, Indian, Henderson, Excelsior, Cleveland, Cylinder grinding, rings, bearings, gaskets, chains, sprockets, helmets, goggles, accessories, parts new and used for less. Catalogue and wings pin 10c. Ballak, 1115 Chestnut, St. Louis, Mo.

BICYCLE Motor. Push-a-Bike outdoor motor, complete with pneumatic tire, ready to attach. Dept. P. Richburn Company, Aurora, Missouri.

KNUTH'S Motorcycle bargains. Lowest prices. Bulletin 10c. Prompt service on repairs, parts, accessories. Harley-Davidson factory dealer. Knuth's, 2491 Fondulac, Milwaukee, Wis.

MOTORCYCLES. Reconditioned. New, used, parts and accessories. All makes. Large stock. Bargains. Illustrated catalogue, 15c. Indian Motorcycle Sales, Kansas City, Mo.

MOTORSCOOTERS. Midget cars! Easily built. Complete plans and literature on wheels, tires, motors, transmissions, clutches, etc. 10c. Honsakers, Masontown, Penna.

BARGAINS: Bike generators \$1.75; was \$2.95; order today. Electrical Products, Kendallville, Indiana.

BUILD Sensational, clutch-operated, motorscooter speedster in record time with our factory finished kits. Rockbottom prices—fork \$2.95, etc. Complete plans, literature, 10c. Zipscoot, 3622-A North Troy, Chicago.

BICYCLE And parts catalogue free. Coupon for identification plate with your name engraved in gold. Fastens to bicycle. Krause Supplies, St. Clair Shores, Mich.

MOTORSCOOTER, Speedking sensationally easy to build. Complete steel kit \$3.95, plans free. Catalog—80 illustrations—20c. Midmotors, Box 1959-AD, Chicago.

AVIATION

PROPELLERS, Summer special hardwood copper tipped 2 blade Continental, Petenpol \$12.50, Le Blond \$15.50, OX 5 \$16.00, Air-oil cooled model A conversion 10 castings \$22.50. Universal Aircraft Co., Fort Worth, Texas.

PROPELLERS For airplanes, sleds. Iced-blueprints, supplies. Catalog dime. Lorenzen Propellers, Niles, Michigan.

AIRCOOLED 70-H.P. Ford A conversion, diagrams, instructions 25c. Propellers, airwheels, supplies. Standard Aircraft, Ft. Worth, Texas.

AVIATION Apprentices—Airminded young men interested in training for entering aviation as apprentices see ad on page 10A.

HAVE FUN! Pilots card 25c. "Press," 1483 Washington, Boston, Mass.

CASH For photos, stories, articles. New aviation magazine. Details dime. Davis, 48 North 7th Street, Newark, N. J.

PROPELLERS, Hardwood, clear, Harley \$3.60, Henderson \$4.86, Fordchev \$6.84. Headquarters all types. Airliner, Ft. Worth, Texas.

PRACTICAL Course in stunt flying—Illustrated, complete, only \$1.00, postpaid. Aircraft Directory, Athens, Ohio.

PRACTICAL Course in flying—29 chapters, only \$1.00. Illustrated, complete. Aircraft Directory, Athens, Ohio.

100 AIRPLANES \$55 Up. Terms. Located everywhere. New spring directory 25c. Used Aircraft Directory, Athens, Ohio.

GET INTO AVIATION! Train now at this Lincoln Aeronautical Institute for responsible position as aeronautical engineer, air transport pilot, aviation mechanic or aircraft sheet metal craftsman. Good jobs open! Big money paid! We assist graduates in locating positions. Part time employment for board and room while in training. Write today for information. Lincoln Aeronautical Institute, (Inc.), Lincoln Airplane & Flying School Division, 2007 Aircraft Building, Lincoln, Nebraska.

AIRPLANE Mechanic. Ten week's home study. \$1.25 week! Employed graduates. Diploma. Catalog, stamp. Aeronautical, Dundee, Illinois.

LEARN Airplane and engine mechanics in government recognized school. Aviation Institute, 24-13 Bridge Plaza, Long Island City, New York.

PROPELLERS For airplanes, sleds, boats, fans, dehydrators. Catalog 10c. Banks Propellers, Love Field, Dallas, Tex.

LEARN To fly free. Folder, dime. Ohmeyer, Box 391, Hempstead, N. Y.

AIR CONDITIONING

FURNACE Blowers \$22.50. 13" wheel. Also larger sizes for cooling, air conditioning. 2,500 CFM to 30,000 CFM. \$47.50 to \$265.00. Variable speed control, belts and pulleys included. Reynolds Mfg. Co., Grand Rapids, Mich.

BATTERIES, GENERATORS, ETC.

BUILD electric plant for your cabin. Operates from wind. Complete plans and valuable catalog 10c. LeJay Manufacturing, 447 LeJay Building, Minneapolis, Minn.

EDISON Lifetime storage batteries for light and power. Eliminates acid battery diseases. Long guarantee. All kinds rebuilt generating plants, motors, and miscellaneous articles at bargain prices. Free interesting literature. T. Hawley Smith Co., Croton Falls, N. Y.

NEW Process opens big future for battery rebuilders. Details 10c. Utah Battery Co., Salt Lake, City.

WINDING Data 200 late automobile armatures \$1.00. Sabina Armature Works, Peebles, Ohio.

EDISON Storage batteries for light-power systems. Non-acid. Odorless. fifteen year life. Five year unconditional guarantee. Bargains in complete lighting systems. Low prices. Free illustrated literature. "See-Jay" Battery Co., 82 Sterling Ave., Yonkers, N. Y.

BUILD 1000 Watt 110 volt a.c. generators from automobile generators. Constant voltage at variable loads and speeds. Prints, one dollar. Particulars free. Cellner Electric Co., Salina, Kansas.

PLUMBING AND HEATING

KNOW Your plumbing. 405 page book of valuable data—formulas, drawings, tables, sketches on layouts, estimating, installing, ordinances, joint wiping, etc. Price \$2.00. Johnson Plumbing Supply Company, 3647 South Halsted St., Chicago.

ELECTRICAL SUPPLIES—EQUIPMENT

DEALERS Build air conditioning attic ventilating outfits. Send 10c for wholesale catalog electric motors, attic fan blades, bearing sets, vari-speed pulleys. Evaporative cooler pumps 75c. 10 inch 110 a.c. motor, fan blade combination \$1.75. Other bargains. CMCO, 1111 Washington, Chicago.

ELECTRIC Eye, with wiring diagram, literature, \$1.00 postpaid. Photobell, Dept. 8C, 123 Liberty St., New York.

ELECTRIC Engraver, engraves hardest steel, deeply, \$1.00. Hudson Engravers, East Syracuse, N. Y.

ACCURATE Data immediately on all electrical or mechanical problems. Reasonable fees. Address inquiries to Graphics, Post Office Box 4581, Miami, Florida.

ELECTRO-SCRIBE: Electric pencil. Writes—engraves all metals \$1.00. Health Lamp: dual ray—ultra violet—infra red. Promotes sun-tan vitamin "D." Automatic—ac-dc current, \$3.90. Details. Beyer Mfg. Co., 4515-H Cottage Grove, Chicago.

MAGNETS. New Alnico alloy horse shoes lift 50 times own weight \$1.00. Many other sizes and items. Floating bars \$1.10 per pair. Alnico tricky dogs per pair 25c. Bulletins stamp. Mechanics, Box 861, Minneapolis, Minn.

ELECTRIC FENCING

ELECTRIC Fencer easily made from old automobile coil. Complete plans 10c. LeJay Manufacturing, 947 LeJay Building, Minneapolis, Minn.

WELDING—SOLDERING—PLATING

WELDING Shops. Build rubber tired steel farm wagons, stock trailers, dual wheel tractor trailers. Use junk auto parts. Prints \$1.00 each (3 for \$2.00.) Particulars stamp. "Doc" Fixit's, Mt. Vernon, Ohio.

ACETYLENE Welding generators, latest type, \$25.00. Johnson Generator Co., Brookfield, Mo.

75-200 AMPERE Welders from old generators. Complete plans 35c. Plans show single and dual welder connections. LeJay Manufacturing, 347 LeJay Building, Minneapolis, Minn.

WELDERS, New and used. Write Lincoln Electric Company, Cleveland, Ohio.

A.C. Welders, plans, material. Free literature. Holgeron's Service, Canton, Kas.

ACETYLENE Welding outfits, \$27.73; electric welders, \$59.62; acetylene generators, \$59.90. Superior Oxy-Acetylene, Hamilton, Ohio.

POWERFUL A.C. welder, kits, plans \$1. Marvelweld, Box 1156, San Francisco.

D.C. Arc-welder plans \$1.00 each (three for \$2.00). Build it yourself without re-winding armature. 25-200 amperes from farm light plant generators. 25-200 amperes from Northeast, Dodge automobile generators. 25-600 amperes from d.c. vehicle motors originally storage battery driven. Welders Club, A6B-3432 M-Mart, Chicago. For sale: D.C. vehicle motors, supplies, etc.

NEW General Electric portable arc welder. List price \$175.00. Our price \$39.50. Complete with rectifier bulbs. 15-90 ampere—Welding range, 9 point arc selection switch. Furnished in single phase or three phase. (Specify when ordering.) Width 24", height 27", depth 14". Shipping weight approximately 200 lbs. Ideal for garages, shops, factories, etc. Ample capacity for welding as heavy as 1/4" steel. Quotations F.O.B. New York City. Offered only while present supply lasts. 25% with order. Balance C.O.D. Free circular on request. Wholesale Electric Motors Co., Inc., 533-41 Canal Street, New York, N. Y.

BARGAINS. Demonstrator arc welders, gasoline and electric drive. Liberal trial, easy terms. Write Hobart Welder Exchange, Box M-6402, Troy, Ohio.

BUILD 200A A-C welder for \$10. Others cost less—no winding. Plans \$1.00. Information dime. Hi-Point Electric Products, Bellefontaine, Ohio.

ENGINES, MOTORS, DYNAMOS

GOVERNORS. Make your own. Auto engines, tractors, stationary gas engines. Blueprints \$1.00. Box 88, Barnum, Minn.

"PEPY" Governors make automobile engines power units. Sensitive and accurate. Low price. \$9.50 postpaid. Trial and refund guarantee—circulars. Harris Machinery, Minneapolis, Minnesota.

BARGAIN—1/2 Hp. motors, 60 cycle, 1 phase, 110 volt, like new, guaranteed, \$7.40. Send check to Erie Electric Motor Co., 120 Church, Buffalo, N. Y.

600 NEW Motor diagrams, tables, and controller connections for the practical electrician. Makes dual-voltage, multi-speed, star and Delta circuits clear and simple. Also includes all standard split phase, repulsion induction, compensated, series, two and three phase. Data for re-winding and reconnecting all types. Over 100 valuable tables. Money-back guarantee. Price \$2.00 prepaid. Educational Advancement Company, Lakewood, New York.

AIR Compressors 1 1/4x1 3/4 \$6.00; 2x2 \$7.00; 2 1/2x2 \$8.00; electric drills 1/4 in. \$5.95. Free folder. National, 1915 S. State, Chicago.

RECLEAN Used oil without cost. Particulars. F. Gerwin, Fairview, Okla.

RELIABLE Motor winding books. Lessons, connecting diagrams, winding data. Introductory data selection, \$1.00. Motor Data Co., Box 7631, Kansas City, Missouri.

THREE To ten KVA alternating generators. Motors, converters. State your needs. Queen City Electric, 519 South California, Chicago.

MOTORS, 1/4 H.P. General Electric, etc. \$3.50, guaranteed. Larger sizes. List 10c. A. C. Motors, 3008 Bailey, Philadelphia, Penna.

ALTERNATING, 1/2 Horse, 110 volt, induction motors. Rebuilt, guaranteed, \$7.25. Wilmot Auto Supply, 2247 St. Paul Ave., Chicago.

BARGAINS—Welders, electroplating, motor generators, guaranteed, liberal terms. Write Hoberts, Box M-6404, Troy, Ohio.

YOU Design motor windings, instructions \$1.00. Sabina Armature Works, Peebles, Ohio.

MACHINERY, TOOLS AND SUPPLIES

THE Ford 7" bench model shaper. A new wrenchless, gearless, variable speed precision machine complete with 1/2 h.p. motor and stand—\$222.00 shaper only \$175.00. Write for illustrated folder containing prices blueprints with finished or unfinished castings. Ford Machine Co., 1030-32 Herrick Ave., Racine, Wis.

BUILD Your own machine tools. Castings and blue prints at nominal cost. Send 10c for 2 color 28 page catalog. 34 prints covering 12 metal-working projects, \$1.50. 23 prints covering 6 wood-working projects, \$1.00. Lewis Machine Tool Co., Dept. M-6, 1000 Alhambra Ave., Los Angeles.

TREMENDOUS Surplus of factory tools selling out. Drills, taps, files, hacksaws, etc. Send for free lists, include six cents postage. Travers Tool Co., 264 Jackson Ave., Long Island City, N. Y.

KELLOGG Air compressors, \$6.00. Vacuum pumps, \$6.00. Brand new Remington portable typewriters, \$13.00. Refrigeration units, \$20.00. Taylor, 105 East 102nd Street, New York.

CONCRETE Building block machines and molds. Easy payments. Catalog free. Concrete Machine Co., 5129 South Compton Ave., St. Louis, Mo.

LONMPOWER Attachment converts any hand lawnmower into complete power lawnmower economically. Agents wanted. Lonmopower, 347 North Crawford, Chicago.

COMPLETE Plans and instructions for building electric drill from old washing machine motor. Comparable to 1/2 inch drill. \$1.50. Conrad Elmes, Havre, Mont.

SENSITIVE Speed-Indicator 0-30,000 r.p.m. Surface speeds; substantial; accurate. Guaranteed. \$3.75. Laboratories, machinists, experimenters, etc. Odometer, 2349 Cambridge, Chicago.

LATHES—We have a few bargains in slightly used lathes, 9" to 16" swing. Write for June Blue List. South Bend Lathe Works, 454 E. Madison St., South Bend, Ind.

10 POUNDS Screws, bolts, nuts, washers, gears, springs, rivets, brackets, etc.—1000 valuable gadgets in kit. Worth \$7.50, yours only \$1.98. Satisfaction guaranteed. Manufacturers Screw, 220 W. Hubbard, Chicago, Ill.

DRILL Grinding attachment. Fits bench grinder, hand or power. Turned, handles, sizes 3/16 to 1 1/4". Price \$7.85. Descriptive literature on request. Tractor-Lite Co., Sidney, Iowa.

14" x 6' GREAVES Klusman cone head engine lathe, quick change. No. 0 Cincinnati miller, cheap. Write for particulars. Cincinnati Machinery & Supply Co., 221 E. Second St., Cincinnati, Ohio.

BOATS, OUTBOARD MOTORS, ETC.

GENUINE New Evinrude and Elto outboard motors now as low as \$26.50 (plus small transportation charge.) Down payment as low as \$6.00. Fifteen advanced 1940 models to choose from. Write for catalogs, boat directory and handy Boat-and-Motor Selector—all free! Address, Evinrude Motors, 4288 N. 27th St., Milwaukee, Wis.

BUILD A boat by the Welch system. It's inexpensive, interesting and profitable. Everything for building, equipping or repairing boats. Use Welch ready cut parts. Send 10c for catalog showing boats of many types; boat hardware; propellers; marine paints; sails; boat finishing materials and Welch White Cap marine motors. Welch Boat Company, Station K-1, Milwaukee, Wisconsin.

AMERICA'S Finest kayaks. Weldwood ready-cut kits. Watertight compartments. Catalog. Cre-Craft Boats, Dept. F, Millburn, New Jersey.

SAILBOATS, Sailboat fittings. Weldwood prams, dinghies. Price-lists free. Barnegat Boat Works, Bryn Mawr, Pennsylvania.

EASY Built kayaks—inboards, outboards. Complete kits. Free catalog. Kayak Boat, 154-K East 129th, New York.

BUILD Electric outboard from automobile generator. Smooth—quiet. Uses car battery. Complete plans 10c. LeJay Manufacturing, 547 LeJay Building, Minneapolis, Minn.

TEN Plywood boat plans 50c. Free catalog boat building plans. The Rudder, 15 Murray St., New York.

LEARN—Piloting, seamanship and small boat handling at home. 266-page profusely illustrated instruction book prepared by experts especially for beginners. Easy to grasp and remember. \$2.00 postpaid. Motor Boating, 574 Madison Avenue, New York, N. Y.

BOATS, Outboard motors. New Nephunes 30% off. Want guns, machinery. Delambert, Janesville, Wis.

CRUISERS—17 1/2 Ft. mahogany outboard and inboard overnight cruisers \$325.00 up. Knocked down assembly kit—\$195.00. Streamlyn Company, 3213 Kentucky, Louisville, Ky.

"AEROBOAT" Engines, new, 80 horsepower, aircooled, \$75. Allison Aircraft, Lawrence, Kansas.

BUILD Your own boat! Brooks pre-cut, factory-milled, knock-down parts save time and money. 30 boats to select from. Send 25c for big catalog. Brooks Boat Co., Dept. P.M., Saginaw, Michigan.

FORD—Mercury-Zephyr marine conversions. Catalog 10c. Lehman Engineering Company, Dept. D, Newark, N. J.

OUTBOARD Motors, all makes. Used motors and parts. Stamp brings motor list. Outboard Headquarters, 305 Atlantic Ave., Boston, Mass.

MARINE Power—Easily convert any Ford motor (domestic and foreign) with Osco parts and kits. Complete catalogue 25c (coin). Osmithson, 3644 Lawrence St., Philadelphia, Penna.

OUTBOARDS—Save 1/2. Good used parts, all makes and models. Bargains re-built motors. Crandall Hicks Co., 959 Commonwealth, Boston, Mass.

BOAT Designers are highly paid professionals. Complete course by mail. Catalog. Westlawn, Montville, N. J.

SPORTING GOODS, GUNS, FISHING TACKLE, ARCHERY

FISHERMEN—Twelve dry and wet flies, cork head bugs and streamers, assorted. Trout and panfish sizes. Guaranteed values to 25c each. Postpaid \$1.00. Robey Tackle Company, Newaygo, Michigan.

TREASURE Finders? Read Goldak advertisement on page 132A.

FISHING Tackle outfits; bait or fly casting. An unusually fine assortment of lures and accessories included in a snappy steel tackle box. Only \$5.95. Send express or postal order. No stamps. Garland's Specialty Supply, North Tonawanda, N. Y.

NEW 1940 Catalog fly tying and rod making materials free. Work Fly Company, Pueblo, Colorado.

RECONDITIONED Golf balls, popular 75c grades, 3 for \$1.00, 35c grades, 6 for \$1.00. Dads, 330 So. Wells, Chicago.

GOLF Clubs. Five club matched set \$2.50. Lincoln Surplus, 123 Galena, Freeport, Ill.

SEND 10c List 100 guns, Maytag engines. Frayseth's, Willmar, Minn.

TENNIS Restrainers: Frames, gut, silk. Free catalog. Tennis Supply, 1407 Sixth Avenue North, Minneapolis, Minnesota.

WALL Type line drying reel for drying and dressing lines. Electric welded spool 12x6, simple, durable, \$1.98 postpaid. James J. Condon, 410 Main Street, Ansonia, Conn.

ARCHERY Headquarters—617 South State, Chicago. Catalogue free. Complete archery book 50c.

ARCHERY Supplies. Instructions 10c. Catalogue free. Mid-West Archery, 2209-A East 75th, Chicago.

RIFLE Barrels custom made, popular calibers. Sukalle Barrel Maker, Phoenix, Arizona.

TENTS, Factory to you. Catalog free. Willis Co., Everett, Mass.

BARGAINS! Gun catalog 5c, camera catalog 10c, archery catalog 5c, golf catalog 5c, tennis catalog 5c, medal-award catalog 10c. Warshal's, First-Madison-PM, Seattle.

ARCHERY Kits complete, everything that's needed. Krons-Noble Co., Kenosha, Wis.

HOOT Indian twin spinner—goes deep among the big ones—weedless—legal—\$1.00 postpaid. Hootspinner, 4629 Kingswell Avenue, Los Angeles, Calif.

FLY Fishermen! Get my book "Making and Using the Dry Fly," \$2.00 postpaid. Satisfaction guaranteed. Special get acquainted offer—14 fine quality dry flies, 10-12-14, \$1.00. New catalog 10c. Paul Young, 8065-C6 Grand River Ave., Detroit, Mich.

SAVE 40% On sleeping bags. Duck down filled. Mothproofed. Regular \$38.25 value, by mail \$22.95. \$17.50 wool bags only \$10.95. Guaranteed. Write for circular. Alaska Sleeping Bag Co., 1414 S. W. Harrison St., Portland, Oregon.

FIELD GLASSES, TELESCOPES AND MICROSCOPES

ASTRONOMICAL Telescope mirrors. Frazine, 1016 North 17th Ave., St. Petersburg, Fla.

ASTRONOMICAL Telescopes, binoculars, cameras, microscopes, bought, sold, repaired. Send 10c for list of instruments desired. Rasmussen, Box 294, Amsterdam, N. Y.

LENSES—Assortment of fifteen, ground and polished. High quality. Slight imperfections as small chip on edge. Diameters 10mm. to 53mm. Various focal lengths, including negative eyepieces. Suitable for telescopes, microscopes, field glasses, etc. \$1.00 postpaid. Satisfaction guaranteed or money refunded. American Lens Company, 148 North Mayfield, Chicago.

TELESCOPES, Microscopes, binoculars: 1940 bargain catalog free. Brownscope Co., 5 West 27th Street, New York.

ANTIQUES, RELICS, INDIAN GOODS CURIOS

MINIATURE Hurricane lamps, pitchers, vases, crystal-colored, 4 samples \$1.00 insured. Garcity, 12 Madison, Newtonville, Mass.

INDIAN Relics, coins, bills, gems, crystals, curios, etc. Illustrated catalog 5c, 100 ancient arrowheads \$3.00. H. Daniel, Hot Springs, Ark.

30 **GENUINE** Indian arrowheads, \$1.00. Catalog. Geo. Holder, Glenwood, Ark.

INDIAN Relics, beadwork, coins, curios, minerals, old glass. Catalog 6c. Indian Museum, Osborne, Kansas.

CHINQUILLA'S Indian Craft Museum. Handiwork of all Indian tribes. Jamaica, N. Y.

ARROWHEADS! Glacial boulder beauties. Rainbow variations. Don McKillop, Regina, Sask.

TAXIDERMY

TAXIDERMY Supplies—Quality artificial eyes, teeth, genuine Jonas head forms. Tools, materials, etc. Everything for the progressive taxidermist. Send 10c for big illustrated catalogue. Jonas Bros., 1049 Broadway, Denver, Colo.

DOGS, PETS, BIRDS

SPECIAL Sale, pheasants, partridges, peafowl, ducks, geese, swan, pigeons, bantams, 140 varieties, free list. Mareen's Pheasantry, Wickliffe, Ohio.

GREAT Danes: Dependable guards, companions. On approval \$25.00. Kaimar Danery, Stone Mountain, Georgia.

GUARANTEED Live arrival, guaranteed songsters, seeds, supplies. Write for price list. Universal Bird Co., P.O. Box 7, Bergen Station, Jersey City, N. J.

PUPPIES! Low prices! 20c brings photographic prospectus with delightful novelty. Royal Kennels, Chazy, N. Y.

DOGS, Chicks, turkeys for sale. Flocker, Box 7720, Sharpsburg, Penna.

BIRDS? Get American Canary Magazine monthly. Year, \$1.00. 2839-P North Halsted, Chicago.

BEAUTIFUL Pure white police dogs. Ansonia Kennels, Mose, N. Dak.

POULTRY AND FARM SUPPLIES

FARMERS! Save dollars! Make your own paint on farm. Unusual! Simple directions \$1.00. J. Halligan, 105 Bradford St., Albany, N. Y.

MAKE Money with poultry. Read America's leading poultry magazine. Five years \$1.00; one year 25c. Poultry Tribune, Dept. E-93, Mount Morris, Illinois.

BABY Chicks, cockerels \$2.45 per 100 and up. 21 different breeds. Free catalog. Write Salem Hatchery, Box 81, Salem, Ind.

BUY Davis chicks if you want more eggs this fall. Write for 24 page catalog and our rock bottom, money-saving prices. 21 different breeds. Sexed chicks, poults and ducks. Davis Poultry Farm, Route 34, Ramsey, Indiana.

\$2.25—100 **LEGHORN** Cockerels. All breeds priced at rock bottom. Don't order before you get my free catalog. Write today. Greensburg Hatchery, Box 40, Greensburg, Indiana.

BABY Chicks for immediate delivery. 21 different breeds. Light cockerels \$2.50—100. Write for complete prices. Free catalog. Dubois County Hatchery, Box 912, Huntingburg, Indiana.

TREES, SHRUBS, ROOTS, HERBS

JUST Out! World's greatest "Herbalist Almanac." Beautifully illustrated in natural colors. Contains over 200 old-fashioned herb medicine recipes for home use. 10c postpaid. Worth dollars! Botanica, Box 1109, Evergreen Park, Illinois.

COLORADO Blue Spruce trees—2 year old. Extra strong, 25 prepaid to you for \$1.00. H. D. Belcher, Brook Forest, Colo.

VITAMIN B1 valuable information, imprints, free. Special trial, 10 tablets 10c. Dealers wanted. Growers Guild, P-5, Barryton, Mich.

FARM MACHINERY AND SUPPLIES

BUILD Your own selfstarter for F-20 Farmall. Prints \$1.00. Stevens, Galion, Ohio, Route 1.

WRITE For free large 1940 catalog of used and new tractor parts. Satisfaction guaranteed. Central Tractor Wrecking Co., Boone, Iowa.

FARMS AND FARM LANDS

MORE New farm land, Washington, Minnesota, Idaho, western Montana, Oregon. Dependable crops, favorable climate. Write for impartial advice, literature and list of typical bargains. Specify state. J. W. Haw, 119 Northern Pacific Ry., St. Paul, Minn.

94 **ACRES** On water and U. S. hwy. 250 ft. on tidewater stream, pleasant 6-room house, outbdgs, roadside stand; bargain at \$1500; page 56 free catalog of 1400 bargains. Strout Realty, 255-P 4th Ave., New York City.

40 **ACRES**. Near White River, unimproved; poultry land. \$175, \$5 down, \$5 monthly. Free list and literature. Hubbard, 216 Grossman Bldg., Kansas City, Kans.

STAMP Magazine free—Breezy, authoritative, articles on new issues, questions and answers, philatelic subjects. Sample copy Philatelic Monthly free. Empire Stamp, Dept. P. M., Toronto, Canada.

SENSATIONAL Combination offer! Big packet 105 all different including Greenland (new country), Congo, Manchukuo, Costa Rica triangle, air-mails, commemoratives, giant diamond-shaped stamp. \$4 United States; complete set United States telegraphs, cataloging 20c. scarce set Siberia cataloging 50c. Packet British colonies including Gwalior, Hyderabad, Burma (new country), jubilee and coronations. Total catalog price over \$3.00! Everything for only 5c to approval applicants! World-Wide Stamp Company, Department 600, Camden, New York.

CANADA: Fifty different 10c. Approvals. Chester, Box 545-P, Utica, N. Y.

DIAMOND Airmail! Georgia! Pictorials etc. 5c. Approvals. Dobres, 4108 Garrison Blvd., Baltimore, Maryland.

ASK For our wonderful one cent approvals. Prospect Stamp Co., 225 Broadview, Toronto, Canada.

U. S. 300 Mixed 53c. Laurence Toomey, 65 Essex St., Malden, Mass.

IRAQ, 10 Different, 6c with approvals. Leduc, Saint Petersburg, Florida.

NINETEENTH Century U. S.—10 different 10c; 20 different 30c. Elsea, Bowling Green, Ohio.

\$2.00 PACKET For 3c. Request approvals. Quality Stamps, Englewood, Colo.

10 AIRMAILS Cataloging \$1.00 for dime with approvals. References, Glass, 1214 North 8th, Philadelphia, Penna.

UNITED States approvals, try us once and be satisfied always. Seminole Stamp Studio, Box 416, Miami Beach, Florida.

AGENTS Wanted, sell stamps, no investment, particulars free. William Waugh, 3225 Berkshire, Cleveland, Ohio.

FRENCH Colonies, 1000 different, \$6.00. Belgium, 300, \$2.00. Lecomte, Frere Orban, Jumet, Belgium.

FREE Complete set of triangles, also 5 other sets, 3c postage. Approvals sent. Gaybree Bros., 706 Sumner, Springfield, Mass.

20% OFF On dollar purchases. Exceptional stamp values. Skinner, 306 East Fourth, Long Beach, Calif.

1940 WHOLESALE Catalogue free—Eighty pages. Empire stamp, Dept. 5, Toronto, Canada.

BARGAINS! 300 Different 15c; 500, 35c; 1000, 75c. Star, 148 Forbell, Brooklyn, New York.

SOUTH Sea stamp service. Packets or approvals, \$1, \$2, \$3. Write Box 660, Auckland, New Zealand. Your satisfaction is our success.

FREE Extraordinary combination! Large beautiful pictorials (Martinique, Guadeloupe, Madagascar)—National heroes pictorial issue, Constant, Cabral, Wandenwolk (Brazil)—60 years old classics (Philippines, Turkey-Eastern Roumelia)—Malta (King George pictorial), Selangor (Mosque), Sembilan (coat of arms), Mozambique (Lusiads). Everything offered approval applicants only 3c postage. Imperial Stamps, Department 130, G.P.O., New York.

72 DIFFERENT U. S. 10c. Album Service, Route 57-13, Sioux City, Iowa.

NEJD (Arabland). Bolivia triangle, Caymans, Negri Sembilan, Turks Calcos, Manchukuo, Bahamas, British Solomons (Cannibaland). Everything 3c with approvals. Viking, 130-Z Clinton St., Brooklyn, N. Y.

50 DIFF. British Colonials 3c. Davison, Box 568, Manchester, N. H.

FREE! Royal visit packet, Postage 3c. Roberts, 312F Shearerblg, Bay City, Mich.

MEXICAN Revenues, 20 vars, 5c to foreign revenue approval applicants, Park, 589 Beacon, Boston.

500 MIXED Stamps, prize set, excellent value, 25c. N. Ennis Arcade, New York.

FREE Packet and approvals. Send dime. Stampio, Box 3, Baring, Maine.

128 DIFFERENT, Triangle, 10c. Approvals. Foley, 2038 E. 24 St., Brooklyn, N. Y.

1000 U. S. including commemoratives and precancels, 15c. Lee, Bridgenport, N. Y.

FIFTY Different U. S. ten cents, Mampe, 4204 No. Wolcott, Chicago.

25 U. S., 50 European, 35 world-wide, a triangle and list, 10c (wrapped). Approvals if requested. Colvary Co., Box 1988, Greensboro, N. C.

130 NEW Different stamps! Pictorials, triangles, odd stamps. Catalog price \$5. Only 5c with approvals. Falk, Inc., Dept. 522M Jacksonville, Florida.

APPROVALS, Foreign and U. S., 3c postage. Garvey's, Box 295, Pittsburg, Kansas.

55 UNITED States commemoratives, air-mails 15c. Motzer, 1022 Liberty, Cincinnati, Ohio.

YOU Can now have famous Spanish Goya nude stamp, world's largest diamond stamp and world's largest triangle. These beauties sent for only 5c to collectors requesting approvals. To make this the year's biggest bargain, we will include absolutely free collection of 100 varieties containing weird scarce stamps from Transcaucasia, Georgia, Azerbaijan, etc. Cactus Junior, Box 1870-B, Tucson, Ariz.

1000 MIXED United States 15c postpaid. Superior, 3815-P Wabash, Kansas City, Mo.

5 MONGOLIA 1c With approvals. Nathanson, Box 75, Kensington, Brooklyn, N. Y.

500 FOREIGN Mixed stamps; interesting; unpicked, 13c with approvals! Saxon Company, Valley Stream, N. Y.

STAMPS From 75 countries 10c, approvals. Ransom, 1333 Pontiac, Ann Arbor, Mich.

10,000 MIXED U. S. \$1.00, 3,000 mixed foreign \$1.00. Kuhn, 3712 - 85th, Jackson Heights, N. Y.

LARGE Illustrated booklet showing prices I pay for stamps. Only 5c. George Wentz, Brownsville, Texas.

BRITISH Colonials, 63 different 10c. Hayek, 3130M Brighton 6 Street, Brooklyn, N. Y.

NEW Philippine commemorative set complete 15c with approvals. Riedell, Greensburg, Penna.

PANAMA Bargain packet:—115 different including 15 Panama, Canal Zone, 25c with approvals. L. Marchosky, David, Panama.

PENNY Approvals by country. M. H. Hoerning, Merriam, Kansas.

U. S. Park set complete 19c. Fine approvals. Box 488, Minneapolis.

SOUTH AND Central America 100 different including large commemoratives only 7c to approval applicants, must give references. Kuzma, 1291 Washington Avenue, Bronx, N. Y.

FREE—Six unused commemoratives including Constitution airmail, to approval applicants enclosing postage. Green & Company, Norwood, Ohio.

10 BEAUTIFUL Pictorial stamps 3c to approval applicants. Stamp Shop, 5805 Delmar, St. Louis, Mo.

LINDBERGH Cuban airmail—Huge packet 10c. Approvals. Kingsbury, West Burke, Vt.

CZECHOSLOVAKIA! Getting scarce. We offer 50 different Czechoslovakia for only 5c to those requesting our bargain approvals. Official Stamp Company, Dept. 301, Fairlawn, N. J.

AIRMAIL Headquarters, 50 different 25c. Approvals. George Davis, Webster, Mass.

WHY Buy stamps? New cooperative plan 25c. Increases interest in hobby. Universal Service, 4227 Wyoming, St. Louis, Mo.

55 DIFFERENT Senglor Bolivar, Ecuador, Palestine, Egypt, etc. Approvals 5c. Libby Stamp Co., Station P, Box 43M, Brooklyn.

U. S. \$1.00, \$2.00, \$3.00, \$4.00, \$5.00, \$10.00, including 35 different U. S. commemoratives—25c. Approvals sent with all orders. Regal Stamp Co., 3505 Aldine St., Philadelphia, Penna.

PENNY Approvals, Airmails, pictorials, commemoratives. Treasure Stamps, Mount Prospect, Illinois.

"CHACO Peace" commemorative set including airmails, also 97 different stamps, 10c approvals. Tipre Stamp Co., 976 So. Westmoreland, Los Angeles, Calif.

25 SWEDEN, 25 Norway, 25 Denmark, all 75 different, ten cents with approvals. Pocono Stamp Co., Dept. P, Box 512, Wilkes-Barre, Penna.

200 DIFFERENT 10c. Big 50% approvals. Covert Stamp, 39 State, Rochester, N. Y.

ELEVEN Sets for twenty cents. Reed's, Citizen Office, Houtzdale, Penna.

WEEKLY Stamp magazine, thirteen weeks, 10c. Stamp Journal, Kalamazoo, Mich.

U. S. Only. Lowest prices. Send dime for \$5.00 stamp and catalogue. Adam Bert, Park Building, Pittsburgh.

NUDE Duchess set (2 varieties.) 5c—approvals. Shutes, Berne, N. Y.

CANADA 100 Different 25c—approvals all countries. Lists, Victoria Stamp Co., London, 4, Canada.

105 DIFFERENT South American with airmails only 20c to approval applicants. Davis, Silver Lake, Ind.

FREE—Five different Finland stamps with fine approvals. Reimers, Fort Worth, Texas.

BECOME Mailorder stamp dealer. Men, women, young or old. Sparetime at home. Make more money than working hard on job. Free instructions sent that guarantees success. Confidential wholesale pricelist included. Postage 3c. Superior, 276A Palms Station, Los Angeles, California.

PENNY Approvals, that satisfy. Neil Gronberg, Box 5441-P, Philadelphia, Penna.

600 DIFFERENT 50c; 1111, \$1; 2000, \$2.50. Fred Onken, 630 79th Street, Brooklyn.

300 DIFFERENT Stamps 10c approvals. Kravat Company, 1925-Q Quentin Road, Brooklyn, N. Y.

45 DIFFERENT United States, gauge, hinges, pricelist—all for 10c. Seidenberg, Baroda, Mich.

50 DIFFERENT U. S. to approval applicants only, 5c. Theodore Stevens, 3576 Maryland Ave., Detroit, Mich.

SCARCE Diamond airmail! Wonderful packet 115 different from strange countries, British Colonies, Haiti, Tasmania, pictorials, etc. 5c to approval applicants. Reliable Co., Box 139, Dept. 3, Church Annex, New York.

SELANGOR Perak, Albania, Haiti, Bhopal, Palestine, Johore, Manchukuo, Congo, Kadah, Cochin, Kookaburra-bird and 200 different stamps only 10c with approvals. Reich Stamp Co., 4647 Kenmore, Chicago, Dept. M.

UNITED States stamps on approval. Over 1500 varieties in stock. Send for a selection and be convinced that we offer an outstanding service. Reasonable prices, high quality. Southern Stamps, Drawer 70, Miami, Florida.

FREE—The Stamp Finder! Our new 24 page edition, fully illustrated, which will enable you to instantly identify all difficult stamps. Also fine packet of odd and unusual stamps from Bosnia-Herzegovina, Monaco, Patiala, Cyprus, etc., including maps, ships, animals and strange scenes. All free to approval applicants inclosing 3c postage. Garcelon Stamp Co., Box 900, Calais, Maine.

FREE! Austria war set. Postage 3c. Williams, 606 Archerblg, Bay City, Mich.

25 UNITED States, including \$4 and \$5 stamps free to approval applicants, 3c postage. Brownie Stamp Shop, Flint, Mich.

SMOKY Mountain commemorative sheet, largest U. S. stamp issued, and 33 U. S. including commemoratives, airmail, revenues, etc. Catalogs 75c—To approval applicants for 5c. Curhan Stamp Company, Gloucester, Mass.

WHOLESALE Dealer's catalog. Illustrated. Postage 5c. Frank's, 4900 Chalmers, Baltimore, Md.

SIX Dollars for 9c! 300 different stamps (cat. price \$6) only 9c with approvals. Tatham Stamp Co., Springfield-30, Mass.

FREE—From every continent, 155 different, airmails, triangle, commemoratives, pictorials, many U. S. and others, with 1c approvals. Send 5c for postage and handling. Ace Stamps, Euclid Arcade, Cleveland, Ohio.

WHOLESALE Supplements to dealers for 10c postage. Hundreds of bargains. Grossman Stampco, 102 West 42nd, New York.

50 DIFFERENT, Fine U. S. including perforation gauge, 10c with approvals. The Stamp Shop, 809 Holland Bldg., St. Louis, Mo.

GIANT Packet 200 all different from Africa, South America, Asia, South Sea Islands, etc. Includes world's smallest stamp; triangle and diamond-shaped stamps; animal stamps. Nicaragua "Will Rogers" airmail; many others. Also packet 17 different United States (cataloging 50c)—all obsolete, including \$4 denomination, commemoratives, etc. Total catalogue price over \$5.00! Everything for only 5c to approval applicants! Mystic Stamp Company, Dept. 80-N, Camden, New York.

UNITED States illustrated looseleaf catalog, \$1.00. Send postage for free United States price list, precancel list. Stanley Gibbons, 38-P Park Row, New York.

HOBBIES AND COLLECTIONS

SPIR-IT Cocktail sticks; unused; imprinted with names of prominent hotels, restaurants, clubs. One hundred, all different names, for \$1.00. Start fascinating collection idea. Spir-It, Inc., Malden, Mass.

STAMPS! Coins! Photography! Hobbies! "Chinese Hobby Journal," 50c year. Honolulu, Hawaii.

FREE Blotter picturing auto markers 48 states, actual colors. Other specialties. Arrowprint, Dept. 5HPM, Waterbury, Connecticut.

EXCHANGE Your duplicate stamps, match covers, etc. with collectors everywhere. List swappers, dime. (Mention hobby.) Secretary, Box 2166, Denver, Colo.

SAILORS. Battleships, submarines, 15 photographs \$1.00. Lynn Pelletcher, 4772 Del Monte, San Diego, California.

PHONOGRAPH Records 10c. Catalogue. Paramount, AC-358 East Market, Wilkes-Barre, Pennsylvania.

UNUSED Book match covers, 100 all different, \$1.00. Free list. Charles Edelman, 1311C East 84, Cleveland, Ohio.

PHOTO FINISHING

TECHNIFINISH—35mm., 36 Exposure rolls fine grain developed and perfectly enlarged to 2 5/8" x 3 3/4" glossy prints, 75c. New exclusive methods and equipment make this low price possible. Cartridge reloaded with Eastman Plus X, 25c. One day service. Satisfaction guaranteed or money back. Write for free mailing bags and information. Technifinish Laboratory, 109-G Lexington, Rochester, N. Y.

CASH Weekly. You do not have to be a professional, any simple picture may be a winner. During the campaign cash prizes awarded for best pictures submitted. Weekly prizes: First \$5.00; second \$3.00; third \$2.00. Requirements are that your pictures must be finished in our studio. The judges' decisions shall be final. In case of tie duplicate prizes awarded. Send in as many rolls of film as you choose. Any six or eight exposure roll developed and printed for 25c. Free enlargement coupon with all roll orders. Notice the quality of our work. The winners of the previous week furnished all entrants upon request. Empire Photo Finishers, Box 297, Dept. P, Ordensburg, New York.

EXTRA Fast service. Roll developed, 16 prints 25c. Send for free mailing envelope, price list. Star Photo, Dept. R, 20 W, Jackson, Chicago.

FREE! Best snapshot on attractive photo button with 16 prints each roll 25c. Beautiful novelty premiums. Novel-Ad Co., BM-3327 North Ave., Chicago.

PROMPT Service—Quality work; 2 beautiful doubleweight gloss enlargements, 8 guaranteed neverfade prints each roll 25c. Excel Photos, Dubuque, Iowa.

YOU Get one 5"x7" silk enlargement. Send negative—10c—P.D.Q., Elmhurst, Ill.

ROLL Developed, prints and enlargement 25c coin. Crawford's Service, Humboldt, Iowa.

FREE Snapshot magazine, mailing equipment and price list. H.F.H. Co., Jamaica Plain, Mass.

PROFESSIONAL. Overnight service. Developed, printed, 2 enlargements, 25c. Fotoservice, 1942-D Marlow, Toledo, Ohio.

20c DEVELOPS Your roll, eight prints. Catlin Films, Catlin, Illinois.

ROLL Filmachine developed and your choice (1) 8 Finerfots and 2 professional bromide enlargements; or (2) 16 guaranteed Finerfots or (3) 8 Finerfots and one beautiful oil colored enlargement, 25c. Order by number. Prompt service. Finerfots, Box D-898, Minneapolis, Minn.

MILLIONS Now know "Hollytints Means Better Prints." Two enlargements, eight prints with trial roll developed—25c. Framed enlargement coupon free. Hollytints, P-1350 Hollywood, California.

ROLL Fine grain developed and enlarged, 8 exposures—25c; 16—50c; 36—\$1.00. Ohio Finisher, Station E, Box 96-J, Columbus, Ohio.

PROMPT Service. Guaranteed work. Two beautiful portrait type doubleweight enlargements, eight neverfade gloss prints, each roll 25c. Dubuque Film Service, Dubuque, Iowa.

SPECIAL Miniature service. 35mm. rolls, fine grain development, 36 enlargements 3 1/2"x5. \$1.00. Cartridge reloaded 35c. Osborne, Box 114, Dorchester Center, Mass.

FREE Beautiful album with cellophane envelopes plus roll developed and two sets brilliant prints, 25c. Same-day service, Pho-T-Pho, Box 24-F4, Highland Park, Mich.

SIX Or eight exposure roll developed and two deckled edged prints of each. Guaranteed, never fade. Highest quality. Same day service. All for 25c. Knickerbocker Photo Service, General Post Office, Box 546, New York City.

PHOTOGRAPHY For pleasure and profit. Prepare for profitable business or fascinating hobby at home. Common school education sufficient. Write for information and requirements. American School of Photography, 3601 Michigan Avenue, Dept. 3454, Chicago.

8 PRINTS And 1 tinted enlargement, or 16 prints from your roll, 25c coin. Sunbeam Film Service, Box H-876, LaCrosse, Wis.

20 REPRINTS 25c, 100—\$1.00. Roll developed 16 prints 25c. 5x7 enlargements 10c. 3—25c. Nordskog, 4 Maywood, Illinois.

FREE Album and negative file, 2 enlargement coupons with each roll developed; 8 guaranteed prints 25c. Memrlane Studios, Dept. "W," General P.O., Box 666, New York.

ROLL Developed and printed, two enlargements, one in colors, all for 25c coin. Photo Finisher, Station E, Box 42K, Columbus, Ohio.

ROLL Developed, eight sparkling prints, deluxe mounted enlargement, 25c (coin). Tiptop, Box 2460-R, Philadelphia, Penna.

ROLLS Developed 8 fadeless prints, 2 enlargements 25c. Dewitt Studio, 4023 Gage, Bell, Calif.

FREE Enlargement with each roll developed and printed 25c. Reprints 20 for 25c. Luczak Photos, 3451 Lemoyne, Chicago.

ROLLS Developed latest methods. 2 prints each 25c. Reprints 2c. Unusual results guaranteed. Heen Photo Service, Highland Station, Box 2651A, Minneapolis, Minnesota.

ROLL Developed eight enlargements 25c. Send for free mailing bags. Photo-Electro-Lab, Box 861, Bridgeport, Conn.

TO Introduce our finer service, we make this amazing offer. One 8x10 enlargement coupon, 2 5x7 enlargements and 16 neverfade glossy prints with film developed only 25c. Aro Photo, Dept. 12, Box 597, Des Moines, Iowa.

ROLL Developed, 16 Velox prints 25c or 8 prints and 2 enlargements. Rapid, Villa Park, Illinois.

COLOR. Beautifully tinted 5x7, one untinted, 8 prints, 25c. Richtone, 35X, Culver City, California.

SPECIAL! 5x7 Enlargements made from your 116, 120, or 127 size negatives, 5 for 25c. Minimum order 25c. Send negatives (not rolls). We return them. Golden Gate Photo Service, Box 428, San Francisco.

CANDID Specials. Beautiful big enlargements, 36 ex. roll, \$1.00. 18 ex. 55c. 16 ex. 50c. 6-8 ex. 25c. Reprints, 4c. Finest quality, fastest service guaranteed. Dick's Photo, B-1, Louisville, Ky.

ROLLS Developed and printed new electric eye way, 8 beautiful, guaranteed neverfade, dated, deckled edged enlargements. Any 8 exposure roll. All for 35c coin each roll. Extra enlargement coupon free. Bonus certificate free. 2-day service guaranteed. Send rolls now to Bostonian Photo Laboratories, 401 Uphams Corner, Boston, Mass.

ROLL Developed. Triple size pictures from every negative. 116 size enlarged 5x7. 120 enlarged 4x6. 127 enlarged 3 1/2"x4 1/4. Inbetween sizes proportionately. 8 exposure rolls developed and 8 triple size pictures, 25c. 12 exposure rolls, 35c. 16 exp., 50c. Split sizes tripled individually. All reprints, 8 triple size, 25c. Tri-Plex Photo Service Co., Box 369, San Francisco.

THE Modern Finishers, St. Paul, Minn., are the outstanding finishers in America for low prices, fast service, guaranteed neverfade pictures. Roll developed 8 Moderntone prints 20c. Roll developed, 16 Moderntone prints 25c. Reprints 2c each, 16 for 25c. Coupons on enlargements, 35mm. 36 exposure roll developed fine grain, 1 each enlarged \$1.00.

35MM. Fine-grain developed, 36 big 3 1/2"x5 enlargements \$1.00. Cartridge reloaded 35c. Photoshop, Linton, Indiana.

HIGHEST Class photo finishing in America. Roll developed and two prints each good negative, plus enlargement coupon 25c. Sixteen reprints, plus enlargement coupon 25c. Kelso, Box 549-B15, Inglewood, California.

ALL Enlarged. Film developed and 8 brilliant enlargements 25c. 20 regular sized prints 25c. Diamond Photos, Hutchinson, Kansas.

THREE Lovely Silktone enlargements and two sets sparkling Lifetime prints with roll developed—25c. Trial. Lifetime Studios, L-39, Des Moines, Iowa.

MINIATURE Films developed, 36 enlargements or positives only \$1.00; 18 exposures developed, enlarged, reloaded \$1.00. Miniservice, Dept. PMS6, Box 318, General P.O., New York.

SNAPPY Developing, 25c roll. Humphrey's, 164 Baker, Northwest, Atlanta, Georgia.

FINER Finishing specials 25c. 6—8 exposure rolls developed, your choice—16 prints or 8 prints with 2 professional enlargements or 8 prints and one colored enlargement. Genuine nationally known Moentone superior quality. Moen Photo Service, 431 Moen Bldg., La Crosse, Wis.

CANDID Special. 35mm. rolls enlarged to 3 1/2"x4 1/4, \$1.00. 18mm. rolls 60c. 3 1/2"x4 1/4 reprints 3c. Brown Photo Company, 1910-61 Emerson, Minneapolis, Minn.

IMMEDIATE Service! Better pictures. Sixteen guaranteed prints from roll, 25c. One colored or two plain enlargements and 8 guaranteed prints, 25c coin. Special! Coupon for 8x10 enlargement given with every 25c worth Kodak finishing. Any 36 exposure, 35 mm. film fine-grain developed and each good negative enlarged to 3x4 prints for only \$1.00. 3x4 reprints, 4c each. One day service. Details and mailers free on request. American Studios, Box 22, LaCrosse, Wis.

ROLL Developed, 8 brilliant fadeproof Velox prints and two professional enlargements 25c. Overnight service. Young Photo Service, 405-C, Albany, N. Y.

FREE Enlargements—your roll developed (8 beautiful Velox prints) for only 25c and coupons for free enlargements. Send stamps or coin. Potoprint Service, Box I, Roanoke, Virginia.

ONE 6 1/2"x8 1/2" Plate sunk enlargement or one 5x7 hand colored enlargement with each roll developed and 8 prints 25c. 36 exposure roll developed and 36—3 1/2"x4 1/2 enlargements \$1.35. 18 exposure roll 75c. Vidor, 321-P Hennepin, Minneapolis, Minn.

BEAUTIFUL Enlargement from each picture on roll 25c. Cut Rate Photos, Dept. B-4, Janesville, Wis.

PROFESSIONAL Service, any 6 or 8 exposure roll, including two 5x7 enlargements 25c. Film Capital Service, Box 504, Rochester, N. Y.

TWO Beautiful prints from each picture on roll 25c. Twenty years of satisfied customers. Quick service. Lens Photos, Dept. J-4, Janesville, Wis.

OIL Coloring photographs a fascinating hobby or profitable business. Learn at home by easy simplified method. Previous experience unnecessary. Send for free information and requirements. National Art School, 3601 Michigan Avenue, Dept. 3434, Chicago.

ROLLS Developed, 16 guaranteed prints, 25c, reprints 2c. Photolab, 1806-C Wabash, Chicago.

ROLLS Developed. Two 5x7 and 8 prints, 25c. Reprints 2c. Photolab, 1806-CA Wabash, Chicago.

ROLL Developed, 16 Velox prints 25c. Dividend coupon, 16 Velox reprints 25c. Willard Studios, Box 3535-A, Cleveland, Ohio.

TRIAL Roll developed, 8 glossy prints, 15c. Kase Photo, Box 1047, Omaha, Nebr.

ROLL Developed, 8 enlargements; or 8 prints and 2 enlargements, 25c. Enlarged reprints 4c. Aircraft, Box 3580A, Cleveland, Ohio.

FINER Enlargements, 5x7 3 for 25c; 8x10 3 for 50c. Lee Photos, P.O. Box 2053, Chicago.

ROLL Developed—16 guaranteed prints, two coupons on enlargements, 25c. Smart Photo, Winona, Minnesota.

IDEAL Photos beautiful finished with wide border, deckled edged, 25c per roll of 8 and free enlargement. Ideal Photos, Box 2255, Paterson, N. J.

THE Photo Mill, Immediate service; No delay! Eight-exposure roll developed, carefully printed and your choice of two beautiful 5x7 double weight professional enlargements, one tinted enlargement, or eight reprints for 25c coin. Reprints two cents each. Highest quality guaranteed. The Photo Mill, Box 629-12, Minneapolis, Minn.

PROMPT Service! Rolls developed, two Velox prints each negative 25c. Hensch Studios, Harrisburg, Penna.

18 LIFETIME Prints. 2 sparkling Holly-wood enlargements each roll 25c. 21 re-prints 25c; 100—\$1.00. Finished 3 hours. 25 other bargains. Overnight Studio, Al-
bany, Wis.

BETTER Pictures, quicker service! Roll developed and 16 prints 25c. 20 reprints 25c. Hundred reprints \$1.00. Mercury Studios, D-109 N. Dearborn, Chicago.

8 ENLARGEMENTS—Films developed plus 8 enlargements, 25c coin—116 or smaller. Enlarge Photo, Box 791, Dept. PMM, Boston, Massachusetts.

ROLLS Developed, two prints each and two free enlargement coupons, 25c; re-prints, 2c each; 100 or more, 1c. Summers' Studio, Unionville, Mo.

THREE Prints each good negative in roll 25c. Reprints 3c. Fred D. Eastman, Bode, Iowa.

16 PRINTS With roll 25c. 16 reprints 25c. Rex Photo, Ogden, Utah.

FOR The discriminating amateur—Rolls developed 2 prints each, 25c. Reprints 3c. Superior workmanship. Same day service. Paramount Co., 327 E. 92nd St., New York.

TRIAL Roll 10c and this ad. Beautiful deckled album prints. Positively finest finish obtainable. Mailbag, Box 5440A, Chicago.

CAMERAS, PHOTO SUPPLIES

CAMERAS And supplies. Free illustrated catalog listing everything photographic—still and movie cameras, films, lenses—at tremendous savings. Hundreds of bargains, new and used. All guaranteed. We take your old camera or equipment in trade. Write now for your free copy of our newest money-saving bargain book—just out! Limited edition. Hurry! Central Camera Co., (Photographic Headquarters since 1899), 230 S. Wabash, Dept. F-16Z, Chicago, Ill.

DOLLARS With a kodak. (\$50 weekly reported). Sell your snapshots. Huge market list, booklet, 25c (coin). Beeskau, Route 8, Box 764B, Wauwatosa, Wisconsin.

MAKE Money in photography. Learn quickly at home. Easy plan. Previous experience unnecessary. Common school education sufficient. Interesting booklet and requirements free. American School of Photography, 3601 Michigan Avenue, Dept. 3432, Chicago.

TREASURE Finders? Read Goldak advertisement on page 132A.

USED Camera bargains. 6 5x9 Maximar P4, 5 L. N. \$28.50. Filmo 70A, F3, 5 \$29.50. Trades accepted, write for free bargain bulletin. Camera Mart, 70M West 45 Street, New York.

PRINT Washer: Automatically changes water 4 to 8 times a minute. Takes prints 8"x10" or smaller, \$1.00. Sirn Photo Supply, 9413 Holton Ave., Cleveland, Ohio.

LEICA IIIa Summar f:2 \$122.00. Contax, Argus, Reflex, Filmpack cameras, etc., new, used. Prices without any competition. Pay after inspection. Trade-ins! Special list "PM3" free. Importers Brenner Co., 943 Pennsylvania Avenue, Wash-
ington, D. C.

PROTECT Your negatives, put heat resisting glass in your enlarger. Write now. Better Photo Products, Rochester, N. Y.

BARGAINS Galore in new and used equipment, free lists. Movie Shop, 838 Broadway, Bayonne, N. J.

SEND For photographic bargain lists. Moxull's, 64 West 48th, New York.

BASS Says: Shrewd buyers, write Bass. For 30 years headquarters for everything in photography. 72-page Bargainingram No. 242 is interesting and free. Write for your copy. Don't trade until you write Bass Camera Company, Dept. AG, 179 West Madison St., Chicago, Ill.

HAVE You a camera? Send ten cents for recent number of our big magazine, showing how to make better pictures and earn money. American Photography, 116 Camera House, Boston, 17, Mass.

CAMERAS, Films, paper 25% to 35% discount. Paramount Photo Division, 327 East 92nd St., New York.

FREE To camera owners: Set of 3 filters for names and addresses of 3 camera owners. Photo-Craft, Dept. ME, Canton, Ohio.

ENLARGER \$1.59. Enlarges eight times size of small negatives. Fully guaranteed. Paramount Sales Company, 89 Dudley Street, Boston, Mass.

CAMERA Repairing. Bellows made to order, shutters repaired. Bellows made to fit all standard cameras! United Camera Co., Inc., A-1515 Belmont, Chicago.

THE Phaostron Electric Exposure Meter will read lower light and higher high-light intensities more accurately than any other meter, regardless of price. Only \$5.00. Write for free descriptive literature. Phaostron Company, 7 South Granada, Alhambra, California.

MOTION PICTURES AND SOUND EQUIPMENT

WE Reprocess your films by machine to prolong life and flexibility, absolutely stops de-hydration. Loco Reprocessing Company, 2007 East Prospect Ave., Cleveland, Ohio.

HOW To start a 16mm. movie circuit, or improve your present one. Write for your copy of our handbook "Making Money With Movies" today. Eastin Films, Dept. PM3, Davenport, Iowa.

WRITE For new large two color 1940 catalogue nationally advertised movie cameras, projectors, films, accessories. Payments low as \$2.50 monthly. Don Elder's Home Movies, Dept. 16, 739 Boylston Street, Boston, Mass.

MOVIES—1c Per foot. Double 8-16mm. Develop yourself. Confidential instructions, sample; 25c. Cinetography, 1410 Bull, Columbia, S. Car.

16MM. Sound films—Weekly roadshow service our specialty. Large library, attractive rates. Swank's, 5861 Plymouth, St. Louis, Mo.

COPY "Movie Tips" and listings. No-Wat-Ka, 151 Broadway, Paterson, N. J.

8MM—16MM. library. Low rates. Dayton Film Rental, 2227 Heppburn, Dayton, Ohio.

8MM—16MM. movie equipment, cheap, write wants. Edco, 199 West Broadway, Paterson, N. J.

COMPLETE 16mm. And 35mm. talking programs \$15.00 per week. Colson Service, 2040 Chatterton Avenue, New York City.

BARGAIN List! Silent 35mm. films. Demsey, 1223 Berkeley, Youngstown, Ohio.

JOIN Exchange club, lists 3c. Hoffman, 57 Broad, Albany, N. Y.

MOGULL—Duplex 16mm. sound-projector, school, auditorium, home, road show (\$410 latest model) \$289.50 complete. 2 year guarantee, 2 years to pay. Used silent film 8-16mm. full length short \$2.50 reel. Odd 16mm. film 400' silent \$1.95, sound \$2.95. Free membership world's largest library—Rentals sent anywhere, lowest rates. 35mm. projector \$29.50. RCA 35mm. twin sof portable projector complete with amplifier, speaker, \$525. Used sound 16mm. shorts \$8. features \$62.50. Mogull's 16mm. cine-camera film \$2.39 with processing. \$38 amateur-professional course silent-sound projection \$3.95, developing-printing course \$3.95. Victor 16mm. silent projector, case \$47.50. 16mm. motorized printer \$55. Stineman 35mm. movie printer \$45. Lens sale. Trades accepted, bought. Catalogs free. Mogull's, 64 West 48th, New York.

5x7 MOVIE Stars, 8x10 photos late re-releases 10c. Box 575, Riverside, California.

1c FOOT 16mm., 8mm. Film 1c foot processing. Write Morrison's, Province Street, Boston, Mass.

MONEY Maker! "The World's Greatest Passion Play." 16mm. and 35mm. Sound or silent. Purchase or rent everywhere. Superior than Oberammergau play. Write Hemenway Film Co., 37F Church Street, Boston, Mass.

8-16MM. Films; cartoons, comedies, travel, sport, War in Europe. Silent-sound. Tremendous assortment. Perfect odd sound reels, \$3 per reel. Films rented everywhere. Trades accepted. Free catalogue (with sample film 10c). Garden Film Service, 317 West 50th, New York.

GENERA 400 Feet 16mm. bulk film, \$4.25. 100 feet double 8mm. \$1.50. Process with powders. Sample for stamp. Fromaders, Davenport, Iowa.

ART Films, sample 10c; others, lists free. Goodwill Company, Jackson, Tenn.

8MM-16MM. Bargains. Free catalog. Movie Shop, 838 Broadway, Bayonne, N. J.

ACTIVE Movie making, mail order, customer list for sale, 1000, \$16.00. State products. Gard, 54 West 74, New York.

16MM. VELOTEX. Perfect outdoor film. 100 ft. rolls \$1.95 including free processing. Sample free. Velotex Laboratories, 600-W, Gary, Indiana.

ART Films, Sample, dime; catalog free. Cineart, 2443 Gunnison, Chicago.

FREE, 16mm., 8mm. Bargain lists, Home Movies, Box 216, Easton, Pennsylvania.

BASS Says: 8 mm., 16 mm., 35 mm., sound on film, all fully described in our new 66-page Cine Bargainingram No. 240. For 30 years movie fans have been writing Bass. Money back guarantee always. Send for your copy. It's free. Bass Camera Company, Dept. A, 179 W. Madison St., Chicago, Ill.

10 SOUND (16mm.) Projectors. Bargains. Roshon, State Theatre, Pittsburgh, Penna.

MOVIE Film. Develop yourself. Univex, Eastman, etc. Chemical samples 15c. Raw film wholesale. Lake Camera Exchange, Gary, Ind.

GUARANTEED 8MM. 24-hour reversal processing. Double 8mm., 45c. Single, 25c. Univex 15c. Eso-S, 3945 Central, Kansas City, Missouri.

15% TO 25% Discount on still or movie cameras. Free circular. Paramount Co., 327 E. 92nd St., New York City.

MOVIE Cameras, projectors, films, etc., bought—sold—exchanged. Lists free. Art samples 25c. Peerless, Box 1310-P, Hollywood, Calif.

RADIOS, SUPPLIES, INSTRUCTION

BUILD Your own receivers with Meissner kits! 48-page catalog free! Big 168-page instruction manual with complete constructional information on 28 models, one to fourteen tubes; 18 pages of television! Contains charts, schematics and pictorial wiring diagrams. Anyone can build a modern receiver from a Meissner kit. Send 50c to Dept. PM-6, Meissner, Mt. Carmel, Illinois.

RADIO Announcing. Study at home for career that leads many to fame and fortune. Full particulars no obligation. Glennmore School of Radio, Box 1853, Hollywood, Calif.

PLANS 18 Distance record crystal sets, with "Radiobuilder"—year, 25c. Laboratories, 7700-C East 14th, Oakland, Calif.

RADIO Kits—\$3.95 up. Single band; all wave, 5-10 tubes. Save 50%. McGee Radio, EP-10, Kansas City, Mo.

RADIOS—\$8.95 Up. Save 50%. Wind-chargers, electric fences, power plants. Home agents wanted. Catalog free. Marco-E, Kansas City, Mo.

FACTORY Prices—Magic, indoor aerial, better reception, sixty cents. Free short wave map (ten cents handling charge). Radio City Labs., 1222-30 Rockefeller Plaza, New York.

RADIO Engineering, broadcasting, aviation and police radio, servicing, marine and Morse telegraphy taught thoroughly. All expenses low. Catalog free. Dodge's Institute, Ames St., Valparaiso, Ind.

SEND For free giant money saving radio and phonograph record catalogue. United Radio Company, 1000-M, Newark, N. J.

MUSIC AND MUSICAL INSTRUMENTS

SONGWRITERS—Write today for free booklet "Building An Income Through Songwriting." Songwriters Institute, 1234-C Broadway, New York.

SONGWRITERS! Poems, melodies. Outstanding offer. Hibbeler, C-5, 2157 No. Avers, Chicago.

SONG Poems wanted by professional music writers, send poem today. Five Star Music Masters, 6 Beacon St., Boston.

ADULT Beginners' piano course \$1.25. Moses, 315 West 86th, New York.

PHONOGRAPH Records 10c. Catalogue. Paramount, AD-358 East Market, Wilkes-Barre, Pennsylvania.

SONGWRITERS. Real proposition. Newark Song Publications, 1207 Carbon, Syracuse, N. Y.

SONGS; Song poems; bought; composed; published. Broadcast on regular radio programs. Free advice. Best offer. Metro Melody Music Publishers, San Francisco.

SONGWRITERS—Helpful publishing information. Sunbeam Publications, 20 West Jackson, Chicago.

SONGWRITERS. Attention! Orchestra World Magazine's big contest gives you opportunity to write song lyrics to six melodies written by Isham Jones, famed songwriter, during the coming year. Full details, write Orchestra World—Isham Jones Contest, 1619 Broadway, Suite 410-P, New York City.

ORIGINAL Songs and poems with commercial appeal wanted for recordings. Melodies supplied for poems accepted. Monthly awards. Hollywood Recording Studios, Box 87 K, Preuss Station, Los Angeles, Calif.

MUSIC Composed to poems \$5.00. Prof. Cole, Box 5433, Tampa, Fla.

SONGWRITERS—Send poems; free plans, reports. Variety, Dept. H, Salem, Indiana.

SIMPLIFIED Swing courses! Accordion, saxophone, clarinet, trumpet, violin. Write Swinmaster, 1259-N Bender, East Cleveland, Ohio.

DUO-FLEX Reeds for clarinets, and saxophones eliminate your reed troubles. Write for circular. Duo-Flex Reeds, 1204 1st Ave., Evansville, Ind.

SONG Poems wanted. Free examination. McNeil, Master of Music, 510-PM South Alexandria, Los Angeles, Calif.

ORIGINAL Poems, songs wanted for immediate consideration, publication. Music Corporation, Dept. N12, Portland, Ore.

LEARN Swing piano! Postal brings free folder. Christensen, 751 Kimball Hall, Chicago.

SONGWRITERS. Write for free inspiring booklet outlining new opportunities for amateur songwriters. Allied Music, Dept. 4, Box 507, Cincinnati, Ohio.

MUSIC Composed to words. Wonderful proposition. Bauer Bros., Oshkosh, Wis.

PIANO By ear. Free booklet. Day-V-Way, 13265 Michigan Ave., Dearborn, Michigan.

MUSIC Composed to words. Rhyming pamphlet on request. Phonograph recording of completed songs. Send poem for consideration. Keenan's Studios, Dept. PM, Box 2140, Bridgeport, Conn.

WRITE Songs. Big money and reputation. Write for information. J. Gordon Pub. Co., 201 N. Hoyne Ave., Chicago.

WANTED! Lyrics, melodies for songs. We arrange, publish, sell. Superior Song Studios, Passaic, N. J.

SONGWRITERS: Send your poem today for immediate consideration. Richard Brothers, 24 Woods Building, Chicago.

SONG Writers. Send for publishing agreement. McKinley Music Publishers, 1501 E. 55th St., Chicago.

BUSINESS OPPORTUNITIES

REAL Estate taught by twelve actual leaders. Home study course. Start own office. Earn real money. Morrison School Real Estate, 100 No. La Salle St., Desk 9, Chicago.

REAL Cultured pearl rings 200% profit. Sell anybody easily everywhere. Good repeats. Sample 25c. Otto Stumpf, 29 E. Madison, Chicago.

"MONETARY Tips" Magazine, money making news, opportunities, plans, formulas. Copy 10c. Deavenport, 1086 Lyell, Rochester, N. Y.

127 PRACTICAL Money-making plans. Also scores of formulas. Start own business; home, office. Particulars free. Le Win Service, 6340-A N. 18 St., Philadelphia, Penna.

START Home business making statuary, plaques, art goods, novelties, souvenirs, concrete pottery, garden furniture, artificial marble flooring, liquid marble. Make your own flexible molds. Amazing profits. Valuable folder free. Creative Publishers, (P6), Glencoe, Illinois.

GRIND Lawn mowers! Factory method. \$2.00 capital. \$800 reported! Mowers, Janesville, Wis.

START Home Mailorder Business. "25 Lesson Course 20c." Ideal Service, 98, Park Ridge, Ill.

AMAZING Auto specialty. Easily made. Real money maker. Build big business. Details free. Anthony Burgio, 1332 - 58 St., Brooklyn, N. Y.

OPERATE A collection-credit bureau. Very profitable. Permanent. Free folder. Cole Associates, Syracuse, N. Y.

POPCORN Machines, caramelcrisp, crispettes, cheese coat, potato chips. Long Eakins, 2035-F High St., Springfield, Ohio.

M. M. Earned \$1174 in spare time for exceptional "cellar crop" Snow-King mushrooms! Free book tells if your cellar, shed suitable. We buy crops. United, 3848 Lincoln Ave., Dept. 68, Chicago.

MAKE Color-glazed concrete pottery, gravestones, tiles, floors, walls. Basement waterproofing, etc. Booklet 3c stamp. National Potteries, Minneapolis, Minnesota.

YOU'LL Like resilvering mirrors, reflectors, making chipped glass nameplates, signs. Write Sprinkle, Plater, 127, Marion, Indiana.

FREE Catalog mailorder opportunities amazing money-making possibilities. Seider, 24 Watson St., New Haven, Conn.

SENSATIONAL Sideline. Exotic Mexican-type perfume. Big profits. Generous sales sample 25c. Leco, 8830 Betty Way, Los Angeles.

WORK For yourself. Pays good profits. Amazing opportunity. Eye-opening literature free. Sava Service, 707 1/2 South 16 St., Omaha, Nebr.

"RUBBER Mold Making." Plaster Casting. Working instructions 25c. Ideal Service, RM-6, Park Ridge, Ill.

PROFITABLE, Clean, sparetime business—at home. Randolph Service-B, Atwater, Ohio.

SIGN Painting with lettering patterns, cutting block, samples, instructions, 10c. Clark System, Ellwood City, Penna.

SMALL Capital starts "route" coin operated peanut, gum and amusement machines. Particulars free. Robbins Co., 1141P DeKaib Ave., Brooklyn, N. Y.

MAIL Order business course shows you how to make money, spare or fulltime. Teaches professional mail order technique—not penny-catching schemes. Free details. Nelson Company, 404-F Manhattan Building, Chicago.

RECAST Old batteries into new. Latest achievements. Battery Laboratories, St. Paul, Minnesota.

TELEPATHY. Amazing informative booklet 10c. Dr. Green, Box 1177pm., San Francisco, Calif.

MAKE Money at home! Grow mushrooms in cellar or shed, with U.S.-Patented Ami Mushroom Spawn and easy-to-follow Manual of Instructions. Fascinating, profitable. Booklet free—write today. Anglo-American Mushroom Industries, Dept. 41, Toronto, Ont.

BASEBALL—Enjoy earning money with Basebo-el. Write Basebo, Queens Village, Long Island, New York.

A "New high" in a business opportunity, with continuous profits, on limited capital. Facts, not statements, available in our literature, 3c postage appreciated. Rowland Service, Wheatland, Wyoming.

BIG Mail for you. Latest money-making offers, opportunities, catalogs, magazines. Name listed in directory 10c. Ideal Service, 106M, Park Ridge, Ill.

START Used car business. Part. full time. No capital or experience needed except driving. Unlimited opportunities for serious minded men who want to build a business of their own. A. A. Barlow, 89 State, Binghamton, N. Y.

TREASURE Finders? Read Goldak advertisement on page 132A.

COLUMBUS Peanut vendors make money. Free catalog. Rake, 5415 Woodland, Philadelphia, Penna.

CASH Paid for insects. See Sinclair display advertisement on page 10A.

INSIDE Facts—Agents, beginners—"Business Starters" 25c. Williams, 4M Grant Ave., Allston, Mass.

35 DOLLAR Secrets 25c. Circular free. Emmelmann, 1425 Terrace Avenue, Indianapolis, Indiana.

NEW Reflecting novelties. Sell by mail, car owners, agents. Superior Specialties, Springfield, Illinois.

HANDY Men—Earn money home operating Community "Fix-It" Shop. Stafford, Makanda, Illinois.

YOUR Own business. Tested plans, formulas. No trash. Literature 10c. Buist Co., 7532 Buist, Philadelphia, Penna.

COLOR Concrete with chemicals. Wish-ing wells. Stucco-rock. Benches. Spin concrete pottery. Cement artistry. Garden ornaments. Cold glaze. Water paints. Marbling. Sample 10c. Hollywood Cement Craft, 8527 Wonderland, Hollywood, Calif.

SELL Snow balls. Own a business—400% profit. Outfits \$4.75 up. Circular free. Instructions 25c. Snowball Company, Riverview, Jacksonville, Fla.

START A worthwhile business of your own. Voltera Art Marble Co., largest manufacturer of imitation marble and rubber molds offers you the opportunity to start manufacturing art goods in imitation marble. No experience necessary, small capital needed. We furnish molds and material for speedy production. Ask for free catalog. Convince yourself. Voltera Art Marble Co., 530 West Broadway, New York, N. Y.

MAKE Big money using sawdust. Full instructions 25c. Rontier, 787-D Chilli, Rochester, New York.

MONEYMAKERS' Opportunity Digest Magazine—60 pages of golden opportunities—10c. Lewis Co., 828-S Carpenter, Oak Park, Ill.

LIKE Afternoons free? Work home! 12 000 word surprise literature free! \$2,000 month reported (fulltime—no implication exceptional amount can be duplicated.) National, Box 1240-D, San Bernardino, California.

LEGITIMATE Business! No canvassing! Samples dime. Information free. Doctor Swearingen, Station "S," Los Angeles.

MAIL Order lists—Over million names—Compiled by states, alphabetically. Write for particulars. Charles Listings, 276 West 43 St., New York.

DOLLAR Enterprises: Barn dances, "Snow-Balls," hayrides; your choice \$1.00 postpaid. Four \$1.00 formula books, 50 circulars, \$1.00 postpaid. Other dollar deals. Roadman's Guide, PM, Toledo, O.

MAKE Your own rubber molds. Sample mold and details 10c. June, 101-M Beech, Holyoke, Mass.

MAKE Artificial marble, glazed tiles, uncanny. Tabletops, plaques, floors, honos, novelties. Hard, fireproof, inexpensive, cement secrets. Brilliant tile and liquid rubber samples 3c. John A. Payn, 945 Grande Vista Avenue, Los Angeles, Calif.

NEW Book, Woodworking for Profit, tells how to start and operate small furniture factory in your home work shop. \$2.00 post paid. Boaz Lumber Industries, Boaz, Wis.

RESOLE Work shoes with waste material. Directions 10c. Jaycon, 191 Park Place, Brooklyn, N. Y.

MAKE Extra money weekly! 10,000 "how-to-do-it" ideas; starting own business. Home spare time, mail order, agency supply. Write! Wolverine-Menden, 3545 St. Clair, Detroit.

BIG Money. Make plastic costume jewelry. The latest hit. Sells on sight. Information free. Plastics, Scottsville, N. Y.

RECEIVE Stacks of mail. Your name listed in 10,000 directories 25c. Liberty Sales Service-A, Sheboygan, Wis.

SOAP Making. Learn home. No machinery. Stamp. Posera, AC-4545 Bartlett, Milwaukee.

EXCEPTIONAL Profit opportunity—Hurry! Merritt Co., Drawer H, Roseland, N. J.

BE Credit collection specialist. New method. Work from home. Full—part time. Unlimited opportunities. 70% profit. Details, samples, franchise 25c. Modern Collections, 5000-G Cordelia, Baltimore, Md.

1000 SURE-FIRE Money-making opportunities! 25c coin. Rayburt, Brisbane, California.

START Small at home! Clean, dye and pressing shop. Be independent. Big profit. Flocos Co., 2311 Eagle Ave., Alameda, Calif.

OPERATE Profitable "route" four compartment vendors. Small investment. Penny King, 1233 Chouteau, St. Louis.

MONEYMAKING Books, plans, formulas. Literature free. Watson, 621 South 31st Avenue, Omaha, Nebr.

RAISE Your income! Particulars 3c stamp. Brookman, 2043 Berwyn Ave., Chicago.

"NEW Business" opportunities. Drop postal. Porter, Box 6346P, Pittsburgh, Penna.

VULCANIZING Business, well equipped, can teach buyer. Box 156, Eagle Pass, Tex.

YEAR'S Greatest novelty. "When Fish Bites—Bob Lights." More fun. Bigger catches. Distributors-agents protected territories. Retail \$1.00. Ingenutics Engineering, P.O. 903, Pittsburgh, Penna.

MAKE Money resilvering mirrors. Work at home. Build profitable business. Complete process and 23 other moneymakers only 25c. Ulysses Barnes, 3011 Glasgow Street, Portsmouth, Virginia.

WANT More business! 2c daily opens individual New York branch office. Co-operative Mail Service, 126 Lexington Ave., New York.

PROFITABLE New home business! Preserve baby shoes in beautiful bronze! Anyone can metallize baby shoes! Ornamental, useful! Market: All parents! Big profits! Small investment! Easy, illustrated instructions, \$2.00. Novelty Metallizers, P.O. Box 933, Church Street Annex, New York City.

MONEYMAKING Quick mail order business. In your home. Send stamp. Continental, 3405 Prairie, Chicago.

AMAZING Patented screw-holding screw drivers! Factories, stores buy quantities; big profits, fast sellers, quick repeats. Foreign territories open. Free trial! Toolco, 6028 Journal Bldg., Boston, Mass.

INVESTIGATE Immediately! Surprising profits possible. Be independent. Work home. Empire, 106K Tuckahoe, N. Y.

\$2500.00 JOB in Alaska—That is what I got from my letter of application. Perhaps it will help you get a good position too. I'll send a copy for \$1.00 in currency, together with genuine suggestions for adapting it to your qualifications. J.P.M., care A. P. & T. Co., Unalaska, Alaska.

OPPORTUNITY Manufacturing food product at home. Muller System, Glen Moore, Penna.

CHARTERS: Delaware; best, cheapest; free forms. Colonial Charter Co., Wilmington, Del.

EARN Money at home making imitation diamond jewelry, bracelets, barbings, millinery ornaments, religious medals, etc. High prices now paid on account of German and French jewelry shortage. Exceptional spare or full time opportunity. Write United Jewelry Manufacturers, Dept. A, 1692 Boston Road, New York City.

SINGLE-INGREDIENT Formulas. No manufacturing! Information free. B. Kinford, Wayne, Penna.

GET Big mails—Samples galore. Your name listed in Midstates Mail Trade Directory, copy sent you, directory 500,000 articles wholesale, 10c. Eagle, 414-P W. 65th, Chicago.

MAIL Order business is your opportunity. Many began small, now earn thousands yearly. No personal contact. Boundless opportunities. Have had over 30 years experience; will help you succeed. Send 25c for valuable booklets, none free. B. Breniser, 257 E. 21st, Philadelphia.

INVENTION Finance Magazine, 80-G Wall Street, New York. Important particulars free.

WE Help start you in business, furnishing outfits and instruction, operating "specially candy factory" home. Men—women, opportunity to earn good steady income, all or spare time. (Our 31st year.) Booklet free. Ragsdale Candies, Drawer 4, East Orange, N. J.

A REAL Future for you with Red Comet fire control products. Low prices. Proved seven years. Splendid sales outfit free. Some good territory open. Exclusive. Write quick, 766 Red Comet Building, Littleton, Colorado.

BIG Profit in mold making and plaster casting. \$1.50 profit on every dime invested. Foolproof rubber. Tremendous market. Simple interesting work. 24 page instructive catalogue free. Plastic Arts, 711 Neely, Muncie, Indiana.

START "Home mail order business." Immediately. Information 10c. Maples, 3418 So. Marshfield, Chicago, Illinois.

"NEW Money Makers" 70-page mail-order magazine, prints hundreds new, novel, sparetime plans monthly. Sample copy 10c. M. Marvin, Publisher, 330 South Wells, Chicago.

MANUFACTURE From Phospholene. Bleach 2c gallon; glass spray 1c gallon; hand soap 2c pound; and ten fast sellers. Sample 25c. Details free. Western 401 Climax Bldg., Cleveland, Ohio.

SUCCEED With your products. Make-sell them. Formulas, Processes. Accurate analyses. Catalog free. B. Thaxly Co., Washington, D. C.

PLASTEX Industries offers industrious men an opportunity to start a business of their own, manufacturing art goods, novelties, souvenirs, etc., in Plastex and marble imitation. 5c material makes \$1 articles. Rubber moulds furnished for speed production. Small investment brings big returns. You are just in time for big wholesale season now starting. Write for interesting booklet mailed free. Plastex Industries, Dept. A, 1085 Washington Ave., New York.

INVENTORS:—We successfully sell inventions, patented and unpatented. Write for proof, and tell us what you have for sale. Chartered Institute of American Inventors, Dept. 4-C, Washington, D. C.

GOOD Paying business silvering mirrors, plating autoparts, reflectors, bicycles, bathroom fixtures by late method. Free particulars and proofs. Gunmetal Co., Ave. H, Decatur, Ill.

LIQUID Marble—anyone can make! Colorful, glazed! Moulded, brushed, sprayed. Rubberlastic moulds. Composition flooring. Big money in these! Particulars free. Marbleizing Service, Edwardsville, Ill.

ELITE Collection of business plans, contains 127 tested plans and scores of formulas. Start own business; home, office. Particulars free. Elite Co., 214 Grand St., New York.

127 WAYS To make money, in home or office, business of your own. Full particulars free. Elite Co., 214 Grand St., New York.

HOW And where to obtain capital fully explained, free particulars. Star Service, Wapakoneta, Ohio.

EARN Extra money at home. Increase your income at home by new, simple Wentworth Tempera Color method. We instruct you and supply you with work. Write today for free booklet. Wentworth Pictorial Co., Ltd., Dept. 3, Hamilton, Ont.

MAKE Money by mail, the way we do. Free information. Maywood, P-1107 Broadway, New York.

ADVERTISERS! 1,600,000 Mail order circulation. Inch advertisement, \$15.40. "Get results," 20 newspapers, 18 words, \$6.50. Diener-Dorskind, 1474P Broadway, New York.

WHERE To buy at lowest wholesale prices. Information free. Yorena, Box P-312, Bayonne, N. J.

100 PROFITABLE Mail order and local plans. Gilbert Supply, 5-P West 24th, New York.

MAKE. Sell luminous paint. Literature free. Gordon Laboratories, 1265-H Broadway, New York.

SECURE Financial independence by placing coin operated merchandise vending machines, out on profitable basis, no experience required, little capital needed, write for free details. Torr, 2047 1/2 South 68th St., Philadelphia, Pennsylvania.

MONEYMAKING OPPORTUNITIES

AGENTS: Tested and proven battery service, cost only few cents yet keeps batteries charged. In every territory Sure-Start is opening up rich source of income for salesmen. At last, a product that keeps batteries charged, stops overheating, prevents excessive corrosion, stops sulphation, keeps plates clean, never known to freeze and doubles life of battery. Every motorist, fleet and truck owner, filling station, garage, auto accessory and drug store a prospect. Write for details or send \$1.00 cash for agents trial offer two battery services, regular \$3.00 value. Sure-Start Chemical Co., 1617 W. 10th St., Ft. Worth, Texas.

BOOKKEEPERS—Operate new profitable bookkeeping service. Box 614, Kalamazoo, Michigan.

MANUFACTURE Perfume, three generous samples; details: 25 cents (coin). Normandy Press, 3310 Tudor Street, Philadelphia, Penna.

SIX Moulds for candy suckers 85c. Home Candies, Franklinville, N. Y.

LOOKING For something? "Money-making secrets exposed" is the book you need. Write: Art Printing Service, P.O. Box 5617, Chicago, Ill.

MONEYMAKING Opportunities, mail order magazine, 3c. G. Fenner, 1618 Lucia, Louisville, Ky.

DIMES, Quarters, dollars—by mail. Opportunities, 7 pulling ads, 3c. Kay, 3916 Telegraph, Oakland, Calif.

MILLION Articles. Buy wholesale. Valuable directory 10c. Ideal Service, D-6, Park Ridge, Ill.

"PROFITABLE News," magazine for unemployed, dime. Varvel's Service, Burlington, Kans.

NEW. Non competitive one man business, profitable, or prosperous chain enterprise. Work done with Marvel preparation. Information free. Sava-Service, 707 1/2 South 16th Street, Omaha, Nebraska.

600% PROFIT By mail. New, different. Everything supplied. T. Moore, 152 Broad, Newark, N. J.

WANT Extra money? Write: Elar, 2634 N. 25th, Milwaukee, Wis.

WIN Money! Prizes! Contest Magazine 10c. Butler, 39PM, Braxton, Mississippi.

YOU'LL Like resilvering mirrors, reflectors, making chipped glass nameplates, signs. Write Sprinkle, Plater, 287, Marion, Indiana.

BE A professional scrapbooker. Big fees. Unlimited opportunities. Can be done at home. No competition. No capital needed. Write to Scrapbookers Guild, 59 Park Place, New York, N. Y.

STOP Looking for work "Try My Way." Literature free. Kemper, 420 Geiger St., Huntingburg, Ind.

"LUMINOUS Paint" shines in dark. Easily made. 300 other formulas, plans—all 25c. Ideal Service, 300P6, Park Ridge, Ill.

MAKE Money—Others do—Collecting reptiles, toads, frogs. Easy! Profitable! Sure! We buy all varieties. Particulars dime. Biological Research Laboratories, Dept. 3C, Little Rock, Arkansas.

TREASURE Finders? Read Goldak advertisement on page 132A.

"EASILY Started" mail business. Proved. Particulars free. Rogers, Moose Lake, Minn.

BE Independent. Sell by mail, buy wholesale. Wetzel, Valhalla, N. Y.

"SCHEMER" Magazine. Alliance, Ohio, (42nd year) answers questions, prints schemes, opportunities, helpful hints, profit paragraphs, advertising rates, formulas. Copy, and special subscription offer, only 10c.

CASH Paid for insects. See Sinclair display advertisement on page 10A.

BUILD A business of your own mailing circulars. Send \$1.00 for complete details. Bernie Pyles, 1566 Jones Street, San Francisco, Calif.

MONEYMAKING Plans, formulas, opportunities. Literature free. Midwest Distributors, Box A-94, Batavia, Ill.

"SILENT System" money making. New, legitimate, home. Sparetime way. Write quickly. Atkins, 659 22nd, Newport News, Va.

FREE—300 Wonderful business, mail-order and homework moneymaking offers. Lewis Co., 828-D Carpenter, Oak Park, Ill.

LIKE Afternoons free? Work home! Expect surprise details! \$2,000 month (orders) reported (fulltime—no implication exceptional amount can be duplicated.) National, Box 1240-C, San Bernardino, California.

LETTERING Patterns, free literature. Sample alphabet 5c. Display Letters, Box 28, Ft. Hamilton, Brooklyn, N. Y.

"PROSPERITY" For home workers. 64 page magazine. Sample, dime. Sizemore, 4917N Kostner, Chicago.

\$50.00 WEEKLY At home. Make cosmetics, flavors, etc. Employ agents yourself. A. Wilcox, Nicholls, Ga.

BECOME Expert collection manager. Easily learned profession. Matz Adjusters, Reading, Pennsylvania.

SURE-PROFIT Magazine directory. Sample 10c. Arden, 796 Green, Detroit.

RAISE Rabbits. We pay to \$7.00 for young. Catalogues 10c. Rabbitries, Bowling Green, Kentucky.

650 KEYPED Secrets. Gain employment. Genuine business starters. Good paying mailorder opportunities at home. Write. Stamp appreciated. Frank H. Battles, Ann Arbor, Michigan.

DOLLARS For you, 10c, refunded later. Ruths, Sidney, Manitoba, Canada.

WANTED. Men, women interested in earning far above average income operating route of one-cent confection machines. Full or part time. Small investment. LaCrosse Distributing Co., LaCrosse, Wis.

DOUBLE Your income. Read "Mail Salesman." Copy dime. Sidney, Pottsville, Penna.

LIQUID Latex makes molds by spraying, brushing, dipping. Instructions, 1/2 pint trial package \$1.00 prepaid. Box 156, West Toledo Station, Toledo, Ohio.

ELECTROPLATE Non-metallic articles, also electrolyte at home. \$1 brings carefully written theory, complete processes, formulas for electroplating non-metallic articles, baby shoes, vases, etc.; also electrolyte or reproducing from wax mold. A list of our low price equipment included. Choate Mfg., 3464-H Principio Ave., Cincinnati, Ohio.

IF You can write you can draw with a Mur-O-Graph. Make \$30.00 weekly at home. Write. Mur-O-Graph, Box 4, 801 North Marsalis, Dallas, Texas.

MOULDS. Guaranteed, for casting toy soldiers, Indians, trappers, warships, sinker moulds, 244 kinds. Send 5c for illustrated catalogue. Send \$1.00 for large sample mould. Henry C. Schiercke, 645 Spencer, Ghent, N. Y.

"RAISE Earthworms for profit," new, interesting home business. Bureau Zoological Research, 106A Broadway, Peoria, Ill.

AMATEUR Cartoonists, earn cash at home, copying and duplicating cartoons for advertisers. Ad-Service, Argyle, Wis.

WHOLESALE Sources, 500,000 articles. Free directory. Maywoode, 1107 Broadway, New York.

GROW Plants without soil. Folder free. Gordon Laboratories, 1265-J Broadway, New York.

EARN Money addressing envelopes, circulars, typing. Information 10c; none free. Ace-PMF, 316 Empire, Birmingham, Ala.

FORMULAS, PLANS, ETC.

ANALYSIS. Duplication guaranteed. Valuable formulas. Consultation. Associated Chemists, Indianapolis, Indiana.

FORMULAS: — "Chemist Approved." None better. Lowest prices. Catalog free. Kemico, 12-G, Park Ridge, Ill.

INSECT Spray formula; material; 25c. Kaplan, 13 South Eden, Baltimore.

10 ONE-INGREDIENT Formulas, 10c. Peterschmidt, 16th Locust, Quincy, Ill.

FORTUNES In formulas! 10,000 processes, secrets, formulas, 900 page volume, \$1.00! Pat Distributing, Noroton, Conn.

ANY Formula for any product! "Just name it." Satisfaction guaranteed! 27 years supplying the best. Miller's Analytical Laboratory, Tampa, Florida.

ICELESS Ice! Colder! Cleaner! Cheaper! Instructions 25c. Duffy, Covington, Ky.

THAXLY Formulas, processes, for perfect products. Accurate analyses. Catalog free. B. Thaxly Co., Washington, D. C.

FLY Spray formula—25c. None better! R. McKinley, Wayne, Penna.

SINGLE-INGREDIENT Formulas — No manufacturing! Information free. A. Kinford, Wayne, Penna.

10,000 MONEY-MAKING Formulas, recipes, secrets. Make most anything, 900 page book, \$1.50 postpaid or C.O.D. (foreign \$1.85). Catalog 3c. Adams Brown Company, Chestnut Hill, Massachusetts.

FORMULAS—All kinds. Real money-makers. Lowest prices. Catalog free. Clover Formulary, 108-P3, Niles Center, Ill.

FORMULAS—List free. Andco Laboratories, 225 7th St., Rockford, Ill.

REAL Manufacturing formulas. Lists free. Cummings, Chemist, Gordon Avenue, Syracuse, N. Y.

FORMULAS. Latest money makers. Literature free. Belfort, 4042 N. Keeler, Chicago.

ELITE Formulas and plans; make and sell your own products. Descriptive booklet free. Elite Co., 214 Grand St., New York.

CHEMISTRY

FREE: 40 Page catalog of chemical and laboratory supplies for amateur chemists. Wollensak microscopes and supplies, scientific books at big discount. JE6 Winn, 124 West 23 Street, N. Y. C.

FREE Chemistry catalog. Supplies at 5c! Equip complete laboratory. Kemkit Scientific Corp., 397P Bridge St., Brooklyn, N. Y.

FREE Catalog. Chemistry, mineralogy, biology, microscopes, telescopes. Send postage. Tracey Laboratories, Evanston, Illinois.

FREE Magnesium, chemical, apparatus catalogue. Beck, Braeland Ave., Newton Centre, Mass.

CHEMICALS. Laboratory, glassware, apparatus. Send 3c for catalog CP1. Biological Supply Company, 1176 Mt. Hope Avenue, Rochester, N. Y.

SPECTROSCOPE For quick chemical analysis \$2.50. Kutting Sons, Campbell, California.

CHEMICALS In 5c quantities. Catalog 5c. Fleischer's Laboratories, Medford, Mass.

CHEMISTRY Courses at bargain. Particulars. A. Shapereau, 620 E. 8th St., Brooklyn, N. Y.

HELP WANTED

LOCAL Agents wanted to wear and demonstrate suits to friends. No canvassers. Partial payment plan. Up to \$12 in a day. Experience unnecessary. Valuable demonstrating equipment, actual samples free. Stonefield Corp., 1300 Harrison, Dept. F-817, Chicago.

STEADY Work—Good pay. Reliable man wanted to call on farmers. No experience or capital required. Pleasant work. Home every night. Big money every day. Wonderful new proposition. Particulars free. Write McNess Co., Dept. 401, Freeport, Illinois.

BOOKKEEPERS—Learn credit management from experienced credit man. Cooke, 41 Washington St., Rutland, Vt.

M. M. Earned \$1174 in spare time for exceptional "cellar crop" Snow-King mushrooms! Free book tells if your cellar, shed suitable. We buy crops. United, 3848 Lincoln Ave., Dept. 69, Chicago.

NEW Polishing pad just out. Polish in pad. Sample 25c. \$1.20 doz. Du-Bee, Box 695, Central Station, St. Louis, Mo.

BOOKKEEPERS—Learn insurance payroll auditing. Special course prepares you. Roth, Box 487, Oklahoma City, Okla.

SALARIED Positions—\$2500 yearly and up (none lower). Let us find one for you. Small cost. Write for valuable information. Executive's Promotion Service (16), Washington, D. C.

AGENTS WANTED

AMAZING New patented knife and scraper. Details free. Pays big profits. Apex Co., Dakota Bldg., St. Paul, Minn.

YOUR Own local shoe business. Free outfit starts you! Big advance commissions, bonus shoes, 208 different styles. Experience unnecessary. Tanners Shoes, 331, Boston, Mass.

MEXICAN Curios sell on sight. Large profits. Free particulars. Samples 10c stamps. Marquez, P.W. Apartado 1176, Mexico City.

UP To 100% profit in new perfected 1940 quick action self-starting cigar lighter. No flint or friction. Lights easily in the wind. Retail 25c. Costs you \$1.75 dozen. Sample and can fluid 25c. New Method Company, Box PM-90, Bradford, Penna.

BUSINESS Proposition resilvering mirrors, reflectors, making chipped glass nameplates, signs. Write Sprinkle, Plater, 128, Marion, Indiana.

AGENTS Lightning seller. Amazing new hosiery replacement guaranteed against holes, snags, or runs. Hose for your own use sent with large outfit. Send hose size. Rush name, no money. Wilknit, Desk FF-37, Greenfield, Ohio.

RAWLEIGH Men make good money. Supply everyday household necessities to Raleigh routes of 800 family users. Ambitious men can make good earnings at start. We furnish everything but the car. Write today. Rawleigh's, Dept. F-A-PPM, Freeport, Ill.

500% PROFIT Selling new "20-in-1" kitchen utensil. Retail 25c. Costs you \$1.00 a dozen or \$7.20 a gross. Sample 10c. New Method Co., PMM-90, Bradford, Penna.

AGENTS! Big weekly cash profits; quick, steady repeats. Housewives wild about ready preparations for luscious pies, puddings, desserts, cookies, etc. No guesswork. No skill required. Time and money saving. Marvelous profits for you. Big line. Write for liberal trial offer. E. J. Mills, 3546 Monmouth, Cincinnati, Ohio.

DOLLARS Daily, selling dog leads. Sample, quarter. American Doll Syndicate, Newton, Illinois.

RUBBER Steering wheel cover. New design. Soft, velvety, nonskid. Autoists thrilled. Sells like wild. Samples sent on trial. Rush name, Kristee, 119, Akron, Ohio.

BIG Money daily making beautiful braided leather belts, no tools—no experience!—materials furnished. Assemble by hand anywhere. Panda Belt, PM-140 N. Dearborn, Chicago.

STOREKEEPERS Can't resist Nu-Way Sign Writer, Kingston, N. Y.

MAKE And sell your own products. No machinery needed. Amazing profits. Guaranteed "Chemist Approved" formulas. Catalog free. Kemico, 10-G, Park Ridge, Ill.

ASPERCOL Products need exclusive distributors for carded merchandise. Oakland Calif.

UP To 500% profit with new perfected 1940 quick action, no flint, automatic gas lighter. Retail 25c. Sample 10c. New Method Company, Box PMG-90, Bradford, Penna.

MONEY Making information on any subject, merchandise, formula, etc. Send stamp for free particulars. Technical Service Bureau, 6805 North Clark, Dept. 113, Chicago.

AGENTS: Big profits stamping social security plates. Our outfit is inexpensive. Write for details. Morton Sales Company, P.O. Box 93, Flatbush Station, Brooklyn, N. Y.

QUICK Cash. Colored people buying new hair dressing, bleach cream on sight. Samples free. Valmor, 2241-AA Indiana Ave., Chicago.

PERSONALIZED Face powder. Purchaser's name on box in gold. Unique. Attractive. 100% profit. Charlie, Jamaica, N. Y.

SELL "Whee" liquid cleaner. It is different. Out-demonstrates competition. Wins friends. Big profits. Free sample. Cal-Western Manufacturers, 4850 1/2 Santa Monica Boulevard, Los Angeles, California.

AGENTS—200% Profit on amazing new discovery. Cleans, polishes, waxes cars in 30 minutes. Magic all-purpose polish. Instant demonstration sells most skeptical auto owner and housewife. Enduro, 2420-C Grand River, Detroit, Mich.

BIG Money taking orders; shirts, ties, hosiery, underwear, pants, jackets, sweaters, uniforms, etc. Sales equipment free! Experience unnecessary. Nimrod, 4922-AN Lincoln, Chicago.

HUSTLERS—Easy pitch—Clean deal. For restaurants, taverns, up to 300% profit. Investigate. M. Sheridan, 624 S. Michigan, Chicago.

COIN Money selling pat. salt and pepper shaker. Every home a prospect. 5 colors. Write Condon, Box 176, Upper Darby, P'nna.

NEW. Different, gas station "service-signal." Cheaper, better. Knipp, Long Beach, California.

BOYS! Girls! Earn cash or premiums. Sell 25 packages 10c flavoring, shampoo, etc. Order today! We trust you. General Products, 776F, Springfield, Mass.

EX-O-LENE! Powerful mile increasing, top lubricant, anti-knock compound. Works like magic! 35 gallon test 25c. Power-speed-pep. Guaranteed. Thermo D-X, Peoria, Illinois.

ONE Dollar bottle Glas Glos will clean all windows in five room house for five years. Sent postage paid. Agents everywhere make big money. Write, Pioneer Sales Company, Commerce Building, Erie, Penna.

FREE Samples feather pictures, Stamp appreciated. Gamy, Apartado 1176, Mexico City.

WINDOLENE Sells for dime. Beats competition, 400% profit. New plan. Free sample. Atkinson, 756-P Carpenter, Akron, Ohio.

INSTRUCTION Book. "How to Be a Successful Agent." Independent. Big money. Fioccos Co., 2311 Eagle Ave., Alameda, Calif.

GRANITE Monuments, markers. Fifteen colors. Lettered. Guaranteed. Prepaid. Free catalog. Lowest manufacturers prices. Mikelich Company, St. Cloud, Minn.

SELL—Moth crystals, cakes, polishing cloth. Write. Wayne Products, Pleasantville, N. J.

NEW Product! Repeats! Sample 6c postage. Pomoco, Sparkill, New York.

MR. Agent! Astounding repairs easily made with Terry's Waterproof Household Cement! No heat, no equipment necessary! Every home, office, store a prospect! Retail 25c, profits to 200%! Terry Products, Box 27, Atlanta, Georgia.

SELL "Shaveaid." Triples smooth shaving life of blades. Details, sample 50c. "Shaveaid," 1800 Sunnyside Ave., Chicago.

REVOLUTIONARY Window cleaning tool. Good Housekeeping approval. Only ten \$2.25 sales daily to housewives, factories, schools, stores will make you \$350.00 monthly. Carter Products Corp., 900 Front Ave., Cleveland, Ohio.

AGENTS: Stamping names on pocket-key protectors. Sample check with your name, address, 25c. Stamping outfits. Emblem checks, check-fobs, name plates. Hart Mfg. Co., 303 Degraw St., Brooklyn, N. Y.

BIG Money applying initials on automobiles. Easiest thing today. Free samples. Also, sideline salesmen for short order decalomania name plates. "Ralco," 1305 Washington, Boston, Mass.

FREE Water and our concentrates make 68 products. Labels, bottles, everything supplied. Qualco, E-20030 Russell, Detroit.

MANUFACTURE Your own window cleaner. Sell housewives, filling stations, etc. Formula 25c. Klenzo Products, 65 E. Livingston Ave., Columbus, Ohio.

FREE Sample—Amazing cleaner; sells homes, taverns, everywhere. Big profit—fast repeater. Betco, 5007 Irving Park, Chicago.

500% PROFIT. Gold and silver colored sign letters. Offices—stores. Large sizes 1c. Free samples. Modernistic, B-3000 Lincoln Ave., Chicago.

NEW 25c Household necessity costs 2c. Linnell, University Center, Cleveland.

LARGE Profits selling Magic Fluid. Repairs instantly any fabric or rubber, heat and laundry proof. Eureka, 1911 S. Wash. Chicago.

AGENTS Wanted, large profits. Address Lamont Company, Beacon, New York.

SUCCEED With your products. Make-sell them. Formulas, Processes. Accurate analyses. Catalog free. B. Thaxly Co., Washington, D. C.

WINDOW Sign letters. Penny each, large sizes. New styles. Absolutely beautiful. Free samples. Atlas, 7941 Halsted, Chicago.

MANUFACTURE Specialties, hire agents yourself. Big money. Free literature. Gilbert Supply, 5-P West 24th, New York.

MONOGRAMMING Automobiles real money maker. Write for samples. International Co., Box 9360, Philadelphia, Pa.

AGENTS—300% Profit selling gold leaf letters; stores and offices. Free samples. Metallic Letter Co., 438-B North Clark, Chicago.

AGENTS: Smash go prices! Santos coffee 12c lb. 4-oz. vanilla 8½c. Razor blades 10 for 8½c. 100 sticks chewing gum 12c. 150 other bargains. Premiums. Experience unnecessary. Carnation Company, P.O. St. Louis, Mo.

GOOD Paying business silvers mirrors, plating autotaps, reflectors, bicycles, bathroom fixtures by late method. Free particulars and proofs. Gunmetal Co., Ave. N. Decatur, Ill.

AGENTS—Opportunity make money; book containing 127 successful business plans; home-office; send for free introductory booklet. Elite Co., 214 Grand St., New York.

AGENTS Make big profits on food products, bargain deals. Low wholesale prices. Rush name for trial outfit offer. Ho-Ro-Co, 2810-T Dodier, St. Louis, Mo.

AGENTS—To mail our literature. Good profits. Home business. Maywood, 1105-1107 Broadway, New York.

ENGRAVED Name plates, numbers, signs, etc., easily sold, profits large. Brett Bros., Winthrop, Mass.

BIG Money applying initials on automobiles. Write for particulars and free samples. American Letter Company, Dept. 40, Dunellen, New Jersey.

HIGH-GRADE SALESMEN

PLACED On free trial to customers. Sells itself. Tremendous sales possibilities! Revolutionary inter-communication system. Talk to one or as many as ten people, even 2000 feet away. Loud speaking, back and forth, private conversation. Operates like radio—one electric connection. No servicing or installing problems. Fully guaranteed. Technical experience unnecessary. Easy two-minute demonstration. Thousands prospects—factories, offices, lumber yards, garages, parking lots, restaurants, etc. Accounts receivable carried by factory. Present low price opens big new field. Men earning high as \$100-\$150 week. Protected territory available. Free demonstrator offer. Inter-Communication System of America, 2440 Lincoln Ave., Dept. 307, Chicago.

BIG Firms need men—You. With or without experience they offer you daily cash money for your spare or full time. You can choose the company from hundreds of well established firms who are ready to help you make money working for them. No matter where you live or what your age is, here is your chance. Long established magazine tells how. Six issues sent to you free to get acquainted. No obligation now or ever. Send name on card today to "What to Sell." Box M60, 168 N. Michigan, Chicago, Ill.

SENSATIONAL Quick-cash opportunity. My route building plan gives you chance for good steady income. Real future. Handle regular route local stores. Collect, deliver orders for famous 5c—10c counter display goods. Nationally advertised in 120 magazines and radio. Show merchants proven plan for beating competition and increasing sales, profits. Experience unnecessary. Use home as headquarters. Chance to operate Silver Fleet service truck. Facts free. World's Products Co., Dept. 10-T, Spencer, Ind.

SELL Printing at cut prices. 2,000 business cards \$1.50; 1,000 envelopes or statements, etc. \$1.75; 25 printed sales books \$1.50; 1,000 process embossed cards \$1.50; 2,000 two-color labels, free holder \$1.50; 2,500 printed handbills \$1.75. One-third comm. Free outfit. Bargain Prtg. Co., 189-F W. Madison, Chicago.

ADVERTISING Book matches—Sell union label book matches. Fastest selling line in America. Large sales producing kit, sample matches, complete cut catalog, eight color combinations make selling easy. Commission in advance. Superior Match Co., 7530 Greenwood, Dept. M-6, Chicago.

EVERY Business must buy printing, advertising specialties, book matches, etc. Take orders for the pioneer line—725 necessity items at 50% price saving. Free d'als. 40% advanced commission, bonus. Experience unnecessary. Outfit free. David Lionel Press, 312 So. Hamilton, Dept. XH, Chicago.

EVERY Service station and garage a prospect! Up to \$3.95 profit on \$6.95 sale. Vernon Co., Newton, Iowa.

MAKE Big money! Demonstrate automatic electric hot dog cooker. Sells on sight. Eating places, taverns, drug stores wild about it. Write for big profit deal. Wienle Chef, 2301 W. Hubbard, Dept. T-18, Chicago.

BIG Commissions—selling to stores celluloid pricing tickets, metal shelf moulding. To restaurants, menu covers, signs. P. Pricing Press, 124 White St., New York.

SALESMEN Making \$20 to \$50 daily demonstrating new air circulating fans. All business places hot prospects. General Fan Company, Peru, Indiana.

IT'S Hot! Big repeater with plenty immediate and repeat commissions. No investment. Sells to every type retail dealer and service station. Sales kit free. Hurry! Universal, 2222 Diversey, Dept. C56, Chicago.

LIQUIDATING! \$75,000.00 Wholesale stock—greeting cards, novelties, Christmas merchandise! Catalog free! Elfco, 436 North Wells, Chicago.

SALESMEN—Amazing new glass cleaner sells fast, repeats. Demonstrations reap big profits. Needed everywhere. Universal Utility, Box 602, Gloversville, N. Y.

CALENDARS All sizes—Orders are being placed now for 1941 calendars, advertising fans and novelties. Free samples—get started now and book those early orders. Fleming Calendar Co., 6543 Cottage Grove, Chicago.

SELL Candidates! No competition. Most complete line of auto signs, posters, novelties on market. Big commissions. Ad-Nov-Co., Newton, Iowa.

COMPLETE Line everyday business necessities—Over 2000 items at big money saving prices. Experience unnecessary. Samples free. Commissions advanced daily. Northwestern, 625-BC Jackson, Chicago.

ADVERTISING Book matches offer liberal earnings—full, spare time. Experience unnecessary. Factory direct. Low prices for fine quality, quick deliveries, help get orders; faster repeats. All business firms prospects. Free outfit, instructions. American Match & Printing Co., Dept. 66, 4822 South Trumbull Ave., Chicago.

MAKE \$300 Profit next month on \$425 sales. America's finest line of automatic fire protection. Restricted territories. Pyrotector, Bradleybeach, N. J.

SALESMEN, Distributors, 200 items, brushes, mops, marvelous magnetic brush—excels vacuum cleaner. Big profits. Neway Brush Co., Hartford, Conn.

SEVERAL Choice territories open for salesmen and distributors to handle "Unek" bookkeeping system. Simplest yet most efficient system on market. No experience necessary. Big earnings. Write at once for full information. Magid Industries, Unek System Division 4, P.O. Box 314, Altadena, California.

STARTLING Profits selling "Orange Concentrate." Delicious natural orange drink. Sells like wildfire. Roadstands, soda fountains, resorts, camps, farmers big buyers. Sample free to hustlers. Sunset Valley Orange Co., 3341 Clifton Ave., Chicago.

PROFITABLE, Permanent business, building a store route for Sig's 10c Insect and Rodent killers. Attractive displays. Steady, repeat business. Morco, 1758A Lunt, Chicago.

ASPIRINS, Chocolate laxatives, under your name. Burton Laboratories, Cincinnati, Ohio.

NO-CO-RO Insures automobile batteries against corrosion; sell display cards—service, filling stations; 10 daily pays \$9.50; exclusive territory. No-Co-Ro Company, Oakland, California.

"GOLD-SILVER" Embossed personal stationery. Perfumed exquisitely. Sensational! Different! Rienzi Press, 31½ Sixth Ave., Newark, N. J.

TIRE Accessories. Guaranteed 10,000 mile Tiger Grip tire patch, and fast-selling line tire accessories. Salesmen-distributors easily earn up to \$60 weekly, selling garages, service stations, etc. Protected territory. Economy Rubber Products, 700 Burkhardt, Dayton, Ohio.

DISTRIBUTORS, Crew managers, organizers of agents, send quick for news of amazingly-seasonable device for traveling autoists. Fifty cents retail or more value. Quick easy seller. Light, permanent. Immense commissions. Write or wire for details. Also can use few lone salesmen in unoccupied districts. Act promptly. Nichols Company, 7137 Cottage St., Philadelphia, Penna.

BLADES—Big profits. Best quality. Factory prices. Postpaid. Ace Blades, Buffalo, N. Y.

A REAL Future for you with Red Comet fire control products. Low prices. Proved seven years. Splendid sales outfit free. Some good territory open. Exclusive. Write quick. 704 Red Comet Building, Littleton, Colorado.

EXCELLENT Opportunity selling our complete line of brushes, largest commissions. Write for sales plan. Wire Grip Sanitary Brush Company, 2300 5th Ave., New York.

NEW Specialty—Sells every business and professional man. Four \$15 sales daily pay \$280 weekly. Farrell cleared over \$1,000.00 monthly. Write F. E. Armstrong, President, Dept. PM, Mobile, Ala.

I WANT Experienced, responsible salesmen, to call on banks, hotels, realtors, newspapers, professional men with amazing new service. 10 sales weekly net \$70.00. Extraordinary opportunity for real salesmen. William Hall, Sales Manager, 1512 Orleans St., Chicago.

ONLY Two sales per day makes over \$1200.00 monthly profits. Auto tools. Every mechanic a prospect. 95% virgin. \$50.00 sales makes \$36.00 profits. New. Proven. Protected territory to producers. Year around demand. Mescos, Beaver City, Neb.

AMAZING Patented screw-holding screw drivers! Factories, stores buy quantities; big profits, fast sellers, quick repeats. Free trial! Toolco, 6029 Journal Bldg., Boston, Mass.

EDUCATIONAL AND INSTRUCTION

AIR Conditioning—Electric refrigeration. Rapid growth creates big demand for trained men. Earn up to \$35-\$50 weekly. Write for free facts. Utilities Engineering Institute, 404 North Wells, Dept. 106, Chicago.

AIR Conditioning—Electric refrigeration course \$14. Free literature. Keystone Technical Bureau, Box 412, Scranton, Penna.

HOME Study for degree. Psychology, Metaphysics, Philosophy, Bible. Free information. College of Universal Truth, 20-B East Jackson, Chicago.

LEARN Auto finance business. We teach you this rapidly-growing profession. Information free. No obligation. Nebraska Finance Co., Lincoln, Nebraska.

"MULTIPLICATION Game": Acquire rapidly visualizing results playing this game. Sent postpaid 50c. Newell, Dept. 14, Newaygo, Michigan.

ACQUIRE Emotional stability! Nervousness, fear, bashfulness—afflicted? Free, inspiring information. Write! John Englund, Ironwood, Mich.

WORK For "Uncle Sam." Start \$1260-\$2100 year. Men-women. Try next announced examinations. Prepare immediately at home. Common education usually sufficient. List positions, particulars telling how to qualify and full information—free. Write today. Franklin Institute, Dept. E3, Rochester, N. Y.

WATCH Repairing is steady profitable work. Experts usually in demand. You can learn watchmaking trade at home, spare time. New original instruction system. Script engraving course included. Write for free details today! Nelson Co., F-2001 Manhattan Building, Chicago.

MILLIONS Paid men annually for operating gas-diesel shovels, draglines, clamshells, cranes. You can learn this trade at home. Information free. G. W. Sjoboen, 442 S. 96, Tacoma, Wash.

YOUNG Men—Learn linotype (typesetting). Booklet "X" free. Mergenthaler School, 244 West 23rd, New York.

ENGRAVE On jewelry, etc. Earn extra cash. Inexpensive course. E. Karl, 75 Newell, Painesville, Ohio.

LEARN Arc welding. It's easy—get big pay jobs—complete individual instruction at bare cost of materials used. Write for details. The Arc Welding School, Box M-6405, Troy, Ohio.

INDEPENDENT! Start candy kitchen at home. Enormous profit. Spare time. Fioco Co., 2311 Eagle Ave., Alameda, Calif.

CLAIM Adjusting. Excellent pay. Investigate tragic accidents, fires; outwit fraudulent claimants. Burns School, 311 Morewood, Pittsburgh, Penna.

SUCCESS Is effective thinking! Apply God's mental mechanics and motivation. Succeed 100%. Guaranteed. Taught only by: 100% Effective Thinking, Hollywood, California.

LOOK—Simplified shorthand in ten easy lessons. Send 25c for first lesson. Severance, 220 Garden, Fountain City, Tenn.

BIG Money. Enroll now. Learn in a few weeks decorating, paperhanging, graining, marbling, sign and pictorial painting. Catalog free. Chicago Painting School, 102 West Lake St., Chicago, Ill.

TELEGRAPHY Taught thoroughly. Railroad retirement act creating opportunities for new operators. Expenses low. Catalog free. Dodge's Institute, Hiatt Ave., Valparaiso, Ind.

U. S. Gov't jobs pay up to \$40 a week to start. Get ready for next examinations; railway postal, rural carrier, mail carrier, office help and others. Free book tells how you may qualify. Write quick. Patterson School, Dept. P.M., Rochester, N. Y.

SHEET-METAL Drafting. Home taught. Davison Technical School, 7 East Grand; Detroit, Michigan.

MASSAGE. Hydrotherapy, dietetics, drugless therapeutics, chiropody, taught by mail. Evans Correspondence School, Montgomery, Ala.

BOOKS on advertising, art, color, photography, engraving, printing, offset, silk screen, journalism, sales, management, correspondence, etc. Trade magazines. Discounts. List free. Commercial Engraving Publishing Company, 34C North Ritter Avenue, Indianapolis, Indiana.

LEARN Auto mechanics, body repairing, welding electricity, refrigeration. Diesel. Stevinson's, 2008A Main, Kansas City, Mo.

SECRET Investigation. Experience unnecessary. Detective particulars free. George Wagner, M-2640 Broadway, N. Y.

PLAYS, STORIES, MANUSCRIPTS

ILL Typewrite your short story and place on market. Write, Hursh, Box P-1013, Harrisburg, Penna.

CARTOONING, COMMERCIAL ART, SHOWCARD WRITING, SIGN PAINTING

DRAW Without training with a Mur-O-Graph. Free literature. Address, Mur-O-Graph, 801 North Marsalis, Dallas, Texas.

\$100 WEEKLY Possible! Make show cards, sign painting. Fiocos Co., 2311 Eagle Ave., Alameda, Calif.

COMPLETE Cartoon course with cartoonist's working kit. \$1.00. Cartoon Publishers, West Springfield, Mass.

PEN And ink drawings. Let us draw your advertising and catalogue illustrations, from photos, copies or objects. Best work and fair prices. Heraldic Studios, 1914P Oakdale Avenue, Chicago, Ill.

AMATEUR Cartoonists. Earn cash at home, copying advertising cartoons. Ad-Service, Arkyle, Wis.

ADVERTISING AGENCIES, LETTER WRITERS, FOR ADVERTISERS

ADVERTISE Profitably: \$15 reaches 5,000,000 Sunday newspaper readers with 24-word ad. Newspaper, magazine, mailing-list ratebook, free. Chicago Advertising Agency, 20-PA West Jackson, Chicago.

INCH Thrice. 40 magazines. \$2.00. Gibbs, 502 W. 151, New York.

LEARN Advertising at home. Easy practical plan. No text books. Common school education sufficient. Interesting booklet and requirements free. Page-Davis School of Advertising, 3601 Michigan Avenue, Dept. 3439, Chicago.

MAIL Order—Complete advertising service. Planning, placing, merchandising. Your proposition analyzed. Consultation free. Clyde Smith Advertising Co., Kansas City, Mo.

ADVERTISE: 24 Words, 149 newspapers \$6.50. Lists free. Advertising Bureau, 4515-C Cottage Grove, Chicago.

25 WORDS 50 Magazines 25c. Thrice 50c. Mayer, Swedeborg, Mo.

FREE—New advertisers rate guide. Lowest rates! Midwest Advertising Agency, 491 West State, Columbus, Ohio.

ADVERTISING Placed all magazines, newspapers, radio. Lowest rates. Free service. 54 page rate book free. Baker Advertising Agency, A-189 West Madison, Chicago. Successors to Ankrum. Established 28 years.

FREE—New Advertisers Rate Guide, 44 pages. Includes everything. Lowest rates. E. H. Brown Advertising Agency, 140 S. Dearborn, Chicago.

BUSINESS SERVICE

FREE Samples—Hundreds designs—Gummed picture and business labels, metal signs office forms. Arrowprint, Dept. 5BPM, Waterbury, Connecticut.

HOLLYWOOD Mail address \$1 monthly. Reforwarding daily. Hollywood Mailers, 763 North Seward, Hollywood, Calif.

WASHINGTON, D. C., mail address and reforwarding service. Hawkins, 908 Fourteenth.

YOUR Broadway address. Only \$1.00 monthly. Particulars free. Karavan, 1241 Broadway, New York.

STORES Want to buy items. We will assist you market your product in chain stores. Unlimited opportunities. Send \$1.00 Chain Store Promotions, Box 1243, Muncie, Ind.

MONEY Making, pay raising big catalogue of books free. Send name. Popular Mechanics, 200 E. Ontario, Chicago.

RUBBER STAMPS AND OFFICE SUPPLIES

HANDWRITTEN Signature rubber stamps \$1.00. Artcut, Box 4244, Dallas, Texas.

SUPERIOR. Indexed, cushioned. Two lines. 25c; three 35c; four 50c; signatures \$1.50. Slocum, 814 Bradley, Peoria, Ill.

"RUBBER Engravings." Make cartoons, signatures. Complete outfit \$1.50. Sent postpaid. Janes Service, Quincy, Ill.

CUSHIONED. 2 Lines 25c. 3—35c. Ours are better! Adcrafts, Lacrosse, Wis.

2 LINES 25c. 3—35c. Cushioned. Stamp Works, Centerport, N. Y.

CUSHIONED 3 Lines. 35c. Stamp-Works, Box 402, Youngstown, Ohio.

2 LINES 25c, 3 Lines 35c. Stamp Works, Auburn, Nebr.

TYPEWRITERS, DUPLICATORS, OFFICE DEVICES

THE New "Figurall" adding machines add and subtract fractional dimensions and inches and feet, as well as dollars and cents. Price \$1.65. Write "Figurall," Box 24, Hackensack, N. J.

REMINGTON Portable typewriters, brand new, \$18.00. Taylor, 105 East 102nd Street, New York.

TYPEWRITERS. Adder, mimeograph, multigraph, addressograph. Send for free lists of machines that will help you at half price. Pruitt, 28 Pruitt Bldg., Chicago.

INCREASE Business now. "Excelligraph" Rotary Stencil Printer reprints thousands everything you typewrite, hand-write, draw or trace. Colors. \$19.75 to \$44. Terms. Illustrated literature free to business or professional men. Pittsburgh Typewriter Supply, Department K-2, Pittsburgh, Penna.

NEW \$3.75 Automatic adding machine. Fully guaranteed. Bassett, Box 302-A, Altadena, California.

PRINTING, MULTIGRAPHING, MIMEOGRAPHING, GUMMED LABELS

BOND Envelopes, letterheads, 500 \$1.25, thousand \$1.85. Krueser, 5751 Justine, Chicago.

1,000—3x6 CIRCULARS, 125 Words—\$1.00. Lincoln Sales, Box 32, Irwin, Penna.

500 ENVELOPES, 6³/₄, Sub. 24, \$1.10. Pohle Press, Honesdale, Penna.

\$1.00 POSTPAID, 125 Each, envelopes, 8¹/₂x11 Hammermill letterheads, Orberts, LaFeria, Texas.

\$1.00 FOR 200 Personal letterheads and envelopes. Good bond paper. Luxurious. Roselle, N. J.

8¹/₂x11 LETTERHEADS, 5¹/₂x8¹/₂ Bill-headers, statements, or 6³/₄ envelopes, 300—\$1.00. Benneville, 907 West Roosevelt, Philadelphia.

5000 5¹/₂x8¹/₂ CIRCULARS, Envelopes, post cards, statements, etc. \$5.95. Reed, 115 West 116th, New York.

WE Print anything. Write for samples, prices. Herald, Seymour, Iowa.

LETTERHEADS. Envelopes, statements—low prices. Samples. Colonial, 1617 Beach, Chicago.

\$1.00 EACH—250 Letterheads, envelopes, statements, cards. Stump, South Whitley, Indiana.

5000 250-WORD Circulars, \$3.50. Stationery, folders, booklets, catalogs—all printing—lowest prices. Samples, Good-print, Harrisonburg, Va.

PRINT Anything reasonable. Samples free. Hamilton Press, 4341 North Meade, Chicago.

PRINTED Envelopes \$1.10 M. Letterheads, statements, Maloney Sales, 36 St. Paul, Rochester, N. Y.

BUSINESS Cards \$1.00 1000 postpaid. Superbo Print, 836 Crocker, Los Angeles, Calif.

75 POKER Chips monogrammed in gold. \$1.00. Match packs, other initialed items. Wolf's Head, Glencoe, Illinois.

THOUSAND: Two color shipping labels, 4x2¹/₂—\$1.75; large envelopes—\$2.95; 3x6 circulars—\$1.50; advertising cards—\$2.45. Quantities much cheaper. Okayprint, Martins Ferry, Ohio. Samples.

250 LETTERHEADS, 250 Envelopes prepaid \$2.00. Reliable Print Shop, 901 East Jefferson, Louisville, Ky.

LOOK! Attractive 2-color shipping labels, business cards, \$1.00 thousand. Many other specials, cut prices. Prepaid to fourth zone, half beyond. Free samples. Printed Products, 708-14 Madison, Chicago.

1000 NEAT Business cards \$1.00 postpaid. Taft Co., Box 5366, Chicago.

100 NEAT Personal cards postpaid, 35 cents. Joseph Sandling, 600 West 157th Street, New York.

PRINTED Stationery—200 8¹/₂x11 bond letterheads, 200 6³/₄ envelopes, both \$1.00 postpaid. Franklin Printery, Box 5062, Chicago.

500 STICKERS, Four lines, 2¹/₂x3³/₈, 25c. Outstanding Gazette, Spickard, Missouri.

HAMMERMILL Letterheads, any color paper, ink: 300 8¹/₂x11, \$1.48 postpaid, 30 styles type. Free particulars. Woodruff's, 217A Lewis, Duluth, Minn.

BETTER Grade printing, free trade illustrations. Reasonable. Economic Press, Leonia, N. J.

50 SHEETS, 20 Envelopes, 25c postpaid. Western Stationery, Topeka, Kansas.

500 3⁴/₂x2¹/₄ FOUR Line gummed stickers, 25c. Moritz Printery, Saginaw, Mich.

PRINTING OUTFITS AND SUPPLIES

NEW Type. Reasonably priced. M. R. Landis Co., Richland, Penna.

INEXPENSIVE 6x9 Press. Bargain literature free. Novelty Shop, Downsview, Louisiana.

BARGAINS. Presses, type. List 3c. Exchange, D-15, 222 Columbus, Meriden, Conn.

NEW Type. Specimen sheet, 3c. Type-setters, 218 Sycamore, Greensboro, N. C.

WORLD'S Greatest printing equipment catalog. Send stamp. Bradshaw, 3214-P Huron, Chicago.

HAND Presses, type and complete printers supplies. Send stamp for new 52-page catalog. P. Peiffer & Company, 6 Columbia St., Newark, N. J.

STOCK Cuts to illustrate advertising and printer matter. Catalog free. Cobb Shinn, 721 Union Street, Indianapolis, Ind.

BARGAINS — Presses, type, supplies. Send stamp. 159 Harvard, Cambridge, Mass.

PRINT Your own cards, stationery, circulars, advertising. Save money. Easy rules furnished. Print for others, big profits. Junior outfits \$8.25, senior outfits \$16.55 up. Details free. Kelsey Presses, H-11, Meriden, Conn.

USED Presses, type, supplies. Lists 3c. Turnbaugh Service, Loysville, Penna.

PATENT ATTORNEYS

PATENTS: Inventors, take first step to protect your rights to your invention—without cost. Write today for free "Record of Invention" form and complete instructions for making legal disclosure of invention and establishing date. We also send 48 page free book, "Patent Guide for the Inventor" telling importance of prompt action; how to sell and market your invention; how to make application for patent, examples of successful inventions. Also details of how a patent protects you; our reasonable charges for preparing applications including official drawings and technical specifications; confidential search service to be reasonably certain invention is patentable; prompt service; strict secrecy; plan for you to pay in small payments as application progresses; other facts you want to know about patent protection. Send for free book and Record of Invention form today. See page 19A for further information. Clarence A. O'Brien, Registered Patent Attorney, Dept. OF1B, Adams Building, Washington, D. C.

PATENT Your Idea. Write immediately for two free books, "Patent Protection" and "When and How to Sell an Invention." Fully explain many interesting points to inventors and illustrate important mechanical principles. With books we also send "Evidence of Invention" form. Prompt service, reasonable fees, forty-two years' experience. Avoid risk of delay. Address: Victor J. Evans & Co., Registered Patent Attorneys, 561-G Victor Building, Washington, D. C.

"INVENTOR'S Guidebook," full information about patenting, selling inventions, free. Patent Attorney-Engineer Frank W. Ledermann, 154 Nassau Street, New York.

IT'S Wise to secure patent protection but first be certain that your design or model is practical. Our service to inventors is complete. We guide you safely every step of the way—from creation of idea; development of model; patent protection; manufacturing; distribution. Our large explanatory book is free. Write for yours today. Crescent Tool Co., Dept. PM-1, Cincinnati, Ohio.

INVENTORS—Before disclosing your invention to anyone send for form "Evidence of Conception"; "Schedule of Government and Attorneys' Fees" and instructions. Sent free. Lancaster, Allwine & Rommel, 411 Bowen Building, Washington, D. C.

INVENTORS—Send for free booklet "Patent-Sense." Information based on 64 years experience. Lacey & Lacey, Dept. 5A, 635 F St., Washington, D. C.

PATENTS. Booklet free. Highest references. Best results. Promptness assured. Watson E. Coleman, Patent Lawyer, 724 Ninth St., Washington, D. C.

L. P. RANDOLPH, 302-B Victor Bldg., Washington, D. C. Low cost. Book and information free.

PATENTS—Trade marks. Preliminary advice, book and disclosure form free. Personal service. Irving L. McCathran, 1060 International Bldg., Washington, D. C. Registered Patent Attorney.

PATENTS. Protect your idea by securing free "Proof of Invention" folder. Exceptional personal service. Established 1906. E. E. Vrooman, 871 Woodard Bldg., Washington, D. C.

FOR INVENTORS

INVENTORS—Free list of books on patents. E. S. Daley, 189 W. Madison St., Chicago.

INVENTORS—Time counts. Don't delay. Protect your idea with a patent. Get 48 page Patent Guide free. No charge for preliminary information. Write today. Clarence A. O'Brien, Registered Patent Attorney, OF1A Adams Building, Washington, D. C.

MECHANICAL Problem help. Send sketch or description with dime for examination, estimated charge. Strictly confidential. Mechamo, Box 1585, Amarillo, Texas.

INVENTORS—Need help? Write Zschau Engineering Service, 1952 Humboldt, Chicago.

PROFESSIONAL Draftsman at your service. Box 1A - 45 West 3rd St., New York City.

SONGWRITERS. Authors, inventors! Protect your ideas. Total cost \$2.00. Request free booklet. Evidence Bureau, 1501 Broadway, New York City.

DOLLARS Saved by honest, friendly advice. Gurney & Histed, 118 Vermont, Rochester, N. Y.

SEVERAL New inventions, we recently developed, have been successfully placed by us on the market through department and chain stores. Items manufactured on cooperative basis. Submit your item for free estimate and complete details. Patented or unpatented items handled, proof of disclosure furnished. We also obtain patents through our associated attorney. We construct models and manufacture. Write for "4-Points of Service" bulletin and circulars describing inventions recently completed. R. & S. Engineering Co., Dept. AF-6, 17 East 42nd Street, New York City.

INVENTORS. Do not patent your invention until you are acquainted with some details rarely told in patent counsel. Portfolio sent free. U. S. Drafting Co., Room 3103, 120 Wall Street, New York, N. Y.

INVENTORS—Registered patent engineer offers a complete patent and sales service. Est. 1916. Starck, 332 Wells Building, Milwaukee.

IDEAS Developed. Working drawings. Models. 30 years experience. Keyes Engineering, 3007 Farnam, Davenport, Iowa.

INVENTORS: Profit by your invention. A practical talk to inventors by an experienced manufacturer. Our 68 page booklet "Mind vs. Matter" mailed upon receipt of 25c. Rex Engineering Co., Cincinnati, Ohio, Dept. D.

INVENTING Taught at your home by Trofimov School of Inventive Practice, Hanna Rd., Willoughby, Ohio.

INVENTORS: "Making Inventions Pay" our 32-page illustrated book mailed absolutely free. Crescent Tool Co., Dept. ZS, Cincinnati, Ohio.

SELL Your invention, get results. Write Walter Kreuzer, Edwardsville, Illinois.

WE Locate buyers meritorious patented, unpatented inventions. If will sell, reply immediately. Descriptive booklet, references, free. Invention Reporter, 5A-11236 South Fairfield, Chicago.

CASH For practical ideas and inventions. Stamp appreciated. Mr. Ball, AB-9441 Pleasant, Chicago.

INVENTORS—Send for 72-page book on patents. Reasonable terms. Conscientious treatment to inventors. L. F. Randolph, Registered Patent Attorney, 302-E Victor Bldg., Washington, D. C.

I SELL Patents. Established in 1900. Charles A. Scott, 773PM Garson Ave., Rochester, N. Y.

HAVE You a sound, practical invention for sale, patented or unpatented? If so, write Chartered Institute of American Inventors, Dept. 4-A, Washington, D. C.

INVENTORS. Your ideas may be worth a fortune. Learn without cost what the Camco Institute can do for you. Send for valuable free booklet, "Inventing For Profit." Camco Institute of Invention, Dept. 45, Camco Bldg., Grand Rapids, Mich.

INVENTIONS WANTED

EARN Cash income, inventing toys, games, novelties for special markets. Hendrickson, Argyle, Wis.

MAKE Your inventions pay. We help you. 36 year old firm offers complete services, free estimates. Ample facilities regardless size of invention. Stampings, metal specialties, dies, models, etc. Catalog giving "inside" information free. Crescent Tool Co., Dept. W, Cincinnati, Ohio.

WANTED—Meritorious patented, unpatented inventions. Booklet, references, free. Invention Reporter, 5B11236 South Fairfield, Chicago.

INVENTION Finance Magazine, 80-G Wall Street, New York. Important particulars free.

CASH For inventions—Patented or unpatented. Stamp appreciated. Mr. Ball, A-9441 Pleasant, Chicago.

SMALL Inventions wanted by manufacturers. I'll help you sell your invention. Write for free circular. Stanley Hull, 7829-K Euclid Avenue, Cleveland, Ohio

SIMPLE, Practical inventions wanted by manufacturers, patented or unpatented. For information write Chartered Institute of American Inventors, Dept. 4-D, Washington, D. C.

PATENTS FOR SALE

SAFETY Razor business—\$20,000 possibility. \$600. Harold Motlow, Lynchburg, Tennessee.

PATENTED Electrical device energizes nerves. Grows hair. F. A. Hickernell, Phoenix, Arizona.

SAFETY Razor handle may be turned to various angles. Facilitates shaving. Patent No. 2,150,056 Samuel Ferich, 3664 Georgia St., Gary, Indiana.

MODERN Air brush; all parts completely controlled: spray, speed and needle. Emerson Crumley, 1716 Sanford, Muskegon, Michigan. Patent 2187195.

FOR Sale: Collapsible table, new patent. William V. Bussey, 606 Arlington Ave., Greenville, S. C.

500 INVENTIONS Described with selling plan 10c. Write Patentee System, 9443 Pleasant, Chicago.

PATENTED Portable self-dumping device used inexpensively on vehicles. Andrew Pabian, 3 Franklin St., Somerville, Mass.

MANUFACTURERS: For free information latest inventions your line manufacture, write: Invention Reporter, 5C-11236 So. Fairfield, Chicago.

SELL Your patent through a small classified ad in Popular Mechanics. Many inventors have found buyers in this way. Ask me for proof—I'll gladly send it to you. F. W. Johnson, Manager Classified Advertising, 200 E. Ontario St., Chicago.

MANUFACTURING

MANUFACTURING, Dies, models, brass-work, moulds to order. Special work. Baum's Metal Specialties, Kansas City, Mo.

INVENTIONS Developed and manufactured. Send us your ideas. Model Engineering, Osgood, Indiana.

DIES Stampings, screw machine products, specialties. Porsberg Engineering, Northfield, Ohio.

DIES, Models, stampings, metal products. Hagstrom Manufacturing Company, Kansas City, Missouri.

INVENTIONS — Manufactured in any quantity at low cost by old-established reputable company. No branches anywhere. Stampings, metal specialties, dies, models, etc. Free estimates. Free catalog. Crescent Tool Co., Dept. XS, Cincinnati, Ohio.

MANUFACTURING, Any material, any quantity, inventions developed. Milburn, Burlington, Kentucky.

INVENTIONS Manufactured by an experienced company, in any quantity at low cost. Metal specialties, novelties, stampings, dies, and models. Free estimates. Our booklet "Mind vs. Matter" sent upon receipt of 25c. Rex Engineering Co., Cincinnati, Ohio, Dept. C.

MODELS AND MODEL SUPPLIES

AEROPLANES, Racers, boats, motors. 52 page giant catalog, listing 1500 items, 500 illustrations, only 10c. All-Nation, 1209 P. East 55th, Chicago.

MODEL Supplies for the inventor. Send 3c stamp for catalog. Pierce Model Works, Tinley Park, Ill.

ASSEMBLE Real fifth-horsepower gasoline engine. Completely finished parts kit, with Champion spark plug, coil, gas tank, etc. Formerly \$35.00; now only \$4.95. Twenty minute assembly. Send \$1.00, balance C.O.D. Catalog 6c. G. H. Q., Dept. BB, 40 East 21st St., New York City.

ENGINE Catalogue castings, supplies, 25c. Howardco, A-2417 North Ashland, Chicago.

MODELS—36 Years successful experience developing ideas into practical working models. Thousands of satisfied customers. Your idea may be worth big money. Confidential, reputable service guaranteed. Bank references. Write for free booklet, "Making Inventions Pay." Crescent Tool Co., Dept. Y-S, Cincinnati, Ohio.

STEAM Locomotives! $\frac{3}{4}$ " scale. Build one by "Easy Steps." Our illustrated catalog lists all needs. 25c. Little Engines, Box 15B, Wilmington, Calif.

SUBMARINE—Beautiful 15" model—kit 35c postpaid. Spotts Models, 3925 N. Broad, Philadelphia, Penna.

CARVED Hull ship model kits. Ship and yacht model fittings; model yacht sails. Illustrated catalog 20c. A. J. Fisher, 1002-M Etowah Ave., Royal Oak, Mich.

MODELS—Practical models put over your ideas. We develop models from the crude to perfect working devices. Your idea might have large commercial value. Services confidential. Bank references. Registered graduate engineers at your service. Send 25c for our 68 page booklet "Mind vs. Matter." Rex Engineering Co., Cincinnati, Ohio, Dept. B.

STEAM Locomotives, 1/4" scale. Send 10c for descriptive folder. Little Engines, Box 15B, Wilmington, Calif.

BLUEPRINTS AND PLANS

RADIO Diathermy. A new and profitable field. The therapy that uses radio principles. Complete constructional plans, blueprint and photographs \$1.00. Order from this ad. Infograph Company, Box 328, Camden, N. J.

HOME CRAFTSMEN

COPY Wooden ornaments from favorite drawings. Comics, animals, anything easily copied to desired size. Anybody can do it. Simple instructions \$1.00. Bob Tillman, 216 East Duffy St., Savannah, Ga.

GET Free leathercraft instruction pamphlets, prices of leathers, tools, projects. Make extra money. Beautiful gifts. Leather samples 5c. Wilder & Company, 1038 Crosby, Dept. 6F, Chicago, Illinois.

80 PATTERNS, 20 Lawn ornaments, 20 silhouette, 20 novelties, 20 lawn ornaments, 30c each set, all for \$1.00. Modern Woodcraft, Saginaw, Mich.

LAWN Ornaments—easy to make, 20 full size patterns, birds, animals, etc., 25c; Dutch boy, Dutch girl, sprinkling girl, fox terrier, Scotties, bulldog, 15c each, any two 25c; Dutch windmill, 36 inches high, 25c. Entire collection, 27 patterns, \$1.00 postpaid. Wickman Co., Dept. 130, Dayton, Ohio.

TWELVE Actual samples of inlay strips, 25c or 25 for 50c. Price list of rare woods and veneers included. Screen-Inlay Mfg. Co., Flint, Mich.

22 LAWN Ornament patterns 25c. Other patterns: 15"-20" high; Dutch girl, Dutch boy, pirate, bull terrier, Mexican girl, Mexican boy, dwarf, penguin, flower girl, 10c each; 3 for 25c. 25 novelty patterns 30c. All 56 full size patterns \$1.00 postpaid. Strother, Box 383-BE, Belington, West Virginia.

VENETIAN Blind supplies. Catalogue 15c. New York Venetian Blind Mfrs., 12 West 18 Street, New York City.

HUNDREDS Patterns—Plans. Projects for camp, garden, lawn, home. Plywood novelties, silhouettes, bird houses, miniature aircraft, action toys, wood turning, whittling, wood puzzles, decorative stenciling. Water transfer decorations. New catalog superbly illustrated. Wo-Met Shop, Ashburn, Georgia.

BIRDHOUSE Patterns, full-size; original, different, houses built from orange crate material, complete directions; wren, bluebird, swallow, robin, martin, 25c each, 12 different styles for \$1.00. Brule Manufacturing Company, 515 - 22nd Avenue East, Superior, Wisconsin.

LUMBER, Direct from sawmill to you. Maple 2x2-18, bundle of 24, \$1.25. Free catalog. Harris Sawmill, Boaz, Wis.

DOOR Chime kits; easily assembled, all materials, full instructions. Excellent wedding gifts. 4 tube, 8 notes, \$12.00; 3 tube, 6 notes, \$10.00. Seidel, 406 W. Airy, Norristown, Penna.

VENETIAN Blinds, supplies, machinery, wholesale. Catalog 10c. "Roberta," Box 260, Gloversville, New York. Manufacturing booklet \$1.00.

MEXICAN Wood novelties easily made! 20 Mexican patterns and instructions 30c. 20 cowboy silhouette patterns 30c. 10 lawn ornament patterns 15c. Mexican Arts, Crafts, Eagle Pass, Texas.

MAKE Your own work benches, tables and machine stands with steel angle legs. Detailed drawings and specifications 50c. W. P. Estes, 1228 N. Tyler Ave., Dallas, Texas.

OLD GOLD, WATCHES, JEWELRY, PRECIOUS STONES

WATCHMAKERS' Tools, supplies. Watch parts. Lowest prices. Write for price list 43. Dean Company, 87 Nassau St., New York.

WATCHES—Hamilton, Elgin, Waltham, Bulova start at \$2.95. Send for free illustrated wholesale catalog. Quaker City Jewelry Company, Eighth and Walnut Sts., Philadelphia, Penna. Dept. "S."

BULOVA, Gruen, Hamilton, Elgin, Waltham wrist and pocket watches for ladies and gents. Positively lowest wholesale prices. 1941 styles now available. Write for free money making wholesale catalogue. Norman Rosen, Wholesale Jeweler, Dept. P.M., 801 Sansom Street, Philadelphia, Penna.

ELGIN-WALTHAM Watches from \$3.50. Make big money. Send for free illustrated jewelry catalog. Plymouth Jewelry Exchange, 163-M Canal St., New York.

FOSSIL Woods and gem stones, three pounds rough, \$1.25 postpaid. Jay Ransom, Aberdeen, Wash.

WATCHMAKERS' Materials—Tools, watches, jewelry. Bought, sold, exchanged. Wholesale catalogue. Ben Segal Company, 5 South Wabash, Chicago.

5000 REBUILT Watches! Free catalogue—Diamonds, jewelry, (3c postage). The New York Jobbers, 74 Bowery, Dept. M, New York, N. Y.

AUSTRALIA'S Lovely opals. Illustrated catalogue free. Good selection \$5.00. Norman Seward, Melbourne, Australia.

HIGHEST Prices for old gold—Mail your teeth, watches, jewelry, 100% full cash value mailed day shipment received. Satisfaction guaranteed or articles cheerfully returned. Information free. Chicago Gold Smelting Company, 300-P Champlain Building, Chicago.

GOLD \$35 Ounce. Ship old gold teeth, crowns, jewelry, watches—receive cash by return mail. Satisfaction guaranteed. Free information. Dr. Weisberg's Gold Refining Co., 1500-Q Hennepin, Minneapolis, Minn.

TOBACCO

GUARANTEED: Cigarette, pipe or chewing 5 lbs. \$1.00, ten, \$1.75. Pay when received. Pipe and box cigars free. Rives Tobacco Co., Paducah, Ky.

SPECIAL Offer: Five pounds our finest smoking tobacco \$1.00 postpaid. Good Tobacco Company, Paris, Tenn.

SURVEYING INSTRUMENTS

GUARANTEED Factory rebuilt transits and levels for rent (with purchase option) or sale (cash or terms). Order now before prices advance. We will repair, trade in, or buy your old instruments. Ship prepaid for estimate and valuation. Write for List M-56 and complete information to Warren-Knight Co., 136 N. 12th St., Philadelphia, Penna.

FOR SALE—MISCELLANEOUS

RECLAIMED Army goods bargains new and used merchandise. Pants 50c, army shirts 35c. Free catalogue. Atlantic Sales, 6A Suffolk, New York City.

WANTED—MISCELLANEOUS

CASH For used microscopes, binoculars, slide rules, drawing sets, scientific instruments, tools, cameras. Satisfaction guaranteed or shipment returned. Elman's, 2302 VanBuren, Chicago.

QUICKSILVER (Mercury), 90c pound paid. Any quantity. Wholesale Terminal, Norwood, Massachusetts.

PERSONAL

NERVOUSNESS, Nervous fears! Afflicted? Discouraged? Free, inspiring information. Write! John Englund, Box 335, Ironwood, Mich.

TREASURE Finders? Read Goldak advertisement on page 132A.

OVERCOME Eye-weakness, astigmatism, nearsightedness without glasses. Complete course \$1.00. Satisfaction guaranteed. Eyesight Improvement, Box 193, Hamilton, Ohio.

WIN Prize money! Booklet—"Successful Contesting"—shows how. 10c postpaid. Bulletin listing \$100,000.00 prizes included. World Publishers, 4515-B Cottage Grove, Chicago.

POSITIONS Abroad—A survey of world conditions as related to Americans seeking foreign jobs. If interested write Julius, Amarillo, Texas.

HAY-FEVER Victims get quick continuous relief without medicine. New inconspicuous nasal filter ends sneezing. Relieves irritation. Send 3c stamp for proof. H. E. Clarke Co., 363 Northeast 76th St., Miami, Florida.

PERSONALIZED Buying service gives tremendous savings to smart buyers. Jewelry, watches, clocks, electrical appliances, radios, sporting goods, etc., at wholesale savings up to 50%. What do you need? Special confidential price list now ready. Harry Sault, 5722 Warrington Ave., Philadelphia, Penna.

PERSONALITY Plus learn "the simple and amazing secret of being clever and witty." Sent postpaid for \$1.00. Department M, 26 Howard Street, E. Braintree, Mass.

MISCELLANEOUS

ENJOY A real sport. New gun kills flies quick as a flash. Fun galore for everybody. Practical, safe. Nothing to load or furnish. Won't scratch furniture or hurt anyone. Steel constructed, pistol grip, 10 inches long. Only one of its kind, free circular. Kahler Fly Gun, St. C. Kankakee, Ill.

SAG-PROOF Trams \$3.50. For designers, draftsmen, engineers. Box 13, Station I, Cincinnati, Ohio.

MAKE Your own calfskin belt. Kit 50c. Florest, 612 N. Spaulding, Chicago.

STANDARD Electric lamp insect killer, \$2.00 up. Literature free. Sauer Bros., San Leandro, Calif.

SEND Favorite photograph and \$1.00 for enlarged portrait drawing. Parker Studio, 3607 Oxford, Maplewood, Mo.

LEARN About milk goats. For free literature and sample magazine, address: Goat World, Vincennes, Indiana.

MAIL Order business course shows you how to make money, spare or fulltime. Teaches professional mail order technique—not penny-catching schemes. Free details. Nelson Company, 408-F Manhattan Building, Chicago.

RATTLESNAKE Xray and catalog describing leather, oil, rattles, biologicals, free. Headquarters, Rattlesnake, Florida.

TATTOOING And engraving machines. Finest chrome plated. Illustrated list. Jensen, 412 South Main Street, Los Angeles.

RECEIVE Gigantic mails, magazines. Your name in numerous mailing lists 10c. Albert Howard, 396 Broadway, New York.

TREASURE Finders? Read Goldak advertisement on page 132A.

"LET'S Keep our driving readable." The millions club, join now. 143 Jones St., West Haven, Conn.

EYE Glasses—Save 50%. Lenses duplicated—\$1.49; attractive frames—\$1.98. Prescriptions filled. Catalog free. Money-back guarantee. Hays Optical Co., 906-F, Grand, Kansas City, Mo.

KONSTANT, Speedy shaving comfort. Double blade often lasts year with amazing, guaranteed! "Abrasive-stropper," 250,000 delighted. Special \$2.97 postpaid. Bank reference brings tryout. "Bello," Gardner, Mass. (County distributorship available.)

COCOONS, Butterflies, collectors' supplies, free lists. Maynard, 1192 Lewiston, Rochester, N. Y.

GOOD Eyesight without glasses. Use my inexpensive home treatment. Eyestrain quickly vanishes. No drugs. A. Jacobson, Upsala, Minnesota.

TATTOOING Made easy! We furnish outfits, colors, designs, tattoo removers, complete instructions. Free literature. Tatuco, 651 South State, Chicago.

MEXICAN Jumping beans. The best curiosity in the world. Joaquin Hernandez, Exporter, Alamos, Sonora, Mexico.

NATIONWIDE Opportunities 25c year! "B. & B.," 228 East 45th, San Bernardino, California.

RECLEAN Used oil, without cost. Particulars, F. Gerwin, Fairview, Okla.

COATS Of arms and crests, correctly painted in colors or black and white, from heraldic description or furnished copy, \$10.00 and up. Highest grade work. Heraldic Studios, 1914P Oakdale Avenue, Chicago, Ill.

TATTOOING Outfits, supplies, illustrated list free. Percy Waters, Anniston, Alabama.

SWAPPER'S Friend, R4, Saline, Michigan. Interests swappers, collectors. 50c year, sample 10c.

LIQUID Soap, suitable every purpose, very economical. \$1.23 gallon. Ellar, 190 Wadsworth Avenue, New York.

MOTOR Oil free—reclaim used oil by original costless method, complete instructions \$1.00. Technical Laboratories, East Haven, Conn.

I WANT To send you proof of the wonderful pulling power of Popular Mechanics Magazine's classified pages. What's your proposition? Write me today. F. W. Johnson, Manager Classified Advertising, 200 E. Ontario St., Chicago, Ill.

FACTORY-TO-YOU SAVES YOU UP TO 50%

EASY TERMS



PUT THIS NEW
14 TUBE

CHASSIS IN
YOUR PRESENT
CABINET

only
\$19.95
COMPLETE

30
DAYS
TRIAL

FOREIGN
RECEPTION

Other models from 5 to 17 Tubes,
and up to 5 Wave Bands.

Write for FREE 1940 catalog,
showing complete line. (User-agents
make extra money!) See MIDWEST'S Answer to TRADE-INS!

MIDWEST RADIO CORPORATION

Dept. 15-N

Cincinnati, Ohio

Learn
To

MOUNT BIRDS

Tan SKINS, Make Up FURS

Be a Taxidermist. Double your hunting fun. We teach you at Home. Mount Birds, Animals, Pets, Heads and Fish. Save your hunting trophies; decorate home and den. **MAKE MONEY.** Mount and Krome-tan for others. Big sparetime profits. **INVESTIGATE TODAY.**

FREE BOOK with 100 game pictures, 48 pages.

Hunters, get yours! It's Now Free—send postal card TODAY—This Minute! State your AGE. NORTHWESTERN SCHOOL OF TAXIDERMISTRY: Dept. 337A, Omaha, Nebr.



PLAY THE REAL HAWAIIAN WAY



PLAY LIKE THE REAL HAWAIIANS
HAWAIIAN GUITAR—Learn right in your own home. EASY, SHORT-CUT METHOD. No tiresome practicing, all melody. **LEARN TO PLAY BY PLAYING.** Win friends and popularity. Get "on the air". Make money. Hundreds of our students now successful in orchestras, radio and teaching. You can do the same. **BIG ILLUSTRATED BOOKLET** "Learn to Play the Hawaiian Way" tells all about this easy, fascinating way. Write today. Enclose 10c to cover mailing.
OAHU SCHOOL OF MUSIC
1806 Film Bldg. Cleveland, Ohio

RADIO

ENGINEERING, broadcasting, aviation and police radio, servicing, marine and Morse telegraphy taught thoroughly. 48 weeks' engineering course equivalent to three years' college radio work. School established 1874. All expenses low. Catalog free.

Dodge's Institute, Ada St., Valparaiso, Ind.

\$5, \$10, \$15 FOR ONE DRAWING

LEARN TO DRAW

Train for a profitable, fascinating career in **COMMERCIAL ART, ILLUSTRATING, CARTOONING**—at home in your spare time. Trained artists are capable of earning \$30, \$50, \$75 weekly. No previous Art experience necessary—we teach from the beginning. Our practical method has been famous since 1914. Write for catalog—"Art for Pleasure & Profit," describes method of our training and the **TWO BIG ART OUTFITS** included with course.

FREE BOOK gives details!

**Washington School of Art, Studio 126P
1115—15th St., N. W., Washington, D. C.**

Yes! I am interested in learning to draw. Please send me your catalog, "Art for Pleasure and Profit."

Name..... Age.....
Address.....
City..... State.....



The I. C. S. student
**STANDS
OUT!**



• Read this letter recently received by the International Correspondence Schools:

"In our organization it is easy to pick out the men who have been trained by the I. C. S. In fact, our Manager and Vice-President, Steel Shop Foreman, Chief Engineer, Foundry Foreman, and Machine Shop Foreman are all products of your Schools, and rank high in their fields.

"I unhesitatingly commend your training to any one who has in mind advancing in his work.

JAMES H. MILLER, Pres.
Inter-State Foundry and Machine Co.
Johnson City, Tenn."

The time to start preparing yourself for the future is **RIGHT NOW!** And the **WAY** to start is to clip this coupon —and mail it—**TODAY!**

INTERNATIONAL CORRESPONDENCE SCHOOLS

BOX 5580-J, SCRANTON, PENNA.

Explain fully about your course marked X:

TECHNICAL AND INDUSTRIAL COURSES

- | | | |
|--|--|--|
| <input type="checkbox"/> Agriculture | <input type="checkbox"/> Air Brake | <input type="checkbox"/> Managing Men at Work |
| <input type="checkbox"/> Air Conditioning | <input type="checkbox"/> Architectural Drafting | <input type="checkbox"/> Manufacture of Pulp and Paper |
| <input type="checkbox"/> Architecture | <input type="checkbox"/> Auto Engine Tune-up | <input type="checkbox"/> Marine Engines |
| <input type="checkbox"/> Auto Technician | <input type="checkbox"/> Auto Technician | <input type="checkbox"/> Mechanical Engineering |
| <input type="checkbox"/> Boilermaking | <input type="checkbox"/> Bridge Engineering | <input type="checkbox"/> Navigation |
| <input type="checkbox"/> Building Estimating | <input type="checkbox"/> Civil Engineering | <input type="checkbox"/> Patternmaking |
| <input type="checkbox"/> Civil Engineering | <input type="checkbox"/> Concrete Engineering | <input type="checkbox"/> Pharmacy |
| <input type="checkbox"/> Coal Mining | <input type="checkbox"/> Contracting and Building | <input type="checkbox"/> Plumbing |
| <input type="checkbox"/> Chemistry | <input type="checkbox"/> Cotton Manufacturing | <input type="checkbox"/> Practical Telephony |
| <input type="checkbox"/> Coal Mining | <input type="checkbox"/> Diesel Engines | <input type="checkbox"/> Poultry Farming |
| <input type="checkbox"/> Coal Mining | <input type="checkbox"/> Electrical Engineering | <input type="checkbox"/> Public Works Engineering |
| <input type="checkbox"/> Coal Mining | <input type="checkbox"/> Electric Lighting | <input type="checkbox"/> Radio Operating |
| <input type="checkbox"/> Coal Mining | <input type="checkbox"/> Foundry Practice | <input type="checkbox"/> Radio Servicing |
| <input type="checkbox"/> Coal Mining | <input type="checkbox"/> Fruit Growing | <input type="checkbox"/> R. R. Section Foreman |
| <input type="checkbox"/> Coal Mining | <input type="checkbox"/> Heat Treatment of Metals | <input type="checkbox"/> R. R. Signalmen |
| <input type="checkbox"/> Coal Mining | <input type="checkbox"/> Highway Engineering | <input type="checkbox"/> Refrigeration |
| <input type="checkbox"/> Coal Mining | <input type="checkbox"/> Locomotive Engineer | <input type="checkbox"/> Sheet Metal Work |
| <input type="checkbox"/> Coal Mining | <input type="checkbox"/> Management of Inventions | <input type="checkbox"/> Steam Electric |
| <input type="checkbox"/> Coal Mining | <input type="checkbox"/> Machinist | <input type="checkbox"/> Steam Engines |
| <input type="checkbox"/> Coal Mining | <input type="checkbox"/> Welding, Electric and Gas | <input type="checkbox"/> Structural Drafting |

BUSINESS COURSES

- | | | |
|--|---|---|
| <input type="checkbox"/> Advertising | <input type="checkbox"/> Bookkeeping | <input type="checkbox"/> Grade School |
| <input type="checkbox"/> Business Correspondence | <input type="checkbox"/> Business Management | <input type="checkbox"/> High School |
| <input type="checkbox"/> Cartooning | <input type="checkbox"/> Civil Service | <input type="checkbox"/> Illustrating |
| <input type="checkbox"/> College | <input type="checkbox"/> Cost Accounting | <input type="checkbox"/> Lettering Show Cards |
| <input type="checkbox"/> College Preparatory | <input type="checkbox"/> Commercial | <input type="checkbox"/> Railway Postal Clerk |
| <input type="checkbox"/> Foremanship | <input type="checkbox"/> C. P. Accounting | <input type="checkbox"/> Salesmanship |
| <input type="checkbox"/> French | <input type="checkbox"/> Spanish | <input type="checkbox"/> Secretarial |
| <input type="checkbox"/> Sign Lettering | <input type="checkbox"/> Service Station Salesm'n | <input type="checkbox"/> Sign Lettering |

DOMESTIC SCIENCE COURSES

- | | | |
|---|--|--|
| <input type="checkbox"/> Advanced Dressmaking | <input type="checkbox"/> Foods and Cookery | <input type="checkbox"/> Professional Dressmaking and Designing |
| <input type="checkbox"/> Home Dressmaking | <input type="checkbox"/> Home Dressmaking | <input type="checkbox"/> Tea Room and Cafeteria Management, Catering |

Name..... Age.....

Address.....

City..... State.....

Present Position.....

Canadian residents send coupon to the International Correspondence Schools Canadian, Limited, Montreal, Canada. British residents send coupon to I. C. S., 71 Kingsway, London, W. C. 2, England

OL' JUDGE ROBBINS



AT A FIESTA IN THE SOUTHWEST



HO! HO! JUDGE, LOOK AT THE CAKE IN THIS PIPE — YOU COULDN'T HARDLY GET A PENCIL IN IT

WELL, I'M JUST TRYIN' TO GET MY PIPE TO SMOKE COOL



LET ME DIG THAT PIPE OUT FOR YOU — I'D LIKE TO SHOW YOU SOMETHING

B-B-BUT, JUDGE, IT TOOK ME MONTHS TO GET THAT CAKE



NOW—THERE WE ARE — IT'S ALL LOADED AND READY FOR YOU TO TRY

AT LAST SOME ONE IS GETTING JOE TO TRY PRINCE ALBERT, THE COOL-BURNING TOBACCO

IN RECENT LABORATORY "SMOKING BOWL" TESTS, PRINCE ALBERT BURNED

86 DEGREES COOLER

THAN THE AVERAGE OF THE 30 OTHER OF THE LARGEST-SELLING BRANDS TESTED — *COOLEST OF ALL!*

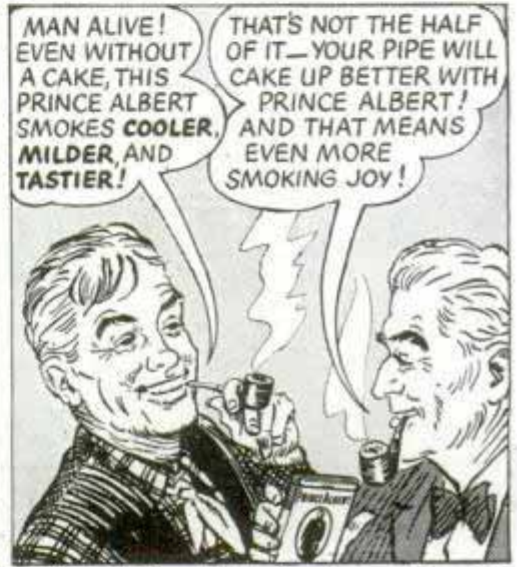

MAN ALIVE! EVEN WITHOUT A CAKE, THIS PRINCE ALBERT SMOKES COOLER, MILD, AND TASTIER!

THAT'S NOT THE HALF OF IT — YOUR PIPE WILL CAKE UP BETTER WITH PRINCE ALBERT! AND THAT MEANS EVEN MORE SMOKING JOY!

PUFF YOUR WAY IN

Copyright, 1940, R. J. Reynolds Tob. Co., Winston-Salem, N. C.

PRINCE ALBERT IS THE TOBACCO I USED TO DREAM ABOUT—**COOLER-BURNING, EASIER ON THE TONGUE — REALLY FRAGRANT**

YOU DON'T HAVE TO RELIGHT P.A. EVERY MINUTE. IT **STAYS LIT BETTER, BURNS EVEN, AND DRAWS LIKE A CHARM!**

ONE TWIRL PUTS PRINCE ALBERT OVER FOR 'MAKIN'S' SMOKES TOO—**FAST AND EASY FOR FIRM, STREAM-LINED ROLLED SMOKES**

TO THE CIRCLE OF **SMOKING Joy!**



50 pipefuls of fragrant tobacco in every handy pocket tin of Prince Albert

PRINCE ALBERT
THE NATIONAL JOY SMOKE

Popular Mechanics Magazine

REGISTERED IN U. S. PATENT OFFICE AND CANADA

WRITTEN SO YOU CAN UNDERSTAND IT

Vol. 73

JUNE, 1940

No. 6

NEW WONDERS of AGRICULTURE

R245
see Dec. 1940
834

RAISING crops for the factory instead of for human consumption is slowly altering the agricultural picture in the United States, and the time may come when industry will consume more food than is eaten by the population.

The steering wheel of your automobile may have been grown in a field, your fountain pen may have been planted, cultivated and harvested as a crop, and the cabinet of your radio set may have been raised from seed. These and a thousand and one other useful objects, products of the new plastics industry, are proc-

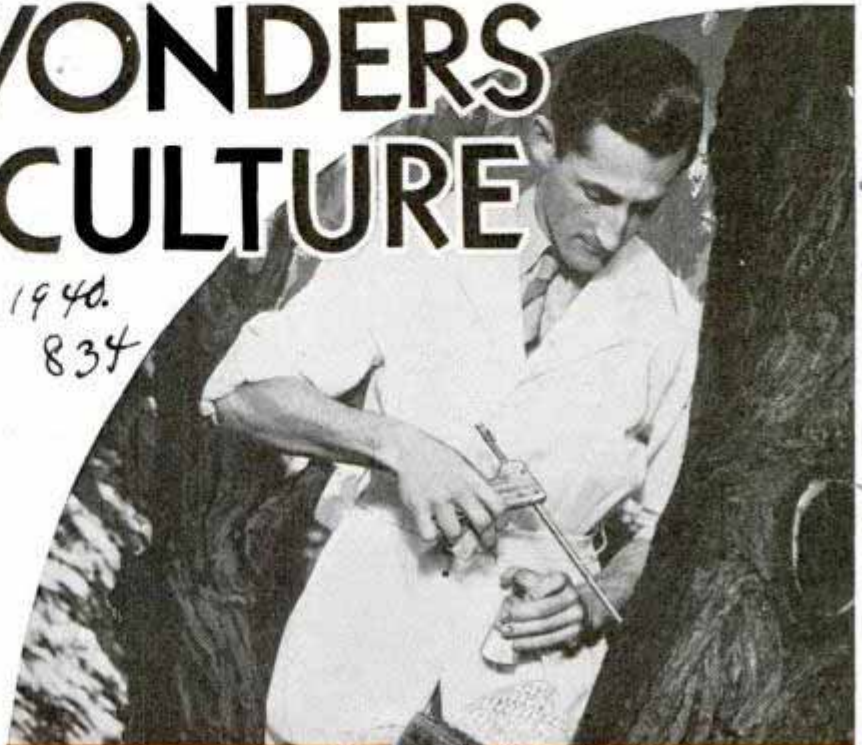

Left, orange-tree roots are studied in glass-walled tank as minerals are added to soil. Top, injecting minerals into tree to supply soil deficiency; below, cellulose acetate handbag

JUNE, 1940

non-food uses.

Dept. of Agriculture

801

Cent. Thomas G. Stinson, Jr. Pacific

K 245

Quinter & Bashard Corona Calif.

Shadden Co. Producers Soybean Beans

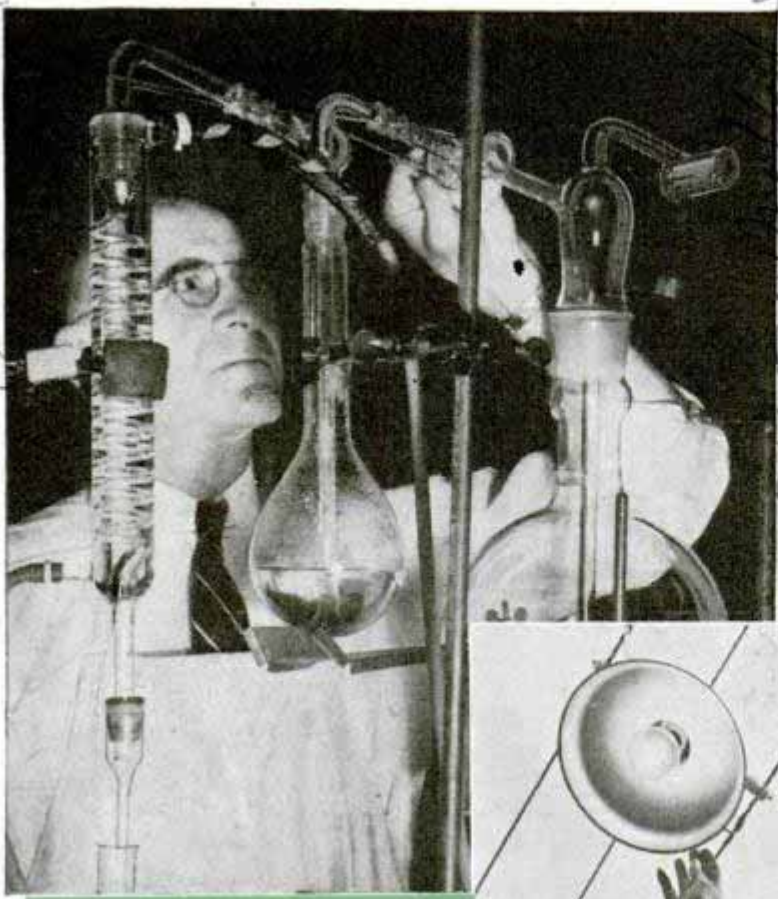

article that does not or could not use a product of corn in its manufacture. Five and a half pounds of material used in the manufacture of plastics are available in every bushel of corn. *Chem*

Clothing from casein that is procured from skim milk is manufactured in Europe by a process resembling the conversion of wood into rayon. Lignin obtained from wood is a new cover material for metal objects. Power alcohol is being distilled from farm wastes and eventually may consume large portions of corn and grain crops.

The versatile soybean that you can eat or mold into doorknobs is also being made to pose for the whites of eggs, a material in demand for candies and desserts. Petroleum ether is added to soybean flour to remove the fats, hydrochloric acid is used to remove material that gives a bitter taste, and the resulting powder is an ideal synthetic egg white.

Under a new process

essed from material extracted from vegetable fiber.

The walls of your room may have had their start as sugar cane on a Cuban plantation. The paper of your cigarette is probably made of flax straw and the chances are that its tobacco was cured with the help of a corn product.

What has been happening to corn is just one example of the possibilities that chemists foresee for numerous other farm products. Corn on the cob and corn in the can almost seem to be by-products now that cornstarch is used in the textile, paper and laundry industries, corn syrup is used in the rayon, tanning, and tobacco curing industries, and corn dextrans go into the manufacture of ink, mucilage, explosives and plywood glues.

Yeast, dusting powder, coloring matter, paper, glycerin, carbon dioxide, wallboard and twine are other present or potential corn products. One concern boasts that it would be difficult to name an



Top, distillation apparatus for measuring fumigant absorbed by citrus tree to prevent damage by overfumigation. Center, infrared lamp wards off frost damage in orchard. Bottom, working design in cellulose acetate panel made from vegetable fiber

carding. Catal. Mendolal. Catal. 150. Please. Smedlaw.

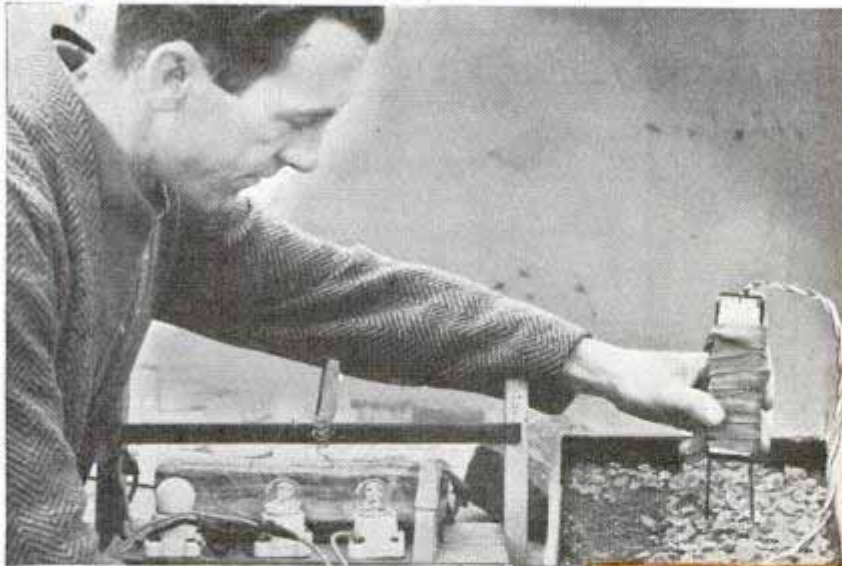

see May 1939
 surplus coffee crops may be converted into a plastic material and pressed into objects ranging from coffee cups to tables, with the extracted coffee oil finding a place in cosmetics manufacture. Oil extracted from grapes is now an ingredient in some soaps and lubricants. Medicines are being processed from orange by-products. Glycerol from animal fats is used in anti-freeze solutions and in dynamite.
 Rapid as is the pace at which new uses are being



Upper left, testing salinity of soil with electrodes; right, plastic lamp stand made from vegetable fiber. Center, studying nutritional needs of cabbage by adding minerals to distilled water. Bottom, plastic articles made of cellulose derived from agricultural products

found for agricultural products, the chemists haven't been able to keep up with the farmers. Overproduction and surplus crops have been the despair of agriculturists for years and so far the farmer has raised more tonnage than industry can use. Every time industry finds new uses for farm products

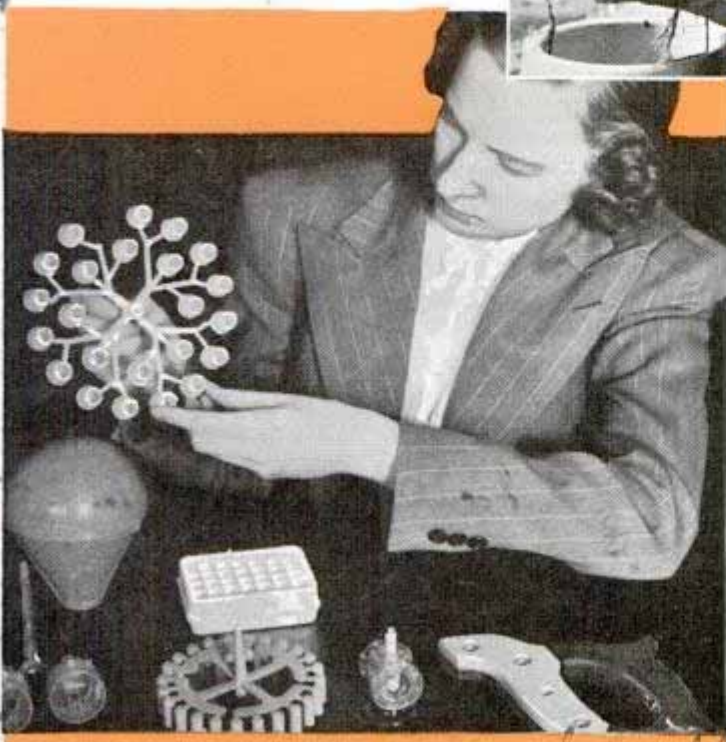

and thus helps solve overproduction, new discoveries in plant breeding or pest control seem to increase the size of harvests.

Farmers might be able to earn better livings if they lost this race to the chemists. To help them lose, the Department of Agriculture is opening four experiment stations devoted to seeking new non-food uses for crops. New clothing materials, building materials, insulating materials, and plastics are probable results that the experiment stations will achieve.

At the same time that science has been hunting non-food uses for the products of agriculture it has been learning a lot of new things about the food value of things to eat. Fresh vegetables from one garden,

(Continued to page 147A)

see handle
see comb
John E. Bacon 803

Gomes & Laughlin
Steel Corp

Curtiss - Wright
Technical Institute

Lightweight Metal Stairway Welded from Steel Channels

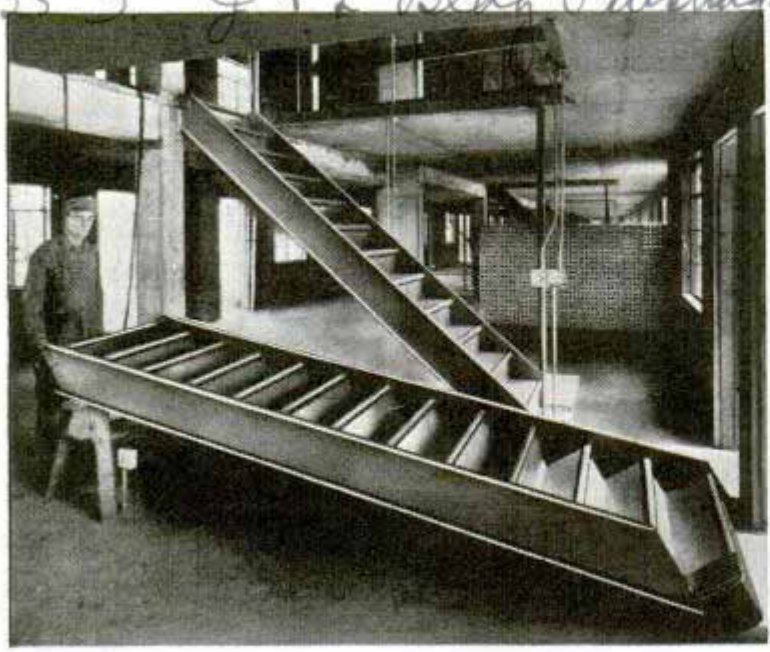

All-welded stairways made of hot rolled-steel channel sections are assembled at factory and ready for immediate installation

All-metal stairways, assembled at the factory, are delivered ready for installation in residences, apartments, housing projects or other buildings where they will require only light use. They are made of ten-inch hot rolled-steel channels, forming neat and rigid stairs that weigh only six and one-half pounds to the foot.

K 350 Landing Gear in Army Air School Shows How It Works on Plane

To show the future mechanics of the U. S. army air corps what makes a bomber's landing gear "tick," a full-sized hydraulic gear has been installed

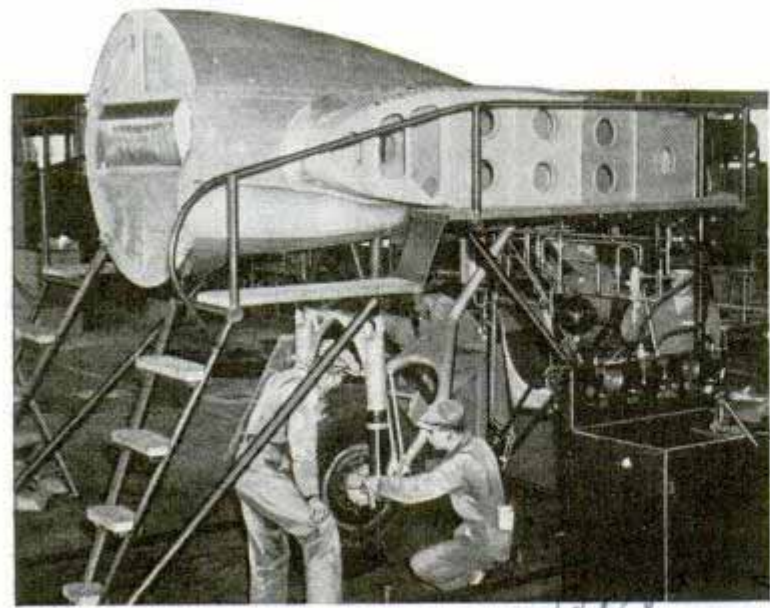

Students at school for army air corps mechanics take apart and reassemble full-size hydraulic landing gear of a big plane

in the ground school at Glendale, Calif. Mounted on a special framework which permits it to operate as if on a plane, the mechanism can be studied. Toward the close of the course, it is dismantled and reassembled by students.

K 361 Small Flash-Bulb Reflector Slips into Coat Pocket

So small that it can be carried conveniently in the photographer's pocket or camera accessory kit, a featherweight reflector now on the market is designed especially to accommodate the new Mighty Midget flash bulb. Made of spun aluminum, it is only five inches in diameter; but despite its limited surface it is claimed that



Ready to "shoot" picture with flash bulb in new five-inch aluminum reflector

the reflector greatly increases the illuminating power of the tiny flash bulb. This is made possible by using every bit of available light, all the rays being directed in a straight line. The new reflector is adaptable to any flash gun.

Deciding on a limit of forty pounds of paint per plane, an aircraft manufacturer started research that developed a one-coat lacquer weighing only fifteen pounds per plane and added five miles an hour to its air speed.

James L. Walsh
New York Times 5/10/40
Escholden Co. 11, 100 Escholden Co. Ireland
Stuart Studios 729 Wabash

R 311. Cont. Allen Warren Alexander
120 E. 34th Street New York City

Welder Sculptures Tiny Figures with a Torch

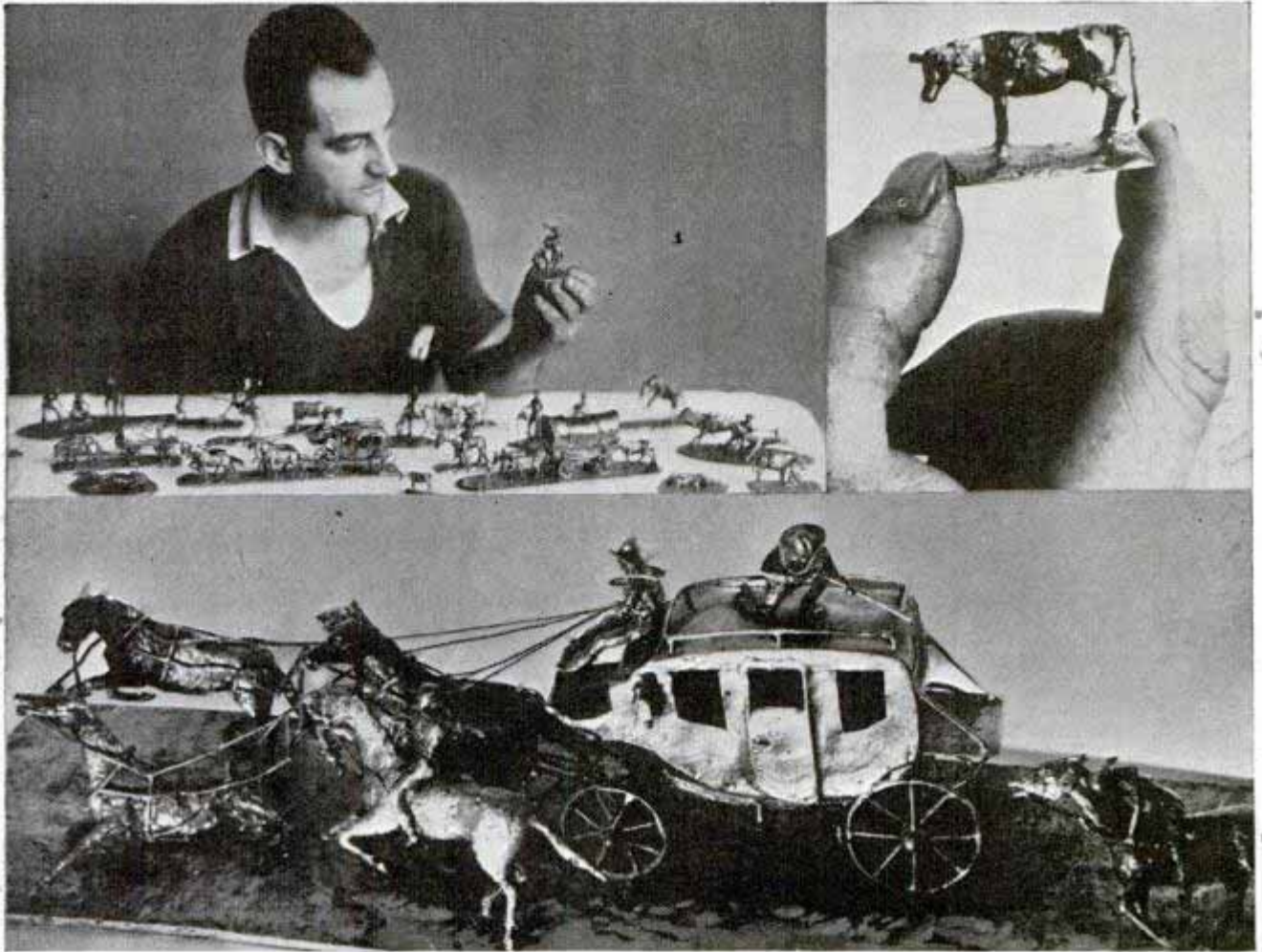

In ten years Floyd Nichols of David City, Neb., has welded just twenty-three miniature statues, shown above at left. At the right is the smallest, a steel and bronze cattle figure an inch long representing weeks of work. Below, "Stagecoach Attack," the most elaborate group, three inches high and made of 410 pieces, various metals being used for color contrast

As a boy, Floyd F. Nichols played sculptor with mud from the bank of a creek. He graduated from farm boy to cowhand, then repairman in a David City, Neb., auto and farm tool shop. There he began sculpturing tiny figures with a blowtorch. It was painstaking, painfully slow work shaping miniature cowboys, broncos, bits of the old west from droplets of steel, nickel, gold, bronze or copper under the heat of an acetylene flame. After ten years he had completed twenty-three miniature pieces worthy of exhibiting in a New York art gallery. The smallest, an inch-long steel and bronze cattle figure, took weeks to

shape. The largest, in which many different metals were used for color contrast, is a miniature stagecoach with four horses, one of them struck down by an arrow, and a cowboy on the roof firing at a pursuing Indian; three inches high, this group includes 410 pieces of metal. Mr. Nichols thus far has refused to sell any of his welded statuettes, although offered \$1,000 for one. Percy D. Cowan, director of Temple's Exhibition Galleries in New York, where the work was shown, said the Nebraskan had created "a new phase of art, typically American." Nichols uses a torch temperature of 1,600 to 2,600 degrees.

Atom Smasher Discovers Substance Believed to Be Missing Element

What appears to be one of the two substances still missing from the table of elements was discovered with the help of the atom-smashing cyclotron at University of California. It would fit into space number

eighty-five, being related to iodine, chlorine, bromine and fluorine, and has been tentatively called eka-iodine. To complete the list of ninety-two, element number sixty-one remains to be discovered.

K 121.
**Facsimile Unit in Airplane
 Sends Map by Radio**

*Telecommunications Laboratories,
 Chm. 1819, Broadway
 New York City
 Finch*

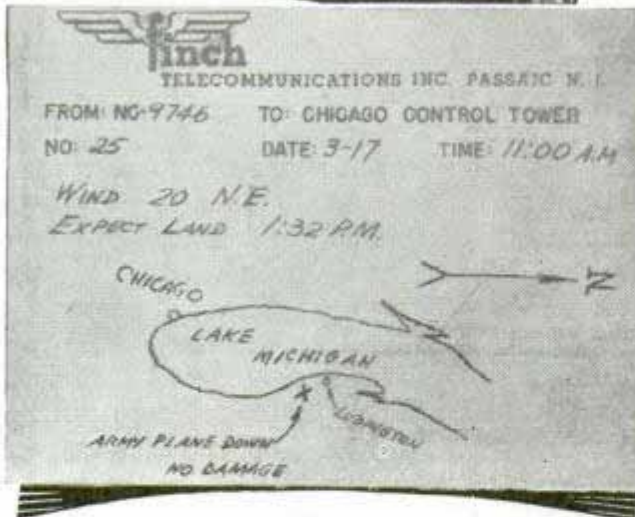
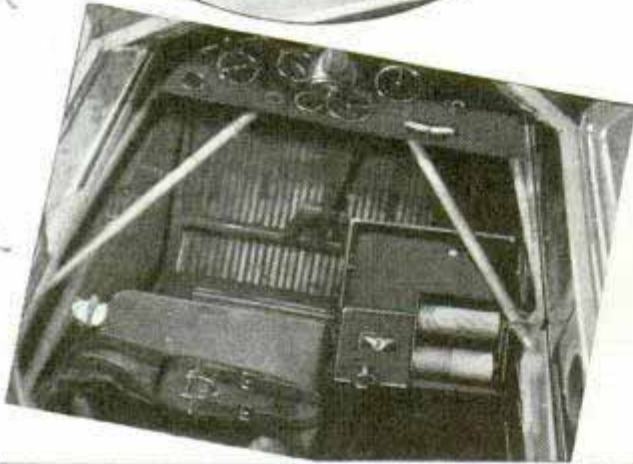

Radio facsimile set in police car and plane cockpit, and map sketched by pilot and sent by radio

Flying down the eastern shore of Lake Michigan an aviator notices a U. S. army plane grounded and signaling for aid. Continuing on his course, the pilot sketches a map of the lake, marks with an "X" the approximate location of the disabled plane, inserts the sketch in the two-way facsimile

unit at the right of the cockpit and transmits message and map by radio to the Chicago airport. This is an example of the peacetime usefulness of the Finch facsimile device now being installed in airplanes as well as in police squad cars, where they "stand by" to receive or transmit pictures and reports. In military planes the units can radio to headquarters the location of troop concentrations, artillery emplacements and similar information, in complete secrecy, transmitter and receiver being coordinated to "scramble" the message into a hodgepodge which only the receiver can decode.

K 370.
**Flexible Track for Toy Train
 Bends into Small Loop**

Flexible track now available for model or toy railroad builders can be bent to a radius as small as thirteen and one-half inches, ending one of the bugbears of the average "tinplate" user. If you step on the track accidentally, it merely increases its grip on the ties, due to the shape of the rail and method of fastening. Made in sections three feet long, the track is furnished either with only two rails, with a third rail in the center, or with every fifth tie longer so the owner can install his own outside third rail. The sections can be sawed easily into any desired lengths.



Smaller bends are possible with new flexible track that resists injury if stepped on accidentally

*Robb's Train Exchange
 2261 Dewey Ave
 Rochester, N.Y.*

K 334. Chevrolet motor sleep
General motor Co
Detroit Mich.

'Tracer Lights' Show Top Retracting into Car

To demonstrate the automatic top of a 1940 cabriolet, which disappears into the body at the touch of a dashboard control, "tracer lights" were placed on the top at two points and the top was retracted while a camera shutter remained open. The resulting picture showed two smooth curves tracing the path of the top as it folded away in a compartment behind the car seat. The motor vacuum operates the opening and closing mechanism of the top.

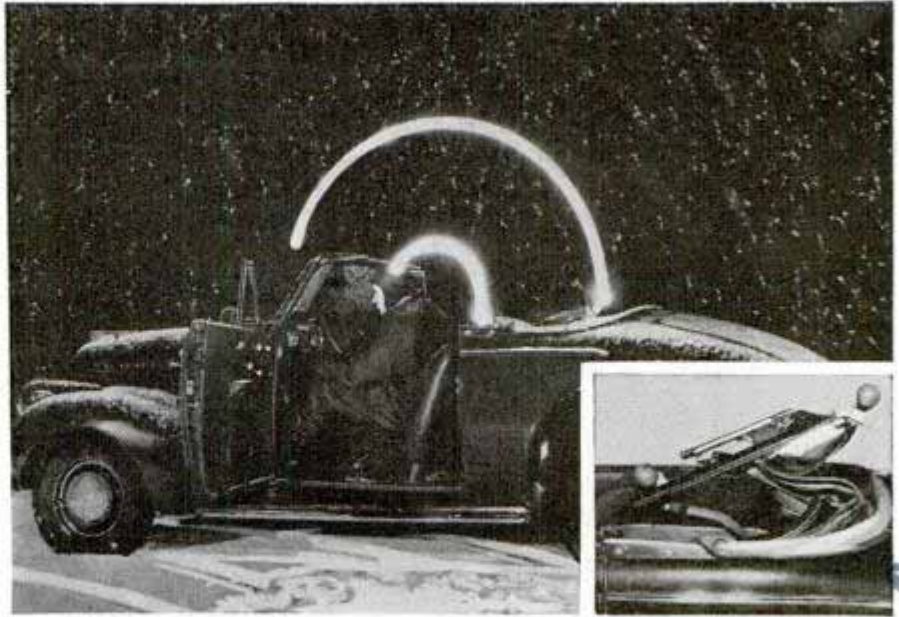

Two light bulbs mounted as shown in inset at right described smooth curves on photo film as the automobile top was retracted

K 355

'Purifying' Bath of Fire for Soil Exterminates Farm Pests

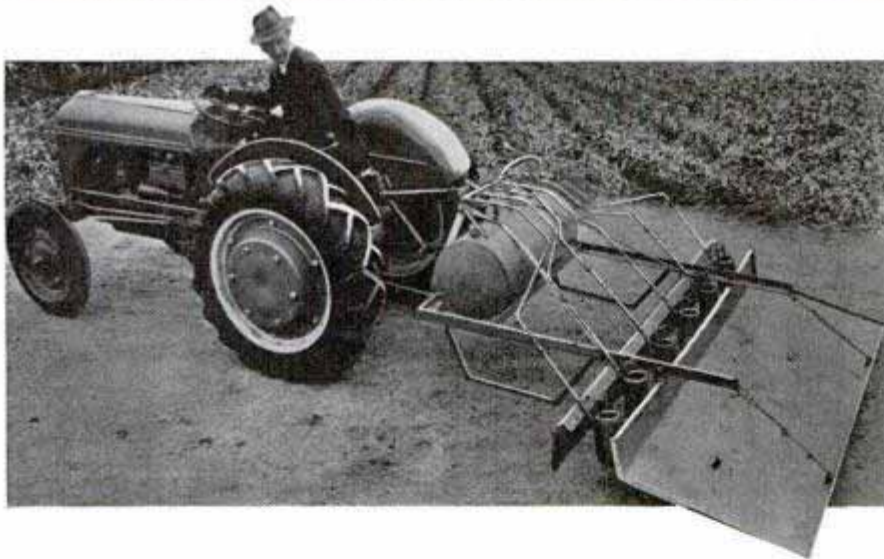

Burners fed by gas from kerosene tank throw intense flames beneath metal shield, creating an "inferno" to consume lice in the soil after harvest

To purge soil of tiny lice which frequently infest it after onions and other vegetables have been harvested, a tractor-drawn "inferno" spreads a deadly sheet of fire. Kerosene is stored in a pressure tank and converted into gas by pre-heating, a uniform heat of 2,000 degrees Fahrenheit being developed at each burner. A broad steel shield at the rear concentrates the flames over the ground area.

K 367

Rear-Engine Fighting Airplane Has More Room for Mounting Arms

Additional space for armament and crew is provided in a new U. S. army plane by mounting its two engines at the rear with pusher propellers. Delivered recently by Bell Aircraft company, the ship weighs 17,500 pounds and is powered with Allison twelve-cylinder V-1710 type engines. It is known as the YFM-1.



This is called a multiplace army plane because use of pusher-type propellers and engines provide two extra "cabins" for crew and armament

19050 Elmwood Ave 807

W. B. Dackwell
2709 Perez
St. James
St. James, Mo.

SKY HIGH

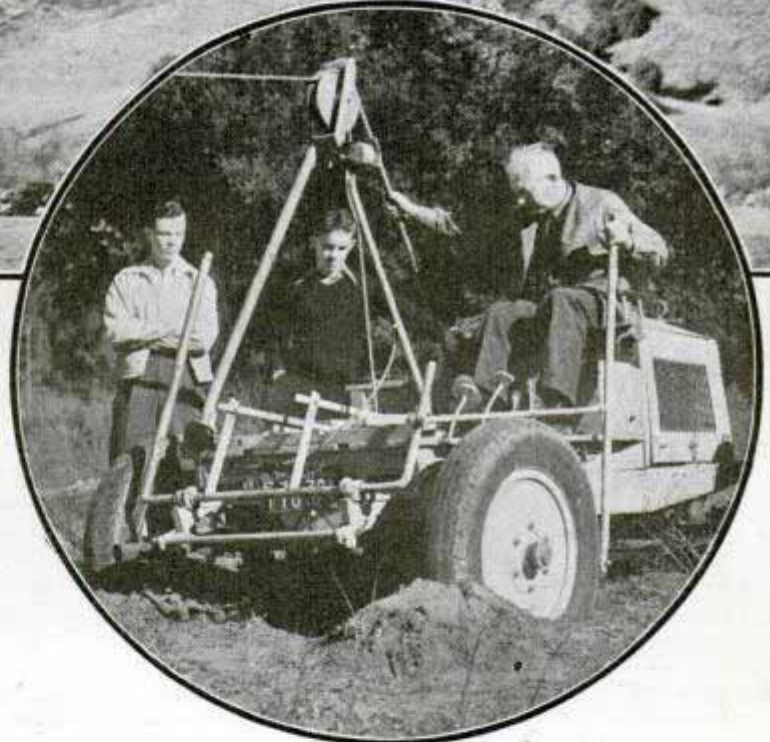

SLOPE SOARING

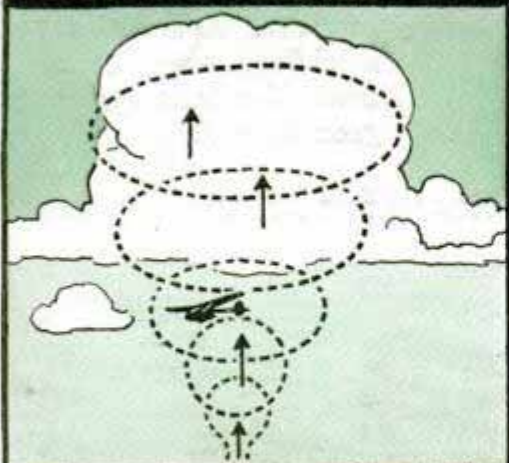

THERMAL SOARING where Sailplane spirals up on "bubbles of warm air"

Top, takeoff of motorless plane. Circle, operating power winch for launching glider. Below, diagram showing two kinds of lifting air currents used by the sailplane pilot

FOR new thrills, American sport fans are turning to gliding. Sailplane clubs are springing up, manufacturers are studying production possibilities and the government is giving consideration to the glider in connection with its pilot training program.

A glider is a small, light airplane, but has no power plant. Yet the craft is able to sustain flight for hours, traveling cross-country for hundreds of miles and sometimes reaching altitudes of five or more miles. It is able to do this because in addition to surface winds blowing from every direction there are "up" winds generated by uneven heating of the earth. Under certain conditions these upward movements can attain near-gale force, lifting sailplane and pilot at speeds up to twenty feet per

see ad on pages 76 & 77

*Soar plane
Franklin Engineering Co. #363*

Without a MOTOR

an arbat mesh

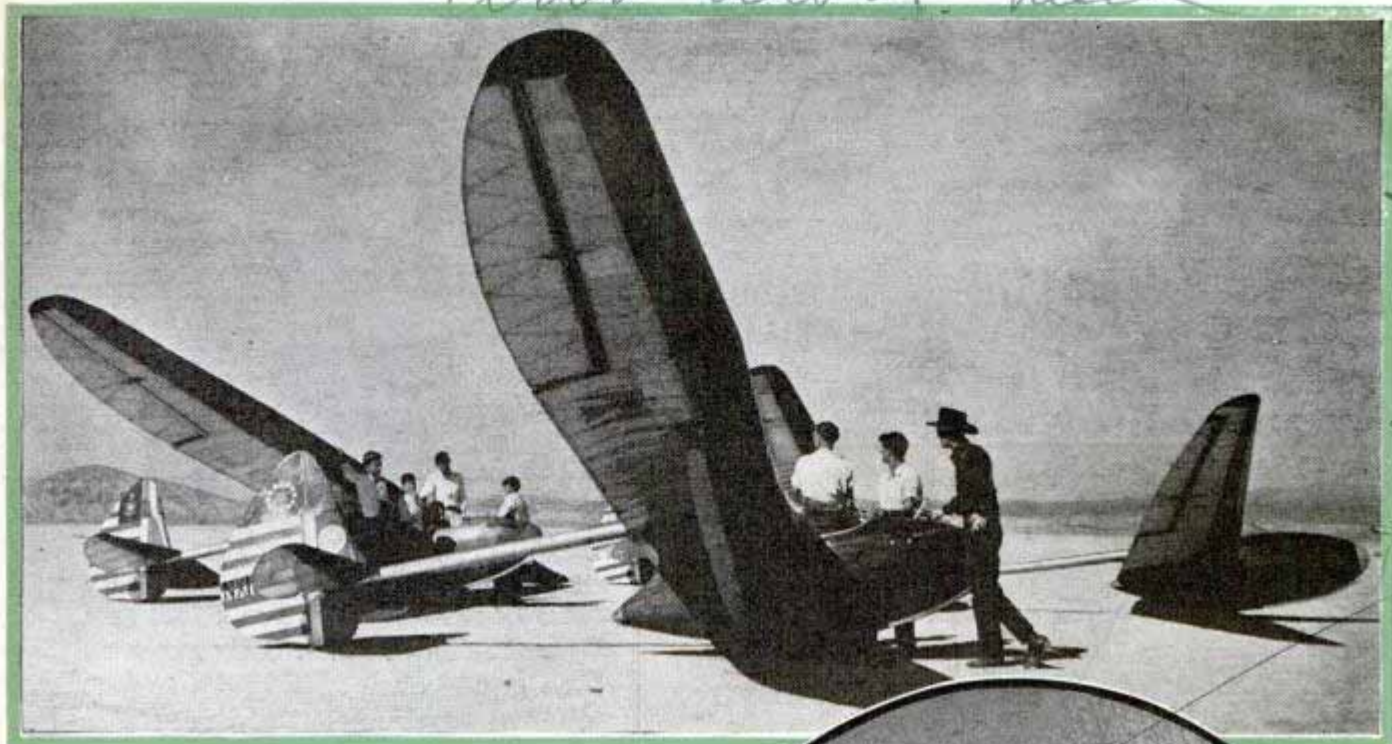

second. These sun-generated vertical winds are called thermals and recently acquired knowledge of the principles under which they function is responsible for tremendous strides made by soaring.

During the thirty-five years in which gliders have been flying in this country there have been so few fatalities that no record of them is available. Not a single fatality nor serious injury has marred any of the ten national glider meets held under Soaring Association of America auspices

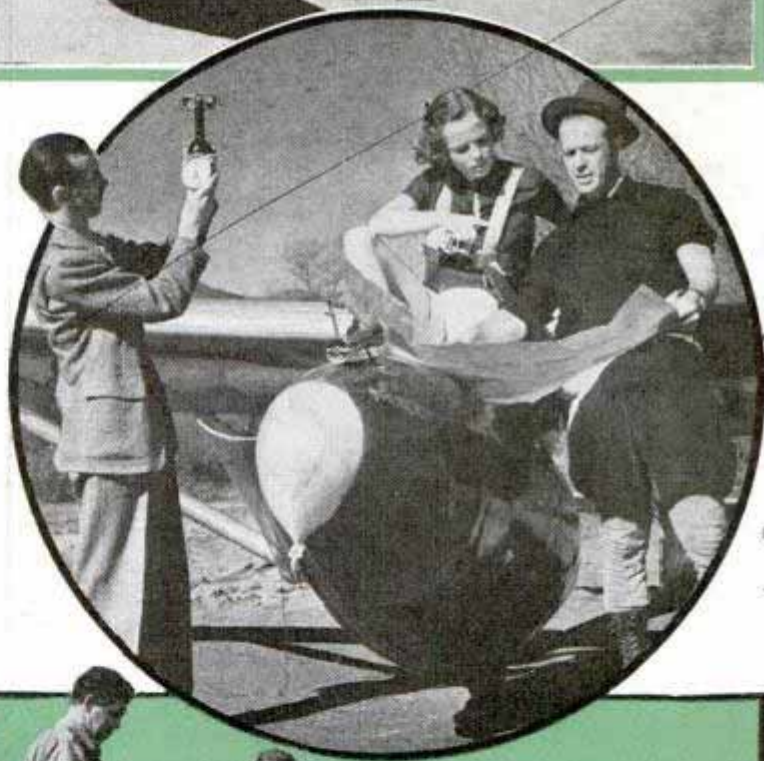

Planes lined up for the takeoff (top), pilot taking wind-velocity reading before going aloft (center) and crew attaching wings to fuselage "pod" in preparation for a flight

*Selby Calhoun
Soaring Society of America
1939 Massachusetts Ave.*

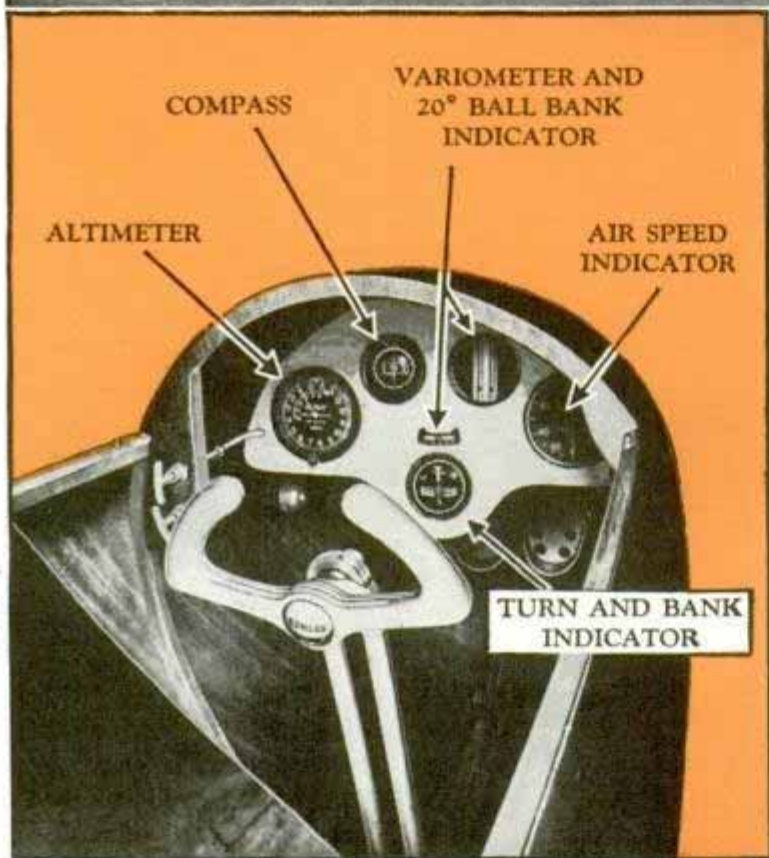

Gliding may well be called a poor man's recreation, lending itself best to cooperative effort and the sharing of costs. This explains the glider club idea and the fact that ninety per cent of the sport's devotees learned to fly in, and are affiliated with, clubs.

A modern, well-engineered utility glider or sailplane will cost \$250 to \$3,000, with \$600 a logical price. For transporting the dismantled glider to soaring sites and retrieving it after cross-country flights should be added, by way of necessary equipment, a two-wheeled trailer, costing about \$100. It may be taken for granted that one club member possesses an automobile to tow the trailer and,

annually at Elmira, N. Y., with dozens of gliders and hundreds of pilots competing. More than 600 pilots have been trained by one large glider club alone without death or injury. This record compares favorably with other sports, particularly when you remember that until recently most sailplanes have been of back-yard construction. There are more than 900 glider clubs and associations in the U. S., with memberships running anywhere from five to 150, and all active pilots flying hundreds of hours weekly.

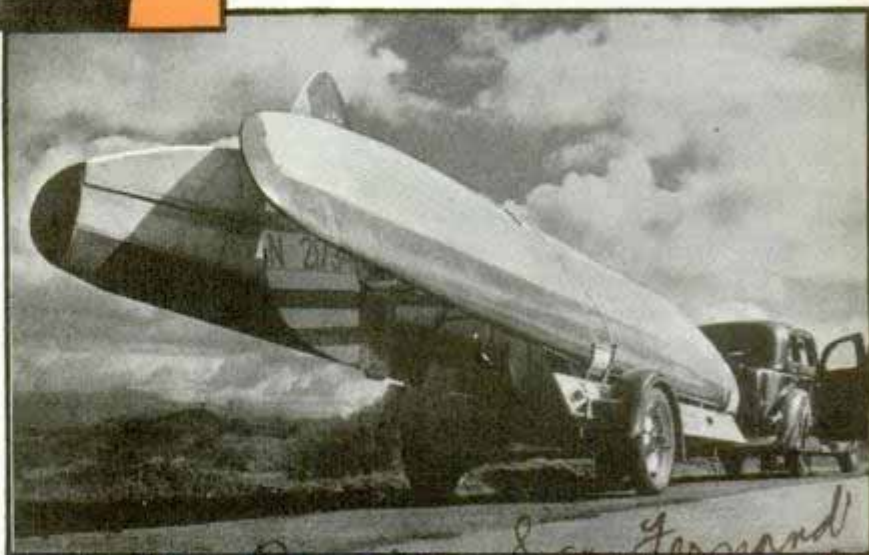

13785 *Parsons San Francisco Calif*
 Top, pilot in open cockpit plane at soaring meet. Center, instrument panel of Bowlus craft. Bottom, plane loaded on trailer

later, to launch the glider by means of a rope or cable. Many clubs have power winches mounted on old trucks and utilize the engine power to wind up launching lines on a drum. Such an installation should not exceed fifty dollars in cost. Allot another fifty dollars for towlines and incidental paraphernalia and the total club investment would be about \$800. Divide this cost among ten members, spread over a four-year period, and you arrive at twenty dollars per year per man.

Let us assume that you have joined a club and are ready to begin your instruction. Your group of five to ten members proceeds to the best local spot and you begin with ground skims. Using a 200-foot cable, the towcar rolls you along the ground just fast enough to keep the wings from dragging. You manipulate the steering wheel or "dep" control to learn lateral balance on your single-wheeled landing gear and how even keel is managed with the ailerons. After an hour of this the towcar speeds up until the glider leaves

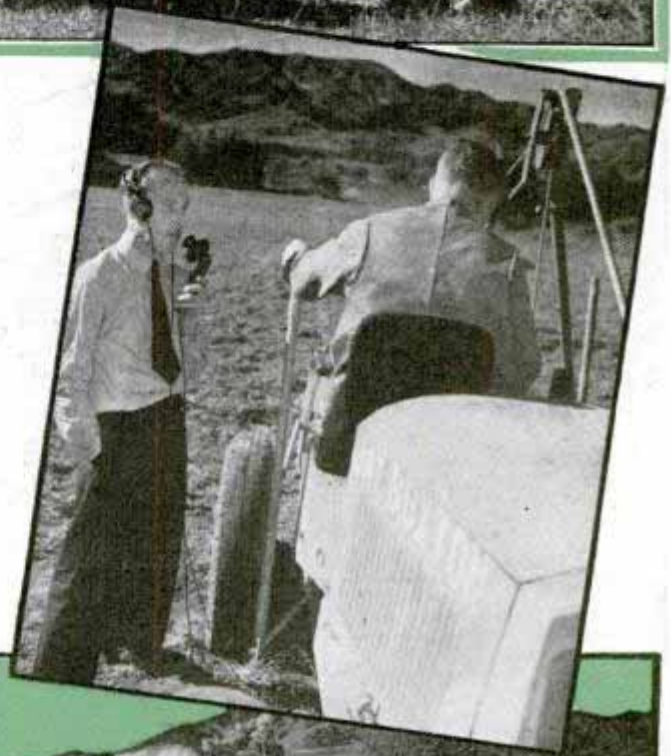
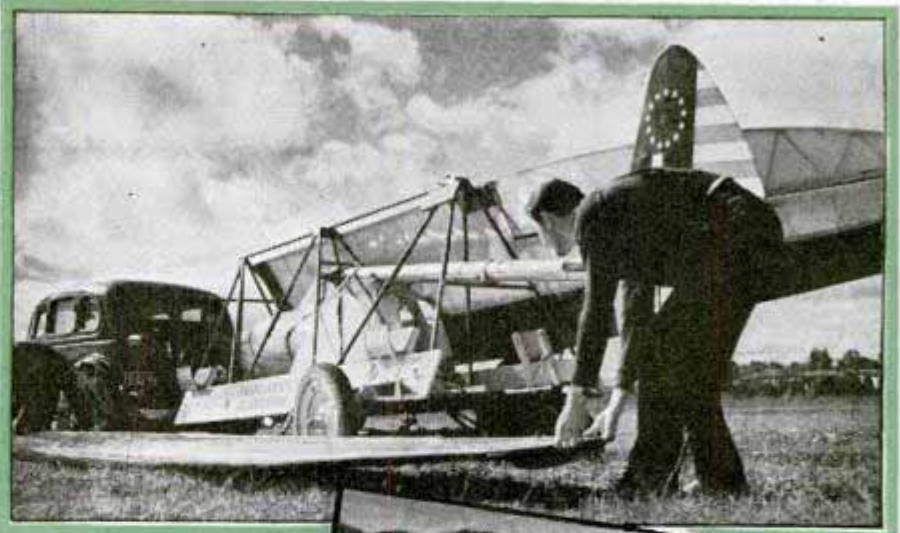

Top, unloading glider from tubular framework trailer. Center, power winch, with radiophone operator waiting for takeoff signal. Bottom, soaring club members at week-end meet

363

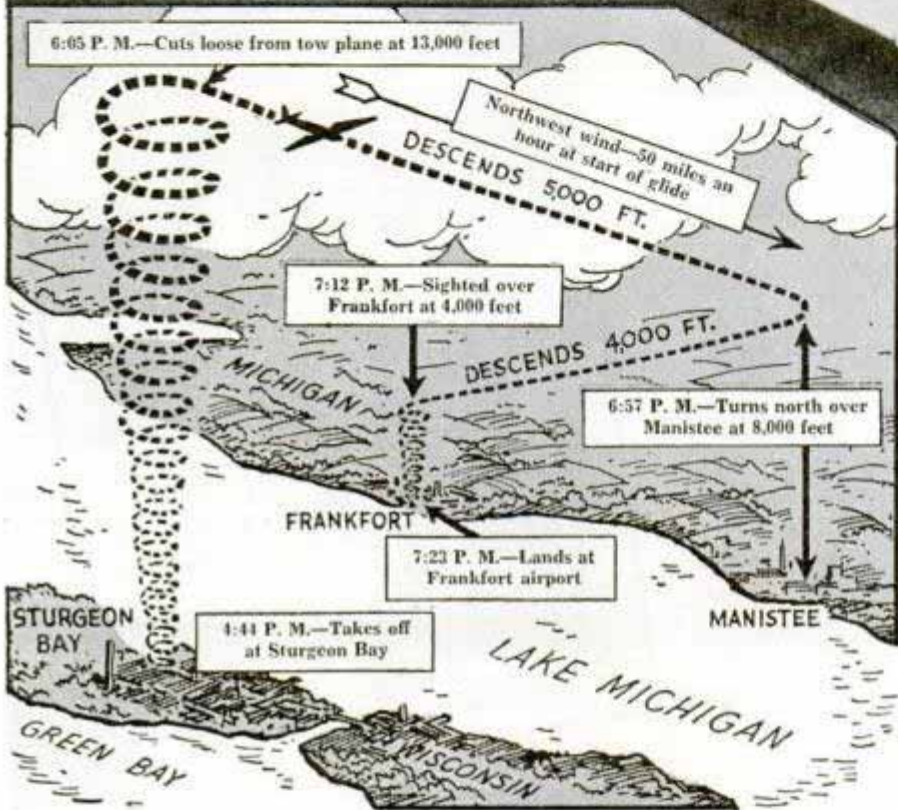
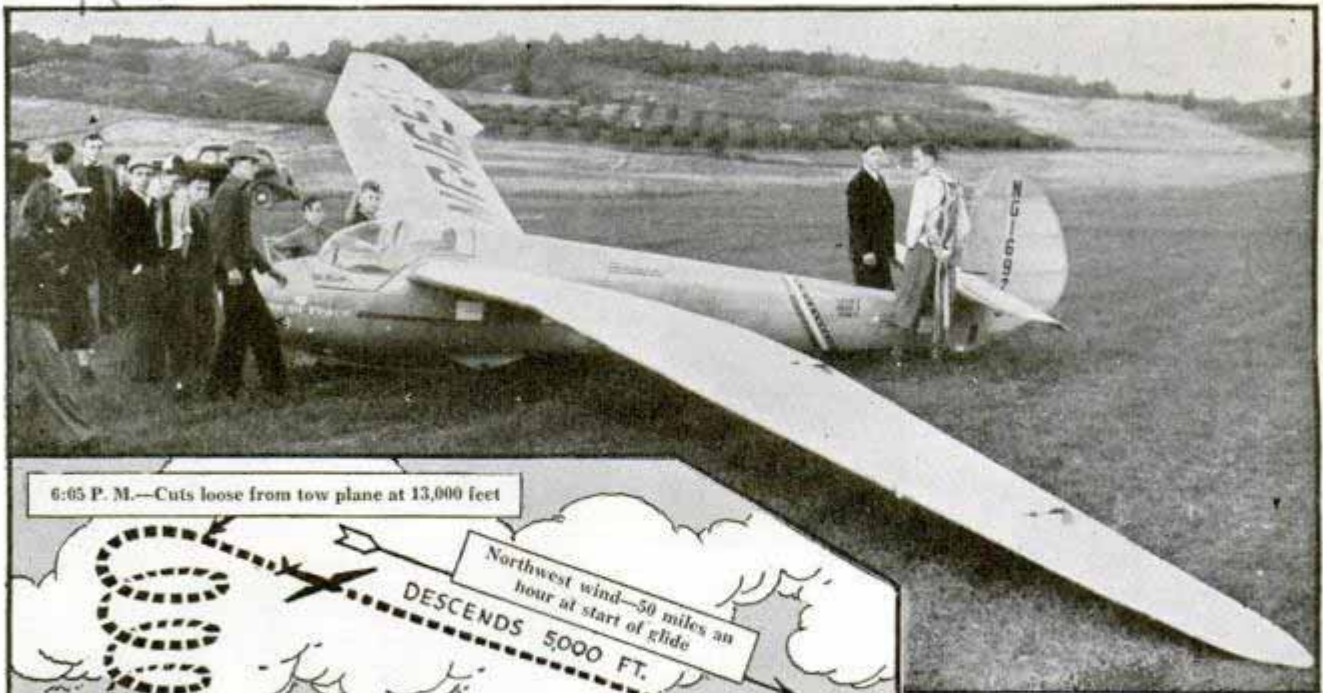

Above, Ted Bellak (extreme right) directing care of sailplane after record water-crossing flight from Sturgeon Bay, Wis., to Frankfort, Mich., a direct line distance of fifty-four miles. Left, diagram of the flight, on which he covered more than ninety miles because he was blown off his course. Flying time from shore to shore of Lake Michigan was fifty-two minutes

from some hill top, half-hour soaring from hill top with landing below and ridge soaring with landing back at point of take-off. In this connection surface winds deflected

the ground about two feet. Now you ease the wheel forward and back to learn the up-and-down action of the elevators.

Another day you continue your training with straight tows at progressive altitudes of ten, twenty, fifty and 100 feet. At twenty feet you have mastered the art of setting the glider down with ease and some precision. At fifty feet you are permitted to drop your towline and come down by yourself. Then follow more straight tows at perhaps 100 feet where you practice gentle "S" turns. Next comes the ninety-degree turn free of the line, then 180 and 360-degree turns, all under the eye of your instructor.

Further training, during which you are towed to 500 feet, includes slips or fish-tailing, precision landings into the wind, downwind and in cross-winds, a rectangular flight path, Figure-8 flight path, a glide

upward by low hills and ridges afford the glider pilot his steadiest and most dependable source of lift. This is called slope or ridge soaring.

By the time you are ready for graduation to flights in which you are towed by airplane you have qualified for distance, duration and altitude experience in thermals and must learn a new technique.

There are today half a dozen schools where glider instruction is available. Glider flying, construction and ground schooling also are taught in more than thirty universities and colleges. If eligible under the government's pilot-training program, you may receive instruction from Uncle Sam himself. Finally, the National Youth Administration has taken up gliding and makes instruction available to a few hand-picked students.

(Continued to page 143A)

'Eye' in Brass Gun Clocks Speedboat Record

Successful photo-electric clocking of the speed of racing boats has been accomplished with a portable timer which records the time to 1/1,000 of a second. Light reflection from spray and waves doomed previous efforts to failure, but the new equipment conquers this problem of "light spill." An "electric eye" is housed at the end of an eleven-foot brass tube fitted with photographic lenses so it can be focused on an automobile spotlight lashed with its battery to the starting and finishing line flags. As the boat crosses the starting line and interrupts the light beam, a relay sets the timing clock's hands in motion instantly; then it acts again to stop the hands when the boat cuts past the finish line. A "second" hand sweeps around the dial once each second, and the "minute" hand rotates once a minute, a third one recording successive minutes on the dial. Power to run the clock comes from a six-volt storage battery working through a converter which in turn uses a crystal oscillator to change the direct current to sixty-cycle, 110-volt alternating current. The clock motor runs constantly, and an over-riding clutch on the main shaft in conjunction with an electromagnetic solenoid operates to start the hands moving. Two push buttons control the unit, one starting the mechanism to catch the beginning of a speed run and the other starting it for the finish.

Top, timing an outboard speed trial. Bottom, brass tube resting on carrying case of clock contains "electric eye"

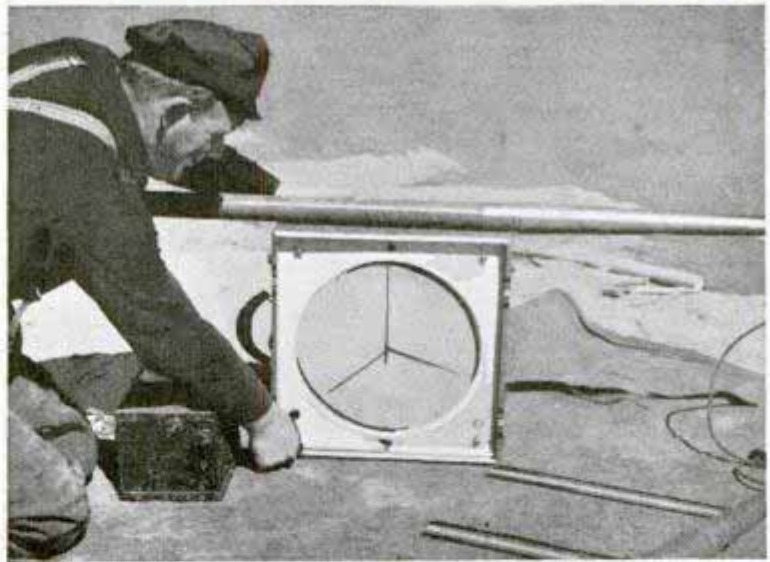
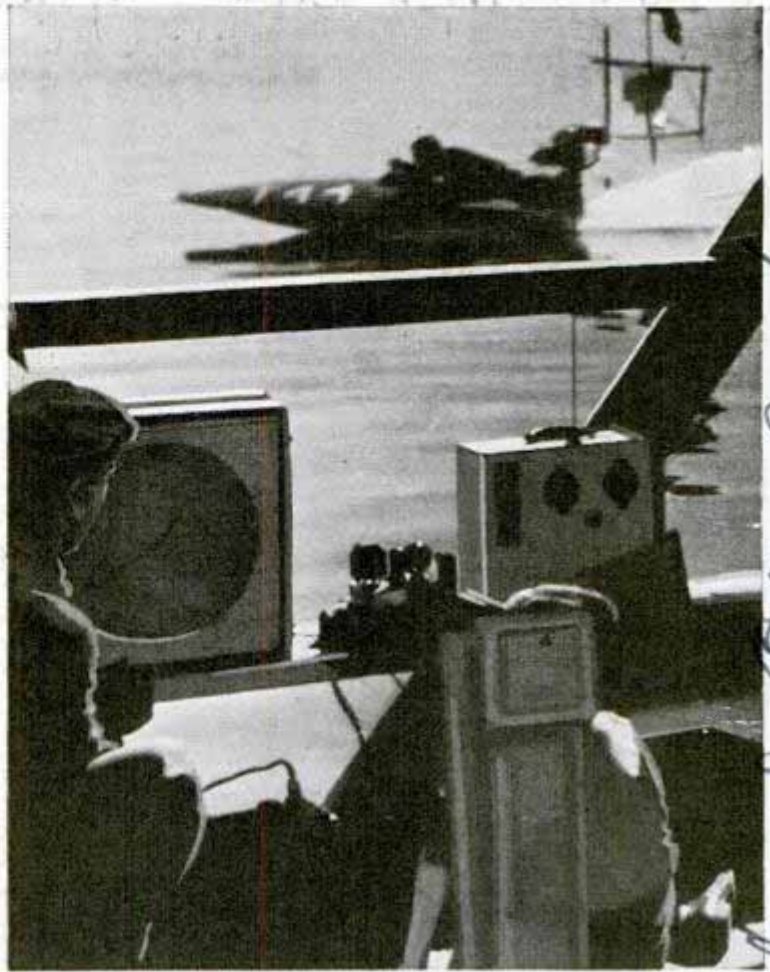

Dr. J. Edgar Crocker, 4466-41st. San Diego

Service Service
 June 1940

Manganese-Copper Alloy Is Silent as Rubber and as Strong as Steel

Drop a piece of steel or brass on the floor and you hear a metallic clang. Drop a piece of the new manganese-copper heat-treated alloy and it hits the floor with a dull thump like a hard rubber ball. Dr. R. S. Dean, chief metallurgical engineer of the U. S. Bureau of Mines, said this alloy has the strength of steel yet "dampens or absorbs vibrations like rubber." Rubber, of

course, cannot be used in tension, rubber axles or drive shafts being out of the question. But Dr. Dean suggested that the silent manganese alloy offers possibilities of chatterless spring suspensions, noiseless gears, mufflers for many industrial noises.

~~Curator of Ethnology~~
 [There are 180 different tribes represented among the American Indians living today.]

Smithsonian Institution
 Dr. Herbert H. Kroeber

K 310. Congr. Dr. W. S. Beecher, Jr. 57
 U. S. Navy, Public Relations Dept.
Explorers 'See Antarctica' by Plane and Sled

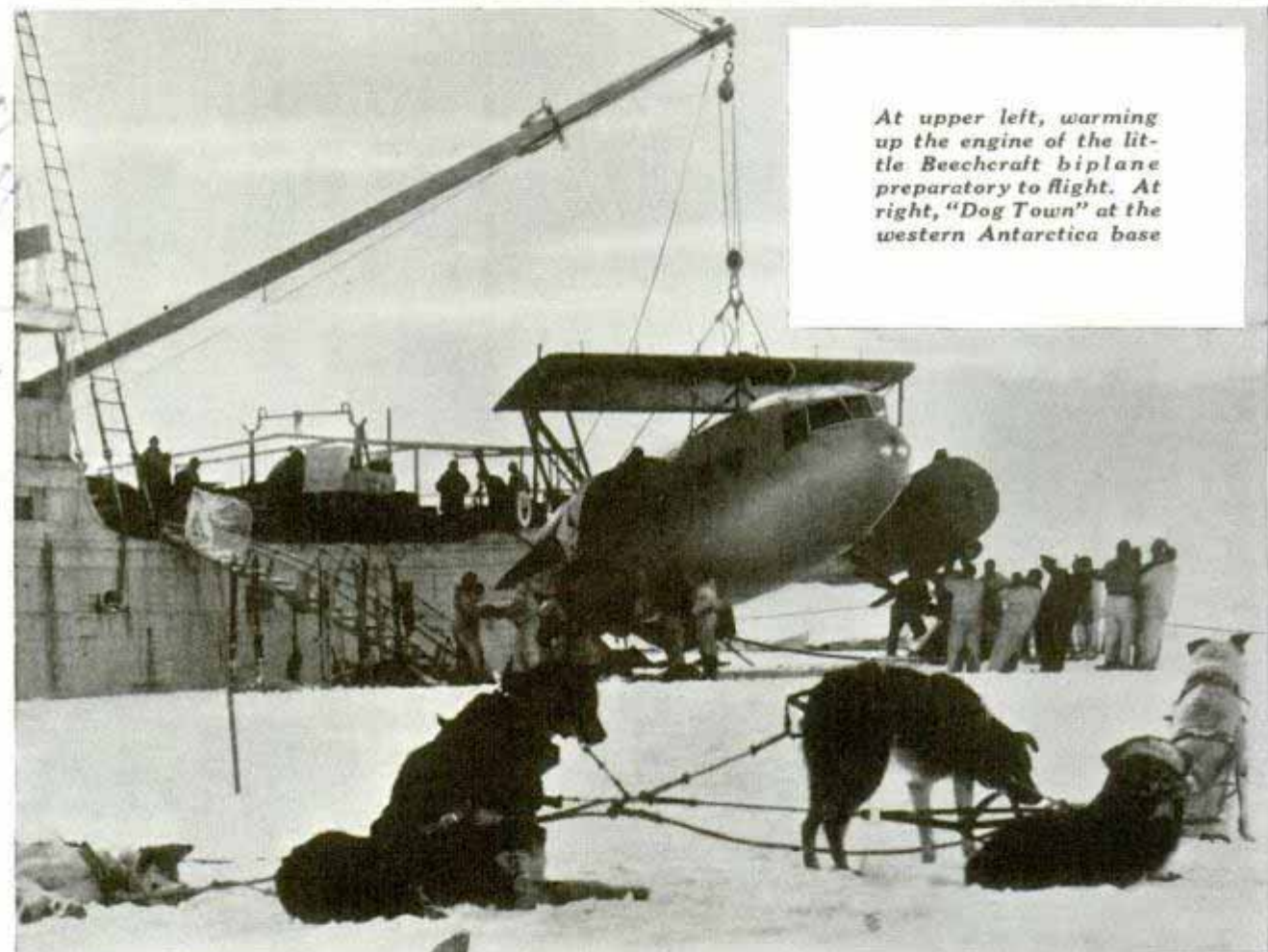

At upper left, warming up the engine of the little Beechercraft biplane preparatory to flight. At right, "Dog Town" at the western Antarctica base



Official photos, U. S. Antarctic Service

Earlier expeditions led by Rear Admiral Richard E. Byrd established bases and prepared the way for the present U. S. Antarctic expedition, purpose of which is to conduct thorough and extensive survey of the region. Airplanes will be used as heretofore, but dog sleds must be depended on for much of the actual survey work on the ground. Center picture shows the big Condor plane being unloaded from the supply ship at the West Base; below, the twin-motored biplane gets back its wings and tail

R 370

Little America Settles Down for Long Winter



Official photos, U. S. Antarctic Service

Moving Day at Little America is a colossal task. When the two supply ships anchored at the edge of the ice they had to unload supplies for the long winter, and the huge Diesel "snow cruiser" (bottom) was only saved from disaster by quick action of its driver when it rolled ashore, full power on its giant wheels taking it safely in from the crumbling ice at the edge. At top, a tank finds itself in an embarrassing spot in a snow-bank crevasse. Center pictures show dog teams sledging supplies in from the "Bear" and "North Star." When the snow cruiser goes exploring it is to carry a biplane on its back for liaison and survey flights

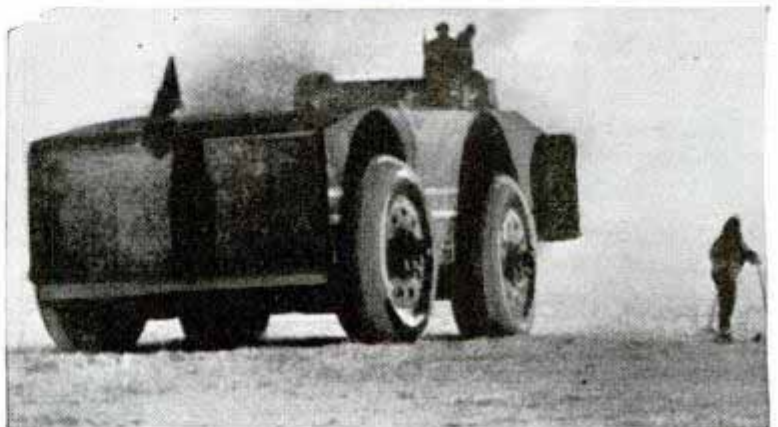

K325. Central Feature News Service, Times Herald News

Speeding Up the Ancient Art of Rug Making



In ancient times a lifetime frequently was spent weaving one rug. Today American manufacturers produce a million pounds of rugs each working day. Above, a card puncher "piano playing" a pattern, translating a paper design into the cards on the loom by pressing keys on the cutter

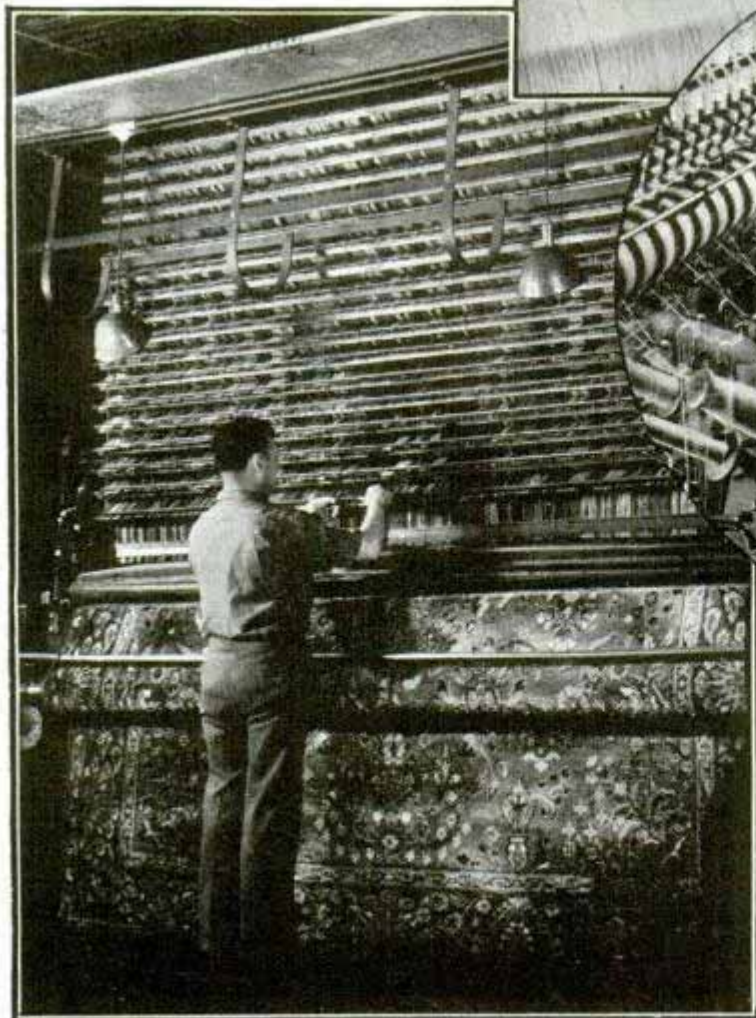
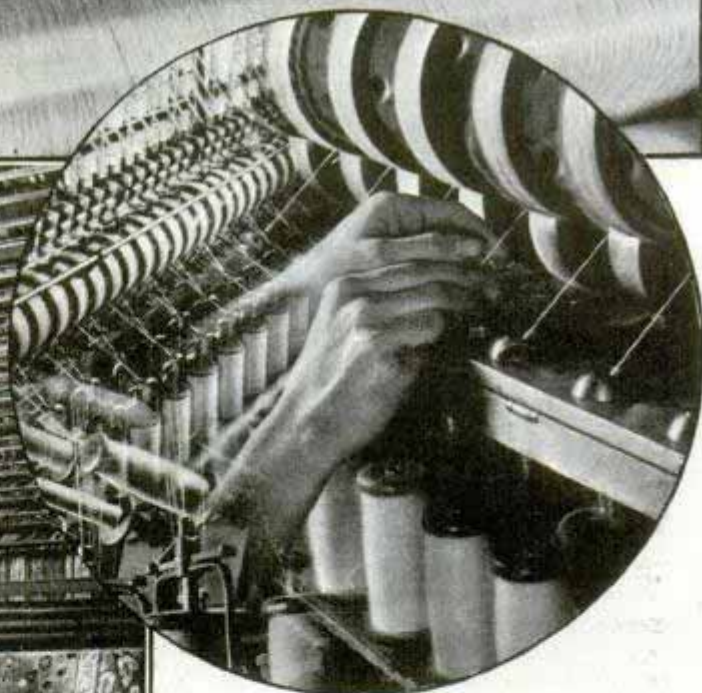

Modern engineering and scientific methods enable rug makers to meet the increasing demand. Top, right, operating cotton beamer, which combines several banks of warp threads and transfers them to the loom beam. Circle, how the long fibers are changed into yarn. Bottom, endless chain of spools which successively brings each spool into position in loom. Note the rug coming from the loom before which the worker stands

OUR FLYING NAVY

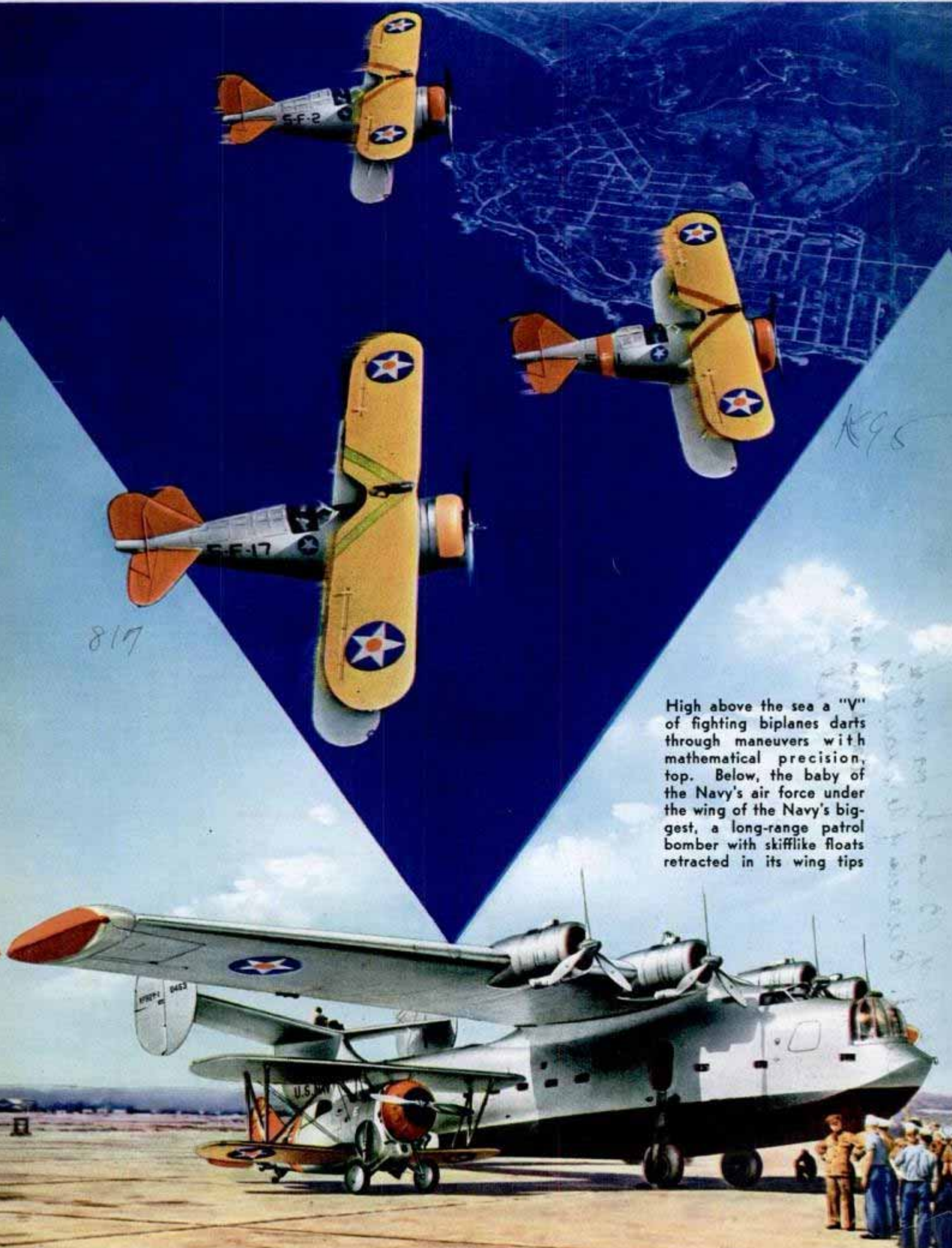

K95

817

High above the sea a "V" of fighting biplanes darts through maneuvers with mathematical precision, top. Below, the baby of the Navy's air force under the wing of the Navy's biggest, a long-range patrol bomber with skifflike floats retracted in its wing tips

U.S. Navy

1296



*Cmt. Mrs. J. B. Hancock
13 night Hancock
navy Dept. Do record of aeronautics
Washington
JBC*

PART I 818

By J. B. HANCOCK



This way to the coveted Navy Wings! A student pilot, above, receives pats of encouragement and good-natured banter as he prepares for his first flight. Below, aviation cadets "gas up" an N3N-1 seaplane for a training flight at Pensacola school

YOU'RE clutching the stick of a training plane wobbling through what looks like a serene sky but feels like a condemned roller coaster. Down below there is the blue but terrifying ocean, at its edge the Pensacola air school where you hope some day to win the coveted Wings of the Navy.

Instructions pour into your gopost helmet in a confusing fog. No chance to ask questions. Scarcely time to keep up with commands. "Bring the nose up!"

Your mind flashes back to the text book, bounces swiftly back to business as directions come from the instructor. You maneuver the stick with a tense fist, find the left wing dropping, finally coax it level again.



75
"Try it again." Over and over, for forty minutes, and your first flight ends. You can grin now. It wasn't so easy as it looked from below when you saw that flight of trim, twin-motored seaplanes roaring overhead in perfect geometrical formation; but it was a thrill, the first on the road to that ultimate in thrills, the receiving of Navy Wings. You're on the way to becoming one of the 8,000-odd young fellows who in a little more than a quarter century have proved themselves mentally, physically and psychologically sound enough to complete the flight training course at the U. S. Naval Air Station.

Only volunteers are enrolled at Pensacola. Either you're an officer, graduated from Annapolis, with two years at sea behind you; or you're an enlisted man in the Navy with specialized rating as radioman, machinist, etc.; or an aviation cadet, a civilian graduate of an accredited college, or with two years of academic work plus other training equal to make up the deficiency. And you're between twenty and twenty-eight years old, and unmarried.

819
Ground school—which takes up

Torpedo bombers form a stepladder in the sky at upper right; in circle, the class in rigging at Pensacola. Below, future navy fliers learn about communications in the radio laboratory, and, at right, an SBC-3 gets a change of engines with student help

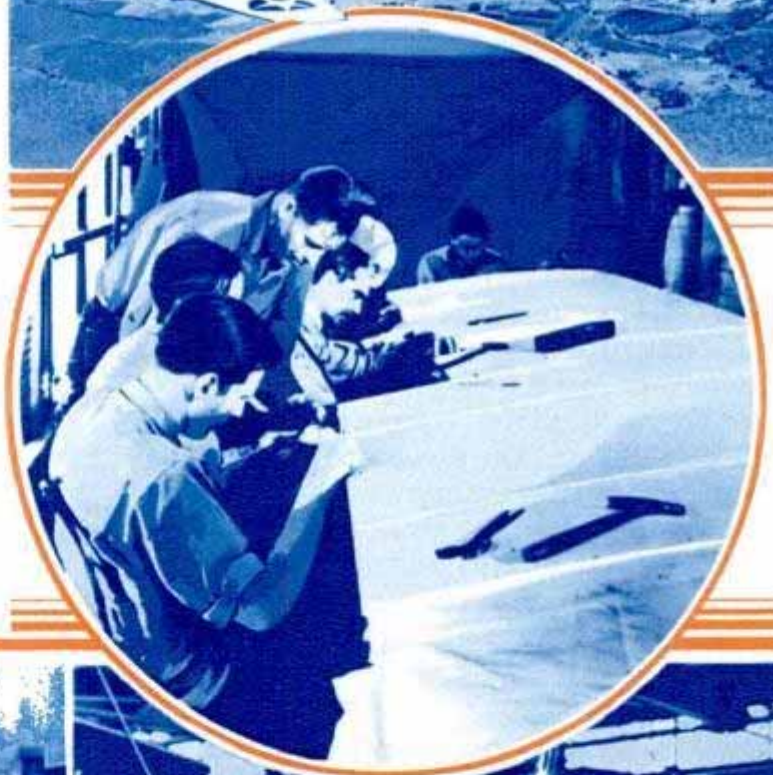
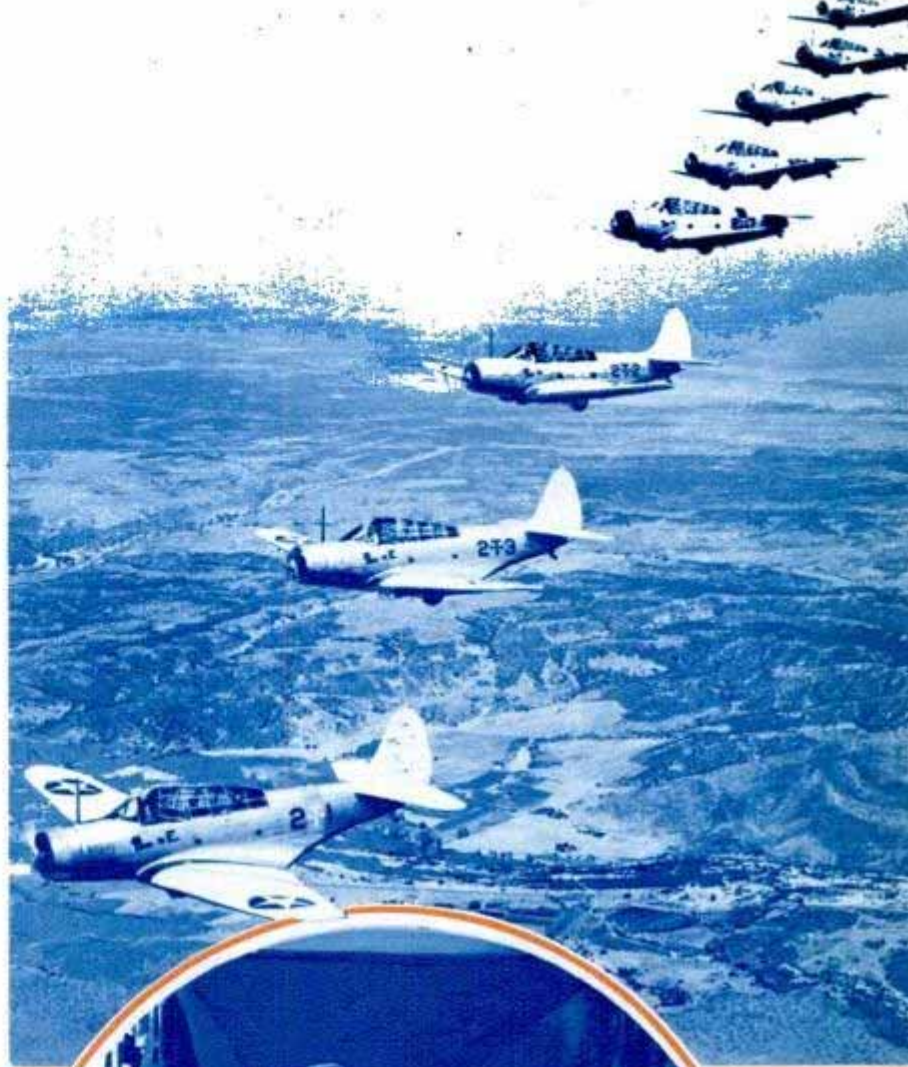

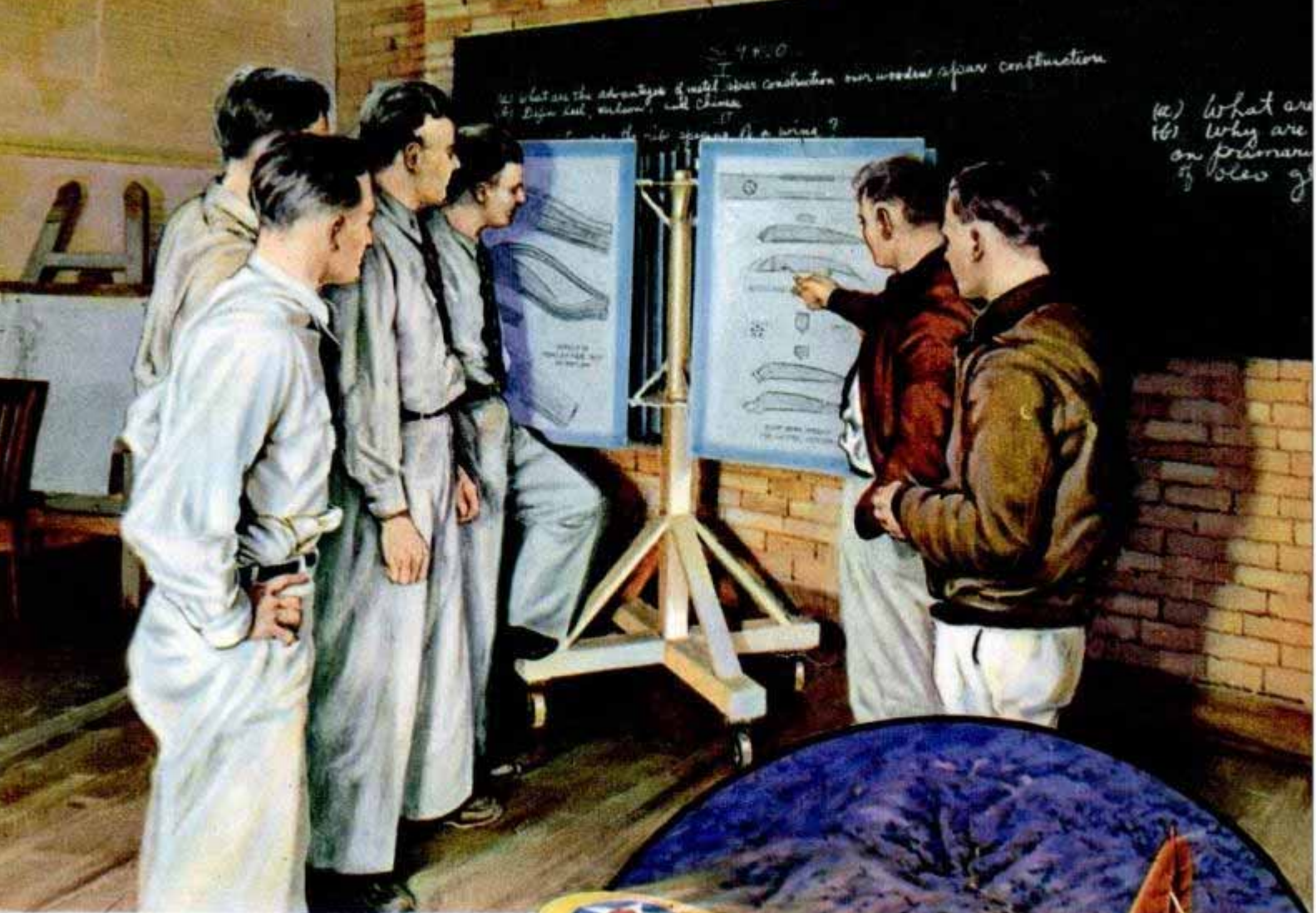

K95
 820
 engines, gunnery, photography, communications, aircraft structures, aerology and navigation—starts simultaneously with flight training. The pace is fast. Once you can keep that little trainer seaplane on a reasonably straight course you're told to bank and land. The plane never seems to act the same way twice. For a week you bank and turn, land, take off; then your instructor tells you, surprisingly, that you're ready to solo. A check pilot, stranger to you, climbs in, administers crisp advice about relaxing to get the feel of the plane, grins encouragement and you're taxiing across the bay. You do some of your worst flying under the strain, but the check pilot—familiar with the disease of "checkitis"—says a few calming words and you actually make a creditable landing.

Out steps the check pilot,



Theory and practice run parallel at the naval air school. Along with ground school and its textbook study of aircraft construction, aerodynamics, engines and radio, the young pilots immediately get actual flight training. At top, a class studies theory of flight; below, a navy flier in an F2F-1 biplane with wheels retracted cruises over rough terrain on special training mission



calling: "All right, take her around the course." You're on your own! But, up in the air, you find yourself so busy you have to postpone a feeling of thrill until you're down again. Twenty minutes later your record is marked "Completed solo flight satisfactorily."

The big hurdle is behind! Following time-honored custom, classmates toss you bodily into Pensacola bay. It's the fate of every student who completes his first solo, whether he's an enlisted man or a four-striper. The plunge seems to loosen every strained muscle, every kink of the brain. From here on no problem can be too hard to lick.

But the next few weeks you alternate between triumph and despondency. When you stop to analyze, you know you're getting better, but your preconceived

Above, land training planes "on the line" ready for class at Corry Field, Pensacola, Fla. Below, an instructor gives an aviation cadet an "upcheck." It's up to the student to put the two-seat trainer through its paces, but the check pilot is there to shout orders into the gosport helmet if needed





X95

ideas of flying are dissipating. Maybe it's just the navy method that calls for perfection; but why does a fellow have to practice for five hours what it took the instructor only an hour to show over and over? Smooth landings and take-offs, spiraling to a buoy with a cut gun, fishtailing if you overshoot a bit, a kick at the rudder until you discover it's automatic and the old trainer is obeying your slightest commands. For forty-five hours you explore the air over Pensacola bay, then the final check of Squadron One, the "Primary Seaplane" class. Only a little nervous now, even when the instructor cuts the throttle on the takeoff to see if you can get back on the water safely. Wing-overs, flipper turns, spins, precision landings go well, but you're a bit ragged on



822



Wheeling over the coast, at top, are three TBDS planes. At left, center, a squad of cadets receives last-minute instructions before taking off; bottom, VCS-6 seaplanes get formation flying down to perfection over the ocean. Target practice on the pistol range, right, is an essential sideline at the school for navy fliers



823

spirals and beach approach. After a second check you're told to report to Squadron Two at Corry Field for primary landplane training.

You're back at the beginning again; takeoffs, landings, but under different conditions. Corry Field's 500 acres look like a postage stamp from any altitude, with hangars, flagpoles, trees crowding in on every side. But soon the cut gun loses its horror, for you're learning to judge quickly whether you can glide in or push her over before the instructor has to take hold. Five hours are devoted to "shooting the circle," then the check comes so soon you don't do too well. The circle seems to slide out from under you, or pick itself up and rush ahead. Your instructor reports this to the Squadron Flight Board and you're given two more hours to make good. You get nice and tense over that.

"Sure you can fly," says the check pilot. "You're just not letting yourself."

In time you do calm down, and at the end of the extra hours you move on to Squadron Three—"Service Landplanes." By now you have a fairly good knowledge of aerobatics and a taste of formation and night flying. It's been mostly fundamentals, with emphasis on prompt and correct decisions in emergencies. As an introduction to Squadron Three you're advised to digest a mass of printed matter about fatal spins at low altitude, fleet instructions, maneuvering restrictions on service planes. Then the instructor shows you that awesome cockpit: fuel gauges, bomb releases, shutters, stabilizers, brake ped-



Top, three fighting planes in "V" formation. At right, cadets gather at the Operations Board to learn their afternoon flying assignments



A sea-going patrol bomber flies past the U. S. S. "Concord," top. Below, in line formation, are a trio of advanced trainers, low-wing monoplanes

824.

als. And furthermore, he says, plenty more instruments and dials are missing from this trainer because you won't need them at present. It's getting fairly obvious now that flying is tougher than bicycling.

There's no time out for thinking discouraging thoughts. The plane taxis forward, earth sinks away, orders bang at you through the gosport.

"Roll the stabilizers forward!" Just in time the nose comes down. For days the plane insists on floating past the landing circle or squashes too quickly. But at length you learn to guide and not push this sensitive creature. You solo, and come home very creditably. For hours you practice coordination with other pilots, fire free machine guns, try aerial radio communication by code and voice. As you romp home from an ex-

(Continued on page 128A)

K308.

1552

World's Largest Liners at Same Dock in U. S.

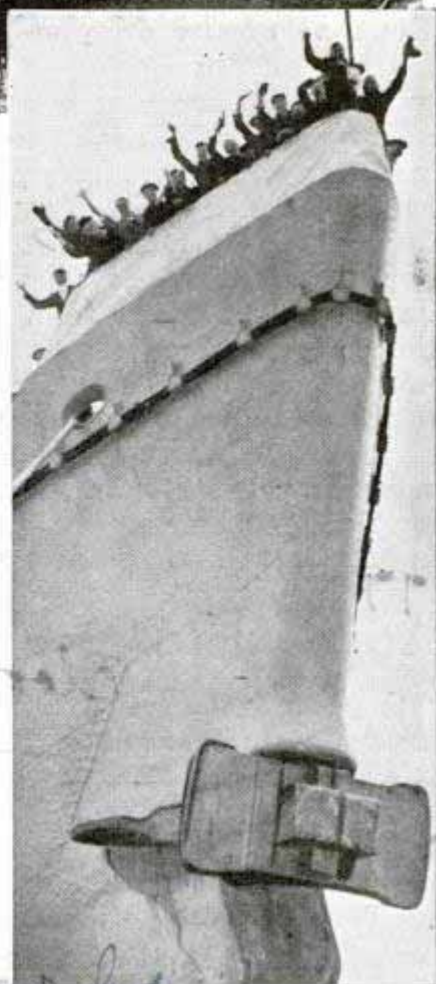
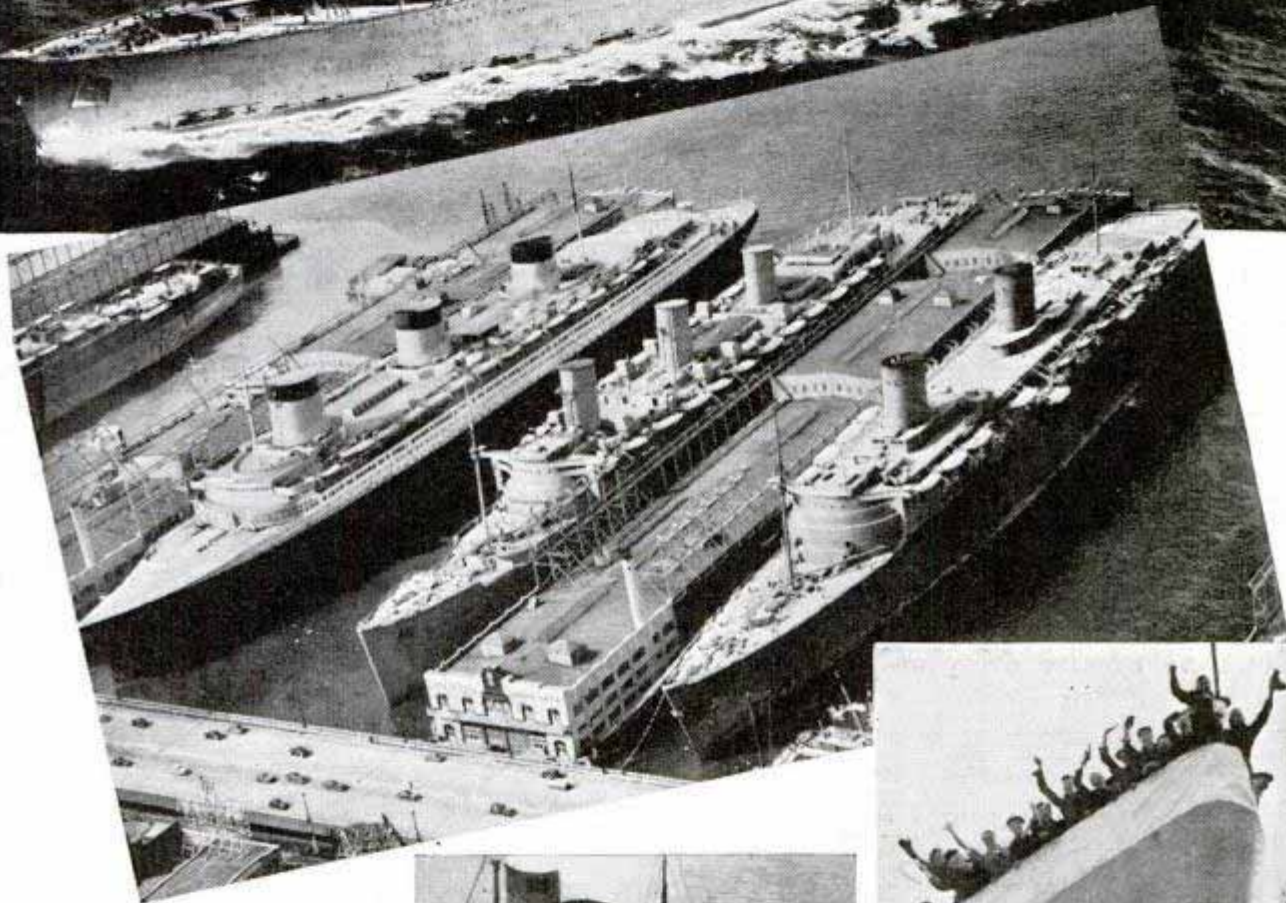

Three of the world's largest liners were tied up at the same dock in New York after England's new super-liner, "Queen Elizabeth," completed a secret dash across the Atlantic. Center photo, "Queen Elizabeth" at right is 1,030 feet long, with 85,000 gross tonnage, the world's largest; center, her sister ship, "Queen Mary," and, left, "Normandie," 83,423-ton French ship, second largest in the world. Top and bottom, left, air views of "Queen Elizabeth" arriving. Right, anti-magnetic mine girdle around the new ship's hull, protecting her from one type of explosive reported in use in sea warfare. The girdle is an insulated cable electrically energized to neutralize trigger action of mines designed to be set off by the magnetic field of passing steel-hulled vessels

Handwritten notes and scribbles at the bottom of the page.

R 388

Superbomber Could Fly to Europe and Back

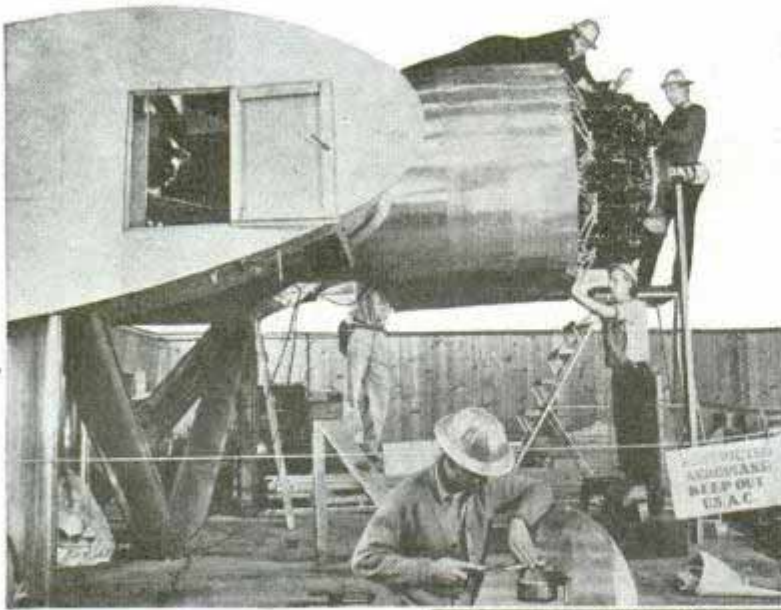

Seventy-ton bomber was nearly completed before the public learned of its construction in a secret section of Douglas plant. At left one of its four motors is being installed; below, its skyscraping tail—five stories high—gives an idea of its immensity

Kept "under wraps" during many months of secret development, the world's mightiest bombing plane has been built in the Douglas aircraft plant at Santa Monica, Calif., for the U. S. Army. Weighing seventy tons loaded—more than twice the size of the army's thirty-ton "flying fortresses"—this superbomber with its 6,000-mile range should be able to fly to Europe and back with a twenty-eight-ton load of bombs. Even as the big plane was prepared for test flights, many of its details were kept secret, and visitors have been barred for more than a year from the section of the factory where its construction was progressing. But it had to be moved outdoors to have its wings attached, and some of its dimensions were made public. Its wing spread is 210 feet, its four engines develop 6,000 horsepower, and although it is half again as large as the famous old

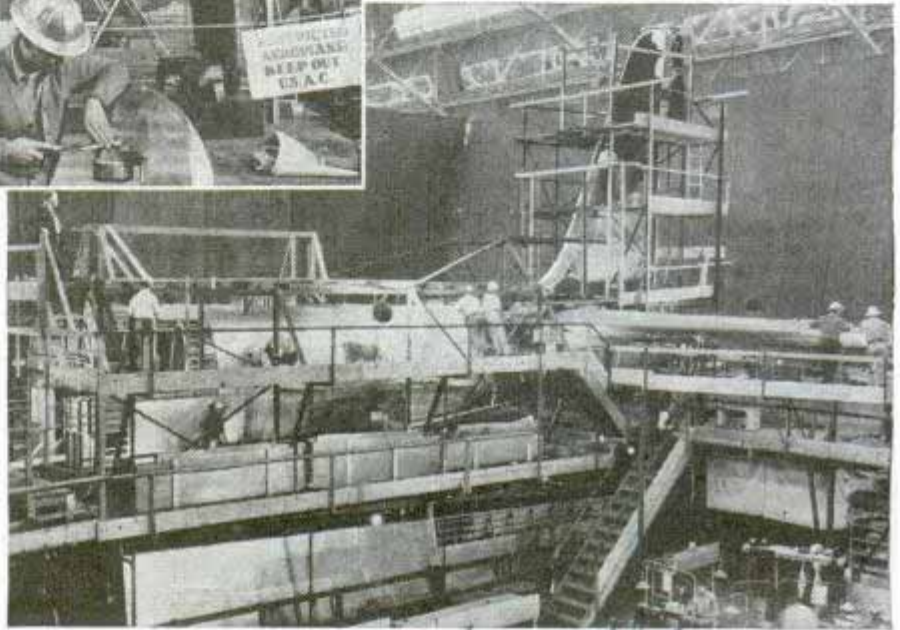

German 112-passenger "DO-X," it is built to carry a war crew of ten men. The heated and ventilated sleeping quarters, radio room and navigator's compartment have been soundproofed. The three-blade propellers, sixteen feet in diameter, are of the constant-speed type. As to its speed, the war department only stated that it would be "more than 200 miles an hour." In general outline the million-dollar B-19 resembles the big overland sky liners used by the commercial air lines, which, however, it dwarfs by comparison. Its retractable landing gear is of the tricycle type.

Atom 'Meter' Counts Explosions in a Millionth of Second

So acute is the action of an atom counting device, built at Indiana university, that it can observe and record atomic explosions and the rays that follow one after another, within the infinitesimally short period of a millionth of a second. Its purpose is to penetrate the last barrier to the secret structure of all matter—the nucleus

of an atom. When an atom explodes, it blows off a particle of matter, like an electron, and emits a flash of energy known as a gamma ray. The gamma rays are similar to X-rays or radium rays. Usually the explosions are only a few billionths of a second apart, but the recorder separates and tabulates them accurately by electricity.

Chicago Tribune 3/4/47

Bloomington, Ind. Dr. A. C. Es. Mitchell

Experimental Car Hints of Tomorrow's Auto



Advanced ideas of design, many of which eventually may become standard, are incorporated in an experimental automobile built recently by Buick engineers. Emphasizing the modern tendency to reduce over-all height, the car has unusually small wheels fitted with thirteen-inch tires, placing the body and chassis so low to the ground that it is virtually impossible to overturn the car. Wheel tread is standard but body and chassis are of unusual width. To provide maximum braking efficiency with smaller wheels and brake drums, special airplane brakes of the sirocco air-cooled type are used. Among the advanced features are: heavy wind-stream bar bumpers, bumper guards and license plate bracket in a well-designed unit; front fenders housing retractile head-lamps concealed behind "doors" operated by electric motors controlled from the instrument panel; inbuilt running boards, concealed by the car doors and equipped with safety step and scuff plates; door windows raised and lowered by electric regulators controlled from the instrument panel, and flush-set door handles that pop out at slight pressure, affording a firm grip. A "machine gun sight" radiator ornament surmounts the hood. The rear deck has a cover of the alligator type similar in design and operation to the hood. Rear deck and hood locks are operated from the driver's compart-



Top and center, two views of ultra-streamline auto. Bottom, raising top at the touch of a button

ment. The top of the car is raised and lowered automatically, by pressing a button. It fits into the deck immediately behind the driver, the deck cover automatically opening as the top comes down and then closing after the top is stored.

Brooms colored to match the kitchen scheme — blue, red or green — have just been introduced by an eastern manufacturer, the dye serving also as a protective coating that makes the straw wear longer.

21373

Cont. - Albert H. ...
Boston Sunday Post, Boston Mass

JOB HUNTING

Northeastern Univ
Boston

Ref.: Richard B. Cross, Secretary, New Products Committee, New England Council of the Old Breed, Mass

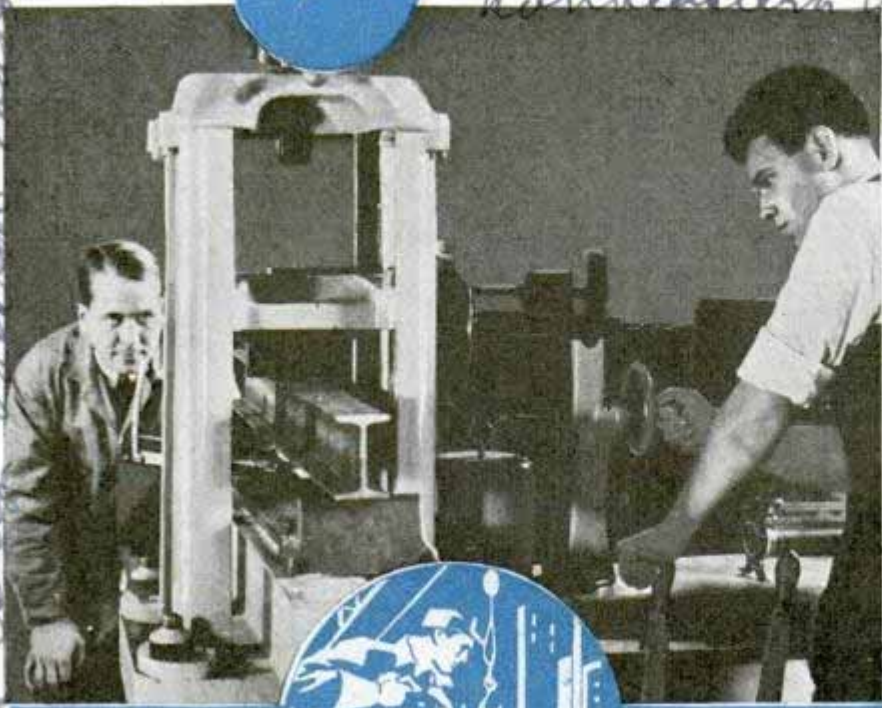

where no jobs grew before. Professors and students are using their equipment to better old materials and to discover new inventions. These are turned over to industries which put them on the market and hire new employes to make them.

Large numbers of students actually are making their own future jobs in the laboratories and experimental stations, for as soon as they are graduated, they are snapped up by factories to put in practice the ideas they originated in school.

This is the old depression "made-work" idea gone scientific. Such jobs are not temporary make-

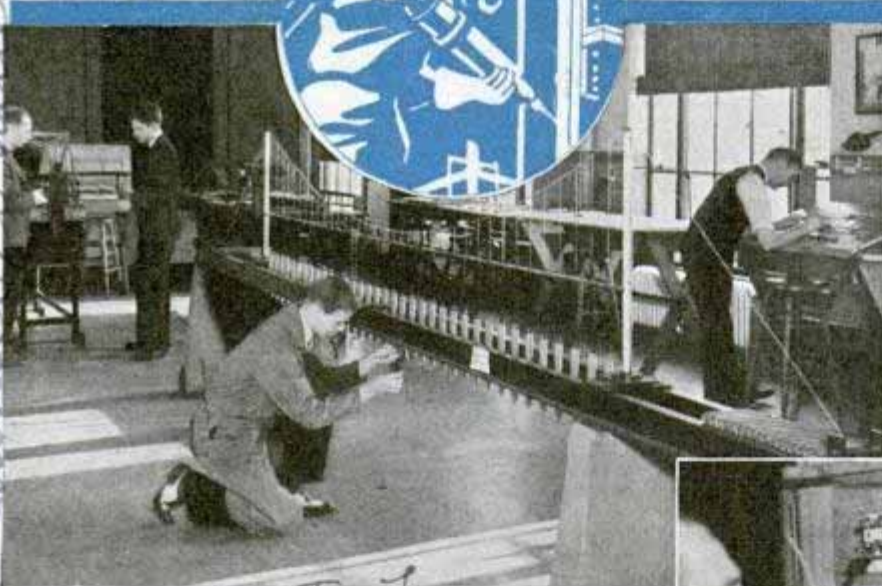

Top, research students test strength of I-beam in effort to develop better construction materials. To study bridge building, students erected model of a Detroit bridge, center. Below, college scientist and student work on project to make plastics from milk

M. T. J.
ALL sorts of strange schemes were tried during the depression to take men off the relief rolls and put them back on private-industry payrolls. But perhaps the most unique employment-idea now is being carried out on a large scale in New England.

They are going job hunting in test tubes. Under the leadership of Dr. Karl T. Compton, President of the Massachusetts Institute of Technology, leading scientists and industrialists have organized the laboratories in colleges, manufacturing plants, and independent research agencies in a program which creates new products and thus not only restores jobless men to steady work but also makes new jobs

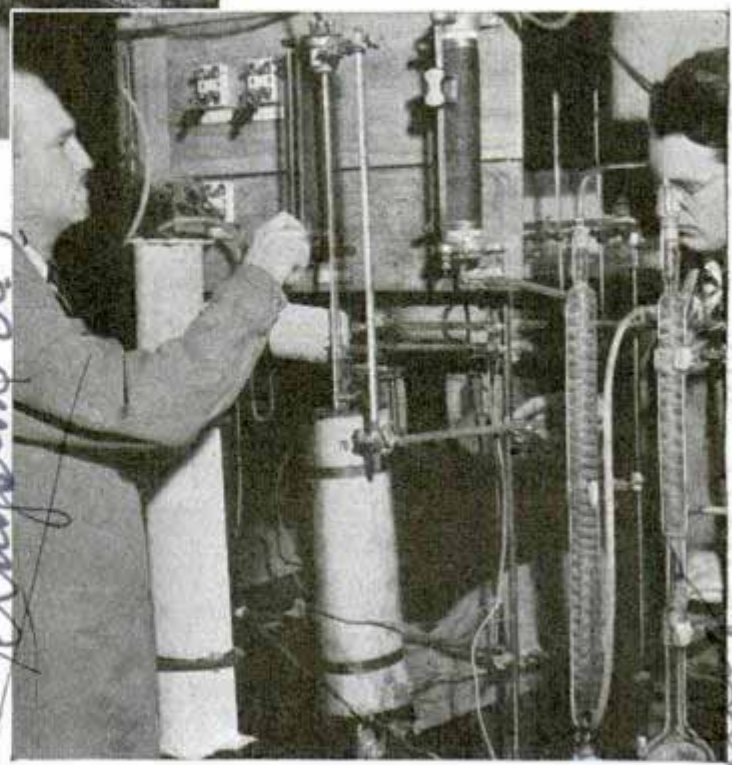

W. George Park's

in TEST TUBES

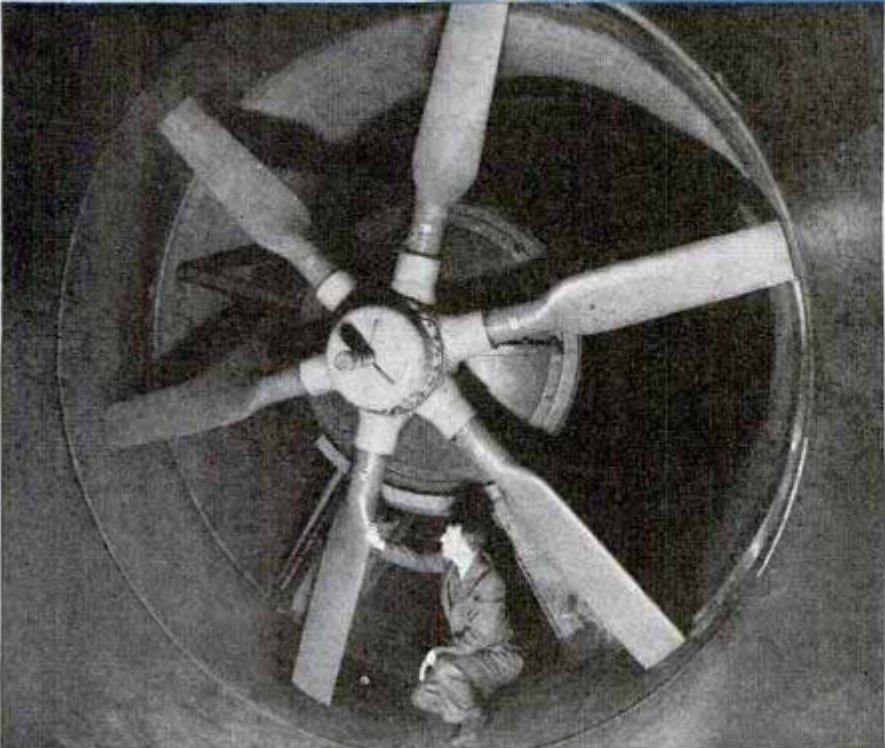
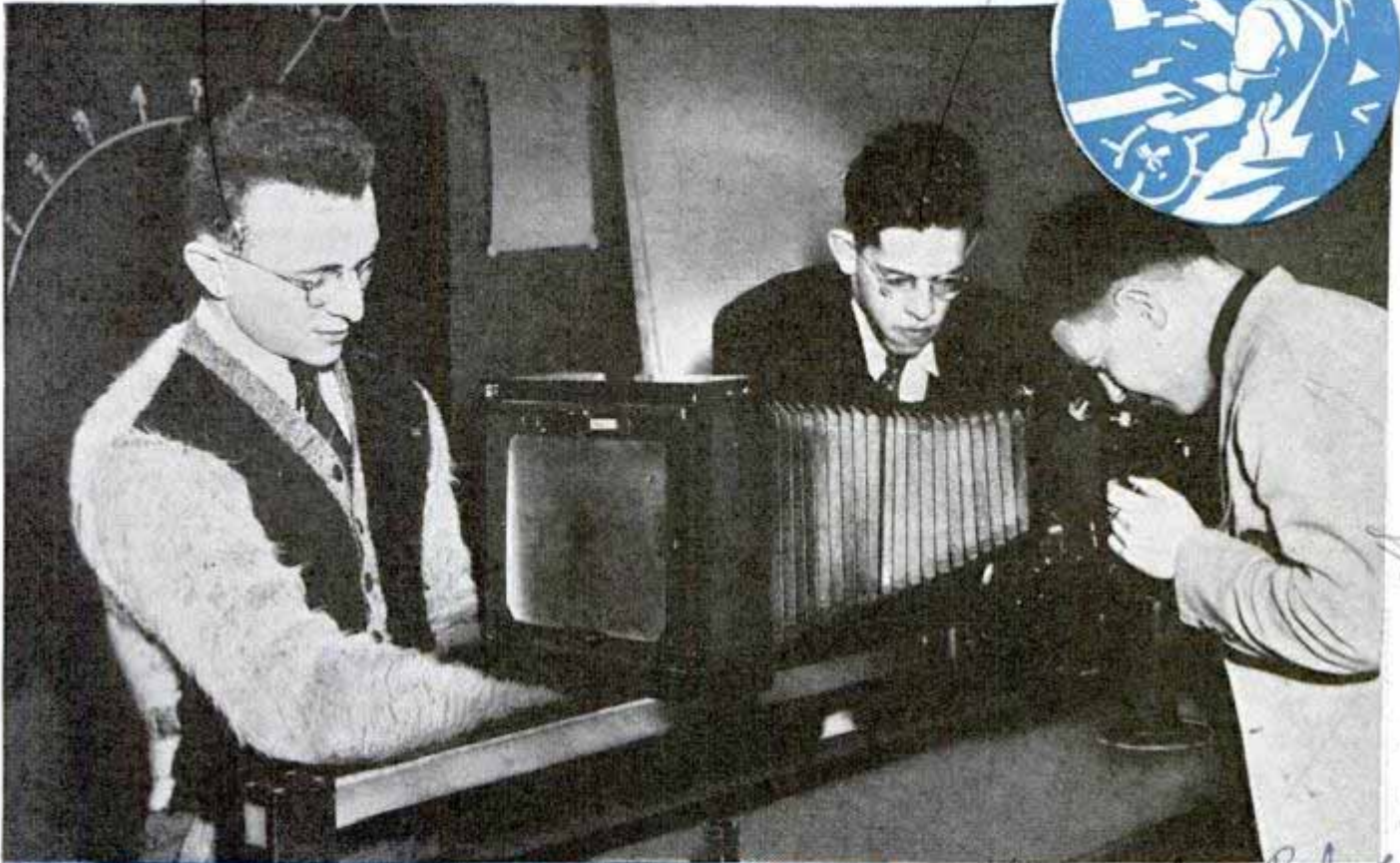

Worcester Polytechnic
Above, hair looks like baseball bat under metaloscope, metal research tool with 2,000-diameter magnification. Below, thirteen-foot propeller creates 400-mile winds in tunnel

M.T.
shifts. They are permanent. They yield real salaries.
A Harvard student in the physics laboratory had been studying polarized light. One day absent-mindedly he drew a lead pencil across some stretched rubber. In a flash it gave him an idea which he developed into a new form of polarized glass, which eliminates sun and headlight glare. Now he runs a big factory making the new product.
A Northeastern student discovered a new scientific way of making pies. A big bakery hired him as superintendent. A South Sudbury student did some research work in low-velocity air flow. A fan factory gave him a job to manufacture his product. A Massachusetts Institute of Technology professor with the aid of students de-

Prof. Charles O. Baird; Worcester

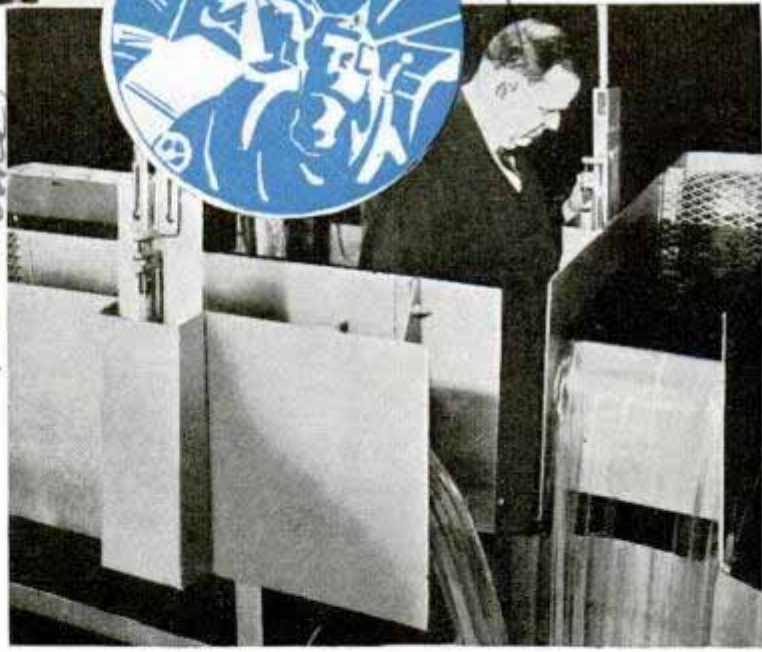
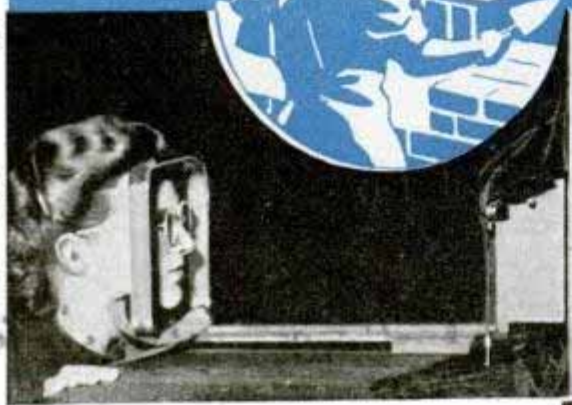
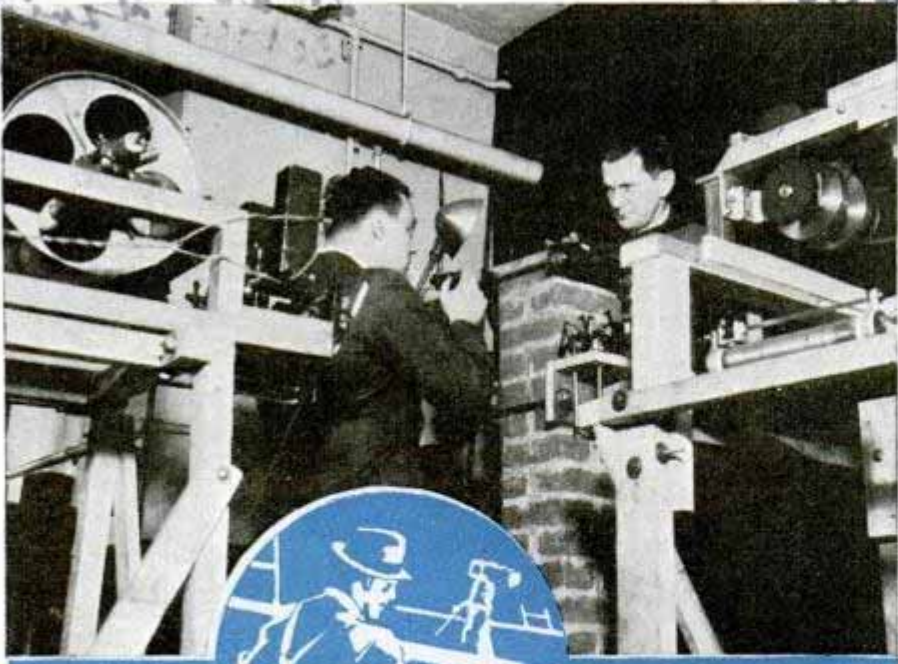

covered a method of controlling air streams, was given charge of carburetor development in an aircraft factory.

The Massachusetts state college has developed numerous uses for waste farm products. A young scientist in Newtonville is using skim milk for traffic-line paint. Wentworth Institute students made jobs for themselves in the airplane industry through research on gyroscopes. Researchers at Rhode Island state college are making new plastics from milk. University of Maine boys have extracted oil from balsam needles.

Universities are not the only places where jobs are being created. New England alone has 1,200 agencies handling industrial research problems ranging

Top, seeking improvements on masonry in a college laboratory. Center, testing ratio of Vitamin A to night blindness. Right, waterpower testing machine built by students of irrigation as a research problem

developed an "invisible film" to spread over glass. It made new jobs in the camera lens, window-pane, watch-crystal and glass industry. Students at Norwich University produced a new type stove that burns gas given off by burning waste wood. It is far hotter than the old-fashioned range. A college boy at Worcester Polytechnic Institute tackled a lighting problem which had baffled experienced engineers. He invented a tiny glass glow tube which insures prompt starting of the new fluorescent lamps. Another did such valuable research work in shoe machinery that one of the biggest manufacturers in America set him to work after he finished college. One of his classmates developed a lubricating oil and was hired by a big petroleum corporation; another, who dis-

from aerodynamics to yeast chemistry. Over 300 private research firms have created new products and new jobs in the fields of rubber, paper, petroleum, pharmaceuticals, chemicals, paint, glass, rayon, plastics, soap, food, casein products, ink, paper, and electrical equipment.

Almost every big manufacturer main-

M.I. Rhode Island State College

and Research Student Edwards

213 93

1936 X 389

Journal of the American Chemical Society

tains a research department. A chemical plant discovered a chemical oil that is replacing Spanish olive oil as a lubricant for textile spinning. It developed a substance which, dropped into dirty streams and ponds, makes them as clear as a glass of ice water. Another firm made a wood plastic with a basket weave that is making new jobs in the aircraft, cigarette holder, and coffin industry. An inventor developed a "cold light" lamp in which a twenty-five-watt fluorescent bulb gives a light equal to that of a conventional 500-watt lamp.

Researchers devised a metering pump about the size of a quarter, which forces tiny jets of "man-made silk" fluid to spinnerets. These spin threads half as thick as a human hair. Accurate to 25/1,000,000 of an inch, these pumps are essential to the rayon and similar textile industries.

These new ideas not only provided new jobs in the factories but brought new money to old salesmen and gave a new line of goods to new salesmen. It was "Yankee ingenuity," the inventive genius of such men as Elias Howe, Eli Whitney, Alexander Graham Bell, Charles Goodyear, Samuel F. B. Morse, and scores of others, which originally gave New England its industrial supremacy and literally created millions of jobs.

The depression and other economic conditions forced New England history to repeat itself and today the section has gone in strong for Yankee ingenuity—modernized, scientific, and streamlined. It is inventing its way out of economic difficulties. It is making gold in its laboratories by making new things which will bring money across the counter.

Although the northeastern states were filled with public and private research facilities during the past score of years, the little manufacturer either didn't know about his opportunities or was unable to utilize the scientific knowledge of his bigger competitors. Yet three-quarters of all New England manufacturing is done in plants with the average payroll of fifty workers. The average American factory hires forty-three workers.

Now President Compton's scientists and industrialists are teaming to give a break to the little fellow as well as the big corporation. Public and private research institutions cooperate for the mutual benefit of the region. They are swapping ideas,

(Continued to page 152A)

Compression 'Bomb' Exerts 3,000,000-Pound Squeeze



"Cascade bomb" able to produce 6,000,000 pounds pressure gives clue to conditions deep in the earth

To duplicate pressures existing deep in the earth, scientists at Carnegie Institution in Washington have constructed a "cascade bomb" they believe to be capable of developing 6,000,000 pounds to the square inch. This is the approximate pressure 745 miles within the earth. The first experiments with the apparatus, however, were stopped at 3,000,000 pounds, or 200,000 atmospheres—half of its potential capacity—because the pressure gauge was not calibrated beyond that point. Nevertheless, it squeezed table salt so tightly its volume was decreased by one-fifth. Further research is expected to reveal other secrets of what happens to matter's properties under the earth's terrific crushing forces. The cascade bomb is a pair of pressure chambers, one inclosed within the other. The inner chamber is suspended in a kerosene-like oil under a pressure of 255,000 pounds. This pressure appears to strengthen its steel walls and permit it to withstand extreme interior pressures created by a tiny plunger.

Ellis Johnson. Dept of Physical Chemistry

U.S. Geol. Surv. U.S. Geol. Surv. Dept of Physical Chemistry

1342 U. M. V. Lester P. Barlow
Eslen L. Martin Co.
Powerful 'Liquid' Bomb Is Fire and Shockproof
Baltimore Md



Explosion at left is an eight-ounce charge of liquid oxygen-carbon shattering pile of logs during demonstration, while newspaper cameramen and other spectators looked on from behind parapet of sandbags. Below, the inventor displays large aerial bomb. One of its advantages in wartime is the availability and low cost of both liquid oxygen and carbon, main ingredients used in explosive



Huddling behind a barricade of sandbags, spectators recently witnessed tests of a liquid oxygen-and-carbon bomb developed by Lester P. Barlow and his colleague, B. G. Holderer. To show that fire and shock will not explode them, bombs were burned, rifle bullets were fired into them, they were shot out of a trench mortar 500 feet into the air, and shot against a steel plate so they ricocheted 300 feet. But when an eight-ounce charge was detonated by a blasting cap under logs, it reduced them to matchwood and hurled fragments high in the air. According to Mr. Barlow, the explosive, which is made by soaking carbon

and other secret substances in liquid oxygen, does not deteriorate until about thirty hours after saturation. While liquid oxygen explosives have been used for many years, the inventor claims his bomb has a great killing potency, which is said to result from unusually powerful pressure waves. Another advantage claimed is low cost of manufacture, said to be four and one-half cents a pound.

Cleveland Lighting Dept.
Raymond Bell

Ball Parks' Floodlamps Could Light Big City

To turn night into day for night baseball, three additional major league fields have been flood-lighted this year. To make reflectors for the 2,464 new lighting units, 10,000 pounds of aluminum were spun and processed at the Westinghouse plant — enough to form a metal covering one-sixteenth inch thick over nearly seven acres. Visibility in these parks — Sportsman's field at St. Louis, New York's Polo Grounds and Pittsburgh's Forbes field — will be 700



Machinist is mirrored in highly polished surface of aluminum reflector disk, above, being spun in lathe. Left, floodlamps ready to be installed at ball parks



times better than in the brightest moonlight, and fans in all parts of the parks can see the ball in play. When each reflector is fitted with its 1,500-watt lamp, the combined output will approximate 36,960,000 watts, enough to light all the homes in a city of more than 500,000 population. If the light from all these lamps could be concentrated into one beam it would total 554,000,000 candlepower.

Synchronized Auto Map Unrolls as Speedometer Turns

Advance information of the road ahead is revealed by a scrolled road map that unrolls as the automobile travels, being synchronized through a speedometer attachment. As it rolls past a "window," the map indicates the approach of road markers, landmarks and points of interest, also forewarning the driver of hazards such as sharp curves, dangerous crossings and steep hills before the usual warning signs are encountered. Distances are marked clearly in miles, and it is easy to reckon the mileage between two points. The tape travels an inch per mile, and can be stopped temporarily if detours are made from the charted course.

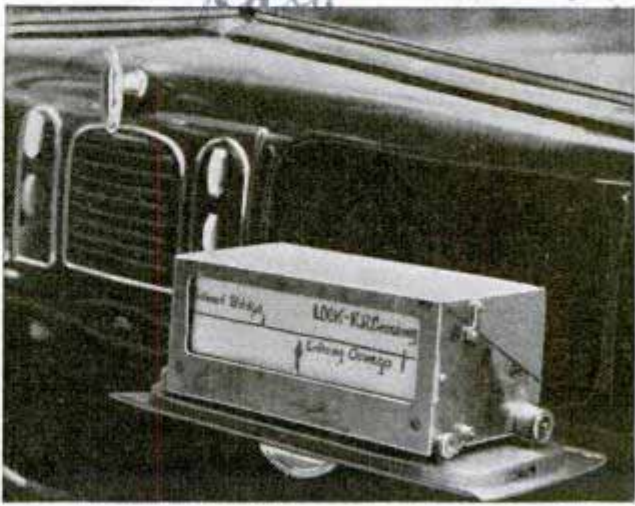

Highway map travels past window, keeping pace with progress of car by speedometer attachment

Travel Guide Case
721 S. E. Archery St.
833

Driven by
Walter D. Brown

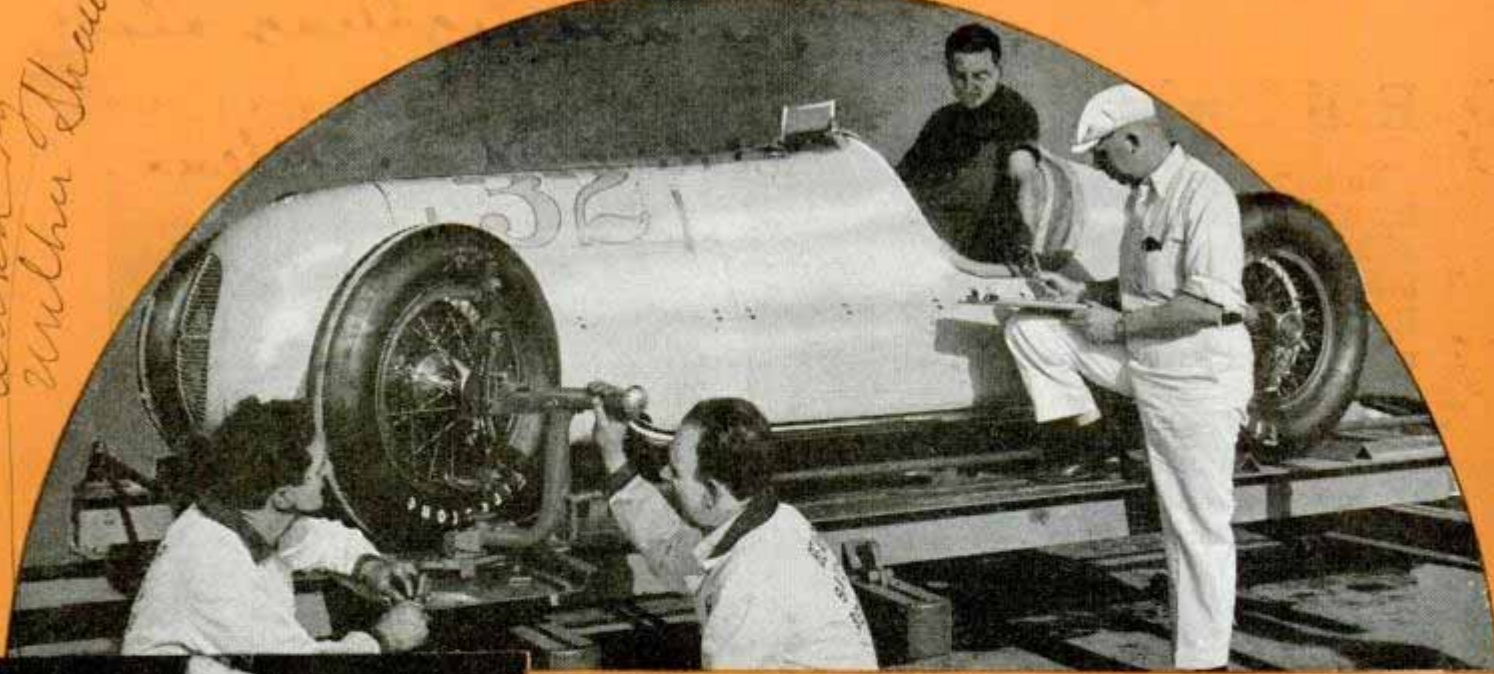

500 MILES

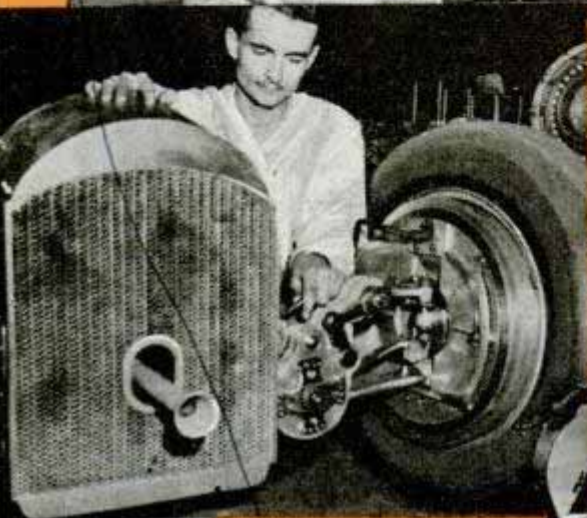

Mechanics check camber and toe-in of a racer's front wheels, top. Below, at left, a new radiator is given a fitting on last year's winning Maserati car; right, new Offenhauser engine for Joe Marks has enlarged crankcase providing more air and better circulation

K 75.
Cub. Thomas E. Stinson, Jr.
17618 Malibu Road
Pacific Palisades
Calif

DRIVING skill will count as it never has before when America's thirty-three leading drivers roar past the starting line in the annual 500-mile race at Indianapolis on Memorial Day.

Last year's race, in a way, was simply a mechanical try-out for the race this spring. The same rules apply and with a few exceptions the same cars and drivers will compete. Weak oil lines, faulty radiators, and other "bugs" that were revealed in the last race have been remedied. Fewer cars should have to make pit stops except to pick up supplies. Sixteen cars failed to finish last year because of mechanical trouble.

Year by year the pace has been getting faster. Barring accidents that will slow the race down, the winner this year must average close to 120 miles per hour to win. He will really have to drive several miles per hour faster than that because the average speed includes time out for pit stops. Competing cars are powered with four, six, eight, and sixteen-cylinder engines.

Drivers reckon that it costs nearly a lap to make a pit stop and because of this the four-cylinder cars have an advantage the others don't enjoy. The four-cylinder cars run from ten to thirteen miles on a gallon of fuel, the eights get seven or eight miles

R 758

Colm. Penning
W. Shaw
maserati

Owner Mike Boyle

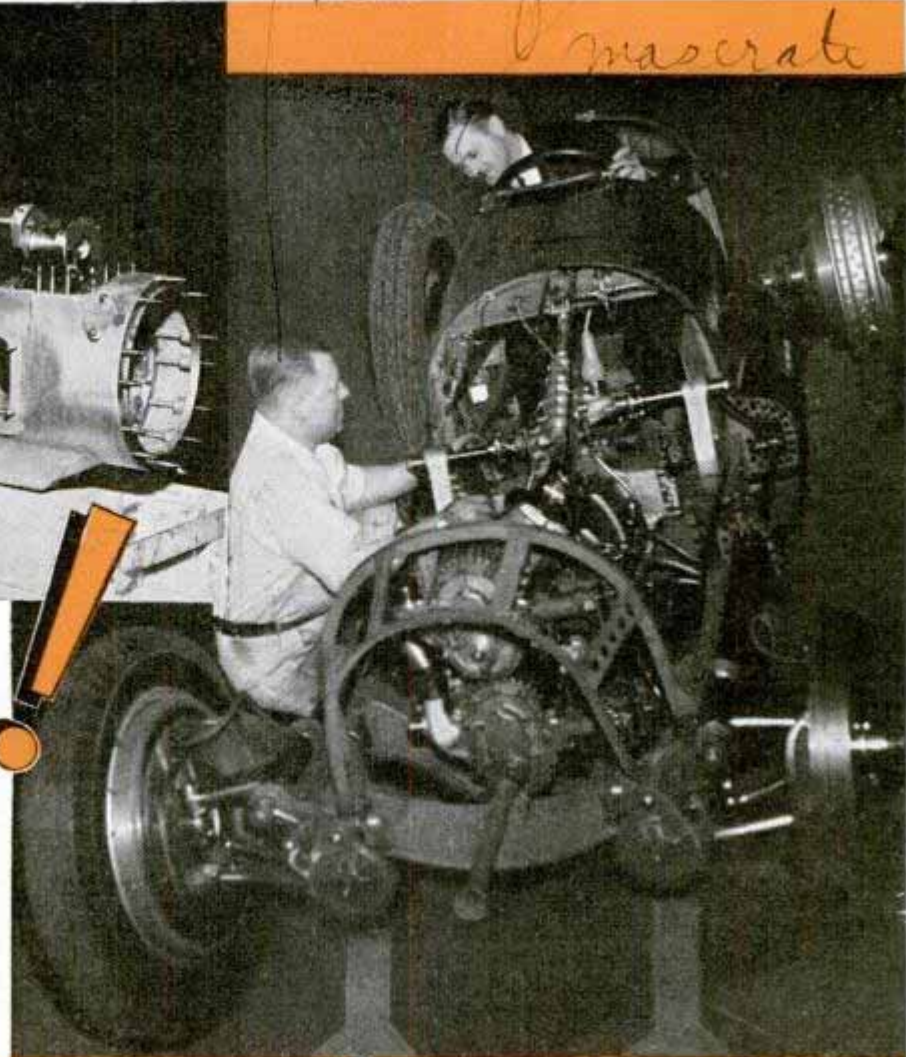
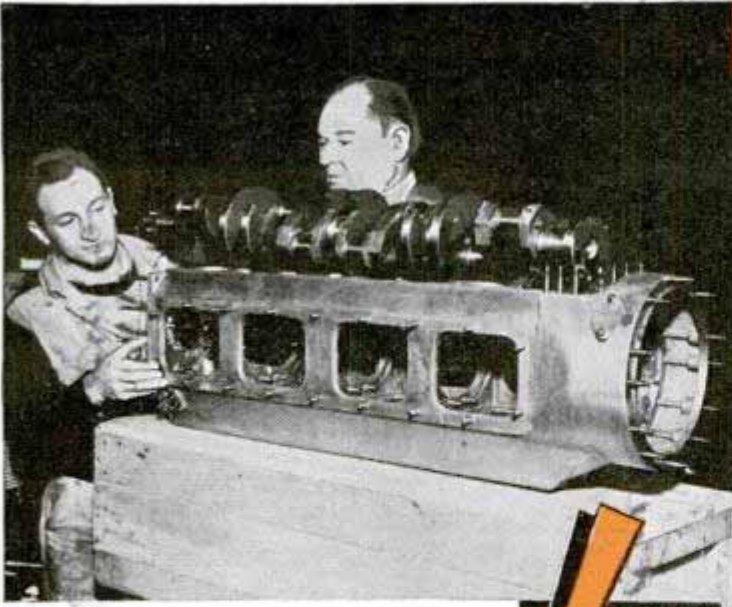

To GO!

per gallon, and the cars that burn alcohol instead of gasoline average four or five miles per gallon. Cars in the race have engines ranging from 200 to 350 horsepower.

With the emphasis on driving skill, six car owners are entering teams of two or more cars this year. An owner may tell one driver to get up among the leaders and stay there as long as he can, while the other driver is told to act as safety man and to drive a more conservative race, trailing the leaders but ready to step up his pace if anything happens to his teammate.

Joe Thorne, owner and driver, will be in the seat of his unsupercharged six-cylinder 270-cubic inch racer. Thorne's second entry is a six, equipped with a special supercharger that was built last winter. Thorne's team of drivers and mechanics travels in a special fourteen-ton capacity truck and trail-



Top, left, crankcase and crankshaft of eight-cylinder engine. Right, Italian-built Maserati driven by Wilbur Shaw burns alcohol-base fuel and is supercharged. Below, an early tune-up of rear-engine, four-wheel-drive car with Harry Miller, owner (left), George Bailey, driver (right)

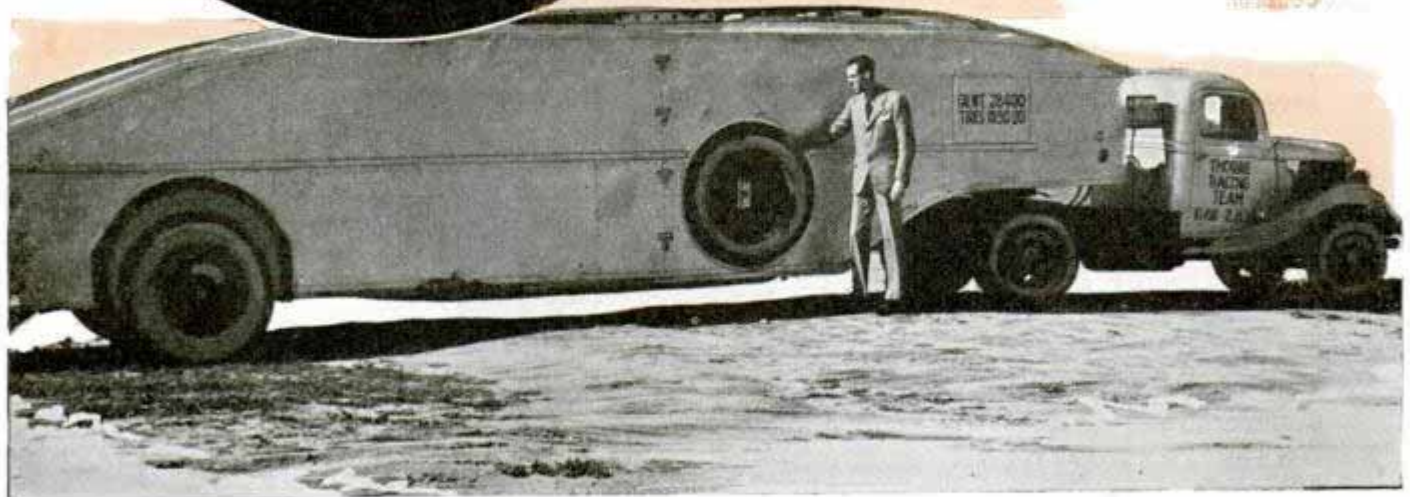
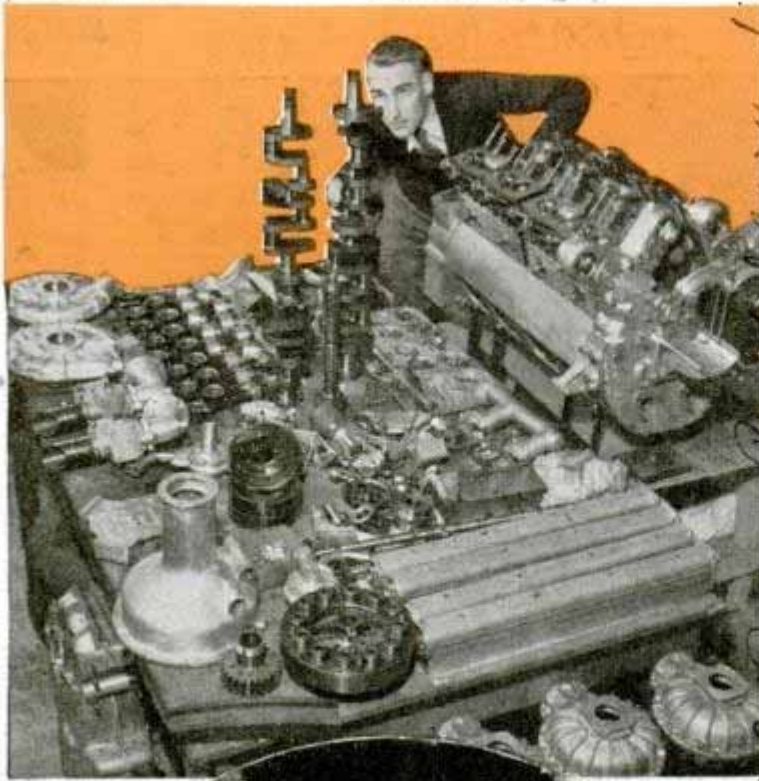

er with room inside the trailer for three race cars. Tracks run up on the low roof where a small pleasure car and a light truck may also be carried.

Fred Offenhauser has built a new 200-horsepower, four-cylinder unsupercharged engine for Joe Marks of Gary, Ind. The new engine has a special enlarged crankcase that provides a larger volume of air as well as better circulation in the crankcase. The engine is mounted in the chassis that was running in fifth place last year, with two laps to go, when a ball bearing broke in the gear train putting the car out of the race. The engine has two Winfield carburetors of a new design, of the downdraft type and using two floats each instead of one.

The fuel capacity of the car, of twenty-seven and one-half gallons, is divided between a tank mounted conventionally behind the driver's seat and a special tank built around and below the drive shaft. This combination keeps the weight low and prevents the surging on the turns that may happen when the fuel is carried in one large tank. Frank Del Roy, mechanic for the Marks team, has mounted the oil tank between the

Thousand and one parts of sixteen-cylinder engine, top, are disassembled before race for inspection and rebabbiting of bearings. Center, assembling the Maserati racer. Joe Thorne hauls three race cars in trailer (bottom), loads pleasure car and light truck on roof

*Fred Offenhauser Engineering K 76
Co. 1935 W. 62nd Los Angeles Calif*

frame horns in front of the radiator, with air-cooling tubes running through the tank that pull the oil temperature down twenty degrees or more. The car is equipped with hand-operated mechanical brakes on all four wheels and foot-operated hydraulics on the rear wheels. It will be driven by Tommy Hinnershlitz.

The second car of the Marks team is a sleek racer powered with a 255-cubic-inch Offenhauser. It will be driven by Duke Nalon of Chicago. Both of Marks' entries are owned by "Grandma" Falcioni of Gary, a sixty-two-year old feminine racing fan who has watched her own cars compete since 1932.

Wilbur Shaw, Chet Miller, and Ted Horn are the drivers in the

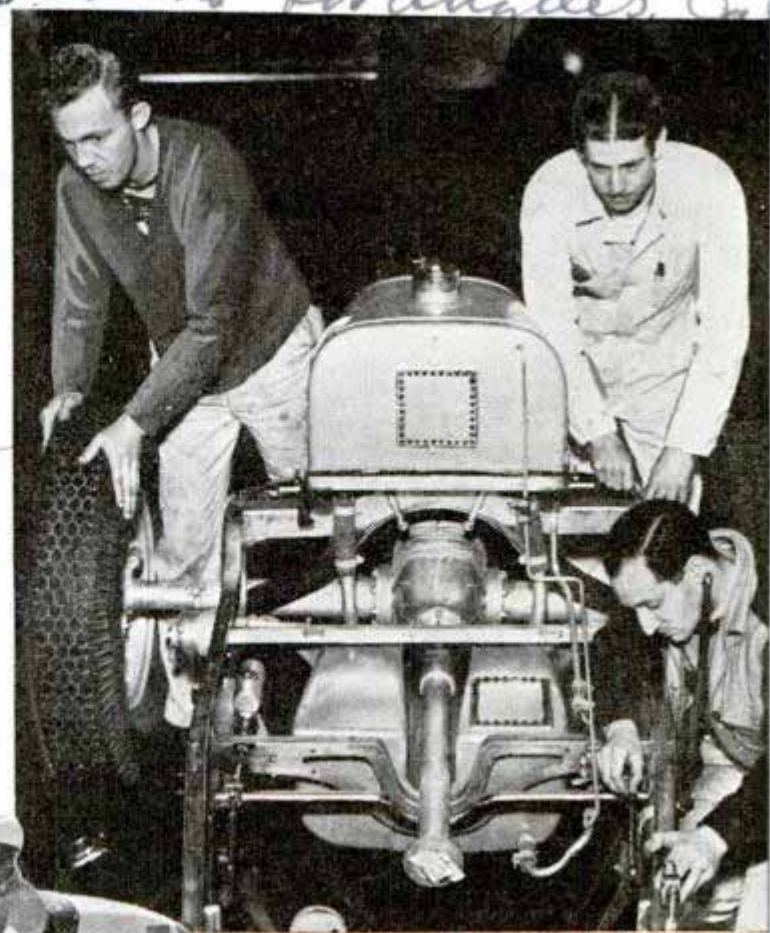

Mike Boyle team. Shaw's car, the 1939 winner, is being thoroughly checked over and inspected in Indianapolis. It is a Maserati machine built in Italy. All parts required for it had to be imported from the Italian manufacturer or specially made in this country to metric dimensions. Among the changes incorporated in Shaw's car for this year are an improved radiator, installation of American-made hydraulic shock absorbers on the rear, and additional ventilation for the driver's cockpit. The Maserati, being supercharged, burns an alcohol base fuel, and experiments to improve the fuel mixture for better performance are under way.

Horn's front-drive, fourth-place winner in 1939, has also received a number of changes directed to-

(Continued to page 139A)

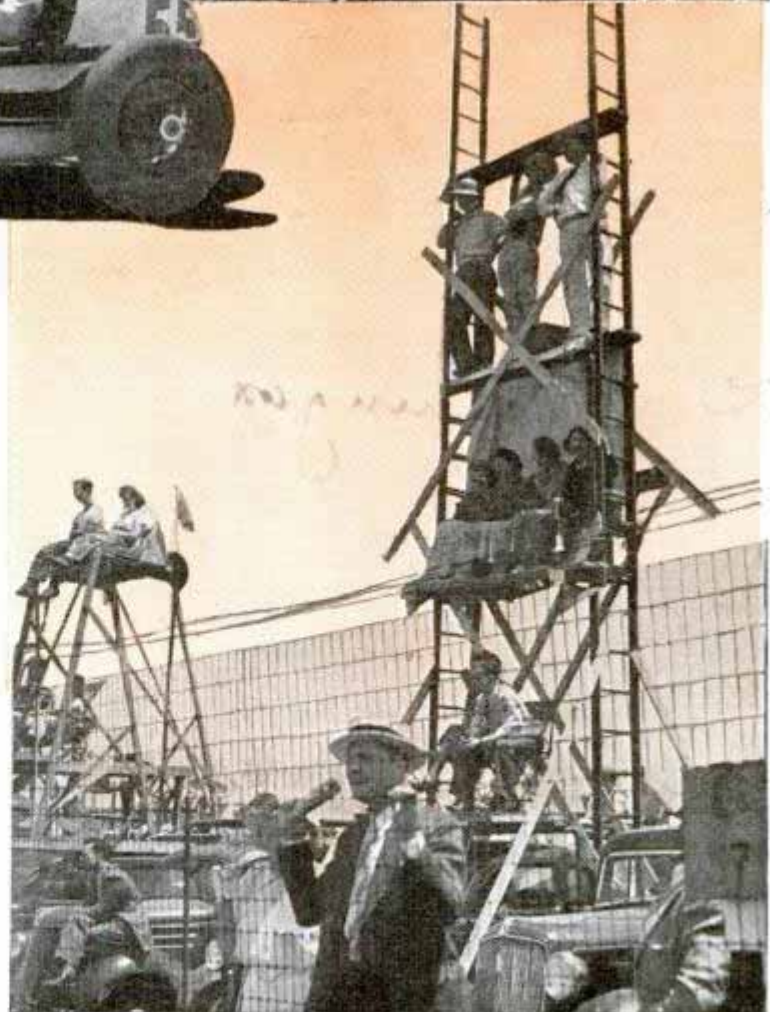

Joe Marks' car (top) carries fuel in underslung tank around drive shaft and another tank over rear wheels, keeping center of gravity low. Left, Louis Tomei on a trial spin. Below, three-story stand built by spectators at Indianapolis race

Handwritten notes on the right margin, including 'Joe Marks' car' and 'three-story stand'.

V 330.

High-Speed Flash "Freezes" Swimmers in Air

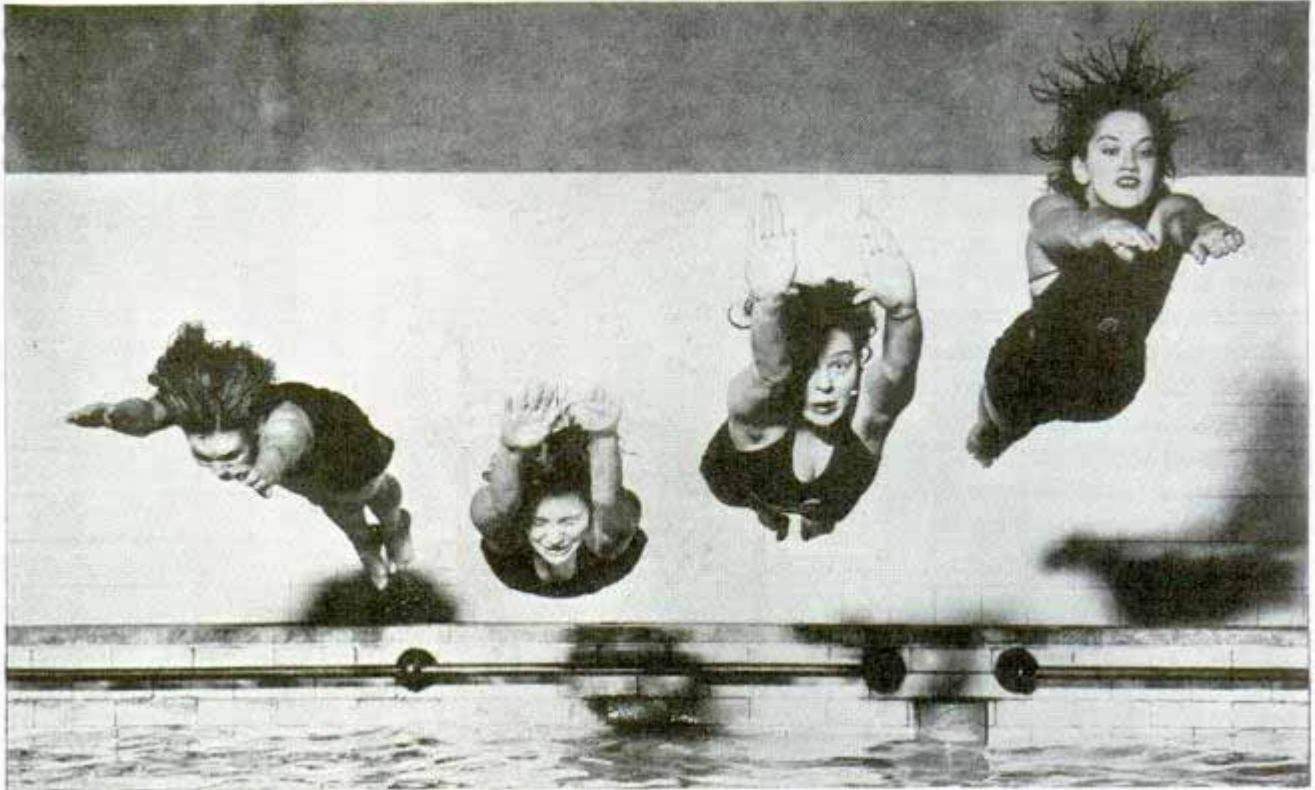

One of the fastest pictures ever taken of a sports event, this view stopping four swimmers in air at start of a race was snapped at 1/100,000 second by the ultra-speed flash process

At the tense moment of their flying start in a free-style race four swimmers were "frozen" in the air by the high-speed camera. The picture was taken at an ex-

posure of 1/100,000 of a second, using the ultra-fast flash process developed by Prof. Harold E. Edgerton at Massachusetts Institute of Technology.

Cambridge Mass

K29²

Boat Engine Built of Old Auto Parts for Less than \$100

Lacking the means to buy a suitable engine for their thirteen-and-one-half foot

speedboat, two enthusiastic racers had to depend on their talents to design and build a twin-cylinder opposed inboard engine at a cost of 100 dollars, using as many old auto parts as possible. Taking eight months to complete, the engine measures eighteen inches from tip to tip of the crankshaft, weighs 200 pounds, is capable of winding up 3,500 to 4,000 revolutions, develops fifty horsepower and drives the craft at more than forty miles an hour. Its small size takes up little more room than an outboard, and placing it farther forward makes the boat trim better. Cylinders, with walls made of iron pipe cut vertically and welded to size, have a three and seven-eighths inch bore and a four and three-eighths inch stroke, the pistons being a heavy-duty type with four rings. Large

Washington



Inspecting speedboat engine, with two opposed cylinders, that was built from used automobile parts at a cost less than \$100

W.H. Godwin and Robert King

valves with seven-sixteenths inch lift, added to high compression heads of cast aluminum, produce a hopped-up engine which will do everything required of it for small boat racing. The crankshaft, specially machined to fit, is from an old automobile engine, and the crankcase is made of sheet steel with welded seams. The engine is lubricated by a full-pressure oiling system and cooled by a water jacket, with a supplementary finned water line through the crankcase for additional cooling. A small centrifugal pump takes water from outside the boat. The only new parts which had to be purchased include carburetor, pistons, oil gauge and distributor.

R 344

Pipe Cleaner Artist Models Carriage Like Cinderella's

Among the many novelties made from pipe cleaners is a miniature vehicle that its builder calls Cinderella's carriage. This pipe-cleaner "sculpture" was exhibited at a recent hobby show in New York.



Nothing but pipe cleaners were used in constructing this "open work" model of Cinderella's carriage recently displayed at hobbyists' exhibit

R 29

Furniture Hangs from Walls of an "Upside-Down Room"



acme
It doesn't seem right, but all is in order if you get the right slant. Here a model is being "seated" in topsy-turvy room at architectural show

Startling feature of an architectural show recently was an "Upside-Down Room." Everything was topsy-turvy—although, if you could stand horizontally, things were in perfect order and taste. The furniture was hung from walls and ceiling, a model supposedly seated on a lounge was actually on her—or its—back and a spiral of wire projecting horizontally from an ash tray represented up-coiling smoke from a cigarette.

Mr. W. H. S. Baker

Radio engineers say a single television antenna could serve the entire United States if it were located in Nebraska and its top were 300 miles above the ground.

manager, rades. television antennas

TAPPING NEPTUNE'S

California Fish and Game Commission

Capt. Thomas G. Stinson, Jr. Pacific Palisades 18618 Malibu Road, Calif.

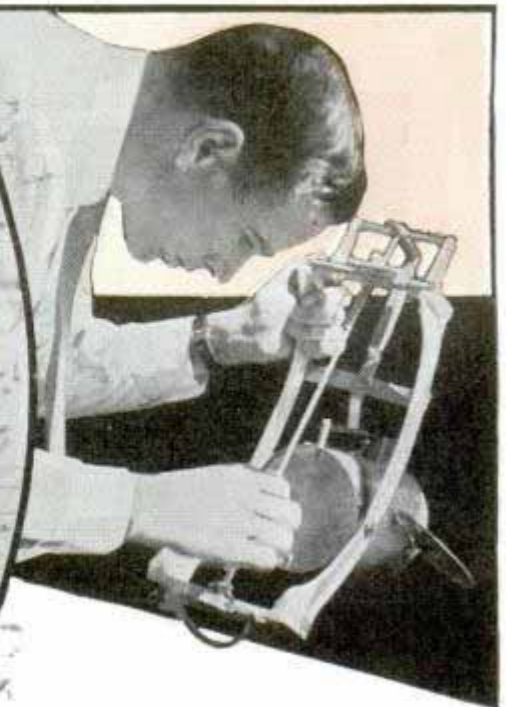
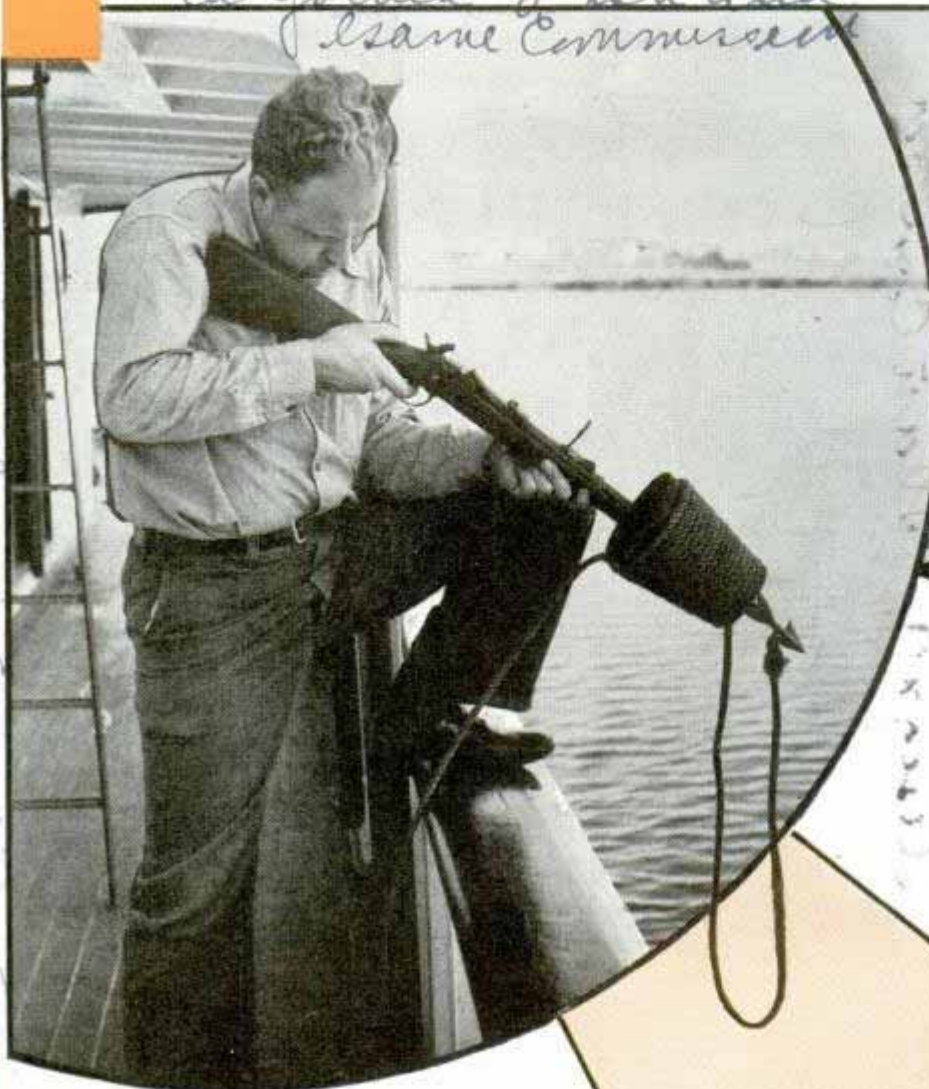

Large marine specimens are captured with harpoon gun, left; old-style rifle is used to carry heavier powder charge. Above, meter for measuring velocity and direction of ocean currents helps predict location of fish. Below, landing a load of kelp

Scripps

THERE are \$60,000,000 worth of iodine and 250,000 tons of bromine, among other ingredients, in a cubic mile of ocean water. All known elements including gold and radium are found in the sea. Yet minerals are only part of its wealth.

"The world's fisheries alone earn more than thirty billion dollars per year and employ nearly twenty million people," declares Dr. Claude E. ZoBell of Scripps Institution of Oceanography at La Jolla, Calif. "If the vast natural resources of the oceans were fully exploited many more millions of people could be employed. New uses for marine products and new ways to extract them economically from the ocean are being studied with this in mind."

Already mankind is using an imposing list of sea products. Millions of tons of salt are extracted annually, and thousands of tons of bromine are recovered to be used as an anti-knock ingredient in motor fuels. Iodine and potash are taken from kelp instead of directly from the water because the seaweed stores these minerals in high concentrations.

"The greatest wealth of the sea is not in its mineral resources,



Philip B. Park, Inc. 2145
San Pedro, Calif.

TREASURE CHEST



Kelp leaves, held to stem by bulbs or "floaters," above, cling together at tips until strong enough to withstand rough sea. Diver, right, carries air bottles on back and weights on belt while studying shallow-water flora and fauna. Below, taking aboard a net full of fish

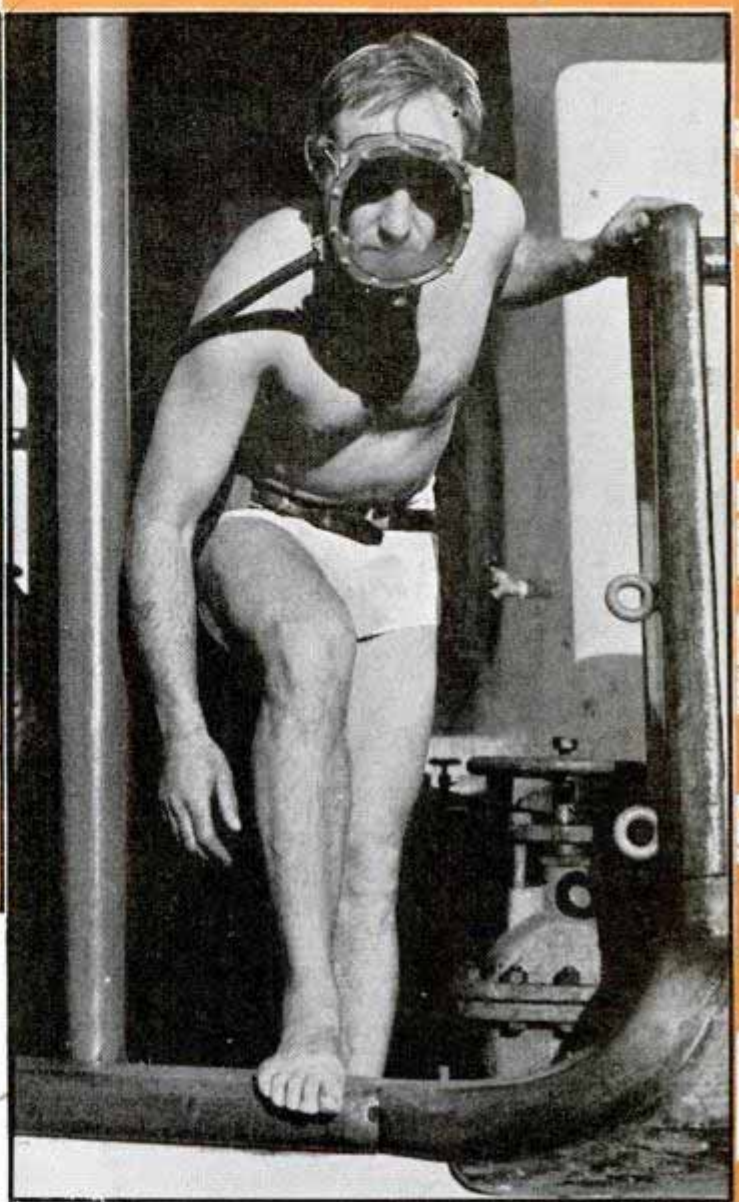

Cannal locale



including the oil deposits below it, but in its natural productivity," Dr. ZoBell says. "Only the top few inches of earth are productive yet photosynthetic plants grow as deep as 800 feet below the ocean's surface. There is never any drought in the sea, even temperatures prevail, and the water is a perfectly balanced nutrient solution in which marine plants flourish.

"In the seas grow 8,000 kinds of marine plants that range from floating microscopic 'ocean pasturage' on which certain kinds of fish feed, to giant kelp that grows as long as 300 feet. Seventy different kinds of marine plants are eaten in Hawaii. We are just beginning to appreciate the value of marine vegetation."

The harvesting of kelp is a major industry that produces nearly half a billion dol-

California

Research 841

21451 Seaprops

CO. 10/10
only 100%

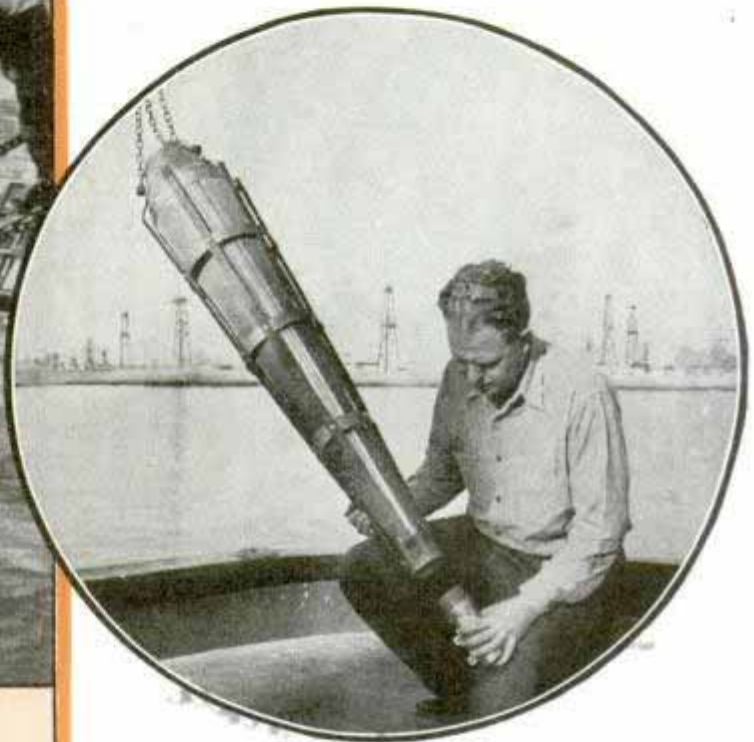
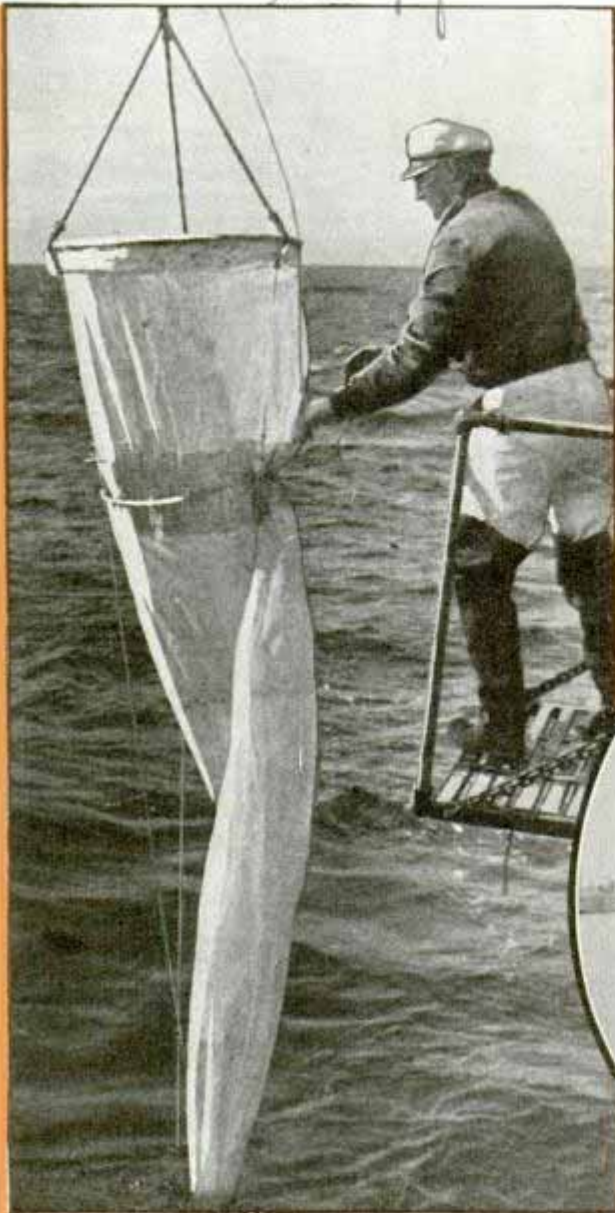

lars worth of products annually. The plant is used as paper pulp and insulation and, in Europe and Japan, as fertilizer.

One company harvests 100,000 tons of kelp a year off the California coast, using sea-going mowing machines to cut and gather the wide fronds that lie on the surface. The high vitamin and mineral content of the dried product makes it a desirable tonic and beneficial as a supplemental food for cattle and poultry. Extracts from kelp are used in breadstuffs, infant foods, in soup, condiments and relishes. Alginic acid extracted from seaweed is an impor-

tant ingredient in some malted-milk drinks and improves the quality of lacquers. Agar-agar from certain red algae is used in confections and medicinal preparations.

Excluding insects, four-fifths of all the animals known to man live in the oceans. These include 15,000 species of fish, 40,000 species of mollusks, and nearly as many crustacea. Food, fertilizer, cattle feed, sponges, leather, industrial and medicinal oils, pearls, corals, and whale products are only a few fishery products. Fish is always an important item in the national diet and the consumption of fish usually attains a peak during war years, as during the last World War when meat prices increased. Oil from the livers of many fish has high medicinal value. Shark oil is used in manufacturing soaps and paint, and oil from its liver has recently been found to have desirable medicinal properties, so that the

(Continued to page 130A)

Top and right, traps for small organisms used by fish as food, abundance of organisms presaging presence of fish. Bottom, hauling in a big catch

California Fisheries

K 282

Airplane Muffler Has 'Safety Exit' for Backfire

Tests of an airplane exhaust silencer just developed indicate it will cut engine noise by as much as seventy per cent. Tried on the exhaust of a sedan-type private plane, it made the cabin as quiet as that of an insulated air liner. A trap door on the silencer opens automatically in case of backfire, rendering the muffler "blowout proof." Besides this automatic feature, the door also can be opened by the pilot as a cutout. The weight of the entire muffler installation on a plane with fifty to 1,000 horsepower engine ranges from eight to twenty-three pounds.

At top, exhaust silencer is installed on a 200-horsepower cabin plane, which it made as quiet as an insulated air liner. Below, closeup of "safety" door which opens in case of backfire

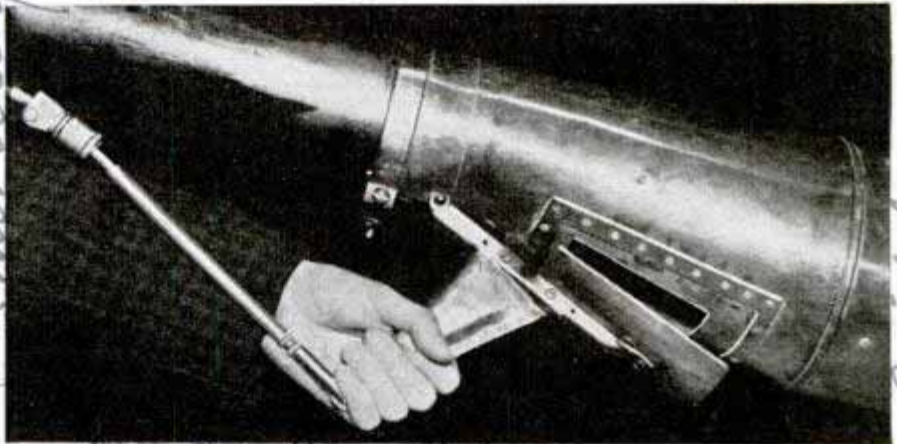

Handwritten: *Hand Eddy... muffled*
airplane & improve my... old.
14, 60 30 Park Ave. m... b... a

K 306

Automatic Fire-Fighting 'Bomb' Thrown Like a Grenade



Thrown into a fire, the glass "hand grenade" breaks and releases a cloud of gas that smothers flames but does not injure furnishings or papers

Hurled like a hand grenade into the flames, a glass "bomb" bursts and drenches the fire with liquid that becomes a smothering gas, harmless to rugs, fabrics and papers but a powerful agent against flames. Besides its usefulness as a hand extinguisher, it has an automatic feature that makes it a "robot" watchman. In its non-rusting metal handle is a coil spring held by a fuse; when heat melts the fuse, the spring throws a projectile against the glass, breaking it and releasing the fluid.

Handwritten: *Y. Burn... 217... ave*

K 256 *Senior Scientist, Bureau of Agricultural Chemistry & Engineering, Dept. of Agriculture*

Insects Preserved by 'Freezing' in Solid Blocks

Completing in days or weeks what Mother Nature takes years to accomplish, Dr. Chas. E. Sando, a biochemist, has succeeded in preserving plants, insects and other biological specimens by "freezing" them within solid blocks of transparent

Plexiglas, a crystal-clear acrylic resin. An exhibition of his work, at The Franklin Institute of Philadelphia, includes frogs, butterflies, insects, vegetables, fruits, flowers and grains. They are preserved in their natural forms and colors as faithfully as nature has preserved insects in amber; some of which have been found to be thousands of years old. Specimens are dehydrated by washing with alcohol or drying in air, then imbedded in the resin while it is in a sirupy state. Part of the process sometimes is carried out under a vacuum in order to prevent formation of air bubbles before the Plexiglas solidifies. The block, which is clearer than glass, transmits colors in their true shades, and the material may be ground to lens shape, if desired, to magnify the inclosed object. This method of mounting specimens is expected eventually to take the place of the familiar rows of jars filled with alcohol and formaldehyde now in use in medical and other schools.



Above, tarantula spider and bullfrogs preserved in crystal-clear blocks under process many times faster than nature's method of preserving insects in amber. Right, another group of specimens, in disks of same material, that permits close inspection

K 305 *Pat. # 2,192,194*

Synthetic Silk and Wool Fibers Are Made from Soybean

Strong synthetic fibers which can be made to resemble wool or natural silk, depending on production methods, have been manufactured from soybeans by Japanese chemists. Patent claims for a silklike fiber, according to scientists in this country, are novel, but woollike fibers have been created experimentally from soybeans in

Prophet Inve
America. It is believed probable that the two fibers are similar except that in one form they might be straight, without the kink of wool, and having a sheen like silk.

☐ If the ice of the arctic and antarctic regions were melted it would raise the sea level fifty or sixty feet the world around.

K 335 New York Municipal Airport

Air School Trains Stewardess for Job in Sky

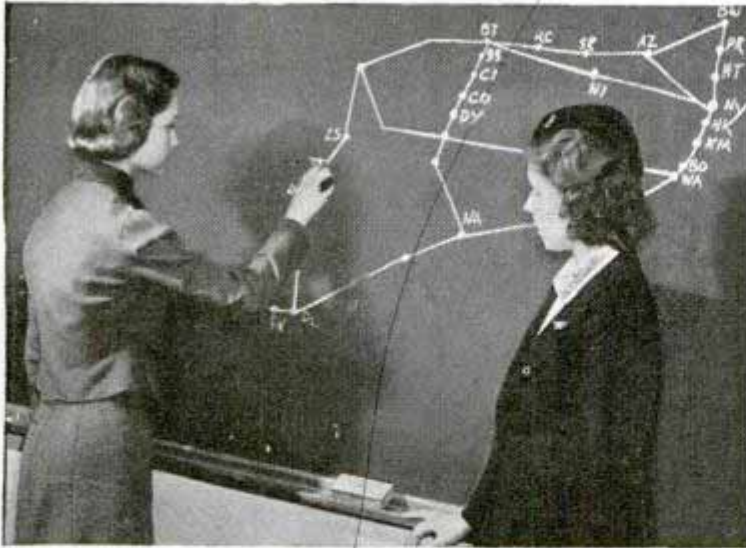

To be of service to passengers on a sky liner, the stewardess must know her company's routes and connections thoroughly. Above, a student draws American Airlines' map from memory, symbols indicating cities on routes. At top, right, a group studies Link Trainer, used by student pilots



Thirty registered nurses answer morning roll call, above, at American Airlines training school for stewardesses at LaGuardia field, New York. School lasts seven weeks and students must pass rigid examinations to qualify for jobs in the sky. Scene above is in a big hangar where American's "Flagships" are groomed for transcontinental flights; here the candidates for stewardess positions are shown the cockpits, told the purposes of controls and instruments and instructed in the principles of flight so that they may answer questions of passengers intelligently. In circle, instructor uses a "mock-up" of buffet service on an air transport to demonstrate routine of serving meals in the sky. At left, an operator in the control tower at New York Municipal Airport explains radio ranges

Municipal airport air traffic control tower

K307

Coin-Operated Duckpin Alley Resets Its Pins

H. C. Evans & Co.
1520 W. Adams
Chicago

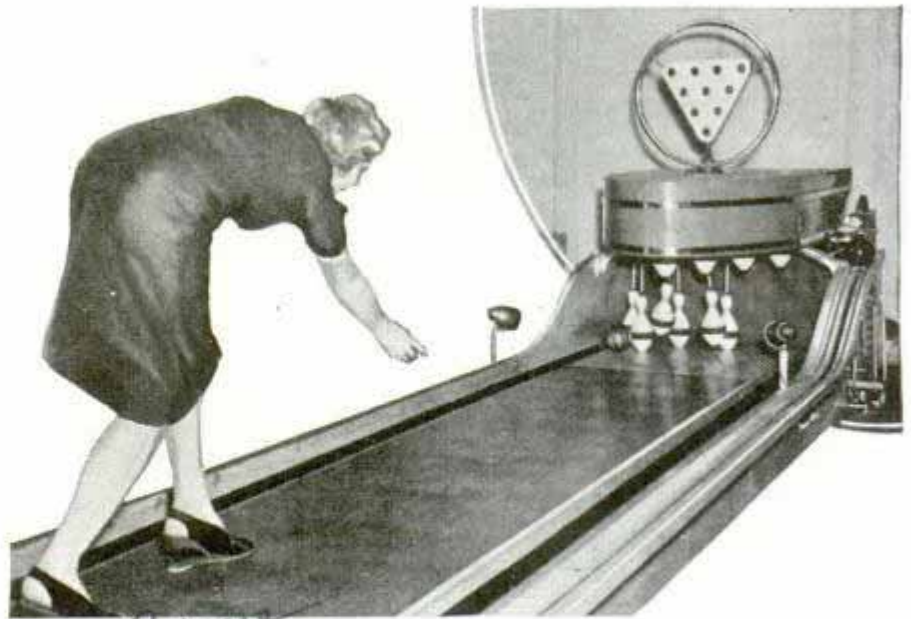

Top, heaving ball down automatic duckpin alley, and, at left, score-sheet desk with push buttons at top

No pin setters are required to attend to an automatic duckpin bowling alley, operated by push buttons, after a coin is inserted in the slot. The ball is returned automatically after it has been rolled down the thirty-foot alley, and the toppled pins are lifted out of the way, a scoreboard above lighting up to indicate which pins were knocked down. To reset the pins, the player merely presses one of the buttons on the "desk" that holds the score sheets.

K357

Double Bicycle for the Family Replaces Car in Wartime

There's no back-seat driving on the double bicycle introduced as a family conveyance in Italy, where gasoline in wartime comes high. Instead of the tandem seats of the old-fashioned "bicycle built for two," the new style has cushioned seats mounted side by side, steering wheels instead of handlebars, and share-the-work pedals.



There's no gas to buy when this Italian family goes for a twin-bike ride

Exceeding the speed limit was blamed for 36.5 per cent of the fatalities and 22.5 per cent of the injuries in 1939 traffic mishaps.

Travelers
846
New Bureau

Curved Reflectors Put New Angles on Light

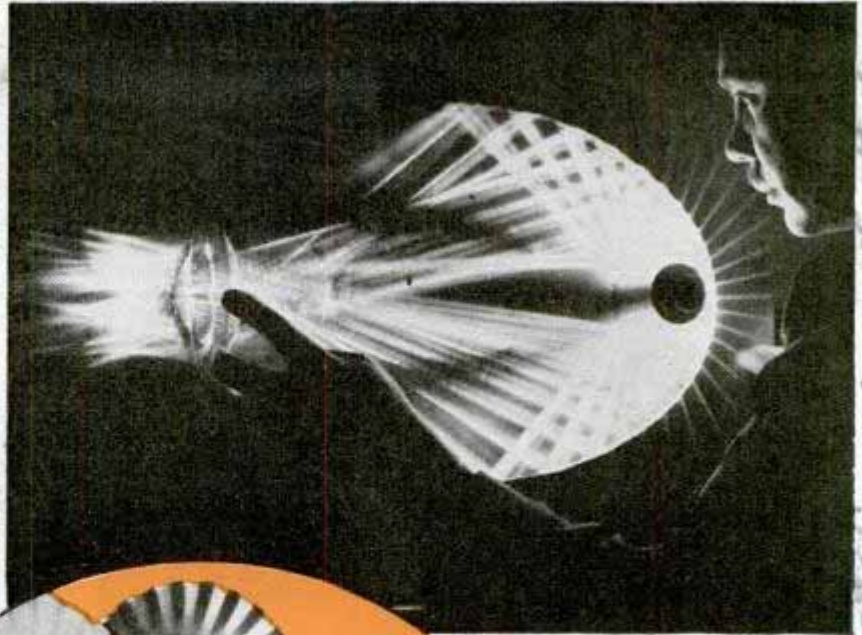
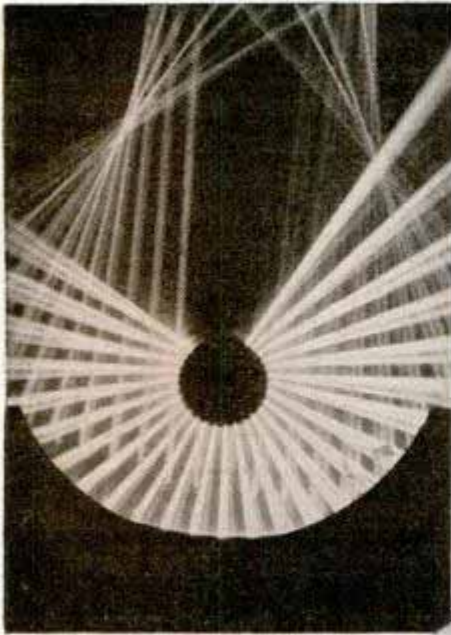

Since the third century B.C., man has used reflectors to multiply light, but only in this electric age have curved surfaces been developed to twist light into patterns for special ends. Semicircular reflector above, left, is used to concentrate light not far from source. Upper right, elliptical reflector with lens at its focus, showing how automobile headlamp focuses rays



Center, a few specialized reflectors for outdoor lighting. Model's "hat" is a reflector for alley light, bent to keep light out of bedroom windows. Bottom, left, elliptical reflector with lens out of focus produces this effect; railroad signals and traffic lamps have elliptical reflectors. "Rising sun," below, is a section of sodium floodlight reflector

Photos from General Electric Co.

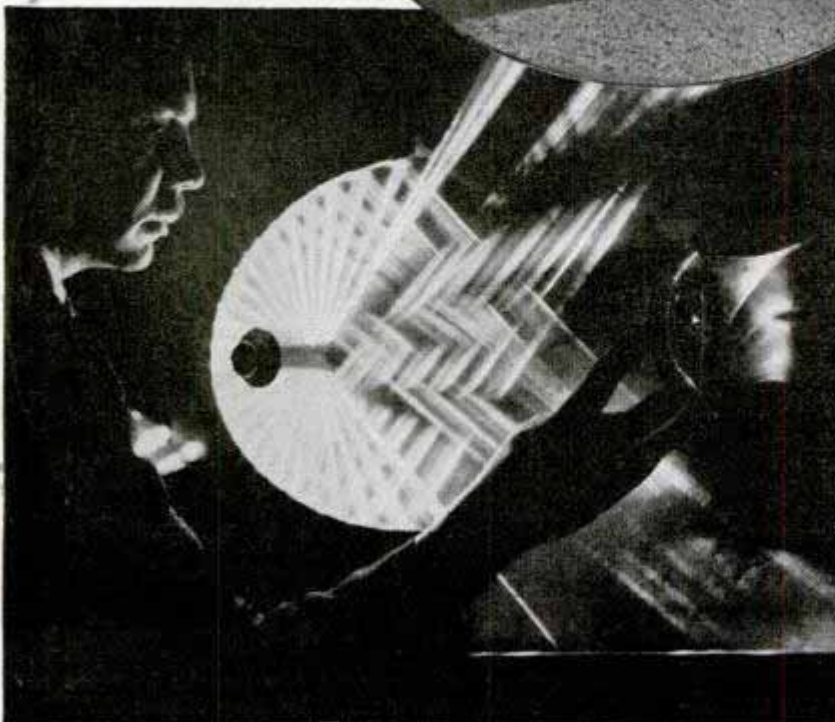

Handwritten notes:
 K374
 123
 To get the same effect
 as the elliptical reflector
 the light source must be
 at the focus
 Group
 123
 123
 123

K280

Portable Floodlight Tower Carries Its Own Generator

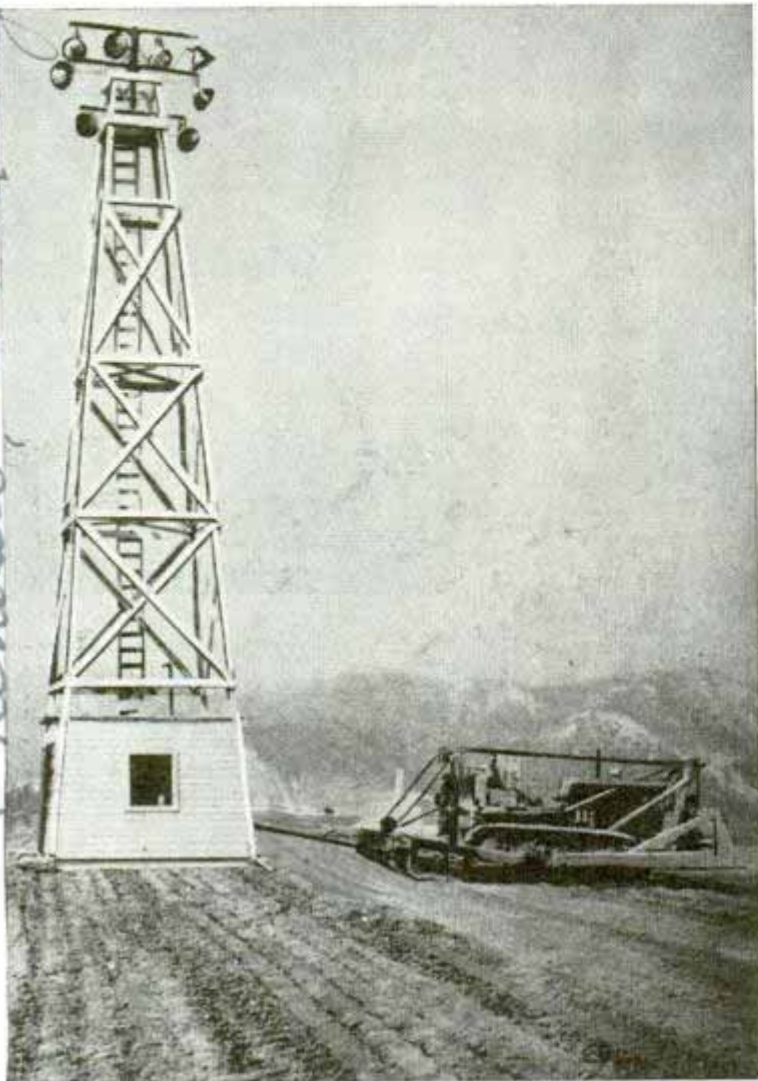

Portable floodlight tower, towed by tractor, is not dependent on power lines since it carries its own electric generator

Producing its own electricity to operate a bank of lights, a portable floodlight tower, mounted on skids, may be towed by truck or tractor to out-of-the-way locations beyond reach of electric power lines. A Diesel engine and fifteen-kilowatt generator, housed in a shed at the bottom, deliver the 8,000 watts required by the battery of lamps atop the forty-foot mast. Spreading a brilliant circle of light over a radius of 800 feet, the tower is effective in all kinds of large-scale outdoor operations, such as road construction and excavation work at night.

Bacteria Brought Back Alive After Million-Year Sleep

Bacteria that may have been in a state of suspended animation for a million years or more were recovered recently when sci-

Chicago Tribune
3/26/40

entists of the Scripps Institution of Oceanography, La Jolla, Calif., took a sample with a coring tube that penetrated twenty-five feet into the ocean floor. Dr. Claude E. ZoBell, research director, expressed the theory that the bacteria had been buried beyond the reach of free oxygen for more than 1,000,000 years, and since they were of the aerobic type requiring oxygen to sustain life, theorized they must have lain dormant through the long period until the coring tube reached them.

Waterproof Trousler Legs Keep Entire Suit Dry

This year's spring rains saw the debut of the "raincoat with pants" for men. Knee-length trousers made of the same waterproof material as the coat are attached to the skirt of the coat by snap fasteners, and slide fasteners from ankle to knee make the protective trousers easy to put on and take off. The legs fold under the coat or may be removed entirely.



Waterproof coverings for the trouser legs are attached to raincoat by snap fasteners

Cont. Raymond P. Clay, 204 E. Kendall, Corona, Calif.

Caliphillar

K290

212
All. Levi Rainwear Co. Cleveland, Ohio
124 S. Clair Ave. N.E.

Camera Sees Inside a High-Pressure Turbine

What happens when a high-pressure steam jet traveling 1,500 miles an hour hits a turbine blade making 3,600 revolutions per minute can be seen on the ground-glass screen of a viewing device that has given engineers their first glimpse of the heart of a turbine in action. Westinghouse engineers built the viewer into a special turbine to watch the behavior of the turbine blades under 1,250 pounds steam pressure at 900 degrees Fahrenheit, hot enough to melt lead. Experiments indicated the blades vibrate at a rate of 126,000 times per minute. To record the vibration photographically, the beam of an arc light was deflected by a mirror into the rotating turbine shaft, reflected through the blade toward a curved mirror on the end of the blade and then to a ground-glass screen where a camera taking two pictures per second caught the pattern of vibration.

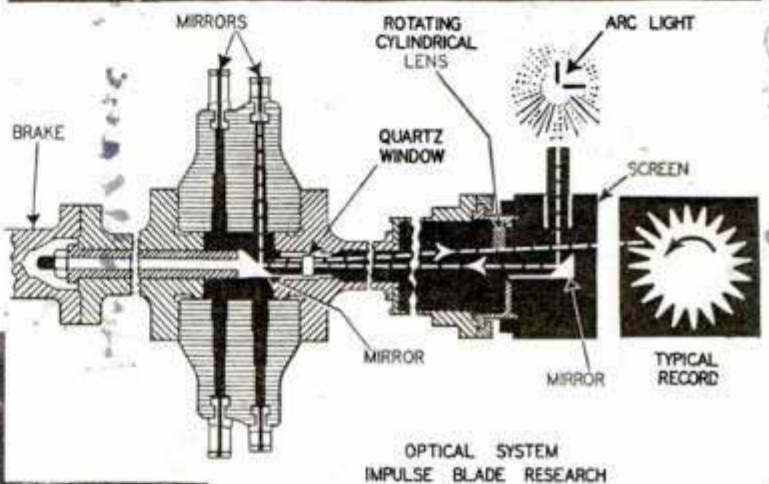
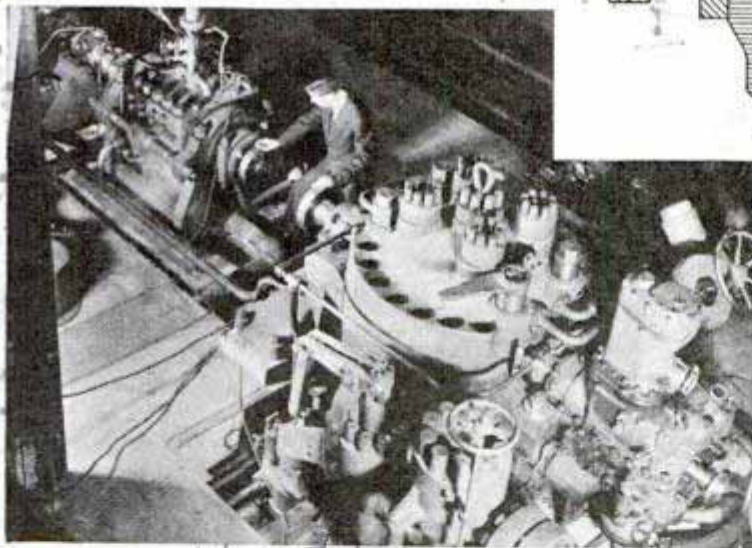

Diagram indicates how optical viewer peering into turbine (above and left) records vibration pattern. When the turbine turns without vibration, the light describes a circular path; when there is vibration, waves or notches appear in the circle



Non-Collapsing Ironing Board Fits into a Wall Bracket

Taking up less floor space than the collapsible type, an ironing board just introduced fits into a permanent wall bracket. There are no legs or braces to interfere with the work, and the bracket and retainer are built to withstand heavy pressure.



Of a world total of 44,542,137 motor vehicles registered during 1939, the United States had 30,180,224, Europe only 9,463,293.

Automobile Industries

3/1/40

Philadelphia Electric Co. 1000 Chestnut St. Phila. Pa. 8 E. Funk in charged of agency
Saint. Bend. Dr. D. Bague Westinghouse
Michael A. Husvar chm. 923 Swinburnham Drive

Directional 'Mike' Is Varied at Turn of a Switch

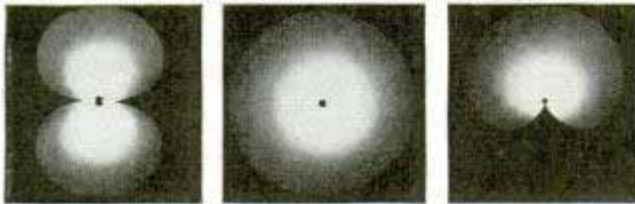

Diagrams indicate by light-to-dark variations how microphone (top) decreases in field of sensitivity

Sounds coming from any chosen direction can be picked up at will by the newest type microphone. By merely adjusting a switch at the back of the "mike," it can be made sensitive to sounds emanating from any single direction or a combination of directions, while unwanted sounds from all other sources are suppressed. This permits the instrument to be adjusted to suit the acoustic characteristics of individual studios or locations.

X 3 4 4

Fliers Carry Oxygen in Pocket for Leap from High Altitude

Airplane pilots who "bail out" at altitudes of 35,000 feet would die from lack of oxygen if they had no emergency supply. Dr. Walter M. Boothby of the Mayo clinic

Scenic Servo

has devised a pocket-sized tube containing just enough oxygen to keep the pilot alive on his way down through rarefied air until he reaches altitudes where there is enough oxygen to support human life. Further protection for high-altitude fliers is given by a sponge-rubber valve now being used on oxygen masks. The new rubber valve does not freeze in the cold upper air as metal valves sometimes do.

K 182 Cleveland Ohio

Automatic Storage Water Heater Fits under Kitchen Sink

For the house or apartment with limited space there is an automatic storage water heater that can be concealed in a compartment under the sink. It has a snap-action thermostat with built-in dirt trap, and is easily regulated to provide a supply of hot water at any desired temperature.

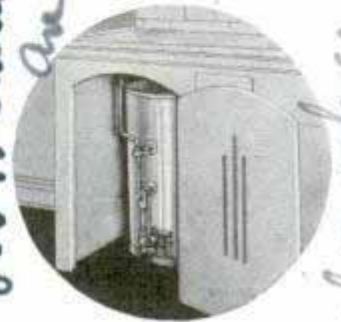

K 131

Wall Rack for Drying Clothes Folds Out of the Way

Little space is required for a drying rack for clothes or towels which folds into a wall-mounted case. Extended, it offers fifteen feet of drying surface. All metal parts are plated to prevent rusting.



Fifteen feet of surface are available when this drying rack for clothes and towels is pulled out

Rockester,

Western Electric Co

Waterman Dental Co

800 Strand

W. L. Lawrence

W. L. Lawrence Co. 101 N. 1st St. N. D.

Via

*Gifts. 8. Curt. D.G. 26. 216. Well. Muller
Robert Bogue - 3860 Danania Ave.
Vergel.*

BATTLING BUGS with BACTERIA

*457 A day demand
cure for crickets*

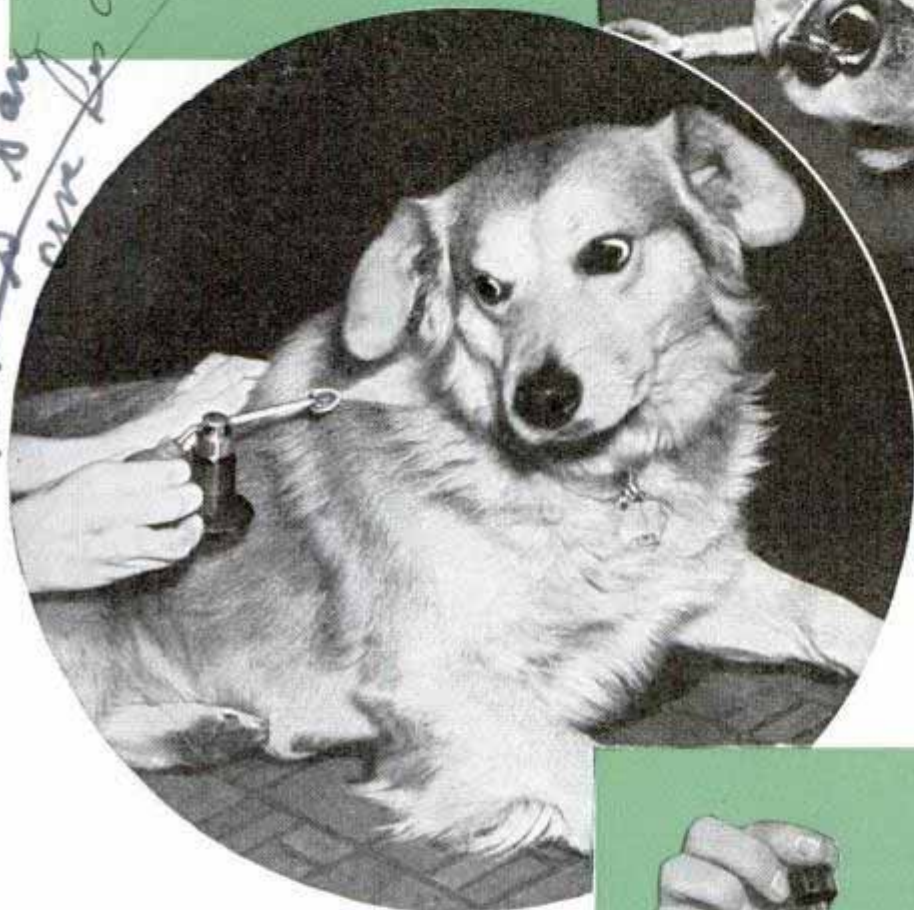

Mormon cricket, above, costs millions of dollars annually in crop damage. Soon you may rid your dog of fleas (left) with liquid from atomizer containing insect-killing bacteria. Below, Robert Bogue tests solution used for culture medium in which bacteria are grown

THERE is one war that never ends. It is a war in which every man, woman and child is engaged—the war against worms, beetles, roaches, spiders, ants, locusts, borers, fleas—and the thousands of other insects which rob, bite, and kill us.

Within recent months a new weapon has come into use in that war, a weapon which carries the possibility of controlling the world's pests with a few puffs of colorless liquid—thereby saving untold millions of dollars and once and for all assuring victory to man over his greatest enemy.

That liquid contains billions of bacteria which are deadly to insects, harmless to men and animals. And behind the discovery of this bacteriological weapon is a thrilling tale of a small group of men fighting defeat and scorn, and at last succeeding in



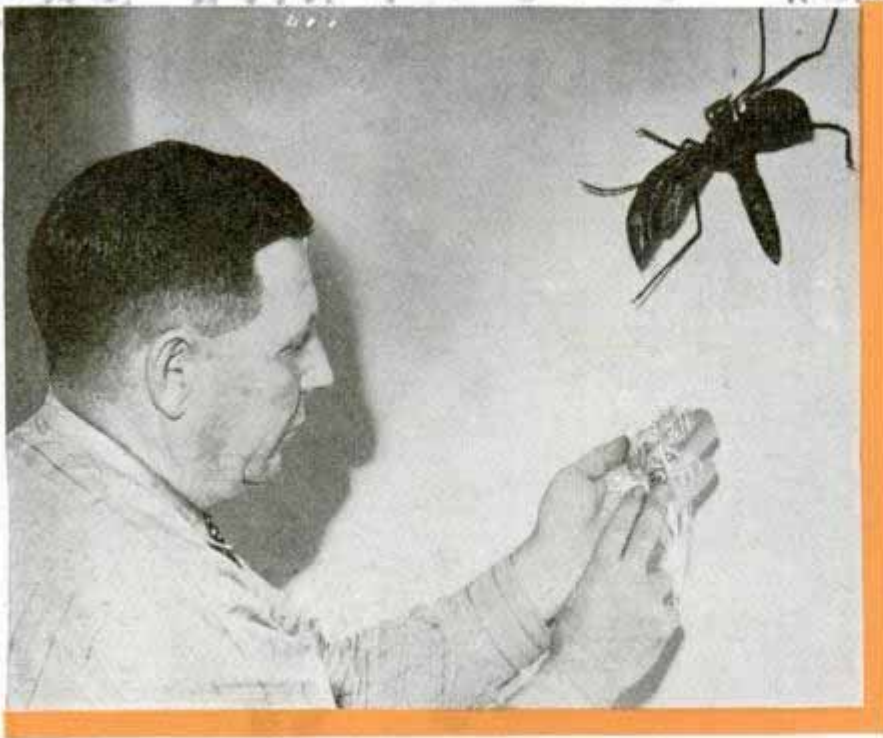

turning nature's own weapons against her.

It began when Louis Pasteur was almost driven out of one section of France because he suggested that silkworms were dying of a bacteriological disease. Pasteur's sole idea was to save the silkworms and so preserve one of France's most valuable industries, but he later hinted that if bacteria could kill useful insects, they might also kill harmful pests. By that time Pasteur was famous, and both the silkworm growers and the scientists had decided he was right about what was killing the worms.

But Pasteur never went beyond hinting that bacteriological warfare against insects might be possible. That odd end of research slept until the French biologist d'Herelle picked it up and tried to kill ants with their own disease. After succeeding with one type of ant, he concentrated on killing locusts. The locusts had been swarming over Yucatan, leaving desolation in their wake, when suddenly the swarm began to dwindle. The following year the attack was less serious, the third year the locusts vanished. D'Herelle discovered bacteria were killing them. After breeding the bacteria in his laboratory, he tried artificially infecting locust swarms in Argentina and Algeria. The locusts were de-

stroyed, the ground littered with their blackened bodies. There the line of research stopped again.

Years later Allan Dustin of the Canadian department of agriculture discovered that apple suckers, which were destroying crops in Nova Scotia, were being killed by a fungus disease. This fungus destroyed the body structure of the suckers, leaving mere shells filled with the parasites.

Dustin decided to take leaves covered with the infected suckers and fasten them to trees in orchards where the insects

were raging. Then trouble began. "Don't fool with our orchards," the ranchers threatened. "Maybe those bugs would kill us too."

But Dustin knew his fungus was harmless to men and animals, and continued his efforts. Finally, he received permission to experiment on a few small orchards, which were being destroyed by the suckers. He pinned his infected insects to the trees—and waited.

A week went by. In the untreated orchards the apple suckers were more numerous than ever, but in the orchards

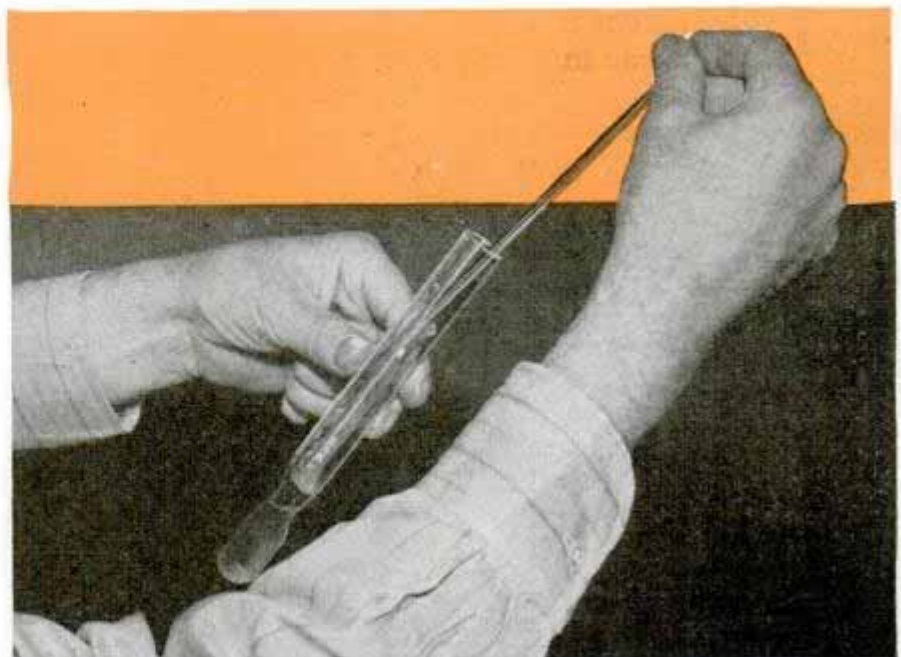

At top, Mr. Bogue examines corn worms he has just inoculated with bacteria; on wall is one of the huge insect models he collects as a hobby. Bottom, culture for raising bacteria is kept slightly moist by solution in bulb at base of test tube

artificially infected with fungus the suckers appeared to be thinning out. In another week there could be no doubt; in the orchards which he had infected, the suckers were dying by millions. Then a strange thing happened. The few remaining suckers in the fungus-infected groves gathered in a swarm. Like human beings fleeing a plague-ridden city, they scattered. Dustin smiled as he saw them go, for they were spreading the infection to ever larger areas.

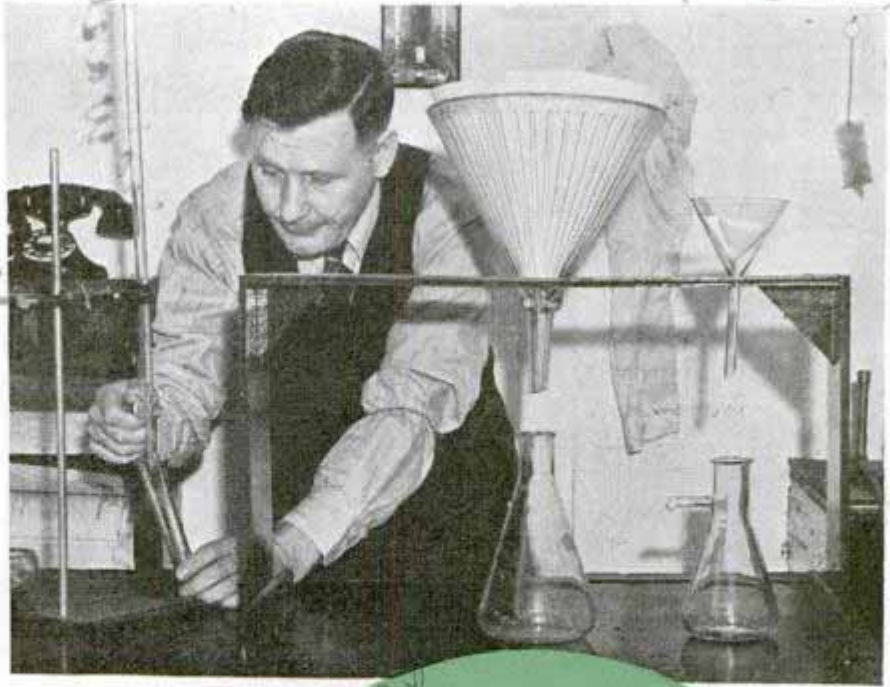

After Dustin and his pest-killing fungus, research on killing insects with their own diseases dwindled again. Finally in 1936 Robert Bogue, an entomologist with degrees from Johns Hopkins and Northwestern, began to study whether bacteriological warfare was effective against many types of insects. Since that time he has used bacteria to kill corn worms, grasshoppers, fleas, cockroaches, bedbugs, and a dozen other insects. And his bacteria remain perfectly harmless to men and animals. As he says:

"When people are skeptical, I just

(Continued to page 133A)

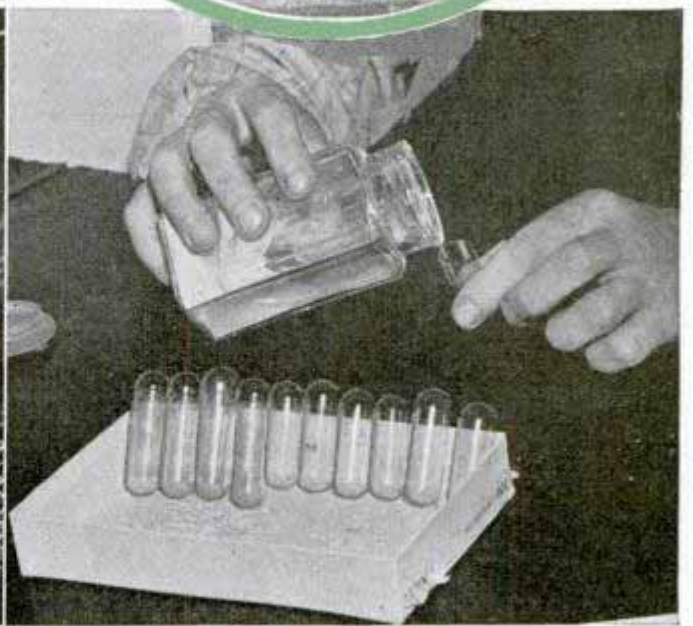
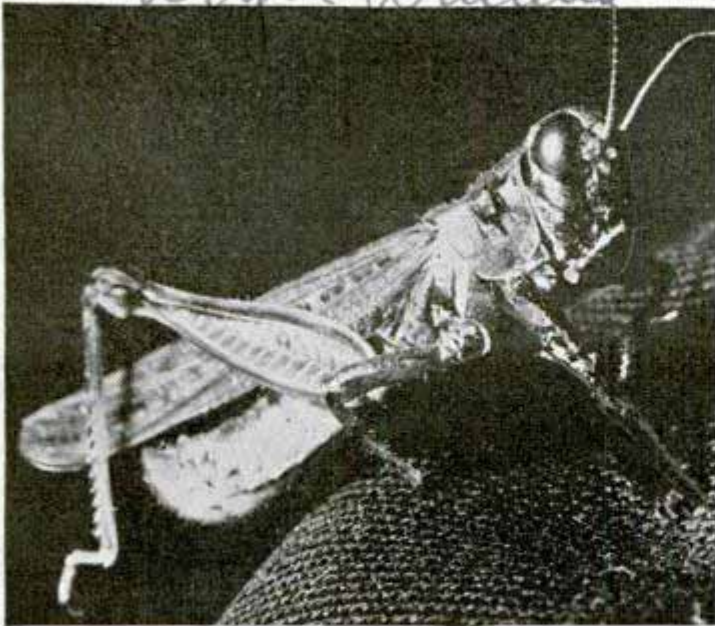
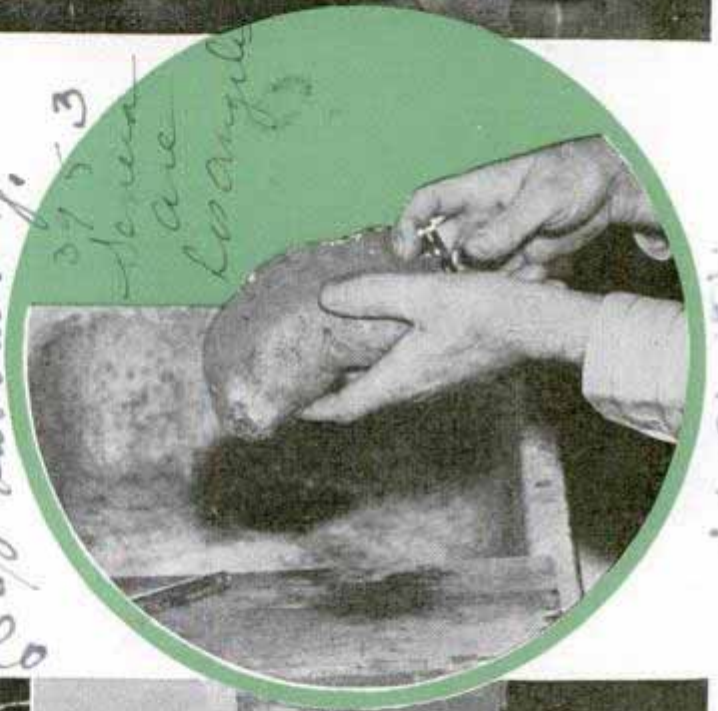

Top, preparing delicately balanced saline solution for bacteria culture. Circle, planting potato bugs in heart of potato; these bugs will be inoculated with bacteria to build up strength of insect-killing germs. Periodic destruction of Rocky Mountain locust, left, by natural bacterial disease, was a clue aiding science in its new war on insects. Before shipping, bacteria are dried and placed in capsules, right

K 239

'Detectives' Sniff Subway Air to Safeguard Riders' Health

Consolidated Edison Co. 41st St. and 1st Ave. Buffalo



"Sleuth" tracking down a gas odor in subway sometimes drapes coat over his head to concentrate air for good whiff near train

In New York subways four gas sleuths work in day and night shifts to detect gas leaks which might injure the lives or health of subway passengers. The "detectives" ride from station to station sniffing the air for the smell of gas, but rarely finding what they seek because of extraordinary precautions taken to avoid leakage. Some trains have a small window in the front car that may be opened, and on others the sniffer stands on a platform between cars to get a whiff of tunnel atmosphere as the train rushes through.

Sometimes an inspector stands on the station platform with his coat draped over his head as a train comes in. This excludes other odors, and if there is any gas it clings to the wool for a few seconds, making it easier to detect.

Boeing Aircraft Co. Wash.

K 286

Electric 'Stratoliner' Model Tested in Wind Tunnel

In order to study the performance of the Boeing "Stratoliner" in controlled conditions as near as possible to actual flight, a scale model one-tenth the size of the big four-motored liner was constructed at a cost of \$16,000 and put through its paces in a wind tunnel. The model does everything but fly away. Its fuselage is filled with electric motors and other equipment by which the rudders, ailerons, wing flaps and elevators are remotely controlled. Each engine nacelle houses a five-horsepower electric motor driving 13.8-inch propellers up to 20,000 revolutions per minute. As the control surfaces are moved in the wind-tunnel tests, the engineers can read each change in position, including deflection caused by the wind, on the instrument board.

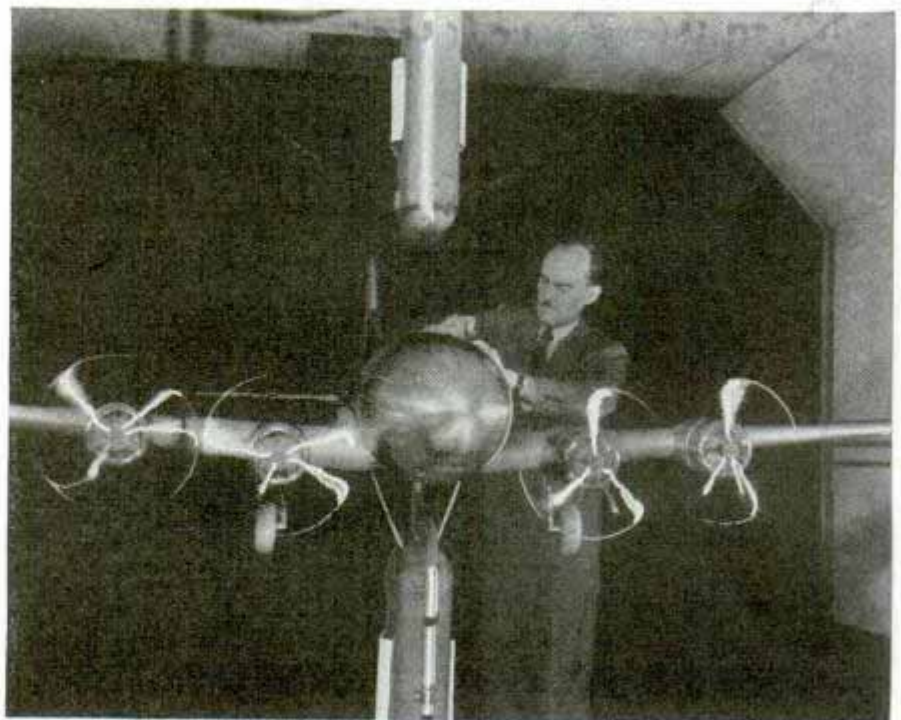

Its engines and controls all remotely operated, this scale model of Boeing "Stratoliner" was built at cost of \$16,000 for wind-tunnel tests

Suggenheime
POPULAR MECHANICS

R 252.

Battleship Model Helps Train Young Seamen

British youths get their first training as future officers of the Royal Navy by studying a working model of a battleship. Boys as young as thirteen years of age are instructed at the naval college at Dartmouth, England, a training school for boys who expect to become midshipmen and officers.

Royal.

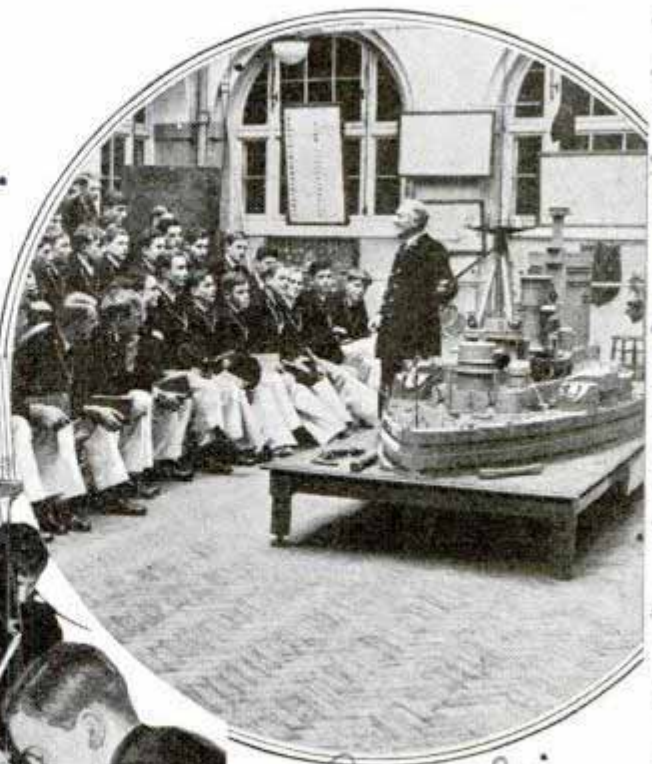

Acme.

Above, group of attentive students hearing lecture illustrated with working model of battleship. At left, learning to hoist "picket" boat from deck under guidance of naval instructor



R 273

Spring Pistol Shoots Newspaper from Car to Rural Box

Stopping his car and reaching through the window each time he came to a rural subscriber's box was too slow and arduous a procedure for an enterprising newspaper carrier, so he devised a gun to shoot the paper from car to box. Rolled and secured with a rubber band, the newspaper is loaded into the barrel and pressed against a spiral spring. As he approaches a box he slows to five or ten miles an hour, takes careful aim, pulls the trigger and the newspaper shoots into the box. The carrier rarely misses his aim.



Slowing down but not stopping, carrier shoots newspaper into open box

Eli Keith 241

West Palm Beach, Fla.

SOLVING

Photographing fingerprints on safe, left, with special camera, which automatically focuses to take full-size prints. Photograph of rubber-heel impression compared with burglar's heel, below, brought confession. Bottom, micrographic photographs of edge of "jimmy" found on burglar, and its impression on window sill

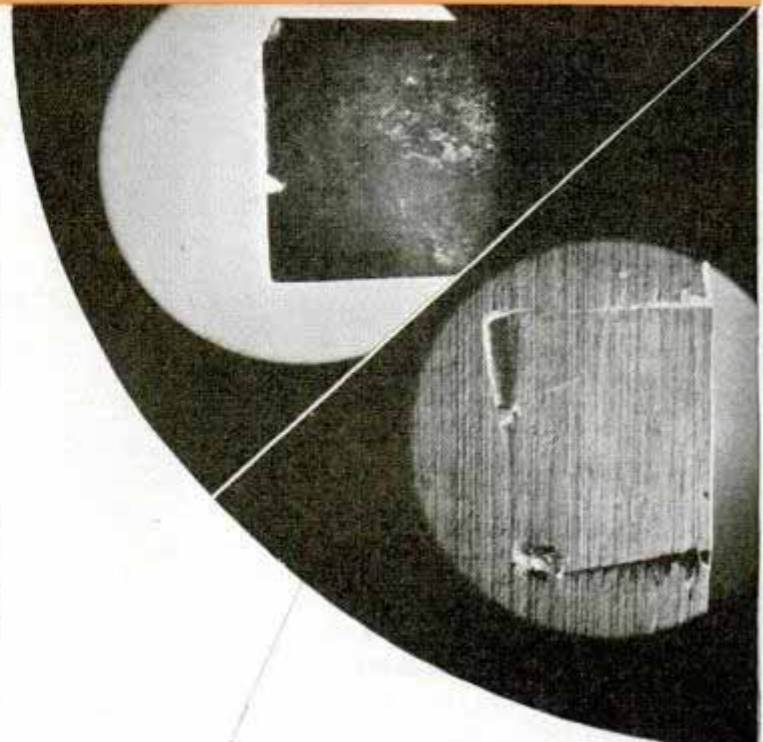
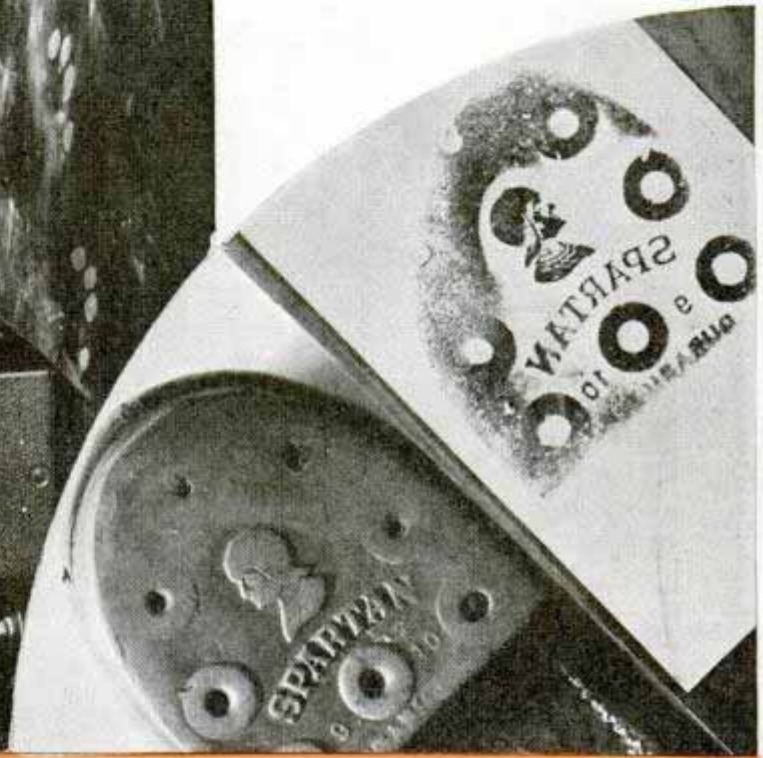

WITH impudent bravado the youth admitted the iron bar was his, challenged the Newark detectives to prove anything against him.

"How long have you had it?" he was asked.

He thought fast. He had bought the jimmy in a Newark pawnshop. Police checked up on those places, probably had a record of the sale; the truth might be safest.

"Oh, about six months," he said.

The officer glanced at a typed memo.

"And on the night of October seven," he accused, "you forced open the bathroom window at 2842 Blank street, stole silver and—" here he read off a long list of missing articles.

The youth blanched suddenly, but remained defiant.

Emb. Herbert U. Webb
4322 Second Good.
Jimmy
1450

data card has information for police officers only

CRIME *with the* CAMERA

2 1450

J. B. T.

Right, examining a suspected parcel under X-ray. Below, matched fragments of button from thief's overcoat, and expansion bolt and wrench used for step of ladder between buildings. Bottom, photographic room of the Federal Bureau of Investigation

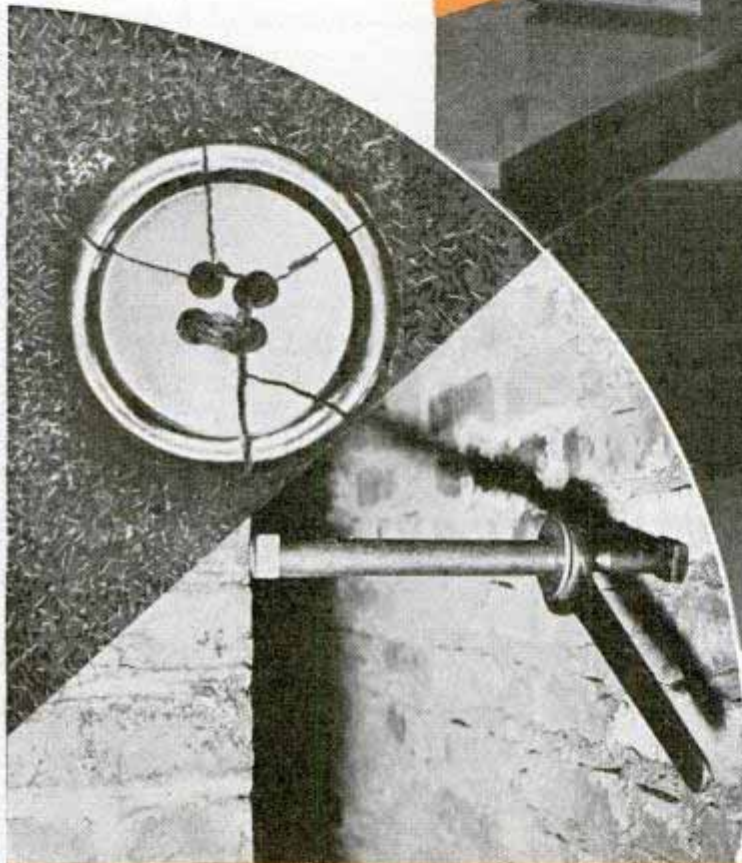

"Prove it!" he challenged.

The detective produced enlarged photographs of that bathroom window ledge and frame, plainly showing the imprint of a jimmy. He then produced transparent slides to the same scale, showing the tip of that very jimmy which the youth admitted was his. He fitted one photograph over the other. Flaws and marks on the jimmy matched perfectly with the marks made three months before.

The prisoner promptly confessed that and a dozen other robberies. What else could he do? A criminal will go before a jury, match his wits against a policeman's memory, win an acquittal more often than not. But this mechanical memory—the camera—is something he cannot combat. Years may

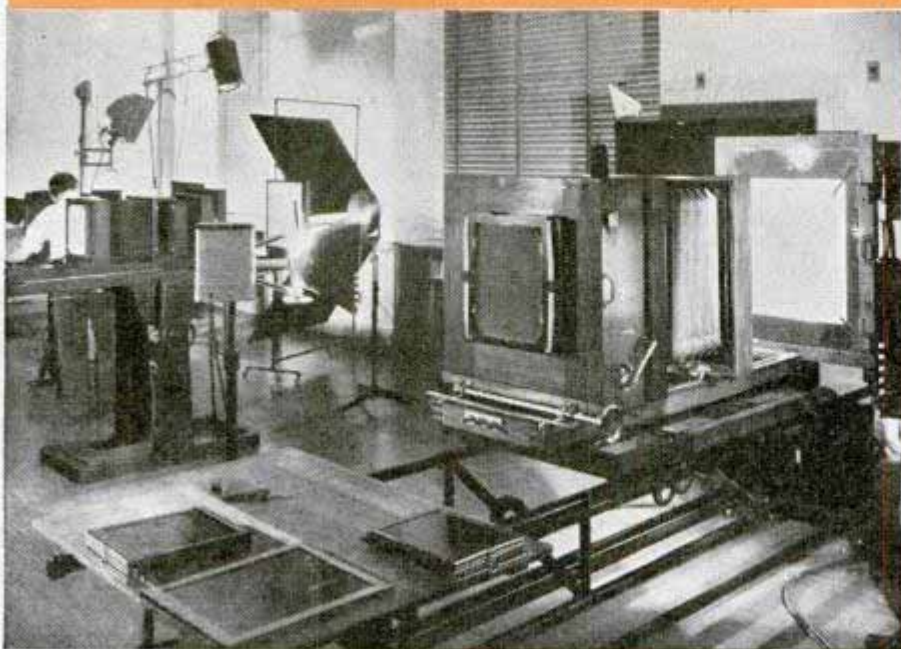

subject of photographing the coat - brass studs
21950



the prints. This is seldom done because it is seldom necessary. Confronted with that kind of photographic evidence, the criminal in a routine police case usually confesses.

Take another burglary case in Newark, where the thief broke a button of his overcoat while entering a house. Four pieces of the button were picked up at the scene. The dragnet brought in a collection of known thieves next day, among them one who had a broken fragment of button clinging to his overcoat.

Shown the pieces, he was contemptuous. "A black button is a black button," he said, "and a thousand guys might have busted one."

John Day, Newark police photographer, placed the pieces beside the bit still hanging on the coat. Not only did all pieces fit together perfectly, but the microscopic machine marks, made in cutting the button, matched up in the enlarged photograph. One glance at the result brought a confession from the thief.

The mechanical memory of the camera

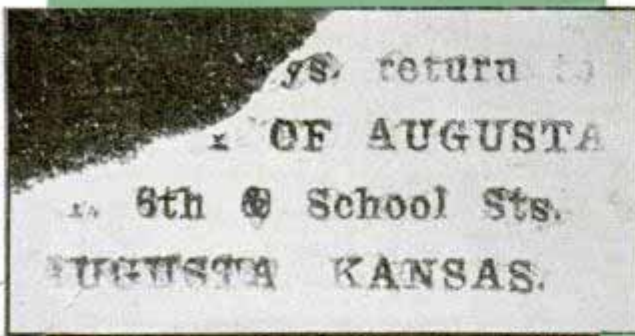
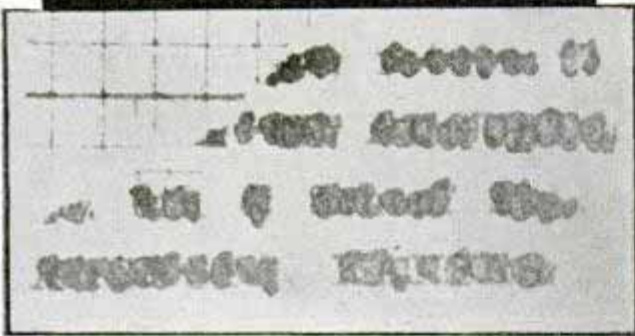

elapse between the crime and the day of reckoning, but the camera never forgets. Its record remains to haunt the criminal after time has erased the recollection of eye-witnesses.

In modern law enforcement, all evidence is photographed. With an efficient photographic department, a district attorney might present his whole case in photographs, calling as his only witness the police cameraman to identify

Holdup victims examine file of pictures in effort to identify robbers, top. Center, infrared photography brings out illegible printing on an important bit of evidence. At right, a police photographer makes a "portrait" of a murder weapon

21450 K265

Policeman's Pocket Radio Receives Orders on Beat

is of great importance in preserving evidence. The scene of a murder may change materially between the commission of the crime and the presentation of evidence in court. Furniture may be removed, blood-stained floors washed, buildings torn down. But a photograph is a permanent record of things as they were.

Even a few minutes may alter an important bit of evidence. In a recent murder a witness arrived while the homicide squad was still investigating, volunteered that he was talking over the phone to the victim, that the conversation had been interrupted by loud voices, followed by a shot. If this were true it solved the crime, for the victim had shouted the murderer's name before he was shot. But the handset phone was on its cradle, and detectives and reporters all denied having touched it, thus impeaching the witness.

An alert police photographer hurried to headquarters, developed his plates, returned with photos showing the phone off its cradle. A reporter then admitted calling his paper while detectives were out of the room.

Special agents of the Federal Bureau of Investigation carry two cameras as part of their field equipment. One is a Graflex fingerprint camera, permanently focused to take prints at full size, and with a self-contained light. The other is a bellows Kodak with both ground glass and wire-and-peep finders, synchronized flash, and built-in self-timer.

Since a municipal police force need never work at any great distance from its headquarters, all photography may be left to experts who may be called to the scene in a few minutes. The Newark police force, listed by the F.B.I. as among the most progressive in crime detection, keeps one man on duty at all times in headquarters, to take "mugs" and do laboratory work. Two others are on duty for instant dispatch to the scene of accident or crime. In each portable photographic kit is a fingerprint camera, a four by five-inch Speed Graphic, an eight by ten-inch commercial view camera with three lens boards, and photo-flash and photoflood equipment. The eight by ten view cameras are huge, unwieldy affairs, by the miniature fan's standard. But John Day, director of the photographic laboratories, insists they be used whenever speed is not a requisite. Actually, little

(Continued to page 116A)

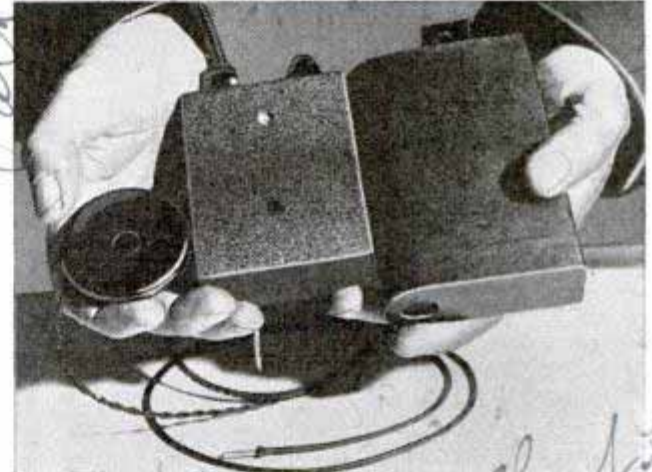

With the lapel earphone and the tiny pocket battery the policeman is always in touch with headquarters

Policemen of the Chicago park system are trying out a one-way pocket radio set for receiving orders while on their beats. Its tiny earphone is attached to the uniform lapel when not being used. The radio has a "pant-leg" aerial and a battery case one by three by five inches that slips into the coat pocket.

Penguin Travels in the Ice Box

First of its kind to travel north of the equator, an emperor penguin sent from Little America to the National Zoo in Washington was kept in a refrigerator at thirty-four degrees Fahrenheit aboard ship, with a mirror in its pen because it seemed to enjoy looking at its reflection.

David Fortney

Camden N.J. Camden N.C.A. Camden

K286

Motorcycle 'Fire Truck' Fights Airplane Blaze



Two white-clad firemen and a motorcycle "fire truck" form a complete, self-contained fire department at the Naval Reserve Air Base at Floyd Bennett field. The motorcycle carries two 235-pound tanks of carbon dioxide for extinguishing fires, as well as two portable thirty-pound tanks. Other compartments contain asbestos suits, a fifty-foot hose, and an assortment of tools.

Top, left, holding bolt cutters used in rescue work, and, right, unreeing carbon-dioxide fire hose. Bottom, asbestos-clad firemen on motorcycle "fire truck"

Tiny Planes on Wire Tracks Illustrate Formation Flight

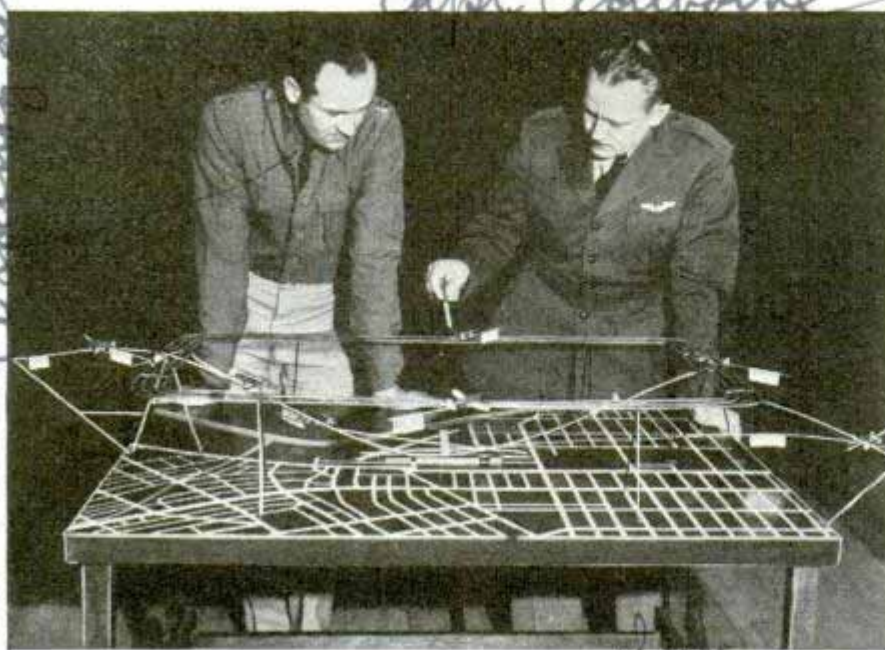

Models of planes are arranged on wire to simulate formation flights

Model airplanes mounted on what appears to be a miniature trolley system give the "orders of the day" to the army's flying cadets at Glendale, Calif. Capt. H. C. Clairborne, chief instructor, devised the three-dimensional method of illustrating formation flights. The tiny planes are fixed to wire tracks over a table map of airport and city, and before the cadets go aloft for maneuvers they see the planes arranged in the military formation they are to follow.

Capt. H. C. Clairborne
C.O. Army
Glendale, Calif.

Rudy Arnold

K298

Capt. Clairborne

air terminal
Loranda Central

R62. Black Star Publishing
420 Lexington Ave N.Y.C.

'Ski Slide' Proposed to Launch Heavy Planes

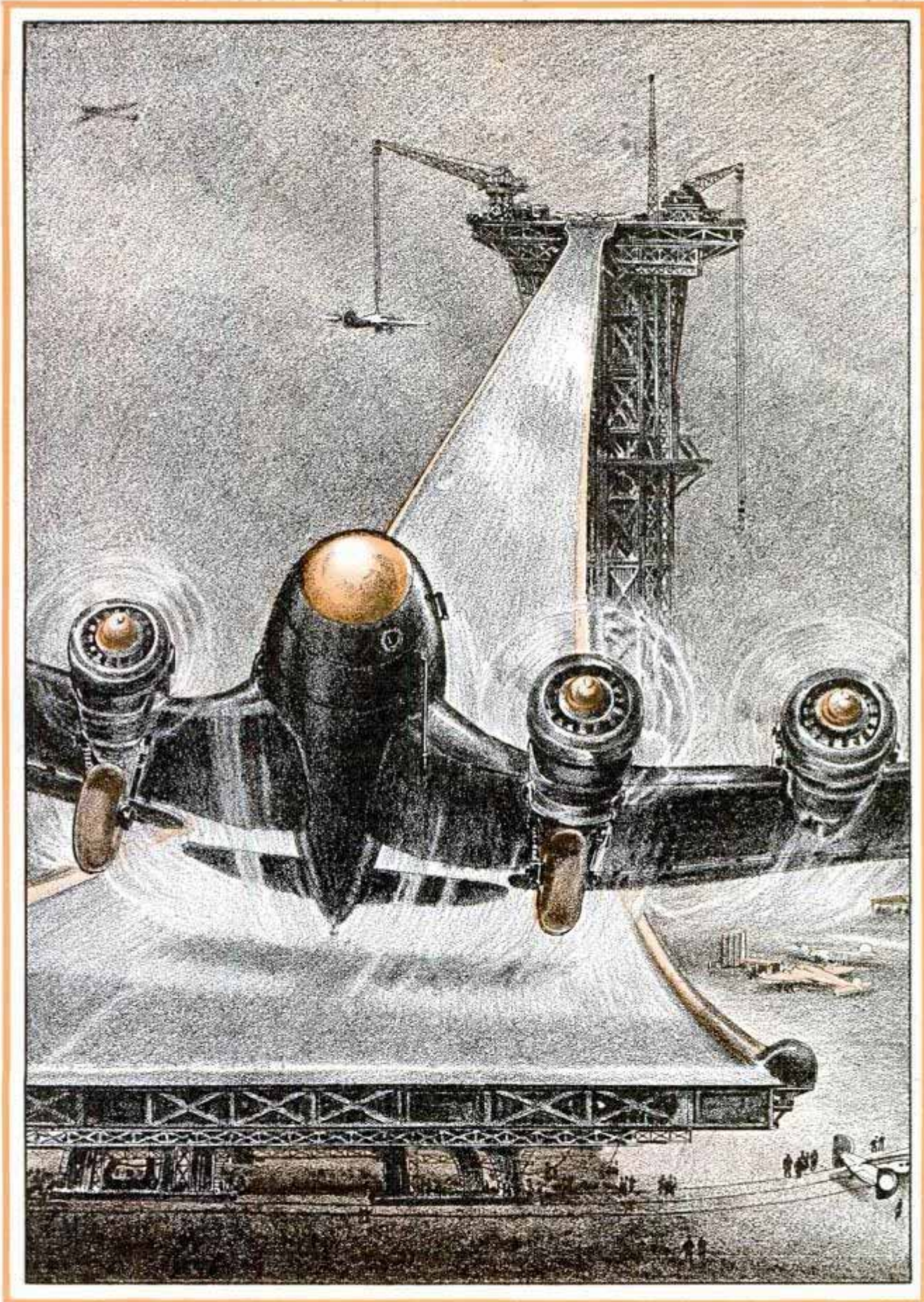

One spectacular solution of the problem of launching heavily laden aircraft from airports with limited takeoff areas is the "ski jump" method under consideration in Germany, where it was proposed as a means of getting big bombers into the air from small airports. The plane would be hoisted by crane, then take off down the incline until speed is picked up to rise. The tower would rotate to head into the wind

Speedboat with V-6 Engine to Seek World Title

In an attempt to push still higher the world's speed record for power boats, Lou Fageol, widely known racing boat enthusiast and sportsman, will drive his newly built racer, "So Long," over a one-mile

course at Newport beach, Calif. The twenty-one foot speedster is powered with a 728-cubic-inch V-6 engine, equipped with a Roots type blower supercharger. At 3,000 revolutions it develops 550 horsepower, and the propeller shaft turns at 7,000 revolutions per minute. Gasoline is consumed at about sixty gallons an hour, a seventeen-gallon tank being carried. In trials, "So Long," designed with a concave bottom, attained speeds of more than ninety-three miles an hour. In an official race two runs are made through a one-mile time trap, traveling the straight course once in each direction, and the average is taken as official for one mile. The Gold Cup title, which had been won in 1937 by Theo Rossi, of Italy, was brought back to America last February when Hugh Gingras piloted George C. Cannon's non-supercharged "Gray Goose III" at 92.308 miles an hour at Rockledge, Fla.

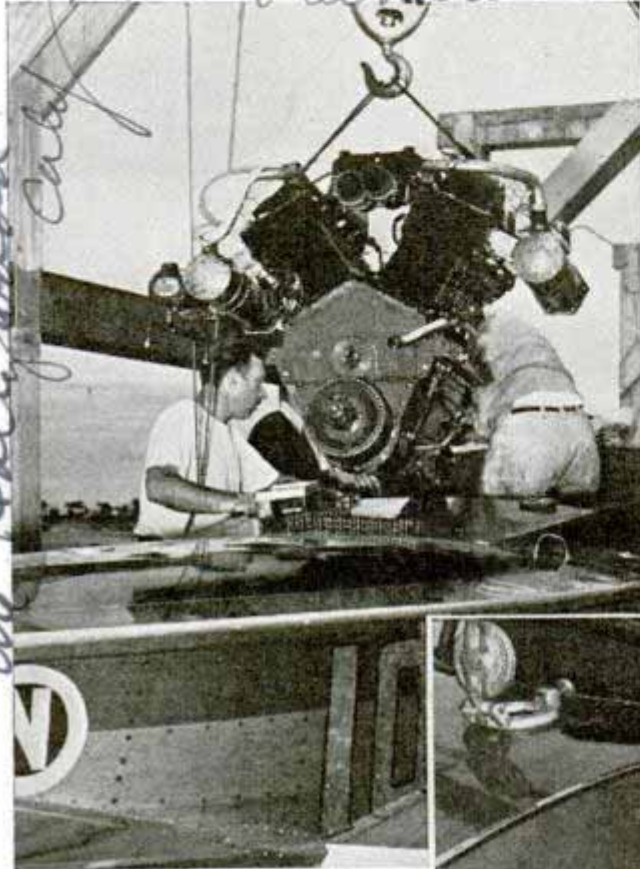

Left, mechanics installing the 728-cubic-inch V-six engine in racing boat, "So Long." Before the run is made, at right, tanks are electrically heated to warm the oil. Bottom, in trial runs "So Long" already has demonstrated her ability to travel faster than ninety miles an hour

Black Is Nation's Favorite Finish for Automobile Bodies

Color preferences differ widely throughout the country, according to a study by E. I. du Pont de Nemours and company, but the only finish agreed upon in all sections is black, which leads other shades by five to thirty per cent in all localities. One exception, however, occurred in 1939 on the Pacific coast when dark gun-barrel gray held first place. Aside from black, the tastes of buyers are at sharp variance,

depending on their location. Almost forty per cent of cars sold this year in California are finished in creamy beiges and light greens. In Florida also the demand for light cars is great. In the deep south, despite semi-tropical climate, almost fifty per cent of cars sold are black; last year dark blue was second choice, and now dark green runs second. Preference is largely for black in middle Atlantic states, with

Cmd Charlie Miching 8/10/39 A. Fuller
Are Italy wood
Cuba

San Marino Calif

1960 Panzerboat

K22

Auto-Color Advisory
Diverse Mechanisms

dark gray and dark green following. New England turns thumbs down on light colors and brown. The northwest and prairie states are turning from dark green as second choice to maroon. There is similar disagreement among individual cities. For instance, Syracuse, N. Y., accepts dark grays, Memphis refuses them. Indianapolis likes dark green, Omaha dislikes it. St. Louis buys many cars finished in maroon, yet New York does not care for that color. Dark blues sell best in Charlotte, N. C., while Philadelphia holds dark blue in disfavor. Pale gray beige is more popular in Los Angeles than in any other city. Omaha is one of the few places where mapleleaf browns sell well.

K 105
**Convertible Bridge Table
 Has an Extra Top**

Whether it's a table of bridge or a six-sided game of poker or hearts, a convertible table just introduced will furnish a top to fit the game. A fifty-four-inch circular top fits over the square bridge top, each having a linoleum surface banded with aluminum. The chrome post is mounted on a non-tip base of porcelain.



Circular top fifty-four inches wide fits over square table when more than four play

K 275
**Powerful Arc Extinguished
 by Twenty-Pound Air Blast**

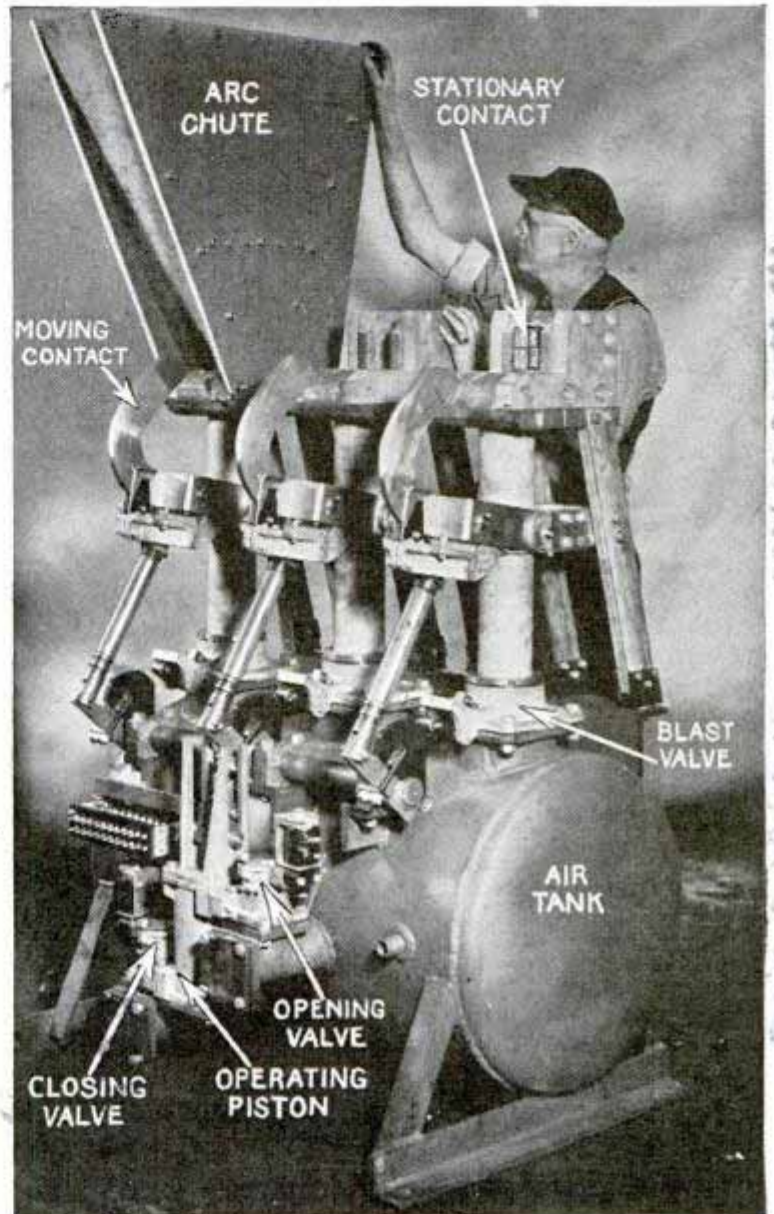

To "blow out" arc, valve admits air from tank to small cylinder, operating piston moves down, and the blast valves open to permit rush of air through arcs

It takes only 1/120 of a second for a twenty-pound blast of air, racing at 600 miles per hour, to extinguish an arc of 1,500,000 kilovolt-amperes, in the new Westinghouse compressed-air circuit breaker. All that is left of the arc is a slight puff of smoke. The job of the circuit breaker, controlling about 500,000 times the amount of power in the average home circuit, is to open the circuit in case of trouble on the line and prevent its reaching the powerhouse. It is used also by power engineers when they want to open and close the circuit. The temperature of an arc at the start is about 9,000 degrees Fahrenheit, almost as hot as the sun. This is cooled to about 200 degrees almost instantly when the compressed air puffs it out as you would a candle. In ordinary still air the arc would have to be pulled out some forty feet before it would be extinguished.

Royal Metal Mfg. Co. 175 N. Michigan Chicago

K 292

Rubber 'Lung' for Rescuers Stimulates Circulation



Applying rubber "lung" at normal breathing pace restores respiration and revives heart and lung action

One person can operate a new rubber "lung" which is applied like the Schafer hand method to resuscitate victims of gas, smoke or drowning. While the victim lies prone, the two large suction cups comprising the lung are pressed just beneath the point of his shoulder blades. Then with a rhythmic action of alternate pressure and lifting, the abdomen and chest are drawn in and out, restoring normal breathing by forcing air into the lungs and expelling it. Since they cover a larger area of the body than is possible with the hands alone, the cups are said to stimulate blood circulation through the heart and lungs, also preventing blood pools from forming or remaining within the body.

K 297

U. S. Plans 250,000-Pound Plane with 11,000-Mile Range

Basic plans for a 250,000-pound airplane that could cruise for 11,000 miles with a top speed of 380 miles an hour have been developed in the United States, according to Glenn L. Martin, aircraft manufacturer. Such a plane could carry 64,000 pounds of bombs 3,000 miles, with a crew of sixteen. While the actual building of so tremendous

new York Times Feb 29, 1940

an air vehicle is probably distant, Mr. Martin said the nation is planning aircraft that can stay aloft three days at a time, and that a new era of commercial aeronautics with 150,000-pound planes is at hand.

K 269 San Francisco

Plastic Cover Makes Safelight of Darkroom Lamp

By removing the plastic jacket of a darkroom safe-light just offered for photographic fans you have an inspection light. Inside is a seven-and-one-half-watt frosted white bulb, sufficient for ordinary darkroom illumination; the outer cover, removable, is of shatterproof plastic in red, yellow or green. This dual light obviates the need for two separate outlets.



K 145

Wafer-Thin Mechanical Pencil Can Be Used as Bookmark

As thin as a pocket comb, and with two flat sides, a mechanical pencil does not cause the usual bulge when it is clipped in the vest pocket. It can be carried in a notebook or used as a bookmark.

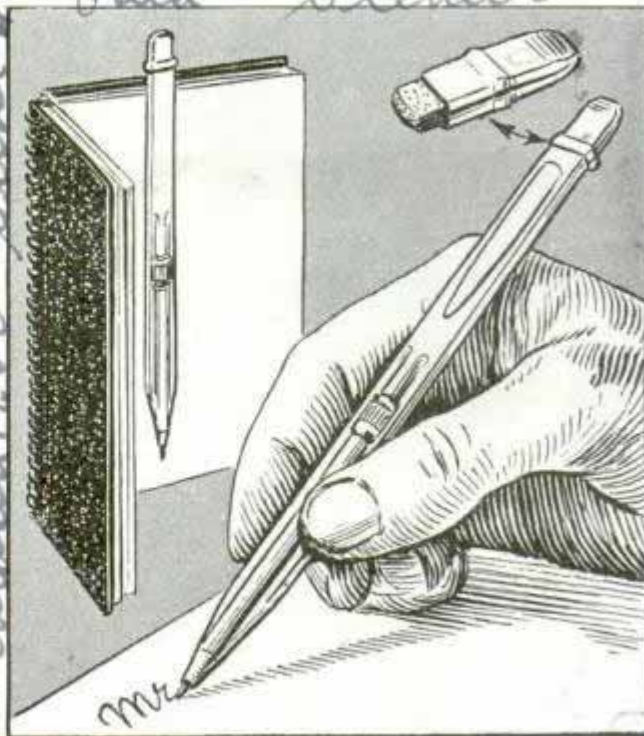

Slender pencil lies flat in notebook or vest pocket. Cap that closes extra lead compartment holds eraser

Supple and Ark
Dr. J. J. Jewell, Jr. 1000
Dr. J. J. Jewell, Jr. 1000
Baltimore Md
50x Two-Light
279
Patd. S. Jewell
entirely new design
Mr. Martin
Mr. Martin

Effect of Side Wind on Car Shown by Movies

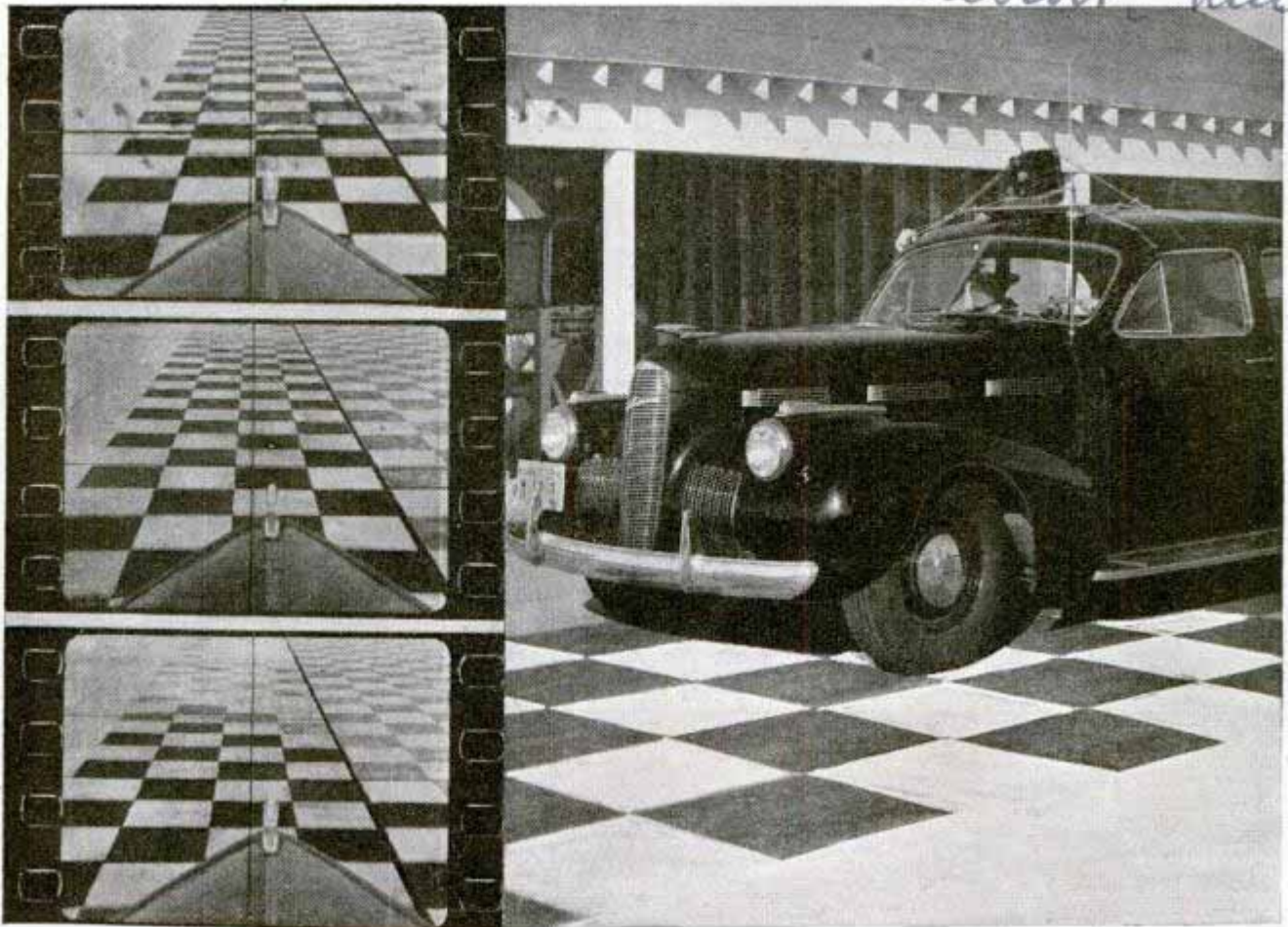

Views at left are taken from film made to analyze effect of side winds, shift of film center-line indicating extent of deviation from straight path. Right, camera on car roof is focused on checkerboard road

Motion pictures played a part recently in studying the effect of cross winds on the steering and stability of an automobile. A movie camera was strapped on top of the car and focused forward upon a checkerboard strip of pavement. When the car drove into this section of roadway, it was struck broadside by a blast of air from a battery of propellers, the driver making no effort to hold the car in a straight line.

Here the camera, started from the driver's seat, made its pictorial record of the checkerboard surface showing accurately the amount of deviation caused by the cross wind. Engineers could regulate the wind velocity at any point up to twenty-five miles an hour. This permits tests to be made under identical conditions in analyzing the many factors that enter into car stability and steering ease.

'Recipe Books' on Metal Shelf Tilt to Reveal Card Index

Favorite cooking recipes can be filed conveniently in an attractive set of "books," each of which holds 100 three-by-five cards. Each book is titled, and the set of seven are held in place on the shelf by a steel rod that permits tilting the book forward for access to the card index.

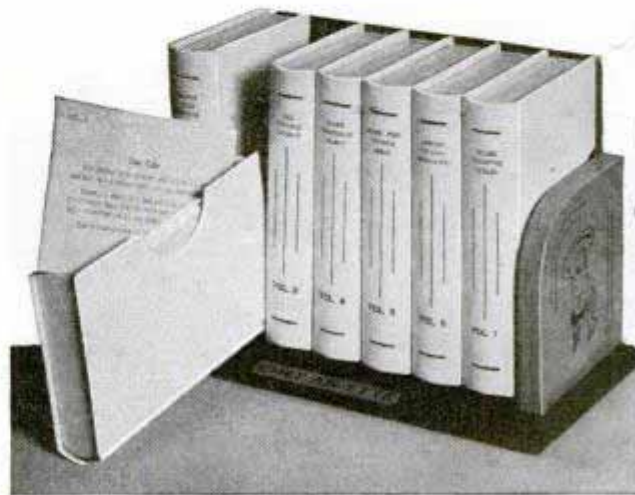

More than 5,000 pounds of nails, screws and other bits of metal were picked up on gravel roads of five Missouri counties in one month by highway maintenance crews with a truck carrying three electromagnets.

Public Safety March 1940

Vertical text on the right margin: Terry's Originals, 1028 W. 1st St., St. Louis, Mo. Contact: Abby Cheney



Forest L. Johnson
S SCIENCE

*at Randall's Island
 New York*

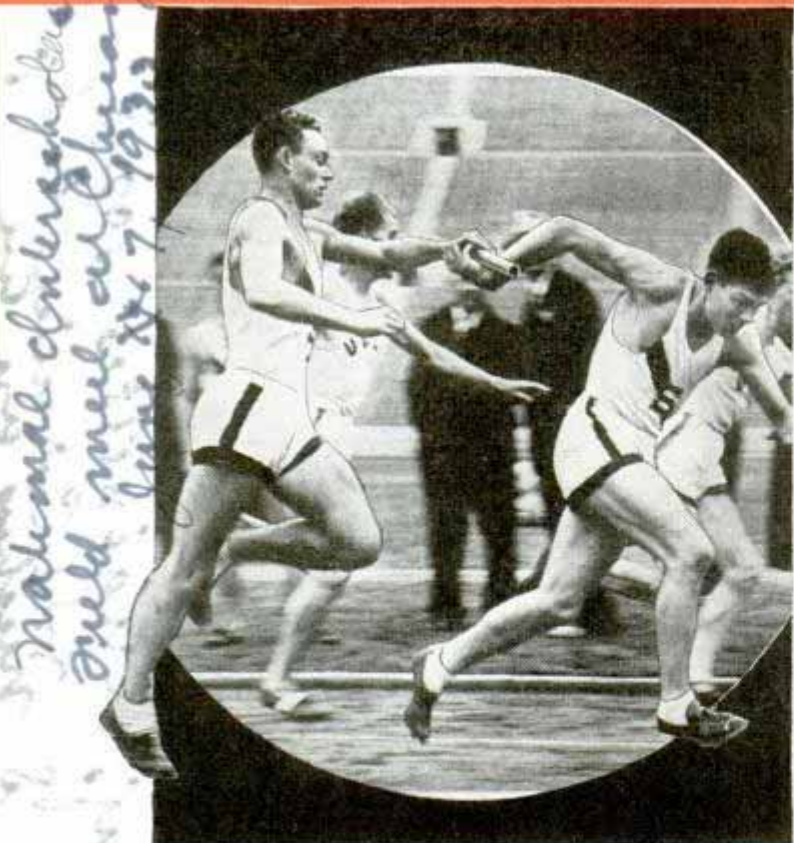
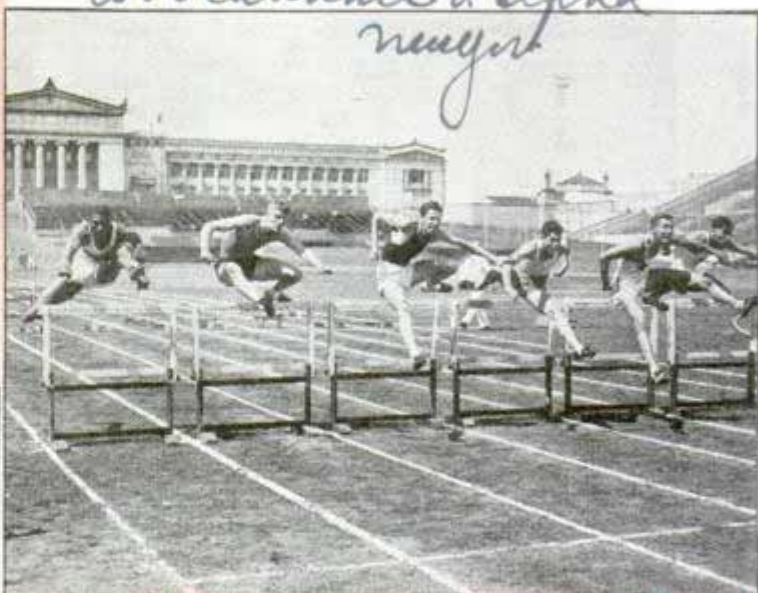

World record holder clears hurdle, top; right, clearing barrier in race that set "prep" record. Bottom, passing baton. Drawing across center of page shows hurdling technique

By Lawson Robertson

Philadelphia
 Coach of University of Pennsylvania and Olympic Track Teams

Weightman Hall
NOT a single Olympic record, among all the track and field events still listed for men, dates back farther than 1932. Except for two distance walks and the hammer throw, all world records are less than twelve years old.

Has man suddenly become more fleet of foot, more enduring, more agile? Are muscles better today than they were a generation, even a decade, ago?

I do not believe so. Howard Drew was national champion in 1913 with 10% seconds for the 100-yard dash and 22% seconds for the furlong. Today the records for these sprints are 9.4 and 20.3; yet I firmly believe that Drew at his best could have beaten Wykoff and Owens.

Not the brawn of man has improved, but his brain. Science has taught him how to reach the peak of physical perfection on the day of the race. Science has refined his form. Science has given him infinitely

RULES *the* CINDERS

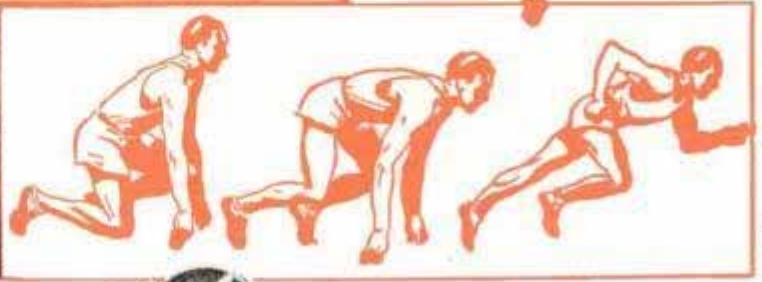

Top, 400-meter Olympic record holder starts a sprint; compare with drawing which illustrates starting positions. Right, a decathlon winner ready to let fly the discus. Below, breasting tape at finish

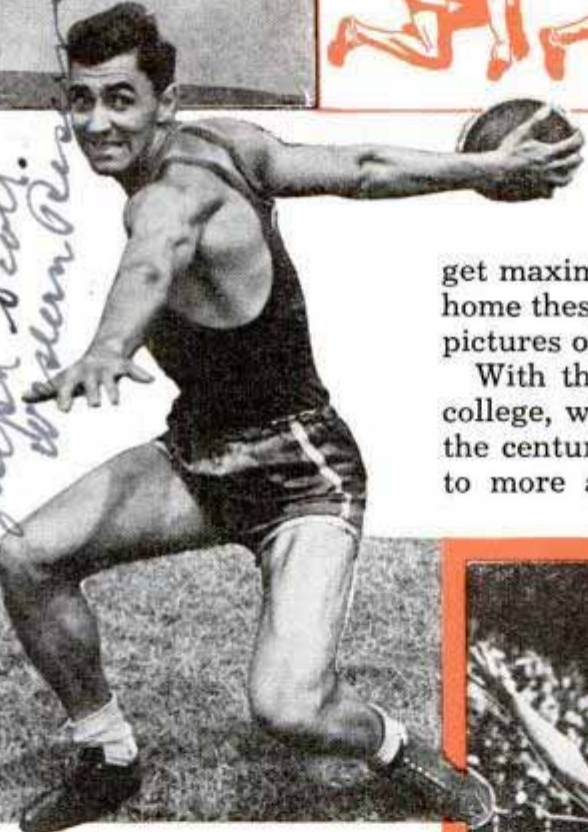

All drawings from "Track and Field." by Ray M. Conger, Copyright 1939, by A. S. Barnes and Company, Inc.

get maximum speed. The coach can drive home these points by showing slow-motion pictures of champions.

With thousands of young men going to college, where dozens went at the turn of the century, these things are being taught to more and more men. Competition is

better equipment than was available to the champions of old.

Good sprinting is a matter of mechanical precision. The old-time champion had that precision as a natural gift; today it can be taught. A coach can develop form, teach the track candidate to toe straight ahead, distribute his weight properly, strive for high knee action. He can teach the technique of the crouched start, the stride, the carriage of the body. He can teach him to attempt to swing his arms faster than his legs. This can't be done, of course, but a sprinter must attempt it to



Patd by Lawson Robertson
 U. S. Olympic Coach
 Carl Meacham
 Emblem
 Noel Conleton
 Calif

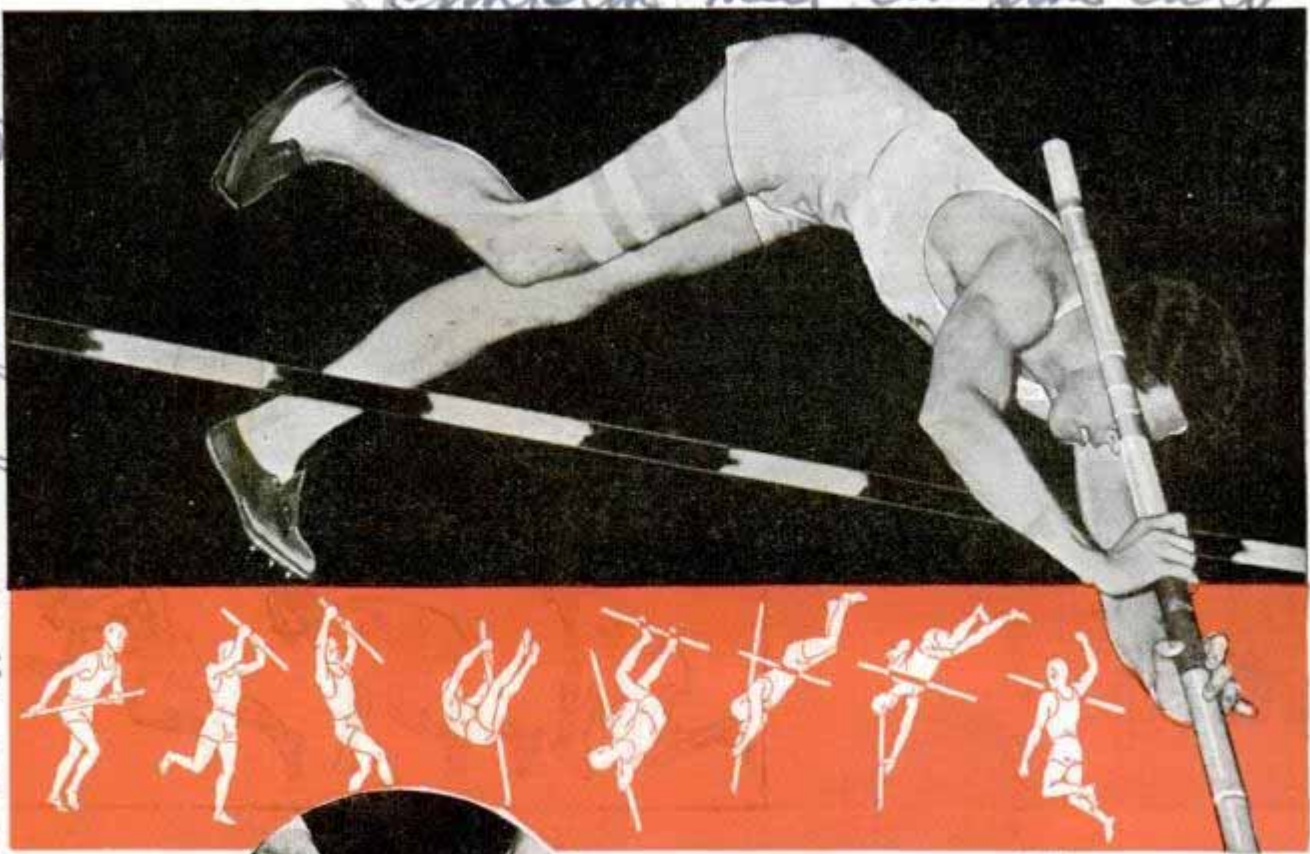

Pole vaulter clears bar at 14 feet 7 inches, top. Below, electric starting gun invented by the author can't be fired if runner lifts a hand for false start

keener. Men must push record time to win. Pushed hard enough and often enough, records are bound to fall. And records continually being broken are no longer mental hazards.

Mechanical science has come to the aid of the sprinter, too, since Burke won the first Olympic 100-meter dash in 12 seconds, in 1896. Better drained, firmer, more springy tracks permit shorter spikes, hence lighter shoes. Starting blocks have speeded up sprints by a tenth of a second. These blocks give a firmer takeoff than holes in the cinders, and raise the runner slightly above the track instead of compelling him to start from a hole. The result is a slightly longer first step; a matter of inches, but inches are important.

Burke won the first Olympic 400 meters in 54½ seconds. High-school boys beat that today. Pennsylvania's Bill Carr has lowered that record by a full eight seconds; what was once a middle-distance run is now a sprint for the entire lap.

The most remarkable improvement in

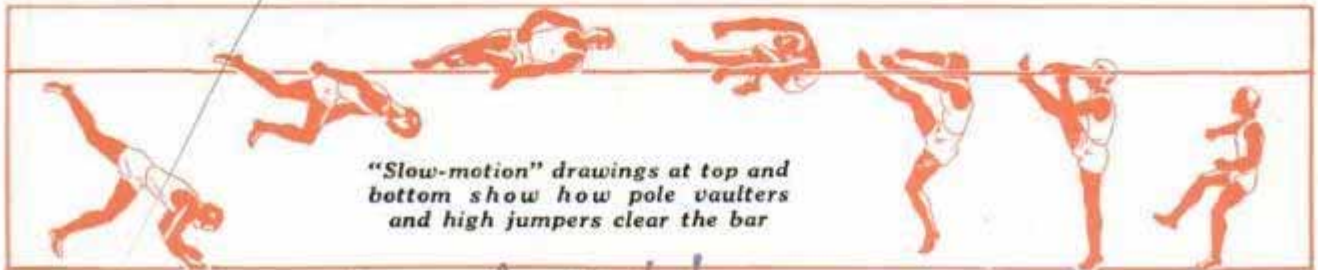

"Slow-motion" drawings at top and bottom show how pole vaulters and high jumpers clear the bar

Penn Track Capt.

K14.

K320

running time has been in the middle distances. There is 28.1 seconds difference between Flack's time for the 800 meters at the first Olympiad, and Tom Hampson's in the tenth. Flack also won the first Olympic 1,500-meter race, so he must have been considerable of a runner forty-four years ago. Yet his time, only 4 minutes 33½ seconds, has since been lowered 45.4 seconds. Lovelock would have beaten Flack by three quarters of a lap.

That man has improved physically to that extent in a generation is absurd. Scientifically designed tracks account for a second or two per lap of this improvement. Better shoes have perhaps cut another second or two. The rest has been mental. Men have learned to pace themselves, have improved their running form.

Competition is part of this mental stimulus. Those early champions didn't have to run any faster to win. As the century opened, man was thinking in terms of the 4:30 mile. A dozen years later Abe Kiviat forced milers to think in terms of 4:20. Joie Ray came along and 4:20 was not good enough. Nurmi forced the time down to 4:10. Today half a dozen runners chase Glenn Cunningham across the tape, all well under that mark. Cunningham's mile record of 4:4.4 was made indoors, like most top performances above the half mile. Track surface, wind velocity, and other conditions, can be more nearly ideal indoors. The Madison Square Garden track, where many records have been made, is scientifically banked on the turns to permit an even pace, and its soft wood permits light spikes. With more and sharper corners, shorter straightaways, and consequent jostling, the intelligent runner is at a great advantage here. Men who master indoor tracks invariably better their outdoor times. If indoor tracks could be air conditioned, to correct the overheated, smoke-filled atmosphere, the four-minute mile would be almost a certainty.

Long-distance races seem to bear out my contention that it is man's mind that has improved, rather than his body. While records continue to be lowered for the longer races, there is not such marked disparity in times. In the long grinds, endurance is the principal factor.

Four full seconds have been whittled from the high hurdle mark in a generation; the time has been cut twenty-five per

(Continued to page 118A)

Adjuster for Front Car Seat Has Forty-Five Positions

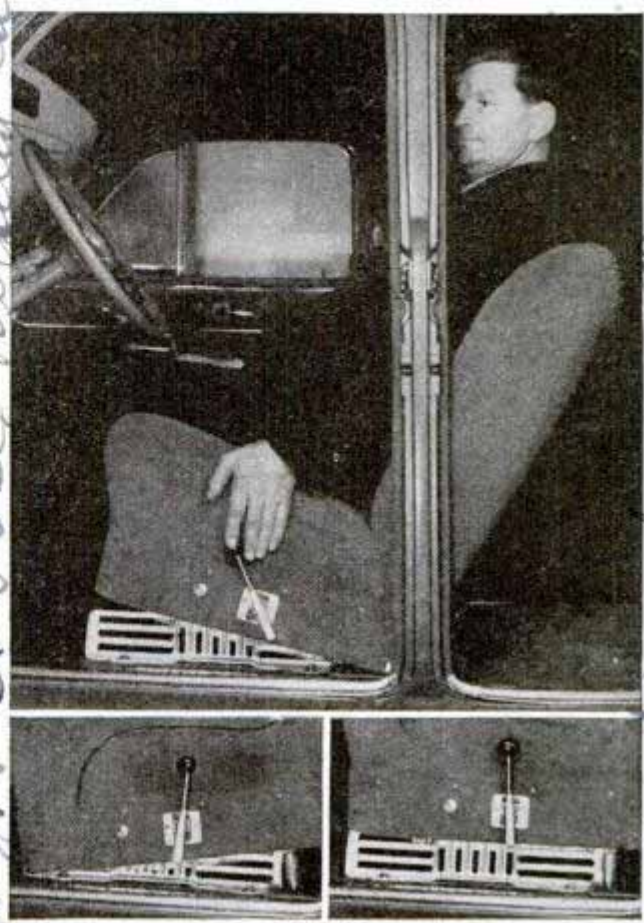

Tilting lever is reached easily by driver's left hand, above. Two bottom views show other seat positions

Comfort for drivers of all sizes and proportions is offered by a three-way adjuster that permits changing the front seat to any of forty-five positions. To meet individual needs, the seat can be moved five inches forward and backward, one and three-fourths inches up and down, and it has a reclining range of about forty-five degrees. By means of the control lever at his left-hand fingertips the driver may change the angle of tilt while riding.

Hose Washer Can't Get Lost

Loss of washers from garden hose is effectively prevented by a new type connection. The washer is inserted into a slot in the coupling nut by deforming the washer slightly; once in place it springs back into its original form and fits tightly.



Oliver Russell
1543 Venice Blvd

National Lamp Company
620 St. Franklin Street
Los Angeles

291 Madison Ave
Sledge for Hand Ambulance
Glides through Deep Snow



Major Harold Frutberg
Frutberg's Infantry Coaction Carriage
Double-deck ambulance mounted on sledge glides easily over heavy snow where wheeled vehicle would make slow progress

see Feb. 1940. 123a
 Field ambulances used by armies on far northern fronts are being mounted on specially constructed sledges for ease in transporting wounded soldiers over snow. When sled runners are not needed, the hand ambulance can be run off the sledge and wheeled on its rubber-tired chassis. Invented in England, the cart has twin stretchers to carry two injured men.

new York Times March 10.
Magnetic "Brain" for Telescope
Keeps It Trained on Star

Osland Moss.
 Pointed skyward, and turning like the hand of a gigantic electric clock, the fifty-five foot long telescope on Mount Palomar will require unerring accuracy in following the star its 200-inch "eye" is to photograph. This exacting task will be turned over to a robot, developed by Henry E. Warren, of the Warren Telechron company. It consists of a dancing wire that has much in common with a violin string, its duty being to keep the telescope in step with the rotation of the earth, while compensating also for variations caused by bending of the star's beam in the atmosphere. Its vibra-

tion frequency being unaffected by large temperature changes, this wire normally is "kicked" sixty times a second by a tiny magnet. However, the frequency of vibration can be increased or decreased as little as one a second by a powerful alnico magnet hidden in a weight attached to the lower end of the wire. Motors, synchronized with the electric "kicks," thus are regulated by the magnetic "brain" so they will move the telescope just fast or slow enough to keep a star in view.

287
Tiny Four-Cycle Engine
Has Overhead Valves

Designed especially for model builders, a four-cycle engine with overhead valves fits into the palm of your hand, weighs but fifteen ounces and delivers two-thirds horsepower. Its four-cycle operation provides instant starting, smooth power, lower battery consumption and permits use of throttle control on radio-operated model planes. The engine is built in twenty, fifteen and ten cubic centimeter displacements, and conversion from one to another size is possible with a few interchangeable parts. The motor is available complete or in kit form.

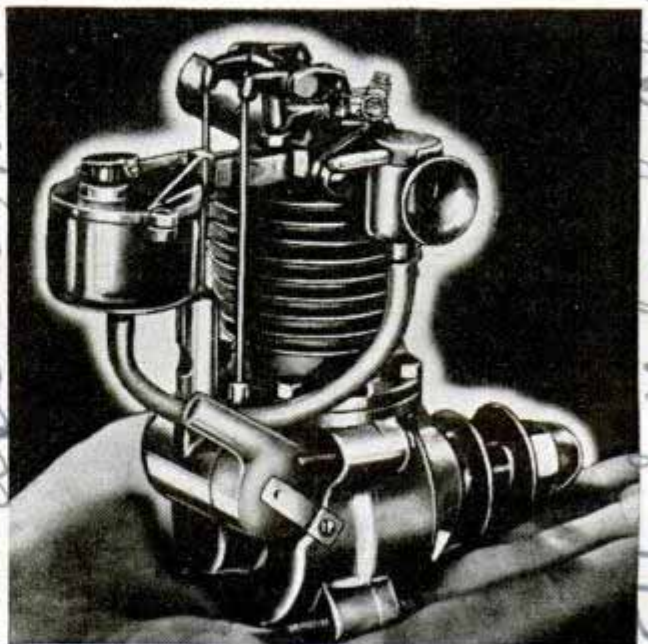

1516 W. Wash. Chevy 9151
Throttle control on model planes operated by radio is possible when this fifteen-ounce engine is used

K 210
Dr. J. H. ...
Director Research Laboratory
Million-Pound 'Nutcracker' Thrust Splits Oak

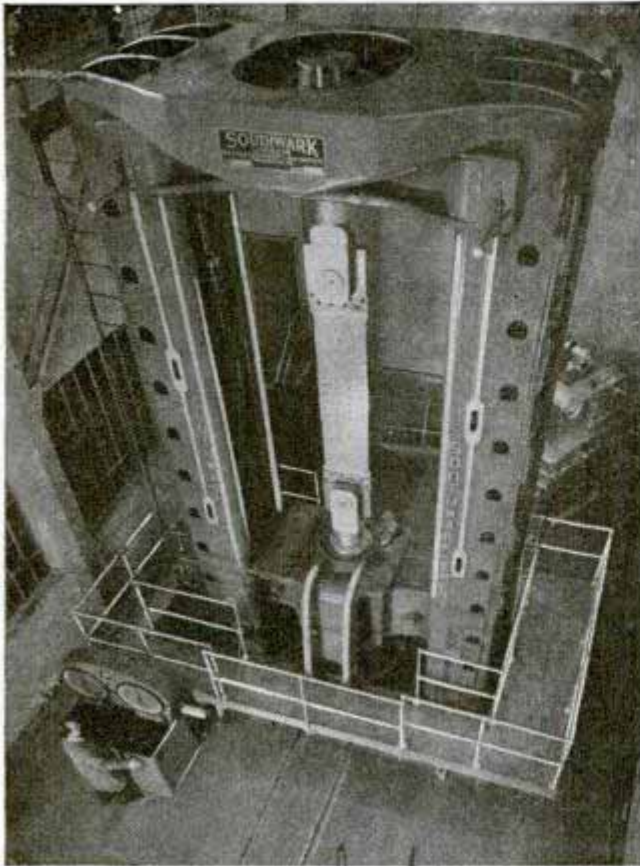

clerk
 At left is the research machine that can exert a 3,000,000-pound push; it was built to test fabricated aluminum products. At right, it uses a third of its muscle power to split a sturdy oak *

So delicate that it can measure the force it exerts in cracking an egg, a precision metal-working machine at New Kensington, Pa., split the trunk of an oak tree with a million-pound thrust—only one-third of the power it could have mustered. It can exert a 3,000,000-pound push, a 1,000,000-pound pull. The machine stands twenty-

Aluminum Company of America
 five feet high above the floor and extends fifteen feet below. Powerful enough to flatten a locomotive boiler or crack a watch crystal without damaging the hands, the tool is to be used in a research laboratory for testing the behavior of fabricated aluminum products in full size instead of scale models, as has been the custom.

K 315
'Crash Boat' for Seaplane Base Has a Four-Bed Hospital

In the forward cabin of an army "crash boat" assigned to a Gulf coast seaplane base is an emergency hospital accommodating four litters. Intended for rescue work at army seaplane stations, the twin-screw boat can step out at better than thirty miles an hour. It carries a portable derrick and six-man raft and has a ship-to-shore radio telephone. The boat is forty feet long and has an eleven-foot beam.



Acme
 Army rescue boat carries portable derrick and an emergency hospital

Dr. J. H. ...
Director Research Laboratory
Southampton
Pa.
940
Aluminum Company of America
Eddystone, Pa.

20,000 FEET DOWN

Cent. City, 502 W. 2nd St. Pasadena, Calif.
Thomas E. Stinson, Jr., 18618 N. Hollywood Blvd. Los Angeles



drilling bit is placed on the end of a pipe, the pipe is rotated, and the bit cuts its way down. Mud forced down the inside of the drill pipe picks up the chips and debris and carries them up to the surface outside the pipe. More lengths of pipe are screwed on as the bit goes deeper.

Down two miles or more, this procedure becomes costly and complicated. It may cost only a dollar a foot and require only thirty days to drill a well a mile deep, yet the minimum cost for an 11,000-foot well runs ten dollars a foot and drilling takes at least six months. Every day or so the drilling has to stop while the drill pipe is raised section by

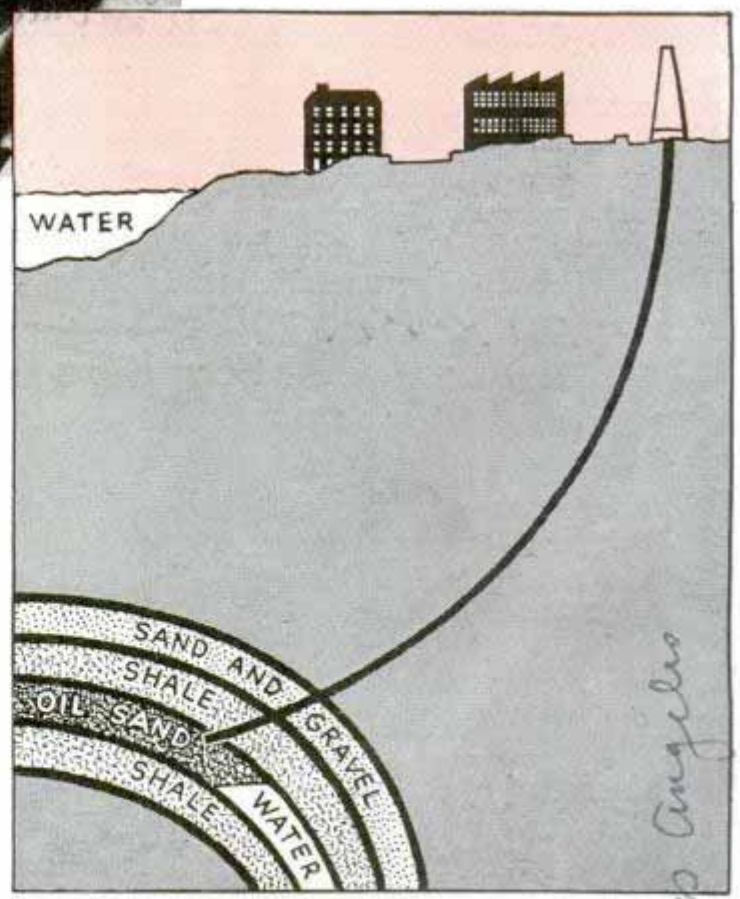

Top, making up tubing string above a deep-well plunger pump which sends oil to surface. Below, directional drilling allows a convenient location of rig

WHENEVER dwindling oil reserves warrant it, petroleum engineers are ready to take their new tools and technique and bore four miles down into the earth for oil—a mile further than the deepest well yet drilled.

To recover the cost of a 15,000-foot well, an oil company has to produce from it about 7,500,000 gallons of gasoline, equivalent to the annual consumption of 10,000 passenger cars. A 20,000-foot well is an even greater gamble and the engineers might spend half a million dollars before learning whether they had tapped a new oil basin or merely drilled a hole in the ground. Wells approaching that depth, however, may soon be attempted in California where the potential production of new pools discovered last year barely equaled the amount of oil taken from the ground during the same period.

Drilling a well sounds simple. A sharp

Laine Wells Co. 5610 S. Soto St. Los Angeles, Calif.

Axelsson Int'l. Co.

KIP
Name Wells
6997
for OIL
Rec. Jan. 1940

Right, derrick field seen through old bull wheel. Left, setting gun perforator before firing bullets electrically. Below, engineer making a Lape-Wells Oriented Oil-Well Survey measures rotation as pipe is lowered

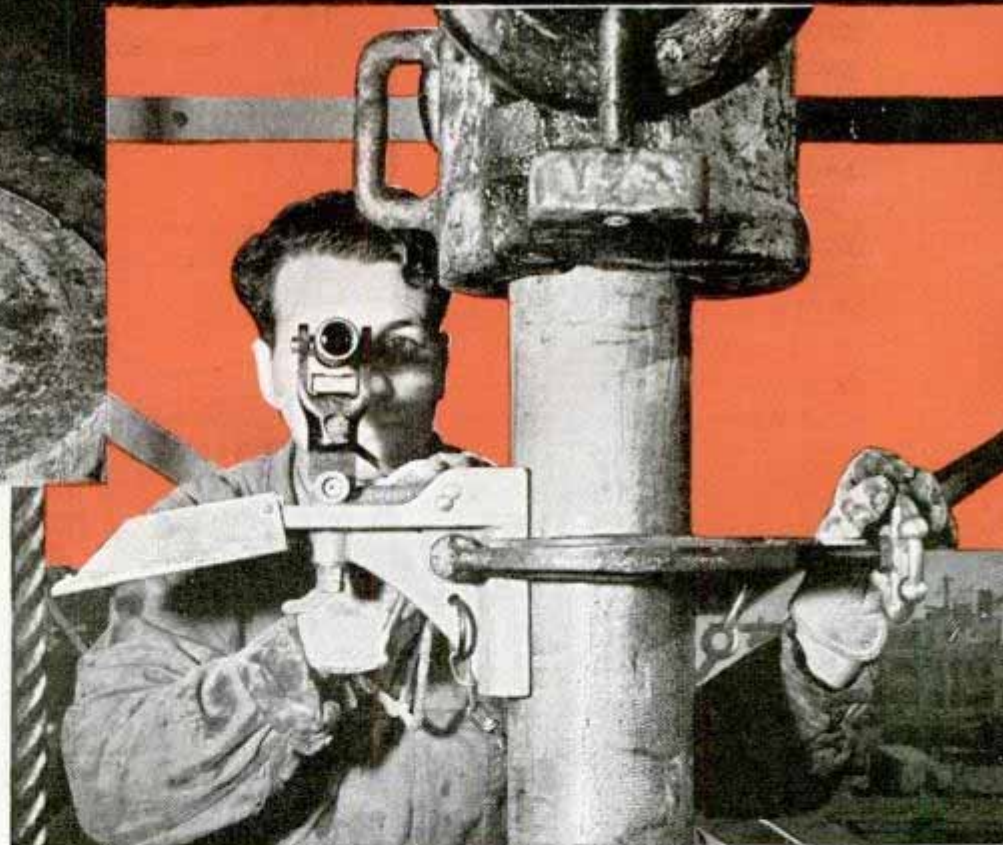

section and the worn bit is replaced, a job that costs \$500. A drilling contractor with modern equipment may charge \$2,250 a day.

At 11,000 feet the temperature is more than 200 degrees Fahrenheit and rises to more than 300 degrees below 15,000 feet. The heat increases wear on the bit and causes complications when water is encountered. The flowing water, above boiling, must be shut out with cement; the high temperature is apt to harden the cement before it can be forced down into place. A new cement remains pumpable for two hours at a temperature of 212 degrees.

At 15,000 feet below the surface the earth is under a pressure of 6,000 pounds per square inch. Fortunately for oil-well engineers the pressure exerted on the drilling mud to make it travel the six-mile round trip tends to counterbalance this pressure. Belief that the earth has a molten core is shaken by recent seismic stud-

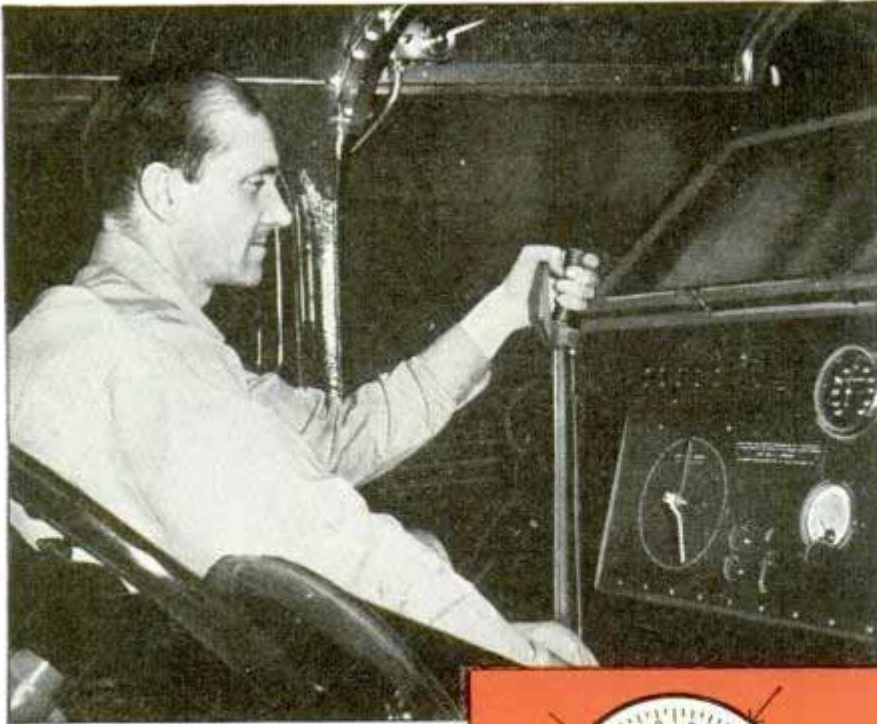

ies indicating the greatest part of the interior is solid in spite of its high temperature.

Field engineers and laboratory men have been preparing their tools for the time when deep drilling becomes necessary. Derricks as high as 178 feet are used, 250-foot derricks are proposed. These tall rigs could handle longer lengths of drill pipe, reducing the delay in changing bits. Drill pipe is now made of alloy steel and provided with a new square thread for increased strength. Boiler steam pressures are raised as high as 500 pounds per square inch and the rotary table that spins the string of drill pipe turns as fast as 300 revolutions per minute, with twice that speed anticipated.

The circulating mud is pumped at 800 gallons a minute under pressures as high as 1,500 pounds per square inch. A 50,000-pound hoist that lifts the pipe in and out of the hole is equipped with water-cooled brakes and can lift a string of pipe weighing more than a quarter million pounds.

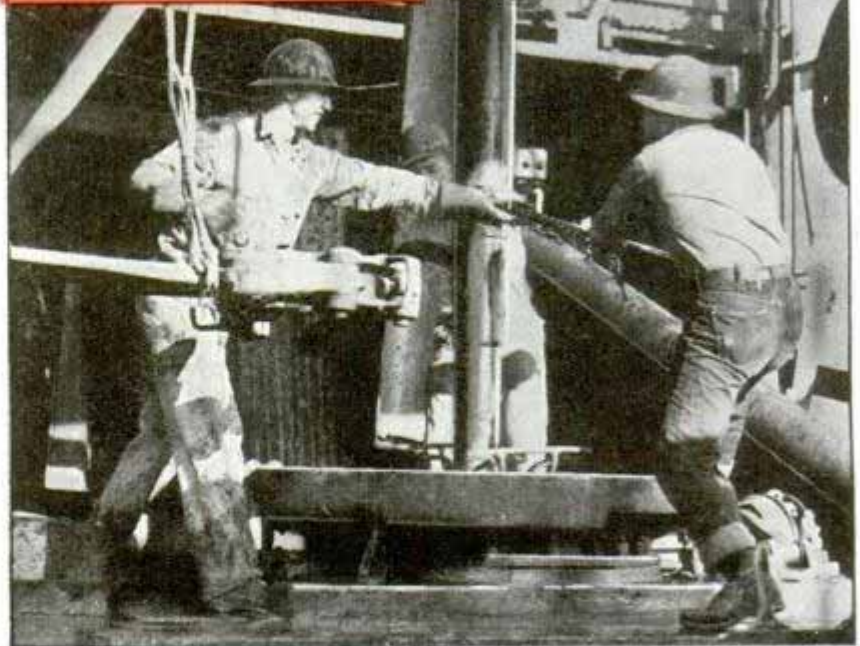
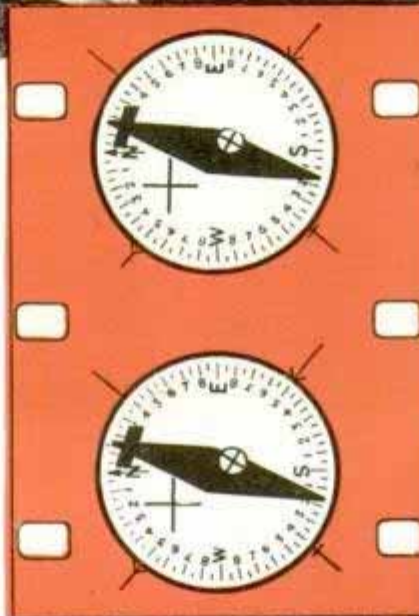

Operator of gun perforating truck (top) fires gun from panel when dial shows right depth. Center, movie film from Lane-Wells Multiple Shot Survey instrument shows inclination of bore. Below, attaching rotating "kelly" to drill pipe on floor of well

Along with these mechanical improvements is a host of new instruments that takes most of the guessing out of drilling. Dials in front of the chief driller tell him the pump pressure, weight on the bottom, and revolutions per minute. The Lane-Wells motion-picture survey instrument, lowered into the hole, makes a record of inclination and direction as it goes down, giving the driller a picture that helps him drill in the direction desired. Without close control the bit may slant to one side as it encounters resistance, may even turn corkscrew fashion.

Temperature indicators determine the heat at various depths. In holes partly filled with oil or water an echo meter translates time into feet and shows the depth to

K16
the surface of the liquid after a shot is fired from the floor of the drilling rig. The location and width of oil-bearing sands that may not flow into the hole without special treatment are detected by electrical logging or by geochemistry.

A multiple cannon known as the Lane-Wells gun perforator, stimulates production from an oil sand by firing bullets horizontally into the stratum after it has been lowered into the well. The slugs penetrate the oil casing and enter the consolidated sand, opening up the formation so that oil can flow from it. Instead of exhausting one formation, then drilling on in search of another producing zone, the oil engineers can now drill down through a number of formations and then tap each of them with the gun perforator, obtaining production from a number of zones at the same time. Sometimes tons of gravel are pumped down the drill pipe and forced out around the bottom to enlarge the diameter of the hole and to prevent the oil sand from squeezing in and damaging equipment after the well is placed on production.

In most places you can't give mud away, but under unfavorable circumstances as much as \$75,000 have been spent on mud to drill one well. Besides lifting debris from the hole the mud lubricates the drill pipe, seals the walls to prevent caving, cleans and cools the bit, and controls any gas or oil pressure in the formations through which the hole is being drilled. Ordinary mud won't do. A major company may employ half a dozen mud chemists to check the cake thickness, alkalinity, and salt content of the mud and study its reactions under heat and pressure. Water glass and common salt are frequently added to help seal the walls of deep wells before the casing is installed. In some soft formations the mud does much of the actual drilling, being forced down under high pressure so that it "hydraulics" the material out from the bottom.

The result of these advances is that "hoodoo" wells are becoming few and far between. Of course, hard luck even today, sometimes will dog a well. On one occasion the bit mysteriously "froze" in a tough formation at 4,000 feet and the drill pipe twisted off 1,000 feet below the surface. A fishing tool was lowered to engage the broken end of the drill pipe and bring it up, but only a hundred feet of pipe were

(Continued to page 120A)

T258
**Floor Squeegee Steers Itself
When Handle Is Twisted**



By twisting handle, V-shaped floor squeegee is made to steer itself when working in close quarters

Especially handy for working in confined places, around corners, or under trucks, worktables and benches, a V-shaped floor squeegee steers itself in any direction when the handle is twisted. It can be used for removing water, snow or slush, and the double-edged blade is reversible.

2147
**Cake or Pie Cut in Equal Slices
by Handy Divider**



Cake divider, right, makes ten equal cuts simply by forcing it through the cake as illustrated at left

Dividing cakes and pies into equal portions is a task performed by a wheel-shaped cutter with wire "knives" mounted like spokes. Made of material that will not rust, two types are available for making either eight or ten wedge-shaped pieces. To serve uniform-size cuts you simply press the cutter down firmly over the cake.

K 274. Westinghouse Clearing Co. N.Y.C.
 Lamp Division
 30 Cornfield N.Y.

Infrared Rays of Drying Lamp Can Broil Steak

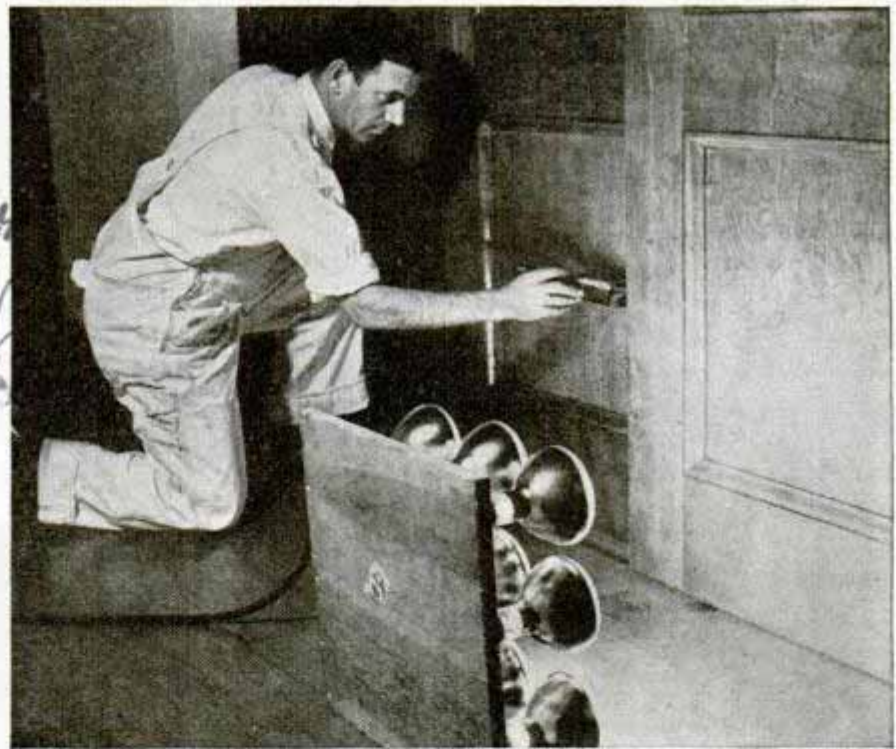

J. D. Hall, engineer
 Westinghouse Lamp
 Div. 30 Cornfield N.Y.

Top, left, filet mignon, sizzling in heat from two infrared drying lamps, was well done after nine minutes; right, battery of radiant heaters in special reflectors hasten drying of paint on automobile accessories. Bottom, drying door panel with rays emitted by nine 250-watt lamps

Radiant infrared heating lamps soon may be doing hundreds of heating and drying tasks in home and industry, such as drying the family washing, drying painted surfaces, photographic negatives and prints, food products, and many others. Already they are drying enamel on auto bodies and furniture quicker than it can be done by other methods. Four new lamps use less than five per cent of their energy to produce visible light, and most of the balance

goes into invisible infrared rays or radiant heat. The most versatile of these is a 250-watt drying lamp and reflector hermetically sealed in a single unit, which can be operated in an ordinary light socket. In two unusual tests, an inch-thick steak was broiled between two of the lamps in nine minutes, and popcorn started popping within two minutes after the lamps were turned on. Varnish on a door panel was completely dry after sixty-seven minutes

X 3/8

Oil-Well Drill on a Trailer Can Bore 4,000 Feet Deep

of exposure to a battery of nine lamps, whereas twenty-four hours were required by another sample to dry without assistance. The other three new lamps, comprising 250, 500 and 1,000-watt sizes, have clear glass bulbs and are designed for use with auxiliary reflector equipment. Infrared rays, like light, travel in straight lines, and produce an increase in temperature when they strike a substance capable of absorbing them, just as those from the sun warm the earth after they have passed through sub-zero space.

X 302

Hollow Plastic Chessmen Are Ballasted by Buyer

Chessmen with the appearance of rich ivory or marble but actually molded of the plastic Tenite have just been introduced. The secret of their low cost is the fact that they are molded hollow, to be ballasted by the purchaser. They may be filled with plaster, putty, or similar material, or even with a metal screw sealed into the base. Felt tabs are supplied for covering the base after the ballast is introduced. Available in two sizes, the plastic chessmen are virtually unbreakable. They may be had in the conventional black and white or in a rich red.

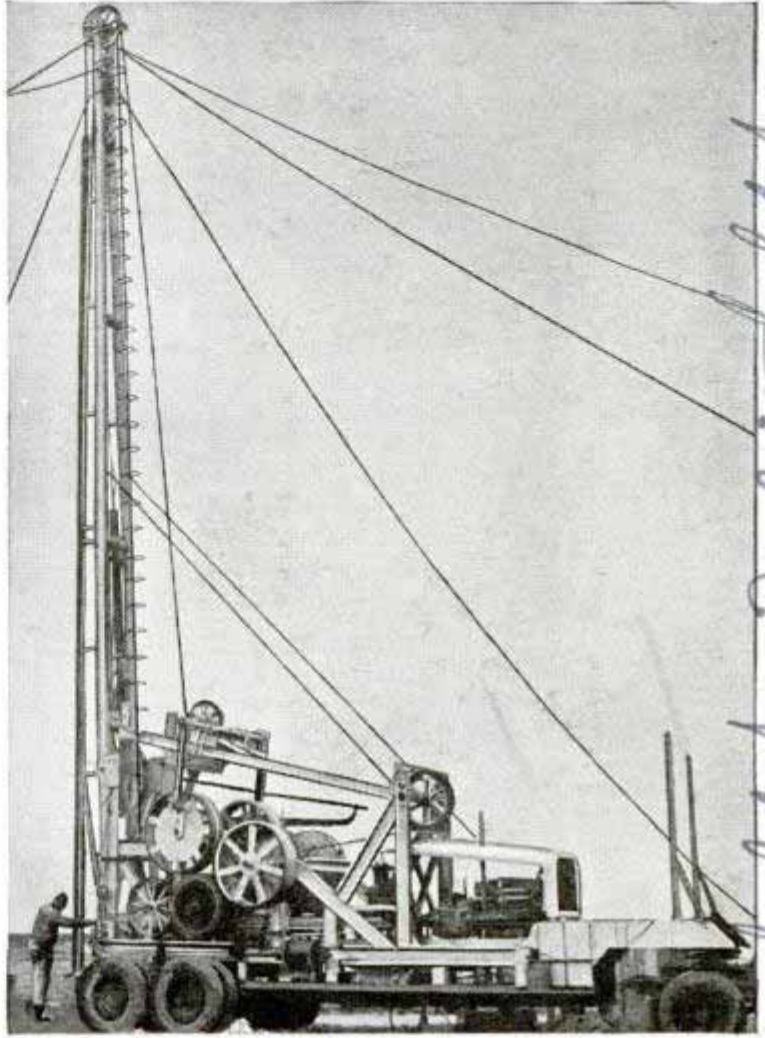

Portable oil-well rig set up in preparation to make test drill; it is economical to operate and will drill well 4,000 feet deep

Despite its seventeen and one-half tons, an oil-well drilling rig, mounted on a semitrailer, can travel over soft ground by dividing the load among four dual wheels at the rear. While on the go, its fifty-foot mast lies parallel with the chassis, and to raise it upright a chain is used. During drilling operations the rig is controlled by compressed air, eliminating the need for chain belts, sprocket gears and jaw clutches. The rig carries its own power plant, an eighty-horsepower gasoline engine. Its inventors claim unusual economy for their drill and believe it capable of boring wells to a 4,000-foot depth.



After filling plastic shells of chessmen with ballast, felt bases are applied

De Menhold & Melingholdt
 Welding Co. 169 Sumner
 Sapeha

Moore Ink Co.

Tel. Hollywood 5/6/ Award

K2 55. Cml. Co. for Amer. 502
 Wickliffe Lewis Pasadena, Ca.

WEIGHING *the* WEATHER



FOREST fires don't wait for the rangers. To be there when things start, the rangers "weigh in" all the factors conducive to a runaway blaze, add them up and if the total looks dangerous they spot men in strategic locations to wait for something to start.

Weather, and moisture in the vegetation are two of the most important elements in plotting fire probabilities. One of the ranger's simplest yet most scientific forecasting instruments is the fuel moisture stick. Baked tinder-dry in ovens, these sticks are suspended on a wire rack ten inches above natural vegetative litter on the ground. The same side is always upward, the same end always points north to assure equal exposure. Like blotters, they absorb moisture, and after a fixed period of exposure they are weighed on a special instrument and their moisture content recorded.

On the wall at the Fire Dis-



Forest service radio truck with collapsible mast, top, used as field base in fighting fires. Below, (left) weighing fuel moisture sticks for humidity; (center) ranger reports progress of fire fighters to headquarters; (right) measuring wind velocity with anemometer in plotting fire danger factors

Head. Forest Service, Washington, D.C.

K255j

to Combat FOREST FIRES



patcher's office is a great relief map of the vast forest area under his jurisdiction. Tiny electric-light bulbs mark the location of every forest lookout tower in the region, and the glow from each bulb extends over an area of the map representing the actual range of vision from the ranger's tower. The dispatcher can tell by a glance at the map whether a forest section particularly susceptible to fire is within the view of one of the rangers.

Every day the Forest Service broadcasts a report of fire-hazard factors throughout the wooded areas, and, in fighting fires, two-man radio trucks with folding antenna equipment and portable back-pack radios keep rangers in touch with headquarters.



Light bulbs on relief map represent lookout towers and area they light on map is actual range of vision from tower. Below, a ranger places oven-dried sticks on rack to test humidity of air and vegetation

Handwritten notes:
 on the left: *W. J. ...*
 on the right: *Central Forest Office*
 at the bottom: *W. J. ...*

national RCA a Cold...
Personnel RCA a Cold...
Chicago
Rochester
N.Y.

K 299.

Light Television Set in Plane Broadcasts Air View of City



Lightweight electronic television cameras ride in a plane high over New York; below is view of companion plane as received on its own screen

Passengers in a sky liner above Manhattan saw themselves flying on a television screen and earth-bound watchers saw on their screens a view of New York's skyscrapers from the plane window as lightweight electronic television cameras made a pioneer flight over the city recently. The equipment, mounted in a United Air Lines plane, consisted of a two-camera chain with a relay transmitter operating on 104 centimeters, shortest wave length ever used in practical television, the ten units packed in carrying cases weighing about 700 pounds. A 4,000-watt gasoline generator was mounted in the baggage compartment. Cameras were focused from ports in the fuselage, from the top of which non-directional antennas shot signals to the RCA building receiver for relay. Perfect reception was reported as far distant as Schenectady, nearly 130 miles away. Au-

tomobiles on the express highway below, ships at their berths, skyscrapers, the Statue of Liberty and Brooklyn bridge were televised from the air, and the cameras were trained on a companion plane flying alongside, the signals bouncing back from the RCA building to produce the companion plane's own portrait on the screen of a television receiver it carried.

K 290 Pistol-Grip Spotlight Throws Beam a Quarter Mile

Aimed by a pistol grip and "fired" by a trigger, an emergency lamp just introduced has an 85,000-candlepower light that will throw a bright beam a quarter of a mile. Its batteries fit in a flat pack carried on the back. Intended for police, firemen, safety officials, sportsmen, woodsmen and travelers, the lamp can be supplied with colored lenses which snap over the regular lens for signaling or warning.



Batteries carried in the back pack have enough power to throw a strong beam over a quarter of a mile

Statue of Liberty
Brooklyn Bridge

R. W. O.

Chute Kills Flies as Cattle Pass through It

FLIES ARE ATTRACTED TO LIGHT AND ELECTROCUTED BY OVERHEAD GRILL

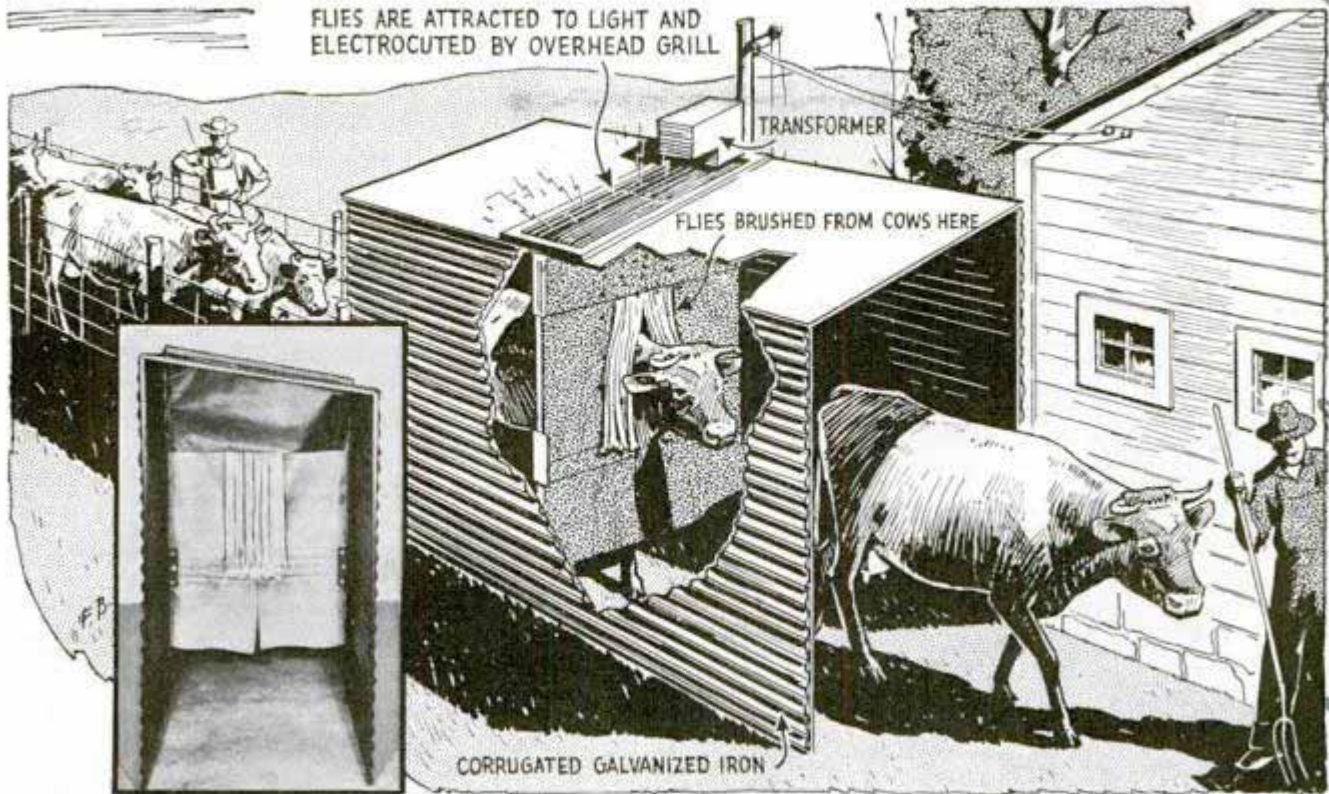

Cutaway drawing shows how curtains brush off flies as cattle pass through chute. Flies trying to escape through the "skylight" are electrocuted. Inset, lower left, photograph looking into chute

Flies of the biting and sucking variety that nestle on helpless cattle are brushed off the animals as they pass through a chute that is designed to electrocute the insects when they try to escape. The brushing equipment includes flexible aprons that spread open when the knees of a cow strike them, springing back immediately to their normal position to scrape the under part of the animal. A rope curtain hanging overhead drags over the horns and around the

ears to remove the horn flies. The chute is dark inside, and when flies are brushed off they dart toward the nearest source of light—an electric screen installed in the roof—where contact means instant death. The chutes are made with galvanized steel sides and roof, and may be placed in any passageway used by the cattle, as at the entrance to the milking barn, although cows have been trained to enter the chute even when it was placed in an open field.

*National Electric Screen Corp.
25 N. Peoria, Chicago*

Three-Cylinder Plane Engine Yields Fifty Horsepower

Better streamlining of small planes is said to be possible with a new three-cylinder motor that has no cam, gears or valves, but generates fifty horsepower and weighs only 130 pounds. The tiny power plant is a barrel-type engine, having its three cylinders parallel to the shaft. Still a mystery, according to engineers, is what is termed the "wabble-plate," or conversion mechanism. Water is the cooling agent.



Small engine with three cylinders helps streamlining of light airplanes

being developed

*National Motors Inc
Stout Field Indianapolis Ind*

Making YOUR VOICE

By Julian Leggett



HOW would you like to trade your voice for a new one, perhaps a high tenor for a deep bass?

While science can't give you a new voice, it can change your old one so that you wouldn't recognize it. Among the strange machines devised for turning voices topsy-turvy is an electrical arrangement that makes the same voice sound like a man's, a woman's, a child's or even a locomotive's. Another scrambles speech so that it is unintelligible in

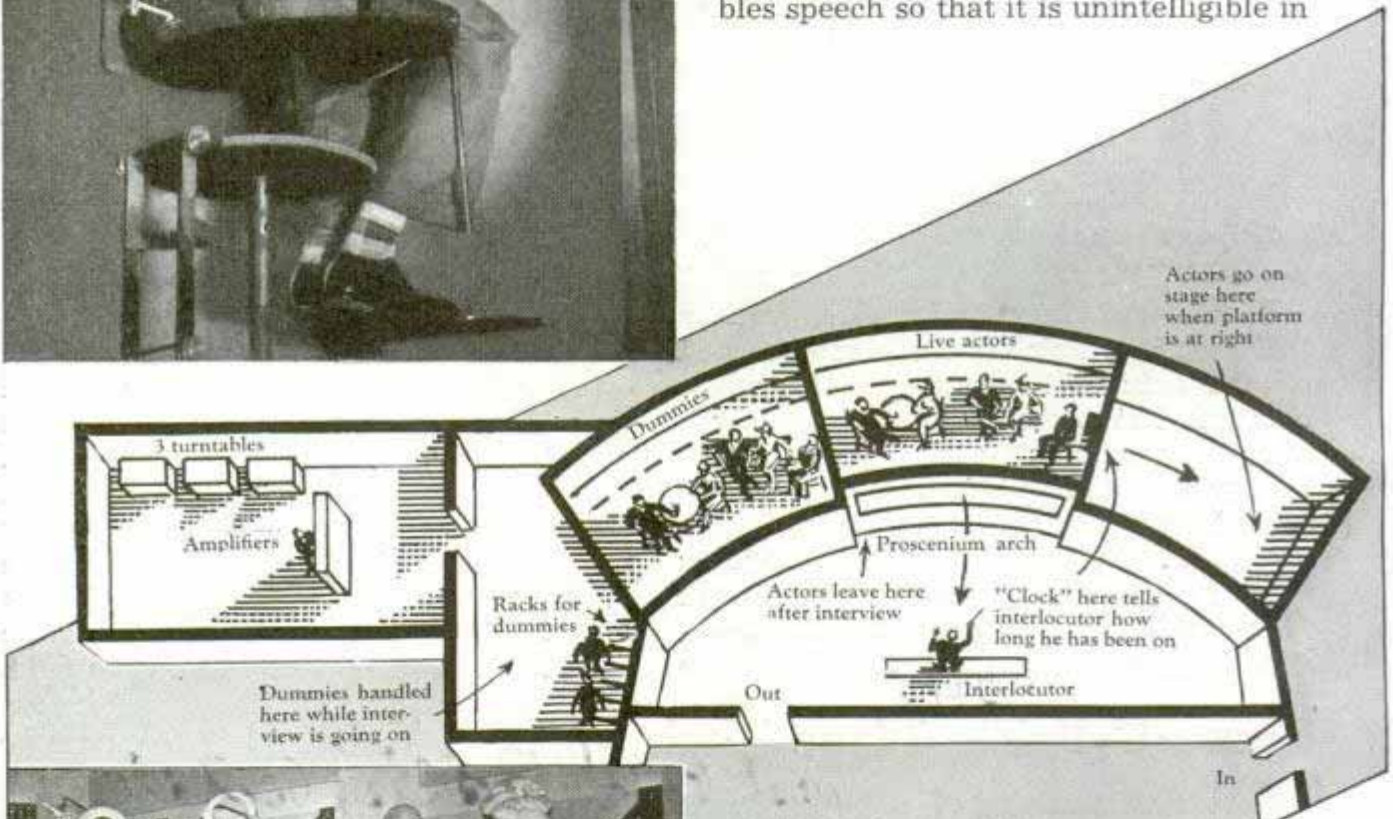

Testing sound perception, top; curtains break up reflections, prevent creation of sound pattern. Below, diagram of the "stereophonic" stage and talking dummies used in the demonstration

transmission until a companion machine at some distant point puts the scattered sounds back in their proper places. Still other equipment actually creates speech, selecting one of two complex tones—a hiss and a buzz—and controlling its intensity and tone quality by a keyboard. You can even "see" your voice as a light pattern on the oscilloscope.

do TRICKS

2 14 6 7
*Portable magnetos
 Western Electric Co.*

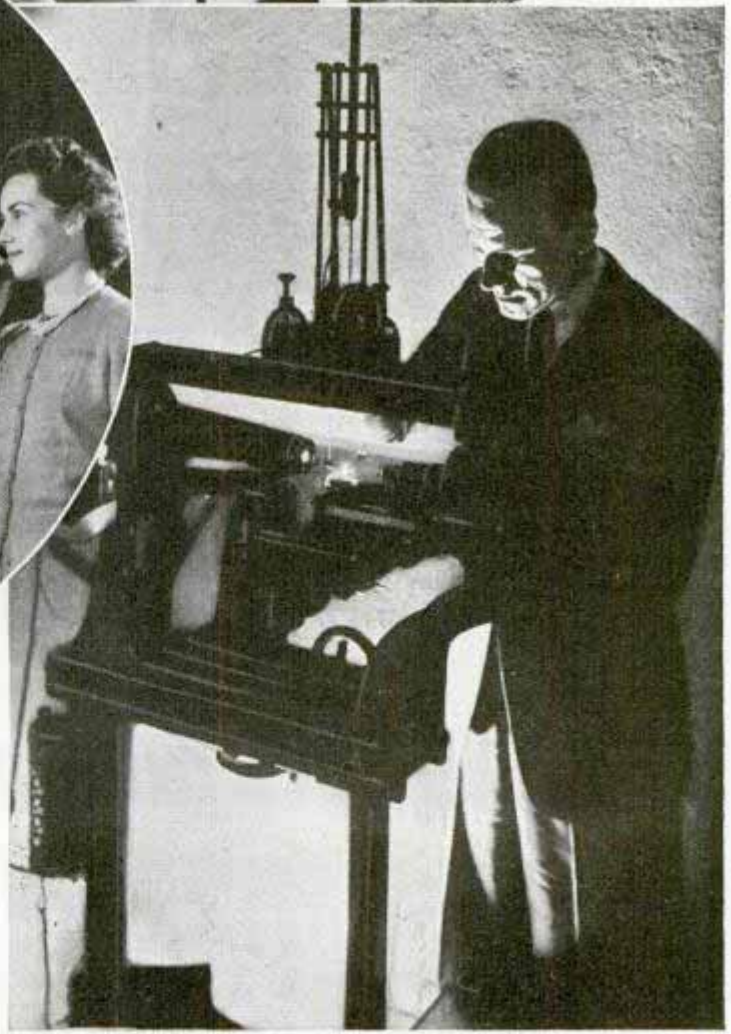
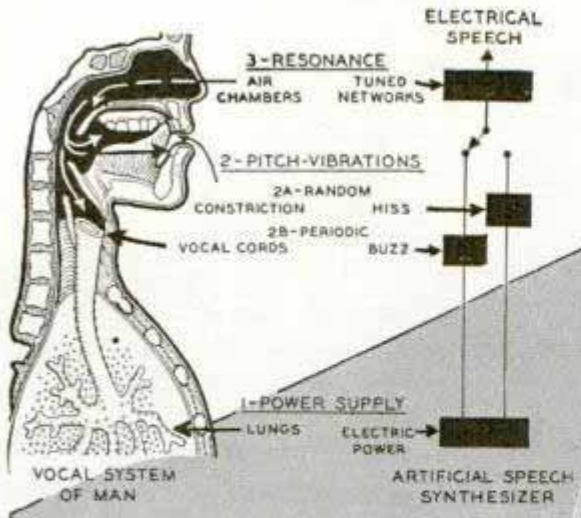

Before the invention of the telephone, man could transmit his voice about 300 feet in one-third of a second, by shouting. Today your voice may travel around the world in less than one-third of a second, by telephone and radio. Thus the speed of sound has been increased about 400,000 times by electrical waves.

This amazing advancement is due, in large part, to experimenters in the Bell Telephone Laboratories. Search for ways to improve the telephone

Diagram shows analogy of human vocal system to that of Voder; upper right, voice-powered telephone. Circle, speech pattern on oscilloscope. Bottom, measuring thickness of paper rings to cushion edges of telephone diaphragms

20 Sept 47

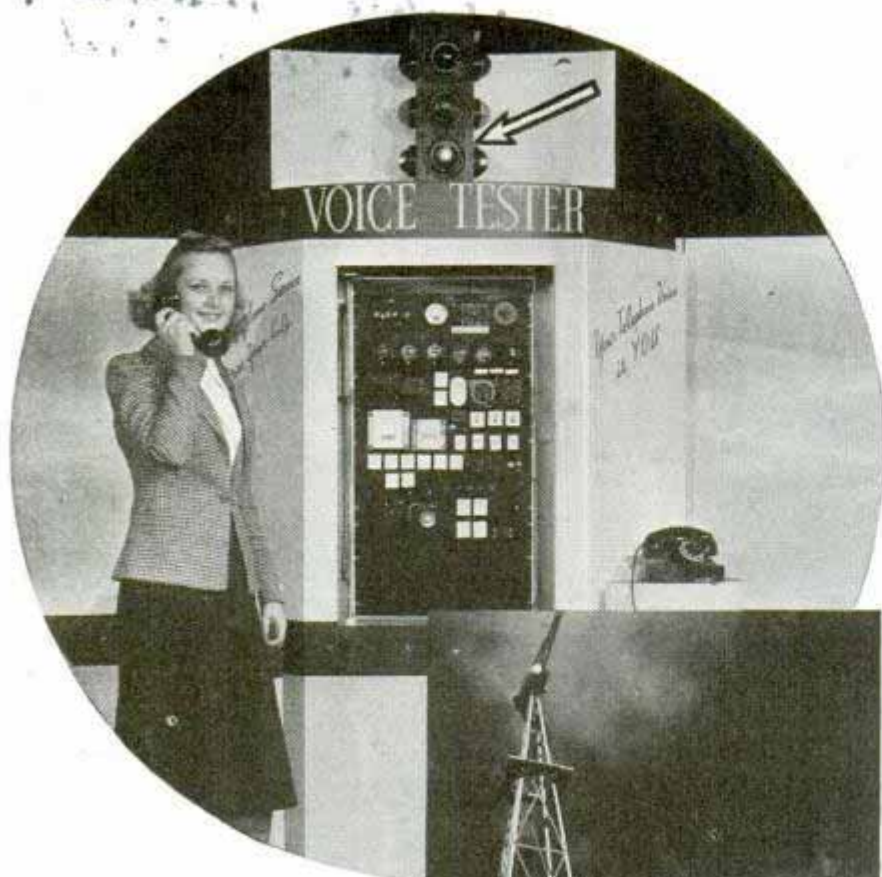

has led these scientists into investigation of the human voice, with the result that machines which analyze, improve and even simulate the voice have been invented. Who knows but that these men, joining hands with medical experts, some day may create artificial parts for the vocal system that will change the pitch and intensity of a person's voice?

The Vocoder, or voice-coder — the machine which changes your voice — first takes it to pieces, measures the pieces and then builds a new voice out of the electrical sounds. The raw material of speech is two streams of sound; proper variations of these streams give us speech. The first stream is characterized by three properties: a pitch determined by the fundamental frequency of vibration, an intensity determined by the sound power issuing from the mouth, and

a quality determined by the relative amounts of sound power carried in fixed frequency bands. The second sound stream has no pitch, it is a noise and has an intensity and quality which vary as the stream proceeds.

The first sound stream, the buzz, is demonstrated in the Vocoder as a rich full note, like a muted automobile horn. From this note electrical filters pick out thirty different ranges of overtones covering the range of the human voice. The same filters also break down the second stream, called the hiss, into these thirty ranges. These different sounds in proper proportion form all the sounds of speech. Thus the machine analyzes a voice into thirty parts and then uses the results to control the proper amounts of each of the sounds before they reach the loud speaker. A shift in relative amounts may change one vowel into another.

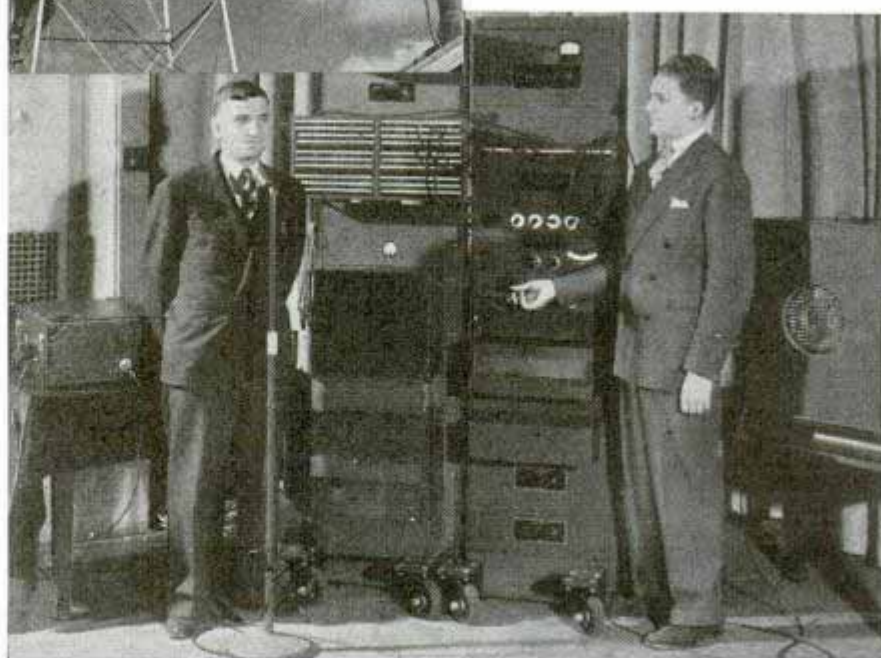

Top, a subject tries out the electrical voice tester. Center, wind-driven generator helps recharge storage batteries at unattended amplifying station on transcontinental telephone line. Below is the Vocoder, which takes your voice apart and makes a new one from the pieces

2 146 7

X 229

By manipulation of dials and switches, normal speech becomes a throaty whisper when the hiss is substituted for the buzz. While the hiss is relatively faint, it is essential in discriminating between "church" and "shirts."

Ordinarily the pitch issuing from the Vocoder moves up and down with the original coming from the speaker. If variation is prevented, the recreated speech is a monotone, like a chant. When the variation is cut in half, the voice seems flat and dragging. When the swings are twice normal, the voice seems more brilliant. The controls can be reversed so that high becomes low; a melody is then unrecognizable and speech has the odd lilt of Scandinavian tongues. Another control fixes the basic values of the recreated pitch; if this is "fluttered" by hand, the voice becomes that of an old person. By appropriate setting of the basic pitch the voice may be anything from low bass to high soprano. Thus the singer may sing a duet with himself, if the machine is set to produce a harmonizing pitch. The basic pitch control also may enable the speaker to sound like a father reprimanding his daughter, then the girl herself and finally the grandfather interceding. In one demonstration, a puffing locomotive is made to sound as though actually saying the words, "We're starting—slow—ly—faster—faster—faster." Or a church bell may say "Stop—stop—stop—don't—do—that." These tricks suggest uses for the Vocoder in creating artificial voices for radio and sound pictures. It appears to have possibilities as a tool in the investigation of speech, in developing privacy of communications or in reducing the frequency range required for telephonic transmission.

The machine which creates speech is the Voder. It consists of a small table with a dozen or more keys, a pedal, knobs and a bay of apparatus including vacuum tubes,

(Continued to page 125A)

Exposure Meter for Radium Warns If Packing Is Unsafe



Meter keeps watch over stored radium, issuing a warning of danger if vault becomes "overloaded" or insulation is inadequate

Automatic warning is sounded by a radium exposure meter when the radiations from stored radium approach a point that is regarded as the limit of safety. Placed in a room where there is a vault in which radium is kept, the instrument will notify workers if the vault's lining gives inadequate protection, which may happen when more radium is stored than the vault is intended to hold. It will also indicate whether the necessary precautions have been taken in packing radium for shipment so persons handling it will be guarded against dangerous exposures. The warning device was developed by the Bureau of Standards in Washington.

Sawtoothed Cutter Trims Lawn Edge on Forward or Backward Stroke

Lawn edges are trimmed neatly by a saw-toothed cutting tool turned by the friction of its hardwood roller on the sidewalk or sod. Its shears operate on both the backward and forward stroke. A tension spring holds the cutter against the stationary shearing blade.



Ⓢ A Tahitian has patented a method of partly drying bananas without loss of essential juices and flavor, and, reduced to half their original size, wrapping them for shipment in a transparent film.

Henri Daniel Rey 885

England Tool Co. Scatter Wash
501 5th St. Wash.
501 5th St. Wash.

2 192, 293

K 225.

Engine Fire in Wind Tunnel Promotes Safer Air Travel

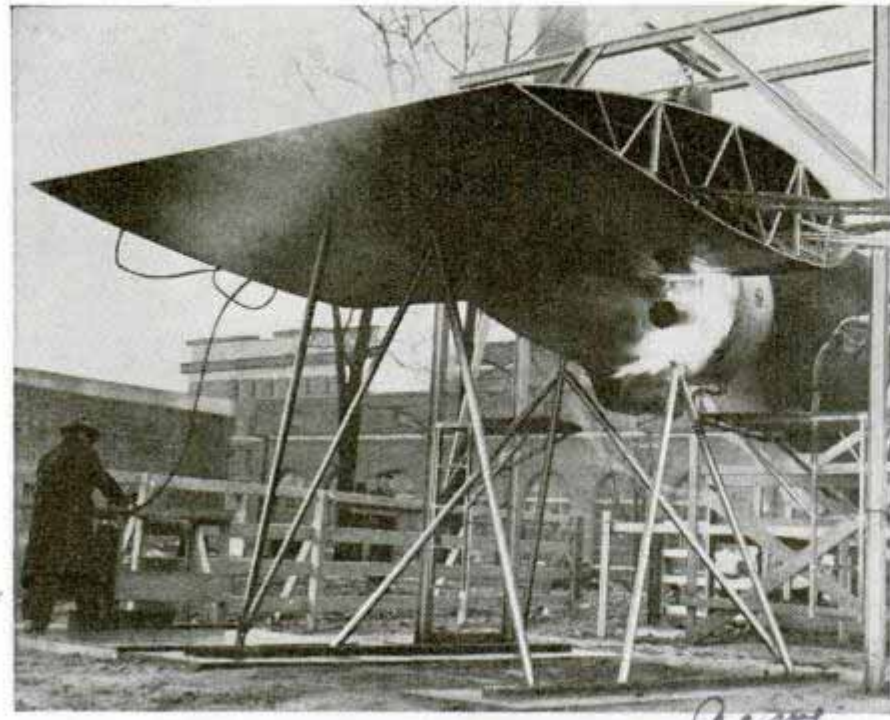

Blazing aircraft engine was extinguished quickly by carbon-dioxide gas to demonstrate safeguards installed in airplanes to defeat fire hazard

To develop safeguards against aircraft engine fires, engineers of the Civil Aeronautics Authority start an oil blaze in an airplane engine placed in a wind tunnel to simulate flying conditions. In a recent demonstration, two fire detectors mounted on the cowling behind the engine cylinders reported the presence of fire instantly by closing an electrical circuit and lighting a red bulb in the control room. After burning about twenty seconds the fire was put out in five seconds by carbon-dioxide gas, distributed around the engine by two tubular rings perforated with tiny holes. The gas was stored in a steel bottle in liquid form under high pressure. Tests of this kind help to develop detecting devices and fire-extinguishing apparatus, and to compare fire-resisting qualities of various aircraft construction materials.

in magnetic waves as far as five miles. Telephones could be stationed in the mine, with portable transmitters at various stations and a fixed transmitter on the surface.

Model Trains Test Men for Jobs as Trolley Drivers

Before an applicant is given a job as motorman of a trolley car of the Cleveland Railway company he has to prove he can run a model electric train safely. The power cars of the miniature system are operated by the regulation controls and brakes of the street cars, and if the candidate can't avoid a crash on the toy line he lacks the judgment and quick reaction to drive a trolley.



If he is to win a job as motorman, the man at the control should have proved his aptitude by averting this accident on the model railway

Wireless Magnetic Telephones Aid Mine-Rescue Work

Telephone wires may be cut in a mine disaster, radio fails to penetrate earth to any depth, but a wireless magnetic telephone system holds the promise of maintaining communications between rescuers and entombed miners when all other links are severed. The system uses a low-frequency signal which transmits the voice

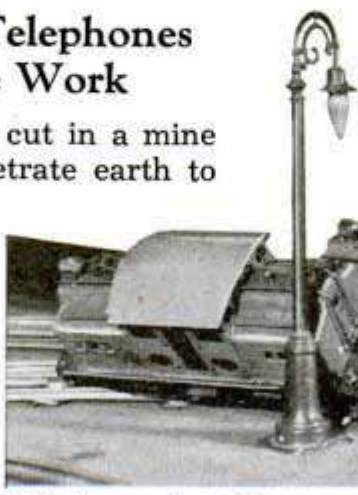

American Telephone Corp
150 W. 56 St.
New York

Planes 'Bomb' River to Find Thin Ice for Ships



*Lieut.
W. A. Burtok
Commanding
Group*

Top, left, aerial ice survey "quiz block," dropped from plane as shown at right, falls near resident of Hudson river town. Bottom, examining an "ice bomb"

graphed requests for information concerning local ice conditions were inclosed in hollow, wooden "quiz blocks" and tossed from the plane within the sight of a person on the ground. Each block contained a blank reply form and a government franked envelope for mailing the report.

12331 Eighth Vitamin Is Synthesized as Pantothenic Acid

Of ten vitamins recognized thus far by science, eight have been successfully synthesized and the newest of this group, announced recently, is pantothenic acid. In nature this vitamin is widely distributed, found universally in all animal tissue, and it is believed that the synthesized product will be found highly valuable in nutrition. The exact field of usefulness for the vitamin has not been discovered.

Announced by Dr. Royal G. Williams.

Brooklyn, N.Y.

Airplanes from the U. S. Coast Guard air station at Floyd Bennett field helped keep Hudson river channels open to shipping through the winter by conducting an aerial ice survey in cooperation with ice breakers. Flying over remote areas of the river, the planes dropped non-explosive "ice bombs" from an altitude of 500 feet to test the thickness of the ice. If the lead-filled missile broke the ice, it was thin enough to permit passage of a ship. The aerial ice-survey units also called on residents along the shores to aid in their work. Mimeo-

*U.S. Coast Guard
Hudson River
Merch. to C. & N.Y. Railway
1935
Research Dept.
Dr. R. G. Williams
and Dr. Pandothenic
Acid*

R316.

Isant

KEEPING *the*

THE Santa Fe Railway now introduces the rectangular roundhouse. Its growing fleet of Diesel-electric locomotives needed a home of their own; since they are physically no relation to the steam engines there was no reason for stabling them together in the roundhouse. So the new rectangular roundhouse at Chicago is a huge garage where the streamliners roll in over pits to be serviced. Giant "jacks" that can lift more than a half million pounds are stationed at the pits to hoist the 3,600-horsepower locomotives off their trucks, and overhead is a traveling crane capable of lifting ten tons on its high-speed hook or forty tons on its main hook. The crane is used to hoist engine cabs, or to remove engines or generators. From one repair track a pit extends sideways, tunneling into a repair shed; power trucks can be dropped into this pit, up-ended and rolled aside for overhauling. In a machine shop alongside the main 111 by 342-foot shed, wheels are ground smooth, air-conditioning units, electric equipment and other parts are repaired. The principal repairs necessary are the maintenance of cylinder liners, connecting rods, cylinder heads, valves, pistons and connecting bearings, replacement of worn wheels and traction motors and their bearings. Changing of lubricating oil in crankcases and the cleaning of oil and air filters is a routine job as with your own car.

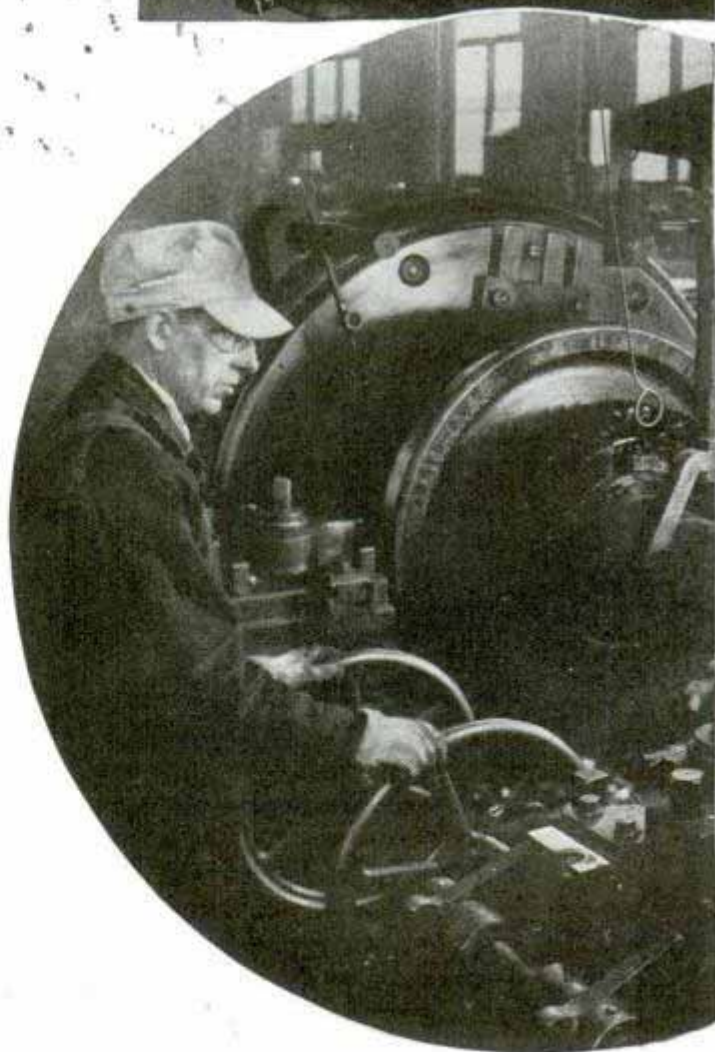

Diesel repairmen above, at left, remove piston assembly from 900-horsepower engine; right, roller bearings that smooth the streamliner's ride. Below, skilled lathe operator machines a pair of power wheels

K 316

DIESELS *Moving*

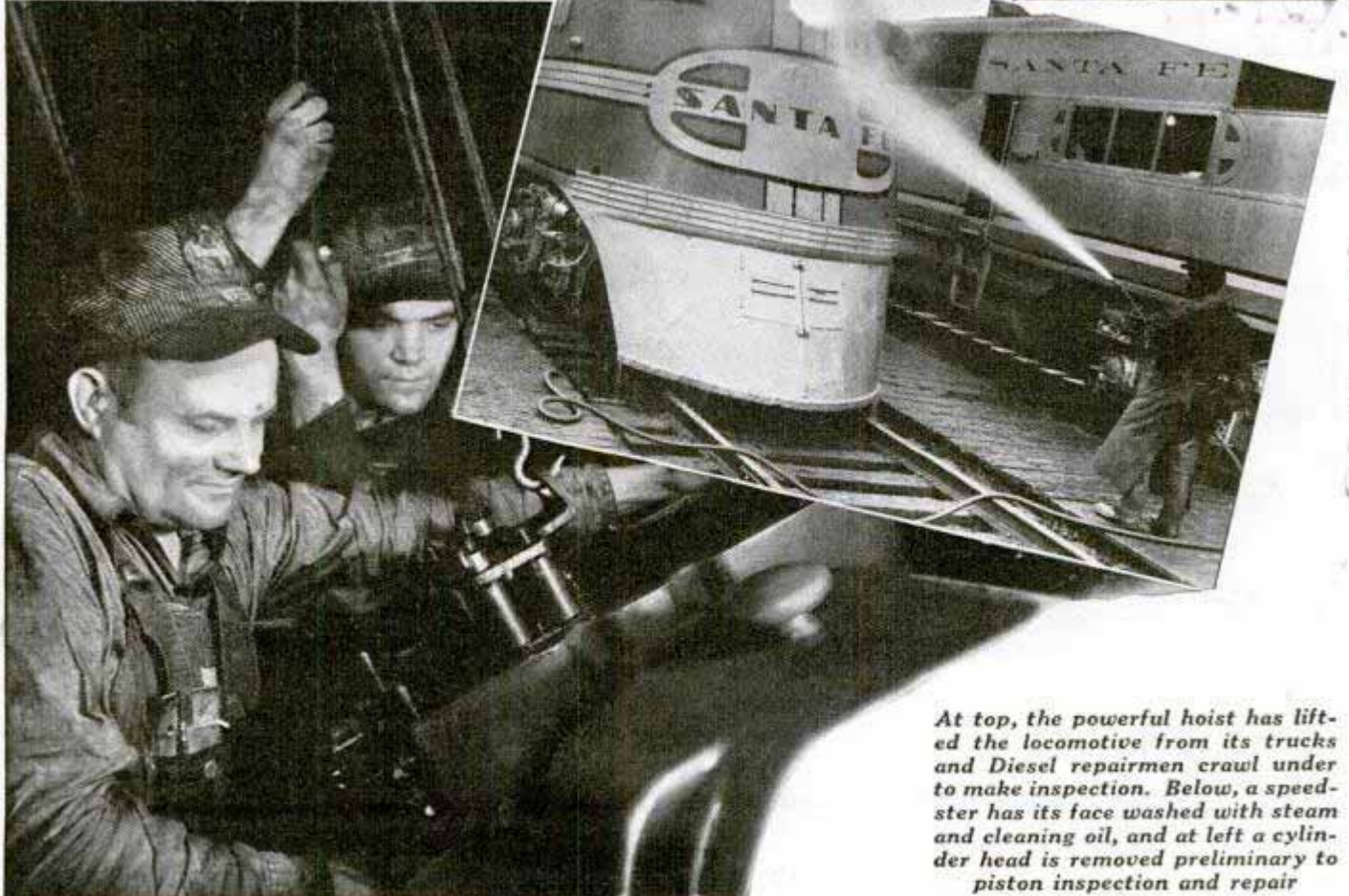

At top, the powerful hoist has lifted the locomotive from its trucks and Diesel repairmen crawl under to make inspection. Below, a speedster has its face washed with steam and cleaning oil, and at left a cylinder head is removed preliminary to piston inspection and repair

K 219.3
Smith by Engineering and Research Corp. Riverdale, Md

Sheet Metal Stretched to Form Airplane 'Skin'

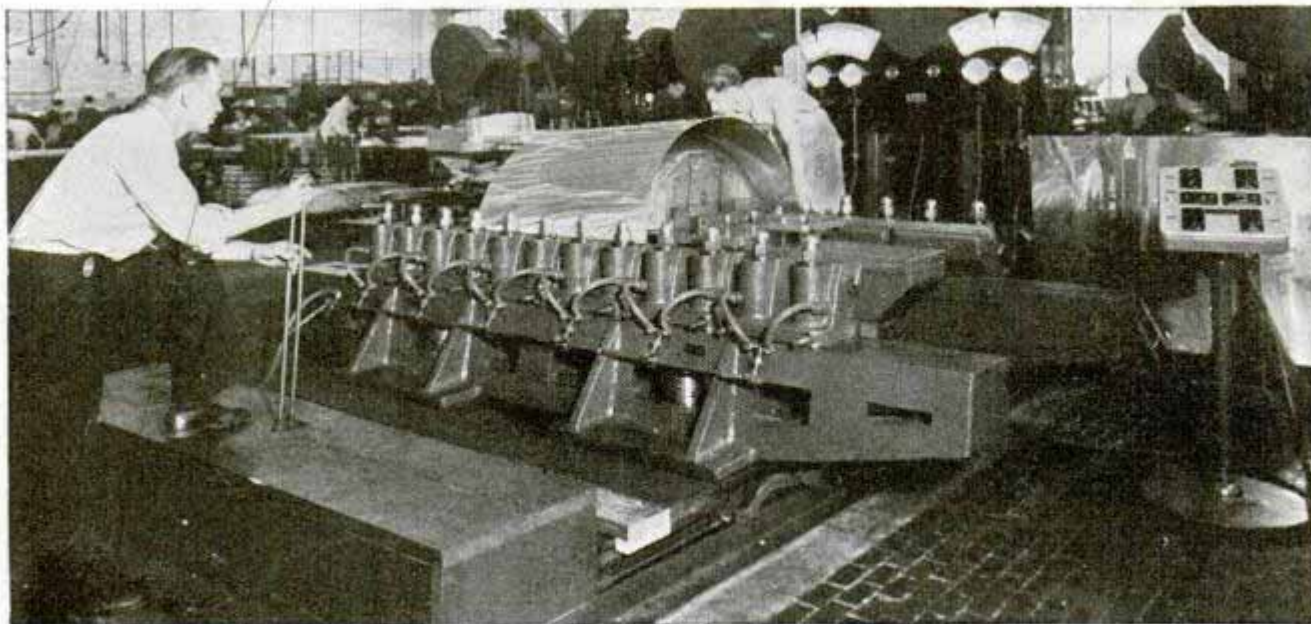

Hydraulic pressure applied to two cylinders under platen forces the form upward against sheet metal, stretching it into the shape of the form. Strong clamps grip the two ends of the sheet

Baltimore, Md
 Airplane "skins" and engine cowlings formerly shaped by hand tools and power hammers are now being formed by a hydraulic metal-stretching press, first of its kind in this country, put into operation recently at the Glenn L. Martin aircraft plant. It consists of two hydraulic cylinders under a platen on which the form

rests. A sheet of metal is placed over the form and its ends clamped tightly in two rows of jaws. When pressure is applied the platen is forced upward, stretching the sheet until it hugs the form tightly. The operation takes but a few minutes, during which the sheet, in taking its new form loses five to seven per cent in thickness.

Ghostlike Car with 'X-Ray' Body Reveals Working Parts

K 212
 To show the public what its cars are made of, one automobile manufacturer inclosed a 1940 model in a body of glass and

transparent plastic. Its engine, working mechanism and framing structure thus have been converted into "an open book" for the spectator. The car, which is now being driven about the country on a demonstration tour, carries passengers who enjoy vision in all directions through the "all-window" body.

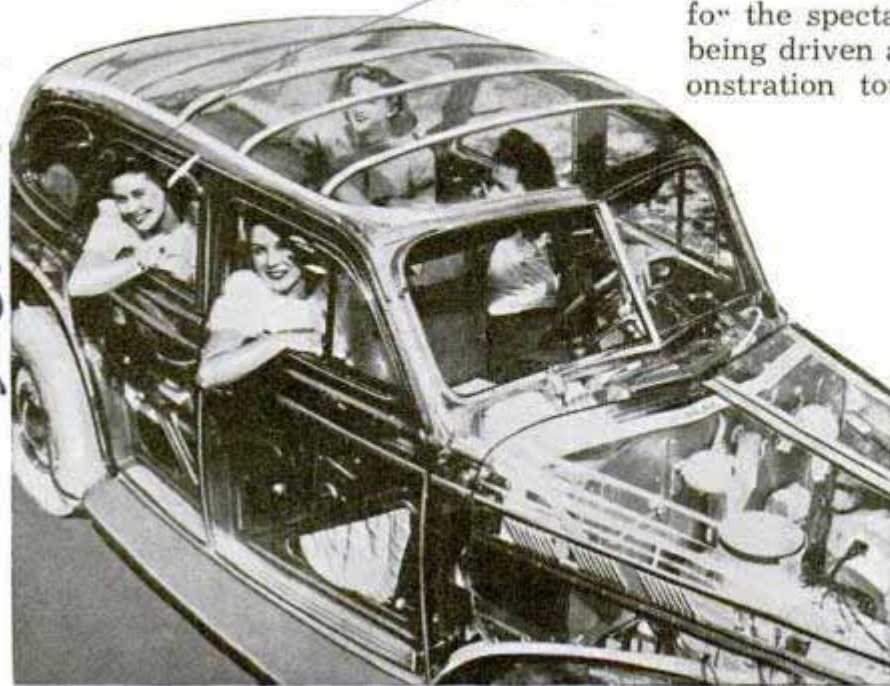

Automobile inclosed in transparent body exhibits structural bracing and mechanical features, also giving passengers unrestricted vision

Two Crops Grown in 'Soilless Garden' at the Same Time

K 304
 Growing corn and potatoes simultaneously in the same tank is the latest development in hydroponics, or "soilless farming." Similar multiple cropping has been accomplished with such combinations as potatoes, tomatoes and celery; and

Fisher Body Craftsmen General Motors Body Detroit

Carl Byrd and

*Dr. William F. Isenke
Berkeley Calif.*

daffodils, godetias, gladioli and chrysanthemums. The plants are kept out of each other's way through differences in height, varying harvesting times, and sometimes a little pruning. The potatoes and corn were planted in a basin having a surface area of 1/220 of an acre, yielding a harvest of 6.8 bushels of potatoes, and 1.11 bushels of corn. This is equivalent to getting 1,496 bushels of potatoes and 224.2 bushels of corn from one acre.

K 231

"Blotter" for Drying Concrete Forms Smooth Surface

Scene Service

Government engineers have found a simple and inexpensive method of drying the concrete spillways of giant dams to produce a smooth, hard surface. They use "blotting" paper. Highly absorbent fiber board is unrolled over the soft concrete, drawing out the moisture and letting air bubbles escape. This lets the concrete dry evenly and leaves an unusually hard, smooth and wear-resistant surface.

U.S. Reclamation Service

K 242

"Bobsled" Tests Waxed Floor to Eliminate Skid Hazard

Industrial Hygiene Engineer Edgar C. Darn

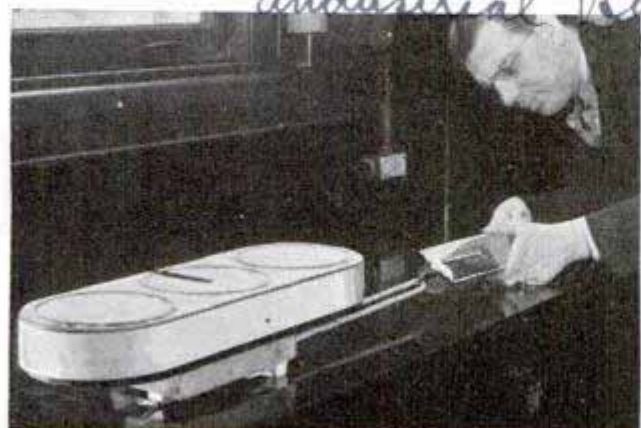

Effort required to pull 100-pound weight on "bobsled" over waxed surface is read on spring scale

In an effort to reduce the hazard of falls on slippery floors, a Westinghouse engineer has devised a "bobsled" test for waxed surfaces. The little robot that takes the falls for you is an eight-inch wood base resting on three leather runners like those of a bobsled. A hundred-pound weight is placed on it, and the sled is pulled by a spring balance across a waxed surface. Thus the amount of pressure required to start it and keep it slipping is easily read.

(Nearly forty per cent of all traffic accident victims in 1939 were pedestrians.

Bomb Shelters in Paris Jails Prepare to Aid Gas Victims

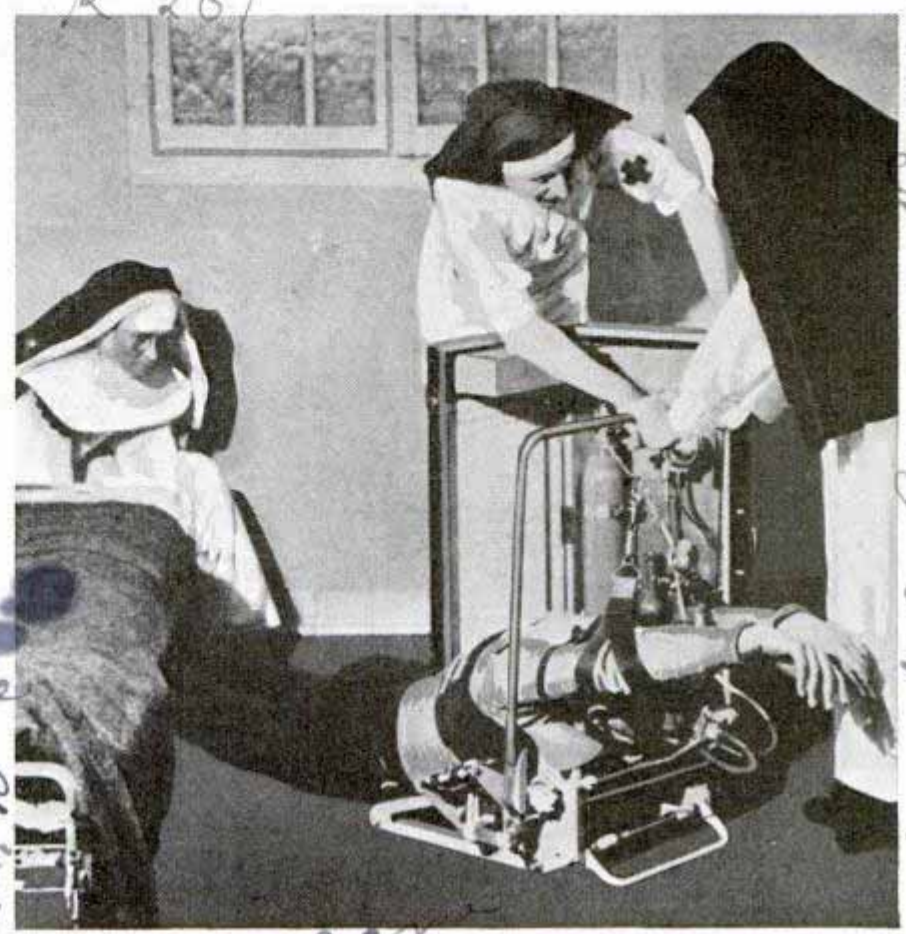

Nuns learn to operate respirator so they will be prepared to care for prisoners who may fall victim to gas attacks of enemy warplanes over Paris

Precautions have been taken in Paris prisons, as in the city proper, to protect inmates during wartime aerial attacks. When the alarm warns of enemy bombers, the prisoners follow prearranged directions for an orderly descent into their air-raid shelters, where provisions have been made for the care of casualties. Respirators are ready for emergency treatment of gas victims, and nurses have been trained to operate them.

*Departmental Prison of Comman dard
St. Resines - Les Cluzelles, Paris*

Travelers Bureau

21256

The WORLD'S

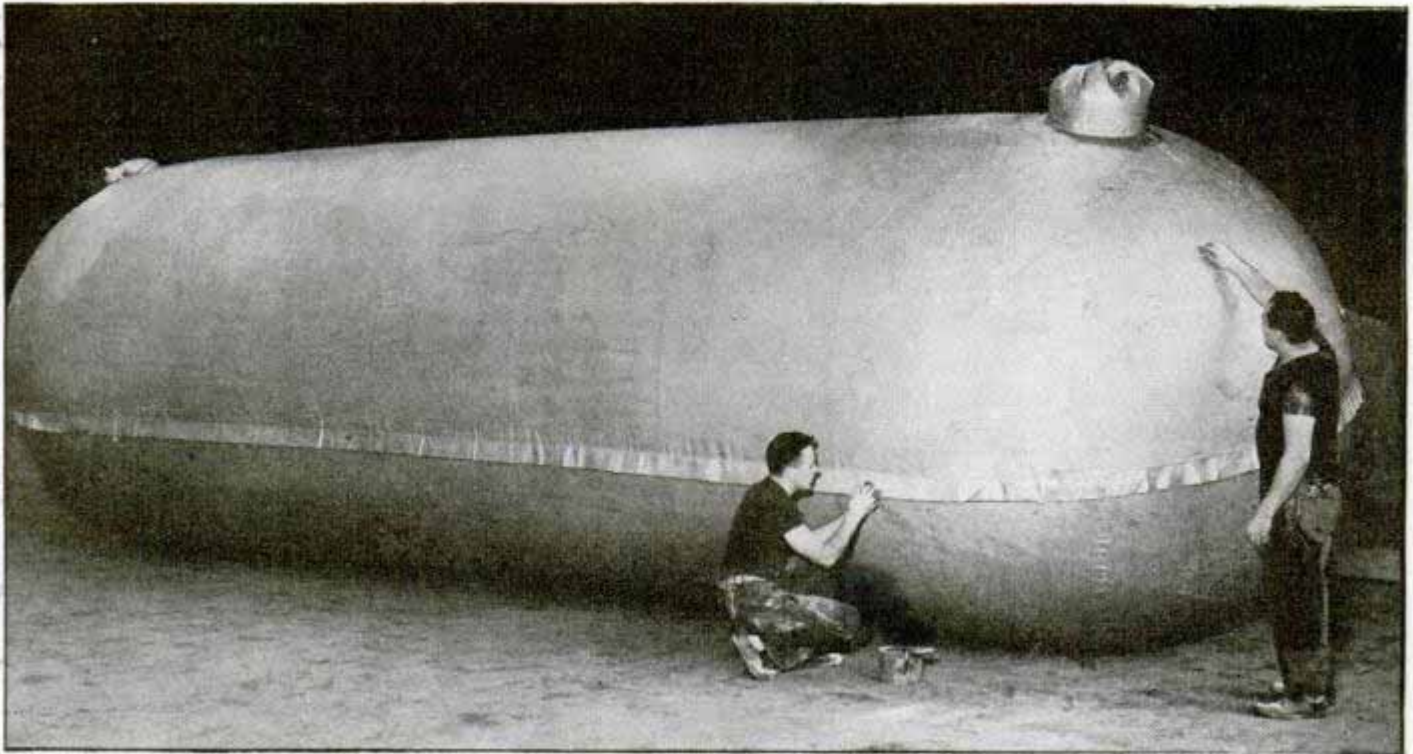

By P. W. Litchfield

President, The Goodyear Tire & Rubber Co.

Alvin Clark

BACK of the tremendous advance in almost every field in the last century is the work of men who have devoted their efforts toward harnessing for man's benefit the properties of one of nature's most curious substances—rubber.

Rubber has played an important part in making possible numerous things we re-

gard as necessities. An outstanding characteristic of our modern civilization is fast transportation of masses of people and materials. Across many thousands of paved highways and streets speed millions of passenger cars, buses and trucks. Air lines reach out to greater distances as the speed and safety of flight increase. Great ocean



Top, giant breather bag used in petroleum industry to reduce evaporation losses. Bottom, left, machine employed in testing new type of rubber-and-fabric balls used in sports. These balls discard the traditional leather covering. Right, huge tire used on earth-moving machinery

W. L. V. Rubber Co.

2/256

SHOCK ABSORBER

liners have crowded sailing ships from the seas.

It is likewise characteristic that the materials used in the manufacture of these units of transportation are available in mass quantities—that we fully employ and enjoy the boons of the Bessemer and parallel processes.

In this connection we cannot overlook our systems of communication. These implements of modern civilization grew out of the genius of Bell, Marconi and kindred intellects. They serve us in a million ways and closely knit together geographically scattered units of modern civilization. Another phase of modern living combines the elements of prophylaxy, hygiene and sanitation. Behind a protecting shield conceived by Pasteur, Lister and many others, the span of modern life has been extended, we live in greater safety and we live in better health.

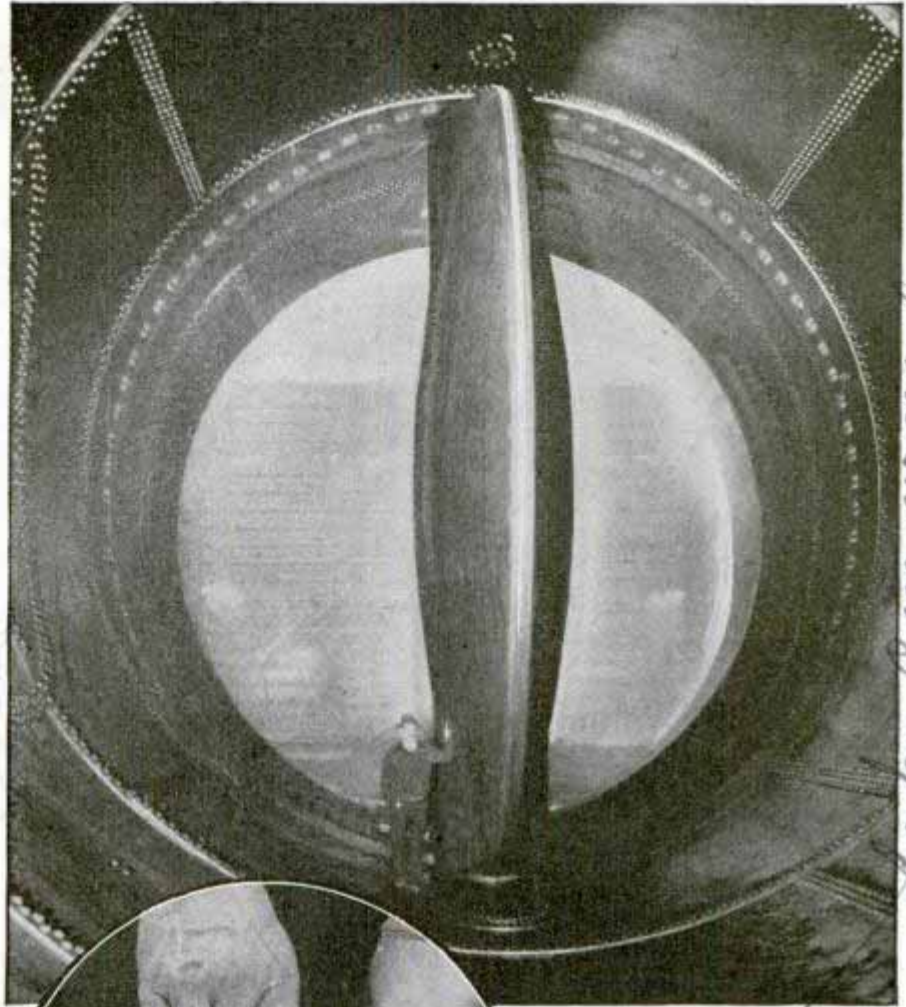

Make Coverings



Big rubber seal (above) used at dam; spray-on covering for shoes (left); high-speed rubber tracks for military vehicles (bottom, left), and Koroseal textile roll covers (right)
Photos supplied Popular Mechanics by B. F. Goodrich Co.

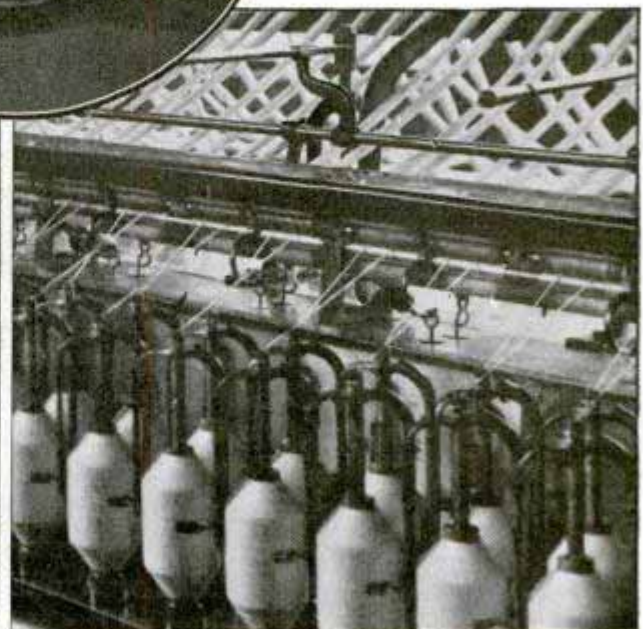
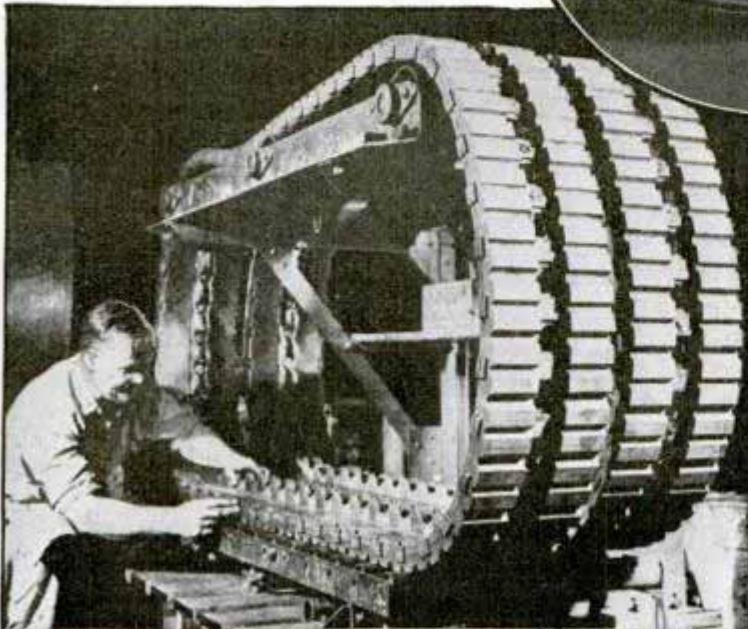

Goodrich

21266



Top photos and sketch courtesy Goodyear Tire & Rubber Co.

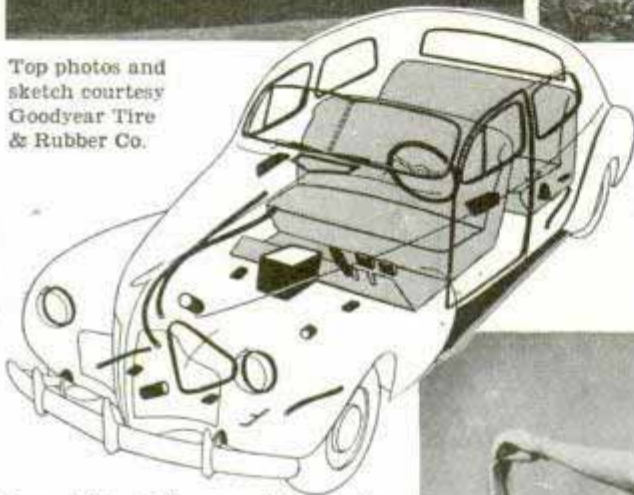

Top, left, Airfoam rubber mattress introduces new sleeping comfort. Right, rubberized fabric boat useful to sportsmen. Below, sketch showing some of the points at which rubber is used in the automobile. Right, curtain made by heat-sealing rubberized material.



These characteristics—transportation, mass production, communication and mass hygiene—were not created by rubber. But in each instance rubber is the fluxing material

without which they would be either totally impossible or tremendously restricted.

The fast motor under the hood of the modern car may perform its function only because it exerts its power through the cushioning and traction qualities of the modern tire. And there are more than 200 rubber parts in the modern motor car aside from the tires. The plane's takeoff and landing are safely accomplished by the aid

of pneumatic cushions made from rubber. The giant ocean liner is served in numerous essential respects by devices of rubber.

In the field of communication, as in all functions of the electrical impulse, insulating properties of rubber are indispensable.

There could be no system of sanitation without rubber gaskets, and a scalpel in the hands of the most highly skilled surgeon is a deadly blunderbuss unless the hands are covered by sterilized rubber gloves.

All this has been made possible by the discovery, 100 years ago, of the process of vulcanization by Charles Goodyear. Prior efforts to make rubber useful to mankind had met with discouraging results. Regardless of the compounds with which it was mixed, the rubber

grew hard and brittle in winter, became sticky in summer, seemed destined to remain on the outer fringe of commodities beneficial to the human race. Application of heat to a mixture of rubber and sulphur yielded the secret for which Goodyear had been searching, resulted in a product that maintained its sturdy resiliency through heat and cold. From the crude rubber-coated fabrics and other articles of that day have sprung thousands of uses for

9/250

2/465

rubber, with more being added to the list each passing year.

When the word "rubber" is mentioned, the average man thinks of tires. This is a natural reaction, for during the past forty years the pneumatic tire has steadily reduced the cost and increased the comfort of automobile transportation. Today, many different types of tires are available to do as many different types of jobs. The huge tractor-trailer units that convey heavy loads at high speeds over long distances need tires that withstand the terrific heat generated in that type of service. The light delivery truck needs tires that will give long tread wear through hundreds of starts and grinding stops each day. The earth-moving vehicle needs traction that will get it through the sand and mud of a construction job. The airplane tire must be able to withstand the terrific shocks of landing.

Passenger and truck tires quite naturally have accounted for the bulk of the world's consumption of rubber products up to this time. But the future will witness great expansion in other directions. It seems that the rubber industry stands on the threshold of an era of vastly multiplied usefulness to civilization.

The modern automobile includes almost as many pounds of rubber, aside from the tires, as the tires weigh. This includes radiator hose, fan belts, engine mountings, floor mats, seat cushions and many other parts. Rubber is being brought into ever increasing use by the designers of the modern streamline trains.

Mattresses, cushions and upholstering made from beaten and molded latex are just now coming on the market. With their superior cushioning qualities, their comparative lack of weight and bulk, and the advantages they offer by reason of their being verminproof, it is indicated that a new market of vast potentialities is now being tapped.

The two-mile long conveyor belt which transports 48,000 tons of crushed rock each day to the base of Grand Coulee dam is prophetic of the future use of rubber in mining and similar operations.

Plastics and many other materials derived from latex are in the immediate offing. There are wide possibilities for the use of rubber to compensate for irregularities in dealing with rigid materials.

There is no other material that will so

(Continued to page 123A)

Folding Top for Table Tennis Fits on Card Table



Folding table top, smaller than standard size tennis table, permits game to be played in close quarters

For playing table tennis in homes where lack of space makes it impossible to use a full-size table, a folding top that opens to seventy-two by twenty-four inches will fit on either one or two card tables and provides a hard playing surface that is said to give the ball a good bounce. Made of non-warping material, the board measures twenty-four by thirty-six inches folded.

K127

Electric Stove Fits Travel Case

Small enough to carry in an overnight bag or brief case, an electric stove for travel has a six-inch heating plate, thermostatically controlled from high to very low heat, and is only one and one-half inches deep when its legs are folded. Operating on alternating current, it is handy for camp, hotel or office and for use of doctors on emergency calls.



Only one and one-half inches deep when the legs are folded, this stove serves many purposes

Deplex Appliances Co. 895
F. P. H. ...

Walter Bros. Co. 288 E. 4th St. Boston, Mass.

K 2 48

Foot Regulated Coil Winder Insures Uniform Tension



With foot on treadle operator can govern rotation of reel to assure uniform tension of finished coil

Constant wire tension is maintained by a coil winder equipped with a foot lever that controls its speed. It can be operated at 120 to 650 revolutions per minute, an automatic counter recording the number of turns on a dial either forward or in reverse. A pilot light shines when the motor is running, and there is a handwheel to permit removal of a few coils from the winding if needed.

New 1924 Car Costing \$1,685 Brings Only \$40 Today

Forgetting the "frosting" of mere styling and appearance, how would a new automobile of fifteen or twenty years ago—kept "under glass" since it emerged from the factory—compare with a modern car in performance? A Chicago man had a practical answer to the question the other day when he bought from a friend a car that had cost \$1,685 new in 1924. The original owner had driven it only four and a half

miles, became ill, put it in a garage under good protection for sixteen years, then sold it for \$40. Only technical advances had intervened to reduce its value. The car has an engine about the same size as engines today, yet without modern hill-climbing power, pick-up and economy. It lacks four-wheel brakes, balloon tires and safety glass, has no automatic choke, fuel pump, crankcase ventilation, shock absorbers, air cleaner nor oil filter, no steel top, nor has it the headlight power and trunk capacity of today's automobiles.

K266

Carpet You Can See in the Dark Illuminates Theater Aisle

Theater patrons will find it easier to walk down unlighted aisles which are carpeted with a fluorescent floor covering introduced recently. When the lights are switched off, invisible "black light" causes the carpet to glow brightly as though it were woven with luminous yarns.

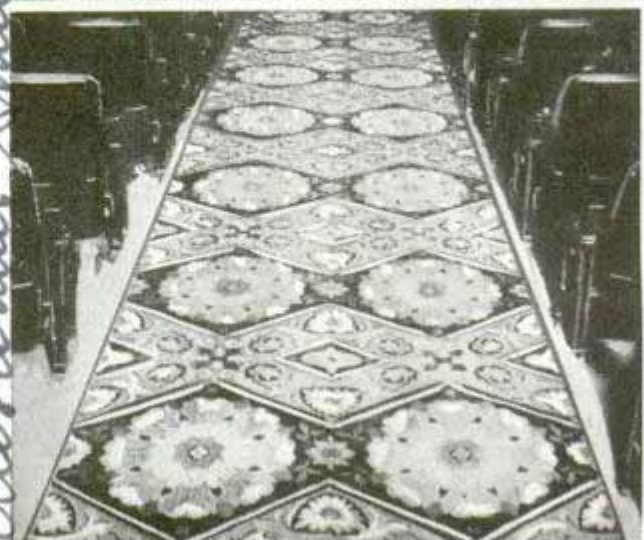

Top, fluorescent carpet as you would see it in darkened theater, and bottom view shows it with lights on

I deal Commercial Wire Co. Springfield, Ill.

Grand

Alexander Smith & Son Carpet Co.



The CRAFTSMAN

Modeling in SHEET METAL

FASHIONING decorative animals and novelties in gleaming metal is an interesting pastime, which can be enjoyed by anyone. The suggestions given are only a few of the many figures which can be reproduced. All the tools you will need to work the paper-thin metal to shape are an ice pick for punching holes, a pair of long-nose pliers, a dressmaker's tracing wheel and a pair of household shears. For material, No. 30-ga. non-tarnishable monel metal is preferred, although sheet aluminum, while it does not have such a bright finish, can be used if you are unable to obtain the former. For fastening the pieces together, you will need a spool of No. 30-ga. bright-finish wire, and a few feet of $\frac{1}{8}$ -in. aluminum tubing will also be needed to form a framework required by the larger figures.

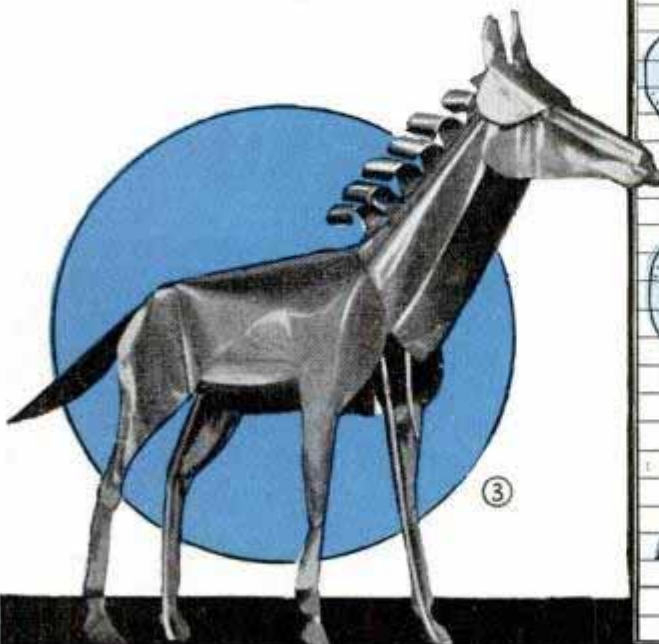
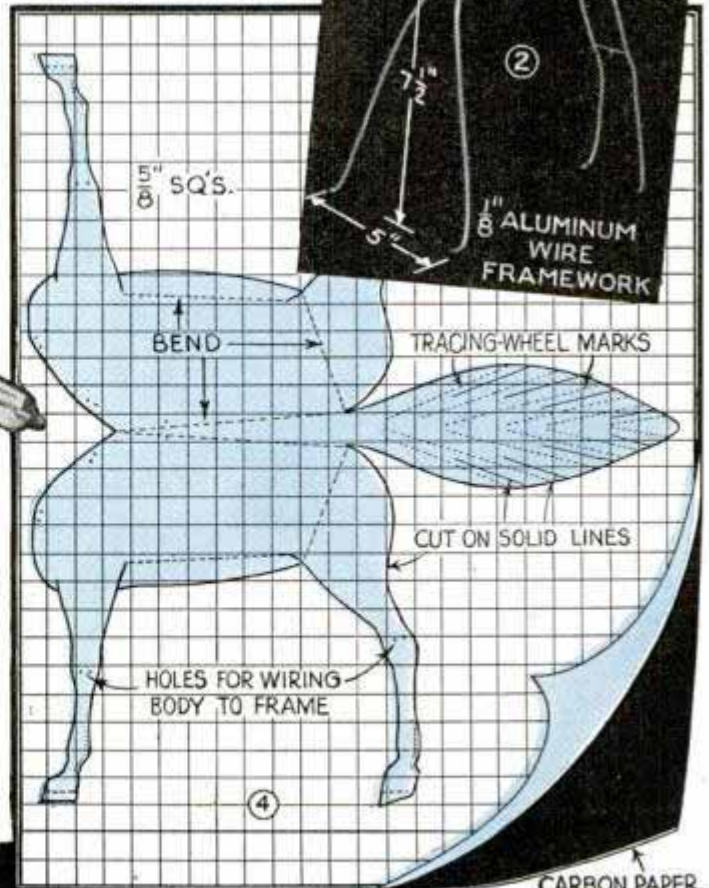
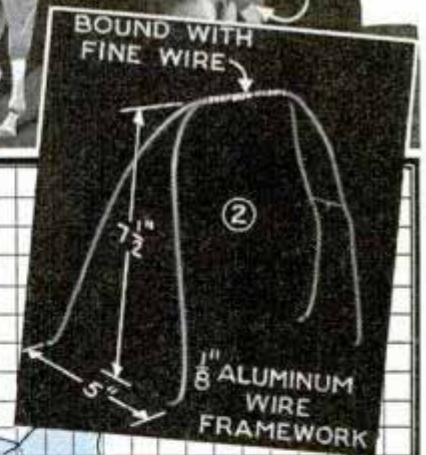

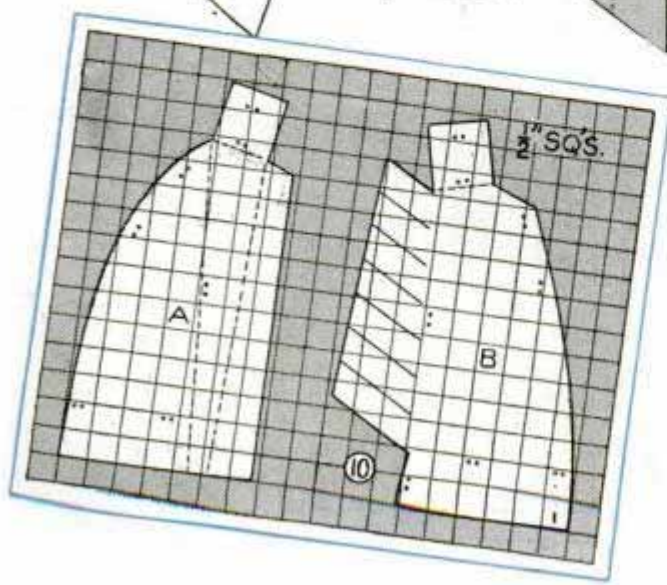
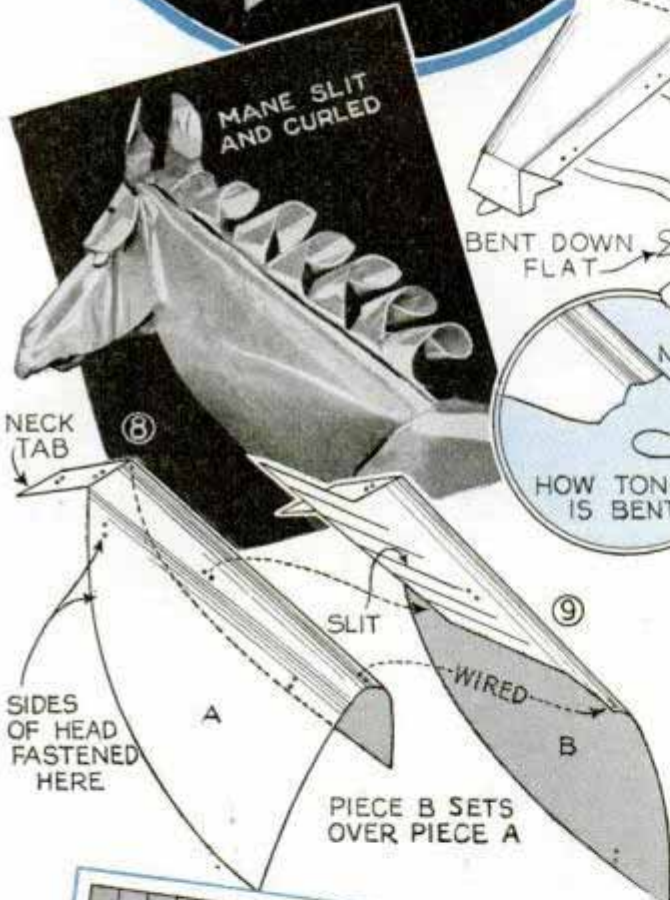
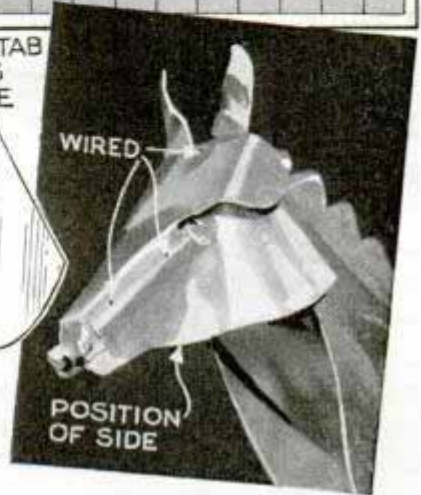
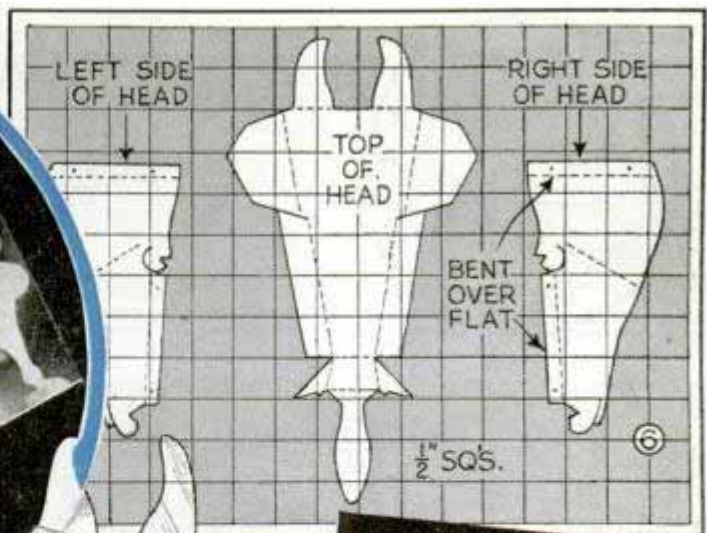

To model the horse shown in Figs. 1 and 3, first enlarge the pattern of the body given in Fig. 4. As both sides are identical only half of the pattern need be enlarged full size. In cutting the metal, you'll find it much easier to follow the outlines if the paper pattern is fastened directly to the metal as in Fig. 5. Ordinary household shears will do to cut the metal, and by cutting the complete pattern from one side, a slightly rounded edge is obtained. Where indicated on the patterns, lines of small dots, which are made on the underside with a dress-maker's tracing wheel, are used to represent hair on a figure and to give a shaggy effect. Bend the body on the dotted lines, studying Figs. 1 and 3 to determine the approximate shape. The body is wired to a supporting framework of aluminum wire, Fig. 2, with short lengths of silver-finish wire. The head is made in three pieces, the patterns for these being given in Fig. 6. These are bent and wired together as shown in Fig. 7 and the photo at the right. The two neck pieces, Fig. 10, are shaped as in Fig. 9. Piece (b) fits over

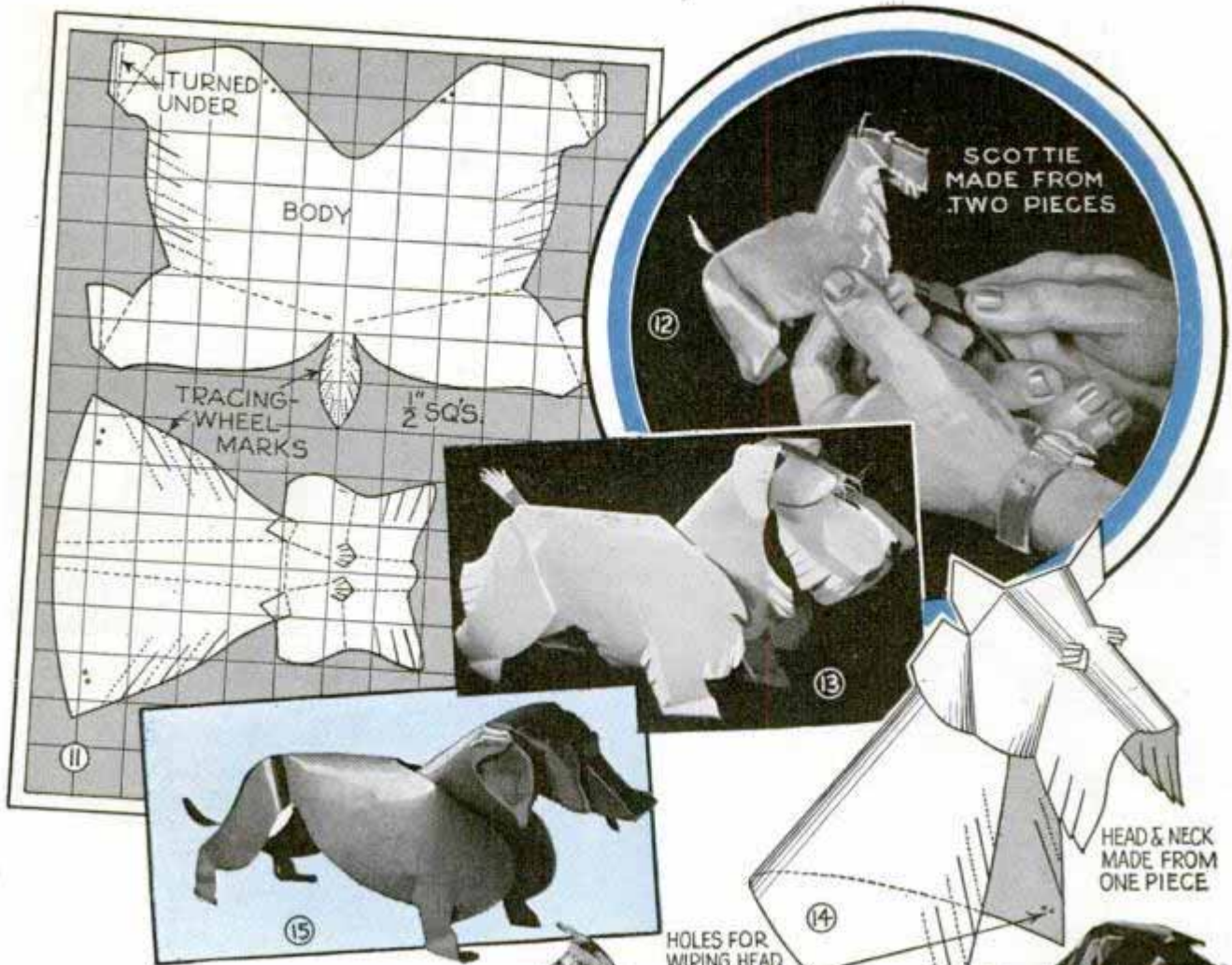

piece (a) and they are wired together at the points indicated on the patterns. The head is joined to the neck by wiring the neck tab in the position shown in Fig. 7. Finally, the neck is wired to the body at the shoulders, after which the slits in the mane are curled as in Fig. 8. The feet are formed by simply turning the metal under at right angles.

The body of the Scottie dog, shown in Figs. 11 and 12, is similarly bent to shape, but does not require a wire framework, Fig. 11 gives the pattern for the one-piece head and neck, which is bent on the dotted lines to look like Fig. 14. The figure is completed by fitting the neck between the V-cut in the body and fastening with wire at each side. Finger marks can be removed with metal polish. Figs. 13 to 18 inclusive, with the exception of Fig. 14, show other examples which can be reproduced.

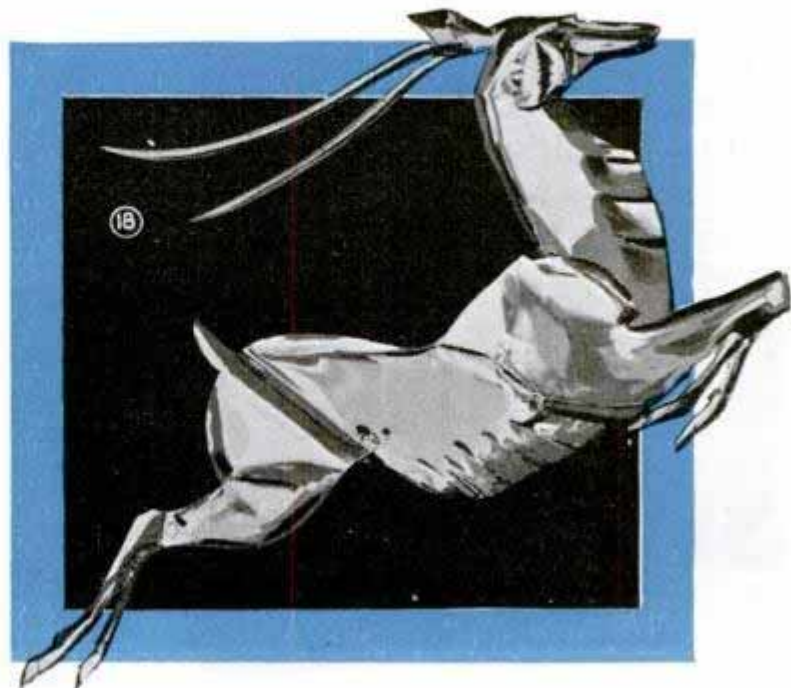

Outboard-Motor Mounting Block Has Shock Absorbers



This auxiliary mounting block for an outboard motor reduces vibration to a minimum and protects the transom of your boat. As shown in the drawing, the block is attached to the transom by means of bolts, which are mounted in the block with rubber bushings. These are of the type used in the front motor mounting of model-A Fords, and can be obtained at auto-supply stores. A mounting board of the type described will support motors weighing up to 50 lbs. Heavier motors will require sturdier construction.

Abrasive Disks Held on Sander with Linoleum Cement

Of the many adhesives for attaching abrasives to a disk sander, I find that ordinary waterproof linoleum cement, which



is inexpensive, is very satisfactory for the purpose. It can be spread on the disk with a knife and dries rapidly so the sander can be used soon after applying the abrasive.—Kenneth Murray, Colon, Mich.

Two-Size Hole in Bottle Stopper Protects Laboratory Glassware

By drilling a rubber cork or stopper as shown, to accommodate a thermometer or thistle tube, the latter can be inserted and removed with little possibility of breaking them. The diameter of the small part of the hole is sufficient to provide a seal around the tube, yet the short depth of this portion reduces friction, which is often responsible for breaking the glass.

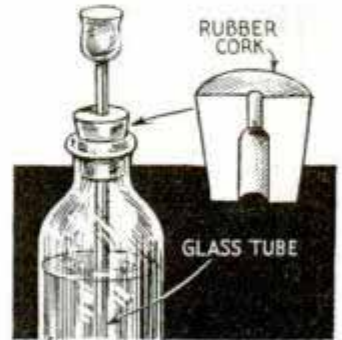

Holder Keeps Soldering Iron and Accessories Handy

Your solder, flux and iron are always together as a unit in this holder. Spools of solder are kept on short projecting dowels, and the ends of the solder are run

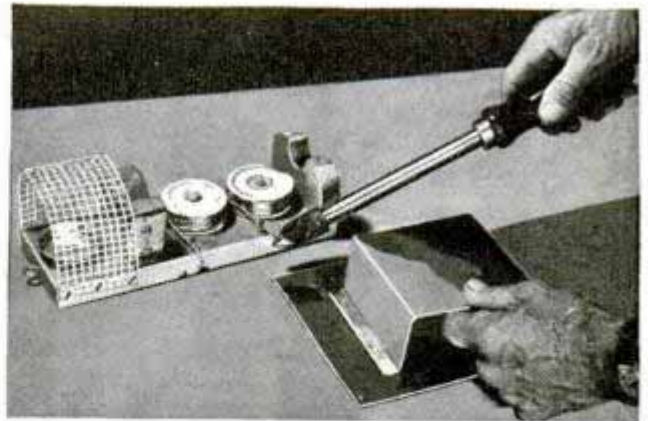

through screw eyes at one side of the holder where the hot iron can be pressed against them. The iron itself is supported on two brackets, and the point is shielded by a strip of wire mesh curved over it and fastened to the sides of the holder.

☞ A smooth paste made of whiting and lemon juice is a good cleaner for bone or ivory cutlery handles. Allow the paste to dry for a few minutes on the handles before rinsing and polishing.

Swan Cutouts Enhance the Garden Fish Pool

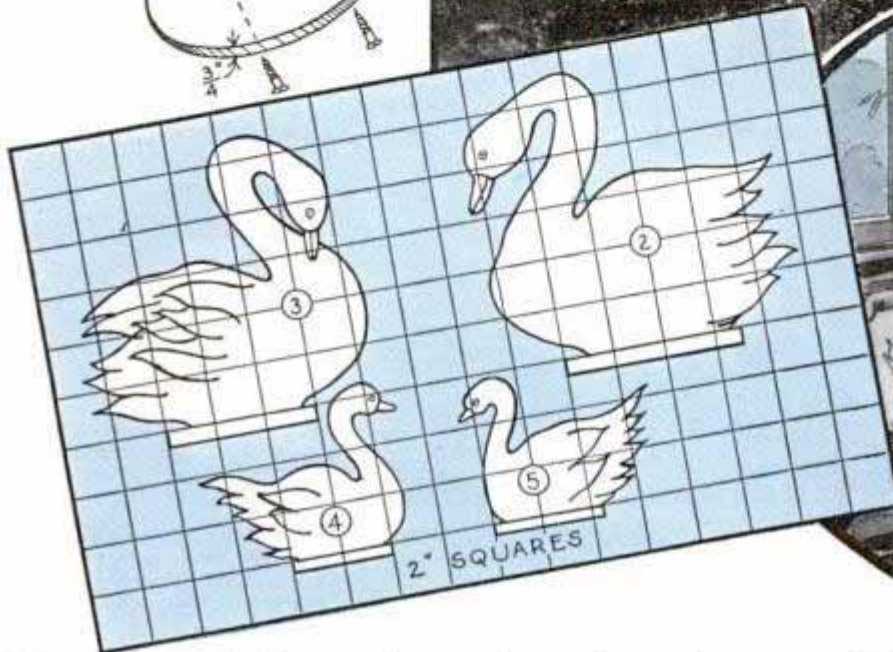
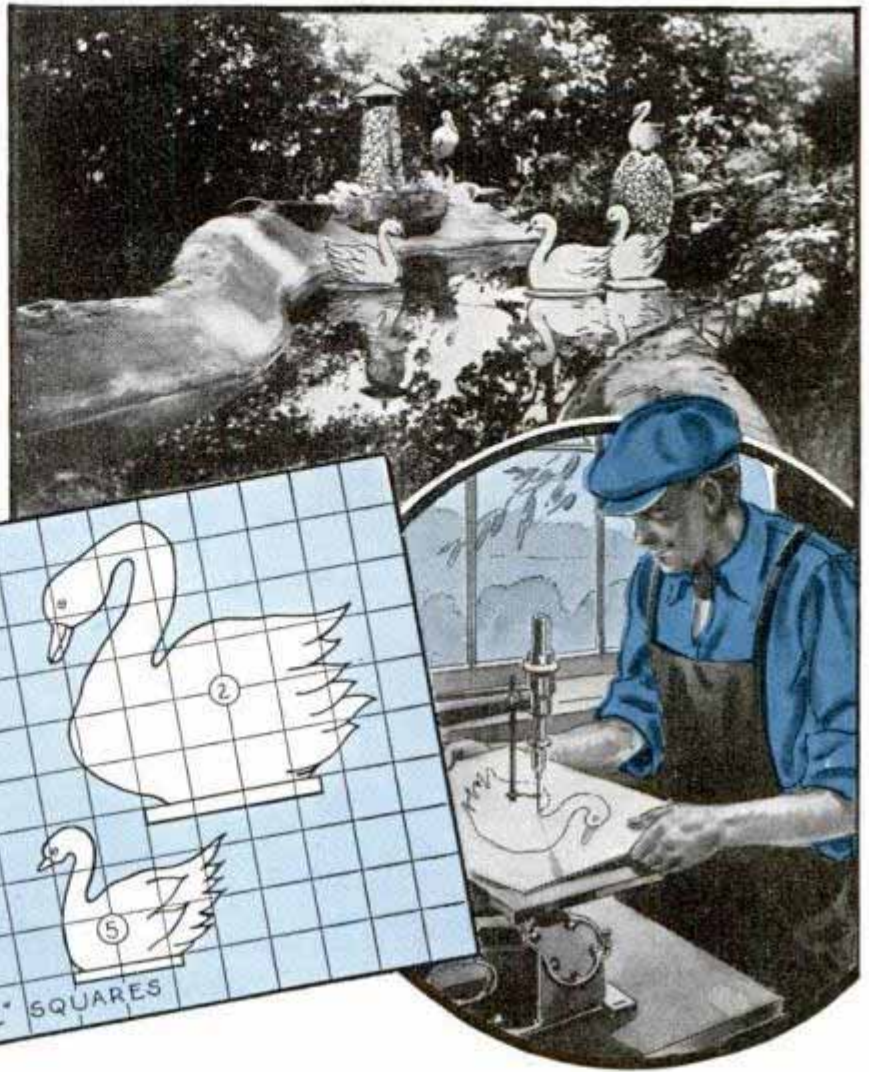

Floating gracefully on the surface of your fish pool, these cutouts of stately swans add much to its appearance. They are sawed from solid wood—not plywood—to the shapes given, and the floats are cut to resemble water lilies. The floats for the cutouts in Figs. 1, 2 and 3 should be $\frac{3}{4}$ in. thick and about $8\frac{1}{2}$ in. across at the

widest point. Wood $\frac{1}{2}$ in. thick will do for the floats on the smaller cutouts in Figs. 4 and 5. These are about $6\frac{1}{2}$ in. wide. Paint the swans all white with bright yellow beaks and black eyes and outline the wings with black. Paint the floats green and fasten the swans to them with wood screws.

—Adelaide Blanton, New Albany, Ind.

Fishing Rod Wrapped with Aid of a Pencil and Eraser

To apply a tight, smooth wrapping of thread when making repairs on a split-bamboo fishing rod, one angler suggests the use of a pencil and eraser. The pencil carries the spool of thread so that it may be rotated easily around the rod, and the eraser is slit to receive the thread and hold it tightly during the operation.

☐ To dispel a moldy smell in bookcases and clothes closets caused by damp weather, sprinkle a few drops of oil of lavender on the shelves.



Solving HOME

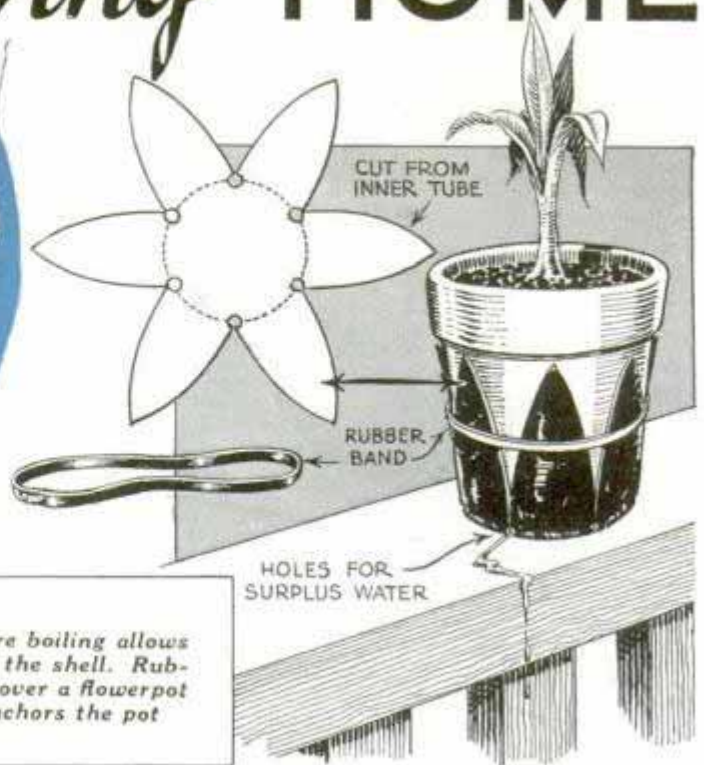

Above, tiny hole made in large end of egg before boiling allows gas to escape and helps to prevent cracking of the shell. Rubber doily tacked to porch railing and folded up over a flowerpot as at the right, serves as a decoration and anchors the pot

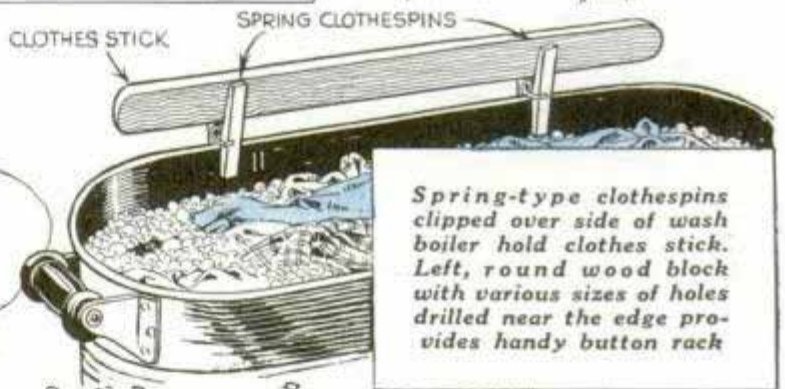
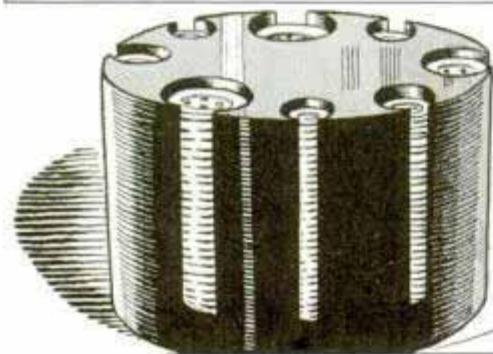

Spring-type clothespins clipped over side of wash boiler hold clothes stick. Left, round wood block with various sizes of holes drilled near the edge provides handy button rack

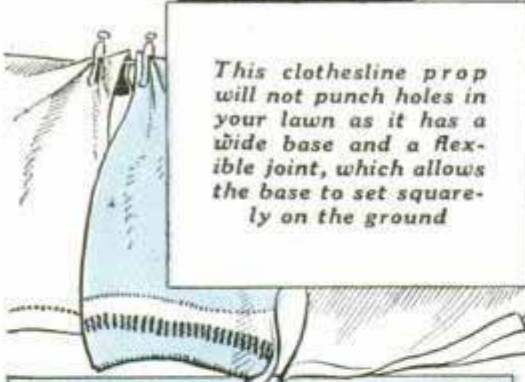

This clothesline prop will not punch holes in your lawn as it has a wide base and a flexible joint, which allows the base to set squarely on the ground



Clean silverware sealed in a fruit jar is not likely to tarnish rapidly

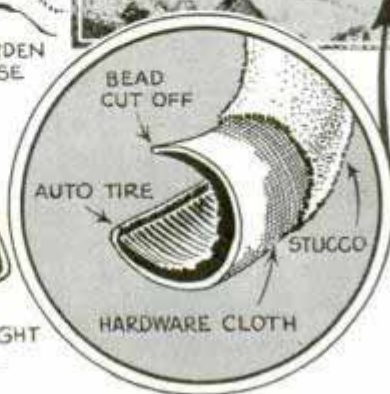

This flower bed was made from an old auto tire having the beads removed and turned inside out. The tire was covered with $\frac{1}{2}$ in. of stucco and surfaced with colored stones, first wrapping it with fine mesh wire to anchor the stucco

PROBLEMS

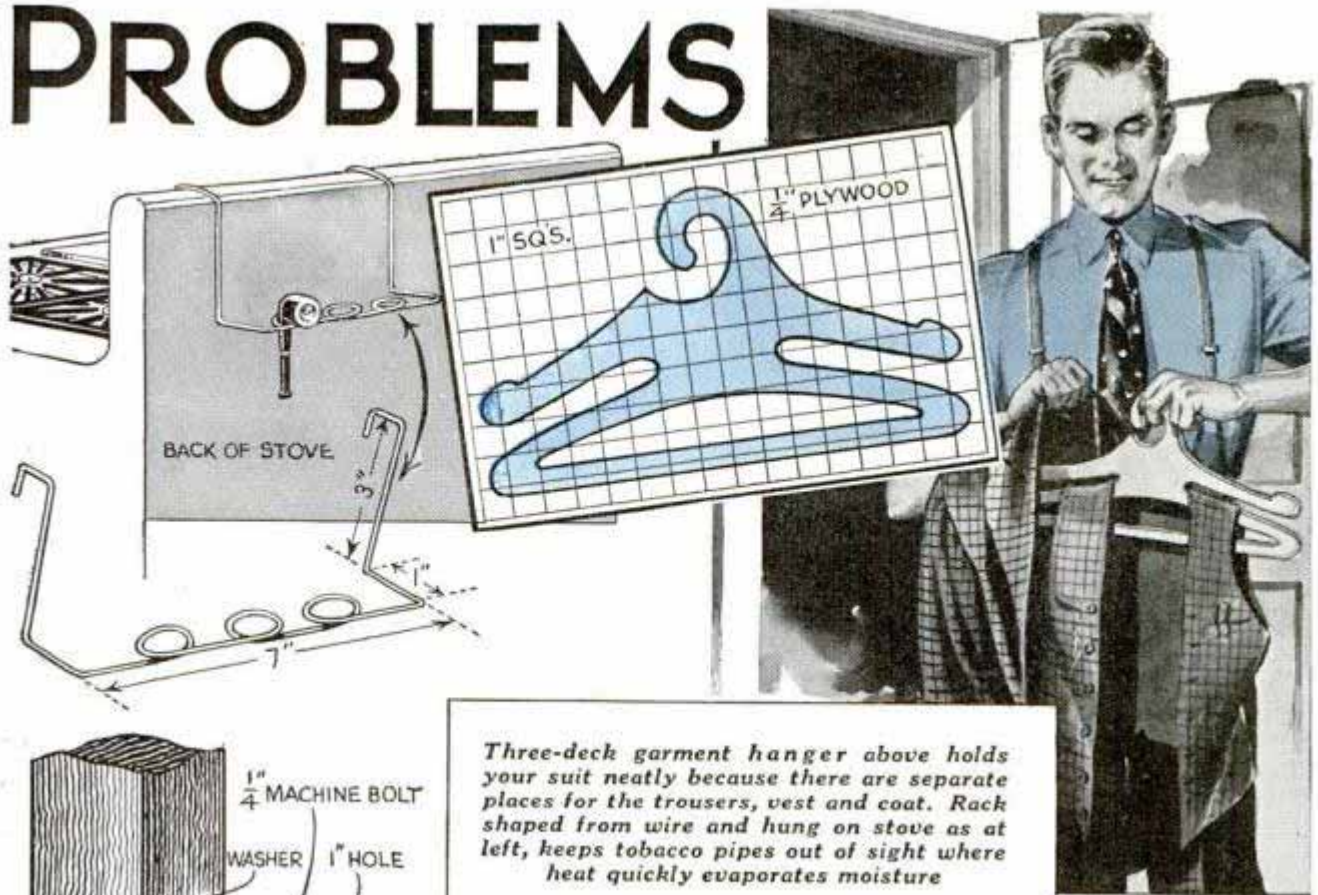

Three-deck garment hanger above holds your suit neatly because there are separate places for the trousers, vest and coat. Rack shaped from wire and hung on stove as at left, keeps tobacco pipes out of sight where heat quickly evaporates moisture

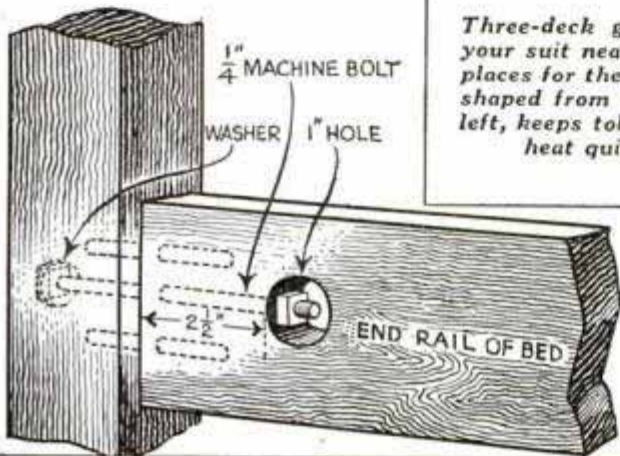

Loose end rails of a bed can be repaired by the method above, while a wedge-shaped doorstop will always be at hand if it is kept in a large staple driven into the door near the bottom as shown at the right

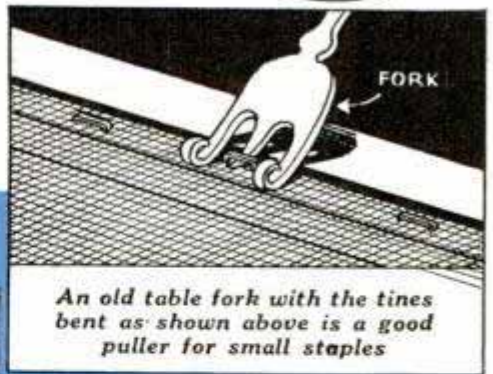
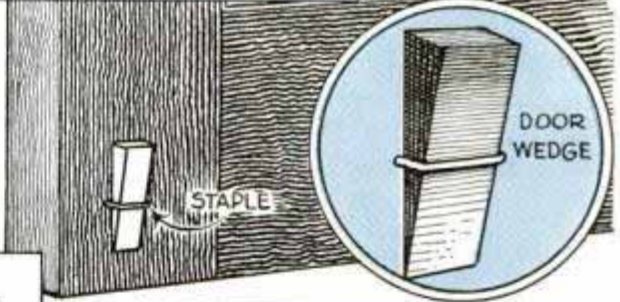

An old table fork with the tines bent as shown above is a good puller for small staples

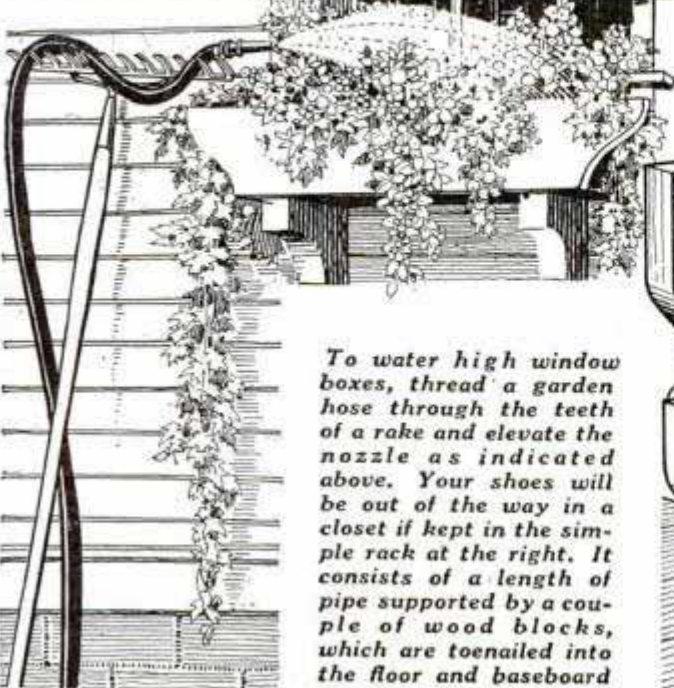

To water high window boxes, thread a garden hose through the teeth of a rake and elevate the nozzle as indicated above. Your shoes will be out of the way in a closet if kept in the simple rack at the right. It consists of a length of pipe supported by a couple of wood blocks, which are toenailed into the floor and baseboard

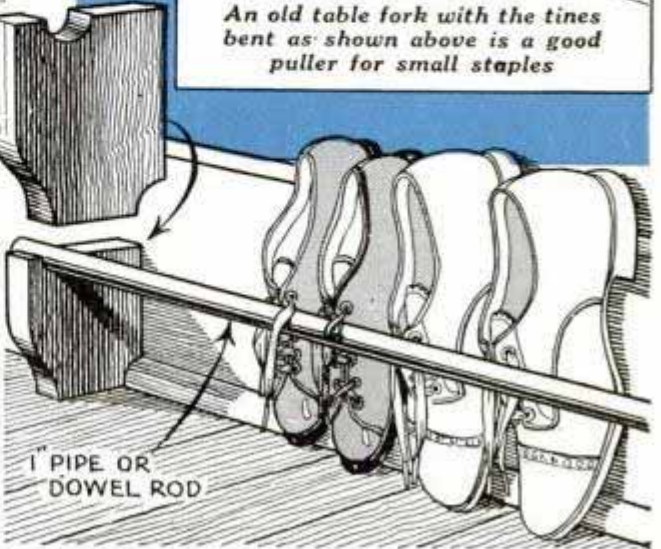

Baby Carriage Kept on Porch by Broom Clamp



When you leave a small baby in a carriage on the porch for an airing, a broom clamp screwed to the wall to grip the handle is a further safety precaution in addition to the brake. This is especially true if there are small children who might, in playing, release the brake.

Boat Anchor Raised from Seat with Aid of Rope Holder

Use this holder for the anchor rope on your rowboat and the anchor can be raised or lowered from the seat. The holder is

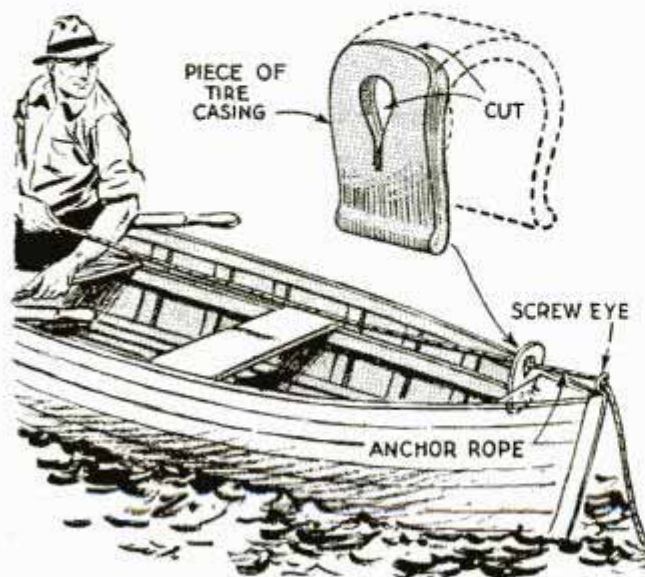

cut to the shape shown from a piece of auto-tire casing. The rope is first run through a large screw eye on the end of the boat and then through the holder. Raising the rope allows it to slide freely through the holder, and lowering it causes the holder to grip it securely.

Scratching Surface of Match Book Points Fishhooks

If hooks used for trout and other small game fish are dulled against submerged rocks and pebbles, just rub the pointed ends across the scratching surface of a book of matches. This abrasive surface will restore the point quickly.



Re-Gluing Loose Veneer Tops



When veneer or thin material is glued to a table top and it loosens in places, we re-glue it as follows: From the underside of the table directly under the spot where the material has loosened, a hole is drilled through to the underside of the material. Then adhesive is forced through the hole, which is then sealed tightly with a dowel.

—Paul Adams, Loma Linda, Calif.

Grinder Dust for Potted Plants

Instead of inserting nails or bits of iron into the soil of potted plants to provide a supply of iron, use dust that has collected about a grinding wheel. This is composed largely of iron and steel in finely divided form, which is readily taken up by the soil and supplied to the plants.



—W. C. Wilhite, Carlinville, Ill.

Make this Double-Deck CHAIRSIDE TABLE

Grace and utility are pleasingly combined in this dainty, chairside table to provide a refining touch to the decorative scheme of any home. Although it can be made of any hardwood, walnut or mahogany are the two most suitable woods to use. The curved handle and braces of the table are cut from 5-in. stock and may be joined to the uprights with either dowel or tenon joints. The arch-shaped legs are screwed to the face of the uprights, after which the screw heads are covered with wood plugs and sanded flush. While the trays can be built up around glued-up panels of solid stock, the use of $\frac{1}{2}$ -in. veneer-faced plywood will simplify the work. The tray edges are formed by first bending steamed strips around a form, which conforms with the shape of the tray bottom, and then nailing, when dry, to the plywood edge. A narrow half-round molding, bent and glued to the lower edge, conceals the nail heads. Finish the table with stain and wax, before fastening the trays in place with screws inserted in counterbored holes made in the cross rails

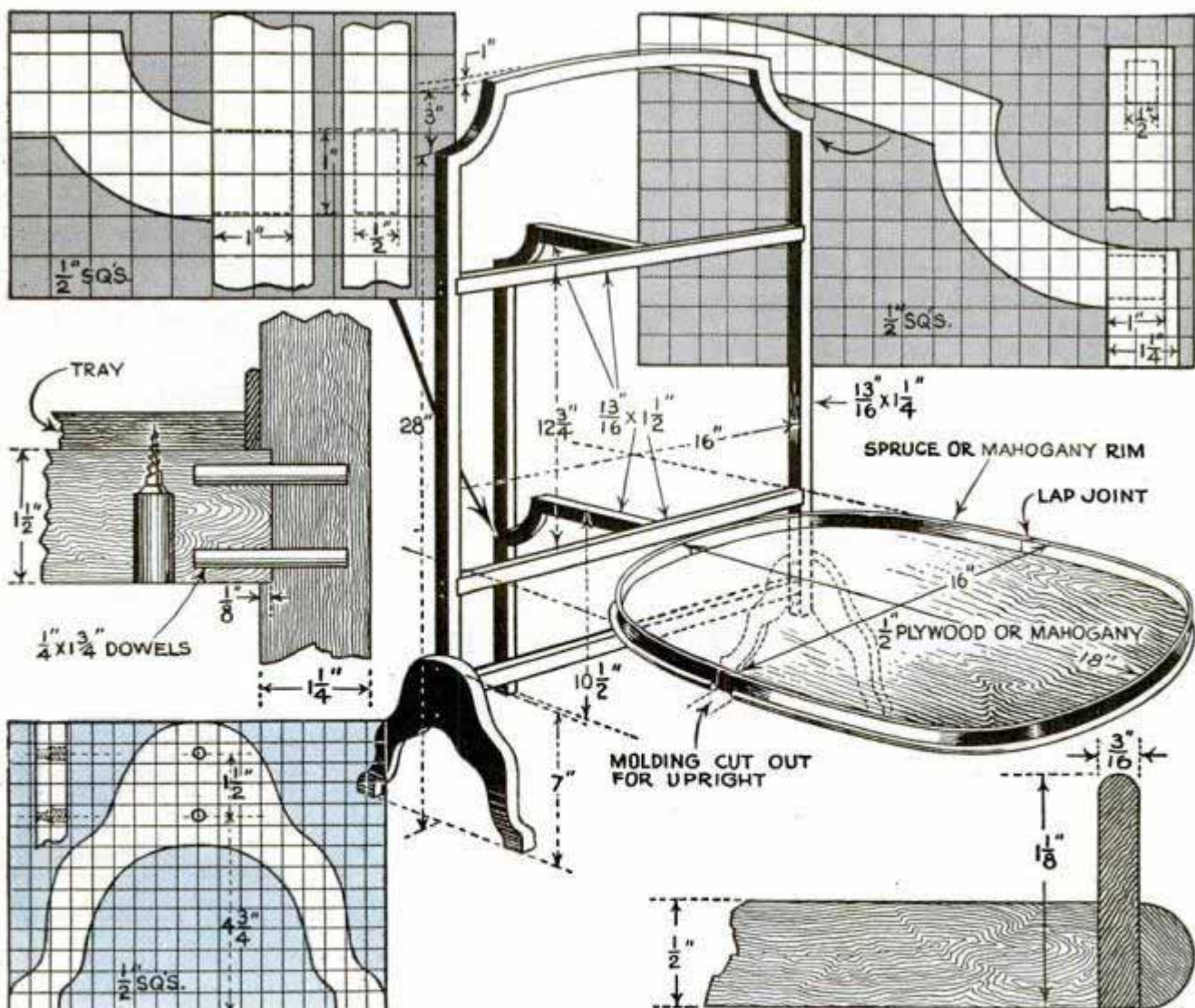

T-Square with Two Tacks in Head Serves as Armrest for Artist

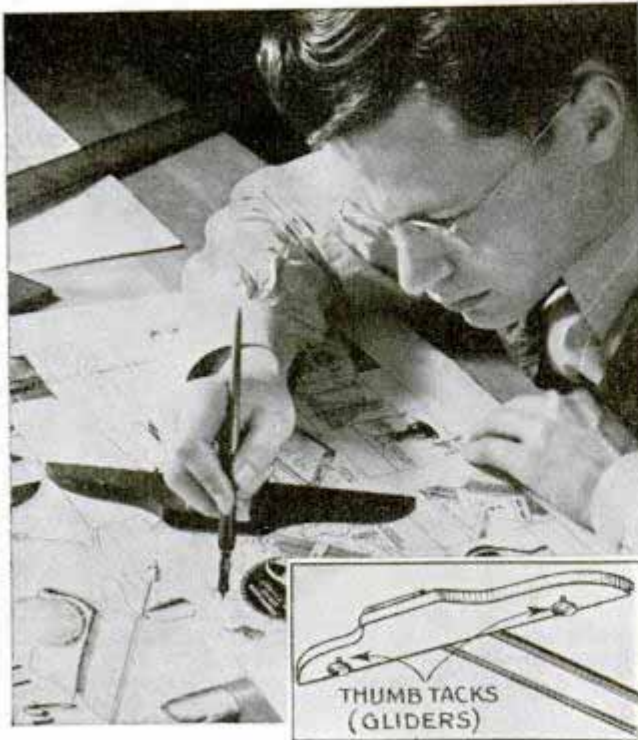

When working on drawings, lettering, etc., that may be soiled easily, a handy armrest to avoid this can be made from your T-square. Just drive a couple of thumbtacks in the underside of the head as indicated in the detail. The tack heads serve as gliders on which the square may be moved about easily over the work.

Tripod Head Does Double Duty in Chemical Laboratory

In my amateur chemical laboratory, I use my universal camera tripod head in

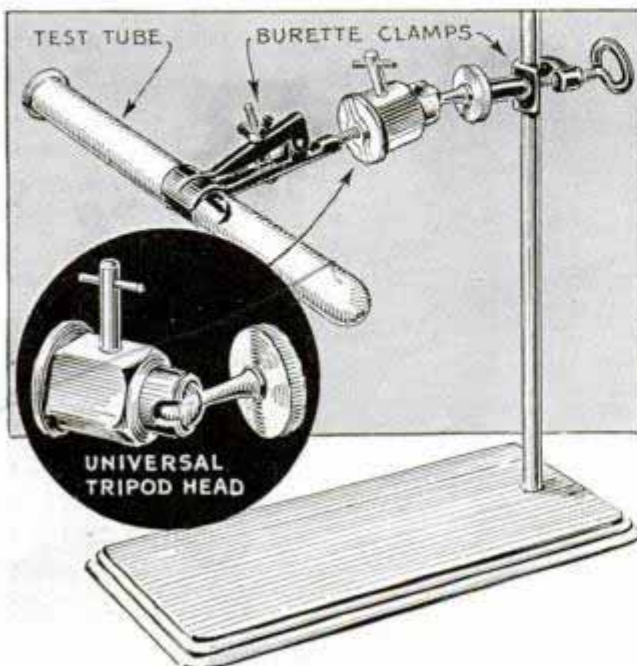

conjunction with two burette clamps to support test tubes and other glassware at any desired angle. The threads of the tripod head will take those of the clamps.

—George Vias, Chicago.

Match Book on Cigarette Package Is Always at Hand

Disliking to hunt through various pockets for a book of matches, one smoker solved the problem by attaching the matches right to the package of cigarettes. A narrow strip of adhesive tape was used to attach the book of matches, as shown in the photograph.



A narrow strip of adhesive tape was used to attach the book of matches, as shown in the photograph.

Worn Ferrules of Fishing Rods Repaired with Solder

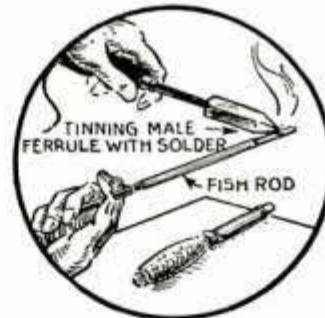

If ferrules on a fishing rod have worn so that the rod comes apart when in use, they can be repaired by simply coating the plug part of each ferrule with solder. Apply a light

coating and then smooth it down with fine emery paper so it will fit snugly.

Tape on Your Finger Starts Nuts in Hard-to-Reach Places

On various assembling jobs where space does not permit inserting the hand to start a nut on a small bolt, one workman does the job with the aid of a piece of adhesive tape on one finger.

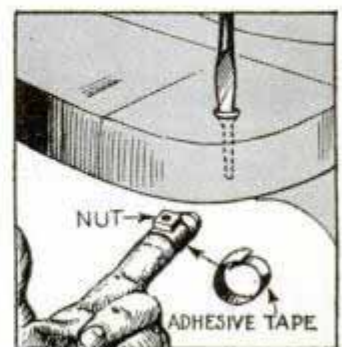

The tendency of the nut to adhere to the tape enables one to hold it against the bolt, which is then turned to screw the nut on.

Decorating with Thin PLASTICS..



Plain or illuminated window cornices and lampshades are some of many things that can be made with thin plastics

THIN plastics in all the colors offer the craftsman and small production shop owner a medium that lends itself admirably to modern design. Thicknesses run from slightly under $\frac{1}{64}$ in. to $\frac{1}{16}$ in. The large sheets or rolls available and the thinness of the material, make it ideal and practical for many purposes. The material is purchased by weight or by the square foot, the cost being about the same as a fine grade of wood veneer.

Working with thin plastics follows the same general routine used for heavy plastics, with the exception that buffing and polishing are seldom necessary. The material can be bent to almost any shape after dipping it in boiling water, as shown in Fig. 2. The sheet can be bent around any suitable form, as in Fig. 4, and will retain its shape when cool. A typical project showing the application of the bent sheet is the window cornice in Fig. 1.

Shades for round hall and porch lamps are easily made by simply snapping a strip of the material inside the framework, as in Fig. 5. For permanence, the seam can be glued with the acid cement used in plastic work, or with any other type of glue. Fig. 3 shows a cylindrical lampshade being glued. The plastic for this type of work is generally about $\frac{1}{64}$ in. thick and can be cut with

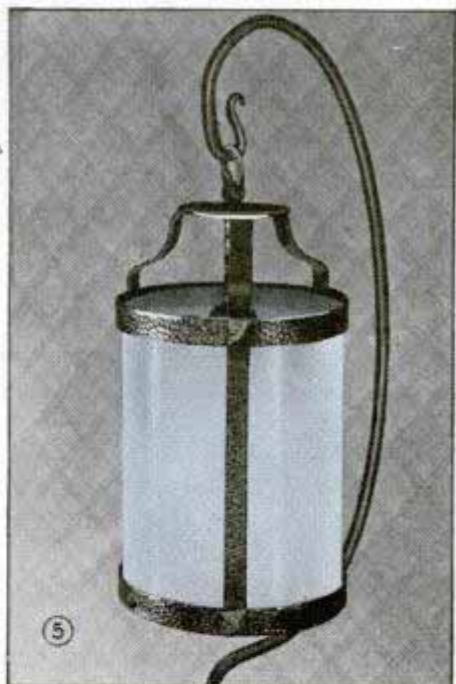

THIN STOCK CAN BE CUT WITH SCISSORS

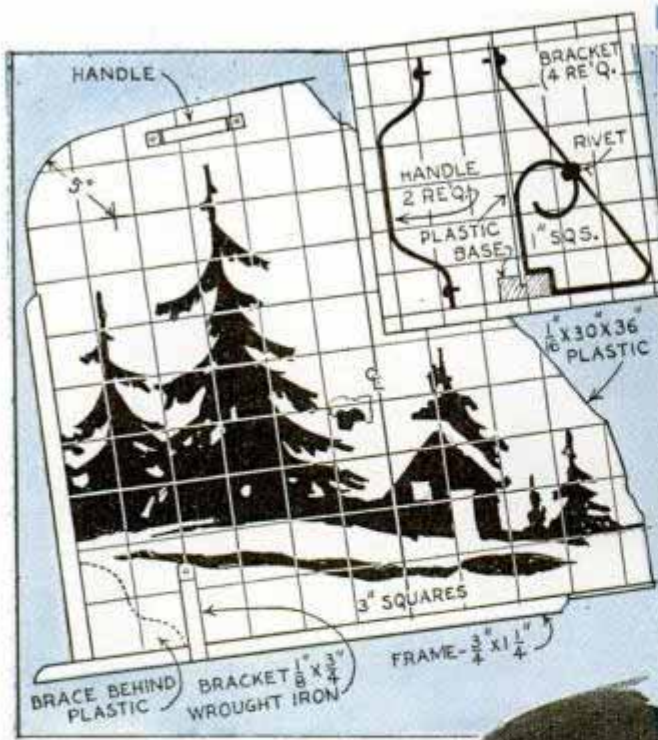

7 $\frac{1}{16}$ " STOCK FOR HALF-BOUND FIRE SCREENS



8 THE DESIGN CAN BE SPRAYED, BRUSH PAINTED OR SANDBLASTED

opposite side is a fine mat surface. Painted decorations of any kind always should be applied to the mat side as better adhesion will result. Ground or sandblasted designs work out very well and can be worked on either side of the plastic. Table mats with a simple ground border are shown in Fig. 9. The mat in the foreground of this picture was

a pair of scissors. Heavier stock can be cut on a circular saw or band saw, using the same cutting edge as for wood.

A neat project utilizing the heavier plastic is the fire screen shown in Fig. 7. This is partly framed with wood in order to give the $\frac{1}{16}$ -in. thick plastic sufficient rigidity. With a full-bound frame of wood or metal, thinner plastic could be used. The construction details are shown at the left of Fig. 7. Fig. 8 shows the silhouette design being applied by a spray gun, working through a paper stencil. One side of thinnest plastics is highly polished while the



9

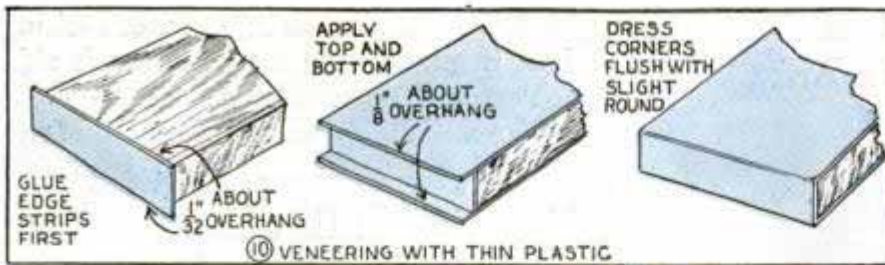

made by interweaving plastic strips of contrasting colors.

Thin plastics can be obtained either translucent or opaque. Where the material is to be used as a veneer the opaque plastic should be used in order to conceal the surface on which the plastic is glued. For an all-over veneering job the edges are applied first, as in Fig. 10. Projecting edges are sanded flush, after which the top

APPLIED AS A VENEER TO BATH BENCHES TABLES AND TRAYS

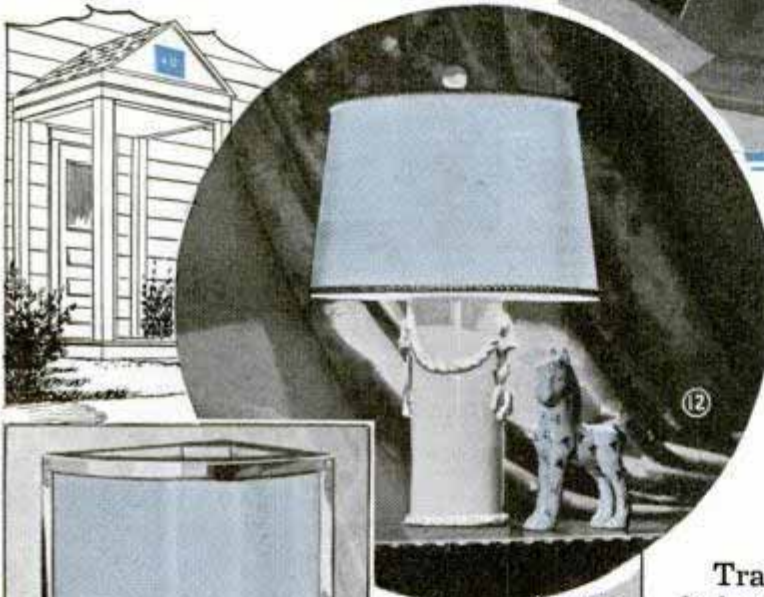
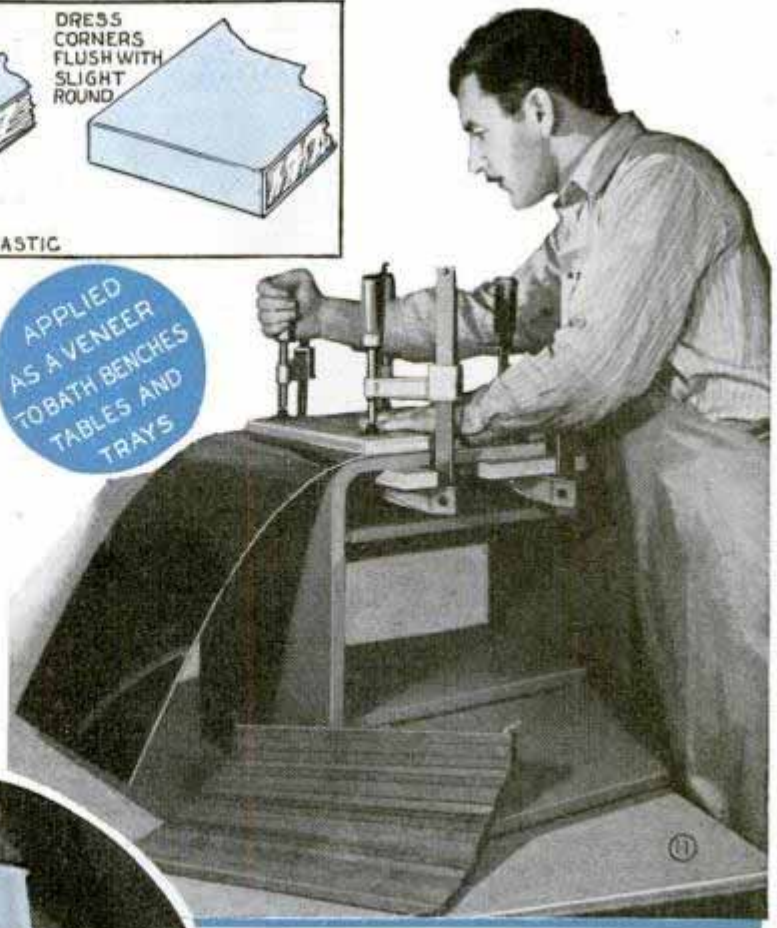

and bottom pieces are applied. A slight bevel at the edges makes the joint almost invisible. Fig. 11 shows the top of a bath bench being veneered. No edging was used on this job. The material is ideal for table tops, serving trays, etc., as it is proof against liquids, cigarette burns, and can be cleaned in an instant with a damp rag.

Translucent plastic is the type to use for lighting fixtures, indoors or out, wherever a flexible colored "glass" is required. Figs. 12 and 14 show a lampshade made by laminating three pieces of plastic together in steps to produce a three-tone effect. Figs. 13 and 15 show a corner light, which is typical of many excellent lighting units. Where the work does not require bending, as a straight piece of colored plastic in an illuminated house number, the material should be $\frac{1}{32}$ in. or more in thickness. Thin plastics are quite rigid and somewhat brittle when cold and always should be worked in a warm room. A rag saturated with boiling water should be applied to the line of cut before sawing. Where an especially flexible material is required, thin plastics with a celluloid base should be used. A celluloid base plastic can be bent double without cracking.

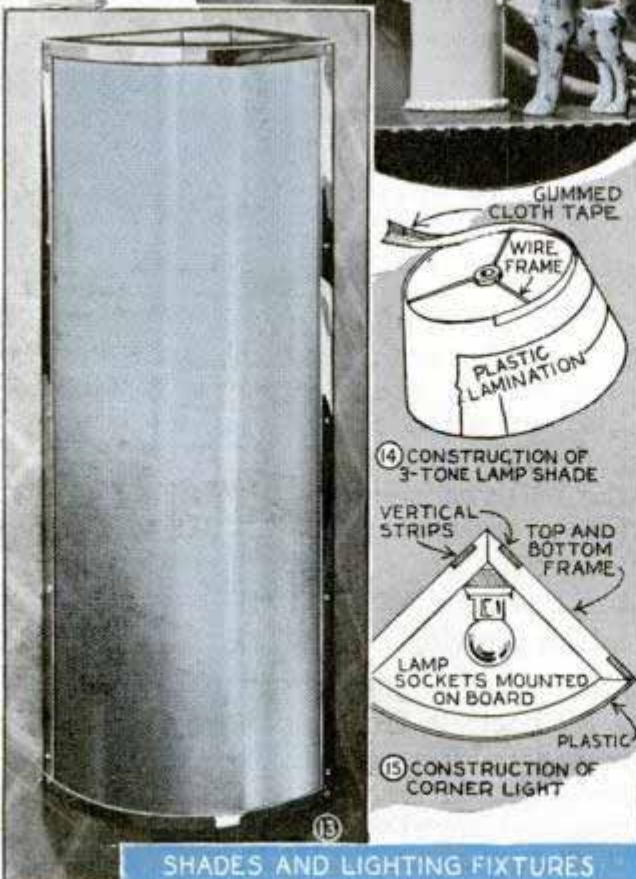

SHADES AND LIGHTING FIXTURES

Artist Wears Two-Finger Glove to Prevent Soiling Work



One artist wears a glove with the thumb and first fingers removed to prevent the hands from soiling the work. It is best to prepare two or three gloves in this manner so that you will always have one to wear while the others are being washed.

Bolt Improves Lathe Tool Rest When Boring Bowls and Vases

Located near one end of a tool rest of a woodturning lathe, as shown in the circular detail, a bolt improves the rest when boring out bowls and vases. The rest can be inserted into the work and the tool rested on the bolt. The bolt hole may be

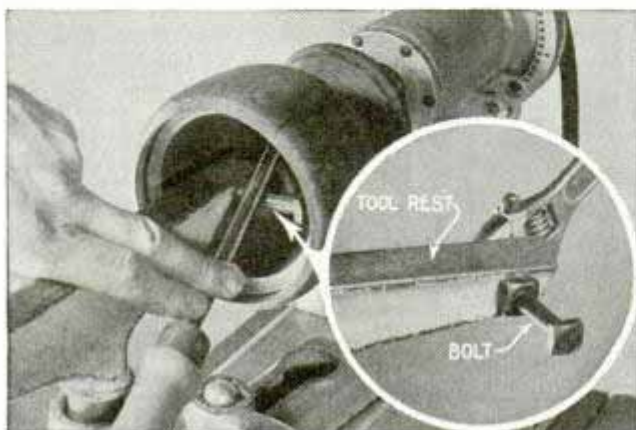

tapped if desired, but in most cases locking the bolt in place with a nut on each side of the rest will be sufficient.

—Howard R. Heydorf, Missoula, Mont.

Fishing-Tackle Box Held on Seat of Boat by Rubber Bands

To keep your fishing tackle on the boat seat beside you, just saw two notches in the front and rear edges of the seat to take stout rubber bands as indicated. Then set the

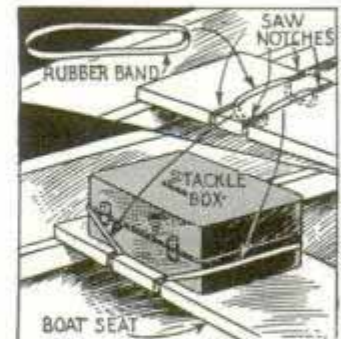

box on the seat, slip the bands up over the ends and the box will be held securely.

Grass Shears Are Carried Safely on Lawnmower Handle



Fasten your grass shears to the lawnmower handle and they will always be at hand when needed. A wide rubber band cut from an inner tube and slipped over the handle as shown will hold the shears.

Fuller Ball Keeps Bail of Bucket in Vertical Position

Slit along one side to fit over the wire bail of a paint bucket, a fuller ball will support the bail vertically by resting against the rim of the bucket as shown in the drawing.



As bacteria from old bouquets tend to hasten wilting of fresh blooms, vases always should be washed thoroughly with soap and rinsed with hot water before putting in a new bouquet.

Game-Fish ASH TRAY

proves the story

By L. IRWIN DUPUY

WHILE the thrill of catching a big fish lasts only a few minutes, the pleasure of reminiscence, or telling your friends about it, can last for years if you mount the head to serve as a paperweight, penholder or ash tray, Fig. 1. When removing the head, it's best to leave about 2 in. of the skin on it. If you forgot to do this, the skin can be imitated with plaster of paris. After as much flesh as possible has been removed, the mouth is propped open with a stick so that it resembles the one in Fig. 2. Then it is placed in a bucket or can of 5 per cent-formaldehyde solution, Fig. 3. It should be left in this solution for at least 3 days, or it can be left until ready for use.

When you are ready to mount the head, it is taken out of the solution, rinsed in running water as in Fig. 5, then dipped in denatured alcohol, Fig. 4, and hung up to dry. After it has dried, which will only be a few minutes, it is given a coat inside and out of water glass, Fig. 6. When dry, a second coat is applied. When this

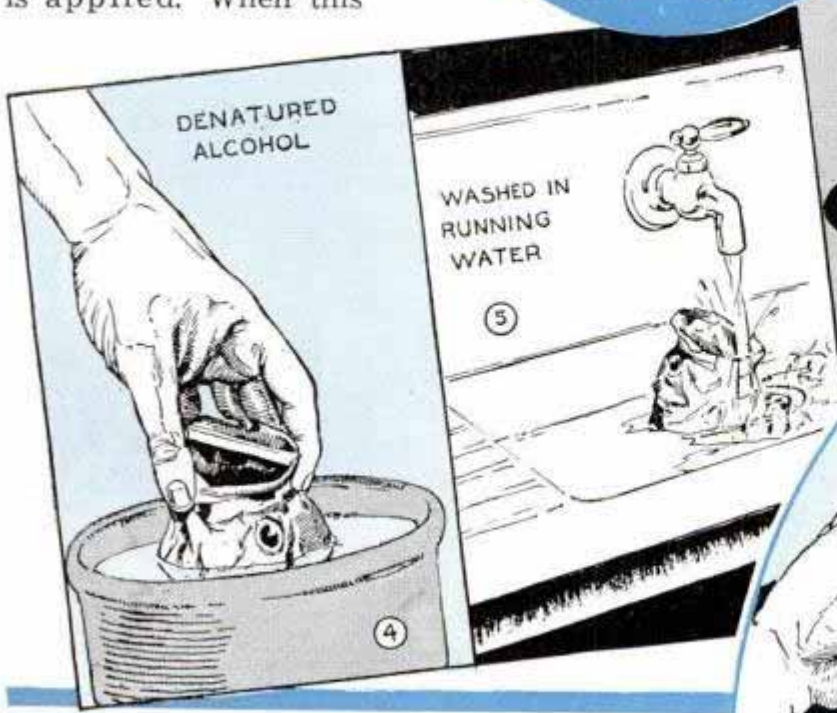
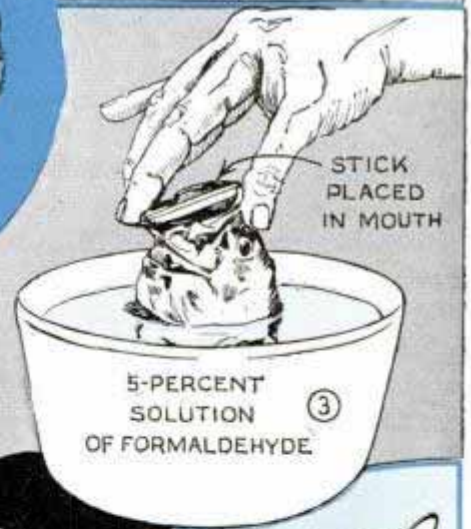
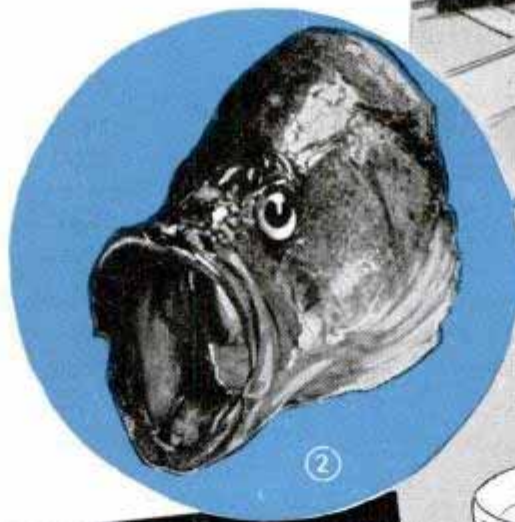
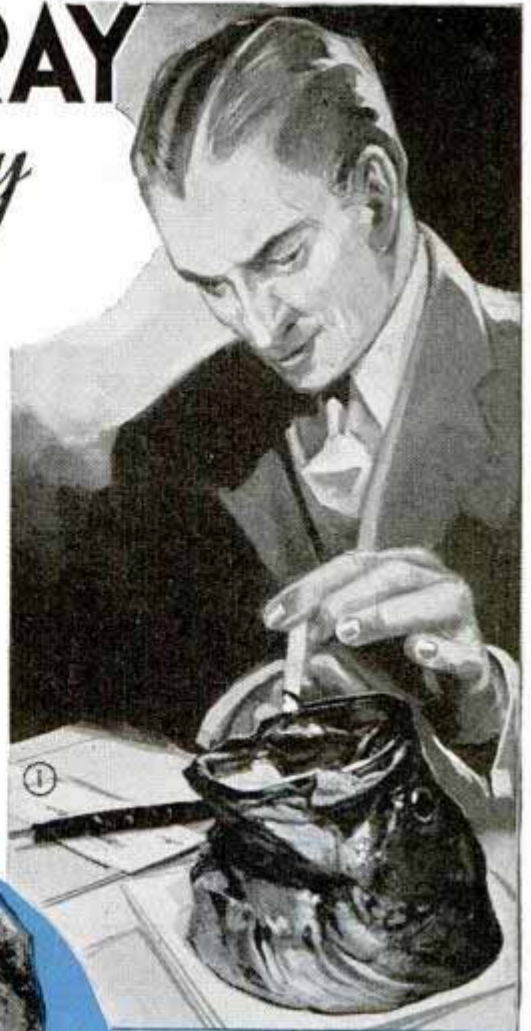

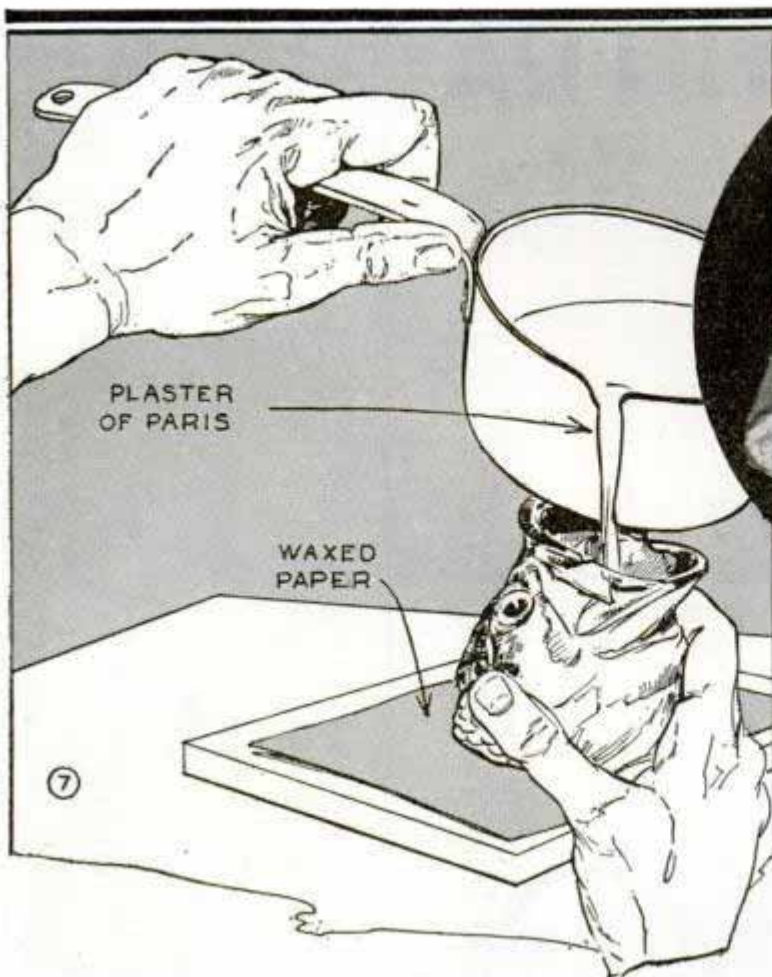

has dried, the head is given a coat of quick-drying clear varnish, which is repeated in a few hours. As soon as the second coat of varnish is dry, the head is ready for a base, which can be made of plaster of paris.

Twist a 3-in. length of small wire to the backbone in a position where it won't show, but so it will go into the base material. The head is then placed on a piece of waxed paper on a flat surface and the plaster of paris is poured in through the mouth, Fig. 7. When the plaster is about $\frac{1}{2}$ to $\frac{3}{4}$ in. deep, it is spread out on the inside and smoothed up on the outside in any place where it pushed through. If the head was cut off too short and no skin was left to cover the back of the neck, the plastic material is built up to fill these places. When the plaster is almost dry, artificial scales are worked in with a sharp instrument to make it look natural. Place a small piece of plaster for the tongue as this improves the inside of the mouth. The name and date can be cut before the plaster gets hard, either inside the mouth or on the back of the base.

Fill the eye holes with the same base material and set the eyes in this. Artificial glass eyes are not expensive and make a neater job, but buttons of the proper size

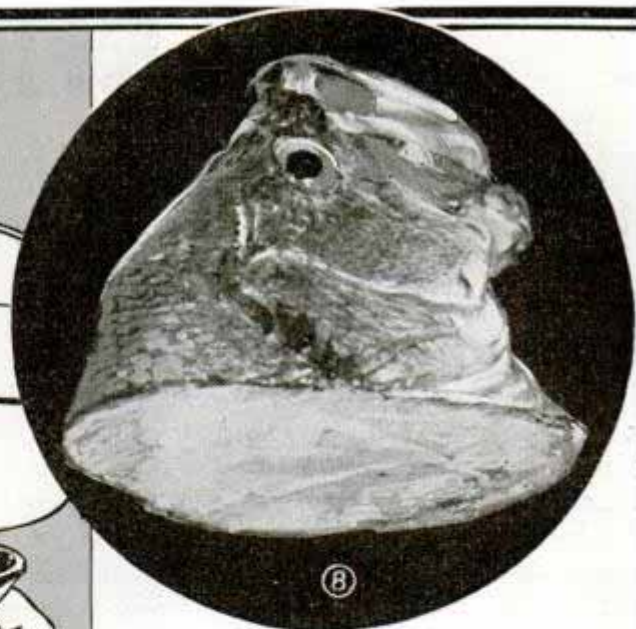

and color can be used if a black dot is painted in the center of each one. When the plastic is dry, give it two coats of clear varnish. If the plaster shows, or if there are any light spots on the head, they can be touched up with a mixture of black and medium-brown oil color in a few drops of clear varnish to match the rest of the fish.

Don't forget to paint around the eyes. Next, mix a little medium-green in oil with varnish and apply this as dots with a small piece of cotton on a stick. While still damp rub over this with a cloth that will not shed lint, to give it a natural greenish color. The inside of the mouth is rubbed with a light flesh color in varnish. The tongue and the surfaces around the teeth are painted with a darker flesh color to brighten up the inside of the mouth. Fig. 8 shows the completed head.

Steel-Tube Case for Fishing Rod

Fishing rods of the one-piece type may be protected against rough handling by inserting them into a length of thin-wall steel tubing. These are cut to the required length and both ends are closed with rubber crutch tips, which may be purchased at a dime store.



—John C. Michalek, Kansas City, Mo.

Inexpensive Portfolio Has Adjustable Ends

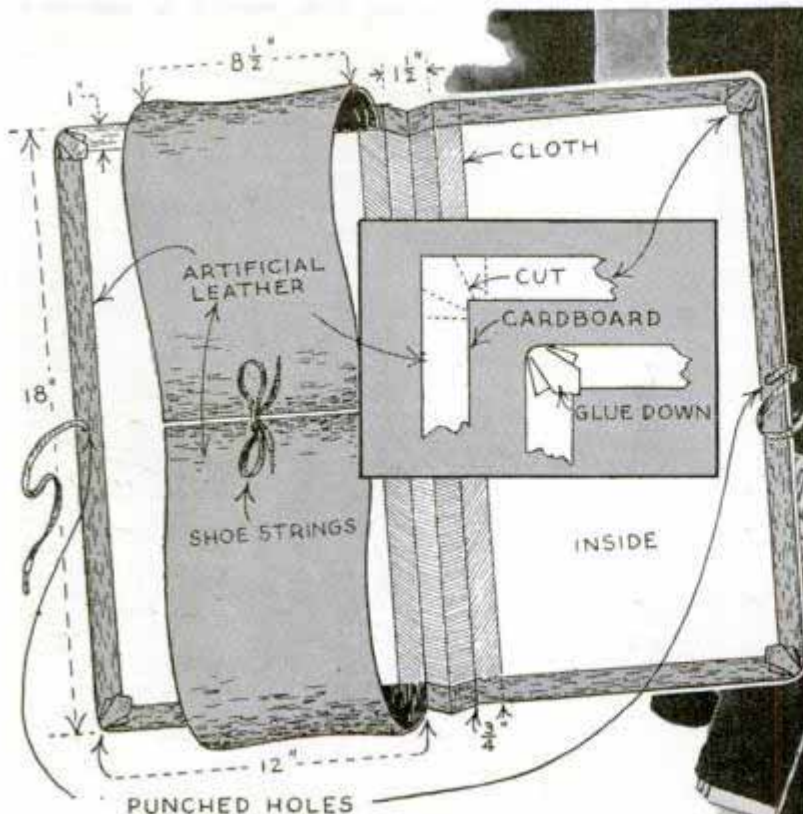

This portfolio is just the thing for school children and for art students. It has two adjustable flaps that serve as ends to cover the contents. To make it, two pieces of heavy cardboard, 12 by 18 in., are hinged together lengthwise with a strip of cloth. Then artificial leather is glued to the outer surfaces of the cardboard, taking care to smooth the leather to avoid wrinkles. The leather is folded over the edges of the cardboard and cemented to a portion of the inner surfaces as indicated, to give a good

job. The flaps of artificial leather are then glued in place to the inner surfaces, and a shoestring is provided for tying them together. A shoestring is also used as a fastener to keep the portfolio closed.

—R. L. Fairall, Los Angeles, Calif.

Car Vacuum Tank Serves as Bilge Pump on Small Boat

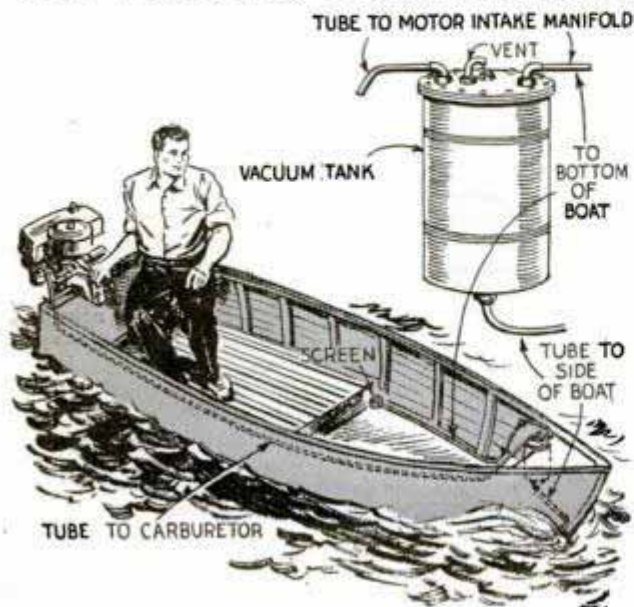

Connected to an outboard motor, a vacuum tank from an old car will serve as a bilge pump on small boats. Operation of the tank on the boat is the same as it was on the car, except that it handles water instead of gasoline. The vacuum line of the tank is connected to intake of the motor, and the line that formerly carried gasoline from the car tank is run to the bottom of the boat. The outlet line, which comes out the bottom of the tank, goes out through the side of the boat above the waterline. This makes it necessary that the tank be mounted high enough in the boat to permit the line to come out as indicated.

—Arnold Austin, Janesville, Wis.

Colonial CORNER DISH SHELF

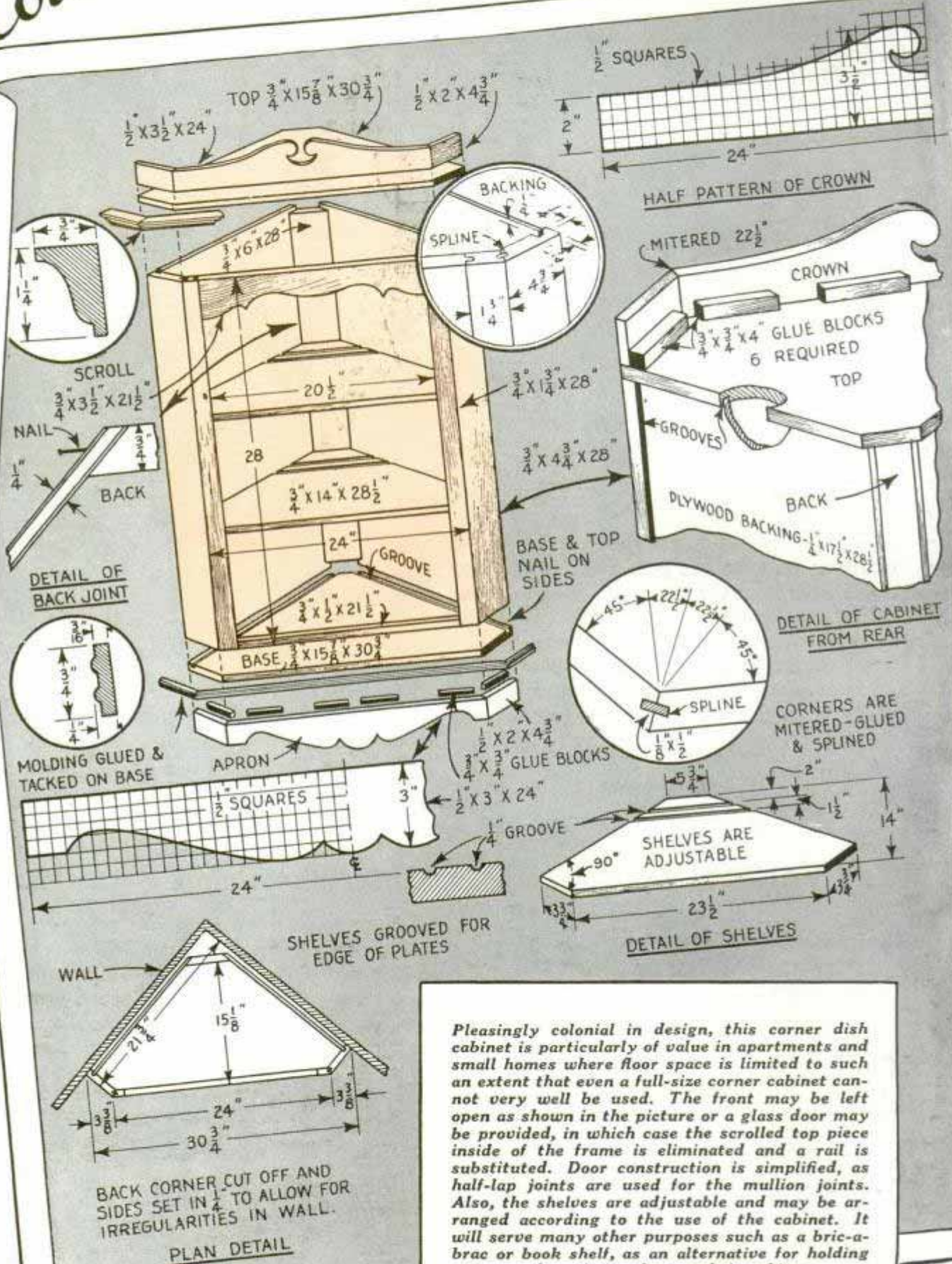

Pleasingly colonial in design, this corner dish cabinet is particularly of value in apartments and small homes where floor space is limited to such an extent that even a full-size corner cabinet cannot very well be used. The front may be left open as shown in the picture or a glass door may be provided, in which case the scrolled top piece inside of the frame is eliminated and a rail is substituted. Door construction is simplified, as half-lap joints are used for the mullion joints. Also, the shelves are adjustable and may be arranged according to the use of the cabinet. It will serve many other purposes such as a bric-a-brac or book shelf, as an alternative for holding a few pieces of your choice china

in maple

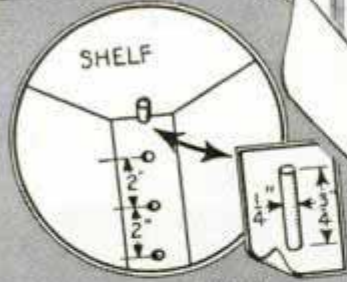
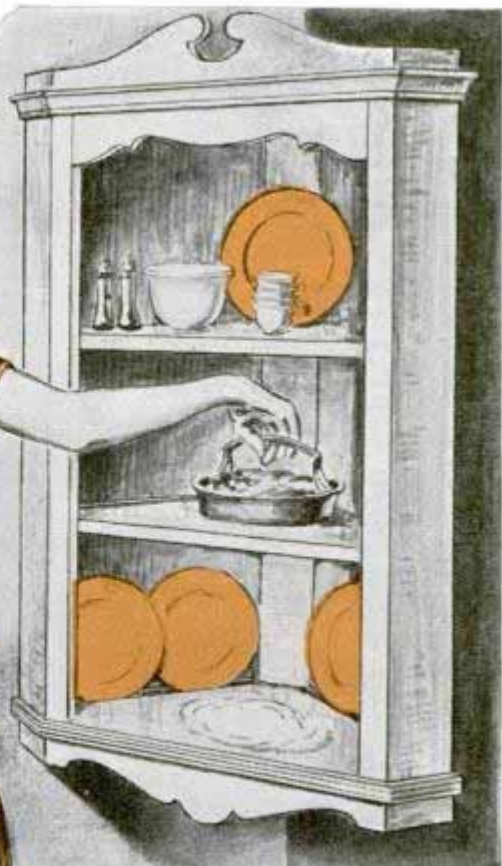

DETAIL OF SHELF PINS

MATERIAL LIST

- 1 pc. Pine— $\frac{3}{4}$ x 6 x 28 in.—Back
- 2 pcs. Pine— $\frac{3}{4}$ x 4 $\frac{3}{4}$ x 28 in.—Sides
- 2 pcs. Pine— $\frac{3}{4}$ x 1 $\frac{3}{4}$ x 28 in.—Front
- 2 pcs. Plywood (Fir)— $\frac{1}{4}$ x 17 $\frac{1}{2}$ x 28 $\frac{1}{2}$ in.—Backing
- 2 pcs. Pine— $\frac{3}{4}$ x 15 $\frac{7}{8}$ x 30 $\frac{3}{4}$ in.—Shelves
- 2 pcs. Pine— $\frac{3}{4}$ x 14 x 28 $\frac{1}{2}$ in.—Scroll
- 1 pc. Pine— $\frac{3}{4}$ x 3 $\frac{1}{2}$ x 21 $\frac{1}{2}$ in.—Door Strip
- 1 pc. Pine— $\frac{3}{4}$ x $\frac{1}{2}$ x 21 $\frac{1}{2}$ in.—Door Strip
- 1 pc. Pine— $\frac{1}{2}$ x 3 $\frac{1}{2}$ x 24 in.—Crown
- 2 pcs. Pine— $\frac{1}{2}$ x 2 x 4 $\frac{3}{4}$ in.—Crown
- 1 pc. Pine— $\frac{1}{2}$ x 3 x 24 in.—Apron
- 2 pcs. Pine— $\frac{1}{2}$ x 2 x 4 $\frac{3}{4}$ in.—Apron
- 12 pcs. Pine— $\frac{3}{4}$ x $\frac{3}{4}$ x 4 in.—Glue Blocks
- 3 linear feet— $\frac{3}{4}$ x 1 $\frac{1}{4}$ in.—Crown Molding
- 3 linear feet— $\frac{1}{4}$ x $\frac{3}{4}$ in.—Base Molding

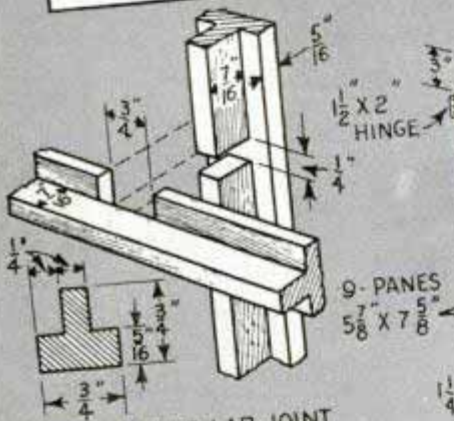

DETAIL OF HALF-LAP JOINT ON DOOR MULLIONS

GLASS SECURED WITH $\frac{1}{4}$ x $\frac{1}{4}$ STRIPS

$\frac{3}{4}$ x $1\frac{1}{2}$ x 21 $\frac{1}{2}$ RAIL INSTEAD OF SCROLL

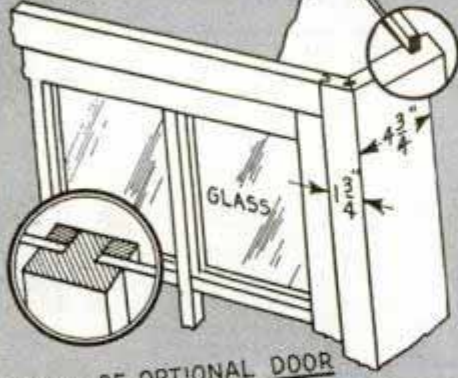

DETAIL OF OPTIONAL DOOR

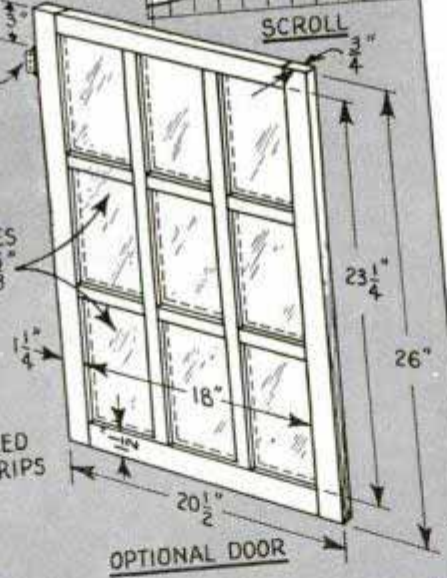
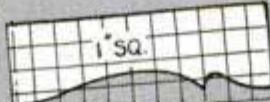

OPTIONAL DOOR

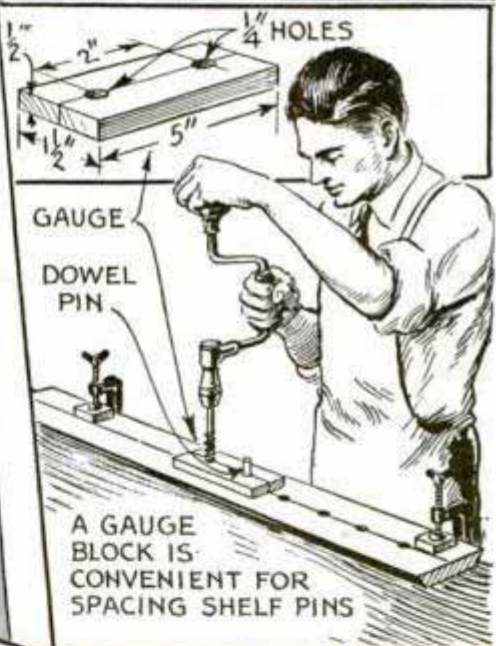

GAUGE
DOWEL PIN

A GAUGE BLOCK IS CONVENIENT FOR SPACING SHELF PINS

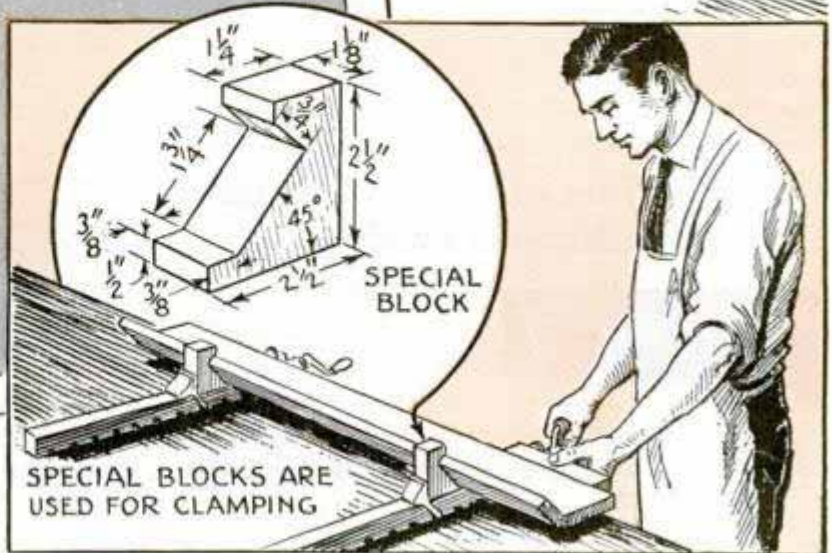

SPECIAL BLOCK

SPECIAL BLOCKS ARE USED FOR CLAMPING

Mirror Held Safely on Tent Pole by Strip of Inner Tube

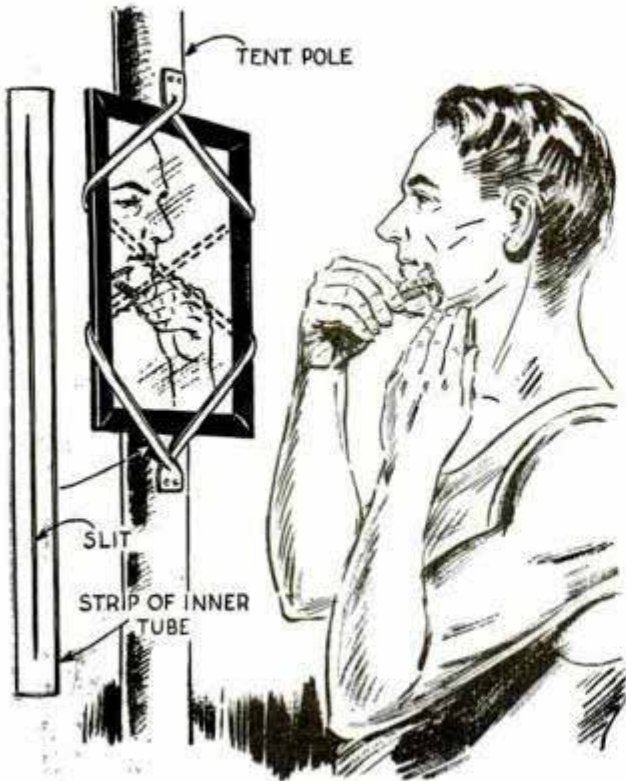

To support a mirror on the pole of his tent, a sportsman slit a strip of inner tube and used it as shown. Unlike hooks often used for this purpose, the strip need not be removed when the tent is packed.

Doorstop Made from Spring

Shaped as shown and screwed to a door near the lower edge, a short length of clock spring provides a good doorstop. The spring must be located so that it will act as a friction catch when it engages a door bumper screwed to the wall.—A. E. Ogren, Chicago.

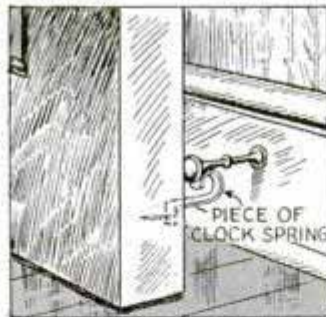

Loop in End of Line to Change Fishhooks Easily



When it is necessary to change hooks or plugs frequently while fishing, the following kink will save time: Double the line at the end and

tie it in a knot, forming a loop large enough for the hook or plug to slip through. Then thread the loop through the eye of a hook, pass the hook through the loop as indicated, and draw the line tightly.

Acids Filtered Through Funnel

Strong acids and alkalis that would destroy paper filters can be filtered through a slurry of water and asbestos fibers placed in a glass funnel. A glass marble keeps the slurry out of the funnel neck. After the slurry has

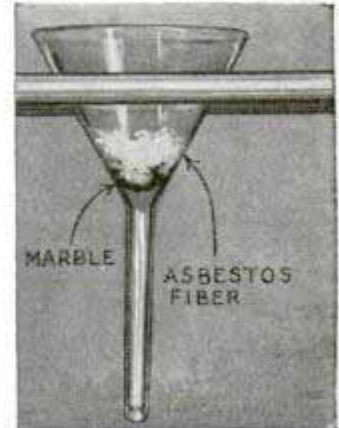

dried, acids can be poured into the funnel to filter through the fibers. In some cases, the fluffy thermal insulation used in houses can be substituted for the asbestos.

Salt Removes Starch from Iron

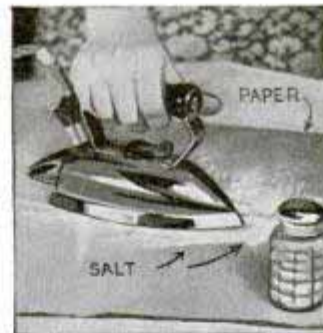

When ironing starched clothes, the starch has a tendency to collect on the iron. It can be removed quickly and easily by rubbing the hot iron over a piece of brown paper on which salt has been sprinkled.

—William Swallow, Brooklyn, N. Y.

Rack for Collapsible Tubes

This rack is just the thing for collapsible tubes containing many preparations that are kept around the home. It is made by notching the inner surfaces on the jaws of spring-type clothespins, the handles of which are screwed to a strip of wood, the latter being attached to a wall or inside a cupboard door out of the way.

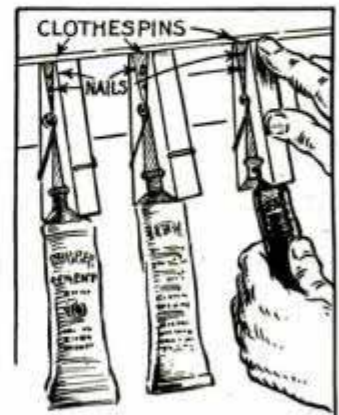

from the WOODPILE

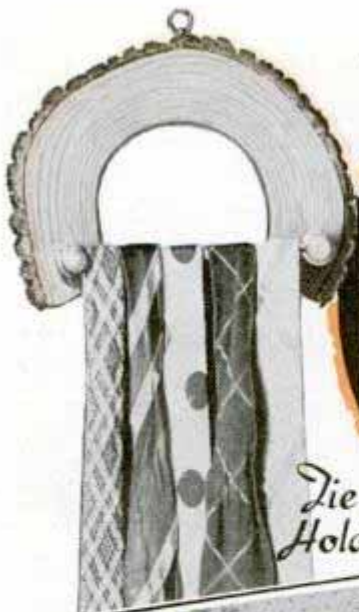

Tie Holder



Bark-covered tie holders, flower baskets, pipe racks and nut bowls are just a few of the interesting and useful things you can make from material in the woodpile. The stock is sawed and turned to shape and is then sanded smooth before applying shellac for finish. Green wood often splits upon drying out rapidly, so in order to make the wood dry slowly, put the pieces in sawdust, saturate this with water and set away to dry. After the sawdust and wood have dried thoroughly, which may take several months, you can work the latter and be reasonably certain that it will not split



Pipe Rack

Nut Bowl



Bank



Novelties



Sewing Set



Small Articles Are Dry-Cleaned in a Fruit Jar



A fruit jar is handy when dry-cleaning neckties, ribbons and other small articles. Just pour the cleaning liquid in the jar, insert the article to be cleaned and screw on the lid tightly, using a rubber ring under it. Then shake the jar. This method saves cleaning fluid and assures a good job.

Vine Trellis from Notched Picket



Notched along the edges and driven into the ground, a picket provides a simple, neat trellis for single vine or climbing rose. The staggered notches will support the vine without tying.

Car Rim Filled with Concrete Provides Good Cistern Cover

A good cover for a cistern can be made by filling an old car-wheel rim with concrete. A handle for the cover is provided



by sticking a U-shaped iron rod into the concrete while it is still soft. Such a cover is neat, permanent, and is too heavy for children to dislodge. If desired, the concrete may be put in only the top two-thirds of the rim, leaving a recess on the underside into which the top of the cistern will fit.

Flypaper Keeps Ants Off Cot

Wrap a strip of flypaper around each leg of your camp cot, and ants will not crawl up them and get into the bedclothing. A rubber band around each strip will hold the flypaper in place.

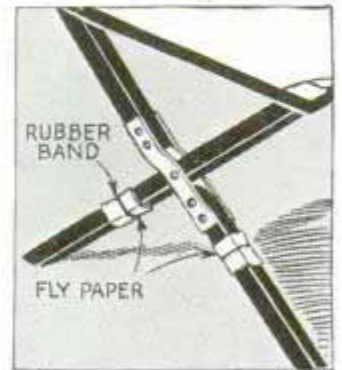

Cork Measures Finger-Ring Size

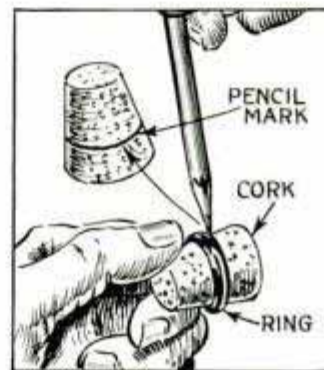

If you are going to purchase a ring for a friend or relative and it is inconvenient to carry one along to the store for the correct measurement, use a cork. Slip a ring of the correct size over the cork and mark its position. From this it will be easy for a jeweler to determine the size.

Making Candles Fit the Holders

When ornamental candles are too large to fit their holders, they can be made smaller at the base by dipping them in boiling water. Dip the candle repeatedly until enough of the wax has been melted away from the base to make it fit the holder.



☞ Dates will keep a long time if stored in tightly covered jars to exclude air.

COFFEE TABLE

has plate-glass top

THERE are only a few pieces comprising this neat little coffee table, namely: a wooden ring holding a plate-glass disk which forms the top, a wood disk to provide a shelf and assure rigidity, and four gracefully curved legs, having rounded or fluted outer edges. You turn the ring and disk on a lathe, and cut the legs on either a scroll or band saw, and the parts are fastened together with wood screws.

First get the plate-glass disk $14\frac{1}{2}$ in. in diameter, after which you turn the ring from a block made by gluing up several pieces of hardwood. The block should be $17\frac{1}{2}$ in. square and $1\frac{7}{8}$ in. thick. One side is surfaced to fit snugly against a lathe faceplate and the corners are cut off to form a rough round before turning. After mounting, remove some of the center waste until you get a snug fit for the glass. Then turn the outside as in Fig. 5, to the design and dimensions given in Figs. 2 and 3. Sand the surface smooth, polish with No. 000 steel wool and finish with clear lacquer or white shellac. If lacquer is used on gum wood, apply the first coat and immediately wipe it off with a rag pad while the lathe is turning. This will leave just enough lacquer to seal the wood, over which a second coat of lacquer can be applied without trouble. However, two thick coats of lacquer cannot be used as the second one will raise the first. If walnut or other open-grained wood is used, filler, stained dark as desired, is first applied and rubbed down before lacquer or shellac is applied. The ring, after being finished and polished over its entire outside and top surfaces, is finally cut out by using the point of the small skew. Just before the ring is cut loose, the lathe is stopped and the final cut is made while the lathe is being turned by hand. This prevents the ring from being broken.

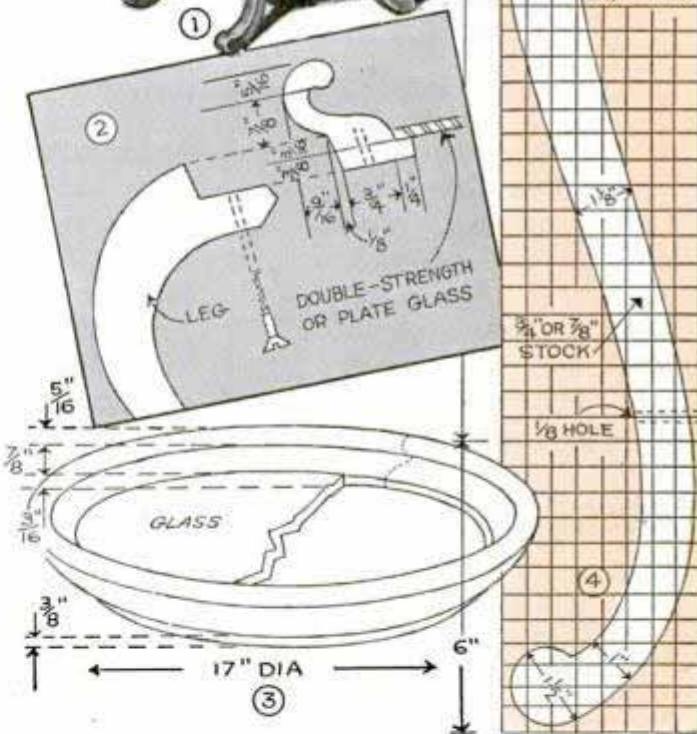

Now saw out the legs, using the pattern shown in Fig. 4. Take care that the notches at the top are all exactly alike so that the ring will seat perfectly. Sand the legs well and rub with fine steel wool before finishing. The outer edges should be rounded or fluted to eliminate severe plainness. To locate the exact position of the legs on the ring, scribe a circle on a large sheet of paper the same size as the bottom of the ring and divide this into quarters. Then

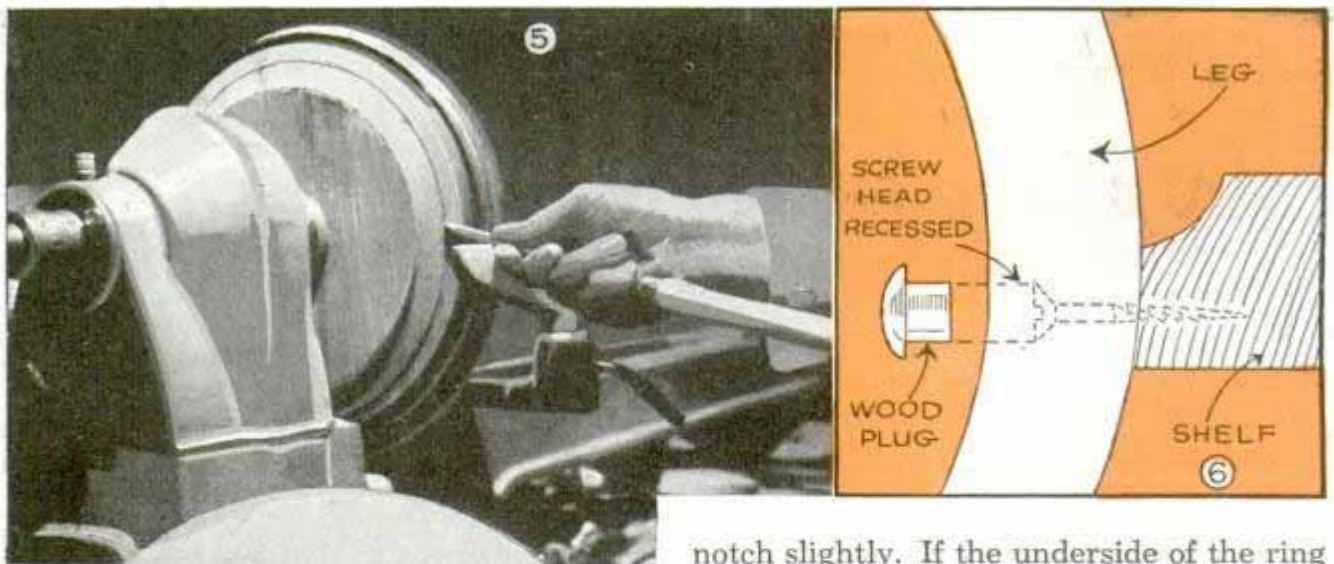

transfer the markings to the underside of the leg. Use No. 5 round-head screws, $1\frac{1}{4}$ in. long, for assembling. Drill $\frac{1}{8}$ -in. pilot holes for the screws through the top of each leg, at a slight angle, and then fasten the legs in place temporarily to check the spread between them so that the shelf will touch each one. If any one of the legs are out of line, alter the angle of the shoulder

notch slightly. If the underside of the ring has been left unfinished, you can spot the joints with glue for added rigidity.

The shelf is fastened in place by No. 5, $1\frac{1}{2}$ -in. screws driven through the legs as indicated in Fig. 6. Here, also, pilot holes are needed, and they are counterbored so that the screw heads will be recessed and concealed with wood plugs, which are glue-coated and driven in place. As most of the lower structure of the table is clearly visible, all parts except the underside of the ring and shelf should be finished nicely.

If desired, a round tray that will match the table top, can be turned as a separate project. Such a tray is shown in Fig. 7, and it is similarly fitted with a glass bottom. The tray can be the same size as the table top, or it can be made smaller and may even be designed so that it fits neatly on the table in such a way that it gives no indication to the casual observer that there is a separate tray, which is removable.

Mosquito Netting on Crib Weighted to Keep It in Place

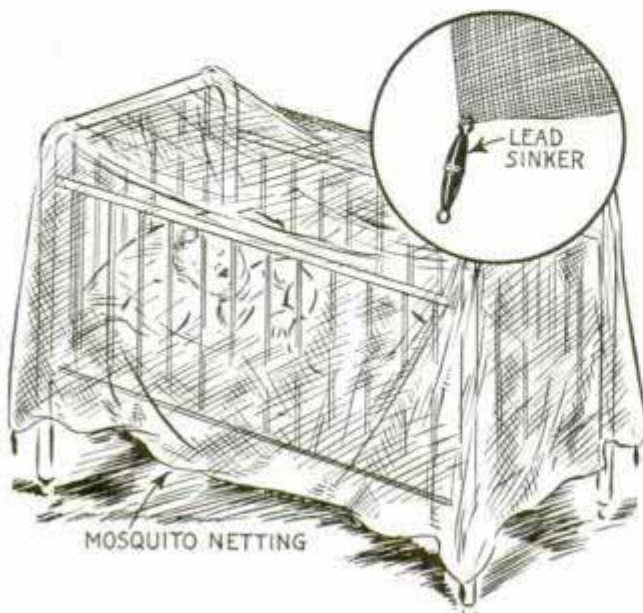

Instead of pinning a mosquito net over a baby's crib to keep out insects, tie a lead fishline sinker to each corner. The weights will keep the net in place, and it is easy to remove or replace.

Tires Deflated to Soften Ride When Taking Movies

Amateur movie fans might profitably follow Hollywood's trick of using low-pressure tires on camera cars to prevent traffic scenes from becoming "jumpy." Though practical only for short runs, deflating ordinary tires to a point where they completely "cushion" the ride should achieve the same result.

Camp Water Pulled from Lake by Windlass

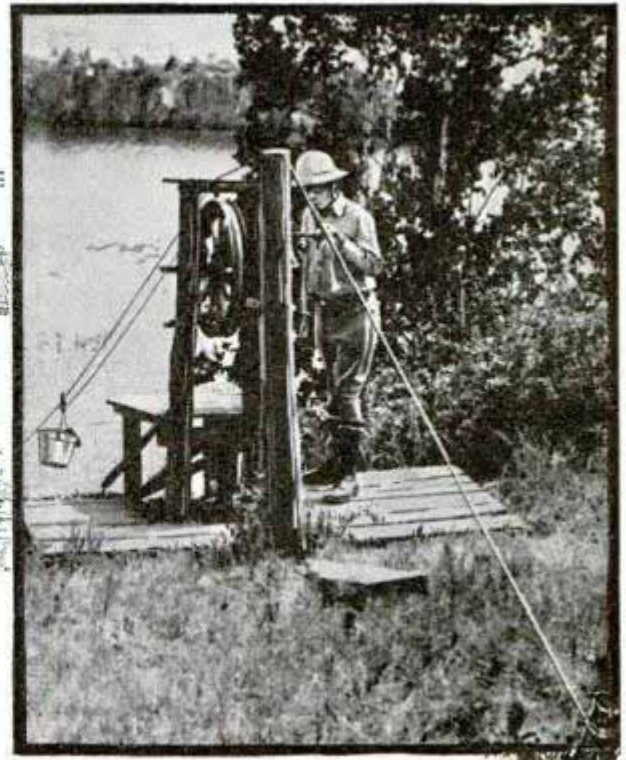
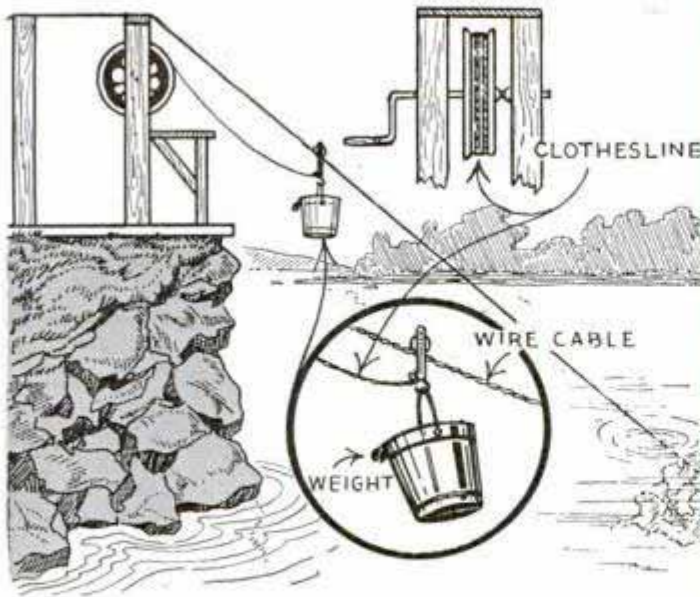

This windlass for pulling a bucket of water up an inclined cable from a lake or stream at your camp will save many steps. Also, it will enable you to get water farther from shore where it is usually cleaner than that near the shore. The windlass consists of an old car wheel mounted on a combination crank and axle, which is mounted on two posts. A third post supports a cable anchored under water at one end with a large boulder and at the other end with a

stake driven into the ground. A length of clothesline wound on the wheel is tied to a pulley that travels up and down the cable. The bucket is weighted at the rim so that it will tip when it reaches the water.

—W. W. Anderson, Minneapolis, Minn.

U-Shaped Bench Stop Swings Out of Way When Not in Use

A simple bench stop that is out of the way when it is not needed, yet is always at hand, can be made from a large U-bolt and a couple of staples. The staples are driven into the side of the bench to support the stop when it is not in use. When lifted and swung to position for use, one leg of the bolt drops into a hole in the bench top.

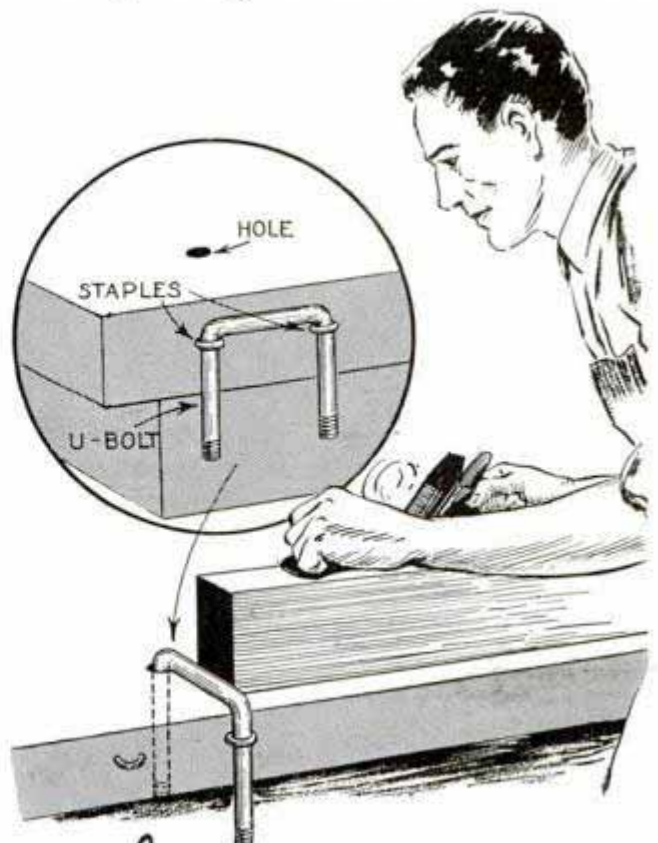

Flies Killed with Poisoned Bait

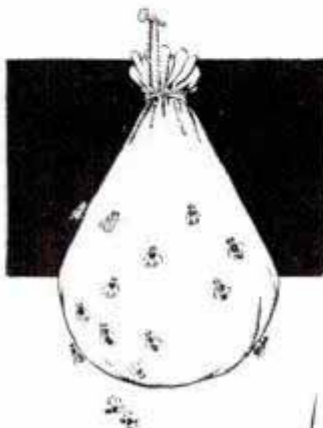

A small sugar sack filled with poisoned grasshopper bait and hung in a barn or other building where flies gather will destroy them. Keep the bag moistened, and place it so animals cannot reach it.

Slotted-Pipe Stakes Support Wire Around Lawn

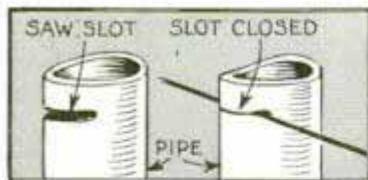

When using lengths of pipe as stakes to support a wire to discourage trespassing on a lawn, slot the pipe near the top end to take the wire. Then you can close the slots on the wire with a hammer.

Cushioned Handle Brackets Stop Rattle in Lawnmower

Rattle in a lawnmower can be reduced if rubber bushings are placed around the posts over which the handle brackets hook. Use a strip of inner tube fastened with tire cement or heavy rubber bands.



Lawn Hose as Hydrant Wrench



To loosen a garden hose at the hydrant or sill cock, make a wrench by cutting a length of hose as shown. When folded around the connection and gripped tightly, it will serve as a wrench to loosen

the connection without any possibility of crushing the thin metal ring on the end of the garden hose.

Spilled Mercury Salvaged Easily with Medicine Dropper

Spilled mercury usually can be saved with a medicine dropper. Just compress the bulb of the dropper, hold the end against one of the small mercury drops and then release the bulb.

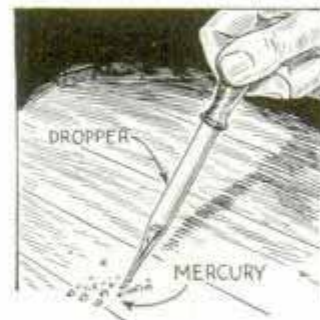

Safe Catch on Pole for Fishhook



The annoyance of a dangling fishhook while carrying the pole along a creek or river can be avoided by tying a rubber band near the butt of the pole. Tie the rubber so that it must be stretched to engage the hook. In this way, the hook cannot slip out of the band and catch in the clothing.

Locking of Type Forms Aided with Blotting Paper

Amateur printers who experience difficulty in locking forms of small type can avoid much of the trouble by inserting a strip of blotting paper between the side of the type form and the locking strips.

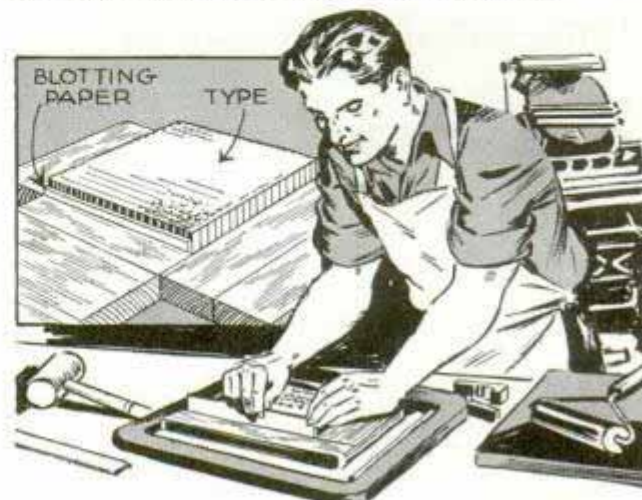

ZEPHYR - a sailing dinghy

By CHAS. H. McALARY

PART III—Mast, boom, rudder, rig, sail and painting

HAVING completed the hull of "Zephyr" as described in the previous installments, the 24-ft. mast is made next. Eight pieces of $\frac{1}{2}$ -in., straight-grain spruce, $2\frac{1}{2}$ in. wide are required to build up the hollow mast as detailed in Fig. 34, four of these pieces being 10 ft. long and four 14 ft. long. The mast runs straight to a point 40 in. from the peak from where it tapers to 2 in. square at the end. The pieces are assembled to form the hollow section by lapping adjacent edges as shown in the circular detail of Fig. 34, and are spliced together by cutting the ends 45 degrees and then centering the butted ends over filler blocks fitted in place at these joints. Note that the joints are alike on opposite sides. The blocks should measure 2 in. square by 4 in. long, with the exception of those fitted at the base and peak which should be 6 in. long. Assemble the pieces with casein glue and brass screws, and clamp the work perfectly flat while the glue is drying. The aft edge of the mast, you will notice, is planed flat to receive the sail track.

The sheave for the halyard is installed as shown in Fig. 35. It should be either of brass or galvanized iron and should turn in a slot which is at least $\frac{1}{8}$ in. wider, so that it will not bind when the wood swells. Eye plates for the stays are screwed to the mast at the beginning of the taper and like all other fittings, they should be of brass, especially for salt-water use. The gooseneck, shown in the insert in Fig. 34, can be made from brass stock or a similar fitting can be purchased ready-made.

For the boom, select a good, straight-



Top photo shows the foot of the sail being tracked on the boom in readiness to be hauled aloft, while the lower photo, a stern view of "Zephyr," shows the fast, trim lines of its hull

grained piece of spruce $1\frac{3}{4}$ in. square and 12 ft. 6 in. long. Beginning at the center of the piece, taper one end to measure $1\frac{3}{8}$ in. square, planing the work on the bottom and sides only, as shown in Fig. 37. The top is left flat for the sail track and the opposite end of the boom is trimmed to fit the gooseneck brackets. Location of the blocks for the sheet and the method of securing the sheet to the end of the boom, are also shown in Fig. 37. Quarter-inch hemp rope is used for the sheet.

Locations of the chocks, cleats, stays and

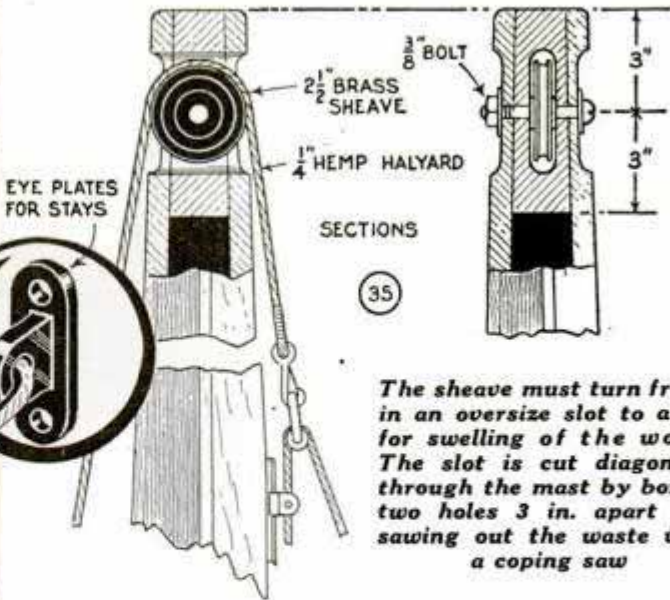
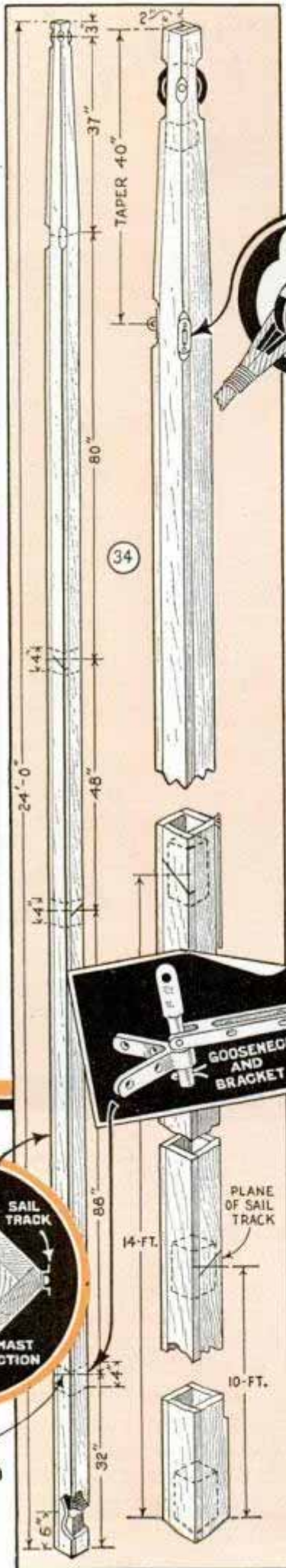

The sheave must turn freely in an oversize slot to allow for swelling of the wood. The slot is cut diagonally through the mast by boring two holes 3 in. apart and sawing out the waste with a coping saw

traveler are given in Fig. 38. The side stays are screwed to the second rib aft of the mast, which brings them approximately 10 in. behind the center of the mast. The traveler is screwed to the top of the transom. A square, chromium-finished plate is screwed over the mast hole in the deck and a grommet through which the halyard passes through the deck, Fig. 43, is fitted just above a block installed beneath the deck. Deck cleats are screwed into pieces of stock previously fitted under the deck before it was covered. When the sail is raised, the halyard is belayed to a cleat screwed to the seat, Fig. 43. The side stays are fastened to chain plates with chromium turnbuckles of the pipe type, Fig. 38. The forestay is fastened to the oak stem with an eyebolt as in the circular detail, Fig. 38.

The centerboard is conveniently raised and lowered by means of two blocks fitted



TO CENTER OF BLOCK BULKHEAD (FOR GOOSENECK)

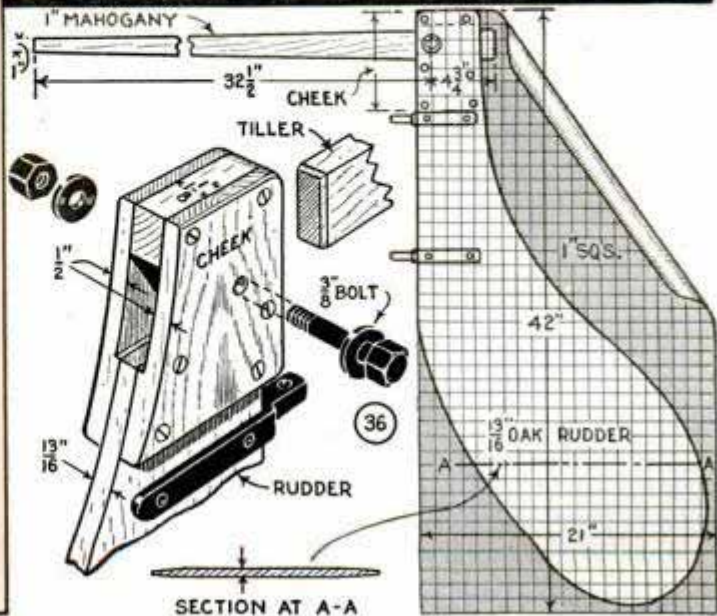

SECTION AT A-A

as in Fig. 42. An upright, screwed to a deck beam and the keelson, provides a solid support for attaching the block and the end of the line. The other end of the hemp rope is belayed to a cleat on the seat. The rudder, Fig. 36, is cut from a single piece of oak $1\frac{3}{16}$ in. thick. Lay out a full-size pattern on 1-in. squares and transfer to the wood. The edges are tapered, below the waterline, as shown in the section A-A. The tiller, which may be made of either mahogany or oak, is located between rabbeted cheeks at the top of the rudder and is bolted in a tapered slot to permit a slight up-and-down movement. Place thin washers on each side of the tiller and be sure that the slot is wide enough to avoid binding when the wood swells. Strap and plate gudgeons, fastened to the rudder and transom, as in Figs. 36 and 38, permit the rudder to be detached easily by means of a removable pin. This type of hinge will not come loose and checks the tendency of the rudder to float upward. The 3-in. mahogany splash board, Fig. 44, is fastened to the deck with screws, which are inserted in counterbored holes and driven into the deck beams. This is centered forward of the cockpit, just aft of the mast, and is reinforced at the peak with a brass strip.

Now for painting the boat. First sand the entire hull thoroughly, using progressively finer grades of paper until the surface is glass smooth.

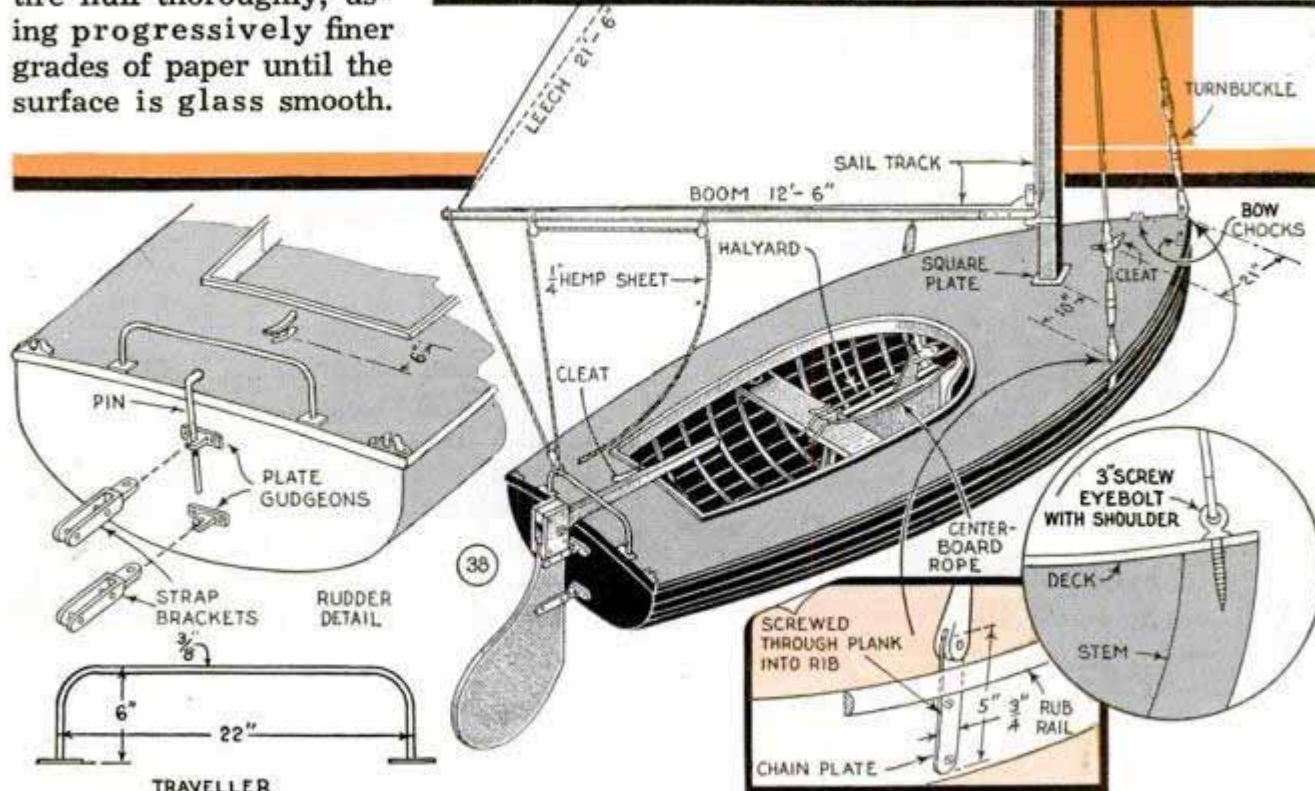
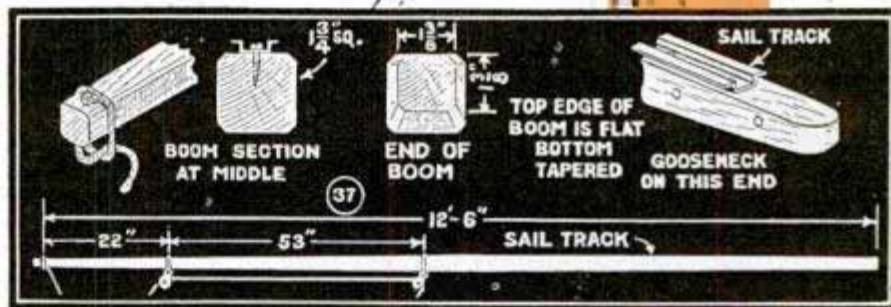
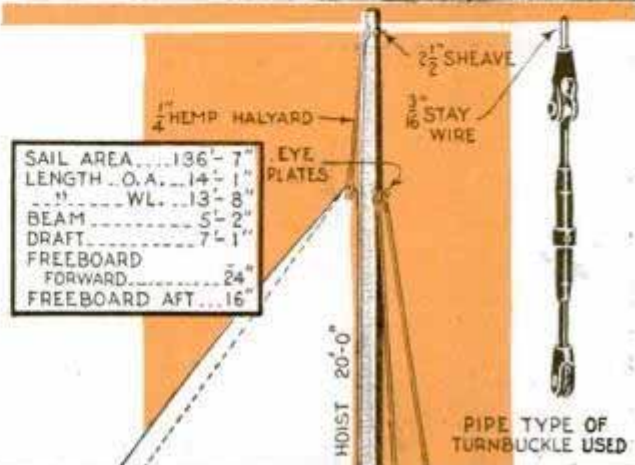
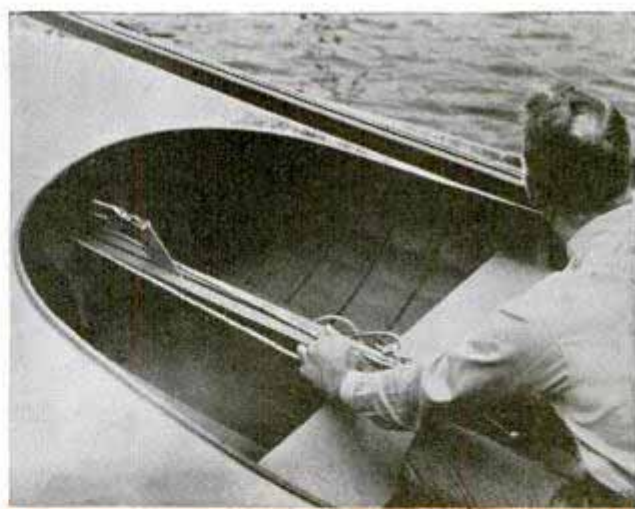

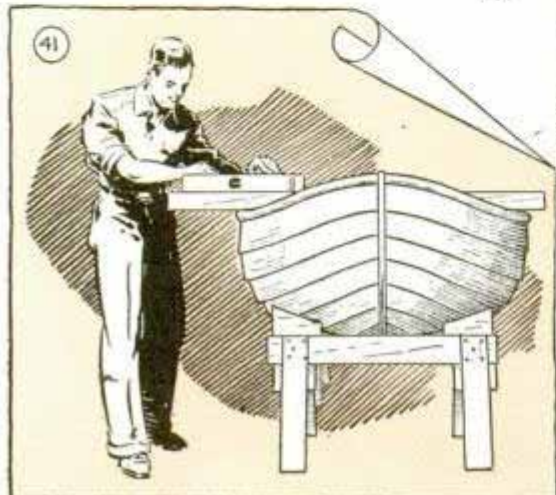
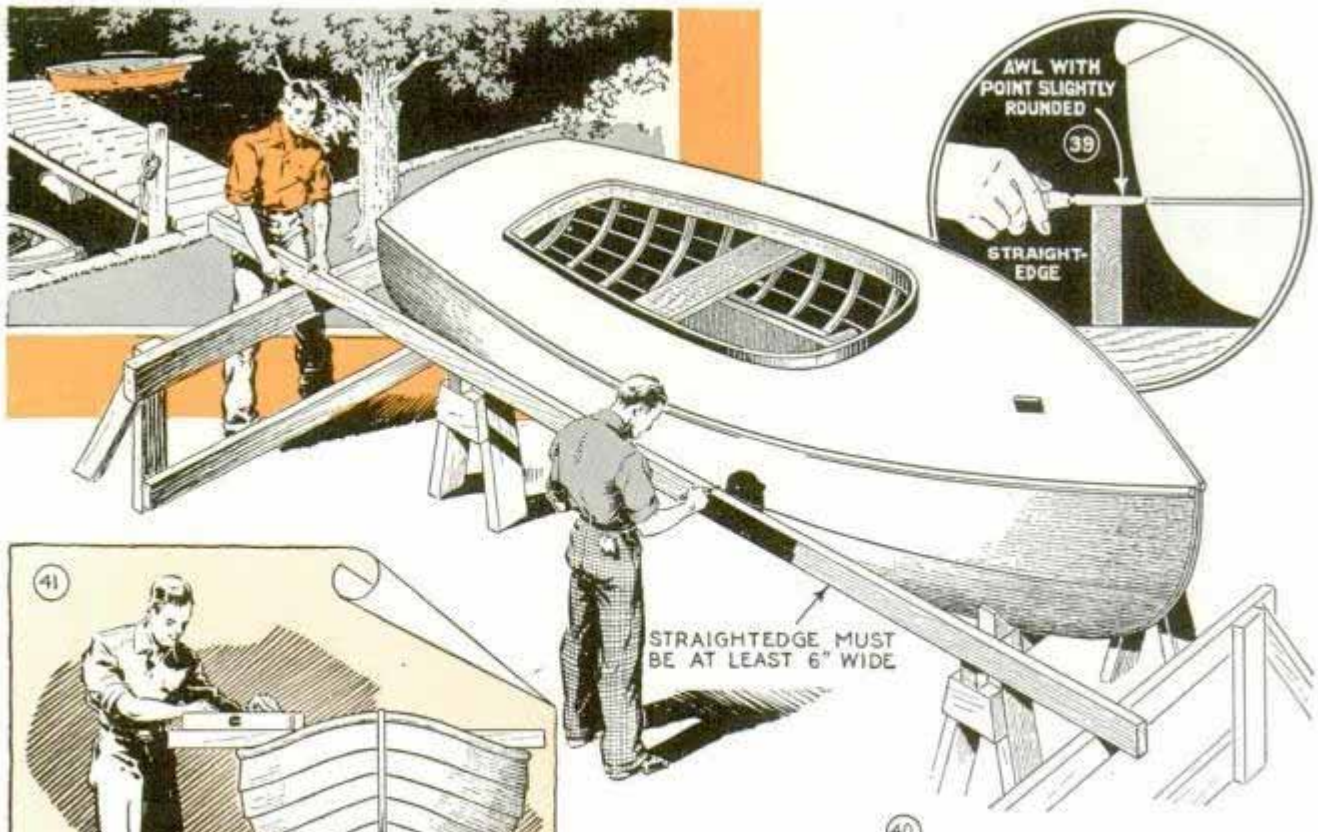

STRAIGHTEDGE MUST BE AT LEAST 6" WIDE

40

Marking the waterline is an easy job if the straightedge is guided against the hull by an assistant as shown above

Now, before proceeding further, a waterline must be marked on the hull. This is done easily by first blocking up the hull level on a pair of sawhorses as in Fig. 41. Referring to the profile view of the hull and the table of offsets given in the first installment, you can locate points A and B, Fig. 45, where the true waterline meets the stem and transom. Now, block up the hull horizontally so that each point is 30 in. above a level floor or driveway. At the stem and at the transom erect a trestle as in Fig. 40. The height of these must equal points A and B when a 6-in. straightedge is placed across the top, Fig. 45, and must be set perfectly level laterally with the hull. Then, as an assistant moves the straightedge across the top of the trestle to bring it in contact with the hull, a pencil can be run along the top of the straightedge to mark the waterline. To make a permanent guide line, which is easy to follow with a brush, a pointed tool such as an awl, with the end slightly rounded, can be used to score the wood as in Fig. 39.

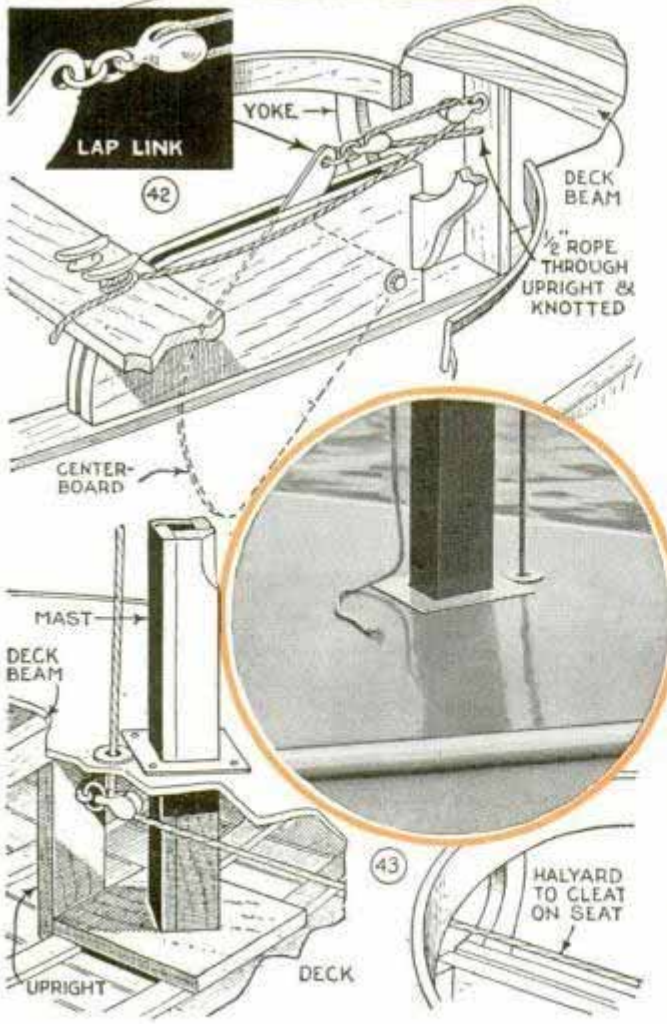

A coat of oil paint is applied to the hull above the waterline. After this priming coat is dry, apply four coats of flat white paint, allowing ample time between coats for each to dry thoroughly. Sandpaper this lightly and then apply a final coat of gloss

enamel. The deck is given several coats of flat paint to fill the canvas covering, and when dry, is sanded lightly as before. This procedure is repeated until the desired finish is obtained. The bottom of the hull, below the waterline, is given three coats of copper paint, using the type which is expressly prepared for use on boat hulls. This will give a smooth, durable finish below the waterline. Sand the mast, boom, tiller and cockpit coaming smoothly and finish with three coats of high-grade spar varnish. If each coat is rubbed lightly with fine steel wool, an excellent surface will be had for the final coat. All fittings should be removed from the mast and boom before varnishing.

As previously mentioned, the use of a $\frac{3}{8}$ in. thick centerboard is advised for amateur sailors, as the extra weight provides more ballast than a thinner one. More expe-

Several applications of flat paint, sanded lightly between coats, will give a smooth finish to the canvas-covered deck

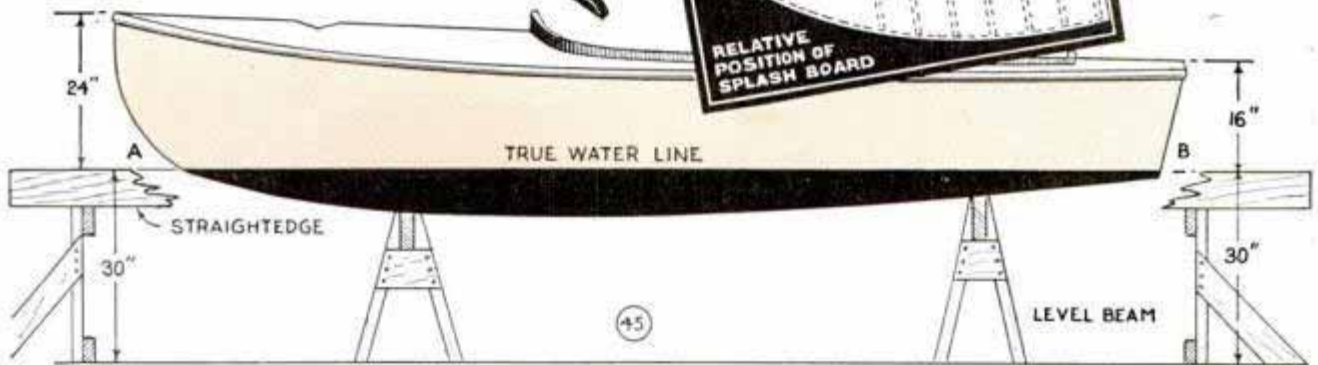
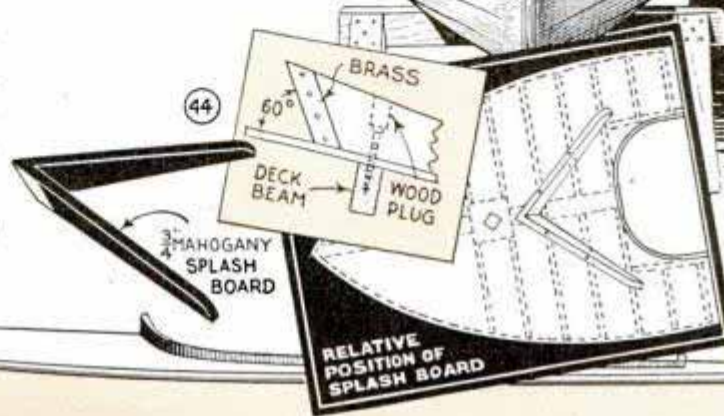

rienced seamen will be able to handle the hull easily, when a $\frac{3}{16}$ -in. centerboard is used. Naturally the width of the centerboard well must be varied accordingly so

that when the centerboard swells it will not bind in the well. Fig. 38 gives full dimensions for the sail. It is best to have this made up by a competent sailmaker.

Fishpool Kept Cool in Summer by Evaporation of Water

One gardener keeps the water in his fishpool at a comfortable temperature on hot days, by spreading a piece of burlap over an inflated inner tube, which floats on top of the water. The cloth will provide a shady spot for the fish and the evaporation of water taken up by it will tend to lower the temperature of the water in the pool several degrees.

☞ When holding small parts such as a rivet in a vise to shorten it by filing, grip the part between the jaws of a pair of pliers and put the pliers in a vise.

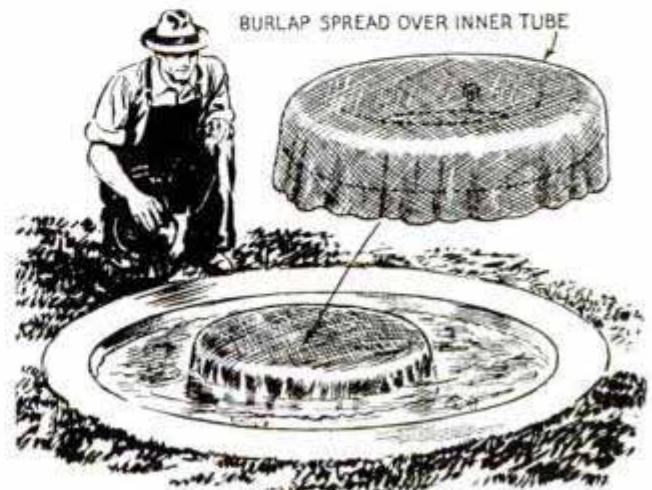

Reversible Divider in Mortar Box Saves Time and Labor

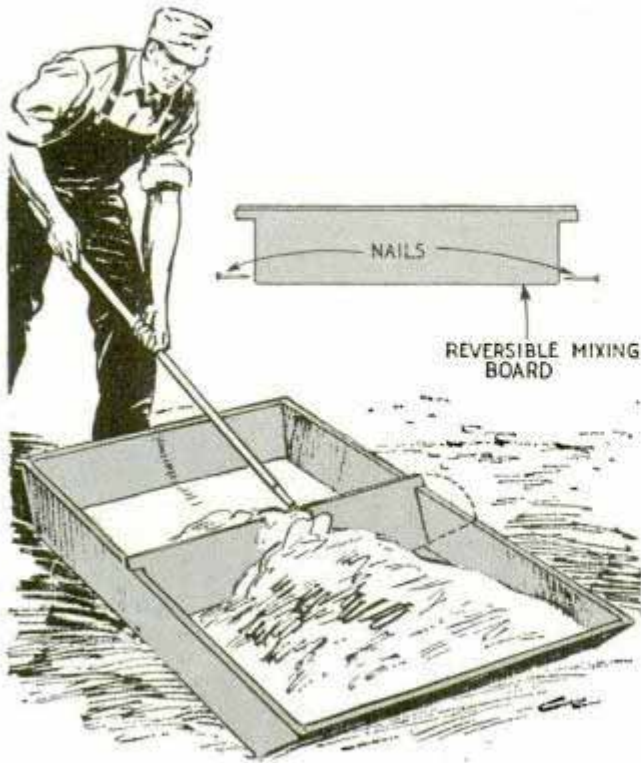

Pivoted in the center of a mortar box, this reversible dividing board will save time and labor when mixing sand and plaster. The contents of the box are pulled over the board with a mixing hoe, after which the board is reversed and the work repeated in the opposite direction.

Spectacle Case to Carry Drills

An old spectacle case is handy for carrying a number of small drills, especially if you carry them in your pocket. The spring lid of the case stays closed securely, yet is opened quickly for selection of the desired drill.—Earl E. Hanna, Canton, Ohio.

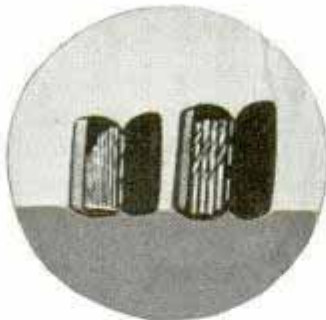

Pressure Aids in Cutting Glass

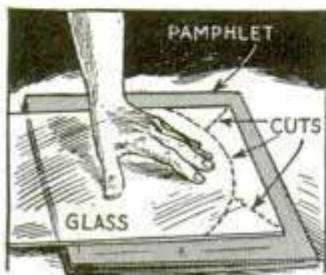

The next time you want to cut disks or other shapes of a circular nature from glass, try the following method: Make the arc or

circular score in the regular way, with additional scores out to the edge of the glass. Then turn the glass over on a thick pamphlet or magazine with the scored lines on the underside. By spreading the fingers and pressing down on the glass as shown, the outside pieces will break away.

Rubber Tip on C-Clamp Screw Avoids Marring Work

When using a C-clamp on varnished or finished work, a rubber crutch tip slipped over the end of the screw will keep it from marring the work. These tips can be obtained in several sizes to fit various clamps.

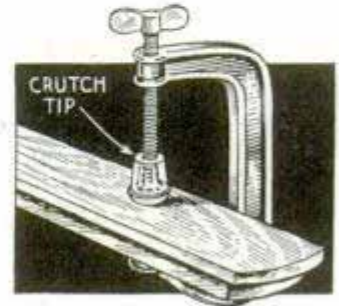

—A. H. Waychoff, Phoenix, Ariz.

Screen-Door Hooks Shielded to Protect Clothing

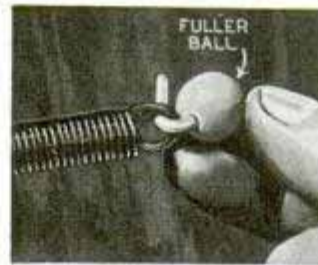

Hooks to attach screen-door springs, and for other uses where the hooks are exposed, can be shielded to prevent tearing the clothing by simply slipping fuller balls over them. Avoiding damage to one garment will more than pay for the time and trouble of shielding the hooks.

Door Knocker Holds Caller's Card

If you have a door knocker of the type shown, solder a couple of L-shaped metal pieces to the knocker in the position indicated. Then if friends come while you are away they can leave their cards to let you know they called.

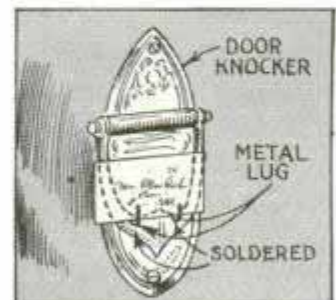

☐ A coating of automobile wax on the inside sections of flat curtain rods will help to protect the finish against wear.

Turned Swedish Top Sings While It Spins

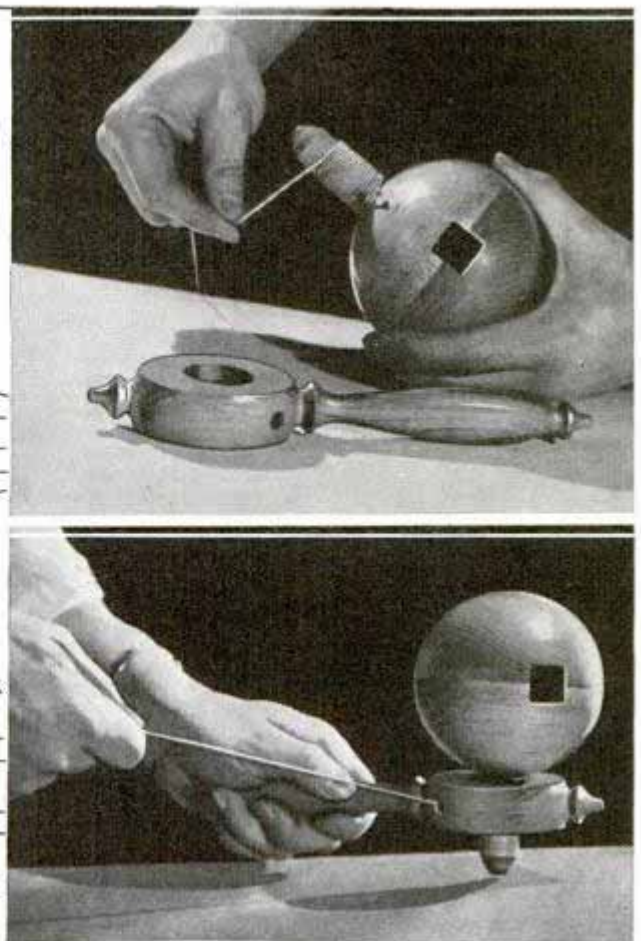
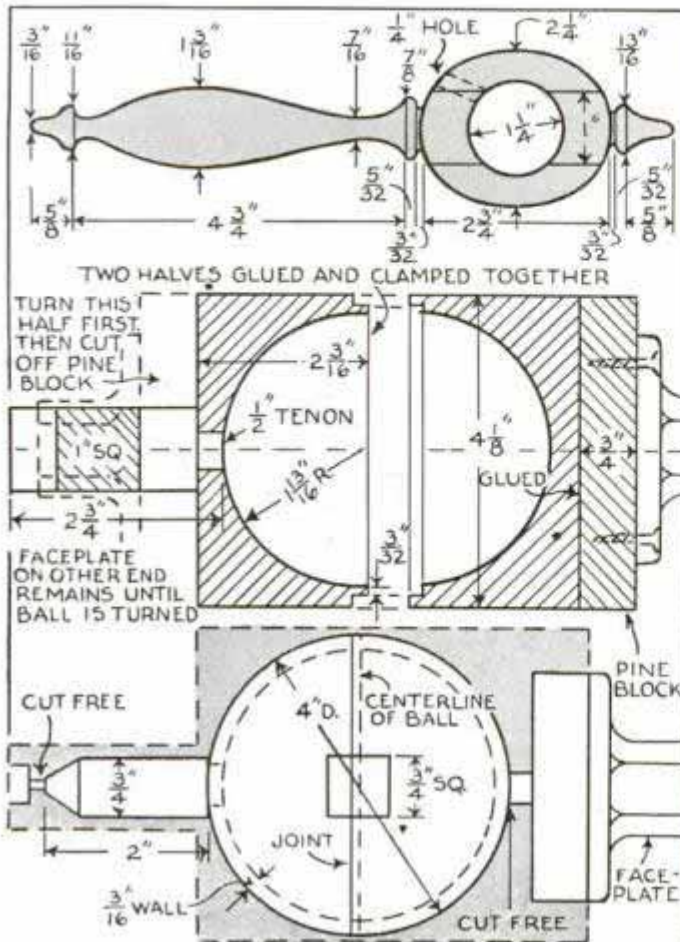

PATTERNED from an original made in Sweden more than a century ago, this unusual, wooden top, which is turned on a lathe, produces a pleasing hum as it spins swiftly over the floor. The hollow, ball part of the top is turned from two maple blocks on a faceplate, each half first being glued to a scrap, pine block, after which the latter is attached to the faceplate. Then the center of each half of the ball is turned concave and the edges rabbeted to fit together snugly. Stock for the spinner is glued at the base of one block and the two halves are glued and clamped together between the lathe centers. The outside diameter is turned to the dimensions given above, checking the work frequently with a cardboard template to obtain a perfect sphere. The square opening made in one side of the ball is filed to shape after first drilling a starting hole. Variation in sounds can be obtained by varying the size of the opening, this being accomplished by providing snug-fitting inserts of various sizes which can be pressed into the opening.

The handle, in which the top is held to spin it, is turned from a $2\frac{3}{8}$ -in. square piece and is planed or sanded flat on two

sides to measure 1 in. thick. A hole to take the spinner is bored through the center of the flat portion and an opening is made through the side through which a string is pulled to spin the top. To do this, the string is wound around the spinner, as shown in the upper photo, after which the end of the string is passed through the hole in the side of the handle. Holding the top upright as shown in the lower photo, give the string a quick pull and with a slight upward motion, throw the top clear of the handle to align on the floor.

Simple Aerator for Fish Pool

The owner of a large fish pool keeps the water well aerated by simply directing fresh water into the pool in the form of a spray. The spray is produced by forcing the water through a slotted pipe cap.



Sub-Surface Watering of Trees and Shrubs



Nursing a newly planted tree or shrub through a hot, dry summer is easy if you use this method of directly watering the delicate root system. A pail or large can is placed in the ground at a distance of 16 in. from the trunk. Holes are punched in the bottom of the can, and a row of them are also punched about 1 in. apart around the sides, to permit filtration of the water into the soil. In the fall the can is removed and the aperture filled with compost and fertilizer which leeches down to feed the roots.

—M. E. Bridston, Port Blakely, Wash.

Long Tent Ridgepoles Hinged for Easy Storing

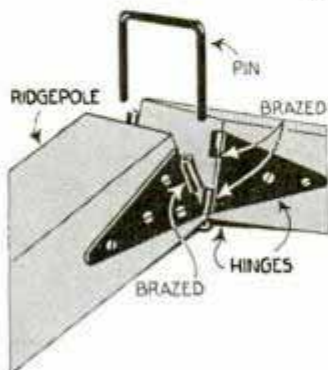

By hinging tent ridgepoles in one or more places, they can be folded compactly for carrying or storing. For each joint you will need three strap hinges. After squaring the ends of the pole, put

one of the hinges on the underside. Then remove the pins from the other two and

screw them to the sides of the pole. Make a U-shaped pin for both of the hinges from a length of small rod. To fold the pole, just remove the U-shaped pin, which holds the pole rigidly when it is inserted into the hinge eyes.—E. Rushing, Groveton, Tex.

Birdhouse You Can Make Quickly

Here is a birdhouse that you can make in one evening. The ends are cut from $\frac{1}{2}$ -in. wood, and the roof, sides and bottom are cut from composition roofing, which is merely nailed to the edges of the end pieces.

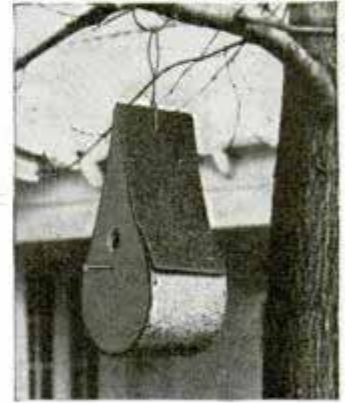

A $\frac{1}{4}$ -in. dowel projecting underneath the entrance hole serves as a perch. The house is about 12 in. high and 6 in. wide at the roof edge, depending on the size of the bird for which it is intended.

Slotted Punch to Drive Tacks

When driving tacks in places that are rather hard to reach, or when retacking upholstery material where it is desirable to have one hand free to stretch it, this punch is just the thing, because it holds the tack while starting it. Two slots are cut at the lower end of the punch as shown.

—A. V. Bergquist, Maple Plain, Minn.

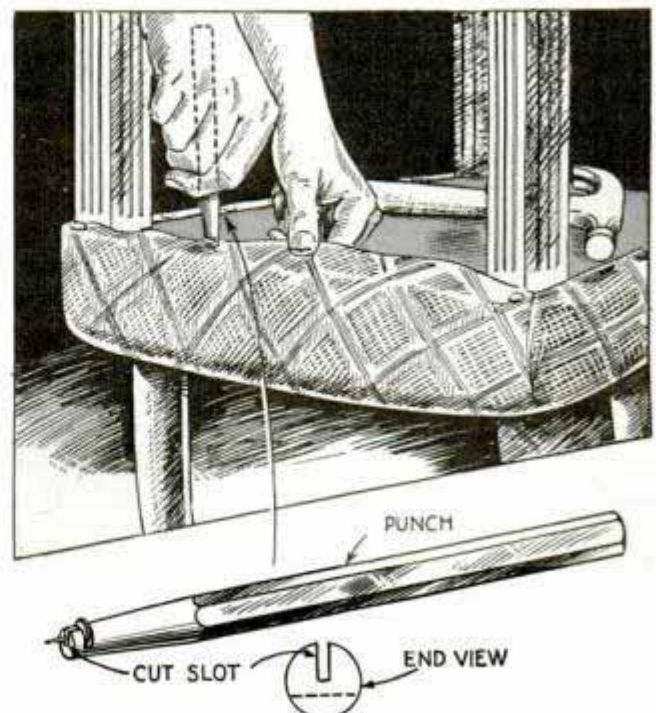

"SWING" PHOTOS

stop racing cars

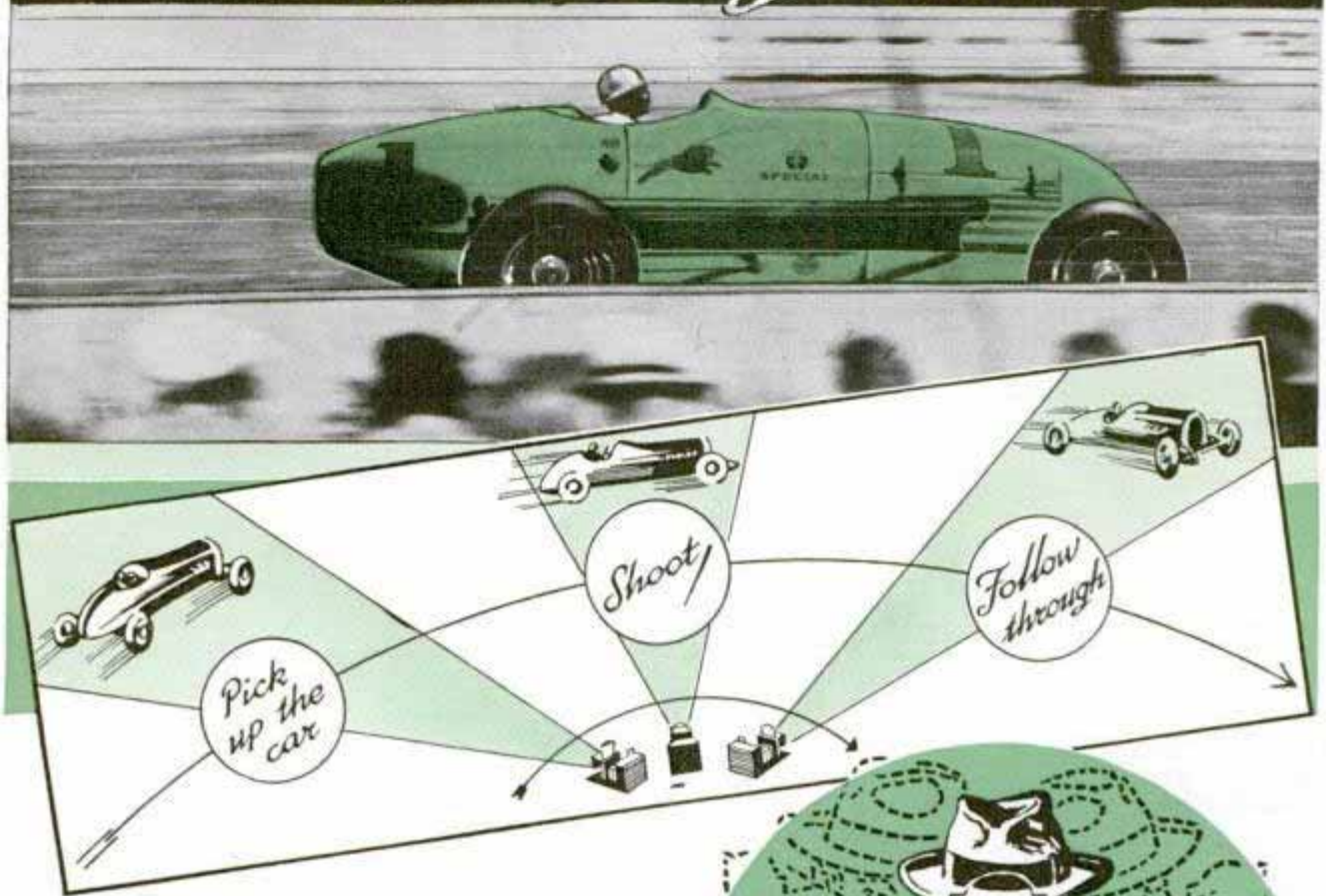

Pick up an approaching car in the view finder and swing around to hold it while snapping the shutter

By THOMAS P. LAKE

AT INDIANAPOLIS speedway, on Decoration Day, cars will roar out of the turns and flash past the stands at 120 m.p.h. and more. Yet those speed demons can be stopped in a fraction of a second by the winking eye of a camera.

At 120 m.p.h. a racing car is traveling 176 ft. per second. Camera exposures are measured in tenths, hundredths, and thousandths of a second. Yet in $1/10$ of a second the racing car has traveled 17.6 ft. In $1/100$ of a second the car has traveled 1 ft. 9 in. Even in $1/1,000$ of a second the car has traveled slightly more than 2 in. The mechanics of shutters put a limit on their shortest exposures. Between-the-lens shutters on some small cameras will give



$1/500$ of a second, on larger cameras $1/200$ or $1/250$ of a second. Roll-curtain shutters give exposures of $1/1,000$ or $1/1,250$ of a second, yet these very short exposures are somewhat misleading as the slot in the shutter curtain moves across the negative, giving in effect a series of exposures, the total time of which is found by multiplying the nominal exposure by the number of times the width of the slot is contained in

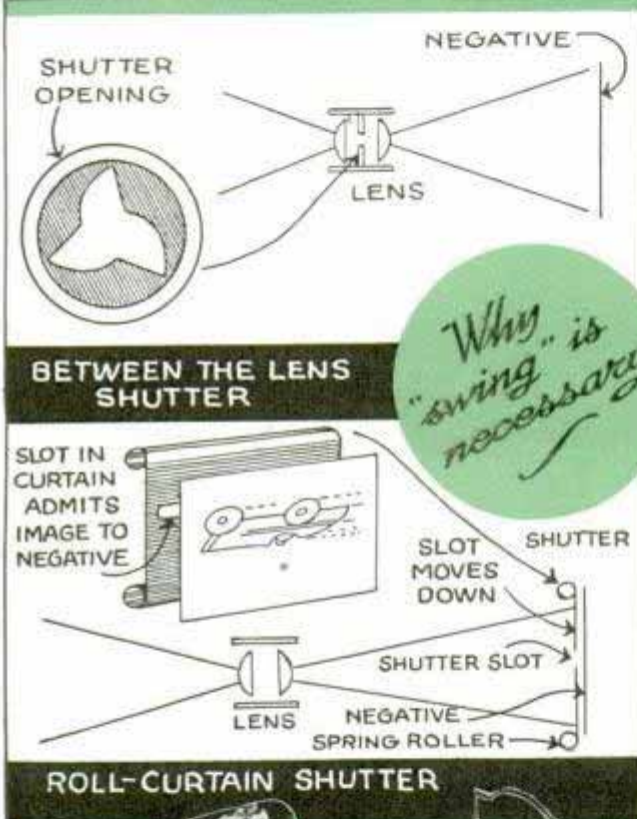

the distance it must travel to expose the whole picture. In many cameras this amounts to about 1/40 of a second, during which the racing car moves more than 2 ft.

As the shutter of the camera is incapable of giving a fast enough exposure to stop the motion of the racing car, the photographer must do it. He can take a photo of a car traveling at a speed of 120 m.p.h., and show small details with an exposure of only 1/500 second. The way to do this is stand with the feet slightly spread, and face the point where you want to make the picture. This may be only 50 ft. from the track. If the camera is of the reflex type, hold it firmly against your chest; if the camera is of a miniature type or if an eye-level finder is used, brace it against the side of the head. Twist the body toward the point where the car will first appear and then follow it in the finder, increasing the speed of the swing as the car approaches. When you face the pre-selected point for which the camera was focused beforehand, make the exposure, and continue the swing to allow the mechanism to complete its action. Practice this a few times and then make at least five exposures to be sure of matching the camera swing to the car's speed in order to obtain one good picture. Of course, background will be blurred but the car has been "stopped."

The same technique of arresting other fast-moving objects such as trains, airplanes, speedboats, divers, etc., can be applied with equally successful results, whether the swing is horizontal or vertical.

Big Camera Takes Inexpensive Small Pictures

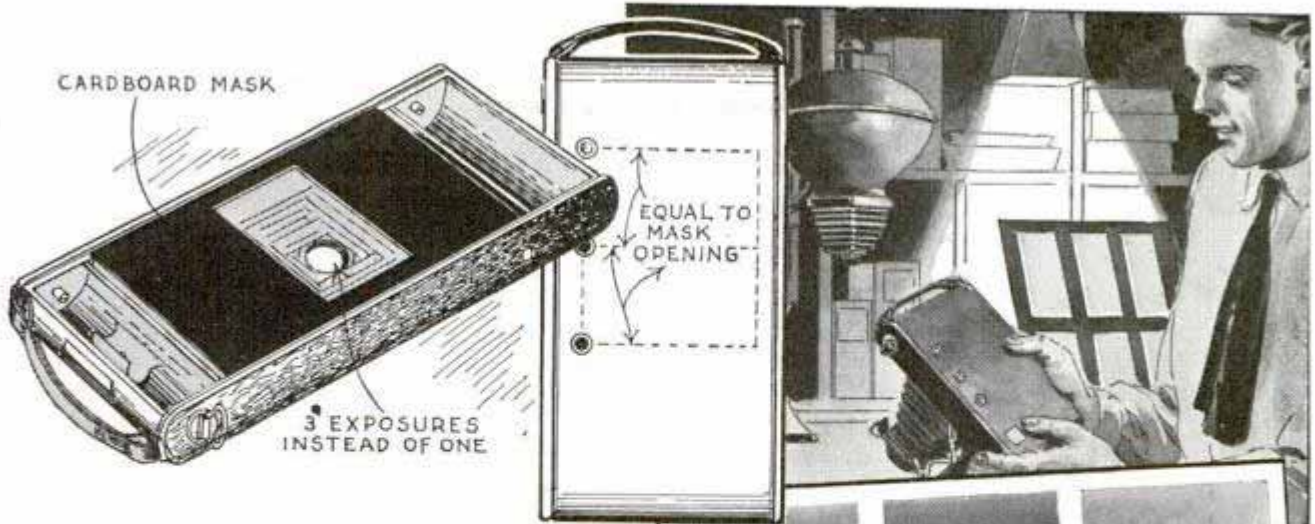

With the idea of reducing the cost of each picture, I fitted my large folding camera with a cardboard mask and two extra ruby windows. Now I get eighteen pictures instead of six on each roll of No. 122 film. The mask covers all but the center one-third of the regular picture space and is fastened in the camera with shellac. The extra ruby windows, which can be purchased at a photo-supply store, are spaced as shown in the center detail, the top one being the original window. The first exposure on a roll is made with the number 1 opposite the center window, the second



with 1 opposite the top window, the third with 2 opposite the lower window and so on. The view finder is masked with tape, leaving only the center one-third exposed.
—Lawrence Harshbarger, Superior, Wyo.

Films and Prints Dried in Dish Rack over Hot-Air Register

Both ferrotyped prints and films are dried quickly when placed in a rack like the one shown and set over a warm-air

register. Almost any size ferrotype plate will fit in the rack in the position shown and the film rack from a cut-film tank can be placed so the negatives will drain at one corner. The dish rack folds compactly and takes little space when not in use.

—John Modroch, Chicago.

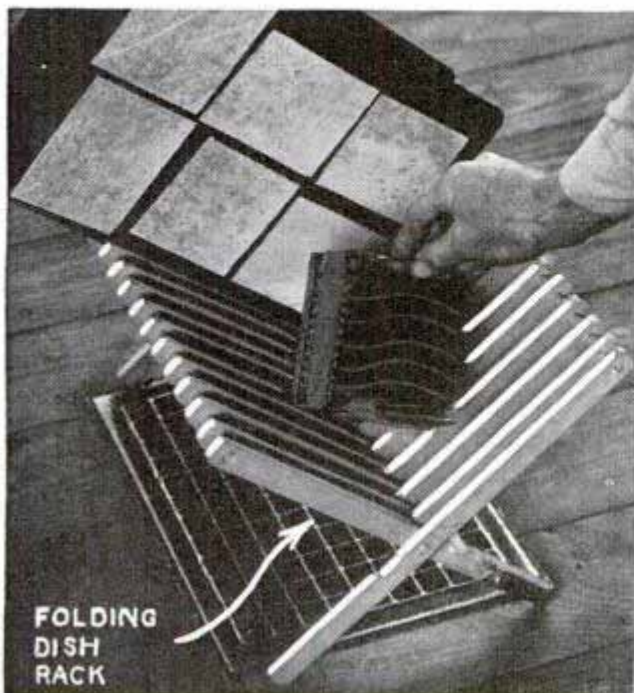

Wire Holders Adapt Single Filter to Different-Size Lenses

One unmounted filter can be used on several cameras if a wire holder is made to fit each lens. The wire should be sufficiently flexible to permit the holder to be slipped on and off the lens without being bent out of shape.—H. F. Williams, LeRoy, N. Y.

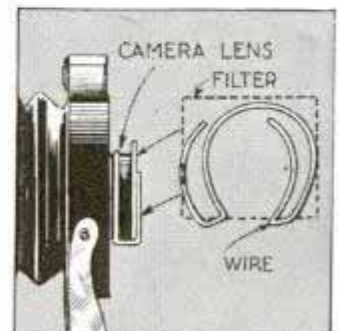

Extension Cord Wound on Cleat Soldered to Lamp Standard

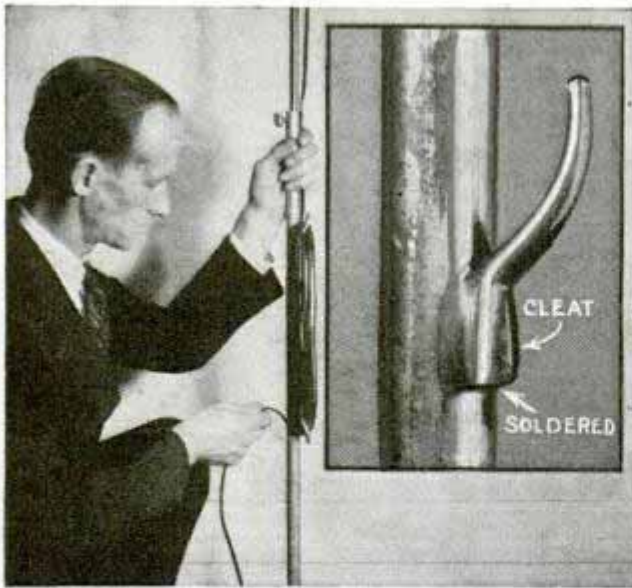

Two halves of a clothesline cleat soldered to the standard of a photo light provide a reel on which to wind the extension cord. Choose a cleat of the right size to accommodate the cord on the lamp, cut it in two, and place the halves about a foot apart on the standard.

Cork in End of Steel Print Tongs Keeps Them Out of Tray

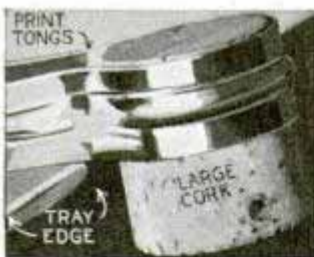

Steel print tongs won't slide into a tray when laid on the edge if a cork is fitted in the loop end. A cork from a gallon jug is just about right.

Small Strips of Colored Paper Identify Film in Holders

Green and red poster paper cut in strips is convenient for indicating the kind of film your holders contain. The strips should be about $\frac{3}{4}$ by $2\frac{1}{2}$ in. and are slipped between



the dark slide and the edge of the holder when the film is loaded. Use green for panchromatic film and red for orthochromatic. If you wish to indicate fast, medium or slow film of either kind, the strips can be cut in different lengths. Remove the paper before a picture is taken and return it afterward. Date, exposure data, or other notes can be written on the strips of paper if desired.

—Arthur Trauffer, Davenport, Iowa.

Diffuser with Two Folded Pockets Slips On and Off Reflector

In an emergency, a square of tracing cloth or other suitable translucent material folded over at two ends and stapled as shown makes a handy diffuser for photoflood lights.



It should fit loosely so it can be slipped on and off the reflector easily and so air can circulate freely around it to keep it from getting too hot.

Cut Films Wedged in Slotted Stick Developed without Scratching



Several cut films can be developed at once in a tray by this method without danger of scratching them. With a sharp knife, make a cut about $\frac{1}{4}$ in. deep on each side of a clean piece of wood. Wedge the ends of the film sheets in the slots as shown and they cannot rub together during development. If a large tray is used for developing, the stick can be made long enough to hold up to a dozen negatives.



BAND-SWITCHING

"25-Watt" for Phone and CW

COMPLETELY self-contained, this compact phone and key transmitter includes modulator and power supplies in a table-type cabinet only 20 in. long, 15 in. deep and 9 in. high. Using an 807 or an RK39 in the final stage, the power output is 25 watts on most bands ranging from 1.7 megacycles to 60 megacycles.

Coils for any three amateur bands may be plugged in, pre-tuned, and then switched at will by a

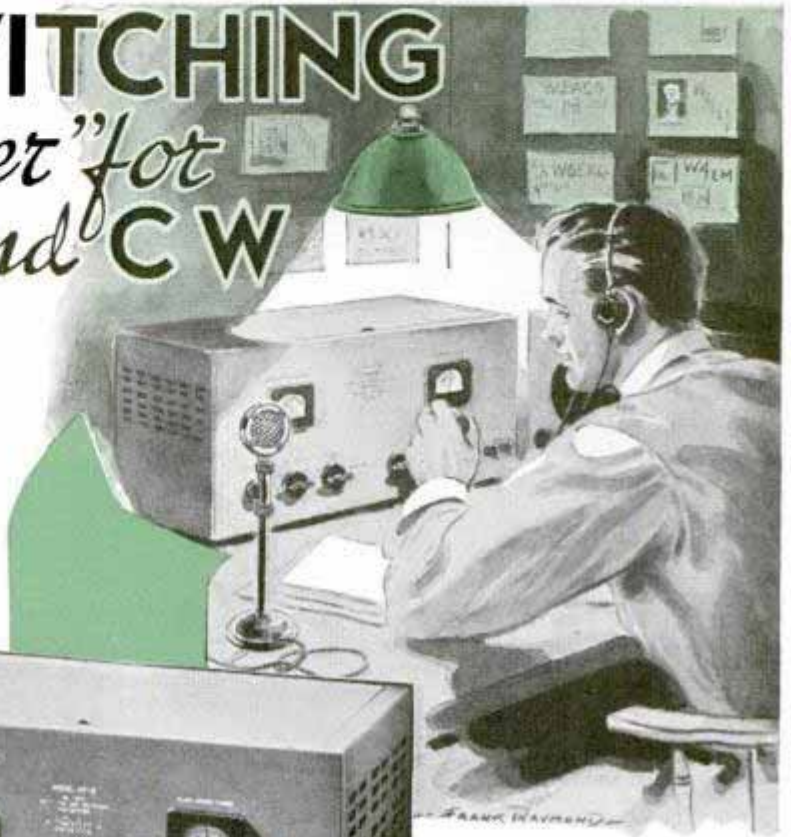

control on the front panel, which properly connects all circuits from crystal to antenna. It is only necessary

to retune the final amplifier plate. A high-level high-impedance microphone may be used. The output circuit is adjustable to match any type of standard antenna resistive load of from 10 to 600 ohms. Operation is normally from 115-volt a.c. line; however, provision is made for connecting external generator or vibrator supply units for operation from battery or other d.c. sources.

Tubes employed: 1-6L6 oscillator-doubler; 1-RK-39 or 807 final r.f. amplifier; 1-6F5 microphone amplifier; 1-6J5 audio amplifier; 2-6L6G modulators and 2-5Z3 rectifiers.

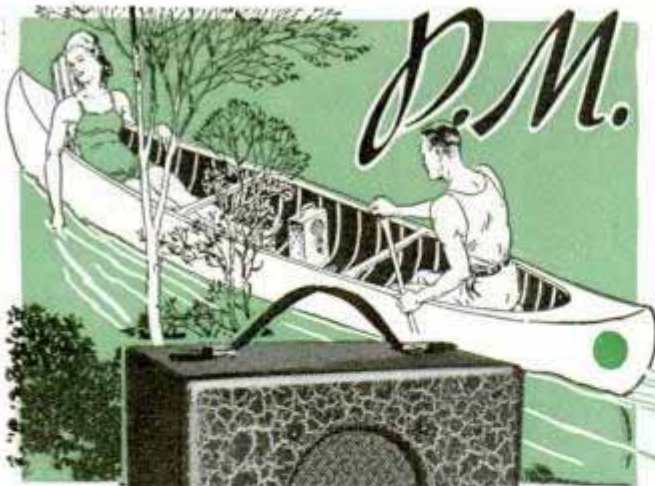

PORTABLE

By F. M. Lund

ONE combination plug-in A and B-battery operates this highly efficient portable vacation receiver for more than 200 hours. Complete in every detail, entirely self-contained and easily portable, it can be operated anywhere in trains, boats, camps, summer homes or on the lawn or beach, without external antenna or ground connections.

When tested and checked for this construction article, the night range with built-in loop antenna was in excess of 1,500 miles. Provision has been made for the use of an external antenna in locations remote from broadcasting stations during daylight hours, but was not required for powerful stations within a 100-mile range. This unusual sensitivity is due to the full superheterodyne circuit, and to strong directional loop effects easily obtained by rotating the cabinet until reception from the desired station is favored. Automatic volume control, permanent-magnet dynamic speaker and four of the new 1.4-volt tubes that draw a total of only 12 ma. from the battery, all contribute to provide excellent tone and good volume.

The cabinet and metal base are detailed in Fig. 1, and clearly shown in photos A and B. The battery compartment is designed to hold a type 60A-2L General "A" and "B" combination pack firmly, and is

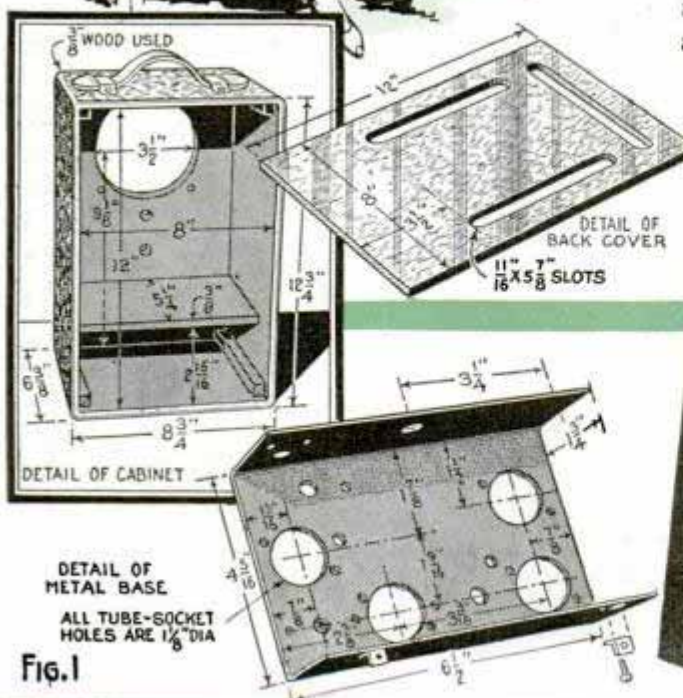

BATTERY-OPERATED *Vacation Receiver*

easily accessible. One battery plug and a short length of 4-conductor cable, make all connections automatically, as shown in the simplified wiring diagram Fig. 2; if separate leads are used, tape them together. This diagram presents an underside view of the metal base and shows every lead continued on to the parts that are mounted above. A schematic circuit diagram is given in Fig. 3; these diagrams, with photos C, D and E, show every construction detail. The volume control is the only variable resistor employed. This is a 1-megohm "Centralab" or "Stackpole" type with a double-pole single-throw switch built in. This switch controls both the "A" and "B"-battery supply, and the switch terminals are carefully labeled in diagram Fig.

(Continued to page 134A)

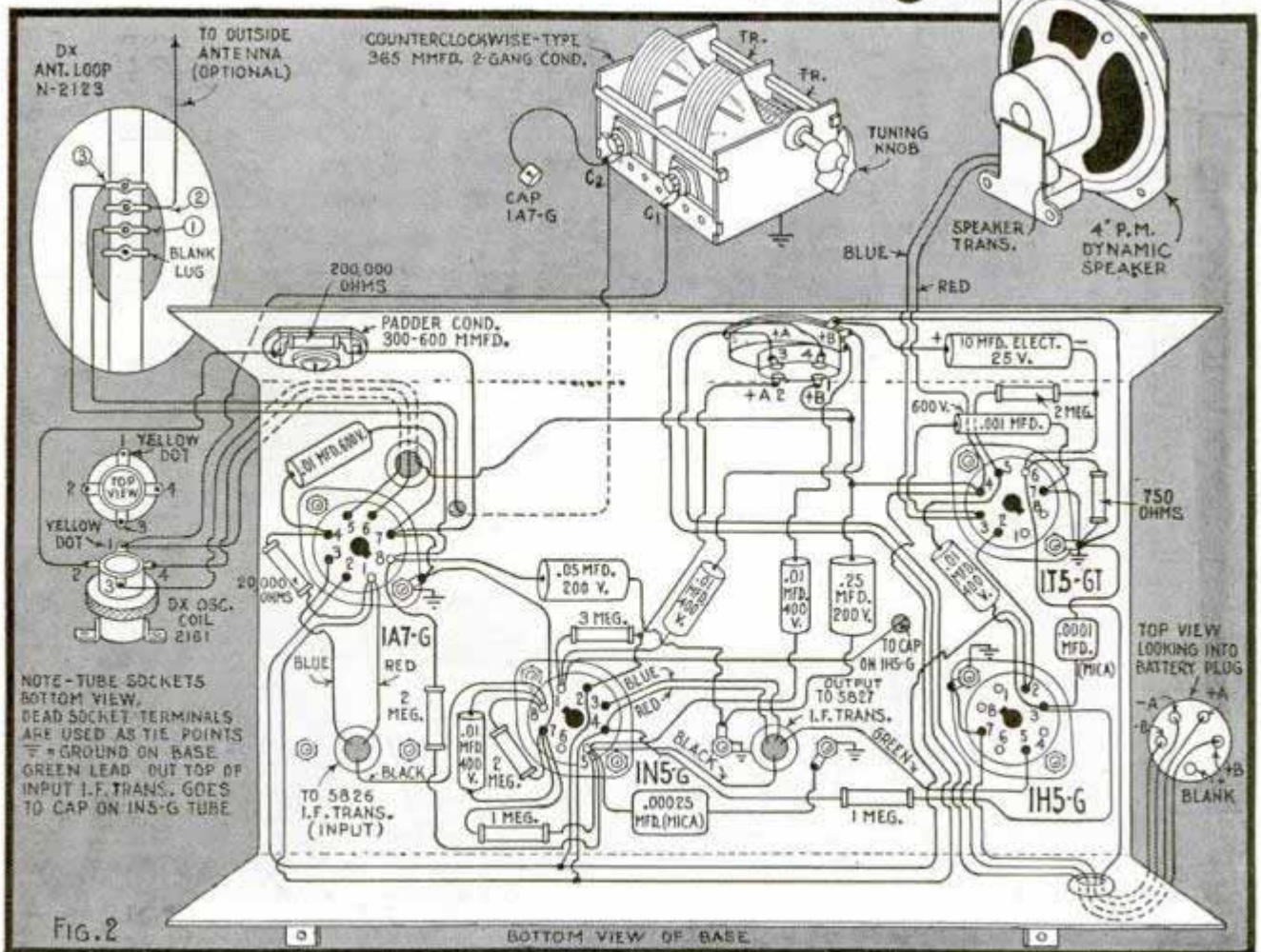

Improving Tone of Console-Type Receivers

ANY radio serviceman will tell you that the ideal location for a large console is across a corner in the room. In this position plenty of air space is available for the tones coming out of the back of the loud speaker. These sound waves, if properly controlled, add much to tone quality.

Owners of large consoles can obtain excellent results by installing a panel of 1-in. soft pressed wood from the top back of the set up to the ceiling. Outlet holes may be located near the top of the panel so that the sound waves have to travel as far as possible before emerging into the room. The front of the panel is covered with cloth or loosely woven tapestry to hide the outlets. The area of the outlet holes should add up to roughly 1½ square feet. A further improvement in fone quality may be obtained by making the sound waves travel down various sizes of tubes made of the same material as the panel and glued in position as indicated in Figs. 1 and 2; dimensions are not critical. The largest tube should be 7 or 8 in. square and each succeeding tube should be one-third smaller both in length and diameter. Panel is framed with 1-in. cove molding placed back to back to a piece of 1-in. quarter-round molding carefully mitered to fit snugly after cloth is placed over panel. Triangular spaces between cabinet and wall may be left as is, or closed in with shelves for logs or record albums as indicated in Fig. 1 and photos.

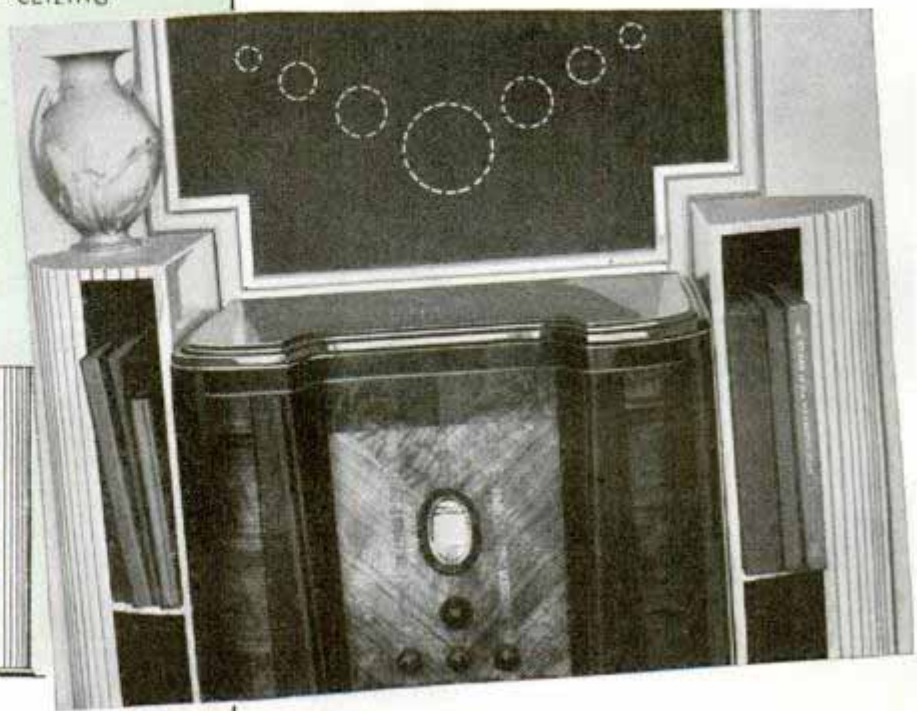
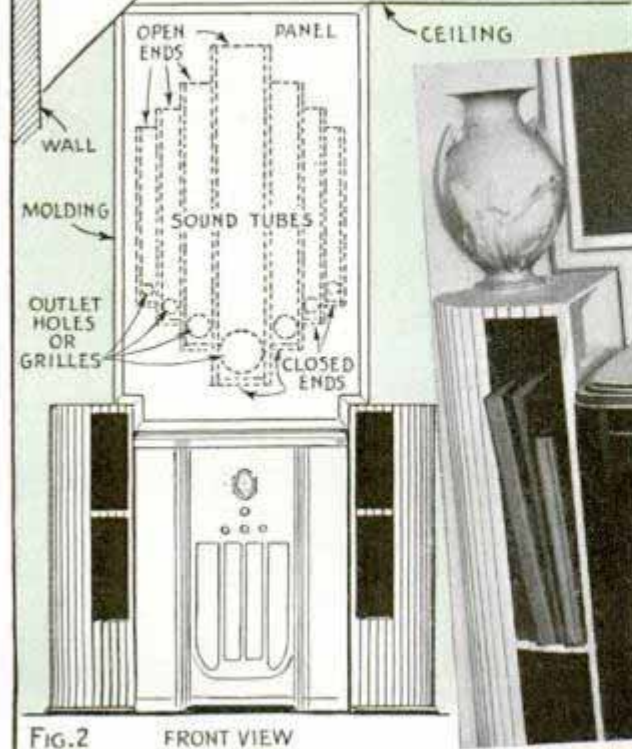
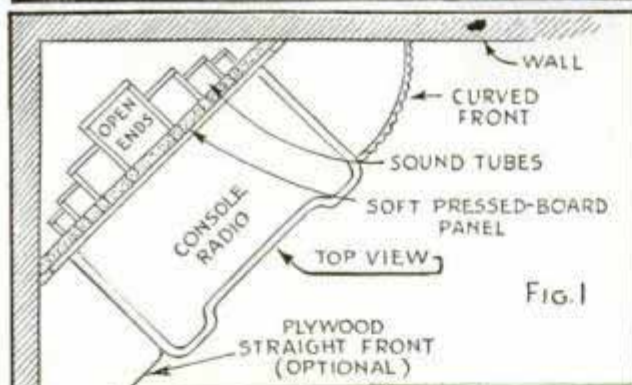
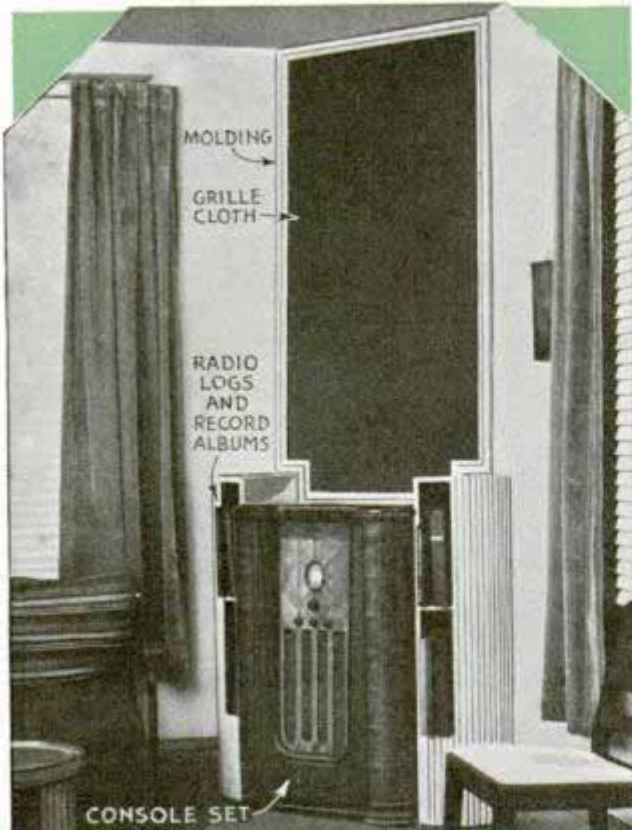

American Radiotelec. Corp
1250 W Van Buren Chicago

Practical RADIO HINTS

Fig. 1, ordinary permanent-magnet dynamic speaker, with universal transformer to couple to grid of first audio amplifier tube, makes practical low-cost "speaker-microphone" for home broadcasting and amateur use. Efficient operation depends on proper baffling

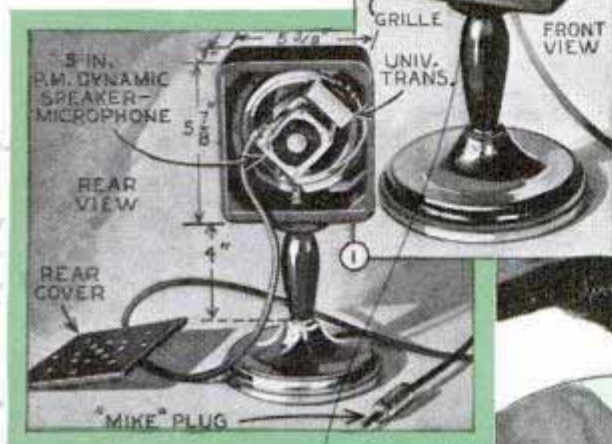

Above, cutting grille opening for front of "speaker-microphone" baffle case; grille is backed with cloth and case is mounted on an old-lamp or "mike" stand. Holes are drilled in rear cover by cut and try method; start with 3 or 4 and increase until natural voice-frequency response is obtained

Photo, Fig. 2, shows tiny 5 and 6-prong tube sockets and retainer ring designed for the new "Bantam Jr." tubes now available for portable hearing-aid circuits, pocket-type receivers and compact testing equipment. Fig. 3, tin funnel soldered in end of ground pipe so that water may be added easily as required to provide sufficient moisture to insure a good radio ground in dry, sandy localities where efficient ground connection is difficult to obtain

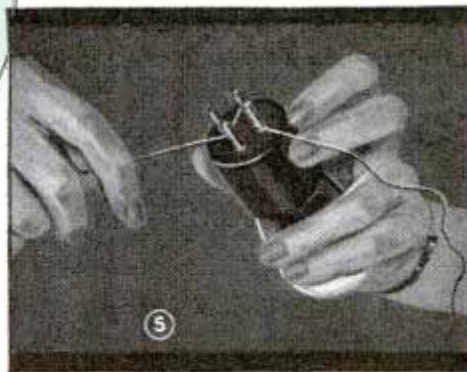
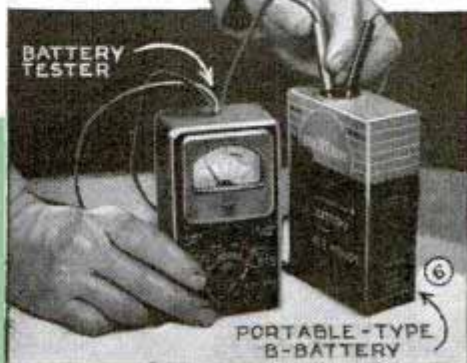
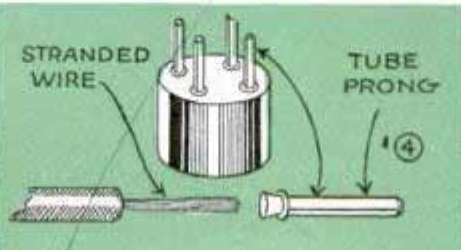

Fig. 4, prongs taken from an old tube base make neat cord tips to fit clips or tip jacks; tin wire, insert and apply heat to prong. Fig. 5, kinks and twists in coil wire quickly removed by pulling wire through prongs of a tube base. Fig. 6, pocket-type dry battery checker and voltmeter tests all dry batteries under load



6.216 Riggie
Cherry

Frequency-Modulation Receivers

for operation from any 110-volt a.c. line to avoid unnecessary battery drain while in service at a dock. Five crystal-controlled transmitting frequencies are available, also five corresponding receiving channels.



Wide Range Signal Generator

Providing accurate test signals for lining up any type of radio receiver, this a.c. operated signal generator has a range of from 75 kilocycles to 30 megacycles.



Special-Purpose Television Tubes

Iconoscope photo A, is a special form of cathode-ray tube used in television transmission for "picking up" a scene and con-

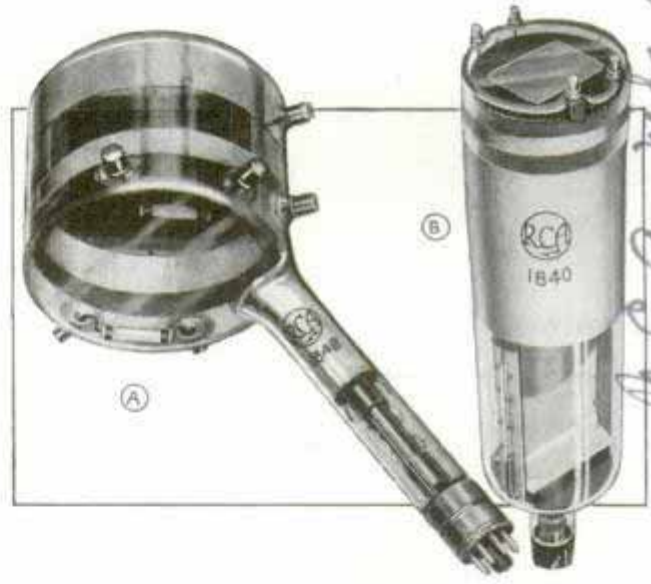

Although both of these receivers have the general appearance of standard table-top and console instruments, they are designed to receive the new "staticless" frequency-modulation programs now on the air in several states. The small set is for the 39 to 44 megacycle FM band only; the console set covers FM, short-wave, police-amateur and standard broadcast.

Marine 'Phone' for Battery or A.C.



This small craft radiophone transmitter and 7-tube superheterodyne receiver operates on the boat's battery, but by interchanging one plug, provision is made

verting it to an electrical signal. Small in size, it is used in portable television cameras. Orthicon, photo B, is for direct pick-up and pickup from motion-picture film.

Blueprints covering radio construction articles in this and past issues are available for 25 cents each. Original material lists, with names of manufacturers and dealers, can be obtained from our Radio Department upon receipt of postage.

NEXT MONTH—Beginner's "Mighty Midget" One-Tuber for Short Waves. This simple, compact and inexpensive short-wave receiver takes full advantage of the sensational new type-1D8GT, 1.4-volt battery tube, and is a real distance-getter. Also—**How to Build a Volume Expander Unit;** for improving tone of any amplifier

Isenpal Electric Co
570 Lexington Ave, N.Y.C.
Cherry
26 Hudson St.
Bellcrafters Inc.

Simpson & Co

Harman Int'l
MCA Int'l Co



SHOP NOTES

Circulating PUMPS *of flat metal*

Refer to Shop notes.

USEFUL for numerous purposes in the shop, laboratory, or darkroom, a small circulating pump such as shown in Fig. 1, can be built out of sheet brass or aluminum. No castings are required. A motor, from $\frac{1}{32}$ to $\frac{1}{4}$ -hp., is needed, depending on the size of the pump, three sizes being covered in the table Fig. 7.

The body is made from three square brass plates, as indicated in Fig. 1. Dimensions are indicated by letters, which are used when referring to the table. Find the letter corresponding to the dimension from the illustrations, and then obtain its numerical value for the proper size pump from the table. The thickness of the center block is indicated by "B" in Fig. 2. In assembling the pump the three pieces are clamped together and drilled at the corners for machine screws. For pumps of the large size additional screws should be

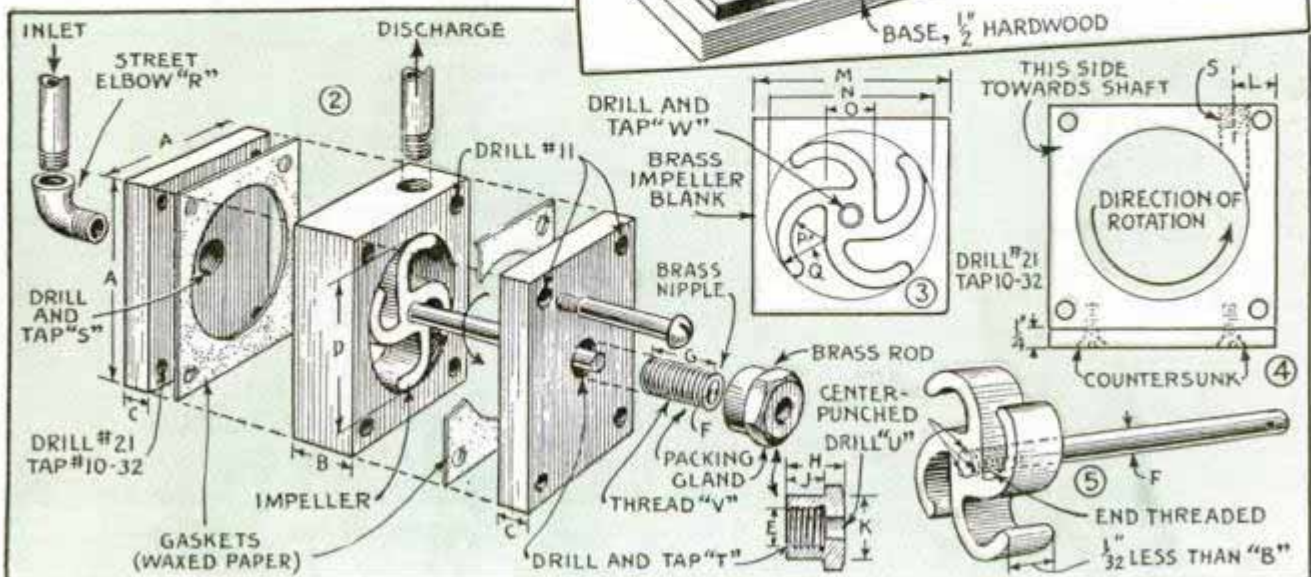
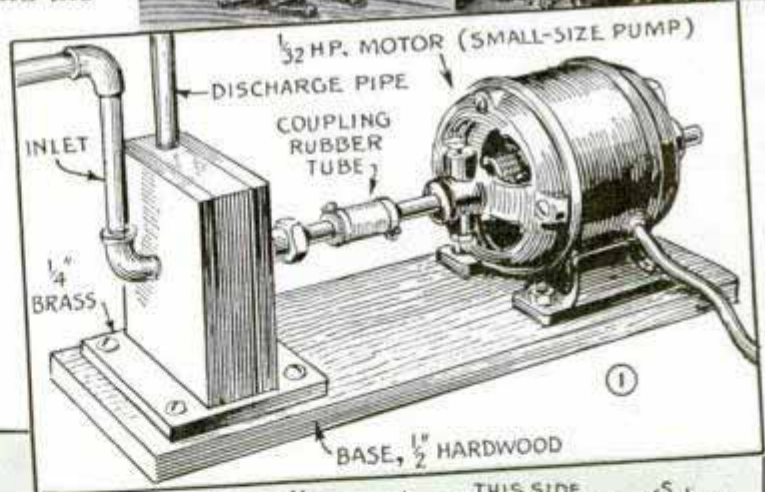

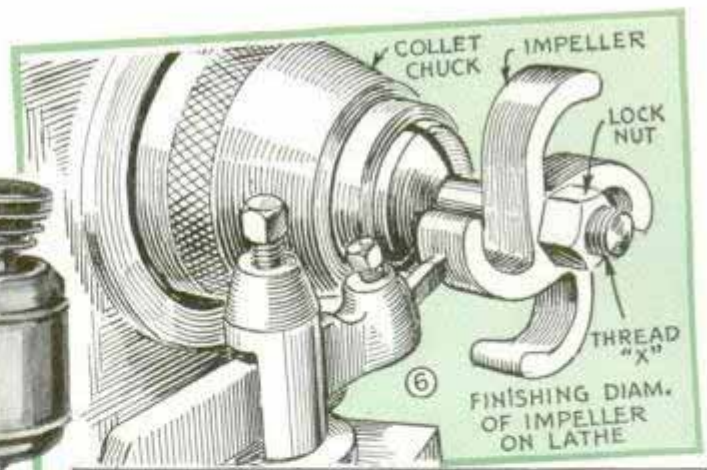
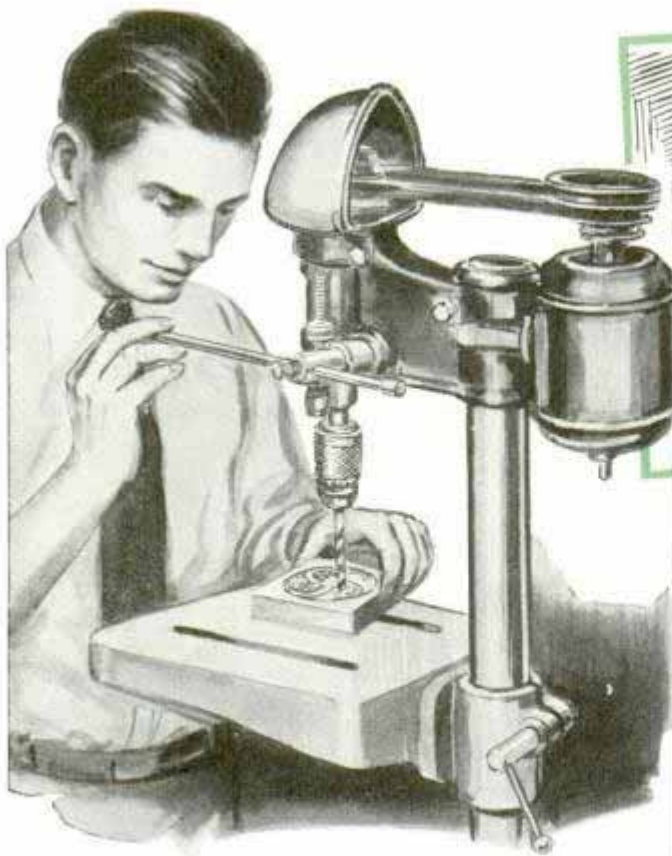

used at the center of each side. The plates are screwed together in proper alignment, and a pilot hole is drilled at the center, after which the plates are taken apart. One outside plate is drilled centrally and tapped "S" for a street elbow of the proper size. The second outside plate is drilled centrally and tapped dimension "T." The bearing for the shaft is a piece of seamless brass tubing having an outside diameter, "E," and an inside diameter, "F," which equals the shaft diameter. The outside of the bearing is threaded "V," and is to be screwed in place.

The center block is bored out to dimension "D" to receive the impeller. A pilot hole is used as a guide to keep this central, and the hole is bored in the lathe. After it has been bored, the discharge hole is drilled, it being located by using the reference letter "L" in Fig. 3. Drill and tap "S" for a pipe nipple, which is screwed in place to serve as the discharge pipe. In the bottom of the center block, drill and tap two holes for machine screws for attachment to the base.

The construction of the impeller is indicated in Figs. 3, 5, and 6. Fig. 3 shows a piece of brass of proper size from which the impeller is cut. On the small pump this piece must be $\frac{1}{32}$ in. thinner than the thickness of the center block of the pump body. For the larger pumps this clearance can be

⑦ DIMENSIONS OF PARTS (in inches)

References to drawings	Motor Horsepower		
	$\frac{1}{2}$ to $\frac{3}{8}$	$\frac{3}{8}$ to $\frac{1}{2}$	$\frac{1}{2}$ to $\frac{3}{4}$
A	3	$4\frac{1}{4}$	5
B	$\frac{1}{2}$	$\frac{3}{4}$	1
C	$\frac{3}{4}$	$\frac{1}{2}$	$\frac{3}{4}$
D	$2\frac{1}{8}$	$3\frac{1}{2}$	$4\frac{1}{4}$
E	$\frac{3}{8}$	$\frac{1}{2}$	$\frac{5}{8}$
F	$\frac{1}{4}$	$\frac{3}{8}$	$\frac{1}{2}$
G	$\frac{3}{4}$	1	1
H	$\frac{1}{2}$	$\frac{5}{8}$	$\frac{3}{4}$
J	$\frac{3}{8}$	$\frac{1}{2}$	$\frac{1}{2}$
K	$\frac{5}{8}$	$\frac{3}{4}$	$\frac{3}{4}$
L	$\frac{5}{8}$	$\frac{5}{8}$	$2\frac{1}{16}$
M	2	$3\frac{1}{4}$	4
N	$1\frac{1}{4}$	$3\frac{1}{16}$	$3\frac{7}{8}$
O	$\frac{1}{2}$	$\frac{7}{8}$	$1\frac{1}{8}$
P	$\frac{3}{8}$	$1\frac{1}{16}$	$1\frac{1}{8}$
Q	$\frac{1}{2}$	$\frac{7}{8}$	$1\frac{1}{8}$
R	$\frac{1}{8}$	$\frac{3}{8}$	$\frac{1}{2}$

Drill, Tap and Thread Sizes.

S	$\frac{1}{8}$ pipe tap	$\frac{3}{8}$ pipe tap	$\frac{1}{2}$ pipe tap
T	$\frac{3}{8}$ -20 tap	$\frac{1}{2}$ -13 tap	$\frac{5}{8}$ -11 tap
U	$\frac{1}{4}$ drill ream to fit	$\frac{3}{8}$ drill ream to fit	$\frac{1}{2}$ drill ream to fit
V	$\frac{3}{8}$ -20 thread	$\frac{1}{2}$ -13 thread	$\frac{5}{8}$ -11 thread
W	No. 7 drill and $\frac{1}{4}$ -20 tap	$\frac{3}{8}$ drill and $\frac{3}{8}$ -16 tap	$2\frac{3}{4}$ drill and $\frac{1}{2}$ -13 tap
X	$\frac{1}{4}$ -20 thread	$\frac{3}{8}$ -16 thread	$\frac{1}{2}$ -13 thread

increased to $\frac{1}{16}$ in. The central hole of the impeller is drilled and tapped, "W," to fit on a cold-rolled steel shaft which is threaded at one end, the threaded end projecting to take a lock nut. Then the impeller is turned down to the finished diameter "N," Fig. 6. Excess metal is removed by drilling, sawing, and filing, the shaft being removed temporarily. When the impeller is finished it is screwed onto the shaft, the end of which is sawed off, and the impeller is pinned permanently in place by striking with a center punch, Fig. 5.

The pump can now be assembled. The shaft is slipped through the bearing, wrapped with graphitized packing, and the gland is screwed down. The center section of the pump is screwed to the base and the two end plates are put in place. Gaskets will have to be used between the sections

of the body. If the pump is to be used for handling water, brown paper cut to the proper size and shape and impregnated with oil will make a suitable gasket. For other liquids the gasket will have to be chosen accordingly. Shellac is frequently used to impregnate a paper gasket where oiled paper would not be satisfactory.

The completed pump is mounted on a suitable base together with the motor which drives it. In operation, it is essential that the pump be full of liquid at all times. It is not self-priming and must be filled before operation is begun. If air gets into the pump, it will have to be primed again. It is best to place the pump at the lowest point in the circuit, so that it will tend to clear itself of air.

Pipe Wrench Serves as Vice



Not having a pipe vise at hand to hold a length of pipe while threading it, one mechanic used a pipe wrench locked in a bench vise. A second wrench slipped over the pipe near the outer end, so that the end of the handle rests against the bench top, will help hold the pipe rigidly.

WHAT HAVE YOU DONE?

Have you solved some troublesome everyday problem of a mechanical nature pertaining to your home, work or occupation, your hobby, play or recreation? If so, why not send a short description and a sketch or photo to our Homecraft Editor. Many other readers might benefit from what you have done. We pay promptly for accepted material.

Valves Changed in Storage Tank Without Draining It

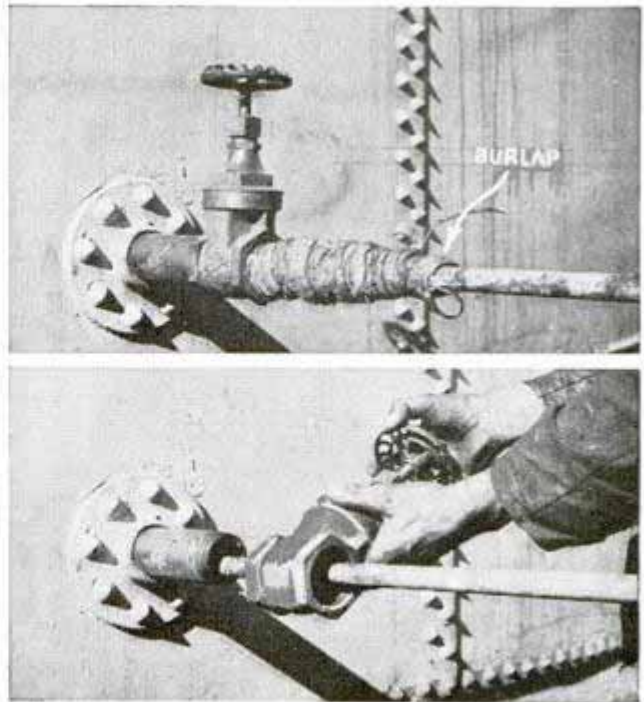

Defective globe valves on large tanks can be renewed or repaired without draining the tank by using a swab as shown. This is made by wrapping a burlap sack around the end of a length of small pipe. In use, the swab is started into the valve, which is then opened and the swab pushed into the pipe or nipple close to the tank. The swab plugs the line so that the valve can be removed. Oil that leaks past the swab can be caught in a pail. After replacing the valve, the swab is pulled out.

Rubber Tube Shields Dividers

Points of large dividers and compasses can be protected by merely slipping short lengths of small rubber tubing over them as indicated. Corks and bits of rubber usually used for this purpose on small dividers are of little use on the larger ones, carried in a box with other large tools.

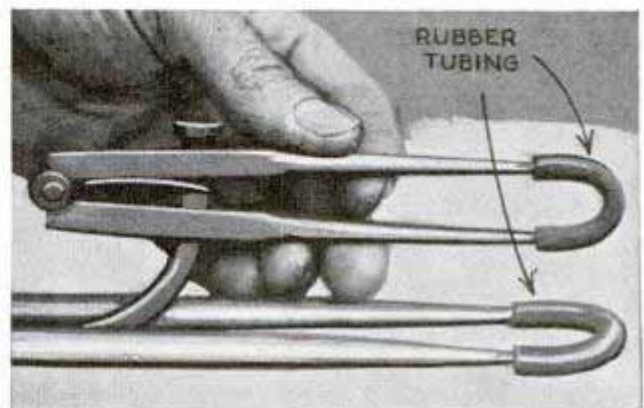

Rubber 'Saddlebag' Hung on Wire Holds Lineman's Tools

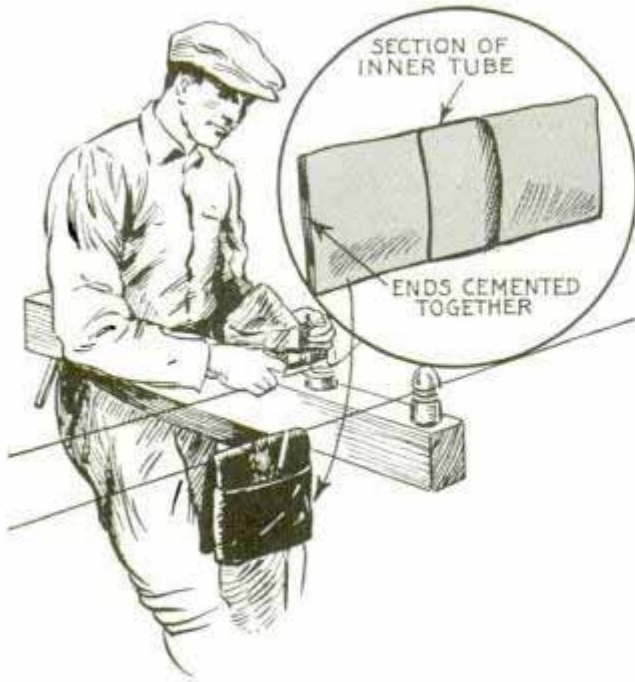

The inconvenience often experienced by electricians and linemen of removing their tools from a belt while working at the top of a pole or while working among many wires, is avoided with this saddlebag. It is made from a section of inner-tube, cut and cemented as shown, and when hung on a wire, two tool pockets are exposed.

Inverted Pail Covers Tether Peg to Protect Animal

To prevent a tethered animal from injuring itself on the peg, just invert a pail over the peg. If the top of the peg has become mushroomed by frequently driving it

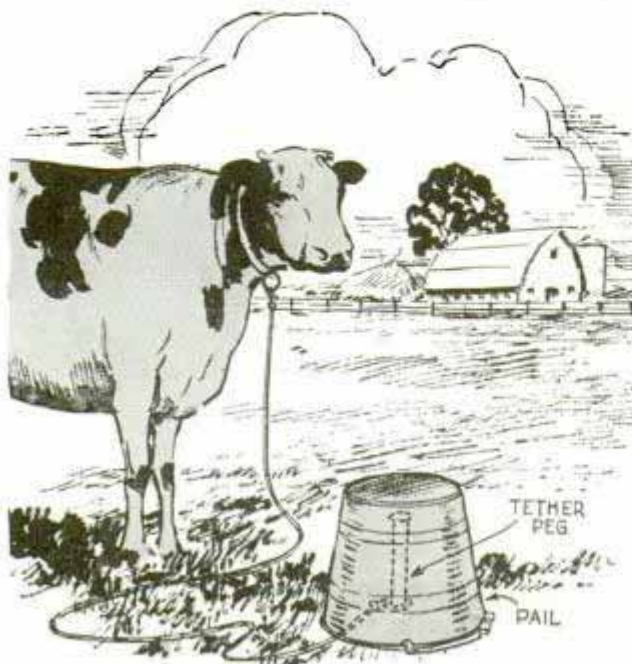

into the ground, the animal is almost sure to injure its leg on the jagged edges unless they are covered.

Spring Avoids Jerk on Chain of Electric-Light Socket

In shops and other places where lights are sometimes controlled by long pull chains, breakage caused by jerking the chains too hard can be avoided by putting a small coil spring in each chain or cord. Pieces of a light screen-door spring are just the thing for this purpose.



Desk Penholder Shows Date and Day of the Month

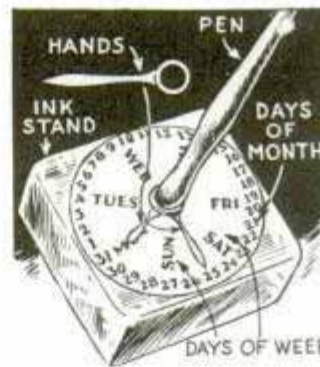

Mounted on the base of your desk penholder, this calendar shows the date at a glance when you pick up your pen to write. The calendar is a paper disk numbered around the edge from 1 to 31 with the days of the week printed on the face as indicated. Pointers or hands like those of a clock are pivoted to the holder. Each morning, they are set to show the date and the day of the week.

Mower Guards Cleaned with Wire

Gum on mower sickle guards that is caused by juices from grass and weeds mixing with dirt can be removed easily with a length of cable-type clothesline. This is pulled back and forth in the slot of the guard as indicated, the rough surface of the clothesline quickly scraping the gum loose.



Non-Chatter Tool for Grooving Metal Disks

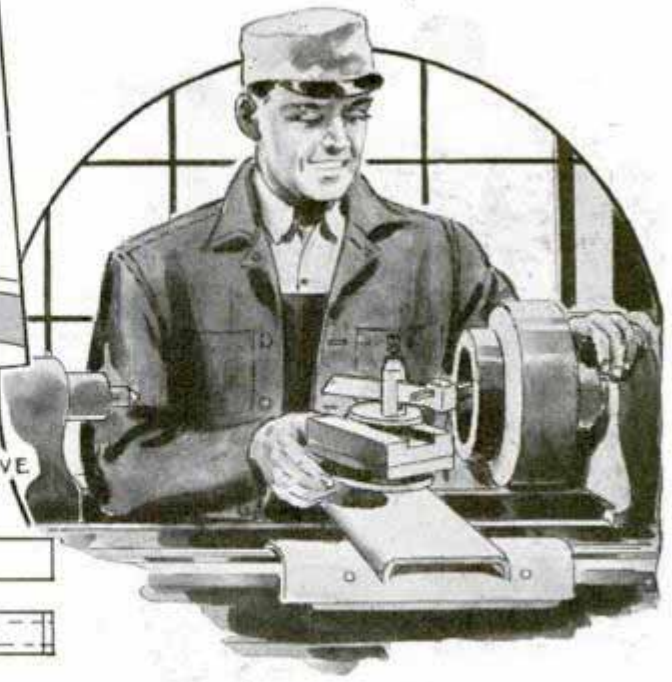
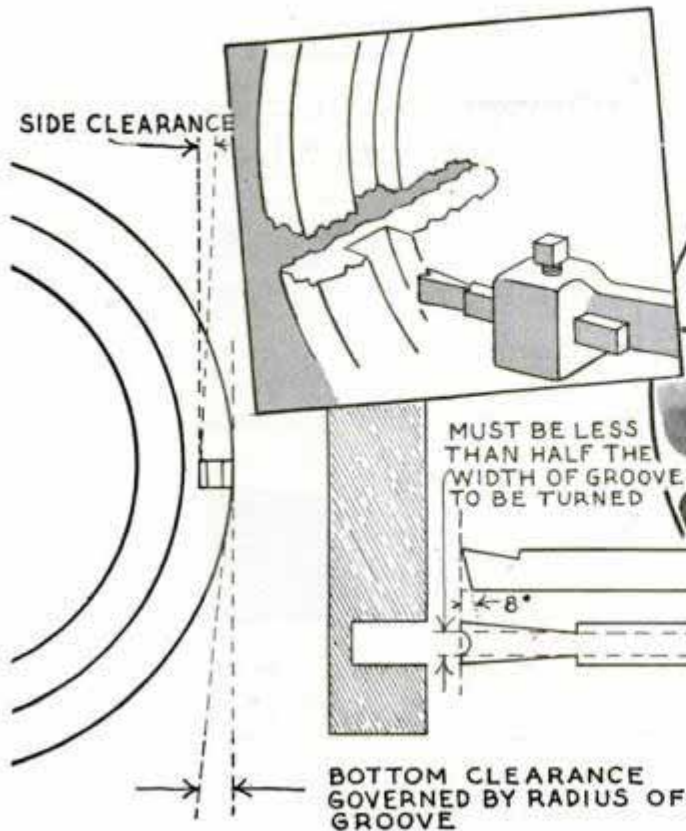

Then, by feeding the tool radially back and forth across the groove, with the crossfeed of the lathe set to suitable stops, a perfectly smooth groove results and there is no tendency to chatter. The distance between the two cutting edges of the tool should be less than half of the width of the groove to be turned. This permits the tool to be moved radially to avoid leaving a ridge in the bottom of the groove as it is cut.

—E. B. Davenport, Ross, Calif.

This Jig Supports Round Work Vertically to Drill the Ends

Capable of gripping round work varying in diameter from $\frac{1}{32}$ in. to $\frac{1}{2}$ in., this jig was made to support rods and pins in a bench vise or vertically in a drill press for drilling holes in the ends. Made of steel, the jig consists of two jaws bolted together at the ends, short coil springs being slipped over the bolts and held by collars to keep the jaws spread slightly for easy insertion of the work. In use, the jig is clamped in the drill-press vise, the jaws of the latter forcing the jaws of the jig to grip the work tightly. Notice that the outer edges of the jig are flanged to rest flatly on the upper surfaces of the vise jaws. The depressions ground in the facing edges of the jig to form holes when the jaws come together, must be slightly smaller than one-half the diameter of the work to be gripped so that the latter will be clamped tightly before the jaw edges touch.

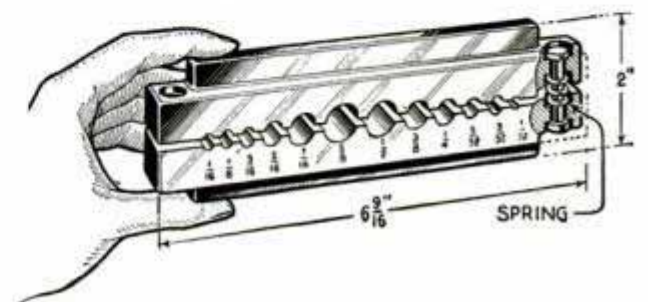
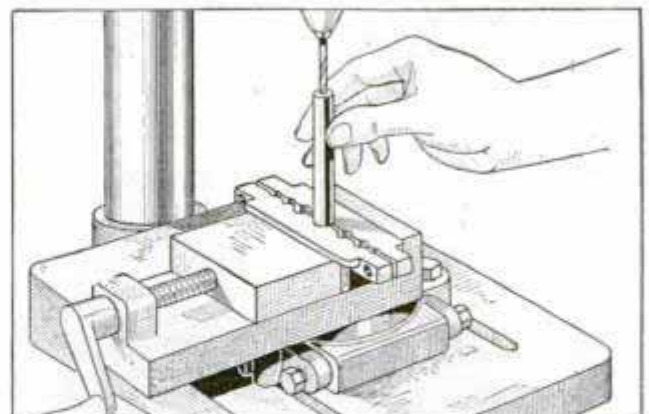

Cabinet Hooks on Stepladder Legs Support Plywood for Sawing

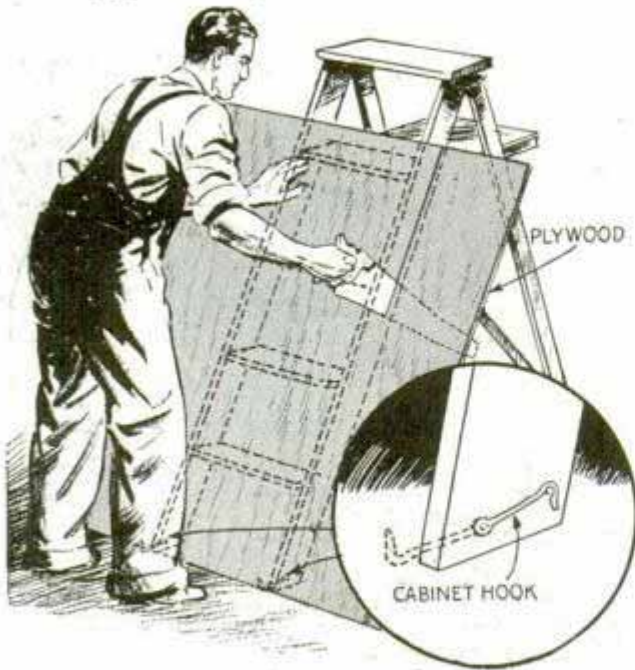

To hold wide sheets of plywood conveniently for sawing, one carpenter has a pair of cabinet hooks attached to the bottom of the legs of his stepladder. When the hooks are turned outward, they engage the edge of the plywood sheet to hold it, and when not in use, the hooks are turned back over tacks driven into the legs.

Roller Jig Makes Welder's Work Easy to Handle

This jig makes the welding of tractor track rollers and similar work easy. The jig consists of two 6-in. metal rollers 18 in. long, mounted on a stand of angle iron and pipe welded together. A chain and two sprockets are used to rotate the rollers, which turn the work as desired. A wheel



from a child's tricycle welded to the hub of one of the sprockets serves as a hand-wheel.—Jos. C. Coyle, Yuma, Ariz.

Blowtorch Kept from Tipping by Spring Hook

To keep a blowtorch from tipping or being overturned on his bench, one tin-smith uses a spring hook similar to the one shown. The hook passes through a hole in the bench, and a coil spring slipped over it holds it down until it is pushed upward to engage the hole in the filler plug of the torch.

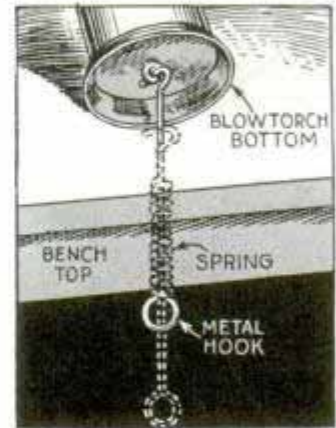

Sandpaper "Needle" to Thread Tape on Newspaper Folders



To save time in replacing tape or fabric belts on newspaper folding machines, one printer uses a sandpaper "needle" to thread the belt through the various pulleys. The needle is a strip of sandpaper folded over the end of the belt.

Screw Aids in Setting Dividers

Driven into your workbench in an out-of-the-way place, a round-headed screw provides a stop, which helps in setting dividers and calipers with the aid of a scale. One side of the screw head is filed away flush with the bottom of the slot. In use, the scale and one leg of the dividers are rested against the screw head as indicated.



—Frank Bentley, Clinton, Ia.

"Split-second" SOLDERING

new fluxes - new solders - new methods

By ALEXANDER MAXWELL

KEEPING abreast with the development of numerous new alloys, solders and fluxes especially prepared for use with these alloys have been put on the market, and are available to every shop man, craftworker and experimenter. Since the advent of these special solders and fluxes, the previous specific distinction between "hard" and "soft" solders has become practically obsolete and is now merely a general distinction between groups of solders, while the individual solders have highly specialized uses for certain definite purposes. Several of the new alloy solders have proved so phenomenal in application that they have opened fields which were until recently the exclusive "property" of riveting and welding. To avoid confusion, manufacturers are labeling the solders and fluxes according to their exact purpose and method of application. Those for the base metals and alloys are stocked by mill-supply houses; those for the precious metals by dealers in jewelers' supplies and equipment.

Aluminum Soldering: Aluminum has defied soldering most persistently of all popular metals. When aluminum is heated, an invisible layer of oxide is formed on its surface, which prevents ordinary solder from reaching the metal. A special oxide-cutting flux and a solder of zinc alloy have solved this problem if the proper method is applied carefully. Take for example a leaky aluminum pan: The surface to be soldered must be cleaned thoroughly with steel wool and then with emery cloth, after which the dust is brushed away and a generous drop of liquid flux is applied to the metal around the hole. With a torch, the metal is heated until the flux boils as indicated in Fig. 1, taking care that the flame does not touch the flux. As aluminum conducts heat very rapidly, a blowtorch, either of the alcohol or gasoline type, which provides intense heat, should be used. The flame is played on the surface in a circular

Special flux used for soldering aluminum is heated by playing a blowtorch flame on the metal around the flux so that the latter will not burn. The flux lifts up the oxide from the metal and the solder is applied the instant that the flux goes up in a puff of smoke

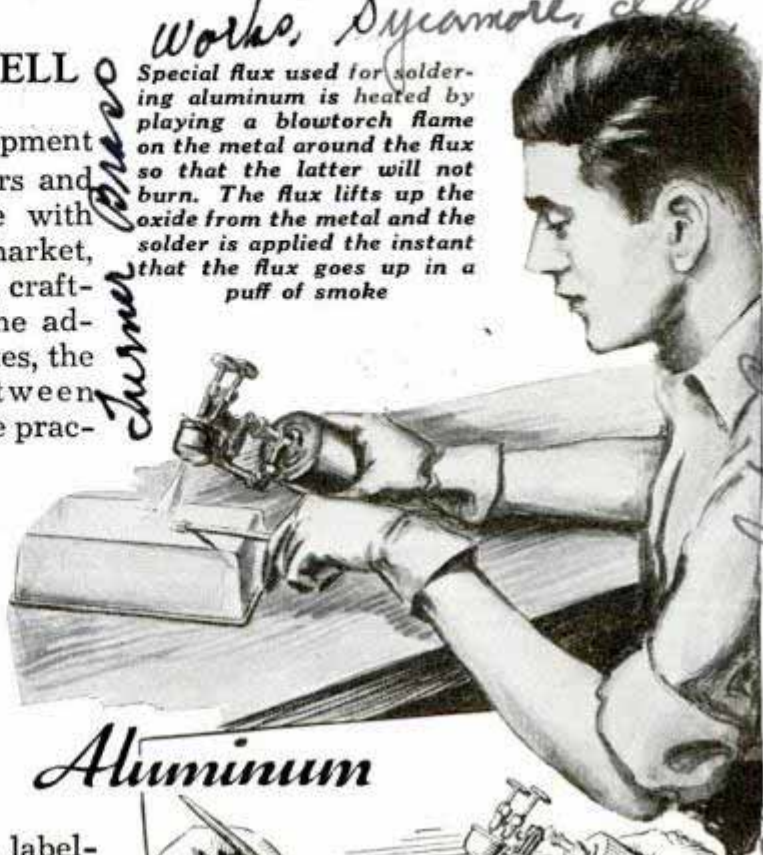

Aluminum

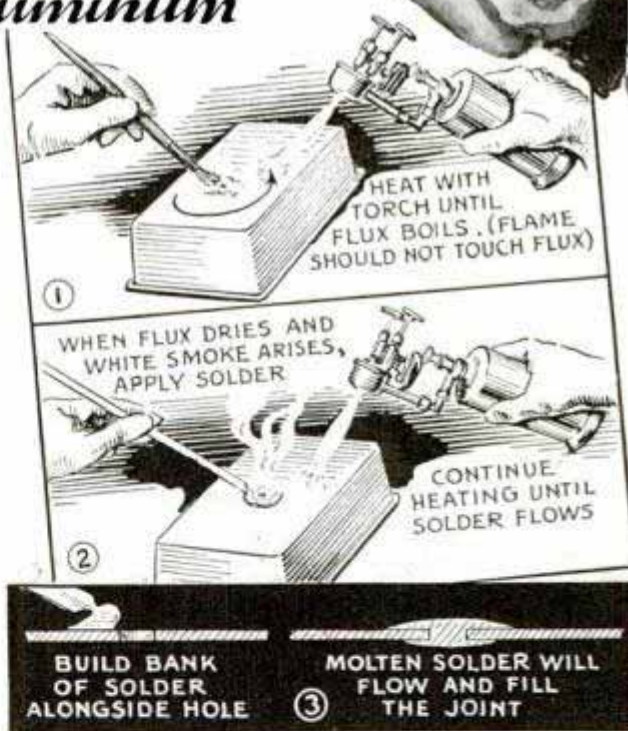

path as indicated by the arrow, until the flux boils. The flux lifts the oxide, but a single breath of the flame will replace it, so be sure to keep the torch moving well back from the hole. When the flux has boiled dry, it will suddenly go up in a puff of white smoke. Have your solder stick ready and apply it the instant the smoke appears as in Fig. 2. Keep on heating the

C. E. Marshall

Turner Press

Worke, Dymore, etc.
Aluminum sold by G. J. J. Co. Parkersburg, W. Va.
2241

Fills for broken castings



④
SMALL CRACKS
ON ALUMINUM
CYLINDER HEADS

Cracked Cylinder Heads: Many cracked cylinder heads can be repaired for less than it would cost to replace them. Cast metal, be it iron or aluminum alloy, resists ordinary flux, but yields to a penetrating liquid which "bores" down into the metal itself, allowing the solder to knit in a positive bond. First, you chip a V-groove along the edges of the fracture as in Fig. 5, then preheat the entire head slowly and evenly in an oven or with a heavy-duty torch as in Fig. 6, until the metal gets hot enough to melt solder when touched to it. When pre-heating, be sure to keep the flame away from the chipped portion. As soon as solder will melt on contact, the flux is applied. In the case of an iron cylinder head, the solder is applied as the flux boils away. In case of an aluminum cylinder head, solder is applied when the flux smokes. Then, by means of a wooden tamper, you ram the semi-liquid solder well down into the crack as shown in Fig. 7. Go over the crack repeatedly, building up and ramming the solder into it until it will take no more. Use extreme care not to warp the cylinder head by uneven heating or too rapid cooling. After it has cooled, the job is cleaned up by scrubbing thoroughly with a

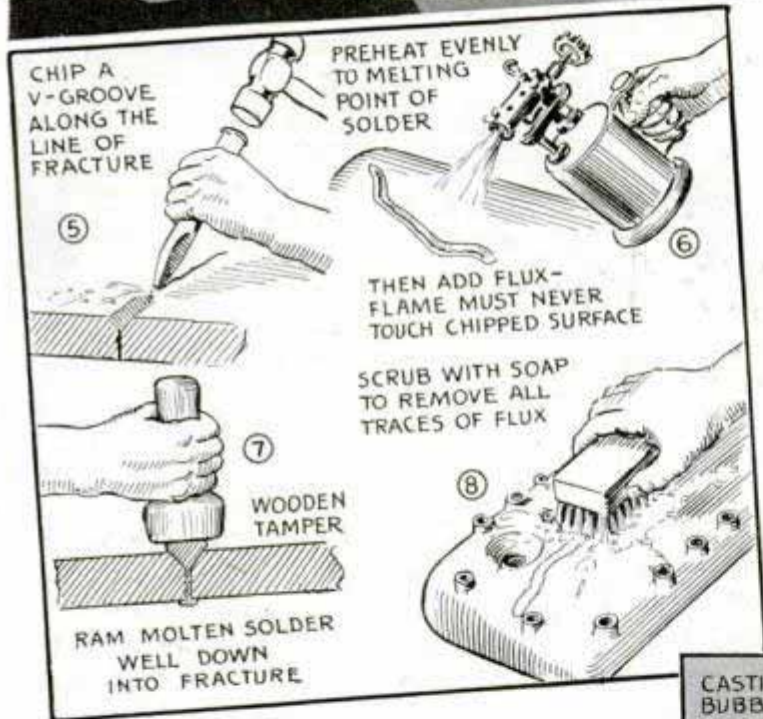

A special penetrating flux bores down into the metal and allows the solder to knit in a positive bond. The casting is preheated and the solder is rammed down into the crack firmly

vessel and build up a bank of solder alongside the hole as in Fig. 3. The solder will presently melt, will slowly encircle the hole and at last fill it. Then you remove the heat gradually and allow the metal to cool. The plug, formed as shown in the right detail of Fig. 3, can be left as is, or it can be dressed down flush. The same solder and method also can be used on sheet copper, brass, iron or steel with equal success, but the white smoke is most noticeable when using the flux on aluminum.

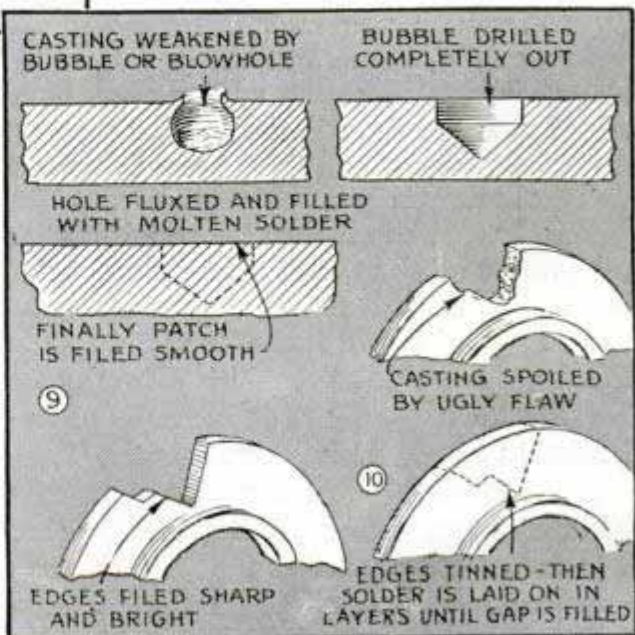

Capillary fabrication

soap solution, Fig. 8, and the ridge of solder is filed down neatly as in Fig. 4.

Other Castings of Hard and Soft Metal: In general, castings run all the way from slush metal to steel and bronze, with a high percentage in the new aluminum-zinc alloy group. Pewter and Britannia metal, being softer than ordinary solder, are repaired with bismuth-alloy solder, which flows at only 518 degrees F., about a hundred degrees less than lead. Alloy metals containing magnesium will take a zinc solder without flux. The casting is tinned with dry solder brushed on with steel wool or a wire brush, then bonded in the usual manner. For the very hard metals and castings, which must withstand hard service, a copper-base solder and proper flux are used. Stainless steel is soldered best with a solder containing antimony applied at about 900 degrees F. This solder will bond with Iconol, Monel, hard steel, bronze, gold and platinum.

Repairing Blowholes in Castings: Frequently a

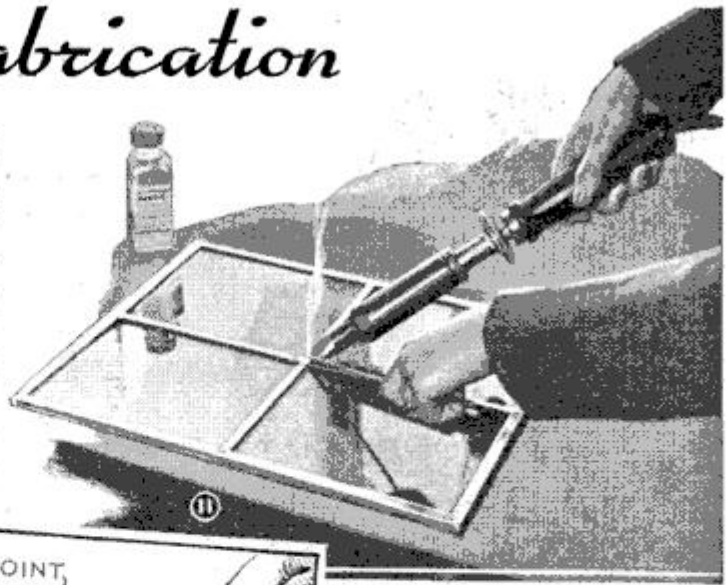

The flux used with zinc-alloy solder causes the solder to enter a seam by capillary attraction and the joint produced will often be as strong as one which is riveted

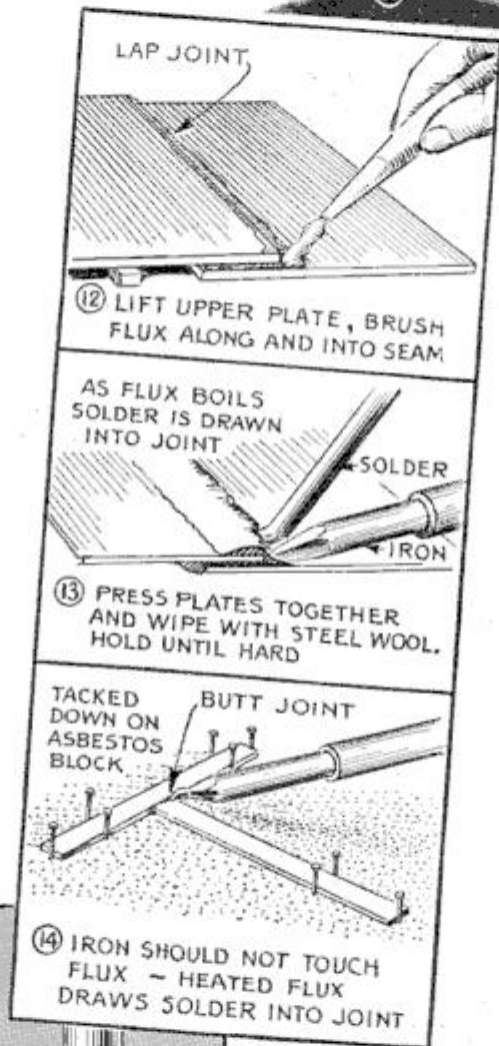

casting is weakened or ruined by the presence of a tiny blowhole, although the casting may be perfect in all other respects. To repair a blowhole in any metal, select the proper solder and flux to use, then drill out the defect slightly larger than the hole as in Fig. 9. After heating the casting carefully, fill the hole with flux and apply solder in the manner already explained. When the casting has been allowed to cool, file the patch flush with the surrounding surface. Many of the solders that are in use will take plating, including chromium, and any defects

that have been patched in this way will be concealed fully after plating.

Missing Parts of Castings Filled: Zinc-alloy solder can be patted and molded into shape and can be used frequently to build up missing sections on castings as illustrated in Fig. 10. After the casting has been prepared by filing down the broken edges until they are bright and preheating the metal as already explained, the brightened edges are tinned at high temperature, and the heat is slowly lowered while layer after layer of solder is applied until the gap has

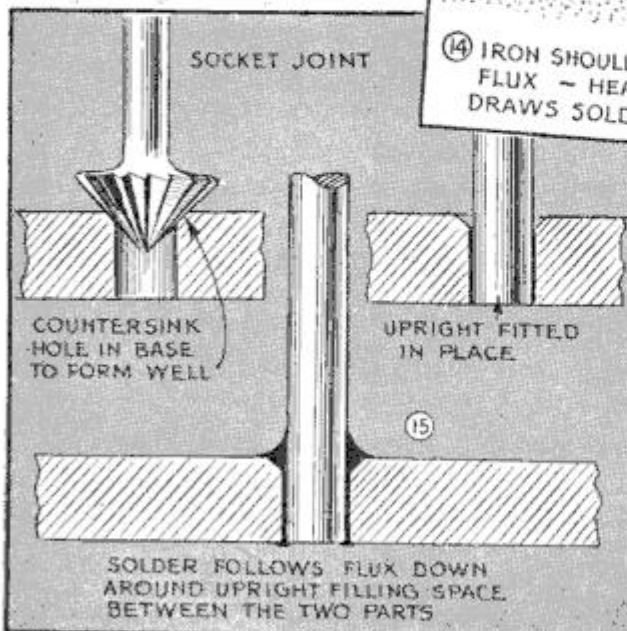

"Touch soldering"

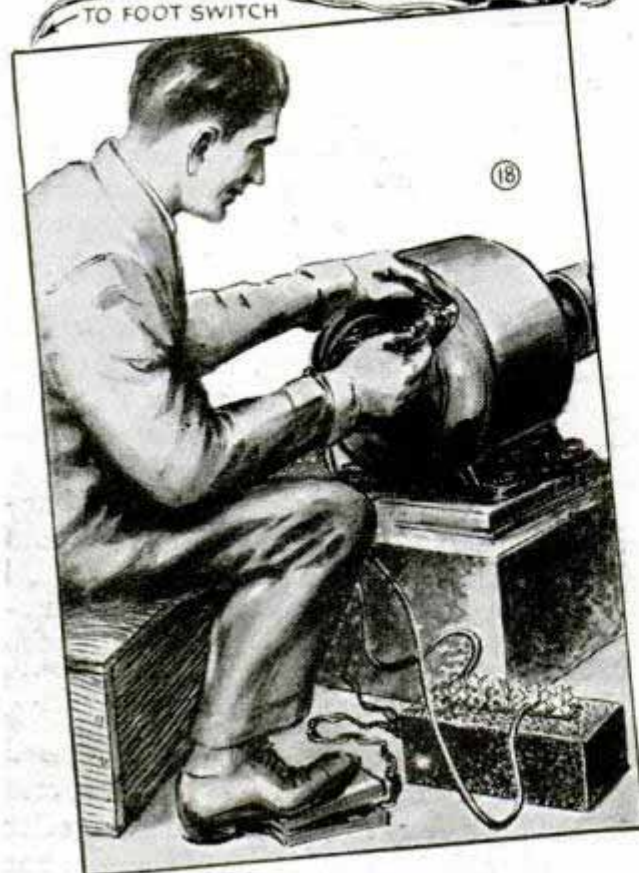
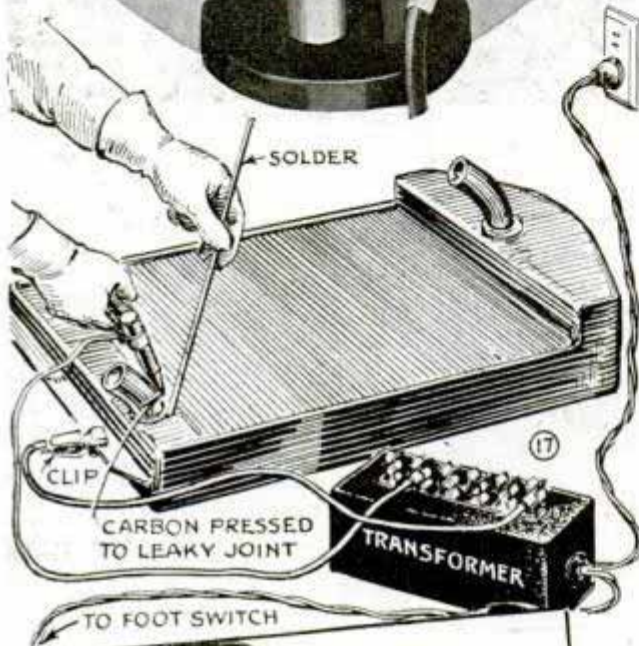
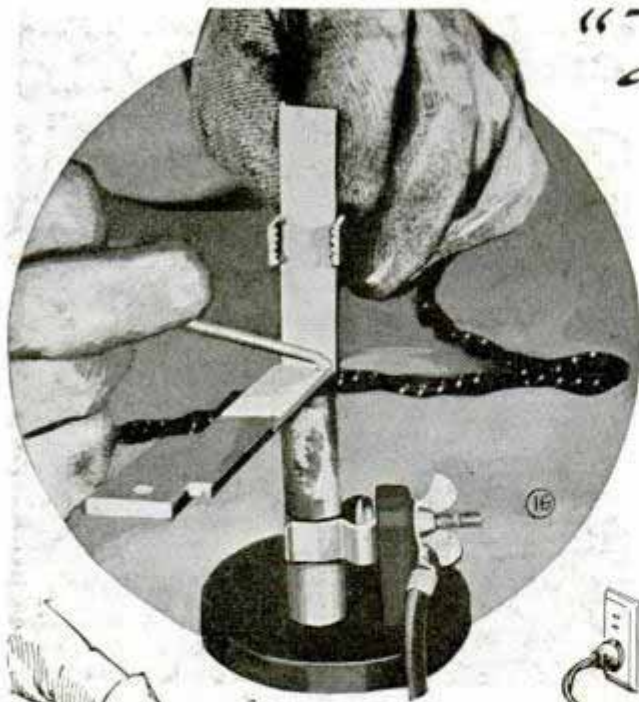

been filled. Zinc-alloy solder is very sluggish in flowing and must be encouraged with a metal or wooden paddle.

Help from Capillary Attraction: Zinc-alloy solder and its flux will also enter a seam by capillary attraction. Modelmakers and workers on delicate projects will find these of great value on many jobs. It is possible to solder joints which formerly had to be riveted or tapped and threaded. In the case of brass, bronze, aluminum and copper, the soldered joint is stronger than the metal itself. With this in view, model locomotives and engines, which run on live steam, can be built up from stock material and held together entirely by carefully soldered joints. On some delicate work, Figs. 11 to 14, an electric soldering iron should be used because it gives a uniform heat, but for socket joints in the larger sizes, Fig. 15, a blowtorch is desirable. In all work of this nature, the evaporating flux pulls the liquid solder along after it. If the flux dries before the joint is finished, add some more. A tiny quantity of solder will cover a vast area.

Electric-Arc Soldering: An electric arc, used for melting and welding is quite common, but it is not generally known that a small arc has vast possibilities in the field of soldering. A low-voltage, heavy-duty transformer, carbon electrode, circuit-completing clip and a foot switch, are all that is needed. Fig. 19 shows such a "touch"-soldering outfit, which the user plugs into any convenient 110-volt a.c. outlet. When turned on full, the tiny arc will produce heat at 4,000 degrees F., in which steel and bronze drip like melting ice. It takes only a few seconds to produce such heat, and the secret of operation is to use the foot switch to cut off the current the instant that the solder melts. On delicate work this is a split-second proposition. With the arc there is no need to clamp work in position, for fairly heavy pieces may be held in gloved hands, Fig. 16, soldered in a second and they will be cool and rigid in less than a minute. The intense heat of the electrode is confined to a limited area, which makes possible soldering that is difficult with either a blowtorch or a soldering iron, such as mending an open seam in an auto radiator, Fig. 17, where the

with a carbon arc

joint must be completed before near-by seams get hot enough to melt. Commutator leads and starting-coil connections that break usually mean taking down an electric motor to do a two-minute repair job. However, with this arc-soldering outfit, these leads can be reached and repaired in most motors by merely removing the end plate and reaching inside the motor as shown in Fig. 18. Oil and gas pipes on automobiles, refrigerating coils and other pipes also can be repaired easily. With ordinary soldering irons and torches these jobs are often very difficult because the copper conducts the heat away so rapidly from the area to be soldered that sometimes the solder applied will not even melt. But with the arc, the intense heat suddenly applied over a relatively small area, is so great that the job is quickly accomplished in spite of the conductivity. An arc-soldering torch, which consists of a 10-tap reactance coil in series with a carbon holder, was described in the May, 1938, issue of Popular Mechanics, and a plan showing its construction is also available for those who wish to make one. In this arc torch, the two carbons are held in a V position so their ends can be touched together to start the arc and then allowed to separate slightly to keep it.

Tiny Joints: When used in conjunction with capillary solders, the electric arc is capable of producing positive joints which are almost invisible. Figs. 20 to 24 inclusive show work such as done by jewelers. As you see, there are several methods of using the arc soldering outfit shown in Fig. 19. In these cases the solder is cut in tiny pieces and is laid in place against the joint, being held there by flux. On certain jobs it is advisable to pulverize the solder, mix it with lard and stick the paste in place. The lard goes up in smoke, and the flux handles the solder. For jewelry and model work, the quantity of solder needed is unbelievably small. Gold solder, silver solder and steel solder are obtainable in sheet form for all hard-soldering operations. Borax flux does not work in electric-arc soldering because it insulates the carbon and breaks the contact. There is a prepared solution available which will handle most hard-soldering jobs.

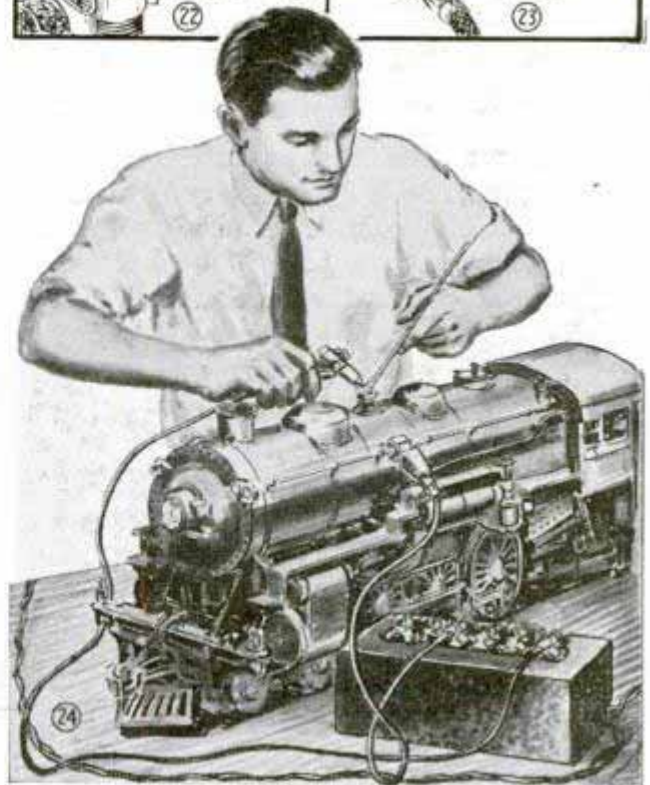
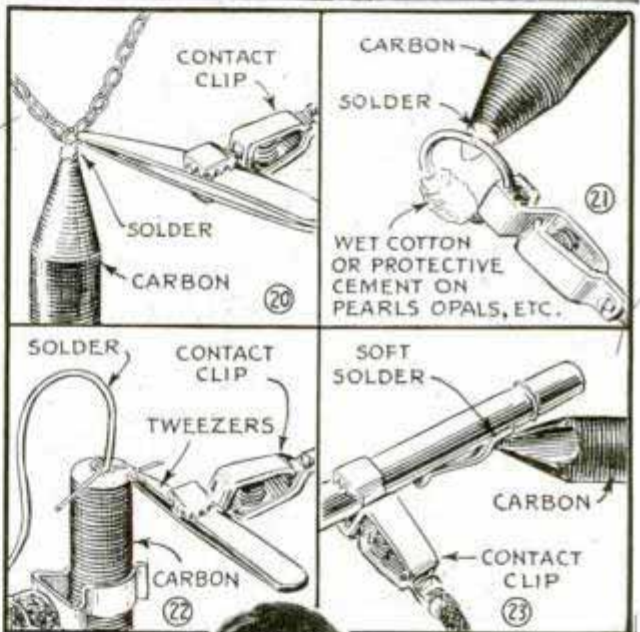
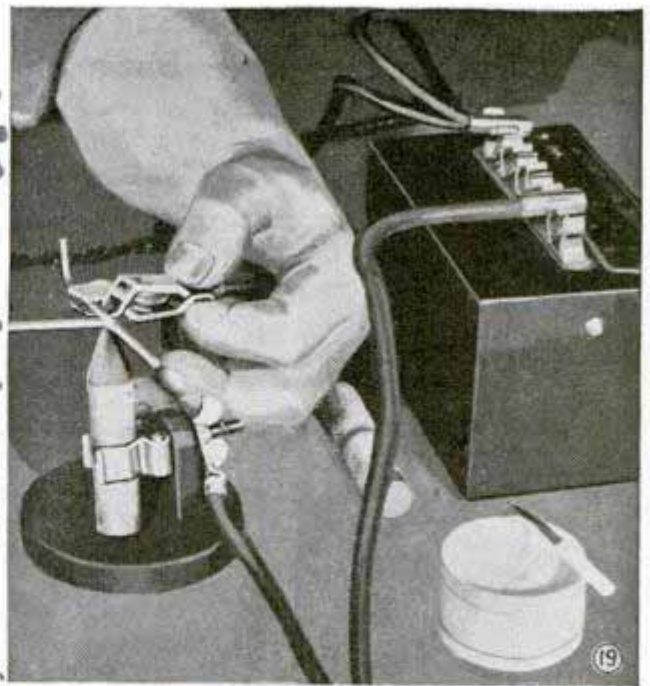

Drill Blocks Aid in Setting Up Work of Irregular Shape

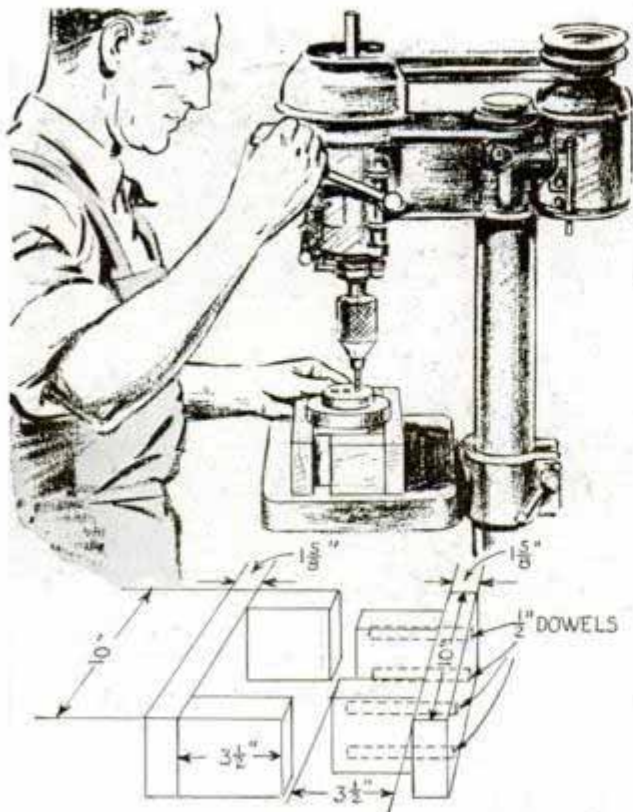

In my work as a machinist, I find that blocks made similar to the ones shown are handy in setting up small work of irregular shape, for drilling or for working on a bench. Both blocks are identical and they are made of 2 by 4-in. pine. Use $\frac{1}{2}$ -in. dowels in assembling the blocks, as nails or screws would interfere with the drill bits—M. B. Birge, Hinsdale, Ill.

Small Clamp Holds End of Tape When Measuring Long Pipe

When working alone with long work such as pipe, and it is necessary to measure it, a small clamp such as used to ground radios to a water pipe will be helpful in holding one end of the tape measure. The

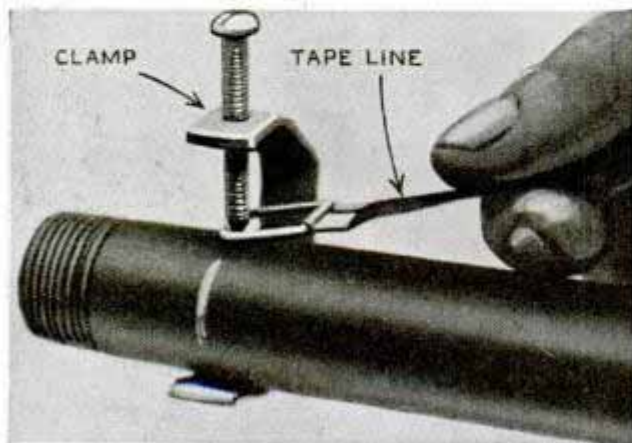

clamp will hold the measure securely without any chance of it slipping when pulled taut at the other end.

Cleaning Greasy Goggles

In one factory where goggles worn by the workmen often became coated with a film of oil and thus tempted the men to neglect eye protection, the foreman provided each one with a small bottle of a mixture consisting of equal parts of water and alcohol. It took only a minute to clean the goggles with this mixture. A bottle like those used for hair tonic is ideal for the purpose, or a hole can be punched in a regular cork.



Spacing Parallel Lines Evenly

While doing some drafting work where it was necessary to draw parallel lines in pairs, each pair being equidistant from a center line, I solved the problem of avoiding irregular lines when they were closer together than $\frac{1}{4}$ in. as

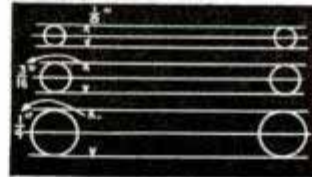

shown. A drop pen was used to draw circles having a diameter equal to the spacing desired for the lines, after which the lines were drawn in as indicated.

—F. H. Peterson, Monroe, La.

Slotless Mailbox Keeps Out Rain

Here is a mailbox that you can make in one evening, and there is no letter slot for moisture to enter. It consists of two parts, a box having three sides and the ends closed,



and a pivoted front. This is made like a V-shaped trough and is pivoted in the open side of the box, the pivots being located at the lower end as indicated.

Cutout Chef and Peon Hold Restaurant Menus

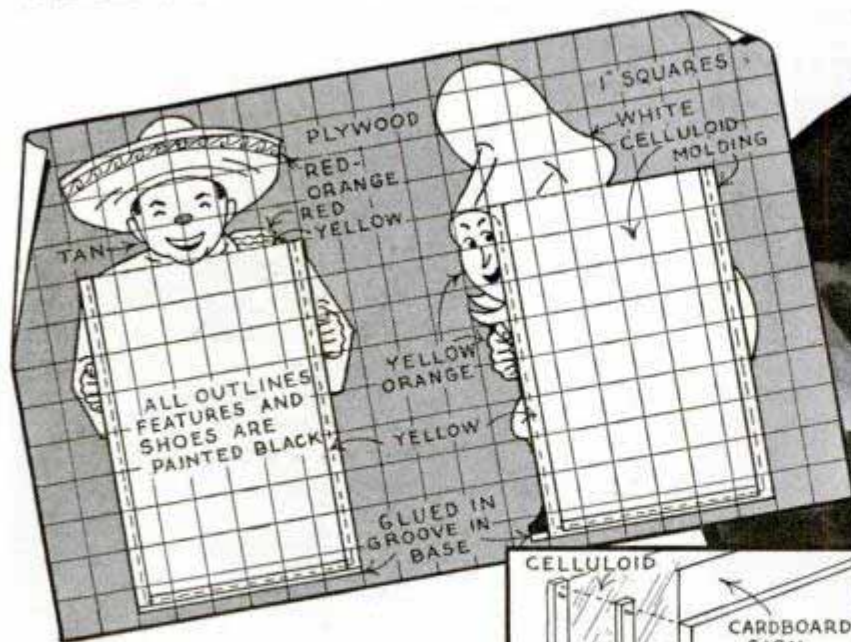

This attractive holder displays a menu on a counter or table, and the saucy face of a plywood cutout peeking over the edge invites your inspection. To make the holder, first saw the cutout from $\frac{1}{8}$ -in. plywood, and then make a base to support it from 1-in. pine. Groove the base through the center to take the lower edge of the cutout, which is held in place by means of glue and small brackets. The grooves to accom-

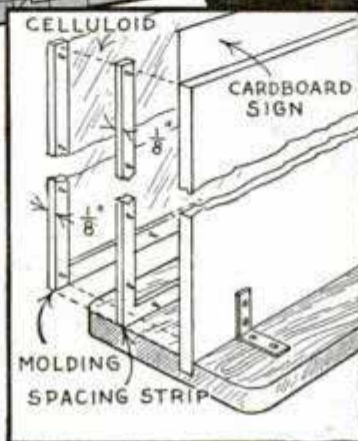

modate the menu are made by tacking molding strips to the front of the figure. Spacing strips placed between the figure and molding form the grooves. A piece of clear celluloid slipped into the grooves in front of the menu protects it so that it will not be soiled by handling.

Pipe Threaded and Tapped to Make Emergency Bushings

Pipe bushings can be made when none are available, by simply threading and tapping pieces of standard pipe. Data for bushings that can be made in this way are given in the table. For example, to bush from $\frac{1}{4}$ in. to $\frac{1}{8}$ in. get a piece of extra heavy pipe. Drill or ream it with a $\frac{21}{64}$ -in. drill and then tap it with a $\frac{1}{8}$ -in. pipe tap, and thread the outside. Note that in one case, $\frac{3}{8}$ in. to $\frac{1}{4}$ in., the internal diameter of $\frac{3}{8}$ -in. extra heavy pipe is such that reaming is unnecessary. Note also, that in bushing from $\frac{1}{2}$ to $\frac{3}{8}$ in. either extra heavy or double extra heavy pipe can be used. In making a bushing, the reaming, tapping and threading are done on the pipe before cutting off the desired length.—W. F. Schaphorst, Newark, N. J.

INCHES TO BUSH FROM	SIZE OF PIPE, INCHES		SIZE OF DRILL OR REAMER, INCHES
	EXTRA HEAVY	DOUBLE EXTRA HEAVY	
$\frac{1}{4}$ TO $\frac{1}{8}$	$\frac{3}{8}$		$\frac{21}{64}$
$\frac{3}{8}$ TO $\frac{1}{8}$	$\frac{3}{8}$		NONE
$\frac{1}{2}$ TO $\frac{1}{8}$		$\frac{1}{2}$	$\frac{21}{64}$
$\frac{1}{2}$ TO $\frac{1}{4}$		$\frac{1}{2}$	$\frac{21}{64}$
$\frac{1}{2}$ TO $\frac{3}{8}$		$\frac{1}{2}$	$\frac{9}{16}$
$\frac{1}{2}$ TO $\frac{3}{8}$	$\frac{1}{2}$		$\frac{9}{16}$
$\frac{3}{4}$ TO $\frac{3}{8}$		$\frac{3}{4}$	$\frac{9}{16}$
$\frac{3}{4}$ TO $\frac{1}{2}$		$\frac{3}{4}$	$\frac{11}{16}$
$\frac{3}{4}$ TO $\frac{3}{4}$		1	$\frac{23}{32}$
$1\frac{1}{4}$ TO		$\frac{1}{4}$	$\frac{1}{16}$
$1\frac{1}{2}$ TO		$1\frac{1}{2}$	$\frac{1}{16}$
$1\frac{1}{2}$ TO $1\frac{1}{4}$		$1\frac{1}{2}$	$1\frac{15}{32}$
2 TO $1\frac{1}{2}$		2	$1\frac{23}{32}$
$2\frac{1}{2}$ TO 2		$2\frac{1}{2}$	$2\frac{3}{16}$
3 TO $2\frac{1}{2}$		3	$2\frac{9}{16}$
$3\frac{1}{2}$ TO 3		$3\frac{1}{2}$	$3\frac{3}{16}$
4 TO $3\frac{1}{2}$		4	$3\frac{11}{16}$
$4\frac{1}{2}$ TO 4		$4\frac{1}{2}$	$4\frac{3}{16}$

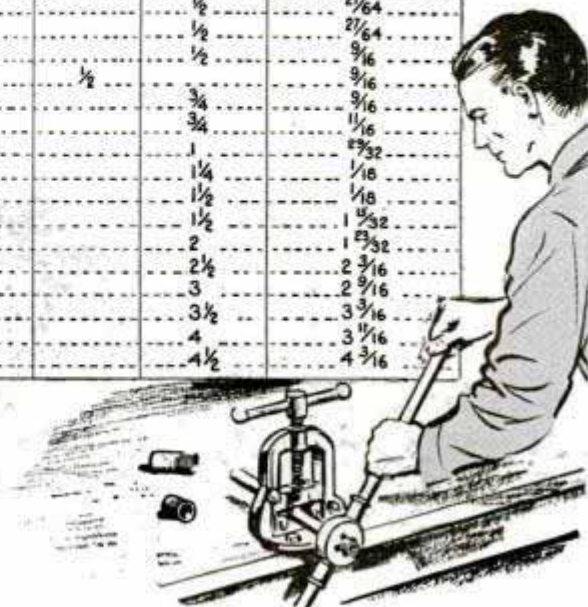

Cold Frame Cover Is Adjusted to Control Temperature

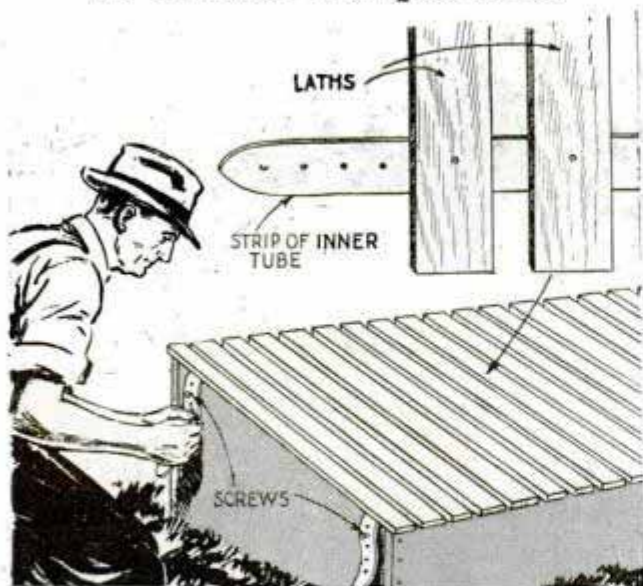

To protect plants in a cold frame from direct rays of the sun or from extreme changes in temperature, one gardener uses an adjustable lattice for a cover. The lattice is made by tacking pieces of wood to strips of inner tube. Stretching the rubber strips spaces the slots.

Handle for Long Chisel or Drill

The next time you have to use a long chisel or star drill and have no tongs for holding it, use the handle of an old floor

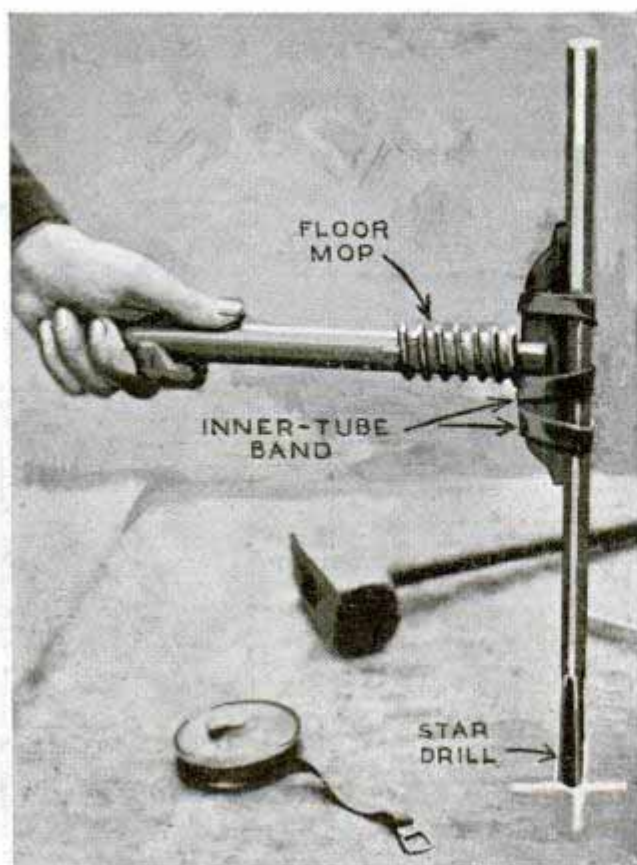

or scrubbing mop. The groove formed where the mop jaws meet provides a good bed for the chisel so that the handle can be attached with heavy rubber bands.

Rubber on Plasterer's Hawk Protects the Hand

Slipped over the handle of a plasterer's hawk, a sponge-rubber disk will prevent pressure of the hawk from causing the hand to become sore. The disk can be cut from a ten-cent kneeling pad.



Metal Strip on Spindle Bill Holder Guards Against Injury

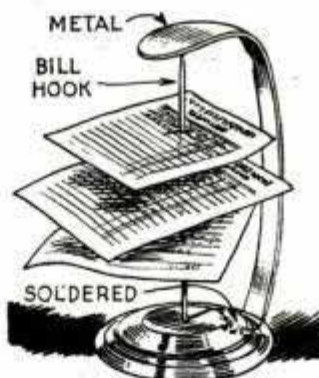

To avoid any possibility of his workers accidentally injuring themselves on the pointed end of a spindle-type bill holder or bill hook sitting on his counter, one store-keeper fitted a

shield over the pointed end of the spindle. This consisted of a piece of spring brass bent to the shape indicated and soldered to the base of the holder.

Binder Twine Prevents Chickens from Flying over Fence

Noticing that chickens in flying over a fence into his yard, always flew to the plainly visible top wire of the fence, one farmer stretched a single strand of binder twine along the posts on the side opposite to that on which the wire was fastened. Then when the chickens flew, they always tried to alight on the twine, encountered the wire barrier and dropped back onto the ground.



Jigsaw Stand Has Drawers for Accessories

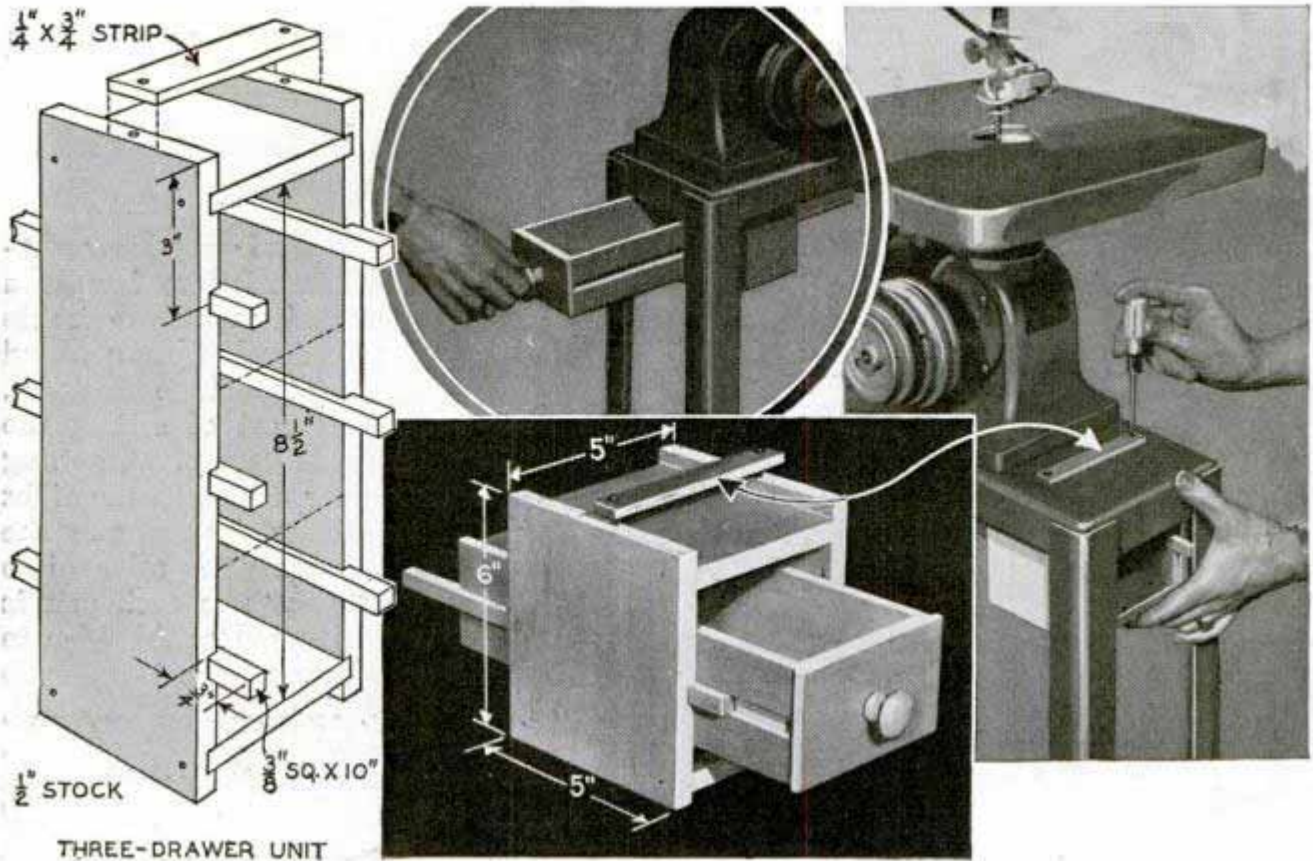

Jigsaw accessories such as saw blades, auxiliary jaws, machine wrenches, etc., are less apt to become misplaced when stored in one or more small drawers suspended beneath the top of the metal stand, and are always within easy reach. While dimensioned above to fit a stand of the type shown in the photo at the upper right, the exact size to make the unit depends, of course, upon the stand in which it is to be installed and must, therefore, be made to fit accordingly. As can be seen, the sides of the drawers are grooved to slide on $\frac{3}{8}$ -

in. runners which are glued and bradded in corresponding grooves cut across the inner faces of the upright side pieces. The box and drawer front are made of $\frac{1}{2}$ -in. material, while $\frac{1}{4}$ -in. stock is best for the drawer sides. A narrow wood strip, placed over original holes in the top of the stand and fitted with two screws, as shown, clamps the unit in a position to allow the drawers to slide freely between the front legs of the stand. If the base of your jigsaw is recessed on the bottom, it can be set over the strip to conceal it.

Magnetic Eraser Holder Clings to Side of Your Typewriter

Fasten your typewriter eraser to a small horseshoe magnet and it will cling to the metal of your typewriter so that it will always be at hand when needed. A tiny bolt will attach the eraser to the magnet. It may be necessary to scrape the paint from the typewriter frame at the point where you wish to have the magnet cling to it.—C. A. Oldroyd, Barrow-in-Furness, Lancs., England.

☐ It is easy to pick up sheets of paper rapidly if a small amount of glycerin is applied to the finger tips.

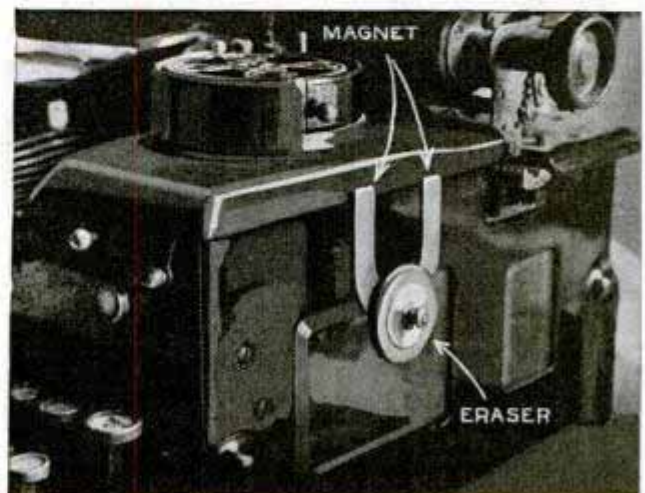

Removal of Fruit from Barrel Simplified with Tray



A merchant who dispenses apples, potatoes, etc., directly from barrels in his store improves the appearance of partly emptied barrels and simplifies removal of the contents in small quantities with this tray. It is made from heavy wire, the side stay wires being bent to a hook shape at the upper ends to fit over the side of the barrel. After the contents have been lowered sufficiently to make room for it, the tray is filled and placed in the barrel.

—Opie Read, Jr., Chicago.

Reflector Protects Mailbox

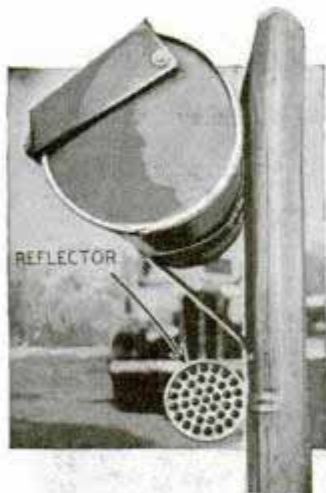

Rural mailboxes are often knocked over at night by motorists who in passing other cars on narrow roads, sometimes get off the pavement slightly and do not see the boxes in time to avoid them. To help prevent this, one farmer placed a red reflector on the

standard of his box as indicated. The reflector should be fastened to the post about

30 in. above the ground. At this height, it will be sure to reflect the light of cars coming toward it.

—John M. Avery, Holley, N. Y.

Changing Lathe Gears in Pairs Saves Time

In small shops a general-purpose screw-cutting lathe is often used to handle a great variety of work for which desirable feeds cover a considerable range, and much time is required to change the gears. The time-consuming part of setting the yoke and intermediate gear pivot, getting the intermediate gear center in the right place, can be speeded up by changing the gears in pairs, with the pairs selected so that the sum of the teeth in each pair is the same. The application of this idea to my lathe is as follows: Gears available were 24, 32, 36, 40, 42, 44, 45, 46, 48, 52, 54, 56, 60, 80 and 96-tooth. By cut and try, the table for longitudinal feeds worked out as shown. It will be seen that the sum of the teeth for the stud gear and the first intermediate one is 92 in each case, and as the sum is constant, the proper center distance for each of these pairs is the same. Thus eight feeds from .005 to .017 in. per spindle revolution are available by selecting the proper pair for the first gears in the train without making any other changes.

—Walter T. Gorton, Washington, D. C.

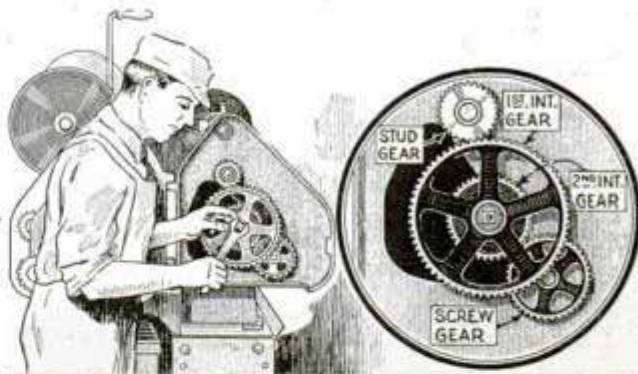

STUD GEAR	FIRST INT. GEAR	SECOND INT. GEAR	SCREW GEAR	FEED, IN. PER REV. OF SPINDLE
32	60	42	54	.005
36	56	42	54	.006
40	52	42	54	.007
44	48	42	54	.008
48	44	42	54	.010
52	40	42	54	.012
56	36	42	54	.014
60	32	42	54	.017
32	60	54	42	.008
36	56	54	42	.009
40	52	54	42	.011
44	48	54	42	.013
48	44	54	42	.016
52	40	54	42	.019
56	36	54	42	.023
60	32	54	42	.028

AUTO SHORTCUTS

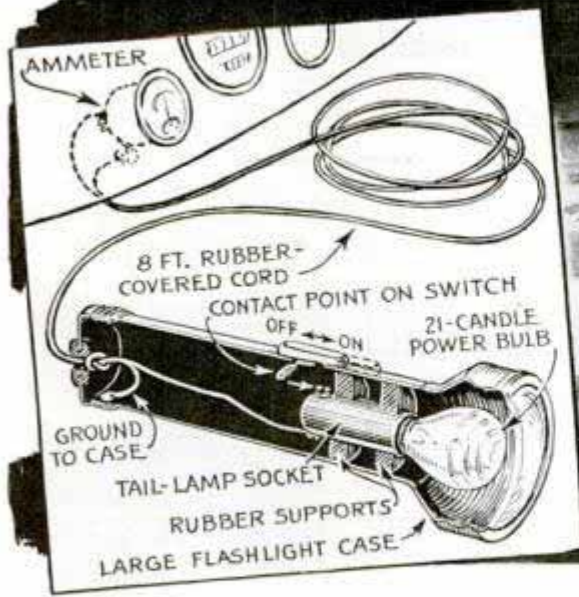

Carried in the glove compartment, this trouble lamp is always ready for instant use because it is connected permanently to the electric circuit of the car. It consists of a flashlight case having a socket and 6-volt bulb mounted inside by means of two rubber disks cut from an old rubber heel and installed as above

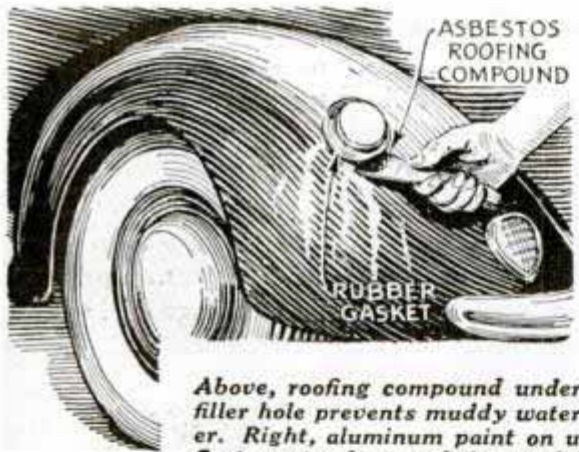

Above, roofing compound under gasket at gas-tank filler hole prevents muddy water running down fender. Right, aluminum paint on underside of hood reflects motor heat to help avoid dulling outside finish

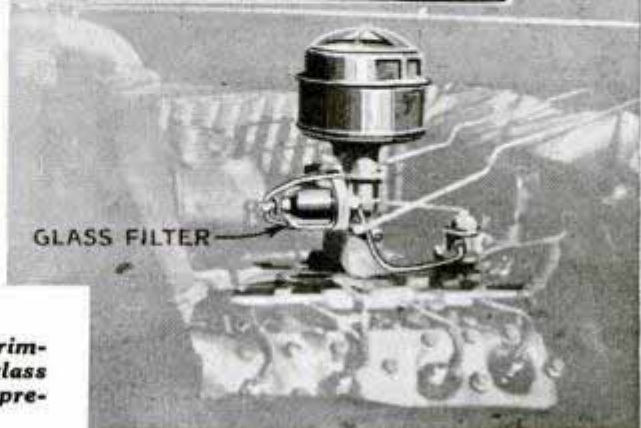
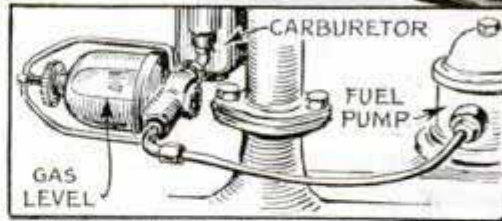
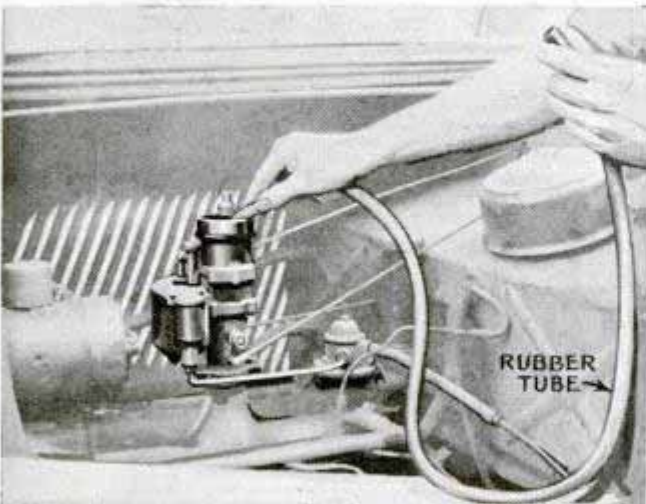

Rubber tube filled with gas by siphoning is handy for priming carburetor, as above, if fuel pump is dry. Right, glass sediment bowl in fuel line smooths pump impulses and prevents surging as the fuel enters the carburetor

Flashlight on Door Illuminates Ground When Leaving Car

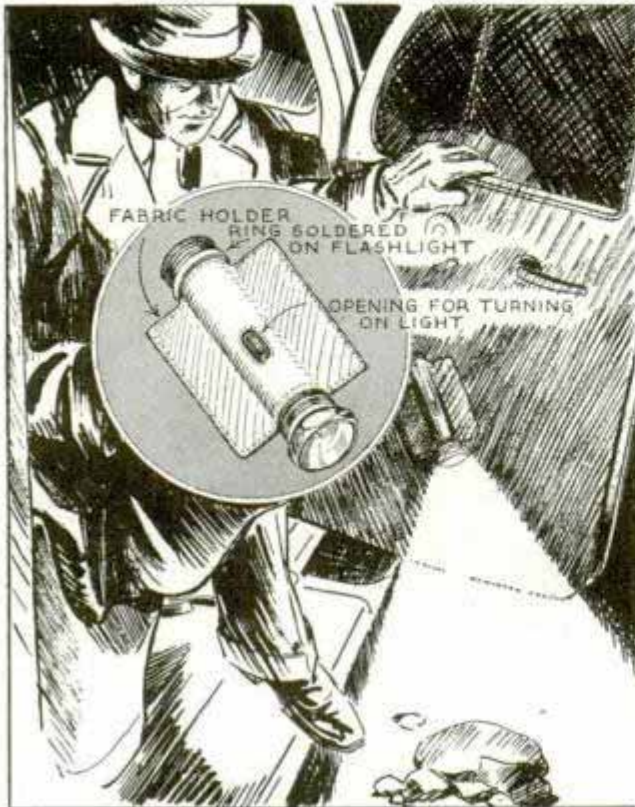

As most motorists carry a flashlight, why not keep it in a holder near the bottom of the door so that it can be turned on to illuminate the ground when leaving the car at night? The holder is made from cloth to match the upholstery material, and is sewed to the fabric on the door.

Broken Speedometer Chains Removed with Breast Drill

If a speedometer chain breaks and twists up inside the housing, it can be removed easily with the aid of a breast drill. Just put the end of the chain in the drill chuck and turn it in the opposite direction from which it rotates inside the housing.

—William Searles, W. Nanticoke, Pa.

Repairing Sockets in Reflectors of Headlamps

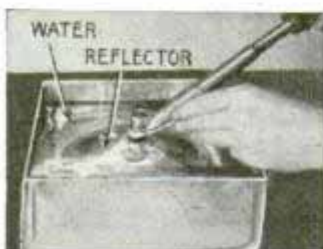

When a socket loosens in the reflector of a headlamp, the lights will be dim or will flicker unless the socket is soldered tightly in place. A

good way to do this without heat of the soldering iron damaging the silvered surface of the reflector, is to submerge it in water to within about $\frac{1}{4}$ in. of the area to which the socket is to be fastened. The water will dissipate the heat fast enough to avoid discoloring the reflector.

Spoon Holder Serves as Memo Clip on Door Handle of Truck

Truck drivers sometimes desire to leave a memo on their locked trucks for someone who may arrive while they are away from them. A metal spoon holder of the type shown is handy for this purpose. It slips over the door handle easily and the coiled portion will hold a piece of folded paper.



Tool Rack for Outside Work

When working on your car at home you usually do it outside where there is plenty of light, with the result that tools are laid on the ground where they often become



dirty or misplaced. A grill taken from an old stove oven serves nicely as a tool rack for outside work. It can be supported with bricks at the corners and you can see at a glance just the tool that you want.

Battery Charged While Making Minor Repairs on Car

We often have a car come in with the battery run down by the owner trying to start it when something was wrong with the starter or ignition system. While the

repair is being made, which may take a half hour or so, we hook a charger to the battery right in the car. In this length of time, the battery usually has stored enough current to start the car with a little to spare. To do the charging easily, no matter where the car is set, we ran two cables from the charger along one wall of the repair room and provided outlet sockets every car width. With this arrangement we just plug in a couple of cables from one of the sockets to the car battery.

—H. W. Swope, Danville, Pa.

Stopping Squeaks in Shackle Bolt

Before going to the expense of replacing squeaky shackles of the composition-mounted type (not rubber mounted) with new ones, try the following methods of stopping the noise. Apply penetrating oil to the shackle, at the same time striking the main spring leaf sharply with a hammer to aid the oil in penetrating around the bolt. If this doesn't stop the squeak, remove the shackle links and turn the bolt with a socket wrench while applying oil.

Shield Slipped over Door Handles Protects Car Finish in Garage

One motorist who kept his car in a public garage found that the finish on the side of the car was often marred by the handle when the door was opened on the car in the next stall. To avoid this trouble, he cut a piece of cardboard as shown and slipped it over the door handles whenever he put the car in the garage.



Strap Handle Aids in Removing Spare Tire from Trunk

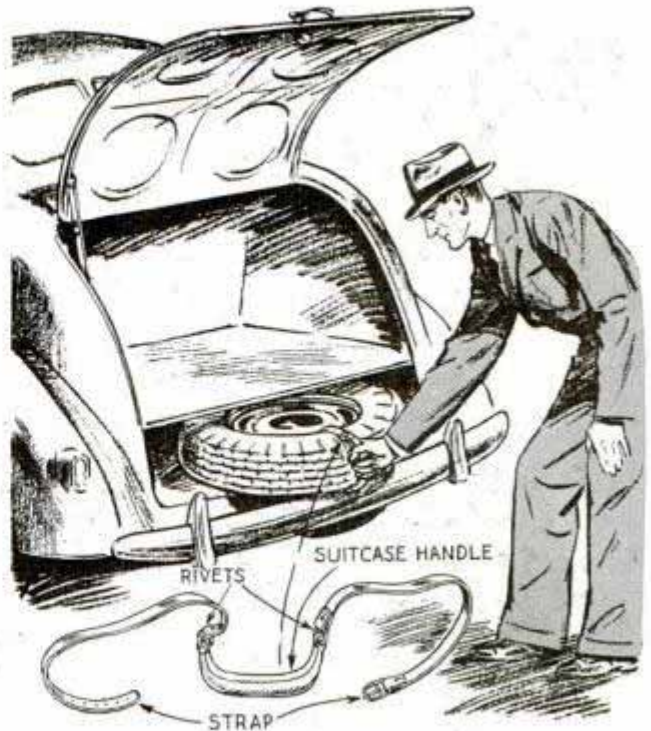

Difficulty of removing a spare tire that is carried in the trunk in the position shown, can be avoided by fitting it with a strap handle. This consists of a leather handle similar to one used on a suitcase with two straps fastened to it and buckled around the tire.

Adhesive Tape Repairs Sun Visor

When the hinged sun visor loosened on its shaft so that vibration of the car caused it to drop, one motorist repaired it with a strip of tape.



This was wound around the shaft to increase its diameter and produce enough friction to hold the visor in place.

Doorbell Locates Short Circuit in Car Wiring

The next time you have a short circuit in the electrical system of your car and it seems almost impossible to locate it, a 6-volt doorbell may solve the problem. Remove the fuse in the wiring and connect the bell to the clips that held the fuse. Then remove all the light bulbs and turn on all the car switches. Now go over the wiring, shaking and pulling it lightly. When the wires short circuit, the bell will ring.

Auto Hood Clamps Hold Gasoline Pan on Workbench



After having the gasoline pan for washing small parts accidentally upset a time or two, a mechanic clamped it to the workbench. The clamps were taken from an old auto hood, and were screwed to the bench top. These enabled him to attach or remove the pan instantly.

Heat from Exhaust of Tow Truck Aids in Starting Stalled Car

Needing some method of applying heat to thaw frozen radiators and pumps, or to aid in starting motors stalled on the road during winter, one garageman used the exhaust gases from his service or tow truck. To do this, he installed a cutout in the exhaust pipe close to the motor, and from there ran a long length of flexible tubing. With this arrangement, hot exhaust gases could be directed on the radiator or other parts to be warmed.

How to Build a Farm Tractor in Your Spare Time

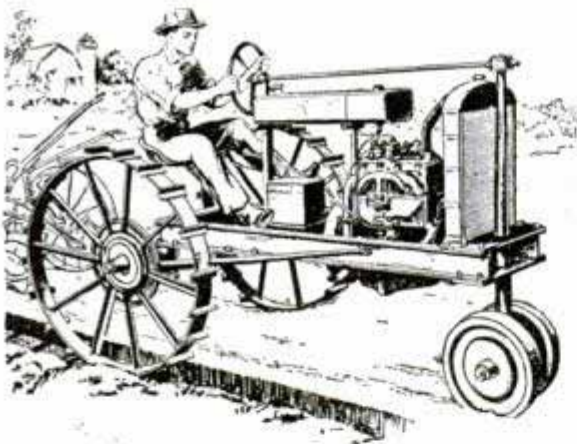

Having plenty of power to pull a two-bottom plow and other implements, this farm tractor, built from old car parts, includes a Ford model-A motor and twin transmissions giving six speeds forward. Wrenches, hacksaw and drill are about the only tools needed—welding can be done at your local machine shop. Set of three 17 by 22-in. plans, Nos. 1024 to 1026 incl., containing all necessary constructional details and a list of materials needed will be sent postpaid upon receipt of 75c.

OTHER BUILD-IT-YOURSELF PLANS

STREAMLINE FAMILY TRAILER—937 to 942: Includes all the conveniences of home with sleeping accommodations for four. Trailer is 15 ft. long and weighs approximately 1,400 lbs. Six prints \$1.00.

UTILITY TRAILERS—986 and 987: Built of old auto parts and lumber. Adaptations of body to suit various purposes. Two prints 50c.

ELECTRIC SPOT WELDER—891 and 892: Works on 110-volt, 60-cycle alternating current. For small work up to $\frac{1}{8}$ in. in thickness. Two prints 50c.

ELECTRIC ARC TORCH—1006: Carbon electrodes $\frac{1}{8}$ in. dia. produce arc for soldering, brazing, light welding. For 110-v. 60-cycle a.c. 25c.

METAL WEATHER VANES—520: Scroll-sawed from sheet aluminum. Complete assembly details. 25c.

NOVELTY FOOT SCRAPERS—1009: Unusual scrapers that lend distinction to doorsteps. Patterns are full size ready to trace onto metal. 25c.

ARTISTIC DOG HOUSES—826: Shows four attractive designs. Also tells how to determine right size house for any dog. 25c.

LAWN CHAIR ON WHEELS—978: Light in weight and easy to wheel to any location. 25c.

DUTCH WINDMILL FOR GARDEN—890: Excellent place to store garden tools. 10 ft. high, 54 in. in diameter at base. 25c.

Any six of these plans (not projects) will be sent upon receipt of \$1

Catalog listing 400 plans included free with your order if specified

Address Plan Service, Popular Mechanics Magazine, 200 E. Ontario St., Chicago, Ill.

These **KODAKS** for **COLOR** start at \$14⁵⁰.

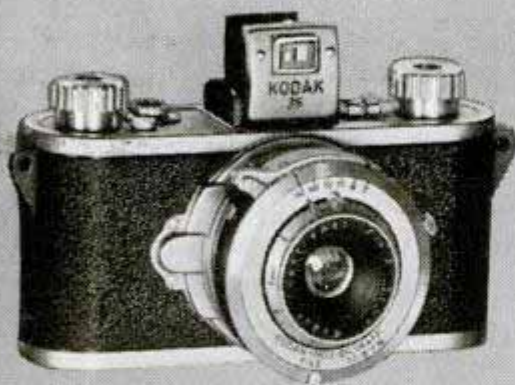

*ONLY EASTMAN
MAKES THE KODAK*

ALL three of these Kodak "miniatures" make Kodachrome (full-color) transparencies. It's easy as black-and-white. Just load with Kodachrome Film. And through modern photo-finishing methods these little cameras lead to black-and-white pictures 2 $\frac{3}{4}$ x 4 inches.

KODAK 35 (f/5.6)

Kodak Anastigmat lens, 1/100 Kodex shutter. \$14.50.†

KODAK 35 (f/4.5)

(Illustrated) Kodak Anastigmat lens. 1/150 Diomatic shutter, double-exposure prevention. \$24.50.

KODAK 35 (f/3.5)

Kodak Anastigmat Special lens and 1/200 Kodamatic shutter, double-exposure prevention. \$33.50.

Kodak 35's have tested shutters, eye-level finders, fingertip focusing, automatic exposure counter, film-centering device. Eastman precision construction throughout.

KODACHROME
IS EVERY FAN'S FIELD NOWADAYS

Kodaslide Projectors start at \$18⁵⁰

KODASLIDE PROJECTOR, Model I

For projecting Kodaslides—or other 2" x 2" slides, color or black-and-white. Small, efficient, thoroughly dependable. Fitted with high-quality 4-inch lens. With 100-watt lamp, 11½-foot cord, and plug, \$18.50. Other models, \$33.50 and \$52.

KODASLIDES

Kodachrome Film is processed by Eastman. Finished transparencies are returned individually mounted as Kodaslides—ready for projection. No charge for finishing or mounting. See literature at your dealer's, or write Eastman Kodak Company, Rochester, N. Y.

GOING TO THE NEW YORK WORLD'S FAIR?

Take your Kodak—visit the Kodak Building—see the Greatest Photographic Show on Earth.

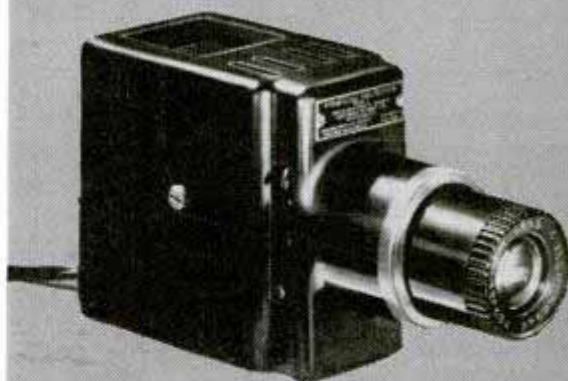



SOUTH BEND

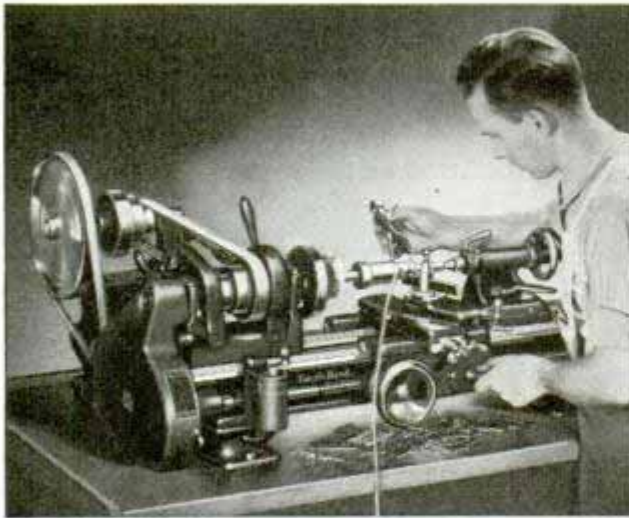

9" x 3' Workshop Model C Bench Lathe with Horizontal Motor Drive and reversing motor, complete as shown. Shipping weight 320 lbs. . . . \$109.50

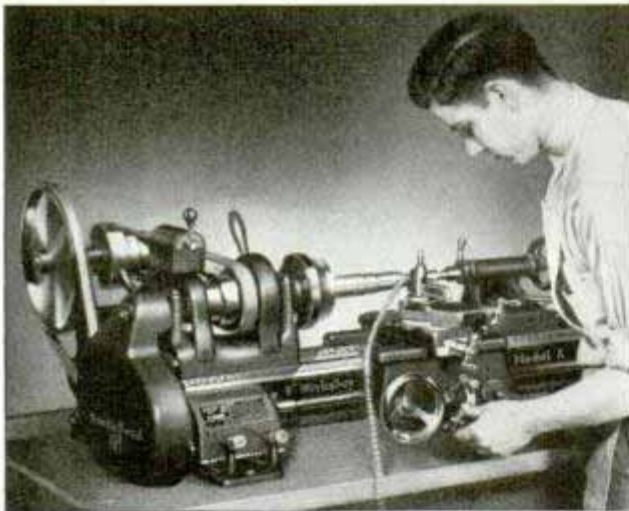

9" x 3' Workshop Model A Quick Change Gear Bench Lathe with Horizontal Motor Drive and reversing motor complete as shown. Has power carriage feeds. Shipping weight 340 lbs. . . . \$199.50

FOR THIRTY-THREE years South Bend Lathes have been giving efficient, dependable service in the tool rooms and production shops of America's leading manufacturers. Throughout the world, their practical design and fine workmanship have made them the popular choice of men who know machinery.

All types of operations, including highly accurate production work and precision finishing on tools and gauges, are economically performed on South Bend Lathes. They have ample power, extreme accuracy and an unusually wide range of smooth, vibrationless spindle speeds.

SOUTH BEND LATHE WORKS
606 E. Madison St., South Bend, Ind., U. S. A.

Below—10" swing x 3½' bed 1" Collet Underneath Belt Motor Driven Bench Lathe, with All Steel Bench. Shipping weight 880 lbs. . . . \$700.00

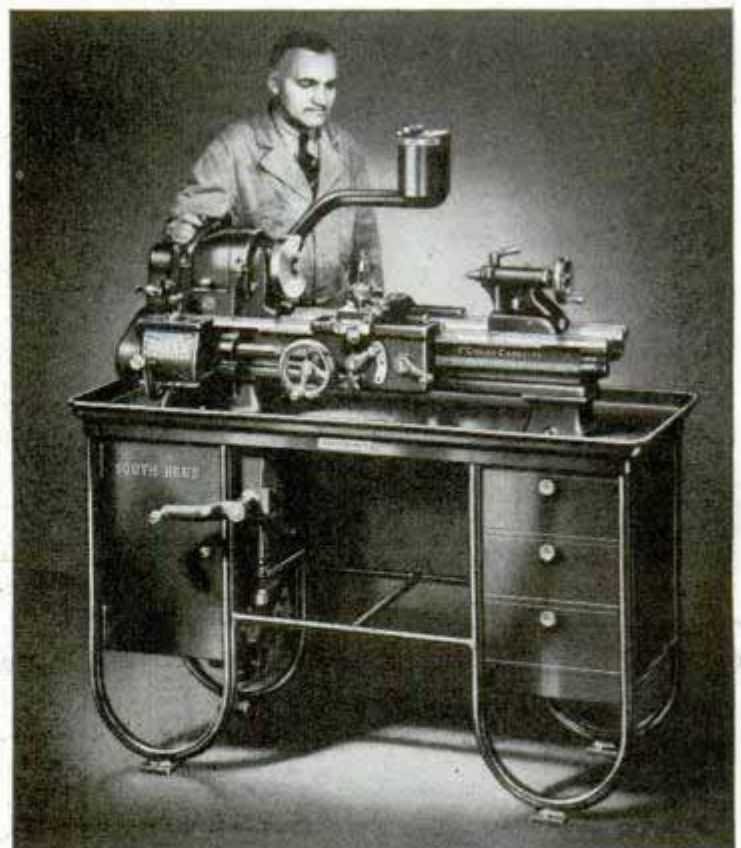

Send for CATALOG

Mail coupon or postal card for free catalog of South Bend Precision Lathes.

SOUTH BEND LATHE WORKS
606 E. Madison St., South Bend, Ind., U. S. A.
Please send catalog checked:
 9" Workshop Lathe Cat. No. 50A
 Complete General Cat. No. 100

Size of Lathe _____
Name _____
Address _____
City _____ State _____

SOUTH BEND LATHE WORKS

Precision LATHES

Built in Six Sizes

South Bend Precision Lathes are built in six sizes, 9" to 16" swing inclusive. Each size is made in Tool Room Type, Quick Change Gear Type and Standard Change Gear Type with Individual Motor Drive or Countershaft Drive.

SIZES AND PRICES OF SOUTH BEND LATHES

Size	Bed Lengths	Price Range
9"	3' to 4½'	\$ 79.50 to \$ 280.50
10"	3' to 4½'	268.00 to 969.00
11"	3¾' to 5½'	388.00 to 941.00
13"	4' to 7'	478.00 to 1144.00
14½"	5' to 10'	609.00 to 1431.00
16"	6' to 12'	723.00 to 1578.00

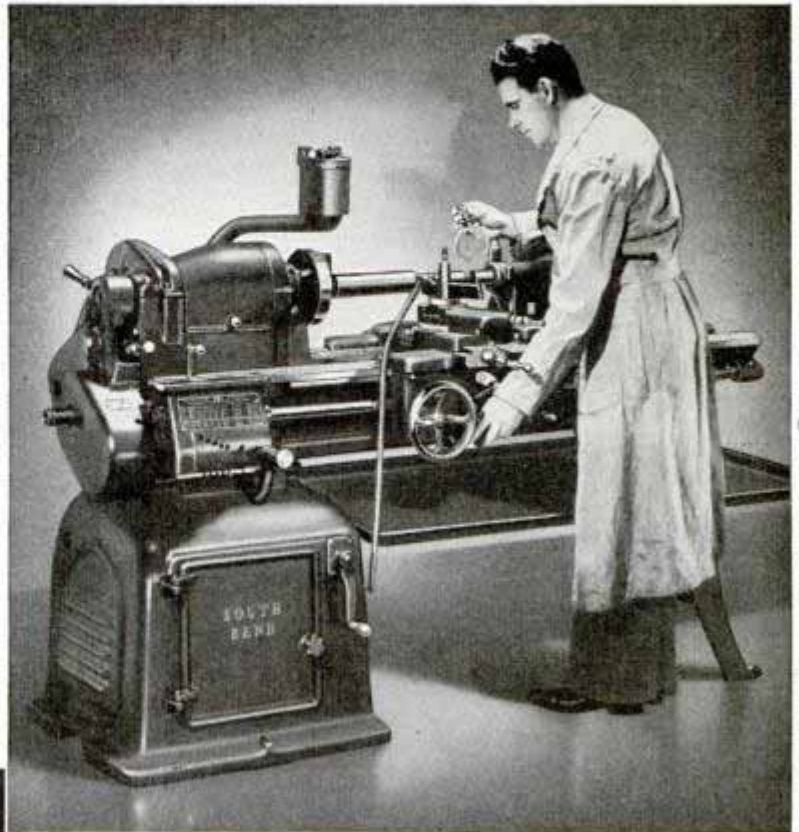

Above—14½" x 6' Quick Change Gear Underneath Belt Motor Driven Lathe with Chip Pan. Ship. Wt. 2070 lbs. . **\$1000.00**

Below—16" x 6' Quick Change Gear Pedestal Motor Driven Lathe. Shipping weight 2165 lbs. **\$938.00**

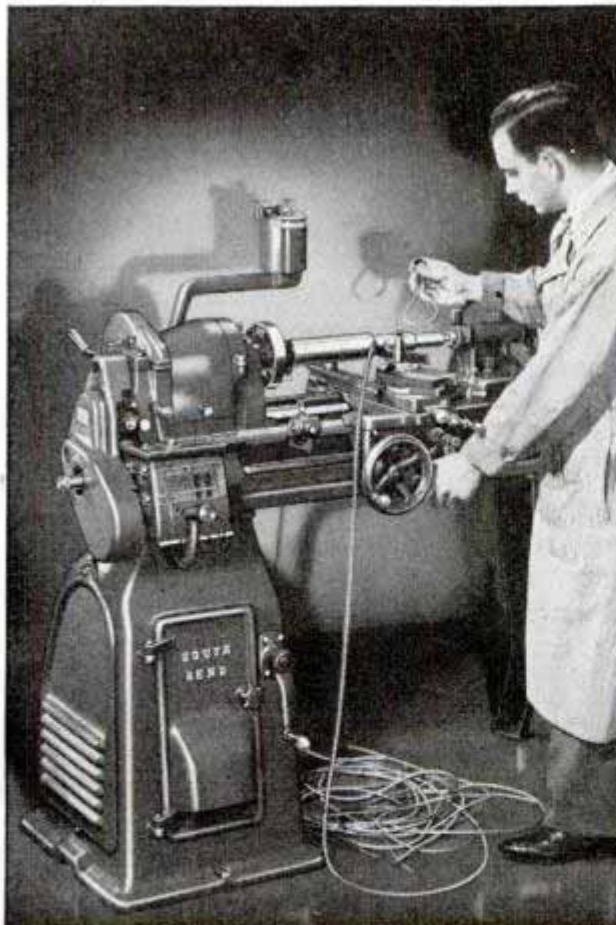

Above—11" x 4' Quick Change Gear Underneath Belt Motor Driven Lathe. Shipping weight 965 lbs. **\$625.00**

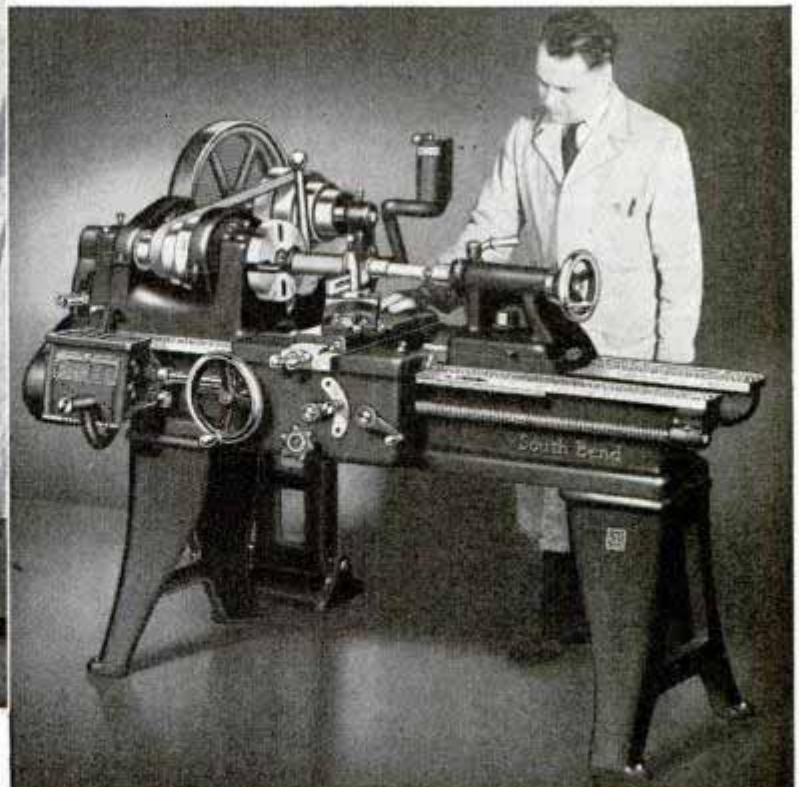

LATHE BUILDERS FOR 33 YEARS

g. 1450

Solving Crime with the Camera

(Continued from page 859)

time is lost by their use. It takes only a few seconds to set one up on its tripod, and its flexibility of focusing and adjustment makes it possible to photograph anything from a landscape to a pin—on a full-size negative that needs no enlargement.

Even the motion-picture camera is being used in certain types of crimes, both to secure evidence and to present it in court. Movies of mob scenes and riots enable po-



Here is some of the field equipment used by special agents of the Federal Bureau of Investigation

lice to pick out the ringleaders and particularly violent participants and convict them, when no other acceptable evidence could be obtained.

The F.B.I. recently used amateur movie cameras to defeat a pair of war risk insurance frauds. In one case a veteran claimed he was totally disabled by a leg injury received in service, so that he was unable to earn a living. When investigators found he had a large bank account, was operating a prosperous chicken farm, he produced witnesses to prove the farm was owned and operated by his wife—that he was unable to assist her.

A special agent, taking advantage of ill feeling existing between the veteran and a neighbor, obtained permission to take motion pictures from the window of her home. His films showed the "totally disabled veteran" going about his strenuous chores without a limp, even cutting the grass with a lawnmower. The case died before it came to trial.

In the other case a veteran claimed total blindness. At the first trial the jury dis-

agreed, though the judge was convinced the man was "a consummate actor, quite capable of sustaining the role of a blind person and of collecting money from the government in that guise."

A special agent, secreting himself in a shed near by, photographed the veteran walking about without the use of glasses and cane, even running up and down the back steps without bothering to use the rail. The second jury, after viewing the films, immediately brought a verdict for the government.

Not only does the camera record evidence that the eye can see, but it reveals evidence invisible to the eye. A thrifty New York murderer was caught wearing a shirt with the bloodstains of his victim on the collar—completely washed away, as he thought. But though the eye could not see the stains, the camera recorded them when the suspect was "mugged." Chemical analysis showed the invisible stains to be blood. The murderer promptly confessed.

Infrared photography leaped across a continent to implicate a Utah motorcar thief in a Georgia bank robbery. When arrested at Ogden the suspect had a leather money bag on his person, but the bag apparently bore no clue as to whence it came. Under microscopic examination it was thought that traces of obliterated printing were present. Photographed under infrared rays, the obliterated printing could be read easily—the name of a bank in La Grange, Ga. A telegram to La Grange quickly implicated the thief with a robbery there.

The latest use found for the mechanical memory is to "fingerprint" precious gems. All diamonds, rubies, and other precious stones contain flaws—bubbles, fissures—which do not detract from the value of the gem, but do identify it. Insurance companies take microphotographs of gems on which they issue policies. If stolen, copies of these photos are broadcast to police, jewelers, and pawnbrokers, making it virtually impossible to dispose of the stone undetected.

☐ Stamped, self-addressed envelope, sent to our Bureau of Information, will bring you the name and address of the maker of any article described in Popular Mechanics.

You may worry about the stork



but here is one worry you can avoid

When the old boy with the long bill steps into your life, you've got to pace the floor and like it.

But why in the name of Harry anyone should worry about chassis lubrication is beyond your Texaco Dealer.

Let him Marfak your car every 1,000 miles and you'll have Peace Of Mind on that score.

No more fret about whether he got that grease cup or checked the battery and tires.

Marfak is Texaco's standardized 40-Point Lubrication Service—and when the job is done you know it's thorough and dependable.

The service, in fact, takes its name from Marfak—the famous lubricant that is so

tough it lasts twice as long as ordinary grease.

Sure, you want that Peace Of Mind this extra protection gives. Drive in and let us Marfak your car.

TEXACO DEALERS INVITE YOU TO tune in the **TEXACO STAR THEATRE**—A full hour of all-star entertainment—Every Wednesday night—Columbia Network—9:00 E.D.T., 8:00 E.S.T.; 8:00 C.D.T., 7:00 C.S.T., 6:00 M.S.T., 5:00 P.S.T.

Let us
MARFAK
your car



Copyright 1940
The Texas Company

TEXACO'S 40-POINT LUBRICATION SERVICE AT ALL TEXACO AND OTHER GOOD DEALERS

Science Rules the Cinders

(Continued from page 869)

cent. The old hurdlers sailed over the barriers. Today's champion clears the timber with the barest margin, snaps the leading leg straight down, hits the ground sprinting. He has learned that he travels faster on the ground than in the air. The low and 400-meter hurdles require stamina, the ability to take the hurdles in stride, rather than the technique and form required in the 120-yard event. The hurdles them-

techniques are not natural jumping motions; rather they are intricate gymnastics performed in mid-air.

The first Olympic pole-vault winner cleared 10 feet 9 $\frac{3}{4}$ inches. It was considered remarkable when Gilbert and Cooke, using the new bamboo pole instead of the spruce pole, cleared 12 feet in 1908. In those days the tip of the pole was spiked, the spike being driven into a hole or a platform of wooden blocks when the leap was made. Vaulters really began to soar when the boxlike vaulting trough was introduced. Sabin Carr cleared 13 feet 9 $\frac{1}{2}$ inches in 1928. Since then Sefton and Meadows have raised the mark to 14 feet 11 inches. The vault is really a gymnastic event; since success is based absolutely on mechanics of form, modern coaching methods have had more effect here than on the more natural forms of competition.

The shot put calls for more scientific coordination than any other field event. Hence it is hardly surprising that the present record shows a sixty per cent improvement over the first Olympic mark of 36 feet 2 inches. The present world record, held by Jack Torrance, is 57 feet 1 inch.

Seventy feet have been added to the discus mark of 95 feet 7 $\frac{1}{2}$ inches made by Garrett at the first Olympic games. Part of this improvement came by increasing the circle from seven feet to 8 feet 2 inches. But science has also had a big hand in raising the mark. Today's streamlined discus is cut with the grain running along its face instead of vertically through the wood. Greater weight is put on the rim by eliminating interior rings and shrinking a drop-forged ring flush with the wood around its perimeter, increasing spin by a flywheel effect. New York University's wind-tunnel tests show that the discus travels farther against the wind than with it. A head wind provides a vacuum over the discus, which gives lift to keep it in the air longer.

That the javelin-throw record has increased from 175 feet to 258 feet in thirty years is in part due to greater interest in the event, with consequent refinement of throwing technique. Moreover, the improved javelin is stiffer, has less whip and can fly truer. Its balance permits it to be thrown on a flatter trajectory, yet still maintain altitude.



Javelin throwing is one field event in which perfection of form is highly important

selves have been improved. The swinging hurdle has lessened injuries, encouraged hurdlers to clear it with the least possible clearance.

Among the cream of the world's athletes at the Athens Olympic Games thirty-four years ago, not a man could clear 5 feet 10 inches in the running high jump. Today the record is 6 feet 9 $\frac{3}{4}$ inches. This remarkable improvement is due to an intensive study of body mechanics, combined with superior jumping facilities. The new

Bob Peoples U. of Southern Calif.
at Long Beach Calif.

K14

TERROR STRICKEN, I LEAPT TOWARD THE SINISTER SHAPE!

A true experience of J. H. WILLIAMS, Victoria, B. C.



"ONE BLACK NIGHT I was returning to Vancouver, in my 15-foot inboard motorboat," writes Mr. Williams. "Suddenly, a dark and sinister shape loomed up directly ahead. There was no time to avoid it.

"I LEAPT as the boat crashed into the object—and found myself sitting on a crossbeam of a huge log boom that was being towed by a distant tug. My boat was gone. Shivering with cold, I shouted in vain—the tug was too far away for my voice to reach it.

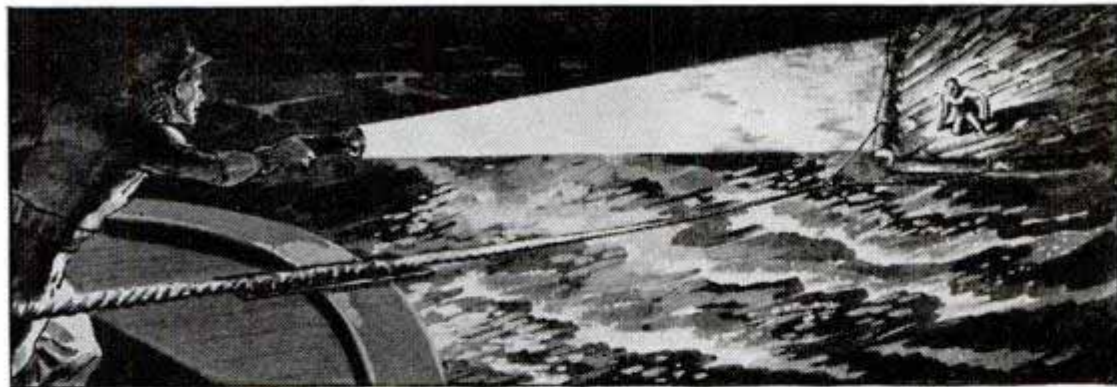

"AFTER HOURS OF TORTURE, the night became stormy and the tug skipper shortened his line. Again I shouted—and this time a flashlight on the tug picked me out with its powerful beam. To the 'Eveready' fresh DATED batteries in that flashlight I probably owe my life—and you can take it from me, I am an 'Eveready' convert now. (Signed) *J. H. Williams*"

The word "Eveready" is a registered trade-mark of National Carbon Co., Inc.



FRESH BATTERIES LAST LONGER... Look for the DATE-LINE

NATIONAL CARBON COMPANY, INC., 30 EAST 42nd STREET, NEW YORK, N. Y.

Unit of Union Carbide **UCC** and Carbon Corporation

GRANDMA CALLED IT SINFUL

IN MY DAY we women couldn't do much about those bristles on the manly chin that scraped like sin. But nowadays any woman's a fool to put up with one of those human porcupines. Which reminds me, my dear, Margie has picked the most delightful young man—always so well groomed—he must shave twice a day—yet his skin's never the least bit irritated looking. It's what Margie calls a Barbasol Face.



YOUR OWN WIFE or sweetheart would be a lot happier, too, if you got yourself a Barbasol Face. Barbasol not only gives you the cleanest, smoothest, sweetest shave you ever had—its beneficial oils protect your skin from razor irritation while you shave—and leaves it feeling softer, smoother, and fresher after you shave. That's why Barbasol has changed the shaving habits of a nation. (Your druggist sells Barbasol in three sizes, 25¢, 50¢, 75¢. Five Barbasol Blades, 15¢.)



For Modern Shaving
No Brush • No Lather • No Rub-in

K1 20,000 Feet Down for Oil

(Continued from page 875)

recovered. It had snapped again. Half a dozen times the pipe was engaged, breaking off a few hundred feet each time without stirring the lower end. Finally the derrick itself buckled under the strain of pulling against the force that held the bit in the earth, and the well was abandoned.

Sometimes a new development in production brings its own difficulties. Several years ago it was found that production in



Drill boss at controls by which he governs speed of rotation of drill and weight on drilling bit

old or poor wells could be stimulated by pumping acid down into the formations, opening up the sands so that oil could flow more freely. Many old fields were rejuvenated by this method and then it was learned that thousands of miles of pipe lines and scores of refineries were being ruined by corrosion from salts produced by the acidizing treatment. In some cases the tubes of refining stills were blocked solidly by salt. The engineers had to develop a method of electrical desalting that removes all but a trace of the salt from the crude. Now acidizing is being continued without harmful results.

Every oil field is marked by a forest of derricks, though the main usefulness of the

K 66

derricks ended when drilling was finished. They are left standing because the tubing and other equipment of producing wells occasionally need to be pulled out and cleaned. Portable truck-mounted derricks with telescoping sections are being tried out to avoid the expense of permanent derricks in shallow fields. Such an outfit can drill as many as eighteen shallow wells a year and then service the wells whenever necessary.

In the laboratory, research on breaking down the hydrocarbons of petroleum is continuing. Theoretically it ought to be easy to manufacture gasoline from the two elements of which it is composed but science can't yet duplicate the petroleum that nature created. One step toward this goal is suggested in the recent discovery that certain hydrogen atoms can be made radioactive by means of the atom-smashing cyclotron. It may be that the hydrogen atoms of petroleum can be "tagged" this way in the laboratory so that they can be traced while the petroleum is put through various oxygenation, polymerization, and cracking processes. This may solve many of the unanswered questions about petroleum.

K 2 78

Spring Stand for Holding Picture Adjusts Self to Fit Any Size

Any size picture can be slipped into a self-adjusting holder which will stand on a table, mantel, piano, or hang on the wall. Coil springs at top and bottom, made of

gr 1-00 scrollable screws

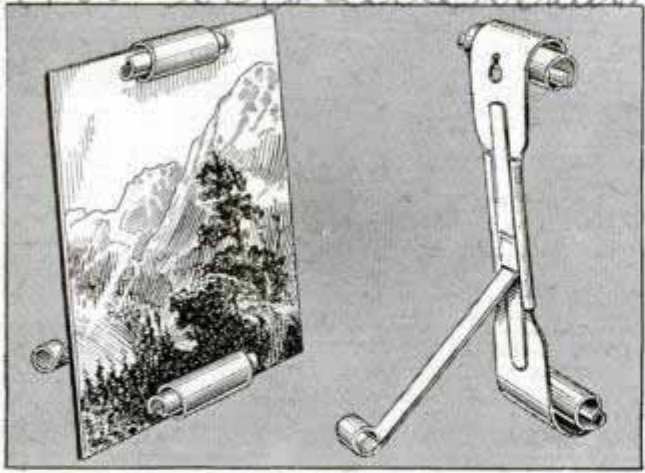

Picture fits tightly under lightweight springs of holder that stands by itself or may be hung on wall

phosphor bronze, automatically roll up to a firm grip. The small size takes any picture from six to nine inches, and the larger one expands from ten to fourteen inches.

Revere Copper & Brass, Inc.

JUNE, 1940

Rome Mfg Co. Inc. Rome NY



"Speed to Spare!"

Compare with any expensive foreign-made candid! Not only in features—but in results!

Check These Features! • 1/1000th second focal plane shutter • Tricolor deep-focus f3.5 lens • Built-in photoflash synchronizer • Automatic film transport—makes double exposures impossible • Quick-action simplified controls • Interchangeable lens equipment.

\$1000 Mercury Prize Contest! Get details from your dealer or write to Universal Camera Corp., Dept. M-1, New York, N. Y.

NEW! Accessory Cartridge for daytime loading all types 35mm. film.

America's Challenge To World's Finest Cameras!



\$29⁷⁵

With Deep-Focus Tricolor f3.5 Lens

On Easy Terms At Many Dealers

1/1000th SECOND
Univex MERCURY

MAKE BIG MONEY AT HOME *Electroplating!*

A Business of Your Own ... Plating Gold, Silver Copper, Nickel etc.

Automatic Equipment Makes Experience Unnecessary! **EASY AS PAINTING!**

NEW FIELD ... NEW PATENTED SYSTEM!



Warner's *simplified* 2-in-1 brush-and-tank system enables you to own complete Electroplating Plant at *unusually low cost*. Does same work as expensive, cumbersome outfits. Deposits layer of gold, silver, nickel, cadmium, copper by electrolysis. You do work guaranteed "Satisfactory or Money Back." *We teach you!*

A Permanent Business! Big profits at low prices bring you business from homes, offices, factories, jewelers, doctors, dentists, autoists, car dealers and most all store owners.

BIG PROFITS FIRST DAY! One hour practice

starts you—then earnings come fast. Warner now makes possible replating of worn articles at a profit... *an untouched field!* Total capacity \$12,000 volume per year—year after year!

AMAZING 2-MINUTE DEMONSTRATION

Draws Big Crowds and Gets the Business Send for details of *self-selling*, money-making plan and earning records of present operators. Learn how you can qualify for *Exclusive Franchise*. Get started right away in this profitable field. **WRITE TODAY.** Just say: "Send full details on new Warner System!"

WRITE AT ONCE

WARNER ELECTRIC COMPANY.

360 No. Michigan Ave., Dept. B-5, Chicago, Ill.

FREE SAMPLE PROVES CLAIMS



GERSTNER Tool Chests

Often imitated—Never equalled. The choice of Machinists and Toolmakers everywhere. Free Catalog.

GERSTNER TOOL CHESTS

440 Columbia St. Dayton, Ohio

Make Big Money The American Way



Get into something for yourself where your income is practically unlimited—the **AMERICAN ELECTRIC METHOD** of floor surfacing gives you that opportunity. Large profits—work easy to get—no previous experience necessary. Start with as little as \$75 in this tried and proven money-making business. Write quickly—no cost or obligation.

The American Floor Surfacing Machine Co.
523 South St. Clair Street • Toledo, Ohio

BURN YOUR NAME ON TOOLS

WITH THE ARKOGRAF

PROTECT YOUR TOOLS FROM THEFT

Write with electricity any name or design on the hardest and finest tools and instruments, or any metal, like writing on paper with pen or pencil. **Complete Outfit \$3.50—Prepaid Anywhere** Interesting illustrated circular free. Write today. Agents wanted. **ARKOGRAF PEN CO., 3927 S.E. Stark St., Portland, Ore.**

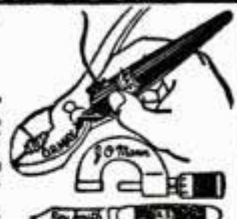

"MARVEL-OU" TRAILER PARTS

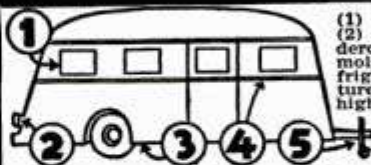

(1) "Famous" Marvel Windows, (2) tail lights, (3) complete undercarriage equipment, (4) body moldings, (5) couplers. Also refrigerators, stoves, lighting fixtures, everything you need in highest quality. Largest trailer equipment stock in U. S. Immediate delivery, low prices. Send 10c coin for 40-page ill. catalog.

Marvel Trailer Parts Co., 19020 Celestine Ave., Detroit, Mich.



FLASHES from REAR WINDOW—DASH Control

AGENTS A whirlwind seller. Drivers buy on flash demonstration. Dealers buy 3 to 12. Your profit mark-up as high as 264%. Biggest sensation of year. Rush name quick for facts and Demonstrator sample plan. All Free! Rush. **WATCH-MY-TURN SIGNAL CO., Dept. W-166, Walnut Bldg., Des Moines, Iowa**

FIREWORKS FREE Oh Boy!



THINK OF IT! An assortment of over 605 pieces of fireworks worth \$6.15, for \$2.95 cash with order. We have the famous "ZEBRA" flashlight crackers. World's loudest. You get more for your money at **BANNER**. 100 FREE salutes with every order. Write for free catalog.

BANNER FIREWORKS

3916 1/2 Detroit Ave. Toledo, Ohio

RE-STRING RACKETS AT HOME



EARN MONEY WITH THE WONDER VISE

It's pleasant, profitable work. No experience or skill required. Easy to learn. Full line of guaranteed Stringing Tools, Frames, Gut and Silk Strings. Every item high quality.

W. A. BICKEL & CO.

137 N. Marion, Dept. A-60, Oak Park, Ill.



CATCH FISH!

minnows, eels, mink, muskrat, with our folding galvanised Steel Wire Traps. **Walton's Automatic Hooks** are so constructed that when a fish gives the slightest pull on the bait the upper hook reaches down and gets a hold that lands him. 3 for 50c. Write for descriptive catalog of Traps, Hooks, Lures, and other specialties. **Walton Supply Co., 3567 Junata Ave., St. Louis, Mo.**

Print Your Own

Cards, stationery, circulars, tags, labels, advertising, etc. Save money. **Print for Others; Big Profits;** easy rules sent. Will do popular Raised Printing like Engraving. Junior outfit \$9. Senior outfit \$17 and up. Send for free catalog and all details. **KELSEY PRESSES. E-37. MERIDEN, CONN.**

BUILD YOUR GRANDFATHER CLOCK

SIMPLE SHOP TESTED BLUEPRINT SYSTEM 25c
The Simple Sensible Red-Kut way as thousands have, **DIME** brings PLANS and sixty picture "HOW TO" book pricing many fine brass weight Westminster, tube chimes, electric and battery movements showing nine beautiful colonial grandfather cases. Build now and save half. **KUEMPEL CHIME CLOCK CO., Bldg. 41, Guttenberg, Iowa.**



Do more Earn more Work less with a

Red Universal E Tractor

You plow, disc, cultivate, mow, haul, do belt work, for about 33c a day. Safe, trouble-free long life. New plow lift, new reverse. Hundreds used. Save by buying from maker. Two weeks trial. **FREE** catalog. Write today.

PIONEER MFG. COMPANY
Dept. V-60 West Allis, Wis.

2125L

The World's Shock Absorber

(Continued from page 895)

effectively absorb energy and at the same time retain its original form. The day is close at hand when all vibrating machinery will be mounted on rubber, thus prolonging the life of the structures which house such machinery and the life of the machinery itself.

Making a name for itself in the food-packaging field is another product derived from rubber. Coming in sheets of various thickness, clear or opaque, in a wide range of colors, this product is impervious to air or moisture and makes a completely sealed package by application of heat to the seams. First used in making raincoats, umbrellas and other waterproof garments, this material is finding wide use as decorative wrappings for packages of all sorts. Colorful ribbons are made from it, and it is estimated that enough of this ribbon to festoon both sides of a coast-to-coast highway was used to add beauty to 1939 Christmas packages.

Rubber base paints are available for protection of many surfaces, while rubber cement is useful in certain operations. Rubber impregnated fabrics, known for years in the manufacture of balloons and airships, are extending their usefulness, and we now have especially treated bags in use in bulk gasoline storage plants, where they catch the gasoline-saturated vapors and reduce to a minimum evaporation losses which run into millions of dollars annually. Rubberized fabric boats that occupy small space and may be inflated quickly, are carried by airplanes flying over water, and sportsmen use them in lakes and streams where conventional boats may not be taken. Tanks and pipes used for storage or conveying of acids now may be lined with a rubber composition that resists the action of the acids. Use of rubber flooring and wall rubber is specified in modern homes, hospitals, office buildings, trains and ocean liners.

Through the building industry, the modern conveniences of our homes and offices, the operating rooms of hospitals, and through mines and factories the threads of vulcanized rubber are woven back and forth in the fashioning of the fabric of modern living.

(Continued to page 125A)

"I certainly am
NOT loafing"

ME LOAFING? I should say not! When Susan called, I was merely deep in thought. "I know I am supposed to polish the car," I said. "But, Susan, you do not understand. I have been lying here inventing a new and easier method for polishing autos."



"WELL, you can stop inventing right now," said Susan, pointing to the No. 7 Polish ad in my magazine. "Somebody beat you to it. And if this polish is as easy to use as everybody says it is, even you can shine the car quickly. Now get goin'!"

SOON AFTER, Susan stuck her head out the window and shouted: "Stop gawking at the neighbors' new car and get that polish!" "But, Susan," I replied, "this is our car. It was so easy polishing it with No. 7 I think I'll go into the car-polishing business!"



**DU PONT
No. 7 POLISH**

made by the makers
of DUCO* and DULUX*

*Reg. U. S. Pat. Off.

WANT A SAMPLE?

DU PONT CO., Dept. 3-MP, Wilmington, Del.

Please send me a sample of the improved No. 7 Polish—enough for hood and fenders. I enclose 6¢ to help cover mailing costs.

Name _____

Address _____

City & State _____

Offer good in U. S. only

WINDSHIELD AND TOP MOULDING LEAKS stopped quickly and securely with DU PONT TOP SEALER. Good for rear window leaks, too.



THIS OUTBOARD MOTOR HANDY CHART

TELLS AN EXCLUSIVE STORY

● All about the wonderful new Sea-Horse outboard motors and their many exclusive refinements: including (1) *Perfected Alternate Firing* (2) *Built-in Underwater Exhaust* (3) *REVERSE*. Only *Johnson has all three!* Two new *Bantam Singles*, with 36% power increase. Sensational new *HI-POWER Perfected Alternate Firing Twin*. \$49.50

Eight other great models. Priced as low as f. o. b. factory
Get the new 1940 Sea-Horse Handy Chart. Sent FREE! Write Johnson Motors, 400 Pershing Road, Waukegan, Illinois.

JOHNSON SEA-HORSE OUTBOARD MOTORS

TEST-O-LITE

Tests Everything Electrical
From 100 to 550 Volts

A real necessity for electricians and home because it has 1001 uses. Equipped with a Neon light which tells instantly where trouble lies in electric circuits, fuses, cut-outs, motors, radios, all kinds of electric appliances, etc. Tells A. C. from D. C. Far superior to ordinary clumsy test bulb. Fountain pen size with clip for carrying in vest pocket. Lifetime guarantee.

PATENTED

L. S. BRACH MFG. CORP.
55 Dickerson St., Newark, N. J.



APPLIANCES



MOTORS



FUSES

\$1.50
At
Elec-
trical
Stores
or
Post-
paid

Build the COMET ZIPPER, JR.

RUBBER-POWERED
—BUT IT LOOKS
AND FLIES LIKE A
GAS MODEL!



Scaled down from the champion Comet Zipper, designed by Carl Goldberg. Detachable wing, finished cylinder, bent landing gear, finished prop, plenty of fresh, peppy rubber, etc. Big 32" wingspan; amazingly complete kit. Ask for Kit No. P8, \$1; postage 15c, none if ordered from dealer.

BIG, NEW CATALOG
Shows hundreds of models, including gas models, motors. Send 5c stamps.

COMET MODEL AIRPLANE & SUPPLY CO.
129 W. 29th St., Chicago, Dept. P6 — 688 Broadway, New York

NOW ONLY \$4.95 **REAL ENGINE VALUE**

Over 7,000 GHQ Gas Engine Kits were sold at \$8.50. Over 15,000 sold last year. Now is your chance to buy the *New Improved* kit for \$4.95. Absolutely complete with coil, plug, etc. For boats, planes, etc. All parts guaranteed. Send only \$1.—*Shipped Express Collect for balance same day. Send 6c for new 20-page illus. catalog. DEALERS WANTED.*

All parts finished. Only a screwdriver needed. 1/5 H.P. Average assembly time 30 minutes.

GHQ MOTORS, 40B East 21 St., New York, N. Y.

\$13.95
Full
Set



MICROMETERS

Six piece set, in velvet lined leather case. Special price, only \$13.95. Precision machined in one thousandths, up to 4" outside and 3/4" inside measurements. Guaranteed accurate, easy to read and adjust. Satisfaction guaranteed or money back.

FREE
FOLDER

This is your opportunity to get one at a Bargain Price if you act now. Shipped prepaid on receipt of remittance. On C.O.D. shipments, send deposit of \$2.00.

MICRO PRODUCTS, 529 E. Jefferson Ave., Detroit, Mich.

Send for my new BARGAINGRAM NO. 242

A monumental work—lists thousands of STILL Cameras — New and Used. . . apparatus galore — Slide Projectors—Gigantic Book Section . . . Chemicals, etc. etc. Also Cine Catalog No. 240 — Both FREE.

Bass CAMERA CO.

179 W. MADISON ST., CHICAGO, ILL. DEPT. P



only
10c

Wood workers: Here it is!

Harold Hunt's 1940 catalog! Latest, UP-TO-DATE IDEAS for experts and amateurs; **SPECIAL BARGAINS** in rare woods, machines, and all kinds of supplies. Get posted! Send only 10c to **CRAFTSMAN'S WOOD SERVICE CO.** 2729 S. Mary Street Div. 337A, CHICAGO

TRAILER BUILDERS • BUYERS • OWNERS TRAILER

Send 25c for this Big Book Today
Over 100 pages! Beautifully Printed and Illustrated! Trailer Suggestions and Ideas galore! Catalog shows America's greatest line of Trailer Parts and Equipment at lowest prices. Everything from wheels to top. Rush 25c today. Satisfaction positively guaranteed!

TRAILER SUPPLY CO.

Box 438-A

WAUSAU, WIS.



BUILD IT YOURSELF

The *Jim Dandy Cabin Cruiser*. The Trailer that has everything. Clean! Roomy. Easy to build in any size with my simplified Plans and Instructions—Price \$1.00. Rush dollar bill today to **JIM DANDY Box 125-A WAUSAU, WIS.**



PUSH-BUTTON CONTROLLED GAS TANK LOCK

A new invention SNAP-UP "ELECTRIC HAMMER ACTION" obsoletes all other gas caps. ELIMINATES TRoublesome KEYS. STOPS LOSS OF GAS AND CAPS. Features PUSHBUTTON CONTROL FROM DASH—STREAMLINE DESIGN. A fast selling—high quality product at NEW LOW PRICES—YEAR GUARANTEE. If your dealer cannot supply you, order direct. DISTRIBUTORS, DEALERS, HERE

IS YOUR MONEY MAKING OPPORTUNITY. Write for literature.

SNAP-UP GAS CAP CO.

DEPT. U.

ASHLAND, KY.

BUILD AN ARC WELDER FROM OLD GENERATOR

For Light or Heavy Work. 75-200 amperes. Complete PLANS and valuable catalog 35c. Over 900 Electrical Supply Bargains. LeJay Mfg. Co., 1347 LeJay Building, Minneapolis, Minnesota



GARDEN TRACTORS

• S P E E D E X •

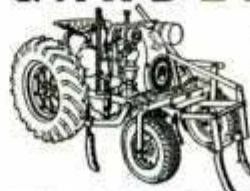

Built to give years of service. Hundreds in use. **Low Factory to User Prices.** Several models available. 5-H.P. Riding type also Walking types in **Three** sizes. Light Power Cultivator now only \$77.50. Write for Free Illustrated folder.

POND GARDEN TRACTOR CO., Box 216, Dept. 106, Ravenna, O.

Say you saw it in Popular Mechanics!

91256
(Continued from page 123A)

All this we have. And much more is to come.

In fixing rubber's position in modern civilization it is possible to say that 4,000,000 persons, the world over, are employed in the rubber business; it also may be pointed out that almost \$3,000,000,000 are invested in the facilities for the growing, manufacture and distribution of rubber; we may consider the fact that there are more than 50,000 different and useful products made of rubber and that more than 2,000,000,000 pounds of pure rubber are consumed in a normal year.

But such measurements are inadequate. I believe we get closer to the real answer when we think of our social and economic structure as a living thing, the skeleton of which is composed of metal and stone, the arterial system of which carries a life stream of oil, and the flexing muscles and sinews of which are of rubber.

21467
Making Your Voice Do Tricks

(Continued from page 885)

coils and electrical filters. From its loud speaker, when a trained operator manipulates the keys, come sounds resembling vowels and consonants. The vowels and consonants may be combined into words, at the will of the operator, and simulation of the human voice is completed by operation of the foot pedal which raises and lowers the pitch. A synthetic speaker doing electrically what one does in talking, by controlling through keys sources of sound corresponding to vocal cords and breath, the Voder is expected to play an important part in telephone research and engineering. Both the Voder and Vocoder are outgrowths of research by Homer W. Dudley in electrical analysis and synthesis of speech.

Among the interesting devices for testing the voice is the oscilloscope, which permits the subject to "see" his voice. A regular telephone set is connected to the input of an amplifier, the output of which is connected to a vibrating mirror assembly. The mirror vibrates with an amplitude corresponding to the volume of speech impressed on the transmitter and with a frequency corresponding to the frequency of sound on the transmitter. An optical sys-

(Continued to page 126A)

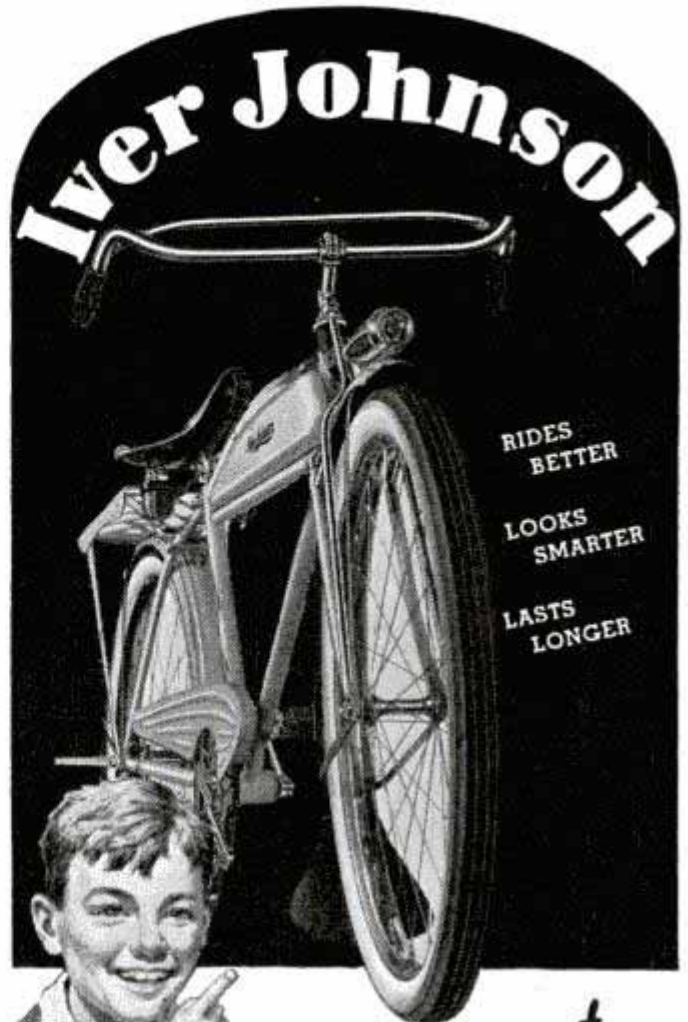

America's Finest
FOR 3 GENERATIONS

This is our pledge to you that every Iver Johnson is tops for quality. Your dad learned this was true. So will you. An Iver Johnson is a true pal for thousands of happy miles. More than 20 models to choose from. Streamlined design; stunning colors; costly steel frame; drop-forgings at all vital parts — an Iver Johnson HAS EVERYTHING. Send for Bicycle Folder B 66.

Here's Another Winner!

— the Iver Johnson Self-Cocking .22 Single Shot Bolt Action Safety Rifle. Loaded, cocked and locked with one operation of hand. Only \$5.75. Send for Folder A 66 featuring this swell rifle; also Target Revolvers and Shotguns.



Booklets are FREE

IVER JOHNSON'S ARMS & CYCLE WORKS
21 RIVER STREET, FITCHBURG, MASS.
New York: 85 Chambers Street



YOU ARE never very far from a can of Sani-Flush. You'll find it in most bathrooms for cleaning toilets. So don't wait for a car radiator to hiss and boil. Keep it cleaned out. Use Sani-Flush twice a year. See directions on can.

It cannot injure motor or fittings. It removes rust, scale, sediment and sludge. Your car runs cooler. Power is saved. You may save on expensive repair bills due to overheating. Clean out the radiator yourself for 10c (25c for the largest truck or tractor). Or ask your service station to do the job for you. Insist on Sani-Flush. Sold by grocery, drug, hardware, and 5-and-10c stores. 10c and 25c sizes. The Hygienic Products Co., Canton, Ohio.

Sani-Flush **Safe**
CLEANS OUT RADIATORS **NOT CAUSTIC**



MAKE MONEY WITHOUT SELLING
30c returns \$4.50

Step into big money with "King Jr", \$3.95. Vends breath pellets, nuts, gum, candy. Place in taverns, stores, waiting rooms, etc. Start small—full or spare time. Get FREE facts today.
AUTOMATIC GAMES, 2425-V Fullerton, Chicago

Rheumatism **Relieve Pain in Few Minutes or Money Back**

To relieve the torturing pain of Neuritis, Rheumatism, Neuralgia or Lumbago in a few minutes, get NURITO, the fine formula, used by thousands. No opiates. Does the work quickly—must relieve cruel pain to your satisfaction in a few minutes—or your money back. Don't suffer. Clip this ad now as a reminder to ask your druggist for NURITO today.

21909

tem produces a spot of light on the vibrating mirror, which reflects it eventually to a screen so that voice vibrations appear on the screen as a light wave pattern, giving a picture of the sound of your voice.

A stereophonic demonstration by Bell engineers gives a hint of what may be accomplished on the stage in the future. Several persons seated together carry on a conversation heard through loud speakers. After a few minutes, they leave their chairs, the floor revolves and another stage is presented, with chairs similarly placed. In the chairs, however, are dummies. All that the human group said is now repeated through the loud speakers and this reproduction, accomplished by magnetic tape recording, is stereophonic so that the reproduced sounds appear to come from the same place on the stage as they did originally—thus, each dummy seems to have a part in the conversation. This apparatus is believed to offer a means of creating unusual effects on the stage and in symphony orchestra productions.

Strict privacy in telephonic or radio communication is provided by speech-scrambling machines. Words spoken into the transmitter are garbled so that they are unintelligible to anyone listening in, but the unscrambling receiver reproduces them exactly as spoken.

Among recent developments is a portable telephone which gets its power solely from the speaker's voice and will transmit speech over 200 miles. A small, powerful magnet is its secret, voice currents being generated when the flux from the magnet is influenced by a diaphragm vibrating under the sound waves. The portable phone finds wide use in railroad yards, ships, coal mines, construction camps and similar locations.

Bell scientists may appear to be playing tricks on you and your voice, but they're really creating instruments that will make it easier for you to telephone your grocer a block away or a friend perhaps two-thirds of the way around the world.

ⓄNew York had but a slight lead over California in auto, truck and bus registrations last year, New York counting 2,634,285 to California's 2,605,147, while Pennsylvania's 2,099,234 was the only other passing the two-million mark.

Automotive Products

Wear HORSEHIDE HANDS and Save Your Own!

YOU'LL think Horsehide Hands are never going to wear out. That's how tough they are. But, more amazing still — they're soft as buckskin — stay soft always — even dry soft after soaking. That's because they're tanned a secret way known only to Wolverine tanners — the same ones who tan leather for the famous Wolverine Shell Horsehide Work Shoes. If your dealer can't supply you, send his name and 75c. We'll mail you a pair postpaid. Ask for style 569. **Wolverine Shoe & Tanning Corp., Dept. H-111, Rockford, Michigan.**



Style No. 569
Old Gold Color

**MAN!
THEY'RE
TOUGH!**



DEALERS:

Horsehide Hands making big hit everywhere. Write for catalog and tested sales plan.

WOLVERINE HORSEHIDE WORK GLOVES

Enjoy VACATION Travel



Why waste precious vacation time through lost directions and wrong-way travel? No matter where you drive . . . town or country . . . every confusing turn is solved for you with a Hull Streamline Auto Compass on your windshield. Attractive Bakelite case, genuine sapphire bearing, built-in compensator. Only \$2.95 at your dealer. Write for literature.



HULL MFG. CO., P. O. Box 246-D6, WARREN, OHIO

STANDARD GARDEN TRACTORS

Plow
Seed
Cultivate
Mow Hay
and Lawns

Powerful Gas Tractors for Small Farms, Gardeners, Florists, Nurseries, Fruit Growers, Poultrymen.

1 & 2 Cylinders

High Wheels. Rubber or Steel Tires. Walk or Ride.

Do Belt Work—Free Catalog

STANDARD ENGINE CO.

Minneapolis, Minn. Philadelphia, Pa. New York, N. Y.
3221 Como Ave. 2546 Market St. 290 Cedar St.



BRUSH PLATING OUTFITS

for autoparts, reflectors, faucets, bicycles.
No tanks necessary. Free particulars.

GUNMETAL CO., AVE. M, DECATUR, ILLINOIS

NEW TRAILER BUILDERS' GUIDE AND CATALOG

WORLD'S BEST LINE OF TRAILER AXLES, HITCHES AND PARTS including New Universal Trailer Draw Bar, readily attached to any late model car. Complete house trailer working blue prints only \$50. SEND 10c TODAY FOR THIS NEW CATALOG.

HAMMER BLOW TOOL COMPANY, DEPT. 106, WAUSAU, WIS.

DO YOU

WANT a new business profession of your own, with all the trade you can attend to? Then become a foot correctionist, and in a few weeks earn big income in service fees,—not medical nor chiropody—easy terms for home training, no further capital needed, no goods to buy, no agency. Established 1894. Address Stephenson Laboratory, 1 Back Bay, Boston, Mass.

ONAN ELECTRIC PLANTS ALTERNATING AND DIRECT CURRENT



Produce Current, same as City Power Lines, for FARMS, SCHOOLS, THEATRES, PUBLIC BUILDINGS . . . Operate Lights, Radios, Motors, All Appliances.

Over 40 STOCK MODELS—350 to 50,000 Watts.
Any Voltage—Any Frequency.
Combination A. C. - D. C. Types.
Manual, Full Automatic and Self-Starting. \$79 up.
Shipped—COMPLETE, READY FOR OPERATION.
THOUSANDS IN USE IN ALL PARTS OF THE WORLD

Write for Complete Details.

D. W. ONAN & SONS

1046 Royalston Avenue - MINNEAPOLIS, MINN.

MEGOW'S

Model

- AIRPLANES
- SHIPS
- "HO" & "O" GAUGE RAILROADS

SEND 5¢ TODAY

FOR NEW CATALOG



MEGOW Dept. PM, How. & Oxf. Sts., Phila.
217 N. Desplaines St., Chicago

Our Flying Navy

(Continued from Coloroto Section)

1095
tended flight by dead reckoning you see beginners struggling around the bay in primary seaplanes, and realize you've come a long way. Looking ahead toward the time when you'll be flying over hundreds of miles of water, where every wave looks alike and navigating ability means life or death, you tackle instrument flying with zest and move up confidently to Squadron Four and its twin-engined flying boats.

Now you look over at close hand the huge seaplane that stirred your first desire to fly. The instructor says you are to do horizontal bombing, navigate at sea and fix positions by dead reckoning and celestial navigation. But first, to fly the boat. The old familiar stick is now a wheel. And you sense that all these tons won't answer so quickly to the controls. At last you're allowed to take it up, and you feel that you're flying the hangar itself. In six hours you're able to lift her off the water properly and land, taxiing on one motor despite wind and current.

Time now to try practical application of the textbook on bombing. With a fellow student at the controls, 10,000 feet up, you kneel over the bomb sight to find the barely visible target, turn the knobs till you're "on," pull the toggle and the bomb drops. Down, down, nearly two miles, then a splash. Generally a miss, but soon enough come the thrills of perfect hits.

Later on there's fun, if it is tough, in navigational problems—"Find your object, whereabouts unknown." And as a parting test in "Advanced Seaplanes" you ride the catapult. Taking the instructor's advice you relax and don't try to fly the plane till it's in the air. It isn't a very long wait!

Squadron Five, "Advanced Landplanes," puts you in a single-seat fighter, and for the first time you take up a new-type plane without friendly advice coming in through your gosport. Single-seater tactics call for the highest physical and mental coordination. After grueling hours of drill you're able to put on an acceptable show of advanced acrobatics for the official board, but you have to do a full repeat simply because you neglected to notice that some clouds obscured your best snap rolls and some perfect loops. In the encore performance you even remember not to get between the sun and your instructors.

Dive bombing and fixed gunnery technique, advanced tactics in low-wing monoplanes—including high-altitude flight—and aerial torpedo dropping are mastered along with learning what to do with all the speed that's now at your command. Just as you think you know all there is to know, you're told to finish up the instrument-flying course, which will give you a Scheduled Air Transport rating.

So you arrive at a point where you can actually look back. It has been exhausting work, clouded by many a day of dark depression but with never a dull moment and with certain highspots of encouragement that will always sparkle in your memory. All the while you've been driving, driving toward one goal—a word from the commandant that you have met the test. And at last the summons comes.

Every man of your class who has been able to climb along with you through the five training squadrons assembles before the officers. Proud, in best uniforms that reflect inner exhilaration, you all look fondly toward the stock of little white boxes that hold the coveted Navy Wings. The admiral is pinning one on the lad next to you, and now, rigidly at attention, you hear the sharp point prick the starched white fabric of your own uniform coat. A hand is thrust into yours in firm clasp, and as you look up you notice a pair of wings like your own on the commandant's coat. "Why," it suddenly occurs to you, "he's gone through all of this himself."

The commandant proceeds down the line. At the end he steps back a few paces and addresses the class:

"Gentlemen, I am happy to present you with your Navy Wings, for you have earned them. Your work here at Pensacola has prepared you for what you must learn in carrying out your tasks in the fleet. You now belong to that group of officers known as naval aviators. Your predecessors have established a high standard of efficiency, progress and safety. They have made naval aviation what it is today. It is your duty to live up to that standard and contribute to it. It is a difficult assignment but I believe you can do it. I congratulate you and wish you a happy cruise. Report to my office for orders."

(Concluded next month)

"TUNE-UP, MY EYE!"

Says Mr. Smith

"If there's any tuning-up to be done on this car, I'll do it myself—and pocket the money I save. All she needs is to have the spark plugs cleaned, and maybe a little carburetor adjustment."



"That's where you're wrong, Mr. Smith," points out Fred. "What your car needs most is a Certified Re-Wiring check-up with this voltmeter. You know, a car won't run sweet if 'bottle-neck' wiring is choking off the juice to the coil, distributor and spark plugs."

"Boy, that's something like it!" says Mr. Smith after Fred has done the job. "It ought to be good!" says Fred. "I found bad wiring and dirty connections in three of your circuits. She's fixed right now—with Packard cable."



CERTIFIED RE-WIRING FOR A BETTER SPRING TUNE-UP

The chances are 4 to 1 that your car's performance is suffering from faulty wiring—worn-out or undersize cables and poor connections. To get rid of these electrical "bottle-necks" and restore pep and power, drive into a Packard Certified Re-Wiring Station. That blue-and-gold Certified Re-Wiring sign outside the door means that your wiring will be checked by a trained mechanic with accurate instruments—and that all necessary cable replacements will be made with Packard cable.

DEALERS

Ask your jobber about Packard Certified Re-Wiring, and have him arrange to show you the new Packard film, "Copper Dollars." Packard Electric Division, General Motors Corporation, Warren, Ohio.



Packard

REG. U.S. PAT. OFF.
TRADE MARK

THE STANDARD WIRING EQUIPMENT OF THE AUTOMOTIVE INDUSTRY

Tapping Neptune's Treasure Chest

(Continued from page 842)

once despised shark is now sought by commercial fishermen. Thousands of gallons of sardine oil are used annually in paint, soap, linoleum, and other products. Fish meal, a by-product of sardine oil reduction, is used as fertilizer and cattle feed.

Short-wave radio has recently been adopted by fishermen for conversing at sea, the captain of a boat that has located a school of fish being able to advise other boats of his location. Lately progressive fishermen have started to use ultrasonic depth-finders to locate fish. Waves from the apparatus radiate under water and are reflected in a recognizable pattern to the boat when they strike a body of fish.

Federal and state agencies are conducting intensive research with the idea that the sea should be "farmed" instead of depleted of its fisheries wealth. The fisheries bureau of California, for instance, investigates the migratory and other habits of fish as far south as Panama and as far as 500 miles to sea. Some species such as the California sardine are threatened by over-fishing and the expectation is that by proper restrictions this and other valuable species can be made to yield an annual "crop" large enough to satisfy demand and yet not so large that the species will disappear. One example of successful conservation is the fur seal herds of the Pribilof Islands, which, threatened with extinction early in the century, are now yielding a sustained supply of high-quality fur.

Aquiculture, the cultivation of oysters, crabs, and lobsters in quiet bays and estuaries, is practiced extensively and holds the promise of supplying tremendous quantities of food and other products.

The potential power resources of the sea have intrigued engineers for centuries and novel ideas have been proposed for harnessing the waves and tides. A number of small plants use tidal power along the New England coast. These, as would have been the case with the Passamaquoddy Project that was abandoned because of lack of a potential market for the power, trap large quantities of water in ponds at high tide and then allow the outflowing water from the ponds to spin electric turbines or turn mill shafts. Numerous wave machines have been patented or suggested, the most satisfactory of which appear to be

those that use the hydraulic ram principle, utilizing the fall of water to lift small quantities of water from the ocean to storage tanks at the top of a cliff. This raised water is then allowed to flow through a turbine or mechanical waterwheel. So far, tide or wave power seems unable to compete in most places with power obtained from other sources.

Using treated sea water for irrigation and drinking purposes is another idea that has received much thought and that some time may be tried in arid areas adjoining a coast. In one experiment sea water was circulated through semi-permeable pipes laid in the ground, most of the salt and mineral content of the water being trapped in the pores of the pipes while the relatively pure water slowly soaked through to the earth. Periodic renewal of the pipes or some means of removing their salt load would be necessary in a successful salt-water irrigation project. Such power and water schemes, impractical today, are probably no more fantastic than the plan for a fresh-water aqueduct from the Colorado river to Los Angeles appeared a few decades back, Dr. ZoBell suggests.

One study at Scripps is directed toward elimination of marine growths from the hulls of ships, an infestation that slows down ocean commerce and that causes losses of millions of dollars per year. All anti-fouling antidotes to date have used poisons with the idea of killing or slowing the growth of the parasites. The people at Scripps recently found that the speed-retarding growths attach themselves to a primary layer of micro-organisms on the hull instead of directly to the hull itself. The suggestion now is that by preventing the first layer of bacteria and diatoms from fastening themselves to the hulls the problem may be solved.

More than two-thirds of the earth is covered with water and the nearly 300,000,000 cubic miles of ocean directly or indirectly influences the life of every inhabitant of the world, yet in some respects science knows more about stars thousands of light-years away than it does about the seas of our own planet. Eventually, with more knowledge, civilization will make far greater use of the oceans' treasures.

*Sandring
margin
Hume
Blues
Ltd
Marconi
Co
London
W.C.2, E.C.4
England*

HOW TO GET "MOST FOR YOUR MONEY"

OUT OF A BATTERY



To get the maximum satisfactory service from your storage battery, follow these four points of battery care . . .

1 KEEP ELECTROLYTE AT PROPER LEVEL.

Water must be added regularly to the battery, particularly during the summer months when evaporation is rapid, in order to keep the electrolyte at its proper level— $\frac{1}{4}$ " to $\frac{3}{8}$ " above the separators. Distilled water is preferable, since the continued use of water with mineral content will eventually damage the battery. Excessive consumption of water is usually due to overcharging.

2 MAKE SURE THAT BATTERY IS TIGHT IN CARRIER.

Excessive vibration shortens the life of a battery. Therefore, it is important to make sure that the clamps hold the battery firmly in its carrier. If clamps are too tight, the battery case will be damaged.

3 HAVE TERMINALS CLEANED PERIODICALLY.

A good battery cannot deliver its full power to the electrical system if the terminals have become dirty or corroded. Have terminals, battery cables and cable connections inspected regularly, and the terminals cleaned, when necessary, with steel wool or baking soda water. Your battery will serve you better—last you longer.

4 KEEP BATTERY FULLY CHARGED.

A battery does not store up electricity—it stores up *chemical* energy that is converted into electrical energy. A hydrometer reading will reveal whether the chemical condition of the battery is up to standard. Since this standard varies according to the temperature of the electrolyte and the length of time a battery has been in service, let your Delco battery dealer help you. Have him check your battery regularly, and avoid the danger of an undercharged battery.

MOST IMPORTANT OF ALL—GET A GOOD BATTERY TO BEGIN WITH

Regardless of how much care you give to a battery, it won't give you good service if it wasn't *designed* and *built* right in the first place. The engineers who design Delco batteries have taken into account all the conditions that affect battery life and performance—heat, cold, vibration, starting, accessory

draw, self-discharge, and many other factors. They have used the information gained through years of building batteries for America's leading cars—40% of which are factory-equipped with Delco batteries. For long, dependable service, replace with a Delco—at your nearby Delco battery dealer's.

Delco-Remy

World's Largest Manufacturer of Automotive Electrical Equipment

A STRONG BOAT FOR A LONG LIFE



• What do you ask of a boat? Speed? Old Town Boats are fashioned for maximum speed with any sized motor. Do you want toughness and strength? Old Town Boats are built to last for years of hard use. And you want reliability. Sponson Old Town Boats combine speed and strength with the safety of an easy chair.

FREE CATALOG illustrates boats for sport, for the family, and all kinds of canoes, rowboats, dinghies. Write today. Address Old Town Canoe Company, 636 Main St., Old Town, Maine.

"Old Town Boats"

NEW STREAMLINE BENJAMIN AIR RIFLES WITH LEVER HAND PUMP



BENJAMIN

HARD ACCURATE SHOOTING WITH CHAMBERED AIR
You can use new models BENJAMIN AIR RIFLE WITH LEVER HAND PUMP anywhere, for practice firing or just plinking around the house or camping, fishing, hunting, at the lowest cost. Shooting force is adjustable depending on AIR PRESSURE—amazing maximum power and accuracy—will penetrate to 1". Hair trigger firing without lunge or recoil. Single Shot BB \$7.50. Repeater BB \$9.00. Rifled Cal. 22 or 177 Single Shot \$8.50. Ask your dealer all about them or write for complete specifications—targets and blueprints FREE if requested. We also make a complete line of BENJAMIN AIR PISTOLS for target and small game. **WRITE TODAY.** BENJAMIN AIR RIFLE CO., 895 MARION ST., ST. LOUIS, MO. U. S. A.



EASY PROFITS IN PAINT SPRAYING

Paint walls, ceilings, screens, furniture, radiators, machinery faster, better! 1/4 H. P. motor 110 Volt 60 Cycle AC, complete with Spray Gun, 15 ft. hose. Weighs only 44 lbs. Carry anywhere, FULLY GUARANTEED. Complete with motor only \$31.15, or only \$25.00 less motor, f. o. b. Chicago. \$5 Deposit, Balance COD, or SEE YOUR DEALER. Circular FREE. Get started making money NOW! **\$2500 Less Motor**
Ideal Automatic Pump Co.

Dept. PM-6, 801 Washington Blvd., Chicago, Illinois

Saw-Filing

Pays up to \$2 or \$3 an Hour in Spare Time

A FOLEY Automatic Saw Filer files hand, circular and band saws better than the best hand filer. Cash business, no canvassing, no eyestrain. No experience needed. Louis F. Wadwick, Ohio, says, "I have filed 784 saws in spare time and have earned \$850.00 in carpenter work due directly to my saw filing contacts." Send coupon for FREE PLAN, no obligation.



FOLEY MFG. CO., 616-40 Foley Bldg., Minneapolis, Minn.

Send Free Plan on Saw Filing business.

Name.....
Address.....



Here's Amazing Relief For Acid Indigestion



YES—TUMS bring amazing quick relief from indigestion, heartburn, sour stomach, gas caused by excess acid. For TUMS work on the true basic principle. Act unbelievably fast to neutralize excess acid conditions. Acid pains are relieved almost at once. *TUMS are guaranteed to contain no soda.* Are not laxative. Contain no harmful drugs. Over 2 billion TUMS already used—proving their amazing benefit. Get TUMS today. Only 10¢ for 12 TUMS at all druggists. You never know when or where



NEW KIND OF MAN'S SHOE

The new sensation in men's shoes—The Chippewa Clipper. It zips on and off in a "jiffy". Now is the right time to get into a dignified and highly profitable shoe business of your own with this fast seller, and a complete line of almost 250 styles of dress, work and sports shoes. Prices as low as \$1.98 a pair. Free 10-second demonstrator sells super-comfort air-cushion shoes like magic.

Sales division for manufacturer established 36 years wants salesmen. No experience needed. Write for complete sales kit. It's free!

VICTOR THOMAS SHOE CO.
6803 No. Clark St., Dept. S-22, Chicago, Ill.



ZIPS ON AND OFF

SALESMEN WANTED BIG PAY EVERY DAY

FINDS BURIED TREASURE! NEW GOLDAK RADIOSCOPE



NEW PATENTED METAL LOCATOR. LATEST TYPE HIGH EFFICIENCY LOW DRAIN TUBES. NEW LOW PRICES. SENSATIONAL NEW MODELS. MONEY-BACK GUARANTEED DETECT BURIED GOLD AND SILVER. The new Radioscope is the most powerful and most sensitive metal locator ever known. Write World's Largest Manufacturer of Successful Metal Detector for free interesting information.

THE GOLDAK CO., Dept. P
1031 South Broadway, Los Angeles, Calif.

build this COAST GUARD CUTTER



Complete Kit
\$2.50
Post Paid

Makes perfect building easy

CARVED HULL
Included!

24" Super Detail Model
Catalog—10c

IDEAL AEROPLANE & SUPPLY CO., Inc., 26 W. 19th St., New York

FREE CAMERA BOOK of Timely "Buys"

Illustrates and compares hundreds of amazing, money-saving Bargains in still and movie Cameras, Lenses, Films, Exposure Meters, Enlargers, Darkroom Supplies... Used equipment accepted in trade. Money-back guarantee! **WRITE!**
CENTRAL CAMERA CO., 230 S. Wabash Ave., Dept. F-16, Chicago, Illinois

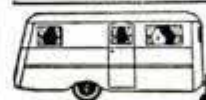

Complete Plans and Building Instructions. 10c

FREE TRAILER PARTS CATALOG

We'll save you money on—axles, springs, wheels, couplers, windows, sinks, water pumps, brakes, refrigerators, beds, lamps, inside and out, 6V lamps, furniture, jacks—everything. Special discount to Mrs. NATIONAL TRAILER EQUIPMENT CO. Successors to Kar-A-Van Industries, Inc. Dept. P. 714 W. Wisconsin Ave., Milwaukee, Wis.

KINKADE GARDEN TRACTOR

and Power Lawnmower
A Practical Power Plow and Cultivator for Gardeners, Suburbanites, Florists, Truckers, Nurserymen, Fruit Growers

Low Prices - Easy Terms
American Farm Machine Co.
1058 33rd Av. SE. Minneapolis, Minn.



Catalog Free

Battling Bugs with Bacteria

(Continued from page 853)

eat some of the bacteria. I have also fed some to my dog, and my canary."

The first great success for Bogue was when he wiped out grasshoppers in the destructive invasion of southern California last spring. He merely sprayed the edges of the fields with bacteria-laden liquid, the grasshoppers spreading the infection themselves. Within twelve hours the "hoppers" in the infected fields were dead.

Recently the French government has begun the use of bacteria to kill rat fleas, which carry deadly bubonic plague. Other work being done indicates that bacteria are effective against termites and silver fish.

But to return to Bogue. His dog had fleas. Bogue sprayed him with bacteria. The fleas vanished. There were ants in his back yard. He sprayed them. They died.

How does it all work? How do scientists create this deadly infection which is harmless to man?

First, the bacteria which are fatal to the type of insect you wish to kill must be bred on a proper laboratory medium. Then their killing power must be intensified. Suppose you are intensifying a corn-worm killing bacteria. First, the bacteria are injected into worms. When the first worms die, indicating that the bacteria which infected them were of a particularly deadly strain, the dead worms are ground in a mortar and from the resultant culture new bacteria are grown. These are again injected into worms, and again cultures are made from those which die first. Eventually the bacteria reach their maximum potency, at which time they are placed on the culture medium and allowed to grow until needed.

Germ-laden liquid is sprayed on the edges of a field or orchard infected with insects, on an ant hill, on fleas, roaches, bedbugs, and other household pests. The dying insects infect other insects and form an endless chain of death.

So, in the not distant future, you may be able to kill your pest with a few puffs of mist from an atomizer. For man has a new weapon against those insects with which he struggles in the real "war of the worlds."

☐ Heating plants on big transport planes are large enough to heat a ten-room house.

JUNE, 1940

Science Service
5/12/40



LUCKY DAY FOR ME WHEN I FOUND OUT THAT THE GILLETTE TECH RAZOR MAKES SHAVING A BREEZE

FRED PERRY, International Tennis Champion

Millions Of Men Now Enjoy Shaving Speed And Comfort Never Experienced Before

FOR SHAVES worth telling your friends about, get acquainted with Gillette's new Tech Razor. "There's no discomfort . . . no nicks or cuts," says Fred Perry. "Easiest-shaving razor I ever used," agrees Coach Crowley. "Bucky" Walters, Gene Sarazen and thousands of others say the same.

Sets Up Your Beard

The Tech has four basic advantages. One is the solid bar guard. This sets up your whiskers like a barber does, speeds shaving and prevents nicks and cuts.

Made For Each Other

Today's Gillette Blue Blade has edges of a new kind. They're sharper, longer lasting. And because these blades are made to fit your Gillette Razor exactly, they spare you all the smart and burn of misfit blades. Ask your dealer for the new Tech Razor and five Gillette Blue Blades. You pay only 49c . . . and satisfaction is guaranteed.



NO TROUBLE GETTING GOOD LOOKING SHAVES IN A JIFFY WITH THE NEW TECH RAZOR AND GILLETTE BLUE BLADE

JIM CROWLEY, Head Football Coach, Fordham University

FOUR BIG IMPROVEMENTS

- 1 SOLID BAR GUARD ASSURES COMFORT
- 2 CLEANS QUICKLY—NEVER CLOGS
- 3 NON-SKID TREAD PROTECTS FACE
- 4 RIGID BLADE SUPPORT SPEEDS SHAVING

TECH RAZOR AND FIVE GILLETTE BLUE BLADES 49¢



TAKE BETTER PICTURES and Save Real Money!

GET THIS NEW FREE
CATALOG OF CAMERA VALUES TODAY

Photographers—this is your book! Never before has so much value-merchandise been packed into a catalog for camera fans only! You'll find here all types of cameras—Stills, candid, home-movie—all nationally advertised. The biggest camera equipment section you've ever seen—with every item accurately described. You'll find new low prices, too, making this book a real money-saver. Now it's easy to own the camera and apparatus you need. Now you can really go ahead in photography. Just mail the coupon for your copy of this great camera catalog today. It's FREE. Act NOW!



LAFAYETTE CAMERA

NEW YORK, N. Y.
100 SIXTH AVENUE
CHICAGO, ILL.
901 W. JACKSON BLVD.
ATLANTA, GA.
245 PEACHTREE STREET
BOSTON, MASS. * BRONX, N. Y.
NEWARK, N. J. * JAMAICA, L. I.

LAFAYETTE CAMERA

Dept. 7FC—100 Sixth Ave., New York, N. Y.

Please rush FREE Camera Catalog

NAME

ADDRESS

CITY

STATE

PASTE COUPON ON PENNY POSTCARD

MOTORIZE YOUR BIKE PLANS ONLY 25c

With a powerful electric motor made from old auto generator. Easily done with LeJay PLANS. Imagine the fun in building this one wheel power "Go-Bike"—more fun to ride. Turn control on handle-bars and away you go. Operates up to 75 miles from single charge of ordinary storage battery. Easily attached to any bicycle. Send 25c today.



LEJAY MFG. CO.

1247 LeJay Bldg. Minneapolis, Minn.

60 POWER TELESCOPE... \$219

VARIABLE EYEPIECE 20X—40X—60X

NEW! Three telescopes in one. 3 different magnifications. 20 power for ultra-bright images with 40 and 60 power for extra long range. Guaranteed to bring distant objects, people, sports events, ships, moon, stars, etc., 60 times as close.



Most powerful made foot in length. Multiple lens system. 30 mm. objective lens. 5 sections. Directions included for using as a compound 4 lens microscope. American made. Prompt shipment guaranteed. We pay the postage. Only \$2.19. BROWNSCOPE CO., Dept. 46, 5 W. 27th St., New York, N. Y.



FOR QUICK AND
EASY CUTTING USE
A DURO BAND SAW

From our 9½" Band Saw to our 16" Production Saw you will enjoy a new standard of smoothness, rigidity and accuracy in band sawing. Many features are built into these saws that make each one an exceptional value. Catalog E-40-B describes in detail our complete line of tools, a copy will be sent free.

DURO METAL PRODUCTS CO.
Dept. PM6 2653 N. Kildare Ave., Chicago, Ill.

DURO TOOLS ARE BEST

Battery-Operated Receiver

(Continued from page 937)

2, and numbered accordingly in diagram Fig. 3.

All parts are standard and cost about \$7.50 less tubes, battery and case. Radio parts houses catalog the 1½-volt "A," 90-volt "B" combination battery pack for \$2.36 net to experimenters and set build-

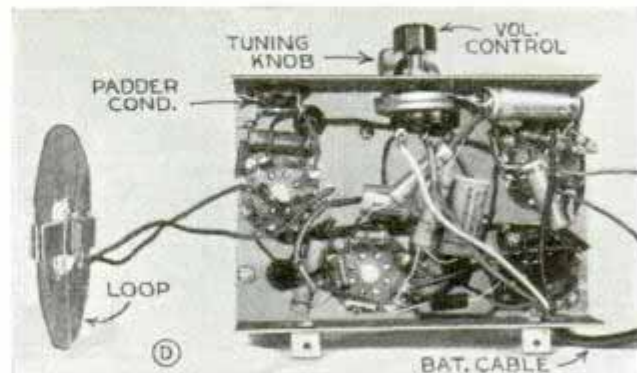

ers; the I.F. coils, oscillator coil and loop are all standard "DX" types under the numbers given. The metal base may be homemade or purchased formed and drilled, if desired. A detailed list of the original parts is available from Popular Mechanics radio department without charge. Although similar wooden cabinets are available, many builders will prefer to make their own. The dimensions shown in Fig. 1 are for the original hand-made mod-

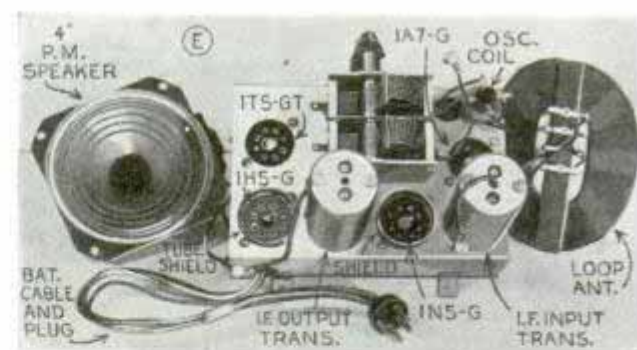

el which was carefully sanded and given a coat of gray crystallizing lacquer.

When wiring the set, make all connections with rosin-core solder and keep each grid and plate lead as short as possible. Plate terminals are No. 3 on tubes 1A7-G, 1N5-G and 1T5-GT; plate terminals for the diode tube 1H5-G are 3 and 5. Terminal 2 is filament positive and 7 is filament negative on all four tubes.

To balance the set outside the cabinet, set the loop in a vertical position, plug in

(Continued to page 136A)

GRIPPING AS FICTION

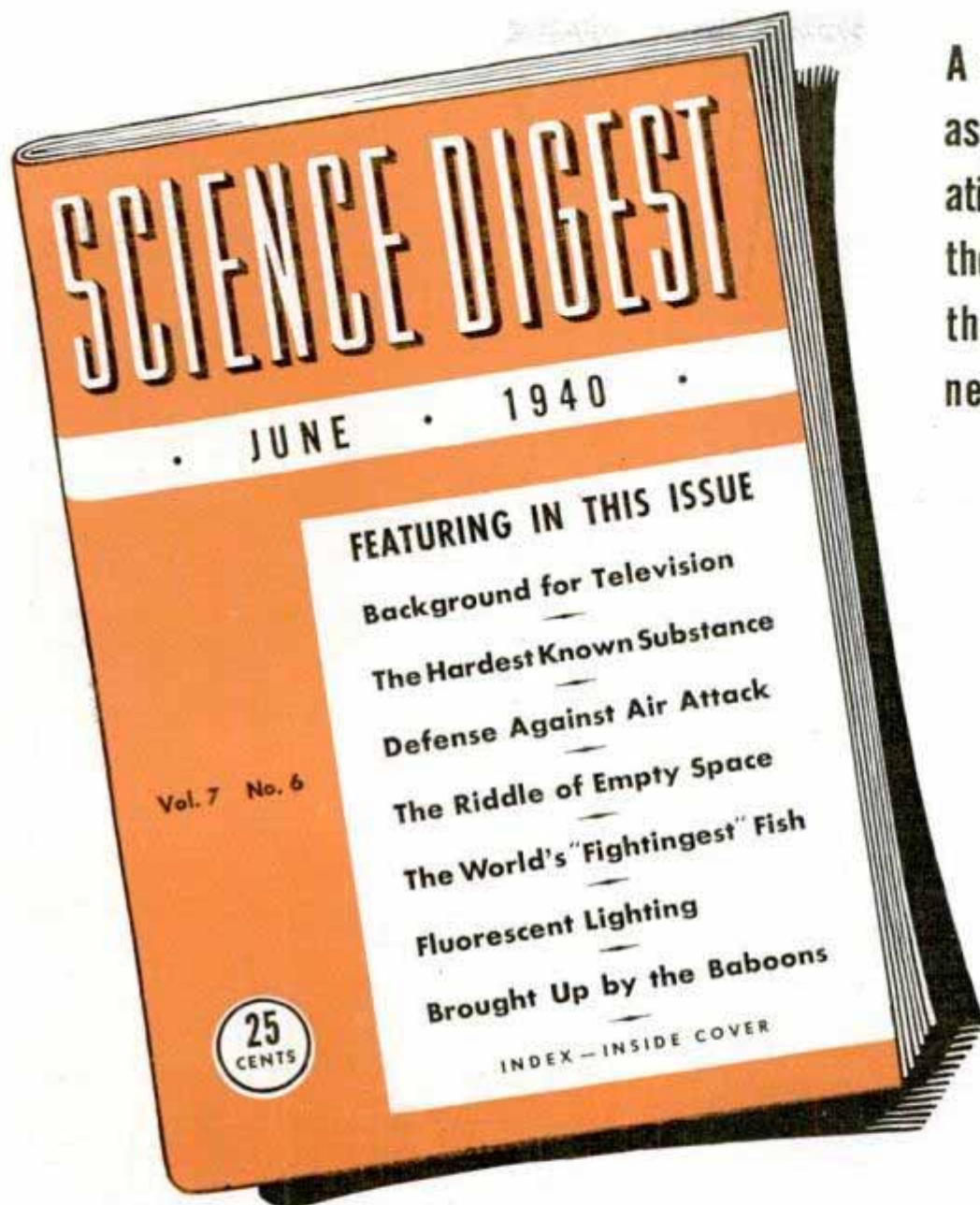

A score of articles as thrilling, informative and helpful as the five featured on the June cover. On newsstands today!

Want real facts about supplying a field army? Or how television has developed? Read about either in the June issue of Science Digest. The authentic story of an African native reared by baboons, the way war fliers outwit elaborate air defenses, the fish that is pure ferocity, the latest developments in fluorescent lighting—every article is one you won't skip once this June issue is in your hands. Just the one section—Patents,

Processes, Inventions—should lead every alert ambitious mechanically-minded man to buy Science Digest today. Over three hundred scientific journals and books were studied to give you these ninety-six pages of news from all branches of science from all over the world. There is no other publication like Science Digest.

SCIENCE DIGEST, INC.
631-643 St. Clair St., Chicago

ON NEWSSTANDS NOW—25 CENTS

EVERYTHING IN RADIO

At Lowest Prices



FREE ALLIED CATALOG

Big 172 Page Book—packed with new Radio Equipment—more than 60 new sets—new Builders' Kits—new Sound Systems—Bargain Section, etc.—all at lowest prices.



See the new Miniature and 3-way Portables, new Home Recorders and Phonographs, Auto Radios, low-cost 2-band radios; new 7-75 watt Sound Systems; dozens of new Radio Builders' Kits; new testers, tools, books—more than 15,000 quality items at lowest prices!

Radio Builders' Handbook. Valuable book for beginning Builders and Experimenters. Explains radio fundamentals, how to read diagrams, how to build popular circuits, etc. Fully illustrated. Easy to understand. Only **10c**



Free RADIO CATALOG SEND FOR IT NOW!

ALLIED RADIO CORP.

833 W. Jackson Blvd. Dept. 5-F-Q
Chicago, Illinois

Rush me your FREE 172 Page Catalog.

Enclosed is 10c. Send me Builders' Handbook.

Name.....

Address.....

\$ EARN BIG MONEY \$

P.D.Q. AUTOMATIC PHOTO MACHINE takes and finishes Black and White, or Sepia photos, day or night, in about one minute. No films or dark room. Easy to operate. Simple Instructions. Take photos everywhere—friends, neighbors, parties, parks, beaches, etc. Travel and make money. Every day is pay day with P.D.Q. WRITE TODAY.

P. D. Q. CAMERA CO.

109 E. 35th St., Dept. 10, Chicago

Reline Your Own Brakes

All the tools you need are a hammer and the "Little Giant" Brake Relining Kit to do an expert job. Kit consists of: Malleable Shockproof Housing, Rivet Clincher, Knockout Punch, Removable Anvil (to permit old rivets to be punched out), combination Drill and Counterbore. All tools hardened, cadmium plated, and interchangeable. Patented Spring Tension Device leaves both hands free. "Little Giant" is swell for other tubular riveting jobs, too. Riveting instructions included. Send \$1 for it today—enclose cash, check or M. O. (no C. O. Ds.)—we pay postage anywhere in U. S. A.

LAKEWOOD TOOL CO.,
P. O. Box 2643, Lakewood, Ohio

IT'S EASY! SAVE \$6 TO \$8



LITTLE GIANT BRAKE RELINING KIT

FACTORY PRICE

\$1.00

YOU HAVE BEEN WAITING TO PAINT

COMPLETE WITH 110 V. MOTOR **ONLY \$9.85**

Now Everyone Can Paint This Easy Way—with a Spray Gun! A complete paint-spraying unit, light and compact, (weighs only 8 lbs.) designed for home use for lacquer, enamel, varnish, insecticides, moth-proofing; for screens, radiators or furniture. Strictly quality equipment—material and workmanship guaranteed. Complete unit includes high grade 110 V. A. C. D. C. motor, 9 ft. cord and plug, piston type compressor with cast iron cylinder on sturdy base, efficient spray gun with 1/4 pt. glass container and 10 ft. air hose. Write for Circulars, or Send \$1.00 today—pay postman balance, or shipped postpaid if full price accompanies order—dealers write.

Miller-Simens Inc., 2903 S. 81st Ct., Cicero, Ill.



(Continued from page 134A)

the battery unit, and tune in some station at about 1,500 kc., or with the condenser plates about seven-eighths out. Turn the trimmer (Tr.) on the rear (C₂) section of the variable condenser until station is loudest; next tune set to a station at about 600 kc. and adjust the padder condenser, at the same time keeping the station tuned in with the ganged variable condenser, until the station comes in at loudest point. It will be noted that when the padder is correctly adjusted it will be approximately

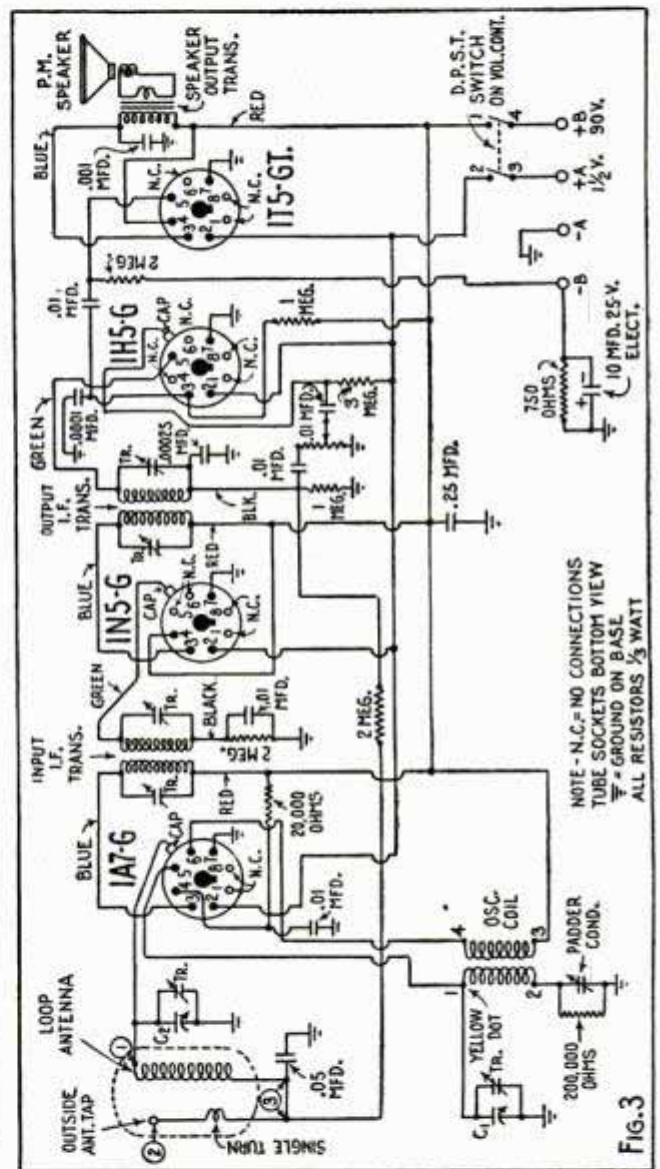

FIG. 3

one full turn from tight. The oscillator section (C₁) trimmer (Tr.) should be set one-eighth turn from tight. Note—if set will not receive police calls loosen this trimmer slightly until they are heard. After above operations are completed, again tune to some weak station near 600 kc. and adjust trimmers (Tr.) on the I.F. transformers for maximum volume. The blueprint number for this article is R-279.

*Be The Life
Of The
Party!*



NEW MOVIE CAMERA
Thrilling life-like results!
Uses economical UniveX
69c film. Fast f4.5 lens!
Built-in Optical True-
View Finder!

\$15



8 MM. PROJECTOR

Projects any 8 mm.
film including color!
15 minutes contin-
uous projection!
Easy to thread—
easy to operate!
Quiet, smooth per-
formance! Other
quality features!



\$16.50

On Easy Terms At Many Dealers

Your own thrilling, unposed movies that you will treasure and be proud to show your friends for years to come! See the new UniveX Movie Outfit today! At all dealers, or write Dept. C-7, Universal Camera Corp., New York, N. Y.

UniveX Movies AT LESS COST THAN ORDINARY SNAPSHOTS

NEW STAPLING MACHINE! TOT LOW COST!

This Swineline stapling machine STAPLES, TACKS; has "eye appeal," perfect mechanism, staples 15 sheets at a time, yet costs so little. Hundreds of uses—ideal for offices, homes, schools, stores, factories, printers, etc. Beautiful color selection—jade, ebony and walnut plus ultra tacking features. Send for SPECIAL BARGAIN OFFER TODAY —Package of 1,000 TOT staples plus machine ready to use for only \$1.75 (specify color of machine), we pay postage or C. O. D. plus postage, Dept. P. GUTHMANN CO., 600 W. Jackson, Chicago, Ill. (Attractive Proposition for Agents Everywhere)

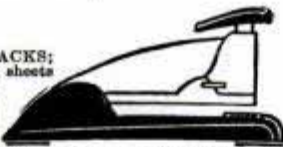

ONLY \$1.75
WITH 1,000 STAPLES

WITTE DIESELECTRIC PLANTS

Power and Light for 1c a Kilowatt

Make your own electricity at this amazingly low cost. Quality built, dependable, efficient WITTE Diesels operate on cheap, non-explosive fuel. Rugged, compact, easy to install, simple to operate. 1500 to 8000 Watts; vertical, horizontal. Easy to buy. Pay for themselves out of savings. WRITE now for literature and name of dealer.



WITTE ENGINE WORKS

1746 OAKLAND AVE. KANSAS CITY, MO.

ATLAS STICK-ON LETTERS

Beautiful Gold Colored. New Styles. 5 Year Guarantee. Large Sizes—Penny Each. Tremendous Demand. Amazing Profits. Write for Samples and Starting Equipment. Hurry! ATLAS SignWorks, 7941-A Halsted, Chicago



POWELL

"SETS THE PACE"

100 miles per gal. 35 miles per hour. 2 1/2 H.P. 4-cycle engine. Centri-matic clutch. Hill-climber transmission. Foot brake, foot throttle. Welded alloy steel, shock-absorbing frame. Easy riding, dependable, durable, beautiful. Many Powell Streamliners ridden over 40,000 miles a year. Write for free folder. Powell Mfg. Co., Los Angeles, Cal., Dept. PM-3.



Always write your name and full address clearly when answering advertisements.

LIGHT POWER TOOLS
Save Time, Money, Labor



Delta tools are portable, rugged, efficient—yet astonishingly low priced. Ideal for small shops, home shops, and factories. Many new features and improvements. Complete DELTA line includes: Circular Saws, Scroll Saws, Lathes Jointers, Shapers, Band Saws, Grinders, Drill Presses—and full line of accessories. Send today for big 44 page FREE Catalog.

DELTA MFG. CO. (Dept. A640)
600 E. Vienna Ave., Milwaukee, Wis.

Amazing NEW GLAZE
Beautifies and Protects



Car Owners! Meet MASTER GLAZE—the sensationally different luster for new and used cars!

Not a wax—not an oil polish—not a paint—nothing that "smears" over the surface. A creamy liquid—quick and easy to apply! Gives a hard, glass-like surface. Even gasoline cannot dull it! Lasts six months to a year! Amazing luster—beautiful, sparkling clean and brilliant! Doesn't fingerprint—doesn't smear! Seals the pores—protects! Nothing like it!

FREE Write now for Free booklet and **SAMPLE OFFER**. Free Trial offer. Just send your name and address.

MASTER GLAZE CO., 7720-207 W. HARWOOD AVE., MILWAUKEE, WIS.



Armature reconditioning in less than 10 minutes, bushings and bearings, valve re-facing, pistons, boring, keyways, screw-cutting, tool making—these are but a few of the many ways garage men can make money with an Atlas Lathe. Send today for full details and big free catalog.



ATLAS PRESS CO.
643 N. Pitcher St., Kalamazoo, Mich.

EASY TO BUILD KAYAKS IN & OUTBOARDS



Complete Cut-to-Fit "Double Processed" Home Assembly Kits. No Experience Necessary. Detailed Illustrated Instructions. Save Money—Build Your Own—1001 Satisfied Builders.

Write today for FREE COMPLETE CATALOG Illustrating 20 models.

KAYAK BOAT CO.
154P East 129 St., New York
"America's Oldest Kayak Factory"



OTTAWA LOG SAW \$39



BIG BOOK FREE
PUTS THIS OTTAWA to work for you. MAKE MONEY! Wood is valuable. Does more than 10 men. Easily operated. Falls trees—saws limbs. Use 5-hp. engine for other work. Write for FREE Book. OTTAWA MFG. CO. 3227 Wood St., Ottawa, Kans.



EARN MONEY STRINGING TENNIS RACKETS

Easy! Profitable! Interesting!

● No experience needed—we teach you how! Build a business all your own and become influential in tennis circles. Tennis players need 2 or 3 stringings yearly. Pays up to 140% profit per stringing! Besides, you save money on your own racket. See how simple it is to get into this business. Costs practically nothing to start. Begin NOW. Write today.

THOMPSON MANUFACTURING CO.
4535 Packers Ave., Chicago, Ill.

Makers of TOMGUT Court-Tested Tennis Strings

FREE!
Profit Plans (based on methods of thousands of stringers), plus special offer on strings and stringing equipment.

SAVE THAT LAMP!



DON'T BUY NEW LAMPS—Repair the old with Rogers Glue—that goes for furniture, mirrors and broken articles too—Rogers Glue is ready to use and works quickly—stays put longer because it is stronger. Sells 10c and up in tube, jar or can at hardware stores only or send 10c for full size jar and you receive a Free Product Book giving new ideas, new plans for making useful articles to Dept. B.

ROGERS GLUE COMPANY, Gloucester, Mass.

ROGERS

the best LIQUID FISH GLUE



CAPE COD CHAIRS

Style "B", "C", "A"
Blueprint 50c. All 3 for \$1.00. TRELLISES—12 original designs. Blueprint of all 12 only 50c. BENCH ARBOR—A beauty, 4" high, 5' 6" long, 2" wide. Blueprint 75c. Send 10c

for catalog illustrating many projects. "Over 35,000 Satisfied Customers."
CRAFTSMAN'S MODEL CO., Dept. P-41, 2030 N. 41st St., Milwaukee, Wis.

HAVE DEPENDABLE FORD BRAKES

Your Ford Car is listed in the so-called lower priced class but has more brake lining area and larger drums than all but the higher priced cars. You can have safe, sure, unflinching mechanical brakes. Install easily yourself our Simplex Floating Wedges to center the shoes for mechanical assurance with hydraulic performance. A set of four, one for each wheel, all for \$1.75. All models 1928 to 1938—Send for circular.



SIMPLEX WEDGE EXCHANGE. Dept. PM-6, 613 Jefferson St., Ottawa, Ill.

WET BASEMENTS!

Amazing new Seal-Seep method, anyone can use. Applied to inner masonry wall and floor surfaces; no digging. Guaranteed permanently effective. Agents write for unusual earnings opportunity. Details FREE.

Waterproof Your Own
Save up to \$100 to \$150

National Seal-Seep Co., Dept. 692, Cincinnati, Ohio

LEVEL STOVES, PLUMBING, CLOCKS, etc.

New Aluminum Cigar shaped level. Won't tear pocket. 9" long. Shows plumb, level, 45°, 1/4°, 1°, pitch. Grooved Bottom. Only \$1.35.



BEAUTIFUL CHROME ALUMINUM POCKET LEVEL
Clips to Vest pocket like a fountain pen. Always handy. Accurate. Pitch graduations, on level vial. Only 75c. Order direct or from your dealer. Send 10c for catalog. Empire Extreme accuracy levels used. **EMPIRE LEVEL MFG. CO., Dept. PM-8** 717 S. 6th St., Milwaukee, Wis.

Choose from World's Largest Line of Power Tools!

FREE New 1940 Catalog covers Metal and Woodworking Tools, accessories, motors for every purse. Write Walker-Turner Co., Inc., 160 South Ave., Plainfield, N. J.

DRIVER Engineered POWER TOOLS

NOW a DYNAMIC HEAVY DUTY INDUSTRIAL WELDER

Works Off 110-Volt Light Socket. This marvelous Dynamic Power Welder does the work of much higher priced types. It is easily portable. **WELDS Cylinder Blocks, Bumpers, Fenders, Tanks, Farm Machinery, etc.** Will also solder and braze on the lightest material. Works on iron, steel, tin, brass, copper and all other metals. Men without previous experience can make as much as \$5.00 on a one hour repair job. In a year's time a Dynamic Welder Costs You LESS THAN 6 CENTS A DAY. Instructions Free—Open a welding shop now. **AGENTS**—Make big profits selling to garages, factories, janitors and machine shops. Write today for our 10-DAY TRIAL OFFER. **DYNAMIC WELDER CO.** 2226-MZ Silverton Road Chicago, Illinois



500 Miles to Go!

(Continued from page 837)

ward increased performance. Its eight-cylinder engine is equipped with new camshafts and crankshaft, on which the firing order has been changed to provide smoother operation. This permits the engine speed to be raised somewhat, with a resultant increase in power. The engine, eight years old, has been rebuilt several times. The mechanical fuel pump, of aircraft engine type, is driven at slower speeds through a reduction gear, for great-

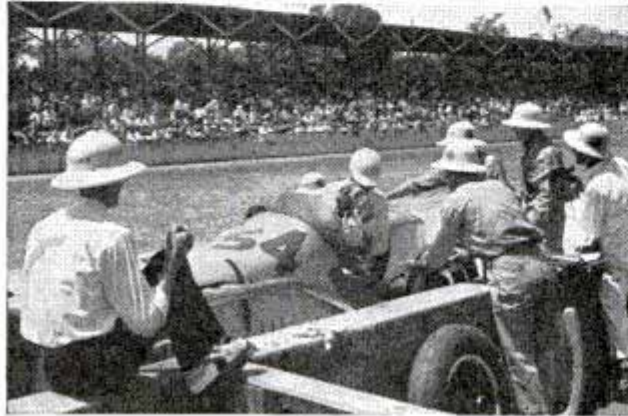

Driver yanks goggles off for a short rest while pit crew refuels and changes tires

er durability. The radiator mounting has been modified and the water-circulation system of the engine has been altered slightly to obtain more uniform cooling.

Chet Miller's car is receiving a new, lighter, crankshaft, to help in accelerating, and a pair of new type carburetors. This car, fitted with hydraulic brakes of large size, has been provided with a new hydraulic system this year. Two master cylinders are used, one for the front brakes and one for the rear, but the two are operated simultaneously through an equalizing linkage. This method of operation leaves one pair of brakes effective in case of a failure in the oil line to the other pair. This car has a four-cylinder unsupercharged Offenhauser engine mounted in a new rear-drive chassis.

The Alfa-Romeo owned by Bill White, in which Babe Stapp finished fifth in 1939, is also an Italian car. As originally constructed, it had independent wheel suspension in the rear, as well as the front. For the 1940 race the independently sprung rear axle has been replaced with a rigid system, suspended by a transverse spring. This is said

(Continued to page 141A)



Be Your Own Boss GET INTO AIR CONDITIONING

WORK OUT OF YOUR HOME—IN SPARE TIME— Newspaper and phone book ads work for you. Make summer coolers and fans so cheap they sell themselves. \$20 and a little work will start you in business. No books—no studying—just assemble and sell. Easy sales—quick profits—easy work because everybody buys fans in summer.

MAKE A YEAR'S PAY IN 4 MONTHS

Borell made \$3600 gross—Lewis made \$6100 gross—Whitlow made \$2700 gross—Walters made \$6800 gross—Cox made \$3200 gross—Colet made \$2300 gross. You can make \$1500 to \$5000 gross in 4 months. Don't wait! Get in the money now!

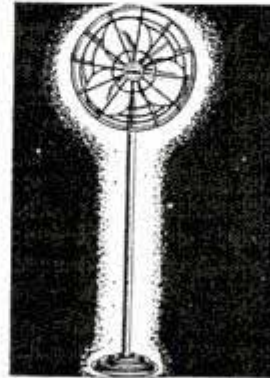

MAKE Pedestal FANS

We sell you all the parts for a \$60 store, office or factory cooling fan for as little as \$16.95 and you assemble it yourself. You can make \$10 to \$25 on every sale! Restaurants, stores, offices, factories buy thousands.

20 in. Set No. 1 of parts consisting of 20 in. blade, G. E. motor, plated guard, chromium 6½ ft. column, 20 in. floor base, cord, plug and switch bolts, nuts, washers, etc. Complete \$16.95.

Hundreds of men found comfortable incomes selling these fans!

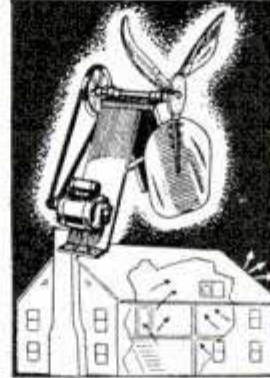

MAKE Attic FANS

We sell you all the parts for a \$75 job, that will keep an entire home 10 deg. cooler ALL DAY, for only \$22.50! Every home, every builder, every store is a hot prospect! Just mount on attic floor above grill and inside a box.

30 in. Set No. 2 of parts for a 30 in. attic night fan consisting of quiet 5500 CFM, certified rating Torrington blade, steel frame, rubber-mounted bearings, steel shaft and collars, G. E. motor, pulleys and belt, set screws and wrenches, bolts, nuts, washers—complete \$22.50.

This is a big, profit opportunity. Air conditioning SELLS!

MAKE Evaporative COOLERS



Where Humidity is under 45%, in summer, desert coolers sell best. With a little chicken wire, copper tubing and a cabinet you can build plus our motor and blade units at \$7.67 up will make a unit you can sell for \$50. Silent Torrington blades, G. E. and Dayton fan motors are furnished. Every home and business needs them.

12 in. blade with proper motor for 1900 C.F.M. 1 room unit.
SET No. 3 only \$7.67
 16 in. blade with proper motor for 2200 C.F.M. 2 room unit.
SET No. 4 only \$8.37
 18 in. blade with motor for 4180 C.F.M. 4 room unit.
SET No. 5 only \$11.89

This is a BIG BUSINESS west of the Mississippi.

INSTALL A UNIT IN YOUR HOME NOW!

BLUE PRINTS FURNISHED WITH EACH ORDER

AIR CONDITIONING HEADQUARTERS, Dept. 4
 914 W. Ohio St., Chicago, Ill., U. S. A.

Show me the way to earn a year's pay this summer in my own business and rush me the items ordered below:

Sets	Description	Price	Total
.....	No. 1, 20 in. Pedestal fan	\$16.95
.....	No. 2, 30 in. Attic fan	22.50
.....	No. 3, 12 in. Desert Cooler set	7.67
.....	No. 4, 16 in. Desert Cooler set	8.37
.....	No. 5, 18 in. Desert Cooler set	11.89
.....	Parts circulars and plans .25 (Free with order)

I am enclosing \$.....cash Balance \$.....C.O.D.

Name..... City.....

Street..... State.....

ALL MDSE. SOLD ON MONEY-BACK GUARANTEE

WIN INDEPENDENCE—ORDER NOW!

**NOW A GENUINE
EVINRUDE
FOR ONLY \$29.95**



Prices
F.O.B.
Factory

**EVINRUDE
"MATE"**

Weights only
10 pounds

Costs only
2¢ an hr.
to run



The lowest price . . .
the biggest value . . . in
Evinrude history!

A smart and capable outboard offering all of Evinrude's famed features — Hooded Power — Co-Pilot steering — finger-tip controls — Underwater Silencing — trouble-proof Centrifugal Pump Cooling — extraordinary starting ease — a complete 1940 Evinrude for only \$29.95! Fits any boat . . . a great motor for fishermen . . . runs all day on a gallon of fuel!

WRITE FOR 1940 CATALOG — FREE!

New catalog describes complete line of nine 1940 models, including sensational new 4-cylinder "Zephyr" — thrillingly smooth 4-cylinder performance with light weight and low cost. Also catalog of 1940 Elto models, with prices starting at \$26.50. Write today. Address, **EVINRUDE MOTORS**, 4467 North 27th Street, Milwaukee, Wisconsin.

Get a Genuine **MOTO-TOOL**
100 TOOLS in ONE



Only \$9.85 POST PAID
MASTER \$16.50
MODEL 16

Grinds, polishes, sharpens, drills, engraves, etc. Saves time, cuts cost. Handiest tool in home or shop . . . use it daily. Same tool as used on precision jobs in factories.

OVER 25,000 R.P.M. High speed conserves cutters, does finer work. Has oil-less (oil-sealed) bearings, cooling fan, balanced armature, 110 V. (AC-DC), MODEL 1 MOTO-TOOL with chuck, 3/8" collet, only \$9.85. MASTER MODEL 2, 27,000 R.P.M., heavier, more powerful, only \$16.50.

10-DAY TRIAL. See the genuine DREMEL MOTO-TOOLS at better Dealer's or order direct from factory on 10-day money-back trial. Catalog of Dremel tools, equipment and special combination offers, FREE.

Dremel Mfg. Co., Dept. M-110-F, Racine, Wis.

PROJECT BOOK

Big 24-page book shows how to make 41 plastic projects. Sent postpaid for only \$1.

**Big Money for Workers
In Home or Shop**

MONEY-MAKING PROJECTS. Color-glazed concrete pottery, garden novelties, statuary, giftware, cemetery products, gravestones, tiles, walls, floors, etc. Basement waterproofing. New, patented method makes concrete pottery without molds, cores or costly tools. Use only sand, cement, cheap materials. No experience needed. Get the facts about these new money-making projects NOW. Send 3c stamp TODAY for booklet, colorplate, details.



NATIONAL POTTERIES COMPANY

Dept. 6, 13 W. 26th St. Minneapolis, Minn.

When writing please mention Popular Mechanics

●40 Big Fascinating Pages
119 Colorful Illustrations
6 Official Road Maps

**Free
VACATION GUIDE**

"JOYOUS VACATION DAYS in Tennessee" completely describes the mile-high Great Smoky Mountains; battlefields and historic shrines; gigantic TVA dams and lakes; metropolitan cities and quaint mountain villages; State and National Parks; plantations and unspoiled wilderness; and everything in Tennessee—the ideal vacation State. It's FREE, send for yours now!

DEPARTMENT OF CONSERVATION
Room 945 State Bldg. Nashville

Scenic State of **TENNESSEE**

ANNOUNCING
New Daisy **1000-SHOT**
RED RYDER
CARBINE

New Daisy COWBOY CARBINE features:
16" Leather Saddle Thong on genuine Western CARBINE RING!
Golden Bands! Red Ryder BRAND on Pistol Grip Stock! 1000-Shot Repeater!
Lightning-Loader Device! \$2.95 at Dealers. If he hasn't it, send us \$2.95. We'll mail yours postpaid.

Write for **FREE New Catalog** DAISY AIR RIFLES

DAISY AIR RIFLES IT'S REALLY YOURS for only \$2.95 DUTY ADDED IN CANADA
DAISY MANUFACTURING COMPANY
546 Union St., PLYMOUTH, MICH. U.S.A.

**MAKE YOUR OWN!
FLUORESCENT LAMPS**

We furnish all material for 24 inch 20 Watt lamp—beautifully finished, ready to assemble, all parts complete for \$3.00, tax and post paid—except bulb which you buy locally for safety in shipping. Made in mass production cheaper than you can buy the raw material. All you need is table and screw driver. Start a business of your own. Full or spare time. Order today. Be first in your community.

FLUORESCENT ELECTRIC CO., 1120 N. DEARBORN ST., CHICAGO

IDEAL Lawnmower Sharpeners

● Go into business for yourself. Earn up to \$25 per week sharpening lawnmowers. **BIG CATALOG FREE.** Send post card to **The Fate-Root-Heath Co., 640 Bell St., Plymouth, Ohio**

TROPICAL FISH
Richly colored tropical fish . . . exotic in shape . . . makes a wonderful hobby or sideline. Easy to breed. Large 60 page catalog packed with illustrations, descriptions, instructions for starting an aquarium and breeding fish. 10c stamps or coin.
EASTERN GARDEN, Dept. M6
Kissena Blvd. & Rose Ave., Flushing, N. Y.

FIREWORKS
Buy them direct

Assortments \$1.00 and up. Make your selection from FREE catalog. Send postal for it today.
ROEHRS FIREWORKS CO. Dept. 3 Closter, N. J.

Earn Cash at Home!
M.M. EARNED \$1174 at Home!
We paid M. M. \$1174 for exceptional cellar crop Snow-King mushrooms! We furnish materials; buy all crops. Big FREE picture book tells if your cellar, shed, barn, suitable. Est. 1908. Write today. **United Co., 3848 Lincoln Av., Dept. 310, Chicago**

to improve the directional stability of the car and make it easier for the driver to handle. The Alfa-Romeo engine is supercharged, burns alcohol fuel, and has cast aluminum-alloy cylinder blocks in which the valves seat directly on the aluminum.

Lou Moore has two unsupercharged 270-cubic-inch four-cylinder cars entered. Mauri Rose will drive one and Cliff Bergere is named as driver for the other, which has been rebuilt and supplied with a new crankshaft and block since it was wrecked with Floyd Roberts in last year's race. Two unique "Man from Mars" cars, designed by Harry Miller, have their six-cylinder engines in the rear. Power is supplied to all four wheels. The engines are the only ones in the race that are fueled with ordinary gasoline. George Bailey will drive one of the cars.

Race experts think that Bob Swanson, driving the sixteen-cylinder "Sampson Special" is apt to set the pace in qualifying and draw the pole position in the starting line-up. His motor consists of two ninety-one-cubic-inch eight-cylinder engines set side by side on a common crankcase, the two crankshafts operating gears that spin the drive shaft. Trouble that sent the car to the pits last year has been remedied.

Sam Hanks will be driving Leon Duray's super-streamlined supercharged 183-cubic-inch engined racer, and Louis Durant will drive for Bill Schoof, a new entrant in the racing field, who has built a chassis and body for the 255-cubic-inch Offenhauser formerly owned by Billy Winn. Frank Brisko of Chicago has installed a new crankshaft in his car, which has an aluminum engine block strengthened with steel sleeves.

One of the surprising things about high-speed racing is that engines are rarely damaged when cars crash. The body, axles and frame take most of the punishment. Louis Meyer's car that slid into the fence almost at the end of last year's race has been rebuilt and will be driven by Rex Mays. The rear end and steering mechanism have been replaced and the chassis checked. Tony Gulotta's car, which was wrecked and burned last year, has been discarded but he has mounted the same Offenhauser engine in a new chassis and body.



YOUR CAMERA can do as well!

You're probably thrilled when you *happen* to get a picture as good as this...but actually, you can do it every time. Every picture you take with your camera will be as sharp, as rich in detail, if you use a WESTON Exposure Meter. Just point this compact meter at the scene and it gives the correct camera settings to use. Even pictures taken indoors, or under the most difficult light conditions outdoors, will be correctly exposed. Extremely compact, the WESTON can be used with all still and movie cameras, and all film, including color. See all models at your dealer's today, or write for literature. Weston Electrical Instrument Corporation, 671 Frelinghuysen Avenue, Newark, New Jersey.



WESTON Exposure Meters

NEW...FREE BIKE BOOK!



Write TODAY for your FREE copy of the Schwinn-Built Bike Buyer's Guide. Tells you everything to look for when buying your bicycle. 24 pages of pictures. America's best bicycles in colors! Get your copy NOW! Address: Arnold Schwinn & Co., 1746 N. Kil-dare, Chicago.

Ride Schwinn-Built Bicycles

THE
Genuine
BERRY
PAT. PENDING
SAFETY
ROTARY
WOOD PLANER

Patent
Pending

**MONEY-BACK
OFFER \$7.50**



Use Your Drill Press As a Wood Planer!

**Planes, Parallels, Finishes—Perfect Work
—Safest to Use!**

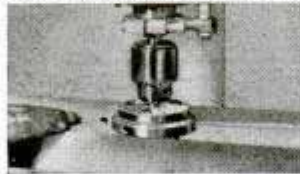

Swiftly planes all wood—leaves knots smooth and finished. End grains no obstacle. **AMAZING SPEED**—30 seconds for planing, paralleling and finishing 8" x 24" board surface with 1/32" cut or less. 3 high-speed steel blades—Patented **DOUBLE SET-SCREW ADJUSTMENT**. Safe, accurate—no experience required. Beautiful heavy chrome finish—a lifetime tool. Ideal for inlaid work. A perfect paint and varnish remover—blades cut underneath surface. \$7.50, complete, postage paid. If planer does not meet your requirements, return it to us in good condition within 5 days and we will refund your \$7.50. Free descriptive literature. **ACT TODAY!** (Splendid opportunity for dealers)

H. J. BERRY MFG. CO., Detroit, Mich.
Dept. M, 2291 Scott Street

Ship me 1 BERRY PLANER. Enclosed is \$7.50. Ship C.O.D.

NAME.....

ADDRESS.....

BUILD YOUR OWN AIRPLANE FAN



Easily, cheaply. Discarded washing machine motor and Ace Aeroplane Blade produces fan equal to those selling at \$25 up, fraction of cost. Giant 24-inch spread; attractive, graceful lines; well-seasoned wood; lightweight, sturdy; exceptionally quiet, smooth running; perfectly balanced; warp-proof treated; beautiful mahogany finish. Triple-inspection assures quality workmanship. Special introductory offer: \$1.25! Also aluminum guards for Ace Blade.

AGENTS, DEALERS: Drop us card, latest price list blades, guards and motors. Real profits!!!
ACE CO., 1601 MARKET ST., ST. LOUIS, MO.

OPPORTUNITY

*Surfacing
Business*



• Make new or old buildings more attractive outside or inside with waterproofed plastic Colorcrete. It fuses with any masonry surface—can be sprayed in any thickness and in 30 colors. Proven by over 13 years use in all climatic conditions.

Big earnings. Operators report costs of 2c and up per sq. ft. and sell up to 7c. Some have paid for their equipment from first few jobs. Machine capacity up to 1000 sq. ft. per hour.

Get the facts. Send for book "Proven Business Opportunity". Write today.

COLORCRETE INDUSTRIES, INC.
579 Ottawa Ave., Holland, Mich.

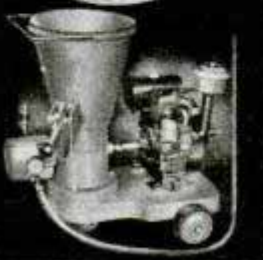

**VALUABLE TREATISE ON
PHOTO ENLARGING**

Get prize winning enlargements with a Solar—the new enlarger sensation. Reduces! Enlarges! May be used as a camera for copying, etc. Valuable 36 page book prepared by photo experts tells you how—gives valuable tips on dodging, photo montage, diffusing, mounting, double printing, etc. A valuable book for every amateur. Special to Popular Mechanics readers for 10c—to cover cost of mailing, etc. Send today (enclosing dime) for Enlarging Treatise PO6.

BURKE & JAMES, Inc.

223 W. MADISON ST. • CHICAGO, ILLINOIS

BIG MONEY-MAKERS THAT WORK
EIFEL-GEARED PIERENCH KIT-7" & 8 1/2"



"Pocket Machine Shops" that do the work of \$50 worth of other tools. Amazingly Quicker, Better, Easier!

• Now of **ALLOY Steel—65% Stronger!**
• **NEW PLANT..**
• **Quadrupled Capacity.**
• **Now have your Own Business in a New Selling Case.** Full-time men making \$1,500 to \$4,000 Yearly... Part-timers in proportion. We need Many More!



NEW FREE



Bottle-Cap Opener, etc.

Mail Your Address Today (on a post card will do) Get **FREE**—this **6-Edge End-& Angle Screw-driver and 101-Picture Manual of Mechanics**, with... User Offers: or, with... **DISTRIBUTOR, Territory, Demo, and SELLING Kit Offers!**

AMERICAN PIERENCH CORP. PMF-4611 N. RAVENSWOOD AV. CHICAGO, ILL.



Thrills APLENTY!
IN STAR METAL BOATS



Sixty smartly styled boats to choose from! New lightweight construction. 59 lb. cartop boats, outboards, rowboats, fishing and resort boats. Low priced. Safe—leakproof seams, no caulking, no wood to rot—no upkeep. Cushioned operation. Buoyant, easily handled. **WRITE FOR FREE CATALOG! Box H-6**

STAR METAL BOAT CO., GOSHEN, IND.

FIREWORKS FREE Oh Boy!
SALUTES



THINK OF IT! An assortment of over 605 pieces of fireworks worth \$6.15, for \$2.95 cash with order. We have the famous "ZEBRA" flashlight crackers. World's loudest. You get more for your money at **BANNER**. 100 Free salutes with every order. Write for free catalog.

BANNER FIREWORKS

3916 1/2 Detroit Ave. Toledo, Ohio

Start a Profitable BUSINESS of Your Own

Get the New 480 Page Book MONEY MAKING FORMULAS

Fortunes have been made from a single formula like thousands in this money-making book. Modern, up-to-the-minute. Contains valuable information on how to make, package and sell cosmetics, household, auto, shop and other articles of all kinds. Nothing like it elsewhere. Rush postcard for free, illustrated circular.

POPULAR MECHANICS PRESS, Dept. 640, 200 E. Ontario St., CHICAGO

THOUSANDS HAVE WAITED FOR THIS BOOK

What to Make Only 50¢

Get this new book and turn happy home workshop hours into extra cash. 188 pages packed with instructions, plans, valuable data and pictures showing what to make and how to make it. Anyone who can use simple tools can work from this book and make it pay him a profit. Order today. Sent postpaid for only 50 cents.

POPULAR MECHANICS PRESS
Dept. 640, 200 E. Ontario St., Chicago

Sky High Without a Motor

(Continued from page 812)

Actually, there are four basic types of glider craft. There is, first, the glider. It is a primary trainer and will not remain aloft, even under the most favorable conditions, beyond its fixed gliding angle of perhaps fifteen to one. Glide angle means that at a height of 100 feet, the plane will glide a distance of 1,500 feet.

Next is the utility plane which combines limited soaring ability with its glider characteristics. It will have a glide angle of twenty to one, thus remaining aloft better and at greater length. One reason for the excellent safety record of gliders and utility planes is low landing speed of perhaps fifteen miles an hour, low flying speed of less than thirty miles and a correspondingly low "stall" speed. A well-designed glider will not spin. If stalled, the nose simply drops forward into another glide or at worst drops with a wing only slightly down, a position from which easy recovery is possible.

On mastering the utility glider you are ready for the sailplane, a high-performance craft which literally sails before the warm winds blowing upward from the earth's surface. It will have a glide angle of thirty to one or even higher and combines, so far as aeronautical principles will permit, high speed with a low sinking rate.

Among sailplane pilots the term "sinking rate" is employed instead of glide angle. The sinking speed means that such a craft will descend at so many feet per second, and relates to time. Glide angle is relative to the earth's surface and interprets itself in terms of distance. Thus, if you are at an elevation of 200 feet with a plane whose designed sinking speed is two and one-half feet per second, you will land in precisely eighty seconds, provided you encounter neither up nor down currents.

The fourth type is the two-place plane, of which there are but few in existence. On the west coast Bowlus builds a two-place craft weighing less than 400 pounds. Some all-metal planes weigh 700 pounds.

Both gliders and sailplanes must have reasonable cockpit room and comfort, good visibility, a foolproof tow-cable release mechanism operated from the cockpit, high degree of maneuverability in the air and a

(Continued to page 144A)

"It's great to HEAR again"



Western Electric HEARING AID Ortho-technic Model

You, too, will *hear clearly* again... as thousands do... with Western Electric's Audiphone. Based on advanced design, this product of Bell telephone research enables users to "hold up their end" in life's everyday situations. There's a dealer near you. Consult him... he'll help you to hear again.

Accepted by American Medical Association

GRAYBAR ELECTRIC CO. PM-54
Graybar Building, New York, N. Y.
Please send details on Western Electric Audiphone
(Ortho-technic) Model and name of nearest dealer.

Name

Address

AGENTS and DEALERS WANTED To Sell or Rent the NEW

Mead Ranger SCOOTER

120 MILES
Per Gallon

30
m. p. h.



**PAY AS
YOU RIDE!
EASY
TERMS**
Available in
Most States

These sensational, new, improved Ranger Scooters, sell like hot cakes all over the country! Order your demonstrator while territory is still open—there's big money selling to all stores needing quick, cheap delivery... sell to messengers, mechanics, garages, canvassers, friends; or rent for easy hourly profits at beaches, resorts, etc. World's CHEAPEST transportation! New low prices! ALL STEEL frame, automatic gear shift, clutch, starter, generator, spring fork, 15 models for 1940—solo, tandem, delivery, sidcar, etc. — 1 1/2 or 2 1/2 h.p. Write for FREE circular. HURRY!

Send for FREE CIRCULARS.

CYCLE CO.
Mead
DEPT. P-1, CHICAGO, USA

Ranger Bicycles
for 50 Years!

simplicity of construction that makes for quick assembly and dismantling. A well-drilled crew sets up a glider from trailer to flight readiness in four to eight minutes.

Scientifically designed sailplanes are so efficient aerodynamically that often they must be fitted with "spoilers," a hinged slot device top-wing for quick modification of lift. Otherwise under unusually strong thermal or ground-wind conditions it is difficult to get them down. Spoilers operate to some degree like wing flaps on powered craft which create drag vacuum at trailing edges. Spoilers do not merely interrupt airflow but definitely destroy wing-lift efficiency.

One reason why glider experience is an asset to the airplane pilot is because, from the moment a glider or sailplane pilot cuts loose from his tow, he is "on instrument." His rate of descent, as recorded by the variometer, is of the utmost importance and must be watched with close attention. Variometers are exceedingly sensitive altimeters that register to inches and with virtually no lag. Lifting a variometer from the ground to eye level brings instant response even for so short a distance. With it, each tiny upward luff of the wind is calibrated in foot-movement per second.

Another necessary instrument is a bank-and-turn indicator. This is essential in flying through clouds because few pilots can trust their own senses of lateral balance and be sure they are flying right-side up.

Equally vital is an air-speed indicator, which helps the pilot avoid stalls by indicating flying speed with relation to the air. A barograph for recording every detail of a flight is invaluable. On return to earth the pilot can study its report at leisure and profit accordingly on future flights. A reliable compass is, of course, essential, as is a good thermometer. Some planes are equipped with wing-tip thermocouples, sensitive thermometers indicating the slightest variations of temperature within the distance of its own wing span.

To recently acquired knowledge of thermal currents may be ascribed the great advance in soaring since 1929, when Robert Kronfeld first developed the technique of cloud soaring. The German pilot Wolf Hirth, England's A. E. Slater, our own Jack O'Meara, the U. S. Navy's Lt. Robert Stanley, who holds the present American alti-

tude record of 17,000 feet—all contributed vitally to our present better understanding of the thermal.

Warm air lingers near the ground until large masses are heated. At intervals sometimes steady as a pulse, these break away from earth and float aloft like a soap bubble leaving a pipe. In diameter they may vary from a few feet to a mile or more and do not necessarily go straight up, but may drift. When a sailplane pilot is notified by his variometer that one of these up-moving masses has been encountered, his problem is to determine its area by flying through. Then by circling, sometimes in very tight spirals, if it is a limited mass, he is carried aloft. Wing-tip thermocouples help to determine the exact boundaries.

As a rule these thermals continue rising and, incidentally, expanding until the cooler atmosphere above condenses them into clouds. In such cases the best soaring conditions are found just below large cumulous clouds. Here a pilot might soar for hours, except that cloud masses are continually breaking up and reforming. The pilot then glides to another cloud and "hitches on."

Within the past five years thunderstorm soaring has come into vogue with the soaring experts. This calls for daring, parachutes and structural strength in equipment. Most of the high-altitude flights—the present world's record held by a German being above 30,000 feet—have been made under storm conditions. Intense cold, icing of wings and instruments and the beating of hail are some of the discomforts and hazards. Where the air-line pilot avoids thunderheads if possible, the venturesome sailplane pilot has explored them and contributed much to the world's knowledge of their phenomena.

Summer usually is the best time for soaring, although there are winter thermals. Hilly country provides the most constant source of energy, although the American distance record made last year by Woodbridge P. Brown—263 miles from Wichita Falls, Tex., to Wichita, Kan.—was set over country flat as a pancake. This area, where summer thermals abound, has the further advantage of furnishing safe landing fields everywhere. But whether it be the sand dunes at Frankfort, Mich., San Diego's Point Loma and Torrey Pines, Palm Springs and the Mojave, the 2,500-

(Continued to page 146A)

The Ford Good Drivers League Nation-wide Driving Contest for Boys of High-school Age

\$30,000.00 in Prizes!

Consisting of 48 University Scholarships

96 Free Trips to N. Y. World's Fair

Championship Cups to State and National Winners

Beginning at once—ending August 29 at the World's Fair in New York, when the Champion High-school Age Driver of the United States will be selected from the 48 State Winners.

★ FIRST PRIZE

University Scholarship of \$5000 and Championship Cup.

★ SECOND PRIZE

University Scholarship of \$2000 and Runner-up Cup.

★ NEXT THREE PRIZES

University Scholarships of \$500 each.

★ NEXT EIGHT PRIZES

Scholarships of \$250 each.

★ NEXT THIRTY-FIVE PRIZES

Scholarships of \$100 each.

Each of the 48 State Winners will be given a Free Trip to the New York World's Fair for himself and a parent or other sponsor of his own choosing, with expenses paid both ways and during the five days in New York when the final contest is held. (For contest purposes, the District of Columbia is included with Maryland.) State Championship and Runner-up Cups will also be awarded. In case of ties, duplicate prizes will be awarded.

• Become a League Member

Any boy is eligible for membership (1) who is a resident of the United States, (2) who is qualified and legally authorized to drive a car in his home state, (3) who is at least 14 years of age, (4) whose 19th birthday is not earlier than Aug. 29, 1940. The make of car owned or driven by an entrant or his family does not matter. The League is for *all* boys eligible under the four requirements stated above.

All that is necessary is to fill out and sign an Enrollment Blank which you can obtain from any Ford, Mercury or Lincoln-Zephyr automobile dealer. If you are unable to obtain

an Enrollment Blank from the dealer, write directly to the Ford Good Drivers League, Dearborn, Michigan.

Read the blank carefully. It contains a Pledge of Careful and Courteous Driving, which must be signed before you will be accepted as a member. There are no dues or fees to pay—no obligations of any kind except to live up to your pledge of good driving. Mail your Enrollment Blank to the Ford Good Drivers League, Dearborn, Michigan.

• Enter this Contest

As soon as your Enrollment Blank is received, you will be sent a Membership Card, a lapel Membership Button, and a copy of the League's new 64-page book, "How to Become a Skilled Driver," by Ray W. Sherman.

You will also receive immediately full details and Entry Blank for the Nation-wide Driving Contest to which only members of the Ford Good Drivers League are eligible.

The State Elimination Contest requires:

1. The answering of questions based largely on the new book, "How to Become a Skilled Driver."
2. A letter, of not more than 300 words, on "What I Can Do Personally to Reduce Automobile Accidents."
3. A 25-mile driving test, scored by a competent adult observer.

All contest material must be mailed to the Ford Good Drivers League on or before midnight, July 10, 1940.

The Board of Judges for both state and national contests will be: J. Stannard Baker, National Safety Council; Elmer P. Grierson, Pub-

lisher of The American Boy; Louis R. Morony, Executive Director, American Association of Motor Vehicle Administrators; Dr. F. R. Noffsinger, Educational Consultant, American Automobile Association; Ray W. Sherman, author.

• National Finals at New York

This will be a notable occasion. Each of the winners from the 48 States will arrive in New York with his sponsor in time for registration Monday forenoon, August 26. They may travel to New York either by train or automobile. In either case, an amount equal to train fare and pullman both ways, plus an allowance for meals, will be paid by the League for both contestant and one sponsor. In New York, both will be guests of the League for five days.

On the afternoon of August 26, there will be a parade of State Champions. Cars for this and final driving tests will be furnished by the League.

On Tuesday and Wednesday the Contest Finals will be held. Contestants will be judged on:

1. Day and night driving.
2. Maneuver operations, such as parking, braking, clutching, etc.
3. Physical reaction tests, including vision.

Upon the results of these practical tests, the judges will select the National Champion and Runner-up and will award all scholarship prizes.

• The Banquet of Champions

On Thursday evening, August 29, these awards will be announced at the League's First Championship Banquet in New York City. Edsel Ford, President of the League, and members of the Honorary Board are scheduled to be present.

On Friday there will be a visit to Radio City for all contestants and their sponsors, a luncheon with prominent sports stars as guests, a big league baseball game, and a visit to the World's Fair at night.

Join the Ford Good Drivers League now and become eligible for this contest. Read again the requirements and mail Enrollment Blank to

FORD GOOD DRIVERS LEAGUE

DEARBORN
MICHIGAN

Edsel Ford PRESIDENT

Vagabond The Coach that has Everything

*Comfort
Stability
Convenience*



Travel America the smart new way, by Vagabond Coach. Comfortable as good hotels but without hotel expense.

Your Vagabond goes anywhere: It's sturdy, solid as your car, gives years of service. Kept cool in summer, warm in winter with double walls, double floors, and insulation. Exclusive circulating heat system, optional at extra cost. Sizes 16 to 24 ft. with variety of interior arrangements.

GET FREE 1940 CATALOG illustrating all models and specifications: Steel chassis, steel turret top and bows, strong axle and wheel equipment, finest materials and workmanship throughout, improved spring suspension, luxurious beds and furniture, heating and cooking equipment, ample wardrobe space, modern floor coverings, draperies, decoration; 5-coat paint job in attractive new colors; improved doors, jacks, couplers; many other features and conveniences you must read about. Send for book and national list of Vagabond dealers.

VAGABOND COACH MFG. CO.

746 Grand River Ave.,

New Hudson, Mich.

DRESS YOUR OWN LUMBER—SAVE \$ \$

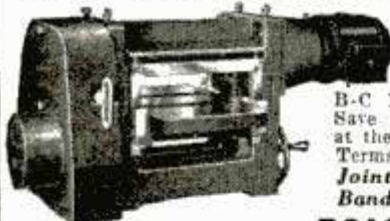

12" x 4" Capacity Thickness Planer

Finished lumber from low cost rough stock in your own shop with a B-C 12"x4" Thickness Planer. Save planing cost and waiting at the mill. Pays for itself. E-Z Terms. Also, B - C Saws, Jointers, Sanders, Shapers, Band and Jig Saws.

Send for Catalog

BOICE - CRANE CO.
Dept. 260, Toledo, O.



Now BUILD YOUR OWN METAL BOAT

Hull and air tanks shipped set up (less lumber) low as \$12.50 for 12 ft. model f.o.b. factory. Easy to complete with home-bought materials. Instructions included. Save up to 50%. Also factory completed boats. 47 years' experience. Write for Literature.

FREELAND SONS CO. Dept. L Sturgis, Mich.

HERE IT IS !! 1940 LE JAY ELECTRIC TROLLER



with all the good points of its famous predecessors including many added 1940 features.

The Electric Outboard Motor that sells itself by simple demonstration.

AGENTS — Dealers — Salesmen — Why not handle this profitable item in your own territory? Write today for Agents plan.

LE JAY MFG. CO.
2547 LeJay Bldg., Minneapolis, Minnesota

foot plateau jump-off over the San Joaquin valley's Arvin or the plantations of Georgia and Alabama, the best soaring, like gold, is where you find it.

The sport of soaring lends itself well to competition and there is now talk of soaring leagues in which clubs will organize themselves into competitive groups with perhaps a national pennant for winner of the glider "world series."

A successful meet was held at Arvin recently. Spectators by the hundreds attended daily, and week-end crowds of 20,000 shared in the fun. There were cash prizes of \$2,500, in addition to merchandise awards and trophies. Events included distance, altitude, duration, goal flights to surrounding cities, distance and return competitions, glider assembly races, spot landings, balloon bursting, target bombing with flour-filled paper sacks and others.

When you join or form a glider club, the Civil Aeronautics Authority will give you a student permit and on completion of training, following flight tests, your glider-pilot license. It will not, however, permit you to carry passengers without a further and more stringent examination.

Even more coveted is the Silver "C" and Gold "C" honorary certificates issued to sailplane pilots by the Federation Internationale Aeronautique for certain achievements. There are less than fifty of the former held in this country and only three Gold "C" ratings. To obtain a Silver "C" a pilot must have made a thirty-five-mile distance flight, 3,200 feet altitude and five hours duration. The Gold "C" calls for 200 miles distance, 10,000 feet altitude and possession of a Silver "C."

Centrifuge Is Tool of Medicine for Diagnosing Disease

Centrifugal forces that have a pull 8,000,-000 times greater than gravity, created in modern centrifuges, hold the promise of becoming a new medical tool in the diagnosis of disease, according to Prof. J. W. Beams of the University of Virginia. He has reported the separation and purification of certain viruses by means of the terrific force produced in the whirling rotors. Centrifuges also have been successful in separating fractions of complex body proteins and determining their weight.

New Wonders of Agriculture

(Continued from page 803)

we learn, will keep a person in good health while similar vegetables, apparently just as good, from a different locality, may contain not nearly as much nutriment. Mineral content of the soils is different.

Some time ago a rancher had a brain-storm. His orchard was stunted and he thought he could help the trees along by a contraption that he believed would extract mysterious ether waves from the atmosphere. Around each tree he planted a circle of wire fencing. To everyone's amazement the trees began growing by leaps and bounds and the rancher decided that he really had found the secret of a new science.

But research men had a different explanation. The soil around the trees, they found, was deficient in zinc. After the galvanized wire was planted some of the zinc surface had leached off, making it available to the trees. Lack of zinc in the soil had been stunting them.

Soil analysts have learned to cure many agricultural problems by supplying minerals to soils that are naturally barren or from which needed minerals have been exhausted by continual planting. Especially has this work been done in tobacco and citrus crops. The needed elements are spread on the ground, sprayed on the leaves, or injected through the bark. Iron, manganese, potassium, boron, and zinc in minute amounts are among the elements required. Too much of any mineral is as bad as not enough. Tiny amounts of boron, for instance, are required by many growing things, yet as much as several parts per million in the soil may be injurious. One effect of excessive soil mineralization is found in some parts of the Rocky Mountain states where livestock grazing on native vegetation is apt to be stricken by selenium poisoning, the forage having absorbed some of the excessive selenium contained in the soil.

Much of what has been learned about plant nutrition has been discovered by experiments in hydroponics or water culture. Popularly supposed to have been developed three or four years ago, hydroponics has been a standard method of laboratory investigation for three-quarters of a cen-

(Continued to page 149A)

Now! ALL MOTORISTS
Can Own and Enjoy
America's Finest
AUTO RADIO



Regardless of Make or Model Motorola EXACTLY FITS and MATCHES the Instrument Panel of Your Car

● Motorola has shown millions of motorists how to get more fun out of driving. It has given them a new conception of tonal quality and shown them how easy it is to bring in station after station under difficult conditions. Motorola owners tell us that they enjoy the finest reception at highest cruising speeds and that Motorola rivals the *best* home radio performance. *Insist on a genuine Motorola.*

Motorola Gets More Stations Gets them Easier—Clearer—Stronger

Radio's rich world of fun and entertainment is at your finger tips when you have a Motorola in your car. There is sensitivity and power to spare that brings in far away stations when and how you want them no matter where you drive.

Automatic Push Button Tuning

Hit your favorite station "right on the nose" without taking your eye off the road. That's how easy and accurate it is with Motorola. Engineers who have mastered auto radio problems give you in Motorola a set that is tops in radiant tone—in sheer beauty of performance—and in better dollar for dollar value!

Auto Radio Facts Booklet

FREE

If you'd like to know the secrets of peak auto radio performance write to

GALVIN MFG. CORP'N.
4555 Augusta Blvd., Chicago



Motorola Radio
AMERICA'S FINEST RADIO FOR YOUR CAR AND HOME

"You'll Make \$150 to \$300 Monthly with this New 'SIMPLIFIED' ARC WELDING"

30 DAYS TRIAL
at our risk to PROVE it.
Easy "Pays for itself" terms



A BUSINESS OF YOUR OWN!

It's easy to start a big paying arc welding business with Hobart Arc Welders... especially with Hobart's new reduced prices... the lowest prices in arc welding history! You get the big profits because it handles all kinds of repair and construction welding. Simplified operation features make it easier to get high quality welds faster and with less effort. Extra profits pay for your welder in a surprisingly short time. Don't miss this opportunity!

REMOTE CONTROL

Remote Control is standard equipment on Hobart Welders, lets you control your welder at the work. Saves time, labor and the need for a helper on difficult work. You get this feature without extra cost, on any Hobart model.

EASY TO OPERATE

"Simplified" operation of Hobart Arc Welders enables you to weld faster, with the right current for every job. 1,000 combinations of welding heat give the exact voltage and amperage for all kinds of work. It's as easy to get as the right station on your radio!

"PAYS FOR ITSELF" TERMS

With 30 days trial on your own work, at our risk, you prove to yourself that extra earnings and savings make it easy for you to own your Hobart with almost no actual cash outlay. Easy monthly installments let you pay for it from extra profit!

"BUILD YOUR OWN" WELDER

You can build your own portable gas drive welder by coupling a Hobart generator to a used auto engine and chassis. This portable unit lets you operate any place, especially on the profitable outside jobs. Mail coupon for details.

"The Fastest Selling Arc Welders on the Market Today"



"Build Your Own"

Save \$300 to \$500 by building your own welder. Ask about it.

NEW WELDER SENSATION

The Hobart A. C.

Easy to operate, low current cost. Completely equipped only \$12.50 monthly.



● Hobart Bros. Co., Box M-640, Troy, Ohio

Tell me more about—
 Build Your Own Gasoline Drive 30 Days Trial
 Electric Drive A. C. Welder Easy Terms

Name.....

Address.....

Come to the Hobart Arc Welding School. Check here if you want more information.

Check Here for the Book You Want
 "New Profits"
 "Hobart Catalog"
 "Carbon Arc Welding"

EARN MORE MONEY GRINDING LAWN MOWERS "THE UNIVERSAL WAY"



"BUILD A BUSINESS OF YOUR OWN"

Larger profits made more quickly and with less effort, in Basement, Garage or Shop, by grinding lawn mowers in spare or full time. Repair men are amazed at the accurate results obtained with the UNIVERSAL GRINDER. Grinds reel blades to proper clearance and angle, also inside face and edge of stationary blade without removing blade from mower. Grinds more mowers per day than any other grinder. Tool grinding attachment included.

"THE UNIVERSAL WAY IS THE MODERN WAY"

Compare with others
WRITE FOR FREE FOLDER

ROGERS MANUFACTURING CO., Dept. J, LINDSEY, OHIO

Why Build Your Own Trailer?



When you can buy this big 17-ft. Stream-lined, Factory-built Trotwood ECONOMY model for what the materials alone would cost you. Think of it! Fully equipped with big wardrobe; Drapes & Screens; Dinette; Luxurious daveno; 6 & 110 volt lighting; Kitchenette, Cooking & Heating Stove; water supply and refrigeration, for only \$375.00 at the factory, ready for the road. Better than any home-made trailer and has high re-sale value. Finest materials used. Send for new literature today. Buy Direct from Factory and Save!

TROTWOOD TRAILERS, Inc., 806 Main St., TROTWOOD, OHIO



ELECTRIC EYE ANNUNCIATOR AND BURGLAR ALARM

STORES, Homes, Taverns, Shops, Garages—scores of others—waiting for the RAY-ALARM Burglar Alarm and Annunciator. Real protection—guards against intrusions. Invisible beam of "Black Light," when interrupted, sounds continuous alarm. Plugs in any light socket. Unfailing demonstration takes 10 seconds—makes sales on the spot.

SEND NAME Huge profits. Write AT ONCE for particulars of Distributor Plan or Agent proposition. No money. Just send name.

RAY-ALARM, 225 Fifth St., Dept. R-166, Des Moines, Iowa



SILVER

Lustrous, durable coatings of REAL Silver applied "AS EASY AS PAINTING" (Process Pat.) Used by nationally-known companies. Equals commercial plate of equal thickness. Repairs worn spots on silver or any white metal finish. Improves radio and other electrical connections. Plates 200 sq. in. Additional compound at low prices. 24 Kt. GOLD also available. Satisfaction Guaranteed. Postpaid U. S. & Can. COD if desired. \$5.50 Foreign. **RAPID ELECTROPLATING INC. 1414 AF S. WABASH CHICAGO, ILL**

COMPLETE KIT \$5 NOTHING ELSE TO BUY

A LITTLE LIBRARY OF USEFUL INFORMATION

25c Each—5 for \$1.00

THESE booklets have been carefully prepared as authoritative and fully illustrated digests of the subjects listed. Each one is complete in itself. The list of titles follows:

- 1 PHOTO ENLARGERS.** Complete plans and details for building both vertical and horizontal types.....25 cents
- 2 OUTBOARD RUNABOUT.** How to build a V-bottom 14-foot boat suitable for small motors, which will carry the entire family.25 cents
- 3 ELECTROPLATING.** Electro-chemist tells secrets of plating with copper, nickel and chromium—electroplating with gold and silver—copper and nickel plating without cyanides and plating with lead, zinc and cadmium. Also, electroplating leather, wood, plaster and non-conductors.25 cents
- 4 WOODWORKING POWER TOOLS.** How to make your own wood lathe, scrollsaw, large saw table, ball-bearing drill press, portable belt sander, bandsaw, plane, drum sander, etc...25 cents
- 5 WELDERS.** Complete plans and details for building your own electric arc and spot welders. Designed to operate on 110-volt, fifty or sixty cycle current.25 cents
- 6 CONCRETE GARDEN FURNITURE.** How to make benches, pottery, bird baths and sundial pedestals in either plain or colored concrete.25 cents
- 7 BIRD HOUSES.** How to build for fun or profit many kinds of bird houses, including four-apartment log cabins and single-apartment homes of rustic design. Also, bird baths, cages, feeding and a table-top aviary.....25 cents
- 8 FARM AND GARDEN TRACTORS.** Complete details on the building of a small farm tractor from old automobile parts, at small cost. Also, plans for a garden tractor powered with a single cylinder, motorcycle engine.....25 cents
- 9 TAXIDERMY.** Complete details of how to mount birds, fish and small animals in lifelike poses, with hints on the preparation of the skins. Fully illustrated and prepared by experts.....25 cents

POPULAR MECHANICS PRESS, 200 E. Ontario St., Chicago

(Continued from page 147A)

W. K. 24 5
tury. Walnuts and oranges were harvested as long as twenty years ago from trees that were grown in nutritious water solutions.

An important offshoot of soil deficiency and plant nutrition research has been the discovery that fruits and vegetables grown in anemic soils may not contain large enough amounts of the so-called trace minerals to supply the nutriment that the body needs. Iron, calcium, phosphorus, iodine, copper, zinc and manganese are some of the trace minerals that the body obtains from the vegetables we eat, and we suffer when the foodstuffs themselves are deficient in the minerals.

In some instances children in poor health have gained weight rapidly after moving to new homes where vegetables richer in minerals were available. A taller, more vigorous, and probably more intelligent race has been predicted for the time when vegetables themselves are placed on a scientific diet that insures their carrying the minerals we need. Similarly, dairy and poultry products from penned animals that are fed dry rations are low in vitamin content and a current problem in animal husbandry is to increase the vitamin content of eggs and milk in cases where the chickens and cows are kept in barns or pens. "Pedigreed" foods containing high vitamin, protein and mineral values possibly could be sold at higher than normal prices.

Another kind of research promises the production of out-of-season vegetables and fruits by means of infrared radiations. Developed by Quinter E. Bashore, California citrus rancher, to protect his groves against frost damage, the infrared system uses carbon-filament lamps such as are used in "sun tan" machines and in automobile factories for hastening the drying of paint. Vegetation keeps growing even after dark when exposed to the rays, the effect of the lights being to increase the length of the day. The radiation warms trees and plants but does not warm the air.

The lamps protect Bashore's prize lemon grove against frost at about one-eighth the cost of smudging. His system is thermostatically controlled to turn on and off with changes in temperature. Oranges and bananas couldn't be raised in Alaska by employing the lights because the system is protective for only four or five degrees below freezing.

JUNE, 1940

Does Noise Interfere with Your Shop Phone?

Try This Amazing Acoustic Booth

Do you work in a noisy manufacturing department, where punch presses, tumblers, riveters, or other machines make shop phones hard to use? If so, investigate the amazing Burgess Acousti-Booth. This remarkable doorless telephone booth has a patented acoustic lining which absorbs factory noise. It produces a "zone of quiet" in your noisiest department. Telephoning in a Burgess Acousti-Booth is easy and pleasant. The open design makes it easy to clean. Sturdy steel construction means long life without maintenance expense. No locks, fans, hinges, or other parts to wear out. Used today in hundreds of factories, power houses, and subway stations. Mail coupon for catalog describing the Burgess Acousti-Booth.



Patented

Burgess Battery Company, Acoustic Division
Dept. PM, 500 W. Huron St., Chicago, Ill.
Please send catalog describing the Acousti-Booth.

Name

Firm Name

Street - City

BURGESS ACOUSTI-BOOTH

Operating under Burgess Patents



BUILD THIS BOAT YOURSELF

FOR \$27.50

Fishing, or outboard models, lightweight. Ready cut, knock-down parts, glue, screws, illustrated instructions.

N. S. RIEGER CO., 95-2nd St., MIAMISBURG, OHIO

25c for Sensational KEY CHAIN IN Miniature GADGET

ALL STATES—The latest novelty. A perfect Miniature of your own license plate, iridium frame and key chain for 25c, coin or stamps. Actual reproduction of your license in exact colors—just as it appears on your car. Practical too, because FREE service returns lost keys to you. Also with 24 Karat gold plated frame only 50c. LIMITED QUANTITY—ORDER NOW—AGENTS WANTED.



IDENTIFICATION CO., Dept. P1, 1560 B'way, N.Y.C.

HANDEE

Tool of 1001 Uses

A WHOLE TOOL SHOP IN YOUR HAND

Smooth, steady power at your finger tips. Uses 300 accessories to grind, drill, polish, rout, cut, carve, sand, saw, sharpen, engrave, etc. Plugs in any AC or DC socket.



Save Hours of Hand Work

10 Days' Money-Back Trial
Order today. Standard Model (illustrated) 18,000 r.p.m. 16 oz. \$10.75 postpaid with 3 Accessories . . . DeLuxe Model 25,000 r.p.m. 12 oz. \$18.50 postpaid with 6 Accessories.

FREE 64-PAGE CATALOG
Complete information on Handee Products and their wide application in crafts work and industry all over the world.

Chicago Wheel & Mfg. Co., 108 S. Aberdeen St., Chicago, Ill.

NEW BOAT READY!

BUILD OK-4 at Home in a Few Evenings!



Here is Mead's sensational new 14-foot portable Outboard K1-YAK—the OK-4! Carries 4 adults and duffel—takes motors up to 9 H. P., oars and sail! Weighs only 75 lbs. Seaworthy. Leakproof. Big! Light! STRONG!

You can build yours easily, quickly, perfectly at home in a few evenings from our patented, complete construction kit and save nearly HALF! Big money assembling, selling to others. Then there's the 50-lb. OK-2 for motor, sail, oars—and 3 other paddle-sail K1-YAKS from 18 to 45 lbs! Double Paddle or Oars now INCLUDED with your Kit! Write for FREE big colored "Picture Circulars," amazing low Factory-to-You Prices!

OK-4 speeding along using 9 h. p. motor

Write FOR BIG LAVISHLY ILLUSTRATED Free CIRCULARS

OK-8 with sail rig



MEAD GLIDERS

15 S. MARKET Dept. B-60 CHICAGO, U.S.A.

FREE FIREWORKS CATALOG AND GIFT COUPON

Have more fun for your money—buy FIREWORKS direct. With every order a 35c gift box of Salutes FREE.

WANT TO EARN FIREWORKS ASK US HOW

SPENCER FIREWORKS CO. Box PM-150 POLK, OHIO

CALBAR CAULKING COMPOUND

A weather proof, non-staining plastic substance that holds fast, unaffected by heat or cold. Seals openings around Door & Window frames for regulated Heat Control & Air Conditioned Buildings. Sold by Paint & Hardware Stores or ask your Contractor.

Manufacturers of Technical Products
Calbar Paint & Varnish Co. 2614-26 N. Martha St., Phila, Pa.



WORLD'S LOWEST PRICED ADDING MACHINE

IDEAL FOR BUSINESS OR PERSONAL USE GUARANTEED ACCURATE. Not a toy. Operates with only a finger flick. Adds, subtracts, multiplies, divides. Counts up to a million. Pays for itself over and over. Ideal Gift—for Business, Income Tax and School use. MONEY BACK GUARANTEE. Send name and address. Pay postman only \$2.50 plus postage. (Send full cash if outside U.S.) Money back in 10 days if not delighted. AGENTS WRITE.

CALCULATOR MACHINE CO., (Mrs.) DEPT. 166, P. O. BOX 1118, CHICAGO, ILL.

NEW INVENTION!

SENSATIONAL SELLER!

AMAZING PROFITS

Pat. Nos. 1886560 and 1954250

Ellis of Texas made \$78.00 in one day

Never in all history of garden, lawn and farm tools has anything like the WONDER CULTIVATOR been equaled. Imagine a single light, handy tool that does the work of a hoe, spade, drill, weeder, cultivator, lawn edge trimmer, pulverizer, rake, weed picker, grubbing hoe and plow. Pays for itself first day used. Does more work—easier, better—in less time! So simple a child can use it. Exclusive—sensational—fully patented—sells like a flash. Ellis made exceptional record of \$78.00 in one day! Virginia man ordered 250! Texas man sold 282 in 5 calls. Illinois man, 79 in 80 calls. Tested and used by home owners, farmers, florists, nurserymen, gardeners, parks, golf courses, schools, oil companies. Over 50 million sales possible, direct and to 612,000 stores. No capital required. A "natural" for all salesmen and saleswomen.

WRITE FOR DEMONSTRATOR OFFER. Rush name and address for Big Profit Sales Plan. Big season now starting. Hurry!

WONDER MANUFACTURING CO.

620 N. Michigan Ave. Dept. 116 Chicago, Ill.



SHAW GARDEN and ALL-PURPOSE TRACTOR

Write for FACTORY-TO-FARM prices. FREE CATALOG and TEN DAY TRIAL PLAN on the lowest priced quality tractors. All models have air-cooled engines, auto-type gear shift, many fine features.

WIDE CHOICE OF MODELS

Three types: 2-wheel GARDEN TRACTORS in 2, 3, 4, 5 H. P. sizes; 4-wheel RIDING TRACTORS in 5 and 8 H. P. and HIGH ARCH Models (8 H. P.) with 24" clearance. Auto-type gear shift, air-cooled engines. All have many fine features. Also complete line of mowing equipment and tools for all farm work. Write for FREE CATALOG.

SHAW MFG. CO., 4506 Front St., Galesburg, Kans.; 5812-G Magnolia Ave., Chicago, Ill.; 138-G West 42nd St., New York City; 668-G North 4th St., Columbus, O.



HOW!

TO START A SUCCESSFUL BUSINESS OF YOUR OWN—by MAIL! FREE FOLDER tells you how Sears-Blair-Davis-Larkin-Vicks and many others, started successful Mail-Order Businesses on limited capital, by the "ace" of them all, Robert Collier. WRITE PERSONAL INCOME BUILDERS, 6605 HOLLYWOOD BLVD., HOLLYWOOD, CALIF.

AGENTS Get Into PLASTICS

TODAY'S BEST SELLERS—TOMORROW'S MAGIC MONEY MAKERS! Everyone wants PLASTICS—It's the fastest growing market today with quick, easy sales at plus profits . . . a big new field with no off seasons. Cash in on the big demand—sell our line to retail customers, retail stores, gas stations, novelty and premium buyers, manufacturers and business concerns. LONG TIME PROFITS Available from production accounts. Let us tell you how to get big volume, extra profit business. WRITE FOR FREE DETAILS or enclose 25c for samples having retail value of 75c. WARD PLASTIC & RUBBER CO., 1021 Hilton Road, Ferndale, Mich.



HEY FELLOWS! BUILD AND RACE! GAS POWERED MODEL RACE CARS!

Thrilling, Exciting and Fun Galore. Racing Clubs all over the country. Less than 24 inches long. These Little Speed Demons have turned over 62 m.p.h. This is America's Fastest Growing and Most Interesting Hobby. Complete line. Catalog 10c. MINICARS, 652 Neil, Columbus, Ohio

Say you saw it in

POPULAR MECHANICS



TENNIS

SAVE on our NEW LOW PRICES!

GENUINE LAMB GUT

- Got Tennis Strings direct from factory to you.
- Silk Tennis Strings • Vises and Frames • Tennis Equipment.

EARN MONEY Re-Stringing!

TENNIS CATALOG FREE!

Write for Free Catalog!
H. E. WILLS CO.
 1047 W. 47 St. Dept. PM-60
 Chicago



Your HAIR

IS IT THINNING OR FALLING OUT?

If your hair is causing you this kind of trouble and it is due to poor blood circulation in the scalp, rent a Crosley XERVAC and try home treatments with this amazing machine. It is designed to help correct just such conditions of the scalp as the lack of proper blood circulation.

Rent a CROSLLEY XERVAC

Write for free particulars, how you can rent a brand new machine, the same type now used in many barber shops and scalp clinics, for a small rental fee per month, without any obligation to buy. The Crosley XERVAC operates on the principle of alternate vacuum and pressure, known to be effective for forcing fresh, stimulating blood into the deep-rooted blood vessels. Very compact, easy to use. Now that you can rent one you can get its benefits on easiest of terms. Write today for details of this new home rental plan.

THE CROSLLEY CORPORATION
 Dept. F-10 Cincinnati, Ohio

SAVE MONEY BUILD YOUR OWN FAN

THREE-BLADE for 1/4 H.P. Motor			TWO-BLADE for 1/6 H.P. Motor		
Size	Shaft	Price	Size	Shaft	Price
20 1/2"	1/2"	\$4.00	12"	1/2"	\$2.25
24"	3/4"	4.50	16"	3/4"	2.50
26"	3/4"	5.00	20 1/2"	3/4"	3.00

Aluminum Propellers Shipped Collect

MICHAEL ELECTRIC COMPANY, Dept. P., Fort Worth, Texas



World's Smallest Pocket Radio

NO TUBES NO BATTERIES NO PLUG IN

Midget Radio fits your pocket or purse. Weighs only 6 ozs. Small as cigarette packages. Receives stations with clear tone. "PATENTED FIXED CRYSTAL" —NO UPKEEP—only one moving part. TUBELESS. BATTERYLESS. NEW PATENTED DESIGN. Has enclosed geared luminous color dial for easy tuning. MANY OWNERS PLEASSED WITH RECEPTION AND DISTANCE OBTAINED WITH THIS NOVEL RADIO.



PUT MAGIC IN YOUR CAR!

• A set of Magic Spark Plugs GUARANTEED to give you trouble-free performance during entire life of car in your ownership. Any plug failing will be replaced at once without question and without cost. Solve your spark plug troubles once and for all the MAGIC way. A new product of a long established manufacturer of strictly QUALITY Spark Plugs. SPECIAL INTRODUCTORY OFFER, \$2.50 for 5 plugs with EXTRA PLUG FREE; \$3.50 for 7 plugs with EXTRA PLUG FREE; postpaid. SATISFACTION GUARANTEED. Order today, giving make and year of car.

DEFIANCE SPARK PLUG CORP., TOLEDO, OHIO

ONE YEAR GUARANTEE

Sent ready to listen with instructions and tiny phone for use in hotels, offices, homes, boats, in bed, etc. SIMPLE TO CONNECT—NO ELECTRICITY NEEDED. SEND NO MONEY! Pay postman only \$2.99 plus postage and charges on arrival or send \$2.99 (Check, M. O., Cash) and yours will be sent postpaid. A most unusual value. ORDER NOW! MIDGET RADIO CO. Dept. P-6, Kearney, Nebr.

FLY A KIT-BUILT BOWLUS SAILPLANE

The Bowlus Sailplane holds soaring record of 263 miles yet it's a safe, rugged trainer. Kit only \$75 down, then pay as you assemble 10 units. Send 10c for folder.

BOWLUS SAILPLANES, INC., San Fernando, Calif.



This Complete HOME WORKSHOP \$29.75

A AND N SUPPLY CO.

Bargains—Military, Sport Goods, Firearms, Clothes, Shoes, etc. Send 10¢ for new catalog, to be redeemed on first order.

1866 A & N Supply Co., 4772 Lester St., Richmond, Va.

- LATHE
- DRILL PRESS
- CIRCLE SAW
- EMERY WHEEL
- SANDER

Five power tools in one complete unit! Made of fabricated steel with smooth needle roller bearings. Lathe 37" between centers. Drill Press pulls 1/2" drill in steel. 6" or 8" circle saw. Uses 1/4 H.P. Motor. A fine practical unit. WRITE FOR LITERATURE!

SENSATIONAL Flexible SHAFT TOOL

The FOREDOM FLEXIBLE SHAFT TOOL SEND FOR FREE CATALOG Complete except power unit \$4.50

bring new skill, new ease for home and master craftsmen. Uses over 200 accessories. Grinds, polishes, drills, mills, engraves, sharpens, slots, sands, carves, etc., etc. Every hobbyist should own one. Send for free illustrated catalog. FOREDOM ELECTRIC CO., Dept. 148, 27 Park Place, New York, N. Y.

SIGNS

Do a Professional Job the First Time—with LETTER PATTERNS—Simple, quick, can be used over and over. Make money on side.

THIS IS HOW EASY IT IS... First you trace around letter pattern with pencil—then fill in color with your brush!

ABC ABC ABC ABC ABC
 NO. 21 NO. 13 NO. 27 NO. 30 NO. 32

PRICE PER ALPHABET 26 LETTERS—NUMBERS TO MATCH
 1/2" 60c 2" 70c 3" 85c | 1 1/2" 25c 2" 30c 3" 35c
 4" 1.10 6" 1.75 8" 2.50 | 4" 45c 6" 70c 8" 1.00

Order by number. POSTPAID. Folder included.

JOHN F. RAHN, A1330 N. CENTRAL AVE. CHICAGO, ILL.

Build Sensational New CLEVELAND AIRCAR

Airplane-propeller driven model gas powered car. Complete except power unit \$4.50. Send 10c for complete cat. along describing model gas cars, airplanes, RRs, ships, etc.

CLEVELAND MODEL & SUPPLY CO. INC.
 4508D51 Lorain Ave., Cleveland, Ohio.



MAKE YOUR HOME A BROADCASTING STATION

Amazing, new MYSTIC MIKE enables anyone to broadcast from any part of his home with NO WIRES CONNECTED TO RADIO. Simply plug unit into A.C. or D.C. electric socket, speak or play music into the microphone and it will be picked up by any radio anywhere in the house. Mystify your friends with MYSTIC MIKE. Send wholesale price of \$3.95 plus 25c postage (complete—nothing else to buy) and have the time of your life, or order C.O.D. and pay postman on delivery. 10 DAY MONEY BACK GUARANTEE. Order today.

OLSON MFG. CO., Dept. 105, 362 Wooster Ave., Akron, Ohio

COMPLETE SET with Microphone and RCA Tube \$3.95 Add 25c postage



Write to Demco Products, Inc., Kalamazoo, Mich.

Bulletin on Request FREE

BETTER SANDING

10 Times
Faster

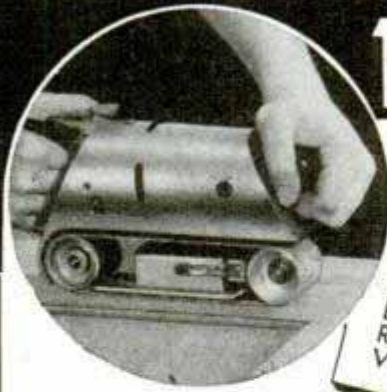

**1000
USES**

Sands-Grinds
Planes-Polishes
Buffs-Sharpens
Removes Paints,
Varnishes, Etc.

The New Popular Priced

PORTABLE GuildSander ELECTRIC

Now—save time, save tedious labor . . . get a satin-smooth job that is a delight to the eye, a joy to the touch. With GuildSander you can do the job 10 TIMES FASTER, a hundred times easier. The fast-cutting abrasive belt—quickly changed to any degree of fineness—gives a straight-grain finish. No cross-swirls, no gouges. It makes you an expert, even without practice. Works on wood, wall board, metal, stone or plastic—on either flat or curved surfaces.

GuildSander is a precision tool—at a price you can afford—with a written guarantee. Runs from any light socket. Weighs only 9 lbs.—handy in any position. Try it at your hardware or supply dealer's, or write us for complete details.

SYRACUSE GUILDTOOL COMPANY
1740-6c North Salina Street, Syracuse, New York

HANDIEST LUBRICANT

for home, shop, office, store, car



DO as thousands are doing—shift to oilless, dripless, greaseless, odorless powder lubrication with Dixon's "Junior" Graph-Air Gun. Squeeze the Flexophone cylinder and shoot Dixon's Microfyne Graphite to the seat of trouble. Nothing better on locks, firearms, fishing reels, etc. It stays put where liquid and paste lubricants run out, squeeze out, burn out or wash out. Works perfectly on surfaces of any material. Stops squeaks, removes rattles, bans binding, fights friction. Dixon's "Junior" Graph-Air Guns filled with about 900 shots, 30¢ at most dealers or write for booklet CG-26.

JOSEPH DIXON
CRUCIBLE CO.
JERSEY CITY, N. J.



DIXON'S JUNIOR GRAPH-AIR GUN



HAVE FUN

with this

Telescope!
POWER ONLY
\$3.75

For motoring, sports events, all outdoors. This high-grade telescope brings in distant objects clearly and sharply, takes you to center of exciting scenes. Money-back guarantee. At dealer's, or direct, postpaid, (or C.O.D.). Write for Catalog.

WOLLENSAK OPTICAL CO., 790 HUDSON AVE., ROCHESTER, N.Y.

WOLLENSAK

Job Hunting in Test Tubes

(Continued from page 831)

trouble-shooting, borrowing laboratory equipment and specialists, giving financial and expert aid to inventors, and passing around reference material. They are developing new products, new uses for old products, new materials, new manufacturing methods, new markets, and new jobs.

The area now is enjoying an industrial renaissance. Roy F. Williams, general manager of the Associated Industries of Massachusetts, says: "The New England business boom began in the research lab-

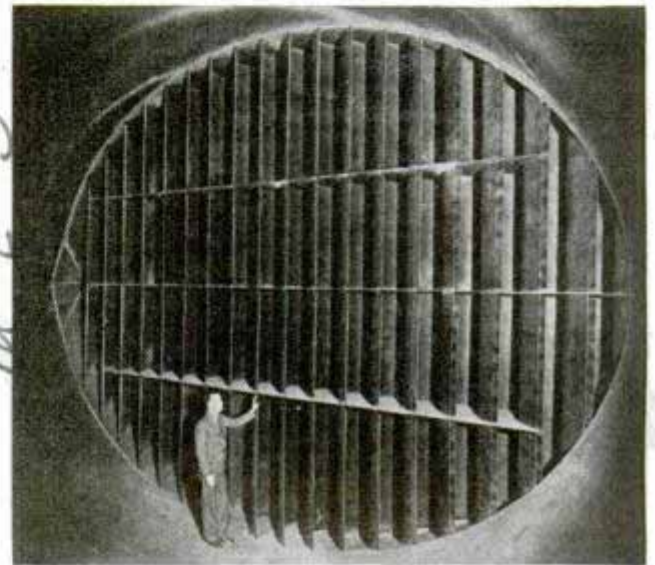

Nineteen-foot crescent-shaped vanes guide high-velocity wind around corners of wind tunnel

oratories. It came with the diversification of industry and the development of new products."

In the old days the fertile western plains always absorbed the unemployed from the east. Now that frontier is closed. Free land has vanished. Modern pioneers must explore the frontiers of science in search of new jobs.

Once jobless youth was given a plow horse and a covered wagon and told, "Go west, young man." Now he is given a row of chemical bottles and an assortment of laboratory apparatus and told, "Go test, young man."

Our Bureau of Information keeps on file the names and addresses of makers of, and dealers in, all devices described in the pages of Popular Mechanics Magazine. We are glad to furnish this information to our readers upon request, accompanied by stamped, self-addressed envelope.



Try This New ROYAL Portable In Your Own Home FREE

READ WHAT OWNERS SAY:

"Earn more money—make that correspondence course pay real dividends" (Sales engineer) . . .
"Get ahead faster—make home work count" (A student) . . . "A real help to everyone in the family." (Housewife)

SEND NO MONEY don't spend a cent—until you *know* that a New Royal is going to be worth many times its cost to you. *Know* how easy it makes writing—how its many office typewriter features and controls help *you* turn out neat, accurate business-like letters and reports. Maybe you've never used a typewriter—never thought of owning one . . . Then you owe it to yourself, to your future, to clip the coupon *at once* and get the **FACTS**. No obligation.

*Trade-mark, Reg. U. S. Pat. Off.



WITH MAGIC*
Margin new Sensational! Sets margin automatically 3 times faster.

Royal Typewriter Company, Inc.
Dept. C-43, 2 Park Avenue, New York, N. Y.

Tell me how I can get a genuine New Royal on **FREE HOME TRIAL**; also, how I can own one for **ONLY A FEW CENTS A DAY** including small carrying charge.

NAME

STREET

CITY.....COUNTY.....STATE.....

MAKE THAT OLD TYPEWRITER HELP PAY!

Please quote trade-in allowance on a.....Typewriter, Serial No.....

ACT NOW! . . NO OBLIGATION

FREE!



Royal's Instant Typing Chart. Shows you how to type **RIGHT!**



YOURS!

The Duo-Case! With every Royal Portable—at no extra price!



It's FREE! It's NEW! LAFAYETTE RADIO CATALOG

Send for new **FREE** Summer catalog of values in radio and P.A. 64 beautiful new Lafayette radio models, P.A. for every purse and purpose, all the nationally advertised radio tubes, parts and equipment—including Build-It-Yourself Kits. The book is **FREE!** Send at once.

LAFAYETTE RADIO, Dept. 7F, 100 Sixth Ave., N.Y.C.

BRONZE FOUNDRY Schools and Home Workshops

Make your own castings of aluminum, copper, bronze, silver. Foundry sets are available in three sizes including 2400 Deg. F. blast Furnaces. \$13.50, \$19.00, \$27.50, f.o.b. Kansas City. Free Circular.

KANSAS CITY SPECIALTIES CO.

P. O. Box 6022, Dept. P-3

Kansas City, Mo.

COLUMBIAN METAL BOATS

Light weight, durable, carefully built boats at remarkably low prices. Made of toughest galvanized copper bearing steel. Wood gun-wales. Heavy transoms for outboard motors. Two or more built-in air chambers for extra buoyancy in case of upset. Real wave riders; easy to handle. Never leak or warp. Always ready for use. Both round and flat bottom boats; all sizes and styles.

Write For **Free Boat Booklet** with description and prices of complete line of metal boats—knockabouts for fishermen, light weight livery boats for parks and resorts, heavy duty craft for outboard motors.

Dealers Wanted—who can develop volume sales.
COLUMBIAN STEEL TANK COMPANY,
P. O. Box 4226-A Kansas City, Missouri



Like An Invisible Hand



NoRoL KEEPS CAR FROM ROLLING BACKWARDS on UP-HILL STOPS

--leaves right foot free for accelerator

HERE'S HOW IT WORKS

- 1 Driver brings car to a stop and depresses the clutch and brake pedals as he normally would do. Then, NoRoL acts automatically.
- 2 While holding the clutch pedal down with his left foot, the driver can remove his right foot from the brake pedal. NoRoL holds the brakes applied just as though the driver were pushing down on the brake pedal.
- 3 When ready to proceed up the hill or incline, the driver steps on the accelerator, and lets out the clutch pedal. The brakes are automatically released as the car moves forward.



When ordering a new car, specify that it come complete with a NoRoL. . . . Also available for many 1937, 1938 and 1939 makes of cars and trucks having hydraulic brakes.

**Many Models Only \$12.00 Installed
SEE YOUR CAR DEALER—or write us**

N 40-8D

Wagner Electric Corporation

(Manufacturers of Lockheed Hydraulic Brakes)
6438 Plymouth Avenue, St. Louis, Mo., U. S. A.
Send **FREE CIRCULAR** and details on NoRoL.

Name

Address

State

Make And Model Of My Car Is

"Smash Hit" of the Season—these NEW RIFLES!

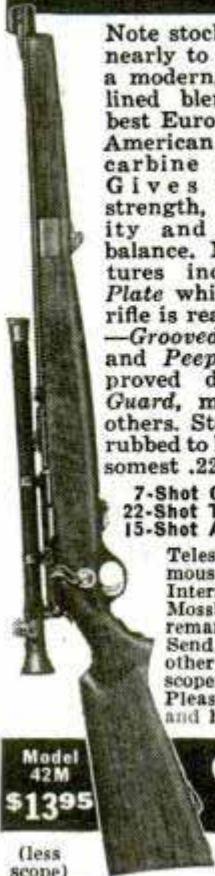

Note stock extends nearly to muzzle—a modern, streamlined blending of best European and American military carbine designs. Gives added strength, durability and perfect balance. New features include exclusive *Safety Cover Plate* which fits over loading port when rifle is ready to fire—*Military type Lever*—*Grooved Trigger*—*Front, Open Rear and Peep Sights* of exclusive and improved design—*Streamlined Trigger Guard*, molded *Finger Grip* and many others. Stocks are genuine Walnut, hand rubbed to beautiful finish. About the handsomest .22 cal. rifles that money can buy.

NEW DESIGN

NEW FEATURES

NEW BEAUTY

Send for Booklet

7-Shot Clip Repeater—Model 42M...\$13.95
22-Shot Tubular Repeater—Model 46M 15.95
15-Shot Automatic—Model 51M..... 17.95

Telescope Sight shown is Mossberg's famous 4-power model 5M4, with patented Internal Adjustment features. Fits all Mossberg and most other .22 rifles. A remarkable value at \$5.75.

Send for catalog in which these and other Mossberg rifles, shotguns and telescope sights are illustrated and described. Please enclose 3c to help cover postage and handling.

Model
42M
\$13.95

(less
scope)

**O.F. MOSSBERG
& SONS, INC.**

6506 St. John St.,
New Haven, Conn.

GIGANTIC PROFITS—MAKING AND SELLING FLUORESCENT LAMPS A MILLION DOLLAR BUSINESS

Hundreds of prospects waiting. Stores, Factories, Schools, Hospitals, Clubs, Taverns, Restaurants. Cuts lighting costs approximately 50%. We supply necessary parts and material ready to assemble. No equipment necessary; only a screw driver needed. Write today for prices and full particulars. Be first in your territory.

MID-WEST SALES CO.

35 East Wacker Drive Room 556 CHICAGO, ILL.

Mows and Trims Lawns in One Simple, Easy Operation



Save Time
and Labor with a
MONTAMOWER

Tired backs and aching arms just don't happen to users of Montamower. All the drudgery and noise of lawn mowing is done away with. No dead weight to push and pull. Instead, just 7 pounds of live mechanism that first gathers then cuts the grass closely, smoothly, and to the correct height; no matting; no streaking; no clatter; no rattles. Cuts a 16" swath through long grass, dandelions, spike grass and weeds. Cuts right up to walls, fences, trees or posts; leaves no fringes to be trimmed by hand. Cutters are self-sharpening. Built to last many years. Guaranteed. Thousands in use. Sold direct from factory. Costs little. Write at once for guarantee information and literature.

MONTAMOWER DISTRIBUTING CO.

329 Houseman Bldg. GRAND RAPIDS, MICHIGAN

MANUFACTURING OPPORTUNITIES



Now is the time to cash in on the growing building industry. Make a new and better building material—one that cuts building costs at every step—the kind your builders demand and are waiting for.

We equip you with a Line Production Machine—Raw materials enter at one end—finished products emerge from the other—You make them in more than 40 beautiful colors—You operate with 1 to 3 men who produce a volume selling up to \$200.00 per day.

Investigate now. Send for "4 Keys to Success." It tells how manufacturers already established are making outstanding progress from modest investments. Write today while your territory is still open.

W. E. DUNN MFG. CO.
600 W. 24th St. Holland, Mich.

By Hook or Crook?

The old expression, "By Hook or Crook" surely applies to Syncro Jig Saws—only the meaning is different. Syncro Saws cut cleanly every hook or crook, circle or corner in your pattern. There's no sanding necessary and Syncro Saws deliver 7200 power strokes per minute with no moving or rotating parts to oil or wear out. You cannot accidentally injure yourself on a Syncro Saw. They're powerful, sturdy, and portable. 3 Models to choose from—Deluxe Power Saw \$12.50, Power Saw \$10.95, Junior \$5.95. Write for catalog No. A40.



NEW YORK OFFICE - - 200 FIFTH AVE.

SYNCR0 DEVICES INC. 747 BEAUBIEN ST. DETROIT

SAVE 1/2 ON BULK MOVIE FILM WITH DAYLIGHT LEADERS

Buy in bulk, roll your own! 100 ft. dbl. 8mm. scored and notched in 25 ft. lengths including DAYLIGHT LEADERS \$1.75. 100 ft. single 8mm. \$1.00; 400 ft. 16mm. \$4.00 postpaid by return mail. Results GUARANTEED. FREE circulars, processing prices, etc., on request. SUPERIOR Bulk Film Co., Dept. PM6, 188 W. Randolph, Chicago.

In answering advertisements always write name and full address clearly.

Thompson BEATS the World on BOATS



Better Built
Lower Prices

Canoes \$66 and up

Rowboats \$42 and up

Outboards \$42 and up

Very fast utility model

Safe Boats With
Full Length Spray Rails

Keep passengers perfectly dry—even at high speeds. Catalog also shows today's five most popular models of sailboats. Two big factories. Prompt shipment.

CATALOG FREE
Write for your copy. State kind of boat in which you are interested.

THOMPSON BROS. BOAT MFG. CO. (94)
213 Ann St. PESHTIGO, Wis. (Write to either place) 113 Elm St. CORTLAND, N. Y.

FREE! WHOLESALE CATALOG

260 pages chock-full of tested fast sellers, for salesmen, dealers and operators. New, Big 1940 issue, just off the press. Describes many plans for boosting sales, one of which may add \$3 to \$15 a day to your earnings. It illustrates carded goods, automobile accessories, household necessities, office specialties, wearing apparel—over 4000 first quality items at low wholesale prices. Cost about 35c. FREE while stock lasts. Get your copy by mailing your request for it, now.



4000 BARGAINS

HEAT WATER EASILY PLUG HEAT-KWIK IN YOUR LIGHT SOCKET

No. E541. Big season starting. Furnaces being shut down, create a hot water problem. Heat-Kwik heater helps solve it. Intense heat given by the heater, goes directly into the water. Offices, homes, shops—need this amazing device. Simple demonstration, incites quick sales. Complete, ready for operation, in any 110 volt light socket. Guaranteed to please or money back. Costs agents, only



Sample 85c Dozen \$8.88

Spors Co., 4-40 Federal, Le Center, Minn.

Amazing CHEAP OIL BURNER

Sweeping the Country!!

COOK and HEAT Slips Into Any Stove, Range or Furnace

With Oil in Your Present Stove or Furnace—No Drudgery, Dirt or Ashes—Intense Heat Quick at SMALL COST.



OVER 40,000 SOLD

Beats any cheap burner ever gotten out for low cost, perfect performance. Burns ordinary distillate or fuel oil, no clogging up. Quick, clean, intense heat by Simple Turn of Valve. GUARANTEED.

30 DAYS' TRIAL Prove its efficiency, convenience and economical operation without risk.

Write Immediately for SPECIAL OFFER TO AGENTS who will demonstrate and take orders. Write quick, be first to learn how to make REAL MONEY right now, spare or full time—mail 1c postcard today.

UNITED FACTORIES, F-751, Factory Bldg., Kansas City, Mo.

RE-STRING TENNIS RACKETS

ARCHERY and GOLF. FREE CATALOG.

Earn Good Money at home. Everything furnished.

CHARLES-GERARD CO., 400 S. State, Dept. PM-6, Chicago, Ill.

AGENTS 300% Profit SIGN LETTERS

For Store Fronts and Office Windows. Anyone can put them on. Free Samples. Liberal Offer to general agents. METALLIC LETTER CO., 438 N. Clark St., Chicago

FREE!

240 Page handy reference book on complete line of Stanley Tools, plus helpful tables and information. Write for Catalog 34.

STANLEY TOOLS Division Of The Stanley Works CONN.

NEW BRITAIN

105 ELM ST.

SPARE TIME MONEY . . .

There's a big demand for the many hand-tooled articles you can make with the Easco Leathercraft Set. Easily learn to make good money in your spare time. Complete outfit including tools, leathers, patterns, etc., and full instructions, only \$2.00—on sale at leading Department Stores or order direct and pay postman on arrival. \$2.50 outside U. S.

LEATHERCRAFT

Free When ordering direct, clip name of your Department Store to this ad. and we will include with your set, one extra free project. Illustrated handbook 10c. E. A. SWEET CO. Dept A-35 Binghamton, N. Y.

COMBINATION 5 IN 1 ROTARY WOOD PLANER PANELER • TENONER • RABBETER & ROUTER

FITS ANY DRILL PRESS

ONLY \$750

READY TO USE



HOW IT WORKS: Simply slip the 1/2" ground steel shank of the planer head into the chuck of any 1/4 h.p. or larger drill press. Lock spindle. Turn on the power and pass work piece beneath the rotating head with finger tip control. Operates perfectly at 3000 to 5000 r.p.m. with unvarying planing speed. This 5-in-1 tool is inherently balanced and safety designed—will not damage drill press or harm the operator. Eliminates need for numerous, high-priced workshop tools. Parallels, planes, and finishes simultaneously all sizes of woods and plastics.

PLANES—The trickiest grains and knotty woods quickly, simply, without effort—to finest precision tolerances and agate smoothness. Eliminates hand or mechanical planing and sanding. Will not score, scratch, mark, burn or gouge the surface.

PANELS—Now you can achieve all manner of beautiful paneling effects on doors, drawers, furniture, cabinets, etc. with lightning speed. Provides true edges and satin-smooth surfaces.

TENONS—With amazing mechanical precision to within .002 inch, providing perfectly parallel tenon surfaces. Only tool of its kind. Will not check, feather or chip work piece. No special experience required.

RABBETS—All types and kinds of rabbets and grooves with absolute precision and agate-smooth edges.

ROUTES—This difficult operation now simplified beyond belief. No blade changes or adjustments required for any distinct operation.

— MONEY BACK FREE TRIAL GUARANTEE — Try this versatile, low cost, safety tool at our expense. Send check, money order, or order C.O.D. and we will ship parcel post, prepaid, any place in the U.S.A. for \$7.50. We offer you a 10-day trial—guarantee a full refund if not completely satisfied . . . No questions asked. Try it and be convinced.

FREE LITERATURE • DEALER OPENINGS

BARRON TOOL CO., INC., 305 Architects Bldg., DETROIT, MICH.

THE BARRON MULTI-PURPOSE 5-IN-1 ROTARY WOOD PLANER

GEAR REDUCTION MOTORS

40-1 ratio, 5000 RPM to 120 RPM; 6 volt D.C. Ideal for driving model cranes, locomotives—building elec. drills, turntables, etc. While they last, only \$2.00 postpaid.

\$2.00 ea.

Postpaid



EARL EQUIP. CO., 561 Washington Blvd., Chicago.

Calling All Cars

A MYSTERIOUS DISCOVERY SAVES UP TO 30% ON GASOLINE or Costs Nothing to Try

Stop wasting Gas!—trim dollars off gas bills—get more power—quicker pickup—faster acceleration! AUTO OWNERS everywhere praise VACU-MATIC! Proven so efficient, it is guaranteed to satisfy, or the trial costs you nothing.

Automatic Supercharge Principle Vacu-matic is entirely different! It operates on the supercharge principle by automatically adding a charge of extra oxygen, drawn free from the outer air into the heart of the gas mixture. It is entirely automatic and allows the motor to "breathe" at the correct time, opening and closing as required. Saves up to 30% on gas costs, with better motor performance.

FITS ALL CARS Constructed of six parts fused into a single unit, adjusted and sealed at the factory. Easily and quickly installed by anyone in a few minutes.

AGENTS Get Yours FREE FOR INTRODUCING. Here's a splendid opportunity for unusual sales and profits. Every car, truck, tractor owner a prospect. Send name and address now for big money making offer and how you can get yours Free. The Vacu-matic Co., 7617- 513 W. State Street, Wauwatosa, Wis.

ADVANCED COMFORT

in the longest, widest, strongest Unisteel Turret Top
BODY BY FISHER ever built

Although increased roominess is one major source of advanced comfort in the new Body by Fisher, an analysis of its construction reveals still others. Seat construction, insulation and the type of glass used are important factors, too. Here are examples of these modern features as they apply to the new Body by Fisher on the 1940 Chevrolet.

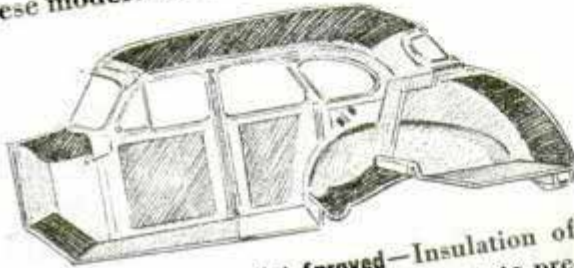

Pad-Type Insulation—Not Sprayed—Insulation of a car body serves a threefold purpose: to prevent radiation of engine heat and high climatic temperatures; to keep out cold; to deaden engine, road and traffic noises. Spraying insulation material on the panels is an inexpensive, old-type method some cars still employ. Body by Fisher, however, uses a more efficient method: the application of pad-type insulation, which insures adequate coverage at all points—even in the lowest-priced models. Chevrolet, for instance, is the only car in its price class with a rock wool padded cowl.

Reducing Eyestrain—There is no Safety Sheet (or laminated "window") Glass in the new Body by Fisher. All glass areas—not only the windshield—contain genuine, Safety Plate Glass. With Safety Plate Glass there is considerably less distortion than with ordinary Safety Sheet Glass. Tests show, in fact, that Safety Sheet Glass produces 62% more eyestrain than Safety Plate Glass.

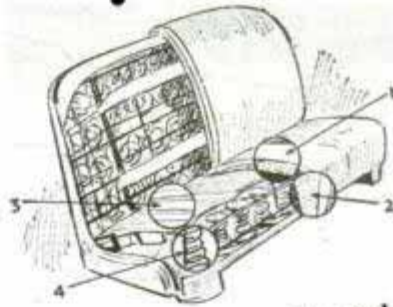

Constructed Like Fine Furniture—Beneath the finest upholstery—cut to precise size and hand-fitted—you find all of the following features in the seats of the new Unisteel Turret Top Body by Fisher. First, a deep cotton blanket (1) atop an abundant layer of special padding (2). Then a burlap sheet (3) to keep the springs permanently in place. And the springs themselves (4) are specially designed for lasting resilience and to prevent sagging.

"IT'S FIRST AGAIN" is what value-minded motorists are saying of the 1940 Chevrolet. And a major "first" most certainly is its new Body by Fisher—in beauty, comfort and safety. For instance, it provides the new Chevrolet Special De Luxe Sport Sedan shown here with stronger, safer Hi-Test Safety Plate Glass throughout all door windows and Ventipanes as well as the windshield.



BODY BY

Fisher

ON GENERAL MOTORS CARS ONLY.
CHEVROLET • PONTIAC • OLDSMOBILE
BUICK • LA SALLE • CADILLAC

"Pick up and Go"



HERE'S THE CHAMPION FOR YOUR CAR

MODEL	YEAR										
	'34	'35	'36	'37	'38	'39	'40				
AUBURN	H10 14 mm. Hds.										
AUSTIN AM. BANT.	C7	C7	C7	C7	J8	H10	H10				
BUICK	15	15	15	15	J8	J8	J8				
CADILLAC	7	7	8 cyl. J8 Others 7				Y4	Y4			
CHEVROLET	J5	J5	J8	J8	J8	J8	J8				
CHRYSLER	All Reg. Hds. J8 Alum. Hl. Hds. H10										
CORD	C7	C7	H10	H10	H10						
DE SOTO	All Reg. Hds. J8 Alum. Hl. Hds. H10										
DE VAUX	C7										
DODGE	All Reg. Hds. J8 Alum. Hl. Hds. H10										
DUESENBERG	6M	6M	6M	6M	6M	6M	6M				
FIAT	P5 P5 Models A & B 3X										
FORD	Big V8 18mm. Hd. 7 7 7 7 7 7										All Mds. H10
	1938 Big V8 14mm. Hd. H10										
	'32 V8 C4 60 H.P. H10										
FRANKLIN	C7	C7	C7	C7							
GRAHAM	C4	7	7	7	H10					H10 J10 Com.	
HUDSON	6s J8 All Reg. Hds. J8										
	8s 7 All Hl. Hds. H10										
HUPMOBILE	C7	C7	C7	C7	7	7	7				
LAFAYETTE	15	7	7	7	7	7					
LA SALLE	7	J8	J8	J8	J8	J8	Y4	Y4			
LINCOLN	7	7	7	7	7	7	H10				
MARMON	C7									H10 H10	
MERCURY											
NASH	To '29-6 L-Hd. C7										
	Ov. Hd. Vol. 15 14mm. Hd. J5										
OLDSMOBILE	7	7	7	J8	J8	J8	J8				
OVERLAND											
PACKARD	J8	J8	J8	Y4	Y4	Y4	Y4				
PIERCE ARROW	12 Cyl.-J5 8 Cyl.-C4										
PLYMOUTH	All Reg. Hds. J8 Alum. Hl. Hds. H10										
PONTIAC	J8	J8	J8	J8	J8	J8	J8				
REO	C7	C7	H10								
STUDEBAKER	1935 Alum. Hd. 7										
	All Reg. Hds. 8 Hl. Hds. 7										
STUTZ	6M	6M	6M	6M	6M	6M					
TERRAPLANE	All Reg. Hds. J8 Hl. Hds. H10										
WILLYS 4, 6 & 8	C7	C7	C7	C7	C7	J8	J8				
WILLYS KNIGHT	Big 6, 66 Series, C4 Light 6, 6										
ZEPHYR	H10 H10 H10 H10 H10										

WITH NEW CHAMPION Spark Plugs!

EVERYONE KNOWS that old, worn-out or inferior quality spark plugs, or those that have had 10,000 miles or more service, greatly impair engine performance and economy. But because deterioration is gradual, and hence not always noticed—millions of motorists depend on Change Week to remind them that a new set of Champion Spark Plugs definitely restores lost power, speed, economy and dependability.

Your Champion Spark Plug dealer renders special spark plug service this week. Checking and cleaning will reveal where new spark plugs are necessary to



restore lost "pick up and go."

Demand Champions, if new spark plugs are needed, because they make every engine a better performing engine; because they are the spark plugs champions use; because they alone have the leakproof qualities so necessary in today's high compression engines. Pick up and go to your Champion Spark Plug dealer NOW, because you can depend on him to put new "pick up and go" in your car.

Introducing Chesterfield's
own graduation cap



Learn Real Mildness... it's easy

Just make your next pack Chesterfields, that's all, and as quick as you can light up, you'll learn the meaning of real mildness . . . and you will learn this too, Chesterfields are cooler and definitely better-tasting. You get all of the right answers to your smoking pleasure with Chesterfields . . . the busiest cigarette in America.

Chesterfield
THEY SATISFY