

The HORNETS of the AIR CORPS

POPULAR MECHANICS

MACHINE



REG'D. TRADE MARK, GREAT BRITAIN, NO. 410426

MARCH
25 CENTS



SEE PAGE 347

"BLACK, SWIRLING WATERS SWALLOWED OUR BABY!"

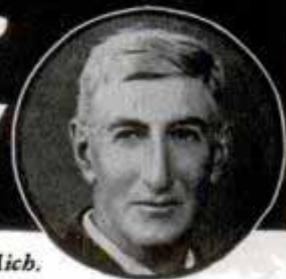

A true experience of GEORGE W. HOYT, Litchfield, Mich.



1. "NO FOREBODING of impending danger warned my wife and me as we walked home from town one night, pulling our two-year-old boy in his wagon," writes Mr. Hoyt. "We were in the middle of a narrow footbridge, spanning a stream, when fate struck.

2. "SUDDENLY A WHEEL came off the wagon, hurling our baby into the black, swirling waters of the river. Luckily I had my flashlight with me. I switched it on as I jumped over the railing. Despite a thorough soaking, that light did not fail me.

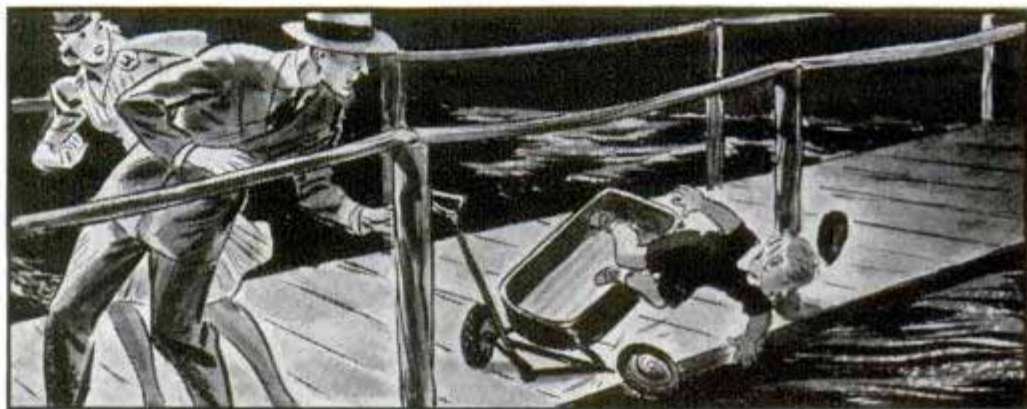

3. "ITS BRIGHT, faithful beam disclosed my boy clinging to the branches of a floating tree! Those dependable 'Eveready' fresh DATED batteries helped save our little boy's life. I will never be without them in my flashlight!

NOTE: An "Eveready" flashlight with "Eveready" batteries, will normally continue to burn under water.

The word "Eveready" is a registered trade-mark of National Carbon Co., Inc.

(Signed) George W. Hoyt



FRESH BATTERIES LAST LONGER... Look for the DATE-LINE

NATIONAL CARBON COMPANY, INC., 30 EAST 42nd STREET, NEW YORK, N. Y.

Unit of Union Carbide  and Carbon Corporation

The "One-Two" Answer on How "All 3" Stack Up!

① The 1940 Quality Chart shows which low-priced car gives you most size, comfort, all-around value.

② Take Plymouth's Luxury Ride...see how much pleasure and riding smoothness low price now buys.

TWO-WAY GUIDE FOR CAR BUYERS

1. SEE THE QUALITY CHART FOR FACTS

2. TAKE THE LUXURY RIDE FOR PROOF



Of 22 Important Features Found in High-Priced Cars... PLYMOUTH has 21... CAR "2" has 11... CAR "3" has 8

THIS YEAR, high-priced cars resemble each other in 22 important quality features. But of "All 3" low-priced cars only Plymouth gives you a majority of these features.

In size, in style, in riding comfort—Plymouth is most like the high-priced cars. See the facts on the Quality Chart. Then take Plymouth's Luxury Ride. And Plymouth is easy to own!



Be sure to see and drive the new low-priced Plymouth Commercial Pick-Up and Panel Delivery.

Tune in Major Bowes' Hour, C. B. S., Thurs., 9 to 10 P. M., E. S. T.

PLYMOUTH BUILDS GREAT CARS

Velvet ... the right word for smooth smoking

You can't put more smoothness in a smoking tobacco

... the mildness of fine old Kentucky Burley, aged in wood
 ... the extra flavor of real maple sugar
 ... a lasting joy in smoking.

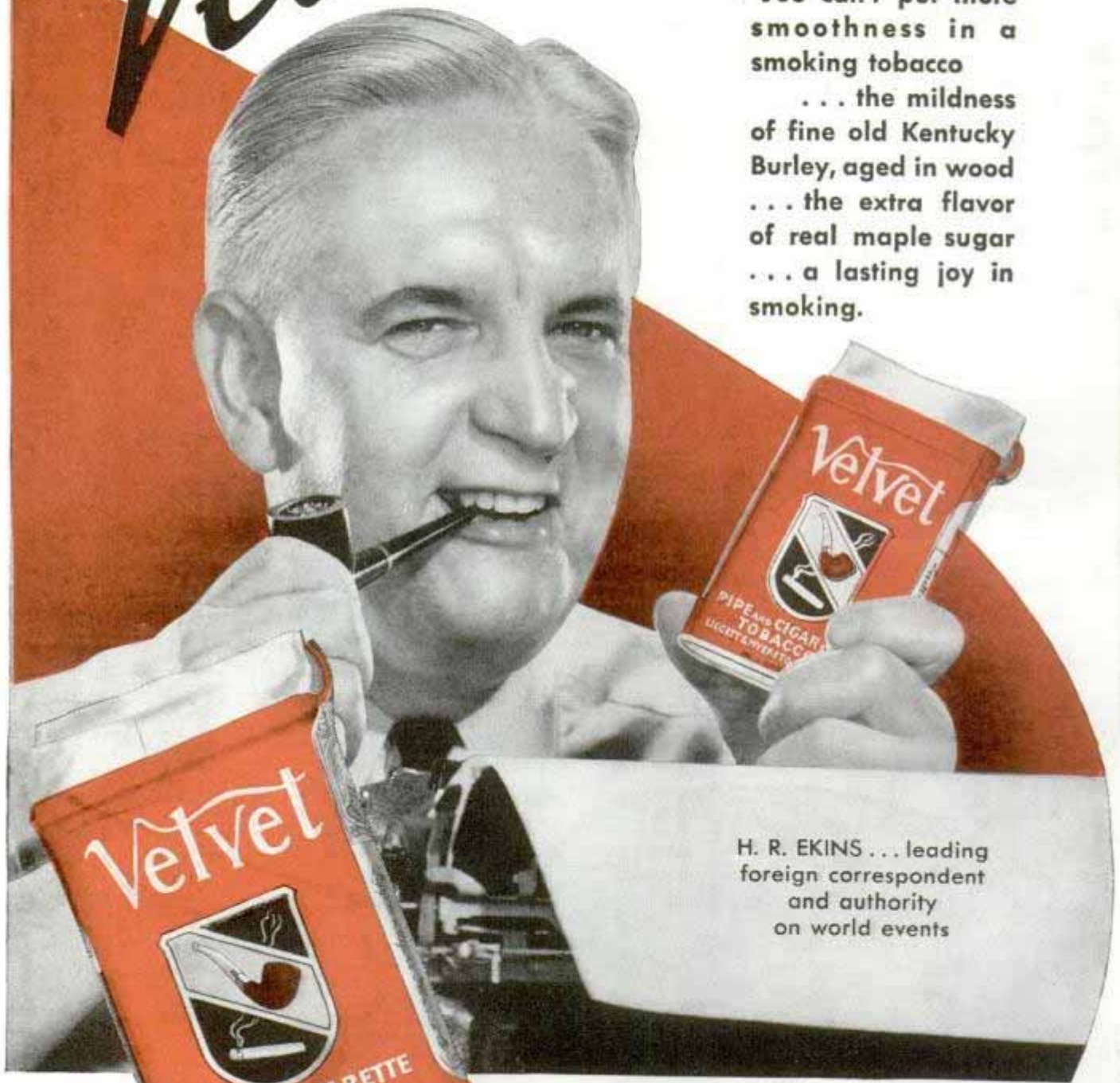

H. R. EKINS ... leading foreign correspondent and authority on world events



Copyright 1940,
 LIGGETT & MYERS
 TOBACCO CO.

for Better Smoking Tobacco
 —say **VELVET!**

Popular Mechanics Magazine

H. H. WINDSOR, Founder

H. H. WINDSOR, Jr., Editor and Publisher

March, 1940

Vol. 73, No. 3

IN THIS ISSUE

New Metals from Powder	321
Cameraman at the Front—Part I	328
100,000-Mile Tires	334
The Glass Age	Coloroto
Destroyer Versus Submarine	347
The Fast Freight Rides the Hump	354
School Days for Elephants	360
Bug Hunters Wage War on Insects	370
Bull Run Up-to-Date	376
The Chemist Spins a New Yarn	382
The Hornets of the Air Corps	386
Rolling Up the Strikes	392
Profits from Cliff-Dwelling Hens	402
Ocean Currents Forecast the Weather	408
Torture Chambers of Industry	412

(Continued on next page)

World's Greatest Chess Game

THE world's greatest chess game is played with battleships and aircraft carriers, heavy and light cruisers, destroyers, mine layers and submarines. It is a game of strategy, of forcing the enemy into action on your terms. In every war that has involved America, the U. S. Navy has been an important factor. Next month Commander Leland P. Lovette of the navy explains the tactics of sea warfare and summarizes the units built and building which make up the well-balanced American fleet. His article is illustrated by eight pages of Coloroto pictures.

Champions in the Making

BOB FELLER learned at Cleveland's training camp that he was taking too long a stride in his pitching. Roy Bell, fielding for the St. Louis Browns, raised his batting average from .250 to .350 on a tip from Rogers Hornsby. Big league baseball is a science, and how it's taught to veterans and rookies in spring training is told in the April issue.

Next Month

YOU run out of superlatives in talking about the Grand Coulee dam. Described in the April issue as "The Largest Thing Ever Built," it is a mile wide, 550 feet high, four times the volume of the Great Pyramid. Railroads, highways, towns and villages are being moved above the shore line of the vast lake it will create, reaching 150 miles up to Canada. Don't miss the story and pictures of this colossal undertaking and the new agricultural and power empire it will open in the northwest.

Golden Fleece, 1940

ANGORA may mean only sweaters, mittens and yarn to you, but it also means angora fur, the Golden Fleece that you can raise in your own back yard. Starting with a \$25 pair of angora rabbits you should have a herd of fifty within a year, and every one of them should produce every year a pound of wool worth three to five dollars. One man with 1,000 rabbits cleared \$200 a month last year. An article next month tells how to run a back-yard wool farm.

Rural Revolution

THERE'S a revolution sweeping American farms. Science, which long ago went to the aid of big grain farmers with heavy power machinery, has at last arrived at the small farm with low-priced tractors and baby combines designed for the 5,000,000 farmers who haven't yet been "sold." Read in April how mechanizing of the farm is even changing crop-growing and harvesting methods.

Again Pyroil goes to the south pole with Byrd



Among the precious supplies going with Rear Admiral Richard E. Byrd on his third daring expedition into the Antarctic, is Pyroil. There, in biting cold, freedom of controls and mechanical

parts of equipment must be sustained. Safe operation must prevail. And Pyroil will be depended on to perform this service, to help in keeping efficiency up to requirements necessary for success.

Many are the conquests in which Pyroil has served and discharged its duty well. And it can serve you. For Pyroil will safeguard all moving parts of your automobile engine. It can increase its efficiency. Help you keep your car working properly under many extremes of operation. In coldest weather. In all weather.

Ask for a trial treatment of Pyroil at your favorite service station or garage, today, and find out why this is so. Manufactured and guaranteed by Pyroil Company, W. V. Kidder, Founder, 53 Pyroil Bldg., LaCrosse, Wisconsin, U. S. A.



ADD
MERELY
OUNCES TO
GAS & OIL

DISTRIBUTORS:
CHECK AND MAIL
COUPON FOR FRAN-
CHISE FACTS.

PYROIL COMPANY

53 Pyroil Bldg., LaCrosse, Wisconsin

Please send me your Free Booklet and interesting story of Pyroil and its many achievements.

Send details of your plan for Distributors:

Name.....

Address.....

City..... State.....

(Contents—Continued)

AUTOMOTIVE

Super-fuels to bring super-engines.....	325
Sealed-beam headlamps for pre-1940 cars.....	326
Self-dumping sugar-cane truck.....	327
"Wings" between tractor and trailer.....	365
Gas plant on trailer makes fuel for bus.....	368
Tractor does locomotive's job hauling freight cars.....	373
Miniature "street" on auto measures lighting.....	375
Umbrella holder for auto.....	389
Auto made into sleeper by folding seats.....	390
Mechanical air-conditioning system for autos.....	391
Sound truck displays eight advertisements.....	400
Four-lane road has safety center strip.....	401
Spring "claws" in tire grip icy road.....	416

AVIATION

"Plastic shell" body for airplanes.....	326
Retractable catwalk in wing next to engine.....	365
Blimp rescues man at sea.....	373
Wheels in pontoons make light amphibian.....	385
Portable "cockpit" trains aerial gunner.....	407

GARDENS

Hanging window garden suspended from sash.....	368
Self-cleaning attachment for rake.....	389
Greenhouse in sections is easily erected.....	397

HOUSEHOLD

Circular electric outlet is easy to plug in.....	358
Milk in two-quart carton to cut price.....	359
Roast carving holder.....	364
Porcelain enameled hot-water tank.....	368
Electric scissors cut at touch of button.....	369
Electric screen for killing flies.....	374
Self-cleaning comb does not tear hair.....	391
Wartime blanket worn as robe in air raid.....	400

PHOTOGRAPHY

Clip holds film on reel.....	358
Developer corrects under and over exposure.....	363
Photo of tracer bullets shows gun's accuracy.....	375
Looseleaf file for photo film.....	396
Carrying case of camera serves as rest.....	411
"G-men's" giant enlarger weighs over a ton.....	416

RADIO AND ELECTRICITY

Portable two-way radio worn by policeman.....	379
Electric "eyes" count arrivals, skip those leaving.....	396
Telephone dial steers radio-controlled boat.....	401
Eighteen tuber for short-wave listeners.....	455
Little giant push-button a.c.-d.c. four tuber.....	456
Photocell-operated relay for experimenters.....	458
Practical radio hints.....	459
A, B, and C-battery eliminator.....	460
Automatic tube tester employs card index.....	460
Improved "wireless" record player.....	460
Seven-station inter-office communication system.....	460

RAILWAYS

Locomotive vibration studied on greased rail.....	324
Light truck with rotary brake rides smoother.....	358
Twenty-mile belt system hauls gravel to dam.....	369

SCIENCE AND INDUSTRY

Cull oranges shredded into fertilizer.....	352
Self-grinding valve disk spun by steam.....	352
Crops to take infrared and ultraviolet treatments.....	364
Sky camera made of glass aids astronomers.....	368
Welder rides in weird light to fuse pipe.....	380
Flickering light seeks upper-air secrets.....	384
Interest of reader plotted by filming eye.....	385
Electric micrometer measures 5/1,000,000 inch.....	396
"Machine gun" crew mans drills in tunnel.....	406
Vanishing act of salmon puzzles canners.....	406
Papermaking waste yields profitable product.....	411
Tractors and roofer lay underground cable.....	411
Meter records state of nerves.....	130A

SPORTS

Fish mounted on aquaplane carved of cypress.....	324
Miniature basketball court aids coach.....	324
Bike has small wheel in front.....	326

TOOLS

Pipe-pulling jack saves digging trench.....	384
Tools adjust tappet while engine is running.....	397

(Continued to page 6A)

Ask Your Dealer to Show You These *Atlas* Features

See what Atlas engineers have done for you in developing the new F-Series 10" Lathe. Then you'll know why experienced machinists everywhere are advising—"Get a modern Atlas." You'll discover it is the only lathe that gives you precision and performance at a sensible price, because it is modern in design and efficiently engineered. Whatever the job, these are some of the Atlas features that will help you do it easier and better:

- **Power Cross Feed** standard equipment. Atlas is the only popular-priced lathe giving you this feature that saves much laborious work on facing operations.
- **Precision-Ground Bed**—first essential of a precision lathe. All six Atlas bearing surfaces are aligned to within .001" in all planes.
- **Custom-Bored Spindle Bearings** positively aligned by boring after the headstock has been fitted to the bed.
- **Backgeared Power**—Complete V-Belt Drive—Wide Screw-Cutting Range—Quick-Change Countershafts—Rugged Zamak Alloy Parts—at no extra cost.
- **Sensible Prices.** The 10" horizontal countershaft model below is \$104.75 complete as shown less motor (36" bed)—with vertical (attached) countershaft only \$99.75.

Atlas Lathes are sold on easy terms through good dealers. Use the coupon below to send for your free 1940 Catalog and name of the Atlas dealer in your locality today.

ATLAS PRESS CO.

343 North Pitcher Street, Kalamazoo, Michigan

CHICAGO

35 E. Wacker at Wabash

NEW YORK

130 W. 42nd Street

PHILADELPHIA

113 N. Third Street

ATLAS PRESS CO.

343 N. Pitcher St., Kalamazoo, Mich.

Please send 1940 Catalog on 10" Metal Lathe, 6" Metal Lathe, 7" Metal Shaper, Drill Presses, Arbor Presses, and the name of nearest Atlas Dealer.

Name.....

Address.....

City and State.....

**FREE
CATALOG**
Send Coupon

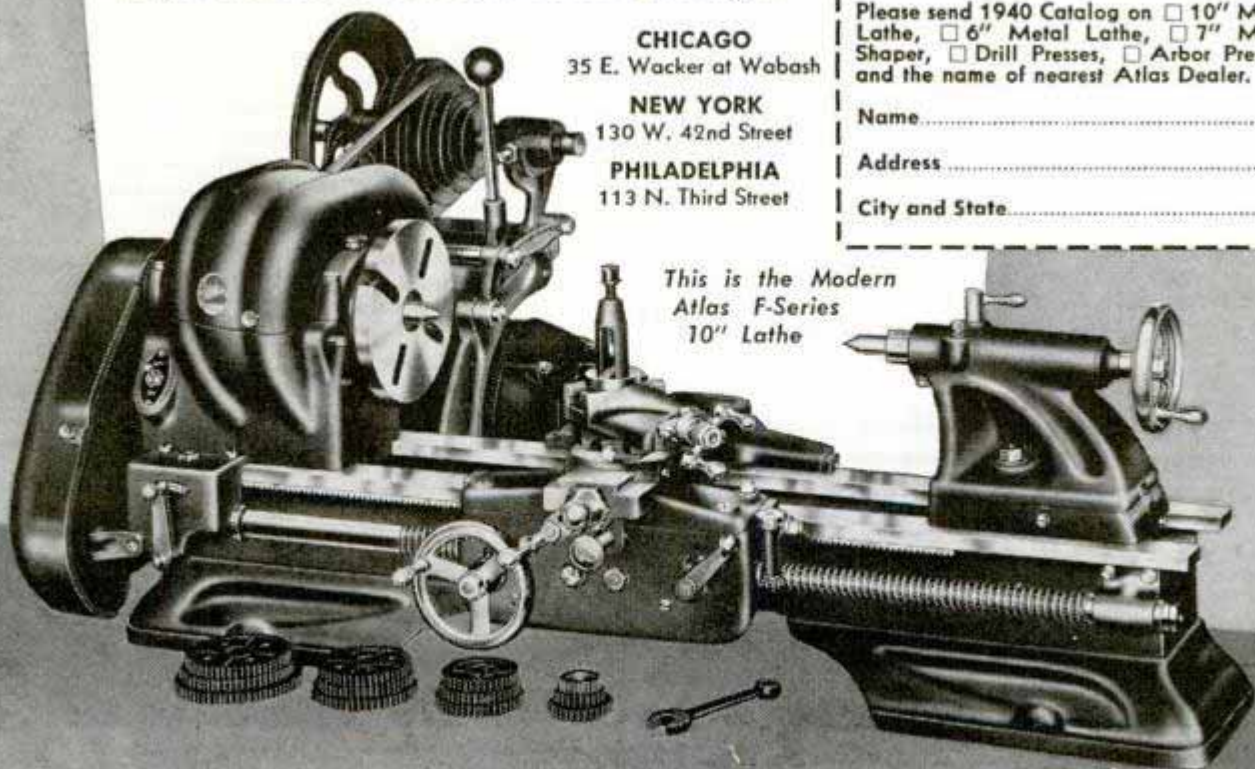

*This is the Modern
Atlas F-Series
10" Lathe*

This One



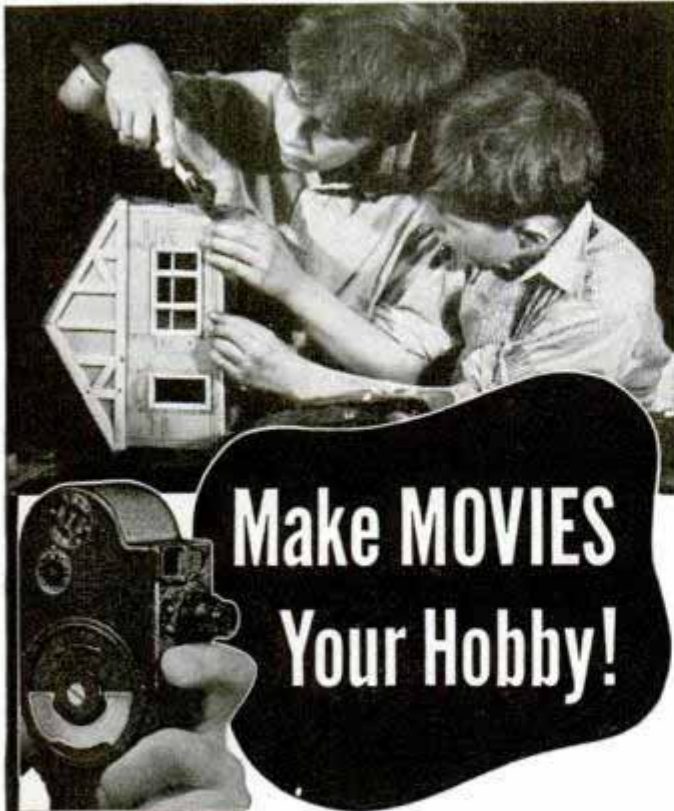

**Make MOVIES
Your Hobby!**

**PALM-SIZE
Filmo 8**
Makes Movies
at Snapshot Cost!
Only \$49.50
\$10 Down

● Make your hobby the most fascinating hobby of all—*home movies!* It's fun! There are unlimited opportunities! And with a Filmo Camera, you get *professional* results with *amateur* ease. For Filmos are precision-built by the makers of Hollywood professional movie equipment.

Just press a button, and *what you see, you get!* It's *that* easy! Palm-size Filmo 8 makes movies in color or black-and-white, indoors and out. Has extra speeds, device for animating cartoons, provision for using special lenses, and other features which make it a basically complete camera that keeps pace with your skill. Only \$49.50. Mail coupon today for free movie booklet. Bell & Howell Company, Chicago; New York; Hollywood; London. *Established 1907.*

**NEW 16 MM. FILMO
SHELLOADING CAMERA**

Eliminates film threading and permits mid-reel changes from color to black-and-white film. With fully color-corrected F 2.7 lens, \$115.



FREE Movie Booklets

BELL & HOWELL COMPANY
1844 Larchmont Ave., Chicago, Ill. PM 3-40
Send free, 16-page booklet telling how to make superb movies with () palm-size Filmo 8; () new 16 mm. Shelloading Filmo.

Name.....
Address.....
City..... State.....

PRECISION-MADE BY
BELL & HOWELL

(Contents—Continued)

Drain-plug wrench with crossbar handle.....400
Tubular "nail" for metal parts401
Folding metal sawhorse legs need no nails.....406
Jacklike lever and chain handle heavy loads.....407

MISCELLANEOUS

Magnets move armies on a canvas battlefield.....325
Lamp on safety jacket lit by water.....327
Trip to the moon offered by model.....336
Welding of "pocket" battleship saves weight.....352
"Hot dogs" cooked by electric current.....358
Bridge span lowered to barges in sections.....359
Portable plug-in traffic light363
Ten-foot high chair advertises business.....364
"Ears" for Britain's air-raid defense.....365
Germ-free crib guards baby374
Magnifier on flashlight helps close work.....374
Blotter wheel blots paper by rolling on page.....379
Detector finds metal in logs and saves saw.....380
Heat baffle for oil burner increases efficiency.....380
Thirteen-gun tank is a rolling dreadnaught.....381
Telephone in fireman's gas mask.....390
Vibrationless Diesel engine390

Craftsman and Shop Notes

AUTOMOTIVE

Streamline midget trailer for vacation needs.....441
Toolbox held on car by hood clamps.....466
Dispensing cotton waste in garage.....478
Oil tank on motorcycle removed without draining...478
Supporting flashlight at angle to illuminate wheel...478
Tank cap altered to make it theftproof.....478
Air cleaner keeps dust out of windings.....479
Water column in pipe tests leaky radiator.....479
Oil-barrel vent from tire valve.....480
Rotary cutter removes paper from new tire.....480

FARMS

Avoiding tangled tether438
Rain barrels filled in sequence from gutter.....449
Keeping clevis pin in doubletree.....464
Poultry-house window hung for draftless ventilation 465
Hobble cures broody hen466
Shields on trough save waste of feed.....474
Broom on stall cleans tines of barn fork.....477

FURNITURE

Glass in furniture construction412
Tray on porch glider serves as end table.....427
Cottage telephone stand430

HAND TOOLS

Bent putty knife to scrape siding boards.....420
Scratch awl made from automatic pencil.....424
Improvised vise clamp is lead lined.....428
Guide to start handsaw straight in plank.....433
Hose keeps punch from sticking440
Screwdriver has "hammer knob" to remove screws.466
Brush aids in soldering uneven surfaces.....472
Large pipe flange removed with iron bar.....474

HOME IMPROVEMENTS

Built-in corner cabinets417
Preventing hydrant from freezing.....428
Improving furnace water pan.....429
Plywood facing saves cost of new doors.....429

HOUSEHOLD

Moth balls keep flies out of garbage can.....420
Rubber doorknob protects wall420
Homemade andirons improve the fireplace.....421
Child's crib has hammock bed.....432
Drop leaf under high-chair tray.....432
Clips keep rugs from shifting while beating them...448
Solving home problems450

OFFICE

Improving the typewriter eraser420
Mimeograph stencil compass from pair of scissors...428
Stenciling stamp made from string and wood.....433
Skirt on typewriter keeps pencils from under it...438
Paper stencils made quickly with glass cutter.....466

(Continued to page 8A)



Plan Your Future

Choose Your Field NOW For Success

Will you master fate or will fate master you? That's a question deserving your honest answer . . . right now! Actually it is largely up to you. You can do with Life almost what you will. LaSalle will help you establish yourself for real success by providing you with the comprehensive, specialized training for which it is so famous. Choose your field . . . now! Check the coupon below for the free booklet you want us to send you. It can be your first step toward assured success.

Opportunities in Traffic Management

The field of Traffic Management offers real opportunity only to the man who knows. Spare time study and the will to succeed have pushed scores of Traffic employees up the ladder to financial success. Many LaSalle-trained traffic managers—both in the railroad and industrial field—now command salaries of \$3,000.00 to \$5,000.00 a year—and better. Investigate. Find out how you can qualify for these higher positions through LaSalle home-study and guidance.

Law for Business Success

And it isn't necessary to practice law to get this Success. In fact probably most of the men who study law today have no idea of taking the bar examination or becoming lawyers—they want law training to give them mastery of men and situations in business. You know that—

- (1) the man with legal training is a leader—not a follower.
- (2) legal training keens your mind—clears away the problems that stump the ordinary fellow and makes you master instead of man.
- (3) knowledge of law simplifies the complications of executive work.
- (4) Many top executive places are filled by men who have studied law.

No matter whether you are in a big corporation or a small business—in a great city or a little town—a practical knowledge of law cannot fail to be of real and vital help to you in making a more successful career.

In every state in the union you'll find law-trained men who came up through LaSalle. What others have done, you can do.

And LaSalle offers either a full law course leading to LL. B. or a shorter business law training—whichever you prefer. All text material, including valuable 14-volume Law Library. Training comprises the most effective features of modern law instruction.

Executive Training

Executives who are efficient managers command responsible positions and good incomes. And the need for

trained executives is growing rapidly. We train you thoroughly at home in your spare time for every type of executive work—teach you the principles and practices used by our most successful business leaders and help you develop your management capacity—by a training built with the aid of outstanding executives.

Become an Expert Accountant The Profession That Pays

The demand for skilled accountants—men who really know their business—is increasing rapidly. New state and federal legislation requires much more, and more efficient accounting from business—big and small. Corporations are in constant need of expert counsel in matters relating to Auditing, Cost Accounting, Business Law, Organization, Management, Finance. Men who prove their qualifications in this important branch of business are rapidly promoted to responsible executive positions—given an opportunity to earn real salaries. The range is from \$2,000.00 to \$10,000.00 a year—even to higher income figures.

Under the LaSalle Problem Method you can at home acquire a thoro understanding of Higher Accountancy, master its fundamental principles, become expert in the practical application of these principles—this without losing an hour of work or a dollar of pay.

Your training will be under the direct supervision of a staff of legal, organization and management specialists, business efficiency engineers and Certified Public Accountants.

Preliminary knowledge of bookkeeping is unnecessary. We train you from the ground up, or from where you now are, according to your individual needs.

Mr. Salesman: What's Wrong?

Why aren't you making more sales—more money? Is it you—or your proposition? Check up first on yourself. Other men—no better than you—have found their earnings jump and stay up when they trained with LaSalle. Literally thousands of men—many of them years at the game—have increased their sales volume and earnings through home study with LaSalle guidance. Sound—practical—usable—right from field experience. Train for top-notch production with LaSalle.

LASALLE EXTENSION UNIVERSITY A CORRESPONDENCE INSTITUTION Dept. 364-R CHICAGO

I would like to have your special booklet—without any cost or obligation to me—about my opportunities and your success training in the business field I have checked.

- | | | |
|--|--|--|
| <input type="checkbox"/> Higher Accountancy | <input type="checkbox"/> Commercial Law | <input type="checkbox"/> Business English |
| <input type="checkbox"/> Law: Degree of LL. B. | <input type="checkbox"/> Expert Bookkeeping | <input type="checkbox"/> Business Correspondence |
| <input type="checkbox"/> Traffic Management | <input type="checkbox"/> C. P. A. Coaching | <input type="checkbox"/> Effective Speaking |
| <input type="checkbox"/> Modern Salesmanship | <input type="checkbox"/> Industrial Management | <input type="checkbox"/> Stenotypy |
| <input type="checkbox"/> Business Management | <input type="checkbox"/> Modern Foremanship | |

Name _____ Age _____

Position _____ Address _____

When writing to advertisers please mention Popular Mechanics



Get Every Atom of POWER from Your Car!



Only 29¢ EACH

Double check W DOUBLE POWER

GUARANTEED 18,000 MILE SPARK PLUGS

Highest Quality Obtainable! Less Than Half The Price of Other Nationally Advertised Spark Plugs! A Real Buy!

Offered by the stores famed for economy throughout New Jersey, E. Pennsylvania, Delaware, Maryland, Dist. of Col. and California. Tested in service and enthusiastically endorsed by over 210,000 customers.

Double Check Spark Plugs, in design and construction, are patterned after multiple electrode plugs used in airplanes. Two longer and parallel side electrodes (ordinary plugs have only one) insure **EVERY ATOM OF POWER . . . UNFAILING IGNITION . . . GREATER GASOLINE SAVINGS . . . a SMOOTHER RUNNING MOTOR.**

ORDER A COMPLETE SET TODAY—and SAVE MAILED POSTPAID NO EXTRA CHARGE ANYWHERE IN THE UNITED STATES SEND CHECK OR MONEY ORDER

A complete set for 4-cylinder cars, only \$1.16; 6-cylinder cars, \$1.74; 8-cylinder cars, \$2.32. Designed in the correct heat range for your car, truck or tractor. Be sure to specify make, year and model of car.



The PEP BOYS
MANNY, MOE & JACK

General Offices and Warehouses
10th St. & Somerville Ave., Philadelphia, Penna.
1122-24 W. Washington Blvd., Los Angeles, Calif.

(Contents—Continued)

PAINT AND PAINTING

Paint insulated beehive	432
Simple method of matching ink or paint	433
Paintbrush wrapped in paper to prevent drying	438
What you can do with tire "paint"	439

PHOTOGRAPHY

Solvent to remove photos applied with oilcan	420
Hints on using your photo-light reflectors	452
Compact studio background arrangement	453
Folding cardboard flash reflector	453
Sponge cubes keep movie film from unwinding	453
Curved ferrotype plate dries photo straight	454
Photos scored to avoid curling	454
Sun glasses as camera filters	454

POWER TOOLS

Dowel aids in drilling out threads	426
Chuck on drill-press table grips round work	448
Precision chuck backs machined on your lathe	461
Angle guide on saw handles wide work	463
Off-center lathe turning balanced quickly	472
Worm gears made with ordinary threading tap	473

STORE AND SHOP

Nail container fitted with rubber lip	432
Funnel cap prevents evaporation of volatile fluids	462
Tape repairs torn grain sacks	464
Theftproof bottle display rack	466
Type sheets help visualize finished printing	472
Temporary window-sign lettering done in colors	474

TOYS AND NOVELTIES

"Beehive" jewelry box has two compartments	425
Midget acrobat on toy windmill	437
Jig to reshape ends of toy-train track	463

WOODWORKING

Belt dressing holds sandpaper on block	426
Removing plugs that hide countersunk screw heads	426
Metal tape ornaments wood lamps	440
V-blocks to hold round work on sawhorse	448
Washer scored to prevent turning under a nut	472

MISCELLANEOUS

Turned lamp base of "sandwiched" woods	419
Mesh bags prevent erosion of seeded terrace	421
Crutch-like rests on wheel chair aid patient	426
Steel wool in shotgun shell a good polisher	426
Cold drafts to heater minimized by air duct	427
Telescope cells from cooking utensils	428
Bucket keeps hole in ice open	433
Experiments with a vest-pocket "lab"	434
Complete drawing outfit fits in brief case	437
Drawer knobs from clothespins	438
Safety-razor guard holds microscope slides	438
Eaves trough shields mousetrap	440
Sack improves broom for sweeping snow	440
Soldering tube joints	440
Flexible scraper to remove snow from skis	446
Slip-on handles for metal beakers	446
Transformer used as coil for electric-arc current	446
Tooling mat paper a new arcraft	447
Mud on shoes removed with cap on brush	448
Pencil line on floor saves time when sanding	448
Sealing opening made in partition for pipe	449
Measuring narrow grooves	464
Vise mounting permits turning in any direction	464
Two simple jigs aid in starting taps straight	465
How castings are made in a foundry—Part III	467
Warning flag kept furled by hose	472
Welder's universal vise is easy to assemble	473
Brush holder on artists' palette	474
Pencil clip keeps nail set in pocket	474
Oscillating-type magnets easily tested and serviced	475
Cotter pin used as emergency dropper	477

IMPORTANT NOTICE

It is the intention of this magazine to provide its readers with information regarding the latest developments in the mechanical arts. We take no responsibility as to whether the disclosures contained in our articles are covered by patents and advise readers to investigate this subject before making, using, or selling any of the products, machines, or processes described, in order to avoid possible liability for patent infringement.

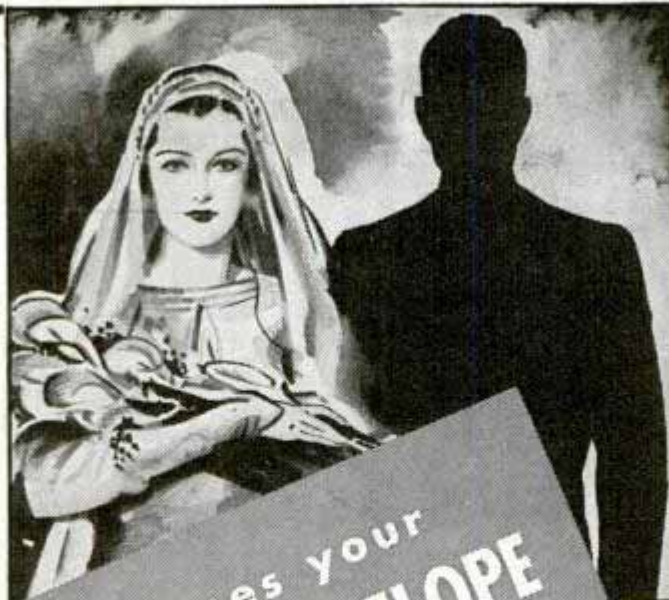

Does your
PAY ENVELOPE
keep you out
of this picture?

If it does, do something about it! Get a raise in salary—but first get the training that will entitle you to this raise. Thousands of men in the same fix as you have gotten this training by spare-time study of an I. C. S. Course. Mail the coupon today!

INTERNATIONAL CORRESPONDENCE SCHOOLS

BOX 5568-J, SCRANTON, PENNA.



Without cost or obligation, please send me a copy of your booklet, "Who Wins and Why," and full particulars about the course *before* which I have marked X:



TECHNICAL AND INDUSTRIAL COURSES

- | | | | | | |
|---|---|--|---|--|--|
| <input type="checkbox"/> Agriculture | <input type="checkbox"/> Air Brake | <input type="checkbox"/> Cotton Manufacturing | <input type="checkbox"/> Marine Engines | <input type="checkbox"/> R. R. Signalmen's | <input type="checkbox"/> Refrigeration |
| <input type="checkbox"/> Air Conditioning | <input type="checkbox"/> Architectural Drafting | <input type="checkbox"/> Diesel Engines | <input type="checkbox"/> Mechanical Drafting | <input type="checkbox"/> Sanitary Engineering | |
| <input type="checkbox"/> Architecture | <input type="checkbox"/> Auto Engine Tune-up | <input type="checkbox"/> Electrical Engineering | <input type="checkbox"/> Mechanical Engineering | <input type="checkbox"/> Sheet Metal Work | |
| <input type="checkbox"/> Auto Technician | <input type="checkbox"/> Aviation | <input type="checkbox"/> Electric Lighting | <input type="checkbox"/> Mine Foreman | <input type="checkbox"/> Steam Electric | |
| <input type="checkbox"/> Boilermaking | <input type="checkbox"/> Bridge Engineering | <input type="checkbox"/> Fire Boases | <input type="checkbox"/> Navigation | <input type="checkbox"/> Steam Engines | |
| <input type="checkbox"/> Building Estimating | <input type="checkbox"/> Building Estimating | <input type="checkbox"/> Fruit Growing | <input type="checkbox"/> Patternmaking | <input type="checkbox"/> Steam Fitting | |
| <input type="checkbox"/> Chemistry | <input type="checkbox"/> Civil Engineering | <input type="checkbox"/> Heat Treatment of Metals | <input type="checkbox"/> Pharmacy | <input type="checkbox"/> Structural Drafting | |
| <input type="checkbox"/> Coal Mining | <input type="checkbox"/> Concrete Engineering | <input type="checkbox"/> Highway Engineering | <input type="checkbox"/> Plumbing | <input type="checkbox"/> Structural Engineering | |
| <input type="checkbox"/> Contracting and Building | <input type="checkbox"/> Contracting and Building | <input type="checkbox"/> House Planning | <input type="checkbox"/> Poultry Farming | <input type="checkbox"/> Surveying and Mapping | |
| | | <input type="checkbox"/> Locomotive Engineer | <input type="checkbox"/> Practical Telephony | <input type="checkbox"/> Telegraph Engineering | |
| | | <input type="checkbox"/> Machinist | <input type="checkbox"/> Public Works Engineering | <input type="checkbox"/> Textile Designing | |
| | | <input type="checkbox"/> Management of Inventions | <input type="checkbox"/> Radio, General | <input type="checkbox"/> Toolmaking | |
| | | <input type="checkbox"/> Managing Men at Work | <input type="checkbox"/> Radio Operating | <input type="checkbox"/> Welding, Electric and Gas | |
| | | <input type="checkbox"/> Manufacture of Pulp Paper | <input type="checkbox"/> Radio Servicing | <input type="checkbox"/> Woolen Manufacturing | |
| | | | <input type="checkbox"/> R. R. Section Foreman | | |

BUSINESS COURSES

- | | | | | |
|--|--|--|---|---|
| <input type="checkbox"/> Accounting | <input type="checkbox"/> Advertising | <input type="checkbox"/> Civil Service | <input type="checkbox"/> First Year College | <input type="checkbox"/> Railway Postal Clerk |
| <input type="checkbox"/> Bookkeeping | <input type="checkbox"/> Business Correspondence | <input type="checkbox"/> College Preparatory | <input type="checkbox"/> Foremanship | <input type="checkbox"/> Salesmanship |
| <input type="checkbox"/> Business Management | <input type="checkbox"/> Business Correspondence | <input type="checkbox"/> Commercial | <input type="checkbox"/> French | <input type="checkbox"/> Secretarial |
| <input type="checkbox"/> Cartooning | <input type="checkbox"/> Cost Accounting | <input type="checkbox"/> C. P. Accounting | <input type="checkbox"/> Grade School | <input type="checkbox"/> Service Station Salesmanship |
| | | | <input type="checkbox"/> High School | <input type="checkbox"/> Sign Lettering |
| | | | <input type="checkbox"/> Illustrating | <input type="checkbox"/> Spanish |
| | | | <input type="checkbox"/> Lettering Show Cards | <input type="checkbox"/> Traffic Management |

DOMESTIC SCIENCE COURSES

- | | | |
|---|---|---|
| <input type="checkbox"/> Advanced Dressmaking | <input type="checkbox"/> Home Dressmaking | <input type="checkbox"/> Tea Room and Cafeteria |
| <input type="checkbox"/> Foods and Cookery | <input type="checkbox"/> Professional Dressmaking and Designing | <input type="checkbox"/> Management, Catering |

Name..... Age..... Address.....

City..... State..... Present Position.....

Canadian residents send coupon to International Correspondence Schools Canadian, Limited, Montreal, Canada
British residents send coupon to I. C. S., 71 Kingsway, London, W. C. 2, England

Say you saw it in Popular Mechanics!

DIDN'T DREAM HE COULD LEARN MUSIC WITHOUT A TEACHER



Surprised to Find He Could PLAY!

YES, just like thousands of others, who thought music was hard, this man got the surprise of his life when he tried this easy way to learn music at home. And no wonder! Instead of months of tedious study and practice, he found himself actually playing real tunes in the very first few weeks!

But read this unsolicited letter for yourself:

"I didn't even dream that I could actually learn to play without a teacher, because I had always heard that it couldn't be done. I couldn't afford a teacher so I didn't think it would do me any harm to take your course.

"When I received the lessons I took the instantaneous note finder and struck the notes right off. You can imagine my surprise when after three or four weeks I found that I could actually play real tunes.

"Now, when I play for people they will hardly believe that I learned to play so well with just a correspondence course in so short a time. I am getting to the point where even the hardest music holds no terrors for me."

(Signed) *H. C. S., Calif.

Read How Thousands Have Learned to Play Their Favorite Instruments! Free Proof that You Can, Too



Plays on Radio

I am happy to tell you that for four weeks I have been on the air over our local radio station. So thanks to your institution for such a wonderful course.

*W. H. S., Alabama.

Wouldn't Take \$1000 for Course

The lessons are so simple that anyone can understand them. I have learned to play by note in a little more than a month. I wouldn't take a thousand dollars for my course.

*S. E. A., Kansas City, Mo.



Easy to Understand

The manner in which the various lessons are explained is very helpful as well as interesting. It makes one feel that the explanation is being given in person.

*W. W., Florida.



Which instrument would you like to play? The piano, violin, guitar, saxophone, accordion? Never mind if you don't know one note from another. Don't worry about "talent." And forget all you have ever heard about tedious study and practice. Here's proof you can learn quickly in spare time at home—without a teacher, at amazingly little cost.

It's easy as A-B-C. It's FUN! You learn to play by *playing*. If interested, send at once for the Free Demonstration Lesson that shows HOW and the handsome illustrated booklet that gives complete information. Just mail the coupon. (Instruments supplied when needed, cash or credit.) U. S. SCHOOL of MUSIC, 73 Brunswick Bldg., New York, N. Y.

Forty-second Year (Est. 1898)

FREE PRINT & PICTURE SAMPLE

U. S. School of Music, 73 Brunswick Bldg., N. Y. C.

I am interested in music study, particularly in the instrument indicated below. Please send me your free booklet, "How to Learn Music at Home" and your Print and Picture Sample. (Do you have instrument

Piano	Mandolin	Trombone	Piano Accordion
Violin	Saxophone	Banjo	Plain Accordion
Guitar	Clarinet	Ukulele	Hawaiian Guitar
Cello	Trumpet	Cornet	Other Instrument

Name

Street

City..... State.....

Check here for Booklet "A" if under 16 years of age.

* Actual pupils' names on request. Pictures posed by Professional models.

FINED FOR IGNORANCE!

Don't Let It Happen to You!

The average grade school graduate earns \$16.30* a week less than high school graduates earn.

The average high school graduate earns \$25.25* a week less than do men with college or vocational training.

*Figures computed from Government report. For basis of computation, write American School.

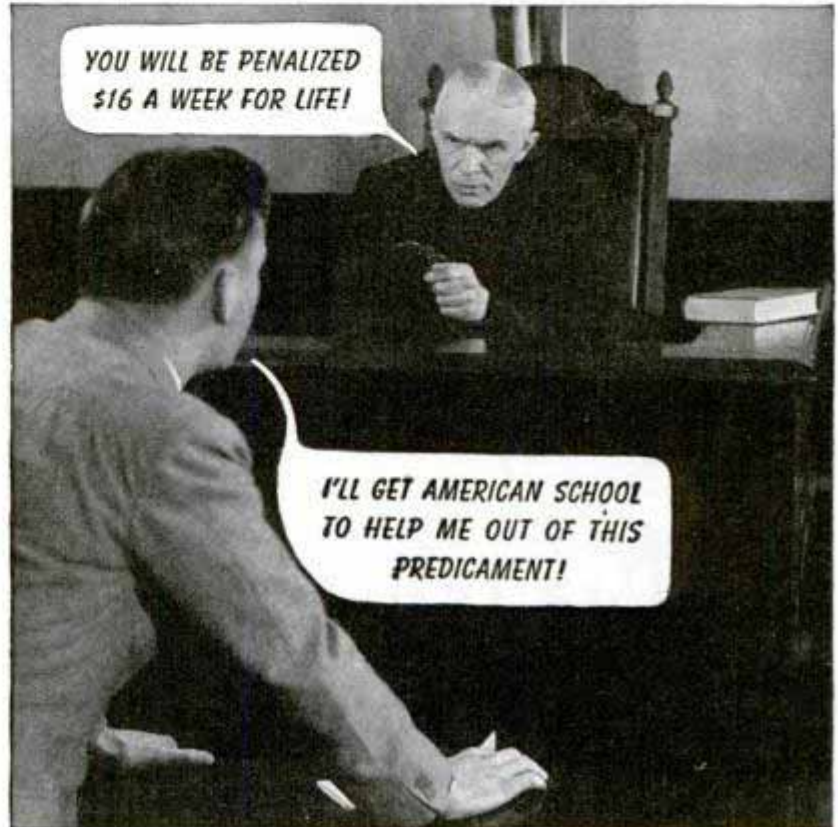

**College Grade
Training Pays
Up to
\$40 a week*
EXTRA
income
Study at HOME!**

You Too Can Win a Better Job!

HAVE YOU thought about *home study*? You look around you at your friends, neighbors and fellow employes: This one earns \$10 a week more than you—that one earns nearly double—a third, though appreciably younger than you, seems to be making better progress. Why? How can you catch up with them? You know that literally *thousands* of ambitious men and women have won substantial Success through using their spare time at home to master the principles and practice of their chosen lines. How can HOME STUDY help *you* make good?

Promotion Begins at HOME
Pay raises depend largely on what you do in SPARE time. Make it pay you dividends!

- American School, Dept. G-345, Drexel Ave. at 58th St., Chicago, Ill.
Gentlemen: I'll sit down and consider my Promotion Problems carefully if you will send me FREE information covering special training insubjects checked below. No obligation on my part.
- | | |
|--|---|
| <input type="checkbox"/> High School Course | <input type="checkbox"/> Diesel Engineering |
| <input type="checkbox"/> Accounting and Auditing | <input type="checkbox"/> Drafting and Design |
| <input type="checkbox"/> Architecture and Building | <input type="checkbox"/> Liberal Arts |
| <input type="checkbox"/> Automotive Engineering | <input type="checkbox"/> Private Secretary |
| <input type="checkbox"/> Business Management | <input type="checkbox"/> Mechanical Engineering |
| <input type="checkbox"/> Aviation | <input type="checkbox"/> Radio and Television |
| <input type="checkbox"/> Electrical Engineering | <input type="checkbox"/> Salesmanship |
| <input type="checkbox"/> Elec. and Gas Refrigeration | <input type="checkbox"/> Business Law |
| <input type="checkbox"/> Air Conditioning | <input type="checkbox"/> Retail Merchandising |

Name.....
Address.....

The "Magic" of Home Study

There's no magic to home study. It's hard work—but it is *worth* the effort because it helps you overcome the handicap of having left school too soon. It frees you from the penalties of Ignorance—enables you to compete to better advantage in this NEW world of *college trained* men and women.

In 1900, only ONE person in 800 was a *high school* graduate. Today, one in every 837 is *college* trained. That's why you need so much more "on the ball" today than ever before. That's why American School has *stepped up* all its complete courses to include so much work of *college level*. You NEED it, to win out today!

These Advantages Speed Your Progress

More than 150 noted educators, engineers and executives helped prepare American School courses. An *Advisory Board* of 20 outstanding authorities—each an active leader in his field—is consulted when our work is prepared or changed. A Staff of competent instructors—*home study specialists*—works closely with the individual student.

Courses are not prepared from the "academic" viewpoint—but from the *practical*. Although dozens of leading universities and colleges use the same texts, the primary aim of *home study* is to help graduates win BETTER jobs at BIGGER pay as QUICKLY as possible. Every course is geared to this end. Jobs and job requirements are analyzed, circumstances of the average student are weighed, then every course is *speed-lined* to put the *Man* in the *Job* he wants at the EARLIEST opportunity.

Write American School about *your* promotion problems TODAY!

American School
Drexel Avenue at 58th Street, Chicago, Illinois

Say you saw it in Popular Mechanics!

Now... You can enjoy a pleasant, profitable career—

Be an ARTIST



Trained Artists are capable of earning \$30, \$50, \$75 a week

Prepare for an Art career, at home in your spare time. WSA has been training men and women for successful Art careers since 1914. No previous Art training necessary.

COMMERCIAL ART CARTOONING and DESIGN

Learn at Home in Your Spare Time!

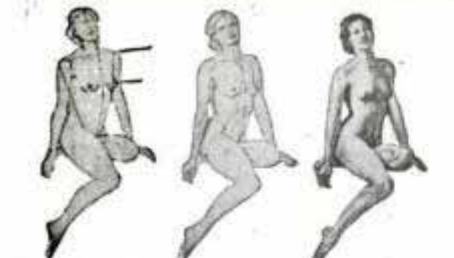

This is the way you learn to **BE AN ARTIST!**

Our proven method of home instruction includes all of the important branches of Commercial Art. Your drawings are corrected and criticized by experienced Art instructors. You start by drawing straight lines and in advancing from lesson to lesson you receive all the personal constructive help you need.

Mail coupon today for **FREE BOOK**

This colorful, illustrated book explains our course in detail and describes the **TWO COMPLETE ARTISTS' OUTFITS** included! They provide everything you need to get started.

PICTURE BRINGS \$25
—Mrs. G. A. Weninger of Cedar Vale, Kans., has sold several paintings. One small picture for \$25.

\$500 IN SPARE TIME
—E. Gandra of Sheboygan, Wis., averaged that amount in a year for spare time Art work.

THANKS WSA FOR JOB!
—J. Beard of Columbus, Ga., credits our course as sole reason for job as Art Director in a advertising agency.

FREE BOOK gives details!

WASHINGTON SCHOOL OF ART
Studio 123P, 1115—15th Street, N. W.
Washington, D. C.

Without obligation, please send me details in your Free Book, "Art for Pleasure and Profit."

Name Age

Address

City State

GET IN THE SWING with Slingerland . . . DRUMS GUITARS MANDOLINS



GENE KRUPA — World's Greatest Swing Drummer uses Slingerland

WONDERFUL VALUE EASY PAYMENTS

Compare the value—tone and power in Slingerland "Radio King" drums, banjos, guitars, mandolins, marimbas or bugles—before you buy. Guaranteed more for your money. Acclaimed the tops in smooth

tone, easy playing, rich power by world's leading musicians. Easy payments. 5-days free trial. See at your dealers.

Write for free special information on how to organize drum and bugle corps. Free Catalog—mention instrument wanted.

SLINGERLAND DRUM CO.
1330 Belden Avenue Chicago, Illinois



Follow This Man!

Secret Service Operator No. 38 is On The Job!

Follow him through all the excitement of his chase after the counterfeit gang. See how a crafty operator solves a murder with tell-tale finger prints! Thrills! Mystery!

FREE! The Confidential Reports No. 38 Made to His Chief Earn a Regular Monthly Salary

Write for reports and free "Blue Book of Crime." Learn how YOU can become a Finger Print Expert, at home, in spare time, at small cost. Our graduates run 47% of all

the Identification Bureaus in America! Send for list of over 600 bureaus employing our graduates. Write today! Literature sent only to persons stating their age.

INSTITUTE OF APPLIED SCIENCE
1920 Sunnyside Avenue Dept. 1353, Chicago, Ill.

AN AVIATION CAREER



OFFERS YOU GREAT FUTURE!

Demand for trained aircraftsmen is increasing and already exceeds supply. Curtiss-Wright Tech, Aviation's foremost school, is located on Grand Central Air Terminal in heart of the aircraft industry and specializes in training MASTER MECHANICS and AERONAUTICAL ENGINEERS. (No flying involved.) Graduates are obtaining immediate employment. Write for details NOW. Dept. PM-3.

CURTISS - WRIGHT TECHNICAL INSTITUTE
Glendale (Los Angeles) California



RESOLE SHOES FOR ONLY

SO-LO mends holes, worn spots in rubber, leather, cloth. Spreads like butter. Dries tough overnight. Flexible, non-skid, waterproof. Won't come off — guaranteed! 25c (25 repairs). At all 10c and hardware stores.

4¢ EACH

"Woolworth, Kresge, Newberry, Murphy, McCrory, Neisner, McLellan, Sears and Ward, now featuring SO-LO".



YES- I'M CONVINCED THAT I CAN MAKE GOOD MONEY IN RADIO. I'M GOING TO START TRAINING FOR RADIO RIGHT NOW.

NO- NOT ME. I'M NOT GOING TO WASTE MY TIME. SUCCESS IS JUST A MATTER OF LUCK AND I WASN'T BORN LUCKY.

BILL SAID "YES"
HE'S MAKING GOOD MONEY IN RADIO NOW



THIS N.R.I. TRAINING IS GREAT. AND THEY SENT REAL RADIO PARTS TO HELP ME LEARN QUICKLY



YOU CERTAINLY KNOW RADIO. MINE NEVER SOUNDED BETTER.

I'VE BEEN STUDYING RADIO ONLY A FEW MONTHS AND I'M ALREADY MAKING GOOD MONEY IN MY SPARE TIME

THANKS



OH BILL! I'M SO PROUD OF YOU. YOU'VE GONE AHEAD SO FAST IN RADIO

YES! I'VE GOT A GOOD JOB NOW AND A REAL FUTURE. THANKS TO N.R.I. TRAINING

TOM SAID "NO"
HE'S STILL WAITING FOR "LUCK"



BILL'S A SAP TO WASTE HIS TIME STUDYING RADIO AT HOME



SAME OLD GRIND -- SAME SKINNY PAY ENVELOPE -- I'M JUST WHERE I WAS FIVE YEARS AGO



GUESS I'M A FAILURE - LOOKS LIKE I'LL NEVER GET ANYWHERE

YOU'LL ALWAYS BE A FAILURE, TOM, UNLESS YOU DO SOMETHING ABOUT IT. WISHING AND WAITING WON'T GET YOU ANYWHERE



I will Train You at Home in Spare Time for a GOOD JOB IN RADIO

J. E. SMITH, President, National Radio Institute, Established 25 years.

have helped many make \$200 to \$500 a year in spare time while learning. I send special Radio equipment to conduct experiments and build circuits. This 50-50 training method makes learning at home interesting, fascinating, practical. I ALSO GIVE YOU A MODERN, PROFESSIONAL, ALL-WAVE, ALL-PURPOSE SET SERVICING INSTRUMENT to help you make more money fixing Radios while learning and equip you for full time work after you graduate.

they are doing and earning. Read my money back agreement. MAIL COUPON in an envelope, or paste on a penny postcard—NOW!

J. E. SMITH, President
Dept. OCP,
National Radio Institute
Washington, D. C.

Why Many Radio Technicians Make \$30, \$40, \$50 a Week

Radio broadcasting stations employ engineers, operators, technicians. Radio manufacturers employ testers, inspectors, foremen, servicemen in good-pay jobs. Radio jobbers, dealers, employ installation and service men. Many Radio Technicians open their own Radio sales and repair businesses and make \$30, \$40, \$50 a week. Others hold their regular jobs and make \$5 to \$10 a week fixing Radios in spare time. Automobile, police, aviation, Commercial Radio; loudspeaker systems, electronic devices, offer good opportunities. My Training includes Television, which promises to open good jobs soon.

Many Make \$5 to \$10 a Week Extra in Spare Time While Learning

The day you enroll, I start sending you Extra Money Job Sheets which start showing you how to do Radio repair jobs. Throughout your Course I send plans and directions which

Find Out What Radio Offers You

Act Today! Mail the coupon for my 64-page Book, "Rich Rewards in Radio." It points out Radio's spare time and full time opportunities and those coming in Television; tells about my Course in Radio and Television; shows many letters from men I have trained, telling what

IT'S NOT TOO LATE. TAKE MY TIP AND MAIL THAT COUPON TO N.R.I. TONIGHT



J. E. SMITH, President
Dept. OCP, National Radio Institute
Washington, D. C.

Dear Mr. Smith:
Send me FREE, without obligation, your 64-page book "Rich Rewards in Radio" which points out Radio's opportunities and tells how you train men at home to be Radio Technicians. (Write Plainly.)

Name.....Age.....
Address.....
City.....



How to Make YOUR Body Bring You FAME

Instead of SHAME!

Will You Let Me Prove I Can Make You a New Man?

I KNOW what it means to have a body that people pity! I was once a skinny, 97-lb. weakling—such a poor specimen that I was constantly self-conscious, embarrassed. But later I discovered the secret that turned me into "The World's Most Perfectly Developed Man." I'd like to prove that the same system can make a NEW MAN of YOU!

7 DAY TRIAL OFFER

I don't say I can do all this for you in 7 days. But I DO want to prove I can show you enough results in even THAT short time to convince you that my system of "Dynamic Tension" will give you the kind of body you have always longed to have!

Do you want powerful shoulders—a fine, deep chest—biceps like iron—arms and legs rippling with strength—a stomach ridged with sinewy muscle—a build to be proud of? Then let me prove that "Dynamic Tension" is what you need.

FREE BOOK It costs only a stamp—or a postcard—to mail coupon below. I'll send my new, free book, "Everlasting Health and Strength." It tells about my Dynamic Tension method; shows, from actual photos, how I have developed my pupils—explains about my 7 DAY TRIAL OFFER



Charles Atlas, Dept. 83, 115 East 23rd St. New York, N. Y.

CHARLES ATLAS, Dept. 83, 115 East 23rd Street, New York, N. Y.

I want the proof that DYNAMIC TENSION will help make a new man of me—give me a healthy, husky body and big muscle development. Send me your free book, "Everlasting Health and Strength"—and full details of your 7-DAY Trial Offer.

Name..... (Please print or write plainly)

Address.....

City..... State.....



Charles Atlas

This actual snapshot taken at the bench, shows how I look today.

Mail Coupon Now for FREE Book



FREE BOOK TELLS HOW YOU CAN LEARN TO

MOUNT BIRDS and ANIMALS

BE A TAXIDERMIST—Learn by Mail

Easy home lessons teach you quickly how to MOUNT BIRDS, ANIMALS, GAME-HEADS, FISH—to TAN LEATHER, FURS. Save your hunting trophies. Have a home museum. It's thrilling! Taxidermy is wonderful. FUN. A PLEASURE HOBBY AND A MONEY MAKER—Investigate! Get this strange FREE BOOK **EXTRA MONEY:**—Earn in your spare time. Sell your mounts; and do work for other sportsmen. Students report \$30 to \$75 and more per month. Big demand. Fine prices. If you want REAL PROFIT from spare time WRITE TODAY.

Game is growing scarcer—every specimen valuable!

FREE BOOK—with 100 photos of wild game. Tells about Taxidermy and how YOU can learn, easily, quickly. Old reliable school. 275,000 students. — STOP this minute and TEAR OUT THIS AD NOW as a reminder; then write; get the free book. You will be delighted. AMAZED. RUSH postal or letter and learn how to have more FUN, FASCINATION, PROFIT. State your AGE.

Northwestern School of Taxidermy, Dept. 3373 Omaha, Neb.

SECURITY FOR LIFE

Be an expert in an essential business. Learn Meat Cutting. Steady jobs and good pay everywhere. Quick, short course—ACTUAL PRACTICE. Learn with tools and meat—not books. Individual training. Be a fully qualified union Meat Cutter when finished. Union Card FREE. Job help after graduation. Write for catalog and complete details.

NATIONAL SCHOOL OF MEAT CUTTING, INC. DEPT. U-4 TOLEDO, OHIO

ENGINEERING DEGREE IN TWO YEARS

B. S. Degree courses in engineering: Electrical, Civil, Chem., Mechanical, Radio or Aeronautical, 1 yr. Mech. Drafting. Approved by Civil Aeronautics Authority, participation in Pilot Training Program. Large industrial center. Prep courses without extra charge. Earn board if desired. Low tuition. Enter March, June, September, December. Write for Catalog.

530 E. Washington Blvd., Fort Wayne, Ind.

INDIANA TECHNICAL COLLEGE

LEARN AVIATION IN LOS ANGELES • Nation's Aviation Capital

Huge increase in Los Angeles aviation activity has assured splendid positions for graduates. Career training offered for airline piloting, engineering, mechanics, drafting, production mechanics and instruments. Train at one of America's most modern and strategically located schools; fully approved by the government as a ground, flight and mechanics school. Write for free new 64 page catalog.

CALIFORNIA FLYERS SCHOOL OF AERONAUTICS—Dept. PM-3 LOS ANGELES MUNICIPAL AIRPORT, INGLEWOOD, CALIF.

Succeed in Landscaping Send for FREE Book on Landscape Training

Full details about this profitable career for men or women. Study at home in leisure time. Successful graduates receive large fees. Some students earn \$5, \$10, \$15 while learning. Pleasant work; initiative rewarded. Write today, giving age and occupation.

AMERICAN LANDSCAPE SCHOOL 6166 Grand Ave. Des Moines, Ia.



Learn to Write

Begin Today. Write for our Free Book, "How to Become a Good Penman." It contains specimens and tells how others learned to write in spare time. Your name elegantly written on a card if you enclose stamp for postage. Write today. The Tamblin School of Penmanship, 441, Ridge Bldg., Kansas City, Mo.



H.C. Lewis

QUICK EASY WAY ELECTRICITY IN 12 WEEKS by Actual SHOP WORK **NOT BOOKS**

To
TRAIN
FOR

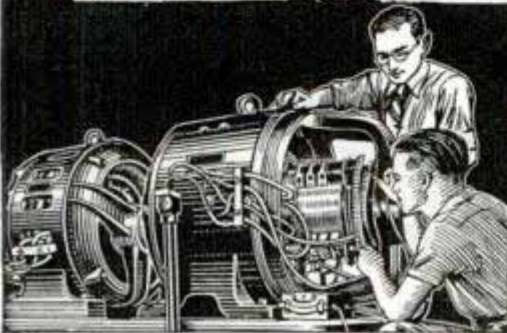

FIRST--You are told and shown how to do it.

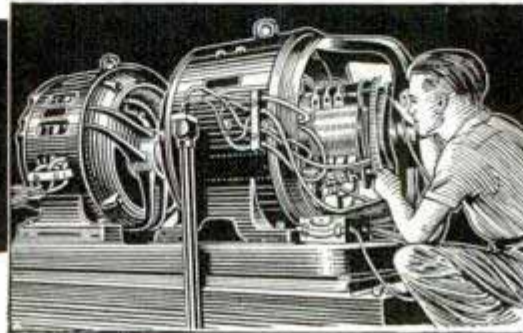

THEN--You do the job yourself.



HOUSE WIRING
only one of the many
branches you
"Learn by Doing."

WANT TO EARN MORE MONEY?

Have you ever dreamed of holding down a steady, good pay job? Have you ever dreamed of doing the work you really like in a job that holds promise of a real future in the years ahead?

Well, we all know that you can't get the good things in life by just dreaming about them. Hundreds of fellows are today holding down mighty fine jobs with prospects of a bright future. They are filling these jobs because they had the foresight to equip themselves with the right kind of training.

Most of these men were only average fellows a short time ago, but the proper training helped to lift them out of the low pay ranks of unskilled workers. The same opportunity is now offered to you.

The great fascinating field of ELECTRICITY offers a real future to many men and young men who are willing to prepare for a place in this giant industry.

AN EXTRA
4 WEEKS
COURSE IN
RADIO
INCLUDED

Here at my school in Chicago, the world's Electrical Center, you can get 12 weeks' Shop Training in ELECTRICITY and an extra 4 weeks Course in Radio, that can help give you your start towards a better job.

You will be trained on actual equipment and machinery and because of our method of training, you don't need previous experience or a lot of education. Many of my successful graduates never even completed Grammar School. Here in my school you work on generators, motors, dynamos, you do house wiring, wind armatures and do actual work in many other branches of electricity and right now I'm including valuable instruction in Diesel, Electric Refrigeration and Air Conditioning at no extra cost. Our practical shop methods make it easier to learn—First the instructors tell you how a thing should be done—then they show you how it should be done—then you do the actual work yourself.



"... Everything was just as stated in literature. And plenty of instructors to take care of everything, easy to learn. I really was satisfied with Coyne Training."
J. Halyk, Canada



"... Coyne has first class instructors to teach you the simplest things to start with and they have the equipment to show you these things as you advance."
Ben Rickman, S. Car.

I'LL FINANCE MOST OF YOUR TRAINING

You can get this training first—then if you are short of money you can pay for most of it later in easy monthly payments, starting 60 days after your 12 weeks' training period is over—then you have 10 months to complete your payments. If you need part time work to help out with expenses while training in my shops, my employment department will help you get it. Then after graduation this department will give you valuable lifetime employment service.

Send the coupon today for all details. When I get it I'll send you my big free book containing dozens of pictures of students at work in

H. C. LEWIS, President
COYNE ELECTRICAL SCHOOL
500 S. Paulina St., Dept. 30-72, Chicago

my shops. I'll also tell you about my "Pay After Graduation" plan, how many earn while learning and how we help our students after graduation. Fill in, clip coupon, mail today for your start toward a brighter future.

MAIL NOW



H. C. LEWIS, Pres., COYNE ELECTRICAL SCHOOL
500 S. Paulina St., Dept. 30-72, Chicago, Ill.

Dear Sir: Please send me free your big catalog and full particulars of your present offer, also your "Pay-Tuition-After-Graduation" Plan, and also your Extra 4 Weeks Radio Course.

Name.....
Address.....
City..... State.....

MECHANICAL ENGINEERING		GERALD G. RICHTER	
Subject	Text Sent	Completed	Grade Earned
Practical Mathematics 1	12-27	1-19-28	93
Mechanical Drawing 1-1	12-27	1-11-28	95
Pattern Making 1-3	7-28	6-13-28	97
Foundry 1-2	10-28	6-21-28	98
Forging 1-2	13-28	7-3-28	96
Practice in Tracing 1	28	2-20-28	86
Machine Drawing 1-6		31-28	94
Machine Shop Work		4-28	95
Tool Making 1		17-28	95
First Year Algebra		3-9-29	88
Tool Design 1		3-5-28	93
Welding 1-3		7-13-28	97
Plane Geometry 1	11-15-28		95
Mechanics 1	10-30-28		95
Metallurgy 1	10-30-28		100
Trigonometry 1		2-21-29	90
Machine Design 1-2		10-9-29	79
Gas and Oil Engines 1-3	2-8-28	4-22-29	96
Steam Engines 1-2	7-2-28	1-8-28	95
Elevators 1	8-26-28	4-5-29	97
Auto Brake 1	3-18-28	8-26-29	100
Flotation 1	10-1-28	10-25-28	75
Refrigeration 1-3	10-18-28		
Valve Gear 1			

Graduated

Promotion Begins at Home

Alice in Wonderland learned: "You must run as fast as you can in order to stay where you are. To get anywhere, you must run TWICE that fast."

Jobs are like that. On your employer's time, you must work as hard as you can—as well as you can—in order to be sure of holding what you already have. To get anywhere—to win promotion—a better job—bigger pay—more consideration from your employer—you must make EXTRA effort on your own time, at your own expense, on your own responsibility.

In 1900, only ONE person in 800 was a high school graduate. Today, one in every 837 is college trained. That's why you need so much more "on the ball" today than ever before. That's why American School has stepped up all its complete courses to include so much work of college level. You NEED it, to win out today!

American School, Chicago, is favorably known to employers everywhere for its high standards in home study. Hundreds of our graduates have won Promotion—big pay positions—in Commerce, Engineering and Professions. All vocational courses recently enlarged to help YOU win true Success in your chosen line. More than 150 educators, engineers and executives cooperated. Investigate your chances TODAY. Mail Coupon!

Promotion Begins at HOME

Pay raises depend largely on what you do in SPARE time. Make it pay you dividends

American School, Dept. K345, Drexel Ave. at 58th St., Chicago, Ill.

Gentlemen: I'll sit down and consider my Promotion Problems carefully if you will send me FREE information covering special training in subjects checked below. No obligation on my part.

- | | |
|--|---|
| <input type="checkbox"/> High School Course | <input type="checkbox"/> Diesel Engineering |
| <input type="checkbox"/> Accounting and Auditing | <input type="checkbox"/> Drafting and Design |
| <input type="checkbox"/> Architecture and Building | <input type="checkbox"/> Liberal Arts |
| <input type="checkbox"/> Automotive Engineering | <input type="checkbox"/> Private Secretary |
| <input type="checkbox"/> Business Management | <input type="checkbox"/> Mechanical Engineering |
| <input type="checkbox"/> Aviation | <input type="checkbox"/> Radio and Television |
| <input type="checkbox"/> Electrical Engineering | <input type="checkbox"/> Salesmanship |
| <input type="checkbox"/> Elec. and Gas Refrigeration | <input type="checkbox"/> Business Law |
| <input type="checkbox"/> Air Conditioning | <input type="checkbox"/> Retail Merchandising |

Name _____
Address _____

When writing please mention Popular Mechanics

PARKS AIR COLLEGE

PARKS AIRPORT EAST ST. LOUIS, ILL.

Offers YOU COLLEGE and PROFESSIONAL TRAINING
Majoring in AVIATION

Accredited by the Illinois Superintendent of Public Instruction, U.S. approved as a Commercial Ground and Flying School and Mechanics' School. Accredited by and cooperating with the United States Army Air Corps in giving flight and mechanical training. Open to high school graduates.

FOUR courses lead to B.S. degrees in Professional Piloting, Aviation Operations, Maintenance Engineering, Aeronautical Engineering. SEVENTEEN TRAINING PLANES are used in professional flight training which prepares graduates for airline flight operations. 74% of graduates enter air transportation in North and South America. 76,000 hours flight training given, 1800 hours being flown monthly.

FACULTY of 48 specialists in various fields of aviation. 1569 graduates. Enrollment limited to a total of 300 commercial aviation students. Total enrollment 415.

100-acre airport, 18 buildings devoted to school purposes exclusively. Dormitories and dining hall at the College.

Spring Term April 1. Send postcard for new 64-page catalog.

13th YEAR Registrar, Dept. PM-3
PARKS AIR COLLEGE, East St. Louis, Ill.



VOICE

100% Improvement Guaranteed

We build, strengthen the vocal organs—not with singing lessons—but by fundamentally sound and scientifically correct silent exercises . . . and absolutely guarantee to improve any singing or speaking voice of least 100% . . . Write for wonderful voice book—sent free. Learn WHY you can now have the voice you want. No literature sent to anyone under 17 years unless signed by parent.

PERFECT VOICE INSTITUTE, Studio 1353
64 E. Lake St., Chicago

Regain Perfect Speech, If You

STAMMER

Every stammerer should have the new 287 page book "Stammering, Its Cause and Correction." Sent free to stammerers. It describes the Bogue Unit Method for the scientific correction of stammering and stuttering. Method successfully used at Bogue Institute for 39 years—since 1901. Endorsed by physicians. Write for full information. No obligation. Benjamin N. Bogue, Dept. 1312 Circle Tower, Indianapolis, Indiana.



TRI-STATE COLLEGE

B. S. Degree in 2 Years

World famous for technical 2-year courses in Civil, Electrical, Mechanical, Chemical, Radio, Aeronautical Engineering, Business Administration and Accounting. Special preparatory department for those who lack required high school work. Short diploma courses (36 weeks) in Surveying, Drafting. Low tuition. Low living costs. Students from every state and many foreign countries. 57th year. Graduates successful. Enter March, June, September, January. Write for catalog. 430 College Ave., ANGOLA, IND.

World famous for technical 2-year courses in Civil, Electrical, Mechanical, Chemical, Radio, Aeronautical Engineering, Business Administration and Accounting. Special preparatory department for those who lack required high school work. Short diploma courses (36 weeks) in Surveying, Drafting. Low tuition. Low living costs. Students from every state and many foreign countries. 57th year. Graduates successful. Enter March, June, September, January. Write for catalog. 430 College Ave., ANGOLA, IND.

PHOTO-ENGRAVING TASOPE SINCE 1931

FREE—a copy of the Tasope' Magazine, monthly treasure chest of photographic and photo-engraving information. Learn why Aurora, Mo., is the photo-engraving, photographic center of America . . . how hundreds of amateurs, free-lance photographers are making money with pictures. No-obligation postcard brings your copy.

TASOPE', DEPT. PM14, AURORA, MO.

Make Big Money

Start making money at once in a simple, pleasant, all year 'round business, distributing home necessities. Over 200 fast selling, quick repeating, nationally known products guaranteed to satisfy. Earnings start every first day with my sure-fire Plan and big, valuable Outfit, including a large assortment full size packages. Full or part time. Liberal credit plan. Old-established company. Write quick for my offer. E. J. Mills, 1623 Monmouth Ave., Cincinnati, Ohio.



They Needed
TRAINED
*Diesel Men**

*and H.D.S. Graduates
went on the jobs!*

* Letters from employers and H. D. S. graduates on file at Hemphill Diesel Schools headquarters

The Nevada gold mine, the lumber camp in the far north, the big Texas refinery, the west coast Diesel manufacturing plant, the great motorship bound for the Orient... ALL needed trained Diesel men... and Hemphill graduates went on those jobs—just as other H. D. S. men—before and since—have gone to other Diesel jobs in this country and abroad.

WOULD YOU LIKE TO KNOW MORE ABOUT DIESELS and DIESEL TRAINING?

On the map above you see pictured only a few of the ways and places Diesel engines are used today. If you would like to know more about Diesels . . . and see interesting pictures of new and unusual applications of Diesel power, send the coupon for your free copy of "March of Diesel".

You will also see how progressive, far-sighted young men are trained in Diesel—by work-

ing on and actually operating Diesel engines, from small stationary power plants to huge motorship Diesels.

You can start this Diesel training at home, no matter where you live or what you are now doing . . . and take your shop training later. Or you can enroll in the day or night resident school courses. Investigate—send coupon for free literature. No obligation.

HEMPHILL DIESEL SCHOOLS

Diesel and Diesel-Electric—Full-Time Resident Courses . . . Or You Can Start Your Training at Home

HEMPHILL DIESEL SCHOOLS

Please send my free copy of "March of Diesel" booklet and information on Hemphill Diesel training.

NAME..... AGE.....

STREET

CITY..... STATE..... m-44-p

Send coupon to the nearest
Hemphill Diesel School—

New York . . 31-26 Queens Blvd., L. I. City
Chicago 2014 Larrabee Street
Memphis 417 Monroe Avenue
Los Angeles 2120 San Fernando Rd.
Vancouver, B.C. 1363 Granville St.

SEND COUPON TODAY!

DO YOU WANT \$36.50 A WEEK?



START \$1260 to \$2100 YEAR MANY 1940 APPOINTMENTS EXPECTED

Railway Postal Clerks get \$1,900 the first year regular, being paid on the first and fifteenth of each month. (\$79.17 each pay day.) Their pay is automatically increased yearly to \$2,450. Advance may be had to Chief Clerk at \$2,700 a year. (\$112.50 each pay day.)



3 Days On—3 Days Off—Full Pay

Railway Postal Clerks on long runs usually work 3 days and have 3 days off duty in the same proportion. During this off duty their pay continues just as though they were working. They travel on a pass when on business. When they grow old, they are retired with a pension.

City Mail Carriers, Post Office Clerks

Clerks and Carriers now get \$1,700 the first year on regular and automatically increase \$100 a year to \$2,100 and \$2,300.

File Clerk—Clerk

Open to Men—Women 18 to 50. Entrance salary \$1,260—\$1,440 a year. Appointments as File Clerks and Clerks in the Departments at Washington, D. C., are made from this examination.

Many Other Positions

Many other positions are obtainable. Those wishing these positions should qualify at once.

Get Free List of Positions

Fill out the following coupon. Tear it off and mail it today—now, at once. This investment may result in your getting a big-paid government job.

FRANKLIN INSTITUTE, Dept. A173, Rochester, N. Y.

Rush to me, entirely free of charge (1) a full description of U. S. Government Jobs; (2) Free copy of illustrated 32-page book, "U. S. Government Positions and How to Get Them"; (3) List of U. S. Government Jobs; (4) Tell me how to qualify for a job.

Name

Address

Use This Coupon Before You Mislaid It. Write or Print Plainly

1 Year Gov't Approved Course

PREPARE FOR A SUCCESSFUL CAREER IN AVIATION

Luscombe trained men are employed with leading Aviation Enterprises throughout the U. S. Practical training under experienced instructors, limited enrollment, strict supervision and modern methods have assured successful careers for Luscombe graduates.

Details will be gladly sent upon request.

LUSCOMBE

SCHOOL OF AERONAUTICS
WEST TRENTON, N. J., Dept. M.

LUSCOMBE • LUSCOMBE • LUSCOMBE

MAIL ORDER BUSINESS

Your Big Opportunity!

Learn how to make money from home or office, spare or full time. Up-to-date copyrighted home study course. Widely endorsed. Teaches professional mail order technique; not penny-catching schemes. Sound instructions by successful money-making experts. Write for **FREE** details today. No obligation.

NELSON CO., C-400 Manhattan Bldg., Chicago

AUTO-MECHANICS & WELDERS

Auto Mechanics and Welders are in big demand. Complete courses in arc and acetylene welding, body and fender bumping, spray painting and metal finishing. Pay after graduation plan. Special low rates. Write today.

MICHIGAN TRADE SCHOOL
3758 Woodward Ave., Detroit, Mich.

Write for FREE CIRCULAR

Want a Career in Photography?

Ever consider photography as a money-making career? Fascinating field. Fine opportunities. We offer you a thorough, individual training. Commercial, News, Portrait, Advertising, Motion Picture; or Color photography. Learn for pleasure or career. Personal Attendance and Home Study courses. Free booklet.

NEW YORK INSTITUTE OF PHOTOGRAPHY
18 West 33 Street (Dept. 49) New York City

Correspondence Courses in RADIO and ELECTRICAL ENGINEERING

LOW AS \$25

ELECTRICAL ENGINEERING. Get good grasp of wide electrical field. Modern. Very understandable. Theory made easy.

RADIO ENGINEERING. Extra fine course in radio, public address, photo-electric work. Trains you to be super-service man, real vacuum tube technician. Tuition ONLY \$25, either course. Deferred payment plan. Experiment kits furnished.

Write for free copies of school catalogs, student magazines, etc.

FREE LINCOLN ENGINEERING SCHOOL, Box 931-P15, Lincoln, Nebr.

Low-Cost LACO Sure Heats!

America's Lowest Priced Oil Burners! For room or furnace! Deliver tremendous heat at Very Low Cost! Thousands of delighted users! Now Improved! Clean. Quiet. Automatic. No attention required.

See your dealer or **WRITE** for Free Folder, full details, low prices on Laco Oil Heaters, Gun-Type Burners!

LACO OIL BURNER CO., 130 Union Ave., Griswold, Iowa

LEARN WATCH REPAIRING

AT HOME You can learn by our modern and original system of instruction every part of the Watch Repairing Trade at home. You can earn money while learning and prepare yourself for a well paying position or start in business after completing our course of instruction. Good watch repairers are in demand and generally earn very good salaries. For particulars apply to the **Wisconsin School of Watch Repairing**

524 E. Mason St., MILWAUKEE, WIS.

FREE



DRAWING TEST!

IF YOU LIKE TO DRAW, test your sense of design, color, proportion, etc., with our simple Art Ability Test. An opportunity to get a frank opinion, *free*, as to whether your talent is worth developing. Magazines, newspapers, publishers and advertisers spend millions yearly for illustrations. Design and color influence the sale of most things we buy. Artists have become important to industry. Machines can not displace them. If you have talent, train it. Drawing may be your surest road to success.

THE FEDERAL SCHOOLS, affiliated with a large art, engraving and printing institution, has trained many young men and women now serving industry as designers or illustrators, capable of earning from \$1,000 to \$5,000 yearly. Its Home Study courses in Commercial Art, Illustrating and Cartooning, contain exclusive illustrated lessons by many famous artists. Practical instruction by experienced men is the reason for its many years' outstanding success. Courses sold on easy payments.

SEND TODAY for Art Test and Free Book explaining present opportunity in art.

JUST FILL OUT
AND MAIL COUPON

FEDERAL SCHOOLS, INC.
3130 Federal Schools Building
Minneapolis, Minnesota

Send me, without obligation, your Art Test and Free Book.

Name

Address

Occupation

Age

Say you saw it in Popular Mechanics!

How to PROTECT YOUR

Secure Your Exclusive Right to Sell, Market

WITH A U.S.



RECORD YOUR INVENTION

A model is usually unnecessary. Your first step is to make a sketch and description of your invention and have it dated and witnessed by a friend. If you mail the coupon we will send you FREE a "Record of Invention" form on which to make your sketch and description in legal form.



PATENT YOUR INVENTION

Mail a Coupon for our Free Book, "Patent Guide for the Inventor"—48 fascinating pages of facts you should know about patents and inventions—what to do, when to do it, pitfalls to avoid, steps to take. We stand ready to give you prompt, efficient service in preparing, filing and prosecuting your patent application.

The U. S. Patent Laws are enacted for your benefit—to give you the exclusive right to make, use and sell your invention. But to secure these benefits, it is important to **APPLY FOR YOUR PATENT PROMPTLY**—because this is a large country and millions of persons have the same opportunity as you to develop an invention similar to yours. Where rival inventors are involved, the law tends to favor the one **WHO FILES HIS PATENT APPLICATION FIRST.**

How We Serve You Before The Patent Office

One purpose of the Patent Law is to protect those features of your invention which are patentable. And these features must be legally and concisely set forth in the form of "Claims"—a phase of procedure so complex that the Patent Office advises the inventor to engage a competent Registered Patent Attorney because "without skillful preparation of the specification and claims, a patent grant is of doubtful value." We have a large and competent staff—carefully trained registered patent attorneys—expert draftsmen—experienced searchers—to serve you every step of the way. Our Free Book explains our services. Mail coupon.

The First Steps You Should Take

Make no mistake—obtain the services of a Registered Patent Attorney and establish the date of your invention. Our Book tells you *how* to do this, and our Free

Record of Invention Form *helps* you to do it quickly. The next step is to have a search made of the Patent Office records to determine whether or not your invention is probably patentable. We, as your patent attorneys, do this for you—**BEFORE FILING YOUR APPLICATION.** This time and money-saving step is fully explained in our Book. Mail the coupon for your Free copy.

Simple Inventions, Improvements, Often Big Commercial Successes

Inventions need not be complicated to be successful. Many outstanding successes have been made by simple devices. The zipper, thumb-tack, collar-button, safety-pin, paper clip, etc.—and methods of making them—have proved profitable to their inventors. The overall buckle is said to have made a fortune for its inventor. Remember, too, that patents are granted on improvements over already-existing inventions. You can secure a Patent for such an improvement, even though you do not hold the patent on the original invention. Sometimes improvements—as was the case, for example, with the zipper—are more valuable than the original invention. Business is constantly striving

CLARENCE A. O'BRIEN

Send for 48 page Patent Guide and "Record of Invention" form, Address:

INVENTION *and Profit from it...* PATENT



3 SELL YOUR PATENT

Once your rights are defined by your United States Patent, secured through this office, we can give you sound advice and guidance. We analyze patent claims, prepare instruments of assignments, royalty agreements, etc., or review them if prepared by others to see if the terms and stipulations are correct. Details in our Free Book. Mail Coupon.

Free

Mail the Coupon today, for 48-page "Patent Guide" which tells you what you should know about making application for your Patent—also "Record of Invention" form which will enable you to visibly record proof of your invention and have it witnessed in legal form.

to improve its products, and the invention of improvements, if commercially practicable, offers a profitable field for inventors. Our Book contains many examples of patents on improvements. Mail coupon for your copy.

MAIL this Coupon Now

SEND NOW FOR FACTS

The word "NOW" is important in patent matters, for prompt action is frequently the key to success. So, *NOW* is the time for you to get and read our FREE BOOK—to get and use our Record of Invention form. The book—cramped with vital facts and fascinating illustrations—shows you every step to take. The Record of Invention form—especially prepared for the inventor—makes it EASY for you to take the first step, without cost or obligation, toward patenting your invention. Mail the coupon now—on a penny postcard, or in an envelope.

Mail Coupon Now for FREE Book

**CLARENCE A. O'BRIEN, Registered Patent Attorney
Dept. OC1, Adams Building, Washington, D. C.**

Please send me your 48-Page Patent Guide and your Specially Prepared "Record of Invention" form FREE. This request does not obligate me.

Name

Address.....

City.....State.....

(Please write or print plainly.)

**REGISTERED PATENT ATTORNEY
WASHINGTON, D.C.**

Dept. OC1, Adams Building

POPULAR



INVENTIONS

USE of several lines by a single fisherman at the same time would be made possible by a device patented recently. It consists of a holder, which may be attached to boat or dock edge, a resilient rod attached to the holder and a trip device for

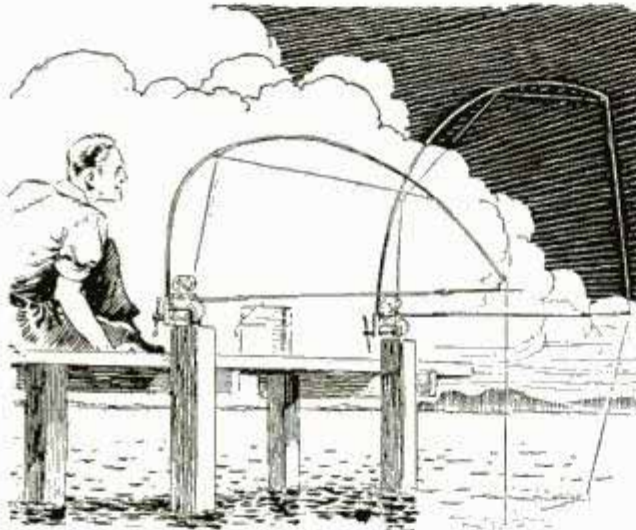

engaging the outer end of the rod and holding it in bowed position for fishing. A reel holds the line, which runs through guides to the end of the rod. When a fish bites, the tip of the rod may be disengaged.

WHEN filling-station attendants are too busy to give quick service many a

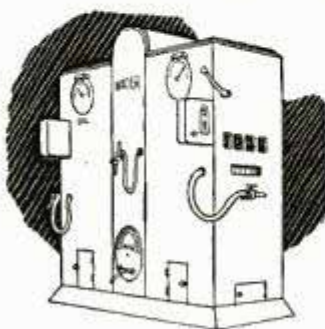

motorist has wished that he might get out and do the work himself. Now comes an inventor with an automatic gasoline station. It includes a container for a measured supply of oil and gasoline, a piston extending into the container for reducing its capacity and an adjustable sign giving the price of oil and gasoline. The sign and

the piston are connected so that when a certain price is indicated on the sign, the piston delivers the proper amount of oil or gasoline desired. Fitting the machine with coin slots would complete the picture. The automatic station also has free water and air hoses.

PROTECTION of the lower part of the radiator grille is the objective of a new

patent for an auxiliary bumper designed for attachment to the main bumper of the automobile. The attachment consists of an invertedly arranged U-shaped bar having

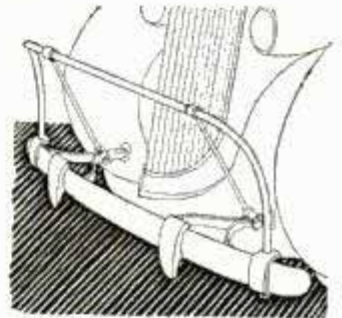

its ends positioned crosswise of the main bumper. There are clamping means for securing the ends to the main bumper bar, and brace rods to help support the auxiliary bar above the main bumper and in front of the radiator grille.

RECONDITIONING the lawn would be made easier by a newly patented

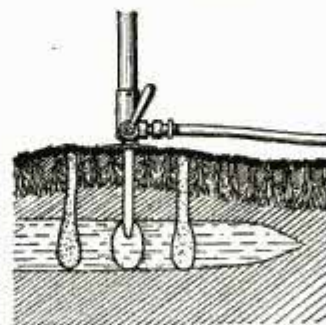

method. It consists of preforming a group of holes in the lawn extending from the ground surface to a point below the grass roots. Fluid would be forced under pressure into one of the holes, resulting in the remaining holes being filled with loosely packed soil forming a porous surface conducive to reception and maintenance of moisture.

(Continued to page 33A)

AMAZING NEWS!

THIS MILLION DOLLAR BUSINESS DRAMATICALLY PASSES INTO HANDS OF LICENSED LOCAL MEN

ONE MAN IN EACH TERRITORY..ARE YOU THE ONE?

This is the Most Sensational News This Magazine Has Ever Published. It Confirms the Amazing Success of a Revolutionary New Invention That Literally Sweeps Opportunity for Wealth—Not Into the Hands of Capitalists, Big Companies—But to Men of Ordinary Means Who Have the Courage and the Enterprise to Start and Expand a 1,000% Profit Business at Home.

Frankly, this astounding opportunity is for men of ordinary means, but it is not for **ordinary** men.

You need not even be an amateur mechanic, but you should be mechanically inclined. You must be willing, eager, to study and practice to perfect yourself as an outstanding expert, a specialist in your community. You do not need a great amount of money, because you should begin earning profits at once, but you will need some, as an investment in equipment.

If you can meet these qualifications, this opportunity has the following to offer you—

A business operated from your own home that can pay you \$60—\$70—and more—a day.

A business which will permit you to expand, train others and make your business just as big as you wish.

A business that in the majority of communities has no competition and in **every** community will capture thousands of ever-present jobs that, because of physical handicaps, existing competition cannot handle.

A business that will be licensed to you by the owners of the **PATENTS** which only you can use in your territory—and only you will use this revolutionary invention that suddenly makes undreamed of earnings possible for operators.

WHAT IS THIS INVENTION?

The **WARNER ELECTROPLATING METHOD** gives you a combined brush and tank method that makes electroplating as easy as painting. Now it is no longer necessary for the family, store, office, factory, to throw away good materials because they are shabby. At last they can be **REPLATED** quickly at **BIG PROFITS**.

This new patented invention has changed dramatically the entire picture. Until now, all electroplating had to be taken to a big plant where the investment was enormous and overhead high. In most cases this meant sending the work hundreds of miles away, further expense, and weeks of delay.

Do you begin to get the vision of the big-money opportunity this startling invention has created? You see why it is sensationally capturing a million dollar industry!

There are far more electroplating jobs than plants to do them. The vast majority of towns have no electroplating plants. Many plants are able to handle only the biggest jobs simply because they cannot afford to change liquids in their tanks. Millions of dollars worth of profitable jobs are lost because the expense of disassembling, plus shipping, is too costly or too great trouble.

Think what it means to be able to do just as good electroplating as the big tanks, but with an electric brush! Fascinating work—the actual brushing easy as painting. And, with the marvelous, patented, precious and common, plating compounds, even an inexperienced man quickly can master the work, and do every job that only big liquid tanks, costing the owner thousands of dollars, heretofore could do.

Yet, you can operate in amazingly small space! You can get business from homes, garages, stores, doctors, dentists, hotels, apartments, restaurants, offices, theaters, key shops, repair shops, bicycle shops, hospitals, factories, optical shops, taverns, beauty parlors, individual auto owners. You, when licensed, can have virtual monopoly on this lucrative business in your community.

BIG PROFITS—NO SEASONAL SLACK

For example, you gold plate rings at a cost of 3 cents each and can charge 75 cents each! Or **REPLATE** a 26-piece set of silverware for \$15.00, your cost \$3.00. A musical instrument at a cost of no more than \$3.00 and charge \$18.00 to \$60.00! You will be told of others who with this new invention are making enormous profits daily.

A COMPLETE PLANT—FREE TRAINING

You will be given, without extra charge, complete easy instructions showing you exactly how to proceed on any job. With this easy training you can't go wrong. You will be shown where and how to get all the work you can handle. You will receive every single piece of equipment and supplies you need to **GUARANTEE AS COMPLETE—PERMANENT—BEAUTIFUL—WORK AS THE HIGHEST PRICED PLANT.**

PAY NO MONEY NOW—GET FREE DETAILS

You are not asked to make any investment whatsoever until you receive the complete story. Then you will learn that the investment asked for your complete plant is amazingly small—actually only a fraction of what is required to establish even the smallest old style plant.

RUSH YOUR REQUEST—GET FREE SAMPLE

You cannot afford to waste any time. Rush your request for **FREE** details at once—now—and get the entire story. Receive **FREE** a sample of this marvelous new method of electroplating. If this opportunity shows you the way to riches,

then you want to be first in your territory. Others are eager as you to have their own big business with amazing life-time profits. Write a letter at once if you want quick action.

PROFITS IN SURPRISING SHORT TIME

Only licensed operators are permitted to use the **COMPLETE** patented Warner method of electroplating with a brush. Thus you can quickly enter an unlimited market, with profits of 1,000% and more, and make your business just as big as you want. Write at once for full details of this remarkable Plan, and the Warner new **COMPLETE** method.

WARNER ELECTROPLATER CO.

Dept. 5-Y

General Offices: 360 N. Michigan, Chicago, Ill.

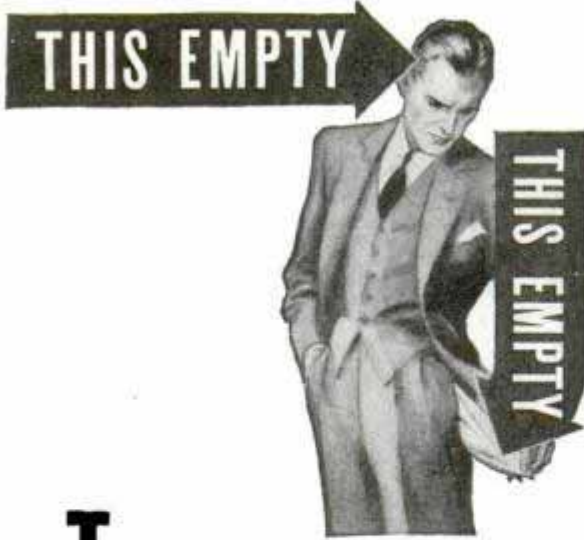

IT TAKES BRAIN to earn money — trained brain! The man without training is usually the man without cash. You can train your brain! Thousands of men have done it through spare-time study of I. C. S. Courses. Be a cash man — be a trained man — mail this coupon!

INTERNATIONAL CORRESPONDENCE SCHOOLS

BOX 5569-J, SCRANTON, PENNA.

Explain fully about your course marked X:

TECHNICAL AND INDUSTRIAL COURSES

- | | | |
|---|--|--|
| <input type="checkbox"/> Agriculture | <input type="checkbox"/> Air Brake | <input type="checkbox"/> Managing Men at Work |
| <input type="checkbox"/> Air Conditioning | <input type="checkbox"/> Manufacture of Pulp and Paper | <input type="checkbox"/> Marine Engines |
| <input type="checkbox"/> Architectural Drafting | <input type="checkbox"/> Mechanical Engineering | <input type="checkbox"/> Navigation |
| <input type="checkbox"/> Architecture | <input type="checkbox"/> Patternmaking | <input type="checkbox"/> Pharmacy |
| <input type="checkbox"/> Auto Engine Tune-up | <input type="checkbox"/> Plumbing | <input type="checkbox"/> Practical Telephony |
| <input type="checkbox"/> Auto Technician | <input type="checkbox"/> Poultry Farming | <input type="checkbox"/> Public Works Engineering |
| <input type="checkbox"/> Aviation | <input type="checkbox"/> Radio Servicing | <input type="checkbox"/> Radio Operating |
| <input type="checkbox"/> Boilermaking | <input type="checkbox"/> R. R. Section Foreman | <input type="checkbox"/> Radio Servicing |
| <input type="checkbox"/> Bridge Engineering | <input type="checkbox"/> Refrigeration | <input type="checkbox"/> R. R. Signalmen |
| <input type="checkbox"/> Building Estimating | <input type="checkbox"/> Sheet Metal Work | <input type="checkbox"/> Refrigeration |
| <input type="checkbox"/> Chemistry | <input type="checkbox"/> Steam Electric | <input type="checkbox"/> Sheet Metal Work |
| <input type="checkbox"/> Coal Mining | <input type="checkbox"/> Steam Engines | <input type="checkbox"/> Steam Electric |
| <input type="checkbox"/> Concrete Engineering | <input type="checkbox"/> Structural Drafting | <input type="checkbox"/> Steam Engines |
| <input type="checkbox"/> Contracting and Building | <input type="checkbox"/> Structural Engineering | <input type="checkbox"/> Structural Drafting |
| <input type="checkbox"/> Cotton Manufacturing | <input type="checkbox"/> Surveying and Mapping | <input type="checkbox"/> Structural Engineering |
| <input type="checkbox"/> Diesel Engines | <input type="checkbox"/> Telegraph Engineering | <input type="checkbox"/> Surveying and Mapping |
| <input type="checkbox"/> Electrical Engineering | <input type="checkbox"/> Textile Designing | <input type="checkbox"/> Telegraph Engineering |
| <input type="checkbox"/> Electric Lighting | <input type="checkbox"/> Welding, Electric and Gas | <input type="checkbox"/> Textile Designing |
| <input type="checkbox"/> Electric Light | | <input type="checkbox"/> Welding, Electric and Gas |
| <input type="checkbox"/> Foundry Practice | | |
| <input type="checkbox"/> Fruit Growing | | |
| <input type="checkbox"/> Heating | | |
| <input type="checkbox"/> Heat Treatment of Metals | | |
| <input type="checkbox"/> Highway Engineering | | |
| <input type="checkbox"/> Locomotive Engineer | | |
| <input type="checkbox"/> Machinist | | |
| <input type="checkbox"/> Management of Inventions | | |

BUSINESS COURSES

- | | | |
|--|--|---|
| <input type="checkbox"/> Advertising | <input type="checkbox"/> Bookkeeping | <input type="checkbox"/> Grade School |
| <input type="checkbox"/> Business Correspondence | <input type="checkbox"/> Business Management | <input type="checkbox"/> High School |
| <input type="checkbox"/> Business Management | <input type="checkbox"/> Cartoonying | <input type="checkbox"/> Illustrating |
| <input type="checkbox"/> Cartoonying | <input type="checkbox"/> Civil Service | <input type="checkbox"/> Lettering Show Cards |
| <input type="checkbox"/> College | <input type="checkbox"/> Cost Accounting | <input type="checkbox"/> Railway Postal Clerk |
| <input type="checkbox"/> College Preparatory | <input type="checkbox"/> Foremanship | <input type="checkbox"/> Secretarial |
| <input type="checkbox"/> Commercial | <input type="checkbox"/> French | <input type="checkbox"/> Sign Lettering |
| <input type="checkbox"/> C. P. Accounting | <input type="checkbox"/> Spanish | <input type="checkbox"/> Sign Lettering |

DOMESTIC SCIENCE COURSES

- | | |
|---|--|
| <input type="checkbox"/> Advanced Dressmaking | <input type="checkbox"/> Professional Dressmaking and Designing |
| <input type="checkbox"/> Foods and Cookery | <input type="checkbox"/> Tea Room and Cafeteria Management, Catering |
| <input type="checkbox"/> Home Dressmaking | |

Name..... Age.....
 Address.....
 City..... State.....

Present Position.....
 Canadian residents send coupon to the International Correspondence Schools Canadian, Limited, Montreal, Canada. British residents send coupon to I. C. S., 71 Kingsway, London, W. C. 2, England

Always write your name and full address clearly when answering advertisements.

EASIEST to master!

THIS NEW P-A

● Such beautiful tone, and so easy to play! Just touch a key and blow normally; you can't miss. Nothing to compare with these new P-A Saxes, Clarinets, Trumpets, and other P-A instruments. Fully guaranteed; your success assured. See your music dealer or write direct for beautiful free book. No obligation. Easy terms. Greatest fun, easiest with P-A. Write today sure.

PAN-AMERICAN
 303 P-A BUILDING ELKHART, INDIANA

You CAN GET IN AVIATION Like hundreds of successful graduates SPARTAN Training following standard College or University planned curriculum will give YOU Aviation training that will qualify for positions now open. Advantages Factory affiliation building ALL-METAL Commercial and Military Airplanes. Unequaled year-round flying weather and country. Government and Army Air Corps approved. All courses Mechanical and Flight. Write for Illustrated Catalog.

HOME OF THE DAWN PATROL
 Capt. MAXWELL W. BALFOUR, Director,
 Dept. PM-29, TULSA, OKLAHOMA

SPARTAN SCHOOL OF AERONAUTICS

HOW How to Win Fortune, Happiness by a Book

Money not essential to begin business or develop a winner. Too much money, unless earned by experience, usually means failure. Success develops itself. Marconi, Carnegie, automobile, telephone, telegraph, camera all started from BOOKS. Read HOW. Learn to get ahead in sure, inexpensive way. For free HOW GUIDE, write your name and address on postcard, mail today to

R. & R. Co., 641 H. St., Melrose, Massachusetts

MECHANICS

KNOW YOUR CAR You Need this Book **JUST OUT!**

Ask to See it!

Every operator and mechanic needs AUDELS NEW AUTO GUIDE. This book saves time, money and worry. Highly endorsed. It presents the whole subject of auto mechanics: 1—Basic principles, 2—Construction, 3—Operation, 4—Service, 5—Repair. Easily understood. Over 1500 pages—1540 illustrations showing inside views of modern cars, trucks and buses with instructions for all service jobs. Diesel Engines fully treated, \$4 fully illustrated. To Get This Assistance for Yourself Simply **4** Fill in and Mail Coupon Today.

COMPLETE • PAY ONLY \$1. A MONTH

THEO. AUDEL & CO., 49 WEST 23rd STREET, NEW YORK
 Please send me postpaid AUDELS NEW AUTOMOBILE GUIDE (\$4) for free examination. If I decide to keep it, I will send you \$1 within 7 days; then remit \$1 monthly until purchase price of \$4 is paid. Otherwise, I will return it to you promptly.

Name.....
 Address.....
 Occupation.....
 Reference.....

READ!! - this is an IMPORTANT MESSAGE, for YOU!



Five minutes reading time NOW may spell the difference between success and failure later on

Nothing can be more fatal to inventive success than procrastination. In a great country of more than 120,000,000 souls; where the inventive spirit is encouraged both by government and by a free, competitive system of barter and trade—it is but natural that often two or several inventive minds may be thinking along similar lines.

WHY ACTION IS IMPORTANT

This may—often does—give rise to complications. Thomas Edison is considered the father of motion pictures. But it is a known fact that a man by the name of Leroy was also an early inventor in this field. Edison was more diligent in taking steps to protect his

rights. The Patent Laws favor the man who is diligent.

Not so many years ago, David Farnsworth was an unknown Western farm boy. Today, still in his early thirties, he is the president of the Farnsworth Television and Radio Corporation, considered by many as the outstanding inventor in the field of television. Suppose Farnsworth had procrastinated and failed to avail himself of the legal protection which our Patent Laws make possible. The story might be different, for at the time he was conducting his own experiments, some of the best scientific brains of the country were wrestling with the same problems.

WHAT TO DO FIRST!

Your very first step is to fully inform yourself—KNOW WHAT TO DO. Find out how the Patent Laws can protect you, what steps are necessary to apply for a Patent, what kind of a sketch, drawing or "disclosure" is needed—what other diligent inventors have done to protect themselves. These facts and many more are simply and clearly explained in the FREE books shown on this page. They are yours for the asking. With them you can quickly place yourself on the SAFE SIDE so far as your knowledge of Patent procedure is concerned. The coupon below was put there for YOU! Use it NOW!

42 YEARS OF HELPFUL SERVICE

For forty-two years it has been our privilege to assist inventors the country over. Write us in confidence. Your questions will be answered fully.

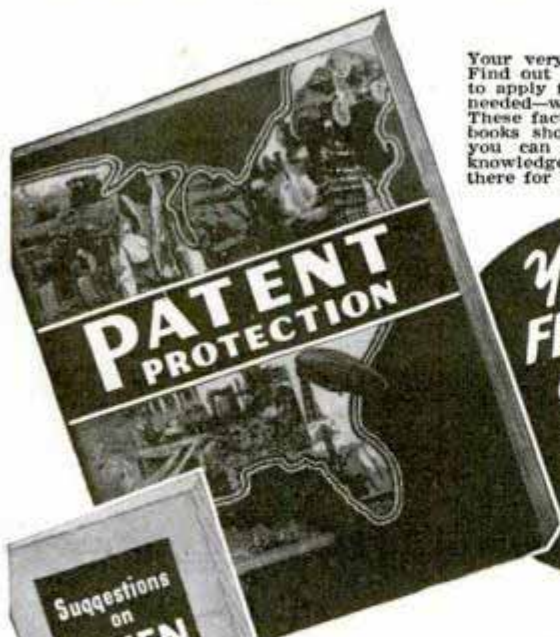

Your FREE book coupon



68 PAGES OF VITAL FACTS!

These interesting books have answered the questions of thousands of inventors. Your copies will be sent by return mail. WRITE US TODAY.

**MAIN OFFICE: 560-C VICTOR BUILDING
WASHINGTON, D. C.**

Pittsburgh Office: 514-N Empire Building

Gentlemen: Kindly send me at once FREE copies of your books, "Patent Protection" and "Selling an Invention". Also include a FREE copy of your "Evidence of Invention" form.

Name.....

Address.....

Place and State.....

**VICTOR J.
EVANS & Co.**
REGISTERED PATENT & TRADEMARK ATTORNEYS

INVENTORS

HOW TO MODERNIZE YOUR OLD RADIO

MIDWEST FACTORY-TO-YOU 20th ANNIVERSARY SPECIAL!



WITH TELEVISION ADAPTATION

Here's today's biggest radio value—the 1940 TELEVISION-ADAPTED Midwest—at sensationally low factory-to-you-price. Amazing foreign reception. Absolute satisfaction guaranteed on money-back basis. Other models from 5 to 17 Tubes, and up to 5 Wave Bands. ●Send 1c postcard for FREE 1940 catalog. (User-agents make easy extra money!) See Midwest's Answer to TRADE-INS!

PUT THIS 1940 14 TUBE CHASSIS IN YOUR PRESENT CABINET
\$19.95
COMPLETE CHASSIS WITH TUBES AND SPEAKER

SAVE UP TO 50% 30 DAYS TRIAL EASY PAY PLAN

14-TUBE CONSOLE \$29.95 COMPLETE

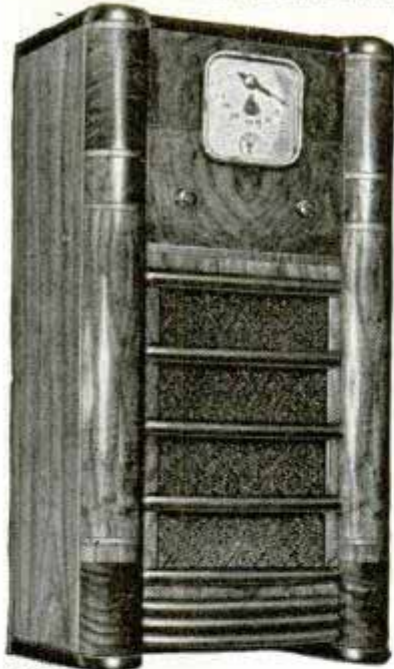

MIDWEST RADIO CORPORATION Dept. 15-K Cincinnati, Ohio

SEND 1c POSTCARD . . . OR WRITE TODAY!

MIDWEST RADIO CORPORATION
 Cincinnati, Ohio
 Dept. 15-K
 Send me your new FREE catalog, complete details of your liberal 30-day Trial offer and factory - to - you prices.

Name.....
 Address.....
 Town..... State.....
 User-Agents Make Easy Extra Money. Check here [] for details.

Gov't EXAMS

MEN - WOMEN AGE 18 TO 50

Eligible for jobs paying

\$1260 to \$2100 A YEAR

FREE BOOK explains requirements. Tells how we help train you to pass govt. examinations with the high mark necessary for appointment. Common school education usually sufficient. Don't delay! Write today! No obligation. **PATTERSON SCHOOL, Dept. 83, Rochester, N. Y.**

ENGINEERING

DEGREE IN TWO YEARS

TECHNICAL AND APPLIED COURSES. Nonesentials omitted. **TIME AND MONEY SAVED.** Degree 2 yrs., diploma 1 yr. Electrical, Mechanical, Architectural, Structural, Civil, Aeronautical, Highway. All courses include Air Conditioning, Electric Refrigeration and Diesel. Short intensive courses 3 and 4 months in Electricity, Power Plant, Diesel-Electric, Electric Refrigeration, Drafting. Extensive modern equipment. **LOW TUITION.** Part-time work for room and board. Thousands of successful graduates in U. S. and foreign lands. Approved by Industry, endorsed by educators, recommended by alumni. One and two-year courses start in Sept., short courses open year round. **40th YEAR.** Residence courses. Catalog free.

FINLAY ENGINEERING COLLEGE

1901 Indiana Avenue

Kansas City, Mo.



MECHANICAL DENTISTRY

Short course—personal, individual, instruction—best technical teachers. Profession offers unlimited opportunity—not affected by Machine Age. Most modern and complete methods embracing every branch from plate to porcelain work. Qualify you to work for dentists or own business. Day or night school. No books—no classes. Catalog upon request.

OR STUDY AT HOME. Write for information on our Home Study Course.

MCCARRIE SCHOOL OF MECHANICAL DENTISTRY

207 N. Broad St.

Dept. 754

Philadelphia, Pa.

How To Get MORE PAY



by learning **DRAFTING and INDUSTRIAL DESIGNING**

If you want to earn more money and advance to a better job—equip yourself now by learning **DRAFTING and Industrial Designing.** You can get practical training quickly in your spare time at home—under the personal supervision of an Engineer and Industrial Designer. Drawing tools and table furnished without extra cost. Learn to draw and design new products, or to improve, re-style, streamline and modernize old products for more "eye appeal" and selling power.

Drafting is a very big field, but drafting with industrial designing is twice as big. Factories must continuously bring out new models, new products, and improved designs. You can be trained for better pay in your home as I have trained many hundred successful students. I'll train you thoroughly by applied instruction on actual work. Send coupon for full facts on "Drafting and Industrial Designing."

ENGINEER DOBE, DIV. 3373, LIBERTYVILLE, ILLINOIS

ENGINEER DOBE, Div. 3373 Libertyville, Illinois.

Send for full FACTS

Please send me full facts on how I can train to earn more and advance by learning "Drafting and Industrial Designing."

Name..... Age.....

Address.....

Town..... State.....

Say you saw it in Popular Mechanics!

John made \$42⁵⁰ in one day in his NEW Business



● Get Into This Business Now—

a business which is so new that it is practically without competition. This should enable you to make really **BIG MONEY**. Hotels, homes, clubs, office buildings offer tremendous possibilities. Our new **DETERGER** washes upholstered furniture, electrically right in your customer's home, with a new soapless soap whipped into **DRY suds**. *No liquid touches the fabric*, therefore the furniture is ready for use soon after cleaning. We have helped hundreds of men get into business for themselves with our automatic equipment. The U. S. Government and many of the world's largest hotels use our machines.

Make Money the FIRST DAY

The Deterger is ready to use when you receive it, so you ought to be taking in big profits the first day. We want an honest, ambitious man in every locality. If you are that man we will help you get started for yourself in a business with tremendous possibilities.

No Rent to Pay You don't have to rent a shop. You don't have to hire a building, for you do the work right in your customer's home. You save the expense of carting furniture back and forth to a central plant; the owner's home is your workshop.

J. S. Corson says

"I cleaned seven living room sets and fourteen chairs, as well as twenty-five automobile interiors the very first month and made \$279.50." Berger Hanson wrote "My investment in your **DETERGER** was the wisest I have ever made. It is my most valued asset." Barrett says: "Made \$28.00 in eight hours, on another job made \$11.00 in two and one-half hours." Alex Gulkin's business expanded so fast that he already has **SIX DETERGERS** making money for him.



No liquid touches the fabric when cleaning with the **DETERGER**.

Pay as you Earn

Only a limited amount of money is needed for a down payment. The balance you send on easy terms. Most men find it possible to make far more than the cost of the machine before the payments come due. Every machine is fully **GUARANTEED** and satisfied customers send their friends to you.

Book sent FREE

Write today for copy of our booklet, "Your Own Business, Profits Instead of Wages." Let us tell you how easy it is to get started in a year around business where you are your own Boss and can stop worrying about just a job. Write today—**NOW**.



VON SCHRADER MFG. CO., 553 Pl., Racine, Wis.

VON SCHRADER MFG. CO., 553 Pl., Racine, Wis.

Send me (without obligation) your free booklet telling me how I can own my own business and become financially independent and how I can pay for the **DETERGER** on easy terms.

Name.....
Address.....
City..... State.....

U.S. GOVERNMENT JOBS

RAILWAY POSTAL CLERKS

\$1900 First year regular

MANY OTHER GOVERNMENT JOBS

File Clerks—Mail Carriers—Stenographers—Typists, etc.

\$1260 to \$2100 First Year

Grade School Education Usually Sufficient

MEN—WOMEN

Mail Coupon immediately—today sure.



MANY 1940 APPOINTMENTS EXPECTED



COUPON

FRANKLIN INST., Dept. A195, Rochester, N. Y.

Gentlemen: Rush to me, without charge, 32 page book with list of U. S. Government big paid positions. Advise me also regarding salaries, hours, work, vacation, etc. Tell me how to qualify for a position.

Name.....
Address.....

RADIO ENGINEERING, broadcasting, aviation and police radio, servicing, marine and Morse telegraphy taught thoroughly. 48 weeks' engineering course equivalent to three years' college radio work. School established 1874. All expenses low. Catalog free.

Dodge's Institute, Ada St., Valparaiso, Ind.

OPTOMETRY

Be a Doctor of Optometry. An uncrowded profession. Excellent faculty. Abundant Clinic material. Not operated for profit. Days, Evenings. Part time employment provided. Coeducational.
Monroe College of Optometry, 164 N. Wacker Dr., Chicago, Ill.

BROOKLYN YMCA TRADE SCHOOL



Unlimited Instruction until you have mastered every part of Course without additional charge.
Full Shop Equipment
Unexcelled Instruction
Fireproof Dormitories.
Special Privileges. **Check your interests** on coupon to receive free literature.

- Mechanical Pre-Engineering
- Diesel Engines Oil Burner
- Diesel Pre-Engineering
- Aeronautical Pre-Engineering
- Aviation Mechanic Welding
- Auto Mechanic Talking Pictures
- Refrigeration Air Conditioning
- Television and Radio Mechanic
- Architectural-Mechanical Drafting
- Machinist Tool and Die Making
- Armature Winding Electrical

MAIL COUPON

1117 Bedford Ave., Dept. P.M.
Brooklyn, New York City, N. Y.

Name.....
Address.....

REAL JOBS OPEN

FOR TRAINED AUTO MECHANICS



LEARN QUICK!
8 WEEKS
practical SHOP
TRAINING!

AUTO, DIESEL and AVIATION mechanics

WELDING—BODY & FENDER

I'll train you quickly, correctly for this fascinating work, paying up to \$60 a week! Based on 25 years' experience knowing how to train men well, in the 2 biggest, best schools of their kind in the world. You learn with real tools, on real equipment, a complete, practical course in Auto, Diesel and Aviation Mechanics, Welding, Body and Fender work so you can step out of low-pay jobs into a career in the biggest field of opportunity in America today!

SPECIAL LOW RATE

SPECIAL LOW TUITION RATE IF YOU ACT NOW!

Again McSweeney leads in real value. If you write at once we will reveal a special new low tuition rate that will amaze you, and on easy terms it makes it easy for you to train AT ONCE for a big-pay job! Write TODAY for details!

McSWEENEY MEN MAKE GOOD! TWO FINE BIG SCHOOLS

25 years' success means something to you! Read how others have succeeded with McSweeney training: "Just got thru writing income tax check. Money spent at your school was best thing I ever did!"—Lee Grant, O.; J. W. Wiggins, Okla., says before we trained him he had no income, now has own business, money in bank and to spend! G. B. Park, Ind., says "Your training fitted me to handle any job in auto field." These men were trained in our fine big schools, best of their kind anywhere!



DETROIT



KANSAS CITY

FREE BOOK!



Send now for your copy of my big book giving all the facts and announcement of amazing new low tuition rate for short time only—but you must write at once!

Address nearest school:

McSWEENEY TRADE SCHOOL

Dept. G-7, Detroit, Mich., or Kansas City, Mo.

Without cost or obligation send me your big FREE book.

NAME.....

STREET.....

TOWN..... STATE..... AGE.....

I'LL TRAIN YOU AT HOME IN SPARE TIME to MAKE GOOD MONEY in RADIO and TELEVISION



Easy to Start . . . Earn While You Learn

Wake up! Get ahead! You fellows with ambition can make a wonderful success in Radio and Television through my new, practical, home training. I teach you in your spare time through interesting experiments with real equipment. Every essential phase of Radio, Television, Electronics, Facsimile, Radio Set Repair and Installation is covered. You get Personalized help. No previous experience needed. So practical—so understandable—so simplified is this training that any man with average education can grasp the money-making knowledge quickly and easily. You will be ready for a business of your own . . . or to hold down a good-paying job. My BUSINESS BUILDERS show you how to make profits while learning.

BIG FREE BOOK! Get complete details in new cat. "HOW TO MAKE MONEY IN RADIO". Write Sprayberry Academy of Radio, 310-C, University Place, N. W., Washington, D. C.

YOU GET

- 146 RADIO PARTS
- RADIO TOOLS
- ALL WAVE ALL PURPOSE ANALYZER

STUDY ENGINEERING AT HOME

Earn a Degree at Home

From A Chartered Institution Of Higher Learning Employers Demand Degree Men For Key Positions

88 Degree Courses in Electrical, Mechanical, Civil, Structural, Diesel, Architectural, Drafting, Automotive, Aeronautical, Radio, Refrigeration, Air Conditioning, Highway, Mining, Geology, Petroleum, Marine, Industrial, Chemical Engineering; Arts; Sciences; Philosophy; Psychology; Chemistry; Education; Business Training; Law; etc. McKinley-Roosevelt Graduate College, 4750-G Sheridan Road, Chicago

EARN THE DEGREE

Doctor of Psychology (Pa.D.), Philosophy, Divinity, Science, General Courses—Arts, Law, Business, etc. A Chartered Correspondence Institution. Send for 32-page FREE Bulletin at once. No Obligation. Temple Bar College Inc., Dept. 2-R, 1411 Fourth Avenue Seattle, Washington, U.S.A.

DRAFTING PAYS BIG

Drafting Jobs Often Pay \$175.00-\$350.00 month. Trained draftsmen always in demand. Learn easily at home in spare time. Experience unnecessary. Common education enough. Employment service FREE. Write today for complete information. No obligation. No Salesmen. MONROE INSTITUTE, Dept. A-103, Alton, Illinois



Know Electricity as Experts Know It—and Get an Expert's Pay!

What about your future? Who is safe today? Surely not the man who is contented to stand still! Know your job thoroughly—prepare yourself for jobs ahead. To do just this thousands of men have used

The Croft Library of Practical Electricity

The Croft Library is a complete electrical educator. It is founded on practice—on 20 years of shirt-sleeve experience—on work as it is actually done. It is jammed from cover to cover with the kind of hard-headed facts you want. Written so that the beginner can easily understand it, yet so sound, so thorough, that it is the daily guide of 50,000 highly paid electrical workers and engineers. Croft tells you the things you need to know about motors, generators, armatures, commutators, transformers, circuits, switchboards, distribution systems—electrical machinery of every type—illumination in its every phase—the most improved methods of lighting—lamps and lamp effects, etc.—how to do a complete job, from estimating it, to completion.

6 volumes, 2155 pages — New low price No money down—Easy payments.

Fill in and mail the coupon attached and we will send you the entire set of six volumes for ten days' Examination on approval. We take all the risk—you assume no obligation. If you decide to keep the books, send \$1.50 in ten days and the balance at the rate of \$3.00 a month. Send the coupon NOW and see the books for yourself.

EXAMINATION COUPON

McGRAW-HILL BOOK CO., 330 W. 42nd St., New York

Send me for ten days' examination on approval the Croft Library of Practical Electricity. If satisfactory I will send you \$1.50 in 10 days and \$3.00 monthly until the price of \$18.50 is paid. If not wanted, I will return the books postpaid. (To insure prompt shipment write plainly and fill in all lines.)

Name.....

Home Address.....

City and State.....

Position.....

Name of Company..... PM-3-40

ELECTRICAL ENGINEERING

★ ONE YEAR Residence Course

Condensed course trains you for technical positions in minimum time. Combines theory with practical work in well-equipped laboratories. High employment record is industry's endorsement of Bliss training. Thousands of successful graduates.

Suburban campus; modern buildings; dormitory. 47th year. CATALOG. Give age.

BLISS ELECTRICAL SCHOOL

133 Takoma Ave., Washington, D. C.



AVIATION APPRENTICES



ARMINDED YOUNG MEN INTERESTED IN TRAINING FOR ENTERING THE WELL PAID FIELD OF AVIATION AS APPRENTICES—Write immediately, enclosing stamp.

MECHANIX UNIVERSAL AVIATION SERVICE CO.

Wayne County Airport, Box 857, Dept. E, Detroit, Mich.

LAW STUDY AT HOME

Legally trained men win higher positions and bigger success in business and public life. Greater opportunities now than ever before. Big corporations are headed by men with legal training.

More Ability: More Prestige: More Money
We guide you step by step. You can train at home during spare time. Degree of LL. B. Successful graduates in every section of the U. S. We furnish

all text material, including 14-volume Law Library. Low cost, easy terms. Get our valuable 48-page "Law Training for Leadership" and "Evidence" books FREE. Send for them NOW.
LaSalle Extension University, Dept. 364-L Chicago
A Correspondence Institution

Learn PHOTOGRAPHY at Home

Splendid opportunities. Prepare in spare time. Easy plan. No previous experience needed, common school education sufficient. Send for free booklet "Opportunities in Photography", particulars and requirements.

American School of Photography
3601 Michigan Ave., Dept. 1353, Chicago, Ill.



CASH PAID for insects — butterflies, moths. I buy them for collections. Good cash prices paid. There are kinds on the large price list in my Instructions and pictures worth \$1 to \$7 each. Simple outdoor work. Beginners get ready now. Send 10c (not stamps) for **Illustrated Prospectus**, before sending any insects.
MR. SINCLAIR, DEALER IN INSECTS
Dept. 6, Box 1830, San Diego, Calif.



Minstrels

Unique First Parts for complete show with special songs and choruses. Make-up. Catalog Free.

T. S. Denison & Co., 203 N. Wabash, Dept. 19, Chicago



LEARN CARTOONING!

Let a prominent cartoonist teach you this fascinating profession by mail. PERSONAL instruction, just like private tutoring. Recommended by America's foremost cartoonists. Write for free details.
DORMAN H. SMITH, Box C597, SAN RAFAEL, CALIF.

Make Money!

IN NEW OCCUPATION Spare Time At Home

START EARNING NOW!

No soliciting! No canvassing! We show you how to make big money decorating fast-selling Giftwares. We start you with a big \$10 Artist's Outfit. We supply you with \$150 worth of Giftwares free of extra charge and show you how to dispose of them without leaving your home. We give you 29 Tested Plans for making money. One Fireside Member says, "I made \$100 on furniture in one week." Another writes, "My sales were \$500 for 5 weeks. This is my first year." R. M. P., of Ill., says, "I did \$3,500 worth of business last year and over \$12,000 this year." D. W., New Mexico, reports, "I would not take \$1000 for my Course."

No Experience Needed

You too may have a splendid income opportunity with Fireside. No tiresome study. You learn by doing. No artistic ability necessary. Our easy 3-Step Method makes the work easy to learn and easy to do and fits you to make good money practically from the start.

Quick Sales in Your Home

No need to leave the house to dispose of everything you make. Our new automatic salesman does all the selling for you. Designed to quickly find cash buyers for your Giftwares.

No Cost Plan

Mail coupon for Free Plan showing how to earn your course and Big Profits besides.

Fireside Industries
Dept. 66-C, Adrian, Mich.

Send me FREE Book on Home Decorating for a big steady income. Also details of plan that will pay for my Course and give me big profits besides.



FREE!
Book and Money Plan tells how Members get Valuable Giftwares

NAME _____
ADDRESS _____
CITY _____ STATE _____

TRAVEL FOR "UNCLE SAM"

RAILWAY POSTAL CLERKS

\$1900 to \$2450 Year

Mail Coupon Before You Lose It



Many other government jobs

City and Rural Mail Carriers — Post Office Clerks — File Clerks — Storekeeper — Gaugers, etc.
Common Education Usually Sufficient

FRANKLIN INSTITUTE, Dept. A182, Rochester, N. Y.

Sirs: Rush to me without charge copy of 32-page book, "How to get U. S. Government Jobs," list of positions open to men, women, and full particulars telling how to qualify for them.

Name.....

Address.....

PATENTS

Booklet Free Highest References
Promptness Assured Best Results

Send drawing or model.

ALL BUSINESS GIVEN PROMPT AND PROPER ATTENTION

Listed Patent Lawyer in the latest editions of the Rand-McNally Directory of Bankers and Bank-Recommended Attorneys, published by Rand-McNally & Co., Chicago, Ill.; The Baggott & Ryall Directory of Guaranteed Attorneys, published by Legal Directory Corporation, Boston, Mass.; American Lawyers Annual, Cleveland, Ohio; Bankers Service Legal Directory, published by Bankers Service Co., Boston, Mass.; Eyre's Law List, 9 Park Place, New York City; Snow-Church Directory Co. Lawyers List, published in New York City, and the Central Guarantee Co., Bankers and Lawyers Directories, 630 Fifth Avenue, New York City.

WATSON E. COLEMAN, REGISTERED PATENT LAWYER Victor Building, 724 Ninth Street, N. W., **WASHINGTON, D. C.**

INVENTORS PATENT YOUR IDEAS SEND FOR FREE BOOK



HOW TO OBTAIN A PATENT

Written by a Former Member of the Examining Corps (1922-24) of the U.S. Patent Office. If you want to profit by your idea, you should take steps to apply for a U. S. Patent at once. Your first step is to get this Free Book. This interesting illustrated book contains valuable information you should have. It tells you fully how to obtain a patent on your idea in the quickest way. With this Free Book you will also receive a "Record of Invention" form on which you can easily record your idea. Personal and Confidential Service! Your case will be personally handled only by a Registered Patent Attorney who is also a Former Member of the Examining Corps of the U. S. Patent Office. All communications confidential.

MAIL COUPON TODAY for FREE PATENT BOOK and RECORD OF INVENTION Form.

CARL MILLER

REGISTERED PATENT ATTORNEY
FORMER MEMBER EXAMINING CORPS U. S. PATENT OFFICE

Woolworth Bldg., 35th Floor, Dept. 30-A, New York City

MILLER BUILDING, Dept. 30-A, WASHINGTON, D. C.

Please send me your Free Book, "How to Obtain a Patent," and your "Record of Invention" form.

NAME.....

ADDRESS.....

New Ideas now Salable Before Patenting

Practical, useful inventions may now be safely marketed without patenting expense. Write for proof that we successfully sell both patented and unpatented inventions.

Chartered Institute of American Inventors
Dept. 4, Barrister Building, Washington, D. C.



G E A R S

In Stock — Immediate Delivery

Gears, speed reducers, sprockets, thrust bearings, flexible couplings, pulleys, etc. A complete line is carried in our Chicago stock. Can also quote on special gears of any kind. Send us your blueprints and inquiries.

Send 10c for Complete Catalog No. 10

CHICAGO GEAR WORKS
440-48 N. Oakley Blvd. CHICAGO, ILL.

PATENTS—TRADE MARKS

All cases submitted given personal attention
Form "Evidence of Conception" with instructions for use and "Schedule of Government and Attorneys' Fees"—FREE!

LANCASTER, ALLWINE & ROMMEL

Patent Law Offices

412 Bowen Bldg.

Washington, D. C.

DIETERICH & RUTLEY

REGISTERED PATENT LAWYERS

512 B Colorado Bldg.

WASHINGTON, D. C.

Booklet on Patents sent free

INVENTORS

who derive largest profits know and heed certain simple but vital facts before applying for patents. Our book, Patent-Sense, gives those facts; sent free. Trade Marks—Copyrights.

LACEY & LACEY, Est. 1869, 635 F St., N. W., Dept. 5, WASHINGTON, D. C.



BUCHSTEIN'S FIBRE LIMB

Soothing to stump, cool, light, strong.

Correct fit. Braces for all deformities. Fair terms.

D. BUCHSTEIN CO.

610 3rd Ave. South, Minneapolis, Minn.



Earn Cash at Home!

We paid M. M. \$1174 for exceptional cellar crop Snow-King mushrooms! We furnish materials; buy all crops. Big FREE picture book tells if your cellar, shed, barn, suitable. Est. 1908. Write today. United Co., 3848 Lincoln Av., Dept. 303, Chicago

MYSTERIOUS DEVICE WELDS BRAZES AND SOLDERS ANYONE CAN OPERATE



Now, an electric welding, brazing and soldering Torch, complete with power unit, goggles and supplies. Works INSTANTLY off any light socket. Does a thousand and one repair jobs at amazingly LOW COST on aluminum, iron, steel and other metals. Indispensable for Auto, Body and Fender Repairs, and home repairs—shop, factory, farm, engineer, janitor, sheet metal, radio and bicycle repairs. Anyone can handle without previous experience with our simple 10-DAY HOME TRIAL.

Write at once for Special Introductory Low Price Offer. Try 3 in 1 Electric Torch for 10 days at our risk, or get one free by helping to introduce it. ELECTRO-TORCH CO., 2613-MH Michigan Ave., Chicago

To PROTECT YOUR INVENTION Use this coupon, NOW

Delays are dangerous and may be very costly. My personal service assures prompt action, strict confidence, and a minimum of expense. I suggest that you send me a model or drawing, or sketch and description of your invention, and \$5.00. I will make a search and report

promptly as to its patentability and send you a copy of my 72-page booklet. Or, if you prefer to read my booklet first, mail the attached coupon at once. I will also send my "Record of Invention" form. (Over 38 years experience as a Registered Patent Attorney.)

L. F. Randolph, 302-D Victor Bldg., Washington, D.C.

Please send me at once, free of charge, your 72 page booklet and "Record of Invention" form.

Name.....

Address.....

A PERSONAL CONFIDENTIAL PATENT SERVICE

RUPTURED?

Get Relief This Proven Way

Why try to worry along with trusses that gouge your flesh—press heavily on hips and spine—enlarge opening—fail to hold rupture? You need the Cluthe. No leg-straps or cutting belts. Automatic adjustable pad holds at real opening—follows every body movement with instant increased support in case of strain. Cannot slip whether at work or play. Light. Waterproof. Can be worn in bath. Send for amazing **FREE** book, "Advice To Ruptured" and details of liberal truthful 60-day trial offer. Also endorsements from grateful users in your neighborhood. Write:
CLUTHE SONS, Dept. 31, Bloomfield, New Jersey

DIESEL

Get **BETTER** training. Realize Adcox advantages. Located in Pacific Northwest, a Diesel center. Established 25 years. Modern equipment, expert instructors. Close cooperation for **YOUR** success. Earn room and board while learning. Send for free book, "What Every Man Should Know About Diesel". Dept. 18. Home study and resident courses.

L. L. ADCOX TRADE SCHOOL
Portland Oregon

TOOL & DIE MAKING DESIGNING

Machinists Trade. Not a correspondence course. Practical shop training in the world's industrial center. Write today for full information.
NATIONAL SCHOOL OF MECHANICAL TRADES
Dept. 15 628 W. Lake St. Chicago, Ill.

Learn
ADVERTISING
at Home

Greater opportunities now in advertising. Learn easily and quickly in spare time. Practical work. No text books. Old established school. Low tuition—Easy terms. Send for free booklet and requirements.
Page-Davis School of Advertising
Dept. 1353, 3601 Mich. Av., Chicago

TELEGRAPHY

Taught thoroughly. Renewed opportunities due to Railroad Retirement Act and increased business; some railroads experiencing shortage of efficient operators now. **EVERY BRANCH OF RADIO ALSO TAUGHT.** School established 1874. All expenses low. Catalog free.
DODGE'S INSTITUTE, Kane St., Valparaiso, Ind.



DRAFTING

BOOKS SENT FREE!
ON APPROVAL

5 VOLUMES—SECOND EDITION

Only 15 minutes a day with these **WONDER** BOOKS can prepare you for a good drafting job. Mechanical and architectural drafting from simple straight lines to important complex plans. A step at a time! Built especially for beginners, for men with only grammar schooling. Drafting room practice, **PLUS ENGINEERING**, made easy and clear. Includes complete information on blue print reading for building and machine trades.

Big Field Big Demand Big Pay
Competent draftsmen are urgently needed in all building and manufacturing lines at \$30.00 to \$75.00 a week. That's just the beginning—**FOR DRAFTSMEN HAVE GOOD CHANCES FOR ADVANCEMENT.** Pleasant, fascinating work, easy to learn and do. Learn quickly with these books—send coupon for a set and see for yourself.

[A year's consulting membership in the American Technical Society now gives to all buyers of this famous cyclopedia of drafting.]

Complete set of high grade drawing instruments if you send for these drafting books **NOW**. These instruments are absolutely accurate and are packed in velvet lined leatherette pocket case. Splendid value, but included with these books.

AMERICAN TECHNICAL SOCIETY
Dept. D319, Drexel at 58th St., Chicago, Ill.

American Technical Society, Dept. D319, Drexel at 58th St., Chicago, Ill.
Send for 10 days' trial, 5 volumes set of drafting. I will pay the few cents delivery charges. If I wish, I may return books in 10 days and owe you nothing but if I decide to keep them, I will send \$2.00 after 10 days, then only \$3.00 a month until \$24.80, the total price is paid. Send latest edition and include drawing instruments and consulting Membership Certificate.

Name.....

Address.....

Please attach letter stating age, occupation, employer's name and address and that of at least one business man as a reference.

Inventors

Get
PATENT
FACTS!



Your ideas may be worth money

Practical Facts You Will Want to Know About

PATENTS TRADE MARKS
COPYRIGHTS

●These **C. A. Snow & Co.**
Free Books will save
you TIME and MONEY!

Now one of America's oldest firms of patent attorneys offers you important facts on how to protect and commercialize your ideas... the very facts which can save you wasted hours and unnecessary expense. These free books are based on 65 years' experience and tell you exactly what to do to protect your invention.

Find Out RIGHT NOW

Before going any further with your idea—be sure you are on the "right track." You will be able to know *before* spending more time and money the costs and procedure in obtaining a patent. In the books you will find the plain answers to questions that have long bothered inventors.

Confidential, quick service

Our years of experience in helping others should make you feel perfectly safe in dealing with this reputable firm. All inquiries are answered immediately and held in strictest confidence. Write today.

TEAR OUT and Mail Coupon Today



C. A. SNOW & CO.

Registered Patent Attorneys Since 1875

103 SNOW BLDG., WASHINGTON, D. C.

Gentlemen: Please send me—without cost or obligation—your **FREE** books, "Suggestions on How to Commercialize Your Invention" and "How We Protect You." Also Certification of Invention form.

Name.....

Street and No.....

City or Town..... State.....

OLD LINE LEGAL RESERVE LIFE INSURANCE

ONLY **77¢** PER MONTH, PER \$1000 OF INSURANCE (AT AGE 21)*

CHECK THESE LOW RATES AT YOUR AGE FOR

Monthly Premium less the 9 1/2% Guaranteed Dividend (at age nearest birthday), per \$1,000

Age	Rate	Age	Rate	Age	Rate	Age	Rate
21	\$.77	30	\$.97	39	\$1.29	48	\$1.87
22	.79	31	1.00	40	1.35	49	1.95
23	.81	32	1.03	41	1.39	50	2.04
24	.83	33	1.06	42	1.45	51	2.15
25	.85	34	1.09	43	1.51	52	2.27
26	.87	35	1.13	44	1.57	53	2.39
27	.90	36	1.16	45	1.64	54	2.53
28	.92	37	1.21	46	1.70	55	2.66
29	.95	38	1.25	47	1.79		

A further saving is made by paying premium annually or semi-annually.
 *Owing to low rates at which this policy is offered, the minimum amounts issued are: ages 21 to 45, \$1,500; 46 to 55, \$1,000. Rates shown are one-half permanent rates beginning fifth year.

POSTAL'S FAMOUS "MODIFIED '4'" POLICY

Cash and loan values; guaranteed 9 1/2% dividends; automatic premium payment clause and all standard provisions.

POSTAL LIFE OF NEW YORK has paid out more than **\$50,000,000.00** to its policy holders and beneficiaries during thirty-five successful years. If this policy does not fit your needs, Postal issues other standard forms, men or women, ages 10 to 60.

Send coupon full details.

Postal Life Insurance Company, 511 Fifth Ave., Dept. M-619, New York, N. Y.

Send me without obligation complete information about your lowest cost Modified "4" policy at my age.

Date of Birth.....

Occupation.....

Name.....

Street.....

City..... State.....



Home of the Sweeney Aviation Schools

PREPARE NOW to Step Out of this Door IN 12 WEEKS INTO AN AVIATION JOB WITH YOUR FUTURE GUARANTEED

Your dream of a big pay job in Aviation really can come true. Aviation factories, airlines and airplane transports need thousands of trained men right now. Start training NOW for a position that assures your future.

35,000 TRAINED MEN WANTED IN AVIATION An urgent call has gone out from the nation's airplane factories for 35,000 trained men. They want men at once because of lack of skilled workmen it has been necessary to hold up \$200,000,000 worth of equipment. It's your opportunity to get into the world's highest paid industry. Why not write for details of Sweeney Training at once!

EASY TO LEARN THE SWEENEY WAY The Sweeney System of Practical Instruction makes it simple and easy. You learn with tools—work on modern airplane equipment in up-to-the-minute shops. You are qualified under Government Rated Instructors.

SPECIAL EMERGENCY COURSES E. J. Sweeney, president of the world's largest and most successful trade schools, has met the man-shortage emergency by offering special short courses in sheet metal fabrications, factory specialist welding, aircraft Engine Mechanics and Airplane Mechanics—at reduced rates.

Get the Facts. Write for FREE BOOKLET—"Opportunities in Aviation" today.



The original and only Sweeney school in U. S.
 101-C ADMINISTRATION BLDG.
 FAIRFAX AIRPORT, KANSAS CITY, KAN.

- BIG PAY JOBS**
- SHEET METAL CRAFTSMANSHIP
 - AIRCRAFT WELDING
 - AIRPLANE MECHANICS
 - ENGINE MECHANICS
 - FLIGHT ENGINEERING
 - AERONAUTICAL ENGINEERING
 - INSTRUCTOR'S AERONAUTICAL TRAINING

The Surest Way to Learn is by Doing!

There is no substitute for practical training. PREPARE NOW for substantial prospects in various branches of

AIR CONDITIONING & REFRIGERATION

PLANNING, ESTIMATING, INSTALLING, SERVICING, INSPECTING, SALES ENGINEER

Learn thru theory and practice on actual machines and equipment operated by students in labs—"Modern Methods in Modern Facilities". This complete organization is devoted exclusively to preparing men for Air Conditioning and Refrigeration. Train in the heart of greatest potential trade development! Convenient Day and Evening Courses—Pay as you learn Plan—See for yourself why so many train the Technicians Way!

Write today for FREE BMLT 50, "Industries of Opportunity", 28 page story of progress and prospects in these fields...



TECHNICIANS INSTITUTE
 Licensed by the State of New York
 244 WEST 14th STREET NEW YORK

How to Write and Speak Your Way to SUCCESS

Send Today for this New FREE BOOK! Learn how to advance yourself financially and socially by putting words to work for you. Turn your ability into money.

ILLINOIS-BROWNE INSTITUTE
 53 W. JACKSON BOULEVARD CHICAGO, ILLINOIS

MAKE MONEY AT HOME! Learn to color photos and miniatures in oil. No previous experience needed. Good demand. Send for free booklet, "Make Money at Home" and requirements.

NATIONAL ART SCHOOL
 3601 Michigan Ave. Dept. 1353 Chicago

Share in Electricity's Prosperity!



EARN MORE MONEY!

These 3 Big Coyne Electrical Guides can help you do it.

The Big-money jobs go to those who know how! You can't hold a good job or get ahead—unless you know your stuff. The good jobs, good pay, and advancement go to the fellow who is prepared. Prepare now for the splendid opportunities in ELECTRICITY.

The **Coyne Electrical Reference Guides** are packed full of practical facts about Electricity, Radio, Refrigeration, Air Conditioning and Diesel engines. They are founded on 41 years practical experience, clearly written, simple language, easily understood. Covers modern practices, up-to-date methods. A practical training program to improve your skill and advance your earning power now.

3 VOLUMES, 1100 PAGES, OVER 2000 ILLUSTRATIONS

Some of the subjects covered are:—Electricity, Magnetism, Signal Systems, Telephones, Illumination, House Wiring, Power Wiring, Armature Winding, Motors, Generators, Convertors, Transformers, Switchboards, Central Stations, Photo Cells, Automotive Electricity, Diesel Engines, Refrigeration, Air Conditioning, Radio, Television, etc. Fill in and mail coupon for 10 days free examination offer—no obligation. If you decide to keep the books send \$2.00 in 10 days and balance \$3.00 per month. Mail COUPON NOW to Coyne Electrical School, 500 S. Paulina St., Chicago.

FREE with Guides

Right now, with each set of guides, we offer one year's free advice by Coyne Engineers on any Electrical problems.

MAIL COUPON NOW

H. C. LEWIS, Pres., COYNE ELECTRICAL SCHOOL, 500 S. Paulina St., Dept. 30-REF, Chicago, Illinois.

Send me your 3 big Coyne Electrical Reference Guides. Within 10 days after receiving the books, I'll either return them or send \$2.00 and then \$3.00 a month for 4 months.

NAME..... AGE..... OCCUPATION.....

ADDRESS.....

CITY..... STATE.....

EMPLOYED BY.....

Sometimes advertisers are unable to respond to inquiries due to lack of complete information.

POPULAR INVENTIONS

(Continued from page 22A)

HANDY for the hunter, fisherman or camper would be a newly patented demountable cabin. The patent covers, in combination, a complete automotive unit with a truck body having sides and an open end. The cabin is constructed and arranged as a weatherproof building suitable

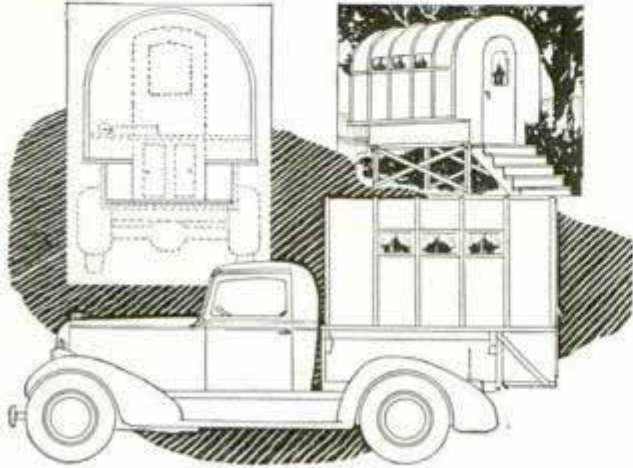

for habitation while on the truck body or when removed to a camping site. Plenty of space is provided in the cabin for sleeping quarters, a stove, ice chest and other equipment. Steps for reaching the rear door of the cabin on the truck are planned, as are substantial supports for the cabin if it is desired that the structure be mounted above the ground at a camp site.

PAINTERS would find useful a newly patented attachment for paint cans. It



consists of a circular metal member, with a flared mouth or upper section extending upward beyond the mouth of the paint can and downward into the can. A flange

within the can is provided to support the bristles of the paintbrush when the brush is not in use. An opening in the attachment permits dipping the brush into the paint at will.

Due to the fact that many of the devices described in this department are still in the patent office stage and are not on the market, Popular Mechanics Magazine cannot undertake to supply further information regarding them.

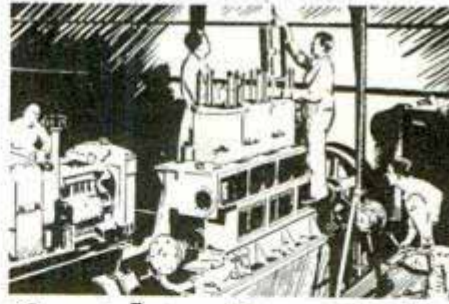

TESTED
PLAN
TO INCREASE
YOUR PAY

Complete, Practical, Profitable

DIESEL TRAINING

—including

**AUTO MECHANICS &
MACHINE SHOP PRACTICE**

No matter where you are or what you do, *National Schools* now offers immediate training to meet your specific needs. It's a tested, flexible plan to fit your circumstances—a plan for those seeking immediate shop training as well as for those who cannot give up their present employment and income.

PRE-TESTED TRAINING FOR YOU

For 35 years *National Schools*, recognized leader in Trade Instruction, has helped wide-awake men to success. Transportation allowance offered from any point in U. S. without extra cost. Earn room and board while learning. More than 35,000 graduates have been assisted. Established 1905. This million-dollar Trade School will supply you with a sincere, honest statement of facts about the opportunities in Diesel, Automotive and Mechanical Fields and show how you can earn more pay. No exaggerations; no misstatements. Pre-tested, easy-to-learn methods.

SEND TODAY FOR FULL DETAILS

Amazing facts are yours for the asking. Simply mail the coupon for free literature. No obligation.



TRAINED MEN

get **TOP PAY** Jobs

Diesel Industry
Diesel Servicing
Auto Industries
Power Plants
Machine Shops
Aircraft Plants
Mining and Marine
Mechanical Depts.

NATIONAL SCHOOLS

LOS ANGELES, CALIF.

FREE

Literature
Mail
Coupon

Complete Training in
Diesels and Gas Engines
Auto and Machine Shop Practice

Oldest Trade School in West
Mail Coupon for **FREE** Literature

Request for Free Literature

NATIONAL SCHOOLS, Dept. PMA-3
4000 South Figueroa Street, Los Angeles, Calif.

Please send me, without obligation, your **FREE LITERATURE** and information about Diesel-Auto opportunities.

NAME _____ AGE _____

ADDRESS _____

CITY _____ STATE _____

WELDING

GET IN
LINE
FOR
**BIG PAY
JOBS**
IN

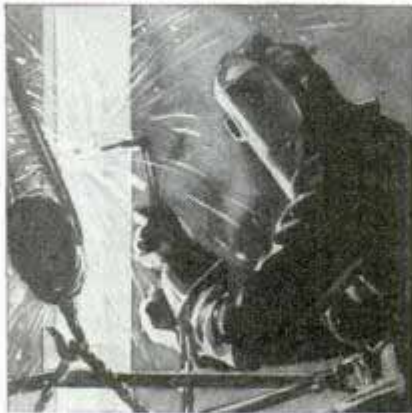

Today's Fast-Growing Industry

As steel and machinery orders increase, the welding industry—like any other new industry—faces the problem of getting capable, trained and certified code welding operators, technicians, engineers and mechanics. The application of gas and electric welding is almost unlimited—aircraft, diesel, automobile and building. Manufacturing, assembly and industrial plants insist upon men who are trained as expert practical operators—with a thorough knowledge of metallurgy as applied to welding.

Welding training offers an easy way to get into business for yourself—with little or no initial investment. Manufacturers of welding equipment will cooperate.

LEARN AT HOME—SHOP WELDING INCLUDED

By using Chicago Tech's new system of training known as the "Modified Oxford Plan" you can learn the basic facts about Welding, Metallurgy, Blue Print Reading, etc., at home in your spare time. Then, upon completion of the home section of your Course in Welding according to your enrollment agreement, you are brought to Chicago (transportation and room furnished by the College) for an intensified course of training in Chicago Tech's new welding shops where you gain actual experience with modern shop equipment under the guidance of expert welding instructors.

DAY and EVENING RESIDENTIAL CLASSES

If situated so that you can go to school at once you can start here any Monday. Train in modern shops—completely equipped. Only average school education is required. Modest budget terms. Investigate! Send for full information now.



Send post card or this coupon for this book that has helped thousands of ambitious men to win promotion and success through the use of time-saving methods of training.

MAIL COUPON TODAY

CHICAGO TECHNICAL COLLEGE

C-600 Tech Bldg., 118 E. 26th Street, Chicago, Ill.

Please send me without obligation free "Blue Book" on how to prepare for a better paying job in WELDING.

LEARN AT HOME under modified OXFORD PLAN Day or Evening Residential Classes

Name.....

Address.....

P.O..... State.....

AGE..... Occupation.....

Say you saw it in Popular Mechanics!

SECRETS ENTRUSTED TO A FEW



The Unpublished Facts of Life

THERE are some things that can not be generally told—*things you ought to know*. Great truths are dangerous to some—but factors for *personal power* and *accomplishment* in the hands of those who understand them. Behind the tales of the miracles and mysteries of the ancients, lie centuries of their secret probing into nature's laws—their amazing discoveries of the *hidden processes of man's mind*, and the *mastery of life's problems*. Once shrouded in mystery to avoid their destruction by mass fear and ignorance, these facts remain a useful heritage for the thousands of men and women who privately use them in their homes today.

THIS FREE BOOK

The Rosicrucians (not a religious organization), an age-old brotherhood of learning, have preserved this secret wisdom in their archives for centuries. *They now invite you to share the practical helpfulness of their teachings*. Write today for a free copy of the book, "The Secret Heritage." Within its pages may lie a new life of opportunity for you. Address Scribe L.F.T.

The ROSICRUCIANS
(AMORC), SAN JOSE, CALIFORNIA, U. S. A.

EARN A DEGREE AT HOME

From A Chartered Institution Of Higher Learning
Employers Now Demand College Graduates With Degrees

88 Degree Courses in Art; Sciences; Philosophy; Education; Psychology; Public Health; Sociology; Physics; Chemistry; Pol. Science; Theology; Law; Business Training; Accounting; Statistics; Adv.; Sales; Agriculture, Electrical, Mechanical, Civil, Structural, Diesel, Architectural, Mining, Drafting, Automotive, Aeronautical, Radio, Refrigeration, Highway, Marine, Air Conditioning, Geology, Petroleum, Industrial, Chemical Engineering. Founded 1908. 170 p. Catalog Free. McKinley-Roosevelt Graduate College, 4750-F Sheridan Road, Chicago



Send for my book how to develop
STRONG ARMS and BROAD SHOULDERS **ONLY 25¢**

With 20 full pages of illustrations, showing and fully describing exercises that will quickly develop, beautify and make you gain great strength in your Shoulders, Arms, Wrists, Hands and Fingers, without any apparatus. This is really a remarkable course of Physical Culture Exercises. Don't fail to send for it NOW—25c coin or 30c U. S. Stamps.

PROF. ANTHONY BARKER
1235 Sixth Ave. Dept. B New York City

WANT A GOOD PAY JOB?

Learn Tool and Die Making, Machinist Trade, Screw Machine work. Earn as much as \$50-\$60 per week. Learn by actual work in one of America's best equipped shops. Training supervised by experts. State certified. Day-Evening classes. Enter any time. Low tuition fee, employment help. Write FREE NOW for booklet "Practical Machine Shop Training."

ALLIED SCREW MACHINE CO., Inc.
School Division
Dept. PM-3 503-9 W. Lake Street, Chicago, Ill.



PLAY A SAW!

Produce wonderful music in 5 days... quickly play popular and classical numbers. No notes to read, no dreary practice — success guaranteed. Since 1924 thousands of my students have amazed friends, starred in shows and broadcasting orchestras. Without obligation, write for 5 DAY TRIAL OFFER now.

MUSSEHL & WESTPHAL
144 W. Water St., Fort Atkinson, Wis.

New York Electrical School
Established 1902
Ask for free illustrated booklet

44 West 17th St., N. Y. C.

LEARN MONEY-MAKING CARTOONING

by America's most famous method. Hundreds of successes! Start today—soon draw for pay. Rush 10c for details and big Picture Chart to test your ability (state age).
THE LONDON SCHOOL, 1039 National Bldg., Cleveland, Ohio



Learn to play..

Easy lessons at home. Inexpensive. 132-page Music Dictionary FREE when you enroll. Stop lessons when you like. Money back guarantee. Write for free details. **Hermann Institute**, 3016 N. 24th Place, Dept. R-15, Milwaukee, Wis.

Hawaiian Steel Guitar
Spanish Guitar
Piano

DIESEL

Maximum training minimum time; practical and theoretical. Modern equipment, experienced teachers. Personal instruction. 40th year. Catalog free. Residence course in three months.
FINLAY ENGINEERING COLLEGE, 10th & Indiana, Kansas City, Mo.

SURE ROUTE TO HAPPY-LAND MAIL TODAY SURE

J. C. DEAGAN, Inc., Dept. 4453
1770 Berceau, Chicago

Without cost or obligation, tell me about the easy-to-play DEAGAN MARIMBA... its sensational rise in the music world... the fun it provides at parties... the opportunities for radio, stage and dance-band fame.

EASY TO PLAY

Name—Please PRINT

Address

Have You FALLEN BEHIND on getting ahead?

If so, don't let today's great Aviation opportunities get away from you. Just consider the record of Aero ITI-trained men... over 700 have entered Aviation in the last year alone... over 250 have been placed with a single famous aircraft plant. For these men Aero ITI training opened the door to careers in aircraft production, aircraft maintenance, and aeronautical engineering. Choice of three courses in Aircraft Mechanics, two in Aeronautical Engineering. You can take full time training at the school or start your course at home. Find out about Aviation careers and Aero ITI training... send for details NOW.

Aero Industries Technical Institute
5253 West San Fernando Road, Los Angeles, Calif.

Aircraft Mechanics... Aeronautical Engineering
Offering U. S. Civil Aeronautics Authority Approved
12 Months Aircraft Mechanics Training.

EXECUTIVE BOARD

C. A. VAN DUSEN Vice-Pres. Consolidated Aircraft Corporation	JOHN K. NORTHROP President Northrop Aircraft, Inc.	ROBERT E. GROSS Pres. Lockheed Aircraft Corporation
---	--	--

AERO INDUSTRIES TECHNICAL INSTITUTE

5253 West San Fernando Road, Los Angeles, California

Please send information on Aviation careers and Aero I.T.I. courses. I am interested in the branch of Aviation checked below:

Aircraft Mechanics Aeronautical Engineering
 Undecided. Please send more information.

Name _____ Age _____

Address _____

City _____ State _____ a-22-p

Do you want

- .. to go to College?
- .. or to enter a Profession?
(Such as Accounting, Architecture, Nursing, Dentistry, Teaching, Social Work, Osteopathy, Beauty Culture, Optometry, Embalming, Chiropractic, Law, Medicine, etc.)
- .. or get an Office Position?

To get anywhere, you practically MUST finish High School FIRST. You can complete our simplified High School Course in SPARE time at home, as FAST as your time and abilities permit. Equivalent to resident school work—prepares you for college, pre-professional examinations, business, industry. Standard texts furnished. Diploma. Credit for H.S. subjects already completed. Single subjects if desired. Low tuition, easy terms. American School, Chicago, est. 1897—endorsed by educators. Finish your high school education NOW. Write TODAY!

High School Course at Home **Many Finish in 2 Years**

American School, Dept. H345, Drexel Ave. at 58th St., Chicago, Ill.

Gentlemen: Send me FREE information covering special training in subjects checked below. No obligation on my part.

- | | |
|--|---|
| <input type="checkbox"/> High School Course | <input type="checkbox"/> Diesel Engineering |
| <input type="checkbox"/> Accounting and Auditing | <input type="checkbox"/> Drafting and Design |
| <input type="checkbox"/> Architecture and Building | <input type="checkbox"/> Liberal Arts |
| <input type="checkbox"/> Automotive Engineering | <input type="checkbox"/> Private Secretary |
| <input type="checkbox"/> Business Management | <input type="checkbox"/> Mechanical Engineering |
| <input type="checkbox"/> Aviation | <input type="checkbox"/> Radio and Television |
| <input type="checkbox"/> Electrical Engineering | <input type="checkbox"/> Salesmanship |
| <input type="checkbox"/> Elec. and Gas Refrigeration | <input type="checkbox"/> Business Law |
| <input type="checkbox"/> Air Conditioning | <input type="checkbox"/> Retail Merchandising |

Name _____

Address _____

FINANCIAL INDEPENDENCE from POULTRY BATTERIES

A Penny Postcard Will Bring
You the COMPLETE STORY

Write Today for FREE 64-Page Text Book
on Scientific Poultry Raising . . .

"BUILD YOUR OWN REAL SOCIAL SECURITY"

Read this book and start a Battery Poultry Plant in Your Garage, Barn, Old Chicken House, Woodshed, Loft, Dry Cellar, Attic, or a Spare Room in Your House—for Quick Returns and Big Profits. Produce Fresh, Germless, Chemically Pure Eggs, and Fancy-Grade Tender Broilers and Roasters the Year 'round, at Low Cost and Spare-Time Labor. Retail them at Fancy Prices in Your Neighborhood or Community, to Families, Hotels, Clubs, Restaurants, Hospitals, or in High-Class Stores.



A 12-Hen Battery Laying Unit—Requires No More Space Than a Refrigerator

Clean, Sanitary, Profitable

The ARNDT Battery System has made poultry raising clean, healthy, and attractive to energetic persons who seek security and independence in dignified and progressive occupation. All-metal cages are arranged in batteries, with feed and water pans attached, and mechanical cleaning devices make neatness, order, and sanitation easily accomplished without excessive labor, or expense, or sacrifice of time. No outdoor yards are used, and climatic and weather conditions don't affect the system.

YOU ARE CORDIALLY INVITED

TO VISIT the ARNDT Model Demonstration Farm, 2759 Nottingham Way, in Mercerville, near Trenton, N. J., any day, between 9 A.M. and 5 P.M., and see 15,000 to 20,000 chickens of all ages, in development and production, in a completely equipped commercial battery poultry plant, on less than 1/2-acre of land.

Ambitious, Energetic Men, Women, Boys, and Girls,



An ARNDT Egg Factory Filled with Healthy, Contented Layers

without experience or previous knowledge of poultry, build profitable enterprises at home. Many have started such plants for temporary occupation and financial aid, and found careers for life.

Figure It Out For Yourself

2 1/2-lb. Broilers from Day-old Chicks in 10 weeks; 200 Eggs, or more, per year from every laying hen, with Steady Income and Handsome Profits, on Smaller Investments than are required for any other practical business which yields equal returns and profits.

Write Today for 64-page Illustrated Text Book, with All Particulars of the System. No Obligations.

MILTON H. ARNDT Dept. 45 Trenton, N. J.
P. O. Box 909

don't WORRY

Why put up with years of needless discomfort and worry? Try a Brooks Automatic Air Cushion. This marvelous appliance permits the opening to close, yet holds reducible rupture securely, comfortably—day and night. Thousands report amazing results. Light, neat-fitting. No hard pads or stiff springs to chafe or gouge. Made for men, women and children. Durable, cheap, **Sent on trial** to prove it. Never sold in stores. Beware of imitations. Write for Free Book on Rupture, no-risk trial order plan, and proof of results. All correspondence confidential. **BROOKS COMPANY, 457-C State St., Marshall, Mich.**



MONEY MEN ALL FREE

THE PLASTEX Industry needs manufacturers on small scale and for big production of Lamp and Clock Stands, Art Goods and Novelties in Plastex and Marble imitation. Experience unnecessary. 1/2c material makes regular 10c store sellers. Rubber moulds furnished for speed production. Small investment brings big returns. BIG CHAIN STORE orders now being placed. Ambitious men have chance for real prosperity. Our FREE booklet will interest and benefit you. **PLASTEX INDUSTRIES, Dept. P, 1085 Washington Ave., New York, N.Y.**

CARTOONING PAYS WELL

Exclusive instruction by a famous cartoonist makes it easy to learn at home. Write for Free Booklet describing details of the course.

NATIONAL SCHOOL OF CARTOONING
437 Penton Bldg. Cleveland, Ohio

PICK THE JOB YOU WANT

TRAIN TO QUALIFY FOR RADIO-TELEVISION

Have you a job or do you seek one? In either case, National Schools can definitely help you. Without giving up present employment you can get practical preliminary training; then receive intensive shop instruction at school at no extra cost. Every branch taught—Radio, Television, Broadcasting, Sound, etc. Oldest trade school in West.

Get the facts. No mis-statements. Learn about this flexible plan to fit your needs.

NATIONAL SCHOOLS FREE LITERATURE POSTPAID

MAIL COUPON FOR DETAILS

NATIONAL SCHOOLS, Dept. PMR-3
4000 South Figueroa Street, Los Angeles, Calif.

Request for Free Literature on Radio and Television.

NAME _____ AGE _____

ADDRESS _____

CITY _____ STATE _____

See mail afterward - 7/14/42
 FREE
 Steady Income-Part or Full-Time Employment No Age Limit
 A 10-Acre Poultry Farm on a City Lot
 \$2000 Profit from Egg Factory on Space 20x50ft
 9000 Broilers in Year from Backyard Plant
 New Book Explains Amazing Method
 Social Security

AVIATION Wants More LINCOLN TRAINED MEN

This Lincoln Government Approved School of Aviation wants to immediately get in touch with men interested in preparing for good-pay positions with Airlines, Airports, Airplane Manufacturers. Huge expansion program calls for thousands more trained men. **BE A PILOT.** Prepare here for your official Government Pilot Rating. 14 Training Planes; Learn night, blind, beam and cross-country flying. **BE AN AERONAUTICAL ENGINEER.** Learn to design and build airplanes. Big pay opportunities for well-trained Aero Engineers. **BE AN AIRPLANE MECHANIC.** Students here get real experience in Airplane and Engine Maintenance, Overhaul, rebuilding and repair. Training prepares for Gov't. Mechanics Rating and immediate employment with Airline, Airport or Factory. We assist Graduates in locating employment. 135 Graduates recently placed with leading companies. Now offering part-time employment for board and room while in training. **WRITE TODAY** for complete information.

LINCOLN AIRPLANE & FLYING SCHOOL
573 Aircraft Bldg. Lincoln, Nebraska

LEARN MECHANICAL DENTISTRY. SEND FOR FREE BOOK

Be A Dental Technician
Learn how to make Crowns, Bridges, Plates in this oldest school, licensed by the State of New York. 5,000 feet up-to-date equipment. Day and Evening Sessions. Easy terms. Write NOW for free catalog P and tool offer.

N. Y. School of Mechanical Dentistry
125-127 West 31st Street, Dept. 9, New York City



CARTOON YOUR WAY TO SUCCESS!

DON'T COPY - LEARN TO ORIGINATE!
RAYE BURNS will teach you HOW to CREATE ORIGINAL CARTOONS at home that you can SELL! Course has 26 lessons and 600 illustrations. Send name and address for free details. Only... **\$285**

RAYE BURNS SCHOOL, Dept. M-9, Box 2194, CLEVELAND, OHIO



AUTO

BOOKS SENT FREE

on approval. Just mail the coupon and we'll send you a set of these remarkable auto books, 19th edition. Whether you are a mechanic or helper, expert or apprentice, auto owner or driver, if you're interested in knowing all about automobile mechanics, take advantage of this **FREE EXAMINATION OFFER.**

GET A BETTER JOB

A better job—in the gigantic auto industry. **BIGGER PAY**—a chance to go into business for yourself and get a share of the huge profits, are waiting for any man who even half tries to improve himself. Learn auto engineering with these wonder books a new way—a quick reference method. Simply use the **JIFFY INDEX** to look up the answer to auto problems. Built by several great automobile engineers, and written in simple language so you can understand it.

6 BIG VOLUMES
19th Edition
2500 pages, 2000 illustrations, wiring diagrams, etc., including Marine Engines, Aviation Motors, Diesel engines, etc. De Luxe edition, gold-stamped flexible binding.

Privilege of consulting Automobile Engineers of American Technical Society for one year without cost if you mail coupon immediately.

Send promptly and we will include an **EXTRA** volume with over 300 pages including wiring diagrams and data sheets.



CAN YOU FIX IT?
These wonder books tell step by step HOW to take out "play" in differential—to kill the shimmy in steering—to set **TIMING**—how to put your finger on engine trouble and the expert way to **FIX** it.

AMERICAN TECHNICAL SOCIETY
Drexel Ave. & 58th St., Dept. A319, Chicago, Illinois

I would like to see the 6-volume edition of your **AUTO BOOKS**. I will pay the few cents delivery charges only, but if I choose to, I may return them express collect. If after 10 days use I prefer to keep them, I will send you \$2 and pay the balance at the rate of only \$3 a month, until \$24.80 is paid. Please include consulting membership and extra Volume No. 7, as per your offer above.

Name.....
Address.....
City..... State.....
Please attach letter stating age, occupation and name and address of employer and that of at least one business man as reference.

Prepare at Home for JOBS in



With this expert drawing outfit—drafting table, drawing board, superior drawing instruments... all sent without additional cost, you are all set to learn **DRAFTING AT HOME**. **FREE TRIAL LESSON** shows how easy. Mail coupon.

YOUR DRAWING OUTFIT

DRAFTING

The draftsman's work comes first. When business improves... and it is improving... there is new construction work, new buildings, new machines, repairs and reconstruction work. All these must first be laid out on paper. So the **FIRST** man that must be hired is the **DRAFTSMAN**.

Drafting Is Well-Paid Work

Drafting is clean, interesting professional-type work. It pays well to start... offers real opportunities for promotion. You need no previous training or experience... no special talent—to learn Drafting. It is one of the steadiest employment fields. No machine ever did the Draftsman's work... and no machine can be invented to do it.

Learn AT HOME

in your spare time (or at the College in Chicago) by the fascinating, easy, step-by-step plan originated by this 36-year old school for Draftsmen.



Free TRIAL LESSON

Sample this easy-lesson system of learning Drafting. Send postal card or this coupon. No charge now or later for this **FREE LESSON**. Prove to yourself how easy it is to learn Drafting by the C. T. C. method in your spare time right in your **OWN HOME**.

CHICAGO TECHNICAL COLLEGE

C-201 Tech Bldg., 118 E. 26th Street, Chicago, Illinois

Please send me **FREE Trial Lesson** in **DRAFTING** and show me how I can prepare for good positions in spare time **AT HOME**.

Name.....Age.....
Address.....
P. O.....State.....

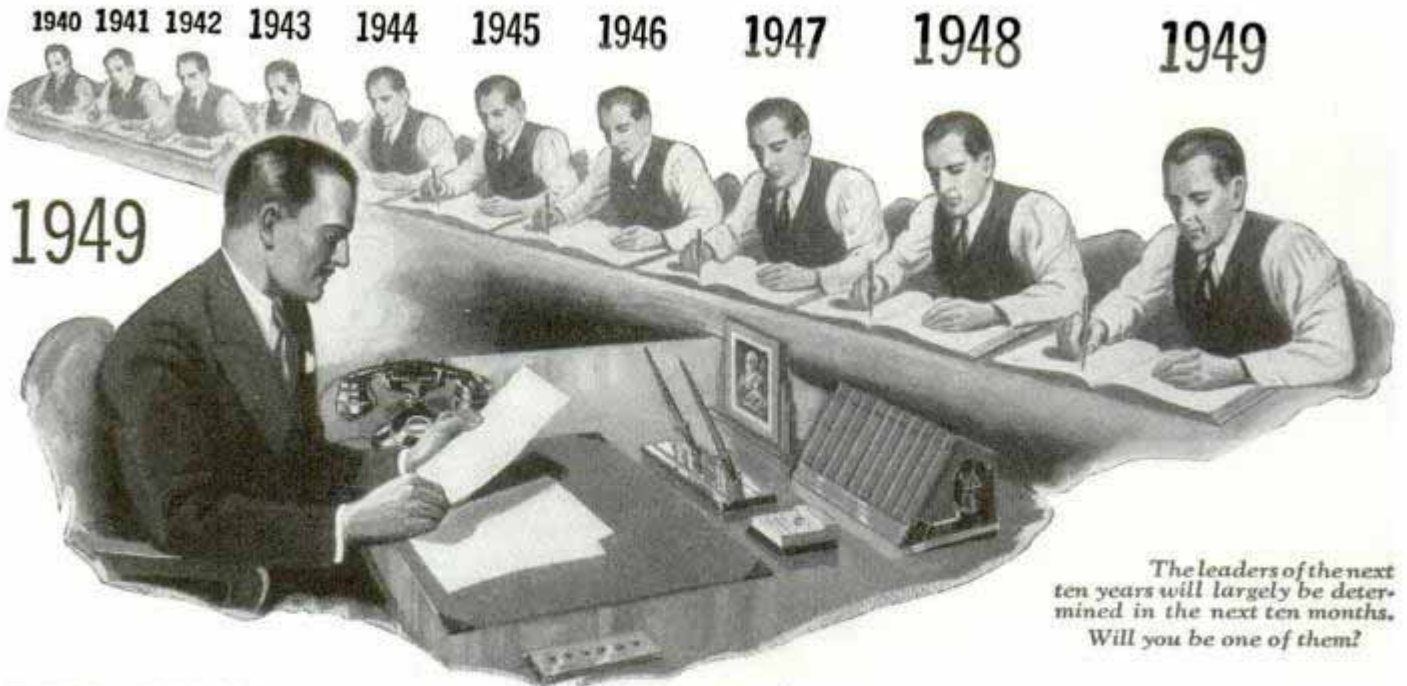

The leaders of the next ten years will largely be determined in the next ten months. Will you be one of them?

Will You Be Clerk or Manager Ten Years from Now?

"SURELY, this could never happen to me," you say—"that I should be sitting at the same desk—be doing the same work—for ten straight years!"

But wait a minute—
Exactly that same thing has happened to thousands upon thousands of men. It has probably happened to men right in the company you now are working for. And—unless you fit yourself for a better job—there is a very good chance that it may happen to you!
Unthinkable? That's what J. N. Dixon of Columbus, Ohio, said to himself. Yet lack of training kept him slaving away at low wages for a long time.

TRIPLES INCOME

Here is Mr. Dixon's own story—"Just after I returned from the war, one of your representatives found me plugging away at a bookkeeper's job in Marietta, Ohio. He performed a real service and explained to me the need of further training, and induced me to take the LaSalle training in Higher Accountancy. After a few months of study, I secured a position with the Trust Department of a National Bank. This was the stepping stone I needed to various responsible positions including handling of receiverships and other important duties. That quickly boosted my income several hundred percent."

ANOTHER AMAZING SUCCESS STORY

If you think Mr. Dixon's success story too unusual read what J. H. Krouse of Memphis, Tennessee, says. "When I decided to take your training in Higher Accountancy, I was a clerk. Today I am Chief Consultant Accountant for the U. S. Engineer's Office in Memphis, Tenn. Whatever success or recognition I have had, I owe to your training. I have had no other specialized training along this line. Your method of teaching is not only instructive but highly engaging. I have observed other courses, but firmly believe LaSalle has the best to be had anywhere."

Another bit of evidence is Mr. R. P. Barthalow's experience. Mr. Barthalow is Chief of the Sales Tax Section of the Tax Commission of Ohio, a department which handles over \$50,000,000 a year. Mr. Barthalow attributes much of his success to LaSalle training.

SEND FOR These Two Books and Start Toward Bigger Success

Need you hear more before you investigate the opportunities in Accountancy?

Or will you face the problem of your future NOW—and send to LaSalle and get further facts and particulars?

Without cost or obligation, the coupon will bring you two interesting books—one a 48-page book entitled "Accountancy, the Profession that Pays"; the other "Ten Years' Promotion in One."

How about those next ten years—will you wait or will you START TODAY to realize the tremendous opportunities that may lie ahead of you through sound and practical home-study business training?

Measure your grit and ambition by what you do with this coupon—NOW.

LaSalle Extension University A CORRESPONDENCE INSTITUTION

Dept. 364-HR CHICAGO

Opportunities in Accountancy—Check below and we will send you a copy of "Accountancy, the Profession that Pays," also copy of "Ten Years' Promotion in One," all without obligation.

Higher Accountancy: Leading to position as Auditor, Comptroller, Certified Public Accountant, Cost Accountant, etc.

Other LaSalle Opportunities: If more interested in one of the other fields of business indicated below, check that.

- | | | |
|--|---|---|
| <input type="checkbox"/> Business Management | <input type="checkbox"/> Traffic Management | <input type="checkbox"/> Stenotypy |
| <input type="checkbox"/> Expert Bookkeeping | <input type="checkbox"/> Law: Degree of LL. B. | <input type="checkbox"/> Business English |
| <input type="checkbox"/> C. P. A. Coaching | <input type="checkbox"/> Industrial Management | <input type="checkbox"/> Commercial Law |
| <input type="checkbox"/> Modern Salesmanship | <input type="checkbox"/> Modern Business Correspondence | <input type="checkbox"/> Effective Speaking |



Name _____ Age _____

Present Position _____ Address _____

**WORLD'S
BEST
WANT AD
MEDIUM**

CLASSIFIED Advertisements



Advertisements in this section, 35 cents per word, each insertion, minimum 10 words, payable in advance

To be inserted under proper classification in April issue, copy should be in our office February 8th

April issue on sale March 1st

Popular Mechanics Magazine, 200 East Ontario Street, Chicago, Illinois

YOU'LL PROFIT

By reading and answering the classified ads in this section. Hundreds of opportunities to make and save money.

Popular Mechanics Magazine,
Chicago, Illinois.

Dear Mr. Johnson: It is with pride that we state, that Popular Mechanics Classified Advertisements have brought us twice the amount of replies, as did five other well known publications at a cost of only one-fourth of what the other publications cost us. This is a fact, as we have keyed all our advertisements. There is no doubt in our minds that the Popular Mechanics Classified Advertising is the best advertising medium in the world. We need no longer experiment, it is already difficult to fill all our orders and we are now seeking larger quarters.

(Original letter on
file in our office)

Very truly yours,
BARRON & JENSEN COMPANY.

AUTOMOBILES—MIDGET CARS

NEW Fifth edition Automobile Racing Book. Tells how to build dirt track bodies, frames, engines. Records, superchargers, rules, formula, plans, stock conversions, roadster racing, fast Fords. \$1.00 postpaid; \$1.15 C.O.D. Ray Kuns, Department 15, Madisonville, Cincinnati, Ohio.

MIDGETS! Builder's supplies—builder's prices. Catalog—planbook, 10c. Late lists 130 used motors, midgets, parts, 20c. Circulars on request. Midgets, Box 543-H, Zanesville, Ohio.

GARAGE Owners and mechanics purchase direct at full factory discount Triple-X Alloy Steel self-locking piston rings. Nationally distributed. Guaranteed performance. Stops oil pumping. Saves gasoline. Re-boring unnecessary. Write for sample and details. Triple-X Co., 3801 S. Racine, Dept. 103, Chicago.

MIDGET Racers, two-passenger roadsters, midget motorcycles. Complete line motors, wheels, parts, kits. Handbook catalog, 90 illustrations, 20c. Midwest, Box 1959-S, Chicago.

RECONDITION Your motor with Mineralite! Increases compression! Checks oil waste! Formula, instructions 50c. H. Devereaux, Box 212, Battle Creek, Mich.

MIDGET Racers, frames, bodies built by AAA driver, Frank Smith, Preakness, N. J.

MIDGET Cars, supplies. Plans 50c. Catalog 10c. Derby Midgets, Woodstock, Illinois.

AUTOMOBILE Superchargers \$3. Guaranteed mileage increase 20%; power 10%. University of Detroit test. Any car; give make, year. Wrench installs 15 minutes. John Hanley, Manufacturer, 5719 Loraine, Detroit, Mich.

AUTO SUPPLIES AND EQUIPMENT

AUTO Mechanics, replace connection rods, new simple way. Plans for tool 15c. A. C. Hranicka, New Richmond, Wisconsin.

NEW invention prevents 90% electrical troubles. Poolproof. 50c postpaid. Distributors wanted. Pontus Manufacturing, 978 Broadway, East Providence, R. I.

"DRY-LUBE" Tablets. New super lubrication. Seals compression—reduces friction—saves gas, oil. More power, pep. Easier starting. Guaranteed. 200-mile sample 10c. Reardon Products, Box 682, Peoria, Ill.

BARGAINS—Compressors, welders, battery chargers, car washers, attractively priced. Terms, trial. Write for bargain list. Hobart Automotive Supply, Box M-3405, Troy, Ohio.

1940 **IGNITION** Supercharger. E. G. Sales & Mfg. Co., New York.

PATENTED Rear axle studs for Chevrolet, Ford and Dodge trucks. Welcomed by automotive trade. Liberal commissions. Write for selling offer. Demonstrators, literature and order book, 25c sent postpaid. Speed Products Company, 1375 N. Highland Ave., Atlanta, Ga.

PLATING Outfits for auto parts. Connect to a battery. No tanks used. Free particulars and proofs. Gunmetal Co., Ave. J, Decatur, Ill.

ANTIFREEZE. Similar to best. Formula 30c. Practical Methods, St. Paul, Minn.

AUTO TRAILERS

ECONOMY House trailer; completely equipped for \$375. Independent wheel suspension unit \$35. Write for catalog. Trotwood Trailers, Inc., 803 Main St., Trotwood, Ohio.

BUILD Your house trailer from our K.D. parts. Arrowcraft Coaches, St. Johns, Mich.

BUILD The famous, low-cost Jim Dandy Cabin Trailer. Complete plans and instructions 50c. Plans to build the beautiful, streamlined Jim Dandy Cabin Cruiser, \$1.00. Trailer Builders Manual and catalog of trailer parts, supplies and equipment—over 100 interesting, illustrated pages, 25c. Order today. Satisfaction guaranteed. Trailer Supply Co., 411-A Jackson St., Wausau, Wisconsin.

MOTORCYCLES, BICYCLES, MOTOR SCOOTERS AND SUPPLIES

MOTORCYCLISTS. Let's get acquainted. We can save you money on parts and accessories. List free. Triangle, 1111 Washington, Chicago.

MOTOR Marvel ready! Mead's sensational new Ranger Scooter goes 120 miles per gallon, 35 m.p.h., ride, rent or sell for profit, pleasure. Dealers, agents write for special introductory offer, easy terms, free circular. Hurry! Mead Cycle Company, Dept. G-1, Chicago.

BUILD Power scooters, midget cars. We supply tires, wheels, motors. Lowest prices. Send 10c for plans, etc. Build-Ur-Own Devices, Dept. 3-A, 536 North Parkside, Chicago.

SEND 10c For catalog new and used parts. Bootz, 622 East Grand, Des Moines, Iowa.

BICYCLE Electric headlight generator \$2.00. Eliminates batteries. Never runs down. Electro-Mechanical, Scottsville, New York.

MOTORIZE Your bicycle with Midco 4-cycle power unit. Fits any standard bicycle. Send dime for circular and price. Midco Manufacturing & Distributing Company, South 13th and Kentucky Avenue, Sheboygan, Wisconsin.

BIKE Generators. Highest quality. Lowest prices. Electrical Products Co., Kendallville, Indiana.

SAVE 70%. Thousands assembling own Comet scooter. We supply parts, tires, engines. Literature, drawing 10c. Comet Cycle Co., Box 3032, Madison, Wisconsin.

MOTORSCOOTERS. Midget cars! Easily built. Complete plans and literature on motors, wheels, tires, attachments for motorizing bicycles, etc. 10c. Honsakers, Masontown, Penna.

BICYCLE And parts catalogue free. Coupon for identification plate with your name engraved in gold. Fastens to bicycle. Krause Supplies, St. Clair Shores, Mich.

MIDWEST'S Speedy motorscooter sensationally easy to build. Steel kit only \$3.95. Catalog—90 illustrations—20c. Midwest, Box 1959-AA, Chicago.

KNUTH'S Motorcycle bargains. Lowest prices. Bulletin 10c. Prompt service on repairs, parts, accessories. Harley-Davidson factory dealer, Knuth's, 2491 Fondulac, Milwaukee, Wis.

1-1/3 H.P. Engines suitable for scooters, cars, boats. At only \$14.95. Clear-Vue Company, Dayton, Ohio.

ALLOY Pistons \$3.00—Harley, Indian, Henderson, Excelsior, Cleveland. Cylinder grinding, rings, bearings, gaskets, chains, sprockets, helmets, goggles, accessories, parts new and used for less. Catalogue and wings pin 10c. Ballak, 1115 Chestnut, St. Louis, Mo.

MOTORCYCLES. Reconditioned. New, used, parts and accessories. All makes. Large stock. Bargains. Illustrated catalogue, 15c. Indian Motorcycle Sales, Kansas City, Mo.

INSIDE Dealer prices. Overstocked, all models. Indians and Harleys. Rebuilt, guaranteed. Dime brings latest list. Crandall-Hicks, Boston, Mass.

MOTORCYCLE Bargains, lowest prices, bargain sheets for stamp. Motorcycle accessories. Rochester Harley Davidson Corp., 129 W. Main St., Rochester, N. Y.

RECONDITIONED Motorcycles. New—used parts for all makes. Authorized Harley-Davidson dealer. Whitman Motorcycle & Supply Co., 405-9 Southwest Blvd., Kansas City, Mo.

AVIATION

PROPELLERS For airplanes, ice, snow sleds, boats, fans, dehydrators. Hubs, face-plates, snow sled skis. Catalog 10c. Banks Propellers, Hangar No. 4, Love Field, Dallas, Texas.

AIRPLANE Manufacturers want mechanics, sheet-metal men, welders. Get your application in now. My list of 75 airplane companies shows names of men to contact about employment. Send 25c (no stamps) to Airlists, Box 1406, Lincoln, Nebraska.

PROPELLERS: All types, airliner three blade leading, get our prices first. Famous 98 Trainer two place blue prints \$4.95, supplies, list free. Standard Aero-Craft, Ft. Worth, Texas.

PROPELLERS: Three blade Airliners and propellers for airplanes, ice boats and other purposes. Correctly built and popularly priced. Prompt service. Specifications sent free. Universal Aircraft Co., Inc., Fort Worth, Texas.

AVIATION Apprentices — Air-minded young men interested in training for entering aviation as apprentices see ad on page 29A.

IDENTIFY Yourself with aviation! Send this dime for huge new illustrated catalog listing 1308 exclusive personal aviation items, jewelry, gadgets, etc., at attractive prices. Send dime today to Karl Ort, Dept. 50, York, Penna.

BUILD. Fly your own motorcycle powered monoplane, home. Easy, cheap. Tested plans \$1.00. Aerotech, Box 7320, Pittsburgh, Penna.

JUST Out—A practical course in flying, 29 chapters, only \$1.00 complete. Aircraft Directory, Athens, Ohio.

AERO Blue Book gives specifications 400 airplanes, 200 engines; illustrations; approximate cost many used planes; other valuable information. Send \$1.00. Aircraft Company, Arcade Bldg., St. Louis, Missouri.

100 AIRPLANES \$50 Up. Terms, trades, Crackups, motors, salvage. Big winter catalogue 25c. Used Aircraft Directory, Athens, Ohio.

LEARN To fly free. Folder, dime. Ohmeyer, Box 391, Hempstead, N. Y.

PROPELLERS For airplanes, sleds, Ice- sled blueprints, supplies. Catalog dime. Lorenzen Propellers, Niles, Michigan.

GET Into-aviation! Wonderful opportunities open! Big money paid! Prepare at this Lincoln government approved school for position as pilot, mechanic or aeronautical engineer. We assist graduates in locating positions. Part-time employment for board and room while training. Write today for complete information. Lincoln Airplane & Flying School, 2006 Aircraft Bldg., Lincoln, Nebraska.

BATTERIES, GENERATORS, ETC.

12 VOLT Heavy duty generators \$8.50. Save money on new, used automotive electrical parts; free catalog. State Ignition, 52 Cullerton, Chicago.

PROPELLERS \$1.50 Up. Postpaid. Information 10c. Beacon Mfg., Minot, N. Dak.

500 WATT, 110 Volt alternating current generators \$22.50. Other bargains. Electrical Surplus Company, 1885 Milwaukee, Chicago.

EDISON Storage batteries for light-power systems. Non-acid. Odorless. fifteen year life. Five year unconditional guarantee. Bargains in complete lighting systems. Low prices. Free illustrated literature. "See-Jay" Battery Co., 82 Sterling Ave., Yonkers, N. Y.

SEE Our display advertisement on page 135A. LeJay Manufacturing Co.

EDISON Lifetime storage batteries for light and power. Eliminate acid battery diseases. Long guarantee. All kinds rebuilt generating plants, motors, and miscellaneous articles at bargain prices. Free interesting literature. T. Hawley Smith Co., Croton Falls, N. Y.

ELECTRICAL SUPPLIES—EQUIPMENT

REBUILT Vacuum cleaners. Hoover \$19.95. Eureka \$14.95. Airway \$12.95. Year's guarantee. United Industries, 321 Broadway, Denver.

ELECTRIC Engraver, engraves all metals deeply, dollar. Hudson Bros., East Syracuse, N. Y.

BARGAINS—Arc welders, also motor generator. Write for new bargain list telling needs. Hobart Bros., Box M-3407, Troy, Ohio.

ELECTRO-SCRIBE: Electric pencil. Writes-engraves all metals \$1.00. Health Lamp: dual ray—ultra violet—infra red. Promotes sun-tan vitamin "D." Automatic—ac-dc current, \$3.90. Details. Beyer Mfg. Co., 4515-H Cottage Grove, Chicago.

ELECTRIC Eye, with wiring diagram, literature, \$1.00 postpaid. Photobell, Dept. 89, 123 Liberty Street, New York.

INEXPENSIVE Electric device tells when doors opened, violated or wires cut. Plans \$1.00. Kit \$2.50. Doctor Garcia-godoy, P.O. Box 1298, El Paso, Texas.

NEW Alnico bar magnets balance in mid-air (pair \$1.10). Horse shoe type lifts 50 times own weight \$1.00. Mechanics, Box 861, Minneapolis, Minn.

AIR CONDITIONING

FURNACE Blowers \$22.50. 13" wheel. Also larger sizes for cooling, air conditioning, 2,500 CFM to 30,000 CFM. \$47.50 to \$265.00. Variable speed control, belts and pulleys included. Reynolds Mfg. Co., Grand Rapids, Mich.

ELECTRIC FENCING

SEE Our display advertisement on page 133A. LeJay Manufacturing Co.

WELDING—SOLDERING—PLATING

LEARN Arc welding. It's easy—get big pay jobs—complete individual instruction at bare cost of materials used. Write for details. The Arc Welding School, Box M-3408, Troy, Ohio.

A.C. Welders, plans, material. Free literature. Holgerson's Service, Canton, Kas.

LOOK! Uses automobile battery! Solders, welds. Plans 20c. Paul Dickson, Beaconsfield, Iowa.

WELDING Equipment, demonstrator bargains. Request list. Hobart Welders, Box M-3404, Troy, Ohio.

BUILD Powerful a.c. welder with starter coils and \$5.00. (No winding). Line transformer makes 200A welder. Complete plans \$1.00. Information dime. Hi-Point Electric Products, Bellefontaine, Ohio.

CONSTRUCTION Plans for a.c. arc-welder 25c. Hanson, 4832 Rice, Chicago.

OXY-ACETYLENE Welding outfits, \$19.95; combination welding and cutting outfits, \$35.64; heavy-duty welding torch, with tips, \$11.25; light welding and sheet metal torch, \$7.50; acetylene generators, \$50.00. Superior Oxy-Acetylene Co., Hamilton, Ohio.

SEE Our display advertisement on page 131A. LeJay Manufacturing Co.

D.C. Arc-welder plans \$1.00 each (three for \$2.00). Build it yourself without re-winding armature. 25-200 amperes from farm light plant generators. 25-200 amperes from Northeast, Dodge automobile generators. 25-600 amperes from d.c. vehicle motors originally storage battery driven. Welders Club, AB-3432 M-Mart, Chicago. For sale: D.C. vehicle motors, supplies, etc.

REBUILT a.c. d.c. Arc welders, all sizes; engine governors, idlers. Terms. Low prices. Guaranteed. Service Co., 3732 Cedar Ave., Cleveland, Ohio.

WELDING And hundreds of money making and money saving ideas. 762 illustrations and 214 pages in 1940 Shop Notes, 50c. Popular Mechanics Press, Room C40, 200 E. Ontario, Chicago.

ENGINES, MOTORS, DYNAMOS

600 NEW Motor diagrams, tables, and controller connections for the practical electrician. Makes dual-voltage, multi-speed, star and Delta circuits clear and simple. Also includes all standard split phase, repulsion induction, compensated, series, two and three phase. Data for re-winding and reconnecting all types. Over 100 valuable tables. Money-back guarantee. Price \$2.00 prepaid. Educational Advancement Company, Lakewood, New York.

FIRST Class electric motors. We also rewind fractional h.p. motors. Rathbun Elec. Shop, Streator, Ill.

GOVERNORS, Auto engine, \$5.00 up. Agents. Candee, Llewellyn St., Los Angeles.

BARGAINS—Plating generators, motor generator sets, also arc welders. New low prices for large and small shops. Trial—easy terms if desired. Hobart Bros., Box M-3406, Troy, Ohio.

AIR Compressors 1 1/4 x 1 3/4 \$6.00; 2 x 2 \$7.00; 2 1/2 x 2 \$8.00; electric drills 1/4 in. \$5.95. Free folder. National, 1915 S. State, Chicago.

GASOLINE Engines, New 3/4 to 5 horse-power. Bargains. Hurry. Lonmopower, 347 North Crawford, Chicago.

CARBON Brush kit containing 144 assorted brushes, 62 springs and wicks, services 130 different fan, vacuum, etc., motors. \$9.25 complete. Reinhardt, 2295 Concourse, Bronx, New York.

MAKE Money, rewind auto generators, washing machine motors, construct arc welder, 10c brings particulars. Catalog material. Ernest Knight, LaSalle, Illinois.

SMALL Elect. motors, with flexible shafts \$3.25 postpaid. McConnell, 1619 Edgewood, Racine, Wis.

RECLEAN Used oil without cost. Particulars. F. Gerwin, Fairview, Okla.

RELIABLE Motor winding books, Lessons, connecting diagrams, winding data. Introductory data selection, \$1.00. Motor Data Co., Box 7631, Kansas City, Missouri.

ALTERNATING, 1/2 Horse, 110 volt, induction motors. Rebuilt, guaranteed, \$7.25. Wilmot Auto Supply, 2247 St. Paul Ave., Chicago.

THREE To ten KVA alternating generators. Motors, converters. State your needs. Queen City Electric, 519 South California, Chicago.

BARGAIN—1/2 Hp. motors, 60 cycle, 1 phase, 110 volt, like new, guaranteed, \$7.40. Send check to Erie Electric Motor Co., 120 Church, Buffalo, N. Y.

MACHINERY, TOOLS AND SUPPLIES

RALKSITE. New case hardening compound for all types iron and steel. Scientifically prepared. Produces clean hard surface of any depth or degree of hardness required. Ralksite process gives a better case, quicker. Positively eliminates usual after-hardening rust effect. Requires no special equipment, employs no unusual methods. Try this easy-to-use, amazingly efficient and economical case hardening compound on your next heat treatment job. Send \$1.00 today for full pound trial can with complete directions. Ralksite Company, 372 Classon Ave., Brooklyn, N. Y.

BUILD Your own machine tools. Castings and blue prints at nominal cost. Send 10c for 2 color 28 page catalog, 34 prints covering 12 metal-working projects, \$1.50. 23 prints covering 6 wood-working projects, \$1.00. Lewis Machine Tool Co., Dept. M-3, 1000 Alhambra Ave., Los Angeles.

GUILDER Complete miniature precision machine tool. All operations, 10c for complete information. Walter C. Guilder, 6 Kingwood Park, Poughkeepsie, N. Y.

1000 GADGETS!—Giant 10 pound kit crammed with valuable assortment of screws, bolts, nuts, washers, gears, springs, rivets, brackets, etc.—worth \$7.50, yours only \$1.98. Satisfaction guaranteed. Manufacturers Screw, 217-W Illinois St., Chicago.

KELLOGG Air compressors, \$6.00. Vacuum pumps, \$6.00. Taylor, 105 East 102nd Street, New York.

MILLING Attachments for 9" to 14" lathes, \$15.00 to \$20.00 F.O.B. Ryan Machine Shop, 742 Orange Ave., Long Beach, Calif.

DRILL Grinding attachment fits bench grinder, hand or power turned. Handles sizes 3/16 to 1 1/4". Price \$7.85. Descriptive literature on request. Tractor-Lite Co., Sidney, Iowa.

POWER Tool bargains, free list. Gardner Electrical Supply, Defiance, Ohio.

PLASTICS, Brass, aluminum, Dowmetal, monel, stainless steel, gears, etc. Catalog 10c. Hobby Supply House, Box 2014, Pittsburgh, Penna.

PROTECTENE Liquid metal-coater. Rust and tarnish preventive. Rapid drying. Removable with gasoline. Many uses. Can. 50c. Norma Chemical Co., Mount Vernon, N. Y.

CASH BUYERS of lathes, shapers, milling machines, presses, drills, electric motors, etc. Steinberg Machinery Company, 1132 Lake Street, Chicago, Illinois.

MILLING, Taper attachments, threading dials, 3" to 8" four jaw chucks, mica undercutter attachments, 8" face plates, turret boring bars, collet chuck attachments, for small lathes. Priced right. Unique Manufacturing Company, 4807 North 31 Avenue, Omaha, Nebraska.

BANDSAWS—New, Swedish steel; 20% discount. Re-sharpened 3c ft., re-welded 20c each; up. List free. Innes-Pirtko, Andover, N. J.

NEW 1/4 Hp. elect. motors \$8.80. Drills, grinders. Catalogue 10c. United Industries, 321 Broadway, Denver.

TREMENDOUS Surplus of factory tools selling out. Drills, taps, files, hacksaws, etc. Send for free lists, include six cents postage. Travers Tool Co., 264 Jackson Ave., Long Island City, N. Y.

14" x 6' GREAVES Klusman cone head engine lathe, quick change. No. 0 Cincinnati miller, cheap. Write for particulars. Cincinnati Machinery & Supply Co., 221 E. Second St., Cincinnati, Ohio.

REWINDING Motors and 330 other valuable articles in Shop Notes, Vol. 31—50 cents postpaid. Popular Mechanics Press, Room (C40), 200 E. Ontario St., Chicago.

BOATS, OUTBOARD MOTORS, ETC.

BUILD Your own boat with Bay City Prefabricated frames and materials. Save up to 2/3s. Lumber, fittings, engines and equipment. Send requirements for quotation. Illustrated catalog 100 boats 9 to 75 feet 10c. Bay City Boats, Inc., 1552 Adams St., Bay City, Mich.

BOATRAILABOUT Transports boats. Data for dollar. Brownbill Sailboats, Marblehead, Massachusetts.

GENUINE New Evinrude and Elito outboard motors now as low as \$26.50 (plus small transportation charge.) Down payment as low as \$6.00. Fifteen advanced 1940 models to choose from. Write for catalogs, boat directory and handy Boat-and-Motor Selector—all free! Address, Evinrude Motors, 4285 N. 27th St., Milwaukee, Wis.

KAYAKS. Biggest values! Safest! Easiest built! Address Playaks, Dedham, Mass.

BUILD Electric outboard from automobile generator. Smooth—quiet. Complete plans 10c. LeJay Manufacturing, 547 LeJay Building, Minneapolis, Minn.

BUILD Your own boat from our accurate patterns, materials, etc. Rowboats, outboards, inboards, cruisers. Send 10c for circulars. German Boat Company, Saginaw, W. S. Michigan.

BUILD A boat—Purchase parts from the Welch Company. 32 models ready to assemble by the famous Welch System. Send 10c for 32 page catalog; full of boat designs; marine hardware; motors and equipment. Write today for this interesting book. Welch Boat Company, Station K-1, Milwaukee, Wisconsin.

KAYAK Blueprint, complete details, instructions—50c. Viking Kanoes, Merrick, N. Y.

HYDROPLANE 13 Foot, speed above 50. Plans \$1.50. Descriptive circular 10c. Hofmeister, Overlea, Maryland.

TEN Plywood boat plans 50c. Free catalog boatbuilding plans. The Rudder, 15 Murray St., New York.

FORD-Mercury-Zephyr marine conversions. Catalog 10c. Lehman Engineering Company, Dept. D, Newark, N. J.

OUTBOARD Motors, all makes. Used motors and parts. Stamp brings motor list. Outboard Headquarters, 305 Atlantic Ave., Boston, Mass.

MARINE Power—Easily convert any Ford motor (domestic and foreign) with Osco parts and kits. Complete catalogue 25c (coin). Osmitson, 3644 Lawrence St., Philadelphia, Penna.

ASSEMBLE Your own boat. Our finished knock-down frames and materials save you 2/3 builder's cost. All types and sizes. Send 25c for big catalog. Brooks Boat Co., Inc., D4, Saginaw, Mich.

OUTBOARDS — Save 1/2. Good used parts, all makes and models. Bargains rebuilt motors. Crandall Hicks Co., 959 Commonwealth, Boston, Mass.

BOAT Designers are highly paid professionals. Complete course by mail. Catalog. Westlawn, Montville, N. J.

SPORTING GOODS, GUNS, FISHING TACKLE, ARCHERY

MAKE Your rods. Everything in tools and supplies. Finest quality. Satisfaction guaranteed. 10c (coin) 16p catalogue. A. H. Benner, 15020 Morgan, Harvey, Ill.

MAKE Your own flies, lures, rods. Instruction books; "Fly Tying," "Rod Making," each 10c. Materials catalog free. Wilpmarths, Roosevelt, N. Y.

FLY Fishermen! Get my book "Making and Using the Dry Fly." \$2.00 postpaid. Satisfaction guaranteed. Special get acquainted offer—14 fine quality dry flies, 10-12-14, \$1.00. New catalog 10c. Paul Young, 8065-C6 Grand River Ave., Detroit, Mich.

KRAG Speed action pleased gun editor. Magazine containing his report 10c. Your Krag remodeled same way \$5.00. Ken E. Clark, Madera, Calif.

TENNIS Strings direct from manufacturer at low prices! Rush postal for free complete price list gut and silk tennis, badminton, squash strings. Manufacturing gut strings since 1916—now selling direct to players, re-stringers. Split gut from \$1.60 to \$2.50. Write: H. E. Willis Company, 1047 West 47th Street, Dept. PM-300, Chicago.

ARCHERY Supplies, catalogue free. Instruction sheets 10c. Midwest Archery, 2209-A East 75th, Chicago.

GUNSMITHING Readily learned at home. Earn money by repairing neighborhood's firearms. Free catalog 20 firearm gunsmithing textbooks. Sanworth, Marines, North Carolina.

GREATEST Thing in camping history. Combination tent-house. Single telescoping tension control! Solves week-end, vacation problems. Plans \$1.00. Franklin Enterprises, Franklin Square, New York.

BUILD Olympic pistol. Page 16 January Popular Mechanics. Stamp. Box 186, Kenosha, Wis.

TREASURE Finders? Read Goldak advertisement on page 135A.

SAVE 40% On sleeping bags. Duck down filled. Mothproofed. Regular \$38.25 value, by mail \$22.95. \$17.50 wool bags only \$10.95. Guaranteed. Write for circular. Alaska Sleeping Bag Co., 1414 S. W. Harrison St., Portland, Oregon.

BARGAINS! Ski catalog 5c, gun catalog 5c, camera catalog 10c. Warshal's, First-Madison-PM, Seattle.

BOWS, Arrows, raw materials. Beautiful catalog (over 125 pictures) and "Essentials of Archery" a handbook on making bows and arrows 35c. Everyone intending to make their own should have this manual. Instruction folder and catalog 10c. L. E. Stemmler, Queens Village, N. Y.

FIELD GLASSES, TELESCOPES AND MICROSCOPES

TELESCOPES, Microscopes, binoculars; 1940 bargain catalog free. Brownscope Co., 5 West 27th Street, New York.

ANTIQUES, RELICS, INDIAN GOODS, CURIOS

GLASS, Books, minerals, curios, catalog 5c. Junes Antiques, Northbranch, Kansas.

COWBOY Kerchiefs, snakeskin belts, western curios. Free catalog. Clemans Specialties, Box 236-P, Coolidge, Arizona.

HUNDREDS Odd, old, dishes, coins, badges, stamps, relics. List for stamp. Cascadden, Lapel, Indiana.

ANCIENT Grooved axe \$1.50. Twenty good arrowheads \$1.00. Charley Drake, Union City, Ga.

30 GENUINE Indian arrowheads, \$1.00. Catalog. Geo. Holder, Glenwood, Ark.

FLORIDA Curios, antique list 3c; 12 shells 10c; stuffed alligator \$1.50. Vincent Grey, Ormond, Florida.

INDIAN Relics, beadwork, coins, curios, minerals, old glass. Catalog 6c. Indian Museum, Osborne, Kansas.

GENUINE Alaskan Indian made moccasins: Seal \$2.25 up, moose \$3.00 up; totems, dolls, specialties; dealers' discount. Alaska Native Brotherhood, Box 81, Juneau, Alaska.

SWORDS, Rapiers, pistols, daggers, armor list 10c. Robert Abels, 860A Lexington Ave., New York.

CHINQUILLA'S Indian Craft Museum. Handiwork of all Indian tribes. Jamaica, N. Y.

ARROWHEADS! Glacial boulder beauties. Rainbow variations. Don McKillop, Regina, Sask.

INDIAN Relics, coins, bills, gems, crystals, curios, etc. Illustrated catalog 5c. 100 ancient arrowheads \$3.00. H. Daniel, Hot Springs, Ark.

TAXIDERMISTRY

"MODERN Taxidermist Magazine." Greenfield Center, N. Y. Devoted entirely to taxidermy. Completely illustrated taxidermy articles, methods, formulas, photographs. Three latest issues 25c.

GLASS Eyes, taxidermists', furriers supplies. Big catalog free. Elwood Company, 222 Smith Bldg., Omaha, Nebr.

TAXIDERMISTRY Supplies—Quality artificial eyes, teeth, genuine Jonas head forms. Tools, materials, etc. Everything for the progressive taxidermist. Send 10c for big illustrated catalogue. Jonas Bros., 1049 Broadway, Denver, Colo.

DOGS, PETS, BIRDS

GUARANTEED Live arrival, guaranteed songsters, seeds, supplies. Write for price list. Universal Bird Co., P. O. Box 7, Bergen Station, Jersey City, N. J.

SAINT Bernard puppies on approval—reasonable too! Photographic prospectus free. Royal Kennels, Chazy, New York.

BEAUTIFUL Pure white police dogs. Ansonia Kennels, Mose, N. Dak.

POULTRY AND FARM SUPPLIES

COVERALL Trash turners for your plows. Two bottom size \$19.50. Trash Turner Co., Lapel, Indiana.

COCKEREL Chicks for broilers \$2.95—100. Poults and ducks. Write for special "hatchery to customer" prices. Make saving of from 1c to 3c per chick by ordering direct from me. Conrad's Jackson County Hatchery, Box 19, Seymour, Ind.

40,000 CUSTOMERS In 40 different states annually buy 10,000,000 Davis chicks for broilers and layers. 21 different breeds. Sexed chicks, Poults, ducks, \$2.90—100 (for light cockerels) and up. Free catalogue. We guarantee chicks for 14 days. Immediate delivery. Davis Poultry Farm, Route 34, Ramsey, Indiana.

IF You want better chicks, write for free Hinkle Chick Catalog. Our prices are low. For example, special broiler lots "all heavies" \$5.40—100; Leghorn pullets \$9.95. Many bargains in straight and sexed breeds. Greensburg Hatchery, Box 40, Greensburg, Indiana.

\$6.45—100 AA Grade Barred, Buff, White Rocks, Reds, White Wyandottes, Buff Orpingtons, English White Leghorns. Can furnish sexed chicks, pullets and cockerels at remarkably low prices. Chicks from tested, culled flocks. We guarantee 95% sex accuracy and expect you to raise 95% of our chicks. We pay postage and guarantee live delivery. Will ship C.O.D. Write for free circular and complete price list. Immediate delivery. Dubois County Hatchery, Box 912, Huntingburg, Indiana.

SALEM Champion chicks—We own 10 birds that were World's Poultry Congress winners, including Grand Champion White Rock. AAA grade, our best, English Leghorn pullets \$12.45. Heavy breeds for broilers as low as \$5.40 per 100. Free catalog. Poults and ducks, Salem Hatchery, Box 81, Salem, Indiana.

SELL Famous chicks. Make quick money. Make to \$3.00 per 100. Cash profits paid in advance. More Famous Hybrid chicks sold than any other kind. World leaders. Thousands chicks hatched daily. Also leading pure breeds. World's Poultry Congress winners. No selling experience needed. Full details free. Write, Famco, Shenandoah, Iowa.

CHICKS—Sexed or unsexed. 52 pure-breeds, 6 hybrids. Business 45 years. Free poultry book. Berry's Farm, Route 13, Clarinda, Iowa.

LOW Factory prices on poultry equipment. Wire fabrics. Free 100-page catalog. Bussey Pen Products, 5151 West 65th Street, Chicago.

WHITE Australorp headquarters—Importers world champion 353-361-364 egg black Australorp hens. Educational catalog shows customers profits. Osborne Farm, Box 70, Holland, Michigan.

MAKE Money with poultry. Read America's leading poultry magazine for latest information. Three years \$1.00; nine months 25c. Poultry Tribune, Dept. E-93, Mount Morris, Ill.

TREES, SHRUBS, ROOTS, HERBS

IMPORTED Hardy English border carnations. Large plants. Write for list. Pratt's Carnations, Renton, Washington.

JUST Out! World's greatest "Herballist Almanac." Beautifully illustrated in natural colors. Contains over 200 old-fashioned herb medicine recipes for home use. 10c postpaid. Worth dollars! Botanicals, Box 1109, Evergreen Park, Illinois.

FARMS AND FARM LANDS

INVESTIGATE The Highlands of Southwestern Louisiana. Gently rolling, well drained, at low prices on cash rental terms. Descriptive book sent without obligation. Long-Bell Farm Land Corporation, 851 R. A. Long Building, Kansas City, Mo.

YOU Can buy a good farm in Minnesota, North Dakota, Montana, Idaho, Washington or Oregon in the agricultural empire along the Great Northern railway. Developed farms or cut-over land at low prices, suitable for dairying, poultry and diversified farming. Farming conditions good. For free book and complete details write E. B. Duncan, Dept. 357, Great Northern Railway, St. Paul, Minnesota.

40 ACRES, Near White River, unimproved; poultry land. \$175, \$5 down, \$5 monthly. Free list and literature. Hubbard, 216 Grossman Bldg., Kansas City, Kans.

GOOD Farms available. Washington, Minnesota, Idaho, western Montana, Oregon. Dependable crops, favorable climate. Write for impartial advice, literature and list of typical bargains. Specify state. J. W. Haw, 119 Northern Pacific Ry., St. Paul, Minn.

GOVERNMENT Land—10c acre up. Information all states 25c. Nat. Tax Service Bureau, 1036A Majestic Bldg., Detroit.

CANADIAN Tax sale lands for a dollar an acre and up. Small monthly payments. Farms, timber, hunting and fishing camps, minerals. Limited number of properties. Write at once for free illustrated booklet. Tax Sale Service, Room 613, 72 Queen St. W., Toronto, Canada.

FARM MACHINERY AND SUPPLIES

TRACTOR Parts—for less, we manufacture them for all makes, write for prices. Ballak, 1115 Chestnut St., St. Louis, Mo.

FARM And garden tractors you can build. Complete plans and instructions 50c. Use old auto parts. Popular Mechanics Press, Room C40, 200 E. Ontario, Chicago.

PROFITABLE OCCUPATIONS

RAISE Rabbits and cavy for us. Full details. Catalog, contract and magazine 10c. Or send 25c for book, catalog and year's subscription to Small Stock Farmers Magazine, Stahl's, Box 10, Holmes Park, Missouri.

ANNOUNCING New home study course in commercial baking. Good field for ambitious men. Nearly depression proof business. Common school education sufficient. Send for free booklet "Opportunities in the Baking Industry" and requirements. National Baking Institute, 3601 Michigan Avenue, Dept. 3433, Chicago.

RAISE Mink. Bred females available. Write for information. Lomman's Fur Farm, Spangler, Penna.

EARN Cash at home! M. M. earned \$267.00, three weeks raising mushrooms in cellar! Exceptional, but your cellar, shed perhaps suitable. Materials furnished. Starting crop guaranteed. We buy all crops. Book free. United, 3848 Lincoln Ave., Dept. 61, Chicago.

BUSINESS Proposition resilvering mirrors, autoparts, reflectors, making chipped glass signs. Write Sprinkle, Plater, 288, Marion, Indiana.

WORK. Pleasure, profit, at home in business. Service, Box 233M, Carnegie, Penna.

TREASURE Finders? Read Goldak advertisement on page 135A.

UNEMPLOYED? Need work? Write H. Foster, Mount Ayr, Iowa. (No selling.)

MEN—Women operate "Specialty Candy Factory" home, all or spare time. Steady income. (Our 31st year.) Hillyer Ragsdale, Inc., Drawer 62, East Orange, N. J.

182 THINGS You can easily make for fun or profit, 50c. Popular Mechanics Press, Room C40, 200 E. Ontario, Chicago.

BOOKS, PERIODICALS, PICTURES, POSTCARDS

EXCELLENT Sparetime profits taking subscriptions—2500 magazines. Agents confidential catalogue. Complete starting supplies free! Dept. 113, Pines, 583 Monroe, Brooklyn, N. Y.

"HORSESHOE Curve," world famous. Felt pennant and postcard 25c. Musser, 3816 Chestnut, Altoona, Penna.

CIRCULATING Library by mail. Latest books. Details 10c. Layne's, P-9515 McQuade, Detroit, Michigan.

NOVELTY! Set of five typical Colombian characters, in colors, 25c (stamps). Blencowe, Apartado 2155, Bogota, Colombia, South America.

NATIONAL News press cards—look genuine, fool your friends, auto or billfold 25c coin. Salan, 325 W. Harvard, Glendale, Calif.

RARE Books, pictures, novelties. Where to get. We tell you. List only 25c. Esse, 5000-G Cordelia Ave., Baltimore, Md.

MACHINISTS Compact reference book. Hardening helps, triangles, thread measurements, taps, drills, taper pin sizes, etc. 70 pages. Price \$1.00 postpaid. G. A. Knudson, 523 - 48th Street, Brooklyn, N. Y.

PHOTOGRAPHS By McGoldrick. Samples, listings, 35c. Albert McGoldrick, Mansfield, Mass.

FINDING A Job During the Depression. by Dr. Harry Kitson. Columbia University vocational guidance authority. Every person seeking employment should read this interesting, practical, and inspiring booklet. Send 25c (coin). Magnolia Publishing Company, Oxford, Mississippi.

NEW. Money making formulas book tells how to go into business for yourself. Send for free details. Popular Mechanics, 200 E. Ontario, Chicago.

GAMES—ENTERTAINMENT

SELL Your game! If you have devised a new game and want to market it, send 3c stamp for particulars. Trend Games, Highland Park, Ill.

USED Pintables—Have fun in your basement. Send for list, \$5.00 up. Goodbody, 1824 East Main, Rochester, N. Y.

TOY Mak-A kit, 100 models 25c U. S. postpaid. Toy Mak-A Company, 12 West 18th Street, New York City.

TRICK Chalk stunts. Catalog 10c. J. Balda, Cartoonist, Oshkosh, Wisconsin.

PLAYS, Operettas, musical comedies, complete minstrel first-parts with song programs, blackface skits, vaudeville acts, monologs, dialog, recitations, juvenile plays and songs, musical readings, entertainments, make-up goods. Catalog free. T. S. Denison & Co., 203 N. Wabash, Dept. 11, Chicago.

MAGIC TRICKS, PUZZLES, JOKER NOVELTIES

ENTERTAIN. 30 minutes of magic \$1.00. Includes equipment, secrets, appropriate talk plus 12 card tricks. Free, stage mystery as featured by Mardoni, famous magician. House of Magic, 6641 Pershing St. Louis, Missouri.

ILLUSTRATED Magic catalog 10c. Davis Co., 1618 St. Paul St., Philadelphia, Penna.

MYSTIFYING Optical illusion, fools your friends completely. Price 25c. Novelties, 464 Main St., Norwalk, Conn.

DRIVE Car blindfolded, make money, free literature, send stamp. Jerry, 307 Felix Street, Saint Joseph, Mo.

294 MAGIC Tricks explained and surprise gift 25c! Carsig, 38 Jefferson, Auburn, N. Y.

BE A magician. Large professional magic catalogue of latest tricks 25c. Cash paid for complete Tarbell Magic Courses. Write, Ireland, C-109 North Dearborn, Chicago.

FIRE Eating, ventriloquism, magic, mind reading. 1315 Ferris, Los Angeles.

MAGICIANS' Headquarters. 216-page catalogue pocket, parlor, professional tricks, 25c. Kanter's, 1311 Walnut, Philadelphia.

NEW 25c Catalogue and 25c secret: 50c value, only 10c. Folders free. Eagle Magic, Minneapolis.

MAGIC: Mindreading. Earn while learning. Particulars free. Magical Browne, Duluth, Minn.

TRICKS You can do! For pocket-parlor-stage. With coins, cards, cigars, ropes, balls, thimbles, watches! Escapes, mind-reading, spirit and mental magic! Illustrations, magical books and stage supplies! Largest assortment; lowest prices! 100 page catalog 500 popular tricks 10c. 80 page catalog larger stage magic 10c. Write today! Lyle Douglas, Station A-5, Dallas, Texas.

JOIN Magicians' Fraternity! Free tricks! Monthly magazine, sample 10c. International Magicians, Mt. Morris, Ill.

WORLD'S Largest magic shop professional catalog. 25c. Holden, 220 W. 42nd St., New York.

LEARN Ventriloquism. 3c stamp brings particulars. Smith, 801 Bigelow, Peoria, Illinois.

LARGE Magic catalog 25c. Hundreds of tricks. Chicago Magic Company, 2300 N. Mason Avenue, Chicago.

EARN Money in any crowd. Call names of strangers, tell unspoken questions. Professional course mind reading, spirit writing, etc., \$1. Henderson, Box 341, San Bernardino, Calif.

OLD STAMPS WANTED

I WILL Pay \$100.00 each for 1924 1c green Franklin stamps, rotary perforated eleven (up to \$1,000.00 each if unused). Send 6c for large illustrated folder showing amazing prices paid. Vernon Baker, (PM-3) Elyria, Ohio.

STAMP COLLECTING

103 DIFFERENT Stamps including Mexican mosquito stamp and valuable airmail, 10c. Tiptre Stamp Co., 976 So. Westmoreland Ave., Los Angeles, Calif.

SENSATIONAL Combination offer! Big packet 105 all different including Greenland (new country), Congo, Manchukuo, Costa Rica triangle, air-mails, commemoratives, giant diamond-shaped stamp, \$4 United States; complete set United States telegraphs, cataloging 20c, scarce set Siberia cataloging 50c. Packet British colonies including Gwalior, Hyderabad, Burma (new country), jubilee and coronations. Total catalog price over \$3.00! Everything for only 5c to approval applicants! World-Wide Stamp Company, Department 600, Camden, New York.

HUNDREDS Of stamps! World mixture including Seychelles, Perak, Ecuador, world's fairs, triangle, Bolivia, 10c to approval applicants. Myers, Merion Sta., Penna.

FREE—The Stamp Finder! Our new 24 page edition, fully illustrated, which will enable you to instantly identify all difficult stamps. Also fine packet of odd and unusual stamps from Bosnia-Herzegovina, Monaco, Patiala, Cyprus, etc., including maps, ships, animals and strange scenes. All free to approval applicants inclosing 3c postage. Garcelon Stamp Co., Box 900, Calais, Maine.

125 U. S. and foreign stamps 3c approval applicants only. Quality Stamps, Englewood, Colorado.

UNPICKED Mixture: 40c pound. U. S.: 150 different—50c, 100 revenues on documents—10c! (700—50c.) Vanvoorhis, Hyndman, Penna.

"HOW To Deal in Stamps" booklet 25c. 68 diff. U. S. catg. \$1.85 only 25c. Wholesale lists. Bargains, Haynes, 115th, Toledo, Ohio.

A REAL Bargain. 200 all different foreign and 60 different U. S. stamps—our pamphlet on "How to Make a Stamp Collection Properly" and our big bargain list of sets, packets and album—all for only 18c. Queen City Stamp & Coin Company, Room 36, 604 Race Street, Cincinnati, O.

5 TRIANGLES, 100 Foreign 10c, approvals. Ransom, 1333 Pontiac, Ann Arbor, Mich.

25 VICTORIAN British Colonies—10c to approval applicants. Cowles, English, Fort Lee, N. J.

MAMMOTH Free packet, maps, boats, savages, animals, 5c. Approvals, Smith, 669 Chilli, Rochester, N. Y.

1000 MIXED Foreign, 25c. Well worth sorting for values. Plaza Stamp Co., Santa Fe, N. Mex.

HONG Kong coronation first day cover plus 10 different Philippines 3c with approvals. Stanley Melzer, 3120 South Adams Ave., Milwaukee, Wisconsin.

25 FINE U. S. 1861-1908, 10c. Weston, Box 383, Ponca City, Oklahoma.

BARGAIN! 25 Different Japan, 20 Canada, 12 South Americans including scarce airmail; all these—3c to approval applicants. Hunziker, Box 225-MP, Minneapolis, Minn.

DANZIG Twenty 10c to applicants quality approvals. Collins' Stamps, 1208 Valmont, New Orleans, Louisiana.

3 SUPERB Used presidential blox only 10c. Hunt, 717 So. 9th, Maywood, Illinois.

40 DIFFERENT Canada dime. Pellerin, 221 Cremazie West, Montreal, Canada.

TEN Different United States over 40 years old, 10c. Eisea, Bowling Green, O.

FREE!—Diamond airmail! Pictorials! British colonies! Wonderful packet 65 different (no Europe) 5c to approval applicants. Bargain Stamp Co., Box 21-P Flatbush Sta., Brooklyn, N. Y.

10 BEAUTIFUL Pictorial stamps 3c to approval applicants. Stamp Shop, 5805 Delmar, St. Louis, Mo.

\$7.00 FOREIGN Collection, 300 varieties 25c. Arrowhead, Box 1793, San Antonio, Texas.

FULL Sheet fifty Spain 1938 semi-postals, one stamp inverted, \$25.00 blocks, \$10.00. Lee Beal, 402 Grand Avenue, Oakland, California.

SWITZERLAND: Red Cross 16c, Gott-hard 10c, peace issue 10c. Approvals, Jan. 201 West 85th St., N. Y.

44 DIFFERENT U. S. commemoratives 25c. Blackstone, Walnut Ave., Wayne, Penna.

25 DIFFERENT Japan 10c. With approvals. Roedel's Stamps, Bell, California.

GIFT Edition stamp annual free—Sixty pages with hundreds of illustrations featuring Canadians, Newfoundlanders, United States, Colonials, foreign supplies. Sent free. Gray Stamp Company, Dept. PM, Toronto, Canada.

NUDE Duchess, Hindenburg zeppelin, transatlantic airmail commemorative, 5c with approvals. Shultes, Berne, N. Y.

FIGHTING Finland! Fifty different 10c. Approvals. Chester, Box 545-P, Utica, N. Y.

SUDAN Camel stamps, 5 different for 5c (actual cost) to approval applicants. Lafayette Stamp Company, 4407 Lafayette Avenue, St. Louis, Missouri.

THIS Ad worth 30c toward foreign approvals. "Post," B367, Lebanon, N. H. 1, 2, 3c APPROVALS. Doty, 5032 So. Gramercy, Los Angeles, Calif.

LOWEST Priced approvals. Trial convinces. Pickering, 3246 E. 29th, Kansas City, Mo.

1,000 MIXED Foreign—25c. Lincoln Club, 173 Columbia, Irvington, New Jersey.

72 DIFFERENT U. S. 10c. with approvals. Album Service, Route 57-14, Sioux City, Iowa.

COLLECTORS—Send 10c for our unusual free stamp offers and beautiful commemorative set. Paramount Distributors, Box 864-P, Denver, Colo.

PHILIPPINES—17 Different including pictorials 10 cts. with approvals. Swedell, 3038 Harriet, Minneapolis, Minn.

BEGINNERS! 30 U. S. pictorials, 25c. Sales, Box 2, Vernon, California.

FREE—Complete set of triangles, also 5 other sets, 3c postage. Gaybree Bros., 706 Sumner, Springfield, Mass.

WILL Buy your unused United States stamps. Small discount. What have you? Mint Sheet Brokerage Co., 418 Caxton Building, Cleveland, Ohio.

1000 DIFFERENT. Almost every country represented. 95c. French, 241 Euclid, Cleveland.

20 DIFFERENT Luxemburg 10c to approval applicants. Approval selections made to your order. Teichmann, 1685 Fillmore, Philadelphia, Penna.

SCARCE Liberian airmail, triangles complete 15c with approvals. Midwestern Syndicate, 2167 Lakewood, Detroit, Michigan.

PAGODALAND Packet, weird people, includes Transjordan, Patiala, Jhind, Jaipur, Indore, Bhopal and plenty of others. Only 5c with approvals. Kravat, 1925-B Quentin Road, Brooklyn, N. Y.

25 DIFFERENT U. S. commemoratives 10c. List free. No approvals. Cannella, 516 Palisade Ave., Jersey City, New Jersey.

SENSATIONAL! 300 Different 15c: 500, 35c; 1000, 75c. Star, 148 Forbell, Brooklyn, N. Y.

FREE Packet with approvals. Hawthorne Stamp Co., 3221 So. 53 Court, Cicero, Ill.

GIGANTIC U. S. assortment, many varieties, 15c. Foreign approvals. Lee, Bridgeport, N. Y.

1000 MIXED United States 15c postpaid. Superior, 3815-P Wabash, Kansas City, Mo.

THE Fighting Finns, 50 different stamps from courageous little Finland only ten cents to approval applicants. Pocono Stamp Co., Dept. P, Post Office Box 512, Wilkes-Barre, Penna.

SEND 100 Mixed U.S.A. stamps; receive 100 different world-wide, and stamp trading plan. Waldo Exchange, Box 266, Dallas, Texas.

BIGGEST Map—odd lands—gold stamp! Our dandy packet includes all these: Giant map stamp (world's biggest), Plume (dead country), Liberia (Bongo antelope), unique Salvador (printed in gold and 3 other colors), tiny Medellin "midget" (dwarf stamp), antique Portugal (60 years old), odd lands of Gwallor, Iraq (Arabia), Selangor, Perak, Malaya, etc.—everything only 5c to approval buyers. R. M. Stamp Co., Box 230P, Port Chester, New York.

ASK For my famous 1/5c approvals. Olivo Alvos, Guadalupe, Calif.

FREE, 25 Different Poland; 3c postage, approvals. Ellis, 2841 West 37th, Brooklyn, New York.

CANADA—35 Different free to approval applicants enclosing postage. "Crescent Stamps," London, Canada.

UNASSORTED Foreign mixtures getting scarce, 1/2 pound eighty cents. Box 128, Needham, Mass.

HOBBIES! Models! Valuable packet, stamps! Dime! Richards, Sun Building, New York.

500 FOREIGN Mixed stamps; absolutely unpicked; many interesting. Only 10c with approvals! Saxon Company, 408-A Jay Street, Brooklyn, N. Y.

FREE! World's smallest triangle, Bolivia triangle, gigantic diamond-shaped airmail. Packet old United States. War packet—Finland, Russia, Danzig, Poland, Czechoslovakia, Asiatics. Set twentieth-century Philippines. Also Devil's Island, Congo, Cannibaland, Tunisia, Sudan, West Indies, Southseas, Africa, Br. Cols., pictorials, commemoratives, perforation gauge, millimeter scale. Postage 3c. Approvals. Davidson, 2297-6E, Salt Lake City, Utah.

SOUTH And Central America, 100 different, only 10c to approval applicants, Davis, Silver Lake, Indiana.

FREE! Beautiful set of three large sized mint Ecuador airmails to new approval applicants sending 3 cents covering postage. You will like our clean, inexpensive approvals. Acme Stamp Company, Box 101, Westmount, Canada.

SELANGOR, Perak, Albania, Haiti, Bhopal, Palestine, Johore, Manchukuo, Congo, Kedah, Cochín, Kookaburra-bird and 200 different stamps only 10c with approvals. L. H. Reich Stamp Co., 4647 Kenmore, Chicago.

FREE! Two coronation sets. Postage 3c. Roberts, 312F Shearerblg, Bay City, Mich.

PENNY Approvals. Thousands different. Pictorials, commemoratives. Raymax, Station Y(21-K), Brooklyn, N. Y.

FREE—Five beautiful new issues with pricelist. Green & Company, Norwood, O.

FREE! Zeppelin airmail set complete. Request approvals. Riedell, Greensburg, Penna.

UNITED States \$1.00 and \$5.00 postage due stamps, set four Bolivia (animals) and complete set Czechoslovakia (legionnaires). Send 10c and request approvals. Kessels, Tucson, Arizona.

PALESTINE, 7 Pictorials 3c. Approvals. Ira Rogers, R2, Grand Rapids, Mich.

PENNY Approvals by country. M. H. Hoerning, Merriam, Kansas.

FREE! Austria war set. Postage 3c. Williams, 606 Archerblg, Bay City, Mich.

25 DIFF. Peru 3c postage. Davison, Box 568, Manchester, New Hampshire.

FREE! Fifty different airmails. Send 3c postage for particulars and approvals. Spartan Stamp, 2053 Decarie, Montreal, Canada.

LINDBERGH Airmail, 12 U. S. commemoratives 5c. Approvals. Kingsbury, West Burke, Vt.

MEXICO! 20 Different 20c. Cassidy, 212 W. 32nd, Covington, Kentucky.

STAMP Collections purchased for cash. Send yours along for my offer. N. Barcus, 3787 Longfellow, Detroit, Michigan.

GERMANY, Ten early stamps free to approval applicants. Ernest Schweppe, 7112 Forrest, Philadelphia, Penna.

FREE, Ten Argentinian stamps. Sanchez Casilla Correo, 452 Rosario, Argentina.

FREE! Airmails, triangle, pictorials—postage, approvals. Apex, 1933 SE 45th, Portland, Oregon.

FREE To approval buyers. Sets, airmails, pictorials. Stamps, East Rochester, N. Y.

SMOKY Mountain commemorative sheet, largest U. S. stamp issued, and 33 U. S. including commemoratives, airmail, revenues, etc. Catalogs 75c—To approval applicants for 5c. Curhan Stamp Company, Gloucester, Mass.

SCARCE Diamond airmail! Wonderful packet 115 different from strange countries. British Colonies, Haiti, Tasmania, pictorials, etc. 5c to approval applicants. Reliable Co., Box 139P Church Street Annex, New York.

FREE! 25 Commemorative stamps with approvals. Eulalia Turner, Azusa, Calif.

20% OFF On dollar purchases. Exceptional stamp values. Skinner, 306 East Fourth, Long Beach, California.

115 DIFFERENT Free! 205 different 3c with 30% approvals. Booher, 1043a Island, Wilmington, California.

AIRMAILS And commemoratives, 25 different, including Columbians, Panama-Pacific, Edison, Zeppelin, etc., only 5c with exceptionally fine United States and foreign approvals. Marco Stamp Co., Box 888, San Francisco, Calif.

25 DIFFERENT Latin American 10c. Lists. Burkhart Stamps, Sandwich, Ill.

FREE. Slovakia set to serious approval applicants. Bluegrass Stamps, 801 Cooper, Lexington, Ky.

150 GOOD Mixed foreign stamps 5c coin. Stanton, Niantic, Conn.

COUNTRY Complete! All stamps of White Russia positively complete only 3c to approval applicants. Cactus approvals, Box 1870-B, Tucson, Arizona.

1940 WHOLESALE Catalogue free—Eighty pages. Empire Stamp, Dept. 5, Toronto, Canada.

FREE! Twelve desirable airmails. Approvals. Barker, 714 Market St., San Francisco.

FREE Looseleaf album to approval applicants sending two dimes for mailing. Park Stamps, LaGrange, Ill.

50 FREE Iraq, Iran, etc., catalogued \$1.00. Album 3c. Bullard, 268 Northampton, Boston, Mass.

FREE—Elaborate United States pricelist (44 pages), including hinges. Seldenberg, Baroda, Mich.

POSTAGE Stamp collections bought and sold. Philatelic Headquarters, Trenton, New Jersey.

40000 VARIETIES Foreign stamps available on approvals, 1/4c up. Representative selection on request. Adults only. PKeigwin Stamp Co., Vineland, N. J.

25 UNITED States, including \$4 and \$5 stamps free to approval applicants, 3c postage. Brownie Stamp Shop, Flint, Mich.

DISGUSTED? Try my approvals 1/4c up. Bargains galore. Premiums with purchase. Viscusi, Scotia, N. Y.

300 DIFFERENT 20c; 1000 75c; 2000 \$2.50. Fred Onken, 630 79th St., Brooklyn.

SILVER Jubilee souvenirs. Third set of twenty beautiful stamps issued by Irish Hospitals' Trust, Dublin. Specimen sheet free of charge to all writing to Mr. J. O'Sheehan, Department P.M. 13, Earlsfort Terrace, Dublin, Ireland.

APPROVAL Sheets. One to three cents. Frederick B. Driver, 2009 Finance Bldg., Philadelphia, Penna.

FREE—Choose any country 10c packet—5c postage—approvals. Victoria Stamp Co., London, 4, Canada.

WHOLESALE Dealer's catalog. Illustrated. Postage 5c. Frank's, 4900 Chalmers, Baltimore, Md.

SIX Dollars for 9c! 300 different stamps (cat. price \$6) only 9c with approvals. Tatham Stamp Co., Springfield-30, Mass.

THREE Sets for three cent stamp! Jack Reed, Houtzdale, Penna.

FREE—From every continent, 155 different, airmails, triangle, commemoratives, pictorials, many U. S. and others, with 1c approvals. Send 5c for postage and handling. Ace Stamps, Euclid Arcade, Cleveland, Ohio.

WHOLESALE Supplements to dealers for 10c postage. Hundreds of bargains. Grossman Stampco, 102 West 42nd, New York.

50 DIFFERENT, Pine U. S. including perforation gauge, 10c with approvals. The Stamp Shop, 809 Holland Bldg., St. Louis, Mo.

GIANT Packet 200 all different from Africa, South America, Asia, South Sea Islands, etc. Includes world's smallest stamp; triangle and diamond-shaped stamps; animal stamps. Nicaragua "Will Rogers" airmail; many others. Also packet 17 different United States (cataloging 50c)—all obsolete, including \$4 denomination, commemoratives, etc. Total catalogue price over \$5.00! Everything for only 5c to approval applicants! Mystic Stamp Company, Dept. 80-N, Camden, New York.

PENNY Approvals, that satisfy. Neil Gronberg, Box 5441-P, Philadelphia, Penna.

UNITED States illustrated looseleaf catalog, \$1.00. Send postage for free United States price list, precancel list. Stanley Gibbons, 38-P Park Row, New York.

200 DIFFERENT 10c. Big 50% approvals. Covert Stamp, 39 State, Rochester, N. Y.

ASK For our wonderful one cent approvals. Prospect Stamp Co., 225 Broadview, Toronto, Canada.

WEEKLY Stamp magazine, thirteen weeks, 10c. Stamp Journal, Kalamazoo, Mich.

STAMP Dealers, your ad here will bring wonderful returns. Ask me for proof. F. W. Johnson, Manager, Classified Advertising, Popular Mechanics Magazine, 200 E. Ontario St., Chicago.

RARE COINS

WANTED U. S. and foreign gold coins. Pay high prices. Send 10c for illus. catalog. Smith & Son, 2267 Clybourn, Chicago, Illinois.

BIG Monthly coin magazine \$1.00 year; sample 15c. Thousands of coins priced for sale each issue. Numismatic, 5450 Clark, Chicago.

OBSOLETE Currency specimen and standard valuation list all types U. S. coins. 48 pages, 300 illustrations, for 25c. Nivison, 540 Ninth St. No., St. Petersburg, Fla.

OLD Money wanted. Will pay \$100.00 for 1894 dime, S. mint, \$50.00 for 1913 Liberty head nickel (not buffalo). Big premiums paid for all rare coins. Send 4c for large coin folder. May mean much profit to you. Numismatic Co., Dept. 20, Fort Worth, Texas.

TREASURE Trove, coins wanted. A. French, Rte. 1, Troy, N. Y.

UNITED States small cents 50 for \$1.00. Box 67, West Hartford, Connecticut.

15 NICE Coins 25c. Bishoff, 500 E. 8th, Kansas City, Mo.

100 DIFF. War money 65c. 10 diff. encased postage stamps \$1.00. Complete set of 11 1893 World's Columbian Exposition tickets 35c. R. Thomas, 161 N. Dearborn, Chicago, Ill.

15 DIFFERENT Coins 25c. 60 different \$1.00. Oddehon, Box 44, Overland, St. Louis, Mo.

UNCIRCULATED San Francisco cent and catalogue 10c. Landon, 901-A Lucerne, Los Angeles.

GET Profit and pleasure in collecting old coins. Send 10c for 56 page illustrated coin catalog. You'll be delighted with it. Send for it now. B. Max Mehl, 370 Mehl Building, Fort Worth, Texas. Largest rare coin establishment in U. S. Established 40 years.

COLLECTORS' Illustrated coin catalog 10c. 2000 quotations. (Not a buying list.) Jas. Randall, 407 South Dearborn, Chicago.

RARE U. S., foreign coins, war medals. Catalogue 10c. Mengelle, Colorado Springs, Colo.

COMMEMORATIVE Half dollars, Lincoln, Stone Mountain, Oregon, Texas, Cleveland, Kentucky, San Diego, Long Island, \$1.50 each. Illustrated catalogue No. 14, 25c. Norman Shultz, Salt Lake, Utah.

FREE! Foreign coin, banknote, and large illustrated coin catalogue. Send 4c postage. Coin approvals sent. Tatham Coinco, Springfield-125, Mass.

HOBBIES AND COLLECTIONS

15 DIFFERENT Cactus plants, \$1. Grow anywhere! Eulalia Turners, Azusa, Calif.

CIGAR Band collecting! Send 25c for 100 beautiful bands. Boy's Hobbies, 1208 No. 36th, Oklahoma City, Okla.

WANTED Old cigarette cards. Write Bray, 1127 Jackson, Easton, Penna.

PHILATELY! Cachets! Hobbies from Hawaii! "Chinese Hobby Journal" 50c year. Box 1813, Honolulu, Hawaii.

EXCHANGE Your duplicate stamps, match covers, etc., with collectors everywhere. Dime brings list. (Mention hobby). Secretary, Box 2166, Denver, Colo.

FREE Information matchbook cover albums. Adams Sales, Dept. 27, State Tower, Syracuse, N. Y.

FREE Swap ads in Hobbyiana Magazine. Sample 10c. 1326 South 27, Omaha, Nebraska.

KNIFE Throwing secrets exposed! Illustrated book tells all. \$1.00 postpaid. F. Dean, 1294 E. San Fernando, San Jose, Calif.

UNUSED Book match covers, 100 all different. \$1.00. Free list, Charles Edelman, 1311C East 84, Cleveland, Ohio.

PHOTO FINISHING

MAIL Roll—and 25c, receive 16 glossy Velox prints; 20 reprints 25c; two 8x10 glossy enlargements, 25c. Established 22 years. Thornley Seabrook, Franklin, Penna.

OUTSTANDING Trial offer. Roll developed and 8 prints, 15c and this advertisement. Saunders, Glenview, Ill.

FREE Print, album, and negative file. Send your negative. Memrlane Studios, General P. O. Box 666, Dept. "P," New York.

ROLL Film developed. Every negative on your roll of 116 size film made into beautiful 5x7 enlargement. 120 size enlarged to 4x6. 127 size enlarged to 3 1/2 x 4 1/4. Only 25c for roll developed and all 8 enlargements! Reprints 8 enlargements for 25c. Never before value like this. Finest quality. Tri-Plex Photo Service Co., Box 369, San Francisco.

TECHNIPINISH—35mm., 36 Exposure rolls fine grain developed and perfectly enlarged to 2 1/2" x 3 3/4" glossy prints, 75c. New exclusive methods and equipment make this low price possible. Cartridge reloaded with Eastman Plus X, 25c. One day service. Satisfaction guaranteed or money back. Write for postpaid mailing bags and information. Technifinish Laboratory, 109-D Lexington, Rochester, N. Y.

DON'T Take chances on valuable films. Roll developed—2 glossy prints each negative and 2 enlargement coupons 25c. 20 reprints 25c. Bartow Studio, Box 272, Topeka, Kansas.

PHOTOGRAPHY For pleasure and profit. Prepare for profitable business or fascinating hobby at home. Common school education sufficient. Write for information and requirements. American School of Photography, 3601 Michigan Avenue, Dept. 3451, Chicago.

35MM. Rolls developed free. 3 1/2 x 4 1/2 enlargements, 36 exposures \$1.00. 18 exposures 60c—reprints 4c. Send roll and money today. Minipix, Dept. 53, P.O. Box 114, Chicago.

IDEAL Photos beautiful finished with wide border, deckle edged. 25c per roll of 8 and free enlargement. Ideal Photos, Box 2255, Paterson, N. J.

ROLLS Developed, 16 guaranteed prints, 25c, reprints 2c. Photolab, 1806-C Wabash, Chicago.

18 LIFETIME Prints, 2 sparkling Hollywood enlargements each roll 25c. 21 reprints 25c; 100—\$1.00. Finished 3 hours. 25 other bargains. Overnight Studio, Albany, Wis.

THE Photo Mill. Immediate service; No delay! Eight-exposure roll developed, carefully printed and your choice of two beautiful 5x7 double weight professional enlargements, one tinted enlargement, or eight reprints for 25c coin. Reprints two cents each. Highest quality guaranteed. The Photo Mill, Box 629-12, Minneapolis, Minn.

COPIES From any photograph, new or old, retouched and enlarged to 8x10—\$2.00. Write for other information. Negatives enlarged and oil colored, 5x7—50c; 8x10—\$1.00. Adell Photo-Copy Service, 27 Clinton Ave. South, Rochester, New York.

THREE Lovely Silkstone enlargements and two sets sparkling lifetime prints with roll developed—25c. Trial, 20 reprints 25c; 50—50c. Lifetone Studios, L-39, Des Moines, Iowa.

GUARANTEED. Roll developed, 16 prints 25c. 20 prints 25c. Quality Photo, Hutchinson, Kansas.

LIFE Photo finishing lasts a life time. Roll developed, 8 prints, 2 enlargements 25c. Reprints 1 1/2c. Life Photos., Hutchinson, Kansas.

PICTURE Fans! Roll developed, two enlargements 25c. Satisfaction guaranteed. Humphrey's, 164 Baker, N. W., Atlanta, Ga.

HIGHEST Class photo finishing in America. Rolls developed and 16 prints 25c. 16 reprints 25c. Kelson, Box 549-B12, Inglewood, California.

ROLLS Developed. Two 5x7 and 8 prints, 25c. Reprints 2c. Photolab, 1806-CA Wabash, Chicago.

ROLL Developed, 8 brilliant fadeproof Velox prints and two professional enlargements 25c. 35mm. roll developed and enlarged to 3 1/2 x 4 1/2 \$1.00. Overnight service. Young Photo Service, 405-C, Albany, N. Y.

BETTER Pictures, quicker service! Roll developed and 16 prints 25c. 20 reprints 25c. Hundred reprints \$1.00. Mercury Studios, D-109 N. Dearborn, Chicago.

60 DAY Trial offer! Roll developed and printed with deckle edged prints by professional experts only 10c, or 2 prints each exposure only 20c. Reprints 25 for 25c. Reliable, 11, River Grove, Illinois.

DOUBLE-QUICK Service! Roll developed 16 Velox prints; or 8 prints, 2 enlargements 25c. Chicago Photo Lab., Box 3A, South Chicago, Illinois.

QUALITY Since 1889—one day service. Roll developed. 2 Brilliantone prints each negative 25c. 8x10 enlargement coupon, 16 reprints 25c. Willard Studios, Box 3535A, Cleveland, Ohio.

MINIATURE Film, fine grain development, 2 1/2 x 3 1/2 enlargements, 35mm. \$1.00, bantam 25c. Film Capital Service, Box 504, Rochester, N. Y.

PROMPT Service! Rolls developed, two Velox prints each negative 25c. Hench Studios, Harrisburg, Penna.

IMMEDIATE Service! Better pictures. Sixteen guaranteed prints from roll, 25c. One colored or two plain enlargements and 8 guaranteed prints, 25c coin. Special! Coupon for 8x10 enlargement given with every 25c worth Kodak finishing. Any 36 exposure, 35 mm. film fine-grain developed and each good negative enlarged to 3x4 prints for only \$1.00. 3x4 reprints, 4c each. One day service. Details and mailers free on request. American Studios, Box 22, LaCrosse, Wis.

8 ENLARGEMENTS—Films developed plus 8 enlargements, 25c coin—116 or smaller. Enlarge Photo, Box 791, Dept. PMM, Boston, Massachusetts.

OIL Coloring photographs a fascinating hobby or profitable business. Learn at home by easy simplified method. Previous experience unnecessary. Send for free information and requirements. National Art School, 3601 Michigan Avenue, Dept. 3431, Chicago.

SENSATIONAL Offer. Five 5x7 enlargements 25c. Cardinal Photos, Summit, N. J.

SPECIALIZING 35mm. Rolls fine grain developed, 36 enlargements 3 1/2 x 5 \$1.00. Cartridge reloaded 35c. Photoshop, Linton, Ind.

PROFESSIONAL, Overnight service. Developed, printed, 2 enlargements, 25c. Fotoservice, 1942 Marlow, Toledo, Ohio.

ROLL Developed, 8 prints all enlarged to double size, 25c. 16—50c. Enlarged reprints 4c. Arcraft Studios, Box 3582-A, Cleveland, Ohio.

ROLL Developed, 16 guaranteed prints, 25c. Smart Photo, Winona, Minnesota.

ROLLS Developed, two prints each and two free enlargement coupons, 25c; reprints, 2c each; 100 or more, 1c. Summers' Studio, Unionville, Mo.

THREE Prints each good negative in roll 25c. Reprints 3c. Fred D. Eastman, Bode, Iowa.

16 PRINTS With roll 25c. 16 reprints 25c. Rex Photo, Ogden, Utah.

ONE 6 1/2 x 8 1/2 Wide border embossed enlargement or one 5x7 hand colored enlargement with each roll developed and 8 prints 25c. 36 exposure roll developed and 36 3 1/2 x 4 1/2 enlargements \$1.35. 18 exposure roll 75c. Vidor, 321-P Hennepin, Minneapolis, Minn.

ROLL Developed and 8 beautiful Velox glossy prints 25c coin or stamps. Reprints 3c each. Fotoprint Service, Roanoke, Va.

TWO Glossy enlargements, 1 colored with roll 25c. Arbor Service, 10, Joliet, Ill.

CANDID Special. 35mm. rolls enlarged to 3 1/2 x 4 1/2, \$1.00. 18mm. rolls 60c. 3 1/2 x 4 1/2 reprints 3c. Brown Photo Company, 1910-61 Emerson, Minneapolis, Minn.

FOR The discriminating amateur—Rolls developed 2 prints each, 25c. Reprints 3c. Superior workmanship. Same day service. Paramount Co., 327 E. 92nd St., New York.

CAMERAS, PHOTO SUPPLIES

PHOTOGRAPHIC Papers for all purposes. Portrait, photo-finishing, commercial, copying; bromide, chloro-bromide for projection; slow contact papers, P.O.F., postcards. A grade for every purpose and a surface for every taste. Buy direct from us, manufacturers of photographic papers since 1895. No order too small or too large. Catalog 6c in stamps. Kilborn Photo Paper Company, Cedar Rapids, Iowa.

CAMERAS And supplies. Free illustrated catalog listing everything photographic—still and movie cameras, films, lenses—at tremendous savings. Hundreds of bargains, new and used. All guaranteed. We take your old camera or equipment in trade. Write now for your free copy of our newest money-saving bargain book—just out! Limited edition. Hurry! Central Camera Co., (Photographic Headquarters since 1899), 230 S. Wabash, Dept. C-16Z, Chicago, Ill.

MAKE Money in photography. Learn quickly at home. Easy plan. Previous experience unnecessary. Common school education sufficient. Interesting booklet and requirements free. American School of Photography, 3601 Michigan Avenue, Dept. 3432, Chicago.

40-70% SAVINGS On new, used quality cameras, supplies, binoculars. Trade-ins. Special list "PM3" free. Brenner, 943 Pennsylvania Avenue, Washington, D. C.

"GETTING Ahead in Photography." Photo guide to more fun, profits, pleasure and entertainment. By Rossiter Snyder, illustrated 50c. "The Miniature Camera," an illustrated guide 50c. L. E. Wood, Webster, Wisconsin.

SUPERLUX Converts inexpensive lamps into photofloods. Makes indoor photography inexpensively easy. Hughes Engineering, 9 Miami, Terracorpark, Ohio.

WANT Money for your pictures? Details free. Rex Service, 126 Lexington, New York City.

ENLARGER \$1.50. Enlarges eight times size of small negatives. Fully guaranteed. Paramount Sales Company, 89 Dudley Street, Boston, Mass.

FREE! Printing outfit with Univex (Iris) candid camera reduced to \$6.00. Milner, 204 Griffin St., N. W., Atlanta, Ga.

BELL Movie cameras, 16mm., 50 ft. capacity \$4.95. American Sptg. Co., 2621 Olive, St. Louis.

TREASURE Finders? Read Goldak advertisement on page 135A.

READY Now! 72-page Bass Still Camera Bargaingram No. 242—your true guide to shrewd camera buying. Backed by 14-day trial money back guarantee. Write for your copy. It's free. Bass Camera Company, Dept. AG, 179 West Madison St., Chicago, Ill.

CAMERA Repairing. Bellows made to order, shutters repaired. Bellows made to fit all standard cameras! United Camera Co., Inc., A-1515 Belmont, Chicago.

HAVE You a camera? Send ten cents for recent number of our big magazine, showing how to make better pictures and earn money. American Photography, 116 Camera House, Boston, 17, Mass.

CAMERAS Films, paper 25% to 35% discount. Paramount Photo Division, 327 East 92nd St., New York.

MAKE Money with your camera. New book tells how. 46 pages, 50c. Popular Mechanics Press, Room (C40), 200 E. Ontario St., Chicago.

MOTION PICTURES AND SOUND EQUIPMENT

GENERA Motion picture films (fresh stock). For all cameras, 50% saving! Stamp for sample. Fromaders, Davenport, Iowa.

MODERN Titles! 8mm., 16mm., illustrated literature. LeMoine Film Service, Nevada, Missouri.

NEW Reflector for motion picture projectors, guaranteed to increase screen illumination 40%. Write Scott Parish, 7407 Euclid, Cleveland, Ohio.

CAMERAS, Projectors, films, processing equipment, enlargers. Liberal trade-in. Catalog, stamp. Cine Service, 459 Irvin Ave., Rochester, Penna.

FILMS Free with purchase of Keystone machines. Send stamps for bargain lists. Hoffman Film Service, 57 Broad, Albany, N. Y.

TAKE Local news reels! 35mm. DeVry camera \$45; 16mm. Bell \$3.99. Eastman \$18.50; like new; projectors; Kodascope \$19. Keystone 500w \$34.50. Standard 750w \$49.50. Victor \$33. 16mm. film miniature "shorts": westerns, travels, cartoons, comedies, each complete, 50' 99c each; 100' \$1.79; 25' 6 for \$2.00. News flash cameras: Flashmaster \$3.25; Pressflash \$8.95; Mini-flash fits all cameras \$11.25. Victor sound film 16mm. projector, used, \$119 complete. Duplex \$410 model, new, world's finest sound film projector, 15w output \$289.50 complete. Trades accepted; easy monthly payments. Free list, new used specials. Mogul's, 64 West 48th, New York.

16-35MM. Projectors, films. List 5c. Bedner, 5300 S. Talman, Chicago.

SILENT 35mm. Films, 95c reel. Demsey, 1223 Berkley, Youngstown, Ohio.

16MM. Medical lecturing, varieties, art-ettes. Homovies, Box 82, Cincinnati, Ohio.

2 MOVIE Films for the price of one. William Schmidt, 626 West Clybourn, Milwaukee, Wisconsin.

ART Films. Sample, dime; lists free. Cine Art, 2443 Gunnison, Chicago.

TABLE-TOP Movies with Palomar turret lens titlers, films, chemicals, accessories, subjects. Film Specialties, P.O. Box 111P, El Monte, Calif.

1000 FEET 35mm, 75c. Others, Calderara, 5119 South St. Louis, Chicago.

MONEY Maker! "The World's Greatest Passion Play," 16mm. and 35mm. Sound or silent. Purchase or rent everywhere. Superior than Oberammergau play. Write Hemenway Film Co., 37F Church Street, Boston, Mass.

CAMERA Film—100 feet double 8mm., 16mm. \$1.25. Criterion Films, P.O. Box 1233, Paterson, N. J.

ART Sample, 10c; other kinds, lists free. Goodwill Company, Jackson, Tennessee.

8-16MM. Films; sell-rent-exchange. Free illustrated catalogue (with sample film 10c). Parkway Exchange, 1040 Eastern Parkway, Brooklyn.

16MM. S.S. Panchromatic, 100 ft. \$3.00. 8mm. 70 ft. \$1.25 including processing. Cope, 3720 S. Figueroa, Los Angeles.

LATEST 8-16mm. Films. Free lists. Niagara Home Movies, 360 Auburn, Buffalo, N. Y.

WANTED—500 Members home movie exchange club. S. R. Movie Exchange, 3690 Warren Rd., Cleveland, O.

SENSATIONAL Films. List free; sample artistic film 10c. Box 1504, Hollywood, California.

EXTRA! Graf Spee scuttled! Filmed as it happened! 8mm.—180' \$5.50; 16mm.—360' \$8.75. Sound on film 350' \$17.50. Order at once! Garden Film, 319 West 50th, New York.

PROFESSIONAL 16mm. Titles \$1.00—12 words including backgrounds. Sound 50c extra. Same expert film service used by thousands of theatres. Send trial order or write for free catalog. Filmack Laboratories, 838 S. Wabash, Chicago.

8-16MM. Films; cartoon, comedies, travel, sport, war in Europe, world's fair, 1001 different subjects, at bargain prices! Films rented everywhere. Trades accepted. Free catalogue (with sample film 10c.). Garden Exchange, 317 West 50th, New York.

ATTENTION Movie makers: Cut your movie costs 50% with Solar Film, America's foremost economy movie film. Write for prices of 16mm., 8mm. films and special discount offer. For better films and faster service write: Solar Film Company, 3827 Archer Ave., Dept. J, Chicago, Ill.

FREE. 16mm., 8mm. Bargain lists. Home Movies, Box 216, Easton, Pennsylvania.

TRACE Movie titles, black and white, color \$2.00 complete. Samples 5c. "AtoZ" Titling Outfit, Flatiron Building, New York.

MOVIE Cameras, projectors, films, etc., bought—sold—exchanged. Lists free. Art samples 25c. Peerless, Box 1310-P, Hollywood, Calif.

16MM. VELOTEX. Perfect outdoor film, 100 ft. rolls \$1.95 including free processing. Sample free. Velotex Laboratories, 600-H, Gary, Indiana.

35MM. ODD 75c, 16mm. \$1.50 complete. Savarese, Woodcliff Lake, N. J.

GUARANTEED 8MM. 24-hour reversal processing. Double 8mm., 45c. Single, 25c. Univex 15c. Eso-S, 3945 Central, Kansas City, Missouri.

MOVIE Film. Develop yourself. Univex, Eastman, etc. Chemical samples 15c. Raw film wholesale. Lake Camera Exchange, Gary, Ind.

15% TO 25% Discount on still or movie cameras. Free circular. Paramount Co., 327 E. 92nd St., New York City.

BASS Says: Write to Cine headquarters for 66-page Cine Bargaingram No. 240. 8mm., 16mm., 35mm. silent and sound. Equipment to gladden the heart of amateur or professional, including the famous 16mm. sound on film RCA camera, exclusive distributors. Write for copy of this great book, it's free, to motion picture headquarters for 30 years. Dept. A. Bass Camera Company, 179 W. Madison St., Chicago, Illinois.

BARGAINS! 8mm., 16mm., free literature. Eider, P-739, Boylston, Boston, Mass.

RADIOS, SUPPLIES, INSTRUCTION

"SERVICING Hints," 32-page booklet, free. Supreme Publications, 3729 Thirtieth Street, Chicago.

ALNICO Love pups, crystal sets. Terry Sales, Central Station, Box 781, Toledo, Ohio.

STANDARD Radios. Agents catalog 10c. Wilson Radio, 2509 North 3rd, Milwaukee, Wisconsin.

DISTANCE Crystal radio kit—\$1.95. C.O.D. Circuits (3)—25c. Esco-PM, Kansas City, Mo.

RADIOS Repaired—Send tubes or radio for free estimate. Accurate Engineers, 3423 Desota, Cleveland, Ohio.

RADIOS: All types; catalog free. Autocrat-A. 3855 North Hamilton, Chicago, Ill.

RADIO Engineering, broadcasting, aviation and police radio, servicing, marine and Morse telegraphy taught thoroughly. All expenses low. Catalog free. Dodge's Institute, Ames St., Valparaiso, Ind.

SEND For free giant money saving radio and phonograph record catalogue. United Radio Company, 1000-M, Newark, N. J.

RADIO Kits—\$3.95 up. Complete. Single band; all-wave; 5-10 tubes. Radio and parts catalog free. McGee Radio, FP-10, Kansas City, Mo.

MUSIC AND MUSICAL INSTRUMENTS

GUITARS—Genuine national \$35.00 "Duolian" amplifying Spanish guitar. Brand new! Written guarantee—Send only \$22.50. National Dobro Corp., 400 So. Peoria, Chicago, Ill.

PHONOGRAPH Records. Slightly used. All late numbers. Ten cents each. Goodbody, 1824 East Main, Rochester, N. Y.

PIANO Course \$1.25. Home study. Moses, 315 West 86th, New York.

EXPERT Violin repairing. Send your violin to us for estimate. A complete stock of fine old and new violins. Whittle Music Co., 1213 Elm St., Dallas, Texas.

SONGS And song poems, bought; published; royalty basis. Your opportunity. Best offer. Free advice. Metro-Melody Publishers, 1204 Sutter, San Francisco.

ORIGINAL Poems, songs wanted for immediate consideration, publication. Music Corporation, Dept. N12, Portland, Ore.

NEED 100 Songs for publishers catalogue. Send songs, lyrics now! Royalty basis. Melody World Music Publishers, Garfield Building, San Francisco.

10 LATE Records \$1.00. Free RCA electric phonograph with \$15.00 order. Record Shop, 2443 Gunnison, Chicago.

SONGWRITERS, Poets. Brilliant opportunity. Write immediately. Vanburen, B-43, Rockhaven, Kentucky.

SONGWRITERS! Poems, melodies. Outstanding offer. Hibbler, C-5, 2157 No. Avers, Chicago.

ORCHESTRATIONS—Popular back numbers 12 for \$1.00. Porges, 6211 Kimbark Ave., Chicago.

LEARN Swing piano! Postal brings free folder. Christensen, 751 Kimball Hall, Chicago.

SONGWRITERS, Write for free inspiring booklet outlining new opportunities for amateur songwriters. Allied Music, Dept. 4, Box 507, Cincinnati, Ohio.

SONGWRITERS—Send poems; free plans, reports. Variety, Dept. H, Salem, Indiana.

PIANO By ear. Free booklet. Day-V-Way, 13265 Michigan Ave., Dearborn, Michigan.

ONLY Published songs bring dividends and popularity. For important information write Sunbeam Publications, 20 West Jackson, Chicago.

RECORDING Songs, poems, dollar per minute. Ray Turner, Hotel Tilden Hall, Champaign, Ill.

SONGWRITERS—Write today for free booklet "Building An Income Through Songwriting." Songwriters Institute, 1234-C Broadway, New York.

MUSIC Composed to words. Rhyming pamphlet on request. Phonograph recording of completed songs. Send poem for consideration. Keenan's Studios, Dept. PM, Box 2140, Bridgeport, Conn.

MUSIC Composed to words. Wonderful proposition. Bauer Bros., Oshkosh, Wis.

WRITE Songs. Big money and reputation. Write for information. J. Gordon Pub. Co., 201 N. Hoyne Ave., Chicago.

WANTED! Lyrics, melodies for songs. We arrange, publish, sell. Superior Song Studios, Passaic, N. J.

SONGWRITERS: Send your poem today for immediate consideration. Richard Brothers, 24 Woods Building, Chicago.

SONG Writers. Send for publishing agreement. McKinley Music Publishers, 1501 E. 55th St., Chicago.

SONG Poems wanted. Free examination. Send poems to McNeil, Master of Music, 510-PM So. Alexandria, Los Angeles, Calif.

POPULAR Orchestrations, unbelievable prices. Samples free. Orchestras, 3309 Lawrence, Chicago.

BUSINESS OPPORTUNITIES

AMAZING Profits "Building Home Coolers." Entirely new business. Unlimited possibilities. Enormous demand. Experience not required. Tremendous opportunity to build big paying business. Write today. Helm Mfg. Co., Decatur, Texas.

EMBOSSING Signs made to order. Name plates, manufacturers' displays, posters. Any color. Sample with your own copy 25c. Sign-O-Graf, 739 Cole, San Francisco.

NIAGARA Falls—Wonder city of the world. Any one question about city or its inhabitants answered for 25c—five questions \$1.00. Individual research. Confidential. No guesswork. Address Niagara Falls Service, P.O. Box 279, Niagara Falls, N. Y.

"NEW Money Makers" 70-page mail-order magazine, prints hundreds new, novel, sparetime plans monthly. Sample copy 10c. M. Marvin, Publisher, 330 South Wells, Chicago.

SELL By mail! Inspiring, constructive, instructive literature. Jay, 1127-p East 61st, Chicago.

START Home business making statuary, plaques, art goods, novelties, souvenirs, concrete pottery, garden furniture, artificial marble flooring, liquid marble. Make your own flexible molds. Amazing profits. Valuable folder free. Creative Publishers, (P3), Glencoe, Illinois.

EARN Money at home making imitation diamond jewelry, bracelets, bairpins, millinery ornaments, religious medals, etc., high prices now paid on account of German and French jewelry shortage. Exceptional spare or full time opportunity. Write: United Jewelry Manufacturers, Dept. A, 1692 Boston Road, New York City.

HANDY Men—Earn money home operating Community "Fix-It" Shop. Stafford, Makanda, Illinois.

START Photo finishing business! Develop films; make money! Details—stamp. Photo, Blawnox, Penna.

SALTED Peanuts in shell! Patent and \$1.00 helped start originator. Later made fortune before retiring! Try plan—home! Contacting agents by mail—in your county. Treatises, Box 1240-B, San Bernardino, California.

BUILD Factory process lawn mower grinder—\$2.75. Mowers, Janesville, Wis.

"LUMINOUS Paint" shines in dark. Easily made. Formula 25c. Ideal Service, LP3, Park Ridge, Ill.

CAPITAL Seekers—Put your project before 360 key-men. Cost trifling. Details free. Amster Leonard, Fox Theater Building, Detroit, Michigan.

SELL Back date comic magazines to stores, friends, neighbors. 50 new 10c magazines (without covers) sent postpaid for only \$1.25. Sell at 5c each. Bookazine Shop, 1528 Market St., Philadelphia, Penna.

YOU'LL Like resilvering mirrors, autoparts, reflectors, making chipped glass signs. Write Sprinkle, Plater, 127, Marion, Indiana.

MONEYMAKING Opportunities. Magazine included. Send stamp, F-116 Church, Foxchase, Philadelphia.

MAILORDER Business on 25c capital. Instructions 25c coin. Kermen, Box 694, Pocatello, Idaho.

"RUBBER Mold Making." Plaster Casting. Working instructions 25c. Ideal Service, RM-3, Park Ridge, Ill.

EARN Cash at home! M. M. earned \$267.00, three weeks raising mushrooms in cellar! Exceptional, but your cellar, shed perhaps suitable. Materials furnished. Starting crop guaranteed. We buy all crops. Book free. United, 3848 Lincoln Ave., Dept. 59, Chicago.

MANUFACTURE From Phospholene. Bleach 2c gallon; glass spray 1c gallon; hand soap 2c pound; and ten fast sellers. Sample 25c. Details free. Western 401 Climax Bldg., Cleveland, Ohio.

SEE Our ad under Educational-Instruction. Cole Associates, Syracuse, N. Y.

WANT Money? Read "Money by Mail." Plans, moneymaking ideas galore. Free copy. Bonrite Press, Box 934, Greensboro, N. Car.

YOUR Own single-ingredient products. No manufacturing! Information free. B. Kinford, Wayne, Penna.

REACH Rural buyers. Private lists compiled from actual sales, 100 names 25c coin. Kaymar, P.O. Box 207, Wilkes-Barre, Penna.

SOMETHING New, formula for "all purpose soap" for home and at work. Complete processing data and four profitable formulas for \$1.00. Make your time pay. Scientific Chemical Compound, Stock Yards P.O. Box 4245, Fort Worth, Texas.

110 OUTSTANDING Money-makers. At home. Anywhere. Service Bureau, Box 4079, South Edmonton, Canada.

POPCORN Machines, carmelcrisp, crispettes, cheese coat, potato chips. Long Eakins, 2035-C High St., Springfield, Ohio.

TURN Tin cans into money at home. Big profits. 25c easy instructions mailed. H. Chaney, 1130 East 16th Street, Jacksonville, Fla.

MAIL Order business course will show you how to make money, spare or full time. Teaches professional mail order technique; not penny-catching schemes. Write for free details today. Nelson Co., C-404 Manhattan Building, Chicago.

EARN \$50-100 Weekly. Load of sawdust starts you. Details 25c. Routier, 787-D Chili Ave., Rochester, N. Y.

\$125.00 MAILORDER Plan. 25c. (Dealers 23c profit). Wm. White, Vineland, N. J.

CASH Daily operating "Commercial Reporter Plan" by mail! Thorne's, 214 W. Trail, Jackson, Mich.

"BINGO," New coin operated amusement game. Large income, operating "route." \$150 investment. Details free. Robbins, 1141P DeKalb Ave., Brooklyn, N. Y.

SPARE-TIME Business—Tremendous profits! Sell to agents—locally and by mail. McKinley Co., Wayne, Penna.

ADVERTISE In "Schemer," big business bringer; 20 words three months including three copies, only \$1.00; extra words 5c each. (42nd year.) Patterson, Publisher, Alliance, Ohio.

BIG Profit in mold making and plaster casting. \$1.50 profit on every dime invested. Foolproof rubber. Tremendous market. Simple interesting work. 24 page instructive catalogue free. Plastic Arts, 711 Neely Muncie, Indiana.

FREE Supplies! "Success by Mail" folio 10c. Kamkay, 173, Norfolk, N. Y.

ADDED Income ideas. Snappy Mail News Magazine, copy 10c. Messenger, 116 Randolph, Roanoke, Va.

MAILORDER Opportunities! Send name—Postal, Wallace, 1724 Monroe, Madison, Wisconsin.

SOAP Making. Learn home. No machinery. Posera, 4545-P Bartlett, Milwaukee.

500% PROFIT—Operate America's lowest priced penny merchandise vendors. Fielding Co., Jackson, Mich.

MAKE Good durable paints and varnish about 60c gallon. Write Emmelmann, 1425 Terrace Avenue, Indianapolis, Indiana.

MAKE Candy suckers. Samples and directions 10c. Home Candies, Franklinville, N. Y.

MAIL Order opportunities! "Keystone" magazine 10c. Q. Taylor, Lemoyne, Penna.

PLANS—Interesting, easy, new. Stamp brings particulars. Thornburgh Service, 1206 Monroe, Wichita Falls, Texas.

BUILD Big business; make maple flavor apple taffys. 10c ingredients makes big batch. Great seller. Complete formula \$1.00. Maple Taffy, 109 N. Dearborn, Room 505, Chicago.

POSTCARD Addressed Excello Sales, Shreveport, Louisiana, brings best proposition ever received.

MIRROR Resilvering offers great opportunities. Joyce Mirror Studios, 12461 Dresden, Detroit.

MAKE Artificial marble, glazed tiles, uncanny. Tabletops, plaques, floors, hones, novelties. Hard, fireproof, inexpensive, cement secrets. Brilliant tile and liquid rubber samples 3c. John A. Payn, 945 Grande Vista Avenue, Los Angeles, Calif.

COMPLETE Mailorder business of your own. Details 10 cents. Pasaak, Box 21, Sta. J, New York City.

MAKE Your own rubber molds. Sample mold and details 10c. June, 101-B Beech, Holyoke, Mass.

MANUFACTURE Polishpuffs. Amazing proposition 10c. Particulars free. Hickorydell, Glenbeulah, Wis.

24 WAYS To make money 50c. Orville Earhart, Hollenberg, Kansas.

CASH Paid for insects. See Sinclair display advertisement on page 29A.

BIG Paying mail order business in your own home. Write. Loftus's, Box 1534, Washington, D. C.

START Vacuum cleaner rebuilding business like mine, home, spare time. Fourth successful year. Plans \$1.00. Hester, 1001 South High, Denver, Colorado.

PROFITABLE Mail business at home. Expert's selected plans. Send 50c. Filipp, 1139 Rosemount, Cincinnati.

GENUINE Mexican imports, \$1.00 brings three samples and wholesale lists. Becker, Mirando City, Texas.

SMALL Investment will make \$300 month. Particulars 3c stamp. Stewart-Jorgensen Company, Sturgis, South Dakota.

MAKE "Folding" money—\$3 and a folding rule starts your profitable weatherstrip contractor business. Send \$1.50 for one complete 5 foot window set. Money back guarantee! E-Z-On, Department 9, 30 North LaSalle, Chicago.

CASH In during 1940, learn real-estate management through home study. Quick, easy way. Prepare yourself, make more money. Morrison School, 100 N. LaSalle, Chicago.

READ "Modern Times Magazine" for money makers. Sample and plans 10c. Glauser, 3220 Turner, Philadelphia, Penna.

TREASURE Finders? Read Goldak advertisement on page 135A.

FORDS Portable Hammermill operators make regularly weekly net earnings, \$50, \$75, \$100 and more. Fords' exclusive molasses impregnator gives operators big competitive advantage. Equipment may be purchased 25% down, balance from earnings. Write for particulars about this safe, sure, profitable year-round business. Myers Sherman Company, 1428 12th, Streator, Illinois.

BUILD A business of your own. Grind lawn mowers the Universal way. Small investment—large profits. Every customer satisfied. Write for Booklet T. Rogers Manufacturing Company, Lindsey, Ohio.

MANY Money making ideas, handy household article free. Profit Guide Service, 1585 Broadway, 303V, New York.

OPPORTUNITY Of doing business by mail. Particulars for stamp. Eastern Sales Service, Box 101, Millville, N. J.

YOUR Own business. Free particulars. Mogul, 10420 Yale, Cleveland, Ohio.

SUCCEED With your products. Make-sell them. Formulas, Processes, Accurate analyses. Catalog free. B. Thaxly Co., Washington, D. C.

PLASTEX Industries offers industrious men an opportunity to start a business of their own, manufacturing art goods, novelties, souvenirs, etc., in Plastex and marble imitation. 5c material makes \$1 articles. Rubber moulds furnished for speed production. Small investment brings big returns. You are just in time for big wholesale season now starting. Write for interesting booklet mailed free. Plastex Industries, Dept. A, 1085 Washington Ave., New York.

PUBLISH A magazine at home. Sample magazine dime. Devino, M620 Wrightwood Ave., Chicago, Ill.

A REAL Future for you with Red Comet Automatic Fire Extinguishers. Low price. Proven seven years. Splendid sales outfit free. Some good territory open. Exclusive. Write quick. 766 Red Comet Building, Littleton, Colorado.

INVENTORS—We successfully sell inventions, patented and unpatented. Write for proof, and tell us what you have for sale. Chartered Institute of American Inventors, Dept. 4-C, Washington, D. C.

GOOD Paying business silvering mirrors, plating autoparts, reflectors, bicycles, bathroom fixtures by late method. Free particulars and proofs. Gunmetal Co., Ave. H, Decatur, Ill.

SELL By mail. Earn money sparetime. New folio by expert shows how. 25c. Ribot, 620 East 62nd, Chicago.

LIQUID Marble—anyone can make! Colorful, glazed! Moulded, brushed, sprayed. Rubberlastic moulds. Composition flooring. Big money in these! Particulars free. Marbleizing Service, Edwardsville, Ill.

127 WAYS To make money, in home or office, business of your own. Full particulars free. Elite Co., 214 Grand St., New York.

HOW And where to obtain capital fully explained, free particulars. Star Service, Wapakoneta, Ohio.

YOUR Own business! Selling by mail. Details free. Maples, 3418 South Marshfield, Chicago, Illinois.

ELITE Collection of business plans, contains 127 tested plans and scores of formulas. Start own business; home, office. Particulars free. Elite Co., 214 Grand St., New York.

WE Help start you in business, furnishing outfits and instruction, operating "Specialty Candy Factory" home. Men-women, opportunity to earn good steady income, all or spare time. (Our 31st year). Booklet free. W. Hillier Ragsdale, Inc., Drawer 4, East Orange, N. J.

MAIL Order business is your opportunity. Many began small, now earn thousands yearly. No personal contact. Boundless opportunities. Have had over 30 years experience; will help you succeed. Send 25¢ for valuable booklets, none free. B. Breniser, 257 S. 21st, Philadelphia.

COLOR Concrete with chemicals. Stucco-Rock. Cement artistry. Benches. Washingwells. Spin concrete pottery. Miniature castles, watermills. Coldglaze, water-paints, marbling. Sample 10c. Hollywood Cement-Craft, 8527 Wonderland, Hollywood, California.

EARN Extra money at home. Increase your income at home by new, simple Wentworth Tempera Color method. We instruct you and supply you with work. Write today for free booklet. Wentworth Pictorial Co., Ltd., Dept. 3, Hamilton, Ont.

MAKE Money by mail, the way we do. Free information. Maywood, P-1107 Broadway, New York.

ADVERTISERS! 1,600,000 Mail order circulation. Inch advertisement, \$15.40. "Get results," 20 newspapers, 18 words, \$6.50. Diener-Dorskind, 1474P Broadway, New York.

I WANT To send you proof of the wonderful pulling power of Popular Mechanics Magazine's classified pages. What's your proposition? Write me today. F. W. Johnson, Manager Classified Advertising, 200 E. Ontario St., Chicago, Ill.

SELL By mail. Books, novelties. Bargains! Big profits! Particulars free. E. Elfc. 438 N. Wells, Chicago.

CHARTERS: Delaware; best, cheapest; free forms. Colonial Charter Co., Wilmington, Del.

WHERE To buy at lowest wholesale prices. Information free. Yorena, Box P-312, Bayonne, N. J.

BUSINESS Knowledge, worth dollars to you 10c. C. Thimilian, Lake City, Minn.

BE Independent—I'll show you how to write successful selling letters for any kind of business. No books to study—no hard rules to learn—you start writing immediately. Many firms pay as high as \$25 for single letter. Complete instructions \$2 postpaid. Coykendall, Letter Specialist, Treasure Village, St. Petersburg, Florida.

100 PROFITABLE Mail order and local plans. Gilbert Supply, 5-P West 24th, New York.

MAKE Sell luminous paint. Literature free. Gordon Laboratories, 1265-H Broadway, New York.

AMAZING Profits. Day-night, year round. No selling. Operate "Silver King" vendors. \$3.25 up. Free instructions. Automatic, 2425A Fullerton, Chicago.

MONEYMAKING Books, plans, formulas. Literature free. Watson, 621 South 31st Avenue, Omaha, Nebr.

\$5.00 LEAST Possible return each day worked according our plan. Light work, canvassing unnecessary. Plan and trial outfit delivered U. S. only \$2.00, refundable on return complete outfit. Scissors-man System, Box 1142, New Haven, Conn.

1059 WAYS To start a profitable business. Get Popular Mechanics book of modern formulas and methods for practical specialty manufacturing. Price only \$1.25 postpaid. Popular Mechanics Press, Room (C40), 200 E. Ontario St., Chicago.

MONEYMAKING OPPORTUNITIES

START Own telephone repair service in your farm community. Good money maker. We furnish instructions, material at low prices. Ideal sideline—Radio, electric, hardware stores. Inquire about local agency. Farm Telephone, Dept. A, Rogers Park Station, Chicago.

BE A professional scrapbooker. Big fees. Unlimited opportunities. Can be done at home. No competition. No capital needed. For complete details send 10c to Scrapbookers Guild, 59 Park Place, New York, N. Y.

AMATEUR Cartoonists, earn cash at home, copying and duplicating cartoons for advertisers. Ad-Service, Argyle, Wis.

MAKE Money quickly collecting accounts anywhere by mail for merchants, doctors and dentists. No special education or previous experience needed. No office required. How to get the accounts and what to charge for collecting them explained fully. Copies of five letters which have collected over \$100,000, and easy instructions how to use them. All sent for \$2 postpaid. Coykendall, Letter Specialist, 624 Treasure Village, St. Petersburg, Florida.

MAKE Composition gold-like nuggets that have weight, color; look genuine. Experts amazed! Oldtimers baffled! Easily compounded. Big demand. Large profits. Guaranteed, copywritten formula \$1.00. Triple-"S," National City, Calif.

YOU'LL Like resilvering mirrors, auto-parts, reflectors, making chipped glass signs. Write Sprinkle, Plater, 287, Marion, Indiana.

300 TESTED Moneymakers. Formulas—Plans. Wholesale Supply Source, 68 pages 25c. Ideal Service, 300-3, Park Ridge, Ill.

PUBLISH Magazine yourself! Plan 10c! Serovid, 139 Navin, Johnstown, Penna.

WOULD You like to work in South America? Send name—postal. Julius, Amarillo, 42, Texas.

MAILORDER. Particulars free. Avon Service, 117-M South Seventh, Wilmington, N. C.

500 COIN-COAXING Imprints 25c. Powell Service, Box 1963E, Cleveland.

MONEYMAKING Ideas Magazine—Sample copy 10c. Kenneth Parish, East Syracuse, New York.

MILLION Articles. Buy wholesale. Valuable directory 10c. Ideal Service, D-3, Park Ridge, Ill.

FREE Questionnaire keeps you posted moneymaking opportunities. Unobligated. Bridger, New Windsor, Illinois.

3 BIG Moneymaking magazines 10c. Publisher, 2620 Stromberg, Pittsburgh, Penna.

"AGENT'S Directory' brings moneymaking propositions galore! Listing 10c. Fromme, 147 Islington, Toledo, Ohio.

"1000 PROVEN Ways of Earning Money"; rent this book 30 days for only 10c. Particulars free. Smith Book Service, W. Palm Beach, Florida.

WIN Prizes! Free information from our staff of winners. Personal Contest Club, Station "P," Brooklyn, New York.

NEW Ways to earn and save! Book, "1100 Uses For Waste" 25c. Box 487, Hollywood, Calif.

"PROSPERITY" For home workers. 64 page magazine. Sample, dime. Sizemore, 4917N Kostner, Chicago.

MAKE Your own show card water color paints. Low costs. Make money, sell to others. P.O. Box 81, Hudson City Station, Jersey City, N. J.

DIMES, Quarters, dollars—in your mail. Get 7 pulling ads; propositions galore; 3c stamp. Kay Service, 3916 Telegraph, Oakland, Calif.

PROFITABLE Mail order business at home. Stamp. Myers Company, Cambridge, Ohio.

AMAZINGLY Profitable! Help unemployed land jobs. Stamp. Vocational Advisors, Spanaway, Tacoma, Washington.

CASH Paid for insects. See Sinclair display advertisement on page 29A.

MAKE Money. No house to house selling. Plan and ad copy 25c coin. Box 181, Barborton, Ohio.

14c STARTED Profitable mail business. Information; moneymaker opportunities 12c. "Worthwhile," 319S Marengo, Pasadena, Calif.

"FIRESIDE" Mail order weekly magazine prints business plans, opportunities, formulas. Big profits reported. Copy 10c. Special! 2 months (8 issues) 20c. "Fireside," Inkster, Mich.

MAIL Order News with valuable folio, 25c. Drew, 710-5, Devils Lake, N. Dak.

TREASURE Finders? Read Goldak advertisement on page 135A.

CHARMING Oil, fascinating fragrance, lasting, cost few cents sell \$1.00. Secret formulas 25c. Darnoc, 95 Station "N," Montreal, Canada.

MAKE Color-glazed concrete pottery, gravestones, tiles, floors, walls. Basement waterproofing, etc. Booklet, details 10c. National Potteries, Minneapolis, Minn.

MONEY By mail, new mailorder opportunities free. Harvey Teeple, Decatur, Indiana.

START Big paying mailorder business at home. Particulars free. Wilson Sales Service, 504 E. Wilson St., Milwaukee, Wis.

BE Funny, make money. Learn gag writing. Stamp brings information. Don Ulsh Studios, B-518 Wrightwood, Chicago.

MOULDS, Guaranteed, for casting toy soldiers, Indians, trappers, warships, sinker moulds, 244 kinds. Send 5c for illustrated catalogue. Henry C. Schiercke, 645 Spencer, Ghent, N. Y.

RAISE Earthworms for profit. Information free, stamp appreciated. Bureau Zoological Research, 106A Broadway, Peoria, Ill.

WHOLESALE Sources, 500,000 articles. Free directory. Maywoode, 1107 Broadway, New York.

MAKE Money. No selling. Particulars free. Arrowhead Enterprises, Duluth, Minnesota.

EARN Extra money writing for publication. Simple method. Demand inexhaustible. Details free. Glen Donaghey, 17 Groton, Lowell, Mass.

START Own mailorder business. Send 25c for big folio "How to Sell by Mail" by expert. Benty, 1741 Melrose, Chicago.

GROW Plants without soil. Folder free. Gordon Laboratories, 1265-J Broadway, New York.

FORMULAS, PLANS, ETC.

ANY Formula 30c, or money promptly refunded. Testing Laboratories, Box 521, Tampa, Florida.

SINGLE-INGREDIENT Formulas — no manufacturing! Information free. A. Kinford, Wayne, Penna.

FORMULAS—All kinds. Real moneymakers. Lowest prices. Catalog free. Clover Formulary, 108-P3, Niles Center, Ill.

HUNDRED Money-making formulas \$1.00. Carlon, 145-23 232nd St., Springfield, N. Y.

BEAUTIFUL, Castable resins. Five formulas, different types—one dollar. Supt. Rose, Benton, Mississippi.

PAINT Shines in dark 10c. Formula instructions 50c. Myers, Box 26, Niles, Mich.

FORMULAS; — "Chemist Approved." None better. Lowest prices. Catalog free. Kemico, 12-C, Park Ridge, Ill.

10,000 MONEY Making formulas, recipes, secrets. Make most anything. 900 page book, \$1.50 postpaid or C.O.D. (foreign \$1.85). Catalog 3c. Adams Brown Company, Chestnut Hill, Massachusetts.

ANALYSIS. Research. Newest guaranteed formulas. Biggest catalog free. Nominal prices. Gibson Laboratory, Chemists, BD-1142 Sunnyside, Chicago.

SENSATIONAL! 110 Successful formulas. \$1.00! List free! Galluzzo, 409P Trenton, Pittsburgh, Pennsylvania.

KILL Bedbugs. Instructions, formula \$1.00. Roaches, \$1.00. Excellent profits. Springfield Mothproofing, 95 State St., Springfield, Mass.

JUST Out, honey-fruit coating for ice cream, lollipops. Formula and details dollar. Harry Moore, Hannibal, Mo.

LATEST Money-making formulas. Literature free. Bradford Laboratories, Jackson, Tenn.

NEWEST Guaranteed formulas. Literature free. Globe Company, 82 Devonshire, Boston.

TEN Thousand formulas, \$4. Send stamp for circular. Jerome Jones, Hollins, Ala.

THAXLY Formulas for perfect products. Accurate analyses. Catalog free. B. Thaxly Co., Washington, D. C.

FORMULAS—List free. Andco Laboratories, 225 7th St., Rockford, Ill.

REAL Manufacturing formulas. Lists free. Cummings, Chemist, Gordon Avenue, Syracuse, N. Y.

FORMULAS. Latest money makers. Literature free. Belfort, 4042 N. Keeler, Chicago.

ELITE Formulas and plans; make and sell your own products. Descriptive booklet free. Elite Co., 214 Grand St., New York.

CHEMISTRY

FREE: 40 Page catalog of chemical and laboratory supplies for amateur chemists. Wollensak microscopes and supplies, scientific books at big discount. JE-3 Winn, 124 West 23 Street, N. Y. C.

FREE Catalog. Chemistry, mineralogy, biology, microscopes, telescopes, Tracey Laboratories, Evanston, Illinois.

CHEMICALS In 5c quantities. Catalog 5c. Fleischer's Laboratories, Medford, Mass.

EXPERIMENTAL Chemistry — Vitamin chemistry. Interesting, instructive, inexpensive. New methods. New plan. Scientific & Technical Service, 210 Post St., San Francisco, Calif.

CHEMISTRY Courses at bargain. Particulars, A. Shapereau, 620 E. 8th St., Brooklyn, N. Y.

FREE Chemistry catalog. Supplies at 5c! Equip complete laboratory. Kemkit Scientific Corp., 397P Bridge St., Brooklyn, N. Y.

CHEMICALS, Laboratory, glassware, apparatus. Send 3c for catalog CP1. Biological Supply Company, 1176 Mt. Hope Avenue, Rochester, N. Y.

SPECTROSCOPE For quick chemical analysis \$2.50. Kutting Sons, Campbell, California.

HELP WANTED

BIG Money taking orders: shirts, ties, hosiery, underwear, pants, jackets, sweaters, uniforms, etc. Sales equipment free! Experience unnecessary. Nimrod, 4922-BG Lincoln, Chicago.

STEADY Work—Good pay. Reliable man wanted to call on farmers. No experience or capital required. Pleasant work. Home every night. Make up to \$10 a day. Wonderful new proposition. Particulars free. Write McNess Co., Dept. 401, Freeport, Illinois.

BOOKKEEPERS—Learn credit management from experienced credit man. Cooke, 98 Killington Ave., Rutland, Vt.

SALARIED Positions—\$2500 yearly and up (none lower). Let us find one for you. Small cost. Write for valuable information. Executive's Promotion Service (16), Washington, D. C.

EARN Cash at home! M. M. earned \$267.00, three weeks raising mushrooms in cellar! Exceptional, but your cellar, shed perhaps suitable. Materials furnished. Starting crop guaranteed. We buy all crops. Book free. United, 3848 Lincoln Ave., Dept. 60, Chicago.

SUPPLY Master toilet bowl cleaner direct to users. Big field. Other everyday necessities. Send 25c for cleaner or write today for particulars. Master Chemical Company, 1950 West Fond du Lac, Milwaukee, Wisconsin.

EARN Money in your spare time taking subscriptions to Popular Mechanics. Unlimited possibilities, every family a prospect. Easy to sell. Bonus paid in addition to liberal commission. Send postcard for further details today. Circulation Dept., Popular Mechanics Magazine, 200 E. Ontario St., Chicago.

AGENTS WANTED

\$1 STARTS You in business selling outstanding line ties, 5c each up; also boxed novelties. Over 100% profit. Wash ties, 60c dozen, sample 7c. Slide-On ties, \$2.40 dozen, sample 25c. Free swatch book with first order. Write for descriptive wholesale catalog, prices, free sample materials. Philip's Neckwear, 20 West 22nd, Dept. P-4, New York.

WRITE Quick for amazing new line of men's shirts and sport ensembles. Easiest sellers. Low as 3 for \$2.98. Beautiful Sanforized fabrics, exclusive features. Money back guarantee. Big profits assured. Repeat business. Valuable outfit free. Stylewear, Dept. A-214, Erie, Penna.

POCKET Pal knife and scraper. New best seller. Details and sample 25c. Apex Co., Dakota Bldg., St. Paul, Minn.

BIG Money taking orders: shirts, ties, hosiery, underwear, pants, jackets, sweaters, uniforms, etc. Sales equipment free! Experience unnecessary. Nimrod, 4922-AN Lincoln, Chicago.

YOUR Own local shoe business. Free outfit starts you! 200 styles. Big advance commissions and liberal bonus. Experience unnecessary. Tanners Shoes, 328 Boston, Mass.

AGENTS-DISTRIBUTORS Territory open new fast selling Ford accessory. Sell filling stations for re-sale. Sheidley Mfg. Co., 418 Ridge Bldg., Kansas City, Mo.

AGENTS: 200% Profit on amazing new discovery. Cleans, polishes, waxes cars in 30 minutes. Magic all-purpose polish. Instant demonstration sells most skeptical auto owner and housewife. Enduro, 2420-A Grand River, Detroit, Michigan.

AMAZING New product—"Sentinel" prevents odors, tastes of one food from permeating others. Keep cantaloupe, fish, onions, butter, etc., uncovered in refrigerator. \$1.00 postpaid. Agents wanted, especially Ladies' Aids. M. O. Sales Service, Atkinson, Nebraska.

WANTED! Agents to sell nationally guaranteed, popular priced, domestic electric refrigerators, direct to consumer. Commissions up to 50%. Gennett & Sons, Manufacturers, Richmond, Indiana.

ALL Sales-people read "Mail Salesman" for successful results; profits; plans; ideas; methods. Sample copy dime and 3c stamp. Sidney, Pottsville, Penna.

PUNCTUATION At a glance. Sells itself. Sample 10c. Royal Publishing Co., Box 93, Milton, Mass.

EVERY Man and woman is a prospect! No experience or money required to represent world's largest shirt manufacturer selling direct to wearer. One year guarantee; half price offer; customized fit. Full line of sportswear including slacks and ensembles. Hosiery for men and women. Big advance cash commissions and 33% cash bonus writing easy orders, spare or full time. We deliver and collect. Write quick for free money-making sales outfit. Rosecliff-Quaker, 1239 Broadway, Dept. 465, New York.

SCHOOL Seniors—Earn graduation expenses selling our popular name cards. Best commissions. Free cards. Big catalogue. Write Craftcards, Box 235, Pittsburgh, Penna.

WANTED: Men—women to supply Blair food and household products to homes. Deep cut prices and lovely premiums. Send no money. Big box of products free for testing. Blair, Dept. 31-U, Lynchburg, Virginia.

EXCELLENT Opportunity agents, routemen, salesmen. Amazing new vegetable spray. Deadly to insects. Harmless to humans. Pyle Products Company, Pevely, Missouri.

DON'T Be a job hunter—Start your own business on our capital. No hard times; no lay-offs; always your own boss. Hundreds average \$3,000 to \$5,000 annual sales year after year. We supply stocks, equipment on credit. 200 home necessities. Selling experience unnecessary. Wonderful opportunity to own pleasant, dignified, profitable business backed by world-wide industry. Write Rawleigh's, Dept. CU-PPM, Freeport, Ill.

STRANGE Chemical sponge cleans wallpaper like magic. Banishes housecleaning drudgery. Sensational demonstration. Samples sent on trial. Rush name. Kristee, 116, Akron, Ohio.

BUSINESS Proposition resilvering mirrors, autoparts, reflectors, making chipped glass signs. Write Sprinkle, Plater, 128, Marion, Indiana.

AGENTS—Men's suits 84c, pants, 37c, top coats 62c, ladies' coats 52c, dresses 15c. Other big bargains. Catalog free. Roosevelt Mercantile, 566-SR Roosevelt, Chicago.

WINDOW Sign letters. Penny each, large sizes. New styles. Absolutely beautiful. Free samples. Atlas, 7941 Halsted, Chicago.

GET Free food products! Send no money. Big \$7 value order-getting demonstration kit given to reliable man to start big pay, year round business. Earnings start at once. Experience not needed. Ed Mills, 3514 Monmouth, Cincinnati, O.

MAGIC Disc heats water without gas, coal or oil. Tremendous seller. Big profits. Pocket samples for agents. Rush name for free offer. Nuway, Dept. X-163, Des Moines, Iowa.

REFRIGERATOR Purifier, new, fast selling. 100% profits, repeat sales. Details free. Sample 25c. Cache Co., Box 728, San Diego, Calif.

MEDICINE Distributors: 500% profit selling 12-ounce \$1.50 Vi-Co laxative tonic. Exclusive agency guarantees success. Vi-Co Sales, V-11, Birmingham, Alabama.

MYSTERIOUS Disc heats water instantly without coal, gas or oil. Pays up to 178% profit. New principle. No risk sample offer. Write Lux Company, Dept. H-126, Elkhart, Ind.

SELL Merchants wall signs. Cost 1c, sell 10c. Richards, 127-M E. New York St., Indianapolis.

MAKE And sell your own products. No machinery needed. Amazing profits. Guaranteed "Chemist Approved" formulas. Catalog free. Kemico, 10-C, Park Ridge, Ill.

SELL Nip external treatment coughs, colds. Sample 10c, sells 25c. Nip Products, Lamoni, Iowa.

BARGAINS—100 Blades 25c; electric razor 55c; candid type camera 50c; laces, gross 39c; 1001 other items. Catalog. World's lowest priced wholesalers. Mills Sales, 901 Broadway, New York.

MEXICAN Curios sell on sight. Large profits. Free particulars. Samples 10c stamps. Marquez-PT, Apartado 1176, Mexico City.

UP To 500% profit with new perfected 1940 quick action, no flint, automatic gas lighter. Retail 25c. Sample 10c. New Method Company, Box PMG-87, Bradford, Penna.

BRAND New item for agents, salesmen. Just out. Sells on sight. Every man needs 3 to 12. Rush name for money-making offer. Remark Mfg. Co., Dept. 10, Butler, Ind.

YOUR Hose free with outfit. Make up to \$32.50 in a week taking orders for amazing new hosiery. Replacement guaranteed against holes, snags, runs. Rush name, hose size. Wilknit, Desk CC-37, Greenfield, Ohio.

SELL New, used clothing from home, auto. store. Men's suits 96c, shoes 10c, dresses 21c. Ladies coats 33c. Hundreds big bargains. Catalog free. S & N, 440-A East 31st, Chicago.

SELL Tricks, jokes and carded merchandise. Dixie Supply, Rosslyn, Virginia.

500% PROFIT. Gold and silver colored sign letters. Offices—stores. Large sizes 1c. Free samples. Modernistic, T-3000 Lincoln Ave., Chicago.

EX-O-LENE Anti-knock power compound. More mileage, power, speed, pep. Tremendous profits! Guaranteed! Thermo Exolene, Peoria, Ill.

MANUFACTURE Specialties, hire agents yourself. Big money. Free literature. Gilbert Supply, 5-P West 24th, New York.

NEW Home laundry aid. Washes cleaner and whiter. Saves soap, labor and time. Nothing like it in stores. Money-back guarantee. Repeat sale item. Amazing demonstration easily made. Exclusive territory. Abbott, 8032 S. Wabash Ave., Chicago.

TIES, Wonderful proposition, free outfit! Eureka, 307 West 38th, Manhattan.

MAKE Time count. If your sales-time is limited, sell our Vision Improver. At least half of those you talk to, buy one or more. Sell singly or groups, offices, clubs, etc. 20c price, dime profit. Fifty weigh less than two pounds. Sample and terms free. Nu Du, 11½ Lake St., Nashua, N. H.

MONOGRAMMING Automobiles real money maker. Write for samples. International Co., Box 9360, Philadelphia, Pa.

MONUMENTAL Agents wanted. All leading granites. Guaranteed. Prepaid. Liberal earnings. Protected territories. Mikulich Company, Manufacturers, St. Cloud, Minn.

MAGIC Polishing block — Removes scratches, mars from furniture and cars. Sample 25c. Dozen \$1.80. Ducks Manufacturing Company, Freeport, Illinois.

SENSATIONAL New item. Sample 25c. "365" Products, Wadesboro, N. C.

MAGIC Roach box. Attractive sales article. Sample 10c. Nock, 1712 Valmont, New Orleans, La.

AMAZING Zipper clothesline. Instant demonstration. Sells on sight. Dunn Mfg., Hempstead, N. Y.

NEW Item for motorists. Fast seller. Clean up with "Ready Wash." 3005-73 Ave., Oakland, California.

500% PROFIT Taking orders for artistic oil painted personal portraits framed. No capital required. Mailed C.O.D. to customers. Free sample. Monarch Studios, McAdoo, Penna.

BIG Profits selling ties. New spring line ready. Slide-on ready-tied ties, hand and machine-made, from \$2.15 doz. 4 in hand \$1.50 doz. Repeat orders assure steady income. Write for details, free catalog and swatches. Empire Cravats, 22 West 21st Street, New York City, Dept. 20.

AMAZING Identification key chain—Many exclusive key holding devices. Sample 10c. Mercer, 101W 76, New York.

900 MEN Wanted immediately; amazing money-making opportunity. Read ad on page 144A.

BIG Money—Taking orders for artistic hand-colored 8x10 photographic enlargements in beautiful Deluxe frames, plus free photo mirror. Send for this unusual proposition. Gibson Photo Jewelry Co., 831 McDonald Ave., Brooklyn, N. Y.

SUCCEED With your products. Make-sell them. Formulas, Processes, Accurate analyses. Catalog free. B. Thaxly Co., Washington, D. C.

SELL Famous Glas-Glo. Big profits. Great repeater. Busy season beginning. Write for very special get acquainted offer. Glas-Glo Co., Box 164, Phelps, N. Y.

AGENTS: Smash go prices! Santos coffee 12c lb. 4-oz. vanilla 8½c. Razor blades 10 for 8½c. 100 sticks chewing gum 12c. 150 other bargains. Premiums. Experience unnecessary. Carnation Company, P.O. St. Louis, Mo.

GOOD Paying business silvering mirrors, plating autoparts, reflectors, bicycles, bathroom fixtures by late method. Free particulars and proofs. Gunmetal Co., Ave. N. Decatur, Ill.

NEW—Different—Gas station "Service Signals." Knipp Specialty, Long Beach, Calif.

AGENTS—300% Profit selling gold leaf letters; stores and offices. Free samples. Metallic Letter Co., 438-B North Clark, Chicago.

AGENTS—Opportunity make money; book containing 127 successful business plans; home-office; send for free introductory booklet. Elite Co., 214 Grand St., New York.

NEW 10c Seller. Costs 1c. Western, 432 Climax Bldg., Cleveland, Ohio.

AGENTS Make big profits on food products, bargain deals. Low wholesale prices. Rush name for trial outfit offer. Ho-Ro-Co, 2810-T Dodier, St. Louis, Mo.

AGENTS—To mail our literature. Good profits. Home business. Maywood, 1105-1107 Broadway, New York.

ENGRAVED Name plates, numbers, signs, etc., easily sold, profits large. Brett Bros., Winthrop, Mass.

DO You want agents for your proposition? Your ad in this space will place your message before hundreds of men seeking fast-selling products. My folder "How to Secure Agents," is filled with proof. I'll gladly send you a copy free. F. W. Johnson, Manager Classified Advertising, Popular Mechanics Magazine, 200 E. Ontario St., Chicago.

BIG Money applying initials on automobiles. Easiest thing today. Free samples. Also, sideline salesmen for short order decalcomania name plates. "Ralco," 1305 Washington, Boston, Mass.

BIG Money applying initials on automobiles. Write for particulars and free samples. American Letter Company, Dept. 40, Dunellen, New Jersey.

REVOLUTIONARY Window cleaning tool. Good Housekeeping approval. Only ten \$2.25 sales daily to housewives, factories, schools, stores will make you \$350.00 monthly. Carter Products Corp., 900 Front Ave., Cleveland, Ohio.

FREE Sample—Amazing cleaner; sells homes, taverns, everywhere. Big profit—fast repeater. Betco, 5007 Irving Park, Chicago.

AGENTS: Stamping names on pocket-key protectors. Sample check with your name, address, 25c. Stamping outfits. Emblem checks, check-fobs, name plates. Hart Mfg. Co., 303 Degraw St., Brooklyn, N. Y.

HIGH-GRADE SALESMEN

HERE Are extra \$\$\$\$ for you. Make money in your spare time. Turn odd moments into cash. Earn extra weekly income quickly, easily. Hundreds of different offers to choose from—all legitimate, well established companies. Regardless of where you live or what your interests are, there is something here for you. Big news monthly magazine tells how. Next 6 issues free as introductory offer to win new friends. No obligations now or later. Write today for this fascinating publication. A postcard will do. Address "What To Sell," Box M30, 168 N. Michigan Ave., Chicago, Ill.

YOUR Own suits and other gifts free as bonus, plus big cash profits for selling your friends fine quality, individually made to measure suits and topcoats. Popular new low price ranges help make sales easy. Exclusive sport and swing styles no extra charge. Elaborate selection new spring and summer materials and patterns. Satisfaction or money back guaranteed by reliable thirty year old tailoring firm. No experience needed. Sample outfit free. Jay Rose & Co., Dept. P-340, 330 South Wells, Chicago, Ill.

ADVERTISING Book matches—World's largest "direct selling" book match factory offers advance cash earnings calling on every type of business. Experience unnecessary; full, part time. Low prices for high quality; quick deliveries, help you get orders. Good repeat profits. Free kit, instructions. Match Corp. of America, 3433 West 48th Pl., Dept. E-3, Chicago.

PLACED On free trial to customers. Sells itself. Tremendous sales possibilities! Revolutionary inter-communication system. Talk to one or as many as ten people, even 2000 feet away. Loud speaking, back and forth, private conversation. Operates like radio—one electric connection. No servicing or installing problems. Fully guaranteed. Technical experience unnecessary. Easy two-minute demonstration. Thousands prospects—factories, offices, lumber yards, garages, parking lots, restaurants, etc. Accounts receivable carried by factory. Present low price opens big new field. Men earning high as \$100-\$150 week. Protected territory available. Free demonstrator offer. Inter-Communication System of America, 2440 Lincoln Ave., Dept. 304, Chicago.

IS Your job a "blind alley?" There's a real future in your own wholesale business. Profits can run into really big money. Start with little as \$2.50. Handle steady year 'round route of local stores. Collect, deliver orders for 200 nationally advertised 5c-10c counter products. Use home as headquarters. Chance to operate one of our Silver Fleet service trucks. No experience necessary. Facts free. World's Products Co., Dept. 10-Q, Spencer, Ind.

PERMANENT Representative wanted for Hoover uniforms to call on restaurants, hotels, beauty parlors, doctors, nurses, others. Excellent income. Leads furnished. Equipment free. Hoover, Dept. BK-10C, 251 W. 19th, New York.

COMPLETE Line everyday business necessities—over 2000 items. 50% savings to every merchant. Experience unnecessary. Samples free. Commissions advanced. Northwestern, 625-J Jackson, Chicago.

AT Home, your own manufacturing business, making popular \$1 novelties. Cost you 3c to 15c. Everything supplied. Write So-Lo Works, Dept. E-842, Cincinnati, Ohio.

SALESMEN: America's finest sideline. 40% commission daily. 725 fast selling repeat items. Every business uses and must buy. No investment. Sales portfolio free. David Lionel Press, 312 So. Hamilton, Dept. TF, Chicago.

MAKE Big money! Demonstrate automatic electric hot dog cooker. Sells on sight. Eating places, taverns, drug stores will about it. Write for big profit deal. Wienie Chef, 2301 W. Hubbard, Dept. P-18, Chicago.

BLADES—Big profits. Best quality. Factory prices. Postpaid. Ace Blades, Buffalo, N. Y.

SILVER-LITE Signs cost 5c; sell for 25c. Every business a prospect. Sample 10c. Butterworth, Box 25, Alfred Station, Detroit, Mich.

\$75 A WEEK for two sales daily. New specialty. Daily necessity all lines business. Low cost, big profit return to merchant. Refill commissions build permanent income. Box 296, Rock Island, Ill.

CALENDARS, All sizes—Orders are being placed now for 1941 calendars, advertising fans and novelties. Free samples—get started now and book those early orders. Fleming Calendar Co., 6543 Cottage Grove, Chicago.

SELL Printing at cut prices. 2,000 business cards \$1.50; 1,000 envelopes or statements, etc. \$1.75; 25 printed sales books \$1.50; 1,000 process embossed cards \$1.50; 2,000 two-color labels, free holder \$1.50; 2,500 printed handbills \$1.75. One-third comm. Free outfit. Bargain Prg. Co., 189-F W. Madison, Chicago.

BIG Money selling rugs, Bibles, curtains, silverware, aluminum, etc. Easy payments. Call or write Highland Merchandising Company, 4624 Woodward, Detroit, 811 Main, Buffalo, 1105 North Saginaw, Flint, 489 South Main, Akron.

BIG Commissions—selling to stores celluloid pricing tickets, metal shelf moulding. To restaurants, menu covers, signs. P. Pricing Press, 124 White St., New York.

ADVERTISING Book matches—Sell union label book matches. Fastest selling line in America. Large sales producing kit, sample matches, complete cut catalog, eight color combinations make selling easy. Commission in advance. Superior Match Co., 7530 Greenwood, Dept. M-3, Chicago.

TIRE Accessories. Guaranteed 10,000 mile Tiger Grip tire patch, and fast-selling line tire accessories. Salesmen-distributors easily earn up to \$60 weekly, selling garages, service stations, etc. Protected territory. Economy Rubber Products, 698 Burkhardt, Dayton, Ohio.

SPECIALTIES For gas stations; garages; battery shops. Wonderful repeaters. Dill Products, Weymouth, Mass.

CASH Profits daily—Nothing like it on market. Large manufacturer has new sensational seller. Patented, third dimension mystery microscope sign. Salesmen wanted all cities—sell direct to stores. Cost \$3.00, sells \$7.50. Renneker Co., 347 W. Hubbard St., Chicago.

NEW Broom sweeps without throwing dust. Tremendous profits. Free details. Emerson Mfg. Co., Spearfish, S. Dak.

SELL Gas stations First National Shoes, 183 Essex St., Boston, Mass.

SPECIALTY Salesmen: New premium deal for 1940. Scruggs, 1105 Willow, Chattanooga, Tennessee.

ONLY Two sales per day makes over \$1200.00 monthly profits. Auto tools. Every mechanic a prospect. 95% virgin. \$50.00 sales makes \$36.00 profits. New. Proven. Protected territory to producers. Year round demand. Mesco, Beaver City, Neb.

SELL The 1940 Driving Master. The only instrument manufactured that shows how the car should be driven, shows miles per gallon while driving as well as being an accurate motor analyzer. Driving Master Company, Sioux City, Iowa.

MEN-WOMEN. Year around business, your own community. New items just invented. Splendid commission. Write, Smith Mfg. Co., Sibley, Iowa.

NEW Sales stimulating plan for retailers pays big, quick profits. Novel, exclusive features. Sample outfit free. Profit-Makers, 160 N. LaSalle, Dept. B-9, Chicago.

900 MEN Wanted immediately; amazing moneymaking opportunity. Read ad on page 144A.

A REAL Future for you with Red Comet Automatic Fire Extinguishers. Low price. Proved seven years. Splendid sales outfit free. Some good territory open. Exclusive. Write quick, 704 Red Comet Building, Littleton, Colorado.

NEW Specialty—Sells every business and professional man. Four \$15 sales daily pay \$280 weekly. Farrell cleared over \$1,000.00 monthly. Write F. E. Armstrong, President, Dept. PM, Mobile, Ala.

EXCELLENT Opportunity selling our complete line of brushes, largest commissions. Write for sales plan. Wire Grip Sanitary Brush Company, 2300 5th Ave., New York.

EDUCATIONAL AND INSTRUCTION

"HOW To Break and Train Horses"—A book every farmer and horseman should have. It is free; no obligation. Simply address Beery School of Horsemanship, Dept. 1103, Pleasant Hill, Ohio.

STUDY Law at home under personal instructions of an ex-judge of 25 years legal experience. Stream line course. Un-essentials eliminated. Particulars, Walter G. Walker, Attorney, Daytona Beach, Florida.

AMAZE With extraordinary memory! Make learning easy! Remember names, dates, facts, ideas with incredible ease. "Super Memory" course tells how. Details free. Write, Info Company, Box 1122, Chicago.

CLAIM Adjusting. Excellent pay. Investigate tragic accidents, fires; outwit fraudulent claimants. Burns School, 311 Morewood, Pittsburgh, Penna.

CLERKS, Teachers, writers—Read "Turning Ideas Into Cash." Forrest Miller, 462 Berwick, Easton, Penna.

For An extremely profitable lifetime business, operate a collection-credit agency. Free folder. Cole Associates, Dept. M, Syracuse, N. Y.

CLINICAL Laboratory technique taught in your own home at actual cost. Bulletin free. Imperial Technical Institute, Box 198, Elkhart, Indiana.

WATCH Repairing is steady profitable work. Experts usually in demand. You can learn watchmaking trade at home, spare time. New original instruction system. Script engraving course included. Write for free details today! Nelson Co., C-2001 Manhattan Building, Chicago.

AIR Conditioning—Electric refrigeration. Rapid growth creates big demand for trained men. Earn up to \$35-\$50 weekly. Write for free facts. Utilities Engineering Institute, 404 North Wells, Dept. 103, Chicago.

BECOME Practical scientific investigator. Modern illustrated course. Thorough training by former agent U. S. secret service. Particulars free. International Secret Service Institute, PM-30, Hoboken, N. J.

"UNCLE Sam" 1940 jobs. Start \$105-\$175. Men-women. Prepare now for next examinations. Common education usually sufficient. Full particulars—list positions, free. Write today. Franklin Institute, Dept. B3, Rochester, N. Y.

LEARN Tap dancing. Complete instructions 35c. Standard Educational Service, Box 221, Toledo, Ohio.

SERVICE Men—Army, navy, marine corps, coast guard. Know your rights! Sample copy "Regular Service" magazine free. National Association of Regulars, Victor Building, Washington, D. C.

HIGH School boys—Send 25c coin your copy "Ten Sevens" and plan your future success. Ticen, Box 742, Minneapolis, Minn.

DRAFTING. Blueprint reading, architectural, airplane, mechanical, electrical, ship, structural, surveying, mathematics, sciences, engineer's licenses. Civil service engineer examinations. Mondell Institute, 230 West 41st, New York.

FINE U. S. government jobs obtainable through civil service examinations. Get ready now. Rent our training course and save 40%. No obligations. Write. Ozment Institute, 101-A, St. Louis, Mo., quickly.

BOOKS On advertising, art, color, photography, engraving—all processes, block cutting, printing—all methods, offset, silk screen, journalism, sales management, letter writing, etc. Trade journals and other helps. Quantity discounts. List free. Commercial Engraving Publishing Company, 34C North Ritter Ave., Indianapolis, Indiana.

LEARN Air conditioning, refrigeration. Practical work in our Hollywood shops. Free catalog. Chief Engineer, 1141 North Highland, Los Angeles.

JOB For you in your community if you're mechanically inclined and maintain permanent address. New training method puts you in business with all equipment for less than \$20.00. Limited time offer at this price. Details free. Universal Mfg. Co., 2145 Walnut, Chicago.

BLUEPRINT Reading taught by mail. Write Blueprint Reading Institute, Dept. A, Box 5662 Metropolitan Sta., Los Angeles.

SUCCESSFUL Stenographers, typists, bookkeepers, accountants, secretaries, social secretaries trained in home study department. Write for folder showing graduates' success. Give age, occupation, course preferred. Low tuition. Perry Schools, Brunswick, Georgia.

LEARN Beautiful penmanship—Inexpensive course. Hotel School, 36 Paulding, Tarrytown, New York.

NEWSPAPER Jobs—Learn practical reporting, freelance journalism from experienced editors, by mail. The Millers, 10, Bakersfield, California.

BE A dental laboratory technician. One year course. Write Ohio School for Mechanical Dentistry, 811 Prospect, Cleveland, Ohio.

BECOME Trick cartoonist. Illustrated catalog 10c. Balda, Cartoonist, Oshkosh, Wisconsin.

BIG Pay trades you can learn in a few weeks. Decorating, paperhanging, graining, marbling, card writing. Enroll now. Booklet free. Chicago Painting School, 102 West Lake Street, Chicago, Illinois.

HOW To secure a gov't job in the classified civil service. Railway postal clerk, \$1900 a year. Postal clerk, city mail carrier, \$1700. Other jobs, \$1260 to \$2100. Our method helps you pass exams. Men-women, age 18 to 50. Send for free book. Patterson School, 8C Mercantile Bldg., Rochester, N. Y.

MASSAGE, Hydrotherapy, dietetics, drugless therapeutics, chiropody, taught by mail. Evans Correspondence School, Montgomery, Ala.

LEARN Auto mechanics, body, repairing, welding electricity, refrigeration. Diesel. Stevinson's, 2088A Main, Kansas City, Mo.

TELEGRAPHY Taught thoroughly. Railroad retirement act creating opportunities for new operators. Expenses low. Catalog free. Dodge's Institute, Hiatt Ave., Valparaiso, Ind.

SECRET Investigation. Experience unnecessary. Detective particulars free. George Wagner, M-2640 Broadway, N. Y.

PLAYS, STORIES, MANUSCRIPTS

WRITERS! Identification, contacts, protection, opportunities. Guild, 1727 Lee, Evanston, Illinois.

CARTOONING, COMMERCIAL ART, SHOWCARD WRITING, SIGN PAINTING

LEARN Cartooning for profit. Leon Gray School, Box 1901, Dallas, Texas.

LEARN Chalk talking. Quick, easy method. \$2.98. Marland Haines, Bloomfield, Indiana.

DRAW Instantly without training with the Mur-O-Graph. Guaranteed accurate. \$2.00 prepaid. Amaze your friends. Draw for advertisers. Draw portraits. Make showcards, etc. Complete instructions free. Mur-O-Graph, 801 North Marsalis, Dallas, Texas.

ANIMATED Cartooning. Mondell Institute, 230 West 41st, New York, licensed by New York state.

AMATEUR Cartoonists. Earn cash at home, copying advertising cartoons. Ad-Service, Argyle, Wis.

EARN Money making signs, posters, show cards with my new machine. Matthews, 2325 Cass, St. Louis, Mo.

ART Magazine including directory art books—free! Send 10c postage. Art Headquarters, Doty Street, Madison, Wisconsin.

PEN And ink drawings. Let us draw your advertising and catalogue illustrations, from photos, copies or objects. Best work and fair prices. Heraldic Studios, 1914P Oakdale Avenue, Chicago, Ill.

ADVERTISING AGENCIES, LETTER WRITERS, FOR ADVERTISERS

LEARN Advertising at home. Easy practical plan. No text books. Common school education sufficient. Interesting booklet and requirements free. Page-Davis School of Advertising, 3601 Michigan Avenue, Dept. 3439, Chicago.

ADVERTISE: 24 Words, 149 newspapers \$6.50. Lists free. Advertising Bureau, 4515-C Cottage Grove, Chicago.

MAIL-ORDER Ad reaching over 1,000,000 families throughout United States \$14.00 inch. Newspaper, magazine, rateguide—free. Chicago Advertising Agency, 20-P West Jackson, Chicago.

INCH Display, 28 magazines, \$1.50; year \$12.00. Paramount Press, Atlanta, Mo.

ADVERTISE Best mail order weekly magazine. Better, quicker results. Inch \$1.00. Special! 4 weeks \$2.00. Sample 10c. "Fireside," Inkster, Mich.

DISPLAY Advertising: 205 newspapers, \$1.47 agate line. Fidelity Advertisers, 3838-P Washington, Chicago.

ADVERTISING Placed all magazines, newspapers, radio. Lowest rates. Free service. 54 page rate book free. Baker Advertising Agency, A-189 West Madison, Chicago. Successors to Ankrum. Established 28 years.

FREE—New Advertisers Rate Guide, 44 pages. Includes everything. Lowest rates. E. H. Brown Advertising Agency, 140 S. Dearborn, Chicago.

BUSINESS SERVICE

YOUR Broadway address. Only \$1.00 monthly. Particulars free. Karavan, 1241 Broadway, New York.

127 MONEY Making plans for home folks. Particulars free. Guardian, 971 College, Toronto, Canada.

WILL Handle any business or personal assignment in Cleveland. Forwarding mail a specialty. Free details. Gordons Research, 3667 E. 63 St., Cleveland, Ohio.

WILL Develop household and novelty products for reliable mfg. on royalty base. Edward Brooks, 1332 N. 11 St., Philadelphia, Penna.

WASHINGTON, D. C., mail-reforwarding address. Hawkins Mail Service, 817 Fourteenth.

SEND Me your typing. Duplicate manuscripts 50c thousand words. 229 Ardmore, Trenton, N. J.

FOR Hard to get articles try George Babcock, Broadway, North Tarrytown, N. Y.

COMMERCIAL Printing at lowest prices. Samples. Modern Print, 6 Forest Place, Fredonia, N. Y.

COLLECT Your bad debts. Merchants write Lamont Company, Beacon, New York.

RUBBER STAMPS AND OFFICE SUPPLIES

CUSHION Stamps, 1 line 25c, 2 lines 35c, signatures \$1.50. Stamp Works, Hastings, Nebr.

DEEP Letters! Two lines 25c. 3—35c. Adcrafts, Lacrosse, Wis.

2 LINES 25c. 3—35c. Cushioned. Stamp Works, Centerport, N. Y.

TWO Lines 20c; three 25c; 3 cushioned 30c. Stamprite, Wauwatosa, Wis.

CUSHIONED 3 Lines. 35c. Stamp-Works, Box 402, Youngstown, Ohio.

ORIGINAL, Cushion mounted. One, two lines, 25c; three 35c; four 45c; facsimile signatures \$1.50. Stamp Works, 814 Bradley, Peoria, Ill.

2 LINES 25c, 3 Lines 35c. Stamp Works, Auburn, Nebr.

TYPEWRITERS, DUPLICATORS, OFFICE DEVICES

NEW \$3.75 Automatic adding machine. Fully guaranteed. Bassett, Box 302-A, Altadena, California.

TYPEWRITERS, Adder, mimeograph, multigraph, addressograph. Send for free lists of machines that will help you at half price. Pruitt, 28 Pruitt Bldg., Chicago.

INCREASE Business now. "Excellograph" Rotary Stencil Printer reprints thousands everything you typewrite, handwrite, draw or trace. Colors. \$19.75 to \$44. Terms. Illustrated literature free to business or professional men. Pittsburgh Typewriter Supply, Department K-2, Pittsburgh, Penna.

PRINTING, MULTIGRAPHING, MIMEOGRAPHING, GUMMED LABELS

WATERMARKED Bond letterheads—29 lb. Envelopes matching, 250 of each, \$2.50; 500—\$4.30! Postpaid! Stanley Press, Drawer 1500, St. Augustine, Florida.

2,000 BUSINESS Cards \$1.50. 1,000 envelopes, letterheads, billheads, statements, \$1.75. Fine workmanship. Free printing samples. United Business Card Co., Fairmont, West Virginia.

DISTINCTIVE Letterheads, fine printing, friendly service. Forest, 202 Ashland, River Forest, Illinois.

TWO Hundred each envelopes, letterheads, dollar fifty. Wickens, West Lafayette, Ohio.

STATIONERY—Personal, professional, 100 sheets, 100 envelopes Hammermill, printed—\$1.00. Robey, East Lansing, Michigan.

6x9 CIRCULARS, Letterheads, envelopes, postcards—1000, \$2.95; 5000, \$8.99. Folders, booklets, catalogs—lowest prices. Samples. Goodprint, Harrisonburg, Va.

1,000 3x6 CIRCULARS: 125 Words—\$1.00. Lincoln Sales, Box 32, Irwin, Penna.

1000 BUSINESS Cards \$1.50. Willmar Press, 61 President Ave., Providence, R. I.

MERCHANT'S Drawings tickets. Flat. Tested form. 50,000—\$18.95. Merchants Press, Lamoni, Iowa.

\$1.00 POSTPAID—125 8½x11 Twenty pound bond letterheads and 125 6¾ envelopes. Benneville, 907 West Roosevelt, Philadelphia.

PRINTING Prices slashed! Pricelist stamp. Square Deal Printery, Humboldt, Iowa.

BOND Letterheads, envelopes, \$2.75 thousand. Samples. Anything quoted. Ireland Printing Co., Berkeley Heights, Route 7, Dayton, Ohio.

6x9 CIRCULARS—Assorted colors. 2,500, \$3.49; 5,000, \$5.78. Samples. Record Press, Lancaster, Ky.

250 20-LB. 8½x11 Letterheads and 250 6¾ envelopes printed \$2.00. D. Matuska's, Girard, Ill.

LETTERHEADS, Envelopes, \$2.10 thousand postpaid. Cash. Julian Frier, Douglas, Ga.

1000 PRINTED Adcards 3½x5½, \$2.39. Samples free. Comstock, Charlestown, N. H.

PARTICULAR? Neargravure Emboss-O processed letterheads satisfy! Samples. Solidays, Knox, Indiana.

EXCEPTIONAL Value. 250 letterheads, (6x7), 125 envelopes. Name, address neatly printed. Fine white bond. \$1.00 postpaid. Kling Press, 7407 So. Western Ave., Los Angeles, Calif.

SPECIAL. 260 Letterheads, envelopes, each postpaid \$1.00. Evansprint, 44NT, Reading, Penna.

1,000 TWO Color shipping labels, 4x2½—\$1.75. 10,000 3x6 circulars, \$4.95. Letterheads, envelopes, typewritten letters, cards, etc. Okayprint, Martins Ferry, Ohio. Samples.

250-85c LETTERHEADS. Envelopes, 2½x4 labels, statements. Paramount Press, Atlanta, Missouri.

500 LETTERHEADS, Envelopes, statements or billheads \$1.00. 5000 \$7.50. Carter, Box 52, Orange, Calif.

1000 ENVELOPES, Letterheads \$1.66. Samples. American Envelope, 7015 Fenkell, Detroit.

500 TWO Color stickers, 50c. Labels. Catalog. Cott's Spickard, Missouri.

1000 LETTERHEADS, Envelopes, circulars—\$2.50. Estimates. Quality Printers, 317 Scott, Covington, Kentucky.

BETTER Grade printing, free trade illustrations. Reasonable. Economic Press, Leonia, N. J.

6x9 CIRCULARS—\$1.00 Thousand in quantities. Marcus, 1608 South Lawndale, Chicago.

1,000 LETTERHEADS \$2.50. Samples 10c refunded. Kingston Press, Kingston, Ohio.

BUSINESS Envelopes printed 1,000 \$2.50. Darling's, 196 Hudson, Johnson City, N. Y.

GOOD Printing quick, reasonable. Free samples. Atlantic, Box 653-H, Rock Hill, S. C.

250 LETTERHEADS And 250 envelopes, \$2.49, postpaid. Webpress, Farmland, Ind.

150-8½x11 LETTERHEADS And envelopes \$1.00. Vicks Print, Exeter, N. H.

FREE—Card case, prices quality printing (twenty years experience). Ace, 720 Wyandotte, Kansas City, Mo.

2 COLOR Shipping labels, 500, \$1.00; 1000, \$1.85. Postpaid. Franklin Printery, 2932 Pershing, Chicago.

1000 6¾ ENVELOPES—\$2.00. 1000 Cards—\$1.00. Savar, 429 Market, Philadelphia.

PRINT Anything. Reasonable. Samples free. Hamilton Press, 4341P Meade, Chicago.

1,000 LETTERHEADS, Statements, envelopes, \$2.79. 5,000 \$9.95. 1,000 business cards \$1.49. H. Cotter, 2457 Seyburn, Detroit.

HAMMERMILL Letterheads, any color paper, ink; 300 8½x11, \$1.48 postpaid. 30 styles type. Free particulars. Woodruff's, 217A Lewis, Duluth, Minn.

1000 NEAT Business cards \$1.00 postpaid. Taft Co., Box 5366, Chicago.

50 SHEETS, 20 Envelopes, 25c postpaid. Western Stationery, Topeka, Kansas.

500 ¾x2¼ FOUR Line gummed stickers, 25c. Moritz Printery, Saginaw, Mich.

PRINTING OUTFITS AND SUPPLIES

HAND Presses, type and complete printers supplies. Send stamp for new 52-page catalog. P. Peiffer & Company, 6 Columbia St., Newark, N. J.

INEXPENSIVE Home-made press. Details free. Holman Brothers, Downsville, Louisiana.

PRESSES, New type that satisfies. Lists 3c. Landis, Richland, Penna.

NEWSPAPER Halftones — Send photo and \$1.00 for 2"x3" cut. Harold Halftones, 27 Frederick, Oshkosh, Wis.

BARGAINS — Presses, type, supplies. Send stamp. 159 Harvard, Cambridge, Mass.

PRINT Your own cards, stationery, circulars, advertising. Save money. Easy rules furnished. Print for others, big profits. Junior outfits \$8.25, senior outfits \$16.55 up. Details free. Kelsey Presses, H-11, Meriden, Conn.

USED Presses, type, supplies. Lists 3c. Turnbaugh Service, Loysville, Penna.

PATENT ATTORNEYS

INVENTORS: Send immediately for your copies of our new free books, "Patent Protection" and "Suggestions on Selling an Invention." Sixty-eight pages of interesting facts. They tell how Patent Laws protect you; kind of sketch or model needed; simple steps to take without cost; how successful inventors have secured financial assistance; show interesting inventions; illustrate important mechanical movements. With books we also send free Evidence of Invention form to help establish date of disclosure. Prompt service, reasonable fees, special deferred payment plan. Strictest secrecy. Forty-two years' experience. Highest references. Write us today. The facts in our books are worth money to the man with a good invention. Address: Victor J. Evans & Co., Registered Patent Attorneys, 561-C Victor Building, Washington, D. C.

PATENTS. Send sketch or model for free opinion. Stanley Burch, Patent Attorney, Cherryville, N. C.

PATENTS—Trade marks. Preliminary advice, book and disclosure form free. Personal service. Irving L. McCathran, 1060 International Bldg., Washington, D. C. Registered Patent Attorney.

PATENTS: If you have an invention that is patentable—and want to secure your inventor's sole right to profit from that idea—you can't afford to lose time in securing patent protection. Big free book "Patent Guide for the Inventor" shows importance of quick action—how to obtain patent and market your invention. Send for it today. We include our free Record of Invention Blank on which you can make and date a sketch or description of your invention and establish date of disclosure. We offer inventors and manufacturers an inexpensive, thorough, prompt, confidential search service to determine whether or not the idea has been patented before—plus experienced counsel and assistance in every phase of patent and trade-mark practice. Write for free book and Record of Invention form now. See page 20A-21A for further information. Clarence A. O'Brien, Registered Patent Attorney, Dept. OC-1B, Adams Bldg., Washington, D. C.

INVENTOR'S Universal Educator; contains 900 mechanical movements; 50 perpetual motions; instruction on procuring and selling patents and selecting an attorney, etc. Suggests new ideas. Price \$1 postpaid in U.S.A. Address Albert E. Dietrich, 511-B Colorado Bldg., Washington, D. C.

PATENTS. Gerald P. Welch, Registered Patent Attorney, Plankinton Arcade, Milwaukee, Wisconsin.

PATENTS. Protect your idea by securing free "Proof of Invention" folder. Exceptional personal service. Established 1906. E. E. Vrooman, 871 Woodard Bldg., Washington, D. C.

INVENTORS—Send for free booklet "Patent-Sense." Information based on 64 years experience. Lacey & Lacey, Dept. 5A, 635 F St., Washington, D. C.

INVENTORS—Before disclosing your invention to anyone send for form "Evidence of Conception"; "Schedule of Government and Attorneys' Fees" and instructions. Sent free. Lancaster, Allwine & Rommel, 411 Bowen Building, Washington, D. C.

"INVENTOR'S Guide," 100 mechanical movements, free; advises on patenting, selling inventions. Frank Ledermann, Tribune Bldg., New York.

L. F. RANDOLPH, 302-B Victor Bldg., Washington, D. C. Low cost. Book and information free.

PATENTS. Booklet free. Highest references. Best results. Promptness assured. Watson E. Coleman, Patent Lawyer, 724 Ninth St., Washington, D. C.

FOR INVENTORS

SELL Patent! List buyers, Albert B. Davis, Box 40, Smithfield, Virginia.

IDEAS: Ten for a penny. "1000 Needed Inventions" \$1.00 postpaid. F. Richins, 1394 Boston Rd., New York.

SELL Your invention, get results. Write Walter Kreuzer, Edwardsville, Illinois.

INVENTIVE Minded! Proved ways to independence explained free. I-Higbee, Cantil, Calif.

ELECTRIC Pinframes containing abundant experimental parts. Box 1591, Rockford, Ill.

PROTECTIVE "Chart for Inventors." Price 50c postpaid. Thomas A. Jenkins, Roselle, N. J.

INVENTORS Meeting, exhibit and public sale of inventions March 12th to 15th. Write Inventors of America, Hotel Continental, Kansas City, Missouri.

WE Locate buyers meritorious patented, unpatented inventions. If will sell, reply immediately. Descriptive booklet, references, free. Invention Reporter, 5A-11236 South Fairfield, Chicago.

CASH For practical ideas and inventions. Stamp appreciated. Mr. Ball, AB-9441 Pleasant, Chicago.

INVENTORS: "Making Inventions Pay," our 32-page illustrated book, mailed upon receipt of 3c postage. Crescent Tool Co., Dept. Z, Cincinnati, Ohio.

INVENTORS—Send for 72-page book on patents. Reasonable terms. Conscientious treatment to inventors. L. F. Randolph, Registered Patent Attorney, 302-E Victor Bldg., Washington, D. C.

I SELL Patents. Established in 1900. Charles A. Scott, 773PM Garson Ave., Rochester, N. Y.

HAVE You a sound, practical invention for sale, patented or unpatented? If so, write Chartered Institute of American Inventors, Dept. 4-A, Washington, D. C.

INVENTORS: Profit by your invention. A practical talk to inventors by an experienced manufacturer. Our 68 page booklet "Mind vs. Matter" mailed upon receipt of 25c. Rex Engineering Co., Cincinnati, Ohio, Dept. D.

INVENTIONS WANTED

INVENTION Finance Magazine, 80-G Wall Street, New York. Important particulars free.

INVENTIONS Of merit wanted, patented or unpatented. Proof of disclosure furnished. Write for "4-Points of Service," bulletin. R. & S. Engineering Co., AW-3 17 East 42nd Street, New York City.

SALABLE Inventions wanted. Albert G. Burns, Box 147, Oakland, California.

WANTED—Meritorious patented, unpatented inventions. Booklet, references, free. Invention Reporter, 5B11236 South Fairfield, Chicago.

CASH For inventions—Patented or unpatented. Stamp appreciated. Mr. Ball, A-9441 Pleasant, Chicago.

SMALL Inventions wanted by manufacturers. I'll help you sell your invention. Write for free circular. Stanley Hull, 7829-K Euclid Avenue, Cleveland, Ohio.

SIMPLE. Practical inventions wanted by manufacturers, patented or unpatented. For information write Chartered Institute of American Inventors, Dept. 4-D, Washington, D. C.

PATENTS FOR SALE

V-BELT Thread splicing machine: Efficiently joins loose ends of V-belt; incorporates safety features to prevent injury to operator. Edward W. J. Diehl, Route 4, Red Bud, Illinois.

PATENTED Multiple hanger, wire, eyelets, practical. Conveying chain. Davidson, 41 West, Boston.

MANUFACTURERS: For free information latest inventions your line manufacture, write: Invention Reporter, 5C-11236 So. Fairfield, Chicago.

500 INVENTIONS Described. Send dime or stamps for latest Invention Sales Bulletin and sales plan. Address Patentee System, 9443 Pleasant, Chicago.

SELL Your patent through a small classified ad in Popular Mechanics. Many inventors have found buyers in this way. Ask me for proof—I'll gladly send it to you. F. W. Johnson, Manager Classified Advertising, 200 E. Ontario St., Chicago.

MANUFACTURING

MOULDS For candles, white metal products, vulcanizing. Baum's Specialties, Kansas City, Mo.

WE Build models which "put over" your idea. Complete engineering service, developing and designing. We market and manufacture in any quantity. Write for bulletins. R. & S. Engineering Co., Dept. AM-3, 17 East 42nd Street, New York City.

WILL Design your ideas, make working drawings and models, also manufacture at reasonable costs. Model Engineering, Oswood, Indiana.

MANUFACTURING, Any material, any quantity, inventions developed. Milburn, Burlington, Kentucky.

INVENTIONS Manufactured by an experienced company, in any quantity at low cost. Metal specialties, novelties, stampings, dies, and models. Free estimates. Our booklet "Mind vs. Matter" sent upon receipt of 25c. Rex Engineering Co., Cincinnati, Ohio, Dept. C.

INVENTIONS — Manufactured in any quantity at low cost by old established company. Stampings, metal specialties, dies, models, etc. Free estimates. Send for catalog. Crescent Tool Co., Dept. X, Cincinnati, Ohio.

WOODWORKING Power tools — Make them yourself. Lathe, scroll saw, saw table, drill press, portable sander, bandsaw, motorized plane. Complete plans and instruction book—all for only 50c. Popular Mechanics, 200 E. Ontario Street, Chicago.

MODELS AND MODEL SUPPLIES

BUILD Ship models, coach models. Fully shaped hulls with complete kits \$1.00 to \$6.00. Newest model of Constitution \$1.45 postpaid. 3c stamp for catalog. Miniature Ship Models, Dept. R. Perkassie, Penna.

MOLD Rare coins, small parts. Instructions 25c. Precision Molders, 2012 N. 11th St., Milwaukee, Wis.

MODEL Supplies for the inventor. Send 3c stamp for catalog. Pierce Model Works, Tinley Park, Ill.

ENGINE Catalogue castings, supplies, 25c. Howardco, A-2417 North Ashland, Chicago.

READING Consolidation "O" blue prints (7) \$2.00. Everson's, 6 Franklin, West Orange, New Jersey.

SHIP Model kits. 1000 fittings catalogue 10c. Polk's, 429 Seventh Ave., New York.

50" RERWIN Model airplane construction kit \$1.15 prepaid. Catalog 3c. Leader, 5130 So. Damen Ave., Chicago.

MODEL Railroad Shop, Dept. PM., Dunellen, New Jersey. 1940 catalog 10c.

CARVED Hull ship model kits. Ship and yacht model fittings; model yacht sails. Illustrated catalog 20c. A. J. Fisher, 1002-M Etowah Ave., Royal Oak, Mich.

SPEED! Racing hull construction kits. Free literature. Enclose 5c for mailing. St. Louis Model Boat Co., Clayton, St. Louis, Mo.

MODELS—Blue prints made, models developed. Send us your ideas for estimates. Model Engineering, Osgood, Ind.

STEAM Locomotives, 1/4" scale. Send 10c for descriptive folder. Little Engines, Box 15B, Wilmington, Calif.

MODELS—Practical models put over your ideas. We develop models from the crude to perfect working devices. Your idea might have large commercial value. Services confidential. Bank references. Registered graduate engineers at your service. Send 25c for our 68 page booklet "Mind vs. Matter." Rex Engineering Co., Cincinnati, Ohio, Dept. B.

POWER Models. Electric railways, steam locomotives, steam and gasoline engines, all accessories, metals, tools. 84 page catalog 35c. Chas. Cole, Ventura, Calif.

STEAM Locomotives! 3/4" scale. Build one by "Easy Steps." Our illustrated catalog lists all needs. 25c. Little Engines, Box 15B, Wilmington, Calif.

MODELS—Your ideas developed into practical working models. 30 years successful experience; thousands of satisfied customers. Confidential service guaranteed. Bank references. Send 3c postage for our large booklet—"Making Inventions Pay." Crescent Tool Co., Dept. Y, Cincinnati, Ohio.

HOME CRAFTSMEN

"HEAT Treat" your own tools, dies, etc., with Ralksite, scientifically prepared new case hardening compound. Depth of hardness easily controlled. No special equipment needed. Gives a better case, quicker. Efficient, economical—saves time, money. Pound can \$1.00 postpaid. Send today: Ralksite Company, 372 Classon Ave., Brooklyn, N. Y.

SQUAREKNOTTERS! Make belts, handbags, etc. Quality cord samples with catalog, free. Beginners book, catalog and samples, 10c. Special! Regular \$1 book with 50c beginners outfit, all for \$1. P. C. Herwig Co., Dept. J-20, 121 Sands St., Brooklyn, N. Y.

NEW. Make beautiful plywood handles for crocheted or tapestry bags. 6 patterns 25c. No stamps. Asenath Designs, No. 13 Shealy Ave., Towson, Maryland.

FAST-SELLING Novelties, furniture, easily made. Catalog hundreds illustrations, blueprints, valuable premiums, money-saving prices on materials, wood-kits, construction sets, machinery, accessories, 10c. Woodcraft Service, Plainview, Minn.

LAWN Ornaments, easy to make. 20 full size patterns, birds, animals, etc., 25c; Dutch boy, Dutch girl, sprinkling girl, fox terrier, Scottie, bulldog, 15c each, any two 25c; Dutch windmill, 36 inches high 25c. Entire collection, 27 patterns, \$1.00 postpaid. Wickman Co., Dept. 111, Dayton, Ohio.

PRACTICAL Wood mitre box, will outwear several old type. 19"x3", 65c. 24"x4", 80c. Postpaid. Special sanding block included. Get more wear from sandpaper. 20c extra west Mississippi. E. Handberg, Housatonic, Massachusetts.

SCRAP Leather, 50c per lb. F. Nelson, 911 Pine St., Muskegon, Mich.

GET Free leathercraft instruction pamphlets, prices of leathers, tools, projects. Make extra money. Beautiful gifts. Leather samples 5c. Wilder & Company, 1038 Crosby, Dept. 3F, Chicago, Illinois.

BEAUTIFY With wrinkle finish. Brushes on and air dries. 615 Commonwealth Annex, Pittsburgh, Penna.

22 FULL Size lawn ornament patterns 25c. 25 novelty patterns 30c. Both sets 50c (coin). Strother, Box 383-AH, Belington, West Virginia.

VENETIAN Blind supplies. New York Venetian Blind Mfrs., 12 West 18th Street, New York City.

RESILVER Your mirrors. Make those old mirrors new and brighten your home. Formulas, instructions guaranteed. \$1.00 postpaid. Broco, Point Pleasant, New York.

PATTERNS—100 Silhouettes—40 plywood novelty furniture. Workable drawings 236 miscellaneous projects. Lowest prices transfer decorations. Literature superbly illustrated. Write: Wo-Met Shop, Ashburn, Georgia.

VENETIAN Blinds, supplies, wholesale catalog 10c. Roberta, Box 260, Gloversville, New York.

"MODERN Wood Sculpture." Complete instruction book on carving statues \$1.00. Lee, Wood Art Studio, Centerville, Ia.

GARAGE Door over the car. Install yourself. Particulars. Universal Doors, 908 North Spadra, Fullerton, Calif.

PRACTICAL Modernized Spanish furniture designs. Dime for sample and descriptive list other designs. Low quantity prices. Milton McCole, 428 Camino, Santa Fe, New Mexico.

20 MEXICAN Novelty patterns 30c. 20 western silhouette patterns 30c. 10 evening project patterns 25c. 10 lawn ornament patterns 15c. Patterns for girl's Mexican belt 15c. (Dollar bill brings all.) Mexican Arts, Crafts, Eagle Pass, Texas.

KNOCKDOWN Furniture, lumber, veneers. Illustrated catalog 10c. Giles-Kendall Co., Decatur, Alabama.

MAKE Money building bird houses. Great demand. Complete plans and instruction book 50c. Popular Mechanics, 200 East Ontario, Chicago.

OLD GOLD, WATCHES, JEWELRY, PRECIOUS STONES

ALASKA Gold ore specimens 75 cents, three pounds rough gem material \$1.25. Jay Ransom, Aberdeen, Wash.

WATCHMAKERS' Materials — Tools, watches, jewelry. Bought, sold, exchanged. Wholesale catalogue. Ben Segal Company, 5 South Wabash, Chicago.

WATCHMAKERS' Tools, supplies. Watch parts. Lowest prices. Write for price list 43. Dean Company, 87 Nassau St., New York.

ELGIN, Waltham watches, \$3.50. Make big money. Send for free watch and jewelry catalog. Plymouth Jewelry Exchange, 163-B Canal Street, New York.

AGATES, Gems, minerals. 20 gemstones \$1.00. Pricelist free. Hill, Route 7, Salem, Oregon.

5000 REBUILT Watches! Free catalogue—Diamonds, jewelry, (3c postage). The New York Jobbers, 74 Bowery, Dept. M, New York, N. Y.

LUCKY Opals multi coloured brochure 5c. Glorious specimen \$2. Royalty Traders, Sydney, Australia.

AUSTRALIA'S Lovely opals. Illustrated catalogue free. Good selection \$5.00. Norman Seward, Melbourne, Australia.

HIGHEST Prices for old gold—Mail your teeth, watches, jewelry. 100% full cash value mailed day shipment received. Satisfaction guaranteed or articles cheerfully returned. Information free. Chicago Gold Smelting Company, 300-P Champlain Building, Chicago.

GOLD \$35 Ounce. Ship old gold teeth, crowns, jewelry, watches—receive cash by return mail. Satisfaction guaranteed. Free information. Dr. Weisberg's Gold Refining Co., 1500-Q Hennepin, Minneapolis, Minn.

TOBACCO

GUARANTEED: Cigarette, pipe or chewing 5 lbs. \$1.00, ten, \$1.75. Pay when received. Pipe and box cigars free. Rives Tobacco Co., Paducah, Ky.

FOR SALE—MISCELLANEOUS

RECLAIMED Army goods bargains new and used merchandise, pants 50c, army shirts 35c. Free catalogue. Atlantic Sales, 6P Suffolk, New York City.

WANTED—MISCELLANEOUS

QUICKSILVER (Mercury). Any quantity. 90c pound sent day shipment received. Purity unimportant. Wholesale Terminal, Norwood, Massachusetts.

WANTED: Scrap copper brass aluminum. Starmetals, 4201 No. Sawyer, Chicago.

CASH For used microscopes, binoculars, slide rules, drawing sets, scientific instruments, tools, cameras. Satisfaction guaranteed or shipment returned. Elman's, 2302 VanBuren, Chicago.

PERSONAL

POSITIONS Abroad; where they are and how to get them. Honest information about such positions for Americans. Details free. Julius, Amarillo, 41, Texas.

WIN Prize money: Booklet—"Successful Contesting"—shows how. 10c postpaid. Bulletin listing \$100,000.00 prizes included. World Publishers, 4515-B Cottage Grove, Chicago.

FORMULAS—Medicinal, cosmetic. Will sure help you. 50c each. Tabcin Co., 5600 Hamilton, Detroit.

TREASURE Finders? Read Goldak advertisement on page 135A.

MISCELLANEOUS

IF You break your glasses, mail them to Box 427, Mt. Vernon, Illinois, for repairs. We make a new bifocal lens as low as \$1.00. Dr. John W. Williams, Optometrist, Eye Sight Specialist.

500 ADVERTISING Pencils \$5.00. Samples 5c. Adcraft Company, Lacrosse, Wis.

WIN Money! Prizes! Sample contest magazine 10c. Butler, Braxton, Miss.

PLAQUES Make beautiful gifts. Photos. One dime. R. Edmondson, 441 E. Main St., Rochester, N. Y.

FOR Home, shop, office. Ten drawer cabinet 14x3 3/4x4 1/4 inch drawers. Kit 75c. Finished cabinet \$1.50. 10c extra west Miss. Attractive dealer proposition. Taylorcraft, 120 W. Howard, Hagerstown, Md.

RECLEAN Used oil, without cost. Particulars. F. Gerwin, Fairview, Okla.

RECEIVE Gigantic mails, magazines, samples. Your name in numerous mailing lists 10c. Waltman, 460 Grand Street, New York.

AMATEUR Tattooing outfits. Illustrated list free. Tatuco, 651 South State, Chicago.

RELIABLE, Authentic, information 25c. Ask us anything. Factfinder, 340 Wyandotte E., Windsor, Ontario.

PRESSURE Tobacco pipe cleaner. Costs nothing. Easy to make. Instructions 25c coin. L. Lee, Mapleville, R. I.

TREASURE Hunters—Use the patented Hedden Metal Locator to help find your lost or buried treasure. Locates all conducting metal through any substance including water. Hedden Metal Locators, Inc., 6230 N. W. Second Ave., Miami, Fla.

PERFECT Eyesight without glasses. No drugs. Simple, inexpensive home treatment. A. Jacobson, Upsala, Minnesota.

FOSSILS—Vegetation and sea life. Specimen of each \$1.00. Stark I. & B. Co., Box 289, Bellingham, Washington.

COATS Of arms and crests, correctly painted in colors or black and white, from heraldic description or furnished copy, \$10.00 and up. Highest grade work. Heraldic Studios, 1914P Oakdale Avenue, Chicago, Ill.

TATTOOING Outfits, supplies, illustrated list free. Percy Waters, Anniston, Alabama.

SWAPPER'S Friend, R4, Saline, Michigan. Interests swappers, collectors. 50c year, sample 10c.

TREASURE Finders? Read Goldak advertisement on page 135A.

1001 WAYS to Use Concrete. Send for large free illustrated folder describing new Popular Mechanics book covering every known use of concrete for the home, farm, building, business and industry. Popular Mechanics Press, Room (C40), 200 E. Ontario St., Chicago.

Know AVIATION

LATEST NEWS

Here's fun with up-to-the-minute knowledge on AVIATION! Live wires follow MODEL AIRPLANE NEWS because it's the technical authority on modeling and flying. Material from experts all over world. Latest on BIG SHIP news, too, and MILITARY flying.

MODEL PLANS

64 or more big pages of tested designs and news. Hundreds of pictures. IT PAYS to know Aviation! It's exciting! It's fun! You can make money building scale or flying models in spare time. Knowledge may lead to big job as mechanic, engineer, flyer, or airline executive.

FREE SAMPLE ISSUE

Get this big 76 page copy full of interesting news, contests, flights, records, model plans, pictures. Sent FREE. Encl. 5c in stamps for mailing and handling. Write now! JAY PUBLISHING CORP. 551 Fifth Ave., New York



Get MODEL AIRPLANE NEWS 20c at all Newsstands

GET INTO THE BAKING BUSINESS!

National Baking Institute announces a new home study course in commercial baking. Baking now America's fifth industry in wages. Nearly a depression-proof business. Good field for ambitious men. Common school education sufficient. Send for free booklet "Opportunities in Commercial Baking" and requirements.

National Baking Institute
3601 Michigan Ave. Dept. 1353 Chicago, U. S. A.



WELDERS WANTED!



ELECTRIC ARC-OXY-ACETYLENE

Skilled Welders earn \$8 to \$15 a day. The demand now greater than the supply. Learn this highly paid trade in 3 weeks by actual shop work. One of America's leading schools. Established 1902. 7 floors of shops. Endorsed by welding industry. Limited number of students. 3 weeks course in Electric Arc or Acetylene Welding, including room and board, only \$105. Write or wire for reservation. Ask for "Welding Facts." State age.

GREER COLLEGE, Dept. 130, 2024 S. Wabash Ave., Chicago

LOOK! Baby Chicks



THOUSANDS WEEKLY ALL YEAR. Finest quality & Layers in 40 breeds. Hybrid Baby Pullets and Cockerels, B. W. D. Tested. Ducklings, Goslings, Baby Turkeys, Guineas. In business 30 years. Catalog free. ORDER NOW. Make BIG money raising NABOB QUALITY CHICKS.

NABOB HATCHERIES, BOX M, GAMBIER, OHIO

MAKE POULTRY PAY YOU A GOOD LIVING FOR LIFE

POULTRY RAISING PAYS GOOD PROFITS FOR THOSE WHO KNOW ITS SECRETS

Healthful, interesting occupation for whole or part time in country, village or city suburbs. Win independence of low wages, uncertain employment with your own Poultry Business.

TRAIN AT HOME IN SPARE TIME TO BE A SUCCESSFUL POULTRYMAN

For over twenty years, Harry M. Lamson, formerly Senior Poultryman, U. S. Dept. of Agriculture, has been teaching people how to make money in their own business, or preparing them for well-paid jobs in the Poultry Industry. His famous Home Study Course, endorsed by graduates, successful poultrymen, colleges, shows success secrets of experts, how to avoid costly mistakes, to increase profits. Time tested methods plus complete modern, scientific advancements all covered in these fascinating, easy-to-learn lessons.



FREE BOOK TELLS HOW

Whether you keep chickens now or are just planning to enter the Poultry Business, you should read Mr. Lamson's FREE BOOK describing his Courses of Home Study Training.



Mail NOW for FREE BOOK

Harry M. Lamson, Pres.
National Poultry Institute
Dept. 50-G, Adams Center, N. Y.

Dear Mr. Lamson: Send me your FREE BOOK, "HOW TO RAISE POULTRY FOR PROFIT." I want to know more about my opportunity to make a good living for life in this business. Also send list of testimonials.

NAME.....
STREET.....
TOWN..... STATE.....



MACHINE SHOP MEN

Needed NOW!

Learn to set up and run ANY kind of machine; MAKE MORE MONEY NOW by learning quickly HOW TO DO THINGS which usually take years of study and practice. The demand for SKILLED men is ALREADY far ahead of the supply, then what WILL IT BE a month or two from now?

Bigger Pay Don't miss this chance to qualify for promotion, don't miss this Big Opportunity which is yours almost for the asking. Eight Big Books chockful of important mechanical facts told simply and clearly. Over 3000 pages, nearly 3000 illustrations cover every subject fully, including Tool Making, Pattern Making, Foundry Work, Mechanical Drawing, Forging, Machine Shop Practice and Management, and hundreds of other subjects.

8 Big Books Sent FREE for examination. Yes ALL of these books will be sent to you for examination. Decide in your own home or place of business whether or not you want to keep them, check up on any facts you want to. Note their great MONEY MAKING value, then, if you want them, pay on the easiest kind of payments. Send NOW and we will include a year's consulting membership in the American Technical Society without extra charge—and also a Big Binder of nearly 800 pages with 267 original shop tickets with 1200 illustrations. Theshow, step by step, how to set up and run almost any kind of job and are in addition to the 8 books.

American Technical Society, Dept. 5319, Drexel at 58th St., Chicago.

American Technical Society, Dept. 5319, Drexel at 58th St., Chicago. You may send me the 8 big NEW books and binder of shop tickets for free examination. I will pay the few cents delivery charges only, unless I decide to keep them in which case I will send \$2.00 in ten days and \$3.00 per month until the total price of only \$29.80 is paid. If I return them in 10 days I will owe you nothing. Because I send now you agree to give me a membership in the American Technical Society entitling me to consulting privileges with any of your experts for one year.

Name.....
Address.....
Please attach a letter stating age, occupation, employer's name and address and that of at least one business man as reference.

AUDELS Carpenters and Builders Guides 4 vols. \$6



Inside Trade Information for Carpenters, Builders, Joiners, Building Mechanics and all Woodworkers. These Guides give you the short-cut instructions that you want—including new methods, ideas, solutions, plans, systems and money saving suggestions. An easy progressive course for the apprentice and student. A practical daily helper and Quick Reference for the master worker. Carpenters everywhere are using these Guides as a Helping Hand to Easier Work, Better Work and Better Pay. To get this assistance for yourself, simply fill in and mail the FREE COUPON below.

Inside Trade Information On:

How to use the steel square—How to file and set saws—How to build furniture—How to use a mitre box—How to use the chalk line—How to use rules and scales—How to make joints—Carpenters arithmetic—Solving mensuration problems—Estimating strength of timbers—How to set girders and sills—How to frame houses and roofs—How to estimate costs—How to build houses, barns, garages, bungalows, etc.—How to read and draw plans—Drawing up specifications—How to excavate—How to use settings 12, 13 and 17 on the steel square—How to build hoists and scaffolds—skylights—How to build stairs—How to put on interior trim—How to hang doors—How to lath—lay floors—How to paint.



THEO. AUDEL & CO., 49 W. 23rd St., New York City

Mail Audels Carpenters and Builders Guides, 4 vols., on 7 days' free trial. If O.K. I will remit \$1 in 7 days, and \$1 monthly until \$6 is paid. Otherwise I will return them. No obligation unless I am satisfied.

Name.....
Address.....
Occupation.....
Reference..... P.M.

Always write your name and full address clearly when answering advertisements.



ARE YOU JUST HOPING TO LAND IN A GOOD JOB?

HOPE without foundation doesn't go far in this competitive age. But hope *plus* training is a winning combination!

Today, in all kinds of professions and trades, men are earning more money—getting promotions—because of serious, systematic study of International Correspondence Schools Courses.

I. C. S. Courses are prepared by outstanding authorities. Instruction is a *personal* relationship between student and instructor. Mail coupon for full information.

INTERNATIONAL CORRESPONDENCE SCHOOLS

BOX 5570-J, SCRANTON, PENNA.

Explain fully about your course marked X:

TECHNICAL AND INDUSTRIAL COURSES

- | | | |
|---|--|--|
| <input type="checkbox"/> Agriculture | <input type="checkbox"/> Air Brake | <input type="checkbox"/> Managing Men at Work |
| <input type="checkbox"/> Air Conditioning | <input type="checkbox"/> Architecture | <input type="checkbox"/> Manufacture of Pulp and Paper |
| <input type="checkbox"/> Architectural Drafting | <input type="checkbox"/> Auto Engine Tune-up | <input type="checkbox"/> Marine Engines |
| <input type="checkbox"/> Architecture | <input type="checkbox"/> Auto Technician | <input type="checkbox"/> Mechanical Engineering |
| <input type="checkbox"/> Auto Engine Tune-up | <input type="checkbox"/> Aviation | <input type="checkbox"/> Navigation |
| <input type="checkbox"/> Auto Technician | <input type="checkbox"/> Aviation | <input type="checkbox"/> Patternmaking |
| <input type="checkbox"/> Boilermaking | <input type="checkbox"/> Aviation | <input type="checkbox"/> Pharmacy |
| <input type="checkbox"/> Bridge Engineering | <input type="checkbox"/> Aviation | <input type="checkbox"/> Plumbing |
| <input type="checkbox"/> Building Estimating | <input type="checkbox"/> Aviation | <input type="checkbox"/> Practical Telephony |
| <input type="checkbox"/> Civil Engineering | <input type="checkbox"/> Aviation | <input type="checkbox"/> Poultry Farming |
| <input type="checkbox"/> Concrete Engineering | <input type="checkbox"/> Aviation | <input type="checkbox"/> Public Works Engineering |
| <input type="checkbox"/> Contracting and Building | <input type="checkbox"/> Aviation | <input type="checkbox"/> Radio Operating |
| <input type="checkbox"/> Cotton Manufacturing | <input type="checkbox"/> Aviation | <input type="checkbox"/> Radio Servicing |
| <input type="checkbox"/> Diesel Engines | <input type="checkbox"/> Aviation | <input type="checkbox"/> R. R. Section Foreman |
| <input type="checkbox"/> Electrical Engineering | <input type="checkbox"/> Aviation | <input type="checkbox"/> R. R. Signalmen |
| <input type="checkbox"/> Electric Lighting | <input type="checkbox"/> Aviation | <input type="checkbox"/> Refrigeration |
| <input type="checkbox"/> Foundry Practice | <input type="checkbox"/> Aviation | <input type="checkbox"/> Sheet Metal Work |
| <input type="checkbox"/> Fruit Growing | <input type="checkbox"/> Aviation | <input type="checkbox"/> Steam Electric |
| <input type="checkbox"/> Heat Treatment of Metals | <input type="checkbox"/> Aviation | <input type="checkbox"/> Steam Engines |
| <input type="checkbox"/> Highway Engineering | <input type="checkbox"/> Aviation | <input type="checkbox"/> Structural Drafting |
| <input type="checkbox"/> Locomotive Engineer | <input type="checkbox"/> Aviation | <input type="checkbox"/> Structural Engineering |
| <input type="checkbox"/> Management of Inventions | <input type="checkbox"/> Aviation | <input type="checkbox"/> Surveying and Mapping |
| | | <input type="checkbox"/> Telegraph Engineering |
| | | <input type="checkbox"/> Textile Designing |
| | | <input type="checkbox"/> Welding, Electric and Gas |

BUSINESS COURSES

- | | | |
|--|--|--|
| <input type="checkbox"/> Advertising | <input type="checkbox"/> Bookkeeping | <input type="checkbox"/> Grade School |
| <input type="checkbox"/> Business Correspondence | <input type="checkbox"/> Business Management | <input type="checkbox"/> High School |
| <input type="checkbox"/> Business Management | <input type="checkbox"/> Cartooning | <input type="checkbox"/> Illustrating |
| <input type="checkbox"/> Cartooning | <input type="checkbox"/> Civil Service | <input type="checkbox"/> Lettering Show Cards |
| <input type="checkbox"/> College | <input type="checkbox"/> Cost Accounting | <input type="checkbox"/> Railway Postal Clerk |
| <input type="checkbox"/> College Preparatory | <input type="checkbox"/> Commercial | <input type="checkbox"/> Salesmanship |
| <input type="checkbox"/> Commercial | <input type="checkbox"/> Foremanship | <input type="checkbox"/> Secretarial |
| <input type="checkbox"/> C. P. Accounting | <input type="checkbox"/> French | <input type="checkbox"/> Service Station Sales'm'p |
| | | <input type="checkbox"/> Sign Lettering |
| | | <input type="checkbox"/> Spanish |

DOMESTIC SCIENCE COURSES

- | | |
|---|--|
| <input type="checkbox"/> Advanced Dressmaking | <input type="checkbox"/> Professional Dressmaking and Designing |
| <input type="checkbox"/> Foods and Cookery | <input type="checkbox"/> Tea Room and Cafeteria Management, Catering |
| <input type="checkbox"/> Home Dressmaking | |

Name..... Age.....
 Address.....
 City..... State.....
 Present Position.....

Canadian residents send coupon to the International Correspondence Schools Canadian, Limited, Montreal, Canada. British residents send coupon to I. C. S., 71 Kingsway, London, W. C. 2, England

HOW TO PLAY THE HAWAIIAN WAY



HAWAIIAN GUITAR—Learn to play this EASY, SHORT CUT WAY, right in your own home. No tedious practicing. No special talent necessary. Have Fun. Be popular. Surprise your friends. Get "on the air." Make money teaching others. Hundreds of our students now successful in orchestras, teaching, radio. You can do the same.

FREE ILLUSTRATED BOOKLET
 "How to play the Hawaiian way" tells all about this quick, fascinating method. Write today.
OAHU SCHOOL OF MUSIC, Room 800 Film Bldg. Cleveland, Ohio.



Auto-Diesel

Master a real trade. Auto Mechanics, Diesel Mechanics, Arc Welding, Acetylene Welding, etc. Let us train you to be an expert Auto-Diesel Mechanic and help you get a good job. The cost to you is reasonable. Learn on modern equipment with tools under experienced instructors. Real shop work. Steam heated buildings. Room and board in our steam heated dormitory. We pay your fare to Nashville. For free catalog write

Nashville Auto-Diesel School, Dept. 75, Nashville, Tenn.



BE A PASSENGER TRAFFIC INSPECTOR

RAILWAY OR BUS—WE HAVE JOBS

Men—19 to 50—who complete easy, home-study course are placed at up to \$135 per mo., plus expenses to start, or we refund tuition. Qualify in your spare time. Get Free Booklet describing our 21 yrs. service. **STANDARD BUSINESS TRAINING INSTITUTE, Div. 203, Buffalo, N. Y.**

DENISON'S PLAYS

Musical Comedies, Operettas, Vaudeville Acts, Minstrels, Comedy Songs, Make-up Goods.

60 YEARS OF HITS

Catalog Free
T. S. Denison & Co., 203 N. Wabash, Dept. 9, Chicago

FORGE AHEAD

with the Thinking Alphabet—now "exactly how" short cut to new ideas effective mind training, self advancement. Builds personality, brain power, originality. **FREE BOOKLET, THINKING ALPHABET INSTITUTE, 99 J. Fern St., Philadelphia, Pa.**

There's MONEY IN ARC WELDING!



U. S. Manufacturers

desire men to learn Electric Arc Welding and get practical experience under actual production conditions in the laboratories of the School of Engineering. Moderate training fee. Accepted applicants will be fully trained until ready to pass rigid test and assisted in securing employment.

AIRCRAFT WELDING

"We want more planes!" That's the demand on every side. No wonder there is a shortage of aircraft welders. Other industries need welders, too. There's almost no limit to what Milwaukee School of Engineering trained welders can do. They get good pay because they know the "how and why" of Welding, Metallurgy, Drawing, Blueprint Reading, Set-up Work and Fabrication—and they enable manufacturers to cut production costs. Remember—industries need practical trained Aircraft Welders, Arc Welding Operators, Technicians and Welding Engineers, and Air Conditioning and Refrigeration Technicians. Don't be satisfied to struggle along on ordinary, hit-or-miss jobs with poor pay—when in a short time you can become a trained specialist. Send coupon today—classes begin within a month.

MILWAUKEE SCHOOL of ENGINEERING

Institute of Electrotechnics

P.M. 340 North Broadway and E. State, Milwaukee, Wis.

- Without obligation send Free Booklet "The Dawn of a Gigantic Industry and its Outstanding Opportunity." Also tell me How to Become an:
- | | |
|------------------------------|--|
| Arc Welding Operator (3 mo.) | Air Conditioning & Refrig. Tech. (4 mo.) |
| Air Craft Welder (6 wks.) | Radio Serviceman (6 mo.) |
| Welding Technician (5 mo.) | Commercial Electrical Engineer (1 yr.) |
| Welding Engineer (1 yr.) | Commercial Radio Engineer (1 yr.) |
| Electrical Engineer | Student Loan Plan |
| B. S. Degree (4 yrs.) | Earn Part Expense Plan |

Name..... Address.....
 City & State..... Age..... P.M. 340



STUDY AT HOME BE AN OPTICIAN

Earn up to \$65 in a Week and More

Get into this good paying, uncrowded profession. Great demand. Earn up to \$4,000 a year. Dignified, interesting work. Open to men and women. Earn while you learn. No experience needed. Low cost—easy terms. College diploma given. Write for FREE BOOK. Give age.

ILLINOIS COLLEGE OF MECHANICAL OPTICS
30 N. Dearborn St., Dept. PM-3, Chicago, Ill.

GET U. S. GOV'T JOB

Mark the Position you're interested in.
Cut out ad and mail to us:

- | | | |
|------------------|---------------|----------------|
| R. R. Mail Clerk | City Carrier | Postmaster |
| P. O. Clerk | P. O. Laborer | Typist |
| Rural Carrier | Stenographer | Meat Inspector |

Many civil service jobs obtainable through examinations. Get ready NOW. Rent our training course and save 40%. Write Immediately—To-day. Ozment Institute, 111-D, St. Louis, Mo.

Learn Public Speaking

At home—in spare time. Many overcome "stage-fright," gain self-confidence and increase earning power, this easy way. Write for free booklet, *How to Work Wonders With Words* and requirements.

North American Institute, Dept. 1353
3601 Michigan Ave., Chicago, Illinois

Start a POTATO CHIP BUSINESS
IN YOUR KITCHEN! and MAKE MONEY!



BUY potatoes for 2c a lb. Make sensational new "Greaseless" Potato Chips and sell for 35c a lb. Ideal business for men or women in spare or full time. Small investment buys complete equipment. No experience needed. I show you how to get stores to sell all you make; tell you how to make profit first day. All information, pictures, prices and terms sent free. Send a postal card for Free Facts on this big "Home Business" Opportunity.
G. H. HARDT, Dept. F-53, 620 N. Michigan Ave., Chicago, Ill.

Learn this Profitable Profession



in 90 Days at Home

Hundreds of men and women of all ages 18-50 make \$10.00 to \$20.00 in a single day giving scientific Swedish Massage and Hydro-Therapy treatments. There is a big demand from Hospitals, Sanitariums, Clubs, Doctors and private patients as well as opportunities for establishing your own office.

Learn this interesting money-making profession in your own home by mail, through our home study course. Same instructors as in our NATIONALLY KNOWN resident school. A diploma is awarded upon completion of the course. Course can be completed in 3 to 4 months. High School training is not necessary. Many earn big money while learning.



Anatomy Charts & Booklet FREE

Enroll now and we will include uniform coat, medical dictionary, patented reducing roller and Hydro-Therapy supplies without extra cost. The reducing course alone may be worth many times the modest tuition fee.

Send coupon now for Anatomy Charts and booklet containing photographs and letters from successful graduates. These will all be sent postpaid—FREE.

THE College of Swedish Massage (Successor to National College of Massage)
Dept. 364—30 E. Adams St., Chicago.

You may send me FREE and postpaid, Anatomy Charts, booklet containing photographs and letters from graduates, and complete details of your offer.

Name
Address
City..... State.....



It Is Easy To Be A Contractor

Learn to estimate, to plan buildings, to take contracting jobs, and make money on them. Here are 9 up-to-the-minute books on building, estimating, and contracting which cover in an interesting way, the subjects that carpenters, builders, and contractors should know to make the most out of their jobs. The Steel Square, Architectural Drawing and Design, Estimating, Painting and Decorating, Heating, Air Conditioning, Building, Contracting, and other subjects are all well covered.

Boss Carpenters in Demand

BRAND NEW 1940 EDITION

Vast public works jobs, immense projects, and the rapid growth of home building, are making jobs for MEN WHO KNOW HOW. These books give you quick training. With them you won't be afraid to tackle any job, for needed facts can be found in a hurry.

These books just off the press in 1940 are the most up-to-date, complete we have ever published.

Coupon Brings Nine Books FREE For Examination

AMERICAN TECHNICAL SOCIETY
Dep't. G319, Drexel at 58th Street, Chicago, Illinois

You may ship me the new 1940 edition of your nine big books, "Building, Estimating, and Contracting" without any obligation to buy. I will pay the few cents delivery charges only, and if fully satisfied in ten days, I will send you \$2.00, and after that only \$3.00 a month, until the total price of only \$29.80 is paid. I am not obligated in any way unless I keep the books.

Name.....
Address.....
City..... State.....
Please attach a letter stating your age, employer's name and address, and that of at least one business man as a reference.

This MACHINISTS' Home-Study Course



helps men get ahead

Newly assembled—specially priced—these five recent books give you the practical facts on modern machines, up-to-date methods, you need to advance in machine shop work. Take advantage of the other man's experience as found in books, to solve your problems, increase your efficiency, with

The NEW AMERICAN MACHINISTS' LIBRARY

5 volumes—2014 pages—1853 illustrations
(A combined home-study course and reference library)

This library of machine shop practice was written for practical men. It gives you the best methods for every kind of machine shop work. It fully explains lathes, drills, and other machine tools and their operation, automatic screw machines, speeds and feeds, gear design and production, punch and die work, metal surfacing, etc., etc. Plainly written—completely illustrated—the best kind of help to the machine shop man who wants to advance himself.

No money down—special price—easy payments.

EXAMINATION COUPON

McGraw-Hill Book Co., 330 W. 42nd St., New York

Send me for ten days' examination the new American Machinists' Library. If satisfactory I will send you \$1.50 in 10 days and \$3.00 monthly until the price of \$16.50 is paid. If not wanted, I will return the books postpaid. (To insure prompt shipment write plainly and fill in all lines.)

Name.....
Home Address.....
City and State.....
Position.....
Name of Company..... PM-3-40

Say you saw it in Popular Mechanics!

WHAT THE BLAZES DO YOU MEAN—

"MY BATTERY'S ALL RIGHT"?



No wonder the terrible-tempered Mr. X is mad. Here this guy at the service station tells him his battery is okay—and he's just spent half an hour trying to get someone to give him a push to get started!

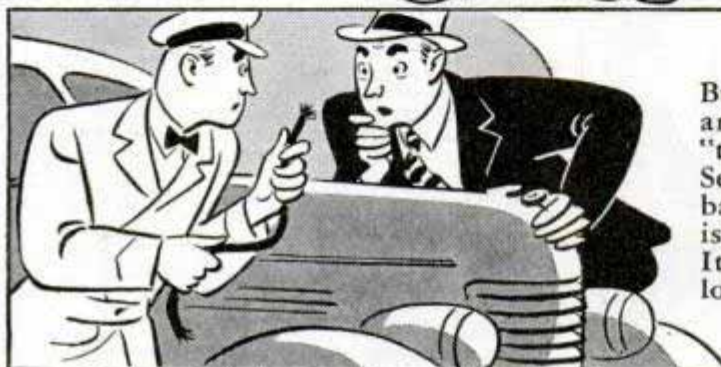

But the service man gives him an argument. "Mister," he says, "this is a Certified Re-Wiring Service Station, and I say your battery tests okay. Your trouble is right here in this battery cable. It's corroded, undersize—and look at the voltage drop it causes."

"Well, blow me down," says Mr. X after a new Packard battery cable and ground strap have been installed. "She starts like a whiz!" "Sure thing," comes back the service man. "That bum cable was chokin' the juice from the battery. Come in tomorrow and let me check all your wiring. That's what Authorized Certified Re-Wiring Service is for!"

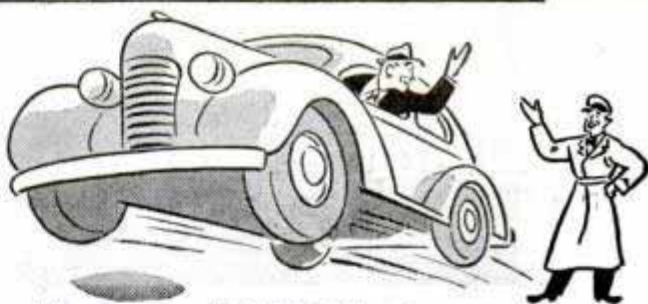

For Sure Starting, Better Performance, Improved Lighting and More Miles per Gallon

When you go to a Packard Certified Re-Wiring Service Station, you can count on *expert* service: Cables in all circuits will be checked with accurate instruments—connections will be cleaned and tightened—and all necessary replacements will

be made with high-quality Packard cable. It will save you money, and give you more driving enjoyment. Look for the blue-and-gold Certified Re-Wiring sign, or ask the mechanic to show you his Certified Re-Wiring Certificate. Packard Electric Division, General Motors Corporation, Warren, Ohio.



SERVICE STATION DEALERS— GARAGE OWNERS

Packard gives you complete service instructions on checking and replacement procedure in all circuits. Ask your jobber about Packard Authorized Certified Re-Wiring Service.

Packard

REG. U.S. PAT. OFF.
TRADE MARK

THE STANDARD WIRING EQUIPMENT OF THE AUTOMOTIVE INDUSTRY

Popular Mechanics Magazine

REGISTERED IN U. S. PATENT OFFICE AND CANADA

WRITTEN SO YOU CAN UNDERSTAND IT

Vol. 73

MARCH, 1940

No. 3

91382

NEW METALS from POWDER



SCIENTISTS have speculated for years on the things they could do if they had a machine that exerted limitless pressure. One daring thought is that with enough compression they could squeeze a substance so tightly that atomic motion would stop and its temperature would drop to absolute zero.

Whether or not they will ever be able to do that, they are already using great pressures to accomplish things impossible in the past. "Squeeze" has opened up a brand new field in the realm of metallurgy. Met-

Left, blowing smoke through powdered-metal filter; right, circuit breaker with disks of powdered metal, and inspecting lamp filaments under magnifier

Carries powder from Boulder claim to

*Emb. Thomas & Stinson Jr. 18618
Machinery, Circuit Breaker, Filter
etc. etc.*

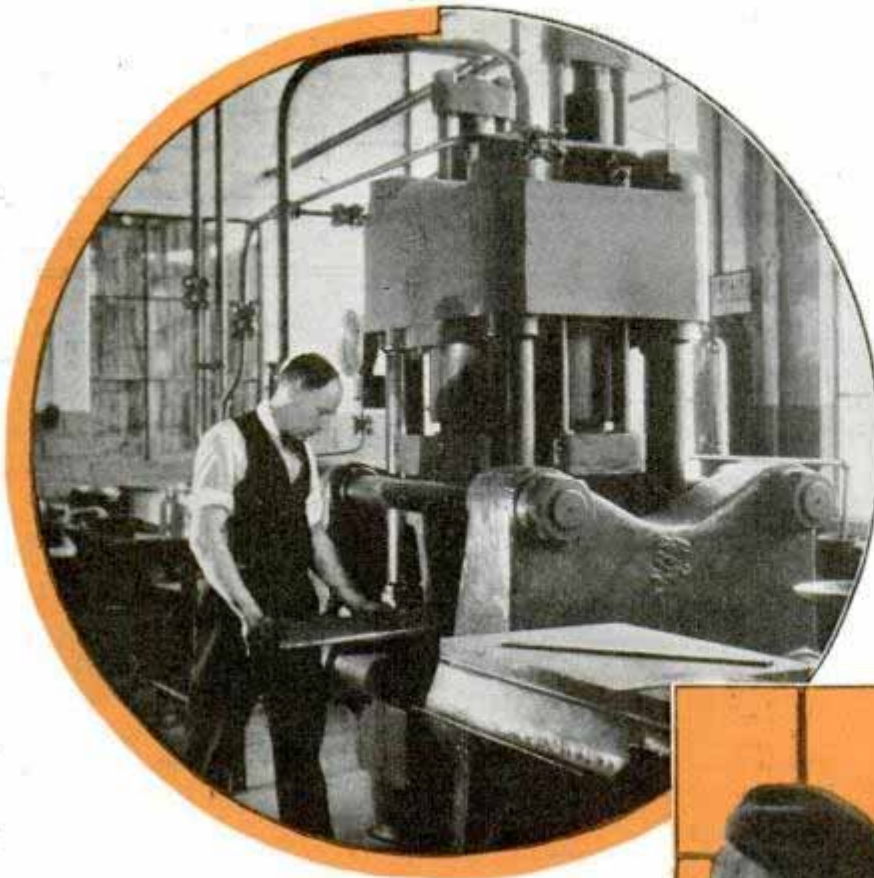

cuit breaker every time a connection was made.

Powdered copper and tin are compressed into the so-called "oilless" bronze bearings by the new method. When the powdered particles are fused together at high temperature the metal is made porous and may be impregnated with oil up to thirty-five per cent of its volume, resulting in self-lubricating bearings. The oil oozes directly from the pores in the surface of the metal.

als and non-metals are combined. Metals that wouldn't mix in the past are being alloyed. Bi-metals, porous metals, metals that are magnetic in desired areas only, and other unusual structural effects are produced.

The secret of this new art is the use of powdered metals that are compacted under tremendous pressure into useful shapes. The metal is reduced to powder so fine that it passes through a 200 or 300 mesh screen and is molded in hydraulic presses under five to 100 tons per square inch.

A handful of iron dust, placed in a press, comes out as a finished oil pump gear, accurate to a thousandth of an inch. Copper and tungsten powders, mixed together, are compacted into switch points that have the high conductivity of copper and the resistance to fusing and wear of tungsten. Copper-silver-tungsten disks only an eighth of an inch thick protect switch points on the 132,000-volt power line between Boulder dam and Los Angeles and deliver perfect service under conditions that would burn half an inch of metal from the contacts of a copper cir-

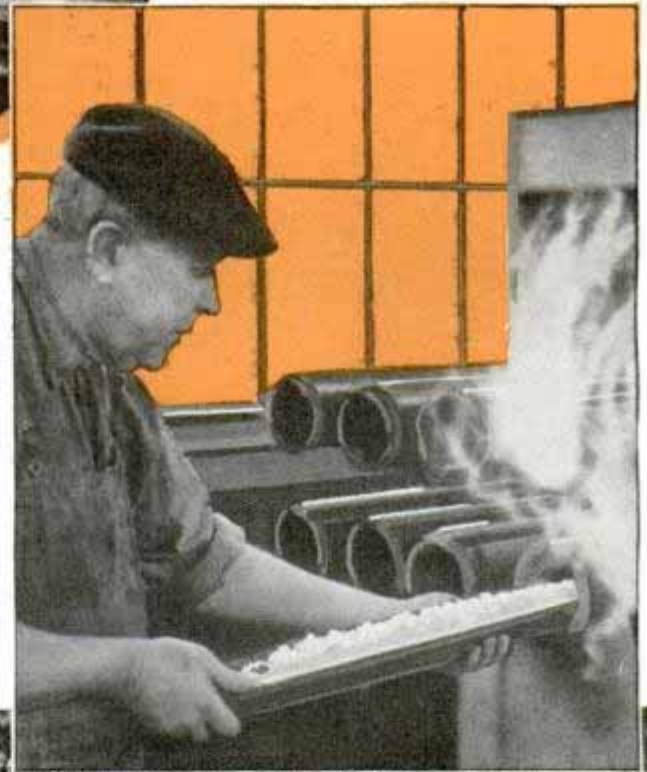

Top, pressing powderlike tungsten into bars. Center, tungsten oxide heated in hydrogen atmosphere in retorts becomes tungsten powder. Bottom, compressed powders of tin (white) and copper (dark) before sintering; on opposite page, after sintering

21382

References: G. & V. Hatch, Worcester, Massachusetts
 Products of the General Motors Corp., Dayton, Ohio. (Notes)

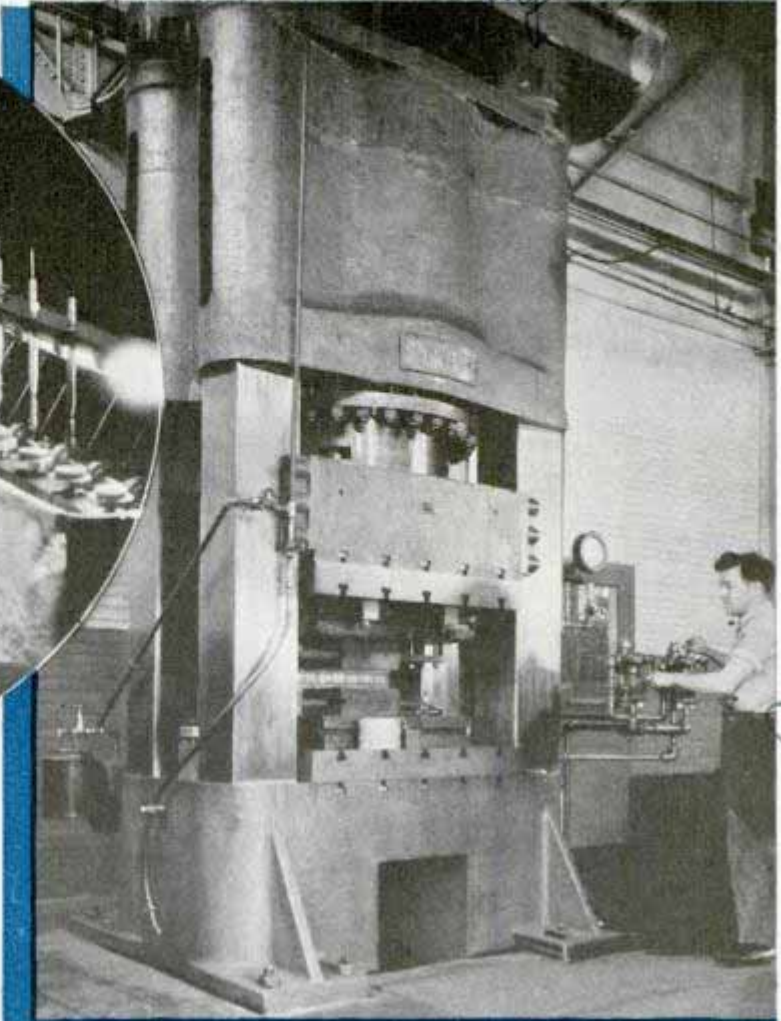

Reference: Westinghouse Electric & Mfg. Co.

The remarkable thing about powder metallurgy is that at no stage are the materials heated to liquid state; thus many of the difficulties in making castings are avoided. In fact, some gears in the Oldsmobile are made of iron that was never molten at any stage in its history. This iron is mined as an oxide in Lapland, deoxidized and crushed to fine powder in Sweden, brought to this country and pressed into gear shapes without ever being subjected to the blast furnace.

(Continued to page 149A)

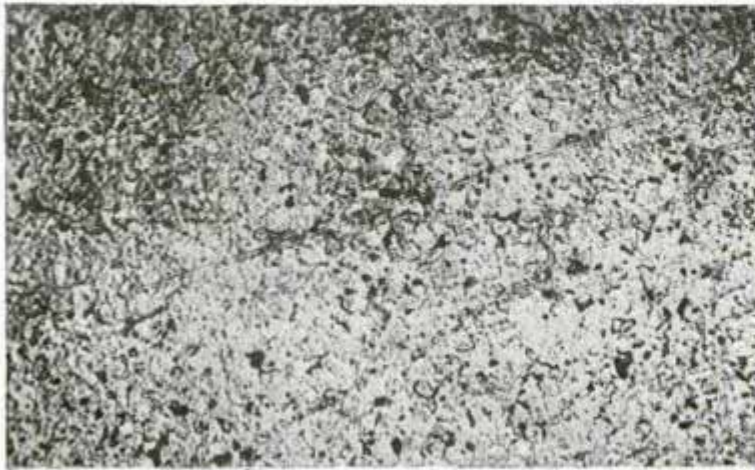

Top, boring diamond dies for drawing tungsten wire; right, 4,000,000-pound hydraulic press; below, fine tungsten wire stronger than steel is drawn from reels at left through gas furnaces and diamond dies

References: G. & V. Hatch, Worcester, Massachusetts
 Products of the General Motors Corp., Dayton, Ohio. (Notes)

Fish Mounted on Aquaplane Is Carved of Florida Cypress



From a distance you'd think this aquatic cowboy was riding a fish's tail. The fish, however, is a bit of sculptured cypress on an aquaplane

Something new in aquaplane riding was introduced in Florida this season when a swimmer climbed on the back of a fish and then drove it across the waters of Biscayne Bay. The fish, however, was homemade. The aquaplane rider had mounted the figure of a large fish, fashioned from Florida cypress and painted in vivid colors, on his board and attached his lines to the jaw of the fish.

Engine Vibration Studied on Greased Rails

To test the vibration of locomotive wheels at high speed, engineers drive into a greased stretch of track at normal speed, open wide the throttle and let the drivers spin on the slippery rails at a terrific rate. With each revolution vibration sets in, due to the difficulty of keeping the wheels in balance. A motion-picture camera mounted below the cylinders on the locomotive obtained photographs which showed that, in some cases, the wheels go through a pe-



Basketball coach demonstrating strategy of game to players by using cut-out figures of men on miniature basketball court

riodic lifting, actually leaving the rails and then coming down with a bump. The camera reveals the speed at which vibrations occur and the heights to which the wheels are lifted off the track. For one locomotive bouncing occurred at a train speed of sixty-six miles an hour and with a slip speed on the wheels of 108 miles an hour.

Basketball Players Taught Strategy on Tiny Court

Tiny cut-out figures of basketball players, moved about on a miniature court, help one coach in explaining new plays to his team and in illustrating points of strategy. During pre-season practice, his men use the model to study their relative positions for executing certain defensive and offensive maneuvers.

Larry Mills 184/1911 4.8.11.11. Sh. Miami, Florida

Gene Service 12/12/39

C. W. Nelson

Research Engineers, Timberline

Crnie Marikomer Temple Guy, etc.

1424
Caulin, Qui

21417

Netheravon, Salisbury
Wilts., England

Magnets Move Armies on a Canvas Battlefield

European war battles are being fought in advance on a battlefield of canvas, thirty feet square, over which miniature armies, supply trains, guns, tanks and airplanes are maneuvered by unseen magnets. This indoor theater of war is used to train young soldiers, air pilots and naval recruits in the fundamentals of military tactics, and was invented by Lieut. Col. D. D. Haskard of the British defense research staff. Green canvas is used as a base for laying out a contour picture of any given battle area, woods and trees being cut from rubber; farms, churches, houses, railroads and highways following exactly the details found on aerial maps. Magnets below the canvas move the trains, guns and troops over the terrain. A miniature smoke-maker projects puffs of smoke upward through the canvas to simulate shell bursts or smoke screens.



© Keystone

At right are views from gallery of school where British recruits learn tactics from maneuvers of armies on contour map thirty feet square. Left, projecting smoke through map from beneath to simulate bomb

Emb. by J. Welkins, 29 Dean
Road, Desleyhead, nr.
London

Super-Fuels for Auto of Future May Double the Power

Automobile engines of the future, burning super-fuel of 100 octane number and having about twice the power for the same size as today's engine, are foreseen by Frank A. Howard, president of the Standard Oil Development company. An engine half the size of those used today would produce at least equal power, and the

mileage per gallon would be twice the present average. The super-fuel already is here and has made possible much better performance and higher efficiency of airplanes. These results, it is believed, can be achieved for motorcars by redesigning power plants to effect small displacement, high compression and supercharging.

21452

26 Broadway, New York

See us at
Exposition

Bike with Handlebar Saddle Is Easier to Mount



Bicycle with small wheel in front and handlebars mounted beneath saddle is easy to mount and control

Somewhat in reverse of the old-fashioned high-wheel bicycle is a new design introduced in Italy. Here the larger wheel is in back and the small wheel in front, while the rider sits between the handlebars which steer from the back. It is claimed that this type of construction permits easier balance and maneuverability.

"Plastic Shell" Airplane Body Has No Rivets or Seams

Airplane bodies are being made by a new plastic process which eliminates ex-



Plastic body and wing covering for airplane permits high-speed mass production to meet need in wartime

posed rivet heads and seams common in metal construction. The body is strong enough, in the case of a training ship, to accommodate engines ranging from 125 to 225 horsepower without extra stressing. The fuselage is shaped in two half sections, and these are united into the structure in a manner that forms a one-piece shell. They are made of spruce plywood which has been impregnated heavily with phenol formaldehyde, a substance similar to Bakelite. When subjected to a secret process of applying heat and pressure these plywood sheets become plastic to the extent that they can be stamped out in the desired shapes and then molded into the exact form required to fit the body of the ship. Covering for the wings, likewise, is formed of two molded halves which are fitted over plywood spars and ribs, and bonded and sealed at all points of contact by the same plastic material. In an emergency, mass production of military planes would be possible, and if wings or body are damaged by rifle fire or shrapnel they could be repaired quickly on the field. Even for major repairs a complete shop is not needed.

Sealed-Beam Lamps for Old Cars Are Installed on Bumper

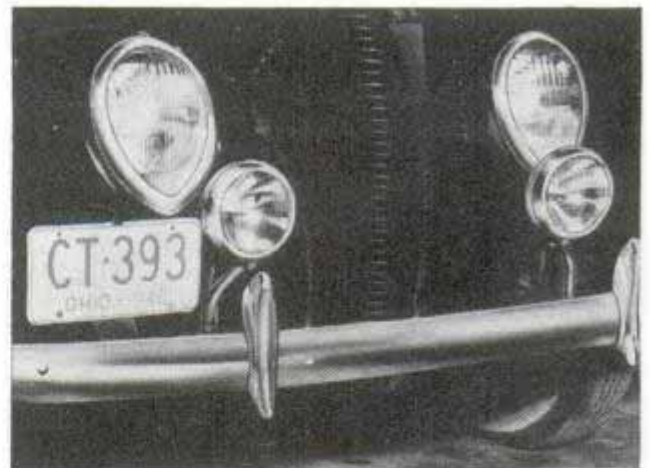

"Driving" and "passing" headlamps of sealed-beam type mounted on bumper to supplement old lights

Owners of cars prior to the 1940 models can obtain the benefit of the new sealed-beam headlamps in use on the new cars. These lamps contain the lens, filament and reflector in a single permanently sealed hard glass unit. When used on old cars, the lamps are designed to supplement those already on the automobile, and their installation involves no changes in wiring

Timin Aircraft Corp. Los Angeles
Metropolitan Airport
No information available
9.13.78

Essential Electric Co.
Nela Park Cleveland

runner a s...
Doomfield 78
Walter House

Life Jacket Distress Signal
**Life Jacket Distress Signal
 Lights When in Water**

systems, batteries or generator capacity. Two auxiliary lamps comprise the unit, one being the "sealed driving lamp," and the other a "sealed passing lamp." Mounted on the bumper, they are wired to the car's upper and lower beam circuits, respectively, so they will operate in conformity with the regular system. So the driver may turn off the auxiliary lights when driving on lighted city streets, they should be wired through a separate switch. Adaptation of the standard sealed-beam system, as used in 1940 models, would call for more powerful generators, rewiring of the car, new switches, or a relay mechanism, as well as special adapters for mounting them.

2137-5

**Self-Dumping Sugar-Cane Truck
 Stays Level on Rough Road**

For use in the sugar-cane fields of the Hawaiian Islands, a self-dumping truck which can empty its load directly into a freight car has been designed and built in Seattle, Wash. It will act as go-between from the fields to railroad cars. The wheels are mounted in seesaw fashion so the body will not tilt if one wheel rides over an obstacle or drops into a hole as it cruises along the rows of cane. Weighing 13,500 pounds empty, the truck holds four tons of cane in a level load. Power delivered through a chain drive comes from a six-cylinder engine of ninety-five horsepower.

Hercules gas engine

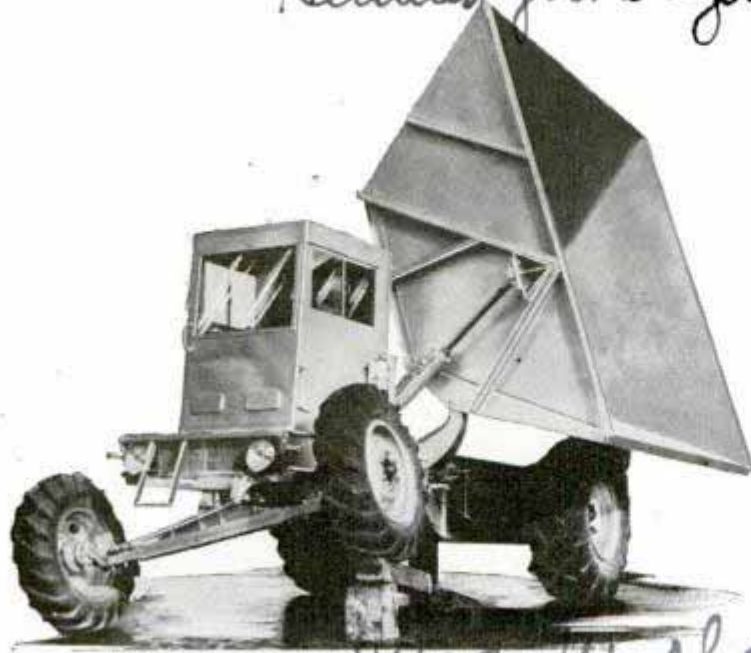

Wide World
 Driver in cab unloads truckload of sugar cane into freight car by tipping body. Note truck remains level with wheel raised

*Renivard Zuator
 1212
 Seattle Wash*

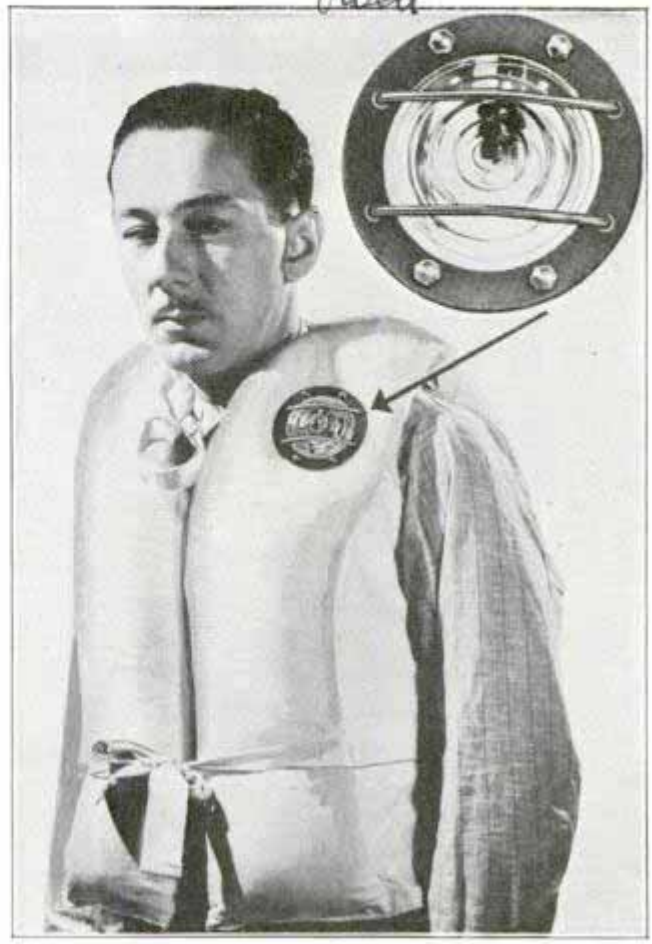

Distress lamp on left shoulder of life jacket and shown in inset, upper right, burns when in water

Lighting automatically as soon as it comes in contact with water, an electric distress signal lamp worn on life jackets increases the chances of rescue for shipwrecked victims. Fitted into the shoulder, the electric light gets its current from a zinc tube with a carbon rod center that becomes actuated upon immersion in water. There are no switches and its operation is positive. The cell does not deteriorate or lose its energy in storage, and the light will burn continuously for seventy-eight hours either in salt or fresh water. Other models may be snapped on any life jacket for use during hazardous work about a boat. One unit for ring buoys may be adjusted to burn with great intensity for a few hours, or for a long period with less brilliancy.

CAMERAMAN

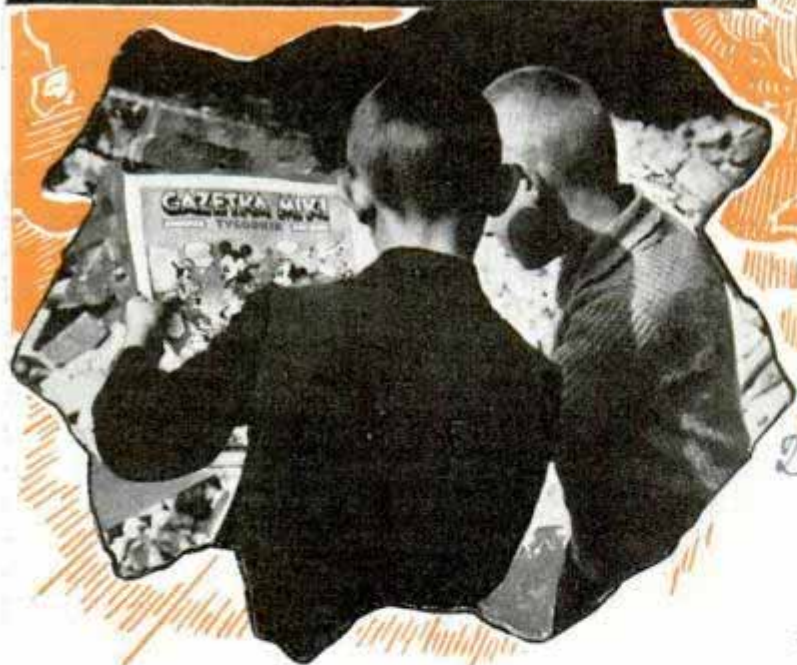

By Julien Bryan

291 W. 12th
PART I
New York City

At top, the author greets wounded man at Warsaw while a woman contemplates ruins from shattered window of her home. Below, two youngsters read Polish "Mickey Mouse"

I COVERED the fall of Warsaw. Strangely enough, in this most dramatic siege in all modern history, I had no competition, for all the other American newspapermen and photographers and even the embassy staff and the Polish government itself had left the city two days before I came barging in, on September 7, from

Rumania, in probably the last train that entered Warsaw.

There was nothing particularly brave about my venture. None of us on the train had any idea of the seriousness of the situation until we reached the beleaguered city. After the first moment of horror, when I found myself trapped in a city un-

Cameras. O'Neil and Havel. *91409*
motion picture

at the FRONT

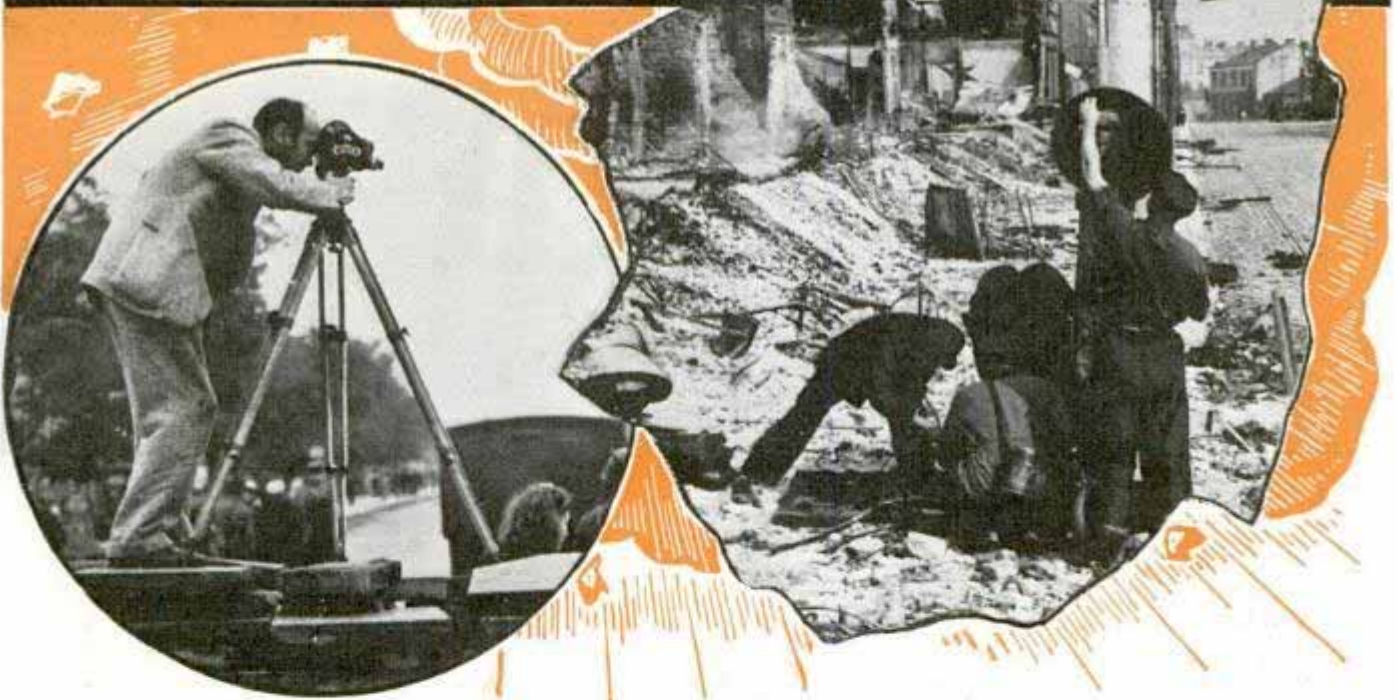

Refugees from bomb and shell flee afoot and in wagons, top, with few belongings. Below, Mr. Bryan films street scene as emergency crew, right, strings temporary telephone lines

der bombardment, I began to realize what a magnificent opportunity this was. A great siege, sunny weather, no rival cameramen about. But there was a slight hitch—the photographer and his pictures might never get out.

Covering this war with a camera is nothing like the last. As a boy of seventeen I took pictures at the French front for seven

months, and drove an American ambulance attached to the French army near Verdun and Argonne Forest. I saw enough there; the “blitzkrieg” in Poland was infinitely worse. In 1917 there was an established front; I knew exactly the demarcations of the trenches, and in quiet periods, for days and weeks, I moved about freely with my camera, and on bright days suit-

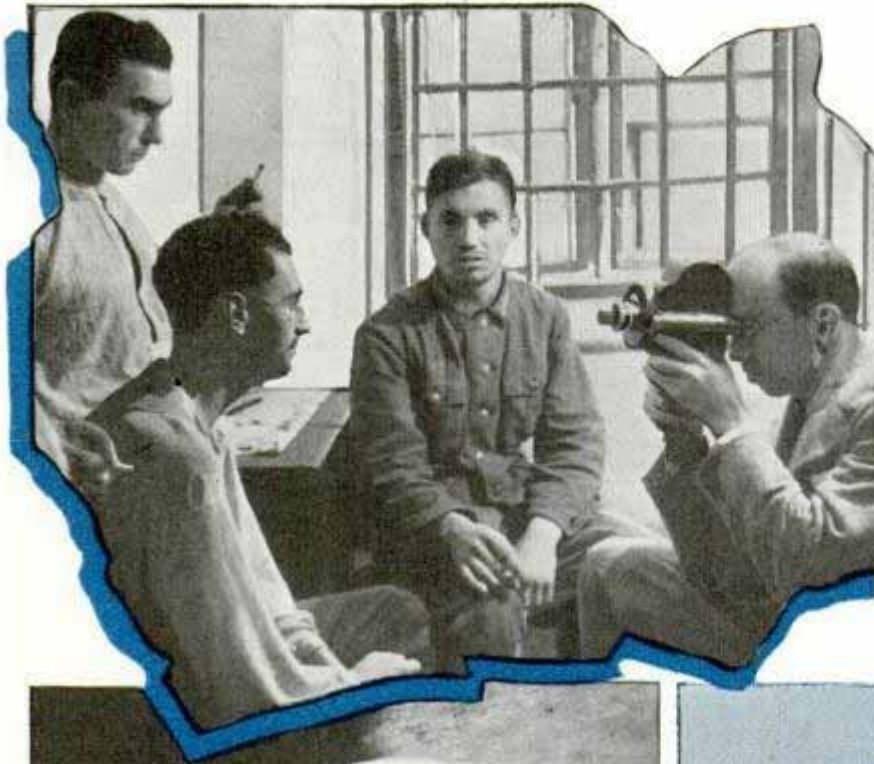

Warsaw is the uselessness of the gas mask and the real need for steel helmets for civilians. I know plenty of stories have been printed charging that gas was used in Poland, but I do not believe them. Nor do I believe gas was withheld for any humane reason, for what Germany did to Poland was not exactly humane; but gas bombs are not very effective. The same amount of high explosive can do a lot more harm. And thousands were killed or wounded by German shells and by falling



Top, taking movies of German prisoners who said they were "forced" to bombard city. Below, rifleman at entrance to dugout, and women helping civilian men prepare barricades across street

able for pictures I would spend many hours in the first and second line trenches. But in Poland we had no such defenses. Each night the lines changed, the enemy came closer. Toward the end the shell fire seemed constant. Again, the war of 1914 was basically between two armies and probably ninety-five per cent of those killed by arms were soldiers. In Warsaw and in Poland it was a total war, not merely aimed at soldiers but at the entire population, and my estimate would be that far more civilians were killed than soldiers.

One lesson that London and Paris—and Los Angeles and New York, if war should ever reach these shores—must learn from

fragments of Polish anti-aircraft shells compared with hundreds hit by bombs. The people of Warsaw had gas masks but did not wear them. They needed helmets to protect them from flying steel. And, to the common people, the incendiary bombs were worst of all. Fires set in crowded home sections nightly burned ten to twenty blocks, rendering thousands homeless.

Plenty of romantic stories have been told of the fearless war correspondents and photographers who leap merrily from one trench to another to get eye-witness stories and pictures. They are not exactly true. All of us in Warsaw were afraid, soldiers, civilians and your photo corre-

spondent. Why wouldn't we be, with bombs dropping constantly and shells raining in the streets?

Still, you do get somewhat used to working under fire. During the first few days I dashed for shelter during every air raid, and spent a good bit of time in the cellar of the American embassy. Then I discovered I was actually more frightened when I stayed with a lot of other scared refugees in the dim-lighted basement. I began to notice that the cook, terribly frightened, forgot her fear by working like a demon. The old janitor kept plugging away at odd jobs. The telephone operators

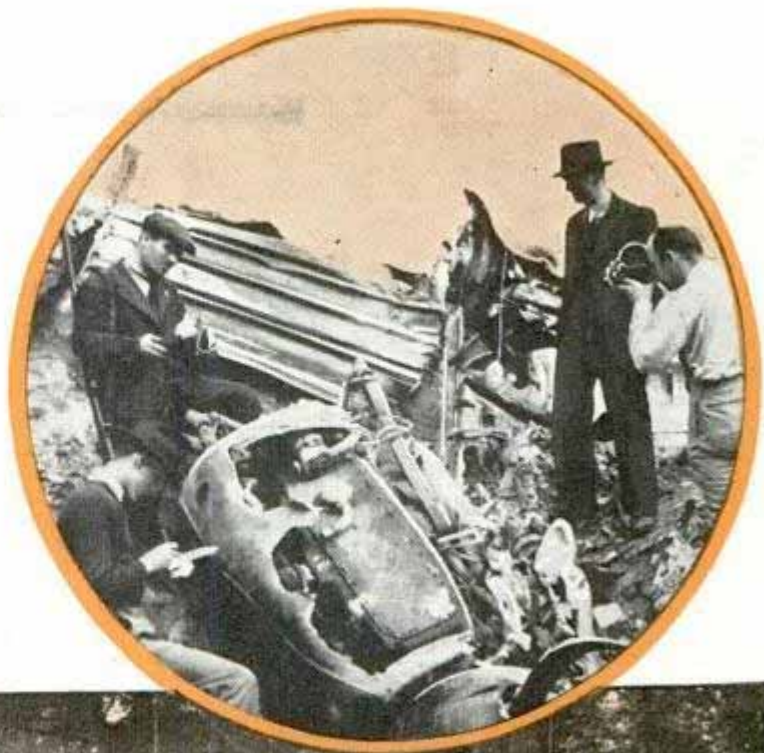

Filming wreckage of fallen bomber, top. Center, automobile placed between rails driven into pavement forms anti-tank barrier across Warsaw street. Below, bomb of delayed-fuse type demolishes apartment

never left their posts, dangerously exposed high up in the building. Seeing this, I decided to try to get a few pictures, and in the two weeks that followed I was much happier when busy in the open, and toward the end was excited but not terrified as I filmed bombers power-diving a few hundred yards away.

Without the best of credentials it means arrest and execution as a spy to be prowling around a besieged city. So first of all, I went to Mayor Starzynski, Warsaw's hero, who gave me an interpreter, a captain and a camouflaged military car. As I waited in his office an air-raid alarm sounded; look-



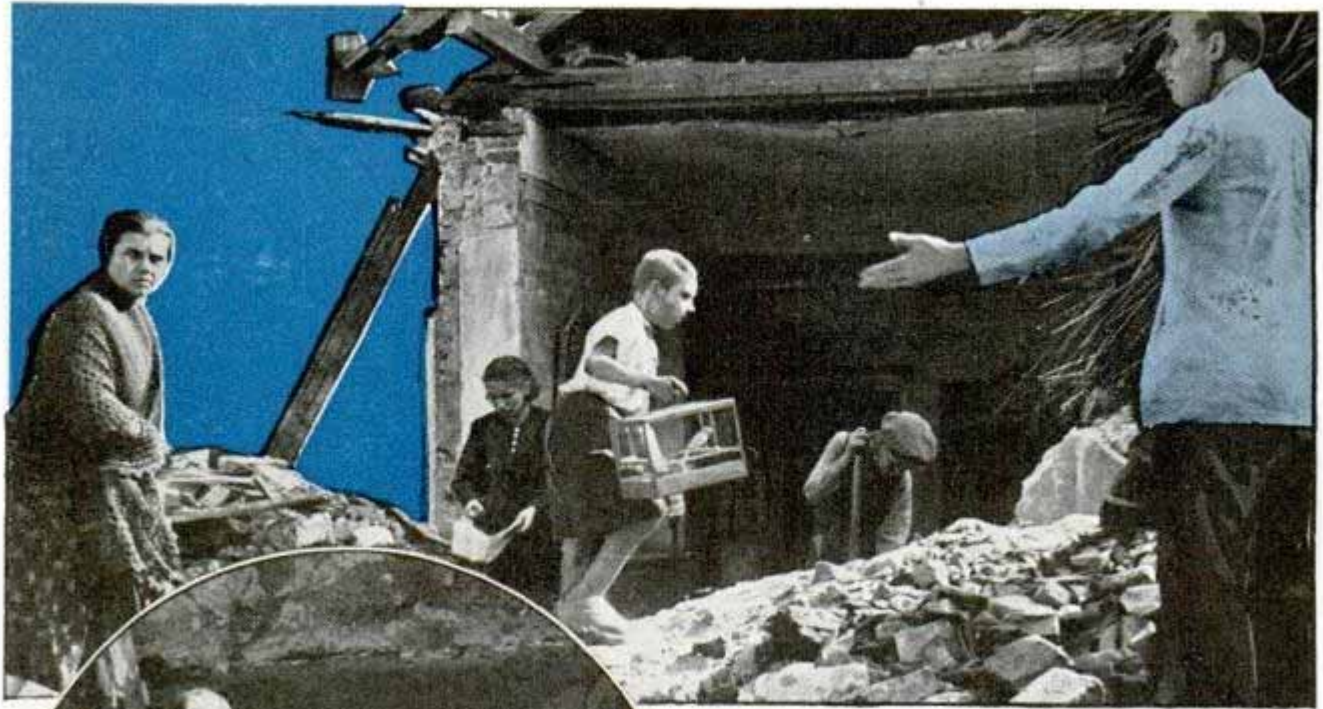

From his shattered home a Polish boy, above, rescues his canary. At left, Mr. Bryan emerges with pictures of a plane just shot down. Below, taking cover from raid in underground shelter



ing out the window I counted forty-two German planes. Starzynski's only comment was that I should not expose myself at the window. He himself stood only six feet away. Two bombs did land barely thirty yards away, another hit one end of our building.

many places by five to ten-foot holes where the big bombs had crashed through. But these delayed-fuse bombs, which are intended to penetrate a five-story building and then explode with shattering effect five seconds after the first contact, tore

(Continued to page 155A)

Consolidated Aircraft Corp
San Diego, Calif
Navy Amphibion Requires No Beaching Crew



acme
Efficient on land and water alike, the navy's new flying boat is equipped with tricycle landing gear which can be lowered in water for beaching on sloping shore without aid of outside crew

X 400 V-5a
Said to be the world's largest amphibion, a new Consolidated airplane ordered by the navy is a twin-engined flying boat with retractable landing gear of the tricycle type. Because its efficiency on water has been extended to land, the ship has a much larger field of operations. It is especially capable of handling itself in remote regions where aircraft tenders and good airports are not available. In water, the landing

gear serves as a sea anchor, assisting in control of the ship on rough open water, and turns are achieved with less skidding. No beaching crew is needed, since the plane can climb a ramp or sand beach under its own power, and launch itself in the same manner. In order to eliminate resistance in the air, the nose wheel, when retracted into the bow, is enclosed completely by hatches that operate automatically.

21357
Gasproof Suit for Air Raids Packs into Lady's Handbag

Made of oiled silk, a gasproof suit that can be packed into a pouch and carried in a handbag offers protection from gas to a person caught in an air raid. Covering the body completely from head to foot, the protective outfit consists of hood, blouse, trousers, gloves and "boots." The suit can be slipped on in three minutes.

It takes a year to eighteen months after a railroad tie is ordered before it can be seasoned, treated with preservative, and made ready for laying.



British Combene
Left, removing gasproof suit from handbag. Right, three minutes later wearer is covered completely from head to foot for air-raid protection

Railway Ages
12/23/29

No data 2/1/46

100,000 - MILE

ONE of the dreams of the automotive engineer—tires that will last as long as the automobile—seems on the verge of coming true. Already a tire good for approximately 100,000 miles in truck or bus service has been created and manufacturers are hard at work on experiments aimed at production of a similar tire for your car.

In the early days of the automobile, owners considered themselves lucky if a set of tires lasted 3,500 miles. Today, owners grumble unless they get 25,000 miles and there are instances in which tires have given 50,000 miles in ordinary service. Since piling up mileage rapidly—before the tire ages—seems to be one of the secrets of success with the 100,000-mile truck or bus tire, the answer may lie in a com-

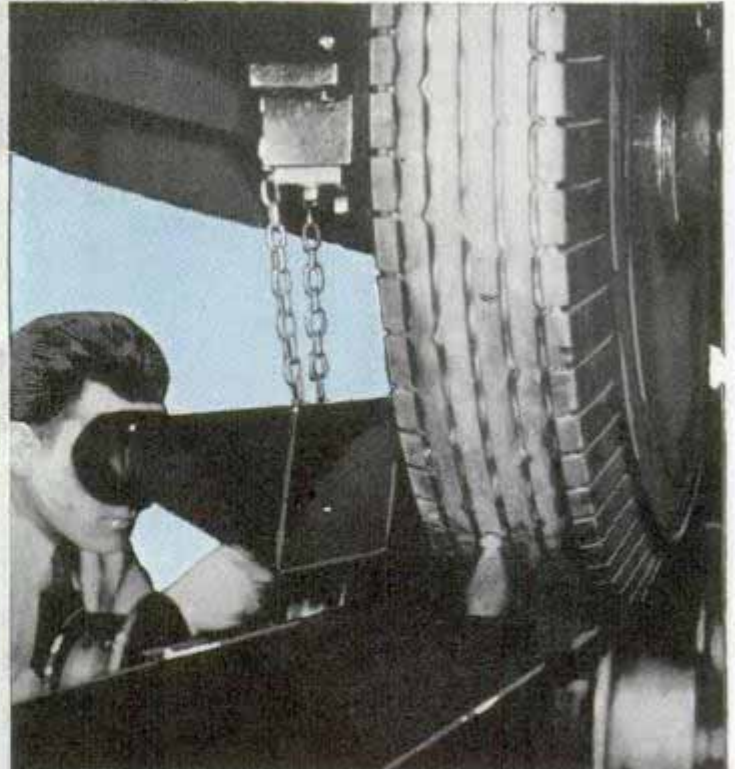
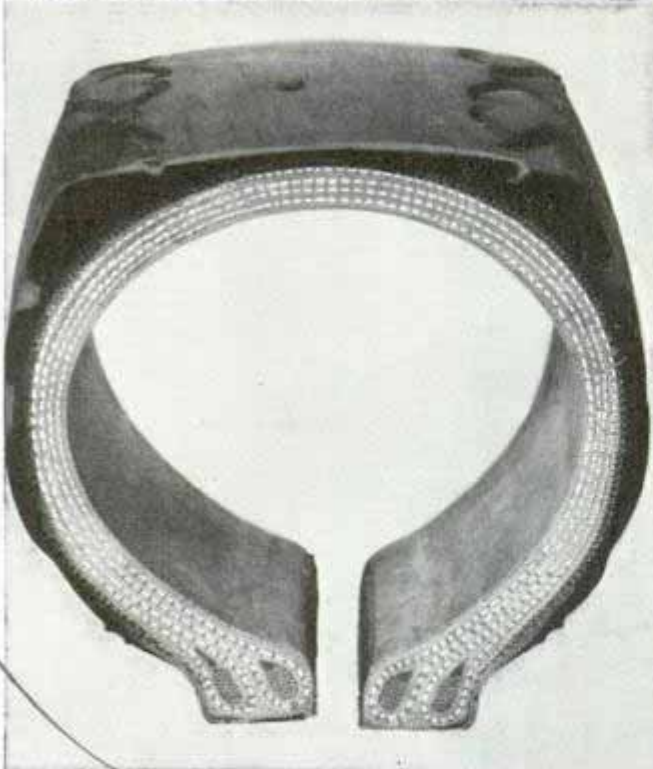

Taking temperature of tire in test at Mohawk plant (top); section of tire run 109,000 miles without recapping or retreading (bottom, left), and fluoroscope test to find how tires break down

Rubber Co., Akron, Ohio

Pyrometer - Cambridge Instrument Co.
Assembly No. 50 & 400dy. J.

2-1-57

Oscar Wagon Co.
Macon, Ga.

2-11-70

TIRES

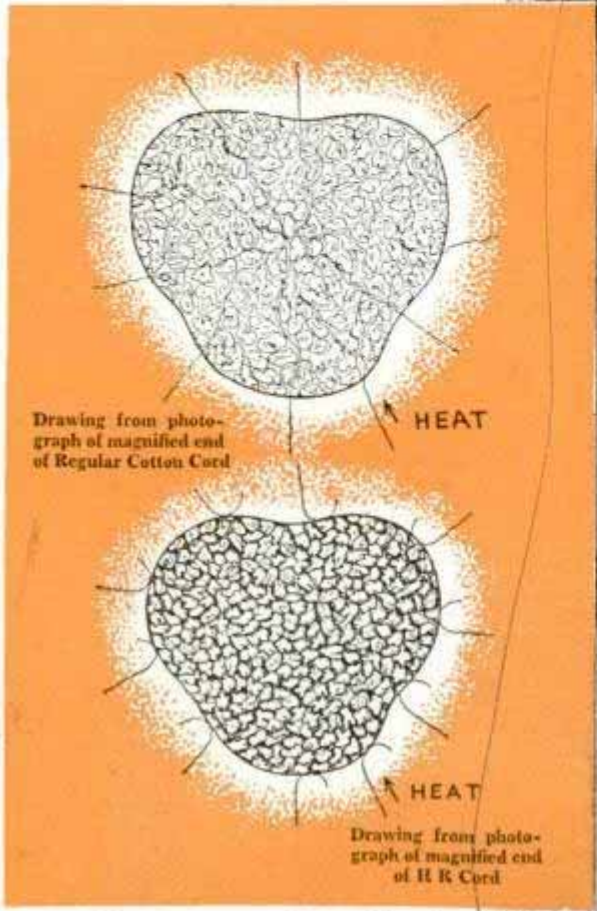
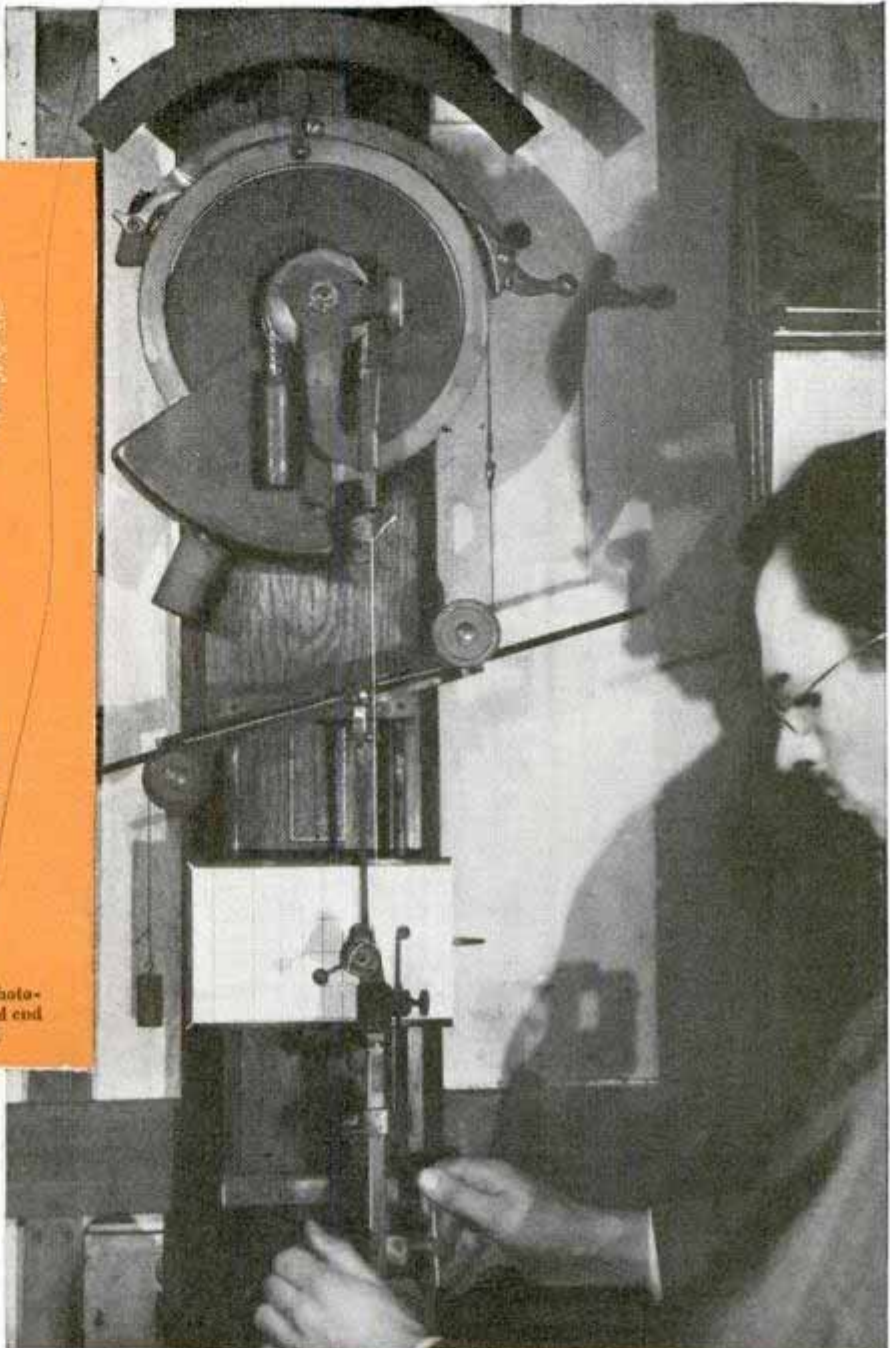

Drawing from photograph of magnified end of Regular Cotton Cord

HEAT

Drawing from photograph of magnified end of H R Cord

HEAT

Above, comparison of ordinary and heat-resistant cords. Right, testing tensile strength of heat-resistant cord. Bottom, removing cord after heat test in Mohawk plant

bination of fabric and rubber that will resist rapid aging—a tire that will be almost as lively and as resistant to cracking at the end of four or five years as it was at the start of service.

Among the latest developments indicating that the "life-time" tire may be just around the corner for the auto owner is a cotton cord that retards generation of heat in the tire and holds down the "growth" of the tire—the two principal enemies of tires. Running under heavy loads at sustained

(Continued to page 130A)

'Trip to the Moon' Offered by Sculptured Map

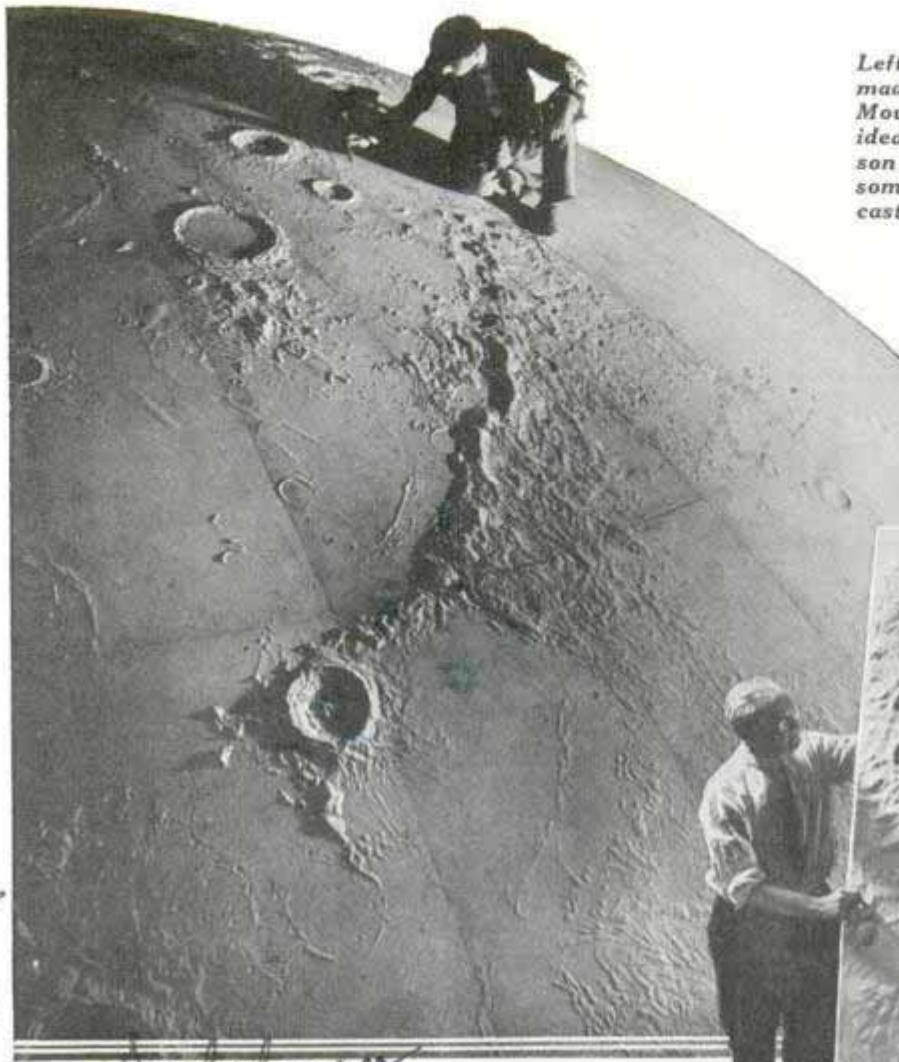

Left, thirty-eight foot model of moon made from photographs taken at Mount Wilson observatory. A fair idea of its size is given by comparison with one of the builders doing some final inspection. Below, finished cast section being inspected before setting it in place



*Designed by Roger Hayward
after Carl Sagan's
model*

Sobelman

A model of a section of the moon as it would appear from a "space ship" 500 miles from the planet is on display at the new Griffith Observatory in Los Angeles. The gondola of the space ship is a spacious observation gallery with broad windows, and the moon is represented as a model made from photographs taken with the 100-inch telescope at Mount Wilson, covering an area that extends from the equator to fifty degrees north, which was chosen as being the most interesting and varied. Built to scale, the model measures thirty-eight feet by nineteen feet. Some 650 features have been charted, including the great craters, steep and weird peaks of the lunar mountains, and many valleys, hills and the so-called seas. Sunrise and sunset, with various gradations of the lunar day, are produced by a light moving overhead in a circular track. Construction of the exhibit required the cooperation of an architectural designer and amateur astron-

omer, and a sculptor who worked out the details of modeling and casting. The spherical body was divided into gores, each shaped in relief separately and supported by adjustable legs so it could be lined up exactly with its neighbors. From these were made plaster molds that were used in producing the final castings, consisting of cement reinforced with metal lath and channel iron. Fitted together like a jigsaw puzzle with joints "pointed" until they vanished, the castings form an unbroken surface. To heighten the effect of the lights and shadows on the surface of the moon model, it has been painted in tones of bluish gray.

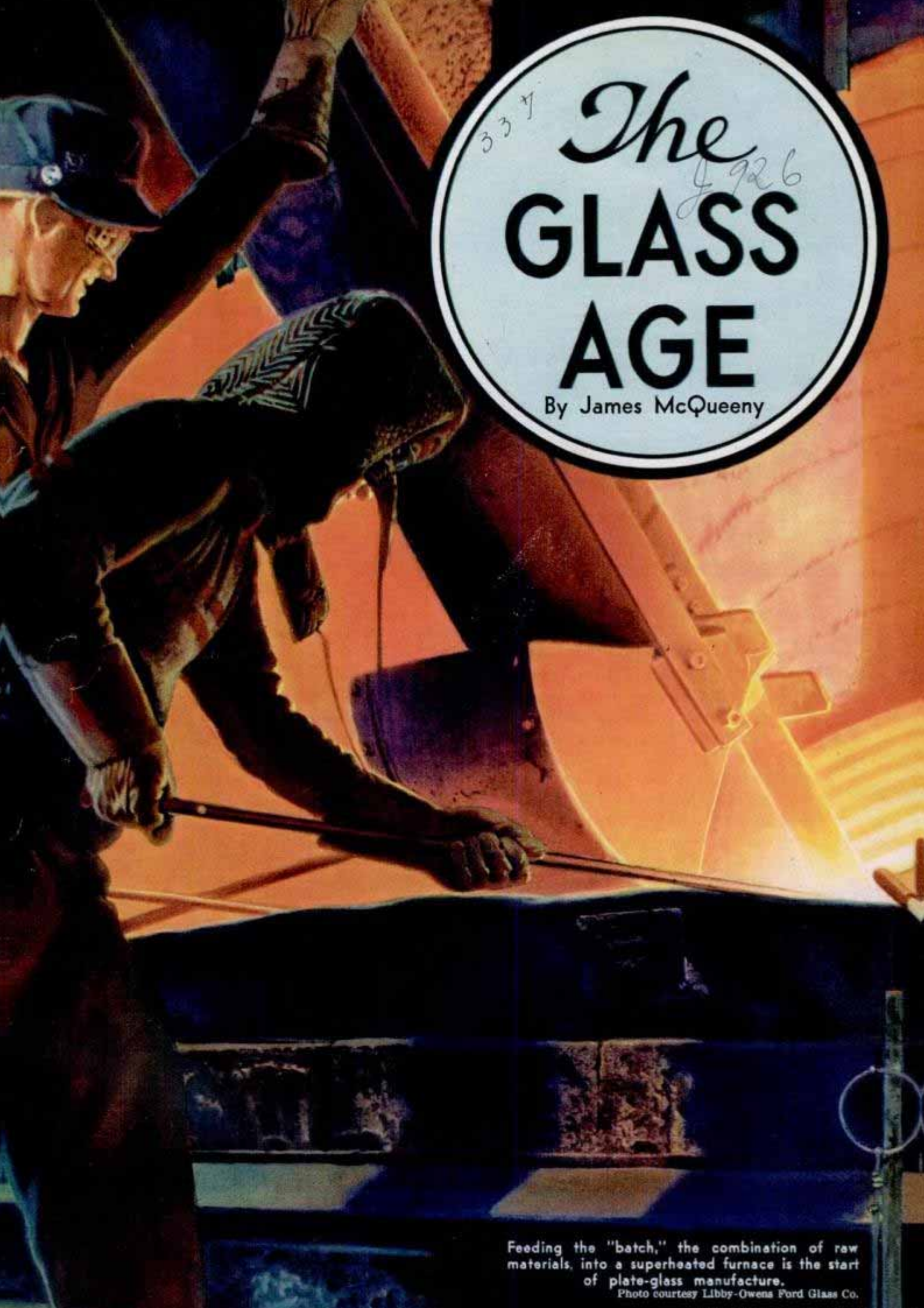

337

J 926

The GLASS AGE

By James McQueeny

Feeding the "batch," the combination of raw materials, into a superheated furnace is the start of plate-glass manufacture.

Photo courtesy Libby-Owens Ford Glass Co.



Claw of steel, operated by overhead crane, reaches into oven for pot of white-hot glass after terrific heat has fused ingredients into a molasses-like liquid.

J 926

338

GLASS, the dictionary says, is a hard, transparent, brittle substance, made by fusing sand with other ingredients. Modern science doesn't agree with this definition, however, for it has developed a glass as soft as silk, another as strong as steel, and a third without a trace of silica.

Just when glass seemed to be at its maximum development a few years ago, the industry put on its seven league boots of research and stepped into a score of new fields. As a result, the present uses for glass defy classification.

A glass having four times the strength, yet with four times the flexibility of ordinary plate, is the most significant recent development. It's a throwback to the time when philosophers first puzzled over the properties of molten glass dropped into cold water. Pear-shaped beads with elongated tails formed and when one was struck with a hammer on the bulbous part nothing happened, but upon breaking the tail it would fly to pieces. Modern glass researchers found the reason for this phenomenon. The drops are highly strained, that is, a heavy compressional layer surrounds a zone of

great tension. Their strength is traceable to this distribution of internal stress.

Applying the same principle in the making of tempered plate glass wasn't so easy. The major difficulty lay in controlling the heat in processing. An electric furnace was the answer to the glassmaker's prayer because with it the prepared glass could be subjected to rapid heating under scientifically regulated conditions and quickly chilled in the air draft of the prescribed coolness.

What actually happens when glass is tempered is that the outer surface, being suddenly chilled, contracts more rapidly than the inner part. Thus, when the

Cont. James McQueen, Jr.
98. 45 lb. / Kansas City, Mo



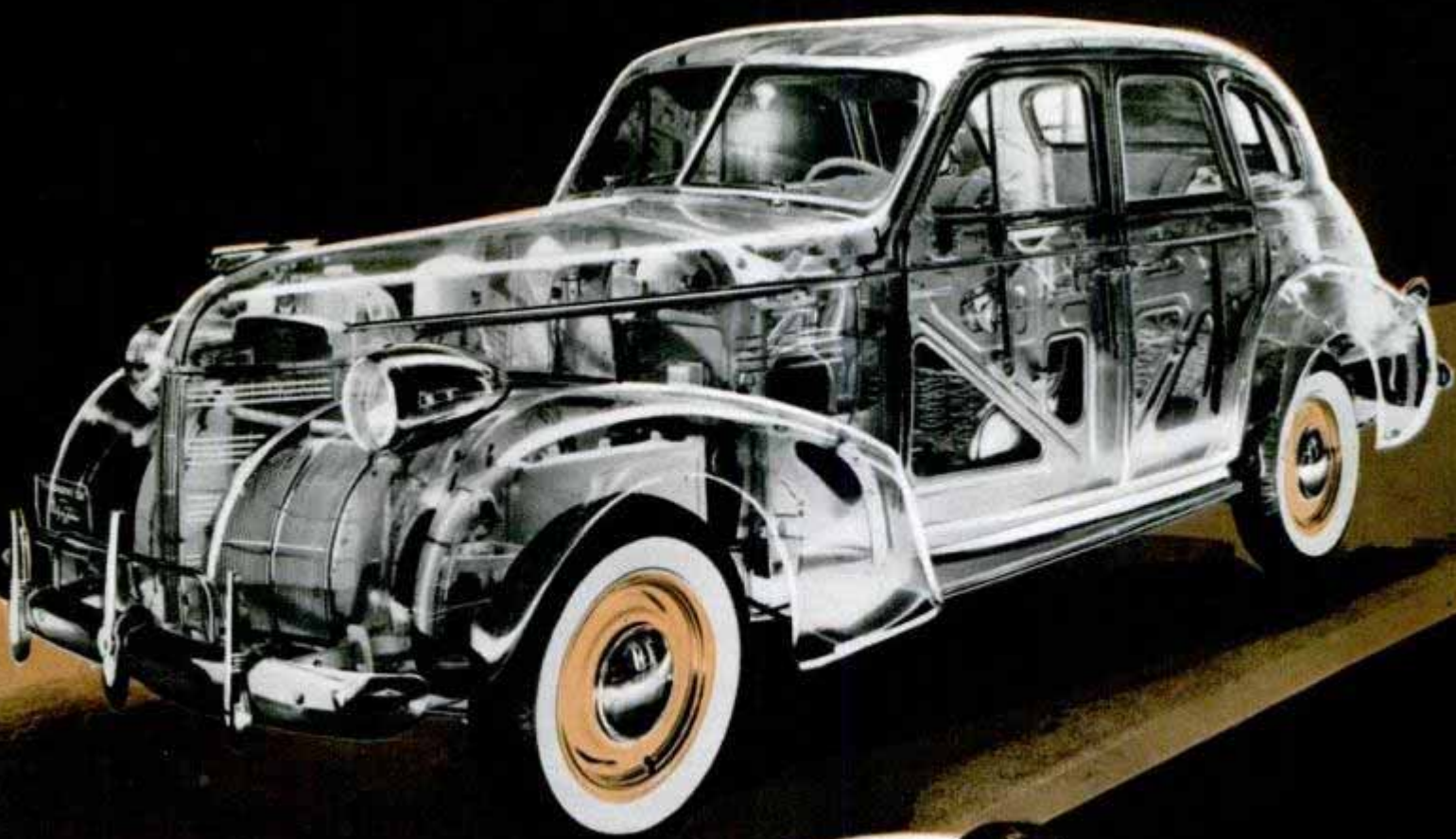

J 926
339
 sheet is thoroughly cooled, that same condition remains, the outer layer being in compression, the inner, in tension. Hence, the high strain that makes possible the superior properties.

Tempered plate can take it. It's possible to expose a sheet to intense heat, 600 degrees Fahrenheit or more, on one side while the other side is at normal temperature, without weakening it. Its resistance to impact is the same whether the mercury is above or below

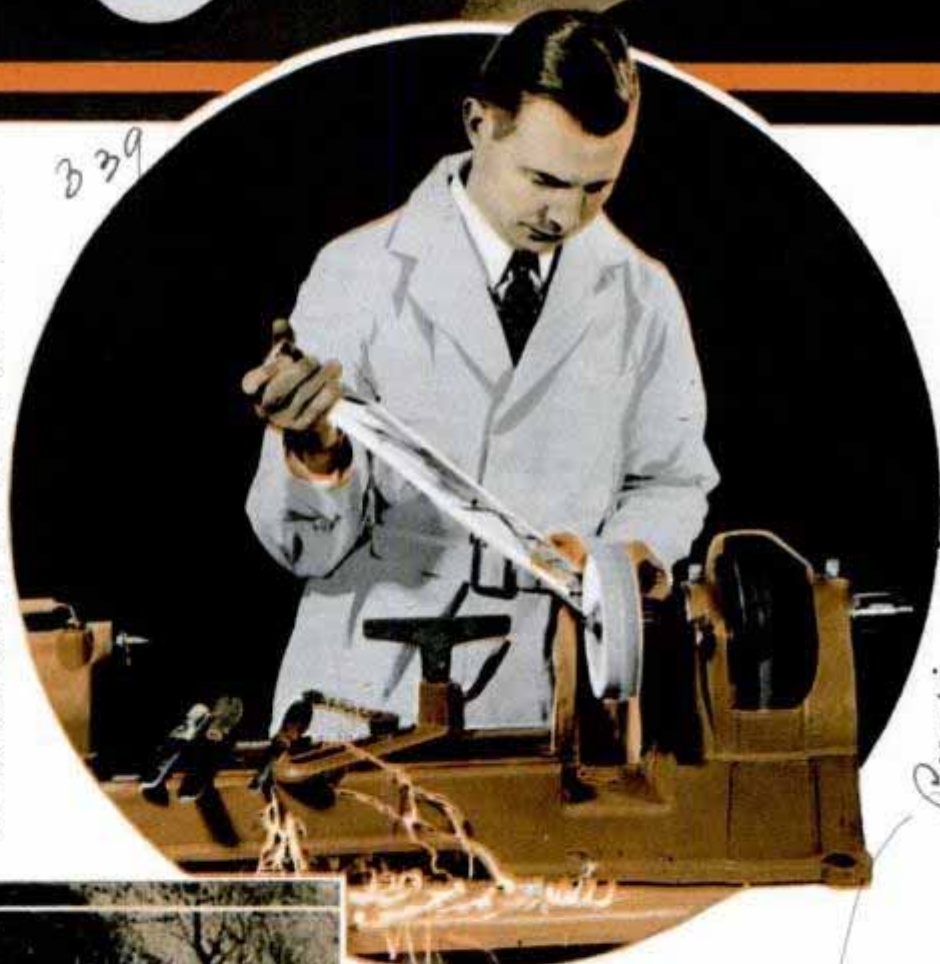

*Pontiac plate
 Body by Fisher*

Multiplate

Girl comes through unscathed as laminated glass undergoes bullet test (bottom of this and page opposite). First car with glass-like body (top of page) makes its appearance, as an exhibit. The car can be driven. Circle, a crystal-clear substance, with many properties similar to those of glass, being polished. The rod is "Lucite," a product of the du Pont company.



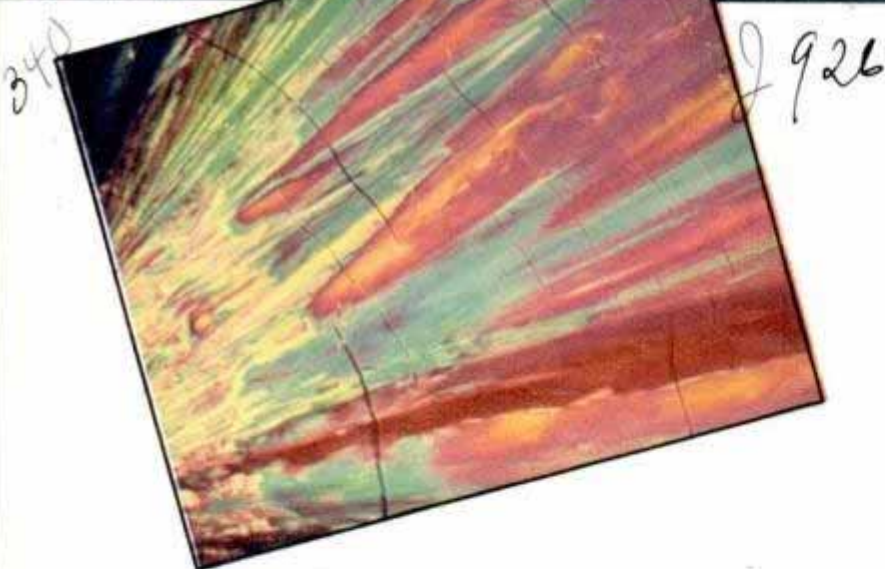

Highly effective use of large glass area to form a corner picture window and (left) natural-color photo of salicin crystal made with polarized light, using Pola-screens and a selenite plate.

Photo courtesy Charles S. Foster

zero, and unlike other plate glasses, the new one does not grow brittle in winter. The dangers of being cut by flying glass are minimized, for when tempered plate does break it shatters into small, blunted pieces.

The major difference between Herculite as it's called, and other flat glasses is that it must be fabricated to order from plates, which have been prepared as to size, edgework, holes, and notches. Any attempt at cutting casehardened plate glass results in fragmentation. Fireplace shields, glass-cooker doors, and furnace peephole lights are a few of the noteworthy applications, but in aquari-

ums, on board ship, and in the making of glass doors, book shelves, and partitions is its greatest usefulness found.

Shortly after the turn of the century, Edouard Benedictus dropped a bottle on a hard floor. There was a resounding crash, but the glass fragments did not scatter. He examined the bottle, found it had contained collodion which had gradually evaporated until the bottle appeared empty. The thin "skin" of collodion on the inside of the bottle held the broken pieces together. From the accident came the idea of joining two pieces of glass with a sheet of nitrocellulose, the beginning of safety glass.

With the recent perfection of a plastic binding known as polyvinyl acetal resin for the inner layer of the glass "sandwich" has come the greatest of all safety glasses. Not only have the faults of earlier laminated glasses been eliminated in the new product but it also has been given four times the resistance to pene-



raincoating in this bathroom polite—the colorful structural glass. Impervious to odors and moisture, its colors never fade, so its beauty is permanently of the glass; it can be cleaned with a few strokes of a damp cloth moist. See samples in a wide variety of colors and combinations, displayed by your local Glass Distributor.

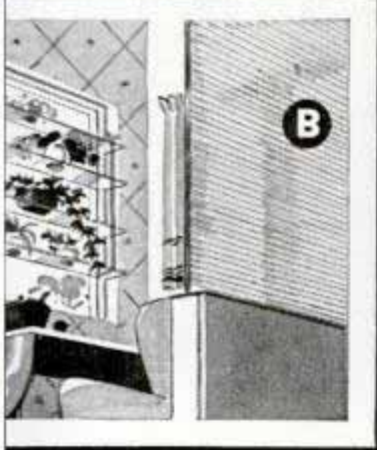

attractive breakfast room is partially walled off from the kitchen by a translucent wall of modern decorative glass—this is Louvrex. Throughout the house, decorative glass may be used to improve the appearance and utility of the home.

If you live in the cold weather zone, storm doors and storm windows will reduce your fuel bills as much as 30%, eliminate fogged and broken windows, and greatly increase home comfort. They generally will pay for themselves in two or three winters.

Modern use of glass makes houses roomier, living more convenient, homes more attractive . . . rentable . . . salable.

This house, planned for the readers of Good Housekeeping Magazine, is a joy to live in. These illustrations show only a few suggestions how glass can be used as part of your building or decorating plan to make rooms more spacious and attractive, to make home duties less work, to make any home more rentable—more salable. For many other suggestions about glass in modern houses, phone your local Libbey-Owens-Ford Glass Distributor—listed in the classified section of your phone book.

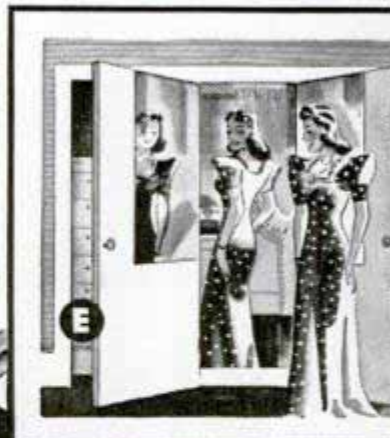
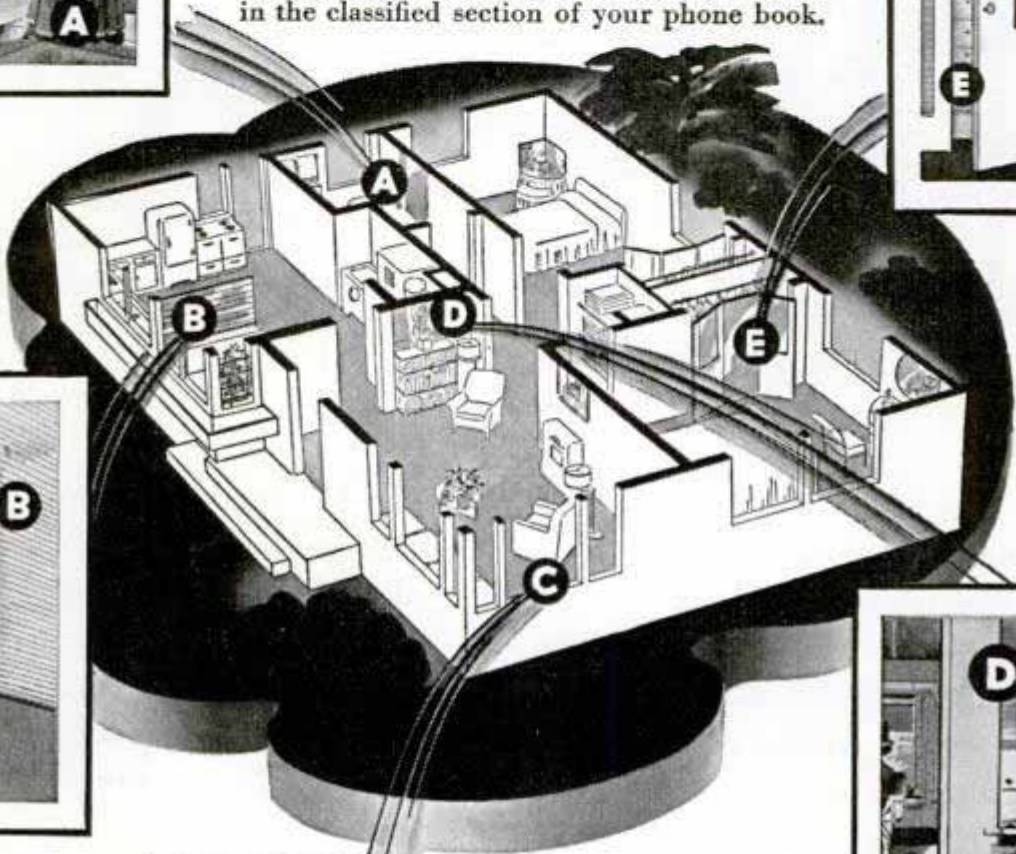

A full-length door with a beauty aid that adds to a woman's poise and confidence. You'll find it a bargain in results you'll achieve. The panel between the closed door and a full-length mirror. The length mirrors on the door give ample angle views. They are made of L-O-F Polished Glass.



Mirrors create a pleasant illusion of spaciousness . . . push walls back . . . repeat the decorative scheme. For what wall mirrors add, their cost is extremely small. You can have these plate glass features in the modest home that costs a dollar a day or less under terms of FHA financing.

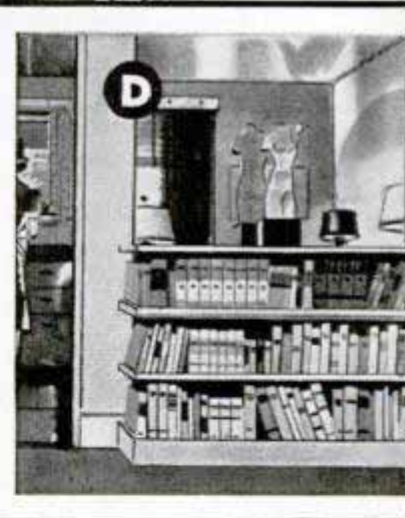

TUNE IN!
LISTEN TO

"DESIGN FOR HAPPINESS" over CBS stations coast-to-coast. Sunday afternoon at 5 P.M. E.S.T. It's family entertainment for the American family.

For other suggestions on Uses of Glass, allow us to send you **OUR BEAUTIFUL COLOR CATALOG . . . IT'S FREE!**

LIBBEY-OWENS-FORD GLASS COMPANY, TOLEDO, OHIO

LIBBEY-OWENS-FORD
QUALITY GLASS PRODUCTS



IT'S DRESS-UP TIME AGAIN

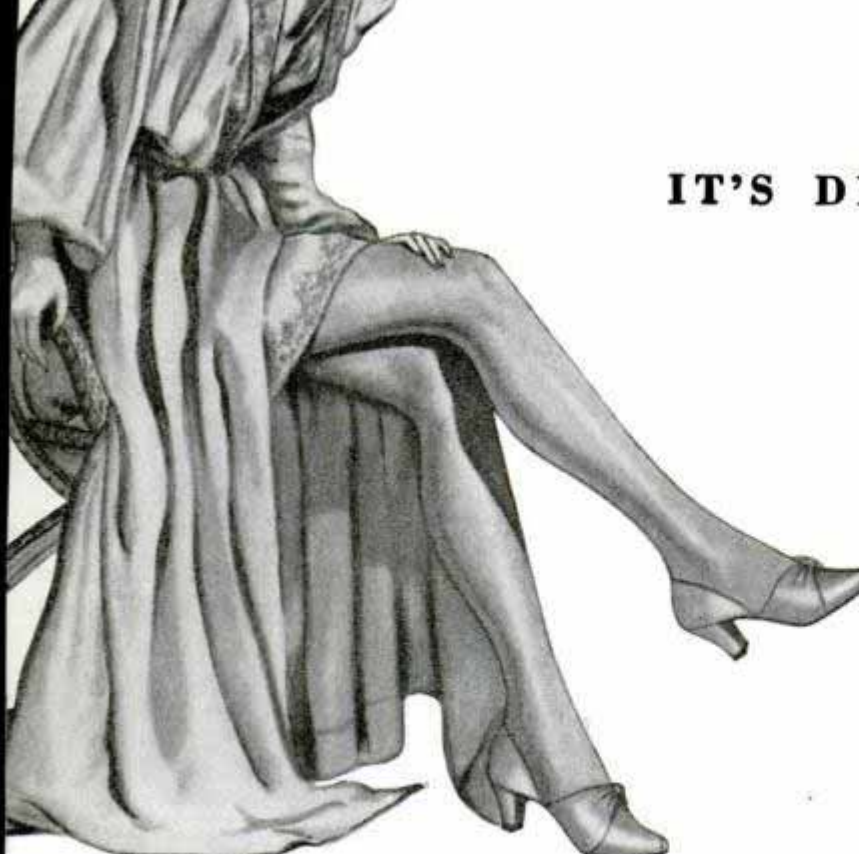

DIDO \$3.50



RAINBOW \$4.50

WHAT you wore with slacks, this summer, didn't matter much. From now on, though, you will want to look your loveliest indoors, and the slippers you select to go with your negligees and house coats are all the more important.

The new Daniel Greens are the slippers you should see . . . with their beautiful styling and materials, their exquisite colors and workmanship. . . . A pair or two of them will add a Park Avenue touch to your wardrobe at a reasonable price.

Leading shoe stores and departments everywhere have Daniel Green slippers. Always look for the name on the sole. It's your guarantee. . . . DANIEL GREEN COMPANY, Dolgeville, New York.

DANIEL GREEN

Comfy

SLIPPERS



RANEE \$5.50



DORM \$3.50



BAMBI \$3.50



JOLI \$

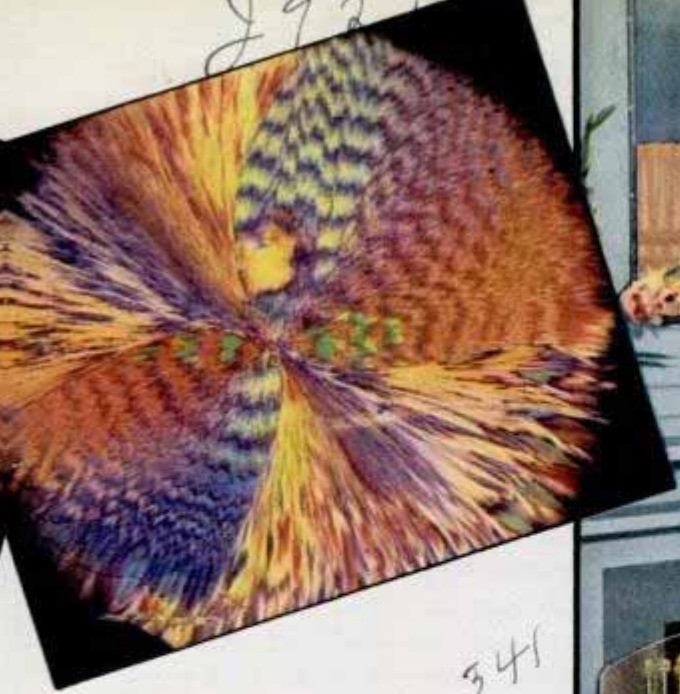

341
 Natural-color photo of asparagine, made with Pola-screens and selenite plate (above). Glass furniture gives unexpected feeling of openness and airiness to a room (right). Below, effective use of glass in modern bathroom. Note the glass-walled shower, glass bench before the dressing mirror and the glass lounge-seat at the right. Most glass furniture is made from clear heavy plate glass or Carrara, or both.

*Number -
 Avon. d.l.l*



*1 glass fireplace screen
 P. Brown and*

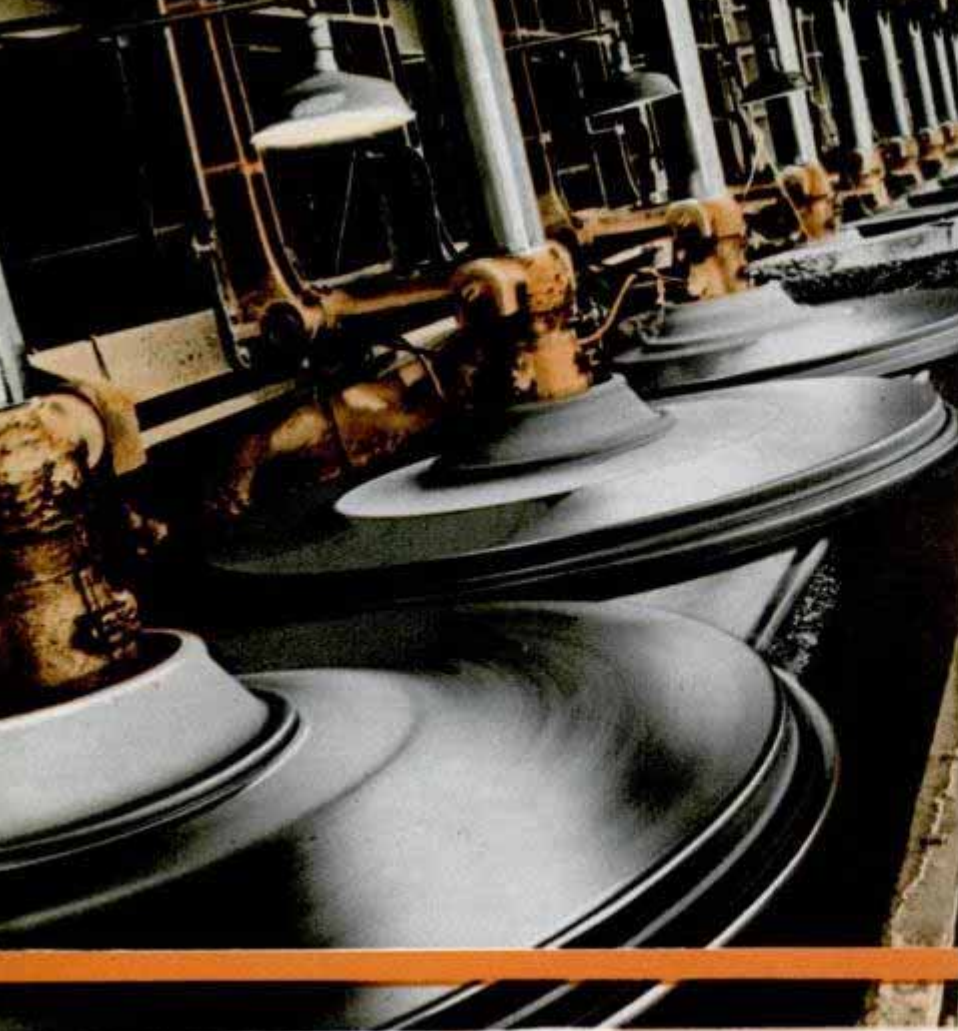

tration by impact and five times the elasticity of its predecessors. When broken by hammering, the glass can be rolled into a rug without any of the pieces pulling loose from the binding.

Bullet-resisting glass for bank cages, armored cars, and police vehicles differs from safety glass only in the number and thicknesses of the glass layers and plastic sheetings. Three to five pieces of polished plate with strong plastic material between layers are assembled into one solid piece by heat and pressure. The flexible plastic sheetings are not cushions to absorb the force of the bullets, as you might suppose, but rather confining walls for the thick glass cores, which owing to their mass and hardness, do most of the bullet stopping. Usually, the first bullet does not penetrate the outer layer

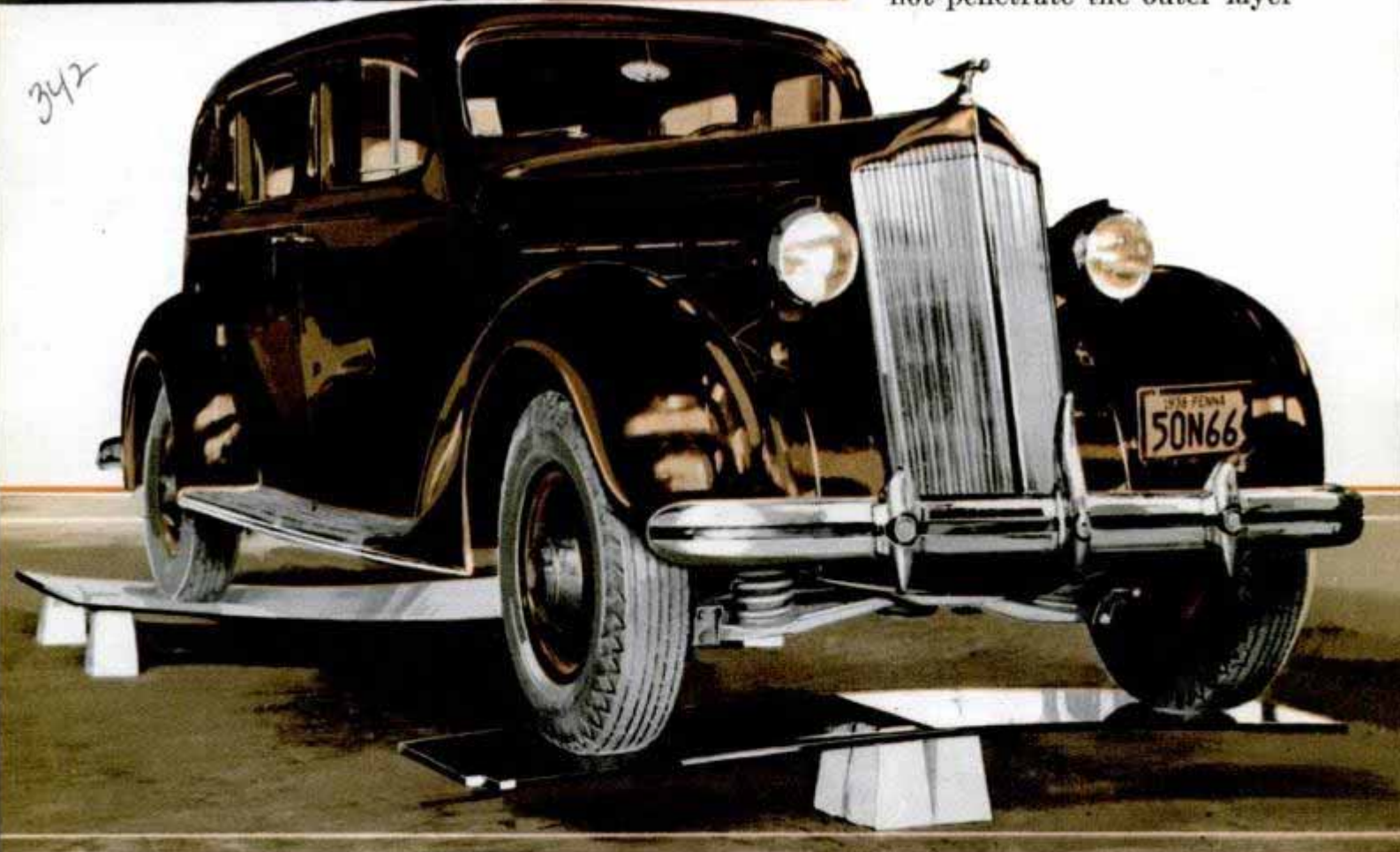

Row of revolving grinding and polishing wheels used in glass making (top) and a heavy automobile resting solely on two plates of Herculite, supported in two different ways, thus demonstrating the great strength of this tempered glass. Note slight bend of the glass, both at front and rear, under the car's weight.

Pittsburgh Plate Glass Co.
Pittsburgh Pa.

J 926

of glass and plastic but pulverizes the glazing directly adjacent to the point of contact. The stress the impact places on it is transmitted through the successive layers in the form of a cone, showing up on the opposite side in a small ring of cracked glass.

The versatility of glass has captured the public's imagination almost overnight. More of it is being used in our homes and buildings than in the heyday of Venetian glassmaking. A striking example is the new \$2,000,000 Museum of Modern Art in New York which has a long facade almost entirely of glass—the first floor plate glass and metal; the second and third floors walled entirely in Thermolux, a new glass never before used in this country. Wide horizontal bands of windows are used on the two office floors above and the entire front of the penthouse is plate glass.

A sandwich of spun glass between two sheets of clear glass, Thermolux was selected to wall the museum because it has only about one-third the heat conductivity of clear glass; because of its sound reduction properties, and because of its qualities of light diffusion and distribution. It transmits light farther into the room than does clear glass, yet the light is easy on the eyes and evenly illuminates objects without deep shadows or sun patches.

Libbey Owens Ford

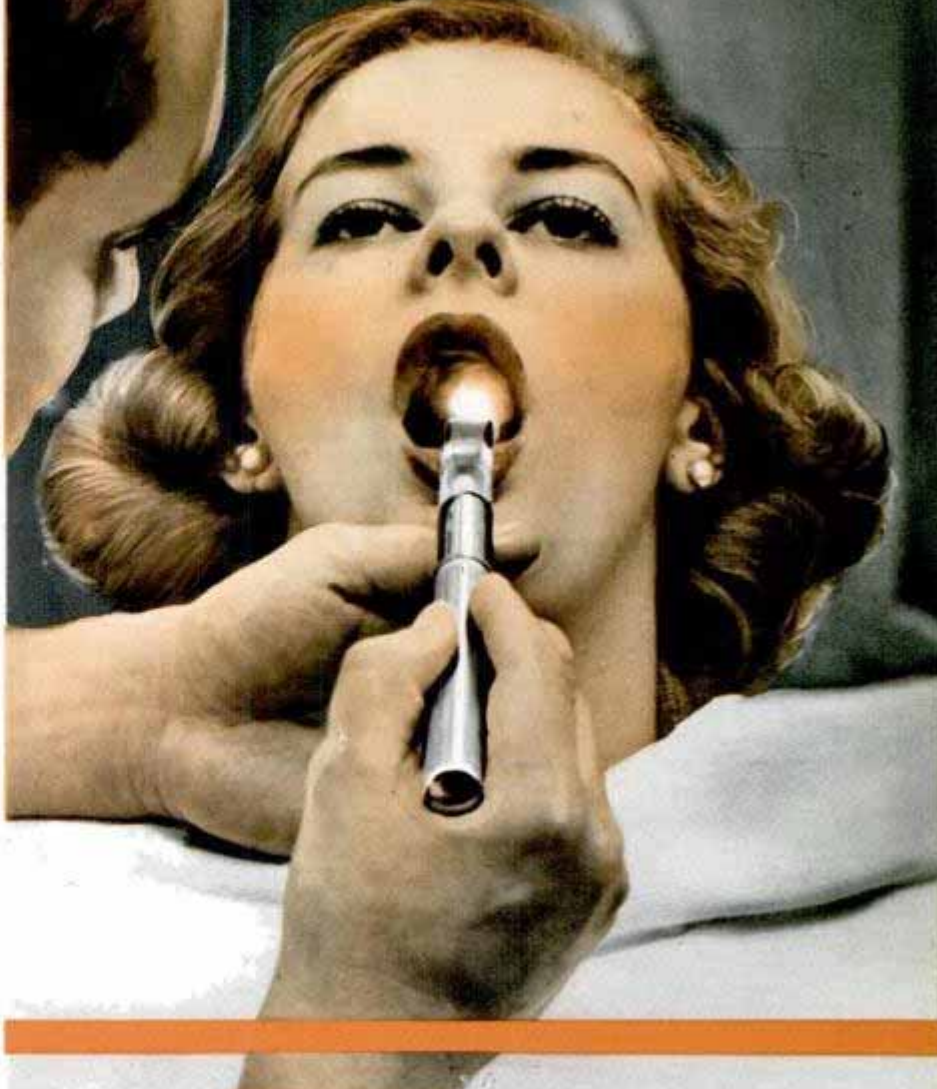

343

Glasslike "Lucite" being used in dental tool (above). It transmits light from one end to the other, or around corners. Two glass blocks (below, left) used in the building trade. Glastone slab (below, right) with detailed diagram showing manner in which Vitrolite facing is anchored to haydite block. A structural masonry unit in colored glass, it is expected to find wide use in building, making possible new architectural designs.

Libbey Owens Ford Glass Co., 1200 2 Nicholas Bldg. Toledo, Ohio

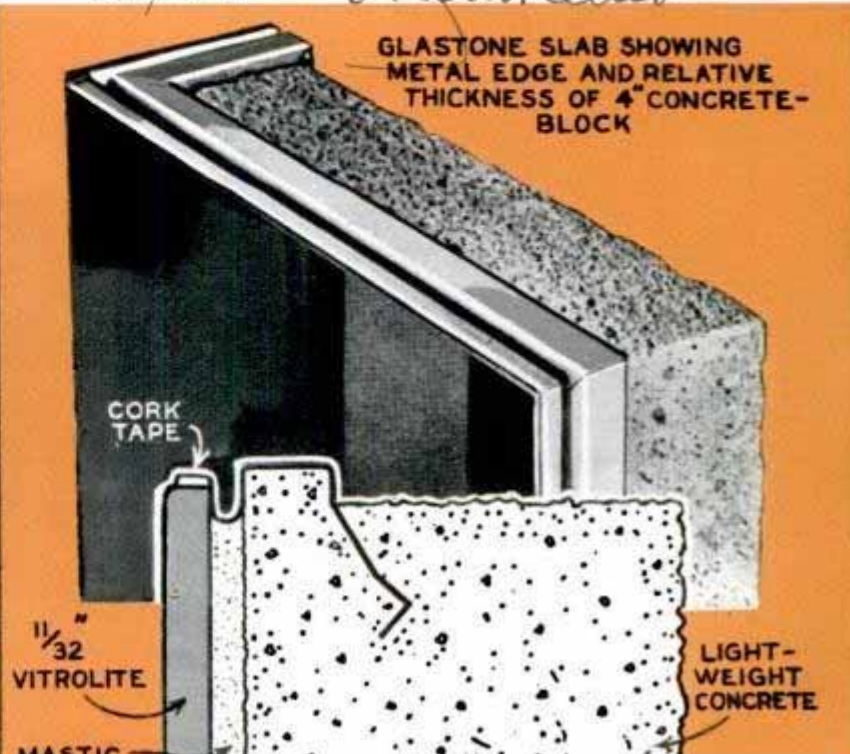
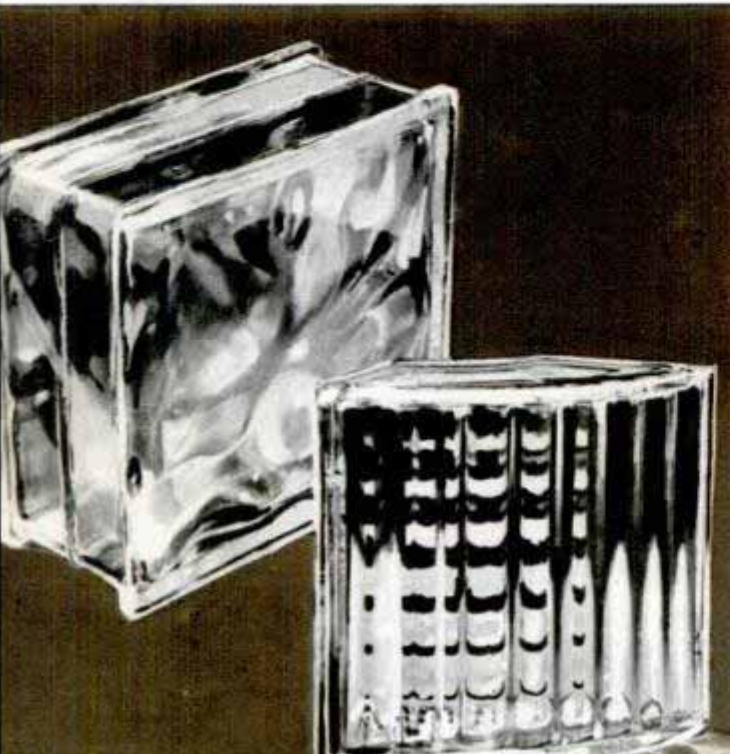

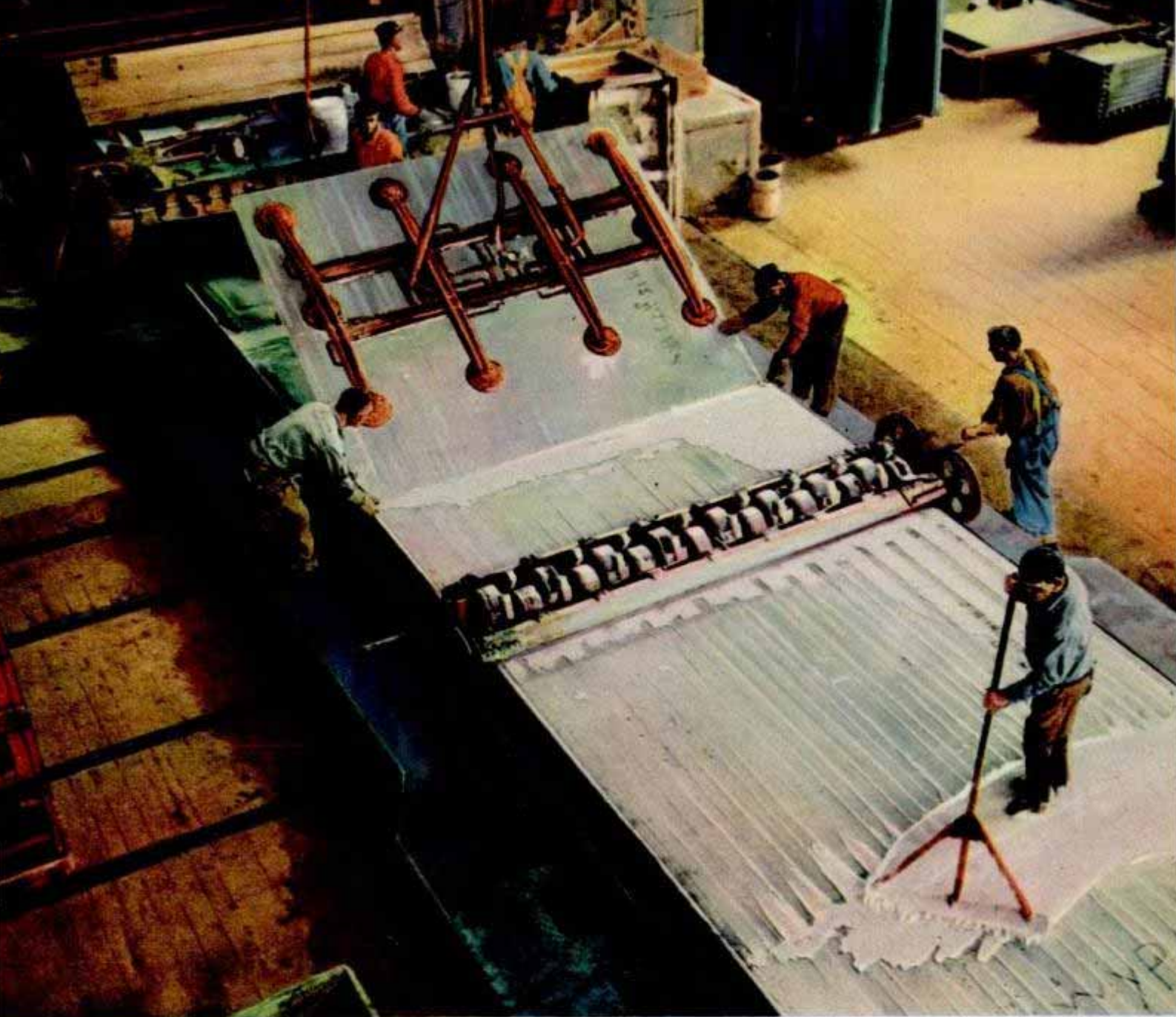

344
Plate-glass blank being deposited on grinding line. Plaster of paris is being spread to "set" the glass so it cannot move around under the grinding units.

A stimulus to a more widespread use of glass on the exterior of buildings and store fronts is the new plan of bonding and mechanically anchoring colored structural Vitrolite to a lightweight concrete block so it becomes a masonry unit and an integral part of the building.

You can now live in a glass house and if your pocketbook is fat, furnish it with everything from glass book ends to bedroom suites. A glass bed can be bought for 895 dollars, a chiffonier, a hundred dollars cheaper, and a dressing table and bench for 850 dollars, which gives you an idea. What about their strength? No worry there—it's all a matter of using glass of the proper thickness. Half-inch glass is sufficient for a chair back, while

portions of a dining-room table must be an inch and a quarter in thickness.

No construction material has ever scored such a pronounced success as has the glass block within the last year or so. Chief reason is the fact that it combines the light-transmitting qualities of glass with the insulating values of a solid masonry wall. With a sealed-in dead air space, seventy-five per cent vacuumized, a glass block is among the best insulators against temperature change. During the day, rooms are brightened with sunlight while at night, lights from within the home or factory create eye-arresting effects.

An aim of contemporary living is to bring the out- (Continued on page 128A)

2 145 1

Vultee Aircraft Co.,
Lawrey, Calif

'Bullet' Pursuit Plane Flies at 400-Mile Speed

Tested under the greatest secrecy, the new Vultee Vanguard plane, streamlined like a bullet, is said to be capable of traveling at speeds better than 400 miles an hour. The all-metal interceptor-pursuit ship is powered by an air-cooled radial engine of radically new design. Its chief claim to distinction, however, is its new construction which permits of rapid mass production.

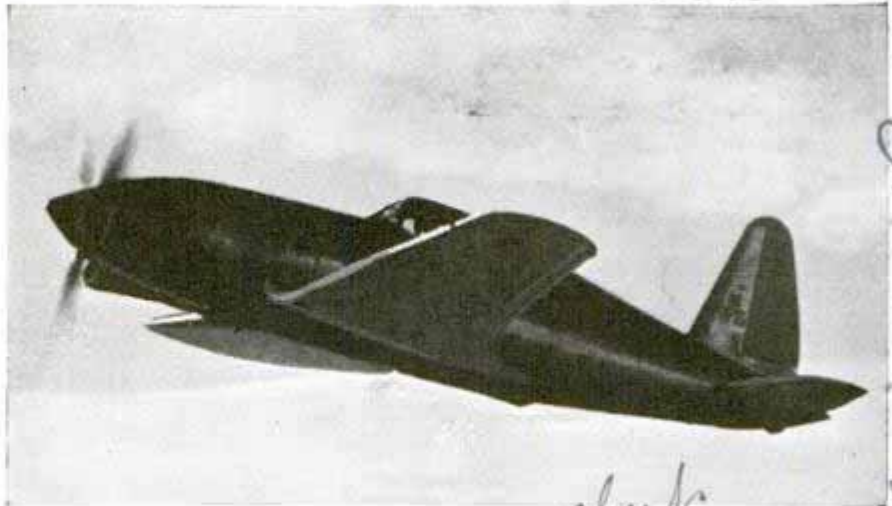

All-metal interceptor-pursuit plane, tested over Los Angeles recently, can be manufactured under mass-production methods if nation goes to war

club

Hydraulic "Tooth Puller" Wrests Pole from Concrete

2 1413



Jerking steel power-line poles loose from six feet of concrete is as easy as pulling teeth for a tractor-driven hydraulic jack that can develop pressure of 160 tons to the square inch. A collar is fitted to the pole and a single pump applies uniform pressure to four jacks, which tear the pole from its base in a few minutes.

To wrest steel power pole from its setting in six feet of concrete, four jacks are fitted to collar around pole and hydraulic pump applies tons of pressure

Intercontinental Harrower Co
180 N. Michigan Chicago

Tiny Airplane Engine's Lucite Crankcase Reveals Its Moving Parts

2 1438

Concealed moving parts of a tiny five-cylinder engine are revealed by the transparent crankcase made of Lucite, a plastic. Thus may the onlooker view oil pumping, crankshaft movement and the ignition system breaking and distributing the spark. The engine has a fourteen-inch propeller that drives a miniature airplane. The cylinder bore is five-eighths of an inch and the stroke three-fourths of an inch. Push rods are ordinary sewing needles threaded and capped with a ball to fit into the rocker arms. Six flashlight batteries, stepped up to 30,000 volts by a coil, provide ignition.

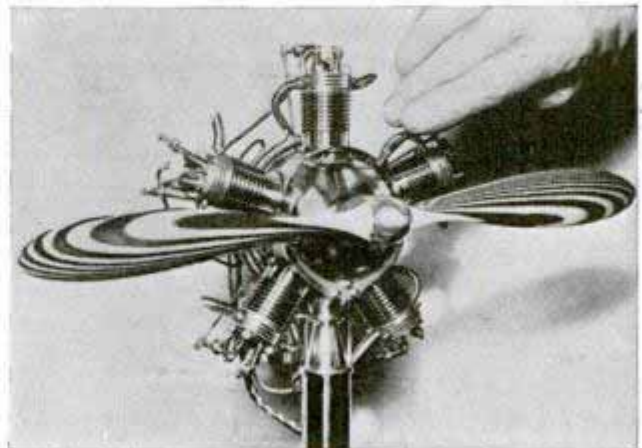

Through transparent crankcase of tiny plane engine you can see crankshaft movement and how oil pumps

Sophus Johnson
Chenander, Ill

Fish Ride Elevator and Taxi in Trip up River

To mean of Fisheries, U.S. Reclamation Service, Dept. of Fisheries, Washington, D.C.

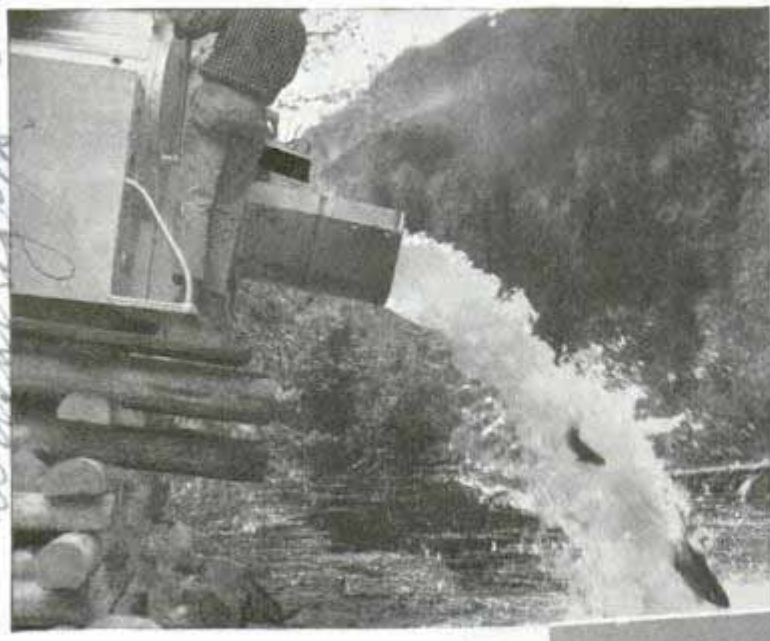

"Taxis" carry fish around dam and dump them (top, left) at upstream spawning grounds. Pickets (circle) sort fish by sizes

There's taxi service available for the thousands of Columbia river salmon and steelhead trout that have found they way home to former upstream spawning grounds blocked by the Grand Coulee dam. A "census" of the fishing industry in the Coulee area indicated the seasonal runs are worth \$250,000 to \$300,000 to the fishermen, traders, and others dependent on these salmon and trout, and blockade of the spawning grounds would mean ruin to many. So the Bureau of Fisheries and U.S. Reclamation Service instituted the taxi service. As the migrating fish climb the "ladders" of Rock Island dam near Wenatchee, Wash., the smaller blueback salmon are separated from the steelheads and chinook salmon by different-sized pickets. The fish are counted as they enter an elevator bucket, and as soon as the required

load is reached the bucket is hoisted to a truck platform, where the fish and 500 gallons of water are discharged into a truck containing an equal volume of water. Ice-cooling systems keep the water temperature close to that of the streams. Eight of these specially designed trucks transported 50,000 fish to spawning grounds in tributaries of the Columbia river in the first season's transplantation.

g. 1372

Adjustable Bracket for Roller Shade Allows Leeway of Two Inches

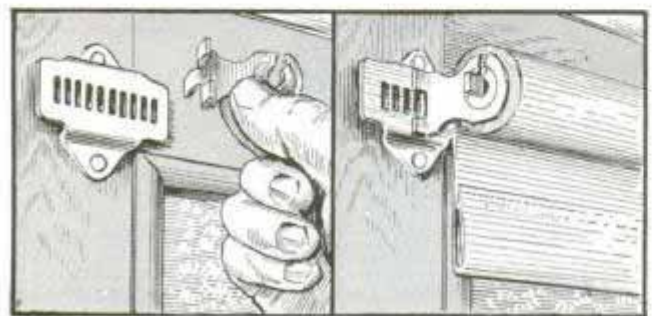

When installing a two-piece window-shade bracket you do not need to observe exact measurements, for it can be widened or narrowed within a range of about two inches after it is in place. When the base has been fastened to the approximate position, the shade-holding fixture may be set in any one of several vertical slots to correspond with the length of the roller.

The Master Key Co. 2962 Harford Road Baltimore, Md

21259 S.W. Clarendon St. 89. Leven Road, Streatham London S.W. 16, England

DESTROYER *Versus* SUBMARINE

DAYS of easy hunting are over for the submarine. Today the once-dreaded underwater craft must do battle, with the odds against them.

The convoy system, adopted late in the World War, has deprived submarines of easy stalking of merchant ships, forcing them to attack in the presence of their deadliest enemy—the destroyer. Back in 1917, Kapitan-Leutenant Gustav Amberger had been ordered: "Remain out until all torpedoes are expended." And the German admiralty demanded a ship



Story and illustrations from 4 3 2 2
H. G. Webster



U.S.S. "Babbitt," top, is one of the fastest and most heavily armed modern destroyers. Below, German submarine reaches base at Kiel, its path cleared of mines by sweepers

for each torpedo. So Amberger, facing the perils of attack under the convoy system, kept the "U-58" outside Queenstown harbor two days, waiting for victims.

At last came two destroyers, followed by eight ships in single file. Through the per-

iscope, Amberger watched them. Submerged to fifty feet, with only an occasional peek through the upthrust eye, he maneuvered the "U-58" to intercept.

They came at him in four rows of two each, the destroyers curving among them.

g 12 50

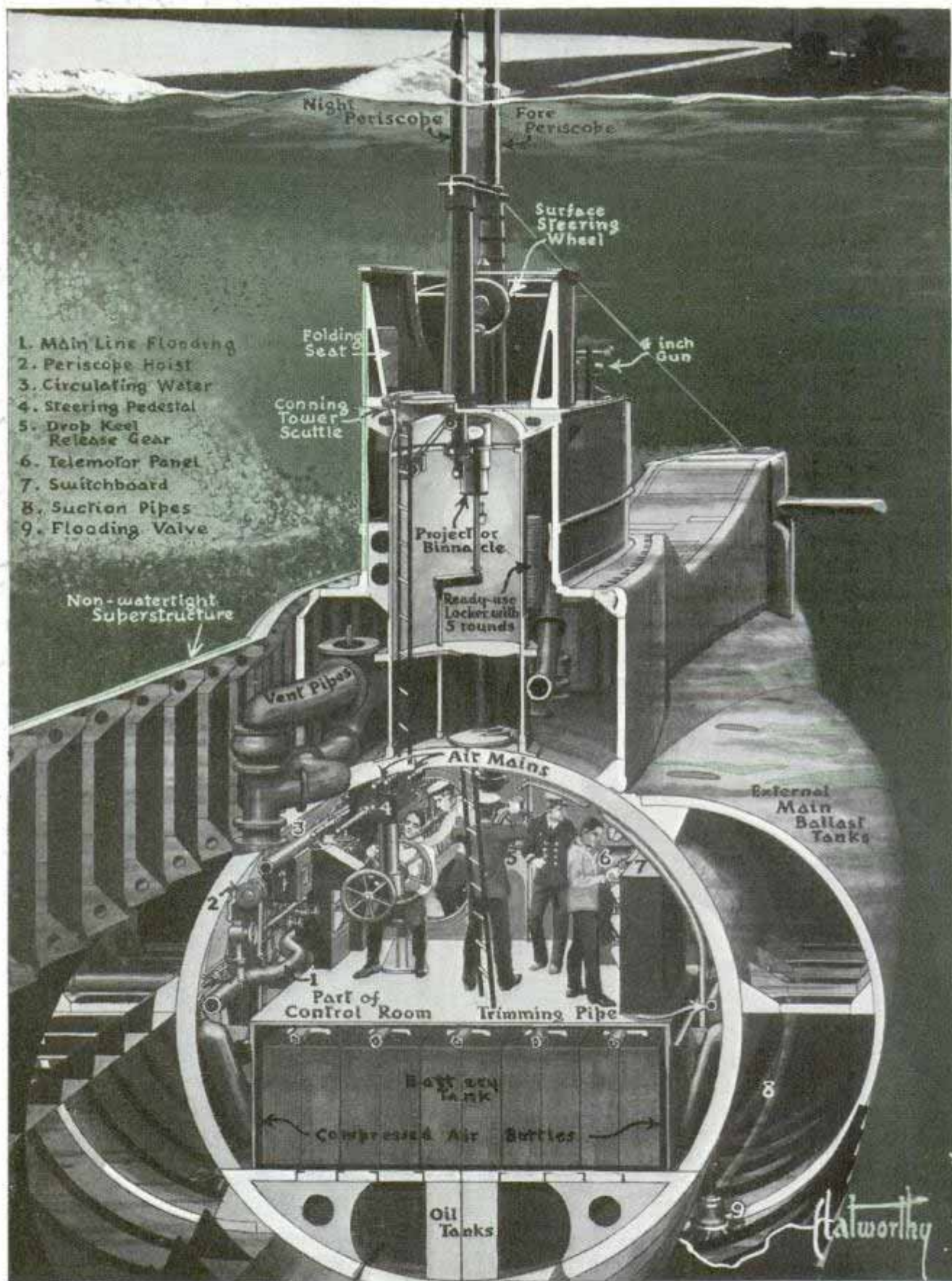

© S. W. Clatworthy

Cross-section drawing of British submarine shows the deadly craft submerged, its two periscopes just breaking the surface and leaving their telltale wake. Below is the projector binnacle and still further below the control room with battery tanks beneath. Bulges on sides are main external ballast tanks. Atop the conning tower is a wheel for steering while navigating on surface, and just forward is the four-inch gun used in surface fighting. The gun is used in preference to torpedoes whenever possible

Half an hour of tense waiting, of listening at the hydrophone to the increasing beat of propellers, while the "U-58" cruised submerged. Then a sharp order:

"Up periscope!"

A quick look and Amberger barked orders to the torpedomen, for there was the "Welshman," a splendid freighter, plowing into position 300 yards off his bow. A torpedo could not miss. Amberger walked the periscope around to select the next victim, before revealing his presence by attacking the first ship. But even the first torpedo was never fired. That swing of the periscope had revealed a destroyer curving down upon him.

Aboard the "Fanning," one of two American destroyers convoying the merchant ships, Coxswain David D. Loomis scanned the water from his lookout post. Suddenly his sharp eyes caught something moving—a feathered, V-shaped wake.

"Periscope!"

Lieutenant Walter S. Henry sprang to the engine telegraph, barked "Rudder hard right!" at the helmsman, and the "Fanning" leaped into a

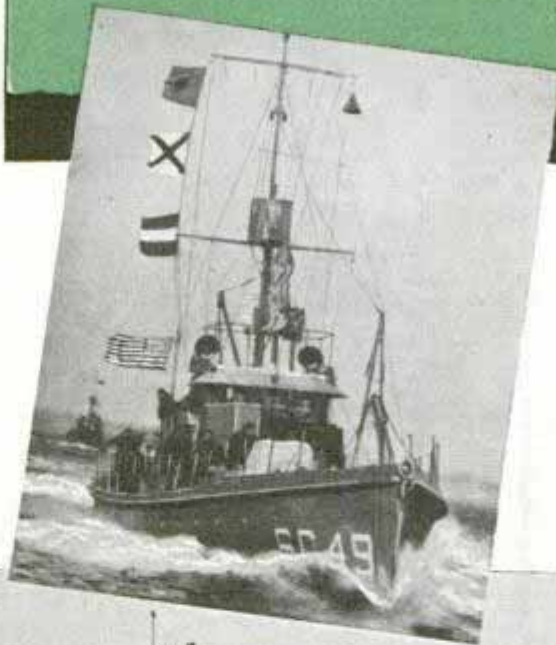
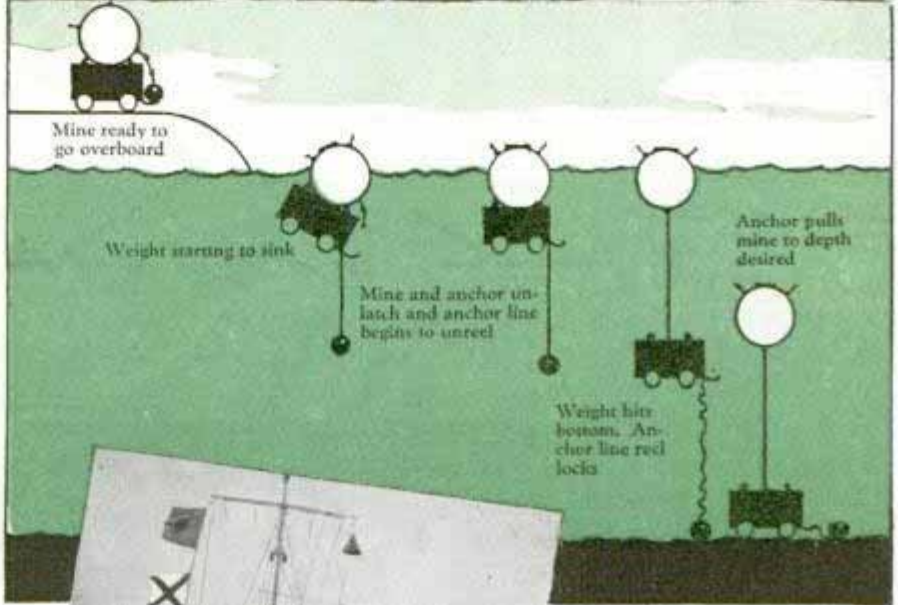

Top, planting mines; with this equipment a ship could lay three a minute. Diagram shows five stages in planting mine at desired depth. Left, U. S. sub-chaser 49, which locates submarine with hydrophones then sows area with depth bombs. Below, U. S. submarine "Perch"



g 1250

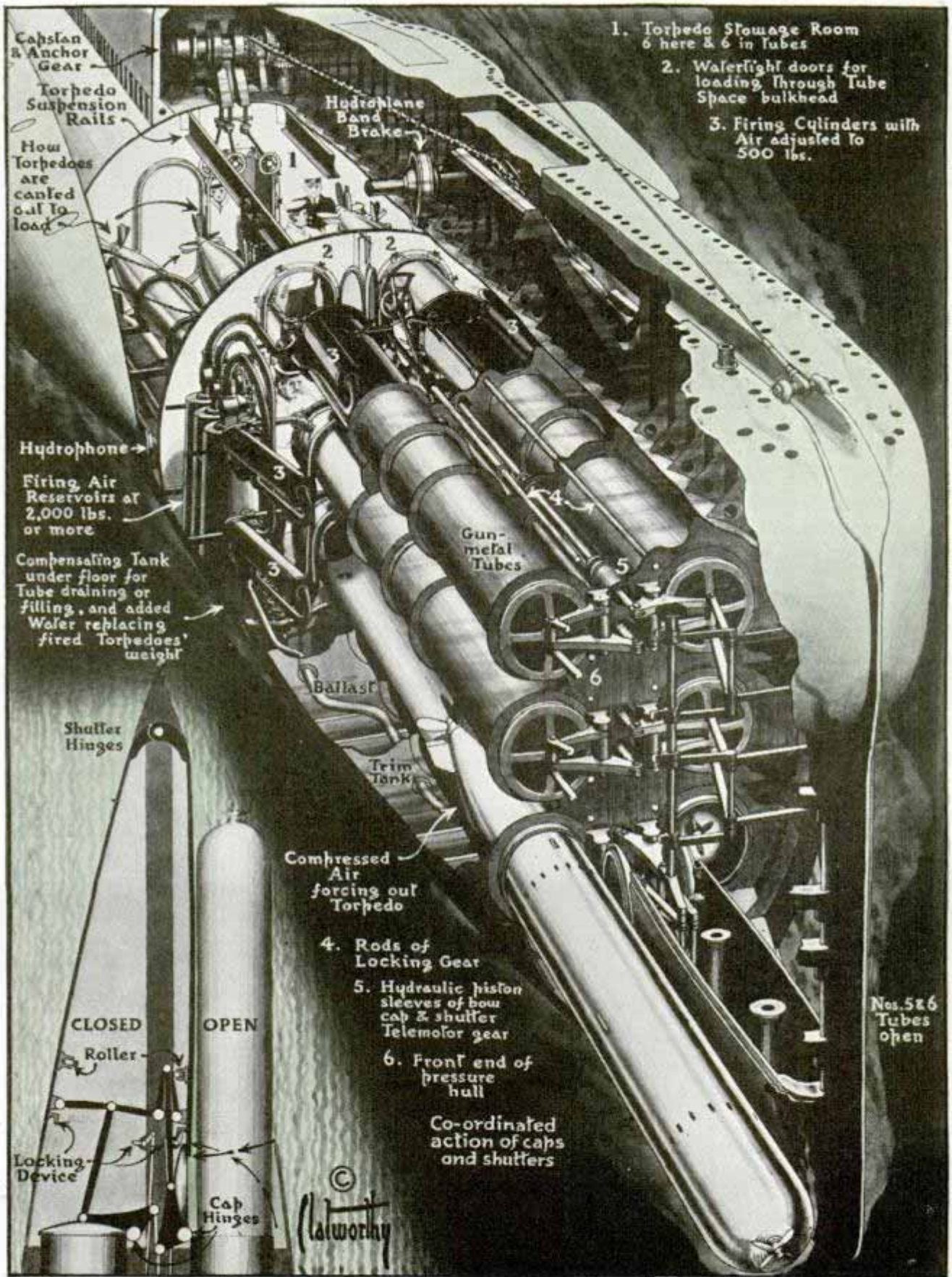

© S. W. Clatworthy

This drawing reveals the essential mechanism for discharging a torpedo from a submarine. The deadly weapon, which travels forty to sixty miles an hour after being launched, is not fired from the ship by explosive but by compressed air which forces it from tube. The actual moment of firing is controlled from periscope amidships where tubes are aimed by maneuvering the whole boat. The inset at left shows the coordinated action of the bow caps and shutters as seen from above. This ship carries twelve torpedoes

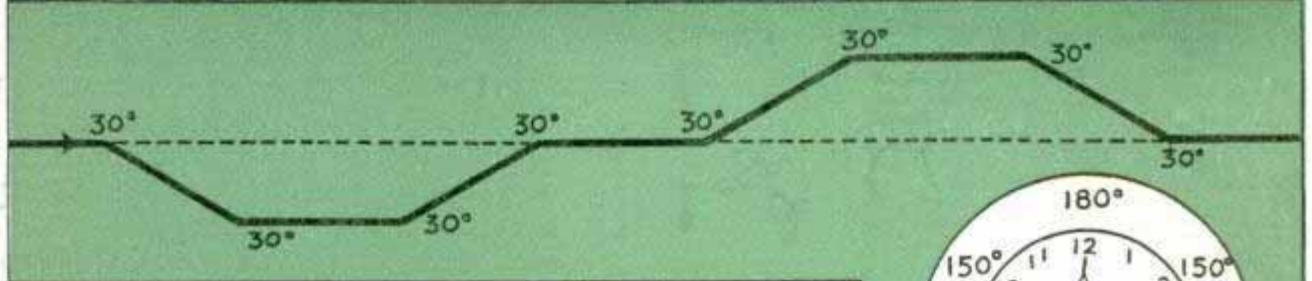

swooping curve. Swiftly it bore down on that fleck of foam on the surface. The flick of a lever, and a depth charge went over the stern, exploding so violently the destroyer's own generators were disabled. The crash brought the other destroyer, the "Nicholson," dashing through the now furiously zigzagging convoy. The two destroyers swept in widening circles, while violent fountains spouted in their wakes. Fifteen minutes of blasting the depths gave no evidence of a hit.

Down under, the "U-58" lurched wildly at the first crash. Kapitan-Leutenant Amberger stared anxiously at quivering needles on the instrument board. He ordered all stations to report. No leaks. Controls still worked. Motors, badly jarred, but still turning, could probably be fixed in a short time. Between the jar of explosions, Amberger ordered a quick dive to greater

(Continued to page 159A)



Top, submarine "U-58," engines disabled by depth bombs, breaks surface and surrenders to U.S.S. "Fanning" in 1917. Diagram shows course of convoy ship; assuming initial course is 150 degrees, ship zigzags thirty degrees every ten minutes. Bottom, aboard an American mine sweeper

Shredder Makes Fertilizer from Cull Oranges

Used at Placentia, Calif.

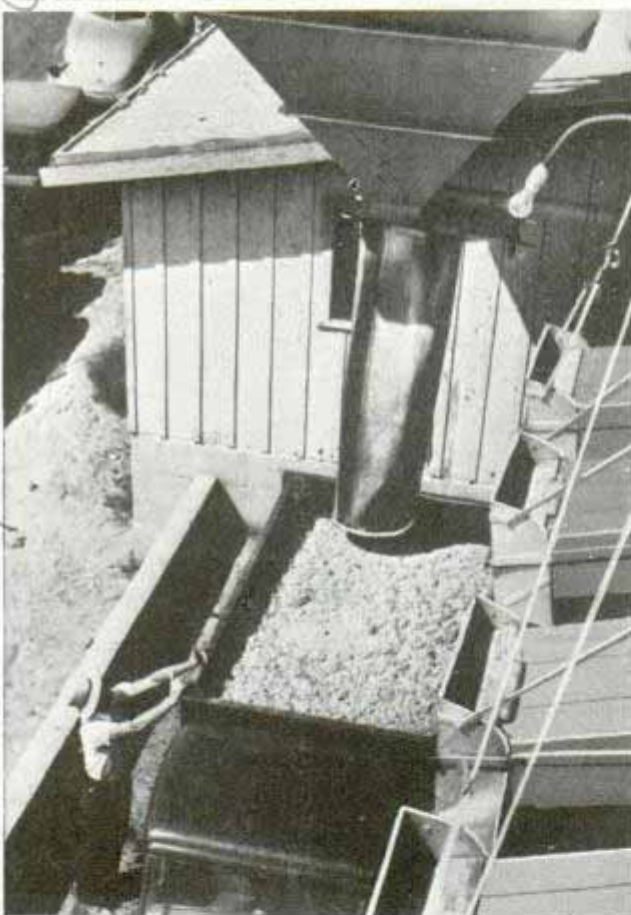
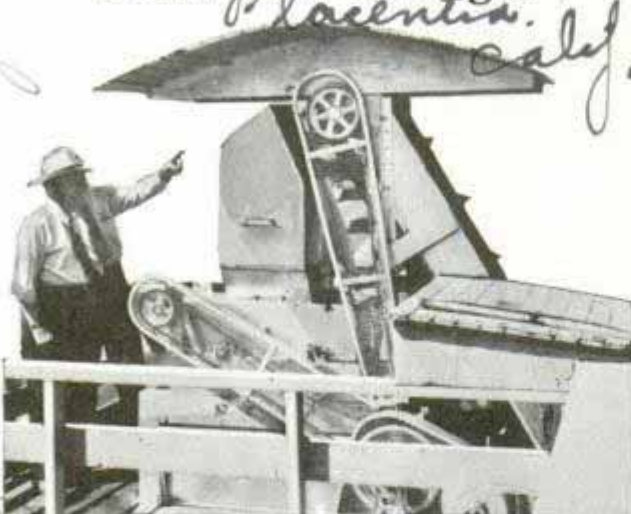

Top, shredder converts cull oranges into fertilizer and, bottom, loads it on waiting truck via chute

Surplus oranges are being turned into an asset through the invention of a machine that shreds them for use as fertilizer, and offers growers and packers a solution to their old problem of disposing of the unmarketable waste. The orange culls are fed into the machine and sixty-four stainless steel disks do the shredding. This shredded product next goes through a hopper and from there it is loaded into dump

trucks which transport it to the groves and spread it along the tree rows. It is claimed that shredding aids in releasing the fertilizing value of the fruit and facilitates disking it into the soil. The machine is driven by a five-horsepower motor.

Welding of "Pocket" Battleship Saved 500 Tons for Arms

Forced by treaty to keep the tonnage of a battleship down to 10,000, Germany sprang two surprises in building its "pocket" dreadnaughts, one of which is shown on the opposite page. These two unique features were electric-welded plates, which saved 500 tons under the conventional riveting method, and the introduction of Diesel engines in heavy warships. By saving weight through the abolishment of rivets, it was possible to install heavier armament and extremely powerful engines—which stretch over one-fifth of the ship's total length—developing extraordinary speed. The eight sets of two-stroke Diesel engines are rated at 6,750 horsepower each, and each group of four engines drives one propeller shaft. The principal armament consists of forward and aft turrets carrying three eleven-inch guns each. In addition there are several lighter guns, anti-aircraft batteries and torpedo tubes. A seaplane is carried just aft of the funnel, launched by catapult.

Self-Grinding Steam Valve Disk Makes Accurate Contact

Spinning at high speed just before it closes against the seat, the disk of a self-grinding steam valve throws off scale and foreign particles and insures a metal-to-metal contact of polished surfaces. A reversing chamber directs the steam flow to turbine vanes, causing the disk to rotate. The turbine vanes are shielded from the steam flow when the valve is open.



Portland, Oregon

Eng. Edward Sanders, 506 N. Los Angeles St., Anaheim, Calif.

Used at Placentia

Mutual Orange Assn.

1330

see opposite page

1343

Full article in S.M.

93 Langens, London, England
W. C. S. England

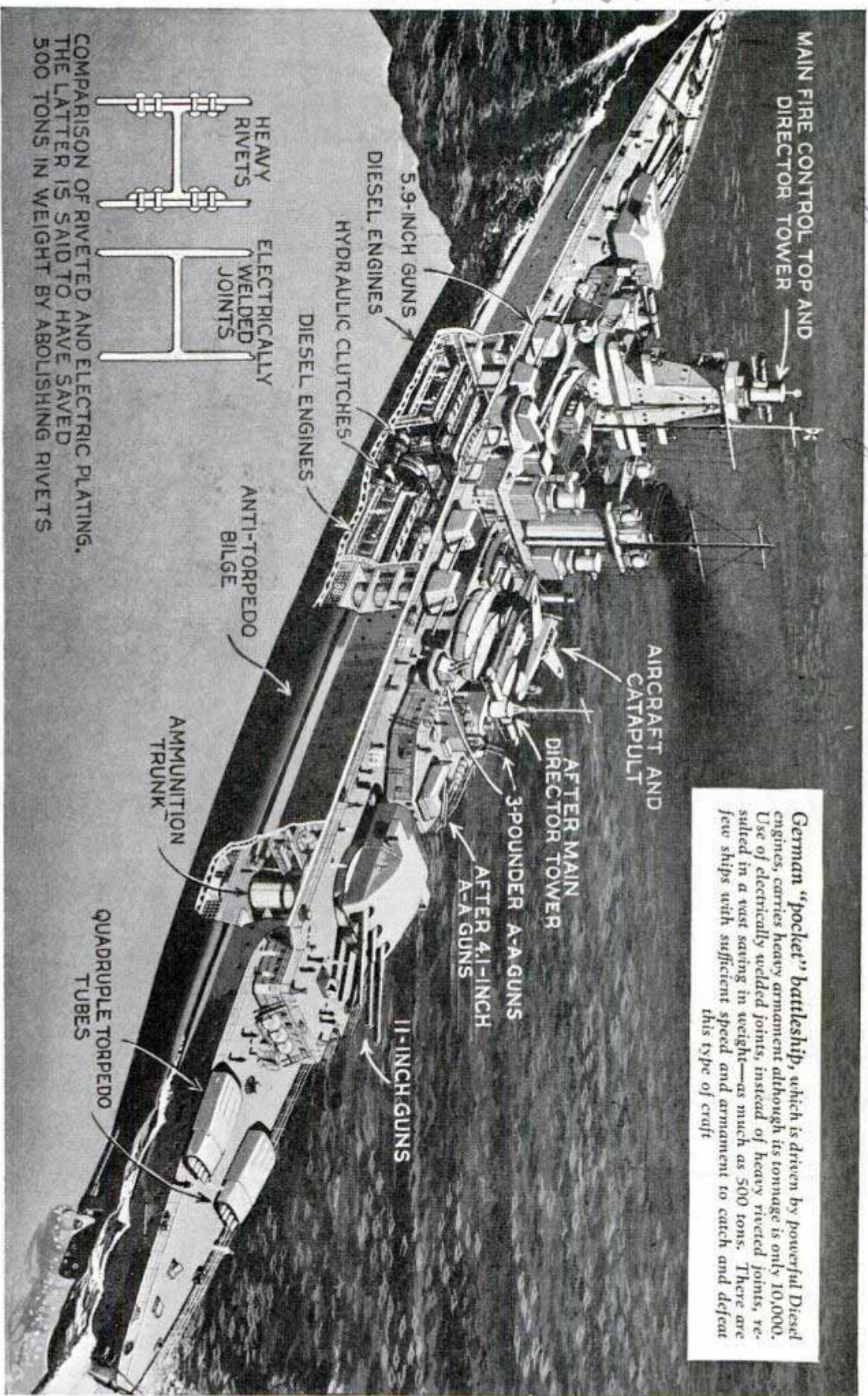

COMPARISON OF RIVETED AND ELECTRIC PLATING.
 THE LATTER IS SAID TO HAVE SAVED
 500 TONS IN WEIGHT BY ABOLISHING RIVETS

German "pocket" battleship, which is driven by powerful Diesel engines, carries heavy armament although its tonnage is only 10,000. Use of electrically welded joints, instead of heavy riveted joints, resulted in a vast saving in weight—as much as 500 tons. There are few ships with sufficient speed and armament to catch and defeat this type of craft

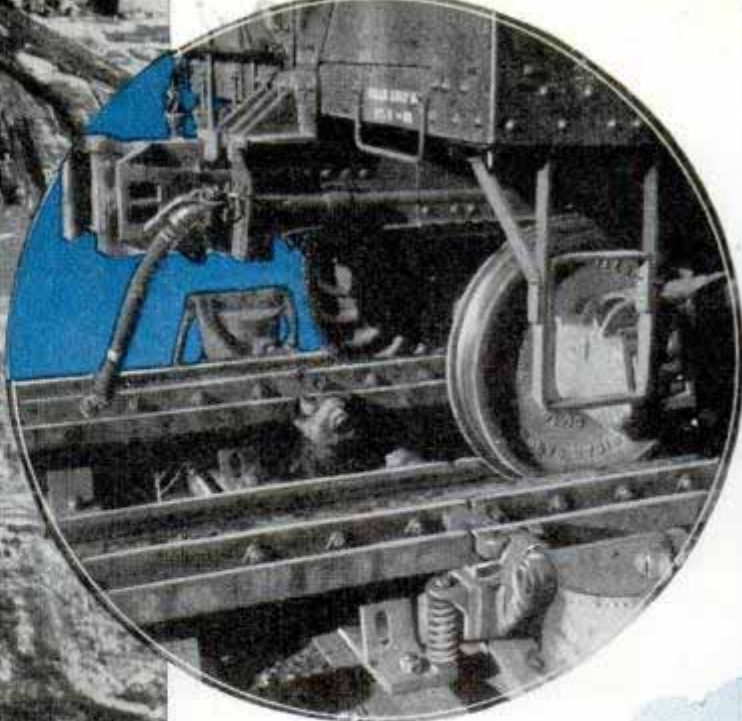

2119 5



The FAST FREIGHT

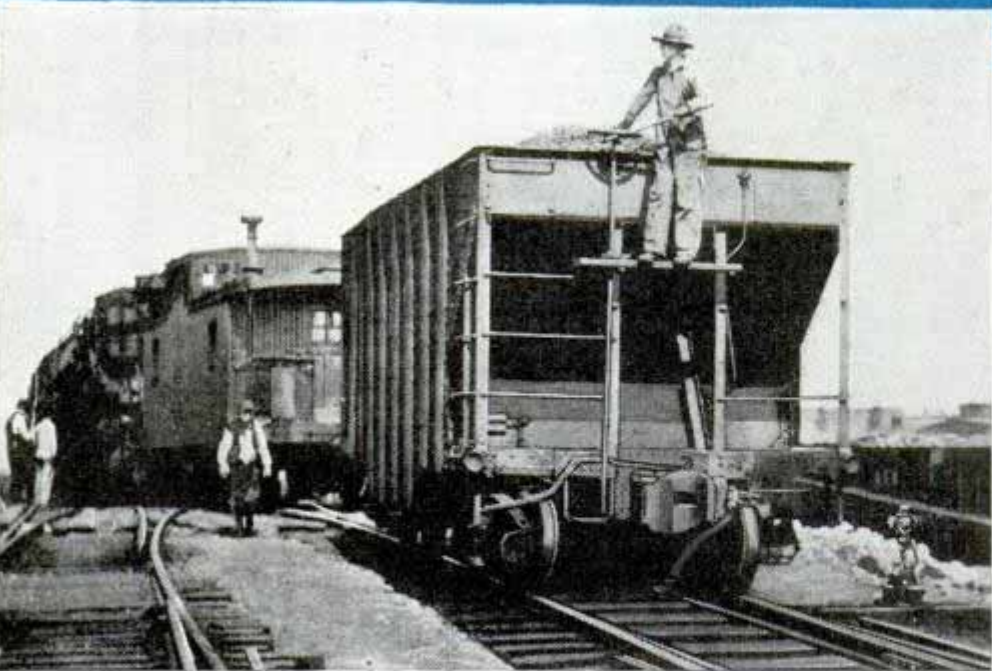

Center of "hour glass," top, left, is hump of freight classification yard at Clearing, Ill., near Chicago airport. At right, freight car stopped by retarder. Bottom, the old way; before remote-controlled retarders arrived, a brakeman rode each car down from hump and applied brakes by hand, a risky business

By Roderick M. Grant

WHEN a trainload of California grapes and eggs and Seattle salmon rolled over the hump in Chicago the other day and in just ten minutes was snaking out of the yard behind the engine of an eastbound freight, it was something for old railroaders to chin about in the smoker of the 5:15.

They could remember the log jams back in '14, when freight terminals were blind alleys and carloads of vegetables rotted on the track, forgotten by all but the neighbors and the consignees, and trainloads of reapers and hoppers full of

seed were lost on sidings until the harvest was in.

In those days the rails in Chicago were glutted with neglected freight. A carload of cement might lie five or six weeks waiting to get across town to a southwestern railway. Perishables perished, claims against the railroads because of delays were staggering. If your

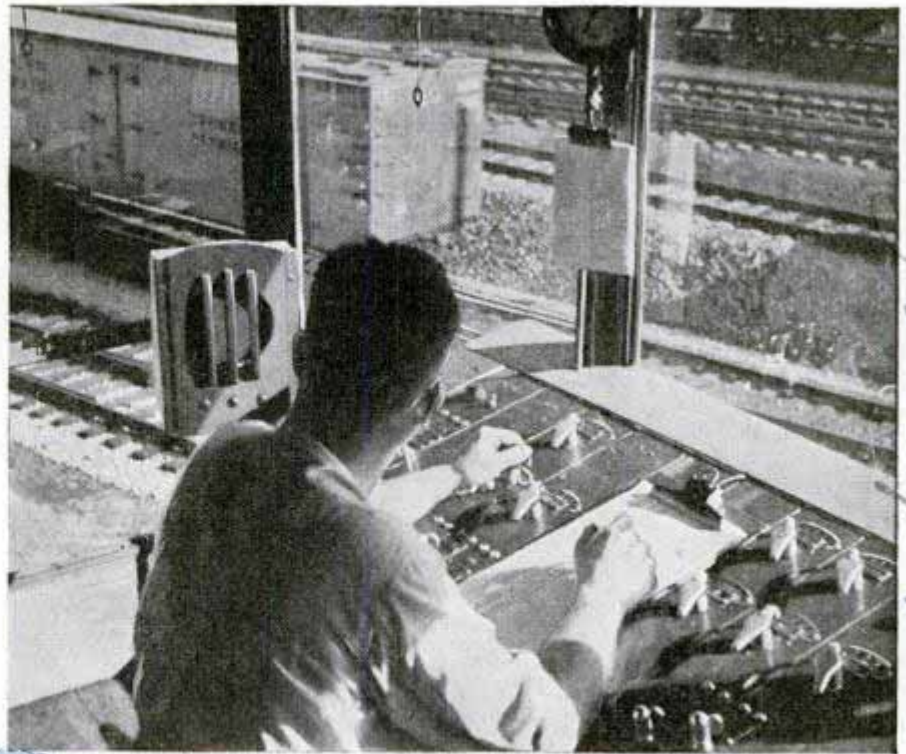

*Train Slightly and signals to
downgrade!*

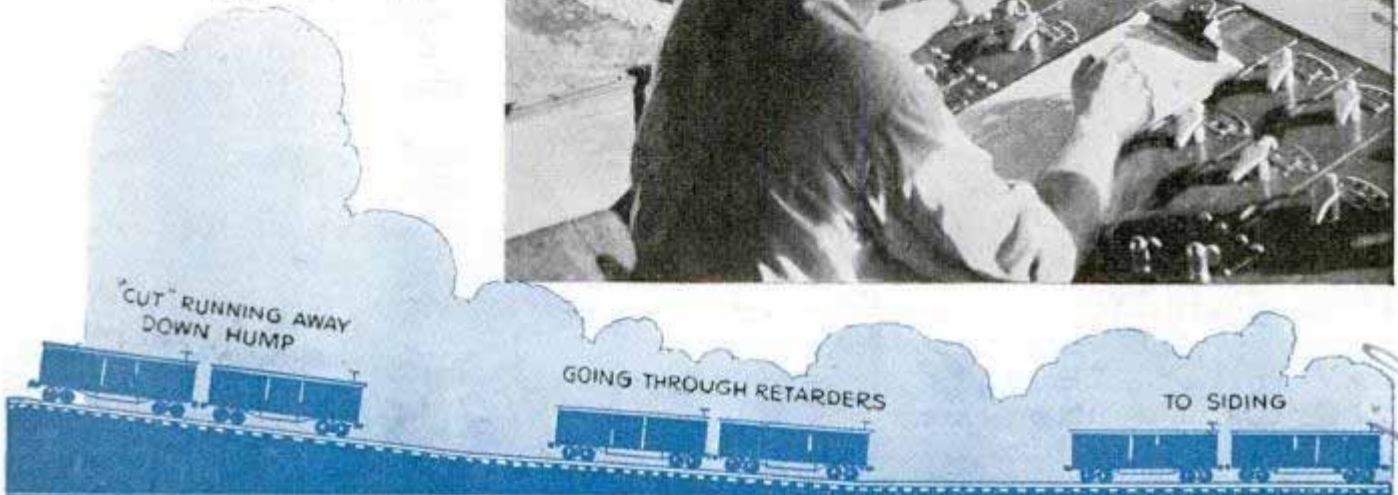

RIDES *the* HUMP

furniture factory in Kankakee was threatened with a shutdown for want of lumber ordered from Minnesota, you'd have to send your man to hunt up the shipment; once located, he could probably get it started your way by quietly tipping the right man. It was no secret then that a railroader who could get your butter and eggs out of the jam might make a little money on the side.

Today 3,500 to 4,500 cars a day roll over the hump in the classification yard at Clearing, Ill., southwest



Towerman at top operates switches sending boxcar to proper track, and, judging speed and weight of car, turns controls applying retarders. Bottom, view at hump as powerful engine pushes last car down grade. Foreman in shanty supervises uncoupling cars according to "train consist" list



of Chicago, and thousands more funnel through the other transfer yards around Chicago, terminus of twenty-five trunk lines. The log jam is broken. Come prosperity, come war, freight will flow on smoothly across the country.

One of the world's busiest men is the humpmaster at Clearing, newest of the automatic freight-sorting yards. From his



Let's pick up a fast freight from the Burlington laden with prunes and lumber, pears, rye, eggs, clay, feldspar and sugar,

tower straddling the hump, surrounded by telephones and Teletypes and loud speakers, surveying 180 miles of track spread fanlike to east and west, he directs the interchange of freight between north, east, south and west. The Belt Railway of Chicago opened its pioneer humpyard in 1915; today it has been rebuilt, completely mechanized. Missing from the picture are the brakemen who swung on hand brakes as the cars rattled down hill, threading switches into the out-bound yard. In place of the car riders are towermen who operate switches by remote control, and twist a controller that clamps retarders against the wheels to hold the car to a safe speed or halt it until a switch is clear.



Humpmaster, top, watches operations from post directly above hump and has telephone and loud-speaker connections to every tower and shanty office. Below, a heavily loaded boxcar slows down on a retarder

as it pulls into the west receiving yard at 4:55 a.m. It has some quick connections to make for eastern and southern points.

Waybills are dropped at the receiving shed and immediately shot by pneumatic tube to the Teletype room at the hump. Meanwhile a checker notes the number of each car as it passes, calls it off, and a list of the cars is typed showing their position in the train, car number, contents, outgoing railroad and its track number in the eastbound classification yard. The fourth car in the train, a load of pears for an Erie train leaving at 7:05, must be re-iced, so the train is sent along the icing platform, where 90 cars can be serviced at once.

While cars of perishables are being re-iced and the whole train inspected, a multiple list of the cars is going over the Teletype to the humpmaster, the hump conductor's shanty below, the towerman who must route each car to its proper track, and to the eastern outgoing yard office. At the same time the waybills are run through the Recordak, which photographs them at fifty per minute; the waybills go on by tube to the east-yard office and are distributed to con-

(Continued to page 146A)

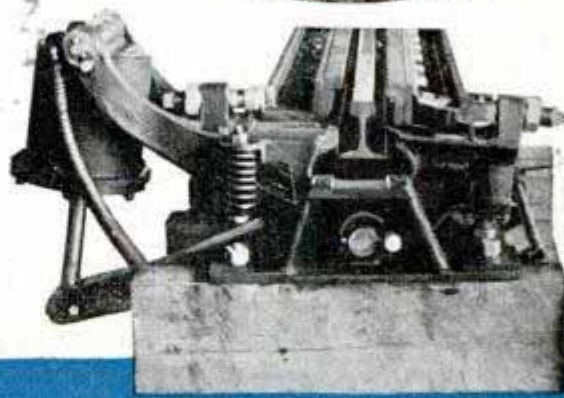
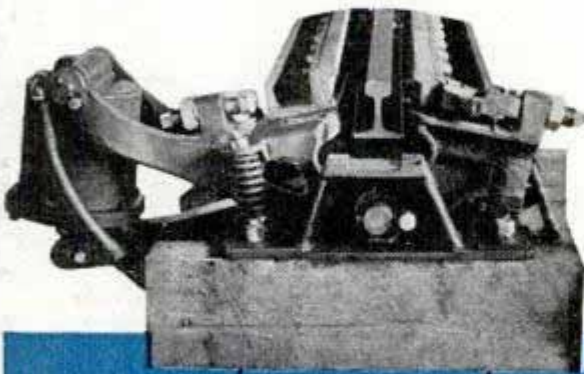
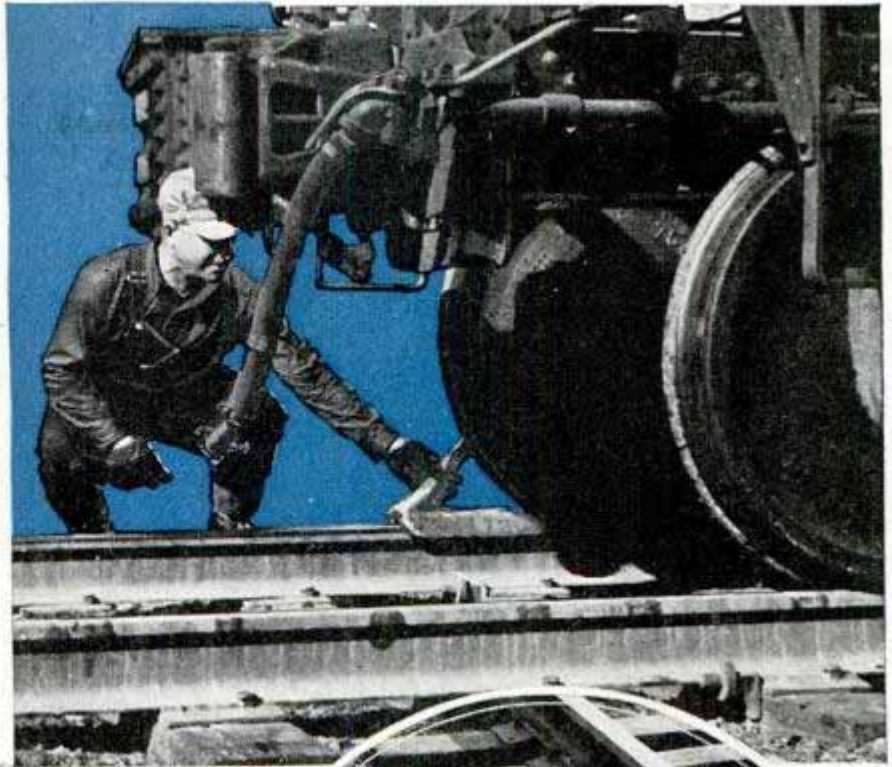

At top, yardman places a hand skate on rail to hold a string of freight cars; in center is an automatic skate thrown on rail by remote control. Bottom, sectional view of retarder in open position with brake beams released (left) and with air applied and retarder closed (right)

Co. *Prentiss, n.g.*

Electric "Hot Dog" Cooker Has Automatic Shut-Off



Electric current creates heat inside "hot dogs" to cook them, and automatic switch prevents shock

Electricity cooks frankfurters by an "electrocution" method using a "cold" grill which has no heating element. Both ends of the "hot dog" are pushed down over needle-sharp contact points and the switch is turned on by closing the cover. Cooking is done with internal heat created by the electric current passing through the sausage, and requires but a minute to complete. The safety switch cuts off the current as soon as the cover is raised.

1414 Circular Electric Outlet in Wall Takes Plug at Any Angle

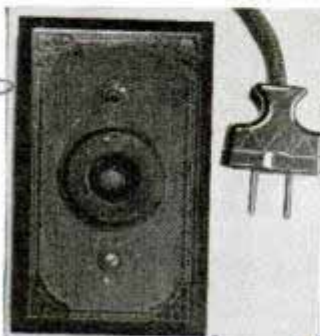

Less annoyance in plugging in an electric appliance is claimed for a wall outlet with circular openings instead of the usual parallel ones. The ordinary two-prong plug is

inserted easily anywhere in the circle, one of the points being thrust into the outer ring and the other making contact through the inside ring.

21370 Spring Clip Holds Film on Reel to Keep It from Uncoiling

Movie films cannot jump out and uncoil from their reels if a clip now on the market is used to hold them. It fits between the reel flanges, and spring fingers fasten the film securely. It is available for either eight or sixteen-millimeter sizes. A matte outer surface provides space for marking the title or other film identification.

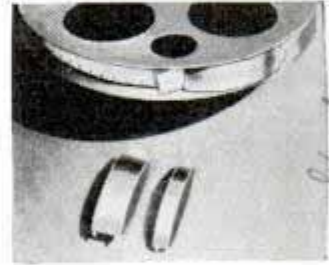

21883 Light Truck with Rotary Brake Gives Smoother Ride on Rails

In three years the Milwaukee railroad has reduced the weight of its passenger-car trucks from 50,000 pounds to 25,000 pounds per car, the newest trucks proving not only a notable saving in cost but producing a smoother ride. The lightweight truck just introduced has inboard bearings

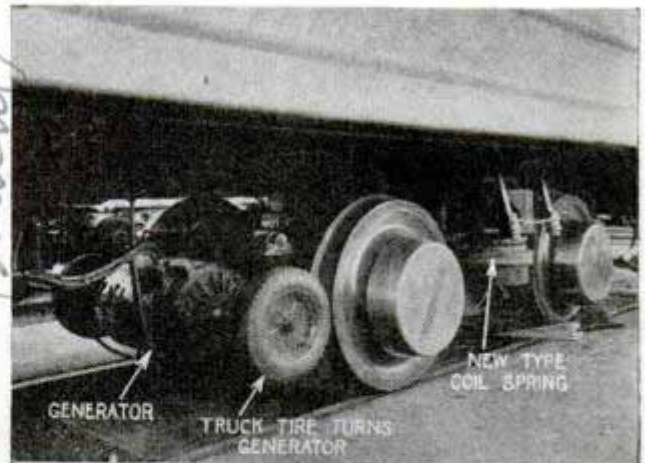

Notice absence of conventional brake shoe on this new type railway-car truck, which has rotor brakes

of automobile type instead of the conventional outboard bearings, and coil springs with snubbers replace the former elliptical springs. The brake shoes which applied friction to the wheel tread are gone, and in their place are rotor brakes which stop the car more smoothly and with less noise; they

1200 R. Cranko, % Bourard, 2301 W. Hubbard, Chicago

Adams Fisher Co. 183 Exchange St.

Md.

have 576 square inches of braking area in contrast with the ninety-two square inches of the conventional brake shoe. Another innovation is the use of a small automobile truck tire, turning against the wheel tread, to drive the generator. The saving in costs by a weight reduction of 25,000 pounds is evident when it is considered that it costs the railroad nine-sixteenths cent per year to haul an ounce of dead weight.

B.
Pv

21302
Two-Quart Carton for Milk Brings Lower Price

Cost of milk to consumers has been reduced one and one-half cents per quart as a result of the introduction of a two-quart paper container by a distributor in New York City. Because of its rectangular shape, the package takes up less space in the refrigerator than do two single quarts.

Barges Hold Span of Bridge While Cables Are Replaced



Lowering one of five sections of center span to barge in river to relieve weakened cables of their weight so they may be replaced with new ones



Delivering two quarts of milk in one carton instead of two glass bottles has lowered price to consumer

Failure of two huge cables supporting a bridge at Portsmouth, Ohio,—believed to have been caused by the flood of 1937—made it necessary to remove the old cables and install new ones. Before lowering them, however, engineers were faced with the problem of relieving the cables of their enormous burden—a 700-foot center span. The solution was to remove 350 feet of the center span in five intact sections, and to cantilever the two 175-foot ends. The sections, each weighing sixty-two tons, were lowered to barges, on which they would remain until the new cables were in place.

Send return postage to our Bureau of Information to learn the name of the maker of any device described in this magazine.

Sheffield Farms, Inc.
New York City 524 W 57th

Emb. Graber & Tabler
1124 4th St
Portsmouth
Hornby
1937
21302

1227

SCHOOL DAYS for

Paras - Carmen
Cubine & Shao
D.D. Madison Ave
Fenford
Ringling
D. D. Sibley

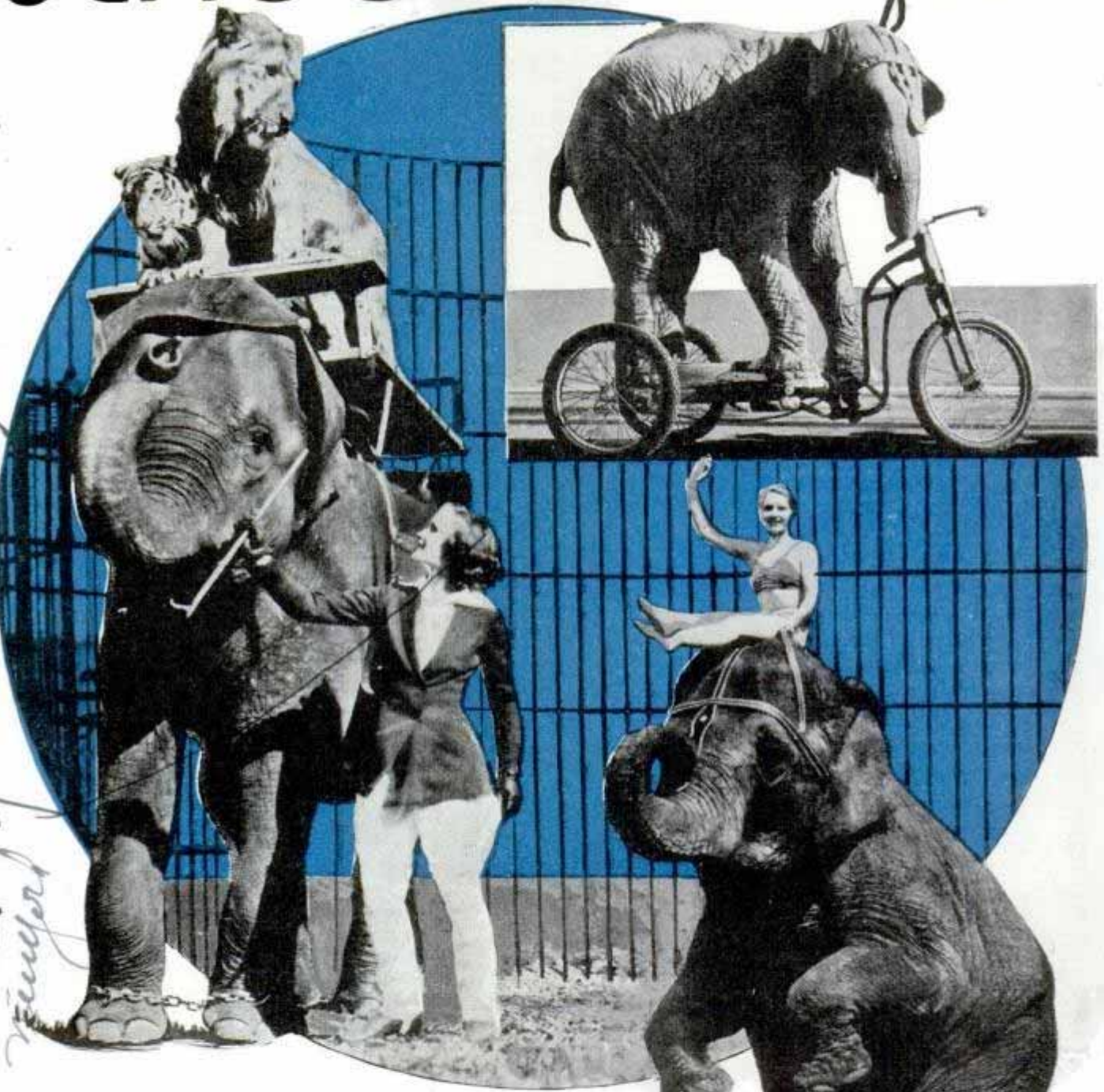

By Edward Allen
Professional Animal Trainer

(As told to F. Beverly Kelley)
65 Oak Hill Ave Schlaware
Chri

IN THE mechanics of elephant education, those of us on the circus "faculty" have things in common with teachers of humankind. We know that a pupil who learns slowly may become a better and more reliable performer than some of the more innately talented who learn very quickly. And, like the misfit who was molded for manual accomplishments far removed from the ivy-clad walls of high-



Lion and tiger riding elephant (left); going through cycle-riding routine (right), and a familiar sight at the circus (bottom)

ELEPHANTS

er education, there are elephants that are absolute failures as actors but that make good workers in harness.

The first thing to teach them is to understand plain English and to obey commands when they are given. Once Bill Emery went to New York to unload a pair of young elephants purchased from a South American circus and guaranteed to be perfectly trained. Trouble began as soon as he tried to get his passengers off the ship. Simple commands that any trained elephant should have obeyed had no effect on the "foreigners" unless it was to make them more stubborn.

The difficulties encountered at the dock were minor compared to the task that loomed

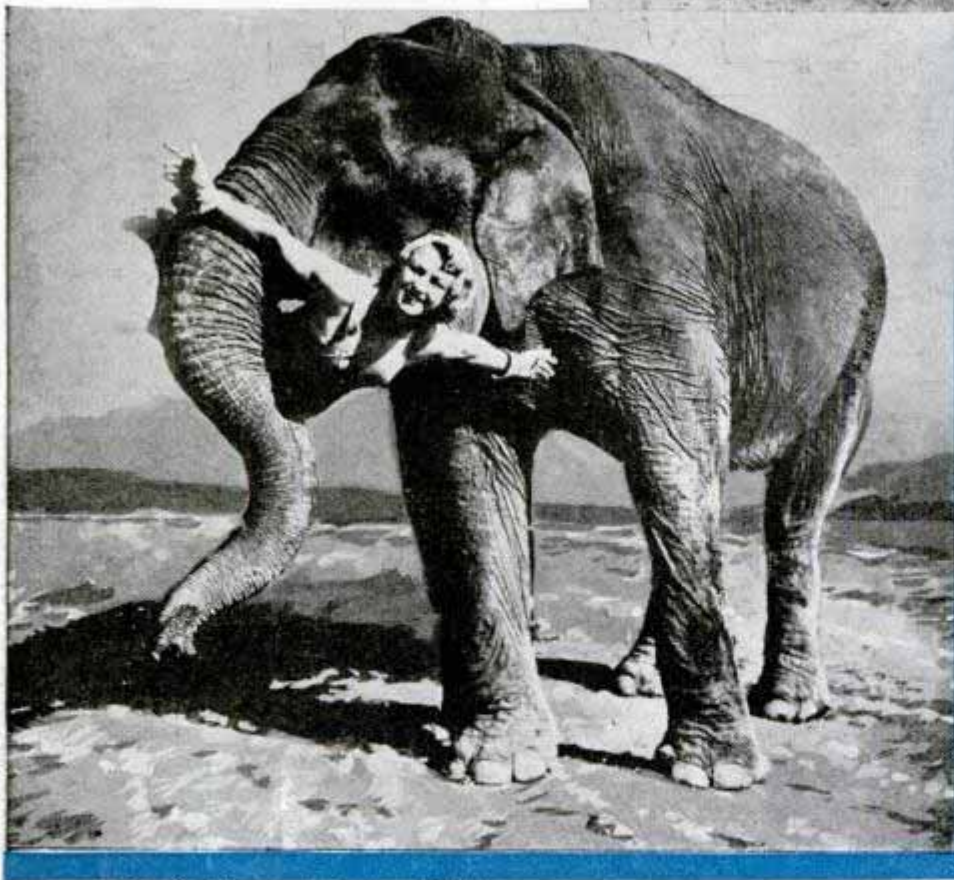

© Ringling Bros. and Barnum & Bailey

Top, the elephant as a clown draws laughs from circus crowds. Below, trained elephant carries woman performer. This act must be executed carefully to avoid injury

once the elephants had reached the circus. The circus manager cabled the former owners that the "trained" bulls didn't know a single trick. Next day a cablegram arrived, explaining that these animals had been trained in Latin America and, of course, they didn't understand English.

In teaching elephants you use only simple words and use them over and over again until the animals respond.

The wise trainer feels out an elephant's mind and tries to discover what the animal wants to do. Some tricks will be attempted by the beast with more willingness than others. No matter how long it takes them to get

2/22/21



They are: standing on the hind legs, lying down on the left side, sitting up on the ground and standing on the head. The leg stand is the hardest to teach because it requires development of those muscles and entails a balancing of great weight. This calls for a rigging which consists of ropes running from each front foreleg, through a pulley and into the hands of a capable assistant. The animal usually has a drumlike seat placed behind it and this helps with the balanc-

the "feel" of a trick, they must not be hurt or caused to lose confidence in what they're trying to do. There are four principal tricks that an elephant has to learn before a circus act can be routined.

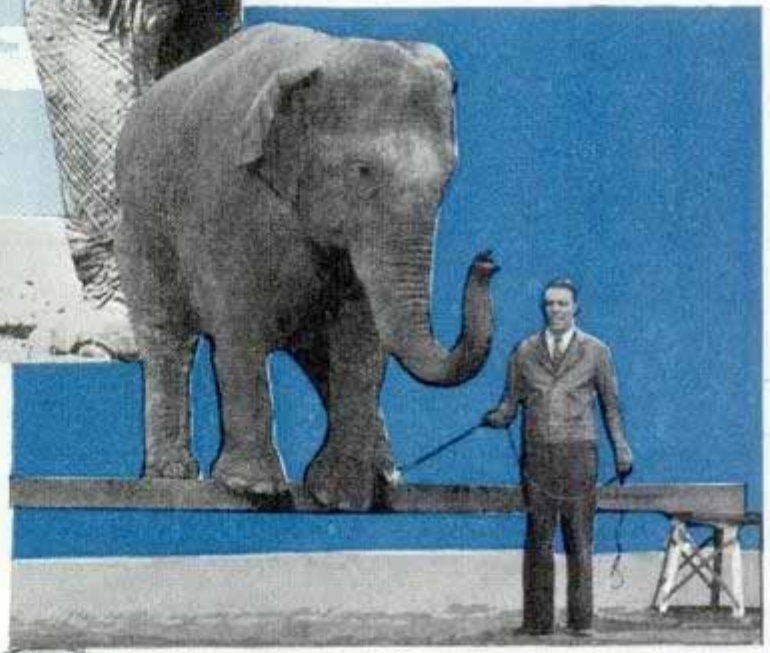

Hazardous "Head Carry" (top); elephant performing the difficult trick of walking a plank (center), and Jean and Eddie Allen with elephants that have been taught a military drill (bottom)



ing, enabling it actually to sit down as the hoisting takes place. Similar rigging is then used on its trunk so that the elephant may be taught to lift its trunk in salute as it stands up on its hind legs. As the lifting takes place, the trainer

Jean and Eddie Allen

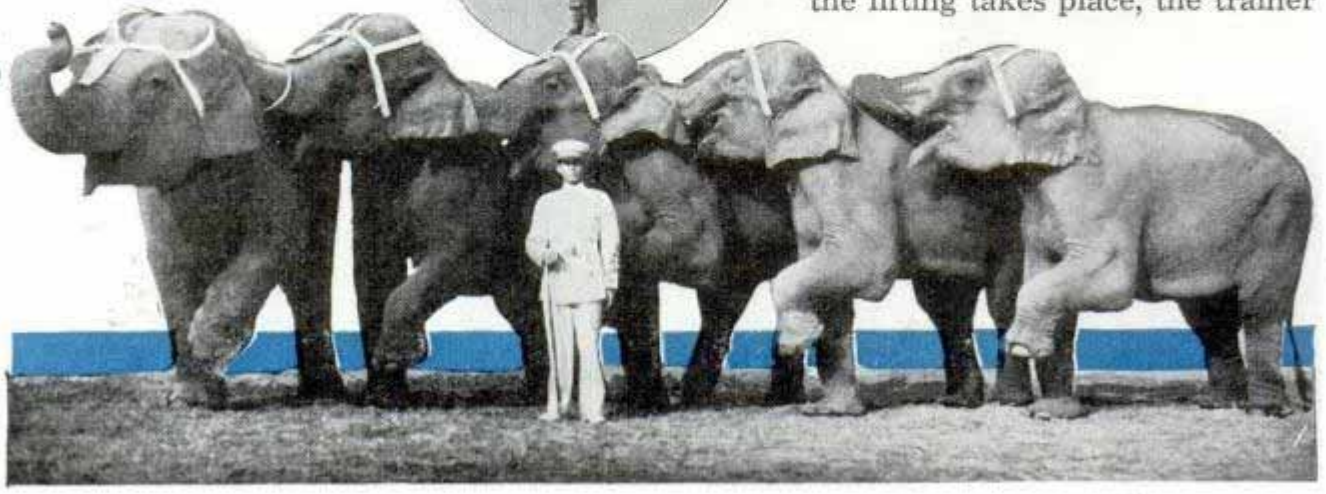

Portable Plug-In Traffic Light Guards Street during School

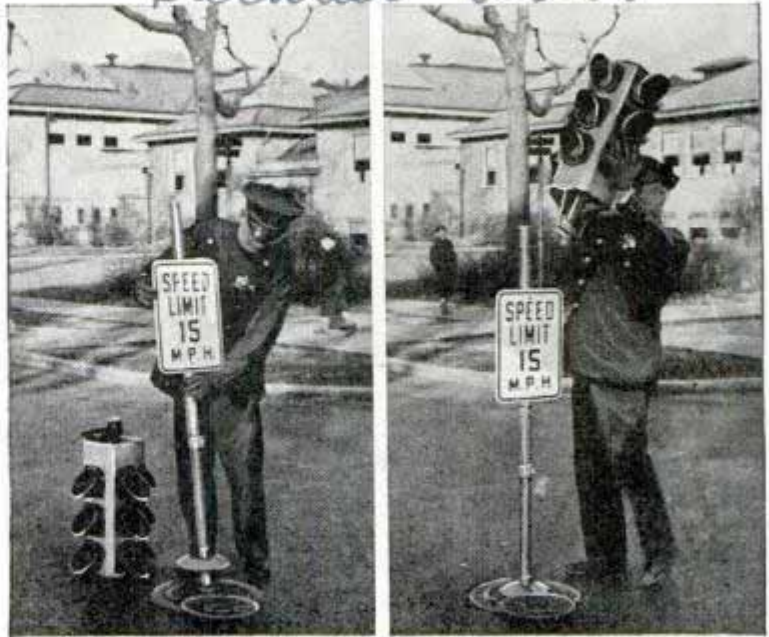

Policeman plugs pedestal into socket at center of crossing, then sets traffic lamp on top to operate during school hours

For guard duty at school crossings where protection from passing automobiles is needed only during the hours before and after classes, there is a portable traffic light that plugs into the pavement. An officer fits the pedestal into a contact socket in the street, then places the automatic stop-and-go lamp on top of the post.

Overexposed Films Are Corrected in Process of Development



Both underexposure and overexposure in the same film roll are corrected when a new developer is used in conjunction with a combined tank and squeegee. The film is immersed in the tank for about one minute and then placed in close contact with a smooth inert surface by means of the squeegee. As only enough of the solution has been absorbed to permit development to a predetermined density, it continues to build details in the shadows after developer in the highly exposed areas is exhausted.

Medical authorities say the human heart at rest pumps blood at the rate of 3,000 foot-pounds of work per hour; at hard work, the figure might reach 15,000 foot-pounds.

American Medical Journal vol 1939

shouts the command so that the animal soon associates the sound of the word with the trick itself.

To the casual spectator the head stand seems most difficult; really it is a comparatively simple trick to teach because the trunk acts as a balancing leg. After an elephant has mastered these four tricks, you can start building the act. The waltz, mounting of other elephants, working on tubs, dancing and "London Bridge" call only for patience and understanding.

Teaching an elephant to shimmy calls for plenty of patience. I begin by having a large grain sack filled with sand placed in the middle of the back with the weight divided on each side. Then we tell the elephant to "shake it up!" Most elephants like to throw things onto their backs and shake them off, so the first thing you know the elephant is doing its best to dislodge the sack. This is done repeatedly and the command to "shake it up" accompanies each trial, so that in about two weeks the sack can be discarded, for the elephant gets the idea and starts to shimmy when the word is given.

Two years ago, Clyde Beatty and I decided to try something really spectacular, to train an elephant to carry both a lion and a tiger on its back. Harriet Beatty, Clyde's wife, was to present the act once it was broken and ready.

Of two dozen elephants in the circus, there was only one that I felt pretty certain would do. This was a young female of about fifteen summers, almost perfectly developed and possessed of a rather quiet disposition. I first taught it to carry a howdah, which in this case turned out to be a platform wide enough for both cats, and this required about two weeks of rehearsal.

Then it was taken into the steel-barred training arena so it might become familiar with the smell of the cats. For several days we sim-

(Continued to page 139A)

21227
21343
Lewis Mfg Co.
Alcatraz Cal.

Hollywood
Romaine St.
4000

Vertical text on the left margin, possibly a page number or reference.

Giant High Chair Near Road Attracts Eyes of Customers



Ramona, Calif

Gigantic proportions of this 100-pound high chair draw attention of prospective customers to firm's place of business alongside highway

Driving along a highway on the west coast, tourists behold an enormous high chair displayed prominently at the roadside. It was made by a manufacturer of playground equipment to advertise his place of business. Built to scale, the chair weighs 100 pounds.

Farm Crops to Take Infrared and Ultraviolet Treatments

Ultraviolet and infrared radiation will find many a practical application on the farm, when electric current is available at an economical level and suitable equipment is developed. The electrified farm of the future, for example, may use infrared

heating elements to dry hay quickly, to heat poultry houses and keep new-born animals warm. Incandescent lamps with globes that emit ultraviolet rays may be used in greenhouses to promote well-proportioned plant growths by closely approximating natural sunlight under better-than-natural control. Germicidal ultraviolet lamps could be installed in stables and dairies to kill air-borne germs, to control epidemics among livestock and check fungi growth in grain and hay.

21396

Skidless Holder for Roast Makes It Easy to Carve

Inexperienced hands carve roasts with skill when the meat is anchored to a skidproof holder. The base of the holder is a metal disk with suction-cup feet to grip the platter, and there are five upright pins on which the roast or fowl is impaled. Thus more uniform slices can be cut.

\$ 1.00



Sharp-pointed pins of roast holder keep meat steady on platter to make carving an easy task for anyone

*Roast Holding
Device Co*

*See W. B. ...
Pat. # 2152023
12/4/39*

Reference - ...

*Chicago, Ill.
Ar. Brooklyn, N.Y.*

21380

Walter L. Martin

Baltimore, Md.

Retractable Catwalk Speeds Engine Servicing

When it is time for the mechanic to service or repair the engine of a Martin transport plane, a retractable catwalk is swung out from the wing next to the nacelle. From there vital parts are within easy reach, and after the job is finished the platform is swung back where it fits flush in the leading edge of the wing.

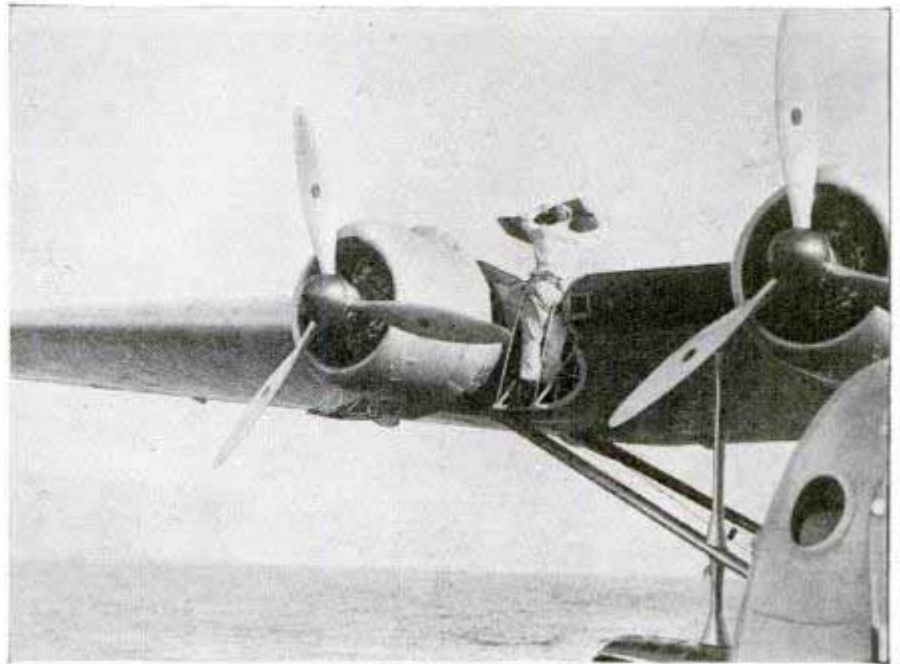

Mechanic stands on retractable catwalk while servicing engine; when job is finished, catwalk is folded into wing

21365

"Ears" for Mechanical Brains Help British Air Defense

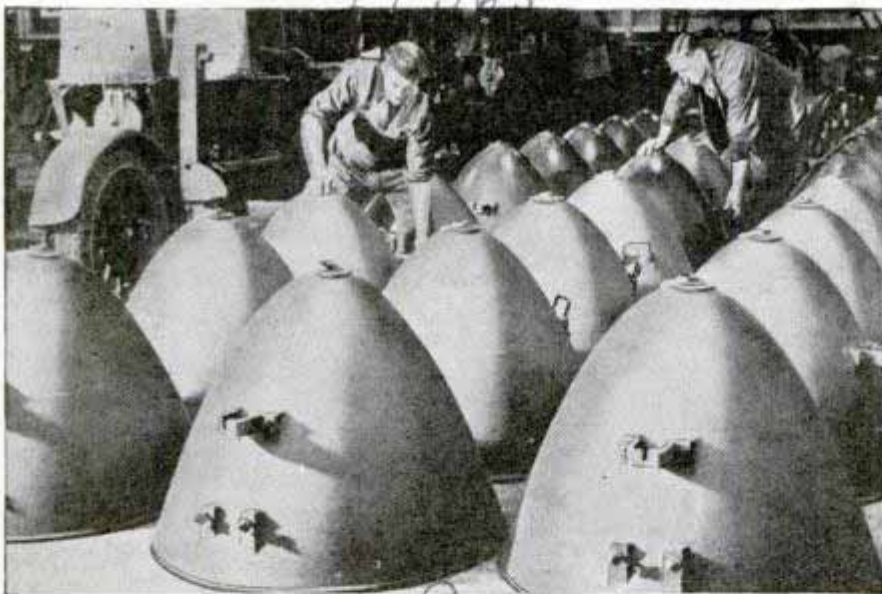

One factory in England is turning out "ears" by the dozen to be used in defense against air raids. Called paraboloids because of their shape, the ears are fitted to sound locators which can detect the approach of airplanes.

Rows of mechanical ears on factory floor being prepared for assignment in England to a twenty-four hour watch for approach of enemy planes

Acme

21360

Sliding "Wings" Streamline the Sides of Tractor-and-Trailer Truck

"Wings" sprout at the sides of mammoth tractor-trailer trucks to conceal the space between and give them the appearance of a single unit. As installed on one ice-cream truck of 750 gallons capacity, the vertical metal panels slide at one end so they will not interfere with turning. The streamline effect results in reduction of wind resistance on long hauls and improves the truck's appearance.



Open space between tractor and trailer is concealed by "wings" at the sides, which slide along body when vehicle makes a turn

Used by: Matthews Frechtling Dairy Co., 2363 St. James

Acme
Clubs

21385

Exploring the

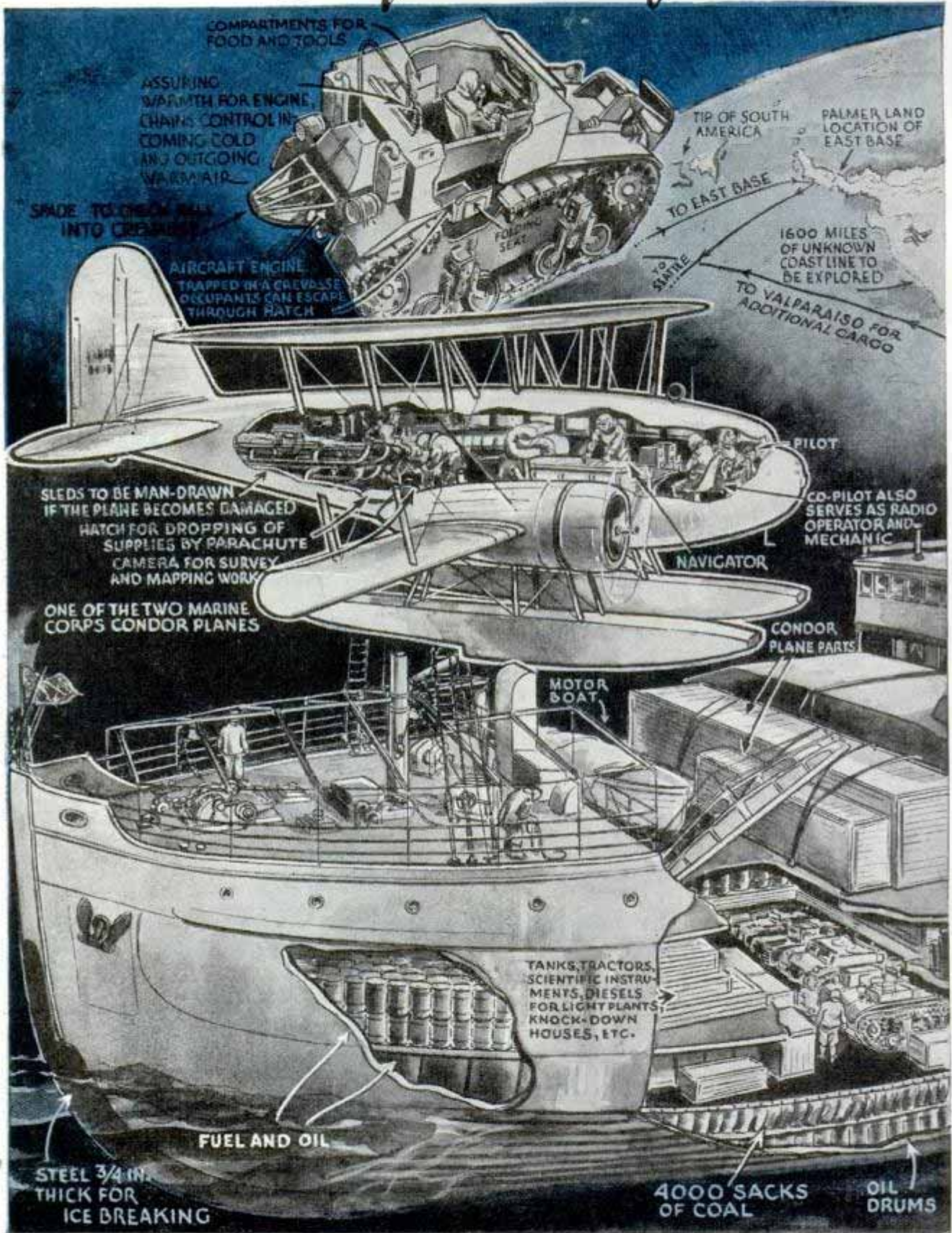

Exploration of vast areas in the Antarctic by the Byrd expedition is in progress, with the objective of claiming a large territory for the United States. The "North Star," pictured on this and the page opposite, was selected after investigation of many ships. It is 226 feet long, has a beam of forty-one feet and its hull is rugged enough to withstand severe ice pressure

21385

"LAST FRONTIER"

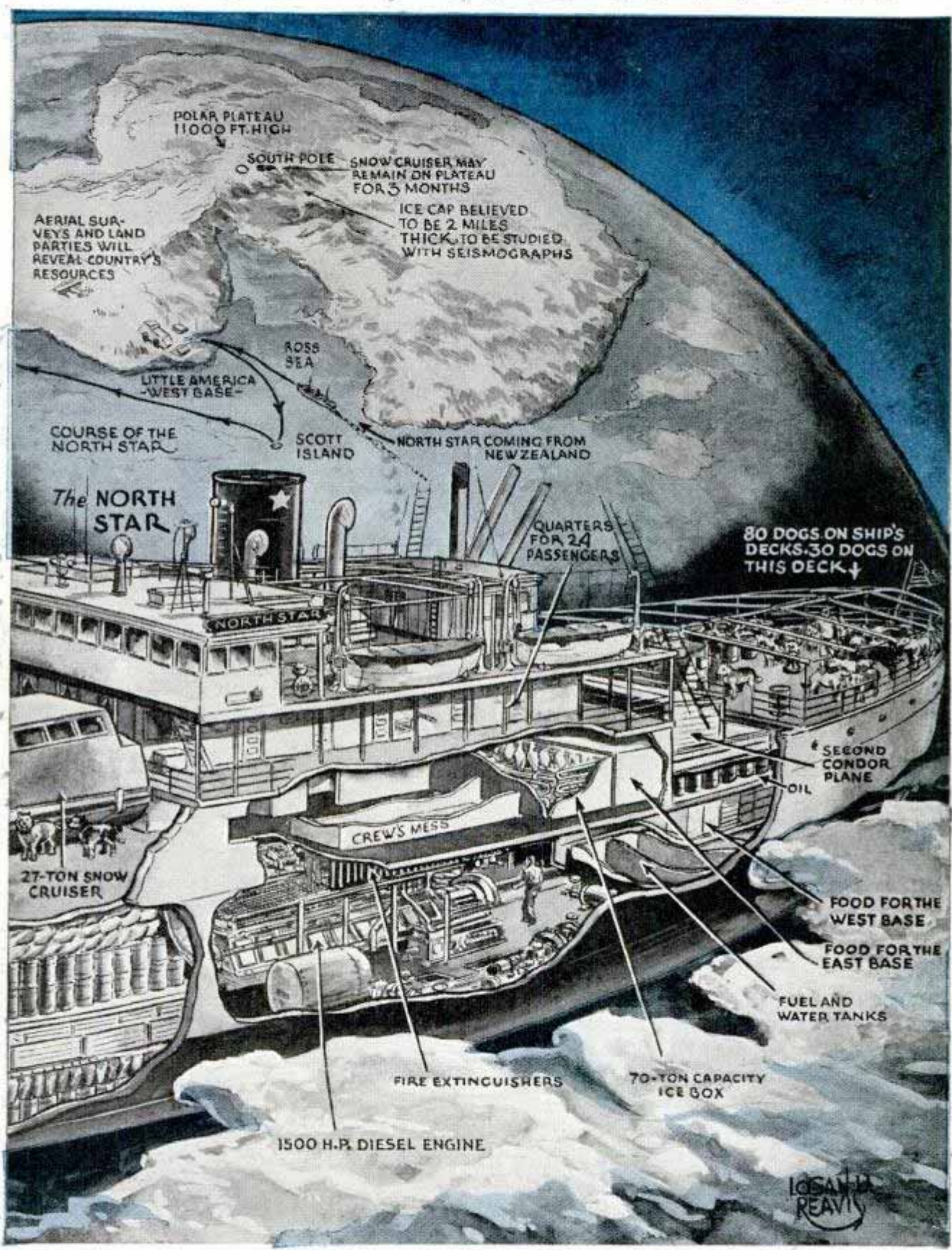

Aboard the "North Star" is complete equipment for exploring the Antarctic. Army-type tanks, tractors and several airplanes will enable the expedition to roam far from its bases. The giant Snow Cruiser also is expected to aid. Note the route of the expedition along the coast. The expedition is expected to spend several months in the vicinity of the South Pole

14800. Ysch

Gas Plant on Bus Trailer Makes Fuel to Run Engine

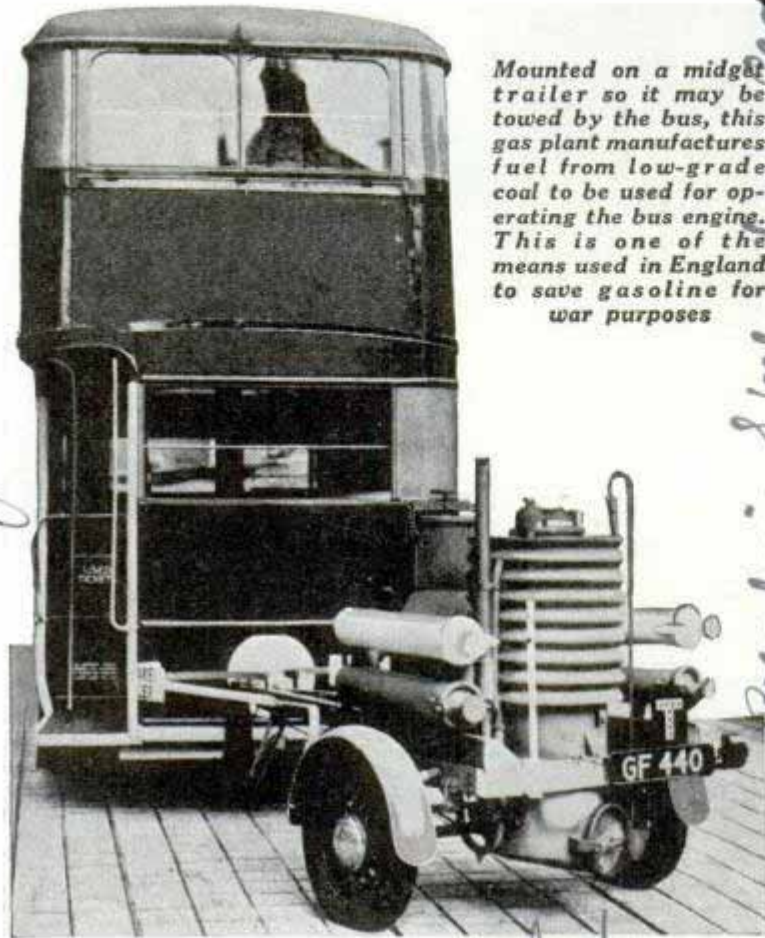

Mounted on a midsize trailer so it may be towed by the bus, this gas plant manufactures fuel from low-grade coal to be used for operating the bus engine. This is one of the means used in England to save gasoline for war purposes

Buses and trucks in London carry their own generating plants for making fuel gas from low-grade coal to conserve Britain's gasoline supply for war needs. A "gas producer" recently introduced is mounted on a special trailer, and as fuel is generated it is piped to the engine.

no infer.

rests on a thin glass plate cemented to the front, the contact being made through a film of oil. It is its greater light-gathering ability and the sharper definitions produced over a larger field that enable this piece of glass to expand the known universe.
214-45

Rustless Hot-Water Tank Is Porcelain Enameled

Coated inside and out with porcelain enamel, hot-water tanks for the home are made in attractive colors that match kitchen stoves and refrigerators while the inside lining withstands the corrosive action of hot water under pressure, and will not deposit rust in the water. Welded on a 30,000-pound machine, the seams are so smooth that they are virtually impossible to detect.

Flower Box for Window Suspended from Sash

Indoor hanging gardens can be planted all year around in a window box that is designed for easy installation. Two hangers hold the box and are fastened to the sash by brads. The box may be removed from the hangers, if preferred, and set on the window ledge.



Flower garden in window box is suspended from sash by two sixteen-inch hangers that are easy to install

Sky Camera Made of Solid Glass Peers Farther into Space

Astronomers have pushed back the boundaries of space with a sky camera made of a block of glass, which they use with a powerful telescope. Developed at Mount Wilson observatory, the camera permits the 100-inch telescope to "peer" farther into space than ever before, revealing facts about stars and nebulae which are beyond its ordinary range. This camera is constructed from a block of highly transparent glass and measures about two by three inches. The front of the block is flat and the back is concave and covered with aluminum. The photographic plate

Dr. Walter S. Adams

1454

Pasadena Calif

George Koch
Sond chue.

Porcelain Enamel, D. S. D.
Flower Box, D. S. D.
2112 Pennsylvania St. Evansville, Ind.

Twenty-Mile Belt System Hauls Gravel to Dam

Columbia Construction Co. Redding, Calif.

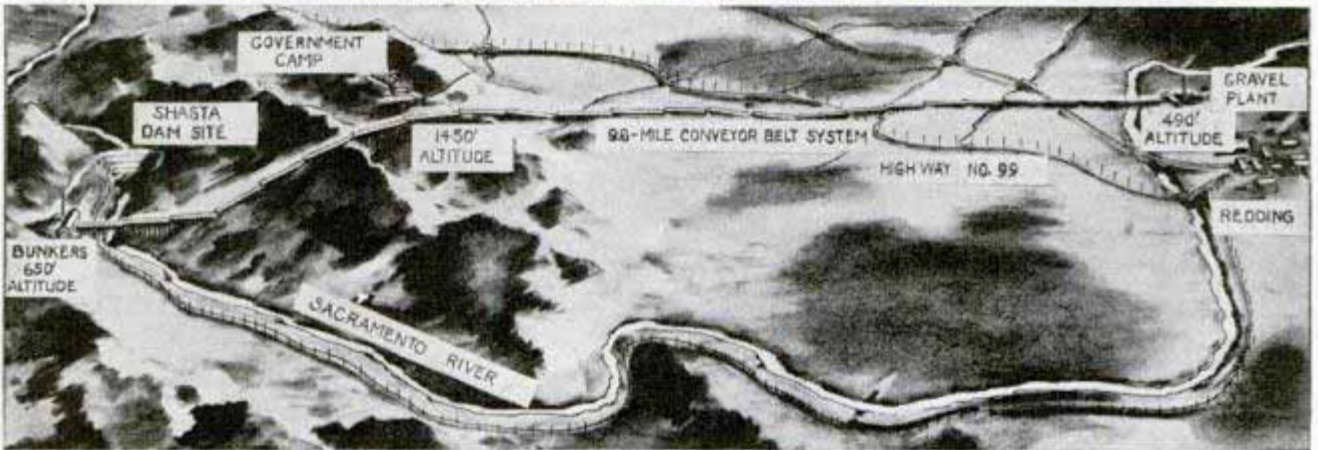

Top, a cross-country belt conveyor like that which is to carry materials from Redding, Calif., to Shasta dam. The map shows how the twenty-six endless belts climb a range of hills, then drop to site of dam

More than twenty miles of rubber-covered cotton belt will be used in the conveyor system to carry sand and gravel nine and six-tenths miles from Redding, Calif., to the site of the new Shasta dam. Twice as long as any previous conveyor-belt system, it will haul as much as 1,100 tons of construction materials per hour, moving at 550 feet per minute. It is expected that four years of operation will be required to complete the 10,000,000-ton dam project. The belt itself, to be installed in twenty-six endless units, will weigh about 1,500,000 pounds, including a million pounds of rubber and 1,000 bales of cotton. The conveyor system will cross the Sacramento river twice, pass over several highways and creeks and a railroad, and will climb nearly 1,000 feet over a ridge before

dropping to the site of the dam. Each unit is to be driven by a 200-horsepower motor, except for three units which travel downhill and generate power.

Electric Scissors Plug in Outlet and Cut at Touch of Button

Now the old-fashioned scissors have gone electric. Press the button with your thumb and the "plug-in" shears zip quickly and smoothly through cloth or paper without effort. The chrome-plated steel blades are precision-ground and the case is of ivory plastic



Special Transformer Corp. 1250 W. Van

Esoodnyar Tire - Rubber & Abrasive
Zipichair

2927

Mr. Marshall Brennan - 7-7-51
1128 Stearns Drive
Los Angeles

BUG HUNTERS Wage



MENTION an entomologist and the average person pictures in his mind an absent-minded professor flitting around with a butterfly net in his hand. But that conception is entirely erroneous, for the modern entomologist is a semi-commercial scientist who raises bugs the way that cattlemen raise steers and who offers them for sale.

A bring-'em-back-alive hunter and explorer who braves the dangers of the wildest regions on earth, the entomologist seeks useful bugs to help man save his civilization. Hunger, hardship, disease, adventure, romance—they're all in the day's work for these men to whom bugs are bread and butter.

Top, left, distributing parasites on leaves of tree. Right, testing fruit for parasitic activity. Bottom, cages of insects and parasites on way to United States

WAR ON INSECTS



Top, left, testing insects' reaction to light. Right, sunroom in which insects and parasites are propagated. Circle, access to cage is through sleeve that prevents insects from escaping

Should you visit a bug store you would see an order counter, with busy clerks, and to the rear, heavy double-screen doors cutting off the office from the laboratory. Through the doors, you might hear a dialogue like this:

"Hey Mike, have you got that order of ten thousand beetles packaged yet?"

"Take your time, I'm busy!"

"Well, the customer is in a hurry."

"Then come back here and help me get this consignment of black widows ready for shipment."

Now, what's it all about? What is the use of bugs, that whole businesses can be built around the raising and sale of them?

One of the largest customer groups is educational; high schools and colleges. Their demand for bugs of all kinds for their laboratories is enormous. Research laboratories of all kinds make another group. It has been found that many of the experiments on the potency of serums, on the virulence of bacteria, and on the strength of vitamins can be made by in-

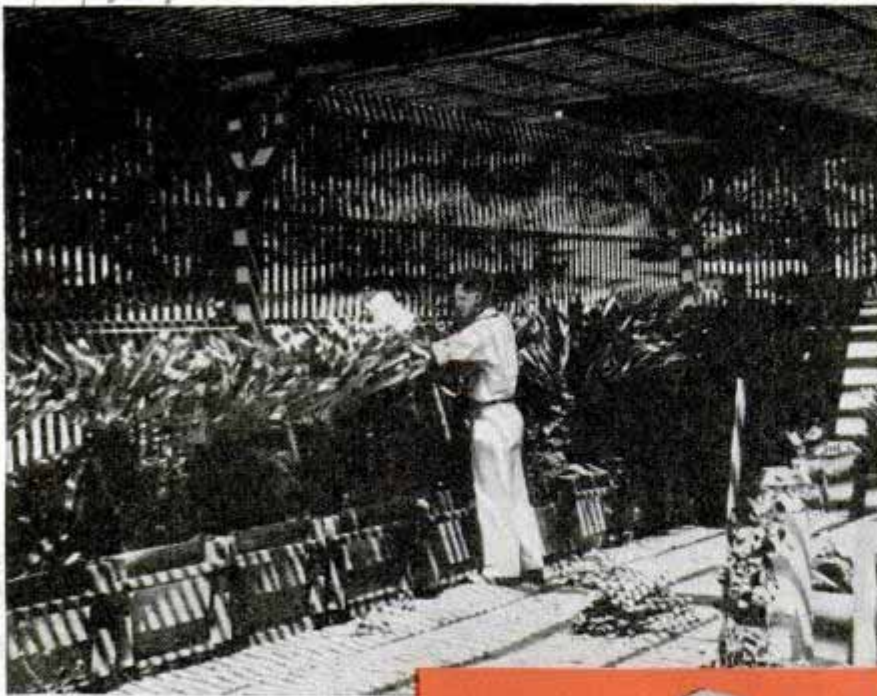

jecting several types of insects, particularly roaches. Once such animals as guinea pigs, rats, rabbits, etc., were used. This was far more expensive, and the results of the experiments usually took longer to determine.

But the most romantic and adventurous phase of the whole industry is military. The next time you speak of the United States military strength remember it consists of less than a million men who can be mobilized quickly, but that we have a mercenary force of over 10,000,000,000 insects fighting a war against our enemies right now.

It is to find these mercenaries that men enter the jungles, fever-ridden islands, danger and adventure.

Every insect should have, according to entomological theory, an insect parasite, which keeps its numbers in check, otherwise it would overrun the world. But many species of insects have

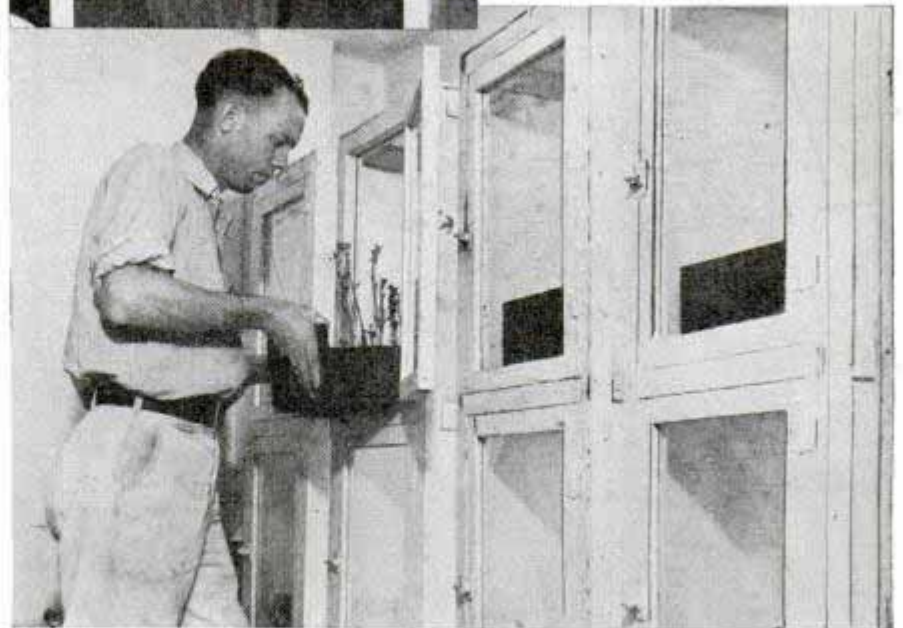
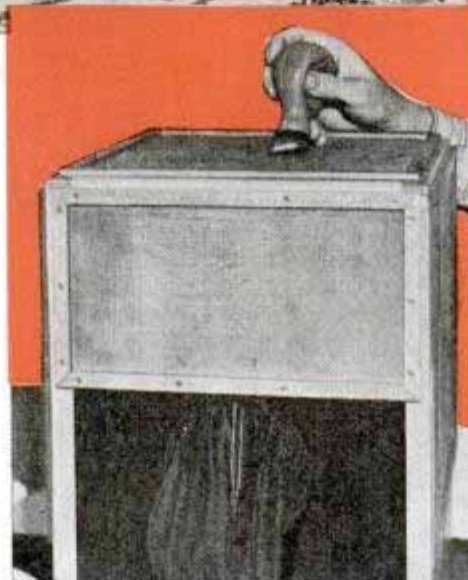

been brought far from their native homes by commerce, and in some cases, they have left their parasites behind. For that reason, they thrive in their new homes, and cause man heavy damage.

Methods used to trace down the original homes of insect pests, so men may be sent to collect parasites, are like the thrilling incidents of a combination detective-adventure story.

First clue to be examined is world trade routes. Suppose a certain pest had attacked crops in western United States, and it was found to have no restraining parasite. That would be a fairly sure indication it was an undesirable alien. To find its home, research would be made to determine other places it appeared. Suppose a search had been made in Asia without finding it. It was

(Continued to page 118A)

Top, hothouse in which specimens are kept before developing wings. Center, forcing food into cage in a spray breaks hunger strike. Bottom, testing insects with plants to determine immunities and parasitic activities

Licensed by Lieut. Clinton & Round

Blimp 'Rescues' Man at Sea on Raft 'Stretcher'

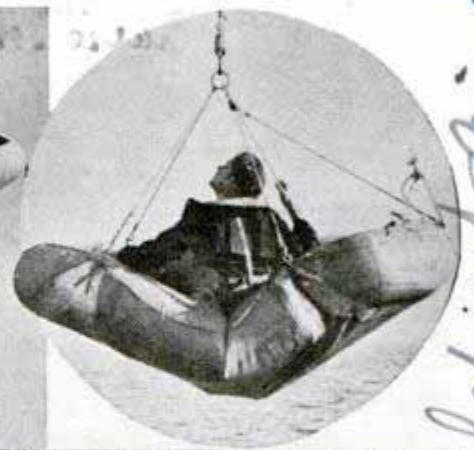
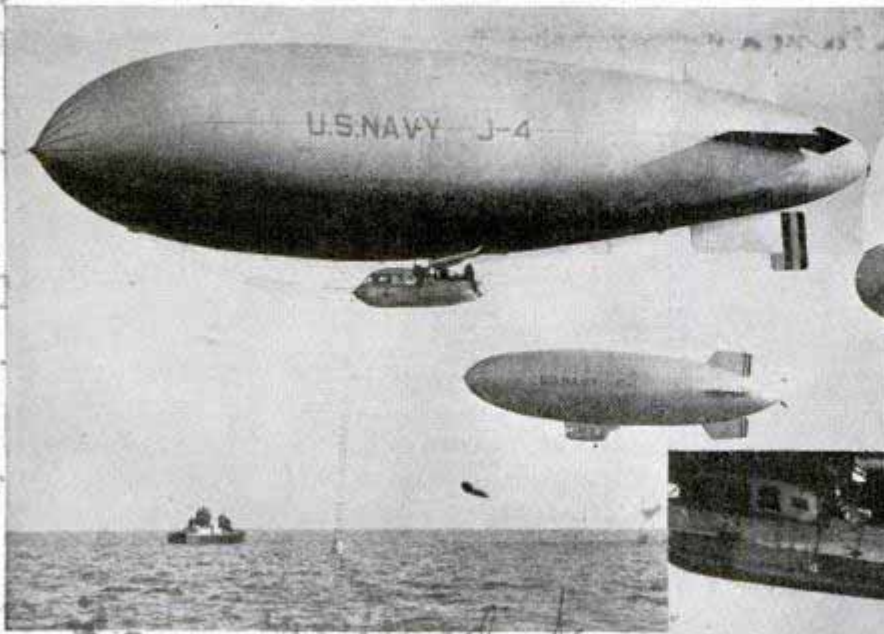

dot.
Above and right, navy blimp G-1 hovers near by as J-4 raises man into gondola from sea; circle, going up.

How disabled persons can be rescued from the sea by a blimp was demonstrated in tests conducted by United States navy blimp J-4 ten miles off New Jersey's coast. It was proved that men can be lifted aboard a blimp either from the deck of a boat or from the water's surface. In performing the "rescue" an inflated rubber life raft, like those carried by seaplanes, served as a stretcher to haul the man safely into the blimp hovering about fifty feet above. To anchor the ship a drogue, a circular metal disk, is dropped by a cable until it sinks twenty-five feet below the surface.

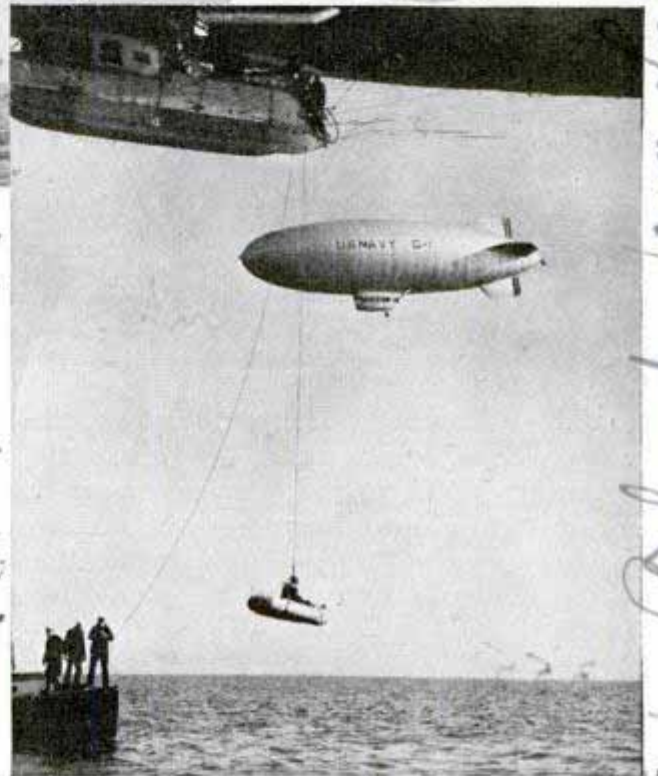

Tractor Does a Locomotive's Job Hauling Freight Cars



Tractors are being put to work on tasks traditionally assigned to steam, and more recently to Diesel locomotives. Small tractors capable of handling several freight cars are used in yard switching operations, either pulling or shunting the cars. Since it is independent of rails and switches, the tractor is not restricted by track limitations but can maneuver readily from one string of cars to another.

Needing no rails, tractor hauls freight cars in yard operations and can move to next track to pick up another string without using switches

*International Harvester Co
180 N. Michigan Ave*

By hand from St. Louis to New York off Decatur County N.C.

Germ-Free Crib for Baby Safeguards Health



Baby breathes only clean air in this germ-free crib sealed to prevent entry of air-borne contamination

Babies now can be protected against contagious diseases in a "baby cubicle," conditioned to keep out germs borne in the air or brought into the nursery by humans. It is one of the first practical applications of experiments with germ-free enclosures at the University of Notre Dame

Magnifier Held on Flashlight Helps View Close Work

Mounted on a spring clip that can be clamped easily on a flashlight having a diameter of one and three-fourths inches,



Magnifier that clips on flashlight can be mounted on stand, as at right, to leave both hands free

a magnifier helps reduce eyestrain in doing close work. The lens may be tilted to correspond with the light beam, and one hand remains free while the other holds the light and magnifier. Among its many uses, it is handy for inspecting electrical connections, laboratory work and household appliances, or for reading fine print.

Electric Screen for Killing Flies Has Protective Grille

Flies and other insects are electrocuted upon contact with an electrified screen that is easy to install in the door, window or transom. Made to order to fit the opening, the screens are entirely automatic. The transformer requires a normal input of four watts. A lightweight metal guard is

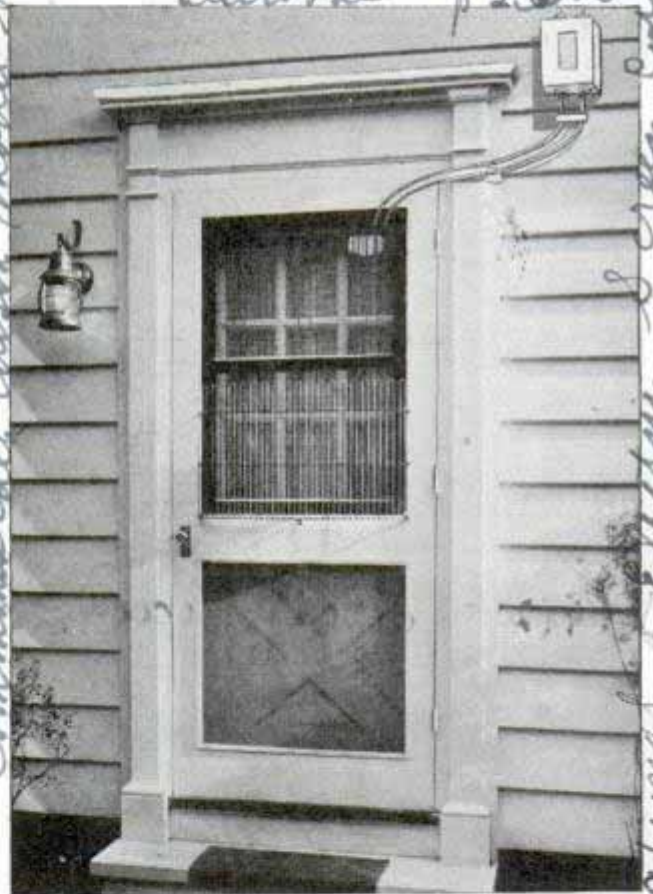

Protective grille covers electric screen able to kill flies but not injurious to humans and animals

available for installations where the screen is within reach of persons or animals. The manufacturer says the screen's injurious power affects only insects.

Send return postage to our Bureau of Information to learn the name of the maker of any device described in this magazine.

21332 Leon G. ... South Bend Ind.
nurse human
21339
21355
811 N. ... St. ...
old \$1.50

Chicago
M. Pleasa
25
Microbat \$25.00
Waterloo ...

21362

Miniature 'Street' on Auto Measures Lighting

Rapid diagnosis of faults in the lighting conditions of any street is accomplished by an automobile that carries a miniature street projecting over its hood, the latest weapon offered by the General Electric company to help eliminate the causes of traffic accidents after dark. The tiny street model, mounted forward like a stubby springboard, is given a reflecting surface similar to that of the street being tested, and upon it are placed a number of typical obstacles. Above the windshield is a glare collector that measures the total glare from all street lamps within the driver's view and the loss of vision it causes. On the front seat is a control box, on which are dials and selector switches that the operator manipulates. It automatically records on a card measurements of visibility, brightness and glare.

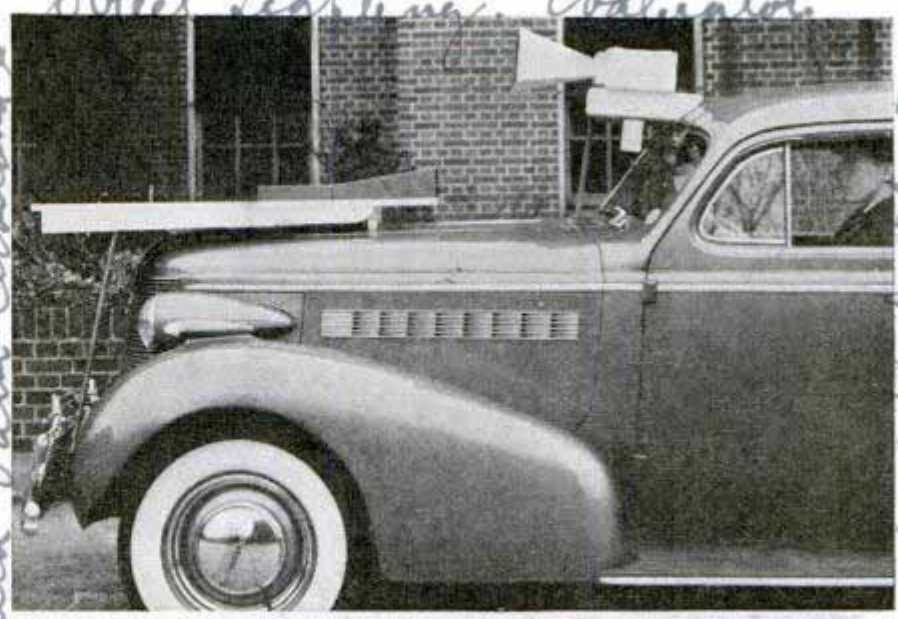

Top, note figure on miniature "street" directly above headlight lens; "eye" over windshield measures glare. Bottom, making street-light test

Tracer Bullets from Machine Gun Prove Its Accuracy

Tracer bullets, which leave a luminous trail from the muzzle to their mark, were used in a sub-machine gun when a G-man

demonstrated its accuracy before police at a west coast city. A photograph taken in a fraction of a second with flash-bulb lighting



Photograph of tracer bullets shows accuracy of machine gun by revealing their paths from the weapon as well as points where they strike target

clearly revealed the tracks of eight bullets streaking toward the target, all striking the figure in the chest and stomach.

The surface of a human lung is equivalent in area to the ground occupied by a house thirty-one feet square, and in a normal day's respiration you breathe air that would fill a room seven by seven by seven feet.

W. H. Limberg
research scientist

Charles W. Campbell, Washington

Street Test... Evaluation
Kerke M. Reid, Army Lt. J. Chamney
and P. La. Dink...

America's Special Lt.
1939

g 1093
4322 Second Road, Hotel
Arlington, Va.

BULL RUN

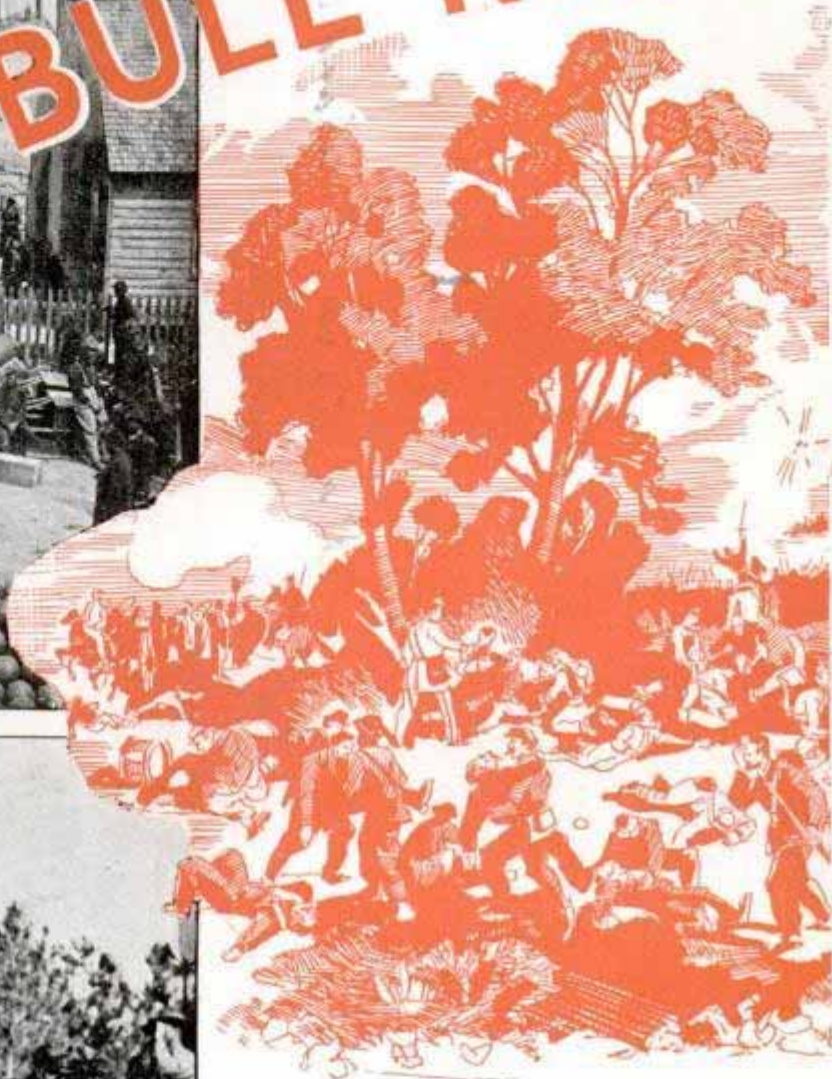
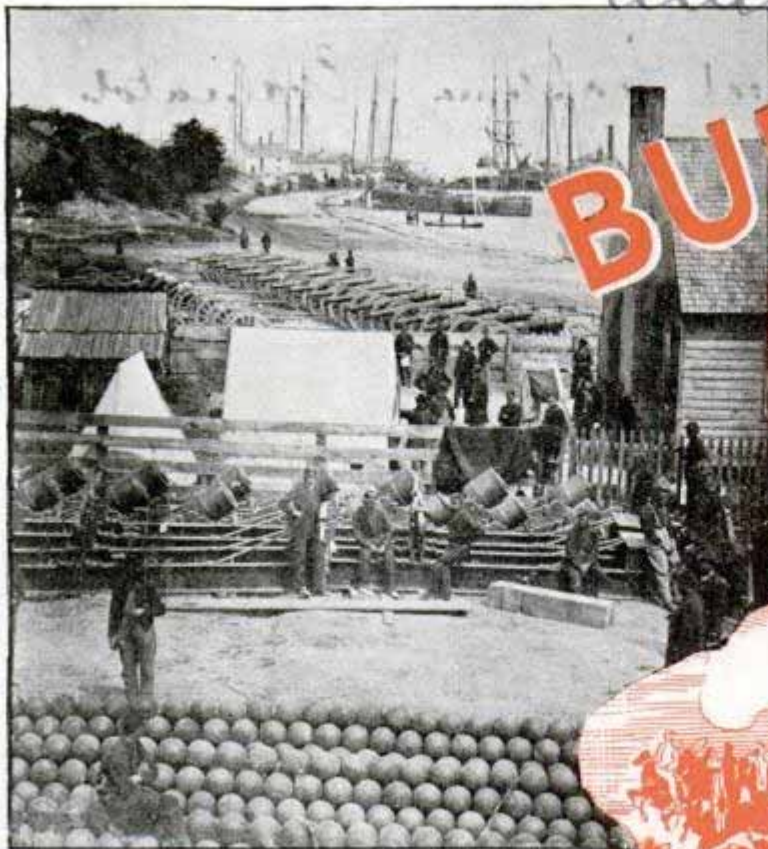

Civil War photos by Brady

Above (on this and page opposite), artist's conception of first battle of Bull Run. Top, left, Civil War artillery depot. Below, field piece camouflaged with tree branches

FLAGS flying. Bugles blowing. Bewhiskered generals on white chargers waving swords, urging their men on in close-packed ranks against gray-clad warriors massed on the hill. Congressmen riding out from Washington in horse-drawn buggies to see the spectacle.

That was Bull Run of the Civil War. Battle, then, was a spectacle.

Comes the third battle of Bull Run, in 1939, and Americans are once more pitted against Americans, in our greatest peace-

time maneuvers. Sixteen thousand national guardsmen and reservists are out here to smash the attack of a streamline division of regulars, but there is little to see.

A khaki-clad figure advances cautiously down the edge of a country road, rifle at the ready. Behind him on the other side of the road comes another soldier. Then a third and fourth, all widely spaced. From a clump of bushes up the hillside a machine gun stutters, and the point of the advance guard disappears, firing tentatively from cover at the unseen gun.

The din increases as invisible artillery opens a shattering fire from somewhere a mile off the road. A pair of observation

UP-TO-DATE

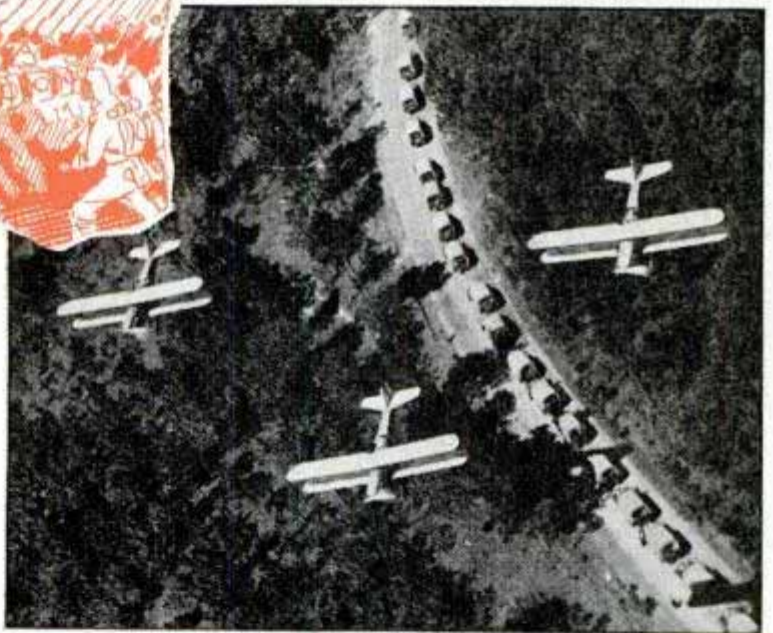
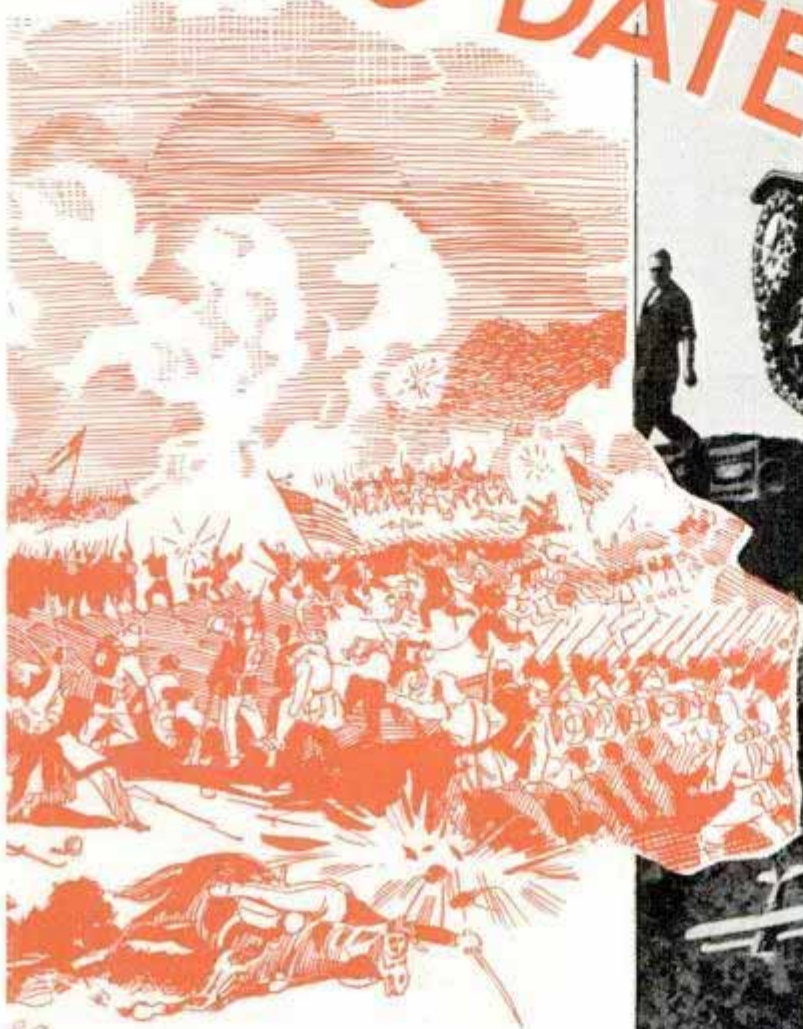

Right, top, light tank mounting flatcar to move to maneuvers. Center, supply convoy being "attacked" by planes. Bottom, National Guardsmen manning heavy machine gun

planes drones overhead. There is a rumble and clanking from bushes off to the flank, and half a dozen tanks lumber past toward the nearest machine gun, which breaks into insane chatter, then suddenly stills. And that is all, though this is the main attack.

As a spectacle, our modern battle is a complete washout. Flags cannot fly; they would draw fire. The general cannot lead a charge; a charge today is a sneaking and dashing from cover to cover by small groups of men, widely separated to offer poor targets.

So the general stays back in his tent, which would be a dugout in

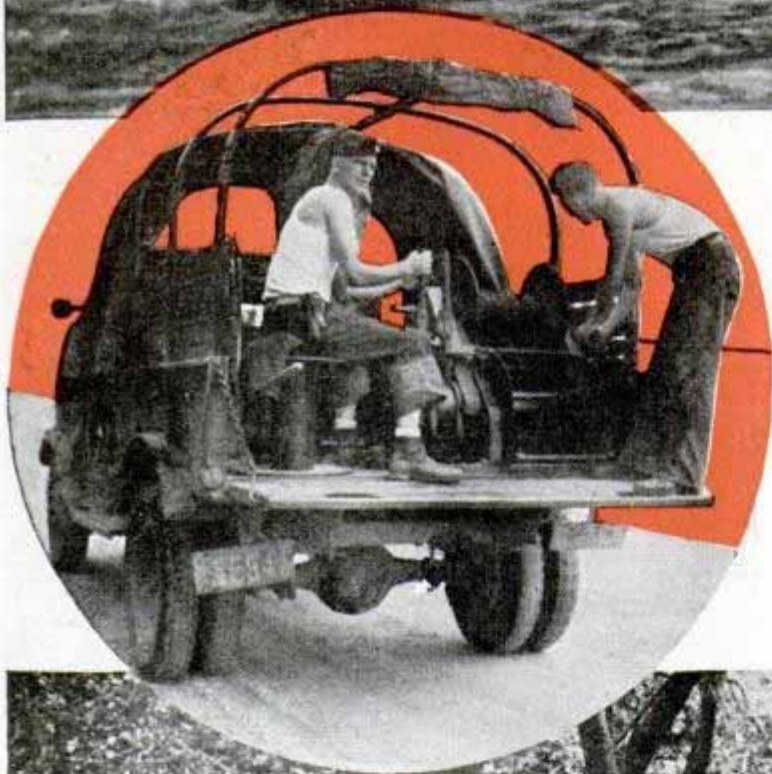
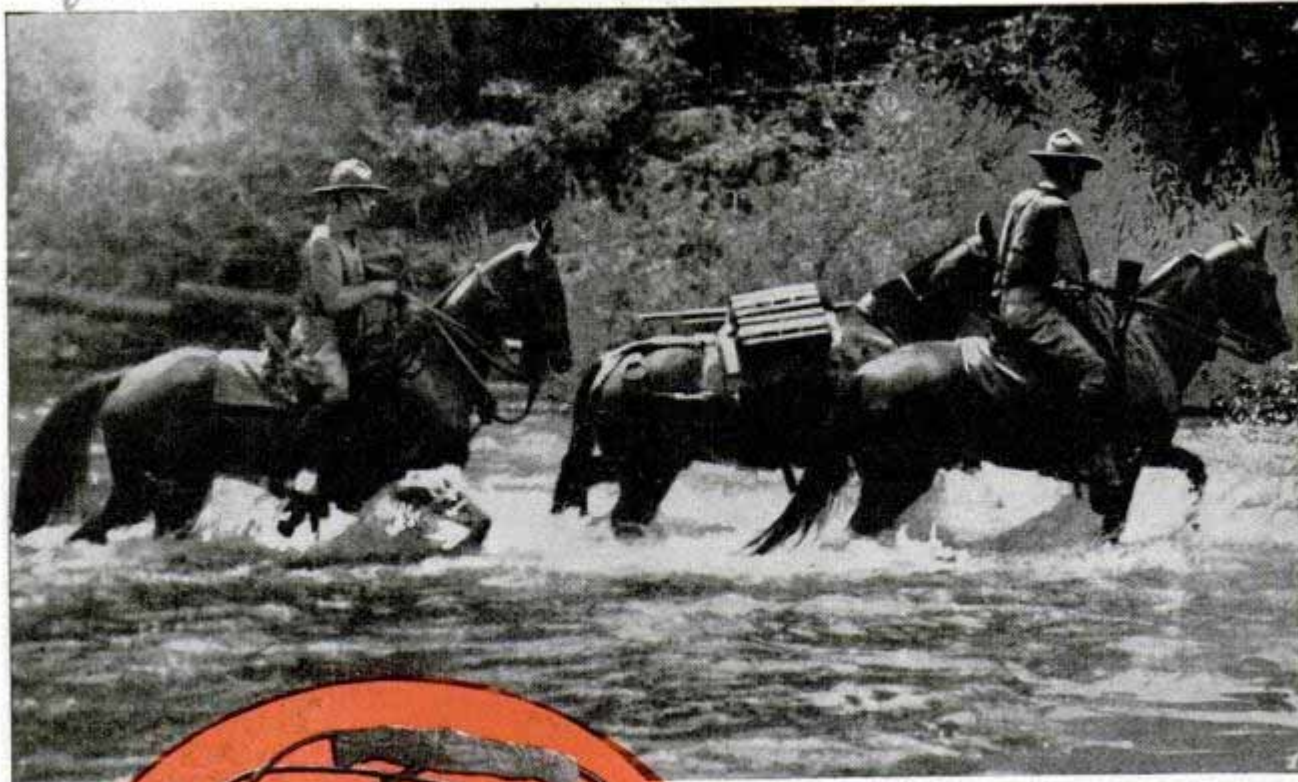

Courtesy U. S. Army Signal Corps

Top, cavalry machine-gun squad, such as this, can maneuver quickly over rough terrain. Circle, laying field telephone lines at twenty-five miles per hour. Bottom, rifleman and automatic rifleman firing from behind cover

case of real war—not for his own safety, but because it is only back here that he can control his scattered troops. A brigade is now spread over several square miles of territory.

From the headquarters tent to regiment, then battalion, then company, the general is in touch by radio and phone. With truck or handcart or breast reel, signal troops lay wires as fast as the fighting lines advance. And when that isn't fast enough, or when a staff officer moves around off the lines of communication, a private goes along with a pack radio slung on his back, so the officer may report what little he can see of the battle.

And though there are only 20,000 men here, as compared with 67,000 in the Bull Run of 1862, the killing power of this modern force is vastly more effective.

When the Civil War opened, the entire federal army possessed only eight batteries of artillery, totaling but forty-eight pieces. Half of these were three-inch muzzle-loading rifles having a range of 2,800 yards. The other half were twelve-pound smooth-bore Napo-

leons, with a range of 1,520 yards. But beyond 600 yards the effect of the smoothbores was very uncertain. The velocity was so low at long ranges that alert soldiers could and did dodge the shot, which came at them only twice as fast as would a hard-hit baseball. Working at top speed, these old muzzle loaders could be fired about once a minute—for short periods.

In the 1939 maneuvers, the smaller forces employed were armed with 120 seventy-five-millimeter guns, having a range of 12,800 yards and the ability to hurl twenty-five shots a minute—with extreme accuracy. Then there were thirty-six 155-millimeter howitzers with a range of 15,400 yards, firing two shots a minute with ease; and twenty-four anti-aircraft guns.

Infantry troops employed twenty Stokes-Brandt mortars, each capable of hurling thirty eighty-one-millimeter high-angle shells a minute at a maximum range of 3,300 yards; and twenty thirty-seven-millimeter guns, carried on light hand-drawn carts. These little guns, extremely effective against tanks and machine-gun emplacements, have a range of 4,500 yards, and can be fired thirty-five times a minute. That's a total of nearly 5,000 explosive shells a minute, as against a possible forty-eight at the first Bull Run.

The Civil War troops carried about 50,000 muzzle-loading, single-shot rifles, deadly at 500 yards, and with an extreme range about double that. Highly trained troops could reload and fire such arms twelve times a minute, but most of the soldiers at the first Bull Run were the rawest of recruits. Four aimed-shots a minute would be an extremely generous allowance for them.

First army troops at the 1939 maneuvers carried 9,044 Springfield rifles, with which ten aimed-shots a minute can be fired with ease. This rifle has an extreme range of 5,500 yards, though few men can see well enough to hit anything with a rifle at more than 1,200 yards. Then there were 1,120 automatic rifles capable of discharging 150 rounds a minute, and 559 machine guns firing 600 shots a minute—a total of nearly 700,000 rounds every sixty seconds, rounds which kill at much greater distances. Many of the machine guns were carried in the seventy-six light tanks,

(Continued to page 125A)

Portable Two-Way Radio Worn by Policeman



Rear and front views of two-way radio. Transmitter and receiver hang on right side, batteries on left

Police in New York are testing a portable transmitting and receiving radio set that can be slung over the shoulder and carried by the officer like a knapsack. The set weighs five pounds, costs \$109 and is worn on one side suspended by a canvas strap. On the other side are carried two batteries. The policeman talks into a microphone pinned to his vest, and one earphone is attached to a headpiece. At present the set has a radius of only 200 feet, and its use will be confined largely to cases where police have provided a "plant" to trap their man.

Rolling Blotter Moves over Paper without Smudging Ink



With one stroke of a rolling blotter, designed to fit the hand, the entire writing surface is dried without moving the paper or causing the ink to smudge. Rolls consisting of forty layers of blotting paper are available for refilling the holder, one such roll being sufficient to outlast many ordinary blotters, according to the manufacturer.

Developed by the Telephone
 Electric
 Co.
 244 W. 23rd
 St. New York
 City

Handwritten notes at the bottom left of the page, including the word "Handwritten" and other illegible scribbles.

Handwritten notes at the bottom right of the page, including the word "Handwritten" and other illegible scribbles.

Welder Rides in Weird Light as He Fuses Aqueduct Pipe

Cleveland, Ohio.

Electrician, Torrance



Two sheets of steel are rolled into half-cylinders, then a welder rides his machine through the tunnel and fuses halves into pipe for aqueduct

Grotesque in the lights and shadows of his own machine, a welder rides his electric steed through pipe destined to carry Colorado river water to southern California. Here the electric arc, guided by this "midget motorist," converts three-eighths-inch steel plate into pipe of fifty-one-inch diameter. Rolled first into half-cylinders, the two halves are then fused together by the automatic arc welder. Thirteen and one-half miles of this pipe were fabricated.

Detector Finds Metal in Logs and Saves Saw from Damage

Many a lumber-mill saw has been smashed, sometimes with fatal results, by spikes and other metal buried in logs. To safeguard the saw, the U. S. Forest Service has developed a portable detector consisting of an exploring coil that sets up a howl when it is held near a log in which metal

is imbedded. By moving the coil and listening for the peak of the howl, the exact location of the hidden metal can be determined. The need for such a detector arose in the salvaging of timber blown down in the 1938 New England hurricane, when a high percentage of the timber was found to conceal old spikes, fence nails, hammock hooks, sugar-sapspouts and even parts of scythe blades.

2/13/19

Oil Burner Baffle Prevents Loss of Heat

Extra heat from an oil burner can be obtained through use of a baffle. It has adjustable legs which support it above the combustion chamber, deflecting the hot gases against the furnace or boiler wall and thus helping to extract extra warmth before the gases escape up the chimney. The cone-shaped baffle is made of high-temperature alloy. Its top heats quickly and gives a radiant effect. Cleaner burning of the fuel is said to result from use of the baffle.

Radiant Heat

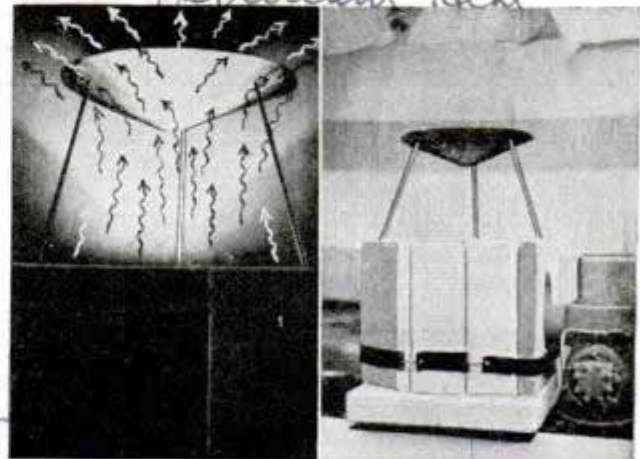

Left, how heat waves are deflected. Right, the baffle in place on burner

*made by -
Inco. Electric and
Component Co. Torrance, Calif.*

*Madison Wis
Radio Laboratories Portland
Gones Product
Co. Ferrisdale*

2136.75 shells received

027-18

Thirteen-Gun Tank Is a Rolling Dreadnaught

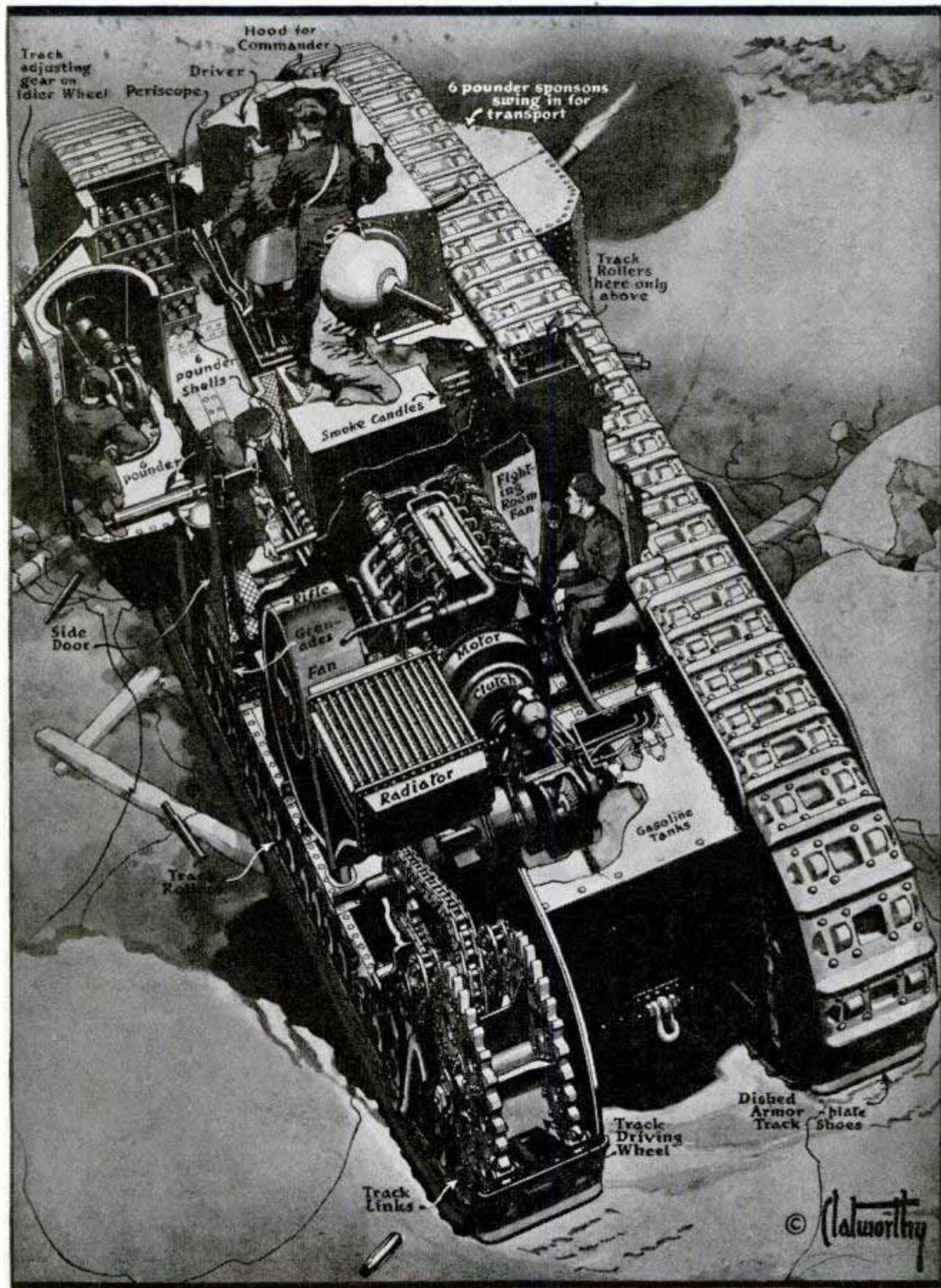

Here is a glimpse inside Britain's thirty-seven-ton rolling fortress. Manned by crew of eight, it carries two six-pound guns with 208 shells, seven machine guns with 13,200 rounds. Thirty-four feet long, the tank could span a thirteen-foot gap. It has a 300-horsepower engine fed by a 200-gallon gasoline tank

84, Lewin Road,
London S.W. 14 England

21420

Plastics Dept. 12

The CHEMIST SPINS

Estan
Buckle

Westerbach

Hughes Autograph
Brush Co.

500 5th
are very

new
blain

Bristles of hairbrush, left, are made of nylon; tough, resilient, they outwear any natural bristle. Below, processing nylon yarn; here the machines twist a "bundle" of filaments into thread. Bottom, brushes with nylon bristles used for cleaning bottles in bottling plant

Nylon p dimer and nylon
yarn. Nylon dier, J. & J. du Pont de Nemours & Co.



William
deed

IF YOU say there are no frontiers left for Americans to explore, you haven't heard about nylon.

Columbus wasn't hunting for America when he discovered it, and the research chemists who pioneered the way to nylon weren't looking for a magic yarn that would revolutionize the textile industry and a few others besides. They were not interested in stockings nor toothbrushes, but in superpolymers. Wondering, as the "pure research" scientist does, why and how certain of nature's tiny building blocks, the molecules, united to form the giant molecules called superpolymers, they developed a new type of synthetic material from which fibers of remarkable strength and elasticity could be spun. They called it nylon.

Nylon fibers have a higher strength-elasticity factor than corresponding fibers of cotton, linen, wool, silk or rayon. Truly elastic nylon yarn will return to approximately its original length after being stretched for days. Water can't hurt it, and it dries quickly; most chemicals and oils are harmless to nylon. It's no home

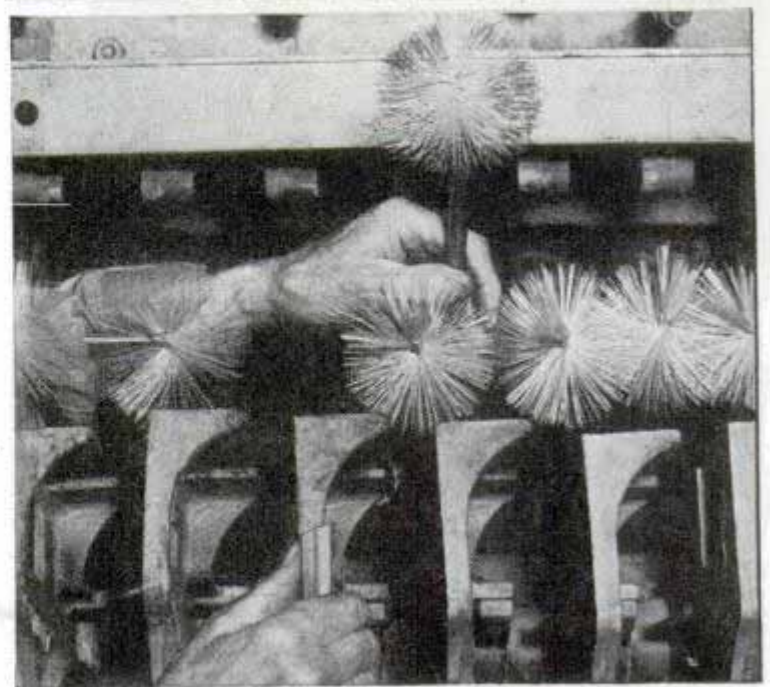

a NEW YARN

2 1240

for moths, nor for the fungi that start mildew. The nylon family has some admirable traits, and while it has practically no past its future is bound to be brilliant.

Perhaps you haven't made the acquaintance of nylon, but you can't escape it long. It was announced at the du Pont laboratories October 27, 1938. Commercial production of the yarn has just begun. But in its first year of life, nylon, produced in a "pilot" factory of the du Pont company, has been launched on a versatile career in the forms of fishing lines and leaders; surgical sutures; bristles for toothbrushes,



Sheer hosiery of nylon yarn, top. Drawing in center indicates random arrangement of molecules in section of undrawn nylon fiber (left) and orderly lineup of molecules after drawing (right). Bottom, control panel which maintains precision in nylon processing

hair and clothes brushes; thread and hosiery. Tomorrow you may find it in rugs and bathing suits, upholstery and parachutes, sweaters, insulation, linings of men's suits—in fact, almost anywhere that silk can go, nylon can go and last longer.

Will it displace silk entirely? That's what some predicted of rayon, back in 1911; but in 1938, when the United States produced 288,000,000 pounds of rayon, twice as much silk was consumed as in 1911.

In the simplest terms, nylon is a combination of coal, air and water. It is a protein-like chemical, somewhat resembling silk, hair and wool in composition, but actually unlike

(Continued to page 114A)

Handwritten notes on the right margin, including "2 1240" at the top and "This is a... of rayon..." written vertically.

Handwritten notes at the bottom left, including "polymer..." written diagonally.

Light Beam Pries Secrets from Upper Air

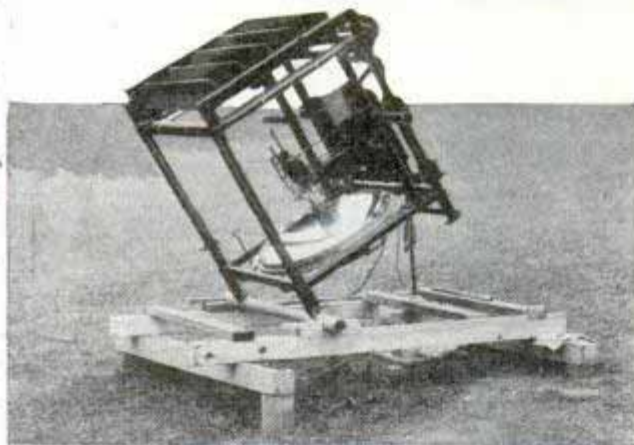
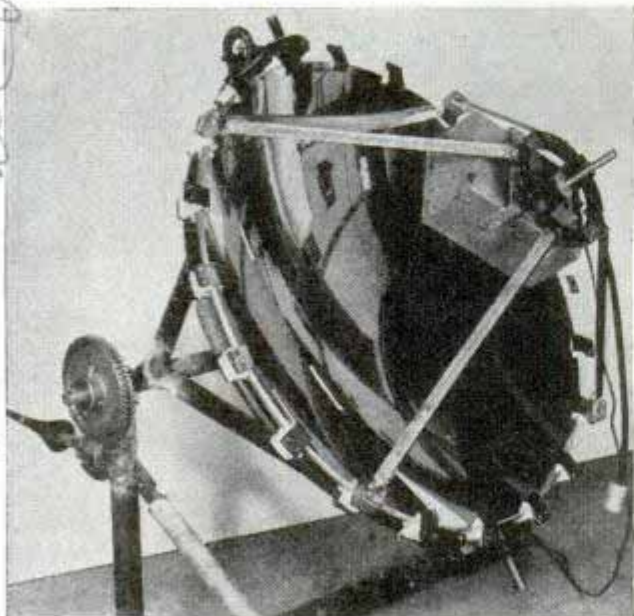

Photocell on mirror, top, receives beam of light from sky which emanates from searchlight, bottom

To bring down the atmosphere's secrets from altitudes higher than stratosphere balloons can soar, scientists of Carnegie Institution are playing a searchlight beam into the sky and studying its behavior by means of a mirror and photoelectric cell. In order to distinguish it from ordinary light of the night sky, the beam was made to flicker about ten times a second by an automatic Venetian-blind type of shutter. Located some three and one-half miles away, a large mirror facing upward caught the light from the beam and focused it upon the photocell. The current thus generated was amplified by a special radio amplifier, and from the angles of the searchlight and the receiving mirror the altitudes at which the beam is studied can be calculated. Preliminary experiments

indicate that studies can be carried out to determine the height of water vapor in the atmosphere, the amount of turbulence, the winds, dust, fluorescence and absorption of the sun's rays at altitudes up to nearly twenty miles. From actual measurements it was found that the beam itself could be detected as high as 24.8 miles. This is the "no man's land" of the atmosphere, being beyond heights reached by balloons, and lower than the radio reflecting layers in the ionosphere. Knowledge sought will be useful in meteorology and may lead to information concerning factors that influence world weather.

Pipe-Pulling Jack Saves Labor of Digging Long Trench

New piping from basement to water main is laid without the labor and expense of digging a long trench by using a pulling jack that "noses" the pipe through without opening the ground. Clamped to the pipe, the tool is said to exert a "break away" power of twenty tons and will handle pipes up to one and one-half inch diameter.



Pulling water pipe through ground with jack saves digging long ditches to reach water main in street

Templeton Kenly

21359
Science Service
Nov. 9, 1939
recpt. of Aerial...
6241...
1620 S Central Ave. Chicago

g/295. Leonard & Lucas 1630
 91 Archer Road, New York, N.Y. 10018

Eye Motions Filmed to Show Reader Interest

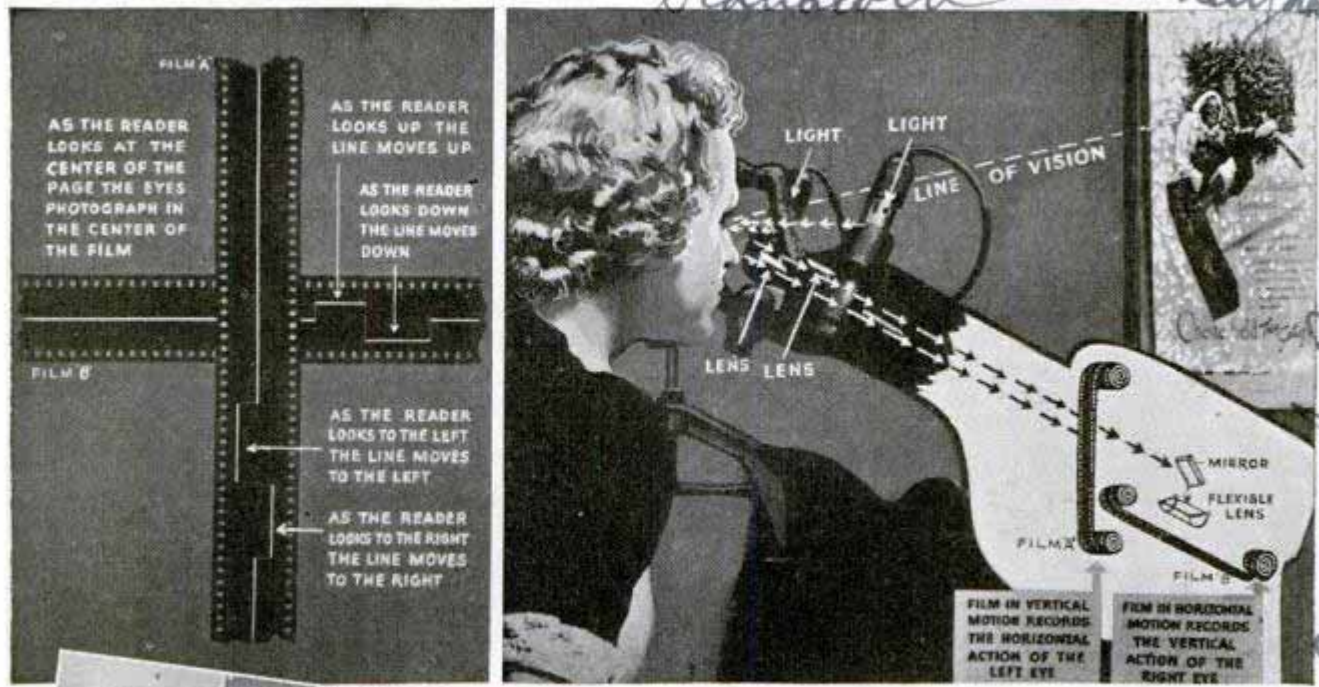

Top, left, tracks on film represent eye movements; right, sketch illustrates operation of apparatus. Below, subject's interest in picture being filmed

one item after another. The subject sits behind the device while he inspects a printed page on the wall in front of him. As his eyes scan the page, the "eye camera," using the cornea of his eye as a reflector, passes a beam of light onto a slow-moving, sensitized film, thus recording the path traveled by the eyes. When this film is developed, movements of the eyes are shown in a zigzag track punctuated by black dots, and by placing this over the page, one is able to see what ground was covered in the reading and where and how long the reader paused at different places.

Wheels Built in Plane pontoons Make Light Amphibian

Just as much at home on land as in the water, a lightweight plane is equipped with both pontoons and wheels. The wheels are built into the pontoons and there is a pair of unusual skids in front. The pilot can take off, land or taxi on either water or land.



Amphibian plane, right, is at home both in water and on land

Taylor Aircraft Co. Pa.
 10120 Blvd

Vertical text on the right margin: New York City, New York, N.Y., 10018

The HORNETS

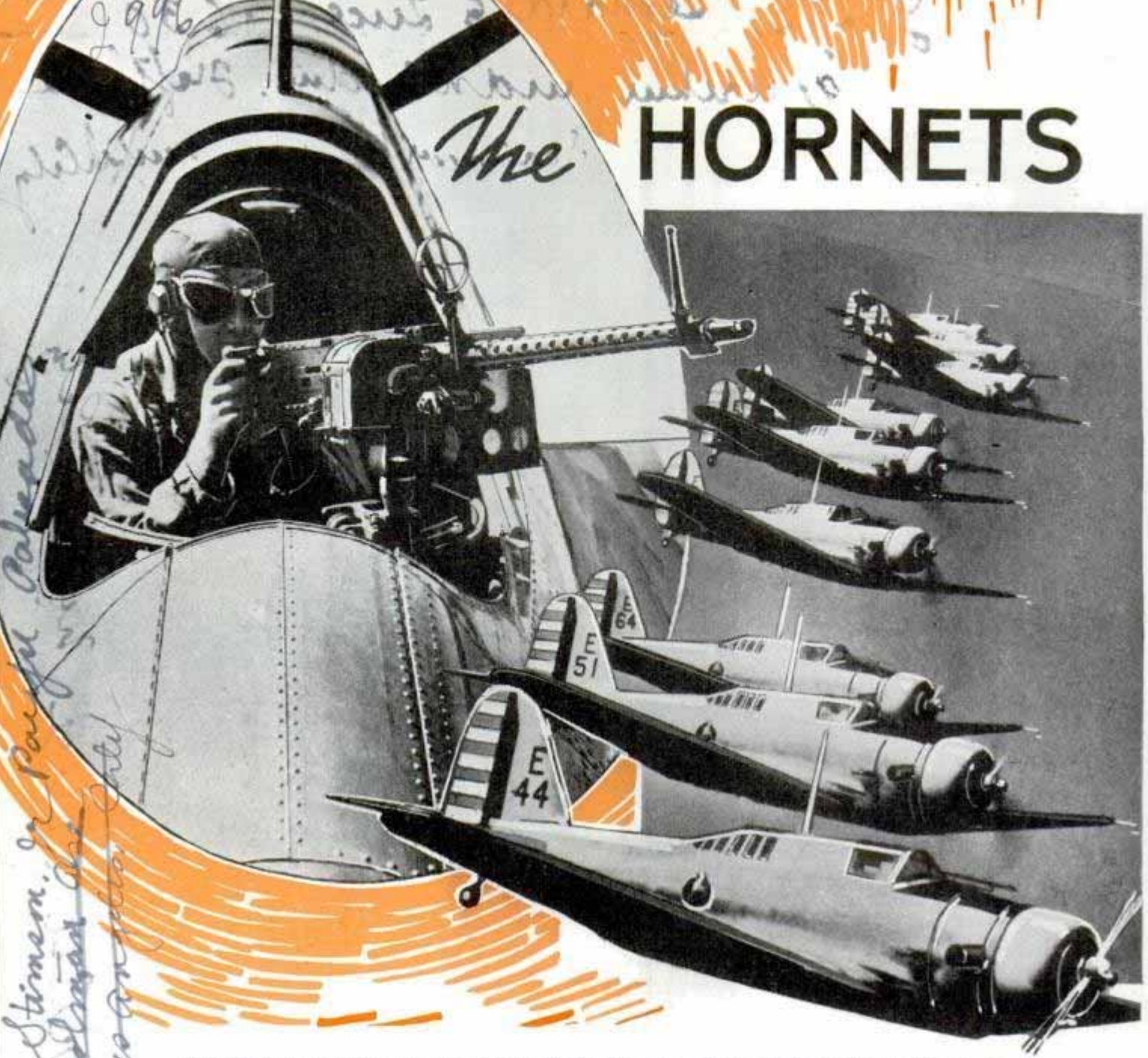

Showing how machine gunner can fire at almost any angle to ward off attack of pursuit planes (left), and squadron of attack planes (right). On crossing "enemy" line the ships descend to a few feet above ground and fly straight toward their objective

HAZARDOUS as are their own jobs, pursuit and bombing pilots shake their heads when they watch a flight of attack planes skim over the ground at three or four miles a minute.

Hugging the ground so closely that they sometimes have to zoom upward for room to bank their wings in a turn, attack pilots play a game of hide-and-seek with the enemy. They strike without warning and are gone in a flash. They fly around hills instead of over them to avoid being seen, and when possible they fly upwind to keep the sound of their motors from giving away their approach.

Their object is to harass the enemy and keep it in a state of alarm, to destroy air-

planes on the ground, and to raid anti-aircraft defenses as a preliminary to heavy bombing attacks.

Four machine guns, two in each wing, lay a sweeping barrage on the ground in front of a Douglas A-17A attack plane when the pilot presses the master trigger. Fragmentation and small demolition bombs in the racks can be dropped singly or in groups. In the rear cockpit a gunner watches aft against pursuit planes that may sweep down on the plane.

At March Field, Calif., a squadron commander of the 17th Attack Group outlines a typical mission to his pilots.

"We assume that an enemy airdrome has been established on dry Red Lake in north-

18618 Capt Thomas E. Stinson, or Paul Calder...
 machine gunner...
 1946

Douglas A-17A...
 machine gunner...

Public Relations Dept.
March Field, Riverside, Calif. 2 1916

of the AIR CORPS



western Arizona. Orders are to destroy it at dawn tomorrow. The three flights will attack at one-minute intervals, each from a different direction. Objectives are airplanes and personnel on the ground, hangars, and to make the landing surface unusable. There will be radio silence after taking off."

Then, from photographs rushed to him from observa-

Top, left, pilot giving last-minute instructions to gunner before taking off on a practice flight. Right, pilot in attack plane repeating radiophone orders to squadron commander. Center, examining machine guns projecting from wing of fighting plane. Bottom, Peruvian ship modeled after early Army Air Corps plane

2996
388

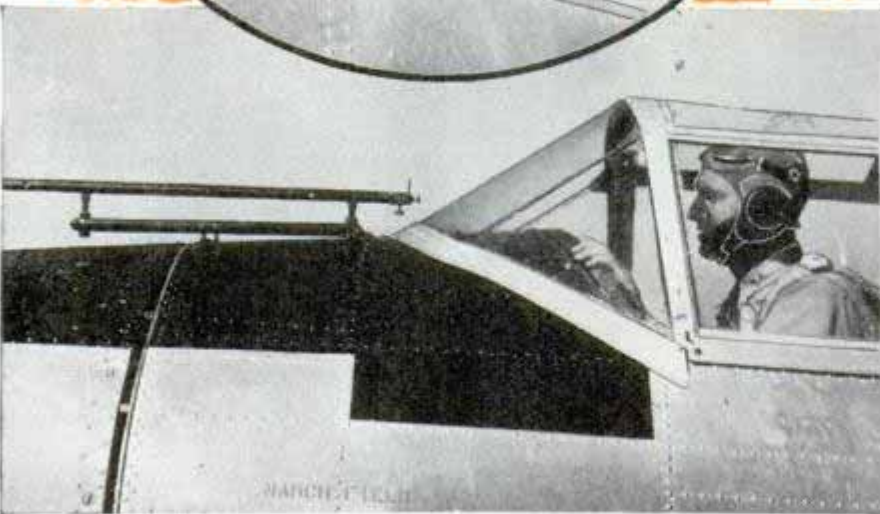

Top, pilots studying flight orders. Center, machine gunner in rear cockpit of attack plane preparing for target practice against small balloons as plane rockets past them. Bottom, pilot sighting along telescopic sight that is lined up with four machine guns at point in front of plane where their fire converges

tion planes the commander traces the path that the squadron will follow, deciding on the "initial point" where the three flights will split up for their attacks, and arranging a time schedule so that each element will attack immediately on the heels of the last. Leaving their home field, the planes take off in groups of three with only a few seconds between each group. This gets more airplanes up into the air faster than would be possible with single take-offs.

The surprise and whirlwind fury of their arrival are the attack planes' best defense. They are on their target almost before the defenders can decide from what direction the sudden roar of motors is coming, and they are over the hills and out of sight again only a few seconds later. About the only defense against them is a ring of machine guns with the gunners steadily on the alert, under a constant tension that makes for poor marksmanship.

The attack planes are hard to see from above and they fly so low that observers only a mile or so away may fail to spot them. The pilots are trained like Indians to take advantage of every dip and fold in the terrain. They fly more by check points than by compass, even on flights several hundred miles long, and every inch of their exact route has to be worked out meticulously ahead of time. Their idea is to fly straight to the target and across it

with no time wasted in maneuvering for position. In bad weather they fly "contact" under the clouds and close in, wing tip to wing tip, to follow their leader when visibility is reduced.

Neutralizing anti-aircraft defense would be their most dangerous work in actual warfare because on such a mission they purposely offer themselves as targets in order to locate the defenses and try to destroy them. On a night raid they go out ahead of the bombers to tempt the defenders to turn on the searchlight beams. Then their task is to put the searchlights out of commission with machine-gun fire. On daytime raids their job is to lay smoke screens through which the defenders can't aim their guns and to make such a noise with their motors that the mechanical ears on the ground can't pick up the fainter hum of the high-altitude bombers.

One of the unusual hazards of the attack service is that if a pilot is careless he can be blown up by one of the bombs he has just dropped. Depending on the size of the missiles they drop, the pilots fly at altitudes of from 100 to several hundred feet when releasing bombs, giving them time to get far enough away to feel nothing but a sharp jar and lift to the planes as each bomb explodes. The latest idea is to use parachutes to lower bombs from minimum altitudes. A small parachute automatically opens when a bomb is released from its rack and serves to drop the bomb at a slower than normal speed. This permits more accurate target work and gives the plane a chance to escape even when it is flying only fifty feet above the ground.

In the air a pilot is too busy to give a second thought to his hazards. Over his own territory he flies at a safe distance from the ground but by the time he is in "enemy" country he has descended to just above the tree tops. The ground at each side and below the plane is nothing but a blur and the pilot keeps his attention directed forward. Besides flying his own plane he has to keep his place in the formation and watch the leading plane for signals. During the day the leader signals by wagging his wings or tail, and after dark by flashing groups of small blue signal lights on his fuselage and stabilizers.

Attack pilots get special training in effi-

(Continued to page 126A)

2996 W. O'Leary
Chas. Plantoville Conn
Umbrella Holder for Auto
Clamps on Steering Post *40*

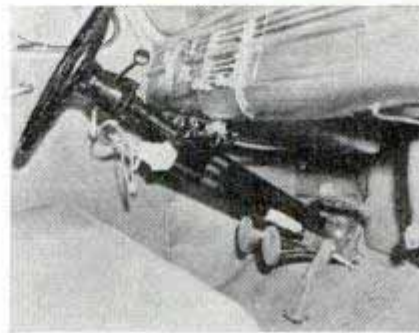

Cherril
Carry out Bluffs
Main St. Carry out
Carry out
Sheathed in a socket attached to steering post or wall of car, the umbrella is handy for a rainy day

Umbrella holders that can be installed in the car in a few minutes are keeping motorists prepared for rainy days. The eleven-inch "scabbard" is clamped to the steering post or screwed to the side wall and does not interfere with driving.

9.14.19
Self-Cleaner for Your Old Rake
Removes Matted Grass

Fitting many of the old sixteen-tooth standard rakes, a self-cleaning attachment strips the teeth clear of matted grass and twigs by merely flipping the rake on its



back and pressing on the handle. A metal scraper bar, perforated with sixteen square holes that fit snugly over the tines, is fastened at the ends to a spring-steel bow secured to the rake handle by means of a small loop. This bow forces the cleaner bar against the back of the rake so it will not interfere with normal use. The attachment can be slipped off the rake easily when not needed.

Cherril
Carry out Bluffs
Main St. Carry out
Carry out

Phone in Fireman's Mask Aids in Giving Orders



Fireman wearing gas mask can enter smoke-filled rooms and telephone instructions to his men outside

Firemen are aided in fighting fires in smoke-filled interiors by a combination gas mask and telephone. With it a fire fighter can enter a burning building and give instructions for fighting the fire to those outside.

Vibrationless Diesel Engine Jiggles to Balance Piston

Differing radically from previous designs for a vibrationless engine, a single-cylinder, ten-horsepower Diesel engine created by a Swedish engineer delivers power with virtually no vibration. The main part of the motor body, having been transformed into a mobile counterbalance for the piston movements, serves to com-

pensate the power impulses by its own jiggling motion. The majority of efforts to do away with vibration centered about multi-cylindrical engines in which the various moving parts compensated each other. Installed in a boat, the new Diesel has given almost perfect compensation for both the reciprocating and rotating parts as well as the power impulses.

Auto Converted into Sleeper by Folding Seats

You can convert your sedan into a bed by replacing its present seats with others that may be changed into a single or full-size double bed fifty-four inches wide and seventy-six inches long. The equipment consists of two front seats and a rear seat, and only simple maneuvers are needed to change them quickly into a bed, or back into seats. With the right seat made up as a single bed, two drivers can take turns sleeping and driving or the bed can be used as a couch for transporting sick or injured persons. The double bed turns the interior of the car into a sleeping berth, roomy enough for two. Both front seats can be reclined separately at any angle.

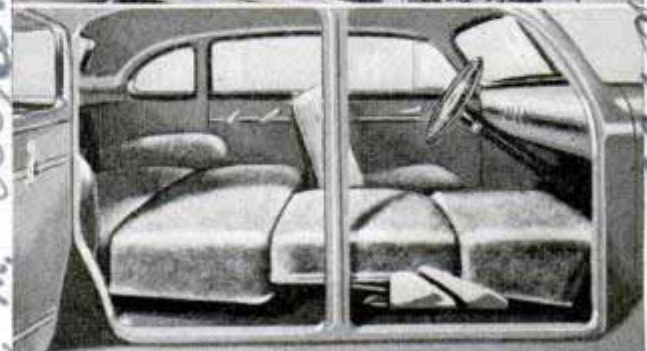

Top, made up double, bed holds two people. Bottom, single bed to right does not interfere with driver

*Country Club
Hempstead
Long Beach
Los Angeles
New York
San Francisco
Seattle
Washington*

no information

21341

229.00

Top of business?

reg. car company

Reported to Dept. of Commerce by Asst. Sec. Commissioner

Autosleeper Corp. 70 Central Park W.

Auto Air Conditioned for Summer and Winter

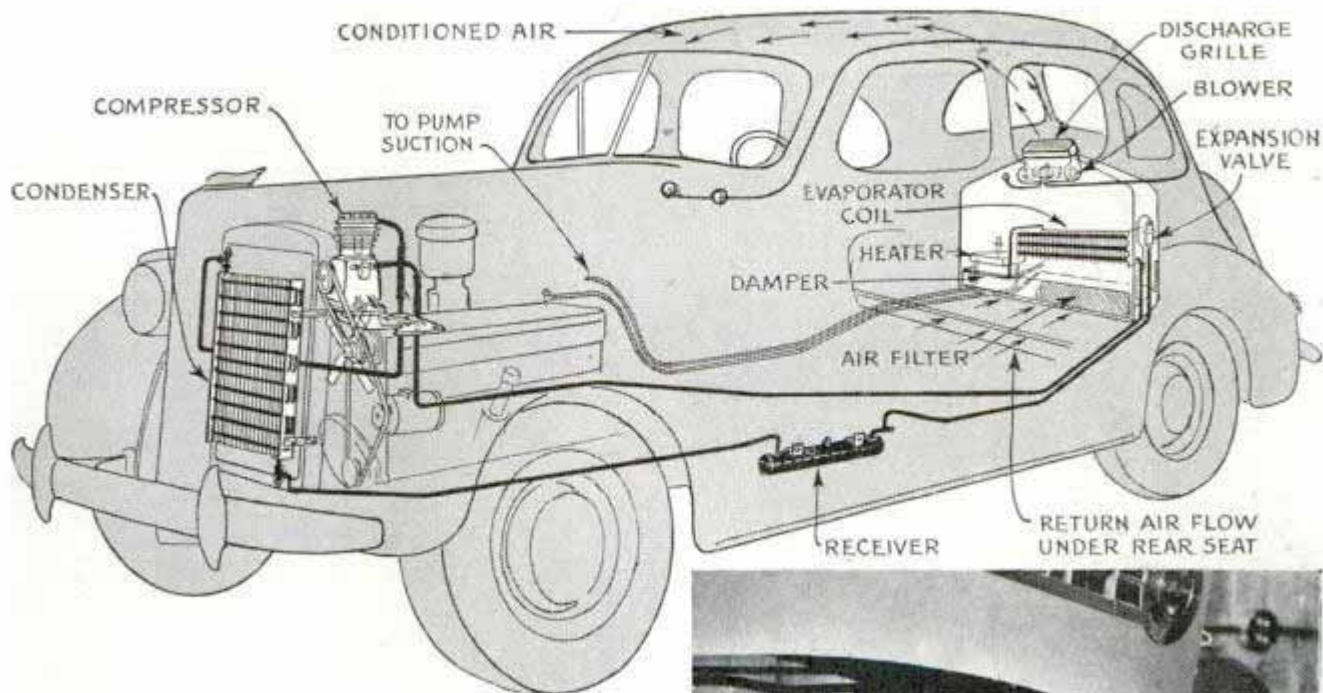

Air conditioning for automobiles, which includes cooling in summer and heating in winter, as well as filtering and dehumidifying, is being built into Packard sedans as extra equipment. Air is cooled by a refrigerating plant, similar to that used in household refrigerators, and its moisture is condensed as it passes over coils that are defrosted automatically. The refrigerator coils are located behind the rear seat in an air duct, which also contains the winter heater in a separate compartment, and two dampers easily reached through the trunk are opened and closed to select hot or cold air. Drawn into the duct by a fan, the speed of which can be varied by a switch on the instrument panel, air is filtered before it passes over the cooling coils, and the treated air is discharged through a grille above the rear seat toward the roof of the car, whence it is distributed naturally over the entire interior, entering the duct again under the

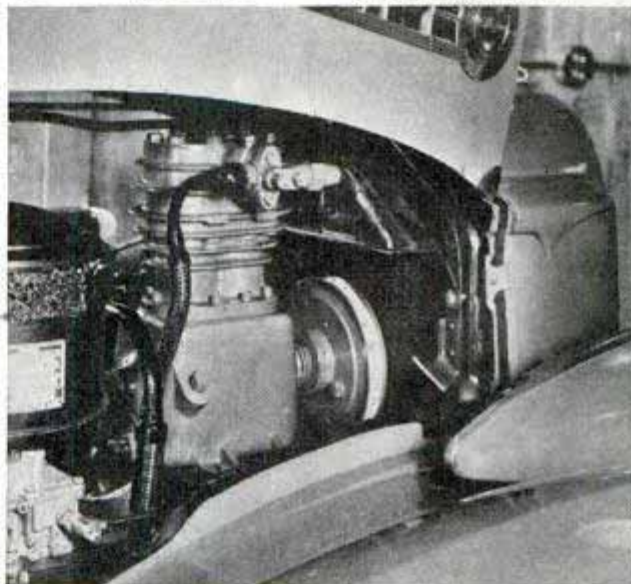

Top, sketch shows installation of automobile air-conditioning equipment and how both warm and cool air are circulated. Bottom, compressor mounted over engine is run by auto fan

rear seat. The compressor, mounted on top of the engine, is driven by the radiator cooling fan, and the refrigerant is admitted through an expansion valve to the coils. Its cooling capacity is rated at one and one-half tons of ice in twenty-four hours, at a car speed of sixty miles an hour.

Teeth of Comb That Cleans Itself Extend Clear to the Backbone

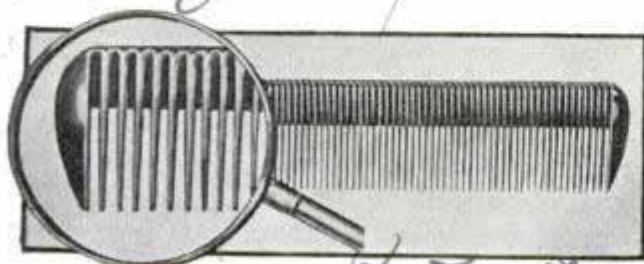

In addition to being designed to clean itself, it is claimed by the manufacturer that a new comb will hold three times as much wave-setting solution, will increase the life of permanent waves, and will not pull the hair out nor tear it. The teeth of the comb extend clear to the backbone.

Comate, Inc. 280 Madison Ave New York

ROLLING UP *the*

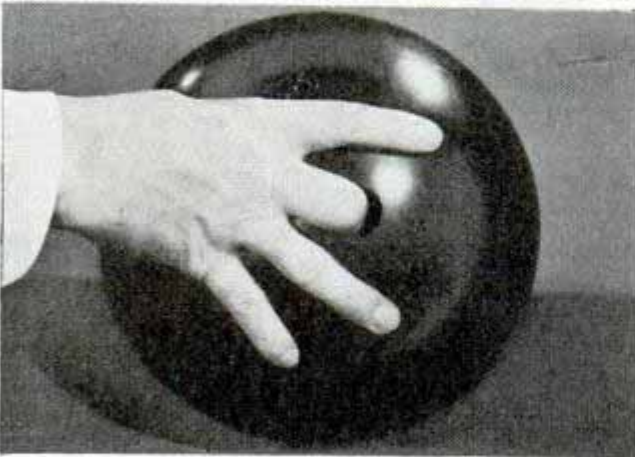
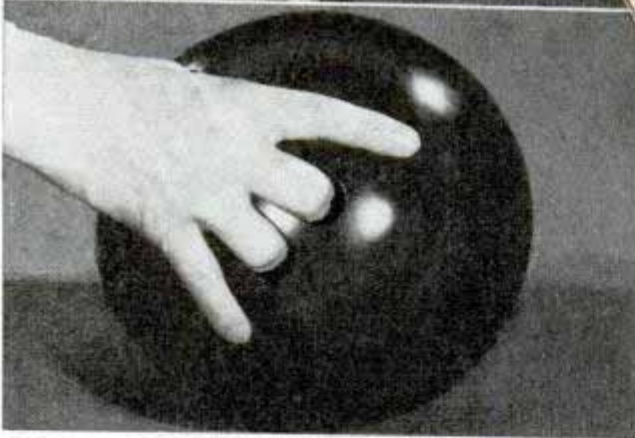
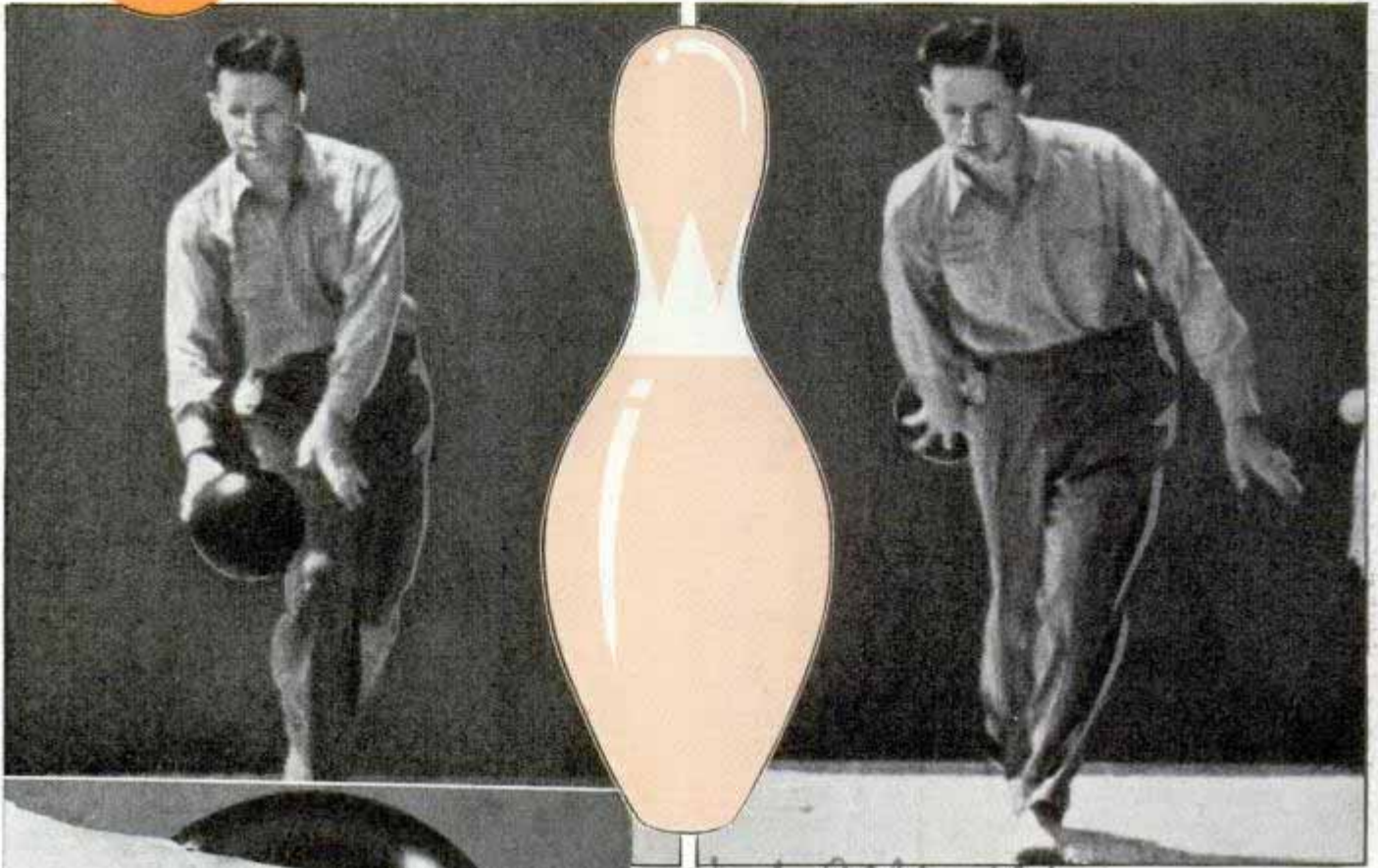

West Allis, Wis
By NED DAY
6014 W. Burnham,
National Match Game Champion

IF YOU'RE weary of sitting in a stadium watching someone else grow healthy, try bowling.

Here's a sport that's more fun to play than watch, where the emphasis is on individual participation. Wherever it's played you'll find a dozen bowlers to every spectator. This is borne out even in bowling's world series, the American Bowling Congress. More than 25,000 bowlers from all over the country take part in the fifty-day classic, but the box-office receipts seldom amount to one-tenth the sum the contestants pay in entry fees.

The bowling army pays its own expenses just for the privilege of getting a crack at sixty per cent of its own money. In the aggregate this will amount to a tidy sum, approximately \$200,000; but nobody will go home rich because the amount will be split about 8,600 different ways so that one out of every four entrants wins a prize.

Left, center, three-finger Ned Day grip, a new development that is said to impart uncanny accuracy to a hook ball. Bottom, fingers on the outside of the ball should be held in a natural manner

Chas. James Mc Dweeney, 9845 W. Kansas City, Mo

21236

STRIKES

1	Al	15	55	20
2	Jim	12	45	20
3	Bud	18	35	20
4	Ann	10	25	20
5	Tom	14	30	20
6	Frank	11	25	20
7	Arny	16	40	20
8	Harry	13	35	20
9	Art	17	45	20
10	Bill	14	35	20
11	Mike	12	30	20
12				

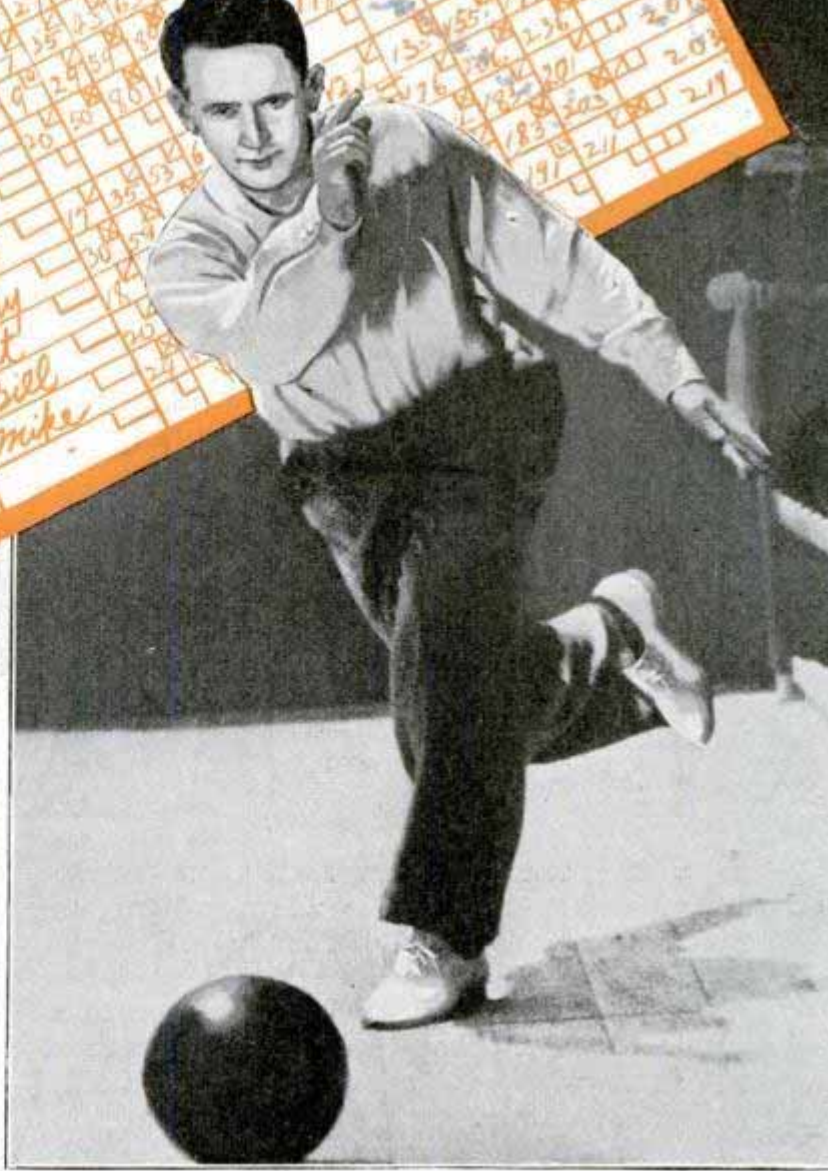
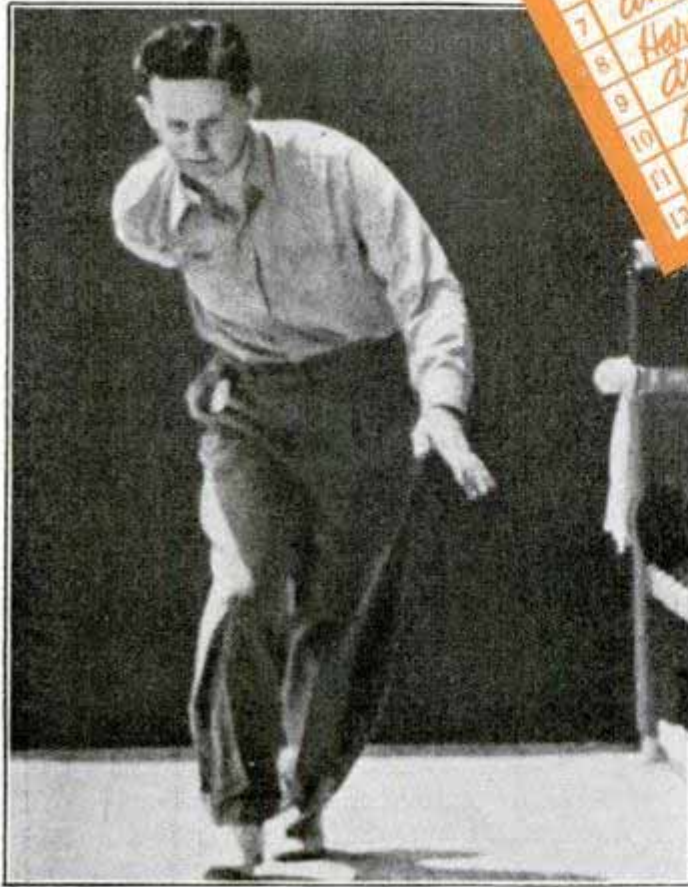

The richest plum in the singles event, for example, will net the winner \$300.

A more astonishing picture of sports participation is the \$50,000 Red Crown Sweepstakes in which 250,000 bowlers under ABC sanction compete on their respective home alleys prior to the congress.

Bowling is truly a national game. It's good exercise, though not of the violent character, and it's mentally exhilarating. And because the general theory is to shove, not blast the pins into the pit, mere physical strength isn't nearly so important as timing, rhythm and control. There's a good deal of skill in rolling a high score, but it's not the exacting skill that causes the beginner to give up in despair.

The number of players, or keglers, is estimated at 12,000,000, and a check of the different types of devotees lends credence to this figure. During the last several years, there has been a rapid upward swing in the number of industries and organizations installing bowling alleys on their own premises. One New York manufacturer has 140 teams that roll on company-owned alleys,

Top (starting on opposite page and continuing on this), first step, with right foot, ball descending, right arm straightening, body balanced; second step, with hand turned in front of ball, arms straight; third step, with ball at top of back swing, body beginning to bend forward for glide, and, fourth step, a glide and the delivery. Note follow through. Right hand indicates top spin has been applied. Below, pencil test shows whether ball has correct span

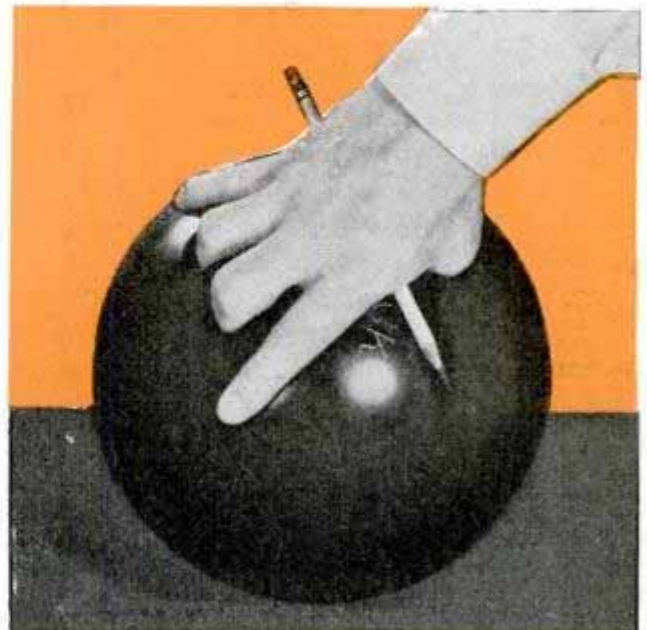



and the rest is up to the player. In competitive matches, some of the blind youths have rolled scores above 140.

On his first visit to an alley, a novice upon hearing such expressions as spare, railroad, cherry pick and baby split is apt to conclude that bowling is a complicated game. It isn't. You simply try to knock down ten pins, set in the form of a triangle and weighing about thirty-three pounds, by rolling a sixteen-pound ball—or a lighter one if you wish—down a sixty-foot

while an insurance organization makes use of twenty-four public alleys two nights weekly. The growth in feminine interest is shown in the fact that several large firms have more women bowlers than men, and in Chicago, a hotbed of bowling interest, as many as 8,000 roll in the women's city championship.

Many clubs have installed bowling facilities at the insistence of their members. So have hundreds of churches, an outstanding example being the Riverside Baptist in New York, where its chief benefactor, John D. Rockefeller, Jr., is among the regular group of financiers who use the five alleys. In Hollywood, bowling is popular and many actors have bowling alleys in their homes.

That the sport bridges physical handicaps is demonstrated whenever a team from the New York Guild for the Jewish Blind engages in a match with players of normal sight. A handrail on the left side of the alley that serves to guide each player on the approach is the only concession given the sightless. When any pins are left standing after the first ball, the pin boys call them out

white maple alley with the aid of speed, timing and control.

Frequently, a 134-pound bookkeeper with no apparent athletic ability will join an office league and within a short time be rolling good scores. There's no reason why the erratic player or the run-of-the-mine dub cannot improve his average if he's

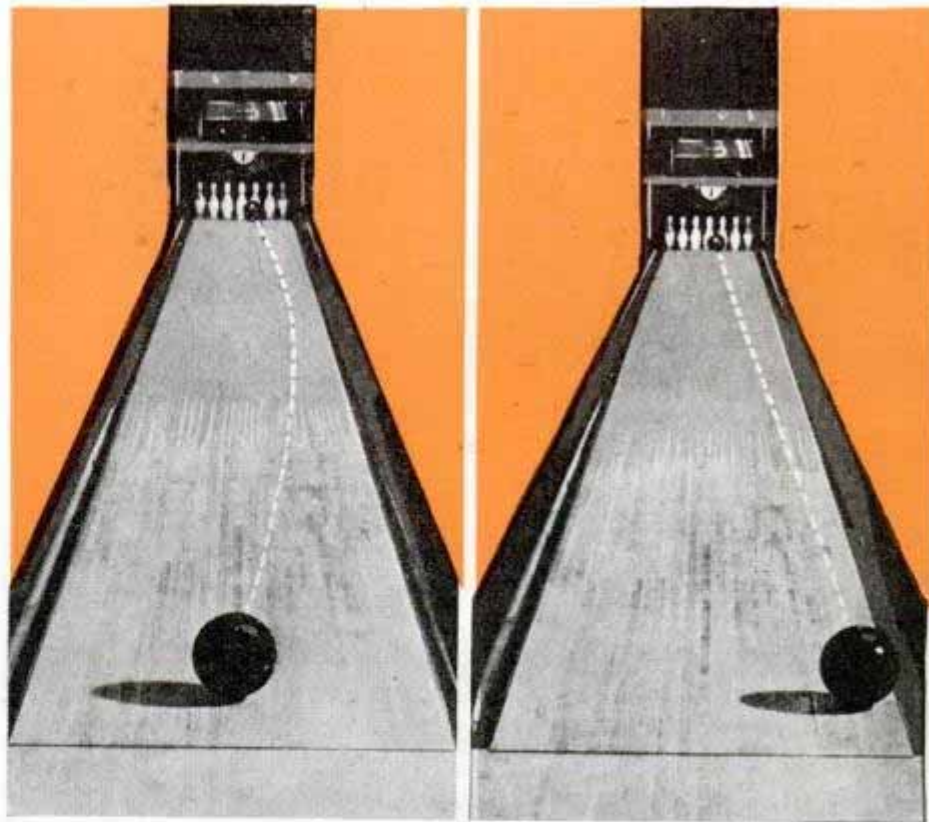

Top, ball returns about to be sandblasted in Brunswick factory. Bottom, left, curve ball is played from near alley center and thrown out toward gutter, but it eventually hits 1-3 pocket. Right, straight ball, which is easiest to roll and control, takes straight course from right corner to 1-3 pocket

2/29/26

Brunswick
muskegon

388 C. 2

willing to take stock of his game.

When you bowl with an ill-fitting ball you'll never get any better. Instead of having a ball with the thumb and finger holes of the proper size and so spaced as to provide the correct span, many players, at the expense of their games, persist in using a grip so narrow that it is impossible for them to hold the ball without having their thumb so deep in the hole that it's carrying all the weight. The weight of the ball should be distributed evenly between the thumb and fingers, so don't let anyone sell you on the idea of using a short span ball, that is, one with the holes too close together, otherwise your hand will be in a cramped position and the ball won't be properly balanced.

Remember, in holding the ball, the index finger is for balance, the middle finger must share the weight of the ball and

impart spin to it, while the ring and small finger assist on the follow through.

An easy way to make sure you're using a ball with the correct span is to allow enough bridge between the palm of the hand and the surface of the ball for the insertion of a pencil which may be rolled over several times freely in this space.

(Continued to page 140A)

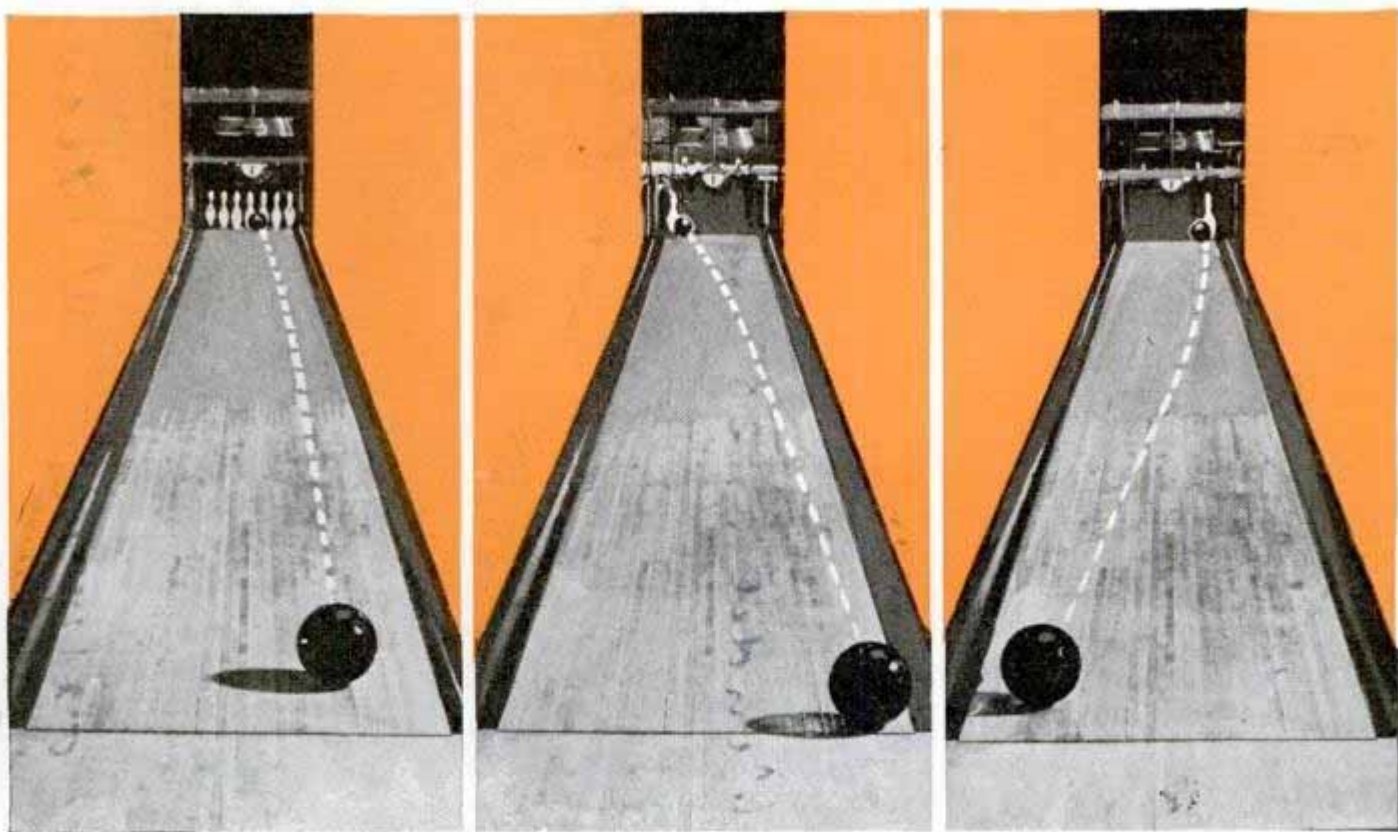
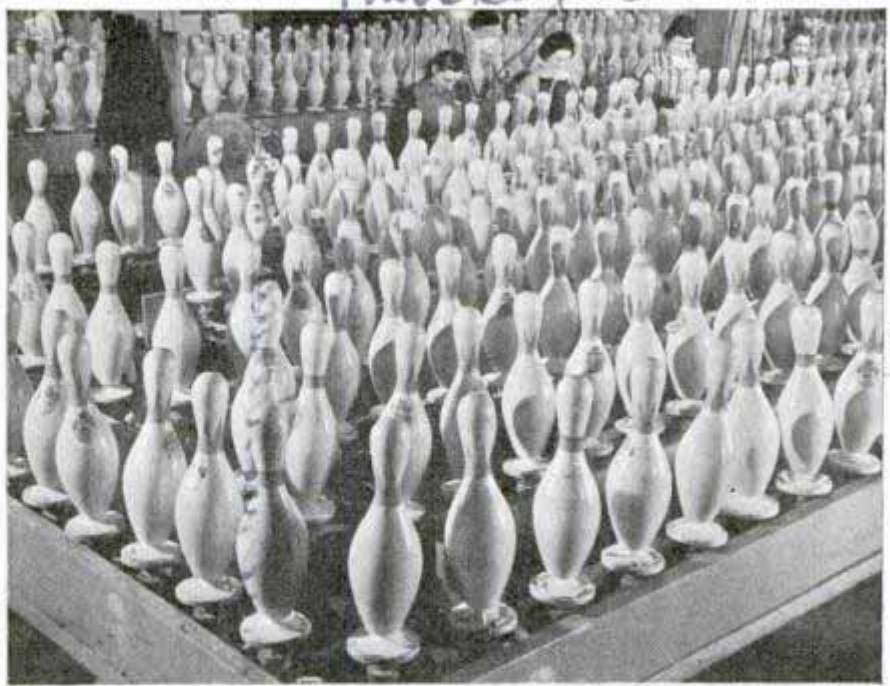

Top, moving production line in factory. Bottom, left, greatest pin getter, the hook ball, is dropped eight or ten boards in from right-hand gutter. Center, how to make that seven-pin spare. Right, nothing to the ten-pin jinx when it's handled like this

Vertical handwritten notes on the right margin, including the word "Gutter" and other illegible scribbles.

Large, illegible handwritten scribbles at the bottom of the page.

21304
396

Electric "Eyes" Count Gate but Skip Those Going Out

the deflection of that instrument's needle indicates the measurement of the original displacement. The electrical micrometer is a radio tube consisting of an electron-emitting filament and two tiny plates, insulated from one another and jointly supported by a rod which goes into an elastic diaphragm fixed in the bulbous part of the radio tube. Outside the tube, and attached to the diaphragm, is spot welded another small rod whose job it is to detect tiny displacements. Slight displacements of this rod, communicated through the diaphragm, bring one plate nearer to the filament and the other plate farther away, resulting in a decided difference in flow of electrical current, proportional to the displacement.



Photo-electric "eyes" in panels at sides of door and overhead scan visitors and count attendance

An attendance register built to watch the "gate" for movie houses, skating rinks and the like seems able to think with its photoelectric brain. It will count persons entering the door and yet ignore those who go out by the same door. When you go in, your body cuts off light beams between double windows in metal pillars at each side, and the counting device checks you in. Going out, however, you aren't counted. If two persons walk in side by side, light beams from overhead spot both. And if someone holds his hand in the beam to stop its normal operation, the register lights a signal in the manager's office.

Five-Millionths Inch Measured by Electric Micrometer

Measurements as small as five-millionths of an inch are indicated by a special radio tube that converts any microscopic displacement of its detecting rod into a proportionate flow of electric current. This current goes through a microammeter and

Looseleaf File for Photo Films Holds Twelve Slides in View

Twelve transparencies can be mounted on every page of a looseleaf filing system for miniature photograph slides which offers easy access for viewing. By holding the panel in front of a table light the twelve slides can be examined at once. Each two-by-two transparency is individually housed and protected from handling.



Placing photo slides in cardboard panels for viewing in front of lamp; panel fits in looseleaf book

Civic. chs. 49 Clinton St. Newark, N.J.

Sumner Service 11/28/39

21396

Under \$1.25 - panels etc.

Handes, Mt. Arce, N.Y.

Dr. J. Ross Sweeney, U.S. Naval Research Laboratory

2135 Lord and Burham Co

Dr. W. J. Hudson, N.Y.

Garden Greenhouse in Sections Easily Set Up

Anyone can build his own garden greenhouse with sections which are delivered ready for quick assembly. No special skill is required in bolting them together and fastening them to the foundation. The foundation consists of heavy rot-resistant plates with stakes to anchor them to the earth. Side panels and roof sections are assembled with brackets, being joined together at the peak by pin hinges, and fastened to the foundation by hooks and eyes. Framing material is made of red cedar coated with aluminum paint. A site need never be regarded as permanent, since the building remains portable. Also additional sections may be purchased to enlarge the greenhouse. With clear glass from the roof peak to within three or four inches of the ground, there is virtually no shaded section inside. Children can use the greenhouse as a solarium, and the experimenter finds it a good place for raising chemical gardens. Heat can be piped into it from the home heating plant or special heaters are available.

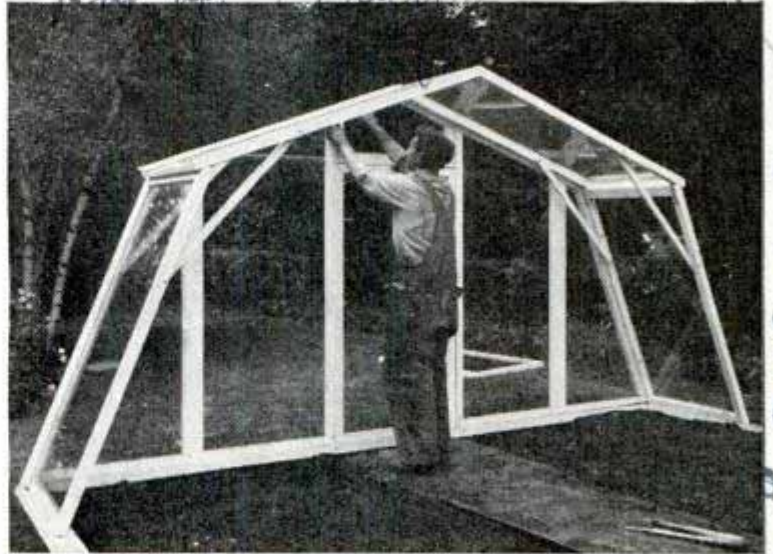

Top, right, door is added after two side sections are on foundation; center, finishing with end frame and door; bottom, greenhouse completed

Dancing Blade Adjusts Tappets While Engine Is Running

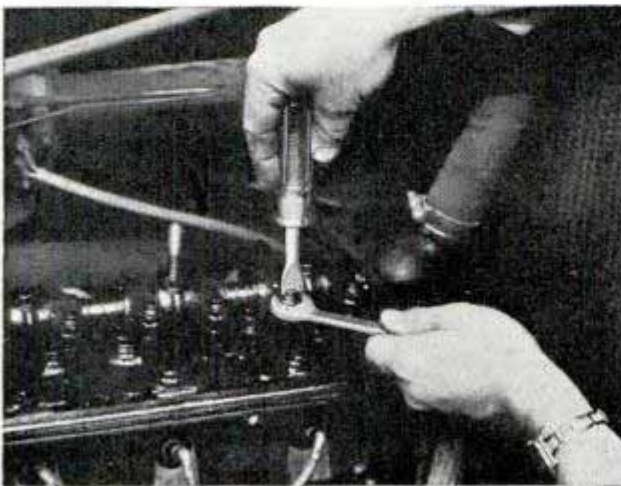

Spring in handle permits blade to ride with tappet

Tappets on overhead valves are easier to adjust while the engine is running, with a tool that follows the up-and-down motion without transmitting it to the handle. Its blade retracts into the breakproof and shockproof handle when the tappet rises, and a spring forces it out as the tappet is lowered, thus leaving the hand steady for making the necessary adjustment.

Names and addresses of manufacturers and dealers in articles described in this magazine will be furnished by our Bureau of Information upon request accompanied by stamped, self-addressed envelope.

21326
 Shuro Metal Products Co.
 2646 N. Kildare, Chicago

0.5.626 & 0.5.688

CAMERA

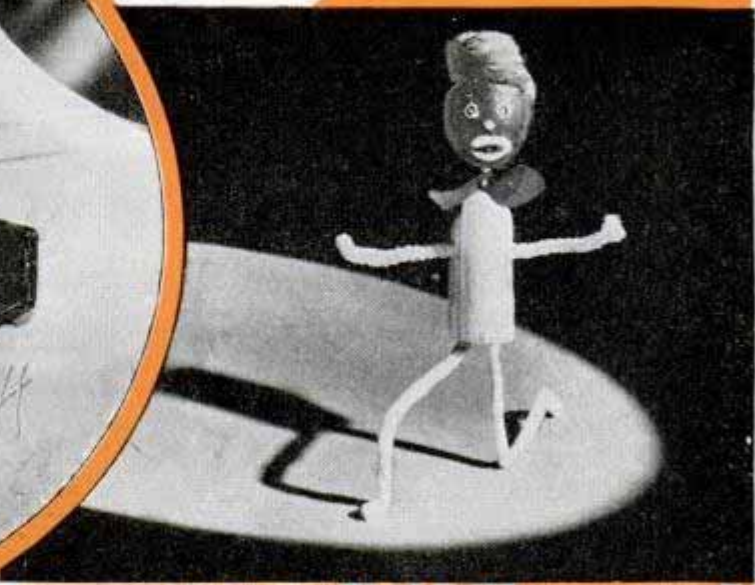
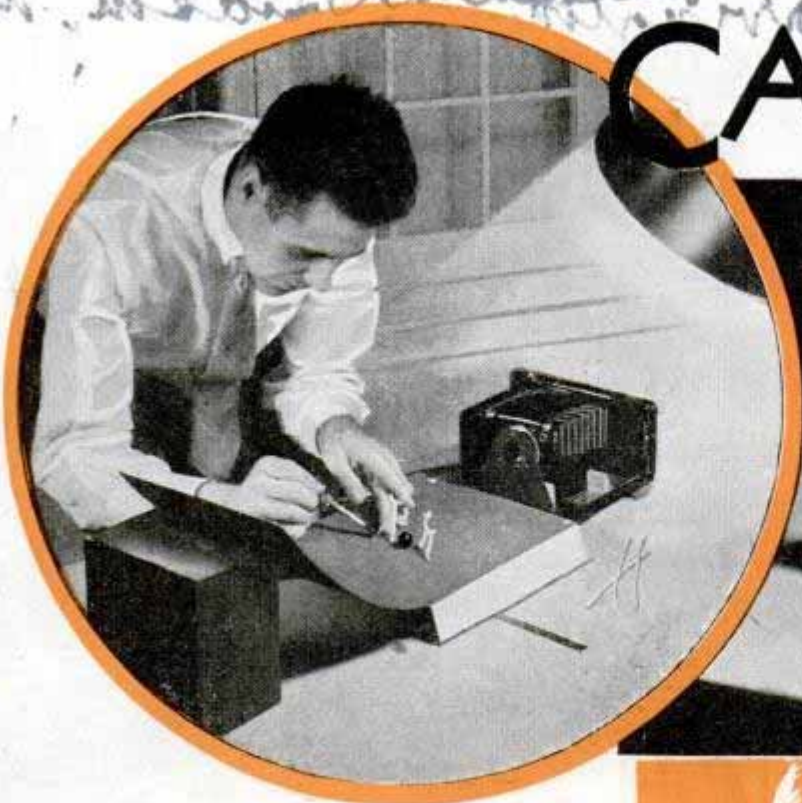

Perhaps you can't cartoon with a pen—but you can with a camera. The hall closet is full of the "makings," and the dime store can supply plenty of "props." Use a fine-grain panchromatic film, flood or spotlights, and for extreme close-ups you may need a portrait lens attachment. Sometimes a movie titler serves as stage. Above, cameraman arranges setup for "ostrich polo" picture on opposite page. "Mammy singer" has a radish head, celery body, pipe-cleaner legs and arms. Below, amusing figures that can be animated for movies; skier slides down a salt mountain

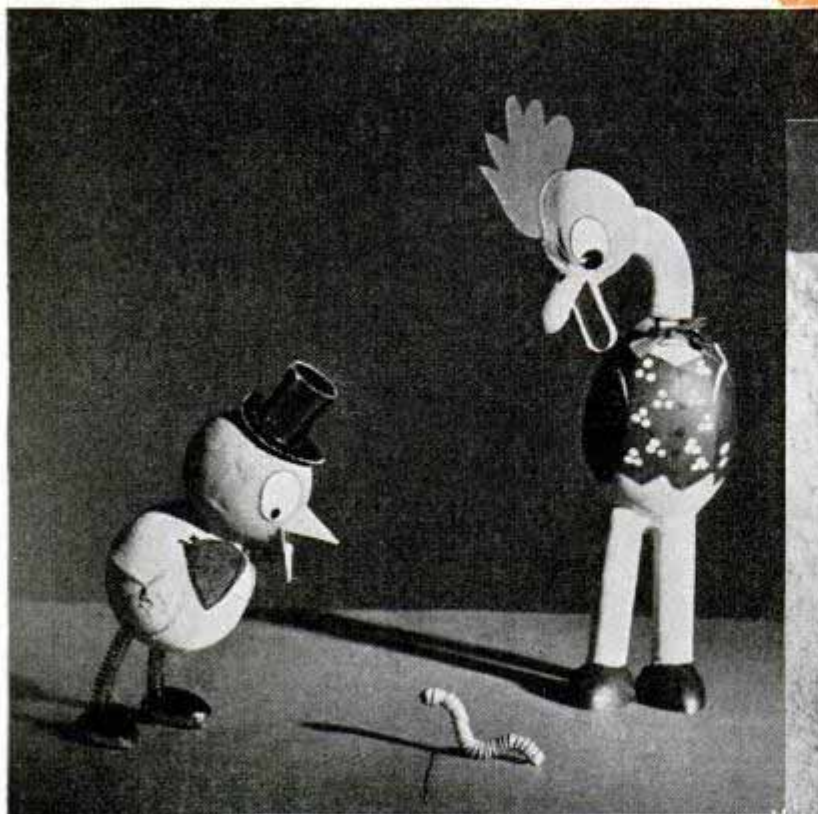

The Eastman Kodak 21317
Rochester NY

CARICATURES

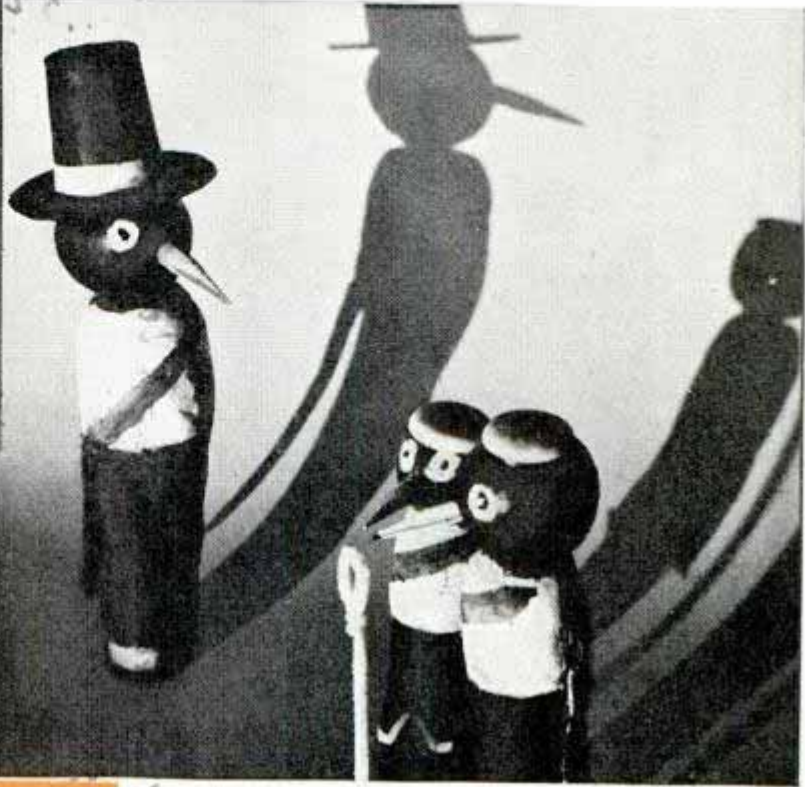
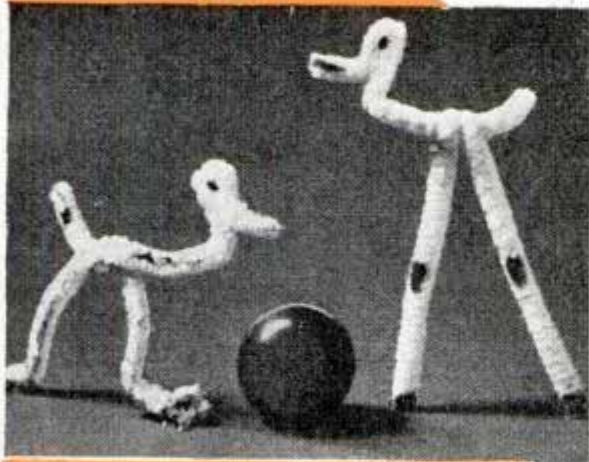

Posing at the microphone above are birds with carrot bodies and onion heads, painted black and white. With one floodlight, exposure was one second at f.16

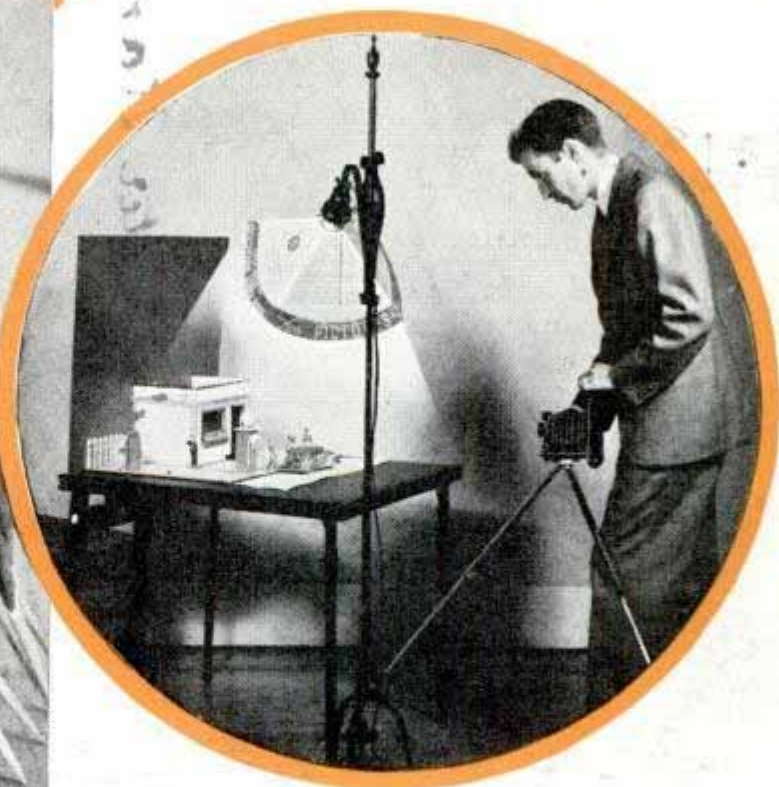
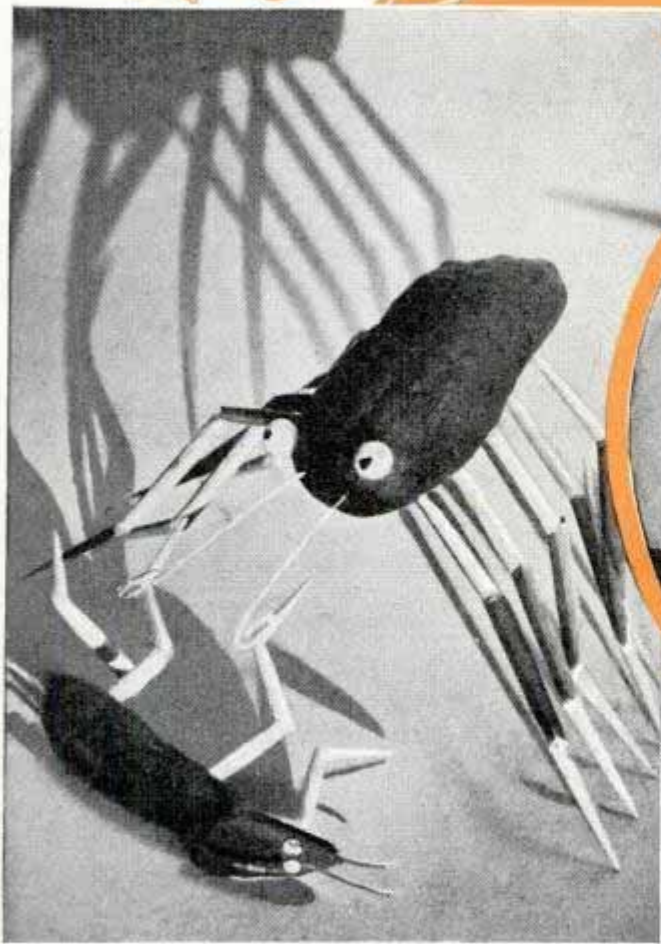

That weird monster just finishing off an enemy, at left, was made of pickles and toothpicks with bead-headed pins for eyes and antennae made of fine wire. Above, a simple arrangement for table-top scene of gas station

Handwritten notes at the bottom of the page, including 'The Eastman Kodak 21317' and other illegible scribbles.

Blanket Is Worn Like Robe If Air Raid Comes at Night



Bed cover, left, is quickly converted into hooded robe, right, for dash to shelter in night air raid

When Londoners are awakened in the middle of a chilly night by air-raid warning sirens, a wartime blanket which can be converted quickly into a robe enables them to hurry into their outdoor shelters without losing time or warmth. Sewn at one edge of the coverlet is a hood that slips easily over the head, and there are drawstrings at the neck.

Crossbar on Hexagonal Wrench Opens Drain Plugs Easily

Two-handed leverage can be applied to a wrench with a crossbar handle designed to ease the operation of opening tight oil-

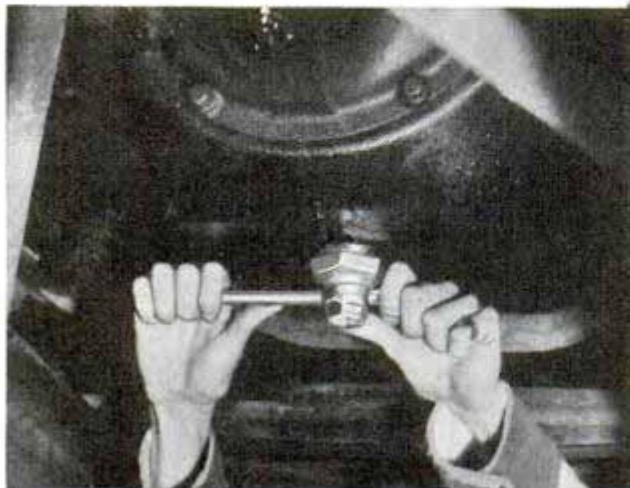

Tight drain plugs open easy with this crossbar tool

drain plugs. The tool has two hexagonal openings, one measuring two inches and the other fifteen-sixteenths. It is especially useful on some of the smaller cars.

Signs on Sides of Truck Change as Messages Are Broadcast

Eight different advertising messages are delivered in both sound and pictures by a sound truck equipped with two rotating cylinders mounted lengthwise inside the body. Side panels of the truck are cut open to provide a two-by-five-foot space through which the cylinders protrude, exposing one-fourth of their surface. Each cylinder bears four signs that appear in the

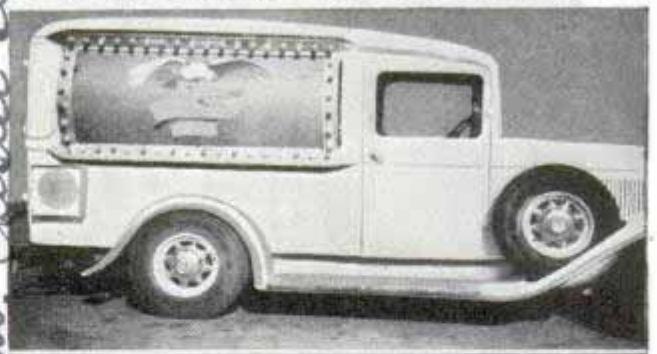
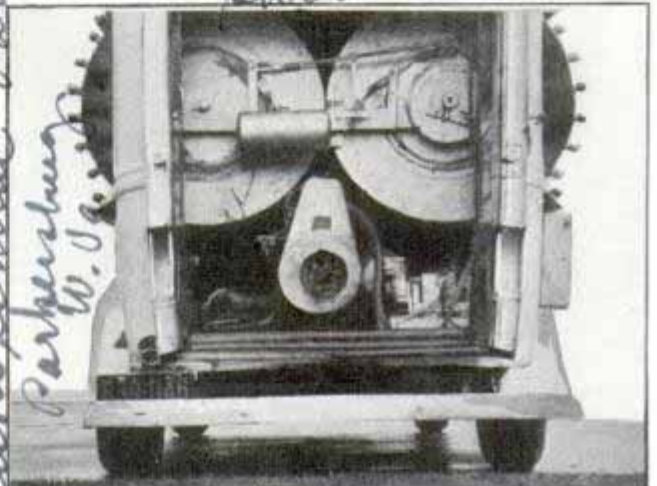

Top, rear view of cylinders in truck. Bottom, sign at side, rimmed with lights, changes as roller turns

openings, one at a time for twenty seconds, an announcement relating to the sign, picked up from a phonograph record, being broadcast simultaneously. A 500-watt alternating-current plant furnishes electricity for the light bulbs around the sign spaces as well as power for the twenty-watt amplifying system. To turn the cylinders, a shaft running the full length of the truck gets its power at the cooling fan of the engine.

Ford, Mercury, Gephys

Chester Davis, Central Tire & Rubber Co., W. J. G. ...

Clure Metal Products Co.
2646 N. Kildare Chicago

Telephone Dial Steers Radio-Controlled Boat



Left, radio-controlled boat responds to orders transmitted by short-wave impulses. Below, operating new telephone dial that is used for selecting the proper impulses to send in executing any given maneuver

Howard Madden



Designed by: W. Parviche West. Appl. Associate Director in charge of Technical Conventions

Operation of a radio-controlled boat is greatly simplified by the development of a speed and direction selector that is manipulated like a telephone dial. In tests made at Franklin Institute a five-foot scale model yacht was steered about in a tank and its speed regulated entirely by dialing the short-wave radio impulses, which were picked up by a receiver in the model.

Metal Parts Nailed Together by Clip That Spreads

Metal parts are virtually nailed together with a tubular clip of spring steel which spreads after being driven home. At opposite sides are two cam-like tongues that spring out, firmly locking the clip in the hole. A flange at the end performs the service of a nail head. To make it more secure, a stud is inserted to fully expand the curled-in end of the clip.

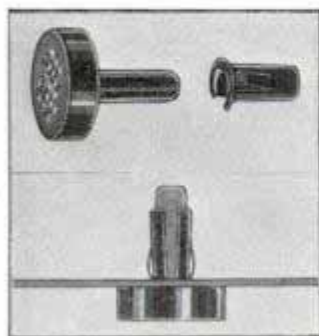

forming a double lock. By forming the clip with the correct degree of "bite," it can be adjusted so any predetermined amount of "pull" will remove it. It is not necessary to have access to both sides of an assembly, as is the case when bolts are used.

Four-Lane Road "Jacked" Apart to Form Safety Center Strip

Fatal accidents on a New Jersey four-lane highway were reduced more than eighty-three per cent by the novel method of splitting the road lengthwise and jacking the concrete slabs apart to form a dividing center strip. Accidents of all kinds decreased forty per cent after the two-way division was effected.

Send return postage to our Bureau of Information to learn the name of the maker of any device described in this magazine.

Timmerman Co, 2038 Fulton

Arnold H. Vey Traffic Engineer

2/28

U.S. Navy, Charles, Seattle, Wash.

W. Chapel, Seattle

William Cochran

ac m

2 196 2

Patent 2,111,111

1063

all ad ma

MAKING MONEY *with*



SHE used to live in the country, where she had to scratch around for a living and turn over her meager and irregular earnings to the farmer's wife to buy Easter bonnets and make down payments on the new sewing machine.

Now the hen has gone to town. She has sacrificed the freedom of the farm—if you call it a sacrifice—for the social security of a one-room apartment in a skyscraper of wire cages where there is nothing to do but listen to the radio, eat and lay eggs. Thousands of suburbanites and city dwellers have put millions of hens to work on the production line in back yards and basements and idle factory space.

You see, there's money in it. You can figure on, roughly, \$2.50 a year, clear, from every laying

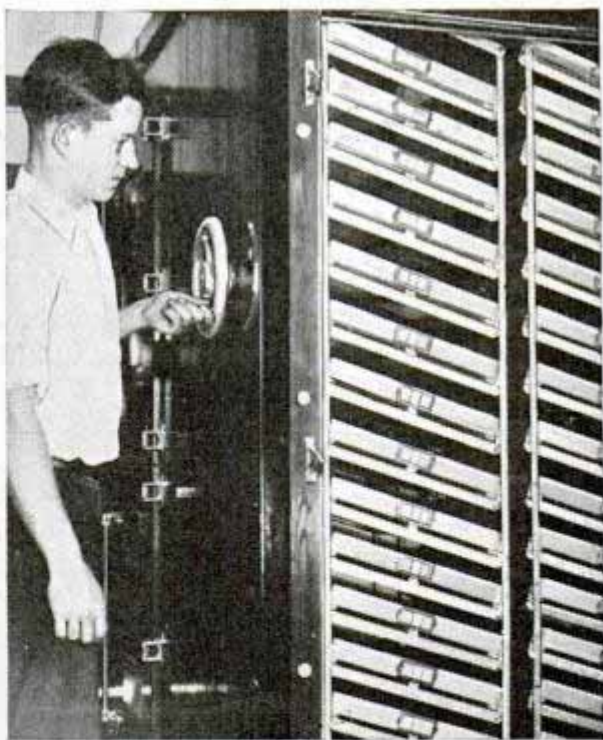

Photos courtesy M. H. Arndt Mfg. Co.

Radio music induces hens to step-up production, top. Center, hen looks on as she gets credit on chart for one egg. Bottom, turning crank to clean endless belt that serves as floor for cages. Right, turning eggs in incubator

Mr. H. Arnold Mfg. Co. 21063
Trenton, N.J.

Cliff-Dwelling HENS



hen. One hundred hens in your basement will pay you \$250 rent. A thousand caged in a backyard shed add \$2,500 a year to your income. A hen won't ask much of your time. One man at a college farm spent four hours a week caring for 108 hens; they weren't pedigreed pullets picked for their laying talents—they were the run of an ordinary flock, and in a year they earned \$298.37, or \$2.77 per bird before deducting the cost of labor. After paying for labor, each hen earned \$2.17.

And you don't need to be a professor of poultry or an experienced farmer



Sorting eggs for market is done quickly and automatically by grader at top. Below, a three-story apartment for baby chicks. In cages three feet by six feet, 200 chicks snuggle for warmth under an "electric mother"

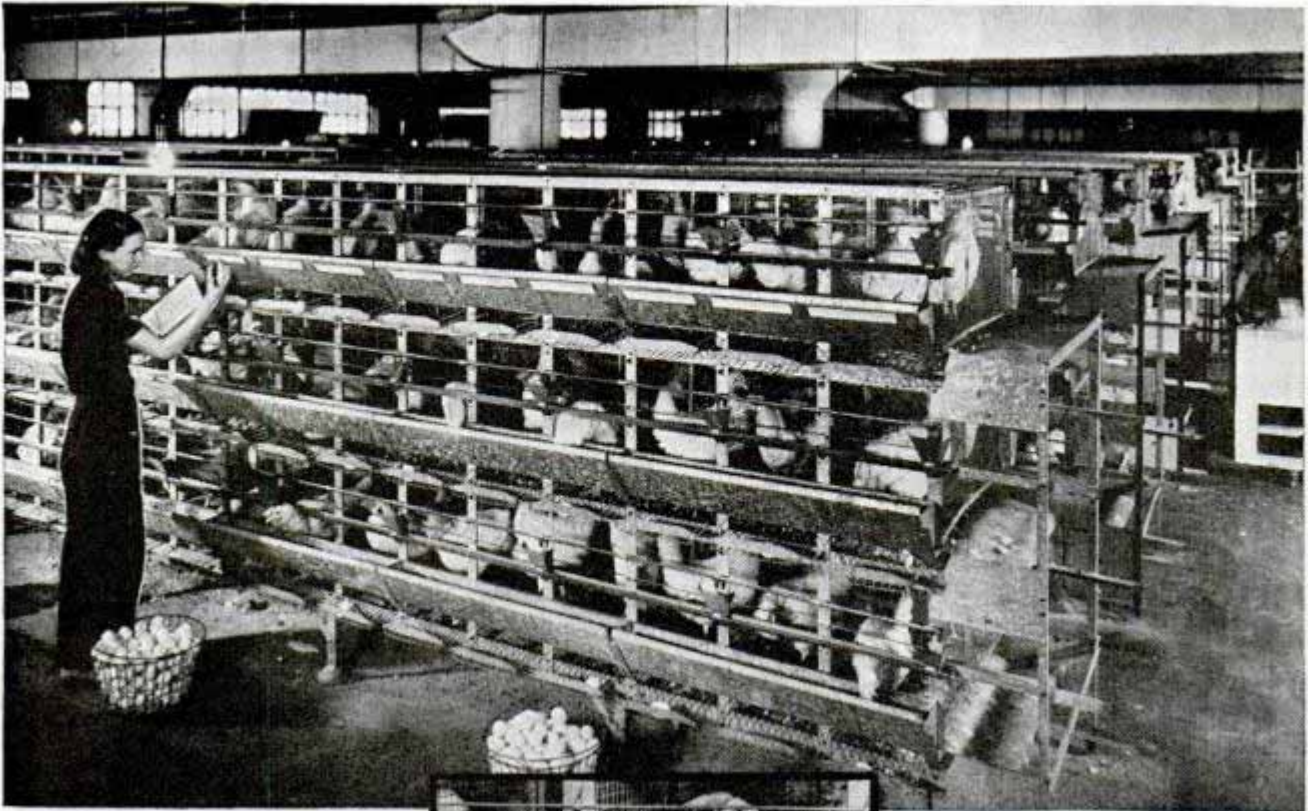

to run an egg factory. Even if your training in the handling of chickens has gone no further than managing a drumstick at Sunday dinner, you can learn what you need to know in a few days at a demonstration farm.

You wonder how a hen can be happy in solitary confinement, with never a grasshopper to chase nor a hen-party to attend, without sunshine or exercise. Well, you can't interview the hen, but she lays down the evidence convincingly: 21,000 hens in cages on Milton H. Arndt's half-acre demonstration farm near Trenton, N. J., produce fifteen per cent more eggs than the same number of hens that range over Mr. Arndt's ninety-acre breeding farm.

Ten years ago, when Mr. Arndt started his cliff-dwelling hen colony, there were just 1,000 hens in single cages in the United States. Today there are 40,000,000. One of the largest batteries is in an old factory in New England. Another is in a Long Island church. Millions of eggs roll off the production line from cages in a Chicago warehouse; thousands of hens are at home in Manhattan boiler rooms and Detroit

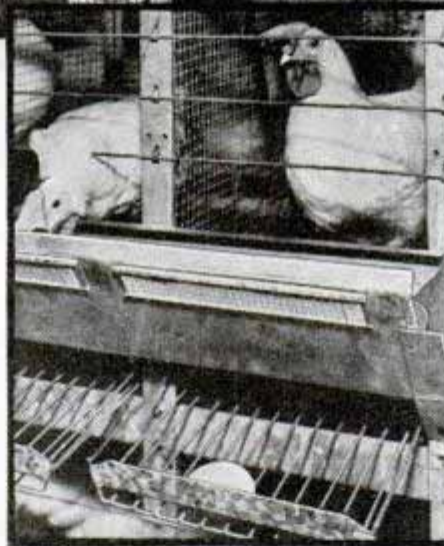

Harvesting eggs on Arndt experimental farm near Trenton, N. J. Notice how the eggs roll into collecting trays out of sight and reach of the hens. Laying hens are housed in individual cages



breweries. A New York delicatessen owner raises broilers in the cellar, roasts them in the kitchen for sale in the store.

These batteries are tiers of cages equipped with feed and water troughs and belts which, turned by cranks, remove the manure—which brings ten cents a bushel—and keep the cages sanitary. Seventy-five per cent of poultry disease is contracted on the hen-house floor or in the barnyard. Life in batteries is healthy.

As soon as it is laid, the egg rolls down the wire floor of the cage to a trap out of the hen's sight, where it can cool quickly. Under each cage is a score card, which is also a death warrant. For every egg, an "X" is marked on the card. And if she loves life, Mrs. Hen had better keep a nice, healthy string of "X's" on her calendar. The moment her monthly output falls below twelve eggs she is doomed to a fricassee. Nine eggs a month pay her board and keep. If she can't hand you a profit of three eggs a month she must be culled, to be served with dumplings while a more efficient layer moves into her room.

Quiet life in a cage produces tenderer, better-flavored meat because diet is controlled, and feed is manufactured into tender meat instead of muscle. On the other hand, imagine the embarrassment of the broiler colony owner who made his first big sale to a hotel for a banquet. The broilers were dressed and delivered the day of the dinner, and the chef browned them in his finest style. Tenderer chicken was never served; but at the first forkful, anticipatory pleasure of the guests faded into dismay. The chicken had a disagreeable fishy taste. The chef was chagrined, the banquet ruined. The meat had been flavored by cod-liver oil fed to the chickens. Omission of the oil from the feed two days earlier would have eliminated the flavor.

If you're interested only in eggs, you can buy matured pullets ready for laying. Or you may run your own nursery, hatching eggs or buying day-old chicks.

To keep egg production at his farm at a high level, Mr. Arndt selects the top five per cent of the layers in his egg factory and sends them to the breeding farm. From there the fertile eggs are sent to mammoth incubators. Millions of chicks are born every year in these orphanages, kept auto-

(Continued to page 122A)

Portable Drawing Machine
Fits in a Brief Case



Well-equipped drawing board slips into a brief case

No bigger than a brief case, a portable drawing machine just offered is complete with board, square, triangle, scale, protractor and paper clamps. Its L-square is always held true by a permanently attached semi-universal arm which swings over the entire surface of the board.

Automatic Insulation Stripper
Catches Waste in Drawer

Insulation is removed quickly from the ends of wires when they are inserted in an automatic stripper that is completely enclosed to keep from scattering the waste. The length of stripping is adjustable, and insulation scrapings fall into a drawer which can be taken out and emptied.



Drawer catches insulation waste stripped from wire

Handwritten notes:
 21063
 21308
 Autodraft
 Eugene Dietgen Co. Am. Chicago
 2425 S. Dearfield
 21356
 A deal Commodore
 Messer Co.

"Machine-Gun" Crew of Five Drills a Tunnel

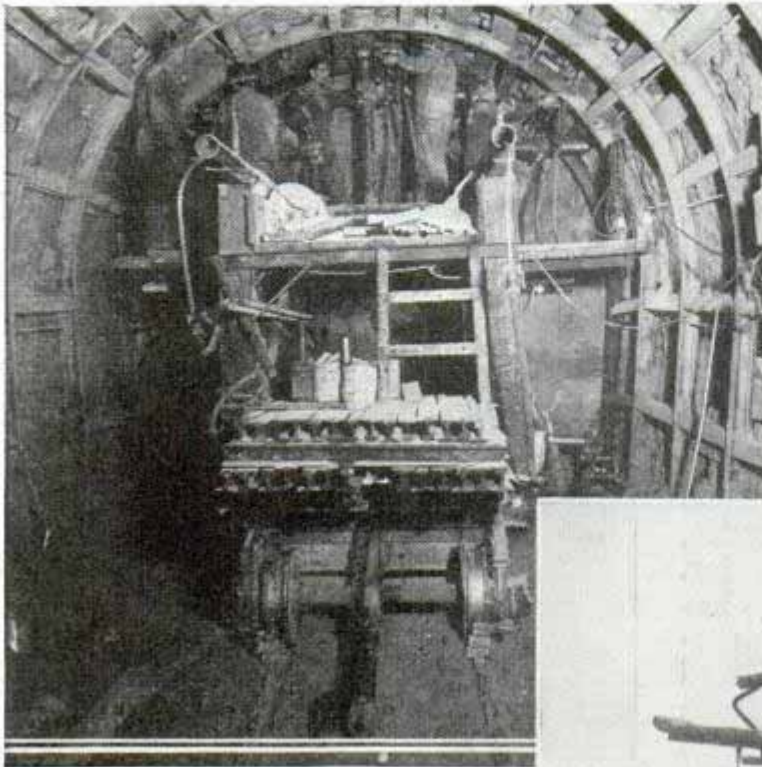

Machine gunners of peace are the steel-helmeted team of five men who manned the drills boring a 3,925-foot tunnel on the Roza Canal project at Yakima, Wash. The five automatic-feed drifting drills mounted on a Jumbo drill carriage advanced an average of nearly twenty-seven feet per day and on their best day moved forward forty-three feet, driving a sixteen-by-sixteen foot horseshoe tunnel.

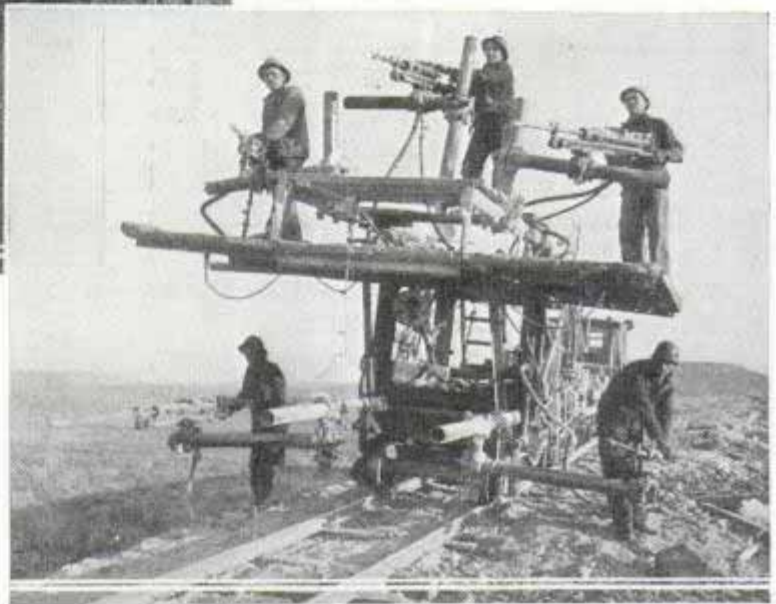

Those "machine gunners" at the right are really very peacefully inclined. The guns, mounted on a railway carriage, are automatic drills used in boring the 3,925-foot Roza Canal project tunnel near Yakima, Wash. Above they are seen at work

Folding Metal Sawhorse Legs Need No Nails or Screws

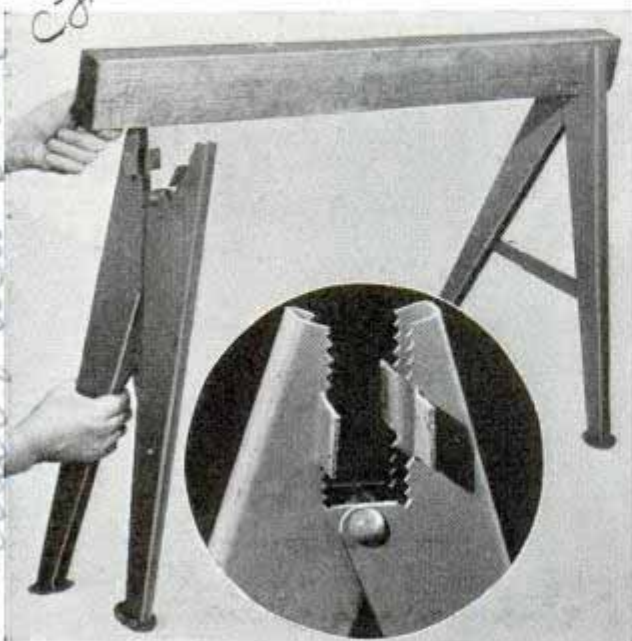

Folding sawhorse leg holds by teeth shown in circle

Sawhorses are easy to set up or knock down when assembled with folding metal legs that can be attached quickly. Teeth at the top bite into any two-inch board regardless of its width, when the feet are spread and the hinged connecting piece is pressed down between them. No nailing is necessary, although holes are provided if permanent horses are desired. They require little space in the car or truck when carried for outdoor use as at picnics to support tables or temporary booths.

Disappearance of Red Salmon Puzzles Canning Industry

The strange disappearance once every five years of red salmon in Bristol bay waters off Alaska is one of nature's mys-

Wagner Mfg. Co. Cedar Falls, Ia.

J 1294 Warner-Alenro Co.

Gurnon & Co.

J 1363

teries. These cycles occur in years ending in zero and five, so experts of the canning industry and of the U. S. department of the interior expect a small run of red salmon in 1940. The average annual catch for the twenty-year period from 1920 to 1939 has been about 15,600,000 fish. Compared with this, the 1920 catch was 8,897,915, declining steadily every fifth year until 1935 when only 3,154,150 were taken. However, the decline for 1940 may not be quite as much as it has been for preceding years in the bi-decade list. This is because drastic restrictions were imposed on the catching of red salmon in Bristol bay during 1935, resulting in the escape of a larger percentage of fish into the spawning grounds. Salmon return to the spawning grounds at an approximate age of five years, although thus far no definite relation has been noted between the numbers in which they return and the number of fish that spawned five years previously, except in this one mystery cycle.

Portable Airplane "Cockpit" Teaches Use of Aerial Gun

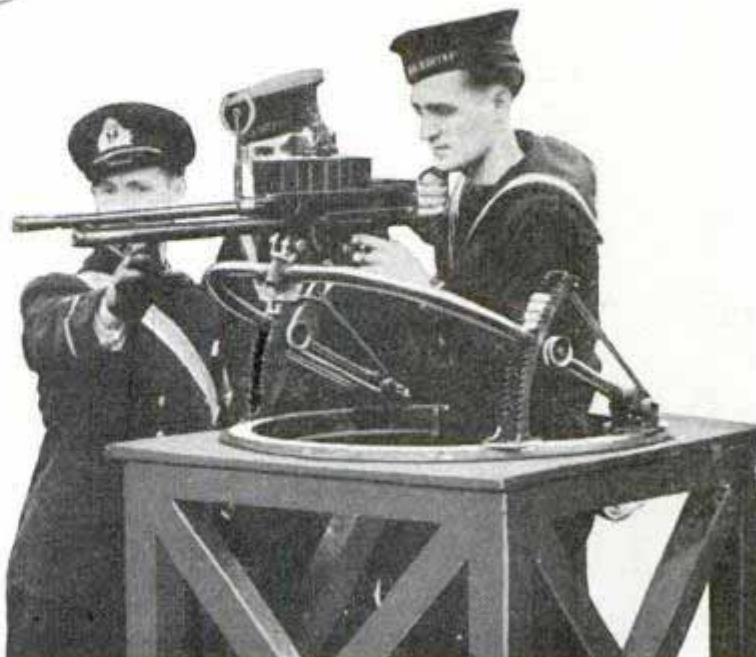

Aerial gun mounted in portable "cockpit" helps train recruits in rudiments of handling rifle prior to practice in a plane

To help instruct classes in aerial gunnery, the British navy's air force has constructed a portable "cockpit" with a gun mounted on it as in an airplane. The recruit thus can learn how to handle the gun before he steps into a ship.

One Man Lifts Three Tons with Lever and Chain "Jack"



More than three tons can be lifted by one man with aid of lever and chain "jack" that has many uses

With his strength multiplied many times through a jacklike lever and chain, one man can lift, lower or move exceedingly heavy objects, stretch cable and fence wire, bind loads, and do many other jobs without undue exertion. So designed that it will pull in any direction from any position, the tool is made in four sizes with lifting capacities up to three and three-tenths tons. No power is lost through interior friction because pressure on the lever is transmitted directly to the chain. Two pawls, functioning alternately upon the chain, cannot be released until lever tension is applied, thus keeping the load under the operator's control at all times. In lifting or pulling, the lever is pushed forward until a vertical link of the chain is engaged. Then the lever is pulled backward until the limit of the stroke is reached and the pawl is locked, after which the lever is disengaged by a slight sidewise thrust and the operation is repeated.

Paramount Equipment Corp
11 E. 42nd St. New York, N.Y.

g 12 2 8
Thomas G. Thomson Jr
18618 Malibu Road
Pacific Palisades Calif

Developed by U.S. Navy
La Jolla Calif
Scripps Institution



OCEAN CURRENTS

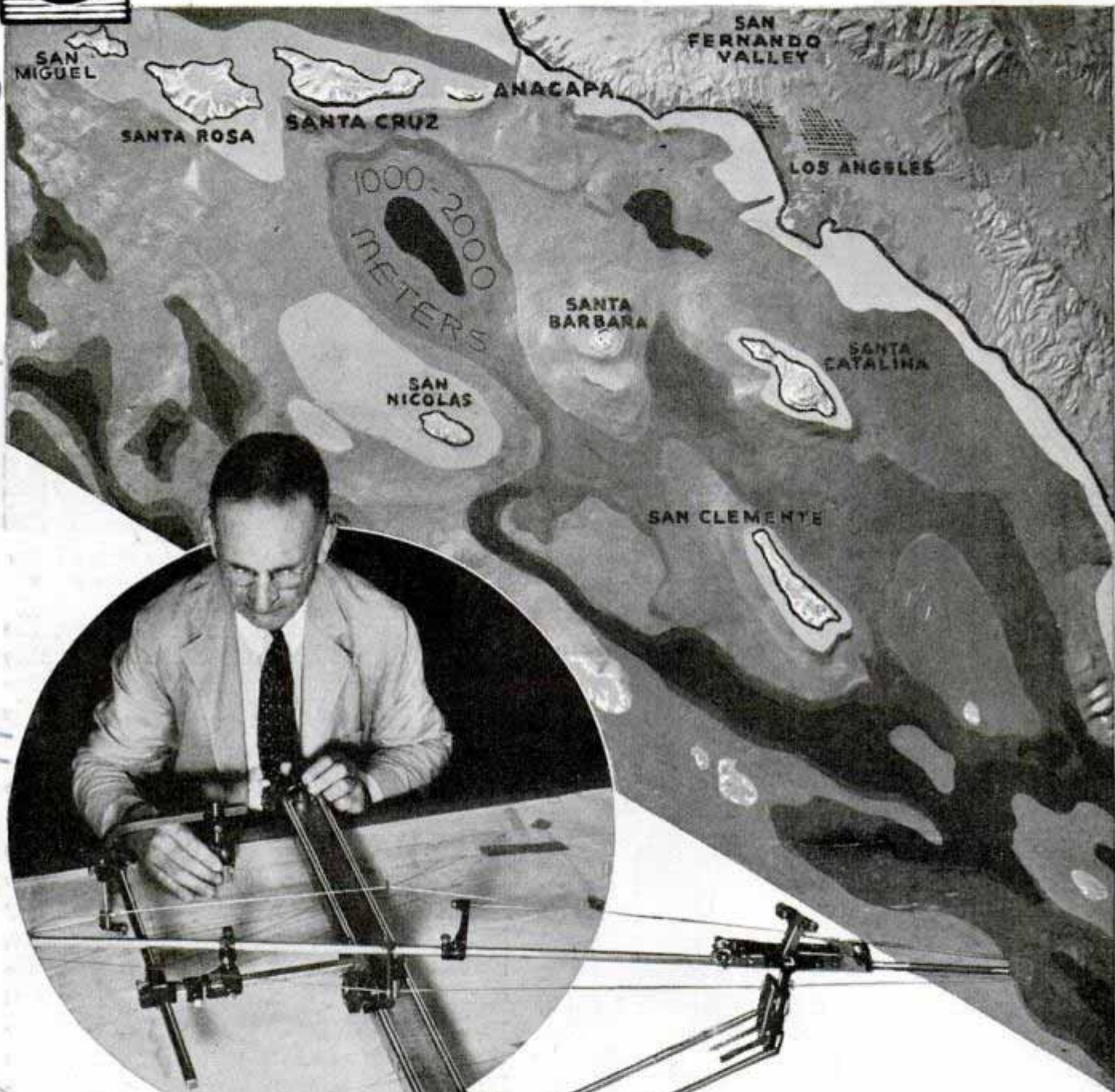

Map of ocean floor off southern California, showing islands, banks and depths. Normally the main current flows down the coast, but the islands break it up. Below, "thinking" machine that automatically works out trigonometry problems

SCIENTISTS hope to forecast general weather conditions a season in advance. In fact they are doing so now in southern California, using methods that seem absurd until they are explained.

One investigator, after an inspection of beach sand, is apt to announce: "There is less sand than usual on the beach, so there won't be much rain next winter." Another, studying a thermometer he has raised

from the ocean, may declare: "You are right. The water is a little colder than usual." A third scientist, who has been measuring the height of sea level agrees and a fourth, comparing reports of strong winds radioed in from ships at sea, likewise declares that rainfall during the coming winter will be less than average.

21288

Forecast the WEATHER

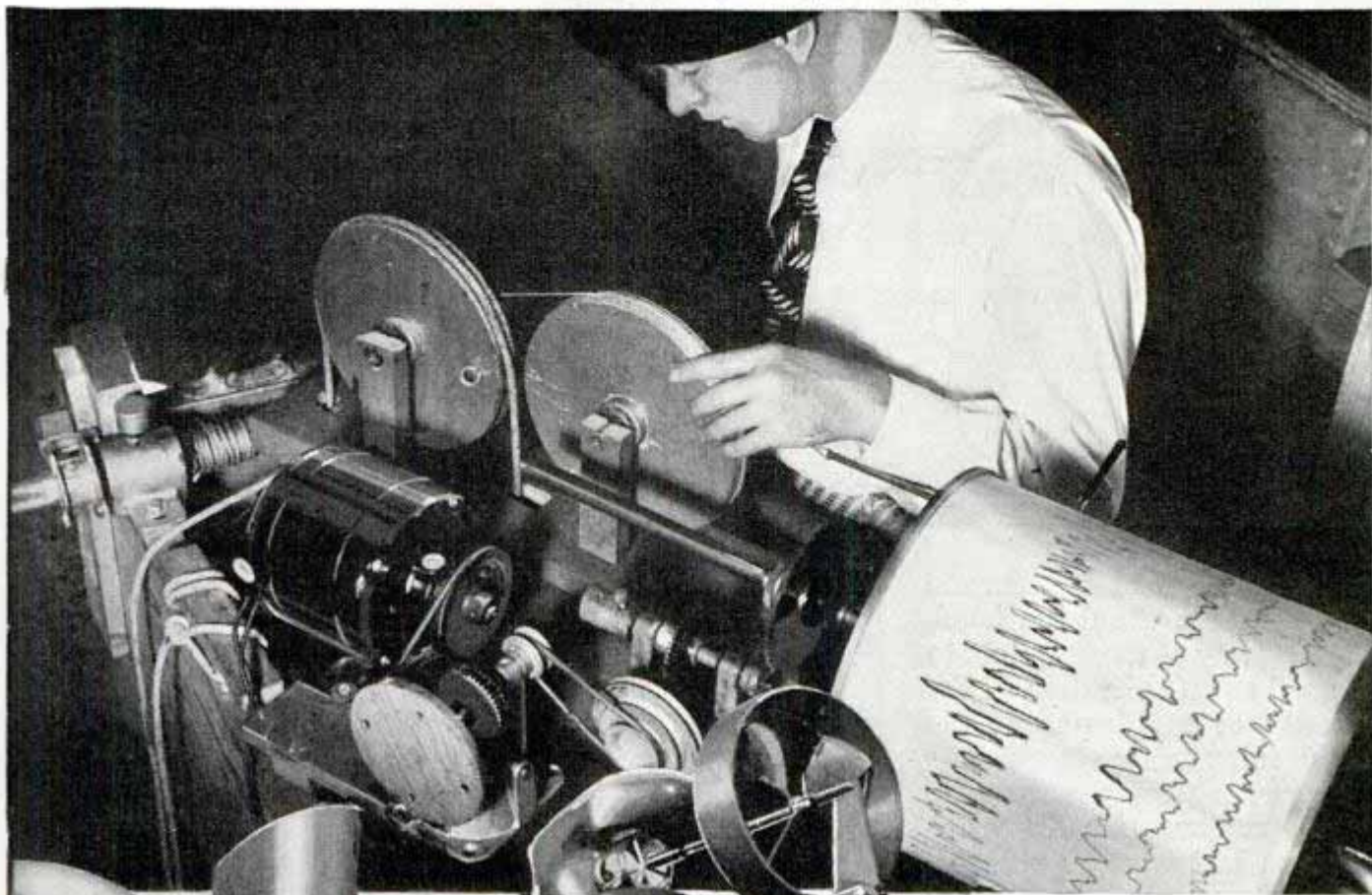

Top, wave meter that automatically draws exaggerated profile of wave shapes to indicate their heights. Center, current meter that measures speed of subsurface currents. Bottom, measuring amounts of gas found in samples of sea water

If you don't believe that the amount of sand on a beach influences the coming weather you are right because it doesn't. The amount of sand, the ocean temperature and the height of the sea are all affected by the force and direction of the summer winds off the west coast of the continent, and this wind also has a direct bearing on the weather. Scientists at the Scripps Institution of Oceanography at La Jolla, Calif., have observed that weak winds several hundred miles off the coast during the spring and summer are usually followed by excessive rainfall the following winter. The weak winds likewise are associated with high water

Dr. H. U. Sverdrup
Director

2628

Scripps Laboratory
La Jolla, Calif

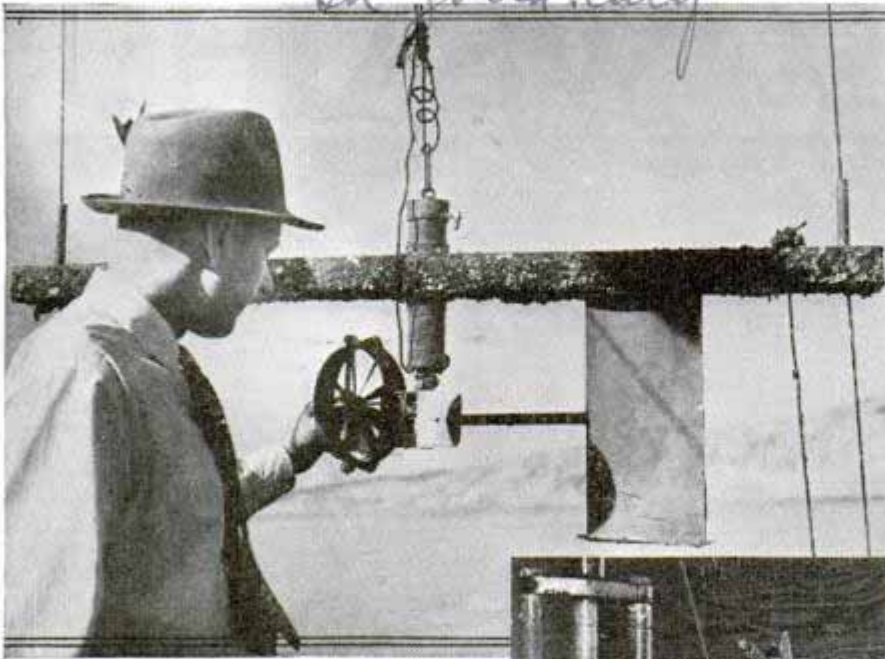

influence has a delayed action. The sun influences the winds, the winds influence ocean currents and these in turn affect the general weather.

"The characteristics of the ocean currents are known in a general way," says Dr. H. U. Sverdrup, director of the Scripps Institution, "but we know practically nothing about their internal structure. Just like a prevailing wind that really consists of gusts, calm periods, flurries and breezes that blow steadily at times, an ocean current is an average of many small varying water movements, each body of which may have its own individual temperature, salinity, density and direction.

"Each different component of a main current may be formed or dissipated by many confusing

(Continued to page 116A)

temperatures, sand deposits and a higher than usual sea level, allowing any of these factors to be used as an indication of the severity or mildness of the forthcoming rainy season.

From such observations the oceanographers issued predictions on last winter's weather that at La Jolla was accurate to within half an inch of the actual precipitation for the season, although the scientists don't expect to be that accurate every year.

Unfortunately for weather forecasters elsewhere, southern California lies in a critical meteorological belt in which a definite cause and effect relationship has been found between summer winds and winter rainfall, an association that doesn't seem to exist elsewhere.

Nevertheless the oceanographers think that the key to coastal climates in most parts of the world can be found in the oceans and that eventually they will be able to anticipate climatic changes. The sun, of course, is the real mainspring of the weather although some of its

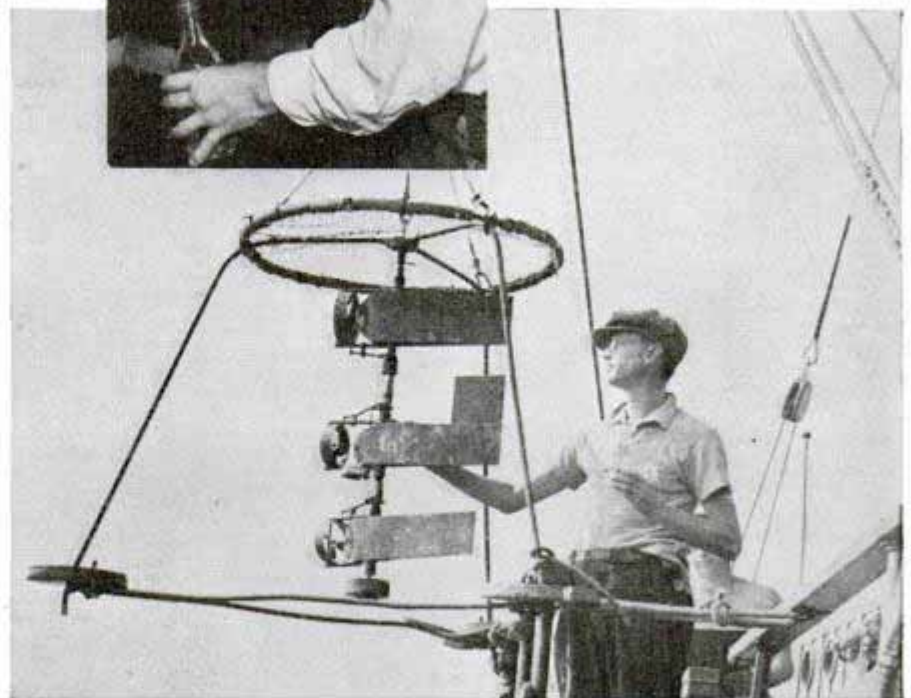

Cleaning blades of current meter that measures force and direction of ocean flow past pier (top); taking water sample from tube that brings sample from any depth desired to the surface (center), and lowering group of current meters to bottom from laboratory ship

Cable Laid by Tractors in Double Quick Time

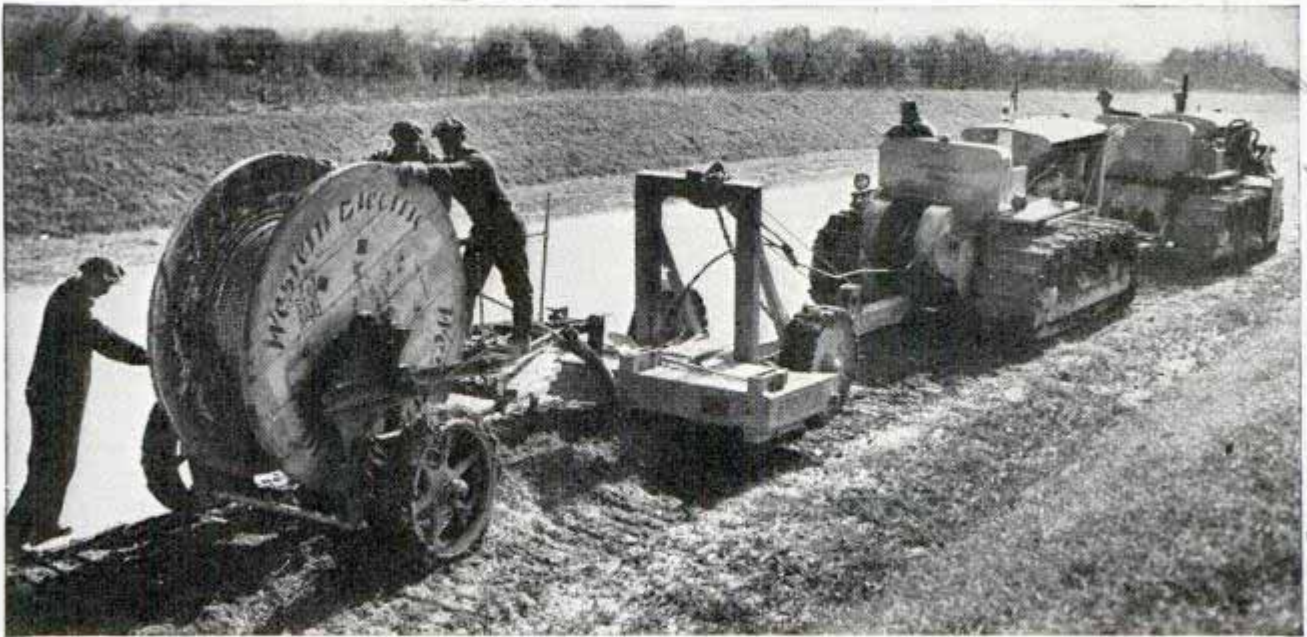

Two tractors in tandem arrangement helped lay cable in double quick time by pulling a roofer converted into a cable-laying machine. Cable was fed into opened ground from huge reel

Four miles of underground cable recently were laid in double quick time by converting a standard roofer into a cable-laying machine. Two ninety-seven horse-

power tractors pulled the implements at a speed faster than a man can walk, the ground being opened to a depth of three feet and the cable laid by a feeding device.

Camera Case Serves as a Rest While Making Movies

Redesigned so that it can serve a double purpose, the carrying case of one movie camera becomes a camera rest while making movies. The camera is screwed to a tongue permanently attached to the case, which rests on the chest for steadiness during picture-taking.



Screwed to tongue attached to its carrying case, camera is steadied in position for taking movies

Waste Product of Papermaking Yields Profit for Industry

After cellulose is taken out of wood in making paper, there remains a waste product, sulphite liquor, which was once poured into streams. It made them ugly and uninviting, killing fish and plant life. Now sulphite liquor is being mined for its lignin, a substance used in producing certain plastics that find many applications in the building industry and serve also as impregnating resins. In addition to lignin, other useful products come from the waste of papermaking, including sweet-smelling vanillin, the basic constituent of vanilla extract and a tanning extract that makes cement harden more quickly.

Marathon Paper Mills
Cochisechild, Wis

Used by George and Lynch
Williamson, Ill

Deane Deme 12/8/39

L. Tourneau

1306

Along Alaska Road near Uelmington

Second 14/16 mm camera

1429

Dell and Howell
1801 Lachmont Ave

2141

Caterpillar Incitor

Georgia, Ill

21128
Cont. Beebe, O. Webb,
Apr. 3, 4 3 22 Second Road
Arlington Va

TORTURE CHAMBERS

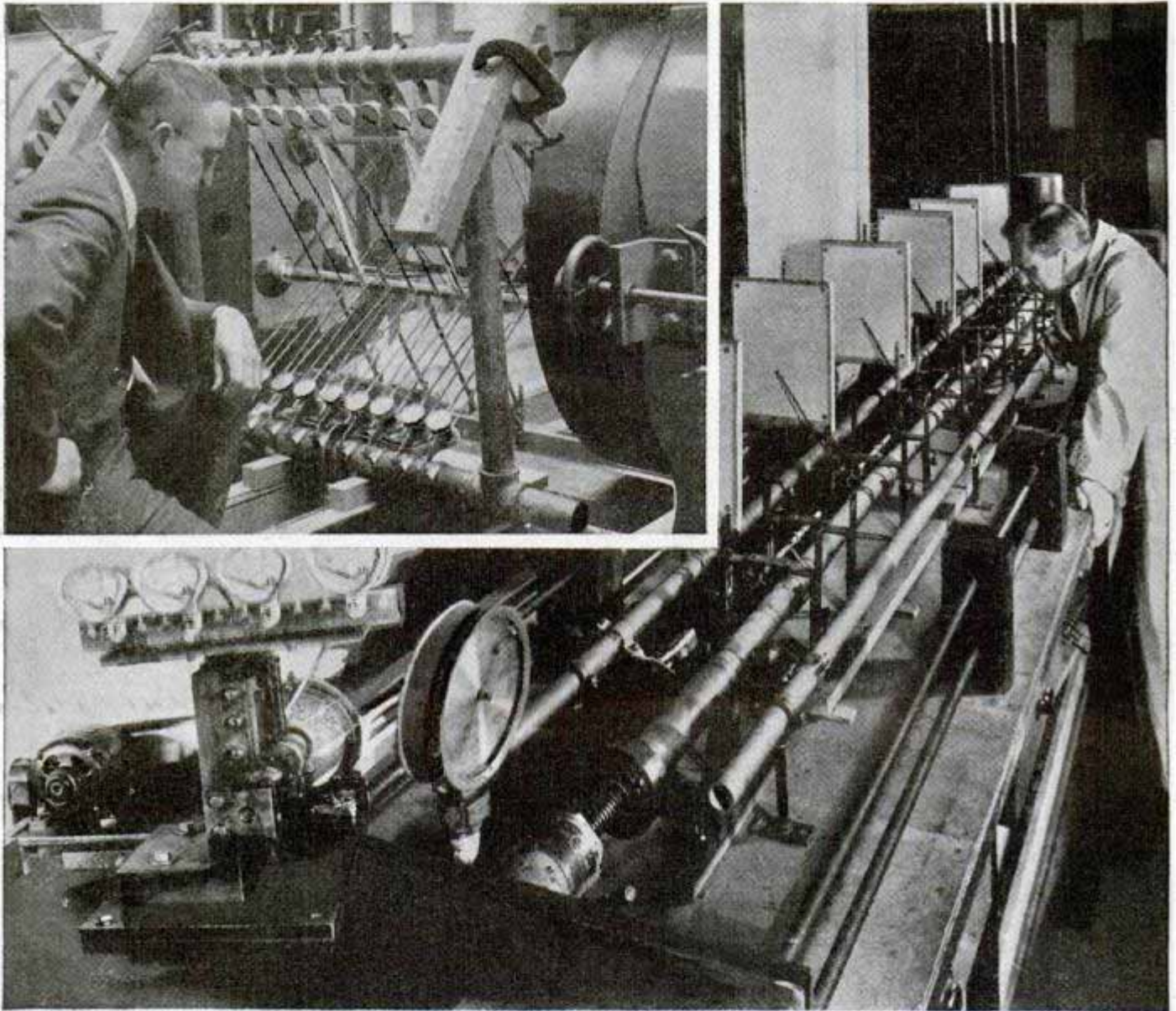

Micrometer dials (top) are arranged to study deflection and twist of a short duralumin girder for dirigible under compression test. Below, at left, bicycle speedometers vibrating 1,700 times per minute in shakedown test; right, recording effect of compression on cable sheath

THE things you buy today stay whole because they've been broken, last indefinitely because they've been worn out. Modern industry saves you trouble by deliberately making trouble.

In the Bell Telephone Laboratories of New York is a room full of machines whose purpose you would never guess. One of them performs the "Wrong Number" or "Bill Collector" test, picking up hand sets and slamming them down onto the cradle, just as you and I do when we become angry at the phone. A hundred times a minute it does this, day after day, until a set

breaks somewhere. The part that breaks is redesigned to make it stronger. Then the whole procedure starts over again. Pick 'em up! Slam 'em down! until the next part breaks. This goes on indefinitely, until today it is almost impossible for an irate customer to break his telephone without deliberately resorting to the ax.

There is a machine with reciprocating fingers that dial numbers day in and day out, until somewhere the mechanism breaks down. There is a device that slams switchboard plugs against a shelf of steel. There is one that slides a phone endlessly

Bureau of Standards

John ... *21128*

of INDUSTRY

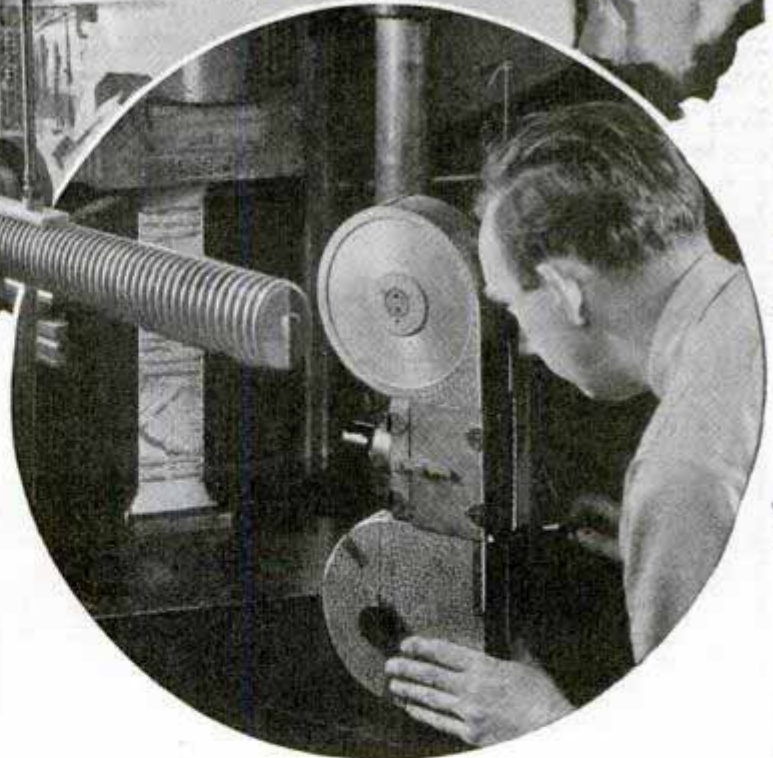
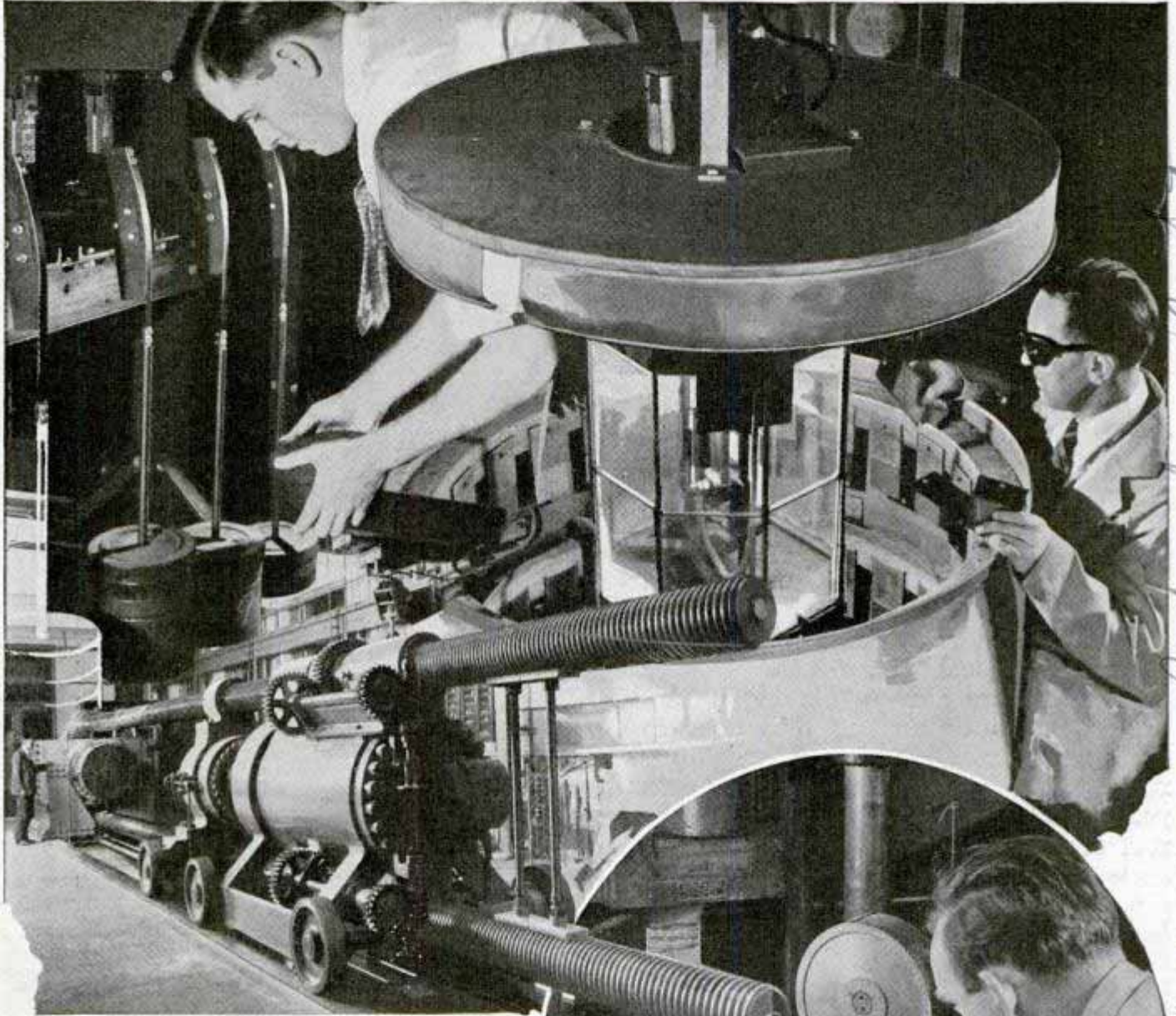

ref

across a hardwood desk top, to test the wearing qualities of the non-skid material, and its effect on the finish of a desk. Still another slams 200 pounds of metal onto the seat of a telephone booth, until the screws are loosened which attach it to the wall, or until something else gives way. And always, with all of these tests, the weakest part is made stronger.

Samples of wood used for poles are treated with various preservatives, then placed in glass jars where they are exposed to termites, fungus, various types of rot. Insulators and other outdoor fit-

and ...

At upper left, Westinghouse engineer stretches copper bars by loading on weights; below, hydraulic machine at Bureau of Standards puts 2,300,000 pounds compression on girder. Upper right, fadometer tests durability of auto enamel in "sunshine" of carbon arc. Bottom, movie camera records slip lines formed by movement of crystals of atoms as steel strip is stretched

2628

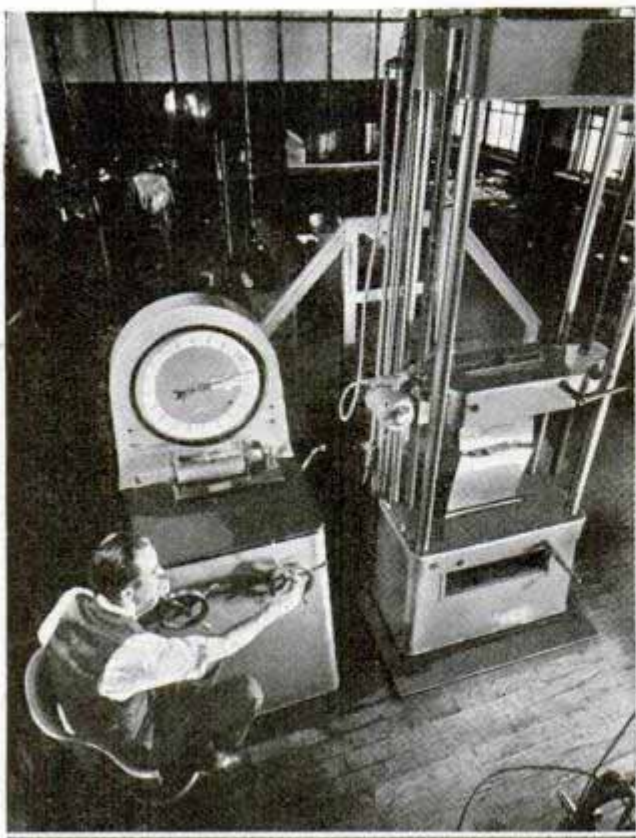

temperatures all the way from forty below zero to 115 above. Engineers figured that each fan had revolved more than 7,500,000,000 times; the only breakdown in nine years was a momentary halt when a cable feeding electricity to one of the fans failed.

One manufacturer puts bicycle speedometers on a torture machine that tries to shake them to pieces, vibrating 1,700 times per minute. Before any experimental combination of metals is tried out in an airplane it is tried out in a laboratory, where it must stand up under far greater abuse than it can ever encounter in the sky. For example, aluminum alloy sheets destined for an aircraft factory are bent and twisted and overloaded until they buckle, while aeronautical engineers jot down the buckling point shown on dials.

Probably the world's worst weather is in Newark, N. J., and that is no discredit to the eastern seaboard for it's man-made weather, mixed in suitable strengths to test electrical apparatus in a Westinghouse plant. Meters, for example, must operate as precisely at sixty below zero as in tropical climates, and they must keep "ticking" for months in a driving salt mist four times as corrosive as ordinary ocean spray.

There is a special agony in store for the steel blades that are to be pummeled throughout their useful life by steam pressure in turbines. The torture machine pounds the blades incessantly, 600 blows

things stand up under artificial sleet storms and super-tropical heat.

Engineers are always thinking up ingenious ways of making things go to smash; sometimes, of course, things simply refuse to break down. For more than nine years, three fans have been running on the roof of a General Electric company laboratory, exposed to rain and snow and

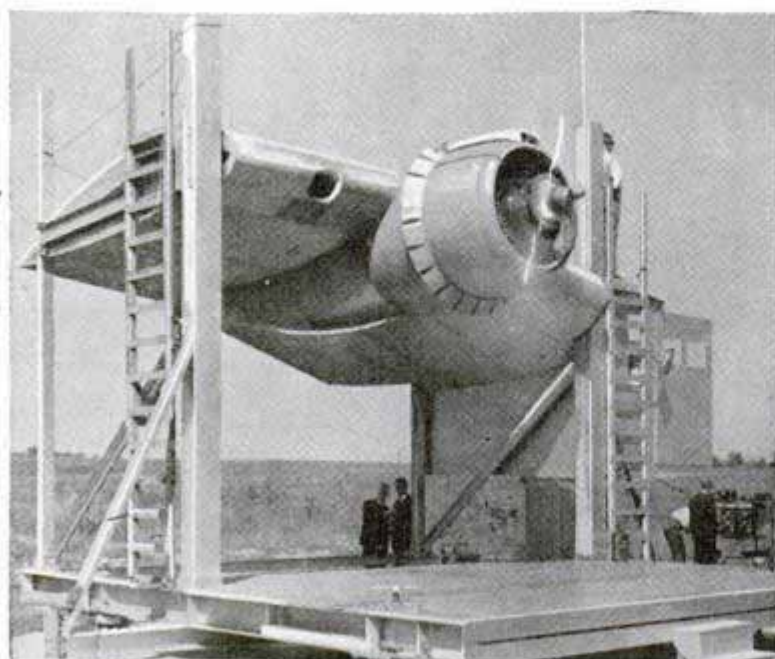

Breaking strength of belts is determined on machine at top, which has 50,000-pound capacity and also records tensile stress and stretch of belt. Below, left, airplane engine on test rack; right, breaking crockery with impact apparatus in the search for more durable tableware

Baldwin Southworth of Edgemoor
940 Sanson St.

Bureau of Standards

21128

per minute for 277 hours; if there are any weaklings in the lot, those blades will fall apart. But properly designed turbine blades of tough steel will survive 10,000,000 beatings with more than a ton of force behind each blow. Another test for turbine steel is the ordeal of the electric furnace. Sample rods of various steel alloys have been kept as long as ten years in furnaces at 1,200-degree temperatures and measured for "creep" as minute as one-millionth of an inch per inch of length. These rods are subjected to a lever pull as high as 60,000 pounds per square inch and finally deliberately broken to discover the ultimate strength of the various alloys.

In a tractor factory, a half-inch sample bar of steel is pulled apart by a 100-ton hydraulic machine as you pull taffy, for some tractor parts must withstand a pull of 300,000 pounds per square inch.

(Continued to page 120A)

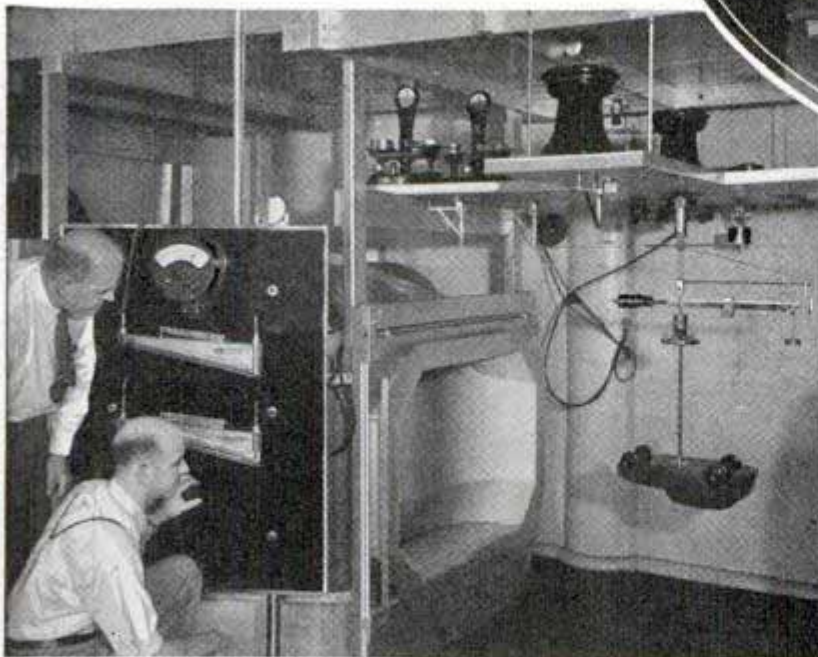
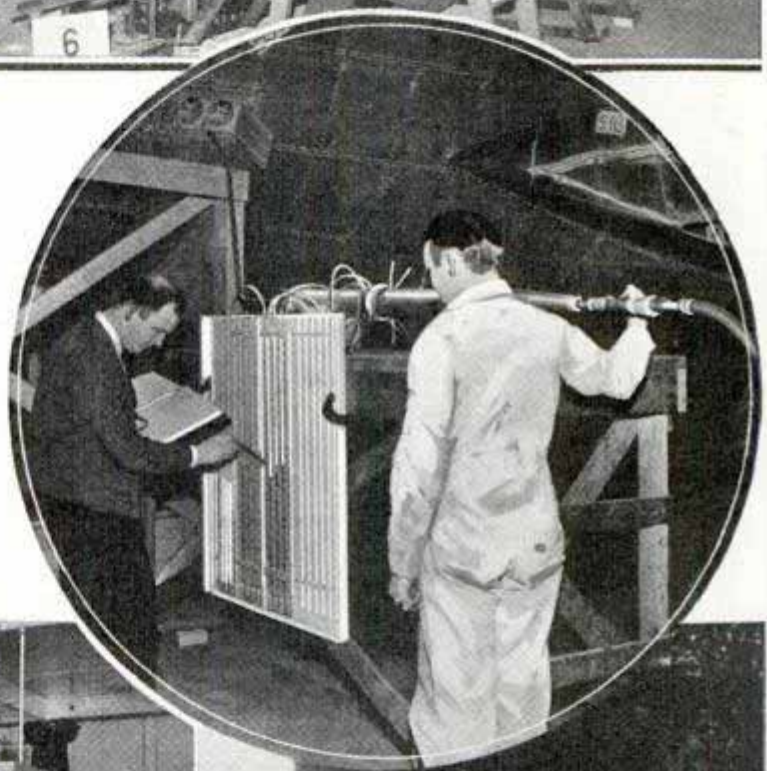
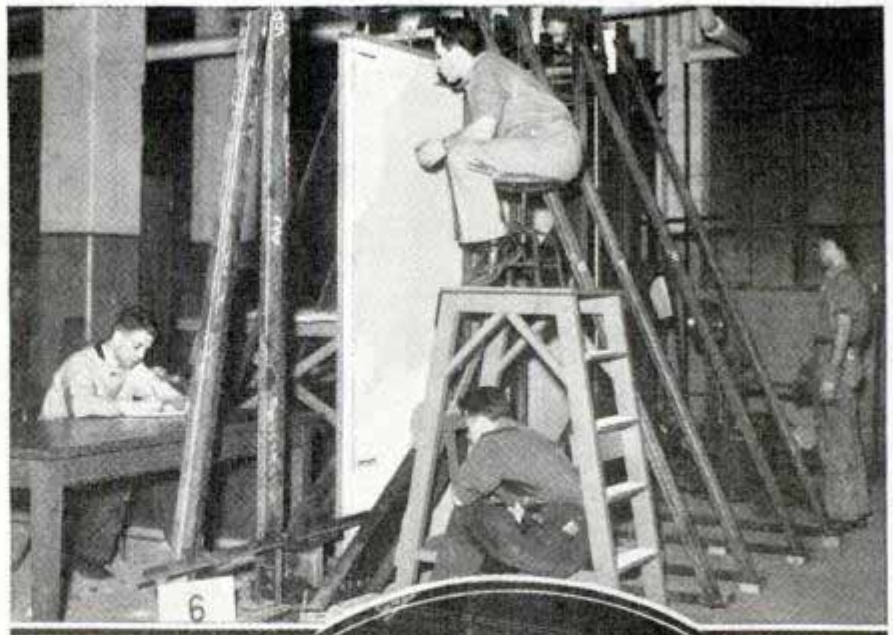

Structural properties of walls developed for low-cost housing are determined by subjecting them to racking loads at Bureau of Standards (top). In circle, compressed air is forced into sealed cabin of Boeing "Stratoliner" for high-altitude test in factory. Bottom, left, models for future automobile designs are tested in wind tunnel at Chrysler engineering laboratory; right, a stock car on one of those back-breaking runs that show up any weak spot in the automobile

"G-Men's" Giant Enlarger Weighs over a Ton

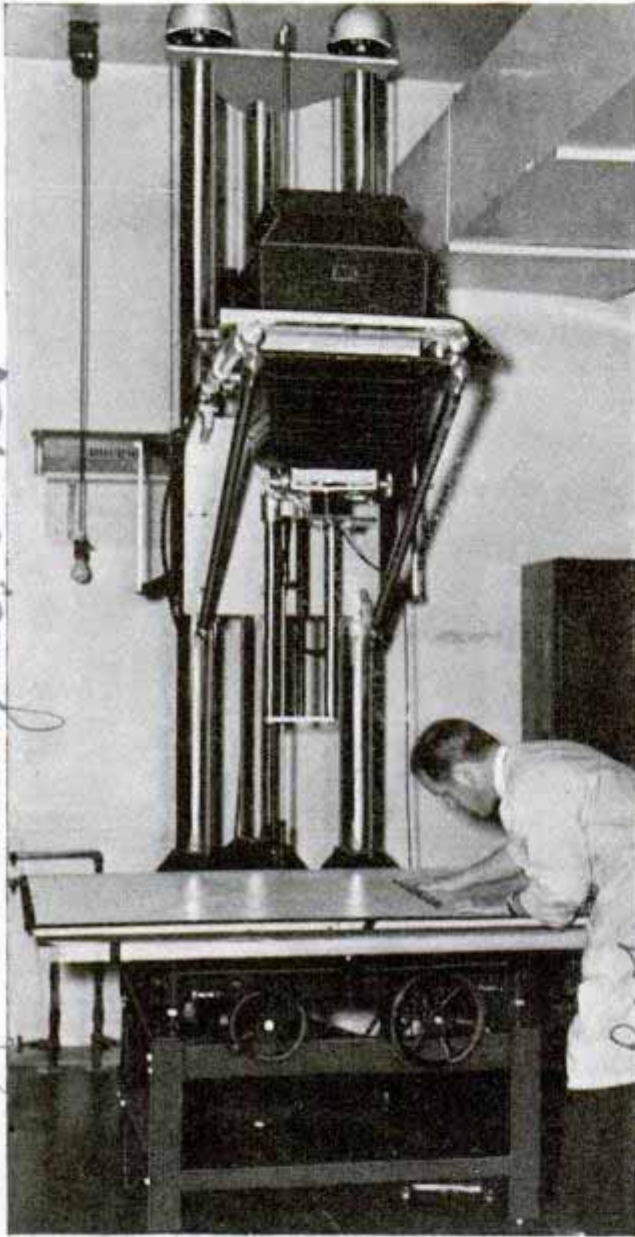

Huge enlarger in photographic laboratory of Bureau of Investigation in Department of Justice

Specially built for the sort of precision work a crime laboratory demands, the giant photographic enlarger in the "G-men's" headquarters at Washington can work with negatives ranging in size from thirty-five-millimeter miniatures to eleven-by-fourteen inch films. One of the largest vertical enlargers ever built, it weighs more than a ton, yet is so delicately balanced that the camera can be adjusted by a slight finger pressure. The Bureau of Investigation of the Department of Justice required a highly specialized instrument for crime detection work and preparation of evidence. Lenses of various focal lengths

can be installed to obtain any magnification desired. Two square mercury-vapor tubes, one fitted inside the other, provide fast and even light, cool enough to obviate any danger of warping the negatives. The outer tubes have twelve-inch sides. The enlarger is thirteen feet six inches overall in height, and its camera is mounted on a frame supported by four-inch steel tubes.

Spring "Claws" in Tire Tread Grip Icy Road Surface

Spiral spring "claws" that grip and dig into the surface of icy roads are molded into the treads of a new skid-resistant automobile tire. There is one endless, corrugated spring to each rider strip, running entirely around the tire. The principle is that as the rubber expands under the load, the spring points are thrust out of the tread to dig into the road surface. The tire is constructed so that there are scores of these claws gripping the road at all times. The tires with the built-in claws are said to give ice traction for about ten thousand miles, after which the owner may use the balance of the tread for ordinary driving. There is no objectionable noise when the tire is used on paved surfaces and the car may be driven at the usual speeds. Tests indicate that the tire may solve one of the major problems of winter driving, since it enables the driver to maneuver, in apparent safety, over ice-covered roads.



Corrugated spiral wire in foreground is imbedded in tread of tire to grip ice when car tends to skid

2100
Federal Bureau of Investigation, U. S. Dept. of Justice, Washington, D. C.

21311
cooper
Keefer
Baker
Campbell
N.Y.

15 inch 13 1/2 x 13 1/2

Designed by J. L. Saltzman Co.

Antagon Rubber
D. E. Crocker
Antagon Rubber



The

CRAFTSMAN



CORNER CABINETS

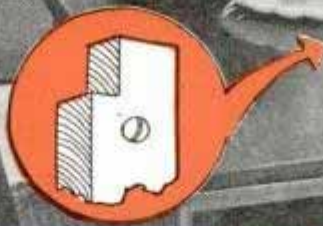

WHILE separate, removable cabinets are generally desirable for those who rent houses and apartments, permanent built-in cabinets are easier and cheaper to build by the home owner. The two adjacent walls in a corner provide sides for the cabinet and many of the frame pieces and shelf cleats can be attached directly to the wall. Either screws or nails can be used for attachment but they should be located so that they can be driven through the plaster and into the studs underneath. Although screws can be driven into lath under plaster where much holding strength is not required, the driving of nails at right angles through plaster and into the lath, frequently causes damage to the wall. Before

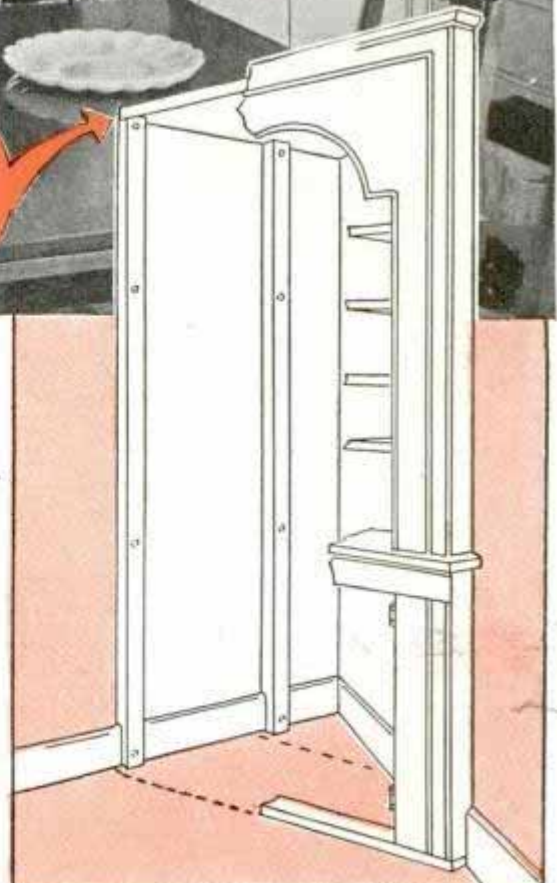

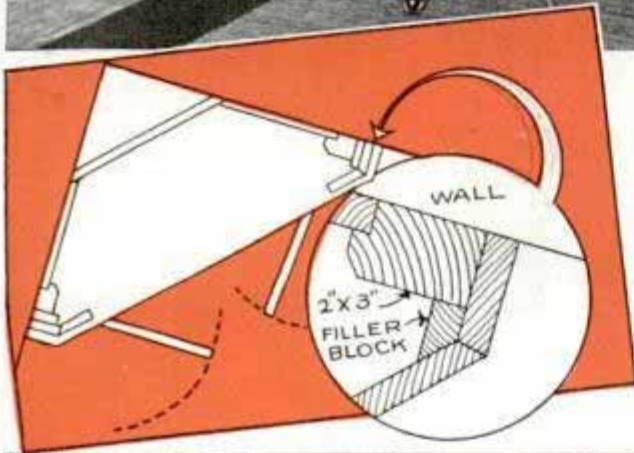

driving a screw through plaster, drill a hole to take the screw, which will prevent the plaster from chipping off. It's easy to locate studs, which are usually spaced 16 in. on centers, by lightly tapping the wall with a hammer; a hollow sound indicates space underneath, but a "solid" sound with a slightly higher pitch means that you are tapping over a stud.

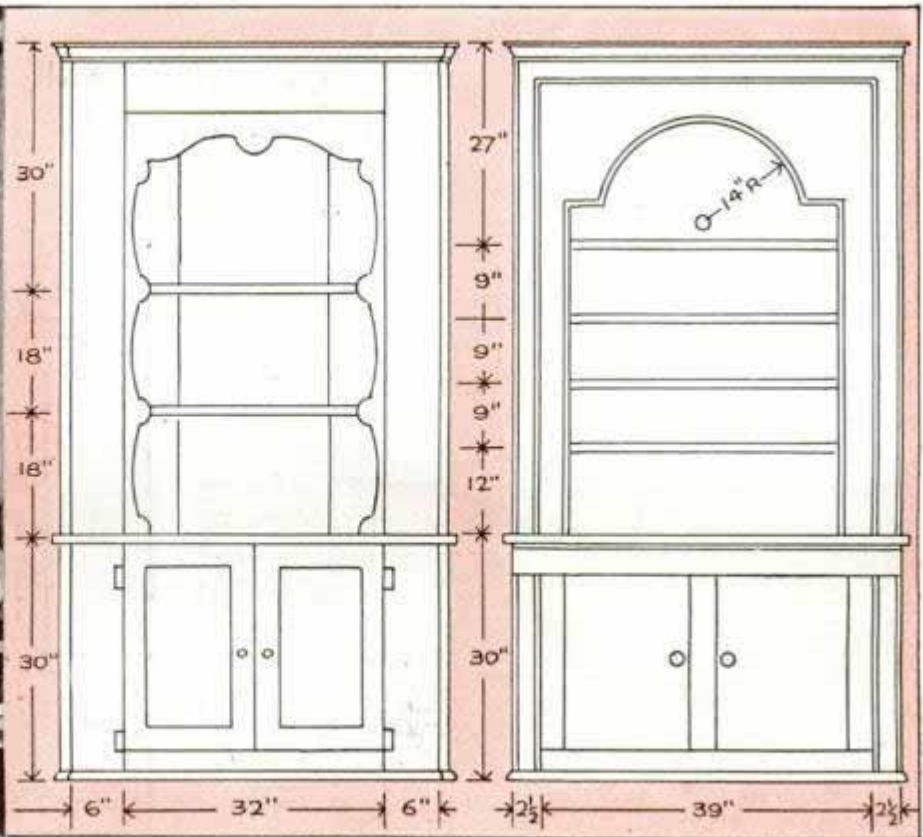
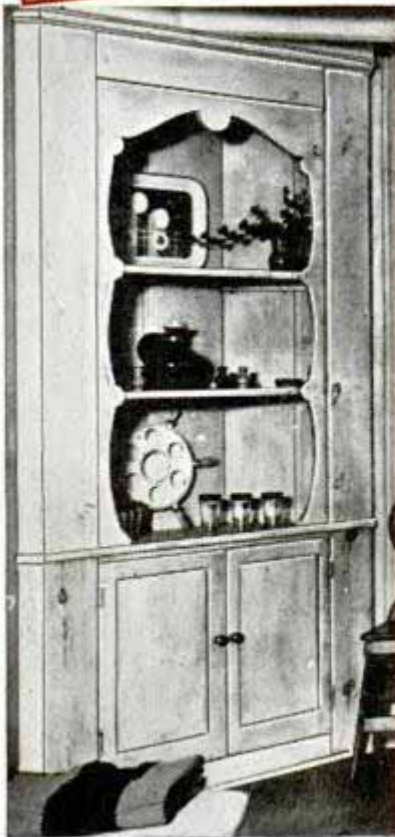

Turned LAMP BASE of "sandwiched" woods

For sheer beauty in contrasting woods, there is nothing like a turned lamp base made of selected blocks of cabinet woods glued up and turned to expose portions of the various woods in the finished work. When gluing up the blank to be turned, the joints must be made perfectly and the blocks of each kind of wood must be exactly the same size and in the same positions on all four sides. The center or core block of the blank has a hole through the center to take a lampcord. Use good glue and mix it according to directions. Keep the blank clamped together tightly until the glue dries thoroughly. For a finish, a lathe polish applied with a cloth is best, although a French polish or a rubbed-varnish finish will show up well on this type of work

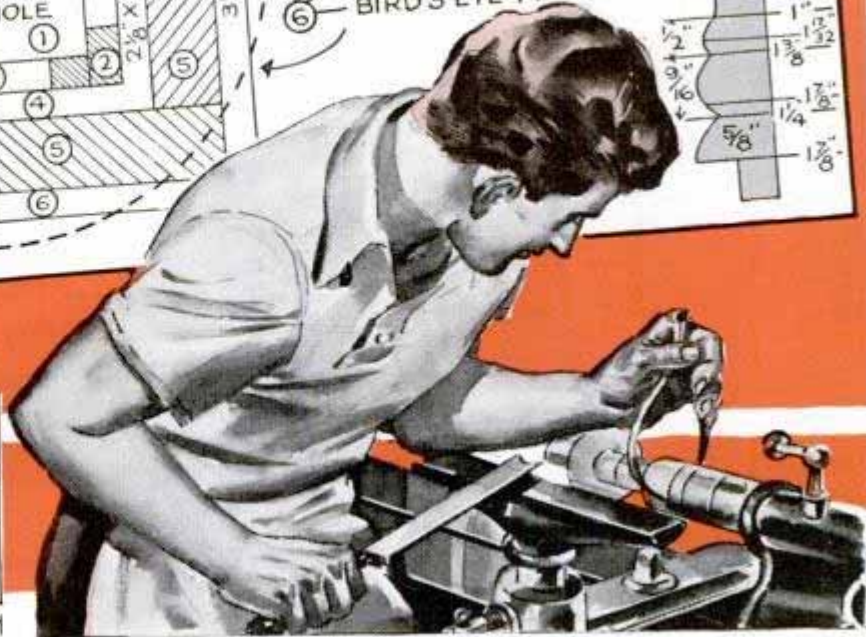
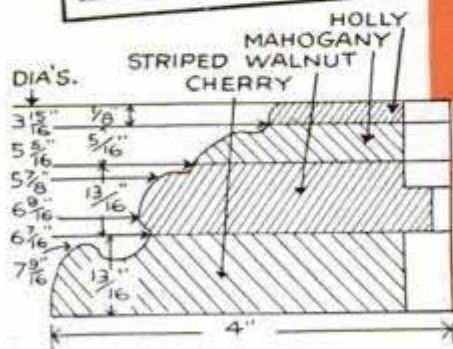
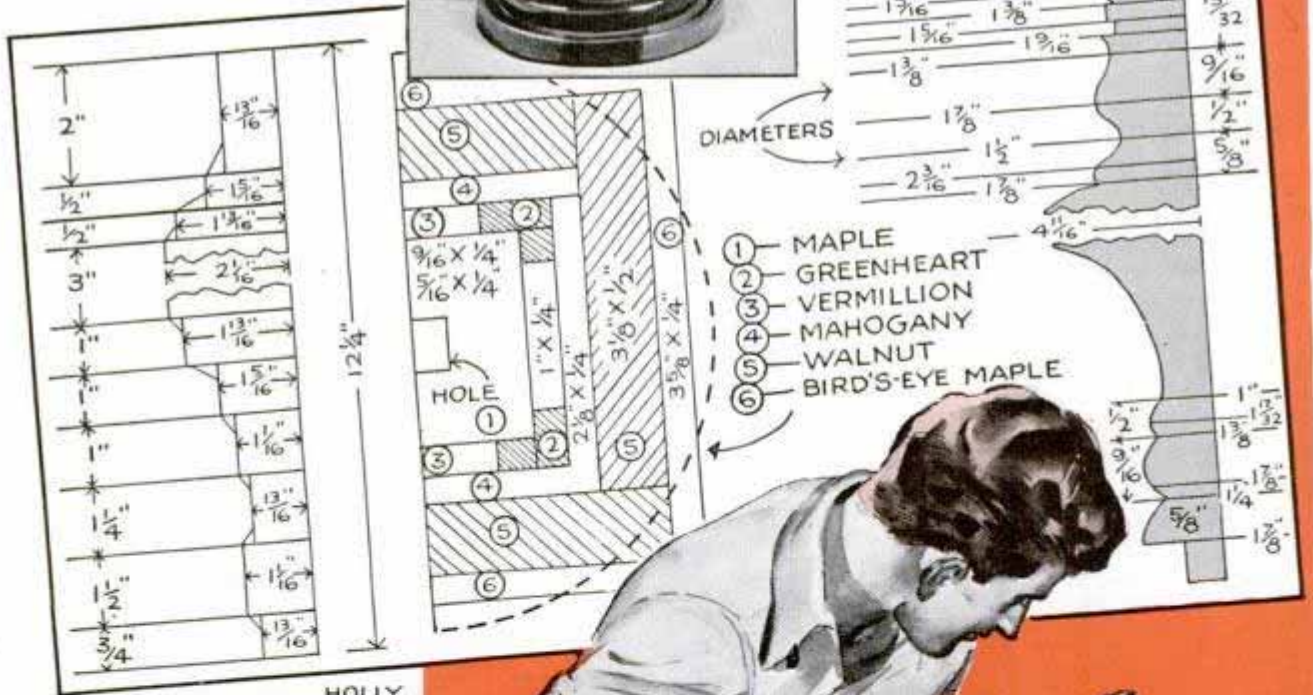
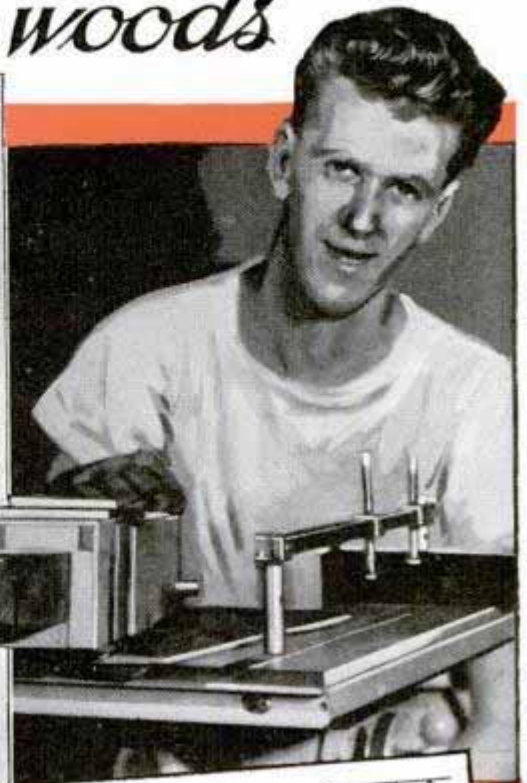
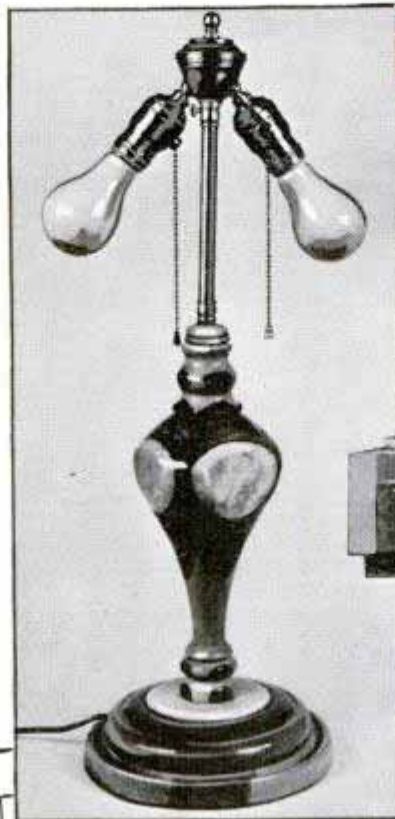

Solvent to Remove Photographs Applied with Oilcan



When removing a photograph that has been attached to a sheet of art work with rubber cement, use a clean oilcan to apply the solvent, such as benzine. With the can, you can apply the solvent to the cement without waste as the photograph is peeled off slowly.

Siding Boards Scraped on Bottom with Bent Putty Knife

When removing paint from a house with a blowtorch, bend a putty knife as indicated and you can scrape the bottom edge of

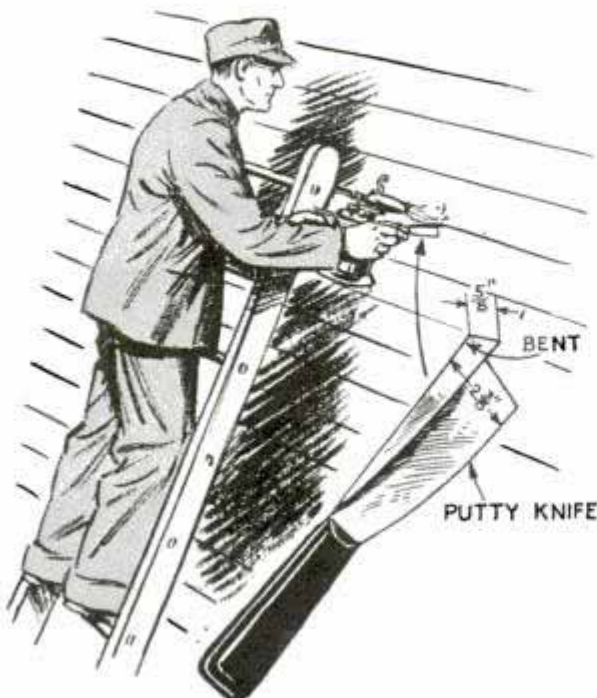

a siding board and part of the surface of the one under it in one operation. Be sure that the portion of the knife that is bent over is at the same angle as the lower edge of the siding so that the knife will scrape cleanly.—Frank Meyers, Toledo, Ohio.

Moth Balls in the Garbage Can Help to Keep Flies Away

One home owner hangs a wire strainer full of moth balls (about ½ lb.) in the lid of the garbage can to keep out flies and other insects. A wire was soldered across the lid of



the strainer to engage a hook soldered to the lid. However, instead of using a strainer, an ordinary mesh bag will serve.

Rubber Doorknob Protects Walls

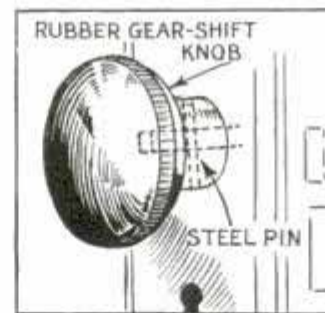

If a door opens so that the knob is likely to strike a wall, sink or refrigerator, damage to these can be avoided by substituting a rubber gear-shift knob for the regular

knob. It may be necessary to use a steel pin to keep the knob on the lock shaft.

—John M. Avery, Dexter, N. Y.

Improving the Typewriter Eraser

The difficulty of erasing single letters or characters with a roller-type eraser may be overcome by notching the rubber to provide a series of points. To prevent the wheel from turning when in use, a rubber band is slipped over the metal part of the eraser to engage the rubber teeth of the wheel.

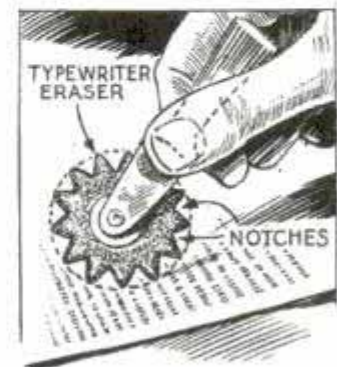

Homemade Andirons Improve the Fireplace

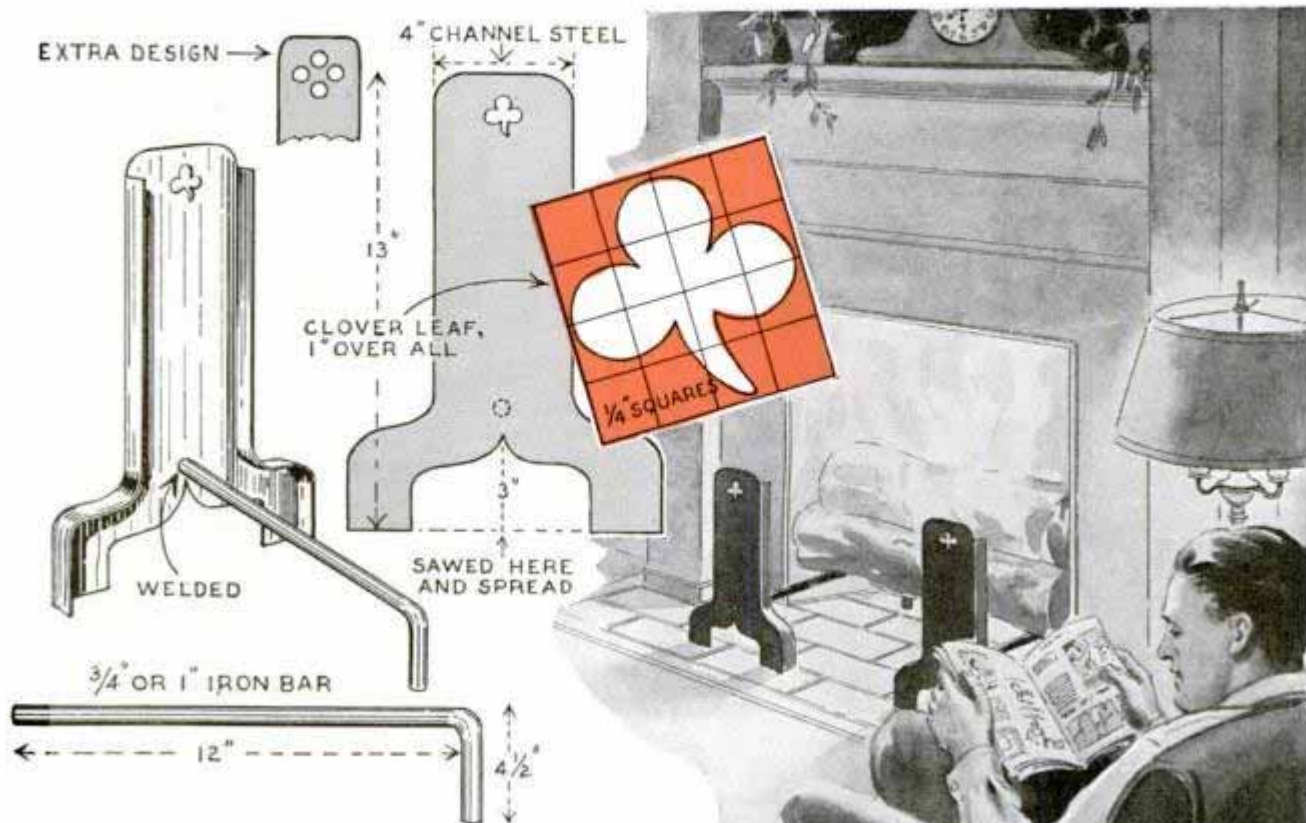

All you need to make these andirons for your cottage or home is two lengths of channel steel and two iron rods or bars. Each channel is split at one end and forged outward to form the feet. The cloverleaf decoration at the top is made with a drill and file.—E. J. Tangerman, Port Washington, New York.



Vegetable Bags Prevent Erosion of Newly Seeded Terraces

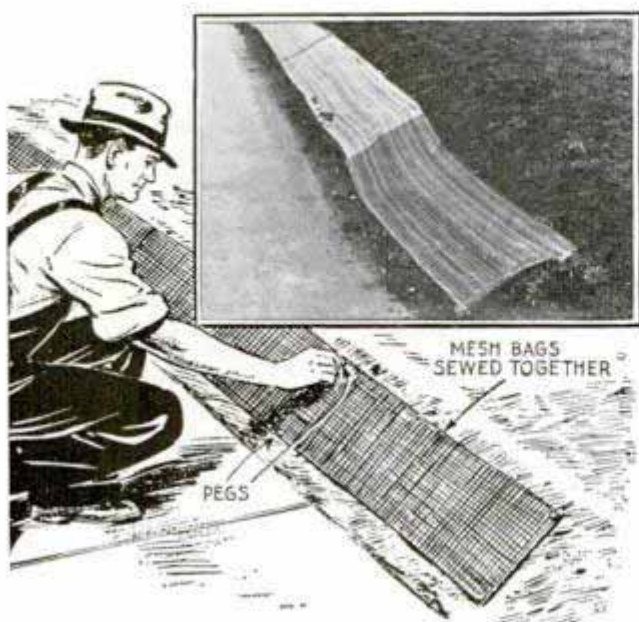

Vegetable mesh bags are better than cheesecloth to prevent erosion of newly seeded terraces because the larger mesh of the sacks permits plenty of air and sunlight to pass through the cloth and allows more space for the growing grass. Also, the bags can be left on the ground permanently as they will not be visible after the grass grows, and they will rot away in time. The bags are opened at the seams and sewed together so that only one layer of cloth covers the ground.

—Dale R. Van Horn, Lincoln, Nebr.

Many hard seeds such as cannas, sweet peas and morning-glories will germinate quicker if they are nicked slightly with a knife and soaked over night in warm water.

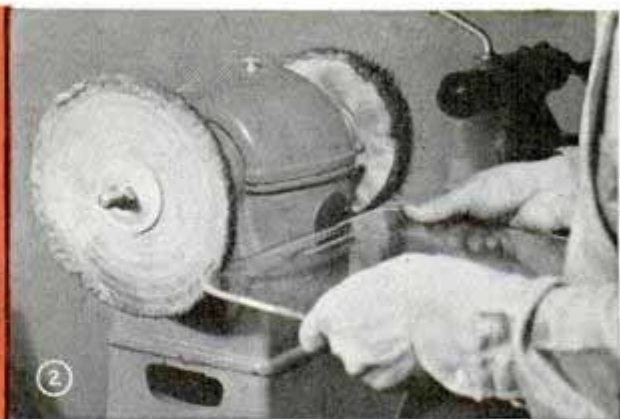

Polishing is done with silicon-carbide abrasive. For the last stage use red rouge (above), which is then washed off with muriatic acid (below)



GLASS in Furniture



Glass edges can be ground smooth on common shop equipment. Below, running in a border with a small silicon-carbide wheel mounted in the drill-press chuck

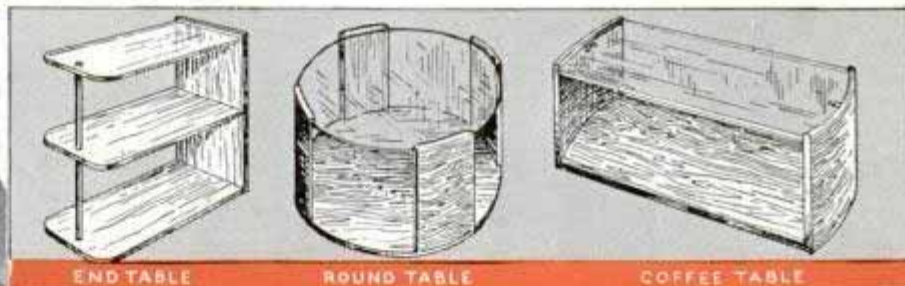

END TABLE

ROUND TABLE

COFFEE TABLE

THE utility and beauty of glass when combined with wood has set a new style in furniture construction—a style well within the scope of the average home workshop. Glass is not difficult to work. Contrary to the common viewpoint, it can be shaped and polished as easily as plastics or soft metal, and this with ordinary equipment and materials.

As cut with a glass cutter, glass presents a raw sharp edge. The polishing of this edge is necessary in using it in furniture construction. The abrasive used is silicon carbide, familiar to most craftsmen under one or more trade names—the black variety used for wet or dry sanding. Following the schedule given at the top of this page, glass edges can be brought to any degree of polish. The work can be done on the disk sander, Fig. 1, or on the belt sand-

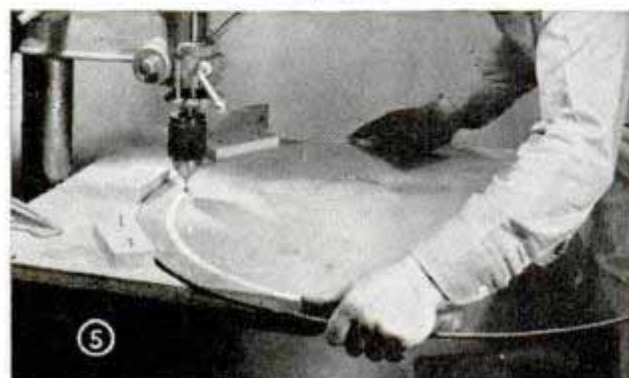

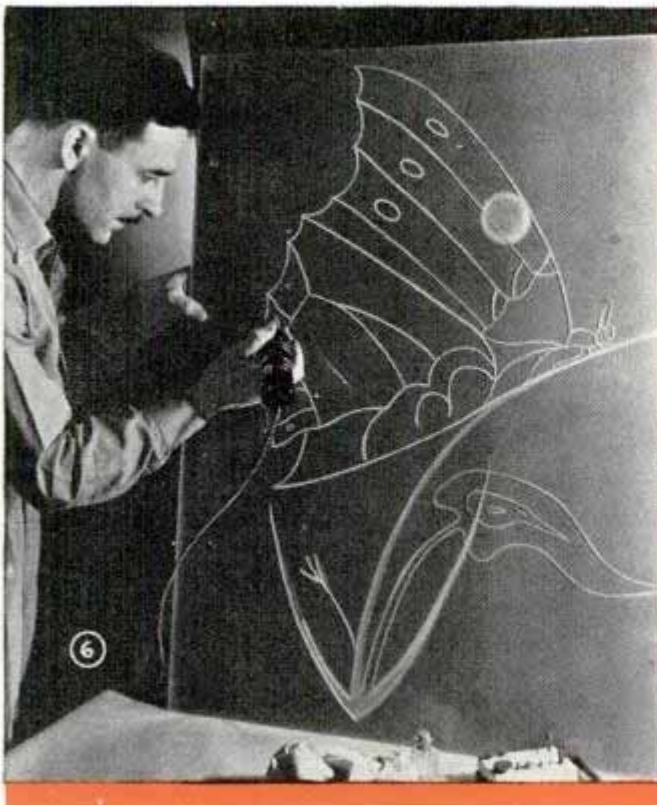

Construction

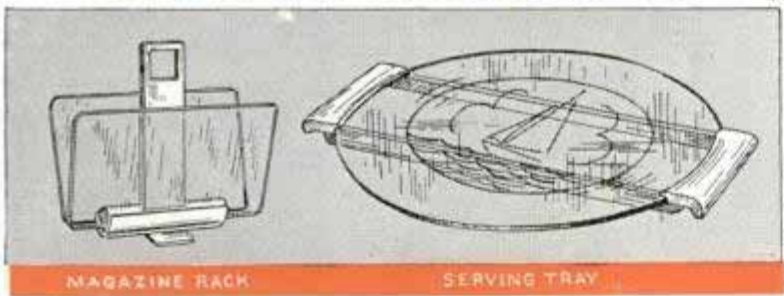

er, Fig. 4. The glass should be treated like a piece of tempered steel, grinding it dry but allowing the work to cool between bites. For a high polish, the final operation is done with red rouge mixed with water and applied to a felt or stitched canvas buffing wheel, as shown in Fig. 2. Any traces of rouge left on the glass can be removed with muriatic acid, Fig. 3, using rubber gloves to protect your hands. For average work, rouge is not required as a very good edge can be obtained with 220 to 320-grit abrasive.

Small silicon-carbide grinding wheels can be used to advantage in the treatment of edges and also in cutting designs on the glass. Fig. 5 shows a border being run on a disk, using a grinding wheel mounted in the drill press. These small wheels, available in a wide variety of shapes, are con-

venient to produce any design on the surface of the glass. Figs. 6, 7, and 8 show typical examples of such work. The tool used is a small hand grinder. The high speed of these grinders combined with the small size of the grinding wheels makes the cutting as simple as drawing with a pencil. The illustrations show the work in an upright position, but in actual practice the glass is placed over a penciled sketch of the design. The panel in Fig. 6 is sandblasted on the opposite side. The design itself also can be cut by sandblasting. In this method of working, a sheet of tough brown paper is fastened with rubber ce-

*Worcester, Mass
Chambers
Grinding wheels*

*Chicago Wheel Mfg Co
110 S. 111th
Minneapolis*

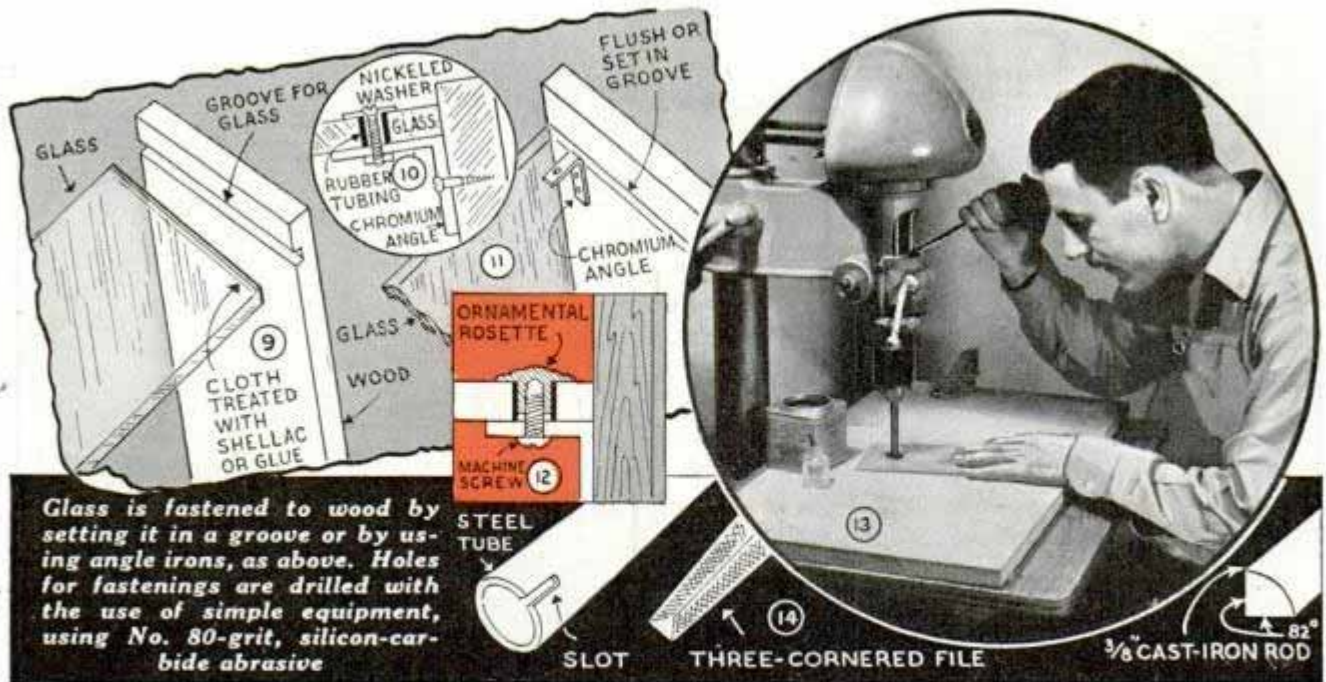

ment to the glass. Then the design is cut with a stencil knife, exposing the portions which are to be blasted. Sandblasting is done by any monument works at a nominal cost.

Two simple methods are commonly employed in fastening glass to wood. The simplest of these, as shown in Fig. 9, is a housed construction in which the glass edge is set in a groove. A strip of cloth glued to the glass provides good adhesion. With or without the groove, chromium angles provide a neat and positive method of assembly, as shown in Figs. 10, 11 and 12. Rubber tubing should be used over all screws. Plastic or metal rosettes, turned to shape and threaded, make a neat and solid job, as shown in Fig. 12.

Holes for fastenings are drilled with a steel or hard brass tube, the working end of which has been slotted with one saw cut, as shown in Fig. 14. A solid rod can be used for small holes. Good handwork can be done with a three-cornered file. Holes can be countersunk for fastenings with the use of a cast-iron rod turned to an 82-degree point, as shown in Fig. 14. The cutting is done with 80-grit silicon-carbide grains. These are mixed with water to form a paste. For accuracy it is best to use a drill press, as in Fig. 13. Cutting can be done also by means of turpentine mixed with a small amount of camphor. This can be used in grinding designs or polishing edges.

A word about the glass itself. The most

used variety is $\frac{1}{4}$ -in. polished plate glass, available in crystal, blue and pink. The colored glasses make up very nicely. Good plate glass can be obtained cheaply from auto wrecking firms. For ordinary work, heavy sheet glass, $\frac{1}{4}$ in. thick, is somewhat cheaper than plate glass. Safety (non-shattering) glass is worth-while protection at slight extra cost. Special tempered plate glass should be used where the work is to be subjected to great heat (fire screens) or where additional strength is required. Plate glass, $\frac{3}{8}$ and $\frac{1}{2}$ in. thick, is effective for table tops and shelving.

Automatic Pencil Used as Awl

An automatic pencil of the propel-repel type provides a handy pocket scratch awl when a scriber point is substituted for the lead. A scriber for the pencil can be made from a needle by breaking off both ends and pointing one end of the remainder. The needle, of course, must be of about the same size as the lead used in the pencil.—Burl Knutson, Bismarck, N. D.

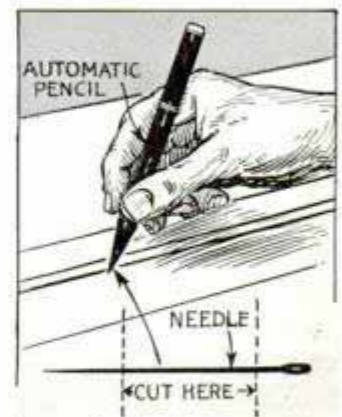

☐ Newspapers rolled as tightly as possible and tied into knots provide good kindling.

"BEEHIVE" JEWELRY BOX

has two compartments

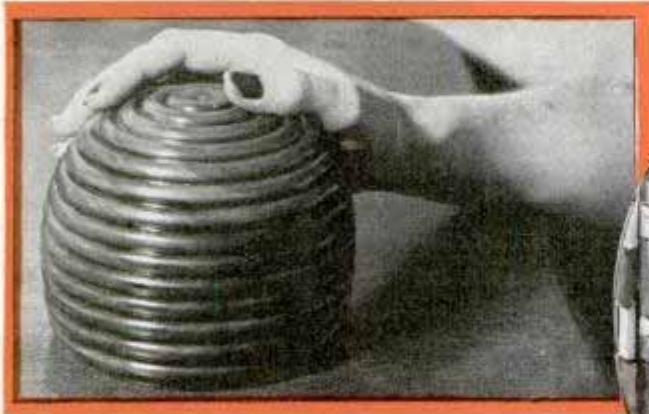

A PLEASING beaded exterior distinguishes this little jewelry box from most turned boxes. Each compartment is of such size that jewelry can be seen and picked out easily. The lower compartment holds necklaces and brooches while the tray is convenient for rings. There are four operations in this turning job. First, the inside of the lower half is turned out. Second, the inside of the top half is turned out to match the lower half. Third, the two halves are fitted together, placed between lathe centers and the exterior is turned as one piece, which assures continuity of line. In this operation, the beading is done. Fourth, the false bottom or tray is turned to fit.

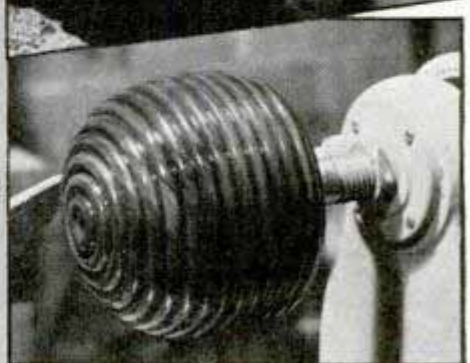
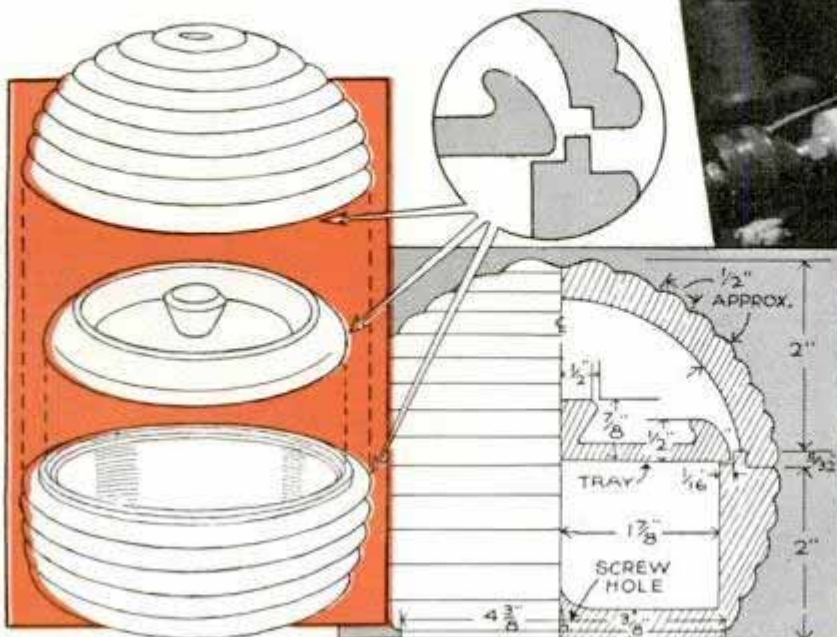
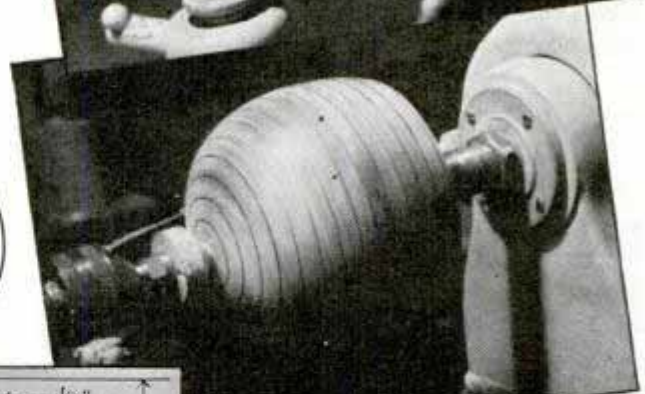
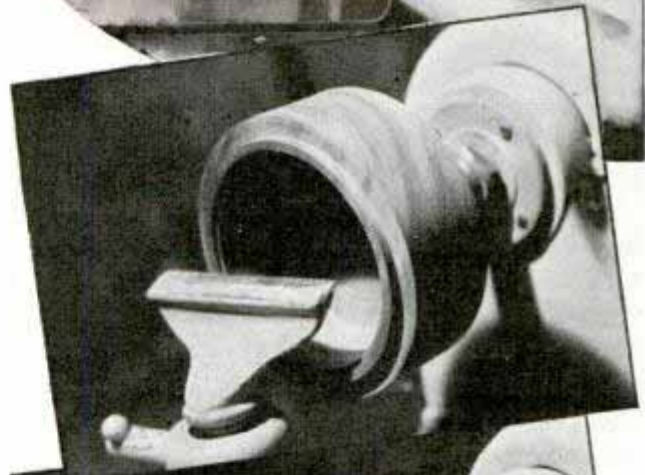

Crutch-Like Rests on Wheel Chair Aid Patient While Arising



Patients who have to use wheel chairs and experience difficulty arising from them will find armrests of the type shown helpful. The rests, which are made like the top of a crutch, fit in holes drilled through the chair arms. The distance that the rests must extend above the arms will have to be found by experiment.

Wood Dowel Guides Drill Point When Reaming Out Threads

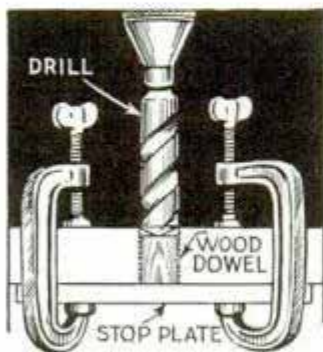

When drilling out the threads of a tapped hole in metal, I find that a hardwood dowel of approximately the same size as the hole, driven or turned into it, makes an excellent retarder for the drill, to prevent "digging" and to assure against breakage. The top of the dowel should lie in a little below the surface of the metal in order that the drill will center just before it contacts the wood.

When drilling out the threads of a tapped hole in metal, I find that a hardwood dowel of approximately the same size as the hole, driven or turned into it, makes an excellent retarder for the drill, to prevent "digging" and to assure against breakage. The top of the dowel should lie in a little below the surface of the metal in order that the drill will center just before it contacts the wood.

When drilling out threads in a hole that goes through the work use a stop piece, held by C-clamps as shown.

—W. C. Wilhite, Carlinville, Ill.

Countersunk-Hole Plug Removed Easily with Screw

Wooden plugs that have been glued over countersunk screw heads to hide them are easy to remove with another screw. Just drive it into the center of the plug. When the end of the screw touches the head of the countersunk one, the plug will rise as the screw is turned.

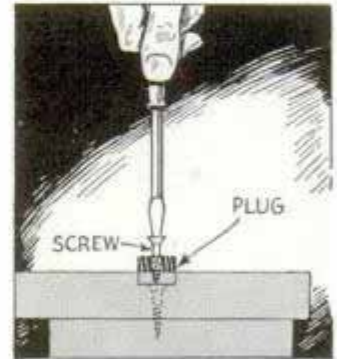

—Herbert L. Arrall, Newburyport, Mass.

Belt Dressing Cements Abrasive to Sanding Block



Next time you are obliged to use a scrap piece of wood as a sanding block, rub the under surface with a stick of belt dressing. This will cause the sandpaper to adhere to the block and will prevent slipping.

Steel Wool in Shotgun Shell Is a Good Polisher

Stuffed tightly with fine steel wool, an empty shotgun shell that has been fired provides a good polisher for metal. The paper of the shell wears away with the wool so that the latter is always exposed.



Tray on Porch Glider Serves as End Table

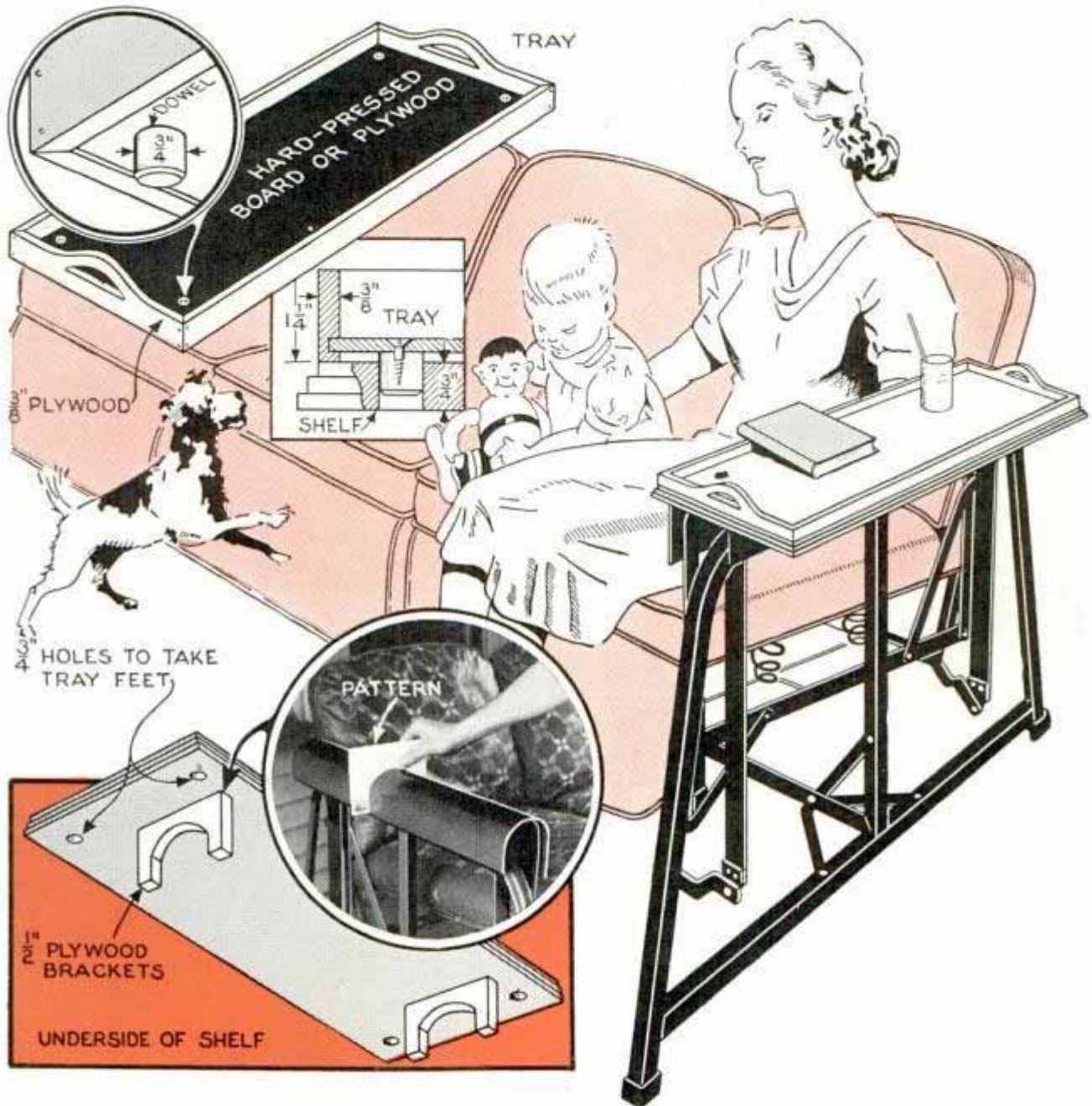

Slipped on the rounded, sheet-metal arm of a porch glider, this removable utility tray takes the place of an end table. U-shaped brackets are attached to the bottom of the shelf which supports the tray. Short dowels screwed to the bottom of the tray register in corresponding holes in the shelf

Cold Drafts to Heater Minimized by Air Duct under Floor

Where a circulating heater is used in a room and cold drafts moving over the floor toward the heater are objectionable, they can be eliminated to a large extent by installing an air duct under the floor, registers being provided at both ends as shown. The steady flow of air in the duct can be accelerated by using a fan placed in the duct or just under one of the registers. It should be the type having thrust bearings if it is installed in the manner shown.

—George Sirn, Macedonia, Ohio.

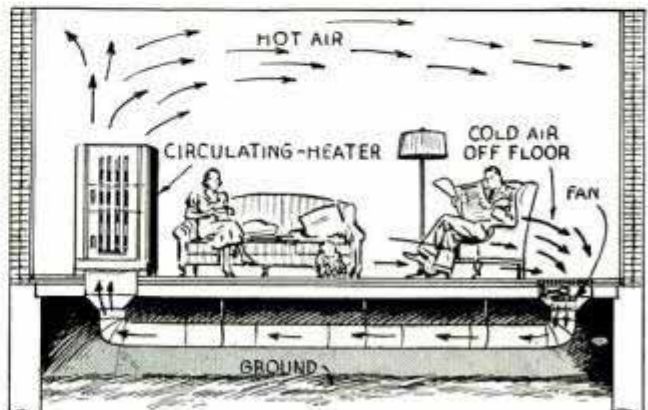

Lead-Lined Clamping Blocks Serve as Pipe Vise

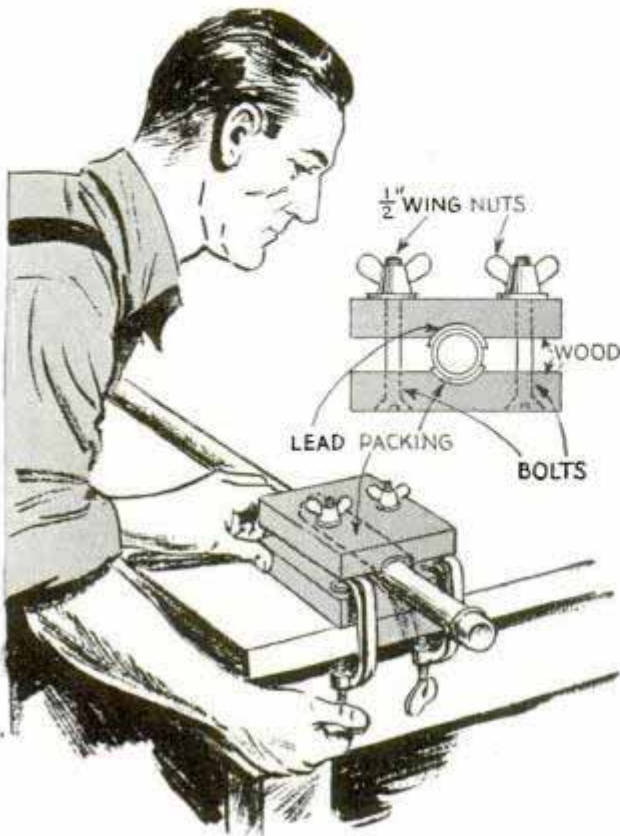

If a regular pipe vise is not at hand, one can be improvised from two wood blocks and two strips of lead. The blocks are roughly grooved to suit the diameter of the pipe, and drilled for two clamping bolts. In use, one block is fastened to a bench with C-clamps after which the other one is clamped over the pipe with the lead strips next to the pipe. This presses the soft metal into the rough surface of the pipe and prevents it from turning.—C. A. Oldroyd, Barrow-in-Furness, Lancs., Eng.

Hydrant Protected in Winter

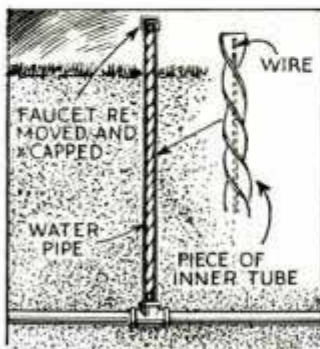

rubber about 1 in. wide from an old inner tube. Wind this spirally around a piece of No. 9 wire long enough to reach below the

During the winter months exposed water pipes that are not convenient to drain, such as lawn hydrants, may be prevented from bursting by the following method: Cut a long strip of

frost line. Remove the faucet, insert this in the pipe and cap it. The rubber will compress enough to prevent the pipe from bursting when the water freezes.

Pair of Scissors to Cut Circles on Mimeograph Stencil

To trace circles on a mimeograph stencil, a compass may be constructed from a pair of scissors and a paper clamp. To avoid perforating the stencil at the center, place a small rubber disk under this point of the scissors.

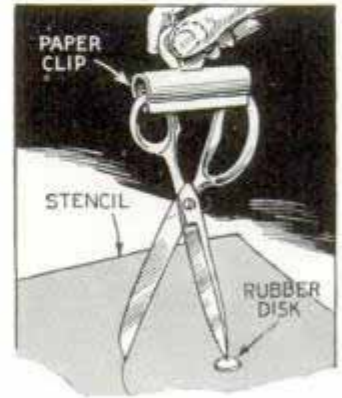

Telescope Cells and End Trim from Cooking Utensils

One of the most important points in securing a finished appearance in a telescope tube is to have a good-looking cell and end trim. Good cells for this purpose can be made inexpensively from cast and spun-aluminum cooking utensils. While the drawing shows how a cell can be made from a pitcher or percolator, the various shapes of other utensils will suggest many novel adaptations.

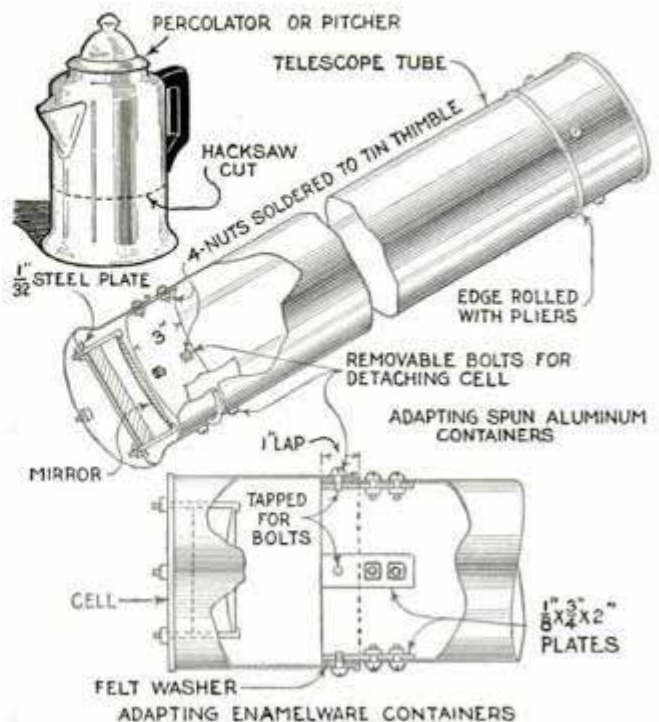

Plywood Facing Saves Cost of New Doors

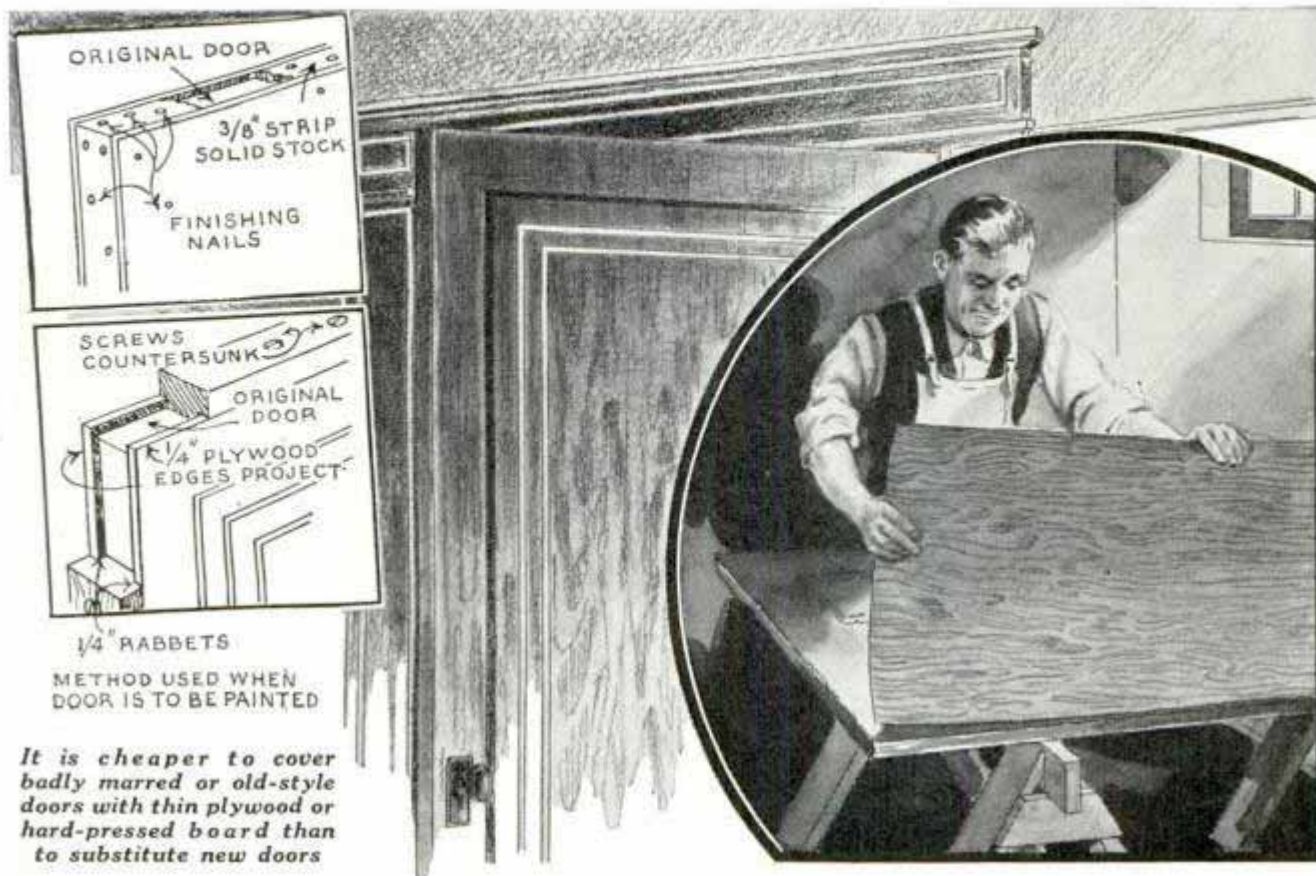

It is cheaper to cover badly marred or old-style doors with thin plywood or hard-pressed board than to substitute new doors

Instead of replacing old interior doors when they are badly scarred or are so far out of date that they will not harmonize with a modernized room, you can avoid this unnecessary expense by simply covering the old ones with $\frac{1}{4}$ -in. plywood or with hard-pressed board. In some cases the covering may be glued to the door, if the varnish or paint is entirely removed so that the glue will adhere. The covering also can be fastened in place with finishing nails or flat-head screws, nail holes and screw heads being filled if the surface is to be painted later. The simplest way to apply the covering is to cut it slightly larger than the door, after which you carefully saw off the excess and smooth down the edges to be flush with the edges of the door. However, if the door edges are rounded, which would leave a groove between the door and the covering, or if the edges are badly marred, it will be necessary to use facing strips. For application of strips remove the door and rip $\frac{3}{8}$ in. off the edges of the door. Then rip $\frac{3}{8}$ -in. stock to a width slightly more than the thickness of the door and attach with glue and finishing nails or screws. Miter the strips at

the corners. Plane the strips flush with the door on both sides. Cut the covering slightly oversize, spread glue on the edges of the facing strips and covering, after which screws are used to fasten the latter down securely, the heads of the screws being countersunk below the surface. When the glue is dry, plane the covering edges flush and round the corners slightly with fine sandpaper. In re-hanging the door you will have to reset the hinges, lock striker plate and the stops to take care of the added thickness. The new surface may be finished to suit. Striping done carefully will relieve the flat appearance if this is objectionable.

Improving Furnace Water Pan

If you heat your home with a warm-air furnace, and humidity is too low, you can increase evaporation of water in the furnace pan by hanging strips of old towels in it. One end of each strip should be in the water and the other should hang over the side of the pan. The number of strips necessary will have to be determined by experiment.

Cottage TELEPHONE

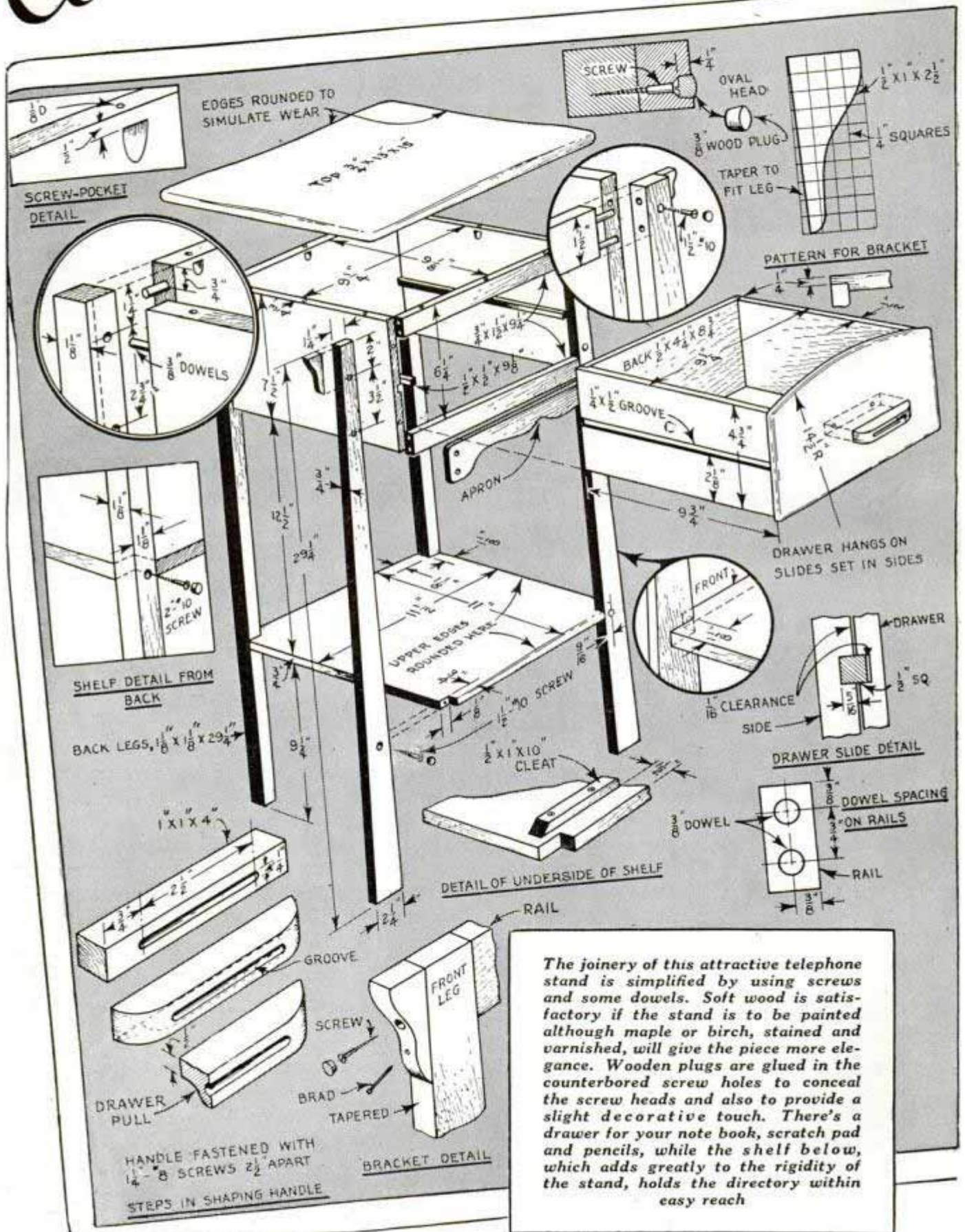

The joinery of this attractive telephone stand is simplified by using screws and some dowels. Soft wood is satisfactory if the stand is to be painted although maple or birch, stained and varnished, will give the piece more elegance. Wooden plugs are glued in the counterbored screw holes to conceal the screw heads and also to provide a slight decorative touch. There's a drawer for your note book, scratch pad and pencils, while the shelf below, which adds greatly to the rigidity of the stand, holds the directory within easy reach

STAND

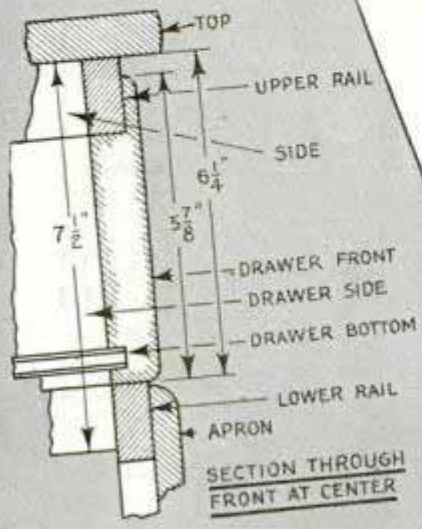

MATERIAL LIST

- 1 pc. Birch $\frac{3}{4}$ x 13 x 15 in.—Top
- 2 pcs. Birch $\frac{3}{4}$ x $2\frac{1}{4}$ x $29\frac{1}{4}$ in.—Front legs
- 2 pcs. Birch $1\frac{1}{8}$ x $1\frac{1}{8}$ x $29\frac{1}{4}$ in.—Back legs
- 2 pcs. Birch $\frac{3}{4}$ x $7\frac{1}{2}$ x $9\frac{1}{8}$ in.—Sides
- 1 pc. Birch $\frac{3}{4}$ x $7\frac{1}{2}$ x $9\frac{1}{4}$ in.—Back
- 2 pcs. Birch $\frac{3}{4}$ x $1\frac{1}{2}$ x $9\frac{1}{4}$ in.—Front rails
- 2 pcs. Birch $\frac{3}{4}$ x $1\frac{1}{2}$ x $11\frac{3}{4}$ in.—Apron
- 1 pc. Birch $\frac{1}{2}$ x 3 x $11\frac{3}{4}$ in.—Shelf
- 1 pc. Birch $\frac{3}{4}$ x 11 x $9\frac{1}{8}$ in.—Drawer slides
- 2 pcs. Birch $\frac{1}{2}$ x $1\frac{1}{2}$ x $9\frac{1}{8}$ in.—Brackets
- 2 pcs. Birch $\frac{1}{2}$ x 1 x $2\frac{1}{2}$ in.—Drawer front
- 1 pc. Birch $\frac{3}{4}$ x $5\frac{7}{8}$ x $9\frac{3}{4}$ in.—Drawer sides
- 2 pcs. Birch $\frac{1}{2}$ x $4\frac{3}{4}$ x $9\frac{3}{4}$ in.—Drawer back
- 1 pc. Birch $\frac{1}{2}$ x $4\frac{1}{4}$ x $8\frac{3}{4}$ in.—Drawer bottom
- 1 pc. Plywood $\frac{1}{4}$ x $8\frac{3}{4}$ x $9\frac{3}{4}$ in.—Drawer handle
- 1 pc. Birch 1 x 1 x 4 in.—Drawer handle
- 2 pcs. Birch $\frac{1}{2}$ x 1 x 10 in.—Shelf cleats

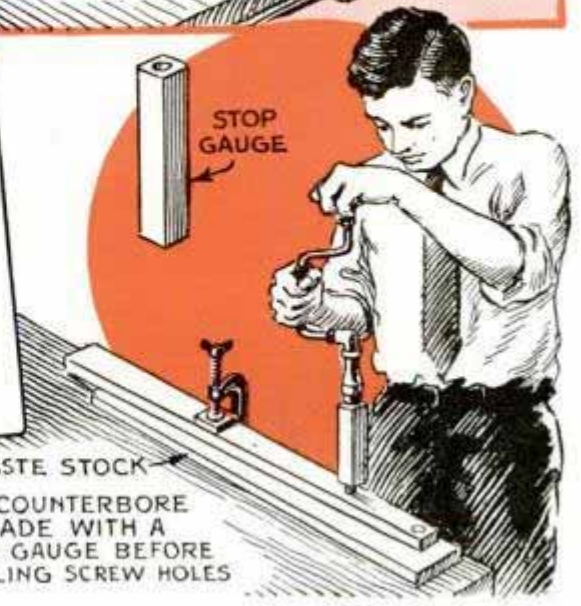
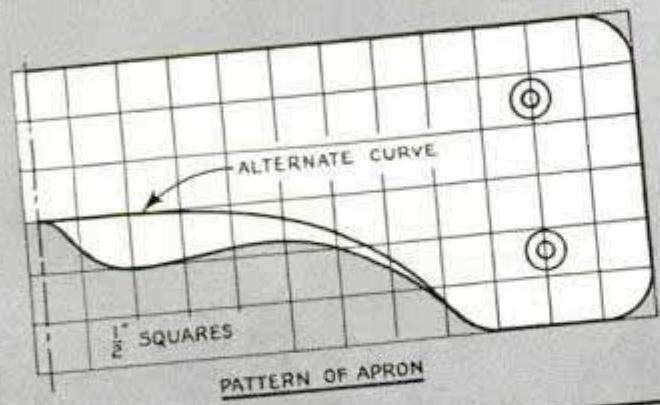
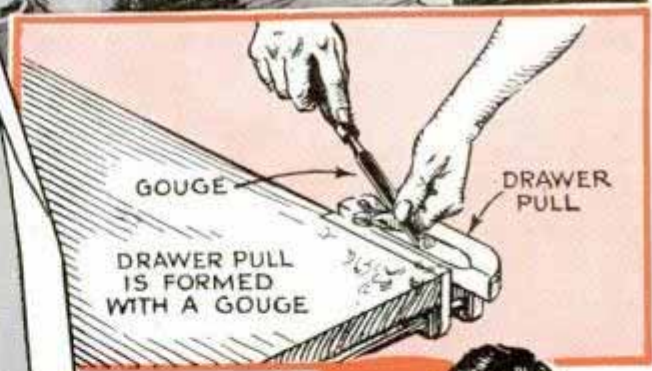

Painted Beehive Covers Reflect or Absorb Sun's Rays



Taking advantage of the reflective and absorbent powers of different colors of paint, a bee keeper made the covers of his beehives reversible, painting one side black and the other side aluminum. In the early spring, the boards are turned with the black side out to absorb all possible heat from the sun and stimulate brood rearing to build up the strength of the colonies. Later, during the hot weather, the boards are reversed, aluminum side up, to reflect the heat and keep the interiors cool.

Drop Leaf under High-Chair Tray Prevents Child Standing Up



To prevent a small child from standing up in its high chair, hinge a drop leaf to the underside of the tray. When down, the leaf leaves so little room between chair and tray that it is impossible for the child to withdraw

its legs from a sitting position. When not in use, the leaf may be raised and held against the tray with a turn button.

Rubber Lip on Nail Container Makes Selection Easy

Rubber lips cut from old inner tubes and attached with rubber bands to tin cans containing nails, screws and other small parts make it easy to select a desired part. Just tip the can over so that the contents roll out on the lip. After the selection has been made, tip the can back and the contents slip into it.

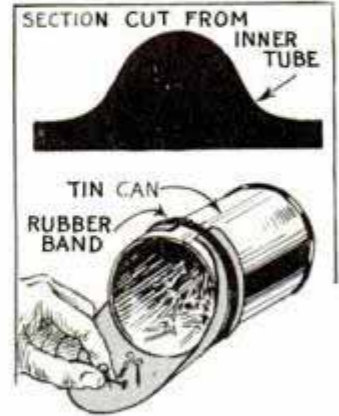

Child's Crib of Unusual Design Has Hammock Bed

Originated in England, this child's crib is unusual in appearance, and can be made inexpensively as it consists merely of two ends spaced apart by four heavy dowels, from which the hammock bed is suspended.

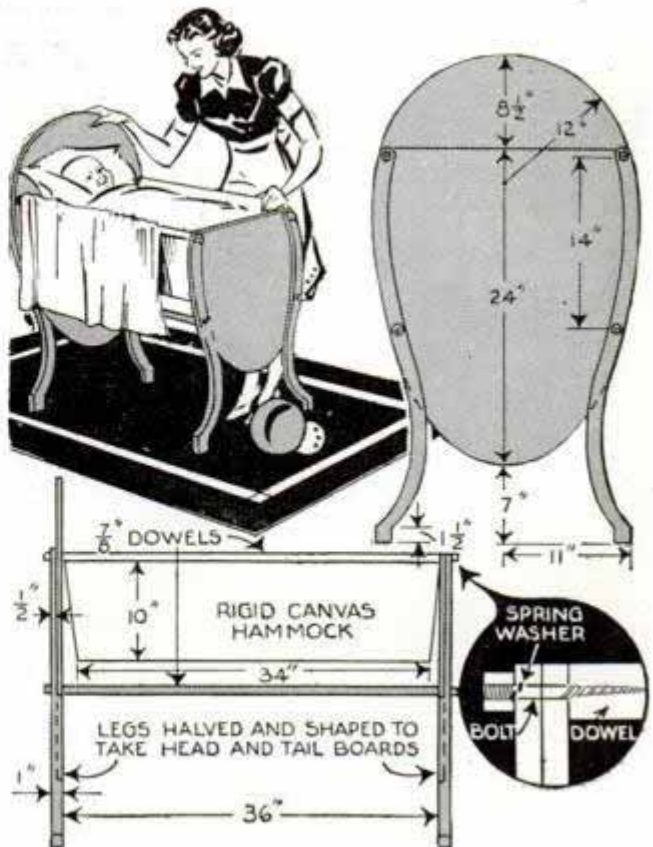

ed. This is made of canvas, which is hemmed at the ends to slip over the two upper dowels. The hammock lining extends down over the sides in form of valances to hide the dowels and canvas. It is best to make the hammock semi-rigid by sewing a couple of hems in each side to take strips of thin plywood. The legs are cut from solid wood and the end panels are plywood. Notice that the inner surfaces of the legs are cut away or halved to take the panels.—N. S. Candy, Southampton, Eng.

Simple Method of Matching Paint or Printing Ink

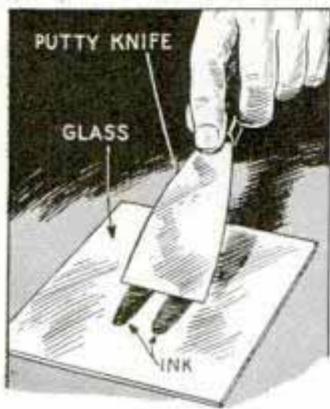

On jobs of printing or painting where certain colors must be blended accurately to match a color already in use, try a piece of glass as a matching surface on which to compare the various colors. Put small

amounts of the colors on the glass and spread them with a putty knife. Apply pressure as equally as possible in spreading the colors and you will be able to tell at a glance those that match.

Stamp Aids in Stenciling

This stamp will prove useful for those who wish to paint a design around a ceiling, cut a number of duplicate wood figures or decorate cloth and paper. A wood block slightly larger than the design to be stenciled, is coated with glue or varnish, after which a heavy string or light cord is laid on the tacky surface to form the design. The finished stamp may be inked with a pad, roller or brush, as the ink will not adhere to the glue-covered surface of the block.

—Paul A. Ruddell, Washington, D. C.

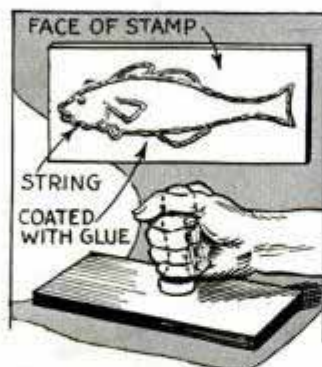

Metal Guide to Saw Straight Through Thick Work



Difficulty some workmen experience in sawing straight through a thick plank can be avoided by using this simple guide. It is shaped from flat iron and is held on the work with one hand while the other hand operates the saw.

Keeping Holes Through Ice Open for Fisherman

During moderately cold weather, holes chopped in ice for fishing may be kept from freezing over at night by placing snow-filled pails in them. As a further precaution against freezing, one fisherman inserts a lath in each pail and ties a cloth to it. The cloth serves as a marker, and the slightest breeze causes the pail to rock back and forth, which helps prevent ice forming.

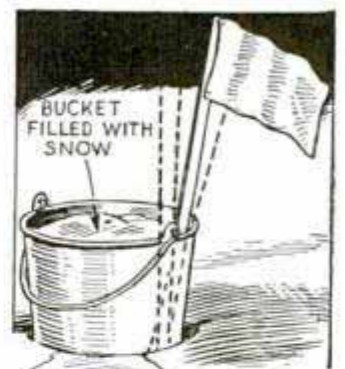

☞ Crayon marks may be removed from wallpaper by covering the soiled surface with a paste made of fuller's earth and carbon tetrachloride; allow it to dry and remove by brushing.

Experiments with a VEST-



The kit contains

Two flashlight dry cells, a pocket voltmeter or ammeter, a milli-voltmeter, an electroscope, neon tube, two coils of wire, a pair of magnets, a small compass and five vials containing sulphuric acid, copper-sulphate solution, toluene, bromide water and ammonia. Also a small funnel, pieces of sealing wax, silk and a couple of test tubes

FITTING in a box no larger than a post-card size camera, this miniature laboratory, which can be assembled for a few dollars, will serve to demonstrate many electrical, chemical and physical phenomena for entertainment and instructive experimentation. Contents of the kit are listed under the photo at the left.

Using an Electroscope: A sealing wax or sulphur rod becomes electrified when rubbed briskly with a dry piece of silk as in Fig. 1. The charged rod then can be used to charge an electroscope, Fig. 2, which can be made from a small flask or old bottle and a piece of gold leaf, Fig. 3.

By touching the charged rod to the knob of the electroscope, the leaves will be charged the same as the rod, and they will then repel each other. If the charged rod is held close to the knob and the latter is touched momentarily with the finger, the electroscope will be charged by induction, oppositely to the sealing-wax rod. Then the leaves will repel each other as soon as the rod is taken away, but not when it is brought close. Other nonconductors such as glass rod, hard rubber, wool and fur can be used. In some cases the non-conductor will be charged oppositely to a wax rod rubbed with silk.

How Electric Generators Work: An electric current is generated when a magnetic field is cut by a wire. A coil of 1,000 turns of No. 34 insulated magnet wire is connected to a smaller coil of 1,500 turns of No. 38 wire. A small compass is placed over the latter coil, and a powerful permanent magnet is moved over the larger

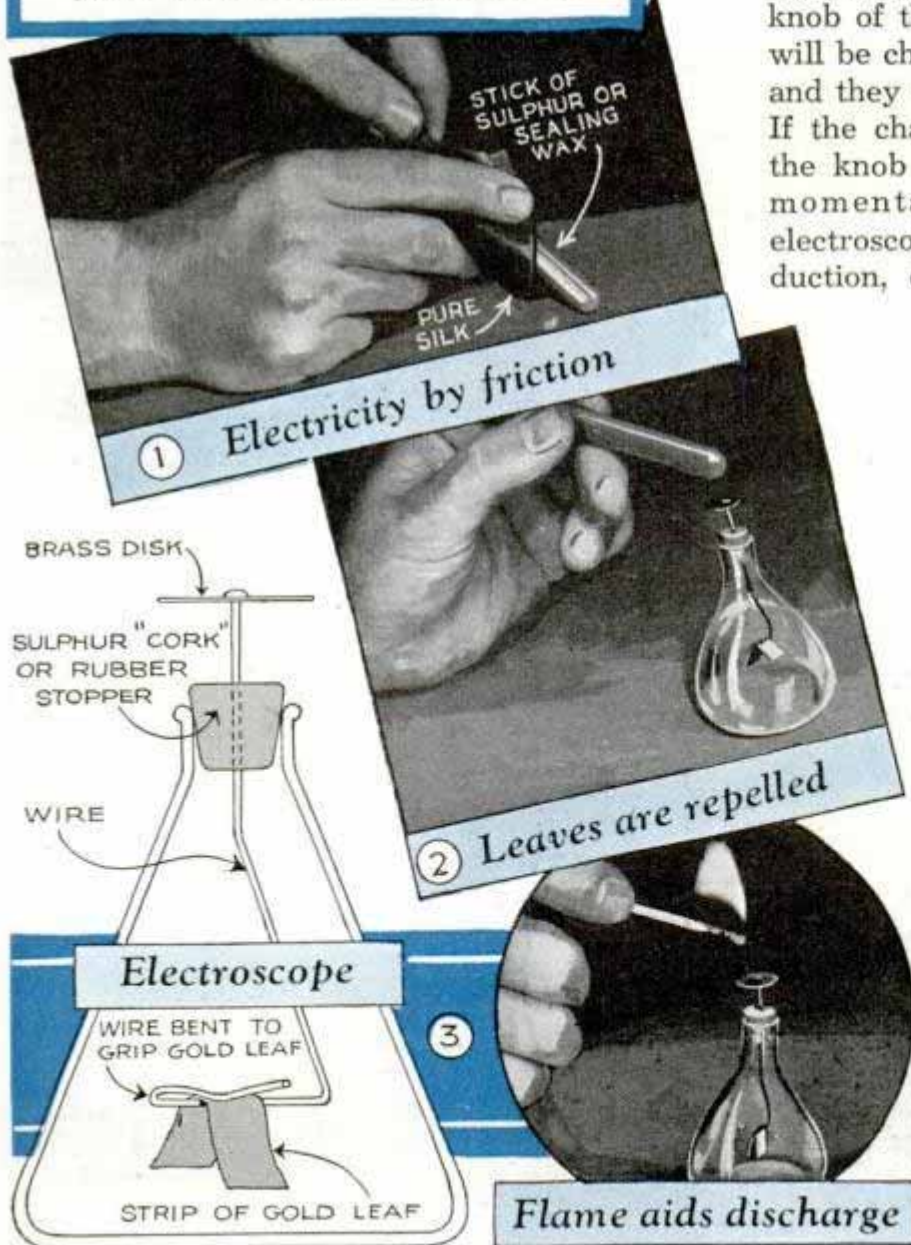

POCKET "LAB"

coil as in Fig. 4, at which instant the compass needle will be deflected slightly, indicating generation of current. If the compass is placed on a coil of wire connected to a battery of two dry cells, as in Fig. 5, the needle will be deflected. This shows that the passage of an electric current through a conductor produces a magnetic field. The compass needle deflects only when the circuit is closed or opened.

How a Transformer Works: The principle of a transformer is illustrated in Fig. 6. The 1,000-turn coil is connected to a 110-volt a.c. line, and the 1,500-turn coil to the small neon tube, which will light, although it is not directly connected to the current from the battery. If an iron core is slipped through the two coils, the efficiency will be improved greatly.

Electroplating Demonstrated: How electroplating is accomplished is illustrated in Fig. 7. Two dry cells are connected as shown. The negative line goes to a strip of brass or iron, and the positive to a strip of clean copper. The two strips are immersed in a solution of copper sulphate in a test tube so that they will not touch each other. They can be kept apart by little pieces of cork. The brass or iron strip will become covered with a red deposit of copper.

Electricity Decomposes Water: Electrolysis, or decompo-

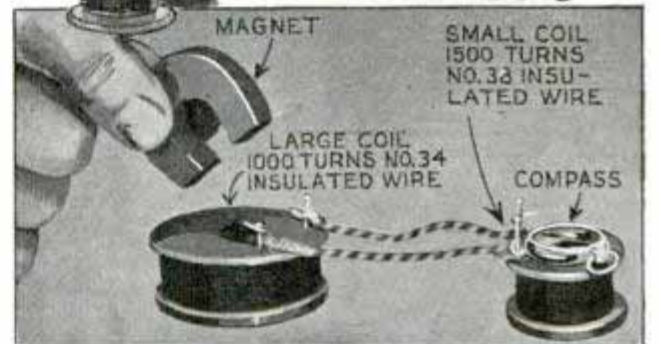

④ *Compass needle deflects*



⑤ *Causing magnetic field*

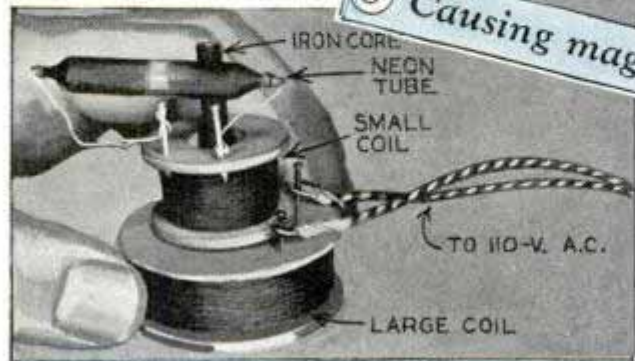

⑥ *How transformers work*

sition by electricity, of water into hydrogen and oxygen is shown in Fig. 8. Copper wires attached to the terminals of a two-cell battery are immersed in a test tube full of water to which a few drops of sulphuric acid have been added to

make it conductive. Do not get the acid on hands or clothes as it will cause burns. Should you spill some of the acid, wash with water in which a copious amount of ordinary baking soda has been dissolved. Or use ammonia. At the negative wire, bubbles of hydrogen will be released, and

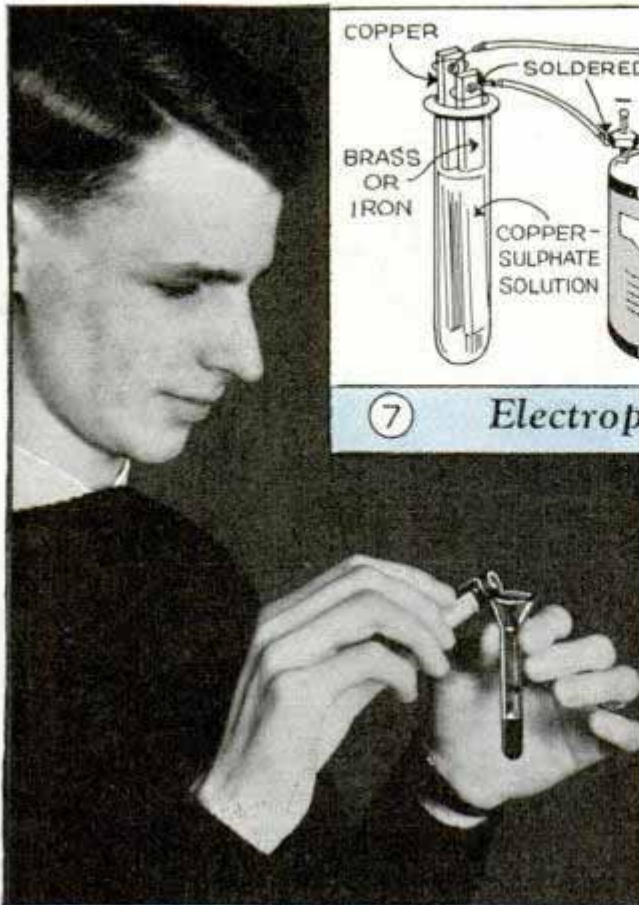

⑨ *Simple electric cell*

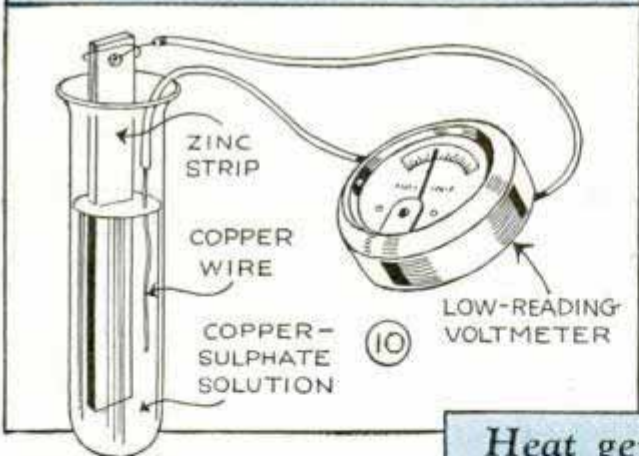

⑩ LOW-READING VOLTMETER

at the positive wire, bubbles of oxygen.

Simple Electric Cell: If a small strip of zinc and a short length of copper wire are immersed in a solution of copper sulphate a current will be registered when you connect the two metals to a low-reading voltmeter as in Figs. 9 and 10. The needle of the voltmeter will deflect, registering a voltage. This illustrates the principle of an electric cell consisting of two electrodes of different metals, and a conductive solution in which they are immersed.

Heat Generates Electricity: In the simple experiment illustrated in Fig. 11, an

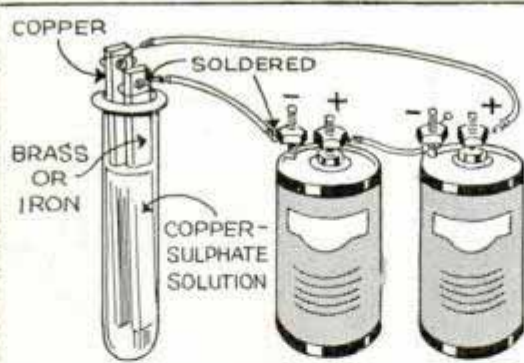

⑦ *Electroplating*

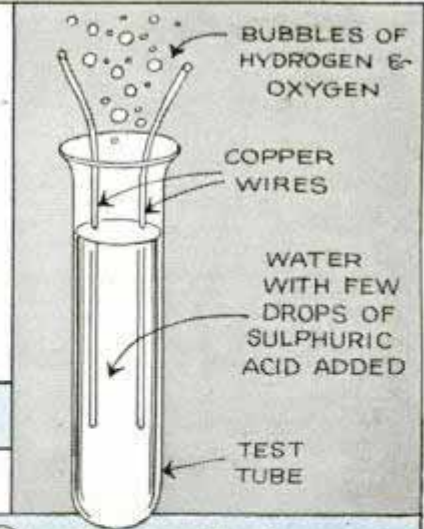

⑧ *Electrolysis*

iron and a copper wire are tightly twisted together at one end, and the opposite ends are connected to the millivoltmeter. If the twisted junction is heated, a voltage will be produced, as indicated by the meter. This demonstrates the operation of a thermocouple.

Photo-Chemical Reactions: Many chemical reactions are induced or accelerated by the action of light. If a small amount of toluene and a few drops of bromine water are placed in a test tube, no reaction will occur as long as the mixture remains in the dark. However, when exposed to light, a reaction will take place, as evidenced by a change in color. The role of light energy in chemical change is important in photography and particularly in nature as witness the variegated colors of vegetation.

Heat generates current

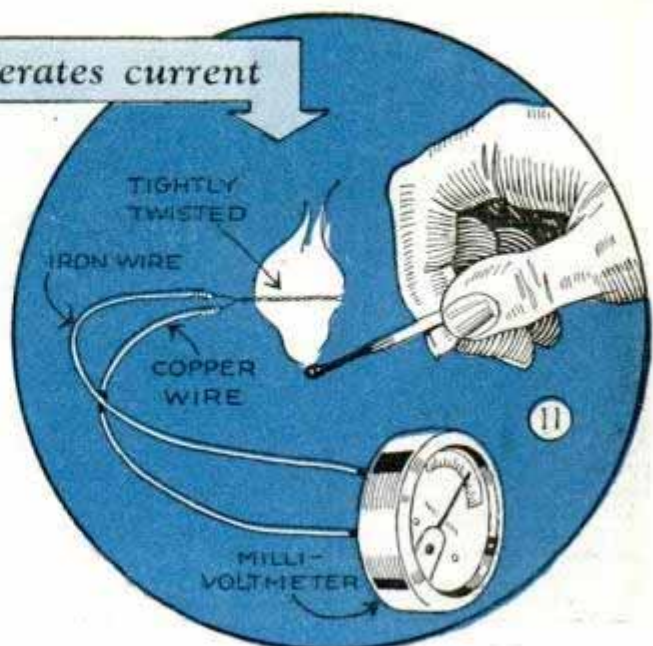

⑪

Complete Drawing Outfit Fits in Brief Case

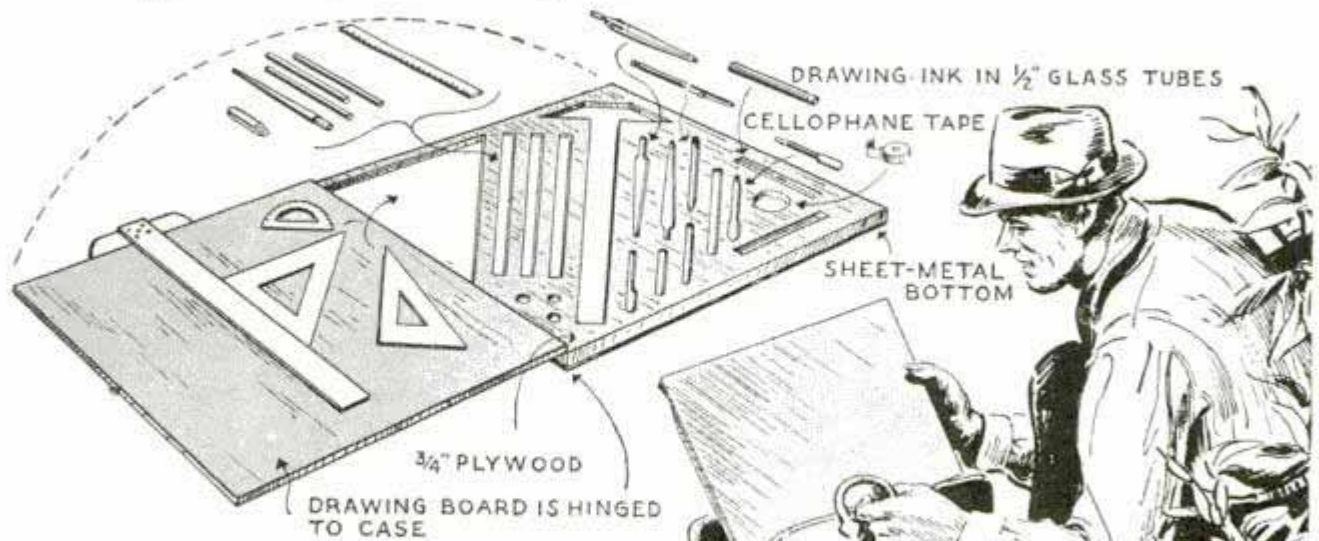

Designed especially for field work and made to fit into an average-size portfolio, this compact draftsman's case includes a drawing board and holds ink, triangles and a T-square, besides other instruments. Unhooking the cover, which is a piece of hard-pressed board, exposes everything all ready for instant use. The cover is hinged to a piece of 3/4-in. plywood cut out to accommodate the instruments. When the cover is closed it holds the instruments in place. After the plywood is cut out, a piece of light sheet metal is tacked on to form the bottom.

Midget Acrobat on Toy Windmill Cuts Amusing Capers

Actuating a trapeze performer in a realistic manner, this wind toy will afford you many laughs, especially on a gusty day when the mill runs erratically. First get a

base for the assembly, which can be a piece of hardwood or light channel iron. Fasten vertical pieces to it to carry the shaft and pulley that rotate the figure. Then provide simple bearings on the base for the air-wheel shaft, which is a length of brass rod. Next make up the wheel hub and pulley from hardwood, and drill it to take the shaft with a force fit, placing a washer between the hub and shaft bearing to prevent binding. Now you are ready for the wheel, which is a tin disk cut to resemble the wheel on a regular farm windmill. This is tacked to the hub. A tin tail vane is fastened to the rear of the base. Arms and legs of the figure are pivoted loosely to the body, while the arms are clamped tightly to the shaft.

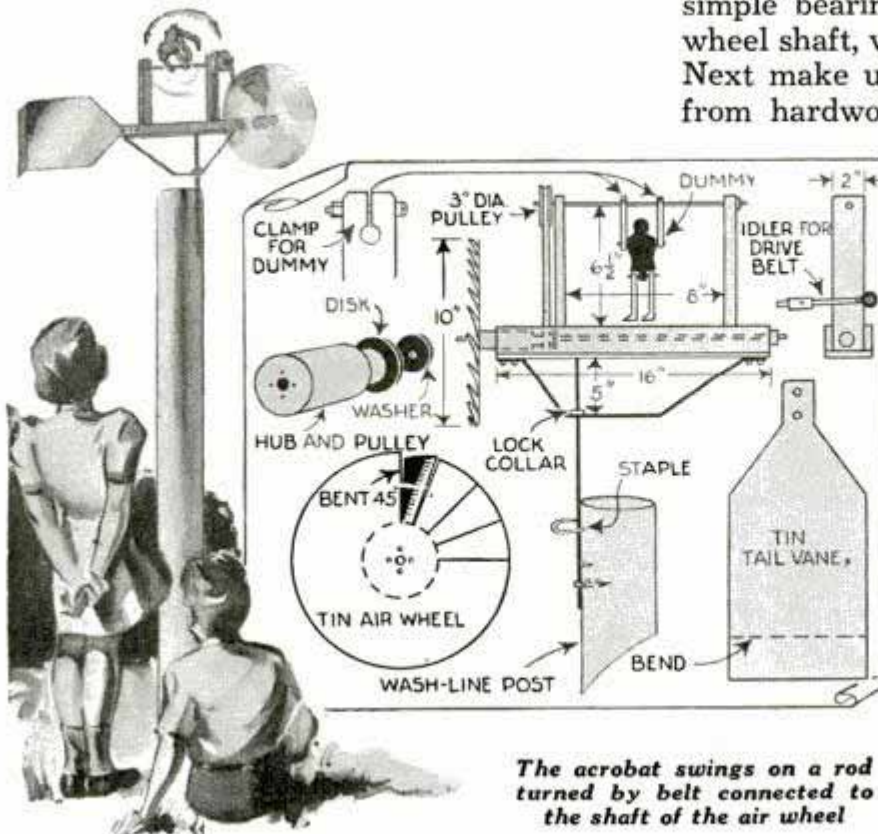

The acrobat swings on a rod turned by belt connected to the shaft of the air wheel

Ammonia and water will often remove red-ink stains from white cloth.

Typewriter Skirt Keeps Pencils from Rolling under It

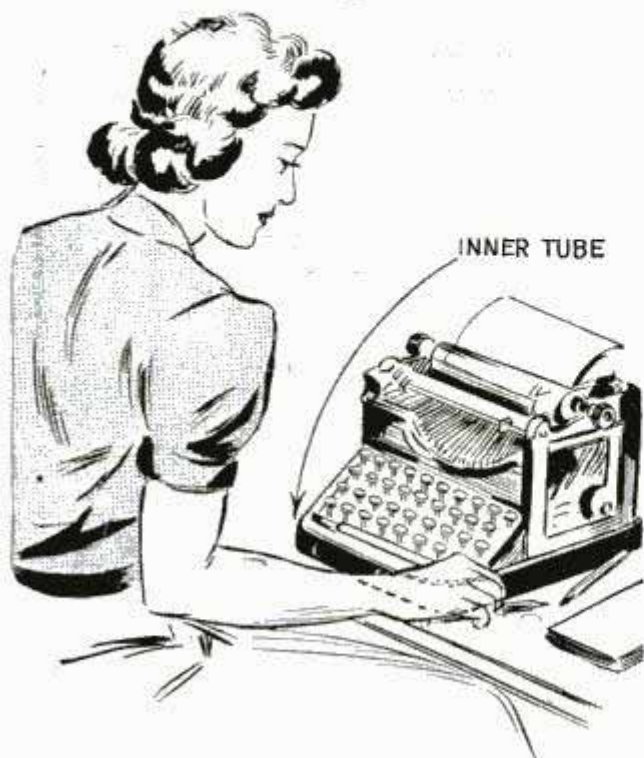

If you are annoyed by having pencils roll under your typewriter, a wide rubber band placed around the feet of the machine will prevent this trouble. A section cut from a large inner tube will be just the thing for the purpose.

Tangling of Tether Avoided by Double Stakes

Two stakes, driven into the ground at the angles shown, will keep a tether from becoming tangled, regardless of the num-

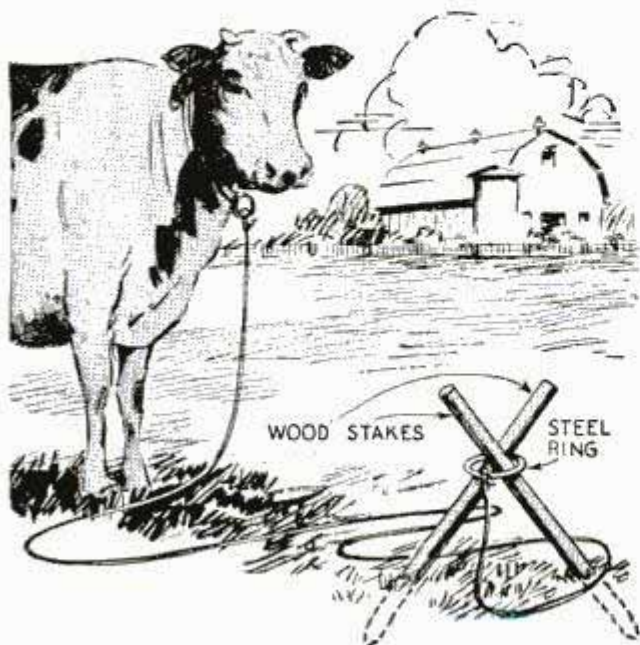

ber of times the animal circles the anchorage. The tether should be made fast to the stakes by a loose loop or a large ring.

Safety-Razor Guard Used as Rack for Microscope Slides

A guard or comb from a double-edged safety razor is a convenient holder for microscope slides. The slides fit between the prongs, which can be bent slightly to hold them firmly. With the

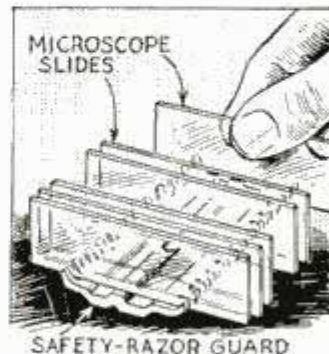

slides placed in order, they will collect fewer fingerprint or dust smudges than if they were put in a box or laid flat on a table.

Paintbrush Wrapped in Paper to Prevent Drying Out



One good method of preserving paintbrushes is to wrap them in paper and soak this with linseed oil. Wrap the paper on the brush to a thickness of 1 in., letting it extend well above the ferrule. This provides a well into which the oil can be

poured to saturate the paper.

Clothespin Heads Provide Pulls on Small Drawers

In fitting his shop with a small wall cabinet for storing screws, nails, etc., one craftsman quickly provided neat, little knobs for the drawers by cutting the heads off of clothespins. Screws through the drawer fronts from inside attached the knobs.

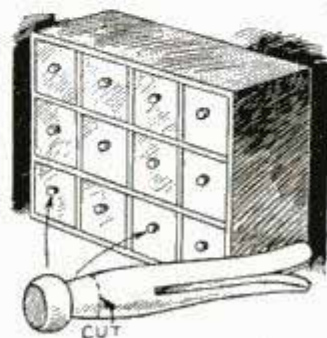

What You Can Do With TIRE "PAINT"

White or black auto-tire paint, which consists of liquid rubber with a pigment, has many uses. Besides those pictured below, it may be used to prevent slipping and marring, as on the bottoms of ash trays and similar articles, and to whiten or darken the surface of any rubber article. It may be applied with a brush or air gun, and dries to an elastic surface that will withstand wear, creasing and weathering. One coat is sufficient over a non-porous surface of similar color. Use two coats when white is applied over black, or when the surface is porous as in the case of wood or leather



An application of tire paint on the underside of throw rugs will keep them from slipping on polished floors



Above, sealing chipped surfaces of photographic trays. Below, film of rubber gives traction to toy-train wheels



Closely woven cloth may be waterproofed with one coat, while several coats may be applied to make rubberized sheeting

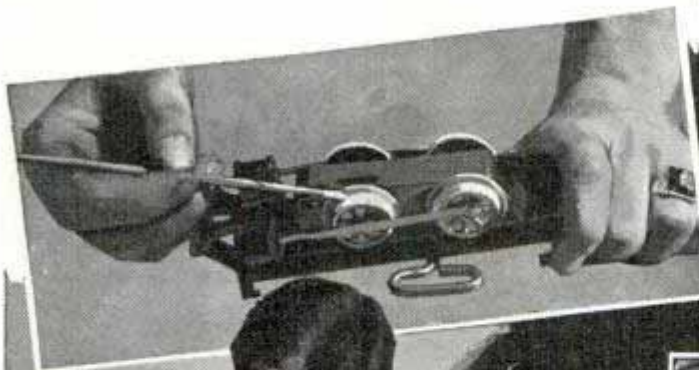

Left, improving surfaces of table-tennis paddles. Right, protecting garden hose from heat



Broom Slipped Inside Sack When Sweeping Snow



If you use a broom to sweep paths through light snow, slip a sack over the straws and fasten it in place with a rubber band. The sack not only will aid in effecting a clean sweep of the snow, but will protect the broom from damage and wear.

Metal Tape Ornaments Lamps

After turning a wood standard for a table or bridge lamp, it may be given an attractive metal finish by winding it with a strip of zinc tape of the kind sold for

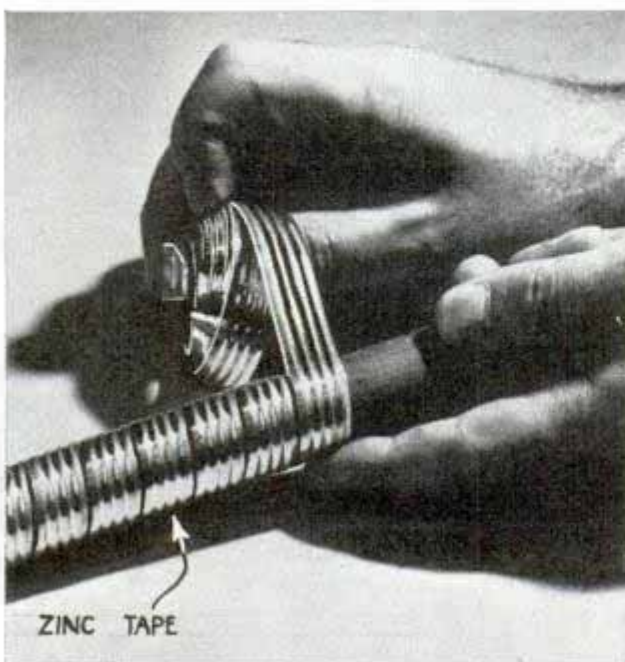

binding linoleum seams. Apply the tape in a spiral, first coating the wood with shellac to hold the tape in place.

Simple Method of Soldering Joints on Telescoped Tubing

When soldering two pieces of tubing together, where one fits tightly inside the other, the difficulty of flowing solder into the joint can be overcome by drilling a small hole in the outer tube. Flux and solder can be fed into the hole to form a perfectly soldered joint. This method can be applied to other jobs where it is difficult to "tin" the work before soldering.

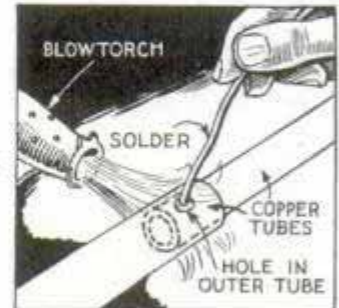

—Roy S. MacNeill, Shelley, B. C., Can.

Metal Shield over Mousetrap Safeguards Poultry

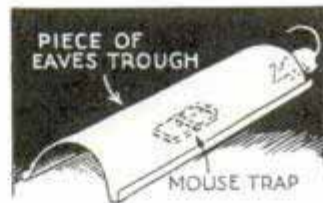

Scrap ends of eaves trough, which may be obtained for practically nothing at almost any hardware store or tin

shop, provide good covers for mousetraps that are to be set in a poultry house, or in other places where fowls or household pets might get into them. The open ends of the trough invite the inspection by the little rodents, and the traps are therefore more effective than when set in open places.

Hose Keeps Punch from Sticking

To keep a tapered punch from sticking in wood or metal, drill a hole through a piece of lawn hose and force the punch through it. This will prevent the punch wedging in the hole.

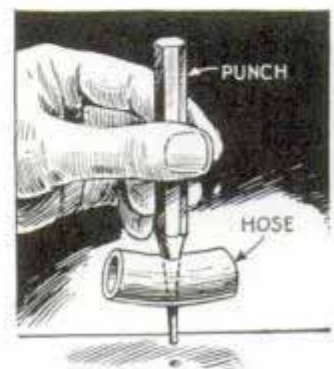

Streamlined MIDGET TRAILER...

serves your vacation needs

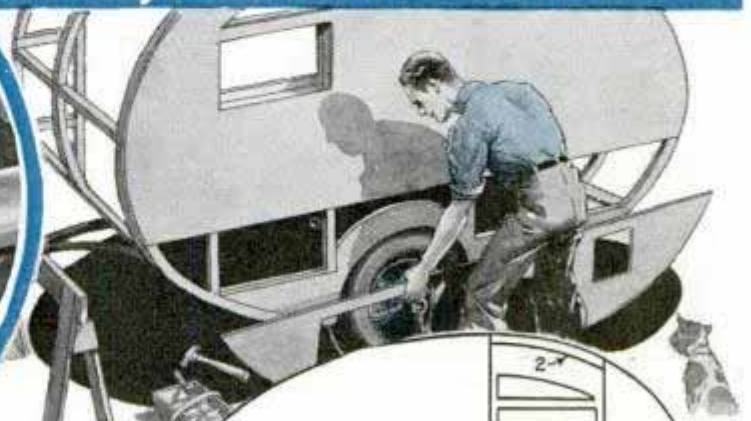

PART II—Sheathing, Interior Furnishings, Kitchenette

By CHARLES W. BRENTNER

WEATHER-TIGHT Sheathing: Now that you have the chassis and the side frames finished, you use the latter as templates in laying out the side panels to size. These are cut from $\frac{1}{8}$ -in. tempered hard-pressed board. Before you cut the board, note carefully the number and arrangement of the pieces on the right and left sides of the body as in Fig. 7. Five pieces are required for the right side frame on the outside, but only one small piece, No. 6, is needed for the inside. The balance of the exposed frame is covered by a cabinet and clothes closet. Only two panels are required for the exterior of the left side and one large panel for the interior.

An easy way to cut hard-pressed board by hand is to clamp the side frame to the large sheet and cut with a fine-tooth compass saw or with a hacksaw blade, reversing the blade so that the teeth cut on the up stroke. Smooth the edges of the board after sawing with a block plane. This done, you lay the panels aside while you assemble the body frame and the fenders over

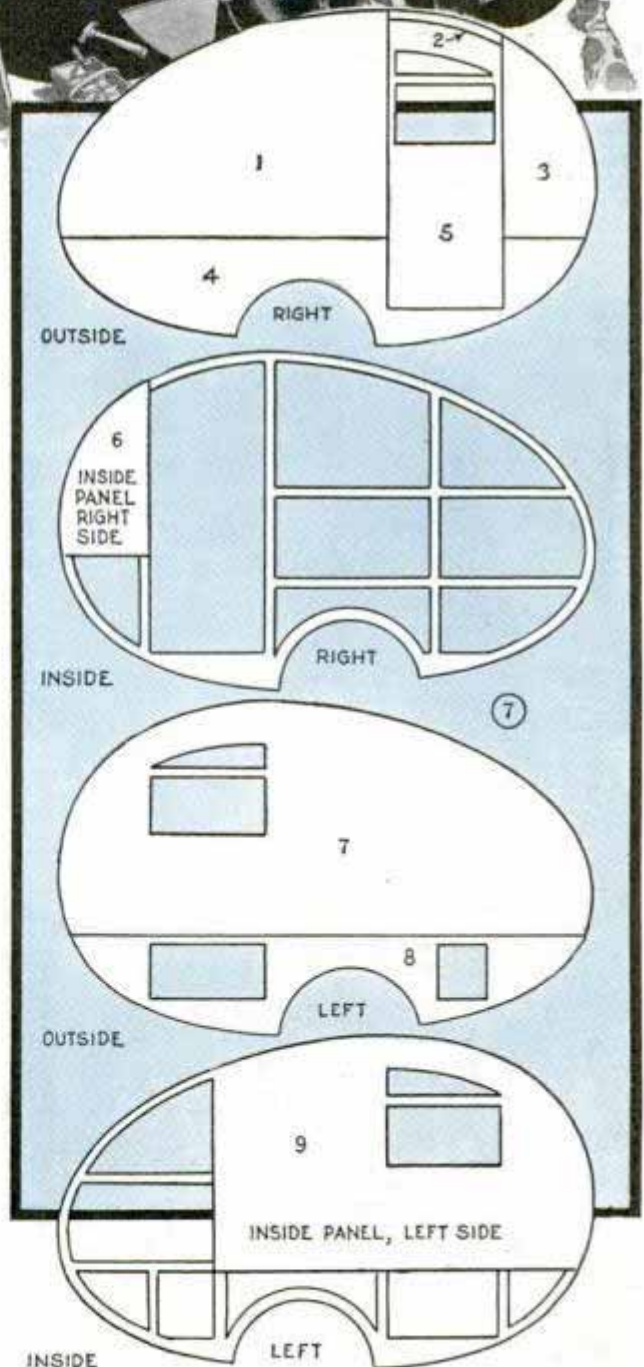

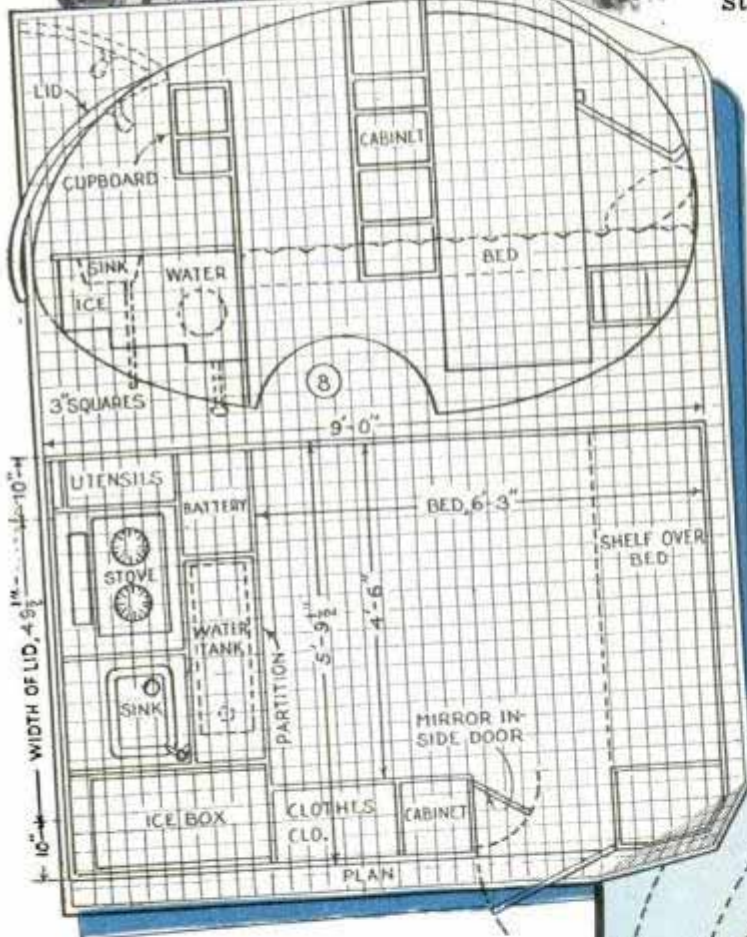

the wheel wells. The latter are finished with semicircular pieces of plywood screwed to the inside of the wheel-well openings and an arch, made of the same material, is built into the side frame on each side over the well. Then the galvanized-iron fender is fastened over this with screws. These parts are shown in place. With the frame assembled and

squared up, you're ready to put on the sheathing. This is fastened with oval-head screws and washers spaced approximately 6 in. apart. Metal-trim moldings finish up this part of the job.

Sleeping Quarters: The two details in Fig. 8 give sizes and locations of the built-in equipment. A standard bed spring and mattress unit is supported by two cross members, but before this is shoved in through the rear (the kitchenette partition is not yet installed) the cabinet and clothes closet on the right or door side are built in, in the positions shown in Fig. 10. A small chemical toilet is built forward, just inside the door. Thin wallboard, supported by suitable framing, is used in the construction of this equipment. The rear partition, Figs. 8 and 10, is also of the same material.

Kitchenette: After installing the partition, the kitchenette can be built in the individual's favorite method of cabinet work. In the original, Fig. 9, the units were built separately and then set into the rear compartment, the perspective view showing the general arrangement. When not in use, stove, sink and water-tank compartment are covered with hard-pressed board in tile pattern, making a neat, clean table in appearance.

Icebox Is Cork-Insulated: A large icebox is built into the original trailer, the details being shown

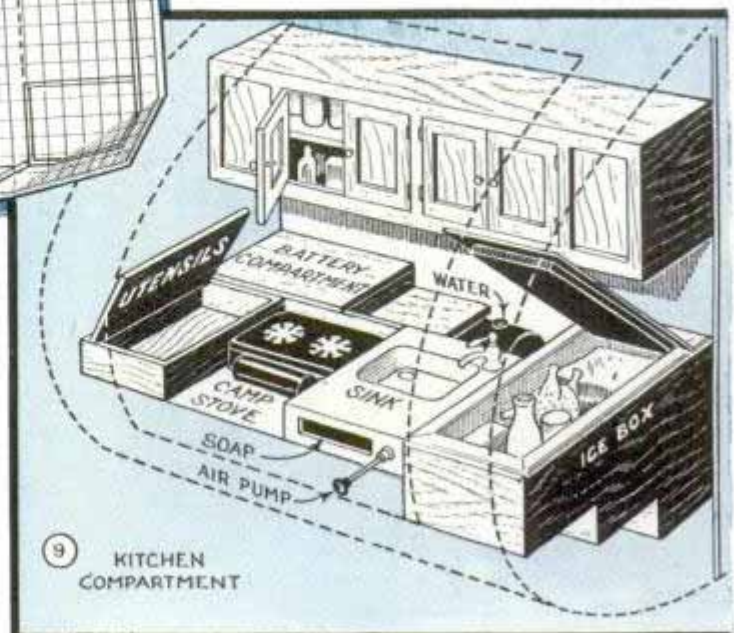

in Fig. 11. As you will see, a stepped-box of plywood is made first and lined with 1-in. sheet cork, then a galvanized sheet-metal lining with corners soldered is made to fit over the cork insulation. Around the edge of the lid is a strip of sponge-rubber weatherstrip to make a tight seal. The drain pipe is fitted with a water-seal or trap made from an alarm-clock bell. This prevents loss of cold air from the box. The ice tray shown is especially adapted for trailer use, being fitted with a pair of stiff spring feet, and with nail ends about 1/2 in. long soldered to the sheet-metal bottom so that the ice melts down upon them and will not slide about. No nails should be used in assembling and fastening either the icebox or the other kitchenette units in place. Use screws instead. They hold better than nails of any size under the conditions of vibration to which these parts are subjected. Not only that, but units fitted into close quarters such as these can always be removed intact if assembled and fastened with screws of proper size. It's a good idea to anchor the stove and sink securely, otherwise these units might be thrown about loose in the compartment should the trailer be called upon to travel over a rough road or steep mountain trail.

Water System and Sink: A Model-T Ford gasoline tank is fitted out for an air-pressure water system, Fig. 13. The filler

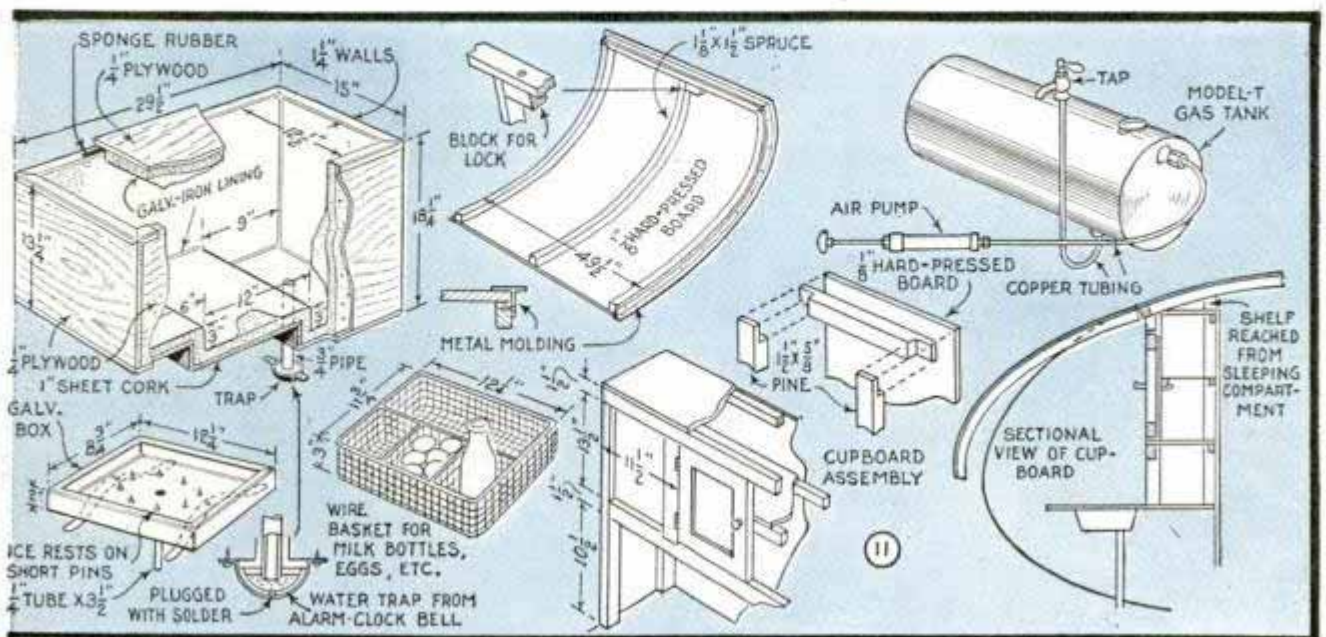
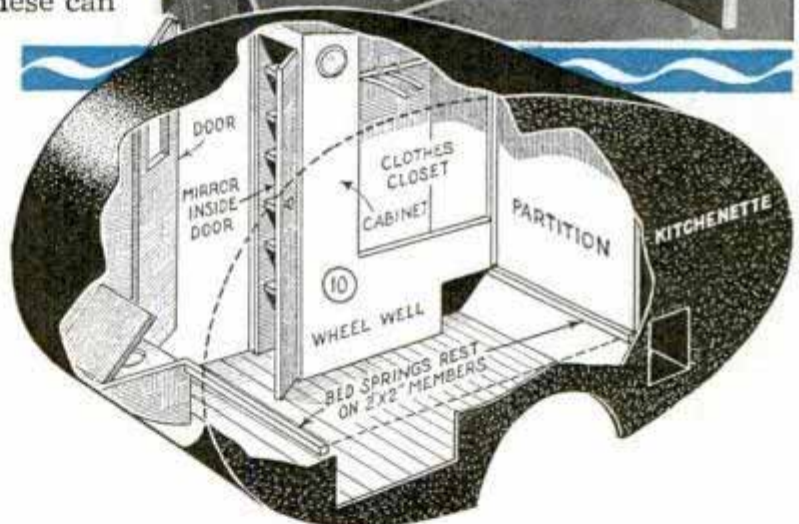
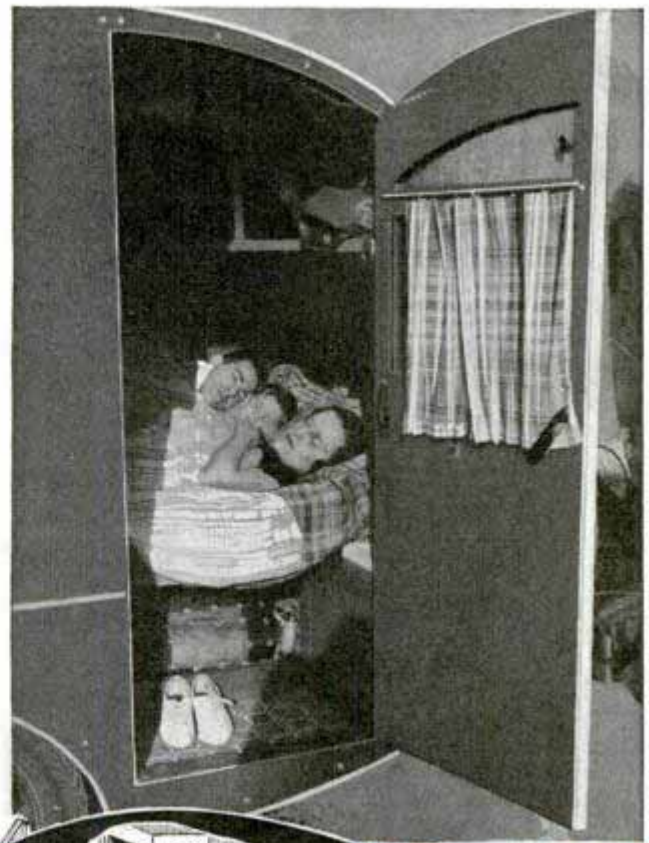

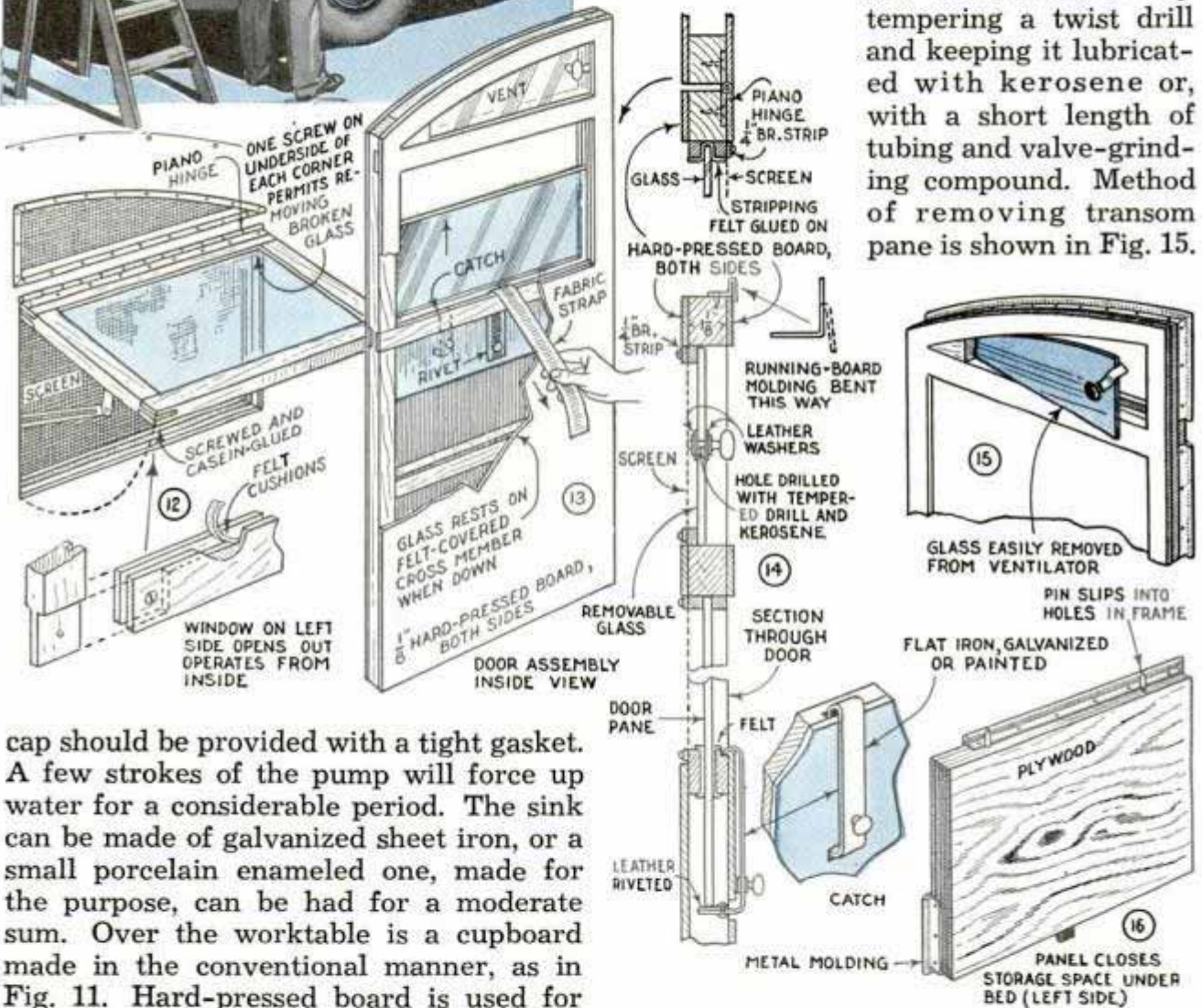

has a screened transom ventilator fitted with a removable glass pane, a screened window that can be lowered, a lock, window latch, and curtain rod. The framing is the same as the rest of the body, and is covered both sides with $\frac{1}{8}$ -in. hard-pressed board. Fig. 14, the sectional view, illustrates the inner construction, while Figs. 13 and 15 show perspective views of the door assembly. The sliding window moves in felt-covered slots and the pane is otherwise protected against rattling and chafing, as the drawings will show. Holes for the rivet and handle in transom pane, Fig. 15, are bored either by tempering a twist drill and keeping it lubricated with kerosene or, with a short length of tubing and valve-grinding compound. Method of removing transom pane is shown in Fig. 15.

cap should be provided with a tight gasket. A few strokes of the pump will force up water for a considerable period. The sink can be made of galvanized sheet iron, or a small porcelain enameled one, made for the purpose, can be had for a moderate sum. Over the worktable is a cupboard made in the conventional manner, as in Fig. 11. Hard-pressed board is used for the paneling, and all framing is $\frac{3}{4}$ by $1\frac{1}{2}$ -in. pine. The top of this cupboard serves as a shelf for the sleeping compartment on the other side of the partition. Construction of the lid for the kitchenette is similar to that of the body, and details are given in Fig. 11. The edges are bound with aluminum running-board molding.

Door Has a Transom: A great deal of convenience is built into the one door. It

These panes are cut from plate glass with an ordinary glass cutter, and the edges smoothed with an oilstone. The window on the left side is swung out by a bracket on the inside, working through the screen. The transom vent above this is the same as in the door, and the frame assembled as shown, Fig. 12. Also on the left side are two removable panels, one to give access

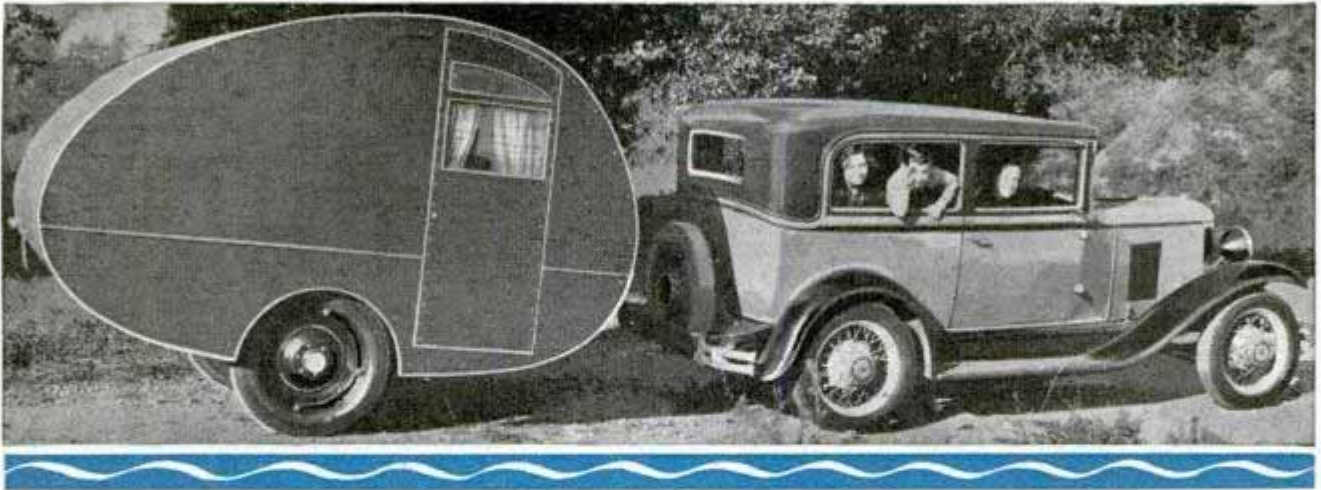

MATERIAL LIST

SHEATHING

- 1 pc. 4x10 ft. $\frac{1}{8}$ -in. tempered hard-pressed board
- 2 pcs. 4x12 ft. $\frac{1}{8}$ -in. tempered hard-pressed board
- 2 pcs. 3x12 ft. $\frac{1}{8}$ -in. tempered hard-pressed board
- 5 pcs. 4x6 ft. $\frac{1}{8}$ -in. tempered hard-pressed board
- 2 pcs. 4x12 ft. $\frac{1}{8}$ -in. tempered hard-pressed board
- 1 pc. 4x6 ft. hard board in tile pattern for kitchenette worktable

MISCELLANEOUS

- 4 pcs. windshield glass, sizes in drawings
- 1 pc. 12 in. x 8 ft. copper screen for windows
- 1 bracket for opening left window
- 12-ft. brass piano hinge, door window, and kitchenette lid
- 6 cupboard latches, 6 pr. hinges
- 1 trailer sink, drain for sink, 1 stove
- 8 sq. ft. galv. sheet metal for icebox lining
- 8 sq. ft. 1-in. sheet cork for icebox lining
- Tubing for drain
- 1 pc. galvanized sheet metal 3x4 ft. for fenders
- 4 locks, to door, kitchenette and two side panels
- 1 set bed springs and mattress

SCREWS, BOLTS, ETC.

- 2 U-bolts for tow bar
- 1 gr. $1\frac{1}{4}$ -in. round head No. 8 screws and 200 washers to fit
- 1 gr. $\frac{3}{4}$ -in. No. 6 flat-head screws
- 1 gr. $\frac{3}{8}$ -in. No. 8 R.H. screws and 200 washers to fit
- 2 gr. 1-in. No. 8 oval-head screws
- 1 gr. $\frac{3}{4}$ -in. No. 5 screws
- 1 gr. $1\frac{1}{4}$ -in. No. 8 R.H. screws and 1 gr. washers to fit
- 1 gr. $1\frac{1}{4}$ -in. F.H. No. 8 screws
- 1 gr. $1\frac{1}{2}$ -in. F.H. No. 8 screws
- 2 gr. $\frac{1}{2}$ -in. No. 5 F.H. brass screws

ELECTRICAL

- 36 ft. insulated wire
- 2 dome lights for 6-volt current
- 1 6-v. socket and bulb, kitchenette
- 2 sockets and bulbs for 110-volt current
- 1 plug-in socket for 110-volt current
- 2 plug-in sockets for 6-volt current
- 1 two-way switch
- 1 storage battery
- 1 tail light, 1 blue clearance light

FINISHING

- 94 ft. aluminum running-board molding
- 12 ft. $\frac{1}{4}$ -in. brass strip for over screens
- 12 ft. half-round molding
- Paint, spar varnish, casein glue

to storage space under the bed, the other to the battery box. Each is fitted with a lock, and with two pins at the top that set in holes bored for the purpose, Fig. 16. The larger panel is taken out in warm weather, in camp, and a screen substituted, giving excellent ventilation as in Fig. 18.

Wiring: Three circuits are installed for lights in the original trailer, Fig. 17. One is a plug-in for 110-volt lines, while the other two are for 6-volt lines from car and from storage battery in the trailer. The wiring can be extended to any point in the trailer for convenience.

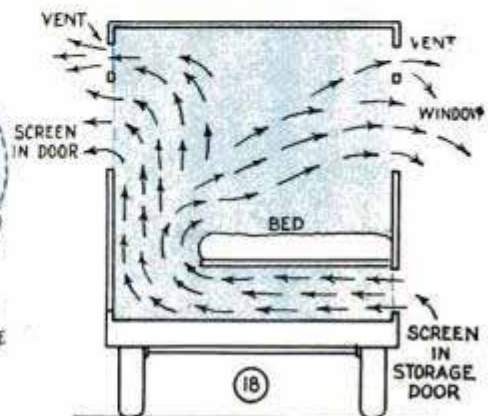
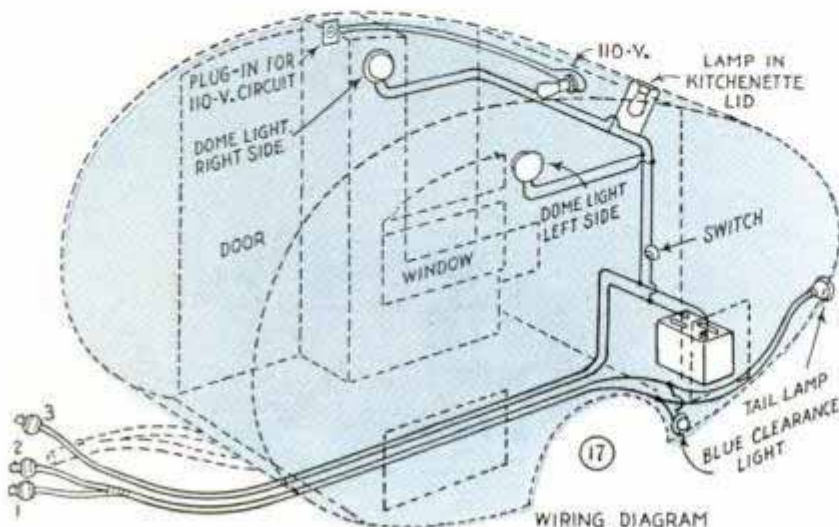

Snow Packed under Feet on Skis Is Removed Easily



It's no trick to remove snow that packs on skis under your feet if you use a scraper like the one shown. It consists of a wood handle having several thicknesses of screen wire tacked around one end to form a flexible scraping surface. As there are no sharp edges on the scraper to come in contact with the ski there is little danger of damaging the finish.

Slip-On Handles for Beakers

Metal beakers and similar round containers can be made convenient for pouring or for handling when hot by adding

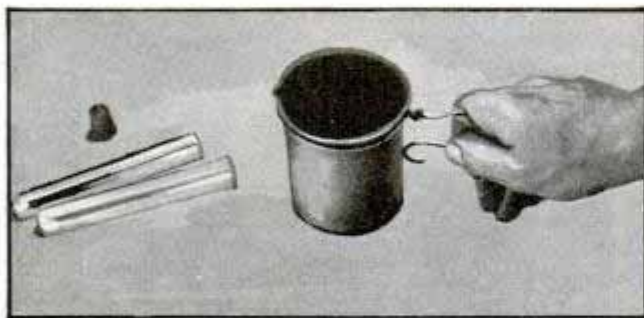

simple wire handles to them. Bend the wire around the beaker and twist the ends together, leaving one long to form the hand grip. The flange at the top of the beaker will keep the handle from slipping off.

—Burl Knutson, Bismarck, N. D.

Old Transformer Used as Coil for Electric-Arc Circuit

If you are going to make an electric-arc soldering outfit or other apparatus requiring a similar reactance or choke coil in the circuit, a transformer from a battery charger can be used as the coil. This will save the tedious work of making one. If the wire of the primary winding of the transformer is too small, it will be necessary to rewind it. The secondary winding

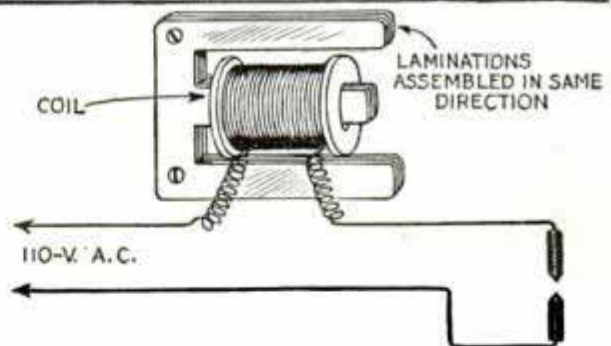
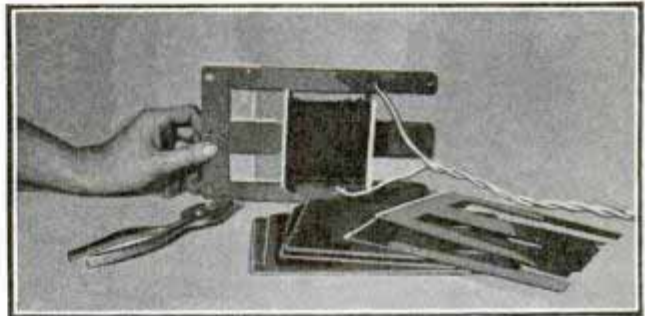

is not used and may be removed. In the normal assembly of the transformer, the laminations are inserted through the winding core alternately, one from one end and the next from the other end. Remove these laminations and insert all of them from the same end. Then attach lead wires to the ends of the coil and connect it in series with the arc feed line. Try out the apparatus with all the laminations in place. Then remove a few of the pieces and try it again, continuing in this manner until the arc operates well without an excessive current flow. An a.c. ammeter in the line while experimenting for the proper core is a handy guide.

Tooling MAT PAPER

— a new artcraft

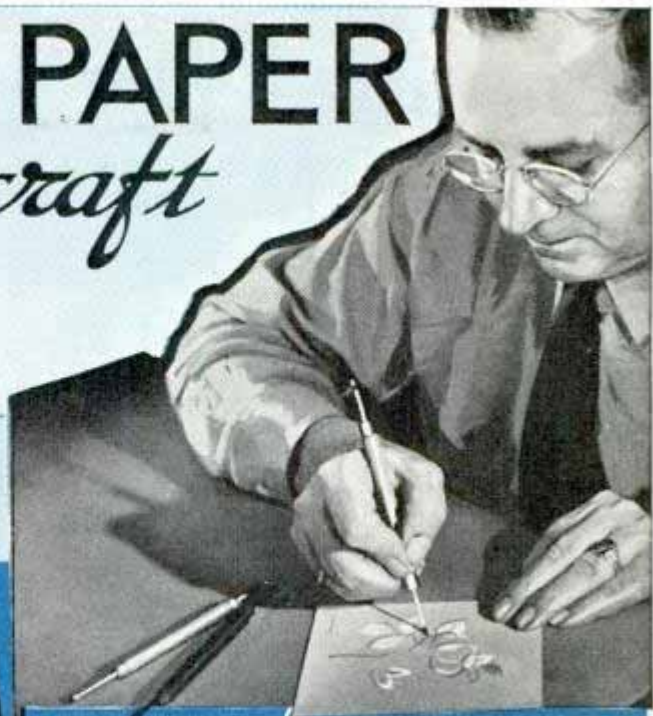
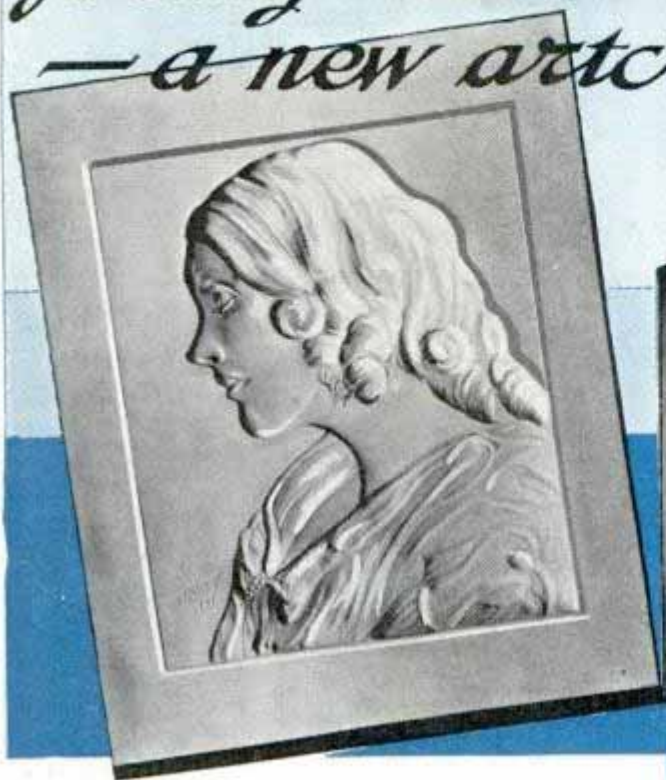

Tooled in much the same manner as leather, printers' mat paper, which is relatively soft and retains impressions, can be used for making novelties such as plaques, key-holder covers, book ends, coverings on boxes, vases, cigarette holders, etc. After moistening the back of the mat paper, it is laid on a flat surface and a design is transferred to it with carbon paper. Then you indent the surface with tools used for leather work, or by means of an orange stick obtainable at any drugstore. The paper retains indentations and the design can be decorated in colors

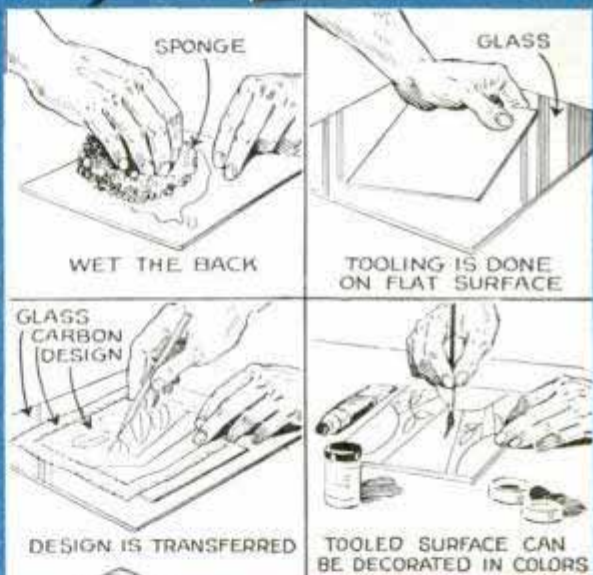

A few of the many articles that can be made with mat paper which looks like leather when tooled

V-Block Fittings for Sawhorse to Hold Round Work

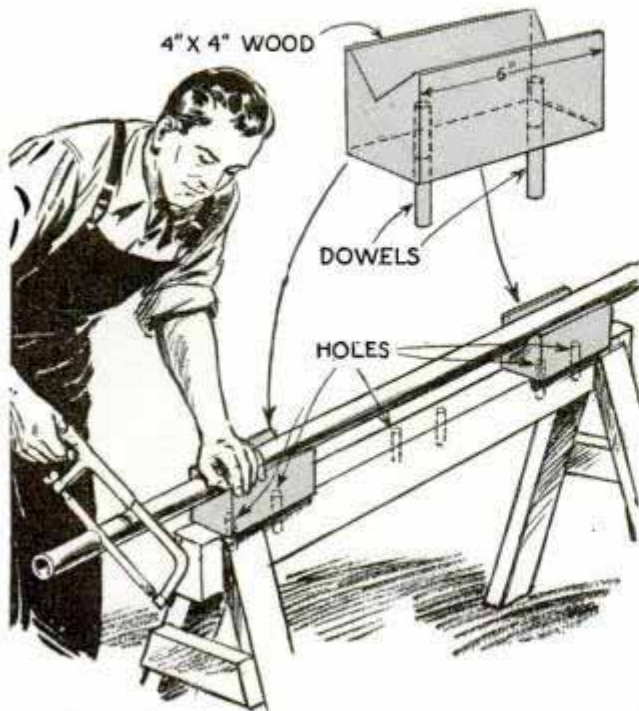

These V-blocks are handy for holding round work on a sawhorse. Pipe and tubing, drive-shaft housings, house gutters, stovepipe and round porch posts are among the many articles that can be accommodated. The blocks are held by dowels, which fit into holes in the sawhorse.

Pencil Line on Floor Disappears When Boards Are Sanded Evenly

When sanding the edges of a floor the time wasted in running your hand over the boards to see if all high ones have

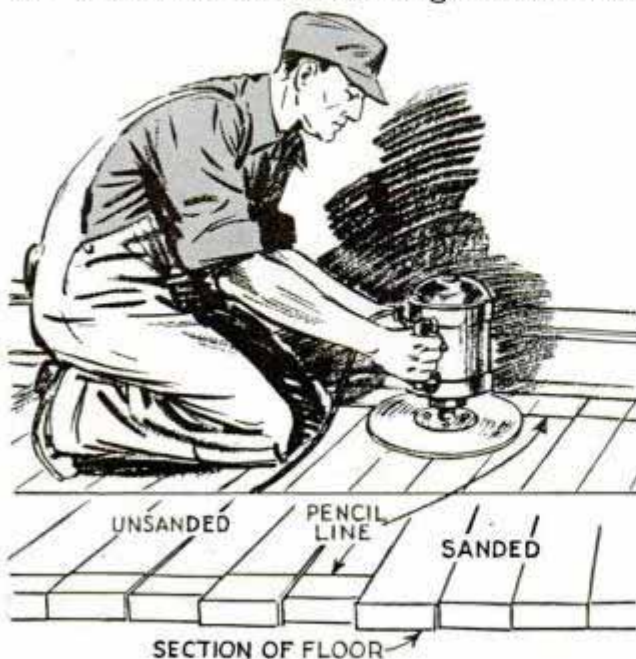

been cut down can be saved by drawing a pencil line across the board. When the line disappears the boards are even.

Clips Keep Rugs from Shifting While Beating Them

When beating small throw rugs and others that have a tendency to wrinkle and shift around, you can anchor them to the ground with large battery clips at the corners. Long wire staples pushed through openings in the clips and into the ground will hold them in place.

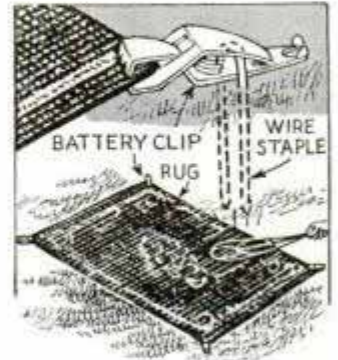

Mud on Child's Shoes Removed with Bottle Cap on Brush



Cleaning and polishing children's shoes may be simplified by using a bottle cap tacked to the back of the blacking brush. The crimped edges of the bottle cap provide a good scraping action for this purpose.

Chuck on Drill-Press Table Grips Round Work

A chuck fitted in the central hole of a drill-press table will be found useful for holding round or other small stock while drilling it lengthwise. A bolt holds the chuck to the table, the work being inserted in the chuck and trued with a level.

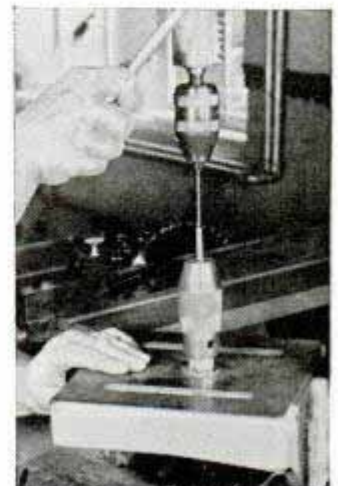

Rain Barrels Filled in Sequence from Gutter

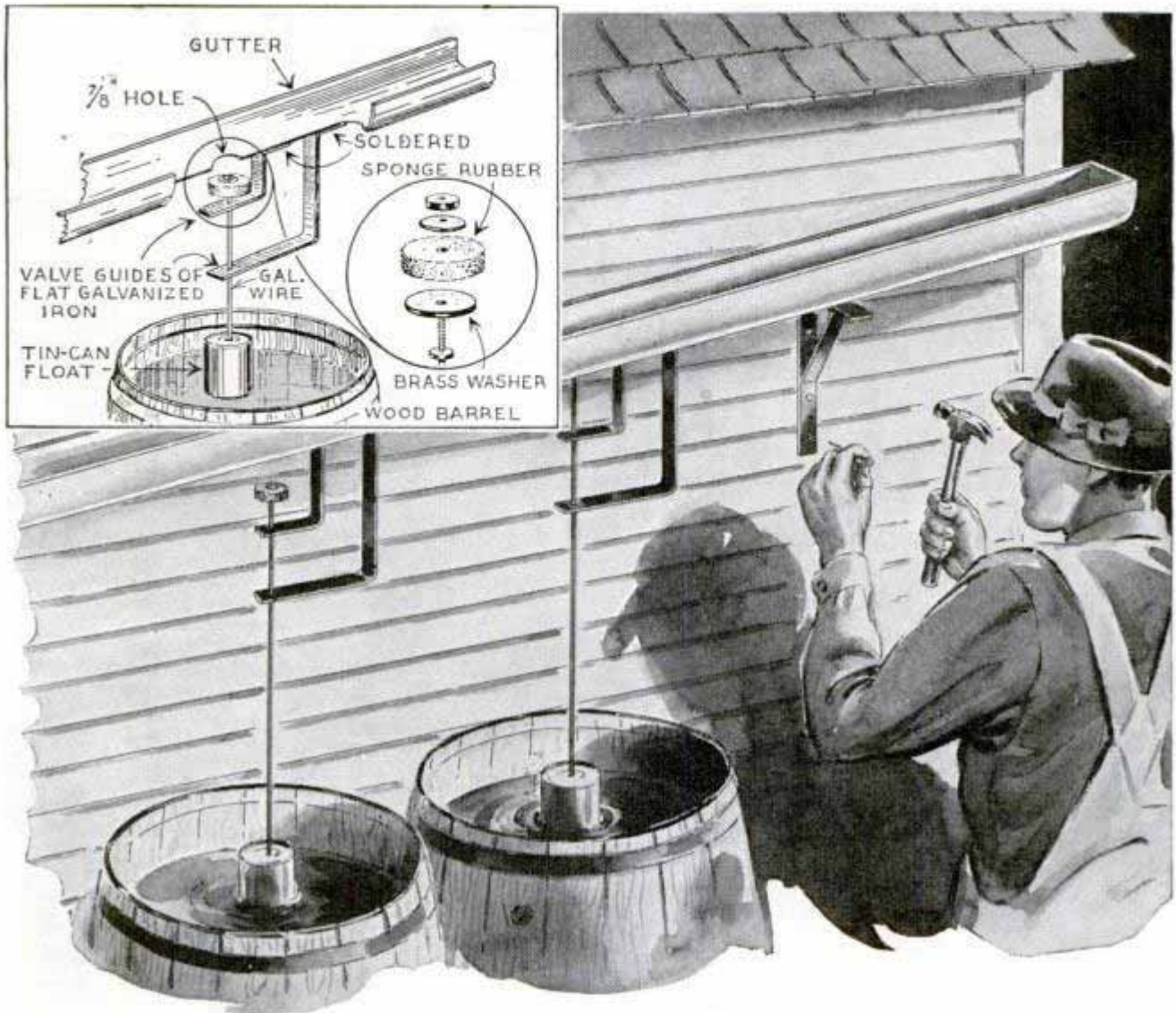

Where more rain water was needed than could be held in a single barrel, the arrangement shown above was used to fill several barrels in sequence. This method was preferred rather than having several barrels fill up at the same time, which could have been done by simply connecting them with pipe near the bottom. The barrels were located close together under the gutter near the end of the building. A drain hole was cut in the gutter for each barrel and a stopper controlled by a float-and-plunger arrangement was provided for each hole. Water flowing down the gutter during a moderate rainfall was drained into the first barrel and as soon as this one was filled, the float on the surface pushed the plunger and stop up against the hole in the gutter, closing it and enabling the water to continue on its course to the next hole. In this way one barrel

was usually completely filled, which made it easier to remove the water than if all the barrels were partly filled. The last barrel was provided with an overflow pipe to carry surplus water away from the building.

Pipe Opening in Wall Sealed with Paper Cone

The opening around a pipe that passes through a partition can be sealed with the cone-shaped core from a spool of wrapping cord. Just cut the cone in two pieces and force them tightly into the opening.



Solving HOME



PIPE CLEANERS

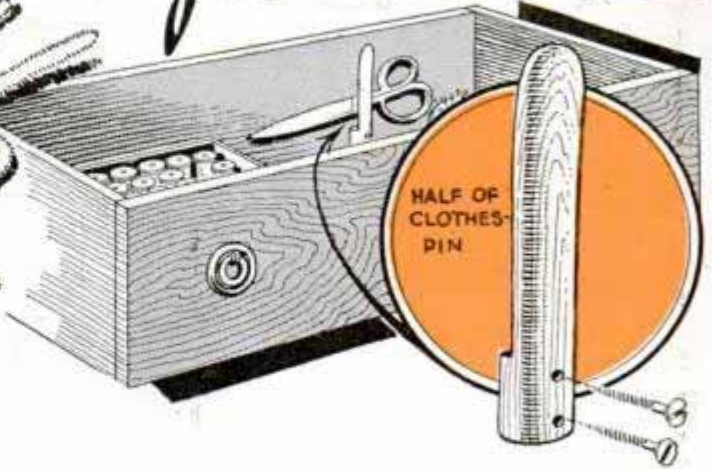

HALF OF CLOTHES-PIN

A good holder for a pair of scissors inside a drawer is made from a clothespin by cutting off the head and one leg and screwing it in place as above. Left, pipe cleaners are just the thing for removing particles from the perforated disks of a food chopper

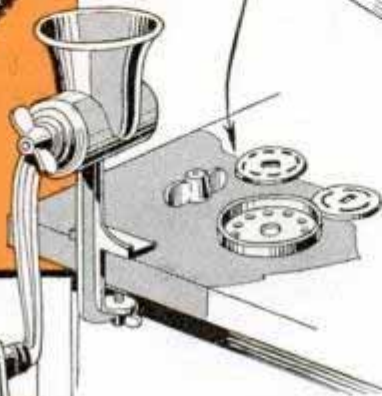

VACUUM CUP



SPONGE RUBBER

Ticking of a watch won't annoy you at night if it is hung on a vacuum cup inside of an inverted tumbler. A closed-end mailing tube, used like a bicycle pump, blows dust out of stair corners, window sills, etc. A small hole is punched in one end

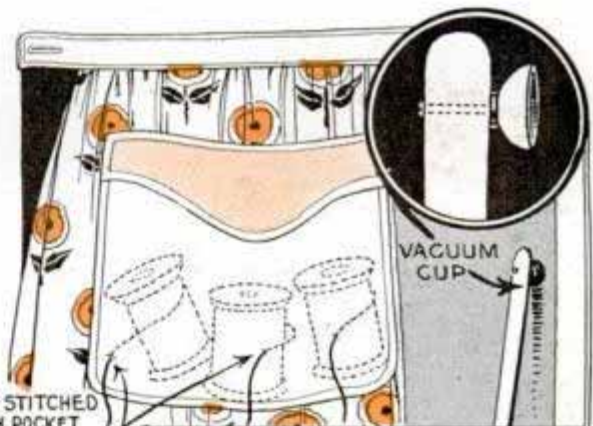

VACUUM CUP

THREAD STITCHED THROUGH POCKET

When carrying spools of thread in her pocket, a seamstress runs the ends through the pocket which prevents tangling and makes selection easy



MAILING TUBE

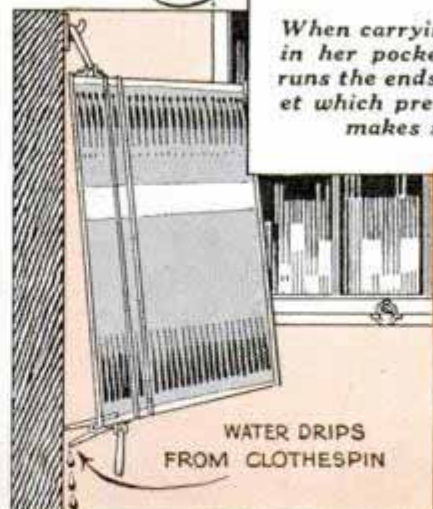

WATER DRIPS FROM CLOTHESPIN

After you empty a washtub and hang it up, a clothespin slipped over the lower edge will prevent water running down the wall. A broom "stays put" when leaned against a wall if you fasten a small vacuum cup to the end of the handle as above

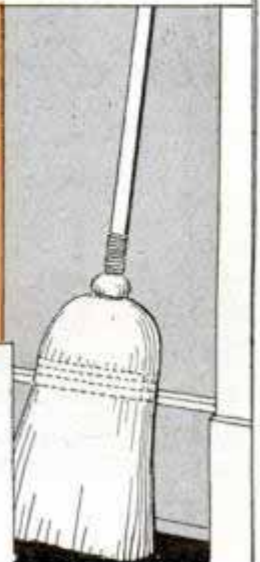

PROBLEMS

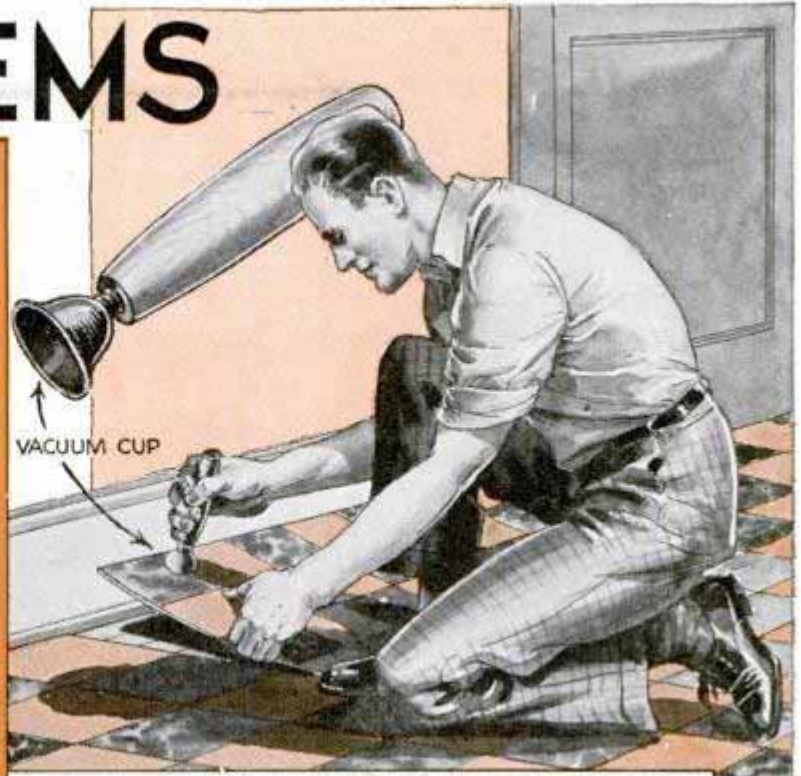
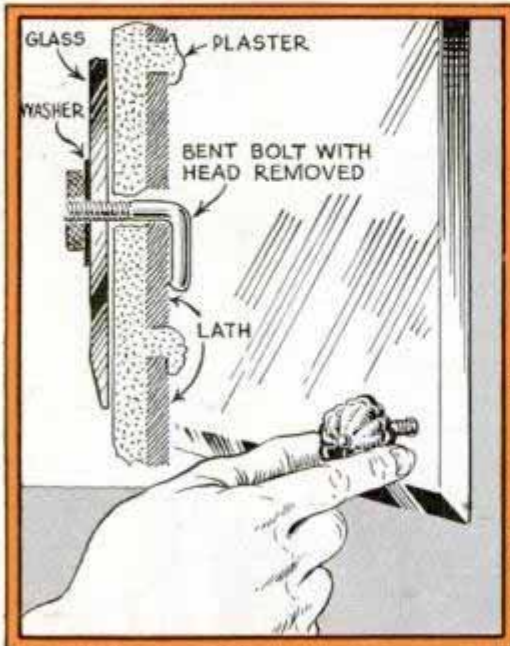

TWO HANGERS



Instead of using a knife to pry up the edges of linoleum in corners and close to baseboards, when cutting and fitting, try a vacuum cup on the end of a stick. A headless bolt of suitable length bent to hook behind a lath as at the left, is ideal for attaching heavy objects to a plastered wall

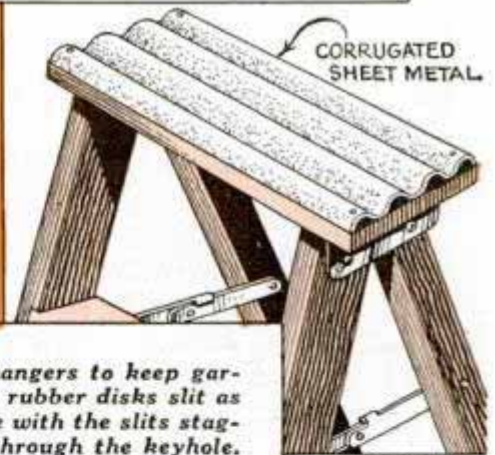
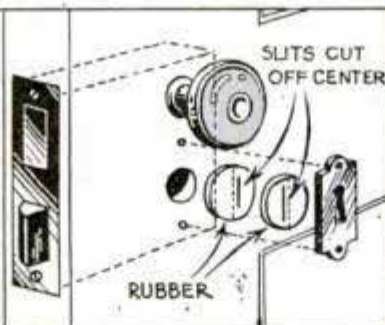

Left, how to use a couple of coat hangers to keep garments from blowing off a line. Two rubber disks slit as above and placed behind a lock plate with the slits staggered keep cold air from entering through the keyhole. Right, tools can't roll off top of this stepladder

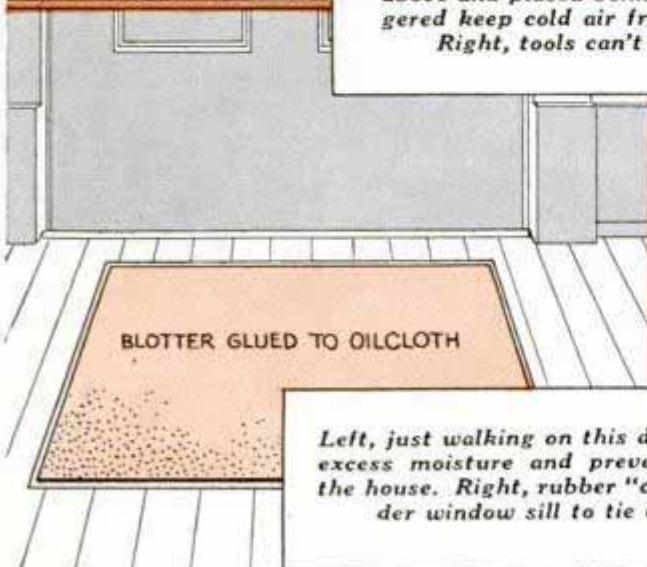

BLOTTER GLUED TO OILCLOTH

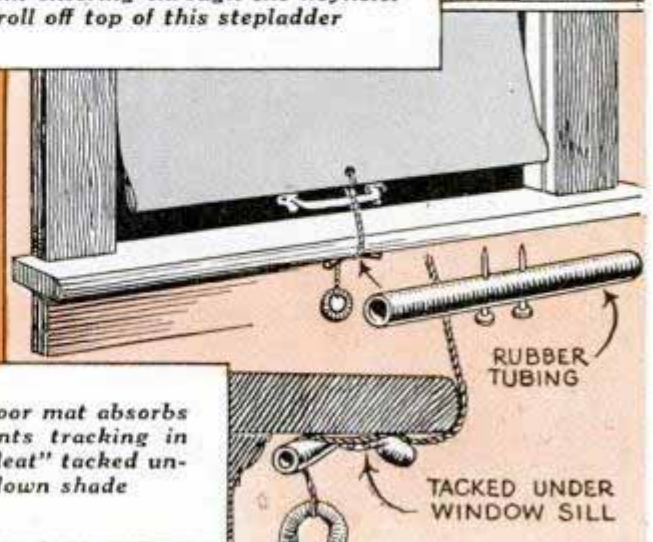

Left, just walking on this door mat absorbs excess moisture and prevents tracking in the house. Right, rubber "cleat" tacked under window sill to tie down shade

Hints on Using Your Photo Lights at Home

The average home photographer whose equipment is somewhat limited will find that photo-light reflectors having a rubber-covered clamp will often serve a two-fold purpose. Placed on the seat of a chair, the reflector can be used to support a back-



Spate reflector holds backdrop

METAL
BOOK
END

PENCIL

Securing reflector to tubular support

COAT HANGER

← TRACING CLOTH

Improvised diffuser

drop when taking portraits, as shown above. Also it will hold a diffusing screen, which may be simply a piece of tracing cloth slipped on a

wire clothes hanger, which is rested on the reflector and is hooked onto the socket as shown at left. Be sure to provide space for air circulation between the reflector and the screen to prevent burning the latter. When you have to set a reflector in some position where it cannot be clamped to the back of a chair, and other available mountings do not offer sufficient rigidity, try a metal book end as a base on which to clamp the reflector, after which the book end can be set on any flat surface. When a lamp standard or other tubular support would be handy to clamp the reflector, but the round surface does not permit the clamp to hold securely, a pencil slipped through the two sides of the clamp as shown in the circular detail will make it hold securely on the round surface.

Folding Photoflash Reflector Is Easy to Carry

Cardboard photoflash reflectors that fold flat and take up almost no space in the camera case can be made in a few minutes from materials available to anyone. Two triangular and two rectangular pieces of heavy cardboard are held together with strips of adhesive tape. The triangular pieces are creased in the center so they will fold inside as shown in the lower detail. A hole in one piece allows the bulb to be slipped through and screwed into the battery case. Tinfoil or aluminum foil is glued to the inside of the reflector.

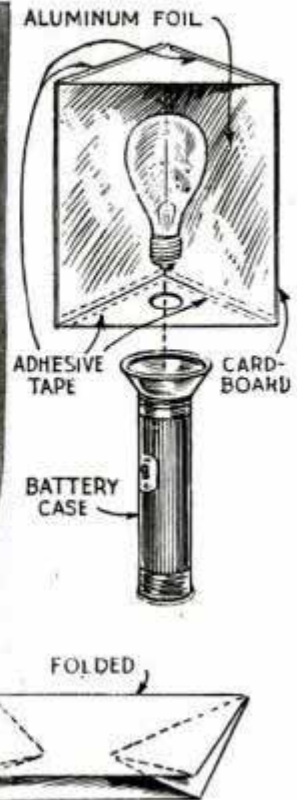
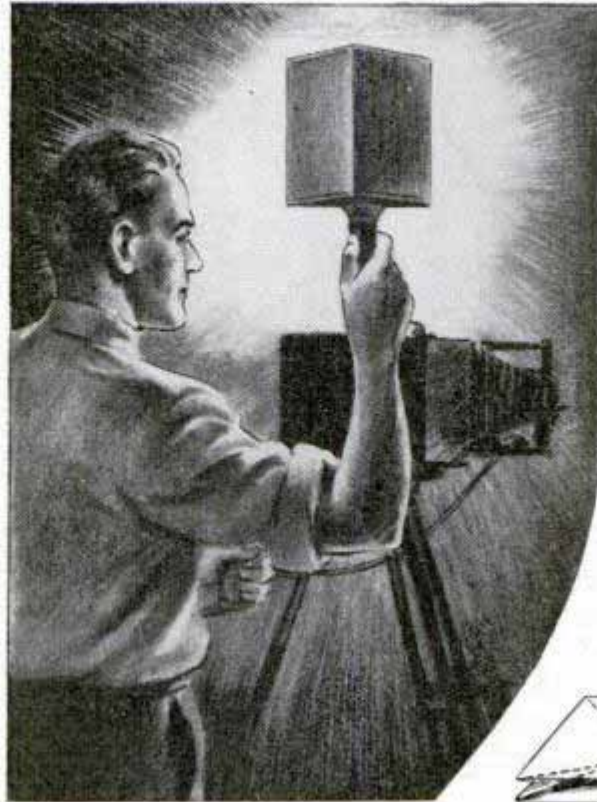
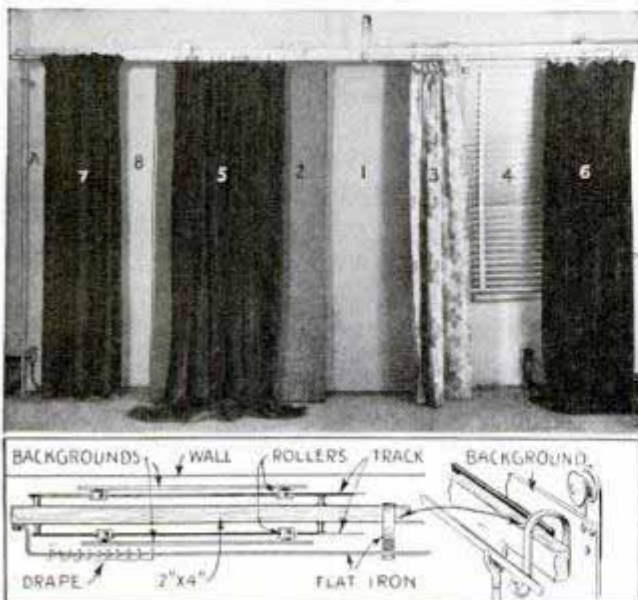

Photo Backgrounds on Track Take Small Space in Studio

Offering a wide variety of background combinations, this arrangement of drapes and sections of wallboard extends only 1 ft. out from the wall of the photo studio. The drapes slide on barn-door track mounted on each side of a 20-ft. rail of 2 by 4-in. stock, which is supported 9 ft. above the floor by $\frac{3}{4}$ -in. pipes in floor flanges. Solid backgrounds (1 and 2 in the photo) and the Venetian blind (4) are fitted with

barn-door hangers that roll on the track. Attached to the front of the rail at each end and supported in the center by a flat-iron bracket, is a length of 1 by $\frac{1}{4}$ -in. flat iron. On this the drapes are hung by rings. A pole for lifting the drape bar off the center bracket to push drapes beyond that point is shown in the right-hand detail. No. 1 in the photo is a light gray section of wallboard; 2 is a slightly darker gray section; 3, figured drape; 4, Venetian blind; 5, dark gray drape; 6, black drape; 7, dark brown drape; 8, white wall.



Sponge-Rubber Stops in Reel Keep Film from Unwinding

Small cubes of sponge rubber will keep movie film from unwinding. The cubes are compressed and slipped between the disks of the reel and against the end of the film.

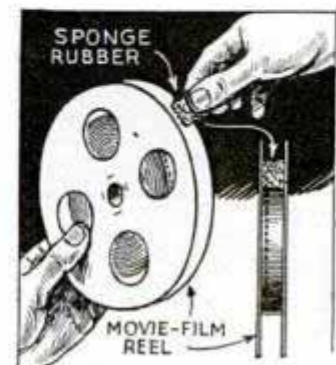

Curved Ferrotypes Plate Dries Prints Straight

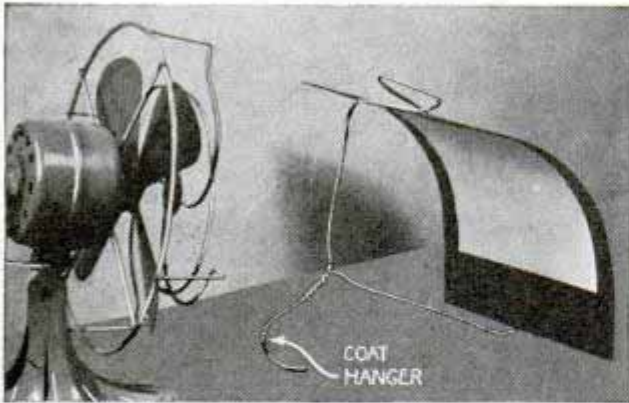

As a photo has a tendency to curve toward the glossy side as it dries, curve the ferrotypes inward and the photo will be more likely to be straight when it is removed from the plate. A good way to hold the ferrotypes plate in a curved position is to use a wire coat hanger as indicated.

—Jacques H. Upshaw, College Park, Ga.

Sun Glasses as Camera Filters

Many amateur photographers have found they can use one lens of a pair of sun glasses as an emergency filter and some

have even made up a complete set of filters from lenses of various tints. For emergency use, one side of the glasses can be held in front of the camera lens while the picture is snapped. The normal exposure will have to be increased two to ten times, depending on the tint of the sun glasses. If a permanent set of filters is to be made, they can be mounted in cardboard or metal holders that will slip over the camera lens, and the proper increase in exposure for each one determined by experiment.

—K. F. Keith, St. Petersburg, Fla.

Photos Scored to Avoid Curling

Unmounted photo prints will not curl excessively if the edges are scored with a case knife. Place each print face down on a paper-covered book or magazine and score the edges, using a



a ruler as a straightedge. Do not press hard enough to cut the paper.

DO YOU LIKE TO MAKE THINGS?

Then don't miss this unusual 188-page book of handicraft projects—the most diversified selection of practical popular projects of special interest to home craftsmen



182 CRAFTWORK PROJECTS

This book is chuck-full of carefully prepared information that tells and shows you just how to make things—things you want and need in your home and garden—outstanding furniture in good taste—craftwork novelties for gift and sale purposes—things that will please the children.

564 PICTURES AND PLANS

More than half the space of this book is used for pictures and drawings, that show you exact sizes of parts, method of construction and assembling, besides the articles as they look when finished.

PARTIAL LIST OF CONTENTS

Some of the articles described are modern table lamps, desks, tables, vanities, chests, beds, chairs, hampers, hassocks, bookcases, cabinets, clocks, smoking stands, cupboards, screens, racks, costumers, mirrors, shelves, weathervanes, pergolas, fencing, flower boxes, bird houses, doorshelves, portable fireplaces, house numbers, home humidifier, improvements on sinks and clothes closets, installation of attic ventilator, child's merry-go-round, steam engine, bobsled, and other juvenile items.

SENT POSTPAID UPON RECEIPT OF 50c

(Money promptly refunded to any one not entirely satisfied)

Address Popular Mechanics Magazine

Dept. S1, 200 East Ontario Street

Chicago

RADIO



EIGHTEEN TUBE *for* Short Waves

ENTHUSIASTIC short-wave DX-ers (long-distance listeners) demand certain refinements in receiver design that the average set owner knows very little about. Under good receiving conditions most standard "all-wave" receivers bring in distant short-wave programs that satisfy the average set owner but do not meet the requirements of the exacting short-wave listener, and amateur, who desires to log these DX stations when handicapped with poor listening conditions.

The 18-tube "super-pro" set il-

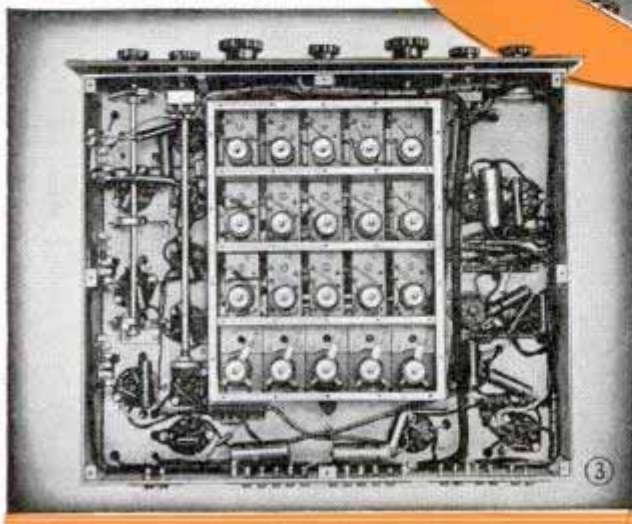
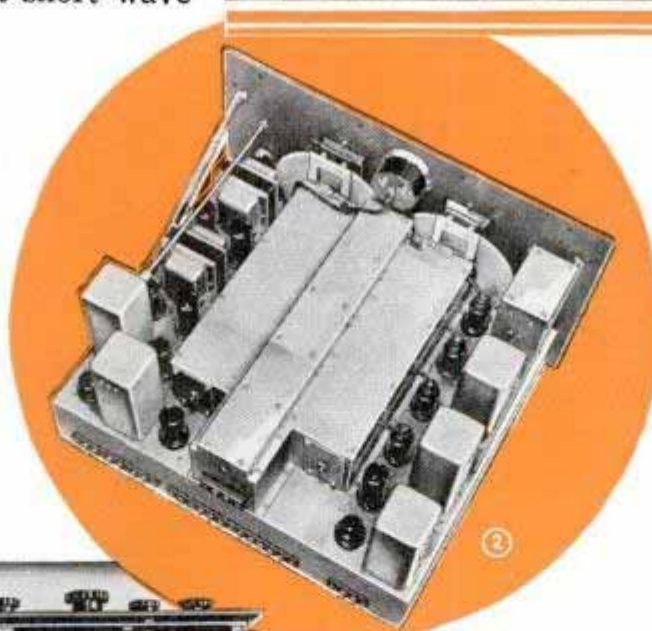

lustrated is one of the current models of a receiver especially designed for maximum efficiency in the short-wave bands from $7\frac{1}{2}$ to 240 meters. Sixteen tubes are employed in the receiver proper shown in photos 1, 2 and 3. A separate power-supply unit uses a type-5Z3 high-voltage rectifier and one type-80 low-

voltage rectifier for low voltage and C-bias supply. The speaker is also housed in a separate cabinet. Photo Fig. 2 is a top view of the well-shielded chassis, and Fig. 3 is a bottom view showing the coil and condenser assembly. Outstanding features include: selectivity variable from 16 k.c. to better than 100 cycles; 5-range crystal filter; high sensitivity obtained with two stages of tuned R.F. and three stages of I.F.; noise limiter and an adjustable "S" meter for reporting strength of signals.

Hammarlund ref 8
424 11 22 12 2000

1940 LITTLE Push-Button

By Frank M. Lund

BY FAR the most popular 4-tube t.r.f. receiver circuit ever described for construction in Popular Mechanics Magazine, this 1940 model offers a simple, practical, low-cost, tuned-radio-frequency 4-tuber of advanced design.

It makes an excellent general-purpose broadcast set that is easy to build, has good distance-getting ability, excellent tone and a 2-watt output that leaves nothing to be desired in the way of volume. This new model has several outstanding features; it employs a method of mechanical push-button tuning so simple that any novice can set up four favorite local stations in less than 5 minutes. Setting up these four stations does not interfere in any way with the usual manual tuning of the set. Other features include, permanent-magnet dynamic speaker, a.c.-d.c. operation, and four of the very latest high-filament-voltage tubes that do away with the line-cord resistor or ballast tube usually employed in

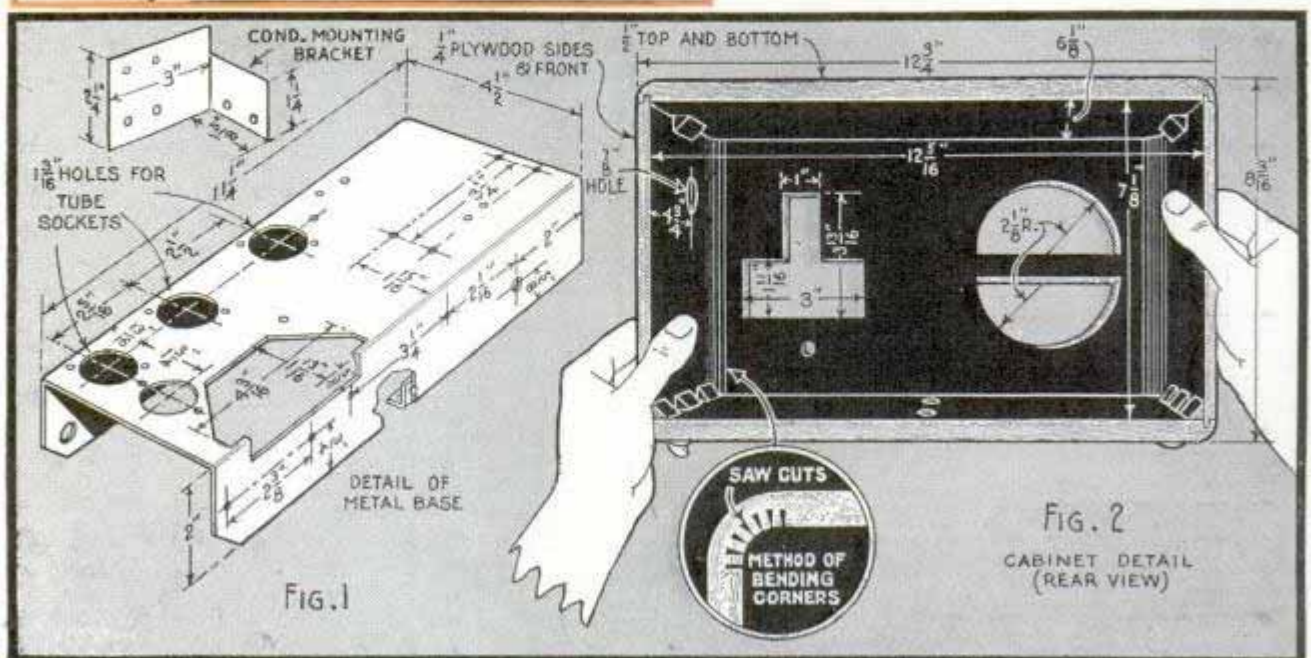
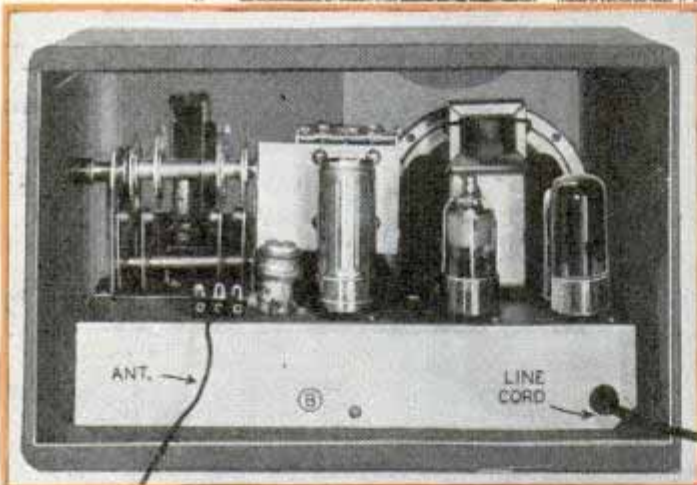
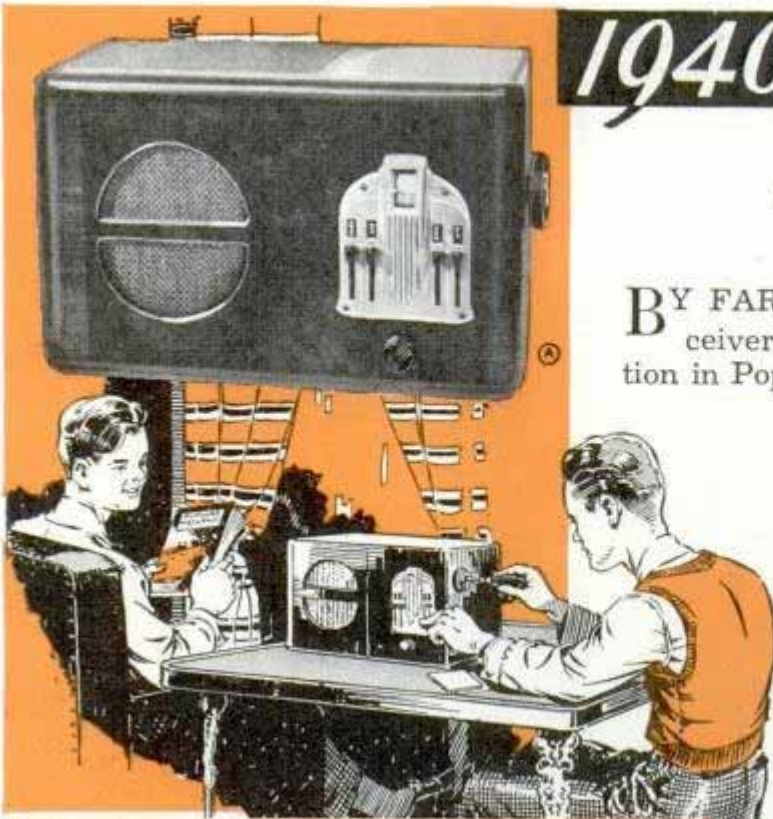

GIANT A.C.-D.C. FOUR TUBER

a.c.-d.c. receivers. The line voltage is distributed between the tubes, and the current drain is about one-half that required for similar tubes of older design. Heating is reduced to a minimum, and the 45Z5-GT rectifier tube is provided with a heater tap so that a single pilot lamp can be lighted to normal brilliancy.

The sheet-metal chassis base and condenser mounting bracket are detailed in Fig. 1; these may be home-made, or, they can be purchased formed and drilled if desired. Fig. 2

(Continued to page 132A)

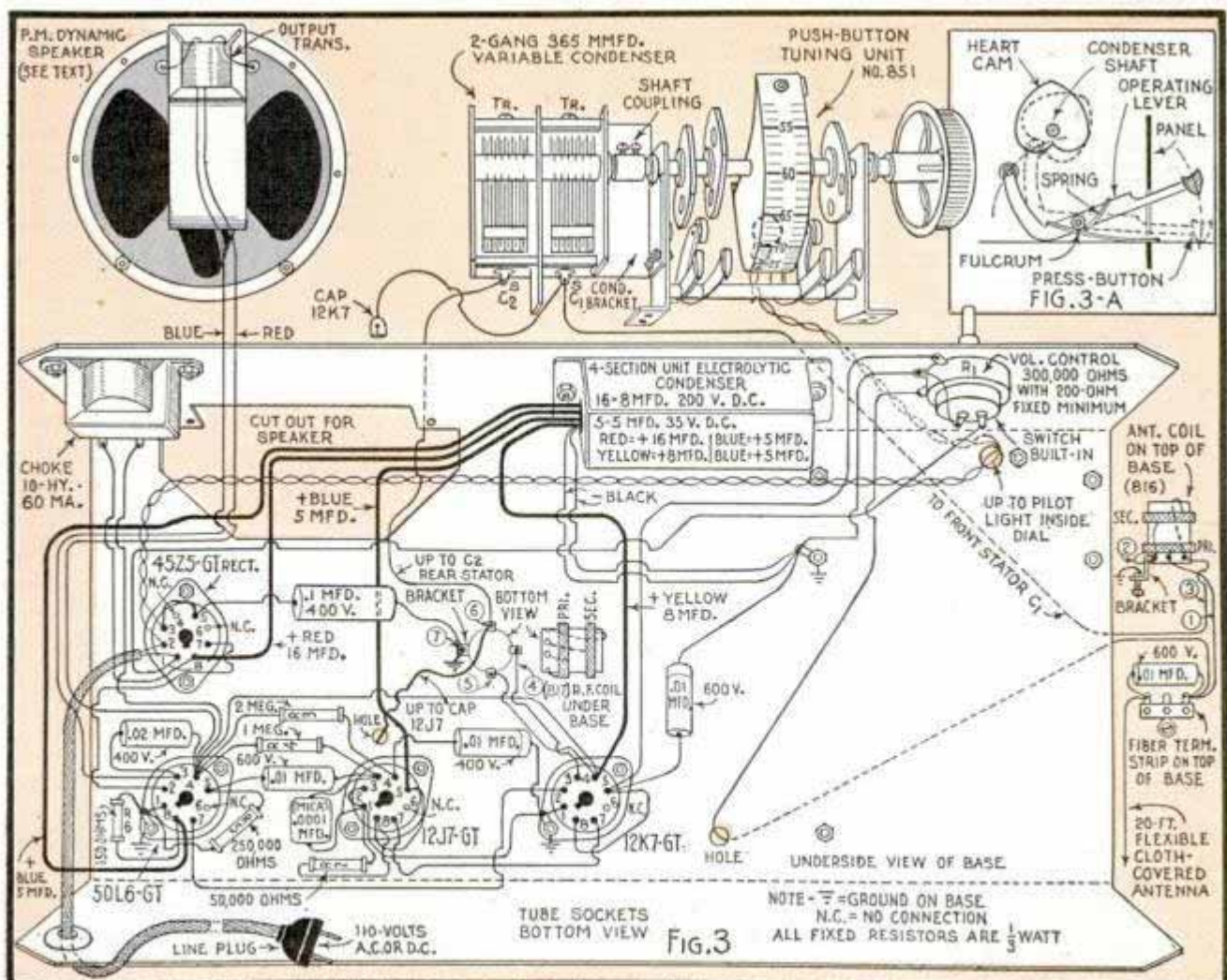
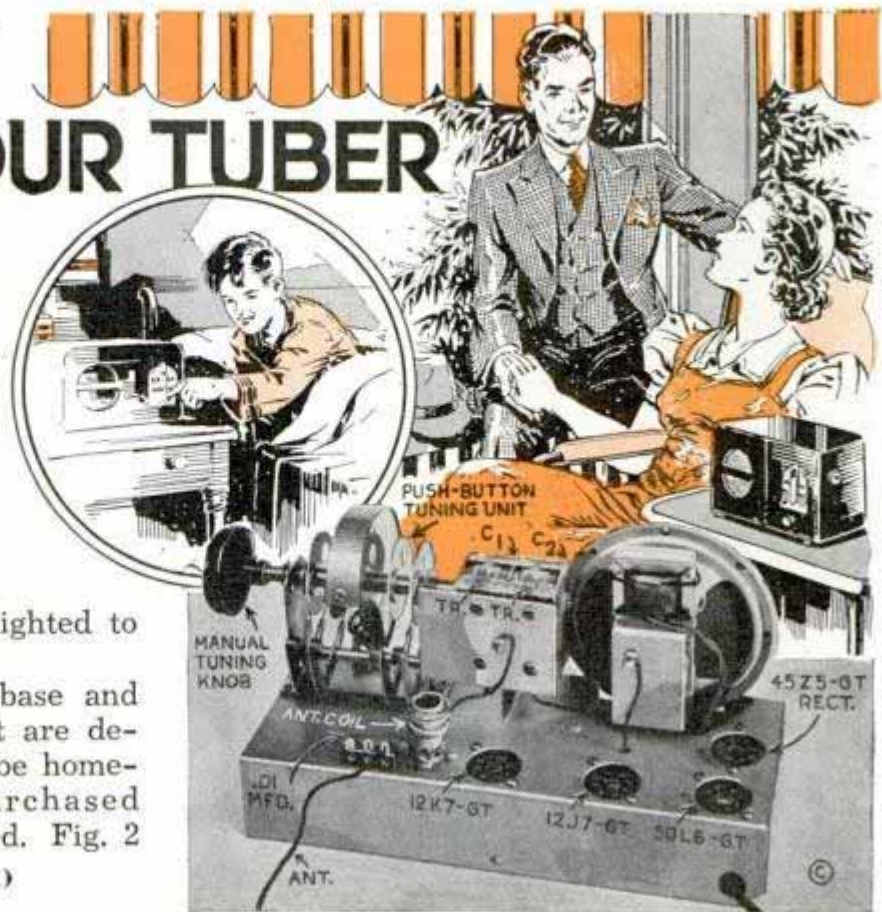

Photocell-Operated Relay for Experimenters

By L. L. Worner

THIS easily assembled low-cost photoelectric-cell-operated relay is heavy enough to turn lights "on" or "off," operate an electric counter, actuate other relays to operate electrically driven door-opening devices and many other applications of interest to students and experimenters. It is rated at 5-amp. non-inductive load and 1-amp. inductive load at 110 volts.

Photos A, B and C show various views of the completed instrument. The chassis base and cover with mounting holes drilled, and all radio construction parts are available in kit form from mail-order parts houses. The sheet-metal base is 5 in. long, 4 in. wide and

2 in. high, and the cover extends 4 in. above the top of the chassis base. This cover is provided with a recessed lens holder in case the builder wishes to use a condensing lens. Although the instrument can be used without the cover for certain applications, the cover is necessary to prevent extraneous light from falling upon the photocell when a beam of light is used to control the operation of the relay.

Only a handful of parts is required and these are all plainly specified in wiring diagrams Fig. 1 and Fig. 2. Mount tube sockets with terminals as shown in diagram Fig. 1. The transformer is mounted on the side of the base. Please note that the compression-type trimmer condenser is supported directly on the insulated lug on terminal strip.

To test and adjust the instrument, turn the potentiometer to the extreme left. Connect a milliammeter, of 0 to 25 m.a. range, with the positive terminal to the No. 8 pin of 25L6-G, and the negative terminal to ground. Cover the photocell so that light cannot fall on it, plug

(Continued to page 136A)

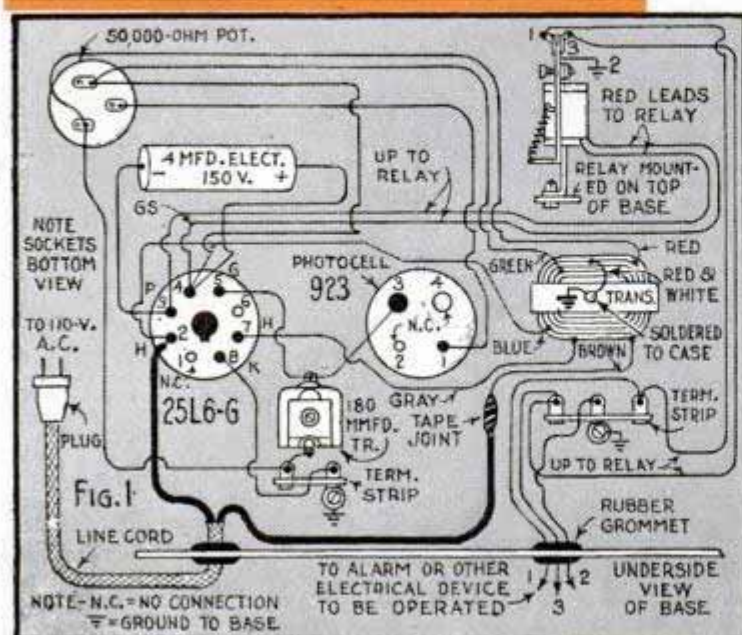
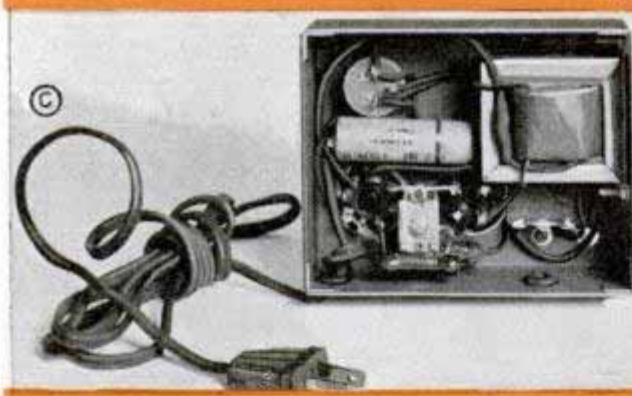

*Technical
Appliance Corp
178.16 St.
Newark*

*Ward Products Corp.
1527 E 45th. Cleveland
Ohio*

Practical RADIO HINTS



Photo Fig. 1, and sketch above, show a peak-band doublet kit antenna system specially designed for maximum efficiency in the 10, 20 and 40 meter bands. Traps A and combination trap and loading coils B-C are weatherproofed

Fig. 2, mirror unit clamps on any coil or hinge-type antenna rod; provides increased signal strength and a rear-view mirror for safe driving

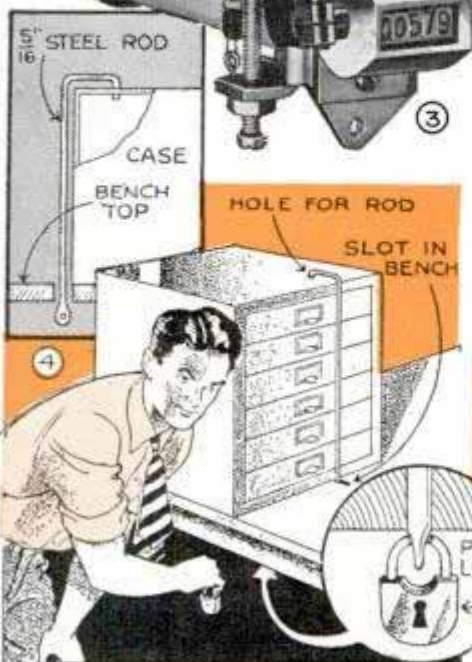

Fig. 3, speedy, low-current electric counter, capable of recording up to 600 counts per minute, is easily adaptable for electronic uses; Fig. 4, padlocked rod prevents removal of drawers from small radio parts cabinet. Rod is bent into an L-shaped hook which, when engaged in hole drilled in top of cabinet and padlocked beneath the bench top, prevents drawers from being opened

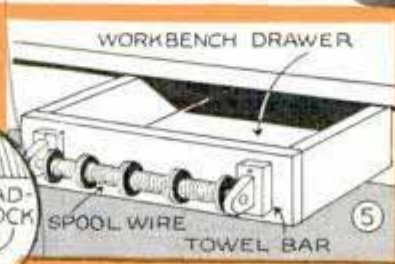
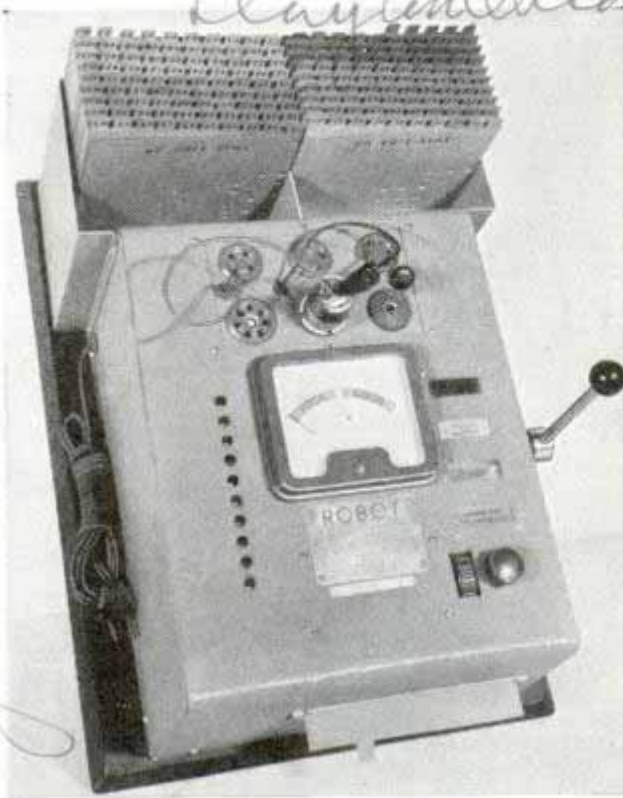

Fig. 5, short towel rack, or dowel, fitted with wood brackets and fastened across the front of a drawer in your radio workbench, serves as a handle and also provides an excellent rack for spool wire; Fig. 6, compact heavy-duty vacuum-sealed tank condenser for single-ended or push-pull amplifier in cw or phone rigs



*C. P. Clare & Co.
4901 W. Lawrence Chicago*

Automatic Tube-Tester Unit Employs Card Index



Operating in a manner similar to a time clock, this device automatically tests shorts, leaks and all important functions; 185 index cards cover 580 tube types. Operator simply places tube in socket, inserts proper punched card from index into slot until stop is reached, and pulls lever.

Seven-Station Office System



Up to seven of these "multiple master" stations may be used for inter-office communication. Each station unit consists of an a.c.-d.c. amplifier, power supply and microphone speaker. Transmission occurs only while push-to-talk switch is down, otherwise unit is in receive position.

A, B, and C-Battery Eliminator

Where 110-volt, 50-60 cycle a.c. current is available, this small "battery to all-electric converter" can be used to supply A, B and C power to battery sets designed for 3-volt dry battery, 2.5-volt air cell or 2-volt storage cell "A" power.



Improved Wireless Record Player

Housed in a case of mahogany-colored plastic material, this inexpensive record player has a 3-position power switch, crystal pickup, self-starting electric motor and employs two tubes. No wired connections to receiver are necessary, and records can be played from any location in a room.



Blueprints covering radio construction articles in this and past issues are available for 25 cents each. Original material lists, with names of manufacturers and dealers, can be obtained from our Radio Department upon receipt of postage.

NEXT MONTH—How to Build a Loop-Operated Battery Portable. This compact little set uses four of the 1.4-volt, low-drain tubes, has its own built-in loop antenna and can be installed in any sort of carrying case the builder may prefer. Also—**Homemade Telescoping Antenna Mast.** Rugged construction, easily raised.

Lafayette Radio Corp. 100 6th Ave. New York 5, N.Y.

General Information to Mrs. E. W. Van...

General Information to Mrs. E. W. Van...



SHOP NOTES

Precision CHUCK BACKS *machined on your lathe*

By C. W. WOODSON

UNLESS you purchase your workshop metal-turning lathe already equipped with a complete kit of accessories, machining and fitting a chuck back, or chuck plate as it is frequently called, is one of the first jobs you will get into when you "tool up" for more pretentious work. Although there are certain niceties in machining the chuck back to fit, the job is one of the easiest and simplest of all precision operations on the small lathe. Also, you will save several dollars by doing the whole job

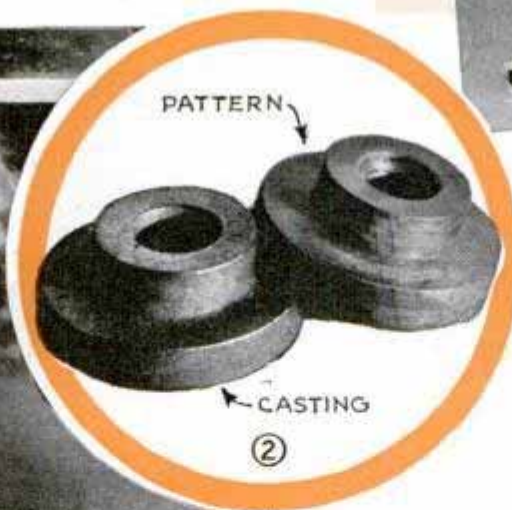

yourself. It takes only a few minutes to turn out the wood pattern, Figs. 2 and 5. The upper detail, Fig. 5, gives the dimensions of the pattern, from which a flanged gray-iron casting is made at your local foundry. Finish dimensions

of the casting, lower detail in Fig. 5, are for a 9-in. lathe with 1½-in. spindle having 8 t.p.i. (threads per inch).

With the casting on hand it is mounted on the faceplate with lugs and bolts adjusted to run true. The end is faced smooth and the hole bored to size for threading. The change gears are set for cutting 8 t.p.i. and a cutter bit, ground to shape, is inserted in the boring bar. A cross slide threading stop will be very

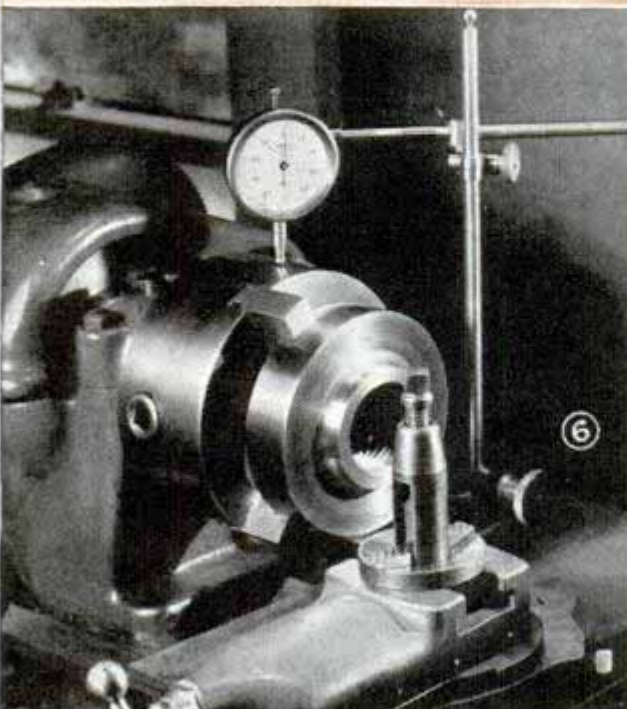
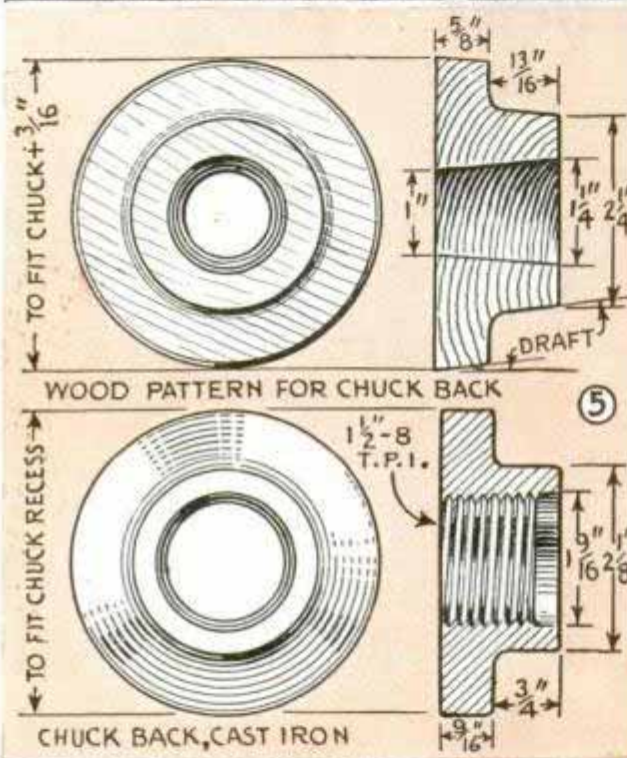

useful for adjusting the depth of cut, Fig. 3. Many passes of the tool will be needed to cut the threads to the full depth. Test for fit on the lathe spindle occasionally. When doing this leave the work attached to the faceplate. After a close fit has been obtained the chuck back is screwed on the lathe spindle and smoothly faced with a sharp cutter bit and the flange turned down to a push fit in the recess of the chuck, Fig. 4. Keep in mind that a "push" fit means a very close tolerance, so you will have to check often when the flange nears the finish dimension. Bolt holes in the chuck can be spotted on the chuck back by chalking the face rather heavily, inserting in the recess of the chuck and tapping with a soft hammer. The edge of the bolt holes will make an impression on the chalked surface of the plate. Lay out and drill the holes $\frac{1}{16}$ in. larger than the diameter of the bolt. Be sure that the drill does not run when the holes are started. To prevent this it might be well to put through a pilot hole first. If you get one hole off it will mean reaming this hole oversize, which is not so good. Although true running of the chuck will perhaps be little affected due to the push fit of the parts, the shearing strain of heavy cuts on work held in the chuck comes on the capscrews. When you're sure the holes are right, screw the back to the chuck, drawing the screws up with equal pressure as in Fig. 1. Then turn the chuck on the spindle, clamp a piece of circular work in the jaws and test the work and chuck with a dial indicator, Fig. 6.

Funnel Cap Prevents Evaporation of Volatile Fluids

The necessity of pouring volatile cleaning fluids into open-mouthed vessels for use in dry-cleaning stores adds to the expense for such materials by rapid evaporation. One cleaner avoided much of this loss by using a small funnel, with a cork in the spout, as a handy cover that could be removed or replaced in an instant.



Angle Guide on Saw Handles Wide Work

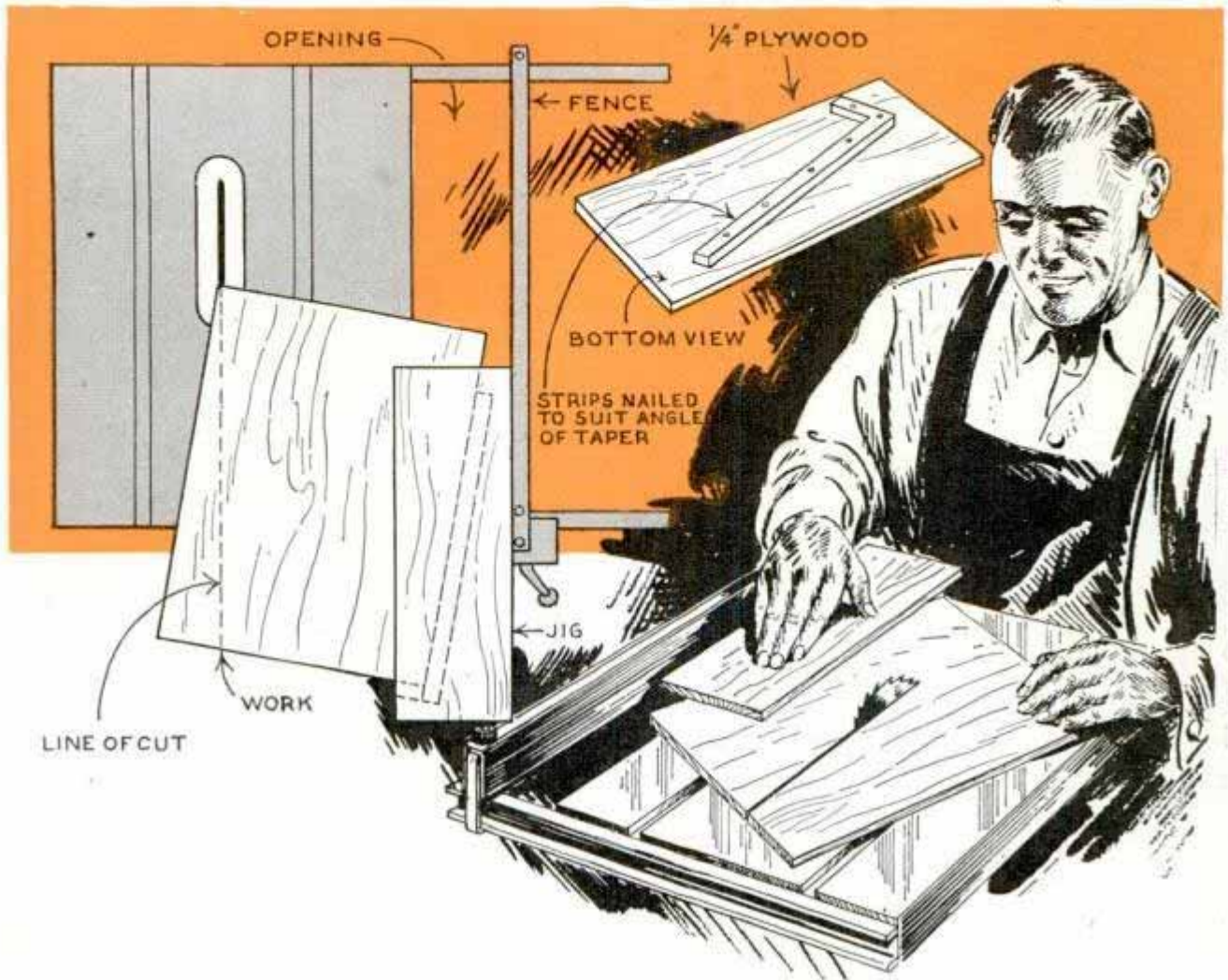

If you have tried to make an angle cut, on a circular saw, along the edges of stock that was wider than the saw table, with the aid of a conventional jig for sawing angle cuts, you can well appreciate the value of this jig for the purpose. As you can see in the drawings, the work supports the jig as it passes over the opening between the table and the rip fence, whereas

the regular jig would fall between the fence and table to the floor. The jig consists simply of a piece of plywood having a cleat nailed to its underside at an angle to suit the angle of the cut to be made. A short block nailed at right angles to the cleat engages the rear corner of the work next to the fence.

—Wayne C. Leckey, Aurora, Ill.

Damaged Ends of Toy-Train Track Are Easily Reshaped

When the ends of toy-train track are damaged so that the connecting pins do not hold, a jig made by slotting one side of a nut is handy in reshaping them. Just slip the nut over the end of the rail as indicated and shape it with a tapered punch. The nut keeps the web of the rail from spreading and also aids in rounding the end.

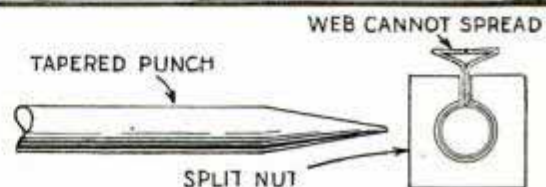

☛ Paint can be removed from reed furniture with a solution made by mixing trisodium phosphate, 3 lbs., in hot water, 1 gal.

Special Mounting Permits Vise to Be Turned Any Direction

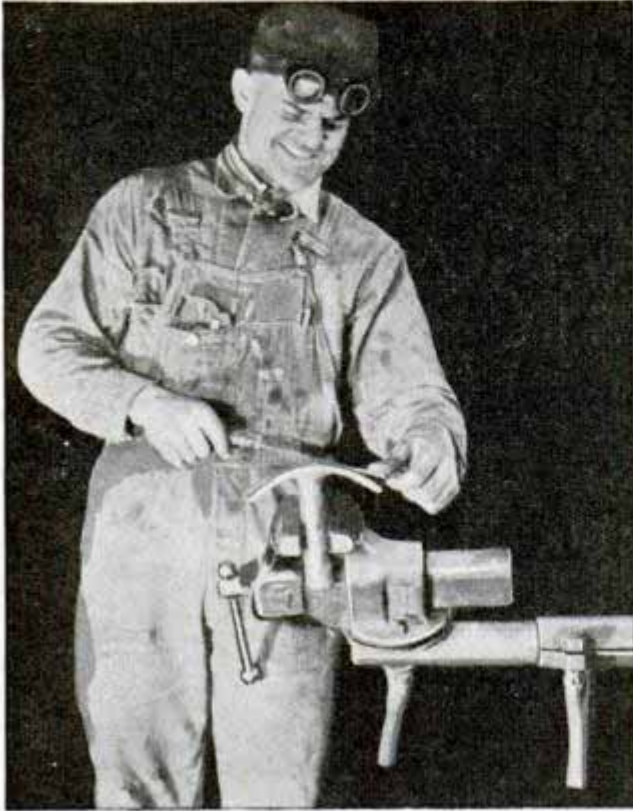

Used at a welding table, this mounting permits a vise to be swung completely around in a horizontal plane, or tipped to either side. The mounting consists of two lengths of pipe, one to fit snugly inside the other. One end of the larger pipe is fastened to a table or bench and the other end is slit back along one side a few inches. Lugs welded on each side of the slit and drilled to take a tightening bolt permit the pipe to be drawn up to grip the smaller pipe. The outer end of this pipe carries the vise, which is swiveled to it.

Measuring Narrow Grooves

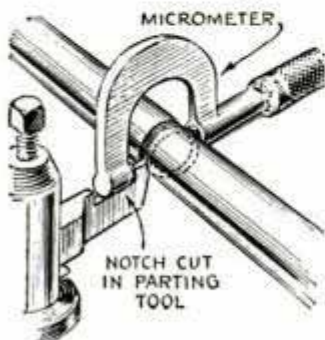

When narrow grooves had to be cut to an accurate depth in round work the following method of measuring them was adopted, as a micrometer could not be used in the ordinary way. The parting tool has a clearance slot on top so that a micrometer can be used. It is brought up to just scrape the

work and the over-all dimension noted. This groove had to be exactly $\frac{1}{8}$ in. deep so the parting tool was advanced until the over-all dimension No. 2 was $\frac{1}{8}$ in. less than the first over-all dimension when the tool was just scraping.

Emergency Repair on Grain Sacks Made with Adhesive Tape

Confronted with the problem of immediately repairing some torn sacks containing expensive seeds, a Wisconsin seed merchant found that the mending



could be done with strips of adhesive tape. The area to be repaired was cleaned with a cloth moistened in gasoline and the patches applied as shown. The cloth must be merely dampened with gasoline.

Clevis Pin Kept in Doubletree by Rubber Strip

When using a team of horses with a chain and doubletree to move objects, the pin can be kept from slipping out of the clevis with a strip of old auto casing. This is nailed to the doubletree so that one end extends over the pin as indicated.



Two Jigs That Aid in Starting Taps Straight

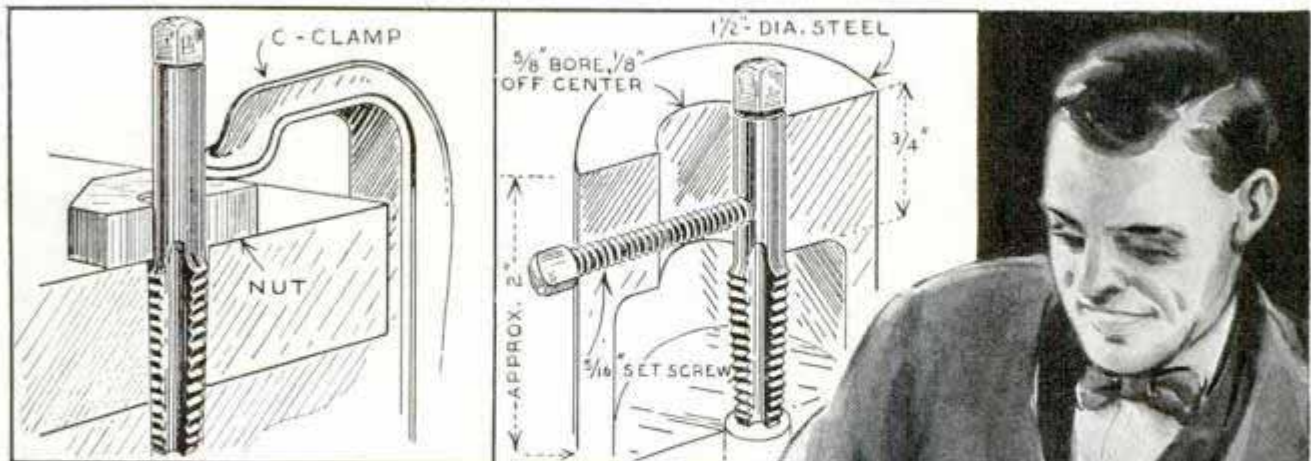

Either one of these jigs will help avoid guesswork in starting a tap straight. One is simply a nut clamped directly over the hole to be tapped, the nut having the same thread as the tap. The other jig permits more accurate work, but requires some machine work to make it. As shown in the detail, a piece of steel is bored out at one end and a $\frac{5}{8}$ -in. hole is drilled through from the other end slightly off center. A setscrew driven in from one side bears lightly against the tap to hold it in alignment.

Poultry-House Window Is Hung for Draftless Ventilation

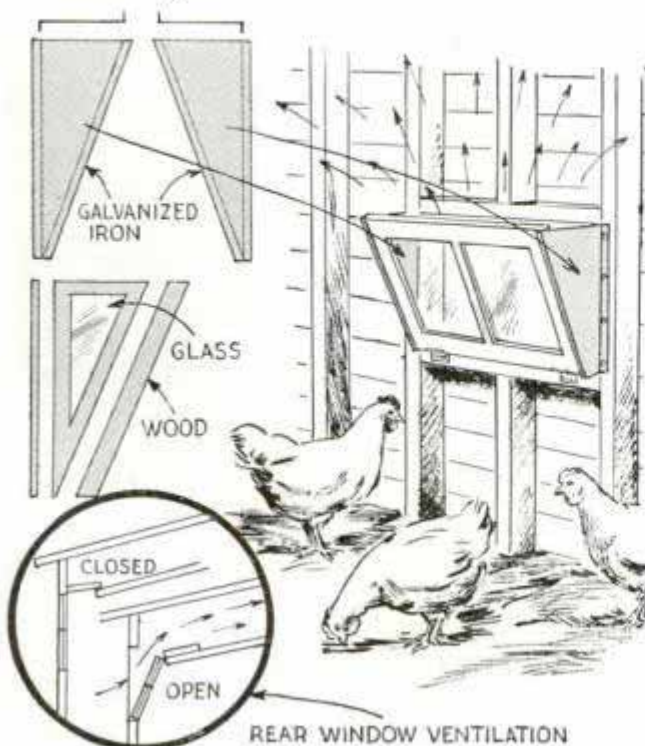

You can have fresh air without drafts, for ventilation in a poultry house, by nailing triangular fins or wings to the wall so that a window can be opened partly as indicated. The fins can be made of wood or sheet metal. If the latter is used, flanges are bent on one side of each fin for nailing and on the other to serve as window stops. When wood is used, cleats nailed to the sides of the fins take the place of flanges. If desired, glass can be set in the wood fins to admit additional light. When the window is in the rear wall, an opening can be made in the ceiling and the window hinged so that air is directed through it. This current of air passing through the ceiling tends to pull foul air from the lower part of the building. A flap or door should be provided to close the ceiling opening when the window is closed.

—Ed. Ahrens, Vanderbilt, Mich.

Bottled Goods Displayed Neatly with Theftproof Rack



Faced with the problem of displaying bottled goods so that it would be difficult for anyone to remove one of them while his attention was distracted for a moment, one merchant used the rack shown. Necks of the bottles fit in notches cut in the rack where they are held by a molding strip. The bottles cannot be removed without first taking off the strip, which is fastened in place with screws.

Screwdriver Has 'Hammer Knob' to Remove Painted Screws

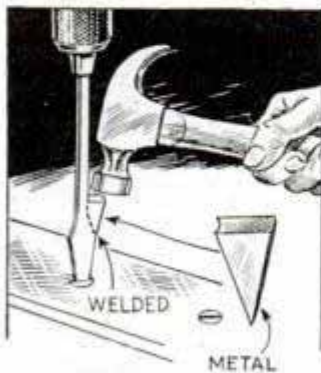

Confronted with the job of removing and replacing a number of seats in railway cars, a workman found that paint in the screw slots made it almost impossible to insert the blade or point of the screwdriver. To overcome this difficulty without using a small chisel to remove the paint, he had a "hammer knob" welded onto the side of the screwdriver.

By tapping on this with a hammer, while operating the ratchet brace, the driver was made to engage the slot instantly.

Auto-Hood Clamps Hold Toolbox on Car Running Board

To carry a box of light tools on his car where it would be convenient, a furnace repairman attached a pair of auto-hood clamps to the running board to engage staples into the ends of the box. In this position, it is not necessary to unload heavy equipment to get at or replace the tools.

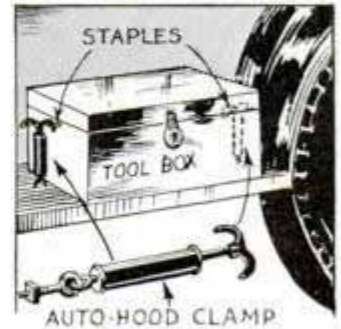

Paper Stencils Made Quickly by Using Glass Cutter

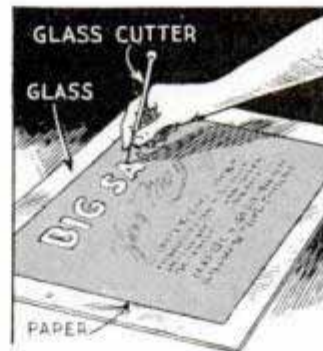

A sign artist who had many stencils to cut from heavy paper found that a glass cutter was just the thing for the job. If the work is laid on a pane of glass, the cutter makes a clean outline, and

can be manipulated to accommodate curves and sharp corners in the design.

Hobble Cures Broody Hen

A petty but constant annoyance will usually break up the broodiness of the most persistent hen. One of the simplest and easiest remedies is a hollow rubber-ball "hobble." A hole is made in the ball to fit comfortably around the leg of the fowl, and slits from this permit the opening to be enlarged sufficiently to receive the foot. Wearing this hobble for a day or so will not injure the bird.

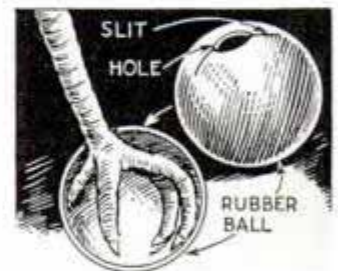

from **PATTERN** to **CASTING**

PART III

Foundry Methods—Sand Molding

MAKING castings successfully involves the use of a carefully made pattern for the construction of a sand mold, melting of the metal, and finally the pouring of the mold. Once the pattern has been completed, it is not a difficult task to prepare the mold and cast the metal. By following through with details carefully, anyone can make small castings readily out of such metals as aluminum, brass, pewter and other low-melting alloys. Although essentially the same methods apply, the higher temperatures involved render casting from iron and steel impractical for the small home shop.

Castings are ordinarily made in a sand mold. The mold is prepared from the pattern in a box, generally of wood, which is called the flask. The latter is constructed according to the general plan outlined in Fig. 30, which gives dimensions suitable for small castings. Large flasks or smaller ones also can be prepared according to the same general plan. The two parts of the flask, called the cope and drag, are con-

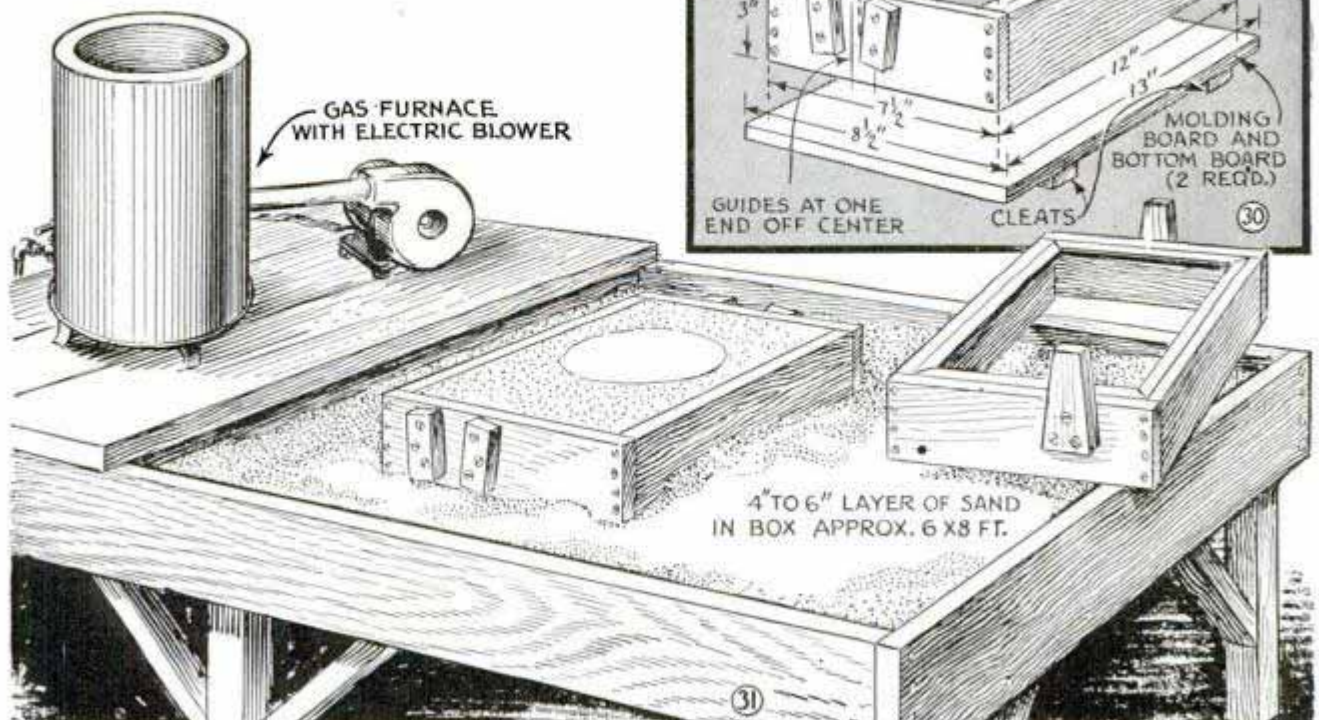
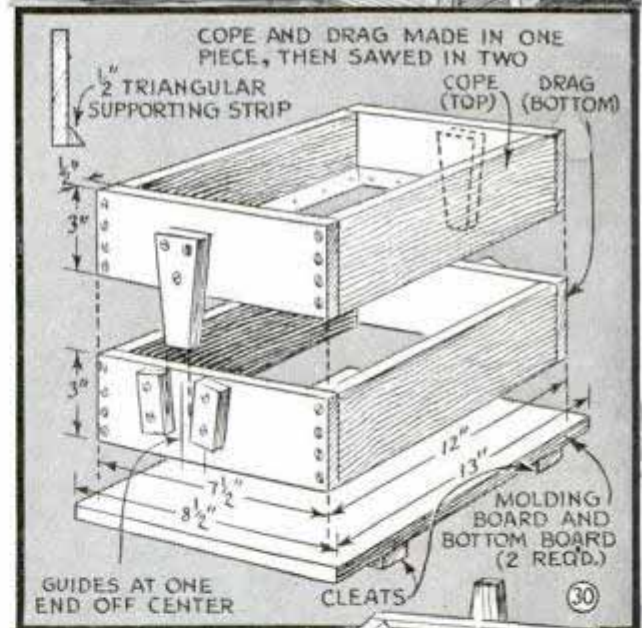



structed as one piece, then the wedges and cleats which make it possible to align the cope and drag are fastened in place with flat-head wood screws. The guides at one end should be off center so that it will be easy to realign the parts. The long wedge is then removed, the flask is sawed in half to form the cope and drag, and the wedges are replaced. A triangular strip is nailed on the inside of the cope to help retain the sand. When two flat boards (molding board and bottom board) of the size shown in Fig. 30 are prepared, the flask is complete. Fig. 31 gives you a suggestion for a handy molding bench, entirely practical for the home foundry or the small shop. It's just a roughly built affair of $1\frac{1}{8}$ -in. boards, the latter for the bottom and sides and 4 by 4-in. stock for the legs. Height to the top of the bench sides should be about 28 in.,

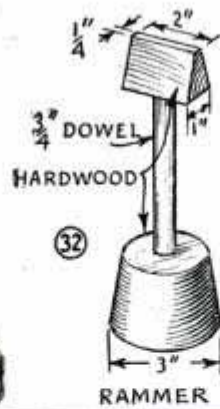

a trifle lower than standard table height. This is an aid in handling the heavy sand-filled flask and the ladles or crucibles of molten metal.

Preparation of the mold is begun by placing the drag upside down on the molding board, A, Fig. 33, and placing the pattern in position, with parting surface down and near one end of the flask, as shown. If the draft of the pattern runs both ways from the parting line, the pattern will have

been made in two pieces and either of these may be put in position at this time. The sand must be "tempered" or dampened to the proper consistency. The sand should not be ordinary beach sand, which is generally too coarse, but regular foundry sand such as can be obtained from a foundry or a foundry supply house. It can be moistened with a small sprinkling can. To test its moistness, take up a handful and squeeze it into a lump. If it retains its shape and shows all finger marks it is right. If it crumbles it is too dry, and if it leaves moisture on the hands it is too wet. Sand that is too dry will crumble in the mold, while if the sand is too wet steam will be formed, causing blowholes in the casting and sometimes

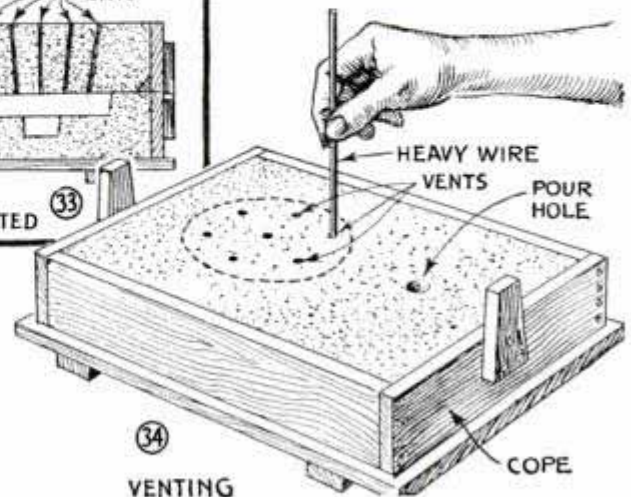
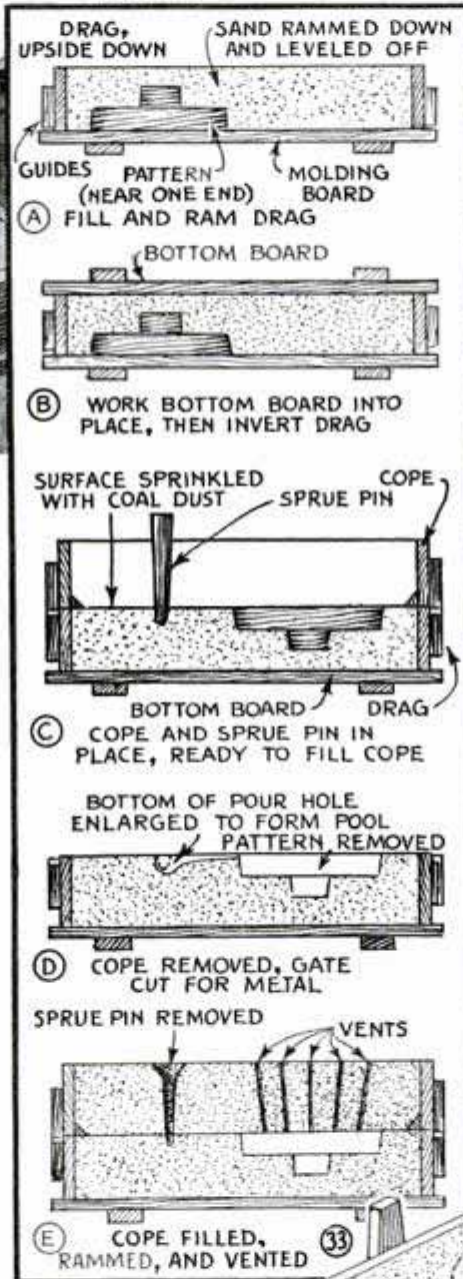

dangerous blowing out of the molten metal.

The sand is spread over the pattern and rammed down firmly with a rammer, such as is shown in Fig. 32. The wedge-shaped end is convenient for ramming close to the edges of the flask. When the drag is filled and rammed, level off the top with a straightedge, sprinkle a little dry sand over the top, and place the bottom board on top, as at B in Fig. 33. Rub the board around until it rests firm without rocking, then grasp the drag and the two boards firmly between your hands, and turn the drag over. Slip the molding board off and sprinkle fine coal dust or parting sand from a cloth bag over the surface to aid in parting. Excess coal dust or parting sand should be blown off. For this operation a hand-operated bellows is very useful.

The cope is now put in place and a tapered pin set into the sand a few inches from the pattern as shown at C in Fig. 33. This is called the sprue pin and forms the sprue or pour hole. If preferred, the sprue pin can be omitted and the pour hole cut with a sharpened length of $\frac{1}{2}$ -in. pipe, or preferably tubing, after the cope is filled. If the pattern is in two pieces, the upper half is put in place at this time. When these preparations are finished the cope is filled with sand and rammed down in the same manner as the drag was. The top should be struck off carefully with a straightedge.

A straight length of heavy iron wire is used to punch the vents, E, Fig. 33, in the manner shown in Fig. 34. These are to permit the

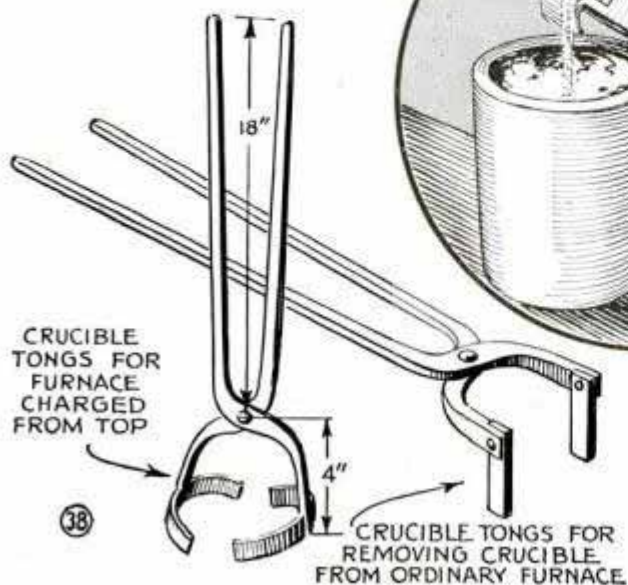
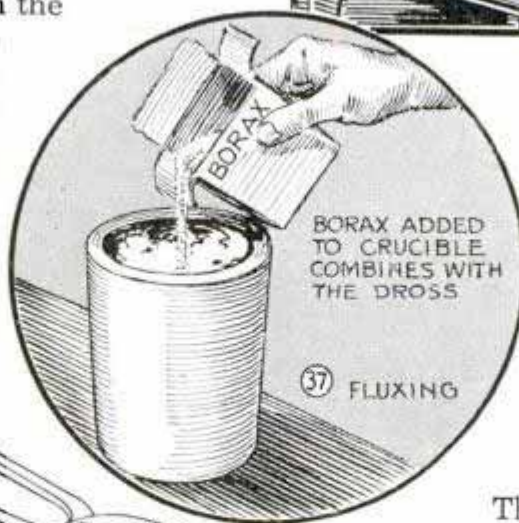
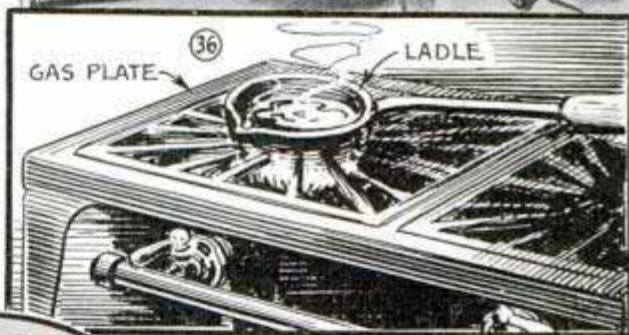

escape of gases evolved when the hot metal is poured, and should be about an inch apart over the entire face of the pattern. After the vents are finished, the sprue pin is removed and the mouth of the pour hole enlarged to funnel shape, so that the mold appears as in D, Fig. 33.

The cope is now temporarily removed and set aside, care being taken not to damage the mold. It is best to place the molding board on top of the flask, then lift the cope and set it bottom side up on the molding board. A gate or path for the metal is cut in the surface of the drag, from the bottom of the pour



39 CHARGING
SMALL GAS
FURNACE



40 SIFTING



41 LEVELING

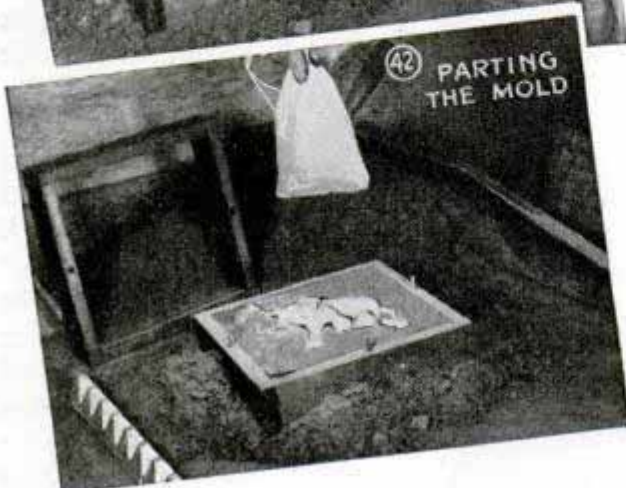

42 PARTING
THE MOLD

hole to the pattern. A small pool can be dug at the bottom of the pour hole. A spoon or trowel should be used to cut the gate, and all loose sand must be removed or tamped down carefully. A draw spike is driven into the pattern, the pattern is carefully rapped all around, and then is lifted from the mold. Any loose sand may be removed, and all breaks in the mold must be repaired. If the pattern is in two parts, the cope should be laid upside down on the molding board while the upper pattern is removed. The mold is now completed and it is only necessary to place the cope back in place on the drag.

A number of metals will be found suitable for casting, among them brass, aluminum, lead, tin, zinc, Britannia metal, pewter, and the like. Where alloys are used it will be just as satisfactory and cheap to buy them already alloyed, rather than attempt to prepare the alloy yourself. The metal should be melted in a crucible, either of clay or graphite or of iron. A cheap substitute for a crucible can be made from a pipe nipple and a malleable iron pipe cap. The cap must be of malleable iron to stand heating. For small quantities of soft metal an iron ladle with a long handle will be found convenient. The melting preferably should be carried out in a special gas furnace, such as the one shown in Figs. 31 and 39. This one is gas fired and is fitted with an electric blower. The softer metal also can be melted in the basement furnace, as shown in Fig. 35. The crucible should be covered, and the live coals banked around it. Low melting-point metals such as lead and pewter can be melted on an ordinary gas plate or stove, Fig. 36. In all cases a small amount of borax should be added to combine with the dross that is formed. This is called fluxing, Fig. 37. Crucibles should be handled with a pair of crucible tongs. Blacksmith's tongs to which iron jaws have been riveted as shown in Fig. 38 will be found most convenient for handling the crucible and pouring the hot metal.

Because of the high temperatures involved, it is most important to be sure that no molten metal strikes wood, paper, or anything else inflammable. In all cases, a clear gangway should be left open between the molding bench and the furnace. It is also wise to work over a bed of dry sand, especially if the shop floor is of wood. It is necessary to make sure before you lift the hot crucible from the furnace that you have a firm hold on it with the tongs. Special precautions always must be taken to

offset any chance that the crucible might slip from the tongs and spill metal on the floor or on your hands or clothing.

The two halves of the flask must be held together as there will be a tendency for the cope to float when the metal is poured. One method is to lay a heavy slab of stone or metal on top of the mold.

When the mold is prepared and the metal is molten, it should be poured against the side of the sprue hole so that it flows gently into the mold. The crucible should not be held so high that the liquid will fall with excessive force. When the mold is filled it should be set aside until the metal has solidified. The excess metal in the crucible should be poured into a cavity in the sand, and allowed to cool. The "pig" thus formed can be remelted when needed. The metal never should be allowed to freeze in the crucible. Finished castings can be ground and polished as required. The molding sand can be used again but about 20 to 25 per cent of new sand should be mixed in at frequent intervals. Figs. 39 to 46 inclusive picture a variation of methods already described. Here any number of castings can be made from the same pattern, but it is necessary to ram up the mold for each separate casting. Frequently this is easier to do than making up a parted pattern, especially if the pattern is of irregular shape or is composed almost wholly of rounded or curved surfaces. In this method the drag is rammed right side up before the pattern is placed in position. The sand should be a trifle less moist than that used in the conventional procedure. After the drag has been rammed and struck off, the one-piece pattern is bedded one-half its thickness in the sand and the latter is leveled and parted as shown in Figs. 41 and 42. Then the cope is placed in position and rammed to complete the upper half of the mold. The remaining steps will be self-evident from examination of the illustrations. The cone of sand built up around the sprue pin as shown in Fig. 43 is sometimes a help when you are casting from a small pattern which has a projection extending well up into the cope. Frequently, in making small castings, the mold is not gated in the manner described, but instead the sprue pin is inclined slightly to form a slanting hole down which the molten metal runs directly into the mold.

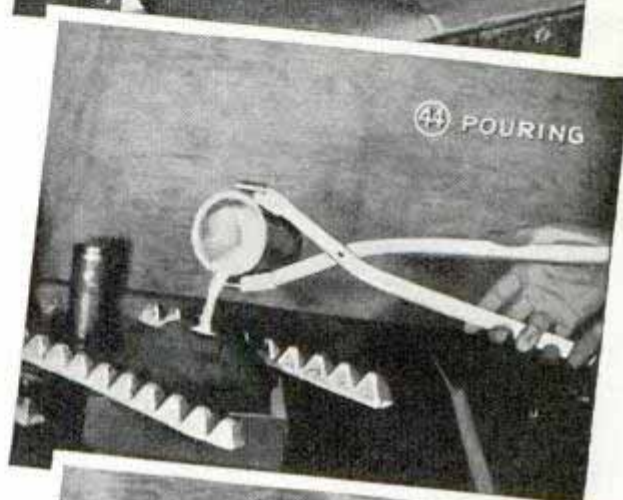

Type Sheets to Help Visualize Headlines and Price Spots



Headline	Price	Type Size	Line Length
No MONEY Down	\$24.75	48 pt.	1
No MONEY Down No C	\$24.75	36 pt.	1
No MONEY Down No Charge for	\$24.75	30 pt.	1
No MONEY Down No Charge for Credit Spiegel	\$24.75	24 pt.	1
<i>No Money Down No Charge for Credit Spiegel's Change No</i>	\$24.75	18 pt.	1
<i>No Money Down No Charge for Credit Spiegel's Change No Money Down</i>	\$24.75	14 pt.	1
No MONEY Down No Charge for Credit Spiegel's Change NO MONEY DO	\$24.75	12 pt.	1
No MONEY Down No Charge for Credit Spiegel's Change NO MONEY DOWN NO CH	\$24.75	10 pt.	1
No MONEY Down No Charge for Credit Spiegel's Change NO MONEY DOWN NO CHARGE FOR C	\$24.75	8 pt.	1

If you have considerable printing done, ask your printer to make up type sheets on clear celluloid showing the points and faces of type you intend to use for headlines, subheads, prices, etc., similar to the example given. With this transparent sheet you can determine better the space required for headlines, etc., as well as see how the type suits the page. The type sheet should be of the same size as the pages to be printed.

Lathe Work Turned Off Center Balanced by Weights



Vibration caused by lathe work turned off center can be reduced by using a counterweight on the faceplate. The weight consists of metal disks held in place by a bolt in one of the faceplate slots. A

number of the weight disks of various thicknesses can be made up so that any work can be balanced quickly.

—S. J. Gancher, Richmond Hill, N. Y.

Scored Surface of Washer Prevents Turning

When assembling wood parts with bolts, where washers are used under the nuts, score the undersides of the washers with a file. When a nut is turned down, the scored surface of the washer will be forced into the wood surface and it will not turn as the nut is tightened.

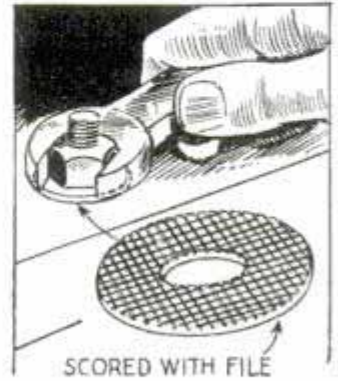

Rubber Hose Keeps Flags Furled When Not in Use

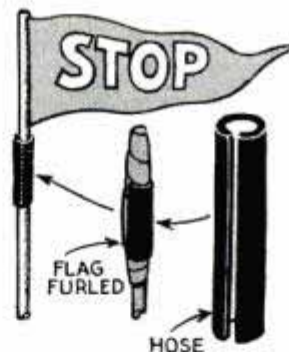

To keep his warning flags closely furled so that they will not become soiled or torn easily when stored in trucks, one contractor employs lengths of lawn, or radiator hose. These are slit along one side to

slip over the furled flag. When not in use, the hose may be slid down onto the staff.

Brush Aids in Soldering Uneven Surfaces

When soldering pieces of corrugated metal together, a tinsmith uses a stiff-bristled scrub brush to apply pressure to hold the parts in place. The surfaces of the bristles shape themselves to the work so that it is held in close contact.



Welder's Universal Vice Is Easy to Assemble

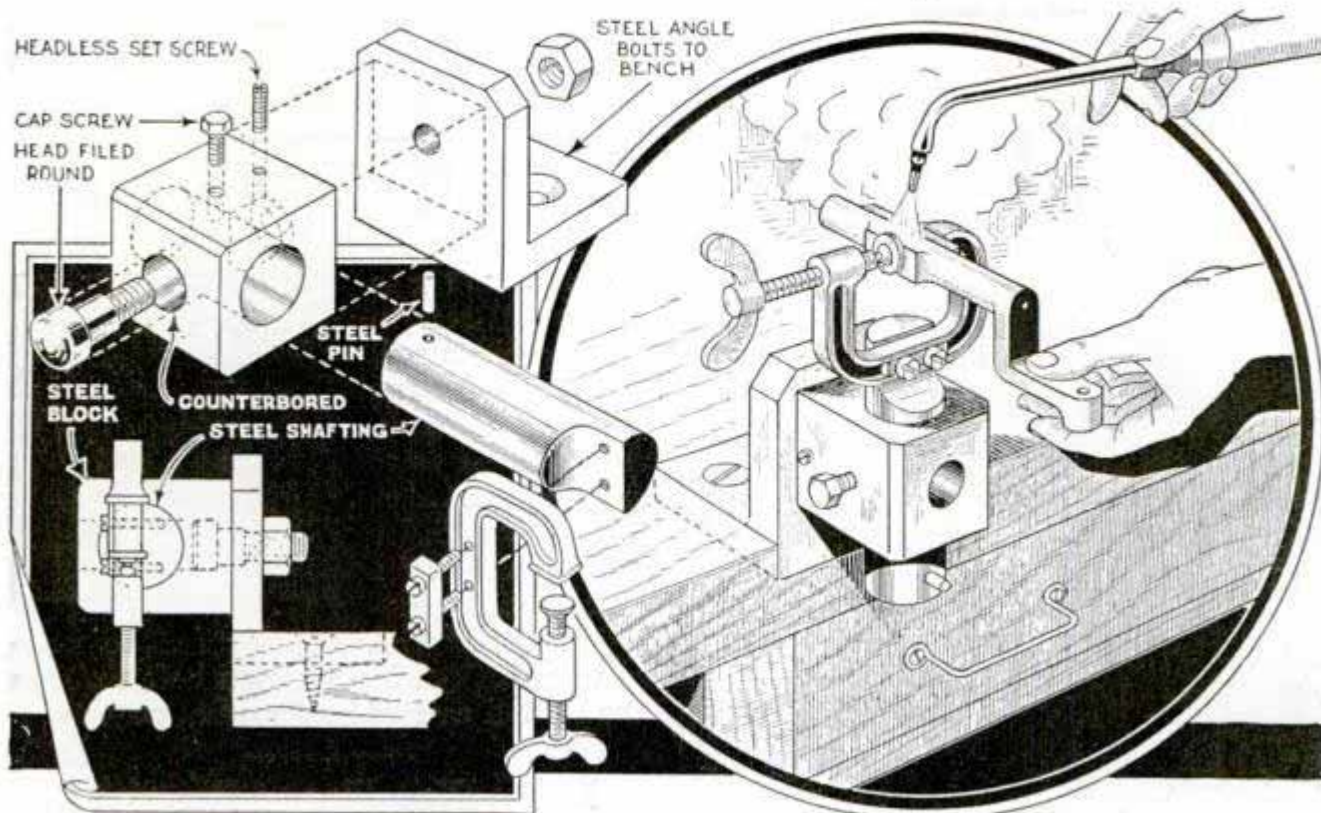

Adjustable to any angle in any plane, this vise is just the thing to hold small parts while welding, brazing or soldering them. It consists of a steel block drilled to take a small steel shaft, which carries a C-clamp on one end to grip the work. After adjustment, the shaft is locked by a cap screw bearing on it. By use of a clamp bolt the block is pivoted to a steel angle

which is screwed to the bench. The clamp bolt fits in a hole in the block, the hole being counterbored to permit the bolt head to clear the shaft. A headless set screw tightened on the bolt head, which is filed round to slip into the counterbored hole, helps to hold the adjustment after the bolt nut has been tightened.

—J. A. Honegger, Bloomfield, N. J.

Teeth Cut on Worm Gears with Ordinary Threading Tap

Anyone who has access to a lathe or drill press can make small worm gears with ordinary taps. First, turn the gear blank to size. Then cut a shallow groove around its face to the same contour as that of the tap to be used. The gear blank must be mounted so that it turns freely, and the machine must be run very slowly, taking care to see that the blank rotates in relation to the tap, using the hand to help it rotate through the first two or three revolutions. In a lathe, the tap is held in a chuck and the cutting end is supported by the tailstock for rigidity. On a drill press, it is necessary to put the gear blank on an arbor and mount it between centers supported securely on the table by means of angle irons as indicated in the lower detail.

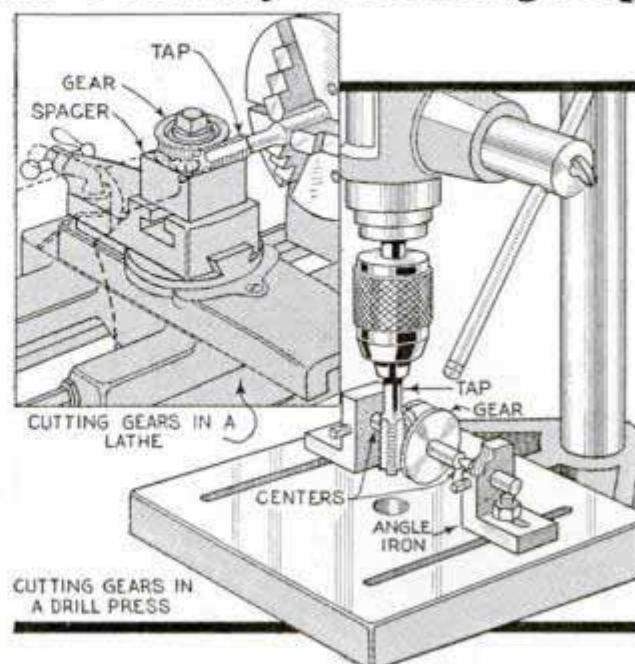

Temporary Window Lettering Done in Colors



Window signs for special sales will wear well, yet be easy to remove, if the lettering is done with soap and ocher powders. The lettering is first marked with yellow soap, after which the ocher powders in colors are applied with pounce bags. The powder will adhere to the soap and make an attractive sign.

Waste of Live-Stock Feed Avoided by Shields on Ends of Trough

Cattle are not likely to throw feed out of this trough with their noses, because of the shields on the ends and the crosspieces through the center. Notice that the shields



tip inward, thus deflecting any feed that is thrown against them back into the trough. Also, the crosspieces tend to prevent the cattle from swinging their noses from side to side to throw out the feed.

Pencil Clip Keeps Nail Set in Your Pocket

Carpenters who carry nail sets in their pockets will find pencil clips just the thing to keep them from slipping out. Also, a clip prevents the pointed end of the nail set from coming in contact with the bottom of the pocket where it quickly wears a hole through the cloth if carried in the usual way.

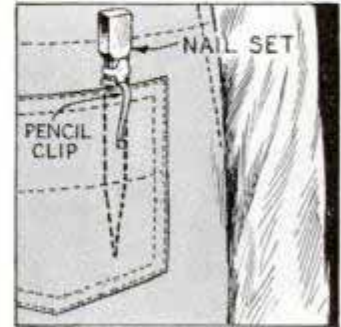

Large Pipe Flange Removed with Iron Bar

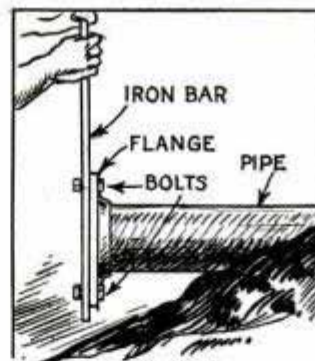

When a large pipe flange has to be removed and a suitable wrench is not at hand, try a long iron bar. Just attach it to the flange with a couple of bolts on opposite sides as indicated, and use it as a handle to loosen the flange.—P. Cowley, Benoni, Transvaal, S. Africa.

Brush Holder on Artist's Palette

Instead of holding my artist's brushes in the same hand that holds the palette, which tires the hand on long jobs of oil painting, I attached a holder to the palette for them. The holder is simply a coil spring having the coils stretched to permit inserting the brush handles.

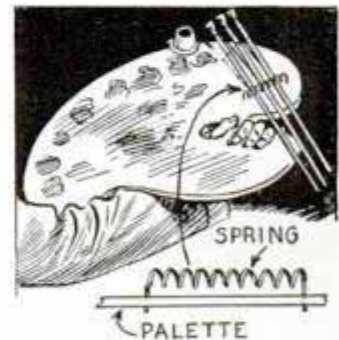

—L. B. Robbins, Harwich, Mass.

Oscillating-type MAGNETOS

EASILY TESTED AND SERVICED

By JACK BEATER

ONE of the most popular types of oscillating magnetos, which is used extensively on small one-cylinder gas engines supplying power for boats, lighting plants, light machinery and pumps, cannot be tested on any ordinary type of generator or magneto test bench as the magneto has no rotating parts. The crossbar or "armature" of this magneto is "kicked" up and down on the pole ends to make and break the magnetic field, and to open and close the primary circuit. It is a simple high-tension magneto, consisting mainly of two laminated pole pieces, eight plain-bar magnets, two coils containing both the primary and secondary windings, points, condenser, and laminated armature. The operating principle is easily understood. The bar magnets, clamped between

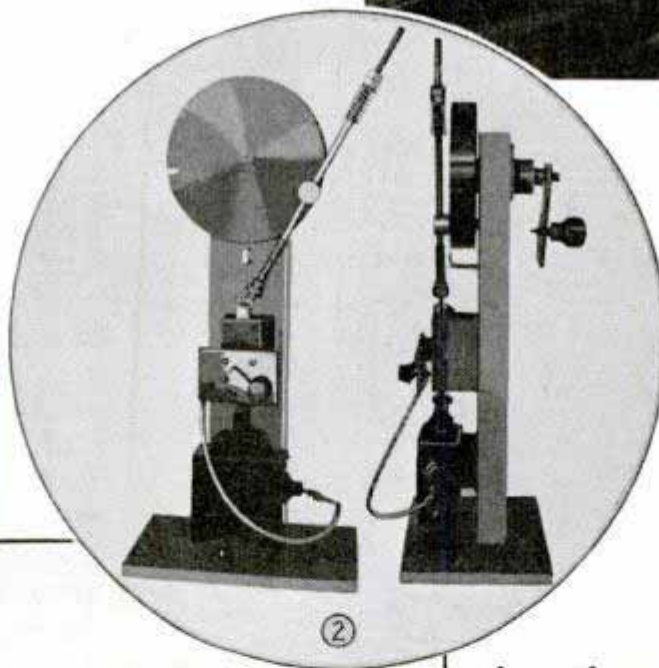
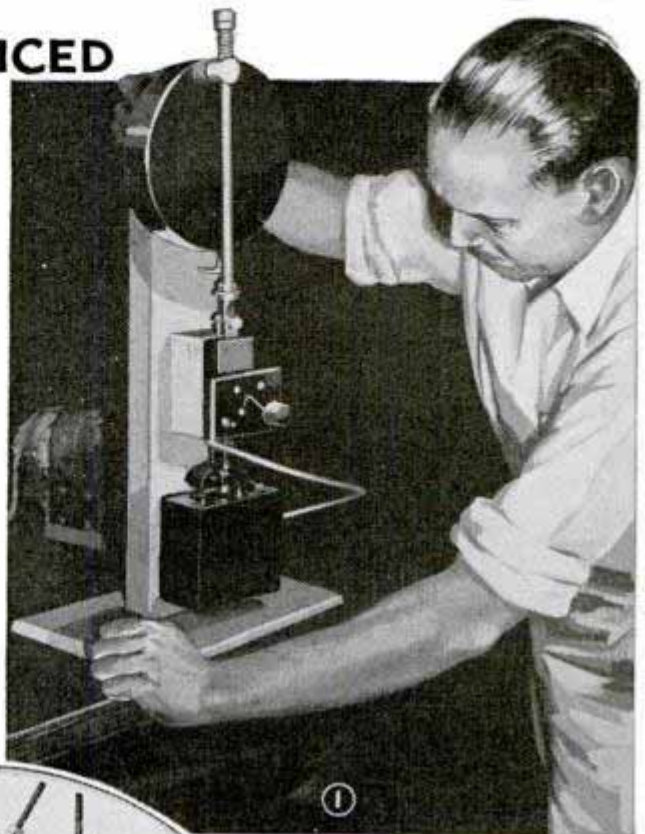

the pole pieces, supply the initial energy and make one pole piece a north pole and the other a south pole. The coils are hollow and slip over the pole pieces. The laminated crossbar, or armature, rests upon the tops of the pole pieces and provides a path for the magnetism to travel

from the north to the south pole. When the engine mechanism moves the crossbar from the tops of the pole pieces, the flow of magnetism is interrupted. This action creates an electrical current that flows through the primary windings of the two coils. An instant after the crossbar has left the pole tops the continued movement of the crossbar opens the points, and the current flow in the primary is suddenly interrupted. This inter-

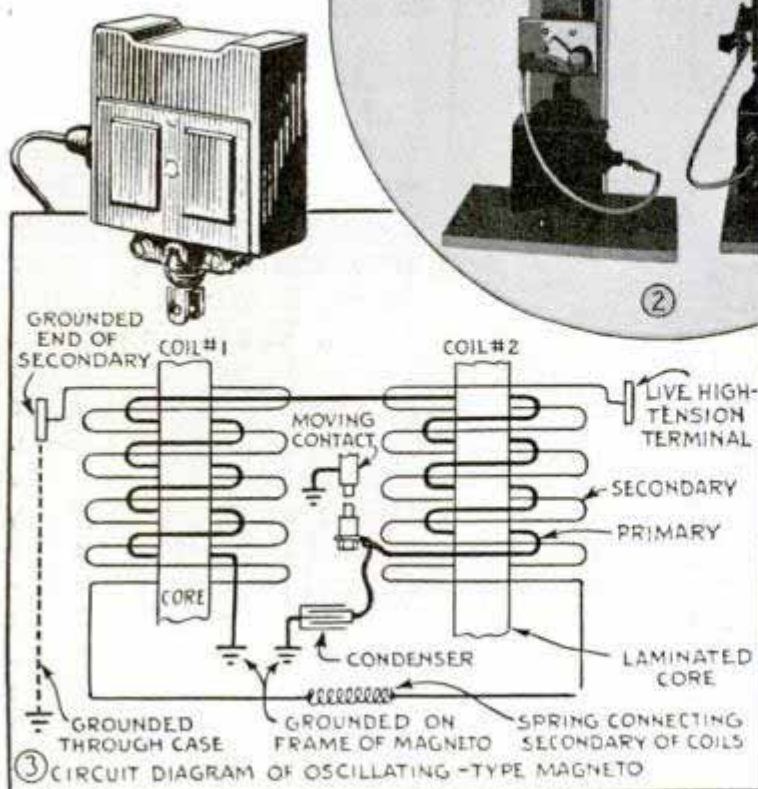

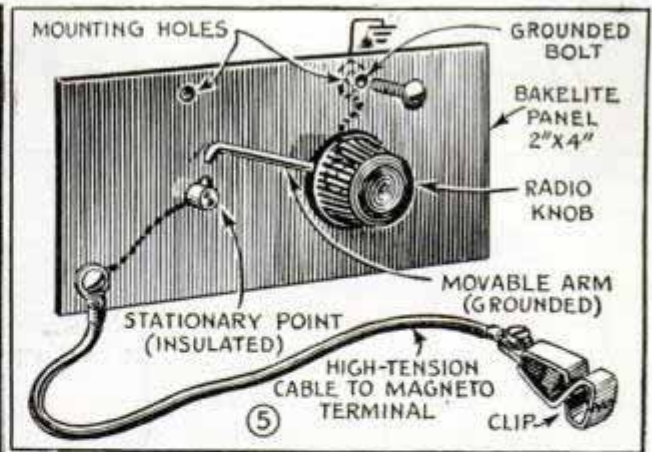

coils is made by a short coil spring insulated with varnished tubing. The terminal button on one coil is always grounded to the outer cover, while the other button connects through a small coil spring to the high-tension terminal

of the magneto. The paths of the primary and secondary circuits are shown in the circuit diagram, Fig. 3. The coils can be tested on one of the standard magneto coil testers such as that shown in Fig. 4.

The construction of a test stand for this magneto is shown in detail, in Figs. 5 and 6. The channel-steel upright is welded to the steel base plate. Above this a small steel block is welded to the upright to hold the magneto in the right position for testing with the crossbar down, Fig. 1. Immediately above the magneto, the trip-shaft guide block is welded to the frame. The guide block is

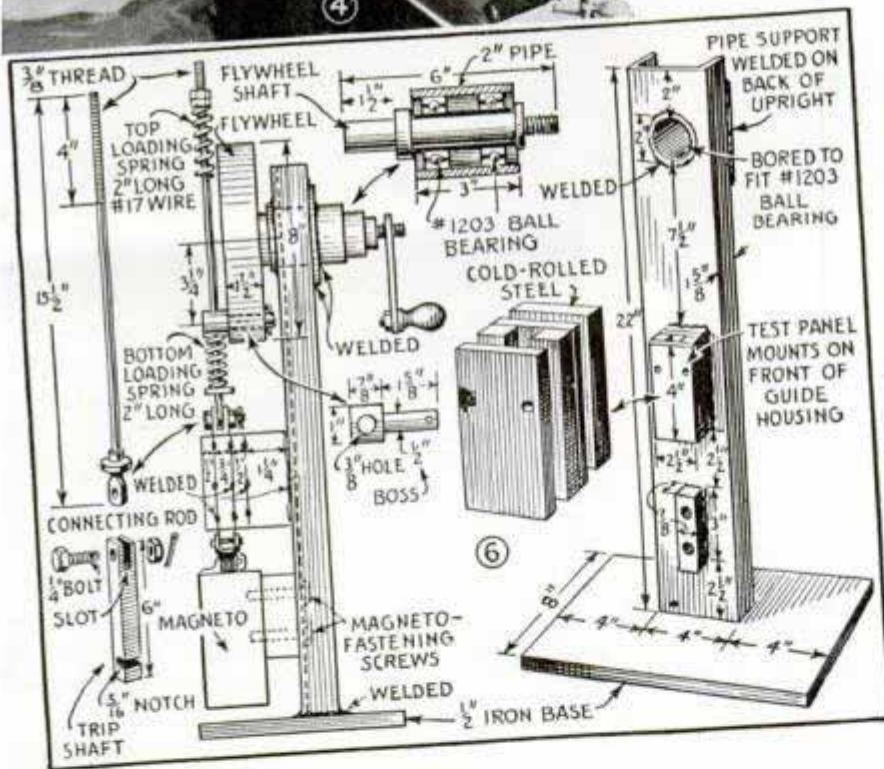

ruption induces a high-voltage current in the secondary windings of the coils that passes out of the magneto terminal and to the spark plug. The engine mechanism then returns the crossbar to its original position on the ends of the pole pieces, completing the cycle.

The coils of this magneto are quite rugged but occasionally become defective due to excessive moisture or other causes. The high-tension terminal of each coil consists of a small brass button, and the high-tension connection between the two

assembled from ordinary square and flat steel stock and spot welded together. Near the top of the upright a 3-in. length of 2-in. pipe is welded through and at right angle to the frame. Before welding into place, this pipe is machined inside to take the two ball bearings used to support the flywheel shaft. The flywheel can be of cast iron or steel and is a press fit on the shaft. A floating boss is mounted in a drilled hole near the rim of the wheel and controls the action of the spring-loaded connecting rod.

The latter is made of 3/8-in. cold-rolled

steel rod, threaded at one end and heated and flattened at the other. A turned collar at the bearing end supports the bottom loading spring, while the tension of the top loading spring is adjusted by means of a nut and lock nut. The loading springs are of the coiled-wire type.

The trip shaft is easily made from $\frac{3}{4}$ -in. square steel bar. It must be notched at both ends as shown and must slide freely in the guide. A crank handle can be provided on the flywheel shaft for manual operation, or a pulley for motor drive.

Now, in operation the floating boss compresses the top spring as it moves upward. Slightly before top dead center the coil spring is fully loaded and the continued movement of the boss "bumps" the connecting rod upward. The latter being engaged with the lifter pin of the crossbar on the magneto, snaps the armature from the pole tips and pulls it upward as the spring unloads tension. The bump of the flywheel boss on the fully compressed loading spring causes the initial separation of the armature from the pole tips but the balance of the snappy upward movement of the armature is caused by the unloading of the top coil spring. On the downward half of the cycle the flywheel boss loads the lower coil spring and re-engages the armature with the pole tips. Unless the armature makes a good contact with the pole tips after each spark the magneto will miss on the next revolution. Hence the lower loading spring is important but not critical in adjustment.

A small Bakelite panel is mounted above the magneto on the front of the trip-shaft guide housing, Figs. 2 and 5. The panel is fitted with an adjustable spark gap for checking the condition of the spark. A high-tension cable and clip are permanently attached to the panel for connection to the magneto high-tension terminal.

When operated by hand the magneto can be tested at any speed, from one revolution per minute up to several hundred or more. Because it duplicates the tripping action as found on all engines using this type of magneto, the tester can be depended upon to prove the condition of the magneto before it is put back into service. The tester shown here was designed and built in a magneto repair shop, where it has given splendid results.

Discarded Broom on Horse Stall Cleans Pitchfork

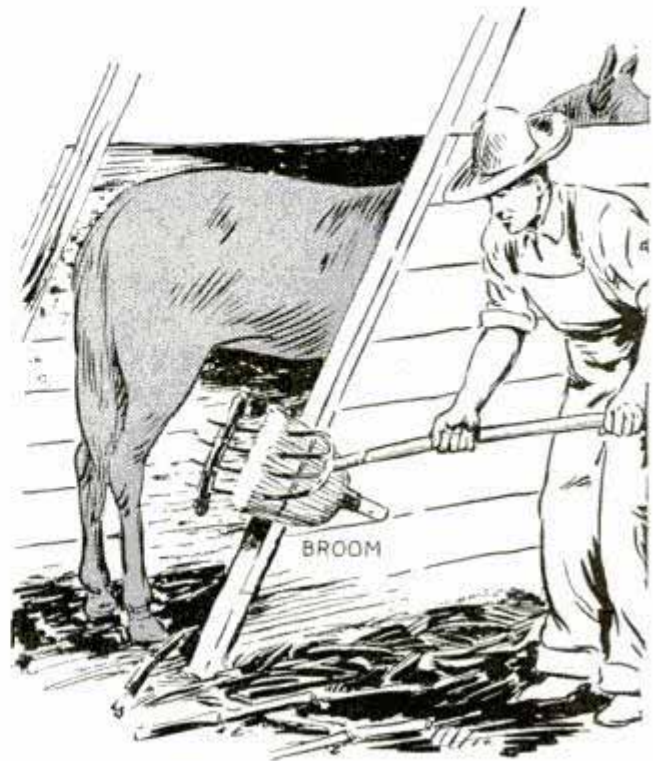

The annoyance of having cornstalks become impaled on the barn fork may be overcome by nailing a section of a discarded broom onto the side of the stall. It takes just a moment to draw the tines of the fork through the projecting bristles of the broom and clean them thoroughly. If desired, flat-iron brackets can be attached to the stall so that the broom pieces can be inserted or removed without the use of a hammer and nails.

Cotter Pin Makes Good Dropper

When a dropper is needed for applying liquids in a workshop or garage, open a cotter pin slightly, file the ends and force them into the cork of the bottle.



When the head of the key is inserted into the liquid and lifted, the liquid can be applied drop by drop.

☐ Stains on white enameled stoves often can be removed by rubbing the spot with a paste made of scratchless cleaning powder and kerosene.

Gasoline-Tank Cap Altered Easily to Make It Theftproof

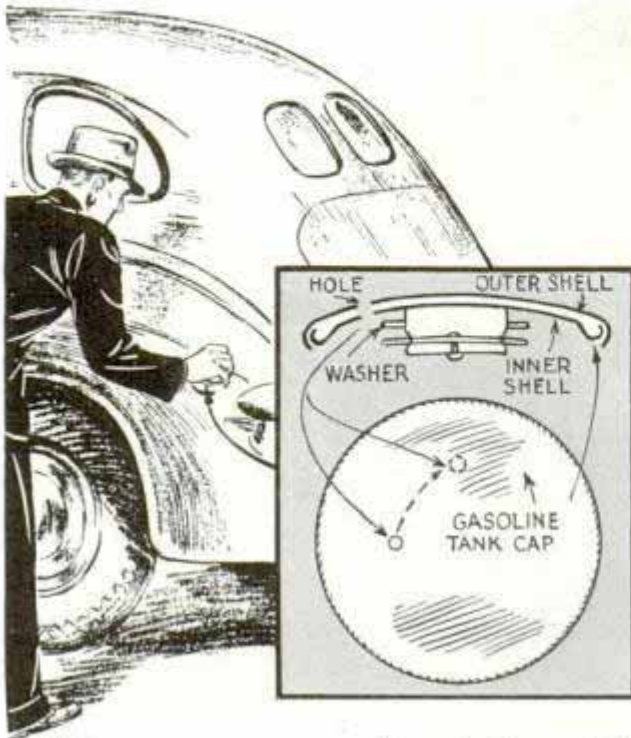

If the cap on your gasoline tank consists of two parts similar to the one shown, it is a simple matter to make it difficult for a thief to remove the cap unless he knows the secret. Squirt penetrating oil between the two shells of the cap, and then with a screwdriver or knife pry on the rolled edge of the outer shell a little until the inner shell will turn inside it. When this has been done, drill a hole through both shells to take a thumbtack or small wire. To remove or replace the cap, turn the outer shell so that the holes align, and insert the tack so that the inner shell will move when the outer one is turned. When the cap is in place, remove the tack and turn the cap so that the holes are not together.

—Adolph F. Lonk, Chicago.

Oil or Fuel Tank on Motorcycle Removed without Draining



It is unnecessary to drain the oil or fuel tank when you have to remove it from a motorcycle. Just take off the oil or fuel line at the tank, and quickly slip a steel ball of

the proper size into the outlet. A union nut driven down over the ball will hold it in place so none of the liquid can escape.

—Ivan J. Stretten, Detroit, Mich.

Waste Is Dispensed in Garage with Length of Downspout

Suspended in a convenient place in a garage or workshop, a short piece of corrugated eave downspout is handy for dispensing cotton waste. It is pulled out at the bottom, and, if too large a quantity is removed, it may be returned at the top.

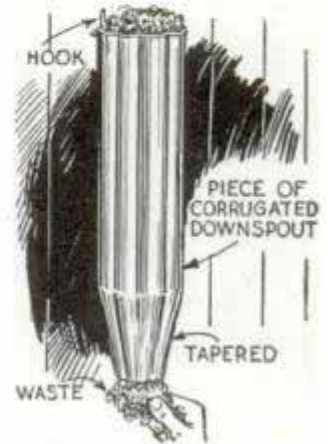

Flashlight Supported at Angle to Illuminate Wheel

When you have tire trouble on the road at night and there is no device at hand to hold your flashlight at the proper angle, prop it against the can of tube patches or other article of similar size. A rubber band around the light and can will hold the assembly together.

—G. E. Hendrickson, Argyle, Wis.



Water Column in Pipe Tests Leaky Radiator

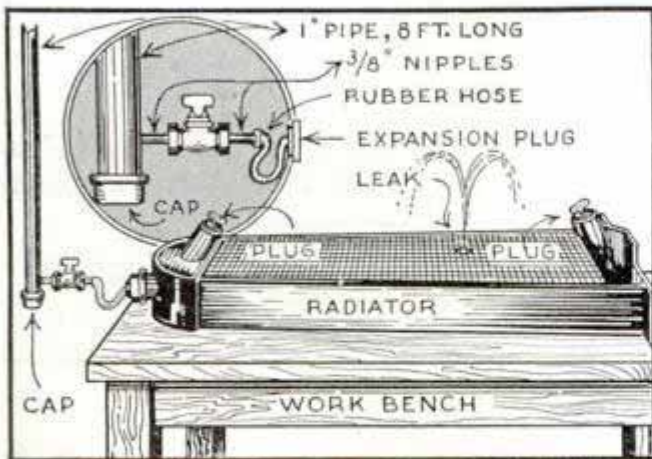

Instead of lifting a heavy radiator in and out of water when testing it for leaks with air pressure, a mechanic saves this work by using a column of water in a 1-in. pipe to produce the pressure. This enables him to place a radiator on a bench, locate the leak and solder it without moving the radiator. The inlet, outlet and overflow of the radiator must be plugged. If water interferes while soldering, it can be removed by taking out one of the plugs. Use of an expansion plug for the filler hole will permit quick attachment to various radiators. Water in an 8-ft. length of 1-in. pipe set

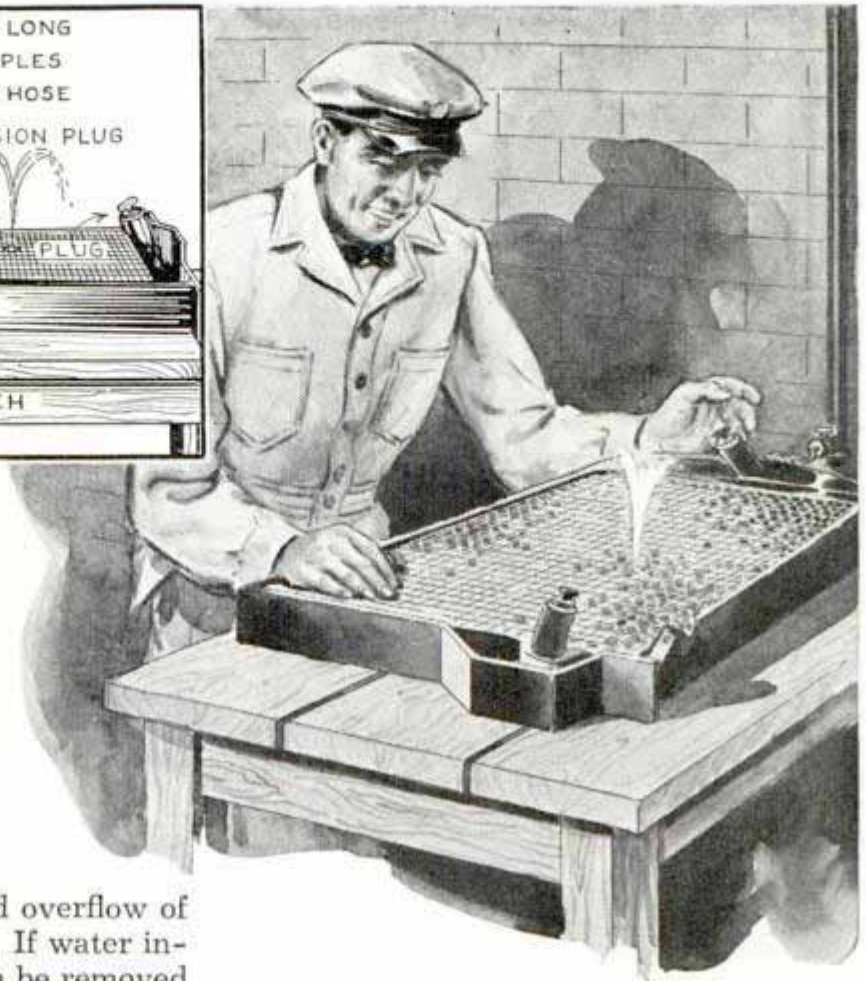

vertically will produce a pressure of about $3\frac{1}{2}$ lbs., which is enough to locate most leaks. It is necessary to refill the pipe after each test to maintain the pressure.

Air Cleaner on Car Generator Keeps Dust Out of Windings

After experiencing trouble with my air-cooled generator by dust being sucked into the windings and bearings, I rigged up this air cleaner. Two tin cans were used for the bowl or cleaner part, one to fit inside the other with a $\frac{1}{2}$ -in. clearance all around, including the bottom, which was cut and bent upward as indicated. A lead-in pipe or tube extends through the bottom of the larger can to within $\frac{1}{2}$ in. of the top. The other end of the pipe is soldered over a hole cut in the generator-cover band. Space between the tube and inner can is filled with copper wool, and the bottom of the lower can is covered with thin oil. The lid from the large can, assembled as shown, serves as a top for the cleaner.

—V. Caranci, Colorado Springs, Colo.

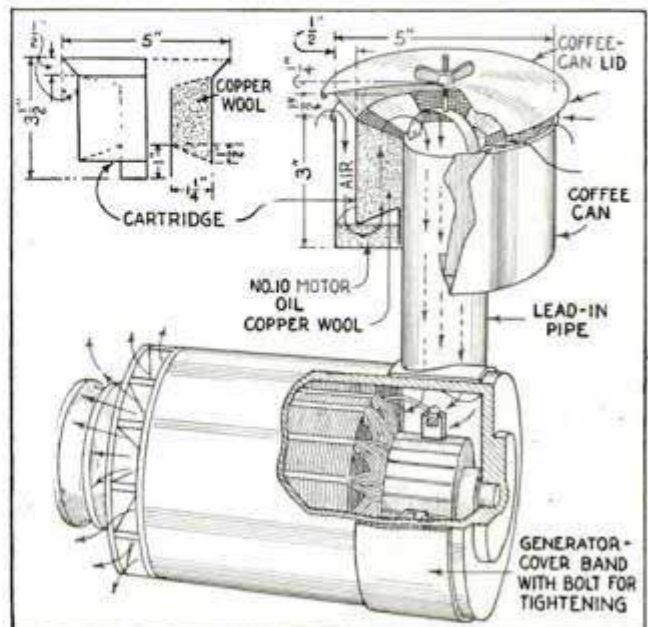

Paper on New Tire Removed with Rotary Knife



One service-station operator who mounts many tires devised a rotary cutter to re-

move the paper wrapping. It consists of a steel disk $\frac{1}{2}$ in. in diameter fitted with a handle as shown. In use the sharp edge is forced through the wrapping directly over the tire beads and then pulled or pushed around the tire. The rounded bevel on each side of the cutting edge forms a guide to keep the knife edge between the beads.

Tire Valve Used as Air Intake for Oil Barrel

To avoid opening the screw cap whenever gasoline or kerosene is removed from a barrel, a tire valve can be used. To install it, drill a hole in the cap large enough to hold the bottom of the valve, and seal with solder. The valve allows air to come into the tank when contents are drained out, but prevents any gases from escaping.

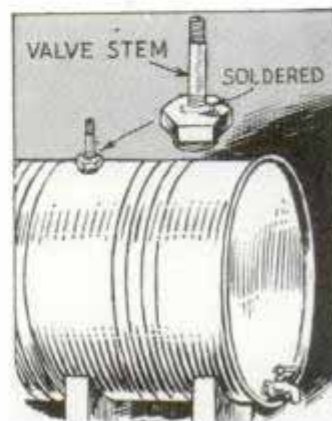

"Skipper"—Low-Cost, 14-ft. Outboard Runabout



At an expenditure of only \$30 to \$40 you can build this trim, five-passenger runabout, which is powered by a 4 to 24-hp. outboard motor. Its speed ranges from 9 to 24 m.p.h. depending on the size motor used. The boat has a 54-in. beam, 15½-in. freeboard, 24-in. depth, a 5-in. draft at 725 lbs., and a weight of about 275 lbs. Six plans (Nos. 1018 to 1023 incl.) showing details of building besides sheets giving material list and outline of procedure will be sent postpaid on receipt of \$1.

Other Boats You Can Build

"Roamer"—765 to 770: Outboard cabin cruiser; two berths. Six prints \$1.00.

"Sea Saucer"—893: 9½-ft. sail boat. Deck, bottom and sides are 3/16-in. plywood. 25c.

12-Ft. Utility Rowboat—707: Flat bottom. Four seats. Sturdy design. 25c.

16-Ft. Canoe—811 and 812: Cedar planking covered with canvas. Two prints 50c.

"Arrowhead" Sloop—944 to 951: Fast sailboat 21 ft. long, 5 ft. 11 in. beam. Set of 8 prints \$1.50.

Any six of these plans (not projects) will be sent upon receipt of \$1

400 Build-It-Yourself Plans

Every home workshop owner should have our illustrated catalogue for constant reference to get ideas on what to build. Shows nearly all projects as they look when finished. Includes modern and colonial furniture, home and garden improvements, workbenches, tool cabinets, motor-driven machines, models of all kinds, outdoor-sport devices, radio equipment, electrical devices, toys and novelties, juvenile articles, etc. The only cost to get this new catalogue is a three-cent stamp. Be sure to print your name and address carefully when ordering.

Address Plan Service, Popular Mechanics Magazine, 200 East Ontario St., Chicago

*...and you've
got to be
good to tell
them apart*

OUTDOORS
IN THE SUN

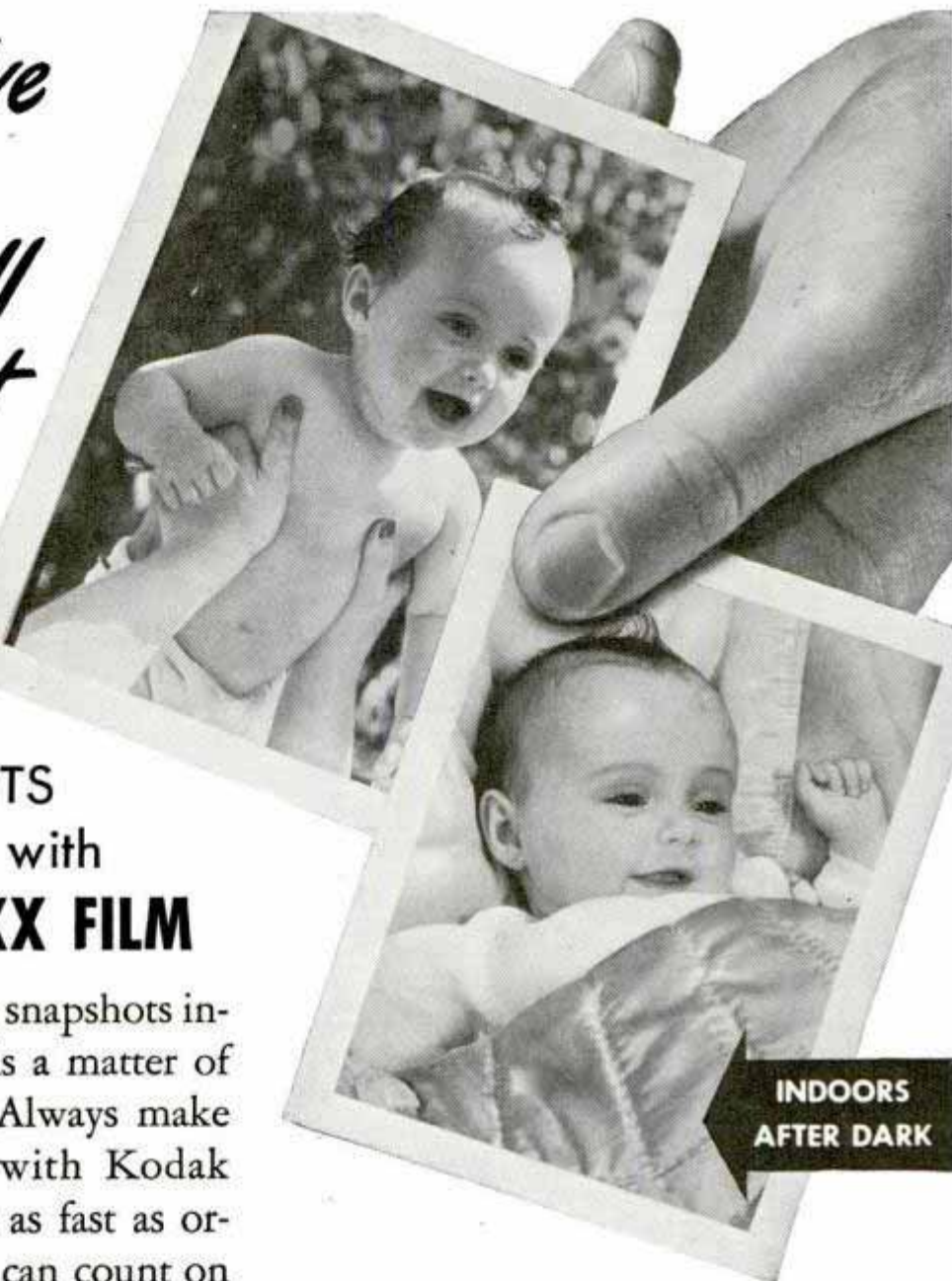

INDOORS
AFTER DARK

NIGHT SNAPSHOTS SIMPLE AS A-B-C with KODAK SUPER-XX FILM

GETTING excellent snapshots indoors after dark is a matter of using the right film. Always make sure that you load with Kodak Super-XX, four times as fast as ordinary film. Then you can count on getting pictures under Photoflood lamps that rate as highly as the snapshots that you have been making outdoors. You don't need an expensive

new camera for snapshots indoors after dark. Any camera at all will do, just as long as it takes Kodak Super-XX Film—even a \$1 Baby Brownie.



A . . . Load your present camera with Kodak Super-XX Film



B . . . Use a couple of inexpensive Mazda Photoflood lamps in Kodak Handy Reflectors



C . . . Follow the few simple directions in the FREE Booklet

A few minutes with this helpful booklet and you're headed for splendid nighttime snapshots. Photos, diagrams, easy-to-understand directions. At your dealer's . . . Eastman Kodak Company, Rochester, N. Y.

The Chemist Spins a New Yarn

(Continued from page 383)

912 40

anything in nature. It can be formed into fibers, sheets, bristles and other forms. Thousands of different nylons are possible, since many different chemical intermediates can be used. One type which appears promising for textile yarns can be made from a dibasic acid derived from phenol and a diamine also derived from phenol with the aid of ammonia. Since oxygen from the air is needed in making the dibasic acid, phenol comes from bituminous coal, and ammonia used in making the diamine is produced synthetically by uniting hydrogen from water with nitrogen from air, it follows that your nylon stockings may have originated in a coal mine, the air, and the river. Other types may call for raw materials from the farm as well as the mine. But between the mine or farm and the dress counter lie intricate chemical processes requiring elaborate equipment and rigid control.

One of the odd traits of nylon fiber is the orderly behavior of its molecules. When the fibers are first spun, their long, chain-like molecules are tossed together helter-skelter like straws in a stack. But draw the fiber out to several times its original length and the molecules line up parallel and close together. What this means to the hosiery maker is that cold-drawn nylon fibers become extremely strong and elastic. Stretch the fiber to double its original length and it will keep that length; but at a certain point, say four to seven times its original length—depending upon the particular type of nylon—the fiber becomes truly elastic: stretch it further and it always springs back to this point. For example, take a ten-inch bit of undrawn fiber of a certain type and pull it out to forty inches; at any point up to forty inches it will hold the length to which it has been stretched. But stretch it to forty-four inches and it always will spring back to forty, or very near forty—for no solid material is perfectly elastic. Stretched for days, "oriented" nylon fiber will not lose true elasticity.

Nylon is the first fiber to surpass silk in the strength and elasticity needed for fine hosiery. Bristles made from large, cold-drawn nylon filaments wear several times longer than natural pig bristles and resist the chemicals and grease destructive to

brushes in bottle washing and similar industrial operations. Nylon bristles can be manufactured to any gauge, from soft complexion brushes to tough scrub brushes. They absorb little water and do not split like pig bristles.

Another valuable characteristic is nylon's habit of "setting" when treated with hot water or steam. Nylon fabric steamed while smooth tends to remain smooth. Nylon hosiery thus treated will keep its form despite repeated wear and washing. Clothes of nylon fabric will not blaze. Fire will melt a nylon dress; eventually the fire would consume the molten nylon but the fabric would never burst aflame.

Because it has good insulating properties and resists abrasion, experiments are being made with nylon coatings for electric wires. The wire might be coated with molten nylon, or it might be wrapped with nylon yarn. Doctors have found surgical sutures of nylon smooth, nonirritating and excellently adapted to closing wounds.

Just how nylon is manufactured is du Pont's secret. It is known, however, that nylon yarn is extruded through a spinneret much as rayon—to which it is no cousin, for rayon has a cellulose base—is spun. In the new du Pont plant, a pump forces molten nylon through the spinneret—a cup with as many tiny holes in the bottom as there are to be individual filaments in the finished yarn. As the molten filaments reach the cool air they "freeze" into solid filaments. The size of the filaments is determined by the rate of pumping and the rate at which the yarn is drawn away from the spinneret. If the yarn is to be drawn to four times its original length to reach the point of true elasticity, this can be done by winding it on one spool four times as fast as it is unwound from the last spool. This achieves a four-fold stretch. In other ways, some of them quite complex, nylon will be given an infinite variety of forms to serve an infinite variety of purposes.

So an infant industry that promises to become a giant was born out of the keen observation by a research chemist, not looking for textile filaments but "playing" with big and little molecules, that a bit of molten superpolymer could be stretched out like a silken fiber.

A NEW *Thrill* EVERY MINUTE
IN MOTORCYCLING

EXCITEMENT

ADVENTURE



LOTS OF FUN

VACATION TRIPS

HARLEY-DAVIDSON
WORLD'S CHAMPION MOTORCYCLE

SEND COUPON NOW

These pictures tell more than a thousand words the countless thrills and pleasures of motorcycling. See your Harley-Davidson dealer. Get the complete story of this great sport—right in the saddle of a new 1940 model!

HARLEY-DAVIDSON MOTOR CO., Dept. P, Milwaukee, Wis.

Send FREE copy of big 24-page "Enthusiast" motorcycling magazine filled with pictures and stories of thrilling motorcycle doings. Also literature on new 1940 Harley-Davidsons. Stamp is enclosed for mailing cost.

Name.....

Address.....

Ocean Currents Forecast the Weather

(Continued from page 410)

agencies such as the winds, tides and changes in atmospheric pressure. Other currents and the configuration of the coasts also play their parts. In a deep cross-section of water we are apt to find a number of currents moving one below the next in varying directions, with possibly a warm saline current below a cold and less saline one. The ocean is in a continual state of unbalance and before we can understand its dynamics we must learn more about the details of its operation."

The scientists are investigating a brand new field that they have termed micro-oceanography, an examination in detail of the maze of small bodies of water that make up a major current. There are a lot of queer things about the physical ocean, one of which is the fact that although the water is salty its salinity varies at different times and places. Sea level is usually regarded as the permanent point of zero elevation and yet sea level, entirely aside from tidal fluctuations, may vary within a range of a foot a year. This may be caused by wind or by atmospheric pressure.

A surface current produced by wind moves at a forty-five-degree angle to the wind because of the rotation of the earth and yet at increasing depths this flow swings around until finally it is moving in a direction opposite to that of the wind that produced it. A north wind that parallels a west coast in the northern hemisphere moves the surface water out to sea, causing the upwelling of cold water from the depths. Some of this cold water may have left high latitudes hundreds of years ago and may have a higher than usual salinity content because it contains salt excluded by freezing of ice in high latitudes.

There are no whirlpools in the ocean such as are described in mythology but there are many giant eddies, fifteen to 150 miles across. Some of these are located permanently off certain coastal areas and others travel with the general flow of water at sea. Such an eddy current may have a speed of half a knot and along half of its circumference its direction is opposite to that of the main current that surrounds it.

This spring and summer the Scripps' survey vessel is to cruise back and forth off southern California, making complete records of the water temperature, salinity,

density, biological life and direction and velocity of the currents at various depths at a large number of stations, and then repeating the same thing over and over again. What the investigators hope to do is to cover the same area so frequently that they will be able to follow the movement of each individual body of water that differs physically from the water surrounding it and observe whether such a body dissipates in the general mass of water or whether it retains its density, and what happens to it during its passage through the selected area.

For some of the work they will use a new type of sensitive current meter that consists of a small propeller that turns a short shaft through which has been bored a hole. A beam of light passes through the hole at each half revolution of the propeller and operates a photoelectric cell counter on the other side of the shaft. A temperature-recording instrument that will be used for measuring vertical distribution of temperature in the ocean consists of a long, brass wire mounted in a framework insensitive to temperature changes. Lengthening or shortening of the brass wire, caused by temperature change, will be recorded on a drum turned by a vertical propeller that spins while the instrument is descending.

Studying the small flows of a main ocean current is difficult because the scientists may be confused by records of subsurface waves that have no relationship with surface waves and that have amplitudes of up to 100 or 150 feet. These giant invisible waves are created by friction at the boundaries of different currents. Other subsurface waves may be created by tidal forces. Other kinds of periodic oscillating motions at different depths will be found that may or may not be associated with the net transport of water in an ocean current, and in all of these cases the investigators will have to decide which movements that they observe are really pertinent to their work.

Aside from weather prediction, one hope of the oceanographers is that their studies of currents will help them to predict the scarcity or abundance of commercial fish. Spawning and the growth of young fish are dependent on food conditions and the amount of food available seems to depend on current movements.



Copyright, 1940
by F. Lorillard Co.

Who says laziness doesn't pay?

*Years of sleeping in shaded
oaken casks gives Briggs Tobacco
its matchless mellowness*

YOU can't improve on Father Time when it comes to nursing smoothness, mellowness, and bouquet into a vintage wine or a fine tobacco. That's why every pound of leaf selected for Briggs Tobacco—

and only the blue-ribbon best is chosen—is tucked away in oaken casks to slumber in the shade of the mellowing sheds season after season, while Nature works a wondrous alchemy. Harshness and tongue-bite steal away. Each golden leaf takes on mellowness, smoothness, flavor. Lazy aging—for months longer than lots of brands at twice its price—gives Briggs five-dollar-a-pound flavor, at 15¢ a tin. Try Briggs today. Meet the "friend a feller needs".

CASK-MELLOWED



Extra Long for Extra Flavor

Guild Sander

PORTABLE
ELECTRIC

does Those

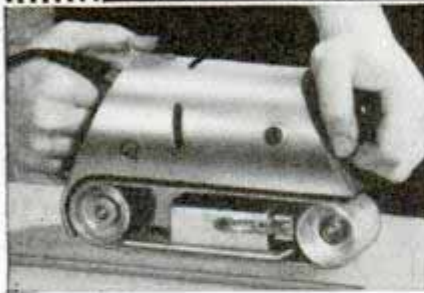

Tough

Sanding-Scraping

Planing Jobs!

10 Times
FASTER

You're SURE to get an "expert" finish!

Whether it's wood, metal, stone or plastics whether it's a flat or curved surface whether you want to sand, grind, polish, buff, remove paint or varnish, or sharpen tools—let GUILDSANDER help you! It's light-weight, easily portable—yet it's solidly made by sanding machine experts!

Even an inexperienced user is sure to get a clean, smooth, "expert" finish, because the high speed endless abrasive belt leaves no swirls, no scratches!

GUILDSANDER soon pays for itself by helping you to do MANY tedious, difficult, disagreeable jobs 10 TIMES FASTER—and a hundred times easier—than can be done by hand! Try out GUILDSANDER for yourself—or write direct for price and full information, also names of nearest dealer.

Weights only 5 lbs.
AC or DC
Universal Motor
Quality
Guarantee
POPULAR PRICES

SYRACUSE GUILD TOOL COMPANY
1740-3c No. Salina St. Syracuse, New York

10 NEW SETS OF STANLEY PLANS

Each set includes five interesting things to make. Complete instructions.

Set No. 1	Hanging Shelves	10c
Set No. 2	Lamps	10c
Set No. 3	Trays	10c
Set No. 4	Tables and Stands	10c
Set No. 5	Book Ends and Small Articles	10c
Set No. 6	Flower Pot Holder and Desk Articles	10c
Set No. 7	Mirrors, Footstool and Table	10c
Set No. 8	Magazine Stands and Tables	10c
Set No. 9	Chests and Boxes	10c
Set No. 10	Smokers' Stands	10c

Select the sets you want; send check, money order or stamps to

STANLEY TOOLS

DIVISION OF THE STANLEY WORKS
123 Elm Street, New Britain, Conn.

SAVE THAT CHAIR!

DON'T THROW FURNITURE, mirrors, glassware, etc. away... repair them with Rogers Glue—makes them as good as new... Rogers Glue is ready to use and works quickly—stays put longer because it is stronger. Sells 10c and up in tube, jar or can at hardware stores only or send 10c for full size jar and you receive a Free Project Book giving new ideas, new plans for making useful articles—to Dept. B.

ROGERS GLUE COMPANY Gloucester, Mass.

ROGERS

the best LIQUID FISH GLUE

Bug Hunters Wage War on Insects

(Continued from page 372)

known in both Europe and Africa, but not as a virulent pest. No information had come regarding it from South or Central America, nor from Australia.

With this evidence, meager as it is, and a map of trade routes, scientists can go almost invariably to the undesirable alien's home. The finger of science indicates a spot where trade routes of Africa, Europe, and western America cross—Australia. There a searching party is sent. The task is not simple. Often hundreds of square miles must be covered. Paradoxically, the insect pest is seldom numerous in its native land, for its enemies have kept it in check. So jungles have to be crossed, wild beasts have to be braved, fevers endured, while the very grass is examined in hopes of finding the creature.

You hear little of this side of the story, for these men are scientists, and however hard their task, they consider it only incidental. It is only after much wheedling that you can learn of the way one party, deep in Africa, encountered a herd of stampeding elephants, or the night a lion crept into camp, burned itself on a car radiator, and proceeded to wreck everything in sight before a bullet shattered its brain.

It's the bugs that are important, you see, the little creatures and their parasites—those all-important parasites—which have to be brought home so carefully.

Once home, the rest is easy. There all facilities for raising bugs to full maturity exist. The bugs go through the first stages of quarantine and if they develop no diseases or personal parasites, they are liberated into a sunroom, approached by a long, black corridor, illuminated by one overhead light. Upon opening a door, this light goes out. Bugs seek the light, so they stay in the brilliant sunroom, surrounded on three sides by glass, rather than escaping into the dark corridor. Here they are raised through one or two generations, and then several hundred are gathered for further experimentation. They are taken to a private room, and placed in cages containing varieties of food. In another room, the same food may be in cages, but a different temperature is maintained. In another, the same food, but a different humidity. These tests go on until it can be determined the conditions best suited for mass production.

\$200 My First Week



... Now in my OWN Business.

Would you, too, like to own a business where it is possible to take in as much as \$200 your first week as did L. A. Eagles in his new business?

We want a reputable, honest man in each county. This man need not have any special experience or more than ordinary ability, but he must be honest and courteous.

Such a man we will start in business for himself. You can make far above average profits in the rug-washing business—a high-grade business all your own. Many earn \$125 to \$200 per week—some considerably more.

NO SHOP NECESSARY

The rug-washer cleans rugs like new on the customer's floor. Anyone can run it. Electricity does the work. A quick, thorough and highly-efficient method that brings out the natural beauty of floor coverings.

There are hundreds of customers—in your vicinity and nearby towns. The business grows steadily. Simply wash a few rugs or carpets. These customers tell others and also give you their future work. Soon you will have a prosperous year-around business. Send coupon for booklet explaining everything.

"Profits Pay for Home"

Harry Hill built and paid for a home from rug-washer profits. His first day's business was \$86. Another man writes, "Made \$70 in 13 hours." A. L. Miller says, "Have had rug-washer 6 years—have earned as high as \$92 a day." M. O. Malmin earned 3 times the cost of his machine the first two months. You, too, can enjoy a large income.

VON SCHRADER MFG. CO., 103 PL., RACINE, WIS.

Free Book!
MAIL COUPON now

VON SCHRADER MFG. CO.
103 Pl., Racine, Wis.

Send at once (no obligation) your free booklet illustrating rug-washer and telling how I can own my own permanent business; how I can earn large profits at prices below other methods; how I can become financially independent in a short time; and how I can pay on easy terms.

Name.....
Address.....
City..... State.....

"Never a Complaint"

C. J. White says: "\$100 business in six days—never a complaint." That is the nicest part of this business—every customer is more than satisfied. Stains and blotches disappear and vivid colorings and freshness in faded floor coverings come back.

EVERY MACHINE GUARANTEED

You take no risk. These machines have been manufactured since 1918 and are used by the United States Government and by many of the world's largest hotels. They are fully GUARANTEED.

EASY TERMS

The complete equipment is inexpensive. A reasonable down payment brings everything to you and the balance is paid monthly. From the start, you have your own business—one that is profitable and of which you can be proud.

MAIL COUPON Today



FACTORY TO YOU
WRITE for FREE CATALOG

NEW SUPER-QUALITY KITSELMAN FENCE

Heavier, amazingly improved galvanizing. Tougher, longer-lasting Copper-Bearing Steel. Low Factory Prices. WE PAY FREIGHT. Farm, Poultry and Lawn Fence; Steel Posts, Gates, Barb Wire, Electric Fence, Poultry Supplies, Paints, Roofing. Write—**KITSELMAN BROTHERS** Dept. 94 Muncie, Indiana



KINKADE GARDEN TRACTOR and Power Lawnmower

A Practical Power Plow and Cultivator for Gardeners, Suburbanites, Florists, Truckers, Nurserymen, Fruit Growers

Low Prices - Easy Terms

American Farm Machine Co.
1058 33rd Av. SE. Minneapolis, Minn.



Catalog Free

DO YOU WANT a new business profession of your own, with all the trade you can attend to? Then become a foot correctionist, and in a few weeks earn big income in service fees,—not medical nor chiropody—easy terms for home training, no further capital needed, no goods to buy, no agency. Established 1894. Address **Stephenson Laboratory, 1 Back Bay, Boston, Mass.**

MAN IN EACH TOWN To Plate Auto Parts

Reflectors, Bicycles, Fixtures, Mirrors, by late method. Simple plan of manufacturing at home starts you IN **GOOD PAYING BUSINESS**. Write today for **FREE** particulars and proofs.

GUNMETAL CO.
Ave. M Decatur, Ill.

THE FISHING DIGEST



FISHING DIGEST Sent Free!

NEW! Fishing facts, fiction, thrills—a collection of the year's best articles in digest form. Edited by Wisconsin Cal Johnson, master fisherman. Includes chart of world's record catches. Also valuable information on outboard motors. **Sent Free! Write** **JOHNSON MOTORS, 1211 Pershing Road, Waukegan, Illinois**

21128

**MAKE UP TO \$25 PER WEEK
EXTRA WITH AN
IDEAL LAWNMOWER
SHARPENER!**

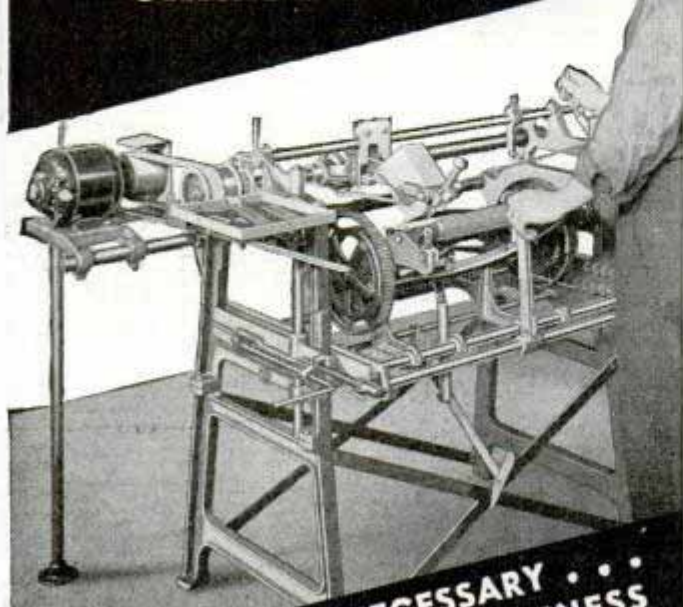

**NO EXPERIENCE NECESSARY . . .
BUILD A PROFITABLE BUSINESS
OF YOUR OWN . . . OUR FREE
PLANS SHOW YOU HOW!**

● Let us show you how to build a permanent and profitable business of your own—sharpening lawnmowers. Most men earn up to \$25 a week. Roy F. Stier, Wisc., writes, "I paid for my Ideal Sharpener in exactly 36 days and have to date sharpened 200 mowers at \$1.25 each. I live in a village of 500 people." Howard Hellen, Minn., writes, "I sharpened 745 lawnmowers, sold 60 used mowers and grossed \$1,000.00 from April 5 to Sept. 15." A. M. Larsen, Utah, writes, "We average 9 lawnmowers a day." Chas. H. Chism, Ohio, writes, "I have had as high as 30 mowers come into my shop in one day." P. G. Armour, Pasadena, Calif., writes, "We get \$1.00 for small 4-blade machines, \$1.25 for 5-blades, \$1.50 for large mowers."

**GOOD LAWNS Require Sharp Lawnmowers . . .
Cash in Now!**

With the Ideal Sharpener, it takes only a few minutes to make an old dull, badly worn mower cut like new. Set the mower in the Ideal, make a few simple adjustments, and the machine does the rest. Sharpens any mower to a perfect edge in 15 to 20 minutes—usual charge \$1.00 to \$1.50. Customers come back year after year. Positively no experience necessary. Attach to light socket. Start in your basement or garage. Work in spare time only if you wish. Attachments for grinding skates, grass shears, hedge shears, sickles, scythes, and axes. FREE CATALOG tells complete story.

THE FATE-ROOT-HEATH COMPANY
340 Bell St. PLYMOUTH, OHIO

make money--
SHARPEN LAWNMOWERS!

HOW TO
BUILD A
Profitable
BUSINESS
OF YOUR
OWN

Torture Chambers of Industry

(Continued from page 415)

The automobile you ride in withstands abuse on the road because it has been subjected to much greater torture than it will ever receive in service. There is the "Death Chamber," where engines are run to de-

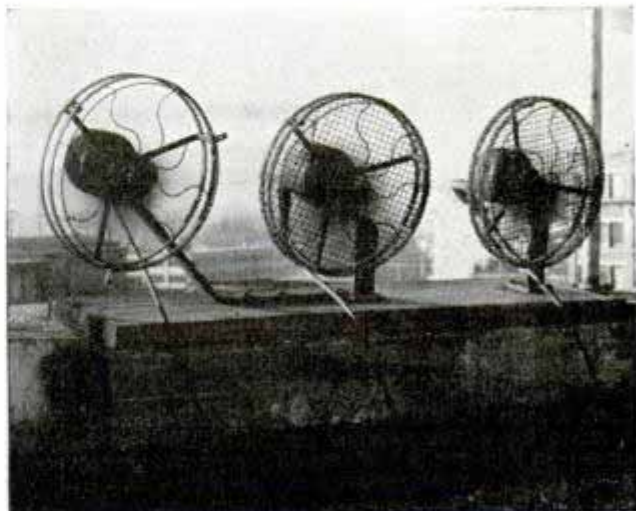

For more than nine years these fans have run, winter and summer, rain or shine, on laboratory roof

struction. With throttle wide open, a motor roars hour after hour, until the manifold is cherry red. Finally something rebels, and the engineers hold an autopsy that will enable them to design a still better motor.

There is an underground armored pit where a flywheel spins 12,000 revolutions per minute or faster, until it bursts through centrifugal force. An automatic device intermittently pushes an automobile starter button; it takes 60,000 such starts before failure begins—the equivalent of ten starts a day for sixteen years. Springs are tested by continuous dropping of a thousand-pound weight on them, then suddenly releasing it. Today's springs rebound from such a test half a million times without breaking. The front-wheel suspension parts are tortured in a machine that produces a combination of shimmy, hula, and rumba. They've reached the point where the parts tested outwear the machine.

The most brutal test of all is the "Belgian Roll." Here a car is mounted on sets of drums and chained in place. The drums, with lugs bolted to them, are revolved rapidly, pounding the tires and causing constant spring action and car movement, similar to the roughest "scrubboard" road. Ninety hours of this is the equivalent of 100,000 miles of average driving.

21128
 Will the hydraulic lines and brakes carry pressure and the whip of rough roads for the life of the car? A breakdown device whips brake hose around like a jumping rope at 850 revolutions per minute, with 250 pounds of hydraulic pressure inside the hose. Stock equipment now stands up under 150 hours of this punishment—equal to 100,000 miles of fast driving over rough roads. A torsion machine twists steel bars used for axles completely around, not once but twice—and then some—before they fracture. In the "Rocky Road to Dublin" test, weights of 155 pounds are bounced on seat cushions 1,200 times an hour, until the cushion comes apart.

In the National Bureau of Standards in Washington a massive compression-tension machine subjects specimens to 2,300,000 pounds of hydraulic pressure. Safer buildings and bridges have been made possible through hundreds of tests on this machine.

There is a dish smasher, much more effective than the newest bride, which de-

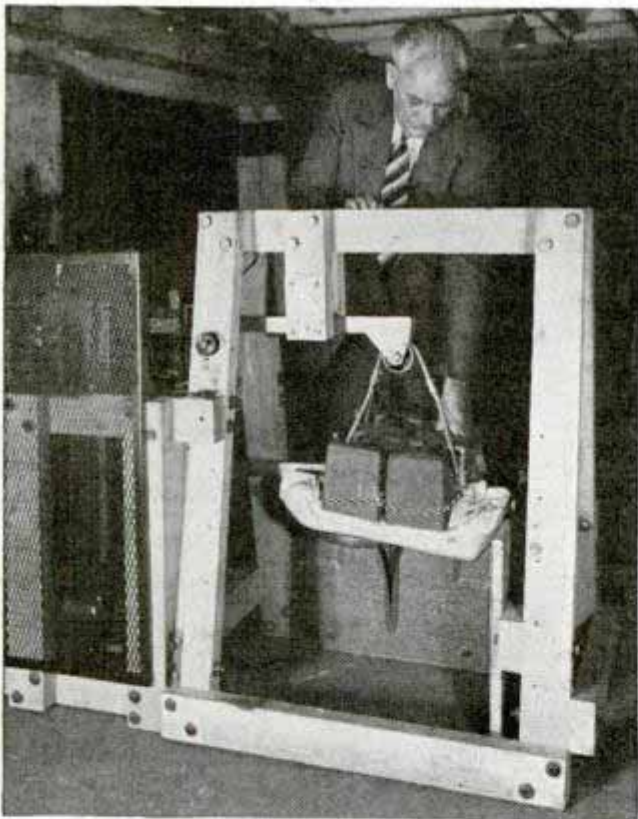

Dropping 200 pounds of metal on seat of telephone booth repeatedly until screws are torn from wall

molishes thousands of tableware samples, to develop long-lived crockery. There is a walking machine that tests the wearing quality of shoes. Shoes fitted to artificial feet mounted on the spokes of a wheel walk along a belt until they wear out.

Stanley Screw Driver

No. 25

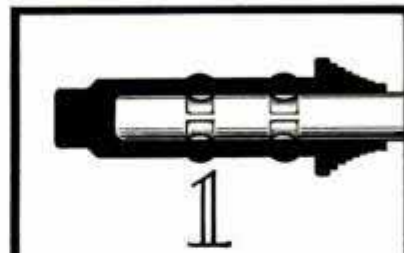

Blade tempered entire length. Recesses forged into butt end which is driven into steel bolster . . .

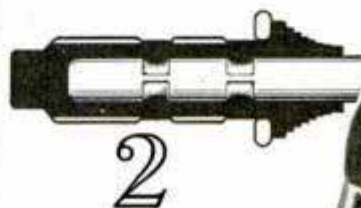

Bosses are swaged into blade recesses. Four sharp wings are swaged on outside of bolster. Blade is now locked into bolster . . .



No. 45 Small blade parallel sided tip

No. 55 Small blade, flared tip

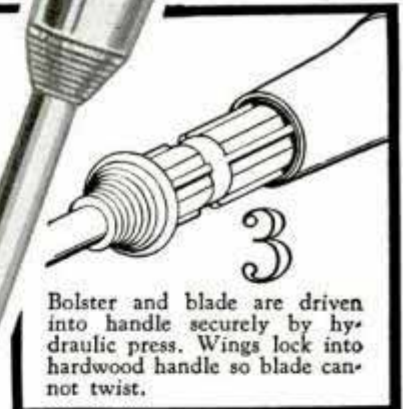

Bolster and blade are driven into handle securely by hydraulic press. Wings lock into hardwood handle so blade cannot twist.

This patented construction makes it possible to temper the blade its entire length, providing greater strength. Stronger, better insulated, and with accurately machine cross-ground tips, the Stanley No. 25 Screw Driver is made in 8 lengths, 2½" to 12".

See them at your hardware store, or write for Catalog 34, which describes all Stanley Tools.

STANLEY TOOLS

Division of The Stanley Works, 105 Elm St., New Britain, Conn.

THE TOOL BOX OF THE WORLD

\$10⁰⁰ SAVED per dollar spent — a fair average for SMOOTH-ON No. 1

Smooth-On No. 1 has a value far out of proportion to its ridiculously low material and application cost, and invariably pays a very high return to the householder who does his own tinkering. Home mechanics appreciate the ease of making Smooth-On repairs (without heat or special tools), the quick readiness for full-capacity service, and the reputation for competency which these repairs give to those who make them. Every one likes the speed with which a Smooth-On job gets things in good working order again after a breakdown or leak has caused annoyances.

The performance of Smooth-On No. 1 has been stepped up to meet every demand in stopping a leak or tightening a loose part, and recent changes in the composition also make application easier than ever. Used judiciously, Smooth-On No. 1 can be depended upon for a repair that is perfect and permanent.

All that would be used in the home in a year usually costs less than the saving in a single simple application, and if you fail to utilize Smooth-On economies, you overlook one of the best opportunities to make household savings. Keep Smooth-On No.

1 and the Smooth-On Handbook in your workbench. The helpful advice, instructions, and working diagrams in the booklet afford a reliable guide, based upon good engineering practice.

Get Smooth-On No. 1 in 7-oz. or 1 or 5-lb. can from your hardware store or direct from us.

SMOOTH-ON CEMENTS



For the Motor Car and Boat, Home, Factory and Power Plant

Write for FREE BOOK



Do it with SMOOTH-ON

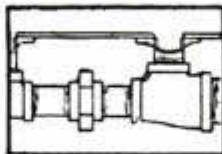

Pipe Leaks



Boiler Leaks

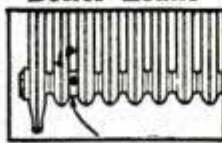

Radiator Leaks



Fire Pot Leaks



Smoke Leaks

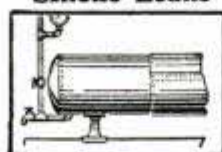

Tank Leaks



Furnace Gas Leaks

SMOOTH-ON MFG. CO., Dept. 37
574 Communipaw Ave.,
Jersey City, N. J.

Please send Smooth-On Repair Book.

Name

Address

3-40

Making Money with Hens

(Continued from page 405)

matically at constant temperature and humidity; the only human attention is the turning of a crank to shift the eggs.

Before they are four days old the chicks are either shipped to battery operators or sent to the starting cages on the Arndt half acre. In these cages, three feet by six feet and twelve inches high, 200 baby chicks snuggle under an "electric mother," a wire heating element that is as comfortable as a hen. The first thing you notice in the nursery is the red windows. Daylight shining through them gives the chicks a reddish cast. You'd think it would make them see red; it does just the opposite. Cute little things, these chicks are cannibals. A bit of red comb invites an investigatory peck; a drop of blood starts a tiny riot. But in the red light from the windows, the red comb and the droplet of blood appear white and attract no attention.

After four weeks in the starting cages they move to another battery accommodating twenty birds, where the pullets stay until they're twelve weeks old and the cockerels stay about four weeks; then they're one-and-a-half to two-pound broilers, ready for market. In a third battery the pullets, twelve in a cage this time, stay from the twelfth to the twentieth week. Then they move into single-room apartments to stay as long as they pay the minimum rent, a dozen eggs a month.

Thinking the hens might appreciate music in the factory, Mr. Arndt installed radio loud speakers. As a "control" for the experiment he turned on the radio one month, left it silent the next; result, three to five per cent more eggs during the musical month. The ladies of the hen house prefer organ music, and do their very best packaging on Sunday mornings.

In the country, hens work shorter hours during the dark days of winter. In the warm battery they work a thirteen-hour day winter and summer; time clocks turn on the lights. Production stays level the year around, and you have more fresh eggs to sell when prices are highest. Mr. Arndt's latest stratagem is to turn on the lights for an hour at midnight and serve an extra snack. He believes the additional meal will step-up egg production. The hens seem perfectly willing to lose an hour's

(Continued to page 124A)

New Buyer's Guide for Power Tools



EASY TERMS
The complete line of Delta low-cost wood working tools—Saws, Lathes, Drill Presses, Shapers, Sanders, Jointers, Grinders—is now available on liberal extended terms through Delta dealers.

If you are interested in power tools for your workshop—there are vital inside facts you simply *must* know before you can make a sound decision. These facts are now available to you in the New 1940 Delta Catalog which not only lists the complete line of Delta "Quality" power tools—but shows you the important points to look for in all power tools. It explains the advantages of "diamond-boring" of bearing seats, "pre-loading" and correct mounting of ball bearings and "sealed-for-life" ball bearings. It illustrates many hidden features of design and construction that make for long, better service in power tools. It takes up the major power tools one by one and analyzes various types of design and shows the advantages and disadvantages of each design. It shows you the features you should look for in selecting power tools for your shop. Truly this new 1940 Delta Catalog is A BUYER'S GUIDE—cramped with useful information that every craftsman should have. Send for your *Free* copy today.



DELTA MANUFACTURING COMPANY
Dept. A 340
600-634 E. Vienna Ave., Milwaukee, Wis.



Red Universal E Tractor
You plow, disc, cultivate, mow, haul, do belt work, for about 33¢ a day. Safe, trouble-free long life. New plow lift, new reverse. Hundreds used. Save by buying from maker. Two weeks trial. **FREE** catalog. Write today.
PIONEER MFG. COMPANY
Dept. V-30 West Allis, Wis.

NEW Grinding Attachment

For 8" to 16" Metal Lathes. Build it Yourself.

At last, a precision grinder within your means. You save 2/3 by finishing our semi-machined castings on your own lathe. HURON handles both internal and external grinding. Accuracies to .00025". Mirror finish easily obtained. Grinds valves, pistons, bushings, shafts, hard or soft. Holes, lathe centers. Sharpens reamers, milling cutters. Does eccentric drilling; laps; polishes; scores of other uses, for home work-shops, garages, machine shops. Write for **FREE** illustrated folder and full information.

Huron Machine & Tool Co., Dept. B-3, Yale, Mich.



Semi-Machined Castings Only \$5.95

New Adding Machine Fits Vest Pocket !..

Adds, subtracts and multiplies up to one billion. Weighs only 4 ounces. Not a toy—strong guarantee. Absolutely accurate, very fast. Sells to offices, stores, homes—wherever figures are used. Write quick for **FREE** sample offer and Money-Making Plan.

VE-PO-AD, Dept. 205, 303 W. Monroe St., Chicago



BURN YOUR NAME ON TOOLS WITH THE

ARKOGRAF

PROTECT YOUR TOOLS FROM THEFT

Write with electricity any name or design on the hardest and finest tools and instruments, or any metal, like writing on paper with pen or pencil. Complete Outfit \$3.50—Prepaid Anywhere. Interesting illustrated circular free. Write today. Agents wanted.

ARKOGRAF PEN CO., 3927 S.E. Stark St., Portland, Ore.

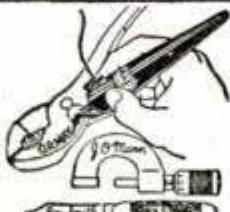

Big Money for Workers In Home or Shop



GUARANTEED basement waterproofing. Color-glazed concrete, gravestones, tiles, walls, floors. Lawn, cemetery pottery. New method. Use only sand, cement, cheap materials. Operators wanted. Full or part time. No skill required. Big earnings. Booklet, details 5¢ (stamps or coin).

NATIONAL POTTERIES COMPANY
Dept. 6, 13 W. 26th St. Minneapolis, Minn.

GUITARS

FREE 32 Page Catalog of World Famous "National" Electric and Amplifying Guitars.

Be Popular and Play One of These New 1940 Models

Write Today. No Obligation.

National Dobro Corporation, 404 W. Peoria St., Chicago, Ill.



MADE \$102500

in 9 Months with the

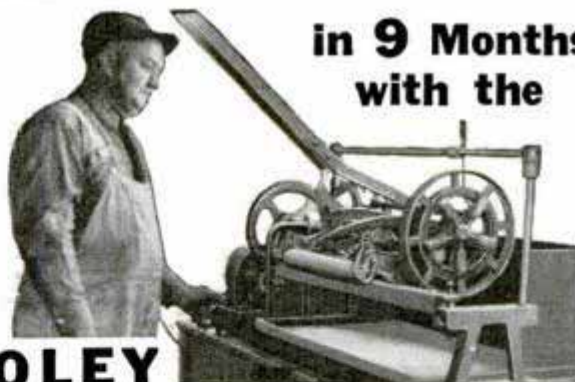

FOLEY LAWN MOWER SHARPENER

"A substantial increase in grind jobs each year, proves beyond any doubt that Foley Grinders do very satisfactory work. We have ground 723 mowers since February 1 to date, November 9. Our total receipts on lawn mower service alone during that period has grossed us \$1,025.00. The prevailing price of grinding and adjusting service is \$1.00 and \$1.25—repairs and parts extra."—W. A. Tulip, Phoenix, Ariz.

You Too Can Make Big Money

Free plan tells you how to start. The Foley Lawn Mower Sharpener turns out perfect work quickly and easily, no experience needed. Simply put the mower in the machine and turn on the power. Uses same system as lawn mower factories. Sharpens all sizes and types in 15 or 20 minutes.

Special Offer: Attachment for grinding axes, hatchets, knives, etc., included **FREE** with Foley Lawn Mower Sharpener on our Special Offer, brings you business the year around. Send coupon today.

FOLEY MFG. CO. 307-40 Foley Bldg., Minneapolis, Minn.

Send Free Plan for making money sharpening lawn mowers, and Special Offer on the Foley Lawn Mower Sharpener.

Name.....
Address.....

9 10 11



JUST YOU TWO IN YOUR CANOE

• THE rustle of leaves in a whispering breeze, with the light of a moon for your mood. An Old Town Canoe is a world of your own . . . your passage to peace and contentment.

The dip, dip, dip of a Redskin's paddle takes you through quiet enchantment. Paddling or resting, it's steady and strong. It's sturdy and easy to own.

FREE CATALOG shows all kinds of Canoes for paddling, sailing or outboards. Also Outboard Boats, including big all-wood family boats. Rowboats. Dinghies. Write today. Address Old Town Canoe Company, 633 Main Street, Old Town, Maine.



NEW STREAMLINE BENJAMIN AIR RIFLES

WITH LEVER
HAND PUMP



BENJAMIN

.22



.177



BB



HARD ACCURATE SHOOTING WITH CHAMBERED AIR You can use new models BENJAMIN AIR RIFLE WITH LEVER HAND PUMP anywhere, for practice firing or just plinking around the house or camping, fishing, hunting, etc., at lowest cost. Shooting force is adjustable depending on AIR PRESSURE—amazing maximum power and accuracy—will penetrate to 1". Hair trigger firing without lunge or recoil. Single Shot BB \$7.50. Repeater BB \$9.00. Rifled Cal. 22 or 177 Single Shot \$8.50. Ask your dealer all about them or write for complete specifications—targets and blueprints FREE if requested. We also make a complete line of BENJAMIN AIR PISTOLS for target and small game. WRITE TODAY. BENJAMIN AIR RIFLE CO., 895 MARION ST., ST. LOUIS, MO. U. S. A.

ONE-MAN SAWMILL

Makes lumber, shingles, lath, ties, crates, boxes, casks, all forms lumber

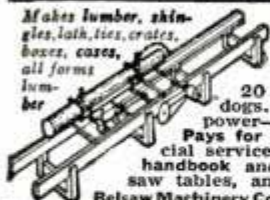

TURN TREES INTO MONEY WITH A BELSAW

Three capacities: 10, 14 and 20 ft. Accurate set works, positive dogs. Hand or power feed. Runs on low power—Many owners use old auto engine. Pays for itself quickly—thousands in commercial service everywhere. Write for free lumber handbook and catalog of mills, supplies, tools, saw tables, and woodworking equipment.

Belsaw Machinery Co., 8111-C Davidson Bldg., Kansas City, Mo.

FARM MODEL \$59.00

CIRCULAR SAW \$3 POST PAID

(Outside U.S. or C.O.D. \$3.25)



\$150 PRIZE CONTEST

"The Ripmaker" Saves hours of tedious hand sawing. Has 4" combination rip and crosscut blade, oilless bearings and 8"x58 1/2" steel table adjustable so that pieces up to 1" thick may be cut (pieces up to 2" by turning stock). Base, saw support and table adjusting slide, heavy iron castings. Adjustable ripping fence. Guarantee: satisfaction or full refund if returned within 5 days.

FREE CATALOG describing \$150 prize contest (1st prize, \$25; 2nd, \$15; 3rd, \$10; 4th other cash and merchandise prizes). Cat. illustr. complete power tool line: Jig Saw, \$1.50; Jointer, \$6.50; Shaper with oilless bearings, \$3; Drill Press, \$2.50; completely equipped Lathes, \$2 and \$4.90; Sander, \$1; etc. Sold direct only. Order today or send card for Catalog.

J & H Metal Products Co. 5 Commercial St. Rochester, N. Y.

(Continued from page 122A)

sleep if they can spend it eating. It's like a midnight raid on the icebox.

Like any business, the egg factory has its problems. You have to sell the eggs. You're better off near a big-city market. You make more by selling at retail to neighbors, or at a roadside egg counter. The large-scale battery can make wholesale contracts with big users: hotels, bakeries and ice-cream manufacturers. Some day industrial chemistry will find new uses for eggs, too. Here's an odd one: rotten eggs, the yolk of fertilized eggs which fail to hatch, are used to tan kid gloves.

To give you an idea of costs and profits, here are Mr. Arndt's figures on a year's operation of a 1,296-hen battery. The original investment comprises a fifty by 100-foot lot, figured at \$62.50; the building, with hot-water heat, ventilation and light, \$2,500; 1,296 cages, \$1,879.20; 1,296 ready-to-lay pullets, \$1,944—a total of \$6,385.70.

The year's estimated expenditures he lists as eighty pounds of feed per bird, or fifty-two tons at \$50 a ton, totaling \$2,600; replacement of culled hens at four per cent per month or 622 pullets a year, \$933; depreciation allowance on building and equipment, \$312.92; reserve for repairs, \$100; insurance and taxes, \$150; fuel, water, light and power, \$125; egg packaging, \$170; total \$4,390.92. If you hire help, a trained man gets \$1,200 a year.

Total estimated income, \$7,760, includes \$7,257.60 from 20,736 dozen eggs at thirty-five cents a dozen; cull hens sold as table fowl, \$372.80; from 1,300 bushels of manure at ten cents a bushel, \$130.

This means an operating profit of \$3,369.48 if you do the work, or \$2,169.48 if you hire a man. The latter figure represents over thirty-three per cent return on the original investment of \$6,385.70.

Maybe 1,296 hens sound like a big flock for a garage mechanic or teacher or bank teller or his wife to take over without a nickel's worth of experience. Well, you could start with only forty; on the other hand, one man can manage 3,000 layers.

Costs and sales prices vary around the country. But a lot of folks with a half acre like Mr. Arndt's or a back yard like your own are discovering that if hens don't lay golden eggs, they do manufacture a steady supply of fresh eggs, neatly packaged and as good as gold.

2107 3

Bull Run Up-to-Date

(Continued from page 379)

hence could advance unharmed against rifle and machine-gun fire.

This tremendous power of modern weapons to kill is what makes today's battlefield apparently devoid of life. The whine of machine-gun bullets, the nerve-shattering crash of high explosive, have so driven the present-day soldier to cover that his opponent catches only fleeting glimpses of him. Only fragmentary bits of battle flash before the observer.

The greatest contrast between the battles of 1862 and 1939 was the matter of mobility. It took General McDowell two full days to march his federal army from Washington to Centerville, only twenty



Thirty-seven millimeter gun being moved into position by infantrymen during maneuvers

miles away. Two hours was all the motorized regular division needed to move that distance in the 1939 maneuvers.

One fact revealed by the Bull Run of 1939 is that the regular army, which is supposed to be ready for action on the day of mobilization, is not ready now. Its ranks are below peace strength, less than half of war strength. It is deficient in all types of modern weapons.

The National Guard suffers from these same defects but in a much greater degree. Though mobilization plans call for the guard to take the field thirty days after mobilization, General Drum, commanding the first army, estimates that from six months to a year of intensive training would be needed before the units are ready for battle.

☞ Inquiries as to makers of articles described in Popular Mechanics will be answered by our Bureau of Information upon receipt of return postage.

More Power

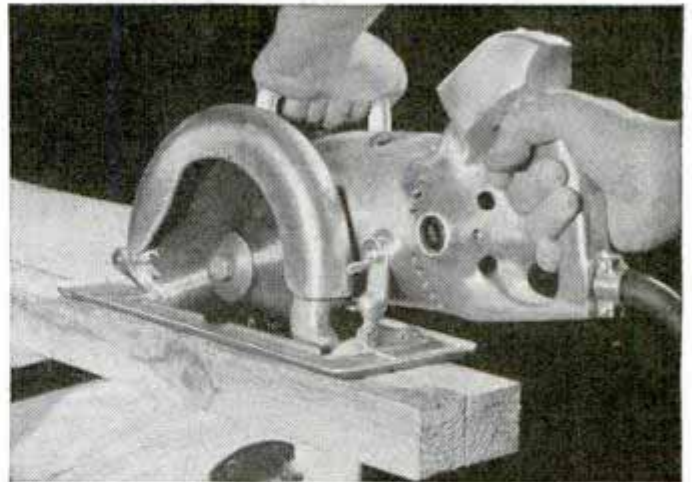

to SAVE TIME on Dozens of Sawing and Cutting Jobs

Van Dorn Portable Electric Saws offer many practical advantages to carpenters, builders, contractors, woodworking plants, shipping departments, freight handlers and other saw users.

They save time, labor and cost in slotting, cutting and sawing wood, metal, stone, tile, transite and a wide variety of compositions.

These new Van Dorn Saws are lighter in weight and shorter in length because of a new close-coupled construction. A comfortable "saw-grip" switch handle and well placed front handle gives perfect balance and makes them a joy to use!

Their deeper cut, increased power, sturdy worm drive, positive safety guard and instant release switch, makes these Van Dorn Saws unusually flexible, fast, dependable and safe. Available in three sizes with $1\frac{3}{8}$ ", $2\frac{3}{8}$ " and $3\frac{1}{8}$ " depth of cut. One will fit your needs. Van Dorn Electric Tools (Division of Black & Decker Mfg. Co.). Mail coupon for circular today!

“Van Dorn”
THE “RED-HEADED”
PORTABLE ELECTRIC TOOLS

MAIL COUPON TODAY!

Van Dorn Electric Tools, 603 Joppa Rd., Towson, Md.
Please send me circular on Portable Electric Saws,
also name and address of nearest Van Dorn dealer.

Name.....

Occupation.....

Address.....

City..... State.....



FISHING TACKLE

at LOW Prices

Send today for New 1940 Catalog listing thousands of bargains in Fishing Tackle, Baseball, Basket Ball, Golf, Tennis, Archery, Guns, Clothing and Sporting Equipment of all kinds. Top quality—**Money Back Guarantee!**

HERE ARE A FEW MONEY-SAVERS

- \$17.50** Bamboo Fly Rod, Alu. Case & 2 Tips **\$8.95**
\$9.00 DeLuxe Split Bamboo Fly Rod . . . **\$4.95**
\$4.00 Split Bamboo Bait Rod, 9½' extra tip **\$2.85**
\$3.00 1-pc. Steel Casting Rod, Offset handle **\$1.89**
\$2.75 1-pc. 3½' Split Bamboo Casting Rod **\$1.79**
\$3.75 Automatic Fly Rod Reel, light weight **\$2.29**
\$6.50 Feather-weight Bamboo Fly Rod, 7½' **\$3.95**
\$5.00 Double Tapered 30-yard Fly Line . . **\$2.95**
\$1.00 doz. assorted snelled Trout Flies doz. **49¢**
\$1.00 doz. Ringed Trout & Bluegill Flies doz. **49¢**
\$1.00 assorted 6 floating Bass Bugs, 1/0 hook **59¢**
 Spalding matched Bobby Jones
 steel shafted Woods, 1940 models, ea. **\$4.95**
 Spalding matched Bobby Jones
 steel shafted Irons, chrome finish, ea. **\$3.95**

Order any above specials C.O.D. or remit cash. FREE with \$6.50 purchase or more, metal snelled hook holder or metal ribbed sport glasses. Other premiums.

FREE 136-Page Catalog

Yours for the asking. Invaluable to every sportsman. Contains the famous "Fisherman's Calendar."

GATEWAY
SPORTING GOODS CO.
 240 Gateway Bldg., Kansas City, Mo.



DRIVE BY COMPASS



In cold weather especially, wrong turns often lead to treacherous driving over almost impassable roads. You can stay on the right road the year 'round with a Hull Streamline Auto Compass on your windshield. Streamlined Bakelite case, genuine sapphire bearing, built-in compensator. Only \$2.95 at your dealer.

Write for literature.
HULL MANUFACTURING CO.
 P. O. Box 246-D-3, WARREN, OHIO



60 POWER TELESCOPE . . . \$219

NEW! Three telescopes in one. 3 different magnifications. 20 power for ultra-bright images with 40 and 60 power for extra long range. Guaranteed to bring distant objects, people, sports events, ships, moon, stars, etc., 60 times as close.



Most powerful made for anywhere near the money. Closest to one foot in length. Multiple lens system. 30 mm. objective lens. 5 sections. Directions included for using as a compound 4 lens microscope. American made. Prompt shipment guaranteed. We pay the postage. Only \$2.19.
BROWSCOPE CO., Dept. 43, 5 W. 27th St., New York, N. Y.



• Every fisherman will want this book! Written by Cal Johnson, noted angler. Tells tried ways, methods of night fishing for bass, wall-eyes, other fish. How, when to cast or troll after dark. Froging. 72 pages of night fishing thrills. Shows the Powerlite and other Delta electric lanterns. Write for this book. Free!
DELTA ELECTRIC COMPANY
 300 W. 33rd St., Marion, Indiana



Power-
 lite
\$3.35
 less
 battery

The Hornets of the Air Corps

(Continued from page 389)

ciency and safety and only those who react rapidly and have a special aptitude for the kind of flying they do are selected for the advanced training that is necessary. The flight training program is slow and positive, gradually bringing the pilot down to minimum altitudes after he has demonstrated his ability at higher levels. Once judged competent, pilots are trained continuously in attack work so that they won't lose the knack of safe flight close to the ground.

Just as exacting is the training that the enlisted gunner receives. The sensation of facing aft in the rear cockpit while maneuvering close to the ground is sometimes similar to the reaction you would get by riding backward on a roller coaster. If he faces forward the gunner can operate a second set of controls to fly the plane if the pilot is disabled, and he is connected with the forward cockpit by means of an interphone and a signal-light system. It is difficult to judge distances in aiming at an airplane diving toward his plane from the sky, and part of the gunner's training is practice with a photo-gun that reveals his degree of marksmanship.

Night missions are the most difficult. Squadron leaders are expected to lead their planes direct to the objective even though check points by which they navigate are lost in the night haze. In fog or clouds the formations bunch up until the navigation lights of the wing pilots shine in the cockpit of the leading plane. Over enemy country and racing downward toward the objective the formations tighten up again to prevent the noise of the motors from spreading over too wide a range and to minimize the chances of being heard by the anti-aircraft listening network. Every pilot switches off his navigation lights and keeps track of the other planes by their shadowy outlines and from what exhaust glow he can see.

The powerful motors of the attack planes are designed especially for low-level operation, just the opposite of the supercharged engines that carry other airplanes to tremendous altitudes. Efficient as present planes and motors are, larger and faster attack planes are to be put in service by the Army Air Corps to make the work of the attack groups even more effective.

SALARY and EXPENSES

Based on Small Monthly Quota

Unlimited opportunity for good salesmen. If you have no connection or if you feel your present line offers no future, write me quick and I will give you the facts about an interesting, Nationally known maintenance product that sells in large quantities to factories, plants, warehouses, public buildings, farms, etc. Saves money for the user so it's easy to sell. You go to work at once on salary and expense based on small monthly quota. I'll be glad to give you a contract. Here's a new opening, a new product, a new future—perhaps just what you've been looking for in the way of advancement. Rush name to me today and a short letter outlining your experience. I'll reply at once with complete information.

AMERICAN ASBESTOS PRODUCTS CO.

Dept. 73, Cleveland, Ohio

STANDARD GARDEN TRACTORS



RIDE or WALK

Powerful Gas Tractors for Small Farms, Gardeners, Florists, Fruit Growers, Poultrymen, Nurseries.

1 & 2 Cylinders
Rubber or Steel Tires.

High Wheels—Free Catalog

Plow
Seed
Cultivate
Mow.Haul.
Belt Work

STANDARD ENGINE COMPANY
Minneapolis, Minn. Philadelphia, Pa. New York, N. Y.
3221 Como Ave. 2546 Market St. 290 Cedar St.

FREE CLUB & CLASS PIN CATALOG SHOWING OVER 300 DESIGNS

300 SMART DESIGNS!

Knit your class or club closer together with pins or rings. Bastian has been the leading maker for 45 years. Clean cut, quality work. Write today for 1940 Catalog.

30¢



BASTIAN BROS. CO. Dept. 74, Rochester, N. Y.

MENDS MOST ANYTHING

Iron Glue holds tight, is extra strong. You can buy it 'most anywhere— $\frac{1}{4}$ pt. to 1 gal. cans or 10c bottles. **FREE:** Send post card for booklet, "Better Results with Glue," by McCormick Sales Co., 402 Light St., Baltimore, Md.

IRON GLUE AN ELEPHANT FOR STRENGTH



PUSH-BUTTON CONTROLLED GAS TANK LOCK

A new invention "ELECTRIC HAMMER ACTION" abolishes all other gas caps. Eliminates troublesome keys. Stops loss of gas and caps. Features PUSH-BUTTON CONTROL FROM DASH—STREAMLINE DESIGN. A fast selling—high quality product at NEW LOW PRICES. Distributors, dealers, here is your money making opportunity. Write now for descriptive literature.

SNAP-UP GAS CAP CO. DEPT. U. ASHLAND, KY.

TRAILER BUILDERS·BUYERS·OWNERS

Send 25c for this Big Book Today

Over 100 pages! Beautifully Printed and Illustrated! Trailer Suggestions and Ideas galore! Catalog shows America's greatest line of Trailer Parts and Equipment at lowest prices. Everything from wheels to top. Rush 25c today. Satisfaction positively guaranteed!

TRAILER SUPPLY CO. Box 438-A WAUSAU, WIS.



BUILD IT YOURSELF

The Jim Dandy Cabin Cruiser

The Trailer that has everything. Classy! Roomy, Easy to build in any size with my simplified Plans and Instructions—Price \$1.00. Rush dollar bill today to JIM DANDY Box 125-A WAUSAU, WIS.

8-TUBE, 2-BAND SUPER AC-DC

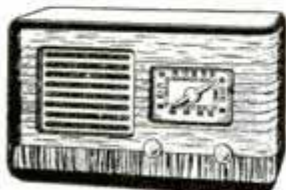

each in lots of six or \$12.48 when purchased singly. **\$11.23**
Regular \$24.95 list model 3T3 GOLDENTONE. Check these 1940 features: Dynamic speaker. Walnut cabinet. Illuminated vernier aeroplane dial. "Goldenscope"—no aerial or ground required. Receives Coast to Coast on Broadcast and Police, Amateur, Aeroplane, etc., on Short Wave. One year guarantee. Send \$1.00 deposit, balance C.O.D. Money back if not satisfied. **ORDER TODAY!**

GOLDENTONE RADIO CO., DEPT. PM, DEARBORN, MICH.

HOT WATER with SPEED KING



From Any Electric Light Socket

MILLIONS of homes, stores and offices everywhere need **SPEED KING**—the new, amazing **Water Heater**—that heats water boiling hot so fast it takes your breath away. No muss! No waste of time or fuel! Just a simple "plug-in" at any 110-volt light socket—and presto... just the amount of hot water you need for the bath, for shaving, for dish-washing. **CHEAPER** because you don't have to heat gallons when you need only a few quarts. **FASTER** because the intense electric heat goes directly into the water. Sells fast on a 60-second demonstration. Small in size—fits the pocket, easy to carry. Anyone can afford it.

**60-SECOND
Demonstration
Amazes Housewives**

SAMPLES for AGENTS

I WANT you to know the almost uncanny heating action of this speedy water-heating invention. Write quick—a postcard will do—for my **SAMPLE OFFER** that brings you an actual **Sample SPEED KING** for demonstration. You can make plenty of cash as my agent. **HURRY!** Big season starting now. **SPEED KING** solves the hot water problem when furnaces shut down. Act quick and I'll show you how to make the fastest money of your life. Send No Money!—Just your name.

JUST SEND

—NAME—
WRITE your name and address in the margin, clip & mail this coupon or send penny postcard to Dept. 163.

Name

Address

City

NU-WAY MFG. COMPANY

Dept. 163 Walnut Bldg., DES MOINES, IOWA

Build the COMET ZIPPER, JR.

RUBBER-POWERED
—BUT IT LOOKS
AND FLIES LIKE A
GAS MODEL!



Scaled down from the champion Comet Zipper, designed by Carl Goldberg. Detachable wing, finished cylinder, bent landing gear, finished prop, plenty of fresh, peppy rubber, etc. Big 32" wingspan; amazingly complete kit. Ask for Kit No. P8, \$1; postage 15c, none if ordered from dealer.

**BIG, NEW
CATALOG**
Shows hundreds of models, including gas models, motors. Send 5c stamps.

COMET MODEL AIRPLANE & SUPPLY CO.
129 W. 29th St., Chicago, Dept. P3—688 Broadway, New York



GERSTNER Tool Chests

Assure full protection for the good tools of Machinists and Toolmakers. Free Catalog.

GERSTNER TOOL CHESTS
440 Columbia St. Dayton, Ohio

RADIOS..SAVE UP TO 50%



DEAL DIRECT—FACTORY PRICES
Many models to choose from at wholesale prices. AC-DC midsets \$4.98. Portable and battery sets \$8.98 up. Car sets \$11.75 up. Also consoles, all-wave etc. Samples at 50% off. Send for FREE 1940 bargain catalog giving details of 10 day FREE trial and agent's proposition and discounts. No obligation, write today. **GOLDENTONE RADIO CO.,** DEPT. PM, DEARBORN, MICH.

*Free
Catalog*



P. W. REPAIRS CRACKS and HOLES

Use Plastic Wood to fill cracks in baseboards, floors, shelving—to fill old screw holes. It handles easily as putty and quickly hardens into lasting wood. In cans or tubes at Paint, Hardware, 10¢ Stores. Try it!



PLASTIC WOOD



WASHING MACHINES NEED 3-IN-ONE

HEAVY BODY 3-IN-ONE Oil works wonders on Washing Machines and Electric Refrigerators. It instantly penetrates the tightest bearings and moving parts. Lubricates—guards against rust. Get it at Hardware, Drug, Grocery, 10¢ Stores.

Ask for

HEAVY BODY

3-IN-ONE Oil



g 926
The Glass Age

(Continued from Coloroto Section)

doors into the home, so the glaziers have popularized the picture window for "framing" a beautiful view of a garden, a lake, or some other vista near the home.

A flesh-tinted plate glass that creates a feeling of warmth in a room during the winter months is another innovation. So is a plate windowpane, sea green in color, designed for rooms getting too much sun. Heat is absorbed by this glass but there is no interference with the transmission of visible light. Thus, while admitting seventy to seventy-five per cent of the sun's total light, the glazing material transmits less than forty-three per cent of the total solar heat.

Murals of glass are a new ally of the decorator. A Chicago restaurant has a series of these panels, thin, opaque glass and tinted mirror pieces being used to carry out designs on a jade background. Mirrored murals in plate glass with edge-lighted figures in sandblast design are coming into favor also.

Colored mirrors have been found to be helpful in giving a room an air of spaciousness. They likewise serve as a magnet of trade for shops. Why? Well, people like to look at themselves and colored mirrors provide a variety of effects. A pink mirror makes persons look sunburned and healthy, a green one gives them an air of mystery, blue is flattering.

Of course, colored glass is not new but until recent years it could not be made except with a rippled surface. The modern system of making flat colored glass is that of laying the material out on slate slabs and heating underneath by steam pipes so the silvering solution, poured on cold, is precipitated on glass. Two coats of this preparation and the mirrors are shellacked, then painted. In place of shellac, copper is electroplated on mirrors that are to be used outdoors or in bathrooms where there's a lot of moisture.

In olden times, a glass blower would heat a lump of glass to a plastic state, and then his helper, seizing one corner with a pair of tongs, would race away with it. The most advanced system of making fiber glass is that of feeding glass marbles into a small electrically heated furnace. By gravity, the molten glass flows through a

row of fine holes in a precious metal die, coming out as fibers. To make the fibers extra fine—those used in spinning are about one-fifteenth the size of the average human hair—the hot, pliable strands are stretched to produce continuous filament fiber by being wound on a rapidly rotating drum or else they are pulled out in a quickly descending column of steam that breaks up the fiber into short lengths. The coarser fibers are being utilized extensively in thermal insulation and acoustical treatments. Because of its flexibility and strength, a bright future is being planned for this type of fiber glass as an insulator for electrical apparatus.

The continuous filament fibers usually are spun directly into thread and may then be woven or braided by cotton machinery that's been adapted for this work. Glass textiles and fabrics can be produced in a variety of colors and, being fireproof, furnish a maximum of safety as well as beauty in theater curtains, draperies, and awnings.

Sand silica has been the base in all glass but by substituting a number of rare chemicals for it, an optical glass promising superior and "faster" camera lenses has been developed.

Photographers are likely to get another break as soon as the revolutionary coating, which makes glass both non-reflecting and invisible, is applied to lenses. Purest glass transmits about ninety-two per cent of light, whereas ninety-nine per cent would be possible with coated glass. In other words, a camera lens ordinarily cuts out eight per cent of the light; on a better type camera with three or four lenses, fully thirty-five per cent of the light never reaches the plate. All but a small portion of this light would be saved by the "invisible glass" announced several months ago by Katherine Blodgett.

And what of the substitutes for glass? At present, only one gives promise of being a threat to glass' supremacy. It's the thermoplastic resin that is known in this country as Lucite. In addition to being virtually unbreakable and much lighter than glass, polymerized methyl methacrylate, as the substance is known technically, can be sawed, cut, drilled and polished. Like quartz, it has edge-lighting facilities, transmitting light around a bend without lighting up the sides.

9926 Newark, Ohio.

CAREER MEN... TYPING IS A BUSINESS ASSET



Today, the man who can type has a real advantage. Executives say typing not only saves time and energy, but brings promotions quicker. Find out how a Speedline Corona can help you. See any Corona dealer... mail coupon for folder today!

\$100 A WEEK TO OWN A CORONA
Plus small down payment

FREE DEMONSTRATION AT ALL DEALERS

SPEEDLINE CORONA

L C SMITH & CORONA TYPEWRITERS INC
Desk 3, 723 E. Washington Street, Syracuse, New York
Please send me free folder describing Speedline Coronas.

Name _____
Address _____
City _____ State _____

YOU HAVE BEEN WAITING TO PAINT

COMPLETE WITH 110 V. MOTOR **ONLY \$9.85**

Now Everyone Can Paint This Easy Way—with a Spray Gun! A complete paint-spraying unit, light and compact, (weighs only 8 lbs.) designed for home use for lacquer, enamel, varnish, insecticides, moth-proofing; for screens, radiators or furniture. Strictly quality equipment—material and workmanship guaranteed. Complete unit includes high grade 110 V. A. C., D. C. motor, 6 ft. cord and plug, piston type compressor with cast iron cylinder on sturdy base, efficient spray gun with ½ pt. glass container and 10 ft. air hose. Write for Circulars, or Send \$1.00 today—pay postman balance, or shipped postpaid if full price accompanies order—dealers write.

Miller-Simons Inc., 2903 S. 61st Ct., Cicero, Ill.

NOW ONLY \$4.95

REAL ENGINE VALUE

Over 7,000 GHQ Gas Engine Kits were sold at \$8.50. Over 15,000 sold last year. Now is your chance to buy the *New Improved* kit for \$4.95. Absolutely complete with coil, plug, etc. For boats, planes, etc. All parts guaranteed. Send only \$1.—Shipped Express Collect for balance same day. Send 3c for new 16-page illus. catalog. **DEALERS WANTED.**

All parts finished. Only a screwdriver needed. 1/5 H.P. Average assembly time 30 minutes.

GHQ MOTORS, 40B East 21 St., New York, N. Y.

ITCH STOPPED in a Jiffy -or Money Back

For quick relief from itching of eczema, pimples, athlete's foot, scales, scabies, rashes and other externally caused skin troubles, use world-famous, cooling, antiseptic, liquid D. D. D. Prescription. Greaseless, stainless. Soothes irritation and quickly stops the most intense itching. 35c trial bottle proves it, or money back. Ask your druggist today for **D. D. D. PRESCRIPTION.**

Say you saw it in Popular Mechanics!

Thompson
BEATS
the World
on BOATS

Better Built
Lower Prices

Canoes
\$66
and up

All popular models, canvas covered. Light, swift, safe, strong and durable. Many color combinations.

Rowboats
\$42
and up

Most complete line ever offered, at real money-saving prices.

Out-board
Boats
\$42
and up

THOMPSON BOATS HAVE FULL LENGTH SPRAY RAILS. KEEP PASSENGERS PERFECTLY DRY AT HIGH SPEEDS.

SAIL BOATS

Today's Six Most Popular Models

12 ft. OLYMPIC . . .	\$148
15 1/2 ft. SNIPE . . .	\$195
16 ft. COMET . . .	\$248
17 ft. NATIONAL . . .	\$290
18 ft. SEA GULL . . .	\$415
19 ft. LIGHTNING . . .	\$460

These boats are complete, with sail, mast and rigging at prices quoted above.

CATALOG FREE—SAVE MONEY—PROMPT SHIPMENT

Please state the kind of boat you are interested in

TWO LARGE FACTORIES
THOMPSON BROS. BOAT MFG. CO.
213 Ann St. [Write to] 113 Elm St.
PESHIGO, WIS. [Either Place] CORTLAND, N.Y.



BUILD WITH DOENUTS

Build your wheelbarrows, hand trucks, midget autos, lawn mowers, portable painting rigs, spraying equipment, boat dollies, etc., with the original patented Musselman Doenut Wheels. They absorb surface obstructions, eliminate jolts and handle larger loads much easier. Size 10" x 2.75" and 12" x 3.30". Furnished with Cadmium plated steel disc wheel with adjustable ball bearings. Send 10c postage for illustrated literature unless you are a rated manufacturer.

MUSSELMAN PRODUCTS CO.
6225-S St. Clair Ave., Cleveland, Ohio

Make MONEY
with BEES

BIG FREE ILLUSTRATED CATALOG—
Contains over 3000 words of information on how to handle bees. You can buy an inexpensive beginner's outfit with directions. Easy to start; Good returns; Sell your surplus honey. Read letters from 30 beekeepers in booklet, "Does Beekeeping Pay".

FREE
Booklet

Bees and chickens make ideal sidelines. Subscribe to **GLEANINGS in BEE CULTURE**, 64-page monthly, 6 months, 25 cents to new readers only. The A. I. Root Co., Medina, Ohio
210 West Liberty Street

NEURITIS Relieve Pain in Few Minutes or Money Back

To relieve the torturing pain of Neuritis, Rheumatism, Neuralgia or Lumbago in a few minutes, get NURITO, the fine formula, used by thousands. No opiates. Does the work quickly—must relieve cruel pain to your satisfaction in a few minutes—or your money back. Don't suffer. Clip this ad now as a reminder to ask your druggist for NURITO today.

100,000-Mile Tires

(Continued from page 335)

speeds of fifty to sixty miles per hour, subjected to the grueling strains and stresses of constant flexing, the inside of an ordinary truck tire gets sizzling hot. The terrific internal heat generated, often as high as 300 degrees Fahrenheit, causes cords in the fabric to lose a large percentage of their tensile strength, to literally burn out, to deteriorate, and the rubber to crack. Tire growth is caused by the stretching of cords weakened by heat. As the tire swells, more tension is put on the rubber compound, causing it to generate additional heat—to age and deteriorate. Thus, the whole tire becomes fatigued, the prelude to a blowout, as cracking and separation of the tread develop.

Heat-resistant cords, during manufacture, are treated to soften the natural gums and waxes inherent in cotton fiber. While softened they are compressed, the gums and waxes allowed to set, forming an excellent bond of the fibers. This prevents slippage of fibers, utilizing all of the steel-like strength of the fibers. Under strain and flexing in the tires, the fibers do not rub together to produce as high heat as do some other cords. Heat that is generated cannot get down into the cord to cause charring and disintegration. Although the finished product is smaller, it is said to be stronger than larger ordinary cords made by twisting and cabling. Tensile strength about one-fourth greater than that of ordinary cords is claimed, plus the ability to maintain strength, stamina and safety factors under the severe operating conditions of truck and bus service.

Grueling tests in Death Valley, with temperatures exceeding 100 degrees, have revealed that the heat-resistant cord is superior to many other cords. During these tests, ninety different cord fabrics were subjected to "murder runs" on the wheels of overloaded trucks running at high speed, hour after hour. Cords burned out, flex breaks occurred and one after another of the tires failed. Under identical conditions, heat-resistant cord tires averaged 40,000 miles on the original tread, were re-treaded and run 30,000 miles more, then given a second new tread and operated beyond the 100,000-mile mark.

Many tires in regular service on a truck line running between Chicago, Ill., and

Waco, Tex., are giving over 100,000 miles of service without recapping or retreading. From Chicago to the Texas border, the trucks are loaded with 18,000 to 20,000 pounds. There part of the loads is removed, because of load-limiting laws, and the run continued. Estimated speed of the trucks averages fifty miles per hour while the tires are in service, and the average mileage for all tires on this run is well over 80,000 miles per tire.

In the laboratories, the new heat-resistant cord has been subjected to tests more severe than ever before used. After the cord has been baked in an oven at a temperature of 300 degrees Fahrenheit, samples are removed regularly at fifteen-minute intervals over a period of thirty-six hours and subjected to a "torture" machine which determines how much of its tensile strength and other desired properties may have been lost in the oven.

Also, from time to time, tires made of the new cord are taken from stock and placed on another torture machine, a testing wheel. The temperature in the room remains at 100 degrees and the tire runs at terrific speed day after day until it blows out. The tire is heavily loaded and runs against a smaller pulley which gives it a great deal more flexing than the tire would receive in actual service. During the test, the temperature of the tire is taken at regular intervals with a pyrometer, a needle-type thermometer.

Heat-resistant cord is being introduced to the passenger-car field where the service is not so severe but where safety is all important.

Meter Records State of Nerves in Millionths of a Volt

You can find out exactly how nervous you are by submitting yourself to a meter developed by a Chicago doctor. Measuring the electric impulses generated by nerve or muscle activity, it translates the state of nerves into terms of millionths of a volt. To operate it, fine wires are inserted into the tissues and a button is pressed. A quiet, phlegmatic salesman showed a low-voltage record on the nervousness meter, a research man of dynamic type gave a relatively high reading. A woman suffering from insomnia, over-fatigue and nervousness had a record showing marked failure to relax when she lies down.

YOU CAN HEAR EASILY... CLEARLY ENJOY LIFE FULLY AGAIN!

You, like thousands of others, should find new happiness through the Western Electric Audiphone. This product of Bell Telephone research helps users to hear in group conversation and at greater distances. Your dealer will recommend the right Audiphone for you. Service available in all principal cities.

Accepted by Council on Physical Therapy, American Medical Association.

Western Electric HEARING AID
Ortho-technic Model

GRAYBAR ELECTRIC CO. PM-52
Graybar Building, New York, N. Y.

Please send details on Western Electric Audiphone (Ortho-technic Model) and name of nearest dealer.

Name.....
Address.....
City..... State.....

BUILD ARC WELDER FROM OLD GENERATOR

For Light or Heavy Work. 75-200 amperes. Complete PLANS and valuable catalog 35c. Over 900 Electrical Supply Bargains.

LeJay Mfg. Co., 1347 LeJay Building, Minneapolis, Minnesota



SENSATIONAL NEW! Flexible SHAFT TOOL!

EASY TO HOLD—EASY TO USE

Here's new skill, new ease for home and master craftsman! FOREDOM TOOLS afford deftly controlled power at your finger tips. Work in hard-to-reach places with professional precision. Motor suspends from wall brackets. You hold only pencil-size, lightweight handpiece. Accessories interchange almost instantly. Hundreds of uses: grinding, polishing, drilling, milling, engraving, sharpening, slotting, non-setting, rust-removing, sawing, carving, cleaning, sanding, scratch-brushing, etc., etc. Since 1922 FOREDOM TOOLS have been quality-tested and proven by thousands of expert craftsmen the world over. COMPLETE PORTABLE WORKSHOP as illustrated, including 50 piece accessory set, postpaid, only **\$14.95**

YOURS ON 10-DAY FREE TRIAL
Order this Model 45 FOREDOM Flexible Shaft Workshop today. Enclose check or M. O. for \$14.95; or, if you prefer, we'll ship C. O. D. Try it for 10 days. If not completely satisfied, return the set and we'll refund your money at once.

FREE CATALOG
Write at once for our Free Illustrated Catalog showing complete line of Flexible Shaft Tools and quality accessories. Dealers: Write for our offer.

FOREDOM ELECTRIC COMPANY, Dept. 123
27 PARK PLACE, NEW YORK, N. Y.



Say you saw it in Popular Mechanics!

June 1931
 2/1473
 Dr. Edna Jayakson
 310 Michigan
 Chicago



**Get This
Book of
RADIO
VALUES
NOW!**

FREE

ALLIED—THE 100% RADIO HOUSE FOR EVERYTHING IN RADIO!

For 17 years Dealers, Servicemen, Amateurs, P.A. Men and Builders have been depending on ALLIED for Everything in Radio at Lowest Prices! ALLIED is Radio Headquarters for sets, parts, kits, tubes, P.A. systems, for more than 15,000 radio items! Get the Free 204 Page Catalog now!



60 RADIO MODELS! NEW P. A. SYSTEMS

A set for every purse and purpose—new Portables, new "Compacts", new models from 4 to 12 tubes, with newest features, including "Air-Magnet"! All at lowest prices! Also electric phonographs, "Ham" receivers—see them all in the 1940 Catalog!

Remarkable values in Public Address Systems designed for any type of sound installation. New "Economy," "Standard" and "De Luxe" lines—6 to 70 watts—new features—new accessories, latest recording equipment—all new Time Payment Plan—all in this complete new super catalog!

**MORE THAN 15,000 RADIO ITEMS!
BIG MONEY-SAVING BARGAIN SECTION!**



**Learn
Radio**
BUILD WITH
ALLIED KITS



Build your own radio set, transmitter or transceiver—learn while you build! Dozens of new, low-cost, easy-to-build kits are shown in ALLIED's Catalog. We also supply matched Parts Lists to build any circuit. Learn Radio quickly—enjoy this Great hobby. ALLIED helps you to learn easily!

Send for **RADIO BUILDERS' HANDBOOK**—a beginner's book on radio; tells how to select circuits, read diagrams, build sets, etc. Easy to understand; illustrated; helpful. Order by coupon below. **10c** Only

ALLIED RADIO

833 W. Jackson Blvd. Dept. 5-C-0
Chicago, Illinois

- RUSH your FREE 1940 Radio Supply Catalog.
 ENCLOSED find 10c. Send your NEW Radio Builders' Handbook.

Name.....

Address.....

City..... State.....

**CATALOG
FREE**
Send this
Coupon!

Little Giant Push-Button Set

(Continued from page 457)

shows a detailed sketch of the cabinet used to house the model; it can be built in the average woodworking shop, or, similar size blank front cabinets can be obtained from parts houses.

A simplified wiring diagram appears in Fig. 3. Readers who have built former models will note that the same types of antenna and r.f. coils are employed. When

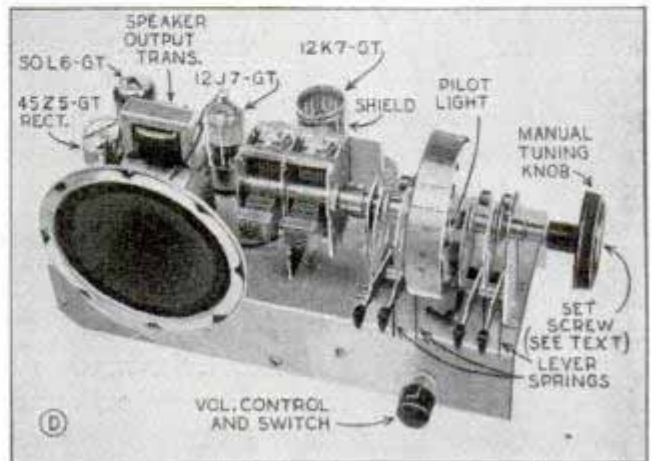

mounting the various parts, refer to photos A, B, C, D and E which show various views of the completed instrument. Please note that the 2-gang variable condenser mounting bracket is fastened to the upright bracket that supports the push-button tuning unit assembly so that the bottom of the condenser unit will be just $1\frac{1}{8}$ in. above the base. A sheet-metal shield $1\frac{1}{8}$ in. long and 1 in. wide is soldered under the center partition that divides the two condenser sections. This shield should

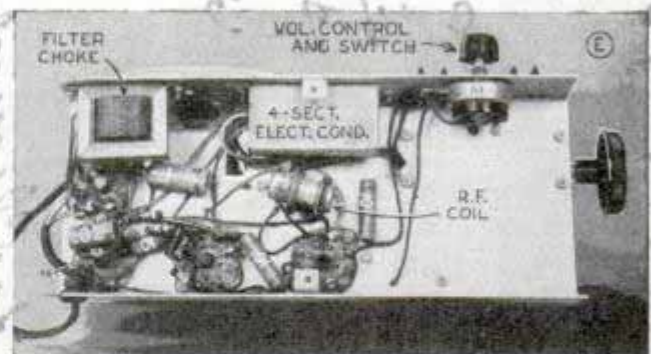

clear the top of the base by about $\frac{1}{8}$ of an inch. Use No. 18 hookup wire with push-back insulation, and rosin-core solder for all soldered connections.

The speaker is a 5-in. type provided with a 5-ounce magnet and a transformer having an impedance of 2,500 ohms. The

(Continued to page 134A)

EASY TO BUILD KAYAKS IN & OUTBOARDS



Complete Cut-to-Fit "Double Processed" Assembly Kits. No Experience Necessary. Detailed Blueprints & Instructions. Build Your Own—Save Money—Enjoy Boating—1001 Satisfied Builders. Paddles Now Included. Write Today. Send 10c Postage for Complete, Illustrated Catalog Describing 20 Models.

KAYAK BOAT CO.
152 East 129 St., New York
"America's Oldest Kayak Factory"



Send FOR MY NEW BARGAINGRAM NO. 242

A monumental work—lists thousands of STILL Cameras—New and Used... apparatus galore—Slide Projectors—Gigantic Book Section... Chemicals, etc. etc. Also Cine Catalog No. 240—Both FREE.

Bass CAMERA CO.

179 W. MADISON ST., CHICAGO, ILL. DEPT. P

BUILD THE DESTROYER PRESTON

**CARVED
HULL
Included!**

24" Super
Detail Model

Catalog—10c



Complete Kit
\$2.50
Post Paid

Makes perfect
building easy

IDEAL AEROPLANE & SUPPLY CO., Inc., 26 W. 19 St., New York

\$13.95

Full
Set



MICROMETERS

Six piece set, in velvet lined leather case. Special price, only \$13.95. Precision machined in one thousandths, up to 4" outside and 3 3/4" inside measurements. Guaranteed accurate, easy to read and adjust. Satisfaction guaranteed or money back. This is your opportunity to get one at a Bargain Price if you act now. Shipped prepaid on receipt of remittance. On C.O.D. shipments, send deposit of \$2.00.

**FREE
FOLDER**

MICRO PRODUCTS, 529 E. Jefferson Ave., Detroit, Mich.

HOLD-E-ZEE AUTOMATIC GRIP SCREWDRIVERS

Hold, start and set-up screws in unhandy places. Gripper instantly released by spring action, sliding up out of way when not in use. Finest materials thru-out, chrome vanadium blades; many have transparent insulating unbreakable handles. (Illustrated.)



No more expensive than ordinary screw drivers. Models for recessed-head screws. Handiest ever. Get one today. At auto-supply, hardware or electrical stores.

UPSON BROS., INC. 86 EXCHANGE ST. ROCHESTER, N. Y.

Class Pins 30¢ up

Artistic pins, rings and emblems for classes and clubs. Attractive prices. Finest quality, gold plated, silver, etc. Over 300 designs.

FREE

CATALOG

Write Dept. N, METAL ARTS CO., Inc., Rochester, N. Y.

BUILD ELECTRIC FENCE FROM OLD AUTO COIL

Costs nothing to build—Dime brings complete Plans and 1940 catalog listing over 900 Electrical Supply Bargains. Send 10c to LEJAY MFG., 1947 LeJay Bldg., Minneapolis, Minn.



NEW ROOFS OVER OLD 3¢ A SQ. FT.

Battleship Roof Coating stops all leaks. Saves 75% of new roof costs. Guaranteed waterproof. Building Owners: Send for free Book "Something New Under The Sun." **MEN WANTED!** A big paying business for salesmen. Write today. No obligation.

PANTHER OIL & GREASE MFG. CO.
Paint Products Division
Sept. 25, Fort Worth, Tex.

I'M SO HAPPY NOW
THAT CHARLES IS
DOING SO WELL IN HIS
NEW BUSINESS



**MADE \$217
in 10 DAYS
WASHING WALLS**

Newly invented machine washes walls 6 times faster and better than by hand.

Charles Steele made \$217.00 the first 10 days. We want more men like him to go into business for themselves. Customers everywhere—homes, schools, offices, stores, churches, lodge halls, hotels all have walls that need washing. You don't rent a store or office; you operate this business from your home. On a job paying you \$10 your cost is 20c. Write for complete facts on new Von Schrader Wall Deterger which washes paint perfectly and postpones repainting many years.

Howard James writes: "I landed a \$40.00 job the first day."

J. A. Crosby says: "I have several jobs to start on Monday, thanks to your help."

Cliff Brown writes: "I got a contract in a public school which will more than pay for my machine in the next few days."



Easy Payments

It takes only a few dollars to get started in this new money-making profession. No experience necessary. The total price is so small and the payments so easy that anyone with ambition should get started NOW.

**SEND FOR FREE
INFORMATION**

MANUFACTURING CO.

773 PL. RACINE, WISCONSIN

Sand Casting—Forging—Heat Treating—Case Hardening BRONZE FOUNDRY



in your own workshop allows you to design and build your own GASOLINE ENGINES, STEAM ENGINES, STATUARY, ART OBJECTS, SPECIAL TOOLS, NEW INVENTIONS, ETC. You can also make forgings and case harden steel. Your shop is not complete without a FOUNDRYETTE. Three sizes are available capable of making bronze castings of 1 1/2, 3, and 6 pounds weight, aluminum, copper, brass, etc., in proportion to specific gravity. Domestic gas supply and 110 volt 60 cycle energy required for operation. Prices, \$13.50, \$19.00 and \$27.50, f.o.b. Kansas City. Write for circular.

KANSAS CITY SPECIALTIES CO.
Box 6022, Dept. P-5
Kansas City, Mo.

SYNCRO JIG SAWS



Syncro Jig Saws are made in three models—De Luxe Power Saw, Power Saw, and Junior Saw. All are ideally adapted for craft-work and eliminate motors or driving belts. Self-contained power. Portable. Durable. Safe. For youngsters 7 to 70 who have

ideas to develop and like to make things. Clean, smooth edges—no sanding necessary. 110-120 volt current, very economical to operate. Send for catalog A.

3 MODELS
De Luxe Power
Saw ... \$12.50
Power Saw ... 10.95
Junior Saw ... 5.95

NEW YORK OFFICE - 200 FIFTH AVE.

SYNCRO DEVICES INC. 747 BEAUBIEN ST. DETROIT

All in this
FREE money **BOOK**
saving



The greatest radio catalog you ever saw, and it's **FREE** if you mail the coupon! 188 pages of nationally advertised radio and sound equipment at save-money prices. 64 smart new radio models for 1940 that can't be matched in performance, looks, or value. Everything for the radio amateur, including sensational Build-It-Yourself Kits. Complete line of powerful, streamlined Sound Systems priced rock-bottom low. A penny brings you this big Value book. Stick this coupon on a postcard and mail!

WHAT'S NEW IN
RADIOS · PARTS
AMATEUR EQUIP'T.
SOUND SYSTEMS
RECORD PLAYERS

NEW YORK, N. Y.
100 SIXTH AVENUE
CHICAGO, ILL.
901 W. JACKSON BLVD.
ATLANTA, GA.
265 PEACHTREE ST.
BOSTON, MASS.
BRONX, N. Y.
NEWARK, N. J.
JAMAICA, L. I.

LAFAYETTE
RADIO

Radio Wire Television Inc.
Dept. 7C—100 Sixth Ave., New York, N. Y.
Rush **FREE** 1940 Radio Catalog No. 78

WORLD'S
FINEST
RADIO
CATALOG
FREE

NAME _____
ADDRESS _____
CITY _____ STATE _____

PASTE COUPON ON PENNY POSTCARD

CLAMPS

The biggest need in most home workshops is more good clamps—clamps for gluing, holding, drawing-up and for setting-up work. They are the extra hands for the I-man shop. Don't spoil or delay work for want of clamps. From over 40 types of clamps we have selected these as the first for homecraft use.

ADJUSTABLE CLAMP CO.
"The Clamp Folks"
421 N. Ashland Ave., Chicago, U. S. A.



PONY Miniatures 9 types 1" to 2 1/4" cap. Not toys but fine tools with 100 uses.

PONY "50" Fittings go on ordinary 1/2" pipe. Any length. Send \$3.00 plus postage (7 lbs.) for fittings for two "50" Clamps. Also "Pony" No. 52 Fittings for 3/8" pipe—2 sets for \$2.00 plus postage.

Catalog **FREE**
Ask your Dealer



Jorgensen Handcrews
Genuine "Jorgensen" Handcrews grip at all angles, never slip, split or loosen. All sizes. Send \$3.20 plus postage (7 lbs.) for 2 No. 1 Handcrews—open 6".



HANDEE Hobbies

Get more out of life. Make things with our easy working plans. 75 new, intriguing projects for the home, gifts or to sell—models of ships, planes, houses; engraved glassware, trays, mirrors; statuettes, book ends, etc. Portfolio of 12 plans, 25c.

TOOL OF 1001 USES

A tool shop and power house in one. Plugs in any electric socket. Grinds, drills, polishes, cuts, carves, routs, saws, sands, sharpens, engraves, all materials. Write for **FREE** 64-page catalog. Shows Handees \$10.75 up.

CHICAGO WHEEL & MFG. CO.
108 S. Aberdeen St.
Chicago, Illinois



10
DAYS
FREE
TRIAL

(Continued from page 132A)

2-gang 365-mmfd. variable condenser is a counter-clockwise type. The "Crowe"-type tuning mechanism and escutcheon comes with mounting brackets and broadcast station labels. A detailed list of the original materials used, is available from Popular Mechanics Magazine radio department without charge. All parts are easily available and inexpensive, but must be as specified for maximum results.

If operating on a d.c. line supply, it may be necessary to reverse plug in wall socket

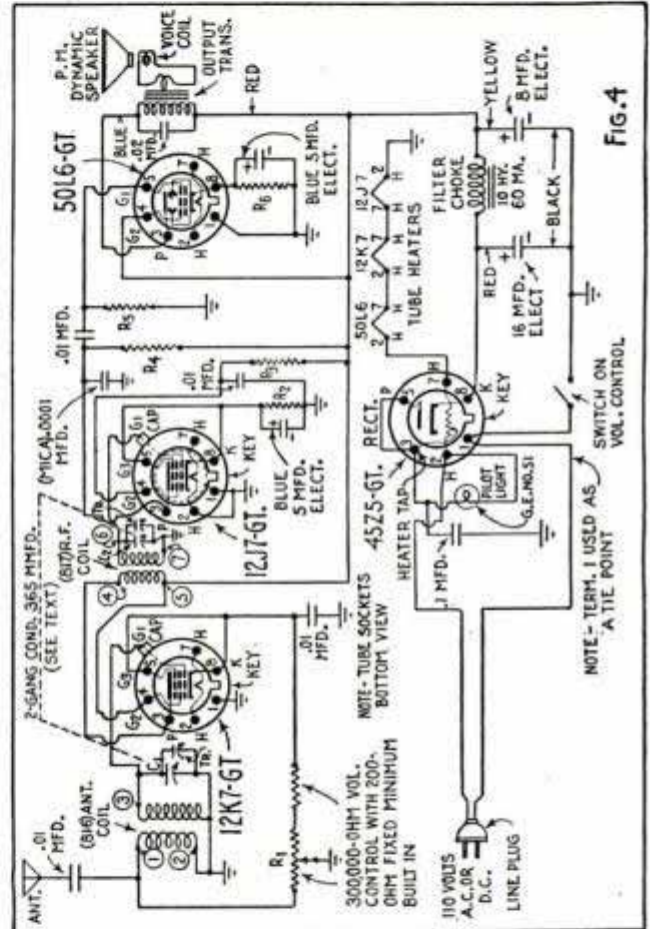

to obtain correct polarity. Reversing plug in a.c. line supply will also often eliminate line hum. To balance the set, turn variable condenser about seven-eighths open and adjust the two trimmers (Tr) with a small screwdriver, for maximum noise. Now, set up the four stations for push-button tuning in their frequency order. Loosen the screw in the center of tuning knob; tune to desired station with knob, and, while holding knob firmly, push down that station button as far as it will go. Repeat this process for the other three station buttons. When all four station buttons have been adjusted, hold the tuning knob firmly and tighten screw in center of knob. The blueprint number for this article is R-276.

How 228 of Our Men DOUBLED SALES with Daring New Selling Plan

Amazing new idea has **DOUBLED** sales with our outstanding shoe line, 200 styles for men, women, children with fast-selling special features. Big cash commissions and your own shoes as bonus. Write today for full information. Tell us about yourself.

NEEDS NO BREAKING IN



WRITE FOR FREE OUTFIT

TANNERS SHOE COMPANY
322 BOSTON, MASS.

LIKE TO FISH?

Shakespeare's WONDEREEL

**LONG CASTS
NO BACKLASHES
NO THUMBING**



Ideal for night fishing and beginners.

3 Wondereels—\$6.50, \$10.00 and \$15.00.

SPECIAL OFFER Shakespeare's **NEW GLO-LITE MOUSE**

NO THUMBING

FREE

New GLO-LITE Mouse Bait. Glows 5 hrs. if exposed 3 min. to sun or flashlight. 50c postpaid (90c value—limited supply). Send cash or stamps.

96 page Fishing Guide and Catalog. Write today.

SHAKESPEARE CO., 238 E. Kalamazoo Ave., Kalamazoo, Mich.

YOU CAN MAKE MORE MONEY

In the Composition Novelty Manufacturing Business. Reports of up to \$100 per week are not unusual. Our Big 48-page book (over 200 illustrations) explains the secrets of this profitable business. It's yours for only 10c. Send for it today!

STEWART'S STUDIO, Dept. PM-16, 2927 Wilcox St., Chicago, Ill.

FINDS BURIED TREASURE! NEW GOLDAK RADIOSCOPE

NEW PATENTED METAL LOCATOR. LATEST TYPE HIGH EFFICIENCY LOW DRAIN TUBES. NEW LOW PRICES. SENSATIONAL NEW MODELS. MONEY-BACK GUARANTEED DETECT BURIED GOLD AND SILVER. The new Radioscope is the most powerful and most sensitive metal locator ever known. Write World's Largest Manufacturer of Successful Metal Detector for free interesting information.



THE GOLDAK CO., Dept. P
1031 South Broadway, Los Angeles, Calif.

ELECTRIC LIGHTS AND POWER

Build Your Own Wind Plant from old generator. Dime brings complete PLANS and 1940 catalog listing over 900 Electrical Supply Bargains.

LeJay Mfg., 1447 LeJay Bldg., Minneapolis, Minn.

COMB-A-TRIM The New Quick Trimmer

Something new! Trim your hair without any experience. It's easy! The excess hair comes off smoothly and easily by just pulling trimmer through hair like an ordinary comb. Save on hair-cut bills. . . Trim your own hair or the whole family's. Send 40c for your Comb-A-Trim.

49c

Comb-A-Trim Co., 502 Bell Block, Dept. P-3, Cincinnati, Ohio

ATLAS STICK-ON LETTERS

Beautiful Gold Colored. New Styles. 5 Year Guarantee. Large Sizes—Penny Each. Tremendous Demand. Amazing Profits. Write for Samples and Starting Equipment. Hurry!

ATLAS Sign Works, 7943 Halsted, Chicago

WINDOW SIGNS



BUILD THESE PROJECTS

For garden or lawn. Easy to build. Easy to sell. Detailed Blueprints Model B-25 Dutch Windmill 50c; Model O-31-60 Old Mill. 85c. Lawn Figure Patterns—Sunbonnet Girl, Dutch Boy, Tulip Girl, Holland Pair, 35c each, all 4—\$1.00. Catalog illustrating many models, send 10c, today.

CRAFTSMAN'S MODEL CO., Dept. P-38, 2030 N. 41st St., Milwaukee, Wis.

FREE TRAILER PARTS CATALOG

We'll save you money on—axles, springs, wheels, couplers, windows, sinks, water pumps, brakes, refrigerators, beds, lamps, inside and out, 6V lamps, furniture, jacks—everything. Special discount to mfrs. **NATIONAL TRAILER EQUIPMENT CO.,** Successors to Kar-A-Van Industries, Inc. Dept. P. 714 W. Wisconsin Ave., Milwaukee, Wis.

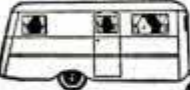

Complete Plans and Building Instructions. 10c

Sani-Flush SAFE • NOT CAUSTIC

CLEANS OUT AUTOMOBILE RADIATORS

Earn Cash at Home!

We paid M. M. \$1174 for exceptional collar crop Snow-King mushrooms! We furnish materials; buy all crops. Big **FREE** picture book tells if your cellar, shed, barn, suitable. Est. 1908. Write today.

United Co., 3848 Lincoln Av., Dept. 304, Chicago

MONUMENT \$9.00 UP FREIGHT PAID

Write For Catalog and Samples Of Genuine Marble & Granite. Low prices. Guaranteed satisfaction. Erecting Service. Free lettering.

U. S. MARBLE & GRANITE CO., A-18, Oneco, Fla.



Shakespeare BALANCED TACKLE

You Can Make BIG MONEY

Surfacing Floors the American Way



Get into something where your income is only limited by your ability to get ahead. The American electric method of floor surfacing gives you the opportunity to make more money for yourself—work easy to get and no previous experience required. If you are not afraid to put on a pair of overalls and go to work, here is the chance of a lifetime.

Let us tell you how to be a success in this business and tell you how many other men who started like you have made themselves independent for life. As little as \$75.00 will start you today on the road to success.

Be sure to sign and send in the coupon below or mail us a post card for complete free details—no obligation.

THE AMERICAN FLOOR SURFACING MACHINE CO.
523 So. St. Clair Street • Toledo, Ohio

Gentlemen:
Send complete free details on how I can make big money with an American floor surfacing machine—no obligation.

Name

Street

City

State

FREE! BIG 1940 MASTER CATALOG

Everything in RADIO!

At Lowest Prices

COMPLETE SELECTIONS GUARANTEED QUALITY

Over 15,000 Radio Parts

Most complete stock. All leading brands at lowest prices. All orders promptly shipped.

P. A. EQUIPMENT

Separate amplifiers or complete systems with any desired assortment of speakers, horns, baffles and microphones. Everything from 5 to 100 watts. Prices that save money for you.

RADIO KITS

Send for our list of radio kits FREE. Complete in every detail. Easy to understand.

MAIL THIS COUPON TODAY

The **RADOLEK Co.**
 601 W. Randolph St., Chicago, Dept. PM-39

Send the 1940 Radolek Radio Profit Guide and complete list of radio kits FREE.

Name.....
 Address.....
 Experimenter?..... Dealer?..... Serviceman?..... Amateur?.....

BUILD-EXPERIMENT with the ELECTRIC EYE ROBOT KIT



Make fascinating experimental and practical uses of the amazing Electric Eye—Invisible Beam, Black Light, Burglar Alarms, Fire Alarms, Industrial Controls, etc.—perform mysterious, entertaining stunts, develop profitable new industrial uses. Duplicate almost all commercial Photo Cell applications with The Rehtron Robot Kit.

Kit includes assembled Robot ready for operation, caesium self-shielded photo cell, low-watt power tube, demonstration board, buzzer, light, socket, SPDT switches for audible and visible signals. Adapter plug makes Robot a wonder-working capacity relay. Easily adjusts for sensitive, stable operation—big 28-page manual with diagrams. 110-120 V. A.C. only—selective open or closed circuit relay contacts deliver 6 V. 1/2 amp. A. C. No batteries—safe, long-lived—satisfaction guaranteed. The first complete Kit at a popular price; only \$9.95 in U. S. Specify model T-98—Send only \$1.00—shipped express collect for balance. Rehtron Corporation, mfrs., Chicago.

Rehtron Corporation, Dept. P-1,
 2159 Magnolia Ave., Chicago, Ill.

Money order (or check) enclosed for \$1. Ship Model T-98 Robot Kit express collect for \$8.95 plus shipping charges.

I prefer to enclose full amount (\$9.95) and receive Kit prepaid.

Name.....
 Address.....
 City..... State.....

(Information on Rehtron commercial equipment on request)

Photocell-Operated Relay

(Continued from page 458)

cord in 110-volt a.c. outlet and allow unit to heat for several minutes. Now adjust trimmer condenser (Tr) until meter shows approximately two-tenths of a milliamperere. Next remove cover from photocell, and, with a moderate light falling on cell,

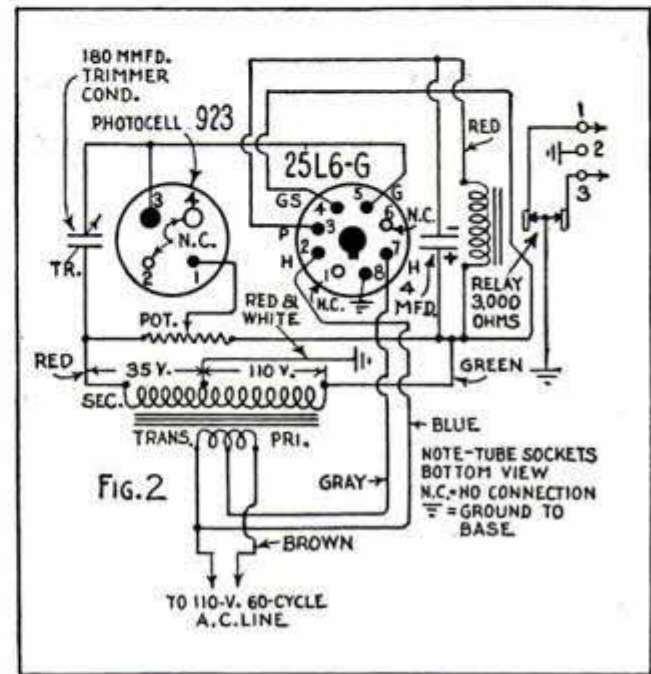

advance potentiometer until the relay closes. Place cover over cell again and the relay should fall out. Recheck meter current and if necessary readjust (Tr) to get two-tenths m.a. Remove meter from the circuit and solder the ground lead back on pin No. 8. The unit is now ready for oper-

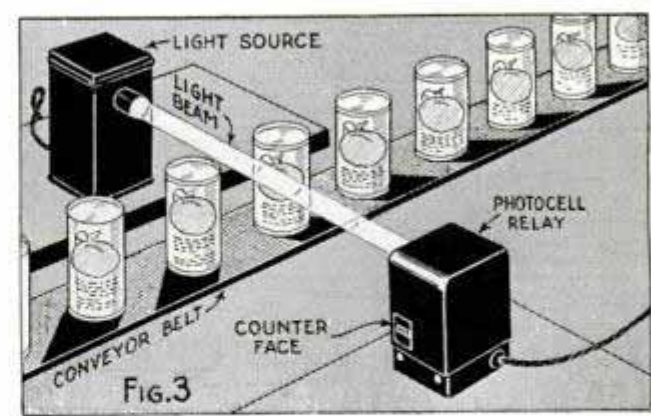

ation. Never advance the potentiometer further than necessary to close the relay.

The light source illustrated in Fig. 3 and the sketch at the head of the article, is merely a 40 or 60-watt mazda lamp housed in a sheet-metal container 4 by 4 by 7 in., fitted with a short tube and lens.

For the First Time... A BINKS PAINT SPRAY

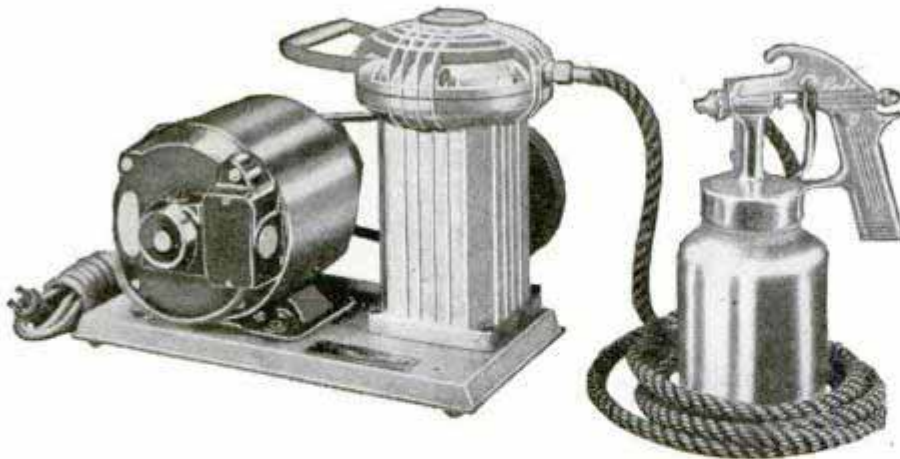

FOR ONLY

\$19.95
Less
Motor

THE POWERFUL NEW ROCHE "DS" OUTFIT FOR HOME AND SHOP

Save time and paint and get a better finish, too! Use a Roche "DS" outfit to finish screens, furniture, radiators, autos, walls, woodwork, toys, and hundreds of other items in the home and shop. It can be easily transported. It plugs into any 110-volt outlet. A specially designed gun gives perfect performance at operating pressure, and eliminates paint waste.

The Roche "DS" outfit, complete with the special Roche "J" type adjustable spray gun and quart pressure cup, 12 feet of 1/4-inch braided hose and connections, two "V" pulleys, a "V" belt, and a handy carrying handle, less motor—\$19.95. Complete with a nationally advertised 1/4 h.p. motor—\$26.95.

SEND TODAY for more information about this and other Binks Spray Painting Outfits. There is one for every job.

this remarkably compact unit has an actual air delivery of 2.2 C.F.M. at 26 lbs. pressure. With the Roche "DS" everyone can obtain professional results with enamels, lacquers, varnishes, paints, kalsomine and other finishes. Ideal for the home and small shop.

SEND FOR COMPLETE DETAILS

Binks Mfg. Co., 3114 Carroll Ave., Chicago, Dept. C340

Please send me more information about the Roche "DS" Unit and other paint sprays made by you.

Name _____

Address _____

City _____

State _____



SUCTION SPONGE Cleans Cars New Way!

AMAZING INVENTION! Banishes auto-washing drudgery. Cleans linoleum, woodwork, windows like a flash. Auto owners, housewives will about it. HOT SELLER FOR AGENTS AND DISTRIBUTORS. Hustlers cleaning up big money.

SAMPLE OFFER Samples sent on trial to first person in each locality who writes. No obligation. Get details. Be first—send in your name TODAY!

KRISTEE CO., 680 Kristee Bldg., Akron, O.

OTTAWA LOG SAW \$39 BIG BOOK FREE



PUTS THIS OTTAWA to work for you. MAKE MONEY! Wood is valuable. Does more than 10 men. Easily operated. Falls trees—saws limbs. Use 5-hp. engine for other work. Write for FREE Book. OTTAWA MFG. CO., 2927 Wood St., Ottawa, Kans.

SAW 10 TO 20 CORDS A DAY

DURO HAND GRINDER KIT

The Kit that fills a long desired need for a practical outfit with a power unit for all types of work plus a large assortment of the most valuable accessories. The Duro Grinder Kit is arranged in a heavy gauge, handsomely finished, steel case—a case that stands up under the harshest punishment—it features the Famous Heavy Duty Grinder and twenty-eight essential accessories for carving, grinding, polishing, sanding, etc.

Ask for full literature describing the complete line of tools—

Made By
The Manufacturers of
America's Finest and
Most Complete Line
of Power Driven Ma-
chinery

Duro Metal Products Co.
Dept. PM-3
2653 N. Kildare Ave.,
Chicago, Illinois



Kit Complete
\$21.95



NOW a DYNAMIC HEAVY DUTY INDUSTRIAL WELDER

Works off 110 volt electric light circuit. For this unheard of price you can get the marvelous Dynamic Super-Charged Welder complete—ready to plug into light socket. The Dynamic does both metallic and carbon arc welding. You can also solder and braze on the lightest material.

WORKS ON IRON, STEEL, TIN, BRASS, COPPER AND ALL OTHER METALS

With our free instructions you can tackle anything and in no time at all you will be able to do finished repair jobs. Once you have the Dynamic outfit, you are all set in a profitable welding business of your own. In a year a Dynamic Welder Costs you Less Than 6c a Day. Write for FREE particulars TODAY.

DYNAMIC WELDER CO., 2226-MG, Silverton Road, Chicago, Illinois

for Only
\$19.95
RETAIL
EASY PAYMENTS

WELDS BUMPERS, FENDERS, CYLINDER BLOCKS, BODIES, FRAMES, ETC. Does Farm, Factory and Home Repairs

Without previous welding experience you can make for yourself as much as \$5.00 on a repair job that can be done in less than one hour. Many welders make as much as \$15.00 to \$20.00 a day. The Dynamic Welder is light and easily portable.

AGENTS WANTED

Get our big profit plan and 10-day trial offer. Send for it TODAY.

MANUFACTURING OPPORTUNITIES



NOW IS THE TIME TO CASH IN on the growing building industry. Make a new and better building material—one that cuts building costs at every step—the kind your builders demand and are waiting for.

WE EQUIP YOU with a Line Production Machine—Raw materials enter at one end—finished products emerge from the other—You make new, scientifically designed building units in more than 40 beautiful colors—You operate with 1 to 3 men who produce a volume selling up to \$200. per day. INVESTIGATE NOW. Send for "4 Keys to Success." It tells how manufacturers already established are making outstanding progress. Write today while your territory is still open.

W. E. DUNN MFG. CO.
600 W. 24th St. Holland, Mich.

EARN MORE MONEY GRINDING LAWN MOWERS

"THE UNIVERSAL WAY"



'BUILD A BUSINESS OF YOUR OWN'

Larger profits made more quickly and with less effort, in Basement, Garage or Shop, by grinding lawn mowers in spare or full time. Repair men are amazed at the accurate results obtained with the UNIVERSAL GRINDER. Grinds reel blades to proper clearance and angle, also inside face and edge of stationary blade without removing blade from mower. Grinds more mowers per day than any other grinder. Tool grinding attachment included.

"THE UNIVERSAL WAY IS THE MODERN WAY"
Compare with others
WRITE FOR FREE FOLDER

ROGERS MANUFACTURING CO., Dept. M, LINDSEY, OHIO

Make time — make money with the popular-priced

PIONEER Model "Z" Tractor



New 1 H.P. machine—ideal for cultivating narrow-row crops, seeding, discing, etc. Covers 90-125 ft. a minute. High clearance, space-saving power turn. Trouble-free, economical, safe. Running parts in oil bath. No chains or belts. Save at low factory price. Two weeks trial—satisfaction guaranteed. Colorful FREE book—write today. PIONEER MFG. CO., Dept. ZV-30, West Allis, Wis.

Saw-Filing

Pays up to \$2 or \$3 an Hour in Spare Time

A FOLEY Automatic Saw Filer files hand, circular and band saws better than the best hand filer. Cash business, no canvassing, no eyestrain. No experience needed. Thor Nedribe, Iowa, says: "I have filed 550 saws, made \$350.00. As I'm a carpenter, I just file saws in spare time. I have not advertised in the papers as I've been getting more than I can take care of." Send coupon for FREE PLAN, no obligation.



FOLEY MFG. CO., 316-40 Foley Bldg., Minneapolis, Minn.

Send Free Plan on Saw Filing business.

Name.....
Address.....

ACE LATHE TOOL SET \$14.50



Be permanently tooled-up for every operation on your Metal Cutting Lathe

The ACE Set is complete—there's nothing more to buy. Drop forged by the manufacturers of cutting tools used by 96 per cent of the plants and shops in industry they are correctly designed, are of special steel, are finely finished, are stronger—will last a lifetime. You can cut easier, faster and more accurately with ACE TOOLS. At your Hardware Store—Circular FREE.

- 3 Turning Tools, 2 Cutting-off Tools, Knurling Tool, Boring Tool, Threading Tool, High Speed Steel Cutters and Blades, and 2 Wrenches in Filled Steel Case.

ARMSTRONG BROS. TOOL CO.

"The Tool Holder People"

368 N. Francisco Ave., CHICAGO, U.S.A.

NEW TURN SIGNAL

FLASHES from REAR WINDOW—DASH Control

AGENTS A whirlwind seller. Drivers buy on flash demonstration. Dealers buy 3 to 12. Your profit mark-up as high as 264%. Biggest sensation of year. Rush name quick for facts and Demonstrator sample plan. All Free! Rush.

WATCH-MY-TURN SIGNAL CO., Dept. W-163, Walnut Bldg., Des Moines, Iowa

PIONEER NON-SINKABLE BOATS

\$23.50 to \$174.00



For 29 years, America's outstanding values in Row Boats, Fishing, Hunting, Outboard and Inboard, Ice, Sail and Play Boats! Always ready to use! Endorsed by leading summer camps and resorts for Safe, Carefree Boating! Send Post Card for 1940 DeLuxe Catalog! It's FREE! 413 PIONEER MFG. CO., 123 Perry St., Middlebury, Ind.

ORDER YOUR 'HOME FOUNDRY' Supplies

Send for BIG FREE CATALOG

Supplies for Home Foundry Electric Wood-Carving, Casting, Wood Burning, Pyrography, Sand Pen, Metal-Tap sets. Large sets, \$2. HOME FOUNDRY MFG. CO., Dept. 3P, 3124 Fifth Ave., Chicago

Print Your Own



Cards, stationery, circulars, tags, labels, advertising, etc. Save money. Print for Others; Big Profits; easy rules sent. Will do popular Raised Printing like Engraving. Junior outfit \$9. Senior outfits \$17 and up. Send for free catalog and all details. **KELSEY PRESSES, E-37, MERIDEN, CONN.**

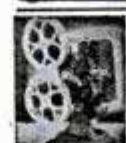

CAPTURE THE COLOR OF LIFE! YOUR OWN MOVIES! ONLY 10c a DAY!

NATIONALLY ADVERTISED 8MM and 16MM Movie cameras, projectors. For home, business, church, school, club. MONEY BACK 10 DAY TRIAL. Payments as low as 10c A DAY. Satisfied customers throughout the world. FREE details. WRITE TODAY. Don Elder's Home Movies, Dept. N-3, 739 Baylston St., Boston, Mass.

FREE TRAILER BUILDERS' GUIDE AND CATALOG



WORLD'S BEST LINE OF TRAILER AXLES, HITCHES AND PARTS including New Universal Trailer Draw Bar, readily attached to any late model car. Complete house trailer working blue prints only 50c. WRITE TODAY FOR THIS NEW FREE CATALOG.

HAMMER BLOW TOOL COMPANY, DEPT. 103, WAUSAU, WIS.

All Your Snapshots in Natural Colors! AMAZINGLY BEAUTIFUL!

Any size roll developed and 8 prints 25c Natural Color Reprints 3c each. Natural Color Photo Service, Dept. C-54, Janesville, Wis.



A AND N SUPPLY CO.

Bargains—Military, Sport Goods, Firearms, Clothes, Shoes, etc. Send 10¢ for new catalog, to be redeemed on first order.

A & N Supply Co., 4773 Lester St., Richmond, Va.

BUILD YOUR GRANDFATHER CLOCK

SIMPLE BLUEPRINT SYSTEM 25c
The Simple Sensible Red-i-Kut way as thousands have. DIME brings PLANS and sixty picture "HOW" Book pricing many fine brass weight Westminster, tube chime, electric and battery movements showing nine beautiful colonial grandfather cases. WHY WAIT LONGER? **KUEMPEL CHIME CLOCK CO., Bldg. 38, Guttenberg, Iowa.**



School Days for Elephants

(Continued from page 363)

ply went through the routine a dozen times in the morning and again in the afternoon until it learned to go and to stop on command. Now came the hard part: letting it see a tiger in the same cage with it.

The moment the delivery door clicked, letting the big Bengal into the circular cage, the elephant whirled to face it and let go with a blast that sounded like the trumpet of doom. Several of us were bruised from being pushed against the bars and into heavy pedestals before we succeeded in quieting the elephant by driving the tiger out into the delivery runs.

Several difficult days went past before the elephant could learn to tolerate the tiger and to stand still while the big cat entered the arena, mounted a pedestal and ran out again. This much was running true to form in acts of this kind; it was harder to teach the mount than to teach the cat.

This simple routine went along for more than a week. Then we put a blind on one side of the elephant and had the tiger mount the platform on the elephant's back. We had a busy time of it before the elephant settled down to a steady jog and began to respond to our commands.

In about ten days they were working so well together that we speeded up the routine which, on more than one occasion, caused the tiger to miss its timing and fall off, running either under the elephant or between its feet, yet neither gave us any undue trouble.

At last the lion was added to the act and taught to ride beside the Bengal and there was plenty of fighting between these two. The elephant, by this time, was so tractable that it paid little attention to the natural antipathy which the riders had toward each other, and the act was ready for presentation in six weeks.

An interesting trick performed occasionally by elephants is plank walking. We start with a wide plank about twenty-three inches off the ground and decrease the width of the plank gradually until it is no more than six inches wide. This trick can be taught in two weeks if the elephant is accustomed to tricks that involve balancing its own weight.

The most dangerous trick I know of with

(Continued to page 140A)



Another handy use
for **CASCO**
POWDERED CASEIN GLUE

Muslin top makes ping-pong table smoother, faster

• Apply coat of thin CASCO to wood table. Smooth out unbleached muslin onto wet glue and tack to edges of table. When dry, apply coat of thin CASCO and scrape it into cloth with paint scraper. Let dry, then sand lightly with 00sandpaper and apply 2 coats of enamel.

For details, see CASCO GLUING GUIDE offered in coupon.



Now you can be ready for *all kinds* of gluing jobs — with CASCO. Make up a *thin* mix for fabrics, soft wood, etc. . . . *standard* mix for heavy-duty wood joints . . . *heavy* mix for hard woods, joints that cannot be clamped, etc.

CASCO is easy to use. Just add water and stir. No heating. No mess. And you get the same heat- and moisture-resistant strength that leading manufacturers and woodworkers use. 10¢ to 65¢ at hardware stores.

NEW ODD-JOB CEMENT

FOR SMALL WORK in home, school and office, use new CASCO FLEXIBLE CEMENT. Sticks wood, felt, fabric . . . to metal, plastics, glass, etc. Doesn't "gum" on fingers. Large tube, 25¢ at hardware stores.



FREE Handy Workshop Folders

CASEIN COMPANY OF AMERICA, Dept. PM-340
350 Madison Avenue, New York, N. Y.

Please send me free folders checked below:

- HOME WORKSHOP HANDBOOK.** Tells where to get free and low-cost booklets on every workshop subject.
- GLUING GUIDE.** Complete gluing directions and 70 successful home uses for CASCO GLUE.
- PROJECT FOLDER.** Descriptions of 24 popular projects available in plan form to CASCO users.
- CASCO FLEXIBLE CEMENT FOLDER.** Directions, suggestions for home, school and office.

Name _____

Address _____

----- Save 2c. Stick coupon on penny postcard -----

9122

(Continued from page 139A)

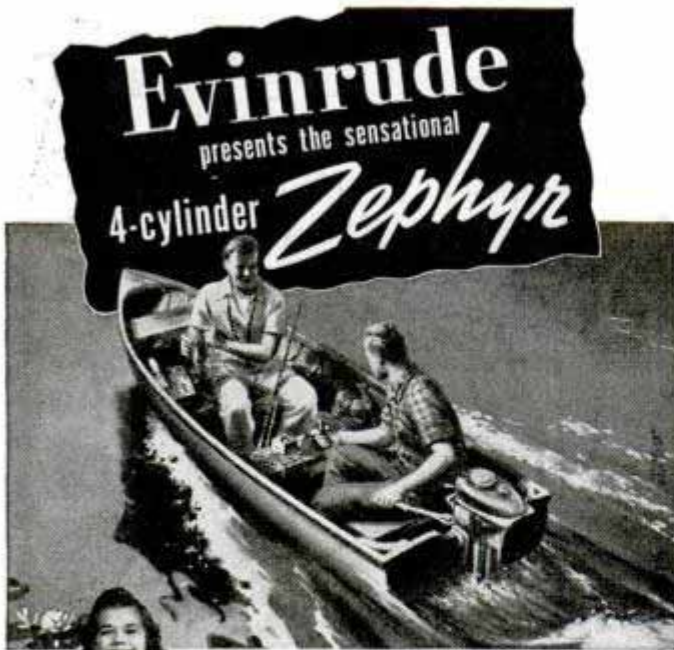

HEADLINER FOR 1940! . . . an amazing new outboard that's smooth as an "eight"—light as a "twin". . . a motor that offers all the matchless Evinrude advantages of *four-cylinder* smoothness and performance. . . but sized, powered and priced for *average* boats and service. *Vibrationless power!* Open the throttle of a Zephyr and feel the rush of 4000 balanced power impulses flow out with liquid smoothness. *Slow trolling speed* . . . down to a drifting glide at a twist of the throttle. *Speed for fast hulls, power for heavy loads!* The Zephyr weighs only 43 lbs. and is priced at only \$127.50.

9 GREAT EVINRUDES TO CHOOSE FROM

For every boat there is an Evinrude just right in size and power. 3 light and handy "singles" now priced as low as \$29.95. 4 powerful, super-smooth "fours". Any Evinrude may be purchased on convenient time payments. See the 1940 models at your Evinrude dealer. . . his name is listed in your classified telephone directory under "Outboard Motors."

CATALOGS FREE!

Catalogs of 9 Evinrude models, and 6 Elto models priced as low as \$26.50 . . . together with handy Boat-and-Motor Selector and Boat Directory of Leading Builders, sent FREE! Address



EVINRUDE MOTORS

4334 N. 27th Street • Milwaukee, Wisconsin
Evinrude Motors of Canada, Peterboro, Canada

an elephant is the famous "Head Carry." I have never used it. Every man I know of who has done this trick has been killed or injured, usually seriously. The pressure required to carry the suspended weight of a man the length of the reserve seat section on one side of the hippodrome oval is about half the pound pressure of his own weight. Which means that a man weighing 150 pounds has seventy-five pounds of pressure on his skull. Even by using the helmet, the head gets out of shape after a time and cauliflower ears are inevitable.

Circuses find elephants valuable not only as performers in the rings, but in the actual movement of the show—putting up and taking down the nomadic city of canvas, often under weather handicaps. Thus several elephants are broken to harness, but there are rules for making harness elephants out of educated, performing elephants just as there are for making actors out of the jungle pachyderms. The most important thing is to be sure of a good fit. If an elephant man does not know how to fit a set of harness, he may cause the elephant to injure its back.

There are many ways that can be employed in teaching obedience to elephants, but I favor the practice of treating them as you would treat a child. Patience, use of the voice instead of the bull-hook, will work wonders, for when an elephant understands what is required of it, a surprising amount of intelligence is yours to command.

Rolling Up the Strikes

(Continued from page 395)

No two hands are alike; thumb and finger sizes vary as do hand spans. The most consistent bowler is one who has a ball fitted to his hand. There are three types: (1) the standard available in two and three-holed borings, which have the holes custom drilled at an angle parallel to the core center; (2) the trick grips designed for bowlers with abnormally shaped hands or peculiar delivery styles, and (3) a new grip that I've had a hand in developing that's based on a new boring principle that imparts uncanny accuracy to a hook from a natural delivery.

In order to understand the idea back of this improved grip, pick up a baseball, a

21236

billiard ball, or any other round object of similar size as though you were about to spin it from right to left. Notice the position of your fingers as you pick it up preparatory to spinning it to the left. That's the way your fingers fit inside the new grip ball.

With regard to the position of the fingers on the outside of the ball, it's pretty hard to lay down any hard and fast rules.

A great many bowlers think their fingers must be spread all over the ball to develop a hook. Actually, however, you can use any style of play, a straight ball, a hook, back-up, or curve, with the fingers spread or close together, just as long as the fingers feel rested in a natural position.

On delivery, a good player will take his stand twelve to fifteen feet back of the foul line, the distance varying according to your stride and whether you're using a three, four, or five-step delivery. When addressing the pins your body should be erect with shoulders square at the pins. Feet may be close together, slightly apart, or left foot slightly extended, but in any event, the weight of the body should be distributed evenly on the feet. Ball should be held somewhere between waist line and shoulders, supported by the left hand.

Here is a four-step delivery I have recommended to many bowlers with good result. Starting with the right foot, you take three steps forward at a fast walk—not a run—and a glide which brings you to the foul line in an easy swinging motion. Keep your steps evenly spaced and deliberate, and exercise only a minimum of effort on approach and delivery. The timing of your swing of the ball and the number of steps you take, as in the delivery, including the swinging of the ball and your stride, must be in perfect rhythm at all times.

Bend your knees on the final step, which is a slide, and release the ball about twelve inches above the alley bed. If you make it a point to keep back of the foul line in practice games you'll bowl better in league and tournament games. If you're a right-handed bowler wear a rubber sole on your right shoe, an elk-hide sole on the left. In this way you can break your slide with the right foot while sliding with the elk-soled one. Don't try to bowl in street shoes or crepe-soled oxfords.

For the strike ball, as the first one's

(Continued to page 143A)



One of 4 amazing baits used by TONY ACCETTA, U. S. Professional Bait and Fly Casting Champion.

Demonstrated by the Champ to over 3,000,000 FISHERMEN!

The PET Spoon designed for both fresh and salt water fishing, has a darting, wiggling action that bass, pike, or medium salt water game fish can't resist. It is heavy enough to cast easily, yet light enough to troll with least water pull and with no line twisting. Absolutely weedless and snagless—goes through weeds like an eel. Rust-proof hook and weed guard are removable—easily replaced if damaged. Spoon is heavy chrome plated—guaranteed not to rust. Buy it at your dealers or direct. Length 2 1/4". Price 75c.



FREE CATALOG with "Short Cuts to Bait and Fly Casting" and showing Tony's other 3 favorites: RIVER DEVIL, SPIN DODGER, and WEED DODGER

Tony Accetta DEPARTMENT P1
853 E. 144th ST.
CLEVELAND, O.



ELECTRIC EYE
ANNUNCIATOR AND
BURGLAR ALARM

STORES, Homes, Taverns, Shops, Garages—scores of others—waiting for the RAY-ALARM Burglar Alarm and Annunciator. Real protection—guards against intrusions. Invisible beam of "Black Light," when interrupted, sounds continuous alarm. Plugs in any light socket. Unfailing demonstration takes 10 seconds—makes sales on the spot.

SEND NAME Huge profits. Write AT ONCE for particulars of Distributor Plan or Agent proposition. No money. Just send name.

RAY-ALARM, 225 Fifth St., Dept. R-163, Des Moines, Iowa

HANDEE
Tool of 1001 Uses

A WHOLE TOOL SHOP IN YOUR HAND

Smooth, steady power at your finger tips. Uses 300 accessories to grind, drill, polish, rout, cut, carve, sand, saw, sharpen, engrave, etc. Plugs in any AC or DC socket, 18,000 r.p.m. 16 oz.

Get A Demonstration at Hardware, Tool or Dept. Stores, or order on 10-Days Money-Back Trial. **\$10.75** post-paid with 3 Accessories . . . De Luxe Model, 25,000 r.p.m. 12 oz. **\$18.50** with 6 Accessories.

Chicago Wheel & Mfg. Co., 108 S. Aberdeen St., Chicago, Ill.



Save Hours of Hand Work

FREE 64-PAGE CATALOG Complete information on Handee Products and their wide application in crafts work and industry all over the world.



EASY to play

With an easy playing Conn band instrument, you can be ready for band or orchestra in 4 to 6 weeks. A sure road to popularity if you start on a Conn. Choice of the world's greatest artists. Magnificent tone. Many exclusive features—yet they cost no more.

Ask to see the marvelous new models now being displayed by Conn dealers.

WRITE FOR THIS NEW FREE BOOK

Home trial. Easy payments. Write us for free book on whichever instrument interests you most. Mention instrument.

C. G. CONN, LTD., 331 CONN BLDG.
ELKHART, IND.



CONN

BAND INSTRUMENTS



TENNIS Strings DIRECT TO YOU from Manufacturer!

Marvelous opportunity to SAVE on fresh, genuine split gut strings for tennis, badminton, squash, buying DIRECT from the manufacturer! Silk string bargains, too! Order NOW from this ad.

TENNIS SPLIT GUT: Aristocrat—finest quality genuine lamb gut 15 or 16 gauge, set of two 19 foot coils, SPIRAL (white, blue), PLAIN (orange, green, white) per set, \$3.50, postpaid. (Was \$3.80). **Wills Special**—selected split gut 15 or 16 gauge, set of two 19 foot coils, SPIRAL (white, cerise), PLAIN (orange, green, white) per set, \$2.50. (Was \$2.95). **Eclipse**—15 gauge split gut, two 19 foot coils, PLAIN (white, red), per set, \$1.60. (Was \$1.90).

SILK TENNIS STRINGS: All Star Grade—15 gauge, 2 coils 18', 19', SPIRAL (white with either red, green, black), PLAIN (orange, green, white), per set, 90c. **Superior**—15 gauge, 2 coils 18', 19', SPIRAL (white & blue, green & black, orange & black), PLAIN (orange, green, white), per set, 55c.

BADMINTON STRINGS: Gut—19 gauge, PLAIN (orange, green, white), two 19 foot coils only \$1.50. **Silk**—37 foot coil, only 75c. **FREE!!!** 5 Yards Trimming Cord GIVEN with orders for \$1 and up. All orders sent POSTPAID for cash in full, or 20% cash on C.O.D. orders. **Satisfaction Guaranteed.** (We reserve right to substitute colors.) Order QUICK. **FREE** Price List sent on request.

H. E. WILLS CO., 1047 W. 47th St., Dept. PM-30, Chicago

Now send for this
FREE Camera Catalog



Find out how much you can actually save on cameras, accessories and supplies. Discover the completeness of this great camera catalog. Here is everything in photography at your finger tips. Quality guaranteed. Send at once for your copy of the catalog that outvalues them all. It's FREE! Just mail a postcard TODAY!

LAFAYETTE CAMERA

Dept. 7CC—100 Sixth Ave., New York, N. Y.

15 Tested Ways to

EARN MORE MONEY!

Give yourself the lift you need with these pay-raising, extra-money books. Use them to prepare for better jobs—bigger pay—to add to your income through spare time work. All are up to date library size volumes.



SEE
OFFER
BELOW

SELECT FROM THIS LIST

BUSINESS COLLEGE SELF TAUGHT. Complete secretarial course in one volume. Includes shorthand, book-keeping, typewriting and 12 other practical office subjects, prepared for home study. Helpful on every office job. Price \$2.39.

MATHEMATICS FOR THE PRACTICAL MAN. A knowledge of mathematics helps on every job. This book makes the study so interesting and simple everyone can be proficient. No teacher or previous experience needed. 143 Pages, 42 Illus. Price \$1.50.

AUTOMOBILE BODY AND FENDER REPAIRS. Brand new. Covers all phases of auto body and fender repairs, the most profitable end of the auto repair business today. This book will put you right into this up and coming business. 325 Pages, 232 Illus. Price \$3.00.

BLUE PRINT READING FOR BUILDING TRADES. Shows how to read and understand blueprints as you would a newspaper. Best book on subject for beginners and experienced building trades men. 111 Pages, 69 Illus. Price \$1.25.

BLUEPRINT READING FOR MACHINE TRADES. Same as above except covers all machine trades and shop work. 154 Pages, 92 Illus. Price \$1.50.

DYKE'S AUTOMOBILE AND GASOLINE ENGINE ENCYCLOPEDIA. New edition of the most practical, complete and widely used auto book ever published. Covers all up to date testing, adjusting and repairing operations. 1434 Pages, 4617 Illus. Price \$6.00.

WEE HOMES. 44 designs (FHA Approved) of one to four room cottages, all types. Cost range, \$750 to \$3500. Price 35 cents.

NEW AMERICAN HOMES. Beautiful illustrations, some in color, of 101 residence designs (FHA Approved). Price range \$3500 to \$15,000. Price \$1.00.

A SMALL BUSINESS OF YOUR OWN. Gives 1000 ways for a man with little or no capital to build a modest, dependable business. Every plan has been used—and works. Price \$1.00.

TURN SCRAP INTO MONEY. Shows how to build power plants, 110 volt motors and generators, wind driven power plants and other electric apparatus from discarded auto parts. Price \$1.00.

SHOE REPAIRING. By Paul A. Klein. Practical and simplified instruction, easy to follow, on modern shoe repair methods. Helps you save money and make money. Illustrated. Price \$1.00.

DIESEL ENGINE MANUAL (AUDELS). Timely and useful information on the construction, maintenance and operation of modern Diesel engines. Includes questions and answers. A fine book on this new power field. Illustrated. 300 Pages, Price \$2.00.

HOUSE WIRING. By Wolber and Rose. New Edition. Covers every detail of house wiring including the latest materials and methods, with full explanations of the National Electric Code. 400 Pages, 669 Illus. Price \$2.50.

BOOKKEEPING MADE EASY. Complete self teaching course in double entry bookkeeping. Best book for the beginner. Price \$1.00.

WATCH AND CLOCK MAKERS' MANUAL. Explains in a practical way, the whole field of watch and clock repair. 361 Pages, 150 Illus. Price \$3.00.

FREE TRIAL—MONEY BACK OFFER

Any book sent postpaid if remittance is sent with order. Sent C. O. D. in U. S. and possessions, plus few cents charges. If not satisfied return book in 3 days and purchase price will be refunded. Order today.

POPULAR MECHANICS PRESS

Dept. 403 200 E. Ontario Street. Chicago

When writing please mention Popular Mechanics

(Continued from page 141A)

called, form an imaginary line to the 1-3 pocket, to the right of the head pin between 1-3 pins, and proceed to roll the ball on that line, starting the ball from the spot you have selected at the foul line. If you have any trouble keeping the ball on the right-hand side, move in a few inches farther from the corner of the alley, or if your difficulty lies in getting the ball up to the head pin, or 1-3 pocket, you should either place the ball closer to the corner of the alley or else point it a little higher. It's been my experience most novices acquire control and delivery much faster when they bowl a straight ball from a spot six to eight inches from the right-hand side of the alley. Whenever you have a few spare moments, practice this with just the 1-2-3-5 pins set up.

A word about the four styles of balls. On the straight ball, as I've already pointed out, control is no problem, as it is rolled without making any attempt to turn the wrist one way or another but with the thumb pointed straight at the 1-3 pocket. This style is particularly effective when delivered with sufficient force to hold direction.

The curve ball is released by the player from the center of the alley with a decided twist of the hand to the left at the moment of release. The curve is acquired by a right to left turn of the wrist, releasing the thumb an instant before the finger, and with a lifting or pulling-up motion of the latter. The curve ball is not widely used by top-flight players as it calls for not only a great amount of practice to control but uncommon judgment of angles and speed to meet alley conditions.

The back-up or reverse ball turns to the right just before reaching the pins, this being effected by the bowler giving a twist of his hand or wrist to the right, imparting a clockwise spin to the ball. When delivering the ball in this manner, point it to the left of the intended mark.

The greatest pin getter of all is the hook ball and for this reason is most widely used. A counter-clockwise spin, similar to that of the curve, is imparted to the bowling ball by the bowler with a quarter-left turn of the hand as it is rolled. The difference between a curve and a hook is that the latter is rolled straight down the

(Continued to page 144A)

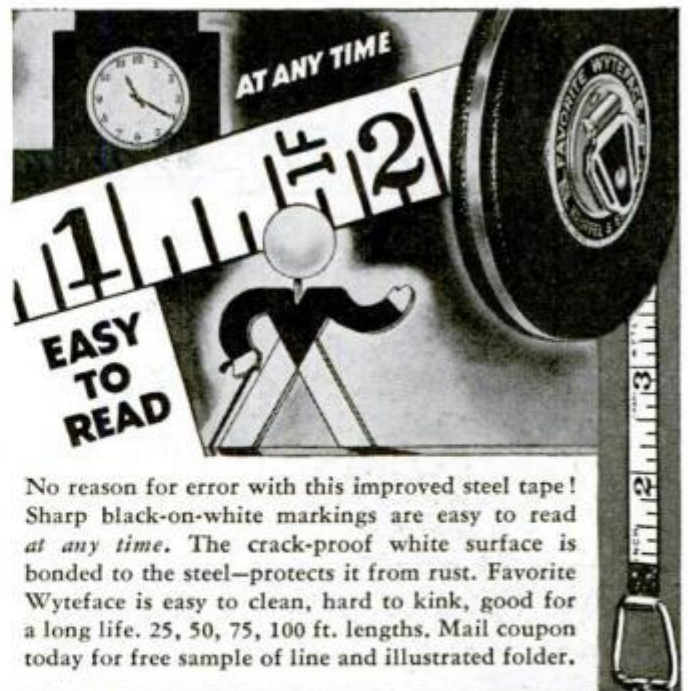

No reason for error with this improved steel tape! Sharp black-on-white markings are easy to read at any time. The crack-proof white surface is bonded to the steel—protects it from rust. Favorite Wyteface is easy to clean, hard to kink, good for a long life. 25, 50, 75, 100 ft. lengths. Mail coupon today for free sample of line and illustrated folder.

K & E FAVORITE WYTEFACE STEEL MEASURING TAPES

KEUFFEL & ESSER CO. . . Est. 1867
Dept. 110, Hoboken, N. J.

LOOK FOR THIS DISPLAY 

Name.....
Address.....
City.....State.....

Get a Genuine **MOTO-TOOL**
100 TOOLS in ONE

Grinds, polishes, sharpens, drills, engraves, etc. Saves time, cuts cost. Handiest tool in home or shop . . . use it daily. Same tool as used on precision jobs in factories.

OVER 25,000 R. P. M. High speed conserves balanced armature, 110 V. (AC-DC). **MODEL 1 MOTO-TOOL** with chuck, 1/8" collet, only \$9.85. **MASTER MODEL 2**, 27,000 r.p.m., heavier, more powerful, only \$16.50.

10-DAY TRIAL. See the genuine **DREMEL MOTO-TOOLS** at better Dealer's or order direct from factory on 10-day money-back trial. Catalog of Dremel tools, equipment and special combination offers, **FREE.**

Dremel Mfg. Co., Dept. M-110-C, Racine, Wis.

PROJECT BOOK
Big 24-page book shows how to make 41 plastic projects. Sent postpaid for only \$1.

GET YOUR COPY

BUILD A MODEL RAILROAD

Learn the thrill of operating a railroad of your own! This BIG 48 page catalog tells you all the secrets and joys of building model trains at home!

Vander Boorn 38th & Broadway—Kansas City, Mo.

SEND 10¢

Vander Boorn MINI-TRAIN CATALOG

WORLD'S LOWEST PRICED ADDING MACHINE

IDEAL FOR INCOME TAX

GUARANTEED ACCURATE. Not a toy. Operates with only a finger flick. Adds, subtracts, multiplies, divides. Counts up to a million. Pays for itself over and over. **IDEAL GIFT—for Business, Income Tax and School use. MONEY BACK GUARANTEE.** Send name and address. Pay postman only \$2.50 plus postage. (Send full cash if outside U.S.) Money back in 10 days if not delighted. **AGENTS WRITE.**

ONLY \$2.50

TOTAL COST SEND NO MONEY

SMALL SIZE FREE TRIAL

CALCULATOR MACHINE CO., (Mrs.) DEPT. 103, P. O. BOX 1118, CHICAGO, ILL

MEN LIKE YOU

are making Big Money



Pat. Nos.
2008615
2108727
Other
Pats.
Applied
for

in the PATENT-PROTECTED
NATIONALLY ADVERTISED

New Art

Cleaner Business

Self-
Wringing.
Hands
never touch
water.

Men with a mechanical slant, quick to recognize the immense sales and profit possibilities of this automatic, self-wringing NEW ART Cleaner that scrubs, sweeps and mops, have made thousands of dollars as local NEW ART salesmen and distributors.

Some of the Many Records—"Averaging 75 sales a week", writes Mr. Mulligan of Iowa. "Sold 11 NEW ART Cleaners in seven hours", reports Mr. Miller of Pa. "Out of 11 demonstrations in one day, made nine sales", says Mr. Brown of R.I. "Sold nine Wednesday, nine today", writes Mr. Schroeder of Mich.

WHAT OTHERS HAVE DONE—YOU, TOO, CAN DO!

Today, national advertising of the NEW ART Cleaner in leading Women's Magazines as well as recommendations by hundreds of thousands of users are bringing in more and more good leads for alert men who want to get ahead in a proven, profitable business of their own.

Start on a full or part-time basis. But don't delay. Your BIG opportunity is HERE! NOW! Mail coupon today.

ARTMOORE COMPANY 108 N. Water St., Dept. PM-30
Milwaukee, Wis.

Tell me all about the NEW ART Business Opportunity you have for me.

Name

Address

City..... State.....

MEGOW'S

MODEL AIRPLANES

MODEL SHIPS
HO-GAUGE RAILROADS

Send 5c postage for new Megow Catalog! 100 pages, profusely illustrated. Shows scores of gas-powered and rubber-powered Model Airplanes. Also Ship Models, HO-Gauge and O-Gauge Railroads, equipment and supplies.

MEGOW'S Dept. PM, How. & Oxf. Sts., Phila.
217 N. Desplaines St., Chicago

(Continued from page 143A)

right side of the alley from a point close to the side with a sharp break into the pins rather than a sweeping curve.

After a time, many bowlers develop what they like to call "jinx spares." These are due to the fact they don't take advantage of the proper angles for their particular style of ball. Remember to use extreme angle on every shot wherever possible. Bunches or combinations 1-2-4; 1-2-4-8; 2-8 and 1-2-4-7 are bad spares and the most effective way of handling them is to hit them high or full, covering as many pins as possible with the ball. Such spares as 2-4-5-8; 2-4-5-7-8, and 2-4-5, with the same combinations on the right side of the alley, have a pocket the same as the 1-3 of a strike set-up. Such combinations as 2-8; 2-5-8, and 2-4-8 are considered difficult for any ball but usually can be made when hit full.

Single-pin spares, particularly No. 10, are a jinx to many players. The bowler who consistently misses it outside or inside is doing so because he's wrong on his angle for his ball. If he rolls across the alley from the left to the right only to see his ball skid into the gutter, he is taking too much alley and should move more to the center of the alley. If he always misses it inside, he should move more to the left of the alley.

The beginner will learn much through the medium of experimentation.

Door in Toothbrush Cabinet Closes to Shut Out Dust

Opened and closed by rotating a knob at the top, a plastic cylinder that holds six toothbrushes is sealed against dust by a sliding door. Two ventilating filters at the top permit the air to circulate and dry the brushes.

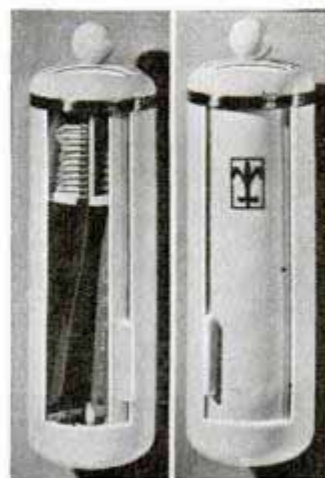

Send return postage to our Bureau of Information to learn the name of the maker of any device described in this magazine.

Practical Products
Aug. 1431, E. Washin.



Try This New ROYAL Portable In Your Own Home FREE

READ WHAT OWNERS SAY:

"Earn more money—make that correspondence course pay real dividends" (Sales engineer) . . .
 "Get ahead faster—make home work count" (A student) . . .
 "A real help to everyone in the family." (Housewife)

SEND NO MONEY don't spend a cent—until you know that a New Royal is going to be worth many times its cost to you. Know how easy it makes writing—how its many office typewriter features and controls help you turn out neat, accurate business-like letters and reports. Maybe you've never used a typewriter—never thought of owning one . . . Then you owe it to yourself, to your future, to clip the coupon *at once* and get the **FACTS**. No obligation.

*Trade-mark, Reg. U. S. Pat. Off.



WITH MAGIC*
Margin new Sensational! Sets margin automatically 3 times faster.

Royal Typewriter Company, Inc.
Dept. C-41, 2 Park Avenue, New York, N. Y.

Tell me how I can get a genuine New Royal on **FREE HOME TRIAL**; also, how I can own one for **ONLY A FEW CENTS A DAY** including small carrying charge.

NAME

STREET

CITY.....COUNTY.....STATE.....

MAKE THAT OLD TYPEWRITER HELP PAY!

Please quote trade-in allowance on a.....Typewriter, Serial No.....

ACT NOW! . . NO OBLIGATION

FREE!

Royal's Instant Typing Chart. Shows you how to type **RIGHT!**

YOURS!

The Duo-Case! With every Royal Portable—at no extra price!

Build a BOAT

FOR PLEASURE OR PROFIT

Shows

EXACTLY HOW TO BUILD 15 DIFFERENT BOATS

This is the new edition with 42 added pages, 6 new boats, and conversion of Ford motor for marine use. Full directions and details for cabin cruiser, racing, hydroplane, outboard runabout, sail boats, kayak, sled type—15 boats in all. Also sectional boat to carry on car.

EASY—LOW COST
with
POPULAR MECHANICS BOAT BOOK

Build a boat at home! You can do it. Just the kind you've wanted—power, sail, or row boat. The "Boat Book" shows you how in simple step-by-step directions. Specially prepared for those with limited tools, little skill and money. Build boats to sell for profit too. Book tells how.

GIVES PLANS, METHODS AND MATERIALS

Actual working plans and photos of real boats under construction makes building easy. Hundreds of pictures. No chance for mistake. Includes also, navigation and pilot rules, handling sailing craft, boat kinks, boating terms. Everything a boat enthusiast should know. Size 7x10 inches. 312 pages. Fine cloth binding.

SEND NO MONEY

Write for new edition of Boat Book today! Sent anywhere. Pay postman \$3.00 plus small C. O. D. fee. Outside U. S. and possessions remit with order. Money refunded if not satisfied.

POPULAR MECHANICS PRESS—Dept. 403
200 East Ontario St., Chicago

MUSSELMAN FITS ALL WRENCH

Only 25c or 5 for \$1. postpaid. Hardened-Cadmium plated.

Musselman Universal Wrench. Fits 21 of the most common size nuts with square and Hex heads. Sizes 1/4", 5/16", 11/32", 3/8", 7/16", 1/2", 9/16", 5/8", 11/16", 3/4", 7/8". A real mechanical and household wrench. Made of heat treated steel, rust-proof Cadmium plated. Everyone should have several of these wrenches for home, shop, garage and office. Introductory price once only, postpaid each 25c, or five for \$1.00 postpaid. **MUSSELMAN PRODUCTS CO., 6323 St. Clair Ave., Cleveland, O.**

POWELL "SETS THE PACE"

100 miles per gal. 35 miles per hour. 2 1/2 H.P. 4-cycle engine. Centri-matic clutch. Hill-climber transmission. Foot brake, foot throttle. Welded alloy steel, shock-absorbing frame. Easy riding, dependable, durable, beautiful. Many Powell Streamliners ridden over 40,000 miles a year. Write for free folder. Powell Mfg. Co., Los Angeles, Cal., Dept. PM-1.

In answering advertisements always write name and full address clearly.

BIG MONEY-MAKERS THAT WORK

EIFEL-GEARED PIERRECH KIT-7" & 8 1/2"

"Pocket Machine Shops" that Do the work of \$50 worth of other tools, Amazingly Quicker, Better... Easier!

- Now of ALLOY Steel—65% Stronger! NEW PLANT.. Quadrupled Capacity.
- Now have your Own Business in a New Selling Case. Full-time men making \$1,500 to \$4,000 Yearly... Part-timers in proportion. We need Many More!

NEW FREE

Bottle-Cap Opener, etc.

Mail Your Address Today (on a post card will do) Get **FREE**—this 6-Edge End-&-Angle Screw-driver and 101-Picture Manual of Mechanics, with... User Offers: or, with... DISTRIBUTOR, Territory, Demo, and **SELLING KIT Offers!**

AMERICAN PIERRECH CO. INC. P.O. Box 4611 N. RAVENSWOOD AV. CHICAGO, ILL.

HERE IS ATKINS' LATEST— The Sensational "2000"



**LOOK—Your Own
Initials—Free—On This
Remarkable New Saw**

The new Atkins "2000" Hand Saw offers double value:

First: New scientific handle design brings the grip closer to blade—makes the saw easier and more comfortable to use—adds to its modern handsome appearance. Blade is taper ground, edge-holding Silver Steel.

Second: Free black and gold decalcomania initials furnished every purchaser. You can personalize your saw, and always identify it. Ask a nearby hardware dealer to show you this latest Atkins triumph!

ATKINS *Silver Steel* SAWS

E. C. ATKINS & COMPANY, 426 S. Illinois St., Dept. M-3, Indianapolis, Ind.

MEN and WOMEN

TURN POTATOES INTO CASH

Newest process enables you to make delicious "NON-GREASY" type Potato Chips. An instant hit. We supply complete equipment and instructions including money-making plans. No previous experience necessary. Groceries, restaurants, taverns, markets do the retailing for you. Profits large—unusually so. Start this money-making business in your community on a small outlay of cash under our credit terms. Send name today for FREE Potato Chip Business Book. **LONG EAKINS CO., 328-5 High St., Springfield, Ohio**



STUCCO MACHINE

Offers EXTRA EARNINGS



Make new or old buildings more attractive and water-proof. Plastic COLORCRETE fuses with any masonry surface. It fills cracks. It can be sprayed in any thickness and in 30 colors. Fully proven by over thirteen years actual use under all conditions and every climate.

Owners everywhere want to enhance values. With this machine you can supply this big waiting market with permanent COLORCRETE at amazingly low cost.

Big earnings. Operators report costs of 2c and up per sq. ft. and sell up to 7c. Some have paid for their equipment from first few jobs. Machine capacity up to 1,000 sq. ft. per hour.

Get the facts. Send for book "Proven Business Opportunity". Write today. It may mean business independence for you.

COLORCRETE INDUSTRIES, INC.
570 Ottawa Ave. Holland, Mich.



The Fast Freight Rides the Hump

(Continued from page 357)

ductors of the various eastern and southern trains, while their pictures remain in the files, to be used as the basis for the Belt Railway's revenues. The yard collects \$5.86 for every loaded car passing through, \$2.90 for empties.

The forty-three-car train is ready for the hump. A powerful steam locomotive that often shoves 150 cars up this grade is coupled on the rear, ready for the big push. The humpmaster calls the order into the loud speaker, the signal changes from red to yellow—four miles an hour—then green, eight miles an hour, and the long string of cars starts the climb.

At the hump stands the conductor, train list in hand, directing the cut. At his command: "Cut one," the pin puller uncouples the first car, a load of lumber for the Wabash. It breaks from the train, gathers momentum as it leaves the hump and glides down into the Wabash track, No. 9. "Cut one." Lumber, again, but destined for the Pittsburgh, Ft. Wayne line. The towerman notes "EH" on the car list, indicating it is extra heavy, and as it gravitates toward track 34 he throws a retarder switch. Compressed air thrusts against pistons, lever arms press down, steel brake beams clamp like a vise against the car wheels. They grind to a stop as the track brakes tighten their grip under 100 pounds of air pressure. Then the towerman releases the air and the car slides on at a safe speed. Beyond the last retarder the tracks are all scientifically graded so that a car will roll at a constant speed of two miles an hour to the end of its assigned track.

Sometimes there is a crash on the retarder as a heavily loaded car rolls onto the brake section before the car ahead has started. But not often. An alert towerman can keep them traveling from the hump at nine a minute when there's a close connection to make—but if he's to avoid any crackups he's got to concentrate on cars and forget the sky liners skimming overhead on their way to the near-by airport.

When the car retarders went into operation a few months ago there was a critical labor problem to meet. These towermen who operate switches and retarders had to be experienced men, and there weren't any.

21195
The Belt line had to find some wide-awake fellows who could learn by practice how to judge a car's momentum from its weight, the effect of the prevailing wind and other factors; they had to know whether to apply the retarders in position one, two, three or four, representing air pressures from twenty-two to 100 pounds.

In the old days, when a car went careening out of control bound for a bang-up finish, there would be a whistle for help from the car rider and a skate boy would race across the maze of rails to intercept the runaway and shove an iron skate on the rail in front of it. The retarders have ended most of these emergencies, but some modern yards have automatic skates that flip into position on the rail at the touch of a remote button.

Cutting of cars at the hump goes on. Car No. 3, paper, for an industrial track, No. 54. Car No. 4, the re-iced pears for the Erie 7:05 train. The next two are headed for the same track, No. 43; the conductor at the shanty calls "Cut two," and the pin puller turns the pair loose, boxes for the New York Central and lumber for the Michigan Central. And so they roll, rye for the Monon, paper for the Panhandle, sugar for the Pere Marquette and Nickel Plate, salmon, butter, eggs, prunes for a dozen different lines east and south.

At 6:11 a.m. the last car breaks from the pusher engine, the hump is cleared for another string from the west. A train that used to spend eight hours to a day in dissolving and reassembling has been humped in little over an hour.

Four thousand cars a day, 125,000 a month, 1,500,000 a year flow east and west through the two main arteries of the Clearing hump and down into the capillaries that lead them to the main trunk lines again. The yard was designed to handle 6,000 a day. In a pinch it could handle 8,000. Its record so far has been 5,236, but on one busy day 3,147 cars were sorted on the eastbound track alone. A wartime surge of traffic some day might bring another critical jam of transcontinental freight, but it will never be like the old days when car riders planted their feet on the rocky roofs of swaying boxcars, swung hard on the rusty brake wheels and hoped the electric speeders waiting at the end of the yards would bring 'em back alive.

SHORT CUTS FOR THE HOME CRAFTSMAN

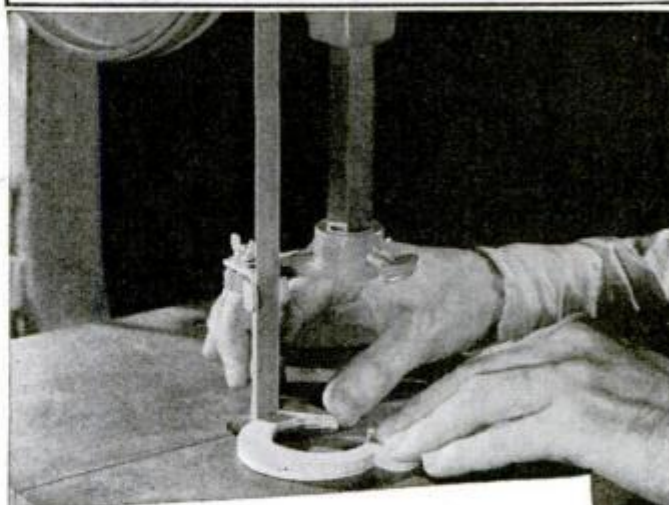

How to smooth the edges of delicate scrollwork

● Here's another shortcut with Electrocoated Aloxite Brand Aluminum Oxide "K-5" Abrasive Cloth. A long, narrow endless belt of this material can be joined at the ends and mounted on an ordinary bandsaw and used for a wide variety of delicate sanding operations, to very close tolerances.

This arrangement is particularly useful for sanding small pieces of wood, metal or other materials, and for smoothing the edges of scrollwork whose shapes permit them to be reached by the belt. Beveled cuts can be made by tilting the bandsaw table. Complete directions for converting your bandsaw are contained in the manual offered below.

Ask your hardware dealer or mill supply house to show you the complete line of Carborundum-made coated abrasives, sharpening stones, grinding wheels and other abrasive products for the home craftsman. Send 20c, coin or stamps, for souvenir sharpening stone and valuable illustrated manual on how abrasive products can save time and help you do better work.

VISIT your hardware dealer during National Hardware Open House—April 25 to May 4—for exceptional values.

THE CARBORUNDUM COMPANY

REG. U. S. PAT. OFF.

Niagara Falls, N. Y.

{Carborundum, Aloxite and "K-5" are registered trade-marks of The Carborundum Company}

Get Into AVIATION Train At LINCOLN



Now is the time to get into aviation! Airplane factories are flooded with orders! Airlines continue to expand! Airline Pilots earn up to \$6000 a year—mechanics up to \$2400! Aeronautical Engineers also get big pay! Come to LINCOLN now and train for one of the many good pay jobs open to Lincoln-trained men.

Lincoln Government Approved Flight Training prepares you for any Pilot's Rating up to and including Commercial (Transport) Pilot. Lincoln Government Approved Mechanics Training prepares you for your Merchant's Rating. 14 Modern Training Planes, 15 Shops and Laboratories, with wide variety of modern airplanes and engines for practical experience, 20th year teaching aviation. We assist graduates in locating positions. 135 Graduates recently placed in good-pay jobs. WRITE for complete information.

LINCOLN AIRPLANE & FLYING SCHOOL
573-A Aircraft Bldg. Lincoln, Nebr.

SAVE MONEY

build your own

SMITH COMPRESSOR

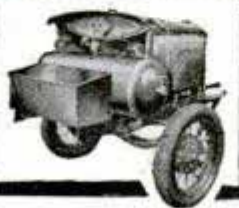

We will furnish complete instructions with a Smith Compressor Head and Accessories

With a Ford Motor and shop facilities you can easily assemble a Smith Air Compressor. You'll have a smooth-performing, efficient compressor with 60 cu. ft. a minute capacity—all the power you need to operate rock drills and paving breakers. Pressure up to 175 lbs. a square inch. Head equipped with high speed compressor valves; automatic unloading and idling.

write today

GORDON SMITH & CO. Inc.
410 College Street
Bowling Green, Ky.



SELF-INKING COMPLETE POST CARD PRINTER \$8.50

Cuts printing-postage costs 70%. Builds trade, sales, memberships. Prints writing—typing—cartoons—2000 to 4000 Clear, Clean Copies to 1 filling. Handy Case—Pkg. Base for exact registration. Guaranteed. FREE SUPPLIES! Order from this AD, get 2 Tubes—Ink—0 Stencils—Scope for tracing—Stylus—Correction Fluid. Offer Limited! ORDER NOW! MONEY-MAKING PLAN FOR AGENTS—WRITE! THE HEYER CORPORATION 907 W. Jackson Blvd., Dept. C-1, Chicago, Ill.

MIDGET LATHE ONLY \$2.95

ATTACHMENT FOR DRILL PRESS

Amazing, sturdy MIDGET LATHE attaches to any drill press—handles thousands of metal-turning jobs like regular lathe. Does perfect turning on small round work held in drill-press chuck. Face plate supplied for flat work and other jobs. SEND NO MONEY—GUARANTEED. Rush name, address on postcard. Pay postman only \$2.95, plus postage on delivery. Use 5 days. If not delighted, return lathe and we refund money. Order today. Midget-Lathe, 4031 Eastern Ave., Dept. B-2, Cincinnati, Ohio



Stoves AT FACTORY PRICES!



Write today for FREE CATALOG

New FREE Catalog

New designs, new features. Nearly 170 Styles and Sizes of Heaters, Ranges, Furnaces. Up to 18 months to pay for stoves. 3 years for furnaces. Write today for FREE CATALOG, 30 days FREE TRIAL—24 hour shipments.

Kalamazoo Stove & Furnace Co.
391 Rochester Ave.
Kalamazoo Michigan
Over 1,500,000 Satisfied Users
40 Years in Business

"A Kalamazoo Direct to You"

9-13-39
Camber of Knee-Action Car Set Without Disturbing Brakes

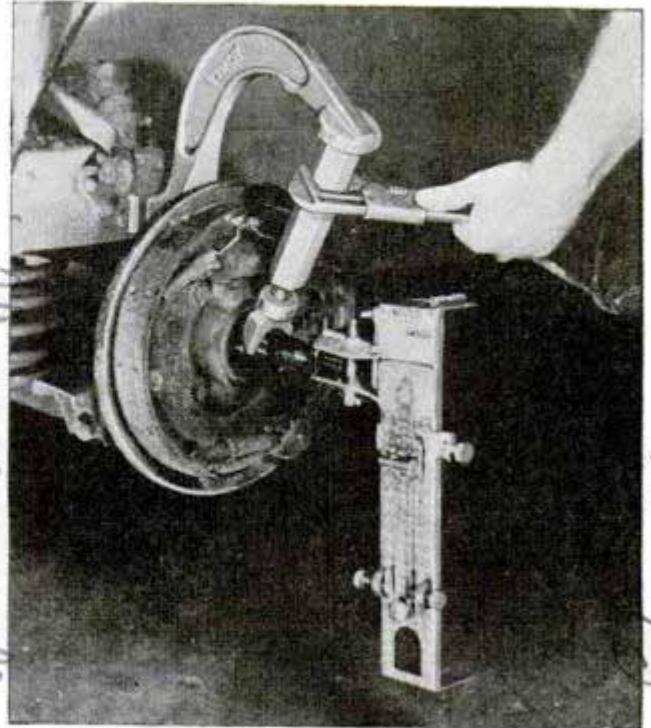

Adjusting the camber on coil-type knee-action cars, which may become necessary due to slight bending of the knuckle support arms, has been simplified by a tool recently placed on the market. With the new tool, this job is done without disconnecting brake tubing or otherwise disturbing brakes. It can be used on any make of car and two models are available, one for operation with hydraulic jack and the other with a screw jack.

21453
Glycerin Saves Lives of Plants by Keeping Roots Moist

Glycerin, used in making war munitions, has been given a peacetime task of saving millions of young tomato and cabbage plants from dying during shipment, due to drying out of their roots. The plants are grown in the south and shipped north with their roots packed in moist moss. An industrial chemist experimented with a glycerin solution as a substitute for plain water, and found that a protecting layer of glycerin would remain over the roots if the moss pack dried. Last season the method received a full-scale commercial work-out and more than 75,000,000 plants were shipped with the glycerin-solution protection. The treatment discourages the fungus that causes stem canker, resulting in additional savings.

See Mr. H. De Luis
1111 1/2 W. 1st St. (2)

Weaver, My. Co. Springfield, Mo.
 Kalamazoo Stove & Furnace Co., 907 W. Jackson, Chicago, Ill.
 Kalamazoo Stove & Furnace Co., 391 Rochester Ave., Kalamazoo, Mich.
 Kalamazoo Stove & Furnace Co., 391 Rochester Ave., Kalamazoo, Mich.

2138

New Metals from Powder

(Continued from page 323)

What makes the powder stay together? You might think it would crumble after removal from the press. Instead, a pressed and sintered object is as strong as if it had been cast. It may be machined like any other metal. The reason is not fully understood. One belief is that extreme pressure expels the air from between the particles of powder and that interlocking of the angular and irregular surfaces occurs. A certain welding action seems to take place, possibly from the heat developed during compression. Evidence of alloying has been



Lamp filaments with coils invisible to naked eye are inspected under microscope during manufacture

observed under the microscope, suggesting atomic migration from one powder particle to another. When desired, definite alloying is produced by heat and sintering treatments after an object has been molded in the press.

Young as it is, powder metallurgy already has found wide application. "There is hardly a modern American home that doesn't use self-lubricating bearings compressed from powder," says E. S. Patch of the Moraine Products Division of General Motors Corporation. "They are used in washing machines, refrigerators, ironers, mixers, fans, and automobiles. Even the casters under your chair are probably equipped with self-lubricating bearings."

The process got its start more than a century ago when some practical way was

(Continued to page 151A)

POST PAID

LISTERINE SHAVING CREAM

20 Shaves

FREE

We are so sure that you will like Listerine Shaving Cream, that we offer this 20-shave tube absolutely "free and postpaid." We don't even ask you to share the mailing costs.

How can we afford to do this? Experience has proved that this offer works to our advantage. The cream seems to *sell itself*. Men who get the sample apparently remain steady customers . . . like it so well they talk about Listerine Shaving Cream to others. You can see what happens when newly made friends begin working for us that way!

Send for your sample *now*. See how much faster it lathers . . . in hot water, cold water—even ice water. Note that we have a really moisture-laden lather, which stays up right to the end of your shave!

The regular tube at 35¢ gives between 130 and 175 shaves! Any drug counter has it—as well as Listerine Brushless Cream.

Or send for the free size, *today!*

CLIP THE COUPON

LISTERINE SHAVING CREAM

20 SHAVES FREE

Lambert Pharmacal Co., Dept. 160, St. Louis, Mo.

Please send me free and postpaid your large sample tube of Listerine Shaving Cream; Listerine Brushless Cream. (Check whichever is desired.)

Name _____

Address _____

City _____ State _____

FREE WHOLESALE CATALOG



260 pages chock-full of tested fast sellers for salesmen, dealers and operators. New, big 1940 issue, now out. Describes many plans for boosting sales, one of which may add \$3 to \$15 a day to your earnings. It illustrates carded goods, automobile accessories, household necessities, office specialties, wearing apparel—over 4500 first quality items at low wholesale prices. Every item sold under a money back guarantee. Cost about 35¢, FREE, while stock lasts. Get your copy by mailing your request for it, now.

2 OF THE TESTED SELLERS SHOWN IN THE CATALOG.

4000 BARGAINS

QUICK MAKING CIGARETTE MAKER WITH 100 FILTER TIP TUBES



No. M15. Marvel model. Turns out perfect cigarettes as you like them. Granulated, mentholated or Turkish tobacco may be used. Metal construction assures dependable service. Coriscrew-like conveyor does not break or cut the tobacco. It entwines the shreds and puts an even fill into each tube. Makes 20 cigarettes for about 7¢ in 5 minutes. 100 cigarette tubes are included with each maker. A demonstration assists in quick sales.

Wholesale price each, 39¢. Dozen, \$4.32.

Here's A NATURAL—FRIENDLY ENEMIES

No. J6821½. Cash in on this year's political battles. Elephant is stamped G.O.P. Donkey is stamped Dem. Their magnetic quality, makes endless pranks, such as, running, whirling and moving under their own power as though they were alive. Lots of fun for Democrats and Republicans alike. Each pair in a box. Sample pair, 16¢. Dozen, \$1.25. Gross, \$13.45.



SPORS CO. 1-40 Main St., Le Center, Minn.

Own A Profitable Greaseless DOUGHNUT BAKESHOP Start In Your Kitchen!



Who else wants to enjoy profits from this amazing new business you can start in your own kitchen? New electrical invention turns out delicious, different Brown Bobby Doughnuts. Everybody wants them! Stores eager to sell for you. Big daily profits possible selling production of one machine at wholesale only. We supply equipment and tested money making plans. This is your chance. Send No Money. Rush postcard for FREE details.

BROWN BOBBY CO., 620 N. Michigan Ave., Dept. E-183 CHICAGO, ILL.

FISHERMEN prefer this NEW BAIT!



At ALL leading stores. Three sizes — CASTING, FLYROD & MUSKIE-SALT-WATER. Many exciting colors. FREE booklet — and FREE rubber Pork Rind mailed with each copy.

THE WEEZEL BAIT CO., Dept. N, Disney St., Oakley, Cincinnati, O.

WEEZEL LURES

SPARE TIME MONEY . . .

There's a big demand for the many hand-tooled articles you can make with the Enasco Leathercraft Set. Easily learn to make good money in your spare time. Complete outfit including tools, leathers, patterns, etc., and full instructions, only \$2.00—on sale at leading Department Stores or order direct and pay postman on arrival. \$2.50 outside U. S.

LEATHERCRAFT

Free When ordering direct, clip name of your Department Store to this ad. and we will include with your set, one extra free project. Illustrated catalog 10¢.

E. A. SWEET CO., Dept. A-32 Binghamton, N. Y.

SpeedWay DRILL 7⁹⁵ GRINDER 5⁹⁵



QUALITY TOOLS
... products of SpeedWay, for 20 years leading manufacturers of electric tools. Specially wound high torque 110V universal tool motors. Improved designs, correct speeds. 1000 RPM Drill with diecast handle has ¼" capacity in steel. 20,000 RPM Hand Grinder has speed essential for efficiency and collet for both ¼" and 3/32" arbors. Drill and Grinder sold singly or together with 5 accessories in fitted Steel Kit. Stand takes either drill or grinder. Router Frame converts grinder into router. Bench Grinder is complete with motor. Write for Circulars. **SpeedWay Mfg. Co.,** 1842 S. 52nd Ave., Cicero, Ill.

KIT 14⁹⁵
ROUTER 3⁹⁵
GRINDER 5⁹⁵
STAND 3⁹⁵

NEW KIND OF MAN'S SHOE



The new sensation in men's shoes — The Chippewa Clipper. It zips on and off in a "jiffy". Right now is the right time to get into a dignified and highly profitable shoe business of your own with this fast seller, and a complete line of almost 250 styles of dress, work and sports shoes. Prices as low as \$1.98 a pair. Free 10-second demonstrator sells super-comfort air-cushion shoes like magic.

Manufacturer established 35 years wants salesmen. No experience needed. Write for complete sales kit. It's free!

MASON SHOE MANUFACTURING CO.
Dept. H-5, Chippewa Falls, Wis.

SALESMEN WANTED BIG PAY EVERY DAY

do-it-with-squabs



Ready for market ONLY 25 DAYS OLD. Write a post-card, get FREE EYE-OPENING Squab Guide. Why breed for ordinary trade when these great luxury national markets are wide open for all the SQUABS you can ship, every day in the year? Go after this desirable, profitable trade now.

RICE FARM, 640 H St. Melrose, Mass.

NEW TRAILER and BOAT PARTS CATALOG

Complete replacement parts and accessories for all trailers. Lowest wholesale prices on Sinks, Pumps, Hitches, Jacks, Beds, Undercarriages, Stoves, Refrigerators, etc. Positively every part you need—Streamline Marine Parts. Send 10¢ today to Dept. P-3.

C. M. HOOF COMPANY, 1734 S. MICHIGAN AVE., CHICAGO, ILL.

BERRY'S New POULTRY BOOK



BERRY'S Hand-Picked CHICKS, also SEXED, STARTED, 52 Breeds, 5 HYBRIDS, World-Famous Money Makers. All Iowa Inspected, Pullorum Tested, Fowls, Turkey Poults, 40 years' Service. LOW PRICES, Beautiful POULTRY BOOK FREE, stamps appreciated.

BERRY'S POULTRY FARM, Box 25, CLARINDA, IOWA

Best Poultry Paper 6 BIG ISSUES 10¢



Helps increase Poultry Profits. Send coin or stamps, 50 cents for 3 years or 10 cents for 6 months trial. Agents wanted. American Poultry Journal

532 So. Clark Street Chicago, Illinois

Always write your name and full address clearly when answering advertisements.

PAYS Up To This MAGIC-DISC HEATS WATER INSTANTLY!

178% PROFIT

60 second Demonstration.

EVERY HOME CAN AFFORD THIS AMAZING LOW COST NEW IMPROVED ELECTRIC WATER HEATER



Made by an OLD Reliable Company. Amazing New Principle Heats Water Instantly. Just plug in the light socket. SELLS FAST and Pays Agents up to 178% PROFIT. No Risk SAMPLE OFFER. Write at once for details.

THE LUX COMPANY
Dept. H-119. Elkhart, Ind.

(Continued from page 149A) *21382*

sought for producing ingots of such refractory metals as tungsten and molybdenum. These metals require extremely high temperatures for melting and they have unsatisfactory characteristics after they are poured. Oxides of the metals were reduced to powder and the powder was compacted into ingots, which were put through a series of swaging operations and heat treatments. That solved the problem and this method of refining is still used for refractory metals. The tungsten filaments used in modern electric lights are a more recent development of the process, tungsten ingots being drawn through dies until reduced to the right diameters. For some small lamps the final diameter of the tungsten filament is one-tenth that of a human hair.

Powder metallurgy has made possible safer electrical switches, current interrupting devices, and electrodes by providing special mixtures of metals suited to the particular requirements of the electrical industry. Silver and molybdenum or copper and graphite may be united into mixtures that preserve the characteristics of each constituent, the last combination, for instance, serving as ideal current-collecting brushes in motors and dynamos.

Hard-cemented carbide compositions such as the tungsten carbide alloys and tantalum carbides, made possible by powder metallurgy, provide better tools and dies for cutting and working tough metals. For oil-well drilling, tungsten carbide is pressed into rods so that the material may be applied by electric welding to the faces and cutting edges of drilling bits, creating hard surfaces that wear more than four times longer than the best metals available previously. Tantalum and columbium, compressed from powder, are gaining extensive use in the vacuum-tube industry. As many as six elements have been compressed into one homogeneous compound, one example of multiple mixing being the permanent magnets pressed from powders of iron, cobalt, nickel and aluminum.

Another use to which the process is put is the creation of metal disks, sections of which are permanent magnets set in the nonmagnetic structure of the disk. This is done by pouring the right powders in their proper places in the mold.

(Continued to page 152A)



"You can earn \$150 to \$300 extra profit monthly with this HOBART WELDER"

30 Days Trial
in your shop on your own work to prove it
SEND for complete details

Get Into Arc Welding With Dependable, Long Life HOBART 40-Volt Equipment

You can now build a big paying business of your own with a new "Simplified" Hobart Arc Welder. Prices are the lowest in arc welding history . . . low enough to allow even the smallest shops to own one of these new welders. Extra profits will pay for it in a short time. And remember, there must be a good reason why Hobart is the fastest selling arc welder on the market today. Arc welding is today's profit opportunity . . . don't miss it!

Remote Control This is an important feature you get at no extra cost with Hobart. It lets you control your welder from any working point. Saves time, temper and eliminates the need for a helper on overhead or concealed work.

Easy to Operate Hobart Welders have "Simplified" operation. This means faster welding—with the right current for every job. Hobart is simplified, so any of your men can weld easily and successfully. The mystery and uncertainty of obtaining correct welding current settings are removed.

60% Extra Capacity Over old style 25-Volt Welders . . . necessary for welding with the new coated rods. Automatic reactance lets you handle light welder work without losing the arc. Users don't understand how they got along with old style welders after trying this new Hobart. Furnished in ELECTRIC DRIVE, GASOLINE ENGINE DRIVE, or GENERATOR ONLY.

"Pays-for-Itself" Terms You have 30 days trial at our risk to prove that extra earnings and savings obtainable with this improved welder makes it easy for you to own a Hobart with practically no cash outlay.

"Build Your Own" Let us tell you how you can build your own portable electric welder by using Hobart generator and coupling to your own engine and chassis. This equipment lets you operate any place, especially on the profitable outside jobs. Check coupon for detailed information.

HOBART One of the World's largest builders of Arc Welders

Own this PROFIT MAKER for only \$20 MONTHLY

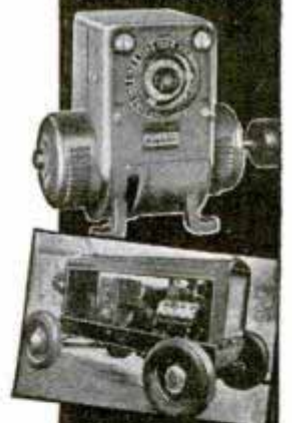

Build Your Own Arc Welder with above Hobart unit SAVES YOU \$300 TO \$500

Use this Coupon to get FREE Arc Welding Book



HOBART BROS. CO., Box M-340, Troy, Ohio

Tell me more about—

- Building My Own Portable Welder
- Complete Gas Engine Drive
- Electric Drive Welder
- Send FREE Book on "New Profits in Arc Welding"

Name

Address

Interested in 30 DAYS TRIAL, EASY TERMS

2138



Increase YOUR SKILL IN METALWORKING

It's easy to build model ships, trains, cars and planes by using Kester Metal Mender. There's a real satisfaction in making these miniatures and this handy home solder adds to your skill as a craftsman.

It's also easy to repair anything made of metal with Kester Metal Mender. All you do is apply heat and the flux, inside the solder itself, cleans the broken metal. Then the solder does a real job of mending.

Buy it at your hardware or other stores.

For a sizable free sample of Kester Metal Mender and "How-to-Use-It" Booklet — *Mail coupon now.*



KESTER METAL MENDER

Kester Solder Company, 4251 Wrightwood Ave., Chicago, Ill.

Please send me free sample of Kester Metal Mender and "How-to-Use-It" Booklet.

Name _____
Address _____
City _____ State _____

HOW TO GET A DAISY air Rifle for YOUR BIRTHDAY

If you have a birthday between now and July 15th send us your (1) Name (2) Your Complete Address (3) Date of Your Next Birthday. You'll receive a FREE Birthday Reminder Kit of printed material from us about 2 weeks before your birthday. Use the Kit to "sell" your folks on getting you that DAISY AIR RIFLE. It's fun using it. Get a swell Daisy NOW if you can—but if you can't—and want our "birthday help"—send name, address, birth date for

500
SHOT Repeating
Lightning-Loader
CARBINE
\$2.50 Higher
in Canada

FREE BIRTHDAY REMINDER KIT!

DAISY MANUFACTURING COMPANY, 543 Union St., Plymouth, Michigan, U.S.A.

FLEXIBLE ... transparent, waterproof

● Holds permanently on china, glass, wood, metal, leather, paper, fabrics. Not affected by heat, cold, moisture. Dries quickly. Ideal for model making, as well as for mending.

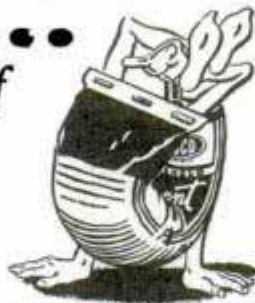

DUPONT DUCO CEMENT

CATCH MORE FISH

Send for **FREE BAIT BOOK**

This practical handbook, for fishermen, is a fascinating, reliable guide to better fishing! It tells how and why Creek Chub True-to-Nature Lures and Flies Catch More and Bigger Fish! Beautifully illustrated! Sent FREE upon request!

CREEK CHUB BAIT COMPANY
413 Randolph St. Garrett, Ind.



(Continued from page 151A)

Some thirty metals are now available in powdered form. Few alloys have been reduced to powder although it is expected that some alloy steels and most of the common non-ferrous alloys can be adapted to powder metallurgy.

Advantages of the process include the fact that delicate parts can be formed to precise dimensions without necessitating subsequent finishing, that metals can be mixed in the exact proportions desired, and that impurities sometimes unavoidable in casting may be excluded. Special structural effects not possible by the melting and casting process can be obtained. Metals difficult to alloy together because of great differences in melting temperatures may be combined easily. Practically no material is lost or wasted in powder metallurgy and in some cases production costs are lower than other methods.

On the other hand powder metallurgy has its limitations. The process is limited to the production of fairly simple shapes and does not compete with die casting in that respect. So far the technicians have been unable to "press around corners." Limitations in the sizes of molds and presses make the process applicable only to the manufacture of small objects of not more than several pounds in weight. Ultimately much larger objects may be pressed although costs probably would be extremely high.

Today, bearings, bushings, brushes, brakes, medals, coins, welding rods, resistances, magnets, thermostats, and lamp filaments are only a few of the objects produced in large quantities by powder metallurgy. Frequently the process is the answer to problems that can't be solved otherwise, an example of which is the new metallic "sponge" used to filter fuel in the injection apparatus of General Motors Diesel engines. In every field in which the process has been tried out its value has traveled far beyond original expectations and it now seems to be on the eve of further wide commercial applications.

Popular Mechanics Magazine can furnish the name and address of the maker of, or dealer in, any article described in its pages. If you wish this information, write to the Bureau of Information, inclosing a stamped, self-addressed envelope.



Here's Power for FARM, ROAD, BELT and SHOP WORK!

BUY AT NEW LOW PRICES!

● The newly developed, fully tested Master DU-ALL is the lowest priced quality riding tractor on the market today. It is a complete, all-purpose machine—fully equipped and powered for practically all tractor jobs. It cultivates, plows, hauls, runs belt equipment and does nearly all farm and workshop power jobs. Engine is air-cooled. Auto-like gear shift has three speeds forward and reverse. Idles to one-half mile per hour; speeds up to 7 miles per hour. Plant clearance, 16 inches. Turning radius, 5 feet. Rear wheel tread is adjustable from 17 to 30 inches between tires.

Burns kerosene or gasoline. Air or steel tires. Has tool control, convenient hitches and cultivating depth gauge. "Factory-to-you" selling plan makes this the biggest tractor bargain of the year. Mail coupon for full facts and low factory price!

Master
SHAW
"DU-ALL"
ALL-PURPOSE TRACTOR

● This complete 4-wheel tractor comes in 5 and 8 H.P. sizes. Two-wheel SHAW "DU-ALL" GARDEN TRACTORS in 2, 3, 4, and 5 H.P. 5 H.P. with single or twin cylinder engine.

10-DAY TRIAL OFFER—All Shaw Models can be tried for 10 days on your own place without risk. Mail coupon now for full details of this offer. See for yourself that you can actually get efficient, economical tractor power at unbelievable low cost.



NEW HI-ARCH MODEL

SHAW'S latest innovation; has 24-inch plant clearance under axles; 58-inch wheel-base; rear wheels have adjustable tread approximately 38 to 52 in. Has husky 8 H.P. Wisconsin engine. Will outwork the average team of horses or mules. Priced amazingly low. Mail coupon for price and full details.

SHAW MFG. CO.
4503 Front St., Galesburg, Kan.;
5812-G Magnolia Ave., Chicago, Ill.;
130-C West 42nd St., New York, N. Y.;
668-G North 4th St., Columbus, Ohio

Send FREE information checked below about SHAW DU-ALL TRACTORS.

Factory Prices and details on Master Shaw DU-ALL.
 Factory Prices and FREE Catalog on SHAW DU-ALL Garden Tractor.
 Factory Prices and details on High Arch Model.

Name

Address

Town..... State.....

A DEPENDABLE STEAM ENGINE for boat models up to 36" in length. Model SE-3, a two cylinder, slide-valve type. Bore 5/16", Stroke 1 1/2". Length 7". Width 3". Height 3 1/2". Price complete ready to run with burner and propeller... \$3.00 Postage extra, shipping weight 1 1/2 lb.

SHAWNEE ENGINE CO.
Box 162, Station D, Cincinnati, Ohio

Socony Vacuum Oil Company, Inc.
Marketers of Mobiloil Mobilgas

ITALIAN ACCORDIONS
HAND MADE. Very best. Lowest prices. Direct from Factory Representative. Send your name and address for FREE catalog.
ITALIAN ACCORDION COMPANY
323 W. POLK ST., DEPT. M-3 CHICAGO, ILL.

S AGENTS 300% Profit SIGN LETTERS
For Store Fronts and Office Windows. Anyone can put them on. Free Samples. Liberal Offer to general agents.
METALLIC LETTER CO., 438 N. Clark St., Chicago

HANDY TAPS and DIES...
Accurate—carefully hardened and tempered. Complete range of sizes at your local five and ten cent store
HENRY L. HANSON, WORCESTER, MASS

Calling all Cars
A MYSTERIOUS DISCOVERY
SAVES UP TO 30% on GASOLINE
or Costs Nothing to Try

Stop wasting Gas!—trim dollars off gas bills—get more power—quicker pickup—faster acceleration! AUTO OWNERS everywhere praise VACU-MATIC! Proven so efficient, it is guaranteed to satisfy, or the trial costs you nothing.

Automatic Supercharge Principle
Vacu-matic is entirely different! It operates on the supercharge principle by automatically adding a charge of extra oxygen, drawn free from the outer air into the heart of the gas mixture. It is entirely automatic and allows the motor to "breathe" at the correct time, opening and closing as required. Saves up to 30% on gas costs, with better motor performance.

FITS ALL CARS
Constructed of six parts fused into a single unit, adjusted and sealed at the factory. Easily and quickly installed by anyone in a few minutes.

AGENTS Get Yours FREE
FOR INTRODUCING. Here's a splendid opportunity for unusual sales and profits. Every car, truck, tractor owner a prospect. Send name and address now for big money making offer and how you can get yours Free.
The Vacu-matic Co., 7617- 503 W. State Street, Wauwatosa, Wis.

MYSTIC MIKE WIRELESS BROADCASTING OUTFIT

IT'S LIKE HAVING YOUR OWN BROADCASTING STATION

THOUSANDS PRAISE IT'S EXCELLENT PERFORMANCE AND CLEAR TONE

This set enables you to do YOUR OWN BROADCASTING from any part of your home with NO WIRES CONNECTED TO RADIO. Simply plug this unit into any AC or DC electric socket, speak or play music into the microphone and it will be picked up by ANY RADIO ANYWHERE within the same building. Has variable frequency control for easy radio dialing.

Use it for entertaining, auditions, rehearsals, etc., MYSTIC MIKE has endless possibilities. **ORDER TODAY!**

FREE Write for Bulletin P-3
OLSON MFG. CO., 362 Wooster Ave., Akron, Ohio

Tear out this ad, write name and address in margin. Send cash, check, or money order, or send \$1 and pay postman balance.

COMPLETE SET with TUBE and MILITARY TYPE MICROPHONE

\$3.95

ADD 25c POSTAGE

Nothing else to buy!
MONEY BACK GUARANTEE

READY CUT HOMES

\$416 and up. Freight paid. Save \$500 or more. Buy direct. Modern waste in production methods prevent material and assembly time. 75 home plans to select from, including 10 new feature 1940 designs. All modern, practical, distinctive, complete. Includes all for easy assembly. Includes lumber, insulation, roofing, bronze weather stripping, built-in features, attractive one-panel doors, latest hardware, nails, lath, paint, varnish. Also, summer cottages, garages, tour-ist cabins, etc. Information and plans for FHA Financing requirements on request. For new 1940 full color catalog, with floor plans, send 25 cents to cover mailing.

NEW COLOR CATALOG FOR ONLY 25¢

Dept. P.M.-30, International Mill and Timber Co., Bay City, Mich.



MYSTERIOUS

When I tell my agents they make 75c on every \$1.00 sale, they're mystified. Yet the secret is so simple, you'll "get it" in a split second. My deal is a whirlwind that sells at every door, handing out premiums. Rush your name for free facts and actual sample, all free. No money now or any time. Get in quick for your share of the "mystery" profit of 75c on every \$1.00. Send name to day to

ARWELL, INC., DEPARTMENT 53, WAUKEGAN, ILL.

WHY BUILD YOUR OWN TRAILER?

When you can buy this big 17-ft. Streamlined, Factory-built Trotwood ECONOMY model for what the materials alone would cost you. Think of it! Fully equipped with big wardrobe; Drapes & Screens; Dinette; Luxurious Daveno; 6 & 10 volt lighting; Kitchenette; Cooking & Heating Stove; water supply and refrigeration, for only \$375.00 at the factory, ready for the road. Better than any home-made trailer and has high re-sale value. Finest materials used. Send for new literature today. Buy Direct from Factory and Save!

TROTWOOD TRAILERS, Inc., 802 Main St., TROTWOOD, OHIO



New-TYPE Cheap OIL BURNER INVENTED Sweeping the Country!

COOK and HEAT Without Coal or Wood

In Your Present Stove or Furnace—**HOTTER—No Drudgery, Dirt or Ashes—More Heat Quick at SMALL COST.**

OVER 40,000 SOLD

Beats any cheap burner ever gotten out for low cost, perfect performance. Burns cheap oil a new way, without pre-generating or clogging up. Quick intense heat by Simple Turn of Valve.

AGENTS Salesmen BIG MONEY

F. Silver says: "I can dispose of 250 HEAT KINGS before this year ends." Sample Burner FREE to producers. Write us now for agents' offer.

GUARANTEED



Slips into Any STOVE RANGE or FURNACE

Quick HEAT At Turn of Valve!

Prove its efficiency, convenience and economical operation. Write Immediately for **FREE BURNER OFFER TO AGENTS** who will demonstrate and take orders. Write quick, be first to learn how to make **REAL MONEY** right now, spare or full time—mail 1c postcard today.

UNITED FACTORIES, C-751, Factory Bldg., Kansas City, Mo.

Decidedly Unusual . . . THURSTON'S 1940 CATALOG of "HARD-TO-GET" MATERIALS

For Homecrafters, Schools, Institutions, Antique, Novelty and Cabinet Shops

A few of the items we show: Chest hardware, locks, hinges, supports, casters, copper trim, etc. also midgets, overlays, etc. Finishing materials glue, stains, varnish, wax, flint and garnet papers, rubber sanding blocks, stick shelving, burnings in knives, etc. Upholstering supplies and coverings. Complete line of electrical findings for lamp manufacture, also cluster and indirect fixtures. Chair cane, woven and in strands, spline, reeds, fibre cord, etc. Trays for smoking stands and glass liners. Large line electric and spring clock movements, with and without dials. Complete line Venetian Blind hardware, tapes and cords. Table slides and leaf supports. Tea wagon wheels and casters. Wood dowels, also dowel screws, dowel centers, wood screw hole buttons. Excellent line card table leg supports. Bed hardware of every description. Desk pens, complete with funnel and fastening, without base. Water transfers, inlays, small moldings, etc. Furniture glides and casters, office chair spiders, wood legs and K. D. chair frames. Small box hardware of every description. Large selection pulls, knobs, handles, hinges, locks, catches, etc. Perforated steel panels, chair braces, revolving chair fixtures, rocker springs, candlestick sockets, bill board clamps, banquet table equipment, many sizes braces, corner irons, hanger bolts. Step ladder braces, pillar strips, sliding track and sheaves. Typewriter desk hardware, binoculars, mirrors, nut bowl hardware. Bar pins for novelties. Catalin Plastics. Crib hardware, swivel top table fixtures, sectional bookcase hardware, clamp nails, electric pens for burning, etc., etc. Send 10c cash or stamps.

THURSTON SUPPLY COMPANY, Dept. P.M., ANOKA, MINN.

FIRE EXTINGUISHER only \$3.95 Complete

Full quart size—pump type—with fluid and bracket at a **LOW PRICE!** For boats, cars, trailers, shops, homes, etc. Complies with government regulations for motor boats. If your dealer can't supply send \$3.95 and we pay postage. We have no agents, but sell through established firms.

JAMES KING & CO., 523 S. W. Pine St., Portland, Oregon



New 1940 WOODWORKERS Catalog

Latest, most complete list of rare woods in lumber, veneer, mouldings, plywood—at attractive money-saving prices. Finest list of inlays ever offered—with inlay pictures and kits. Full line of cabinet hardware and workshop accessories. Send only 10¢ for this big book of valuable craft information.

Woodcraft Supply Company—417 N. Hoyne—Chicago, Ill.



GET THIS SEAT WEAVING BOOKLET!

Complete, illustrated 24 page manual on fascinating art of Seat Weaving. Learn this useful, profitable craft easily. We furnish all materials. Send ten cents for booklet and price list.

H. H. PERKINS COMPANY, 266 SHELTON AVE., NEW HAVEN, CONN.

Looking for a Good Job?

Employment Manager who knows the ropes has prepared unique booklet of proved plans and inside hints on how to **GET A GOOD JOB**, a raise or promotion. Send 25 cents today. Nothing else to buy.

J. A. Bannick, Box 55, Harper Station, Detroit, Michigan.

"FIRST CHOICE" No. 60 Sport Model

—in KNIVES

Byrd, Peary, Lindbergh and other famous names top the list of explorers and sportsmen who know that—

MARBLER'S Knives give the utmost in service and satisfaction. No. 49—4 1/2 in. blade, \$2.00; No. 60—4 in. blade, \$1.50. Prices include sheath. At Dealers or direct. Write for catalog. (A-149)

Marble Arms & Mfg. Co. 578 Delta Avenue Gladstone, Mich., U.S.A.



BUSINESS OPPORTUNITY

During the next 60 days we expect to appoint a number of reliable middle age men as Distributors in several hundred counties. Desire men who can operate car and also do service business with old and new customers. Connection offers opportunity for steady and profitable year around business. No high pressure salesmen desired. Large nationally known concern. Write details, age, former work, and reference. Address your reply to Manufacturer, P. O. Box 983—Dept. 90-51, Dayton, Ohio



Say you saw it in

POPULAR MECHANICS

Cameraman at the Front

(Continued from page 332)

through the bridges without doing real damage and exploded in the water.

From the bridge we proceeded to a hospital that had just been bombed. Five direct hits had been made by 500-pounders on the hospital and its grounds, blasting thirty-foot craters. I clambered into these holes, shot pictures from the second story of a ruined building near by, and then went into the hospital. Everything was in ruins, beds were covered with plaster, on one bedside table stood bowls of soup and half-finished plates of food, and one end of the building was shot away and you felt as if you were in a doll house with all three floors exposed. Next day I photographed another vast crater in the center of a street; luckily an air-raid alarm had sent everyone to cover, and no one was killed. Even the buildings on either side were scarcely damaged, for the main force of these explosions is upward.

This brings up an interesting theory from which you can compute your chances under bombardment. Even in crowded Warsaw, less than twenty-five per cent of the total area is covered with buildings; the rest is streets, parks, rivers, etc. Thus, of a thousand bombs dropped indiscriminately, only 250 would ordinarily strike buildings.

Just around the corner a 500-pounder pierced a five-story modern apartment. It looked as though a giant ice-cream scoop had slashed out the central section. Fourteen women and children were killed, twenty wounded. I photographed them. It was not pleasant, it was horror; but I was not making a travelogue, I was making an historical record on film of what happens in modern war.

Fortunately I had plenty of film, for supplies were at a premium. In a maternity hospital I had occasion to use the three photo-flood lamps I carried, photographing pathetic women with new-born babies resting on the tile floor of the cellar. And from there we went to the Eastman Kodak laboratory, still open, to have six rolls developed. At 4:30 the film was put in the developer and I started home. The mile-and-a-half walk seemed endless, for the streets were now heavily strafed by small artillery, three, four-and-a-half and six-

(Continued to page 157A)

BIG MONEY!

ASSEMBLING MEAD'S

NEW PORTABLE KI-YAK

IN A FEW DAYS AT HOME!



—from Complete
Cut-To-Fit Construction
Kit!

Weight
as little
as 20 LBS.

Use with PADDLE!
OARS! SAIL! MOTOR!

Assemble for PROFIT
or Personal FUN!
NO Experience Needed!

MEAD'S perfected, patented, aluminum-ribbed Cut-To-Fit Construction Kit GUARANTEES successful assembly easily, quickly, *INEX-PENSIVELY*—in a few days at home with simple hand tools without previous experience. Build yours for personal sport use, or sell at splendid profit! Mead's quality KI-YAKS (available in 5 models, kits or factory assembled) are beautiful and PORTABLE. Take yours anywhere by hand or car for sailing, fishing, touring, fishing, camping, hunting. Leak-proof. Sensitive. Durable. THOUSANDS in use. Strong as a giant—light as a feather! More fun at less cost! Double-Blade Paddle or Oars now included with your KIT! Write or Rush Coupon below for Free Colored Circular, low Factory-To-You price!



OK-2

Weights only 50 lbs.
Takes ANY Outboard
4 1/2 H. P. or less!

Carry motor in one hand—OK-2 in other!

AMAZING LOW COST!

Don't buy any boat until you see the low Factory-To-You Prices on MEAD KI-YAK Construction Kits and Factory-Built jobs. (You can even Pay As You Build, on our special Progressive Group plan!) EARN money assembling, selling! Remember, Mead KI-YAKS are unsurpassed . . . the lightest, strongest, most portable boats of their kind! Join in the FUN—and PROFITS being made. Rush Coupon NOW for full Free details BEFORE prices go up!



OK-2 as rowboat



OK-2 as motor boat. Convertible in 10 minutes into fast sailboat.

Mail Coupon NOW!

Write for lavishly illustrated
FREE
Circulars!

Gentlemen:
Please rush your FREE New Colored KI-YAK Circulars, low Factory-To-You Prices! (Please Print Plainly.)

NAME

STREET & NO.

CITY STATE

MEAD GLIDERS
15 S. MARKET ST. Dept. B-30 CHICAGO, U.S.A.

KILL RATS WITHOUT POISON

YOUR MONEY BACK IF RATS DON'T DIE



K-R-O won't kill Livestock, Pets or Poultry; Gets Rats Every Time. K-R-O is made from Red Squill, a raticide recommended by U.S. Dept. Agr. (Bul. 1533). Ready-Mixed, for homes, 35¢ and \$1.00; Powder, for farms, 75¢. All Drug and Seed Stores. Damage each rat does costs you \$2.00 a year. K-R-O Co., Springfield, O.

K-R-O KILLS RATS ONLY

MAKE MONEY AT HOME

RUBBER MOLDS

Low as **6¢** EA.



Amazing rubber mold-making outfit makes perfect flexible molds of plaques, ash trays, book-ends, etc. Molds cost from 6c to 25c each. Each mold makes hundreds of novelties and gifts to sell up to \$1.00 apiece! No experience necessary. Quick and easy. Start profitable business in your home. Sell to stores, gift shops, friends, resorts, road stands, by mail. Full or spare time. "Molders Handy Book" and list of buyers FREE. Write

SO-LO WORKS

Dept. E-827

Cincinnati, Ohio

WITTE DIESELECTRIC PLANTS**Power and Light for 1c a Kilowatt**

Make your own electricity at this amazingly low cost. Quality built, dependable, efficient WITTE Diesels operate on cheap, non-explosive fuel. Rugged, compact, easy to install, simple to operate. 1500 to 8000 Watts; vertical, horizontal. Easy to buy. Pay for themselves out of savings. WRITE now for literature and name of dealer.

WITTE ENGINE WORKS

1743 OAKLAND AVE. KANSAS CITY, MO.

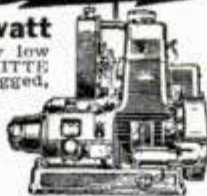

FREE CAMERA BOOK

Timely "Buys" on Rising Market

Illustrates and compares hundreds of amazing, money-saving Bargains in still and movie Cameras, Lenses, Films, Exposure Meters, Enlargers, Darkroom Supplies. Used equipment accepted in trade. Money-back guarantee! WRITE!

CAMERA CO., Dept. C-16
230 S. Wabash Avenue
Chicago, Illinois

Send to **CENTRAL**

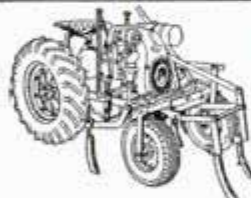

SPEEDEX
GARDEN TRACTORS

Built to give years of service. Hundreds in use. **Low Factory to User Prices.** Several models available. 5-H.P. Riding type also Walking types in three sizes. Light Power Cultivator now only \$77.50. Write for Free Illustrated folder.

POND GARDEN TRACTOR CO., Box 216, Dept. 103, Ravenna, O.

Yes! YOU CAN MAKE BIG MONEY WITH HOOVER UNIFORMS!



Big earnings for ambitious men and women in new uncrowded field with famous nationally-advertised Hoover line of smart, exclusive Uniforms for restaurants, hotels, taverns, stores, offices, doctors, dentists, etc. Not house-to-house. No experience—no money needed to get into this new, big-income business. Mail postcard now for beautiful new Uniform Style presentation, actual samples and money-making equipment—sent FREE.

HOOVER 251 West 19th Street
Dept. BK-10 New York

Helps You **EARN MORE**

SAVES TIME and MONEY



Thousands of Money-Making, Time and Labor-Saving Ideas You Can Use

Shop Notes will help you on your job—on home repairs—on the farm—in hundreds of different ways—will make money for you and save you time and money.

If you do machine shop work of any kind, sheet-metal work, painting, carpentry, auto repairing, farming, concrete work, plumbing, electrical work, welding, building, glass work, general repairing, tool-making, poultry raising, masonry or home repair work, you need the Shop Notes Library.

NOW READY—

SHOP NOTES for 1940

214 Pages • 384 Articles • 762 Illustrations

Just published—the world's biggest 50 cents' worth. Packed with new shop kinks, short cuts, helpful ideas, time and labor saving methods you can use. Here are just a few of the many subjects covered:

Novelty Paint Finishes	Building and Using a Wattmeter
Auto Mechanics	Cementing Glass, Metal and Celluloid
Drill-Vise Milling Unit	Making Precision Machine Tools
Density Meter for Separation	Tricks of Soldering
Negatives	Universal Photo Enlarger
Modern Plant Stands	Wood Finishing
Hand Loom Weaves Cane Webbing	Paint Straying
High-Speed Cutting with Abrasive Wheels	Negative Dryer
Motorized Lawn Mower	Making Silk Stencils
Making Choke Coils	Tap and Die Holders
Gem-Cutting Bench	Correct Centering
Tractor Built from Old Car Parts	Motorized Garage Doors
Making Unit Castings	

Special BARGAIN OFFER

7 SHOP NOTES VOLUMES While Present Supply Lasts \$2.98

Start your Shop Notes Library now. We will send seven issues, (approximately 400 articles in each) now in print, including the new 1940 Shop Notes and those published in 1932-1935-1936-1937-1938 and 1939—7 Shop Notes in all—for only \$2.98. Single books 50 cents each. Offer withdrawn when present supply is sold. Order today and avoid disappointment. If you have earlier years, rush order for 1940 Shop Notes. Money refunded if not satisfied.

Mail Coupon... Pay Postman

POPULAR MECHANICS PRESS, DEPT. 403
200 East Ontario St., Chicago

Send 7 Volumes Shop Notes Library as offered. I enclose \$2.98
 Send C. O. D. I will pay postman price and small amount of postage.
 Send 1940 Shop Notes at once. Remittance for 50 cents enclosed.

Name.....

Address.....

City..... State.....

*C. O. D. applies to U. S. and possessions only. If you reside elsewhere, remittance must accompany order.

(Continued from page 155A)

inch shells that did little damage to buildings but were timed to explode fifty to 100 yards in the air and spray hot steel on pedestrians. This turned out to be Warsaw's most terrible form of punishment, calculated to paralyze street traffic and end civilian resistance. Luckily, civilian France and England will be free of shell fire unless the Maginot line crumbles or England's soil is invaded. Bombs were bad enough, but when the German guns came close enough to shell the city we figured fifty to 100 shells exploded for every bomb dropped, and that 10,000 to 30,000 shells fell daily.

But to return to the kodak laboratory. The two Eastman men took my films out at five o'clock, put them in the hypo, and at 5:25 placed them in a tank of water. For a minute or two they left the room. While they were gone, at 5:30, a six-inch German shell made a direct hit, smashed the laboratory wall and ruined the developing tank. By an amazing stroke of luck the water tank six feet away was not touched. Most of the pictures appearing here were enlarged from those six rolls.

That night I waited late at the embassy for Thaddeus, my interpreter, and the car. At last there was a timid knock. Thaddeus came in, his arm bandaged, blood on a hole at the shoulder of his uniform. He was very apologetic about being late. The car had been hit, all four men injured, one probably fatally. After that we had to walk, carrying cameras and film.

A strange aspect of life toward the last was that, unlike most wars, soldiers and civilians were thrown much together. Front lines were just at the edge of the city, and soldiers came back each day to their families. Meanwhile civilians were busy digging trenches for the soldiers, sticking street-car rails into street pavements at an angle to block tank attacks, and building barricades. Despite bad organization it was amazing how spontaneously the entire population worked.

How does a city go on living, without shelter, with traffic paralyzed, with public utilities and supplies cut off? Next month I shall tell of my last days in Warsaw, of my interview with war prisoners, my escape across "No Man's Land" with my pictures to Germany, and flight from Germany to the United States.

(Concluded next month)

21409

Neptune Ned KNOWS:



I've seen 'em come an' I've seen 'em go, but—man, woman an' child—durned if they ain't most all gettin' NEPTUNES this year!

★

Sez I to one of 'em, "I see ye got a motor there, son." He climbs in, gives 'er a flick—like that—an' she starts to purr, an' he yells back, "Cain't afford not to have one at NEPTUNE'S price." An' he wuz right!

By cracky, the feller that ketches fish is the one that keeps fishin' 'stead of rowin' and wishin'.

BUY A NEPTUNE!
 Sizes from 1.2 H. P. to 16 H. P.
 Send for FREE Illustrated Literature
MUNCIE GEAR WORKS Inc. ★ Muncie, Indiana
 New York Office 45 E. 17th St. Graneray 7-6310

NEPTUNE
Motors
BUILT FOR SALT WATER AS WELL AS FRESH WATER

No Bite! — No Juice!

from the guaranteed **SEPRABOL PIPE**

You will get undreamed of smoking pleasure from a SEPRABOL PIPE. It's guaranteed not to bite, smoke hot or get soggy. Start enjoying this handsome pipe now.



A new, exclusive two-bowl principle protects your health . . . adds to the rich tobacco flavor . . . and is easy to clean. No wasteful, gummy heel. No unpleasant odors . . . no metal. Doesn't cause heart-burn or upset digestion. A fine briar pipe endorsed by smokers everywhere. A gift appreciated by every smoker.

The smoke is filtered through your favorite tobacco so it is always cool and dry.

GUARANTEE

Purchase price plus postage refunded if you are not completely satisfied.

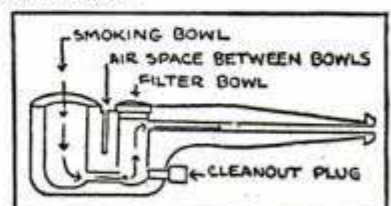

Ask your dealer or write for your SEPRABOL PIPE today.

Only \$3.50 postpaid

SEPRABOL PIPE CO. 365 Central Ave., Dept. P. M.
 ATLANTA, GA.

Always write your name and full address clearly when answering advertisements.

FOR MACROPHOTOGRAPHY



New!

\$17.50

Here's a copying stand at a popular price which permits the Mercury Camera to be used for photographing small objects or flat work at close range. Invaluable for all candid fans—as well as scientists, librarians, physicians, students and business firms. Endorsed by various government bureaus. Ideally adapted for Macro photography and Photomicrography because its Tricolor lens has a circle of confusion of only 1/1000th of an inch—thus insuring ultra sharp negatives. Four extension tubes and a shim are available at extra cost, which may be used for photographing fields from 9" x 11 1/2" down to 3 1/8" x 3 1/4". Each tube covers a different field size. **FREE BOOKLET!** Send for it today! Department S-3, Universal Camera Corporation, New York . . . Chicago . . . Hollywood

MERCURY COPYING STAND

"MARVEL-OU'S" TRAILER PARTS

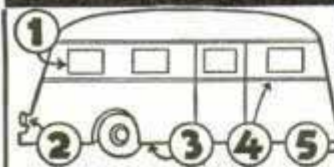

(1) "Famous" Marvel Windows, (2) tail lights, (3) complete undercarriage equipment, (4) body moldings, (5) couplers. Also refrigerators, stoves, lighting fixtures, everything you need in highest quality. Largest trailer equipment stock in U. S. Immediate delivery, low prices. Send 10c coin for 40-page ill. catalog.

Marvel Trailer Parts Co., 19020 Celestine Ave., Detroit, Mich.

NEW SCIENTIFIC WONDER

"X-RAY" CURIO

10c
3 for
25c



Reg. U.S. Pat. Off.

"Silver Only"
BOYS BIG FUN. You apparently see thru cloth, Wood, Stone, any object. See Bones in Flesh. **FREE PACKAGE** radio picture films, take pictures without camera. **IT'S GREAT SPORT!** 1 package with each 25c order.
MARVEL MFG. CO., Dept. 75-B **DEVON, CONN.**



LEARN to PLAY BY EAR

Here is a wonderful NEW way to learn to play the piano, without notes, in as little as 90 DAYS. Play anything—swing to classical. **NEW SYSTEM** is easy. You don't have to practice scales, you don't have to study for years. Young or old have equal opportunities. Amaze your friends. Play for pleasure or for money. Cost is very low, payments easy. Send for complete FREE details. No obligation.
Karl Ostrum, Pres.
HARWOOD SCHOOL OF MUSIC DEPT. 32
500 N. Dearborn St. Chicago

BUILD MODEL COACH



18th Century Coach, 20" long. Complete Kit, drawings, wood, metal, upholstery, etc. Heavy cutting done. All parts sawed to shape. \$6.50 postpaid, or \$1.00 balance C. O. D.



YACHT ENTERPRISE

30" scale model. Kit includes all parts and drawings. Keel is ready-built with lead ballast. Semi-finished hull. \$6.00 postpaid. CATALOG of many low priced de luxe models for 3c stamp.

K. C. MODEL SUPPLY, DEPT. 20
2714 Summit St. Kansas City, Missouri

ARMATURE REWINDING



For Drills, sanders, grinders, oil burners, alemitte grease guns, vacuums, sewing machines, washers, refrigerators, mixers, hammers, saws, etc. Any make—any model. 1/4" drill 3.25, 3/8" 5.00, 1/2" 5.75, 5/8" 7.00, 3/4" 8.75, 7/8" 10.50, standard vacs 1.50, mixers, 2.50. **FINEST QUALITY GUARANTEED WORK.** Full line washer, vac parts, rebuilt cleaners in **FREE** 68 pg. dealers catalog.

TRIANGLE APPLIANCE COMPANY, 3250 Tyler Ave., Detroit, Mich.

IT'S EASY TO LEARN ARC WELDING

6 hours actual practice daily paves way for profitable jobs. Expert instructors—individual attention. A non-profit school—pay only for materials used. Enroll today. Three to four weeks qualifies you as good welding operator. Write for details.
HOBART WELDING SCHOOL, BOX M-3401, TROY, OHIO

Say you saw it in

POPULAR MECHANICS

Make Your Hobby and Spare Time Pay You EXTRA MONEY



Here are selected books to help you cash in on your hobby, earn extra money or establish a profitable business of your own. Pay postman or remit with order for pre-paid delivery. Money refunded if not satisfactory, if returned in 3 days.

ORDER UNDER MONEY-BACK PLAN

A SMALL BUSINESS OF YOUR OWN. Gives 1000 ways for a man with little or no capital to build a modest dependable business. \$1.00.

MAKING AMATEUR PHOTOGRAPHY PAY. Turn your prints into extra money. Tells what to take, where to submit and how to sell pictures. \$1.00.

TURN SCRAP INTO MONEY. Shows how to build power plants, 110 volt motors and generators, wind power plants and other electrical apparatus from old auto parts. \$1.00.

HOME AND WORKSHOP FORMULAS (HENLEY). 10,000 opportunities to make and save money through the use of these tested recipes, formulas and processes, etc. Tells how to make salable preparations of all kinds. 883 Pages. \$4.00.

A LIVING FROM THE LAND. The information that thousands of people have, who are seeking security and productive uses for their leisure time, want and need. \$1.50.

SHOE REPAIRING. Practical and simplified instruction on modern

shoe repair methods. Helps you save money on your own work and make money repairing for others. \$1.00.

AUTOMOBILE BODY AND FENDER REPAIRS. Covers thoroughly, the best paying end of the auto repair business. Prepares for regular job or good source of extra, spare time money. \$3.00.

PAINTING AND DECORATING. Use this book for complete study or to pick up extra money on spare time jobs. Includes estimating and cost figuring. \$1.50.

HIGH SCHOOL SELF TAUGHT. Complete four year high school course in one volume. Broaden your knowledge and increase your income with high school subjects. 1000 Pages. \$2.39.

BUSINESS COLLEGE SELF TAUGHT: Here's your practical training for business all in one handy volume, 15 courses covering all essential subjects taught in a modern business college. Over 1000 pages. Cloth. \$2.39.

POPULAR MECHANICS PRESS

Dept. 403 200 E. Ontario Street Chicago

Destroyer Versus Submarine

(Continued from page 351)

depth. One hundred feet. One-fifty. Two hundred. The engineer reported the engines had stopped. "Could they rest on the bottom while they were fixed?"

No! Too deep! The cold black water would crush the boat. Two hundred and fifty feet! The diving officer reported headway was lost, the hydroplanes no longer acted. The game was up. Either they had to go down and be drowned, or rise and face the guns of those destroyers. Amberger chose the mercy of American sailors over that of the sea and ordered the tanks blown.

American tars were amazed to see the submarine's stern suddenly break surface at a sharp angle, settle back as the conning tower and the hull appeared. Quickly guns were remanned, shots were fired, the "Nicholson" hastily ran up and dropped a depth charge. Then out of the conning-tower hatch crawled thirty men, arms upraised in surrender. Once again the strategy of the convoy had been proved.

Already in the current hostilities, Britain and France have reorganized the convoy system. Tonnage figures demonstrate that submarine warfare can cause losses and force the employment of hundreds of ships, thousands of men, to combat it, but the easy hunting is gone.

First defense against the U-boat is the mine field, sown outside harbors where subs are based. Mines are laid usually at night by submarines and trawlers, protected by destroyers and cruisers. They sink few subs, these mines, for they are swept up almost as fast as planted by trawlers and drifters. But they hamper the U-boat's movements; for frequently it takes two or three days to get one safely in or out of harbor.

During the World War the British admiralty plotted on a chart the approximate position of every U-boat, frequently posting its number, and the name of its commander. This information came from Naval Intelligence agents at the very bases of the U-boats. And sweeping operations caused enough delay so this information could reach London in time to be of use.

After a sub broke clear, its own radio gave it away, for whenever the radio spoke, direction finders got a fix, promptly

(Continued to page 160A)

Down Go PRICES!

On Fine
WOODS
and Craftsmen's Supplies

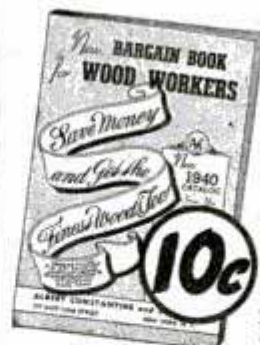

And what have you got against paying LESS for FINER woods? Top quality woods from all parts of the world—SEASONED and DRIED to PERFECTION! No checking! For 112 years the name CONSTANTINE in imported woods has stood for top quality just as now in the Craftsman field.

Save Up To \$15! Here's your answer to rising prices! Get our NEW 1940 Catalog and enjoy real BARGAINS! Imagine! 16 special offers on VENEERS. Save up to \$13.53! Fancy matched veneers, ideal for PLAQUE BACKS, DRESSER TOPS, DRAWER FRONTS, ART BOXES, CABINETS, TEA TRAYS, or other plain surfaces to decorate. On FACE VENEERS, save up to \$14.81!

Send For Bargain Book TODAY!

Full of surprises from cover to cover! Now, for the first time—**BURL TURNING BLOCKS!** Also **NEW INLAY BORDERS** in patterns never offered before! 15 Special Offers on LUMBER and TURNING SQUARES. Save up to \$3.88! HOLLY SQUARES—save up to \$15.88! On fine VENEERS, save \$15.33! Here's your chance... 45 SPECIAL Offers—a carnival of bargains on extra fine woods. You may never see such woods at these bed-rock prices again. Even if you don't need woods right now, scoop up these exciting VALUES, and salt them away! Send 10c for catalog TODAY, and find out how much you can SAVE!

Albert Constantine & Son, Inc.
791-H East 135th St., New York

Catalog Tells You:

How To Work With Inlays
Everything You Want To Know About Working With Veneers
How To Make Inlay Pictures (Experts' Secrets Simplified)
NEW Kind Of Veneer Press (Build It Yourself. Save \$22.50)
How To Finish Fine Woods And Bring Out All Their Natural Beauty.

RE-STRING RACKETS AT HOME

● EARN MONEY ●
WITH THE WONDER VISE



It's pleasant, profitable work. No experience or skill required. Easy to learn. Full line of guaranteed Stringing Tools, Frames, Gut and Silk Strings. Every item high quality.

W. A. BICKEL & CO.

137 N. Marion, Dept. A-30, Oak Park, Ill.



World's Smallest
Pocket Radio
NO TUBES
NO BATTERIES
NO PLUG IN

Midget radio fits your pocket or purse. Weighs only 4 ozs. Small as cigarette package! Receives stations with clear natural tone. "PATENTED FIXED CRYSTAL"—NO UPKEEP—only one moving part. "TUBELESS, BATTERYLESS." ENTIRELY NEW PATENTED DESIGN. Has enclosed geared luminous dial for perfect tuning. Many owners report amazing reception and distance.

ONE YEAR GUARANTEE

Sent completely ready to listen with instructions and Tinyphone for use in homes, offices, hotels, boats, in bed, etc. **TAKES ONLY A SECOND TO CONNECT—NO ELECTRICITY NEEDED! SEND NO MONEY!** Pay postman only \$2.99 plus postage on arrival or send \$2.99 (Check, M.O., Cash) and yours will be sent complete postpaid. A most unusual value. **ORDER NOW! MIDGET RADIO CO., Dept. P-3, Kearney, Nebr.**

ELECTRICITY

ANYWHERE

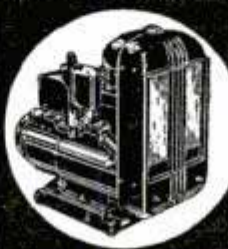

ONAN ELECTRIC PLANTS furnish 110 Volt, 60 Cycle, A. C. Current same as City Power Lines for Farms, Camps, Construction Jobs and Emergency Service in Hospitals, Schools, Theatres, Public Buildings. SAVE PROPERTY, even LIVES in case of Power Line Failure. Thousands in use in all parts of the World. Operate Lights, Radios, Water Systems, all Appliances. Models 350 to 50,000 Watts, 12, 32 and 110 Volt D. C.—110 or 220 Volt A. C. Also Combination A. C.-D. C. Units. Manual, Full-Automatic and Self-Starting Types. Shipped COMPLETE—READY TO RUN, \$99 and up. Write for details.

D. W. ONAN & SONS

1043 Royalston Ave. Minneapolis, Minn.

Remember! ONLY JOHNSON HAS ALL THREE

It's *twice* the fun to handle an outboard motor that reverses! It's *twice* the fun to run quietly—with a real, built-in underwater exhaust. It's *twice* the fun to give 'er the gun when you get smooth, Perfected Alternate Firing power! These are Johnson features and only Johnson has all three! Models as low as \$49.50 (f.o.b. factory).

FREE HANDY CHART Complete details on the eleven Sea-Horses for 1940 including new Hi-Powered alternate firing sensation and two Bantam Singles with 36% power increase. Sent free. Write!

JOHNSON MOTORS
400 Pershing Road., Waukegan, Ill.

912 58

(Continued from page 159A)

posted on the admiralty chart. Then, too, subs were constantly being sighted by fishing and patrol craft, or prospective victims. When a ship was attacked, its position was flashed before the victim plunged to its doom.

Then why weren't these U-boats sunk, if their location was known? Well, many were hunted down by plane and destroyer; but that is not so simple. It is one thing to draw a twenty-mile circle on a chart and say a submarine was there at 11:30 a.m. It is quite another to arrive in a destroyer two hours later and find that submarine.

For a sub can become invisible at will. On the hunt for prey, it cruises on the surface day and night, recharging the batteries on which it must operate when submerged. Lying low in the water, it can spot an enemy or victim ten to fifteen miles away, while it cannot ordinarily be spotted at farther than four or five miles.

But a submarine's invisibility ceases, temporarily, the moment it attacks. To use its deck gun, or board a ship to sink it with time bombs, it must come to the surface. The moment a torpedo is launched, the exhaust from its compressed-air motor leaves a telltale wake easily seen from a ship. The end of that wake marks the location of the submarine the moment the torpedo was fired. The submarine's speed, submerged, is only six to ten knots, so it takes an appreciable time to get very far from the end of that wake. On this fact the convoy system is founded. It forces the submarine to attack in the presence of swift destroyers, which can dash down that wake and sow depth bombs before the sub has time to get far enough away for safety.

The submarine cannot fight on anything like equal terms with a destroyer. Its narrow deck is a most unstable gun platform, making gunfire extremely erratic. A fishing smack armed with only a three-pounder has been known to defeat a U-boat, simply because the latter's crew could not make enough hits with its heavier gun before its fragile hull was riddled. A destroyer mounts heavier guns than a sub, and more of them; can move fast enough to select its own position and range, and can absorb many hits and still fight back. But any kind of a hit on a submarine will deprive it of power to submerge.

It is extremely difficult to torpedo a de-

(Continued to page 162A)

for SAFETY'S SAKE equip your car with a

NoRoL

- HOLDS CAR on UP-HILL STOPS
- leaves right foot free for accelerator

NoRoL gives you a "third foot" . . . It not only holds the car on up-hill stops, but it helps eliminate possible cause of clashing of transmission gears, lessens clutch-plate wear that would be caused by slipping clutch. . . Also helps quick getaway when traffic signal turns green. Right foot is relieved of brake duty, and is ready to step on the gas . . . Sturdily built for years of service.



When ordering a new car, specify that it come complete with a NoRoL. . . Also available for many 1937, 1938 and 1939 makes of cars and trucks having hydraulic brakes.

Many Models Only \$12.00 Installed
SEE YOUR CAR DEALER—or write us

N 40-7

Wagner Electric Corporation

(Manufacturers of Lockheed Hydraulic Brakes)
6400 Plymouth Avenue, St. Louis, Mo., U. S. A.

Send FREE CIRCULAR and details on NoRoL.

Name _____
Address _____ City _____
State _____ Make And Model Of My Car Is _____

**RIDE
RENT
OR SELL
THE**

MAKE BIG MONEY! NEW RANGER SCOOTER

The 1940 models are ready, and selling like hot cakes—but—order your demonstrator while territory is still open! **You can make money:** sell to stores for quick cheap delivery, or to riders who admire your demonstrator. Start your own delivery service. Rent for easy hourly profits at resorts, beaches, gas stations. **You can save money:** 120 miles per gallon, 30 m.p.h.! Store owners build up business by quick cheap deliveries. Employees going to work, farmers to town—a Ranger pays for itself. Vacationers cross U.S. for \$6.00 gas! Write for FREE details!

15 MODELS Solos, Tandems, Delivery, Sidecar —also Power-Units for bikes. All have the sparkling performance and reliability for which the Ranger is famous.

Specifications: 1½ or 2½ h.p. 4-cycle motor, positive oil pump lubrication, automotive float feed carburetor, clutch, starter, lights from generator, automatic 2-speed gearshift, all-steel X-member frame, spring fork, double tube balloon tires, finger tip controls.

**Write today
for Full Details!**

If you are in a position to sell or rent Ranger Scooters, there is good territory still open—but hurry! Please indicate if you are interested in sales or in personal use of Rangers.

EASY TERMS

available in most states.

**Amazing Low
Direct-To-
You Prices**



**CIRCULAR
FREE!**

**120 Miles
per gallon!**



Mead CYCLE COMPANY Ranger Bicycles
DEPT. H-1, CHICAGO For 50 Years

Write with Electricity

NEW MODEL ELECTROGRAF

Writes easily on the hardest metals or tools. Positively identifies your tools, protects against theft. Absolutely permanent. Requires few seconds only—anyone can operate. Pays for itself. A Money Maker. Order yours today—two for \$3.00 P.P. to agents. If M. O. or check accompanies order, we pay postage. AGENTS: Write today for our proposition.

\$1.98

POSTPAID **NATIONAL LABORATORIES, Portland, Ore.**

BOAT PATTERNS

full size, cut-to-shape; and blueprints. Big selection. Low prices. Send 10c (coin) for illust. catalog. "HOW TO BUILD BOATS" book, \$1.00 postpaid

Cleveland Boat Blueprint Co.
Station A-6 Cleveland, Ohio

MONEY IN RABBITS—CAVIES

WE BUY and put you in touch with other markets. Catalog and copy of magazine 10c. Or send 25c for Book Catalog and Price List and Year's Subscription to the AMERICAN SMALL STOCK FARMER.

OUTDOOR ENTERPRISE CO., BOX 919, NEW CITY, N. Y.

Always write your name and full address clearly when answering advertisements.

Choose from World's Largest Line of Power Tools!

FREE New 1940 Catalog covers Metal and Woodworking Tools, accessories, motors for every purse. Write Walker-Turner Co., Inc., 130 South Ave., Plainfield, N. J.

DRIVER Engineered POWER TOOLS

EASY PROFITS IN PAINT SPRAYING

Paint walls, ceilings, screens, furniture, radiators, machinery faster, better! ¼ H. P. motor 110 Volt 60 Cycle AC, complete with Spray Gun, 15 ft. hose. Weighs only 44 lbs. Carry anywhere. **FULLY GUARANTEED.** Only \$31.15 f. o. b. Chicago. \$5 Deposit. Balance COD, or SEE YOUR DEALER. Circular FREE. Get started making money NOW!

\$31.15 Complete

Ideal Automatic Pump Co. Dept. PM-3, 801 Washington, Chicago

GET RID OF DRUDGERY

Write today for illustrated catalog and prices. Describes all models. Many exclusive features. Easy operating. It's fun to run a BOLENS. LAWN MOWERS & GARDEN TRACTORS

BOLENS PORT WASHINGTON, WIS.

3044 PARK ST.

PRESTO! ANYONE CAN MASTER GLAZE

LEAVES HARD GLASS-LIKE FINISH
EASY TO APPLY
PROTECTS THE SURFACE
NO SMEAR OR STREAKS AS WITH WAX
LASTS SIX MONTHS TO A YEAR

SEALS THE PORES OF THE SURFACE
WILL NOT FINGER-MARK
NO OILY FILM AS WITH POLISH

SAVES YOU MONEY

Car Owners! Meet Master Glaze—the sensationally different luster for new and used cars! Not a wax—not an oil polish—not a paint!—nothing that “smears” over the surface.

MASTER GLAZE is a unique discovery—a creamy liquid—quick and easy to apply! Gives a hard, glass-like surface. Even gasoline cannot dull it! Lasts six months to a year! Amazing luster—beautiful, sparkling clean and brilliant! Doesn't finger-mark—doesn't smear! A match box full glazes an entire car. Seals the pores—protects! **NOTHING LIKE IT!**

FREE Offer! Write now for FREE BOOK-LET and FREE TRIAL OFFER. Just send your name and address. Write **MASTER GLAZE CO., 7720-173 W. Harwood Ave., Milwaukee, Wis.**

AGENTS
An unusual opportunity! Quick, flashy demonstrator. Big profits. Good territory. Write today!

Say you saw it in Popular Mechanics!

(Continued from page 160A)

AT LAST!**A COMBINATION HI-SPEED
WOOD PLANER and FINISHER**FITS ANY
DRILL PRESS**\$7.50**

COMPLETE

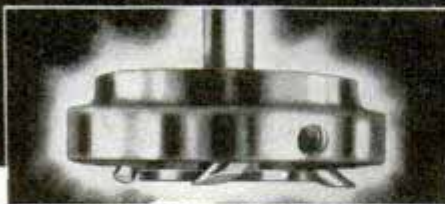
**COMPLETELY PLANES, FINISHES AND PARALLELS ANY BOARD — ELIMINATES HAND PLANING AND SANDING.**

A sensational, low priced, time-saving safety tool, accurate to .001 inch. Requires no sanding or smoothing. Planes every type of wood and plastics without scratching, marking, gouging or roughing. Parallels and surfaces—requiring 30 seconds to plane an 8" x 2" board with 1/32" cut or less. Finishes knots, hard grains and surrounding surfaces to agate smoothness. Unexcelled for cabinet and pattern makers, carpenters and home workshops. A lifetime tool for precision work.

**OUR MONEY BACK FREE TRIAL OFFER
TRY IT AND BE CONVINCED**

We will ship prepaid our new Hi-Speed Planer on full five day trial. Send check or money order for \$7.50. Or order C. O. D., paying small collection charge. If not 100 per cent satisfied, we refund full \$7.50. You risk nothing. FREE DESCRIPTIVE LITERATURE.

BERRY TOOL COMPANY, 314 Architects Bldg., Detroit, Mich.**FLAME-GUN Destroys Weeds****Does Work of 4 Men!**

Hauck Kerosene Flame-Gun—2000° F. controlled heat—quickly, easily, economically destroys weeds (seeds and all), brush, other objectionable growths. Keeps roadways, fences, irrigation ditches, orchards, etc., clean. Hundred and one uses. Inexpensive—Safe—Easy to use. Pays for itself in time and money saved. 10 day Free Trial. Write for Free booklet and special introductory price.

Hauck Mfg. Co., 134 Tenth St., Brooklyn, N. Y.

**AUTO ENGINE SPEED CONTROL
GOVERNORS**

Gives constant speed to any make of auto or truck engine, regardless of load changes, when used as a stationary or portable power plant. No better governor can be made. Fully guaranteed. \$5.00 up. No cash down. Courtesies to garages and established agencies. Free circulars. 129 Llewellyn St., Los Angeles.

**Earn a Suit AND UP TO
\$30 CASH****FOR A LITTLE SPARE TIME WORK**

Sell 6 Suits to friends and you get your own suit as a bonus without cost! Cash profit on each order, besides. It's so easy when you show our fine selection of attractive woolsens. UNION Made-to-Measure, \$20.95 and up. Cash or budget. Guaranteed to satisfy. Also ladies' suits. Earn extra money—build steady business, full or spare time. Big sample outfit FREE. HERBERT A. STRONG TAILORING CO., 2360 W. Wabansia Avenue, Chicago, Ill.

**HOW TO WORK IN
Wood**136 PAGES
Only **10¢**

L EARN the latest knack, e. g. how to finish 35 kinds of imported woods and domestic woods. — Up to date advice for EXPERTS; also detailed directions for BEGINNERS, showing how to make beautiful furniture the first week—and—

Up-to-date-bargains

123 special "deals"; about 300 furniture and scroll saw patterns showing exact price of materials. Bargains in woods, machinery, hardware, miscellanies of all kinds for craftsmen.

SEND ONLY 10c (currency or stamps) TO

CRAFTSMAN WOOD SERVICE CO.

2729 S. Mary St., Div. 3373 Chicago, Illinois

stroyer, because of its speed, ability to maneuver, and shallow draft. A torpedo moves through the water under its own power—a compressed-air motor. A gyroscope and fins hold it on a straight course. It is set to run submerged at a certain depth, usually about fifteen feet, and has a mechanism for maintaining that depth. If it runs too shallow, wave action will deflect it; and the depth required to insure its running true is greater than the draft of a destroyer—hence it frequently would pass under such a vessel without doing damage. Even in smooth water, where the torpedo need not run so deep, the speed of the destroyer will protect it. For a torpedo runs only forty to sixty miles an hour and can be avoided if its wake is seen in time.

One American contribution to the anti-submarine campaign was the sub-chaser, with its hydrophones. These chasers, operating in threes, would patrol sub-infested waters, listening for the characteristic sound of the U-boat's propeller. Having heard it, each of the trio would note the direction, lines would be plotted to obtain a fix, and the speedy little craft would dash to the scene, obtain another fix, then strew the area with depth bombs.

In the World War, 100 allied subs sank twenty U-boats, a better batting average than any type of surface craft obtained. Sub against sub was not a case of the blind groping after the blind. Submarines must spend more time on the surface than submerged, coming up to recharge batteries, so they can run under water. A sub cannot stay under without its electric motors driving it forward, any more than an airplane can stay up when its motor stops. Once the motors stop, a sub must either fill its ballast tanks and sink to the bottom, or blow them, and come up. In enemy waters, its commander never knows when he will be forced to make an emergency dive, and a long, submerged run. Therefore he must strive constantly to stay on the surface, so his batteries will have full charge when needed. The defending sub is not in this constant danger; it may recharge batteries at night, cruise submerged most of the day, keeping watch through the periscope. It can thus see the rival submarine, with its conning tower and deck exposed, without being seen; can steal up and discharge a torpedo into the fragile side of its unsuspecting opponent.

PRICE SMASHING SALE!

LATE MODEL • WORLD FAMOUS
TYPEWRITERS
 Less than $\frac{1}{2}$ MFRS. DRIG. PRICE



BUY DIRECT FROM ME and SAVE OVER ONE-HALF



Act now—if you want to get the **GREATEST BARGAINS EVER OFFERED** in late model standard office size world famous typewriters. My **DIRECT-TO-YOU** plan brings you these late Standard make Typewriters at **SENSATIONAL LOW PRICES**—at less than $\frac{1}{2}$ Mfrs. orig. price. Some even as low as \$26.90—less than $\frac{1}{2}$ mfrs. orig. price! Because I deal Direct With You—I give you **TREMENDOUS SAVINGS** on whatever standard make late model typewriter you choose.

ALL STANDARD MAKE LATE MODEL TYPEWRITERS!

Think of it!—you get typewriters that cost up to \$110.00 for less than $\frac{1}{2}$ the mfrs. orig. price—with amazing savings up to \$72.60. **UNDERWOOD—ROYAL—REMINGTON—L. C. SMITH—WOODSTOCK.** All with up-to-date features and **FULLY GUARANTEED.** Completely Refinished and Rebuilt with many late improvements. Do not confuse these fine late office size typewriters with old, inferior models or portables. I ship you only **GUARANTEED** Late Model Standard make machines at new sensationally **LOW ROCK BOTTOM PRICES.** I TAKE ALL THE RISK on my 10 day No Money Down trial Plan—the typewriter you select must sell itself on straight merit test and you are the sole judge.

OVER 200,000 SATISFIED CUSTOMERS BOUGHT FROM ME

Through the same Golden Rule Policy I offer you—the Ten Day Trial, No money down, **MONEY BACK GUARANTEE**—and shipment on approval, I have served over 200,000 customers all over the world. I give the savings of my direct-to-you plan to you, my customer. You can buy with confidence on my Personal Money Back Guarantee, backed by over a quarter-million assets and 30 years of fair dealing.

SEND COUPON NOW WHILE STOCK IS COMPLETE

Don't buy a typewriter until you get my **FREE BIG COLOR CATALOG** showing all late standard make typewriters at amazing smashed prices! **NO OBLIGATION**—it costs nothing to see—so fill out coupon and mail today. **INTERNATIONAL TYPEWRITER EXCHANGE, 231 W. MONROE ST., CHICAGO, ILL.**

FREE!

ROLL-AWAY-SECRETARIAL TYPEWRITER STAND



Big Working Surface

Two metal wings, correct working height.

All metal, mounted on castors.

Yours FREE with typewriter you select on this price smashing sale. *Makes every typewriter portable.* Can be moved by touch of finger. Strong, compact, rigid, attractive, light weight. Ask for details.

10 DAY TRIAL

No Money Down
EASY TERMS—50c^a week
MONEY BACK GUARANTEE

Yes, I mean it! I will ship your choice—**UNDERWOOD, ROYAL, REMINGTON, L. C. SMITH or WOODSTOCK**—at my own risk so you can try it in your own home or office for 10 days. *Don't even pay one cent down*—the typewriter comes to you strictly on approval. You are the sole judge—no salesman, no pressure—no obligation to buy. When you have thoroughly convinced yourself that you have the biggest value ever offered then say, "I'll buy." Use easiest terms yet—as little as 50c a week (only 8c a day) or \$2.00 a month!

FREE —Complete VAN ZANDT TOUCH TYPING COURSE!

I give you **FREE** this famous Home Study Course. Learn to type quickly and easily. **SEND COUPON** below for all details and **BIG FREE CATALOG** in natural colors. **NO OBLIGATION**—Mail Coupon today!

SEND COUPON FOR BIG FREE CATALOG!

Mr. W. F. Clausing, President,
INTERNATIONAL TYPEWRITER EXCHANGE
 231 W. Monroe St., Chicago, Illinois. Dept. 301

Please send **WITHOUT OBLIGATION** complete illustrated **FREE CATALOG** in colors, showing late model Standard **TYPEWRITERS** at tremendous savings, with no money down and 10 day Trial. Also Free Stand and Touch Typing course offer.

Name.....
 Address.....
 Town..... State.....

Free!
TO SHOP
MEN



New 1940 Catalog of SOUTH BEND LATHES



THIS new 48-page catalog describes the 1940 line of South Bend 9-inch Workshop Lathes. Twenty-three different models are listed at prices ranging from \$115.00 up, complete with drive equipment.

Improved engineering features of the new 1940 model lathes include quick change gear equipment making all power feeds and threads instantly available at the touch of a lever and an automatic apron with friction clutch drive for power cross feeds and power longitudinal feeds.

Attachments, chucks and tools for production manufacturing, precision tool room work, general machine work and automotive service machine work are also listed in this catalog.

SOUTH BEND LATHE WORKS, 603 E. Madison St., South Bend, Ind., U. S. A.

WRITE FOR YOUR COPY TODAY

6 SIZES OF SOUTH BEND LATHES

Manufactured in 9", 10", 11", 13", 14½" and 16" swing, in 3' to 12' bed lengths. Motor Drive or Counter-shaft Drive, Quick Change Gear or Standard Change Gear type.

SOUTH BEND LATHE WORKS
603 E. Madison St., South Bend, Ind., U. S. A.

Please send me Free your New 1940 Catalog of South Bend Lathes.

Size of Lathe _____

Name _____

Address _____

City _____ State _____

A copy of this new 9-inch Workshop Lathe Catalog will be mailed on request. Use the Coupon or a post card. State size of lathe best suited to your work.



SOUTH BEND *Precision* LATHES

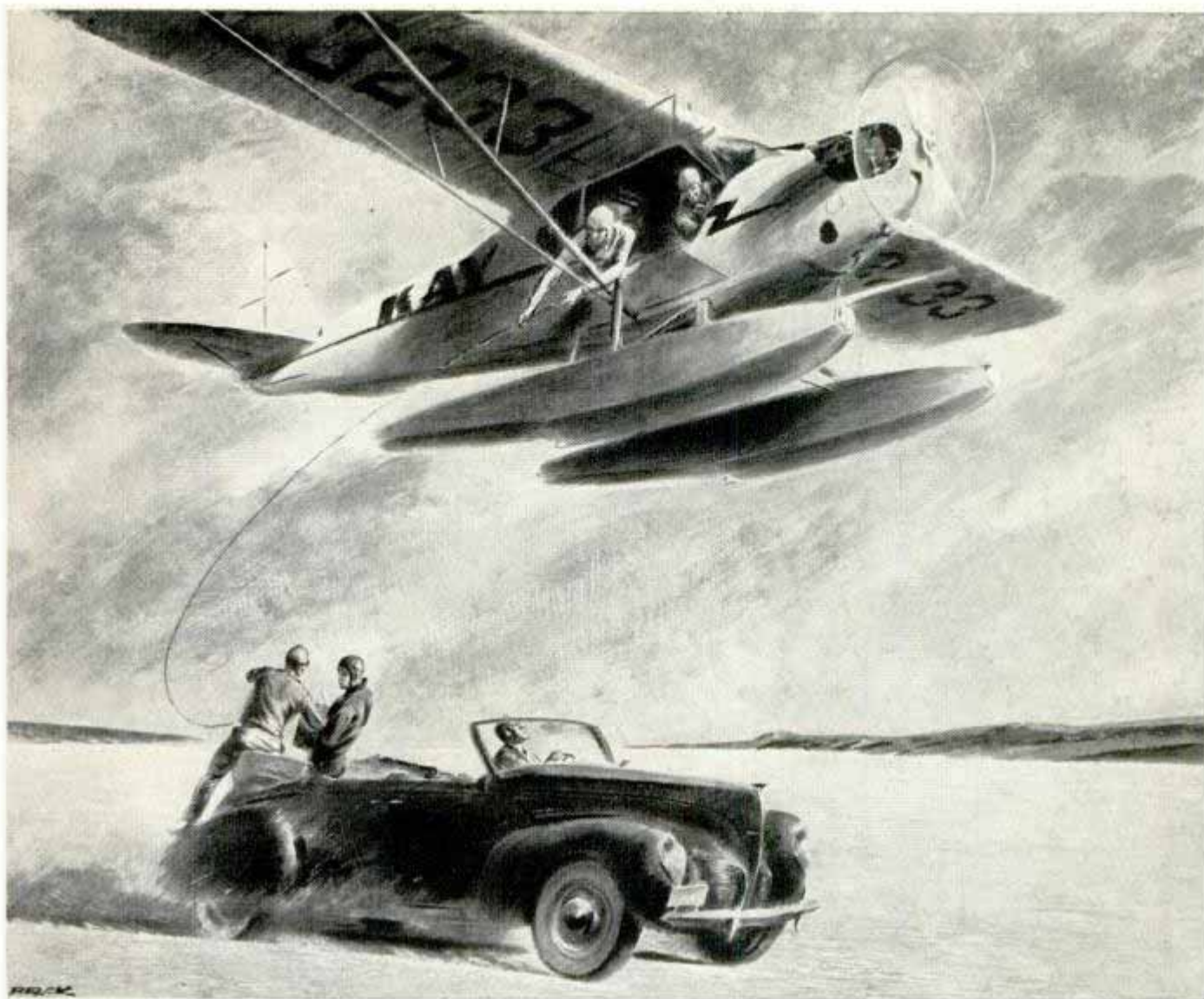

2 NEW WORLD'S ENDURANCE RECORDS PROVE CHAMPIONS THE BETTER SPARK PLUGS

It would be difficult to think of a more exacting test of spark plugs than that provided by two world airplane endurance (refueling) records recently set with Champion-equipped engines. Absolutely dependable ignition was imperative in both instances. Champion Spark Plugs provided perfect performance, as they have in practically every major racing and record breaking event on land, water and in the air for many years past.

Wes Carroll and Clyde Schlieper stayed aloft 726 continuous hours—30 days and 30 nights without a miss! More than 150,000,000 sparks were required to carry the ship roughly 55,000 miles, or more than twice around the world at the Equator. A week prior Robert McDaniels and Kelvin Baxter set

a new Class IS endurance record for light land planes of 535 hours.

Dependable ignition is more important to the performance of your car than ever before. Modern high compression engines and anti-knock fuels need the leak-proof qualities, the greater insulator strength and the all around better performance of Champions. Demand Champions for dependable service in every engine.

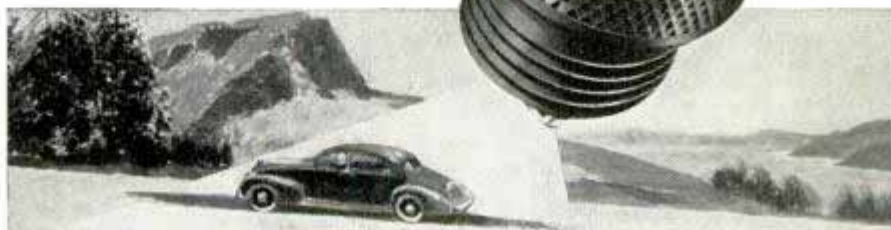

"I GET

EXTRA
MILDNESS

EXTRA
COOLNESS

EXTRA
FLAVOR

in slower-burning
Camels," says Bill Corum,
famed sports writer
and columnist



SURE
I WORK FAST—
BUT I LIKE MY
SMOKING SLOW.
MILDER, COOLER
CAMELS ARE CHAMPS
WITH ME

LIGHTNING-FAST in the press-box. Why, Bill Corum's been known to file 3,000 words of copy during a single big sports event. But no speed for him in smoking—slower-burning Camels are Bill Corum's cigarette.

And here's Bill at work in the quiet of his office. Bill . . . typewriter . . . books . . . pictures . . . and Camels—slow-burning Camels. "I find them milder and cooler—and thriftier," he says.

Copyright, 1940, R. J. Reynolds Tobacco Co., Winston-Salem, N. C.

BILL CORUM'S sports news isn't just printed...it's *sprinted*...at lightning speed from press-box to press and the Five-Star Final. But when the candid camera catches Bill in his office with a cigarette—well, "No speed for me in my smoking," he says.

His own common sense and smoking experience tell him what scientists have found out in their research laboratories—that "slow-burning cigarettes are extra mild, extra cool, fragrant, and flavorful."

Cigarettes that burn fast just naturally burn hot. And nothing

so surely wrecks the delicate elements of flavor and fragrance in a cigarette as excess heat. No wonder you get a hot, flat, unsatisfactory smoke.

The delightful mildness, coolness, fragrance, and flavor of Camels are explained by this important finding—Camels proved to be the *slowest*-burning cigarette of the sixteen largest-selling brands tested! (*The panel at the right explains the test.*)

So take a tip from Bill Corum—and find out for yourself how Camels give you more pleasure.

In recent laboratory tests, CAMELS burned 25% slower than the average of the 15 other of the largest-selling brands tested—slower than *any* of them. That means, on the average, a smoking *plus* equal to



5 EXTRA
SMOKES
PER
PACK!

MORE PLEASURE PER PUFF...MORE PUFFS PER PACK!

Camels—the cigarette of Costlier Tobaccos