



POPULAR MECHANICS



MAGAZINE

WRITTEN SO YOU CAN UNDERSTAND IT

**FEB.
25 CENTS**

SEE PAGE 246

WINNING RACES IN THE PITS

**MORE SPEED
MORE POWER
LESS WEIGHT
SMALLER OVERALL
DIMENSIONS**

★24000 R.P.M.★17 WATTS OUTPUT

★WEIGHT 12 OUNCES★6³/₈" LENGTH



**THE GRINDER
THAT COMBINE
THE BEST AT
LOWEST COST**

PRICE \$9.95



Vital Advantages Make The
NEW DURO STREAMLINE
the truly Modern Grinder

**THE FAMOUS
Heavy Duty
GRINDER**



Recognized by Industry and The Super Craftsman as the most powerful and durable tool on the market for all types of work.

A new field of usefulness has been opened for uses of this powerful tool by introduction of new attachments.

Lathe attachment to convert it into an accurate and fast cutting woodworking lathe.

Drill Press attachment to convert it into a sensitive type Drill Press for accurate and speedy work.

The Duro Heavy Duty Grinder has 42 watts output—ample power for woodturning or drilling without stalling.

Write for full particulars.

✓ Check the New Duro Streamline with any other grinder in this price field—compare its many advantages—contrast the super-abundance of power developed—its greater speed—its light weight and the ease of handling by actual tests. You will find the Duro Streamline a sensational value.

The New Duro Streamline is powered by a full universal General Electric motor of the same type that has made the Famous Heavy Duty Grinder so outstanding. 17 Watts output at the spindle means surplus power with which you can accomplish difficult jobs faster and easier. The high speed, 24,000 R.P.M., gives a smooth, finished cut on all types of work. Its light weight—only 12 ounces—plus its Streamline design makes it ideal for fine single hand work. It is only 6³/₈ inches in length.

The motor is enclosed in a shock-proof case. Self-aligned sleeve bearings of oil retaining bronze with oil wicks for continuous and perfect lubrication and trouble free service. Improved fan produces the necessary volume of air for efficient cooling. Square, replaceable brushes insure proper commutation. Push button type switch is flush with housing and is conveniently located for instant starting and stopping. Specially designed collet chuck holds 3/32" and 1/8" shanks.

Truly, this is the modern Grinder that every Craftsman will want to own. Send for one on our ten-day trial, money back guarantee.

Made By

The Manufacturers of America's Finest and Most Complete Line of Power Driven Machinery

DURO METAL PRODUCTS COMPANY

DEPT. P.M. 2, 2653 N. KILDARE AVE, CHICAGO, ILL.

DURO *Streamline*

**HAND
GRINDER**

Are worn-out spark plug cables robbing you

OF PICK-UP?

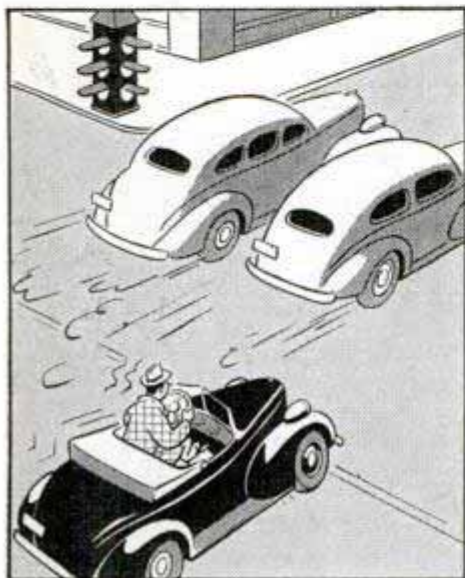

OF POWER?

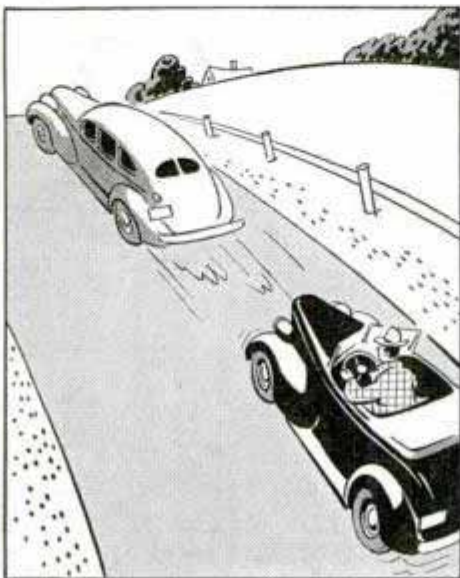

OF GOOD GAS MILEAGE?

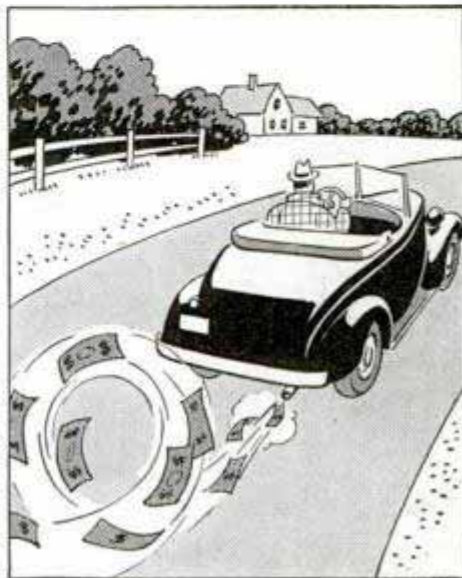

When you neglect the wiring in your car, you are getting short-changed both in money and in driving enjoyment. Worn-out spark plug cables reduce engine performance and economy; undersize or corroded battery cables starve your starting motor and coil, causing hard starting; faulty lighting wires and connections can cause greatly reduced headlight candlepower; and improper accessory wiring can spoil the performance of your radio. In addition, the poor condition of a cable in one circuit can do real harm to the electrical units in other circuits, and hand you a big repair bill.

YOU NEED PACKARD'S AUTHORIZED CERTIFIED RE-WIRING SERVICE



Go to a service station that offers Packard's Authorized Certified Re-Wiring Service. Many such stations are identified by blue-and-yellow Certified Re-Wiring signs; others do not yet have their signs but can be identified

by the mechanic's Certified Re-Wiring Certificate displayed inside, and by the Packard cable in stock.

Authorized Certified Re-Wiring Service is your assurance that the mechanic has the service infor-

mation and instruments to make a quick, accurate check for faulty cables and connections in your electrical system... that all necessary replacements which you authorize will be made with high quality Packard cable of the correct gauge and construction.

Packard cable is original equipment on the majority of American-made cars, trucks and buses. It's logical, therefore, to insist on Packard cable for your replacements. Packard Electric Division, General Motors Corporation, Warren, Ohio.

DEALERS AND MECHANICS

See your Packard jobber for information on Packard's Authorized Certified Re-Wiring Service. Includes 24-page illustrated service instruction book, "Copper Nerves," and full support in helping you offer this important service to the public.

Packard
REG. U.S. PAT. OFF.
TRADE MARK

THE STANDARD WIRING EQUIPMENT OF THE AUTOMOTIVE INDUSTRY



A NATION UNITED BY TELEPHONE

JUST twenty-five years ago, on January 25, 1915, the first transcontinental telephone call was made. East and West were united.

President Woodrow Wilson talked from the White House across the country, testifying to the nation's pride "that this vital cord should have been stretched across America as a sample of our energy and enterprise."

The inventor of the telephone, Alexander Graham

Bell, in New York, repeated across the continent to San Francisco the first words ever heard over a telephone—"Mr. Watson, come here, I want you"—to the same Thomas A. Watson who had heard them in the garret workshop in Boston in 1876.

That ceremony ushered in transcontinental service twenty-five years ago. At that time it cost \$20.70 to call San Francisco from New York. Now it costs \$6.50 for a

station-to-station call and only \$4.25 after seven in the evening and all day Sunday.

In 1915 it took about half an hour, on the average, to make a connection. Now most calls are put through without hanging up.

These are measures of progress in the never-ending effort of the Bell System to give faster, clearer, more useful and courteous service to the people of the United States.

BELL TELEPHONE SYSTEM



Say you saw it in Popular Mechanics!

Popular Mechanics Magazine

H. H. WINDSOR, Founder

H. H. WINDSOR, Jr., Editor and Publisher

February, 1940

Vol. 73, No. 2

IN THIS ISSUE

Wonder "Food" for Plants . . .	161
It's Easy to Fly Your Own . . .	168
Uncle Sam Helps Himself . . .	174
Winning Races in the Pits . . .	Coloroto
The Big Eye Takes Shape . . .	188
Super-Senses of Science . . .	194
There's Magic in Everything . . .	200
Radio Goes to War . . .	210
Army on Wheels—Part II . . .	216
The Young Giant of Sport . . .	226
The Rookie Goes to College . . .	232
How Long Can Germs Live? . . .	238
America's Dinner Rides the Rails . . .	242
Counting Noses . . .	248
Making Better Home Movies . . .	252

(Continued on next page)

Destroyer Versus Submarine

SHARP eyes on the destroyer's bridge catch a glimpse of a foamy "V" in the water. "Periscope!" The commander barks a swift order to the helmsman and the ship fairly heels over as the wheel spins and the greyhound bears down on that tiny wake that betrays a submarine. Other destroyers in the convoy join the chase, sweeping in wide circles and dropping depth charges that explode violent fountains at the surface and jar the ship now hiding 200 feet down. An article in the March issue will take you to sea to watch the war between those natural enemies, the submarine and the destroyer.

New Metals from Powder

METALS that never would mix when molten are being mixed today into new alloys by a method that is revolutionizing metallurgy. It is the "squeeze" process. Finely powdered metals are molded into useful shapes under pressures as high as 100 tons to the square inch. Some of the amazing results of this new technique are described in the next issue.

Next Month

GLASS used to be simply that brittle, transparent stuff of which windows and goblets were made. Today you can buy neckties and draperies of silky glass, woolly bats of glass for insulation, vacuum walls of glass brick and "sandwich" glass that will stop a bullet. Youngest of the family is the tough-tempered glass that stops a bowling ball dead, yet flies into a thousand fragments at the impact of a tiny dart. Next month "The Age of Glass" is revealed in an eight-page Coloroto section.

Cliff-Dwelling Hens

FORTY million hens that never saw a barnyard are living happily in wire cages, not a care on their minds except the business of producing eggs to pay their board and room. Their keepers are mechanics and clerks, teachers and business men who have found there's something to the claim of agricultural schools that you can clear \$2.50 a year on every laying hen. A feature in March tells how city and town folk are making money with cliff-dwelling hens.

Air Corps Hornets

SKIMMING just above the earth at four miles a minute, three flights of attack planes converge, seconds apart, on an enemy hangar. A master trigger is pressed and four machine guns in the wings strafe the ground. Bombs drop, and the blast jars the low-flying attackers dangerously. The "Hornets of the Air Corps" take the most chances, you'll agree. Read their story in March.

**THROUGH 48 STATES
IN 9 DAYS 21½ HOURS**
...BOB MCKENZIE'S TORTUROUS
RACE PROVES PYROIL'S RUGGEDNESS



OVER THIS PUNISHING ROUTE
Bob McKenzie raced hour
after hour to cover 9986
miles in less than 10 days

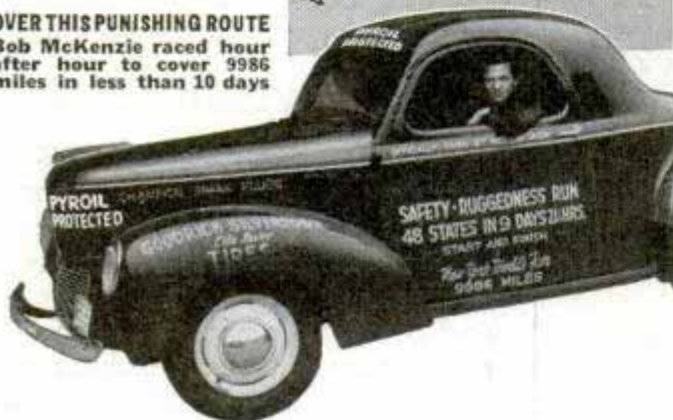

Nine thousand, nine hundred eighty-six miles through forty-eight states in less than ten days. Eight days through rain. One through deep snow. Temperatures from 30 to 86 degrees. That's the story of Bob McKenzie's recent record-breaking ruggedness run.

"For the entire trip," says McKenzie, "oil consumption was only 2 quarts with two changes. Motor temperatures stayed extremely low. The sealed radiator consumed but 1½ pints of water. Rings and valves worked perfectly. I give Pyroil due credit for this splendid performance."

Whether it is the extreme or the usual, Pyroil keeps cars running better because it is a SUPER lubricant. We can tell you exactly what you may expect from it when you use it in your car. Mail the coupon below for a Free booklet and a Free pamphlet that tell you everything about Pyroil. Meanwhile ask for Pyroil at your favorite Service Station or Garage, today. Manufactured and guaranteed by Pyroil Company, W. V. Kidder, Founder, 52 Pyroil Bldg., LaCrosse, Wisconsin, U. S. A.



DISTRIBUTORS:
CHECK AND MAIL
COUPON FOR FRAN-
CHISE FACTS.

ADD
MERELY
OUNCES TO
GAS & OIL

PYROIL COMPANY
52 Pyroil Bldg., LaCrosse, Wisconsin, U. S. A.
Please send your Free Pamphlet and Free Booklet telling
me all about what Pyroil is, what it does.
 Send details of your plan for Distributors,
Name.....
Address.....
City..... State.....

(Contents—Continued)

AUTOMOTIVE

Pliers with milled slots remove snap rings.....172
Tire has one white and one black sidewall.....172
Dashboard light warns when battery needs water...192
Oil-insulated ignition coil has hotter spark.....204
Incubator ambulance carries babies in safety.....221
Expander installed without removing piston.....230
Handy card file for automobile.....230
Swamp car pulls self through mud.....250
Sidecar loud speaker used by police.....251
Highway sign flashes when car passes.....255

AVIATION

Parking airplanes on their noses saves space.....165
Steel-hearted aerial camera.....166
Safety belt is worn like suspenders.....208
Mechanical brain computes "flight plan".....214
Target plane controlled by radio.....222
U. S. aircraft plants produce 15,000 a year.....224
Fliers watch own plane land by television.....237
Movies of takeoff help study of army planes.....240
Super-liner to fly 500 over Atlantic.....246
Fast scout plane joins navy.....255
Thermocouples on glider detect rising currents...128A

BOATS

Air-propelled boat glides over shallows.....166
Three-man submarine makes 1,800-foot dive.....176
Folding metal boat trailer.....187

HOUSEHOLD

Bed in "minute man" design trimmed with guns...165
Six-cup tray of ice "cones".....172
Electric biscuit baker for top of table.....192
Fan in furnace chamber saves lost heat.....214
Waffle iron and sandwich toaster in one.....221
Beanbag ash tray can't be upset.....236
Suction-cup hook serves as vacuum lever.....236
Weatherstrip put on without removing window...236
Vacuum cleaner bag is easy to empty.....245
Electric iron presses clothes on or off.....256

PHOTOGRAPHY

Low-cost photo print driers.....198
Camera attached to kite snaps aerial photos.....209
Flash bulb nicknamed "mighty midget".....251

RADIO AND ELECTRICITY

Antenna "paddles" sharpen television signals.....167
Tiny water-cooled lamps in giant searchlight.....198
Short-wave helmet delivers a radio facial.....208
"Hot sticks" repair high-power lines.....247
Improved radio equipment for small craft.....295
Beginner's two-tube flashlight-battery set.....296
Electrical recording for home or school.....298
Practical radio hints.....299
Combination reading lamp and radio for bedroom...300
Portable receiver works on batteries.....300
Small playroom phonograph is motor driven.....300

SCIENCE AND INDUSTRY

Stainless steel applied to iron at low cost.....167
Ear mask protects welder from flying sparks.....172
Side vision tested to find driving dangers.....185
Prefabricated track laid in sections.....186
Alcohol changes iron to steel.....187
Atom-smasher latest aid to science.....199
Safety-belt shock absorber breaks fall.....230
Gold made from platinum by radium gun.....240
Sun's corona poses for a television picture.....245
Lungfish shipped in can of dried mud.....250

WAR

Anti-aircraft searchlight has "outrigger" guide...167
Suit of armor worn by modern soldier.....204
Submarine freighter to evade sea raiders.....205

(Continued to page 6A)

BOY- WHAT SPORT MOTORCYCLING



YOU reel off new thrills every day when you ride a Harley-Davidson. It takes you where the fun's going on! You "ride the range" with other sport-loving motorcyclists — on club runs, gypsy tours, wonderful vacation trips — to hillclimbs, tourist trophy races and other exciting events. Get complete story and see the new 1940 models at your Harley-Davidson Dealer!

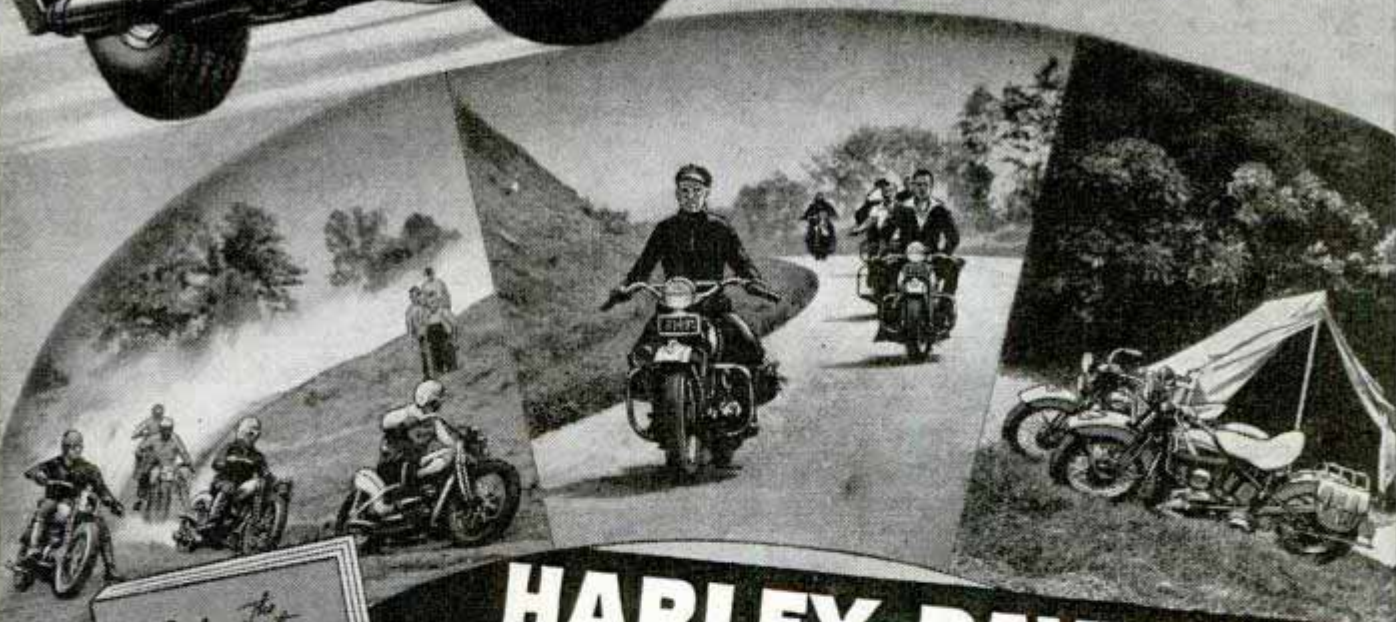

HARLEY-DAVIDSON

WORLD'S CHAMPION MOTORCYCLE



FREE

SEND COUPON NOW

HARLEY-DAVIDSON MOTOR CO., Dept. P., Milwaukee, Wis.
Send FREE copy of big 24-page "Enthusiast" motorcycling magazine filled with pictures and stories of exciting motorcycle doings. Also literature on new 1940 Harley-Davidsons. Stamp is enclosed for mailing cost.

Name.....
Address.....

Warning!

When You Say "Webster's Dictionary"
You MEAN the MERRIAM-Webster



Accept Nothing Less Than
the "SUPREME Authority"

LOOK FOR THIS CIRCULAR TRADE-MARK
AND THE "NW" MONOGRAM ON THE COVER.



THROUGH four generations Webster's Dictionary has earned and maintained first place among reference books. When you are confronted with any question of fact, whenever you need to know, you think of Webster as the utmost in authority, the judge of judges, the court of last appeal. That confidence is warranted only if you use the MERRIAM-Webster.

Why the Only Genuine Webster is the MERRIAM-Webster

At the death of Noah Webster in 1843, the G. & C. Merriam Company bought and paid for the exclusive rights to publish the only genuine Webster's Dictionary.

In an effort to preserve the integrity of the Webster name on dictionaries, the G. & C. Merriam Company obtained a Federal Court Injunction directing that the following statement appear plainly on the so-called "Webster" dictionaries there under consideration: "This dictionary is not published by the original publishers of Webster's Dictionary, or by their successors."

Look for the Merriam-Webster trade-mark. The New Second Edition of Webster's New International (unabridged) is twenty years newer than any similar dictionary and provides information in all branches of knowledge for today's needs.

Genuine Merriam-Websters are not sold in connection with any newspaper offer; they are not given as premiums with magazines.

GET THE BEST. 600,000 entries—122,000 more than in any other dictionary. 3,350 pages. Illustrations for 12,000 terms.

Any bookdealer will be glad to show it to you. Mail the coupon for free, illustrated, descriptive booklet.

G. & C. MERRIAM CO., DEPT. 380, SPRINGFIELD, MASS.

G. & C. MERRIAM Co., Dept. 380,
Springfield, Mass.

Please send me free illustrated booklet describing Webster's New International Dictionary, Second Edition—"The New Merriam-Webster: What It Will Do For You."

Name _____

Address _____

City _____ State _____

(Contents—Continued)

Camera fights paintbrush in camouflage war.....	215
Semi-automatic rifle for U. S. army.....	224
London is ready for "blackout" emergencies.....	231

MISCELLANEOUS

Ski-cycle and ice bike give thrills.....	185
Sun's heat trapped in roof to heat home.....	186
Mowing with rotating disks.....	192
Forest-fire fighters parachute into treetops.....	193
Vise holds work at angle for machining.....	198
Bicycle converted into tandem.....	204
Giant oxen and covered wagon.....	205
Chart plots danger of fire from forest conditions.....	224
Interlocking steel shingle is waterproof.....	225
Slingshot marksman rivals pistol tricks.....	225
Telescope on car sells peeks at prison.....	236
Pillow slips and "dry diving" beach fun.....	241
Model steel mill carved from wood and ivory.....	247
Picture "painted" with inlaid wood.....	250
Mines and bridges tested in centrifuge.....	256
Storage battery for flashlight.....	256
Double-deck ambulance cart wheeled by hand....	122A

Craftsman and Shop Notes

AUTOMOTIVE

Streamlined midget trailer.....	284
Celluloid protects upholstery at bottom of door....	318
Hub cap raises wheel to put on chains.....	318
Quieting noisy hood fasteners.....	318
Truck endgate serves as step.....	318
Vacuum cup covers lock to prevent freezing.....	318
Auto shortcuts.....	319
Bleeding hydraulic brakes easily.....	320
Oily waste lubricates springs.....	320
Shields for bumper guards to prevent scratching..	320
Warning system aids truck backing to platform....	320

ELECTRICAL

Shock absorber protects flashlight bulb.....	260
Brass shim stops relay sticking.....	268
Simple tester for short circuits.....	294
Homemade sign flasher.....	311

FARM

Insulating pipe to water-storage tank.....	278
Water-pumping engine drives grinder.....	282
Cleaning cistern without removing water.....	303
Auto rim protects poultry fountain.....	304
Hinged windows held open by iron strip.....	304
Strong wire stretcher made easily.....	306
Simple hitch evens pull of unmatched team.....	312
Muslin impregnated with wax substitute for glass..	313
Pocket in barn for brush and currycomb.....	314

FURNITURE

Graceful three-tier table.....	257
Furnishing the doll house.....	262
Tubular furniture assembled with babbitt plugs....	283
Cabinets fitted with flat drawer pulls.....	303

HAND TOOLS

Rings on plumb bob provide reel for cord.....	268
Rubber grip for tool handles.....	272
Simple wire bender.....	273
Tool-handle wedge held by corrugated fastener....	282
Monkey wrench turns pipe.....	290
Simple clamp for light work.....	290
Special saw cures sticking doors.....	290
Plate on pliers to help hold small work.....	306
Lip on chisel avoids flying particles.....	311
Brad keeps wooden wedge from loosening.....	312
Scale fixed to angle plate saves time.....	314
Sleeve aids in drilling through round work.....	314

(Continued to page 8A)



WHERE DO YOU GO FROM HERE?

YOU'RE like a million other men—you're facing a big question. The depression turned business topsy-turvy and now the rebuilding period stares you in the face.

Are the things that are happening today going to help or hinder you—what will they mean in your pay check? Where will they put you five, ten, twenty years from now? How can you take full advantage of this period of opportunity?

We believe you will find the answer here—a suggestion the soundness of which can be proven to you as it has been to thousands of other men.

The whole trend today—legislation, spirit, action—is to put men back to work, raise earning and spending power, *give every man a fair chance to work out his own salvation.*

The road to success remains unchanged but, bear this in mind, *what it takes to win is radically different!*

No employer today would dare risk an important post in the hands of a man who had not learned the lesson of '29. Why should he, when right at this moment he can pick and choose and get almost any man he wants at his own price?

Business organizations are rebuilding—reorganizing for the new conditions. Before it is over every man and every method will be judged in the cold light of reason and experience—then dropped, remade or retained. This spells real opportunity for the man who can meet the test—but heaven help the man who still tries to meet today's problems from yesterday's standpoint! Out of the multitude still

jobless there are sure to be many frantically eager to prove him wrong and take his place.

Some Men Have Found the Answer

Seeing these danger signs, many aggressive men and women are quietly training at home—are wisely building themselves for more efficient service to their employers.

You naturally ask, "Has your training helped men withstand conditions of the last few years?"

Our answer is to point to a file of letters from many of our students reporting *pay raises and promotions while business was at its lowest ebb*—together with a myriad of others telling of greater success during these recent months of recovery.

Unusual evidence is ready for your investigation. We have assembled much of it in a booklet that is yours for the asking, along with a new and vitally interesting pamphlet on your business field.

This is a serious study of the possibilities and opportunities in that field. It is certain to contain an answer to vital questions bothering you today about your own work and earning power.

Send for these booklets—coupon brings them free. Be sure to check the LaSalle training that interests you most. We will tell you also how you can meet and take fullest advantage of today's situation. No cost or obligation—so why not mail the coupon now?

LASALLE EXTENSION UNIVERSITY

A Correspondence Institution

Dept. 264-R, Chicago

Please send me—without cost or obligation—full information about how I can, through your training, equip myself for the new problems and opportunities in the business field I have checked.

- | | |
|--|--|
| <input type="checkbox"/> Higher Accountancy | <input type="checkbox"/> Business Management |
| <input type="checkbox"/> Law: Degree of LL.B. | <input type="checkbox"/> Traffic Management |
| <input type="checkbox"/> Commercial Law | <input type="checkbox"/> Business Correspondence |
| <input type="checkbox"/> Industrial Management | <input type="checkbox"/> Business English |
| <input type="checkbox"/> Stenotypy | <input type="checkbox"/> Salesmanship |
| <input type="checkbox"/> Modern Foremanship | |

Name Age

Position

Address



LaSalle Extension University
A CORRESPONDENCE INSTITUTION



P. W. RESETS BATHROOM FIXTURES

You can quickly and easily reset loose bathroom fixtures, loose tiles, seal unsightly cracks around bathtubs and sinks with water-proof Plastic Wood. At Paint, Hardware, 10¢ Stores. Try it!



PLASTIC WOOD



GOOD TOOLS NEED GOOD OIL

When you work with tools, they must be in working condition. 3-IN-ONE Oil keeps tools clean and bright. It oils the working parts; protects against harmful rust and tarnish. Get it at Hardware, Drug, Grocery, 10¢ Stores.



3-IN-ONE Oil

(Contents—Continued)

HOUSEHOLD

Everyday uses for rubber suction cups.....	271
Oil-soaked logs burn briskly in fireplace.....	272
Absorbent ruffles slip on stems of glasses.....	289
Solving home problems	292

OFFICE

Stencils cut from old negatives	268
Pocket on typewriter holds eraser	270
Sponge rubber helps in mimeographing cards.....	314

PHOTOGRAPHY

Splashless pan to wash photo films.....	260
Movie titles that "live"	269
Imitating spotlight effects on photos.....	270
Tilting head tripod for new photoflood lamp.....	279
Camera lens shade from trouser belt.....	282
Easy panoraming with any tripod	290
Handling photo film and paper	305

POWER TOOLS

Chuck attached to drill press with screws.....	272
Fun with steam engines	274
Index indicator on lathe saves time.....	282
Jig to form coil springs quickly.....	289
Lathe turns large disks	301
Rubber bands protect grinding wheels.....	302
From pattern to casting	307
Blast burners you can make	315

STORE AND SHOP

Work leveled with string and envelope.....	267
Trough on workbench catches small articles.....	278
Shipping clerk's pencil writes several colors.....	304
Shoe trees serve as tag holders.....	304
Novel fruit display simulates active volcano.....	306
Sheet-metal worker moves flat pieces with mallet...	306
Removing enamel letters from glass.....	312
Washing machine actuates sign	312
Gummed tape aids in laying out sheet-metal work..	317

WOODWORKING

Gluepot made from two tin cans.....	260
Scrolled hot pads of plywood	261
Playing cards as template for irregular work.....	291
Medicine dropper spreads glue thinly.....	294
Wall rack for handsaws	302

MISCELLANEOUS

Block holds wood saw while sharpening it.....	260
Glass rods light up clock face	267
Burlap-sack tray to sort vegetables.....	268
Paintbrush kept off bottom of pail	268
First-aid equipment slipped into car quickly.....	270
Rigging ship-model deadeyes	270
Soldering torch tip shielded by pencil eraser.....	270
Waterproofing seams of leather shoes.....	272
Dip-painting flowerpots gives novel effects.....	273
Slotted bottle stopper vents funnel.....	276
Novel shelf and table ornaments in brass.....	277
Simple motor-reversing switch	278
New designs for doghouses	280
Close end of acid-core solder after using.....	282
Skull caps of paper easy to fold.....	283
Oilcan is handy gluepot	288
Rubber pockets in drawers store small parts.....	290
Cannibal king guards ash or cigarette holder.....	291
Rubber thumbtack tray on drawing board.....	291
Horseshoes improve chopping block	304
Portable holder for artists' ink and pens.....	305
Trick in uncoiling wire cable avoids kinks.....	305
Opening drain outlet on roof	313
Slotted wood strip saves base of miter box.....	313
Paper clip keeps show-card brushes shaped.....	314

IMPORTANT NOTICE

It is the intention of this magazine to provide its readers with information regarding the latest developments in the mechanical arts. We take no responsibility as to whether the disclosures contained in our articles are covered by patents and advise readers to investigate this subject before making, using, or selling any of the products, machines, or processes described, in order to avoid possible liability for patent infringement.



"THE RUDDER'S GONE, SIR!"

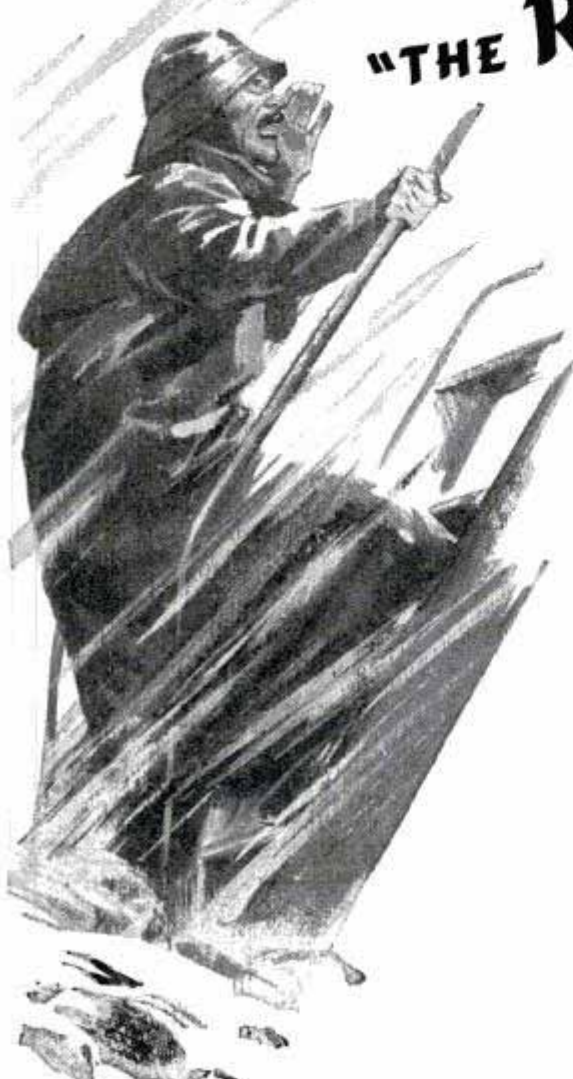

● Fateful moment — when a ship loses its rudder! Then a great hulk drifts helplessly — and unless aid comes, that ship goes "on the rocks."

There are *men* who drift all their lives. Is it surprising that these rudderless souls end up "on the rocks"?

I. C. S. students are men who fashion their own "rudders" — out of common sense, determination, and *sound, essential training!* If you want to come into the Port of Prosperity and Security, then you must get the training you need. Get it "the I. C. S. way" — from textbooks that have been adopted by 25 State Universities — through methods that are *individualized* to fit your own *personal* requirements. Send the coupon — *today* — for complete information.

INTERNATIONAL CORRESPONDENCE SCHOOLS

BOX 5565-J, SCRANTON, PENNA.



Without cost or obligation, please send me a copy of your booklet, "Who Wins and Why," and full particulars about the course *before* which I have marked X:



TECHNICAL AND INDUSTRIAL COURSES

- | | | | | | |
|---|---|---|---|---|--|
| <input type="checkbox"/> Agriculture | <input type="checkbox"/> Air Brake | <input type="checkbox"/> Cotton Manufacturing | <input type="checkbox"/> Marine Engines | <input type="checkbox"/> R. R. Signalmen's | <input type="checkbox"/> Refrigeration |
| <input type="checkbox"/> Air Conditioning | <input type="checkbox"/> Architectural Drafting | <input type="checkbox"/> Diesel Engines | <input type="checkbox"/> Mechanical Drafting | <input type="checkbox"/> Sanitary Engineering | <input type="checkbox"/> Sheet Metal Work |
| <input type="checkbox"/> Architecture | <input type="checkbox"/> Auto Engine Tune-up | <input type="checkbox"/> Electrical Engineering | <input type="checkbox"/> Mechanical Engineering | <input type="checkbox"/> Steam Electric | <input type="checkbox"/> Steam Engines |
| <input type="checkbox"/> Auto Technician | <input type="checkbox"/> Auto Technician | <input type="checkbox"/> Electric Lighting | <input type="checkbox"/> Mine Foreman | <input type="checkbox"/> Steam Fitting | <input type="checkbox"/> Structural Drafting |
| <input type="checkbox"/> Aviation | <input type="checkbox"/> Boilermaking | <input type="checkbox"/> Fire Bosses | <input type="checkbox"/> Navigation | <input type="checkbox"/> Structural Engineering | <input type="checkbox"/> Surveying and Mapping |
| <input type="checkbox"/> Bridge Engineering | <input type="checkbox"/> Fruit Growing | <input type="checkbox"/> Heating | <input type="checkbox"/> Patternmaking | <input type="checkbox"/> Telegraph Engineering | <input type="checkbox"/> Textile Designing |
| <input type="checkbox"/> Building Estimating | <input type="checkbox"/> Heat Treatment of Metals | <input type="checkbox"/> Highway Engineering | <input type="checkbox"/> Pharmacy | <input type="checkbox"/> Toolmaking | <input type="checkbox"/> Welding, Electric and Gas |
| <input type="checkbox"/> Chemistry | <input type="checkbox"/> House Planning | <input type="checkbox"/> Locomotive Engineer | <input type="checkbox"/> Plumbing | <input type="checkbox"/> Woolen Manufacturing | |
| <input type="checkbox"/> Civil Engineering | <input type="checkbox"/> Management of Inventions | <input type="checkbox"/> Machinist | <input type="checkbox"/> Poultry Farming | | |
| <input type="checkbox"/> Coal Mining | <input type="checkbox"/> Managing Men at Work | <input type="checkbox"/> Management of Pulp Paper | <input type="checkbox"/> Practical Telephony | | |
| <input type="checkbox"/> Concrete Engineering | <input type="checkbox"/> Contracting and Building | | <input type="checkbox"/> Public Works Engineering | | |
| | | | <input type="checkbox"/> Radio, General | | |
| | | | <input type="checkbox"/> Radio Operating | | |
| | | | <input type="checkbox"/> Radio Servicing | | |
| | | | <input type="checkbox"/> R. R. Section Foreman | | |

BUSINESS COURSES

- | | | | | | |
|--|--|--|---|---|--------------------------------------|
| <input type="checkbox"/> Accounting | <input type="checkbox"/> Advertising | <input type="checkbox"/> Civil Service | <input type="checkbox"/> First Year College | <input type="checkbox"/> Railway Postal Clerk | <input type="checkbox"/> Secretarial |
| <input type="checkbox"/> Bookkeeping | <input type="checkbox"/> Business Correspondence | <input type="checkbox"/> College Preparatory | <input type="checkbox"/> Foremanship | <input type="checkbox"/> Salesmanship | <input type="checkbox"/> Spanish |
| <input type="checkbox"/> Business Management | <input type="checkbox"/> Business Management | <input type="checkbox"/> Commercial | <input type="checkbox"/> French | <input type="checkbox"/> Service Station Salesmanship | |
| <input type="checkbox"/> Cartooning | <input type="checkbox"/> C. P. Accounting | <input type="checkbox"/> Cost Accounting | <input type="checkbox"/> Grade School | <input type="checkbox"/> Sign Lettering | |
| | | <input type="checkbox"/> C. P. Accounting | <input type="checkbox"/> High School | <input type="checkbox"/> Traffic Management | |
| | | | <input type="checkbox"/> Illustrating | | |
| | | | <input type="checkbox"/> Lettering Show Cards | | |

DOMESTIC SCIENCE COURSES

- | | | |
|---|---|--|
| <input type="checkbox"/> Advanced Dressmaking | <input type="checkbox"/> Home Dressmaking | <input type="checkbox"/> Tea Room and Cafeteria Management, Catering |
| <input type="checkbox"/> Foods and Cookery | <input type="checkbox"/> Professional Dressmaking and Designing | |

Name..... Age..... Address.....

City..... State..... Present Position.....

Canadian residents send coupon to International Correspondence Schools Canadian, Limited, Montreal, Canada
British residents send coupon to I. C. S., 71 Kingsway, London, W. C. 2, England



Do *You* Smile at the Idea of Learning Music by Mail?

Here Are Some Facts That May Surprise You!

YOU have undoubtedly heard of the U. S. School method of teaching music by mail. This remarkable system of instruction has been in operation for over forty years and more than 700,000 people in all parts of the world have enrolled for it. Men, women and children of all ages and from all walks of life have taken up their favorite musical instruments this convenient, money-saving way. They have studied the piano, violin, guitar, accordion and, in short, every kind of popular instrument.

No Special Talent Required

Many of these pupils did not know one musical note from another when they enrolled. Many had previously tried other methods of instruction without success. And not a few were frankly skeptical. They doubted whether it was possible to learn music by mail, just as you may doubt it.

To some of these "Doubting Thomases" it came as the surprise of their lives when they actually heard themselves playing. Simple, popular melodies at first, then more and more advanced pieces, all the way to Grand Opera.

One after another, pupils testify to the amazing ease with which they learned, and the fascination and pleasure they found in the lessons. They say it was "easy as A-B-C"—"so simple that a child could understand"—that "with all the wonderful photographs and diagrams to guide you, you simply cannot go wrong"—that "it's really fun to learn music this easy, fascinating way."

Will You Accept This Challenge?

The experience of thousands upon thousands of people should be proof positive that you, too, can learn to play your favorite instrument by the famous print-and-picture method of the U. S. School of Music. Is it not a pity, then, to deny yourself all the enjoyment, the good times and popularity that music offers? Do you not owe it to yourself, at least, to examine all the facts, and to decide, once and for all, whether you can afford to pass by this opportunity to enrich your life with music?

If you really want to play a musical instrument—if you are willing to devote just a few minutes a day to learning, not through tedious, old-fashioned practice, but by actually playing real tunes—then you should mail the coupon at once. It will bring you an interesting illustrated booklet that tells all about this wonderful way to learn music at home—without any special talent—without any previous knowledge of music at amazingly little cost. Read it carefully and earnestly and act upon it. If interested, tear out the coupon now, before you turn the page. (Instruments supplied when needed, cash or credit.) Address: U. S. School of Music, 72 Brunswick Building, New York, N. Y. (Established 1898)

INSTRUMENTS

As a special accommodation to our students we can supply instruments at a special discount. Liberal terms extended. For particulars, inquire Instrument Dept.

U. S. SCHOOL OF MUSIC, 72 Brunswick Bldg., New York, N. Y.

I am interested in music study, particularly in the instrument checked below. Please send me your free illustrated booklet, "How to Learn Music at Home."

- | | | | | |
|--|------------------------------------|-----------------------------------|------------------------------------|---|
| <input type="checkbox"/> Piano | <input type="checkbox"/> Saxophone | <input type="checkbox"/> Mandolin | <input type="checkbox"/> Clarinet | <input type="checkbox"/> Ukulele |
| <input type="checkbox"/> Violin | <input type="checkbox"/> Cello | <input type="checkbox"/> Trombone | <input type="checkbox"/> Flute | <input type="checkbox"/> Organ |
| <input type="checkbox"/> Guitar | <input type="checkbox"/> Hawaiian | <input type="checkbox"/> Cornet | <input type="checkbox"/> Piccolo | <input type="checkbox"/> Modern Elemen- |
| <input type="checkbox"/> Piano Accordion | <input type="checkbox"/> Guitar | <input type="checkbox"/> Trumpet | <input type="checkbox"/> Drums and | <input type="checkbox"/> tary Harmony |
| <input type="checkbox"/> Plain Accordion | <input type="checkbox"/> Banjo | <input type="checkbox"/> Harp | <input type="checkbox"/> Traps | <input type="checkbox"/> Voice Culture |

Name.....

Address.....

Town.....State.....

Check here for Booklet "A" if under 16 years of age.

When writing to advertisers please mention Popular Mechanics

FINED FOR IGNORANCE!

Don't Let It Happen to You!

The average grade school graduate earns \$16.30* a week less than high school graduates earn.

The average high school graduate earns \$25.25* a week less than do men with college or vocational training.

*Figures computed from Government report. For basis of computation, write American School.

**College Grade
Training Pays
Up to
\$40 a week*
EXTRA
income
Study at HOME!**



You Too Can Win a Better Job!

HAVE YOU thought about *home study*? You look around you at your friends, neighbors and fellow employes: This one earns \$10 a week more than you—that one earns nearly double—a third, though appreciably younger than you, seems to be making better progress. Why? How can you catch up with them? You know that literally *thousands* of ambitious men and women have won substantial Success through using their spare time at home to master the principles and practice of their chosen lines. How can HOME STUDY help *you* make good?

Promotion Begins at HOME
Pay raises depend largely on what you do in SPARE time. Make it pay you dividends!

American School, Dept. G-245, Drexel Ave. at 58th St., Chicago, Ill.

Gentlemen: I'll sit down and consider my Promotion Problems carefully if you will send me FREE information covering special training in subjects checked below. No obligation on my part.

- | | |
|--|---|
| <input type="checkbox"/> High School Course | <input type="checkbox"/> Diesel Engineering |
| <input type="checkbox"/> Accounting and Auditing | <input type="checkbox"/> Drafting and Design |
| <input type="checkbox"/> Architecture and Building | <input type="checkbox"/> Liberal Arts |
| <input type="checkbox"/> Automotive Engineering | <input type="checkbox"/> Private Secretary |
| <input type="checkbox"/> Business Management | <input type="checkbox"/> Mechanical Engineering |
| <input type="checkbox"/> Aviation | <input type="checkbox"/> Radio and Television |
| <input type="checkbox"/> Electrical Engineering | <input type="checkbox"/> Salesmanship |
| <input type="checkbox"/> Elec. and Gas Refrigeration | <input type="checkbox"/> Business Law |
| <input type="checkbox"/> Air Conditioning | <input type="checkbox"/> Retail Merchandising |

Name.....

Address.....

The "Magic" of Home Study

There's no magic to home study. It's hard work—but it is *worth* the effort because it helps you overcome the handicap of having left school too soon. It frees you from the penalties of Ignorance—enables you to compete to better advantage in this NEW world of *college trained* men and women.

In 1900, only ONE person in 800 was a *high school* graduate. Today, one in every 837 is *college* trained. *That's* why you need so much more "on the ball" today than ever before. *That's* why American School has *stepped up* all its complete courses to include so much work of *college level*. You NEED it, to win out today!

These Advantages Speed Your Progress

More than 150 noted educators, engineers and executives helped prepare American School courses. An *Advisory Board* of 20 outstanding authorities—each an active leader in his field—is consulted when our work is prepared or changed. A Staff of competent instructors—home study *specialists*—works closely with the individual student.

Courses are not prepared from the "academic" viewpoint—but from the *practical*. Although dozens of leading universities and colleges use the same texts, the primary aim of *home study* is to help graduates win BETTER jobs at BIGGER pay as QUICKLY as possible. Every course is geared to this end. Jobs and job requirements are analyzed, circumstances of the average student are weighed, then every course is *speed-lined* to put the *Man in the Job* he wants at the EARLIEST opportunity.

Write American School about *your* promotion problems TODAY!

American School

Drexel Avenue at 58th Street, Chicago, Illinois

Say you saw it in Popular Mechanics!

HOW A "TIP" GOT TOM A GOOD JOB



I will train YOU too at Home in Spare Time for Good Jobs in Radio

J. E. Smith, President
National Radio Institute
Established 25 years

Radio is a young, growing field with a future. It offers many good pay spare time and full time job opportunities. And you don't have to give up your present job, go away from home, or spend a lot of money to become a Radio Technician. I train you right at home in your spare time.

I Trained These Men



Makes \$50 to \$60 a Week
"I am making between \$50 and \$60 a week after all expenses are paid, and I am getting all the Radio work I can take care of, thanks to N.R.I."
H. W. SPANGLER
126 1/2 S. Gay St., Knoxville, Tenn.

\$10 to \$20 Week in Spare Time
"I repaired many Radio sets when I was on my tenth lesson. I made \$600 in a year and a half, and I have made an average of \$10 to \$20 a week—just spare time."
JOHN JERRY
1529 Arapahoe St., Denver, Colo.



Operates Public Address System
"I have a position with the Los Angeles Civil Service, operating the Public Address System in the City Hall Council. My salary is \$170 a month."
R. H. ROOD, R. 136, City Hall
Los Angeles, Calif.

Jobs Like These Go to Men Who Know Radio

Radio broadcasting stations employ engineers, operators, technicians and pay well for trained men. Radio manufacturers employ testers, inspectors, foremen, servicemen in good-pay jobs with opportunities for advancement. Radio jobbers and dealers employ installation and servicemen. Many Radio Technicians open their own Radio sales and repair businesses and make \$30, \$40, \$50 a week. Others hold their regular jobs and make \$5 to \$10 a week fixing Radios in spare time. Automobile, police, aviation, commercial Radio; loudspeaker systems, electronic devices, are newer fields offering good opportunities to qualified men. And my course includes Television, which promises to open many jobs soon.

Why Many Radio Technicians Make \$30, \$40, \$50 a Week

Radio is already one of the country's large industries even though it is still young and growing. The arrival of Television, the use of Radio principles in industry, are but a few of many recent Radio developments. More than 28,000,000 homes have one or more Radios. There are more Radios than telephones. Every year millions of Radios get out of date and are replaced. Millions more need new

Get Facts About THIS



HEY, TOM!
HOW ARE
YOU, OLD
BOY?

BILL! GOSH, I DIDN'T
KNOW YOU IN THOSE
NEW CLOTHES AND
THAT SNAPPY CAR.
SOMEBODY LEAVE
YOU A MILLION?



ONLY A SHORT TIME
AGO YOU WERE
SLAVING AWAY AT
THE SAME JOB AS
THE REST OF US.
NOW LOOK AT YOU.
HOW COME?

WELL, TOM, I DECIDED
I'D NEVER GET
ANYWHERE UNLESS
I PICKED A BUSINESS
WITH LOTS OF OPPOR-
TUNITIES AND TRAINED
MYSELF FOR THEM--
SO I PICKED RADIO



YOU HAD THE SAME CHANCE, TOM.
ABOUT A YEAR AGO I SHOWED
YOU A BOOK FROM NATIONAL
RADIO INSTITUTE TELLING ABOUT
THE OPPORTUNITIES AND FUTURE
IN RADIO AND TELEVISION AND
HOW OTHERS HAD SUCCEEDED
THROUGH THEIR HOME TRAINING--
WELL-- I ENROLLED



YOU CERTAINLY
KNOW RADIO.
MINE NEVER
SOUNDED BETTER

THANKS. N.R.I. TRAINING
CERTAINLY PAYS. I JUST STARTED
A FEW MONTHS AGO AND I'M
ALREADY MAKING \$5 TO \$10 A
WEEK IN MY SPARE TIME.



ON TOM, IT'S WONDERFUL
YOU'VE GONE AHEAD SO FAST
IN RADIO. WE NEVER
COULD HAVE GOTTEN
MARRIED ON WHAT YOU
WERE EARNING BEFORE

OUR WORRIES ARE OVER. I'M
A TRAINED RADIO TECHNICIAN
NOW. THERE'S A BRIGHT
FUTURE AHEAD FOR US IN
RADIO AND TELEVISION

tubes, repairs, etc. Over 5,000,000 auto Radios are in use and thousands more are being sold every day. In every branch Radio is offering more opportunities—opportunities for which I give you the required knowledge of Radio at home in your spare time. Yes, the few hundred \$30, \$40, \$50 a week jobs of 20 years ago have grown to thousands.

Many Make \$5, \$10 a Week Extra In Spare Time While Learning

The day you enroll, I start sending you Extra Money Job Sheets which start showing you how to do Radio repair jobs. Throughout your Course I send plans and directions which have helped many make \$200 to \$500 a year in spare time while learning. I send special Radio equipment to conduct experiments and build circuits. This 50-50 training method makes learning at home interesting, fascinating, practical.

Find Out What Radio Offers You

Act today. Mail coupon for my 64-page book, "Rich Rewards in Radio." It points out Radio's spare time and full time opportunities and those coming in Television; tells about my course in Radio and Television; shows many letters from men I trained, telling what they are doing and earning. Read my money back agreement. Find out what Radio offers you. Mail coupon in envelope or paste on penny postcard—NOW.

J. E. SMITH, President
Dept. OBP, National Radio Institute
Washington, D. C.

THIS Free Book HAS HELPED HUNDREDS OF MEN MAKE MORE MONEY



TESTED WAY TO BETTER PAY



I Also Give You This Professional Servicing Instrument

Here is the type of instrument successful Radio Technicians use—an All-Wave Set Servicing Instrument. It contains everything necessary to measure A.C. and D.C. voltages and current; to check resistances; adjust and align any set, old or new. It satisfies your needs for professional servicing after you graduate—can help you make extra money fixing sets while learning.

GET THE FACTS, MAIL THIS COUPON NOW!

THIS COUPON GOOD FOR ONE FREE COPY OF MY BOOK!

J. E. SMITH, President, Dept. OBP, National Radio Institute, Washington, D. C.

Dear Mr. Smith: Send me FREE, without obligation, your 64-page book "Rich Rewards in Radio" which points out spare time and full time opportunities in Radio, those coming in Television, and explains your 50-50 method of training men at home in spare time to be Radio Technicians. (Write Plainly.)

NAME.....AGE.....
ADDRESS.....
CITY.....STATE.....

This One



The Mechanism of Mind

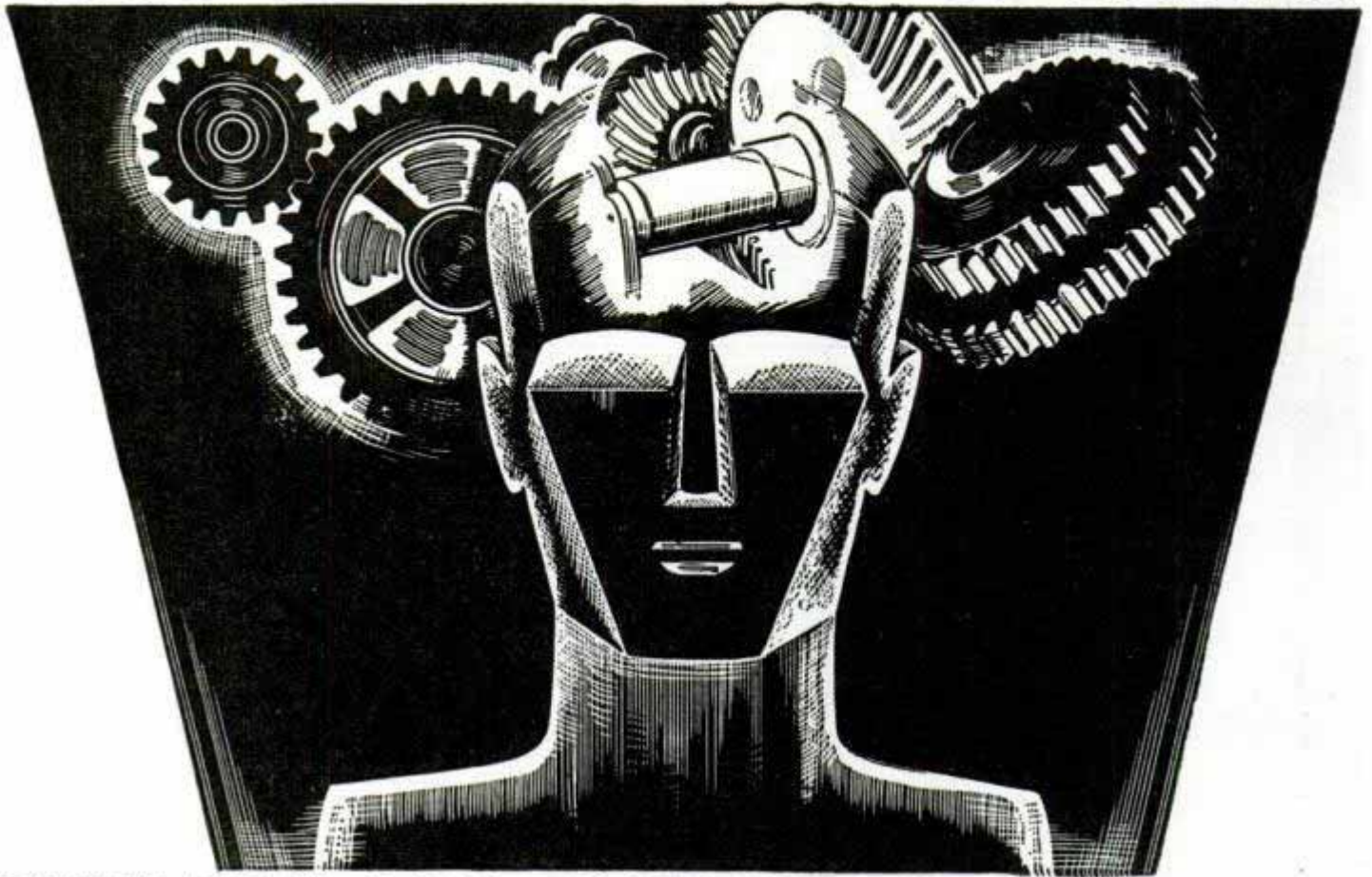

WHY YOU ARE AS YOU ARE—

and What You Can Do About It!

DID you ever stop to think *why* you do the things you do? Have you often—when alone—censored yourself for impulsive urges, for things said or done that did not truly represent *your real thoughts*, and which placed you at a disadvantage? Most persons are *creatures of sensation*—they react to instinctive, impelling influences which surge up within them and which they do not understand—*or know how to control*. Just as simple living things involuntarily withdraw from irritations, so likewise thousands of men and women are content to be motivated by their undirected thoughts which haphazardly rise up in their consciousness. *Today you must sell yourself* to others—bring forth your best abilities, manifest your personality, if you wish to hold a position,

make friends, or impress others with your capabilities. You must learn how to draw upon your latent talents and powers, not be bent like a reed in the wind. There are simple, natural laws and principles which—if you understand them—make all this possible.

For centuries the Rosicrucians (not a religious organization), a worldwide movement of men and women devoted to the study of life and its hidden processes, have shown thousands how to probe these mysteries of self. Renowned philosophers and scientists have been Rosicrucians—today men and women in every walk of life owe their confidence and ability to solve personal problems to the Rosicrucian private, *sensible* method of self-development. Send today for a copy of the book, "The Secret Heritage," which will be sent to you without obligation. It will tell you of the Rosicrucians *and what they can do for you*. Address: Scribe A. U. A.

THE ROSICRUCIANS (AMORC), SAN JOSE, CALIFORNIA, U. S. A.

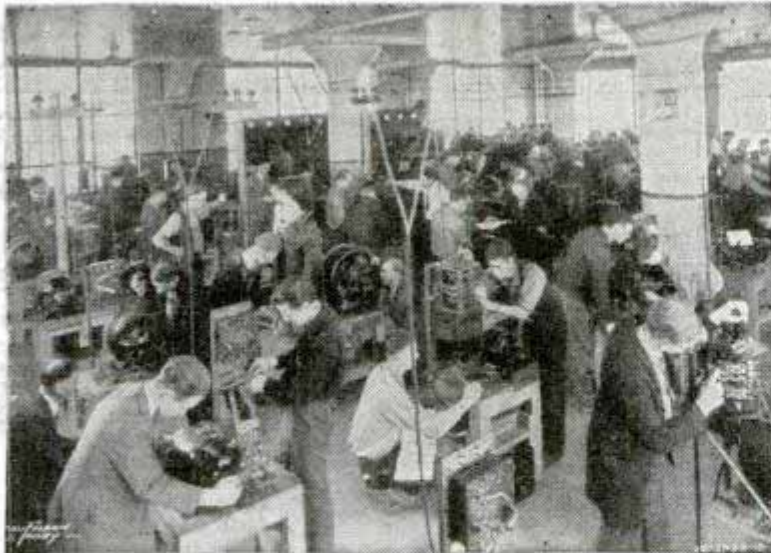

STUDENTS BUSY AT WORK IN LARGE COYNE SHOPS

Learn ELECTRICITY

Pay For Your Training After You Graduate

Find out all about this wonderful offer. My big Free Book tells you how you can train for your start to a big pay job in Electricity . . . And through my "Pay Tuition After Graduation" Plan you can get your training now and pay for most of your tuition in easy monthly payments after you graduate.

"LEARN BY DOING"

12 Weeks Practical Training in COYNE Shops

In the Big Coyne Shops you have individual help by expert instructors so that you quickly and easily learn Electricity by actual work. No advanced education or previous electrical experience is needed. You are taught . . . Not by correspondence, not by books or embarrassing reciting . . . but by the Famous Coyne "Learn-By-Doing" training method which has helped hundreds of successful graduates to get and hold the job they like, or go into business for themselves.

At Coyne you do PRACTICAL ELECTRICAL WORK on real electrical equipment.

**PART TIME WORK
WHILE TRAINING**
**EMPLOYMENT HELP
AFTER GRADUATION**

If you are short of money and need part-time work to help pay for your room and board while training, my Employment Department will help you get a part time job. When you have graduated, they will give you Lifetime Employment Service.

You wind real armatures . . . run real motors, dynamos, generators. When you have finished each step, you KNOW HOW because you have done it yourself. If you are ambitious here is your chance to get the PRACTICAL TRAINING to qualify you for your start in the great electrical field.

H. C. Lewis

READ WHAT THESE GRADUATES SAY

I think the "pay after graduation" plan . . . offers the fellow who wants to get ahead in life a wonderful opportunity . . . I am now employed by the ——— Power Co. I have been employed by this Company ever since graduating from COYNE . . . I make almost double what I did at my previous work . . . COYNE School helped me in landing the job I now have.
James Dible

I owe a lot to COYNE . . . I secured a job after returning home wiring cranes for the ——— Machine Co. Before going to COYNE I was clerking in a grocery store earning the usual clerk's wages. I was in doubt about quitting my job but I have tripled the cost of the entire course. . . in the first ten months. The school is everything you say it is and more. I was completely satisfied. Thanking you for your kind cooperation while at school and since returning home.—Jack E. Stroup



GET THE FACTS

Don't let lack of money keep you from sending in the Coupon now. My Big FREE Book is full of facts and photographs which tell you about Coyne Training. It also gives you the details of my Pay After Graduation Plan, Spare Time Employment Offer, Graduate Employment Service, Lifetime Scholarship and other advantages.

MAIL
COUPON



AN EXTRA
4 WEEKS
COURSE IN
RADIO
INCLUDED

ELECTRIC REFRIGERATION AIR CONDITIONING

At this time I am including additional valuable instruction in these two important branches of electricity.

COYNE occupies this entire Modern, fireproof Building



COYNE H. C. LEWIS, President FOUNDED 1899
ELECTRICAL SCHOOL
500 S. Paulina St., Dept. 20-72, Chicago, Ill.

Send Today for this FREE Book!

H. C. LEWIS, President,
COYNE ELECTRICAL SCHOOL,
500 S. Paulina Street,
Dept. 20-72, Chicago, Ill.

Dear Mr. Lewis:—Without obligation send me your big free illustrated catalog, with all facts about Coyne Training and details of your "Pay-Tuition-After-Graduation" Plan, as well as the details of your 4 weeks Radio Course you are including.

Name.....

Address.....

City.....State.....

Mail in envelope or paste on a postcard



High School Course at Home

Many Finish in 2 Years

You can complete this simplified High School Course as rapidly as your time and abilities permit. Equivalent to resident school work—prepares you for entrance to college. Standard H. S. texts supplied—Diploma. Credit for H. S. subjects already completed. Single subjects if desired. High School education is very important for advancement in business and industry and socially.

College Entrance

During the past 14 years, our High School graduates have been admitted to 531 different Universities, Colleges, Junior Colleges and Normal Schools—80% of them without entrance examination. Course also prepares for teachers' certificate and pre-professional examinations.

Business—Industry

To get and hold a good position in Business today you must be able to write clear, accurate letters and reports—do figuring involving Algebra and Geometry—talk intelligently on matters requiring a knowledge of Geography, History, and Economics.

In Industry—Mechanical and Engineering lines—you must have at least an elementary knowledge of Physics and Chemistry—be able to figure quickly and accurately—know something of Mechanical Drawing and blueprints—and be able to talk and write accurately and clearly on both your work and ordinary topics of conversation.

Our High School course meets the preparatory educational requirements for Business and Industry.

An Educational Institution

The American School was chartered in 1897 as an educational institution, not for profit—and is exempt from paying Federal income tax, like the best resident colleges and universities.

Don't Be Handicapped—Complete Your Training Now

Be a High School Graduate! Prepare yourself for promotion in Business and Industry—for the Professions, College Entrance and social success. No matter what line you may select, High School training will prove invaluable to you! Our moderate fees cover all instruction, standard textbooks and Diploma. Easy monthly terms. Get ahead in life. Start your training NOW!

20 Other Courses

Over 150 noted Educators, Engineers, and Business Men helped prepare our special instruction material, which is used by many resident schools and colleges, U. S. Navy, and Province of Manitoba, Canada. We offer you quality training at home for the best-paying lines of Industry and Business, as listed in the coupon.

in Business and Industry—for the Professions, College Entrance and social success. No matter what line you may select, High School training will prove invaluable to you! Our moderate fees cover all instruction, standard textbooks and Diploma. Easy monthly terms. Get ahead in life. Start your training NOW!

Mail coupon for information about line that interests you
American School, Drexel at 58th, Chicago

American School, Dept. H-245, Drexel at 58th, Chicago
Tell me how to train for success in line checked. No obligation.

- | | |
|--|--|
| <input type="checkbox"/> Accounting & Auditing | <input type="checkbox"/> Diesel Engineering |
| <input type="checkbox"/> Architecture & B'lding | <input type="checkbox"/> Drafting & Design |
| <input type="checkbox"/> Automotive Engin'ring | <input type="checkbox"/> Liberal Arts |
| <input type="checkbox"/> Business Management | <input type="checkbox"/> Private Secretary |
| <input type="checkbox"/> Commercial Aeronautics | <input type="checkbox"/> Hi'er Ac't'g (C.P.A.) |
| <input type="checkbox"/> Electrical Engineering | <input type="checkbox"/> Highway Engin'r'g |
| <input type="checkbox"/> Electrical Refrigerat'n | <input type="checkbox"/> Mechanical Engin'r'g |
| <input type="checkbox"/> Air Conditioning | <input type="checkbox"/> Radio & Television |
| <input type="checkbox"/> Civil Engineering | <input type="checkbox"/> Salesmanship |
| <input type="checkbox"/> Complete Law | <input type="checkbox"/> Steam Engineering |

Name.....
Address.....

GET IN THE SWING with Slingerland . . . DRUMS GUITARS MANDOLINS



GENE KRUPA — World's Greatest Swing Drummer uses Slingerland

WONDERFUL VALUE
EASY PAYMENTS

Compare the value—tone and power in Slingerland "Radio King" drums, banjos, guitars, mandolins, marimbas or bugles—before you buy. Guaranteed more for your money. Acclaimed the tops in smooth

tone, easy playing, rich power by world's leading musicians. Easy payments, 5-days free trial. See at your dealers.

Write for free special information on how to organize drum and bugle corps. Free Catalog—mention instrument wanted.

SLINGERLAND DRUM CO.
1330 Belden Avenue Chicago, Illinois



You CAN GET IN AVIATION

Like hundreds of successful graduates SPARTAN Training following standard College or University planned curriculum will give YOU Aviation training that will qualify for positions now open. Advantages Factory affiliation building ALL-METAL Commercial and Military Airplanes. Unequaled year-round flying weather and country. Government and Army Air Corps approved. All courses Mechanical and Flight. Write for Illustrated Catalog.

HOME OF THE DAWN PATROL
Capt. MAXWELL W. BALFOUR, Director,
Dept. PM 28, TULSA, OKLAHOMA

Regain Perfect Speech, If You STAMMER

Every stammerer should have the new 287 page book "Stammering, Its Cause and Correction." Sent free to stammerers. It describes the Bogue Unit Method for the scientific correction of stammering and stuttering. Method successfully used at Bogue Institute for 39 years—since 1901. Endorsed by physicians. Write for full information. No obligation. Benjamin N. Bogue, Dept. 1311 Circle Tower, Indianapolis, Indiana.

CARTOONING PAYS WELL



Exclusive instruction by a famous cartoonist makes it easy to learn at home. Write for Free Booklet describing details of the course.
NATIONAL SCHOOL OF CARTOONING
439 Penton Bldg. Cleveland, Ohio

CASH PAID Why not get ready now to spend spring, summer, fall, outdoors gathering insects—butterflies, moths. I buy hundreds of kinds for collections. Good cash prices paid. Some \$1 to \$7 each. Easy. Simple. Send 10c (no stamps) for **Illustrated Prospectus** before sending any insects. Write today. Hurry!

MR. SINCLAIR, DEALER IN INSECTS,
Dept. 6, Box 1830 San Diego, Calif.

Own A Profitable Greaseless DOUGHNUT BAKESHOP Start In Your Kitchen!

Who else wants to enjoy profits from this amazing new business you can start in your own kitchen? New electrical invention turns out delicious, different Brown Bobby Doughnuts. Everybody wants them! Stores eager to sell for you. Big daily profits possible selling production of one machine at wholesale only. We supply equipment and tested money making plans. This is your chance. Send No Money. Rush postcard for FREE details.
BROWN BOBBY CO., 620 N. Michigan Ave., Dept. E-182 CHICAGO, Ill.



**I'LL TRAIN YOU AT HOME
IN SPARE TIME to MAKE GOOD
MONEY in RADIO and
TELEVISION**



Easy to Start . . . Earn While You Learn

Wake up! Get ahead! You fellows with ambition can make a wonderful success in Radio and Television through my new, practical, home training. I teach you in your spare time through interesting experiments with real equipment. Every essential phase of Radio, Television, Electronics, Facsimile, Radio Set Repair and Installation is covered. You get Personalized help. No previous experience needed. So practical—so understandable—so simplified is this training that any man with average education can grasp the money-making knowledge quickly and easily. You will be ready for a business of your own . . . or to hold down a good-paying job. My **BUSINESS BUILDERS** show you how to make profits while learning.

BIG FREE BOOK! Get complete details in new catalog "HOW TO MAKE MONEY IN RADIO". Write Sprayberry Academy of Radio, 310-B, University Place, N. W., Washington, D. C.

YOU GET

- 146 RADIO PARTS
- RADIO TOOLS
- ALL WAVE ALL PURPOSE ANALYZER



PLAY A SAW!

Produce wonderful music in 5 days . . . quickly play popular and classical numbers. No notes to read, no dreary practice—success guaranteed. Since 1924 thousands of my students have amazed friends, starred in shows and broadcasting orchestras. Without obligation, write for 5 DAY TRIAL OFFER now.

MUSSEHL & WESTPHAL
142 W. Water St., Fort Atkinson, Wis.

**GET INTO THE
BAKING BUSINESS!**

National Baking Institute announces a new home study course in commercial baking. Baking now America's fifth industry in wages. Nearly a depression-proof business. Good field for ambitious men. Common school education sufficient. Send for free booklet "Opportunities in Commercial Baking" and requirements.



National Baking Institute
3601 Michigan Ave. Dept. 1352 Chicago, U. S. A.

MECHANICS

**KNOW
YOUR
CAR**

**You Need
this
Book**

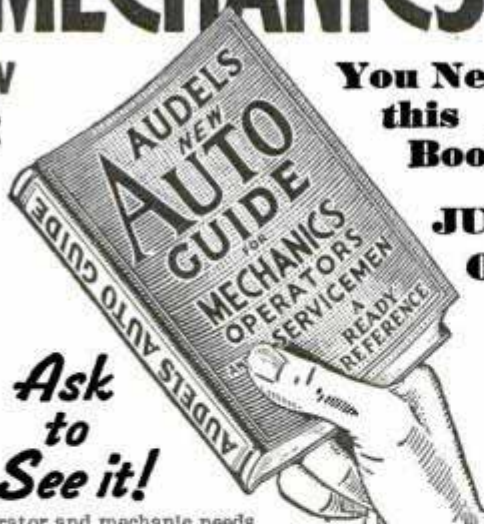

**JUST
OUT!**

**Ask
to
See it!**

Every operator and mechanic needs **AUDELS NEW AUTO GUIDE**. This book saves time, money and worry. Highly endorsed. It presents the whole subject of auto mechanics: 1—Basic principles, 2—Construction, 3—Operation, 4—Service, 5—Repair. Easily understood. Over 1500 pages—1540 illustrations showing inside views of modern cars, trucks and buses with instructions for all service jobs. Diesel Engines fully treated, 4 fully illustrated. To Get This Assistance for Yourself Simply Fill in and Mail Coupon Today.

COMPLETE • PAY ONLY \$1. A MONTH

THEO. AUDEL & CO., 49 WEST 23rd STREET, NEW YORK
Please send me the postpaid AUDELS NEW AUTOMOBILE GUIDE (\$4) for free examination. If I decide to keep it, I will send you \$1 within 7 days; then remit \$1 monthly until purchase price of \$4 is paid. Otherwise, I will return it to you promptly.

Name _____
Address _____
Occupation _____
Reference _____ PM



**Our Graduates
Run
47%
of ALL the
Identification Bureaus
in America**

Send for complete list of over 600 Bureaus where our graduates have been placed in good positions as **FINGER PRINT EXPERTS**. Then write the nearest Bureau and learn what our graduates think of us!



We have space here to list only a FEW of these more than 600 institutions, so be sure to send for the complete list!

- | | |
|----------------------|----------------------|
| State of Utah | Schenectady, N. Y. |
| State of Ohio | Seranton, Pa. |
| Boston, Mass. | Lincoln, Neb. |
| New York, N. Y. | Mobile, Ala. |
| Pittsburgh, Pa. | Little Rock, Ark. |
| St. Paul, Minn. | Pontiac, Mich. |
| Mexico City, Mex. | Havana, Cuba |
| Augusta, Ga. | Miami, Fla. |
| Seattle, Wash. | Birmingham, Ala. |
| Omaha, Neb. | Columbus, Ohio |
| Des Moines, Ia. | Galveston, Tex. |
| Montreal, Can. | Houston, Tex. |
| Cedar Rapids, Iowa | Windsor, Ont. |
| Elgin, Ill. | Pueblo, Colo. |
| Syracuse, N. Y. | Salt Lake City, Utah |
| Tampa, Fla. | Atlantic City, N. J. |
| Long Beach, Cal. | Sioux City, Iowa |
| St. Louis, Mo. | Rochester, N. Y. |
| Lansing, Mich. | Cleveland, Ohio |
| Burlington, Ia. | Spokane, Wash. |
| Erie, Pa. | Fort Worth, Tex. |
| Oklahoma City, Okla. | Shreveport, La. |
| Trenton, N. J. | Waltham, Mass. |
| Detroit, Mich. | Berkeley, Calif. |
| El Paso, Tex. | Paterson, N. J. |

- State of Michigan
- State of Wash.
- State of Mass.
- State of Illinois
- State of Idaho
- State of Colorado
- State of Iowa

Want a Regular Monthly Salary?

Be a Secret Service and Identification Expert!

Enjoy the thrill of getting your man—with no personal danger—PLUS a regular monthly paid salary and the opportunity to share in Rewards. Learn at home, in spare time, and at low cost, the unique secrets of this young, fascinating and fast growing profession. You have exactly the same opportunity that was offered the hundreds of our graduates who now hold splendid positions in more than 600 institutions. Each of these bureaus has anywhere from ONE to FIFTEEN of our graduates on regular salaries—and new openings develop from time to time.

**Wonderful Opportunity for TRAINED MEN
In This Young, Fast Growing Profession.**

Of the thousands of towns in America, three-fourths are still without identification bureaus. Many more are bound to come! That spells OPPORTUNITY. But you must be READY. It's easy to master this profession that combines thrills with personal safety. AND the security of a steady income. We show you HOW—just as we have already shown the hundreds who now hold good pay positions.

**FREE! The Confidential Reports Operator
No. 38 Made to His Chief.**

Just rush coupon! Follow this Operator's exciting hunt for a murderous gang. Also, get free, "The Blue Book of Crime," showing the wonderful opportunities in the field of Finger Prints and Crime Detection. Take your first step TODAY toward a steady income and success. Mail coupon NOW!

INSTITUTE OF APPLIED SCIENCE
1920 Sunnyside Ave., Dept. 1352, Chicago

INSTITUTE OF APPLIED SCIENCE
1920 Sunnyside Ave., Dept. 1352, Chicago.
Gentlemen: With no obligation on my part, send me Confidential Reports of Operator No. 38, also illustrated "Blue Book of Crime," complete list of bureaus employing your graduates, together with your low prices and Easy Terms offer. (Literature will be sent ONLY to persons stating their age.)

Name _____
Address _____
Age _____

When writing please mention Popular Mechanics



Start \$1260 to \$2100 a Year Get Ready Now for 1940 Examinations

Railway Postal Clerks

Railway Postal Clerks get \$1,900 the first year regular, being paid on the first and fifteenth of each month. (\$79.17 each pay day.) Their pay is automatically increased yearly to \$2,450. Advance may be had to Chief Clerk at \$2,700 a year. (\$112.50 each pay day.)

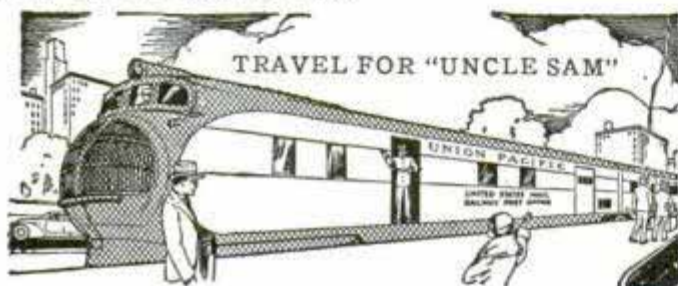

3 Days On—3 Days Off—Full Pay

Railway Postal Clerks on long runs usually work 3 days and have 3 days off duty or in the same portion. During this off duty their pay continues just as though they were working. They travel on a pass when on business. When they grow old, they are retired with a pension.

City Mail Carriers, Post Office Clerks

Clerks and Carriers now get \$1,700 the first year on regular and automatically increase \$100 a year to \$2,100 and \$2,300.

GOVERNMENT CLERK



File Clerk—Clerk

Open to Men—Women 18 to 50. Entrance salary \$1250—\$1440 Year. Appointments as File Clerks and Clerks in the Departments at Washington, D. C., are made from this examination.

Many Other Positions

Many other positions are obtainable. Those wishing these positions should qualify at once.

Get Free List of Positions

Fill out the following coupon. Tear it off and mail it today—now, at once.

This investment may result in your getting a big-paid government job.

FRANKLIN INSTITUTE, Dept. W173, Rochester, N. Y.

Rush to me, entirely free of charge (1) a full description of U. S. Government Jobs; (2) Free copy of illustrated 32-page book, "U. S. Government Positions and How to Get Them"; (3) List of U. S. Government Jobs; (4) Tell me what to do to qualify for one of these jobs.

Name.....

Address.....

Use This Coupon Before You Mislay It. Write or Print Plainly.

DRUM YOUR WAY TO FAME AND FORTUNE!

Begin now to be a big-name drummer. A money-making career awaits you if you will plan now, today, to master the drum...it's easy, requires no long study, comes naturally. Start with a **GRETSCH DRUM**, chosen above all others by **Bernie Mattinson** and dozens of other star drummers. Lots of fun learning, easy to pay on liberal **GRETSCH** terms.

BERNIE MATTINSON
with **HORACE HEIDT**

Send penny postcard for **FREE DRUM Catalogue** and full information about **EASY-PAYMENT Plan** and **FREE TRIAL**. Please give street address and send to Dept. PM 21

The FRED. GRETSCH MFG. CO.
Musical Instrument Makers Since 1883
60 BROADWAY, BROOKLYN, N. Y.

EASY TO PLAY
★
EASY TO PAY

GRETSCH also offers **SUPER VALUES** in Guitars, Saxophones, Trumpets, Trombones, Accordions. Send for **FREE catalogue**. Mention instrument.

ANY BOOK IN PRINT!

Delivered at your door. We pay postage. Standard authors, new books, popular editions, fiction, reference, medical, mechanical, children's books, etc.—all at **guaranteed savings**. Send card now for **Clarkson's 1940 Catalog**.

FREE Write for our great illustrated book catalog. A short course in literature. The buying guide of 300,000 book lovers. The selection of a metropolitan book store brought to your home. **FREE** if you write **NOW—TODAY!**

CLARKSON PUBLISHING COMPANY
Dept. PM4—1255 So. Wabash Ave., Chicago, Ill.

ARTISTS MAKE MONEY

Find out your ability. Send name, age, occupation and address for **Free Vocational Art Test**.

Federal Schools, Inc., 2130 Federal Schools Bldg., Minneapolis, Minn.

DENISON'S PLAYS

Musical Comedies, Operettas, Vaudeville Acts, Minstrels, Comedy Songs, Make-up Goods.

60 YEARS OF HITS

Catalog Free
T. S. Denison & Co., 203 N. Wabash, Dept. 9, Chicago

TELEGRAPHY

Taught thoroughly. Renewed opportunities due to Railroad Retirement Act and increased business; some railroads experiencing shortage of efficient operators now. **EVERY BRANCH OF RADIO ALSO TAUGHT**. School established 1874. All expenses low. Catalog free.

DODGE'S INSTITUTE, Kane St., Valparaiso, Ind.

Make Big Money

Start making money at once in a simple, pleasant all year 'round business, distributing home necessities. Over 200 fast selling, quick repeating, nationally known products guaranteed to satisfy. Get my sure-fire Plan and big, valuable Outfit, including a large assortment full size packages—all **FREE** to reliable persons. Full or part time. Liberal credit plan. Old-established company. Write quick for my Free Offer.



E. J. Mills, 1591 Monmouth Ave., Cincinnati, O.

PARKS AIR COLLEGE
PARKS AIRPORT EAST ST. LOUIS, ILL.

Offers YOU COLLEGE and PROFESSIONAL TRAINING
Majoring in AVIATION

Accredited by the Illinois Superintendent of Public Instruction, U.S. approved as a Commercial Ground and Flying School and Mechanics' School. Accredited by and cooperating with the United States Army Air Corps in giving flight and mechanical training. Open to high school graduates.
FOUR courses lead to B.S. degrees in Professional Piloting, Aviation Operations, Maintenance Engineering, Aeronautical Engineering.
SEVENTEEN TRAINING PLANES are used in professional flight training which prepares graduates for airline flight operations. 74% of graduates enter air transportation in North and South America. 76,000 hours flight training given, 1800 hours being flown monthly.
FACULTY of 48 specialists in various fields of aviation.
1569 graduates. Enrollment limited to a total of 300 commercial aviation students. Total enrollment 415.
100-acre airport, 18 buildings devoted to school purposes exclusively. Dormitories and dining hall at the College.
Spring Term April 1. Send postcard for new 64-page catalog.
13th YEAR Registrar, Dept. PM-2
PARKS AIR COLLEGE, East St. Louis, Ill.

TRI-STATE COLLEGE
B. S. Degree in 2 Years

World famous for technical 2-year courses in Civil, Electrical, Mechanical, Chemical, Radio, Aeronautical Engineering, Business Administration and Accounting. Special preparatory department for those who lack required high school work. Short diploma courses (36 weeks) in Surveying, Drafting. Low tuition. Low living costs. Students from every state and many foreign countries. 57th year. Graduates successful. Enter March, June, September, January. Write for catalog. 420 College Ave., ANGOLA, IND.

VOICE
100% Improvement Guaranteed
We build, strengthen the vocal organs—*not with singing lessons—but by fundamentally sound and scientifically correct silent exercises . . . and absolutely guarantee to improve any singing or speaking voice of least 100% . . . Write for wonderful voice book—sent free. Learn WHY you can now have the voice you want. No literature sent to anyone under 17 years unless signed by parent.*
PERFECT VOICE INSTITUTE, Studio 1352
64 E. Lake St., Chicago

Landscaping Is Profitable
FASCINATING CAREER OR HOBBY FOR MEN AND WOMEN

Send for free book giving details of Landscape Gardening course! Train yourself at home, in spare time, for fascinating profession of Landscape Architect, or to get more out of your gardening hobby. H. S. M. writes, "My annual income is \$4000. Your course paid me well." Send postal today for "Success Thru Landscape Training."
AMERICAN LANDSCAPE SCHOOL
6153 Grand Ave. Des Moines, Ia.

Best Support for Rupture Is the Human Hand

Why worry and suffer with that rupture any longer? Learn about my perfected truss invention. It has brought ease, comfort and happiness to thousands who suffered from reducible rupture. Equipped with easy Automatic Air Cushion, it softly yet securely holds the rupture in any position.

The Brooks Appliance most closely resembles the human hand as a rupture support

No steel springs or hard pads. No salves or plasters. Durable, low in price. Sent on trial to prove it. Beware of imitations. Never sold in stores nor by agents. Write today for full information sent free in plain envelope.
BROOKS CO., 457-D State St., MARSHALL, MICH.
Always write your name and full address clearly when answering advertisements.

START DRAWING BIG MONEY!



LEARN TO DRAW AT HOME

↓ TRAINED ARTISTS are capable of earning \$30, \$50, \$75 A WEEK! ↓

Train to become an Artist and prepare for a real future in this pleasant, profitable field. Our proven, practical spare-time study method has trained men and women for successful art careers for over 25 years. No previous art experience necessary. Many of our graduates are now in their own art studios, or working for newspapers, publishers, stores, etc.

COMMERCIAL ART CARTOONING and DESIGN
All in ONE practical course



PICTURE BRINGS \$25
—Mrs. G. A. Wemmer of Cedar Vale, Kans., has sold several paintings. One small picture for \$25.
\$500 IN SPARE TIME
—E. Gandre of Sheboygan, Wis., averaged that amount in a year for spare time Art work.
THANKS WSA FOR JOB!
—J. Beard of Columbus, Ga., credits our course as sole reason for job as Art Director in advertising agency.

This is the way you learn to BE AN ARTIST!

Our proven method of home instruction includes all of the important branches of Commercial Art. Your drawings are corrected and criticized by experienced Art instructors. You start by drawing straight lines and in advancing from lesson to lesson you receive all the personal constructive help you need.

Mail coupon today for FREE BOOK

This colorful, illustrated book explains our course in detail and describes the TWO ARTISTS' OUTFITS included with the course. These outfits include everything you need to get started.



FREE BOOK gives details!

WASHINGTON SCHOOL OF ART
Studio 122P, 1115—15th Street, N. W. Washington, D. C.
Without obligation, please send me your Free Book, "Art for Pleasure and Profit."
Name..... Age.....
Address.....
City..... State.....

INVENTORS

Act Now TO PROTECT
YOUR INVENTION WITH U.S. PATENT

Small Ideas May Have Large Commercial Possibilities

Inventions do not have to be complicated to be profitable when Patented. The 5c and 10c stores flourish on simple Patented products which are commercially successful. The zipper, safety pin, thumb tack, paper clip, collar button—all are simple yet familiar inventions—brought their inventors rich rewards. If you have a Patentable invention—act to protect it. Send for our FREE 48-Page Book that tells you how.

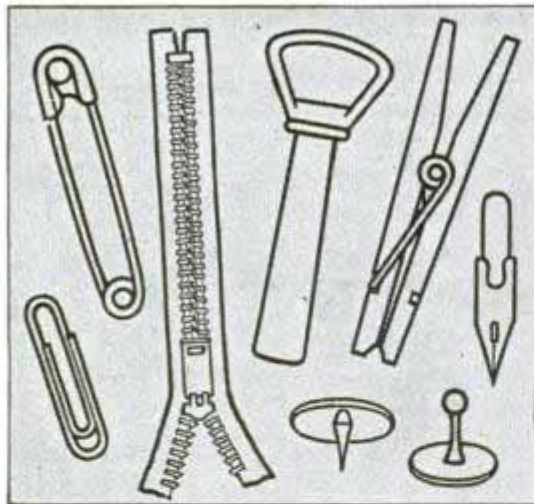

CLARENCE A. O'BRIEN

Dept. OB1, Adams Building, Washington, D. C.
Registered Patent Attorney before U. S. Patent Office

Free Book TELLS IMPORTANCE OF QUICK ACTION—HOW TO OBTAIN PATENT AND MARKET INVENTIONS

If you have invented something, if you're interested in inventing something, you need our new 48-page book that gives the entire Story of Patents. It tells you for the first time about new phases of invention, how others succeeded, how the patent laws protect you, how to market your invention, where to obtain finances, how to form a company, partnership, or arrange for royalties from your invention's sale.

PRACTICAL BENEFITS OF THIS BOOK

You will find 6 complete pages illustrated with simple inventions that have succeeded in six different fields of industry. Over 100 illustrations are in this book. You will read the stories of ten (illustrated) of America's most famous inventors. You will find an experienced and thorough survey of market conditions affecting the inventor—showing the possibilities for commercial invention today. Entire chapters are devoted to the value of a patent in promoting the final success of your invention. The importance of quick action in applying for patent is stressed—facts revealing danger of delay are emphasized.

If you expect to realize profits from your invention you must protect it with a U. S. Patent. Otherwise you may find that all your time and labor have been lost, because it often happens that other inventors are working on the same invention. If you have an invention, or an ambition to invent—get the information on obtaining patent AT ONCE!

FREE RECORD OF INVENTION FORM

When you send for our FREE BOOK, we include, also Free, our specially prepared Record of Invention blank, on which you can quickly make and date a sketch and description of your invention. This "disclosure" as it is called, may be absolutely invaluable as evidence for you, should your rights ever be contested. Be sure to get it and use it.

CLARENCE

REGISTERED PATENT ATTORNEY before U. S. Patent Office

For Quick Action

SEND TODAY



GET FREE 48-PAGE BOOK
and Free Form for Recording Your Invention

MAIL COUPON NOW
TO CLARENCE A. O'BRIEN
Registered Patent Attorney
BEFORE U. S. PATENT OFFICE

Clarence A. O'Brien, Dept. OB1, Adams Building, Washington, D. C.
Please send me your Big, Free 48-Page Book for Inventors and your Specially Prepared Record of Invention form. This request does not obligate me.

Name.....

Address.....

City.....

State.....

(Please write or print plainly).

You Can Patent

IMPROVEMENTS IN MACHINERY, ARTICLES, DESIGNS, FORMULAS, ETC., IF NEW

Every year thousands of Patents are granted. Very few, however, represent the discovery of entirely new principles. Most of them provide new methods of doing some every-day thing in a better way—changes for greater efficiency, usefulness, adaptability, or beauty in some previously Patented thing. These IMPROVEMENTS are patentable if new, and actually represent new inventions. These improvement Patents offer large chances for profit if commercially useful. The business world wants improved products and services.

FINISHED DRAWINGS NOT NECESSARY

Our Big Book tells you how you can start immediately to apply for Patent Protection even if you haven't finished models or drawings available now. It will tell you how we can prepare the specifications and finished drawings necessary in the form prescribed by the Patent Office—so as to secure for you full Patent Protection. Mail Coupon for Our Big Book TODAY.

OUR SERVICES TO YOU

We are Registered Patent and Trade-Mark Attorneys, serving Inventors all over the United States and abroad. Our Organization is complete. We have Draftsmen, experienced Searchers and Attorneys to serve your interests.

We can act as your legal adviser in all Patent Matters. Our complete service is described in Our Big Book. Mail Coupon for it NOW.

REASONABLE FEES—CONVENIENT TERMS

Don't worry about finances. Our fees are very reasonable—we can arrange convenient terms of payment. It is our custom to permit clients to pay for our services in installments as the application progresses in our office. See our Big Book for fees in obtaining Patent. It explains our arrangements clearly. Send for it NOW.

GET FREE BOOK—MAIL COUPON NOW

If you have an invention in the making—if you simply have the crude elements of an invention in mind—you should have our Big FREE BOOK without delay. It will guide you every step of the way—from the preliminary search stage to the issuance of the final patent grant. This book contains twenty-five chapters describing in plain man-to-man language the story of obtaining a patent and marketing an invention. This book is absolutely FREE—just tear off the above coupon or write us a letter or postcard TODAY!

CLARENCE A. O'BRIEN

Dept. OB1, Adams Building, Washington, D. C.
Registered Patent Attorney before U. S. Patent Office

A. O'BRIEN

Dept. OB1, Adams Building WASHINGTON, D. C.

POPULAR INVENTIONS

SURVEY of the ocean floor would be made easier by recently patented apparatus for determining the slope of the bed of a body of water. The device is intended to be drawn along the ocean floor by a ship on the surface. It has means op-

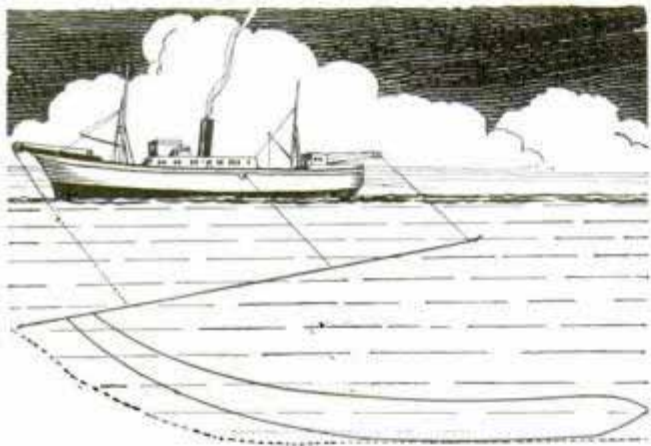

erable under water for transmitting signals corresponding to angular positions assumed by the device as it travels along the sea bed. A receiver on the ship would pick up these signals and translate them into degrees, thus giving the surveyors a means of mapping the submarine area.

HARNESSING the wind has been man's goal for a long time. Now comes an inventor with an idea for a wind-propelled turbine motor, on which a patent has just been issued. It consists of several motor units connected together and each equipped with a drive shaft and a power takeoff connected to each shaft. Each of the motor units would have a frame in which there is a tube extending around the drive shaft and formed with a gear box. Wind wheels

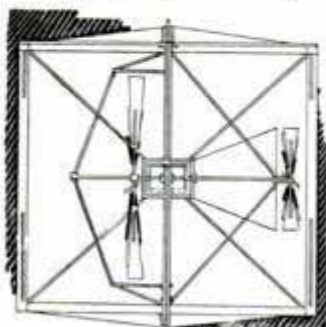

are mounted on the propeller shafts, with the blades of the respective wind wheels oppositely inclined. Gearing within the gear box would turn the drive shaft as the wind wheels rotated in opposite directions. The power plant is a sort of super-windmill.

SIMPLE conversion of two facing seats in a railway coach into a bedlike arrangement is the purpose of a recently patented device. It consists of a rectangular flexible bridge, attached to each of the seats and arranged to support the user's body in the space between the seats. Attachment to the seat is effected by means of straps and hooks. The device is intended to give the day-coach passenger an added measure of comfort in sleeping.



SOMETHING new in motor propulsion of the bicycle is found in a newly patented arrangement. It consists of a motor supported between the front and rear wheels and a transmission that has a small wheel for engaging the rear tire at the approximate height of the bicycle chain. This small wheel turns the bicycle wheel, thus driving the cycle. A lever located in convenient position for the rider permits disengagement of the small wheel from the tire. Pedals and the usual drive are retained.

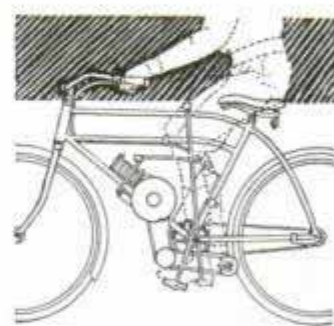

(Continued to page 35A)



Be a wholesale manufacturer. Let the storekeepers sell your product. Frazier and Rarick lined up 580 dealers their first two weeks in business and had an output of 180 pounds a day.



YOU

can be one of a country-wide Chain producing Vita-Seald — the one, standard National Brand of Potato Chips, known everywhere as the most delicious of Potato Chips and at the same time, famous for its health giving qualities due to our unique method of extracting excess grease and retaining the 9 vital minerals so essential to good health.

I'll Start YOU in the Potato Chip Business

and show you how you can "coin money"
right in your own kitchen

NOT long ago it took a lot of money to break into the Potato Chip business. Now, you can start with so small an investment you'll be surprised and "raring to go." You don't need a store or factory. Start right in your own kitchen and grow. My compact, efficient, Vita-Seald Machine represents years of engineering experience. This machine with its high-speed slicer and oil extractor, is all you need to turn out delicious, golden brown Vita-Seald chips which are the rage of the Century. No wonder they sell like hot cakes wherever introduced. When you get your Vita-Seald equipment, you are ready to start making money the very first day. I supply you with everything necessary including beautiful, embossed Vita-Seald trademarked bags and free advertising material. But I do not stop at that. I also furnish you a book of instructions telling exactly how to start and build a business which will produce profits to satisfy any man's ambition.

Experience Not Needed

Here's a business where selling is no problem. You don't need to create a demand for Potato Chips. Millions of pounds are sold and eaten daily. All you have to do is make the kind of chip I will show you how to make, and the orders will flock in.

This is where the Vita-Seald secret comes in. When I discovered how to make a greaseless, mineralized Potato Chip, I revolutionized the Potato Chip business and started to build a nationwide chain of small home-factories, all making and selling the same famous Vita-Seald brand of chips. When I start you in business, I give you full rights to the use of the nationally known Vita-Seald trademark. Just think what it means to produce a famous brand of food instead of a nameless product! Already hundreds of Vita-Seald manufacturers are cleaning up big profits—but the surface is hardly scratched. There's room for thousands! It takes lots of chips to supply the appetites of America's millions!

Few people realize what a big profit margin there is in making Potato Chips. Only \$2.50 invested in raw materials brings back \$10.00 in cash at wholesale. Profits roll in day in and day out. There's no limit to the volume you can do nor the territory you can cover—but "start small and grow big" is my motto. Who knows but some day you may be the Potato Chip King of your state?

Don't Buy Anything — Just Write Me Today!

If you think you want a part in this big-profit industry, let's get down to business. I don't expect you to jump in blind. I want you to make a thorough investigation. Put it up to me to explain and prove every detail. But for heaven's sake, don't hang back through fear I'm going to ask you to put up a lot of money. You'll be astounded at the liberal proposition I have to make you. Just send me your name and address on

a card and say, "Show me." I'll then give you the secret of making greaseless, mineralized Potato Chips and every bit of information I have gathered during years of experience in this line. There's no cost or obligation, yet this may prove to be the most important step you have ever taken to insure a future free from money worries. Address your letter or card personally to me:

I'm Talking
to Men and Women who want to own
a permanent business that can pay

**Big Daily Profits from the Start
Without Overhead Expense**

**Think of it! You buy potatoes at 2c a
pound and sell them as potato chips
at 35c a pound**

That's what I call a *business*. Just
write to me and I'll give you without
obligation, the amazing facts about the
sweetest, soundest business proposition
you ever dreamed of.

George H. Hardt — 620 N. Michigan Ave., Dept. F-52, Chicago, Ill.

FELLOWS-YOU'VE SEEN ALL THESE DIESELS...

but

WHAT ARE YOU DOING ABOUT THEM?

★ ★ Everywhere you look you can see Diesels forging ahead—new types for trucks, busses, trains, boats and general industry. You've seen the ads of world-known firms announcing their entry into Diesel—magazines making Diesels the subject of their feature articles. Never before has there been greater activity in this field. ★ ★ But are you connecting your future with the inevitable growth of this great industry? ★ ★ Find out about it—start doing so by sending for free copy of March of Diesel, and data on Hemphill Diesel training. Use coupon now.

HEMPHILL DIESEL SCHOOLS

All communications concerning enrollment in any of the Hemphill Diesel Courses should be sent to one of the following addresses:

NEW YORK . . . 31-26 Queens Blvd., L. I. C.
 CHICAGO . . . 2014 Larrabee Street
 MEMPHIS . . . 417 Monroe Avenue
 LOS ANGELES . . . 2120 San Fernando Road
 VANCOUVER, B.C. . . . 1363 Granville St.

HEMPHILL DIESEL SCHOOLS (use nearest address)

Please send data on your Diesel courses, also free copy of illustrated booklet "March of Diesel."

Name _____ Age _____
 Street _____
 City _____ State _____ M-42-P

Applications for enrollment will be accepted from English speaking students residing in foreign countries. Write for special terms.

LEARN to PLAY BY EAR

Here is a wonderful NEW way to learn to play the piano, without notes, in as little as 90 DAYS. Play anything—swing to classical. **NEW SYSTEM** is easy. You don't have to practice years. Young or old have equal opportunities. Amaze your friends. Play for pleasure or for money. Cost is very low, payments easy. Send for complete FREE details. No obligation. **Karl Ostrum, Pres.**
HARWOOD SCHOOL OF MUSIC DEPT. 22
 500 N. Dearborn St. Chicago

CRIME DETECTION SECRET SERVICE AND FINGER PRINTS

SECRET SERVICE BOOK FREE

For 30 Days Reading No Money Down—Actual Crime Cases—If You Act Quick! We will send you this stirring book on Crime Detection, Secret Service and Identification Work for 30 days free reading. Send no money. If you decide to keep it, then send me only \$1. If not, return it. **WRITE TODAY.** Literature will be sent only to persons stating their age.

T. G. COOKE, Dept. 1352, 1920 Sunnyside Ave., Chicago, Ill.

ENGINEERING DEGREE IN TWO YEARS

B. S. Degree courses in engineering: Electrical, Civil, Chem., Mechanical, Radio or Aeronautical. 1 yr. Mech. Drafting. Approved by Civil Aeronautics Authority, participation in Pilot Training Program. Large industrial center. Prep courses without extra charge. Earn board if desired. Low tuition. Enter March, June, September, December. *Write for Catalog.*
 520 E. Washington Blvd., Fort Wayne, Ind.

INDIANA TECHNICAL COLLEGE

LEARN AVIATION IN LOS ANGELES • Nation's Aviation Capital

Huge increase in Los Angeles aviation activity has assured splendid positions for graduates. Career training offered for airline piloting, engineering, mechanics, drafting, production mechanics and instruments. Train at one of America's most modernly equipped and strategically located schools, fully approved by the government as a ground, flight and mechanics school. Write for free new 64 page catalog.

CALIFORNIA FLYERS SCHOOL OF AERONAUTICS - Dept. PM-2
 LOS ANGELES MUNICIPAL AIRPORT, INGLEWOOD, CALIF.

NEW YORK SCHOOL OF MECHANICAL DENTISTRY

Learn how to make Crowns, Bridges, Plates in this **OLDEST** Laboratory Center. Practical training. Day, Eve. Easy terms. Ask for free Catalog P and tool offer.
N. Y. SCHOOL of MECHANICAL DENTISTRY, 125 W. 31 St., N. Y. C.

MUSEUM TAXIDERMISTRY

Learn Under Personal Direction **MUSEUM STAFF TAXIDERMIST**
 COMPLETE COURSE • ALL SUBJECTS • WRITE TODAY
 Chicago School of Taxidermy • P.O. Box 343 • Dept. A2 • Chicago

How To Secure A Government Position

In the Classified Civil Service! Railway Postal Clerk, \$1900 a year regular. Postal Clerk, City Mail Carrier, \$1700 regular. Other attractive positions paying \$1260 to \$2100 a year. Our tested method helps you pass examinations. Men—Women, age 18-50, send for our **FREE BOOK** explaining requirements **TODAY.**



PATTERSON SCHOOL, 82 Mercantile Bldg., Rochester, N. Y.
 Send, without obligation, free book "How to Secure a Government Position."

Name _____ Age _____
 Address _____



**EASIEST
to master!**

THIS NEW P-A

● Such beautiful tone, and so easy to play! Just touch a key and blow normally; you can't miss. Nothing to compare with these new P-A Saxes, Clarinets, Trumpets, and other P-A instruments. Fully guaranteed; your success assured. See your music dealer or write direct for beautiful free book. No obligation. Easy terms. Greatest fun, easiest with P-A. Write today sure.

PAN-AMERICAN
203 P-A BUILDING ELKHART, INDIANA

**AVIATION
APPRENTICES**



AIRMINDED YOUNG MEN INTERESTED IN TRAINING FOR ENTERING THE WELL PAID FIELD OF AVIATION AS APPRENTICES—Write immediately, enclosing stamp.

MECHANIX UNIVERSAL AVIATION SERVICE CO.
Wayne County Airport, Box 857, Dept. E, Detroit, Mich.

LEARN WATCH REPAIRING



AT HOME You can learn by our modern and original system of instruction every part of the Watch Repairing Trade at home. You can earn money while learning and prepare yourself for a well paying position or start in business after completing our course of instruction. Good watch repairers are in demand and generally earn very good salaries. For particulars apply to the Wisconsin School of Watch Repairing
524 E. Mason St., MILWAUKEE, WIS.



How to Win Fortune, Happiness by a Book

Money not essential to begin business or develop a winner. Too much money, unless earned by experience, usually means failure. Success develops itself. Marconi, Carnegie, automobile, telephone, telegraph, camera all started from **BOOKS**. Read **HOW**. Learn to get ahead in sure, inexpensive way. For free **HOW GUIDE**, write your name and address on postcard, mail today to

R. & R. Co., 641 H. St., Melrose, Massachusetts



Learn to Write

Begin Today. Write for our Free Book, "How to Become a Good Penman." It contains specimens and tells how others learned to write in spare time. Your name elegantly written on a card if you enclose stamp for postage. Write today. The Tamblin School of Penmanship, Dept. 12, Ridge Bldg., Kansas City, Mo.

**Photography
for**



PLEASURE or PROFIT

Prepare for profitable business or fascinating hobby, at home under guidance of qualified instructors. No previous experience necessary, common school education sufficient. Many earn while learning. Our practical studio methods also qualify for well-paying positions upon graduation. Send coupon below at once for free booklet "Opportunities in Modern Photography", particulars and requirements.

AMERICAN SCHOOL OF PHOTOGRAPHY
3601 Michigan Avenue Dept. 1352 Chicago, Illinois

Send booklet "Opportunities in Modern Photography," full particulars and requirements.

Name.....Age.....

Address.....

City.....State.....

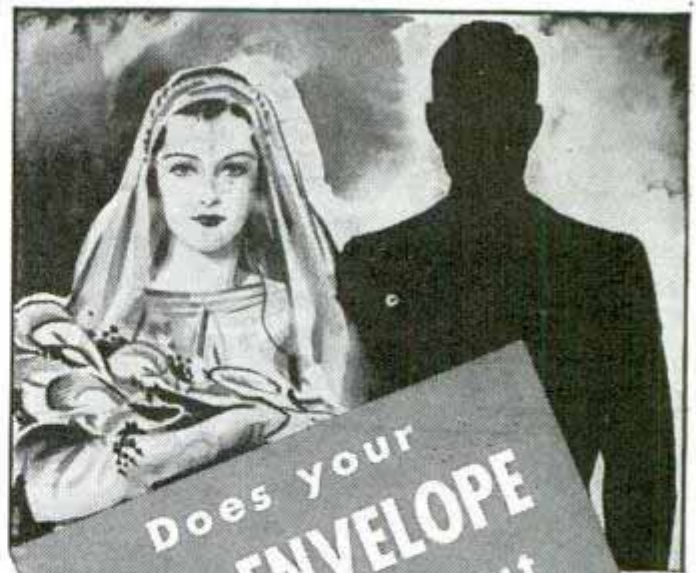

Does your
PAY ENVELOPE
keep you out
of this picture?

● If it does, do something about it! Get a raise in salary—but first get the training that will entitle you to this raise. Thousands of men in the same fix as you have gotten this training by spare-time study of an I. C. S. Course. Mail the coupon today!

INTERNATIONAL CORRESPONDENCE SCHOOLS

BOX 6566-J, SCRANTON, PENNA.

Explain fully about your course marked X:

TECHNICAL AND INDUSTRIAL COURSES

- Agriculture Air Brake
- Air Conditioning Manufacture of Pulp and Paper
- Architectural Drafting Marine Engines
- Architecture Mechanical Engineering
- Auto Engine Tune-up Navigation Patternmaking
- Auto Technician Aviation Pharmacy Plumbing
- Boilermaking Practical Telephony
- Bridge Engineering Poultry Farming
- Building Estimating Chemistry Public Works Engineering
- Civil Engineering Coal Mining Radio Operating
- Concrete Engineering Radio Servicing
- Contracting and Building R. R. Section Foreman
- Cotton Manufacturing R. R. Signalmen Refrigeration
- Diesel Engines Sheet Metal Work
- Electrical Engineering Steam Electric
- Electric Lighting Steam Engines
- Foundry Practice Structural Drafting
- Fruit Growing Heating Structural Engineering
- Heat Treatment of Metals Surveying and Mapping
- Highway Engineering Telegraph Engineering
- Locomotive Engineer Machinist Textile Designing
- Management of Inventions Welding, Electric and Gas

BUSINESS COURSES

- Advertising Bookkeeping
- Business Correspondence Grade School
- Business Management High School Illustrating
- Cartooning Civil Service Lettering Show Cards
- College Cost Accounting Railway Postal Clerk
- College Preparatory Secretarial
- Commercial Foremanship Service Station Salesm'p
- C. P. Accounting French Sign Lettering Spanish

DOMESTIC SCIENCE COURSES

- Advanced Dressmaking Professional Dressmaking and Designing
- Foods and Cookery Tea Room and Cafeteria Management, Catering
- Home Dressmaking

Name.....Age.....

Address.....

City.....State.....

Present Position.....

Canadian residents send coupon to the International Correspondence Schools Canadian, Limited, Montreal, Canada. British residents send coupon to I. C. S., 71 Kingsway, London, W. C. 2, England

Will You Let Me PROVE I Can Make YOU a New Man?

LET ME START SHOWING RESULTS FOR YOU



7-DAY TRIAL OFFER

I could fill this whole magazine with enthusiastic reports from OTHERS. But what you want to know is—"What can Atlas do for ME?"

Find out—at my risk! Just give me a 7-day trial. Just one week!—and even in that short time I'll start giving RESULTS. AND it will be the kind of RESULTS that you (and anyone else) can SEE, FEEL, MEASURE with a tape.

FREE BOOK

I myself was once a 97-pound weakling—sickly, half-alive. Then I discovered "Dynamic Tension." And I twice won the title, "The World's Most Perfectly Developed Man!"

"Dynamic Tension" has done so much for other fellows that I simply ask you to let me prove that it can make a new man of YOU—that it can start new inches of power pushing out your chest—build up your shoulders to champion huskiness—put new, hard, firm muscles on your biceps—make those stomach muscles of yours hard ridges!

Why not risk a postage stamp? Send coupon for my 48-page illustrated FREE BOOK AT ONCE! Address me personally: Charles Atlas, Dept. 82, 115 East 23rd Street, New York, N. Y.

CHARLES ATLAS, Dept. 82
115 East 23rd Street, New York, N. Y.

I want the proof that DYNAMIC TENSION will help make a new man of me—give me a healthy, husky body and big muscle development. Send me your free book, "Everlasting Health and Strength"—and full details of your 7-DAY Trial Offer.

Name.....
(Please print or write plainly)

Address.....

City..... State.....

MAKE POULTRY PAY YOU A GOOD LIVING FOR LIFE



POULTRY RAISING PAYS GOOD PROFITS FOR THOSE WHO KNOW ITS SECRETS

Healthful, interesting occupation for whole or part time in country, village or city suburbs. Open to young and old. Win independence of low wages, uncertain employment, uncongenial labor, with a Poultry Business of your own.

PROVED METHODS BRING SUCCESS FROM START

Harry M. Lamon, nationally known Poultry Expert, former Senior Poultryman U. S. Dept. of Agriculture, quickly trains ambitious men and women for Poultry Success from start. His famous Home Study System, endorsed by thirty leading Agricultural schools. Fascinating study, easy to learn, complete in every detail, shows valuable success secrets used by leaders, how they avoid losses. How to start in small way. Make business grow from sale of Poultry, Eggs and Baby Chicks. Big, ever increasing demand. Or prepare for a good job in large poultry plant. Established nearly twenty years—a multitude of graduates attest the success of his time-tested methods.

Mr. Lamon has prepared a big 32-page book "How To Raise Poultry for Profit", chock full of money-making poultry facts. He offers to send it Free to anyone interested in learning the splendid money-making opportunities in Poultry Raising. If you are "at sea" on your future, send for this Free Book today.

Address: Harry M. Lamon, President,
NATIONAL POULTRY INSTITUTE
Dept. 50-F Adams Center, N. Y.

FREE BOOK TELLS HOW

A multitude of poultry-raisers large and small are making money in this most interesting and profitable occupation.

Whether you have ever kept chickens or not—whether you have ten hens or ten hundred, you should read this FREE BOOK. It's yours for the asking.



LOOK! Baby Chicks

THOUSANDS WEEKLY ALL YEAR. Finest quality & Layers in 40 breeds. Hybrid Baby Pullets and Cockerels, B. W. D. Teed. Ducklings, Goslings, Baby Turkeys, Guineas. In business 30 years. Catalog free. ORDER NOW. Make BIG money raising NABOB QUALITY CHICKS.

NABOB HATCHERIES, BOX M, GAMBIER, OHIO

Best Poultry Paper 6 BIG ISSUES 10¢

Helps Increase Poultry Profits. Send coin or stamps, 50 cents for 3 years or 10 cents for 6 months trial. Agents wanted. American Poultry Journal 532 So. Clark Street Chicago, Illinois

RADIO ENGINEERING, broadcasting, aviation and police radio, servicing, marine and Morse telegraphy taught thoroughly. 48 weeks' engineering course equivalent to three years' college radio work. School established 1874. All expenses low. Catalog free.

Dodge's Institute, Ada St., Valparaiso, Ind.

TIRE PUNCTURED 27 TIMES..

LEAKS NO AIR

1001 Repairs In Home, Auto, Farm For Only

New plastinoid "putty"—SO-LO—fills cracks, holes in tires, shoes, boots—anything of rubber, leather or cloth. Spreads on like butter. Dries tough. Waterproof, flexible, non-skid. Won't come off—guaranteed! 25c package (25 repairs) shows many uses. At any 10c or hardware store.



So-Lo

"Woolworth, Kresge, Newberry, Murphy, McCrory, Neisner, McLellan, Sears and Ward, are now featuring SO-LO".

Law!

LEARN AT HOME

Are you adult, alert, ambitious, willing to study? Investigate LAW! We guide you step by step—furnish all texts, including 14-volume Law Library. Training prepared by leading law professors and given by members of bar. Degree of LL. B. conferred. Low cost, easy terms. Send NOW for Free, 48-page "Law Training for Leadership."

LASALLE EXTENSION UNIVERSITY, Dept. 264-L, Chicago
A CORRESPONDENCE INSTITUTION

AN AVIATION CAREER



OFFERS YOU GREAT FUTURE!

Demand for trained aircraftmen is increasing and already exceeds supply. Curtiss-Wright Tech, Aviation's foremost school, is located on Grand Central Air Terminal in heart of the aircraft industry and specializes in training MASTER MECHANICS and AERONAUTICAL ENGINEERS. (No flying involved.) Graduates are obtaining immediate employment. Write for details NOW. Dept. PM-2.

CURTISS - WRIGHT TECHNICAL INSTITUTE
Glendale (Los Angeles) California

ENGINEERING

DEGREE
IN TWO
YEARS

TECHNICAL AND APPLIED COURSES. Nonessentials omitted. TIME AND MONEY SAVED. Degree 2 yrs., diploma 1 yr. Electrical, Mechanical, Architectural, Structural, Civil, Aeronautical, Highway. All courses include Air Conditioning, Electric Refrigeration and Diesel. Short intensive courses 3 and 4 months in Electricity, Power Plant, Diesel-Electric, Electric Refrigeration, Drafting. Extensive modern equipment. LOW TUITION. Part-time work for room and board. Thousands of successful graduates in U. S. and foreign lands. Approved by industry, endorsed by educators, recommended by alumni. One and two-year courses start in Sept., short courses open year round. 40th YEAR. Residence courses. Catalog free.

FINLAY ENGINEERING COLLEGE

1001 Indiana Avenue

Kansas City, Mo.

Learn CARTOONING



Make money! Have fun! You can learn at home.—2 complete courses—Cartooning and Cartoon Idea Getting—both for only \$2.80 postpaid. Or send \$1.00, balance C.O.D. Order direct or write for details. Moon Gag-Cartoon School, Dept. A, Fall Creek, Wis.



BE A PASSENGER TRAFFIC INSPECTOR

RAILWAY and BUS

Write for Free Booklet describing our 21 yrs.' service placing Men (19 to 50) in jobs that pay up to \$135 per month to start. Simple, home-study course trains you in spare time. STANDARD BUSINESS TRAINING INSTITUTE, Div. 202, Buffalo, N. Y.

LEARN Short-Method Arithmetic



Simplified system used by "master minds" on stage, accountants, bankers, etc. Easy to learn. Add columns of figures short-cut method; multiply 4 figures by 4 figures without using old-fashioned multiplication; use sight method of proving addition, division, etc. Learn horsepower calculation, how to use slide rule, micrometer. Complete illustrated course only \$1.00, postpaid. Satisfaction or refund. Amaze your friends with your mental wizardry! Free details—mail coupon TODAY.

FREE

NELSON CO., B-300 Manhattan Bldg., Chicago, Ill.

Send free details about "Short-Method Mental Arithmetic" without obligation on my part.

Name.....

Address.....

City..... State.....

REAL JOBS OPEN

FOR TRAINED AUTO MECHANICS



LEARN QUICK!
8 WEEKS
practical SHOP
TRAINING!

AUTO, DIESEL and AVIATION mechanics

WELDING—BODY & FENDER

I'll train you quickly, correctly for this fascinating work, paying up to \$60 a week! Based on 25 years' experience knowing how to train men well, in the 2 biggest, best schools of their kind in the world. You learn with real tools, on real equipment, a complete, practical course in Auto, Diesel and Aviation Mechanics, Welding, Body and Fender work so you can step out of low-pay jobs into a career in the biggest field of opportunity in America today!

SPECIAL LOW RATE

SPECIAL LOW TUITION RATE IF YOU ACT NOW!

Again McSweeney leads in real value. If you write at once we will reveal a special new low tuition rate that will amaze you, and on easy terms it makes it easy for you to train AT ONCE for a big-pay job! Write TODAY for details!

McSWEENEY MEN MAKE GOOD!

25 years' success means something to you! Read how others have succeeded with McSweeney training: "Just got thru writing income tax check. Money spent at your school was best thing I ever did!"—Lee Grant, O.; J. W. Wiggins, Okla., says before we trained him he had no income, now has own business, money in bank and to spend! G. B. Park, Ind., says "Your training fitted me to handle any job in auto field." These men were trained in our fine big schools, best of their kind anywhere!

TWO FINE BIG SCHOOLS



DETROIT



KANSAS CITY

FREE BOOK!



Send now for your copy of my big book giving all the facts and announcement of amazing new low tuition rate for short time only—but you must write at once!

Address nearest school:

McSWEENEY TRADE SCHOOL

Dept. F-7, Detroit, Mich., or Kansas City, Mo.

Without cost or obligation send me your big FREE book.

NAME.....

STREET.....

TOWN..... STATE..... AGE.....

FREE ALLIED'S 204 PAGE RADIO AND PARTS CATALOG

OVER 15,000 RADIO ITEMS
AT RADIO'S LOWEST PRICES

60 SET VALUES!

Radio's greatest values—new "Knights" for every purpose. 60 models, 4 to 12 tubes, newest features, "Air-Magnet," Gemloid Dials, etc.—latest portables, electric phonographs, phono-radios, etc., at sensational prices. SEE ALLIED'S CATALOG NOW.



Learn
Radio
"BUILD YOUR
OWN"



Build your own radio receiver, transmitter, transceiver—learn while you build! Dozens of new, low-cost Kits—beginners to most advanced—are shown in ALLIED's big, new Radio Catalog. Write us first for Free matched parts lists to build any circuit. Learn Radio quickly—enjoy this great hobby! ALLIED serves you best at lowest cost!

RADIO BUILDERS' HANDBOOK—A new and different book on radio; tells how to select circuits, read diagrams, build sets, etc. Easy to understand. Packed with valuable data. Latest revised edition. **10c** Only.....
Order by coupon below.

SENSATIONAL P. A.

3 complete new "Knight" lines—"Economy," "Standard," and "Deluxe"—14 new systems (with built-in phono!), 6 to 70 watts, remarkable values!—and latest accessories, recording equipment, etc.—low priced, also available on new Time Payment Plan!



5 BIG BOOKS IN 1!

ALLIED's new Catalog is really 5 Super books in 1, offering every radio need for dealer, serviceman, amateur, sound man and builder! Write for this Catalog today—save money on Everything in Radio! It's Free—just SEND COUPON to—



ALLIED RADIO

833 W. Jackson Blvd. Dept. 5-FB-0
Chicago, Illinois

- RUSH your FREE 1940 Radio Supply Catalog.
 ENCLOSED IS 10c for your NEW Radio Builders' Handbook.

Name.....

Address.....

City..... State.....

ELECTRICAL ENGINEERING

★ ONE YEAR Residence Course
prepares you for technical positions

Thorough training in minimum time. Combines theory with practical work in well-equipped laboratories. Experienced faculty and complete facilities provide training essential for interesting technical careers.

Over 7000 Graduates

High employment record is industry's endorsement of Bliss training. Graduates hold responsible technical and engineering positions. Suburban campus; modern buildings; dormitory. Enjoyable student life. 47th year. CATALOG. Give age.

BLISS

ELECTRICAL SCHOOL
132 Takoma Ave., Washington, D. C.



HOW TO PLAY THE HAWAIIAN WAY



HAWAIIAN GUITAR—Learn to play this EASY, SHORT CUT WAY, right in your own home. No tedious practicing. No special talent necessary. Have Fun. Be popular. Surprise your friends. Get "on the air." Make money teaching others. Hundreds of our students now successful in orchestras, teaching, radio. You can do the same.

FREE ILLUSTRATED BOOKLET
"How to play the Hawaiian way" tells all about this quick, fascinating method. Write today.
OAHU SCHOOL OF MUSIC, 2100 Payne Ave.
Cleveland, Ohio.

AUTO-MECHANICS & WELDERS

Auto Mechanics and Welders are in big demand. Complete courses in arc and acetylene welding, body and fender bumping, spray painting and metal finishing. Pay after graduation plan. Special low rates. Write today.

MICHIGAN TRADE SCHOOL
3758 Woodward Ave., Detroit, Mich.

Write
for
FREE
CIRCULAR

Learn Public Speaking

At home—in spare time. Many overcome "stage-fright," gain self-confidence and increase earning power, this easy way. Write for free booklet, *How to Work Wonders With Words* and requirements.
North American Institute, Dept. 1352
3601 Michigan Ave., Chicago, Illinois

WILL YOU WEAR THIS SUIT and Make up to \$12 in a Day!



Let me send you a fine all wool union tailored suit FREE OF ONE PENNY COST. Just follow my easy plan and show the suit to your friends. Make up to \$12 in a day easily. No experience—no house-to-house canvassing necessary.

Send for Samples—FREE OF COST

Write today for FREE details. ACTUAL SAMPLES and "sure fire" money getting plans. Send no money.
H. J. Collin, PROGRESS TAILORING CO., Dept. C-216,
500 South Throop Street, Chicago, Illinois.

Always write your name and full address clearly when answering advertisements.

THESE FREE BOOKS ARE FOR INVENTORS

AND OTHER MEN WITH IDEAS

"We're only entering the great period of inventive advancement"
—says C. F. Kettering, Vice Pres., General Motors

SOMETIMES we hear people say: "Well, there isn't much left to invent." But Charles F. Kettering, Vice-Pres. and head of Research of General Motors, who helped develop the self-starter, Duco and many other outstanding inventions, doesn't think that at all. Not long ago in a published statement, he said:

"If we took half the men employed in tool making and put them to working out new inventions, new things, we could snap out of this depression in no time. Our return to normal times depends on new manufactured products that will catch the purchaser's eye, get him to buy and thus start the ball rolling. Change and buying go together. *We are only entering the great period of inventive advancement.*"

Many Little Ideas Have Big Commercial Possibilities

Some of the world's best inventions came from men who didn't consider themselves inventors at all. The telegraph was invented by a painter, the typewriter by a farmer, the hand camera by a bank clerk, the stock ticker by a dentist. Or look at small inventions. A husband noticed his wife bending a hair pin to make it stay put. That gave him the idea of the crinkly hair pin. One day a golfer got the idea to make a wooden tee. Now wooden tees are sold by the millions every year. There are many similar examples in inventive history. That is why we say that the books shown here are for INVENTORS and Other Men with IDEAS. Whether you consider yourself an inventor or not—if you have an idea that will make money, save time, save labor, or give pleasure—find out how you can protect your right to it.

Our Business Is To Help You

For forty-two years, this organization has been in the business of helping inventors. During that time inventions from every corner of the country have been turned over to us to protect. Some ideas have represented complicated mechanisms; others have been small, practical articles, like a can opener or a new toy. All this has given us a wealth of experience to use for the inventor of today. Here in Washington, we maintain a large staff of experienced Patent Specialists to give you prompt and expert service. Yet because we work efficiently—our fees are low; and if desired we help you with deferred payments. But first, find out exactly what to do to protect yourself. **Decide on that today by sending for your FREE copies of the books shown above.**

Suggestions
on
WHEN
and
HOW
to Sell an
INVENTION

THESE BOOKS TELL YOU:

How the Patent Laws protect an inventor. Simple steps to take promptly, without cost, to claim your right to your idea. Kind of sketch or model needed. How you can go about selling an invention. They are full of valuable facts, simple, easily understood suggestions and interesting bits of inventive history. We gladly send them to serious men. No charge, no obligation. Write us or use the coupon below. Get that much done today.



VICTOR J.
EVANS & Co.

REGISTERED PATENT & TRADEMARK ATTORNEYS

MAIN OFFICE: 560-B VICTOR BUILDING

WASHINGTON, D. C.

Pittsburgh Office: 514-N Empire Building

Rush by return mail FREE copies of your books, "Patent Protection" and "When and How to Sell an Invention" also important EVIDENCE OF INVENTION FORM. I want to know if I can quickly and safely commercialize my invention.

Name.....

Address.....

City or Town.....

PATENTS

Booklet Free Highest References
Promptness Assured Best Results

Send drawing or model.

ALL BUSINESS GIVEN PROMPT AND PROPER ATTENTION

Listed Patent Lawyer in the latest editions of the Rand-McNally Directory of Bankers and Bank-Recommended Attorneys, published by Rand-McNally & Co., Chicago, Ill.; The Baggott & Ryall Directory of Guaranteed Attorneys, published by Legal Directory Corporation, Boston, Mass.; American Lawyers Annual, Cleveland, Ohio; Bankers Service Legal Directory, published by Bankers Service Co., Boston, Mass.; Eyre's Law List, 9 Park Place, New York City; Snow-Church Directory Co. Lawyers List, published in New York City, and the Central Guarantee Co., Bankers and Lawyers Directories, 630 Fifth Avenue, New York City.

WATSON E. COLEMAN, Victor Building, 724 Ninth Street, N. W.
REGISTERED PATENT LAWYER **WASHINGTON, D. C.**

INVENTORS PATENT YOUR IDEAS SEND FOR FREE BOOK



HOW TO OBTAIN A PATENT

Written by a Former Member of the Examining Corps (1922-24) of the U. S. Patent Office. If you want to profit by your ideas, you should take steps to apply for a U. S. Patent at once. Your first step is to get this Free Book. This interesting illustrated book contains valuable information you should have. It tells you fully how to obtain a patent on your idea in the quickest way. With this Free Book you will also receive a "Record of Invention" form on which you can easily record your idea. Personal and Confidential Service: Your case will be personally handled only by a Registered Patent Attorney who is also a Former Member of the Examining Corps of the U. S. Patent Office. All communications confidential.

MAIL COUPON TODAY for FREE PATENT BOOK and RECORD OF INVENTION Form.

CARL MILLER
REGISTERED PATENT ATTORNEY
FORMER MEMBER EXAMINING CORPS U. S. PATENT OFFICE

Woolworth Bldg., 35th Floor, Dept. 20-A, New York City
MILLER BUILDING, Dept. 20-A, WASHINGTON, D. C.
Please send me your Free Book, "How to Obtain a Patent," and your "Record of Invention" form.

NAME.....

ADDRESS.....

Inventions Wanted Patented or Unpatented

We have been successfully selling inventions, patented and unpatented, since 1924. Write for proof, and tell us what you have for sale.

Chartered Institute of American Inventors
Dept. 4, Barrister Building, Washington, D. C.



G E A R S

In Stock — Immediate Delivery

Gears, speed reducers, sprockets, thrust bearings, flexible couplings, pulleys, etc. A complete line is carried in our Chicago stock. Can also quote on special gears of any kind. Send us your blueprints and inquiries.

Send 10c for Complete Catalog No. 10

CHICAGO GEAR WORKS
440-48 N. Oakley Blvd. CHICAGO, ILL.

PATENTS—TRADE MARKS

All cases submitted given personal attention
Form "Evidence of Conception" with instructions
for use and "Schedule of Government
and Attorneys' Fees"—FREE!

LANCASTER, ALLWINE & ROMMEL

Patent Law Offices

412 Bowen Bldg.

Washington, D. C.

INVENTORS

who derive largest profits know and heed certain simple but vital facts before applying for patents. Our book, Patent-Sense, gives those facts; sent free. Trade Marks—Copyrights.

LACEY & LACEY, Est. 1869, 635 F St., N. W., Dept. 5, WASHINGTON, D. C.

SMALL INVENTIONS WANTED!

Small inventions wanted by manufacturers. I'll help you sell your inventions. Write for free details.
S. HULL, Dept. K, 7829 Euclid Ave., Cleveland, Ohio

—INVENTIVE MINDED—

can become independent! Write NOW for free explanation as this opportunity is limited. Briefly state your qualifications or line of work followed, by letter to:

D. C. HIGBEE,

CANTIL, CALIF.



BUCHSTEIN'S FIBRE LIMB

Soothing to stump, cool, light, strong.

Correct fit. Braces for all

deformities. Fair terms.

D. BUCHSTEIN CO.

610 3rd Ave. South, Minneapolis, Minn.

RUPTURED?

Get Relief This Proven Way

Why try to worry along with trusses that gouge your flesh—press heavily on hips and spine—enlarge opening—fail to hold rupture? You need the Cluthe. No leg-straps or cutting belts. Automatic adjustable pad holds at real opening—follows every body movement with instant increased support in case of strain. Cannot slip whether at work or play. Light. Waterproof. Can be worn in bath. Send for amazing FREE book, "Advice To Ruptured" and details of liberal truthful 60-day trial offer. Also endorsements from grateful users in your neighborhood. Write:

CLUTHE SONS, Dept. 31, Bloomfield, New Jersey

Sometimes advertisers are unable to respond to inquiries due to lack of complete information.

To PROTECT YOUR INVENTION — Use this coupon, NOW

Delays are dangerous and may be very costly. My personal service assures prompt action, strict confidence, and a minimum of expense. I suggest that you send me a model or drawing, or sketch and description of your invention, and \$5.00. I will make a search and report

promptly as to its patentability and send you a copy of my 72-page booklet. Or, if you prefer to read my booklet first, mail the attached coupon at once. I will also send my "Record of Invention" form. (Over 38 years experience as a Registered Patent Attorney.)

L. F. Randolph, 302-D Victor Bldg., Washington, D. C.

Please send me at once, free of charge, your 72 page booklet and "Record of Invention" form.

Name.....

Address.....

A PERSONAL CONFIDENTIAL PATENT SERVICE

ARTISTS HAVE FUN!

How would you like to be paid for the thing you like to do. You can get an inspiration out of the Croydon Institute system of instruction in design, illustration, cartooning and all subjects in which artists are interested. Learn the Croydon way a simple home study method with lessons supervised by such famous artists as William G. Connelly, Helen Chamberlin, Harley Lichtenberger, Erna Faust, Fred Eizensohn, Kathaleen Johnson, Paul Colmoran, C. E. Waltman and Don Nelson. Course covers fashion illustration, color, merchandise illustration, booklet construction, head and figure drawing, perspective, photo retouching, in fact, our training should fit you for any branch of art. Anyone from high school age up should benefit quickly through our training. Write for 6 x 9 copy of this illustration and details. There is no obligation.



CROYDON INSTITUTE
620 N. Michigan, Dept. 212, Chicago, Illinois

Auto-Diesel

Master a real trade. Auto Mechanics, Diesel Mechanics, Arc Welding, Acetylene Welding, etc. Let us train you to be an expert Auto-Diesel Mechanic and help you get a good job. The cost to you is reasonable. Learn on modern equipment with tools under experienced instructors. Real shop work. Steam heated buildings. Room and board in our steam heated dormitory. We pay your fare to Nashville. For free catalog write

Nashville Auto-Diesel School, Dept. 75, Nashville, Tenn.

TOOL & DIE MAKING DESIGNING

Machinists Trade. Not a correspondence course. Practical shop training in the world's Industrial center. Write today for full information.
Dept. 14 NATIONAL SCHOOL OF MECHANICAL TRADES
628 W. Lake St. Chicago, Ill.

do-it-with-squabs

Ready for market **ONLY 25 DAYS OLD**. Write a post-card, set **FREE EYE-OPENING Squab Guide**. Why breed for ordinary trade when these great luxury national markets are wide open for all the **SQUABS** you can ship, every day in the year? Go after this desirable, profitable trade now.
RICE FARM, 640 H St. Melrose, Mass.

Learn by pre-tested Training RADIO plus TELEVISION



A flexible Training Plan to fit your immediate needs

National Schools offer optional training planned to fit your present circumstances. You can master Radio, Television, Sound and allied trades by National's exclusive plan. Actual shop and studio training; also complete training if you cannot give up your present employment and income. A definite plan to fit your needs.

FREE LITERATURE

Explains National's pre-tested plan; how you can master Radio, all branches, Sound-Recording, Public Address & Communication Systems, Broadcasting, Television. This interesting literature sent post-paid, without obligation to you.

NATIONAL SCHOOLS
Los Angeles (EST. 1905)

Request for **FULL DETAILS**

NATIONAL SCHOOLS, Dept. PMR-2
4000 S. Figueroa St., Los Angeles, Calif.

NAME _____ Age _____

ADDRESS _____

CITY _____ STATE _____

Inventors Free Books



Answer your questions!

Practical Facts You Will Want to Know About
PATENTS TRADE MARKS
COPYRIGHTS

●These C. A. Snow & Co. Free Books will save you **TIME** and **MONEY!**

Now one of America's oldest firms of patent attorneys offers you important facts on how to protect and commercialize your ideas . . . the very facts which can save you wasted hours and unnecessary expense. These free books are based on 64 years' experience and tell you exactly what to do to protect your invention.

Find Out RIGHT NOW

Before going any further with your idea—be sure you are on the "right track." You will be able to know before spending more time and money the costs and procedure in obtaining a patent. In the books you will find the plain answers to questions that have long bothered inventors.

Confidential, quick service

Our years of experience in helping others should make you feel perfectly safe in dealing with this reputable firm. All inquiries are answered immediately and held in strictest confidence. Write today.

TEAR OUT and Mail Coupon Today



C. A. SNOW & CO.
Registered Patent Attorneys Since 1875

102 SNOW BLDG., WASHINGTON, D. C.

Gentlemen: Please send me—without cost or obligation—your **FREE** books, "Suggestions on How to Commercialize Your Invention" and "How We Protect You." Also Certification of Invention form.

Name _____

Street and No. _____

City or Town _____ State _____

FOR MEN WHO WANT TO LEARN A PROFITABLE TRADE

Complete DIESEL TRAINING

NO MATTER WHERE YOU ARE OR WHAT YOU DO —we have a training plan for YOU!

IF you are sincerely ambitious and interested in making good in the Diesel field, be sure to immediately investigate our flexible training plan that will fit your circumstances. A Plan for every Man. A Plan for those seeking immediate shop training as well as for those who cannot give up their present employment and income. For 34 years National Schools, a recognized leader in the field of trade education, has helped wide-awake men to success. This million-dollar trade school will supply you with a sincere, honest statement of facts of what you should do to quickly get into the profitable Diesel Industry. No exaggerations—no misstatements; and a definite plan to fit you.

Write Today for Full Details

Mail the coupon below. Find out how you can get the finest in Diesel training without delay. See how this great trade school operates and make its facilities available to every ambitious man. Actual work in modern training shops, a part of every man's instruction. Shop methods time-tested for 34 years. Fascinating, efficient preparation. Get the facts,

WE ARE DEFINITELY INTERESTED IN HELPING MEN OF LIMITED INCOME AND "BLIND ALLEY" JOB HOLDERS.

NATIONAL SCHOOLS

LOS ANGELES, CALIF.

Complete Training in Diesels and Gas Engines.

Oldest Trade School in West

MAIL COUPON FOR FREE LITERATURE



Request for Free Literature

NATIONAL SCHOOLS (established 1905) Dept. PMA-2
4000 South Figueroa Street, Los Angeles
Please send me, without obligation, your FREE Literature and information.

NAME _____ AGE _____

ADDRESS _____ CITY _____ STATE _____

Easy to Play

THE SMALLEST, LIGHTEST, FULL-VOLUMED 90 BASS ACCORDION EVER DESIGNED. IT'S THE NEW SOPRANI AMPLIPHONIC MIDGET

● Think of it! 34 treble, and 90 bass keys, beautiful tone, amazing volume. See and try this wonderful new Soprani at your dealer's, or write for FREE booklet.

SOPRANI, INC. Dept. 229
630 S. Wabash, Chicago, Ill.

FREE BOOK

PHOTO-ENGRAVING TASOPE' SINCE 1931

Cash in on pictures! Learn quickly at home or in our residence school. Make halftones, line cuts for the trade. Qualify for interesting, good pay job. We show you how and supply complete low-cost engraving plant. Small investment. Easy terms. Particulars free!

THE AURORA SCHOOL OF PHOTO-ENGRAVING
Dept. PM-13 Tasope' Bldg. Aurora, Mo.

Yes! YOU CAN MAKE BIG MONEY WITH HOOVER UNIFORMS!

Big earnings for ambitious men and women in new uncrowded field with famous nationally-advertised Hoover line of smart, exclusive Uniforms for restaurants, hotels, taverns, stores, offices, doctors, dentists, etc. Not house-to-house. No experience—no money needed to get into this new, big-income business. Mail postcard now for beautiful new Uniform Style presentation, actual samples and money-making equipment—sent FREE.

HOOVER 251 West 19th Street
Dept. AK-10 New York

Correspondence Courses in RADIO and ELECTRICAL ENGINEERING LOW AS \$25

ELECTRICAL ENGINEERING. Get good grasp of wide electrical field. Modern. Very understandable. Theory made easy.
RADIO ENGINEERING. Extra fine course in radio, public address, photo-electric work. Trains you to be super-service man, real vacuum tube technician. Tuition ONLY \$25, other course. Deferred payment plan. Experiment kits furnished.
FREE Write for free copies of school catalog, student magazines, etc.

FREE LINCOLN ENGINEERING SCHOOL, Box 931-P14, Lincoln, Nebr.

EARN THE DEGREE

Doctor of Psychology (Ph.D.), Philosophy, Divinity, Science, General Courses—Arts, Law, Business, etc. A Chartered Correspondence Institution. Send for 32-page FREE Bulletin at once. No Obligation.
Temple Bar College, Inc., Dept. 2-R, 1411 Fourth Avenue Seattle, Washington, U.S.A.

Learn ADVERTISING at Home

Greater opportunities now in advertising. Learn easily and quickly in spare time. Practical work. No text books. Old established school. Low tuition—Easy terms. Send for free booklet and requirements.

Page-Davis School of Advertising
Dept. 1352, 3601 Mich. Av., Chicago

MYSTERIOUS DEVICE WELDS BRAZES AND SOLDERS ANYONE CAN OPERATE

Now, an electric welding, brazing and soldering Torch, complete with power unit, goggles and supplies. **Works INSTANTLY off any light socket.** Does a thousand and one repair jobs at amazingly LOW COST on aluminum, iron, steel and other metals. **Indispensable** for Auto, Body and Fender Repairs, and home repairs—shop, factory, farm, engineer, janitor, sheet metal, radio and bicycle repairs. Anyone can handle without previous experience with our sim- **10-DAY HOME TRIAL** instructions.

Write at once for Special Introductory Low Price Offer. Try 3 in 1 Electric Torch for 10 days at our risk, or get our free by helping to introduce it. **ELECTRO-TORCH CO., 2613-GA Michigan Ave., Chicago**

FACTORY-TO-YOU SAVES YOU UP TO 50%



EASY TERMS

30 DAYS TRIAL

TELEVISION ADAPTATION
SUPER BUILT-IN AERIAL SYSTEM

GET WAR NEWS DIRECT!

... with this amazing new radio-phonograph chassis combination—or, play records on new-type electric phonograph. Other radio models from 5 to 17 tubes, and up to 5 wave bands. Send 1c post card for FREE catalog showing complete line. (User agents make extra money)

See Midwest's Answer to TRADE-INS!



14 TUBE
RADIO CABINET MODEL
\$29.95 COMPLETE

PUT THIS NEW **14-TUBE** RADIO-PHONO CHASSIS IN YOUR PRESENT CABINET
Only \$22.50 COMPLETE

MIDWEST RADIO CORPORATION
DEPT. 15-J CINCINNATI, OHIO

Want a Career in Photography?
Ever consider photography as a money-making career? Fascinating field. Fine opportunities. We offer you a thorough, individual training. Commercial, News, Portrait, Advertising, Color, or Motion Picture photography. Learn for pleasure or career. Personal Attendance and Home Study courses. Free booklet.

NEW YORK INSTITUTE OF PHOTOGRAPHY
10 West 33 Street (Dept. 49) New York City

PRESTO! ANYONE CAN MASTER GLAZE

LEAVES HARD GLASS-LIKE FINISH
EASY TO APPLY
PROTECTS THE SURFACE
NO SMEAR OR STREAKS AS WITH WAX
LASTS SIX MONTHS TO A YEAR
SEALS THE PORES OF THE SURFACE
WILL NOT FINGER-MARK
NO DILY FILM AS WITH POLISH
SAVES YOU MONEY

Car Owners! Meet Master Glaze—the sensationally different luster for new and used cars! Not a wax—not an oil polish—not a paint!—nothing that “smears” over the surface.

MASTER GLAZE is a unique discovery—a creamy liquid—quick and easy to apply! Gives a hard, glass-like surface. Even gasoline cannot dull it! Lasts six months to a year! Amazing luster—beautiful, sparkling clean and brilliant! Doesn't finger-mark—doesn't smear! A match box full glazes an entire car. Seals the pores—protects! **NOTHING LIKE IT!**
FREE Offer! Write now for **FREE BOOK-LET** and **FREE TRIAL OFFER**. Just send your name and address. Write **MASTER GLAZE CO., 7720-131 W. Harwood Ave., Milwaukee, Wis.**

AGENTS
An unusual opportunity! Quick, flashy demonstrator. Big profits. Good territory. Write today!

WELDING

GET IN LINE FOR BIG PAY JOBS IN



Today's Fast-Growing Industry

As steel and machinery orders increase, the welding industry—like any other new industry—faces the problem of getting capable, trained and certified code welding operators, technicians, engineers and mechanics. The application of gas and electric welding is almost unlimited—aircraft, diesel, automobile and building. Manufacturing, assembly and industrial plants insist upon men who are trained as expert practical operators—with a thorough knowledge of metallurgy as applied to welding.

Welding training offers an easy way to get into business for yourself—with little or no initial investment. Manufacturers of welding equipment will cooperate.

LEARN AT HOME—SHOP WELDING INCLUDED

By using Chicago Tech's new system of training known as the "Modified Oxford Plan" you can learn the basic facts about Welding, Metallurgy, Blue Print Reading, etc., at home in your spare time. Then, upon completion of the home section of your Course in Welding according to your enrollment agreement, you are brought to Chicago (transportation and room furnished by the College) for an intensified course of training in Chicago Tech's new welding shops where you gain actual experience with modern shop equipment under the guidance of expert welding instructors.

DAY and EVENING RESIDENTIAL CLASSES

If situated so that you can go to school at once you can start here any Monday. Train in modern shops—completely equipped. Only average school education is required. Modest budget terms. Investigate! Send for full information now.

FREE "BLUE BOOK"

free "BLUE BOOK"

Send post card or this coupon for this book that has helped thousands of ambitious men to win promotion and success through the use of time-saving methods of training.

MAIL COUPON TODAY

CHICAGO TECHNICAL COLLEGE

B 600 Tech Bldg., 118 E. 26th Street, Chicago, Ill.

Please send me without obligation free "Blue Book" on how to prepare for a better paying job in WELDING.

LEARN AT HOME under modified OXFORD PLAN Day or Evening Residential Classes

Name.....

Address.....

P.O..... State.....

AGE..... Occupation.....

AUDELS Carpenters and Builders Guides

4 vols. \$6



Inside Trade Information for Carpenters, Builders, Joiners, Building Mechanics and all Woodworkers. These Guides give you the short-cut instructions that you want—including new methods, ideas, solutions, plans, systems and money saving suggestions. An easy progressive course for the apprentice and student. A practical daily helper and Quick Reference for the master worker. Carpenters everywhere are using these Guides as a Helping Hand to Easier Work, Better Work and Better Pay. To get this assistance for yourself, simply fill in and mail the FREE COUPON below.

Inside Trade Information On:

How to use the steel square—How to file and set saws—How to build furniture—How to use a mitre box—How to use the chalk line—How to use rules and scales—How to make joints—Carpenters arithmetic—Solving mensuration problems—Estimating strength of timbers—How to set girders and sills—How to frame houses and roofs—How to estimate costs—How to build houses, barns, garages, bungalows, etc.—How to read and draw plans—Drawing up specifications—How to excavate—How to use settings 12, 13 and 17 on the steel square—How to build hoists and scaffolds—skylights—How to build stairs—How to put on interior trim—How to hang doors—How to lath—lay floors—How to paint.



THEO. AUDEL & CO., 49 W. 23rd St., New York City

Mail Audels Carpenters and Builders Guides, 4 vols., on 7 days' free trial. If O.K. I will remit \$1 in 7 days, and \$1 monthly until \$6 is paid. Otherwise I will return them. No obligation unless I am satisfied.

Name.....
 Address.....
 Occupation.....
 Reference..... P.M.

BIG 1940 OPPORTUNITY IN AVIATION INDUSTRY FOR TRAINED AVIATION MECHANICS

"35,000 TRAINED MEN NEEDED RIGHT NOW" SAY AUTHORITIES

Right now factories need 35,000 trained men for jobs in sheet metal work, welding, engine and airplane mechanics. So serious is the shortage of qualified men that the industry reports \$400,000,000 worth of airplane equipment back ordered.

A REAL EMERGENCY

It is a challenge that has been answered. To cooperate with the government and the factories, Sweeney offers four special short courses which can be completed quickly and completely qualifies students to fill this demand for skilled workers.

THE SWEENEY SYSTEM

Intensive training is offered in sheet metal fabrications, in Factory Specialist Welding, in Aircraft Engine Mechanics and Airplane Mechanics—all at special reduced prices. It's your opportunity—courses qualify you to get and hold a good job. It's easy to learn by the Sweeney System of practical training. 87,000 Sweeney School graduates testify to success.

Write today for details and FREE BOOKLET "Opportunities in Aviation."

LEARN BY DOING
Sweeney
 AVIATION SCHOOLS

The original and only Sweeney school in U.S. No branches
 101-B ADMINISTRATION BLDG.
 FAIRFAX AIRPORT, KANSAS CITY, KAN.

TWO HUNDRED MILLION DOLLARS WORTH of Equipment BACKORDERED for LACK of CAPABLE WORKERS

- SHEET METAL CRAFTSMANSHIP
- AIRCRAFT WELDING
- AIRPLANE MECHANICS
- ENGINE MECHANICS
- FLIGHT ENGINEERING
- AERONAUTICAL ENGINEERING
- INSTRUCTOR'S AERONAUTICAL TRAINING

JUST SEND YOUR NAME

When writing please mention Popular Mechanics

Learn To MOUNT BIRDS



Tan SKINS, Make Up FURS

Be a Taxidermist. Double your hunting fun. We teach you at Home. Mount Birds, Animals, Pets, Heads and Fish. Save your hunting trophies; decorate home and den. **MAKE MONEY.** Mount and Krome-tan for others. Big sparetime profits. **INVESTIGATE TODAY.**

FREE BOOK with 100 game pictures, 48 pages. Hunters, get yours! It's Now Free. send postal card TODAY—This Minute! State your AGE.

NORTHWESTERN SCHOOL OF TAXIDERMISTRY, Dept. 3372 Omaha, Nebr.

THIS PIPE Really Stays Lit Briar Hill
 5-6-7-8 MINUTES WITHOUT PUFFING
 ... IT BURNS ALL THE TOBACCO, A DRY, COOL, VELVETY SMOKE FROM A FINE... IMPORTED BRIAR PIPE
 \$1.50
 SEND FOR FREE CATALOG

Briar Hill Corp., 62 Jackson St., Millersburg, Ohio

EARN A DEGREE AT HOME

From A Chartered Institution Of Higher Learning Employers Now Demand College Graduates With Degrees

88 Degree Courses in Art; Sciences; Philosophy; Education; Psychology; Public Health; Sociology; Physics; Chemistry; Pol. Science; Theology; Law; Business Training; Accounting; Statistics; Adv.; Sales; Agriculture. Electrical, Mechanical, Civil, Structural, Diesel, Architectural, Mining, Drafting, Automotive, Aeronautical, Radio, Refrigeration, Highway, Marine, Air Conditioning, Geology, Petroleum, Industrial, Chemical Engineering. Founded 1908. 170 p. Catalog Free. McKinley-Roosevelt Graduate College, 4750-F Sheridan Road, Chicago

BE AN OPTICIAN AT HOME

Learn this well paying uncrowded profession. Many make \$35.00, \$40.00, \$50.00 a week making eyeglasses.—Great demand! Over 70% of population need or wear eyeglasses.—Successful optical stores everywhere earn from \$5,000.00 to \$10,000.00 per year.—Dignified profession.—Has sanction and co-operation of Medical profession.

Spare time study does it all! No interference with your present work.—open to men and women of all ages.—Low cost, Easy terms. Degree conferred by chartered college. Write for Free Bulletin.

ILLINOIS COLLEGE OF MECHANICAL OPTICS
 Dept. 512, 30 N. Dearborn St. Chicago, Illinois

Learn this Profitable Profession



in 90 Days at Home

Hundreds of men and women of all ages 18-50 make \$10.00 to \$20.00 in a single day giving scientific Swedish Massage and Hydro-Therapy treatments. There is a big demand from Hospitals, Sanitariums, Clubs, Doctors and private patients as well as opportunities for establishing your own office.

Learn this interesting money-making profession in your own home by mail, through our home study course. Same instructors as in our **NATIONALLY KNOWN** resident school. A diploma is awarded upon completion of the course. Course can be completed in 3 to 4 months. High School training is not necessary. Many earn big money while learning.

Anatomy Charts & Booklet FREE

Enroll now and we will include uniform coat, medical dictionary, patented reducing roller and Hydro-Therapy supplies without extra cost. The reducing course alone may be worth many times the modest tuition fee.

Send coupon now for Anatomy Charts and booklet containing photographs and letters from successful graduates. These will all be sent postpaid—FREE.



THE College of Swedish Massage (Successor to National College of Massage)
 Dept. 264—30 E. Adams St., Chicago.

You may send me FREE and postpaid, Anatomy Charts, booklet containing photographs and letters from graduates, and complete details of your offer.

Name.....
 Address.....
 City..... State.....

91206

POPULAR INVENTIONS

(Continued from page 22A)

YOUNGSTERS would find a new thrill in a combination toy patented recently.



It includes a heavy vertical shaft to which is attached an arched spring, ground or floor supports for the shaft and a plank on which the rider sits. The arched spring connects the shaft and the riding plank. The device permits the child rider to bounce, in bucking bronco fashion, or to seesaw. The pony-riding effect is further enhanced by attachment of a wood or metal piece, shaped like a horse's head, to the plank just in front of the seat.

FOR protection of workmen operating chipping hammers and the like, a safety guard has been patented. It comprises a wire screen within a frame which is held suspended above the work by means of a rod attached to a wrist strap. Foreign particles dislodged by the chipping hammer are caught beneath the wire screen, thus guarding the workman's eyes. The screen permits the hammer user to view the work as it progresses.

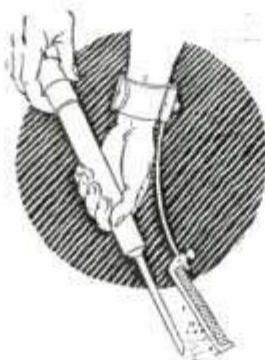

INCREASED safety in motoring would result from use of an anti-skid device for automobiles. It includes a wheel having sharp edges and a clamp to engage the running board and a flat spring bar to which the wheel is attached. The thrust of the spring upon the running board would hold the wheel to the ground and the wheel's sharp edges would reduce tendency of the car to move sideways, or to skid.

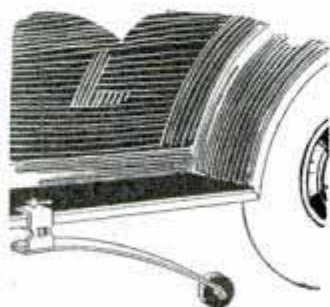

(Continued to page 58A)

You Ask Me...



I'm Getting Ready to Earn More ...Preparing for a Bigger Job

I am a student of the American School, Chicago. A little more than half way through my course—already my increased knowledge has brought me promotion as a result of the hour or so a day I have been spending getting acquainted with the principles of the work I enjoy. I use only part of my spare time, so it doesn't interfere with my home and social life, and certainly helps me on the job.

And I Like It, Too

I have been surprised at the practical manner in which even advanced work is explained. It is a lot easier than I had expected. I only wish I had started this plan of getting ahead a few years earlier. But when I was 18 to 20 I felt pretty sure of myself. I didn't take enough stock in what more experienced people told me about the importance of being thoroughly trained for the job I wanted.

Success Through Home Study

There's no magic to home study. It takes "backbone"—but it is *worth* the effort because it helps you overcome the handicap of having left school too soon. It helps free you from low wage slavery—enables you to compete to better advantage in this NEW world of college trained men and women.

In 1900, only ONE person in 800 was a high school graduate. Today, one in every 837 is college trained. That's why you need so much more "on the ball" today than ever before. That's why American School has stepped up all its complete courses to include so much work of college level. You NEED it, to win out today! Mail coupon NOW.

Promotion Begins at HOME

Pay raises depend largely on what you do in SPARE time. Make it pay you dividends!

American School, Dept. GG-245, Drexel Ave. at 58th St., Chicago, Ill.

Gentlemen: I'll sit down and consider my Promotion Problems carefully if you will send me FREE information covering special training in subjects checked below. No obligation on my part.

- | | |
|--|---|
| <input type="checkbox"/> High School Course | <input type="checkbox"/> Diesel Engineering |
| <input type="checkbox"/> Accounting and Auditing | <input type="checkbox"/> Drafting and Design |
| <input type="checkbox"/> Architecture and Building | <input type="checkbox"/> Liberal Arts |
| <input type="checkbox"/> Automotive Engineering | <input type="checkbox"/> Private Secretary |
| <input type="checkbox"/> Business Management | <input type="checkbox"/> Mechanical Engineering |
| <input type="checkbox"/> Aviation | <input type="checkbox"/> Radio and Television |
| <input type="checkbox"/> Electrical Engineering | <input type="checkbox"/> Salesmanship |
| <input type="checkbox"/> Elec. and Gas Refrigeration | <input type="checkbox"/> Business Law |
| <input type="checkbox"/> Air Conditioning | <input type="checkbox"/> Retail Merchandising |

Name.....

Address.....

**This
MACHINISTS'
Home-Study
Course**



helps men get ahead

Newly assembled—specially priced—these five recent books give you the practical facts on modern machines, up-to-date methods, you need to advance in machine shop work. Take advantage of the other man's experience as found in books, to solve your problems, increase your efficiency, with

**The NEW AMERICAN
MACHINISTS' LIBRARY**

5 volumes—2014 pages—1853 illustrations

(A combined home-study course and reference library)

This library of machine shop practice was written for practical men. It gives you the best methods for every kind of machine shop work. It fully explains lathes, drills, and other machine tools and their operation, automatic screw machines, speeds and feeds, gear design and production, punch and die work, metal surfacing, etc., etc. Plainly written—completely illustrated—the best kind of help to the machine shop man who wants to advance himself.

No money down—special price—easy payments.

EXAMINATION COUPON

McGRAW-HILL BOOK CO., 330 W. 42nd St., New York

Send me for ten days' examination the new American Machinists' Library. If satisfactory I will send you \$1.50 in 10 days and \$3.00 monthly until the price of \$16.50 is paid. If not wanted, I will return the books postpaid. (To insure prompt shipment write plainly and fill in all lines.)

Name.....
Home Address.....
City and State.....
Position.....
Name of Company..... PM-2-40

WORK FOR THE



**GOVERNMENT
START**

\$1260 to \$2100 YEAR

Many 1940 examinations expected.
Many appointments every year.

MEN—WOMEN

File Clerks
Postoffice Clerks, Carriers
Railway Postal Clerks
Stenographers-Typists
Many Other Jobs

GET READY
IMMEDIATELY

Common Education
Usually Sufficient

Mail
Coupon
TODAY



Franklin Institute

Dept. W.182
ROCHESTER, N. Y.

Gentlemen: Rush to me FREE of charge, list of U. S. Government big pay jobs. Send FREE 32-page book describing salaries, vacations, hours, work. Tell me how to qualify for one of these jobs.

Name.....

Address.....

MONEY for MEN ALL FREE

THE PLASTEX Industry needs manufacturers on small scale and for big production of Lamp and Clock Stands, Art Goods and Novelties in Plastex and Marble imitation. Experience unnecessary. 1/2c material makes regular 10c store sellers. Rubber moulds furnished for speed production. Small investment brings big returns. BIG CHAIN STORE orders now being placed. Ambitious men have chance for real prosperity. Our FREE booklet will interest and benefit you. **PLASTEX INDUSTRIES, Dept. P, 1085 Washington Ave., New York, N.Y.**

BE HEALTHY, STRONG!

Follow the "GOOD" System of Physical Training. Build a strong and shapely body. Send for our free booklet "Physical Fitness" and let us show you how it can be done!

GOOD BARBELL CO., Dept. P, Reading, Pa.

Say you saw
it in . . .

**POPULAR
MECHANICS**

Make Your Hobby and Spare Time
Pay You **EXTRA MONEY**

Here are selected books to help you cash in on your hobby, earn extra money or establish a profitable business of your own. Pay postman or remit with order for pre-paid delivery. Money refunded if not satisfactory, if returned in 3 days.

ORDER UNDER MONEY-BACK PLAN

- A SMALL BUSINESS OF YOUR OWN.** Gives 1000 ways for a man with little or no capital to build a modest dependable business. \$1.00.
- MAKING AMATEUR PHOTOGRAPHY PAY.** Turn your prints into extra money. Tells what to take, where to submit and how to sell pictures. \$1.00.
- TURN SCRAP INTO MONEY.** Shows how to build power plants, 110 volt motors and generators, wind power plants and other electrical apparatus from old auto parts. \$1.00.
- HOME AND WORKSHOP FORMULAS (HENLEY).** 10,000 opportunities to make and save money through the use of these tested recipes, formulas and processes, etc. Tells how to make salable preparations of all kinds. 883 Pages. \$4.00.
- A LIVING FROM THE LAND.** The information that thousands of people have, who are seeking security and productive uses for their leisure time, want and need. \$1.50.
- SHOE REPAIRING.** Practical and simplified instruction on modern shoe repair methods. Helps you save money on your own work and make money repairing for others. \$1.00.
- AUTOMOBILE BODY AND FENDER REPAIRS.** Covers thoroughly, the best paying end of the auto repair business. Prepares for regular job or good source of extra, spare time money. \$3.00.
- PAINTING AND DECORATING.** Use this book for complete study or to pick up extra money on spare time jobs. Includes estimating and cost figuring. \$1.50.
- HIGH SCHOOL SELF TAUGHT.** Complete four year high school course in one volume. Broaden your knowledge and increase your income with high school subjects. 1000 Pages. \$2.39.
- BUSINESS COLLEGE SELF TAUGHT.** Here's your practical training for business all in one handy volume. 15 courses covering all essential subjects taught in a modern business college. Over 1000 pages. Cloth. \$2.39.

POPULAR MECHANICS PRESS
Dept. 240. 200 E. Ontario Stret. Chicago

Say you saw it in Popular Mechanics!

Earn Money at Home



GIVEN YOU TO DECORATE

BIG FREE book in colors tells new easy way. You don't need experience. We show you how to decorate beautiful Art Novelties right in your own home by simple "3-step" method. No tedious study. Everything furnished including supply of Novelties for you to decorate and Homecrafters Outfit. Big profit per piece for decorating. Sit at home, and make up to \$25 to \$50 in a week—full time or spare time.

First Lesson Now Free!

Toys, etc. More like fun than work and you earn as you learn. Many have made excellent earnings this fascinating way.

Just mail coupon and get first lesson absolutely free. Start right in decorating Gifts, Bridge Prizes,



MAIL THIS!

NO CANVASSING You risk nothing in sending for Free Lesson. You don't risk a penny for training because our **WARRANTY** of Complete Satisfaction protects you from loss. Costs nothing to find out. Openings for new workers now in every locality. Mail coupon immediately for Free Book and Free Lesson. Get started making money at once.

FIRESIDE INDUSTRIES
Dept. 66-B, Adrian, Mich.

Please send big Free Book and FREE LESSON. This does not obligate me in any way.

Name.....
Address.....

NEW SCIENTIFIC WONDER



10c
3 for
25c

"X-RAY" CURIO
"Silver Only"
BOYS BIG FUN. You apparently see through cloth, Wood, Stone, any object. See Bones in Flesh. **FREE PACKAGE** radio picture films, take pictures without camera. **IT'S GREAT SPORT!** 1 package with each 25c order.
MARVEL MFG. CO., Dept. 75-A **DEVON, CONN.**

MAIL ORDER BUSINESS

Your Big Opportunity!
Learn how to make money from home or office, spare or full time. Up-to-date copyrighted home study course. Widely endorsed. Teaches professional mail order technique; not penny-catching schemes. Sound instructions by successful money-making experts. Write for **FREE** details today. No obligation.
NELSON CO., B-400 Manhattan Bldg., Chicago

DIESEL Maximum training minimum time; practical and theoretical. Modern equipment, experienced teachers. Personal instruction. 40th year. Catalog free. Residence course in three months.
FINLAY ENGINEERING COLLEGE, 10th & Indiana, Kansas City, Mo.

MONEY IN RABBITS—CAVIES
WE BUY and put you in touch with other markets. Catalog and copy of magazine 10c. Or send 25c for Book Catalog and Price List and Year's Subscription to the **AMERICAN SMALL STOCK FARMER**.
OUTDOOR ENTERPRISE CO., BOX 919, NEW CITY, N. Y.

WRITE TODAY FOR FULL SIZE PACKAGES FREE!
\$6 worth full size packages famous Blair Food and Home Products **FREE!** Just write saying you want to be a money-making Blair Dealer. Show samples—take orders for over 300 high quality guaranteed necessities needed in every home.
SEND NO MONEY! Write today. Let us Blair Products **FREE** and start you making good money—**EASY**—supplying friends and neighbors.
BLAIR, Dept. 32-T, Lynchburg, Va.



DRAFTING

BOOKS SENT FREE!
ON APPROVAL

For Beginners or Experts
Written so you can understand every word, by 22 well known engineers and architects. De Luxe flexible binding, nearly 2,000 pages, 1546 blueprints, charts and diagrams; prepares you for a good drafting job in mechanical or architectural lines. Sent for 10 days' free use if you mail coupon immediately.

5 VOLUMES BRAND NEW EDITION
Only 15 minutes a day with these **WONDER BOOKS** can prepare you for a good drafting job in less than a year. Mechanical and architectural drafting from simple straight lines to important complex plans. A step at a time! Built especially for beginners, for men with only grammar schooling. Drafting room practice, **PLUS ENGINEERING**, made easy and clear. **Includes complete information on blue print reading for building and machine trades.**

These Instruments Included



Big Field Big Demand Big Pay
Competent draftsmen are urgently needed right now in all building and manufacturing lines at \$30.00 to \$75.00 a week. That's just the beginning—**FOR DRAFTSMEN HAVE GOOD CHANCES FOR ADVANCEMENT.** Pleasant, fascinating work, easy to learn and do. Learn quickly with these books—send coupon for a set and see for yourself.
[A year's consulting membership in the American Technical Society now given to all owners of this famous cyclopedia of drafting.]
Complete set of high grade drawing instruments if you send for these drafting books **NOW.** These instruments are absolutely accurate and are packed in velvet lined leatherette pocket case. Splendid value, but included with these books.
AMERICAN TECHNICAL SOCIETY
Dept. D219, Drexel at 58th St., Chicago, Ill.

American Technical Society, Dept. D219, Drexel at 58th St., Chicago, Ill.
Send for 10 days' trial, new 5 volume set of drafting. I will pay the few cents delivery charges. If I wish, I may return books in 10 days and owe you nothing but if I decide to keep them, I will send \$2.00 after 10 days, then only \$3.00 a month until \$24.80, the total price is paid. Send latest edition and include drawing instruments and consulting Membership Certificate.
Name.....
Address.....
Please attach letter stating age, occupation, employer's name and address and that of at least one business man as a reference.

FORGE AHEAD

with the Thinking Alphabet "exactly how" short cut for training mind and personality. Helps gain Originality... Self Discovery... Personal Power... Achievement. Free booklet.
THINKING ALPHABET INSTITUTE, 99-J Fern St., Philadelphia

BROOKLYN YMCA TRADE SCHOOL



- Unlimited Instruction** until you have mastered every part of Course without additional charge.
- Full Shop Equipment**
Unexcelled Instruction
Fireproof Dormitories.
- Special Privileges. Check your interests on coupon to receive free literature.**
- Mechanical Pre-Engineering
 - Diesel Engines
 - Diesel Pre-Engineering
 - Aeronautical Pre-Engineering
 - Aviation Mechanic
 - Auto Mechanic
 - Refrigeration
 - Television and Radio Mechanic
 - Architectural-Mechanical Drafting
 - Machinist
 - Armature Winding
 - Oil Burner
 - Welding
 - Talking Pictures
 - Air Conditioning
 - Tool and Die Making
 - Electrical

MAIL COUPON
1117 Bedford Ave., Dept. P.M.
Brooklyn, New York City, N. Y.
Name.....
Address.....

A PENNY POSTCARD May Bring You FINANCIAL INDEPENDENCE

Write Today for Free 64-Page Text-Book on Scientific Poultry Raising "BUILD YOUR OWN REAL SOCIAL SECURITY"

- FREE**
- Steady Income-Part or Full-Time Employment No Age Limit
- A 10-Acre Poultry Farm on a City Lot
- \$2000 Profit from Egg Factory on Space 20x80ft.
- 9000 Broilers in Year from Backyard Plant
- New Book Explains Amazing Method

Read this book and start a Battery Poultry Plant in Your Garage, Barn, Chicken House, Woodshed, Attic or Cellar, for Quick Returns and Big Profits. Produce Fresh Eggs, Broilers and Roasters the Year 'round, at low cost. Retail them at Fancy Prices in your neighborhood or community.

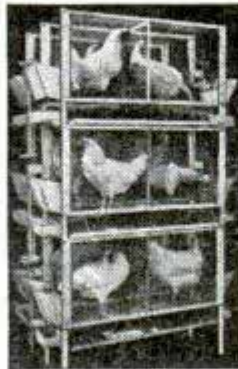

The ARNDT Battery System has made poultry raising clean, healthy, profitable. The all-metal cages are arranged in batteries, with feed and water pans attached, and mechanical cleaning devices. No outdoor yards are used. 2 1/4-lb. Broilers from Day-old Chicks in 10 weeks. 200 Eggs, or more, per year from every bird, in every laying cage.

Ambitious, Energetic Men and Boys build profitable enterprises at home. Many have started such plants for temporary financial aid, and found careers for life.

You are Cordially Invited to visit the ARNDT Model Demonstration Farm, 2759 Nottingham Way, Mercerville, near Trenton, N. J., any day between 9 A.M. and 5 P.M., and see 15,000 to 20,000 chickens of all ages in development and production, on less than 1/2 acre of land.

Write Today for 64-page Illustrated Text Book, with All Particulars of the System. No Obligations.

MILTON H. ARNDT Dept. 45 Trenton, N. J. P. O. Box 909



MACHINE SHOP MEN

Learn to set up and run ANY kind of machine; **MAKE MORE MONEY NOW** by learning quickly **HOW TO DO THINGS** which usually take years of study and practice. The demand for **SKILLED men** is **ALREADY** far ahead of the supply, then what **WILL IT BE** a month or two from now?

Needed NOW!

Bigger Pay Don't miss this chance to qualify for promotion, don't miss this Big Opportunity which is yours almost for the asking. Eight Big Books chockful of important mechanical facts told simply and clearly. Over 3000 pages, nearly 3000 illustrations cover every subject fully, including Tool Making, Pattern Making, Foundry Work, Mechanical Drawing, Forging, Machine Shop Practice and Management, and hundreds of other subjects.

8 Big Books Sent FREE for examination. Yes ALL of these books will be sent to you for examination. Decide in your own home or place of business whether or not you want to keep them, check up on any facts you want to. Note their great **MONEY MAKING** value, then, if you want them, pay on the easiest kind of payments. Send **NOW** and we will include a year's consulting membership in the American Technical Society without extra charge—and also a **Big Binder** of 800 original shop tickets with 1200 illustrations. These show, step by step, how to set up and run almost any kind of job and are in **addition** to the 8 books.

American Technical Society, Dept. 5219, Drexel at 58th St., Chicago.

American Technical Society, Dept. 5219, Drexel at 58th St., Chicago. You may send me the 8 big NEW books and binder of shop tickets for free examination. I will pay the few cents delivery charges only, unless I decide to keep them in which case I will send \$2.00 in ten days and \$3.00 per month until the total price of only \$29.80 is paid. If I return them in 10 days I will owe you nothing. Because I send now you agree to give me a membership in the American Technical Society entitling me to consulting privileges with any of your experts for one year.

Name.....
Address.....
Please attach a letter stating age, occupation, employer's name and address and that of at least one business man as reference.

NEW models EASIER TO PLAY

Find out about these sensational new Conn Band Instruments. Many wonderful, exclusive features! Today, more than ever, Conns are the "choice of the artists." You'll advance faster and take more pride in a genuine Conn—made by the world's largest manufacturer. See your dealer or write us for Home Trial, Easy Payment offer. Mention instrument.

C. G. CONN, LTD.
231 Conn Bldg., Elkhart, Ind.

WRITE FOR FREE BOOK

CONN BAND INSTRUMENTS

Low-Cost LACO Sure Heats!

America's Lowest Priced Oil Burners! For room or furnace! Deliver tremendous heat at Very Low Cost! Thousands of delighted users! Now improved! Clean. Quiet. Automatic. No attention required. See your dealer or

WRITE for Free Folder, full details, low prices on Laco Oil Heaters, Gun-Type Burners!

LACO OIL BURNER CO., 120 Union Ave., Griswold, Iowa

DIESEL

Get BETTER training. Realize Adcox advantages. Located in Pacific Northwest, a Diesel center. Established 28 years. Modern equipment, expert instructors. Close cooperation for YOUR success. Earn room and board while learning. Send for free book, "What Every Man Should Know About Diesel". Dept. 18. Home study and resident courses.

L. L. ADCOX TRADE SCHOOL
Portland Oregon

MAKE MONEY AT HOME

RUBBER MOLDS Low as 6¢ EA.

Amazing rubber mold-making outfit makes perfect flexible molds of plaques, ash trays, book-ends, etc. Molds cost from 6c to 25c each. Each mold makes hundreds of novelties and gifts to sell up to \$1.00 apiece! No experience necessary. Quick and easy. Start profitable business in your home... sell to stores, gift shops, friends, resorts, road stands, by mail. Full or spare time. "Molders Handy Book" and list of buyers FREE. Write

SO-LO WORKS
Dept. D-827 Cincinnati, Ohio

SURE ROUTE TO HAPPY-LAND

MAIL TODAY SURE

J. C. DEAGAN, Inc., Dept. 4452
1770 Berceau, Chicago

Without cost or obligation, tell me about the easy-to-play **DEAGAN MARIMBA**... its sensational rise in the music world... the fun it provides at parties... the opportunities for radio, stage and dance-band fame.

EASY TO PLAY

Name—Please PRINT
Address

When writing please mention Popular Mechanics

**Have You
FALLEN BEHIND
on getting ahead?**

If so, don't let today's great Aviation opportunities get away from you. Just consider the record of Aero ITI-trained men . . . over 700 have entered Aviation in the last year alone . . . over 250 have been placed with a single famous aircraft plant. For these men Aero ITI training opened the door to careers in aircraft production, aircraft maintenance, and aeronautical engineering. Choice of three courses in Aircraft Mechanics, two in Aeronautical Engineering. You can take full time training at the school or start your course at home. Find out about Aviation careers and Aero ITI training . . . send for details NOW.

Aero Industries Technical Institute
5253 West San Fernando Road, Los Angeles, Calif.

Aircraft Mechanics . . . Aeronautical Engineering
Offering U. S. Civil Aeronautics Authority Approved
12 Months Aircraft Mechanics Training.

EXECUTIVE BOARD

C. A. VAN DUSEN Vice-Pres. Con- solidated Aircraft Corporation	JOHN K. NORTHROP President, Northrop Aircraft, Inc.	ROBERT E. GROSS Pres. Lockheed Aircraft Corporation
---	---	--

AERO INDUSTRIES TECHNICAL INSTITUTE
5253 West San Fernando Road, Los Angeles, California

Please send information on Aviation careers and Aero I T. I. courses. I am interested in the branch of Aviation checked below:

- Aircraft Mechanics Aeronautical Engineering
 Undecided. Please send more information.

Name _____ Age _____

Address _____

City _____ State _____ a-21-p



**There's
MONEY
IN ARC
WELDING!**

U. S. Manufacturers desire men to learn Electric Arc Welding and get practical experience under actual production conditions in the laboratories of the School of Engineering. Moderate training fee. Accepted applicants will be fully trained until ready to pass rigid test and assisted in securing employment.

AIRCRAFT WELDING "We want more planes!" That's the demand on every side. No wonder there is a shortage of aircraft welders. Other industries need welders, too. There's almost no limit to what Milwaukee School of Engineering trained welders can do. They get good pay because they know the "how and why" of Welding, Metallurgy, Drawing, Blueprint Reading, Set-up Work and Fabrication—and they enable manufacturers to cut production costs. Remember—industries need practical trained Aircraft Welders, Arc Welding Operators, Technicians and Welding Engineers, and Air Conditioning and Refrigeration Technicians. Don't be satisfied to struggle along on ordinary, hit-or-miss jobs with poor pay—when in a short time you can become a trained specialist. Send coupon today—classes begin within a month.

**MILWAUKEE
SCHOOL OF ENGINEERING**
Institute of Electrotechnics

P.M. 240 North Broadway and E. State, Milwaukee, Wis.

- Without obligation send Free Booklet "The Dawn of a Gigantic Industry and its Outstanding Opportunity." Also tell me How to Become an
- | | |
|------------------------------|--|
| Arc Welding Operator (3 mo.) | Air Conditioning & Refrig. Tech. (4 mo.) |
| Air Craft Welder (6 wks.) | Radio Serviceman (6 mo.) |
| Welding Technician (5 mo.) | Commercial Electrical Engineer (1 yr.) |
| Welding Engineer (1 yr.) | Commercial Radio Engineer (1 yr.) |
| Electrical Engineer | Student Loan Plan |
| B. S. Degree (4 yrs.) | Earn Part Expense Plan |

Name _____ Address _____
City & State _____ Age _____ P.M. 240

**Prepare at Home
for JOBS in**



With this expert drawing outfit—drafting table, drawing board, superior drawing instruments . . . all sent without additional cost, you are all set to learn **DRAFTING AT HOME**. FREE TRIAL LESSON shows how easy. Mail coupon.

YOUR DRAWING OUTFIT

DRAFTING

The draftsman's work comes first. When business improves . . . and it is improving . . . there is new construction work, new buildings, new machines, repairs and reconstruction work. All these must first be laid out on paper. So the **FIRST** man that must be hired is the **DRAFTSMAN**.

Drafting Is Well-Paid Work

Drafting is clean, interesting professional-type work. It pays well to start . . . offers real opportunities for promotion. You need no previous training or experience . . . no special talent—to learn Drafting. It is one of the steadiest employment fields. No machine ever did the Draftsman's work . . . and no machine can be invented to do it.

Learn AT HOME

in your spare time (or at the College in Chicago) by the fascinating, easy, step-by-step plan originated by this 36-year old school for Draftsmen.



Sample this easy-lesson system of learning Drafting. Send postal card or this coupon. No charge now or later for this **FREE LESSON**. Prove to yourself how easy it is to learn Drafting by the C. T. C. method in your spare time right in your **OWN HOME**.

CHICAGO TECHNICAL COLLEGE

B-201 Tech Bldg., 118 E. 26th Street, Chicago, Illinois
Please send me **FREE Trial Lesson** in **DRAFTING** and show me how I can prepare for good positions in spare time **AT HOME**.

Name _____ Age _____
Address _____
P. O. _____ State _____

When writing please mention Popular Mechanics

Business Demands Accountancy

—because Accountants Command Business

ACCOUNTANTS are usually in demand—at better than average earnings.

But today—more than ever before—the competent accountant finds his services at an increasing premium.

In the depression, business tightened up the reins and is watching costs—prices—every move—striving to operate on that basis of close control so essential to profits.

Then too, progressive business is building now for future prosperity—laying plans for expansion, for new processes, new markets—getting ready for the opportunities of the next ten years.

The Home Study Way to Accountancy Success

Thousands upon thousands of men have trained for Accountancy with LaSalle—at night—at home.

Their success—their progress—is a matter of record.

Whether their goal was a C. P. A. degree or advancement in business, our files are full of letters reporting income increases far out of line with the time and cost investment.

Note for instance, these four cases chosen out of many more we might cite. (Names on request.)

F. F. A. was a railroad yard clerk at \$112 a month when he began accountancy training with LaSalle. Five years later, his income was 500% larger and he was a Certified Public Accountant and attorney. F. C. was 22 years of age and general all-around man in an Arkansas lumber yard at \$75 a month. Five months later, his firm made him manager at \$125, and ten months later promoted him to a larger yard at \$250 plus a commission on sales.

O. D. always thought stories about LaSalle training were fairy tales until the training helped him—a clerk at \$75 a month—move up in six months to \$125, and within four years to \$250. He became General Auditor of a large national organization—with his income more than seven times his starting salary.

As an assistant bookkeeper in a great Western bank, C. F. H. looked forward to slow progress. But LaSalle accountancy training speeded up his climb to Assistant Trust Officer and to a salary increase of 400 per cent.

These Men Won Success in Ordinary Times—You Will Profit By Unusual Times

Remarkable as is the success of these men—you will have an advantage over them—you will be entering accountancy when unusual business conditions work with you for success.

Present conditions not only call for more capable accountants—but offer unusual opportunities for both quick and permanent success. The accounting student of 1940 will face real opportunity in 1941 and the accounting leaders of 1945-50 will be largely determined in 1940-1941.

—If You Can Qualify

Ask yourself three questions:

1. Are you ambitious?
2. Have you determination?
3. Can you see and grasp an opportunity?

If you have determination; if you are ambitious; if you can take advantage of circumstances—*prove it* by investigating. A three-cent stamp, sixty seconds time, and the coupon below will bring you full information regarding Accountancy training and the opportunities to which such training leads. Then you can judge intelligently.

LaSalle Extension University

A Correspondence Institution

Dept. 264-HR

CHICAGO

Opportunities in Accountancy—Check below and we will send you a free copy of "Accountancy, the Profession that Pays," also information about our new training in Higher Accountancy, all without obligation.

Higher Accountancy

Other LaSalle Opportunities: If more interested in one of the other fields of business indicated below, check that:

- | | | |
|--|--|--|
| <input type="checkbox"/> Business Management | <input type="checkbox"/> Law: LL.B. Degree | <input type="checkbox"/> Business Correspondence |
| <input type="checkbox"/> Expert Bookkeeping | <input type="checkbox"/> Commercial Law | <input type="checkbox"/> Stenotypy |
| <input type="checkbox"/> C. P. A. Coaching | <input type="checkbox"/> Industrial Management | <input type="checkbox"/> Modern Salesmanship |
| <input type="checkbox"/> Railway Accounting | <input type="checkbox"/> Modern Foremanship | <input type="checkbox"/> Business English |
| <input type="checkbox"/> Traffic Management | | |
| <input type="checkbox"/> Effective Speaking | | |

Name.....Age.....

Present Position.....

Address.....

When writing to advertisers please mention Popular Mechanics

**WORLD'S
BEST
WANT AD
MEDIUM**

CLASSIFIED Advertisements



Advertisements in this section, 35 cents per word, each insertion, minimum 10 words, payable in advance

To be inserted under proper classification in March issue, copy should be in our office January 8th

March issue on sale February 1st

Popular Mechanics Magazine, 200 East Ontario Street, Chicago, Illinois

YOU'LL PROFIT

By reading and answering the classified ads in this section. Hundreds of opportunities to make and save money.

Popular Mechanics Magazine,
Chicago, Illinois

Gentlemen: You will be interested to learn that practically all of our advertising is confined to farm publications as our principal business is selling farm radios. About the only exception in our program is our classified advertising in Popular Mechanics, which we have used for three years. The inquiry cost from Popular Mechanics is less than in any of our farm papers. It is also not only leading in sales, but is producing our export business which is getting to be quite an item.

(Original letter on
file in our office)

Yours truly,
MARCO COMPANY.

AUTOMOBILES—MIDGET CARS

MIDGET Racers and accessories, two-passenger roadsters, midget motorcycles, motorscooters, bicycles. Complete line motors, wheels, parts, plans, construction kits. Handbook catalog, 90 illustrations, 20c. Midwest, Box 1959-S, Chicago.

GARAGE Owners and mechanics can now purchase direct at full factory discount Triple-X Alloy Steel Self-Locking Piston Rings. Nationally distributed. Guaranteed performance. Stop oil pumping. Re-boring unnecessary. Write for sample and details. Triple-X Co., 3801 South Racine, Dept. 102, Chicago.

MIDGET Cars, parts, wheels, tires, motors. Plans 50c. Catalog 10c. Derby Midgets, Woodstock, Ill.

MIDGET Supplies, new or used. Bargain lists—130 used motors, midgets, parts—20c. Circulars free. Midgets, Box 543-H, Zanesville, Ohio.

NEW Fifth edition Automobile Racing Book. Tells how to build dirt track bodies, frames, engines. Records, superchargers, rules, formula, plans, stock conversions, roadster racing, fast Fords. \$1.00 postpaid; \$1.15 C.O.D. Ray Kuns, Department 14, Madisonville, Cincinnati, Ohio.

RACE Cars, frames and bodies built to order. Frank Smith, Oldham Rd., Preakness, N. J.

QUICK Starting. Build patented ignition relay. Avoid timer troubles. Get 3/4 in. blue white starting sparks. License working drawings, expert instruction. One dollar. Weston Laboratory, Elginburgh, Ont.

GASOLINE Saving device \$1.00. Ford V8's 1934-1940. Chevrolet 1935-40. Walert Co., 3429 N. 10th St., Milwaukee, Wis.

AUTOMOBILE Superchargers \$3. Guaranteed mileage increase 20%; power 10%. University of Detroit test. Any car; give make, year. Wrench installs 15 minutes. John Hanley, Manufacturer, 5719 Loraine, Detroit, Mich.

ALUMINUM Alloy pistons, automotive, aviation, diesel, industrial, marine, midget, model, motorcycle, outboard. Finished or semi. Judson Mfg. Co., Hedge and Gillingham, Philadelphia, Penna.

AUTO SUPPLIES AND EQUIPMENT

ELECTRIC Hand turn stop signal for automobiles. James J. Griffin, Parnell, Iowa. Patent pending.

MOTOR Overhauling compound, cost 2c. Sells \$2.00. Formula, instructions \$1.00. Altab, 472 S. Chairty, Bethel, Ohio.

ACCELERATE Your automobile with either foot. Eliminates right foot fatigue. Easily attached. Fits all cars. W & S Manufacturing Co., Dept. A, 4929 N. Kedvale Ave., Chicago.

BENDIX Brake tester \$450.00. Allen synchrograph \$135.00. Engelhard exhaust analyzer \$85.00. Souix valve refacer \$75.00. 8041 Exchange, Chicago.

PICKER-UPPER Removes dog-cat hair quickly from upholstery, clothing, rugs. 50c. Eastern Supply, 30 Perkins, Winthrop, Mass.

FORD Owners—Instant starting for your Ford. Touch button on dash and you're off. 1940 type starter switch for Fords 33-36, complete outfit with instructions \$3.00 postpaid. Easy to install, nothing else to buy. Send money order. Southeastern Distributors, 109 Cleveland Ave., Macon, Georgia.

WHOLESALE Auto parts, accessories, hardware, miscellaneous. Catalogs 10c. United Industries, 321 Broadway, Denver.

ANTIFREEZE. Similar to Formula 30c. Practical Methods, St. Paul, Minn.

SWAY-CHEK Now available for Fords, Mercurys, Lincoln-Zephyrs pays big profits to garage and repair men. Checks wind-wander, curve-sway and load-roll. Agents wanted everywhere. See ad on page 123A of this issue and write Bellflex Corp., 2012 Sylvania Ave., Toledo, Ohio.

BARGAINS—Compressors, welders, battery chargers, car washers, attractively priced. Terms, trial. Write for bargain list. Hobart Automotive Supply, Box M-2405, Troy, Ohio.

RE-FINE Crankcase drainings, request information. Zeiball, Mount Holly N. J.

PLATING Outfits for auto parts. Connect to a battery. No tanks used. Free particulars and proofs. Gunmetal Co., Ave. J, Decatur, Ill.

AUTO TRAILERS

BUILD Your house trailer from our K.D. parts. Arrowcraft Coaches, St. Johns, Mich.

BUILD The famous, low-cost Jim Dandy Cabin Trailer. Complete plans and instructions 50c. Plans to build the beautiful, streamlined Jim Dandy Cabin Cruiser, \$1.00. Trailer Builders Manual and catalog of trailer parts, supplies and equipment—over 100 interesting, illustrated pages, 25c. Order today. Satisfaction guaranteed. Trailer Supply Co., 411-A Jackson St., Wausau, Wisconsin.

MOTORCYCLES, BICYCLES, MOTOR SCOOTERS AND SUPPLIES

MOTOR Marvel ready! Mead's sensational new Ranger Scooter goes 120 miles per gallon, 35 m.p.h., ride, rent or sell for profit, pleasure. Dealers, agents write for special introductory offer, easy terms, free circular. Hurry! Mead Cycle Company, Dept. F-1, Chicago.

BUILD Power scooters, midget cars. We supply tires, wheels, motors. Lowest prices. Send 10c for plans, etc. Build-Your-Own Devices, Dept. 2-A, 536 North Parkside, Chicago.

KNUTH'S Motorcycle bargains. Lowest prices. Bulletin 10c. Prompt service on repairs, parts, accessories. Harley-Davidson factory dealer. Knuth's, 2491 Fondulac, Milwaukee, Wis.

1-1/3 H.P. Engines suitable for scooters, cars, boats. At only \$14.95. Clear-Vue Company, Dayton, Ohio.

BICYCLE And parts catalogue free. Coupon for identification plate with your name engraved in gold, fastens to bicycle. Krause Supplies, St. Clair Shores, Mich.

MOTORCYCLISTS. Let's get acquainted. We can save you money on parts and accessories. List free. Triangle, 1111 Washington, Chicago.

MOTORSCOOTERS. Midget cars! Easily built. Complete plans and literature on motors, wheels, tires, motorized bicycle attachments, etc. 10c. Honsakers, Ma-sontown, Penna.

THOUSANDS Assembling own Comet motorscooters! Save 70%. We supply parts, tires, wheels, motors. Literature, drawings 10c. Hurry! Comet Cycle Company, Box 3032, Madison, Wisconsin

MOTORIZED Your bicycle with Midco 4-cycle air-cooled engines. Fit any standard bicycle. Write us. Midco Mfg. & Dist. Co., S. 13th and Kentucky Sts., Sheboygan, Wis.

ALLOY Pistons \$3.00—Harley, Indian, Henderson, Excelsior, Cleveland. Cylinder grinding, rings, bearings, gaskets, chains, sprockets, helmets, goggles, accessories, parts new and used for less. Catalogue and wings pin 10c. Ballak, 1115 Chestnut, St. Louis, Mo.

MOTORCYCLES. Reconditioned. New, used, parts and accessories. All makes. Large stock. Bargains. Illustrated catalogue, 15c. Indian Motorcycle Sales, Kansas City, Mo.

INSIDE Dealer prices. Overstocked, all models. Indians and Harleys. Rebuilt, guaranteed. Dime brings latest list. Crandall-Hicks, Boston, Mass.

PROFITABLE OCCUPATIONS

NEW Invention—Stops rattles in house windows. Sample for 10c. Jiffy Rattle Stop Co., 1417 Davenport St., Omaha, Nebraska.

BUSINESS Proposition resilvering mirrors, autoparts, reflectors, making chipped glass signs. Write Sprinkle, Piater, 288, Marion, Indiana.

EARN Cash at home! M. M. earned \$267.00, three weeks raising mushrooms in cellar! Exceptional, but your cellar, shed perhaps suitable. Materials furnished. Starting crop guaranteed. We buy all crops. Book free. United, 3848 Lincoln Ave., Dept. 70, Chicago.

SELL By mail—Mail Order News magazine shows how. Sample 20c. "Success Guaranteed"—1500 word treatise included. H. Julius, Amarillo, Texas.

EXCELLENT Paying opportunity helping unemployed land increasingly available jobs. Stamp, Vocational Advisors, Box 1027, Tacoma, Washington.

STANDARD Rabbit Journal, Milton, Penna. Year 50c; sample dime, supplies.

BIG Money raising Angora wool! Brings \$5 lb.! Easily, inexpensively raised anywhere. Small outlay—Steady income! Catalogue, wool samples 10c. Clay's Farm, Sharon, Wash.

\$30 WEEKLY. Grow mushrooms. Cellar, shed. We buy 35c lb. Mr. B. made \$270 spare time. World's largest company of its kind. 40 page book free. Mushrooms, Dept. 701, 2019 Second, Seattle, Wash.

MEN—Women, operate "Specialty Candy Factory" home, all or spare time. Steady income. (Our 31st year.) Hillyer Ragsdale, Inc., Drawer 62, East Orange, N. J.

MONEY In rabbits and cavies. We buy and put you in touch with other markets. Catalog and copy of magazine 10c. Or send 25c for book catalog and price list and year's subscription to the American Small Stock Farmer, Stahl, Box 1, Holmes Park, Mo.

OLD BOOKS WANTED

WE Pay up to \$5000 each for old books, also high cash prices for old magazines, letters, newspapers. A single story book, school book, old Bible, travel book, almanac, etc., that looks worthless may bring you \$50, \$100 or \$500 in cash. Thousands wanted. Send 10c now for latest price list. American Book Mart, 140 S. Dearborn, Dept. 2813, Chicago.

BOOKS, PERIODICALS, PICTURES, POSTCARDS

EXCELLENT Sparetime profits taking subscriptions—2500 magazines. Agents confidential catalogue. Complete starting supplies free! Dept. 112, Pines, 583 Monroe, Brooklyn, N. Y.

BARGAINS Galore! Books, magazines—bought, sold, exchanged. Lists free. Nu-Ideas, Carrollton, Illinois.

PHOTOGRAPHS By McGoldrick. Samples, listings, 35c. Albert McGoldrick, Mansfield, Mass.

RARE Books, pictures, novelties. Where to get. We tell you. List only 25c. Esse, 5427-G Harwood Ave., Baltimore, Md.

GAMES—ENTERTAINMENT

PLAYS, Operettas, musical comedies, complete minstrel first-parts with song programs, blackface skits, vaudeville acts, monologs, dialogs, recitations, juvenile plays and songs, musical readings, entertainments, make-up goods. Catalog free. T. S. Denison & Co., 203 N. Wabash, Dept. 11, Chicago.

FREE Sample. Amazing! Fascinating! "Hollywuzzle." Box 2150, Hollywood. (Stamp appreciated.)

TRICK Chalk stunts. Catalog 10c. J. Balda, Cartoonist, Oshkosh, Wisconsin.

HOW To chalk talk—Complete instruction in this fascinating form of entertainment, by a famous professional. Shows how to draw trick pictures, arrange a program. 52 original illustrations showing how pictures are started and completed—all sure-fire hits. Includes humorous talk for delivery while drawing. Postpaid, \$1. T. S. Denison & Company, 203 N. Wabash, Dept. 66, Chicago, Illinois.

MAGIC TRICKS, PUZZLES, JOKER NOVELTIES

RUSH Dime for realistic mysterious wonder mouse, circular of tricks with order. Columbia Novelties, 2017 S St., N. W., Washington, D. C.

SEND 3c Stamp for catalog of tricks and jokers novelties. Clifford Leerhoff, Parkersburg, Iowa.

LEARN Handcuff escape. Instructions 50c. Particulars free. Chas. Hyde, 311 North Fourth, Reading, Penna.

MAGIC: Mindreading. Earn while learning. Particulars free. Magical Browne, Duluth, Minn.

TRICKS You can do! For pocket-parlor-stage. With coins, cards, cigarets, ropes, balls, thimbles, watches! Escapes, mind-reading, spirit and mental magic! Illusions, magical books and stage supplies! Largest assortment; lowest prices! 100 page catalog 500 popular tricks 10c. 80 page catalog larger stage magic 10c. Write today! Lyle Douglas, Station A-5, Dallas, Texas.

NEW 25c Catalogue and 25c secret; 50c value, only 10c. Folders free. Eagle Magic, Minneapolis.

BARGAIN List of used magical apparatus free. Waldmann, 332 East 77, New York.

JOIN Magicians' Fraternity! Free tricks! Monthly magazine, sample 10c. International Magicians, Mt. Morris, Ill.

MAGICIANS' Headquarters—Latest 216 page professional catalogue, pocket, parlor, stage tricks, 25c. Kanter's, 1311 Walnut, Philadelphia.

SPECIAL Buy! Thurston's card tricks, 30c! J. Otto, Box 864, Sequim, Washington.

BE A magician. Large professional magic catalogue of latest tricks 25c. Cash paid for complete Tarbell Magic Courses. Write, Ireland, C-109 North Dearborn, Chicago.

MYSTERIOUS. Amazing novelty with catalogue 10c. Walnut Specialty, Everett, Mass.

WORLD'S Largest magic shop professional catalog, 25c. Holden, 220 W. 42nd St., New York.

LEARN Ventriloquism, 3c stamp brings particulars. Smith, 801 Bigelow, Peoria, Illinois.

LARGE Magic catalog 25c. Hundreds of tricks. Chicago Magic Company, 2300 N. Mason Avenue, Chicago.

EARN Money in any crowd. Call names of strangers, tell unspoken questions. Professional course mind reading, spirit writing, etc., \$1. Henderson, Box 341, San Bernardino, Calif.

OLD STAMPS WANTED

I WILL Pay \$100.00 each for 1924 1c green Franklin stamps, rotary perforated eleven (up to \$1,000.00 each unused). Send 6c for large illustrated folder showing amazing prices paid. Vernon Baker, (PM-1) Elyria, Ohio.

STAMP COLLECTING

BIG Packet free! Unusual stamps including scarce zeppelin; smallest triangle; Indochina airmail; old Eastern Roumelia; Canadian coronation; silver jubilee; Italian East Africa; giant diamond-shaped stamp; Mozambique; Liberia. Holy Lands stamps from Palestine, Lebanon, Iraq, etc., many others. Only 5c to approval applicants. B. Fitts Co., Framingham, Mass.

SCARCE Diamond airmail! Wonderful packet 115 different from strange countries. British Colonies, Haiti, Tasmania, pictorials, etc. 5c to approval applicants. Reliable Co., Box 139P Church Street Annex, New York.

SENSATIONAL Combination offer! Big packet 105 all different including Greenland (new country), Congo, Manchukuo, Costa Rica triangle, air-mails, commemoratives, giant diamond-shaped stamp, 44 United States; complete set United States telegraphs, cataloging 20c. scarce set Siberia cataloging 50c. Packet British colonies including Gwallor, Hyderabad, Burma (new country), jubilee and coronations. Total catalog price over \$3.00! Everything for only 5c to approval applicants! World-Wide Stamp Company, Department 600, Camden, New York.

FREE—Entire new U. S. issue of "Famous Americans." This new issue consists of 35 commemorative stamps of which 5 will be issued every month starting January. We will send the entire issue free to collectors on our active approval mailing list, and we will also send for 10c at once a most attractive specially prepared album for only this issue, which contains, besides spaces for each stamp, also the history and achievements of each of the 35 famous Americans. Get on our mailing list now and get the entire series free. Send 10c for that album today. We will send it at once together with a nice approval selection. Approval Headquarters, Globus Stamp Company, 268 Fourth Ave., New York City, Dept. 201.

SACRIFICING Dealers' approvals. \$1.50 value \$1.00; \$4.00 value \$2.00; \$11.00 value \$5.00. Smith, 669 Chili, Rochester, N. Y.

NEJD (Saudi Arabia)—Bolivia eucharistic triangle, Cayman Island pictorial, Negri Sembilan, Turks and Caicos Islands, Manchukuo, Bahamas war provisional, five dollar United States, British Solomon Islands (Cannibal), Everything 3c with our famous approvals. Viking Stamp Co., 1-Z Hanson Place, Brooklyn, N. Y.

THE World in a packet. An outstanding value! 100 stamps from 100 different countries, including Abyssinia, Afghanistan, Brunei, Falkland, Samoa and others from Africa, Asia, South America, West Indies, etc. Our pamphlet which tells "How to Make a Stamp Collection Properly," together with our large bargain list of albums, packets, sets, etc. All for only 20c. Queen City Stamp Co., 604 Race St., Room 36, Cincinnati, Ohio.

FREE! 25 Commemorative stamps with approvals. Eulalia Turner, Azusa, Calif.

BRAZIL 120 Different including many fine commemoratives \$1.00. Fernandez, Caixa 1560, Sao Paulo, Brazil.

FREE! Royal visit packet. Postage 3c. Roberts, 312 Shearerbig, Bay City, Mich.

CANNIBAL King set 5c. Approvals. U. S. mixture supreme, quarter pound, 25c. Quality Stamps, Englewood, Colorado.

"GOYA Nude set." 18 varieties, complete 25c. Approvals, Jewells, Tamaqua, Penna.

UNITED States stamps on approval. Big discounts. Stamp Company, Broadway, Albany, New York.

20% OFF On dollar purchases. Exceptional stamp values. Skinner, 306 East Fourth, Long Beach, California.

1000 GOOD Mixed 25c. Includes valuable prize packet. DeMers, Box 1033, Milwaukee, Wisconsin.

FREE—World's only octagonal (eight-sided) set and 25 different Japanese pictorials to approval applicants. Charles W. Cleveland, 806 North Humphrey, Oak Park, Illinois.

TEN Different United States over 40 years old. 10c. Elsea, Bowling Green, O.

FREE Stamp catalog, 1940 edition—giant fifty-page Quarterly listing albums, supplies, Canadians, Newfoundlanders, United States, foreigners, pictorials. Illustrations galore! Empire Stamp Company, Dept. PM, Toronto, Canada.

200 WORLD Wide stamps, 15 cents. Arthur Mantel, 256 13th Ave. So., Minneapolis, Minn.

115 DIFFERENT Free! 205 different 3c with 30% approvals. Booher, 1643a Island, Wilmington, California.

COMMEMORATIVES — Forty foreign 25c. Desirable approvals. Sherman Shook, Nazareth, Penna.

60 DIFFERENT Stamps 5c with approvals. Colonial Stamp Shop, Charlton, Mass.

U. S. Approvals to serious collectors. Lundgren, 1751 Eustis, St. Paul, Minn.

FAMOUS American poster stamps: Set of 35 different (in two colors) for 15c, 10 sets for \$1.00. Frederick Dietz, 135 West 42nd Street, New York.

105 DIFFERENT! United States commemoratives \$1.00. Satisfaction guaranteed. Mace, 151 East 118th Place, Chicago.

200 WORLD Wide packet 10c. Approvals. Smith, 669 Chili, Rochester, N. Y.

HUNGARY—46 Different free to approval applicants. Excel, Box 1315, Chicago.

AIRMAILS And commemoratives, 25 different, including Columbians, Panama-Pacific, Edison, Zeppelin, etc., only 5c with exceptionally fine United States and foreign approvals. Marco Stamp Co., Box 888, San Francisco, Calif.

CAMERAS, PHOTO SUPPLIES

CAMERAS And supplies. Free illustrated catalog listing everything photographic—still and movie cameras, films, lenses—at tremendous savings. Hundreds of bargains, new and used. All guaranteed. We take your old camera or equipment in trade. Write now for your free copy of our newest money-saving bargain book—just out! Limited edition. Hurry! Central Camera Co., (Photographic Headquarters since 1899), 230 S. Wabash, Dept. B-16Z, Chicago, Ill.

READY Now! 72-page Bass Still Camera Bargaining No. 242—your true guide to shrewd camera buying. Backed by 14-day trial money back guarantee. Write for your copy. It's free. Bass Camera Company, Dept. AG, 179 West Madison St., Chicago, Ill.

MAKE Money in photography. Learn quickly at home. Easy plan. Previous experience unnecessary. Common school education sufficient. Interesting booklet and requirements free. American School of Photography, 3601 Michigan Avenue, Dept. 3482, Chicago.

ENLARGER \$1.59. Enlarges eight times size of small negatives. Fully guaranteed. Paramount Sales Company, 89 Dudley Street, Boston, Mass.

CAMERA Eyes, write, Gem Distributing Co., Box 7, Everett, Mass.

DON'T Miss Mogull's spectacular spring clearance offers under Motion Pictures.

SUPERLUX Converts inexpensive lamps into photofloods. Makes indoor photography inexpensively easy. Hughes Engineering, 7 Miami, Terracepark, Ohio.

FREE Bargain list—Used cameras, lenses, professional equipment. Write for list BP, Medo, 15 West 47th Street, New York City.

MEXICO? Wanted: your name and address for literature and prices of finest German cameras, binoculars, movies. Foto Mantel, Apartado 1459 Ven. Carranza 11, Mexico City, No. 105.

CAMERA Repairing. Bellows made to order, shutters repaired. Bellows made to fit all standard cameras! United Camera Co., Inc., A-1515 Belmont, Chicago.

HAVE You a camera? Send ten cents for recent number of our big magazine, showing how to make better pictures and earn money. American Photography, 116 Camera House, Boston, 17, Mass.

CAMERAS Films, paper 25% to 35% discount. Paramount Photo Division, 327 East 92nd St., New York.

MOTION PICTURES AND SOUND EQUIPMENT

ATTENTION Movie makers: Cut your movie costs 50% with Solar Film. America's foremost economy movie film. Write for prices of 16mm., 8mm. films and special discount offer. For better films and faster service write: Solar Film Company, 3827 Archer Ave., Dept. J, Chicago, Ill.

SAVE! Lists! Subjects! Bulk! Title printer! Penn-Craft, 423-MB, Williamsport, Pennsylvania.

18 SOUND (16mm.) Projectors. Bargains. Roshon, State Theatre, Pittsburgh, Penna.

FREE, 16mm., 8mm. Bargain lists. Home Movies, Box 216, Easton, Pennsylvania.

MODERN Titles: Your wording! 8-16mm. Brochure free. LeMoine Film Service, 926 West Austin St., Nevada, Mo.

TRACE Movie titles, black and white, color \$2.00 complete. Samples 5c. "AtoZ" Titling Outfit, Flatiron Building, New York.

SILENT 35MM. films, Projectors. Cheap. Demsey, 1223 Berkeley, Youngstown, Ohio.

35MM, 1000 Feet \$1.10. Jersey Films, 2075 Richland, Lakewood, Ohio.

35MM, Silent sound list 5c. Bedner, 5300 S. Talman, Chicago.

16MM, Titles—\$1.00, 12 words or less including backgrounds, fades, wipes and dissolves. Sound 50c extra. Professional titles and trailers as used by thousands of theatres. Write today. Pilmack Laboratories, 840 S. Wabash, Chicago.

8-16MM, Films: cartoons, comedies, travel, sport, war in Europe, World's Fair, 1001 different subjects, at bargain prices! Films rented everywhere. Trades accepted. Free catalogue (with sample film 10c.) Garden Exchange, 317 West 50th, New York.

SPRING Clearance! Bell-Howell, Victor, Ampro sound film, projectors from \$125.00. Guaranteed! 16mm. Kodascope \$19; Devry \$22; 16mm. Bell F:4.5 camera \$3.99; Eastman F:3.5 \$19; Flashmaster Candid with bulb \$3.49; Reflex-type \$4.49. Professional Cinematography textbooks (were \$2.50) special 39c each; 4 assorted \$1.25 (worth \$10.00). Time payments, trades accepted. World famous film rental library; lowest rates. Mogull's, 64 West 48th St., New York.

MOVIE Cameras, projectors, films, etc., bought—sold—exchanged. Lists free. Art samples 25c. Peerless, Box 1310-P, Hollywood, Calif.

FREE Catalogue, 16mm. silent rentals. We pay transportation. Exchange exclusive. Asha Films, 785 St. Johns, Brooklyn, N. Y.

FREE! Giant bargain bulletin 35mm. Calderara, 5119 South St. Louis, Chicago.

ART Sample, 10c; other kinds, lists free. Goodwill Company, Jackson, Tennessee.

PROCESS Your 8mm., 16mm. films with our drum type outfits, complete—\$6.95. Cameras, projectors. Liberal trade-in. Literature, stamp. Cine Service, 459 Irvin Ave., Rochester, Penna.

MONEY Maker! "The World's Greatest Passion Play," 16mm. and 35mm. Sound or silent. Purchase or rent everywhere. Superior than Oberammergau play. Write Hemenway Film Co., 37F Church Street, Boston, Mass.

RELIGIOUS Features for Lenten season. "Thine Kingdom," "Brother Francis," "Passion Play" and others. Otto March, 630 - 9th Ave., New York City.

16MM. VELOTEX, Perfect outdoor film, 100 ft. rolls \$1.95 including free processing. Sample free. Velotex Laboratories, 600-H, Gary, Indiana.

35MM. ODD 75c. 16mm. \$1.50 complete. Savarese, Woodcliff Lake, N. J.

8MM., 16MM. and 35mm. films, bargain lists 3c. Clifford Hoffman, 57 Broad, Albany, N. Y.

GUARANTEED 8MM. 24-hour reversal processing. Double 8mm., 45c. Single, 25c. Univex 15c. Eso-S, 3945 Central, Kansas City, Missouri.

MOVIE Film. Develop yourself. Univex, Eastman, etc. Chemical samples 15c. Raw film wholesale. Lake Camera Exchange, Gary, Ind.

15% TO 25% Discount on still or movie cameras. Free circular. Paramount Co., 327 E. 92nd St., New York City.

TALKIE Shorts \$3.00 reel. Programs rented \$7.50 two nights. Simpson, 1275 South Broadway, Dayton, Ohio.

BASS Says: Write to Cine headquarters for 66-page Cine Bargaining No. 240, 8mm., 16mm., 35mm. silent and sound. Equipment to gladden the heart of amateur or professional, including the famous 16mm. sound on film RCA camera, exclusive distributors. Write for copy of this great book, it's free, to motion picture headquarters for 30 years. Dept. A, Bass Camera Company, 179 W. Madison St., Chicago, Illinois.

BARGAINS! 8mm., 16mm., free literature. Elder, P-739, Boylston, Boston, Mass.

RADIOS SUPPLIES, INSTRUCTION

ANTENNAS! Portable (cylindrical—10x3 inches). All-band, static eliminating. Scientifically constructed. Very durable. Superior reception. Walnut finish. Three dollars, postpaid. Louisville Radio Antenna Company, Box 53, Highland Park Station, Louisville, Kentucky.

RADIOS: All types. Agents wanted. Catalog free. Autocrata, 3855 North Hamilton, Chicago, Ill.

STANDARD Radios. Agents wanted. Wilson Radio, 2509 North 3rd, Milwaukee, Wisconsin.

PLANS 18 Distance record crystal sets, with "Radiobuilder"—year 25c. Laboratories, 7700-C East 14th, Oakland, Calif.

S-M Crystal distance radio. Sensation. Kit—\$1.95; with speaker—\$2.95. C.O.D. Circuit—25c. Esco-PM, Kansas City, Mo.

RADIO Engineering, broadcasting, aviation and police radio, servicing, marine and Morse telegraphy taught thoroughly. All expenses low. Catalog free. Dodge's Institute, Ames St., Valparaiso, Ind.

SEND For free giant money saving radio and phonograph record catalogue. United Radio Company, 1000-M, Newark, N. J.

RADIO Kits—\$3.95 up. Complete. Single band; all-wave; 5-10 tubes. Radio and parts catalog free. McGee Radio, FP-10, Kansas City, Mo.

MUSIC AND MUSICAL INSTRUMENTS

LEARN Swing piano! Postal brings free folder. Christensen, 751 Kimball Hall, Chicago.

SONGWRITERS! Poems, music. Amazing offer. Hibbeler, C-5, 2157 N. Avers, Chicago.

SONGWRITERS, Write for free inspiring booklet outlining new opportunities for amateur songwriters. Allied Music, Dept. 4, Box 507, Cincinnati, Ohio.

POEMS, Melodies, Publication, Placements. Best opportunity. Songland, "D40PM-1," Thomaston, Maine.

SONGWRITERS—Agents, new sales plan. National Music-D, 532 Sixteenth, Oakland, Calif.

PIANO By ear. Free booklet. McKee School, 6842 Sunset, Hollywood.

SONGWRITERS—Send poems; free plans, reports. Variety, Dept. H, Salem, Indiana.

SONG Writing pays—Let successful song writers set your poems to music. Five Star Music Master, 6 Beacon St., Boston.

POEMS Wanted. Work guaranteed. Publishing, Great Eastern, "D27," Thomaston, Maine.

START Own orchestra, make money, you be drummer, play immediately, new copyrighted system, \$1.00. Class' Drum School, 3609 Stoer, Cleveland, Ohio.

SONGS, Lyrics, composed, published, royalty basis, wonderful opportunity. Free information. Melody World Music Publishers, Garfield, Building, San Francisco.

ONE Dollar brings you twelve guaranteed clarinet reeds. Soft, medium, stiff. State choice. Money back if not satisfactory. Box 413, Mansfield, Penna.

FIFTY Late phonograph records, \$2.50. Wurlitzer selective, amplified, 12 record phonographs, very cheap. Davis Sales Co., Syracuse, N. Y.

PIANO By ear. Free booklet. Day-V-Way, 13265 Michigan Ave., Dearborn, Michigan.

ONLY Published songs bring dividends and popularity. For important information write Sunbeam Publications, 20 West Jackson, Chicago.

RECORDING Songs, poems, dollar per minute. Ray Turner, Hotel Tilden Hall, Champaign, Ill.

SONGWRITERS—Write today for free booklet "Building An Income Through Songwriting." Songwriters Institute, 1234-C Broadway, New York.

WANTED: Original poems, lyrics, songs by a recognized music organization. Our contracts guarantee publication, marketing; include expert collaboration, where required. We give you advantages not obtainable elsewhere. Send your material today. Music Publishers Agency, Dept. X12, Portland, Ore.

MUSIC Composed to words. Rhyming pamphlet on request. Phonograph recording of completed songs. Send poem for consideration. Keenan's Studios, Dept. PM, Box 2140, Bridgeport, Conn.

DUO-FLEX Reeds for clarinets, and saxophones eliminate your reed troubles. Write for circular. Duo-Flex Reeds, 1204 1st Ave., Evansville, Ind.

MUSIC Composed to words. Wonderful proposition. Bauer Bros., Oshkosh, Wis.

WRITE Songs. Big money and reputation. Write for information. J. Gordon Pub. Co., 201 N. Hoyne Ave., Chicago.

WANTED! Lyrics, melodies for songs. We arrange, publish, sell. Superior Song Studios, Passaic, N. J.

SONGWRITERS: Send your poem today for immediate consideration. Richard Brothers, 24 Woods Building, Chicago.

SONG Writers. Send for publishing agreement. McKinley Music Publishers, 1501 E. 55th St., Chicago.

SONG Poems wanted. Free examination. Send poems to McNeil, Master of Music, 510-PM So. Alexandria, Los Angeles, Calif.

SONGS, Song poems, bought, published. Best offer, free advice. Metro-Melody Music Publishers, 1204 Sutter, San Francisco.

BUSINESS OPPORTUNITIES

FORDS Portable Hammermill operators make regularly weekly net earnings, \$50, \$75, \$100 and more. Fords' exclusive molasses impregnator gives operators big competitive advantage. Equipment may be purchased 25% down, balance from earnings. Write for particulars about this safe, sure, profitable year-round business. Myers Sherman Company, 1428 12th, Streator, Illinois.

BUILD A business of your own. Grind lawn mowers the Universal way. Small investment—large profits. Every customer satisfied. Write for Booklet T. Rogers Manufacturing Company, Lindsey, Ohio.

START Your own business. Pleasant work at home. Big profits. Atlas Service, Red Lodge, Mont.

MANY Money making ideas, handy household article free. Profit Guide Service, 1585 Broadway, 303V, New York.

MAKE Sell finest maple syrup, homes, restaurants. Cost 7c a pint. Big profit. Send \$1 for formula, full instructions. We include maple flavor enough for 4 gallons postpaid. Manufacturers Sales Co., 301 West 29th, New York.

FREE Amazing Folder about Artificial Marble Flooring. Covers Wood or Cement Floors. Fireproof. All colors. Low Cost "Ornamental Casting"—Concrete—Plaster—Statuary—Garden Furniture—Flexible Molds—Liquid Marble. Creative Publishers, PM-2, Glencoe, Illinois.

110 MONEY-MAKERS. At home. City or country. Write: Home Service Bureau, Box 4079, South Edmonton, Canada.

OPPORTUNITY Of doing business by mail. Particulars for stamp. Eastern Sales Service, Box 101, Millville, N. J.

POPCORN Machines, carmelcrisp, crispettes, cheese coat, potato chips. Long Eakins, 2035-B high St., Springfield, Ohio.

ANNOUNCING New home study course in commercial baking. Good field for ambitious men. Nearly depression proof business. Common school education sufficient. Send for free booklet "Opportunities in the Baking Industry" and requirements. National Baking Institute, 3601 Michigan Avenue, Dept. 3432, Chicago.

MULTIGRAPH Work given to anyone buying my multigraph equipment for home work. Good opportunity. 300 B St., S.E., Washington, D. C.

A BUSINESS Of your own. No fruitless experimenting. We'll plan your entire business campaign and guide you step by step to success. Write for details. Reliable Service, Box 923, Denver, Colorado.

YOU'LL Like resilvering mirrors, autoparts, reflectors, making chipped glass signs. Write Sprinkle, Plater, 127, Marion, Indiana.

"RUBBER Mold Making." Plastic Casting. Working instructions 25c. Ideal Service, PM-2, Park Ridge, Ill.

NEW Money makers. 70-page mailorder magazine, prints hundreds new, novel, sparetime plans monthly. Sample copy 10c. M. Marvin, Publisher, 330 South Wells, Chicago.

OPERATE Movie shows in theatreless communities. Earn \$50.00 to \$100.00 weekly right away. No experience. We furnish projection equipment, talking film programs. Show you everything. Southern Visual, Dept. PM-4, 494 S. Second, Memphis, Tennessee.

YOUR Own business. Free particulars. Mogul, 10420 Yale, Cleveland, Ohio.

OPPORTUNITIES. Profitable, permanent, no freaks. Sample, dime. Gammell, Dedham, Mass.

NEW Real estate course through home study. Start own office. Big commissions. Easy, reasonable. Morrison School Real Estate, Dept. 9, 100 No. LaSalle, Chicago.

FREE Literature describing many money making plans. Brown Publishing Co., 610 So. Broadway, Los Angeles, Calif.

SUCCEED With your products. Make-sell them. Formulas, Processes. Accurate analyses. Catalog free. B. Thaxly Co., Washington, D. C.

EARN Cash at home! M. M. earned \$267.00, three weeks raising mushrooms in cellar! Exceptional, but your cellar, shed perhaps suitable. Materials furnished. Starting crop guaranteed. We buy all crops. Book free. United, 3848 Lincoln Ave., Dept. 68, Chicago.

AFTERNOONS Free! Work home! \$2,000 month reported (exceptional—full-time). Also wartime plan. Expect surprise! National, Box 1240Y, San Bernardino, California.

CASH, Newspaper clippings. Write Galvin, B724, 207 E. 84, New York City.

PLASTEX Industries offers industrious men an opportunity to start a business of their own, manufacturing art goods, novelties, souvenirs, etc., in Plastex and marble imitation. 5c material makes \$1 articles. Rubber moulds furnished for speed production. Small investment brings big returns. You are just in time for big wholesale season now starting. Write for interesting booklet mailed free. Plastex Industries, Dept. A, 1085 Washington Ave., New York.

CLAIM Adjuster—Investigator. Big field. Dignified, fascinating, profitable. Quickly learned. Overstocked publisher sacrificing new, marvelous, regular \$5.00 instruction courses, complete, 25c. Box 302, Alhambra, California.

"LUMINOUS Paint" shines in dark. Easily made. Formula 25c. Ideal Service, LP2, Park Ridge, Ill.

QUICK Income! Fast-growing business creates lasting independence; attention, intelligent effort, required. Service, Drawer 339-5, Butte, Montana.

MIRROR Resilvering offers great opportunities. Write Joyce Mirror Studios, 12461 Dresden, Detroit.

LOCAL Mail order business established 1900 with postoffice at sacrifice. Particulars free. Fox, Fero, N. Dak.

MONEY By mail magazine 25c. Oksirtep, 133 Farmington, New Britain, Conn.

MAIL Order business course will show you how to make money, spare or full time. Teaches professional mail order technique; not penny-catching schemes. Write for free details today. Nelson Co., B-404 Manhattan Building, Chicago.

SUCCEED! Read Enterprise! 68 pages; homeworker's plans, tips, ideas, 10c. 202 Ashland, River Forest, Ill.

MONEY In "names"! Free instructions. Mailservice, 2231 McKinley, Berkeley, Calif.

"BINGO." New coin operated amusement game. Large income, operating "route." \$150 investment. Details free. Robbins, 1141P DeKalb Ave., Brooklyn, N. Y.

ELECTRIC Razors are in demand. Sell high type guaranteed razors. Long profit. Money making plan outlined. Copyrighted. Research Sales, Box 193-5, Pomona, Calif.

MAKE Artificial marble, glazed tiles, uncanny. Tabletops, plaques, floors, hones, novelties. Hard, fireproof, inexpensive, cement secrets. Brilliant tile and liquid rubber samples 3c. John A. Payn, 945 Grande Vista Avenue, Los Angeles, Calif.

20 MONEYMAKING Plans; not just ideas—complete operating details. Send 25c. Business Guide, 502 Dryades, New Orleans.

PUBLISH A magazine at home. Sample magazine dime. Devino, M820 Wrightwood Ave., Chicago, Ill.

INVENTION Finance Magazine, 80-G Wall Street, New York. Important particulars free.

HANDY Men—Earn money home operating Community "Fix-It" Shop. Stafford, Makanda, Illinois.

CHIPPING Glass signs. Folder free. Beveridge, 160-22 P Locust, Jamaica, N. Y.

A REAL Future for you with Red Comet Automatic Fire Extinguishers. Low price. Proven seven years. Splendid sales outfit free. Some good territory open. Exclusive. Write quick. 766 Red Comet Building, Littleton, Colorado.

INVENTORS:—We successfully sell inventions, patented and unpatented. Write for proof, and tell us what you have for sale. Chartered Institute of American Inventors, Dept. 4-C, Washington, D. C.

GOOD Paying business silvering mirrors, plating autoparts, reflectors, bicycles, bathroom fixtures by late method. Free particulars and proofs. Gunmetal Co., Ave. H, Decatur, Ill.

TURN Tin cans into money at home. Big profits, 25c easy instructions mailed. H. Chaney, 1130 East 16th Street, Jacksonville, Fla.

MAKE. Sell single-ingredient products! Formula catalog free. B. Kinford, Wayne, Penna.

SELL. By mail. Earn money sparetime. New folio by expert shows how. 25c. Ribot, 620 East 62nd, Chicago.

BIG Profit in mold making and plaster casting. \$1.50 profit on every dime invested. Foolproof rubber. Tremendous market. Simple interesting work. 24 page instructive catalogue free. Plastic Arts, 711 Neely Muncie, Indiana.

DIME Brings three issues Moneymaking Opportunities. Sunflower Mailers, Atlanta, Kansas.

LIQUID Marble—anyone can make! Colorful, glazed! Moulded, brushed, sprayed. Rubberlastic moulds. Composition flooring. Big money in these! Particulars free. Marbleizing Service, Edwardsville, Ill.

JEWELRY—Bracelets, bairpins, millinery ornaments, earrings, religious medals, etc., easily cast and set with imitation diamonds. Exceptional profits in this new business which offers opportunity to turn full or spare time into money. Complete outfit includes material and everything needed for production. No experience necessary. Write for free booklet describing this fascinating work. United Jewelry Manufacturers, Dept. A, 1692 Boston Road, New York.

127 WAYS To make money, in home or office, business of your own. Full particulars free. Elite Co., 214 Grand St., New York.

HOW And where to obtain capital fully explained, free particulars. Star Service, Wapakoneta, Ohio.

YOUR Own business! Selling by mail. Details free. Maples, 3418 South Marshfield, Chicago, Illinois.

ELITE Collection of business plans, contains 127 tested plans and scores of formulas. Start own business; home, office. Particulars free. Elite Co., 214 Grand St., New York.

WE Help start you in business, furnishing outfits and instruction, operating "Specialty Candy Factory" home. Men, women, opportunity to earn good steady income, all or spare time. (Our 31st year). Booklet free. W. Hillyer Ragsdale, Inc., Drawer 4, East Orange, N. J.

\$30 WEEKLY. Grow mushrooms. Cellar, shed. We buy 35c lb. Mr. B. made \$270 spare time. World's largest company of its kind. 40 page book free. Mushrooms, Dept. 701, 2019 Second, Seattle, Wash.

MAIL Order business is your opportunity. Many began small, now earn thousands yearly. No personal contact. Boundless opportunities. Have had over 30 years experience; will help you succeed. Send 25c for valuable booklets, none free. B. Brenner, 257 S. 21st, Philadelphia.

COLOR Concrete with chemicals. Stucco-Rock. Cement artistry. Benches, Washingwells. Spin concrete pottery. Miniature castles, waterfalls. Coldglaze, water-paints, marbling. Sample 10c. Hollywood CementCraft, 8527 Wonderland, Hollywood, California.

LEARN Account collecting. Good income; quick results. Interesting folder free. National Collectors Association, Newark, Ohio.

EARN Extra money at home. Increase your income at home by new, simple Wentworth Tempera Color method. We instruct you and supply you with work. Write today for free booklet. Wentworth Pictorial Co., Ltd., Dept. 3, Hamilton, Ont.

MAKE Money by mail, the way we do. Free information. Maywood, P-1107 Broadway, New York.

MANUFACTURE From Phospholene. Cleaning fluid 1c gallon; bleach 2c gallon; hand soap 2c pound; and ten fast sellers. Sample 25c. Details free. Western, 401 Climax Bldg., Cleveland, O.

ADVERTISERS! 1,600,000 Mail order circulation. Inch advertisement, \$15.40. "Get results." 20 newspapers, 18 words, \$6.50. Diener-Dorskind, 1474P Broadway, New York.

I WANT To send you proof of the wonderful pulling power of Popular Mechanics Magazine's classified pages. What's your proposition? Write me today. F. W. Johnson, Manager Classified Advertising, 200 E. Ontario St., Chicago, Ill.

SELL By mail. Books, novelties, Bargains! Big profits! Particulars free. E. Elfco, 438 N. Wells, Chicago.

CHARTERS: Delaware; best, cheapest; free forms. Colonial Charter Co., Wilmington, Del.

WHERE To buy at lowest wholesale prices. Information free. Yorena, Box P-312, Bayonne, N. J.

WANT More business! 2c daily opens individual New York branch office. Co-operative Mail Service, 126 Lexington Ave., New York.

LIVEWIRES—Operate "Commercial Reporter Plan." New. Startling. Dollars daily. Thorne's, 214 W. Trail, Jackson, Mich.

LIFETIME, Profitable business. Plan 10c. Doctor's Budget System, 4947 Pensacola, Chicago.

MAILORDER Opportunities! Send name—postal. Wallace, 1724 Monroe, Madison, Wisconsin.

MEN-WOMEN! 10c brings world wide money making opportunities. Box 5450, Metropolitan Station, Los Angeles, Calif.

VOLUME, Complete on mail order \$1.00. Link, 717 Briarplace, Chicago.

ELECTRICAL Appliances; home workshop tools. Pricelist free. Mailorder Electric, 719 South Dearborn, Chicago.

OPERATE Profitable "route" four compartment vendors. Small investment. Penny King, 1233 Chouteau, St. Louis.

NESTLENE Non-skid for rugs fills a long felt want. Prevents wrinkling, raveling, dust sifting. Liquid Nestlene easy applied with brush, odorless, nonflammable, lasting, flexible like rubber, prolongs life of rug. Other uses. Economical. Attractive distributors proposition. Nestlene Co., Box 38, North Hackensack, N. J.

MAKE Money building and selling electric brooders! Plans available. Send 5c for electric poultry supply catalog. Lyon Electric Company, San Diego, California.

MANUFACTURE Metallic gold and silver flexible sign letters. Can be applied on windows, wood, metal. Full course \$2, worth \$100. Baron Sign Co., 3 Factory St., New Haven, Conn.

BUSINESS Knowledge, worth dollars to you 10c. C. Thimijan, Lake City, Minn.

24 WAYS To make money 50c coin. Orville Earhart, Hollenberg, Kansas.

MAKE Money raising dairy goats. Send stamp for details. Complete information \$1.00. Ingram Supplies, Box 35, Jacksonville, Illinois.

PROFITABLE Home business selling formulas by mail. Geer, Box 515, Fabens, Texas.

BE Independent—I'll show you how to write successful selling letters for any kind of business. No books to study—no hard rules to learn—you start writing immediately. Many firms pay as high as \$25 for single letter. Complete instructions \$2 postpaid. Coykendall, Letter Specialist, Treasure Village, St. Petersburg, Florida.

700% PROFIT. Selling new most successful hits from European countries. Be always the first! \$2—bills or stamps will bring you success, samples. Write: Toujeux & Nouveautes, S.A. Geneva, Switzerland.

EARN \$50 To \$100 weekly. Load of sawdust starts you. Full details, 25c. Routier, 785 Chili Ave., Rochester, N. Y.

LEARN How. "Mail Order News," 20c. Drew, 710-5, Devils Lake, N. Dak.

POSTCARD Addressed Excello Sales, Shreveport, Louisiana, brings best proposition ever received.

PROFIT With new products. Make, sell, repeat. Analysis. Research. Guaranteed formulas. Biggest catalog free. Nominal prices. Gibson Laboratory, Chemists, BD-1142 Sunnyside, Chicago.

100 PROFITABLE Mail order and local plans. Gilbert Supply, 5-P West 24th, New York.

BUILD A business! New! Profitable! No canvassing! Doctor Swearingen, Station "S," Los Angeles.

COMPILE, Publish biographical books without capital. Profitable, dignified. Washer, 2825 Downer, Milwaukee.

FASCINATING Profitable "Fixit" service taught. Houlgate, Station C, Pasadena, California.

START Mail order book business new way. Method thoroughly proven. Substantial supply source. Help in getting started. Circular free. E. P. Pendleton, 433 S. Milton, Whittier, Calif.

SOAP Making. Big repeat profits at home. No machinery needed. Posera, 4545-M Bartlett, Milwaukee, Wisconsin.

MAKE, Sell luminous paint. Literature free. Gordon Laboratories, 1265-H Broadway, New York.

MONEYMAKERS' Opportunity Digest Magazine—60 pages of real opportunities—10c. Lewis Co., 828-S Carpenter, Oak Park, Ill.

AMAZING Profits. Day-night, year round. No selling. Operate "Silver King" vendors. \$3.25 up. Free instructions. Automatic, 2425A Fullerton, Chicago.

RECEIVE Stacks of mail; Your name listed in 10,000 directories 25c. Liberty Sales Service-A, Sheboygan, Wis.

BIG Money insulating homes. Full details, 25c. Routier, 787½ Chili Ave., Rochester, N. Y.

MONEYMAKING Books, plans, formulas. Literature free. Watson, 621 South 31st Avenue, Omaha, Nebr.

\$5.00 LEAST Possible return each day worked according our plan. Light work, canvassing unnecessary. Plan and trial outfit delivered U. S. only \$2.00, refundable on return complete outfit. Scissorsman System, Box 1142, New Haven, Conn.

CASH Paid for insects. See Sinclair display advertisement on page 16A.

MONEYMAKING OPPORTUNITIES

CHARMING Oil, fascinating fragrance, lasting, cost few cents sell \$1.00. Secret formulas 25c. Darnoc, 95 Station "N," Montreal, Canada.

WRITING, Contesting, Cartooning. Extra money without talent. Complete guaranteed instruction only 35c prepaid. C. Moore, 152 Broad, Newark, N. J.

300 TESTED Money-makers. Formulas—Plans. Wholesale Supply Source, 68 pages 25c. Ideal Service, 300, Park Ridge, Ill.

SOME Moneymaking ideas easy to use. Postcard. Spangler, Box 3761, Druid Station, Baltimore, Md.

AFTERNOONS Free! Work home! \$2,000 month reported (exceptional)—fulltime! Expect surprise! National-Z, Box 1240-Z, San Bernardino, Calif.

PICK Your own money-making opportunities from the big "9 Plan Folio": a real opportunity to cash in. Write now. Jones Distributors, Senath, Missouri.

"SCHEMER" Magazine, Alliance, Ohio, (42nd year) prints schemes, tips, opportunities, formulas; winners; \$10,000—\$25,000 reported. Year, \$1.00. Now get acquainted; trial six months only 30c.

MAKE Color-glazed concrete pottery, gravestones, tiles, floors, walls. Basement waterproofing, etc. Booklet, details 10c. National Potteries, Minneapolis, Minn.

POSITIONS Abroad—Reliable information now available. List of companies having foreign branches only \$1.00. Details free. Julius, Amarillo, Texas.

TURN Trash into cash. Information, 15c. Fisher, 1725 Aisquith, Baltimore, Md.

YOU'LL Like resilvering mirrors, auto-parts, reflectors, making chipped glass signs. Write Sprinkle, Plater, 287, Marion, Indiana.

MILLION Articles. Buy wholesale. Valuable directory 10c. Ideal Service, DR-2, Park Ridge, Ill.

START Big paying mailorder business at home. Particulars free. Wilson Sales Service, 504 E. Wilson St., Milwaukee, Wis.

BE Independent. Sell by mail, buy wholesale. Wetzel, Valhalla, N. Y.

START 1940 Right! Using guaranteed Certified Formulas for "Sure Successes." Miller, Chemist, Tampa, Florida.

START Own telephone repair service in your farm community. Good money maker. We furnish instructions, material at low prices. Ideal sideline—Radio, electric, hardware stores. Inquire about county agency. Farm Telephone, Dept. A, Rogers Park Station, Chicago.

BE A professional scrapbooker. Big fees. Unlimited opportunities. Can be done at home. No competition. No capital needed. Write to Scrapbookers Guild, 59 Park Place, New York, N. Y.

MONEY By mail, new mailorder opportunities free. Harvey Teeple, Decatur, Indiana.

BE Funny, make money. Learn gag writing. Stamp brings information. Don Ush Studios, B-443 Wrightwood, Chicago.

MOULDS, Guaranteed, for casting toy soldiers, Indians, trappers, warships, sinker moulds, 244 kinds. Send 5c for illustrated catalogue. Henry C. Schiercke, 645 Spencer, Ghent, N. Y.

RAISE Earthworms for profit. Information free, stamp appreciated. Bureau Zoological Research, 106A Broadway, Peoria, Ill.

WHOLESALE Sources. 500,000 articles. Free directory. Maywoode, 1107 Broadway, New York.

"1000 PROVEN Ways of earning money"; rent this book 30 days for only 10c. Particulars free. Smith Book Service, W. Palm Beach, Florida.

FILING Saws easy this new way. One dollar hour easy. 50c brings instructions. Harvey Pickett, Garden City, Iowa.

GOOD Income! Full or spare time, at home, anywhere. Write. Ren's, 31-P Up-land, Dracut, Mass.

WORK Mornings home. Unique plans. No canvassing. Campbells, 3231 North Dupont, Minneapolis, Minnesota.

MAKE Extra money weekly! 10,000 "How-to-do-it" pointers; starting own business. Home, spare time—local, mail order, agency supply. Write today! Established 1928. Wolverine, 3545 St. Clair, Detroit, Michigan.

REALIZE 97c Profit on each dollar order. No canvassing, peddling, or personal contact. Send stamp for details. J. A. Luczak, 3451 Lemoyne, Chicago.

MAKE Money. No selling. Particulars free. Arrowhead Enterprises, Duluth, Minnesota.

300 BUSINESS Plans, formulas, bargains, secrets, that will earn money for everyone! Send 50c to Singer Research Service, Box 1970, Cleveland, Ohio.

DOLLAR Secrets. 25c. Free circulars, information. Dealers long profits. Helen Wilson, 1724 Monroe, Madison, Wisconsin.

EARN Extra money writing for publication. Simple method. Demand inexhaustible. Details free. Glen Donaghey, 17 Groton, Lowell, Mass.

CASH Paid for insects. See Sinclair display advertisement on page 127A.

START Own mailorder business. Send 25c for big folio "How to Sell by Mail" by expert. Benty, 1741 Melrose, Chicago.

ANALYSIS, Research. Newest guaranteed formulas. Biggest catalog free. Nominal prices. Gibson Laboratory, Chemists, CS-1142 Sunnyside, Chicago.

BOOKKEEPERS: Keep books by mail. Bobertz, 3701 East Hancock, Detroit.

GROW Plants without soil. Folder free. Gordon Laboratories, 1265-J Broadway, New York.

WHIRLWIND Profits—Steady repeat business selling new "Carbo-Sume" folio by mail. Write Gifford, Aberdeen, South Dakota.

START Home business making concrete garden furniture, pottery, bird bath, flower boxes. Amazing profits. Illustrated instruction book 50c. Popular Mechanics, 200 E. Ontario, Chicago.

FORMULAS, PLANS, ETC.

THAXLY Formulas for perfect products. Accurate analyses. Catalog free. B. Thaxly Co., Washington, D. C.

MOTOR Oil 2c gallon. Reclaim used oil. Formula 25c coin. George, 285 Queen, Germantown, Philadelphia, Penna.

FORMULAS—All kinds. Real money-makers. Lowest prices. Catalog free. Clover Formulary, 108-P2, Niles Center, Ill.

FORMULAS:—"Chemist Approved." None better. Lowest prices. Catalog free. Kemico, 12-B, Park Ridge, Ill.

FORMULAS, Valuable ideas from experience. Tried and true. Write for terms. Allen A. Moffitt, P.O. Box 127, East Killingsly, Conn.

AUTOMOBILE Anti-freeze formula. Two chemicals dissolved in water. Tests 40 below. \$1.00. C. C. Moore, Vandalia, Mo.

ANALYSIS, Duplication guaranteed. Valuable formulas. Consultation. Associated Chemists, Indianapolis, Indiana.

TEN Thousand formulas \$4. Send stamp for circular. Jerome Jones, Hollins, Ala.

AGENTS WANTED

10,000 MONEY-MAKING Formulas, recipes, secrets. Make most anything. 900 page book \$1.50 postpaid or C.O.D. (Foreign \$1.85). Catalog 3c. Adams-Brown Company, Chestnut Hill, Massachusetts.

BEAUTIFUL. Gem-like plastics, castable and thermosetting. Experiment. Five formulas, different types—one dollar. Supt. Rose, Benton, Mississippi.

STEPHEN'S Formulas are practical. Make and sell your own products. Can furnish most any formula (or money refunded.) 50c each, 3 for \$1.00. No stamps. Satisfaction guaranteed. Stephens, 116 Pratt, Minneapolis, Minn.

FORMULAS—List free. Andco Laboratories, 225 7th St., Rockford, Ill.

ANALYSIS. Research. Newest guaranteed formulas. Biggest catalog free. Nominal prices. Gibson Laboratory, Chemists, BD-1142 Sunnyside, Chicago.

50 SINGLE-INGREDIENT Formulas requiring no manufacturing! Catalog free. A. Kinford, Wayne, Penna.

START 1940 Right! Using guaranteed Certified Formulas for "Sure Successes." Miller, Chemist, Tampa, Florida.

REAL Manufacturing formulas. Lists free. Cummings, Chemist, Gordon Avenue, Syracuse, N. Y.

FORMULAS. Latest money makers. Literature free. Belfort, 4042 N. Keeler, Chicago.

ELITE Formulas and plans; make and sell your own products. Descriptive booklet free. Elite Co., 214 Grand St., New York.

NEW. Money making formulas book tells how to go into business for yourself. Send for free details. Popular Mechanics, 200 E. Ontario, Chicago.

CHEMISTRY

FREE Catalogue. Chemistry, mineralogy, biology, microscopes, telescopes. Tracey Laboratories, Evanston, Illinois.

FREE Chemistry catalog. Supplies at 5c! Equip complete laboratory. Kemkit Scientific Corp., 397P Bridge St., Brooklyn, N. Y.

FREE: 40 Page catalog of chemical and laboratory supplies for amateur chemists. Wollensak microscopes and supplies, scientific books at big discount. JE-2 Winn, 124 West 23 Street, N. Y. C.

CHEMISTRY Course at bargain. Particulars. A. Shapereau, 620 E. 8th St., Brooklyn, N. Y.

CHEMICALS, Laboratory, glassware, apparatus. Send 3c for catalog CP1. Biological Supply Company, 1176 Mt. Hope Avenue, Rochester, N. Y.

CHEMICALS In 5c quantities. Catalog 5c. Fleischer's Laboratories, Everett, Mass.

SPECTROSCOPE For quick chemical analysis \$2.50. Kutting Sons, Campbell, California.

HELP WANTED

BOOKKEEPERS—Learn credit management from experienced credit man. Cooke, 98 Killington Ave., Rutland, Vt.

EARN Cash at home! M. M. earned \$267.00, three weeks raising mushrooms in cellar! Exceptional, but your cellar, shed perhaps suitable. Materials furnished. Starting crop guaranteed. We buy all crops. Book free. United, 3848 Lincoln Ave., Dept. 69, Chicago.

SALARIED Positions—\$2500 yearly and up. Let us find one for you. Write for valuable information. Executive's Promotion Service, (16), Washington, D. C.

\$30 WEEKLY. Grow mushrooms. Cellar, shed. We buy 35c lb. Mr. B. made \$270 spare time. World's largest company of its kind. 40 page book free. Mushrooms, Dept. 701, 2019 Second, Seattle, Wash.

DISTRIBUTORS For 25c necessity. Master Toilet Bowl Cleaner, easy 100% money maker. 50 other everyday needs. Send 25c for full-sized cleaner, start immediately, or write today for particulars. Master Chemical Company, 1950 West Fond du Lac, Milwaukee, Wisconsin.

EARN Money in your spare time taking subscriptions to Popular Mechanics. Unlimited possibilities, every family a prospect. Easy to sell. Bonus paid in addition to liberal commission. Send postcard for further details today. Circulation Dept., Popular Mechanics Magazine, 200 E. Ontario St., Chicago.

BIG Money—Taking orders for artistic hand-colored 8x10 photographic enlargements in beautiful Deluxe frames, plus free photo mirror. Send for this unusual proposition. Gibson Photo Jewelry Co., 831 McDonald Ave., Brooklyn, N. Y.

WRITE For free samples amazing stain-proof tablecloths. Clean with damp cloth. Require no ironing. Beautiful patterns. Look like linen—cost much less. Commissions big. Also complete line of dresses. Melville Co., Dept. 1543, Cincinnati, O.

CALL On friends with greeting card assortments. Easter, birthdays, other occasions. Big demand. Big profits. Also personal stationery. Experience unnecessary. Samples free. Wallace Brown, 225 Fifth Ave., Dept. K-34, New York.

GIFTS For housewives. Cash income for you. Make real profits on easy-to-get daily orders for groceries, 200 other necessities. Amazing variety of premium gifts—hand out with every order. Full, spare time. Big display products, premiums, samples furnished qualified dealers. Togstad Co., Dept. M-16, Kokomo, Ind.

WANTED: Reliable man or woman to test food products at home, and later take orders if samples are satisfactory. \$6.00 worth full size products free. Send no money. Write Blair, Dept. 31-T, Lynchburg, Va.

WRITE Quick for amazing new line of men's shirts and sport ensembles. Easiest sellers. Low as 3 for \$2.98. Beautiful Sanforized fabrics, exclusive features. Money back guarantee. Big profits assured. Repeat business. Valuable outfit free. Stylewear, Dept. A-114, Erie, Penna.

STRANGE Chemical sponge cleans wallpaper like magic. Banishes housecleaning drudgery. Sensational demonstration. Samples sent on trial. Rush name. Kristee, 115, Akron, Ohio.

MEXICAN Curios sell on sight. Large profits. Free particulars. Samples 10c stamps. Marquez-PS, Apartado 1176, Mexico City.

MAKE And sell your own products. No machinery needed. Amazing profits. Guaranteed "Chemist Approved" formulas. Catalog free. Kemico, 10-B, Park Ridge, Ill.

MONOGRAMMING Automobiles real money maker. Write for samples. International Co., Box 9360, Philadelphia, Pa.

YOUR Hose free with outfit. Make up to \$32.50 in a week taking orders for amazing new hosiery. Replacement guaranteed against holes, snags, runs. Rush name, hose size. Wilknit, Desk BB-37, Greenfield, Ohio.

MAGIC Disc heats water without gas, coal or oil. Tremendous seller. Big profits. Pocket samples for agents. Rush name for free offer. Nuway, Dept. X-162, Des Moines, Iowa.

500% PROFIT! Transfer sign letters for windows, offices, trucks, signs. Colors: gold, silver, red, many combinations. Auto monograms. Easily applied. Neonite, Akron, Ohio.

LOCAL Agents wanted to earn bonus suits and demonstrate to friends. Up to \$12 in a day easy. Experience unnecessary. Valuable demonstrating equipment, actual samples absolutely free. H. J. Graves, 1300 Harrison, Dept. C-817, Chicago.

BUSINESS Proposition resilvering mirrors, autoparts, reflectors, making chipped glass signs. Write Sprinkle, Plater, 123, Marion, Indiana.

SUCCEED With your products. Make-sell them. Formulas, Processes. Accurate analyses. Catalog free. B. Thaxly Co., Washington, D. C.

FREE To reliable man—\$6 worth household products to start profitable home operated business. Can be handled spare time. Earnings start at once. Opportunity to make good living. Get details. Zanol, 3513 Monmouth, Cincinnati, Ohio.

MAN Wanted to supply Rawleigh's household products to consumers. We train and help you. Good profits for hustlers. No experience necessary. Pleasant, profitable, dignified work. Write today. Rawleigh's, Dept. B-53-PPM, Freeport, Ill.

UP To 500% profit with new perfected 1940 quick action, no flint, automatic gas lighter. Retail 25c. Sample 10c. New Method Company, Box PMG-86, Bradford, Penna.

AMAZING Oil burner, slips in old stove, range, furnace; quick heat at valve turn; no drudgery, ashes; easy seller. Sent on trial. Atlas, Box 6058-VX, Kansas City, Mo.

PROFIT Leaders. Fast selling specialties. Electric shavers 70c. Imprinted pens, etc. National Supply, Fosston, Minnesota.

AGENTS Wanted: Every man a prospect for "Edgecomb," the perfect hair trimming device. Enables anyone to trim own hair. Keeps it in perfect form always—never too long, never too short. Look smart. Sample for self and taking orders \$1.00 postpaid. Liberal commissions. Warner Products, (Dept. PM), Norwich, Conn.

AGENTS—Easy money selling Oilco magic range oil burner cleaner. Amazing results, repeater. Send \$1.00 for samples, full particulars. Organic Research Laboratories, 330 Atlantic Ave., Boston, Mass.

UP To 500% profit selling fast repeating daily necessities, housewives everywhere must buy. Lloyd's, 3 No. Paulina, Chicago.

SALES Books bring you biggest profits. \$4.75 per 100, commission \$1.50. Other printed necessities. Free catalog. General Printed Products Corporation, 49 West St., New York.

THE New scientific discovery. Speedee the perfect waxing aid. Wax plus Speedee gives quick high lustre. Sells easily on demonstration to garages, gas stations, etc. Send 25 cents in coin (no stamps) for trial package and sales proposition. Veedee Products, Station "B," Box 34, Buffalo, New York.

START Your own business stamping social security plates. Easy work. Big profits. Send for pamphlet illustrating inexpensive outfit. Morton Sales Company, P.O. Box 93, Flatbush Station, Brooklyn, N. Y.

MONUMENTAL Agents wanted. All leading granites. Guaranteed. Prepaid. Liberal earnings. Protected territories. Mikelich Company (Manufacturing), St. Cloud, Minn.

FAST Selling novelty fun package. Seven novelties 5c, retail \$2.50 100 packages. West Shore Novelty Co., 370 Beach St., West Haven, Conn. (PM.)

EARN \$6 A day and up. Spare or full time. No selling. Write Henry, 5472 Lake Park Avenue, Chicago.

SELL Combination baseball game and schedule. Easy sales. Big money. Caso, 75M West 45th Street, New York.

500% PROFIT. Gold and silver colored sign letters. Offices—stores. Large sizes 1c. Free samples. Modernistic, T-3000 Lincoln Ave., Chicago.

PROFIT With new products. Make, sell, repeat. Analysis. Research. Guaranteed formulas. Biggest catalog free. Nominal prices. Gibson Laboratory, Chemists, BD-1142 Sunnyside, Chicago.

MANUFACTURE Specialties, hire agents yourself. Big money. Free literature. Gilbert Supply, 5-PW 24th, New York.

AMAZING Zipper clothesline. Instant demonstration. Sells on sight. Dunn Mfg., Hempstead, N. Y.

NEW Products: Inventions. Golden opportunity. Paramount Produx, 18834 Marx, Detroit.

STRANGE Ironing cord! Abolishes kinks, snarls. Prevents scorching. Saves time. Saves work. Saves electricity. 100% profit. Exclusive territory. Big offer free. Neverknot, Dept. 2-A, 4525 Ravenswood, Chicago.

MAKE Time count. If your sales-time is limited, sell our Vision Improver. At least half of those you talk to, buy one or more. Sell singly or groups, offices, clubs, etc. 20c price, dime profit. Fifty weigh less than two pounds. Sample and terms free. Nu Du, 11½ Lake St., Nashua, N. H.

SELL Famous Glas-Glo. Big profits. Great repeater. Busy season beginning. Write for very special get acquainted offer. Glas-Glo Co., Box 164, Phelps, N. Y.

FREE Sample. E-Z-Way metal polisher. No liquid, paste or powder. Quick demonstrations, big profits. Superior Specialties, Dept. 18, Springfield, Illinois.

SUPER Profits! 50,000,000 prospects. Brand new auto power product. Harmless—guaranteed. Information free. Thermo Power, Peoria, Ill.

AGENTS: Smash go prices! Santos coffee 12c lb. 4-oz. vanilla 8½c. Razor blades 10 for 8½c. 100 sticks chewing gum 12c. 150 other bargains. Premiums. Experience unnecessary. Carnation Company, P.O. St. Louis, Mo.

CAR-OWNERS To put up our signs. Fine offer for anyone traveling. (Not for kids.) Get details. Atlas Sign Works, 7941 Halsted, Chicago.

GOOD Paying business silvering mirrors, plating autoparts, reflectors, bicycles, bathroom fixtures by late method. Free particulars and proofs. Gunmetal Co., Ave. N. Decatur, Ill.

NOVEL Kitchen article. Multiple repeat sales. No competition. 100% profit. Details, sample 25c. Cache Co., Box 728, San Diego, Calif.

NEW—Different—Gas station "Service Signals." Knipp Specialty, Long Beach, Calif.

BRAND New item for agents, salesmen. Just out. Seils on sight. Every man needs 3 to 12. Rush name for money-making offer. Remark Mfg. Co., Dept. 8, Butler, Ind.

AGENTS—300% Profit selling gold leaf letters; stores and offices. Free samples. Metallic Letter Co., 438-B North Clark, Chicago.

AGENTS—Opportunity make money; book containing 127 successful business plans; home-office; send for free introductory booklet. Elite Co., 214 Grand St., New York.

NEW 10c Seller. Costs 1c. Western, 432 Climax Bldg., Cleveland, Ohio.

SELL Fascinating Jitterpups and carded merchandise. Dixie Supply, Rosslyn, Va.

AGENTS Make big profits on food products, bargain deals. Low wholesale prices. Rush name for trial outfit offer. Ho-Ro-Co, 2810-T Dodier, St. Louis, Mo.

AGENTS—To mail our literature. Good profits. Home business. Maywood, 1105-1107 Broadway, New York.

ENGRAVED Name plates, numbers, signs, etc., easily sold, profits large. Brett Bros., Winthrop, Mass.

DO You want agents for your proposition? Your ad in this space will place your message before hundreds of men seeking fast-selling products. My folder "How to Secure Agents," is filled with proof. I'll gladly send you a copy free. F. W. Johnson, Manager Classified Advertising, Popular Mechanics Magazine, 200 E. Ontario St., Chicago.

BIG Money applying initials on automobiles. Easiest thing today. Free samples. Also, sideline salesmen for short order decalomania name plates. "Ralco," 1305 Washington, Boston, Mass.

BIG Money applying initials on automobiles. Write for particulars and free samples. American Letter Company, Dept. 40, Dunellen, New Jersey.

REVOLUTIONARY Window cleaning tool. Good Housekeeping approval. Only ten \$2.25 sales daily to housewives, factories, schools, stores will make you \$350.00 monthly. Carter Products Corp., 900 Front Ave., Cleveland, Ohio.

FREE Sample—Amazing cleaner; sells homes, taverns, everywhere. Big profit—fast repeater. Betco, 5007 Irving Park, Chicago.

AGENTS: Stamping names on pocket-key protectors. Sample check with your name, address, 25c. Stamping outfits, Emblem checks, check-fobs, name plates. Hart Mfg. Co., 303 Degraw St., Brooklyn, N. Y.

HIGH-GRADE SALESMEN

PLACED On free trial to customers sells itself. Tremendous sales possibilities! Revolutionary inter-communication system. Talk to one or as many as ten people, even 2000 feet away. Loud speaking, back and forth, private conversation. Operates like radio—one electric connection. No servicing or installing problems. Fully guaranteed. Technical experience unnecessary. Easy two-minute demonstration. Thousands prospects—factories, offices, lumber yards, garages, parking lots, restaurants, etc. Accounts receivable carried by factory. Present low price opens big new field. Men earning high as \$100-\$150 week. Protected territory available. Free demonstrator offer. Inter-Communication System of America, 2440 Lincoln Ave., Dept. 303, Chicago.

SELL Printing at cut prices. 2,000 business cards \$1.50; 1,000 envelopes or statements, etc. \$1.75; 25 printed sales books \$1.50; 1,000 process embossed cards \$1.50; 2,000 two-color labels, free holder \$1.50; 2,500 printed handbills \$1.75. One-third comm. Free outfit. Bargain Prtg. Co., 189-F W. Madison, Chicago.

ADVERTISING Book matches—Sell union label book matches. Fastest selling line in America. Large sales producing kit, sample matches, complete cut catalog, eight color combinations make selling easy. Commission in advance. Superior Match Co., 7530 Greenwood, Dept. M-2, Chicago.

CLEAR Up to \$10 daily. Offer deluxe family Bible—\$1.95. Experts say worth \$5. Average \$1 profit. Size, 8¾ by 11¾. Every home, church a prospect. Amazing value makes fast sales. Westcraft, Dept. 214, Racine, Wis.

NEW Inexpensive, constantly repeating specialties for gas stations; garages; battery shops. Dill Products, East Weymouth, Mass.

PERMANENT Representative wanted for Hoover uniforms to call on restaurants, hotels, beauty parlors, doctors, nurses, others. Excellent income. Leads furnished. Equipment free. Hoover, Dept. AK-10C, 251 W. 19th, New York.

ADVERTISING Book matches offer liberal earnings—full, spare time. Experience unnecessary. Factory direct. Low prices for fine quality, quick deliveries, help get orders; faster repeats. All business firms prospects. Free outfit, instructions. American Match & Printing Co., Dept. 62, 4822 South Trumbull Ave., Chicago.

SELL Business cards \$1.50 thousand, business stationery, book matches, advertising gummed tape, pricing sets, paper towels, restaurant necessities, salesbooks, office supplies, advertising specialties, advertising pencils, 40% commission. Free deals. Sales portfolio free. Willens, 2130 Gladys, Dept. SF, Chicago.

IS Your job a "blind alley?" There's a real future in your own wholesale business. Profits can run into really big money. Start with little as \$2.50. Handle steady year 'round route of local stores. Collect, deliver orders for 200 nationally advertised 5c-10c counter products. Use home as headquarters. Chance to operate one of our Silver Fleet service trucks. No experience necessary. Facts free. World's Products Co., Dept. 10-P, Spencer, Ind.

SALESMEN, Distributors, 200 items, brushes, mops, marvelous magnetic brush—excels vacuum cleaner. Big profits. Neway Brush Co., Hartford, Conn.

WHOLESALE Genuine Marblette statuettes. Quick sales, large profits. Send stamp for particulars. Michigan Marblette Company, 1720 Milbourne Ave., Flint, Mich.

SELL Cra-Tex adhesive gauze bandage to physicians, industries, stores, house to house. Enormous profits. Desk S-12, Cra-Tex Corp., Omaha, Nebr.

TREMENDOUS Value, sells to all men. "Samples." R. H. Adams, Blandon, Penna.

ADVANCE Cash profits, bonus. Sell every factory, store, shop, office. Business increasers, advertising specialties. Free outfit. Write quick, Mutual, 753 East 64th, Chicago.

SELL Hot water bottle heaters that have been listed by underwriters. Fenwal, Incorporated, Ashland, Mass.

SELL Low priced aircushioned shoes to nurses, beauticians, waitresses, housewives. Unusual salesplan. Write: Daulec Shoes, 923 Washington, Dept. 67, St. Louis, Mo.

NEW Winter item with strong appeal to women. Can also be worn by all members of the family. Your cost 20c, sells at 39c per pair. Write for details. Clark Leather Products Co., 1811 W. North Ave., Chicago, Ill.

CALL On service stations, factories, restaurants, businesses, professions; with lettered advertising uniforms, shirts, work suits, etc. 100 styles. Exclusive features. Big advance commissions. Free outfit. Topps, Dept. C-7, Rochester, Ind.

LUNCHROOM Restaurant check salesman; also sell numbered printing. Nationally advertised house. Fast-moving sideline item. Liberal commission, including repeat orders. Give references, experience. Arcus, 352 N. Ashland, Chicago.

START Your own steady repeat business. Make up to 200% profit. Handle "Original Underwood" typewriter carbon-paper and long life ribbons for well known office supply company established 65 years. Sold direct from famed Underwood factory at low prices. Wide open market for ambitious and aggressive direct salesmen. You offer customers exceptional value and endless satisfaction—make handsome profit margin on each sale. For full details write John Underwood & Co., Direct Sales Division "D-8," 30 Vesey St., New York.

BIG Commissions—selling to stores celluloid pricing tickets, metal shelf moulding. To restaurants, menu covers, signs. P. Pricing Press, 124 White St., New York.

SELL Firex—Automatic fire extinguisher and alarm. Endorsed by fire chiefs. Prospects everywhere—good commissions. Write for territory and testimonials. Firex Corporation, Dept. B-100, 516 South Broadway, St. Louis, Missouri.

SELL Complete line business necessities—over 1000 items. 50% savings to every merchant. Experience unnecessary. Samples free. Commissions advanced. Northwestern, 625-RR Jackson, Chicago.

SALESMEN To call on retail stores, new line chemical products. Liberal commissions. Weimald, 5852 Broadway, Chicago.

BLADES—Big profit line. Low factory prices. Leather stoppered. Postpaid. Ace Blades, Buffalo, N. Y.

ADVERTISING Book matches—Lowest prices. Big cash commissions. New outfit free. Gem Match, 74-F West Washington, Chicago.

A REAL Future for you with Red Comet Automatic Fire Extinguishers. Low price. Proved seven years. Splendid sales outfit free. Some good territory open. Exclusive. Write quick, 704 Red Comet Building, Littleton, Colorado.

NEW Specialty—Sells every business and professional man. Four \$15 sales daily pay \$280 weekly. Farrell cleared over \$1,000.00 monthly. Write P. E. Armstrong, President, Dept. PM, Mobile, Ala.

EXCELLENT Opportunity selling our complete line of brushes, largest commissions. Write for sales plan. Wire Grip Sanitary Brush Company, 2300 5th Ave., New York.

EDUCATIONAL AND INSTRUCTION

AMAZE With extraordinary memory! Make learning easy! Remember names, dates, facts, ideas with incredible ease. "Super Memory" 7 lesson course tells how. Details free. Write, Info Company, Box 1122, Chicago.

SUCCESSFUL Stenographers, typists, bookkeepers, accountants, secretaries, social secretaries trained in home study department. Write for folder showing graduates' success. Give age, occupation, course preferred. Low tuition. Perry Schools, Brunswick, Georgia.

AIR Conditioning—Electric refrigeration. Rapid growth creates big demand for trained men. Earn up to \$35-\$50 weekly. Write for free facts. Utilities Engineering Institute, 404 North Wells, Dept. 102, Chicago.

For An extremely profitable lifetime business, operate a collection-credit agency. Free folder. Cole Associates, Dept. M, Syracuse, N. Y.

LEARN Beautiful penmanship—Inexpensive course. Hotel School, 36 Paulding, Tarrytown, New York.

WATCH Repairing is steady profitable work. Experts usually in demand. You can learn watchmaking trade at home, spare time. New original instruction system. Script engraving course included. Write for free details today! Nelson Co., B-2001 Manhattan Building, Chicago.

FREE—Vocational students' magazine. Forrest Miller, 462 Berwick, Easton, Penna.

HOME Study for degree—Psychology, Metaphysics, Bible, Philosophy. Free catalog. College of Universal Truth, 20 East Jackson, Chicago.

BECOME Practical scientific investigator. Modern illustrated course. Thorough training by former agent U. S. secret service. Particulars free. International Secret Service Institute, PM-20, Hoboken, N. J.

LEARN Tree doctoring, be independent, healthy and prosperous. Practical training. Van Yahres, Westbury, New York.

1940 GOVERNMENT Jobs. Many appointments expected. \$105-\$175 month. Prepare immediately, at home. List positions free. Write today. Franklin Institute. Dept. A3, Rochester, N. Y.

SUMMER And winter hotel positions. Beginners instruction courses. Write Lee Institute, 30 Huntington Avenue, Boston.

DRUM Major fancy spinning. Send \$1 complete lessons. Barth, 3537 Winthrop, Indianapolis.

MATHEMATICS. Sciences, drafting, blueprint reading, architectural, airplane, mechanical, electrical, ship, structural, building, estimating, engineers' licenses. Mondell Institute, 230 West 41st, New York.

DRAFTING Jobs. \$175.00-\$500.00 month. Qualify now. Details free. Monroe Institute, PM-102, Alton, Illinois.

NEWSPAPER Jobs—Learn practical reporting, freelance journalism from experienced editors, by mail. The Millers, 10, Bakersfield, California.

BE A dental laboratory technician. One year course. Write Ohio School for Mechanical Dentistry, 811 Prospect, Cleveland, Ohio.

BECOME Trick cartoonist. Illustrated catalog 10c. Balda, Cartoonist, Oshkosh, Wisconsin.

GOVERNMENT Engineer draftsman examinations. Mondell Institute, 230 West 41st, New York.

ELECTRIC Welding pays good money. Jobs everywhere. Our short course trains you. Write for information. Welding Company, 4100 Paul Street, Philadelphia, Penna.

CLAIM Adjusting. Excellent pay. Investigate tragic accidents, fires; outwit fraudulent claimants. Burns School, Keystone Building, Pittsburgh, Penna.

BIG Pay trades you can learn in a few weeks. Decorating, paperhanging, graining, marbling, card writing. Enroll now. Booklet free. Chicago Painting School, 102 West Lake Street, Chicago, Illinois.

HOW To secure a gov't job in the classified civil service. Railway postal clerk, \$1900 a year. Postal clerk, city mail carrier, \$1700. Other jobs, \$1260 to \$2100. Our method helps you pass exams. Men-women, age 18 to 50. Send for free book. Patterson School, 8C Mercantile Bldg., Rochester, N. Y.

MASSAGE. Hydrotherapy, dietetics, drugless therapeutics, chiropody, taught by mail. Evans Correspondence School, Montgomery, Ala.

LEARN Auto mechanics, body, repairing, welding electricity, refrigeration, Diesel. Steverson's, 2008A Main, Kansas City, Mo.

TELEGRAPHY Taught thoroughly. Railroad retirement act creating opportunities for new operators. Expenses low. Catalog free. Dodge's Institute, Hiatt Ave., Valparaiso, Ind.

SECRET Investigation. Experience unnecessary. Detective particulars free. George Wagner, M-2640 Broadway, N. Y.

START Plating business at home. Amazing profits. Make your own outfit. Inexpensive. Illustrated plans and complete instructions 50c. Popular Mechanics Press, 200 East Ontario, Chicago.

PLAYS, STORIES, MANUSCRIPTS

STORIES. Novels revised and typewritten for marketing. Welton Tinney, Winnsboro, Texas.

CARTOONING, COMMERCIAL ART, SHOWCARD WRITING, SIGN PAINTING

LEARN Chalk Talking. Quick, easy method. \$2.98. Mariland Haines, Bloomfield, Indiana.

AMATEUR Cartoonists. Earn cash at home, copying advertising cartoons. Ad-Service, Argyle, Wis.

LEARN Cartooning for profit. Leon Gray School, Box 1901, Dallas, Texas.

CARTOONING. Sketching, etc.—46 lessons, 600 illustrations, including drawing paper, pens, pencils, \$1.00 complete. Fraba Service, Cashton, Wisconsin.

FOUR Color automatic pencil. Writes red, blue, green, black. \$2.00. Satisfaction guaranteed. West-Shore Novelty Co., 370 Beach St., West Haven, Conn. (PM).

ANIMATED Cartooning home course prepared by former Disney, Fleisher artist \$10. Mondell Institute, 230 West 41st, New York.

EARN Money making signs, posters, show cards with my new machine. Matthews, 2325 Cass, St. Louis, Mo.

ART Magazine including directory art books—free! Send 10c postage. Art Headquarters, Doty Street, Madison, Wisconsin.

PEN And ink drawings. Let us draw your advertising and catalogue illustrations, from photos, copies or objects. Best work and fair prices. Heraldic Studios, 1914P Oakdale Avenue, Chicago, Ill.

ADVERTISING AGENCIES, LETTER WRITERS, FOR ADVERTISERS

ADVERTISE Profitably: \$15 reaches 5,000,000 Sunday newspaper readers with 24-word ad. Newspaper, magazine, mailing-list ratebook, free. Chicago Advertising Agency, 20-PA West Jackson, Chicago.

LEARN Advertising at home. Easy practical plan. No text books. Common school education sufficient. Interesting booklet and requirements free. Page-Davis School of Advertising, 3601 Michigan Avenue, Dept. 3439, Chicago.

ADVERTISING Ideas, slogans, phrases, 500—25c. Daniels Press, South, Statesville, No. Car.

LETTERS Written for jobs. Also sales letters and advertising copy. Business Counselor Institute, 122 South Michigan, Chicago.

40 WORDS Displayed, 65 magazines, 3 months, \$2.00. Lists, Bagley's, Box 2522, Portland, Ore.

DISPLAY Advertising: 205 newspapers, \$1.47 agate line. Fidelity Advertisers, 3838-P Washington, Chicago.

"PROSPERITY" Pulls! 20 words six times. \$2. Sample free. Sizemore, 4917N Kostner, Chicago.

ADVERTISE: 24 Words, 149 newspapers \$6.50. Lists free. Advertising Bureau, 4515-C Cottage Grove, Chicago.

INCH Display advertisement 30 magazines, year \$24. Wood's Popular Services, Atlantic City, N. J.

ADVERTISING Placed all magazines, newspapers, radio. Lowest rates. Free service. 54 page rate book free. Baker Advertising Agency, A-189 West Madison, Chicago. Successors to Ankrum. Established 28 years.

FREE—New Advertisers Rate Guide, 44 pages. Includes everything. Lowest rates. E. H. Brown Advertising Agency, 140 S. Dearborn, Chicago.

ENLARGE Your own photos. Make money doing work for others. Build your own enlarger. 4 complete plans 50c. Popular Mechanics Press, Dept. C40, 200 E. Ontario St., Chicago.

BUSINESS SERVICE

COMMERCIAL Printing at lowest prices. Samples. Modern Print, 6 Forest Place, Fredonia, N. Y.

WE Will act as your representative in New York City—business, legal, buying, selling, unusual. Strictly confidential. Lederman & Sobel Co., 1700 Longfellow Ave., New York City, N. Y.

WASHINGTON, D. C., mail-reforwarding address. Hawkins Mail Service, 817 Fourteenth.

COLLECT Your bad debts. Merchants write Lamont Company, Beacon, New York.

RUBBER STAMPS AND OFFICE SUPPLIES

DEEP Letters! Two lines 25c. 3—35c. Adcrafts, Lacrosse, Wis.

CUSHIONED 3 Lines 35c. Stamp-Works, Box 402, Youngstown, Ohio.

2 LINES 25c. 3—35c. Cushioned. Stamp Works, Centerport, N. Y.

ORIGINAL. Cushion mounted. One, two lines. 25c; three 35c; four 45c; facsimile signatures \$1.50. Stamp Works, 814 Bradley, Peoria, Ill.

2 LINES 25c, 3 Lines 35c. Stamp Works, Auburn, Nebr.

TYPEWRITERS, DUPLICATORS, OFFICE DEVICES

DUPLICATORS, Staplers, postal scales, labels, stencils, ink. Money saving prices. Write DixieGraph, King, North Carolina.

NEW \$3.75 Automatic adding machine. Fully guaranteed. Bassett, Box 302-A, Altadena, California.

TYPEWRITERS, Adder, mimeograph, multigraph, addressograph. Send for free lists of machines that will help you at half price. Pruitt, 28 Pruitt Bldg., Chicago.

INCREASE Business now. "Excellograph" Rotary Stencil Printer reprints thousands everything you typewrite, hand-write, draw or trace. Colors, \$19.75 to \$44. Terms. Illustrated literature free to business or professional men. Pittsburgh Typewriter Supply, Department K-2, Pittsburgh, Penna.

PRINTING, MULTIGRAPHING, MIMEOGRAPHING, GUMMED LABELS

BOOKS On all engraving and printing processes, offset, art, photography, silk screen, block cutting, etc. List free. Commercial Engraving Publishing Co., 34C North Ritter Ave., Indianapolis, Ind.

UP To date printing, 125 8x11 letter-heads and 125 6 3/4 envelopes high grade white stock, \$1.00 postpaid, quick service. McConnell's Press, 411 N. Gilbert, Danville, Illinois.

6x9 CIRCULARS, Envelopes, letterheads, postcards, \$1.89, quantities. Typewriter letters, slips, labels lowest prices. Samples. Goodprint, Harrisonburg, Va.

125 8 1/2 x 11 BOND Letterheads and 125 envelopes. Business, personal, professional. \$1.00 postpaid. Benneville, 907 West Roosevelt, Philadelphia.

500 TWO-COLOR Stickers, 50c. Free catalog. Cott's, Spickard, Missouri.

500 8 1/2 x 11 LETTERHEADS, 6 3/4 Envelopes, \$1.00. 5000 \$7.50 printed. Carter, Box 52, Orange, Calif.

PRINTING—Lowest prices in America. Samples free. Pitz, Middle, Iowa.

1000 CIRCULARS 6x9, \$2.72. Samples, pricelist. Record Printing Co., Lancaster, Ky.

LETTERHEADS, Envelopes, statements, 1,000, \$2.75. Samples. Price list. Printrite, Biltmore, N. C.

1,000 TWO Color shipping labels, 4x2 1/2—\$1.75. 10,000 3x6 circulars, \$4.95. Letterheads, envelopes, typewritten letters, cards, etc. Okayprint, Martins Ferry, Ohio. Samples.

1000 BOND Letterheads, envelopes \$2.25. Evers' Print Shop, Atmore, Alabama.

250 LETTERHEADS With 9" envelopes \$2.35; including return envelopes \$3.00. Hargett, 3646 Kosciusko, St. Louis, Mo.

BETTER Printing—Letterheads, 6 3/4 envelopes, cards, statements, 500, \$1.50. Franklin Printery, 2932 Pershing, Chicago.

150 LETTERHEADS And 150 6 3/4 envelopes \$1.00 postpaid. Printery, G-226 Madison, Pittsburgh, Penna.

BETTER Business, personal cards 250, 60c. Tittsworth, Cornelia, Flint, Mich.

QUALITY Printing, lowest prices. Samples. Cheser, 3111 West Monroe, Chicago.

MIMEOGRAPHING. Printing, 250 letterheads 75c. Wickesser, Prospect St., Holyoke, Mass.

1,000 LETTERHEADS, Statements, envelopes, \$2.79. 5,000 \$9.95. 1,000 business cards \$1.49. H. Cotter, 2457 Seyburn, Detroit.

PARTICULAR? Neargraveure Emboss-O! Distinctive, striking, different. Samples. Solldays, Letterhead Specialists, Knox, Indiana.

ABSOLUTELY Amazing! What? Our new plan! Samples. Adkins, Union, N. Y.

LETTERHEADS, Envelopes, statements, 250 \$1.00. Samples. Hamilton Press, 4341 P. Meade, Chicago.

HAMMERMILL Letterheads, any color paper, ink; 300 8 1/2 x 11, \$1.48 postpaid. 30 styles type. Free particulars. Woodruffs', 217A Lewis, Duluth, Minn.

1000 BUSINESS Cards \$1.00. Vellum, free cuts. Dixie Business Card Co., PM189 Jefferson, Memphis, Tenn.

200 6 3/4 ENVELOPES Neatly printed, \$1.00 postpaid. D. Matuska's, Girard, Ill.

1000 BUSINESS Cards post paid \$1.00. Superbo Print. Room 303, 815 So. Hill, Los Angeles, Calif.

1000 NEAT Business cards \$1.00 postpaid. Taft Co., Box 5366, Chicago.

50 SHEETS, 20 Envelopes, 25c postpaid. Western Stationery, Topeka, Kansas.

500 3/4x2 1/4 FOUR Line gummed stickers, 25c. Moritz Printery, Saginaw, Mich.

1000 NOTEHEADS, Envelopes, each \$1.75. 4 lines. Zoeller, 5215 Gilmore, St. Louis, Mo.

PRINTING OUTFITS AND SUPPLIES

BARGAINS — Presses, type, supplies. Send stamp. 159 Harvard, Cambridge, Mass.

SIMPLIFIED Cut making. Inexpensive process \$1.00. Alta. 472 S. Chairty, Bethel, Ohio.

NEW Type 29c font. Catalog dime. Box 123E, Jackson, Michigan.

INEXPENSIVE Home-made press. Details free. Holman Brothers, Downsville, Louisiana.

PRESESSES, New type that satisfies. Lists 3c. Landis, Richland, Penna.

PRESESSES, Type, supplies. List free. Catalog ten cents. Model Press Co., York, Penna.

PRESESSES, Type, cabinets, supplies, catalogue for stamp. Lincoln Press, 220-C Hartwell, Fall River, Mass.

CARD Printers' special—Complete font (196 pieces) 14 pt. wedding text type only 50c. Republic, 7150 Cottage Grove, Chicago.

CUTS To order, proofs, list, free. Moritz Printery, Saginaw, Mich.

PRINT Your own cards, stationery, circulars, advertising. Save money. Easy rules furnished. Print for others, big profits. Junior outfits \$8.25, senior outfits \$16.55 up. Details free. Kelsey Presses, H-11, Meriden, Conn.

USED Presses, type, supplies. Lists 3c. Turnbaugh Service, Loysville, Penna.

HAND Presses, type and complete printers' supplies. Send stamp for catalog and new price list. P. Peiffer & Co., Newark, N. J.

PATENT ATTORNEYS

INVENTORS: Send immediately for your copies of our new free books, "Patent Protection" and "Suggestions on Selling an Invention." Sixty-eight pages of interesting facts. They tell how Patent Laws protect you; kind of sketch or model needed; simple steps to take without cost; how successful inventors have secured financial assistance; show interesting inventions; illustrate important mechanical movements. With books we also send free Evidence of Invention form to help establish date of disclosure. Prompt service, reasonable fees, special deferred payment plan. Strictest secrecy. Forty-two years' experience. Highest references. Write us today. The facts in our books are worth money to the man with a good invention. Address: Victor J. Evans & Co., Registered Patent Attorneys, 561-B Victor Building, Washington, D. C.

PATENTS—Before too heavy an outlay of time or money is made on an invention, a search of the Patent Office records should be made to determine as nearly as possible whether or not the same idea has been patented before. The cost of this search is small, while the value of the facts it uncovers is often considerable. We offer inventors and manufacturers a thorough, prompt, confidential search service—plus experienced counsel and assistance in every phase of patent and trade-mark practice. Write for our new free book containing valuable information relating to patent procedure. Clarence A. O'Brien, Registered Patent Attorney, Dept. OB1B, Adams Bldg., Washington, D. C.

INVENTOR'S Universal Educator; contains 900 mechanical movements; 50 perpetual motions; instruction on procuring and selling patents and selecting an attorney, etc. Suggests new ideas. Price \$1 postpaid in U.S.A. Address Albert E. Dietrich, 511-B Colorado Bldg., Washington, D. C.

PATENTS, Gerald P. Welch, Registered Patent Attorney, Plankinton Arcade, Milwaukee, Wisconsin.

PATENTS. Protect your idea by securing free "Proof of Invention" folder. Exceptional personal service. Established 1906. E. E. Vrooman, 871 Woodard Bldg., Washington, D. C.

INVENTORS—Send for free booklet "Patent-Sense." Information based on 64 years experience. Lacey & Lacey, Dept. 5A, 635 F St., Washington, D. C.

INVENTORS—Before disclosing your invention to anyone send for form "Evidence of Conception"; "Schedule of Government and Attorneys' Fees" and instructions. Sent free. Lancaster, Allwine & Rommel, 411 Bowen Building, Washington, D. C.

"**INVENTOR'S** Guide." 100 mechanical movements, free; advises on patenting, selling inventions. Frank Ledermann, Tribune Bldg., New York.

L. F. RANDOLPH, 302-B Victor Bldg., Washington, D. C. Low cost. Book and information free.

PATENTS. Booklet free. Highest references. Best results. Promptness assured. Watson E. Coleman, Patent Lawyer, 724 Ninth St., Washington, D. C.

FOR INVENTORS

PATENTS—Before too heavy an outlay of time or money is made on an invention, a search of the Patent Office records should be made to determine as nearly as possible whether or not the same idea has been patented before. The cost of this search is small, while the value of the facts it uncovers is often considerable. We offer inventors and manufacturers a thorough, prompt, confidential search service—plus experienced counsel and assistance in every phase of patent and trade-mark practice. Write for our new free book containing valuable information relating to patent procedure. Clarence A. O'Brien, Registered Patent Attorney, Dept. OB1A, Adams Bldg., Washington, D. C.

WE Locate buyers meritorious patented, unpatented inventions. If will sell, reply immediately. Descriptive booklet, references, free. Invention Reporter, 5A-11236 South Fairfield, Chicago.

CASH For practical ideas and inventions. Stamp appreciated. Mr. Ball, AB-9441 Pleasant, Chicago.

SHOW Us something good; patented or unpatented. New ideas wanted. Allied Engineering, Box 1445, St. Louis, Mo.

MEETING, Exhibit and sale of inventions. March 5th to 8th. Write Inventors of America, Hotel Continental, Kansas City, Missouri.

INVENTIONS Wanted—Patented, unpatented. If you have an idea for sale write Hartley's, Inc., Box 928-E, Bangor, Maine.

INVENTORS: "Making Inventions Pay," our 32-page illustrated book, mailed upon receipt of 3c postage. Crescent Tool Co., Dept. Z, Cincinnati, Ohio.

I **SELL** Patents. Established in 1900. Charles A. Scott, 773PM Garson Ave., Rochester, N. Y.

INVENTORS—Send for 72-page book on patents. Reasonable terms. Conscientious treatment to inventors. L. F. Randolph, Registered Patent Attorney, 302-E Victor Bldg., Washington, D. C.

HAVE You a sound, practical invention for sale, patented or unpatented? If so, write Chartered Institute of American Inventors, Dept. 4-A, Washington, D. C.

INVENTORS: Profit by your invention. A practical talk to inventors by an experienced manufacturer. Our 68 page booklet "Mind vs. Matter" mailed upon receipt of 25c. Rex Engineering Co., Cincinnati, Ohio, Dept. D.

INVENTIONS WANTED

AMATEUR Inventors. Earn steady income inventing toys, games, novelties. Henderson, Argyle, Wis.

WANTED—Meritorious patented, unpatented inventions. Booklet, references, free. Invention Reporter, 5B11236 South Fairfield, Chicago.

CASH For inventions—Patented or unpatented. Stamp appreciated. Mr. Ball, A-9441 Pleasant, Chicago.

INVENTIONS Of merit wanted, patented or unpatented. Proof of disclosure furnished. Write for "4-Points of Service" bulletin. R. & S. Engineering Co., AW-2, 17 East 42nd Street, New York City.

SALABLE Inventions wanted. Albert G. Burns, Box 147, Oakland, California.

SMALL Inventions wanted by manufacturers. I'll help you sell your invention. Write for free circular. Stanley Hull, 7829-K Euclid Avenue, Cleveland, Ohio.

SIMPLE, Practical inventions wanted by manufacturers, patented or unpatented. For information write Chartered Institute of American Inventors, Dept. 4-D, Washington, D. C.

PATENTS FOR SALE

ATTACHABLE Handprotector for knives, just allowed. Antony, 1364 East Fourth Street, Brooklyn, N. Y.

PATENTED Tire construction. B. Omoto, 2552 Hyperion Ave., Hollywood, Calif.

REGISTERS Air pressure from tire to dashboard of car. Chester Brown, Garden City, Kansas.

MANUFACTURERS: For free information latest inventions your line manufacture, write: Invention Reporter, 5C-11236 So. Fairfield, Chicago.

FOR Sale outright my patent. No brush shoe shiner. Good for mailorder or market business. William B. Derbyshire, 1943 E. Pacific St., Philadelphia, Penna.

PATENTED, Adjustable automobile desk, fits under dash without obstructing leg room. Limited test production sold. Will sell or lease patent and rights to modified designs covering entire field. I. B. Hall, 544 Long Ave., Chicago, Ill.

500 INVENTIONS Described. Send dime or stamps for latest Invention Sales Bulletin and sales plan. Address Patentee System, 9443 Pleasant, Chicago.

SIDEWALK Cleaner for ice and snow. Inexpensive to manufacture. Vernon Simons, Emmetsburg, Iowa.

SELL Your patent through a small classified ad in Popular Mechanics. Many inventors have found buyers in this way. Ask me for proof—I'll gladly send it to you. F. W. Johnson, Manager Classified Advertising, 200 E. Ontario St., Chicago.

MANUFACTURING

MODEL Building inventions, machinery, dies, stampings, Moulds, Brasswork. Manufacturing. Baum's Metal Specialties, Kansas City, Mo.

WILL Design your ideas, make working drawings and models, also manufacture at reasonable costs. Model Engineering, Os-good, Indiana.

WE Build models which "put over" your idea. Complete engineering service, developing and designing. We market and manufacture in any quantity. Write for bulletins. R. & S. Engineering Co., Dept. AM-2, 17 East 42nd Street, New York City.

DIES, Models, stampings, metal products. Hagstrom Manufacturing Co., Kansas City, Missouri.

MANUFACTURING, Any material, any quantity, inventions developed. Milburn, Burlington, Kentucky.

INVENTIONS Manufactured by an experienced company, in any quantity at low cost. Metal specialties, novelties, stampings, dies, and models. Free estimates. Our booklet "Mind vs. Matter" sent upon receipt of 25c. Rex Engineering Co., Cincinnati, Ohio, Dept. C.

INVENTIONS—Manufactured in any quantity at low cost by old established company. Stampings, metal specialties, dies, models, etc. Free estimates. Send for catalog. Crescent Tool Co., Dept. X, Cincinnati, Ohio.

WOODWORKING Power tools—Make them yourself. Lathe, scroll saw, saw table, drill press, portable sander, bandsaw, motorized plane. Complete plans and instruction book—all for only 50c. Popular Mechanics, 200 E. Ontario Street, Chicago.

MODELS AND MODEL SUPPLIES

MODEL Railroad Shop, Dept. PM., Dun-ellen, New Jersey, 1940 catalog 10c.

GAS Engine castings, face plates, brass, steel, tubing, gears, etc. Catalog 5c. Louis Terek, 1000 N. Lamont, Chicago.

CARVED Hull ship model kits. Ship and yacht model fittings; model yacht sails. Illustrated catalog 20c. A. J. Fisher, 1002-M Etowah Ave., Royal Oak, Mich.

SPEED! Racing hull construction kits. Free literature. Enclose 5c for mailing. St. Louis Model Boat Co., Clayton, St. Louis, Mo.

SHIP Model kits. 1000 fittings, catalogue 10c. Polk's, 429 Seventh Ave., New York.

BUILD 16" Flying Cloud. Constitution. Materials, plans, \$1.50. Catalog 15c. Hancock, 323 Douglas Ave., Portsmouth, Va.

TRANSFORMER. 300 Watts, 25 volt secondary, \$5.00 postpaid. Steam locomotives \$9.50 up. Catalogue 25c. Steam Electric Co., Bloomfield, N. J.

ENGINE Catalogue castings, supplies. 25c. Howardco, A-2417 North Ashland, Chicago.

MODELS—Blue prints made, models developed. Send us your ideas for estimates. Model Engineering, Osgood, Ind.

STEAM Locomotives. 1/4" scale. Send 10c for descriptive folder. Little Engines, Box 15B, Wilmington, Calif.

MODELS—Practical models put over your ideas. We develop models from the crude to perfect working devices. Your idea might have large commercial value. Services confidential. Bank references. Registered graduate engineers at your service. Send 25c for our 68 page booklet "Mind vs. Matter." Rex Engineering Co., Cincinnati, Ohio, Dept. B.

POWER Models. Electric railways, steam locomotives, steam and gasoline engines, all accessories, metals, tools. 84 page catalog 35c. Chas. Cole, Ventura, Calif.

STEAM Locomotives! 3/4" scale. Build one by "Easy Steps." Our illustrated catalog lists all needs. 25c. Little Engines, Box 15B, Wilmington, Calif.

BUILD Ship models, coach models, covered wagon. Complete kits \$1.00 to \$6.00. Fully shaped and finished redwood hulls, all parts cut to fit including masts and yards, sails, chain, wire, nails, string and other parts. Detailed drawings and full instructions. Send 3c stamp for catalog. Miniature Ship Models, Dept. R, Perkasie, Penna.

MODELS—Your ideas developed into practical working models. 30 years successful experience; thousands of satisfied customers. Confidential service guaranteed. Bank references. Send 3c postage for our large booklet—"Making Inventions Pay." Crescent Tool Co., Dept. Y, Cincinnati, Ohio.

RAILWAY Models. Catalog handbook 25c. Walthers, 247 E. Erie, Milwaukee.

HOME CRAFTSMEN

PRACTICAL Modernized Spanish furniture designs. Dime for sample and descriptive list other designs. Low quantity prices. Milton McColm, 428 Camino, Santa Fe, New Mexico.

20 MEXICAN Novelty patterns 30c. 20 western silhouette patterns 30c. 10 evening project patterns 25c. 10 lawn ornament patterns 15c. Patterns for girl's Mexican belt 15c. (Dollar bill brings all.) Mexican Arts, Crafts, Eagle Pass, Texas.

LAWN Ornaments, easy to make. 20 full size patterns, birds, animals, etc., 25c; Dutch boy, Dutch girl, sprinkling girl, fox terrier, Scottie, bulldog, 15c each, any two 25c; Dutch windmill, 36 inches high 25c. Entire collection, 27 patterns, \$1.00 postpaid. Wickman Co., Dept. 110, Dayton, Ohio.

FOR Home shop, do silver plating, with silver plater polishing outfit, cost \$2.50 to start, sample 25c. Successful operating system explained. W. S. Anderson Products, 493 - 4th St., San Francisco, Calif.

KNOCKDOWN Furniture, lumber, veneers. Illustrated catalog 10c. Giles-Kendall Co., Decatur, Alabama.

22 FULL Size lawn ornament patterns 25c. 25 novelty patterns 30c. Both sets 50c (coin). Strother, Box 383-AN, Belington, West Virginia.

VENETIAN Blinds, supplies, wholesale catalog 10c. Roberta, Box 260, Gloversville, New York.

BUILD Streamlined plywood kitchen cabinets. Plans 25c. Roger Underwood, 4617 Johnson Avenue, Western Springs, Illinois.

MAKE Money building bird houses. Great demand. Complete plans and instruction book 50c. Popular Mechanics, 200 East Ontario, Chicago.

GET Free leathercraft instruction pamphlets, prices of leathers, tools, projects. Make extra money. Beautiful gifts. Leather samples 5c. Wilder & Company, 1038 Crosby, Dept. 2F, Chicago, Illinois.

INTERESTING Projects. Small powerful turbine. Operate from faucet. Run small generator, lathe, etc. Plans, directions 35c. Hobby display table 30c. Both 50c. Modern Supply, Box 242, Meriden, Conn.

25 TEMPLATES Lawn ornaments 25c. Clark System, Ellwood City, Penna.

FOR The best combination wood-working machinery. Write R. V. Hiscok, Quitman, Georgia.

PATTERNS—Plywood novelties—silhouettes. Lowest prices transfer decorations. Also 236 miscellaneous projects. Superbly illustrated literature. Write: Wo-Met Shop, Ashburn, Georgia.

70 PATTERNS, 20 Lawn ornaments, 14 silhouette, 20 novelties, 16 lawn ornaments, 30c each set, all for \$1.00. Modern Woodcraft, Saginaw, Michigan.

GET Shop Notes for 1940! May easily be best investment of your entire lifetime. Contains 384 money-making, time-saving ideas. Kinks, short cuts for mechanics, farmers, home workshop fans, handymen—for everyone who uses tools. 214 pages, and 762 illustrations. Thousands wait for this book every year. Only 50c. 1939 and 1940 Shop Notes sent postpaid for \$1.00. Popular Mechanics Press, 200 E. Ontario, Dept. C40, Chicago.

OLD GOLD, WATCHES, JEWELRY, PRECIOUS STONES

AGATES, Gems, minerals. 20 gemstones \$1.00. Pricelist free. Hill, Route 7, Salem, Oregon.

5000 REBUILT Watches! Free catalogue—Diamonds, jewelry, (3c postage). The New York Jobbers, 74 Bowery, Dept. M, New York, N. Y.

LUCKY Opals multi coloured brochure 5c. Glorious specimen \$2. Royalty Traders, Sydney, Australia.

OPALIZED Woods, agates, jaspers, 25 specimens, some polished \$1.25. Jay Ransom, Aberdeen, Wash.

WATCHMAKERS' Materials—Tools, watches, jewelry bought, sold, exchanged. Ben Segal's, 5 South Wabash, Chicago.

AUSTRALIA'S Lovely opals. Illustrated catalogue free. Good selection \$5.00. Norman Seward, Melbourne, Australia.

HIGHEST Prices for old gold—Mail your teeth, watches, jewelry. 100% full cash value mailed day shipment received. Satisfaction guaranteed or articles cheerfully returned. Information free. Chicago Gold Smelting Company, 300-P Champlain Building, Chicago.

GOLD \$35 Ounce. Ship old gold teeth, crowns, jewelry, watches—receive cash by return mail. Satisfaction guaranteed. Free information. Dr. Weisberg's Gold Refining Co., 1500-Q Hennepin, Minneapolis, Minn.

TOBACCO

GUARANTEED: Cigarette, pipe or chewing 5 lbs. \$1.00, ten, \$1.75. Pay when received. Pipe and box cigars free. Rives Tobacco Co., Paducah, Ky.

SURVEYING INSTRUMENTS

GUARANTEED Factory rebuilt transits and levels for rent (with purchase option) or sale (cash or terms). Order now before prices advance. We will repair, trade in, or buy your old instruments. Ship prepaid for estimate and valuation. Write for List M-52 and complete information to Warren-Knight Co., 136 N. 12th St., Philadelphia, Penna.

WANTED—MISCELLANEOUS

CASH For used microscopes, binoculars, slide rules, drawing sets, scientific instruments, tools, cameras, jewelry. Write details. Elman's 2302 VanBuren, Chicago.

PERSONAL

1940 HERBALIST Almanac; contains hundreds old-fashioned herb medicine recipes. 3c stamp. Novex, 1210M 11th Ter., Birmingham, Ala.

ATHLETES Foot remedy. Old prescription. Send 35c. A-1-5 Palisades Towers, Palisades Park, New Jersey.

WIN Prize money: Booklet—"Successful Contesting"—shows how. 10c postpaid. Bulletin listing \$100,000.00 prizes included. World Publishers, 4515-B Cottage Grove, Chicago.

COMPLETE Guaranteed course for training the eyes to overcome nearsightedness, weakness, astigmatism without glasses \$1.00. Eyesight Improvement, Box 193-P, Hamilton, Ohio.

MAKE Money with your camera. New book tells how. 46 pages, 50c. Popular Mechanics Press, Room (C40), 200 E. Ontario St., Chicago.

MISCELLANEOUS

CLASSIFIED Directory of swappers, traders, collectors, all over United States. 25c coin. Your articles listed free. Special Features Publishers, Austin, Texas.

EMBOSSSED Signs made to order. Name plates, manufacturers' displays, window signs, etc. Any color. Sample with your own copy 25c. Sign-O-Graf, 739 Cole, San Francisco.

500 ADVERTISING Pencils \$5.00. Samples 5c. Adcraft Company, Lacrosse, Wis.

TATTOOING Machines, finest chrome plated \$3.50 each; tubes 50c. Free photo. Owen Jensen, 412 South Main St., Los Angeles, Calif.

LUMINOUS Paint shines in dark. Easily made. Big profit. Formula, money-making instructions 50c, sample 10c. Myers, Box 26, Niles, Mich.

CARTOON Of yourself. Send photo and 25c (coin). Cartoon Shop, Lock Box 35, Downers Grove, Ill.

182 THINGS You can easily make for fun or profit. 50c. Popular Mechanics Press, Room C40, 200 E. Ontario, Chicago.

PERFECT Eyesight without glasses. No drugs. Simple, inexpensive home treatment. A. Jacobson, Upsala, Minnesota.

CLEAN Used oil, without cost. Particulars. F. Gerwin, Fairview, Okla.

SWAP Or sell articles you don't need for those you want. Send dime for Swapper's Guide listing articles from everywhere. Dept. PM, Swapper's Guide, Delphos, Ohio.

ATTRACTIVE, Guaranteed Neon signs; made to order; indoor and outdoor. Pay only \$1 a week. Write today for colored folder. Harwoods, 1366 West Fort, Detroit, Michigan.

RECEIVE Gigantic mails, magazines, samples. Your name in numerous mailing lists 10c. Waltman, 460 Grand Street, New York.

CHEMICAL Gardening for everybody. Grow soilless plants with few cents worth of chemicals. 272 pages written so you can understand it. \$1.95. Popular Mechanics Press, 200 E. Ontario, Chicago.

FOSSILS—Vegetation and sea life. Specimen of each \$1.00. Stark I. & B. Co., Box 289, Bellingham, Washington.

PRINT Your own pictures, 2 minutes (daylight) from any negative, on cards, stationery, cloth. Kit \$1.00. Box 291B, Iron River, Michigan.

HAND-WOVEN Ties \$1. Write for free sample of tie material and 32 colored pictures of patterns. Log Cabin Hand Weavers, 11 Post Road, Oregon City, Oregon.

COATS Of arms and crests, correctly painted in colors or black and white, from heraldic description or furnished copy. \$10.00 and up. Highest grade work. Heraldic Studios, 1914P Oakdale Avenue, Chicago, Ill.

TATTOOING Outfits, supplies, illustrated list free. Percy Waters, Anniston, Alabama.

SWAPPER'S Friend, R4, Saline, Michigan. Interests swappers, collectors. 50c year, sample 10c.

FOR Home, shop, office. Ten drawer cabinet, 11 1/4 x 3 3/4 x 4 1/4 inch drawers. Kit 75c. Finished cabinet \$1.50. 0c extra west Mississippi. Attractive dealer reposition. Taylorcraft, W. Howard, Hagerstown, Md.

1059 WAYS To start a profitable business. Get Popular Mechanics book of modern formulas and methods for practical specialty manufacturing. Price only \$1.25 postpaid. Popular Mechanics Press, Room (C40), 200 E. Ontario St., Chicago.

AVIATION WANTS MORE LINCOLN TRAINED MEN



Now is the time to get into Aviation! Airlines, Airports, Airplane Factories now expanding, must have thousands more trained men. Graduates of this **Lincoln Government Approved School** are regularly stepping into good-pay positions in Aviation! Opportunities for many more! **BE A SKILLED WELL PAID PILOT.** Learn here to fly fast modern airplanes. 14 Training Planes; 5 types, provide wide piloting experience. Your training here is Government Approved every step of the way. Prepares you for your official Government Rating as Private, or Commercial, (Transport) Pilot.



BE AN AVIATION MECHANIC or AERONAUTICAL ENGINEER. Learn Airplane and Engine Maintenance, rebuilding and repair; Airplane Design and Construction; Aircraft Sheet-Metal or Welding. We teach you. Big demand for engineers, draftsmen and skilled mechanics. Big money paid! 124 Lincoln Graduates recently placed in good positions.

EMPLOYMENT SERVICE GIVEN. We assist Graduates in locating positions. Now offering part-time employment for board and room while in training.

MAIL COUPON NOW for complete information.

LINCOLN AIRPLANE & FLYING SCHOOL
572 AIRCRAFT BLDG., LINCOLN, NEBRASKA

LINCOLN AIRPLANE & FLYING SCHOOL
572 Aircraft Bldg., Lincoln, Nebraska.

I'd like to get into Aviation. Please rush complete information about Lincoln Training.

NAME..... AGE.....
ADDRESS.....
CITY..... STATE.....



ART

MAGAZINE for Artist, Teacher, Student, Lover of the Body Beautiful. Contains splendid Drawings, Prints, Photos of Animals, Birds, Cartoons. Ideal Human Figures, Etc. also Lessons in **CARTOONING**, Lettering, Design, Chalk-talk, Nature, Life, Still-life, Etc. **Can't be described.** To INTRODUCE the finest Art Magazine ever published we offer 3 **BIG BACK ISSUES**, 240 pages, also large **CARTOON book**, also 8 other Art booklets all for **ONLY \$1.** (post. (54 issues, etc. \$2.00 by express). Student writes—"I \$100. would not buy my 64 copies if I couldn't replace!" Interesting! Instructive! Intriguing! A gold-mine of Art and Inspiration! None free.)



CUT THIS OUT Send with \$2. or \$1. NOW. You can't lose, OK or Refd. Kalamazoo, Michigan
Lockwood Art Studio Dept. 43

You Should Get Into DRAFTING and Industrial DESIGNING



Get into a Better Pay field with a big future by learning **DRAFTING** and **DESIGNING** quickly from an Engineer and Industrial Designer. Private, individual training at your home. Drawing tools and table furnished without extra cost. Learn to draw and design new products, or to improve, re-style, streamline and modernize old products for more "eye appeal" and selling power.

Drafting is a very big field, but **drafting with industrial designing** is twice as big. Factories must continuously bring out new models, new products, and improved designs. You can learn both subjects right in your own home, in your spare time. You can be trained for better pay as I

have trained many hundred successful students. I'll train you thoroughly by applied instruction on actual work until you are holding a good paying position. Send coupon for full facts on "Drafting and Industrial Designing." **ENGINEER DOBE, Libertyville, Illinois.**

Engineer Dobe, Div. 3372 Libertyville, Illinois. SEND FOR FULL FACTS

Please send me full facts on "Drafting and Industrial Designing." Also please explain how you assist your graduates to good positions in these fields.

Name..... Age.....
Address.....
Town..... State.....

STUDY ENGINEERING AT HOME

Earn a Degree at Home

From A Chartered Institution Of Higher Learning Employers Demand Degree Men For Key Positions

85 Degree Courses in Electrical, Mechanical, Civil, Structural, Diesel, Architectural, Drafting, Automotive, Aeronautical, Radio, Refrigeration, Air Conditioning, Highway, Mining, Geology, Petroleum, Marine, Industrial, Chemical Engineering; Arts; Sciences; Philosophy; Psychology; Chemistry; Education; Business Training; Law; etc.
McKinley-Roosevelt Graduate College, 4750-G Sheridan Road, Chicago

NEW WAY TO CHOOSE A CAREER

LET SCIENCE PICK A JOB FOR YOU!

TODAY, getting a job or choosing a career is no longer a hit-or-miss task. Science can now accurately determine for you, in advance, just what type of work or profession you are best suited for. Send your name on a penny postcard for **FREE** booklet explaining this new proven way to greater success.
Vocational Guidance Institute, Dept. A-22, Greenway Sta., Tucson, Ariz.

Learn to play...

Easy lessons at home. Inexpensive. 132-page Music Dictionary **FREE** when you enroll. Stop lessons when you like. Money back guarantee. Write for free details. **Hamann Institute, 3016 N. 24th Place, Dept. R-14, Milwaukee, Wis.**

Hawaiian Steel Guitar
Spanish Guitar
Piano

OPTOMETRY

Be a Doctor of Optometry. An uncrowded profession. Excellent faculty. Abundant Clinic material. Not operated for profit. Days, Evenings. Part time employment provided. Coeducational.
Monroe College of Optometry, 164 N. Wacker Dr., Chicago, Ill.

Always write your name and full address clearly when answering advertisements.

U. S. GOVERNMENT JOBS

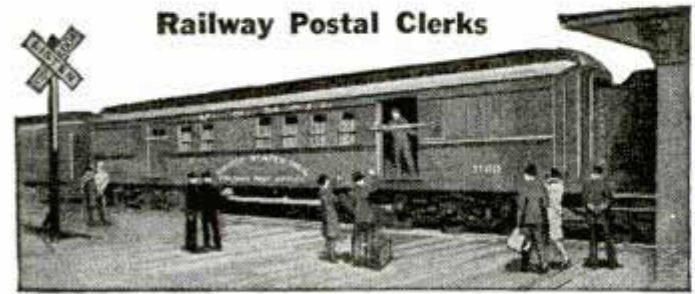

Railway Postal Clerks

Many Other Government Jobs
Mail Carriers—Clerks—File Clerks—
Post Office Clerks—Stenographers, Etc.

START \$1260 to \$2100 Year
Mail Coupon Before You Lose It

FRANKLIN INSTITUTE, Dept. W195, Rochester, N. Y.

Sirs: Rush to me without charge—copy of 32-page book, "How to Get U. S. Government Jobs," with list of positions and full particulars telling how to qualify for them.

Name.....
Address.....



AUTO

BOOKS SENT FREE

on approval. Just mail the coupon and we'll send you a set of these remarkable auto books, just off the press. Whether you are a mechanic or helper, expert or apprentice, auto owner or driver, if you're interested in knowing all about automobile mechanics, take advantage of this FREE EXAMINATION OFFER.

GET A BETTER JOB

A better job—in the gigantic auto industry. BIGGER PAY—a chance to go into business for yourself and get a share of the huge profits, are waiting for any man who even half tries to improve himself. Learn auto engineering with these wonder books a new way—a quick reference method. Simply use the JIFFY INDEX to look up the answer to any auto problem. Built by eleven of America's great automobile engineers, and written in simple language so you can understand it. Very newest cars, all covered.

Privilege of consulting Automobile Engineers of American Technical Society for one year without cost if you mail coupon immediately.

Send promptly and we will include a Brand New EXTRA volume with over 300 pages including ALL latest cars with wiring diagrams and data sheets on each.

CAN YOU FIX IT?

These wonder books tell step by step HOW to take out "play" in differential—to kill the shimmy in steering—to set TIMING—how to put your finger on engine trouble and the expert way to FIX it. Newest improvements, fully covered.

6 BIG VOLUMES
Brand New Edition
2500 pages, 2000 illustrations, wiring diagrams, etc., including Marine Engines, Aviation Motors, Diesel engines, etc. De Luxe edition, gold-stamped flexible binding.

AMERICAN TECHNICAL SOCIETY
Drexel Ave. & 58th St., Dept. A219, Chicago, Illinois

I would like to see the new 6-volume edition of your AUTO BOOKS. I will pay the few cents delivery charges only, but if I choose to, I may return them express collect. If after 10 days use I prefer to keep them, I will send you \$2 and pay the balance at the rate of only \$3 a month, until \$24.80 is paid. Please include consulting membership and extra Volume No. 7, as per your offer above.

Name.....
Address.....
City.....State.....
Please attach letter stating age, occupation and name and address of employer and that of at least one business man as reference.

SEE WHAT 4 MONTHS TRAINING CAN DO!

Our Graduates Earn Big Pay In
Air Conditioning and REFRIGERATION



Hundreds of letters from all over the world tell of our graduates' success in good paying positions. Here are a few examples: I am now employed as Chief Engineer and owe my

success to your school.—Floyd Gray. After finishing your course I opened my own business in California and am doing very well.—Earl Monson. Elmer Voss, one of your graduates, has been our engineer for 2 years and is rendering excellent service.—Ray Smith, Pres., Hotel Pfister.

YOU CAN DO THE SAME

4 months' training will start you on the road to success. Tremendous increase in Industrial and Commercial Refrigeration and Air Conditioning demands men with combined practical, technical and commercial training.

CHOOSE YOUR OWN PLACE

in Home or Commercial Air Conditioning and Refrigeration, Ventilating, Dairy and Transport Refrigeration, Sales, Research and Executive positions. No experience needed. Our 36-year old organization trains you under actual working conditions. Every student given individual instruction. Don't be content with ordinary work and low pay when in a short time you can become a trained Specialist. Send coupon AT ONCE!

MILWAUKEE
SCHOOL of ENGINEERING
Institute of Electrotechnics
PM-240-A N. Broadway & E. State, Milwaukee, Wis.

FREE!
Without obligation send free booklet, "Step Up To Success." Also send letters from successful graduates and tell me how I can

become an AIR CONDITIONING and ELECTRIC REFRIGERATION SPECIALIST in 4 months. . . . Air Conditioning Engineer (1 year) Also send details of Industrial Scholarship. . . . Student Loan and Earn Part Expense Plans. . . .
Name.....Age.....
Address.....
City.....State.....



EQUIP YOURSELF FOR BIG PAY JOBS IN AVIATION!

NEW 400-PAGE BOOK "AVIATION FROM THE GROUND UP" TELLS HOW

Used as a textbook in High Schools and Flying Schools. Learn the fundamentals of ground work and flying including the Theory of Flight, Airplane Construction, Engines, Rigging, Instruments, Weather Forecasting, Navigation, Stunts, Parachutes. Complete with 189 illustrations only \$3.00. SEND NO MONEY. Simply pay postman few cents postage plus cost

of book. Save postage by sending cash with order. Send for your copy NOW—5-day money back guarantee. FREE CATALOG of practical books on allied subjects.

F. J. DRAKE & CO. 175 N. Michigan Ave., Chicago, Illinois

Drake's Books Sold At All Good Book Stores



ITALIAN ACCORDIONS

HAND MADE. Very best. Lowest prices. Direct from Factory Representative. Send your name and address for FREE catalog. ITALIAN ACCORDION COMPANY 323 W. POLK ST., DEPT. M-1 CHICAGO, ILL.



LEARN MONEY-MAKING CARTOONING

by America's most famous method. Hundreds of successes! Start today—soon draw for pay. Rush 10¢ for details and big Picture Chart to test your ability (state age). THE LONDON SCHOOL, 1039 National Bldg., Cleveland, Ohio

Money Making Pay Raising BOOKS Catalog FREE

Send Name and Address Today

Selected books covering all trades, office helps, home workshop, spare time work, hobbies, etc. Learn how to earn more. Write today.



Popular Mechanics Press
DEPT. 240
200 E. Ontario Street
CHICAGO



Know Electricity as Experts Know It—and Get an Expert's Pay!

What about your future? Who is safe today? Surely not the man who is contented to stand still! Know your job thoroughly—prepare yourself for jobs ahead. To do just this thousands of men have used

The Croft Library of Practical Electricity

The Croft Library is a complete electrical educator. It is founded on practice—on 20 years of shirt-sleeve experience—on work as it is actually done. It is jammed from cover to cover with the kind of hard-headed facts you want. Written so that the beginner can easily understand it, yet so sound, so thorough, that it is the daily guide of 50,000 highly paid electrical workers and engineers. Croft tells you the things you need to know about motors, generators, armatures, commutators, transformers, circuits, switchboards, distribution systems—electrical machinery of every type—illumination in its every phase—the most improved methods of lighting—lamps and lamp effects, etc.—how to do a complete job, from estimating it, to completion.

6 volumes, 2155 pages—New low price No money down—Easy payments.

Fill in and mail the coupon attached and we will send you the entire set of six volumes for ten days' Examination on approval. We take all the risk—you assume no obligation. If you decide to keep the books, send \$1.50 in ten days and the balance at the rate of \$3.00 a month. Send the coupon NOW and see the books for yourself.

EXAMINATION COUPON

McGRAW-HILL BOOK CO., 330 W. 42nd St., New York

Send me for ten days' examination on approval the Croft Library of Practical Electricity. If satisfactory I will send you \$1.50 in 10 days and \$3.00 monthly until the price of \$16.50 is paid. If not wanted, I will return the books postpaid. (To insure prompt shipment write plainly and fill in all lines.)

Name.....
Home Address.....
City and State.....
Position.....
Name of Company.....

PM-2-40



SICKNESS OR ACCIDENT

Every hour, day and night, 4,080 people are disabled through sickness and accident. You never know when tragedy strikes. The Policy of the Century comes to your aid at the time of your most dire need—at a time when you are down, financially handicapped, unable to care for your loved ones.

THE POLICY OF THE CENTURY

WILL HELP PAY YOUR BILLS

YOU RECEIVE \$5,000.00
Accumulating to **\$7,500.00**
Benefits for Sickness, Accidental Death, Loss of Hand, Feet, or Eyes

\$25 PER WEEK FOR SICKNESS
\$25 PER WEEK FOR ACCIDENT

\$100 EMERGENCY ALLOWANCE

All subject to Century Policy provisions.

COST TO YOU \$1 ONLY PER MONTH

The Federal Life and Casualty Company of Detroit, a legal reserve insurance company which has paid millions of dollars to policyholders, offers you the new "CENTURY" Policy. This company is not an association or assessment company. Old, reliable. It is approved by state insurance departments. Be safe! Costs only \$1 per month. Just mail coupon.

INSURES MEN AND WOMEN

The new "Century" Sickness and Accident Policy insures both men and women with the benefits shown here, plus many other liberal features outlined in the policy.

NO MEDICAL EXAMINATION

Anyone between 16 and 75 can apply, half benefits after age 60. No agent will call.

SEND NO MONEY Remember you do not send one cent—just mail the coupon below. Don't delay—do this today!

MAIL COUPON NOW FOR DETAILS

FEDERAL LIFE & CASUALTY COMPANY
ELGIN TOWER, SUITE 90
ELGIN, ILLINOIS

NO AGENT WILL CALL

Please mail me at once complete information and how to get the "Century" Policy for my Free Inspection without obligation.

Name.....

Address.....

New York Electrical School Established 1902

Ask for free illustrated booklet

44 West 17th St., N. Y. C.

CARTOON YOUR WAY TO SUCCESS!

DON'T COPY - LEARN TO ORIGINATE!

RAYE BURNS will teach you HOW to CREATE ORIGINAL CARTOONS at home that you can SELL! Course has 26 lessons and 600 illustrations. **\$2.85**

Send name and address for free details. Only....

RAYE BURNS SCHOOL, Dept. M-8, Box 2194, CLEVELAND, OHIO

Minstrels Comedy Stunts, Plays, Songs

Unique First Parts for complete show with special songs and choruses. Make-up. Catalog Free.

T. S. Denison & Co., 203 N. Wabash, Dept. 19, Chicago

Earn Cash at Home!

We paid M. M. \$1174 for exceptional cellar crop Snow-King mushrooms! We furnish materials; buy all crops. Big FREE picture book tells if your cellar, shed, barn, suitable. Est. 1908. Write today. United Co., 3848 Lincoln Av., Dept. 301, Chicago

WANT A GOOD PAY JOB?

Learn Tool and Die Making, Machinist Trade, Screw Machine work. Earn as much as \$50-\$60 per week. Learn by actual work in one of America's best equipped shops. Training supervised by experts. State certified. Day-Evening classes. Enter any time. Low tuition fee, employment help. Write **FREE** NOW for booklet "Practical Machine Shop Training."

ALLIED SCREW MACHINE CO., Inc.
School Division
Dept. PM-2 503-9 W. Lake Street, Chicago, Ill.



Go to High School at Home

You can secure a high school education in your spare time by studying the new courses prepared by the International Correspondence Schools.

These courses are equivalent to the courses given in resident high schools. They have been specially arranged for men and women who wish to meet college entrance examinations, to qualify for a business position, or to make up the education they missed in past years.

The lessons are easy to understand and you will make rapid progress because you will be *in a class by yourself* and you will study under the guidance of instructors who are sincerely interested in you.

Just mark and mail the coupon and we will gladly send you interesting free booklets describing the High School Courses of the I. C. S. or any other subject in which you are interested.

INTERNATIONAL CORRESPONDENCE SCHOOLS

BOX 5567-J, SCRANTON, PENNA.

Explain fully about your course marked X:

BUSINESS COURSES

- College Preparatory Course
- High School Commercial Course
- High School English Course
- High School Vocational Course
- High School Agricultural Course
- Other High School Subjects
- Advertising Bookkeeping
- Business Correspondence
- Business Management
- Cartooning
- Civil Service
- College Cost Accounting
- C. P. Accounting French
- Grade School Illustrating
- Lettering Show Cards
- Railway Postal Clerk
- Salesmanship Secretarial
- Service Station Salesmanship
- Sign Lettering Spanish

TECHNICAL AND INDUSTRIAL COURSES

- Agriculture Air Brake
- Air Conditioning
- Architectural Drafting
- Architecture
- Auto Engine Tune-up
- Auto Technician Aviation
- Boilermaking
- Bridge Engineering
- Building Estimating Chemistry
- Civil Engineering Coal Mining
- Concrete Engineering
- Contracting and Building
- Cotton Manufacturing
- Diesel Engines
- Electrical Engineering
- Electric Lighting
- Foundry Practice
- Fruit Growing Heating
- Heat Treatment of Metals
- Highway Engineering
- Locomotive Engineer Machinist
- Management of Inventions
- Managing Men at Work
- Manufacture of Pulp and Paper
- Marine Engines
- Mechanical Engineering
- Navigation Patternmaking
- Pharmacy Plumbing
- Practical Telephony
- Poultry Farming
- Public Works Engineering
- Radio Operating
- Radio Servicing
- R. R. Section Foreman
- R. R. Signalmen Refrigeration
- Sheet Metal Work
- Steam Electric
- Steam Engines
- Structural Drafting
- Structural Engineering
- Surveying and Mapping
- Telegraph Engineering
- Textile Designing
- Welding, Electric and Gas

DOMESTIC SCIENCE COURSES

- Advanced Dressmaking
- Foods and Cookery
- Home Dressmaking
- Professional Dressmaking and Designing
- Tea Room and Cafeteria Management, Catering

Name..... Age.....
Address.....
City..... State.....

Present Position.....
Canadian residents send coupon to the International Correspondence Schools Canadian, Limited, Montreal, Canada. British residents send coupon to I. C. S., 71 Kingsway, W. C. 2, England.

When writing please mention Popular Mechanics

POPULAR INVENTIONS

(Continued from page 35A)

SOMETHING new in traffic control signals is offered in a "stop" sign patented recently. The signal is mounted in a base which is sunk into the roadway. It

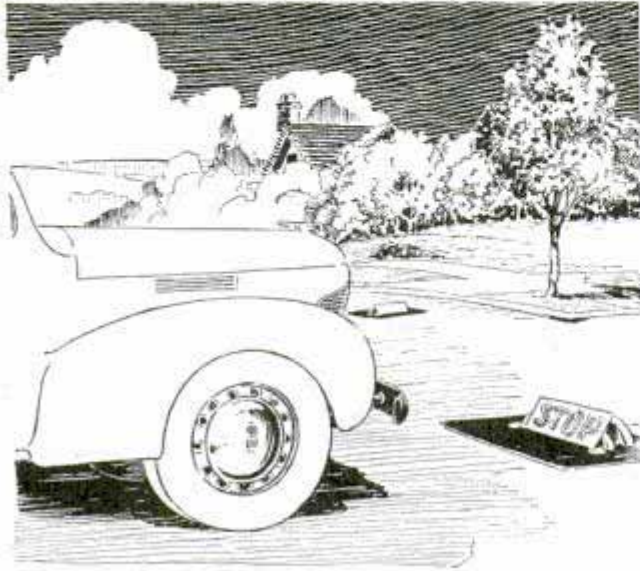

remains at an angle of about forty-five degrees, fully visible to the motorist, until the wheels of the car strike it, forcing it downward into the base. After the car has passed, it returns to its original elevated position.

MECHANICAL aid for the knitter is offered in the form of a newly patented ring that slips on the finger and that controls feeding of the yarn to the needles. The ring is used on the index finger. A tension clip located between the feed loop and guide coil

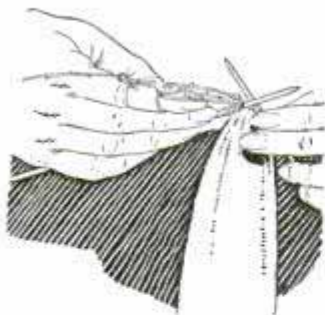

maintains the proper tension on the yarn.

COMFORT for the patient is the objective of an accessory for a hospital bed, patented recently. A supplemental frame for the bed frame consists of pivotally connected sections, with means of elevating certain sections to raise the head and



the knees of the invalid. A number of positions, from full reclining to half sitting, are possible with the mechanism.

SLIPPING on the ice or other slick surface may be reduced by a newly patented non-slip attachment for the shoes. It includes a calked plate with a pair of arms mounted on a pivot and shaped so that their outer ends clamp the edges of the shoe. Other clamping means are provided at the rear of the plate for firm attachment just forward of the instep.



DESIGNED for sport, resort use and possibly in places where the supply of gasoline is restricted, a man-powered vehicle has been patented. It is intended for occupancy by two persons. A wheel is used for steering. An operating lever is mounted on the car's framework for oscillation in a vertical plane. When the lever

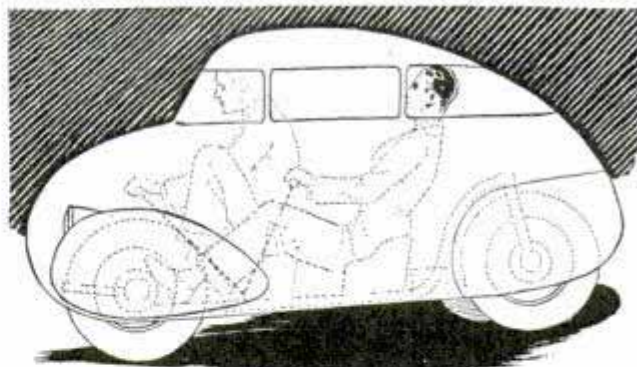

is oscillated, it causes the driving mechanism to turn the wheels and thus propel the vehicle. A braking system also is incorporated into the car, which is complete with sedan-like body.

Due to the fact that many of the devices described in this department are still in the patent office stage and are not on the market, Popular Mechanics Magazine cannot undertake to supply further information regarding them.

**Now . . . YOU CAN
ESTABLISH A
PERMANENT and
PROFITABLE
BUSINESS IN
YOUR OWN TOWN
. . . Plating
Gold, Silver, Cop-
per, Tin, Cadmium
and Nickel at Big
PROFITS!**

MAKE BIG MONEY AT HOME—*Electroplating*

*Amazing New Brush
and Tank Methods!*



Patented Warner System Based on New, More Profitable Methods!

WARNER engineering has now achieved the impossible! High capacity, professional plating equipment at amazing low cost! *No expert knowledge now necessary!* Combines both improved methods—brush and tank. Though priced low, it has capacity for producing more than \$12,000 volume per year. **You invest only once for permanent, profitable, lifetime business.** No job too big, no job too little for you to handle at a nice profit.

SMART OPERATOR CAN GET BACK INVESTMENT IN 2 WEEKS!

Warner Electroplating System pays for itself in double quick time. Everything's included . . . Super Power Pack, three Longlife Plating Tanks, Lectro Plating Brushes, Electric Polisher and Buffer, Automatic Electrically-Controlled Cleaning Tank, Anodes, Chemicals, etc. **Nothing else to buy. You make good money on very first job!**

Have you the vision to see and grasp a real opportunity? Are you capable of handling a proposition that can make you a prosperous business leader in your community? **THEN—MAIL THE COUPON AT ONCE.** Investigate—

learn the facts without obligation. Don't dream . . . **act now!** VALUABLE FRANCHISE IF YOU CAN QUALIFY!

**FREE
SAMPLE
PROVES
CLAIMS**

2 MINUTE DEMONSTRATION with SAMPLE AMAZES EVERYBODY!

Send today for FREE sample and interesting profit details and bona fide evidence of big, steady earnings.

Customers Galore . . . Every Home, Office, Factory, Shop and Store!

Today's demand for plating can support ten times present facilities. Making old articles new is an untouched field. *W. R. Dixen, Kansas City, writes: "Made \$10.00 in 3 hours."* *A. M. Holland, Minneapolis, says: "Earned cost of plater first week."* *L. White, Perry, N. Y., states: "I've done 25 jobs so far."* **WARNER EQUIPMENT NOW USED BY BETHLEHEM STEEL CORP., U. S. NAVY, STANDARD OIL, COLUMBIA BROADCASTING SYSTEM, STATE OF MINNESOTA.**

TEAR OUT-MAIL AT ONCE!

WARNER ELECTROPLATER CO.,
Dept. 5-X, 360 No. Michigan Ave.,
Chicago, Illinois

Please rush photos, facts, free sample and full information on "How To Make Money At Home—Electroplating." Also—details covering your License Agreement.

NAME.....

Address.....

City.....State.....

“How does **COOLNESS** rate with you in pipe tobacco?” *we asked in a drafting room...*

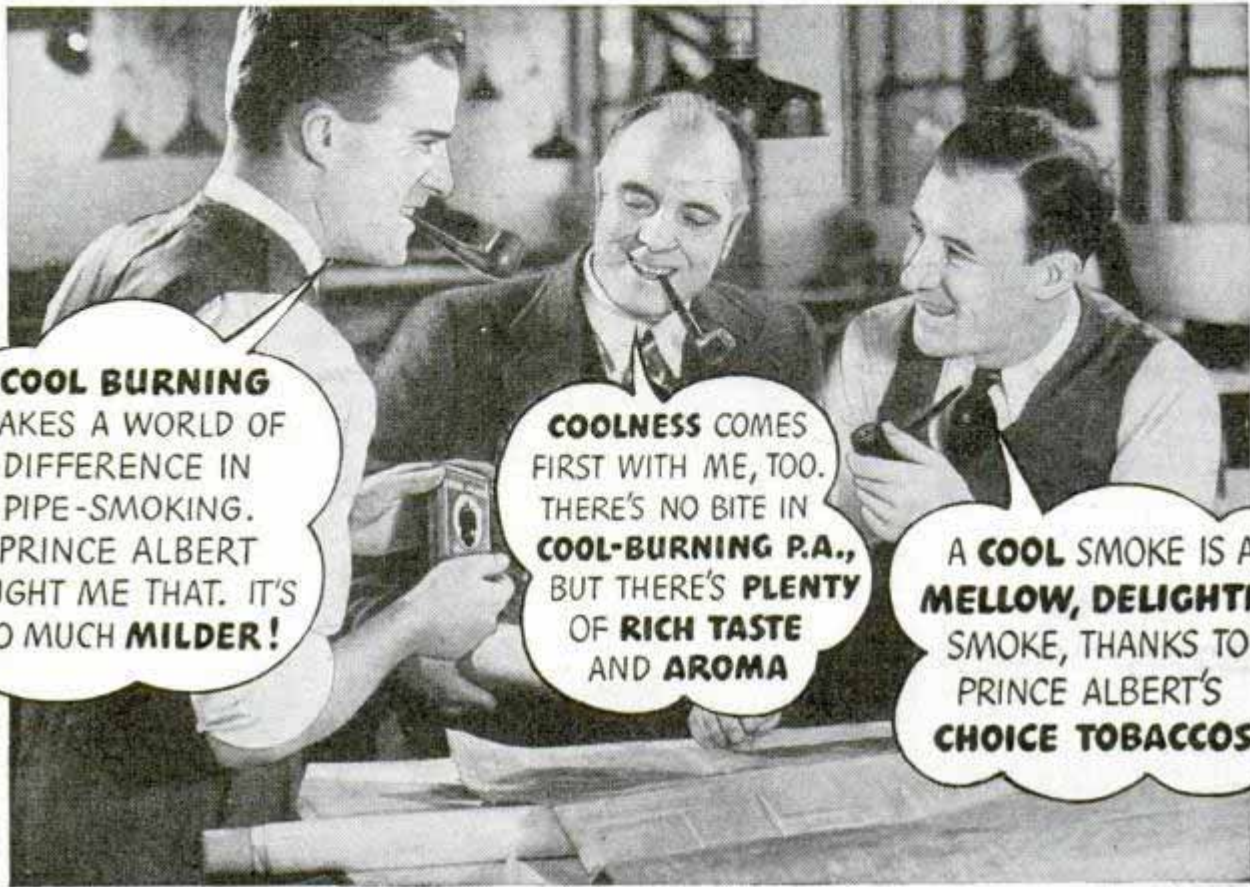

COOL BURNING MAKES A WORLD OF DIFFERENCE IN PIPE-SMOKING. PRINCE ALBERT TAUGHT ME THAT. IT'S SO MUCH **MILDER!**

COOLNESS COMES FIRST WITH ME, TOO. THERE'S NO BITE IN **COOL-BURNING P.A.**, BUT THERE'S **PLENTY** OF **RICH TASTE** AND **AROMA**

A **COOL SMOKE** IS A **MELLOW, DELIGHTFUL SMOKE**, THANKS TO PRINCE ALBERT'S **CHOICE TOBACCOS**

In recent laboratory “smoking bowl” tests, Prince Albert burned

86 DEGREES COOLER
than the average of the 30 other of the
largest-selling brands tested...coolest of all!

UP goes the pleasure of pipe-smoking when burning temperature goes *down!* There's no excess heat to bite the tongue and flatten out flavor and aroma. **COOL-SMOKING** Prince Albert opens the door to **TRUE MILDNESS** and **MELLOWNESS** with **PLEASING TASTE** — the topmost joys of choice tobaccos. “No-bite” treated for *extra* smoothness. “Crimp cut” to pack and draw *easier*. In a pipe (and a “mak-in's” smoke, too) you'll simply be delighted with P.A.!

50
pipefuls of
fragrant to-
bacco in
every handy
pocket tin
of Prince
Albert

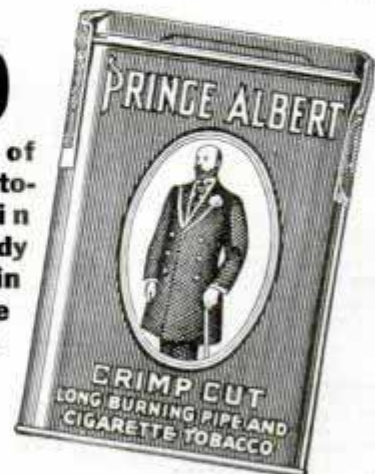

Prince Albert

Copr., 1939, R. J. Reynolds Tob. Co., Winston-Salem, N. C.

THE NATIONAL JOY SMOKE

WONDER "FOOD" for PLANTS

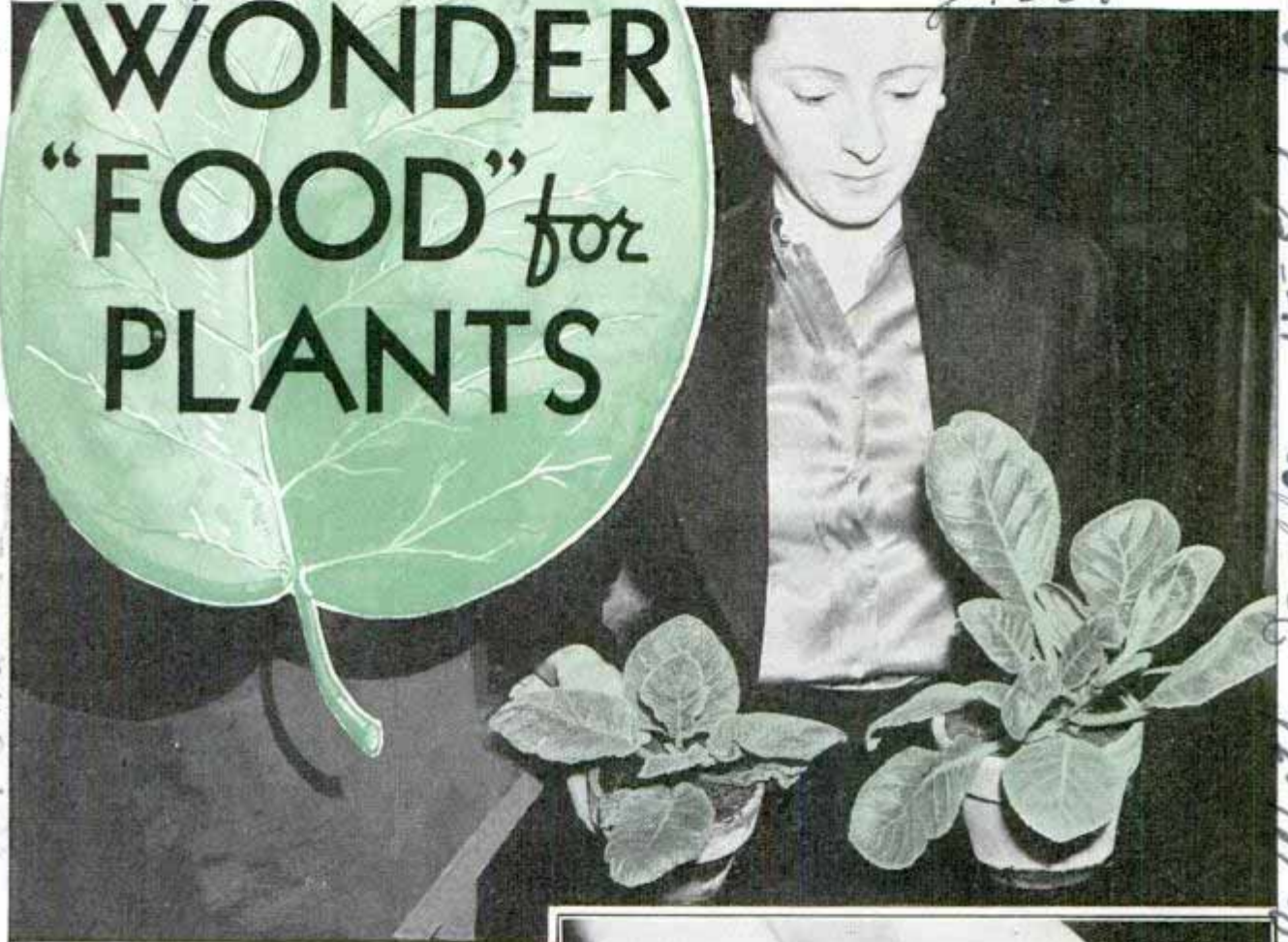

VITAMINS, those wonder-working chemicals, are performing seeming miracles in the plant world, miracles that may revolutionize horticulture, and that have already opened up undreamed of possibilities for the amateur gardener.

Imagine transplanting delicate shrubs with practically no shock or set back, growing shade-loving plants in bright sunlight, returning dying plants and trees to health in a short time, growing huge blooms. Yet all these things are possible for even the rankest amateur gardener, and the only equipment needed is an eye dropper, a measuring jar, a watering

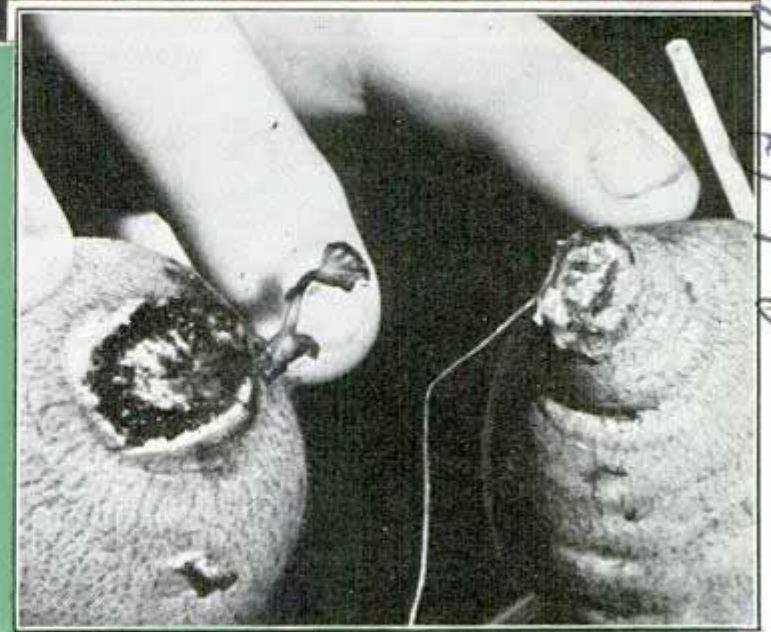

Top, gloxinias planted at same time. One at right was given vitamin treatment. Bottom, vitamin-treated sweet potato (left) grew leaves; one at right, placed in water, grew only roots

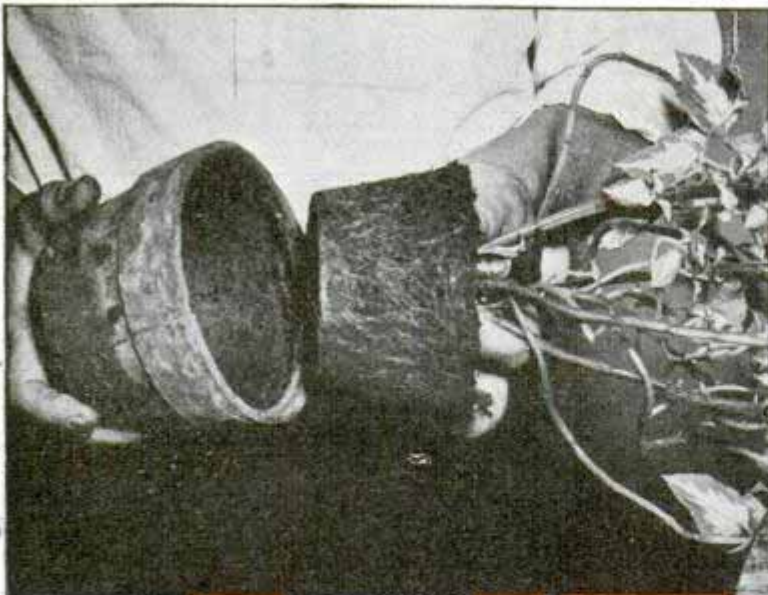

Top, vitamin stimulation of root growth illustrated in heavy matting of coleus. Center, in transplanting, roots are placed in solution and dirt removed. Bottom, roots are soaked for twenty minutes, then replanted and watered with heavy concentration of vitamin solution

pot—and a pinch of white crystals. Those crystals are pure vitamin B₁ which a short while ago began working wonders in the laboratories of the California Institute of Technology. It all started when plant physiologists at the institute began experimenting with the vitamin as a stimulant to root

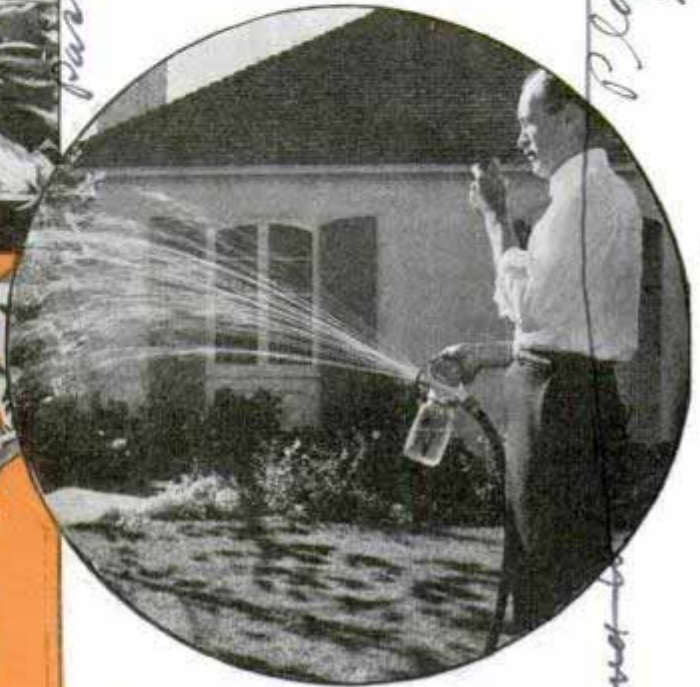

Vitamin spray gun which automatically mixes 250 gallons of working solution

growth. Soon it became clear that the largest field was in connection with garden flowers and shrubs. For mysterious reasons many ornamental garden plants failed to manufacture sufficient quantities of this vitamin. Most commercial and food crops, however, were found to produce all of the vitamin they could use.

Concentrating on the roots of garden plants, the scientists made thousands of experiments. Minute sections of roots were treated with the vitamin. Rigid precautions were taken to prevent contamination from outside sources. Water in which the roots grew was double-distilled in pure glass stills to prevent contamination from copper pipes. All instruments were thoroughly sterilized and the experimenters used glass screens to deflect their breath from the roots being treated.

Plant Culture Supply
165 N. Hill Ave

Plant Culture Supply
Paradise, Calif
Water and to
Paradise, Calif

Gradually it became apparent that although the primary function of the vitamin was to stimulate root growth, it also had a reaction on the stems and foliage of many plants, increasing their size and the speed of growth.

Furthermore, it was discovered that by treating the bare roots of many plants with a heavy concentration, "root shock" could be greatly reduced. Root shock may be compared to the surgical shock which accompanies major operations. Removing a plant from the ground, changing its environment, breaking many of its roots and bruising others, is a pretty major operation as far as the plant is concerned. The result is that it droops, loses its leaves, often dies.

However, if the bare roots of the plant are soaked for a few minutes in B₁ solution, this shock is practically eliminated. Delicate bougainvilleas, which are normally very difficult to transplant, have, after this treatment, been transplanted in hot sunlight. The plants showed no ill effects, whereas control plants which had not received vitamin treatment drooped within a short time.

From the laboratory, experimentation next went into the stage of practical tests. Amateur and

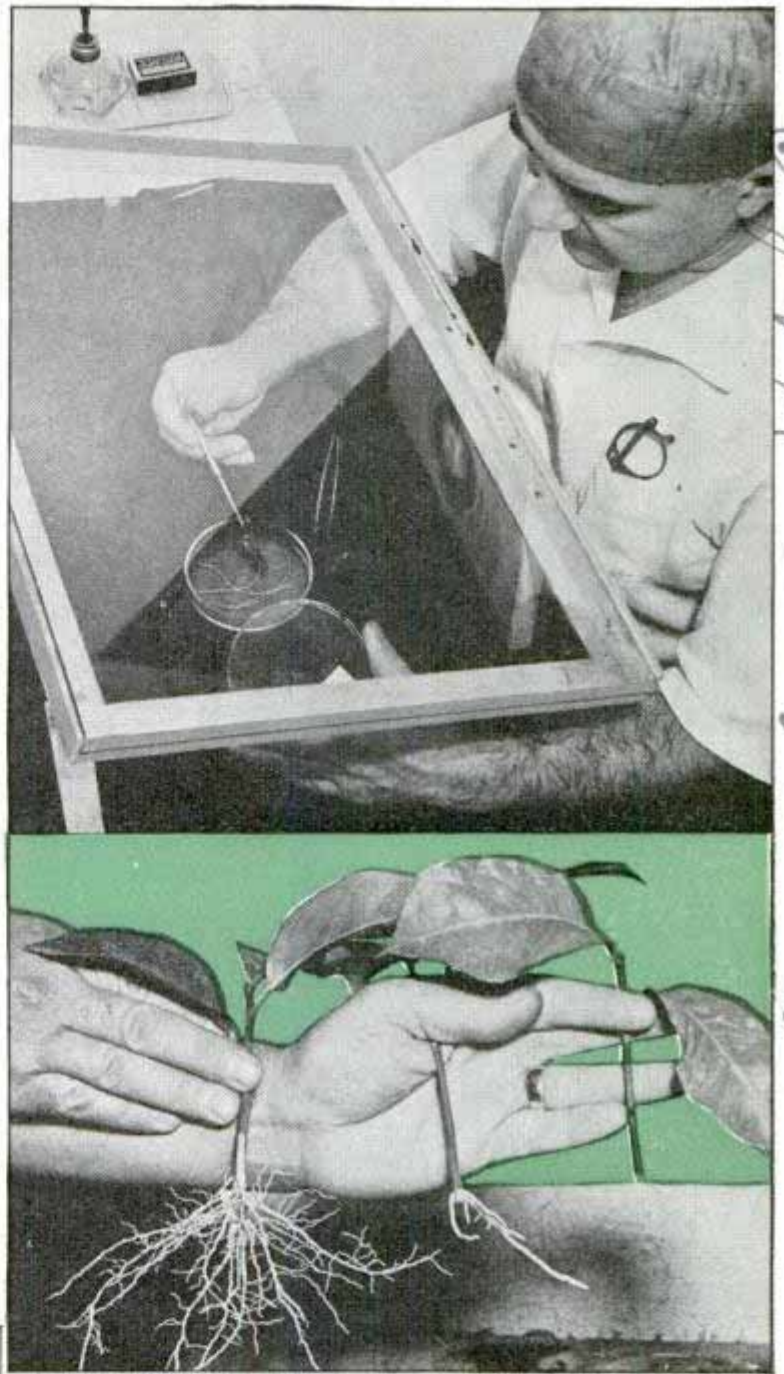

Top, laboratory worker wears sterile cap and uses glass screen to protect plant roots from breath contamination. Center, lemon tree cuttings after five weeks in sand. One at right was fed water, next one was fed indole acetic acid (another wonder chemical) and one at left was fed the acid and vitamin B-1. Note that vitamin-treated cutting has heavy root mat. Bottom, left, how sweet potato is placed in water or solution. Right, using eye-dropper to add one drop of vitamin to one gallon of water

12/19/37 August 1937
 Co. York, Penna. /
 Rochester, N.Y.

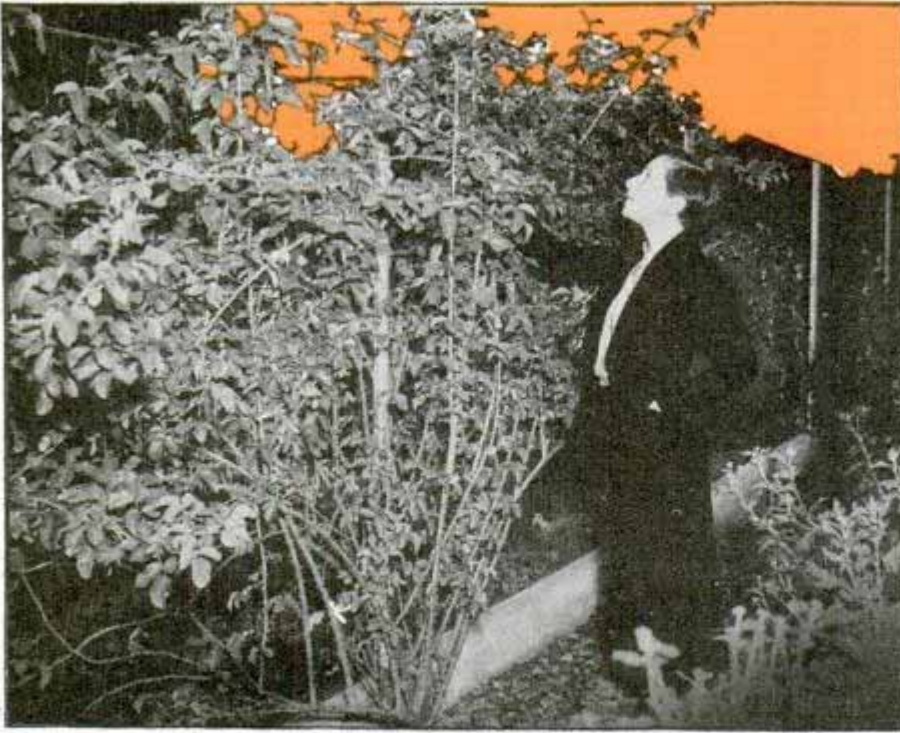

Climbing rose, treated with vitamin, is three times the size of untreated rose planted at same time. Bottom of page, left, all the equipment necessary for vitamin experiments—vial of the crystals, vial for mixing stock solution, eye dropper and a toothpick. Right, tiny amount of vitamin (compared with fingertip) is enough to make twenty gallons of solution

professional gardeners in Pasadena, Calif., conducted many experiments. The results were amazing.

A camellia cutting grew into a fourteen-inch shrub in only eleven months. A narcissus grew to a height of forty-five inches. Vitamin-treated rose bushes grew as if by magic, while untreated ones beside them remained weak and scrawny. In one large rose garden half the shrubs were vitamin treated and half not. The line between the treated and untreated shrubs was as clear

cut as if a magician had touched those on one side with his wand and commanded them to grow.

While the amateurs were achieving such startling results, vitamin treatment began to prove of commercial importance. Although it apparently has no effect on most food crops, it profoundly affects many types of shade and fruit trees. It was tried experimentally on a few trees in an orange grove. Other trees were left untreated as controls. Within a few months, the vitamin-treated trees showed such advance that the idea of controls was abandoned, and all the trees were treated. As the grower

said: "The experiment was such a success that I felt I couldn't afford to let any of my trees go without the vitamin."

One day a shade tree on a Pasadena street was "gassed." The tree was an extremely valuable specimen which had been brought from Tibet. The gassing was caused when a main broke, allowing deadly fumes to seep among the roots. The tree wilted, all the leaves fell. Desperate measures were taken to save it. None of them worked. Just before the tree was given

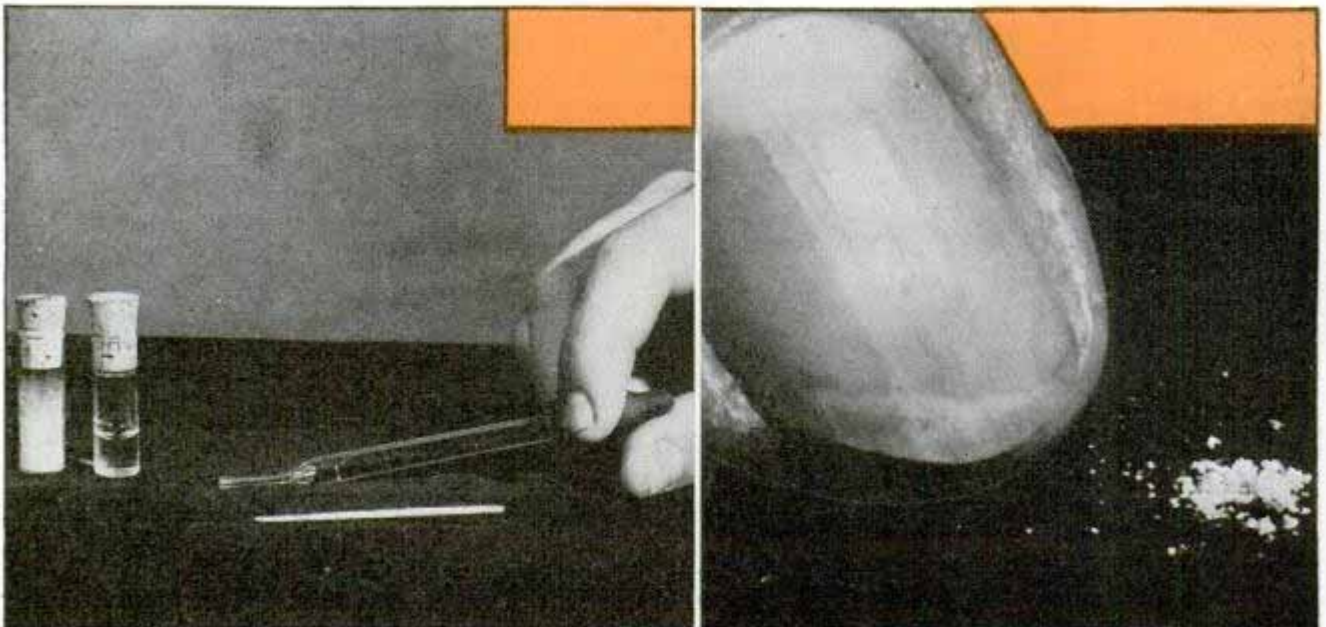

up for dead, some one thought of vitamin B₁. Hundreds of gallons of vitamin solution were poured around the tree. It was saved.

Two weeks after gigantic eighty-foot palm trees were planted around the new Los Angeles union station, a gale whipped the trees to ribbons. Some were damaged so badly that leaves refused to grow. The trees looked more like telephone poles than palms. Just before they were to be dug up, it was decided to try vitamin B₁. Two hundred gallons of the solution were given each tree. Three months later the palms swayed in the sky, green and healthy.

Such results seem almost uncanny, and yet the methods of using and experimenting with this wonder chemical are so simple that any one can apply them in his own garden. Following are the simple directions:

For equipment all you need is a watering can which holds a measured amount. A two-gallon can is preferable, but a one-gallon size will do. It is difficult to measure a small enough quantity of the solution for any can of less than one gallon capacity. Besides the watering pot, you will need a clean eye dropper (one that forms drops accurately), a small vial to hold the stock solution—and a supply of vitamin B₁ which should be pure synthetic crystals. Your drugstore probably has or can get the pure synthetic crystals. Should you have any difficulty securing them locally, they may be obtained from George C. Warner, Pasadena, Calif. Enough of the vitamin to make 2,500 gallons of solution costs only two dollars. For spreading the solution over large areas, a spray gun which attaches to the hose and automatically measures the solution is helpful.

To mix a stock solution, take only enough crystals to cover the head of a pin. This is approxi-

(Continued to page 145A)

251 S Catalina

Bed in "Minute Man" Design Is Decorated with Muskets

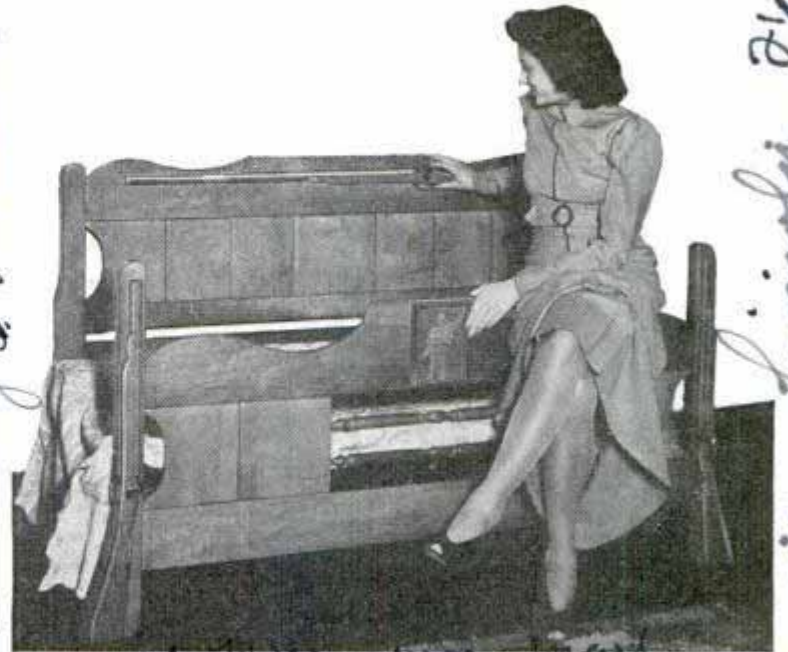

"Minute man" plaque at the foot and old-time muskets trimming bed posts and headboard form war theme in design for bedroom

World events have influenced the decorative scheme of new home furnishings which bear designs commemorative of an important phase of American history. In one bedroom suite guns of early days trim the bed posts and headboard, and a plaque at the foot portrays the "minute man."

Parking Airplanes on Their Noses Saves Space in Hangar

When storage space in a hangar at the East Boston, Mass., airport became overcrowded the problem was solved easily enough by parking the airplanes on their noses. Fifteen light planes could be stacked, tails in air, in the floor space ordinarily occupied by five or six ships. The propellers were protected by resting them on wood blocks.



Planes stacked on their noses in East Boston hangar occupy only a third the space they formerly required on the floor

Wiggins Airways
Municipal Airport

Handwritten notes at the top of the page, including "Sears and Roebuck" and "The Minute Man".

Vertical handwritten notes on the left side of the page, including "Plant Industry Co. Pasadena Calif.", "Miller and White", and "Catalina".

Vertical handwritten notes on the right side of the page, including "Virginia-Lincoln Furniture" and "Merrill".

Fast Air-Propelled Boat Glides over Shallows

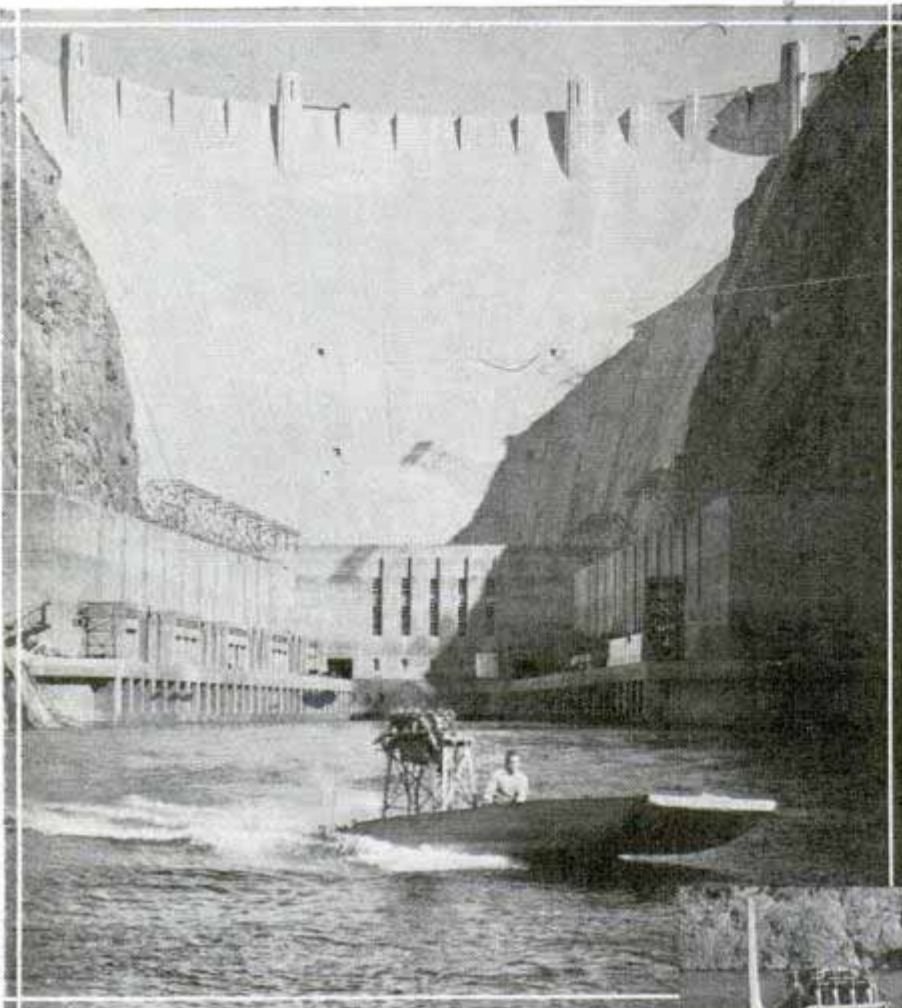

Pushed by an air propeller, a boat has been built to skim over shallow water and cross sand bars which an ordinary boat is unable to navigate with ease. It is used by the bureau of reclamation for its work on the Colorado river below Boulder dam, and has proved to be even more efficient in rapids or moving water — going either up or downstream — than it is in still water. At full speed, which is estimated to be twenty-five miles an hour, the boat has a draft of two and one-half inches, and the rudder kicks up automatically when striking obstructions.

Photos, U. S. Bureau of Reclamation

Air propeller at rear enables boat to navigate shallows and rapids below Boulder dam where other craft would run afoul sand bars. Right, engine and propeller mounted high above deck

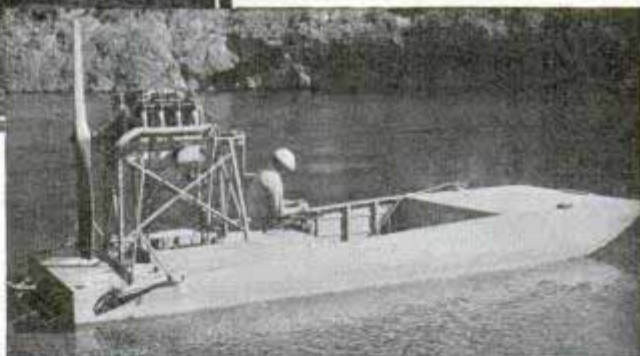

*90 Hp. Q-8 Curtiss
Exp. 5 motor*

Steel-Hearted Aerial Camera Carries 500 Feet of Film



Mapping plane and aerial cameras; that in inset carries 500-foot film

Its heart of steel unaffacted even by stratosphere temperatures, the latest of aerial survey cameras can go up into the sky with a full day's load of nine-by-nine inch film and map the earth for three to five hours without taking time out to reload. Mounted in the floor of a glass-walled "Explorer" plane, its operation is made convenient and accurate by a bubble level on the trig-

*1272
Lansing, Mich.
Argins Aerial Survey Corp
I m, J. M. Loring
Boulder City, Nevada*

Albert Abrams

2712 Colorado

ger and a stop watch, number recorder and film gauge on top of the camera where they can be seen and used easily. The camera carries a 500-foot roll of film, taking 650 pictures. The heart, including focal plane and lens, is of Invar steel which will not contract nor expand within a 300-degree range of temperature and so permits mapping from great heights.

Anti-Aircraft Searchlight Unit Has 'Outrigger' Guide Wheel

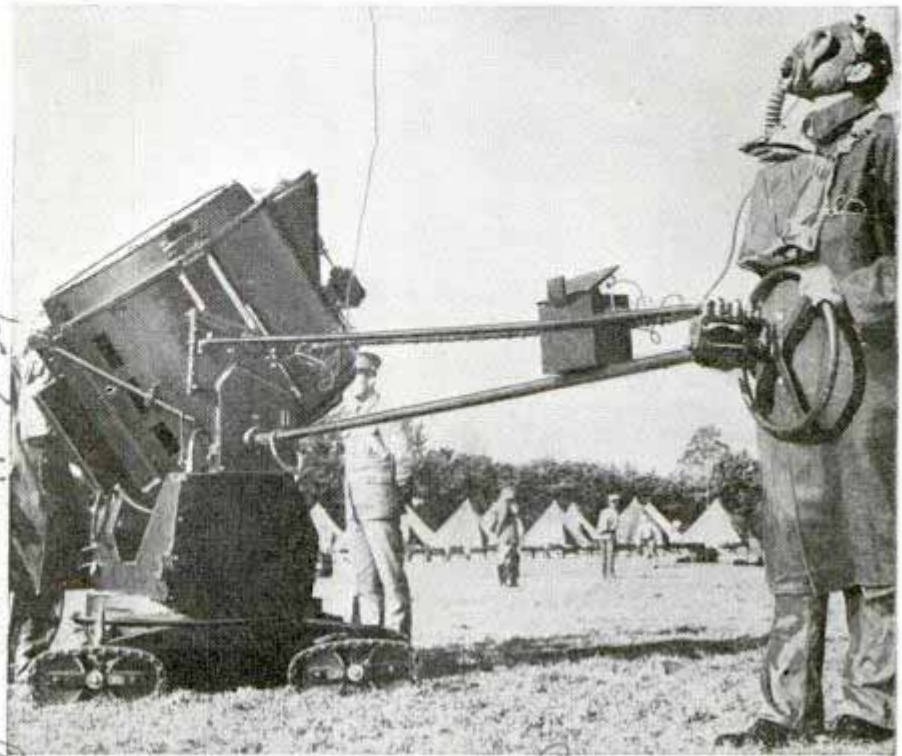

Gas-masked searchlight operator practices maneuvering the big "eye"

Stainless Steel Plate Applied to Iron at Low Cost

Ordinary iron can be given a coating of stainless steel by a recently patented process at prices well below the cost of solid stainless steel. In applying the coating over ordinary low-carbon steel, carbon arc welding is used, and it is said the cost is comparable with that of ordinary steel.

Dotting the English countryside are far-sighted searchlights ready to reach out into the night sky and spot enemy aircraft on forays over the island. Mounted on a swivel truck with chain treads, the light can be maneuvered easily by a geared steering wheel at the end of long steel arms.

"Paddles" on Antenna Pole Sharpen Television Signals

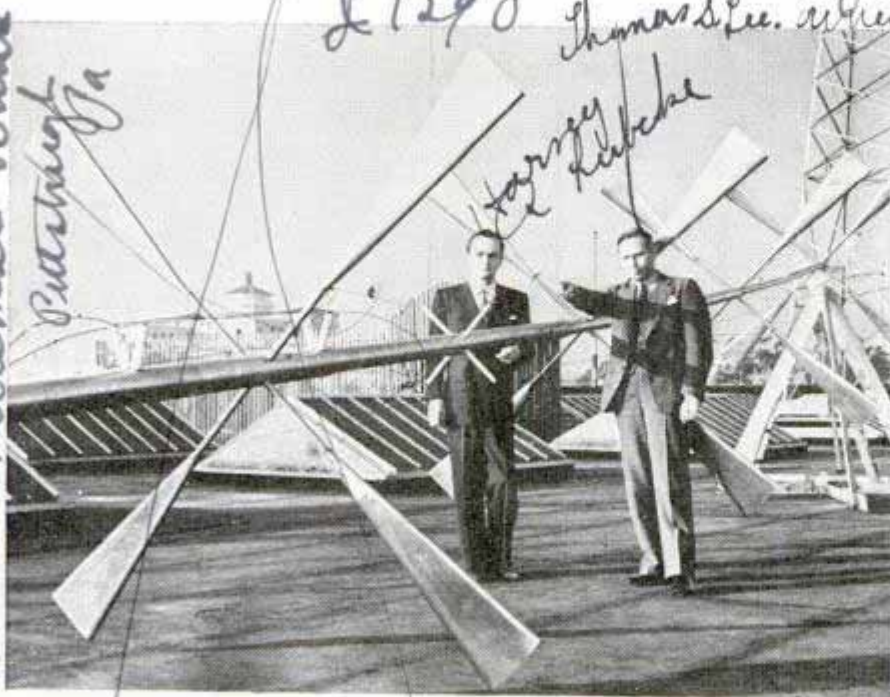

Flaring paddles are intended to widen distribution of television signals

To obtain greater definition in television pictures, a Hollywood transmitting station is trying "paddle" antennas on a sixty-foot pole. Four of these quadruple paddles are stacked at intervals along the vertical pole, which is installed on a roof top so that the horizontal paddles can spread signals over a wider ground area.

Ⓞ Six fires break out every five minutes in the United States, inflicting losses that totaled \$265,000,000 in 1938.

2511-1st National Bank Building
Pittsburgh, Pa.

Patd by Robert K. Kirtland, Engineer, The United States

Fireman's Fund
Record Nov. 19 38

Acme
Exclusive rights & made nearly
L 1290 Thomas Lee, agent transmitter W 6 X 40
D. W. R. Lubecke
Inventor of Television, W 6 X 40, City of Wood

1230

Piper Aircraft Corp. Wayne, Mich.
Stinson Aircraft Corp. Wayne, Mich.

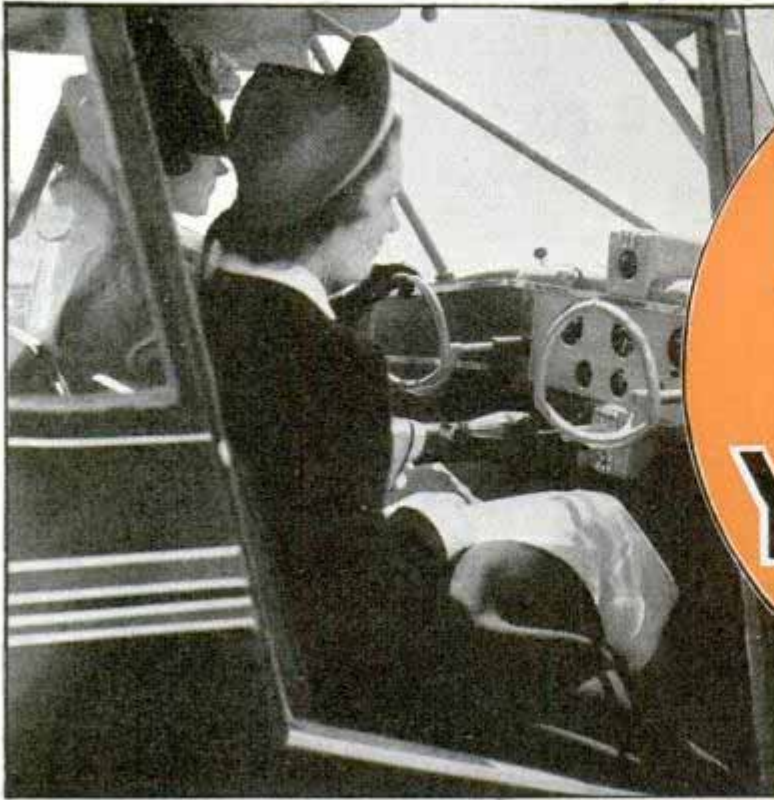

IT'S EASY to FLY YOUR OWN



you get a complete flying course free if you purchase one of the "flivver" planes. Should the flying course be taken without buying a ship, the cost will range from \$250 upward. This includes eight hours of dual instruction and thirty-five hours of "solo" work, flying the plane alone, becoming familiar with the appearance of the ground from aloft and well-versed in airport signals, weather reports, maps and the like. Then, after a written exam-

By Julian Leggett

FLYING your own airplane, once only a dream to the average American because of the expense, now becomes possible for anyone with \$1,000 to spend.

You need not have that amount in cash. A lightweight plane, approved by the government for safe-flying characteristics, can be purchased for one-third down, about \$350, and the balance in twelve to eighteen months, around fifty to seventy dollars per month, depending upon the length of the contract. That amount includes insurance and financing fees.

Learning to fly was too expensive for the average person not so long ago, but today



Pilot's compartment of the Stinson 105 (top); instrument panel of a Piper Cub (center), and testing vibration of tail unit in Piper factory

*Aerom-Aircraft, Inc.
Waco Aircraft Corp. Troy
Ohio*



ination on laws and regulations and a thorough flight test, the pilot is granted a license by government inspectors—if he passes all tests.

Operating and maintaining a plane also was out of the question for the person with a moderate income a few years ago, but the lightweight plane costs its owner even less to fly and keep in good condition than does a

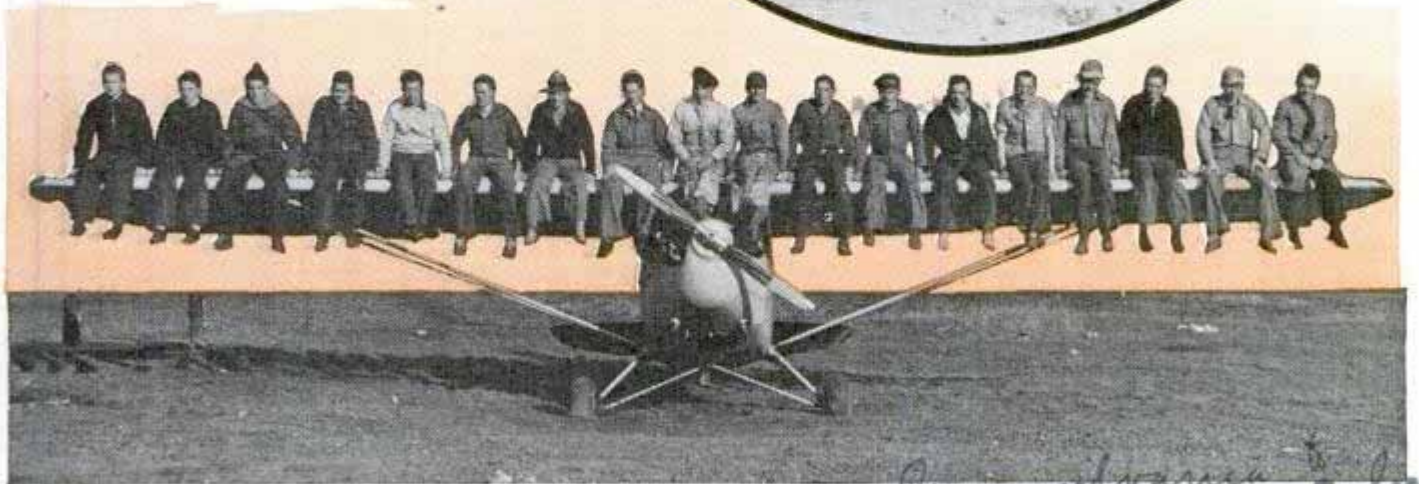

Pennsylvania Colorado
Stinson 105 (top); group of pilots conferring on course for cross-country flight in three light planes (center), and eighteen men seated on wing of Piper Cub test the ship. They weigh 2,700 pounds

\$995.00 w/o.

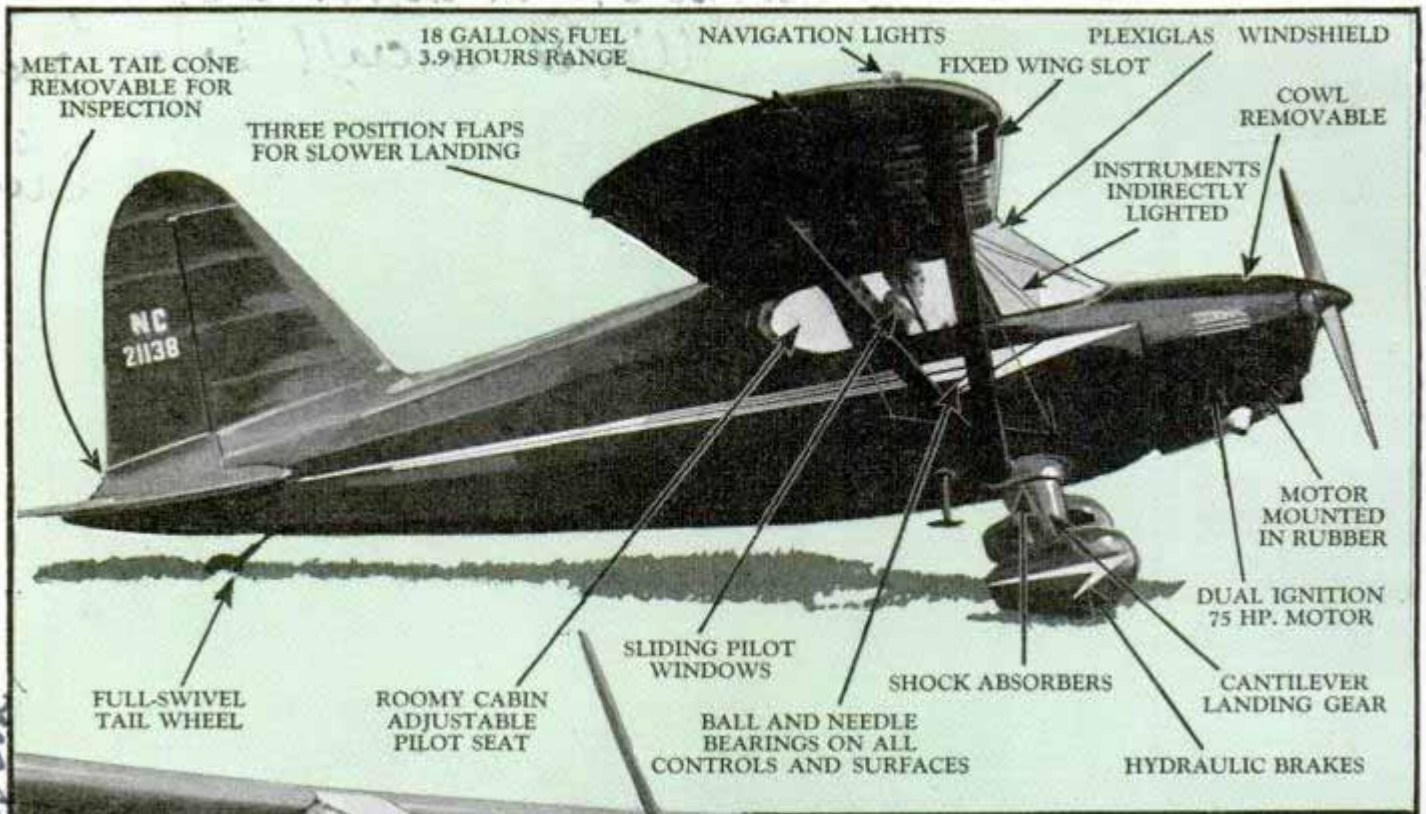

Credited to S. Ghentley
Washington



\$75; maintenance (inspection), \$5; total, \$294.25.

This amounts to 2.94 cents per mile. As more flying per year is done, the cost per mile decreases. Many Cub owners and operators attain a considerably lower cost, depending upon expenses in their territory.

Hangar rental depends largely upon the locality in which the

Stinson 105, with arrows indicating essentials of this 75-horsepower ship (top). Federal inspector examining a Cub just before it leaves factory (center). Aeronca seaplane powered with 65-horsepower engine

Continental
medium-priced automobile, if both are operated over comparable distances. Then the saving in time on long trips is an extra dividend accruing to the owner of the plane, because he encounters no traffic and no speed limitations.

Costs of flying and maintaining a plane of the Piper "Cub" type, powered by a forty-horsepower engine and capable of cruising at seventy-five miles per hour, may be figured like this, for 10,000 miles in the air the first year: Depreciation, \$107.25; gasoline, \$100; oil, \$7.20; hangar,



plane is to be used. Storing your ship in a city airport hangar will cost ten to fifteen dollars per month, but near a small town the cost is less, perhaps five dollars per month. Some owners simply store their ships under a shed in a pasture, while others stake them in an open field. One recommended plan is for the purchaser of a lightweight plane to buy a storage shed, paying nine or ten dollars per month until the purchase is completed, so that hangar expense will be eliminated in a short time.

Maintenance is another item that may vary, but it should not amount to more than sixty dollars for the first 300 hours, or about 22,000 miles of flying. The Civil Aeronautics Authority requires inspection every 100 hours of flying. Any repairs found necessary must be done before the plane takes the air again. Usually the third checkup reveals a condition requiring an expenditure of thirty to fifty dollars for labor and parts, although some planes have been operated 1,000 hours before a major repair job became necessary. Lightweight planes and their engines are so well constructed that they can be operated into the hundreds of

(Continued to page 146A)

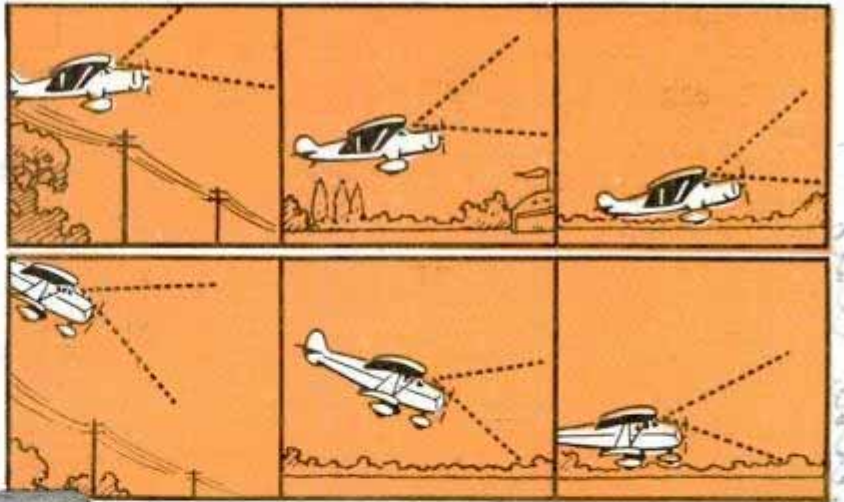
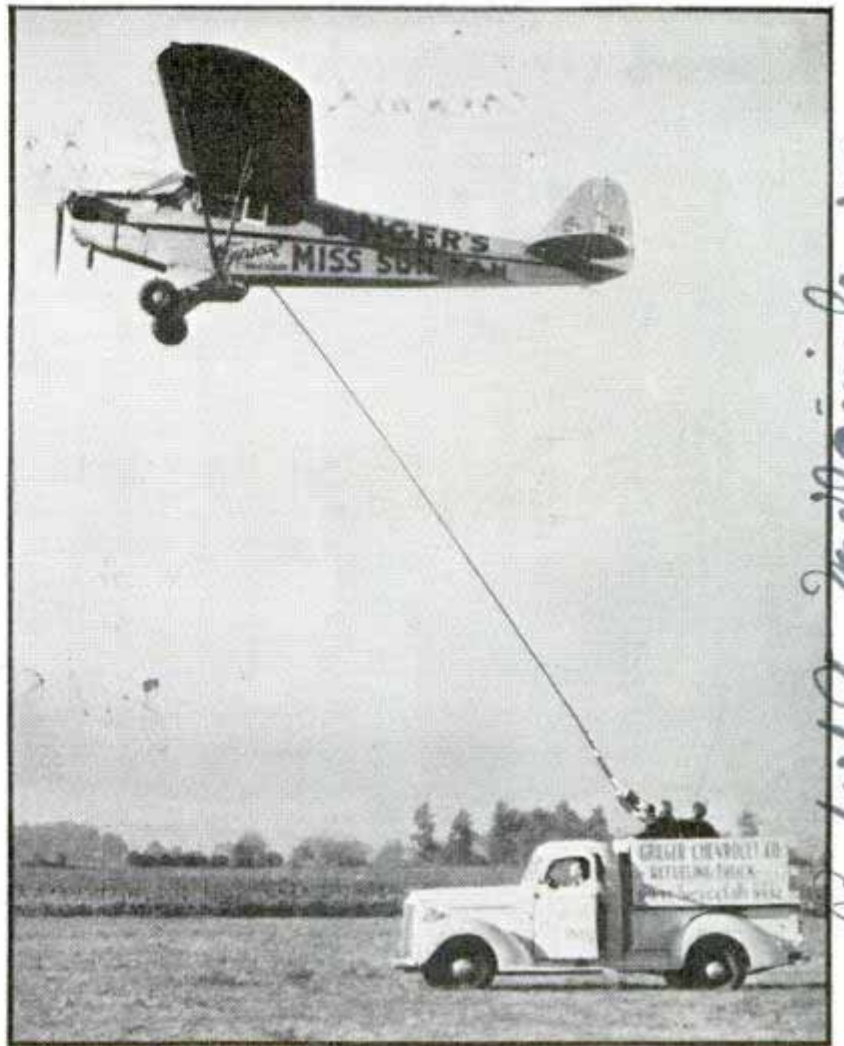

Refueling fifty-five horsepower Cub in midst of its record endurance flight of 535 hours 49 minutes (top); sketch showing difference between landing with standard gear (upper panel) and with tricycle gear (lower panel). Bottom, Waco "N" coming in to land. Note tricycle gear

Robert A. McDaniel
 Marvin J. Baxter
 Murray
 Club

Waco Aircraft Co
 1700 Blvd

"Ear Mask" Guards Welder from Flying Sparks



Metal screen in ear guard shuts out flying sparks from welding but does not interfere with hearing

Since flying sparks are dangerous to the ears as well as to the eyes, an ear guard for welders has been put on the market. Made of sponge rubber, the ear guards weigh only two ounces. A metal screen guards the opening of the ear.

Six-Cup Tray of Ice "Cones" Serves One at a Time

Ice in the form of truncated cones instead of the usual cubes can be frozen in a six-cup rack for the household refrigerator. Each cup is covered to keep out odors, and a projection inside each cover grips the ice cone and removes it without the



The housewife can remove one cone of ice at a time from its cup without melting the entire tray

necessity of thawing. Thus individual cones may be removed without disturbing a trayful. Freezing is rapid because of the large area in contact with the cold air.

Tire Has One White Sidewall While Other Is Black

Automobile tires with the outer sidewall white and the inner wall black are introduced this year as a money-saver for those who like the dressy white tires. Less expensive than the tires with two white sides, the black-and-white tires can be turned about when the white face becomes soiled, exposing the conventional black surface. Because of the tendency of dirt and grease to collect on the inner side of the tire, the double-white tires could not be reversed.

Milled Slots in Nose of Pliers Help Remove Snap Rings

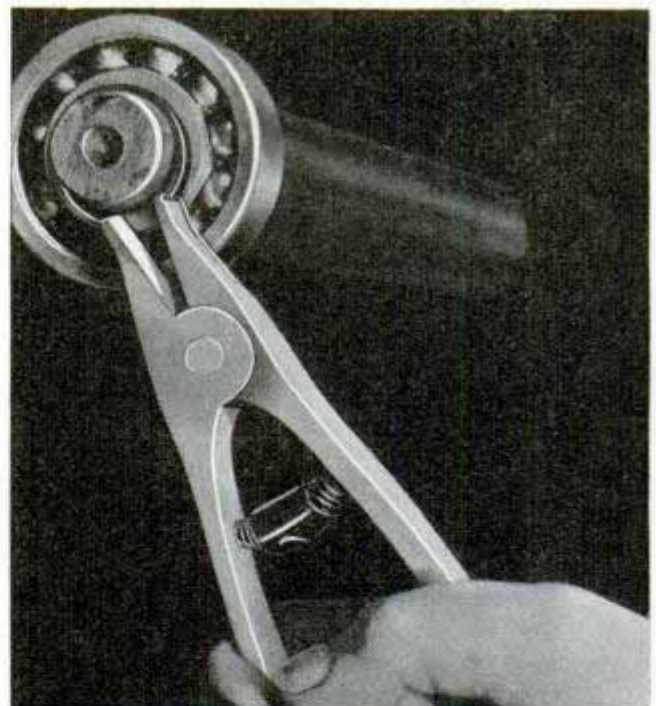

Pliers inserted at split section of snap ring force it to spread open for quick and easy removal

Snap rings used for retaining bearings and gears in trucks and tractors—hard to remove with ordinary tools—can be slipped out easily with special pliers that have two milled slots to engage the ring points and spread them. It takes only a minute for a mechanic to lift out the contracting type rings with the new pliers, which may be purchased separately or in a set including wedges used for removing expanding rings.

Watsona Tools
Watsona, Miss.

Centroid. Inc. 13,000 Athens Ave. Cleveland Ohio

12 4 8 8 Hope
1276 Los Angeles Calif
12334
1150

W. S. Goodrich Co
Akron Ohio

Engine Balancer Flashes Image of Vibration

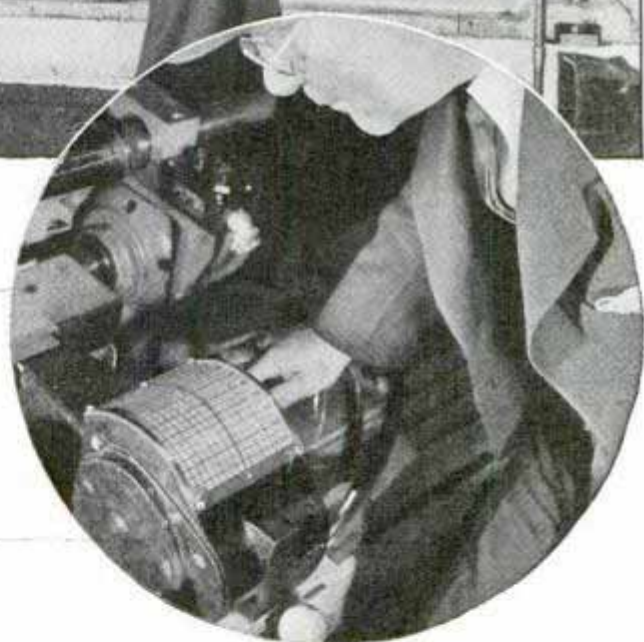
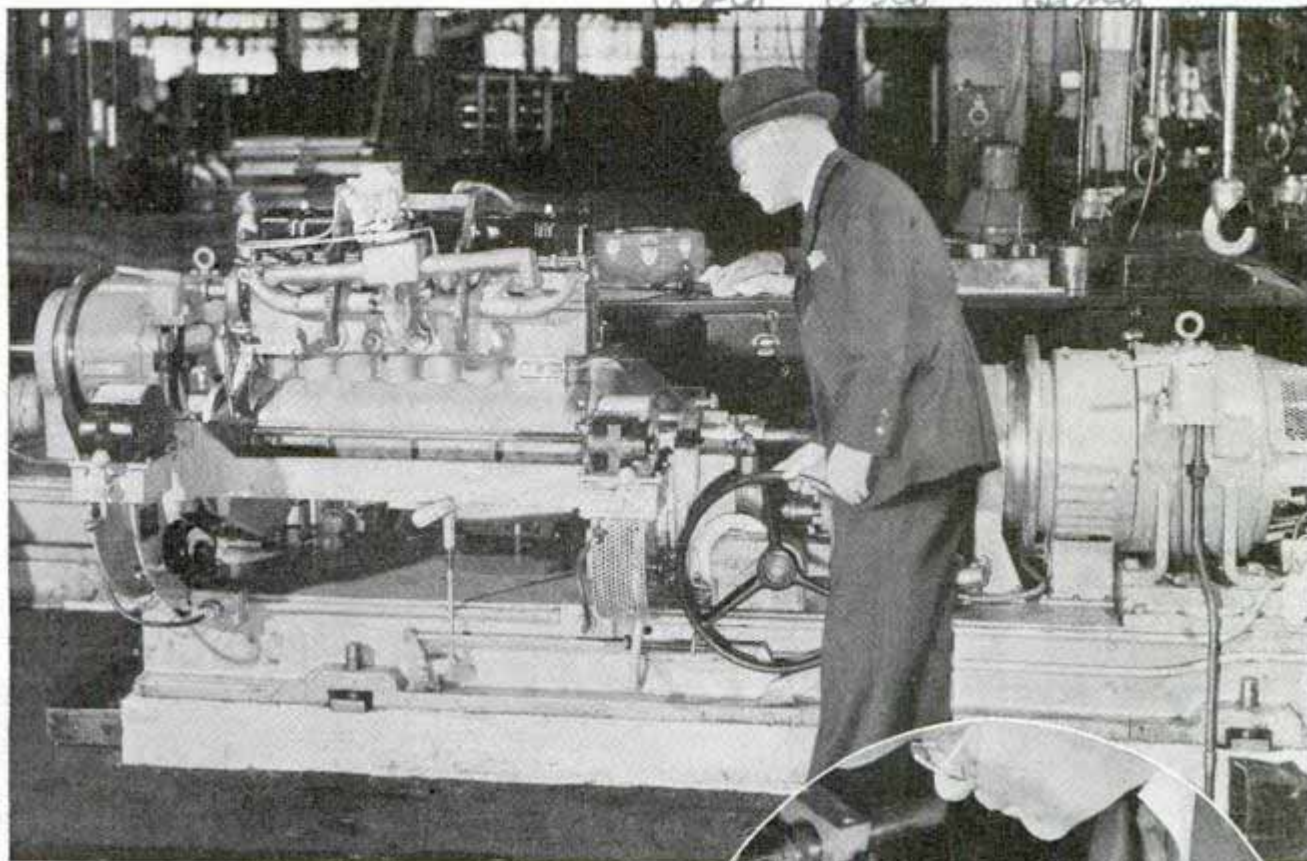

Vibration is detected and its wave image flashed on a screen by a new engine balancing machine now in use at the Buick factory. It does not, however, correct for vibration caused by faulty ignition, carburetion or other uneven firing. The machine consists of a bed for mounting the assembled engine and a fifteen-horsepower electric motor which is used to drive the engine through the speed range where vibration occurs, a vibration indicator whose operation depends upon the projection of a beam of light on a screen to reveal the image of the vibration wave, and an electric drill for drilling the flywheel at the correct location as determined by the vibration indicator, thus restoring the engine's balance. The depth of drilling is determined by the amplitude of the vibra-

Top, engine on testing machine. Circle, examining the vibration indicator during test

tion wave. By means of this machine, an engine may be balanced to within three-eighths inch ounce, which is equivalent to the weight of a dime on the flywheel.

Condenser in Cigarette Holder Filters, Cools and "Dries" the Smoke

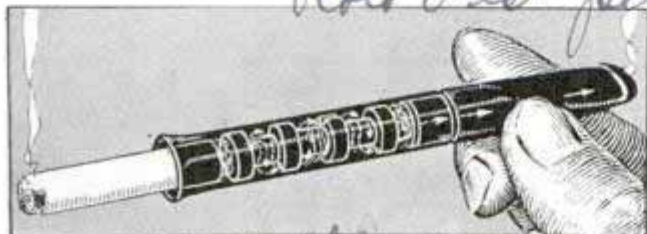

Smoke is given a circuitous course through a patented cigarette holder that acts as a condenser, which does the work of a filter by trapping impurities, while also removing moisture from the smoke and cooling it. The condenser may be removed from the mouthpiece for frequent cleaning.

Ashwood Pipe Co 1343 N St N.W.
 Wash D.C.

2 13 49

UNCLE SAM

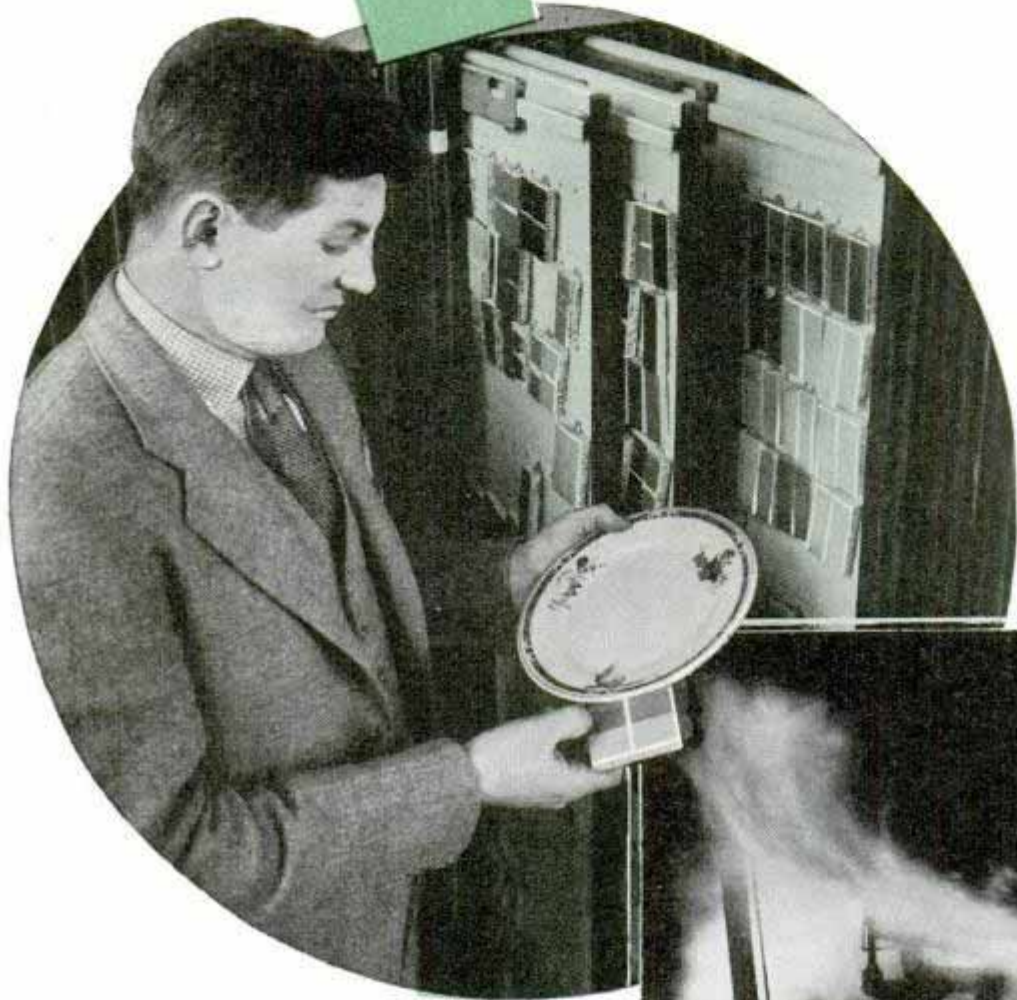

Fired samples of standard colors (top) are kept on file in ceramic color plant of the du Pont company to facilitate matching of any shade submitted. Gas generator blasting directly to the air (center) in process for removing unnecessary gases in production of synthetic ammonia and synthetic alcohol. Steel roller ink grinding machine (bottom) grinding pigments for printing inks

Belle



Wilmington, Del

WHEN newspaper "extras" told of the outbreak of the war in Europe in 1914, few in the United States realized the extent of the threat to industry and employment in this country which was to follow the firing of the first gun.

Last year, guns again roared overseas, but hardly a disturbing ripple was noticed in industry.

Why the difference?

The answer is given by Lamot du Pont, president of E. I. du Pont de Nemours & Company.

"Then, Mr. du Pont says, "numerous industrial activities were dependent upon imports. Employment of millions of our workers was threatened. Even the health of our people was endangered, because the importation of many important medical supplies had been cut off. Conditions bordered on panic.

"Today, in sharp contrast, every im-

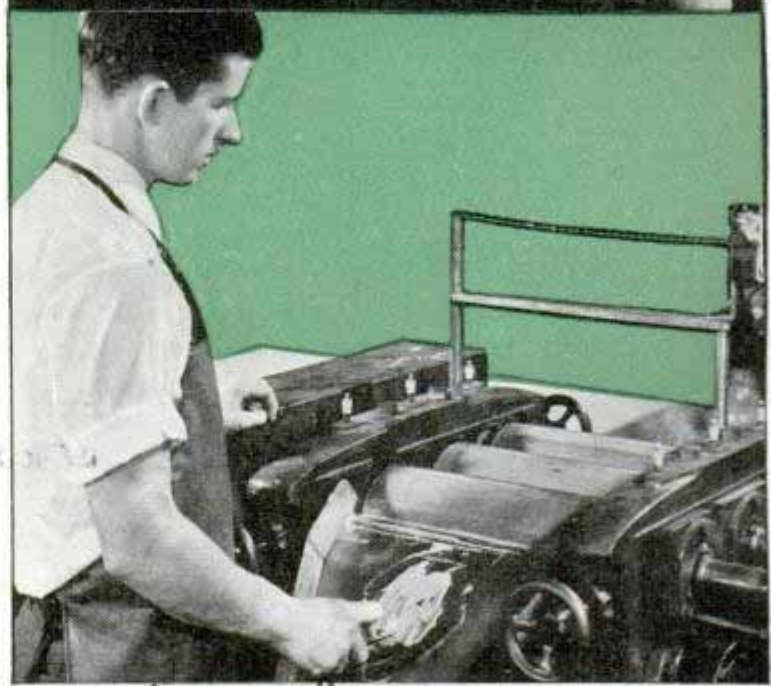

*Technical Laboratory
Lunesville 10/1/49*

g 1349

HELPS HIMSELF

portant American industrial and medicinal need is being filled, and, I am confident, will continue to be filled by American factories on American soil, whatever the emergency stemming from conditions in Europe or elsewhere in the world. This is due in no small degree to the accomplishments of American chemistry achieved during the brief span of two decades.

"This country did not have a single plant in 1914 to extract nitrogen from the air and transform it into the nitrates and other chemicals so vital to agriculture, industry and national defense. Then we were almost completely dependent upon the importation of natural nitrates from Chile. Today, in contrast, America is self-sufficient in nitrogen through chemistry.

"Similarly, the United States produced

(Continued to page 153A)

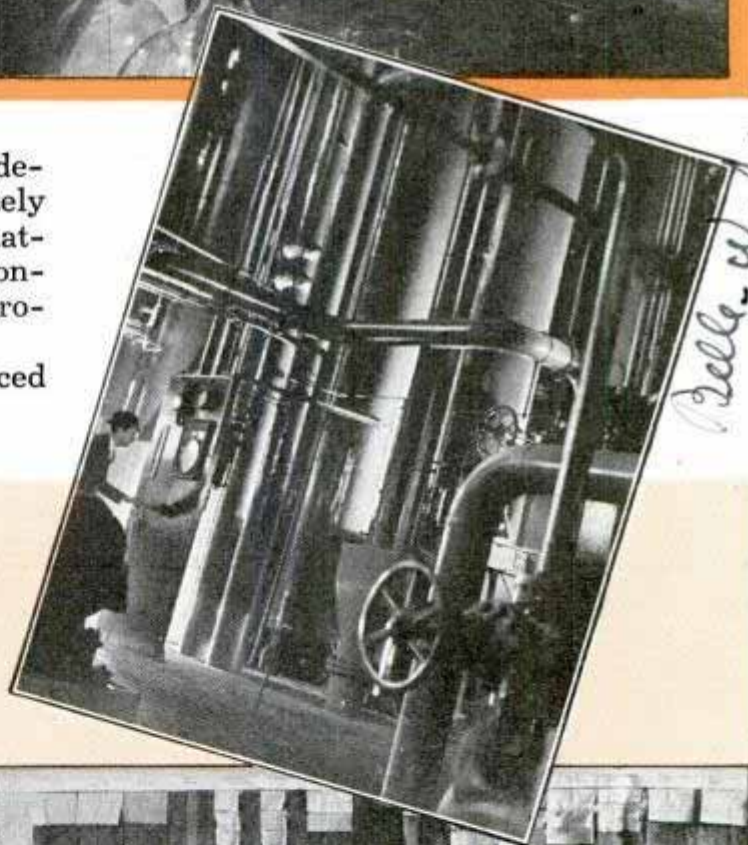

Belle W. A.

Top, bottles of terpeneol, chief constituent of synthetic lilac perfume. Center, equipment used in process by which carbon monoxide reacts with steam to produce carbon dioxide and hydrogen, the latter a component of ammonia and alcohol. Bottom, two dye strips, the upper a fastness test record of vat dye, lower, a direct dye

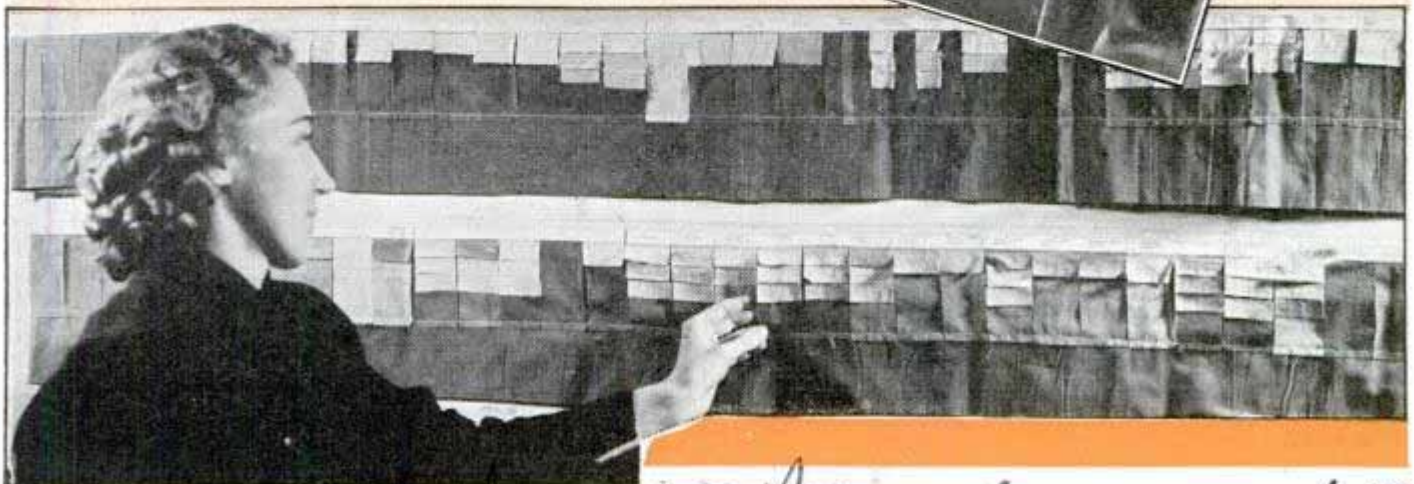

*Technical Laboratory Deepwater
Plymouth Mass. 175*

93 Longacre London W.C.2 England

Three-Man Submarine Makes 1,800-Foot Dive

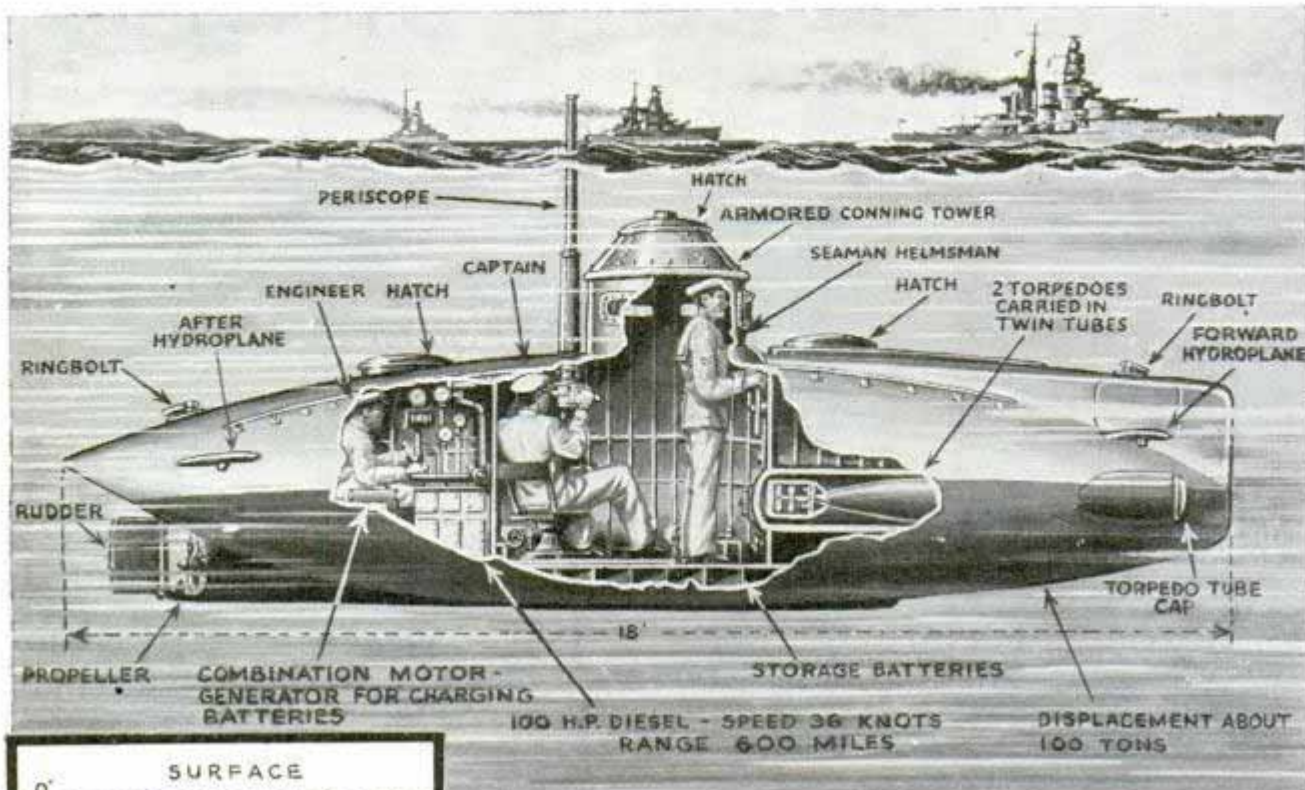

Submarine "mosquitoes" with a powerful sting are reported under construction by Japan. Above is a cut-away view; left, a comparison of size and diving ability with other submarines

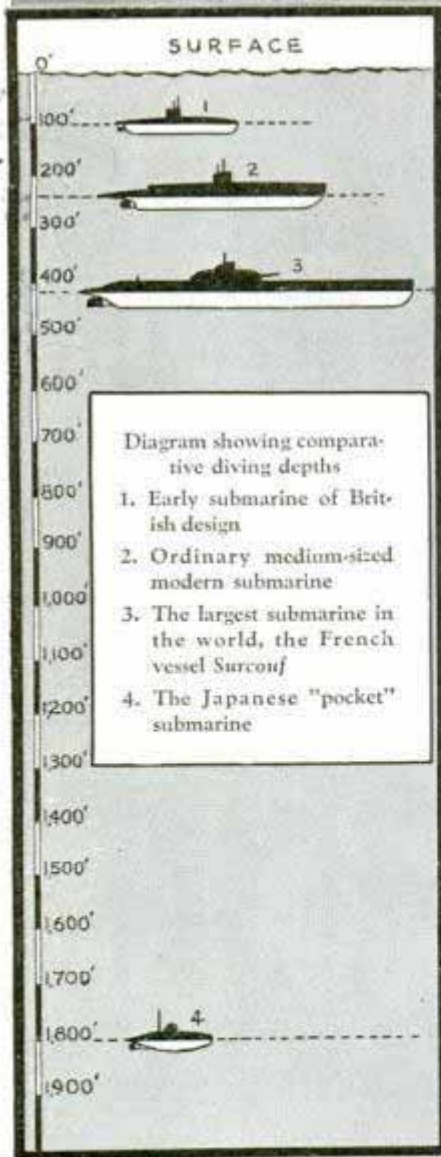

From Germany came the "pocket" battleship, from Japan comes the "pocket" submarine. A fleet of baby submarines that carry a three-man crew and can dive to the amazing depth of 1,800 feet is reported in production in Japan. Only eighteen feet from bow to stern, they are minnows compared with the French navy's 361-foot "Surcouf," world's largest submersible ship. While the conventional submarine may cost from two to four million dollars, Japan's deep-diving babies are understood to cost no more than a high-priced automobile, around \$5,000. They have a displacement of 100 tons, operating on storage batteries submerged, and driven by a 100-horsepower Diesel engine on the surface, with a top speed of around thirty-six knots and a 600-mile cruising range. A dive of 1,800 feet, where the pressure per square inch would be around 800 pounds, is unprecedented in naval annals. The ordinary modern submarine has a bottom of about 300 feet, and the French "Surcouf" is understood to be capable of plunging 400 feet. The pocket submarine carries two torpedoes. Its captain is stationed amidship at the periscope, the engineer sits aft and the helmsman stands forward at his wheel, watching through narrow window slots beneath the armored conning tower.

ⓂDull orange-colored highways built experimentally in the Channel Islands reduced road glare about forty per cent and cut down the accident rate.

Completed Aug. 1939

J. W. Carr, Thomas & Sumner, Jr.
196/8 Malibu Road
Pacific Palisades
Calif

WINNING RACES *in the* PITS



Testing tire and wheel (circle) results in balanced running gear. Below, hood of rear en-



Officials keep an eye on the race (top). These are members of the contest board. Left, Rex Mays at the wheel of a speedster entered in recent race. Note instrument panel

969
 Public Relations Dept.
 Indianapolis Motor Speedway
 444 N. Capitol av. Indianapolis Ind
 Edlund

FAR down the stretch the race driver lifts his foot from the throttle and the car's exhaust stacks flame and sob as he goes into the turn and out of sight. Then there is a sharp staccato crash. It sounds like the car has hit the concrete retaining wall but it is only the noise of the exhaust as the driver tips the throttle momentarily for more speed.

In front of the grandstand a member of his pit crew rapidly compares gasoline capacity with the mileage run and raises a hand. "Pull him in for more fuel," he shouts above the constant roar of the other cars. One of the men chalks "Gas 2 Laps" on the black-

board. By now the car is entering the stretch again and the pit crew holds up the board. The driver acknowledges the message with upturned hand, then points back at the right rear tire. He'll want a tire change when he stops.

Two more laps and the driver slides toward the pit apron, still going seventy miles per hour as he approaches. The brakes stop him and three men dive over the pit wall, one with the fuel hose, one with the wheel jack, and the third with a new wheel and tire. The driver tears off his goggles, reaches for a bottle of water, and slumps back in his seat for a few seconds' rest. That's all he gets before the gas tank is full, the new tire mounted, the dirt and pulverized rubber scrubbed from the windshield, and a clean pair of goggles has been passed to him. Then he is under way again.



2769 199
Starting the mighty racing engines is usually accomplished with the aid of some outside power plant, such as the cart containing air supply and air motor which pit crew is shown wheeling up to the starting line (above) beside the car

Hurting down the stretch the speedsters flash by the spectators and head into the south turn in a group (right), thrilling the thousands upon thousands of racing fans who gather each Memorial Day for the annual renewal of the Indianapolis Speedway classic





8679
180
Unsung heroes are these members of the pit crews, shown at work during the big race. Note blackboard with figures notifying driver that his last lap was run at 118 miles per hour. The pit crews keep a careful check on their entry in order to warn driver when he should come in for fuel or tires

Robert

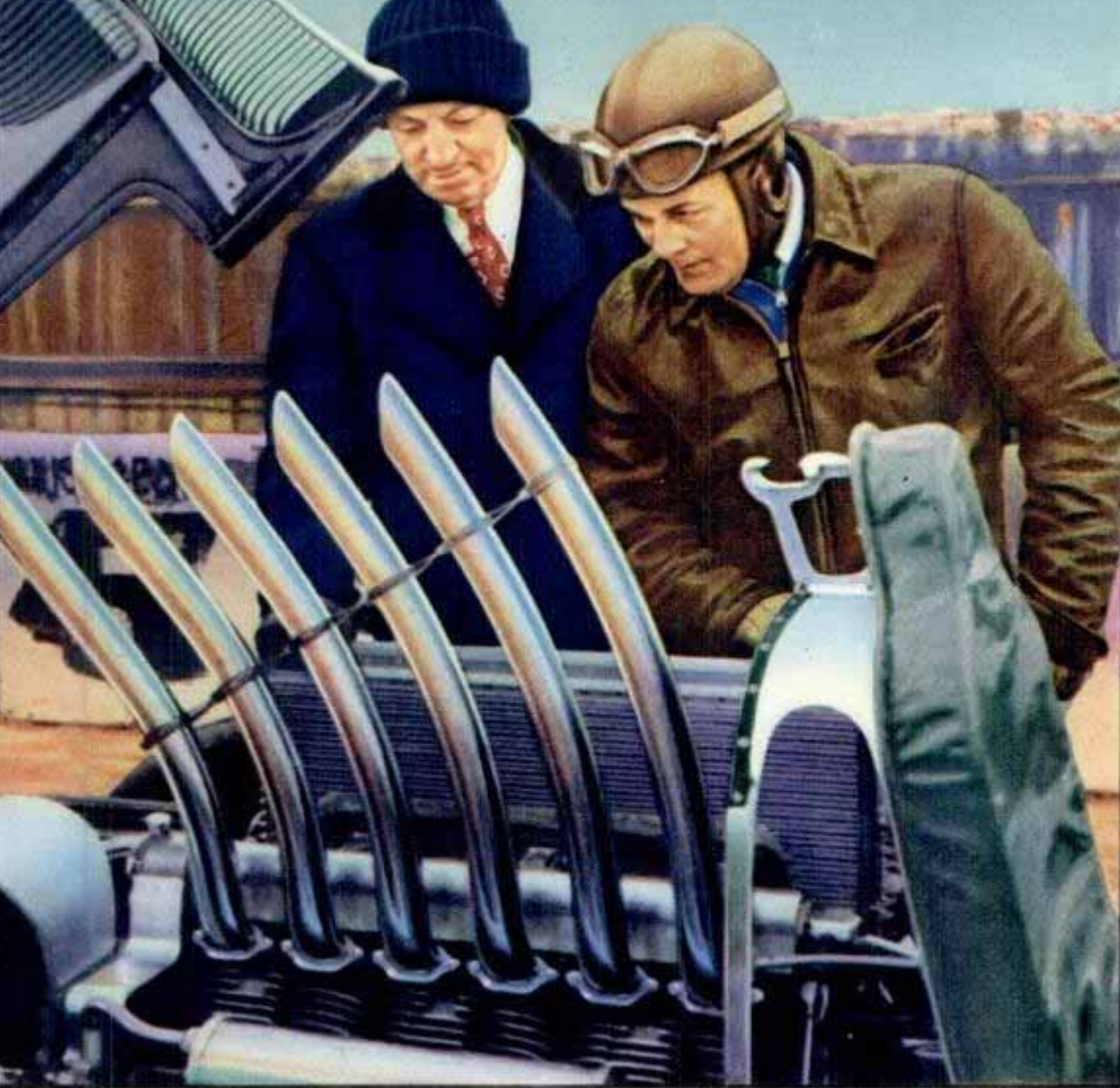

181 2679
 Checking the motor of the Indianapolis racing cars never seems to be finished. Above, Harry Miller and George Bailey make a final inspection. Right, flags used by track officials to control all movement of the cars, from the starting signal shown at top to the checkered finish flag at the bottom

Box 2038, Pittsburgh Pa

A few feet down the line another car draws hastily up to its pit and the crew swarms around it. The driver hops out, his right foot dripping with black oil, and he wipes it from his clothes with a handful of waste while one mechanic sops up the pool in the cockpit and another tightens a connection on the oil line. From in front of another pit a car that stopped ten minutes ago and that won't start again is being pushed back to its garage.

We are in the pits of the Indianapolis speedway on Memorial Day and right now the annual 500-mile race classic is half over. Eight of the thirty-three cars that lined up at the start are out of the race already. One \$20,000 creation that stood a good chance of winning has lost out because of a faulty valve lock that cost no more than a dime. Another car that was a likely winner is in the pits permanently because the mechanics, in making a final inspection the night before, somehow got the drive shaft an eighth of an inch out of line. Al Miller and Russell Snowberger are stopped with broken radiators and Shorty Cantlon has a broken oil line.

Before the race is over every car will have made at least one pit stop and most of them will have been in the pits three or four times for motor adjustments and tires. The leaders are averaging 120 miles per hour, a pace that is bound to leave a trail of



STARTING SIGNAL and CLEAR COURSE

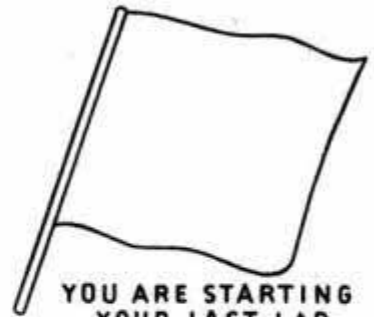

YOU ARE STARTING YOUR LAST LAP



DRIVE WITH CAUTION MAINTAIN POSITION



STOP FOR CONSULTATION



CAR ATTEMPTING TO PASS



STOP RACE IS HALTED



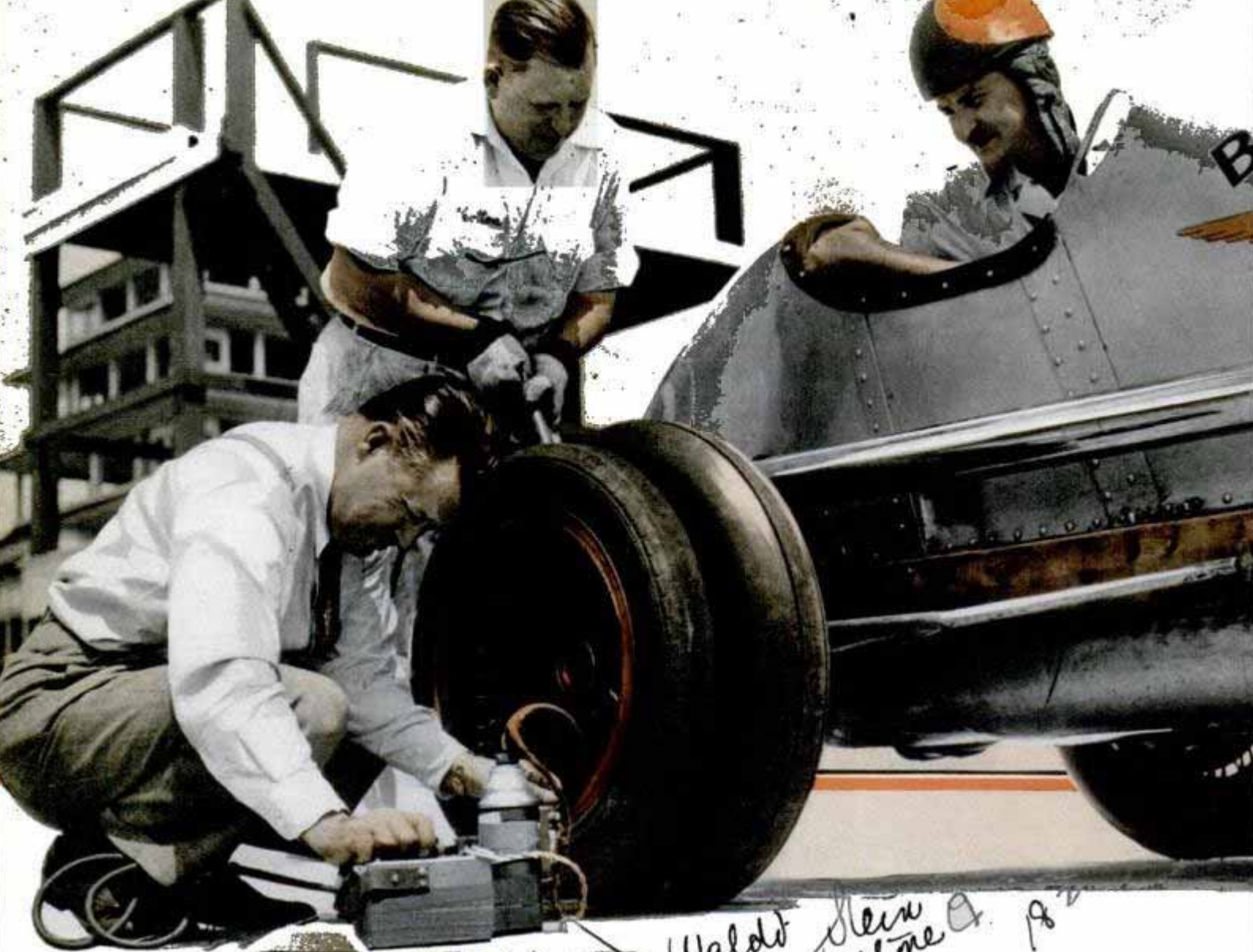

Walden Steer
Firestone 9. 1911

8679

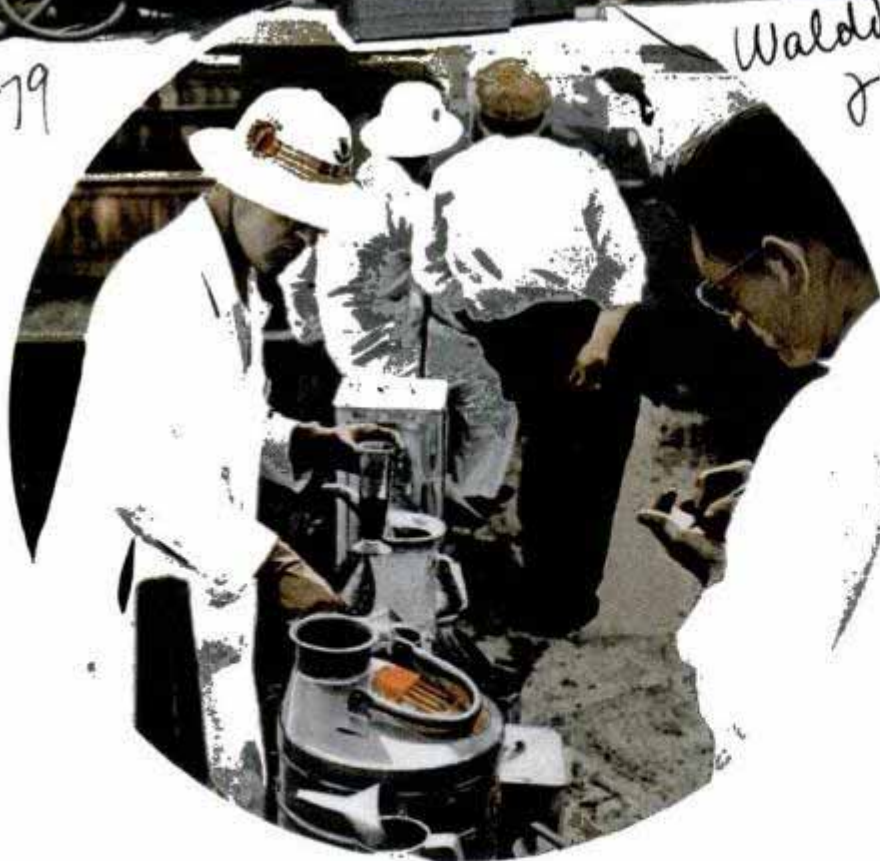

mechanical trouble. The winner this year could finish the race, drive to the next state and have lunch and return to the track in time to watch the finish of the race held in 1911, so much faster is he going.

During most of the race the mechanics have little to do except enjoy the spectacle, keep track of their driver's position and watch him for messages as he drones by. If he points to his mouth he may mean that his engine is running hot; pointing at his chest is the signal that he wants a relief driver. Holding up three fingers tells the pit crew that at least one cylinder is cutting out, and pointing to a tire warns the crew that he is preparing to stop for a tire change. Seven men are allowed in

Tires must be checked for the driver's safety as well as to insure proper inflation for high speed (top). Fuel technician compounding racing fuel from gasoline, tetraethyl of lead and other ingredients (circle)

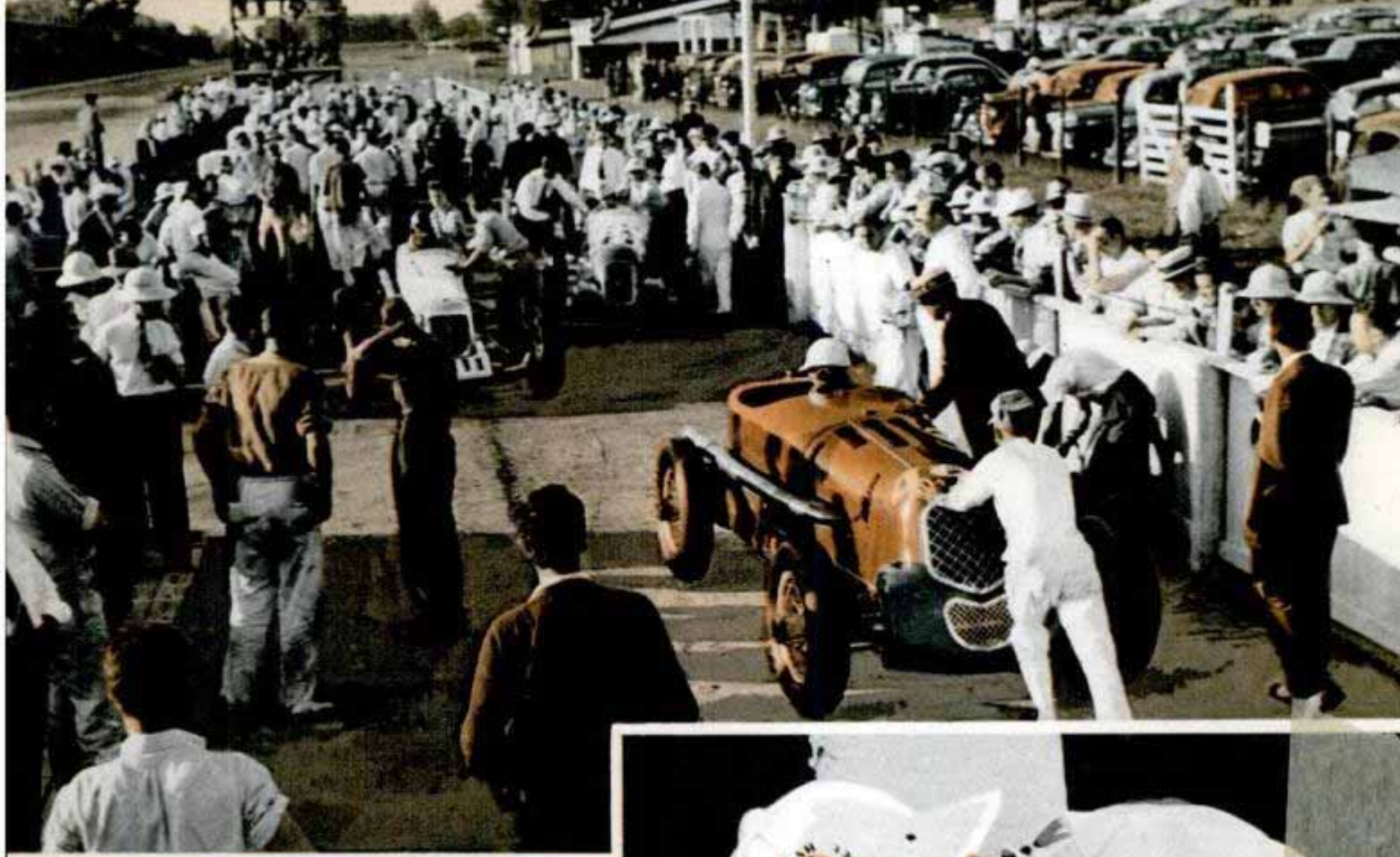

each pit and each is trained for his special job when the car pulls in. Four men are allowed on the track and the other three stay in the pit to pass the needed supplies. The materials in each pit include five extra tires and wheels, five sets of spark plugs, complete sets of tools and socket wrenches, extra goggles and a helmet, four fire extinguishers, fifteen pounds of rags, a blackboard and three pounds of chalk, a quick-action wheel jack and maul, and extra magnetos and other engine parts as well as gasoline, motor oil, and water.

No two fuels in the thirty-three pits are alike. Harry Miller, dean of American race-car builders, uses stock premium gasoline such as can be bought at any service station, but most of the other entries are powered with special high-test fuels ranging from secret mixtures to leaded gasolines having octane ratings as high as 130.

In the pits the odor of scorched rubber that has been torn off the tires by the track is strong and a driver rarely finishes without at least replacing his right rear tire. Each tire and wheel is balanced dynamically as a unit before the race

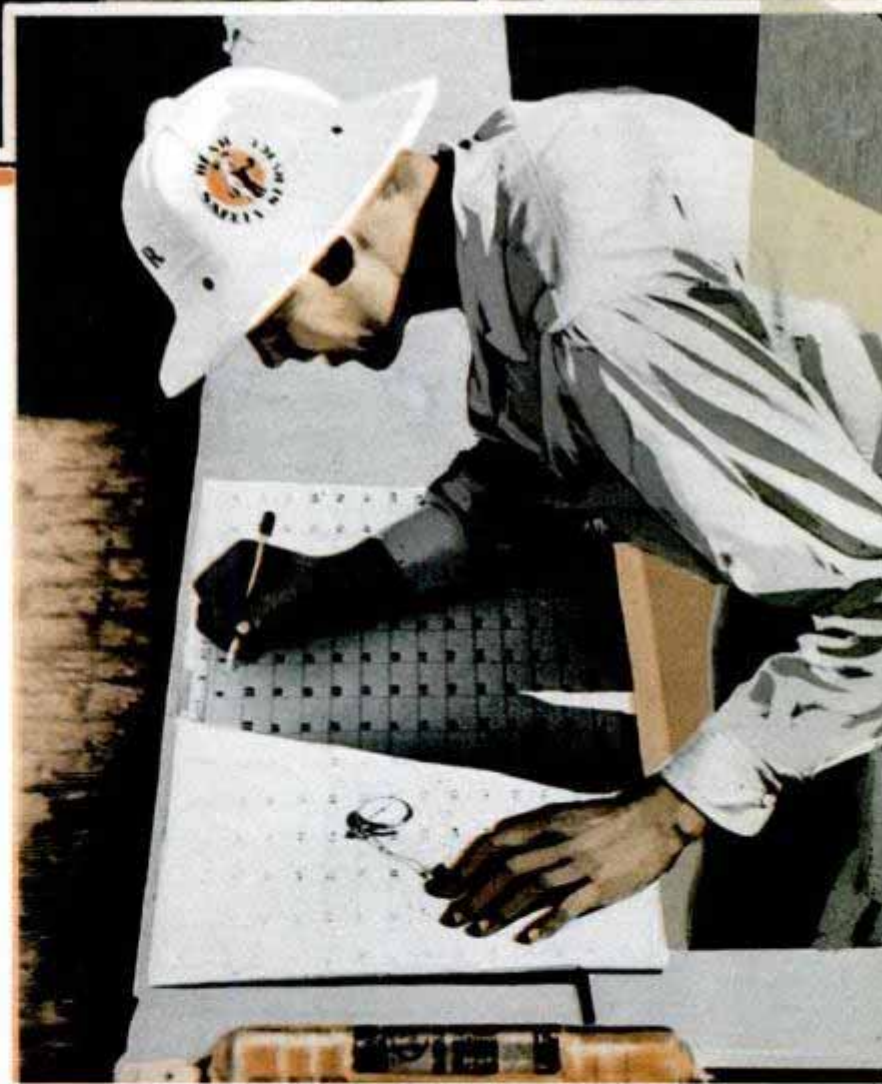

187
Zero hour for the big event finally arrives (top) and the pit mechanics push the cars to the starting line. Below, member of pit crew bending over chart on the pit wall. Speed of each car is clocked with stop watches and the time recorded, thus enabling each crew to have complete data on performance under varying conditions



Efficiency of pit crew is demonstrated as car makes a stop (top). Tony Gulotta gets the checkered flag (below) marking completion of his qualifying run in recent contest

2679

184

and the tubes are filled with nitrogen, this gas being non-explosive and less expansive than air.

For the mechanics the battle for speed really begins when the cars are first wheeled out for test laps, as much as a month before race day. Each pit crew has the job of finding the exact combination of adjustments and clearances that will develop the greatest power in their engine. Wise as they are, it still may take trial after trial before they

find the best combination. One crew tried everything their minds could think of to get their motor to turn up faster than 5,200 revolutions per minute. Finally they started experimenting with the fuel. Just a slight change in the proportions of alcohol, benzol, and leaded gasoline that they were using did the trick and on the next test lap the driver reported that the engine turned as high as 7,200 revolutions per minute.

(Continued on page 128-A)



'Ski-Cycle' and 'Ice Bike' Offer Winter Thrills



Left, "ice bike" pedaled at fast clip over ice provides something new in winter sport thrills. Below is another bikelike vehicle using skis instead of wheels which may be steered to avoid obstacles on snow-covered hills

Two adaptations of the ski and bicycle are offering speed and thrills to winter sport fans in Europe. One, called the "ski-cycle," consists of a frame mounted on three ski runners, upon which the rider sits as he would on a bicycle. The other is an "ice bike," having a runner in front and a wheel at the rear which is driven by pedals.



Freddie Chapman Brighton Englore

no further data

Side-Vision Tester Is Latest Aid in the War on Accidents

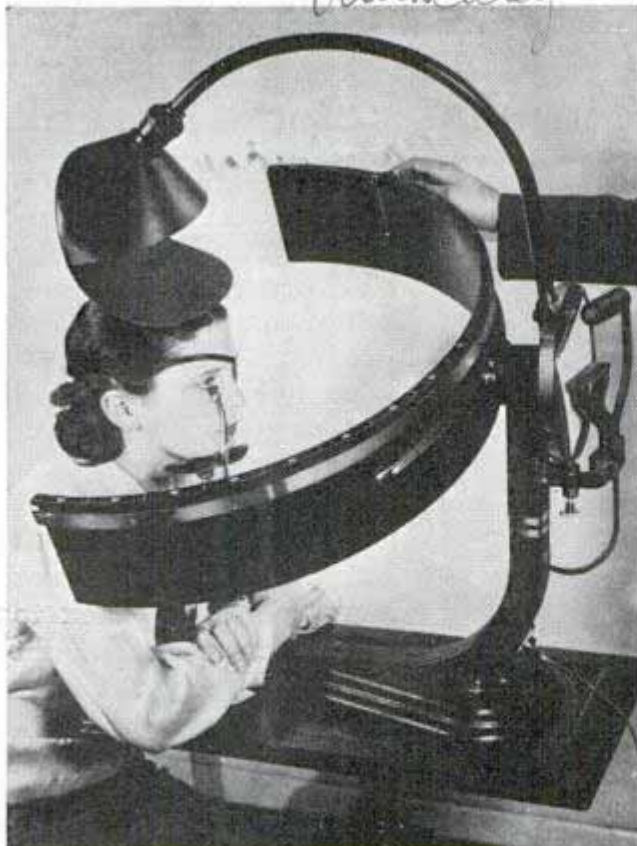

Your eyes, if they are normal, should be able to detect a moving object at an angle of ninety degrees while looking directly ahead, since the outer regions of the retina are extremely sensitive to motion. For measuring accurately the extent of side vision, a perimeter has been developed by American Optical company. The subject, with one eye masked, looks steadily at a point in the middle of the instrument. Then colored objects are moved along the inside of the semi-circular frame which is divided into 180 degrees, and the points at which they can be distinguished indicate the boundaries of his field of vision for the different colors. For normal persons the field is widest for white, then follow blue, red and green in that order. Anyone who fails in the test is advised to visit his doctor because faulty side vision frequently is a cause of traffic accidents.

Perimeter shows patient how far to side she can see moving object while eye is focused directly ahead

ⓂA German newspaper recently printed an edition on paper made from potato leaves and stems, developed experimentally in a search for wood-pulp substitutes.

American Optical Co. Southbridge, Mass

no data

21323
D.W. J. Plator

Rails Laid in Sections to Speed Track Building

Sanford 723.7.4.11
new one

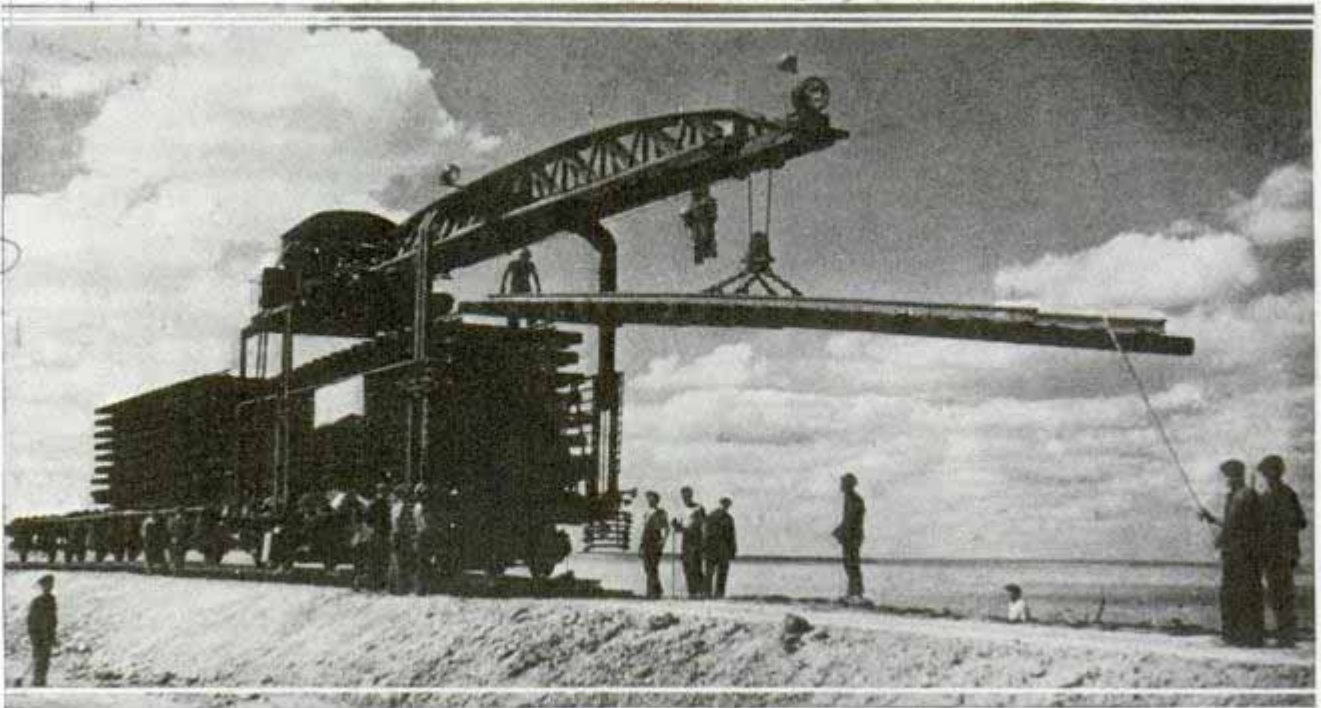

Complete track section, consisting of rails and ties pre-assembled at factory, being placed on prepared roadbed by mobile crane in Russia where railroads are laid in feverish haste

Laying standard length sections of pre-fabricated track, which are carried to the roadbed on flatcars, is one of the methods used in hastening the building of railroads in the Soviet union. Rails can be spiked to the ties faster in shops than on the road, and handling of much material is elimi-

nated. A powerful crane of the track-laying machine picks up a section and swings it out in front of the car where it is guided into place on the prepared roadbed. After the crew has made it fast to the preceding section, the track layer advances upon the new track to put down the next section.

Sun's Heat for Warming Home in Winter Stored in Tank

13/16

Heat and energy from the sun, trapped in the roof and stored in a basement tank for

future use, will warm an experimental house constructed at Massachusetts Institute of Technology for

Cambridge, Mas

Prof. Royl C. Bottel
Dept. of Chemical Engineering



Heat trap under glass roof causes sun's rays to heat water which is then stored in basement tank for use in warming home during cold weather

studying various uses of solar heat, including winter house heating, summer air conditioning and power generation. In a recess on the roof is a shallow, boxlike "heat trap," the bottom of which consists of a thin sheet of metal painted black to absorb the utmost amount of solar energy. Under this is a series of thin-walled metal tubes, which heat water circulating through them by their contact with the sheet. Several panes of glass

... ..
... ..

covering the box let in the sunlight, but prevent heat from escaping, while mineral wool under the tubes keeps heat from slipping out in that direction. The heated water passes through insulated pipes to a large storage tank so well insulated that it will keep water hot from a few weeks to half a year, depending upon the tank's size. To use this heat for warming the home, a system of forced circulation passes air through ducts that have one wall on the hot side of the tank. A small sunlight collector on the roof can be used for storing heat all summer in a tank large enough to hold an entire winter's supply of heat; or a collector large enough to heat the house directly might be used.

* 1296.

Alcohol Changes Iron to Steel in Glass-Tube "Furnace"

Under the influence of alcohol, iron changes to steel. Westinghouse engineers recently paraded on a screen the antics of a thin iron wire as it became hard steel when heated in an eighteen-inch glass tube filled with alcohol vapor. Electrodes entered the tube through plugs at either end, and hydrogen gas bubbled through methanol alcohol into the tube. As the wire heated, the reaction of the alcohol with the surface of the wire caused carbon to leave the alcohol and enter the wire, saturating it and hardening the wire as it cooled.



Image of iron wire tube is seen on screen as it changes to steel under influence of heat and alcohol

Research metallurgist

Boat Folds Up Like Trailer for Towing on Land



Forming its own trailer when towed on land, above, metal boat is unfolded when it reaches water

Hinged in the center so the stern folds upward to form a closed body, a fourteen-foot motorboat can be converted into a trailer within one minute. With airtight compartments fore and aft, and air space beneath the flooring, the 185-pound craft is non-sinkable and may be fitted with an outboard motor. A seal is created at sides and bottom of the two joining sections, by locking with levers the wedge-shaped edge of one section into a rubber-lined V-slot comprising the opposite edge. Two springs and a pair of levers make it possible to lower the boat while the trailer is backed into the water, and the operation is reversed to lift it out. The boat-trailer and its carriage weigh about 500 pounds.

Dr. J. R. Smith, 3.2.25 - 26th Ave. Sacramento, Calif.

90 11 11

Reference: Dr. James Watson
Astronomy Magazine, July 1958



Left, part of north horseshoe bearing of telescope. It weighs 156 tons. Circle, mapping areas to be explored with giant telescope. Below, small telescope with 200-inch dome in background

Schmidt camera

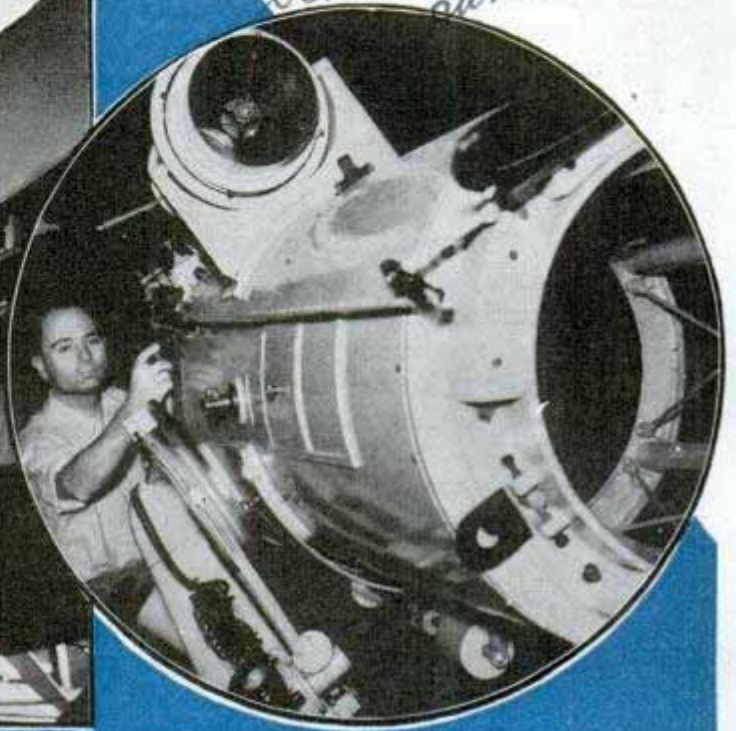

The BIG EYE

BUSY exploring distant corners of the universe, astronomers are taking time out to watch construction of their mightiest instrument, the 200-inch telescope being assembled by the California Institute of Technology on Palomar mountain in southern California. At first scheduled for completion this winter, the new observatory may not be in operation for another year and a half because of the time being taken to improve the original plans.

The huge fourteen-story-high dome has been finished, and work on the telescope is practically complete. Work still to be done consists mainly of the final polishing of the great mirror and completion and mounting of the other optical elements of the telescope.

Palomar's instrument has been called the world's greatest eye, a gigantic spy-glass that will bring unknown reaches of the universe within range of observation

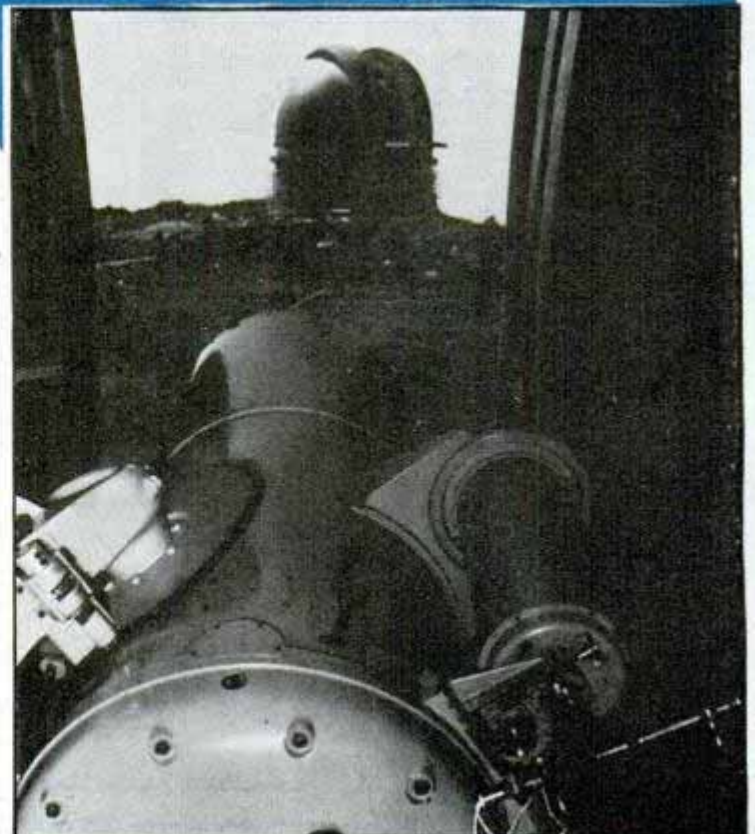
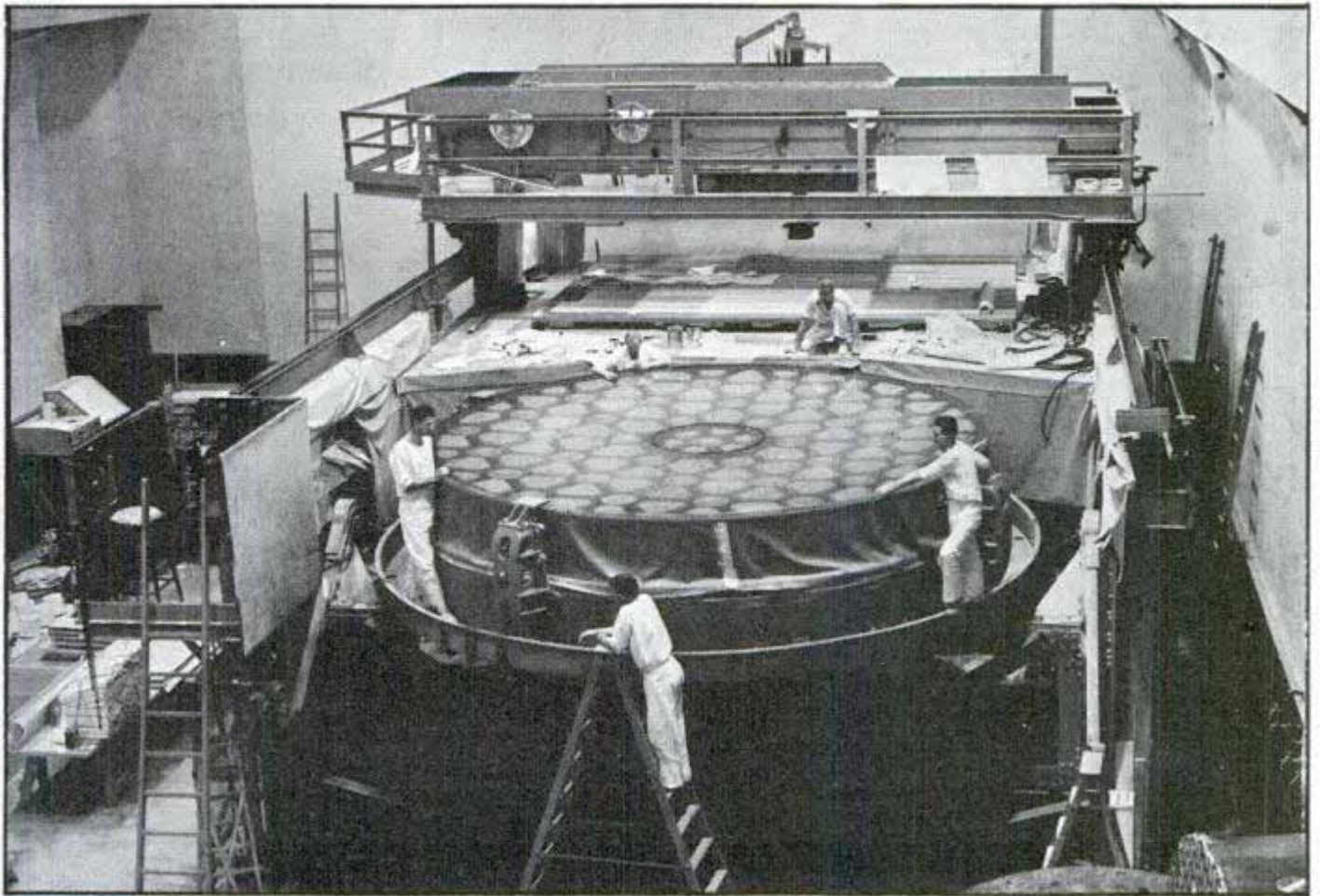
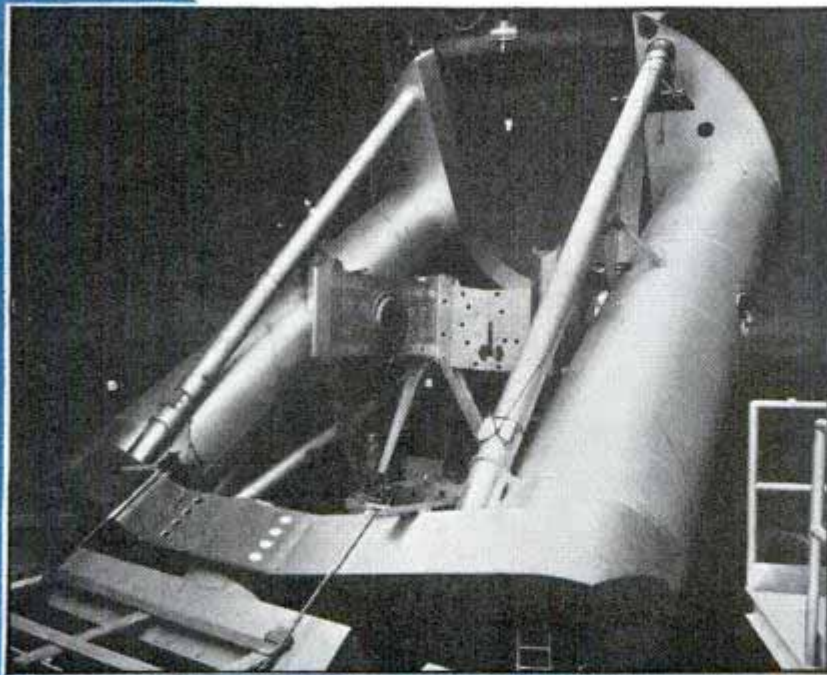

Photo courtesy T. V. Waterson



TAKES SHAPE



Top, 200-inch mirror on bed of grinding machine; white patches seen through clear glass are indentations in bottom which will rest on mirror supports. Bottom, steel yoke to support barrel of telescope; note size of workman in center foreground

and probably solve many of the problems that perplex scientists. It's more than that.

Its construction represents a sort of final examination for most of the physical sciences. If technical knowledge could be asked to tackle one involved problem just to show how capable it is, the construction of this telescope might be the one perfect question to ask it. The hundreds of problems attached to its construction have required the combined brains of the most able men of the world in their fields.

This telescope is so large that you need an elevator to reach its top. Astronomers working at different parts of the apparatus will com-

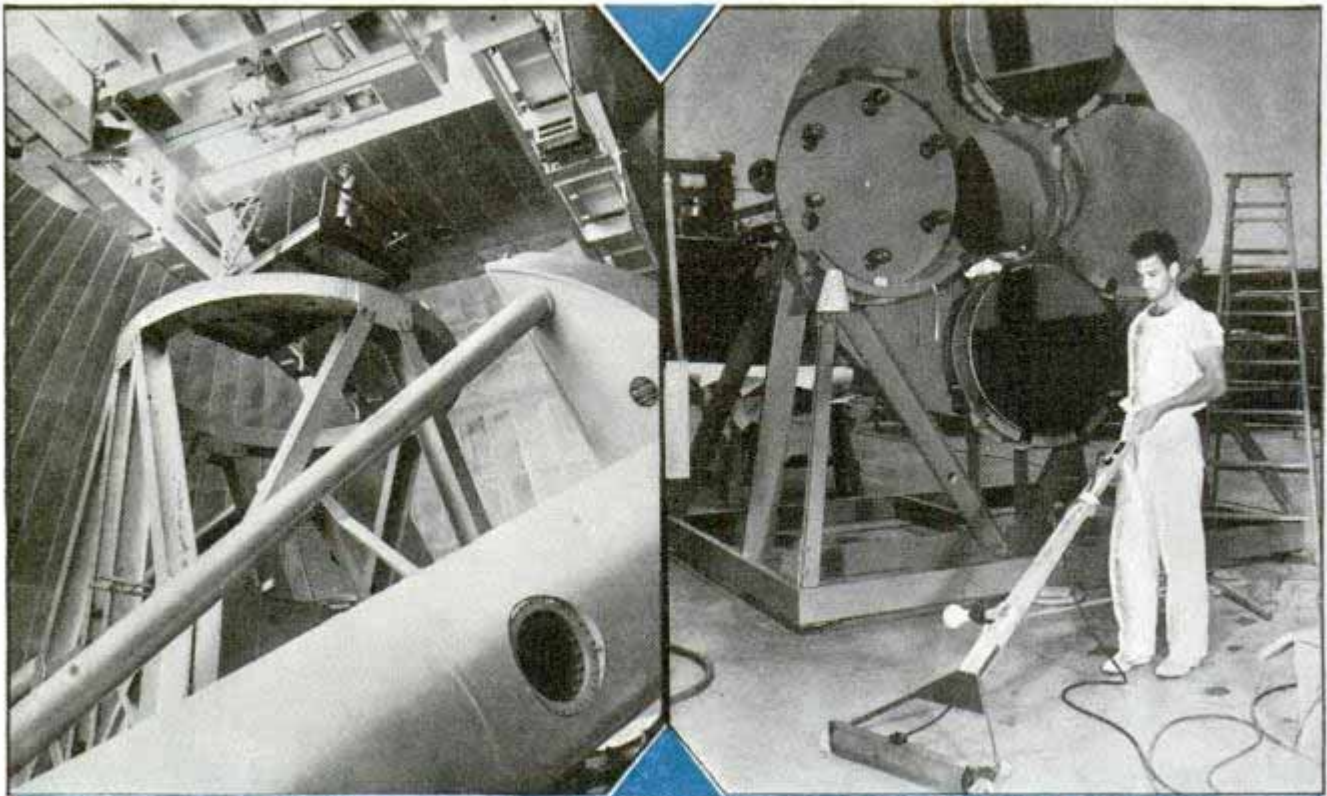

Left, workmen descend from dome to assemble framework of telescope barrel. Right, electromagnetic sweeper picking up metal dust that might scratch mirror; in background, mirrors used to figure optical curves of telescope mirrors. Bottom, attaching pitch facets to grinding tool

municate by telephone. Yet its adjustment has to be so precise that ordinary contraction and expansion might upset its alignment. The dome is doubly insulated with aluminum paint and an inner sheathing of aluminum metal to keep the night and day temperature range within five degrees.

Its moving parts weigh approximately one million pounds, yet the instrument is so delicately balanced that only one-half horsepower is needed to turn it. An ordinary steel structure the size of the telescope would deflect appreciably because of its own weight, yet this instrument is so inflexible that its barrel bends less than eight-hundredths of an inch along its length. Even that amount has to be compensated for.

Glass is one of the most inflexible materials known, yet in some positions the big mirror, more than sixteen feet across, would normally bend one or two ten-thousandths of an inch

from its own weight. A microscope would be needed to measure this deflection but it would be enough to make the mirror worthless. The astronomers have had to arrange an intricate support system to keep the mirror perfectly rigid. Instead of resting flat on its steel bed it is to be attached to its bed by thirty-six supports that consist of lever and counterbalance arrangements.

The light from dim stars is so weak that photographic film must be exposed for hours before satisfactory records are obtained. Make an all-night exposure of the heavens with your own camera and you get star trails that extend from horizon to horizon. The goal of astronomers in photographing a star is to record no more than its tiny pin point of light, and to do this they must keep their telescope pointed unwaveringly at the star all through the exposure. The telescope must turn as slowly and

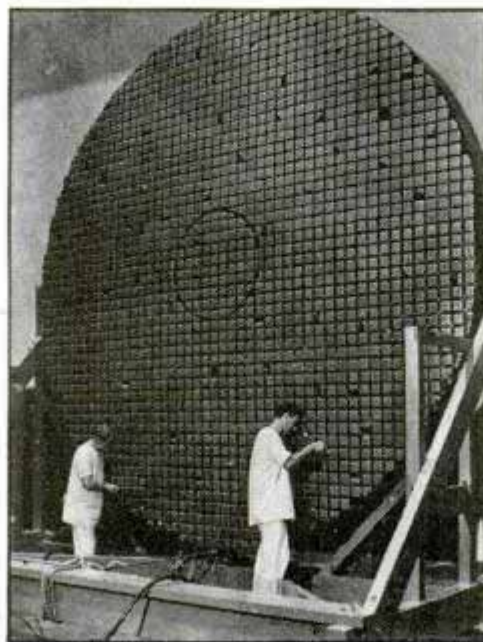

steadily as the earth itself to compensate for the earth's rotation. Its accuracy has to compare with keeping a rifle aimed exactly at a twenty-five cent piece rolling along the ground three miles away. To provide this steadiness the telescope is being floated on a film of oil. It is to be driven by giant gears cut to the precision of those of a fine watch.

Even these precautions are not enough to hold the image of a star stationary on a photographic film. Atmospheric refraction alters the apparent position of a star and the influence of refraction changes as the star's position above the horizon changes. Variations in the weather also influence refraction.

The result is that in today's large telescopes a star appears to jiggle and sway slowly when examined through the sighting eyepiece. While making an exposure the astronomer has to keep guiding his film holder up and down or sideways to minimize these motions. No human is capable of doing the job perfectly, so at Palomar the work is being turned over to complicated sets of electrical brains that will automatically compensate for every variable and will guide the telescope on a course that holds the star still.

Because weather affects the refraction of a star, a complete weather reporting station has been built adjacent to the observatory. At the telescope an attendant turns a group of pointers to the temperature, barometer, humidity and other settings that correspond to the weather conditions and then presses a button that operates the weather computing machine. This device then automatically modifies the speed of the telescope's driving motors to compensate for the exact refractive influence of atmospheric conditions.

At the same time that the telescope slowly turns on its bearings to follow a star across the sky the great steel dome under which the telescope is housed, weighing 1,000 tons, likewise turns to permit continuous observation through its shutter opening.

The public will be able to inspect the great telescope at almost any time from a special glass-enclosed visitors' gallery that has been completed inside the dome. The workings of the complex instrument will

(Continued to page 150A)

2 1370
Gas Mask Has Loud Speaker to Amplify Muffled Voice



Speaker and microphone combined with gas mask enables soldier to be heard without removing guard

Gas masks are being equipped with microphones and loud speakers to make it possible for soldiers to give orders and to be heard in ordinary conversation. In many instances the wearing of masks prevents the men from communicating with one another except by signs.

2 1331
Three-Wheel Streamline Skate Has Brake at Heel



By mounting three wheels in line, new enjoyment and possibly more speed have been added to the sport of skating. Brakes are applied by lifting the front part of the skate.

David Dale Forge

Biscuits Are Baked Quickly in Top-of-Table Oven



Hot biscuits are freshly baked eight at a time right on your table with this diminutive electric oven

It requires only seven minutes to produce a batch of biscuits with an electric baker that may be set on the table. The oven takes no more space than the average size waffle iron, yet it will bake eight large biscuits at one time.

Mower with Rotating Disks Cuts All Field Growths

All types of field growth, except trees more than an inch in diameter, can be cut with a mowing machine that uses three

rotating disks. These disks are mounted beneath the machine, and their edges are studded with replaceable triangular cutters that revolve at 4,000 feet per minute when the mowing speed is twenty miles an hour. At this speed fifteen acres can be cut over in an hour. The standard machine cuts a swath seven feet wide, and it is adjustable to shear down to within one-quarter inch for golf courses or to leave a stubble up to eight inches high. It is said to handle anything from palmetto scrub and small bushes to the finest hay or grass, traveling at speeds from one mile per hour in soft soil or thick scrubland to thirty-two miles on level ground. A side delivery rake may be attached for mowing hay, clover or alfalfa.

Dashboard Light Gives Warning When Battery Needs Water

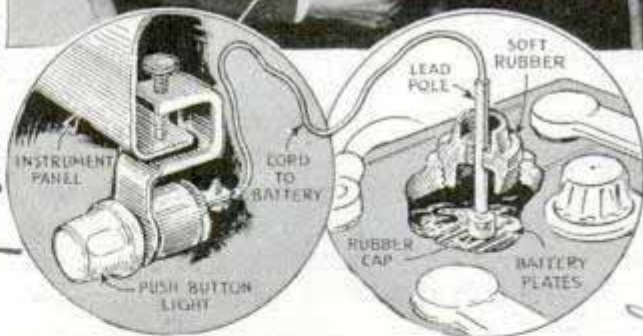

Diagram shows how lead pole is installed in battery to signal water level as dash button is pressed

Motorists can make a frequent check of the water level in the automobile battery with a dashboard connection that tells instantly with a light signal whether water should be added. A rubber cap and lead pole are installed in place of one of the battery plugs, and so long as water touches the pole a circuit to the dashboard light is made. If water falls low enough to endanger the battery, the circuit is broken and the light will not glow when the dash button is pressed.



One of the rotating disks may be seen beneath truck

21313

old chassis

Bishop Machine Shop
Acadia
Florida

Chicago 2909

Sole dist. Franklin Sales Unity Mfg Co.
2909

Forest-Fire Fighters Parachute into Treetops



At left, forest ranger shows how he "bails out" with parachute that can be steered, descending slower than fourteen feet per second. Canvas and sponge-rubber suit and helmet protecting face permit him to land in rough country. Below, parachute comes down in forest and flying fireman lands in tree.



Club.

Flying firemen who drop right into the treetops with specially designed parachutes are to guard western timberlands against the fire menace. Too frequently a small fire breaks out far from road or trail and spreads into a conflagration covering thousands of acres before the Forest Service rangers can reach it. But with airplanes carrying fire fighters and equipment right to the blaze, it can be quelled before it is too big to control. Experiments are being conducted in the Chelan National Forest near Wenatchee, Wash. The fireman goes aloft wearing a canvas and sponge-rubber suit, a "cage" helmet and neck protector, ankle supports and other guards to protect vital parts of the body in the parachute jump over rocky or wooded terrain. Selecting a strategic spot, he first dumps overboard a kit containing shovel, ax, flashlight, matches, two



days' emergency rations and water, map, compass, first-aid kit and perhaps a radio set. The ranger's parachute permits steering and a descent at fourteen feet per second or slower. With his protective garb he can come down safely in a dense forest, using an emergency rope in his coat pocket for descending from treetops if he is snagged in a dangerous spot.

Forest Fire Chief.

Aguculture
Washington, D.C.
Frank Perry
Los Angeles
parachute drops

Methow Valley
near Wenatchee
Wash

2121

SUPER-



Mr. Martine, Research Lab.
By Roderick M. Grant

YOU'RE missing a lot in this world. There are sounds you can't hear, colors too delicate and scenes too swift for the eye to catch, tastes and odors and sensations of touch that are far beyond the range of puny human senses.

The eye of man has been called the most perfect optical instrument, yet in a spectrum stretching over ten quintillion angstrom units—that's ten followed by eighteen ciphers—your eye discerns light from a paltry 4,000-unit span in the middle of the spectrum. You boast of hearing a pin drop in a great auditorium, or the ticking of a watch across the room; yet your ears are tuned only to sounds vibrating from thirty to 16,000 cycles per second, while

idea workshop

At upper left, human eyes behind electric eyes; the photoelectric tubes can perform feats beyond the ability of man's eyes. Top, center, telephone worker "feels" distance to break in line with aid of Wheatstone bridge. Right, microphone picks up tick of watch in General Electric's soundproof room. Below, research worker listens to sound from invisible film

Schenectady, N.Y.

Developed by J. A. S. White
General Electric Co. J 12121

SENSES of SCIENCE

mine safety apparatus Philadelphia

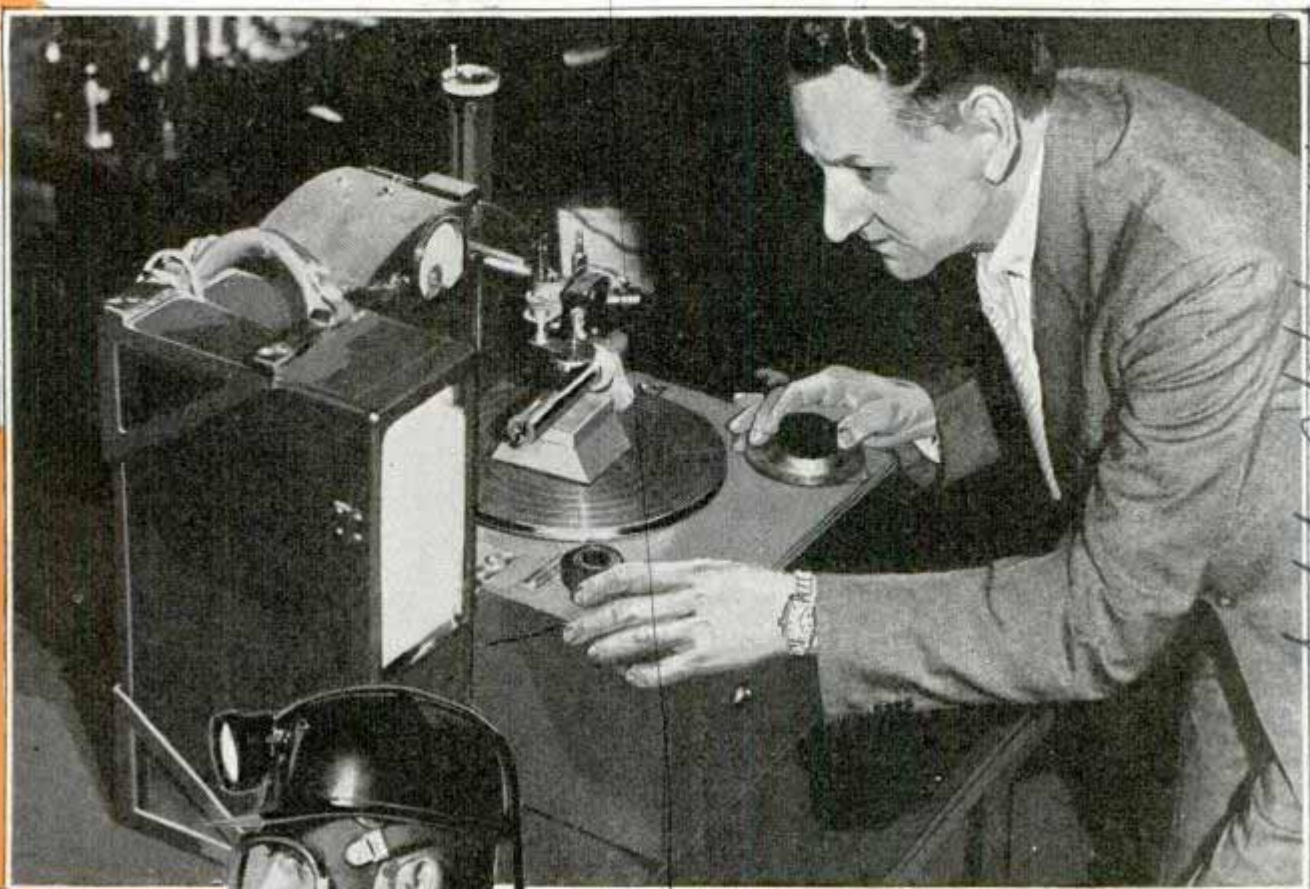

Surface indicator at top measures smoothness of metal or painted surface. Below, miner wearing gas mask and helmet carries a carbon-monoxide detector



enemy in time to escape, and to hunt a meal. They had no need for fitting pistons within cylinders to tolerances measured in millionths of an inch, nor to listen for lurking submarines nor measure the light of distant stars which they never could hope to see.

But while your eyes and ears have lingered as they were 25,000 years ago, science has given you tools of a supersensitivity that staggers human imagination. A camera with multiple eyes and no lenses takes 120,000 pictures per second. Invisible light and inaudible sound are put to work killing bacteria. The odorless, unseen mist rising from a bowl of mercury in so rare a concentration as one part of mercury in 5,000,000 parts of air is made visible to the human eye as a thin shadow cast on a fluorescent screen—yet this mercury could go on evaporating for ten years without a detectable loss in weight.

There is a practical side to these vapor and gas detectors, of course. A miner car-

science has measured and put to work inaudible sound as high as 5,000,000 cycles.

You feel and see and taste and hear and smell with senses attuned to the Stone Age, when your ancestors had only to detect an

Developed by H.C. Price and H. Rankin 195

Engineering Dept. - Es & W. Philadelphia

Developed by Prof. Barney



will expose counterfeit currency or postage stamps. A manufacturer of paper or textiles or other goods can examine his competitor's product under the spectrophotometer and learn whether inferior materials have been used. It is even a shortcut in chemical analysis, for a slight variation in solutions alters the color reflected into the measuring instrument. A millionth of a gram of copper in solution shows up as a characteristic curve on the color graph. When a medical laboratory wanted to

publish a table of human-blood samples so that doctors, comparing the blood of patients with the printed scale, could discover symptoms of anemia, the printers had to find red inks that would match each blood sample perfectly. They achieved perfection by mixing the inks until graphs of blood and graphs of ink samples were identical.

Delicate finger tips of the blind are so sensitive that they learn to read swiftly the raised Braille letters. But an engineer

ries in one hand a little meter that warns instantly of the presence of deadly carbon-monoxide gas he can neither see nor smell. These detectors are constantly analyzing the air in New York's vehicular tunnels. Mercury-vapor detectors in the exhaust stacks of mercury turbine power plants tell of escaping vapor, and the plant is shut down immediately to avert loss. In the mercury-vapor turbines of the General Electric company at Schenectady, for example, there are 100,000 pounds of mercury worth \$2.20 a pound, and any evaporation up the chimney would be expensive.

One of the newest scientific substitutes for imperfect human senses is General Electric's spectrophotometer, whose photoelectric "eyes" translate colors into curves. Pull out of your dresser drawer a pair of stockings that look like identical twins, put them to the spectrophotometer test and in five minutes it will draw two spectral graphs that prove those stockings don't match at all. So sensitive that its motor could be started and reversed by the light of a candle a mile away, this color meter and recorder has already found its way into a dozen industries. It is standardizing dyes, matching colors in the textile, paper and paint industries. A spectrophotometer test of canned food shows whether coloring matter has been added and whether the adulterant was poisonous. A color line varying slightly from normal

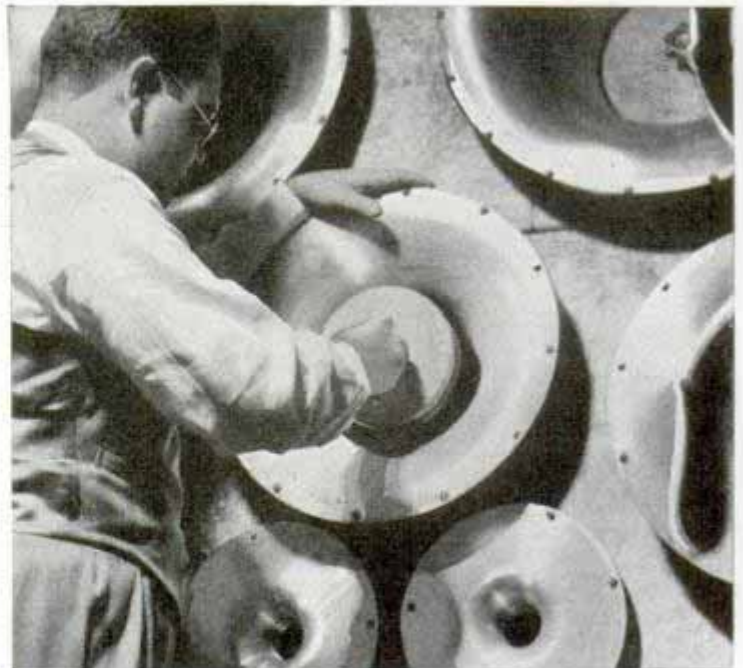

Mercury-vapor detector, top, sounds alarm bell when costly and dangerous vapor escapes in mercury power plant. At bottom, preparing orifice in wall for sound test of fan in General Electric's aphonic room

Research Lab. GE

has developed a "roughness meter" that can measure the thickness of a finger print on a pane of glass. Somewhat resembling a phonograph with a sapphire-pointed needle that "feels" the object being tested, it can sense variations as small as a millionth of an inch in the smoothness of metal bearings or painted surfaces. The "Wheatstone Bridge" gives the sense of touch a sort of third dimension, telling the telephone company's troubleshooter the exact distance to the point where—perhaps several miles away—a line has been grounded. You feel a bit uncomfortable if the room thermometer falls below sixty-five or rises above eighty degrees; an electric potentiometer, tool of the research scientist, detects temperature changes of a few thousandths of a degree. When you catch cold and lose your sense of taste you could munch bonbons and potatoes, while blindfolded, without distinguishing the difference. The chemist has

(Continued to page 120A)

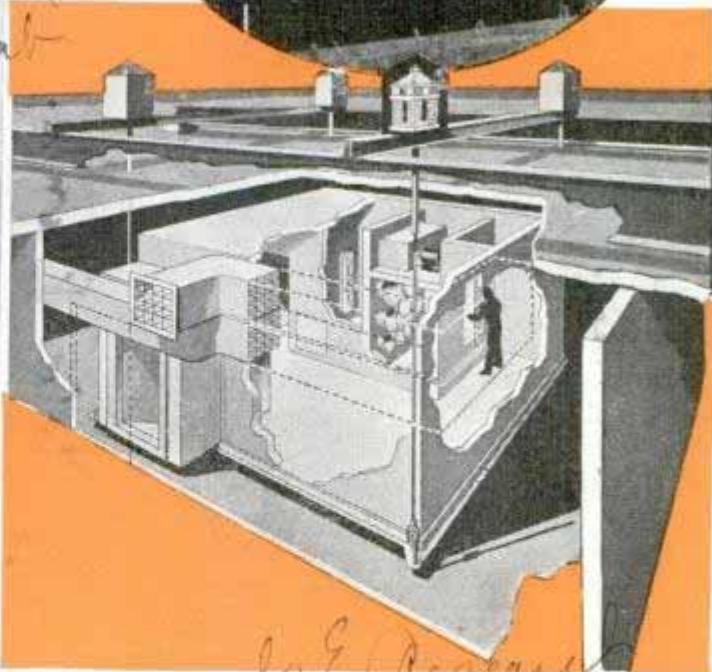

At top, General Electric engineer measures hues of silk stockings with photoelectric eyes of recording spectrophotometer, an instrument that draws curves on graph distinguishing colors seeming identical to human eye. In circle, science's "taster," a Leeds & Northrup company electric indicator measuring acidity and alkalinity. Bottom, diagram of General Electric's soundproof test room showing suspension from rubber-cushioned springs on roof; left, red light replaces telephone bell in quiet room

g 12/2
Leeds and Northrup 490 Lexington

*J. E. Michaelson
 L. E. Englehart*

L. E. Resnick

Tiny Lamps for Searchlight Are Cooled with Water

fluorescent lamp
replaces, holds capsule
see. Also 1938-39



Powerful searchlight is shown above with one of the mercury-lamp units held by lighting specialist

Light for a 25,000,000-candlepower searchlight developed by General Electric comes from three small water-cooled mercury lamps instead of the customary carbon arc. With no carbons to be replaced or adjusted, the new searchlight functions without attention. Although no larger than a cigarette, each high-pressure mercury lamp is rated at 1,000 watts. They are mounted close together, and seventy per cent of the heat they generate is removed by pumping ninety gallons of water an hour through cooling jackets. A time switch turns the lights on automatically according to a prearranged schedule.

Warren Electric Appliances
Warren, Pa.

1279

Low-Cost Photo Print Dryers Furnish Fast Electric Heat

Electric print dryers, reasonably priced for the amateur or professional photographer, turn out smooth, dry pictures in quick time. One of the models recently introduced is a rotary dryer with chromium-plated drum, turned by hand. It dries prints in four to eight minutes, and is available in twenty-eight by twenty-four-inch and twelve by eighteen-inch drying surfaces. Another has an alloy platen area twelve and one-fourth by sixteen and one-fourth inches, a curved platen with a heavy duck apron to cover the prints. Thermostatic controls keep the dryers from overheating.



Electric print dryer with curved platen and duck cover, above, and rotary dryer turned by hand

1285

Vise Holds Work at Any Angle for Machine Operations

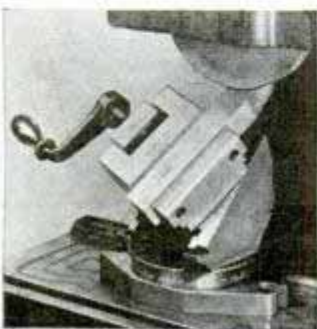

Complicated compound angles are easy to produce in milling, grinding and drilling operations with a universal vise that is adjustable in three planes. Graduated

Photo Print Analizer \$9.95 post 1938

Wesson Co 1050 Mt
Elleath Ave Detroit

Arbay Laboratories, Inc
1570 S 1st St

\$10.75 Wood & Roches
\$9.95

220-Ton Atom-Smasher Latest Aid to Science

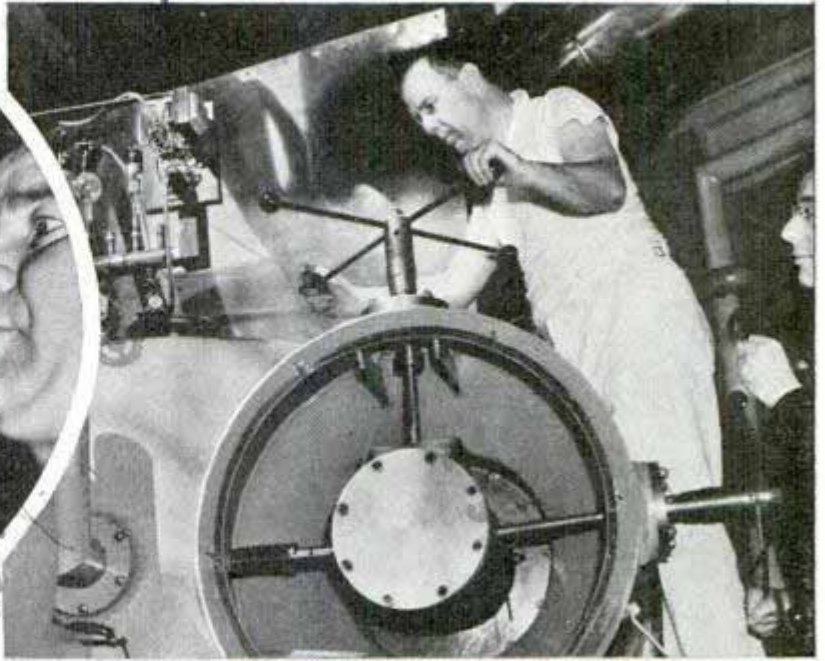
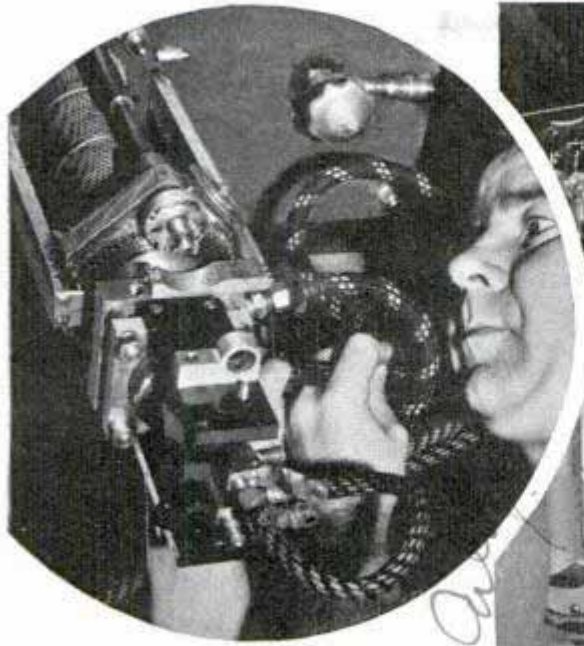

From the mysterious atom, scientists hope to wrest invaluable secrets, such as information that may enable them to release and control vast energy by smashing the atom. One of the latest aids in this research is a 220-ton cyclotron located in the William H. Crocker radiation laboratory of the University of California. Above, left, the point at which ions enter the huge machine before going into their spiral path at "dees" at accelerated speed. Right, adjusting dees for positioning the ion beam

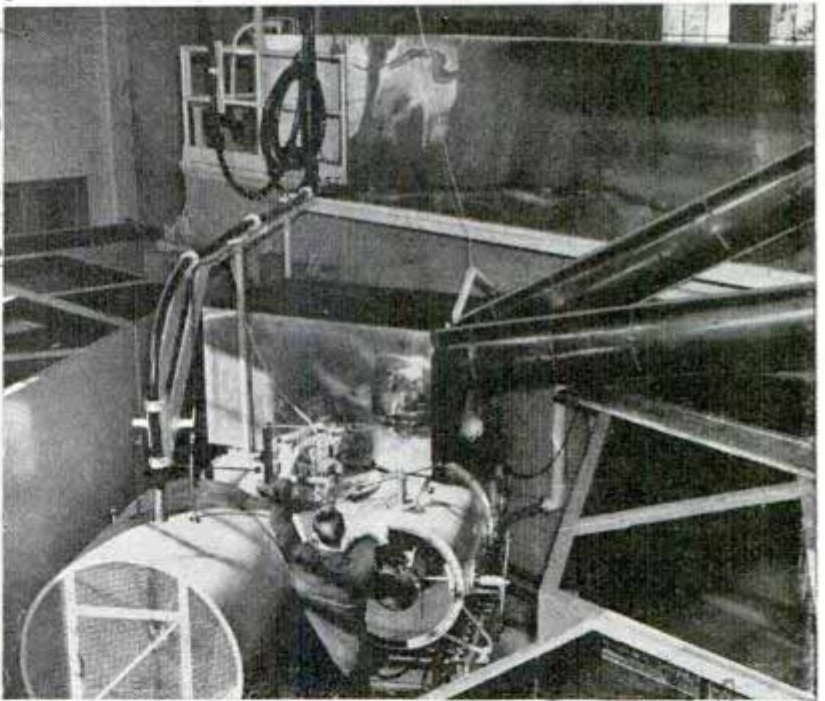

Above, unusual view of the giant atom-smasher. Large vats of water surrounding the machine protect workers from radiation. Tubes above lead from the oscillator. At left, operating control board of the cyclotron. This control board is in another room, away from the machine, and communication with observers is conducted over a public-address system. The loud speaker for the system is shown at the right hand of the attendant. Data obtained with the machine are expected to aid the medical field, and possibly to reveal a new source of power. So great are the possibilities that no scientist cares to predict what the results may be

Robert Carnoy

1261
W. Salesburg
Carnoy

C 10 5 4
 James H. Lee
 98 45th Kansas City Mo

There's **MAGIC** in

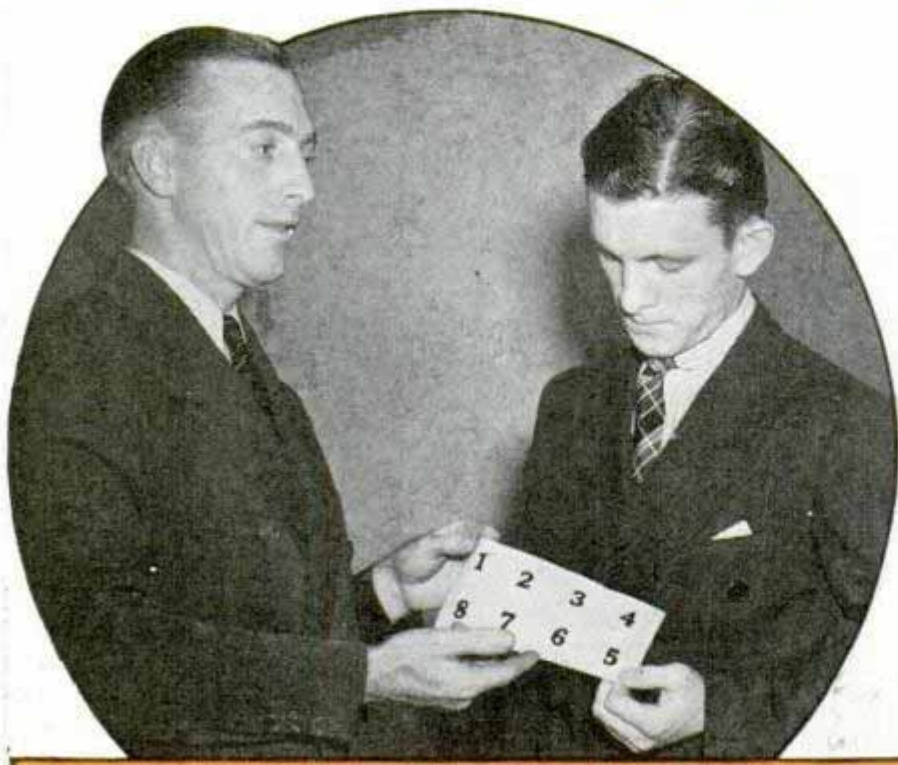

the numbers 1, 2, 3, 4 have been inscribed from left to right and underneath them, from right to left, 5, 6, 7, 8. By a series of folds, the sheet is reduced to a triangle. The performer explains that he will, at a spectator's bidding, make a single tear in the triangle so that the odd or even numbers will be left on the paper.

Making a cornstalk

You need no satchel of "props" for this trick. Write the numbers on a slip of paper, fold as shown, and with a single tear down center of triangle, odd or even numbers are left together

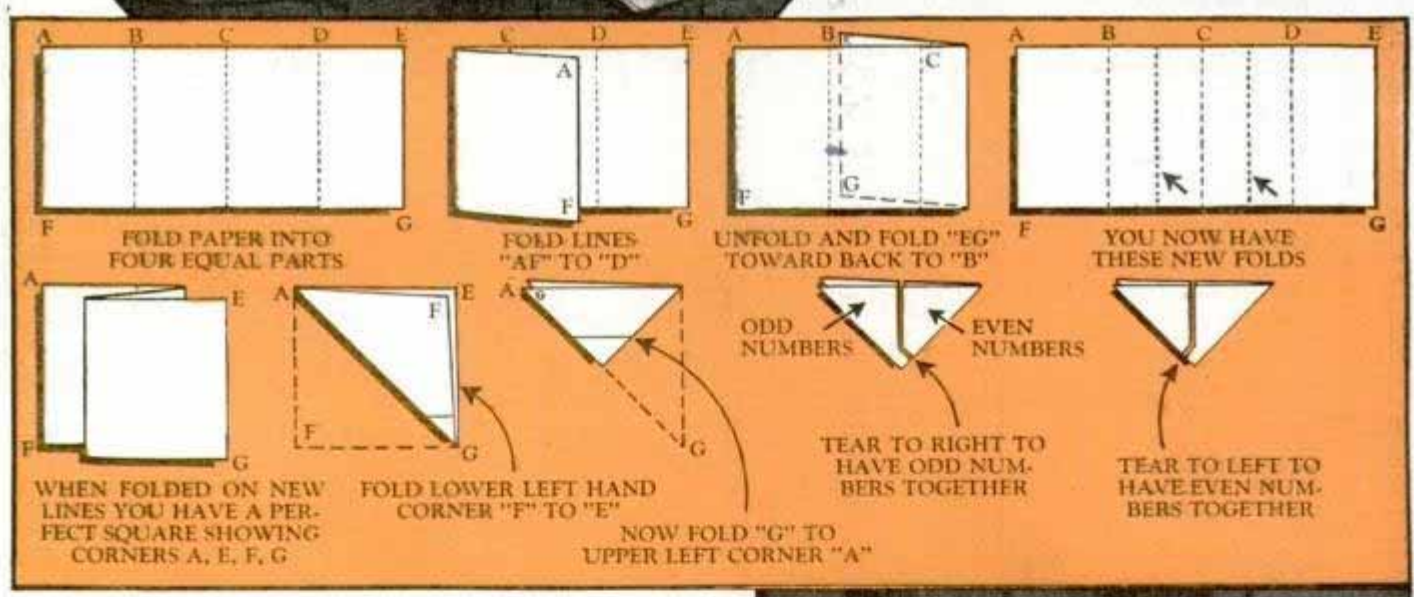

THERE are styles in magic just as in clothes or motorcars and at the moment, simple, close-up stunts performed with everyday objects are enjoying a greater vogue than ever.

A person who yawns while a professional magician saws a woman in half will watch with open-mouthed astonishment as a friend executes a neat trick with paper matches, drinking glasses, or some other household object. The fact that the tricks are executed with such commonplace objects makes them all the more absorbing.

An interesting paper-tearing trick starts with a magician displaying a sheet of paper on which

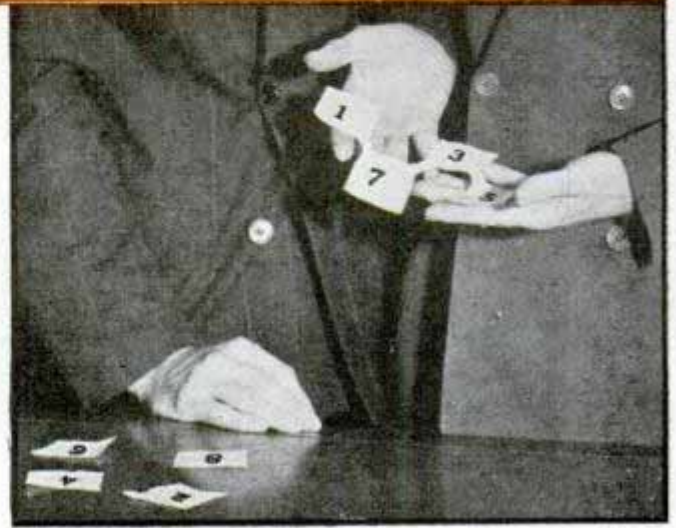

EVERYTHING



sprout is another paper-tearing trick. First, roll lengthwise six or seven double-sheeted newspapers, one at a time, overlapping each sheet about ten inches. Then flatten the roll and starting from the right side, tear down to a point a little beyond the middle. Do the same thing on the left, then rip out the center portion and discard it. Bend the leaves back, inserting a finger in the hole and pull the stalk out in telescopic fashion.

There's an intriguing trick that calls for no par-



Can you change a newspaper into a stalk of corn that suddenly sprouts right up to the ceiling? The photo and diagram at top show how simply it's done. At bottom, string is threaded through straw previously prepared by slitting; before letting spectator cut straw, it is bent and string pulled out, shielded by fingers

1051



ticular magic skill, yet ranks in interest ahead of many that do. Choose a soda straw—apparently at random—and through it thread a piece of string eighteen inches long. Incidentally, the most practical way of accomplishing this is to suck the string through the straw as you would a drink. Then bend the straw in the center and ask someone in the group to cut it with scissors. After the cut is made and the straw pieces straightened, the audience discovers the string has been restored to one piece.

For this trick some advance preparation is needed. The straw you seemingly select at random is one in which you have made a one and one-half inch slit with a razor blade. In bending the straw, make sure the slit is underneath. Just before you invite a spectator to make the cut, pull the two ends of the string downward with the right hand so the string is through

At top is the ladder of newspapers. They are rolled together with ten-inch overlap as seen below; the ends clipped, center section torn out, ends bent down and ladder pulled up. Bottom, the "walking" doll



the slit. Your audience will not be any the wiser if you shield the string with your fingers.

Another paper-tearing trick is known as "Jacob's Ladder." The roll is prepared in the same manner as for the cornstalk trick. To prevent the roll from unwinding, place paper clips at either end and tear out the center portion. When

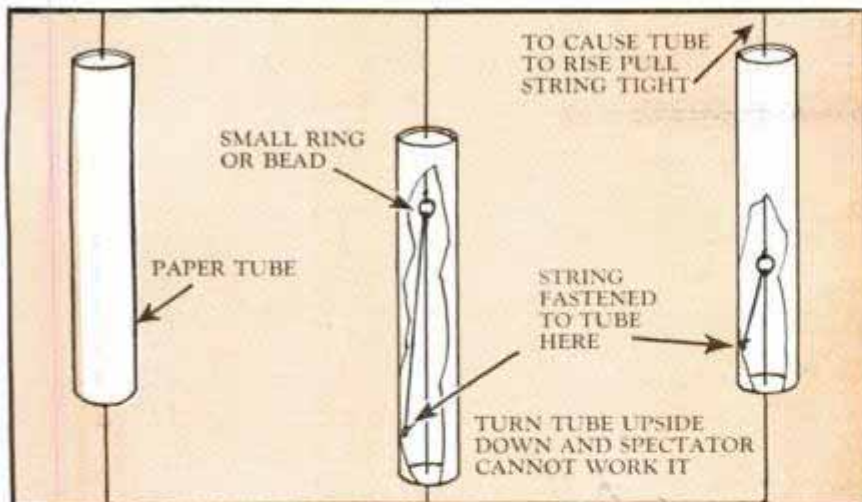
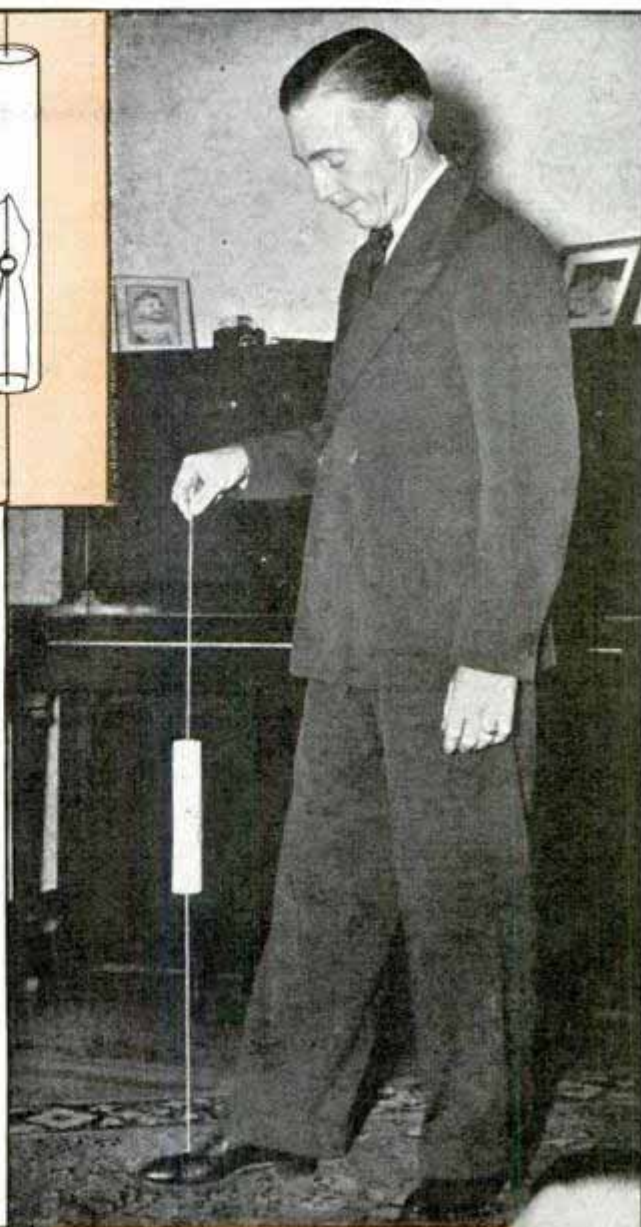

Diagram above shows how tube is prepared for stunt at right, where magician makes tube rise and fall mysteriously at his command. Below, to raise a glass without touching it, lift it with a bent straw



this is completed, bend the rolls downward and, grasping the paper strips between them, pull up the ladder.

Next time you are having refreshments with friends at a soda fountain, tell them you can lift an empty water glass without touching it. All you need is a bell-shaped glass and a soda straw. Before placing the straw inside the glass, bend it so it's a trifle larger than the diameter of the glass. Lift up on the straw lightly and when the end comes in contact with the lip of the glass, a wedge will be formed sufficiently strong to sustain it. On your first attempt, pick out a landing spot for the glass that's softer than a soda-fountain marble top, in the event anything goes wrong.

The controlled tube is a sure-fire hit. A magician shows a cardboard tube with a string passing through it. Holding one end of the string with his foot, he makes the tube rise or fall on the string at his command. When he hands the tube to one of the crowd, however, and suggests he do the same, the latter cannot do so.

Here, again, the crux of the trick lies in the manner in which the tube is made. Inside it, about one and one-half inches from the bottom, glue a

(Continued to page 136A)

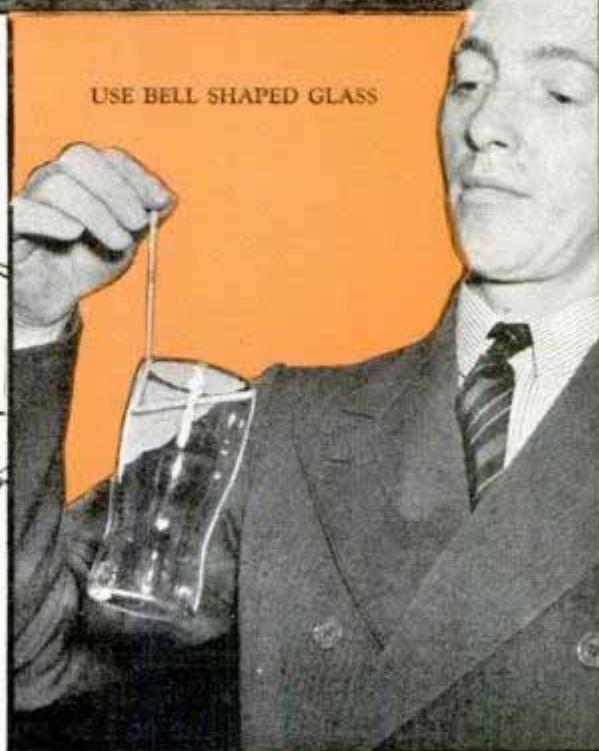

Bicycle Made into Tandem by Adding Rear Frame

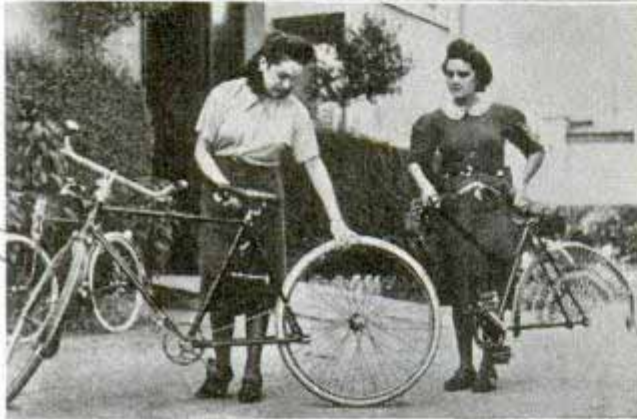

come
Dual bicycle, top, assembled as tandem; bottom, it is an ordinary bike when wheel replaces rear seat

Attaching an extra piece of frame and moving the rear wheel farther back makes a tandem out of a single bicycle which has been produced in Italy. A special sprocket and chain arrangement permits both riders to operate pedals.

Coil Producing Hotter Spark Is Insulated with Oil



Increased engine power and more gasoline mileage are claimed for an ignition coil insulated with circulating oil, in imitation of large electrical transformers. Oil insulation, by rapid

dissipation of heat, allows the coil to work at higher voltages and it is said to "step

up" the output to 28,000 or 30,000 volts, compared with the ordinary 15,000 to 18,000 volts, providing a hotter spark for faster starting, acceleration and hill climbing. No alterations are needed in the car except that the spark-plug gaps and the distance between distributor contacts should be increased. In tests, the new coil was reported to have functioned at 32,000 sparks per minute, whereas other coils showed signs of breaking down at 11,000 sparks. Circulation of the oil may be seen through the transparent enclosure.

Modern Soldier in Suit of Armor Resembles Knight of Old

Fully clad in all of the protective armor which is used in modern warfare, a soldier of today looks pretty much like a knight of the fifteenth century. Today's armor consists of a visored helmet with which Americans experimented during the World War, breastplate worn by German snipers, and leg and arm protectors which likewise were designed at that time. Weighing only fifty-five pounds, this armor plate, according to experts, will stop anything up to bullets from light machine guns. Compared with this, the fifteenth century knight wore 163 pounds of metal.

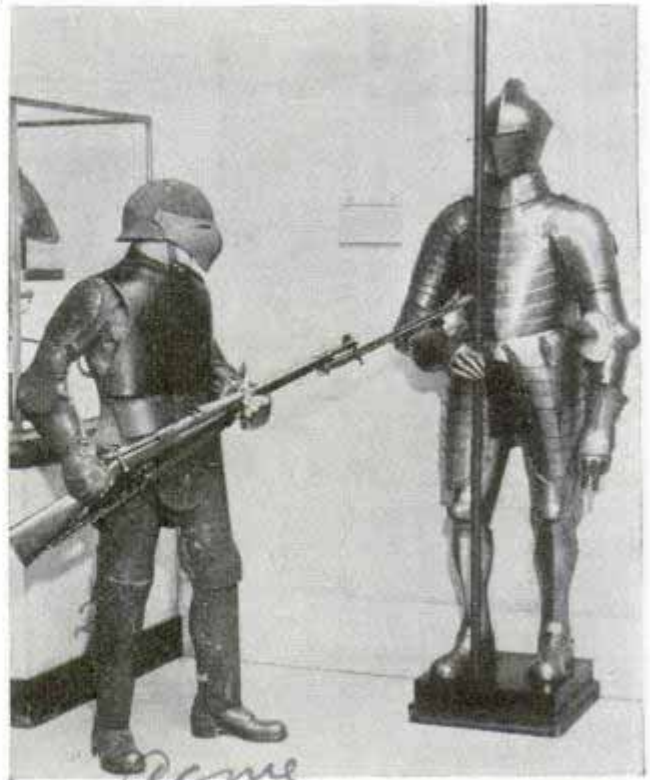

come
Armor used by modern soldier, at left, compared with jointed metal suit of fifteenth century knight

*Manchester 3
Leamington Road
Leamington England
Rumbaker Electrical Products
13/15*

1234.

1281

no 43 agent known

National Metal Congress and

91225. D. I. Woods
POPULAR MECHANICS 205
m. s. l. of James 1733 ranch
miles to Resbee & San Francisco

Covered Wagon Made of Wood and Concrete

Reminding tourists of America's pioneer days, a gigantic yoke of oxen, drawing a covered wagon across the plains, has been reproduced near the outskirts of Kearney, Neb. Built on a scale of one and one-half to one, the team is seven and one-half feet high, having been molded entirely by hand in concrete reinforced with steel. Wood was used for the wagon structure, the wheels, however, being encased in a layer of concrete.

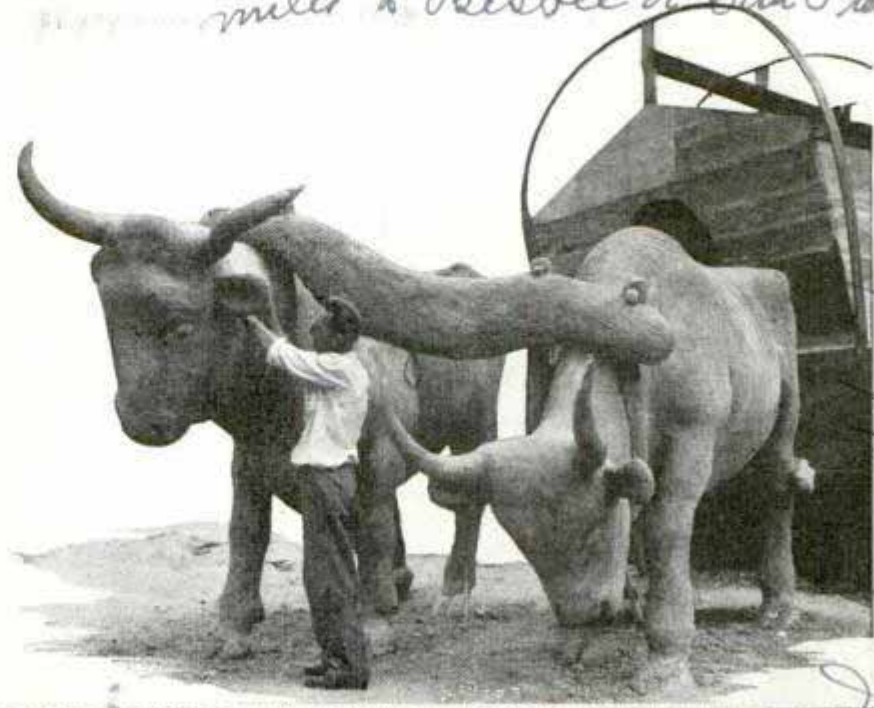

Right, top, enormous proportions of oxen, fashioned in reinforced concrete, may be visualized by comparing with size of man. Bottom, wagon, also modeled on same large scale, is structure of wood with wheels encased in concrete layer

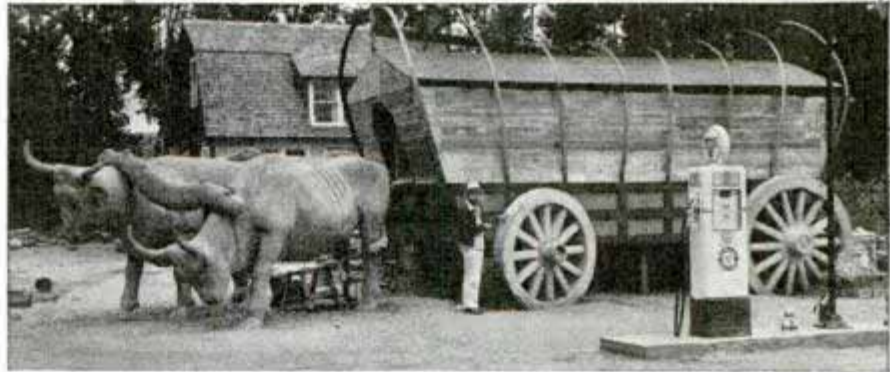

by man, Kearney, Neb.
Wagon

91273

Submarine Freighter to Evade Attacks by Sea Raiders

With the ability to dive whenever it is in danger of attack, a submarine freighter has been designed by Simon Lake, inventor of the even-keel type submarine. He offers the idea to any nation friendly to the United States, for the purpose of run-

ning through blockades set up by belligerents. The underwater craft could carry 7,500 tons of cargo and have a speed of fifteen to twenty knots. Mr. Lake declared it would cost no more to build one of these than an ordinary merchant marine vessel.

Milford Conn.



Drawing shows freight-carrying submarine which is capable of diving below surface of sea when it faces danger of attack by enemy raiders and could be built to take on a cargo of 7,500 tons

21084 W. V. H. ...
 Co-sponsors - City of Chicago
 Lewis and ...

WHAT'S

F. Vernon Hill, 199 W. Washington Chicago
 per Jan. 1938 p. 3



Smoke density chart, below, is held fifteen or twenty feet from eye until lines converge, then compared with smoke under observation; 40-per-cent density is allowed

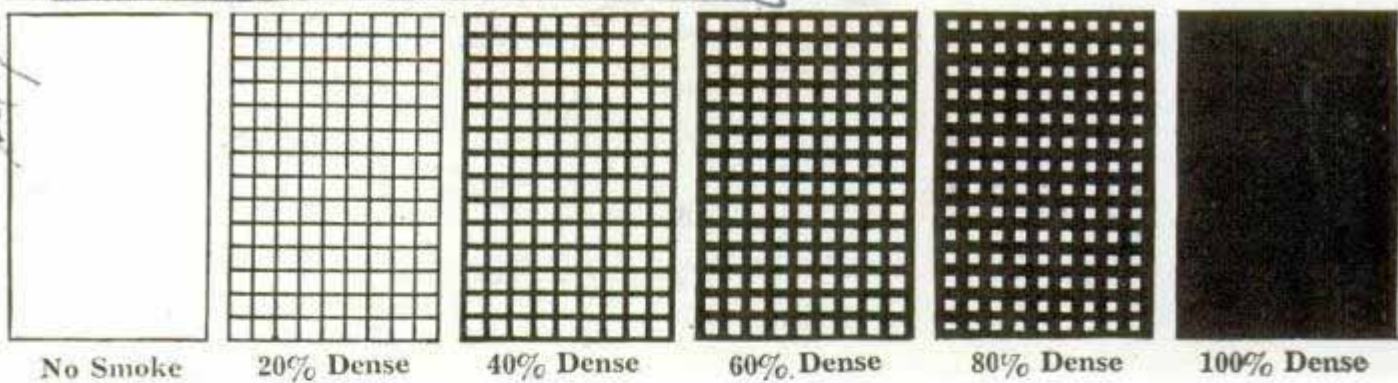

There's no such thing as pure air for you to breathe. Along with air, you take in a vast amount of pollen, dust and chemicals; if you happen to be a Chicagoan, you breathe an average of 47,000 particles of dust per cubic inch of air. Dust counter at upper left, collects dust on greased glass slide in front of eyepiece. In circle, dust caught in distilled water is weighed and analyzed by filtering and evaporating. Chemical, microscopic and spectrographic tests reveal calcium, magnesium, aluminum, lead, silica, iron, tin, potassium, carbon, sulphur and other elements. At right, vacuum from windshield wiper is used to collect air sample

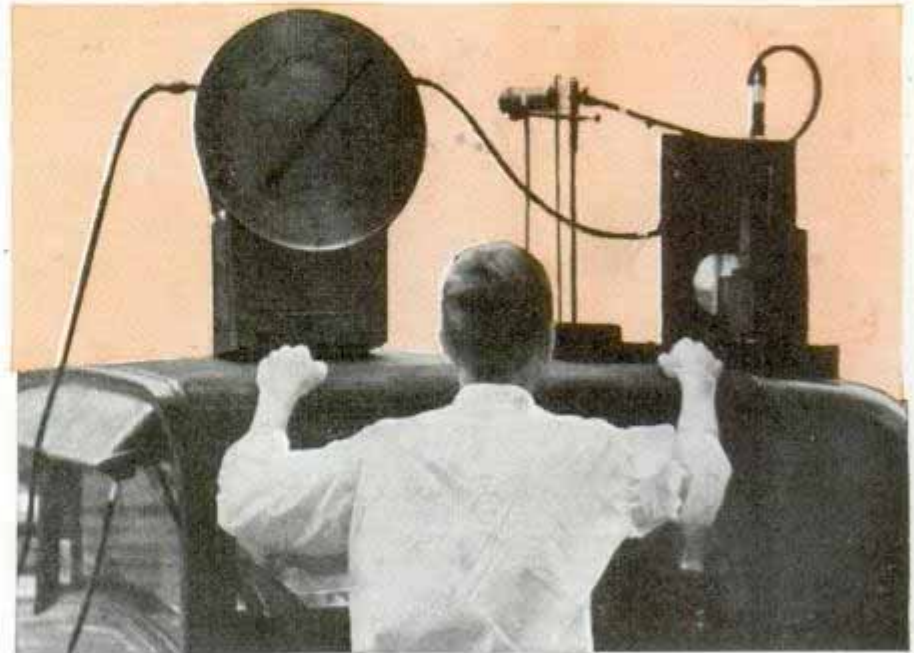

2108-4

in the AIR ?



Pollution of air by dust and smoke is not only a hazard to health but indicates tremendous losses in incomplete combustion of fuel, besides the damage to brickwork and metal surfaces from corrosive gases. To supply scientific information on this problem a vast study of air pollution is being made in Chicago, with more than 400 men making street, roof-top and laboratory tests. Above, to measure dust particles, image of a sample is projected through microscope to camera at right

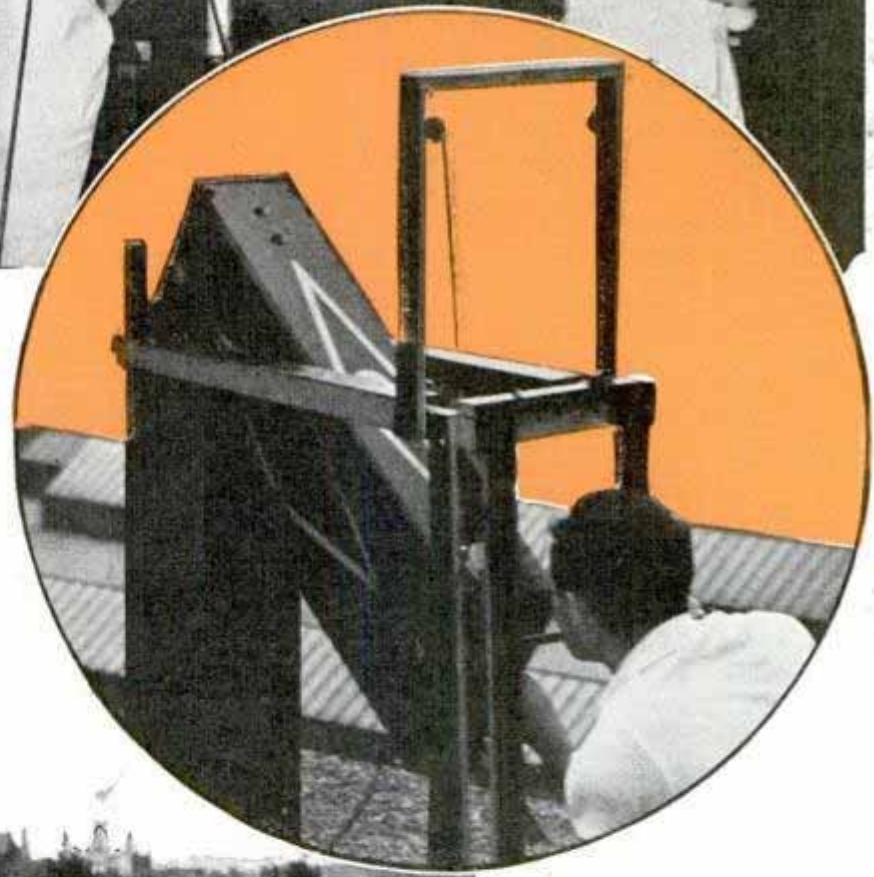

In circle, "shooting the sun" to measure foot-candles of sunlight. Below, adjusting apparatus to observe ultra-violet and visible-light penetration. By weighing dust collected in two jars which are partly filled with distilled water it was found that average dust-fall per month over a square mile varies from 300 tons in winter to eighty tons in summer

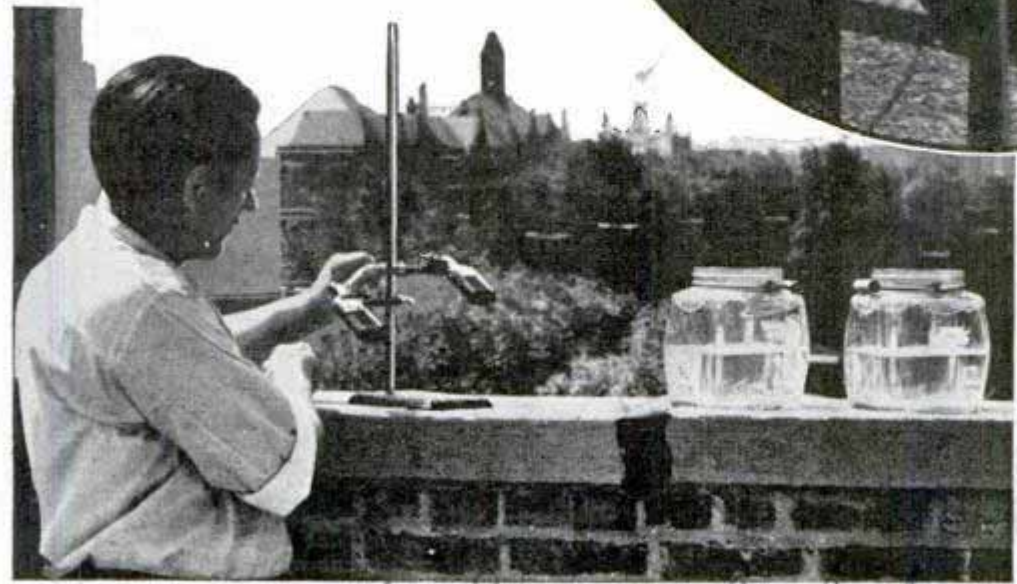

*Carl Eugene E. Lichterman
2712 Crystal St. Chicago*

Short-Wave Helmet Delivers a Radio 'Facial'

Beauty is delivered via short waves at one California beauty shop. The customer desiring a radio "facial" dons a rubber mask which looks like a wartime gas helmet but isn't; in it are concealed the ends of the antenna and ground connections of the ultra-short wave set. The high-frequency oscillations of the seven-meter set are said by the inventor to have a beneficial effect on the skin.

Lee De Forest Laboratories
5106 Wilshire Blvd L.A.

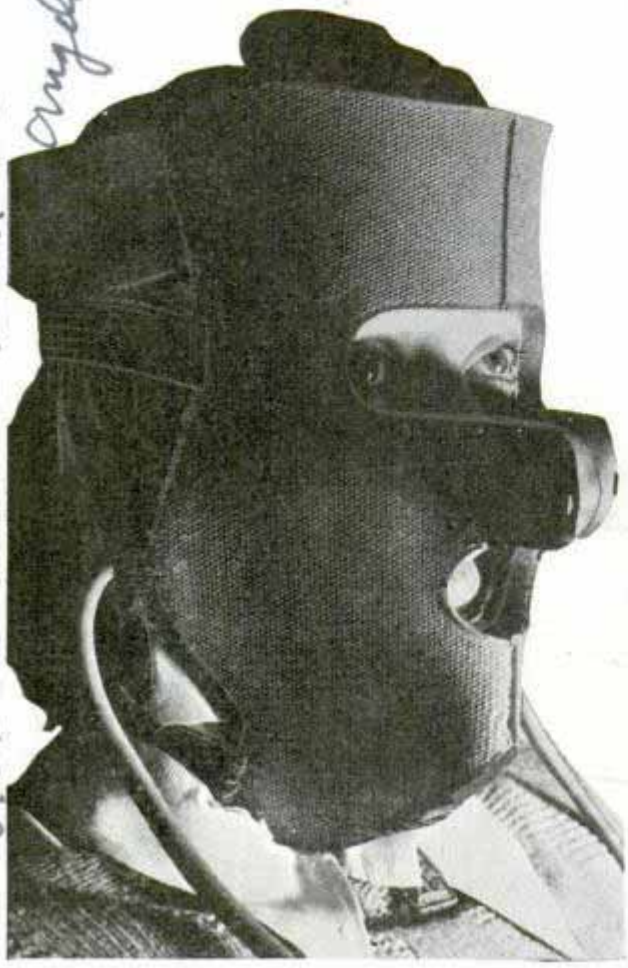

No gas mask, but an electric one, is the grotesque warlike helmet above. Shown with transmitting controls at right, it delivers a facial beauty treatment with ultra-short radio waves

Engineer, J. J. Mackay

Pilot's Safety Belt Has Springs to Absorb Shock of Crash

Injuries suffered by pilots in airplane crashes will be reduced greatly by a safety belt, worn like suspenders, which has been developed by army engineers at Wright field. It will prevent the upper part of the body from plunging into the instrument board, which usually results in severe facial injuries. The belt straps over the shoulders and is attached to the standard belt that fastens down the legs, and to absorb shock, it is equipped with springs.



Spring-equipped safety belt for pilots being tested in chair that vigorously rocks subject and turns upside down

Wayne, Ohio

Cheney

21269 Amar Esongales

105 Willem Ave

Camera Attached to Kite Snaps Aerial Photos

San Antonio, Texas

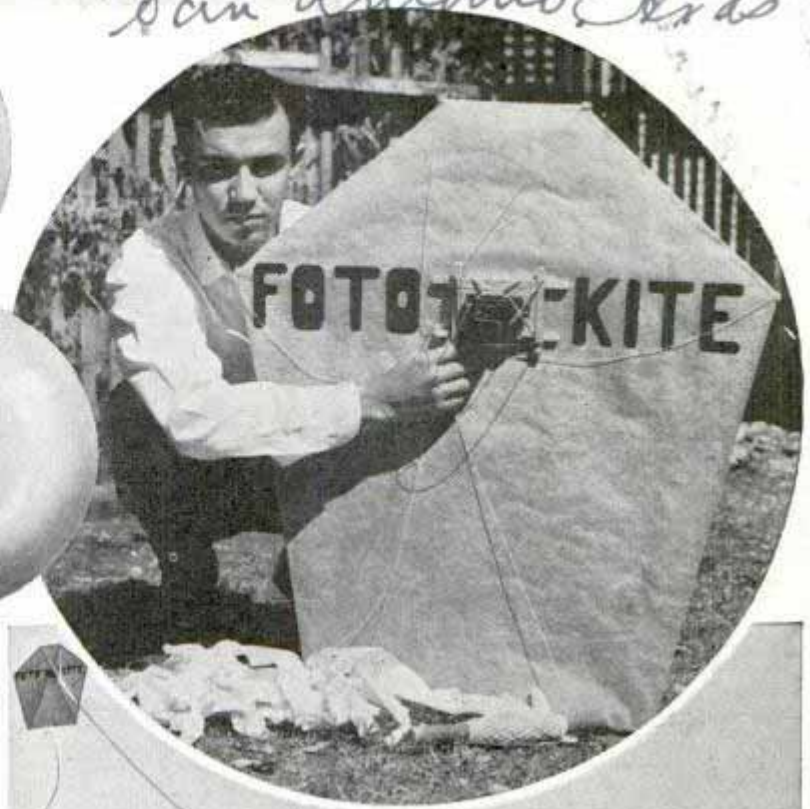
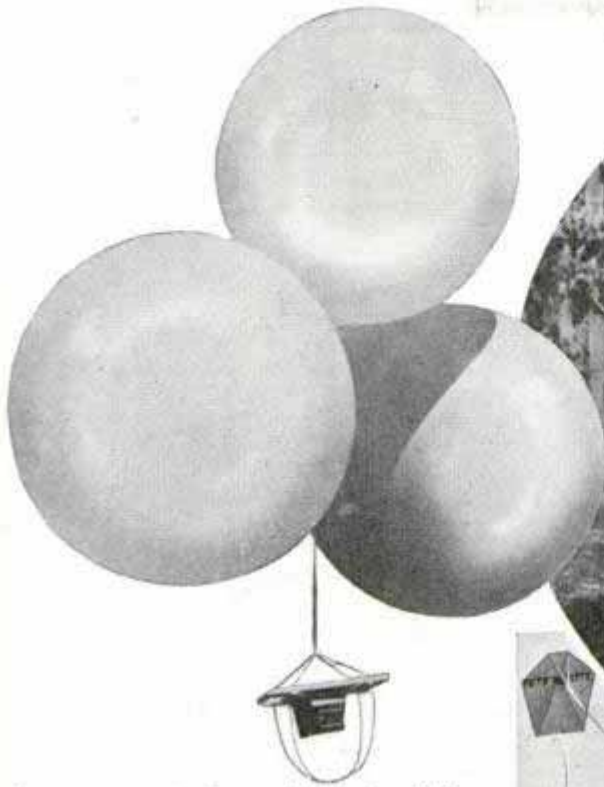

Anyone may take aerial photos if he cares to experiment with an idea developed by a Texan. It consists of attaching a small camera to a kite or a cluster of hydrogen-filled balloons. Because of the expense of balloons, the kite seems best for the job, although it limits the angle of shots and its struts may appear in the photo

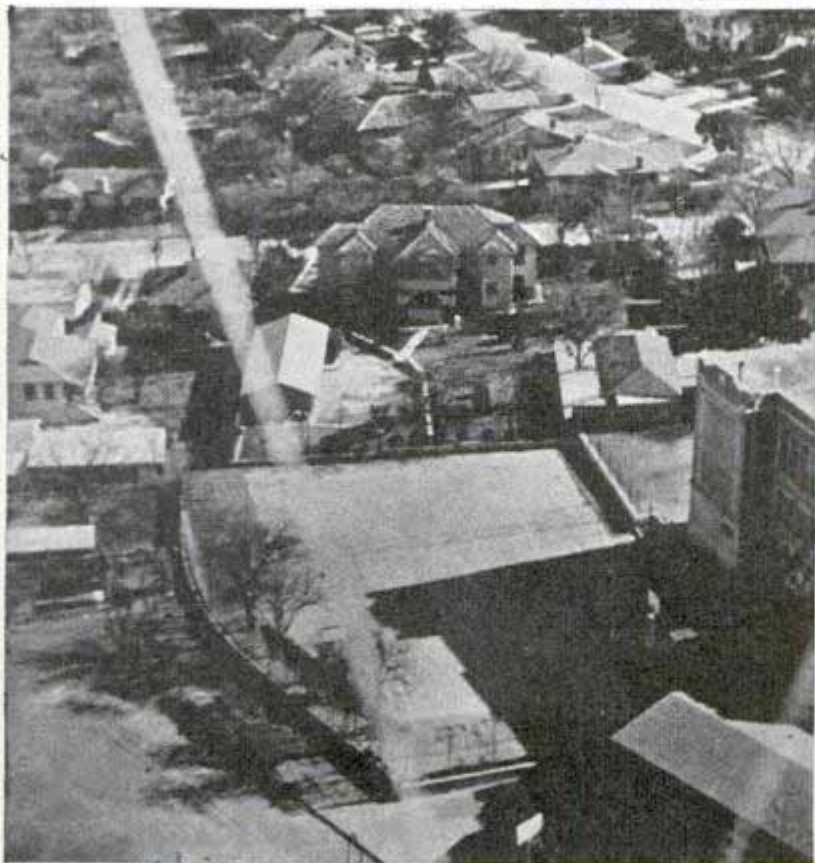

Top, left, camera attached to balloons. Right, camera kite ready for aerial shots which neighbors frequently would like to purchase. Bottom, left, typical photo made with aid of kite. Note strut. Right, launching the kite. Frame of kite and support for camera are made of balsa wood. The camera may be operated by a timer consisting of a short string that burns up to a rubber band that releases the shutter or by a long string that permits releasing the shutter from the ground

Three Lions

Reid Alan's
N.B.C. Inc.
Engineer.

RADIO

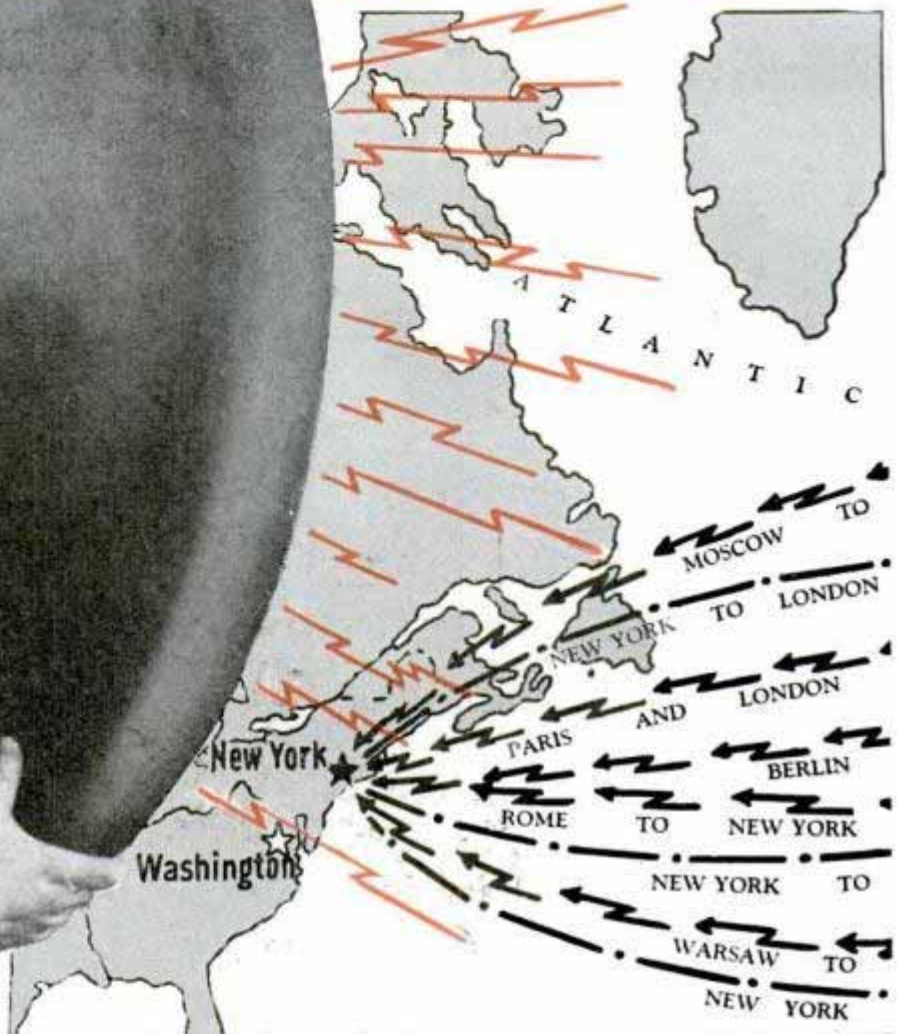

THROUGH the medium of radio, Americans are being taken into the theater of Europe's war. Directly from the capitals of the nations involved come the voices of trained observers, each describing last-minute developments on his part of that far-flung stage of strife, and it is possible that your loud speaker soon may be roaring with the din of battle.

Portable transmitters, tested in sham battles here and abroad, offer the means of broadcasting to a shuddering world the rattle of machine guns, the shriek of shells from booming big guns and the thunder of monster tanks, with the high-pitched whine of fighting planes superimposed on the whole ear-splitting drama. Already the British Broadcasting company has moved transmitters and other equipment on wheels to the front in preparation for



Above, left, parabolic microphone aimed to pick up army band's music. Below, National Broadcasting company transmitter set into U. S. Army caisson helps in broadcast of maneuvers

2/188

GOES *to* WAR

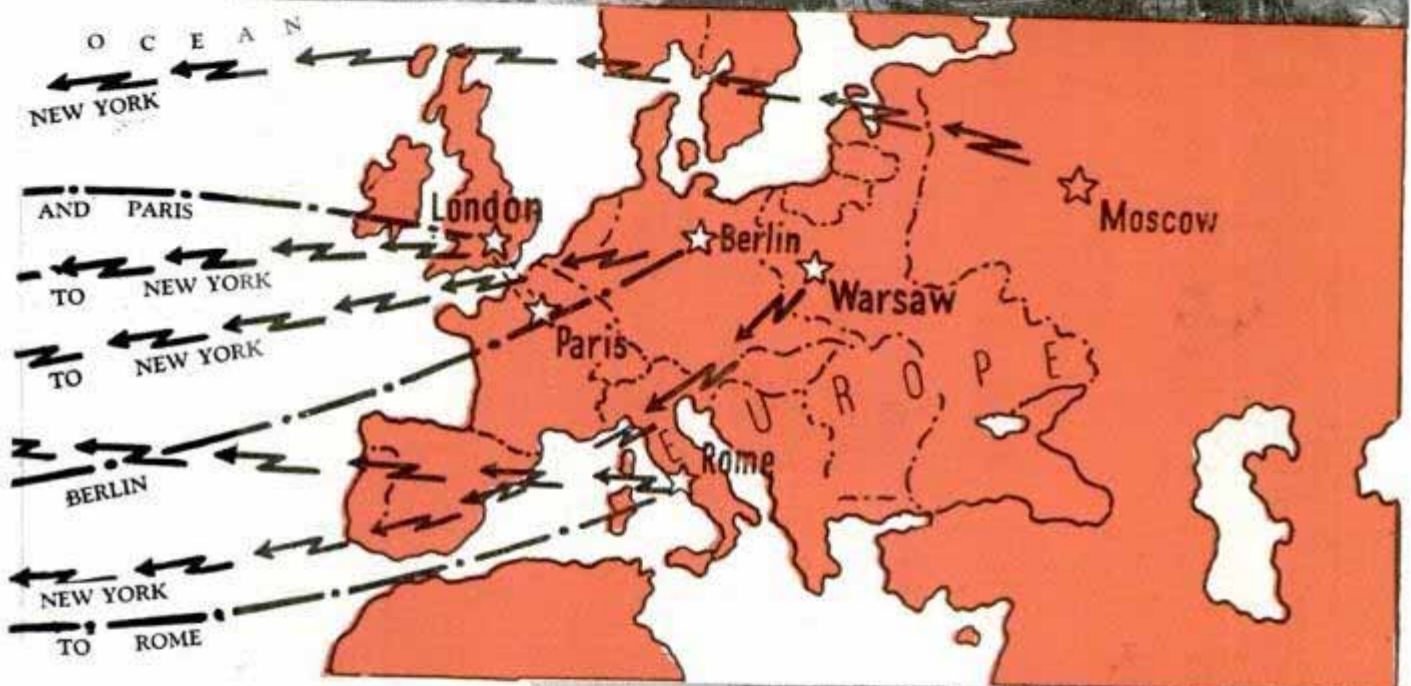

the moment when relaxation of censorship may send announcers into the thick of an engagement.

Not long ago after the war began, listeners experienced a prelude to what may be just ahead. A foreign correspondent in Paris, discussing war problems over the National Broadcasting company's hookup in this country, was summing up: "The situation is now definite. There are no doubts—" and his voice faded out as a screeching yowl filled the Paris studio. Startled Americans hurriedly adjusted their receivers. Above the din



Top, radio setup of the type that may bring sounds of battle into the home. Center, Columbia Broadcasting system's map of its European coverage. Broken arrows denote short-wave air channels, dash-and-dot the cue facilities. Bottom, scene in New York studio, with observers listening in on foreign broadcasts. This was before fall of Poland



from which news analysts broadcast. It is glass-enclosed and streamlined so everyone involved in the news operation may see what is going on in every other division of the department. At one side of this studio, clearly visible through a wide glass panel, is the news room, housing tickers of the leading press associations. Last-minute bulletins can be passed through a slot in the wall to the man at the microphone without disturbing the broadcast. Just behind the news room is the com-

coming from the loud speakers they heard the correspondent again, fairly screaming: "The air-raid sirens are now bawling!" Then for two full minutes the terrifying wail of that alarm for Parisians to flee the danger of enemy bombing planes flashed across the Atlantic. The correspondent heeded the warning, too, and was heard no more that night.

Long before the fighting started, both NBC and Columbia Broadcasting system had their radio machines ready. Key men, trained in radio technique, had been stationed at the storm centers. Paul White, director of public affairs for Columbia, surveyed the field, and in New York technicians carried out his instructions to set up a compact arrangement for handling war news quickly and efficiently. Heart of the setup, on the seventeenth floor of the system's building, is White's office, in which an amazing battery of wires, telephones and dictagraphs permits him to cut into the network with a war bulletin in five seconds—no small achievement when you remember that there are as many as 117 stations in the hookup.

Across from this office is "Studio Nine,"

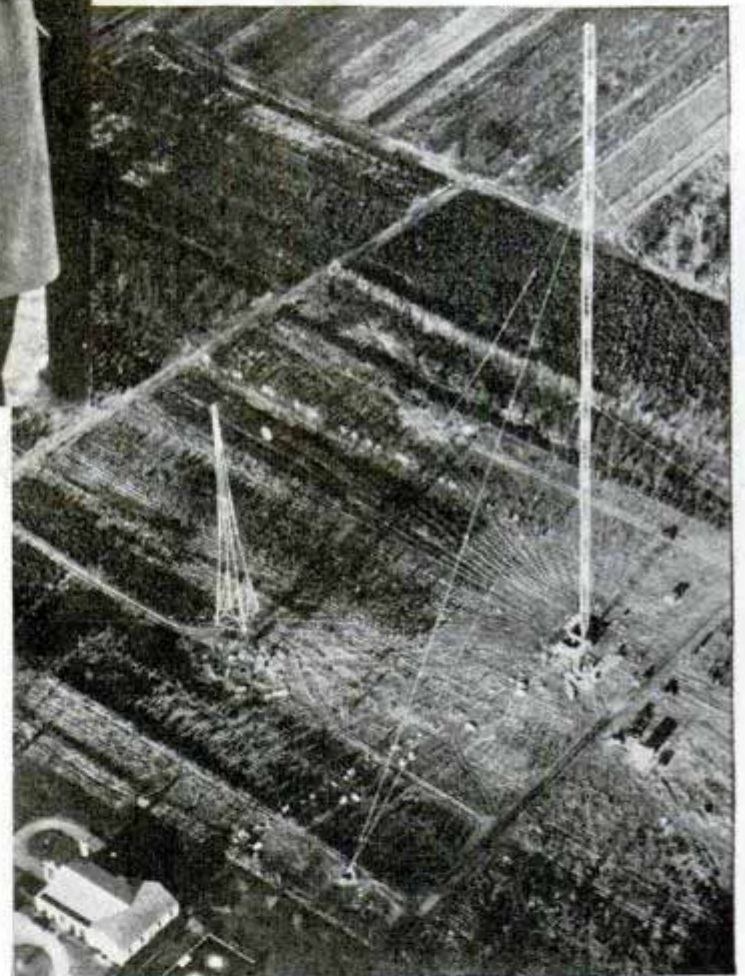

Left, pack transmitter in use during military ceremony. Right, giant antenna aids in bringing war news into American homes. This antenna is located in New Jersey

communications division where contact is maintained with all stations of the network at all times, and on the other side of Studio Nine is the listening station where foreign language experts listen in on European broadcasts as an extra check on picking up news tips and following developments as they are portrayed by government radios abroad.

To the rear of Studio Nine is a specially constructed control room known as the sub-master control room. In times of crisis the entire operation of the network passes through this room so that an important bulletin may be put on the air with minimum delay.

NBC likewise was ready, staff and technical facilities being keyed up far in advance of both the crisis and the war, to flash the latest news through the 176 stations in its Red



Circle, looking over war bulletins just before going on air. Center, Columbia's glass-walled studio especially designed for speeding up war news broadcasts. At left, Paul White is seen at telephone about to give cue to reporter and analyst (wearing headphones). Bottom, tuning in foreign radio stations in search of news tips

and Blue networks. Stationed at various points in Europe were observers and news directors. From London, Paris, Berlin, Rome and Geneva broadcasts traveled directly by transatlantic short-wave

(Continued to page 137A)

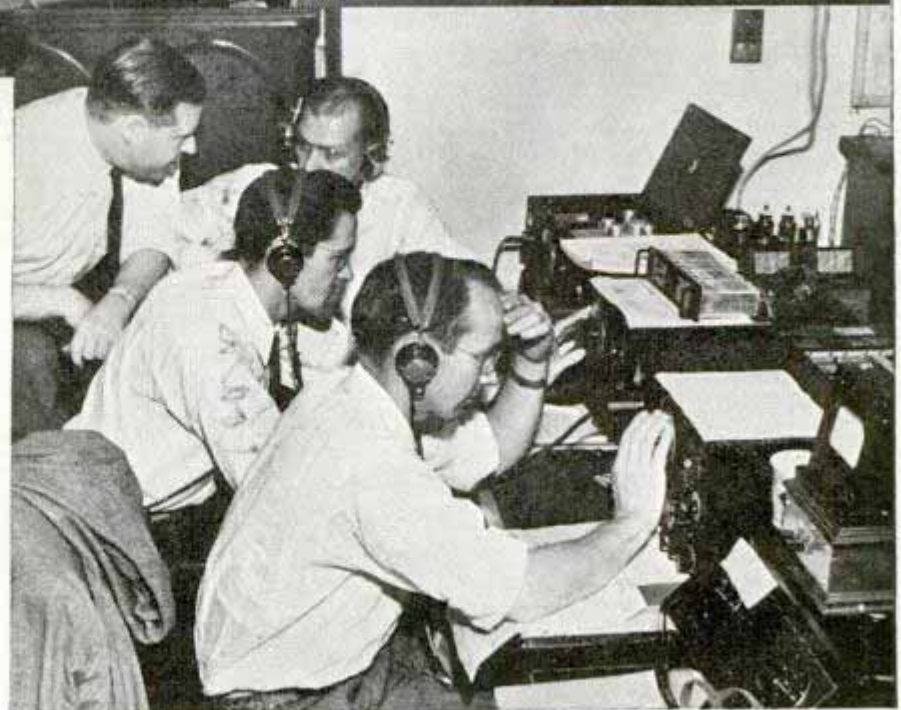

*Los Angeles, Calif.
Escondido, Calif.
2/12/27*

Mechanical Brain Aids Pilot in Checking Plan of Flight

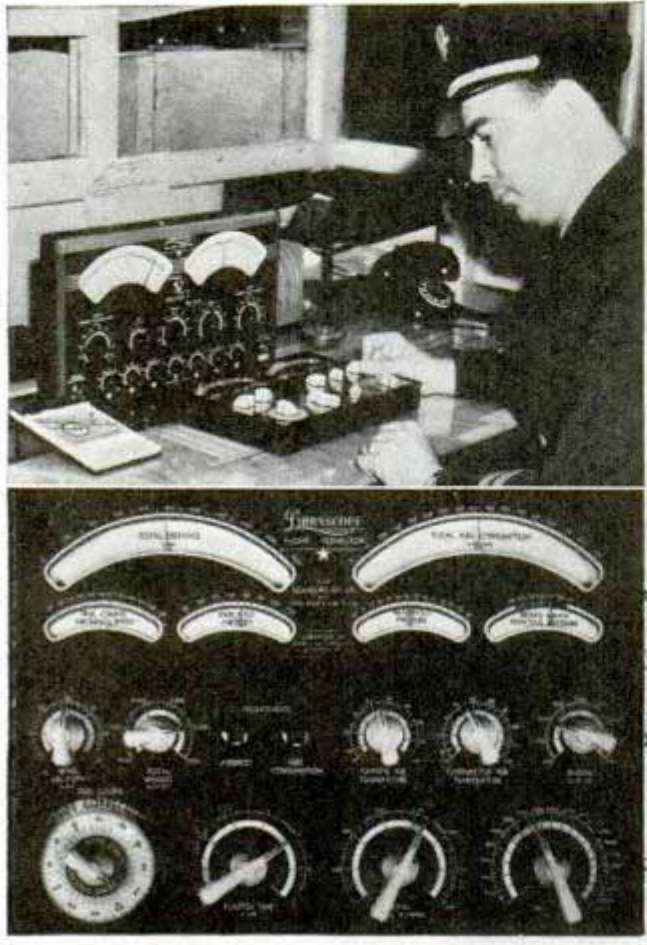

Setting pointers of mechanical brain that charts pilot's flight plan. Bottom, view of pointers

It used to take a pilot as long as forty-five minutes to complete his flight plan before stepping into his ship, but with the development of a mechanical brain the entire calculation may be made within one minute's time. The instrument, about the size of a brief case, combines into one computation many variable conditions. It is said to be very accurate. At the start of his flight, the pilot sets a series of knobs to indicate known conditions, representing such factors as wind velocity and direction, air temperature, true course of flight, total weight, time elapsed, altitude pressure, temperature at carburetor, and horsepower or engine speed. He then can read instantly every factor in his flight, including distance, ground speed, drift angle, indicated air speed, total fuel consumption, manifold pressure and engine mean effective pressure. Long flights are broken into "legs" and advance computations made for each leg. Adjustments are made by the

pilot during the flight for changed conditions immediately as they occur, and as each checking point of the course is passed he can see whether he is on time. Reports of his readings are sent periodically to the dispatcher's office, where a duplicate instrument is operated. One of the important results from the use of this mechanical brain for air lines is the assurance of landings on the minute as scheduled; and maximum engine efficiency is more easily obtained because adjustments can be made instantly to meet changing air conditions or mechanical requirements.

Fan in Furnace Air Chamber Helps Circulate "Lost" Heat

Unless heat is removed from the firebox surfaces of a hot-air furnace, this heat is often lost in the basement or goes up the chimney. To save this loss of heat, a fan now on the market is placed below the firebox in the heating chamber. By speeding circulation around all the heating surfaces the fan increases the volume of hot air delivered into the rooms. An automatic controller starts the fan when a fire is kindled, and proper speed is maintained in proportion to its temperature; then stops it when the fire is extinguished.

*Washington
Co. 1220 W. Washington
Racine, Wis.*

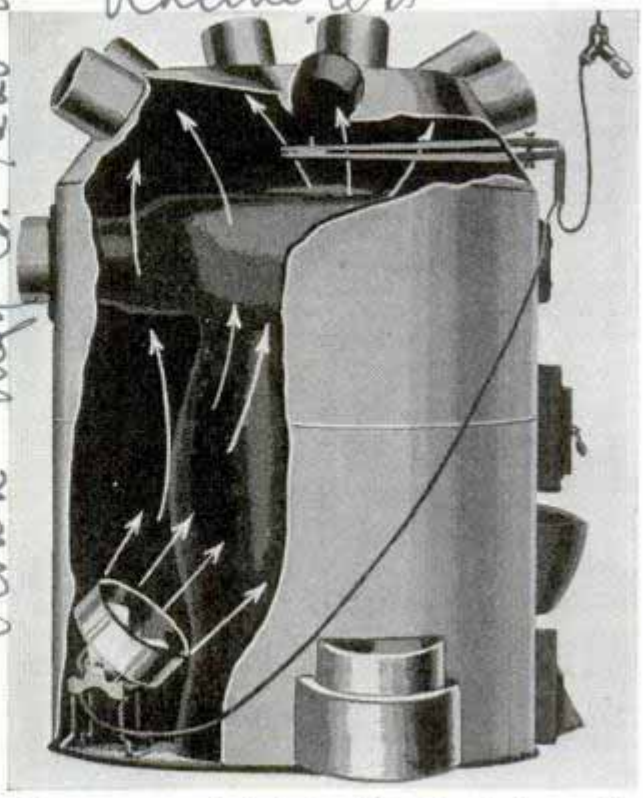

Rising current of air induced by electric fan inside furnace chamber helps circulate warmth in rooms

Camera Fights Paintbrush in Camouflage War



Above is an example of the method of camouflaging roads in war zone. Flimsy cloth or fish netting is strung across and alongside road to make it invisible to aerial observers. The weird masquerade shown at top, right, was designed for scouting from treetops, where the broken stripes in black and white blend with sky and branches

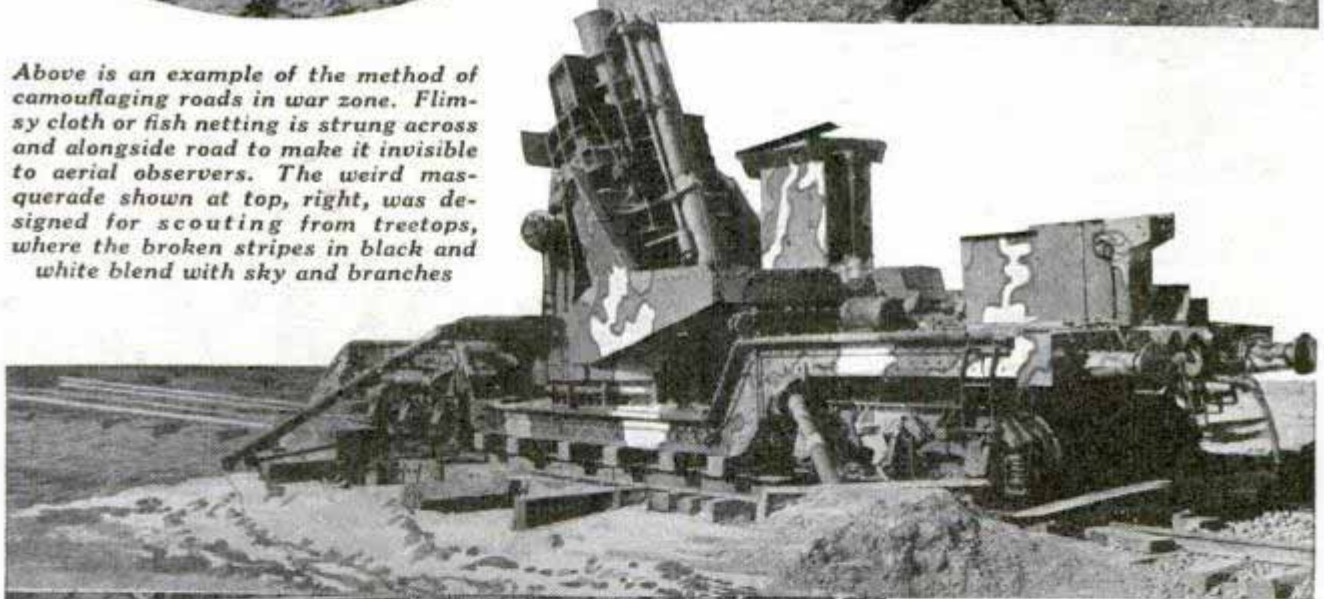

Camera and paintbrush are at war on the European battle front, where natural-color film, infrared and stereoscopic photography try to see what the enemy tries to make unseen by camouflage. The big gun, above, and plane, at left, may hide from human eyes under protective coloring but the camera detects them. Green branches stretched over the gun emplacements are soon noticed on color film or infrared picture as their leaves die. It is the job of the camouflage artist to break up outlines, to break up telltale shadows and to simulate the color of the surroundings

21259

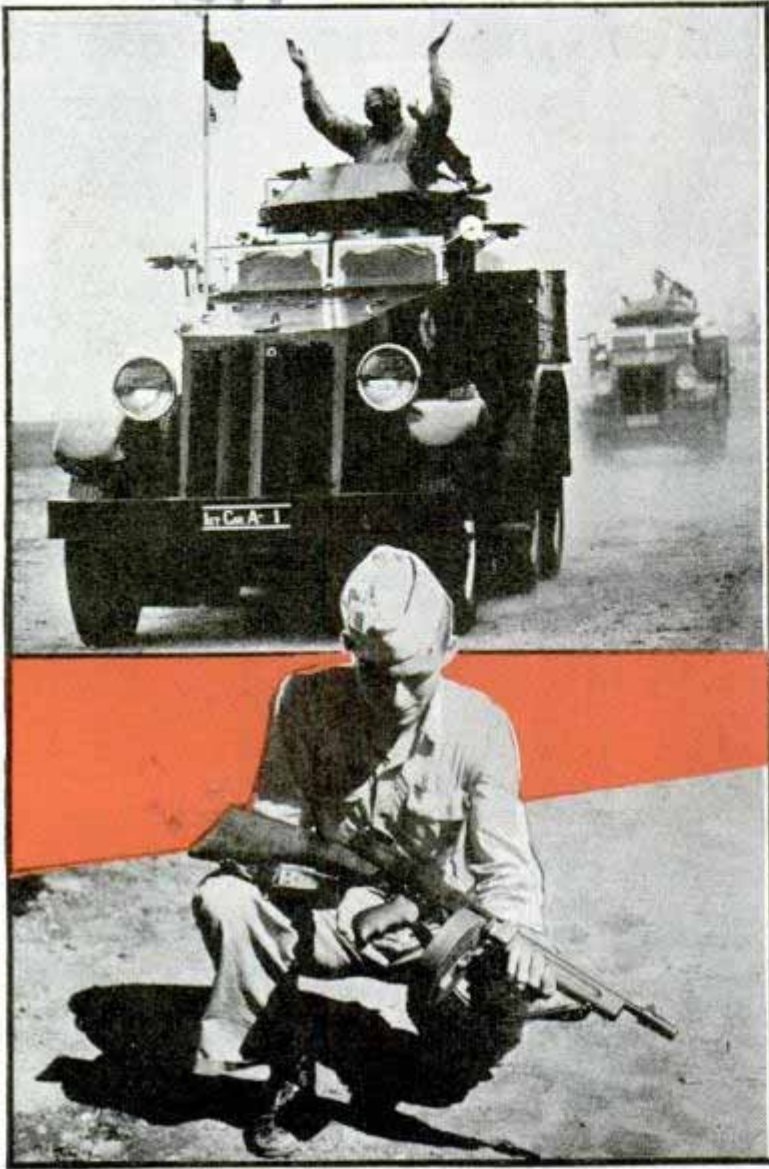

MODERN warfare must expect tank action in two general ways—as part of the infantry attack or as part of a true mechanized force, threatening either a wide end run to strike into vital rear areas, or exploiting a break through. Here the tank is part and parcel of another arm of the service—the cavalry. This is a horse of another color.

Again mechanical developments have forced the issue. High-speed armored vehicles are capable of striking a rapid blow, of seizing, momentarily, vital terrain, piercing a flank, threatening sensitive rear areas, and, above all, of smashing the last bit of “will to fight” out of a breaking enemy, rolling up his retreat, cutting communications, changing a stubborn retirement to headlong flight. Since all of these missions are those which in the past were logically given to horse troops, because of mobility and capability for shock action, it is only natural that the cavalry of today fall heir to the iron horse.

We call these mechanical cavalry units by several names, all

By R. Ernest Depuy
Major, U. S. Field Artillery
West Point, N.Y.

ARMY *on*

PART II



Photos courtesy U. S. Army Signal Corps

Advance of 1st Cavalry's "iron horses" (top); Thompson sub-machine gun, which is deadly at close quarters (center), and .37-millimeter anti-aircraft gun being fired at U. S. Army proving ground (bottom)

21259

Right, modern infantry advancing. Below, type of vehicle used to rush automatic weapons and personnel to vital points. Bottom, infantry's own artillery, a mortar

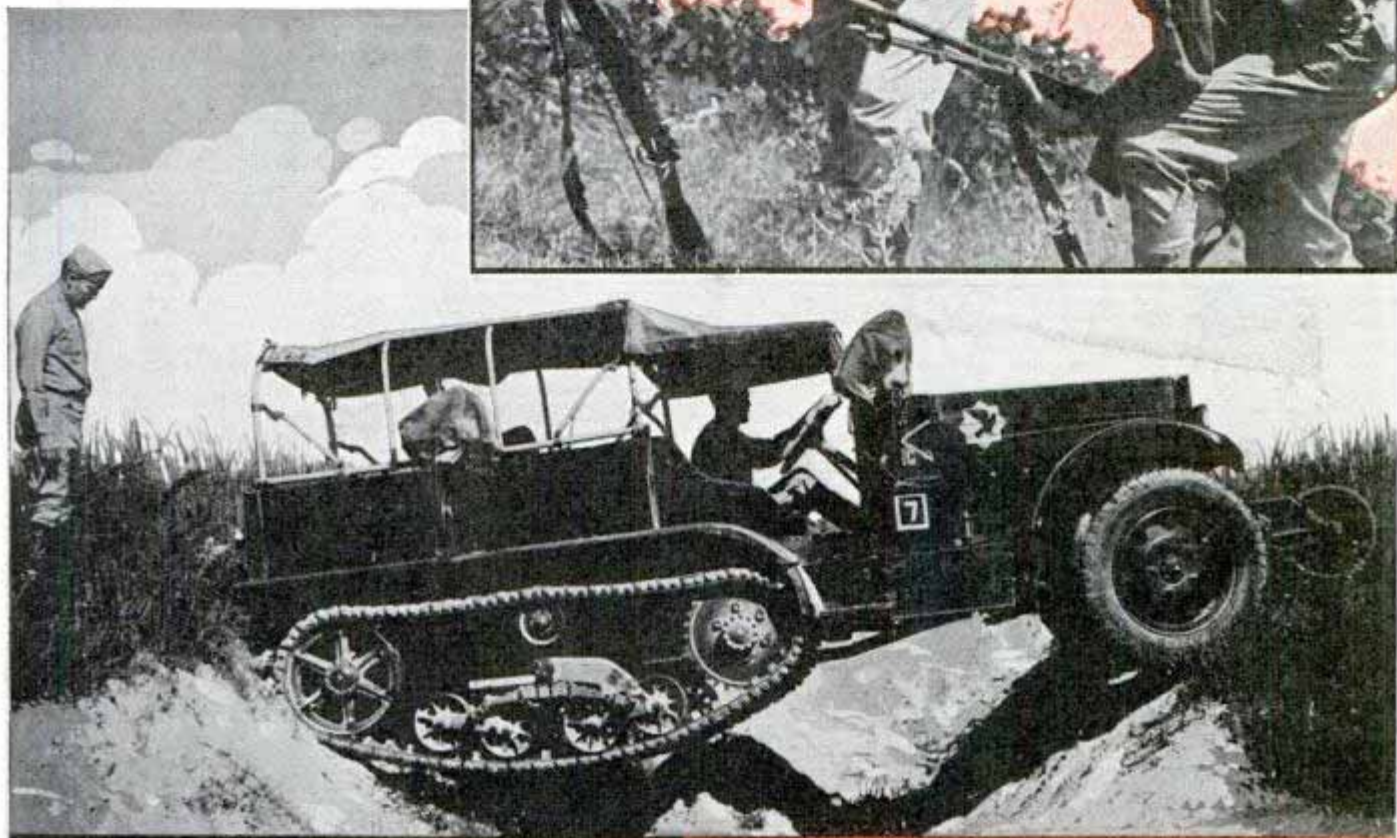

WHEELS

meaning the same thing—mechanized divisions, armored divisions, mobile divisions. They are organized in divisions, since the division is the basic self-contained unit of combat. The fighting vehicles themselves change only in name. Tank to the infantry, combat car to the cavalry, means exactly the same vehicle, exactly the same arrangement. What's in a name? The soldier who sees this roaring, fire-spitting engine of death scuttling at him across country doesn't have time or desire to bother with nomenclature. His defense against it is anti-tank defense—by artillery fire, by mine, by obstacle either artificial or natural.

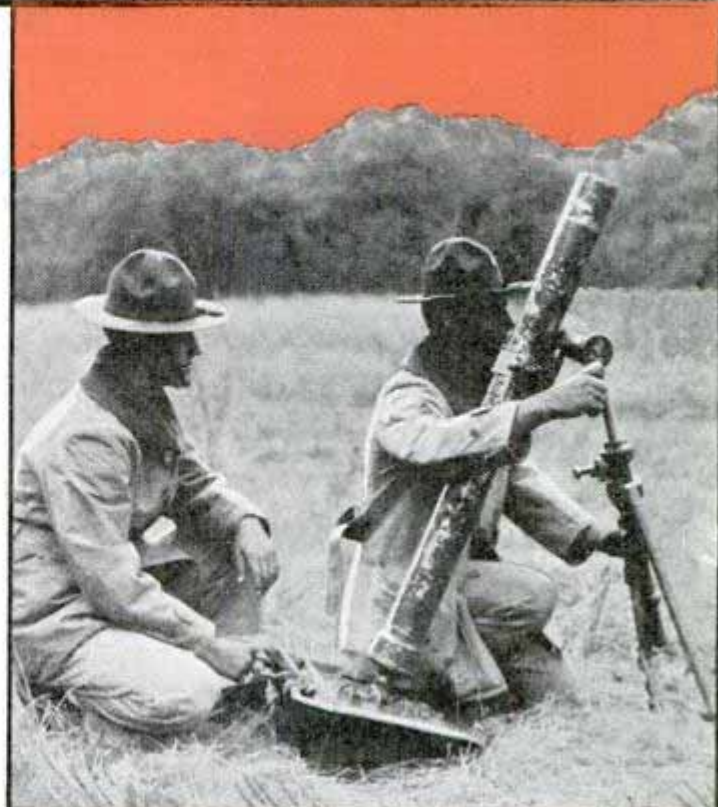

21259

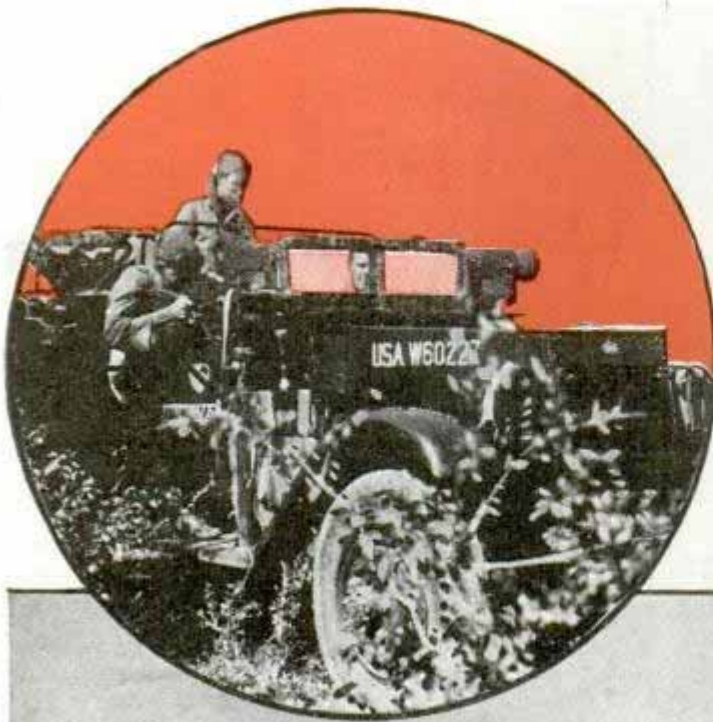

leaping destroyers and light cruisers do for the battle fleet. These we call armored cars. They have slight protection to cover their occupants from small-arms fire, and carry machine guns with which to fight. But since one of the missions of the mechanized division may be to dash out, seize and hold ground somewhere, we must take foot troops along. So, we take them, mounted on trucks, in place of the mounted infantry that were sometimes used in the past to gain mobility, the mounted infantry that became dragoons. It is interesting to note that the French today call

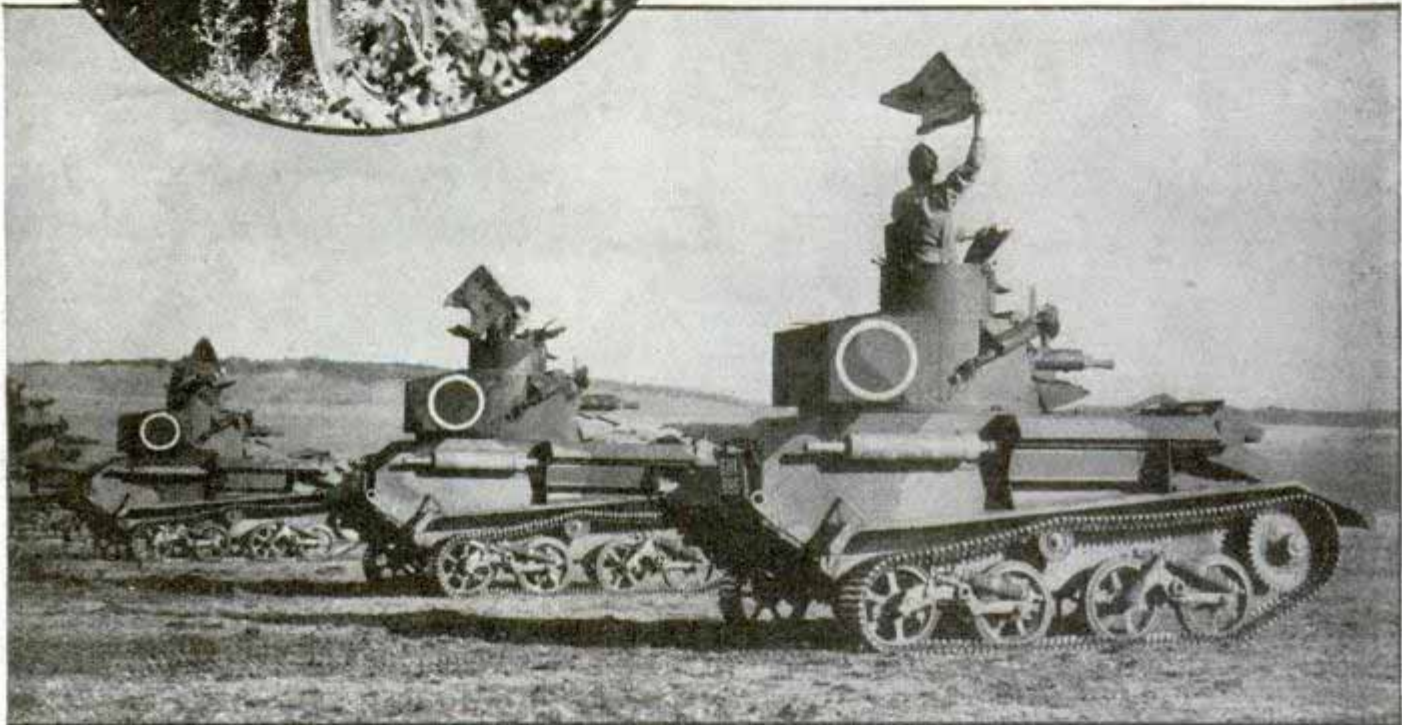

Circle, scout car of "streamline" division. Below, some of Britain's tanks in demonstration of modern armaments. These are light tanks, moving into "action"

To date, since the mechanized division is a new weapon, we find its composition differing in the armies of the various nations, most of whom admit that they are frankly experimenting with the proportions of the various types of weapons, and vehicles, and the man power in such units. The best one can do is enumerate the various pieces of armament which are essential—the proportions may change.

Primarily we have tanks—light and medium—the striking power. Next we must have lighter and faster vehicles which can carry on reconnaissance for miles ahead, which can protect the flanks, and in general do for our land battleships what the

these motorized infantry units, "dragons portees," literally, "transported dragoons." They, of course, cannot fight from their vehicles, and it is not intended that they should thus enter the fire fight. They come to hold ground that the tanks have seized.

We need artillery, entirely aside from the light guns mounted on the tanks; we must have fire power to overcome resistance, to cover our advance, to support our infantry when they have dismounted to fight on foot. So we bring them along, motorized of course, 75-millimeter guns or howitzers—or some similar caliber. And we must have anti-tank guns to fight off enemy tank attacks, so we add a propor-

tion of them, the little wicked, fast-firing .37-millimeter or slightly larger pieces. We have to have adequate protection against aerial attack, so there must be an anti-aircraft artillery unit. We must have machine-gun units, to build up our small-arms fire power, and they are mounted in armored cars, equipped with both light and heavy machine guns and—in our service at least—with a proportion of sub-machine guns—the “Tommy guns” which are

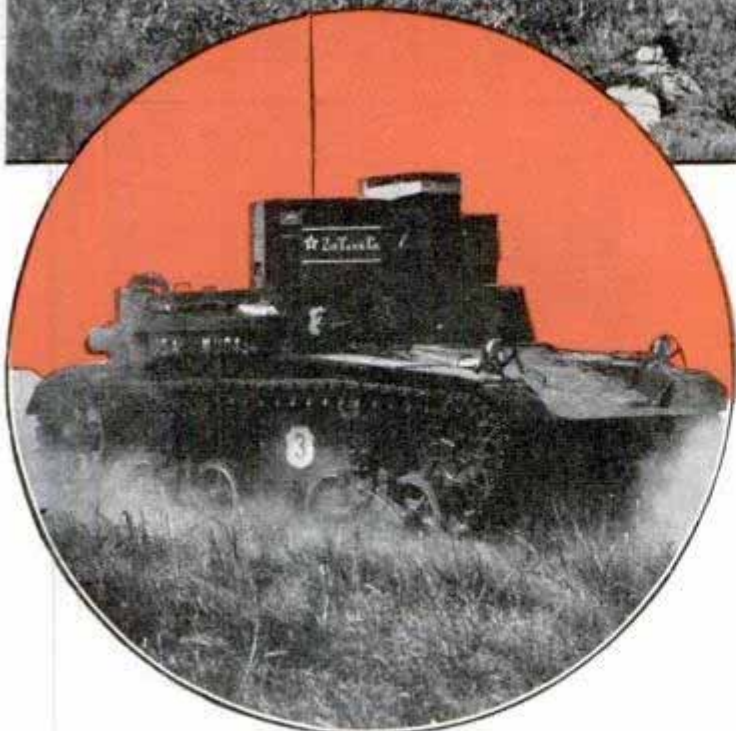
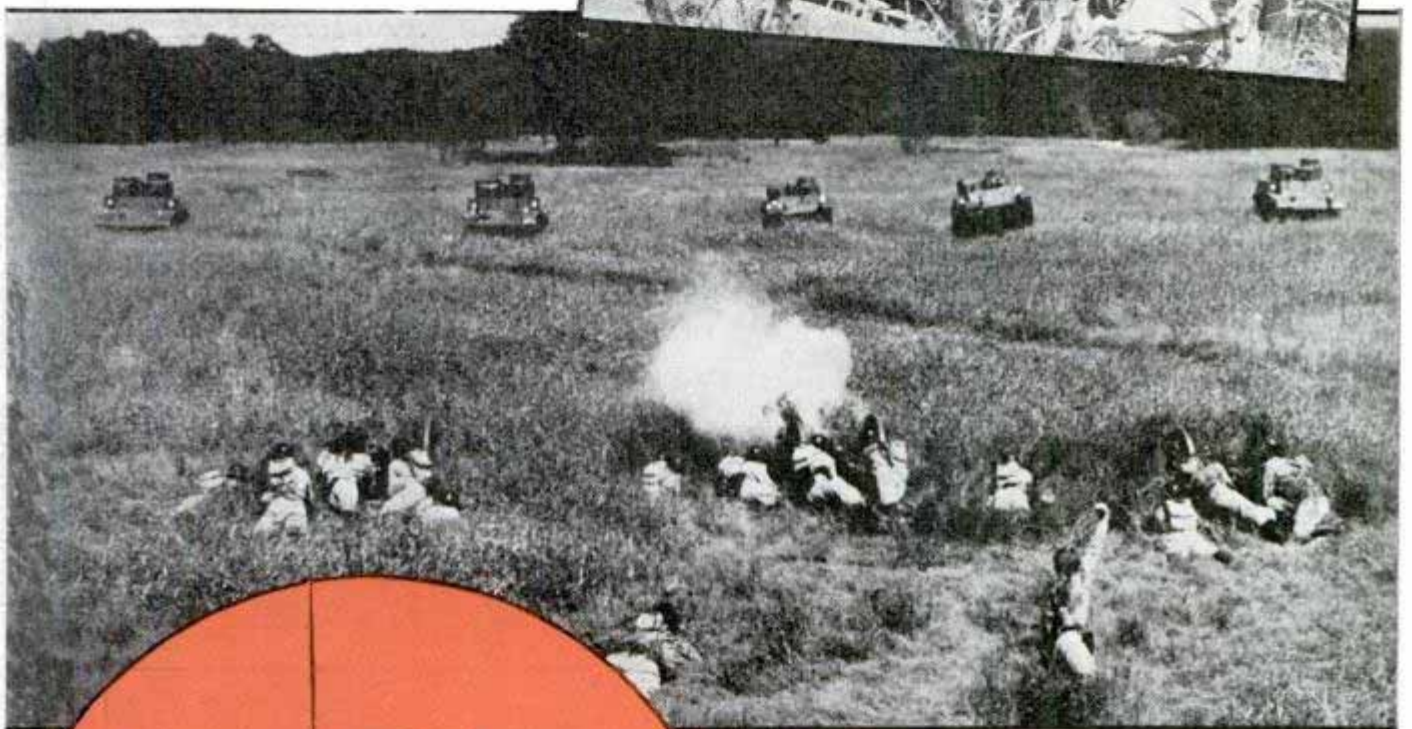

Manning anti-aircraft machine gun (top); tanks “attacking” battery of anti-tank weapons (center), and tank advancing through a smoke screen in battle maneuvers

deadly when they are fired at short ranges.

We must add to these combat units proportions of service troops—signal corps for communications, quartermaster for supply, engineers (all important these, for they are charged with essential road-repair, bridge-strengthening and obstacle-blasting to enable our mechanical cavalry to speed on its way) and medical detachments. And we must carry sufficient supply with this service train to subsist our iron horses and iron men. Here we come to the Achilles heel of the mechanized force. It can carry on its own vehicles, both combat and transport, sufficient gasoline and oil to run for approximately two days. After that, unless it has kept in touch with its supply bases, or unless the enemy has been so sufficiently kind or suf-



replenishment of fuel or ammunition, across country, though with some limitations.

Visualizing the bounds that this force can make, the comparative ease with which it can be shifted from flank to flank in open warfare, the terrific punch that it carries, we see that the mechanized division is a weapon of tremendous possibilities. Not least of them is the moral effect on the other fellow, for the problem of reconnaissance and security is multiplied enormously. No longer will scattered patrols be sufficient flank or rear guard within potential range of the armored force, for its striking power will carry it through them like a bullet through paper. Troops of all arms must be diverted from normal missions to protect on all sides. We come back in effect to the days of Julius Caesar, when the Roman soldier, at the end of each day's march, actually dug himself into a fortified camp—four-square against enemy attack.

ficiently frightened as to leave fuel supplies in our path, we jolt to a halt. Horses and men, animate beings with heart, can go on above and beyond their physical necessities for astounding periods. But who ever heard of a carburetor with a heart? And tanks cannot graze.

Summing up, we find in the average mechanized division a unit combining fire power and mobility, with ability to cover ground at approximately 200 miles per day, and capable normally of moving and fighting for two days without

Crew of anti-tank gun, with protecting rifleman (top); "streamline" division passing in review (center), and tanks advancing across country in semblance of an attack

21280
**Ambulance Has Incubator
 to Carry Babies in Safety**

Best conception of the strength contained in a typical armored division may be gained from a glance at the make-up of a German unit of this type—a so-called "Panzer" division. Its nucleus is a brigade of tanks, consisting of three regiments, each of two battalions of four troops—approximately 680 light and 170 medium tanks. It has a brigade of motorized infantry, consisting of three regiments each of three battalions of four companies, besides a machine-gun battalion of four companies, and a thirty-gun anti-tank artillery battery. One of the battalions in each infantry regiment is motorcycle-mounted. Its artillery consists of a battalion of twelve 105-millimeter howitzers. A reconnaissance squadron of four troops of armored cars, a signal and a pioneer battalion, and a small service train complete the unit. The division has twenty-eight light and twelve heavy armored cars. The fire power of the division, in addition to the weapons mounted on the tanks and armored cars and the 105-millimeter howitzers and anti-tank guns, consists of 260 light and 180 heavy machine guns, to which must be added the rifle companies of the infantry brigade. The estimated man strength of such a division is approximately 11,000. And Germany today is said to have six such divisions.

In our own service, true mechanization—we had tanks before, of course—started in February, 1928, with the organization of the Provisional Platoon, 1st Armored Car Troop, at Fort Myer, Va. Now our mechanized cavalry consists of the 7th Cavalry Brigade, composed of the 1st and 13th Cavalry and the 68th Field Artillery. Since an armored division should include, as stated above, a brigade of combat vehicles plus a brigade of motorized infantry and the necessary motorized field artillery, it

(Continued to page 144A)

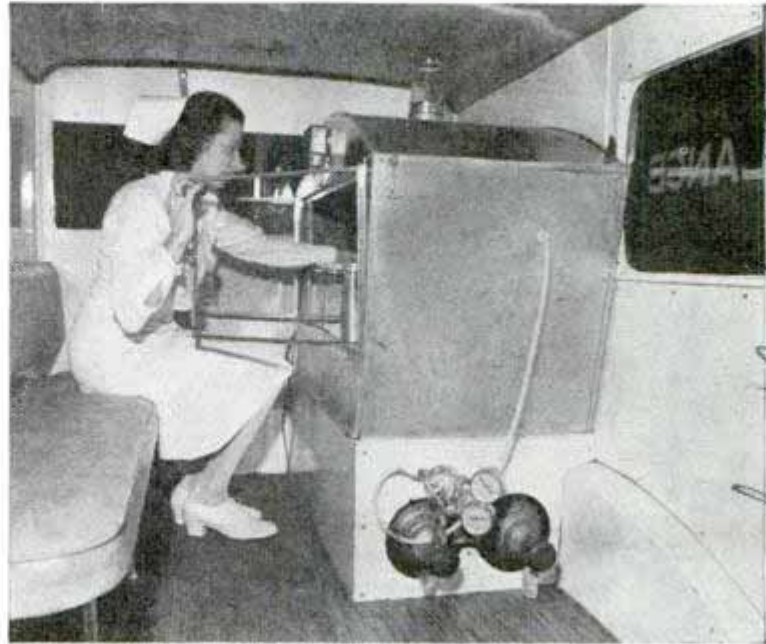

Incubator mounted on sponge rubber mat in ambulance controls temperature and is sealed to exclude air-borne dust and dirt

Babies prematurely born have a better chance of reaching the hospital in safe and healthy condition when transported in an ambulance specially equipped with an incubator that controls temperature, excludes outside air and reduces road shocks. The incubator cabinet, which is constructed of stainless steel and fitted with airtight glass doors, receives oxygen flowing through a rubber tubing from a tank beneath. A glass funnel is attached at the end of the tube so it can be placed over the infant's face if needed. Heat for the interior is supplied by hot water from the ambulance radiator, and a thermostat controls temperatures within two or three degrees. The crib that holds the baby rests upon a heavy sponge rubber mat, to reduce shock.

1283
**Waffle Iron, Toaster and Fryer in One
 Has a Three-Heat Switch**



Sandwiches can be toasted on an electric waffle iron by simply flipping the grids over. On one side of each grid is an iron for baking waffles, and on the other a flat grill for toasting sandwiches and for

frying. The top grid can be raised on its expansion hinge to make room for three-deck sandwiches and when opened to horizontal position it provides an additional flat frying surface.

*Electrical
 Manufacturers*

*21280
 Dodge Truck - Dodge Bros. Corp.
 79 00 Joe. Company and
 Detroit Mich*

C 1169. nagan a. weaver 145W45 the neygal

TARGET PLANE

DANGEROUS, LOW-FLYING AIRPLANES BECOME LESS FEARSOME TO DOUGH-BOYS PRACTICING FIRING AT THIS TARGET PLANE.

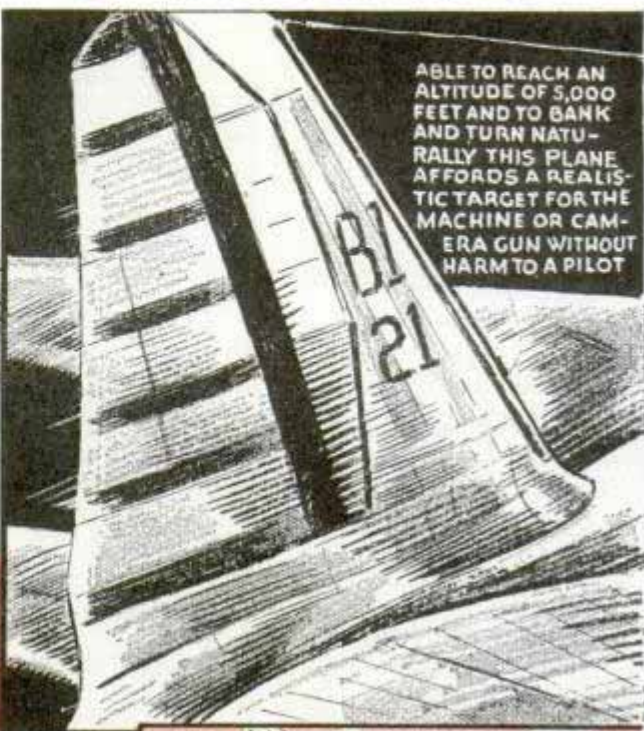

ABLE TO REACH AN ALTITUDE OF 5,000 FEET AND TO BANK AND TURN NATURALLY THIS PLANE AFFORDS A REALISTIC TARGET FOR THE MACHINE OR CAMERA GUN WITHOUT HARM TO A PILOT



SPECIALLY DESIGNED TRUCK USED FOR MOVING PLANE TO AND FROM RANGES



TRUCK, CATAPULT AND PARACHUTE PERMIT OPERATION OF TARGET PLANE IN MINIMUM OF SPACE AND EASY TRANSPORTATION TO GROUND BRANCHES



THE ENTIRE MANEUVERABILITY OF THE PLANE IS ACCOMPLISHED BY RADIO INSTALLATIONS CONTROLLED BY AN OFFICER WITH A SMALL DIALED INSTRUMENT

WIRE RUNS TO TRANSMITTER 1,000 FEET AWAY
HERE IS THE GENERAL SCHEME OF MOTIVATION

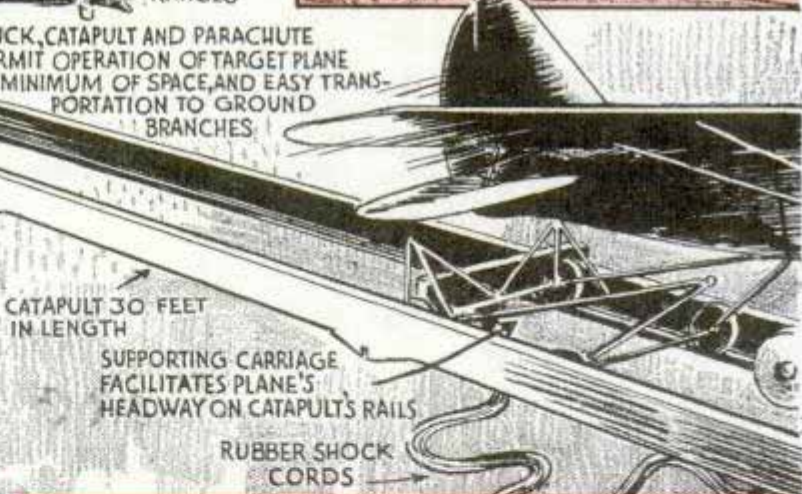

CATAPULT 30 FEET IN LENGTH
SUPPORTING CARRIAGE FACILITATES PLANE'S HEADWAY ON CATAPULT'S RAILS
RUBBER SHOCK CORDS

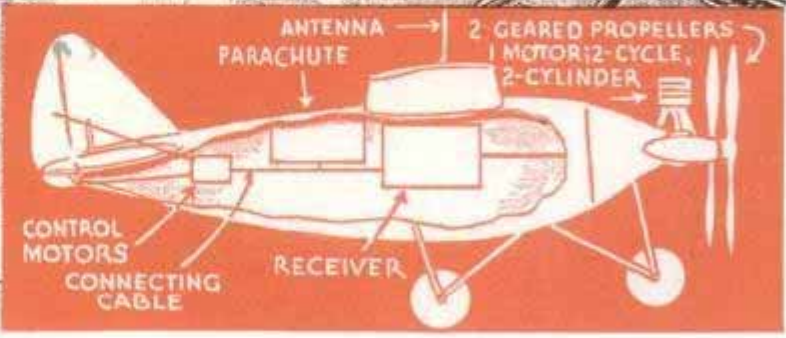

ANTENNA PARACHUTE
2 GEARED PROPELLERS 1 MOTOR 12-CYCLE, 2-CYLINDER
CONTROL MOTORS
CONNECTING CABLE
RECEIVER

Eliminating danger to pilots, a target airplane controlled by radio is being tested by Air Corps engineers. It is designed for training infantry, cavalry and field and coast artillery in anti-aircraft work. About one-third the size of a combat plane, it replaces the old sleeve-type target towed by plane

Capt. Holloman, Capt. Fisher, and Lawrence and Shannon, in development and design

Wright Field Dayton Ohio

21169

Controlled by Radio

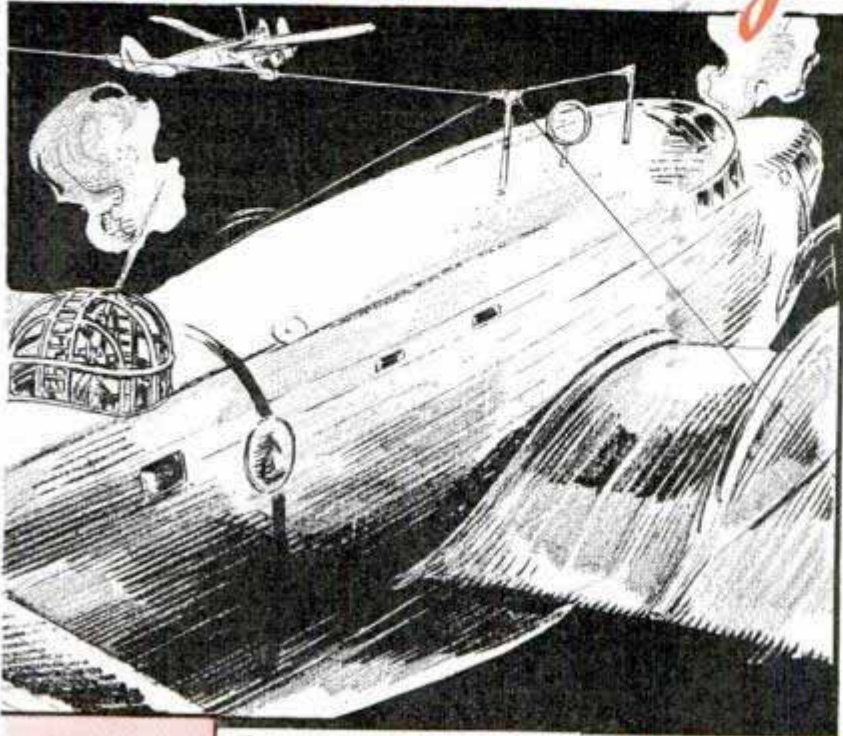

MERE PRESSURE OF A BUTTON ON THE INSTRUMENT HELD BY THE OPERATOR STOPS THE MOTOR, RELEASES THE PARACHUTE AND THE PLANE SETTLES GENTLY TO EARTH

THE OLD SLEEVE-TYPE TARGET LACKS REALISM IN SHAPE, MANEUVERABILITY AND CONVENIENCE IN THE IDENTIFICATION OF VITAL SPOTS OF AN AIRPLANE

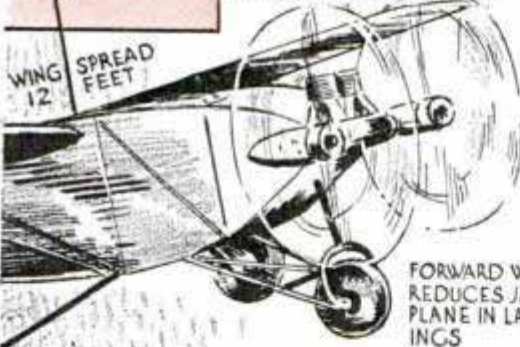

FORWARD WHEEL REDUCES JAR TO PLANE IN LANDINGS



WITH ITS MOTOR ADJUSTED TO A TAKE-OFF R.P.M. THE PLANE, RELEASED BY TRIPPING THE SHOCK CORDS, SHOOTS ALONG THE RAILS AND INTO THE AIR

A REMOTE RADIO-CONTROLLED PLANE AS A FUTURE POSSIBILITY. IT PHOTOGRAPHS ENEMY POSITIONS AND MOVEMENTS AND NO LIVES ARE LOST IF THE PLANE IS DEMOLISHED BY GUNFIRE



Launched by catapult, the target plane attains an altitude of 5,000 feet and can turn and bank in realistic manner. Construction and maintenance costs are low. In addition to serving as a target for practice gunnery, it might be used for photographing enemy positions without loss of life if it should be destroyed

Chart Plots Danger of Fire from Forest Conditions



Relative danger of forest fire is plotted daily on this board after obtaining weather reports

Forest fire danger is plotted from day to day on a chart that takes into consideration the various factors increasing or reducing the hazard at the moment—the relative humidity, wind, recent rains, fuel moisture, growth stage of trees and plants, and so on. Reports from the nearest weather bureau are tabulated on a special slide rule and transferred numerically to the fire-danger board three times a day. At the top of the board appears the number representing the current fire hazard. Number one will indicate no danger, with high humidity, green woods, the wind calm, visibility unlimited and fuel moisture not over twenty-five per cent. Extreme danger is indicated by number seven.

U. S. Aircraft Plants Speed Up to 15,000 per Year Pace

Swift expansion of airplane manufacturing facilities in the United States during recent months has brought production ca-

capacity to 1,250 planes a month, 15,000 a year. Building projects under way will make possible even greater production. Of the forty-three manufacturers included in the survey, twenty-three are busy on military equipment. While airplane factory space was increasing from 6,000,000 to 7,025,000 square feet in the first half of 1939, an expansion of seventeen per cent, aircraft engine factory space reached 1,975,434 square feet for a twenty per cent gain in six months. The thirteen American engine manufacturers can build 16,000 engines a year.

Soldiers Given New Uniforms and Semi-Automatic Rifles

Semi-automatic rifles and more comfortable uniforms are included in the United States army's new equipment. The old Springfield rifles are being replaced by the new gun invented by John C. Garand which works on the principle of a Colt automatic pistol. Clips holding eight thirty-caliber cartridges are inserted by hand, and twelve clips per minute can be fired by an expert. A rod operated by gas works



Soldier at right wearing new uniform bears semi-automatic rifle, as compared with old equipment

the breech mechanism, and an entire clip can be fired without removing the rifle from the shoulder. The Garand gun is said to have a fire power equal to three Springfields.

Ref: Roger White Junior Forester

Commercial... of Commerce, 30 Rockefeller Plaza New York

Ref: Mrs Rodriguez

Ref: Jack P. Hall

Half Jay in Governor's...

Slingshot Used as Gun by Expert Marksman



Two pictures at left show slingshot marksman shattering clay pigeon. Above, the expert flicks ashes from cigar with pellet; below, taking careful aim

Accuracy with a slingshot that rivals tricks performed with a pistol has been developed by a Tennessee marksman. Using a slingshot consisting of a forked stick and two stout rubber bands, he shoots the ash from a cigar held in someone's mouth,

hits clay pigeons thrown into the air, or lights two matches by striking them with a pebble. He makes a living partly by hunting, and boasts that he has never brought in a wounded duck since he always hits them in the head.

JR 65 Charles Taylor, Peelfoot Lake
Interlocking Steel Shingle Ventilates Roof to Avoid Rust

Hexagonal steel shingles with watertight interlocking connections that permit air circulation underneath have just been introduced. Built so simply that an experienced roofer is not required for installing them, these shingles are ultra-rigid and durable. The ventilation feature eliminates "sweating" and the resultant rusting. If a shingle is damaged it can be replaced by prying loose the interlocking connections, and if a building were wrecked the entire steel-shingled roof could be removed and used again.

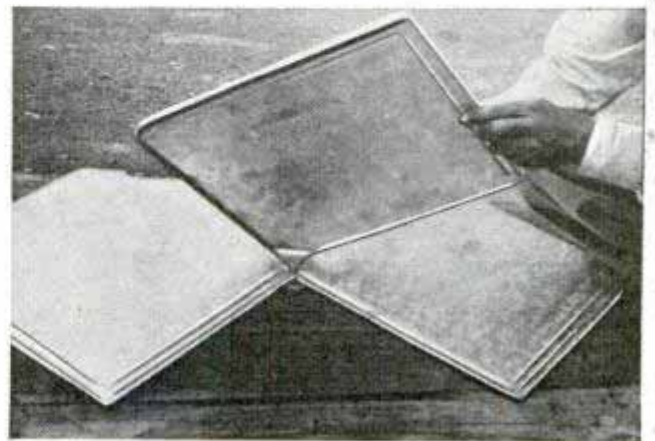

Watertight interlocking shingle lets air circulate

*Chas Taylor - R.C. Harrington
 Bird Lime & Cement Co 1904 W.*

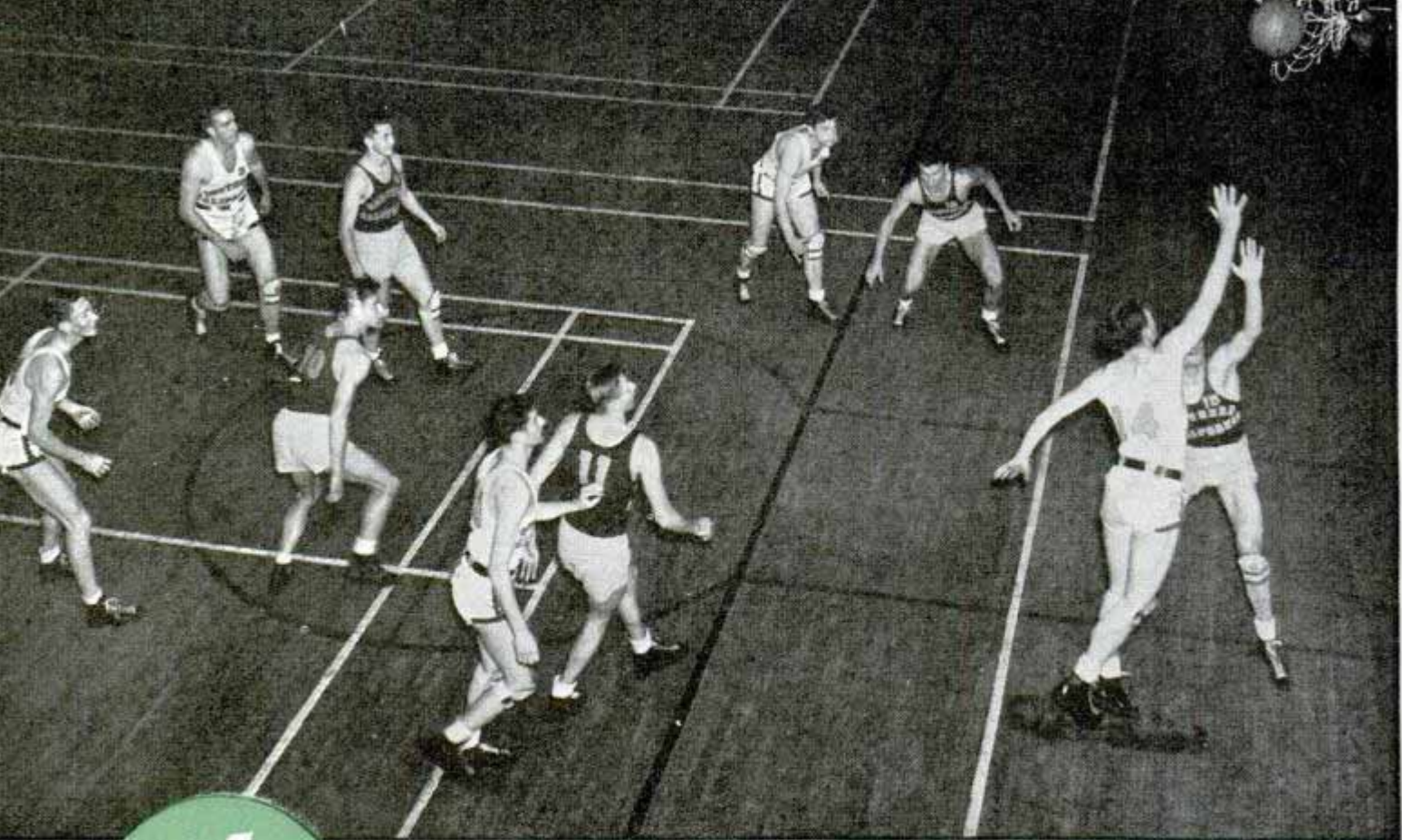

The YOUNG GIANT

By Coach Sam Barry
University of Southern California

University Park Los Angeles, Calif

191060

MORE people will watch basketball games this year than any other sport. Judging by last year's figures some 100,000,000 spectators, about a third more than the total football attendance, will watch the indoor game this winter.

Three or four years ago basketball was just another sport and its sudden rise to the top is because its mechanics have been changed from a defensive to an offensive sort. The game has been tremendously speeded up. Elimination of the tip-off, on

which the writer experimented for several years before it was adopted, makes larger scores possible. The ten-second rule that calls for the ball to be advanced to the center of the floor within ten seconds after it goes out of bounds or under certain other circumstances, as well as the three-second rule that allows a player to stay inside the free-throw area only for that length of



Top, good defense tactics, with each player paired against opponent. Bottom, guarding practice trains players to get control of ball from opposing players

Conf. Thomas G. Stinson Jr. 1/8/68 Malibu Road

Pacific Palisades, Calif



time have added to the speed and versatility of basketball. It always was a fast game and the recent changes have made it faster and trickier than ever.

For a while we thought the strenuous exertions of the modern game might be too hard on a player but scientific tests show that forty minutes of fast play is easier on him than a fast quarter-mile run.

Strategy has become an important factor and a team is apt to try deliberately to decoy opponents out of position

of SPORT

Top, player getting away good distance shot, causing ball to spin with motion of thumbs. Center, showing how player's hands impart spin for long straight flight of ball. Bottom, left, tipping ball into basket. Right, forward and guard in close quarters



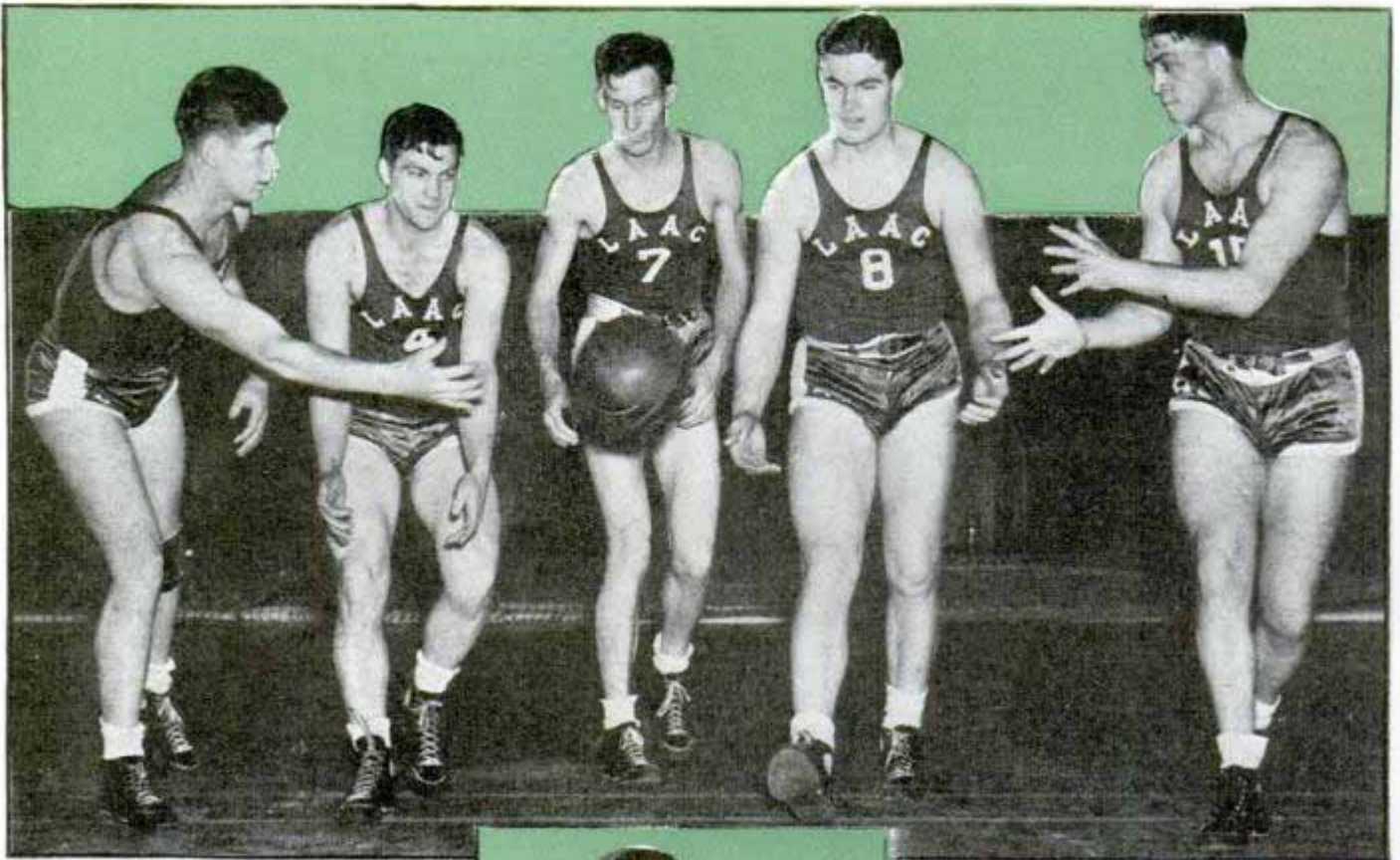

and then, when the stage is set, make a fast drive down the court. Various formations for different plays are used and a ball may be handled by five or six players in maneuvering for a shot.

As time goes on more changes may be made in the rules. Officials are studying the advisability of reducing the length of the official floor from ninety-four to eighty-five feet. Now that the tip-off is no longer used the long floor doesn't seem necessary. Another suggestion is to raise the baskets two feet, to a height of twelve feet above the floor, as a way to reduce the advantage tall men now enjoy over shorter players.

If you can place one out of every four shots in the basket you are a good shooter. The way to hold the ball for a long shot is with both hands on the back half of it, thumbs extended and almost together. The ball is pushed into the air and much of the work is done by the thumbs, which are shot forward and downward in making the throw. It is a natural motion



Learning control of ball by juggling from one player to another and (left) dribbling, with head up to watch opponents. This is considered good form

and an important one. The downward motion of the thumbs puts "english" on the ball and causes it to rotate inwardly, giving it the same spin that you give a baseball in throwing a straight pitch.

Try throwing a long basket by pushing the ball with the palms and fingers alone. You'll notice that the ball is dead, that it falls short and that it wobbles in the air. Then put a spin on your next shot and watch how it flies straight toward the basket. The spin prevents

side waver and gives you better control. Spinning in a direction opposite to the rotation of a wheel along the ground, the top of the big ball travels backward through the air while its bottom is rolling forward and is building up air pressure that tends to make the ball skid upward. That's why you get better distance with a spinning



ball. Since the least air pressure is at the top of the ball there is no tendency for it to fly off to one side, and this accounts for its straight flight.

Use this two-handed throw for long-range tosses up to forty or fifty feet. For short throws, when you are within fifteen feet of the basket, one hand is all you need. This is a push shot and you float the ball toward the basket very much like you were making a shot put. Rotation is not necessary for the short distance the ball travels.

Although shooting is the most important fundamental of the game, you won't be a good player until you learn a number of other phases. Most shots fall off the rim instead of falling through the hoop and you should always be prepared for another try at making a score. This is mainly a

(Continued to page 122A)

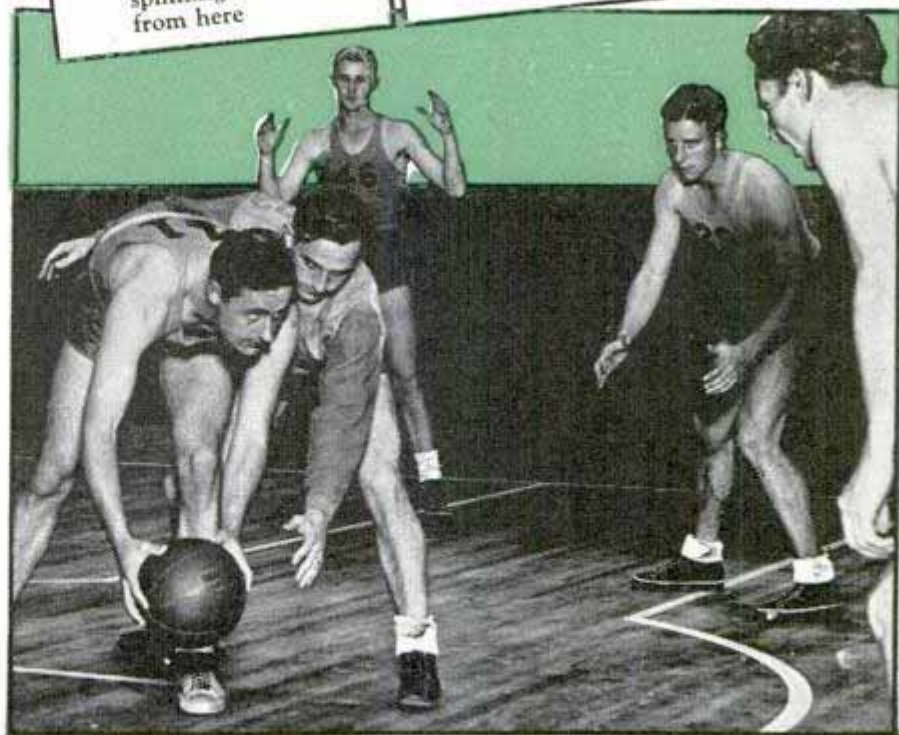
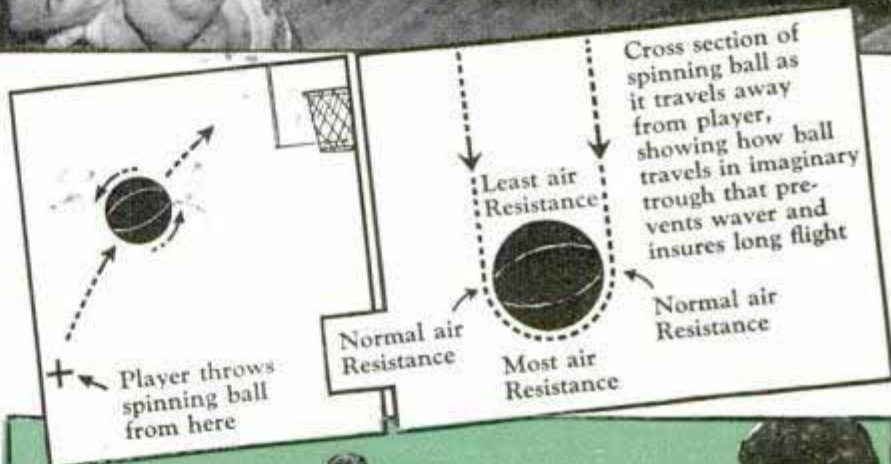

Top, left, tip-in shots are easy for player who times himself properly. Right, practicing one-hand push shots. Center, demonstrating effect of air resistance on spinning ball. Bottom, players posed by coach in working out trick play

Safety-Belt Shock Absorber Breaks Worker's Fall

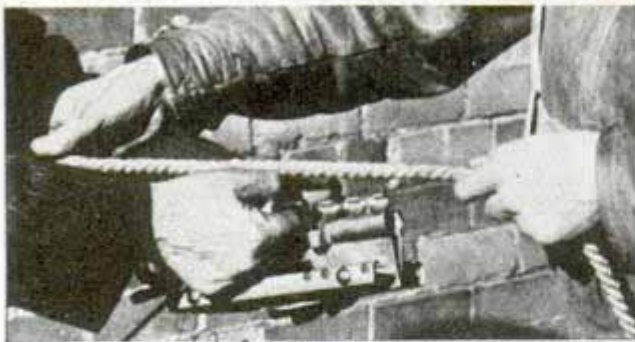

Testing shock absorber in leap from tower, and, below, placing rope in device that breaks man's fall

Men working in high places where they face the risk of injury or death by falling, now may use a shock absorber which protects them in case of accident. The worker wears a woven harness to which a rope is attached. This rope passes through the shock absorber, which in turn is fastened to the structure. If the workman falls, the shock absorber acts as a brake by clamping down on the rope and slowing the

plunge until the man comes to a gradual stop. If he were to fall unchecked for the full length of the rope, the force might snap the rope when its limit was reached, or the sudden jerk might cause injury.

J 1264.

Handy Card File in Automobile Slides under Front Panel

Salesmen with large lists of prospects or voluminous sales data will recognize the convenience of a card file that is installed in the automobile, under the instrument board. It holds 750 standard three-by-five index cards and is equipped with a handle and sliding cover to be used in carrying the case into a prospect's home or office. With the cover on, the container may be pulled out like a drawer to serve as a small writing desk.

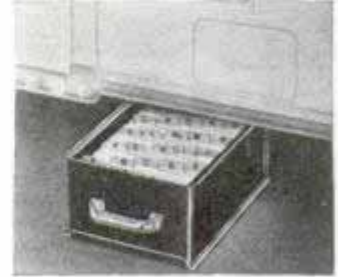

Chase Products Co.
and Orange N.Y.

J 1102

Tool Inserts Expander in Piston without Removal from Engine

Installation of piston expanders has been simplified by the development of a spring-steel one that can be placed without removing either the pin, rod or piston from the cylinder. Furnished with each set of expanders, a special tool, resembling pliers with prongs instead of pincers, is used in placing them, and no grooving, drilling, slotting or other machining is required.



Spring-steel expander is placed in piston while it is in the cylinder and without removing rod or pin

The U.S. Ever Piston
Bureau

pre-bench are man
Feds also

London Is Ready for 'Blackout' Emergencies

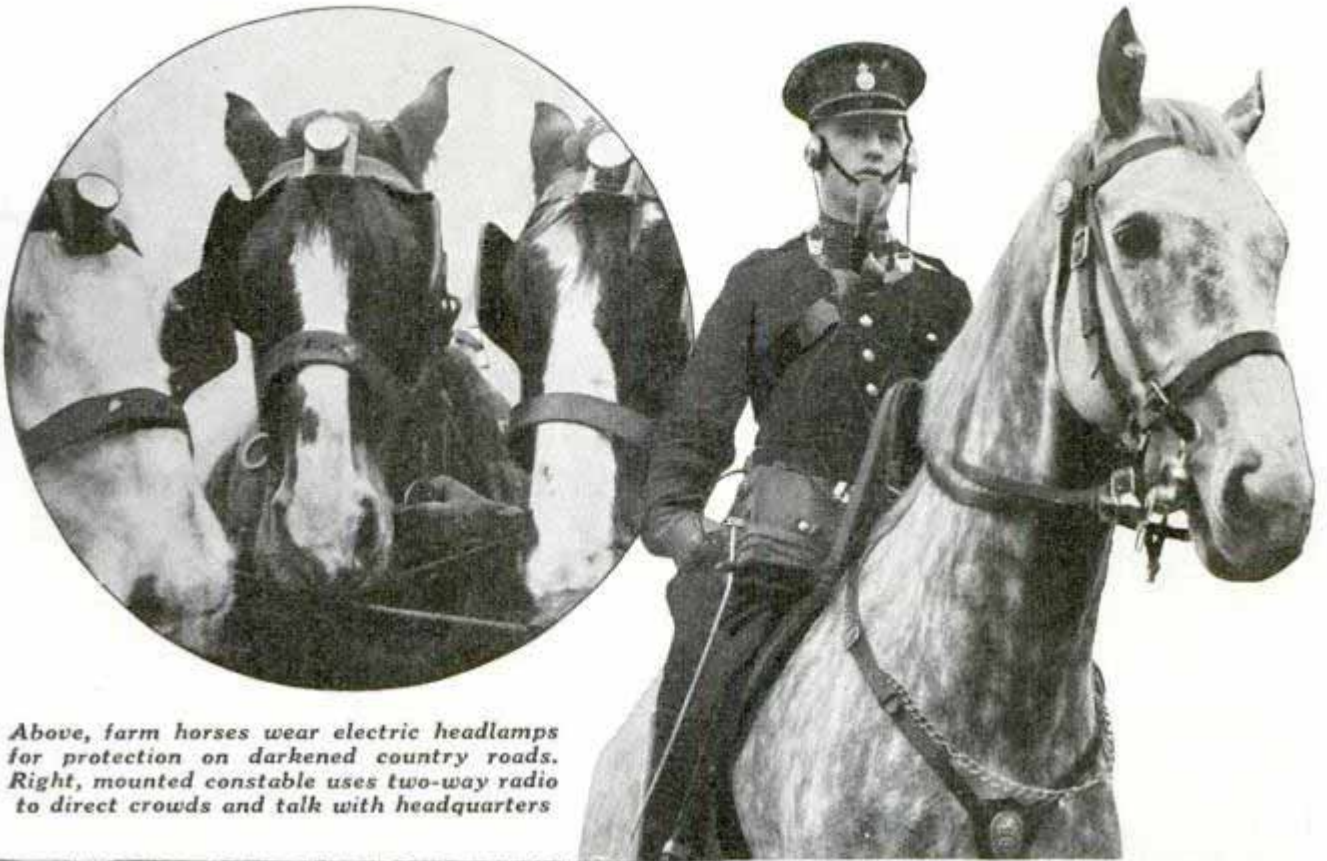

Above, farm horses wear electric headlamps for protection on darkened country roads. Right, mounted constable uses two-way radio to direct crowds and talk with headquarters

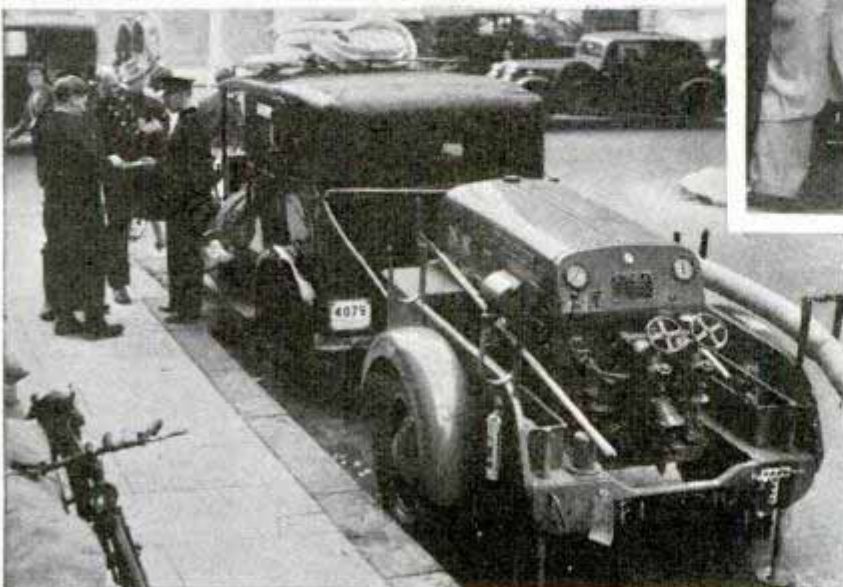
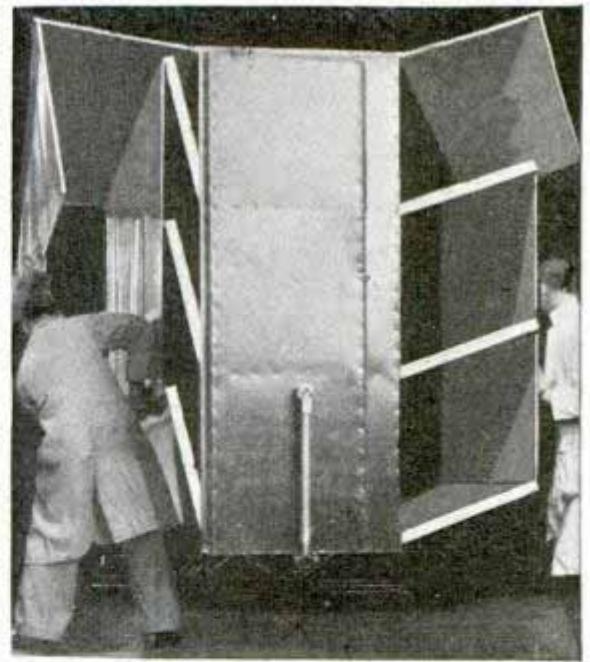
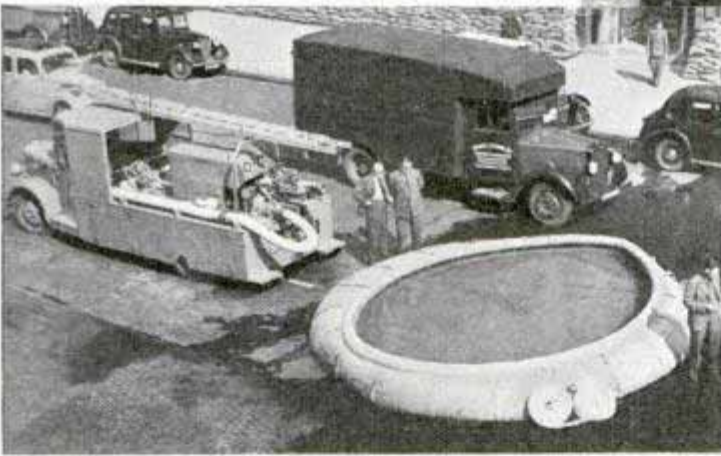

At left, center, auxiliary fire unit with its own emergency reservoir prepares for air-raid service in London. Below, taxicab is commandeered to haul trailer pump of fire-fighting group. Right, collapsible trailer ambulance which can hold twelve injured persons on folding stretchers while nurse patrols center passage. When collapsed it is only two feet four inches wide and can be pushed through a narrow lane when the road is impassable

Paul Connor,
705 Santa Barbara Ave
Berkeley, Calif

The ROOKIE Goes to

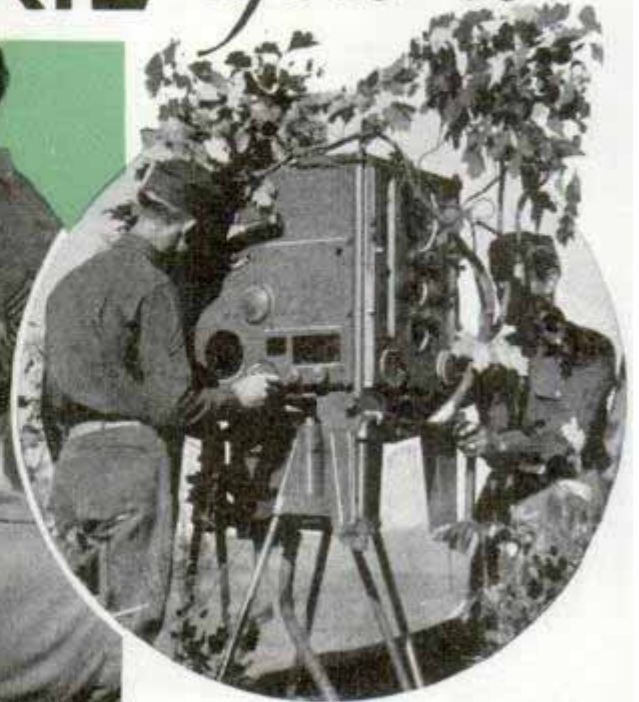
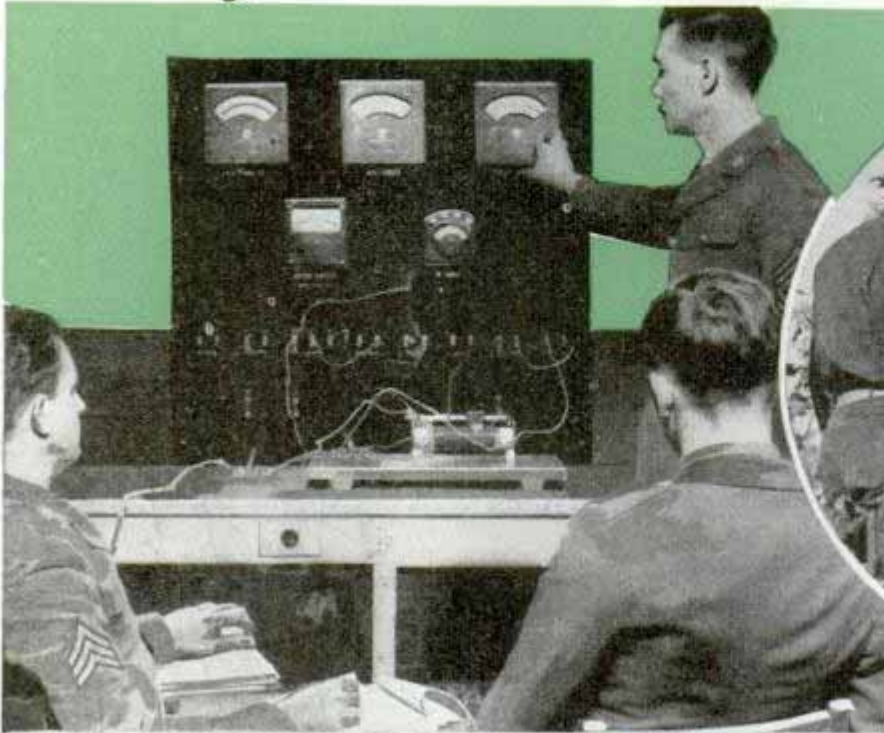

Left, the rookie is given instruction in electricity, if he wants it. Right, here he learns how to operate an anti-aircraft fire director. Below, the army band offers opportunities to the musically inclined recruit



227,000 men—the largest peacetime military strength America has ever seen. And one important thing about this new army is that beef and brawn don't count like they used to. Modern wars are fought with civilization's most intricate instruments, and soldiers have to know how to use them. So the day of the dumb soldier is gone.

“WHAT I want to know,” the red-haired, freckle-faced youth said, “is do you learn anything in this army besides how to shoot guys.”

The recruiting sergeant grinned and replied: “You bet you learn something in this army besides how to shoot guys. Today's army is streamlined and technical, and they won't even let you enlist unless you can prove you have the necessary brains to learn with.”

Uncle Sam is in the midst of a campaign to build up the regular army to a total of

Advantages are greater in today's army. Standards for enlistment are higher. The recruit must present a good school record, and if he's ever been in trouble with the police the army won't take him as a gift.

Suppose our red-haired boy is among the thousands of new men now being sworn in. Where can he go, what can he see, what can he learn?

We'll assume he hasn't a police record, and that he gets checked through with a physical O.K. He's at least five feet four inches tall, not under 115 pounds, has av-

COLLEGE

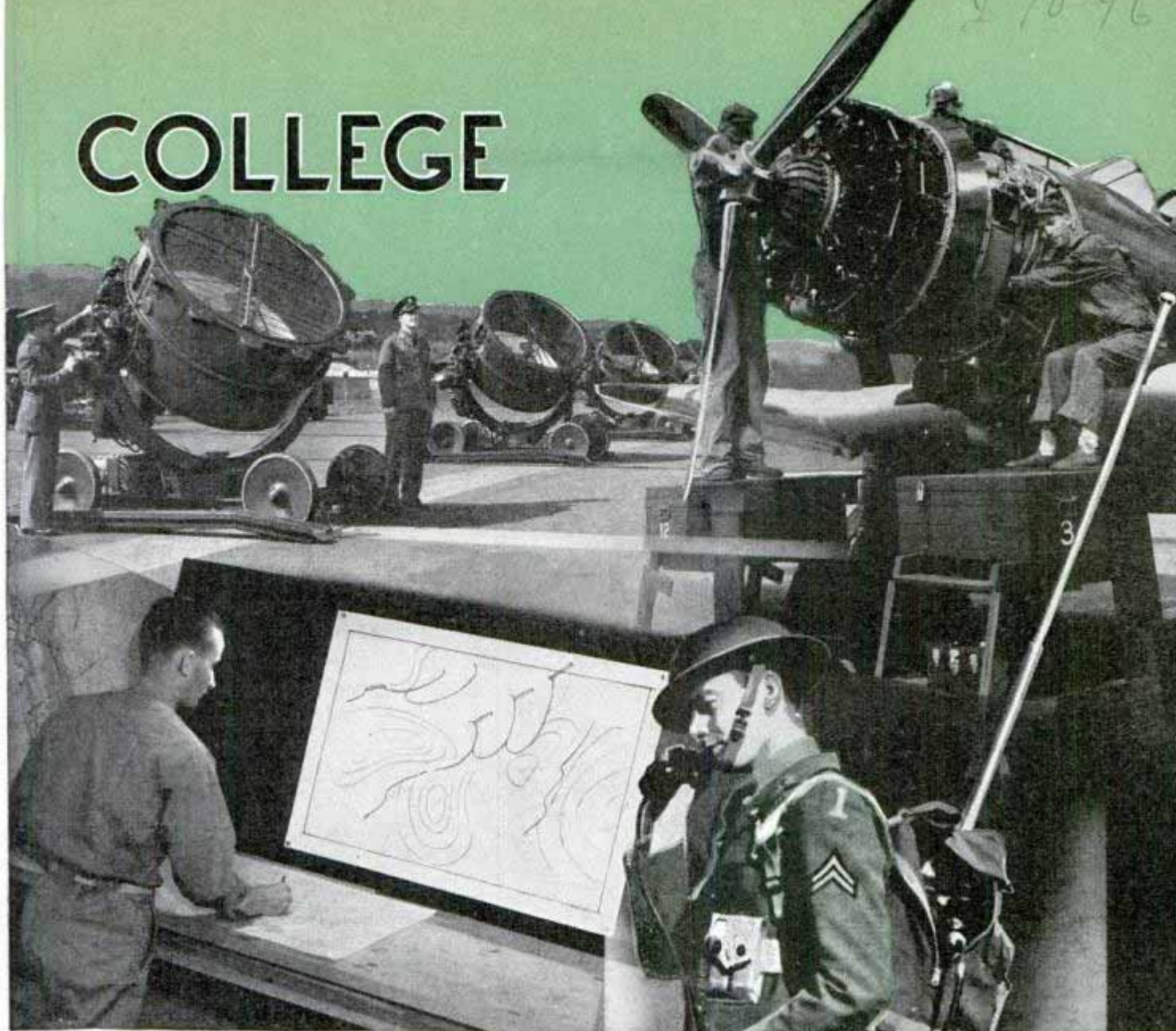

Top, operating giant searchlights in the coast artillery and (right) servicing an attack plane. Center, drawing a weather map. Bottom, using short-wave radiophone developed by the signal corps

erage eyes and sound teeth, and is between the ages of eighteen and thirty-five. His I.Q. shows his brains are all there. Then, before he takes his oath, he has an opportunity to pick a definite place to serve and a specific branch of service. As to the place, he can go nearly anywhere in the United States, to the Canal Zone, to Hawaii, to Alaska, and to the Philippines. As to the branch of service, he may choose the Air Corps, Cavalry, Chemical Warfare Service, Coast Artillery Corps, Corps of Engineers, Field Artillery, Finance Department, Infantry, Medical Department, Ordnance Department, or the Signal Corps.

Encompassed in the army's various arms and services is every kind of pursuit to be found in civil life, plus many specialized and strictly military activities. There are





Top, the recruit learns how to pack a parachute. Center, artillery instrument corporal gets the range for the big guns. Bottom, learning to operate a field radio is another opportunity offered the young soldier

places for stenographers, newspapermen, artists, draftsmen, surveyors, X-ray technicians, photographers, cooks, bakers, precision machinists, metal workers, weather forecasters, veterinarians, radio operators and technicians, chemists, sign-painters, plumbers, accountants, airplane mechanics, storekeepers, and even salesmen, such as the recruiting service itself. Each of the army's branches maintains fine schools, where the necessary training is administered with the systematic thoroughness that is one of the army's finest characteristics.

Suppose our red-haired recruit decides to give the Air Corps a whirl. He enlists for one of the regular units overseas or in "The States." After he gets to his field, whether his unit is bombardment, attack, pursuit or observation, he'll go through a basic course of instruction, a sort of a shaking-down process. When this is over, he'll be assigned to the kind of work for which he seems best fitted.

The Air Corps, of course, has fascinating possibilities. They include aerial photography, airplane engine and airplane maintenance, armament and machine shop work, meteorology, parachute rigging, radio operation and maintenance, sheet metalcraft, welding—and even traffic dispatching. Enlisted men are not pilots, but those properly qualified may be sent to Randolph Field, "West Point of the Air," where they are turned out as officers and fliers. However, they get plenty of passenger-flying as observers, as aerial cameramen, as radio operators, and as mechanical checkers on test flights. Each year about 500 outstanding men, selected from Air Corps stations throughout the army, are sent to the Air Corps Technical School at Chanute Field, Ill., one of the finest aviation schools in the world.

If there's such a thing as a second choice, the rookie might look

over the Signal Corps. This is also a highly technical branch, offering training of great value in civil life. Nerve system of the army, it includes every kind of communication known to man, even carrier pigeons. This corps installs and maintains telephone systems, runs a vast and intricate wireless network, and is also the army's official photographer. Assignments available in this corps include telephone electricians, linemen, switchboard operators, teletype maintenance men, radio operators, radio repairmen, and others as diverse as the communications industry itself. Army radio operators are on all the big army transports plying the Atlantic and the Pacific, and they're scattered ashore all along the line. Alaska is connected with The States by army radio men of the Signal Corps, who supply much valuable data enabling accurate weather forecasts.

The Signal Corps, like the Air Corps, maintains a school. It is at Fort Monmouth, N. J., and qualified enlisted men are sent there every year for systematic training.

One branch of the army that's closely allied with civil projects is the Corps of Engineers. Army engineers built the Panama Canal, miles upon miles of Mississippi levees, they're building the great Fort Peck Dam, and they have constant supervision over America's navigable rivers and harbors. If the

(Continued to page 124A)

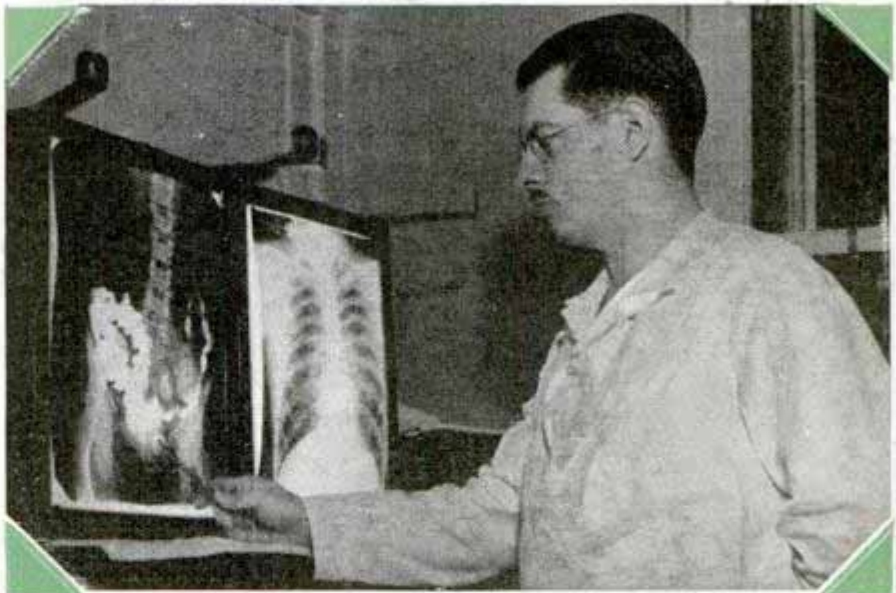

Top, you can become an X-ray technician in the army. Center, Signal Corps' mobile pigeon loft. Handling pigeons as message-carriers is only one phase of Signal Corps work. Bottom, teletype maintenance courses also are offered by some of the many schools operated by the army

Jefferson and Quincy Chicago

Interlocking Weatherstrip Is Tacked on Quickly



It is easy to nail weatherstrip on window frame and sash. Below, interlocking sections keep out wind

Simplicity of application is the outstanding feature of an all-metal interlocking weatherstrip now on the market. An air lock in the stripping keeps out wind, dust and rain, and prevents heat loss. It may be installed without removing sash.

Clothes Hook with Vacuum Lock Attached Firmly to Any Wall

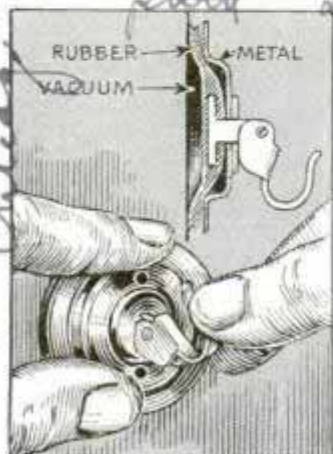

A clothes hook with a vacuum lock requires no pressing or forcing in fastening it to the wall. Simply hold the rubber cup firmly against the surface, pull the hook down and it will stay indefinitely. The hook serves

as a lever to help build up vacuum by drawing the center of the cup inward, while contact at the circular edge keeps air out. It can be attached to car windows, and a clip in place of the hook converts it into a holder for calendars and advertising cards. It also can be equipped for use as a soap dish or tumbler receptacle.

Suede Beanbag Ash Tray Can't Be Tipped Over

Housewives accustomed to sweeping ashes from the rug will appreciate the non-capsizable ash tray. It's a tray fitted into a beanbag, the bag being of suede leather filled with shot. Set it on your knee or a chair arm and it will "stay put."



Telescope Is Mounted on Auto to Sell a Peek at Prison

Mounted on an automobile parked across the water from Alcatraz penitentiary, is a telescope through which passersby may take a peek at the island prison in San Francisco Bay. The nine-inch refractor, with seventy to 700 magnification, depending on the objective used, is balanced so as not to interfere with driving.



Tourists peek at Alcatraz penitentiary, in distance at right, through this telescope mounted on car

Ref: John Jensen, Jr. 370 Danes

Robert H. Balty Chicago
134 S. La Salle
Chicago
2515 W. Hubbard
Chicago
2515 W. Hubbard
Chicago

United Air Lines

Fliers Watch Own Plane Land by Television

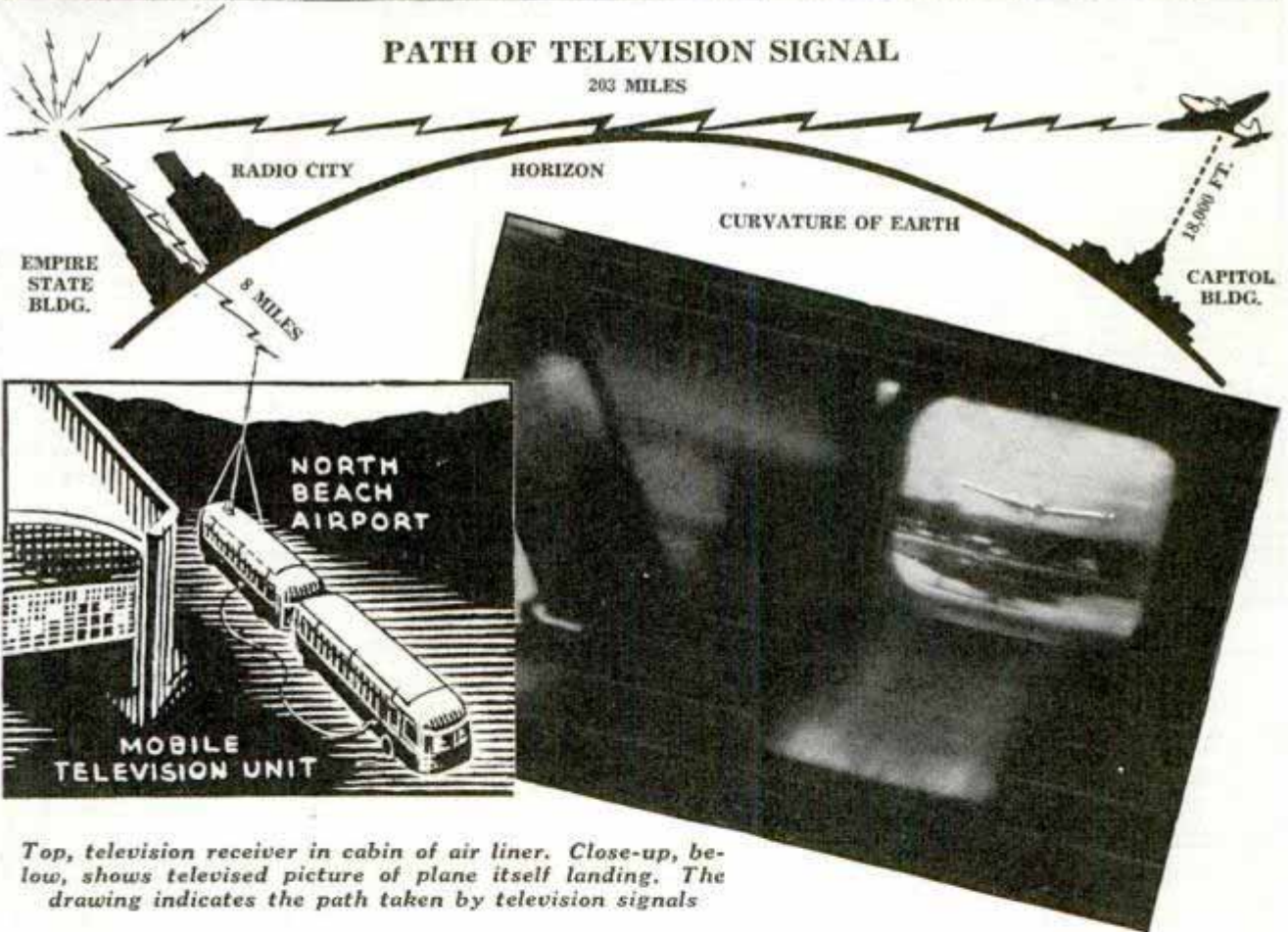

Top, television receiver in cabin of air liner. Close-up, below, shows televised picture of plane itself landing. The drawing indicates the path taken by television signals

It was only a stunt when passengers in an airplane the other day watched on a television screen the landing of their own ship, but it was a stunt that presaged range-finding of military targets by aerial television and perhaps new methods of "blind" landing. The United Air liner was 21,000 feet above Washington. In its cabin a television receiver reproduced images broadcast from Radio City, 200 miles away.

Later, as the plane circled New York's North Beach airport and then landed, the picture on its screen was that of the plane itself. Looking into the future, engineers suggest that some day a television receiver in the cockpit might guide the pilot to land in thick weather. And it may be possible to send up an observation plane to photograph a military objective and transmit television pictures to the artillery.

21090

Cont. of the report
457 of Serrano Ave
Los Angeles, Calif

HOW LONG CAN

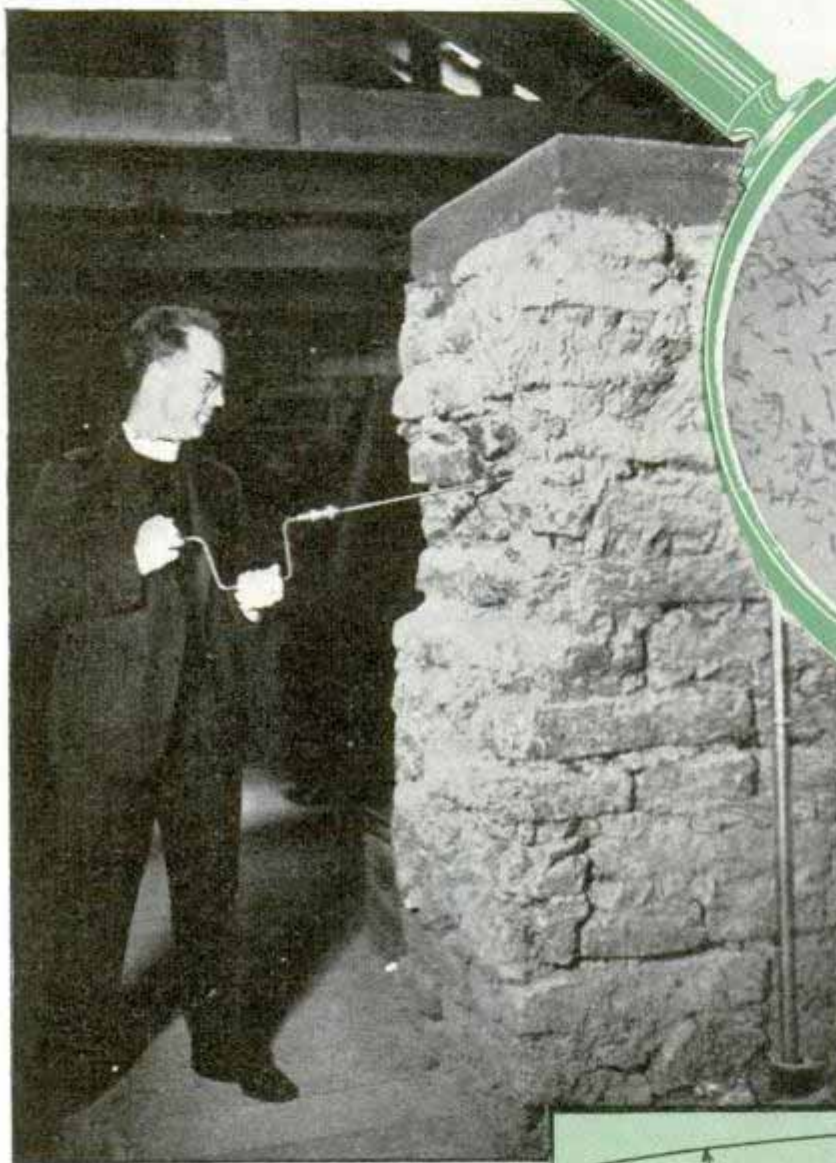

Left, taking specimen with sterile coring auger from wall of 165-year-old mission at San Luis Obispo, Calif. Above, microscopic picture of germs revived after 1,000-year "sleep" in wall of Montezuma Castle, Arizona

INSIDE the test tube a murky cloud is gathering—sleep that began before the Egyptian pyramids were built is ending. For 5,000 years organisms have lain dormant, sealed within a thick wall, cut off from light, air, food, or moisture.

These organisms are bacteria and tiny one-celled spores; the startling discovery that they are potentially deathless is the result of the painstaking experiments of a California doctor. And the upshot of it all is that some of science's most intriguing questions are due for new answers.

How long can germs really live?

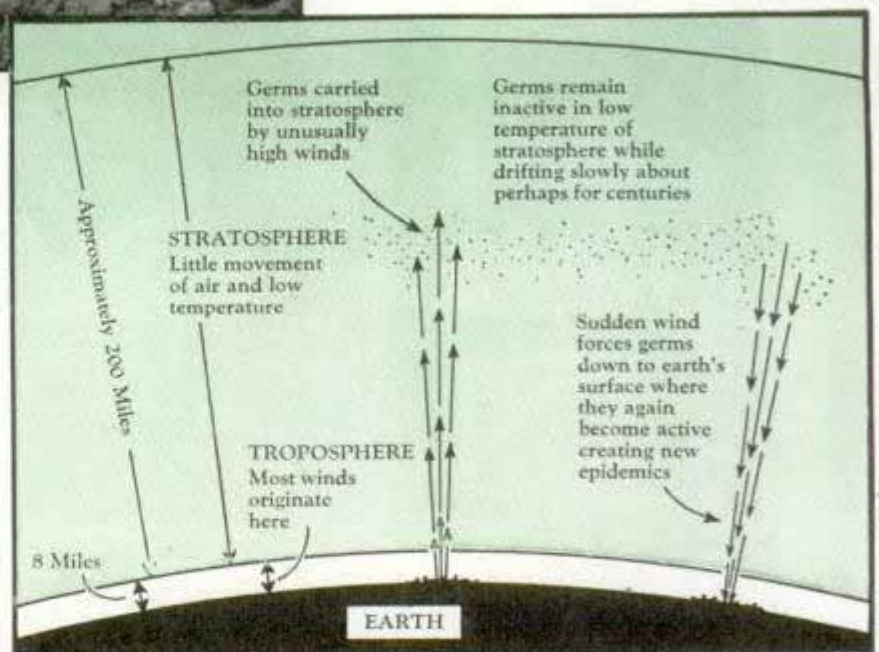

Finding of inert germs in stratosphere by National Geographic Society expedition suggests, as illustrated by diagram, that epidemics are caused by down winds bringing bacteria to earth

2. 1090

GERMS LIVE?

Bacteria were revived from material sealed 5,000 years in Mexican Pyramid of the Sun, right. Below, flaming wall to prevent contamination before boring specimen. Bottom, sequoias, considered oldest living things, may yield that crown to germs.

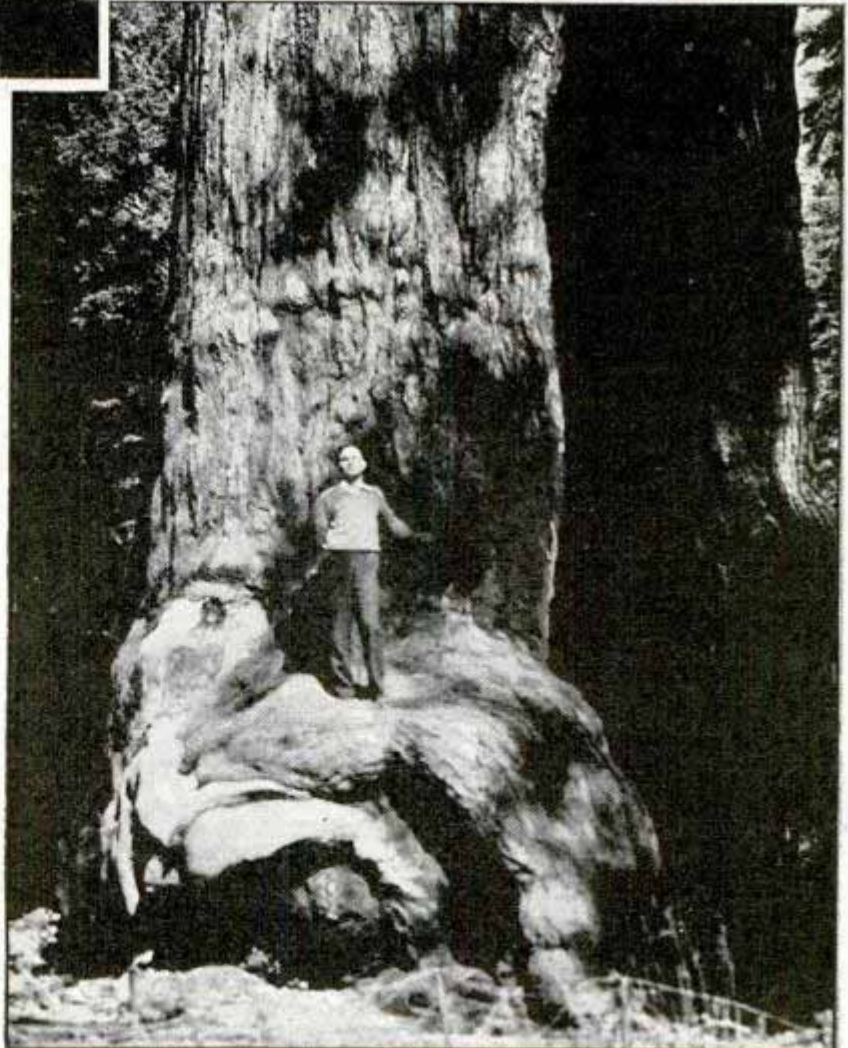
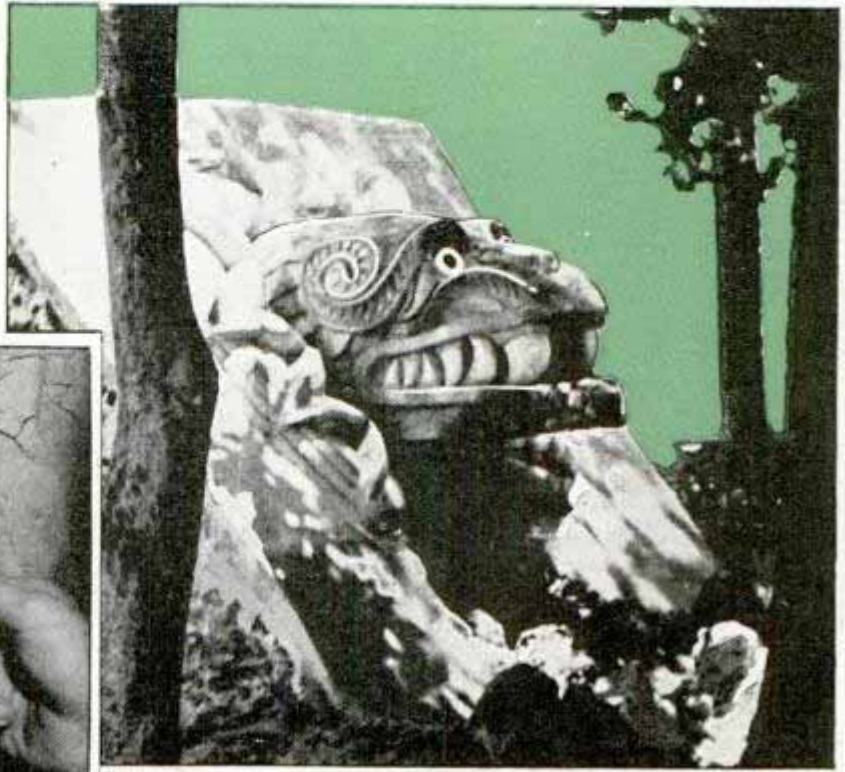

Can living things lie dormant, for centuries, even millenniums, and yet return to normal life when conditions again become favorable? Have great epidemics been caused by disease germs which drifted high in the stratosphere, dormant, but ready to resume their deadly work when a down current of air brought them to earth? These questions have inspired a thousand experiments. The latest of these, performed by Dr. Ira B. Bartle, and checked by scientists from the universities of California and Pennsylvania, throw new light on this age-old problem.

From deep within an ancient Mexican pyramid, from an old California mission, and from a hundred other ancient structures, Dr. Bartle has gathered material which gives

(Continued to page 140A)

San Luis Obispo

Movies Help Test Plane on Marked Runway

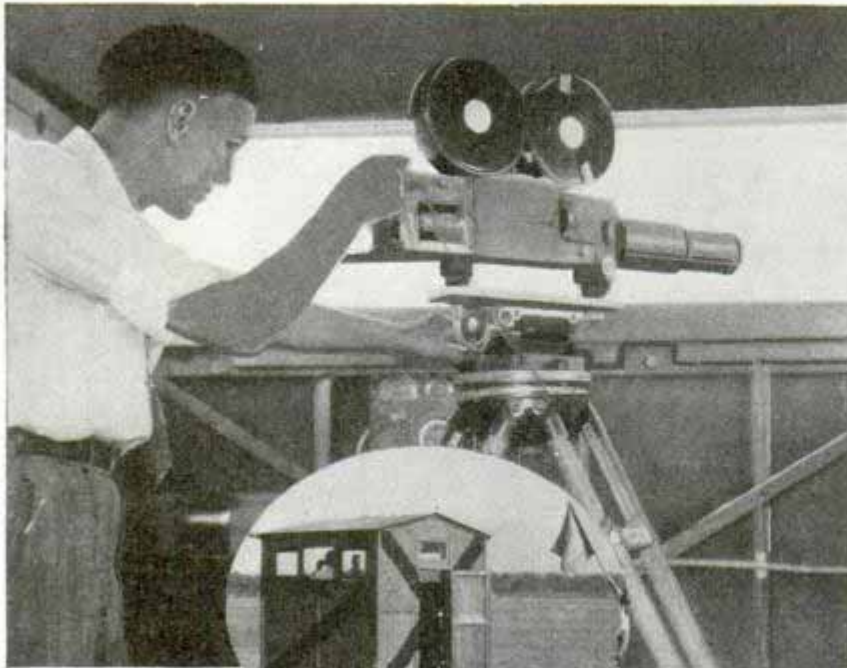

taken beginning just before the actual takeoff and ending when the plane has risen over fifty feet. Landings are recorded from approximately sixty-five feet altitude until the wheels stop. In this way the camera produces charts which show exactly, without need of calculation, the horizontal and vertical position of the plane relative to the markers, with the time recorded at each stage.

Left, movie camera mounted inside shack shown in circle. Below, diagrams of measured runway and arrangement of camera

MOTION pictures made with a camera built along lines of a machine gun for accurate aiming help army air corps engineers at Wright field in studying planes to be tested for landing and takeoff characteristics. The views are compared with reports of the pilot, the course observer and instrument records. Thirty large flags numbered consecutively are spaced equally along a 3,000-foot course, opposite the center of which a portable camera shack is located. At a signal from the cameraman the takeoff starts. A series of continuous shots are

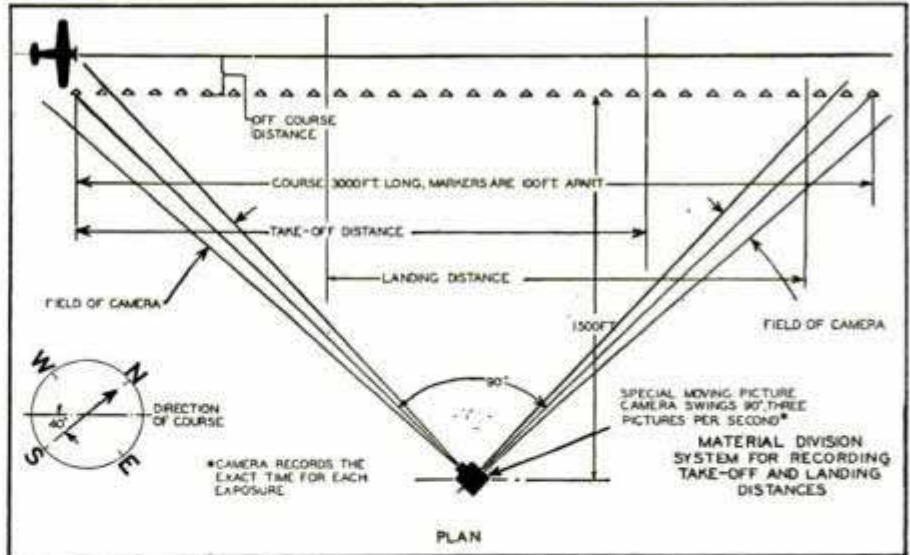
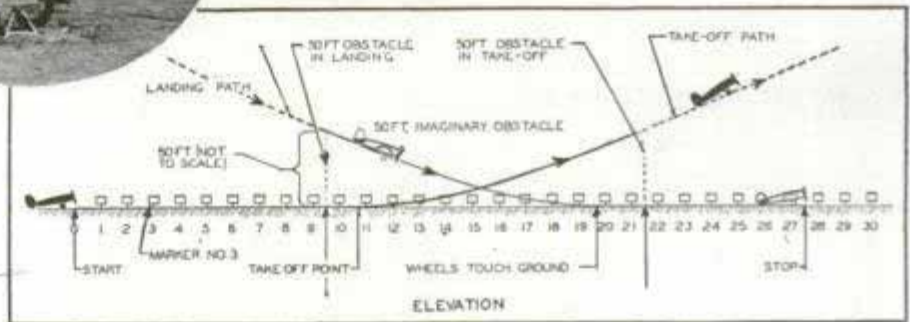

1301
Radium "Machine Gun" Bombardment Converts Platinum into Gold

Gold atoms are manufactured artificially at the laboratories of Columbia University school of engineering by placing a thin sheet of platinum in contact with a glass rod containing radium. Left inside a heavy lead container for several hours, the radi-

um shoots thousands of atomic particles into the platinum, resulting in the creation of gold. The amount of gold produced, however, is so small it can be detected only by an extremely sensitive apparatus that measures atomic radiation of gold atoms.

Prof. John R. Dunning, Dept. of Physics

July 20 of Mrs. Lydia Coury, 502

Weeklife Leisure

Pillow Slips and 'Dry Diving' Offer Beach Fun

Pasadena Calif



The inner tube of a truck tire half buried in sand forms perfect springboard for gymnastics on beach. Above, a seaside acrobat takes off for somersault

Fun on the beach isn't all wet. You don't have to go near the water! One of the current popular sports at winter beach resorts, for example, is a sort of "dry diving." You go through the motions of a dive but you land on the sand. One man runs and jumps on the high end of a teterboard, catapulting his partner, who was on the lower end, into the air for a flip



Motorcycle polo calls for plenty of skill when navigating in sand. Players (left) use a white ball, and kick it instead of swinging mallets. Above, riding pillowcases in surf; a large case is soaked, then inflated with air by running along the beach while holding the end open like a scoop. Then turn the end quickly and tie a knot and it's ready for surf ride



21118
Mt. Thomas 6 Durango
186/8 Malibu Ave.
Pacific Palisades
Calif

AMERICA'S DINNER

Ref: Fred Woodward, Bureau of News
Southern Pacific Co. 417 Pacific Electric Bldg.
Los Angeles

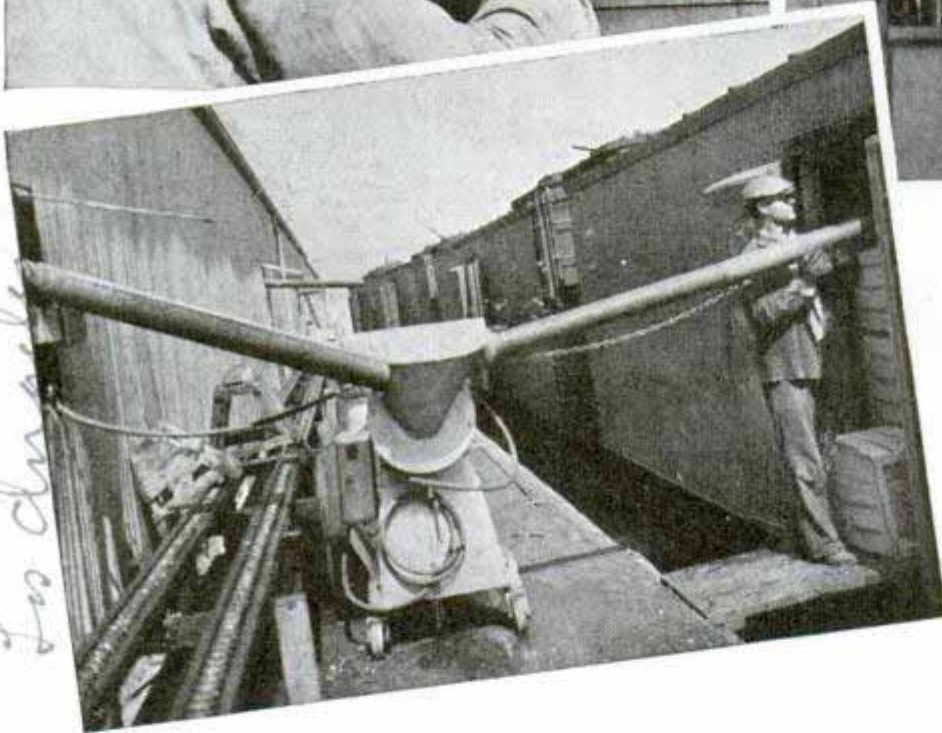
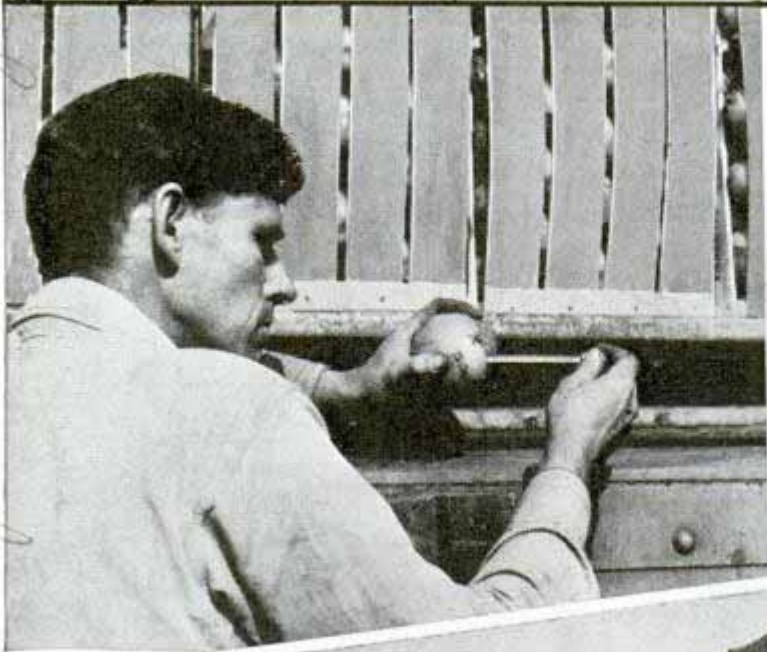

Top, left, sampling interior temperature of orange after pre-cooling and icing. Right, ice blocks on way to loading platform. Bottom, blowing machine forcing crushed ice into freight car

degrees temperature had been blown into the lettuce car instead of warm ice just a degree or so below freezing. Fruits and vegetables have critical temperatures at which they keep best, and temperature control is

FROWNING over a telegram in front of him, the refrigeration chief dialed a phone number several hundred miles away.

"What's the matter down there?" he demanded. "You know that shipment needed warm ice and here you've used cold ice again. If you can't keep the ice warm we're going to lose a lot of vegetables."

His speech sounded like nonsense but he meant every word of it. His complaint was that a carload of lettuce had been frostbitten on the way to Chicago because its ice was too cold. Ice takes on the temperature of the room in which it is stored, and in this case chopped ice of around ten

one of the important factors to be considered in shipping perishables.

Supplying America's dinner table with out-of-season fruits and vegetables accounts for an important part of the nation's rail traffic. Lettuce, carrots and celery may be out of season but the chances are you can buy them at the nearest grocery. Instead of depending on its local gardens, modern America reaches out to all parts of the country for its fresh foodstuffs. Items that are in season locally for only a few weeks now can be bought for months on end. Some fresh vegetables are available practically the whole year around.

2 1118

RIDES *the* RAILS



Behind these everyday facts is a complicated organization that uses short-wave radio and leased telegraph communication and an intricate refrigerated transportation system. The north is supplied with early vegetables grown in the south and the south is sup-

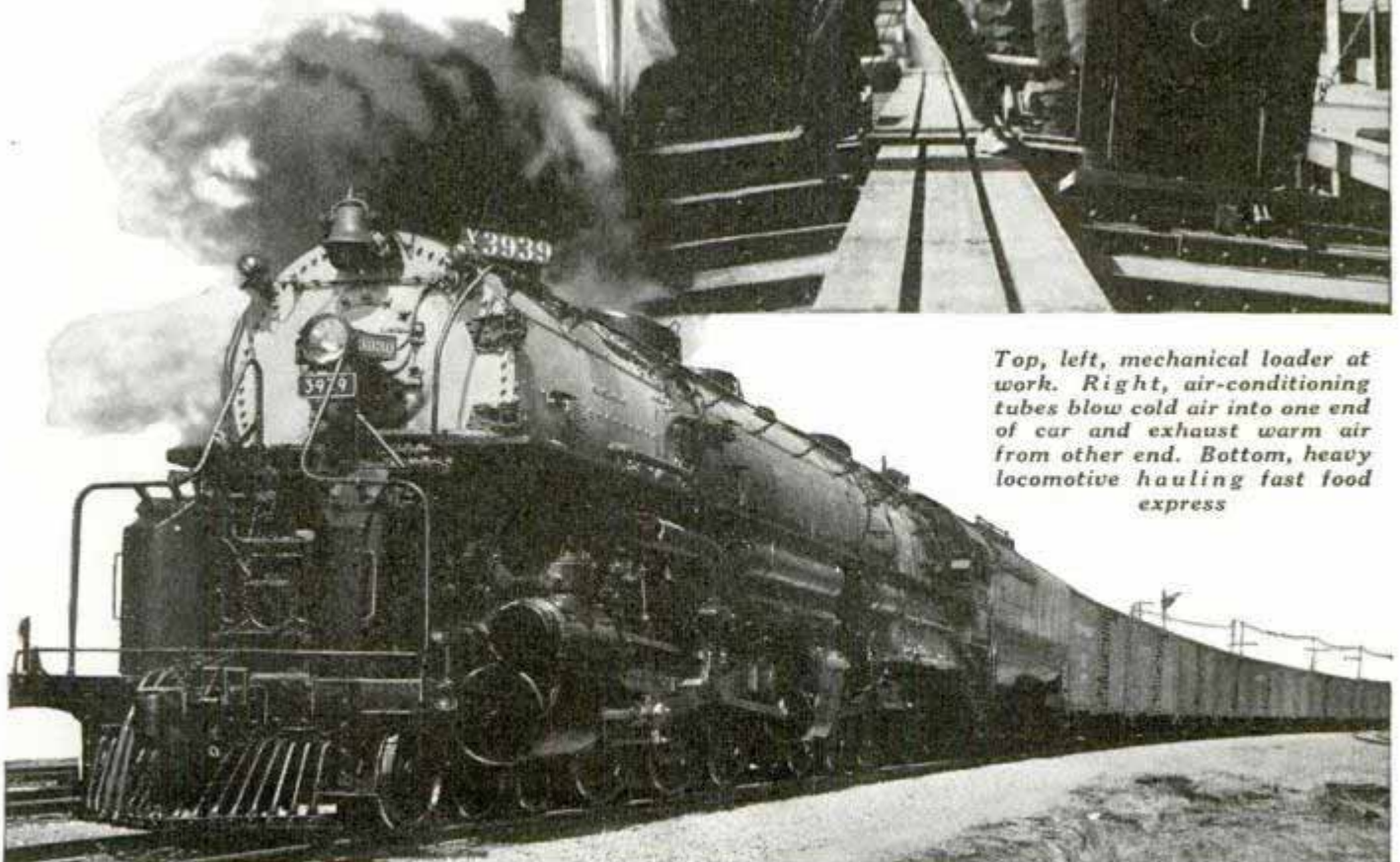

Top, left, mechanical loader at work. Right, air-conditioning tubes blow cold air into one end of car and exhaust warm air from other end. Bottom, heavy locomotive hauling fast food express

Union Pacific Challenger tube



tables to meet the demands of the refrigerated market. Good shipping qualities as well as uniformity and solidity in a variety bring best prices.

In Chicago, home-grown lettuce is scarce even at local harvest time but you can buy California lettuce every month of the year in that city. Local cantaloupes come on the Chicago market in August yet the city begins to eat the fruit as early as May, when the first California shipments

arrive. In June, Arizona and Georgia also ship cantaloupes to the northern markets and in July, Texas, New Mexico and Indiana also join the shipping states. Nine states ship cantaloupes to Chicago in August and the melons are still available from California, Colorado and Utah during September.

Potatoes are the nation's largest vegetable crop and nearly a quarter of a million carloads are shipped annually. Maine is an important source of potatoes, yet early in the season before their own potatoes are ready the Maine farmers eat potatoes that have been shipped from the Pacific coast. Mas-

(Continued to page 130A)



plied with northern vegetables long after its own growing season is over. To a large extent the east lives on what the west raises.

One result is that the eating habits of the nation are undergoing a change. Salads have become an important part of the national diet now that they are nearly always available. Another result is that growers have developed special varieties of many vege-

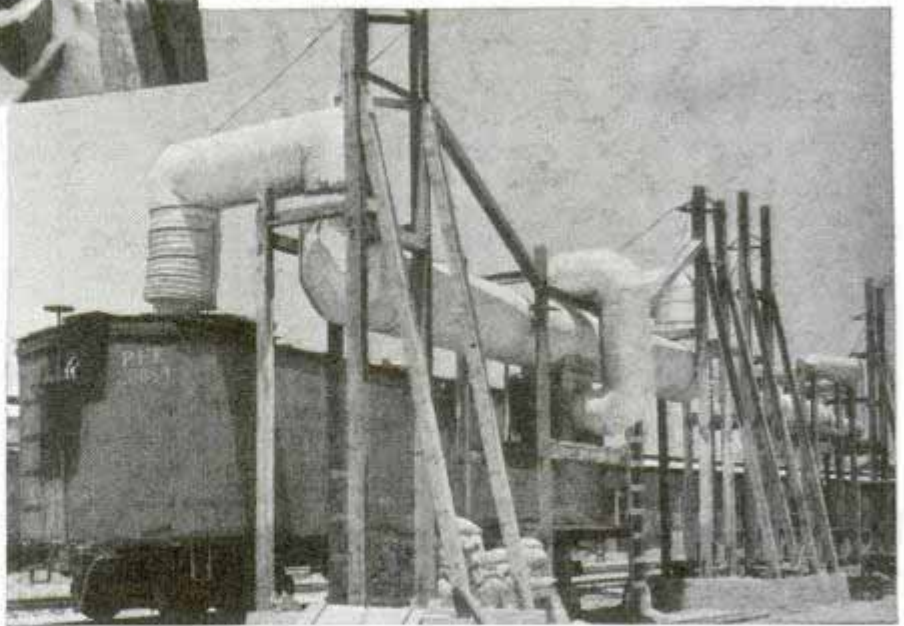

Top, cab-in-front engine used for hauling refrigerated cars over mountains. Center, crew member operating pipe that packs snow ice under pressure into all empty spaces of carload of lettuce. Bottom, air-conditioning equipment used for removing field heat from vegetables before the car is iced

Sun's Corona Poses for a Television Picture

Secrets of the sun are learned from its corona, but that flaming halo only can be studied during solar eclipses because of the brilliance of the sun's orb and the scattering of light in the earth's atmosphere. Now television has suggested a way to put the corona under inspection at

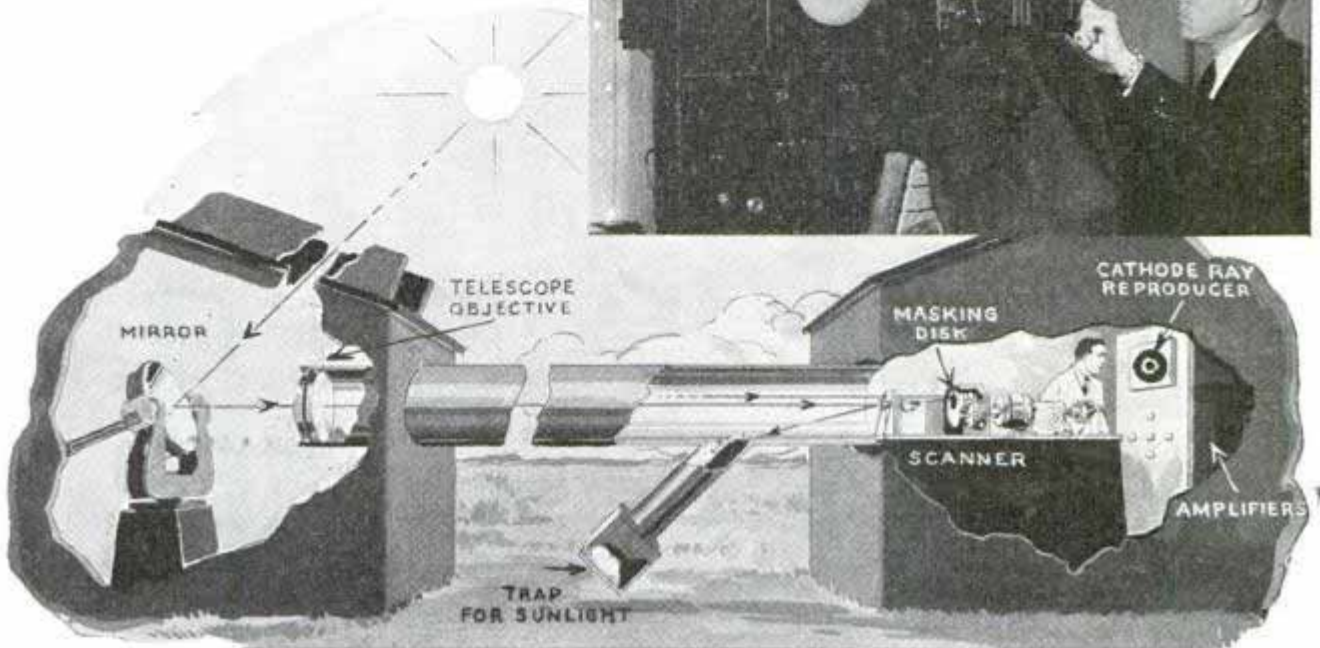

Top, the cathode-ray tube receiver on which sun's corona can be watched "in action." Below, a diagram of arrangement of mirrors and masking disk which dissipate direct image of sun and reproduce its corona

all hours, which radio men will appreciate, for disturbances in long-distance radio transmission start in the sun and it may be possible to predict transmission troubles from day to day by keeping an eye on the sun. Dr. A. M. Skellett of the Bell Telephone Laboratories devised the television system for scanning a ring around the sun. A horizontal telescope focuses a sharp image of the sun on a mirror, and this bright image is reflected away and

dissipated in a trap. Around the sun's image is the corona, and this is scanned by a combination lens and mirror which rotates and rocks, throwing light from the corona into a photoelectric cell where a current of varying magnitude is set up. The steady current due to light from the sky is discarded in the amplifying system and the coronal light is routed to a cathode-ray tube of a television receiver, where the corona may be viewed or photographed.

Slide Fastener on Cleaner Bag Opens to Remove Dirt

Fitting virtually all vacuum cleaners with one attachment and needing no special couplings or adapters, a bag now on the market relieves the housewife of some of the work involved in emptying it. Instead of disconnecting the bag to unload it, you simply drop it to floor level by releasing a tap which holds the bag upright. A slide fastener then is opened which permits accumulated dirt to drop out.



Slide fastener opens vacuum cleaner bag to empty it

463 West St. New York

Chicago Probabatt Bros

\$ 3.00 up

Chicago Probabatt Bros

35-37 E. 20th St. New York

91239

91245

Super-Liner Designed to Fly 500 over Atlantic

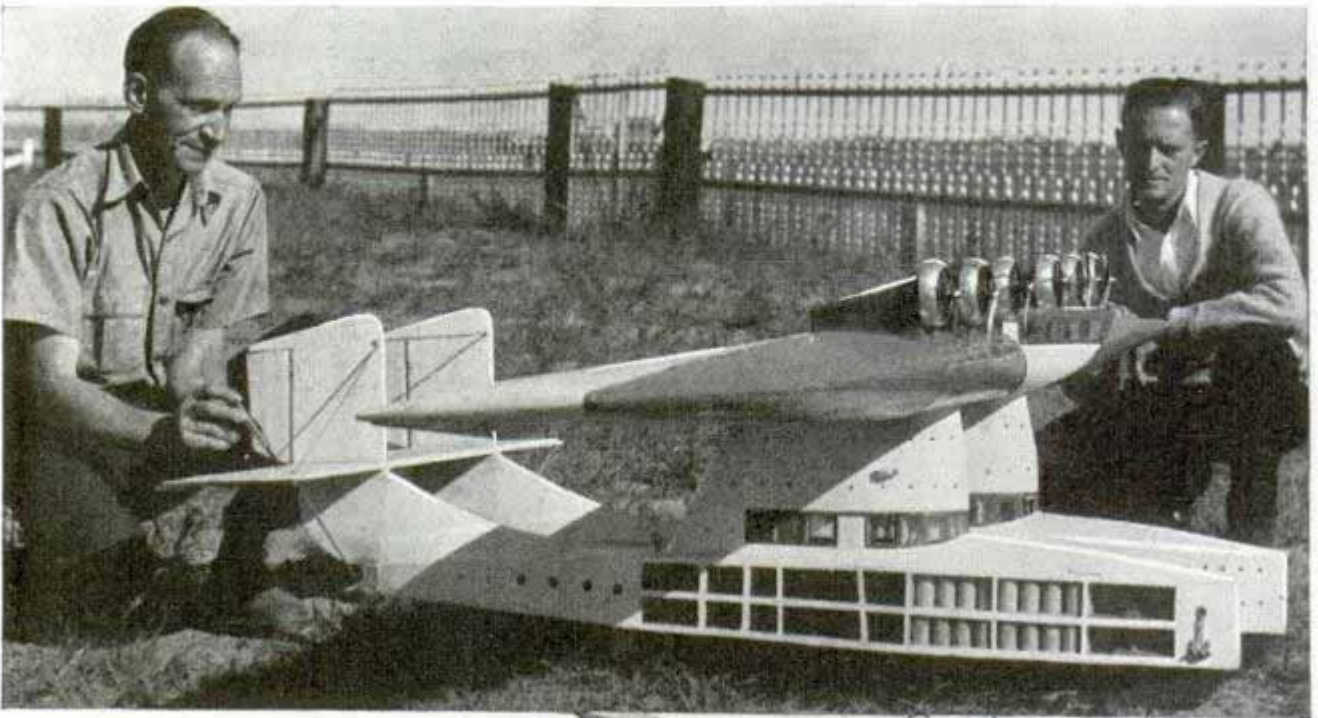

Inventor John Molinet (above, left) of Rosedale, L. I., with model of 500-passenger transatlantic air liner which would be powered by six electric engines served by dynamo generators burning fifty gallons of fuel oil per hour

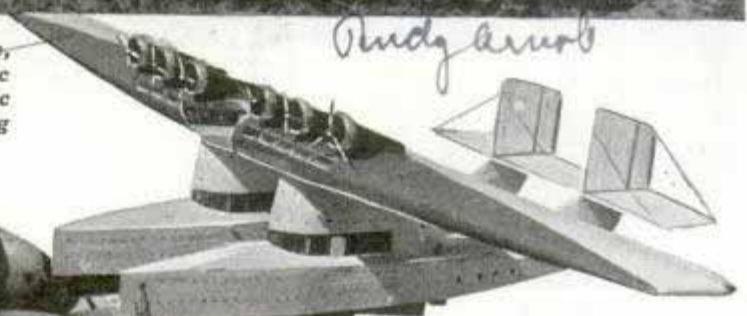

136-21-243rd U



Fins seen underneath the pontoons, above, are to protect the hulls from shock upon hitting the water, and also hold the plane on a straight course on the surface. The great ship would have an air speed of 200 miles per hour; on the water it would be driven by propellers underneath the hulls, with electric motors capable of developing a top speed of thirty knots. Notice the glassed-in promenade for passengers just below the engines. Besides its capacity for 500 passengers, the super-liner would devote the entire bottom section to freight cargo, as indicated in top picture

Above, the inventor explains his model to Coast Guard men at Floyd Bennett field. At the right is a close-up front view showing the huge twin pontoons and the three control cabins. Present plans would put the air crew in the central cockpit on the leading edge of the wing, between the engines. Navigators would be located in the right pontoon, and another crew charged with running the plane when it is on the ocean would have its post in the left pontoon

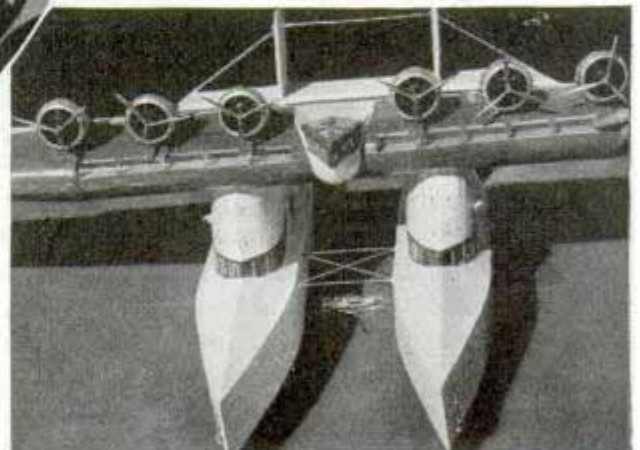

Handwritten notes and scribbles at the bottom of the page.

Model Steel Mill Carved from Wood and Ivory

Twenty years ago Ernest Warther worked in a steel mill. Not long ago he decided to build an animated model of the mill—and, since the plant has not been in operation for fifteen years, he had to build it from memory. There were no blueprints. The task required five months. Carved from walnut, ebony and ivory, peopled by a tiny crew of engineers and workmen at their various tasks, the miniature mill is a faithful copy of the plant as it was a score of years ago. A small electric motor concealed beneath the base of the four-by-five-foot model keeps the wheels running.

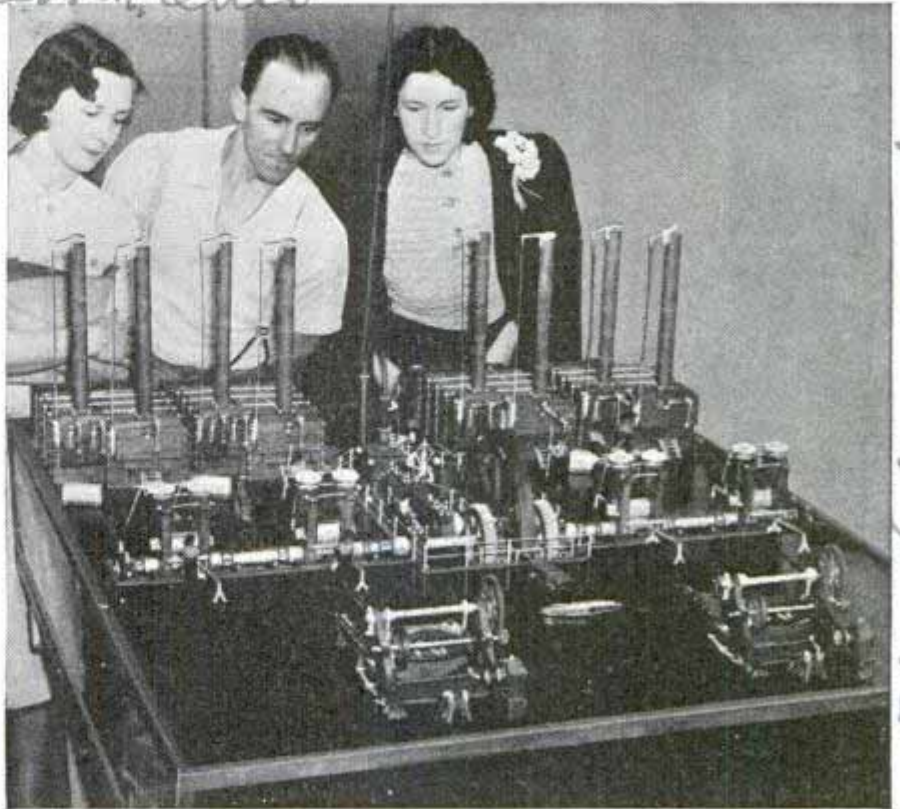

Built from memory long after original plant closed, this model steel mill carved in wood and ivory goes through the motions of steel-making

Linemen Use 'Hot Stick' Tools for Repairing Live Wires

Maintaining and repairing "hot" lines of high-tension electricity without pulling the switches are the daily chores of linemen. This is possible with the use of ingenious "hot sticks," which consist of

rounded lengths of Sitka spruce equipped with various metal attachments including clamps, pliers and other tools. With a set of about ten of them a skilled operator can perform any line work on a pole or tower

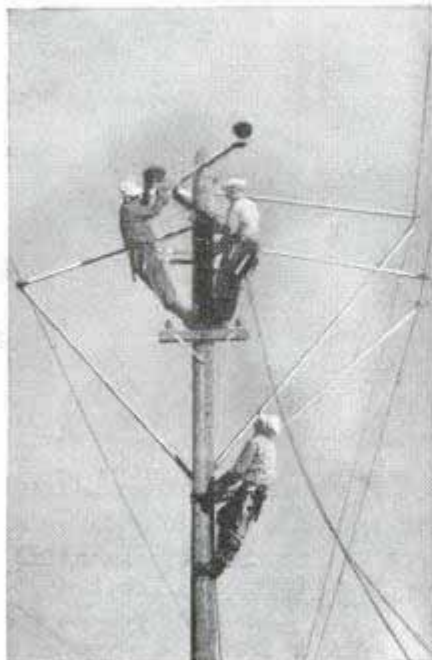

Left, "hot sticks" hold high-tension wires at safe distance while men work on pole. Right, lineman handling "hot" wire with extension tool

which can be done by hand, from changing insulators that weigh as much as 200 pounds to replacing an inch cotter pin, without interrupting service. Workers are careful to keep at least two feet from the lines, because of a field of electricity known as a corona which extends as far as twenty inches around the high-voltage wires. Coming within its range can be disastrous. The men wear rubber suits and head gear for protection against flashes of flame that may occur while throwing big switches.

A. B. Chance Co., Centerville, Ind

21285
Journal of American Sheet
and Iron Plate Co.
Lover Ches
Lover Ches

of construction % maintain & take
Ref: Fred Weberg, Suph.



Circle, census taker at work. Center, semi-automatic population punching machine. Right, electric tabulator which helps to compile the millions of facts gathered in the census. Statistics are fed to the machine in the form of cards on which holes have been punched according to a code

Opposite page—Top, left, old tabulator (at left) and the new portable tabulator. Right, electric gang puncher that records the same facts on a large number of cards. Circle, verifying machine double-checks on population punching machine. Bottom, machine that sorts cards into different classifications

COUNTING



CENSUS experts in Washington, facing the largest population count in the history of the United States, have developed for this year's census a revolutionary technique to meet the numerous problems that have arisen since 1930. A two-weeks test of the new procedure, completed recently in St. Joseph and Marshall counties, Indiana, was so successful it will serve as a model for the head count throughout the country.

The newest problem faced—and tackled—in the Indiana test was that of the person who lives in a trailer. Little is known about the number of persons who call trailers their only home, except that there are a great many of them and that since 1930 they have increased a thousandfold, with 1933, 1934 and 1935 as peak years.

Another new problem was that of ascertaining the effect of the Social Security Act on the nation and the laws of such agencies as the FHA, the HOLC and the USHA. The Social Security Act and these agencies have come into being since 1930. Two questions,

2 18.8.6



NOSES

therefore, have been found pertinent to their administration for the 1940 census. They are: "Does this person have a Social Security account number?" and, "What proportion of this person's wages or salary was subject to deductions for federal old-age insurance during the twelve months ending July 31, 1939?"

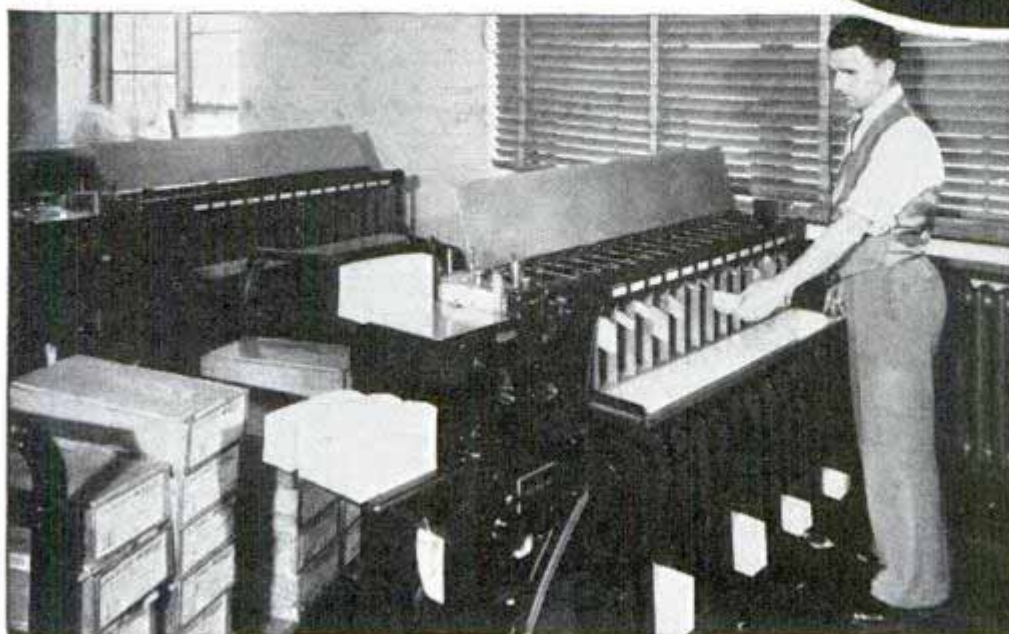

These questions will help the Social Security board in establishing its records for the huge task of administering the old-age insurance and unemployment compensation benefits program. In the case of the FHA, HOLC and USHA laws, questions were asked to bring out the type of home in which the present-day American lives and

(Continued to page 114A)

Swamp Car Pulls Self through Mud by Winch



Left, marsh truck of United States Indian service can navigate water two and one-half feet deep and makes its way through mud and swamps far into Everglades of Florida to reach Seminole reservation. Below, view of winch for pulling out of tough spots, and bars guarding radiator

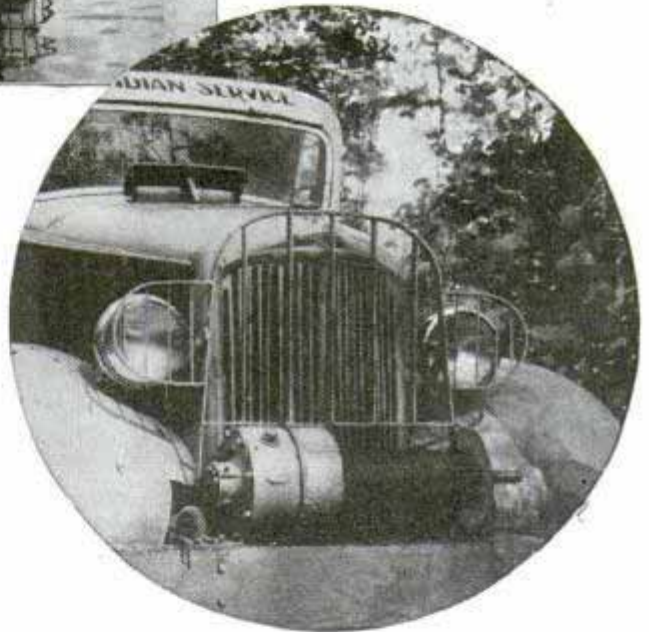

Able literally to pull itself through swamps and water, a truck has been designed for the use of United States Indian service in traveling between civilization and a Seminole reservation set deep in the Everglades of Florida. The swamp car has a power winch mounted in front on an eight-inch channel-iron crossbar, which receives power through a take-off on the transmission. Vital parts of the motor and the crankcase are sealed against water, and the truck can travel through two and one-half feet of water. Mud-grip tires at the rear provide traction, and iron bars guard the radiator and headlamps.

Picture Is "Painted" with Wood from All Parts of World



Pictures made with inlaid wood of many colors

Wood from all parts of the world is used by one artist instead of paint in creating pictures. Cut into tiny pieces, the wood is assembled and inlaid with such expertness that the pictures appear to be paintings. Having learned the art in Austria-Hungary before the World War, the "painter" now works at it as a hobby.

Live Fish Shipped in Dried Mud "Barks" When Released

Surviving a 10,000-mile journey that started at Lake Nairobi in central Africa and ended in Chicago, a lungfish "barked"

Handwritten notes on the left margin:
I m. thought G. Lardin
% Seminole Indian Reservation
Brighton, Florida
1233
John Paulin Cleveland Ohio
1298
Scene Since Nov. 6.

lustily when it was released from its "nest" of dried mud. At the start of the trip, the fish was put into a can containing soft mud, which was permitted to dry out slowly. While the mud remained soft, the fish came to the surface at intervals to fill its lung. Finally it settled to the bottom and secreted its cocoon, obtaining the small amount of air it needed through the channel formed by its risings to the surface. On arrival at destination, the fish was found in the cellulose-like cocoon. Waking from its dormant state, it made barking sounds by exploding air from its lung. Although thin from its long fast, it was in apparent good health. Lungfishes, explains Dr. Homer W. Smith of the New York university college of medicine, are evolutionary leftovers from the Devonian geologic period, about fifty million years ago, when all of the higher-class fishes breathed air with lungs.

Loud Speaker on a Sidecar Aids in Direction of Traffic



Durban policeman using loud speaker mounted on his sidecar for directing vehicles and pedestrians, while his comrade drives the motorcycle

Motorcycle police of Durban in South Africa are using a sidecar loud speaker for directing traffic and promoting safety. The vehicle carries two officers, one to drive, the other to operate the loud speaker.

Flash Bulb the Size of a Peanut Has Quick-Change Base

Only a little larger than a peanut, the newest flash bulb for photographers is

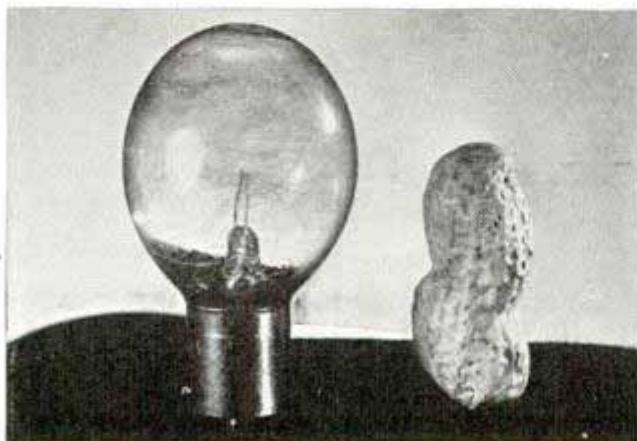

The peanut is there to show you how tiny is this newest flash bulb, which produces a brilliant light

nicknamed the "mighty midget" because of its powerful light packed in a small space. It is wire-filled, and has a bayonet-type base like an automobile lamp to permit rapid-fire loading in reflectors. Designed for all except focal-plane shutter cameras, the bulb produces nearly a million lumens at its peak. The bulb is protected both inside and outside with a lacquer safety jacket.

Popular Mechanics Magazine can furnish the name and address of the maker of, or dealer in, any article described in its pages. If you wish this information, write to the Bureau of Information, inclosing a stamped, self-addressed envelope.

9952.

Emt Thomas E. Thomson Jr
18618 Malibu Road
Pacific Palisades, Calif

Making BETTER HOME



Above, filming an actor against a projected background, and shooting scene with the help of a painted-glass screen. Left, editing film with a small viewer that enlarges each frame separately. Below, amateurs obtain best results by mounting cameras on tripods



Photo from Bell & Howell Co.

DURING the last few years amateur movie photography has grown from a hit-or-miss recording of family scenes to a craftsmanship that sometimes rivals the work of Hollywood cameramen.

Scores of amateur clubs are writing their own scenarios and producing exciting mystery and adventure films. The clubs hold motion-picture parties at which dramas and sport shorts, filmed by members, are shown. Occasionally capable amateurs have been able to turn their hobby into money and have sold their pictures for hundreds or thousands of dollars.

their scenes in color. Some are experimenting with sound accompaniments that they record themselves. They are duplicating nearly all the special effects achieved by the big studios.

The reason for this rapid growth, says Lewis W. Physioc, instructor of cinema-

Today movie fans are shooting many of

1117 North McCadden 1851 Wharhorn

2952

MOVIES

tography at the University of Southern California, is that the hobby has become much less expensive than at first. New small cameras on the market sell as low as ten dollars. In the medium-price field are cameras that are precision instruments adaptable to nearly every demand. Sixteen-millimeter cameras use film only one-fifth the size of professional film and the baby of the art, the eight-millimeter camera that you can hide in your hand, uses film only a quarter the size of the sixteen. The new "eights" project clear pictures that fill a four-foot screen, and even greater enlargements are satisfactory when the film is slightly overexposed to reduce objectionable grain. Black-and-white film for an eight costs two dollars

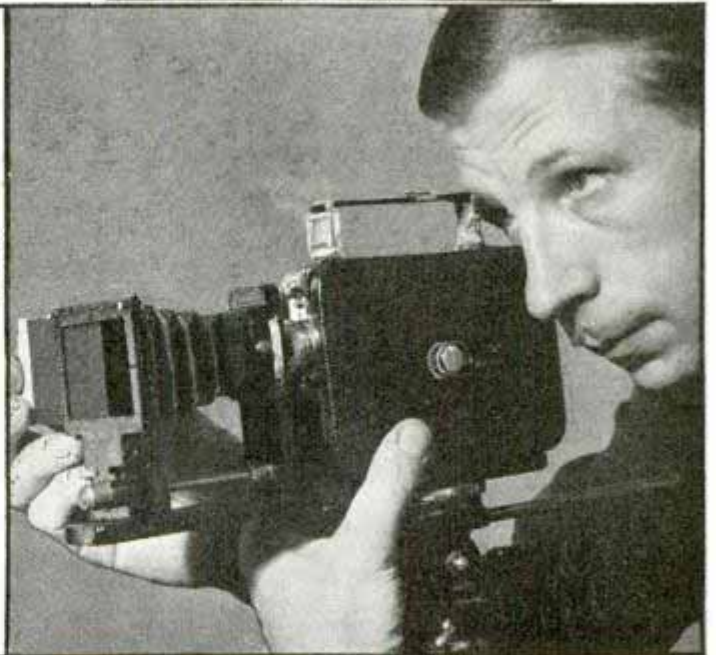
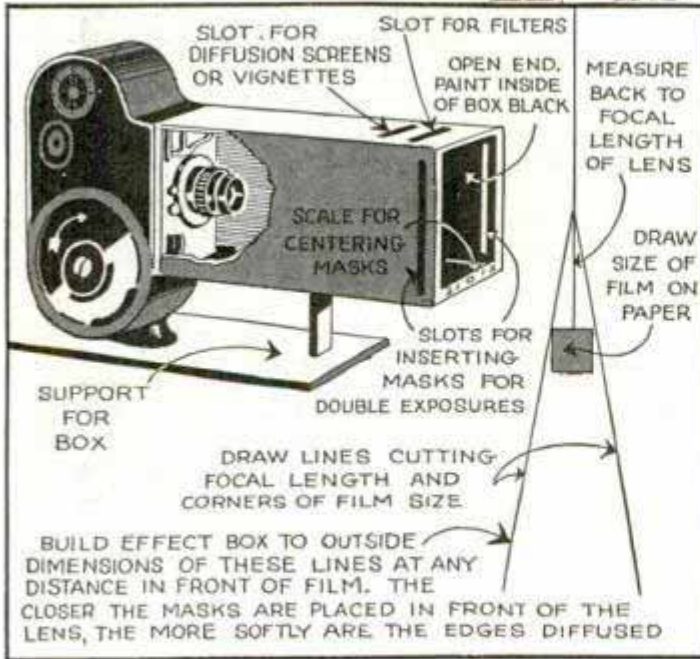
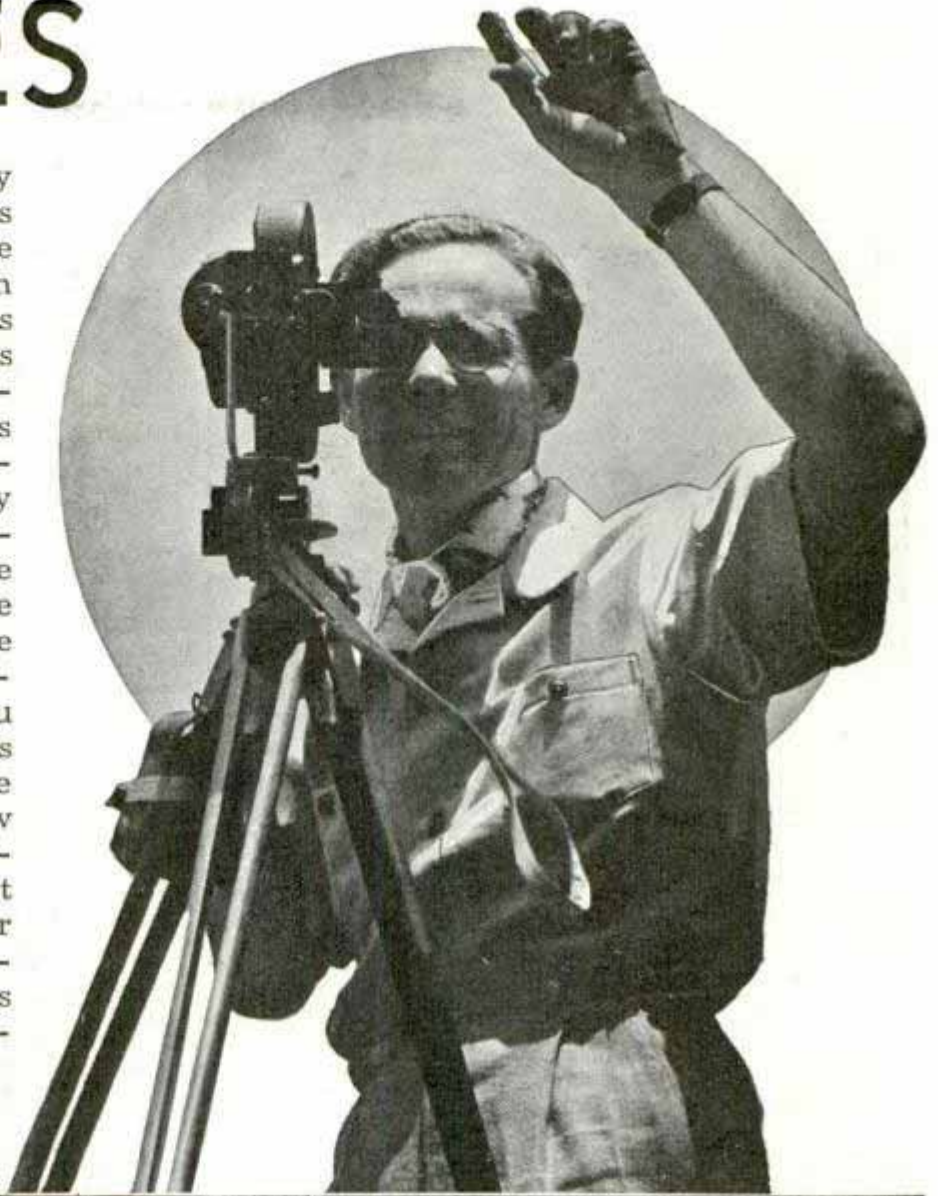

Top, an amateur photographer signals actors to start scene after preparing small movie camera for sequence. Below, at left, diagram showing how to make and install "effect box." At right, an effect box made of an old camera bellows



diagonally across the film so that as many as twenty-four frames on each side of the splice are partly covered. Trim the tape away from the film perforation track. Using the wipe cuts part of one scene away while part of the new scene begins to appear."

One of the simplest and most effective tricks is to make things appear or disappear in a picture. You can film a friend reaching to pluck a candle out of thin air to light his cigaret. Stop the camera when he extends his hand, place the lighted candle in his hand, and resume filming. He shouldn't move his hand while the camera is stopped. Books or other objects can be made to appear or disappear merely by stopping the camera and placing

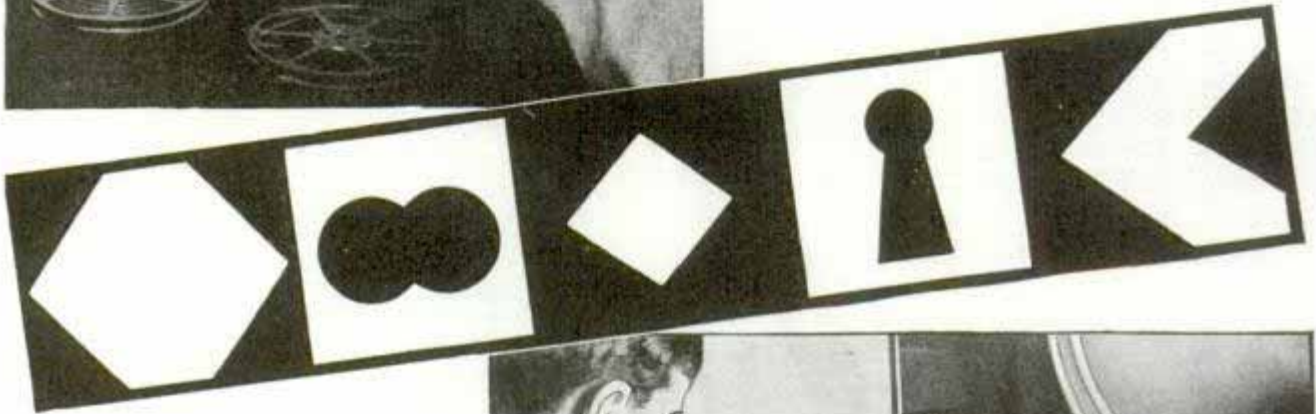

or less for a four-minute length, and color film costs a little less than twice as much. Professional processing into a positive print for projection is included in the price of the film. With photoflood lights, any room becomes a studio.

"Clever titles, wipes and dissolve shots to separate scenes, and trick photography in your films make them much more interesting to your audiences," Mr. Physioc says. "Scenes may be faded in by starting the camera with the lens closed. Then slowly open the lens to the correct aperture. Fade out the scenes by closing the lens while the camera is still operating.

"If you wish, use an artificial wipe between scenes. This is done while editing the finished positive. Splice the two scenes in the usual manner and fasten a thin piece of opaque Scotch cellulose tape

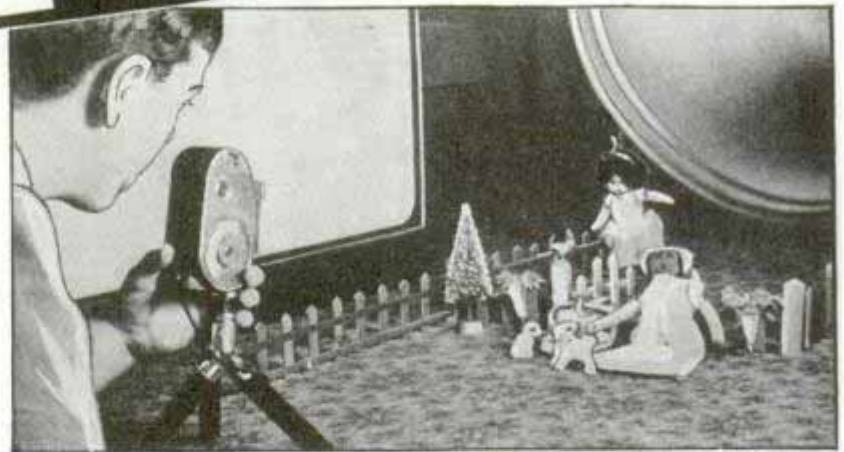

Photo from Bell & Howell Co.

Eight-millimeter movie camera mounted on title-making stand, top. Center, masks for framing pictures in effect box. Below, table-top scenes can be animated by single-frame exposures

them in position or removing them; in the same way you can make an actor appear to pull loaves of bread from a friend's pocket.

Judiciously used, scenes that are recorded backward are an interesting part of a picture. If your camera hasn't a reverse on it, film the scene with the camera upside down and turn the processed film end for end in projection. With the eight

(Continued to page 116A)

*g 1260 Curtiss-Wright Corp. 1111
30 Rockefeller Plaza, New York*

Navy Scouts the Ocean Sky with Fast Seaplane



some
Built primarily for surveillance work by navy fliers, this seaplane also can be adapted for flight over land by installing wheeled gear instead of the triple pontoons. It is a high-speed observation ship

"Eyes of the fleet" are the observation planes sent up from battleships and cruisers to patrol the skies. The U. S. Navy has

just acquired a new "eye," a fast scout-observation seaplane. It is a single-motored ship with triple pontoons.

Road Sign Shows Car's Speed as Auto Nears Danger

Automobiles turn on the lights of an automatic highway sign which will be placed at curves, hill crests and dangerous intersections to warn drivers and reduce accidents. Besides giving notice of hazards ahead, the sign contains a speedometer that informs the motorist, "you are going over" thirty, forty, fifty or sixty miles an hour, as the case may be. The mechanism is operated by impulses received from magnetic detectors placed in the pavement forty feet apart, and over which the cars pass. The first detector acts to illuminate the sign's wording, while speed of the vehicle is indicated by an impulse from the second detector.

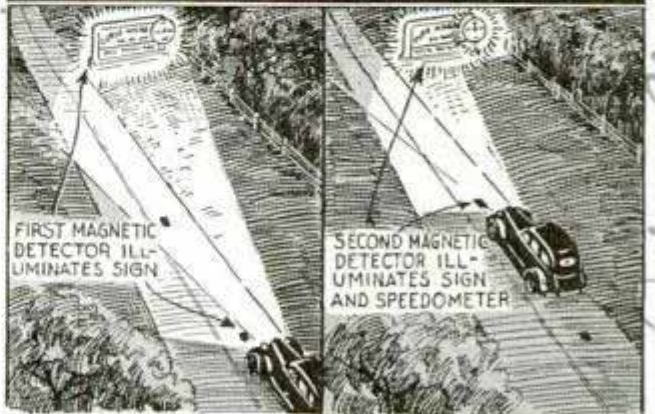

Above, close-up view of sign with speed indicator. Position of magnets in road is shown below

Popular Mechanics Magazine can furnish the name and address of the maker of, or dealer in, any article described in its pages. If you wish this information, write to the Bureau of Information, inclosing a stamped, self-addressed envelope.

Ref: Clyde C. May, 126 E. Canal, Minn.

Flashlight Storage Battery Recharged at Little Cost



Held in hand is storage battery for flashlight that can be recharged by house current or auto battery

Reduction in flashlight expense is claimed for a tiny storage battery that fits standard flashlight cases using two one and one-quarter inch size D dry cells. A cleverly designed chamber and vent arrangement, together with semi-fixation of the electrolyte, combine to make the cell spill-proof. Only simple attention is needed and its transparent Lucite case makes it easy to see when distilled water should be added. Two charging units are available, one working on regular a.c. house current, and the other on the car battery.

Giant Merry-Go-Round Tests Mines and Bridges

Models of mine workings and of bridges, built to scale, are placed in a whirling merry-go-round at Columbia University's school of engineering in order to determine how safe they will be. These models, made of transparent Bakelite plastic, are spun in a giant centrifuge, and the stress built up by the centrifugal force—reaching 2,000 times that of gravity—substitutes for the stress that might be encountered in real mines and bridges under actual working conditions. In the case of mines, engineers learn just how far they can safely drill and at what point the pressure from above would smash the mine, since the

centrifuge can be speeded up until the miniature rock collapses just as a real mine would under the force of gravity. In measuring the stress endured by whirling bridge models, polarized light from a powerful mercury arc lamp is flashed on and off rapidly. This is synchronized with the speed of the centrifuge so closely that the transparent model is seen as though it were standing still. Engineers study the light and dark bands that move through the model, and these photo-elastic fringes enable them to calculate just how and where a bridge of that same design will be stressed in actual service.

Electric Iron with Hinged Grip Presses Clothes on Wearer

Clothes can be pressed while they are worn, or on the ironing board, with an electric presser that has two pressing surfaces and a folding handle. Trousers are given sharp creases, and wrinkles are removed all the way to the seams. In like manner it presses coat sleeves, lapels, col-

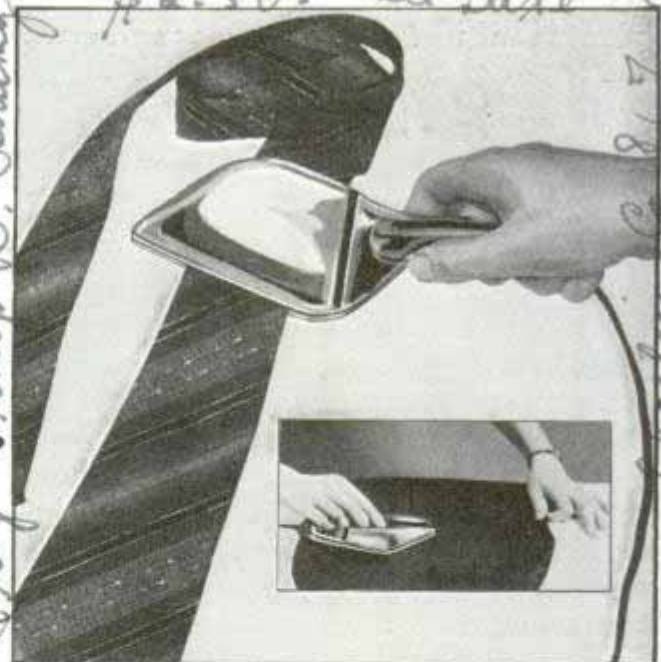

Electric iron grips necktie when pressing it; inset shows iron in position for use on ironing board

lars and vests. The iron is also used for putting a crisp and fresh finish on such smaller articles as ties, gloves and handkerchiefs.

Send return postage to our Bureau of Information to learn the name of the maker of any device described in this magazine.

Quirk - Highland Park, Ill.
21165
Chubb's B. Bunch
21299
School of mines
Science Service
2116

21126
De Luxe
Empire



The CRAFTSMAN

Turn this graceful THREE-TIER TABLE

By HENRY E. BELDEN

COMBINING the utility of three large, round shelves in graduated diameters with the attractive features of a massive turned column and curved legs, tipped with claw-and-ball feet, this tier table fits easily into the decorative scheme of any home. It is made of solid stock throughout. Although other woods can be used, the original tier tables, of which this one is a close copy, were solid mahogany.

Starting with the three turned sections which make up into the column when assembled, you will need two 4 by 4-in. squares for the first and second sections, and one 3-in. square for the top section. See the details A, B and C in Fig. 1. Once you have these turned out to the sizes

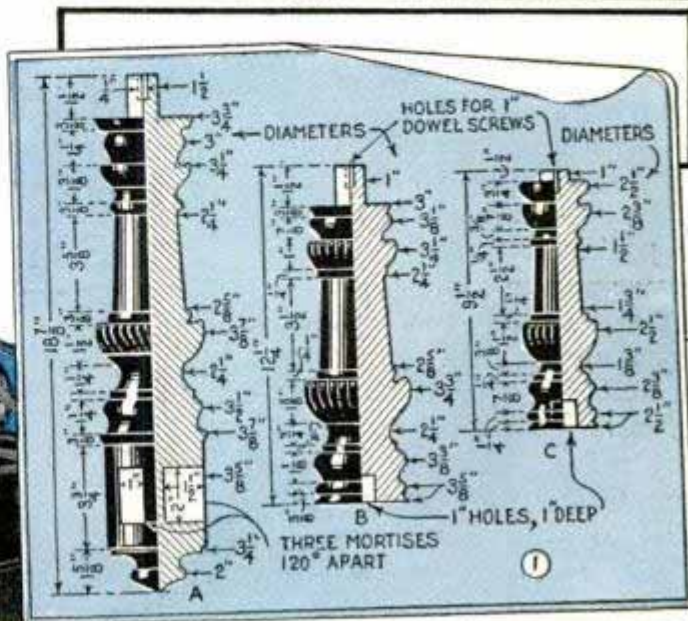
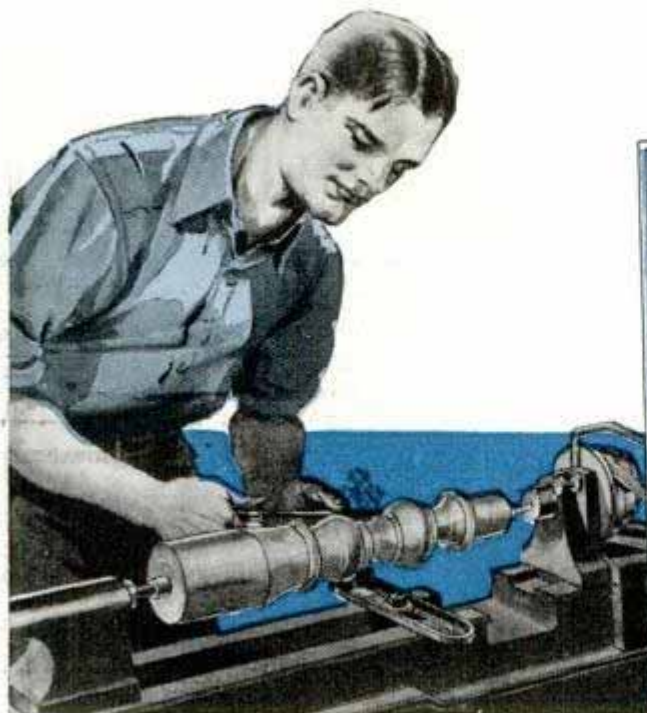

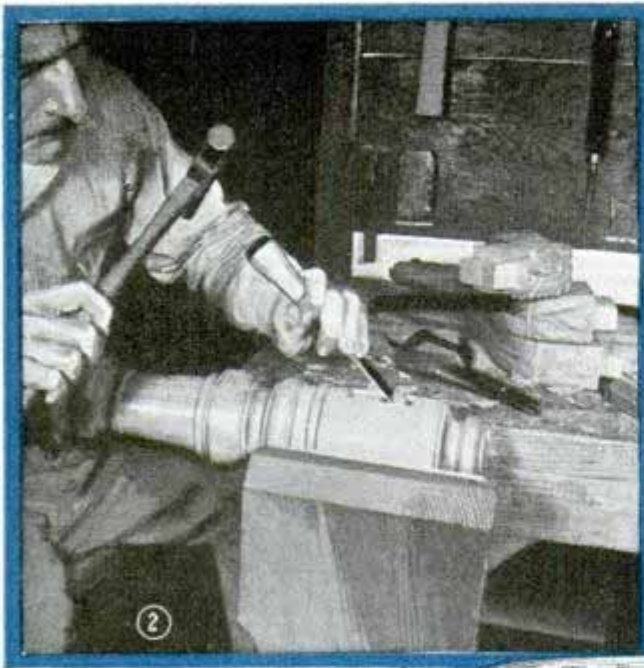

given, mortise the lower section as in Fig. 2 to take the three legs. The large undercut beads of all three sections are ornamented with hand-carved spiral reeding as indicated in Fig. 1. Use dividers to space the reeds an equal distance apart, then cut the vees with a wood carver's V-chisel, taking care to keep the spirals uniform and the vees all the same depth. Of course, if you wish, you can simplify the work on the column considerably by omitting the reeds.

The three legs for the pedestal are cut with a bandsaw from 2½-in. stock, after being laid off with a full-size paper pattern, Figs. 6 and 7. After sawing, the legs are marked off with a center line on both the upper and lower edges. Equal measurements taken from this center line simplify cutting from each side to give a thickness of 2⅛ in. at the upper end and 1¾ in. at the lower end.

In carving the legs the

first step is to make a full-size sketch of the leaf design, Fig. 5. Then use carbon paper as in Fig. 8 to transfer the design to the top of the legs. The carving of the leaf design is completed before starting work on the ball-and-claw feet. If you don't feel equal to carving the feet you can simply square the end of the leg and fit a ready-made brass claw foot which is equally attractive. Carving the leaf design on the

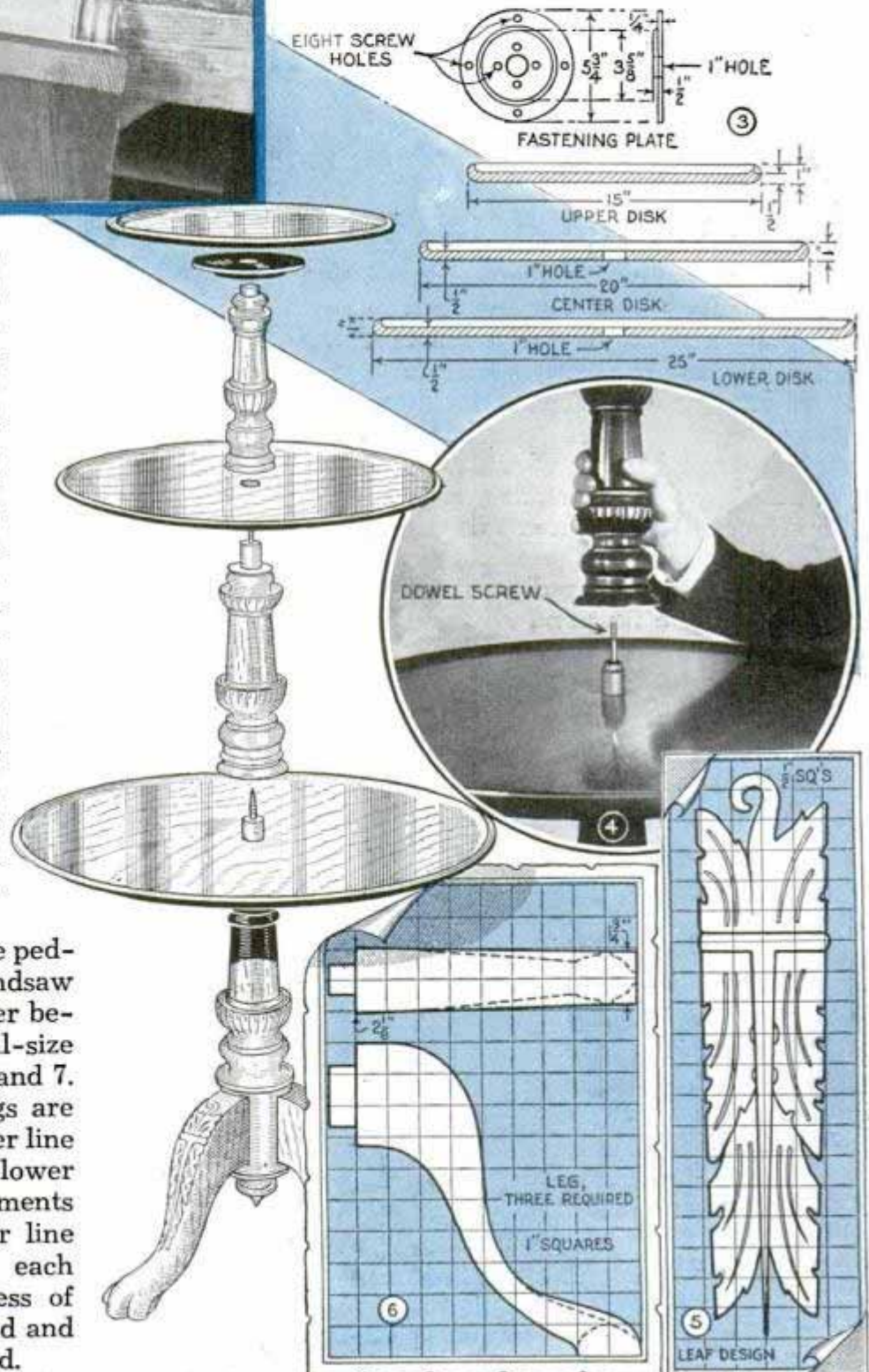

upper curve of the legs is very easy once you have the lines laid out on the wood. Careful work with a V-chisel and fine sandpaper will turn this trick very nicely. The main thing is to get the work smooth so that it takes the finish well. The legs may be fastened to the central column by mortise-and-tenon joints. The tenons were first roughed out on the circular saw and then finished up by hand. The shoulders are then fitted to the round column by paring away with hand chisels to make a tight,



neat joint. Clamping the legs to the column while the glue dries requires a bit of patience and ingenuity. If you have a couple of bar clamps you can use the waste stock which was cut away when you sawed out the legs. This will be curved just right for clamping blocks. Fit the tenons carefully in the mortises and only moderate pressure will be required to hold the legs in position until the glue dries. With the legs glued to the first section of the column you can set this assembly aside until the shelves or trays have been finished. These are made by gluing together a number of strips of $1\frac{1}{8}$ -in. stock to form a square large enough to bandsaw into a circular disk of the required diameter for turning. Note that the lower tray, Fig. 3, is 25 in. in diameter. This means that the rough disk should measure at least $25\frac{1}{2}$ in. to allow for turning. Using an improvised floor rest

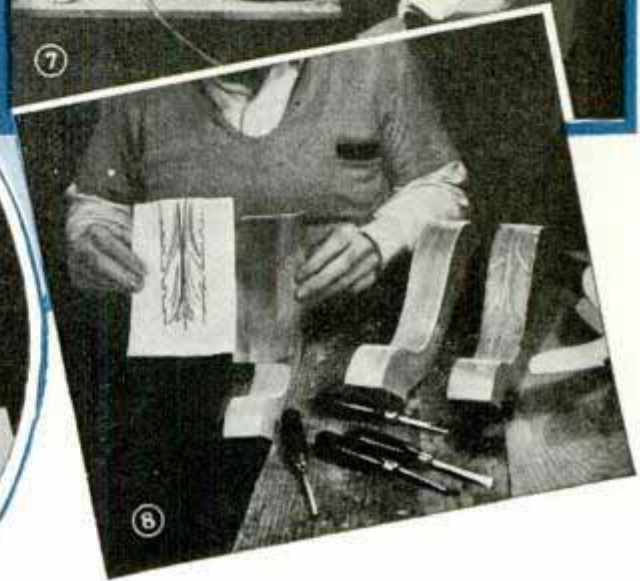
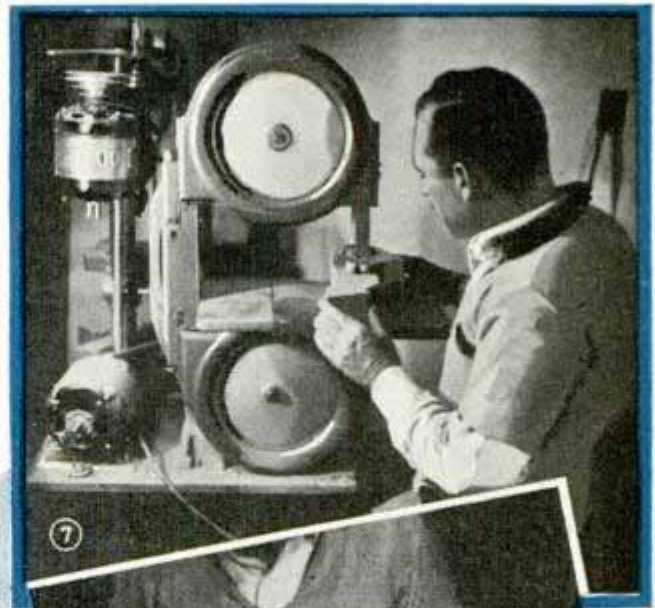

for the tool, you can turn these disks by mounting them on the outer end of the lathe. If your lathe lacks this provision for handling large-diameter stock, you can easily make a special faceplate lathe for turning disks of this size. To do a good job of turning large disks where the work must run at slower speed, you have to have sharp tools. Once the disk is turned and recessed it must be sanded thoroughly. Where the tool crosses the grain there likely will be a rather rough surface. This should be smoothed up carefully by sanding, otherwise you will have trouble with the finish. Fig. 4 and the assembly view at the left show how to set up the table. Don't turn the column section too tight over the dowel screws or you may pull the threads. Use a few drops of glue on the tenons and twist the sections together by hand. Secure the top tray to the fastening plate with screws. To finish, apply either a red or brown mahogany stain, wiping quickly with a cloth to high-light the wood, then when dry, apply shellac or shellac substitute and wax.

Pivoted Block Holds Wood Saw While Sharpening It



As saws used to cut stove wood are usually filed on the mandrel, some means of locking them to prevent turning must be provided. An easy way to do this is to pivot a block to the frame so that it can be swung around to engage the teeth. The end of the block should be beveled so that it will slip between them.

"Shock Absorber" in Flashlight Protects Bulb from Jars

After having the base of my flashlight bulb shattered when the case was dropped, I rigged up a shock absorber to insert be-

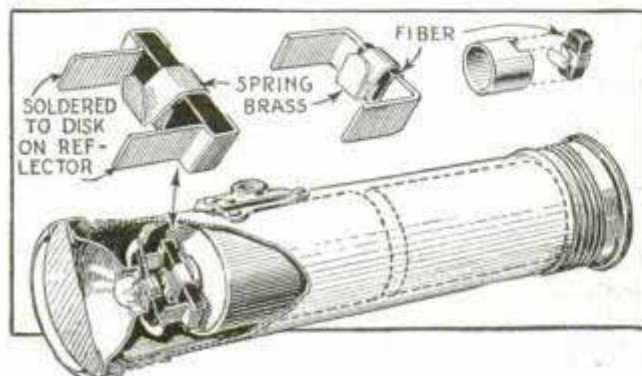

tween the bulb and cells. Either one of the three types shown can be used, depending on the type of flashlight. The spring-brass tongue, which rests against the base of the bulb, absorbs the shock. The tongue must be insulated from the frame that supports it, which is done with Bakelite or fiber as indicated in the detail.

—W. G. Reinhardt, San Francisco, Calif.

Bent Tin Makes Splashless Pan to Wash Photo Films

To avoid splashing water when washing prints or films in a sink, one photographer designed this "pan." It is merely a strip of tin bent and soldered as indicated. Also, it prevents the films or prints from floating away, keeping them separated so that the flow of water gives each a thorough cleaning.

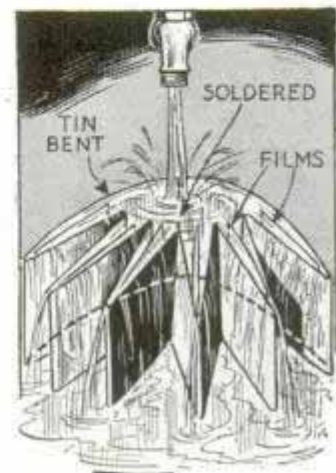

Two Cans Assembled with Clamp Provide Gluepot



If a gluepot is not at hand, one can be improvised from two empty tin cans. Use a small one for the glue and a larger one to hold water, and clamp them together as shown. The large can should hold

enough water to keep the glue hot for some time as it is not always possible to have the source of heat close to the work.

—Edmund C. Villars, S. Elgin, Ill.

☞ When selecting wallpaper, remember that large patterns and dark colors make the room appear smaller, while striped or plain paper, if light in color, will give an impression of increased size.

SCROLLED HOT PADS of Plywood

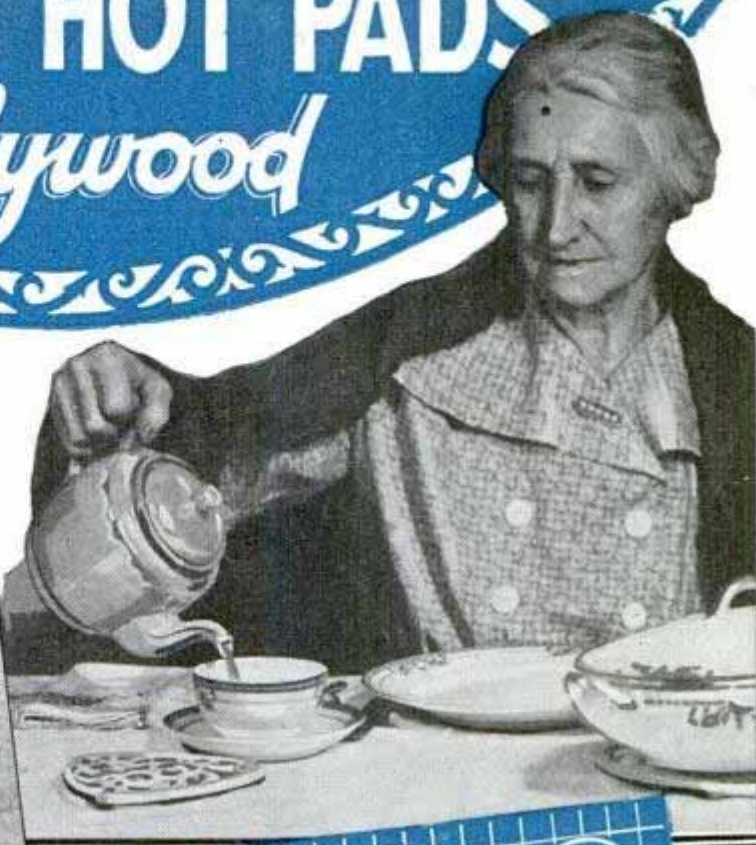
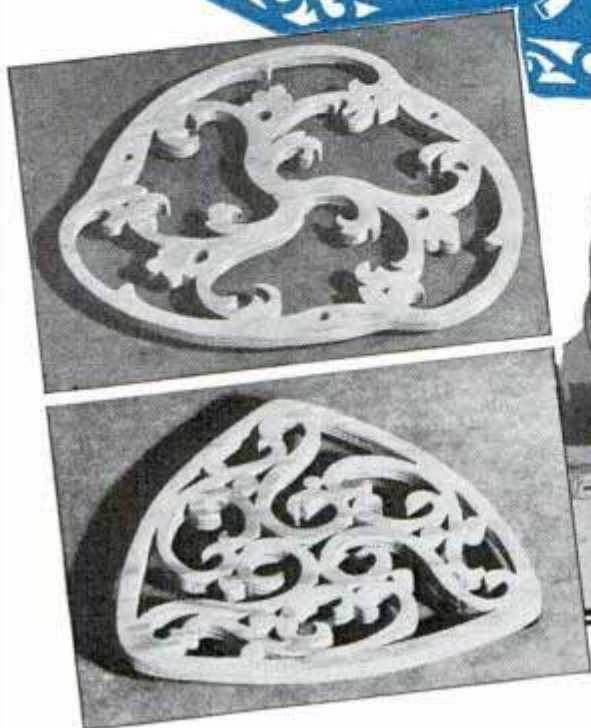

More than a century ago wrought-iron trivets, hot pads to us, were household utensils in everyday use at the pioneer fireplace. Here they are once again in the old patterns and pierced designs, but made of plywood and modernized with colorful heat-resisting lacquers or enamels. Trace the pattern full size on squared paper, then transfer the lines to the wood with carbon paper. Use $\frac{1}{4}$ or $\frac{3}{8}$ -in. plywood and cut away the waste to the pattern lines with a scroll saw. Legs are the small screw-type brass knobs. Finish in color or leave the pads plain as you desire.

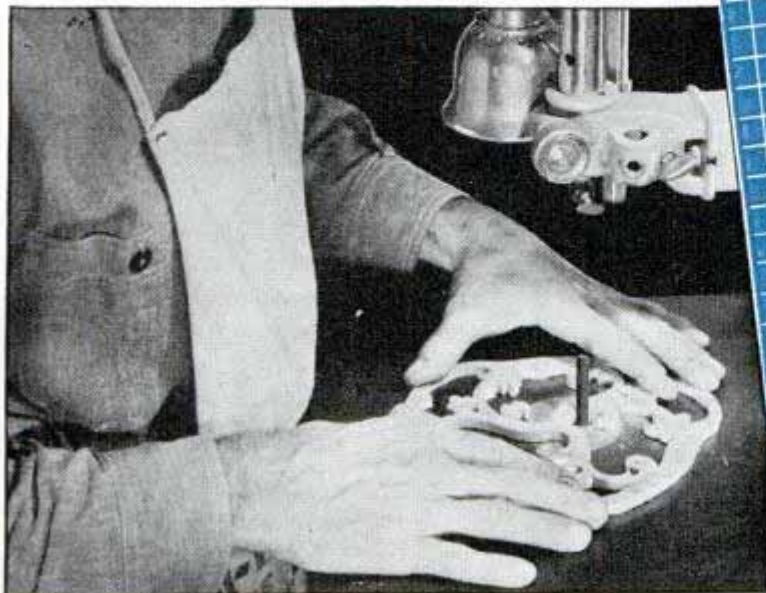
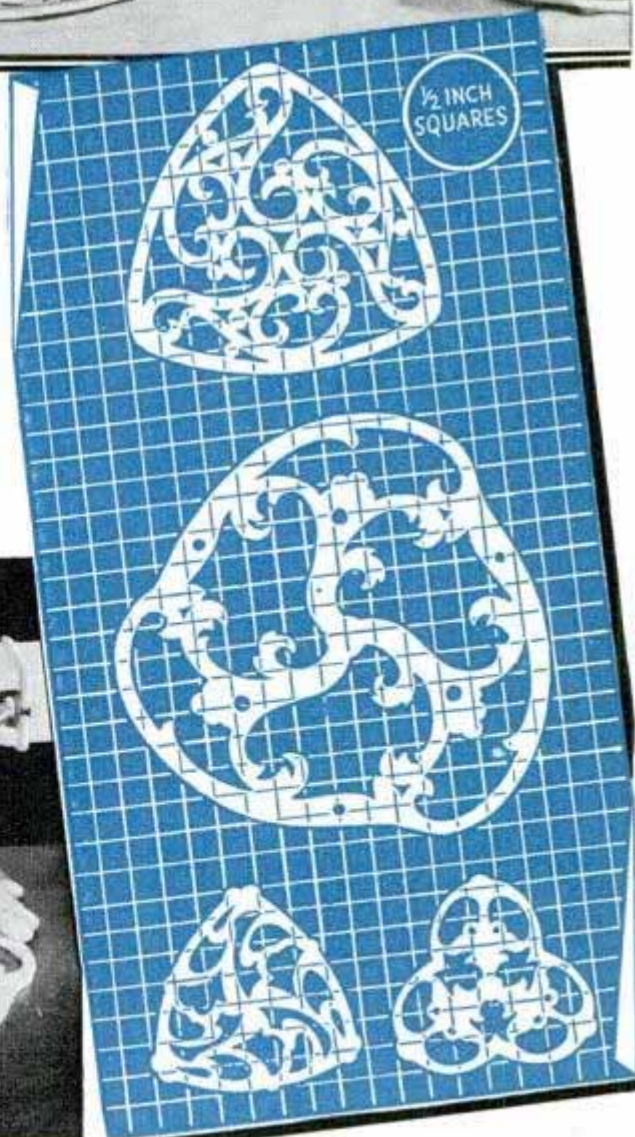

The
living
room

Furnishing the



By **LOWELL R. BROWNE**

AS THIS doll-house furniture is simple and sturdy, it will stand some pretty rough handling by children. Fig. 1 shows the doll's living room furnished with an overstuffed davenport and easy chair, a piano, a Governor Winthrop type of desk and other suitable pieces. Size and construction of these pieces are given in Fig. 2. The davenport and the easy chair are made up of blocks assembled with brads and casein glue. Before assembling the pieces, the sharp corners are rounded off, the upholstery is put on and the feet are screwed in place. The latter are button molds. Cloth or imitation leather used for upholstery is merely glued onto the wood before the feet are attached. Seams on the edges are covered with upholstery tape also glued in place. No tacks are required. When cutting the cushion blocks, be sure that they are small enough so that after the upholstery has been applied, they will

fit on the seat. The base, pedestal and top of the round-top coffee table are assembled with casein glue on the raw wood before staining. The tiny feet on this piece are small whittled knobs.

The Governor Winthrop desk is made up of two blocks glued together. A piece of bristol board upon which rows of books have been painted or drawn gives a striking effect if covered with celluloid or Cellophane to represent glass. Then scroll-sawed doors are applied. Tapered legs are fastened with glue and brads and the drawer fronts are dummies, the knobs being brass escutcheon pins with the heads pounded square. A strip of wood molding around the base completes the job. It is finished in a mahogany stain and waxed.

A simple corner table, also included in Fig. 2, can be placed in a corner of the room, or two of them set on each side of the davenport. Corners are rabbeted for

DOLL HOUSE

revised
1939
756

legs, which are glued in place. It is a good plan to make the rabbets in the square pieces first and then cut the curve. One of the easiest pieces to make is the grand piano. The box is scroll-sawed from a single block of wood and the keyboard is built up, the keys being marked on bristol board with a ruling pen. The music rack is glued to the top. Legs are tapered from square stock and fitted with dowels. Pedals are merely brads pounded flat. A piano bench consists of a seat with rabbeted corners for the legs. Another good piece for the living room is the wing chair detailed in Fig. 5. This material is used for the sides and back, while a thicker piece forms the seat. This piece is not painted,

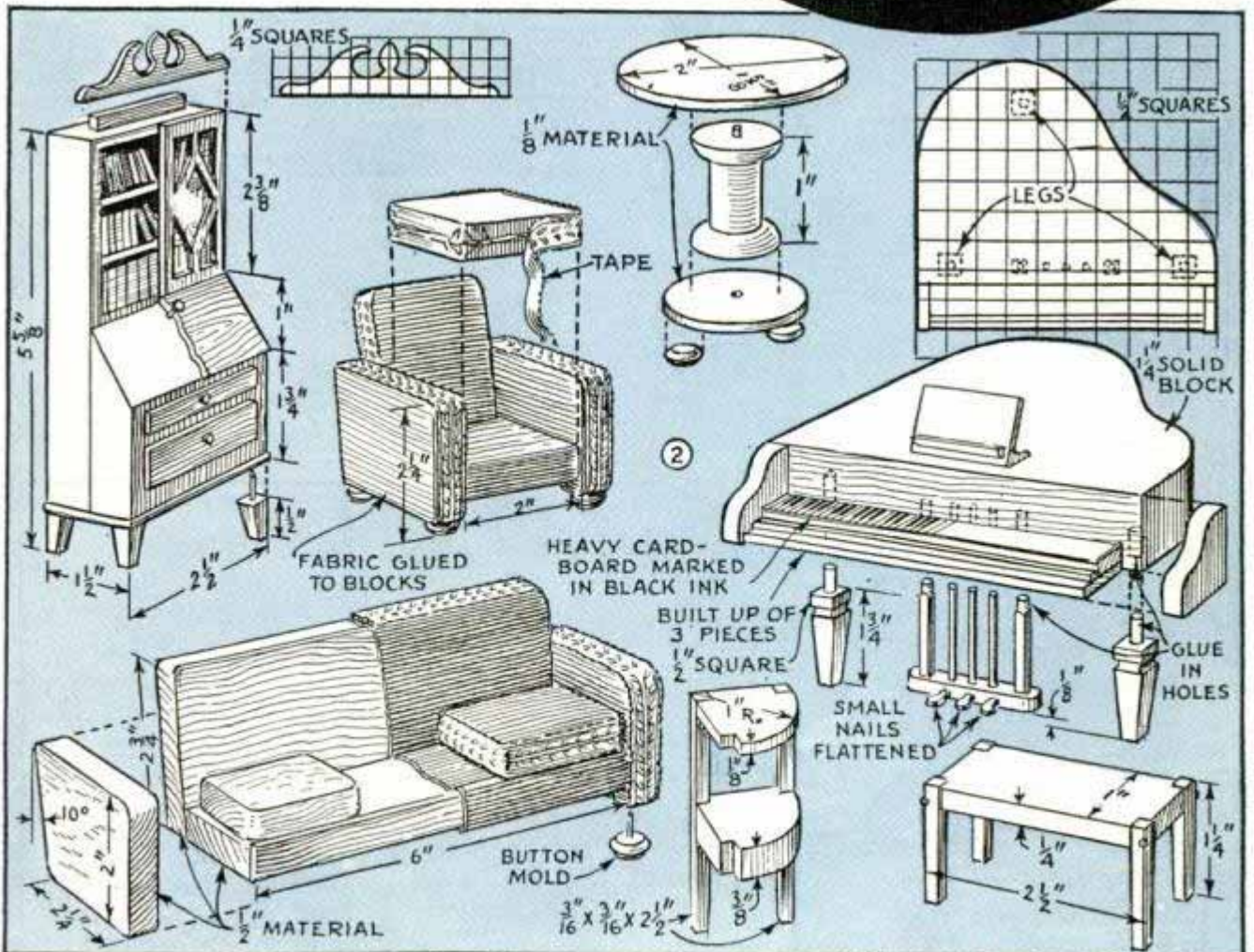



Empire style in the dining room

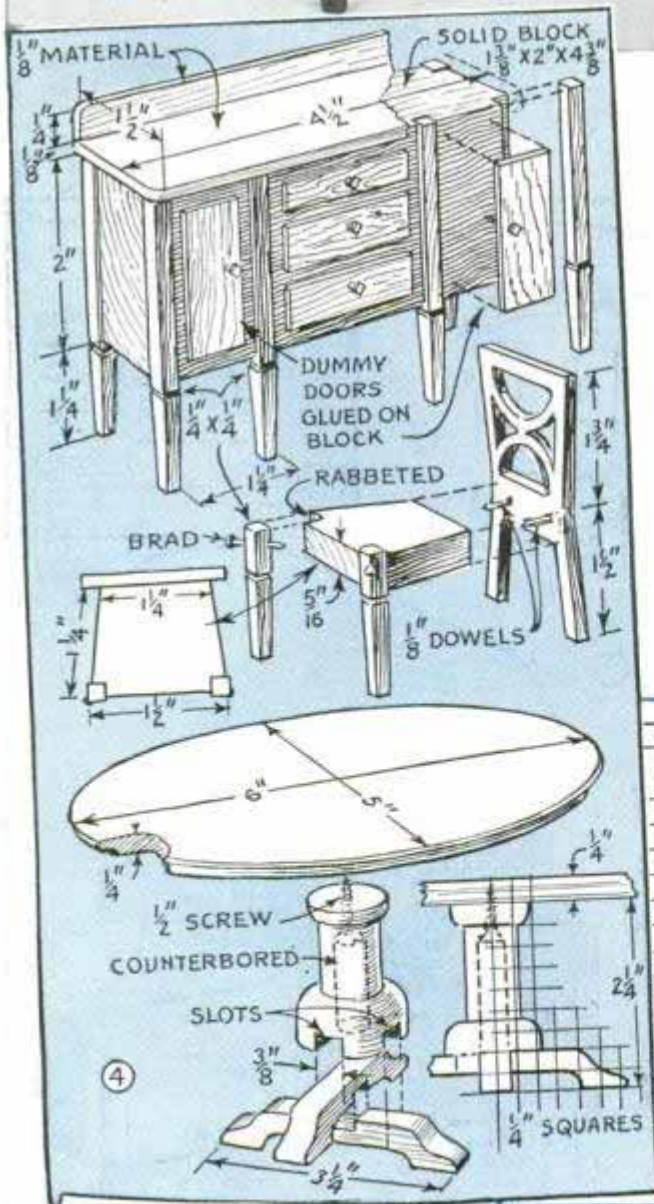

except for the legs, as it is to be covered with fabric. The covering is slipped over the chair, putting in finishing stitches at the curve of the wings, etc., which gives a trim effect.

Next comes the dining-room furniture for which empire style is shown in Figs. 3 and 4. The sideboard is a block of wood with rabbets for the tapered legs, which are casein-glued in place. Drawer fronts are thin material glued on as shown with squared escutcheon-pin heads for drawer pulls. You will find the oval dining table attractive. Its top is a piece of 1/4-in. stock

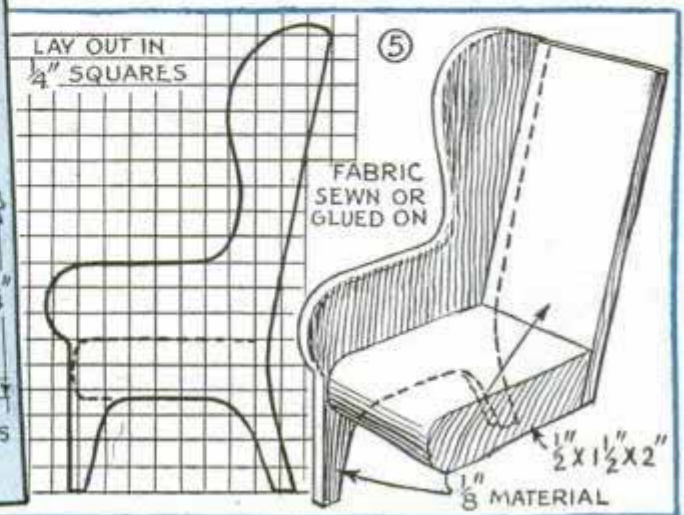

with molded edge. A small screw is inserted up through a hole in the top of the pedestal. In making the pedestal, the bottom is slotted while the stock is square, before turning. Legs are in three pieces; a double one extending through one slot and two single ones glued in the other slots. Each dining chair consists merely of a substantial seat to which the back and the front legs are attached with small dowels and glue, the legs being set in rabbets. The latter are tapered and grooved near the top. As thin wood is used for the backs, they can be scroll-sawed four at a time. For added strength, escutcheon pins are driven diagonally through the front legs and the edge of the seat, a pilot hole being drilled first to avoid splitting.

For one of the bedrooms a four-poster bed is especially attractive. The posts are not turned, but square stock scored with a file is used. Arched members of bamboo, which are heated and bent to shape, span the top to support the covering. See Figs. 6 and 7. Bedroom chairs having scroll-sawed backs are in two simple styles. These are made similar to the dining chairs and may be

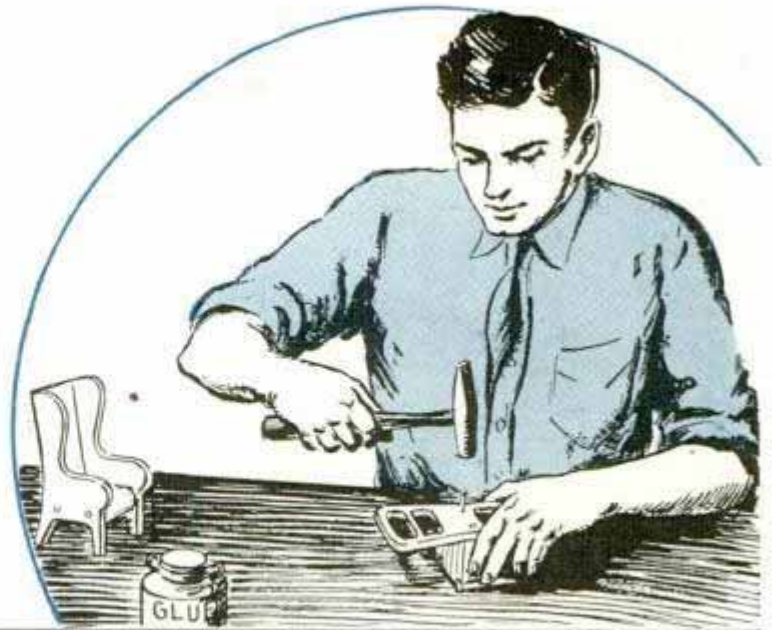

*Quaint
colonial
bedroom
styling*

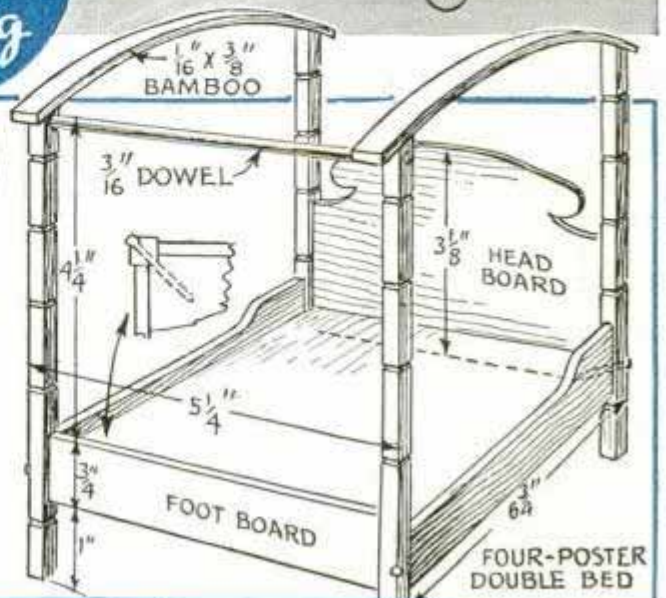
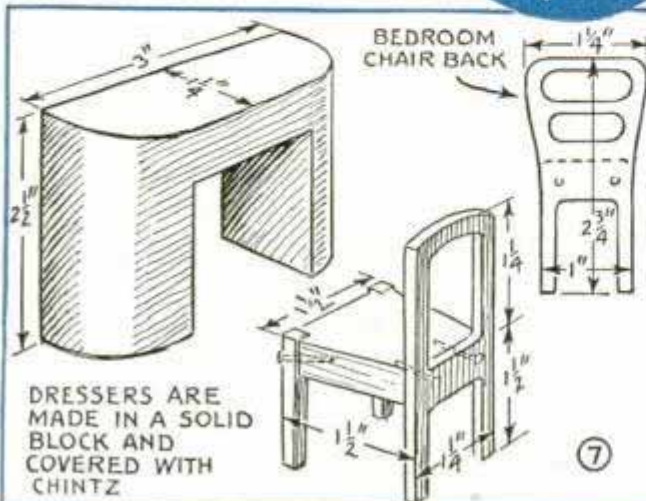

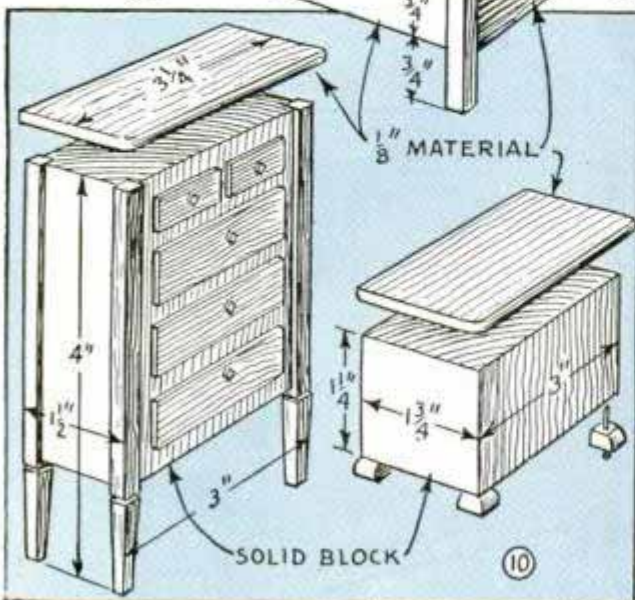

stained or painted white. A dresser is cut out of a single block of wood. The ends are rounded and then a chintz covering is provided. If a mirror is desired, one of appropriate size can be glued to a wood strip.

Double-deck beds, Figs. 8 and 9, resemble the full-size pieces, except for the actual construction of the bottoms. To assure strength, the bottoms are $\frac{1}{2}$ -in. stock, which provides ample surface to which the side members, head and foot boards are glued. The upper unit can be lifted off the lower unit if twin beds are desired. Small dowels in the top of the bed posts of the lower unit prevent the upper one from sliding off. For mattresses, pieces of $\frac{3}{8}$ -in. wood are used, these being cut to fit loosely in the bed to allow for the "ticking" which is glued on later. Other pieces for the bedrooms, such as a chest of drawers and a linen chest, are cut from blocks of wood in much the same manner as the dining-room sideboard. Assembly and sizes of these pieces are given in Fig. 10.

☞ You can test silk for color fastness against perspiration by soaking a sample of the material in diluted acetic acid for about 10 min. and then letting it dry gradually without rinsing; after a few days compare it with the original.

Glass Rods Emit Soft Light over Clock Face

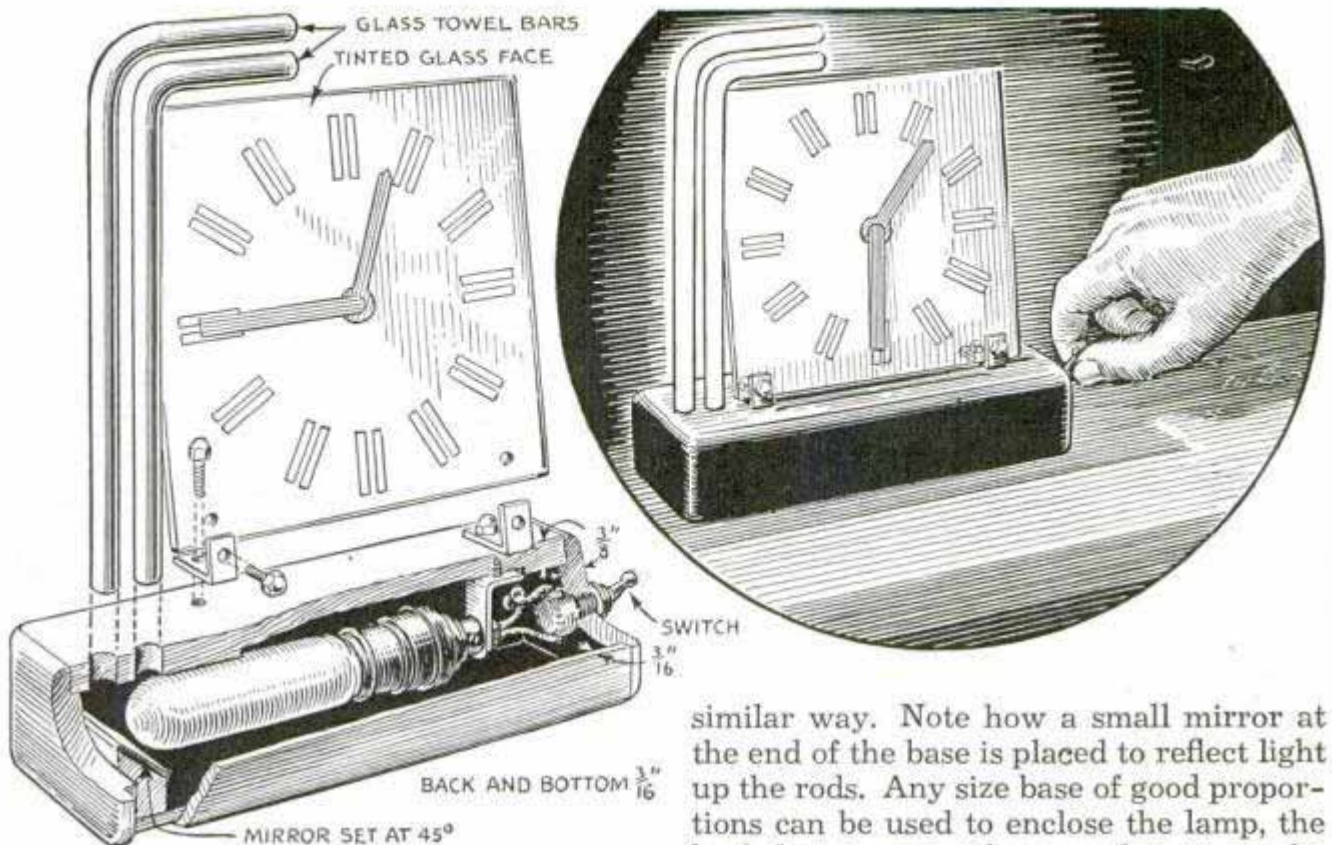

Flipping the tiny switch on the base of this clock holder lights up a low-wattage lamp and sends light through two glass tubes to illuminate the clock face. This arrangement of rods as shown above is particularly adaptable to a clock having a square face, preferably one which has exposed hands and hour marks, although the fundamental idea can be applied differently. The glass rods were part of a twin glass-rod towel rack, obtained at a dime store, in which the rods were spaced in a

similar way. Note how a small mirror at the end of the base is placed to reflect light up the rods. Any size base of good proportions can be used to enclose the lamp, the back being screwed on so that it can be removed quickly for lamp renewal. A radio panel switch is fitted at the end, front or top of the base. Also, vent holes should be provided for the escape of heat from the lamp. Small angle brackets are used to hold the socket and the clock face although it is advisable to use longer brackets to support the clock in order to avoid the tendency of the glass to break when drilled as close to the lower corners as in the original model. However, corner attachment such as this is satisfactory on metal faces.

Work Leveled in Emergency with String and Envelope

When a level is needed for checking shelves and framework and there is none at hand, one can be improvised with an envelope and a weighted string or plumb bob if the leveling job is not too critical. Just suspend the string from the work to be leveled and hold the envelope against both the work and the string as indicated. If the string touches the envelope along the entire edge, the work is level.

☐ If you have soot on a rug, cover it with dry table salt and let it stand a short time before sweeping.

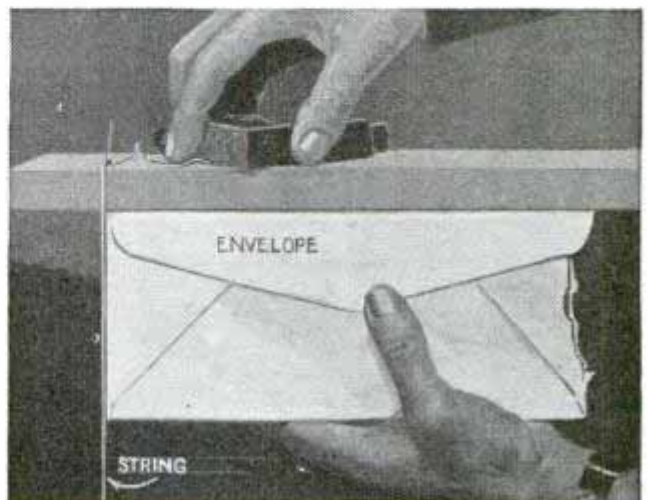

Sorting "Tray" for Vegetables Saves Time



Opened and tacked to a pair of broomsticks, a burlap sack provides a handy tray for use in sorting or grading potatoes and vegetables in the home. The tray is spread on the floor, after which the vegetables to be sorted are spread on it. When sorting has been completed, the vegetables left are dumped into a container by merely lifting the tray by the broomsticks.

Stencils Cut from Old Negatives Last Indefinitely

Old celluloid photo negatives provide good material from which to cut small stencils. If necessary, they can be cemented together to make stencils of any thick-

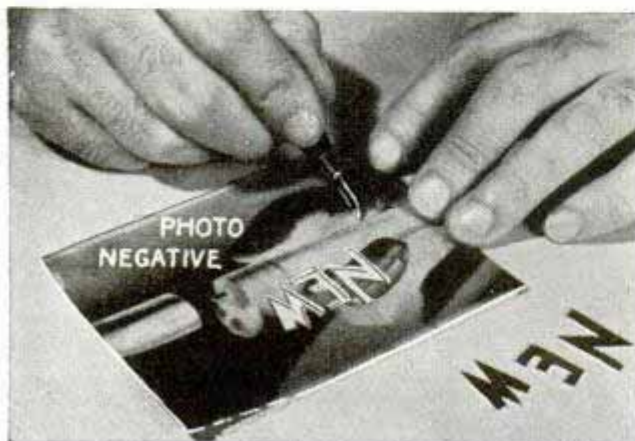

ness. Use a sharp penknife or old razor blade for cutting. Do not cut through the negative, just score the surface deeply, then bend the material once each way at the cut, and the celluloid will part cleanly.

Bent Bail Keeps Paintbrushes Off Bottom of Pail

Instead of letting paintbrushes rest on the bottom of a pail of cleaner, which might cause the bristles to twist out of shape, a workman suspends them in the liquid. This is done by bending a loop in the center of the bail to engage the brush handle as shown.



Rings Soldered to Plumb Bob Provide Reel for Cord

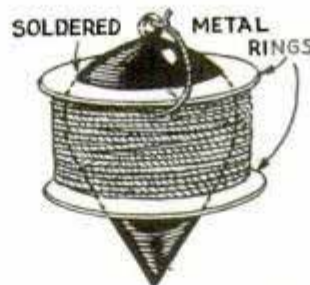

Workmen who use a plumb bob with a long cord will find that a couple of narrow metal rings soldered to the bob as indicated provide a handy place to wind the cord. The rings will not interfere with the regular use of the plumb bob, and they keep the cord from tangling when in a toolbox.

Brass Shim Stops Relay Sticking

Sticking of relays and other electromagnetic devices because of residual magnetism can be avoided by inserting a brass shim over the face of the magnet core. The shim should be as thin as possible, as a thick spacer would interfere with the operation of the magnet.



MOVIE TITLES that "LIVE"

I NTERESTING and effective titles superimposed over still or animated backgrounds are possible with either black-and-white or color movies by the double-exposure method. Marine sunsets, inviting pastoral scenes, trees, flowers, mountains, city skylines and cloud formations all lend themselves to the purpose. For sports events and other shots involving fast movement, action backgrounds are appropriate.

The three steps shown in Figs. 1, 2 and 3 produce the attractive result in Fig. 4. Almost any scene can be used for a background, although the white lettering will show up to best advantage on one that is fairly dark in tone. Film the background at normal exposure. If your camera has a wind-back attachment, it is unnecessary to wind the film back in the darkroom. However, hand winding is not difficult especially if the background scene is taken at the beginning of a reel so you can just turn the film back all the way instead of keeping track of the footage. Titles must be lettered on a flat-black surface and may be made large and filmed direct, or small and used in a regular titler. For color film the lettering may be any color which contrasts well with the background. When taking the lettering, it is best to underexpose about one full stop.

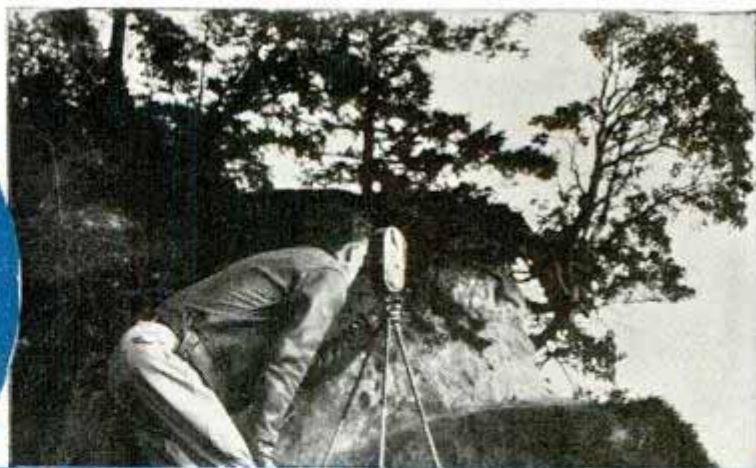

① BACKGROUND SCENE IS FILMED



② FILM TURNED BACK IN DARKROOM



③ SHOOTING THE TITLE

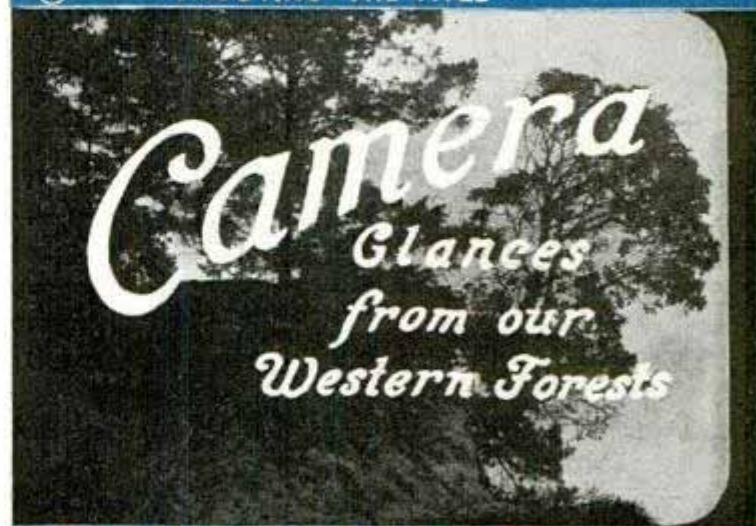

④ AS THE AUDIENCE SEES IT

Jig Simplifies Rigging Deadeyes on Ship Models

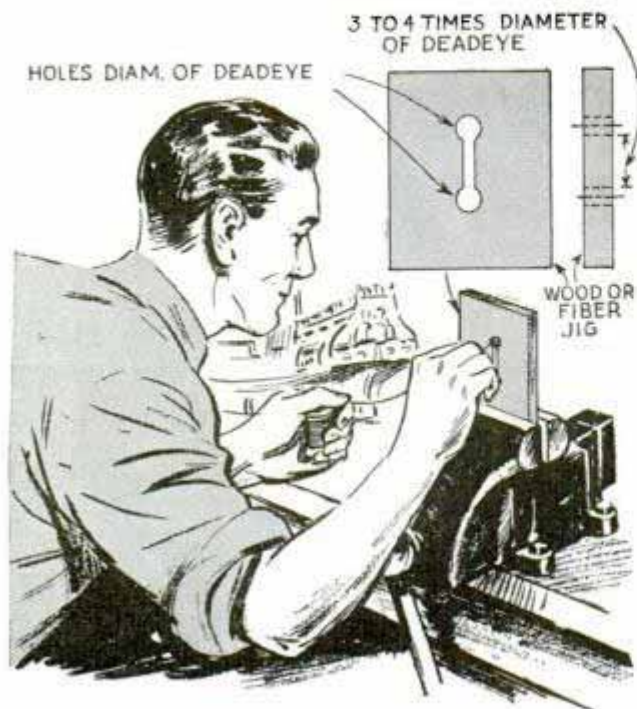

The tiresome job of rigging deadeyes on a ship model can be done easily with the jig shown. In use, a deadeye is placed in each of the two holes drilled in the jig. The lanyard is then laced through the holes in the deadeye and fastened at the last hole. The completed assembly is removed from the jig by pushing it out.

—Fred Hushen, Brooklyn, N. Y.

Tray of First-Aid Equipment Quickly Slipped in Car

Fire chiefs and others responsible for first aid in emergencies will save time in many instances by keeping their equip-

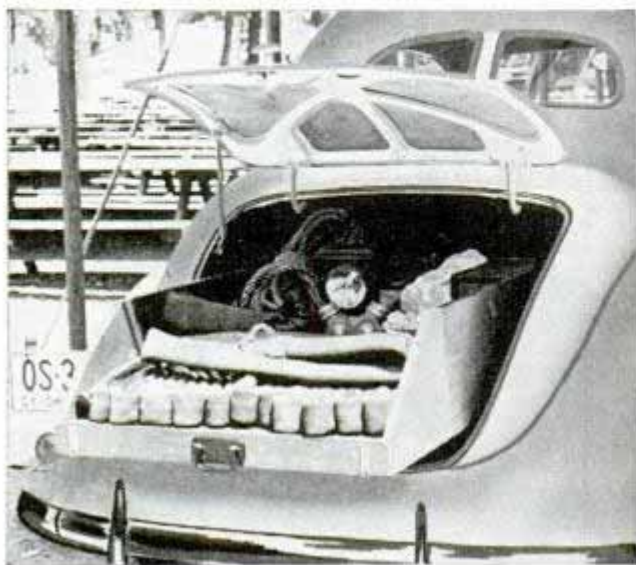

ment in a tray built into the back of the car as indicated. If it is inconvenient to keep the tray in the car at all times, it can be put on tracks permanently attached to the car. This permits the tray to be removed when not needed and instantly slipped in place when a call comes in to the station.—J. L. Burden, Smithville, O.

Tubular "Pocket" on Typewriter Keeps Eraser Handy

Instead of throwing your typewriter eraser around on the stand or desk where it is hard to find, use this pocket to hold it. It is made from a short length of metal tubing which is flattened

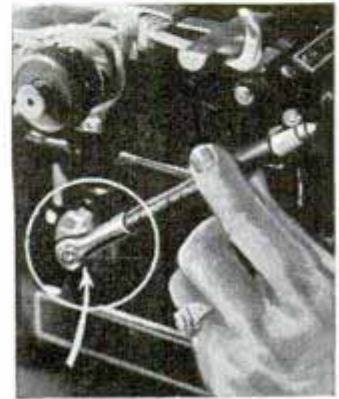

at one end and drilled to slip under the nut that holds the typewriter bell in place.

Imitating Spotlight Effects on Photographs



If you do not have a photo spotlight, you can imitate the effects of one when taking closeup pictures of

small objects. Just place an oval-shaped piece of white paper on black paper and set the object to be photographed on top of the assembly. Use one side light only, in order to cast a strong shadow.

Tip of Soldering Torch Shielded by Pencil Eraser

A slip-on type pencil eraser makes a handy cover for the tip of a small soldering torch. The eraser fits snugly and keeps dirt from plugging the tiny opening.

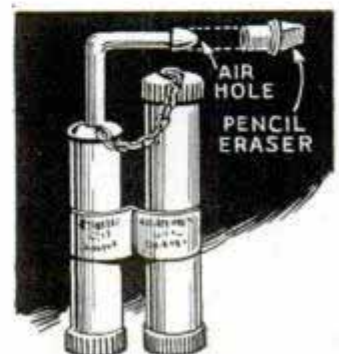

STOP FOR CIRCULAR SAW . . .



MOUNTING GLASS SHELVES .



Everyday Uses for

RUBBER SUCTION CUPS



Here are a few kinks with suction cups that make these versatile little gadgets still more useful. In the photos above, a cup holds a stopblock on a circular-saw table, and another supports a glass shelf on a windowpane. The cup edges should be moistened with glycerin, which prevents them from loosening quickly. In the photo at the right a suction cup serves as a pivot for a guide arm when cutting glass disks. Below, three cups hold a disk of plastic for very light turning in a lathe

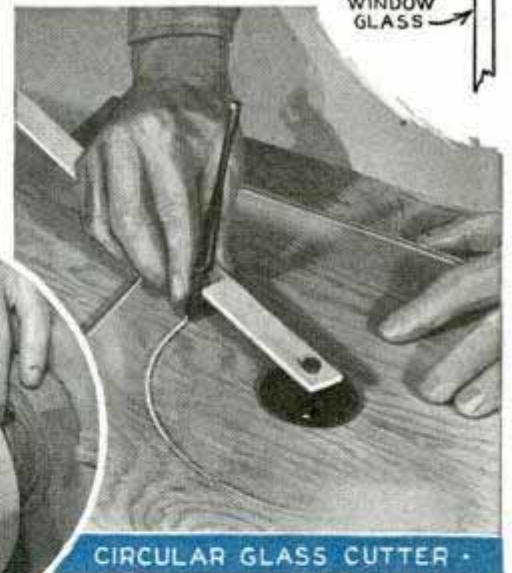

CIRCULAR GLASS CUTTER .



MOUNTING THIN PLASTICS ON LATHE . . .

Besides the applications illustrated, suction cups can be mounted on the outside of your car for carrying fishing tackle, in which case you attach small straps to the cups to fasten around the rods. Suction-cup hangers can be mounted on glass or any smooth surface for holding clothing, signs and lamps on your car or a workshop machine. They are useful to pull out indented portions of light sheet metal when the work cannot be reached from behind with a hammer

Oil-Soaked Logs Burn Briskly in Fireplace



Logs and chunks of wood for the fireplace that are too wet to burn properly can be made combustible with oil. Pour old crankcase oil in a container about 2 in. deep and set the wood on end in it. After a half hour or so, reverse the ends. The logs will absorb the oil at the ends, and when ignited in the fireplace, the flames from the burning oil will drive out the moisture where the oil did not reach.

Rubber Grip on Tool Handle Easy on the Hand

Fatigue and blisters on the hand may be avoided by using a rubber grip on the handles of files, chisels, etc. To make the



handles, cut a piece of the right length from a broomstick. Then drill one end to take the tool tang and slip a bicycle handlebar grip over the stick.

—Benj. Nielsen, Aurora, Nebr.

Rubber Cement Seals Shoe Seams Where Soles Are Attached

When you waterproof a pair of leather shoes or boots, don't forget the seams where the uppers are sewed to the soles. These places can be sealed with rubber cement

such as is used for patching auto tires. First clean the seams with gasoline, then apply two or three coats of the cement.



Chuck "Screwed" to Drill Press When Routing

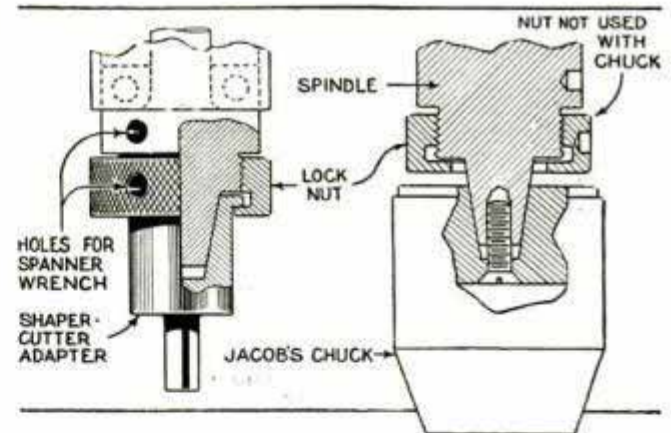

I have a small drill press on which the chuck is held by a tapered shank fitting into the spindle. Routing and shaping attachments are also provided, but these are held on by a special nut. When doing heavy drilling, the chuck sometimes loosens. To avoid this, I attach the chuck with a screw. This passes through the chuck, which is drilled for it, into a tapped hole in the tapered end of the drillpress spindle as indicated. The drilling and tapping must be done carefully so that the chuck will slip onto the spindle. This attaches the chuck so firmly that I can use it to hold routing and shaping tools.

—Carl N. Furay, Manchester, Conn.

Dip-Painting Flowerpots Gives Novel Effects



Colored paint can be picked up readily from the surface of water and deposited on ordinary clay flowerpots to obtain beautiful, variegated-color effects. Skill is unnecessary if you follow this simple method: First of all, the pot to be dipped must be thoroughly clean. Then the inside surface is given two coats of interior primer sealer (white, used for plastered walls). This will prevent moisture from penetrating the walls and causing the outside paint to blister. After the primer has dried, the pot is mounted on a holder, with which it is dipped and rotated in a water-paint bath. To prepare the bath use artists' colors ground in oil, obtainable in small tubes. Thin a little of each color with turpentine so that various colors can be flipped on the water with a small, thin paddle—not poured. Now, partly submerge the pot and slowly turn it completely around. Then lift it out of the water and continue turning until the color has soaked in and will not run. In this way several different colors can be applied simultaneously in pleasing, irregular patterns. Or, first you can brush a heavy coat of one color over the entire outer surface and after this has soaked in, apply other colors by the dip-and-turn process. White must be used a bit thicker than colors. If the water and paint are renewed for each pot, you will produce long, streaky effects. After the colors have dried, black enamel is painted on the bottom and on the inside surface

near the top. When dry, this is followed with two coats of waterproof varnish, both inside and out, to cover thoroughly and to produce a high gloss, which may be rubbed down to a dull finish.

Wire Bender Has Several Heads for Various Diameters

You will find this tool just the thing for bending wire and small rods. The work is clamped in a vise and then bent with the tool as indicated. Heads to handle various sizes of work can be made if desired.

—C. A. Hathaway, Davenport, Ia.

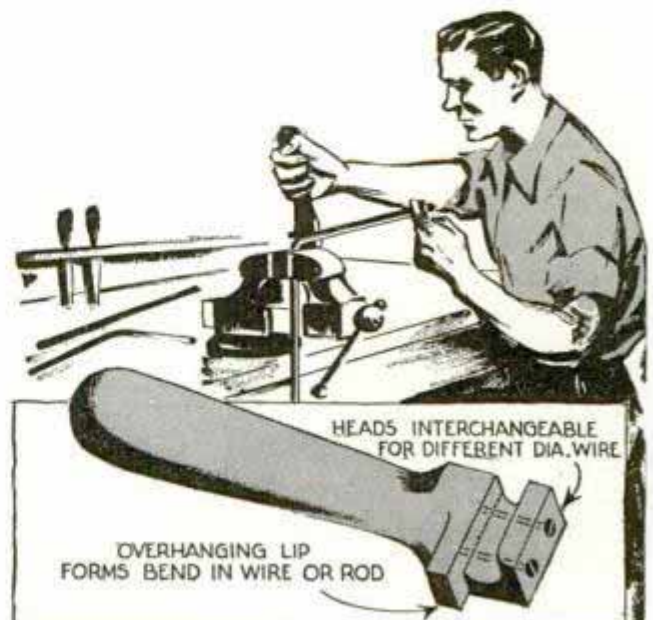

FUN with

By
Alexander Maxwell

FASCINATING to watch and instructive to build, this combination unit comprises an alcohol-fired boiler fitted with a safety valve, a piston-type engine and a turbine. All of these may be mounted on a single base, as in Fig. 1, so that it will be an easy matter to connect the rubber tube on the steam supply line to either engine or turbine. Simplicity of

construction and the use of stock material enable anyone to make these engines.

The piston-type engine shown in Fig. 2 is detailed in Figs. 3, 4 and 5. It is an engine of the single-acting or single-admission type, that is, there is only one power stroke instead of two as in the double-acting type. This means that the flywheel must be comparatively heavy to store up sufficient energy for maintaining a steady and uniform speed. Looking at the left-hand sectional detail in Fig. 4, the valve is

open and live steam from the boiler is rushing through the steam chest into the cylinder. The piston has just started

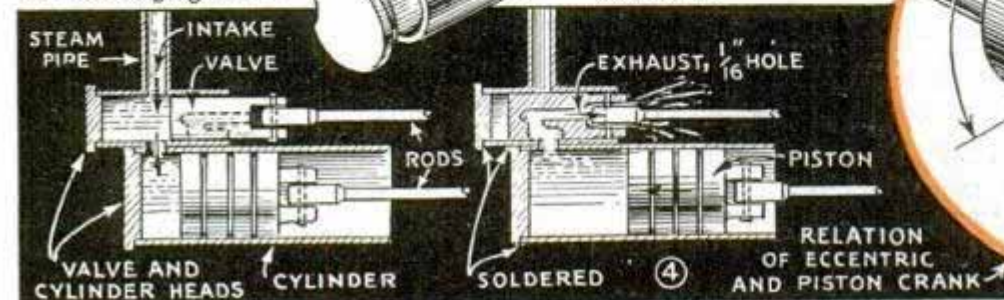
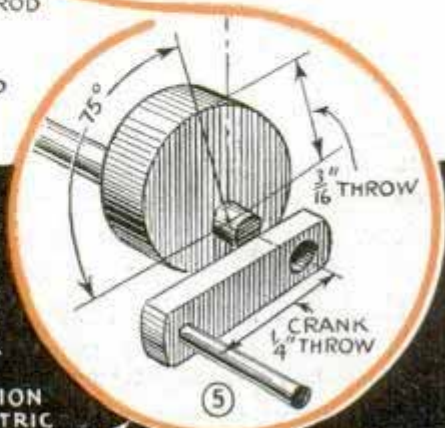
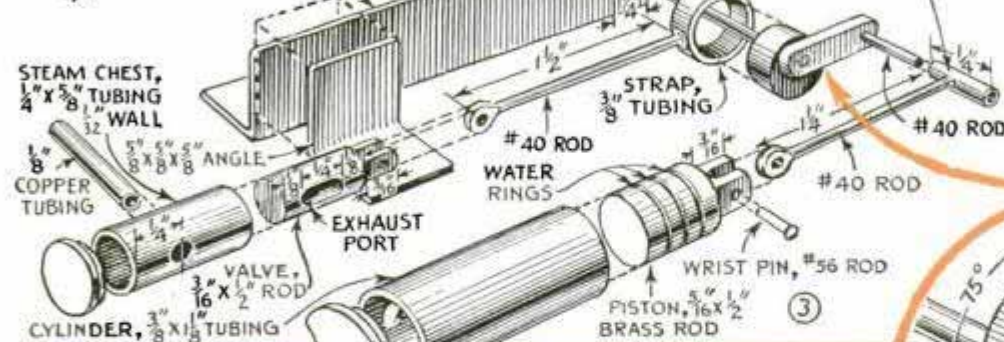
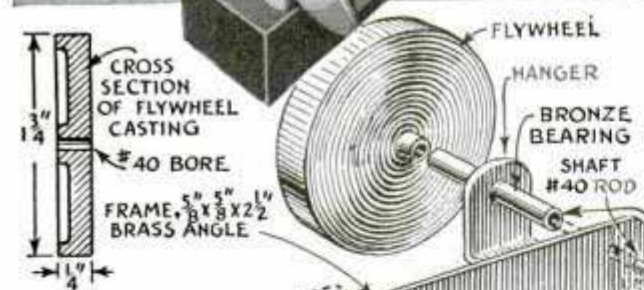
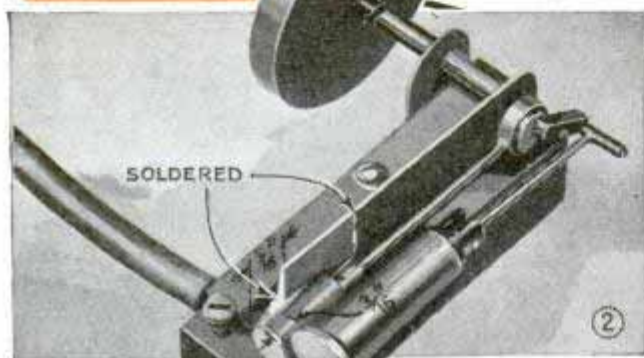
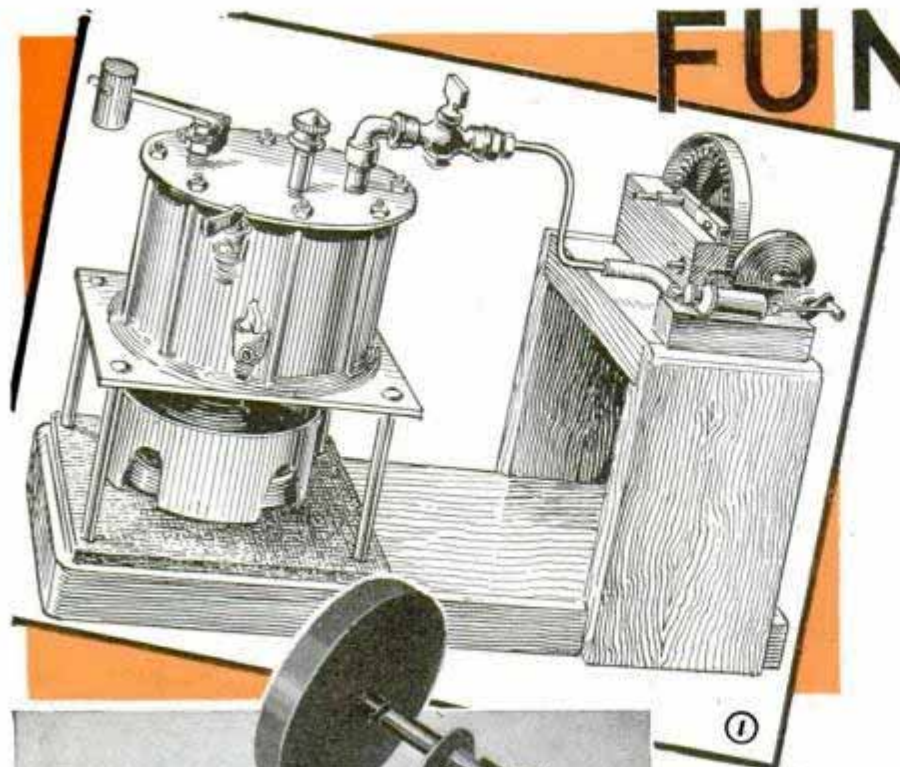

STEAM ENGINES

the outward, or power stroke. While the piston is completing this stroke with the steam pressure forcing it outward, the valve is moving in the opposite direction. Just before the piston reaches the back dead center, the valve closes the live-steam port and by the time the piston starts the return or exhaust stroke the valve has moved into the position shown in the right-hand detail, Fig. 4. This allows the exhaust steam to pass out through a port drilled in the body of the valve.

Thus the cycle is completed, the one opening into the cylinder acting as both inlet and exhaust port.

An alloy solder with a high melting point, 500 to 550° F., must be used. Ordinary tinner's solder will not do. However, before assembly all bearing surfaces of cylinder, piston, valve and steam chest must be tin-plated. This is necessary because contact with live steam produces an oxide film on brass, making the surface rough. Sprinkle pure tin salts on the surface to be tinned, apply heat until the tin is liberated and spreads over the surfaces. While a batch of lead is melting in an

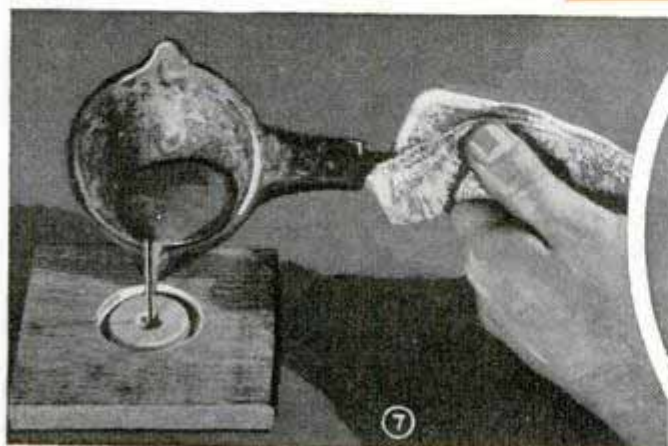
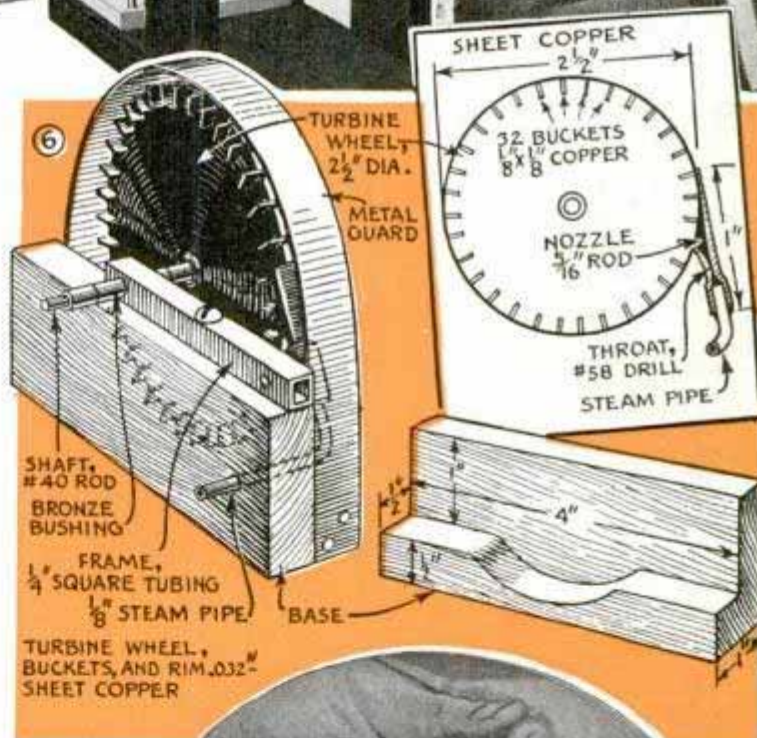
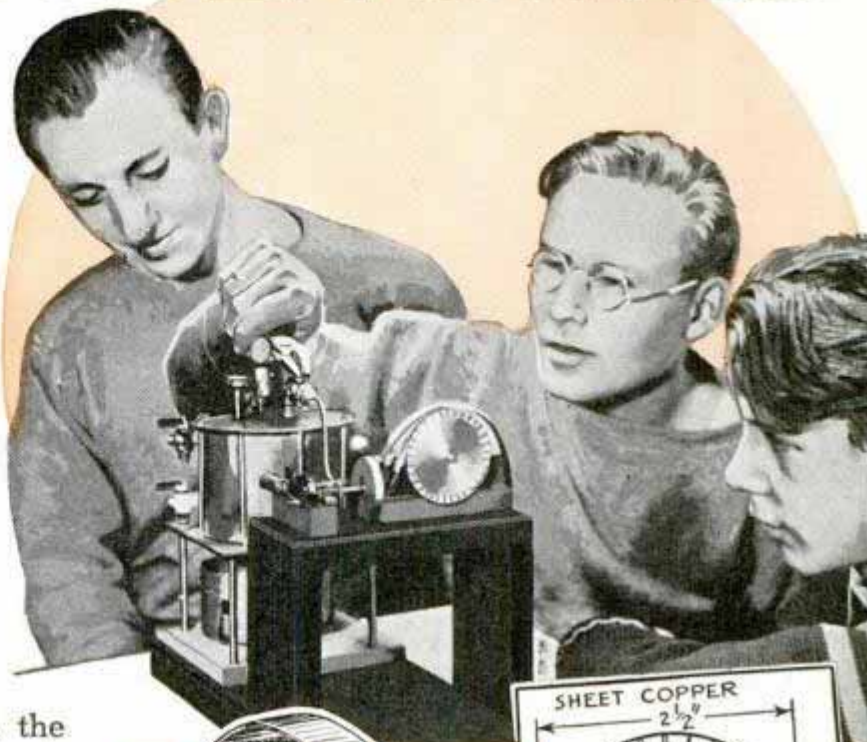

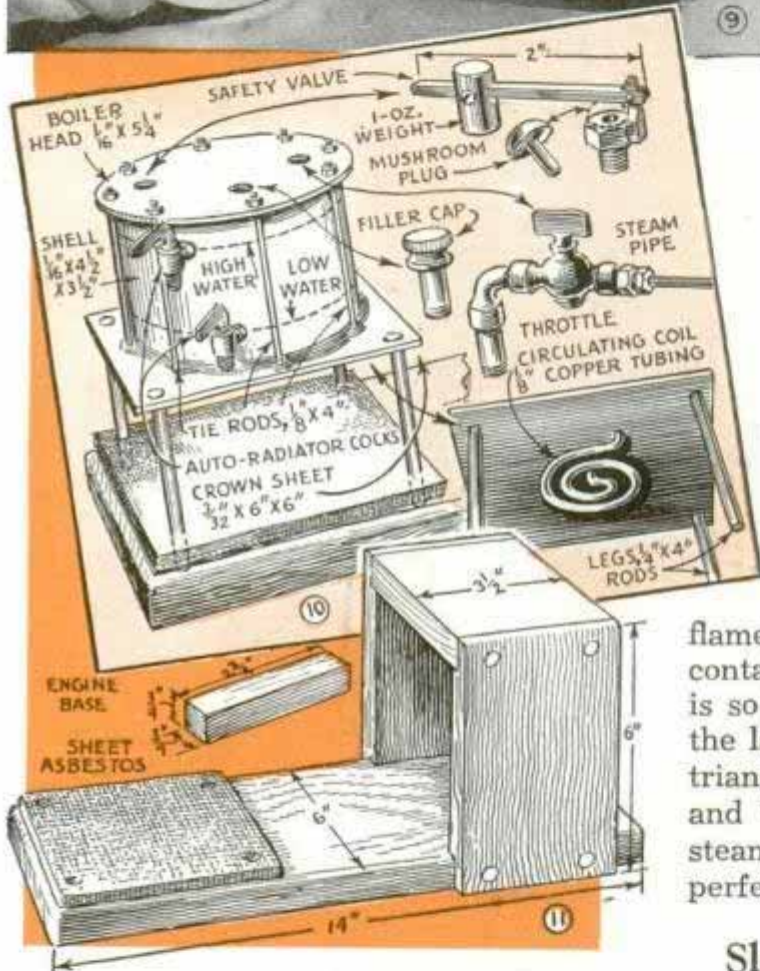

as in Figs. 6 and 8. The nozzle is made of $\frac{5}{16}$ -in. brass rod filed to the shape indicated. The opening in the nozzle is cone shaped by drilling a number of holes of progressively smaller sizes, finishing with a No. 58 drill. The shoulders are smoothed up with a file. Finally the nozzle is filed down to the curvature of the wheel rim and is fastened securely so that the rim just clears. The throat opening is located on a line tangent to the circumference of the wheel. Carefully made, this wheel is capable of very high speeds.

A good boiler, which is simple and safe, is shown in Fig. 10. A circulating coil and an alcohol burner, Fig. 9, make it steam in about half the time ordinarily required. Soldering the boiler is very important. The open ends of the shell must be filed or turned true so that the joint at the head and crown sheet, Fig. 10, is perfect. Then tin the meeting parts for a space of $\frac{1}{2}$ in. each way from the joint. Assemble the boiler with the tie rods and heat over a

flame, taking care that the latter does not contact the tinned joints. When the metal is so hot that hard solder will flow, hold the latter against the joints building up a triangular fillet all the way around, top and bottom. To make the safety valve steamtight be sure that the two parts seat perfectly.

Slotted Stopper Vents Funnel When Filling Bottles

When filling bottles and other small-mouth containers with the aid of a funnel, a cork or other stopper slotted as shown, when put in the mouth of the container with the funnel, will allow the air to escape. Similar results can be had by using a short piece of hose with a section cut out to provide a slot.

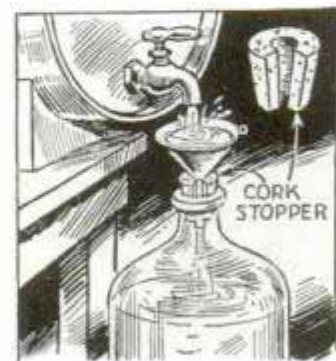

iron ladle, turn the wood mold for the fly-wheel, Fig. 7. Although the wheel is shown separate from the shaft in Fig. 3, it is actually shrunk onto the shaft by simply placing the latter upright in the mold before the metal is poured. This done, the engine is put together complete, except the crank which is pressed on the shaft but not soldered. Connect the engine to an air line furnishing about 10 lbs. pressure. Then move the crank on the shaft until you find the point where the engine runs best, and solder the crank in place.

In the turbine, a jet of steam is directed against buckets on the rim of a disk wheel

Novel Shelf and Table Ornaments in Brass

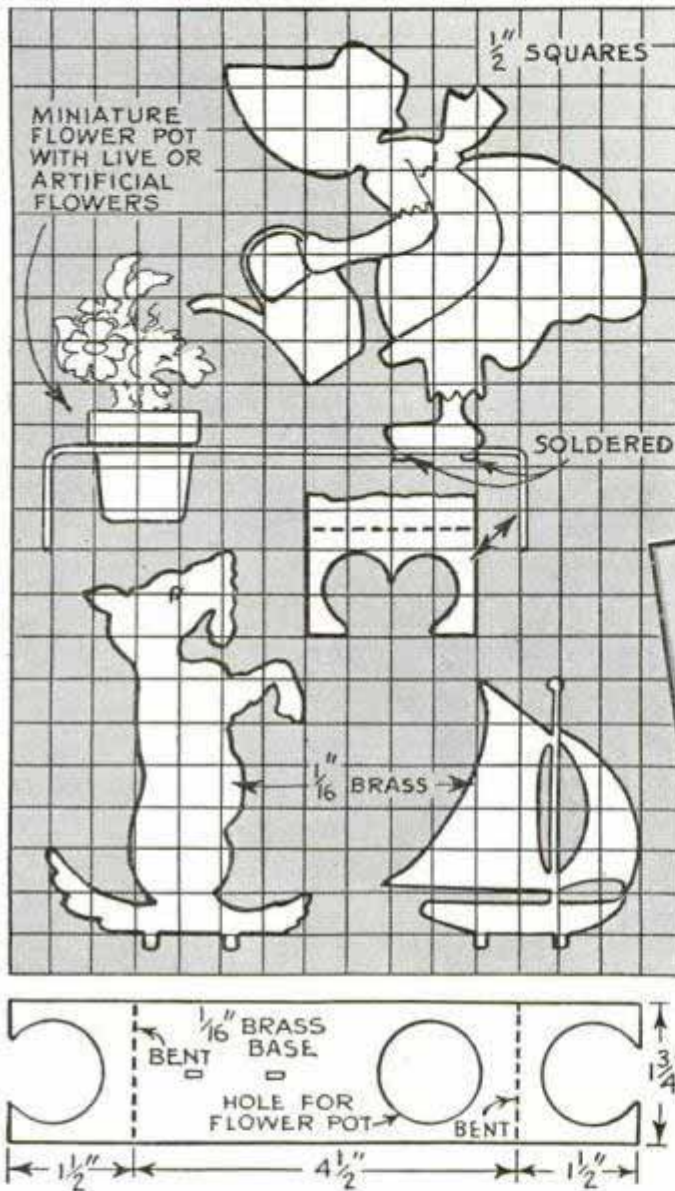

These little sheet-brass ornaments are just the thing for decorating a table, radio or to set on whatnot shelves. After enlarging the figures by drawing them on paper marked off in $\frac{1}{2}$ -in. squares, they are cut out and pasted to $\frac{1}{16}$ -in. brass to serve as patterns in jigsawing the metal. Each figure is attached to a base, which is cut from the same material and has a hole near one end to take a miniature flower pot. Both ends are cut away as indicated and are bent downward to provide legs. The figures can be painted in bright colors or they can be left in silhouette form. In the latter case, the silhouette may be painted in solid color or the brass can be buffed or rubbed with fine steel wool to give a satin-like finish. If the brass is finished in natural color, a coat of thin, clear

lacquer should be applied to prevent tarnishing. The flower pots are wood or porcelain and can be obtained from your local novelty store or flower shop. They may be used to hold artificial flowers, or if desired, you can fill them with rich soil and grow cactus and other live flowers.

—H. R. Wallin, New York, N. Y.

Trough on End of Workbench Catches Small Articles



Extending across the ends of a workbench, short lengths of small eaves trough will help prevent small articles, such as drills, punches, etc., from rolling off on the floor. The ends of the troughs are left open so that sawdust and shavings that collect in them can be removed easily.

Simple Motor-Reversing Switch

I find that a four-way toggle switch is better than a single-throw knife switch for reversing repulsion-induction motors and those of similar type having four leads. The four-way switch is always closed so

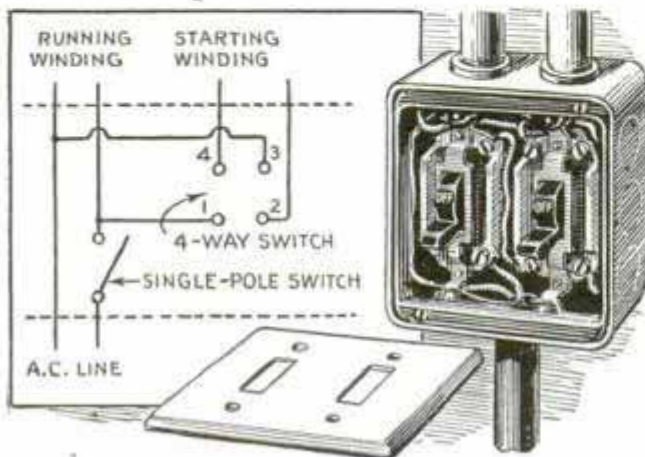

that there is no possibility of burning out the motor when the single-pole starting switch is turned on, which might happen with a knife switch if it is open when starting the motor. The four-way switch is connected as shown by the wiring diagram, and both switches may be housed in a 4-in. outlet box, making a neat installation.

—Albert F. Mueller, New York City.

Stovepipe and Straw Insulate Water Pipe

In running a water pipe from a storage tank to the house, the vertical portion above the ground was protected against freezing with straw and stovepipe. First a section was dropped over the pipe and down to 3 ft. below ground. This was packed with straw, the pipe being kept



well centered. Then the next section was put in place and packed with straw, continuing until the top of the pipe had been reached. Asphalt was applied to the joints to keep out moisture, and the whole column was given a coat of aluminum paint.

Stubborn lipstick stains will disappear if you sponge the stain with carbon tetrachloride before laundering the article.

Tilting-Head Stand for New Photoflood Lamp

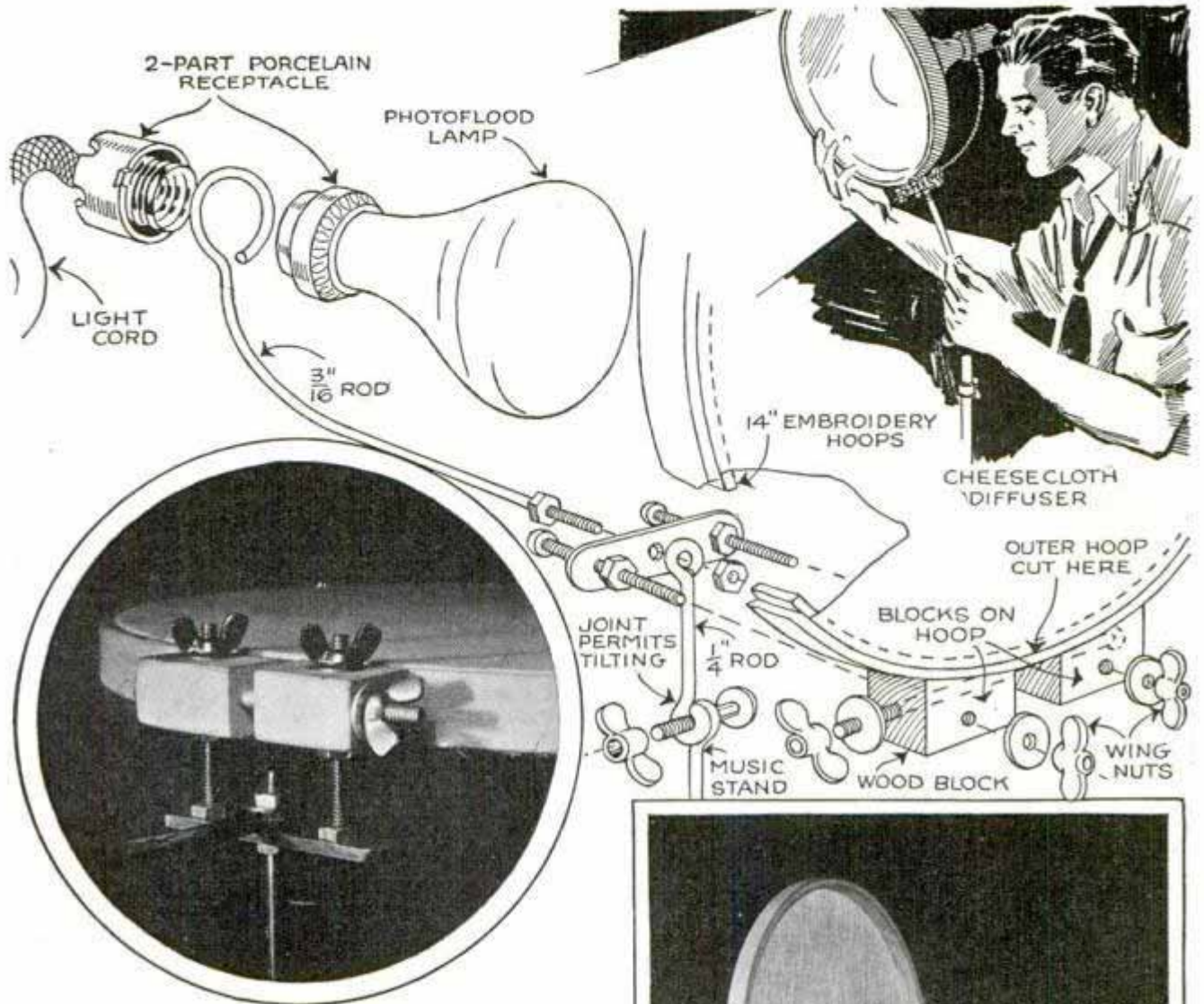

Needing a tripod to support a cheese-cloth diffusing screen and one of the new photoflood lamps while taking portraits indoors, I made this head and pivoted it to a music stand so that the head could be tilted and locked at any desired angle. As shown in the details, the lamp is held by a curved rod with an eye on one end, which is clamped between a two-part porcelain sign receptacle. Embroidery hoops provide a frame for the diffusing screen. They are attached to the head by means of two wood blocks glued to the underside of the outer hoop and drilled to take bolts projecting from the head. The outer hoop is cut away between the blocks, which are drilled transversely for a bolt to draw the hoop tightly around the inner one to clamp the cloth tightly. The diffuser can be removed when not needed by simply unscrewing two wing nuts. Tilting of the

head is accomplished by a short rod having eyes formed on both ends. One end is pivoted to the music stand by a short bolt and wing nut and the other end is fastened to the head by means of the lamp-supporting rod, which is threaded to take a nut. An inexpensive chromium-plated music stand is used to support the fixture.

—Arthur Trauffer, Davenport, Ia.

DESIGNED

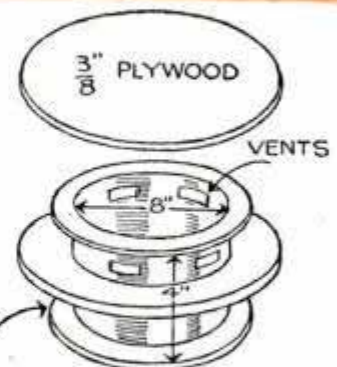
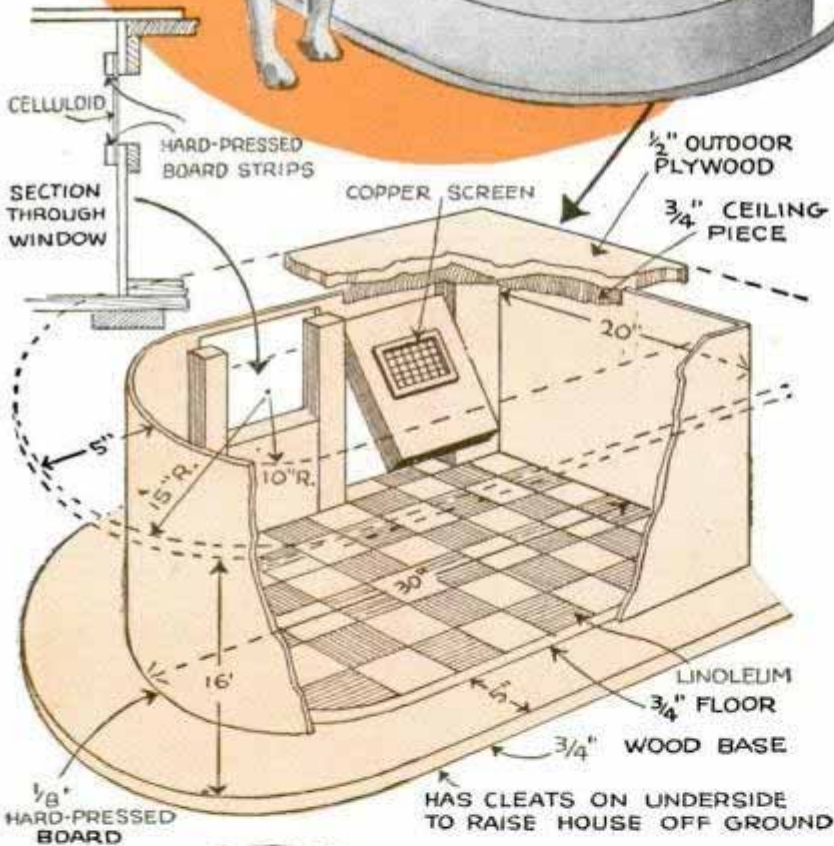
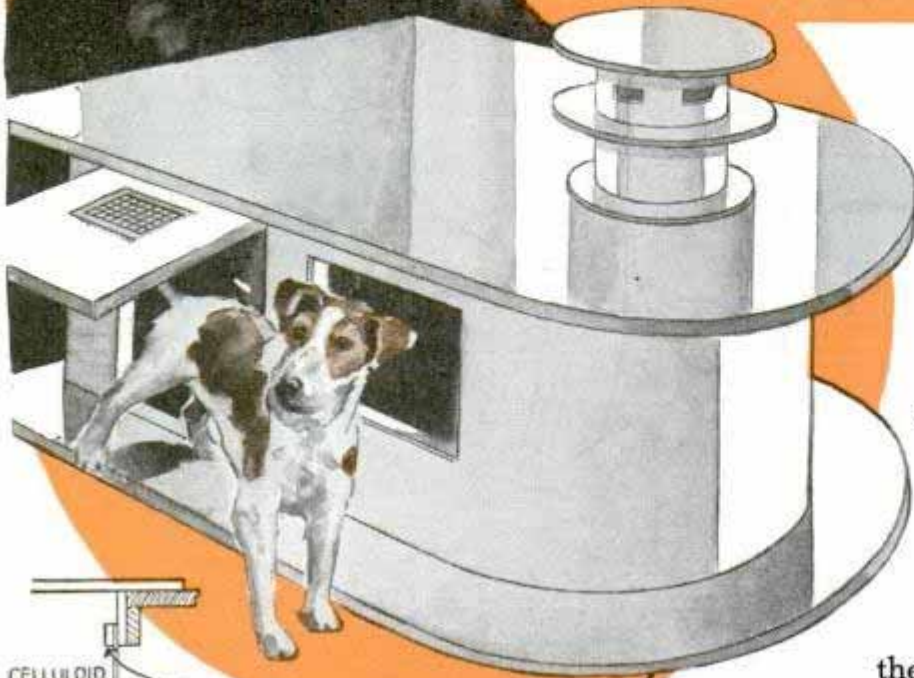

GALV. SHEET-FLANGES SOLDERED ON

CALL them just plain doghouses if you will, it's certain your dog will be quick to show his appreciation of any one of them, and that in his own way. Most dogs won't be fussy about the architectural details; even canine aristocrats are not likely to turn away from a barrel house or a box with a lean-to roof, provided it's warm and clean. Looking at any one of these designs you will see that they fill the latter two requirements without even considering the degree of ornamentation on several of them. Taking the various designs left to right, the first one at the upper left is a rather showy affair of a distinctly modern type made of plywood and hard-pressed board. The detailed view at the left shows you how to

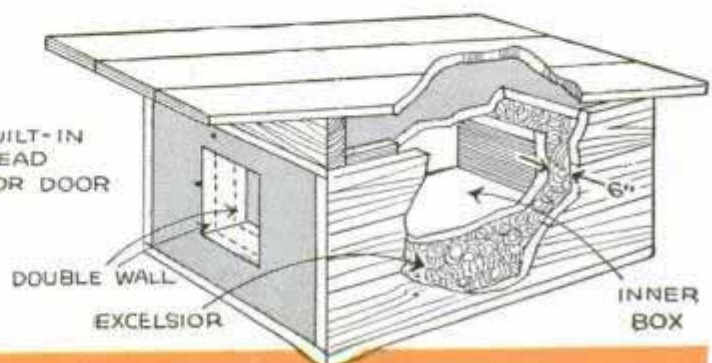
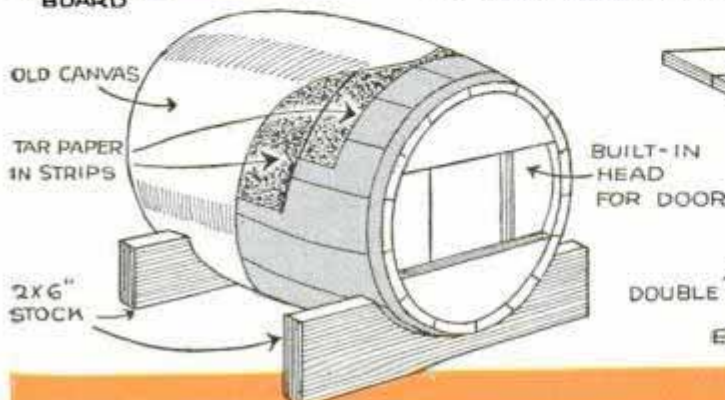

for DOGS

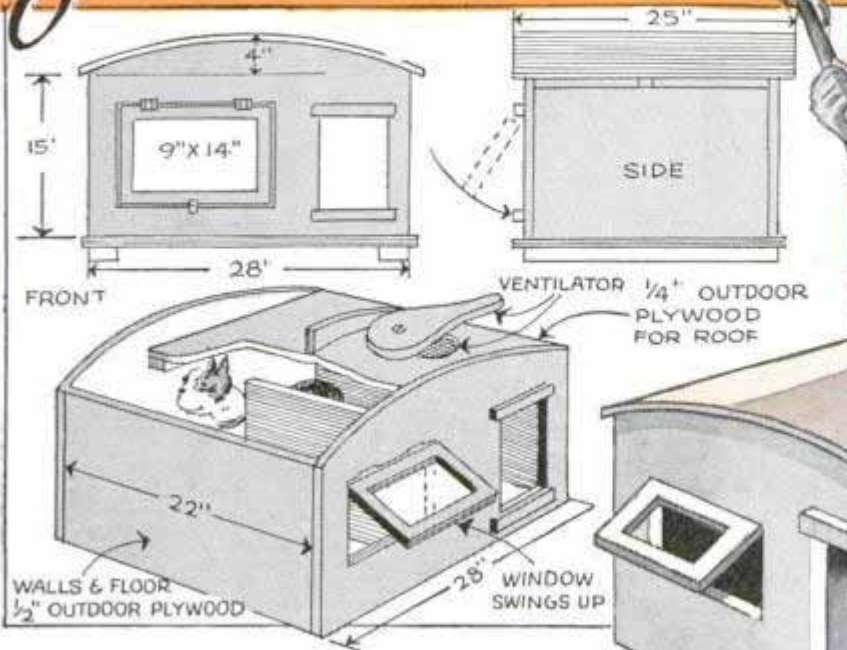

make it. Now, for bare utility combined with a bit of novelty, you have the barrel and the shed or lean-to kennels detailed at the lower left. The barrel is mounted on a cradle as you see and is covered with canvas. Painted white, it's neat and weather-tight. The other is simply a box within a box, the space between the double walls thus formed being filled with excelsior to insulate the interior. The "hanger"-type kennel at the upper left features a vestibule, adjustable ventilator and an up-swinging casement window. At the lower right you have the Cape Cod cottage which will house your pet in snug comfort the year 'round. Directly below is the basement apartment with ground-level entrance. Holes in the back permit warm air to enter.

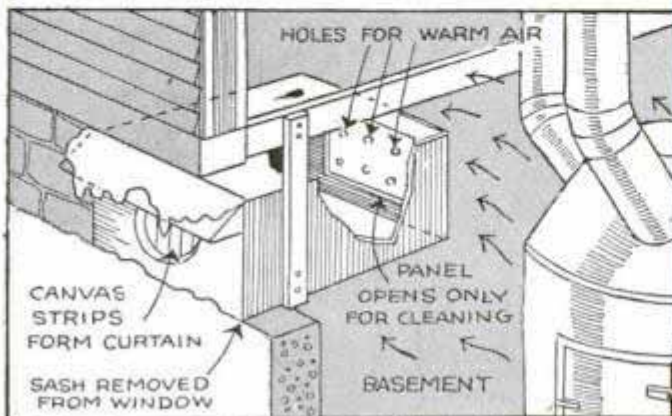
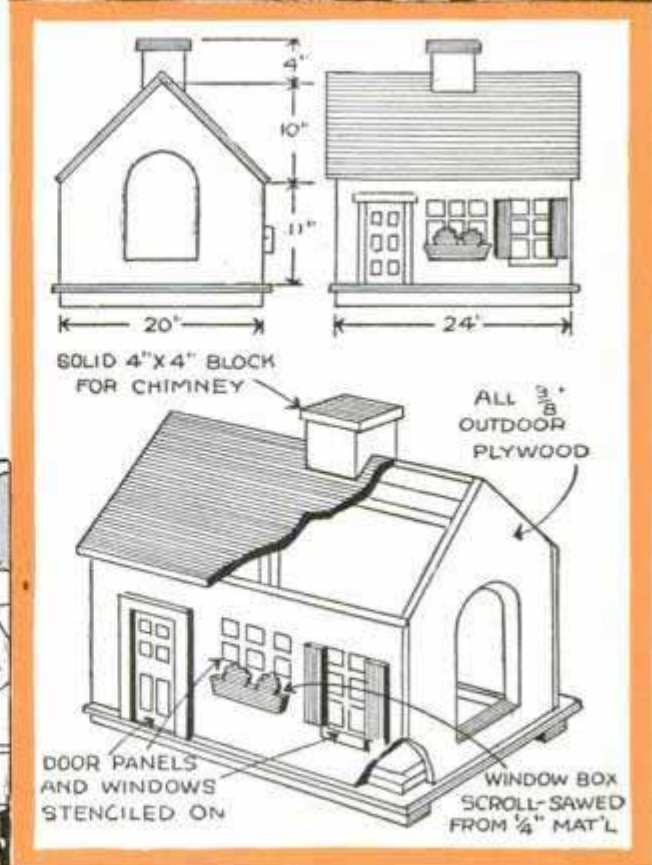

Water-Pumping Engine on Farm Also Drives Grinder

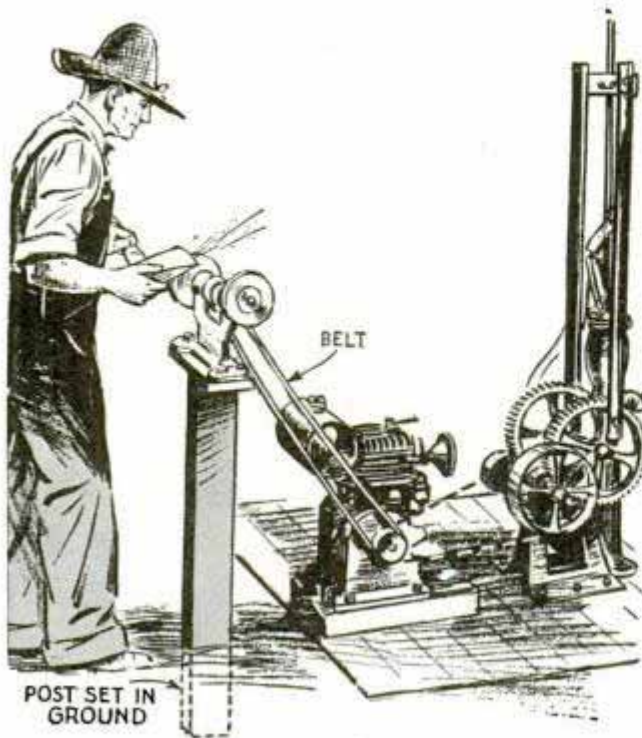

One farmer who pumps water with a small engine also uses it to operate a grinder for sharpening tools. A post is set solidly in the ground near the engine to support the grinder, and a belt runs from this to the engine. When not needed, the belt to the grinder is removed so that the engine can be used for pumping water.

Trouser Belt Serves as Lens Shade in Emergency

Lack of a camera lens shade did not bother one photographer, who simply removed his trouser belt, rolled it into a cone

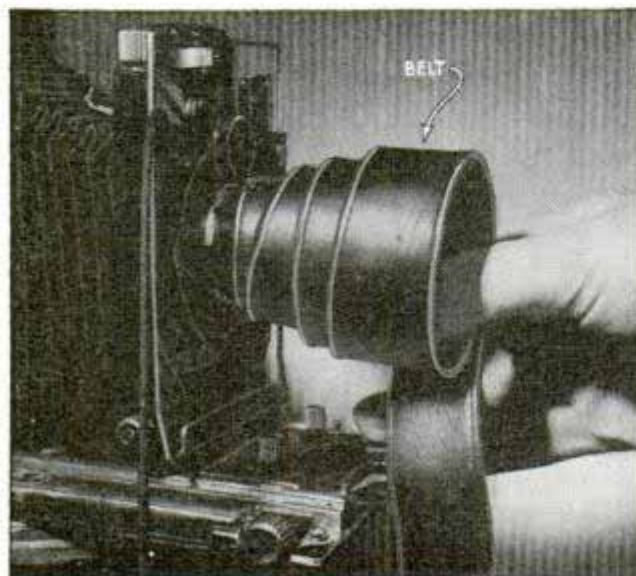

shape and used it as an emergency shade. The belt, of course, had to be held in place with the hands while taking the picture.

Pinch End of Acid-Core Solder After Cutting Off Piece

When you use acid-core solder always pinch the end with a pair of pliers to keep the acid from leaking out. Besides losing the acid for soldering purposes, it will damage other tools with which it comes in contact.—V. Robinson, St. Paul, Minn.



Tool-Handle Wedge Held Tightly by Corrugated Fastener

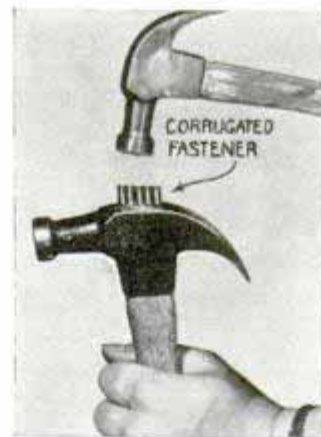

If a wooden wedge in the handle of a hammer, ax or other tool tends to work out, drive a corrugated fastener into it. Start the fastener diagonally across the wood so that it enters both the wedge and the end of the handle.

Index Indicator on Lathe Speeds Work

Instead of counting the holes to the next division when using the index head on a lathe, try this indicator. It is set easily to any position and will show the next hole for the index pin without repeated countings. The indicator is shaped from sheet metal and is slipped over the headstock-spindle housing where it is turned to any position desired.



Snug Skull Caps of Paper Are Easy to Fold

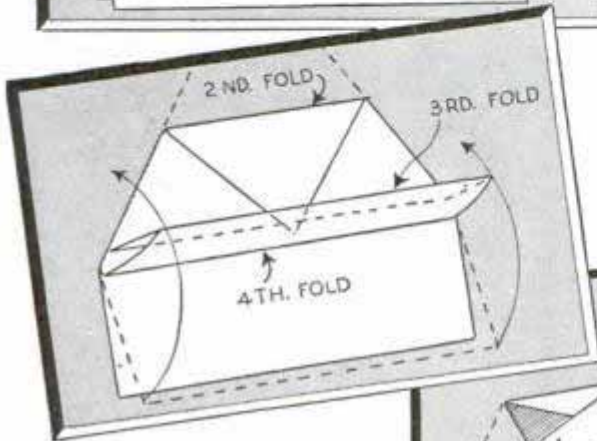
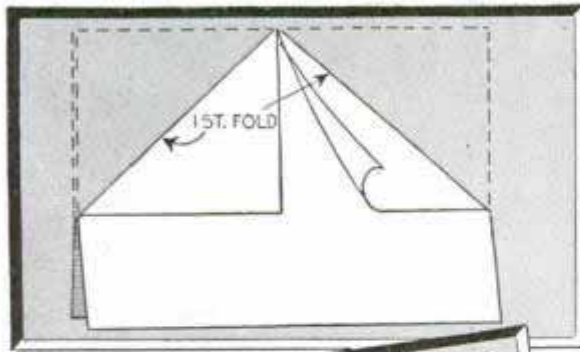

By following these simple steps anyone can form these trim caps which need no pins or glue to hold them together



PAPER IS TURNED OVER BEFORE MAKING 5TH. FOLD

FLAP IS TUCKED IN POCKET MADE BY 3RD., 4TH. AND 5TH. FOLDS

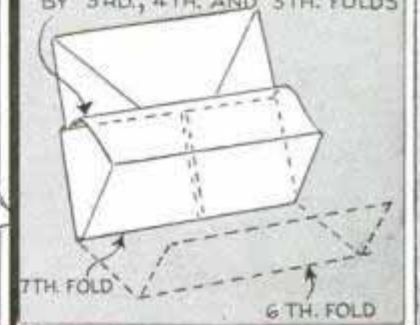
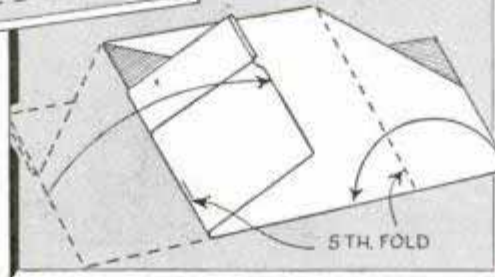

A double newspaper sheet makes one of these caps. The strength and shapeliness of the cap depend on the care in creasing the paper at each fold. To start, you lay the doubled newspaper sheet on the table in front of you and fold down the corners so that the edges of the folded portions meet, as shown in the top detail. Then the second, third and fourth folds are made, after which you turn the whole thing over as indicated, before making the fifth fold. The latter is really two separate duplicate folds as you will see in studying the detail. After the sixth and seventh folds, which should be very accurate, the

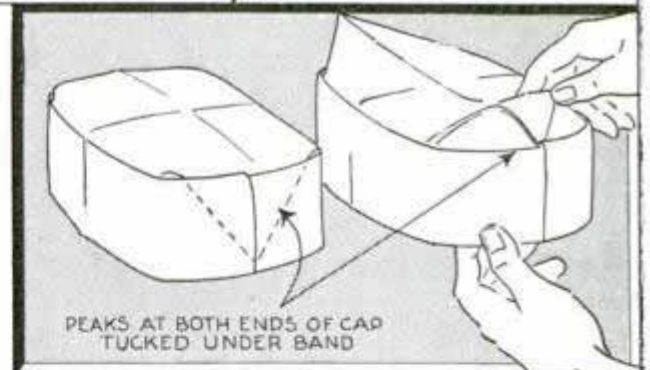

flap remaining is tucked in a pocket formed by the third, fourth and fifth folds. Lastly, the peaks are tucked under the band at both ends.

—W. R. Greer, St. Paul, Minn.

Tubular Furniture Assembled with Babbitt Plugs Instead of Wood

In constructing tubular furniture, I have found that babbitt plugs provide better construction at the joints than hardwood plugs. To use the babbitt, first drill a small hole through one side of the tube, then force a paper wad into it just below the hole. The paper retains the molten babbitt and the hole serves to anchor it in place.

Before pouring the babbitt, turn a nut on a painted bolt flush with the end and center it in the end of the tube with the nut next to the paper. Lock the tube in a vise with one of the jaws over the hole to retain the babbitt. Let stand until the metal has cooled, then back out the bolt.

—K. F. Keith, St. Petersburg, Fla.



"Tear-drop" body provides sleeping quarters for two adults on a full-size bed, besides storage room for six or eight cots or sleeping bags to accommodate as many persons on a week-end trip. There is a large cabinet for food supplies, a sink with running water, stove, worktable, and a cork-insulated icebox with a water-sealed drain. The trailer body is only 9 ft. long, 5 ft. 9½ in. wide and the weight complete ready for the road is approximately 960 lbs. The trailer is balanced so nicely that one man can move it about easily when detached from the car. Although material costs will vary, \$125 will be a fair average.

Part I—By CHARLES W. BRENTNER

GLANCING casually at this little job gives you the impression how much can be done in a small space, how smart it appears in modern streamline design, and how easy such a small trailer should be on your car. Going through the photos, constructional drawings and details as given in this article, you will agree that it is surprisingly complete in its accommodations and provides all the comforts on the road that the average person demands. While it is classed as a midget in comparison with the size of most house trailers, it is just the thing so many people want for greater enjoyment of week-end or vacation trips.

Being light in weight, you will have no cause to worry about undue clutch and rear-axle troubles due to excessive wear. Also, there's no sidesway which is often responsible for uneven tread wear on the rear tires of the towing car. This elimination of sidesway is due to the manner of springing the trailer body to the axle.

The material list gives the general sizes and the quantities of stock and incidentals required for the construction of the chassis and body frame. Of course, allowances are made on the various items for cutting and fitting. In the matter of woods designated in the list, substitutions can be made, if

MIDGET TRAILER

serves your vacation needs



desired, but it should be kept in mind that the body has been designed for maximum capacity in the minimum of space. For this reason the stock sizes of the chassis and body framing have been worked out carefully to give the greatest strength possible with the fewest number of parts and still keep the weight under a given figure. If it happens that you can't get spruce for the parts as specified, pine is a substitute, but in equivalent sizes lacks the strength of the former wood. Oak gives a sectional strength equal to spruce but adds to the weight. In this latter instance, a good compromise would be the use of oak for the chassis frame and pine for the body framing. Adding metal corner plates and iron angles attached with screws will greatly

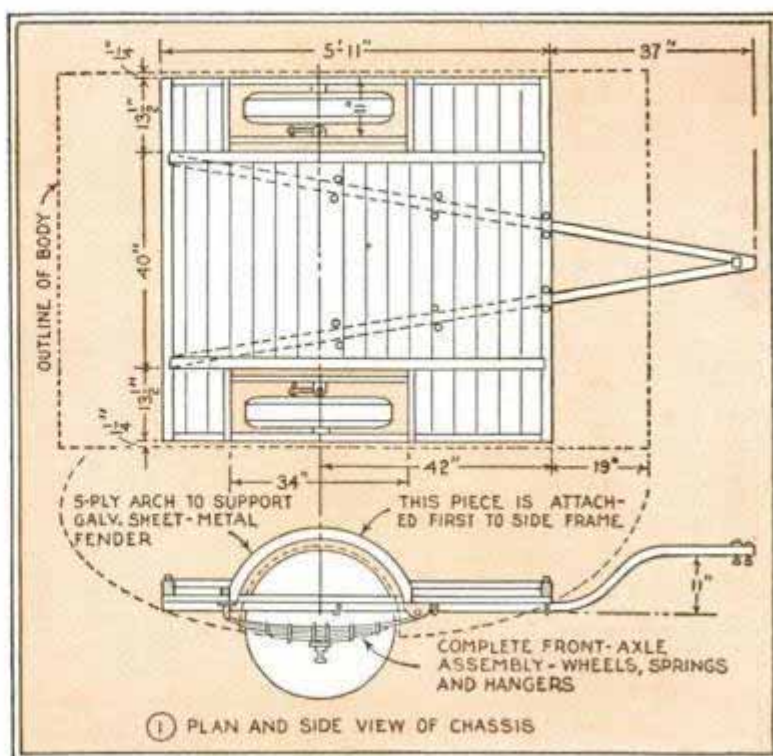



strengthen those parts that are made of pine.

Chassis: General dimensions of the chassis are given in Fig. 1. You will note that the floor area is relatively small, in fact, passengers stand only on a small portion inside the door when getting in or out or putting on shoes while sitting on the bed. The remainder of the floor supports baggage, water tank and battery. Assembly details are shown in Figs. 2 and 3. First buy from a wrecking yard a standard 1924 Chevrolet front axle, springs and shackles, and a pair of 1930 disk wheels of the same make. Make sure that the axle you get has not been sprung or otherwise damaged. Cut the tie rod, flatten the ends and bolt to the axle, after aligning the wheels. Usually this is best done after installing on the chassis and aligning with the towing car. The flat ends of the tie rods, after aligning the wheels, are clamped to the axle and then drilled to insure true register of the holes. A new spring-seat is welded near the wheel on each end, Fig. 2, to bring the point of suspension nearer the wheel, thus preventing sideways on the road.

The tow bar, Fig. 3, is in the form of a vee, made of a pair of 2-in. iron pipes bent to an upswing at the forward end, the ends beveled and welded at the tip, as shown; then two holes are drilled for bolts through the trailer hitch. The latter should be of

a standard make having a ball-and-socket fitting. At this point provision should be made for running the lighting and taillight wires through the left-hand pipe.

Now build the chassis frame as shown in Fig. 2, screwing the tongue-and-groove floor boards to the 2 by 4-in. cross members while the frame is upside down. Next, install the tow bar and the spring shackles. In making up this structure, there are several points to watch. Make certain that it is square and that it remains so until you get all the floor boards screwed in place. Tack on temporary braces, if necessary, to hold it in the squared position. The strength of the whole chassis depends

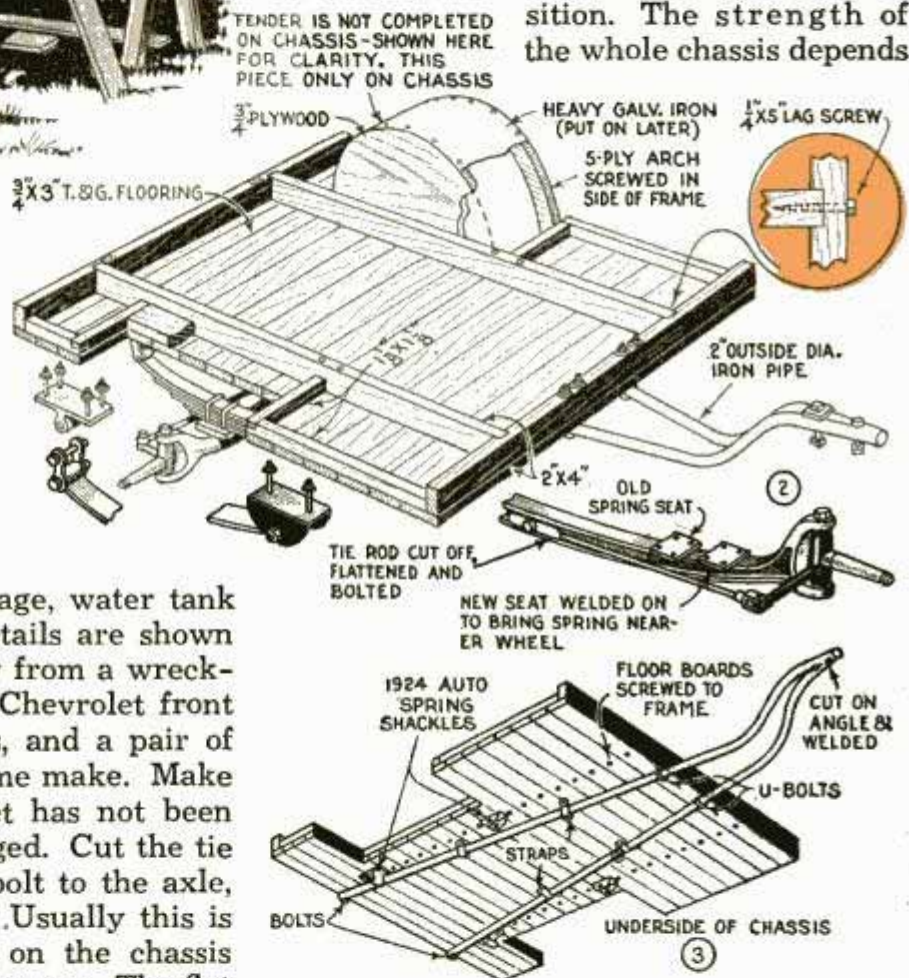

on the care with which you assemble this part of the structure. The housed joints joining the 2 by 4-in. members should be a snug fit. If the joints are an imperfect fit, the vibration and strain to which the parts are subjected will cause them to loosen to such an extent that the lag screws will not hold effectively. Turn the chassis over and set up on sawhorses to keep it steady while going ahead with the construction.

Body frame: As specified, spruce is the best wood to use for the body frame. If it

is not available then use selected white pine. Practically all frame members are $1\frac{1}{8}$ by $1\frac{1}{2}$ in., the curved members, Fig. 4, being bandsawed from 8-in. boards. To simplify the work, lay out a squared diagram full size on the garage or workshop floor, Fig. 5, and outline the entire frame. It then will be an easy matter to get each piece in proper proportion and location. Note that right and left frames are practically the same, Fig. 4, and are altered simply by cutting away different portions in each. This method keeps

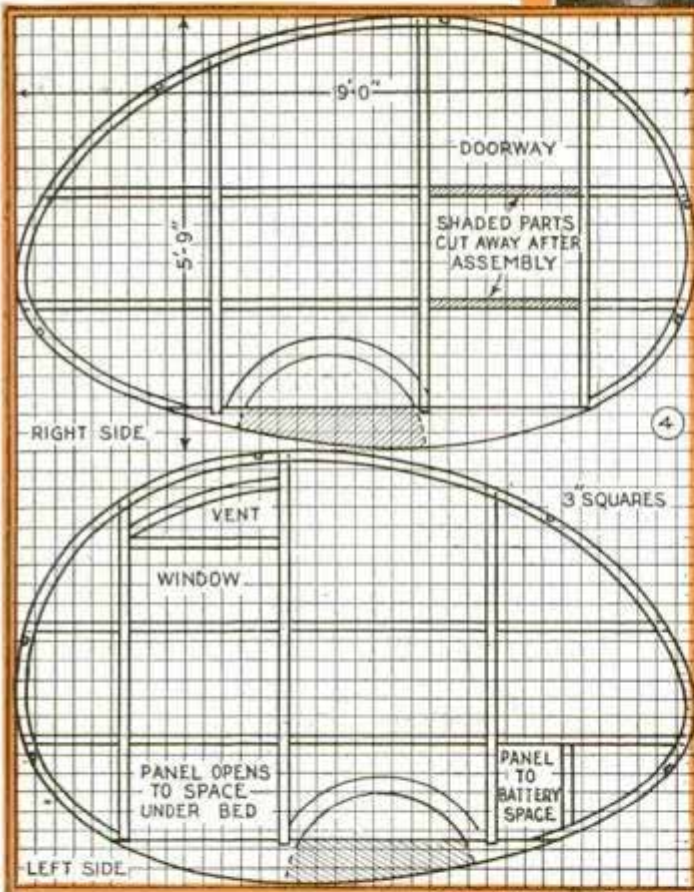
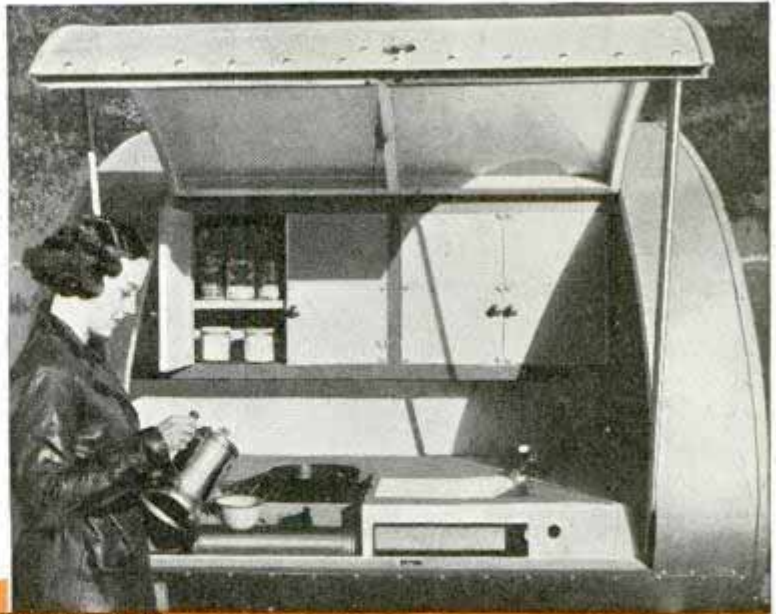

the frame true until entirely assembled. The finished job, with the frames joined by the crossbeams, will appear as in Fig. 6. Casein glue and brass screws are used throughout.

In assembling these frames keep in mind that strength depends largely on the accurate fitting of the joints. The lower details in Fig. 6 show the variations in half-lap joints used in the assembly. As you see, there is no cross bracing on the framework itself. Rigidity depends entirely on the strength of the individual members, the accuracy of the joinery and the sheathing material which goes over the frame-

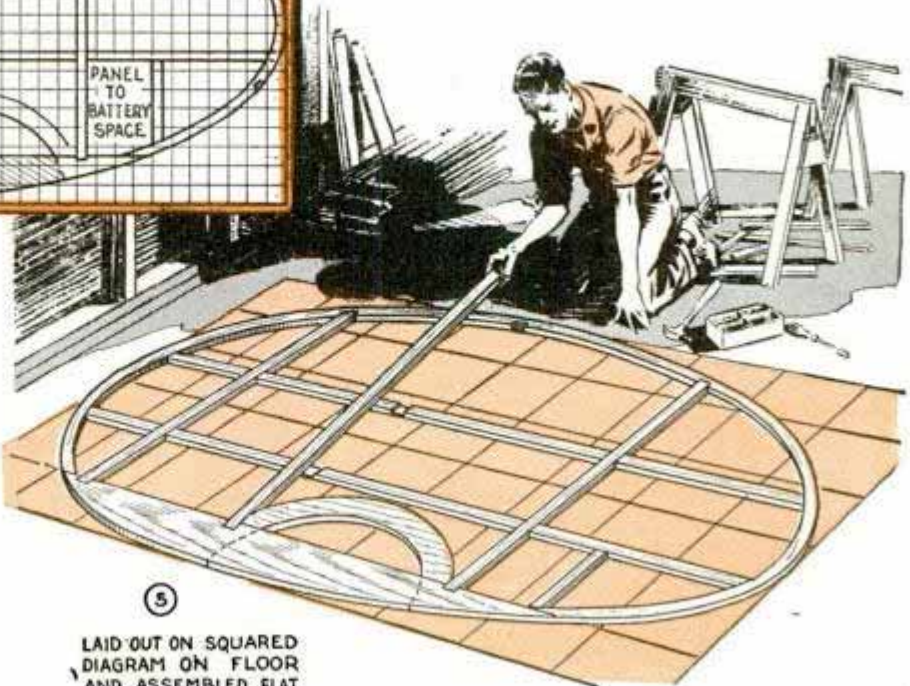

MATERIAL LIST

- 1—1924 Chevrolet front axle, complete with springs and shackles
- 2—1930 Chevrolet disk wheels and tires
- 2 pcs. 2-in. iron pipe, 9 ft. long—tow bar
- 1 standard trailer hitch
- 36 sq. ft. T & G flooring ($\frac{3}{4}$ -in. net)
- 3 pcs. 2 x 4-in. x 6-ft. pine—chassis frame
- 96 lineal ft. $1\frac{1}{8}$ x $1\frac{1}{2}$ -in. (net) spruce—framing
- 10 pcs. $\frac{1}{8}$ x 8-in. x 5-ft. spruce—curved members
- 1 pc. 30 x 30-in. spruce—fender supports
- 1 pc. 15 x 36-in.—for removable panels on left side to storage and battery

5
LAID OUT ON SQUARED
DIAGRAM ON FLOOR
AND ASSEMBLED FLAT

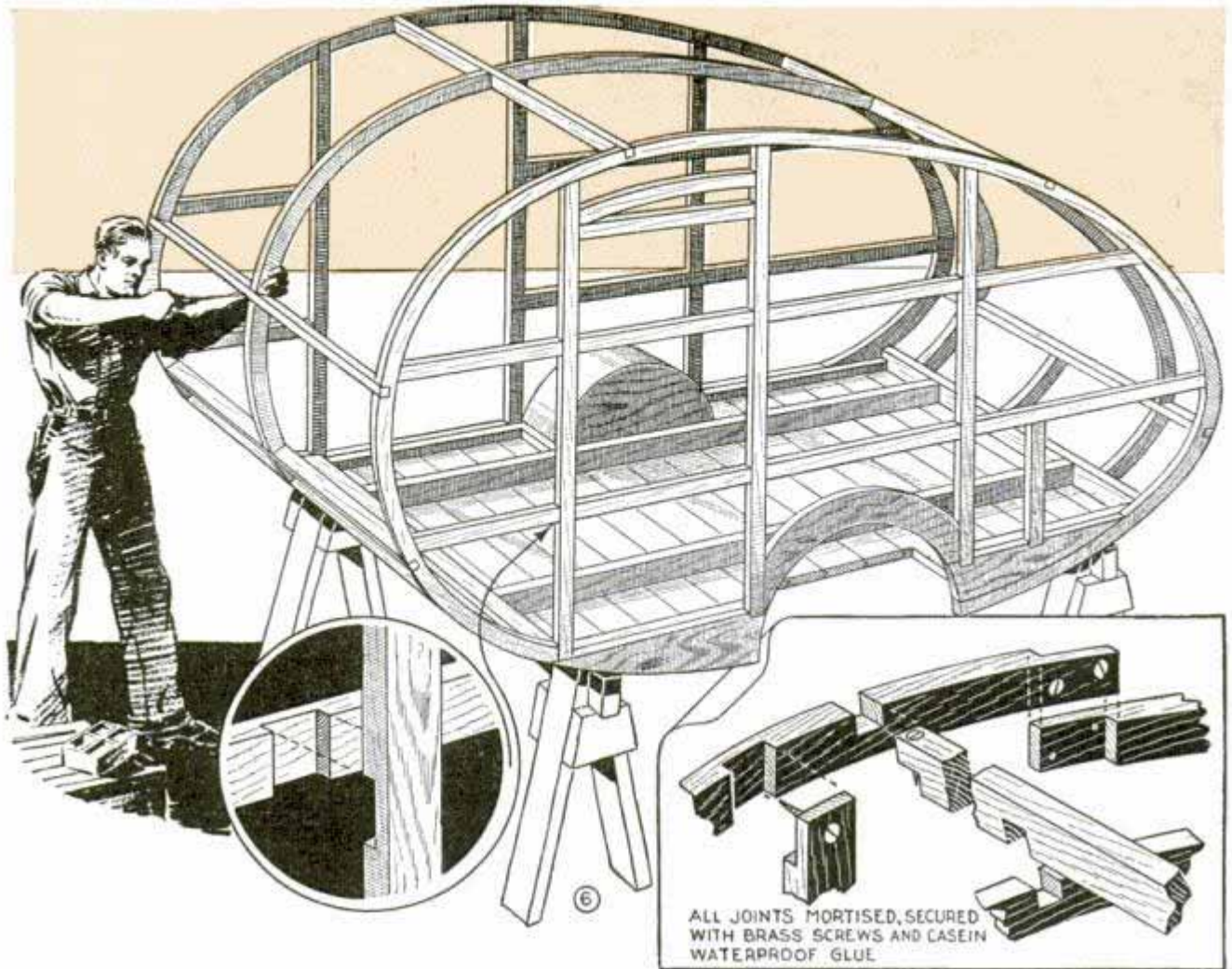

work. For the purpose of clarity the body framework is shown assembled in Fig. 6, but in actual procedure the side frames are first used as templates to lay out and cut the sheathing, which is of $\frac{1}{8}$ -in. hard-pressed board. This will be covered in Part II, which follows in an early issue. The center member, Fig. 6, is cut to the same curve as that of the side frames. It is assembled full length and after installing a header, a portion of it is cut away at the rear of the body and used as a center rib for the flush lid which closes the "kitchenette." Now, while you have the construction at this stage, is a good opportunity to paint all the parts. Use a priming coat first, thinned so that the wood will absorb a good portion of it. Then follow with at least one coat of full-bodied paint in the color desired. Be careful to work the paint well into the joints, particularly the openings between the floor boards, in fact, it's a good idea to prime the tongue-and-groove edges of the floor boards before you lay them. Also prime the top edge of the chassis frame members. These latter precautions

will prevent absorption of moisture. If you decide to prime the side members remember that certain parts will be exposed in the finished job. So it's well to smooth up with sandpaper before applying paint.

(To be continued)

Oilcan Is Handy Gluepot

A handy container for glue, cement or shellac can be made in a jiffy from a clean oilcan. Just cut off the spout to take the handle of a brush so that the bristles will not touch the bottom of the can when the spout is screwed in place. A little sealing wax applied at the point indicated will help make the container airtight. On some cans, it may be necessary to use a gasket under the spout rim.

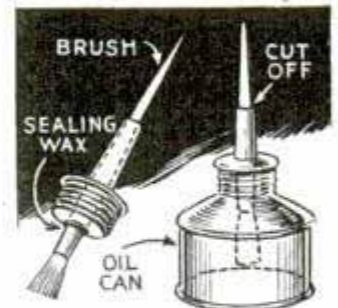

—Sylvan Hass, Jr., Evansville, Ind.

Absorbent Ruffles Slip on Stems of Glassware

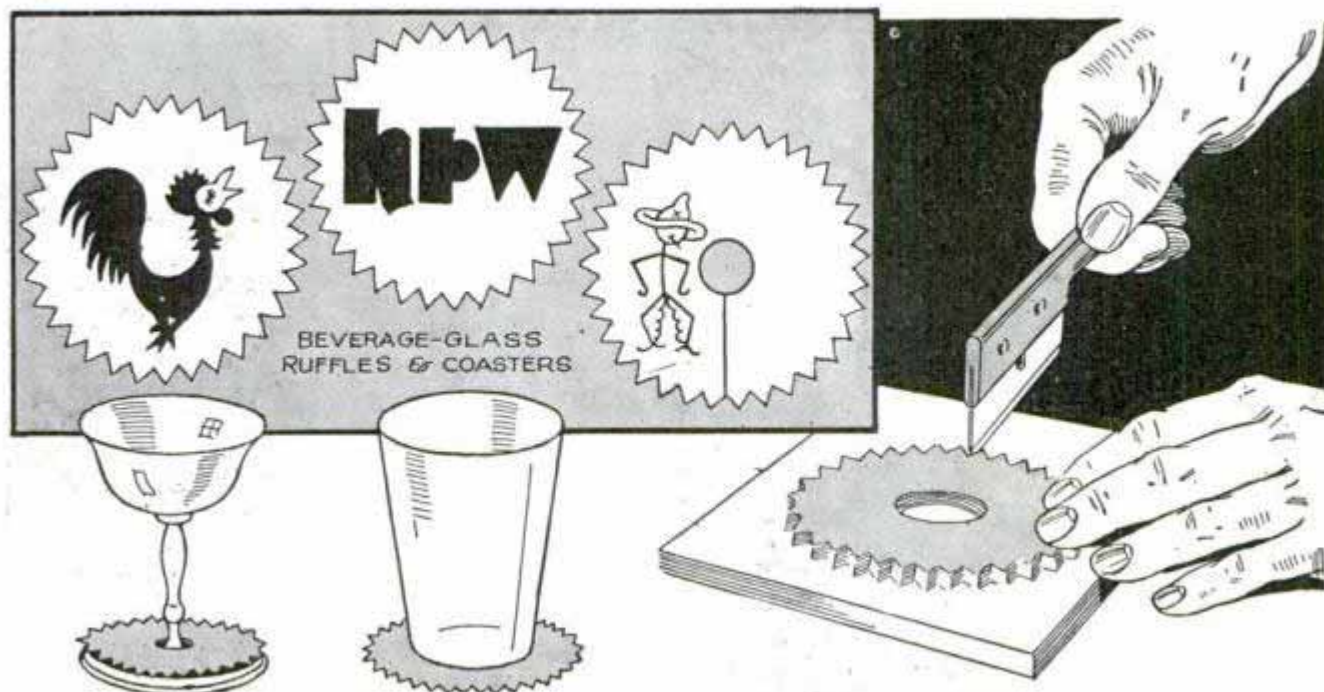

Cut from colored blotting paper, absorbent paper napkins or towels, these ruffles, which are slipped over the stems of glasses, help to protect table tops from beverage stains. If you desire the use of colored paper, first dip a sample in water to determine that the color will not run. Making the ruffles is a simple process and a large number can be cut out at once by

stacking paper and cutting through the pile with a razor blade as shown, the pattern being outlined on the top sheet. Cut a slit from the center hole to the edge to permit slipping the ruffles over the stems. Additional novelty and a personal touch can be had by initials or other means of decoration. The same idea also can be applied to coasters.—H. R. Wallin, New York.

Coil Springs of Many Sizes Quickly Formed in This Jig

Home mechanics or owners of small shops who have frequent occasion to wind small coil springs, will find this jig a time-

saver. A number of holes of different sizes are drilled in a hardwood block, and a drill-rod crank is provided to fit each hole. The cranks are slotted at the ends to grip the wire. In use, the block is clamped in a vise, after which a crank is selected, according to the size of spring desired, and is inserted in the corresponding size hole in the block. A screwdriver resting against a pin above the hole in the block is used to space the turns of wire as desired.

—Michael F. Wolf, Minneapolis, Minn.

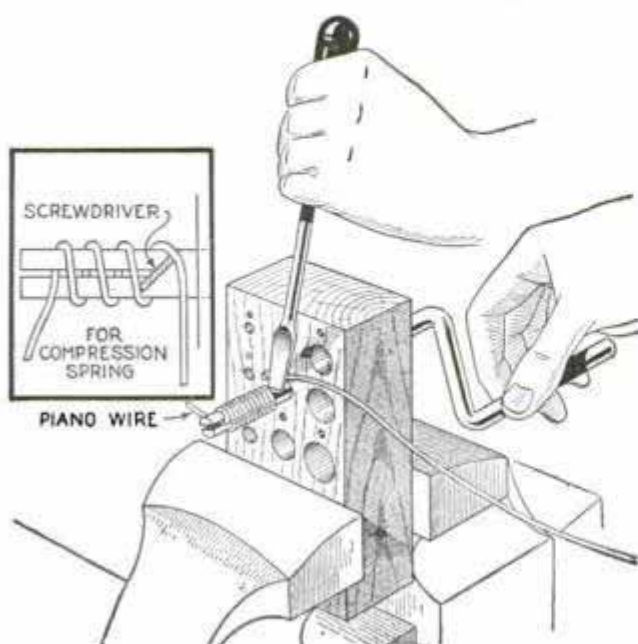

☛ If you have an idea that might be used for a short article in these pages, send it to the Homecraft Editor. Inclose a snapshot or drawing and give all the necessary information in as few words as possible. To be accepted, material must be of general interest and different from any we have published previously.

Bottom of Sticking Door 'Planed' with Altered Saw



To avoid removing a door to plane one or two spots on the bottom where it is dragging on the threshold, one workman uses a special saw. It is an old compass saw from which each alternate tooth has been filed or broken; the remaining teeth having been set to the left angle. By sliding this saw under the door, it may be operated to dress the door without making any marks on the threshold.

Clamp Improvised from a Bolt and Two Spools

Especially useful for clamping small work at the edge and other places where the depth of reach is small, this little clamp will serve in an emergency. It is made by simply slipping a couple of empty thread

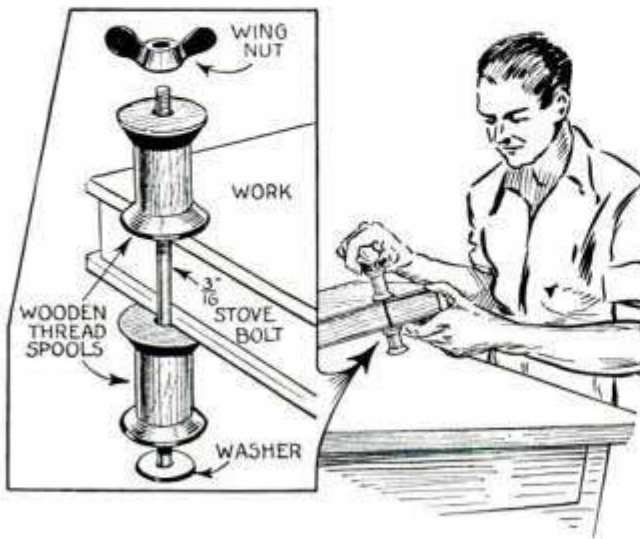

spools over the end of a stove bolt of suitable length. While a wrench can be employed to draw up the nut, a wing nut fitted in its place will be more convenient.

Panoraming with Any Tripod

Unless your tripod is especially built for panoraming of the camera, it is necessary to loosen the tripod screw to follow a fast-moving object. A better method is to slip a thin metal washer over the screw between the camera and tripod top. The camera then can be swung rapidly from side to side and remains securely fastened to the tripod.

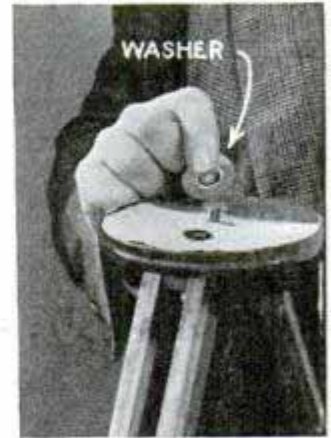

Monkey Wrench Turns Pipe

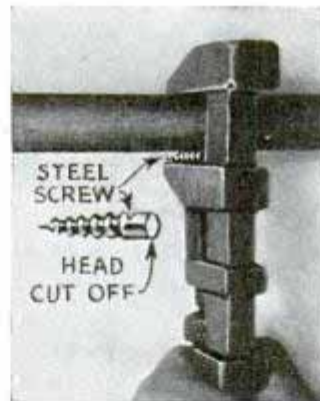

In an emergency, a monkey wrench can be used to turn small pipe if a steel wood screw is inserted between the work and the lower jaw of the wrench. Also, this method may be used in loosening nuts that have their

corners worn off so that the wrench will slip.—James Kawabata, Laramie, Wyo.

Rubber Side Pockets in Drawer Store Small Parts

Inner-tube sections having slits cut in them and nailed to the sides of shop drawers as indicated provide handy pockets for storing small tools. Also, the pockets are convenient for brads, nails, etc.

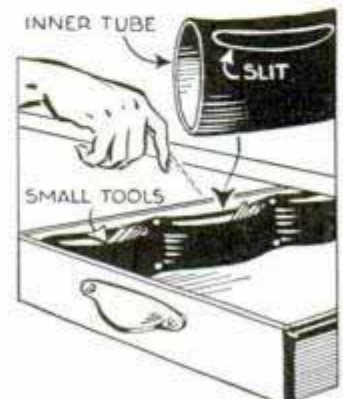

Cannibal King Guards Ash or Cigarette Tray

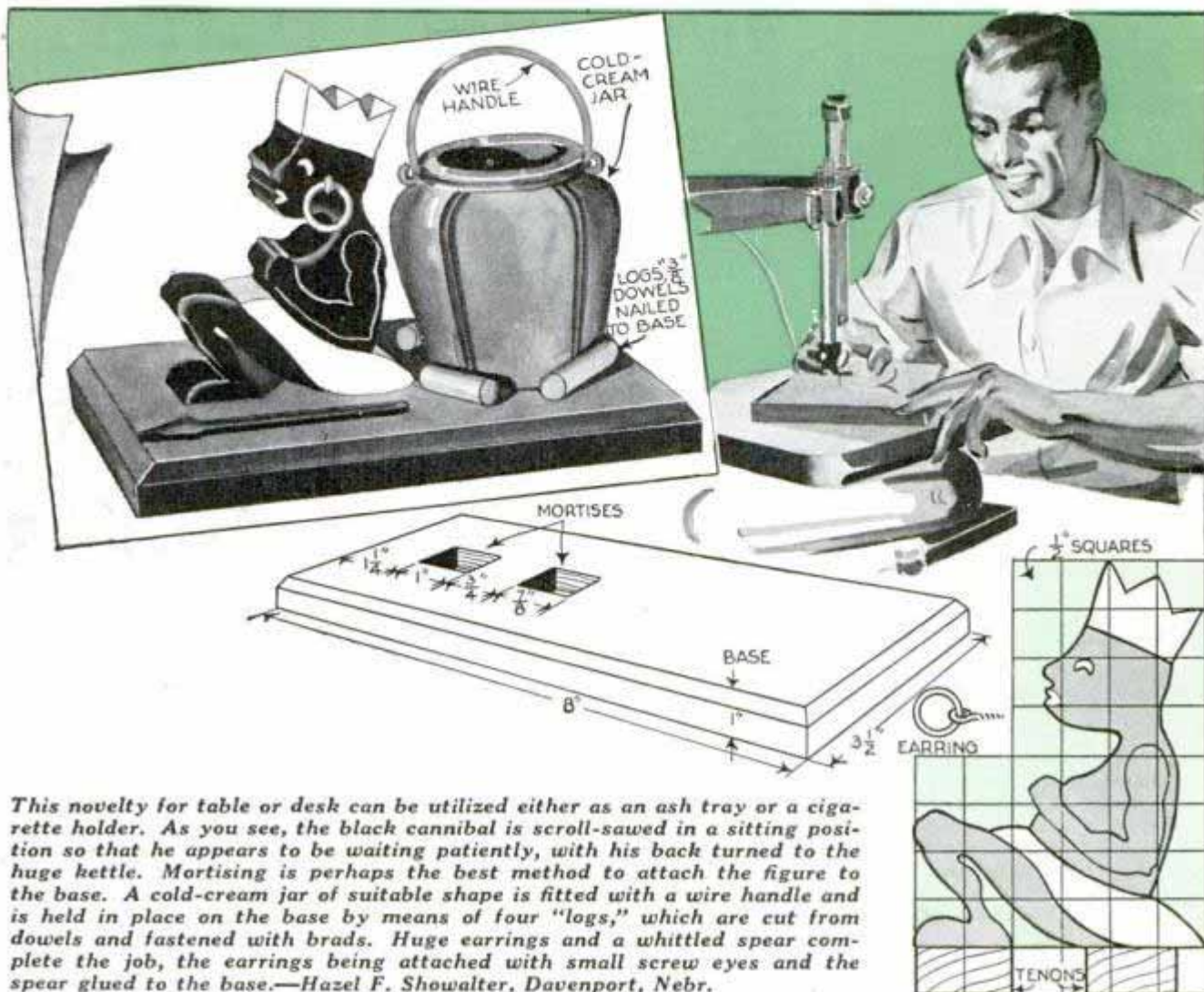

This novelty for table or desk can be utilized either as an ash tray or a cigarette holder. As you see, the black cannibal is scroll-sawed in a sitting position so that he appears to be waiting patiently, with his back turned to the huge kettle. Mortising is perhaps the best method to attach the figure to the base. A cold-cream jar of suitable shape is fitted with a wire handle and is held in place on the base by means of four "logs," which are cut from dowels and fastened with brads. Huge earrings and a whittled spear complete the job, the earrings being attached with small screw eyes and the spear glued to the base.—Hazel F. Showalter, Davenport, Nebr.

Playing Cards Serve as Template to Copy Irregular Work

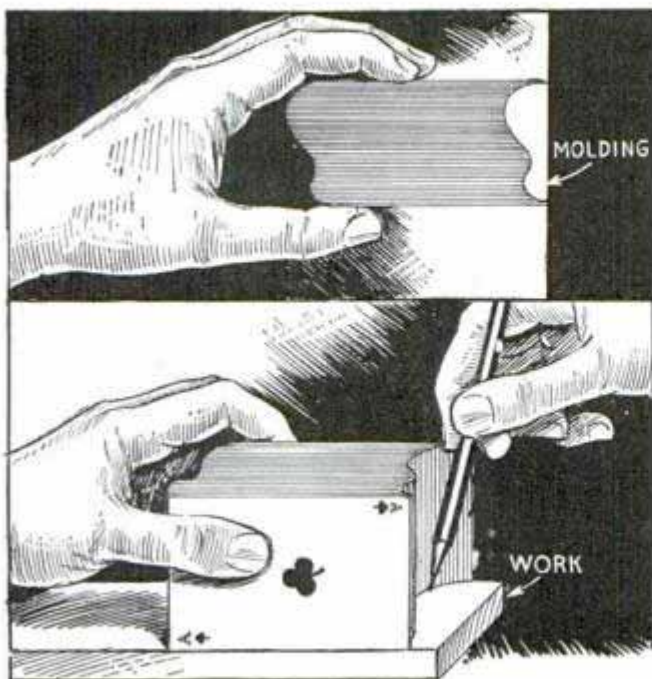

Accurate fittings for moldings, cornices, etc., can be cut by using two decks of playing cards to form a template of the work to be copied. Just stack the cards and then press one end over the contour of the work as shown. After squeezing the stack tightly to avoid slipping, remove it and trace the contour on the piece to be cut.

Tack Holder on Drawing Board

Half of a hollow rubber ball provides a handy thumbtack tray on a drawing board. Flexibility of the rubber makes it easy to select and remove the tacks.

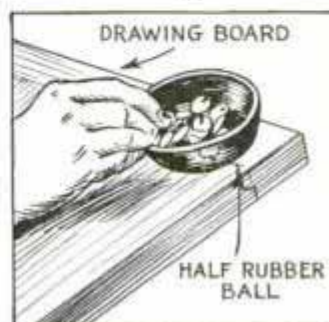

Solving HOME

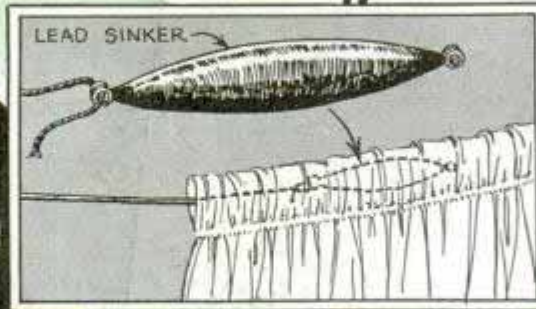

Threading a draw string through the hem of an apron, curtain or other article is no problem if you use a fishline sinker as a shuttle, which is forced through the hem by pressure of the thumb and index finger

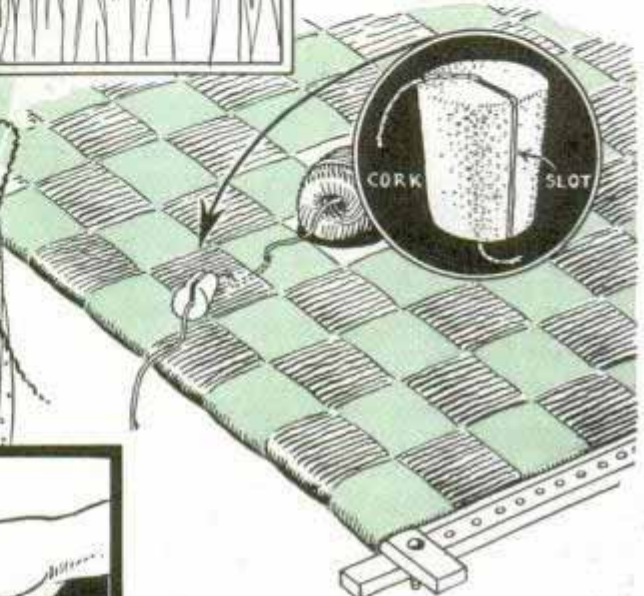

When using one yarn ball while working on a quilt, thread the yarn through the cloth and slip a cork with a slot in one side over the end so it can be tossed to each worker as desired

Scrap pieces of paraffin that accumulate in the kitchen especially at canning time, may be molded into neat blocks by melting the wax and pouring it into a rubber ice-cube tray, which is then placed in the refrigerator

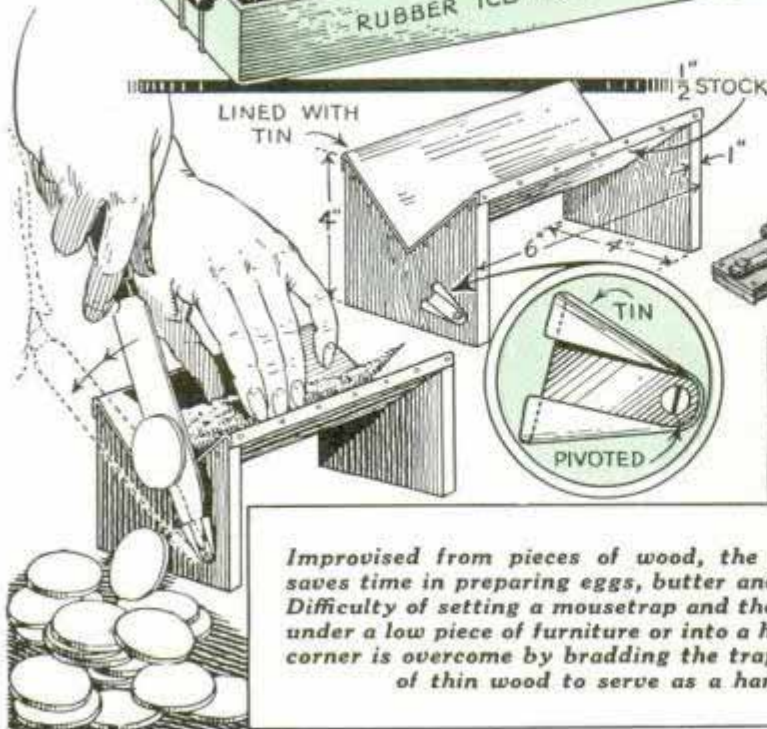
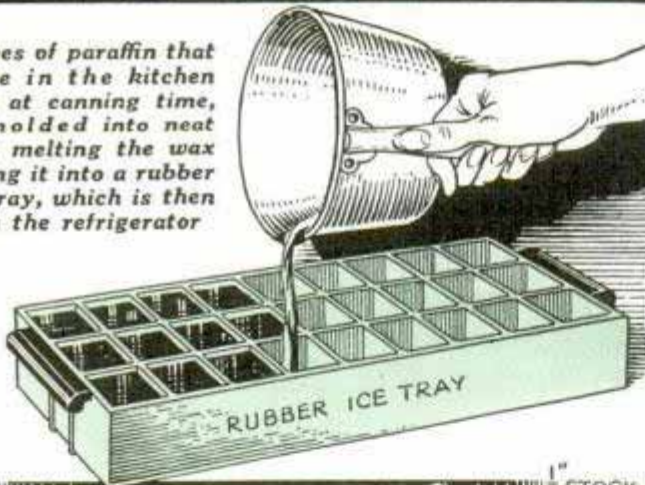

Improvised from pieces of wood, the slicer above saves time in preparing eggs, butter and vegetables. Difficulty of setting a mousetrap and then slipping it under a low piece of furniture or into a hard-to-reach corner is overcome by bradding the trap to a length of thin wood to serve as a handle

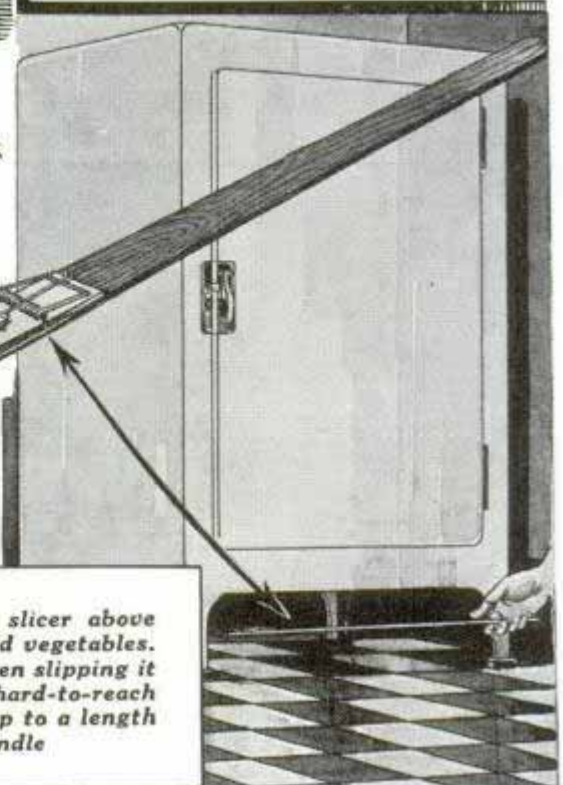

PROBLEMS

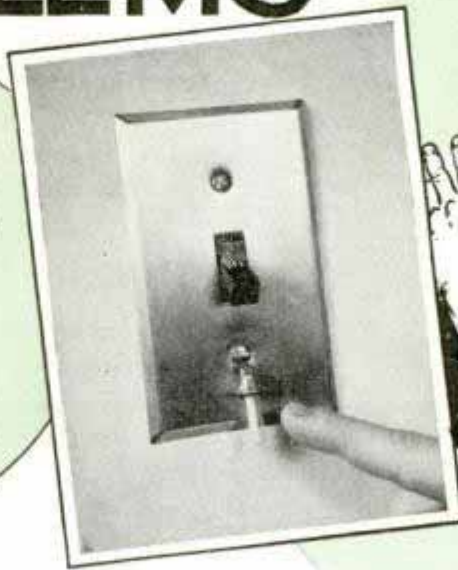
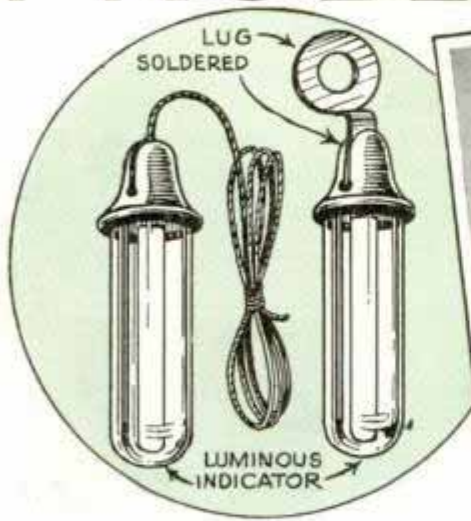

It's no trouble to find a wall switch in the dark if a luminous pennant is fastened to the switch plate as above. A brass eye or lug soldered to the upper end of the pennant slips under one of the plate screw heads

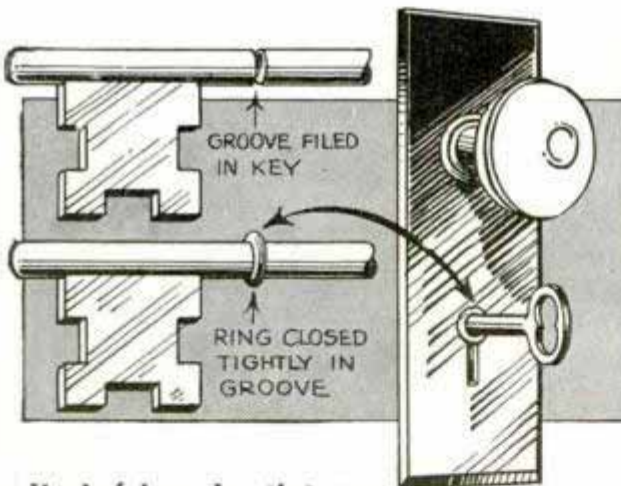

If a lock has a key that can be pushed clear through it, put a ring on the key, the ring being too large to enter the lock-plate hole

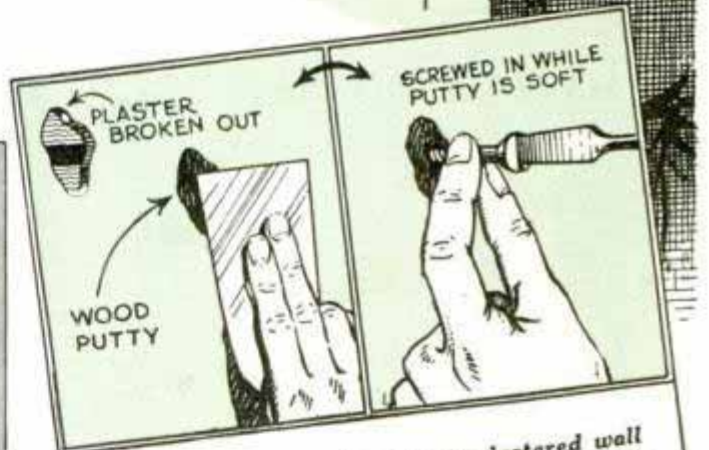

A screw will not pull out of a plastered wall if you first make a tiny opening, fill this with wood putty pressed tightly in place and then drive the screw while the putty is soft

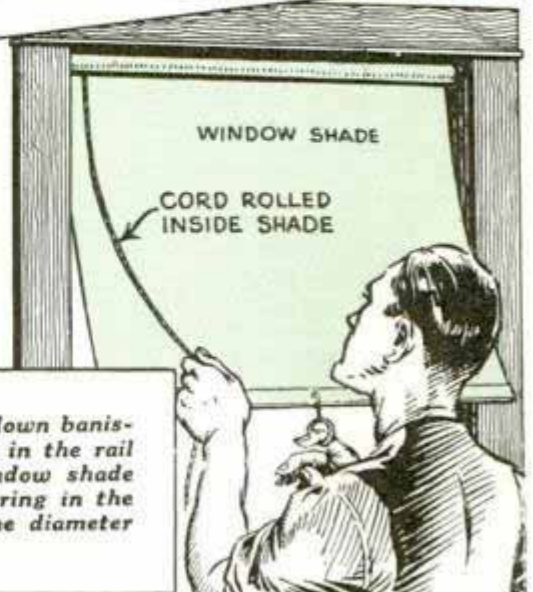
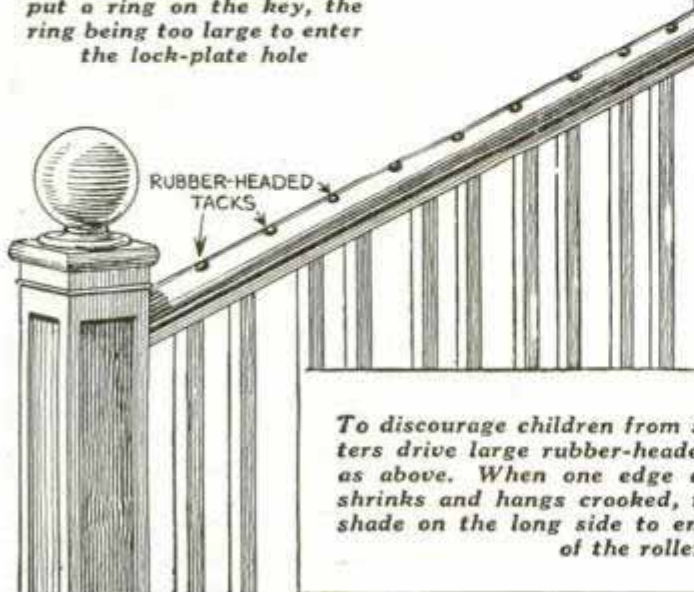

To discourage children from sliding down banisters drive large rubber-headed tacks in the rail as above. When one edge of a window shade shrinks and hangs crooked, roll a string in the shade on the long side to enlarge the diameter of the roller

Simple Tester for Short Circuits

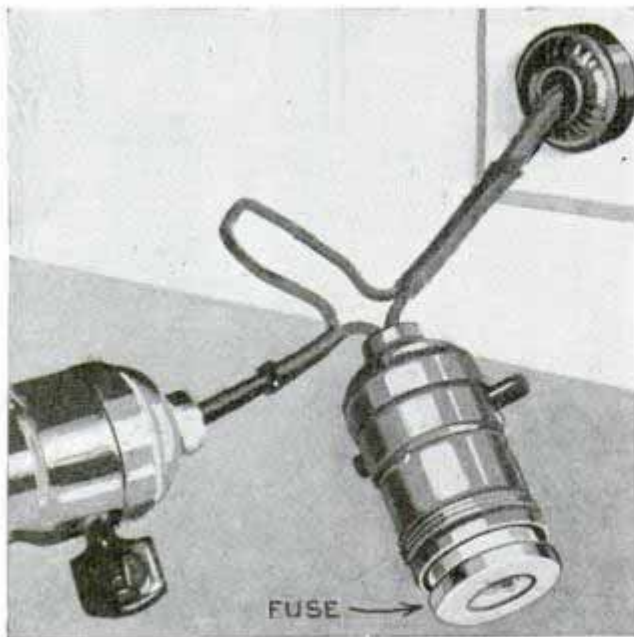

If a lamp or some appliance in the home is blowing fuses, you can make a tester to

locate the trouble. Just take a short electric cord with a plug on one end and a socket on the other. Remove the insulation in the center and connect a socket containing a fuse to one of the wires. To use the tester, remove all appliance wires and then plug in the tester to each one in turn. When the faulty appliance is found the fuse in the tester will blow.

Medicine Dropper Spreads Glue

To aid in spreading glue, one mechanic bent a pipe cleaner and fitted it inside a medicine dropper. This ejects the glue as required to be spread by the cleaner.



How to Build a Farm Tractor in Spare Time

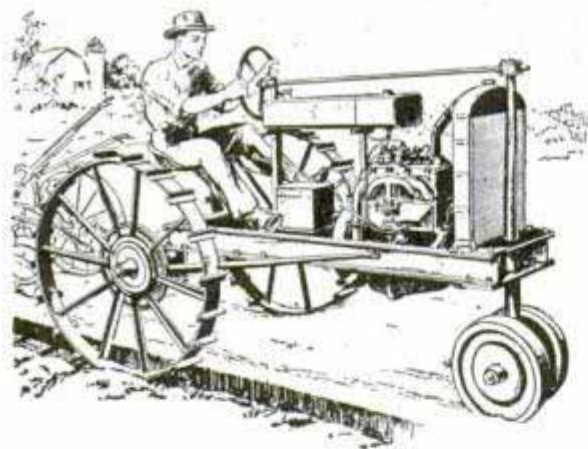

Having plenty of power to pull a two-bottom plow and other implements, this farm tractor, built from old car parts, includes a Ford model-A motor and twin transmissions giving six speeds forward. Wrenches, hacksaw and drill are about the only tools needed—welding can be done at your local machine shop. Set of three 17 by 22-in. plans, Nos. 1024 to 1026 incl., containing all necessary constructional details and a list of materials needed will be sent postpaid upon receipt of 75c.

OTHER BUILD-IT-YOURSELF PLANS

STREAMLINE FAMILY TRAILER—937 to 942: Includes all the conveniences of home with sleeping accommodations for four. Trailer is 15 ft. long and weighs approximately 1,400 lbs. Six prints \$1.00.

UTILITY TRAILERS—986 and 987: Built of old auto parts and lumber. Adaptations of body to suit various purposes. Two prints 50c.

ELECTRIC SPOT WELDER—891 and 892: Works on 110-volt, 60-cycle alternating current. For small work up to $\frac{1}{8}$ in. in thickness. Two prints 50c.

ELECTRIC ARC TORCH—1006: Carbon electrodes $\frac{1}{8}$ in. dia. produce arc for soldering, brazing, light welding. For 110-v. 60-cycle a.c. 25c.

SPEEDY BOBSLED—997: Box-type body gives rigidity and strength. Seat is 10 in. wide, 8 ft. 7 in. long, and accommodates six passengers. 25c.

COASTING TOBOGGAN—657: 7 $\frac{1}{2}$ ft. long by 16 in. wide. Print shows how to make form to bend bottom slats. 25c.

HOW TO MAKE SKIS—569: Three types, 7 ft. long. Data on bending wood and ski sticks. 25c.

FRONT-STEERING ICE BOAT—786: 13-ft. cockpit. Single sail on 18-ft. mast. Safe. 25c.

18-FT. ICE BOAT—774: Roomy cockpit seats four people. 14-ft. mast, main sail and jib. 25c.

AIR-PROPELLED ICE BOAT—785: Motorcycle engine drives a 52-in. airplane propeller. 25c.

Any six of these plans (not projects) will be sent upon receipt of \$1

Address Plan Service, Popular Mechanics Magazine, 200 E. Ontario St., Chicago, Ill.



Radio

RADIO EQUIPMENT for small craft

IMPROVED radiotelephone and direction-finding apparatus especially designed for pleasure craft, fishing boats and other small vessels, proved to be one of the popular radio exhibits at the New York world's fair.

The Federal Communications Commission permits the operation of marine radiotelephones under a third-class radiotelephone operator's license, for which it is necessary only to understand the simple routine of manual operation, and laws governing the use and courtesies of the air. No knowledge of telegraph codes is required.

The combination receiver and transmitter shown in photo (A) enables those on board a yacht or power boat



within the range of a coastal harbor radiotelephone station to have voice access to home or office, or any place that can be reached through available telephone systems. In emergency it

provides direct communication with the coast guard. Powered from any 12, 32 or 110-volt d.c. source, it consists of a 15-watt transmitter and a suitable all-wave receiver. The transmitting daylight range is upward of 50 miles, and the night range should be considerably greater. Direction finder (B) enables small boat owners to tune in any one of the many radio-beacon stations that dot our coast lines, and determine the position of the craft at all times. Receiver and adjustable loop are installed separately in any convenient location.

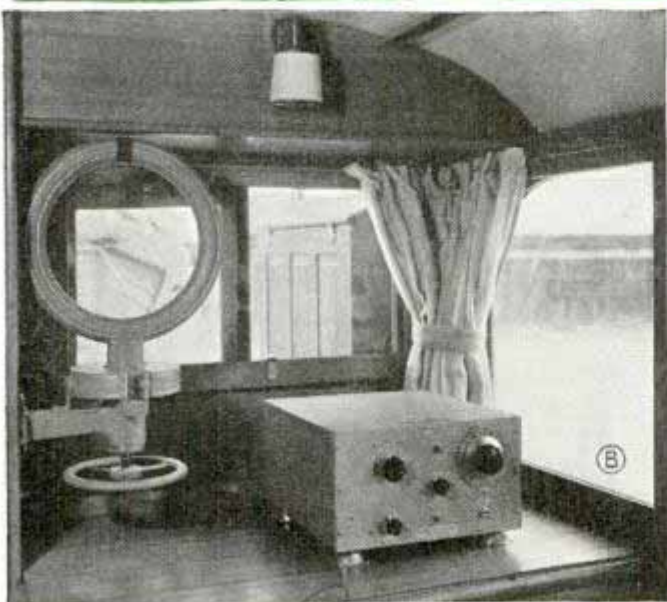

*Radior Marine Corp 75 Jurek
New York*

Beginner's

TWO-BAND

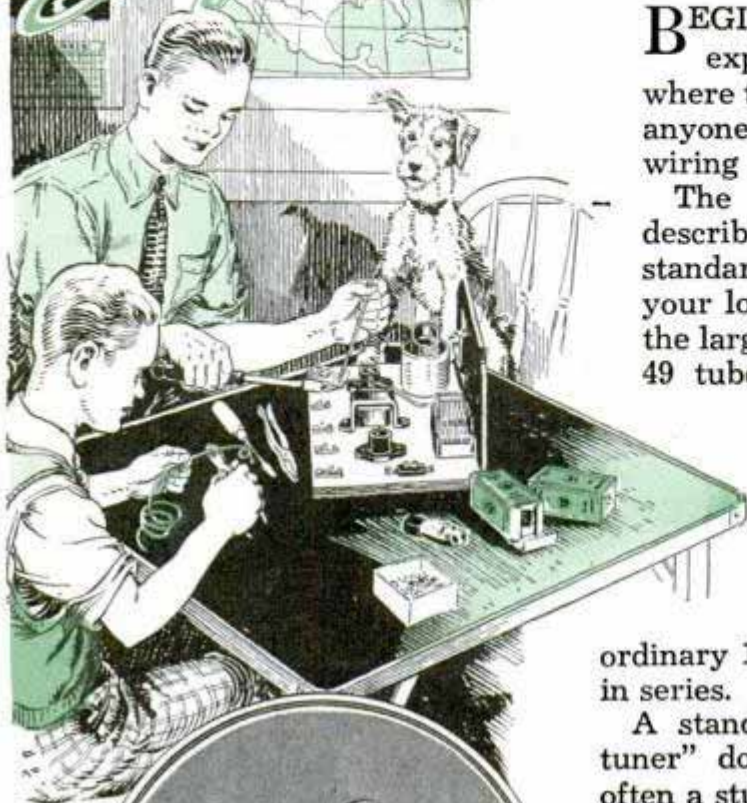

FIG. 2-B

BEGINNERS like to start with a small inexpensive "breadboard" type of receiver where the connections may be made easily by anyone who can use a soldering iron, as all wiring is in plain view.

The simple "flashlight-battery" set to be described is easy to build and uses low-cost standard parts that may be obtained from your local radio parts stores, or from any of the large radio mail-order houses. Two type-49 tubes, popular in flashlight-battery receivers previously described in Popular Mechanics Magazine, are employed. These dual-grid tubes, although designed to operate on a 2-volt d.c. filament supply, work nicely on a single 1½-volt dry-cell battery; the B-battery consists of 8

ordinary 1½-volt flashlight batteries connected in series.

A standard coil known as a "three-circuit tuner" does away with tedious coil winding, often a stumbling block for beginners. This coil comes fitted with a terminal strip marked for proper connections, thus reducing the possibility of wiring errors. It is supplied with a rotating "tickler" coil which makes it easy to control regeneration. Taps on the large coil provide a simple method for obtaining short-wave reception in addition to the regular broadcast band. Change-over from one band to the other is made by merely flipping a toggle switch. The extended short-wave band includes most of the police radio stations, the 160-meter amateur phone stations, and 80-meter C.W. (code) stations.

Wood base and pressed wood panel are detailed in Fig. 1. The metal coil shield will be held firmly against the front panel

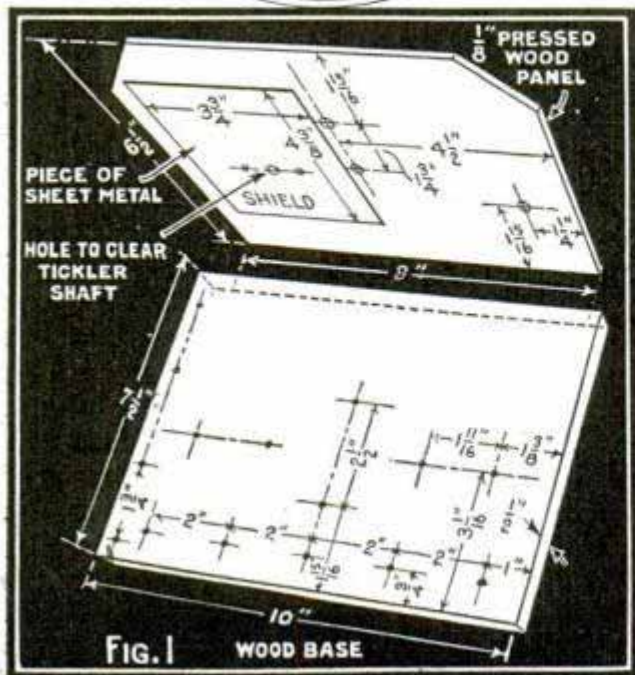

FIG. 1 WOOD BASE

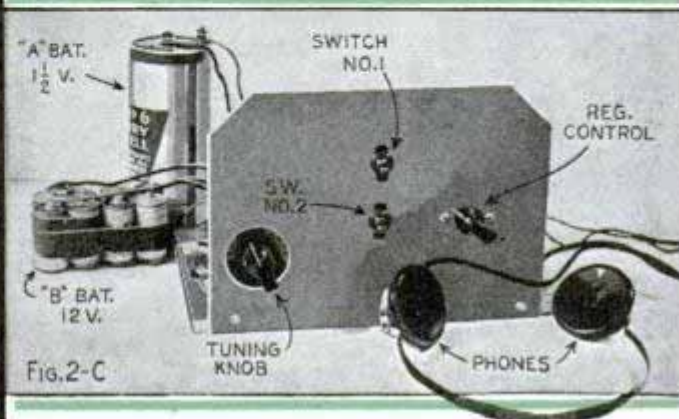

FIG. 2-C

Flashlight-Battery SET

by means of the mounting screws that bolt the 3-circuit tuning unit to the panel, as indicated in the simplified wiring diagram Fig. 2 and photos 2-D and 2-E. Mount the variable condenser on the baseboard by means of a long machine screw, the head of which is countersunk in the wood on the under side. Tube sockets, 3 to 1 ratio audio transformer and clips on the baseboard are fastened down with wood screws. The bottom of the coil should be cemented to the board with china cement. Make all connections exactly as shown in Fig. 2. A schematic circuit diagram appears in Fig. 3.

Complete battery hook-up is shown in Fig. 2-A; when soldering the leads on the B-batteries, scrape the area very carefully on which the solder is to flow, use rosin-core solder and make all soldered connections neat and firm. The flashlight cells are taped together with the positive and negative ends arranged as shown in photo Fig. 2-B.

Please note that the connections to the stationary plates (S) on the variable condenser C₁ are made on both sides of the condenser, as these (S) lugs on the stationary plate section are common. The lug (R) which is mounted directly on the frame

(Continued to page 132A)

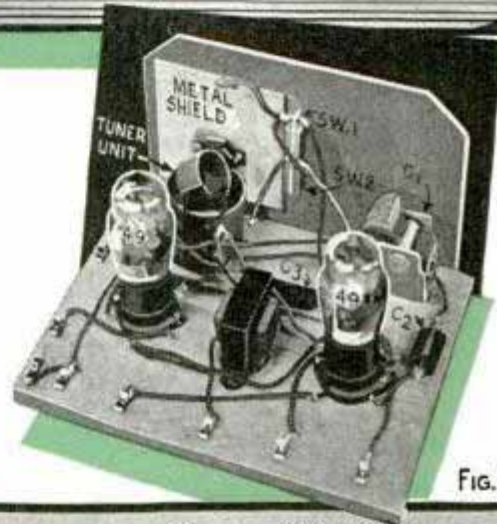
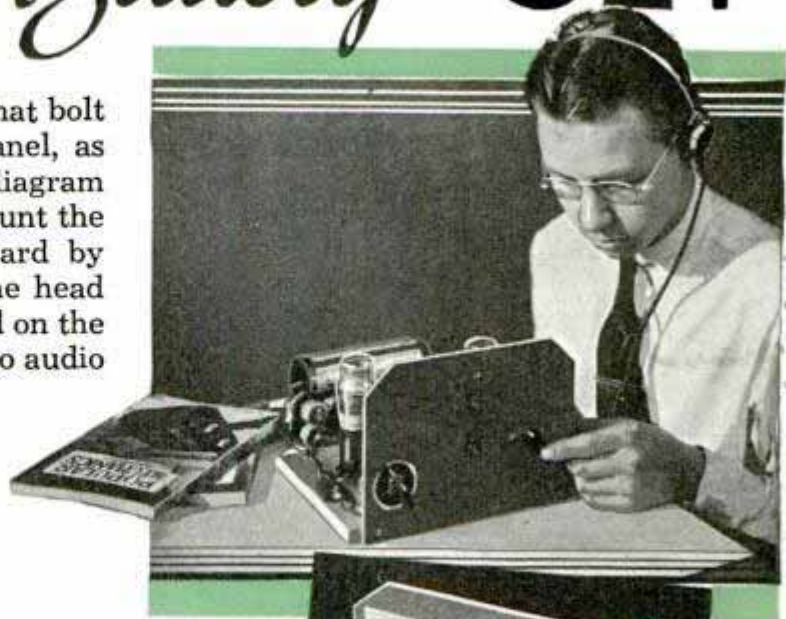

Fig. 2-D

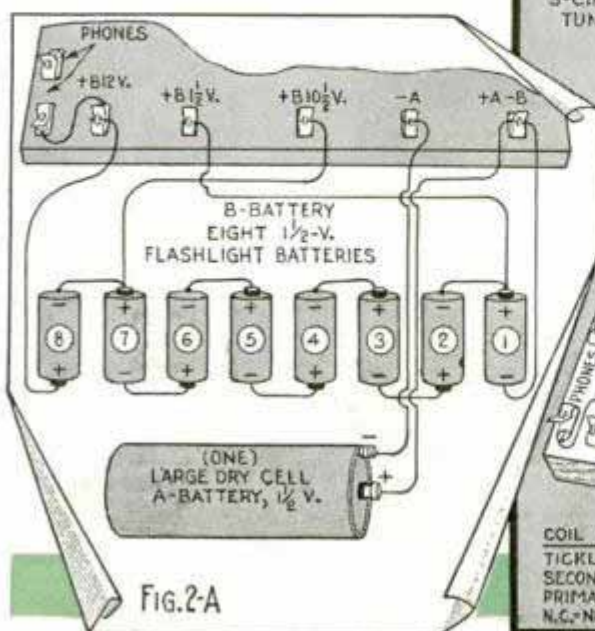

Fig. 2-A

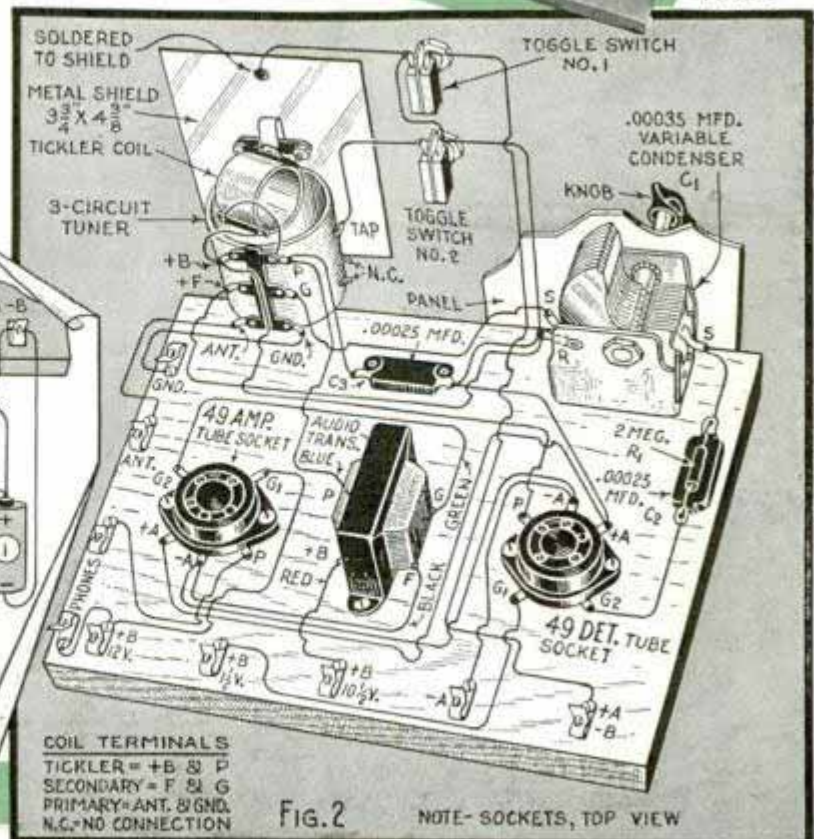

Fig. 2

NOTE- SOCKETS, TOP VIEW

COIL TERMINALS
TICKLER = +B & P
SECONDARY = F & G
PRIMARY = ANT. & GND.
N.C. = NO CONNECTION

Electrical Recording for the Home or School



EVER since the introduction of electrical recording about ten years ago, there has been a growing interest among experimenters, students and instructors in the possibilities of what is commonly referred to as "home recording."

This is merely the process of transferring sound into electrical impulses which cause a cutting head to make mechanical impressions upon metal or composition disks that are available in standard record sizes. When reproduced electrically, the impressions made in these records actuate the needle in a magnetic, or a crystal, playback pickup which transfers them as electrical impulses to an audio amplifier, where they are reproduced as the original voice or music at any desired volume.

Although motor-driven turntables, lead screws, cutting heads and playback parts have been available for some time, experimenters have been handicapped by not being able to obtain the matched equipment necessary for really satisfactory results. The ordinary electric-phonograph turntable, used for reproducing phonograph records, is not suitable for recording purposes. A constant-speed outer-rim-driven turntable of sturdy precision construction, and perfectly controlled starting and tracking mechanism, is necessary to meet the standards of modern high-quality reproduction expected by everybody today. This type of turntable is now available, as well as other matched parts that enable you to build your own recorder, complete with playback and amplifier.

Parts of this description are shown in the accompanying photos, Figs. 2, 3, and 4; two variations of the completed recording

(Continued to page 134A)

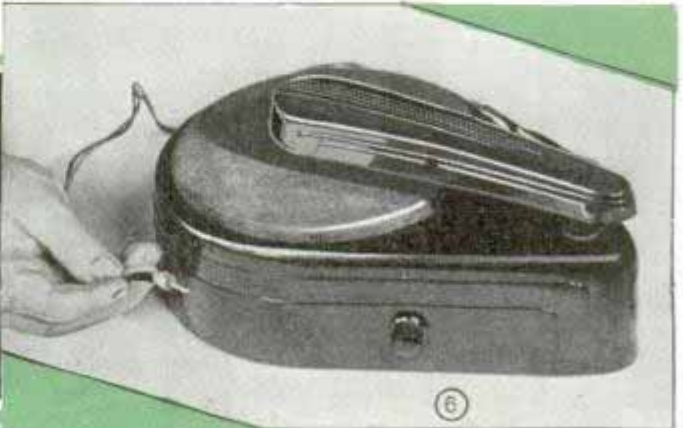
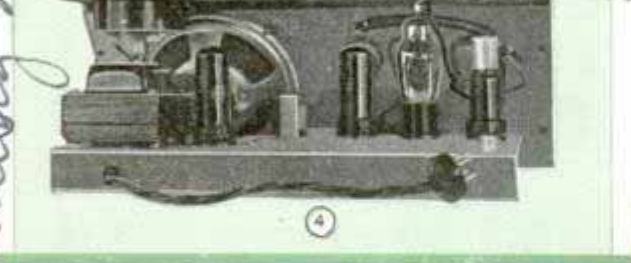
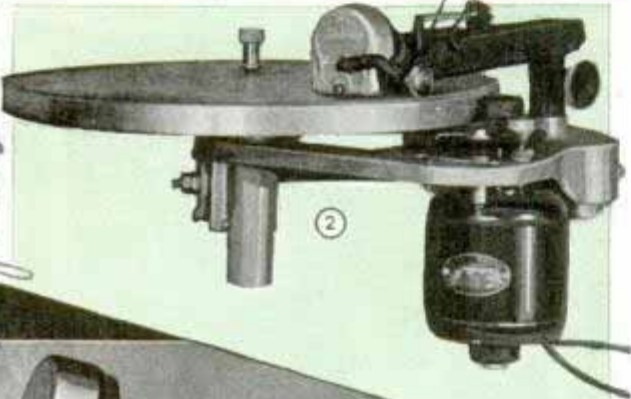

record player. R.C.A. my 66 Camdex. N.Y. speak. O. Phon. Curb 23 W. 60th St.

no further equipment information

Drake Electric Works, Inc.
3656 Lincoln Ave
Chicago

Practical RADIO HINTS



Soldering paste is always at hand when kept inside your spool of wire solder, as shown in Fig. 1. The small soldering iron illustrated in Fig. 2 is designed for working on midget receivers; note cooling flanges that protect the handle

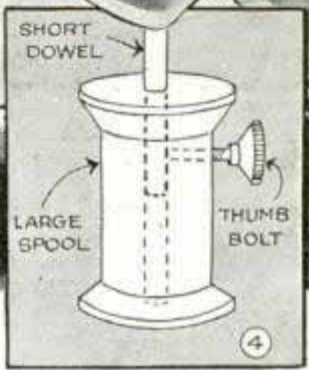
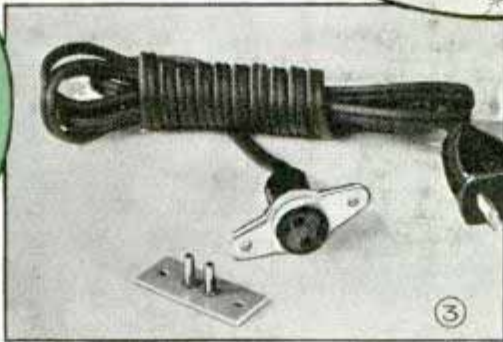
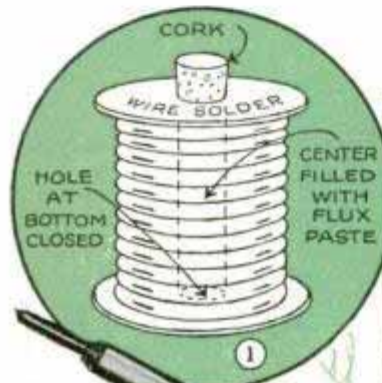
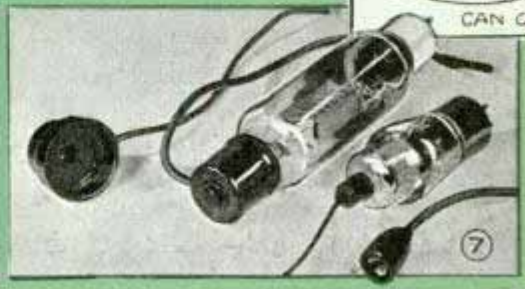

Photo Fig. 3, compact outlet for set chassis, to operate a lamp or record player

Fig. 4, adjustable "spool jacks," easily made from junk-box materials, provide excellent supports for a radio receiver or amplifier chassis on the workbench while testing or repairing. Several of these spool jacks placed at convenient points under the chassis as illustrated in the sketch above, hold the instrument upside-down without damage to tubes, coils or other parts mounted on top of the base. Photo and sketch, Fig. 5, show a television antenna-kit assembly with universal mounting joint which permits adjustments in all directions; the di-pole antenna rods are made of heavy duralumin held together with a sturdy center insulator. Fig. 6, non-tipping stand for soldering iron, improvised by cutting a can cover as shown



Fig. 7, insulated tube caps now available for protecting amateurs, experimenters and servicemen when working on television receivers, amplifiers and transmitters that employ high-voltage tubes



Allen Products Co 715 Central Brooklyn

Reading Lamp and Radio Set



This 5-tube receiver, with high-power tubular-type lamp built in, clamps on head of bed within easy reach for tuning. No antenna or ground wire is required.

Toy Phonograph Is Motor Driven

A cone speaker is built into the streamline tone arm of this junior electric phonograph which plays records of all sizes up



to 12 inches. Specially designed to stand up under the "hard knocks" of playroom games, it has an electrically driven turntable mounted in a cabinet of molded plastic. Easily operated by youngsters, this tiny phonograph is one of a series of practical educational toys.

Five-Tube "3 in 1" Portable

Entirely enclosed in a case of airplane luggage material, and available in several designs planned for easy portability, this little set works from 110-volt a.c. or d.c.

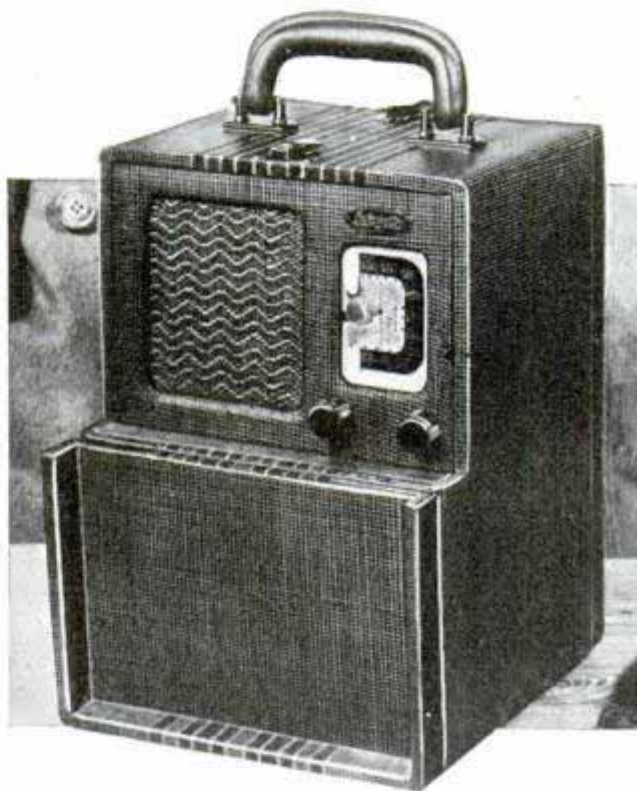

light lines in the home. On camping trips or picnics, it supplies its own power from small self-contained batteries. A built-in loop antenna eliminates all external wires.

Blueprints covering radio construction articles in this and past issues are available for 25 cents each. Original material lists, with names of manufacturers and dealers, can be obtained from our Radio Department upon receipt of postage.

NEXT MONTH—How to Build the Little Giant Push-Button A.C.-D.C. Four-Tuber. This 1940 improved model of the popular low-cost midget broadcast receiver uses new tubes that eliminate line resistor, and also employs a practical method of mechanical push-button tuning. Also—**Compact Photocell-Operated Relay**



SHOP NOTES

LARGE DISKS TURNED on this "lathe"

OF COURSE, this isn't really a lathe at all. It's merely an improvised headstock and about all the materials you need to make it are a length of $\frac{1}{2}$ -in. shafting, two suitable bearings, and a few short pieces of pine stock which you likely will have right at hand. So simple is the construction that you can have the whole thing set up ready for work in a few minutes. Figs. 1 and 3 show how it works, while Fig. 2 gives the details. No over-all sizes are indicated because the headstock base must be made to suit the motor you have and also the diameter of the disks to be turned. For average work the base should be about 28 in. square, which will allow the headstock to swing disks up to 25 in. in diameter. This means that the $\frac{1}{2}$ -in. shaft will have to be approximately 32 in. long to allow projections beyond the bearings for the step pulley and faceplate. The base for the motor can be built up of blocks and two cross members as indicated in Fig. 2. Most anything will do so long as it is solid and places the motor in the proper position, which is above and slightly to one side of the shaft. Its exact location will have to be determined by the length of the drive belt. Of course, the slots in the motor base will give sufficient

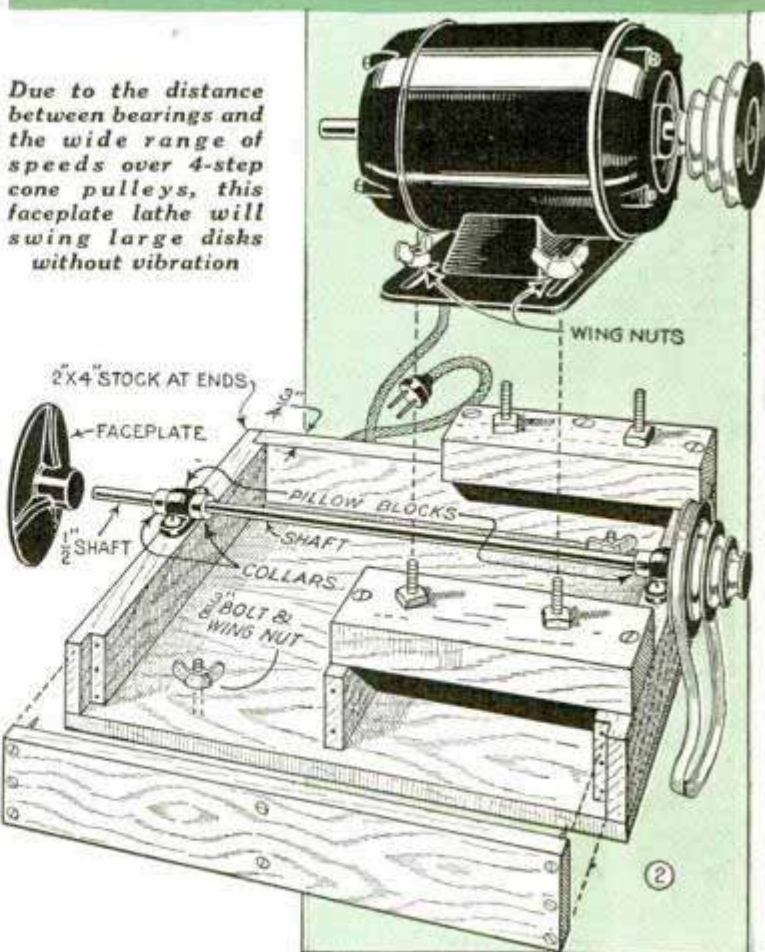
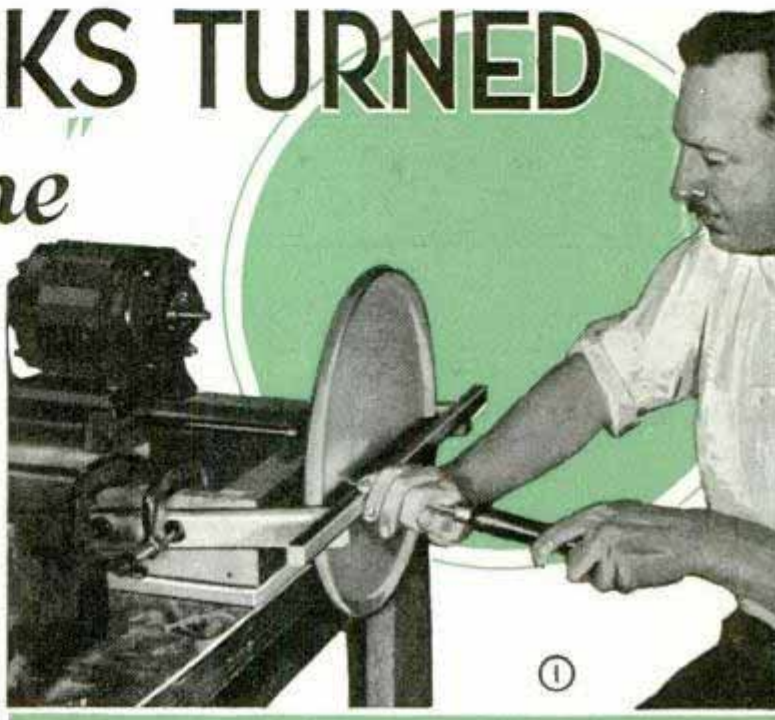

Due to the distance between bearings and the wide range of speeds over 4-step cone pulleys, this faceplate lathe will swing large disks without vibration

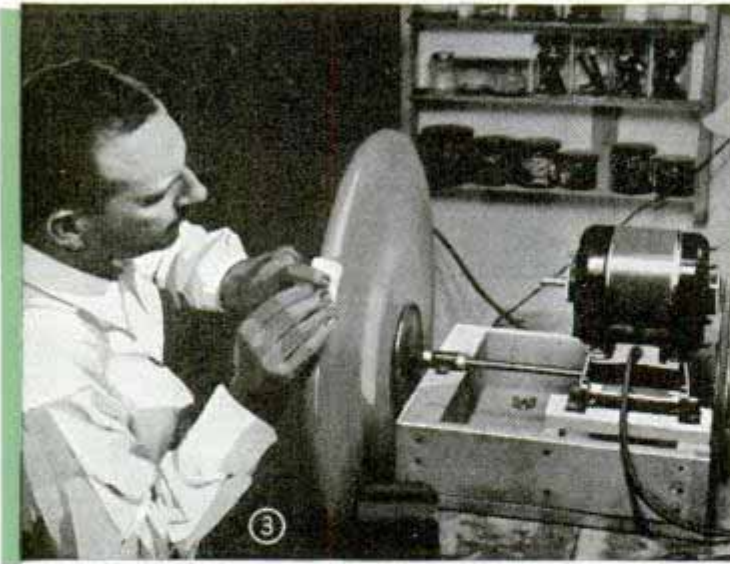

adjustment for tensioning the belt once you have the motor located. Note that nuts are run down over the bolts holding the motor. The base of the latter rests on these, and additional wing nuts are used to tighten the motor in place. This arrangement makes it easy to remove when needed for other work.

Brass one-piece pillow blocks serve as bearings for the shaft. These are fastened

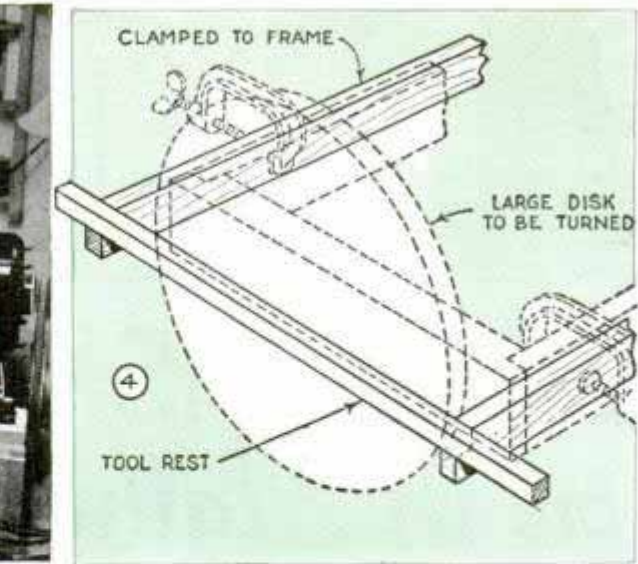

with heavy wood screws. Three collars prevent undue end play in the shaft and take the thrust of turning. The tool rest, Fig. 4, is made of three pieces of hardwood and clamped to the base as shown. It can be adjusted easily to the size of any disk that is being turned. Use an ordinary lathe faceplate of the type which locks to the shaft with a headless set screw. In use the lathe is clamped or bolted to a solid bench.

Handsaws within Easy Reach in Rack over the Bench

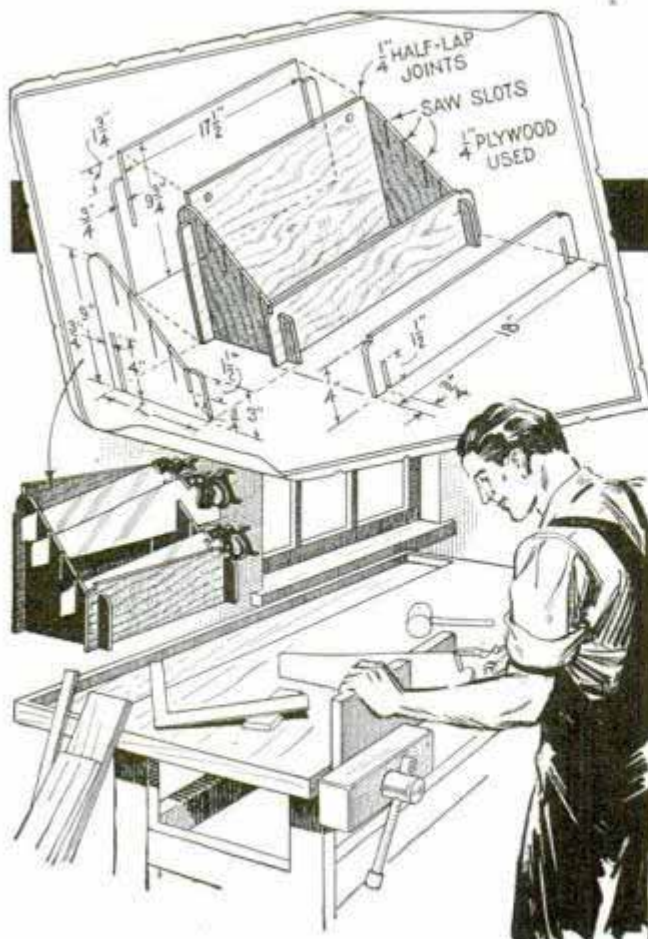

Designed to accommodate several handsaws of various lengths, this handy wall rack, which can be hung in any convenient location over or near your bench, simply fits together without the use of nails or screws. It is cut from $\frac{1}{4}$ -in. plywood and is assembled by slipping the parts together, which is made easy by half-lap joints. Vertical slots are cut in the end pieces.

Grinding Wheels Have "Tires" to Protect Edges

A craftsman who has several grinding wheels on hand protects the edges by slipping a wide rubber band around the wheels. The bands can be cut from an old inner tube. Be sure that they are wide enough to fold over the edges.

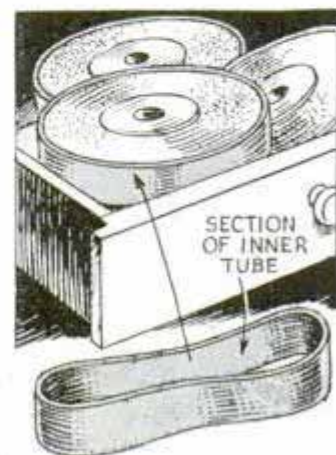

Shop Cabinets Fitted with Flat Drawer Pulls

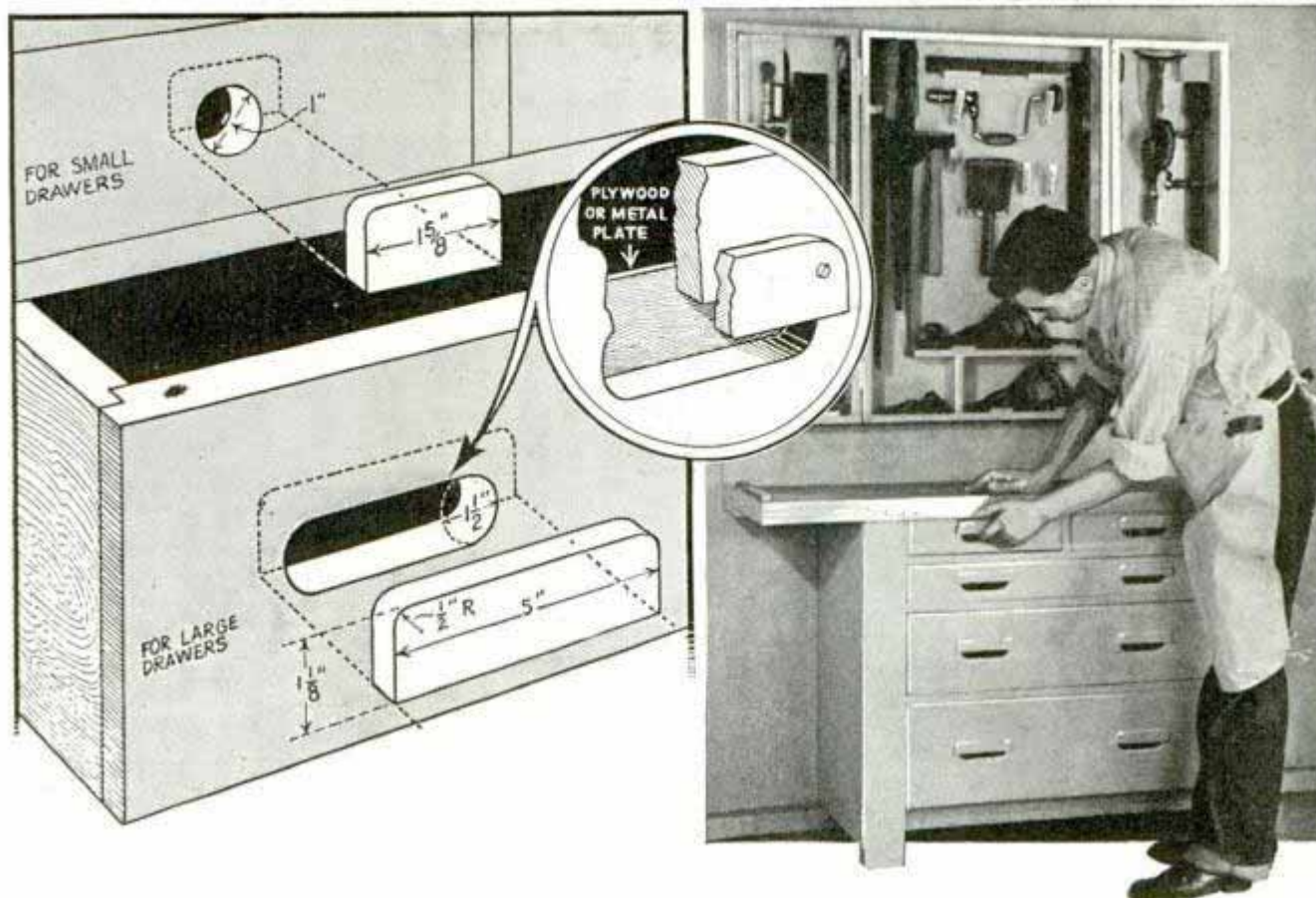

Drawers in workbenches and shop cabinets can be equipped with pulls that project only $\frac{1}{4}$ in. beyond the fronts. If a drawer is large and heavy, a handhole large enough to admit three or four fingers is cut slightly above the center of the drawer front by boring and sawing out the wood. For a small, light drawer, a single

hole to admit one finger is usually sufficient. The edges of the hole are rounded and a piece of $\frac{1}{4}$ -in. plywood is glued and bradded—or screwed if necessary—half-way over the hole. If you desire, a strip of sheet metal or thin wood can be applied to the inside of the drawer front to close the hole.—E. M. Love, Monterey Park, Calif.

Cistern-Cleaning Bucket Excludes Water but Admits Mud

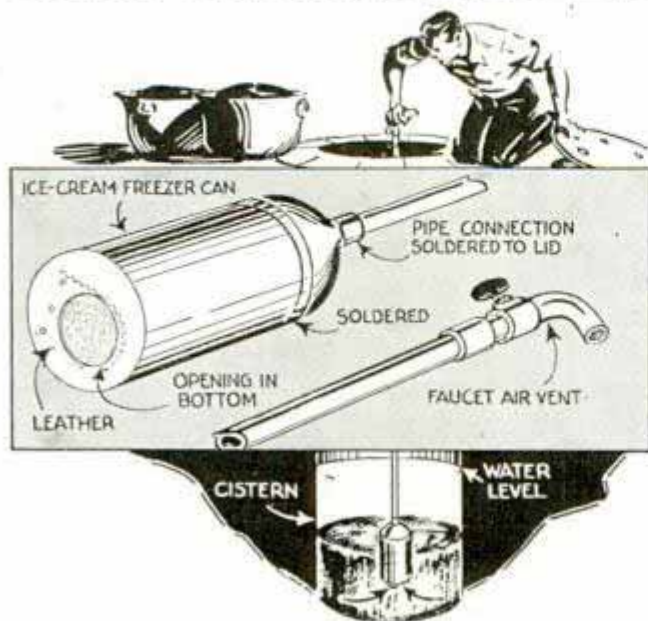

There's no need to drain or pump water out of a cistern if you use this bucket. An ice-cream freezer can, some pipe and a faucet is about all you need to make it. A hole is cut in the bottom of the can and is fitted with a leather valve. The cover is soldered in place and a pipe flange is soldered over a small hole in the cover, after which the pipe and faucet are added. Air trapped inside the can prevents entrance of water while being submerged. When the can is pushed against the mud, the faucet is opened to release air while the mud enters. The leather valve prevents mud from dropping out while the can is raised to the top, where it is emptied.

—Geo. W. Bucklin, Lincoln, Nebr.

Shoe Trees Serve as Tag Holders on Shipping Room Wall

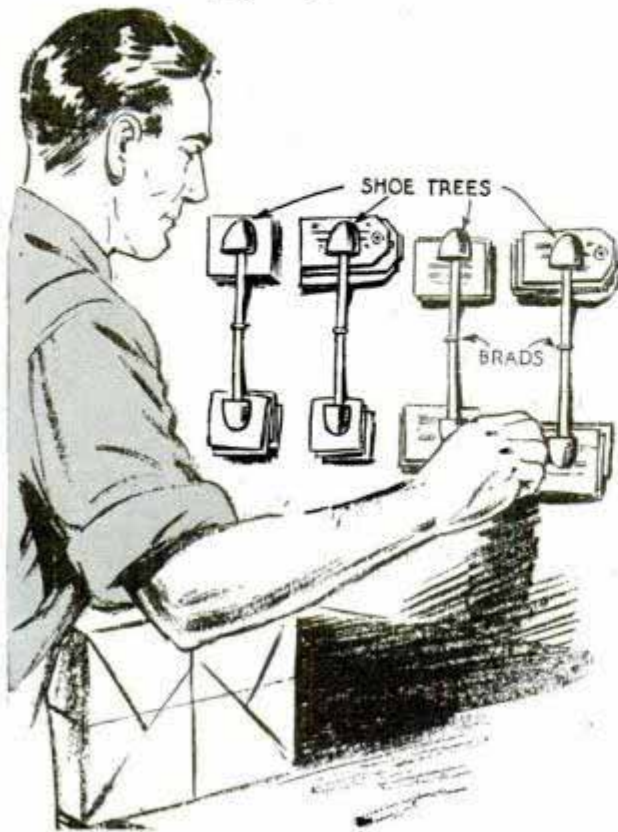

Fastened to a wall with brads or staples as shown, inexpensive shoe trees provide handy holders for tags, labels, etc., which are slipped under the ends of the trees. Numbers or letters can be painted on the ends of the trees to designate the tags or papers under them.

Poultry Fountain inside Auto Rim Does Not Collect Chaff

Large auto-wheel rims placed around poultry water fountains as shown will prevent fowls from scratching chaff and litter

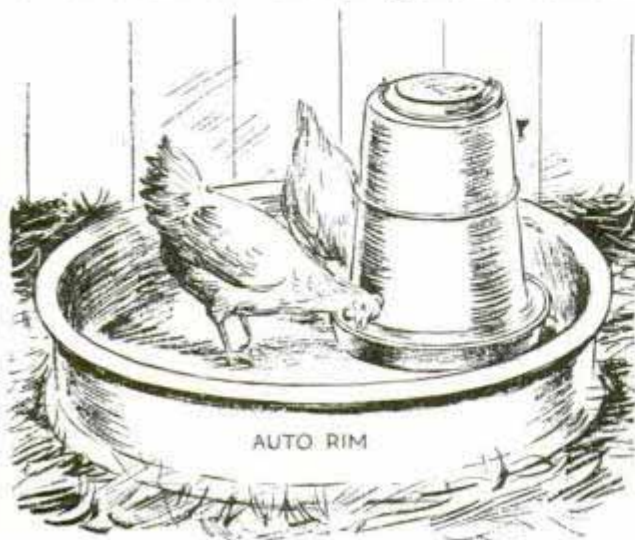

into the water. The rim also prevents water being splashed into chaff and straw on the poultry-house floor.

Hinged Windows Held at Angle by Perforated Metal Strip

Needing a method of adjusting his poultry-house windows, one farmer did it inexpensively by using strips of perforated flat iron, such as pipe straps.

One end of each piece is pivoted to the window casing by means of an angle bracket and a small bolt. A short pin in the sash slips into one of the perforations to hold the window.



Clerk's Multiple "Pencil" Writes in Four Colors

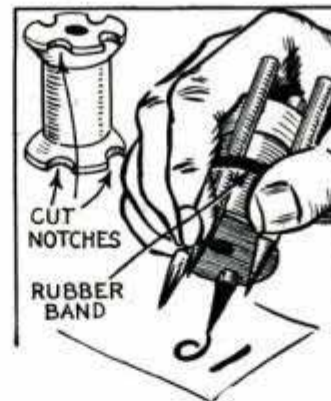

One shipping clerk who had to put identification marks with colored crayons on packages, clipped four of them to an empty thread spool, which served as a pencil with different colored leads.

Ends of the spool were notched and crayons were held in place with a rubber band.

Horseshoes on Chopping Block Keep Kindling from Flying

To prevent pieces from flying when chopping kindling, a farmer attached a pair of horseshoes to the sides of the chopping block. Nailed securely in place, the shoes also serve as handles to move the block.

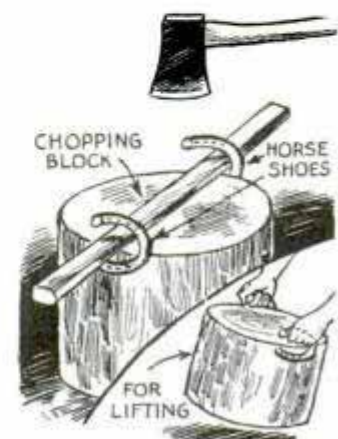

Trick in Uncoiling Wire Cable Avoids Kinks

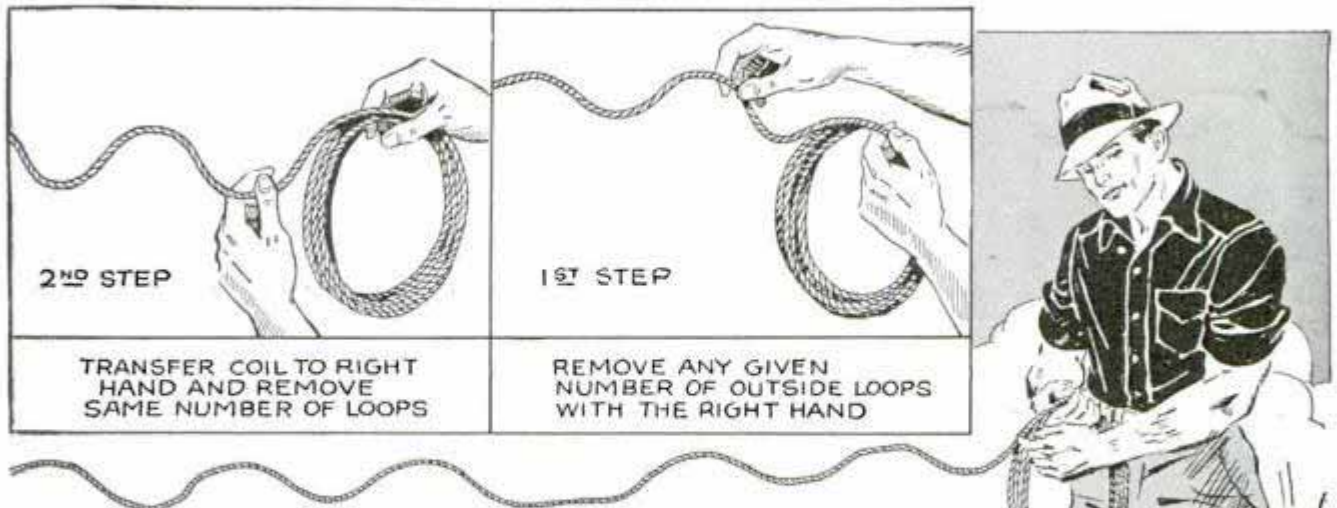

OPERATION REPEATED UNTIL DESIRED AMOUNT IS UNCOILED

Unless you practice a simple trick you are likely to have trouble uncoiling wire or cable, especially the latter. The difficulty is the persistent tendency of the wire or cable to kink. Straightening one kinked section only forms another somewhere else along the length. It takes but a few minutes of this to get the whole thing into an impossible snarl. To avoid this, grasp the coil in the left hand and remove a number of loops with the right as shown above. Then shift the coil to the right hand and remove the same number of loops with the left. Continue this method until enough cable or wire is removed.

—A. E. Rutkowsky, Freedom, Pa.

Artist's Ink and Pens Are Handy in Neat, Portable Holder

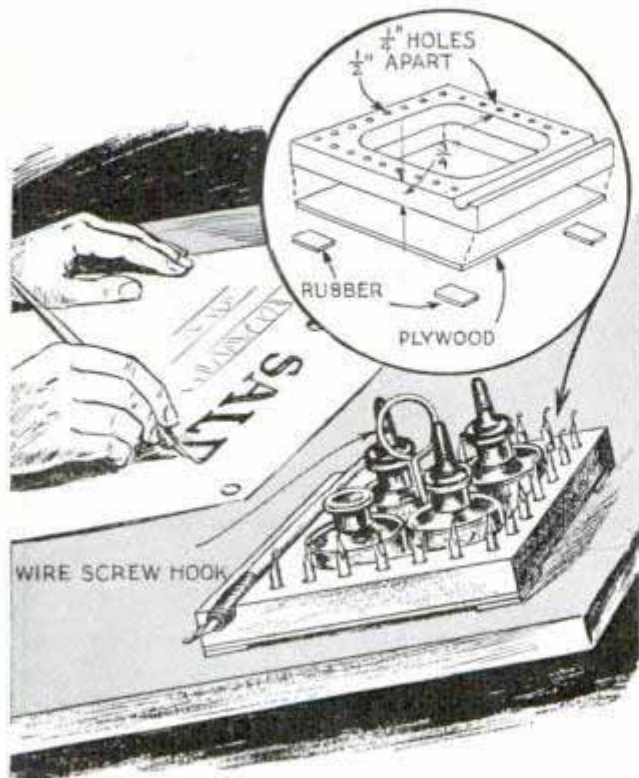

Artists, show-card writers and others doing similar work, will find this holder convenient. It has a well for ink bottles, a place for pencils and a number of holes to take lettering pen points. The whole unit may be picked up by its convenient handle and moved or carried about. Small rubber feet keep it from sliding on a tilted board or table. It is cut from $\frac{3}{4}$ -in. stock and is fitted with a thin plywood bottom.

—M. G. Winterton, Ft. Lewis, Wash.

Handling Photo Film and Paper

The inconvenience in a busy studio darkroom of handling photographic film and paper by the edges to prevent damaging them with the fingers can be avoided by using a couple of fingers cut from a rubber or leather glove. Wear the fingers when handling paper and film and there will be little possibility of damaging them.

Novel Fruit Display Simulates Miniature Volcano

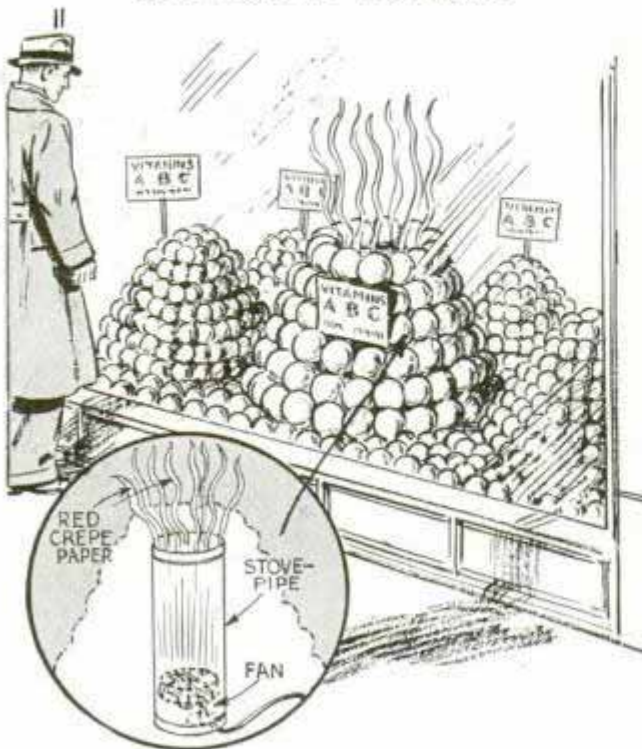

Red-paper streamers waving upward from the center of a conical pile of fresh fruits give this display an unusual animated effect. The fruit is piled around a length of stovepipe, which has a small electric fan in the bottom to force a blast of air up against the streamers of red crepe paper. These are fastened around the inside surface of the pipe at the top.

Sheet-Metal Worker Uses Mallet to Move Flat Pieces

Thin sheets of tin and sheet iron are hard to move with the fingers on smooth surfaces and layout plates. Also, it is difficult

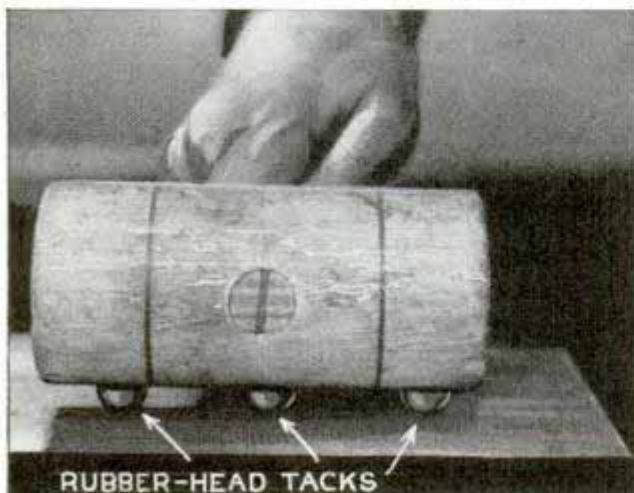

to set them accurately under the blade of foot shears. However, this trouble can be avoided if rubber-head tacks are driven in the side of the worker's mallet. A light pressure of the mallet head on the smaller sheets and strips makes it possible to move and place them easily.

Pair of Pliers Has Plate on Jaw to Help Hold Small Work

You will find a metal plate welded to one jaw of a pair of pliers helpful in holding a small article while working on it. The plate prevents the work from dropping out of the jaws if the grip on the handles is momentarily loosened.

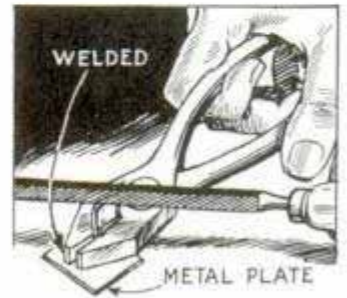

This Stretcher Pulls Long Fence without Resetting Claws

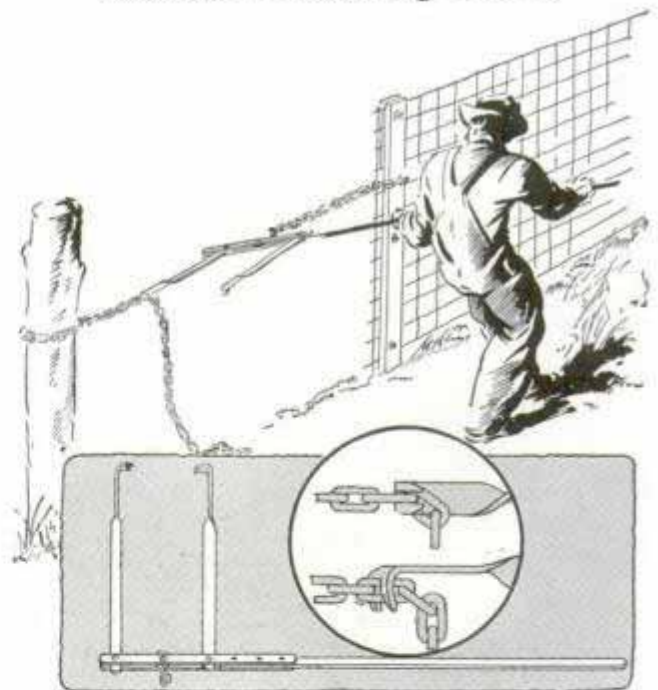

Tightening long lines of fence wire is no job with this stretcher. The long handle gives plenty of leverage so that one man can operate it easily. Made of $\frac{1}{4}$ by $1\frac{1}{2}$ -in. flat iron, the stretcher is assembled as shown. The chain on which the claws operate can be of any length desired, depending on the wire to be tightened.

—Wilmon Mayeaux, Cottonport, La.

From PATTERN to CASTING

PART II

Two-Piece Patterns and Cores

WHERE the pattern must be of such shape that it cannot be made with the draft running in one direction from the parting line, it is necessary to resort to a split pattern of two or more pieces. As an example of this type of pattern, take the small V-pulley shown in Fig. 19. As you will see this pulley has no recessed web or spokes, so it can be cast in the vertical position as in Fig. 20. The parting line in this case will be on the diameter of the pulley. The curvature of the wheel and the V-shape of the belt groove will provide sufficient draft on these surfaces. However, the flat outside surfaces will require draft. Keep in mind that the amount of draft will be not less than

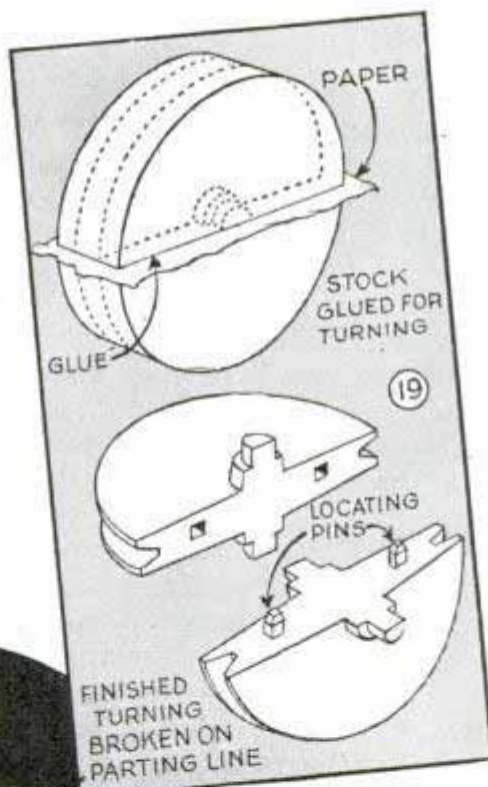

$\frac{1}{8}$ in. to the foot for that part of the pattern below the parting line, while on the half of the pattern above the parting line (the cope section) the draft should be twice as great, or not less than $\frac{1}{4}$ in. per foot. This permits easy parting of the cope and drag when the mold has been completed.

The layout of this pattern is made as shown in Fig. 22, and the method of turning it complete in the lathe is detailed in Figs. 23 to 26 inclusive. Irregular-shaped patterns are usually made with ordinary hand tools and carving chisels. In almost all cases of split patterns, it is best to make the pattern out of two pieces of clear white pine, the joint between the two parts corresponding to the parting line. If these two pieces are joined together with staples, corrugated fasteners or screws in Fig. 21 A, B and C, the pattern can be turned or

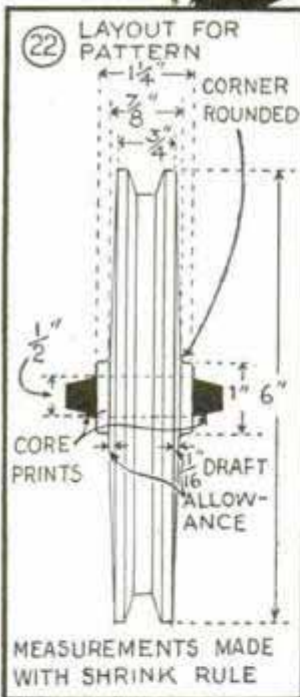
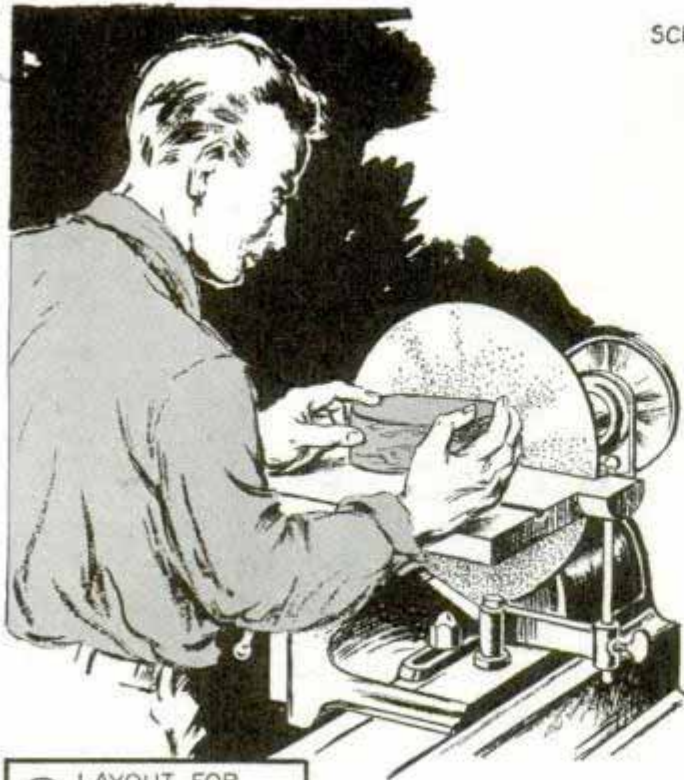

otherwise shaped as though it were in one piece. In those cases where it is not possible to locate staples or screws so that they will hold the parts together, the blocks can be joined by gluing with a sheet of newspaper between as in Fig. 19. This will give a good bond which can be broken easily when the job is complet-

ed without damage to the parts.

Before completing the V-pulley pattern you come to the matter of cores. Where a hole through the casting is required to have straight sides (without draft), or where it must be in such a position that it cannot be formed as a part of the pattern, the hole must be made by coring. In the case of this pulley the hole required for the shaft not only must be cylindrical, but it also would be impossible to form it with the pattern alone. For this reason it must be cored. Note the core prints in Figs. 19 and 22. These are simply projections from

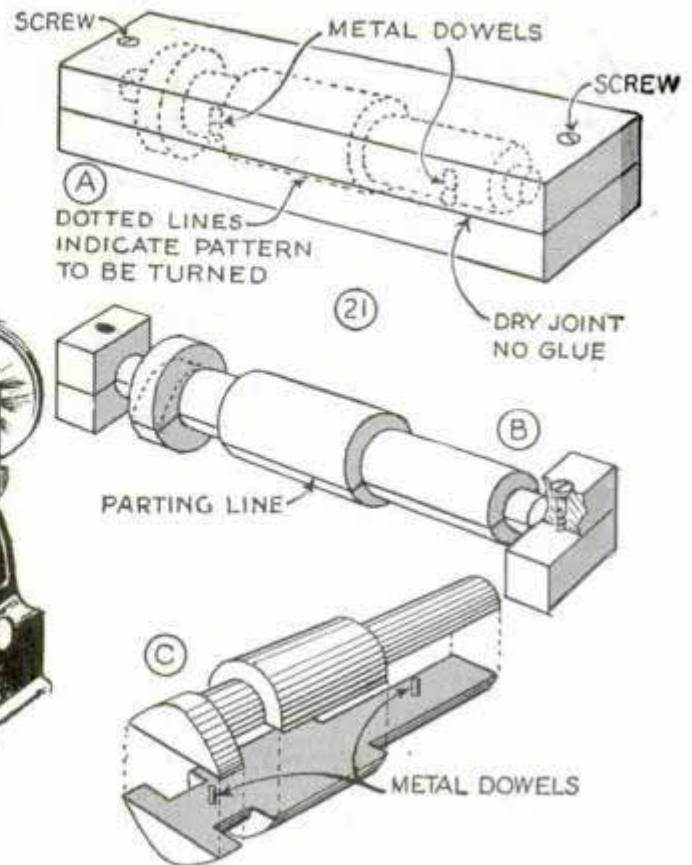

the pattern which form openings in the mold by which the core is supported as in Fig. 30. In regular practice core prints are usually tapered slightly, but in individual work where pattern and core are used only once or at most, a few times, this is seldom necessary. In small work especially, they can be the same diameter as the core and, of course, should be in direct line with the core. Usually the combined length of the core prints should equal at least half the length of the cored hole for proper support. The core prints can be either integral parts of the pattern, or separate turned pieces fastened to the main pattern with screws or dowel pins. In this particular case it will be easier to make them as part of the pattern.

Dry-sand cores are usually made in a core box of the proper shape and then baked dry. A simple core box can be made by inserting locating dowels in two pieces of white pine as in Fig. 27. Cut the pieces to such length as you want the core, then staple them together and drill the blank lengthwise, as in Fig. 28. The two halves are then separated as in Fig. 29, and the surfaces lightly sandpapered and shellacked all over. If the core is not cylindrical or if its cross-section is not constant throughout the length, hand work will be

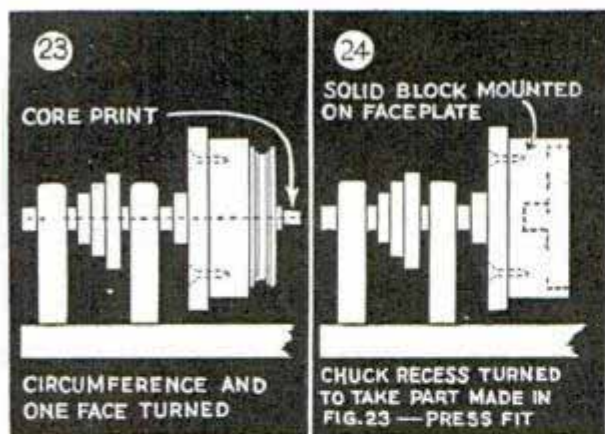

required, involving the use of carving chisels.

The core is made from common molding sand to which a small amount of some binding material such as linseed oil, molasses, or flour is added. The sand is dampened and the mold rammed full, and struck off as in Fig. 32. After this, the core box is rapped lightly to loosen the rammed core, and is then opened. Sometimes, especially with a long and slender core, iron wires are inserted in the core box to reinforce it along the length. The core is then placed in an oven at about 400 degrees F. and baked slowly to remove all excess moisture. When the mold for the casting is finished, the baked core is inserted in the proper position before closing the flask.

In some cases a core must overhang the cavity formed in the sand by the pattern. Fig. 31 illustrates an example of this, showing the casting to be made, the pattern, and the core required. In this case the core print must be longer than that portion of the core which overhangs the mold.

Now something more about fillets. In all castings it is necessary to avoid square edges and corners as much as possible. Outside edges of the casting should be rounded off and inside corners should be filled in. The reason, as shown in Fig. 33, lies in the crystallization characteristics of the metal. Crystals form perpendicular to the surface. The result is that the crystals fail to cohere at sharp corners. Shrinkage at the corner is in two directions, and the crystals are likely to pull apart and leave a crack or cavity, called a shrink hole. If the corners are rounded

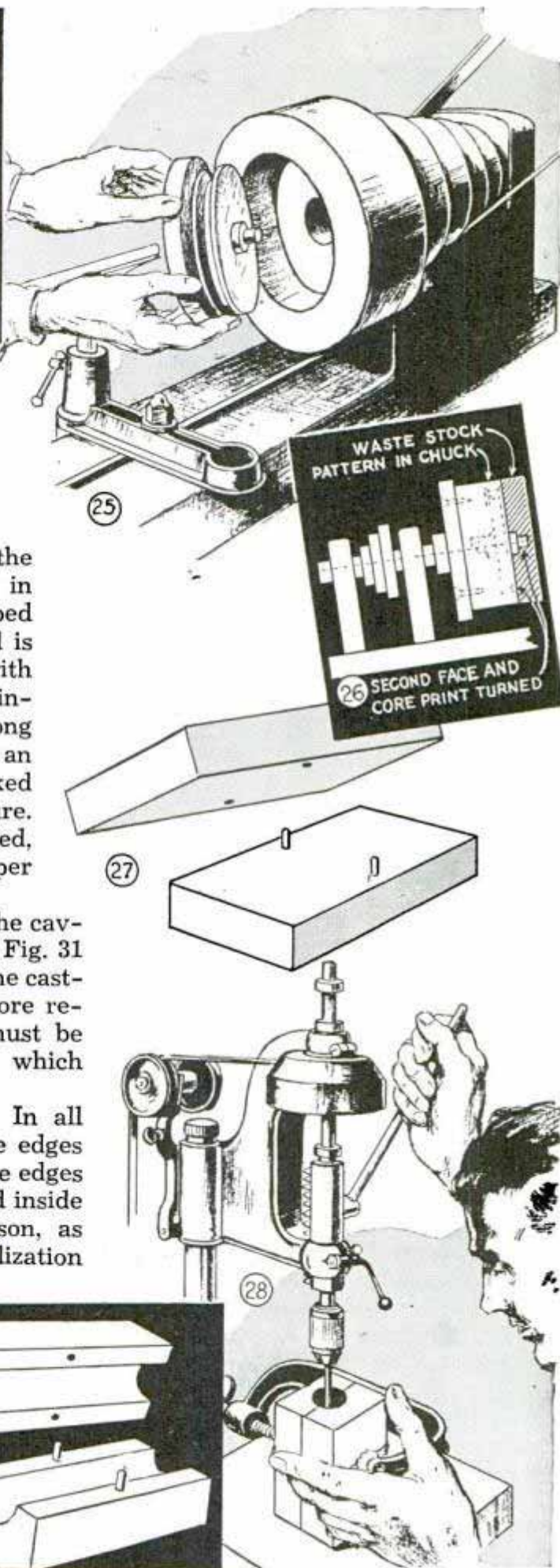

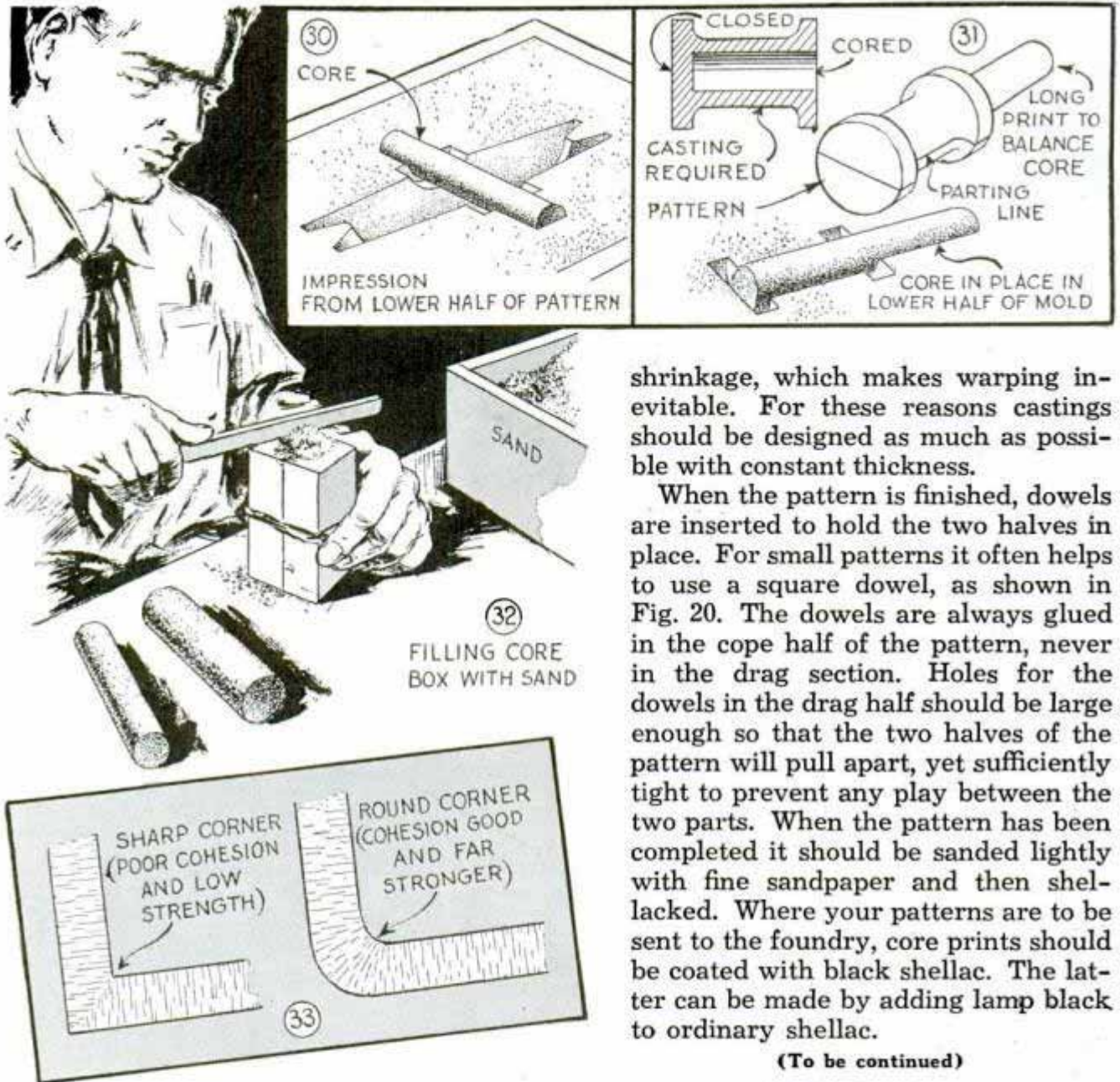

shrinkage, which makes warping inevitable. For these reasons castings should be designed as much as possible with constant thickness.

When the pattern is finished, dowels are inserted to hold the two halves in place. For small patterns it often helps to use a square dowel, as shown in Fig. 20. The dowels are always glued in the cope half of the pattern, never in the drag section. Holes for the dowels in the drag half should be large enough so that the two halves of the pattern will pull apart, yet sufficiently tight to prevent any play between the two parts. When the pattern has been completed it should be sanded lightly with fine sandpaper and then shellacked. Where your patterns are to be sent to the foundry, core prints should be coated with black shellac. The latter can be made by adding lamp black to ordinary shellac.

(To be continued)

there is a gradual change in the direction of the crystal axis, and the strain is far less, resulting in a stronger casting. This is a matter which should be considered in designing an article for casting. In making the pattern, the outside corners are simply rounded off. Inside corners can be made sharp if more convenient, and then filled back with fillets.

Another point to remember in designing articles to be cast is to have as few changes in thickness as possible. Whenever a change in thickness is necessary the change should be made as gradual as possible. Thick and thin sections of the casting will not cool at the same rate and consequently distortion is likely. Moreover, where the difference in thickness is considerable, there actually will be a difference in the

How to Unravel Stitches Quickly When Opening Cloth Sack

When you wish to open a sack of any kind so that the full width of the cloth may be used for some other purpose, simply turn the sack inside out, and with the double stitch to your right, cut the third stitch on either side of the sack with a sharp knife. Then by pulling the ends of the severed string, the sack may be opened.

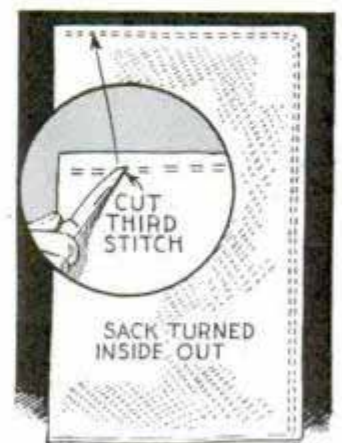

Motorized Switch Flashes Lights in Sequence

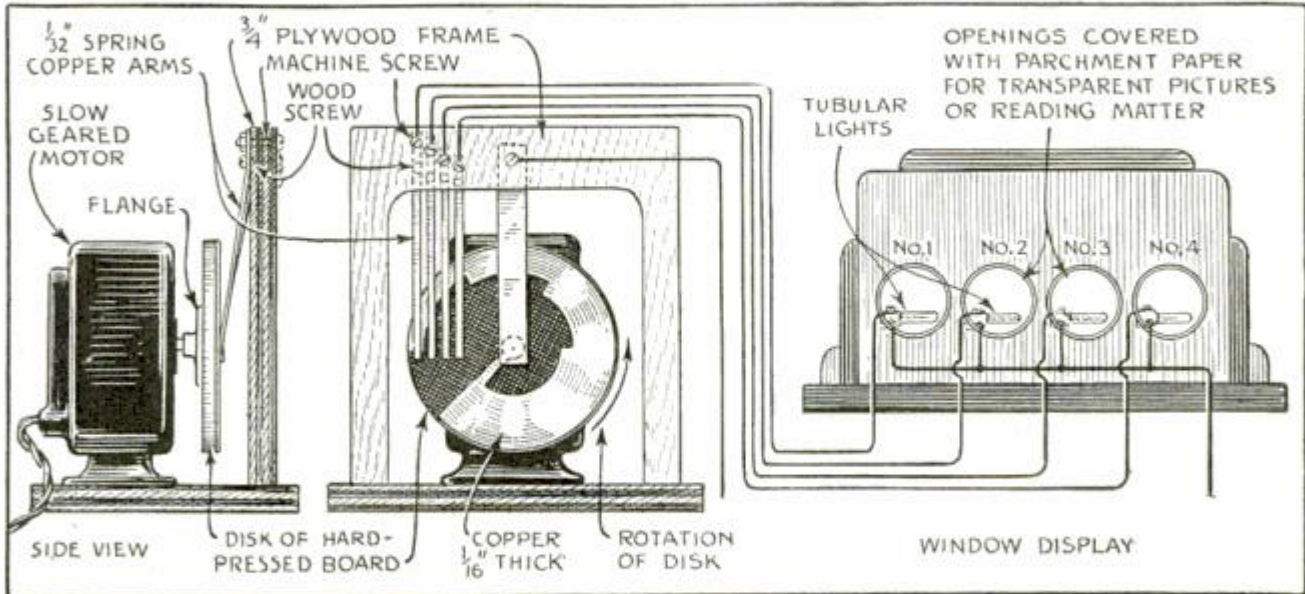

An eye-catching window sign can be made to spell out a single four-letter word, or it will display a series of illuminated pictures or advertising copy in sequence. The display unit may be a rectangular box divided into four light-tight compartments. A single opening in each is covered with ground glass or simply parchment, and the letters or figures to be displayed are mounted behind it so they cannot be seen until a lamp inside is illuminated. In operation, the light in compartment No. 1 flashes on, then, after a short interval, the lights in 2, 3, and 4 go on in sequence. Each lamp remains lighted until all four are on. Then after another interval all four lights go off simultaneously. In a few sec-

onds the cycle is repeated. A speed-reduction motor is needed if the switch is mounted directly on the shaft, or the switch can be mounted on any speed-reducing unit driven by a motor. The two wires having unconnected ends go to the current supply to operate the lamps. For this purpose, you can use a 6-volt storage battery, providing small 6-volt lamps behind the parchment windows of the sign box. However, if you use 110-volt current in this circuit, it will be necessary to install a line filter especially designed for sign flashers to eliminate interference in near-by radio receivers. Such a filter is obtainable at most radio stores.

—Wm. H. Winkler, Pittsburgh, Pa.

Lip Above Cutting Edge of Chisel Stops Flying Metal Pieces

For cutting rivets or for making grooves in soft metal, such as copper, this chisel is just the thing because it has a lip overhanging the cutting edge that prevents particles of metal from flying. Workmen in shops where considerable hand-chiseling is done can make it easily from tool steel to any size desired. The chisel dimensioned in the detail is the size most commonly used.

—V. Vazza, Winnipeg, Manitoba, Can.

When it is necessary to prevent a number of rope ends from raveling, dip them in varnish which has been exposed to air until it is double the usual consistency.

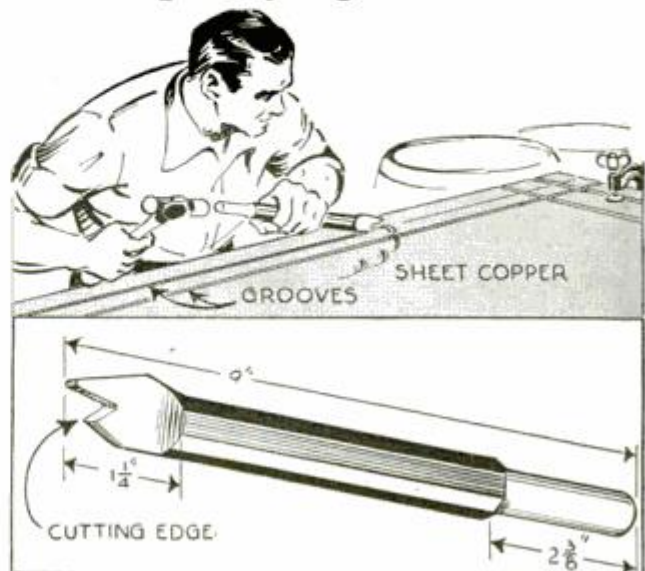

Enamel Letters on Glass Removed with Violin String



Enamel letters that have been attached to a window glass with the usual cement used for this purpose can be removed with a gut violin string without danger of breaking the glass. Just scrape away a little of the cement at the top of the letter to allow the string to rest on the troughlike space. Then apply a seesaw motion to the string, pulling downward as the cutting progresses. A little powdered rosin applied at intervals will hasten the cutting action.

This Simple Hitch Evens Pull of Unmatched Team

When a team of horses have a tendency to pull unevenly, cross the inside traces as

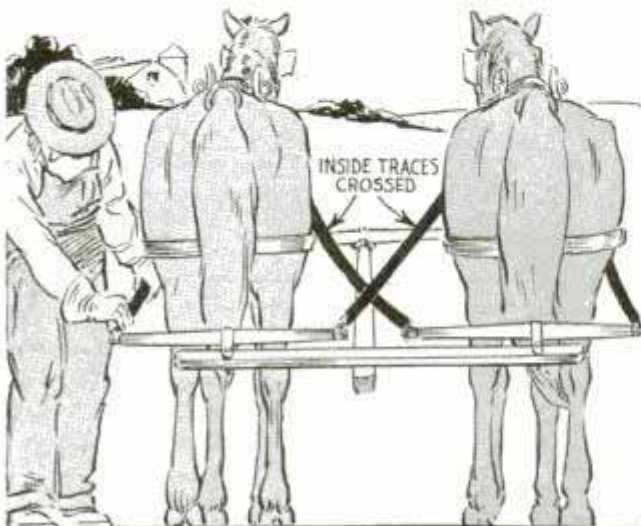

shown. According to an experienced farmer, this will result in even pulling of the team in practically every instance.

Brad Driven Through Wedge Prevents Loosening

To keep wooden wedges from loosening in ax or hammer handles, one carpenter drives a headless brad through the wedge at the approximate point indicated. When the wedge is driven into place, the brad bends and is imbedded in the handle.

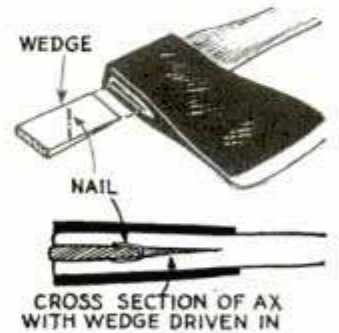

Washing Machine on Display Also Actuates Sign

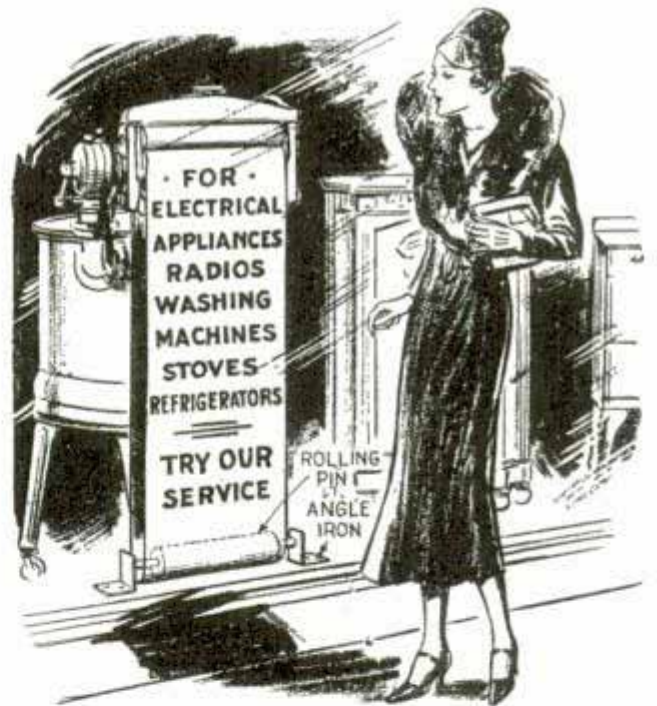

Killing the proverbial two birds with one stone, a hardware dealer utilized a washing machine displayed in his show window to actuate a sign. The latter was an endless "belt" of black oilcloth on which was printed his advertising message. To rotate the belt, it was run through the wringer rollers and over a rolling pin, which rotated between two angle-iron brackets screwed to the floor of the window. Care must be taken in aligning the rolling pin with the wringer rollers.

Slotted Wood Strip Saves Base of Miter Box

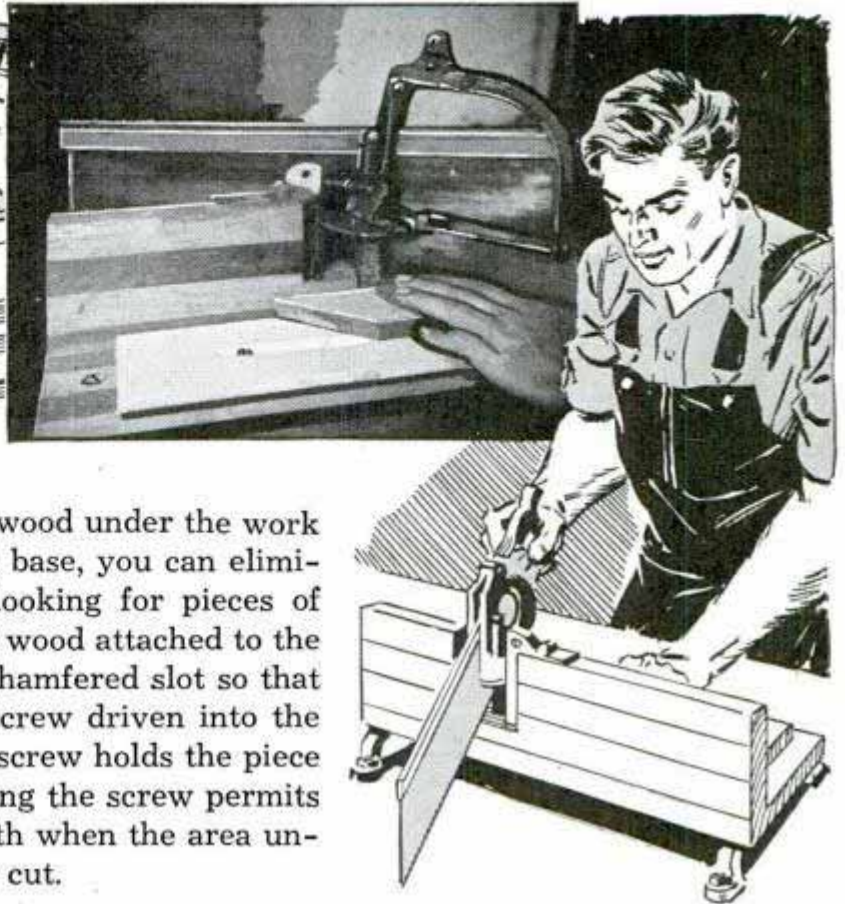
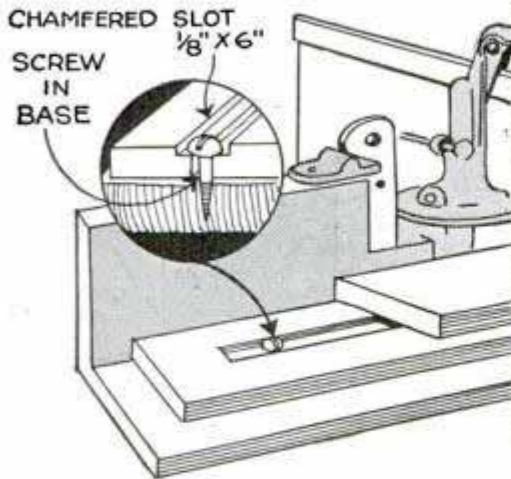

If you have to place a strip of wood under the work in your miter box to protect the base, you can eliminate the bother of constantly looking for pieces of scrap wood by keeping a strip of wood attached to the base. The piece should have a chamfered slot so that it will slide on the shank of a screw driven into the miter-box base. Tightening the screw holds the piece securely on the base and loosening the screw permits the piece to be slid back and forth when the area under the saw teeth becomes badly cut.

Muslin Impregnated with Wax Is Substitute for Glass

A farmer uses muslin impregnated with paraffin as an inexpensive substitute for glass to cover hotbeds, poultry scratch sheds and even as emergency replacements for broken windowpanes in his barns and

stock sheds. The cloth admits a surprising amount of light, is impervious to moisture or wind currents, yet allows sufficient air to filter through it to provide good ventilation. To prepare the impregnating solution, melt some paraffin. After removing it from the fire quickly stir in benzine or pure gasoline in the proportions given in the drawing. This keeps the paraffin in liquid form when cool. The consistency of the solution can be controlled by varying the amount of gasoline. The cloth is dipped in the liquid and is hung up to dry, stretching it to avoid wrinkles.



Opening Drain Outlet on Roof

When snow on a flat roof melts from the heat inside the building it often freezes at the firewall outlet drain, which is hard to free. One can save labor by inserting a piece of pipe or a crowbar into the outlet before cold weather starts. Then if water freezes in the drain just tap the pipe until loose and pull it out. Then insert the pipe into the drain again for the next freeze.

Brush and Currycomb Are Handy in Pocket on Barn Post



To keep a brush, currycomb and other accessories conveniently at hand near his horse stalls, a farmer uses a pocket made from a section of auto casing. This is nailed to a post between the stalls as indicated.

—G. E. Hendrickson, Argyle, Wis.

Sponge Rubber on Paper Backstop Aids in Mimeographing Cards

If a piece of sponge rubber is attached to the paper backstop of a mimeographing machine when printing cards, it will help

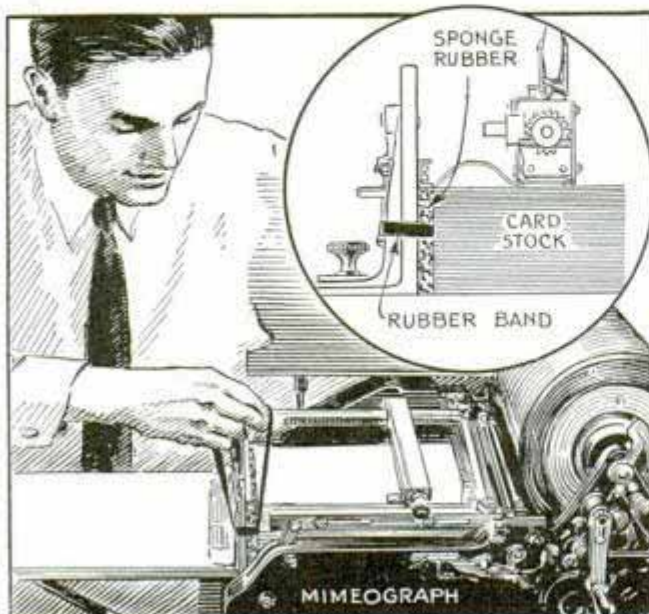

to keep them from binding and curling. A rubber band will hold the rubber in place.

—Walter F. Horan, Plainfield, N. J.

Angle-Plate Scale Saves Time

When layout work is done by means of a scribe and an angle plate, a scale attached to the latter will save time. The scale is doweled and screwed to plate at right angles to the base so that the zero mark coincides with the base surface. In use, the work is clamped parallel to the rule. Any lines to be scribed can be set directly from the scale and laid out on the work.

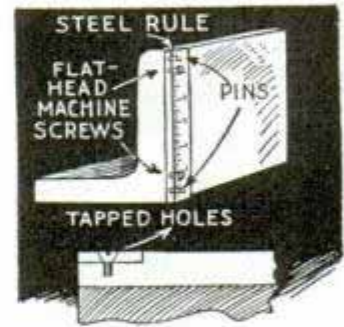

Centering a Hole in Round Work

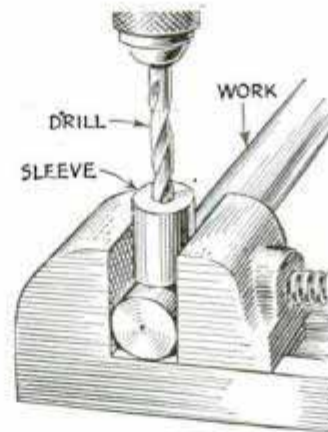

in a vise as indicated, the drill is fed through the sleeve, which acts as a guide.

Keeping the Bristles of Brushes Shaped for Show-Card Work

After using show-card brushes, clean them, shape the bristles, clamp them in a paper clip of the type shown and hang them up. When needed next time, the brushes will be shaped and ready for use.



BLAST BURNERS

you can make

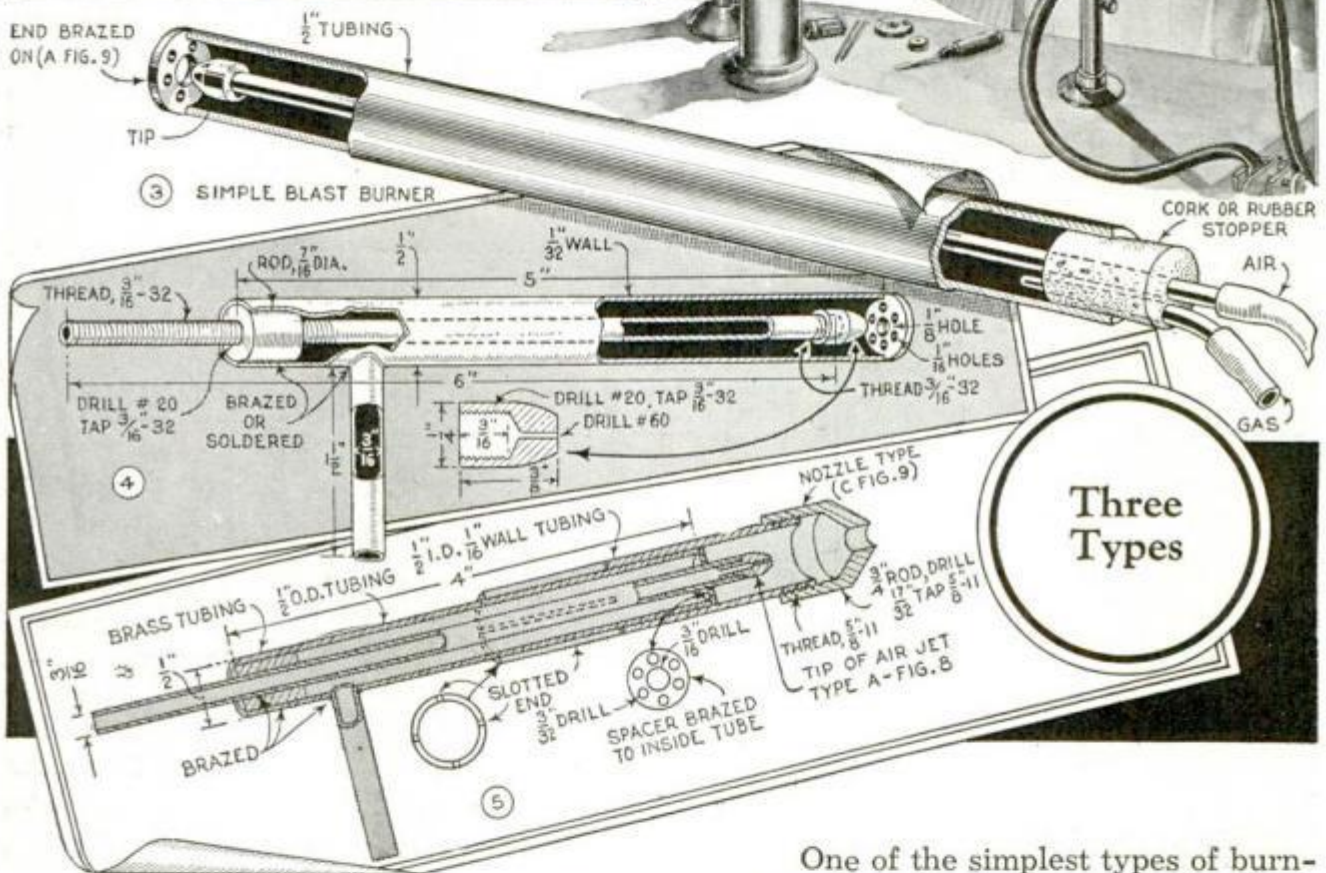
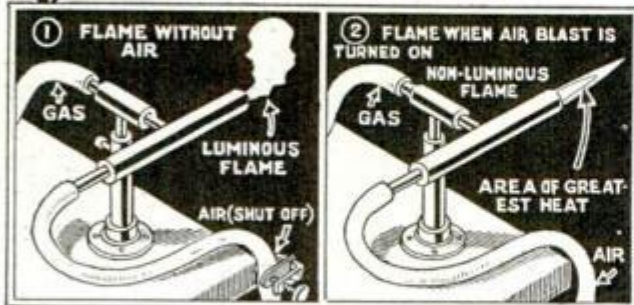

AN INEXPENSIVE blast burner is just the thing in a small shop or home workshop for soldering, light brazing jobs and for heating glass for bending. In fact, the concentrated, intensely hot flame produced by the burner makes it suitable for many jobs where a high temperature is required. Anyone can make one from brass rods and tubes. The principle of a blast burner is shown in Figs. 1 and 2. Gas is fed into a large tube and is burned at the end of the tube. Compressed air is fed by a nozzle into the heart of this flame, producing a concentrated, high-temperature flame that is non-luminous.

One of the simplest types of burners to make is shown in Fig. 3. A washer of suitable size is soldered or brazed on one end of a length of brass tubing, and a cork or rubber stopper is inserted at the other end. The gas is fed through a tube inserted in one hole in the stopper and the air is fed through another tube, which is centered in the stopper, extends the entire length of the tube and has a tip threaded or brazed on the end as in Fig. 8. A cork stopper can be drilled with a piece of brass tubing ground to a knife-edge at one end. In drilling a rubber stopper, the tube should be lubricated with a strong sodium-carbonate (washing soda) solution.

A more elaborate type of burner is shown



Here, type C has the advantage of being interchangeable. This is simply a matter of preference, as proper adjustment will make each satisfactory.

A third type of torch is shown in Fig. 5. In this torch the position of the air jet is fixed, as the air tube is brazed or soldered to the barrel at the end. Also note that it is centered permanently by means of a spacer in the inner barrel. Adjustment of the flame is accomplished by sliding the outer barrel, which carries the nozzle, up or down on the inner barrel. The nozzle for this type of torch can be any one of the types shown in Fig. 9. Additional tips for the air jet, drilled with holes larger than No. 60, and additional nozzles for the barrel can be

provided to give a variety of sizes and types of flames suitable for all kinds of work.

When the torch is completed, it should be mounted on a base of the type shown in Fig. 7. The air and gas inlets can be fitted with small petcocks, such as can be bought at any hardware store, or the rubber tubing carrying the air and gas can be fitted

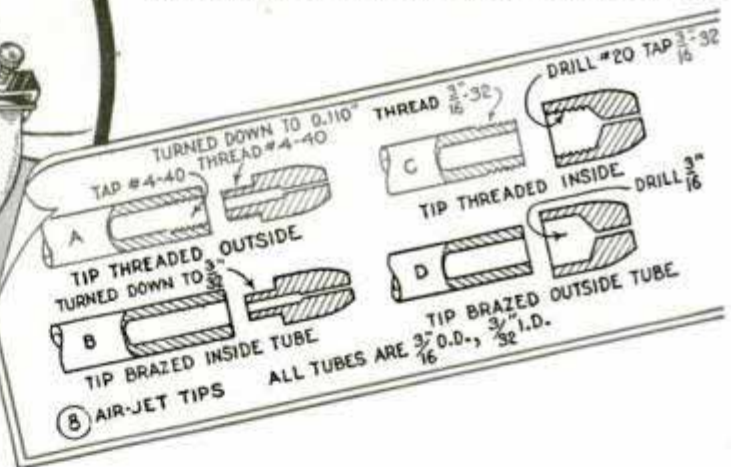

in Fig. 4. A piece of seamless brass tubing is used for the barrel. Near one end a piece of small-diameter brass tubing is soldered or brazed into the barrel, forming a side arm for the gas to enter. The other end of the barrel is fitted with a $\frac{1}{2}$ -in. brass disk or washer as shown for the burner in Fig. 3. This should be brazed on. The air jet is fitted to the barrel and can be of any of the types already mentioned. If preferred, the air tube can be a sliding fit in the plug, instead of being threaded. It is best to make the tip removable, so that jets of various sizes can be provided for different types of work. The type shown at A, Fig. 8, is probably the best to use. Also, the barrel can be fitted with one of the other types of nozzles shown in Fig. 9.

with small clamps. If desired, you can make these from thin flat iron, which is drilled and tapped at one end to take a thumbscrew, then bent to a wide U-shape. A short piece of the iron notched at one end to straddle the back part of the U-shaped piece "floats" under the thumbscrew end to prevent puncturing the tubing. The torch should not be attached permanently to the base, as it frequently will be more convenient to carry it to the work. A hardwood block cut from a piece of 2 by 4-in. lumber provides a good base. If this is just heavy enough to keep the torch from tipping it can be carried about easily and set down wherever the torch is needed. The torch should be attached to the gas and air outlets with good grade of rub-

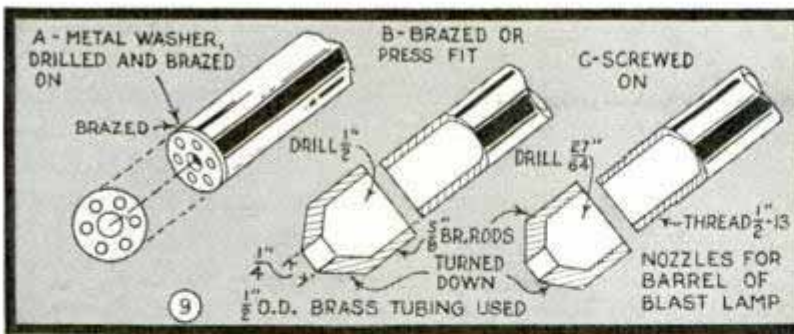

ber tubing. In use, the gas should be turned on first and ignited, then turned down until a fairly small flame is produced, as shown in Fig. 1. The air then should be turned on slowly and the position of the air jet adjusted until the flame appears as shown in Fig. 2. Various flames and their faults are illustrated in Fig. 10.

The use of the torch for brazing is illus-

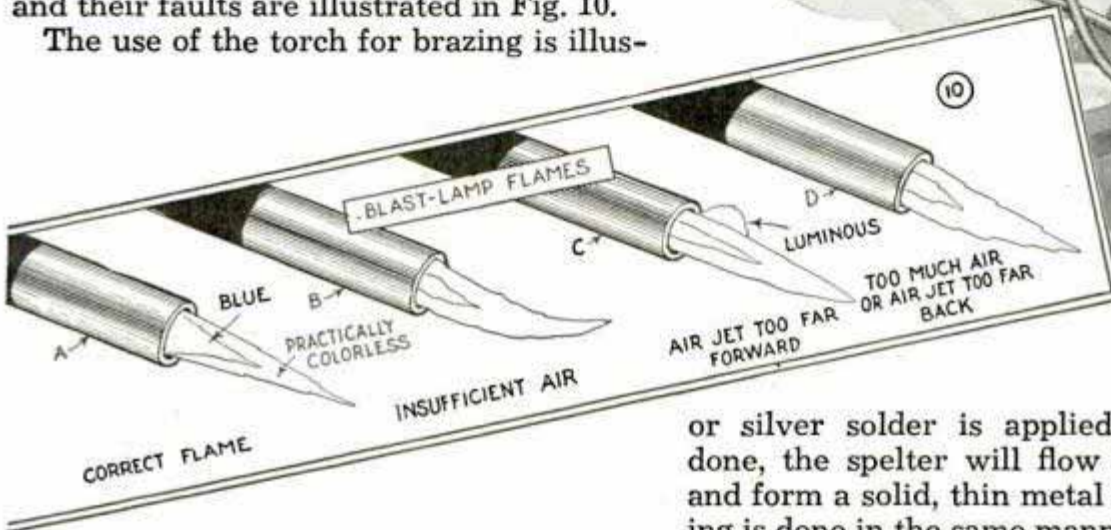

trated in Fig. 6. The work should be heated with the torch and the flux applied. Heat is continued until the work is at the proper temperature and then the spelter

or silver solder is applied. If properly done, the spelter will flow into the joint and form a solid, thin metal joint. Soldering is done in the same manner except that heating is discontinued just before the solder is applied. If you are inexperienced in this work, it may take a little practice to become efficient.

Gummed Tape Aids in Laying Out Work on Sheet Metal

When laying out long sections of sheet metal that are to be marked for accurate punching, a tinsmith puts strips of gummed-paper tape on the metal and marks the locations to be punched on the tape with a pencil. The marks are easy for the workman to see, and if corrections are necessary, they can be made without marring the work.

Paraffin can be used to lubricate a drill when drilling aluminum. Also when finishing aluminum patterns which have been scraped and filed to shape, rub paraffin on the sandpaper. It prevents clogging and allows the paper to cut cleanly.

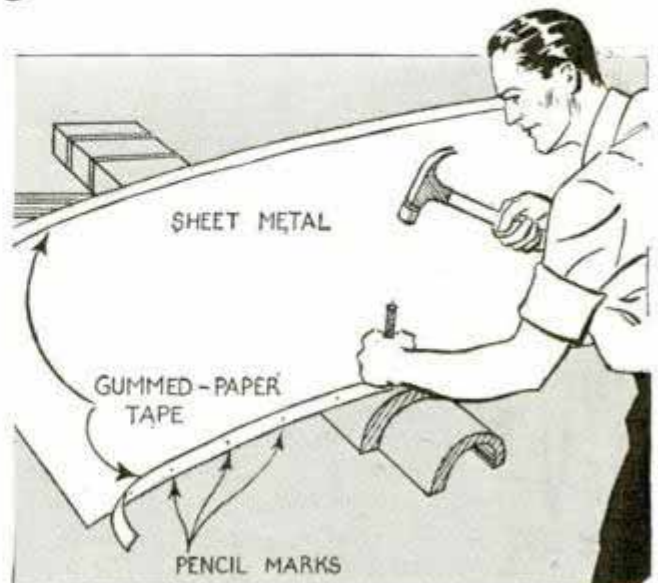

Celluloid Guards on Car Door Protect Upholstery



If the upholstery of your car door near the bottom is soiled and scuffed, clean it thoroughly and then tack a piece of celluloid over it as indicated. The celluloid will hardly be noticeable and if soiled by dirt from the shoes, can be cleaned with a damp cloth.

Truck Endgate Swings Downward to Serve as Step

This endgate automatically swings downward to serve as a step when it is opened. The T-shaped bars that support



the endgate are suspended from swivel rings, the enlarged ends of the bars providing the stops. Bolts projecting from the truck body as indicated keep the step in a horizontal position. Hooks that hold the gate closed are mounted inside the body to avoid interfering with its operation.

Late Model Hub Cap Raises Tire for Easy Attachment of Chains

Carry a deeply cupped hub cap in your car and you will find it handy to raise a wheel when putting on chains. Just lay the chain over the cap and move the car so that the tire rests on the cap. It is better if the tire rests a little off center on the cap. This will allow you to stretch the chains tightly and fasten them in place without using a jack.



Vacuum Cup Covers Door Lock to Avoid Freezing

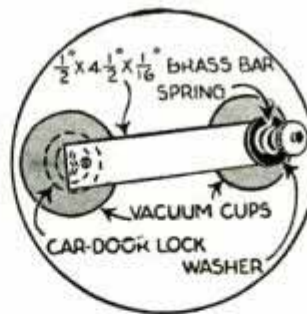

Annoyance of having water freeze in his car-door lock was avoided by a motorist who covered the lock during cold wet weather. Two vacuum cups

fastened to a brass strip were used, one to cover the lock and the other to stick to the side of the door. The latter cup was fitted with a small coil spring, as shown, so that tension would be applied to the other cup to press it tightly over the lock.

—A. J. Dunlap, Calumet City, Ill.

Quieting Noisy Hood Fasteners

If a hood fastener on a Ford becomes noisy and works hard, pack the spring inside it with good grease, and oil the shaft that runs through the hood on the handle. This will stop the noise and make the hood much easier to open and close.

—H. Thomas Winston, Claremont, Va.

AUTO SHORTCUTS

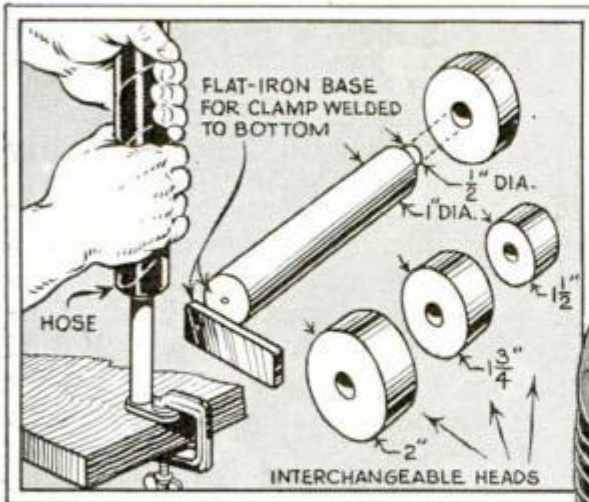

Right, warm air from radiator forced through tube by fan to keep truck windshield defrosted in extremely cold climate where usual types of defrosters do not supply sufficient air volume. Above, jig to remove or replace insert-type of thermostats from radiator hose. Interchangeable heads adapt the jig to hose of various diameters. It is held in a vise or clamped to a bench, and the hose pushed down over the head to force out the thermostat

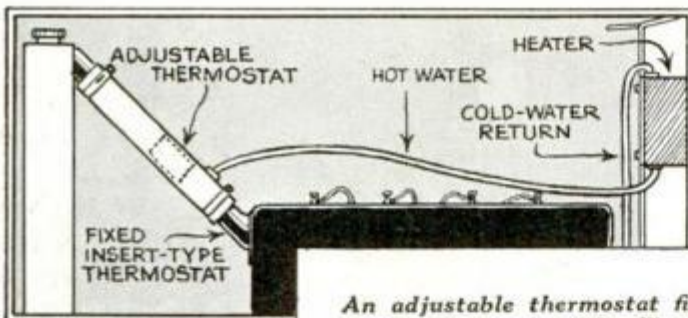
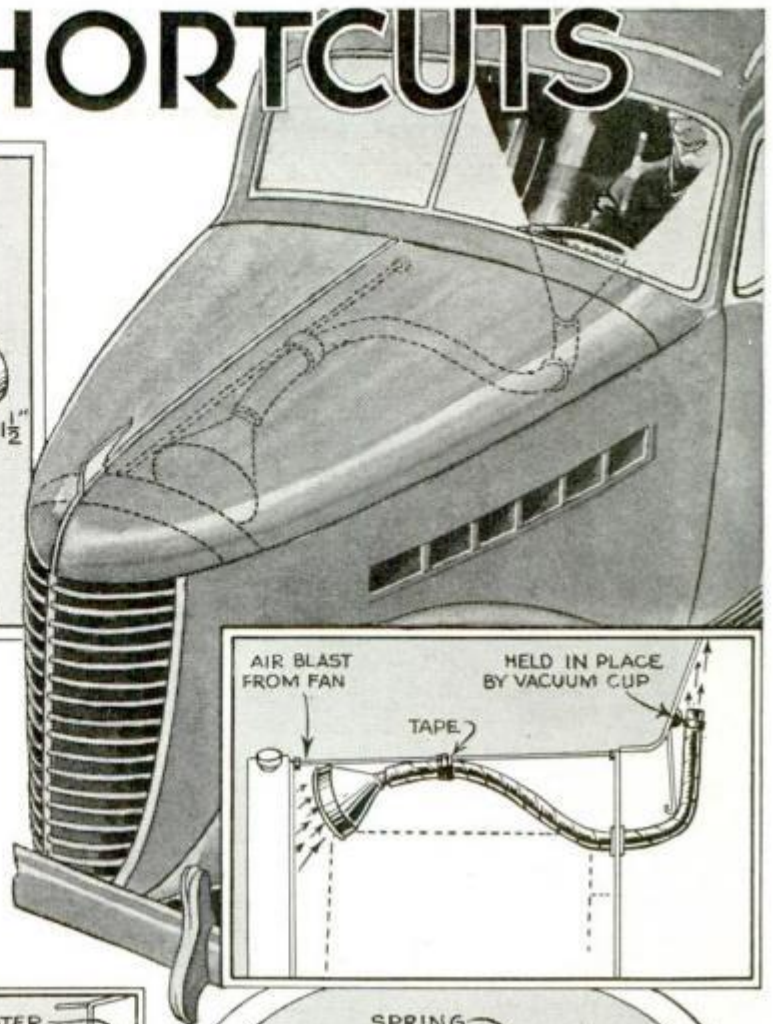

An adjustable thermostat fitted in radiator hose above the regular "fixed" thermostat, provides hotter water for heater. To assure good contact of the copper strip on a new distributor breaker arm, be sure to fasten it by soldering or by inserting it behind the spring as shown at the right

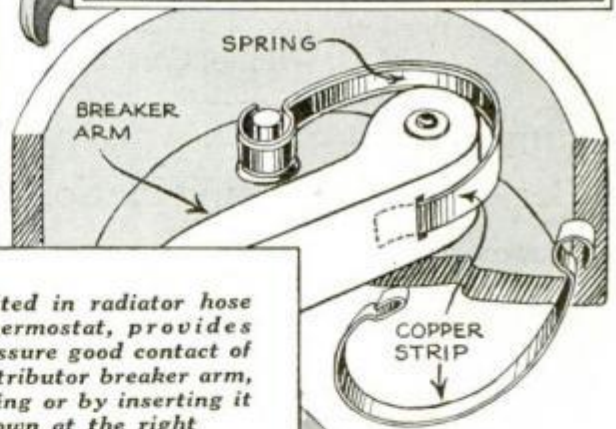

A good electrical ground connection on a fog lamp can be had by sanding the surfaces of both the bracket and bumper brace at the point of contact and inserting a thin lead washer as above. Right, frozen lock on trunk is thawed by means of a hot cigar lighter

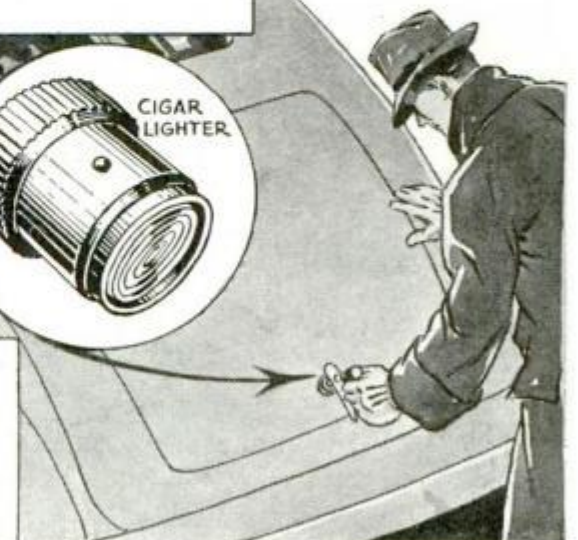

Rubber Shield on Bumper Guard Protects Chromium Finish

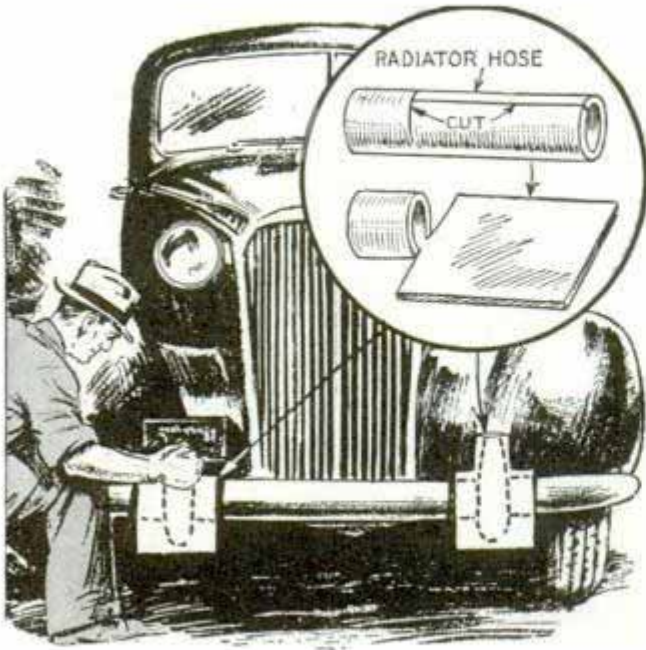

To keep my bumper guards from being scratched when pushing another car or when my car is being pushed, I made shields from short pieces of large radiator hose. These were cut as indicated in the detail and quickly slipped over the guards whenever needed.

—W. C. Wilhite, Carlinville, Ill.

Bell-Warning System Aids Truck Backing into Loading Platform

Stretched from 3 to 5 ft. in front of a loading platform, a rubber-hose signal system of the type used at many filling sta-

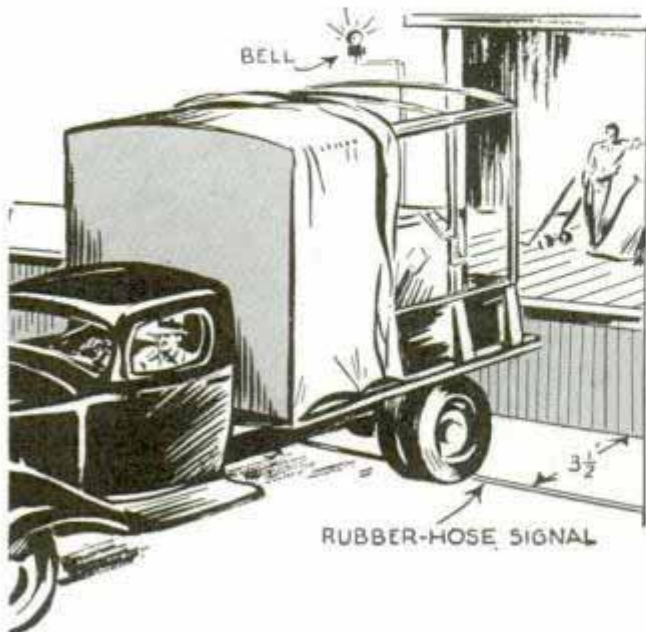

tions will save time for truck drivers. When the rear wheels pass over the hose, the bell sounds so that the driver knows he is close to the platform. This enables him to back quickly until the warning is given, then ease up to the platform.

Bleeding Hydraulic Brakes Easily

When it is necessary to remove the master cylinder of a hydraulic-brake system, I find the following method a timesaver in bleeding it on some cars. After the cylinder has been reinstalled, fill it with fluid and remove the stoplight switch from the cylinder housing. Then pump the brake pedal slowly until fluid pushes all air out through the stoplight hole and fluid is coming out. Screw the switch back in place while the fluid is running, to avoid letting air enter. This will remove the air from the lines without bleeding the wheel cylinders.—John C. Albin, Columbus, Kans.

Oily Waste Lubricates Springs Close to Car Frame

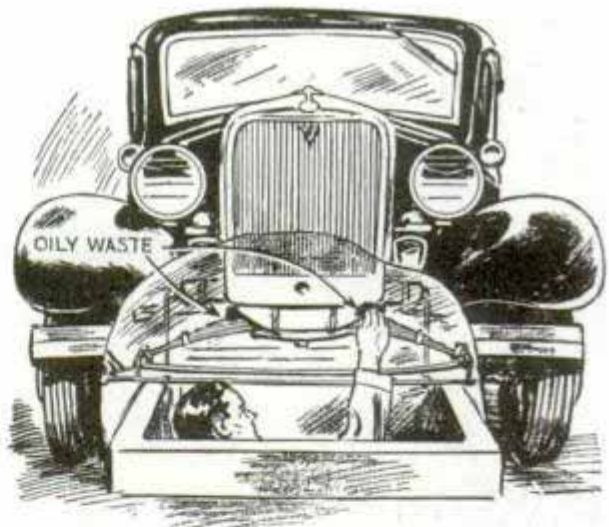

If you have trouble keeping the springs lubricated to avoid squeaks where they are attached to the car frame, soak waste with oil and force it snugly in place between the spring and frame. Oil will be squeezed from the waste by flexing of the springs, and keep them lubricated.

ⓘ Sometimes it is suggested to use aluminum rivets to install brake lining, but it is best to use brass ones. If aluminum rivets are used, heat caused by friction will harden them and they may score the drums.



**OUTDOORS
IN SUNLIGHT**

*...and it's hard to say
which is better*

**INDOORS
AT NIGHT**



NIGHT SNAPSHOTS SIMPLE AS A-B-C with **KODAK SUPER-XX FILM**

EVEN in the hands of a beginner, Kodak Super-XX Film, four times as fast as ordinary film, gets excellent indoor snapshots under Photoflood lamps. The pictures come out every bit as good as though they had been taken outdoors under a

summer sun. To give outdoor excellence to your indoor snapshots, use Kodak Super-XX always. (You don't need an expensive camera to make snapshots indoors after dark; you can use any one at all that takes Super-XX, even a \$1 Brownie.)



A ... Load your present camera with Kodak Super-XX Film



B ... Use a couple of inexpensive Mazda Photoflood lamps in Kodak Handy Reflectors



C ... Follow the few simple directions in the FREE Booklet

A few minutes with this helpful booklet and you're headed for splendid nighttime snapshots. Photos, diagrams, easy-to-understand directions. At your dealer's . . . Eastman Kodak Company, Rochester, N. Y.

Counting Noses

(Continued from page 249)

whether the home is owned free or is encumbered with a mortgage or is rented. The answers will provide information valuable to business, industry, real-estate operators and to the government agencies.

On the basis of the Indiana test the trailer dweller who happens to be in a certain state with no fixed residence elsewhere will be counted as a resident of the county in which he is "found." This means that, though the license plate on the trailer may read "California," "Maine," "Texas," or some other state, the "trailerite" will be enumerated as of "Cook County," Illinois, if, at the time of the census he is parked in that county.

To meet the assembly and classification problem of all this new data, stupendous beyond measure, the Census Bureau has perfected new mechanical apparatus. First is the breakdown of the country into "digestible" districts and the allocation of workers to these districts. There will be approximately 140,000 of these districts with individual maps for enumeration purposes. This meticulous map preparation is for the purpose of avoiding any overlapping of activities by enumerators and also to insure that not one square foot of the country will be missed.

The next stage will be the selection, training and equipping of the 140,000 enumerators who will visit every home, every farm, every factory and every place of business. Each enumerator will be given letterheads, envelopes, pencils and an instruction book, daily report blanks, schedules, a record book, a map and a detailed description for personal use.

Not until the enumerators are thoroughly grounded in the mechanics of the work they are to do will the actual census taking, or counting, be undertaken. And then it will be done very swiftly for the law calls for the job to be finished within thirty days. In the cities only two weeks will be allowed for the task.

The very minute that an enumerator has finished his count he will turn it over to his district supervisor who will check it for accuracy, after which he will rush it by mail to the Census Bureau in Washington.

Here a veritable beehive of robots and humans will set to work digesting the mil-

lions of important facts feeding into the giant Washington hopper. Something like 8,000 workers will wield 328,000 pencils over the mass of material descending upon the Census quarters, 600 typewriters click off data, 468 adding machines and 300 calculating machines. To estimate the amount of paper that will be consumed in this gigantic assembling and classification job would be impossible. It will run into countless reams.

Of the new robots that will be on the "front" the most interesting and spectacular will be the recently developed "census sorter." This machine has almost human intelligence in that it can sort into proper classification groups 300 census data cards per minute. Some forty odd of these machines will hammer away at their task during the height of the count. Another device is the semi-automatic population punch. This machine somewhat resembles a tiny typewriter with numerical keys from zero to nine. It punches holes in the schedule cards to record important population data. Its average production is 200 to 300 cards per hour. Some 800 of these devices will be used in the 1940 census.

The verifying machine will also render "human aid." It determines at once whether the population machine has cut the proper hole in each card. If a hole has not been cut where it should be the verifier refuses to move forward, simultaneously marking the error so the operator can correct his mistake immediately.

The last of this "machine intelligentsia" is the gang punch, devised by Bureau technicians. This machine has the special job of punching certain specific information on the census cards, such as state and county data. It can punch over 100,000 cards a day and is also valuable in checking the number of cards punched for the states, counties and cities.

The 1940 population count will reveal the many changes that have occurred in our social and economic life during the ten eventful years since the last census was taken in 1930.

☐ Send return postage to our Bureau of Information to learn the name of the maker of any device described in this magazine.

DON'T RISK ACCIDENTAL ROLL BACK of YOUR CAR or TRUCK!

NoRoL

HOLDS CAR on HILL STOPS

You probably have often wished for a device that would automatically prevent unintentional back-roll when car is brought to a stop on an incline . . . Such a device is available. It is called a NoRoL. It isn't expensive . . . It is easily installed . . . Is 100% automatic in operation—and should outlast the car.

NoRoL gives you a "third foot"—doing brake duty against back-roll on inclines, while right foot is left free for accelerator duty. Eliminates fatigue and frazzled nerves when you are driving in congested traffic in hilly country or on city streets . . . Does away with chance of back-roll on uphill start which might result in breaking axle shaft . . . Prevents unnecessary wear on clutch facings . . . Also lessens chances for clashing or breaking of transmission gears.

When ordering a new car, insist that it come complete with a NoRoL figured right in with the time payments. NoRoL is available for new models of—

- | | | | |
|-----------|------------------------|------------|---------------|
| BUICK | DE SOTO | LA SALLE | PLYMOUTH |
| CADILLAC | DODGE | NASH | PONTIAC |
| CHEVROLET | GRAHAM | OLDSMOBILE | STUDEBAKER |
| CHRYSLER | HUDSON | PACKARD | INTERNATIONAL |
| | WHITE, MACK and others | | |

Also available for many 1936, 1937, 1938 and 1939 makes and models of cars and trucks.

Many Models Only \$12.00 installed
SEE YOUR CAR DEALER—or write us



HERE'S HOW IT WORKS

When stopping on any incline, no matter how steep, you simply apply the brake and disengage the clutch in the usual manner. An automatic check retains the hydraulic pressure in the braking system which was developed when the brakes were applied. This hydraulic pressure holds the brakes applied as long as the clutch pedal is held depressed, enabling the driver to take his foot off the brake pedal and use it for accelerator duty . . . thus making it unnecessary to keep his right foot on the brake pedal while the car is stopped. It's like having a third foot.

Wagner Electric Corporation

(Manufacturers of Lockheed Hydraulic Brakes) N89-6

6400 Plymouth Avenue, St. Louis, Mo., U. S. A.

Send FREE BOOKLET and details on NoRoL

NAME _____

ADDRESS _____ CITY _____

STATE _____ MAKE AND MODEL OF MY CAR IS _____

I'M GLAD I BOUGHT AN IDEAL LAWNMOWER SHARPENER AND WENT INTO BUSINESS FOR MYSELF . . .

YOU, TOO, CAN HAVE A PROFITABLE BUSINESS OF YOUR OWN . . .

Our free plans show you how to build a successful business of your own sharpening lawnmowers. Most men earn up to \$25 a week, even in spare time. Howard Hellen, Minn., writes, "I sharpened 745 lawnmowers, sold 60 used mowers and grossed \$1100.00 from April 5 to Sept. 15." Roy F. Stier, Wis., writes, "I paid for my Ideal Sharpener in exactly 36 days." Like magic, the Ideal Lawnmower Sharpener makes old, dull, badly worn mowers cut like new. Simply set the mower in the Ideal, make a few simple adjustments and the machine does the rest. Sharpens any mower to perfect edge in 15 to 20 minutes—usual charge \$1.00 to \$1.50. Attach to light socket. Start in your basement or garage. Work spare time or full time. Attachments for grinding skates, grass shears, hedge shears, sickles, scythes and axes. FREE CATALOG tells complete story.

THE FATE-ROOT-HEATH CO.
240 Bell Street Plymouth, Ohio



Make Money! SHARPEN LAWNMOWERS THE "IDEAL" WAY!



Linoleum top converts table for practical kitchen use!

Size table top with one coat of CASCO. Sand when dry. Apply second coat and roll or iron linoleum or oilcloth onto top.

For details, send coupon below for free CASCO GLUING GUIDE. Gives dozens of practical household gluing hints.

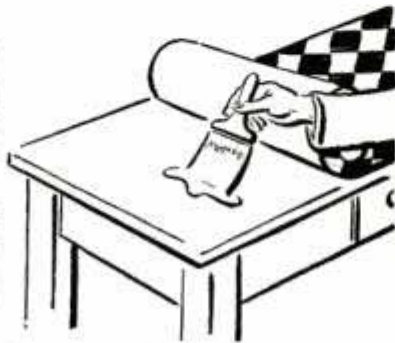

Here's *one* glue that does *many* jobs! Because you mix CASCO, you can mix it to just the right consistency for *any* materials—and make joints that resist heat, moisture, rough handling.

CASCO is easy to use. No heating. No mess. Just add water and mix. You get the same clean, easy-spreading glue that leading furniture manufacturers and wood-workers use for *permanent* joints. 10¢ to 65¢ at hardware stores.

NEW ODD-JOB CEMENT

Used by big industries, now in handy tubes for home, school, office. Sticks wood, felt, fabric... to metal, plastics, glass. Doesn't "gum" on fingers. Large tube, 25¢ at hardware stores.



FREE Handy Workshop Folders

CASEIN COMPANY OF AMERICA, Dept. PM-240
350 Madison Avenue, New York, N. Y.

Please send me free folders checked below:

- HOME WORKSHOP HANDBOOK. Tells where to get free and low-cost booklets on every workshop subject.
- GLUING GUIDE. Complete gluing directions and 70 successful home uses for CASCO GLUE.
- PROJECT FOLDER. Descriptions of 24 popular projects available in plan form to CASCO users.
- CASCO FLEXIBLE CEMENT FOLDER. Directions, suggestions for home, school and office.

Name _____

Address _____

-----Save 2c. Stick coupon on penny postcard-----

Making Better Home Movies

(Continued from page 254)

the film must also be turned over in projection, since the perforations are only on one side.

To make a title arrange itself on the screen, lay the title letters in place on a horizontal board and train the camera down vertically. While the camera is running, blow the letters away gently. When the processed film is turned end for end to make it run backward the letters will appear to move together and assemble themselves into a title. Other variations will occur to you such as having the pieces of a newspaper fly up from the ground and arrange themselves into a whole newspaper in a man's hands, a stunt that is made by turning the camera upside down and filming the man as he slowly tears the paper into shreds and drops them. Shooting backward makes water appear to run uphill or rocks fly up to your hand.

The most important single accessory you can add to your camera is an effect box that helps you perform dozens of professional tricks. The effect box can be described as a rigid overgrown sunshade extending out from the lens and at the front of which is a slot in which black cardboard shapes can be placed to mask off part of the scene. Cut-out masks in the shape of circles, keyholes, or binoculars placed in front of the effect box make appropriate borders for scenes.

An old camera bellows extending large end out from the lens makes a good effect box and an even simpler one is a tin can at least two inches in diameter, with a small hole in one end through which the camera lens fits and the other end open with guides fitted to it so that masks may be placed in front. The inside should be painted black, the box should be rigidly attached to camera or tripod, and it should be lined up with the lens and camera.

To make a double exposure such as a girl holding an animated conversation with herself, use a black mask in front of the effect box that cuts the scene in two. Place two chairs facing each other in the foreground of the scene and with the mask on the left side of the effect box film the girl as she sits in the right-hand chair, smiling and chattering as she faces the other chair. Wind the film back to the start, move the

2952

mask over to the right side of the box, and re-film the girl on the same film as she sits and acts in the other chair. If the camera has no wind-back attachment it may be taken to the darkroom, unloaded, and re-packed by hand, although it is difficult to keep track of the footage this way. Naturally, all such double exposures must be made with a tripod, and the camera must register exactly the same field of vision in the view finder with each exposure. Care must be taken to line the masks up exactly so that the two scenes on the same film neither overlap nor leave a gap.

A freak type of double exposure that convulses the audience is to make up a friend as a clown. Have him hold his head perfectly still and roll his eyes wildly. Shoot only half of his face, screening off the other half with a mask in the effect box. Wind the film back, move the mask across and then shoot the other side of his face while he holds his eyes still or slowly turns them up and down. The effect on the screen is that the clown has independent control over each eye.

You can hide half a dozen friends behind a thin tree by centering the tree in the camera scene. Photograph the left half of the scene, including half of the tree, with the right side of the film masked off. Wind the film back, mask off the left half of the scene, and have the actors walk across behind the tree toward the right. Since their images won't register on the film until they emerge from behind the tree the effect is that they were all concealed behind the thin sapling.

For years Hollywood has used "glass shots" to screen out undesired backgrounds or to add scenery that doesn't exist. If you are filming a camping scene in the backyard and prefer a background of trees and mountains instead of fence and garden, place a sheet of window glass in front of the camera, far enough away for it to be in focus with the rest of the scene. About forty inches is right for most eight millimeter cameras. While you look through the finder, direct an assistant in tracing with a china pencil an irregular line on the glass that cuts out the undesired background. Outside of that line paint on the glass the scenery that you wish to show on the film, using oil paints and remembering that distant objects should be small. The

(Continued to page 118A)

New in Design! Greater in Value!

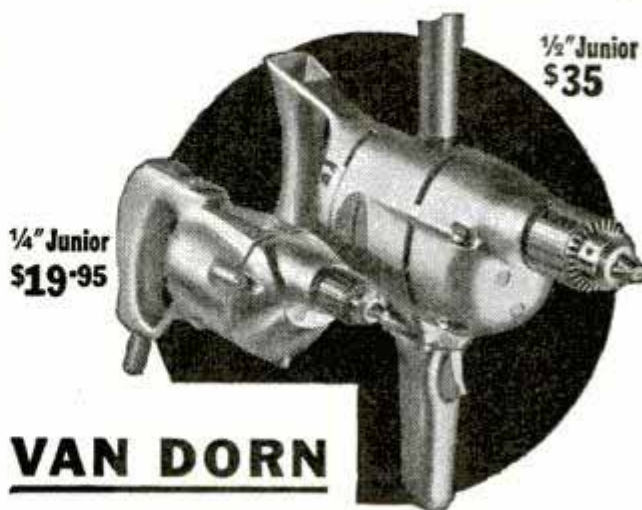

VAN DORN

JUNIOR DRILLS

These brand-new $\frac{1}{4}$ " and $\frac{1}{2}$ " Van Dorn Junior Drills offer the power, ruggedness, perfect balance and superior points of construction usually found only in higher-priced drills. For "general-purpose" drilling—in small shop or large plant, these two new drills can't be beat for value or performance.

Check these fine-tool features: oil-less sleeve bearings; compact gear-train arrangement permits reduction in length and weight; minimum spindle offset facilitates drilling in "tight spots;" chucks are *threaded*, not pressed on; improved cord clamps and cord protectors . . . and on the $\frac{1}{2}$ " model, a new motor with 20% more power and 40% more torque, plus removable commutator end cover to facilitate inspection and servicing.

Don't delay—mail the coupon now for descriptive circular. Van Dorn Electric Tools (Division of Black & Decker Mfg. Co.).

Van Dorn
THE "RED-HEADED"
PORTABLE ELECTRIC TOOLS

MAIL COUPON TODAY!

Van Dorn Electric Tools, 602 Joppa Rd., Towson, Md.
Please send circular on new Junior Drills, also name and address of nearest Van Dorn dealer.

Name.....

Occupation.....

Address.....

City..... State.....



FISHING TACKLE

at LOW Prices

Send today for New 1940 Catalog listing thousands of bargains in Fishing Tackle, Baseball, Basket Ball, Golf, Tennis, Archery, Guns, Clothing and Sporting Equipment of all kinds. Top quality—**Money Back Guarantee!**

HERE ARE A FEW MONEY-SAVERS

- \$17.50** Bamboo Fly Rod, Alu. Case & 2 Tips **\$8.95**
\$9.00 DeLuxe Split Bamboo Fly Rod . . . **\$4.95**
\$4.00 Split Bamboo Bait Rod, 9½' extra tip **\$2.85**
\$3.00 1-pc. Steel Casting Rod, Offset handle **\$1.89**
\$2.75 1-pc. 3½' Split Bamboo Casting Rod **\$1.79**
\$3.75 Automatic Fly Rod Reel, light weight **\$2.29**
\$6.50 Feather-weight Bamboo Fly Rod, 7½' **\$3.95**
\$5.00 Double Tapered 30-yard Fly Line . . **\$2.95**
\$1.00 doz. assorted snelled Trout Flies doz. **49¢**
\$1.00 doz. Ringed Trout & Bluegill Flies doz. **49¢**
\$1.00 assorted 6 floating Bass Bugs, 1/0 hook **59¢**
 Spalding matched Bobby Jones steel shafted Woods, 1940 models, ea. **\$4.95**
 Spalding matched Bobby Jones steel shafted Irons, chrome finish, ea. **\$3.95**

Order any above specials C.O.D. or remit cash. FREE with \$6.50 purchase or more, metal snelled hook holder or metal ribbed sport glasses. Other premiums.

FREE 136-Page Catalog

Yours for the asking. Invaluable to every sportsman. Contains the famous "Fisherman's Calendar."

GATEWAY

SPORTING GOODS CO.
140 Gateway Bldg., Kansas City, Mo.



DRIVE BY COMPASS



In cold weather especially, wrong turns often lead to treacherous driving over almost impassable roads. You can stay on the right road the year 'round with a Hull Streamline Auto Compass on your windshield. Streamlined Bakelite case, genuine sapphire bearing, built-in compensator. Only \$2.95 at your dealer.

Write for literature.
HULL MANUFACTURING CO.,
P.O. Box 246-D2, WARREN, OHIO



60 POWER TELESCOPE . . . \$219

VARIABLE EYEPIECE 20X—40X—60X

NEW! Three telescopes in one. 3 different magnifications. 20 extra long range. Guaranteed to bring distant objects, people, sports events, ships, moon, stars, etc., 60 times as close.

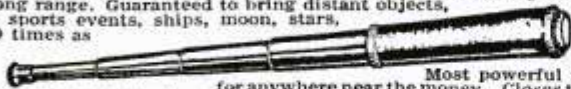

Most powerful made for anywhere near the money. Closes to one foot in length. Multiple lens system. 30 mm. objective lens. 5 sections. Directions included for using as a compound 4 lens microscope. American made. Prompt shipment guaranteed. We pay the postage. Only \$2.19. BROWSCOPE CO., Dept. 42, 5 W. 27th St., New York, N. Y.

Thompson
BEATS
the World
on BOATS



Better Built
Lower Prices

Canoes \$66 and up

Rowboats \$42 and up

Outboards \$42 and up

Very fast utility model

Safe Boats With Full Length Spray Rails
Keep passengers perfectly dry—even at high speeds. Catalog also shows today's five most popular models of sailboats. Two big factories. Prompt shipment.

CATALOG FREE
Write for your copy. State kind of boat in which you are interested.

THOMPSON BROS. BOAT MFG. CO. (94)
213 Ann St. PESHIGO, WIS. (Write to either place) 113 Elm St. CORTLAND, N. Y.

2952

(Continued from page 117A)

one-eyed camera has no way of measuring distances and if your perspectives are correct the illusion should be complete. Remember that shadows should fall the same way as in the foreground and that the foreground action will actually take place behind the glass, so room must be left for the actors to perform without disappearing behind the painted scenery. Make certain that the glass reflects no light into the camera, or use a polaroid filter.

A little experimenting with lighting will help you make use of creditable background projections. Use a large thin light-colored dull-surfaced window shade if you have no translucent screen and project a motion picture on this background from behind it. For a title, fasten the letters on the front of the screen and film that side while the motion picture from behind it shows through. The projector and camera must run at different speeds to avoid filming the lines between the frames. After you have tried this, try filming an actor in front of a moving background.

Now that some cameras are made with a single-exposure feature many amateurs are trying animation, taking motion pictures of dolls or models. The action is worked out carefully ahead of time and the actors are controlled by black threads that extend overhead. Pull the threads to operate the actors in steps that average an eighth of an inch of motion, exposing one frame of film between each motion. When done properly the effect on the screen is a smooth flow of action. A variation of this is to film model automobiles and airplanes while they are being moved by threads. Another use to which you can put the single-exposure feature is filming a sunset. Put the camera on a steady tripod and as the sun sinks into the horizon expose one frame of film every four or five seconds. Clouds will move in a stately manner and the sun will gradually descend.

These are some of the things that amateur photographers have learned from Hollywood. Already, says Mr. Physioc, experimental amateurs are contributing to the advancement of motion pictures just as amateurs in radio and other fields have helped develop their sciences.

Send return postage to our Bureau of Information to learn the name of the maker of any device described in this magazine.

John made \$42⁵⁰ in one day in his NEW Business



● Get Into This Business Now—

a business which is so new that it is practically without competition. This should enable you to make really **BIG MONEY**. Hotels, homes, clubs, office buildings offer tremendous possibilities. Our new **DETERGER** washes upholstered furniture, electrically right in your customer's home, with a new soapless soap whipped into **DRY** suds. *No liquid touches the fabric*, therefore the furniture is ready for use soon after cleaning. We have helped hundreds of men get into business for themselves with our automatic equipment. The U. S. Government and many of the world's largest hotels use our machines.

Make Money the FIRST DAY

The Deterger is ready to use when you receive it, so you ought to be taking in big profits the first day. We want an honest, ambitious man in every locality. If you are that man we will help you get started for yourself in a business with tremendous possibilities.

No Rent to Pay You don't have to rent a shop. You don't have to hire a building, for you do the work right in your customer's home. You save the expense of carting furniture back and forth to a central plant; the owner's home is your workshop.

J. S. Corson says

"I cleaned seven living room sets and fourteen chairs, as well as twenty-five automobile interiors the very first month and made \$279.50." Berger Hanson wrote "My investment in your **DETERGER** was the wisest I have ever made. It is my most valued asset." Barrett says: "Made \$28.00 in eight hours, on another job made \$11.00 in two and one-half hours." Alex Gulkin's business expanded so fast that he already has **SIX DETERGERS** making money for him.

Pay as you Earn

Only a limited amount of money is needed for a down payment. The balance you send on easy terms. Most men find it possible to make far more than the cost of the machine before the payments come due. Every machine is fully **GUARANTEED** and satisfied customers send their friends to you.



No liquid touches the fabric when cleaning with the DETERGER.

Book sent FREE

Write today for copy of our booklet, "Your Own Business, Profits Instead of Wages." Let us tell you how easy it is to get started in a year around business where you are your own Boss and can stop worrying about just a job. Write today—NOW.

VON SCHRADER MFG. CO., 552 Pl., Racine, Wis.

VON SCHRADER MFG. CO., 552 Pl., Racine, Wis.

Send me (without obligation) your free booklet telling me how I can own my own business and become financially independent and how I can pay for the **DETERGER** on easy terms.

Name.....
Address.....
City..... State.....

OTTAWA LOG SAW \$39 **BIG BOOK FREE**



PUTS THIS OTTAWA to work for you. MAKE MONEY! Wood is valuable. Does more than 10 men. Easily operated. Falls trees—saws limbs. Use 5-hp. engine for other work. Write for **FREE Book**. **OTTAWA MFG. CO.** 2827 Wood St., Ottawa, Kans.

SAW 10 TO 20 CORDS A DAY

BUILD A BOAT **SAVE 2/3**

Full Size, Cut-to-Shape Paper **BOAT PATTERNS** and master blueprints enable you to build at 1/3 cost. Newest designs by naval architect. Cruisers, runabouts, sloops, snipe, outboard boats, sailing canoe (Kayak), etc., 7 1/2 ft.-38 ft. Low prices. Rush 10c (coin) for latest catalog. Send \$1 for "HOW TO BUILD BOATS" book, postpaid.

CLEVELAND BOAT BLUEPRINT CO. Station A-667, Cleveland, O.

CLAMPS

The biggest need in most home workshops is more good clamps—clamps for gluing, holding, drawing-up and for setting-up work. They are the extra hands for the 1-man shop. Don't spoil or delay work for want of clamps. From over 40 types of clamps we have selected these as the first for homecraft use.



ADJUSTABLE CLAMP CO. "The Clamp Folks" 421 N. Ashland Ave., Chicago, U. S. A.

PONY Miniatures 9 types 1" to 2 1/4" cap. Not toys but fine tools with 100 uses.

PONY "50" Fittings 40 on ordinary 3/4" pipe. Any length. Send \$3.00 plus postage (6 lbs.) for fittings for two "50" Clamps. Also "Pony" No. 52 Fittings for 1/2" pipe—2 sets for \$2.00 plus postage.

Jorgensen Hand Screws Genuine "Jorgensen" Hand screws grip at all angles, never slip, split or loosen. All sizes. Send \$3.20 plus postage (7 lbs.) for 2 No. 1 Hand screws—open 6".

Catalog FREE Ask your Dealer

NOW a DYNAMIC HEAVY DUTY INDUSTRIAL WELDER



Works off 110 volt electric light circuit. For this unheard of price you can get the marvelous **Dynamic Super-Charged Welder** complete—all ready to plug into your light socket. The **Dynamic** does both metallic arc and carbon arc welding.

WORKS ON IRON, STEEL, TIN, BRASS, COPPER AND ALL OTHER METALS

You can also solder and braze on the lightest material. With our free instructions you can tackle anything and in no time at all you will be able to do finished repair jobs. Once you have the **Dynamic** outfit, you are all set in a profitable welding business of your own. Write for **FREE** particulars **TODAY**.

DYNAMIC WELDER CO., 2226-KT, Silverton Road, Chicago, Illinois

for Only \$195 RETAIL

WELDS BUMPERS, FENDERS, CYLINDER BLOCKS, BODIES, FRAMES, ETC. Does Farm, Factory and Home Repairs

Without previous welding experience you can make for yourself as much as \$5.00 on a repair job that can be done in less than one hour. Many welders make as much as \$15.00 to \$20.00 a day. The **Dynamic Welder** is light and easily portable.

AGENTS WANTED Get our big profit plan and 10-day trial offer. Send for it **TODAY**.

2/12/22
 Super-Senses of Science
 (Continued from page 197)

IF YOU'RE **ASHAMED**
OF YOUR SKINNY
FIGURE,
LISTEN...



Posed by
 professional
 model

**HOW THOUSANDS OF THIN, TIRED,
 NERVOUS, RUNDOWN PEOPLE
 GAIN NEW POUNDS, NEW
 STRENGTH . . QUICK!**

HERE'S grand news for many of the thousands of thin, tired, jittery, discouraged men who have never seemed able to add an ounce, and seldom attract friends and have the good times they deserve.

For thousands of other men have easily put on 10 to 25 pounds of naturally attractive flesh—gained improved health and pep and, with these, many new friends and enviable social success—by simply taking these little Ironized Yeast tablets for a few weeks.

Why they build up so quick

You see, scientists have discovered that great numbers of people today are thin and rundown, tired and nervous—often unable to eat or sleep properly—only because they don't get sufficient Vitamin B and iron from their daily food. Without enough of these two vital substances you may lack appetite and not get the most body-building good out of what you eat.

Now you get these exact missing substances in these scientifically prepared, easy-to-take little Ironized Yeast tablets. That's why they have helped so many skinny, washed-out people quickly to gain new, much more attractive pounds, new pep and enjoyment in life.

Make this money-back test

Get Ironized Yeast tablets from your druggist today. If with the first package you don't eat better and FEEL better, with much more strength and pep—if you're not convinced that Ironized Yeast will give you normally attractive flesh, new energy and life, the price of this first package promptly refunded by the Ironized Yeast Co., Atlanta, Ga.

Only be sure you get genuine Ironized Yeast, not one of the many cheap, inferior substitutes. Insist on the genuine. Look for the letters IY stamped on each tablet. Don't take substitutes.

Special offer!

To start thousands building up their health right away, we make this special offer. Purchase a package of Ironized Yeast tablets at once, cut out the seal on the box and mail it to us with a clipping of this paragraph. We will send you a fascinating little book on health, "Facts About Your Body." Remember, results with the first package—or your money refunded. At all druggists, Ironized Yeast Co., Inc., Dept. 532, Atlanta, Ga.

TUNE IN ON JOHN J. ANTHONY'S GOOD WILL HOUR.
 See your local newspaper for exact time and station.

an electric "taste-indicator" which never catches cold; it can measure with infinite precision the acidity or alkalinity of a solution. As there are instruments to measure the intensity of light from stars, there are others that automatically record the amount of sunshine falling on a given spot. On a sticky midsummer day you may remark sagely, albeit futilely, that "it isn't the heat, it's the humidity," but you probably couldn't guess the relative humidity much closer than ten points. Modern industry can't merely guess, it has to know the amount of moisture present, so there is a moisture detector; thrust two electric needles into the plaster, concrete, brick or wood wall to be painted and it will gauge electrically the exact amount of dampness on and under the surface. It will also help find leaks in pipes buried in the floor or wall.

If you're one of those nervous individuals who are kept awake by the ticking of a watch, you'd love a nap in that floating chamber in the General Electric laboratory that is probably the world's quietest spot. It is so silent that you imagine you hear the clicking of the turnstiles as you count sheep. Insulated by sound traps and sound-absorbent walls, this thirty-ton room is hung from springs that rest on rubber cushions on the building roof. Vibrations cannot reach it. In this chamber scientists play with noise, testing fans, motors, washers and other equipment in an effort to produce noiseless machines. The most efficient fan being the quietest one, blades are designed and redesigned until a fan spinning in the inner sanctum of the quiet room scarcely wavers the needle of the decibel meter. The efficiency of washing-machine agitators and dishwasher sprays is similarly checked on the decibel dial.

Infinitely more sensitive than the imperfect human ear are the electric "ears" that eavesdrop on a submarine cruising submerged more than fifty miles away and hear sky raiders approaching long before your eye or ear could take warning. Even more useful in long-range detection work are the high-frequency sound waves that flow right past your eardrums unheard. This inaudible sound of 50,000 to 100,000 cycles can be pointed like a gun, bounced

Colored Embroidery
 50 Church St. Newark, N.J.

off an unseen obstacle—a ship's hull, a submarine, a hidden roof—and its echo timed to locate the object. Similarly, the sonic altimeter of the airplane translates the echo of transmitted sound into the actual elevation of the aircraft above ground. Scientists believe that some birds, perhaps animals as well, talk to each other in voices too high pitched for man to hear; and it may be that the swift, unerring flight of bats is guided by nature's own sonic altimeter, an ear sensitive to the echo of a high note sung and heard only by the bat itself.

So men work and play with the unseen and the unheard. Infinitesimal charges of electricity emanating from invisible films only one ten-millionth of an inch thick on the surface of water are converted into sound and studied with earphones. Man cannot believe his eyes, so he builds a camera that has, instead of glass lenses, a thousand pin-point apertures arranged in rows around a revolving drum to photograph electric arcs at a rate of 120,000 exposures per second. Man needs a magnet of great power in a little space, so he puts together aluminum and nickel and cobalt and iron, heat-treats the combination, and produces a magnet half the size of the eraser on your pencil, capable of lifting a five-pound weight.

An inch may still be good enough for the carpenter, but it's far too crude a unit of measurement for the airplane builder or the turbine engineer. The inch was first legally defined in England in 1324 A.D. as the length of three grains of barley, round and dry, laid end to end. Twelve inches constitute one foot, which in various times was based on the human foot, the length of King Henry I's arm, or the span of thirty-six barley grains. In 1866 the United States Congress recognized the standard meter, but the inch, commonest unit of measure, has never been legalized.

The foot rule and the vernier and scale of a generation ago give way to the electric gauge of today, measuring generator parts and refrigerator motors and automobile cylinders within one ten-thousandth of an inch, capable even of measuring in millionths of an inch.

In a world of precision, the feeble human senses are not keen enough. But science has endowed man with electrical and mechanical eyes and ears and fingers far more acute than his own.

Foot and large dept. def. - see Jan 1949



"OH, DEAR! I'LL NEVER REMEMBER EVERYTHING WE HAD IN THE HOUSE"

Get This

Household Inventory Booklet

YOUR fire insurance policy states that if there is a fire on your premises you "shall furnish a complete inventory of the destroyed, damaged and undamaged property."

Has it occurred to you how difficult it would be to prepare such a list *after* a fire? Many items would undoubtedly be forgotten until after your claim was paid and you signed a release!

Make this listing *before* the fire occurs. Since you don't know when it will come, act at once.

To make it easy for you, we offer you a special booklet for listing your possessions. It points out items most frequently overlooked. Write for yours now.



THE AMERICAN INSURANCE GROUP
(Dept. 2814) 15 Washington St.
Newark, N. J.

Without charge or obligation, please send me your Household Inventory Booklet.

Name *M* _____

Street _____

City _____ State _____

Special Indiana Steel Product Co. Valparaiso

IT'S NEW-Sensational!

ELECTRIC WOOD CARVING

AN EXCLUSIVE HOME FOUNDRY ACHIEVEMENT!

Just plug in a amazing new tool and carve wood by electricity! Set No. E-102; 5 plaques, 3 interchangeable tools: stain, brush and sandpaper. \$2.



2.00

Electric Casting Set



Exciting new war molds! Casts 3 large figures; electric casting ladle; vise; 12 pigs metal; smoking torch; 2 bottles paint, 2 brushes. Fully equipped electric casting set No. A-104. \$2.

"WONDER PEN"

Electric Wood-Burning New improved pen with ivory bakelite handle and white cord and plug; 12 plaques including book-ends; finishing liquid, water colors, brushes, etc. Complete set No. B-102. \$2.



AT YOUR DEALERS—Get Home Foundry Products from your dealer. If he cannot supply you, write to us.

HOME FOUNDRY MFG. CO.

3124 W. Fifth Avenue Dept. P-2 Chicago, Ill.

NEW STREAMLINE BENJAMIN AIR RIFLES

WITH LEVER HAND PUMP



BENJAMIN

.22



.177



BB



HARD ACCURATE SHOOTING WITH CHAMBERED AIR
You can use new models BENJAMIN AIR RIFLE WITH LEVER HAND PUMP anywhere, for practice firing or just plinking around the house or camping, fishing, hunting, etc., at lowest cost. Shooting force is adjustable depending on AIR PRESSURE—amazing maximum power and accuracy—will penetrate to 1". Hair trigger firing without lunge or recoil. Single Shot BB \$7.50. Repeater BB \$9.00. Rifled Cal. 22 or 177 Single Shot \$8.50. Ask your dealer all about them or write for complete specifications—targets and blueprints FREE if requested. We also make a complete line of BENJAMIN AIR PISTOLS for target and small game. WRITE TODAY. BENJAMIN AIR RIFLE CO., 895 MARION ST., ST. LOUIS, MO., U. S. A.

BUILD YOUR OWN RAILROAD!



NEW CATALOG

The fun of building a model railroad and the excitement of operating it are two good reasons why you should get into this fascinating new hobby right away! Send for new 80-page catalog and Data Book—illustrates and explains all the phases of "model railroading" including new engine and car models never offered before. Send 25c for your copy today!

ONLY 25c

SCALE-MODELS, INC.
1518 So. Wabash Ave., Chicago, Ill.

AMERICA'S FASTEST GROWING HOBBY!

STOP Scratching

Relieve Itch Fast
-or Money Back

For quick relief from itching of eczema, pimples, athlete's foot, scales, scabies, rashes and other externally caused skin troubles, use world-famous, cooling, antiseptic, liquid D. D. D. Prescription. Greaseless, stainless. Soothes irritation and quickly stops the most intense itching. 35c trial bottle proves it, or money back. Ask your druggist today for **D. D. D. PRESCRIPTION.**

The Young Giant of Sport

(Continued from page 229)

matter of timing. No matter what your position is within the shooting area, don't start for the ball too soon or too late on its rebound off the rim. Start for it just at the instant it hits the rim. This way you will just about attain maximum height as you hit the ball. Actually you will still be traveling upward and you are better able to give the ball a controlled push. Your chance of scoring is good because the ball has only a short way to travel up over the rim and into the net.

There are a couple of tricks you can learn about dribbling that will be a big help. Stand or move with your body crouched and your head up. A good dribbler watches the whole floor while he is advancing the ball. He needs to see the ball only out of the corner of his eye at the top of its bounce. Bounce the ball waist high and tap it again at the top of the bounce, taking up the shock with the palm of the hand and controlling the ball with the spread fingers. One of the exercises we use at Southern California is to blindfold the players in training so that they can learn to dribble the ball as long as possible without seeing it at all. That gives them confidence.

Another thing that gives a team confidence is well-chosen uniforms. Knee guards that protect the wearer against floor burns are worn at all times and we use special shoes with built-in heels and arch supporters that have helped reduce the number of sprained ankles and other foot injuries. Vividly colored shirts and trunks materially improve a team's passing game. The player with the ball needs only to see a flash of color before passing to a team mate. Even socks colored the same as the rest of the uniform help him locate a man who is ready for the ball.

Basketball is an especially hard game to referee because it is so fast and because some actions may or may not appear to be foul, depending on the angle from which you happen to see them. The referee tries to watch every action from the best angle and gives his judgment accordingly. Remember that, if you don't always agree with his decisions. A good way to avoid fouls is for a few players to demonstrate the different foul positions in practice so

21066
that the rest of the team can see exactly what they are not supposed to do.

Basketball puts a premium on agility. Because of that the training program is quite different. Quick starting, quick stopping, and quick changes of direction are very important and the players are trained with short dashes that include these maneuvers. Skipping rope is one of the best exercises and tap dancing is also part of the training program. The men pair up for "shadow boxing," one man pretending to bounce and advance an imaginary ball while a guard does his best to stop him.

These days we are scouting opposing teams and are working out special defensive and offensive plays based on what we can learn from motion pictures taken during the games. During a game we compile shooting charts from which the habits of each player may be studied. In some cases we may discover that a star player on an opposing team has one favorite spot from which he likes to make his throws at the basket and our defense is to try to prevent his reaching the area from which his throwing is best. Young players can use this as a tip. If you learn to throw baskets from a number of spots instead of having to get set at one particular place you will become a better player.

21262
Double-Deck Ambulance Cart Is Wheeled by Hand

Two persons can be carried on a double-deck hand ambulance designed to reach places where motor vehicles are unable to

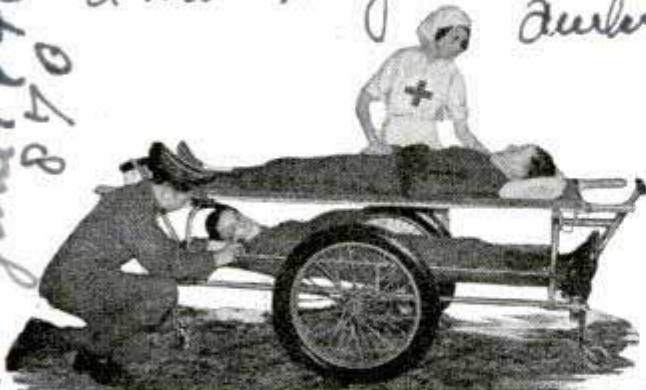

penetrate. One man can operate the high-wheeled cart over rough ground without causing discomfort to its occupants. It was invented in England to meet emergencies which may arise in the event of attack from the air.

SWAY-CHEK

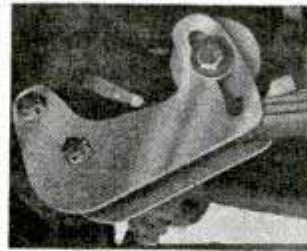

**Checks —
WIND-WANDER
CURVE-SWAY
LOAD-ROLL**

Now Available for FORDS
MERCURYS, LINCOLN-ZEPHYRS

If you appreciate **real roadability** you will get a great ride thru-out of SWAY-CHEK. By checking front and rear "shackle shifts" without impairing spring action, SWAY-CHEK promotes **positive steering response, bee-line steadiness and lack of load-roll.**

SWAY-CHEK is especially appreciated when driving in high winds, along crowned roads, around sharp curves and with heavy loads. With this advanced accessory on your FORD, MERCURY or LINCOLN-ZEPHYR you will enjoy an added sense of stability, handling ease and safety.

QUICKLY INSTALLED WITHOUT SPECIAL TOOLS
Simple, illustrated directions for installing SWAY-CHEK come with each set. A pair can be attached within an hour in your own garage or any repair shop with ordinary tools.

SHIPPED DIRECT WITH MONEY-BACK GUARANTEE
SWAY-CHEK will be sent **postpaid** anywhere in U. S. A. upon receipt of your order with remittance. Or you may order C. O. D. and pay shipping charges. If not delighted with results, return SWAY-CHEK within ten days for refund of full purchase price. Free booklet on request.

- PRICES:** Front Set for 1935-39 FORDS... \$5.95
Complete Front & Rear Set for 1935-39 FORDS and 1940 FORD-40s... 9.95
Rear Set for 1940 FORD-85s and MERCURYS (already equipped with front end stabilizer)... 5.95
Rear Set for 1938-40 LINCOLN-ZEPHYRS... 9.75
(All prices subject to change without notice)

MAIL YOUR ORDER TODAY, stating Car and Year, to

THE BELFLEX CORP.
2012 Sylvania Ave., Toledo, O.

NEW TURN SIGNAL

FLASHES from REAR WINDOW—DASH Control
AGENTS A whirlwind seller. Drivers buy on flash demonstration. Dealers buy 3 to 12. Your profit mark-up as high as 264%. Biggest sensation of year. Rush name quick for facts and Demonstrator sample plan. All Free! Rush.

WATCH-MY-TURN SIGNAL CO., Dept. W-162, Walnut Bldg., Des Moines, Iowa

BIG NEW STREAMLINED LATHE AT SENSATIONAL BARGAIN PRICE

Imagine! This extra heavy wood lathe, steel bed 48" long, at low prices. Heavy duty head stock, 4-step cone pulley for V-belt. No. 2 Morse Taper Centers. Sealed ball bearings. 6" face plate screws onto spindle. Tool rest 18" long. Complete line of accessories at amazing low prices. Write today for free catalog describing machinery. Factory-to-you prices. Not sold through agents. Act at once!

BLUE STAR PRODUCTS, 602 Gate Street, Fairfield, Iowa

Stoves AT FACTORY PRICES!

New FREE Catalog
New designs, new features. Nearly 170 Styles and Sizes of Heaters, Ranges, Furnaces. Up to 18 months to pay for stoves. 3 years for furnaces. Write today for FREE CATALOG. 30 days FREE TRIAL—24 hour shipments.
Kalamazoo Stove & Furnace Co.
391 Rochester Ave.
Kalamazoo Michigan
Over 1,500,000 Satisfied Users
40 Years in Business

"A Kalamazoo Direct to You"
Write today for FREE CATALOG

See June 1940 840

I no major liability

British creation

Further infantry

London W.L. by

MANUFACTURING OPPORTUNITIES



NOW IS THE TIME TO CASH IN on the growing building industry. Make a new and better building material—one that cuts building costs at every step—the kind your builders demand and are waiting for.

WE EQUIP YOU with a Line Production Machine—Raw materials enter at one end—finished products emerge from the other—You make new, scientifically designed building units in more than 40 beautiful colors—You operate with 1 to 3 men who produce a volume selling up to \$200. per day. INVESTIGATE NOW. Send for "4 Keys to Success." It tells how manufacturers already established are making outstanding progress. Write today while your territory is still open.

W. E. DUNN MFG. CO.
600 W. 24th St. Holland, Mich.



Ryan S-T Kit
No. L1—30 in.—50c

BIG, NEW CATALOG

Shows hundreds of models, including gas models, motors. Send 6c stamps.

COMET MODEL AIRPLANES

10c • 25c • 50c • \$1

BIG wingspans—big values! 16-in. models only 10c—giant 25-in. models, 25c; super-detailed models, working shock-absorbing landing gear and other features, 50c and \$1.00! Every model tested for flyability! Get them at your dealers!

ZIPPER Gas Model

Champion gas model of all time—designed by Carl Goldberg! Outstanding winner in events throughout the country! Climbs 2000 ft. per min.; many amazing new features! 54-in. span—postage 25c, \$3.95 none if ordered from dealer.



What a Climb!

COMET MODEL AIRPLANE & SUPPLY CO.
129 W. 29th St., Chicago—Dept. P-2—688 Broadway, New York

WORLD FAMOUS • STANDARD MAKE TYPEWRITERS

as low as

\$26.90

10 DAY TRIAL

No Money Down!



EASY TERMS

as low as 50¢ a week

YOUR CHOICE—UNDERWOODS! ROYALS! REMINGTONS! L. C. SMITHS! WOODSTOCKS! As low as 1/3 mfrs. original price. Typewriters that cost up to \$110.00—some as low as \$26.90. Genuine, standard, full sized rebuilt office models

—up-to-date improvements—standard keyboard, back spacer, ribbon reverse, 2 color ribbon, etc. Never before such rock-bottom prices! FULLY GUARANTEED! Backed by 30 years of fair dealing. Ten day trial. Easiest terms in history—as low as 50¢ a week. FREE big price slashing catalog shows all makes in colors, details on 10-day trial and easiest terms. FREE Van Zandt Touch Typing course with your typewriter. See catalog before you buy. Mail coupon now while stock is complete.

INTERNATIONAL TYPEWRITER EXCHANGE

231 W. Monroe St., Chicago, Ill. (Dept. 201)

Send Free Catalog in colors showing late model standard Typewriters at tremendous savings with no money down and 10 days' trial.

Name..... Address.....

Town..... State.....

The Rookie Goes to College

(Continued from page 235)

rookie wants technical training in the army, he can find it about as technical as it comes in the engineers. One of the famous units is the 29th Topographical Battalion, now stationed in the wilds of the Olympic Peninsula, opposite Seattle. This unit surveyed the Nicaraguan Canal route, and its work in aerial mapping on the Olympic Peninsula was the first thorough workout of this method of map-making over the most difficult terrain imaginable.

Army engineers build roads, bridges, railways, buildings, and the range of technical jobs embraces stationary enginemen, instrument repairmen, lithographers, pho-



Communications section field radio units offer the rookie opportunities in another phase of activity

tographers, painters, rodmen, structural ironworkers, draftsmen, and so on. The Engineer School is at Fort Belvoir, Va.

The Quartermaster Corps is the supply and general maintenance service of the army—and it's extremely important. Members of the QMC are often called the "businessmen of the army." They have to buy supplies and keep the transportation system going. In this day of motorization, the Transportation Division is of singular importance, and the QMC operates big motor transport schools, where enlisted men learn to take automotive engines apart and

(Continued to page 126A)

Get The INSIDE FACTS Before You Buy Power Tools



New Time Payment Plan

This Delta Tilting Arbor Saw is but one of the many power tools that typify Delta extra value and extra quality. It embodies numerous features and advantages described fully in the new 1940 Delta Catalog and here's good news—the complete line of Delta metal and woodworking tools is now available on liberal extended terms through Delta dealers. Send for details.

DELTA MFG. CO.

600-634 EAST VIENNA AVENUE
MILWAUKEE, WISCONSIN

If you are interested in power tools for your workshop—there are vital inside facts you simply *must* know before you can make a sound decision. These facts are now available to you in the

New 1940 Delta Catalog

which not only lists the complete line of Delta "Quality" power tools—but shows you the important points to look for in all power tools. It explains the advantages of "diamond-boring" of bearing seats, "pre-loading" and correct mounting of ball bearings and "sealed-for-life" ball bearings. It illustrates many hidden features of design and construction that make for long, better service in power tools. It takes up the major power tools one by one and analyzes various types of design and shows the advantages and disadvantages of each design. It shows you the features you should look for in selecting power tools for your shop. Truly this new 1940 Delta Catalog is A BUYER'S GUIDE—crammed with useful information that every craftsman should have. Send the coupon for your FREE copy (also send 10c for the new Project Book No. 6, containing working drawings and instructions for many new and "out of the ordinary" things to make).

Delta Mfg. Co., Dept. A-240
600-634 E. Vienna Ave., Milwaukee, Wis.
Send me the latest new 1940 Delta Catalog and list of Delta Dealers nearest me. I enclose 10c (stamps or coin) for which please send me the new Delta Project Book No. 6.
Name.....
Address.....
City..... State.....
 check here if you are a Delta user now.

CAMERA BOOK

FREE!



Illustrates latest methods in Photography and Home Movie Making, for fun and profits. Offers hundreds of amazing money-saving bargains in still and movie Cameras, Lenses, Films, etc. Used equipment accepted in trade. Satisfaction guaranteed or money back with 10-day trial privilege. WRITE FOR FREE BARGAIN BOOK!

CENTRAL CAMERA CO., 230 S. Wabash, Dept. B-16, Chicago, U.S.A.

BURN YOUR NAME ON TOOLS

WITH THE ARKOGRAF

PROTECT YOUR TOOLS FROM THEFT

Write with electricity any name or design on the hardest and finest tools and instruments, or any metal, like writing on paper with pen or pencil. Complete Outfit \$3.50—Prepaid Anywhere. Interesting illustrated circular free. Write today. Agents wanted. ARKOGRAF PEN CO., 3927 S.E. Stark St., Portland, Ore.

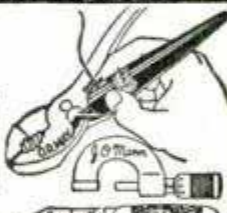

8-TUBE, 2-BAND SUPER AC-DC

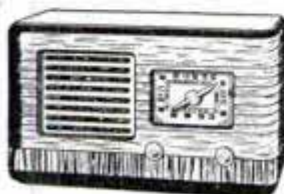

each in lots of six or \$12.48 when purchased singly. Regular \$24.95 list model **\$11.23**. 3T3 GOLDENTONE. Check these 1940 features: Dynamic speaker. Walnut cabinet. Illuminated vernier aeroplane dial. "Goldenscope"—no aerial or ground required. Receives Coast to Coast on Broadcast and Police, Amateur, Aeroplane, etc., on Short Waves. One year guarantee. Send \$1.00 deposit, balance C.O.D. Money back if not satisfied. ORDER TODAY!

GOLDENTONE RADIO CO., DEARBORN, MICH.

RADIOS..SAVE UP TO 50%



DEAL DIRECT—FACTORY PRICES
Many models to choose from at wholesale prices. AC-DC midsets \$4.98. Portable and battery sets \$8.98 up. Car sets \$11.75 up. Also consoles, all-wave etc. Samples at 50% off. Send for FREE 1940 bargain catalog giving details of 10 day FREE trial and agent's proposition and discounts. No obligation, write today. GOLDENTONE RADIO CO., DEARBORN, MICH.

Free Catalog

21076
(Continued from page 124A)**AGENTS and DEALERS WANTED****To Sell or Rent the NEW****MEAD Ranger SCOOTER****AMAZING LOW PRICES!**

Buying Direct From Mead

Pay as you ride!
EASY TERMS
available in most states

Bicycle Circular Free on request

CYCLE CO.
Mead

17 S. Market St., Dept. E-1, Chicago

AMERICA'S MOST FAMOUS CYCLE NAME FOR FIFTY YEARS

HOW TO GET A DAISY Air Rifle**1 Use Your Christmas Cash!**

Buy your Daisy with money you got for Christmas. If you've spent it or didn't get any . . . and have a birthday between now and July 15, listen:

2 WE WILL HELP YOU GET A DAISY For YOUR BIRTHDAY! Just do This:

Send us your name, address, date of your next birthday. You'll receive Birthday Reminder Kit 2 weeks before birthday. It's FUN using it—and we hope it helps YOU get a Daisy for your birthday. Write quick!

DAISY MANUFACTURING COMPANY, 542 Union St., Plymouth, Michigan, U.S.A.**500 SHOT Repeating Lightning-Loader CARBINE****\$2.50 Higher In Canada****NOW ONLY****\$4.95****REAL ENGINE VALUE**Over 7,000 GHQ Gas Engine Kits were sold at \$8.50. Over 15,000 sold last year. Now is your chance to buy the *New Improved* kit for \$4.95. Absolutely complete with coil, plug, etc. For boats, planes, etc. All parts guaranteed. Send only \$1.—*Shipped Express Collect for balance same day. Send Sc for new 16-page illus. catalog. DEALERS WRITE.*

All parts finished. Only a screwdriver needed. 1/5 H.P. Average assembly time 30 minutes.

GHQ MOTORS, 40B East 21 St., New York, N. Y.**FREE CLUB & CLASS PIN CATALOG SHOWING OVER 300 DESIGNS****300 SMART DESIGNS!**

Knit your class or club closer together with pins or rings. Bastian has been the leading maker for 45 years. Clean cut, quality work. Write today for 1940 Catalog.

BASTIAN BROS. CO. Dept. 73, Rochester, N. Y.**Rheumatism** **Relieve Pain in Few Minutes or Money Back**

To relieve the torturing pain of Neuritis, Rheumatism, Neuralgia or Lumbago in a few minutes, get NURITO, the fine formula, used by thousands. No opiates. Does the work quickly—must relieve cruel pain to your satisfaction in a few minutes—or your money back. Don't suffer. Clip this ad now as a reminder to ask your druggist for NURITO today.

put them back together. Equal in importance is the Property Division, which, among other things, keeps the soldiers clothed and equipped. A sales division operates commissaries and stores, as well as bakeries. Utilities are managed by another division.

The Quartermaster Corps also operates a fleet of transports and other ships. The Quartermaster Corps probably runs more kinds of schools than any other branch of the army. There is the main Quartermaster School at Philadelphia, teaching practical business methods, and a Quartermaster Motor Transport School at Camp Holabird, near Baltimore, Md. Schools for bakers and cooks are maintained at nine different posts in the United States and foreign departments. There is also a Horse-shoers' School at Fort Riley, Kan., and selected soldiers are sometimes sent to civilian institutions, such as the General Motors Institute at Flint, Mich., and the Bendix Safety Service School at South Bend, Ind.

There are two other important branches of technical training, the Medical Department, and the Finance Department.

From the first of these come the famous microbe hunters, unsung heroes who have saved millions of lives from malaria, dengue fever, and other scourges of humanity. The Medical Department embraces the Medical Service proper, the Dental Service, and the Veterinary Service. At the Army Medical Center in Washington, D. C., enlisted men can attend two courses a year for developing X-ray, laboratory, dental and veterinary technicians. There is also an important School of Aviation Medicine at Randolph Field, Tex. Graduates of this school become assistants to flight surgeons.

There is a vast amount of paper work in the army, and lots of money to handle. The Finance Department does it, and expert bookkeepers, accountants, cashiers, clerks, stenographers and other specialists are trained in the Finance School, at Washington, D. C.

Another technical branch is the Ordnance Department, charged with the maintenance of arms, where a high degree of skill in precision machine work is developed. The Ordnance Field Service School is at Raritan Arsenal, N. J.

\$200 My First Week



... Now in my OWN Business.

Free Book!
MAIL COUPON now

VON SCHRADER MFG. CO.
102 Pl., Racine, Wis.

Send at once (no obligation) your free booklet illustrating rug-washer and telling how I can own my own permanent business; how I can earn large profits at prices below other methods; how I can become financially independent in a short time; and how I can pay on easy terms.

Name.....
Address.....
City.....State.....

Would you, too, like to own a business where it is possible to take in as much as \$200 your first week as did L. A. Eagles in his new business?

We want a reputable, honest man in each county. This man need not have any special experience or more than ordinary ability, but he must be honest and courteous.

Such a man we will start in business for himself. You can make far above average profits in the rug-washing business—a high-grade business all your own. Many earn \$125 to \$200 per week—some considerably more.

NO SHOP NECESSARY

The rug-washer cleans rugs like new on the customer's floor. Anyone can run it. Electricity does the work. A quick, thorough and highly-efficient method that brings out the natural beauty of floor coverings.

There are hundreds of customers—in your vicinity and nearby towns. The business grows steadily. Simply wash a few rugs or carpets. These customers tell others and also give you their future work. Soon you will have a prosperous year-around business. Send coupon for booklet explaining everything.

"Profits Pay for Home"

Harry Hill built and paid for a home from rug-washer profits. His first day's business was \$86. Another man writes, "Made \$70 in 13 hours." A. L. Miller says, "Have had rug-washer 6 years—have earned as high as \$92 a day." M. O. Malmin earned 3 times the cost of his machine the first two months. You, too, can enjoy a large income.

"Never a Complaint"

C. J. White says: "\$100 business in six days—never a complaint." That is the nicest part of this business—every customer is more than satisfied. Stains and blotches disappear and vivid colorings and freshness in faded floor coverings come back.

EVERY MACHINE GUARANTEED

You take no risk. These machines have been manufactured since 1918 and are used by the United States Government and by many of the world's largest hotels. They are fully GUARANTEED.

EASY TERMS

The complete equipment is inexpensive. A reasonable down payment brings everything to you and the balance is paid monthly. From the start, you have your own business—one that is profitable and of which you can be proud.

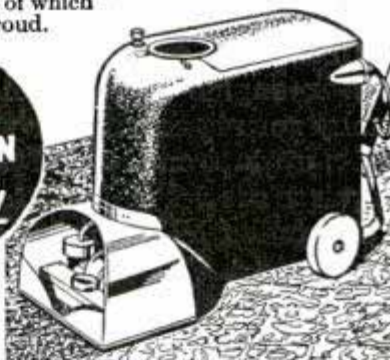

VON SCHRADER MFG. CO., 102 PL., RACINE, WIS.

MAN IN EACH TOWN To Plate Auto Parts

Reflectors, Bicycles, Fixtures, Mirrors, by late method. Simple plan of manufacturing at home starts you IN GOOD PAYING BUSINESS. Write today for FREE particulars and proofs.

Ave. M **GUNMETAL CO.** Decatur, Ill.



CASH PAID Why not get ready now to spend spring, summer, fall outdoors gathering insects—butterflies, moths. I buy hundreds of kinds for collections. Good cash prices paid. Some \$1 to \$7. Easy. Simple. Send 10c (not stamps) for Illustrated Prospectus before sending any insects. Write today. HURRY! MR. SINCLAIR, DEALER IN INSECTS, Dept. 72, Box 1830, San Diego, Calif.

"MARVEL-OU'S" TRAILER PARTS



(1) "Famous" Marvel Windows, (2) tail lights, (3) complete undercarriage equipment, (4) body moldings, (5) couplers. Also refrigerators, stoves, lighting fixtures, everything you need in highest quality. Largest trailer equipment stock in U. S. Immediate delivery, low prices. Send 10c coin for 40-page ill. catalog.

Marvel Trailer Parts Co., 19002 Celestine Ave., Detroit, Mich.

MAKE MONEY



WITH NASH CUSTOM TAILORED CLOTHES
Be your own Sales Manager, take orders; earn money with this famous make of clothes. High quality men's tailoring at popular prices.
WRITE! Write in today. Territories open.

THE A. NASH COMPANY
1913 ELM STREET • CINCINNATI, OHIO

Given WATCH, CAMERA or RIFLE Given for selling 24 packs of Garden Seed. We trust you. SEND NO MONEY. Write today.

EASTERN SEED CO.
Dept. 26, Lancaster, Pa.



WRIST WATCH
Gorgeous Dinner Sets 20 Other Prizes Given according to plan in catalog. **WRITE TODAY!**

Winning Races in the Pits

(Continued from Coloroto Section)

Louis Tomei, another driver, couldn't believe his ears when the pit crew told him that the practice lap he had just finished was the fastest yet. He should have gone slower, for his motor had been badly tuned and had dropped 300 revolutions per minute. But when the pit crew had made the poor adjustment to the engine they had also put on new tires and these had slipped and skidded less in the turns, resulting in faster time around the track.

Most of the race cars are started from battery carts that are wheeled alongside. The three Joe Thorne entries are started by portable compressed-air motors that spin the engines, and Harry Miller uses blank shotgun shells. A cartridge is slipped into a special tube behind the engine and it makes a noise like a giant sneeze when it is fired, its pressure operating a piston that revolves the drive shaft.

Miller's new car looked like no other at the track and it was a revolutionary departure from standard design. It is a supercharged rear-engine four-wheel drive job individually sprung on all four wheels. The driver sits up in front behind the radiator. It requires special training to drive such a car and today Miller is training a group of men to drive in the 1940 race. Most drivers sense their speed by the sound and vibration of the engine, but with the engine and its noise behind him the driver feels he is coasting along. Unless he keeps an eye on the tachometer he is apt to hit a turn too fast. If he takes his foot completely off the throttle in a turn he is bound to spin. He has to keep using some power to keep the car pointed ahead. George Bailey drove one of the Millers until he was forced out at 118 miles with a broken valve lock, an identical car stood in the garage during the race because no competent driver was available, and a third was wrecked in practice.

In the rear-engined Miller the six-cylinder engine lies on its side at a forty-five-degree angle for proper distribution of weight. The engine has a speed of 7,400 revolutions per minute on stock gasoline, enough to average 130 miles per hour or better on the Indianapolis track. The bore is three and one-half inches, stroke is three and one-eighth inches, and the compression ratio is five-and-one-half to one.

There are seven main bearings and the connecting rods are tubular with steel-backed bearings. The aluminum cylinder block is one piece to above the valve ports, combustion chambers are semi-spherical, and the valves seat directly on the aluminum block for better cooling, a practice that is permitted by the soft cam action. The car has a positively locked clutch and a four-speed dry-sump transmission mounted in front of the engine. The transmission is lubricated by a spray of oil.

The supercharger is mounted behind the differential housing at the rear of the engine and works off a shockless planetary gear drive from the crankshaft. It spins at up to 36,000 revolutions per minute, operates under twelve to fifteen pounds pressure, and has a double impeller to prevent back pressure. An inter-cooler between the supercharger and the engine is mounted outside the body to bring the temperature of the fuel down from the 400 degrees at which it leaves the supercharger to about 178 degrees before it enters the combustion chambers. The car has hydraulic disk brakes of special design.

No "jalopies" are allowed to enter the 500 at Indianapolis. Half the time the best cars that men and science can devise fail under the grueling conditions of the race, and the hazard to drivers and spectators alike is cut to a minimum by the strict mechanical requirements of the inspection committee. Some of the cars cost fortunes, some cost relatively little, and there is no way to tell ahead of time which one will win. The driver gets the glory and the checkered flag, but he knows that the pit crew should get much of the credit.

Best Air for Gliding Is Found by Instruments on Wings

21321
Thermal sniffer
College Park, Md.
Glider pilots scouting around in the sky for favorable air currents can find them by watching a cockpit dial. A student at the University of Maryland has invented a "thermal gradiometer" which detects the thermal air currents on which soaring depends. Hairlike thermocouples are mounted on each end of the glider's wing to measure the temperature at the wing tips, and the differential, shown on a dial, enables the pilot to find rising currents.

NOTES FROM A
CRAFTSMAN'S HANDBOOK

WHAT'S NEW IN THE 1940 BODY BY FISHER

Comparison of the new Body by Fisher with motor car bodies of the past shows a marked step-up in three basic characteristics: size, strength and visibility. It is actually the longest, widest, strongest Unisteel body General Motors cars have ever had.

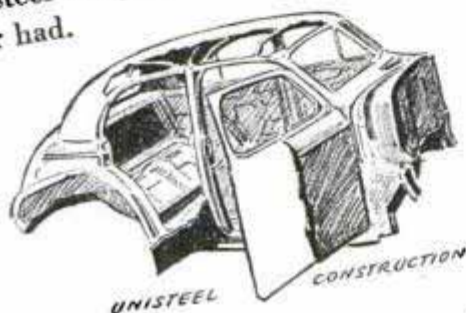

GREATER STRUCTURAL STRENGTH—New engineering at principal points of strain makes the entire Unisteel structure more resistant to weaving and shock. For instance, there are stronger steel support rails overhead and at floor level; longer roof-rails with new reinforcements; new double steel panels in the rear quarter sections; and a higher crowned steel Turret Top.

"In 1940, it's Pontiac for Pride and Performance," and in its brilliant new Body by Fisher are many of the big reasons why. What's more, for the Pontiac Torpedo 8 pictured here, it also provides new safety — by the use of stronger Hi-Test Safety Plate Glass not only in the windshield, but in all door windows and Ventipanes, too.

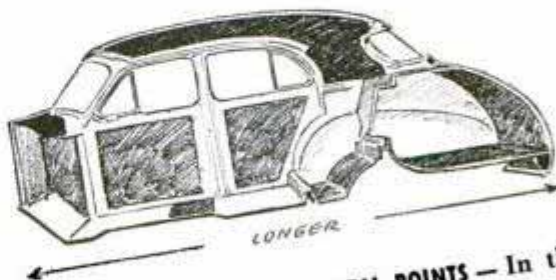

INCREASED DIMENSIONS AT VITAL POINTS—In the Pontiac 8 illustrated, both the lateral and longitudinal dimensions are carried well beyond previous limits to give greater roominess and more graceful contours. The overall length has been substantially increased — as has the width at the center pillars. In addition the windshield is now wider and the back window 18% larger — thus extending the view of the road ahead and behind.

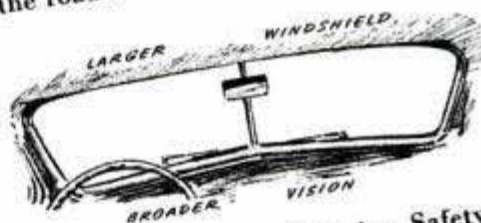

CLEARER, SAFER VISION—Genuine Safety Plate Glass eliminates the distortion waves produced by ordinary safety "window" glass — reduces eyestrain 62%.

Clear, distortion-free Safety Plate Glass is used not only in the windshield, but throughout — for the better visibility of all passengers, in all 1940 General Motors cars.



BODY BY
Fisher

ON GENERAL MOTORS CARS ONLY:
CHEVROLET • PONTIAC • OLDSMOBILE
BUICK • LA SALLE • CADILLAC

America's Dinner Rides the Rails

(Continued from page 244)

sachusetts cranberries travel to western states as fresh and crisp as they are at home.

California is the country's largest vegetable garden and fruit orchard. One-third of all fresh fruits and vegetables that are shipped to other markets originate in that state. The Pacific Fruit Express company, operated jointly by the Southern Pacific and Union Pacific, with headquarters in California, last year handled 40,571 cars of lettuce of more than 300 crates each or ninety-three per cent of the country's total production. The carrier hauled 64,144 cars or thirty-three per cent of all other vegetables and 56,701 cars of citrus fruits. In all, the company and its owners transported thirty-four per cent of all rail shipments of perishable foodstuffs in the United States.

Among the things that make the refrigerator business a complicated one is the fact that crop movements depend on news and that the news changes every day. A shipper tries to consign his cars to the best market and among other things he has to know the number of cars on hand at the different terminal markets, the present wholesale prices, the condition of the markets, and the weather at each point. This and other information is gathered daily by the Department of Agriculture and is furnished by wire and radio to local offices in the growing districts.

Most shipments leave the fields with no definite destinations. A trainload of cauliflower, lima beans, and peas from California may be routed to some point in New Mexico or Texas and then broken up as the strengths of different markets show the demand. Sometimes while a trainload of fresh vegetables is en route to New Hampshire the market falls and the load is hauled back to Indiana. Again the market may fluctuate and, after a number of diversions, the train may once more be sent to New Hampshire or finally delivered to wholesalers in Georgia. Nearly 1,000,000 such diversion orders were handled last year by Pacific Fruit Express. Many vegetables reach the consumers ten days or less after starting a transcontinental trip. Some crops, kept properly iced, can be held in good condition materially longer.

More than five tons of ice are usually loaded into the end bunkers of a "reefer" before it receives its cargo. After being loaded it is returned to the icing point for replenishment and thereafter it is re-iced at designated points along its journey. Pacific Fruit Express is apt to consume 2,000,000 tons of ice yearly at the several hundred icing platforms it uses.

Lettuce and other leafy crops are smothered in crushed "snow ice" blown into the car. The amount and size of the ice chunks used to cool other foods depend on the crop and the temperature at which it is to be maintained. Certain crops are pre-cooled to remove their field heat before they are shipped, and others are shipped in semi-ripe condition so that they can finish their ripening process en route and be at the peak of condition when they are placed on sale. In pre-cooling a loaded car a constant draft of cold dry air is forced into the car, the pre-cooling requiring from four to forty hours, depending on the commodity and load.

In the winter citrus fruits are ordinarily ventilated instead of refrigerated, car ventilators being opened while the outside temperature remains above thirty-two degrees and being closed when the weather becomes colder. Other delicate crops occasionally require heating when the weather is too cold although the insulated cars are a good protection against outside weather changes. Sometimes during a cold spell trainloads of vegetables must be held intact at Chicago and other northern points until the weather abates. Otherwise the foodstuffs would freeze while they are being unloaded. Brine and salted ice furnish the lower temperatures required for transporting meat and fish. Fast-frozen products are carried in super-insulated cars that have been cooled down to low interior temperatures.

Today fresh fruits, vegetables and other perishables move on train schedules materially faster than a decade or so ago and with far more dependability.

☐Inquiries as to makers of articles described in Popular Mechanics will be answered by our Bureau of Information upon receipt of return postage.

"I WAS TRAPPED IN A BLAZING INFERNO!"



A true experience of MRS. LILLIAN POKEDOFF, Brooklyn, N. Y.



"AN OMINOUS, CRACKLING NOISE awoke me the first night I was visiting in a strange farmhouse," writes Mrs. Pokedoff. "Choking and coughing from smoke, I groped for the bedroom door and staggered out into the hall.

"IN THE THICK, BILLOWING SMOKE I couldn't locate the stairway. Then I heard a muffled shout from below and a beam of light bored through the darkness, showing me the way to safety.

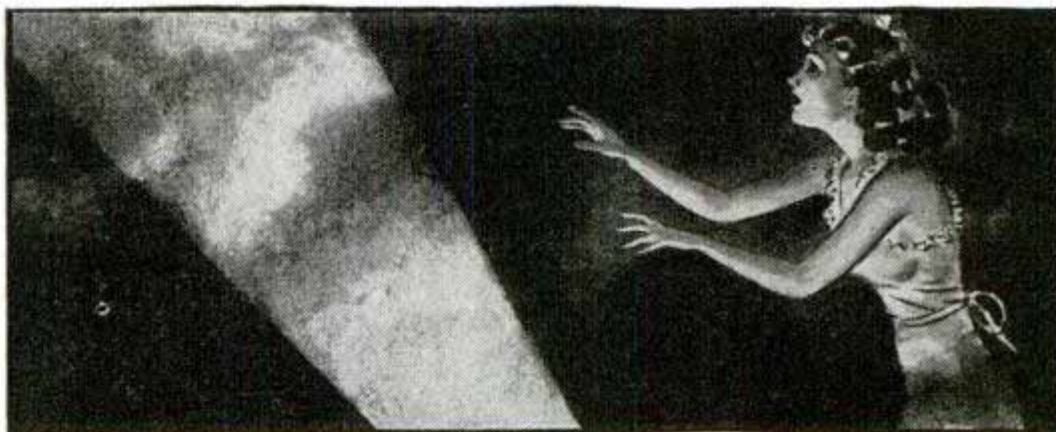

"I STUMBLED DOWN THE STEPS just in time—for a kerosene tank exploded and the house burned to the ground! I sincerely say that I owe my life to those powerful and dependable 'Eveready' fresh DATED batteries!

(Signed) *(Mrs) Lillian Pokedoff*"



FRESH BATTERIES LAST LONGER... Look for the DATE-LINE

NATIONAL CARBON COMPANY, INC., 30 EAST 42nd STREET, NEW YORK, N. Y.

Unit of Union Carbide and Carbon Corporation

SEND FOR THIS
FREE 204
PAGE
RADIO
AND PARTS
CATALOG

See **AMERICA'S Most**
AMAZING RADIO VALUES!

Dealers, Servicemen, Amateurs, P. A. men, Builders save money on every radio need! This famous catalog brings you Everything in Radio at lowest prices!—sets, parts, kits, tubes, tools, ham gear, P. A. systems, phonographs, recorders, test equipment—over 15,000 items! Save money on every order! **FREE—SEND COUPON!**



Choose from 60 MODELS

A set for every need at great money-saving prices—60 different models, 4 to 12 tubes, with newest features, "Air-Magnet", etc., at lowest prices—with biggest values in electric phonographs, phono-radios, etc. All shown in ALLIED's big 1940 catalog—Send coupon!



REVOLUTIONARY! NEW P. A. SYSTEMS!

Remarkable values in P.A. systems for every need—14 sensational new systems, "Economy," "Standard," "De Luxe," 6 to 70 watts. Also latest accessories, complete recording equipment, etc., at lowest prices—in ALLIED's Catalog. New Time Payment plan!

Learn Radio
BUILD YOUR OWN
WITH ALLIED KITS

Build your own radio receiver, transmitter, transceiver—learn while you build! Dozens of new, low-cost, easy-to-build Kits are shown in ALLIED's Catalog. We supply Free, matched Parts Lists to build any circuit. Learn Radio quickly—enjoy this great hobby! ALLIED helps you learn easily!

Send for **RADIO BUILDERS' HANDBOOK**—A beginner's book on radio; tells how to select circuits, read diagrams, cuts, etc. Easy to understand. Packed with helpful data. New revised edition. Only **10c**. Order by coupon below.

ALLIED RADIO

833 W. Jackson Blvd. Dept. 5-BB-0
Chicago, Illinois

- RUSH your FREE 1940 Radio Supply Catalog.
 ENCLOSED find 10c. Send your NEW Radio Builders' Handbook.

Name.....

Address.....

City..... State.....

Two-Band Flashlight-Battery Set

(Continued from page 297)

of the variable condenser is common with the rotor or "movable" plates. C_1 may be either .00035 mfd. or 365 mmfd.

A large 1½-volt dry cell A-battery will furnish several months of intermittent operation. The flashlight B-battery will be good for almost a year, if large flashlight

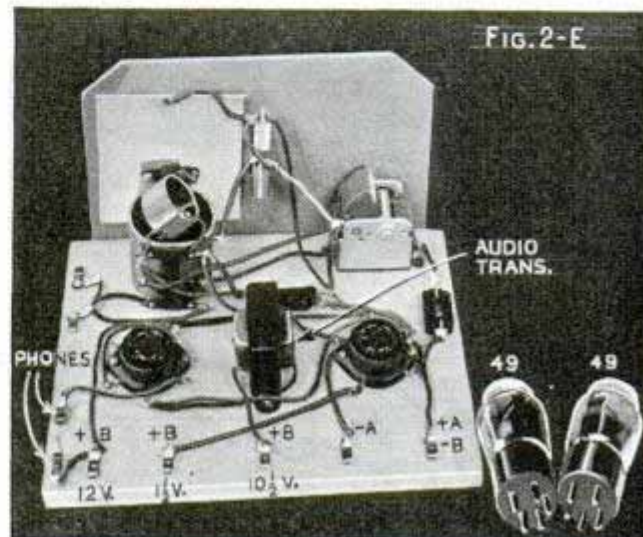

batteries are used. A detailed list of materials can be obtained from Popular Mechanics radio department without charge.

To operate the receiver, use a good pair of 2,000-ohm headphones; connect a ground lead to a cold-water pipe, and use a good outdoor antenna. In tuning,

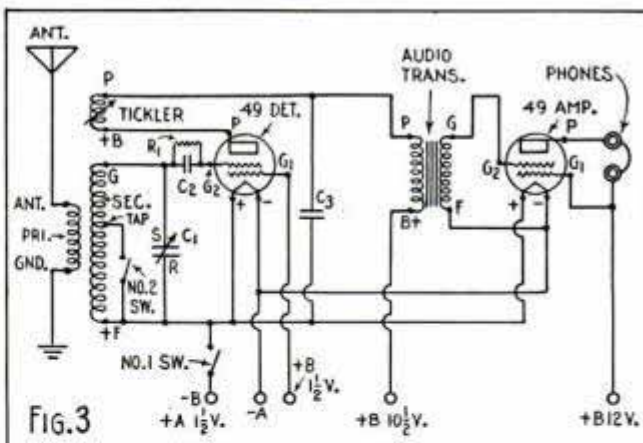

turn "on" switch No. 1 and rotate the movable tickler coil until it is all the way "in." Next turn the variable condenser until a whistle indicating a station is tuned in, and rotate the tickler coil until the whistle stops. Always keep the tickler to a point where the phone stations are tuned in without a whistle. For short-wave reception, switch No. 2 is snapped to "on" position. The tuning procedure is the same. Blueprint number for this article is R-275.



Atlas F-SERIES 10" LATHES

Power Cross Feed Standard Equipment

Whatever the Job... These Features Help You Do It Easier and Better!

You buy a lathe with definite things in mind: Precision workmanship—simple, convenient operation and complete versatility—dependable, long-life construction. And price is usually important. In all these respects you'll find experienced machinists advising—"Get the modern Atlas." Here are some of the reasons why:

Power Cross Feed standard equipment. Atlas is the only popular-priced lathe giving you this feature that saves much laborious work on facing operations.

Precision-Ground Bed—first essential of a precision lathe. All six Atlas bearing surfaces are aligned to within .001 in all planes.

Custom-Bored Spindle Bearings positively aligned by boring each bearing after the headstock has been fitted to the bed.

Backgeared Power—Complete V-Belt Drive—Wide Screw-Cutting Range—Quick-Change Countershafts—Rugged Zamak Alloy Parts—at no extra cost.

Sensible Prices. The 10" horizontal countershaft model above is \$104.75 complete as shown less motor—with vertical (attached) countershaft only \$99.75.

Whatever the job, you can do it easier and better with an Atlas Lathe. See them at your dealer's or send coupon below for 1940 Catalog.

ATLAS PRESS COMPANY

243 N. Pitcher St., Kalamazoo, Mich.

NEW YORK
130 W. 42nd St.

CHICAGO
35 E. Wacker at Wabash

PHILADELPHIA
113 N. Third St.



"Rugged, powerful, accurate, versatile" say shop men everywhere.



"It's a real money-maker," report garages and service men.

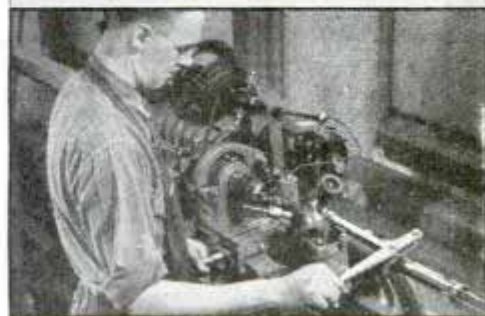

Factory men write, "It's ideal for small part precision work."



ATLAS PRESS COMPANY

243 N. Pitcher St., Kalamazoo, Mich.

Please send 1940 Catalog on 10" Metal Lathe 6" Metal Lathe 7" Metal Shaper Drill Presses Arbor Presses and the name of nearest Atlas Dealer.

Name.....

Address.....

City and State.....

FREE CATALOG

BRINGS YOU MORE FUN IN RADIO AT LESS COST!



GET AN EYEFUL of this FREE book full of values in radios, parts and equipment. 188 jam-packed pages. All the nationally advertised names. 64 receiver models alone to choose from. Sensational "Build-It-Yourself" Kits that double the thrill of owning a radio, and cut the cost in half. Prices consistently lower on everything—from the tops in phonograph-radio combinations to the latest type tubes. Wherever you are, you can order at home . . . save time and money. Every item guaranteed. Send for this big FREE catalog today. Have more fun in Radio. Mail this coupon NOW!

NEW YORK, N. Y.
100 SIXTH AVENUE
CHICAGO, ILL.
901 W. JACKSON BLVD.
ATLANTA, GA.
265 PEACHTREE ST.
BOSTON, MASS.
BRONX, N. Y.
NEWARK, N. J.
JAMAICA, L. I.

LAFAYETTE RADIO

Radio Wire Television Inc.
Dept. 7B—100 Sixth Ave., New York, N. Y.
Rush FREE 1940 Radio Catalog No. 78

WORLD'S
FINEST
RADIO
CATALOG
FREE

NAME _____
ADDRESS _____
CITY _____ STATE _____

PASTE COUPON ON PENNY POSTCARD

10 NEW SETS OF STANLEY PLANS

Each set includes five interesting things to make. Complete instructions.

- Set No. 1 Hanging Shelves 10c
- Set No. 2 Lamps 10c
- Set No. 3 Trays 10c
- Set No. 4 Tables and Stands 10c
- Set No. 5 Book Ends and Small Articles 10c
- Set No. 6 Flower Pot Holder
and Desk Articles 10c
- Set No. 7 Mirrors, Footstool and Table 10c
- Set No. 8 Magazine Stands and Tables 10c
- Set No. 9 Chests and Boxes 10c
- Set No. 10 Smokers' Stands 10c

Select the sets you want; send check, money order or stamps to

STANLEY TOOLS

DIVISION OF THE STANLEY WORKS
122 Elm Street, New Britain, Conn.

A GARDEN TRACTOR THAT Plows!

HERE'S YOUR GARDEN TRACTOR

The Black Hawk plows and cultivates, does belt work and many other jobs—all on a couple gallons of gas a day! Powerful, rugged, easy to handle. Enclosed gears. 1½ horsepower. You'll want to own it because it saves money, increases income for hundreds of farmers, gardeners, truck gardeners, poultry farms, others.



10 Days TRIAL

This "economy champion" is sold to you at rock bottom price. Send post card today for free catalog giving complete details and prices.

THE OHIO CULTIVATOR CO.,
BOX 140, BELLEVUE, OHIO



SEND FOR FREE CATALOG

Electrical Recording

(Continued from page 298)

and playback instrument are shown in photos Figs. 1 and 7. The cutting head with its adjustable arm is clearly shown in photo Fig. 3. Also available with this basic mechanism is the 4-tube audio amplifier which appears in photo Fig. 4. However, some experimenters prefer to build their own high-fidelity, low-hum-level amplifiers. The recording amplifier shown has a distortionless output of 4.2 watts and an extremely low-hum level; it also may be used as a public-address amplifier in addition to a recording amplifier, if desired. A crystal microphone with good frequency range and high output is recommended; crystal microphones of this description are shown in photos Figs. 5 and 7. The one



illustrated in Fig. 5 has the advantage of a side cable outlet and connector plug arranged so that a longer shielded cable may be used when the amplifier is employed for public-address service.

With well designed recording apparatus of this description it is possible for anyone to make high-quality recordings to meet practically any purpose. Recording music and radio programs broadcast on the foreign short-wave bands, addresses of famous speakers, sound accompaniment for home movies, also greetings for every occasion and personal messages that your relatives and friends can reproduce through any modern a.c. receiver by means of inexpensive record players of the type shown in photo Fig. 6, are a few of the interesting applications in the home. In schools and colleges this type of recorder is employed in the study of speech, languages, music and public speaking.

Decidedly Unusual . . .
THURSTON'S 1940 CATALOG of
"HARD-TO-GET" MATERIALS"
 For Homecrafters, Schools, Institutions, Antique,
 Novelty and Cabinet Shops

A few of the items we show: Chest hardware, locks, hinges, supports, casters, copper trim, etc., also mids, overlays, etc. Finishing materials, glue, stains, varnish, wax, tint and garnet papers, rubber sanding blocks, stick shellac, burning-in knives, etc. Upholstering supplies and coverings. Complete line of electrical findings for lamp manufacture, also cluster and indirect fixtures. Chair cane, woven and in strands, spine, reeds, fibre cord, etc. Trays for smoking stands and glass liners. Large line electric and spring clock movements, with and without dials. Complete line Venetian Blind hardware, tapes and cords. Table slides and leaf supports. Tea wagon wheels and casters. Wood dowels, also dowel screws, dowel centers, wood screw hole buttons. Excellent line card table leg supports. Best hardware of every description. Desk pens, complete with funnel and fastener, without base. Water transfer, inlays, small moldings, etc. Furniture glides and casters, office chair spiders, wood legs and K. D. chair frames. Small box hardware of every description. Large selection pulls, knobs, handles, hinges, locks, catches, etc. Perforated steel panels, chair braces, revolving chair fixtures, rocker springs, candlestick sockets, bill board clamps, banquet table equipment, many sizes braces, corner irons, hunger bolts. Step ladder braces, pilaster strips, sliding track and shelves. Typewriter desk hardware, binowings, mirrors, nut bowl hardware. Bar pins for novelties. Catalin Plastics. Crit hardware, swivel top table fixtures, sectional bookcase hardware, clamp nails, electric pens for burning, etc., etc. Send 10c cash or stamps.

THURSTON SUPPLY COMPANY, Dept. P. M., ANOKA, MINN.

Big Money for Workers
In Home or Shop



MAKE color-glazed concrete products, gravestones, tiles, walls, floors. Lawn, cemetery pottery. Basement waterproofing. New, patent method. Use only sand, cement, cheap materials. No skill required. Operators wanted everywhere. Full or part time. Big earnings. Send 10c TODAY for booklet, cost data, details. No obligation.

NATIONAL POTTERIES COMPANY
 Dept. 6, 13 W. 26th St. Minneapolis, Minn.

Sell Advertising BOOK MATCHES

WORLD'S LARGEST "DIRECT-SELLING" BOOK MATCH FACTORY

Offers you a money-making connection in profitable year 'round business. Experience unnecessary. Full or spare time. All business firms prospects. MATCHCORP'S new, faster-selling features: high quality; low factory prices; quick deliveries; bring easier orders. Repents boost earnings. KIT full instructions, FREE. Write today!

MATCH CORPORATION OF AMERICA
 3433-43 W. 48th Place, Dept. M-240, Chicago, U. S. A.



DO YOU WANT a new business profession of your own, with all the trade you can attend to? Then become a foot correctionist, and in a few weeks earn big income in service fees.—not medical nor chiropody—easy terms for home training, no further capital needed, no goods to buy, no agency. Established 1894. Address Stephenson Laboratory, 1 Back Bay, Boston, Mass.



ATTRACTIVE CATALOG

Artistic pins, rings and emblems for classes and clubs. Attractive prices. Finest quality, gold plated, silver, etc. Over 300 designs. Write Dept. N, METAL ARTS CO., Inc., Rochester, N. Y.



FREE TRAILER BUILDERS' GUIDE AND CATALOG

NEW EDITION
WORLD'S BEST LINE OF TRAILER AXLES, HITCHES AND PARTS—Complete house trailer working blue prints only 50c. WRITE TODAY FOR THIS NEW FREE CATALOG.

HAMMER BLOW TOOL COMPANY, DEPT. 102, WAUSAU, WIS.

Choose from World's Largest Line of Power Tools!
FREE New 1940 Catalog covers Metal and Woodworking Tools, accessories, motors for every purse. Write Walker-Turner Co., Inc., 120 South Ave., Plainfield, N. J.
DRIVER Engineered POWER TOOLS

ELECTRIC LIGHTS AND POWER

Build Your Own Wind Plant from old generator. Dime brings complete PLANS and 1940 catalog listing over 900 Electrical Supply Bargains. LeJay Mfg., 1447 LeJay Bldg., Minneapolis, Minn.

BUILD YOUR GRANDFATHER CLOCK

SIMPLE BLUEPRINT SYSTEM 25c
 The Simple Sensible Red-i-Kut way as thousands have. DIME brings PLANS and sixty picture "HOW" Book, pricing many fine brass weight Westminster, tube chime, electric and battery movements showing nine beautiful colonial grandfather cases. WHY WAIT LONGER? **KUEMPEL CHIME CLOCK CO., Bldg. 37, Guttenberg, Iowa.**



NOW A GENUINE
EVINRUDE
\$29.95
FOR ONLY

Prices
 F.O.B.
 Factory

EVINRUDE "MATE"

Weights only 10 pounds

Costs only 2¢ an hr. to run



The lowest price . . . the biggest value . . . in Evinrude history! A smart and capable outboard offering all of Evinrude's famed features — Hooded Power — Co-Pilot steering — finger-tip controls — Underwater Silencing — trouble-proof Centrifugal Pump Cooling — extraordinary starting ease — a complete 1940 Evinrude for only \$29.95! Fits any boat . . . a great motor for fishermen . . . runs all day on a gallon of fuel!

WRITE FOR 1940 CATALOG — FREE

New catalog describes complete line of nine 1940 models, including sensational new 4-cylinder "Zephyr"—thrillingly smooth 4-cylinder performance with light weight and low cost. Also catalog of 1940 Elto models, with prices starting at \$26.50. Write today. Address, **EVINRUDE MOTORS, 4303 North 27th Street, Milwaukee, Wisconsin.**

BRINGS OLD FRIENDS TOGETHER



● Holds permanently on china, glass, wood, metal, leather, paper, fabrics. Transparent, flexible, waterproof—not affected by heat. Dries quickly. Ideal for model making as well as for mending.



DUCO CEMENT

HANDEE Hobbies

Get more out of life. Make things with our easy working plans. 75 new, intriguing projects for the home, gifts or to sell—models of ships, planes, houses; engraved glassware, trays, mirrors; statuettes, book ends, etc. Portfolio of 12 plans, 25c.



TOOL OF 1001 USES

A tool shop and power house in one. Plugs in any electric socket. Grinds, drills, polishes, cuts, carves, routs, saws, sands, sharpens, engraves, all materials. Write for FREE 64-page catalog. Shows Handees \$10.75 up.

10 DAYS FREE TRIAL

CHICAGO WHEEL & MFG. CO.
 108 S. Aberdeen St. Chicago, Illinois

21054

There's Magic in Everything

(Continued from page 203)

small bead or ring. One end of the string is knotted to this, the other goes through a suspended ring and out the top of the tube. A second string is attached to the suspended ring, the end of which the performer holds. When he wishes the tube to rise he merely tightens the cord, or, if the tube is to go down, the string is held limp. In handing the tube to the spectator, the magician turns it upside down. This causes the tube to dangle at the end of the cord, where it can't move.

An absorbing bit of dinner-table hocus-pocus is the pouring of smoke from one glass to another. With six or seven puffs of cigarette smoke, fill a freshly emptied water glass to the brim. The smoke should be pushed out of the mouth gently with the tongue so it's folded rather than blown into the glass. As soon as the glass is filled, bring it in contact with the rim of a second moistened glass and tilt slowly; the smoke will roll from one to the other as if it were a liquid. The pouring operation can be repeated several times, but be sure the two glass edges are brought together as a small air current blowing between them is apt to dissipate the smoke.

A concluding trick with numbers is the telling of a person's age and his street number by a series of commands. The person writes his street number on a sheet of paper shielded from the magician's gaze. His next command is to double it, add five, and multiply the total by fifty. To this amount he adds his age. The last command is to add the number of days in a year to his total and subtract 615. The last two figures will be his age, the others his house number.

With scissors and bond paper you can fashion a walking doll, which can be made to walk backward or forward on a table top to the wonderment of young and old. Blow gently against the doll and it will "retreat." Hold your hand behind the doll, blow against your hand and the doll walks toward you.

(Names and addresses of manufacturers and dealers in articles described in this magazine will be furnished by our Bureau of Information upon request accompanied by stamped, self-addressed envelope.

AT LAST!**A COMBINATION HI-SPEED WOOD PLANER and FINISHER**

FITS ANY
DRILL PRESS
\$7.50
COMPLETE

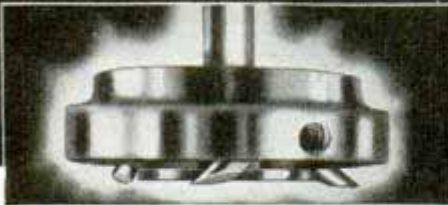

**ELIMINATES HAND PLANING AND SANDING
LIGHTNING FAST—SAFE—ABSOLUTELY ACCURATE!**

No workshop is complete without this sensational, time-saving, mechanical hi-speed wood planer and finisher. Requires no sanding for added smoothness. Accurate to within .001 inch. Planes every type of wood, plastics and similar materials without scratching, marking, gouging or checking. Parallels and surfaces with amazing speed—30 seconds for planing 2 ft. x 8 in. board with 1/16" out or less. Knots, hard grains and surrounding surfaces finished to agate smoothness. No experience or skill required. A lifetime tool. Works in any table or pedestal woodworking drill press. Indispensable for cabinet and pattern makers, carpenters, millwrights and home work shop enthusiasts.

HERE'S OUR MONEY BACK FREE TRIAL GUARANTEE

We will send our new Hi-Speed Planer any place in the U.S.A. for a five day free trial. If you are not 100% sold on its all around usefulness, just return it, getting your full refund. Try it and be convinced. Send check or money order for \$7.50 introductory offer. We prepay shipping. Or order C.O.D. and we will ship parcel post collect.

FREE DESCRIPTIVE LITERATURE. DEALER OPENINGS

BERRY TOOL COMPANY

312 Architects Bldg.

Detroit, Mich.

BUILD THE DESTROYER PRESTON

**CARVED
HULL
Included!**

24" Super
Detail Model

Catalog—10c

IDEAL AEROPLANE & SUPPLY CO., Inc., 26 W. 19 St., New York

**YOU CAN MAKE MORE MONEY**

in the Composition Novelty Manufacturing Business. Reports of \$100 a week or more are not unusual. Our Big 32-page Book explains and illustrates the secrets of this profitable money-making business. It's yours for only 10c. Send for it today! STEWART'S STUDIO, Dept. PM-15, 2927 Wilcox St., Chicago, Ill.

**YOU SAVE MONEY!**

Now — order at home. Select your camera, equipment and supplies from the book that has everything in photography—all the leading names—at real money-saving prices. Amateurs and professionals alike have made this book their photo-buying guide. Send for your **FREE** copy at once. Name and address on a postcard will do.

LAFAYETTE CAMERA

Dept. 78C—100 Sixth Ave., New York, N. Y.

2 118 8

Radio Goes to War

(Continued from page 213)

channels to RCA Communications, the receiving point at Riverhead, Long Island. Thence they were transmitted by wire to a master control room in Radio City, located in New York, and finally by wire lines to stations scheduled to receive the broadcasts. From these local stations the news was transmitted on regular wavelengths to listeners. Broadcasts from other foreign cities, such as Warsaw before its fall, which do not always have dependable direct transatlantic short-wave facilities, were sometimes wired to Geneva, Paris or London and then short-waved across the ocean to diversity receiving units at Riverhead. A diversity unit comprises three receivers, each of which is equipped with an automatic gain control. The strongest of the three receivers automatically feeds the line amplifier, the output of which goes by wire to the master control room. Thus, if one of the signals becomes too weak for dependable U. S. reception, another receiver goes into action automatically.

Most of the foreign talks are arranged well in advance of the actual broadcast. Should a commentator have something important, he radiograms the special events department, which is directed by A. A. Schecter, telling when he wants to go on the air, and transatlantic and local channels are cleared for him.

During the days just preceding the war, NBC's special events department was a chaos of wires, microphones and technical equipment. Events moved so fast that a miniature master control room, with monitoring facilities and all, was established there in order to expedite broadcasts. A twenty-four hour day was in effect for most of the personnel; sandwiches and coffee comprised the diet of most of the staff for a full week, with the result that in the ten days preceding outbreak of hostilities more than 150 foreign broadcasts were brought to American listeners by NBC.

Technically the war has been marked by Columbia's use of a four-way hookup, which renders possible conversations on the same program between experts in New York, Washington, Paris and London. When CBS technicians tackled the problem of giving American listeners a bal-

(Continued to page 139A)

SHORT CUTS FOR THE HOME CRAFTSMAN



How to "antique" a piece of furniture

● A Carborundum Brand Garnet Abrasive Sleeve fitted to a drum rotated by flexible shaft becomes, if anything, even more useful than a disc sander.

The maker of antique furniture reproductions finds such a sanding drum a big time saver. It can be used to make almost any kind of depression in any wood. Edges and corners are easily rounded to simulate wear. And high-lighting the work after staining is a simple matter.

"Antiquing" furniture is only one job for Carborundum Brand Garnet Sleeves. They can be used in dozens of other ways to save you time, labor and money... to help you get more pleasure from your home workshop.

Ask your hardware dealer or mill supply house to show you the complete line of Carborundum-made coated abrasives, sharpening stones, grinding wheels and other abrasive products for the home craftsman. Send 20¢ coin or stamps for souvenir sharpening stone and valuable illustrated manual on how abrasive products can save time and help you do better work.

CARBORUNDUM
ABRASIVE PRODUCTS

THE CARBORUNDUM COMPANY

REG. U. S. PAT. OFF.

Niagara Falls, N. Y.

Sales Offices and Warehouses in New York, Chicago, Philadelphia, Detroit, Cleveland, Boston, Pittsburgh, Cincinnati, Grand Rapids
(Carborundum is a registered trade-mark of The Carborundum Company)

"THE RIGHT SAW FOR
Every Job"



• Using the right type of saw plays an important part in giving work that master-craftsman touch . . . and makes every job a lot easier. Equip your work bench with Atkins Saws of enduring Silver Steel. They give you the "edge" for perfect workmanship. See them at your local hardware store. Send 10c for How-To-Do-It Book.

ATKINS *Silver Steel* SAWS

"For Every Cutting Job — Atkins Has The Edge"
E.C. ATKINS AND COMPANY, 428 S. Illinois St., Dept. M-2, Indianapolis, Ind.

WOODWORKERS NEW BARGAIN BOOK

Yes, rock-bottom prices! On EXTRA FINE woods, too! Send 10c for NEW 1940 BARGAIN BOOK. Learn how much you can SAVE. Forty-one sensational NEW offers solely to prove the HIGH QUALITY of woods that have made the name CONSTANTINE famous for 112 years. Think of it! On some special lots at less than \$5.00 you actually save up to \$14.81! Send 10c for Bargain Book TODAY—WHILE SPECIAL STOCKS LAST!

ALBERT CONSTANTINE AND SON, INC., 791-D, E. 135th St., N. Y.

BIG OPPORTUNITY STUCCO SPRAYING



Renew old buildings. Make new construction more permanent and attractive. Plastic Colorcrete is water-proofed. It fuses with any masonry surface. It fills all cracks. It can be applied in any thickness and in 30 colors. Fully proven by over 12 years actual use under all conditions and every climate.

OFFERS BIG EARNINGS

Owners everywhere want to enhance present values. With this machine you can supply this big waiting market with permanent Colorcrete at amazingly low cost. Operators report cost of 2c and up per sq. ft. and sell up to 7c. Some have paid for their equipment from first few jobs. Machine capacity up to 1,000 sq. ft. per hour. Get the facts. Send for the books, "Proven Business Opportunity." Write today. It offers you big extra income.

COLORCRETE INDUSTRIES, INC.
570 Ottawa Ave. Holland, Mich.



BIG MONEY-MAKERS THAT WORK FIFEL-GEARED PIERRENCH KIT-7" & 8 1/2"



"Pocket Machine Shops" that do the work of \$50 worth of other tools. Amazingly Quicker, Better . . . Easier!

• Now of ALLOY Steel—65% Stronger! • NEW PLANT . . . Quadrupled Capacity.

• Now have your Own Business in a New Selling Case. Full-time men making \$1,500 to \$4,000 Yearly . . . Part-timers in proportion. We need Many More!



NEW FREE



Bottle-Cap Opener, etc.

Mail Your Address Today (on a post card will do) Get FREE—this 6-Edge End-&-Angle Screw-driver and 101-Picture Manual of Mechanics, with . . . User Offers: or, with . . . DISTRIBUTOR, Territory, Demo, and SELLING Kit Offers!

AMERICAN PIERRENCH CORP

PMB-4611 N. RAVENSWOOD AV.
CHICAGO, ILL.

SPARE TIME MONEY . . .

There's a big demand for the many hand-tooled articles you can make with the Esco Leathercraft Set. Easily learn to make good money in your spare time. Complete outfit including tools, leathers, patterns, etc., and full instructions, only \$2.00—on sale at leading Department Stores or order direct and pay postman on arrival. \$2.50 outside U. S.

LEATHERCRAFT

Free When ordering direct, clip name of your Department Store to this ad, and we will include with your set, one extra free project. Illustrated catalog 10c.

E. A. SWEET CO. Dept. A-31 Binghamton, N. Y.

EASY PROFITS IN PAINT SPRAYING



Paint walls, ceilings, screens, furniture, radiators, machinery faster, better! 3/4 H. P. motor 110 Volt 60 Cycle AC, complete with Spray Gun, 15 ft. hose. Weighs only 44 lbs. Carry anywhere. FULLY GUARANTEED. Only \$31.15 f. o. b. Chicago. \$5 Deposit, Balance COD, or SEE YOUR DEALER. Circular FREE. Get started making money NOW!

Ideal Automatic Pump Co. Dept. PM-2, 801 Washington, Chicago **\$31.15** Complete

MAKE MONEY in new Kind of Concrete Business

START YOUR
OWN SPARE TIME OR
FULL TIME BUSINESS

Here's a world beating opportunity to start a profitable business right at home, making salable articles of all kinds from concrete. Make garden furniture—bird baths—statuary—vases and hundreds of other products from both the conventional and the new colored concretes. All these things are in big demand. Little or no capital needed.

256 PAGE BOOK TELLS HOW

Get "1001 Ways to Use Concrete" the amazing new book that covers the whole field of making money in concrete work. Explains all methods and materials, trade secrets, simple equipment you can make—gives 146 short cuts to extra profits. Hundreds of pictures and sixteen full-colored plates. It's the key to a new and growing industry, that you can use now.

SEND NO MONEY. Pay Postman

Price, complete \$4.95. Postpaid upon receipt of remittance. If you live in the U. S. or possessions you may pay postman on delivery, plus few cents charges. Money back if not satisfactory. Order now and get started at once.

POPULAR MECHANICS PRESS
Dept. 240, 200 E. Ontario Street, Chicago

(Continued from page 137A)

anced picture, in one program, of the situation as it developed in world capitals, a four-way conversation required the use of several short-wave channels and cue channels. To eliminate the multiplicity of channels, the staff developed a complicated arrangement of circuits and amplifiers whereby each man on the program could hear the voices of every other man, but not his own. If his own voice had been audible, the slight time lag would have destroyed the clarity of the program. But more important, it was possible to carry the entire program on two channels, one eastbound and one westbound.

Dress rehearsals for the European coverage had been held by the broadcasting companies in the form of broadcasts of U. S. Army maneuvers. In these sham battles, one announcer carries a pack transmitter, weighing perhaps twenty-five pounds, on his back and does most of the talking. Behind him, in a mobile unit, is an engineer and a few miles away, in a tower, are stationed a few observers commanding a view of much of the "battle" front. Their position compares with that of an observation balloon in a real engagement. Other staff men, many of them Reserve Corps officers, are stationed at various strategic points—at General Headquarters, in observation planes, around the battlefield—while others perform the duties of liaison men. The announcer, with his one or two-watt pack set, transmits signals, while the "battle" rages, to the mobile unit, which is equipped with a transmitter, of perhaps twenty-five-watts power. From there the signals are retransmitted to a seventy-foot tower far back of the lines and operated around 2,000 kilocycles. The signal then is picked up by a receiving station located at General Headquarters and retransmitted once more to a central control station, thence by special telephone circuit to the master control room where it is fed to the networks. By using several wave lengths the engineers are able to avoid concentration of interference on any one channel by the hundreds of transmitters being used by the opposing "armies."

Broadcasts of army maneuvers have demonstrated that radio coverage of a single engagement between Germany and the

(Continued to page 140A)

WANTED:

RED-BLOODED ADVENTURERS

Listen to
"SKY BLAZERS"

— true adventures of the
Men and Women
Born to Blaze the Trails
of the Blue

Thrilling! True! Romantic!

EVERY SATURDAY

COLUMBIA BROADCASTING SYSTEM

7:30 P.M., E.S.T.—6:30 P.M., C.S.T.

7:00 P.M., M.S.T.—4:30 P.M., P.S.T.

PRESENTED BY **WONDER BREAD**

YOU HAVE BEEN WAITING TO PAINT

COMPLETE WITH 110 V. MOTOR ONLY \$9.85

Now Everyone Can Paint This Easy Way—with a Spray Gun! A complete paint-spraying unit, light and compact, (weighs only 8 lbs.) designed for home use for lacquer, enamel, varnish, insecticides, moth-proofing; for screens, radiators or furniture. Strictly quality equipment—material and workmanship guaranteed. Complete unit includes high grade 110 V. A. C. D. C. motor, 6 ft. cord and plug, piston type compressor with cast iron cylinder on sturdy base, efficient spray gun with ½ pt. glass container and 10 ft. air hose. Write for Circulars, or Send \$1.00 today—pay postage balance, or shipped postpaid if full price accompanies order—dealers write. Miller-Simons Inc., 2903 S. 61st Ct., Cicero, Ill.





MEGOW'S

MODEL SHIPS
HO-GAUGE RAILROADS

MODEL AIRPLANES

Send 5c postage for new Megow Catalog! 100 pages, profusely illustrated. Shows scores of gas-powered and rubber-powered Model Airplanes. Also Ship Models, HO-Gauge and O-Gauge Railroads, equipment and supplies.



MEGOW'S Dept. PM, How. & Oxf. Sts., Phila.
217 N. Desplains St., Chicago

TO RESPONSIBLE MEN ONLY

who seriously wish to get ahead and who seek

GENUINE OPPORTUNITY and GENUINELY SUBSTANTIAL EARNINGS

we will provide capital and equipment needed for you to build a business of your own
No cost to you—No risk

No previous experience in any kind of selling is necessary. If you are capable of understanding and of applying your own judgment to tested methods, if you are one who likes to practice to gain skill and judgment in what he does, and if you are a worker, willing to pay a working price for success, then we will give you a chance. We cannot guarantee you will be a star, but we do guarantee you opportunity with sincere, earnest, practical instruction and guidance.

This is a large national institution operating from coast to coast. Soundest backing. Starting with 1 office 15 years ago, now hundreds of offices required. Significant Sign: Biggest progress made during past 10 years. We are now introducing this extraordinary product and it already has a greater sale than any product in the world ever attempting any of its services (no device ever having attempted to render all of its services).

Only for Men Interested in PERMANENCE

Do not misunderstand. This is no get-rich-quick scheme. You cannot make money here unless you earn it, and some men who apply to us fail to fulfill the requirements. But we have found also that many men who never previously even thought they could do work of this kind have found it to be just the opportunity they sought for years, and are now making more money than they ever previously dreamed of making. We have men making up to \$500.00 a month or more. Others \$400.00, \$300.00, \$250.00.

No previous experience necessary. If you are intelligent and capable, a responsible man willing to pay a working price for success, Electrolux Corporation will give you the same opportunity.

Can You Meet These REQUIREMENTS?

To be accepted, you must be able:

- 1.—To furnish 3 good character references.
- 2.—To prove, if unemployed, it is not through any fault of your own.
- 3.—To point to past record of activity and diligent application.

No investment or charge of any kind; all training is free; necessarily we must use care in appointing applicants.

PLEASE GET THIS: We realize a man of average ability must MEET SUCCESS FACE TO FACE, see it work, personally, IN HIS LOCALITY, before he can proceed without doubt or fear. Therefore the first step is a personal interview, followed immediately by your direct observation of sales success in actual operation.

You could read descriptions, claims, outlines, bulletins, courses for months and not KNOW as much as you can find out in ONE DAY about actual, successful procedures—applicable at once, since the visual way of showing overwhelming value is in itself simple yet powerful.

Then only can you understand (or accept) published earnings of

\$2,500, \$3,500, \$5,000, \$7,500, \$10,000

or more per year. Not by wondering about it—it is necessary to MEET MEN who do it, and SEE HOW they do it.

We recently published a list of earnings of 10 men totaling \$9,403.29 for the previous month, an average of \$940.32 per man for the month. We realized many would not see it, some would feel doubtful about it, a few would seriously investigate for themselves.

The results for 10 such men making a serious investigation are, TO THE PENNY:

MR.	FORMERLY	EARNED FIRST MONTH
C. F. N.	Burial Pk. Dir.	\$130.95
Fred H.	Mill Worker	243.86
S. S.	Factory Worker	190.55
R. J. F.	Salesman	492.64
D. C.	Bookkeeper	127.50
J. N. Mel.	Barber	93.05
F. S.	Farmer	116.86
P. M.	Store-keeper	126.47
J. B. G.	P.W.A. Worker	135.64
G. McD.	Grocery Clerk	169.33

The results for 10 experienced men are, TO THE PENNY:

MR.	FORMERLY	EARNED SAME MONTH
C. S. G.	Office suppl.	\$ 781.87
J. T.	Brush Salesman	993.04
Dan Y.	Bus Driver	618.90
J. K.	Laundry route	627.55
Joe P.	R. R. shop	954.91
Wm. S.	Dept. store	1314.13
Cyril R.	Radio Engr.	1103.60
E. A. L.	Salesman	1324.30
M. M. H.	Real Estate	1071.21
Rob't. L.	Machinist	1261.50

We can use good men who mean business and show them a fine opportunity already tested and working out successfully for other men—men of good character who work hard every day—who are buying homes, new cars, new furnishings, putting money in the bank regularly—mutually helpful and successful. If you feel you could fit in with men of this caliber and would truly appreciate seeing how they do it, write to **DEALER FRANCHISE DEPT., ELECTROLUX CORPORATION, 500 FIFTH AVENUE, NEW YORK CITY** stating name; address; age; if idle, how long, and why? Previous occupation and earnings; family status; dependents. (Not a mail order proposition—Personal interview in your own locality necessary.)

21188
(Continued from page 139A)

Allies might run into countless thousands of dollars. In the first place the best of short-wave and ultra-high frequency transmission paraphernalia must be put into action. Second, a battle cannot be counted on to occur within the vicinity of the mobile transmitters, and third, a miniature radio army must be used for speedy and efficient coverage. But in the face of tremendous expense and untold mechanical difficulties, the broadcasting companies are ready to undertake battlefield broadcasts. If and when the censorship is lifted by the warring powers, you'll be able to tune in the voice of the big guns.

How Long Can Germs Live?

(Continued from page 239)

proof that organisms have remained dormant for periods up to 5,000 years. Other experiments indicate they can withstand freezing, that they exist high in the stratosphere where the temperature is seventy degrees below zero.

Years ago Dr. Bartle conceived that it might be possible for single-celled organisms to sink into a dormant state in which they would remain potentially alive. Obviously, the only sure proof would be to find something which once contained bacteria, but which had been protected from further contamination and from growth for an extended length of time.

"When I first told people about my theory," Dr. Bartle admits, "the whole thing sounded crazy—even to me. But although I didn't have much hope of succeeding, I decided to try."

A few blocks from Dr. Bartle's home in San Luis Obispo, Calif., was a Spanish mission built in 1775. Some of the basement walls had been untouched since they were constructed. They were several feet thick, made of sun-baked brick, and dry as a bone. These walls seemed ideal for Dr. Bartle's experiment. It was only necessary to devise a method by which material could be removed without contamination from outside sources.

After much experimentation he devised a technique so foolproof that he has continued to use it during hundreds of other experiments. First step in securing a specimen is to flame the surface with a blowtorch until it glows ruby red. Next it is

sprayed with a fifty-per-cent solution of phenol, a powerful disinfectant. Then a hole is bored three or four inches into the material. The hole is also flamed and sprayed with disinfectant. Then a small coring auger is inserted into the hole, care being taken that it does not touch the sides. With the coring auger specimens are taken from various depths. These specimens are placed in sterile test tubes by means of a sterile glass rod. All tools are sterilized before use, and carried in sterile towels. Should they touch anything that has not been sterilized, they are flamed with the blowtorch.

The cores of material taken from the old mission wall were placed in test tubes that contained sterile bacterial media, which



Test tubes filled with germ-laden material were frozen a year in ice then thawed and germs revived

supplied food and moisture for any organisms that might have survived since the year before the American Revolution—the date when the mission wall had been built. The next day Dr. Bartle looked at the test tubes. Nothing had changed. The following day there was still no change. On the fourth day, a slight milkiness, a touch of turbulence, showed in one of the tubes.

Half wild with excitement, Dr. Bartle placed some of the culture beneath his microscope. Before his eye swam millions of moving—living—organisms; organisms which had survived without moisture, air, or food for almost 200 years.

His hand still wasn't steady when he wrote on the chart:

(Continued to page 142A)

Here's **DOUBLE POWER**

at Less than
Half Price!

only
29¢
EACH



And Guaranteed
for 18,000 Miles!

Double Check DOUBLE POWER SPARK PLUGS

Why pay almost twice as much for spark plugs? Buy Double Checks for *only 29¢ each*—and realize a brand new standard of power and economy.

You'll buy gas less often after you install Double Check, Double Power Spark Plugs, because there's *no loss in firing*. Longer and parallel side electrodes are the secret of Double Check's ability to *get every atom of power and speed from your car*.

In design and construction—Double Check Spark Plugs are patterned after multiple electrode plugs used in aeroplanes. *Here's Double Power at less than half price!*

ORDER A COMPLETE SET TODAY

**MAILED POSTPAID—
NO EXTRA CHARGE**

ANYWHERE IN THE UNITED STATES

SEND CHECK OR MONEY ORDER

A complete set for 4-cylinder cars, only \$1.16; 6-cylinder cars, \$1.74; 8-cylinder cars, \$2.32. Designed in the correct heat range for your car, truck or tractor.

Be sure to specify make, year and model of car.

DEALERS: Sell Double Check Spark Plugs in your territory. Write for details.



The PEP BOYS

MANNY, MOE & JACK

General Offices and Warehouses

10th St. & Somerville Ave., Philadelphia, Penna.

1122-24 W. Washington Blvd., Los Angeles, Calif.

LIKE TO FISH?

Shakespeare's WONDEREEL

LONG CASTS
NO BACKLASHES
NO THUMBING



Ideal for night fishing and beginners.
3 Wonderreels—\$6.50, \$10.00 and \$15.00.

SPECIAL OFFER Shakespeare's **NEW GLO-LITE MOUSE**

NO THUMBING

FREE

96 page Fishing Guide and Catalog. Write today.

New GLO-LITE Mouse Bait. Glows 5 hrs. if exposed 3 min. to sun or flashlight. 50c postpaid (90c value—limited supply). Send cash or stamps.

SHAKESPEARE CO., 237 E. Kalamazoo Ave., Kalamazoo, Mich.

21090
(Continued from page 141A)

"Ninety-six hours—thirty-seven colonies of living bacteria."

From then on Dr. Bartle was determined to establish whether there was any limit to the time which bacteria might remain dormant. He traveled thousands of miles searching for ancient structures which complied with the rigid conditions he laid down. Twice he crossed half a continent, only to find that the structure from which he hoped to take specimens had not been sufficiently protected from contamination.

But year after year he continued to secure older and older specimens, and in every case bacteria grew and flourished in his test tubes. Professor Charles Lipman of the University of California became interested, verified many of his results.

And then, deep in the age-old Teotihuacan Pyramid of the Sun, in Mexico, he found exactly what he had sought. Here was a structure whose age was not measured in centuries, but in millenniums. His blowtorch roared as he flamed a wall built 5,000 years before. And from this material, sealed away before the time of King Tut, he revived hundreds of colonies of bacteria.

Next Dr. Bartle heard that a National Geographic Society expedition had taken living organisms from the stratosphere, under conditions as nearly contamination-proof as humanly possible. These organisms, bacteria and spores, appeared to have been floating in the rarefied air where the temperature was seventy degrees below zero—and they had revived when placed under favorable conditions.

To further check the theory that bacteria could remain dormant in extreme cold, Dr. Bartle froze several test tubes full of organisms, kept them frozen for an entire year, then thawed them out. They promptly came back to life.

From these facts has come a new theory concerning the sudden appearance of epidemics of disease. If germs can be carried high into the stratosphere, they might remain for centuries at that high altitude, kept dormant by the low temperature. Then a strong down wind might carry them back to the lower atmosphere, where moisture and higher temperatures would cause them to spread a sudden epidemic.

It's still only a theory. But it explains a lot of hitherto baffling facts. And since Dr. Bartle has proved that bacteria are potentially deathless, the idea isn't so absurd.

Shakespeare BALANCED TACKLE

EASY TO BUILD KAYAKS IN & OUTBOARDS



Complete Cut-to-Fit "Double Processed" Assembly Kits. No Experience Necessary. Detailed Blueprints & Instructions. Build Your Own—Save Money—Enjoy Boating—1001 Satisfied Builders. Paddling.

KAYAK BOAT CO.
152 East 129 St., New York
"America's Oldest Kayak Factory"



dies Now Included. Write Today. Send 10c Postage for Complete, Illustrated Catalog Describing 20 Models.

BUILD AN ARC WELDER FROM OLD GENERATOR

For Light or Heavy Work. 75-200 amperes. Complete PLANS and valuable catalog 35c. Over 900 Electrical Supply Bargains.

LeJay Mfg. Co., 1347 LeJay Building, Minneapolis, Minnesota



Saw-Filing

Pays up to \$2 or \$3 an Hour in Spare Time

A FOLEY Automatic Saw Filer files hand, circular and band saws better than the best hand filer. Cash business, no canvassing, no eyestrain. No experience needed. Louis P. Wadovick, Ohio, says, "I have filed 764 saws in spare time and have earned \$850.00 in carpenter work due directly to my saw filing contacts." Send coupon for FREE PLAN, no obligation.

FOLEY MFG. CO., 216-40 Foley Bldg., Minneapolis, Minn.

Send Free Plan on Saw Filing business,

Name.....
Address.....



ELECTRICITY ANYWHERE



ONAN ELECTRIC PLANTS furnish 110 Volt, 60 Cycle, A. C. Current same as City Power Lines for Farms, Camps, Construction Jobs and Emergency Service in Hospitals, Schools, Theatres, Public Buildings. **SAVE PROPERTY, even LIVES** in case of Power Line Failure. Thousands in use in all parts of the World. Operate Lights, Radios, Water Systems, all Appliances. Models 350 to 50,000 Watts, 12, 32 and 110 Volt D. C.—110 or 220 Volt A. C. Also Combination A. C.-D. C. Units. Manual, Full-Automatic and Self-Starting Types. Shipped COMPLETE—READY TO RUN, \$99 and up. Write for details.

D. W. ONAN & SONS
1042 Baylston Ave. Minneapolis, Minn.

Send FOR MY NEW BARGAINGRAM NO. 242



A monumental work—lists thousands of STILL Cameras—New and Used... apparatus galore—Slide Projectors—Gigantic Book Section... Chemicals, etc. etc. Also Cine Catalog No. 240—Both FREE.

Bass CAMERA CO.

179 W. MADISON ST., CHICAGO, ILL. DEPT. P

Do more Earn more Work less with a Red Universal E Tractor



You plow, disc, cultivate, mow, haul, do belt work, for about 33¢ a day. Safe, trouble-free long life. New plow lift, new reverse. Hundreds used. Save by buying from maker. Two weeks trial. FREE catalog. Write today.

PIONEER MFG. COMPANY
Dept. V-20 West Allis, Wis.

MAKE YOUR OWN VENETIAN BLINDS

and save money. It's easy under our unique plan. We supply all parts and tell you how. Circular free.

VENETIAN BLIND MFG. & SUPPLY CO.
Dept. 2 1760 Lunt Ave. Chicago, Ill.

AGENTS 300% Profit SIGN LETTERS

For Store Fronts and Office Windows. Anyone can put them on. Free Samples. Liberal Offer to general agents.

METALLIC LETTER CO., 438 N. Clark St., Chicago

Earn Cash at Home!



We paid M. M. \$1174 for exceptional cellar crop Snow-King mushrooms! We furnish materials; buy all crops. Big FREE picture book tells if your cellar, shed, barn, suitable. Est. 1908. Write today. United Co., 3848 Lincoln Av., Dept. 302, Chicago

A GERSTNER Tool Chest

is the Right Chest for the particular Machinist and Toolmaker. Free Catalog.

GERSTNER TOOL CHESTS
440 Columbia St. Dayton, Ohio

Print Your Own

Cards, Stationery, Advertising, etc. Save Money, Easy Rules Sent, Junior Outfit \$0.99 Senior \$1.25 Up. Details Free. Write Kelsey Presses, A-37, Meriden, Conn.

EXCELSIOR PROFIT PRINTING FOR OTHERS!

FREE TRAILER PARTS CATALOG



We'll save you money on—axles, springs, wheels, couplers, windows, sinks, water pumps, brakes, refrigerators, beds, lamps, inside and out, 6V lamps, furniture, jacks—everything. Special discount to mfrs. NATIONAL TRAILER EQUIPMENT CO. Successors to Kar-A-Van Industries, Inc. Dept. P. 714 W. Wisconsin Ave., Milwaukee, Wis.

A AND N SUPPLY CO.



Bargains—Military, Sport Goods, Firearms, Clothes, Shoes, etc. Send 10¢ for new catalog, to be redeemed on first order.

EST. 1868 A & N Supply Co., 4772 Lester St., Richmond, Va.

Sweeping the Country! New-TYPE CHEAP OIL BURNER INVENTED!



COOK and HEAT without COAL or WOOD in Your PRESENT STOVE

MORE HEAT AT SMALL COST—No Dirt or Ashes
QUICK HEAT AT TURN OF VALVE

An Amazing New-Type Oil Burner Which Experts and Users Say BEATS ANY CHEAP BURNER EVER GOTTEN OUT FOR LOW COST, EFFICIENT PERFORMANCE. Burns Cheap Oil a NEW WAY Without Pre-generating or Clogging Up. READ BELOW HOW YOU CAN TEST THIS REMARKABLE SUPER FLAME OIL BURNER in Your Own Home FREE OF RISK. Then Mail Coupon.

OVER 40,000 SOLD
Satisfaction Guaranteed

Why burn coal or wood with its dirt and drudgery of building and feeding fires? Why carry ashes and get uneven, slow-starting heat? Burn cheap oil a NEW WAY and get MORE HEAT AT SMALL COST—and have QUICK HEAT regulated by a simple turn of a valve. Positively guaranteed NOT TO CLOG OR STOP UP. Has a record of over 11 years constant use without ever needing any cleaning. Simple—safe—economical—no electrical connections—no moving parts to wear out. Burns 95% air and 5% cheap oil—QUICK, CONVENIENT, EFFICIENT HEAT by simply turning valve.

Engineer of National Reputation Says: Combustion principles are simple, efficient, excellent—assures economical oil consumption and maximum heat. Tests made on burner with one year's hard service prove no evidence of dirt or residue or any carbon on interior parts. No nozzles or tips to "coke up" or stop up.—C. W. Lovelace—K. C., Mo.

USERS SAY: Fifteen oil burners of different kinds here but Heat King is cheapest, best.—J. R. Goldthorp—Washington.

I get more heat from your burner than I ever had from coal or anything burned in my furnace.—W. C. Nicholson—Ind.

Reduced coal bill fifty percent.—W. S. Collins—Pa.



Slips into Any STOVE RANGE or FURNACE

AGENTS SALESMEN BIG MONEY

No wonder salesmen and distributors are breaking records in sales. They show how it gives QUICK HEAT, HOTTER, MORE CONVENIENT, WITHOUT DIRT AND ASHES, and how economical it is in operation—then, reap BIG CASH PROFITS.

SALESMEN SAY:

Installed one when 10 degrees below zero. Kept house well heated. I can dispose of 250.—F. Silver—Canada.

I am a plumber, but never knew such a thing to get that much heat out of oil. There is money in selling them.—W. C. Nicholson—Ind.

SAMPLE BURNER FREE to producers. Write now for Agents Offer. Act quick. Be FIRST in your locality—MAIL COUPON or 1c postcard today—NOW.

SENT ON TRIAL

SENT ON TRIAL for 30 days. If you want quick, efficient heat at small cost you may try the "HEAT KING" AT OUR RISK. Write now for full information. Prove that it ends drudgery and dirt of coal or wood, prove its efficiency, convenience and economical operation. You must be satisfied under our liberal guarantee or YOU PAY ABSOLUTELY NOTHING FOR THE BURNER.

FREE SAMPLE to Agents

and salesmen who will demonstrate and take orders. Send no money—just sign and mail coupon (or 1c postcard will do)—be first in your locality to learn how satisfactory oil heat can really be and how you can MAKE REAL MONEY spare or full time. Mail Coupon or 1c postcard today—NOW.

UNITED FACTORIES
B-751 Factory Bldg. KANSAS CITY, MO.

MAIL COUPON UNITED FACTORIES
B-751 Factory Bldg., Kansas City, Mo.

Without cost or obligation rush full particulars of generous FREE TRIAL OFFER on wonderful "HEAT KING" Oil Burner.

CHECK HERE

Name.....
Address.....
City..... State.....

if interested in free sample to producers and money-making offer.

g 1259

Army on Wheels

(Continued from page 221)

will be seen that the addition of one of our motorized infantry brigades to the 7th Cavalry Brigade would fill the bill.

It is a comforting thought to Americans that our youth are brought up in a motorized atmosphere; that mechanical ability is latent in them. Few and far between are the young Americans who cannot drive a motor vehicle, who cannot almost instantly grasp simple mechanical problems. Now the driving of a tank or combat car is much more difficult and complicated than tooling an automobile or truck. But the man who



Barrier of the type which has been found successful in stopping advance of tanks

can do the latter is prepared to learn rapidly the minutiae of the former. The present increase in our regular army is bringing a great demand for men who can operate motor vehicles of all types, not the least being for service in the swift-moving tanks of the infantry, the combat cars and half-tracks of the cavalry, the rapidly rolling trucks that pull our field artillery along the road at high speeds.

This demand is accentuated by the necessity for duplicate crews of motor vehicles. The army has found out that for long motor marches both drivers and assistant drivers must be shifted for safety's sake as well as for necessary relief from strain. The tired assistant driver may nod to sleep just as dangerously as the tired driver, with equally fatal results.

All of which brings us right back to our initial premise that although this is a mechanical age, machines are run by men, and men fight wars. Man is the director, the machine his servant.



Your HAIR

Is IT THINNING OR FALLING OUT?

If your hair is causing you this kind of trouble and it is due to poor blood circulation in the scalp, rent a Crosley XERVAC and try home treatments with this amazing machine. It is designed to help correct just such conditions of the scalp as the lack of proper blood circulation.

Rent a CROSLLEY XERVAC

Write for free particulars, how you can rent a brand new machine, the same type now used in many barber shops and scalp clinics, for a small rental fee per month, without any obligation to buy. The Crosley XERVAC operates on the principle of alternate vacuum and pressure, known to be effective for forcing fresh, stimulating blood into the deep-rooted blood vessels. Very compact, easy to use. Now that you can rent one you can get its benefits on easiest of terms. Write today for details of this new home rental plan.

THE CROSLLEY CORPORATION
Dept. B-10 Cincinnati, Ohio

BUILD YOUR OWN RECORDER

Why buy complete recording apparatus?

Your own Amplifying Unit Connects Up

Thrilling, entertaining, educational home recording by just building in this capable "Basic" unit! Only mike and amplifier needed. Heavy duty constant speed G.E. motor mounted on solid vibration-proof aluminum casting; flat, wobble-proof turntable; Recording arm instantly adjustable for ACETATE, ALUMINUM discs. Cutter, 15 ohms impedance. What a buy! Order Today!



THIS IS THE WAY TO SAVE MONEY
Almost 50% saved by just building this fine unit onto your P.A. amplifier. What fun you'll have with home recording!

Complete line of cutting heads and amplifiers, pick-ups, turntables, discs.

SPEAK-O-PHONE, 23 W. 60th St., N. Y. City

\$13.95 Full Set

MICROMETERS



Six piece set, in velvet lined leather case. Special price, only \$13.95. Precision machined in one thousandths, up to 4" outside and 3 3/4" inside measurements. Guaranteed accurate, easy to read and adjust. Satisfaction guaranteed or money back. This is your opportunity to get one at a Bargain Price if you act now. Shipped prepaid on receipt of remittance. On C.O.D. shipments, send deposit of \$2.00.

MICRO PRODUCTS, 529 E. Jefferson Ave., Detroit, Mich.

Woodcraft



NOW ready: New 1940 buyers' guide and catalog — 136 pages listing American and fancy hard-to-find foreign woods, trimmings, inlays, ornaments, hardware, tools and miscellany, all with latest price quotations and some remarkable bargain deals. Every expert needs this book to keep posted.

Extra for Beginners!

Free (if requested) with 10c catalog: simplified directions so that you can make beautiful, lasting furniture the first week with just a saw, plane and hammer. The most fascinating of hobbies! A money maker, too, in spare time.—Write for the catalog. Send 10c to

SEND 10c CRAFTSMAN WOOD SERVICE CO.
3372 South Mary Street, Chicago, Illinois

Wonder "Food" for Plants

(Continued from page 165)

mately one milligram. An ordinary toothpick will do nicely as an instrument to measure this small amount of crystals. Place the tiny spot of the vitamin in a clean vial and add twenty drops of water. This is your stock solution. Do not make up any more than you need, and keep it in the icebox. If kept cold, it will retain its strength for at least a month; when warm, it deteriorates quickly. The dry crystals will keep indefinitely.

To make a working solution, use one drop of the stock solution to each gallon of water in your sprinkling can. Water plants in the usual manner, and give the same amount of vitamin-treated water that you would of untreated water. For most plants a vitamin treatment once a week is ample. For roses and gardenias the application should be made twice a week. House plants also should be treated twice a week. Lawns should be treated once a week.

However, when you are treating a plant to prevent root shock during transplanting, you should use a stronger concentration. In this case twenty drops of stock solution should be mixed with one quart of water. The roots of the plant being transplanted should be cleared of dirt and soaked for twenty minutes in the solution. Then plant in the normal way, pressing dirt well around the roots. The solution in which the roots were soaked should then be used to water the plant. Use enough to give a good soaking.

In wet climates potted plants are the best subjects for your first experiments in vitamin feeding, as excessive rains immediately following vitamin feeding are liable to wash away the chemical from the roots of out-of-door plants. This, of course, does not apply to root-shock prevention treatment. In soils very rich in humus, vitamin feeding may be less successful. Gardeners working under such conditions should check their results carefully. Above all, be accurate in measuring and administering the solution, and keep up regular systematic treatment.

☐ Inquiries as to makers of articles described in Popular Mechanics will be answered by our Bureau of Information upon receipt of return postage.

O O M P H !

WHAT DOES THIS DESCRIBE?

Something that's smooth as satin, fresh as a flower and nice to touch? You've guessed it right—it's a Barbasol Face. No harsh irritants in modern Barbasol to dry and roughen the skin—only soothing ingredients that leave your face feeling smoother and softer, looking younger and more attractive.



WHAT DOES THIS DESCRIBE?

No brush, no lather, no rub-in—the speediest, cleanest shave you ever had—whether the water is cold or hot? You've guessed right again—it's a shave with Barbasol, America's fastest-selling shaving Cream. (Your druggist has Barbasol in three sizes—25¢, 50¢ and 75¢. Five Barbasol Blades, 15¢.)



For Modern Shaving
No Brush • No Lather • No Rub-in

21230

It's Easy to Fly Your Own

(Continued from page 171)

thousands of miles. The first Cub ever built is still in use, after flying more than 250,000 miles, nearly 3,400 hours, and lightweight aircraft engines have a life figured at 4,000 to 6,000 hours, if given normal care. A recommended practice is to have the engine checked over at twenty-five hour intervals by a licensed mechanic. A fee of five dollars for this work is usual.

One curious thing about the plane is that the more you fly in a year, the lower the average cost per hour and mile. For instance, the owner of an "Aeronca" flew every day for twelve months, in all kinds of weather. At the end of that time, his log showed a total of 618 hours in the air and a mileage approximating 44,800 miles. His cost figures were: gasoline, 1,845 gallons, \$415.13; oil, thirty-seven gallons, \$35.15; engine and plane overhaul, \$25.60; total \$475.88. Adding depreciation, figured as \$300, and hangar rental, \$100, to that amount gives a total expense of \$875.88, or just under two cents per mile.

In comparison, an automobile costing as much as the "Aeronca" and traveling the same distance would have called for an expenditure of approximately \$1,400 for depreciation, garage, gasoline, oil, lubrication, tires and engine repairs and replacements. If the car averaged forty-five miles per hour, it would have required 996 hours to travel the 44,800 miles flown by the plane. Thus you have a saving in money and in time. Naturally, the plane cannot displace the auto. Both have their particular jobs and the owner of a plane would be wise to have a car in which to travel between the airport and his home, or on short trips. The plane comes into its own for journeys of 100 miles and more.

An outstanding air trip was a non-stop flight covering a distance of 2,785 miles. The ship was an "Aeronca." Cruising at ninety-one miles per hour, the flight required \$25.70 worth of gasoline and oil, less than one cent per mile, a record that cannot be equaled by the average low-priced automobile. Of course, the saving in time over that which the auto driver would have needed is considerable.

Another instance of air economy is a 7,590-mile trip made in a Stinson "105" during the summer. The pilot covered the distance in a little more than seventy-

Can You Equal This Home for 875

Shipped Direct from Our Mill



Save 30% to 40% on Your New Home..

WE PAY FREIGHT

Don't pay several hundred dollars more than necessary when you build a home! Buy it direct from our mill at our low factory price. We ship you the materials—lumber cut-to-fit, ready to erect. Paint, glass, hardware, nails, etc., all included in the price—no extra charges. We pay the freight. Plans furnished—also complete building instructions. No wonder our customers write us that we saved them 30% to 40%, compared with builders' prices. Easy terms—monthly payments.

Handsome Big CATALOGUE FREE

Pictures wonderful homes in colors at money-saving prices. Designs to suit everyone. Write for your catalogue today. LEWIS MANUFACTURING CO. Dept. 1202 Bay City, Michigan

Send for FREE BOOK of Liberty Homes

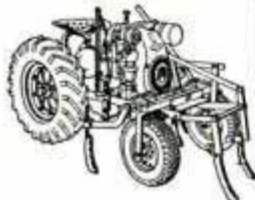

SPEEDEX GARDEN TRACTORS

Built to give years of service. Hundreds in use. Low Factory to User Prices. Several models available. 5-H.P. Riding type also Walking types in three sizes. Light Power Cultivator now only \$77.50. Write for Free Illustrated folder.

POND GARDEN TRACTOR CO., Box 216, Dept. 102, Ravenna, O.

NEW Electric PRESSER

HANDIEST AID FOR BUSY, THRIFTY WELL GROOMED MEN

Do your own Pressing this modern way, at home, in office or when traveling. Easy to use. No wet cloth, board or boiler. Plug in any socket and it's ready to press pants, collars, sleeves, lapels, dress pleats. And man, what it does to crumpled ties! It presses them into crisp newness before you can say Jack Robinson.

\$1 Post-paid Money Back Guarantee.

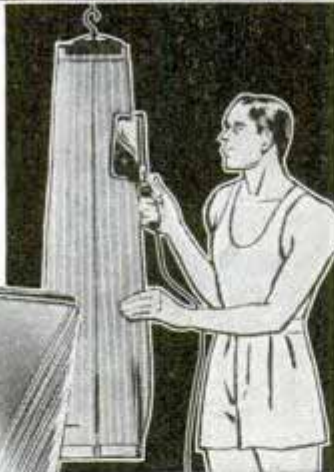

Material slides between two electrically heated pressing blades. Saves time, money, wear on clothes. Don't

let another day go by without an Empire. Send the coupon now. And, remember it's a gift any man or boy will appreciate. Each Empire presser is fully guaranteed. Comes complete with cord, plug, and simple directions.

DEALERS—Over 750,000 sold to date. Order now to take care of growing demand everywhere.

EMPIRE ELECTRIC CO., Dept. PM 817 Main Street, Cincinnati, Ohio

PM-2

Enclosed is \$1.00 for an Empire. If not satisfied, I will return it and my money will be refunded.

Name.....

Address.....

81230
 eight hours flying time, at an approximate average speed of ninety-eight miles per hour, and touched seventeen states. Here are comparative figures for the plane's trip and what an automobile would have required (figures for the car supplied by the Michigan Automobile Club):

	"105"	Auto
Distance by air	7,590 miles	9,230 miles
Distance by road		237.5 hours
Time for trip	78 hours (approx.)	40 m.p.h.
Average speed	98 m.p.h. (approx.)	\$109.61
Cost of gasoline	\$93.72	\$10.00
Cost of oil	\$4.56	

Night storage of the plane and of the auto would have cost approximately the same. Overnight hangar fees range from one to two dollars.

The Stinson is more expensive to buy than the average automobile, but over a period of time this difference probably would be reduced to a minimum by the cheaper operating costs of the airplane.

The more money a prospective airplane purchaser is willing to spend, the more he gets—more horsepower, more interior space, more instruments and more luxurious appointments. The \$995 Cub, powered by a forty-horsepower engine, might be called the "Model T" of aviation, since it offers perhaps the utmost in air-travel economy. From that point prices range upward, Aeroncas, Funks, Taylorcraft, Luscombe and a few other ships being offered at less than \$2,000. The Stinson "105," listed at \$2,995, goes a step farther, showing the performance characteristic of many of the larger and more expensive planes without the same high operating costs. What might be regarded as a deluxe job is the Waco "N," a four-place cabin ship with tricycle landing gear—considered a valuable contribution to safety—a powerful motor that develops a cruising speed of 140 miles per hour and luxurious seats, interior fittings and instruments. The price is \$10,695.

Undoubtedly there are many air-minded people who will say:

"Yes, I'd like to fly, but I don't have enough money to buy even the smallest plane, if it costs \$1,000 and if I have to pay \$250 to \$300 per year operating and maintaining it."

There are two ways in which such a person's yearning to fly can be satisfied. The first is to join a flying club, of which there are several hundred in the United States,

(Continued to page 149A)

Try this cooler SHAVING CREAM at our expense 20 SHAVES FREE

We won't ask you to read a lot of weighty arguments aimed to convince you that Listerine Shaving Cream is superior to others. We'll rest our case on the cream itself. We want you to try it at our expense.

One little dab of it on the face, whipped into a cool, creamy lather, will do more to convince you of its merit than a whole page of arguments.

If twenty free shaves do not remove all doubts of its superiority, nothing will.

It has been our experience that when a man gives Listerine Shaving Cream a thorough trial, he rarely returns to other brands—good as they may be. Possibly you will be an exception. We hope not.

It costs you nothing to learn the secret of cooler, quicker shaving. Simply clip the coupon below and put it in the mail. Tear it out now before you forget it. In return for it, you will receive a generous trial tube of Listerine Shaving Cream—enough for at least twenty shaves.

When that tube is empty, you will probably want the regular size tube. What a whopper of a tube it is . . . containing at least 130 shaves! Some men get as much as 175. What a whale of a bargain at 35¢!

All drug counters have it, as well as the new Listerine Brushless Cream. LAMBERT PHARMACAL CO.



LISTERINE SHAVING CREAM

20 SHAVES FREE

Lambert Pharmacal Co., Dept. 153, St. Louis, Mo.

Please send me free and postpaid your large sample tube of Listerine Shaving Cream; Listerine Brushless Cream. (Check whichever is desired.)

Name _____

Address _____

City _____ State _____

I'M SO HAPPY NOW THAT CHARLES IS DOING SO WELL IN HIS NEW BUSINESS



MADE \$217 in 10 DAYS WASHING WALLS

Newly invented machine washes walls 6 times faster and better than by hand.

Charles Steele made \$217.00 the first 10 days. We want more men like him to go into business for themselves. Customers everywhere — homes, schools, offices, stores, churches, lodge halls, hotels all have walls that need washing. You don't rent a store or office; you operate this business from your home. On a job paying you \$10 your cost is 20c. Write for complete facts on new Von Schrader Wall Deterger which washes paint perfectly and postpones repainting many years.

Howard James writes: "I landed a \$40.00 job the first day."

J. A. Crosby says: "I have several jobs to start on Monday, thanks to your help."

Cliff Brown writes: "I got a contract in a public school which will more than pay for my machine in the next few days."

VON SCHRADER



772 PL. RACINE, WISCONSIN

Easy Payments

It takes only a few dollars to get started in this new money-making profession. No experience necessary. The total price is so small and the payments so easy that anyone with ambition should get started NOW.

SEND FOR FREE INFORMATION

MANUFACTURING CO.

Start Your Own Business



PHOENIX RUBBER MAT MAKER

Part or full time. Turn out mats in 10 minutes
150% to 200% Profit.
Start on "Shoestrings"

It's the "business opportunity of the year"! Actually you can earn back your investment the very first week! Phoenix Live Rubber Mats are the sensation of the hour—and "easy as playing checkers" to make. We supply everything. And in their striking color patterns, the finished mats are really beautiful. Sell homes, clubs, stores, public buildings, hospitals, funeral directors, etc. Super quality—yet at prices competition can't meet. Start spare time—expand. Big possibilities for growth. Act quick. Send 10c at once for complete money-making facts and "fortune test" samples. "\$50.00 a week and independence."

ing color patterns, the finished mats are really beautiful. Sell homes, clubs, stores, public buildings, hospitals, funeral directors, etc. Super quality—yet at prices competition can't meet. Start spare time—expand. Big possibilities for growth. Act quick. Send 10c at once for complete money-making facts and "fortune test" samples. "\$50.00 a week and independence."

PHOENIX RUBBER CO., 9207 Detroit Ave., Cleveland, Ohio, U. S. A.

LEVEL STOVES, PLUMBING, CLOCKS, etc.

New Aluminum Cigar shaped level. Won't tear pocket. 9" long. Shows plumb, level, 45°, 1/4°, 1° pitch. Grooved Bottom. Only \$1.25.



BEAUTIFUL CHROME ALUMINUM POCKET LEVEL
Clips to Vest pocket like a fountain pen. Always handy. Accurate. Pith graduations on level vial. Only 75c. Order direct or from your dealer. Send 10c for catalog.



EMPIRE LEVEL MFG. CO., Dept. P-6
717 S. 6th St., Milwaukee, Wis.

WORLD'S LOWEST PRICED ADDING MACHINE

IDEAL FOR INCOME TAX
GUARANTEED ACCURATE. Not a toy. Operates with only a finger flick. Adds, subtracts, multiplies, divides. Counts up to a million. Pays for itself over and over. **Ideal Gift—for Business, Income Tax and School use. MONEY BACK GUARANTEE.** Send name and address. Pay postman only \$2.50 plus postage. (Send full cash if outside U.S.) Money back in 10 days if not delighted. **AGENTS WRITE.**
CALCULATOR MACHINE CO., (Mfrs.) DEPT. 162, P. O. BOX 1118, CHICAGO, ILL.



SOFT WATER
MAGIC WORDS —that are bringing big profits to Webb Salesmen!
The Webb Portable Water Softener gives every housewife, soft water in an endless flow for washing dishes, laundry, bath, shampoo and every home purpose. Softens hardest water instantly at the turn of the faucet. Provides healthful drinking water equal to many expensive bottled waters.
Distributors Salesmen FREE SALES PLAN
100% profit—simple home demonstration sells it easily. Leads to larger sales. Write today for free literature and full details of the Webb **NO RISK TEST OFFER** and **FREE Sales Plan.**
WEBB MFG. CO. Dept. P-10 1813 Baltimore Ave. Kansas City, Mo.



FREE! WHOLESALE CATALOG

260 pages chock-full of tested fast sellers, for salesmen, dealers and operators. New, big 1940 issue, just off the press. Describes many plans for boosting sales, one of which may add \$3 to \$15 a day to your earnings. It illustrates carded goods, automobile accessories, household necessities, office specialties, wearing apparel—over 4500 first quality items at low wholesale prices. Cost about 35c, FREE, while stock lasts. Get your copy by mailing your request for it, now.

SPORS COMPANY
12-39 Elm St., LeCenter, Minn.



4000 BARGAINS

CAPTURE THE COLOR OF LIFE!
YOUR OWN MOVIES! ONLY 10c A DAY!
NATIONALLY ADVERTISED 8MM and 16MM Movie cameras, projectors. For home, business, church, school, club. **MONEY BACK 10 DAY TRIAL.** Payments as low as 10c A DAY. Satisfied customers throughout the world. **FREE details. WRITE TODAY.**
Don Elder's Home Movies, Dept. N-2, 739 Boylston St., Boston, Mass.



TOMBSTONES \$9 UP Freight Paid

Genuine Marble & Granite At Low Prices. Lettered. Guaranteed. Free Catalog and samples. Write Us before buying.
U. S. MARBLE & GRANITE CO., A-18, Oneco, Fla.



CATCH FISH!
minnow, eel, mink, muskrat, with our folding galvanized Steel Wire Traps. **Walton's Automatic Hooks** are so constructed that when a fish gives the slightest pull on the bait the upper hook reaches down and gets a hold that lands him. 3 for 50c. Write for descriptive catalog of Traps, Hooks, Lures, and other specialties. **Walton Supply Co., 3567 Junata Ave., St. Louis, Mo.**

Always write your name and full address clearly when answering advertisements.

CASH IN ON SPARE TIME
\$30 WEEKLY OR MORE EARN. Grow mushrooms HOME. Cellar, shed suitable. We buy 35c lb. Year round business.
\$270 made by Mr. B. in few weeks **SPARE TIME.** Guaranteed materials. Established 1931. **Write for FREE BOOK.**
WASHINGTON MUSHROOM INDUSTRIES, Dept. 501, 2019 2nd Wash. Seattle.

Say you saw it in
POPULAR MECHANICS

THOUSANDS HAVE WAITED FOR THIS BOOK

What to Make Only 50¢

Get this new book and turn happy home workshop hours into extra cash. 188 pages packed with instructions, plans, valuable data and pictures showing what to make and how to make it. Anyone who can use simple tools can work from this book and make it pay him a profit. Order today. Sent postpaid for only 50 cents.
POPULAR MECHANICS PRESS
Dept. 240, 200 E. Ontario St., Chicago



2/23/47
 (Continued from page 147A)

each with fifteen to forty members. You pay around thirty dollars to join the club and one dollar per week dues. Flying lessons cost approximately five dollars per hour for the period of dual instruction and three dollars per hour for solo time. Since the course may be spread over one year, expenses may be split into weekly or monthly amounts, resulting in the course and club membership costing slightly more than four dollars per week. The second year's expenses per member need not run so high, the individual paying only the dues and the low per-hour fee for using the club's plane. Thus, anyone making twenty to thirty dollars per week might be regarded as able to join such a club and learn to fly.

A flying club may be formed anywhere that ten or more air-minded persons are found. The club may desire to purchase a plane, so the initiation fee for the individual would amount to his share of the down payment. Best results in club work are said to be obtained when a competent pilot is one of the organizers. This pilot instructs the other members in flying, makes up a flight schedule and attends to other duties, for which he receives a small fee from each of the other members. Air-field operators frequently find it desirable to supervise formation of these clubs, since the plan provides a means of keeping one or more ships busy. The initiation fee and dues assure the operator of sufficient income to pay for the plane, which he may use for other work when club members are not flying it.

The second means of becoming a pilot without possessing a large income is by purchasing a secondhand or used light-weight plane. Ships that have been in service from 500 to 800 hours and that are in government-approved condition may be purchased for \$400 to \$700, and up, depending upon the original price.

At the hundreds of large and small air fields scattered over the United States, thousands of persons are learning to fly. One company, the Piper Aircraft corporation, is now training more than 25,000 students, other factories are supervising similar work and flying clubs are adding their "graduates" to the steadily and fast-growing number of private pilots.

Thus, the time when "anyone can fly" seems to have arrived.

SMOKY JOE HAD THE DAMSEL IN DISTRESS!

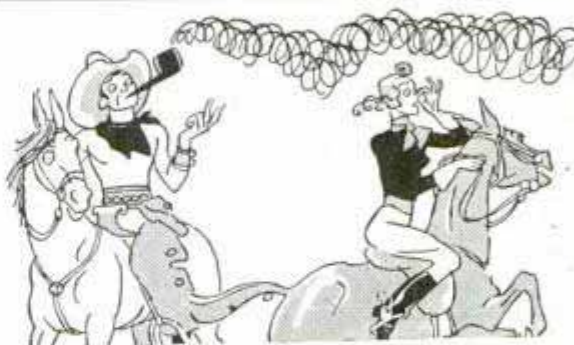

"GIDDYAP, NAPOLEON! Looks like this Romeo is trying his darndest to smoke us out. Phew! His tobacco smells like the backfire from Pa's flivver!" Just then



UP RIDES A RANGER, sniffs the pipe, says to clean it and refill with *mild Sir Walter*, a burley blend famous for aroma. It worked! Joe won her back!

New!
CELLOPHANE
TAPE around lid

seals flavor in . . .
 brings you tobacco
 100% factory-fresh!

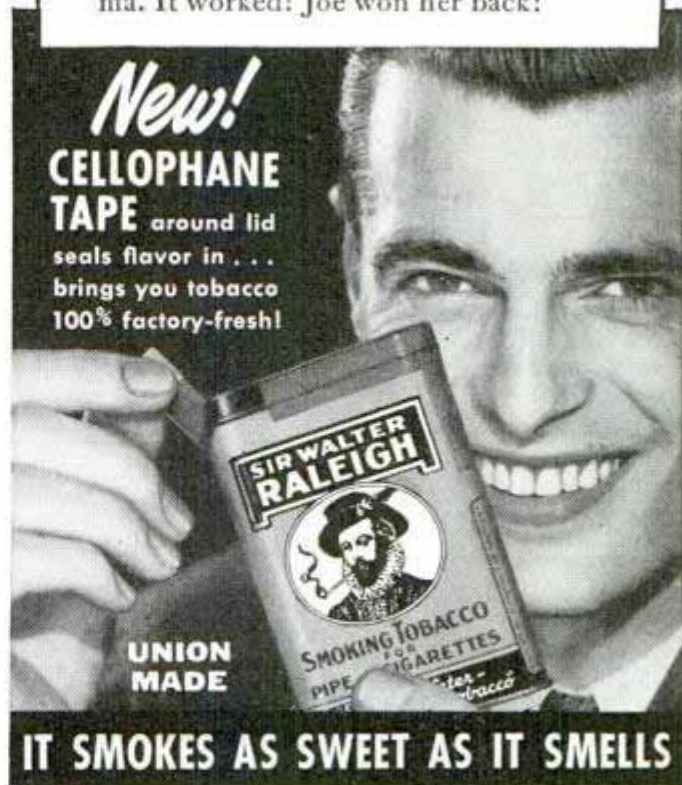

IT SMOKES AS SWEET AS IT SMELLS

TUNE IN—Sir Walter Raleigh "Dog House." Every Tuesday night, coast-to-coast, NBC Red Network.

SMOOTH-ON REPAIRS that save much money!

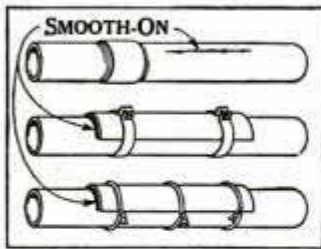

Stopping leaks at pipe cracks or joints

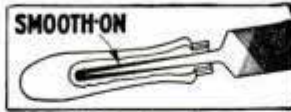

Tightening loose handles

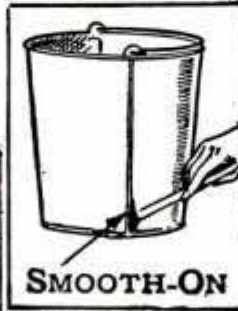

Sealing seams or punctures in thin metal

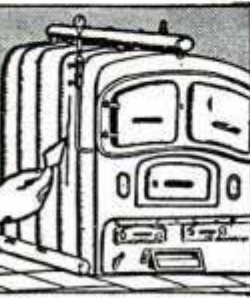
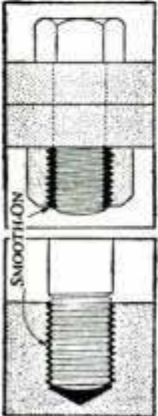

Stopping boiler and tank leaks



Stopping smoke leaks

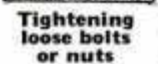

Tightening loose bolts or nuts

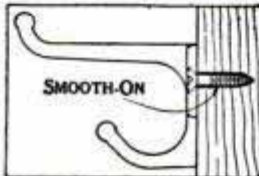

Resetting stripped screws

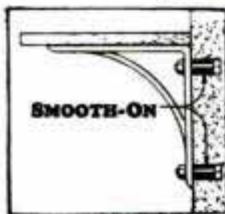

Anchoring in masonry

Dozens more explained in the SMOOTH-ON HANDBOOK

The instructions, working diagrams and advice in this booklet are a reliable guide in picking out the right Smooth-On composition and application method for many repair jobs. By using Smooth-On you save time and avoid much hard work, and by following the suggestions in this Smooth-On booklet, repair expense can be greatly reduced. Get your copy and keep a can of Smooth-On No. 1 handy.

Buy Smooth-On No. 1 in 7-oz. or 1 or 5-lb. can from your hardware store or from us.

SMOOTH-ON MFG. CO., Dept. 37
574 Communipaw Ave.,
Jersey City, N. J.

Please send Smooth-On Repair Book.

Name.....
Address.....
2-40.....

Write for FREE BOOK



Do it with SMOOTH-ON

The Big Eye Takes Shape

(Continued from page 191)

be explained by large detailed drawings prepared by Russell W. Porter of the observatory staff.

The \$6,000,000 which the telescope is costing was donated twelve years ago and at that time the intention was simply to build a telescope that would be twice as large and have four times the light-gathering capacity of the largest existing telescope. But during the last five years many

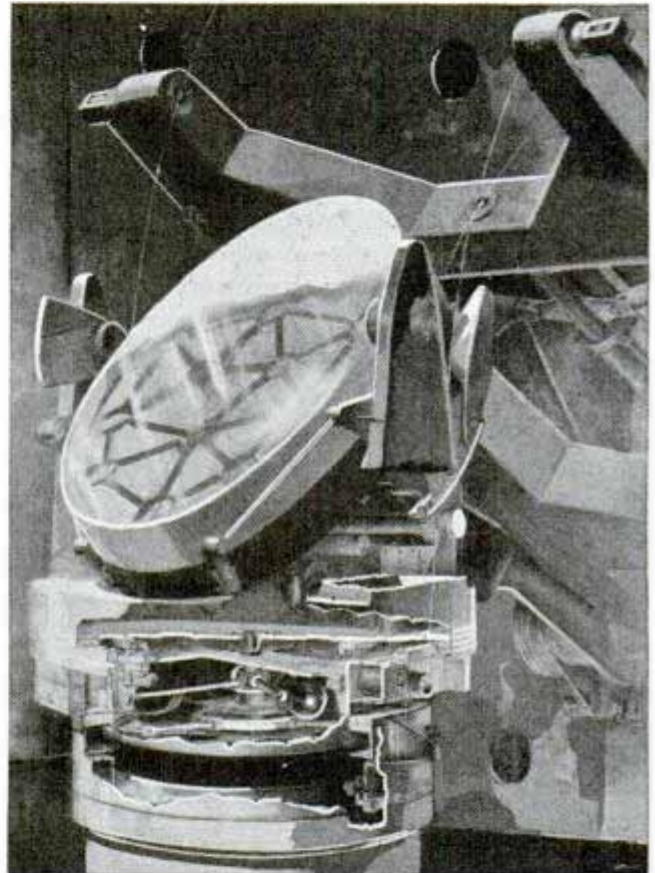

A Russell W. Porter drawing of mirror placed inside telescope barrel to reflect light gathered by 200-inch mirror out to observing point when special focus that gives high magnification is to be used

improvements have been made. For instance the giant reflecting mirror that gathers and focuses the light is to be coated with aluminum instead of silver, practically doubling its efficiency in the ultra-violet end of the light spectrum.

Will the new telescope supersede the instruments that astronomers are now using? Not at all. It is being constructed to do work that existing telescopes are unable to do. Each big telescope in the world is being used for studying a particular phenomenon of the heavens and the new instrument will be assigned to special tasks outside the ability of the others.

FACTORY TO YOU
WRITE for FREE CATALOG

NEW SUPER-QUALITY KITSELMAN FENCE

Heavier, amazingly improved galvanizing. Tougher, longer-lasting Copper-Bearing Steel. **Low Factory Prices. WE PAY FREIGHT.** Farm, Poultry and Lawn Fence; Steel Posts, Gates, Barb Wire, Electric Fence, Poultry Supplies, Paints, Roofing. **Write-KITSELMAN BROTHERS**
Dept. 94 Muncie, Indiana



WET BASEMENTS!

Amazing new Seal-Seep method, anyone can use. Applied to inner masonry wall and floor surfaces; no digging. Guaranteed permanently effective. Agents write for unusual earnings opportunity. Details FREE.

National Seal-Seep Co., Dept. 292, Cincinnati, O.

Waterproof Your Own Save up to \$100 to \$150

CAPE COD CHAIRS

Style "B", "C", "A". Blueprint 50c. All 3 for \$1.00. **TRELISES**—12 original designs. Blueprint of all 12 only 50c. **BENCH ARBOUR**—A beauty, 8" high, 5' 6" long, 2" wide. Blueprint 75c. Send 10c for catalog illustrating many projects. "Over 35,000 Satisfied Customers."
CRAFTSMAN'S MODEL CO., Dept. P-30, 2030 N. 41st St., Milwaukee, Wis.



PUSH-BUTTON CONTROLLED GAS TANK LOCK

A new invention "ELECTRIC HAMMER ACTION" obsoletes all other gas caps. Eliminates troublesome keys. Stops loss of gas and caps. Features **PUSH-BUTTON CONTROL FROM DASH—STREAMLINE DESIGN.** A fast selling, high quality product at **NEW LOW PRICES.** Distributors, dealers, here is your money making opportunity. Write now for descriptive literature.

SNAP-UP GAS CAP CO. DEPT. U. ASHLAND, KY.



New Adding Machine Fits Vest Pocket!

Adds, subtracts and multiplies up to one billion. Weighs only 4 ounces. Not a toy—strong guarantee. Absolutely accurate, very fast. Sells to offices, stores, homes wherever figures are used. Write quick for **FREE AGENTS** sample offer and Money-Making Plan.

VE-PO-AD, Dept. 202, 303 W. Monroe St., Chicago

Costs only \$2.95



AT LAST!

All Your Snapshots in Natural Colors! AMAZINGLY BEAUTIFUL!

Any size roll developed and 8 prints for only **25c** Natural Color Reprints **3c** each.

Natural Color Photo Service, Dept. C-54, Janesville, Wis.

SHOP OWNERS! NOW MORE THAN EVER YOU'LL WANT BOICE-CRANE Shop Tested POWER TOOLS

NEW 1940 CATALOG JUST OUT

In 1940 as before, Boice-Crane stays a step ahead. Boice-Crane gives you the really valuable improvements first . . . others imitate later. Years more service per machine . . . more accuracy that does jobs right. Get all this and more . . . see Boice-Crane first!



Famous Saw has 12 EXTRA Advantages

For 10 years the largest selling tilt-blade saw ever built. Now better than ever! Has Boice-Crane's famed belt drive, plus 12 EXTRA features. Write for facts!

Get Features No Other Power Tools Have

You get the benefit of engineering leadership by buying Boice-Crane . . . extra strength for the tough jobs; exclusive design controls and gauges to save you time setting up jobs plus split-hair accuracy without fumbling, fussing, or cut-and-try methods; more power efficiency using lower cost, standard, cool running motors.

Write Today Catalog FREE! Send 10c and we include 16 pg. Metal Spinning Instruction Book

NEW! America's Finest Drill Press

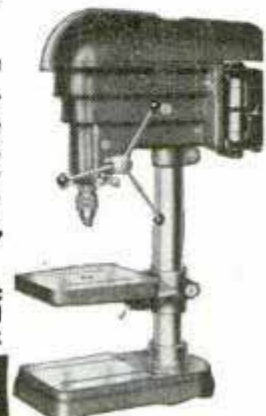

HOT WATER SPEED KING with



From Any Electric Light Socket

MILLIONS of homes, stores and offices everywhere need **SPEED KING**—the new, amazing **Water Heater**—that heats water boiling hot so fast it takes your breath away. No muss! No waste of time or fuel! Just a simple "plug-in" at any 110-volt light socket—and presto . . . just the amount of hot water you need for the bath, for shaving, for dish-washing. **CHEAPER** because you don't have to heat gallons when you need only a few quarts. **FASTER** because the intense electric heat goes directly into the water. Sells fast on a 60-second demonstration. Small in size—fits the pocket, easy to carry. Anyone can afford it.



60-SECOND Demonstration Amazes Housewives

SAMPLES for AGENTS

I WANT you to know the almost uncanny heating action of this speedy water-heating invention. Write quick—a postcard will do—for my SAMPLE OFFER that brings you an actual Sample SPEED KING for demonstration. You can make plenty of cash as my agent. HURRY! Big season starting now. SPEED KING solves the hot water problem when furnaces shut down. Act quick and I'll show you how to make the fastest money of your life. Send No Money!—Just your name.

JUST SEND

NAME

WRITE your name and address in the margin, clip & mail this coupon or send penny postcard to Dept. 162.

Name

Address

City

NU-WAY MFG. COMPANY
Dept. 162, Walnut Bldg., DES MOINES, IOWA

ENGINES

A real money maker for farm or factory. Uses Cheap fuels. Pays for itself out of savings. Costs Less to Own—Less to Operate.

LOG SAWS

Make Money—Start a wood sawing business—turn spare timber into cash. Cash or Terms—Engine and Saw Catalog.

WITTE ENGINE WORKS 1742 OAKLAND AVE. KANSAS CITY, MO.



BOICE-CRANE COMPANY Dept. 220 **TOLEDO • OHIO**

Relieve Heartburn Fast This Amazing Way



YES—TUMS bring amazing quick relief from indigestion, heartburn, sour stomach, gas caused by excess acid. For TUMS work on the true basic principle. Act unbelievably fast to neutralize excess acid conditions. Acid pains are relieved almost at once. *TUMS are guaranteed to contain no soda.* Are not laxative. Contain no harmful drugs. Over 2 billion TUMS already used—proving their amazing benefit. Get TUMS today. Only 10¢ for 12 TUMS at all druggists.

You never know when or where

**Always Carry
FOR ACID
INDIGESTION**



FOLDING METAL SAW HORSE LEGS

HUNDREDS OF USES! Many advantages over regular wooden horses. Legs fold compactly into space 1" x 5" x 25". Easy to transport and are set up instantly. Attached to any standard 2 x 4 or 2 x 6. Alligator grip holds legs securely. Ideal for carpenters, painters, home, shop workers, ping pong tables, banquet tables, display tables, booths, poultry houses, etc.



THEY HOLD

No nails necessary—erected in a jiffy. Rubber pads provided for finished floors. Save time—save space—make horses any width.



PRICES: 24" height for carpenters, etc. . . . \$3.60 per pair!
30" height for tables, etc. . . . \$4.20 per pair!
Discounts to Dealers and Jobbers. Write for folders!

WAGNER MFG. CO., Dept. A, CEDAR FALLS, IA.

MENDS MOST ANYTHING

Iron Glue holds tight, is extra strong. You can buy it 'most anywhere— $\frac{1}{4}$ pt. to 1 gal. cans or 10¢ bottles. **FREE:** Send post card for booklet, "Better Results with Glue," to: McCormick Sales Co., 402 Light St., Baltimore, Md.



IRON GLUE
AN ELEPHANT FOR STRENGTH

RECLAIM USED OIL

Equipment costs nothing to build. Good, clean lubricant obtained from waste oil at no cost. No chemicals. Send postcard for particulars.
F. GERWIN 800 Chester Road Fairview, Oklahoma

NEW AUTOMATIC CALCULATOR

Instantly changes inches in 16ths to 10ths & half 10ths, or to centimeters & vice versa. Converts Centigrade to Fahrenheit, or F. to C. Ideal in shop & school, does sq. root, proportion & div. like slide rule. Reverse side is drawing board; handy T square, Scotch tacks & instructions included. Send 50¢ plus 10¢ postage & handling.
TOLEDO CALCULATOR CO., 3917 BELLEVUE RD., TOLEDO, OHIO

only **50¢**

NEON SIGNS

At last, every merchant and business place can afford to own attractive, guaranteed, made-to-order Neon Signs. Sensational, new easy-payment plan. Appealing eye-catchers that bring increased business. Write today for colored folder.

**NOW ONLY
\$1.00
A WEEK!**

SALESMEN: Big opportunity; easy sales; No investment required.

HARWOODS & CO. 1366-A W. Fort St. Detroit, Mich.

ACE

LATHE TOOL SET

\$14.50



Be permanently tooled-up for every operation on your Metal Cutting Lathe

The ACE Set is complete—there's nothing more to buy. Drop forged by the manufacturers of cutting tools used by 96 per cent of the plants and shops in industry they are correctly designed, are of special steel, are finely finished, are stronger—will last a lifetime. You can cut easier, faster and more accurately with ACE TOOLS.

At your Hardware Store—Circular FREE.

ARMSTRONG BROS. TOOL CO.

"The Tool Holder People"

368 N. Francisco Ave., CHICAGO, U.S.A.

3 Turning Tools, 2 Cutting Tools, Knurling Tool, Boring Tool, Threading Tool, High Speed Steel Cutters and Blades, and 2 Wrenches in Fitted Steel Case.

NEW ROOFS OVER OLD

for 3¢ A SQUARE FOOT

BATTLESHIP

ROOF COATING stops leaks permanently. Saves 75% of new roof costs. Guaranteed waterproof. **Building Owners:** Send for free book—*Something New under the Sun.*
MEN WANTED—A big paying business for salesmen. Write today! No obligation.
PANTHER OIL & GREASE MFG. CO.
Paint Products Division
DEPT. 23, FORT WORTH, TEXAS

HOLD-E-ZEE

Automatic Grip Screwdrivers

Hold, start and set-up screws in unhandy places. Gripper instantly released by spring action, sliding up out of way when not in use. Finest materials thruout, chrome vanadium blades; many have transparent, insulating, unbreakable handles. Models for recessed-head screws. No more expensive than ordinary screwdrivers. At auto-supply, hardware or electrical stores.



UPSON BROS., INC.
86 Exchange St.
Rochester, N. Y.

Get DYKE'S Famous

AUTO Book



Learn to Test, Adjust and Repair all Cars.

If you want to make money in the automobile business today get the world's greatest authority to help you. Get **DYKE'S AUTOMOBILE AND GASOLINE ENGINE ENCYCLOPEDIA.** Now Ready—the 3rd printing of the new 18th edition. Right up to date and the biggest value ever offered in the 27 years of its publication.

You've heard of "DYKE'S". Hundreds of thousands of previous editions have been sold. Successful auto men, students, car owners, everywhere, swear by it. It contains more practical information on auto testing, adjusting and repair than anything else ever printed. Now up to date with all the newer automotive developments. Weighs 6 pounds. Has 1434 pages and 4600 pictures.

ORDER TODAY

Dyke's Famous Auto Book sent postpaid anywhere for \$6.00. If in U. S. or possessions order by postcard and pay postman price plus small C.O.D. fee on delivery. Safe delivery guaranteed.

Automotive Diesel Engines Included.

Tune-up Charts for Cars and Trucks.

Carburetor and Ignition Data.

POPULAR MECHANICS PRESS
Dept. 240, 200 East Ontario Street, Chicago

21349
Uncle Sam Helps Himself

(Continued from page 175)

less than one-tenth of the dyes it consumed a quarter of a century ago; even that meager proportion was made from imported intermediates. Now a great organic chemical industry that has come into being is supplying all but a trifling fraction of the country's needs, not alone in dyes but in other fine chemicals. Likewise, it produces needed medicinals in abundance. There no longer is any cause whatsoever for worry over war abroad curbing our supply of drugs.

"When the World War began, the United States was almost wholly dependent upon Germany for potash, which is so essential to agriculture and industry. In recent years methods have been devised for the economic recovery of potash from America's mineral deposits. This country now produces a major part of the potash it consumes. If necessary, it can produce all it needs.

"A highly essential material is rubber, imported from far-away lands under foreign control. It presented a grave problem during the World War, as supplies dwindled and prices pyramided. That need not happen now. Neoprene, the chemical rubber made from coal, limestone and salt, has every promise of functioning satisfactorily in place of natural rubber. Its price, based on a small production, is less than the cost of natural rubber during the early World War days. Moreover, it is actually superior to natural rubber for many uses.

"In 1914, America likewise was dependent upon Europe for the fine optical glass needed in the manufacture of various instruments vital alike in peace or war. Today, thanks to research by American scientists, this country is producing optical glass of a quality second to none in the world.

"Camphor, used in the manufacture of plastics and photographic film, as well as in medicine, was the instrument of a foreign monopoly twenty-five years ago. That monopoly long since has been broken. Today camphor is produced synthetically at home from southern turpentine at about forty-eight cents a pound, in contrast with the monopoly price of \$3.65 a pound as recently as 1920.

(Continued to page 160A)

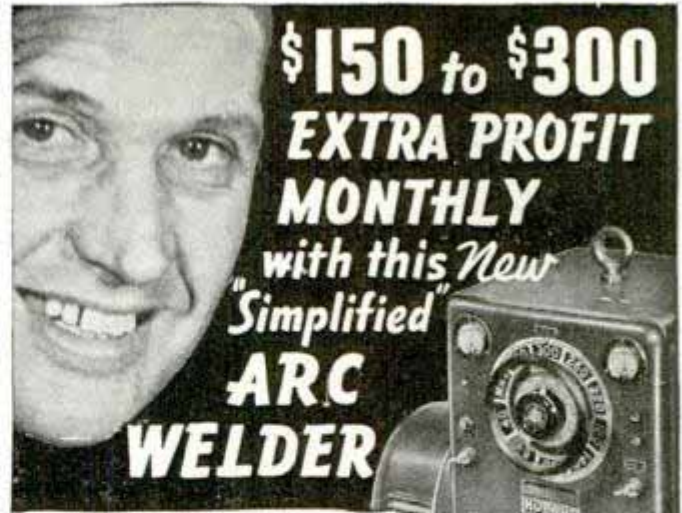

IT'S EASY TO GET BIG PROFITS WITH HOBART ARC WELDING EQUIPMENT

Because of big profits realized with the Hobart 40-Volt "Simplified" Arc Welder you can start a big paying business of your own . . . with almost no investment! Arc welder prices are the lowest in history, making it possible for even the smallest shop to own one of these money-makers. Extra profit from a single job is often more than enough to take care of the small monthly payments. Arc welding is today's profit opportunity . . . don't miss it!

Remote Control. This is an important feature you get at no extra cost with Hobart. It lets you control your welder from any working point. Saves time, temper and eliminates the need for a helper on overhead or concealed work.

Easy to Operate. Hobart Welders have "Simplified" operation. This means faster welding—with the right current for every job. Hobart is so simplified that any one of your men can weld easily and successfully. The mystery and uncertainty of obtaining correct welding current settings are removed.

60% Extra Capacity over old style 25-Volt Welders . . . necessary for welding with the new coated rods. Automatic reactance lets you handle light welder work without losing the arc. Users don't understand how they got along with old style welders after trying this new Hobart.

"Pays-for-Itself" Terms. You can try this complete Hobart Welder in your own shop for 30 Days Trial to prove that extra earnings and savings obtainable with this improved welder makes it easy for you to own a Hobart with practically no cash outlay.

HOBART BROS. CO., Box M-240, Troy, Ohio
 One of the World's Largest Builders of Arc Welders.



BUILD YOUR OWN Simplified ARC WELDER

It's easy and profitable to build your own portable electric arc welder with the aid of this complete Hobart Generator. Simply attach to old motor and mount on chassis and you have the factory equivalent and equipment costing from \$300 to \$500 more! This equipment lets you operate anywhere, especially on the profitable outside jobs. Check coupon for detailed information.

FREE!
 THIS VALUABLE BOOK ON ARC WELDING



PAYS FOR ITSELF WITHOUT EXPENSE TO YOU... 30 DAYS TRIAL TO PROVE IT

ASK ABOUT THE HOBART RENTAL PLAN

This liberal plan lets you rent a new Hobart Welder for use on your own work for any length of time. If you later decide to buy, all rental applies on the purchase price without the loss of a cent to you.

HOBART BROS. CO., Box M-240, TROY, OHIO

Tell me more about—

- () Building My Own Portable Welder
- () Complete Gas Engine Drive
- () Hobart Rental Plan
- () Electric Drive Welder
- () Send FREE Book On Arc Welding
- () 30 Days Trial and Easy Terms.

NAME.....
 ADDRESS.....
 CITY..... STATE.....



HANNES SCHNEIDER says...

"If you want to ski well you must practice everlastingly at snowplows and stem turns."

You've got to have good equipment, too, and you'll find that Northland Skis and accessories give you more for your money, bolster up your confidence in skiing. Hannes Schneider, world's No. 1 skier, uses and recommends precision-matched Northlands.

FREE! Illustrated "How To Ski" folder.

NORTHLAND SKI MFG. COMPANY

World's Largest Ski Manufacturers

95 Merriam Park

St. Paul, Minnesota

Appear **1 1/2** INCHES TALLER Instantly



Appear 1 1/2 inches TALLER AT ONCE. Hite gaining feature hidden. Increase your popularity and money making powers. It's easy and simple. The secret is hidden inside ADD-HITE shoes. No one need know how you appear TALLER unless you care to tell them.



10 day EXAMINATION at our risk. 1c card brings FREE details in plain envelope.

WENTWORTH, Inc., 272 Hunt St., Watertown, Mass.

WANTED MEN PAST 40

If you are past 40 and desire extra money we can help to make your full or spare time profitable. Business pleasant and profitable. Operate from your home. Call on merchants, shops, schools, churches, auto, truck and bus owners, farmers, lodges, public institutions, etc. Large manufacturer of approved first-aid fire extinguishers, fire alarms, recharges, etc. Write details about your past experience, etc. Address FYR-FYTER COMPANY, DEPT. 90-50, DAYTON, OHIO

SpeedWay DRILL \$7.95 GRINDER \$5.95

KIT \$14.95

QUALITY TOOLS
... products of SpeedWay, for 30 years leading manufacturers of electric tools. Specially wound high torque 110V universal tool motors. Improved design, correct speeds. 1000 RPM Drill with cast handle has 1/4" capacity in steel. 30,000 RPM Hand Grinder has speed essential for efficiency and outlets for both 1/8" and 3/32" arbors. Drill and Grinder sold singly or together with 5 accessories in fitted Steel Kit. Stand takes either drill or grinder. Router Frame converts grinder into router. Bench Grinder is complete with motor. Write for Circulars. SpeedWay Mfg. Co., 1842 S. 52nd Ave., Cicero, Ill.

ROUTER \$3.95

GRINDER \$9.95

STAND \$3.95

World's Smallest Pocket Radio

BEAUTIFUL PLASTIC COMPLETE

NO TUBES NO BATTERIES NO PLUG IN

Midget radio fits your pocket or purse. Weighs only 4 oz. Small as cigarette package! Receives stations with clear natural tone. "PATENTED FIXED CRYSTAL"—NO UPKEEP—only one moving part. "TUBELESS, BATTERYLESS." ENTIRELY NEW PATENTED DESIGN. Has enclosed geared luminous dial for perfect tuning. Many owners report amazing reception and distance.

ONE YEAR GUARANTEE

Sent completely ready to listen with instructions and Tinyphone for use in homes, offices, hotels, boats, in bed, etc. TAKES ONLY A SECOND TO CONNECT—NO ELECTRICITY NEEDED! SEND NO MONEY! Pay postman only \$2.99 plus postage on arrival or send \$2.99 (Check, M.O., Cash) and yours will be sent complete postpaid. A most unusual value. ORDER NOW! MIDGET RADIO CO., Dept. P-2, Kearney, Nebr.

15 Tested Ways to

EARN MORE MONEY!



Give yourself the lift you need with these pay-raising, extra-money books. Use them to prepare for better jobs—bigger pay—to add to your income through spare time work. All are up to date library size volumes.

SEE OFFER BELOW

SELECT FROM THIS LIST

BUSINESS COLLEGE SELF TAUGHT. Complete secretarial course in one volume. Includes shorthand, book-keeping, typewriting and 12 other practical office subjects, prepared for home study. Helpful on every office job. Price \$2.39.

MATHEMATICS FOR THE PRACTICAL MAN. A knowledge of mathematics helps on every job. This book makes the study so interesting and simple everyone can be proficient. No teacher or previous experience needed. 143 Pages, 42 Illus. Price \$1.50.

AUTOMOBILE BODY AND FENDER REPAIRS. Brand new. Covers all phases of auto body and fender repairs, the most profitable end of the auto repair business today. This book will put you right into this up and coming business. 325 Pages, 232 Illus. Price \$3.00.

BLUE PRINT READING FOR BUILDING TRADES. Shows how to read and understand blueprints as you would a newspaper. Best book on subject for beginners and experienced building trades men. 111 Pages, 69 Illus. Price \$1.25.

BLUEPRINT READING FOR MACHINE TRADES. Same as above except covers all machine trades and shop work. 154 Pages, 92 Illus. Price \$1.50.

DYKE'S AUTOMOBILE AND GASOLINE ENGINE ENCYCLOPEDIA. New edition of the most practical, complete and widely used auto book ever published. Covers all up to date testing, adjusting and repairing operations. 1434 Pages, 4617 Illus. Price \$6.00.

WEE HOMES. 44 designs (FHA Approved) of one to four room cottages, all types. Cost range, \$750 to \$3500. Price 35 cents.

NEW AMERICAN HOMES. Beautiful illustrations, some in color, of 101 residence designs (FHA Approved). Price range \$3500 to \$15,000. Price \$1.00.

A SMALL BUSINESS OF YOUR OWN. Gives 1000 ways for a man with little or no capital to build a modest, dependable business. Every plan has been used—and works. Price \$1.00.

TURN SCRAP INTO MONEY. Shows how to build power plants, 110 volt motors and generators, wind driven power plants and other electric apparatus from discarded auto parts. Price \$1.00.

SHOE REPAIRING. By Paul A. Klein. Practical and simplified instruction, easy to follow, on modern shoe repair methods. Helps you save money and make money. Illustrated. Price \$1.00.

DIESEL ENGINE MANUAL (AUDELS). Timely and useful information on the construction, maintenance and operation of modern Diesel engines. Includes questions and answers. A fine book on this new power field. Illustrated. 300 Pages. Price \$2.00.

HOUSE WIRING. By Wolber and Rose. New Edition. Covers every detail of house wiring including the latest materials and methods, with full explanations of the National Electric Code. 400 Pages, 669 Illus. Price \$2.50.

BOOKKEEPING MADE EASY. Complete self teaching course in double entry bookkeeping. Best book for the beginner. Price \$1.00.

WATCH AND CLOCK MAKERS' MANUAL. Explains in a practical way, the whole field of watch and clock repair. 361 Pages, 150 Illus. Price \$3.00.

FREE TRIAL—MONEY BACK OFFER

Any book sent postpaid if remittance is sent with order. Sent C. O. D. in U. S. and possessions, plus few cents charges. If not satisfied return book in 3 days and purchase price will be refunded. Order today.

POPULAR MECHANICS PRESS

Dept. 240. 200 E. Ontario Street. Chicago

When writing please mention Popular Mechanics

Foot Scraper Resembling Dog Is Made of Concrete



Attractive doggy fashioned in reinforced concrete invites you to scrape your shoes on its back

Made in the likeness of a dog, reinforced-concrete shoe scrapers are appearing on doorsteps in England. The novelties can be purchased in natural colors or in plain black if preferred.

Wire Frame for Cream Bottle Makes Sanitary Pitcher

Ordinary half-pint cream bottles can be converted into sanitary pouring pitchers with a self-opening cover and wire frame. The wire, besides holding the top in place with spring tension, serves as a handle.

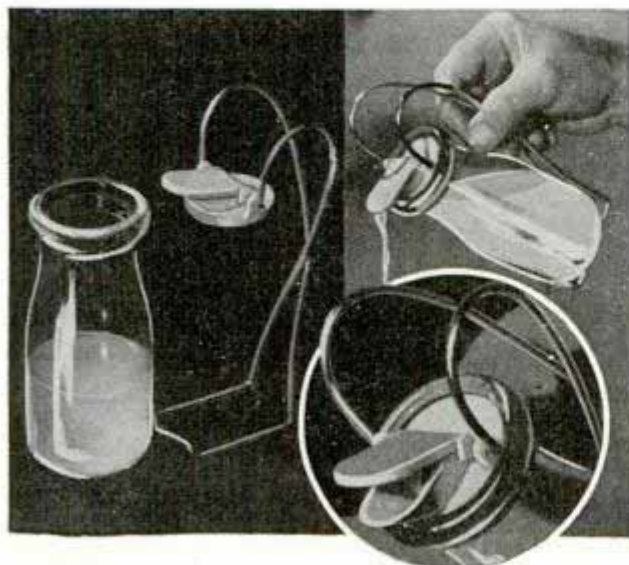

Left, sanitary bottle top and wire frame. Right, pouring from cream bottle; circle, self-opening lip

TYPING AIDS YOUNG MEN SEEKING OPPORTUNITY!



A fellow who can type can land a job more easily. Students can get more work done by typing... better marks too. Today, Corona is "tops" in portable typewriters... latest improvements... the best typing aids. Illustrated booklet free... mail coupon below today.

\$100 A WEEK TO OWN A CORONA
Plus small down payment

FREE DEMONSTRATION
AT ALL DEALERS

**SPEEDLINE
CORONA**

L C SMITH & CORONA TYPEWRITERS INC
Desk 2, 723 E. Washington Street, Syracuse, New York
Please send me free folder describing Speedline Coronas.

Name _____
Address _____
City _____ State _____

You Can Make BIG MONEY Surfacing Floors the American Way



Get into something where your income is only limited by your ability to get ahead. The American electric method of floor surfacing gives you the opportunity to make more money for yourself—work easy to get and no previous experience required. If you are not afraid to put on a pair of overalls and go to work, here is the chance of a lifetime.

Let us tell you how to be a success in this business and tell you how many other men who started like you have made themselves independent for life. As little as \$75.00 will start you today on the road to success.

Be sure to sign and send in the coupon below or mail us a post card for complete free details—no obligation.

THE AMERICAN FLOOR SURFACING MACHINE CO.
523 So. St. Clair Street • Toledo, Ohio

Gentlemen:
Send complete free details on how I can make big money with an American floor surfacing machine—no obligation.
Name
Street
City State

Kapsit Co. 730 W. Broadway
Wisconsin Wisc. 221

READY CUT HOMES

\$416 and up. Freight paid. Modern production methods prevent waste in material and assembly time. 75 home plans to select from, including 10 new feature 1940 designs. All modern, practical, distinctive, complete. Includes all for easy assembly. Includes all weather stripping, built-in features, hardware, nails, lath, paint, varnish. Also, summer cottages, garages, tourist cabins, etc. Information and plans for FHA Financing requirements on request. For new 1940 full color catalog, with floor plans, send 25 cents to cover mailing. Dept. P.M.-20. International Mill and Timber Co., Bay City, Mich.

NEW COLOR CATALOG FOR ONLY 25¢



Spindle SHAPER \$3

less cutters (C.O.D. or outside U. S. \$3.25) Postpaid

Make tongue and groove joints; shape mouldings, picture frames, plaques, etc. Limitless projects can be given a professional finish with this shaper. It has 8" x 5 3/4" steel table; stands 53 1/2" high. Uses standard 5/16" hole cutters. (Cutters 55c each). Oilless bearings. Your fractional H.P. motor runs it.

FREE CATALOG describing \$150 prize contest (1st prize, \$25; 2nd, \$15; 3rd, \$10; 41 other cash and merchandise prizes). Cat. illustr. complete power tool line: 3/4" Saw, \$1.50; New Jointer, \$6.50; Circ. Saw with oilless bearings, \$3; Drill Press, \$2.50; completely equipped Lathes, \$2 & \$4.90; Sander, \$1; etc. Sold direct only. Order today or send card for Catalog.

\$150 PRIZE CONTEST

J & H Metal Products Co. 5 Commercial St. Rochester, N. Y.

A DEPENDABLE STEAM ENGINE for boat models up to 36" in length. Model SE-3, a two cylinder, slide-valve type. Bore 5/16", Stroke 1 1/4", Length 7", Width 3", Height 3 1/2". Price complete ready to run with burner and propeller... \$3.00 Postage extra, shipping weight 1 1/2 lb.

SHAWNEE ENGINE CO.
Box 162, Station D, Cincinnati, Ohio

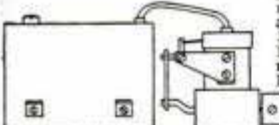

ETERNAL LITE



NEEDS NO BATTERIES | GENERATES OWN CURRENT

FLASH-LITE \$2.25 each postpaid

NO MORE BATTERIES TO BUY—Self-generating mechanism produces its own power. An inexhaustible source of LIGHT AT NO EXPENSE. A built-in Magneto with G-E magnet eliminates battery failures forever. REPAYS ITS COST MANY TIMES.

Finger Pressure Operation: Just press the lever and like MAGIC it produces a beam of light—"always there". Sturdily built. Beautiful black Bakelite case—nickel trimmed.

BATTERYLESS BICYCLE LITE: Here is a boon to all cyclists. This new self-contained Bicycle lite generates its own current as you ride. The same dependable G-E Magnet type generator supplies an endless stream of current with never another penny of expense for batteries. Sturdy construction—Easy to install—Fits all Bikes.

BIKE-LITE \$2.95 each postpaid

PARKER INDUSTRIES, 100 W. North Ave., Chicago, Ill.

General Electric Magnet

Send Flash-lite C.O.D. \$2.25 plus few cents postage
 Send Bike-lite C.O.D. \$2.95 plus few cents postage
 I enclose \$2.25. Send Flash-lite postpaid
 I enclose \$2.95. Send Bike-lite postpaid

NAME.....
 ADDRESS.....

Helps You EARN MORE

SAVES TIME and MONEY

Thousands of Money-Making, Time and Labor-Saving Ideas You Can Use



POPULAR MECHANICS SHOP NOTES

CASTING METAL - GEM CUTTING - TOOL MAKING
 ELECTRICAL - CHEMICAL - PHOTOGRAPHIC - AUTOMOTIVE
 WOOD & METAL FINISHING

50¢

Shop Notes will help you on your job—on home repairs—on the farm—in hundreds of different ways—will make money for you and save you time and money.

If you do machine shop work of any kind, sheet-metal work, painting, carpentry, auto repairing, farming, concrete work, plumbing, electrical work, welding, building, glass work, general repairing, tool-making, poultry raising, masonry or home repair work, you need the Shop Notes Library.

NOW READY—

SHOP NOTES for 1940

214 Pages • 384 Articles • 762 Illustrations

Just published—the world's biggest 50 cents' worth. Packed with new shop kinks, short cuts, helpful ideas, time and labor saving methods you can use. Here are just a few of the many subjects covered:

- | | |
|---|--------------------------------------|
| Novelty Paint Finishes | Building and Using a Wattmeter |
| Auto Mechanics | Cementing Glass, Metal and Celluloid |
| Drill-Vise Milling Unit | Tricks of Soldering |
| Density Meter for Separation | Universal Photo Enlarger |
| Negatives | Wood Finishing |
| Modern Plant Stands | Paint Spraying |
| Hand Loom Weaves Cane Webbing | Negative Dryer |
| High-Speed Cutting with Abrasive Wheels | Making Silk Stencils |
| Motorized Lawn Mower | Tap and Die Holders |
| Making Choke Coils | Correct Centering |
| Gem-Cutting Bench | Motorized Garage Doors |
| Tractor Built from Old Car Parts | |
| Making Unit Castings | |

Special BARGAIN OFFER

7 SHOP NOTES VOLUMES \$2.98

While Present Supply Lasts

Start your Shop Notes Library now. We will send seven issues, (approximately 400 articles in each) now in print, including the new 1940 Shop Notes and those published in 1932-1935-1936-1937-1938 and 1939—7 Shop Notes in all—for only \$2.98. Single books 50 cents each. Offer withdrawn when present supply is sold. Order today and avoid disappointment. If you have earlier years, rush order for 1940 Shop Notes. Money refunded if not satisfied.

Mail Coupon... Pay Postman

POPULAR MECHANICS PRESS, DEPT. 240
 200 East Ontario St., Chicago

Send 7 Volumes Shop Notes Library as offered. I enclose \$2.98
 Send C. O. D. I will pay postman price and small amount of postage.
 Send 1940 Shop Notes at once. Remittance for 50 cents enclosed.

Name.....
 Address.....
 City..... State.....

*C. O. D. applies to U. S. and possessions only. If you reside elsewhere, remittance must accompany order.

Say you saw it in Popular Mechanics!



Here's Power for FARM, ROAD, BELT and SHOP WORK!

BUY AT LOW FACTORY PRICES

The newly developed, fully tested Master DU-ALL is the lowest priced riding tractor on the market today. It is a complete, all-purpose machine—fully equipped and powered for practically all tractor jobs. It cultivates, plows, hauls, runs belt equipment and does nearly all farm and workshop power jobs. Engine is air-cooled. Auto-like gear shift has three speeds forward and reverse. Idles to one mile per hour; speeds up to 7 miles per hour. Plant clearance, 16 inches. High arch model has 21 inch clearance. Turning radius, 5 feet. Rear wheel tread, is adjustable from 17 to 30 inches between tires. Burns kerosene or fuel oil. Air or steel tires. Has tool control, convenient hitches and cultivating depth gauge. "Factory-to-you" selling plan makes this the biggest tractor bargain of the year. Mail coupon for full facts and low factory price!

● This complete 4-wheel tractor costs little more than many walking-type garden tractors. Investigate low price!

Master
SHAW
DU-ALL
ALL-PURPOSE TRACTOR

"My SHAW is the best all around worker I ever had—and it costs about 3c an hour to run."



SHAW
DU-ALL
GARDEN TRACTOR

● The popular and famous line of Shaw Du-All Garden Tractors is now offered at record-breaking low prices—as low as \$136.50. 2, 3, 4 or 5 H.P. riding and walking models do most field and belt work. Equipped with many superior, exclusive Shaw features. Get catalog and list of low factory prices. Mail coupon!

AGENTS:

Get full facts about liberal agent and dealer proposition, now being offered to qualified men. Mail coupon for details, low prices, discounts and terms!

10-DAY TRIAL OFFER—All Shaw Models can be tried for 10 days on your own place without risk. Mail coupon now for full details of this offer. See for yourself that you can actually get efficient, economical tractor power at unbelievable low cost.

SHAW MFG. CO.,
4502 Front St., Galesburg, Kan.;
5812 G. Magnolia Ave., Chicago, Ill.;
130 G W. 42nd St., New York, N. Y.;
668 G No. 4th St., Columbus, Ohio

Send FREE information checked below about Shaw DU-ALL Tractors.

Low Factory Prices, Catalog, 10-Day Trial offer and all details about the new Master and Garden Tractor Models. Liberal proposition for agents and dealers.

Name

Address

Town State

NEW Grinding Attachment

For 8" to 16" Metal Lathes. Build it Yourself.

At last, a precision grinder within your means. You save 2/3 by finishing our semi-machined castings, on your own lathe. HURON handles both internal and external grinding. Accuracies to .00025". Mirror finish easily obtained. Grinds gears, pulleys, bearings, shafts, hard or soft, holes, lathe centers, sharpener reamers, milling cutters. Does eccentric drilling; taps; polishes; scores of other uses for home workshops, garages, machine shops. Write for FREE illustrated folder and full information.

Huron Machine & Tool Co., Dept. B-2, Yale, Mich.



Semi-Machined Castings Only \$5.95

TRAILER BUILDERS · BUYERS · OWNERS TRAILER

Send 25c for this Big Book Today

Over 100 pages! Beautifully Printed and Illustrated! Trailer Suggestions and Ideas galore! Catalog shows America's greatest line of Trailer Parts and Equipment at lowest prices. Everything from wheels to top. Rush 25c today. Satisfaction guaranteed! TRAILER SUPPLY CO. Box 438-A - WAUSAU, WIS.



BUILD IT YOURSELF

The Jim Dandy Cabin Cruiser

The Trailer that has everything. Classy! Roomy. Easy to build in any size with my simplified Plans and Instructions—Price \$1.00. Rush dollar bill today to JIM DANDY Box 125-A WAUSAU, WIS.

Say you saw it in Popular Mechanics!

New MIRACLE WALL CLEANER

AGENTS



HOT SELLER!

Saves Costly Redecorating!

AMAZING INVENTION. Banishes old-style housecleaning mess and mud. No rags—no sticky "dough"—no red, swollen hands. No more dangerous stepladders. Literally erases dirt like magic from walls, ceilings, window shades, upholstered furniture, etc. Ends crudger! SAVES REDECORATING! Approved by Good Housekeeping. Low priced. Housewives wild about it. AGENTS WANTED EVERYWHERE.

SAMPLE OFFER Samples sent on trial to first person in each locality who writes. No obligation. Get details. Be first—send in your name TODAY! THE KRISTEE PRODUCTS CO. 679 Bar St. Akron, Ohio

Start This Business in Your Spare Time at Home

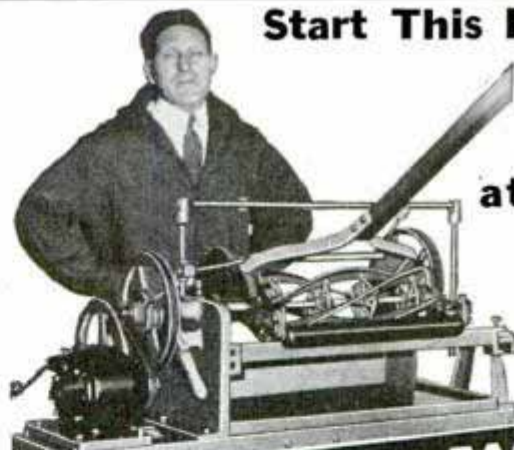

This Is the Way! To Make MONEY!

That is what hundreds are saying about the Foley Electrakeen Lawn Mower Sharpener business. J. LeVert, N. Y., made up to \$104.50 a week clear profit last season. C. A. Buterbaugh, Ill., says, "Am doing fine . . . paid for my machine in 4 weeks."

No Canvassing Necessary Free plan tells you how to start. The Foley Electrakeen Lawn Mower Sharpener turns out perfect work quickly and easily, no experience needed. Simply put the mower in the machine and turn on the power. Uses same system as lawn mower factories. Sharpens all sizes and types in 15 or 20 minutes. You get \$1.00 or more for each job.

FOLEY MFG. CO. 207-40 Foley Bldg., Minneapolis, Minn.

Send Free Plan and Special Offer on Foley Lawn Mower Sharpener.

Name

Address

Special Offer:

Attachment for grinding axes, hatchets, knives, etc., FREE with Foley Lawn Mower Sharpener. Send coupon today.

Steel 6
g 1263 East Moline,
Child's "Handcar" Scooter
Saves Wear on Shoes

AMAZING

**NEW DEVICE...
GIVES BETTER
HEAT FOR
LESS MONEY
FROM OIL
BURNING HEATERS**



Heater Users! Stop Wasting Fuel—Save Money! Enjoy steady, uniform, healthful heat from your Oil Burning Heater—AUTOMATICALLY, regardless of outside weather! Add the new A-P Electric Top Unit to your Heater—then just set the Thermostat and forget heating problems!

★ PAYS FOR ITSELF . . . IN SHORT TIME

Yes, this new A-P Electric Auto-Heat Top Unit WILL PAY FOR ITSELF in greater convenience and comfort, in fuel saved through avoiding overheating. And it's so cheap to install that YOU CAN'T AFFORD TO BE WITHOUT IT!

MODERNIZE TODAY FOR SAVINGS IN HOME HEATING! Ask your local heater dealer for a DEMONSTRATION of the new A-P Electric Thermostatic Auto-Heat Top Unit, or write for circular.

Housewives! Stop Carrying Oil! Find out about the sensational new A-P OIL LIFTER, the Fuel Control that stops all fuss, bother, and mess of Fuel Tank Refilling on Oil Burning Heaters. Replaces Fuel Tank. Keeps oil and tanks out of living quarters. Saves many steps every day. Keeps home cleaner.

AUTOMATIC PRODUCTS COMPANY

Department P1, 2450 N. 32nd Street, Milwaukee, Wisconsin

TEST-O-LITE

**Tests Everything Electrical
From 100 to 550 Volts**



\$1.50 At Electrical Stores or Post-paid

A real necessity for electricians and home because it has 1001 uses. Equipped with a Neon light which tells instantly where trouble lies in electric circuits, fuses, cut-outs, motors, radios, all kinds of electric appliances, etc. Tells A. C. from D. C. Far superior to ordinary clumsy test bulb. Fountain pen size with clip for carrying in vest pocket. Lifetime guarantee.

PATENTED

L. S. BRACH MFG. CORP.
55 Dickerson St., Newark, N. J.



\$2.50 POSTPAID — 19" KIT U. S. SUBMARINE SCALE MODEL

Water ballast chamber and air control valve for diving. Runs on surface or under water. 54 parts ready to assemble. Die cast conning tower, naval gun, keel parts. 19 inch Model completely assembled. \$3.50 P. P.
13 inch Model completely assembled. \$1.75 P. P.
13 inch Kit, 40 parts. \$1.25 P. P. Send 3c for catalog of other models
WESTLAKE MODEL CO., DEPT. PM-24, ERIE, PA.



SAVE THAT CHAIR!



DON'T THROW FURNITURE, mirrors, glassware, etc. away... repair them with Rogers Glue--makes them as good as new... Rogers Glue is ready to use and works quickly--stays put longer because it is stronger. Sells 10c and up in tube, jar or can at hardware stores only or send 10c for full size jar and you receive a Free Project Book giving new ideas, new plans for making useful articles—to Dept. B. ROGERS GLUE COMPANY Gloucester, Mass.

ROGERS

the best LIQUID FISH GLUE



Child pumps driving-handle up and down to propel three-wheel scooter that saves pushing with feet

Propelled by pump handle, like the old-fashioned railroad handcar, a child's scooter transports the rider without the use of foot power. While operating it the child may stand erect, and there is less wear and tear on shoe leather than occurs where feet supply the driving force.

Paint Sprayed from Its Own Can with Siphon-Feed Cover

Quart-size paint cans with friction type tops may be used for spraying by fitting them with a siphon-feed cover that works with any standard size spray gun. Using each color directly from the original can saves investment in separate material cups as well as time in cleaning them. If left on the can, the cover keeps paint in condition for ready use.



Popular Mechanics Magazine can furnish the name and address of the maker of, or dealer in, any article described in its pages. If you wish this information, write to the Bureau of Information, inclosing a stamped, self-addressed envelope.

cannot locate maker

1400 W. First St. Chicago



Use This New ROYAL Portable In Your Own Home FREE

READ WHAT OWNERS SAY:
"Earn more money—make that correspondence course pay real dividends" (Sales engineer) . . . "Get ahead faster—make home work count" (A student) . . . "A real help to everyone in the family." (Housewife)

SEND NO MONEY don't spend a cent—until you know that a New Royal is going to be worth many times its cost to you. Know how easy it makes writing—how its many office typewriter features and controls help you turn out neat, accurate business-like letters and reports. Maybe you've never used a typewriter—never thought of owning one . . . Then you owe it to yourself, to your future, to clip the coupon at once and get the **FACTS**. No obligation.

*Trade-mark, Reg. U. S. Pat. Off.

ACT NOW! . . . NO OBLIGATION

FREE!



Instant Typing Chart. Only Royal has it!



YOURS!

The Duo-Case! With every Royal Portable—at no extra price!



WITH MAGIC* Murfin new Sensational Sets margin automatically 3 times faster.

Royal Typewriter Company, Inc.
Dept. D-206, 2 Park Avenue, New York, N. Y.

Tell me how I can get a genuine New Royal on **FREE HOME TRIAL**; also, how I can own one for **ONLY A FEW CENTS A DAY**.

NAME

STREET

CITY.....**COUNTY**.....**STATE**.....

MAKE THAT OLD TYPEWRITER HELP PAY!

Please quote trade-in allowance on a.....Typewriter, Serial No.....

KINKADE GARDEN TRACTOR
and Power Lawnmower
A Practical Power Plow and Cultivator
for Gardeners, Suburbanites, Florists,
Truckers, Nurserymen, Fruit Growers
Low Prices - Easy Terms
American Farm Machine Co.
1058 33rd Av. SE, Minneapolis, Minn.



Catalog Free

Sani-Flush **SAFE • NOT CAUSTIC**
CLEANS OUT AUTOMOBILE RADIATORS

IT'S THRIFTY TO INSTALL NEW CHAMPION SPARK PLUGS

HANDY TAPS and DIES . . .
Accurate—carefully hardened and tempered. Complete range of sizes at your local five and ten cent store
HENRY L. HANSON, WORCESTER, MASS

Always write your name and full address clearly when answering advertisements.

HANDEE
Tool of 1001 Uses

A WHOLE TOOL SHOP IN YOUR HAND

Smooth, steady power at your finger tips. Uses 300 accessories to grind, drill, polish, rout, cut, carve, sand, saw, sharpen, engrave, etc. Plugs in any AC or DC socket, 18,000 r.p.m. 16 oz.

Get A Demonstration
at Hardware, Tool or Dept. Stores, or order on 10-Days Money-Back Trial. **\$10.75** post-paid with 3 Accessories . . . De Luxe Model, 25,000 r.p.m. 12 oz. **\$18.50** with 6 Accessories.

Chicago Wheel & Mfg. Co., 108 S. Aberdeen St., Chicago, Ill.



Save Hours of Hand Work

FREE 64-PAGE CATALOG
Complete information on Handee Products and their wide application in crafts work and industry all over the world.

FREE! JUST OUT! AMERICA'S MOST BEAUTIFUL Nursery and Seed BOOK

FIRST QUALITY GUARANTEED STOCK FROM AMERICA'S LARGEST Direct-To-You Nurseries. Plan your garden right from this helpful new book of choicest flowers, fruits, seeds, shrubs, roses, etc. Free gift offers and planting guide for customers. Low prices. Write to-day. **INTER-STATE NURSERIES, 3720 E. St., Hamburg, Iowa**

MYSTIC MIKE WIRELESS OUTFIT

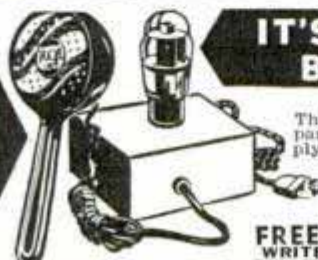

IT'S LIKE HAVING YOUR OWN BROADCASTING STATION

YOU'LL THRILL TO ITS BIG-TIME PERFORMANCE
This set enables you to do **YOUR OWN BROADCASTING** from any part of your home with **NO WIRES CONNECTED TO RADIO**. Simply plug this unit into any AC or DC electric socket, speak or play music into the microphone and it will be picked up by **ANY RADIO ANYWHERE** within the same building. Has variable frequency control for easy radio dialing. Thousands are enthusiastic about its clear tone and performance. Use it for entertaining, auditions, rehearsals, etc. **MYSTIC MIKE** has endless possibilities. **ORDER TODAY!**

FREE WRITE FOR BULLETIN P-2 **OLSON MFG. CO., 362 Wooster Ave., Akron, Ohio**

Complete Set With Microphone and Tube

3.95

ADD 25c POSTAGE
MONEY BACK GUARANTEE

Tear out this ad, write name and address in the margin, send cash, Money Order or order C.O.D. and we will send outfit at once.

(Continued from page 153A)

“There was no synthetic chemical equivalent for natural bristles in 1914. Today these necessities are being met chemically through nylon, which gives gut for surgical sutures; likewise, bristles better than any taken from the hogs of China or Siberia. Further, nylon within a few months will provide yarn for hosiery, the latest triumph of American chemistry.

“The diversified chemical industry, which did not exist in 1914, is well organized, well equipped, well manned today. It stands as a solid guarantee of American self-sufficiency. Never again will our industrial production which depends upon chemistry be disrupted by wars beyond our shores. Never again will our people be deprived of many vital medicines for the preservation of health.”

Some of the causes for fear in 1914 and reasons for confidence in present-day national self-containment, achieved largely through the accomplishments of chemistry, stand in striking contrast.

American consumption of Chilean nitrates in four of the war years—1915-1918—was nearly 6,000,000 tons. Fifty ships were operated to supply this essential of agriculture, industry and national defense.

The situation in 1914 was critical when five German warships engaged a British squadron in battle off the coast of Chile, sinking a British cruiser and disabling another, and forcing others to flee under cover of darkness. The German ships, however, were destroyed by the British on December 8, off the Falkland Islands. Except for that victory, nitrate shipments from Chile would have been imperiled constantly.

Today, nitrogen fixation plants in West Virginia and Virginia can supply the entire American requirement.

Domestic production of dyes, which were derived from imported intermediates and raw materials, was 6,600,000 pounds in 1914. This was less than ten per cent of consumption. But in 1937, American manufacturers of dyes were producing 122,000,000 pounds. At present, the United States is supplying not only home needs, but has become an exporter of dyestuffs.

The shortage in 1915 was so acute that a quantity of a dye known as Rhodamine B Extra jumped in price from four dollars to \$125 a pound.

Frantic buyers snapped up the dyes cargo of the submarine Deutschland which had slipped into the Baltimore harbor after an amazing voyage from Germany.

The position of users of dyes was accurately stated in a cablegram sent by von Bernstorff, the German Ambassador, to his government, “. . . the stock of dyes in this country (America) is so small that by a German embargo about 4,000,000 American workmen might be thrown out of employment.”

Because of the dearth of blue dyes, our navy was faced with the prospect of crews of “men in white,” and indeed an entire nation in white was the outlook, due to the lack of nearly every color of dyes.

The threatened economic effects could only be guessed. It seemed a virtual certainty that a vast number of persons would be deprived of employment and industrial stagnation appeared imminent. Not only the textile industry was near collapse, but various others including the paper, leather, ink and printing, for without dyes and colors production they eventually would have come to a standstill or nearly so.

There was but one answer—America must have her own dyes industry. Among those which pioneered in the field of domestic dyes production was the du Pont company. Executives of the company already had some experience in the manufacture of coal-tar derivatives. There followed months of experimentation and research, and finally synthetic indigo and sulfur black were perfected and placed upon the market in 1918. Shortly after came acid and chrome colors for wool, direct, developed colors for cotton, and, early in 1919, basic colors.

In addition to dyestuffs, the aim was to produce many of the other organic chemicals essential to home industries. Up to this time, the United States was almost entirely dependent upon foreign sources of supply.

It was necessary to design and construct plants to produce wholly new—for du Pont and the country—lines of manufactures. The money invested was considerable and, as was expected, the losses were heavy. At the end of the first five years, the investment in plants and working capital was \$22,000,000, and there were suffered oper-

(Continued to page 162A)

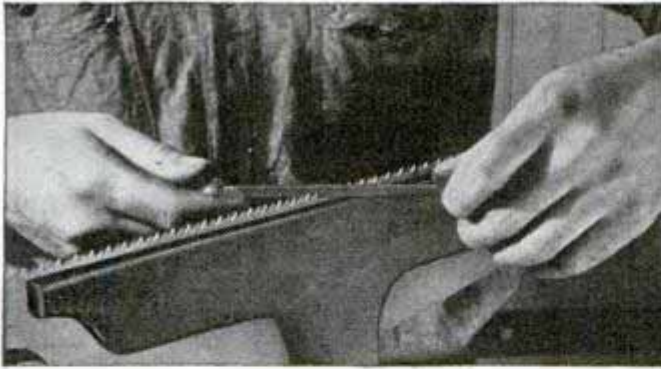

SAW FILING

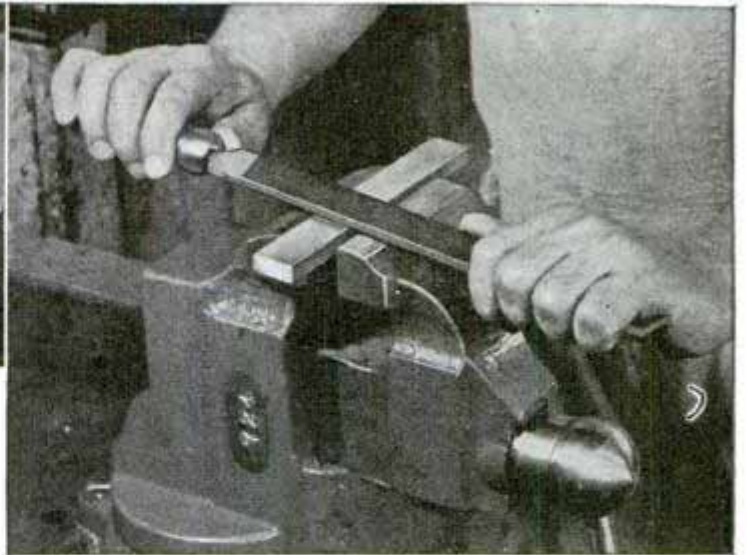

DRAW FILING

IT'S AN ART!

The right file in hands that know how to give it "just the right touch" is often the deciding factor between the success and failure of a working model or experimental job representing hours, days or weeks of patient development.

Yes, filing is an art. Never use the wrong type of file for the job — especially if it's a piece of precision work. With a popular range of Nicholson (or Black Diamond) Files on hand, each file lasts longer, does better work, costs less in the long run. They're easy to obtain — good hardware stores have them or can get them for you.

NICHOLSON FILE CO., Providence, R. I.
CANADIAN PLANT, PORT HOPE, ONT.

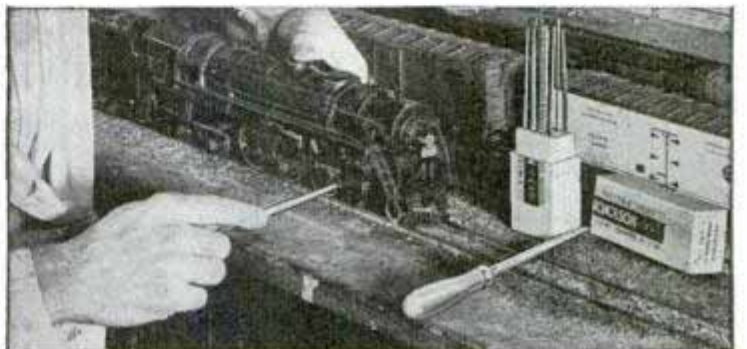

PRECISION FILING



WOOD RASPING

LATHE FILING

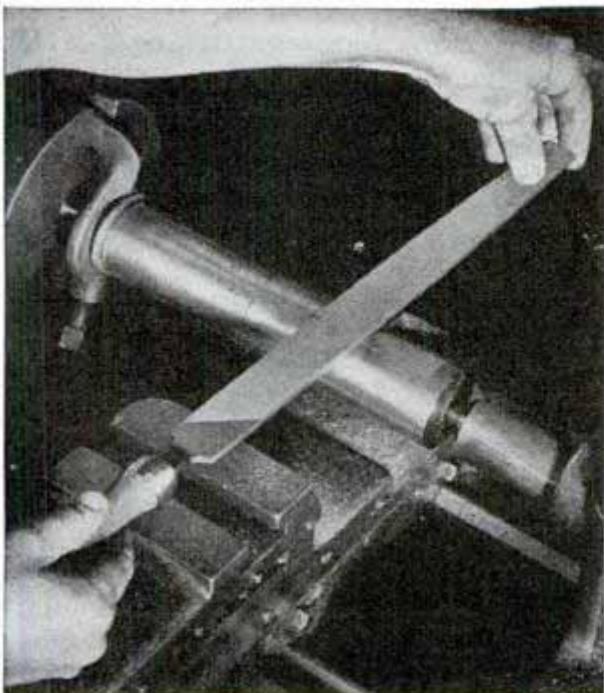

NICHOLSON FILES

NICHOLSON
U.S.A.
MADE IN U.S.A.

FOR EVERY PURPOSE

FREE BOOK...MAIL THIS COUPON



NICHOLSON FILE CO.
22 Acorn St., Providence, R. I.

Please send free book, "A File for Every Purpose," containing information on selection, use and care of files.

Name _____

Address _____

Say you saw it in Popular Mechanics!

(Continued from page 160A)

It's NEW!**The GuildCutter****SAW***Now***More Sawing Jobs***made Easy***POPULAR
LOW PRICE!**

THIS new, handy, 7-lb., easy-to-use *GuildCutter* electric saw is ideal for cutting plywood, wall board, masonite, siding, flooring, crating and other wood or composition materials up to 1 1/4" thick. Trimming of roofers and window openings, also overhead sawing, made easy. With a 1/4" dado head, the "*GuildCutter*" is useful for dadoing, ploughing, grooving and tenoning. A revelation to both skilled mechanics and homeshop workers.

FEATURES: Weighs under 7 lbs. 45° tilting base for bevels. 4 1/2" blade. Capacity 1 1/4". Depth adjustment. Motor 110 V. universal AC or DC. Runs from light socket. Die-cast aluminum frame. Telescope safety guard protects blade at all angles. Complete with combination saw-blade, ripping guide, cord and plug; ready to use.

Write for illustrated descriptive folder and low price **TODAY!**

Syracuse **GUILDTOOL** Company
1740-2c No. Salina St., Syracuse, N. Y.

STANDARD GARDEN TRACTORS

**Plow
Seed
Cultivate
Mow Hay
and Lawns**

Powerful Gas Tractors for Small Farms,
Gardeners, Florists, Nurseries,
Fruit Growers, Poultrymen.

1 & 2 Cylinders

High Wheels. Rubber or
Steel Tires. Walk or Ride.

Do Belt Work—**Free Catalog**

STANDARD ENGINE CO.

Minneapolis, Minn.
3221 Como Ave.

Philadelphia, Pa.
2546 Market St.

New York, N. Y.
290 Cedar St.



Sand Casting—Forging—Heat Treating—Case Hardening

BRONZE FOUNDRY

in your own workshop allows you to design and build your own **GASOLINE ENGINES, STEAM ENGINES, STATUARY, ART OBJECTS, SPECIAL TOOLS, NEW INVENTIONS, ETC.** You can also make forgings and case harden steel. Your shop is not complete without a **FOUNDRYETTE**. Three sizes are available capable of making bronze castings of 1 1/2, 3, and 6 pounds weight, aluminum, copper, brass, etc., in proportion to specific gravity. Economically priced. Domestic gas supply and 110 volt 60 cycle energy required for operation. Prices, \$13.50, \$19.00 and \$27.50, l.o.b. Kansas City. Write for circular.

KANSAS CITY SPECIALTIES CO.

Box 6022, Dept. P-4

Kansas City, Mo.

ating losses of \$18,000,000, a total of \$40,000,000 without a cent of profit during the entire period. But a vital national need had been met.

Early in 1916, agriculture and industry were feeling the pinch of a potash shortage, for imports from Germany had ceased. The little supply available had skyrocketed from forty dollars to above \$400 a ton. Desperate efforts were made to recover the vital element from every possible source, ranging from wood ashes to cement mill dust, yet, even in 1918 only twenty per cent of normal demand—about 55,000 tons—was produced.

Now, with potash consumption at 500,000 tons a year, compared with 200,000 in 1914, the every need for fertilizers and in industrial processes could be provided by potash deposits in Texas and New Mexico, and from Searles Lake in California. The development of our potash resources, extensive deposits of phosphate rock in Florida and Tennessee, and the fixation of nitrogen from the air have combined to enable the United States to become an exporter of fertilizers instead of a helpless importer of two ingredients, as once was the case.

A distressing phase of dependency developed from acute shortages of medicinals of foreign origin. The effect was especially disturbing in relation to such preparations as Salvarsan and Luminal. Aspirin also was among the many German drugs from which we were almost entirely shut off.

Today the situation is so radically changed that anything approaching it could hardly have been dreamed at the time of the inception of America's "Golden Age of Chemistry." In the field of medicinals, it would be decidedly less of a task to list the relatively few which are not produced in this country than to attempt to catalogue those which are produced or those which both have been developed and are being produced here.

Convincing evidence of our position as a developer and producer is evident in the fact that in 1938 our imports of medicinals and pharmaceutical preparations totaled \$4,328,000, while our exports were worth \$17,079,000.

Truly, America in amazing degree has advanced from its wartime plight of a "have-not" to the greatest "have" nation of the world.



Calling All Cars!

A
MYSTERIOUS DISCOVERY
SAVES UP TO 30%
ON GASOLINE!
OR COSTS NOTHING TO TRY

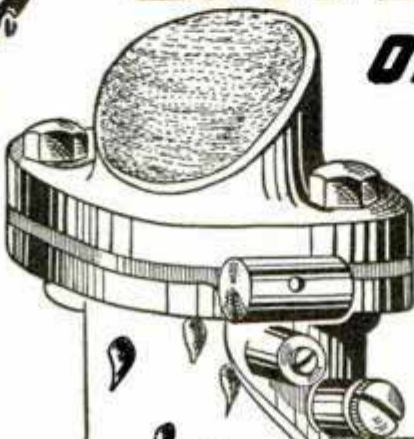
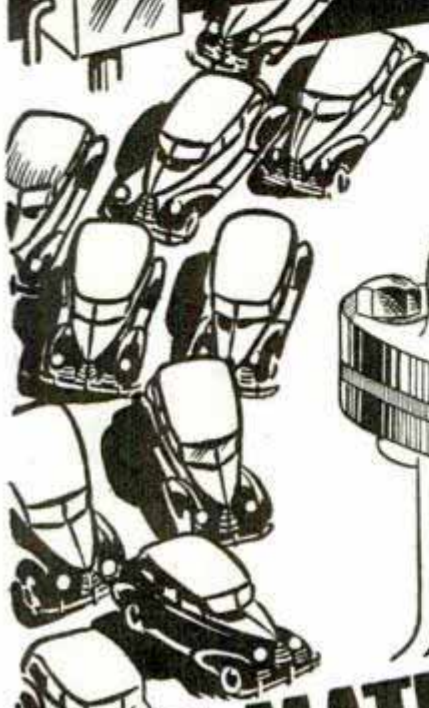

Scores Again

VACU-MATIC
SETS NEW COAST-TO-CHICAGO RECORD

Answer this call! Investigate this remarkable discovery that trims dollars off gasoline bills—gives you worthwhile gas savings—more power—greater speed—quicker pickup—faster acceleration. Proven so efficient, it is guaranteed to save up to 30% and give better performance or the trial costs you nothing.

Automatic Supercharge Principle

Vacu-matic is entirely different! It operates on the supercharge principle by automatically adding a charge of extra oxygen, drawn free from the outer air, into the heart of the gas mixture. It is entirely automatic and allows the motor to "breathe" at the correct time, opening and closing automatically as required to save dollars on gas costs.

Sworn Proof of Gas Savings

This certifies that I have carefully read 300 original letters received from Vacu-matic users testifying to gas savings up to 30%, many reporting added power, smoother running, and quicker pick-up. These letters are just a small part of the larger file of enthusiastic user letters that I saw at the company offices.



Signed *Marcus J. Clancy*
Notary Public

In addition to establishing new mileage records on cars in all sections of the country, the Vacu-matic has proven itself on thousands of road tests and on dynamometer tests which duplicate road conditions and record accurate mileage and horse power increases.

You, too, can make a road test with Vacu-matic on your car and prove its worthwhile gas savings to your entire satisfaction.

Learn all about this remarkable discovery. Get the facts NOW!

AGENTS Get Yours FREE For Introducing

Vacu-matic offers a splendid opportunity for unusual sales and profits. Every car, truck, tractor, and motorcycle owner a prospect. Valuable territories now being assigned. If you help us introduce it to a friend, you can obtain your own free. Check and mail coupon today.

BOB MCKENZIE
TRANS-CONTINENTAL AUTOMOBILE CHAMPION
MAY 19 1937

Vacu-matic Carburetor Co.
7617 W. State Street
Wauwatosa, Wisconsin

Dear Sirs:

Having just completed a new speed record between Los Angeles and Chicago, driving a Chevrolet equipped with a Vacu-matic carburetor control, I thought you might be interested in knowing some of the facts and the important part Vacu-matic played in the success of the run.

The distance covered was 3322 miles in thirty-nine hours and forty-two minutes, officially timed by Western Union, which gave me an average speed of 89.7 M.P.H. based on elapsed time and with the Vacu-matic averaged 18-1/2 miles per gallon on gasoline.

Before leaving Los Angeles, we made several test runs both with and without the Vacu-matic, and the tests proved that Vacu-matic increased my gas mileage 3-1/2 miles per gallon at the driving speed of 80 M.P.H. and also very noticeable increase in both acceleration and power.

Yours very truly,
Bob McKenzie

Fits All Cars

Easy To Install

Vacu-matic is constructed of six parts assembled and fused into one unit, adjusted and sealed at the factory. Nothing to regulate. Any motorist can install in ten minutes. The free offer coupon will bring all the facts. Mail it today!

The Vacu-matic Co. Wauwatosa, Wis.

SEND THIS Free Offer COUPON

THE VACU-MATIC COMPANY
7617-493 W. State St., Wauwatosa, Wis.

Please send full particulars about VACU-MATIC, also how I may obtain one for my own car FREE. This does not obligate me in any way.

Name

Address

City..... State.....

Check here if interested in Agency Proposition.

South Bend 9-inch
"WORKSHOP"
Precision Lathes

MADE IN THREE MODELS

SOUTH BEND LATHE WORKS
Lathe Builders Since 1899
602 E. Madison St. South Bend, Indiana, U.S.A.

No. 415-YC, 9 $\frac{1}{4}$ " swing by 3' Bed Workshop Model C Bench Lathe with Motor Drive as shown. Ship- \$127
ping Wt. 320 lbs. (Easy Payments if desired)

New 1940 Catalog of **SOUTH BEND LATHES**



SIX SIZES
of
SOUTH BEND LATHES

Manufactured in 9", 10", 11", 13", 14 $\frac{1}{2}$ " and 16" swing, in 3' to 12' bed lengths. Motor Drive or Countershaft Drive, Quick Change Gear or Standard Change Gear type. Prices range from \$95 to \$1500.

THIS new 48-page catalog describes the 1940 line of South Bend 9-inch Workshop Lathes. Twenty-three different models are listed at prices from \$115 up, complete with drive equipment.

Improved engineering features of the new 1940 model lathes include quick change gear equipment making all power feeds and threads instantly available at the touch of a lever and an automatic apron with friction clutch drive for power cross feeds and power longitudinal feeds.

Attachments, chucks and tools for production manufacturing, precision tool room work, general machine work and automotive service machine work are also listed in this catalog.

**SOUTH BEND LATHE WORKS, 602 E. Madison St.
South Bend, Indiana, U. S. A.**

Write **FOR YOUR COPY TODAY**

A copy of this new 9-inch Workshop Lathe Catalog will be mailed on request. Use the Coupon or a post card. State size of lathe best suited to your work.



SOUTH BEND LATHE WORKS
602 E. Madison St., South Bend, Indiana, U. S. A.
Please send me Free your New 1940 Catalog of South Bend Lathes.

Size of Lathe _____
Name _____
Address _____
City _____ State _____



SOUTH BEND *Precision* **LATHES**

"HEAP BIG NEW BOAT READY!"

HOLD 'UM 4 BIG PALEFACES! CARRY HIM ON SHOULDER! USE 'UM BANG! BANG! MOTOR UP TO 9 PONY-POWER! OARS & SAIL!

— Chief Eaglebeak

WEIGHS only 75 Lbs.

OARS and OARLOCKS now INCLUDED with your OK-4 Kit!

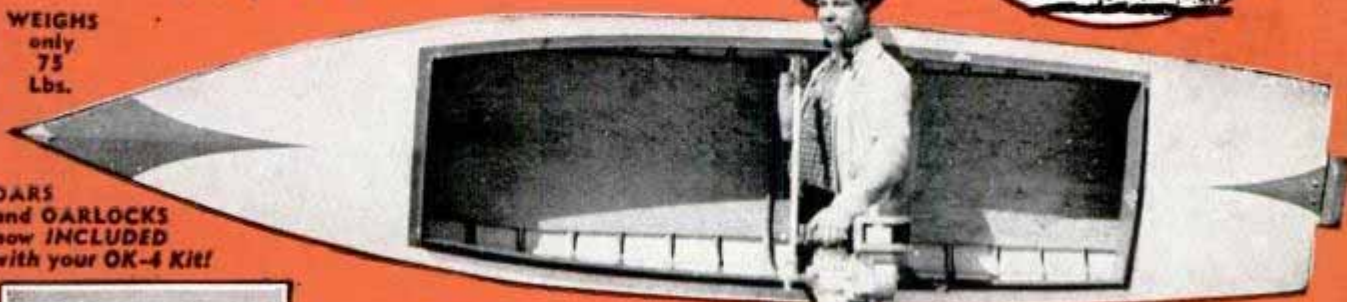

The Biggest, Lightest and Strongest Boat of Its Kind!

BIG MONEY ASSEMBLING NEW OK-4!
IN A FEW EVENINGS AT HOME!



OK-4 is ideal for Sportemen! Light, long, strong and roomy!



Even with 4 passengers, a light weight motor gives plenty of power!



Here's OK-4 speeding along with a 9 horsepower motor.



The new 75 lb. OK-4 easily lifted to car-top. Portable!



Two girls easily launch this sensational 14 footer!

Everybody—even grumpy old Chief Eaglebeak—is mighty excited over Mead's big, new 14-foot portable Outboard KI-YAK! Think of it!—ANYONE, without previous experience, can build OK-4 at home in a few evenings and save nearly HALF the factory-built cost—or sell to others at Big Profit! And get these starting OK-4 features: Carries 4 adults comfortably, and duffle—takes motors 9 h.p. or less, oars and sail—weighs only about 75 pounds for easy portability on shoulder or car-top for fishing, camping, touring, hunting, Seaworthy. Leakproof. Durable. Double canvas bottom for double-safety! The biggest, lightest, strongest boat of its kind—AND—made only by MEAD—in knock-down kits for quick home-assembly, or factory-built, ready for the water. Rush dime for Chief Eaglebeak's big illustrated Circular, amazing Low Factory-To-You Prices! Oars and oarlocks now INCLUDED with your OK-4 Kit . . . hurry!



4 OTHER GREAT KI-YAKS

Double Blade Paddle or Oars Now INCLUDED With Your Kit!



5 1/2 Year Old Carries CK-1

A Mead for every need! Paddle-and-sail model: The sturdy "CK-1", 10 footer, 20 pounder! The Sportsman's 30 lb. CK-2! The "Big bad CK-3" with 90 square feet of sail on 45 pounds of boat—the sailor's delight! Then there's the 50 pound "OK-2"—Snitfire Of The Fleet—takes up to 4 1/2 h.p. motor, oars, sail! and REMEMBER—Mead is America's largest Ki-Yak manufacturer—so buy your Ki-Yak Kit from HEAD-QUARTERS. Rush Coupon and dime now!



CK-3



The 50 Lb. OK-2—Uses Oars, Motor, Sail Rig.

"MAIL 'UM COUPON!"

To: CHIEF EAGLEBEAK, c/o Mead Gliders, 15 So. Market, Dept. B-20, CHICAGO, U. S. A.
Rush 'um new KI-YAK Boat Circulars! Me much interested in heap low Factory Prices, I enclose 10c postage, packing charge! (Please PRINT plainly.)

NAME.....
St. & No.....
City..... State.....

MEAD GLIDERS
15 S. MARKET ST. DEPT. B-20 CHICAGO, U.S.A.



Miss America
CHESTERFIELD'S VALENTINE GIRL
Patricia Donnelly of Detroit

*A Pocketful
of Pleasure*

CHESTERFIELD

The real reason why Chesterfields are in more pockets every day is because Chesterfield's Right Combination of the world's best cigarette tobaccos gives you a better smoke... definitely milder, cooler and better-tasting. *You can't buy a better cigarette.*

MAKE YOUR NEXT PACK CHESTERFIELD

They Satisfy