

WONDERS OF POLAROID GLASS

POPULAR MECHANICS

MAGAZINE



WE EXPLAIN SO YOU CAN UNDERSTAND IT

REGD. TRADE MARK, GREAT BRITAIN, NO. 410426

REG. U.S. PAT. OFF.

JAN.
25 CENTS



SEE PAGE 54

OUTWITTING THE AIR RAIDERS

PROEM

● Here is the Famous 3049 Heavy Duty Grinder—universally acclaimed by users everywhere as the most powerful, speediest and smoothest running Grinder for all types of work. With the new accessories listed below a new field is opened to Model Makers and Craftsmen—makes wood turning, drilling, routing, shaping, carving and many other operations easy to accomplish. Better results are obtained faster and easier.

\$14⁹⁵



For the most thoughtful and exciting Christmas of them all a **DURO HAND GRINDER AND ACCESSORIES**
 AMERICA'S FINEST—MOST DISTINGUISHED HAND GRINDER



\$6⁴⁵
 Less
 Grinder

Here for the first time you have a complete practical set of accessories and a power unit for driving that enables you to do any type of model making. Power, delivered in abundance by the Heavy Duty Grinder, makes it possible for you to use the complete Model Makers Workshop in a confined space—with positive assurance that you can do precision work. Send your order today or write for full information.

Drilling, routing, veining, shaping and many other operations are made easy by the matchless combination of the Famous Heavy Duty Grinder and this Drill Press. Its practical design and extra large capacity makes it an ideal tool for the Model Maker or Craftsman.

The Lathe pictured below, using the Heavy Duty Grinder has plenty of power to do real work—In fact you'll be amazed to see how you can take full size cuts without stalling it. It's ideal for all types of Model Making. An unlimited variety of parts such as masts, spokes, wheels, pulleys, etc., can be turned to size with speed and precision. The high speed provides smooth finished cuts on wood or plastics.



\$5⁴⁵
 Less
 Grinder

\$21⁹⁵
 Kit
 Complete
 with Case

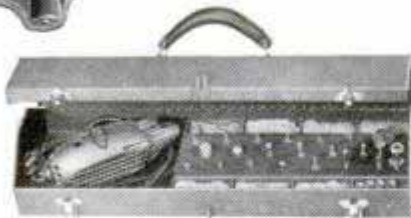

Here is a choice gift—a Kit which includes the Famous Heavy Duty Grinder and a hand picked assortment of twenty-eight of the most valuable cutters and other accessories packed in a heavy gauge, handsomely finished, steel box. The perfect gift that will give him hundreds of hours of relaxation and enjoyment.

The *Streamline* Grinder is ideal for free hand use. The abundance of power developed makes heavy cuts easy, its high speed insures a smooth finish at all times. It is light in weight—only 12 ounces—compact and fits the hand perfectly. It is the ideal tool for fine engraving and other work that must be done in a confined space.



\$9⁹⁵

Make this his most Memorable Christmas—Give a Duro Grinder
DURO METAL PRODUCTS COMPANY DEPT. PM-1
 2653 NORTH KILDARE AVE. CHICAGO, ILL.

Popular Mechanics Magazine

H. H. WINDSOR, Founder

H. H. WINDSOR, Jr., Editor and Publisher

January, 1940

Vol. 73, No. 1

IN THIS ISSUE

Army on Wheels—Part I	1
Flying "Under the Hood"	8
Color-Shooting in Fairyland	Coloroto
Outwitting the Air Raiders	28
Blind Man's Buff	34
The Mechanics of Modern Warfare	40
The Wonders of Polaroid Glass	50
Lifesavers for Old Books	56
Trapping the Radio Spies	61
Tricks of the Figure Skaters	66
Painting Live Pictures	72
"Hams" Circle the Globe	78
College for Seals	82
Floating Freight Yards	88
Keeping the Sea Birds Flying	92

(Continued on next page)

Super-Senses of Science

YOU'VE heard the human eye called the most perfect optical instrument. It is pretty good; but, like your other senses, human sight hasn't improved much in 25,000 years. Meanwhile science has developed super-senses. A "roughness meter" can measure the thickness of a fingerprint. A sonic device hears a submarine fifty miles away. The unseen, odorless vapor rising from a bowl of mercury is made visible to the human eye as a shadow on a fluorescent screen, yet that mercury could go on evaporating for ten years without detectable loss in weight! Read about these super-senses in the February issue.

Winning Races in the Pits

BLACK oil dripping from his shoes, a driver hops out of his smoking car at the pit. The crew mops up the cockpit, tightens an oil-line connection and he's off again, while another \$20,000 racer is out of the 500-mile Indianapolis classic because of a faulty ten-cent valve lock. The Coloroto section next month shows you how races sometimes are won in the pits.

Next Month

OUT of California rolls a train-load of lettuce and peas for New Hampshire. When it reaches New York the market has changed, and the load turns back to Indiana. Prices vary again and it is split into carloads for Georgia, carloads for New Hampshire. Meanwhile some crew has blown in cold ice instead of warm ice, and part of the shipment is frostbitten. But you must have your salad out of season, and how you get it is told next month in "America's Dinner Rides the Rails."

Radio Goes to War

SAFE in your livingroom you may some night hear the whine of fighting planes, the rattle of machine guns and the boom of heavy arms at the war front. Mobile radio transmitters are already there, waiting for the moment to broadcast battle as they were waiting in London and Berlin, Warsaw and Paris to bring you the first word of war's outbreak. In the February issue, pictures and story reveal to you how radio is covering the war.

Anyone Can Fly

FLYING your own plane is no longer "over your head." You can buy a safe-flying "flivver" plane for \$1,000, paying a third down, and that includes a course in piloting that will lead you to a license. And it's a fact today that it costs less to fly and maintain a light plane than a medium-priced automobile over the same distance. If you're skeptical, read the figures in next month's issue.

GET THIS



... FOR EASY STARTING AND BETTER MOTOR PERFORMANCE THIS WINTER

All winter long Pyroil can save you from much of the nuisance of hard engine starting and faulty cold weather performance. Pyroil is made to break the grip of cold upon the engine of your car. It effects such an improvement in operation that you must experience it to know!

Cold weather induces severe drain upon your car's battery when starting. But Pyroil reduces this greatly. It makes parts spin more freely. Starting is easier. Cold works hand in hand with gum, sludge and carbon to foul good engine performance. But Pyroil cleans out these contaminations.

All you need in order to accomplish this cold weather job is a few ounces of Pyroil in gasoline tank and crank case. Then every revolution of the motor carries this special type of lubricant to all vital areas inside the engine. There Pyroil's special safeguarding film blankets the fragile metal surfaces.

Pyroil is purely a lubricant. But it is entirely different from your regular lubricating oil. It goes far and beyond the regular lubricant in protecting the metal. It gives you a better running car.

Ask at your favorite service station or garage today for an inexpensive Pyroil treatment. Manufactured and guaranteed by Pyroil Company, W. V. Kidder, Founder, 51 Pyroil Bldg., LaCrosse, Wisconsin, U. S. A.

Mail the Coupon Below for a Free Booklet and Pamphlet that give you the Whole Important Pyroil Story.

DISTRIBUTORS:
CHECK AND MAIL
COUPON FOR FRANCHISE FACTS.



ADD MERELY OUNCES TO GAS & OIL

PYROIL COMPANY
51 Pyroil Bldg., LaCrosse, Wisconsin, U. S. A.
Send me a Free copy of your Booklet, "QUESTIONS AND ANSWERS ABOUT PYROIL." Also, pamphlet, "WHY PYROIL SHOULD BE USED IN ALL CARS, NEW AND OLD."
 Send details of your plan for Distributors.
Name.....
Address.....
City..... State.....

(Contents—Continued)

AUTOMOTIVE

Streamline tractor for airport	7
Motorcycle with fluid drive starts smoothly.....	13
"Stop" signal on sleeve is new driving fad.....	13
Four-gun anti-aircraft tank	16
Watertight Diesel tractor launches lifeboat.....	38
Tire display rack on rubber-tire wheels	48
Army auto for rough roads climbs slope.....	53
Crosswalk painted white to reduce accidents.....	55
Airplane tires used as springs on truck.....	58
Coal-gas fuel runs autos in England.....	64
Headlights wear slotted hoods in London.....	65
Dry-Ice auto air cooler for desert	70
Extension shield attached to sun visor.....	81
"Trailer" with own motor is overnight sleeper.....	91
Fire truck goes streamline with enclosed body.....	96

AVIATION

"Air traffic cop" guides air liners.....	49
Seaplane bases for private flier	54
Light changed in air from speeding car.....	65
Flash bomb lights city for air cameraman.....	76
Sailplane's two-way radio guides crew in car.....	87
Aerial gunners train with camera gun.....	91

HOUSEHOLD

Socks darned by "vulcanizing" patch.....	16
Baby scooter anchored to weight.....	49
Air-brush motor and compressor in one.....	55
Tabletop electric stove	59
Oscillating electric disk heater.....	75
Dripless flowerpot reservoir prevents sour soil.....	77
Model houses suggest "paint prescriptions".....	86
"Wick" in soilless flowerpot feeds chemicals.....	90

PHOTOGRAPHY

Camera with 1,000 lenses shoots electric arc.....	6
Photofloods attached to camera follow the action... 60	
"Wipeoff" disks produce trick movie effects.....	64
Electric print drier circulates warm air.....	90

RADIO AND ELECTRICITY

Double clock runs both ways to time radio.....	7
Two-way facsimile unit for planes and boats.....	12
Giant loud speaker broadcasts in park.....	13
Readometer times radio speech to the second.....	70
"A" and "B" eliminator for portable sets.....	135
How to build an inexpensive treasure finder.....	136
Improved television antenna system easily installed. 138	
Practical radio suggestions	139
Giant tube for television receiver.....	140
Modern receiver designed to fit old console.....	140
Tiny dual-purpose a.c. receiver.....	140

RAILROADS

Swinging railroad gate releases trapped car.....	70
Old "iron horse" takes ride in truck.....	81
Open-air sightseeing streetcar.....	95

SCIENCE AND INDUSTRY

"Frozen" model of metal part shows stress.....	12
Automatic X-ray camera photographs heart.....	33
Length of life depends on shape of body.....	33
Lustrous stainless steel a precious metal.....	48
"Leaded" steel speeds machining of metal.....	49
Robot chemist analyzes solution.....	60
"Cool" light burns inside cake of ice.....	71
Photocell detects approach of death.....	71
CASTING weighing 170 tons big enough for auto.....	77
Steel hardened in gas furnace.....	80
Eyesight restored by spot-welding.....	86
"Electric eye" pulls molten glass from oven.....	95
Energy in uranium could drive the "Queen Mary". 116A	

SHIPS AND SHIPPING

Testing warships of tomorrow.....	14
Boat on wheels launches self from beach.....	54
Buoys mark sea lanes swept clear of mines.....	60
Floating hose fills tanker.....	65

SPORTS

Fishline drier winds line automatically.....	7
Kit for building target pistol in home shop.....	16
"Shock absorber" helps land big fish.....	55

(Continued to page 6A)

Prepare for a *New Motoring thrill*.. when you drive with the

SEALED BEAM HEADLIGHTING

of a 1940 car **AT NIGHT!**

● It's new! It's better! It's safer! For with the new Sealed Beam Headlighting System, you can see **FARTHER**; see **BETTER**; see **QUICKER**. Look at these pictures and see why.



New G-E MAZDA auto lamp combines light source, reflector and lens in one sealed, all-glass unit.

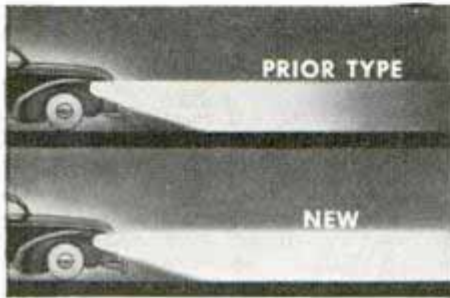

SEE FARTHER — The new Country Beam puts more light ahead and more light on road shoulders. Helps you see farther. Gives a bigger margin of safety.



SEE QUICKER — Because this new Sealed Beam system gives you more light, you pick out unexpected hazards faster... have more time to act.



SEE BETTER — With more light on road shoulders you see curves quicker, more clearly. Roads seem wider because of less tendency to hug center line.



GLARE-FREE TRAFFIC BEAM puts more light on the right and on both sides near the car. Always use it when meeting other cars.

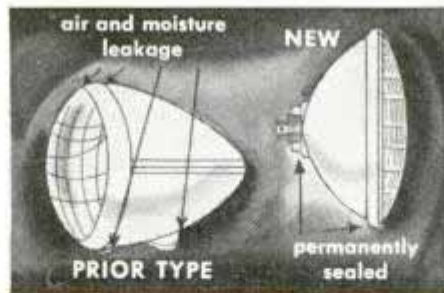

NO LOSS IN LIGHT. Lens, reflector and light source form one sealed unit, keeping out dirt that dulled reflectors and robbed you of light before.



NEW CAR SEEING throughout car life, because sealed-beam units not only stay brighter longer but are completely renewed when you replace burnouts.



See for yourself. Get behind the wheel of a new 1940 car at night and learn first-hand the safety and comfort advantages brought about by the united efforts of the automobile manufacturers, makers of headlighting equipment and highway and safety authorities... through the Sealed Beam Headlighting System

General Electric invites you to
**ASK FOR A
NIGHT DEMONSTRATION**
when you buy a 1940 car!

GENERAL ELECTRIC
Sealed Beam
MAZDA AUTO LAMPS

When writing to advertisers please mention *Popular Mechanics*

THE SAW OF TODAY



Time, now, to enjoy ownership of a finer saw. The Disston D-23: Lightweight, straight back, narrow blade. True taper ground. Runs easy and cuts fast. Disston Steel. High polish, striped back, beautifully etched. Applewood handle, full carved, weather proof finish, 26" length . . . \$3.85 Also Disston D-8, "The Saw Most Carpenters Use." Skew back, 26" length . . . \$3.50 Also KEYSTONE made by DISSTON saws, 26" cross-cut \$1.00 up; Rip \$1.50 up

These prices apply only to United States; for others, write Henry Disston & Sons, Ltd., Toronto, Canada.

and the Hint of the Month



To make a perfectly square end cut is easy, when the face of the board is marked square and a Disston try square used, as illustrated, to keep the saw in a vertical position.

AND NEW EDITION

FREE BOOK

Disston Saw, Tool and File Manual, radically revised. How to set and file saws. How to choose and use saws and tools. Many home workshop hints like one above, in its 48 pages of text and profuse illustrations.



SEND COUPON!

Henry Disston & Sons, Inc.
111 Tacony, Philadelphia, U.S.A.

Please send me FREE copy of the new Disston Saw, Tool and File Manual.

Name.....

Address.....

(Contents—Continued)

TOOLS

Expansive bit is set to size by "dialing".....	59
Surgeon's tool has its own eye.....	77
Trowel cuts roots and makes furrows.....	95

MISCELLANEOUS

Old covered bridge towed to park.....	33
National park visitors increase.....	38
Rubbers packed in handle of umbrella.....	38
Safe given fiery-furnace test.....	39
Slot machines smashed by iron ball.....	48
"Pedalmobile" carries family of five.....	53
Artificial lung worn like vest.....	58
Soil-testing kit for gardeners.....	58
Telescopic glasses for near-blind.....	58
Picture "painted" with dried beans and corn.....	59
"War tape" on Paris windows.....	64
Ball bearings for oil wells.....	71
Braille globe helps blind follow war events.....	75
Coin machine takes blood pressure and pulse.....	77
Ninety-two ton French tank.....	80
Plates attached to grader speed road work.....	81
Handcuff belt fastens about prisoner.....	86
Twelve-broom snow sweeper mounted on sled.....	90
Sleds have colored lights to guard children.....	90
Child's flying gondola driven by propeller.....	96
Community workshop rents space to craftsmen.....	96

Craftsman and Shop Notes

AUTOMOTIVE

Garage doorstops from radiator hose.....	158
Mounted policeman marks cars without dismounting.....	158
Pulley for truck tailboard chain improves operation.....	158
Silencing noisy brake rod.....	158
Uses for soap on your car.....	158
Paper clip provides guide for striping brush.....	159
Pieces of hose hold tags on batteries.....	159
Test of valve springs made with pointer.....	159
Vibrating red glass reflectors attract attention.....	159
Perforated hose to wash car tops.....	160

ELECTRICAL

Electric light aids in soldering.....	116
Rotary electric switch from small vial.....	121
Multiple binding post for small transformer.....	134
"Electric hand" in the shop.....	141

FARM

Forge made from binder wheel.....	144
Rigid support for large rural mailboxes.....	145
Rock salt "pegged" to platform.....	152
Shielded implement tongue keeps reins from tangling.....	154

FURNITURE

Grille-door bookcase.....	97
Simplicity and sturdiness in small tables.....	101
Swedish supper cart.....	110
Clothes rack for child.....	115

HAND TOOLS

Plumb bob from punch and eraser.....	108
Altering C-clamps to hold pipe.....	109
Hose shields glass in level.....	116
Eyes formed on rods with old gear wheel.....	129
Wheel operates vise quickly.....	144
Adapting large micrometer to small work.....	145
Wrench to use hand taps in a lathe.....	145
Lug wrench to remove nuts with a hammer.....	152

HOME IMPROVEMENTS

Tile on furnace grates improves combustion.....	100
Stopping hum of chimney guy wires.....	109

(Continued to page 8A)



SUCCESS—

Will You Pay the Price?

IF you are normal, you want the comforts and luxuries which are the by-products of success—a home of your own—a new car—the leisure to read—the means to travel.

You want these things very much.

But—you are keen enough to perceive that experience and facility in handling *routine* work will never get them for you.

What, then, are you doing to gain that *specialized* experience—that *trained* ability—for which business firms are willing to pay real money?

* * *

During the past thirty-one years more than 1,000,000 men have found the answer to that question in home-study training under the LaSalle Problem Method.

Evening after evening, they have seated themselves, to all intents and purposes, at the desks of men in high-salaried positions, and have squarely faced the *problems* of those positions.

Evening after evening, they have been shown the *principles* involved in the solution of such problems—and how those principles are applied by highly successful business houses.

Evening after evening, they have tackled concrete problems, lifted bodily from business life, and under the direction of some of the ablest men in their respective fields *have worked those problems out for themselves*.

That they have been *well rewarded* for their foresight and their earnestness is shown by the fact that during only six months' time as many as 1,248 LaSalle members reported salary increases totaling \$1,399,507—an *average increase per man of 89%*.

* * *

Many men, *knowing* what home-study training under the LaSalle Problem Method can do for them,

nevertheless prefer to think that there's "nothing in it." That's the excuse they make for their futures.

If you—knowing these facts—are content to drift, you will not profit by reading further.

If on the other hand you have imagination enough to *visualize* your goal—to actually see yourself in a home of your own, enjoying the comforts and luxuries of life—if, in short, you are a man of *purpose*, the coupon below may shorten your journey to success by many years.

Note, please, that the coupon names different lines of training and that it will bring you full particulars of the training which appeals to you, together with a 48-page booklet discussing the opportunity and requirements of that field—all without obligation.

If you want success, and are willing to pay the price, **ACT!**

LaSalle Extension University

A Correspondence Institution

Dept. 164-R

Chicago

I would welcome an outline of the LaSalle plan, together with a copy of "Ten Years' Promotion in One," all without obligation.

- | | |
|---|--|
| <input type="checkbox"/> Business Management | <input type="checkbox"/> Law—Degree of LL.B. |
| <input type="checkbox"/> Modern Salesmanship | <input type="checkbox"/> Commercial Law |
| <input type="checkbox"/> Higher Accountancy | <input type="checkbox"/> Credit and Collection |
| <input type="checkbox"/> Traffic Management | <input type="checkbox"/> Correspondence |
| <input type="checkbox"/> Modern Business Correspondence | <input type="checkbox"/> Industrial Management |
| <input type="checkbox"/> Business English | <input type="checkbox"/> Modern Foremanship |
| <input type="checkbox"/> Effective Speaking | <input type="checkbox"/> Expert Bookkeeping |
| | <input type="checkbox"/> C. P. A. Coaching |
| | <input type="checkbox"/> Stenotypy—Stenography |

Name.....Age.....

Present Position.....

Address.....

NAME and ADDRESS WANTED

If the home, automobile or motor-boat owner who does not know and use Smooth-On, will communicate with us, using the coupon below, he will learn something to his advantage

EXPERIENCED old-time repair men as well as youngsters can reply profitably, because recent composition improvements in Smooth-On No. 1 permit more convenient application, produce greater holding power when hardened and have greatly expanded the field of Smooth-On usefulness.



Stopping leaks in boilers

Smooth-On No. 1 has for 43 years been the standard material for stopping leaks and patching cracks in pipe lines, boilers, heaters, tanks, etc., for sealing threaded or gasketed joints, for making loose or stripped screws, bolts and nuts hold, and for anchoring metal posts, partitions, shelves and cabinets in concrete.

A thorough knowledge of the working principles and application of Smooth-On can be a life saver in many emergencies, and in ordinary repair work can greatly reduce the physical effort and money expenditure. Smooth-On is the lowest-priced dependable repair material on the market, is applied without heat or special tools, makes the repair ready for service in an astonishingly short time, and holds permanently.

The Smooth-On Handbook explains all Smooth-On compositions, contains simple instructions and working diagrams for their application, and is filled with intensely practical repair information that every householder and mechanic should have.



Write for
FREE BOOK



Do it with **SMOOTH-ON**

SMOOTH-ON MFG. CO.,
Dept. 37, 574 Communipaw Ave.,
Jersey City, N. J.
Please send the free Smooth-On Book.

Name.....
Address.....
1-40.....

(Contents—Continued)

Time switch to operate home appliances.....	112
Changing tone of doorbell for two circuits.....	116
Silencing noisy sink drain.....	131

HOUSEHOLD

Cradle for pouring from large bottles.....	107
Coiled book strap is good polisher.....	108
Corn plasters provide feet on small boxes.....	108
Black-cat doorstop reached without stooping.....	109
Healthy house plants.....	117
Key held in lock to prevent intruder entering.....	120
Sandpaper washer prevents knobs from loosening.....	120
Safety pin holds thread spool on work.....	130
Ash tray clamped to bridge lamp.....	131
Solving home problems.....	132

OFFICE

Typewriter oiled with medicine dropper.....	108
Metal domes on ledgers make handling easy.....	152
Waxed paper file prevents drying of stencil.....	152

PHOTOGRAPHY

Cool handle for "mushroom" type photo lamp.....	129
Focusing tube aids photographer.....	144
Mini-camera focuser aids in taking closeups.....	153

POWER TOOLS

Remote control for scroll-saw motor.....	101
Wooden reel holds excess motor cord.....	108
Portable switch for motor drives several machines.....	112
Brush stroker for large belt sander.....	120
Improved lathe gear holder.....	130
Tar holds work on faceplate.....	130
Lathe dog to turn square stock.....	145
Boring-bar cutter set to close limits.....	151

STORE AND SHOP

Spring locks type in galley.....	130
Christmas-tree display attracts shoppers.....	143
Truck has extension rack to haul lumber.....	151
Novel valve stop assures proper opening.....	154
Rubber bands attached to blueprint save time.....	154
Simple rack for displaying vegetables.....	154

TOYS AND NOVELTIES

Winter thrills on sleds and slides.....	102
Tricks with toy rubber balloons.....	107
Animated squirrel toy performs realistically.....	121

MISCELLANEOUS

Wheeled "snack shack" rolls to profit spots.....	99
Calendar on pencil always at hand.....	100
Glass tube bent easily with resistance wire.....	100
Large logs rolled easily on rubber tires.....	100
Cardboard under thumbtacks for easy pulling.....	112
Bench vises serve as clamps for mitered work.....	115
Plant labels coiled to protect bark.....	116
Rubber holder for pencils on drawing board.....	116
Tom-Thumb trellises improve indoor gardens.....	119
Ladder trussed with old brake rods.....	120
Making scratch pad from old pieces of stationery.....	120
Rubber band prevents umbrella handle from slipping.....	120
"Whizz," a fast class-E ice yacht.....	122
Orange crate converted into "kitchenette".....	131
Glass tumbler used as graduate.....	134
Fork and shovel holders from auto casings.....	144
Holder supports test tube vertically.....	144
How castings are made in a foundry.....	146
Rubber band holds handle for easy grasping.....	152
The right weld in the right place.....	155
Brush on oilcan cleans oil holes.....	160

IMPORTANT NOTICE

It is the intention of this magazine to provide its readers with information regarding the latest developments in the mechanical arts. We take no responsibility as to whether the disclosures contained in our articles are covered by patents and advise readers to investigate this subject before making, using, or selling any of the products, machines, or processes described, in order to avoid possible liability for patent infringement.

what will you be doing



MAN, there's no *sense* in drifting along at the same old dull, drab job! You've got one life — that's all. What you make of it is your business — but if you want to make a *success* of it, it's time to *get going!*

Listen. Some of the biggest men in this country were in your shoes once. But they knew one thing! They knew that it takes training—TRAINING—to succeed in this

world! And they got that training through the I. C. S.!

100,000 ambitious men are enrolled with the International Correspondence Schools right now. They're going places! They're getting sound, essential TRAINING by a method based on up-to-date textbooks, personal instruction, and sound vocational guidance. Here's the coupon they mailed!

INTERNATIONAL CORRESPONDENCE SCHOOLS

BOX 5562-J, SCRANTON, PENNA.

★ Without cost or obligation, please send me a copy of your booklet, "Who Wins and Why," and full particulars about the course *before* which I have marked X: ★

TECHNICAL AND INDUSTRIAL COURSES

- | | | | | | |
|---|--|--|---|--|--|
| <input type="checkbox"/> Agriculture | <input type="checkbox"/> Air Brake | <input type="checkbox"/> Cotton Manufacturing | <input type="checkbox"/> Marine Engines | <input type="checkbox"/> R. R. Signalmen's | <input type="checkbox"/> Refrigeration |
| <input type="checkbox"/> Air Conditioning | <input type="checkbox"/> Diesel Engines | <input type="checkbox"/> Diesel Engines | <input type="checkbox"/> Mechanical Drafting | <input type="checkbox"/> Sanitary Engineering | |
| <input type="checkbox"/> Architectural Drafting | <input type="checkbox"/> Electrical Engineering | <input type="checkbox"/> Electrical Engineering | <input type="checkbox"/> Mechanical Engineering | <input type="checkbox"/> Sheet Metal Work | |
| <input type="checkbox"/> Architecture | <input type="checkbox"/> Electric Lighting | <input type="checkbox"/> Electric Lighting | <input type="checkbox"/> Mine Foreman | <input type="checkbox"/> Steam Electric | |
| <input type="checkbox"/> Auto Engine Tune-up | <input type="checkbox"/> Fire Bosses | <input type="checkbox"/> Fire Bosses | <input type="checkbox"/> Navigation | <input type="checkbox"/> Steam Engines | |
| <input type="checkbox"/> Auto Technician | <input type="checkbox"/> Fruit Growing | <input type="checkbox"/> Heating | <input type="checkbox"/> Patternmaking | <input type="checkbox"/> Steam Fitting | |
| <input type="checkbox"/> Aviation | <input type="checkbox"/> Boilermaking | <input type="checkbox"/> Heat Treatment of Metals | <input type="checkbox"/> Pharmacy | <input type="checkbox"/> Structural Drafting | |
| <input type="checkbox"/> Bridge Engineering | <input type="checkbox"/> Highway Engineering | <input type="checkbox"/> Highway Engineering | <input type="checkbox"/> Plumbing | <input type="checkbox"/> Structural Engineering | |
| <input type="checkbox"/> Building Estimating | <input type="checkbox"/> House Planning | <input type="checkbox"/> House Planning | <input type="checkbox"/> Poultry Farming | <input type="checkbox"/> Surveying and Mapping | |
| <input type="checkbox"/> Chemistry | <input type="checkbox"/> Locomotive Engineer | <input type="checkbox"/> Locomotive Engineer | <input type="checkbox"/> Practical Telephony | <input type="checkbox"/> Telegraph Engineering | |
| <input type="checkbox"/> Civil Engineering | <input type="checkbox"/> Machinist | <input type="checkbox"/> Machinist | <input type="checkbox"/> Public Works Engineering | <input type="checkbox"/> Textile Designing | |
| <input type="checkbox"/> Coal Mining | <input type="checkbox"/> Management of Inventions | <input type="checkbox"/> Management of Inventions | <input type="checkbox"/> Radio, General | <input type="checkbox"/> Toolmaking | |
| <input type="checkbox"/> Concrete Engineering | <input type="checkbox"/> Managing Men at Work | <input type="checkbox"/> Managing Men at Work | <input type="checkbox"/> Radio Operating | <input type="checkbox"/> Welding, Electric and Gas | |
| <input type="checkbox"/> Contracting and Building | <input type="checkbox"/> Manufacture of Pulp Paper | <input type="checkbox"/> Manufacture of Pulp Paper | <input type="checkbox"/> Radio Servicing | <input type="checkbox"/> Woolen Manufacturing | |

BUSINESS COURSES

- | | | | | |
|--|--|--|---|---|
| <input type="checkbox"/> Accounting | <input type="checkbox"/> Advertising | <input type="checkbox"/> Civil Service | <input type="checkbox"/> First Year College | <input type="checkbox"/> Railway Postal Clerk |
| <input type="checkbox"/> Bookkeeping | <input type="checkbox"/> College Preparatory | <input type="checkbox"/> College Preparatory | <input type="checkbox"/> Foremanship | <input type="checkbox"/> Salesmanship |
| <input type="checkbox"/> Business Correspondence | <input type="checkbox"/> Commercial | <input type="checkbox"/> Commercial | <input type="checkbox"/> French | <input type="checkbox"/> Secretarial |
| <input type="checkbox"/> Business Management | <input type="checkbox"/> Cost Accounting | <input type="checkbox"/> Cost Accounting | <input type="checkbox"/> Grade School | <input type="checkbox"/> Service Station Salesmanship |
| <input type="checkbox"/> Cartooning | <input type="checkbox"/> C. P. Accounting | <input type="checkbox"/> C. P. Accounting | <input type="checkbox"/> High School | <input type="checkbox"/> Sign Lettering |
| | | | <input type="checkbox"/> Illustrating | <input type="checkbox"/> Spanish |
| | | | <input type="checkbox"/> Lettering Show Cards | <input type="checkbox"/> Traffic Management |

DOMESTIC SCIENCE COURSES

- | | | |
|---|---|---|
| <input type="checkbox"/> Advanced Dressmaking | <input type="checkbox"/> Home Dressmaking | <input type="checkbox"/> Tea Room and Cafeteria |
| <input type="checkbox"/> Foods and Cookery | <input type="checkbox"/> Professional Dressmaking and Designing | <input type="checkbox"/> Management, Catering |

Name.....Age.....Address.....

City.....State.....Present Position.....

Canadian residents send coupon to International Correspondence Schools Canadian, Limited, Montreal, Canada
British residents send coupon to I. C. S., 71 Kingsway, London, W. C. 2, England

Easy as A-B-C



DOESN'T IT LOOK SIMPLE?

Yet it's from the famous "Merry Widow" Waltz!

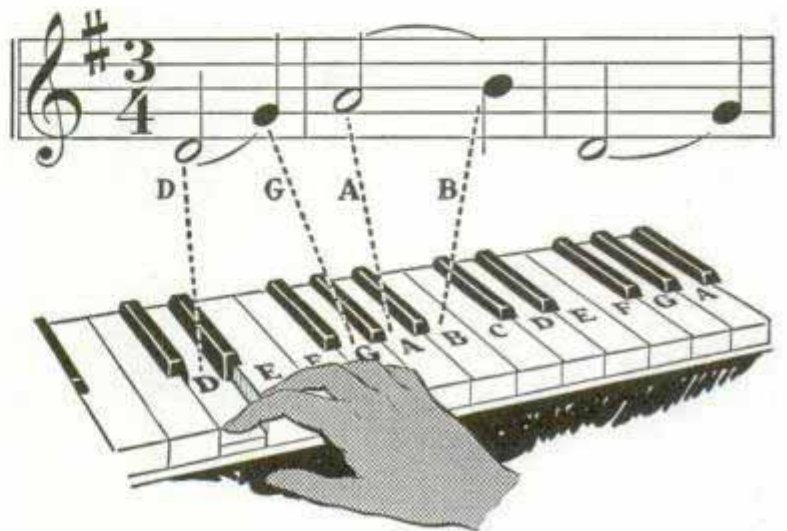

HERE'S PROOF THAT YOU, TOO, CAN LEARN TO PLAY THE PIANO OR ANY OTHER INSTRUMENT!

JUST strike the notes indicated above and you will actually be playing the opening bars of one of the world's favorite musical compositions! And it's just as easy to play other famous melodies, too, when you use the wonderful "Note-Finder."

This invention of the U. S. School of Music takes the mystery out of the piano keyboard, does away with tedious study and practice, enables anyone to play a real tune almost from the start. And that's the way this modern method works. You learn to play by *playing*. Soon you will be thrilled and delighted to find that you can pick up almost any piece of popular music and play it at sight. And that applies to the piano or violin, the saxophone or guitar, the accordion or whichever instrument you choose for your own!

Takes Only Few Minutes a Day!

PICK YOUR INSTRUMENT

Piano
Violin
Organ
Cornet
Trombone
Piccolo
Flute
Hawaiian Steel Guitar
Trumpet
Piano Accordion
Plain Accordion
Voice and Speech Culture
Modern Elementary Harmony
Drums and Traps
Banjo (Plectrum)
5-String or Tenor

Guitar
Saxophone
Mandolin
Ukulele
Harp
Clarinet
Cello

Do you wonder that over 700,000 people all over the world have taken advantage of this easy way to learn music at home? Don't let old-fashioned ideas deprive you of the joys of playing any longer. You don't need special talent; you don't need any previous knowledge of music; you don't need to spend months on monotonous drills and exercises. It's fun to learn music this modern way; it's easy as A-B-C; it takes only a few minutes a day. But see for yourself! Simply send today for our

Print & Picture Sample

This Print and Picture sample will give you the surprise of your life. It will show you, in black and white, how you can quickly realize your dreams of playing your favorite instrument. With the Print and Picture sample, you will also receive a handsome illustrated booklet and details of the remarkable, money-saving offer that enables you to learn music at home for but a few cents a day. All this material will be sent to you by return mail. If interested, mail the coupon or write, mentioning instrument that you prefer. Do it *today*. Note: instruments supplied when needed, cash or credit. U. S. School of Music, 71 Brunswick Bldg., New York City, N. Y. (Forty-second year—Est. 1898.)

U. S. School of Music,
71 Brunswick Bldg., New York, N. Y.

I am interested in music study, particularly in the instrument indicated. Please send me your free illustrated booklet, "How to Learn Music at Home"; also Print and Picture sample.

Name

Address

City State

Check here for Booklet "A" if under 16 years of age.

When writing to advertisers please mention Popular Mechanics

On His Record— Which Man Would YOU Hire?

ELECTRICAL ENGINEER			ELECTRICAL ENGINEER			
Subject	Book Sent	Exam. Ret'd	Subject	Book Sent	Exam. Ret'd	%
Wiring			Wiring			
Batteries			Batteries	14 35	5 2 35	87
Electrical Appliances			Electrical Appliances	14 35	6 18 35	90
Meters			Meters	6 2 35	6 1 35	83
Principles of Motors and Gene			Principles of Motors and Gene	5 20 35	8 17 35	95
Maintenance of Motors and			Maintenance of Motors and	6 18 35	9 27 35	91
Armature Winding			Armature Winding	1 35	11 9 35	89
Power Station and Equipm			Power Station and E		1 4 36	92
Diesel Electric Plants			Diesel Electric Plants		2 10 36	82
Practical Mathematics			Practical Mathematics		3 30 36	84
Mechanical Drawing			Mechanical Drawing		5 9 36	94
Electrical Layouts			Electrical Layouts		8 29 36	88
Practical Physics			Practical Physics	5 9 36	10 4 36	91
Elements of Electricity			Elements of Electricity	8 29 36	11 20 36	80
First Year Algebra			First Year Algebra	10 4 36	12 3 36	94
Plane Geometry			Plane Geometry	11 20 36		86
Trigonometry			Trigonometry		5 26 37	81
Industrial Electricity			Industrial Electric	3 18 37	8 10 37	79
Alternating-Current Electricity			Alternating-Current Electricity	5 26 37	12 20 37	83
				8 10 37	3 22 38	85

Not Started

Graduated

You Are Hired on YOUR Record— Employers Want to Know, Are YOU Prepared for Promotion

Your own ability to hold the better jobs depends entirely on the preparation you have made to accept the opportunities offered every month in the year in the active fields of today such as Air Conditioning, Diesel Engineering, Drafting and Design, etc. Men in these fields and others with preparation as accountants and in merchandising are being advanced into such openings as department heads, managers, foremen, superintendents, travelling auditors, etc.

Your opportunity today simply means being ready for the good jobs looking for good men—your chance for a worthwhile position depends on whether or not you will prepare to meet the demands of employers all over the country who are offering the big jobs to men who can handle them!

Without training a man is no more valuable at 40 than at 30, is old at 50. But the doctor at 40 or 50 is a better doctor than he was at 30—and it's the same with

men trained in other fields—executives, draftsmen, engineers, merchants, architects are young at 40, at 50—and still have many good pay years ahead. Promotion, increased pay, reward properly prepared men!

American School, an educational institution incorporated "not for profit," has used for over 40 years a direct and practical method for preparing men to handle the bigger jobs in business and industry.

American School graduates hold important positions as engineers, accountants, experts, draftsmen, managers, etc., or successfully operate their own business. Thousands of our High School graduates have entered colleges, universities, normal schools, etc., have attained success in business or industry.

Find out how American School can help YOU, the difference it may make in your entire future success and happiness! Mail coupon today for free Bulletin and early lesson in field of your choice. No obligation on your part.

American School, Dept. G145, Drexel Ave. at 58th St., Chicago

Cut Along This Line

Try a Lesson Yourself—No Obligation

American School, Dept. G145, Drexel Ave. at 58th St., Chicago

I have checked the line of work in which I would like a good job. Please send me without expense or obligation on my part a copy of your Bulletin and an early lesson in the field I have selected.

- | | | |
|--|---|---|
| <input type="checkbox"/> Air Conditioning | <input type="checkbox"/> Electrical Engineering | <input type="checkbox"/> Law |
| <input type="checkbox"/> Architecture | <input type="checkbox"/> Diesel Engineering | <input type="checkbox"/> Liberal Arts (College) |
| <input type="checkbox"/> Automotive Engineering | <input type="checkbox"/> Drafting and Designing | <input type="checkbox"/> Mechanical Engineering |
| <input type="checkbox"/> Automobile Repairing | <input type="checkbox"/> Electric Refrigeration | <input type="checkbox"/> Merchandising |
| <input type="checkbox"/> Bookkeeping and Cost Accounting | <input type="checkbox"/> Heating, Ventilating, Plumbing | <input type="checkbox"/> Private Secretary |
| <input type="checkbox"/> Business Management | <input type="checkbox"/> Professional Accounting | <input type="checkbox"/> Radio and Television |
| <input type="checkbox"/> Civil Engineering | <input type="checkbox"/> Incl. C. P. A. Coaching | <input type="checkbox"/> Salesmanship |
| <input type="checkbox"/> Aviation | <input type="checkbox"/> High School | <input type="checkbox"/> Shop Practice |
| <input type="checkbox"/> Contracting, Building | <input type="checkbox"/> Highway Engineering | <input type="checkbox"/> Shop Management |
| | | <input type="checkbox"/> Steam Engineering |



Name..... Age..... Occupation.....

Street..... City..... State.....

HOW A "TIP" GOT TOM A GOOD JOB



I will train YOU too at Home in Spare Time for Good Jobs in Radio

J. E. Smith, President
National Radio Institute
Established 25 years

I Trained These Men



Makes \$50 to \$60 a Week

"I am making between \$50 and \$60 a week after all expenses are paid, and I am getting all the Radio work I can take care of, thanks to N.R.I."

H. W. SPANGLER
126½ S. Gay St., Knoxville, Tenn.

\$10 to \$20 Week in Spare Time

"I repaired many Radio sets when I was on my tenth lesson. I made \$600 in a year and a half, and I have made an average of \$10 to \$20 a week--just spare time."

JOHN JERRY
1529 Arapahoe St., Denver, Colo.



Operates Public Address System

"I have a position with the Los Angeles Civil Service, operating the Public Address System in the City Hall Council. My salary is \$170 a month."

R. H. ROOD, R 136, City Hall
Los Angeles, Calif.



Radio is a young, growing field with a future. It offers many good pay spare time and full time job opportunities. And you don't have to give up your present job, go away from home, or spend a lot of money to become a Radio Technician. I train you right at home in your spare time.

Jobs Like These Go to Men Who Know Radio

Radio broadcasting stations employ engineers, operators, technicians and pay well for trained men. Radio manufacturers employ testers, inspectors, foremen, servicemen in good-pay jobs with opportunities for advancement. Radio jobbers and dealers employ installation and servicemen. Many Radio Technicians open their own Radio sales and repair businesses and make \$30, \$40, \$50 a week. Others hold their regular jobs and make \$5 to \$10 a week fixing Radios in spare time. Automobile, police, aviation, commercial Radio; loudspeaker systems, electronic devices, are newer fields offering good opportunities to qualified men. And my Course includes Television, which promises to open many good jobs soon.

Why Many Radio Technicians Make \$30, \$40, \$50 a Week

Radio is already one of the country's large industries even though it is still young and growing. The arrival of Television, the use of Radio principles in industry, are but a few of many recent Radio developments. More than 28,000,000 homes have one or more Radios. There are more Radios than telephones. Every year millions of Radios get out of date and are replaced. Millions more need new

Get Facts About THIS



HEY, TOM! HOW ARE YOU, OLD BOY?

BILL! GOSH, I DIDN'T KNOW YOU IN THOSE NEW CLOTHES AND THAT SNAPPY CAR. SOMEBODY LEAVE YOU A MILLION?



ONLY A SHORT TIME AGO YOU WERE SLAVING AWAY AT THE SAME JOB AS THE REST OF US. NOW LOOK AT YOU! HOW COME?

WELL, TOM, I DECIDED I'D NEVER GET ANYWHERE UNLESS I PICKED A BUSINESS WITH LOTS OF OPPORTUNITIES AND TRAINED MYSELF FOR THEM—SO I PICKED RADIO



YOU HAD THE SAME CHANCE, TOM. ABOUT A YEAR AGO I SHOWED YOU A BOOK FROM NATIONAL RADIO INSTITUTE TELLING ABOUT THE OPPORTUNITIES AND FUTURE IN RADIO AND TELEVISION AND HOW OTHERS HAD SUCCEEDED THROUGH THEIR HOME TRAINING—WELL—I ENROLLED



YOU CERTAINLY KNOW RADIO. MINE NEVER SOUNDED BETTER

THANKS. N.R.I. TRAINING CERTAINLY PAYS. I JUST STARTED A FEW MONTHS AGO AND I'M ALREADY MAKING \$5 TO \$10 A WEEK IN MY SPARE TIME.



OH TOM, IT'S WONDERFUL YOU'VE GONE AHEAD SO FAST IN RADIO. WE NEVER COULD HAVE GOTTEN MARRIED ON WHAT YOU WERE EARNING BEFORE

OUR WORRIES ARE OVER. I'M A TRAINED RADIO TECHNICIAN NOW. THERE'S A BRIGHT FUTURE AHEAD FOR US IN RADIO AND TELEVISION

tubes, repairs, etc. Over 5,000,000 auto Radios are in use and thousands more are being sold every day. In every branch Radio is offering more opportunities—opportunities for which I give you the required knowledge of Radio at home in your spare time. Yes, the few hundred \$30, \$40, \$50 a week jobs of 20 years ago have grown to thousands.

Many Make \$5, \$10 a Week Extra In Spare Time While Learning

The day you enroll, I start sending you Extra Money Job Sheets which start showing you how to do Radio repair jobs. Throughout your Course I send plans and directions which have helped many make \$200 to \$500 a year in spare time while learning. I send special Radio equipment to conduct experiments and build circuits. This 50-50 training method makes learning at home interesting, fascinating, practical.

Find Out What Radio Offers You

Act today. Mail coupon for my 64-page book, "Rich Rewards in Radio." It points out Radio's spare time and full time opportunities and those coming in Television; tells about my course in Radio and Television; shows many letters from men I trained, telling what they are doing and earning. Read my money back agreement. Find out what Radio offers you. Mail coupon in envelope or paste on penny postcard—NOW.

J. E. SMITH, President
Dept. OAP, National Radio Institute
Washington, D. C.



TESTED WAY TO BETTER PAY

I Also Give You This Professional Servicing Instrument

Here is the type of instrument successful Radio Technicians use—an All-Wave Set Servicing Instrument. It contains everything necessary to measure A.C. and D.C. voltages and current; to check resistances; adjust and align any set, old or new. It satisfies your needs for professional servicing after you graduate—can help you make extra money fixing sets while learning.

GET THE FACTS, MAIL THIS COUPON NOW!

THIS COUPON GOOD FOR ONE FREE COPY OF MY BOOK!

J. E. SMITH, President, Dept. OAP, National Radio Institute, Washington, D. C.

Dear Mr. Smith: Send me FREE, without obligation, your 64-page book "Rich Rewards in Radio" which points out spare time and full time opportunities in Radio, those coming in Television, and explains your 50-50 method of training men at home in spare time to be Radio Technicians. (Write Plainly.)

NAME.....AGE.....
ADDRESS.....
CITY.....STATE.....

This One



what are YOU DOING ABOUT DIESELS?

NO MATTER WHERE YOU LIVE
- Whether you are working or not -
WE HAVE A DIESEL TRAINING PLAN FOR YOU

Everywhere you look you can see Diesels forging ahead—new types for trucks, busses, trains, boats and general industry. You've seen the ads of world-known firms announcing their entry into Diesel—magazines making Diesels the subject of their feature articles. Never before has there been greater activity in this field. * * But are you connecting your future with the inevitable growth of this great industry? * * Find out about it—start doing so by sending for free copy of March of Diesel, and data on Hemphill Diesel training. Use coupon now.

HEMPHILL DIESEL SCHOOLS

All communications concerning enrollment in any of the Hemphill Diesel Courses should be sent to one of the following addresses:

NEW YORK 31-26 Queens Blvd., L. I. C.
CHICAGO 2014 Larrabee Street
MEMPHIS 417 Monroe Avenue
LOS ANGELES 2120 San Fernando Road
VANCOUVER, B.C. 1363 Granville St.

HEMPHILL DIESEL SCHOOLS (use nearest address)

Please send data on your Diesel courses, also free copy of illustrated booklet "March of Diesel."

Name _____ Age _____

Street _____

City _____ State _____ m-43-p

Applications for enrollment will be accepted from English speaking students residing in foreign countries. Write for special terms.

GET IN THE SWING with Slingerland . . . DRUMS



GENE KRUPA — World's Greatest Swing Drummer uses Slingerland

tone, easy playing, rich power by world's leading musicians. Easy payments. 5-days free trial. See at your dealers.

Write for free special information on how to organize drum and bugle corps. Free Catalog—mention instrument wanted.

SLINGERLAND DRUM CO.

1330 Belden Avenue

Chicago, Illinois

You CAN GET IN AVIATION

Like hundreds of successful graduates SPARTAN Training following standard College or University planned curriculum will give YOU Aviation training that will qualify for positions now open. Advantages Factory affiliation building ALL-METAL Commercial and Military Airplanes. Unequaled year-round flying weather and country. Government and Army Air Corps approved. All courses Mechanical and Flight. Write for Illustrated Catalog. **HOME OF THE DAWN PATROL**
Capt. MAXWELL W. BALFOUR, Director,
Dept. PM 27, TULSA, OKLAHOMA

SPARTAN SCHOOL OF AERONAUTICS

ENGINEERING

DEGREE IN TWO YEARS

TECHNICAL AND APPLIED COURSES. Nonessentials omitted. TIME AND MONEY SAVED. Degree 2 yrs., diploma 1 yr. Electrical, Mechanical, Architectural, Structural, Civil, Aeronautical, Highway. All courses include Air Conditioning, Electric Refrigeration and Diesel. Short intensive courses 3 and 4 months in Electricity, Power Plant, Diesel-Electric, Electric Refrigeration, Drafting. Extensive modern equipment. **LOW TUITION**, Part-time work for room and board. Thousands of successful graduates in U. S. and foreign lands. Approved by Industry, endorsed by educators, recommended by alumni. One and two-year courses start in Sept., short courses open year round. 40th YEAR. Residence courses. Catalog free.

FINLAY ENGINEERING COLLEGE

1001 Indiana Avenue

Kansas City, Mo.



CARTOONING

FREE TRIAL LESSON! Cash in on your sense of humor—AT HOME—BY MAIL. Have fun! Make money! No experience needed to start. Write today for **FREE LESSON**, mailed postpaid. No obligation. Moon Gag-Cartoon School, Dept. A, Fall Creek, Wis.

Learn PHOTOGRAPHY at Home

Splendid opportunities. Prepare in spare time. Easy plan. No previous experience needed, common school education sufficient. Send for free booklet "Opportunities in Photography", particulars and requirements.

American School of Photography
3601 Michigan Ave., Dept. 1351, Chicago, Ill.

NEW YORK SCHOOL OF MECHANICAL DENTISTRY

Learn how to make Crowns, Bridges, Plates in this OLDEST Laboratory Center. Practical training. Day, Eve. Easy terms. Ask for free Catalog P and tool offer.
N. Y. SCHOOL of MECHANICAL DENTISTRY, 125 W. 31 St., N. Y. C.

WILL YOU WEAR THIS SUIT and Make up to \$12 in a Day!

Let me send you a fine all wool union tailored suit **FREE OF ONE PENNY COST**. Just follow my easy plan and show the suit to your friends. Make up to \$12 in a day easily. **No experience—no house-to-house canvassing necessary.**
Send for Samples—FREE OF COST
Write today for **FREE** details. **ACTUAL SAMPLES** and "sure fire" money getting plans. Send no money.
H. J. Collins, **PROGRESS TAILORING CO.**, Dept. B-216, 500 South Throop Street, Chicago, Illinois.

When writing please mention Popular Mechanics

TRAIN FOR ELECTRICITY

12 WEEKS TRAINING

ACTUAL WORK ON ELECTRICAL MACHINERY

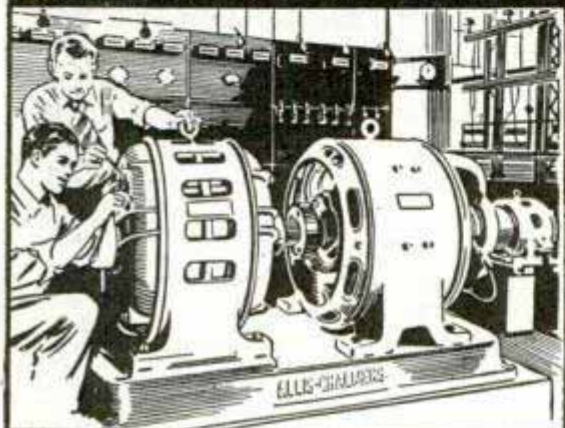
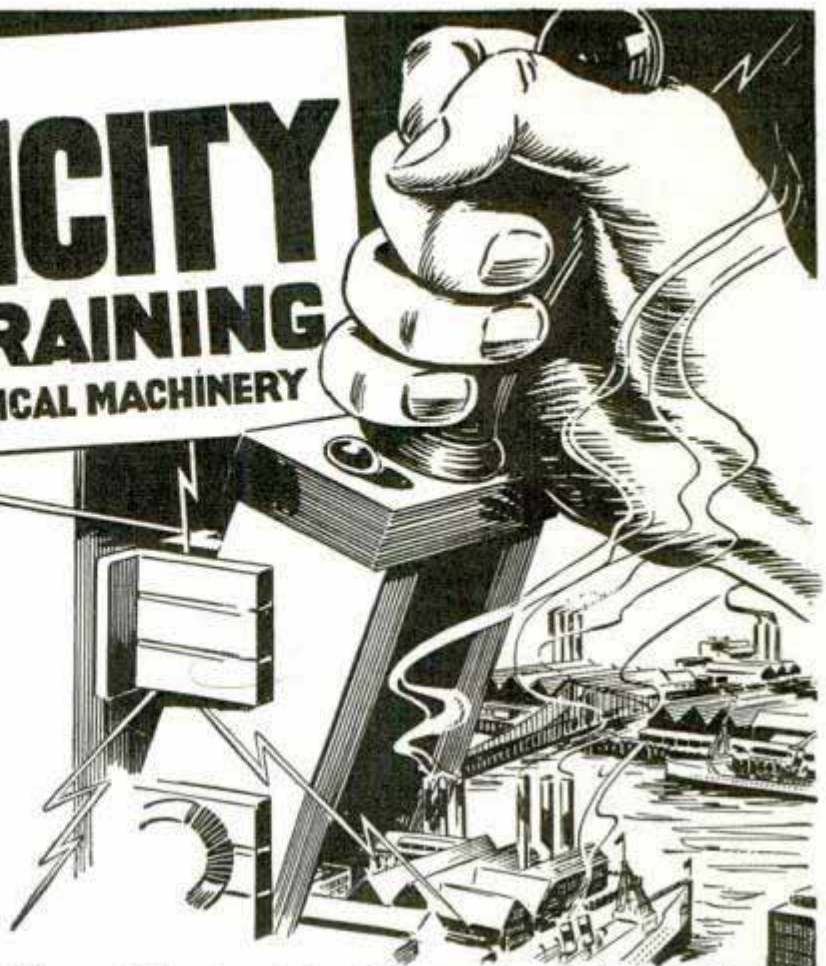

First you are told and shown what to do and how to do it. Then you do it yourself.



Send Today For Details of My Plans TO HELP YOU FIT YOURSELF FOR A GOOD-PAY JOB!

Are you out of a job? Are you working long hours at low pay in a job you don't like? Are you wondering where you can find a job that will give you steady, interesting work with better pay? If this applies to you and you are between 16 and 40 then you owe it to yourself to read every word of this message. Here at Coyne you have an opportunity to get 12 weeks of practical shop training in ELECTRICITY—training that can help fit you for your start towards a better job and better pay. My school is not the usual kind of school. It's more like a shop—a place where a fellow who likes to get his hands on machinery feels right at home. For that's exactly how you train, and because you "Learn by Doing" right here in my shops you don't need previous experience or advanced education. You do real work on real motors, generators and dynamos. You operate big, factory-type switchboards, wind armatures and do house wiring. You train in these and other branches of electricity—all with capable instructors to tell you and show you how. And right now I'm including valuable instruction in Diesel, Electric Refrigeration and Air Conditioning at no extra tuition cost.

EASY TO LEARN — EASY TO PAY

Don't let lack of money hold you back. If you need part-time work to help out with living expenses while you train, my employment department will help you find it. We also give you valuable lifetime employment service after you graduate. And remember this: We have plans to help the fellow who may be short of money.

Mail Coupon for FREE BOOK

Get my big free book. It's filled with facts and pictures which tell the whole fascinating story. I'll also tell you about part-time employment while training, today's electrical opportunities, and my other plans to help you. Mail the coupon for this big free book today.



"LEARN BY DOING" Not a Correspondence Course

In my shops you "Learn by Doing" on real electrical equipment, wind armatures, do house-wiring, work on real dynamos generators, etc.

Home of Coyne Electrical School



H. C. LEWIS, President
COYNE ELECTRICAL SCHOOL
500 S. Paulina St., Dept. 10-72, Chicago, Ill.

Please send me your big free Opportunity Book and all the facts about Coyne training, and the plans to help a fellow who wants to get ahead.

NAME.....

ADDRESS.....

CITY.....STATE.....



U.S. GOVERNMENT JOBS

START

\$1260 to \$2100 YEAR
MANY 1940
APPOINTMENTS EXPECTED

Railway Postal Clerks

Railway Postal Clerks get \$1,900 the first year regular, being paid on the first and fifteenth of each month. (\$79.17 each pay day.) Their pay is automatically increased yearly to \$2,450. Advance may be had to Chief Clerk at \$2,700 a year. (\$112.50 each pay day.)



3 Days On—3 Days Off—Full Pay

Railway Postal Clerks on long runs usually work 3 days and have 3 days off duty or in the same proportion. During this off duty their pay continues just as though they were working. They travel on a pass when on business. When they grow old, they are retired with a pension.

City Mail Carriers, Post Office Clerks

Clerks and Carriers now get \$1,700 the first year on regular and automatically increase \$100 a year to \$2,100 and \$2,300.

File Clerk—Clerk

Open to Men—Women 18 to 50. Entrance salary \$1,260—\$1,440 year. Appointments as File Clerks and Clerks in the Departments at Washington, D. C., are made from this examination.

Many Other Positions

Many other positions are obtainable. Those wishing these positions should qualify at once.

Get Free List of Positions

Fill out the following coupon. Tear it off and mail it today—now, at once.

This investment may result in your getting a big-paid government job.

FRANKLIN INSTITUTE, Dept. T-195, Rochester, N. Y.

Rush to me, entirely free of charge (1) a full description of U. S. Government Jobs, (2) Free Copy of Illustrated 32-page book, "U. S. Government Positions and How to Get Them"; (3) List of U. S. Government Jobs; (4) Tell me how to qualify for one of these jobs.

Name.....

Address.....

Use This Coupon Before You Mislay It. Write or Print Plainly.

1 Year Gov't Approved Course

PREPARE FOR A SUCCESSFUL CAREER IN AVIATION

Luscombe trained men are employed with leading Aviation Enterprises throughout the U. S. Practical training under experienced instructors, limited enrollment, strict supervision and modern methods have assured successful careers for Luscombe graduates. Details will be gladly sent upon request.

PLACED 90% OF OUR GRADUATES

LUSCOMBE
 SCHOOL OF AERONAUTICS
 WEST TRENTON, N. J., Dept. M.

Regain Perfect Speech, If You STAMMER

Every stammerer should have the new 287 page book "Stammering, Its Cause and Correction." Sent free to stammerers. It describes the Bogue Unit Method for the scientific correction of stammering and stuttering. Method successfully used at Bogue Institute for 39 years—since 1901. Endorsed by physicians. Write for full information. No obligation. Benjamin N. Bogue, Dept. 1310 Circle Tower, Indianapolis, Indiana.

Auto-Diesel

Master a real trade. Auto Mechanics, Diesel Mechanics, Arc Welding, Acetylene Welding, etc. Let us train you to be an expert Auto-Diesel Mechanic and help you get a good job. The cost to you is reasonable. Learn on modern equipment with tools under experienced instructors. Real shop work. Steam heated buildings. Room and board in our steam heated dormitory. We pay your fare to Nashville. For free catalog write

Nashville Auto-Diesel School, Dept. 75, Nashville, Tenn.

TRI-STATE COLLEGE
B. S. Degree in 2 Years

World famous for technical 2-year courses in Civil, Electrical, Mechanical, Chemical, Radio, Aeronautical Engineering, Business Administration and Accounting. Special preparatory department for those who lack required high school work. Short diploma courses (36 weeks) in Surveying, Drafting. Low tuition. Low living costs. Students from every state and many foreign countries. 56th year. Graduates successful. Enter September, January, March, June. Write for catalog. 410 College Ave., ANGOLA, IND.

LEARN WATCH REPAIRING

AT HOME You can learn by our modern and original system of instruction every part of the Watch Repairing Trade at home. You can earn money while learning and prepare yourself for a well paying position or start in business after completing our course of instruction. Good watch repairers are in demand and generally earn very good salaries. For particulars apply to the Wisconsin School of Watch Repairing 524 E. Mason St., MILWAUKEE, WIS.

RADIO ENGINEERING, broadcasting, aviation and police radio, servicing, marine and Morse telegraphy taught thoroughly. 48 weeks' engineering course equivalent to three years' college radio work. School established 1874. All expenses low. Catalog free.

Dodge's Institute, Ada St., Valparaiso, Ind.

Minstrels Comedy Stunts Plays Songs

Unique First Parts for complete show with special songs and choruses. Make-up. Catalog Free.

T. S. Denison & Co., 203 N. Wabash, Dept. 19, Chicago

Learn How to Write

Write for my Free Book, "HOW to BECOME an EXPERT PENMAN," which shows how others became experts by my Method. Supplies furnished to students. Your name elegantly written on a card if you enclose stamp. Write Today. T. M. TEVIS, Box 25K, CHILLICOTHE, MO.

Learn to MOUNT Birds and Animals



FUN-FASCINATION PROFITS - IN SPARE TIME

Learn **TAXIDERMY** at home **BY MAIL**. Save your hunting trophies, decorate your home and den, have a grand **HOBBY**. This old reliable school (with 250,000 students) will teach you at home to mount **BIRDS, ANIMALS, FISH, GAME-HEADS**—and to **TAN** hides and furs by wonderful **KROME-TAN** system, also **NOVELTY TAXIDERMY**, using common specimens—no wild game needed.

FREE BOOK 100 beautiful pictures. Tell how **YOU** can learn Taxidermy easily, quickly, at home. Tells how to **EARN FINE PROFITS** in spare time. Rush letter or postal for this strange marvelous **FREE BOOK**. Write **NOW—TODAY**. State **AGE**.
N. W. School of Taxidermy • 3371 Elwood Bldg. • Omaha, Neb.

ELECTRICAL ENGINEERING
Condensed **ONE-YEAR** residence course combines theory with practice in well-equipped laboratories. High employment record. Suburban campus; modern buildings; dormitory. 47th year. **CATALOG**. Give age.



BLISS ELECTRICAL SCHOOL
131 Takoma Ave., Washington, D. C.

PHOTO-ENGRAVING **TASOPE' SINCE 1931**

Cash in on pictures! Learn quickly at home or in our residence school. Make halftones, line cuts for the trade. Qualify for interesting, good pay job. We show you how and supply complete low-cost engraving plant. Small investment. Easy terms. Particulars free!

THE AURORA SCHOOL OF PHOTO-ENGRAVING
Dept. PM-12 Tasope' Bldg. Aurora, Mo.

BE A RAILWAY TRAFFIC INSPECTOR



Write for Free Booklet describing our 20 yrs.' experience placing Men (19-50) in jobs that pay up to \$135 per mo. to start. Easy, home-study course trains you in spare time. **STANDARD BUSINESS TRAINING INSTITUTE**, Div. 201, Buffalo, N. Y.

EARN THE DEGREE

Doctor of Psychology (Ph.D.), Philosophy, Divinity, Science, General Courses—Arts, Law, Business, etc. A Chartered Correspondence Institution. Send for 32-page **FREE** Bulletin at once. **No Obligation**.
Temple Bar College, Inc., Dept. 2-R, 1629 Thirteenth Avenue
Seattle, Washington, U.S.A.

Get into the BAKING BUSINESS

Bakers make good money! Now 7th Industry in wages! Nearly depression-proof. New home study Baking Course qualifies you. Common school education sufficient. If you're ambitious, write for **FREE BOOK**, "Opportunities in Baking."
National Baking Institute, 3601 Michigan, Dept. 1351, Chicago



MAKE MONEY AT HOME

RUBBER MOLDS *Low as 6¢ EA.*



Amazing rubber mold-making outfit makes perfect flexible molds of plaques, ash trays, book-ends, etc. Molds cost from 6c to 25c each. Each mold makes hundreds of novelties and gifts to sell up to \$1.00 apiece! No experience necessary. Quick and easy. Start profitable business in your home... sell to stores, gift shops, friends, resorts, road stands, by mail. Full or spare time. "Molders Handy Book" and list of buyers **FREE**. Write
SO-LO WORKS
Dept. C-827 Cincinnati, Ohio

Our Graduates Run 47% of ALL the Identification Bureaus in America

Think of It!

Send for complete list of over 600 Bureaus where our graduates have been placed in good positions as **FINGER PRINT EXPERTS**
Then write the nearest Bureau and learn what our graduates think of us!



- We have space here to list only a FEW of these more than 600 institutions, so be sure to send for the complete list!
- | | |
|----------------------|----------------------|
| State of Utah | Schenectady, N. Y. |
| State of Ohio | Scranton, Pa. |
| Boston, Mass. | Lincoln, Neb. |
| New York, N. Y. | Mobile, Ala. |
| Pittsburgh, Pa. | Little Rock, Ark. |
| St. Paul, Minn. | Pontiac, Mich. |
| Mexico City, Mex. | Havana, Cuba |
| Augusta, Ga. | Miami, Fla. |
| Seattle, Wash. | Birmingham, Ala. |
| Omaha, Neb. | Columbus, Ohio |
| Des Moines, Ia. | Galveston, Tex. |
| Montreal, Can. | Houston, Tex. |
| Cedar Rapids, Iowa | Windsor, Ont. |
| Elgin, Ill. | Pueblo, Colo. |
| Syracuse, N. Y. | Salt Lake City, Utah |
| Tampa, Fla. | Atlantic City, N. J. |
| Long Beach, Cal. | Sioux City, Iowa |
| St. Louis, Mo. | Rochester, N. Y. |
| Lansing, Mich. | Cleveland, Ohio |
| Burlington, Ia. | Spokane, Wash. |
| Erie, Pa. | Fort Worth, Tex. |
| Oklahoma City, Okla. | Shreveport, La. |
| Trenton, N. J. | Waltham, Mass. |
| Detroit, Mich. | Berkeley, Calif. |
| El Paso, Tex. | Paterson, N. J. |

Want a Regular Monthly Salary?

Be a Secret Service and Identification Expert!
Enjoy the thrill of getting your man—with no personal danger—PLUS a regular monthly paid salary and the opportunity to share in Rewards. Learn at home, in spare time, and at low cost, the unique secrets of this young, fascinating and fast growing profession. You have exactly the same opportunity that was offered the hundreds of our graduates who now hold splendid positions in more than 600 institutions. Each of these bureaus has anywhere from ONE to FIFTEEN of our graduates on regular salaries—and new openings develop from time to time.

Wonderful Opportunity for TRAINED MEN In This Young, Fast Growing Profession.

Of the thousands of towns in America, three-fourths are still without identification bureaus. Many more are bound to come! That spells OPPORTUNITY. But you must be READY. It's easy to master this profession that combines thrills with personal safety, AND the security of a steady income. We show you HOW—just as we have already shown the hundreds who now hold good pay positions.

FREE! The Confidential Reports Operator No. 38 Made to His Chief.

Just rush coupon! Follow this Operator's exciting hunt for a murderous gang. Also, get free, "The Blue Book of Crime," showing the wonderful opportunities in the field of Finger Prints and Crime Detection. Take your first step TODAY toward a steady income and success. Mail coupon NOW!

INSTITUTE OF APPLIED SCIENCE
1920 Sunnyside Ave., Dept. 1351, Chicago

INSTITUTE OF APPLIED SCIENCE
1920 Sunnyside Ave., Dept. 1351, Chicago.
Gentlemen: With no obligation on my part, send me Confidential Reports of Operator No. 38, also illustrated "Blue Book of Crime," complete list of bureaus employing your graduates, together with your low prices and Easy Terms offer. (Literature will be sent ONLY to persons stating their age.)

Name

Address

Age

Concrete-Steel and Bridge Construction



4 BIG BOOKS
shipped **FREE**

for examination. Invaluable to Engineers, Contractors, Builders, County Supervisors, Road Superintendents and Foremen or anyone directly or indirectly connected with the building or construction field. These books are BRAND NEW and contain the very latest and most authoritative information available.

The complete set, 4 big books, over 1200 pages, will be sent upon receipt of coupon for free examination.

Full of Money-Making Facts

Handsomely bound in modernistic long wear binding, these books are crammed full of accurate and easily located, money-making information. They cover CONCRETE MIXING DESIGN AND CONSTRUCTION, ALL FORMS OF STEEL CONSTRUCTION, INCLUDING WELDING, BRIDGE BUILDING, ROOF TRUSSES, STRENGTH OF MATERIALS AND THEIR APPLICATION as well as the field of mathematics as applied to this work.

Anybody in the industry will find them a veritable gold mine of information, worth many times their low cost. Send the coupon (no money) and get this splendid quick way to money-making facts.

THE AMERICAN TECHNICAL SOCIETY
Dept. B119, Drexel at 58th St., Chicago

You may ship me FREE for examination your 4 new books "Concrete, Steel and Bridge Construction." I will pay the few cents delivery charges only. If I decide to keep them I will send \$2.00 in 10 days and \$3.00 a month until the total price of \$19.80 is paid. Otherwise I will return the books collect and owe you nothing.

Name.....Address.....
City.....State.....

Please attach a letter giving age, name of employer and that of some business man as reference.

AUDELS Carpenters and Builders Guides 4 vols. \$6



Inside Trade Information for Carpenters, Builders, Joiners, Building Mechanics and all Woodworkers. These Guides give you the short-cut instructions that you want—including new methods, ideas, solutions, plans, systems and money saving suggestions. An easy progressive course for the apprentice and student. A practical daily helper and Quick Reference for the master worker. Carpenters everywhere are using these Guides as a Helping Hand to Easier Work, Better Work and Better Pay. To get this assistance for yourself, simply fill in and mail the FREE COUPON below.

Inside Trade Information On:

How to use the steel square—How to file and set saws—How to build furniture—How to use a mitre box—How to use the chalk line—How to use rules and scales—How to make joints—Carpenters arithmetic—Solving mensuration problems—Estimating strength of timbers—How to set girders and sills—How to frame houses and roofs—How to estimate costs—How to build houses, barns, garages, bungalows, etc.—How to read and draw plans—Drawing up specifications—How to excavate—How to use settings 12, 13 and 17 on the steel square—How to build hoists and scaffolds—skylights—How to build stairs—How to put on interior trim—How to hang doors—How to lath—lay floors—How to paint.



THEO. AUDEL & CO., 49 W. 23rd St., New York City

Mail Audels Carpenters and Builders Guides, 4 vols., on 7 days' free trial. If O.K. I will remit \$1 in 7 days, and \$1 monthly until \$6 is paid. Otherwise I will return them. No obligation unless I am satisfied.

Name.....
Address.....
Occupation.....
Reference..... P.M.

CLIMBING AHEAD

THESE DAYS IS
tough going...

... **BUT...** consider the hundreds of men now in Aviation who started their careers with Aero I.T.I. training. You may be right where these men once were—wondering how to get ahead faster. If so, you owe it to yourself to find out about the training that has placed so many men in the rapidly expanding Aviation industry. During one 60 day period 126 Aero I.T.I. trained men were placed with one aircraft plant alone!

Find Out about Aero I.T.I. training. Choice of three courses in Aircraft Mechanics, two in Aeronautical Engineering. You can take full-time courses at the school, or start your training at home. For full details, write NOW

AERO INDUSTRIES TECHNICAL INSTITUTE
5253 West San Fernando Road • Los Angeles, California

LAW STUDY AT HOME

Legally trained men win higher positions and bigger success in business and public life. Greater opportunities now than ever before. Big corporations are headed by men with legal training.

More Ability: More Prestige: More Money

We guide you step by step. You can train at home during spare time. Degree of LL. B. Successful graduates in every section of the U. S. We furnish all text material, including 14-volume Law Library. Low cost, easy terms. Get our valuable 48-page "Law Training for Leadership" and "Evidence" books FREE. Send for them NOW.

LaSalle Extension University, Dept. 164-L Chicago
A Correspondence Institution

CRIME DETECTION SECRET SERVICE AND FINGER PRINTS

SECRET SERVICE BOOK FREE

For 30 Days Reading
No Money Down—Actual Crime Cases—
If You Act Quick! We will send you this stirring book on Crime Detection, Secret Service and Identification Work for 30 days free reading. Send no money. If you decide to keep it, then send me only \$1. If not, return it. WRITE TODAY. Literature will be sent only to persons stating their age.

T. G. COOKE, Dept. 1351, 1920 Sunnyside Ave., Chicago, Ill.

HOW

500 PAGES

How to Win Fortune, Happiness by a Book

Money not essential to begin business or develop a winner. Too much money, unless earned by experience, usually means failure. Success develops itself. Marconi, Carnegie, automobile, telephone, telegraph, camera all started from BOOKS. Read **HOW**. Learn to get ahead in sure, inexpensive way. For free **HOW GUIDE**, write your name and address on postcard, mail today to

R. & R. Co., 641 H. St., Melrose, Massachusetts

MONROE COLLEGE OF OPTOMETRY

Be a Doctor of Optometry. Test eyes. Fit Glasses to improve sight. An uncrowded profession. College not operated for profit. We help to provide part time employment. Days, Evenings. Next semester begins Feb. 14. Write for Bulletin.

164 North Wacker Drive Chicago, Illinois

CARTOONING PAYS WELL

Exclusive instruction by a famous cartoonist makes it easy to learn at home. Write for Free Booklet describing details of the course.

NATIONAL SCHOOL OF CARTOONING
439 Penton Bldg. Cleveland, Ohio

DIESEL

Get BETTER training. Realize Adcox advantages. Located in Pacific Northwest, a Diesel center. Established 28 years. Modern equipment, expert instructors. Close cooperation for YOUR success. Earn room and board while learning. Send for free book, "What Every Man Should Know About Diesel". Dept. 18. Home study and resident courses.

L. L. ADCOX TRADE SCHOOL
Portland Oregon

SELL FOOD Complete Outfit FREE!

Everybody must buy food. Own a steady neighborhood route. Full or part time. Make money at once and all year 'round. Complete Outfit, including large assortment regular full-size packages—FREE to reliable persons. No experience needed. Handle nationally known line 200 guaranteed home necessities; fast sellers; steady repeaters. Liberal credit plan. Old reliable company. Write quick for my Free Offer.

E. J. MILLS, 1546 Monmouth Ave., Cincinnati, Ohio.

When writing please mention Popular Mechanics

Monastery Secrets

... THE FORBIDDEN KNOWLEDGE OF TIBET

What strange secrets of nature are locked within the mountain fastness of Tibet? What control over the forces of the Universe do these cloistered sages exercise? For centuries the world has sought to know the source of their power—to learn their mastery of life, and their faculty for overcoming problems with which the masses of mankind still struggle. Have they selfishly deprived humanity of these rare teachings?



WRITE FOR THIS FREE BOOK

Like the streams that trickle from the Himalayan heights to the plateaus below, the great truths of these brotherhoods have descended through the ages. One of the preservers of the wisdom of the Orient is the Rosicrucian Brotherhood (not a religious organization). They invite you to write today for their FREE Sealed Book, with its amazing revelations about these mysteries of life. Address: Scribe E.M.G.

The ROSICRUCIANS
AMORC
San Jose, Calif.
U.S.A.



EARN A DEGREE AT HOME

From A Chartered Institution Of Higher Learning*
Employers Now Demand College Graduates With Degrees

38 Degree Courses in Art; Sciences; Philosophy; Education; Psychology; Public Health; Sociology; Physics; Chemistry; Pol. Science; Theology; Law; Business Training; Accounting; Statistics; Adv.; Sales; Agriculture, Electrical, Mechanical, Civil, Structural, Diesel, Architectural, Mining; Drafting, Automotive, Aeronautical, Radio, Refrigeration, Highway, Marine, Air Conditioning, Geology, Petroleum, Industrial, Chemical Engineering. Founded 1908. 170 p. Catalog Free. McKinley-Roosevelt Graduate College, 4750-F Sheridan Road, Chicago

TELEGRAPHY

Taught thoroughly. Renewed opportunities due to Railroad Retirement Act and increased business; some railroads experiencing shortage of efficient operators now. EVERY BRANCH OF RADIO ALSO TAUGHT. School established 1874. All expenses low. Catalog free.

DODGE'S INSTITUTE, Kane St., Valparaiso, Ind.

NOW a DYNAMIC HEAVY DUTY INDUSTRIAL WELDER

Works ON 110-Volt Light Socket. This marvelous Dynamic Power Welder does the work of much higher priced types. It is easily portable, WELDS Cylinder Blocks, Bumpers, Fenders, Tanks, Farm Machinery, etc. Will also solder and brase on the lightest material. Works on iron, steel, tin, brass, copper and all other metals. Men without previous experience can make as much as \$5.00 on a one hour repair job. In a year's time a Dynamic Welder Costs You LESS THAN 6 CENTS A DAY. Instructions Free—Open a welding shop now. AGENTS—Make big profits selling to garages, factories, janitors and machine shops. Write today for our 10-DAY TRIAL OFFER. DYNAMIC WELDER CO. 2226-KH Silverton Road Chicago, Illinois



REAL JOBS OPEN FOR TRAINED AUTO MECHANICS



LEARN QUICK!
8 WEEKS
practical SHOP
TRAINING!

AUTO, DIESEL and AVIATION mechanics

WELDING—BODY & FENDER

I'll train you quickly, correctly for this fascinating work, paying up to \$60 a week! Based on 25 years' experience knowing how to train men well, in the 2 biggest, best schools of their kind in the world. You learn with real tools, on real equipment, a complete, practical course in Auto, Diesel and Aviation Mechanics, Welding, Body and Fender work so you can step out of low-pay jobs into a career in the biggest field of opportunity in America today!

SPECIAL LOW RATE

SPECIAL LOW TUITION RATE IF YOU ACT NOW!

Again McSweeney leads in real value. If you write at once we will reveal a special new low tuition rate that will amaze you, and on easy terms it makes it easy for you to train AT ONCE for a big-pay job! Write TODAY for details!

McSWEENEY MEN MAKE GOOD!

25 years' success means something to you! Read how others have succeeded with McSweeney training: "Just got thru writing income tax check. Money spent at your school was best thing I ever did"—Lee Grant, O.; J. W. Wiggins, Okla., says before we trained him he had no income, now has own business, money in bank and to spend! G. B. Park, Ind., says "Your training fitted me to handle any job in auto field." These men were trained in our fine big schools, best of their kind anywhere!

TWO FINE BIG SCHOOLS



DETROIT



KANSAS CITY

FREE BOOK!



Send now for your copy of my big book giving all the facts and announcement of amazing new low tuition rate for short time only—but you must write at once!

Address nearest school:

McSWEENEY TRADE SCHOOL

Dept. E-7, Detroit, Mich., or Kansas City, Mo.
Without cost or obligation send me your big FREE book.

NAME.....
STREET.....
TOWN..... STATE..... AGE.....

INVENTORS

Act Now TO PROTECT
YOUR INVENTION WITH U.S. PATENT

Small Ideas May Have Large Commercial Possibilities

Inventions do not have to be complicated to be profitable when Patented. The 5c and 10c stores flourish on simple Patented products which are commercially successful. The zipper, safety pin, thumb tack, paper clip, collar button—all are simple yet familiar inventions—brought their inventors rich rewards. If you have a Patentable invention—act to protect it. Send for our FREE 48-Page Book that tells you how.

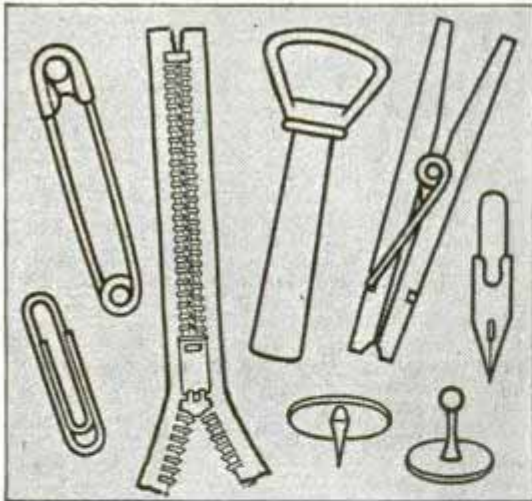

CLARENCE A. O'BRIEN

Dept. OA1, Adams Building, Washington, D. C.
Registered Patent Attorney before U. S. Patent Office

Free Book TELLS IMPORTANCE OF QUICK ACTION—HOW TO OBTAIN PATENT AND MARKET INVENTIONS

If you have invented something, if you're interested in inventing something, you need our new 48-page book that gives the entire Story of Patents. It tells you for the first time about new phases of invention, how others succeeded, how the patent laws protect you, how to market your invention, where to obtain finances, how to form a company, partnership, or arrange for royalties from your invention's sale.

PRACTICAL BENEFITS OF THIS BOOK

You will find 6 complete pages illustrated with simple inventions that have succeeded in six different fields of industry. Over 100 illustrations are in this book. You will read the stories of ten (illustrated) of America's most famous inventors. You will find an experienced and thorough survey of market conditions affecting the inventor—showing the possibilities for commercial invention today. Entire chapters are devoted to the value of a patent in promoting the final success of your invention. The importance of quick action in applying for patent is stressed—facts revealing danger of delay are emphasized.

If you expect to realize profits from your invention you must protect it with a U. S. Patent. Otherwise you may find that all your time and labor have been lost, because it often happens that other inventors are working on the same invention. If you have an invention, or an ambition to invent—get the information on obtaining patent AT ONCE!

FREE RECORD OF INVENTION FORM

When you send for our FREE BOOK, we include, also Free, our specially prepared Record of Invention blank, on which you can quickly make and date a sketch and description of your invention. This "disclosure" as it is called, may be absolutely invaluable as evidence for you, should your rights ever be contested. Be sure to get it and use it.

CLARENCE

REGISTERED PATENT ATTORNEY before U. S. Patent Office

*For
Quick
Action*

**SEND
TODAY**



GET FREE 48-PAGE BOOK
and Free Form for Recording Your Invention

MAIL COUPON NOW
TO CLARENCE A. O'BRIEN

Registered Patent Attorney
BEFORE U. S. PATENT OFFICE

Clarence A. O'Brien, Dept. OA1, Adams Building, Washington, D. C.
Please send me your Big, Free 48-Page Book for Inventors and your Specially Prepared Record of Invention form. This request does not obligate me.

Name.....

Address.....

City.....

State.....

(Please write or print plainly).

You Can Patent
MACHINERY, ARTICLES, DESIGNS, FORMULAS, ETC., IF NEW

IMPROVEMENTS IN
MACHINERY, ARTICLES, DESIGNS, FORMULAS, ETC., IF NEW

Every year thousands of Patents are granted. Very few, however, represent the discovery of entirely new principles. Most of them provide new methods of doing some every-day thing in a better way—changes for greater efficiency, usefulness, adaptability, or beauty in some previously Patented thing. These IMPROVEMENTS are patentable if new, and actually represent new inventions. These improvement Patents offer large chances for profit if commercially useful. The business world wants improved products and services.

FINISHED DRAWINGS NOT NECESSARY

Our Big Book tells you how you can start immediately to apply for Patent Protection even if you haven't finished models or drawings available now. It will tell you how we can prepare the specifications and finished drawings necessary in the form prescribed by the Patent Office—so as to secure for you full Patent Protection. Mail Coupon for Our Big Book TODAY.

OUR SERVICES TO YOU

We are Registered Patent and Trade-Mark Attorneys, serving Inventors all over the United States and abroad. Our Organization is complete. We have Draftsmen, experienced Searchers and Attorneys to serve your interests.

We can act as your legal adviser in all Patent Matters. Our complete service is described in Our Big Book. Mail Coupon for it NOW.

REASONABLE FEES—CONVENIENT TERMS

Don't worry about finances. Our fees are very reasonable—we can arrange convenient terms of payment. It is our custom to permit clients to pay for our services in installments as the application progresses in our office. See our Big Book for fees in obtaining Patent. It explains our arrangements clearly. Send for it NOW.

GET FREE BOOK—MAIL COUPON NOW

If you have an invention in the making—if you simply have the crude elements of an invention in mind—you should have our Big FREE BOOK without delay. It will guide you every step of the way—from the preliminary search stage to the issuance of the final patent grant. This book contains twenty-five chapters describing in plain man-to-man language the story of obtaining a patent and marketing an invention. This book is absolutely FREE—just tear off the above coupon or write us a letter or postcard TODAY!

CLARENCE A. O'BRIEN

Dept. OA1, Adams Building, Washington, D. C.
Registered Patent Attorney before U. S. Patent Office

A. O'BRIEN

Dept. OA1, Adams Building WASHINGTON, D. C.

POPULAR



INVENTIONS

S¹⁰⁴⁵OMETHING new for the water-sports fan is offered in a patent covering a unicycle. The odd craft consists of a circular tubular wheel, resembling a large automobile tire, a seat mounted above the wheel, a weight forming a keel attached beneath the wheel and a pedal-and-gear arrangement by which the rider may rotate the wheel, causing the unicycle to move through the water. The inventor probably visualized races between riders on unicycles as feature events on water-carnival programs.

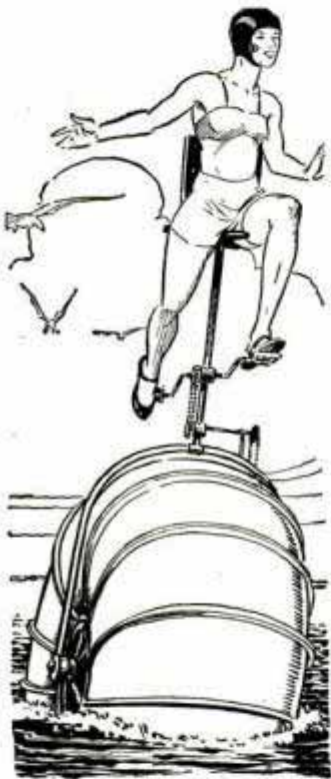

the travelers stop for the night, it may be swung into horizontal position, with legs supporting it at the rear. Mattress and bedding may then be placed on the frame.

IMPROVED means of salvaging sunken ships is the objective of a newly patented device. It comprises a pontoon ship having a well located at one end, a scoop adapted to be positioned under one end of

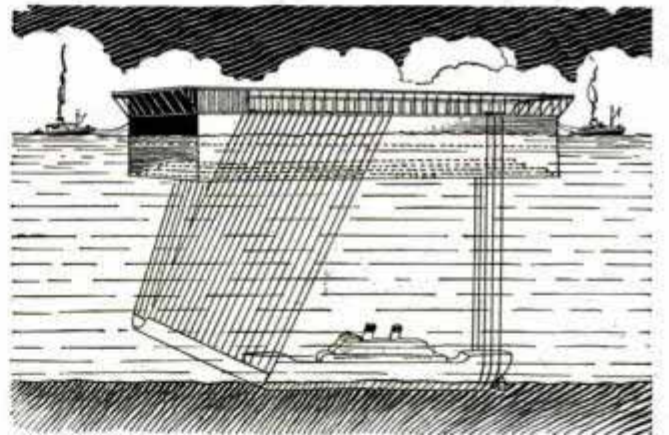

the sunken ship and cables supporting the scoop from the well. Other cables would be attached at the other end of the craft lying on bottom, to facilitate lifting it.

FOR the convenience of the tourist, a handy sleeping arrangement to be attached to the automobile is proposed in a new patent. It consists of an extensible

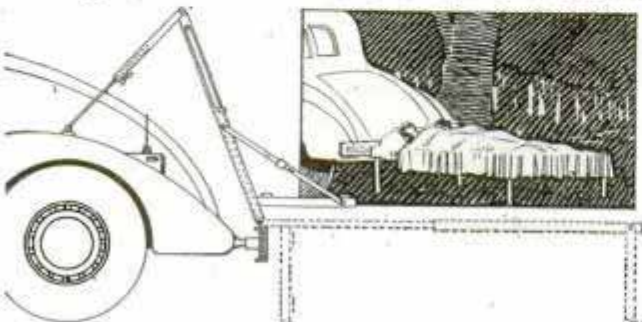

and collapsible bed frame mounted in connection with, and supported by, the rear fenders and rear bumper. While the car is under way, it is in folded position, but when

AS AN aid to the driver, a rotatable grip for the auto steering wheel has been patented recently.

The grip is intended for inclusion in the steering wheel at manufacture. It has an opening into which the hand fits, with indentations for the driver's fingers. The grip has a counterweighted gripping side to give the driver better control in turning the wheel.

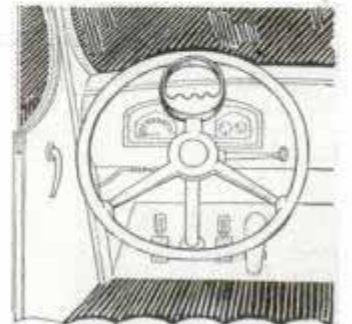

(Continued to page 26A)



AMAZING TRICKS YOU CAN DO ... with your camera!

TRICK poses—foreshortening—double exposures, double printing—"ghost" effects—fake backgrounds. There are dozens of tricks you can do. Here's how you can find out all about them:

New, Easy Way To Take Better Pictures

A new way to learn how to take better pictures has just been perfected by the ACADEMY OF PHOTOGRAPHY. Not only does the ACADEMY bring you novel ideas in trick photography—but it shows you how you can make perfect pictures all the time! Saves you money on wasted film. Cuts down on lost time, effort, materials. Shows you easy ways to do your own darkroom work—turn out prints you'll be proud to show—photos of exhibition calibre that you may even sell!

7-DAY TRIAL OFFER. The ACADEMY OF PHOTOGRAPHY method is simple, inexpensive, NON-TECHNICAL, quickly mastered. And it costs you nothing UNLESS you are convinced—in the first seven days—it can do all these things for you! Send for FREE BOOK describ-

ing this new way to get greater pleasure and profit out of your camera. Mail coupon to: ACADEMY OF PHOTOGRAPHY, Dept. 4A, 115 East 23rd Street, New York, N. Y.

FREE BOOK



ACADEMY OF PHOTOGRAPHY
Dept. 4A, 115 East 23rd St., New York, N. Y.

Send me—free, without obligation—illustrated book describing this New, Easy Way to Take Better Pictures—also details of 7-Day Trial Offer.

Name.....
Address.....
City.....State.....

AVIATION APPRENTICES



AIRMINDED YOUNG MEN INTERESTED IN TRAINING FOR ENTERING THE WELL PAID FIELD OF AVIATION AS APPRENTICES—Write immediately, enclosing stamp.

MECHANIX UNIVERSAL AVIATION SERVICE CO.

Wayne County Airport, Box 857, Dept. E, Detroit, Mich.

CARTOON YOUR WAY TO SUCCESS!



DON'T COPY - LEARN TO ORIGINATE!

RAYE BURNS will teach you HOW to CREATE ORIGINAL CARTOONS at home that you can SELL! Course has 26 lessons and 600 illustrations. \$2.85

Send name and address for free details. Only....

RAYE BURNS SCHOOL, Dept. M-7, Box 2194, CLEVELAND, OHIO



LEARN to PLAY BY EAR

Here is a wonderful NEW way to learn to play the piano, without notes, in as little as 90 DAYS. Play anything—swing to classical.

NEW SYSTEM is easy. You don't have to practice scales, you don't have to study for years. Young or old have equal opportunities. Amaze your friends. Play for pleasure or for money. Cost is very low, payments easy. Send for complete FREE details. No obligation.

Karl Ostrum, Pres.

HARWOOD SCHOOL OF MUSIC DEPT. 12 Chicago
500 N. Dearborn St.

MECHANICAL DENTISTRY



Short course—personal, individual, instruction—best technical teachers. Profession offers unlimited opportunity—not affected by Machine Age. Most modern and complete methods embracing every branch from plate to porcelain work. Qualifies you to work for dentists or own business. Day or night school. No books—no classes. Catalog upon request.

OR STUDY AT HOME. Write for information on our Home Study Course.

McCARRIE SCHOOL OF MECHANICAL DENTISTRY

207 N. Broad St. Dept. 752 Philadelphia, Pa.



RESOLE SHOES FOR ONLY 4¢ EACH

SO-LO mends holes, worn spots in rubber, leather, cloth. Spreads like butter. Dries tough overnight. Flexible, non-skid, waterproof. Won't come off—guaranteed! 25c (25 repairs). At all 10c and hardware stores.

"Woolworth, Kresge, Newberry, Murphy, McCrory, Neisner, McLellan, Sears and Ward, now featuring SO-LO".

BROOKLYN YMCA TRADE SCHOOL MAIL COUPON



Unlimited Instruction until you have mastered every part of Course without additional charge.
Full Shop Equipment
Unexcelled Instruction
Fireproof Dormitories.
Special Privileges. Check your interests on coupon to receive free literature.

- Mechanical Pre-Engineering
- Diesel Engines Oil Burner
- Diesel Pre-Engineering
- Aeronautical Pre-Engineering
- Aviation Mechanic Welding
- Auto Mechanic Talking Pictures
- Refrigeration Air Conditioning
- Television and Radio Mechanic
- Architectural-Mechanical Drafting
- Machinist Tool and Die Making
- Armature Winding Electrical

1117 Bedford Ave., Dept. P.M.
Brooklyn, New York City, N. Y.

Name.....
Address.....

IF MEN WORE PRICE TAGS



HOW WOULD YOU FEEL?

WHAT you make is an excellent barometer of your value! And a big factor in determining your value is — training!

For over 48 years the International Correspondence Schools have provided training for men who realized lack of it was a handicap. The courses through which this training is acquired cost over \$5,000,000 to prepare. Written by leading authorities, they are constantly revised as conditions change. Serious-minded men are invited to mail this coupon.

INTERNATIONAL CORRESPONDENCE SCHOOLS

BOX 5563-J, SCRANTON, PENNA.

Explain fully about your course marked X:

TECHNICAL AND INDUSTRIAL COURSES

- | | | |
|---|--|---|
| <input type="checkbox"/> Agriculture | <input type="checkbox"/> Air Brake | <input type="checkbox"/> Managing Men at Work |
| <input type="checkbox"/> Air Conditioning | <input type="checkbox"/> Manufacture of Pulp and Paper | <input type="checkbox"/> Marine Engines |
| <input type="checkbox"/> Architectural Drafting | <input type="checkbox"/> Mechanical Engineering | <input type="checkbox"/> Navigation |
| <input type="checkbox"/> Architecture | <input type="checkbox"/> Patternmaking | <input type="checkbox"/> Pharmacy |
| <input type="checkbox"/> Auto Engine Tune-up | <input type="checkbox"/> Plumbing | <input type="checkbox"/> Practical Telephony |
| <input type="checkbox"/> Auto Technician | <input type="checkbox"/> Poultry Farming | <input type="checkbox"/> Public Works Engineering |
| <input type="checkbox"/> Aviation | <input type="checkbox"/> Radio Operating | <input type="checkbox"/> Radio Servicing |
| <input type="checkbox"/> Boilermaking | <input type="checkbox"/> R. R. Section Foreman | <input type="checkbox"/> R. R. Signalmen |
| <input type="checkbox"/> Bridge Engineering | <input type="checkbox"/> Refrigeration | <input type="checkbox"/> Sheet Metal Work |
| <input type="checkbox"/> Building Estimating | <input type="checkbox"/> Steam Electric | <input type="checkbox"/> Steam Engines |
| <input type="checkbox"/> Chemistry | <input type="checkbox"/> Structural Drafting | <input type="checkbox"/> Structural Engineering |
| <input type="checkbox"/> Coal Mining | <input type="checkbox"/> Structural Engineering | <input type="checkbox"/> Surveying and Mapping |
| <input type="checkbox"/> Concrete Engineering | <input type="checkbox"/> Telegraph Engineering | <input type="checkbox"/> Textile Designing |
| <input type="checkbox"/> Contracting and Building | <input type="checkbox"/> Welding, Electric and Gas | |
| <input type="checkbox"/> Cotton Manufacturing | | |
| <input type="checkbox"/> Diesel Engines | | |
| <input type="checkbox"/> Electrical Engineering | | |
| <input type="checkbox"/> Electric Lighting | | |
| <input type="checkbox"/> Foundry Practice | | |
| <input type="checkbox"/> Fruit Growing | | |
| <input type="checkbox"/> Heating | | |
| <input type="checkbox"/> Heat Treatment of Metals | | |
| <input type="checkbox"/> Highway Engineering | | |
| <input type="checkbox"/> Locomotive Engineer | | |
| <input type="checkbox"/> Machinist | | |
| <input type="checkbox"/> Management of Inventions | | |

BUSINESS COURSES

- | | | |
|--|---|--|
| <input type="checkbox"/> Advertising | <input type="checkbox"/> Bookkeeping | <input type="checkbox"/> Grade School |
| <input type="checkbox"/> Business Correspondence | <input type="checkbox"/> Business Management | <input type="checkbox"/> High School |
| <input type="checkbox"/> Cartooning | <input type="checkbox"/> Civil Service | <input type="checkbox"/> Illustrating |
| <input type="checkbox"/> College | <input type="checkbox"/> Cost Accounting | <input type="checkbox"/> Lettering Show Cards |
| <input type="checkbox"/> College Preparatory | <input type="checkbox"/> Commercial | <input type="checkbox"/> Railway Postal Clerk |
| <input type="checkbox"/> Foremanship | <input type="checkbox"/> C. P. Accounting | <input type="checkbox"/> Secretarial |
| <input type="checkbox"/> French | <input type="checkbox"/> Domestic Science Courses | <input type="checkbox"/> Service Station Salemen's |
| <input type="checkbox"/> Professional Dressmaking | <input type="checkbox"/> Foods and Cookery | <input type="checkbox"/> Sign Lettering |
| <input type="checkbox"/> and Designing | <input type="checkbox"/> Home Dressmaking | <input type="checkbox"/> Spanish |
| <input type="checkbox"/> Tea Room and Cafeteria Management, Catering | | |

Name..... Age.....
Address.....
City..... State.....

Present Position.....

Canadian residents send coupon to the International Correspondence Schools Canadian, Limited, Montreal, Canada. British residents send coupon to I. C. S., 71 Kingsway, London, W. C. 2, England

When writing please mention Popular Mechanics

NEW YORK ELECTRICAL SCHOOL

Opportunities for Men of All Ages!

Every phase of all branches of Practical Electricity taught by Actual Practice in America's Foremost Institution of Trade Training.

Day and Evening Sessions Open All Year.

Write for FREE Booklets.

Visitors Welcome.

New York Electrical School
44 WEST 17th STREET
New York City

LEARN PHOTOGRAPHY

Our staff of noted experts will teach you Commercial, News, Portrait, Advertising, Natural Color or Motion Picture photography. For pleasure or career. Wonderful opportunities. Personal Attendance and Home Study courses. Free booklet.

from Experts

NEW YORK INSTITUTE OF PHOTOGRAPHY
10 West 33 Street (Dept. 49) New York City

STUDY ENGINEERING AT HOME

Earn a Degree at Home

From A Chartered Institution Of Higher Learning
Employers Demand Degree Men For Key Positions

88 Degree Courses in Electrical, Mechanical, Civil, Structural, Diesel, Architectural, Drafting, Automotive, Aeronautical, Radio, Refrigeration, Air Conditioning, Highway, Mining, Geology, Petroleum, Marine, Industrial, Chemical Engineering, Arts, Sciences, Philosophy, Psychology, Chemistry, Education, Business Training, Law, etc.
McKinley-Roosevelt Graduate College, 4750-G Sheridan Road, Chicago

SURE ROUTE TO HAPPY-LAND MAIL TODAY SURE

**J. C. DEAGAN, Inc., Dept. 4451
1770 Berteau, Chicago**

Without cost or obligation, tell me about the easy-to-play DEAGAN MARIMBA... its sensational rise in the music world... the fun it provides at parties... the opportunities for radio, stage and dance-band fame.

EASY TO PLAY

Name—Please PRINT _____
Address _____

PARKS AIR COLLEGE
PARKS AIRPORT EAST ST. LOUIS, ILL.

Offers YOU COLLEGE and PROFESSIONAL TRAINING
Majoring in AVIATION

Accredited by the Illinois Superintendent of Public Instruction, U.S. approved as a Commercial Ground and Flying School and Mechanics' School. Accredited by and cooperating with the United States Army Air Corps in giving flight and mechanical training. Open to high school graduates.
FOUR courses lead to B.S. degrees in Professional Piloting, Aviation Operations, Maintenance Engineering, Aeronautical Engineering.
SEVENTEEN TRAINING PLANES are used in professional flight training which prepares graduates for airline flight operations. 74% of graduates enter air transportation in North and South America. 76,000 hours flight training given, 1800 hours being flown monthly.
FACULTY of 48 specialists in various fields of aviation.
1569 graduates. Enrollment limited to a total of 300 commercial aviation students. Total enrollment 415.
100-acre airport, 18 buildings devoted to school purposes exclusively. Dormitories and dining hall at the College.
Spring Term April 1. Send postcard for new 64-page catalog.

13th YEAR Registrar, Dept. PM-1
PARKS AIR COLLEGE, East St. Louis, Ill.

ENGINEERING DEGREE IN TWO YEARS

B. S. Degree courses in engineering: Electrical, Civil, Chem., Mechanical, Radio or Aeronautical. 1 yr. Mech. Drafting. Approved by Civil Aeronautics Authority, participation in Pilot Training Program. Large industrial center. Prep courses without extra charge. Earn board if desired. Low tuition. Enter March, June, September, December. Write for Catalog.
510 E. Washington Blvd., Fort Wayne, Ind.

INDIANA TECHNICAL COLLEGE

DO YOU LIKE TO DRAW?

It's easy to learn when shown in the right way.

E. C. SEGAR creator of "POPEYE," CHESTER GOULD who draws "DICK TRACY," "LANE," "LEONARD," "RICK," "FINN" and many other famous cartoonists and comic strip artists learned how to draw during their spare time by following CARTOONIST EVANS' SIMPLE, EASY, INEXPENSIVE COURSE. Send 6c in stamps for full details.
THE W. L. EVANS SCHOOL OF CARTOONING
521 Premier Bldg. Cincinnati, Ohio



Learn to Write

Begin Today. Write for our Free Book, "How to Become a Good Penman." It contains specimens and tells how others learned to write in spare time. Your name elegantly written on a card if you enclose stamp for postage. Write today. The Tamblin School of Penmanship, Dept. 12, Ridge Bldg., Kansas City, Mo.

FAILURE?

Are you discouraged, bewildered, seeing others forge ahead to success, wealth, power while you remain in the ranks? Do you ever ask what it is that makes them successful where you fail, when they have no more intelligence than you? Don't give up... I can help you! Send your name and address to H. C. McCulloch, Desk 61, Pershing Square Bldg., New Rochelle, N. Y.

DRAFTING PAYS BIG

Drafting Jobs Often Pay \$175.00-\$500.00 month. Trained draftsmen always in demand. Learn easily at home in spare time. Experience unnecessary. Common education enough. Employment service FREE. Write today for complete information. No obligation.
MONROE INSTITUTE, Dept. A-101, Alton, Illinois

FORGE AHEAD

with the Thinking Alphabet. New "exactly how" method for Effective Thinking—Mind Training—Self-Advancement. IMPROVES Intelligence—Personality—Originality. CURES—Mind wandering—Self-Consciousness—Inferiority Complex. Free Booklet.
THINKING ALPHABET INSTITUTE 99J Fern St. Philadelphia

BIG BUSINESS AT HOME With New Greaseless DOUGHNUT

Go into sensational new kind of food business! Start in your kitchen. Even without previous experience big daily profits possible even in small towns. Make and sell amazing GREASELESS DOUGHNUTS. We supply equipment and plans. Stores sell for you. Send postcard NOW for special quick-starting offer. Send no money.
BROWN BOBBY CO., 620 No. Michigan Av., Dept. E-181, Chicago, Ill.

WANT A GOOD PAY JOB?

Learn Tool and Die Making, Machinist Trade, Screw Machine work. Earn as much as \$50-\$60 per week. Learn by actual work in one of America's best equipped shops. Training supervised by experts. State certified. Day-Evening classes. Enter any time. Low tuition fee, employment help. Write FREE NOW for booklet "Practical Machine Shop Training."

ALLIED SCREW MACHINE CO., Inc.
School Division
Dept. PM-1 803-9 W. Lake Street, Chicago, Ill.

FOR MEN WHO WANT TO LEARN A PROFITABLE TRADE

Complete

DIESEL TRAINING

NO MATTER WHERE YOU ARE OR WHAT YOU DO —we have a training plan for YOU!

IF you are sincerely ambitious and interested in making good in the Diesel field, be sure to immediately investigate our flexible training plan that will fit your circumstances. A Plan for every Man. A Plan for those seeking immediate shop training as well as for those who cannot give up their present employment and income. For 34 years National Schools, a recognized leader in the field of trade education, has helped wide-awake men to success. This million-dollar trade school will supply you with a sincere, honest statement of facts of what you should do to quickly get into the profitable Diesel Industry. No exaggerations—no misstatements; and a definite plan to fit you.

Write Today for Full Details

WE ARE DEFINITELY INTERESTED IN HELPING MEN OF LIMITED INCOME AND "BLIND ALLEY" JOB HOLDERS.

Mail the coupon below. Find out how you can get the finest in Diesel training without delay. See how this great trade school operates and makes its facilities available to every ambitious man. Actual work in modern training shops, a part of every man's instruction. Shop methods time-tested for 34 years. Fascinating, efficient preparation. Get the facts.

NATIONAL SCHOOLS

LOS ANGELES, CALIF.
Complete Training in Diesels and Gas Engines.
Oldest Trade School in West
MAIL COUPON FOR FREE LITERATURE

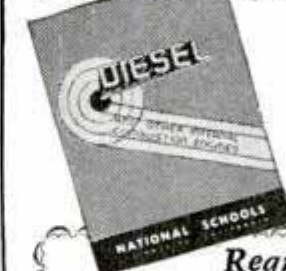

Request for Free Literature

NATIONAL SCHOOLS (established 1905) Dept. PMA-1
4000 South Figueroa Street, Los Angeles
Please send me, without obligation, your FREE Literature and information.

NAME _____ AGE _____
ADDRESS _____ CITY _____ STATE _____

When writing please mention Popular Mechanics



There's MONEY IN ARC WELDING!

U. S. Manufacturers

desire men to learn Electric Arc Welding and get practical experience under actual production conditions in the laboratories of the School of Engineering. Moderate training fee. Accepted applicants will be fully trained until ready to pass rigid test and assisted in securing employment.

AIRCRAFT WELDING

"We want more planes!" That's the demand on every side. No wonder there is a shortage of aircraft welders. Other industries need welders, too. There's almost no limit to what Milwaukee School of Engineering trained welders can do. They get good pay because they know the "how and why" of Welding, Metallurgy, Drawing, Blueprint Reading, Set-up Work and Fabrication—and they enable manufacturers to cut production costs. Remember—industries need practical trained Aircraft Welders, Arc Welding Operators, Technicians and Welding Engineers, and Air Conditioning and Refrigeration Technicians. Don't be satisfied to struggle along on ordinary, hit-or-miss jobs with poor pay—when in a short time you can become a trained specialist. Send coupon today—classes begin within a month.

MILWAUKEE SCHOOL of ENGINEERING
Institute of Electrotechnics

P.M. 140 North Broadway and E. State, Milwaukee, Wis.

Without obligation send Free Booklet "The Dawn of a Gigantic Industry and its Outstanding Opportunity." Also tell me How to Become an Arc Welding Operator (3 mo.), Air Conditioning & Refrig. Tech. (4 mo.), Air Craft Welder (6 wks.), Radio Serviceman (6 mo.), Welding Technician (5 mo.), Commercial Electrical Engineer (1 yr.), Welding Engineer (1 yr.), Commercial Radio Engineer (1 yr.), Electrical Engineer, Student Loan Plan, B. S. Degree (4 yrs.), Earn Part Expense Plan.

Name.....Age.....
City.....State.....P.M. 140



DRAFTING

BOOKS SENT FREE!

ON APPROVAL
5 VOLUMES BRAND NEW EDITION
Only 15 minutes a day with these WONDER BOOKS can prepare you for a good drafting job in less than a year. Mechanical and architectural drafting from simple straight lines to important complex plans. A step at a time! Built especially for beginners, for men with only grammar schooling. Drafting room practice, PLUS ENGINEERING, made easy and clear. Includes complete information on blue print reading for building and machine trades.

Big Field Big Demand Big Pay
Competent draftsmen are urgently needed right now in all building and manufacturing lines at \$30.00 to \$75.00 a week. That's just the beginning—FOR DRAFTSMEN HAVE THE BEST CHANCES FOR ADVANCEMENT. Pleasant, fascinating work, easy to learn and do. Learn quickly with these books—send coupon for a set and see for yourself.

A year's consulting membership in the American Technical Society now given to all readers of this famous encyclopedia of drafting. Many say that it is worth more than the cost of the books.
Complete set of drawing instruments if you send for these drafting books NOW. These instruments are made of the finest of German silver, are absolutely accurate and are packed in velvet lined leatherette pocket case. Real \$10 value, but included with these books.

AMERICAN TECHNICAL SOCIETY
Dept. D119, Drexel at 58th St., Chicago, Ill.

For Beginners or Experts

Written, so you can understand every word, by 22 well known engineers and architects. Deluxe flexible binding, nearly 2,000 pages, 1546 blueprints, charts and diagrams; prepares you for a good drafting job in mechanical or architectural lines. Sent for 10 days' free use if you mail coupon immediately.

These Instruments Included



American Technical Society, Dept. D119, Drexel at 58th St., Chicago, Ill.
Send for 10 days' trial. New 5 volume set of drafting. I will pay the few cents delivery charges. If I wish, I may return books in 10 days and owe you nothing but if I decide to keep them, I will send \$2.00 after 10 days, then only \$3.00 a month until \$24.80, the advertising price, is paid. Send latest edition and include drawing instruments and Membership Certificate.

Name.....
Address.....
Attach letter stating age, occupation, employer's name and address and that of at least one business man as a reference.

POPULAR INVENTIONS

21045 (Continued from page 22A)

MEANS of increasing the fighting power of a plane are contained in a new patent covering turret construction. The patent calls for a plane with two turrets, one extending above the fuselage and the

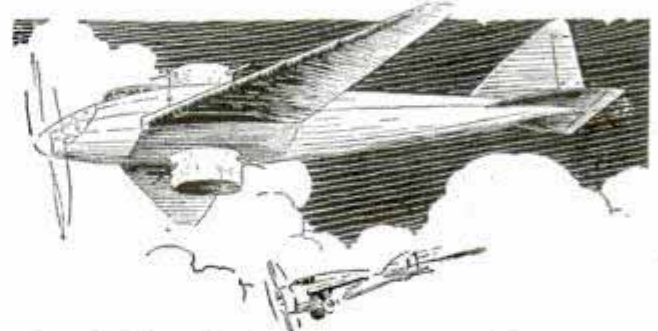

other below. These turrets may be moved into and out of the fuselage, in an up and down simultaneous movement, at the will of the plane's crew, to combat an enemy aircraft attacking from virtually any angle.

ADAPTABLE to many uses, a knapsack spray device has been patented. It is designed to be carried on the back, in knapsack fashion and consists of a tank, a nozzle, a flexible tube connecting tank and nozzle and a holder for the nozzle. The



sprayer might be employed in orchards for combating insects and molds, or in forests for extinguishing small fires.

ELIMINATION of the chain as a means of propelling the bicycle is the purpose

of a recent invention calling for use of pedal levers. Each lever is pivotally connected at the rear to one of the cranks employed to turn the rear wheel. A

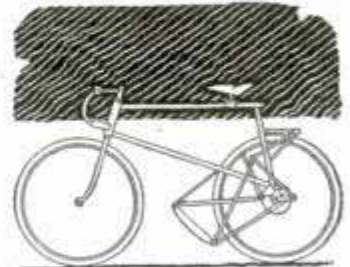

pedal is mounted at the front end of each lever. Means for guiding a point on each pedal lever in an approximately vertical path above the level of the crank circle are provided to assure smooth operation.

(Continued to page 32A)

EASIER *than* EVER



To Master, this New 1940 P-A

● Just touch a key and blow normally; you can't miss. So easy, and such beautiful tone. Nothing to compare with these new P-A Saxes, Clarinets, Trumpets, and other P-A instruments. Fully guaranteed; your success assured. See your music dealer or write direct for beautiful free book. No obligation. Easy terms. Greatest fun, easiest with P-A. Write today sure. 1375
PAN-AMERICAN
 103 P-A Bldg. Elkhart, Indiana

Big Profits!

IN NEW PROFESSION

Start Earning At Home

No soliciting! No canvassing! We show you how to make big money decorating fast-selling Giftwares. We start you with a big \$10 Artist's Outfit. We supply you with \$150 worth of Giftwares free of extra charge and show you how to dispose of them without leaving your home. We give you 29 Tested Plans for making money. One Fireside Member says, "I made \$100 on furniture in one week." Another writes, "My sales were \$500 for 5 weeks. This is my first year." R. M. P., of Ill., says, "I did \$3,500 worth of business last year and over \$12,000 this year." D. W., New Mexico, reports, "I would not take \$1000 for my Course."

No Experience Needed

You too may have a splendid income opportunity with Fireside. No tiresome study. You learn by doing. No artistic ability necessary. Our easy 3-Step Method makes the work easy to learn and easy to do and fits you to make good money practically from the start.

Quick Sales in Your Home

No need to leave the house to dispose of everything you make. Our new automatic salesman does all the selling for you. Designed to quickly find cash buyers for your Giftwares.

No Cost Plan

Mail coupon for Free Plan showing how to earn your course and Big Profits besides.

Fireside Industries
 Dept. 66-A, Adrian, Mich.

Send me FREE Book on Home Decorating for a big steady income. Also details of plan that will pay for my Course and give me big profits besides.



FREE!
 Book on decorating at home for big money. Tells how to get big assortment beautiful Giftwares free of extra charge.

NAME
 ADDRESS
 CITY STATE

When writing please mention Popular Mechanics

AN AVIATION CAREER



OFFERS YOU GREAT FUTURE!

Demand for trained aircraftsmen is increasing and already exceeds supply. Curtiss-Wright Tech, Aviation's foremost school, is located on Grand Central Air Terminal in heart of the aircraft industry and specializes in training MASTER MECHANICS and AERONAUTICAL ENGINEERS. (No flying involved.) Graduates are obtaining immediate employment. Write for details NOW. Dept. PM-1.

CURTISS - WRIGHT TECHNICAL INSTITUTE
 Glendale (Los Angeles) California

DIESEL

Maximum training minimum time; practical and theoretical. Modern equipment, experienced teachers. Personal instruction. course in three months.

40th year. Catalog free. Residence
FINLAY ENGINEERING COLLEGE, 10th & Indiana, Kansas City, Mo.

don't WORRY

Why put up with years of needless discomfort and worry? Try a Brooks Automatic Air Cushion. This marvelous appliance permits the opening to close, yet holds reducible rupture securely, comfortably—day and night. Thousands report amazing results. Light, neat-fitting. No hard pads or stiff springs to chafe or gouge. Made for men, women and children. Durable, cheap, **Sent on trial** to prove it. Never sold in stores. Beware of imitations. Write for Free Book on Rupture, no-risk trial order plan, and proof of results. All correspondence confidential.
BROOKS COMPANY, 457-C State St., Marshall, Mich.



TRAVEL - for 'UNCLE SAM'

RAILWAY POSTAL CLERKS

Men 18 to 35

\$1900 First year regular

MANY OTHER GOVERNMENT JOBS

Mail Carriers—File Clerks—Stenographers—Typists, etc.

Grade School Education Usually Sufficient

\$1260 to \$2100 First Year

MEN—WOMEN

Mail Coupon immediately—today sure.



GET A U. S. GOVERNMENT JOB

COUPON

FRANKLIN INST., Dept. T-173, Rochester, N. Y.

Gentlemen: Rush to me, without charge, 32 page book with list of U. S. Government big paid positions. Advise me also regarding salaries, hours, work, vacation, etc. Tell me how to qualify for a position.

Name.....

Address.....



High School Course at Home

Many Finish in 2 Years

You can complete this simplified High School Course as rapidly as your time and abilities permit. Equivalent to resident school work—prepares you for entrance to college. Standard H. S. texts supplied—Diploma. Credit for H. S. subjects already completed. Single subjects if desired. High School education is very important for advancement in business and industry and socially.

College Entrance

During the past 14 years, our High School graduates have been admitted to 531 different Universities, Colleges, Junior Colleges and Normal Schools—80% of them without entrance examination. Course also prepares for teachers' certificate and pre-professional examinations.

Business—Industry

To get and hold a good position in Business today you must be able to write clear, accurate letters and reports—do figuring involving Algebra and Geometry—talk intelligently on matters requiring a knowledge of Geography, History, and Economics.

In Industry—Mechanical and Engineering lines—you must have at least an elementary knowledge of Physics and Chemistry—be able to figure quickly and accurately—know something of Mechanical Drawing and blueprints—and be able to talk and write accurately and clearly on both your work and ordinary topics of conversation.

Our High School course meets the preparatory educational requirements for Business and Industry.

An Educational Institution

The American School was chartered in 1897 as an educational institution, not for profit—and is exempt from paying Federal income tax, like the best resident colleges and universities.

Don't Be Handicapped—Complete Your Training Now

Be a High School Graduate! Prepare yourself for promotion in Business and Industry—for the Professions, College Entrance and social success. No matter what line you may select, High School training will prove invaluable to you! Our moderate fees cover all instruction, standard textbooks and Diploma. Easy monthly terms. Get ahead in life. Start your training NOW!

20 Other Courses

Over 150 noted Educators, Engineers, and Business Men helped prepare our special instruction material, which is used by many resident schools and colleges, U. S. Navy, and Province of Manitoba, Canada. We offer you quality training at home for the best-paying lines of Industry and Business, as listed in the coupon.

Mail coupon for information about line that interests you
American School, Drexel at 58th, Chicago

American School, Dept. H-145, Drexel at 58th, Chicago

Tell me how to train for success in line checked. No obligation.

- | | |
|--|--|
| <input type="checkbox"/> Accounting & Auditing | <input type="checkbox"/> Diesel Engineering |
| <input type="checkbox"/> Architecture & B'lding | <input type="checkbox"/> Drafting & Design |
| <input type="checkbox"/> Automotive Engin'ring | <input type="checkbox"/> Liberal Arts |
| <input type="checkbox"/> Business Management | <input type="checkbox"/> Private Secretary |
| <input type="checkbox"/> Com'ercial Aeronautics | <input type="checkbox"/> Hi'er Ac't'g (C.P.A.) |
| <input type="checkbox"/> Electrical Engineering | <input type="checkbox"/> Highway Engin'ring |
| <input type="checkbox"/> Electrical Refrigerat'n | <input type="checkbox"/> Mechanical Eng'ring |
| <input type="checkbox"/> Air Conditioning | <input type="checkbox"/> Radio & Television |
| <input type="checkbox"/> Civil Engineering | <input type="checkbox"/> Salesmanship |
| <input type="checkbox"/> Complete Law | <input type="checkbox"/> Steam Engineering |

Name

Address

Always write your name and full address clearly when answering advertisements.

I'LL TRAIN YOU AT HOME IN SPARE TIME to MAKE GOOD MONEY in RADIO and TELEVISION



Easy to Start . . . Earn While You Learn

Wake up! Get ahead! You fellows with ambition can make a wonderful success in Radio and Television through my new, practical, home training. I teach you in your spare time through interesting experiments with real equipment. Every essential phase of Radio, Television, Electronics, Facsimile, Radio Set Repair and Installation is covered. You get Personalized help. No previous experience needed. So practical—so understandable—so simplified is this training that any man with average education can grasp the money-making knowledge quickly and easily. You will be ready for a business of your own . . . or to hold down a good-paying job. My **BUSINESS BUILDERS** show you how to make profits while learning!

BIG FREE BOOK! Get complete details in new catalog "HOW TO MAKE MONEY IN RADIO". Write Strawberry Academy of Radio, 310-A, University Place, N. W., Washington, D. C.

YOU GET

146 RADIO PARTS

RADIO TOOLS

ALL WAVE ALL PURPOSE ANALYZER

LEARN AVIATION IN LOS ANGELES - Nation's Aviation Capital



Huge increase in Los Angeles aviation activity has assured splendid positions for graduates. Career training offered for airline piloting, engineering, mechanics, drafting, production mechanics and instruments. Train at one of America's most modernly equipped and strategically located schools; fully approved by the government as a ground, flight and mechanics school. Write for free new 64 page catalog.

CALIFORNIA FLYERS SCHOOL OF AERONAUTICS - Dept. PM-1
 LOS ANGELES MUNICIPAL AIRPORT, INGLEWOOD, CALIF.

TOOL & DIE MAKING DESIGNING

Machinists Trade, Not a correspondence course. Practical shop training in the world's industrial center. Write today for full information.

Dept. 13 NATIONAL SCHOOL OF MECHANICAL TRADES
 628 W. Lake St. Chicago, Ill.

Learn to play . . .

Easy lessons at home. Inexpensive. 132-page Music Dictionary FREE when you enroll. Stop lessons when you like. Money back guarantee. Write for free details. Hamann Institute, 3016 N. 24th Place, Dept. H-13, Milwaukee, Wis.

Hawaiian Steel Guitar
 Spanish Guitar
 Piano

MECHANICS

KNOW YOUR CAR

You Need this Book

JUST OUT!

Ask to See it!

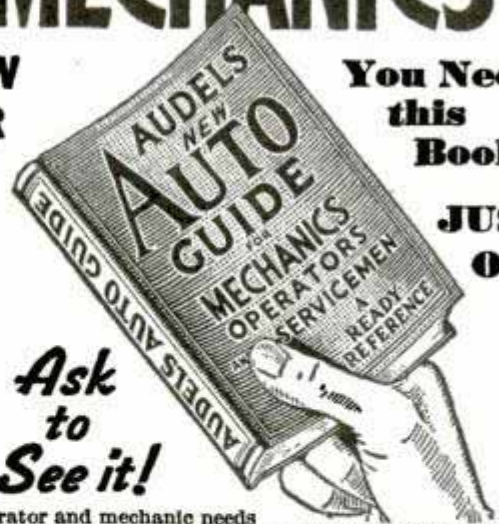

Every operator and mechanic needs AUDELS NEW AUTO GUIDE. This book saves time, money and worry. Highly endorsed. It presents the whole subject of auto mechanics; 1—Basic principles, 2—Construction, 3—Operation, 4—Service, 5—Repair. Easily understood. Over 1500 pages—1540 illustrations showing inside views of modern cars, trucks and buses with instructions for all service jobs. Diesel Engines fully treated, \$4 fully illustrated. To Get This Assistance for Yourself Simply **4 COMPLETE • PAY ONLY \$1. A MONTH**

THEO. AUDEL & CO., 49 WEST 23rd STREET, NEW YORK
 Please send me postpaid AUDELS NEW AUTOMOBILE GUIDE (\$4) for free examination. If I decide to keep it, I will send you \$1 within 7 days; then remit \$1 monthly until purchase price of \$4 is paid. Otherwise, I will return it to you promptly.

Name

Address

Occupation

Reference

PM

Inventors! FIND OUT WHEN AND HOW YOU CAN PATENT *and* SELL *your* INVENTION!

It's just possible that you, who are reading this right now, have an invention that can pay all your bills, buy a home, a car . . . and make you financially secure the rest of your life! Many "simple little gadgets" have done just that for other inventors! They had the bright idea . . . and DID SOMETHING ABOUT IT!

Find out how to go about it! Learn the easy, first steps to take in securing Government protection . . . but do it right now! Rush the coupon TODAY for these fact-packed books—written especially for your guidance at this time! **THEY ARE YOURS FOR THE ASKING!**

HOW WE CAN HELP YOU

For more than two generations, Victor J. Evans & Company has been the confidant of inventors. We have helped thousands of people, just like you. You may write to us in **STRICTEST CONFIDENCE**. We will not disclose any information relating to your business without your specific authority **IN WRITING!**

YOU MUST HAVE GOVERNMENT PROTECTION

Both the U. S. Supreme Court and the Patent Office have made it plain that you need the assistance of a competent patent attorney to help you get **ALL THE PROTECTION** the U. S. Government can give you! Without this protection, your chances for commercialization of your idea may be very small. With it, you may go about selling your invention with complete confidence!

Start NOW!

You may "put off" availing yourself of our assistance only a few short days, only to find someone else has just been granted a patent for an invention so similar to yours that your rights to protection may be doubtful.

First of all, send for these 68 pages of patent knowledge . . . learn what to do and how to do it!



WE SERVE YOU IN WASHINGTON

Our offices are a few short blocks from the U. S. Government Patent Office. We're on the spot . . . to serve you quickly.

FACTS FURNISHED
FREE!



PROMPT ACTION
may be vital
to your
success

FREE!

68 pages of answers to the questions you want to know! Both books sent **FREE**. Also, we send you a **FREE Evidence of Invention Form** which may establish your priority . . . your right to **SUCCESS!**

MAIL COUPON NOW

VICTOR J. EVANS & Co.

REGISTERED PATENT & TRADEMARK ATTORNEYS

Main Office: 560-A VICTOR BUILDING
Washington, D. C.

Pittsburgh Office: 514-N Empire Building

Rush by return mail **FREE** copies of your books, "Patent Protection" and "When and How to Sell an Invention" also important **EVIDENCE OF INVENTION FORM**. I want to know if I can quickly and safely commercialize my invention.

Name.....

Address.....

City or Town.....

PATENTS

Booklet Free Highest References
 Promptness Assured Best Results

Send drawing or model.

ALL BUSINESS GIVEN PROMPT AND PROPER ATTENTION

Listed Patent Lawyer in the latest editions of the Rand-McNally Directory of Bankers and Bank-Recommended Attorneys, published by Rand-McNally & Co., Chicago, Ill.; The Baggott & Ryall Directory of Guaranteed Attorneys, published by Legal Directory Corporation, Boston, Mass.; American Lawyers Annual, Cleveland, Ohio; Bankers Service Legal Directory, published by Bankers Service Co., Boston, Mass.; Eyre's Law List, 9 Park Place, New York City; Snow-Church Directory Co. Lawyers List, published in New York City, and the Central Guarantee Co., Bankers and Lawyers Directories, 630 Fifth Avenue, New York City.

WATSON E. COLEMAN, Victor Building, 724 Ninth Street, N. W.
REGISTERED PATENT LAWYER, WASHINGTON, D. C.

INVENTORS PATENT YOUR IDEAS SEND FOR FREE BOOK



HOW TO OBTAIN A PATENT

Written by a Former Member of the Examining Corps (1922-24) of the U. S. Patent Office. If you want to profit by your idea, you should take steps to apply for a U. S. Patent at once. Your first step is to get this Free Book. This interesting illustrated book contains valuable information you should have. It tells you fully how to obtain a patent on your idea in the quickest way. With this Free Book you will also receive a "Record of Invention" form on which you can easily record your idea. Personal and Confidential Service: Your case will be personally handled only by a Registered Patent Attorney who is also a Former Member of the Examining Corps of the U. S. Patent Office. All communications confidential.

MAIL COUPON TODAY for FREE PATENT BOOK and RECORD OF INVENTION Form.

CARL MILLER

REGISTERED PATENT ATTORNEY
 FORMER MEMBER EXAMINING CORPS U. S. PATENT OFFICE

Woolworth Bldg., 35th Floor, Dept. 10-A, New York City
 MILLER BUILDING, Dept 10-A, WASHINGTON, D. C.

Please send me your Free Book, "How to Obtain a Patent," and your "Record of Invention" form.

NAME.....

ADDRESS.....

NEW BENJAMIN AIR PISTOLS
 WITH MULTIPLE LEVER
 HAND PUMP FOR TARGET-
 SMALL GAME-CAMPING-ETC.



Guaranteed-Accurate-Practical-Economical-Safe-Clean-Quiet-Adjustable Force-Amazing Maximum Velocity. No smoke or fumes. Bolt Action-Hammer Fire-Hair Trigger-Safety Lock-Hand Pump. Single Shot BB \$8.50; Single Shot cal. 177 or 22 with rifled barrel \$8.50; BB 8-Shot \$10.00; Hoister \$2.00. Also a complete line of Benjamin Genuine Compressed Air Rifles for BB and cal. 177 or 22. No license required from dealer or factory. Ask for complete specifications and Free Targets. BENJAMIN AIR RIFLE CO., 850 Marion St., St. Louis, Mo., U.S.A.

WRITE TODAY



G E A R S

In Stock — Immediate Delivery

Gears, speed reducers, sprockets, thrust bearings, flexible couplings, pulleys, etc. A complete line is carried in our Chicago stock. Can also quote on special gears of any kind. Send us your blueprints and inquiries.

Send 10c for Complete Catalog No. 10
CHICAGO GEAR WORKS
 440-48 N. Oakley Blvd. CHICAGO, ILL.

New Ideas now Salable Before Patenting

Practical, useful inventions may now be safely marketed without patenting expense. Write for proof that we successfully sell both patented and unpatented inventions.

Chartered Institute of American Inventors
 Dept. 4, Barrister Building, Washington, D. C.

PATENTS—TRADE MARKS

All cases submitted given personal attention
 Form "Evidence of Conception" with instructions for use and "Schedule of Government and Attorneys' Fees"—FREE!

LANCASTER, ALLWINE & ROMMEL
 Patent Law Offices

412 Bowen Bldg. Washington, D. C.

INVENTORS

who derive largest profits know and heed certain simple but vital facts before applying for patents. Our book, Patent-Sense, gives those facts; sent free. Trade Marks—Copyrights.

LACEY & LACEY, Est. 1869, 635 F St., N. W., Dept. 5, WASHINGTON, D. C.

DIETERICH & RUTLEY

REGISTERED PATENT LAWYERS
 512 B Colorado Bldg. WASHINGTON, D. C.
 Booklet on Patents sent free

RUPTURED?

Get Relief This Proven Way

Why try to worry along with trusses that gouge your flesh—press heavily on hips and spine—enlarge opening—fail to hold rupture? You need the Cluthe. No leg-straps or cutting belts. Automatic adjustable pad holds at real opening—follows every body movement with instant increased support in case of strain. Cannot slip whether at work or play. Light. Water-proof. Can be worn in bath. Send for amazing FREE book, "Advice To Ruptured" and details of liberal truthful 60-day trial offer. Also endorsements from grateful users in your neighborhood. Write:

CLUTHE SONS, Dept. 31, Bloomfield, New Jersey

In answering advertisements always write name and full address clearly.

To PROTECT YOUR INVENTION—Use this coupon, NOW

Delays are dangerous and may be very costly. My personal service assures prompt action, strict confidence, and a minimum of expense. I suggest that you send me a model or drawing, or sketch and description of your invention, and \$5.00. I will make a search and report

promptly as to its patentability and send you a copy of my 72-page booklet. Or, if you prefer to read my booklet first, mail the attached coupon at once. I will also send my "Record of Invention" form. (Over 38 years experience as a Registered Patent Attorney.)

L. F. Randolph, 302-D Victor Bldg., Washington, D.C.

Please send me at once, free of charge, your 72 page booklet and "Record of Invention" form.

Name.....

Address.....

A PERSONAL CONFIDENTIAL PATENT SERVICE

ARTISTS HAVE FUN!

How would you like to be paid for the thing you like to do. You can get an inspiration out of the Croydon Institute system of instruction in design, illustration, cartooning and all subjects in which artists are interested. Learn the Croydon way, a simple home study method with lessons supervised by such famous artists as William G. Connelly, Helen Chamberlin, Harley Liechtenberger, Ernst Faust, Fred Eisensohn, Kathaleen Johnson, Paul Colmorgan, C. E. Waltman and Don Nelson. Course covers fashion illustration, color, merchandise illustration, booklet construction, head and figure drawing, perspective, photo retouching, in fact, our training should fit you for any branch of art. Anyone from high school age up should benefit quickly through our training. Write for 6 x 9 copy of this illustration and details. There is no obligation.



CROYDON INSTITUTE
620 N. Michigan, Dept. 112, Chicago, Illinois

Wind Electric Plant

Build Your Own—We Show You How. Easily made from old auto generator. Dime brings complete plans and Big NEW catalog of 500 electrical items, 100 other generator changes to 6, 12, 32, 110 volt Plants, Motors, Welders, Electrical Fencer. Write today.
LEJAY MFG., 1447 LeJay Bldg., Minneapolis, Minn.

AGENTS 300% Profit SIGN LETTERS

For Store Fronts and Office Windows. Anyone can put them on. Free Samples. Liberal Offer to general agents.
METALLIC LETTER CO., 438 N. Clark St., Chicago

FREE TRAILER PARTS CATALOG

We'll save you money on—axles, springs, wheels, couplers, windows, sinks, water pumps, brakes, refrigerators, beds, lamps, inside and out, 6V lamps, furniture, jacks—everything. Special discount to mfrs. **NATIONAL TRAILER EQUIPMENT CO. Successors to Kar-A-Van Industries, Inc. Dept. P. 714 W. Wisconsin Ave., Milwaukee, Wis.**

LEARN MONEY-MAKING CARTOONING

by America's most famous method. Hundreds of successes! Start today—soon draw for pay. Rush 10c for details and big Picture Chart to test your ability (state age).
THE LANDON SCHOOL, 1039 National Bldg., Cleveland, Ohio



INVENTORS

these Free Books tell

How To Protect And To Profit From Your Ideas • How You Can Save Time and Money

Right now is the time for you to take the first steps to protect your ideas—and this costs you nothing! C. A. Snow & Co. can save you time and expense by giving you advice based on 63 years' experience. If you want competent, professional advice and service, mail the coupon now for our free books on patent facts and special "Certification of Invention" form.



MAIL NOW FOR FREE BOOKS

C.A. SNOW & CO.

Registered Patent Attorneys Since 1875

Dept. 101 SNOW BUILDING, WASHINGTON, D. C.

Gentlemen: Please send me absolutely free and without obligation on my part, your original document "Certification of Invention" together with your two guides for Inventors, "How We Protect You" and "Suggestions On How to Commercialize Your Invention."

Name.....
Street and No.....
City or Town..... State.....

LACO Oil Heater



Still MORE HEAT at Still Lower Cost!

Know what is INSIDE the oil heater you buy—that's the part that really counts! Inside the New LACO are TWO unusual units—(1) LACO's wonder "2-stage" heater, that produces a surprising volume of heat from little low-priced oil, and (2) LACO's newly improved INNER HEATING UNIT, which has made a record for low cost heat! This unit is built with large-surfaced walls of heavy steel—these walls become intensely hot! Air moves up through and around the hot unit . . . delivers an extra volume of slow-moving, moist, heated air into the room. The outer cabinet is of heavy auto-body steel, electrically welded into a solid unit. Fully guaranteed!

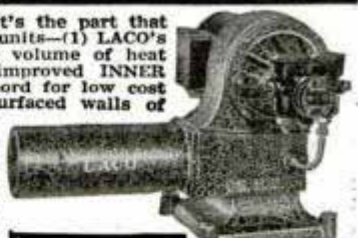

WRITE! See your LACO dealer or send for free folder, prices.
DEALERS Money-making opportunity. Low prices, big discount.

LACO OIL BURNER CO., 110 Union Ave., Griswold, Iowa

LACO's 1940 "Gun-Type" for furnaces has new refinements that make it the greatest buy in LACO history, at the Very Low Price! Send name today for new folder, and the money-saving price.

U. S. GOVERNMENT JOBS

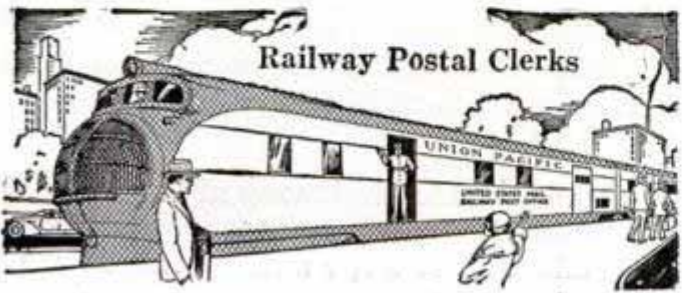

Common education sufficient
Mail coupon at once

FRANKLIN INSTITUTE, Dept. T-182, Rochester, N. Y.

Sirs: Rush to me without charge—copy of 32-page book, "How to Get U. S. Government Jobs," with list of dependable positions for men-women and full particulars telling how to qualify for them.

Name.....
Address.....

City and Rural Mail—City Post Office Clerks, Clerks at Washington, Stenographers-Typists, File Clerks, Accountants. Many other government jobs.

WANTED MORE TRAINED PILOTS and MECHANICS for BIG PAY JOBS IN AVIATION

This Lincoln Government Approved School of Aviation wants to immediately get in touch with men interested in preparing now for positions as Pilots, Mechanics, Sheet Metalsmiths or Aeronautical Engineers. 120 Lincoln Graduates recently placed in good-pay positions. Aviation calling on us for more trained men. **BE A TRANSPORT PILOT.** Large fleet of modern Training Planes. Start with elementary flight maneuvers; advance to night, blind, cross-country flying. Training prepares for any Pilot Rating up to and including Commercial, (Transport). **BE AN AVIATION MECHANIC or AERONAUTICAL ENGINEER.** Learn to overhaul, repair and rebuild Airplanes and Engines. Learn Airplane Design and Construction. Or be an Aircraft Sheet-Metalsmith or Welder. We teach you. **START TRAINING NOW AT LINCOLN.** Be ready soon for a good-pay position with Airline, Airport or Airplane Manufacturer. School in 19th year. Our Student Placement Department assists Graduates in locating positions. Part-time employment for board and room while in training. **MAIL COUPON TODAY for complete information.**



LINCOLN AIRPLANE & FLYING SCHOOL
 571 Aircraft Bldg., Lincoln, Nebraska
 I'd like to prepare myself for a position in Aviation. Please RUSH complete information about Lincoln Training.

NAME AGE.....
 ADDRESS.....
 CITY..... STATE.....



AUTO BOOKS SENT FREE

on approval. Just mail the coupon and we'll send you a set of these remarkable auto books, just off the press. Whether you are a mechanic or helper, expert or apprentice, auto owner or driver, if you're interested in knowing all about automobile mechanics, take advantage of this FREE OFFER.



CAN YOU FIX IT?
 These wonder books tell step by step HOW to take out "play" in differential - to kill the shimmy in steering - to set TIMING - how to put your finger instantly on engine trouble and then the quick expert way to FIX it. Newest improvements - fully covered. Equal to a complete trade course at less than a fourth the cost.
6 BIG VOLUMES
 Brand New Edition
 2500 pages, 2000 illustrations, wiring diagrams, etc. including Marine Engines, Aviation Motors, Diesel engines, etc. De Luxe edition, gold-stamped flexible binding.

GET A BETTER JOB

A better job—in the gigantic auto industry. **BIGGER PAY**—a chance to go into business for yourself and get a share of the huge profits, are waiting for any man who even half tries to improve himself. Learn auto engineering with these wonder books a new way—without studying or memorizing. Simply use the **JIFFY INDEX** to look up the answer to any auto problem. Built by eleven of America's greatest automobile engineers, and written in simple language so you can understand it. Very newest cars, all covered.

FREE Privilege of consulting Automobile Engineers of American Technical Society for one year without cost if you mail coupon immediately

Send promptly and we will include a Brand New **EXTRA** volume with over 300 pages including ALL latest cars with wiring diagrams and data sheets on each.

AMERICAN TECHNICAL SOCIETY
 Drexel Ave. & 58th St., Dept. A119, Chicago, Ill.
 I would like to see the new 6-volume edition of your **AUTO BOOKS**. I will pay the few cents delivery charges only, but if I choose to, I may return them express collect. If after 10 days use I prefer to keep them, I will send you \$2 and pay the balance at the rate of only \$3 a month, until \$24.80 is paid. Please include free membership and extra Volume No. 7, as per your offer above.

Name.....
 Address.....
 City..... State.....
 Attach letter stating age, occupation and name and address of employer and that of at least one business man as reference.

21045
POPULAR INVENTIONS

(Continued from page 26A)

GREATER safety for the professional window cleaner, or the housewife who does the work herself, is the objective of a guard patented recently. It comprises a pair of bars adjustably connected together, to which side bars are hinged, and means for connecting the free ends of the side bars on opposite sides of a window opening. The window cleaner works within the protective area formed by the bars. When not in use, the guard folds for carrying or storage.



PPOINTING the way to stronger construction of the automobile is a combined body and chassis patented recently. Body side panels extend continuously from the front-wheel suspension to the rear wheels. Together with inner angular cross-section side sills, the panels form with the body side panels a closed box section with combined body and chassis sill structures adapted to carry the motor, flooring and seats. Faster construction and assembly would be two advantages of the new method.

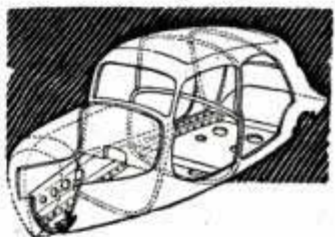

WHEN air pressure drops in the automobile tire, a newly patented gauge on the instrument panel would warn the driver. One part is so mounted in relation to the axle as to be responsive to the tilting of the axle caused by the unbalanced condition of opposite tires. As soon as this unbalanced condition is detected, an impulse is sent to an indicator on the dash.

Due to the fact that many of the devices described in this department are still in the patent office stage and are not on the market, Popular Mechanics Magazine cannot undertake to supply further information regarding them.



EASY to play

With an easy playing Conn band instrument, you can be ready for band or orchestra in 4 to 6 weeks. A sure road to popularity if you start on a Conn. Choice of the world's greatest artists. Magnificent tone. Many exclusive features—yet they cost no more.

Ask to see the marvelous new models now being displayed by Conn dealers.

WRITE FOR THIS NEW FREE BOOK

Home trial. Easy payments. Write us for free book on whichever instrument interests you most. Mention instrument.

C. G. CONN, LTD., 131 CONN BLDG. ELKHART, IND.



CONN

BAND INSTRUMENTS



AIR CONDITIONING is Booming!

U. S. Industries demand young men with combined technical, commercial and real practical training.

CHOOSE YOUR OWN PLACE IN

Air Conditioning for Homes, or Commercial Installation and Service, Ventilating, Dairy Refrigeration, Transport Refrigeration, Sales, Research, or Executive Position.

36 YEAR OLD ORGANIZATION Now receiving applications of men to prepare for good paying positions. No experience needed. We train you under actual working conditions. Every student given individual instruction in immense laboratories on 20th Century Air Conditioned Test Home. Co-operative part-time work Plan. Earnest men of high character assisted to earn part expenses. Student Loans. Moderate training fee. Few Industrial Scholarships awarded to men of outstanding merit. Don't be content with ordinary work and low pay when in a short time you can become a thoroughly trained Specialist in Air Conditioning.

MILWAUKEE SCHOOL of ENGINEERING

Institute of Electrotechnics

GET YOUR FREE COPY OF NEW BOOK

Without obligation send free booklet "Step Up to Success." Also tell me how I can become an Air Conditioning and Refrigeration Specialist in 4 mos. Air Conditioning Engineer (1 yr.) Send details of Student Loan Industrial Scholarship Earn Part Expense

"Step Up to Success" write to

Name Age
City State
If interested in other courses, check here:
Aircraft Welding (6 wks.)
Arc Welding Operator (3 mos.)
Welding Technician (5 mos.)
Welding Engineer (1 yr.)
Radio and Television Service (6 mos.)
Commercial Radio Engineer (1 yr.)
Electrical Engineer B. S. Degree (4 yrs.)

O. Werwath, President
MILWAUKEE SCHOOL OF ENGINEERING
Dept. PM-140A
Broadway and East State
Milwaukee, Wis.

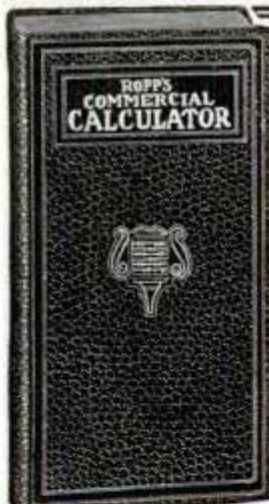

Mathematics Made Easy by ROPP'S CALCULATOR AND SHORT-CUT ARITHMETIC

Shows the Answer as Quickly as a Watch shows the Time to all Problems likely to occur in the Office, Store, Shop, Bank, Farm, or Factory.

Over 2,000,000 Sold
Explains and simplifies every principle in Arithmetic, Mechanics, and Mensuration.

PRICES POSTPAID

Desk Size, Flexible Keratol Binding \$2.00
Pocket Size, Art Leather Binding \$1.00
Pocket Size, Cloth Binding, \$0.50

POPULAR MECHANICS PRESS
Dept. 140 200 E. Ontario St. CHICAGO

This MACHINISTS' Home-Study Course helps men get ahead



Newly assembled—specially priced—these five recent books give you the practical facts on modern machines, up-to-date methods, you need to advance in machine shop work. Take advantage of the other man's experience as found in books, to solve your problems, increase your efficiency, with

The NEW AMERICAN MACHINISTS' LIBRARY

5 volumes—2014 pages—1853 illustrations
(A combined home-study course and reference library)

This library of machine shop practice was written for practical men. It gives you the best methods for every kind of machine shop work. It fully explains lathes, drills, and other machine tools and their operation, automatic screw machines, speeds and feeds, gear design and production, punch and die work, metal surfacing, etc., etc. Plainly written—completely illustrated—the best kind of help to the machine shop man who wants to advance himself.

No money down—special price—easy payments.

EXAMINATION COUPON

McGRAW-HILL BOOK CO., 330 W. 42nd St., New York

Send me for ten days' examination the new American Machinists' Library. If satisfactory I will send you \$1.50 in 10 days and \$3.00 monthly until the price of \$16.50 is paid. If not wanted, I will return the books postpaid. (To insure prompt shipment write plainly and fill in all lines.)

Name
Home Address
City and State
Position
Name of Company PM-140

384 BETTER JOB-BIGGER PAY IDEAS FOR ONLY 50 CENTS

SHOP NOTES

Helps You Earn More Saves Time and Money

Get the new 1940 edition of the famous Shop Notes with 214 pages—384 helpful articles—762 pictures. Including—Auto Kinks—Carpentry Helps—Metal Working—Glass—Celluloid—Electricity—Weaving—Photography, etc. It will make money for you—save you time and money. Specially prepared for mechanics, handymen, home workshop fans, farmers—for everyone who uses tools to make things and do things. Sent postpaid for 50 cents.

SPECIAL LIMITED BARGAIN OFFER

Send \$2.98 and get 7 Shop Notes—all different—postpaid. Volumes for \$2.98. Money back if not satisfied.

POPULAR MECHANICS PRESS
Dept. 140, 200 E. Ontario St., Chicago

When writing please mention Popular Mechanics



HOW TO RAISE POULTRY FOR PROFIT

MAKE MONEY ON SIDE—SPARE TIME—OR BUILD A BUSINESS OF YOUR OWN



Poultry raising pays good profits and I can show you how to get them—with Eggs—Poultry Meat—Broilers—Roasters—Capons—Baby Chicks. My Home Study Training System, successful for twenty years, includes latest scientific methods used by world's leading poultrymen. Shows how to make Poultry Business pay—avoid losses, prepares you for a good paying job in large poultry plant or for a business of your own.

CASH IN Spare Time or Full Time

No matter where you live or what you do now, my proved course will show you what to do with poultry from the start. If you choose to start a business of your own, I'll show you how to make a small investment grow, show you how to expand. Send for the FACTS today.

FREE BOOK TELLS HOW

Mail coupon below TODAY for new big 1940 edition of my FREE BOOK "How To Raise Poultry for Profit". Whether you keep chickens now or are merely thinking about it, this book is an eye opener to the real success that may be yours.



Mail NOW for FREE Book

Harry M. Lamon, President
NATIONAL POULTRY INSTITUTE
Dept. 50-E, Adams Center, N. Y.

Dear Mr. Lamon: Send me your FREE book, "HOW TO RAISE POULTRY FOR PROFIT". I want to know more about my opportunity in this business to make money spare or full time.

Name.....
Address.....

Learn this Profitable Profession



in 90 Days at Home

Hundreds of men and women of all ages 18-50 make \$10.00 to \$20.00 in a single day giving scientific Swedish Massage and Hydro-Therapy treatments. There is a big demand from Hospitals, Sanitariums, Clubs, Doctors and private patients as well as opportunities for establishing your own office.

Learn this interesting money-making profession in your own home by mail, through our home study course. Same instructors as in our NATIONALLY KNOWN resident school. A diploma is awarded upon completion of the course. Course can be completed in 3 to 4 months. High School training is not necessary. Many earn big money while learning.



Anatomy Charts & Booklet FREE

Enroll now and we will include uniform coat, medical dictionary, patented reducing roller and Hydro-Therapy supplies without extra cost. The reducing course alone may be worth many times the modest tuition fee.

Send coupon now for Anatomy Charts and booklet containing photographs and letters from successful graduates. These will all be sent postpaid—FREE.

THE College of Swedish Massage (Successor to National College of Massage)
Dept. 164—30 E. Adams St., Chicago.

You may send me FREE and postpaid, Anatomy Charts, booklet containing photographs and letters from graduates, and complete details of your offer.

Name.....
Address.....
City..... State.....

LET ME PROVE I CAN MAKE YOU A NEW MAN



I changed myself from a 97-lb. weakling to winner of title, "World's Most Perfectly Developed Man." Let me prove that my secret of Dynamic Tension can give you powerful muscles, smashing strength, a handsome build. All I ask is a 7 DAY TRIAL. Write for my 48-page FREE BOOK.

CHARLES ATLAS,
Dept. 81, 115 East
23rd St., N. Y. City

SEND FOR MY FREE BOOK

Correspondence Courses In RADIO and ELECTRICAL ENGINEERING

LOW AS \$25



ELECTRICAL ENGINEERING. Get good grasp of wide electrical field. Modern. Very understandable. Theory made easy. RADIO ENGINEERING. Extra fine course in radio, public address, photo-electric work. Trains you to be super-service man, read vacuum tube technician. Tuition ONLY \$25, either course. Deferred payment plan. Experiment kits furnished. Write for free copies of school catalog, student magazines, etc.

FREE LINCOLN ENGINEERING SCHOOL, Box 331-F1, Lincoln, Nebr.



CASH PAID Why not get ready now to spend spring, summer, fall, outdoors gathering insects—butterflies, moths. I buy hundreds of kinds for collections. Good cash prices paid. Some \$1 to \$7 each. Easy. Simple. Send 10c (not stamps) for Illustrated Prospectus before sending any insects. Write today. Hurry!

MR. SINCLAIR, DEALER IN INSECTS,
Dept. 6, Box 1830 San Diego, Calif.



LOOK! Baby Chicks

THOUSANDS WEEKLY ALL YEAR. Finest quality & Layers in 40 breeds. Hybrid Baby Pullets and Cockerels, B. W. D. Tested. Ducklings, Goslings, Baby Turkeys, Guinea. In business 30 years. Catalog free. ORDER NOW. Make BIG money raising NABOB QUALITY CHICKS. NABOB HATCHERIES, BOX M, GAMBIER, OHIO

Learn by pre-tested Training

RADIO plus TELEVISION



A flexible Training Plan to fit your immediate needs

National Schools offer optional training planned to fit your present circumstances. You can master Radio, Television, Sound and allied trades by National's exclusive plan. Actual shop and studio training; also complete training if you cannot give up your present employment and income. A definite plan to fit your needs.

FREE LITERATURE

Explains National's pre-tested plan; how you can master Radio, all branches, Sound-Recording, Public Address & Communication Systems, Broadcasting, Television. This interesting literature sent post-paid, without obligation to you.

NATIONAL SCHOOLS
Los Angeles (EST. 1905)

Request for FULL DETAILS

NATIONAL SCHOOLS, Dept. PMR-1
4000 S. Figueroa St., Los Angeles, Calif.

NAME..... Age.....
ADDRESS.....
CITY..... STATE.....

Oh Boy! I JUST GOT A GRETSCH DRUM!



And am I happy! No more worrying over what to do after school... no more dull moments. I've got a hobby now that leads to a real career... big drummers make big money... and I can learn to be one... without difficult lessons... and have plenty of fun learning! Wait till I get the gang together and show 'em what it means to have the best drum money can buy.

EASY TO PLAY
★
EASY TO PAY

Send penny postcard for FREE DRUM catalogue and full information about EASY-PAYMENT plan and FREE TRIAL through your GRETSCH dealer. Address Dept. PM 11

The FRED. GRETSCH MFG. CO.
Musical Instrument Makers Since 1883
60 BROADWAY, BROOKLYN, N. Y.

GRETSCH also offers SUPER VALUES in Guitars, Saxophones, Trumpets, Trombones, Accordions. Send for FREE catalogue. Mention instrument.

I WANT 500 MEN To earn real profits taking orders for Baby Chicks this winter. Pleasant, profitable work. Liberal commissions. Exclusive territories. Golden Rule chicks nationally advertised, guaranteed, U. S. Approved. Complete Sales Plan Free.

LIBERAL COMMISSIONS
NO DELIVERIES
EXCLUSIVE TERRITORIES

Send Postcard Today For Full Details

GOLDEN RULE HATCHERY · BOX M BUCYRUS, OHIO



MONEY IN RABBITS—CAVIES

WE BUY and put you in touch with other markets. Catalog and copy of magazine 10c. Or send 25c for Book Catalog and Price List and Year's Subscription to the AMERICAN SMALL STOCK FARMER.

OUTDOOR ENTERPRISE CO., BOX 919, NEW CITY, N. Y.



Best Poultry Paper 6 BIG ISSUES 10¢

Helps increase Poultry Profits. Send coin or stamps, 50 cents for 3 years or 10 cents for 6 months trial. Agents wanted. American Poultry Journal 532 So. Clark Street Chicago, Illinois



BUCHSTEIN'S FIBRE LIMB

Soothing to stump, cool, light, strong. Correct fit. Braces for all deformities. Fair terms.

D. BUCHSTEIN CO.
610 3rd Ave. South, Minneapolis, Minn.

FOR COMFORT

How To Secure A Government Position

In the Classified Civil Service! Railway Postal Clerk, \$1900 a year regular. Postal Clerk, City Mail Carrier, \$1700 regular. Other attractive positions paying \$1260 to \$2100 a year. Our tested method helps you pass examinations. Men—Women, age 18-50, send for our FREE BOOK explaining requirements TODAY.



PATTERSON SCHOOL, 81 Mercantile Bldg., Rochester, N. Y. Send, without obligation, free book "How to Secure a Government Position."

Name..... Age.....
Address.....

Prepare at Home for JOBS in



With this expert drawing outfit—drafting table, drawing board, superior drawing instruments... all sent without additional cost, you are all set to learn DRAFTING AT HOME. FREE TRIAL LESSON shows how easy. Mail coupon.

YOUR DRAWING OUTFIT

DRAFTING

The draftsman's work comes first. When business improves... and it is improving... there is new construction work, new buildings, new machines, repairs and reconstruction work. All these must first be laid out on paper. So the FIRST man that must be hired is the DRAFTSMAN.

Drafting Is Well-Paid Work

Drafting is clean, interesting professional-type work. It pays well to start... offers real opportunities for promotion. You need no previous training or experience... no special talent—to learn Drafting. It is one of the steadiest employment fields. No machine ever did the Draftsman's work... and no machine can be invented to do it.

Learn AT HOME

in your spare time (or at the College in Chicago) by the fascinating, easy, step-by-step plan originated by this 36-year old school for Draftsmen.



free TRIAL LESSON

Sample this easy-lesson system of learning Drafting. Send postal card or this coupon. No charge now or later for this FREE LESSON. Prove to yourself how easy it is to learn Drafting by the C. T. C. method in your spare time right in your OWN HOME.

CHICAGO TECHNICAL COLLEGE

A-201 Tech Bldg., 118 E. 26th Street, Chicago, Illinois

Please send me FREE Trial Lesson in DRAFTING and show me how I can prepare for good positions in spare time AT HOME.

Name..... Age.....

Address.....

P. O..... State.....

How Big Is YOUR PAY-CHECK?

If you earn under \$3,000, Higher Accountancy may be the answer for you

"THE size of my pay-check? What business is it of yours?" Perhaps that's the first reply that comes to your mind.

But—stop a moment. It really *is* our business—to help men just like you. In fact, it's been our business here at LaSalle for 30 years.

If your pay-check isn't all that you'd like it to be, why not consider accountancy? Why not become a member of this well-paid and respected field? Why not, in short, prepare yourself to earn real money—insure a good home for your family—a new car—an education for the growing youngsters—a bank account for a rainy day . . . these and many more of the precious things in life?

Maybe you're one of those ever hoping for "breaks" that will give you a higher standard of living. Yet that's precisely what most of 30,000,000 other employees in this country are doing.

Not all of them, of course. Here and there you find ambitious men who aren't depending on luck to carry them ahead. They're following a tested path to increased earnings—leaving nothing to mere chance. They're *training* themselves for better jobs—every week spending a few hours in serious but interesting study at home.

Some day, as expert bookkeepers and later as accountants, these determined men will have standing and a considerably larger income—in a profession that pays and pays well.

Why don't *you* do as they are doing—take advantage of LaSalle training? Even though you do not know the fundamentals of bookkeeping now—you nevertheless may have an excellent opportunity to master accountancy. Many others have done it.

Perhaps you're asking yourself, "But don't these others possess natural ability that I lack? Don't I need a special talent for all this?"

Ask rather, "If I do my part, won't *I* get results, too?"

You will! For all it takes is intelligence, serious study and work—not genius. Under the LaSalle system you solve problems by simple steps . . . from day to day, as an expert accountant does. You use the same basic principles. And when these problems become difficult and puzzle you, you get counsel that could be matched only through personal coaching by a battery of experts in a big accounting house.

In a comparatively short time, you train yourself in Elements of Accounting, Principles of Account-



ing, Auditing, Cost Accounting, Business Law, Organization, Management and Finance. The training—complete and intensive all the way—takes you right into C.P.A. coaching if you desire.

Later, when you're an accountant, it may be possible to go into business for yourself as a public accountant and be independent. Or, if you choose to work for someone else as an executive accountant, it well may be for a salary several times that which you draw now.

Write for this FREE book

If you're tired of pinching pennies, investigate accountancy and LaSalle training. There isn't a faster, less expensive or more convenient method to master accountancy. Fill in the coupon and mail. We'll send you our 64-page book, "Accountancy, The Profession That Pays."

Then, when you read all the facts, you yourself will be able to judge best whether you have the will to study and apply your best efforts—toward a more secure future.

LaSalle Extension University

A Correspondence Institution

Dept. 164-HR

Chicago, Ill.

I want to earn a bigger salary—through accountancy training. Send me, without cost or obligation, your 64-page book, "Accountancy, The Profession That Pays."

Name

Present Position Age

Address City

**WORLD'S
BEST
WANT AD
MEDIUM**

CLASSIFIED Advertisements



Advertisements in this section, 35 cents per word, each insertion, minimum 10 words, payable in advance

To be inserted under proper classification in February issue, copy should be in our office December 8th

February issue on sale January 1st

Popular Mechanics Magazine, 200 East Ontario Street, Chicago, Illinois

YOU'LL PROFIT

By reading and answering the classified ads in this section. Hundreds of opportunities to make and save money.

Popular Mechanics Magazine, Chicago, Ill.

Dear Sirs: As you know, this agency specializes in "keyed" advertising—so that our advertisers may know how their ads are pulling in various publications. It has been our experience that the Popular Mechanics want ad section is about the most universally productive advertising medium for all kinds of propositions that we know of. Many times clients have expressed their amazement at the long pulling power of a little classified ad in Popular Mechanics. To us, it is, of course, no longer surprising. For, as your own records will show, in the over 30 years that we have been in business, we have been running our own ad in your classified section year after year—through good times and bad—without missing an issue.

Sincerely yours,

(Original letter on file in our office) Chicago Union Advertising Agency.

AUTOMOBILES—MIDGET CARS

INDIANAPOLIS Miller supercharger racer—ready to run—for 1940. Priced right. Trade. H. Kohlert, St. Charles, Illinois.

MIDGET Cars, parts, wheels, tires, engines. Plans 50c. Catalog 10c. Derby Midgets, Woodstock, Ill.

NEW Fifth edition Automobile Racing Book. Tells how to build dirt track bodies, frames, engines. Records, superchargers, rules, formula, plans, stock conversions, roadster racing, fast Fords. \$1.00 postpaid; \$1.15 C.O.D. Ray Kuns, Department 13, Madisonville, Cincinnati, Ohio.

CHANGE Ford motor into air compressor. Instructions \$1.00. Tuck Laboratories, 73 Shirley, Pontiac, Mich.

GASOLINE Saving device \$1.00. Ford V8's 1934-1940, Chevrolet 1935-40. Walert Co., 3429 N. 10th St., Milwaukee, Wis.

MIDGET Racers and accessories, two-passenger roadsters, midget motorcycles, motorscooters, bicycles. Complete line motors, wheels, parts, plans, construction kits. Handbook catalog, 90 illustrations, 20c. Midwest, Box 1959-P, Chicago.

GARAGE Owners and mechanics can now purchase direct at full factory discount Triple-X Alloy Steel Self-Locking Piston Rings. Nationally distributed. Guaranteed performance. Stop oil pumping. Re-boring unnecessary. Write for sample and details. Triple-X Co., 3801 South Racine, Dept. 101, Chicago.

PHOTOGRAPHS, World's finest automobiles. Handbook, 10c. Automobiles, Box 534, Saint Cloud, Minnesota.

10 MIDGET Racers, demonstrators, 1½ hp. motor, clutch, starter, lights, etc.—sacrifice at \$99.50 each. Real buy for sport or concession. Moto-Scoot Mfg. Co., 8440 South Chicago Ave., Chicago, U.S.A.

AUTOMOBILE Superchargers \$3. Guaranteed mileage increase 20%; power 10%. University of Detroit test. Any car; give make, year. Wrench installs 15 minutes. John Hanley, Manufacturer, 5719 Loraine, Detroit, Mich.

MIDGET Racecars, sportcars, motorscooters. New bargain lists—over 130 used motors, midgets, parts—20c. Catalog new kits, parts, plans, 10c. Circulars on request. Shipp's Midgets, Box 543-H, Zanesville, Ohio.

ALUMINUM Alloy pistons, automotive, aviation, diesel, industrial, marine, midget, model, motorcycle, outboard. Finished or semi. Judson Mfg. Co., Hedge and Giltingham, Philadelphia, Penna.

TECHNICAL Bulletins. Many subjects. List free. Popular Mechanics, 200 E. Ontario St., Chicago.

AUTO SUPPLIES AND EQUIPMENT

WHOLESALE Prices auto parts, accessories. 10c catalogue. United Industries, 321 Broadway, Denver.

BARGAINS—Compressors, welders, battery chargers, car washers, attractively priced. Terms, trial. Write for bargain list. Hobart Automotive Supply, Box M-1405, Troy, Ohio.

AUTOMOBILE Seat covers. Washable linen. All cars. Coupes \$1. Coaches, sedans \$1.98. Universal, 4106 West 22nd Place, Los Angeles, California.

RE-FINE Crankcase drainings, request information. Zeiball, Mount Holly, N. J.

CRANKCASE Oil refiner. Have free motor oil. Universal Rect-O-Fier costs nothing to construct or operate. Plans, specifications, \$1.00. Technical Laboratories, East Haven, Conn.

FREE Wholesale bargain catalogue, auto supplies, tires, tubes, equipment, tools. For dealers only. American, 1189 Bedford Ave., Brooklyn, N. Y.

1939 IGNITION Supercharger \$1.25. E. G. Sales & Mfg. Co., New York.

PLATING Outfits for auto parts. Connect to a battery. No tanks used. Free particulars and proofs. Gunmetal Co., Ave. J, Decatur, Ill.

SWAY-CHEK Now available for Fords, Mercurys, Lincoln-Zephyrs pays big profits to garage and repair men. Checks wind-wander, curve-sway and load-roll. Agents wanted everywhere. See ad on page 151A of this issue and write Belfex Corp., 2012 Sylvania Ave., Toledo, Ohio.

AUTO TRAILERS

BUILD The famous, low-cost Jim Dandy Cabin Trailer. Complete plans and instructions 50c. Plans to build the beautiful, streamlined Jim Dandy Cabin Cruiser, \$1.00. Trailer Builders Manual and catalog of trailer parts, supplies and equipment—over 100 interesting, illustrated pages, 25c. Order today. Satisfaction guaranteed. Trailer Supply Co., 411-A Jackson St., Wausau, Wisconsin.

MOTORCYCLES, BICYCLES, MOTOR SCOOTERS AND SUPPLIES

MOTORIZE Your bicycle with Midco 4-cycle air-cooled engines. Fit any standard bicycle. Write us. Midco Mfg. & Dist. Co., S. 13th and Kentucky Sts., Sheboygan, Wis.

SCOOTERS, 5 Different types. Plans 30c. Circular free. Kamm Products, 162 High, Oshkosh, Wis.

BUILD Power scooters, midget cars. We supply tires, wheels, motors. Lowest prices. Send 10c for plans, etc. Build-Your-Own Devices, Dept. 1-A, 536 North Parkside, Chicago.

BOYS And girls, bicycle and parts catalogue free. Coupon for identification plate with your name beautifully engraved in gold. Krause Supplies, St. Clair Shores, Michigan.

SAVE 60%. Assemble Comet's sensational new scooter yourself! It's easy! We supply parts, tires, wheels, motors. Goes 125 miles per gallon. Literature, drawing 10c. Hurry! Comet Cycle Company, Box 3032, Madison, Wisconsin.

NEW And used motorcycle for all makes. Elmer Nelson, LaMoille, Illinois.

MOTOR Scooters—less motors. Solo and delivery models including lights, tires, wheels, brakes, clutch and drive. Slightly used. Just install motor and ride. Originally sold \$111.50 to \$150—sacrificed at \$35 to \$40 while they last. Write for folder. James Liffshin, 7925 S. Essex, Chicago, Illinois.

MOTORCYCLISTS, Let's get acquainted. We can save you money on parts and accessories. List free. Triangle, 1111 Washington, Chicago.

"WHIZZER" Bicycle motor. Quiet, dependable, 4-cycle, 1½ h.p., motorcycle type crankcase. Bicycle structure not weakened. Center of gravity unchanged. Spring motor suspension eliminates vibration. Anyone can install thirty minutes. Further information write Breene-Taylor Engineering Corp., Los Angeles, Calif.

REBUILT Motorcycles. All makes genuine parts and service. Special generator and armature repairing. Send 15c for illustrated bulletin. Western-Harley Davidson Distributor, 914 East 15th, Kansas City, Mo.

ALLOY Pistons \$3.00—Harley, Indian, Henderson, Excelsior, Cleveland. Cylinder grinding, rings, bearings, gaskets, chains, sprockets, helmets, goggles, accessories, parts new and used for less. Catalogue and wings pin 10c. Ballak, 1115 Chestnut, St. Louis, Mo.

MOTORCYCLES, Reconditioned. New, used, parts and accessories. All makes. Large stock. Bargains. Illustrated catalogue, 15c. Indian Motorcycle Sales, Kansas City, Mo.

INSIDE Dealer prices. Overstocked, all models. Indians and Harleys. Rebuilt, guaranteed. Dime brings latest list. Crandall-Hicks, Boston, Mass.

MOTORCYCLE Bargains, lowest prices, bargain sheets for stamp. Motorcycle accessories. Rochester Harley Davidson Corp., 129 W. Main St., Rochester, N. Y.

RECONDITIONED Motorcycles. New—used parts for all makes. Authorized Harley-Davidson dealer. Whitman Motorcycle & Supply Co., 405-9 Southwest Blvd., Kansas City, Mo.

AVIATION

PROPELLERS—Genuine three bladed airpropellers including two blade \$3.98 up, for sleds, aeroplanes, dehydrators, generators, boats, defrosters. Special latest aircooled Ford motors with airliner propeller \$69.30. Standard, Ft. Worth, Texas.

AIRCRAFT Factories need trained men, get your training at the Swallow Airplane Company, Wichita, Kansas.

PROPELLERS For airplanes, ice sleds, snow sleds, boats, fans, frost-fighters, dehydrators, Hubs, countershafts, snow sled skis. Catalog 10c. Banks Propellers, Love Field, Dallas, Texas.

LEARN To fly and get a license for \$125.00. Lew Daitz, approved by C.A.A. Hangar 33, Roosevelt Field, L. I., N. Y. Garden City 4859.

USED Airplanes and equipment! All makes, models, prices. Listings twice monthly. Sample current list a dime. Box 94, Englewood, Colorado.

500 AVIATION Questions answered. Book \$1.00. Tuck, 73 Shirley, Pontiac, Mich.

JUST OUT—A practical course in flying, 29 chapters, only \$1.00 complete. Aircraft Directory, Athens, Ohio.

LEARN To fly free. Folder, dime. Ohmeyer, Box 391, Hempstead, N. Y.

AIRCOOLED Motors, 80 horsepower, \$75. Aero sled blueprints 25c. Allison Aircraft, Lawrence, Kansas.

PROPELLERS: Universally known. For airplanes, ice boats, etc. Correctly built and popularly priced. Universal Aircraft Company, Inc., Fort Worth, Tex., Box 648.

TEL. Aircraft tachometers. Pioneer altimeters. Cost over \$60.00, each \$6.50. Box 1457, Tampa, Fla.

SEND 25c for catalogue of 100 airplanes, \$50 up. Terms. Aircraft Directory, Athens, Ohio.

GET Into aviation! Wonderful opportunities open! Big money paid! Prepare at this Lincoln government approved school for position as pilot, mechanic or aeronautical engineer. We assist graduates in locating positions. Part-time employment for board and room while training. Write today for complete information. Lincoln Airplane & Flying School, 2006 Aircraft Bldg., Lincoln, Nebraska.

AVIATION Apprentices — Air-minded young men interested in training for entering aviation as apprentices see ad on page 23A.

PROPELLERS For airplanes, sleds. Iced blueprints, supplies. Catalog dime. Lorenzen Propellers, Niles, Michigan.

BATTERIES, GENERATORS, ETC.

SENSATIONAL Discovery recharges all dry batteries. Guaranteed charger \$1.00. R. Lueck, 701 Beach Ave., Winnipeg, Can.

12 VOLT Heavy duty generators \$8.50. Save money on new, used automotive electrical parts; free catalog. State Ignition, 52 Cullerton, Chicago.

BUILD A.C. voltage regulators for a.c. generators. Use auto and radio parts. Constant voltage at variable speeds. Prints and instructions, one dollar. Ceco, Box 397, Salina, Kansas.

EDISON Storage batteries for light-power systems. Non-acid. Odorless. Fifteen year life. Five year unconditional guarantee. Bargains in complete lighting systems. Low prices. Free illustrated literature. "See-Jay" Battery Co., 82 Sterling Ave., Yonkers, N. Y.

50-1/2 HORSE. Repulsion induction, 110-220 volt, heavy duty motors, 3400 speed, \$9.75. Also generator bargains. Electrical Surplus Company, 1885 Milwaukee, Chicago.

EDISON Lifetime storage batteries for light and power. Eliminates acid battery diseases. Long guarantee. All kinds rebuild generating plants, motors, and miscellaneous articles at bargain prices. Free interesting literature. T. Hawley Smith Co., Croton Falls, N. Y.

ELECTRICAL SUPPLIES—EQUIPMENT

ELECTRO-SCRIBE: Electric pencil. Writes-engraves all metals \$1.00. Health lamp; dual-ray ultra-violet infra red. Promotes sun-tan vitamin "D." Automatic-ac-dc current, \$3.90. Details. Bever Mfg. Co., 4515-H Cottage Grove, Chicago.

BARGAINS—Arc welders, also motor generator. Write for new bargain list telling needs. Hobart Bros., Box M-1407, Troy, Ohio.

DEALERS Sell electric motors, furnace fans, blowers, unit heaters, exhaust fans, parts wholesale catalog 10c. Cmco, 1111 Washington, Chicago.

MAGNET, Alnico, new wonder alloy lifts 50 times own weight. \$1.00. Mechanics, P.O. Box 861, Minneapolis, Minn.

AIR CONDITIONING

FURNACE Blowers \$22.50. 13" wheel. Also larger sizes for cooling, air conditioning. 2,500 CFM to 30,000 CFM. \$47.50 to \$265.00. Variable speed control, belts and pulleys included. Reynolds Mfg. Co., Grand Rapids, Mich.

ELECTRIC FENCING

BIG Money building-selling electric fencers. Tremendous demand. Lowest wholesale prices. Free information. Hughes, 3 Miami, Terracorp, Ohio.

MAKE Electric fence for automobile coil. Complete plans, no extras to buy. LeJay Manufacturing, 47 LeJay Building, Minneapolis, Minn.

WELDING—SOLDERING—PLATING

GUARANTEED Solder for aluminum, trial sample 25c coin, 1/4 lb. \$1 cash. Pierman, Box 101, Belmar, N. J.

ACETYLENE Welding outfits, \$34.95; electric welders, \$74.95. Agents wanted. Superior Oxy-Acetylene, Hamilton, Ohio.

WELDING Equipment, demonstrator bargains. Request list. Hobart Welders, Box M-1404, Troy, Ohio.

100 AMPERE Transformer ready for instant welding, five heats, operates 110 volts 60 cycles, asbestos insulated, scientifically air-cooled. A rugged unit for practical use, \$16.50, larger sizes available. Transformer Supply Co., Sherry Building, Long Island City, N. Y.

A.C. Arc welders cheap. Free literature. Holgeron's Service, Canton, Kansas.

D.C. Arc-welder plans \$1.00 each (three for \$2.00). Build it yourself without re-winding armature, 25-200 amperes from farm light plant generators. 25-200 amperes from Northeast, Dodge automobile generators. 25-600 amperes from d.c. vehicle motors originally storage battery driven. Welders Club, AB-3432 M-Mart, Chicago. For sale: D.C. vehicle motors, supplies, etc.

ELECTROPLATE Small parts. Low-priced outfit for laboratory or amateur. Choate Manufacturing Co., 3464-D Principio Ave., Cincinnati, Ohio.

REBUILT a.c. d.c. Arc welders, all sizes; engine governors, idlers. Terms. Low prices. Guaranteed. Service Co., 3732 Cedar Ave., Cleveland, Ohio.

WELDING Equipment, list dime. Adastik Bros., Grand Rapids, Mich.

ENGINES, MOTORS, DYNAMOS

ARMATURES Rewound for portable tools. Fast service, low prices, quality work. Send order with armature, give complete name plate data. Keck, P.O. Box 3568, Cleveland Heights, Ohio.

600 MOTOR Diagrams, tables and controller connections for practical electricians. Covers every angle of the electric motor field in simple, clear, language. Contents includes circuits for split phase, capacitor, repulsion induction, compensated, series, two and three phase. Data for rewinding and reconnecting all types. Over 100 valuable tables. Satisfaction guaranteed or remittance refunded. Introductory price \$2.00 prepaid. Educational Advancement Company, Lakewood, New York.

RELIABLE Motor winding books. Lessons, connecting diagrams, winding data. Introductory data selection, \$1.00. Motor Data Co., Box 7631, Kansas City, Missouri.

PRICELIST Free. Motors; grinders; drills; shavers; clocks; electrical appliances. Home workshop tools. Mallorder Electric, 721 South Dearborn, Chicago.

BARGAINS—Plating generators, motor generator sets, also arc welders. New low prices for large and small shops. Trial—easy terms if desired. Hobart Bros., Box M-1406, Troy, Ohio.

AIR Compressors 1 1/4 x 1 3/4, \$6.00; 2x2, \$7.00; 2 1/2 x 2, \$8.00. Free catalog. National, 1915 South State Street, Chicago, Ill.

ALTERNATING 1/2 Horse, 110 volt, induction motors. Rebuilt, guaranteed, \$7.25. Wilmut Auto Supply, 2247 St. Paul Ave., Chicago.

THREE To ten KVA alternating generators. Motors, converters. State your needs. Queen City Electric, 519 South California, Chicago.

REFINE Used oil without cost. Particulars. F. Gerwin, Fairview, Oklahoma.

BARGAIN—1/2 Hp. motors, 60 cycle, 1 phase, 110 volt, like new, guaranteed, \$7.40. Send check to Erie Electric Motor Co., 120 Church, Buffalo, N. Y.

MACHINERY, TOOLS AND SUPPLIES

POWER Drill press \$5.95, 6 inch bench saw \$9.95. Literature. Ebel-Binder, 1825 Queen City, Cincinnati.

CORDWOOD Saw-frames, ball bearing, something new. Write Richardson, Cawker City, Kans.

PAINT Spray equipment, pumps, grinders, drills, motors, work shop machinery, blowers, exhaust fans, belts, pulleys, etc. Free catalog. Sutton Electric Co., 767 Granby, Norfolk, Va.

FOR 9" South-Bend lathes. Milling attachments, universal movement \$9; threading dial indicators \$3; 6" four jaw chucks \$9.50. Unique Manufacturing Co., 4807 North 31 Ave., Omaha, Nebr.

PLASTICS, Brass, aluminum, Dowlmetal, monel, stainless steel, gears, etc. Catalog 10c. Hobby Supply House, Box 2014, Pittsburgh, Penna.

RALKSITE, New case hardening compound for all types iron and steel. Scientifically prepared. Produces clean hard surface of any depth or degree of hardness required. Ralksite process gives a better case, quicker. Positively eliminates usual after-hardening rust effect. Requires no special equipment, employs no unusual methods. Try this easy-to-use, amazingly efficient and economical case hardening compound on your next heat treatment job. Send \$1.00 today for full pound trial can with complete directions. Ralksite Company, 372 Classon Ave., Brooklyn, N. Y.

SURPLUS Stock and repossessed standard line power tools. Send for new price list. Bill Bailey, Box 326, Columbus, Ohio.

CONCRETE Building block machines and molds. Easy payments. Catalog free. Concrete Machine Co., 5129 South Compton Ave., St. Louis, Mo.

TREMENDOUS Surplus of factory tools selling out. Drills, taps, files, hacksaws, etc. Send for free lists, include six cents postage. Travers Tool Co., 264 Jackson Ave., Long Island City, N. Y.

DRILL Grinding attachment fits bench grinder, hand or power turned. Handles sizes 3/16 to 1 1/4". Price \$7.85. Descriptive literature on request. Tractor-Lite Co., Sidney, Iowa.

14" x 6" GREAVES Klusman cone head engine lathe, quick change. No. 0 Cincinnati miller, cheap. Write for particulars. Cincinnati Machinery & Supply Co., 221 E. Second St., Cincinnati, Ohio.

BOATS, OUTBOARD MOTORS, ETC.

BUILD Your own boat with Bay City Prefabricated frames and materials. Save up to 2/3s. Lumber, fittings, engines and equipment. Send requirements for quotation. Illustrated catalog 100 boats 9 to 75 feet 10c. Bay City Boats, Inc., 1552 Adams St., Bay City, Mich.

BOATS \$18.50 Up, with oars. Write P. E. Lescault, Vercheres, Canada.

BUILD Electric outboard from old automobile generator. Operates with car battery. Smooth—quiet. Plans 10c. LeJay Manufacturing, 547 LeJay Building, Minneapolis, Minn.

FORD—Mercury-Zephyr marine conversions. Catalog 10c. Lehman Engineering Company, Dept. D, Newark, N. J.

OUTBOARD Motors. all makes. Used motors and parts. Stamp brings motor list. Outboard Headquarters, 305 Atlantic Ave., Boston, Mass.

ESKIMO Boats. New. Different. Kits. Wonderful gift bargains. Marko Boats, Atlanta, N. Y.

OWN A fine boat at a great saving. Build a Welch boat. We supply all materials cut to shape for skiffs; rowboats; runabouts; and cruisers. Send 10c for a 32 page catalog showing boats, marine supplies, etc. Welch Boat Company, Station K-1, Milwaukee, Wisconsin.

HELPFUL Suggestions. building rowboats. 3000 words. 25c postpaid. Germain Boat Company, Saginaw, W. S. Michigan.

BUILDING Plans 15' keel knockabout—plywood. November Rudder 35c. Catalog boat plans free. Rudder, 15 Murray St., New York.

BARGAINS. Rebuilt motors, used parts, all makes. Send 3c stamp for list. Murray Boat Shop, Traverse City, Mich.

BOAT Plans. building instructions by famous architects. 300 designs, all types—outboard, inboard, sail—cruisers, runabouts, racers, utilities, etc. Compiled in book form containing up to 43 plans each at \$2.00 and \$3.00 per book. Free catalog. Motor Boating, 574 Madison Ave., New York.

MARINE Power—Easily convert any Ford motor (domestic and foreign) with Osco parts and kits. Complete catalogue 25c (coin). Osmitson, 3644 Lawrence St., Philadelphia, Penna.

ASSEMBLE Your own boat. Our finished knock-down frames and materials save you 2/3 builder's cost. All types and sizes. Send 25c for big catalog. Brooks Boat Co., Inc., D4, Saginaw, Mich.

OUTBOARDS — Save 1/2. Good used parts, all makes and models. Bargains rebuilt motors. Crandall Hicks Co., 959 Commonwealth, Boston, Mass.

BOAT Designers are highly paid professionals. Complete course by mail. Catalog. Westlawn, Montville, N. J.

SEE Our ad on page 132A. Cleveland Boat Blueprint Co.

SPORTING GOODS, GUNS, FISHING TACKLE, ARCHERY

SAVE 40% On sleeping bags. Duck down filled. Mothproofed. Regular \$37.50 value, by mail \$21.50. \$17.50 wool bags only \$10.95. Guaranteed. Write for circular. Alaska Sleeping Bag Co., 1414 S.W. Harrison St., Portland, Oregon.

SEND For free illustrated catalog of Lawrence leather belts, holsters, gun cases and other sporting equipment. George Lawrence Company, Portland, Oregon.

"TRAINING Bags" for punch and speed, at cost price. Circulars 10c. Andre's Gym, 3520 Mt. Elliott, Detroit, Mich.

ICE Skating easily learned. Self taught. Men, women, children. Age no bar. Free information. Skating Course, Box 5, Tacoma, Wash.

FREE Catalog—Sportsmen's all-steel cabinets for guns, shells, tackle, rods, clothing. Lowest factory prices. 10 days trial offer. Send no money. Write today. No obligation. Farrell Steel Cabinet Company, 2500-MP East 75th Street, Chicago.

COMPLETE Beginners outfit, 5 ft. bow, \$7.00. Childrens 3 1/2 ft. bow, one arrow, \$1.10. Birch arrows \$1.85 dozen. Pioneer Models, Whitehall, Mich.

BUCKS Bargains. 3 power vest pocket field glasses \$1.25. Stag hunting knife and sheath \$1.25. Taylor, Leedawl compass \$1.25. Special holiday bargain, all three \$2.89 postpaid. MoRo "Buck" Fuller, 307 1/2 Tuscola St., Saginaw, Mich.

ARCHERY Supplies, catalogue free. Instruction book 50c. Midwest Archery, 2209-A East 75th, Chicago.

BARGAIN Catalog, 10,000 new and used guns and other merchandise. Send stamp. Klein's, M-508 South Halsted, Chicago.

TRAP Fox or coyote: Bunch system gets the sly furbearers. Results or no pay. Q. Bunch, Welch, Minn., Box K.

BARGAINS! Gun catalog 5c, ski catalog 5c. J. Warshal Sons, First-Madison-PM, Seattle, Wash.

BOWS And arrows. Construction book 50c. Catalogue of materials free. Chester Brown, 617 South State, Chicago.

HUDSON Bay blankets, complete camping, hunting, outdoor equipment. Catalog. Howe Fur Company, Coopers Mills, Maine.

BOWS, Arrows, raw materials. Beautiful catalog (over 125 pictures) and "Essentials of Archery" a handbook on making bows and arrows 35c. Everyone intending to make their own should have this manual. Instruction folder and catalog 10c. L. E. Stemmler, Queens Village, N. Y.

FIELD GLASSES, TELESCOPES, MICROSCOPES

TELESCOPES, Microscopes, binoculars; 1940 bargain catalog free. Brownscope Co., 5 West 27th Street, New York.

ANTIQUES, RELICS, INDIAN GOODS, CURIOS

INDIAN Relics, large assortment, 90p lists 2c. Grutzmacher, Mukwonago, Wis.

INDIAN Relics for advanced collectors. Skulls \$4.95. Bernard, Box 192, Oakland, California.

SWORDS, Rapiers, pistols, daggers, armor list 10c. Robert Abels, 860A Lexington Ave., New York.

35 GENUINE Indian arrowheads, \$1.00. Catalog. George Holder, Glenwood, Ark.

CHINQUILLA'S Indian Craft Museum. Handiwork of all Indian tribes. Jamaica, N. Y.

ARROWHEADS! Glacial boulder beauties. Rare variations. Don McKillop, Regina, Sask.

INDIAN Relics, coins, bills, gems, crystals, curios, etc. Illustrated catalog 5c. 100 ancient arrowheads \$3.00. H. Daniel, Hot Springs, Ark.

INDIAN Relics, beadwork, coins, curios, minerals, old glass. Catalog 6c. Indian Museum, Northbranch, Kansas.

TAXIDERMY

LEARN By mail to mount birds and animals, tan skins, make leather. Old reliable school teaches, easily, quickly, at low cost. Over 250,000 students. Rush postal for free 48 page book. Northwestern School of Taxidermy, 3371 Elwood Bldg., Omaha, Nebr.

TAXIDERMIST, Deerheads, game, etc., mounted reasonably. G. Link, Phillips, Wis.

EVERYTHING For the taxidermist. New 40 page catalog free. Nowotny's Supply Co., 1331 Broadway, San Antonio, Texas.

GLASS Eyes, taxidermists', furrers supplies. Big catalog free. Elwood Company, 222 Smith Bldg., Omaha, Nebr.

TAXIDERMY Supplies—Quality artificial eyes, teeth, genuine Jonas head forms. Tools, materials, etc. Everything for the progressive taxidermist. Send 10c for big illustrated catalogue. Jonas Bros., 1049 Broadway, Denver, Colo.

DOGS, PETS, BIRDS

PEDIGREED Newfoundland puppies. Baby's protection and companion. Earl Thurston, Hartsville, Indiana.

CHAMELON, Treefrog, salamander, 25c each. Quivira Specialties Co., Winfield, Kansas.

SAINT Bernard puppies on approval—reasonable too! Photographic prospectus free. Royal Kennels, Chazy, New York.

JONES Dog hulls will stop running fits. Also worms your dog. Sold under money back guarantee. Dealers wanted. Sample \$1.00. Queen City Laboratories, 724 W. Trade St., Charlotte, N. C.

ST. BERNARDS—Manitou's famous puppies bring Xmas joy. Literature containing twelve colored pictures of our stock free. Manitou's St. Bernard Kennels, Watrous, Sask., Canada.

SPORTSMEN: 200 Pointers, setters, straight cooners, combination hunters, rabbit and fox hounds. Reasonable. List free. Ramsey Creek Kennels, Ramsey, Illinois.

GREAT Danes—Dependable guards, companions—Pups \$25.00. Pictures free. Kalmor Danery, Stone-Mountain, Georgia.

BEAUTIFUL Pure white police dogs. Ansonia Kennels, Mose, N. Dak.

POULTRY AND FARM SUPPLIES

WHITE Australorp headquarters—Importers world champion 353-361-364 egg black Australorp hens. Educational catalog shows customers profits. Osborne Farm, Box 70, Holland, Michigan.

LOW Factory prices on poultry equipment. Wire fabrics. Free 100-page catalog. Bussey Pen Products, 5151 West 65th Street, Chicago.

IF You want better chicks, write for free Hinkle Chick catalog. Our prices are low. For example, special broiler lots "all heavies" \$5.95-100; Leghorn pullets \$11.95. Many bargains in straight and sexed breeds. Greensburg Hatchery, Box 40, Greensburg, Indiana.

\$3.45-100 LEGHORN Cockerels. Top price Leghorn pullets \$11.45. Many other bargain prices in our 14 day guaranteed chicks. Write for free catalogue, early order discounts, complete prices. Dubois County Hatchery, Box 912, Huntingburg, Indiana.

DAVIS Chicks as low as \$4.45-100. 21 different varieties. Write for free 24-page catalog, prices, discounts. Davis Poultry Farm, Rt. 34, Ramsey, Indiana.

SALEM Champion chicks—We own 10 birds that were World's Poultry Congress winners, including Grand Champion White Rock. Heavy breeds for broilers as low as \$5.95 per 100. Free catalog. Salem Hatchery, Box 81, Salem, Indiana.

COCKEREL Chicks for broilers \$3.45-100. Write for special "hatchery to customer" prices. Make saving of from 1c to 3c per chick by ordering direct from me. Conrad's Jackson County Hatchery, Box 19, Seymour, Indiana.

MAKE Money with poultry. Read America's leading poultry magazine for latest information. Three years \$1.00; nine months 25c. Poultry Tribune, Dept. E-93, Mount Morris, Ill.

LEADING Turkey magazine, devoted exclusively to turkey raising. Explains newest methods. \$1.00 a year. Turkey World, Desk 59, Mount Morris, Illinois.

TREES, SHRUBS, ROOTS, HERBS

NEW Vegetable garden reference data charts. 47 varieties detailed. 50c postpaid. N. Ferguson, 12819 Phillips, Cleveland, O.

JUST Out! World's greatest "Herbalist Almanac." Beautifully illustrated in natural colors. Contains over 200 old-fashioned herb medicine recipes for home use. 10c postpaid. Worth dollars! Botanics, Box 1109, Evergreen Park, Illinois.

FARMS AND FARM LANDS

FREE Books on Minnesota, North Dakota, Montana, Idaho, Washington and Oregon. Low priced land. Write E. B. Duncan, Dept. 157, G. N. Ry., St. Paul, Minn.

CANADIAN Tax sale lands for a dollar an acre and up. Small monthly payments. Farms, timber, hunting and fishing camps, minerals. Limited number of properties. Write at once for free illustrated booklet. Tax Sale Service, Room 613, 72 Queen St. W., Toronto, Canada.

GOOD Farms available. Washington, Minnesota, Idaho, western Montana, Oregon. Dependable crops, favorable climate. Write for impartial advice, literature and list of typical bargains. Specify state. J. W. Haw, 119 Northern Pacific Ry., St. Paul, Minn.

FARM, Home with bath—\$1200, 87 acres only 12 miles to university city, 54 acres tillage, 15 cow pasture, fruit; 10 rooms, furnace and bath, 65 ft. cement-basement barn; value plus and only part down; page 6 supplement and big free catalog. Strout Realty, 255-P 4th Ave., New York City.

40 ACRES, Near White River, unimproved; poultry land, \$175, \$5 down, \$5 monthly. Free list and literature. Hubbard, 216 Grossman Bldg., Kansas City, Kans.

PROFITABLE OCCUPATIONS

ANNOUNCING New home study course in commercial baking. Good field for ambitious men. Nearly depression proof business. Common school education sufficient. Send for free booklet "Opportunities in the Baking Industry" and requirements. National Baking Institute, 3601 Michigan Avenue, Dept. 3431, Chicago.

BUSINESS Proposition resilvering mirrors, autosparts, reflectors, making chipped glass signs. Write Sprinkle, Plater, 288, Marion, Indiana.

EARN Cash at home! M. M. earned \$267.00, three weeks raising mushrooms in cellar! Exceptional, but your cellar, shed perhaps suitable. Materials furnished. Starting crop guaranteed. We buy all crops. Book free. United, 3848 Lincoln Ave., Dept. 67, Chicago.

READ Our war and oil ad under Business Opportunities, it's worth answering. Royal Keystone Enterprise, Berryville, Ark.

STANDARD Rabbit Journal, Milton, Penna., year 50c. Sample dime. Supplies.

SELL By mail. Make own wonder product. Write Springer, 8808 Normal, Chicago.

AFTERNOONS Free! DeHol reported \$2,000 month (exceptional, fulltime). Work home! Expect surprise! National-V, Bx1240, San Bernardino, California.

RAISE Mink. Dime for general information. Lommans Fur Farm, Spangler, Penna.

\$30 WEEKLY. Grow mushrooms. Cellar, shed. We buy 35c lb. Mr. B. made \$270 spare time. World's largest company of its kind. 40 page book free. Mushroom, Dept. 701, 2019 Second, Seattle, Wash.

MEN—Women, operate "Specialty Candy Factory" home, all or spare time. Steady income. (Our 31st year.) Hillyer Ragsdale, Inc., Drawer 62, East Orange, N. J.

MONEY In rabbits and cavies. We buy and put you in touch with other markets. Catalog and copy of magazine 10c. Or send 25c for book catalog and price list and year's subscription to the American Small Stock Farmer. Stahl, Box 1, Holmes Park, Mo.

BOOKS, PERIODICALS, PICTURES, POSTCARDS

HANDBOOKS. Boxing, wrestling, Jiu Jitsu, dancing, astrology, dreams, magic. 30c each. Universal, 371 1/2 Broad, Newark, N. J.

BOOK Bargains—Mechanical, technical, hobbyists, etc. Catalog free! Nu-Ideas, Carrollton, Illinois.

DIFFERENT! 8 Snappy cartoon postcards. 25c. Johnell, 9821 Dequindre, Detroit.

PHOTOGRAPHS By McGoldrick. Samples, listings, 35c. Albert McGoldrick, Mansfield, Mass.

"HOW To Win Contests and Make Money." New book. \$1.00. Contest Publishing Co., Box 894, Milwaukee, Wis.

EXCELLENT Sparetime profits! Taking subscriptions—2500 magazines. Pines, Dept. 111, 583 Monroe, Brooklyn, N. Y.

BOOK Bargains! Catalogues free. Write: Old Prof's Book Shop, B16 Arcadia Court, Pontiac, Mich.

NIAGARA Falls—wonder city of the world. Any one question about city or its inhabitants answered for 25c—Five questions \$1.00. Individual research. Confidential. No guesswork. Address Niagara Falls Service, P.O. Box 279, Niagara Falls, N. Y.

GAMES—ENTERTAINMENT

USED Pintables. Have fun in your basement. Send for list. \$5.00 up. Goodbody, 1824 East Main, Rochester, N. Y.

HOW To chalk talk—Complete instruction in this fascinating form of entertainment, by a famous professional. Shows how to draw trick pictures, arrange a program. 52 original illustrations showing how pictures are started and completed—all sure-fire hits. Includes humorous talk for delivery while drawing. Postpaid, \$1. T. S. Denison & Company, 203 N. Wabash, Dept. 66, Chicago, Illinois.

MAGIC TRICKS, PUZZLES, JOKER NOVELTIES

JOIN Magicians' Fraternity! Free tricks! Monthly magazine, sample 10c. International Magicians, Mt. Morris, Ill.

ELECTRIC Fun! 200 stunts, 110 volts, \$1. Kutting Sons, Campbell, California.

MYSTERIOUS. Amazing novelty with catalogue 10c. Walnut Specialty, Everett, Mass.

FREE Sample—newest craze. "Holly-wuzzle." Box 2150, Hollywood. (Stamp appreciated.)

MAGICIANS' Headquarters. Enormous stock, tricks, books, supplies. "Modern Magic" book and mammoth 220 page pictorial, professional catalogue. 25c. Kanter's, 1309 Walnut, Philadelphia.

ENTERTAIN Your friends. 30 minutes of magic for \$1.00. Includes equipment, secrets and appropriate talk plus 12 outstanding card tricks. Free, stage mystery as featured by that famous master magician, Mardoni. House of Magic, 6641 Pershing, St. Louis, Missouri.

AMAZE And mystify! Catalog 500 pocket-parlor tricks 10c. Professional catalog 10c. Lyle Douglas, Station A-5, Dallas, Texas.

ENTERTAIN With magic! Catalog 500 easily learned tricks 10c. Professional catalog 10c. Lyle Douglas, Station A-5, Dallas, Texas.

500 MAGIC Tricks in wonderfully illustrated catalog only 10c! Professional catalog 10c. Lyle Douglas, Station A-5, Dallas, Texas.

MAGIC. Mind reading, easily learned. Particulars free. Browne, Box 272, Duluth, Minn.

LEARN Ventriloquism, 3c stamp brings particulars. Smith, 801 Bigelow, Peoria, Illinois.

LARGE Magic catalog 25c. Hundreds of tricks. Chicago Magic Company, 2300 N. Mason Avenue, Chicago.

EARN Money in any crowd. All names of strangers, tell unspoken thoughts. Professional course mind reading, spirit writing, etc., \$1. Henderson, Box 341, San Bernardino, Calif.

WORLD'S Largest magic shop professional catalog, 25c. Holden, 220 W. 42nd St., New York.

STAMP COLLECTING

COUNTRY Complete! All stamps of White Russia positively complete only 3c to approval applicants. Cactus Approvals, Box 1870-B, Tucson, Arizona.

ATTRACTIVE Stamp album providing spaces for 2320 stamps with 700 illustrations, packet 300 different stamps, 500 hinges, tweezers, duplicate book, pamphlet which tells "How to Make a Stamp Collection Properly." bargain list of sets and packets, all for only 50 cents. Queen City Stamp Co., Room 36, 604 Race St., Cincinnati, Ohio.

SENSATIONAL Combination offer! Big packet 105 all different including Greenland (new country), Congo, Manchukuo, Costa Rica triangle, air-mails, commemoratives, giant diamond-shaped stamp, \$4 United States; complete set United States telegraphs, cataloging 20c, scarce set Siberia cataloging 50c. Packet British colonies including Gwalior, Hyberabad, Burma (new country), jubilee and coronations. Total catalog price over \$3.00! Everything for only 5c to approval applicants! World-Wide Stamp Company, Department 606, Camden, New York.

CANADA—Newfoundland—Sixty page illustrated wholesale catalogue featuring Canadians, Newfoundland, British Colonials, United States, supplies. Free. Empire Stamp Company, Dept. 5, Toronto, Canada.

FREE—Elaborate United States pricelist (44 pages), including hinges. Seidenberg, Baroda, Mich.

BUILD Your collection to 20,000 varieties on small weekly payments, 50c or more. No duplications. Marvella Co., Burt Bldg., Dallas, Texas.

25 PICTURESQUE French Colonies stamps 5c to acceptable applicants for general foreign approvals. Tingley Stamp Company, 1805 Monroe, Endicott, N. Y.

FREE! Five beautiful sets—Brazil, Ceylon, Czechoslovakia, Denmark; 3c to approval applicants. Stamp Co., East Rochester, N. Y.

POSTAGE Stamp collections bought and sold. Philatelic Headquarters, Trenton, New Jersey.

BRAZIL. 50 Different 10c with bargain approvals. Davis, Silver Lake, Ind.

WEST Indies gorgeous assortment \$1.00, satisfaction guaranteed. Rajnauth, Box 267, Trinidad, B. W. I.

GRAF Zeppelin II in ruins. Last flight cover free premium. Write for details. Charles Beucher, Postville, Iowa.

1000 U. S. including commemoratives, precancels, airs, 15c. Lee, Bridgeport, N. Y.

40000 **VARIETIES** Foreign stamps available on approvals, 1/4c up. Representative selection on request. Adults only. PKeigwin Stamp Co., Vineland, N. J.

LOWEST Priced singles, sets. Gottwirt, 1169 Lincoln Place, Brooklyn, New York.

HOLLYWOOD Movie cover 13c; fifteen for \$1.00. Free sample with approvals. "Hollywood Stamps," 2937 Greenfield, Los Angeles, California.

100 WALL Street stamps 10c. Approvals. Roy Menery, Box 692, Detroit, Michigan.

APPROVALS That satisfy—try them. Jayne, 302 Waverly, Syracuse, N. Y.

APPROVAL Sheets, individually printed—\$1.50—1000 (plus postage.) Coe Printery, Ponca City, Okla.

SEND 1c For triangle stamp, Mexican airmail, and set 4 Djibouti. Sundman, D135, Bristol, Conn.

5 SETS Of stamps 5c. Approvals sent. Gaybree Brothers, 706 Sumner Avenue, Springfield, Mass.

21 FRENCH Colonies, pictorials, sets of 5 each (105) for 35c. French, 241 Euclid, Cleveland.

GIFT Edition stamp annual free—Sixty pages with hundreds of illustrations featuring Canadians, Newfoundlands, United States, Colonials, foreign, supplies. Sent free. Gray Stamp Company, Dept. PM, Toronto, Canada.

33 DIFFERENT United States 5c. Approvals. Utechts, 1143M North Keeler, Chicago.

NOVELTY! Set of five typical Colombian characters, in colors, 25c (stamps). Blencowe, Apartado 2155, Bogota, Colombia, South America.

UNITED States mixture supreme, 1/4 pound 25c. Quality Stamps, Englewood, Colorado.

KING Edward Eighth stamps 10 cents. Arthur Mantei, 256 - 13th Ave. So., Minneapolis, Minn.

TEN Different United States over 40 years old, 10c. Elsea, Bowling Green, O.

UNITED States mixture, pound 35c; 3 lbs. dollar. Odias Demers, Sanford, Maine.

FREE! Two coronation sets. Postage 3c. Roberts, 312P Shearwater, Bay City, Mich.

U. S. imperf. free with 100 fine U. S. 1861-1908, 25c. Weston, Box 383, Ponca City, Okla.

"25" CZECHOSLOVAKIA Or "20" commemoratives 5 cents. Approvals. Lucas, Five Broadway, New York.

U. S. National parks, complete set 27c; bi-centennials 12c; army-navy 12c. Fuld, Dickmann Building, St. Louis, Missouri.

SCARCE Diamond airmail! Wonderful packet 115 different from strange countries. British Colonies, Haiti, Zanzibar, pictorials, etc. 5c to approval applicants. Reliable Co., Box 139P Church Street Annex, New York.

SEND 10c Mixed postage stamps and 10c; receive 15 different U.S.A. 19th century. Waldo Stamp Exchange, Box 266, Dallas, Texas.

25 JAPAN 3c. With approvals 1/4c up. Josiab Babcock, St. Joseph, Michigan.

CANNIBAL King of the Camerouns set 5c approval applicants only. Quality Stamps, Englewood, Colorado.

FREE! Select any 10 stamps from our approval book free. Just send names 2 active collector friends. Ranger Stamp Co., Dallas, Texas.

FREE Mint French Colonials with penny approvals. Mackay, 7200 Yale, Chicago.

POLAND Or Czechoslovakia, 50 different 10c. Approvals? Wollaston Stamps, Wollaston, Mass.

CANADIAN Royal set 5c with approvals. Clark, 1612 Dial, Springfield, Ill.

1000 **MIXED** United States 18c. Two pounds \$1.00. Halay, 452 West 58th, New York.

50 DIFFERENT Stamps from 29 countries. 5c. Approvals. Buchanan, Box 40, College Point, N. Y.

25 UNITED States, including \$4 and \$5 stamps free to approval applicants. 3c postage. Brownie Stamp Shop, Flint, Mich.

SHOE Box full of stamps, foreign, U. S., remainders collection sheets, etc. One dollar. Pickwick, 80 Wall, New York City.

1000 MIXED Foreign, 25c. Well worth sorting for values. Plaza Stamp Co., Santa Fe, N. Mex.

FREE! World's smallest triangle, giant diamond-shaped stamp, Bolivia triangle, packet old U. S., set twentieth-century Philippines, set Brazil patriots, Devil's Island, Congo, Cannibaland, Danzig, Tunisia, Soudan, West Indies, Southseas, Asia, Africa, Br. Cols., pictorials, commemoratives, airmails, bicolours, perforation gauge, millimeter scale, Postage 3c. Approvals, Davidson, 2297-6E Salt Lake City, Utah.

DISGUSTED? Try my approvals 1/4c up. Bargains galore. Premiums with purchase. Viscusi, Scotia, N. Y.

SEE For yourself! 20 different commemoratives. Also U. S. packet. Everything 3c with bargain approvals. Dolve, Box 406F, Minneapolis, Minnesota.

COMMEMORATIVES (Twenty foreign) with desirable approvals. Sherman Shook, Nazareth, Penna.

UNITED States mixtures 35c lb. Canada 70c. Foreign \$1.00. Mission, 4512 No. Racine, Chicago.

FREE Christmas special! A gorgeous set of beautiful Ecuador large sized pictorial airmails to new approval applicants sending 3c postage. You'll like them and our clean inexpensive approvals, too. Acme Stamp Company, P.O. Box 101, Westmount, Canada.

ZOOIE! Lilliputian airstop, Perak, Selangor, weird Afghanistan, Siberia, Palestine, Wurtemberg, bicolored Banana airstop, jungleground beauties—3c with approvals! Saxon Company, 408-A Jay Street, Brooklyn, N. Y.

CZECHOSLOVAKIA—100 Different 19c. Approvals, Niederstadt, 4727 West Beloit, Milwaukee, Wis.

UNITED States parks set complete 19c. Box 488, Minneapolis, Minnesota.

PENNY Approvals. Thousands different. Commemoratives, pictorials, Raymax, Box Blythebourne 11-K, Brooklyn, N. Y.

FREE 100 Different stamps to approval applicants. 3c postage. Evanston Stamp Shop, Box 135, Evanston, Ill.

FREE! 110 Different stamps to approval applicants. 3c postage. Zephyr, 5124 George, Chicago.

NETHERLANDS Goddess triangle. Spanish nude duchess, 25 others—6c with approvals. Virginia Stamp Company, Alexandria, Virginia.

100 DIFFERENT 3c Approvals. Thorgif Stamp Co., Box 77, Marion, Ind.

7 DIFFERENT U. S. airmails 10c. Approvals, Wamsutta Stamp Co., Box 1065, Providence, R. I.

25 VICTORIAN British Colonies—10c to approval applicants. Cowles, 755 Anderson, Grantwood, N. J.

150 HONDURAS, Gabon, Salvador, Congo, etc. 10c. Lufbery, Middletown, Conn.

SCARCE Falkland Islands coronation set complete, unused. 5c. Approvals, Fulmer, Box 532, Florence, S. C.

U. S.—68 Different (commemorative, airmail, etc.) with approvals 9c. Moseley, 4932 Forestpark, St. Louis, Mo.

250 DIFFERENT Foreign. Commemoratives, pictorials, etc., 25c. Kurtz, 523 El-liger, Allentown, Penna.

PHILIPPINES—17 Different including pictorials 10 cts. with approvals. Swedell, 3038 Harriet, Minneapolis, Minn.

LIST Of stamp traders. 15c. Falbaum, 170 South Sunnyslope, Pasadena, Calif.

BUY-SELL. Twenty word advertisement fifty cents. Forty thousand readers. Large antique, stamp, hobby departments. Subscription dollar yearly. Timely Monitor, Ann Arbor, Michigan.

FINE U. S. mission mixture, 3 lbs. \$1.00. Bell Stamps, Box 4, College Point, N. Y.

5 SETS, Packet and premiums, 3c. Approvals included. Mailmart, Box 27, Grand Central, New York, N. Y.

BETTER Try my 1/2c approvals. Oman, 642 Broadway, St. Paul, Minn.

NEJD (Saudi Arabia), Bolivia eucharistic triangle, Cayman Island pictorial, Negri Sembilan, Turks and Caicos Islands, Manchukuo, Bahamas war provisional, five dollar United States, British Solomon Islands (Cannibaland). Everything 3c with our famous approvals. Viking Stamp Co., 1-Z Hanson Pl., Brooklyn, N. Y.

ATTRACTIVE Free gift to applicants for our Nu-Way approvals. Ideal Stampco, 238 Ellis Street, Augusta, Georgia.

FREE. Three sets: Four beautiful new Bolivia (animals), complete set Czechoslovakia (legionnaires), scarce set Ecuador (Olympics). Send 3c postage today and request our famous U. S. and foreign "Four Star Approvals." Kessels, Tucson, Ariz.

NUDE Duchess (Spain), Hindenburg zeppelin. 5c approvals. Shultes, Berne, N. Y.

GAMBLE. Huge auction purchases broken into \$1.00 lots. Enormous value. Worldwide testimonials. Hughes, Queens Rd., Bournemouth, England.

YEMEN—5 Varieties 5c with approvals. LeDuc, Saint Petersburg, Florida.

175 U. S. commemoratives, etc., 10c. 500 25c. P.O. Box 457, Newark, N. J.

43 DIFFERENT Czechoslovakia, 3c with approvals. Pearce, 2833 NW13, Oklahoma City, Oklahoma.

\$10.00 STAMP Free to approval applicants. Foote, 309 Greeley, Webster Groves, Missouri.

BIG Packet free! Scarce Hindenburg zeppelin which exploded mid-air. World's smallest triangle. Indo-China air-mails, Eagle and lion in mortal combat on new Italian East African, Mozambique giraffe, Liberian antelope, 55-year old Eastern Roumelian! Canadian coronation and silver jubilee, Giant diamond-shaped stamp, Holy Lands packet. These and many more in this thrilling package to approval applicants only 5c. B. Fitts Co., Framingham, Mass.

10,000 VARIETIES 1c each! Gordon Davison, Box 568, Manchester, N. H.

150 GOOD Mixed foreign stamps, 3c. Elvin Stanton, Niantic, Conn.

CANNON! Set of stamps showing cannon, firing squad, cavalry charge and 200 other different stamps, only 10c to approval applicants. L. H. Reich Stamp Co., 4647 Kenmore, Chicago.

FREE, U. S. \$1, \$2, \$4 and \$5 stamps. Unbeatable U. S. approvals. Nelson, 369 1/2 Robert Street, St. Paul, Minn.

300 DIFFERENT 20c; 1000 75c; 2000 \$2.50. Fred Onken, 630 79th St., Brooklyn.

UNITED States stamps on approval. Commemorative, airmails, 19th Century issues, parcel post, revenues, etc. Bargain lists with each selection. We have an extensive stock, correctly classified, reasonably priced. Southern Stamps, Box 70A, Miami, Florida.

SILVER Jubilee souvenirs. Third set of twenty beautiful stamps issued by Irish Hospitals' Trust, Dublin. Specimen sheet free of charge to all writing to Mr. J. O'Sheehan, Department P.M. 13, Earlsfort Terrace, Dublin, Ireland.

APPROVAL Sheets. One to three cents, Frederick B. Driver, 2009 Finance Bldg., Philadelphia, Penna.

FREE—Choose any country 10c packet—5c postage—approvals. Victoria Stamp Co., London, 4, Canada.

WHOLESALE Dealer's catalog. Illustrated. Postage 5c. Frank's, 4900 Chalgrove, Baltimore, Md.

SIX Dollars for 9c! 300 different stamps (cat. price \$6) only 9c with approvals. Tatham Stamp Co., Springfield-30, Mass.

THREE Sets for three cent stamp! Jack Reed, Houtsdale, Penna.

FREE—From every continent. 155 different, airmails, triangle, commemoratives, pictorials, many U. S. and others, with 1c approvals. Send 5c for postage and handling. Ace Stamps, Euclid Arcade, Cleveland, Ohio.

WHOLESALE Supplements to dealers for 10c postage. Hundreds of bargains. Grossman Stampco, 102 West 42nd, New York.

GIANT Packet 200 all different from Africa, South America, Asia, South Sea Islands, etc. Includes world's smallest stamp; triangle and diamond-shaped stamps; animal stamps. Nicaragua "Will Rogers" airmail; many others. Also packet 17 different United States (cataloguing 50c) —all obsolete, including \$4 denomination, commemoratives, etc. Total catalogue price over \$5.00! Everything for only 5c to approval applicants! Mystic Stamp Company, Dept. 80-N, Camden, New York.

50 DIFFERENT, Fine U. S. including perforation gauge, 10c with approvals. The Stamp Shop, 809 Holland Bldg., St. Louis, Mo.

PENNY Approvals, that satisfy. Nell Gronberg, Box 5441-P, Philadelphia, Penna.

UNITED States illustrated looseleaf catalog. \$1.00. Send postage for free United States price list, precancel list. Stanley Gibbons, 38-P Park Row, New York.

200 DIFFERENT 10c. Big 50% approvals. Covert Stamp, 39 State, Rochester, N. Y.

ASK For our wonderful one cent approvals. Prospect Stamp Co., 225 Broadview, Toronto, Canada.

WEEKLY Stamp magazine, thirteen weeks, 10c. Stamp Journal, Kalamazoo, Mich.

STAMP Dealers, your ad here will bring wonderful returns. Ask me for proof. F. W. Johnson, Manager, Classified Advertising, Popular Mechanics Magazine, 200 E. Ontario St., Chicago.

RARE COINS

LARGE Cents, 2 different, or Indian heads, 8 different, 25c. M. C. Nivison, Webster, N. Y.

OLD Coin and price list, 10c. Box 73, Acushnet Station, New Bedford, Mass.

OLD Money wanted. Will pay fifty dollars for nickel of 1913 with Liberty head (no buffalo). We pay cash premiums for all rare coins. Send 4c for large coin folder. May mean much profit to you. Numismatic Co., Dept. 20, Fort Worth, Texas.

GOLD Coins wanted, 55% premium, also complete coin collections. A. French, Rte. 1, Troy, N. Y.

COMMEMORATIVE George VI Canadian visit silver dollars. \$1.50 each. Imperial Enterprises, New Toronto, Ont.

RARE Coins at bargain prices. Uncirculated coin with catalogue No. 28—10c. Eugene Morrison, Reseda, California.

FOR A gold souvenir coin of the Golden Gate International Exposition, San Francisco, send \$3 in money order to Jules Charbneau, 645 Stockton St., San Francisco, Calif. Silver coin 75c.

BRILLIANT 1939-S Or 1939-D uncirculated cent and catalogue 10c. Landon, 901 Lucerne, Los Angeles.

100000 MARK Bill 10c. Lists free. Hussman, 211S 7th, St. Louis, Mo.

COMMEMORATIVE \$1/2s. Five different, uncirculated, \$5.00. Koepel Coin Shop, Eighth and Broadway, Los Angeles.

TAX Tokens—Complete official current set (21) fifty cents. Illinois provisionals twelve \$1.00. Harco, 312 W. Harrison, Albuquerque, New Mexico.

GET Profit and pleasure in collecting old coins. Send 10c for 56 page illustrated coin catalog. You'll be delighted with it. Send for it now. B. Max Mehl, 370 Mehl Building, Fort Worth, Texas. Largest rare coin establishment in U. S. Established 39 years.

COIN Collectors' illustrated catalog of coins, books and accessories 10c. James Randall, 407 South Dearborn, Chicago.

RARE U. S., foreign coins, war medals. Catalogue 10c. Mengelle, Colorado Springs, Colo.

COMMEMORATIVE Half dollars, Lincoln, Stone Mountain, Oregon, Texas, Cleveland, Kentucky, San Diego, Long Island, \$1.50 each. Illustrated catalogue No. 14, 25c. Norman Shultz, Salt Lake, Utah.

FREE! Foreign coin, banknote, and large illustrated coin catalogue. Send 4c postage. Coin approvals sent. Tatham Coinco, Springfield-125, Mass.

\$5 TO \$500 Each paid for hundreds of old or odd coins. Keep all until posted. Many very valuable. Send 10 cents for illustrated Coin Value Book, 4x6. Guaranteed buying and selling prices. 31 years in business. Coin Exchange, Box 5, Le Roy, N. Y.

HOBBIES AND COLLECTIONS

12 DIFFERENT Cactus plants \$1.00 f.o.b. Pat Hooks Cact., Box 542, Ranger, Texas.

WANTED Old cigarette cards. Write Bray, 1127 Jackson, Easton, Penna.

CONSULAR Fee, revenue stamp, etc., for cash or old law books, autographs. Americana, Philadelphia Autograph Co., Box 2412, Philadelphia.

FREE Swap ads in Hobbyiana Magazine. Sample 10c. 1326 South 27th Street, Omaha, Nebraska.

COMPLETE Stamp, antique, hobby newsmagazine. Dollar yearly. Timely Monitor, Ann Arbor, Michigan.

EXCHANGE Your duplicate stamps, match covers, etc., with collectors everywhere. Dime brings list. (Mention hobby). Secretary, Box 2166, Denver, Colo.

UNUSED Book match covers, 100 all different. \$1.00. Free list. Charles Edelman, 1311C East 84, Cleveland, Ohio.

PHOTO FINISHING

TECHNIFINISH—35mm., 36 Exposure rolls fine grain developed and perfectly enlarged to $2\frac{3}{8}'' \times 3\frac{3}{4}''$ glossy prints, 75c. New exclusive methods and equipment make this low price possible. Cartridge reloaded with Eastman Plus X, 25c. One day service. Satisfaction guaranteed or money back. Write for postpaid mailing bags and information. Technifinish Laboratory, 109-B Lexington, Rochester, N. Y.

OIL Coloring photographs a fascinating hobby or profitable business. Learn at home by easy simplified method. Previous experience unnecessary. Send for free information and requirements. National Art School, 3601 Michigan Avenue, Dept. 3431, Chicago.

IMMEDIATE Service! Better pictures. Sixteen guaranteed prints from roll, 25c. One colored or two plain enlargements and 8 guaranteed prints, 25c coin. Special! Coupon for 8x10 enlargement given with every 25c worth Kodak finishing. Any 36 exposure, 35 mm. film fine-grain developed and each good negative enlarged to 3x4 prints for only \$1.00. 3x4 reprints, 4c each. One day service. Details and mailers free on request. American Studios, Box 22, LaCrosse, Wis.

LET Us show you how and where to sell those photos. Increasing demand for pictures of unusual reader interest by syndicates, trade journals, etc., opens up money making field for amateur photographers. Write today for complete information without obligation. Photo Sales Guide, Box 2625, Kansas City, Mo.

SPECIAL. Five 5x7 enlargements 25c (coin). Send negatives. Garrett Co., Pittsburg, Kansas.

CHRISTMAS. Photographic, greeting cards 20 for \$1.00. Sample, 10c! 20 reprints 25c! 100 reprints \$1.00! Rolls developed, 2 prints of each negative 25c! Quality guaranteed, prompt service! Free mailing containers, price list. Mercury Studios, G-109 N. Dearborn, Chicago.

8 ENLARGEMENTS—Films developed plus 8 enlargements, 25c coin—116 or smaller. Enlarge Photo, Box 791, Dept. PMM, Boston, Massachusetts.

ROLL Developed and 16 quality prints, 25c. 20 reprints 25c. Mailing envelope, price list sent free. Star Photo Service, J-20 West Jackson, Chicago.

FILM Developing bargains! Hurry! Save! Write for free mailers and details now. Modern Studios, Dept. PM, LaCrosse, Wis.

ONE Day service, roll developed, 16 quality prints in attractive Agfa Snapfolio with cellophane pockets 25c. Pho-T-Pho, Box 24-F, Highland Park, Mich.

PHOTOGRAPHY For pleasure and profit. Prepare for profitable business or fascinating hobby at home. Common school education sufficient. Write for information and requirements. American School of Photography, 3601 Michigan Avenue, Dept. 3451, Chicago.

35MM. ROLLS Developed free. $3\frac{1}{4} \times 4\frac{1}{2}$ enlargements, 36 exposures \$1.00, 18 exposures 60c. Univex rolls \$2.00. Reprints 4c. Send roll and money today. Minipix, Dept. 51, 100 No. LaSalle, Chicago.

DOUBLE-QUICK Service! Roll developed 16 Velox prints; or 8 prints, 2 enlargements 25c. Chicago Photo Lab., Box 3, South Chicago, Illinois.

REMOVE Trees, houses, shrubbery, anything from background in negatives. Does not spoil negative. Can again be printed in original way. Also make etchings, remove pin holes in negatives and white spots from photos. Complete instructions \$1.00. Details free. Maurer Photo Co., Galveston, Texas.

8x10 ENLARGEMENTS 3 for \$1.00. Send negatives. McKinney, 6941 Ozark, Chicago.

BRILLIANT Prints easily made the two-fold way. Exact exposures unnecessary. Complete instructions 50c. Henry Estberg, Waupaca, Wis.

WORLD'S Fair snapshots. Samples free. Forman, 882 Lorimer, Brooklyn, N. Y.

60 DAY Trial offer! Roll developed and printed with deckled edge prints by professional experts only 10c. Reprints 25 for 25c. Reliable, River Grove, Illinois.

PHOTOGRAPHIC Enlargements from pictures or negatives: $5'' \times 7''$ 25c (5 for \$1); $8'' \times 10''$ 39c (3 for \$1); $11'' \times 14''$ (2 for \$1) cash or C.O.D. Photo Art Service, 505-PM Fifth Avenue, New York City.

SIXTEEN Sparkling lifetime prints and 2 beautiful 5x7 Hollywood enlargements with roll developed—25c. Trial, 20 Lifetime prints 25c; 100—\$1.00. Prompt—careful. Lifetone Studios, F-39, Des Moines, Iowa.

SENSATIONAL Offer. Five 5x7 enlargements 29c. Cardinal Photos, Summit, N. J.

IDEAL Photos. Professional work only 25c per roll of 8 and free enlargement. Photographic greeting cards and calendars. Details free. Ideal Photos, Box 2255, Paterson, N. J.

35MM. Special. Developed and enlarged to $3\frac{1}{4} \times 4\frac{1}{2}$. Extra glossy prints \$1.30. Any 6 or 8 roll 25c. Free enlargement coupons. All work guaranteed. Kelso, Box 549-B10, Inglewood, California.

SPECIALIZING 35mm. Rolls fine grain developed, 36 enlargements, $3\frac{1}{2} \times 5$ \$1.00. Cartridge reloaded 35c. Photoshop, Linton, Ind.

BEAUTIFUL Photographic Christmas cards, 75c dozen. Send 10c and negative for sample. Hench Studios, Harrisburg, Penna.

QUALITY Since 1889—one day service. Roll developed, 2 Brilliantone prints each negative 25c. 8x10 enlargement coupon, 16 reprints 25c. 20 Photographic Christmas Cards from your negative \$1.00; 50—\$2.00. Willard Studios, Box 3535-A, Cleveland, Ohio.

EIGHT Silvertone gloss enlargements or eight prints and two enlargements, 25c. Mayfair, Box 261-K, Toledo, Ohio.

ROLL Developed, 8 prints all enlarged to double size, 25c. 16—50c. Enlarged reprints 4c. Artcraft Studios, Box 3582-A, Cleveland, Ohio.

ENLARGEMENT From each picture on your roll 25c. Lifelike enlargements bringing out the best in your pictures. High quality, fast service, low price, an unbeatable combination. Cut Rate Photos, Dept. B-4, Janesville, Wisconsin.

PROFESSIONAL. Overnight service. Developed, printed, 2 enlargements, 25c. Fotoservice, 1942 Marlow, Toledo, Ohio.

TWO Prints from each picture on your roll 25c. Your pictures will speak volumes when finished by our expert craftsmen. One day service. Nineteen years experience. Lens Photos, Dept. J-4, Janesville, Wisconsin.

ROLL Developed 8 prints and two enlargements 25c. Beautiful photographic Christmas cards or calendars from your negatives, 4 for 25c; 17, \$1.00, envelopes included. Young Photo Service, 405-G, Albany, N. Y.

BETTER Photo finishing. Eight exposure rolls developed and printed 25c. Moore Studios, Alstead, New Hampshire.

EMBOSSED Christmas cards, including envelopes, from your own negative 60c dozen. Minimum 4 for 25c. Film Capitol Service, Box 504, Rochester, New York.

ROLL Developed, 16 guaranteed prints, 25c. Smart Photo, Winona, Minnesota.

ROLLS Developed, two prints each and two free enlargement coupons, 25c; reprints, 2c each; 100 or more, 1c. Summers' Studio, Unionville, Mo.

THREE Prints each good negative in roll 25c. Reprints 3c. Fred D. Eastman, Bode, Iowa.

16 PRINTS With roll 25c. 16 reprints 25c. Rex Photo, Ogden, Utah.

ONE $6\frac{1}{2} \times 8\frac{1}{2}$ Wide border embossed enlargement or one 5x7 hand colored enlargement with each roll developed and 8 prints 25c. 36 exposure roll developed and 36 $3\frac{1}{4} \times 4\frac{1}{2}$ enlargements \$1.35. 18 exposure roll 75c. Vidor, 321-P Hennepin, Minneapolis, Minn.

ROLL Developed and 8 beautiful Velox glossy prints 25c coin or stamps. Reprints 3c each. Fotoprint Service, Roanoke, Va.

TWO Glossy enlargements, 1 colored with roll 25c. Arbor Service, 10, Joliet, Ill.

CANDID Special, 35mm. rolls enlarged to $3\frac{1}{4} \times 4\frac{1}{2}$, \$1.00. 18mm. rolls 60c. $3\frac{1}{4} \times 4\frac{1}{2}$ reprints 3c. Brown Photo Company, 1910-61 Emerson, Minneapolis, Minn.

FOR The discriminating amateur—Rolls developed 2 prints each, 25c. Reprints 3c. Superior workmanship. Same day service. Paramount Co., 327 E. 92nd St., New York.

ENLARGE Your own photos. Make money doing work for others. Build your own enlarger. 4 complete plans 50c. Popular Mechanics Press, Dept. 939, 200 E. Ontario St., Chicago.

CAMERAS, PHOTO SUPPLIES

FREE Bargain list—Used cameras, lenses, professional equipment. Write for list BP. Medo, 15 West 47th Street, New York City.

200 CAMERAS! Extraordinary Christmas specials! Regular dealer's invoice and money-back guarantee included. Few examples: Argus "A" 4.5 \$5.25, Leica G Summar 2 new \$128.00. Plate-Film-pack cameras (Voigtlander, Zeiss, Goerz, or Rodenstock) $2\frac{1}{4} \times 3\frac{1}{4}''$ and $3\frac{1}{2} \times 4\frac{3}{4}''$ quality lenses 4.5 Prontor \$15.50 each. Korelle Reflex, Telephoto and enlarger lenses, enlargers, tripods, leather cases, etc. Trade-ins. Send orders and detailed inquiries to Importers Brenner Photo Co., 943B Pennsylvania Avenue, Washington, D. C.

35MM. Film. All types of Eastman, Dupont, and Agfa 36 exposure cartridges, 3 for \$1.00. Free, Weston rating list. National Film Co., 8750 Olympic, Los Angeles, Calif.

CAMERAS And supplies. Free illustrated catalog listing everything photographic—still and movie cameras, films, lenses—at tremendous savings. Hundreds of bargains, new and used. All guaranteed. We take your old camera or equipment in trade. Write now for your free copy of our newest money-saving bargain book—just out! Limited edition. Hurry! Central Camera Co., (Photographic Headquarters since 1899), 230 S. Wabash, Dept. A-162, Chicago, Ill.

BALDOR Light booster. Makes every light a photo-flood. Makes inside picture-taking easy, convenient, inexpensive. Free descriptive folder. Write Baldor Electric, St. Louis, Mo.

SELL Best pics to 2500 publication market. Inquire Tynan Pic Sales, Rhinebeck, N. Y.

MAKE Money in photography. Learn quickly at home. Easy plan. Previous experience unnecessary. Common school education sufficient. Interesting booklet and requirements free. American School of Photography, 3601 Michigan Avenue, Dept. 3432, Chicago.

ALMOST Given away! Zeiss binocular 18 power, (list price \$180.00) only \$98.00. Voigtlander Bessa Rollfilm cameras 4.5 Prontor, new (list price \$27.50) only \$18.50. New Korelle Reflex $2\frac{1}{4} \times 2\frac{3}{4}''$ Schneider lens 2.9 \$63.00, same with Zeiss Tessar 2.8 \$89.00. Send orders or detailed inquiries of all photographic bargains to Importers Brenner Photo Co., 943B Pennsylvania Avenue, Washington, D. C.

ENLARGER \$1.59. Enlarges eight times size of small negatives. Fully guaranteed. Paramount Sales Company, 89 Dudley Street, Boston, Mass.

COMPLETE Enlarger, and masking easel for only \$5.95. Cameras cheaper, too. Argus, Perflex. Order now from Gravlee, Kennedy, Alabama.

DYE-INTENSIFIER For weak, thin negatives. New. No grain increase. 25c postpaid. Spongo Products, Box 305, Hempstead, N. Y.

MAKE Photographic Christmas cards as easily as contact prints! Our negative assortment includes 10 Christmas greetings and 8 decorations with complete instructions. Paper negatives \$1.00. Film negatives including 4 seasonable photographs \$2.00. Merit Photo Service, Bloomfield, N. J.

CAMERAS. Enlargers, on time. See advertisement under Motion Pictures, Mogull's.

FREE—Guide to everything photographic. New 1940 camera catalog—handbook just issued. 84 pages containing over 2000 items. 300 pictures. Latest camera models, new prices. New accessories—enlargers, lens, dark room needs, movie cameras, etc. Also used camera bargains. Liberal allowance for your old equipment. Send for free catalog today. Abe Cohen's Exchange, for 30 years "The House of Photographic Values," Dept. C2, 142 Fulton St., New York, N. Y.

MEXICO? Wanted: your name and address for literature and prices of finest German cameras, binoculars, movies. Foto Mantel. Apartado 1459 Ven. Carranza 11, Mexico City, No. 105.

FROM The great stocks of Bass, you can buy any camera, lens, at bargain prices. Write. All cameras carry 14-day money back guarantee. 30 years of leadership. Dept. AG, Bass Camera Company, 179 W. Madison St., Chicago, Illinois.

CAMERA Repairing. Bellows made to order, shutters repaired. Bellows made to fit all standard cameras! United Camera Co., Inc., A-1515 Belmont, Chicago.

HAVE You a camera? Send ten cents for recent number of our big magazine, showing how to make better pictures and earn money. American Photography, 116 Camera House, Boston, 17, Mass.

CAMERAS Films, paper 25% to 35% discount. Paramount Photo Division, 327 East 92nd St., New York.

MAKE Money with your camera. New book tells how. 46 pages. 50c. Popular Mechanics Press, Room (C39), 200 E. Ontario St., Chicago.

MOTION PICTURES AND SOUND EQUIPMENT

USED Movie cameras. Movie Cameras Exchange, 705 Park Ave., Utica, N. Y.

SAVE! 8-16mm. Bulk! Catalogue! Arts! Penn-Craft, Box 423-MA Williamsport, Pennsylvania.

FREE Catalogue, 16mm. silent rentals. We pay transportation. Exchange exclusive. Asha Films, 785 St. Johns, Brooklyn, N. Y.

SALE! Silent 35mm. films. Projectors, Demsey, 1223 Berkley, Youngstown, Ohio.

PROCESS Your 8mm., 16mm. films with our drum type outfits, complete—\$6.95. Cameras, projectors. Liberal trade-in. Literature, stamp. Cine Service, 459 Irvin Ave., Rochester, Penna.

COMPLETE 16mm. Film rental library. Attractions: "Covered Wagon," "Behind the Front," "Pony Express." Send postage for free catalog. National Cinema, 71 Dey St., New York.

ART Films. Sample, dime; lists free. Cineart, 2443 Gunnison, Chicago.

8MM.-16MM. Varieties. Arts. Home Movies, Box 82, Cincinnati, Ohio.

WRITE Now for free catalog of movie equipment and film subjects. We are never undersold. Paramount Mfg. Company, Dept. G-99, Box 224, Back Bay, Boston, Mass.

WORLD'S Fair movies in color! Lists free! Paragon, Box 453, Meriden, Conn.

8MM. 16MM. Films exchanged. Free lists. Film Exchange, Box 65, Arverne, N. Y.

MONEY Maker! "The World's Greatest Passion Play," 16mm. and 35mm. Sound or silent. Purchase or rent everywhere. Superior than Oberammergau play. Write Hemenway Film Co., 37F Church Street, Boston, Mass.

RELIGIOUS Features for Lenten season, "Thine Kingdom," "Brother Francis," "Passion Play" and others. Otto March, 630 - 9th Ave., New York City.

FREE! Write for Cinescreen Magazine. Latest film news. Movies of movie stars! Bailey Films, Dept. Y-4, 1651 Cosmo, Hollywood.

16 35MM. Silent sound list 5c. Bedner, 5300 S. Talman, Chicago.

ART Sample. 10c; other kinds, lists free. Goodwill Company, Jackson, Tennessee.

8-16MM. Films. Latest release of European war. Actual bombing by land-sea-sky. Lowest prices. Many other subjects. Films rented everywhere. Trades accepted. Free illustrated catalogue (with sample film 10c). Garden Exchange, 317 West 50th, New York.

8-16MM. Films; sell-rent-exchange. Free illustrated catalogue (with sample film 10c). Parkway Exchange, 1040 Eastern Parkway, Brooklyn.

NEW! Movie equipment; films! "Art" samples, 5c. Superior, 126 Fourth, Paterson, N. J.

35MM. Christmas bargains. Films, projectors. Calderara, 5119 South St. Louis, Chicago.

16MM. VELOTEX. Perfect outdoor film. 100 ft. rolls \$1.95 including free processing. Sample free. Velotex Laboratories, 600-H, Gary, Indiana.

AMAZING Sale! Used 16mm. projectors, guaranteed! For professional, church, home! \$160 Eastman Kodascope \$24.50! \$210 Kodascope \$48.75! \$49.50 Duograph \$9.95! \$139 Bell-Howell \$49.50! \$125 Filmo \$24.95! Many others; get free list. 16mm. Bell camera f:4.5 \$3.99! 8mm. Univex \$2.99! \$87.50 Filmo f:3.5 \$33.75. Odd 16mm. sound film subjects 400' \$3.00! Silent 400' \$2.50! 16mm. 400' reels, humidors cans 25c! Trades accepted. Monthly terms. Mogull's, 64 West 48th, New York.

35MM. ODD 75c. 16mm. \$1.50 complete. Savarese, Woodcliff Lake, N. J.

35MM. Sound-silent films, equipment. Thor, 3741 Kenilworth, Berwyn, Ill.

CHRISTMAS Movie, 100 ft., 16mm. \$1.75. 50 ft. 8mm. 89c. Free bargain lists. Home Movies, Box 216, Easton, Penna.

35MM. Bargains—Westerns, comedies. Jersey Films, 2075 Richland, Lakewood, Ohio.

8MM-16MM. Bargains. Free catalog. Movie Shop, 838 Broadway, Bayonne, N. J.

7-16MM. SOUND Projectors—\$145.00. Roshon, State Theatre, Pittsburgh, Penna.

8MM., 16MM. and 35mm. films, bargain lists 3c. Clifford Hoffman, 57 Broad, Albany, N. Y.

16MM. SOUND. Silent, 8mm. films, equipment, supplies, reasonable. State requirements. Send for price list. Nu-Art Films, Inc., 145 West 45 St., New York City.

TALKIE Shorts \$3.00 reel. Programs rented \$7.50 two nights. Simpson, 1275 South Broadway, Dayton, Ohio.

BASS Says: Write to Cine headquarters for 66-page Cine Bargaingram No. 240. 8mm., 16mm., 35mm. silent and sound. Equipment to gladden the heart of amateur or professional, including the famous 16mm. sound on film RCA camera, exclusive distributors. Write for copy of this great book, it's free, to motion picture headquarters for 30 years, Dept. A, Bass Camera Company, 179 W. Madison St., Chicago, Illinois.

BARGAINS! 8mm., 16mm., free literature. Elder, P-739, Boylston, Boston, Mass.

GUARANTEED 8MM. 24-hour reversal processing. Double 8mm., 45c. Single, 25c. Univex 15c. ESO-S, 3945 Central, Kansas City, Missouri.

MOVIE Film. Develop yourself. Univex, Eastman, etc. Chemical samples 15c. Raw film wholesale. Lake Camera Exchange, Gary, Ind.

15% TO 25% Discount on still or movie cameras. Free circular. Paramount Co., 327 E. 92nd St., New York City.

CHRISTMAS Film bargains. 8mm., 16mm. Royal Home Movies, 42A Melrose, Boston, Mass.

8-MM-16 Pricelist free. Illustrated catalog 3c. Taylor, Bx-234, Corning, N. Y.

RADIOS, SUPPLIES, INSTRUCTION

RADIO Engineering, broadcasting, aviation and police radio, servicing, marine and Morse telegraphy taught thoroughly. All expenses low. Catalog free. Dodge's Institute, Ames St., Valparaiso, Ind.

SEND For free giant money saving radio and phonograph record catalogue. United Radio Company, 1000-M, Newark, N. J.

RADIO Kits—\$3.95 up. Complete. Single band; all-wave; 5-10 tubes. Radio and parts catalog free. McGee Radio, PP-10, Kansas City, Mo.

RADIOS—\$4.95 up. Buy direct. Save to 50%. Catalog free. Autocrat-A, 3855 North Hamilton, Chicago, Ill.

RADIOS. All makes. Agents, profit to 50%. Wilson Radio, 2509 North 3rd, Milwaukee, Wisconsin.

S-M Crystal loud speaker radio. Kit—with coils, condenser, circuit—\$2.95. Less speaker—\$1.95. C.O.D. (50c deposit). Circuit—25c. Esco-PM, Kansas City, Mo.

MUSIC AND MUSICAL INSTRUMENTS

POETS. Prominent publisher wants your song. Songland, "D40PM-1," Thomaston, Maine.

ONE Dollar brings you twelve guaranteed clarinet reeds. Soft, medium, stiff. State choice. Money back if not satisfactory. Box 413, Mansfield, Penna.

FIFTY Late phonograph records, \$2.50. Wurlitzer selective, amplified, 12 record phonographs, very cheap. Davis Sales Co., Syracuse, N. Y.

"SINGING Made Easy and the Mastery of the Voice" teaches tone placement, perfection, extended range. Immediate results! Popularly priced. Free prospectus! Approved as correspondence school under New York state laws. Whitney Vocal Method, 245A Wolfs Lane, Pelham, N. Y.

PIANO By ear. Free booklet. Day-V-Way, 13265 Michigan Ave., Dearborn, Michigan.

SONG Writing pays—Let successful song writers set your poems to music. Examination free. Write today. Five Star Music Masters, 6 Beacon St., Boston, Mass.

ONLY Published songs bring dividends and popularity. For important information write Sunbeam Publications, 20 West Jackson, Chicago.

SONGS—Verse or music. Brilliant opportunity. Write immediately. Vanburen, B-36, Rockhaven, Kentucky.

RECORDING Songs, poems, dollar per minute. Ray Turner, Hotel Tilden Hall, Champaign, Ill.

SONG Poems wanted. Work guaranteed. Publishing, Great Eastern, "D27," Thomaston, Maine.

SONGS. Song poems, bought, published. Best offer, free advice. Metro-Melody Music Publishers, 1204 Sutter, San Francisco.

UKULELE Players, change chords to any key. Chord transposing chart. Special 25c (coin). G. M. Publishers, Box 452, New Haven, Conn.

ANALYSIS Of the 100 greatest swing recordings 50c. "Invaluable book"—Basic. Morris Publishers, 905-L deYoung Bldg., San Francisco.

ORCHESTRATIONS — Popular back numbers 12 for \$1.00. Porges, 6211 Kimbark Ave., Chicago.

SONGWRITERS! Outstanding, amazing offer. Hibbeler, C-5, 2157 No. Avers, Chicago.

SONGWRITERS—Write today for free booklet "Building An Income Through Songwriting." Songwriters Institute, 1234-C Broadway, New York.

WANTED: Original poems, lyrics, songs by a recognized music organization. Our contracts guarantee publication, marketing; include expert collaboration, where required. We give you advantages not obtainable elsewhere. Send your material today. Music Publishers Agency, Dept. X12, Portland, Ore.

PHONOGRAPH Records, slightly used. All late numbers. Ten cents each. Goodbody, 1824 East Main, Rochester, N. Y.

MUSICAL Setting, radio publication free. Do not send material. Write first to Norman Spencer, Music Publisher, Studio PM, 145 W. 45th St., New York City.

MUSIC Composed to words. Rhyming pamphlet on request. Phonograph recording of completed songs. Send poem for consideration. Keenan's Studios, Dept. PM, Box 2140, Bridgeport, Conn.

SONGWRITERS—Send original poems—America's finest service. Variety, Dept. H, Salem, Indiana.

DUO-FLEX Reeds for clarinets, and saxophones eliminate your reed troubles. Write for circular. Duo-Flex Reeds, 1204 1st Ave., Evansville, Ind.

MUSIC Composed to words. Wonderful proposition. Bauer Bros., Oshkosh, Wis.

WRITE Songs. Big money and reputation. Write for information. J. Gordon Pub. Co., 201 N. Hoyne Ave., Chicago.

WANTED! Lyrics, melodies for songs. We arrange, publish, sell. Superior Song Studios, Passaic, N. J.

SONGWRITERS: Send your poem today for immediate consideration. Richard Brothers, 24 Woods Building, Chicago.

SONG Writers. Send for publishing agreement. McKinley Music Publishers, 1501 E. 55th St., Chicago.

SONG Poems wanted. Free examination. Send poems to McNeil, Master of Music, 510-PM So. Alexandria, Los Angeles, Calif.

BUSINESS OPPORTUNITIES

FREE Amazing Folder about Artificial Marble Flooring. Covers Wood or Cement Floors. Fireproof. All colors. Low Cost "Ornamental Casting"—Concrete—Plaster—Statuary—Garden Furniture—Flexible Molds—Liquid Marble. Creative Publishers, PM-1, Glencoe, Illinois.

A REAL Future for you with Red Comet Automatic Fire Extinguishers. Low price. Proven seven years. Splendid sales outfit free. Some good territory open. Exclusive. Write quick. 766 Red Comet Building, Littleton, Colorado.

POPCORN Machines, carmelcrisp, crispettes, cheese coat, potato chips. Long Eakins, 2035-A High St., Springfield, Ohio.

"BINGO," New coin operated amusement game. Large income, operating "route." \$150 investment. Details free. Robbins, 1141P DeKalb Ave., Brooklyn, N. Y.

PATENTED Screw-holding screw drivers (not magnetic) no competition! Factories, stores buy quantities. Big profits, repeats. Foreign territories open. Free trial! Mfg'r. 6006 Journal Bldg., Boston, Mass.

INVENTORS:—We successfully sell inventions, patented and unpatented. Write for proof, and tell us what you have for sale. Chartered Institute of American Inventors, Dept. 4-C, Washington, D. C.

"RUBBER Molds." Make them yourself. Formulas, instructions 25c. Ideal Service, RM-1, Park Ridge, Ill.

GOOD Paying business silvering mirrors, plating autoparts, reflectors, bicycles, bathroom fixtures by late method. Free particulars and proofs. Gunmetal Co., Ave. H, Decatur, Ill.

CAPITAL Seekers—Put your project before 260 key-men. Cost trifling. Details free. Amster Leonard, Fox Theater Building, Detroit, Michigan.

EARN Cash at home! M. M. earned \$267.00, three weeks raising mushrooms in cellar! Exceptional, but your cellar, shed perhaps suitable. Materials furnished. Starting crop guaranteed. We buy all crops. Book free. United, 3848 Lincoln Ave., Dept. 65, Chicago.

YOU'LL Like resilvering mirrors, autoparts, reflectors, making chipped glass signs. Write Sprinkle, Plater, 127, Marion, Indiana.

MAKE Money easily, honestly. Details dime. William Scherrer, Coshocton, Ohio.

INVESTIGATE Meritorious business ideas and how operated. Write. Renseb-PM, 30 Church, New York City.

SUCCEED! Read Enterprise! 68 pages; homemaker's plans, tips, ideas. 10c. 202 Ashland, River Forest, Illinois.

POSITIONS Abroad! Where they are—how to get them. Write today for reliable, accurate information. F. Julius, Amarillo, Texas.

TURN Tin cans into money at home. Big profits. 25c easy instructions mailed. H. Chaney, 1130 East 16th Street, Jacksonville, Fla.

MAKE Color-glazed concrete pottery, gravestones, tiles, floors, walls. Basement waterproofing, etc. Booklet, details 10c. National Potteries, Minneapolis, Minn.

MAKE Artificial marble, glazed tiles, uncanny. Tabletops, plaques, floors, hones, novelties. Hard, fireproof, inexpensive, cement secrets. Brilliant tile and liquid rubber samples 3c. John A. Payn, 945 Grande Vista Avenue, Los Angeles, Calif.

WAR And oil. War equipment must have oil in exceedingly large quantities, and this fact makes our plan a "winner." We show you how to cash in concerning oil. Guaranteed legitimate. Send 25c coin. No stamps. Royal Keystone Enterprise, Berryville, Ark.

MAKE, Sell single-ingredient products! Formula catalog free. B. Kinford, Wayne, Penna.

SOUTHERN Selling agent will consider items, articles or ideas to be introduced to the trade channels of the south. We invite correspondence addressed P.O. Box 765, Charlotte, North Carolina.

NEW Profession. Earn \$8 daily. Start immediately. No canvassing. No selling. Amazing opportunity. Complete—50c coin (wrapped). Kenneth Cooke, Box 42, Sarnia, Ontario.

"THE Lord Is Coming," Get proofs. Sheal, 263 Duluth, Minnesota.

STARTLING New chrome and metal polish. Particulars, package, 10c. Rt. 2, Box 186, Escondido, California.

SELL By mail. Earn money sparetime. New folio by expert shows how. 25c. Ribot, 620 East 62nd, Chicago.

PROFIT With new products. Make, sell, repeat. Analysis. Research. Guaranteed formulas. Biggest catalog free. Nominal prices. Gibson Laboratory, Chemists, BD-1142 Sunnyside, Chicago.

MONEYMAKERS' Opportunity Digest Magazine—60 pages of real opportunities—10c. Lewis Co., 828-S Carpenter, Oak Park, Ill.

SOAP Making. Learn at home. No machinery needed. Posera, 4545-R Bartlett, Milwaukee, Wisconsin.

START Mail order book business new way. Method thoroughly proven. Substantial supply source. Help in getting started. Circular free. E. P. Pendleton, 433 S. Milton, Whittier, Calif.

BIG Profit in mold making and plaster casting. \$1.50 profit on every dime invested. Poolproof rubber. Tremendous market. Simple interesting work. 24 page instructive catalogue free. Plastic Arts, 711 Neely Muncie, Indiana.

BIG Profit making leather Xmas gifts. No tools. Materials supplied. Sample 25c. Artra Leather, 400 Joseph Ave., Rochester, N. Y.

AMAZING Profits. Day-night. Year round. No selling. Operate "Silver King" vendors. \$3.25 up. Free instructions. Automatic, 2425-A Fullerton, Chicago.

FASCINATING. Profitable "Fixit" service taught. Houigate, Station C, Pasadena, California.

OPERATE Profitable "route" four compartment vendors. Small investment. Penny King, 1233 Chouteau, St. Louis.

LET Me show you how to make 900% profit selling folios by mail. Double knockout. Free circular. The Better Products Co., Potsdam, N. Y.

START Business of your own anywhere, small investment. Camco, Duluth, Minn.

MAILORDER Opportunities—"Modern Times" Magazine, 10c. Glauser, 3220 Turner, Philadelphia, Penna.

EARN Money "Six" ways! Instructions 25c postpaid. Free details! Altiery, 1300 So. 9th, Philadelphia, Penna.

OWN Your own business made rich by depression. Part or whole time. Earn comfortable living. Dittman, Box 403-D, Youngstown, Ohio.

AFTERNOONS Free! Mr. DeHol reported \$2,000 month taken in. (Exceptional, fulltime). Work home. No canvassing! Also war-time business plan. Expect surprise! National-N. Bx1240, San Bernardino, California.

PLASTER Casters! Rubber molds, models, supplies. Pentucket Arts, Haverhill, Mass.

PROFITABLE. Complete, business plans, 25c coin. Wilbert Peterson, Godfrey, Ill.

PAYING Mail order business. Write Staebler, 79-20 45th, Elmhurst, N. Y.

HANDY Men—Earn money home operating Community "Fix-It" Shop. Stafford, Makanda, Illinois.

START Your own business. Local or mail order. Particulars, 3c stamp. Tumbsted, Box 214, Newport, Arkansas.

HUGE Profits, five valuable formulas, sales plans \$1.00. Scrivener, 407 Maple, Winchester, Kentucky.

DIME Brings three issues Moneymaking Opportunities. Sunflower Mailers, Atlanta, Kansas.

REACH Canadian cash buyers, swappers, bargains. 25 words 25c. Copy dime. "Scoop" Mailorder Magazine, St. Norbert, Manitoba.

"WINS!" Opportunities! Propositions! Employment! Send stamp. Richards, 280 Broadway, New York.

LIQUID Marble—anyone can make! Colorful, glazed! Moulded, brushed, sprayed. Rubberlastic moulds. Composition flooring. Big money in these! Particulars free. Marbleizing Service, Edwardsville, Ill.

CASH Paid for insects. See Sinclair display advertisement on page 34A.

PLASTEX Industries offers industrious men an opportunity to start a business of their own, manufacturing art goods, novelties, souvenirs, etc., in Plastex and marble imitation. 5c material makes \$1 articles. Rubber moulds furnished for speed production. Small investment brings big returns. You are just in time for big wholesale season now starting. Write for interesting booklet mailed free. Plastex Industries, Dept. A, 1085 Washington Ave., New York.

CASH In on your ideas. Let us show you how. Inventors and investors brought together. Mutual profit by new easy plan. Don't be discouraged! Write now for full, free information. Inventors & Investors Institute, 20 E. Jackson, Chicago.

JEWELRY—Bracelets, barbins, millinery ornaments, earrings, religious medals, etc., easily cast and set with imitation diamonds. Exceptional profits in this new business which offers opportunity to turn full or spare time into money. Complete outfit includes material and everything needed for production. No experience necessary. Write for free booklet describing this fascinating work. United Jewelry Manufacturers, Dept. A, 1692 Boston Road, New York.

127 WAYS To make money. In home or office, business of your own. Full particulars free. Elite Co., 214 Grand St., New York.

HOW And where to obtain capital fully explained, free particulars. Star Service, Wapakoneta, Ohio.

COLLECT Accounts by mail. \$2.00 brings sufficient forms and instructions to start your own profitable business. The Collector, Box 265, Zanesville, Ohio.

FREE Literature describing many money making plans. Brown Publishing Co., 619 So. Broadway, Los Angeles, Calif.

YOUR Own business! Selling by mail. Details free. Maples, 3418 South Marshfield, Chicago, Illinois.

ELITE Collection of business plans, contains 127 tested plans and scores of formulas. Start own business; home, office. Particulars free. Elite Co., 214 Grand St., New York.

PROFITABLE Home business. Easily started. Steady profits. Details 10c. Home Service Bureau, Box 4079, South Edmonton, Canada.

BIG Money in candy, make and sell candy for Christmas. Ten basic formulas, \$1.00. Ward Tome, 3468 W. 25 St., Cleveland, Ohio.

POSTCARD Addressed Excello Sales, Shreveport, Louisiana, brings best proposition ever received.

INCREASE Your income. Countless spare time opportunities, magazine, Sample 10c. Katz, 4254 North Kimball, Chicago.

AMBITIONS Realized! Extra income, better jobs. Fascinating hobbies, happiness! Stamp for plans. Seekay, Augusta, Maine.

LUMINOUS Paint—Shines in dark. Made easily. Sells quickly. Big profits. Formula, moneymaking instructions, \$1.00. Generous sample, details, 10c. Gordon Laboratories, 1265-D Broadway, New York.

WE Help start you in business, furnishing outfits and instruction, operating "Specialty Candy Factory" home. Men, women, opportunity to earn good steady income, all or spare time. (Our 31st year). Booklet free. W. Hillyer Ragsdale, Inc., Drawer 4, East Orange, N. J.

\$30 WEEKLY. Grow mushrooms. Cellar, shed. We buy 35c lb. Mr. B. made \$270 spare time. World's largest company of its kind. 40 page book free. Mushrooms, Dept. 701, 2019 Second, Seattle, Wash.

WANTED—Factory representatives for complete Turkish bath outfit for home use. Light, streamlined, compact. Retail \$9.95. Write today for our proven sales plan. Perspir-ator Mfg. Co., First and Utah, Toledo, Ohio.

MAIL Order business is your opportunity. Many began small, now earn thousands yearly. No personal contact. Boundless opportunities. Have had over 30 years experience; will help you succeed. Send 25c for valuable booklet, none free. B. Breniser, 257 S. 21st, Philadelphia.

COLOR Concrete with chemicals. Stucco-Rock. Cement artistry. Benches. Washings. Spin concrete pottery. Miniature castles, waterfalls. Coldglaze, water-paints, marbling. Sample 10c. Hollywood CementCraft, 8527 Wonderland, Hollywood, California.

LEARN Account collecting. Good income; quick results. Interesting folder free. National Collectors Association, Newark, Ohio.

EARN Extra money at home. Increase your income at home by new, simple Wentworth Tempera Color method. We instruct you and supply you with work. Write today for free booklet. Wentworth Pictorial Co., Ltd., Dept. 3, Hamilton, Ont.

100 PROFITABLE Mail order and local plans. Gilbert Supply, 1107 Broadway, New York.

MAKE Money by mail, the way we do. Free information. Maywood, P-1107 Broadway, New York.

MANUFACTURE From Phospholene. Cleaning fluid 1c gallon; bleach 2c gallon; hand soap 2c pound; and ten fast sellers. Sample 25c. Details free. Western, 401 Climax Bldg., Cleveland, O.

ADVERTISERS! 1,600,000 Mail order circulation. Inch advertisement, \$15.40. "Get results." 20 newspapers, 18 words, \$6.50. Diener-Dorskind, 1474P Broadway, New York.

SUCCEED With your products. Make-sell. Formulas. Accurate analyses. Catalog free. B. Thaxly Company, Washington, D. C.

I WANT To send you proof of the wonderful pulling power of Popular Mechanics Magazine's classified pages. What's your proposition? Write me today. F. W. Johnson, Manager Classified Advertising, 200 E. Ontario St., Chicago, Ill.

SELL By mail. Books, novelties. Bargains! Big profits! Particulars free. E. Elfco, 438 N. Wells, Chicago.

CHARTERS: Delaware; best, cheapest; free forms. Colonial Charter Co., Wilmington, Del.

WHERE To buy at lowest wholesale prices. Information free. Yorena, Box P-312, Bayonne, N. J.

WANT More business! 2c daily opens individual New York branch office. Co-operative Mail Service, 126 Lexington Ave., New York.

START Now. Make money by mail. Easily. Details only dime. Stan, 7 Meadow St., Bayonne, N. J.

LIVEWIRES—Operate "Commercial Reporter Plan." New. Startling. Dollars daily. Thorne's, 214 W. Trail, Jackson, Mich.

OPERATE Legitimate amusement machines. Investment required. Box 1591, Rockford, Illinois.

MONEYMAKING OPPORTUNITIES

SWEETHEART Syrup. Sensational. It's a honey. Complete directions fifty cents. Hurry. Hassell, Colton Plant, Arkansas.

YOU'LL Like resilvering mirrors, auto-parts, reflectors, making chipped glass signs. Write Sprinkle, Plater, 287, Marion, Indiana.

"MONEYMAKING Ideas" publishes practical plans how to make money today. Local or mailorder. You've never read anything like it. Sample, dime. Earl Gearhart, Fresno, California.

WORLD'S Only self-tying necktie. 1,000 patterns. Sales guaranteed. Sample 50c. One-In-Hand Tie Co., Clinton, Iowa., Dept. F.

AMAZING Opportunity. Learn to make beauty clay, women's foremost beauty aid, after shaving lotion for men. Instructions and both formulas only \$1.00. Formula Laboratory, P.O. Box 720, Texarkana, Texas.

KEY Check stamping outfits. Emblem key checks, key rings. Catalog free. Sample name and address 25c. Social security plate name number 15c. Kemp & Company, 463-P East 178th St., New York.

RAISE Rabbits. We pay to \$7.00 for young. Catalogues 10c. Rabbitries, Bowling Green, N. Y.

MILLION Articles. Buy wholesale. Valuable directory 10c. Ideal Service, DR-1, Park Ridge, Ill.

START Big paying mailorder business at home. Particulars free. Wilson Sales Service, 504 E. Wilson St., Milwaukee, Wis.

MONEYMAKING Ideas magazine—Sample copy 10c. Kenneth Parish, East Syracuse, New York.

REALIZE 97c Profit on each dollar order. No canvassing, peddling, or personal contact. Send stamp for details. J. A. Luczak, 3451 Lemoyne, Chicago.

NEW! Money making secrets. get's the orders. Details free! Samples 10c. Modern Specials, Box 6346-M, Pittsburgh, Penna.

BE Independent. Sell by mail. buy wholesale. Wetzel, Valhalla, N. Y.

INVENTIVE Minded can become independent. Explanation free! Higbee, Cantil, Calif.

READ Our war and oil ad under Business Opportunities. it's worth answering. Royal Keystone Enterprise, Berryville, Ark.

"SALES Success Stimulator"—36 packed pages point prosperity path—10c. Advertisers' Assistants, West Liberty, Kentucky.

START Mailorder business. Send 25c for big folio "How to Sell by Mail" by expert. Benty, 1741 Melrose, Chicago.

ANALYSIS. Research. Newest guaranteed formulas. Biggest catalog free. Nominal prices. Gibson Laboratory, Chemists, OS-1142 Sunnyside, Chicago.

EARN Extra money writing for publication. Simple method. Demand inexhaustible. Details free. Glen Donaghey, 17 Groton, Lowell, Mass.

SELL By mail. \$1.00 starts you. Complete layout. Particulars on request. Wade, 1023 Oak, San Francisco.

NEW Work for men and women. Excellent fee basis makes good income all or part time. Easily learned by anyone who can type and is neat. Complete instructions 25c. Free circular. E. O. Pendleton, 433 S. Milton, Whittier, Calif.

\$3.00 FOR 2 Hours work operating portable disk sharpener. Easily built. Small investment. Instructions 50c. Harvey Pickett, Garden City, Iowa.

AFTERNOONS Free! DeHol reported \$2,000 month (exceptional, fulltime). Work home. No canvassing! Expect surprise! National-T, Bx1240, San Bernardino, California.

BOOKKEEPERS: Make more money with tested, modern bookkeeping service. Inexpensive, simple. Bobertz, 3701 East Hancock, Detroit.

START 1940 Right! Using guaranteed Certified Formulas for "Sure Successes." Miller, Chemist, Tampa, Florida.

FREE Details. Home mail order business. Unique plans. Campbell's, 3231 North Dupont, Minneapolis, Minnesota.

"OPERATE" — (Specialty) sandwich stand! (Exceptional opportunity.) Davis, Bx1484, Clarksburg, West Virginia.

BIG Mail—Homework opportunities. 10c. Haussler, Station D, Cincinnati, Ohio.

MAIL Dealers! Whirlwind profits and steady repeat business selling new "Carbosome" folio. Send for circular or \$1 for folio and wholesale information. Giff's, Aberdeen, South Dakota.

WANT Money? Wonderful plan; it works; no investment. Write P.O. Box 1928, Hollywood, California.

MAKE Beautiful vases, jars, urns of synthetic pottery with my molds for few cents. Big profits. Write Morrow, 19 North "G" Street, Pensacola, Florida.

CASH. Mailing opportunity folders. Sample 3c. Bernard Hinkle, Joplin, Mo.

CASH Paid for insects. See Sinclair display advertisement on page 139A.

MONEY Making opportunities. Our magazines brim full. 25c. Drew, 710-5th, Devils Lake, N. Dak.

STEADY Income copying—selling names. Sample list with instructions 25c. Hausler, Box Six, Sta. D., Cincinnati, Ohio.

START Own telephone repair service in your farm community. Good money maker. We furnish instructions, material at low prices. Ideal sideline—Radio, electric, hardware stores. Inquire about county agency. Farm Telephone, Dept. A, Rogers Park Station, Chicago.

BE A professional scrapbooker. Big fees. Unlimited opportunities. Can be done at home. No competition. No capital needed. Write to Scrapbookers Guild, 59 Park Place, New York, N. Y.

MONEY By mail, new mailorder opportunities free. Harvey Teeple, Decatur, Indiana.

AMATEUR Cartoonists, earn cash at home. copying and duplicating cartoons for advertisers. Ad-Service, Argyle, Wis.

BE Funny, make money. Learn gag writing. Stamp brings information. Don Ullsh Studios, B-443 Wrightwood, Chicago.

BETTER Yourself. Present position—new job—or your own business. Advance, prosper, succeed. Startling free details. Write, Manager, VR Mfg. Company, Detroit Lakes, Minnesota.

MOULDS. Guaranteed, for casting toy soldiers, Indians, trappers, warships, sinker moulds, 244 kinds. Send 5c for illustrated catalogue. Henry C. Schiercke, 645 Spencer, Ghent, N. Y.

RAISE Earthworms for profit. Information free, stamp appreciated. Bureau Zoological Research, 106A Broadway, Peoria, Ill.

WHOLESALE Sources. 500,000 articles. Free directory. Maywoode, 1107 Broadway, New York.

INCREASE Your income, free literature. Ace Publisher, 60C, Maspeth, N. Y.

SMALL Business of Your Own. 1000 tried and proven methods. \$1.00. Popular Mechanics, 200 E. Ontario St., Chicago.

FORMULAS, PLANS, ETC.

BARBECUEING Pays big profits. Sauce formulas, instructions \$1.00. Lois Raines, Box 96, Salem, Ill.

3 GOOD Formulas with instructions for making gold, silver, gun-metal mirrors, \$10.00. Don't buy cheap formulas. Nashville Mirror Plating Co., 427 Broad, Nashville, Tenn.

FORMULAS—All kinds. Real money-makers. Lowest prices. Catalog free. Clover Formulary, 108-P1, Niles Center, Ill.

MOTOR Oil 2c gallon. Reclaim used oil. Formula 25c. George, 285 Queen, Germantown, Philadelphia, Penna.

FORMULAS: — "Chemist Approved." None better. Lowest prices. Catalog free. Kemico, 12-A, Park Ridge, Ill.

50 SINGLE-INGREDIENT Formulas requiring no manufacturing! Catalog free. A. Kinford, Wayne, Penna.

ANALYSIS. Research. Newest guaranteed formulas. Biggest catalog free. Nominal prices. Gibson Laboratory, Chemists, BD-1142 Sunnyside, Chicago.

FREE Formula catalog. Anything analyzed \$10.00. Western Chemical, Salem, Oregon.

START 1940 Right! Using guaranteed Certified Formulas for "Sure Successes." Miller, Chemist, Tampa, Florida.

HUNDRED Money-making formulas \$1.00. Box M, Saint Edward, Nebraska.

10,000 PROFITABLE Formulas, processes, recipes. Make most anything. 900 page book \$1.50 postpaid or C.O.D. (Foreign \$1.85). Catalog 3c. Adams-Brown Company, Chestnut Hill, Massachusetts.

FORMULAS: 15 Proven moneymaking formulas \$1.00. (Not stock-formula catalogue stuff), real unusual offers. List free. Marvel Laboratories, 6629 No. Maplewood, Chicago.

REAL Manufacturing formulas. Lists free. Cummings, Chemist, Gordon Avenue, Syracuse, N. Y.

THAXLY Formulas for perfect products. Accurate analyses. Catalog free. B. Thaxly Company, Washington, D. C.

FORMULAS. Latest money makers. Literature free. Belfort, 4042 N. Keeler, Chicago.

ELITE Formulas and plans; make and sell your own products. Descriptive booklet free. Elite Co., 214 Grand St., New York.

CHEMISTRY

FREE Catalog. Chemistry, mineralogy, biology, microscopes, telescopes. Tracey Laboratories, Evanston, Illinois.

FREE: 40 Page catalog of chemical and laboratory supplies for amateur chemists. Wollensak microscopes and supplies, scientific books at big discount. JE-1 Winn, 124 West 23 Street, N. Y. C.

CHEMISTRY Course at bargain. Particulars, A. Shapereau, 620 E. 8th St., Brooklyn, N. Y.

HANDBOOK For chemical experimenters, hundreds of experiments, illustrated, 50c. Experiment booklet 15c. Chemical catalogue 5c. Reading Scientific Company, Reading, Penna.

GROW Plants indoors in water. Chemicals and directions 25c coin. Monroe Laboratory, Box 271, Rochester, N. Y.

CHEMICALS, Laboratory, glassware, apparatus. Send 3c for catalog CP1. Biological Supply Company, 1176 Mt. Hope Avenue, Rochester, N. Y.

CHEMICALS In 5c quantities. Catalog 5c. Fleischer's Laboratories, Everett, Mass.

SPECTROSCOPE For quick chemical analysis \$2.50. Kutting Sons, Campbell, California.

FREE Chemistry catalog. Supplies at 5c! Equip complete laboratory. Send 3c for postage. Kemkit Scientific Corp., 397P Bridge St., Brooklyn, N. Y.

HELP WANTED

EARN Cash at home! M. M. earned \$267.00, three weeks raising mushrooms in cellar! Exceptional, but your cellar, shed perhaps suitable. Materials furnished. Starting crop guaranteed. We buy all crops. Book free. United, 3848 Lincoln Ave., Dept. 66, Chicago.

EVERY Employed person your customer! Rare opportunity for clerks, factory, mill or office workers to earn extra money! 50% commission selling social-security, life-time plates and cases. Send 10c with your social security number. Wm. Hament, 665 W. Lexington Street, Baltimore, Md.

SALARIED Positions—\$2500 yearly and up. Let us find one for you. Write for valuable information. Executive's Promotion Service, (16), Washington, D. C.

\$30 WEEKLY. Grow mushrooms. Cellar, shed. We buy 35c lb. Mr. B. made \$270 spare time. World's largest company of its kind. 40 page book free. Mushroom, Dept. 701, 2019 Second, Seattle, Wash.

AGENTS WANTED

YOUR Hose free with outfit. Make up to \$32.50 in a week taking orders for amazing new hosiery. Replacement guaranteed against holes, snags, runs. Rush name, hose size. Wilknit, Desk AA-37, Greenfield, Ohio.

STRANGE Ironing cord! Abolishes kinks, snarls. Prevents scorching. Saves time. Saves work. Saves electricity. 100% profit. Exclusive territory. Big offer free. Neverknot, Dept. 1-A, 4525 Ravenswood, Chicago.

STEADY Profits: New improved wax furniture polish. Private brands; your name. P. O. Box 247, Newport, R. I.

AGENTS: Smash go prices! Santos coffee 12c lb. 4-oz. vanilla 8 1/2c. Razor blades 10 for 8 1/2c. 100 sticks chewing gum 12c. 150 other bargains. Premiums. Experience unnecessary. Carnation Company, P. O. St. Louis, Mo.

CAR-OWNERS To put up our signs. Fine offer for anyone traveling. (Not for kids.) Get details. Atlas Sign Works, 7941 Halsted, Chicago.

TWO Way flashlight. Brilliant spotlight ahead—closeby illumination as well. May Mfg. Co., C-2, 724 Sacramento, Pasadena, Calif.

POLMET Polishing cloth removes tarnish from metals without the use of liquid, paste or powder. Agents say it sells like "hot cakes." Retail 25c. Sample free. Gale & Co., Inc., 15 Edinboro St., Boston, Mass.

AT Home, your own manufacturing business, making popular \$1 novelties. Cost you 3c to 15c. Everything supplied. Write So-Lo Works, Dept. C-842, Cincinnati, Ohio.

BEAUTIFUL Christmas signs selling fast. Beauty and tailor window signs 14x22, slogans 7x11. Free list. E. Z. Display Signs, 4614 Montana, Chicago.

MAKE And sell your own products. No machinery needed. Amazing profits. Guaranteed "Chemist Approved" formulas. Catalog free. Kemico, 10-A, Park Ridge, Ill.

500% PROFIT With new perfected (1940) quick-action, no flint, automatic gas lighter. Retail 25c. Sample 10c. New Method Co., Box PMH-84, Bradford, Penna.

100% PROFIT. Selling new ZZ Salve. Needed by everyone. For muscular aches, pains, sprains, rheumatism, etc. Send 50c for sample jar. Desk 213, ZZ Products, 5948 N. Paulina, Chicago.

SILK-TEX—Sells in every home. 100% profit. Sample 10c. Bunn, 218 S. 40th St., Philadelphia, Penna.

10c BOOKLET, "How to shave wisely," fast seller, direct and through stores. Tremendous discounts. Sample 10c (refundable). Razor Research, 130 Water, New York.

MAKE 125% On new motor accessory. Agents write Magic Co., 417 S. Spring, Sioux Falls, S. Dak.

MEXICAN Curios sell on sight. Large profits. Free particulars. Samples 10c stamps. Marquez-PR, Apartado 1176, Mexico City.

BUSINESS Proposition resilvering mirrors, autopaarts, reflectors, making chipped glass signs. Write Sprinkle, Plater, 128, Marion, Indiana.

COMBINATION Iridium tipped pen and pencil for few minutes spare time. Veltex Co., M-1, Birmingham, Ala.

SELL Magic lines. Samples 10c. Willits Service, South Milford, Ind.

AGENTS, Easy money. Instruction for making instant penetrating oil. Best on the market. 300% profit. Steady repeater. Instruction for making and selling only \$1.00. W. A. Farnsworth, 801 W. Main St., Bellevue, Ohio.

100% PROFIT In new perfected 1940 quick action self-starting cigar lighter. No flint or friction. No wind can blow it out. Retail 25c. Costs you \$1.75 dozen. Sample and can fluid 25c. New Method Company, Box PM-85, Bradford, Penna.

GOOD Paying business silvering mirrors, plating autopaarts, reflectors, bicycles, bathroom fixtures by late method. Free particulars and proofs. Gunmetal Co., Ave. N, Decatur, Ill.

NOVEL Kitchen article. Multiple repeat sales. No competition. 100% profit. Details, sample 25c. Cache Co., Box 728, San Diego, Calif.

POLISHING Cloth for all metals, wood, glass. Repeater. Regent Products Co., 19 West Jackson Blvd., Chicago, Illinois.

READ Our war and oil ad under Business Opportunities, it's worth answering. Royal Keystone Enterprise, Berryville, Ark.

MEXICAN Glass novelties, sample dime. Deluxe Creations, Box 944, Laredo, Texas.

SURE Winner, big sales. Elkin electric shaver. Guaranteed. Clean close shave. Retail 3.00. Wholesale \$12.00 doz. Sample postpaid \$1.50. National Supply, Fosston, Minn.

COLLECT 50c From each person wearing eye glasses selling our anti fog. Prevents glasses from sweating and fogging in cold weather. Jobbers wanted. Gold mine for pitchmen. Sample 50c. Queen City Chemical Co., 724 W. Trade St., Charlotte, N. C.

PROFIT With new products. Make, sell, repeat. Analysis. Research. Guaranteed formulas. Biggest catalog free. Nominal prices. Gibson Laboratory, Chemists, BD-1142 Sunnyside, Chicago.

ACCELERATE Your automobile with either foot. Eliminates right foot fatigue. Easily attached. Fits all cars. W & S Manufacturing Co., Dept. A, 4929 N. Kedvale Ave., Chicago.

WANTED! Agents to sell nationally guaranteed, popular priced, domestic electric refrigerators, direct to consumer. Commissions up to 50%. Gennett & Sons, Manufacturers, Richmond, Indiana.

MAKE Over 1100% profit. Save buyers one half. New home and office necessity. Quick repeats. Start now. Send 25c for sales outfit, samples retailing for \$1.10. Money back if dissatisfied. Tab Products, 2154-A Walton, Chicago.

NEW—Different—Gas station "Service Signals." Knipp Specialty, Long Beach, Calif.

REPEATING Profits selling our aluminum polish in every home. Royal Supply Co., Fairhaven, Mass.

BRAND New, super power auto product. Millions waiting. Harmless—guaranteed. Possibilities unlimited. Thermo-Exolene, Peoria, Ill.

SENSATIONAL Device cuts, trims own hair. Also manufacturing formulas. Plaza Laboratories, AX 1561 North Clark, Chicago.

FAST Selling ladder specialty, liberal commissions, extra profit for installation. P. O. Box 349, Oak Park, Ill.

NEW Furniture polish and cleaner, 230% profit. Have 25 salespeople in Chicago selling nothing else, house to house. All year repeat business. Your name and address on labels. Exclusive territory. Lynbury, Dept. K, 2601 Armitage, Chicago.

PROFITS—Made quickly introducing marvelous new All-Lead pencils. Lightning 10c retailer. "Always a writing point." Outlast wood pencils 25 to 1. Sell individuals, also attention-getting counter cards. Quick repeats build permanent business. Windsor, 41-A Cortlandt St., New York.

BRAND New item for agents, salesmen. Just out. Sells on sight. Every man needs 3 to 12. Rush name for money-making offer. Remark Mfg. Co., Dept. 8, Butler, Ind.

CELLAR-DRY. Waterproofs wet cellars on inside. New guaranteed chemical treatment. Big easy profits. Staminite Corp., Dept. 60, New Haven, Conn.

FAST Selling perfume novelties. Big profits. Vassar, 332-P Washington, Hoboken, New Jersey.

GRAB This amazing product. Proven by three years actual use. Seals punctures automatically. Run ice-picks into tires without losing air. Auto and truck owners amazed and delighted. Whirlwind seller. Salesmen can make \$100.00 per week. Distributors \$1,500.00 per month. Write immediately. Air-Seal Distributors, Inc., 8053 Beverly Blvd., Los Angeles, Calif.

NEW—Cap and handle makes pitcher out of milk bottle. Premium and home use. Sample 25c. Kapsit Co., Winona, Minn.

MYSTERY Invention, carried in pocket, keeps hands, feet, ears, body warm on coldest days. Lasts years. Everybody buys—workmen, housewives, schoolboys, farmers, others. Low prices—big profits. Write quick. Kumfy Warmer, Dept. A-2301, Cincinnati, Ohio.

SELL Artistic oil painted personal portraits. Portraiture, 2637 Evergreen, Chicago.

AGENTS—300% Profit selling gold leaf letters; stores and offices. Free samples. Metallic Letter Co., 438-B North Clark, Chicago.

AGENTS—Opportunity make money; book containing 127 successful business plans; home-office; send for free introductory booklet. Elite Co., 214 Grand St., New York.

DANDY Seller. Good profits. Details free. Societe Cent Quarante, Valley City, N. Dak.

NEW 10c Seller. Costs 1c. Western, 432 Climax Bldg., Cleveland, Ohio.

SELL Fascinating Jitterpups and carded merchandise. Dixie Supply, Rosslyn, Va.

DRESSES 10c. Hats 40c. Shoes 50c. Many other bargains—Used merchandise. Free catalog. Send name on postcard. Fairmount, 160PM, Monroe Street, New York.

AGENTS Make big profits on food products, bargain deals. Low wholesale prices. Rush name for trial outfit offer. Ho-Ro-Co, 2810-T Dodier, St. Louis, Mo.

AGENTS—To mail our literature. Good profits. Home business. Maywood, 1105-1107 Broadway, New York.

SUCCEED With your products. Make-sell. Formulas. Accurate analyses. Catalog free. B. Thaxly Company, Washington, D. C.

ENGRAVED Name plates, numbers, signs, etc., easily sold, profits large. Brett Bros., Winthrop, Mass.

DO You want agents for your proposition? Your ad in this space will place your message before hundreds of men seeking fast-selling products. My folder "How to Secure Agents," is filled with proof. I'll gladly send you a copy free. F. W. Johnson, Manager Classified Advertising, Popular Mechanics Magazine, 200 E. Ontario St., Chicago.

BIG Money applying initials on automobiles. Easiest thing today. Free samples. Also, sideline salesmen for short order decalcomania name plates. "Ralco," 1305 Washington, Boston, Mass.

BIG Money applying initials on automobiles. Write for particulars and free samples. American Letter Company, Dept. 40, Dunellen, New Jersey.

MANUFACTURE Specialties, hire agents yourself. Big money. Free literature. Gilbert Supply, 1107-P Broadway, New York.

REVOLUTIONARY Window cleaning tool. Good Housekeeping approval. Only ten \$2.25 sales daily to housewives, factories, schools, stores will make you \$350.00 monthly. Carter Products Corp., 900 Front Ave., Cleveland, Ohio.

FREE Sample—Amazing cleaner; sells homes, taverns, everywhere. Big profit—fast repeater. Betco, 5007 Irving Park, Chicago.

AGENTS: Stamping names on pocket-key protectors. Sample check with your name, address, 25c. Stamping outfits. Emblem checks, check-fobs, name plates. Hart Mfg. Co., 303 Degraw St., Brooklyn, N. Y.

HIGH-GRADE SALESMEN

CLEAR Up to \$10 daily. Offer deluxe family Bible—\$1.95. Experts say worth \$5. Average \$1 profit. Size, 8 $\frac{3}{4}$ by 11 $\frac{3}{4}$. Every home, church a prospect. Amazing value makes fast sales. Westcraft, Dept. 213, Racine, Wis.

ADVERTISING Book matches—Sell union label book matches. Fastest selling line in America. Large sales producing kit, sample matches, complete cut catalog, eight color combinations make selling easy. Commission in advance. Superior Match Co., 7530 Greenwood, Dept. M-1, Chicago.

A REAL Future for you with Red Comet Automatic Fire Extinguishers. Low price. Proved seven years. Splendid sales outfit free. Some good territory open. Exclusive. Write quick. 704 Red Comet Building, Littleton, Colorado.

NEW Specialty—Sells every business and professional man. Four \$15 sales daily pay \$280 weekly. Farrell cleared over \$1,000.00 monthly. Write F. E. Armstrong, President, Dept. PM, Mobile, Ala.

BIG Commissions—Selling to stores celluloid pricing tickets, metal shelf moulding. To restaurants, menu covers, signs. P. Pricing Press, 124 White St., New York.

LOCAL Agents wanted to earn bonus suits and demonstrate to friends. Up to \$12 in a day easy. Experience unnecessary. Valuable demonstrating equipment, actual samples absolutely free. H. J. Graves, 1300 Harrison, Dept. B-817, Chicago.

MAGIC Clothes brush. Revolutionary invention. "Erases" dirt like magic. Saves drycleaning. Sensational seller. Samples sent on trial. Rush name. Kristee 114, Akron, Ohio.

SALESMEN: America's finest sideline. 40% commission daily. 725 fast selling repeat items. Every business uses and must buy. No investment now or ever. Sales portfolio free. Willens, 2130 Gladys, Dept. RF, Chicago.

OPENING For several good men, absolutely new trade stimulator; sells all dealers; good commission; good territory. Master Fine Arts Studio, Chattanooga, Tenn.

SELL Complete line business necessities—over 1000 items. 50% savings to every merchant. Experience unnecessary. Samples free. Commissions advanced. Northwestern, 625-RP Jackson, Chicago.

YOU Can beat competition yet make up to 40% comm. plus cash bonus. Biggest line restaurant checks, etc. Book matches, salesbooks, standardized printing for all businesses. Popular prices. Outfit free. Nationwide, 160-MB N. Wells, Chicago.

3 SALES Make \$9.00 daily. Inexpensive business stimulator. New idea. Selling prospectus 25c. Grasco, Alton, Illinois.

SELL Printing at cut prices. 500 book matches \$1.50; 2,000 business cards \$1.50; 1,000 envelopes or statements, etc. \$1.75; 25 printed sales books \$1.50; 1,000 process embossed cards \$1.50; 2,000 two-color labels, free holder \$1.50; 2,500 printed handbills \$1.75. One-third comm. Free outfit. Bargain Prtg. Co., 189-F W. Madison, Chicago.

DON'T Be a job hunter—Start your own business on our capital. No hard times; no lay-offs; always your own boss. Hundreds average \$3,000 to \$5,000 annual sales year after year. We supply stocks, equipment on credit. 200 home necessities. Selling experience unnecessary. Wonderful opportunity to own pleasant, dignified, profitable business backed by world-wide industry. Write Rawleigh's, Dept. AU-PPM, Freeport, Ill.

SELL A complete line of specialties. Alvin Swanson, Oelwein, Iowa.

ADVERTISING Book matches—World's largest "direct selling" book match factory offers advance cash earnings calling on every type of business. Experience unnecessary; full, part time. Low prices for high quality; quick deliveries, help you get orders. Good repeat profits. Free kit, instructions. Match Corp. of America, 3433 West 48th Pl., Dept. E-1, Chicago.

\$3,000 PROFIT In six months by Poster. Over \$6,000 in one year by Felton. Over \$30.00 daily for 90 days by D. F. P. All selling our special tool set to garages. Exclusive territory. Mesco, Beaver City, Neb.

CLEVER New auto accessory. Motorists buy on sight. Inalco, 823 Plymouth Bldg., Minneapolis, Minn.

EXCELLENT Sparetime profits! Taking subscriptions—2500 magazines. Pines, Dept. 131, 583 Monroe, Brooklyn, N. Y.

MAN Wanted—Trustworthy, steady worker. Manufacturer established 50 years will finance responsible man with complete stock of guaranteed food, farm and household necessities—you pay when sold. Mighty attractive proposition. Be your own boss. Pleasant outdoor work. Experience not necessary. No slack seasons or layoffs. Products well advertised on popular radio stations including WLW, Cincinnati, WSM, Nashville, WHO, Des Moines, and others—a big help to success. Write for no investment offer. McConnon and Company, Room MA 66, Winona, Minn.

DRESSES 10c. Hats 40c. Shoes 50c. Many other bargains—used merchandise. Free catalogue. Send name on postcard. Fairmount, 162PM Monroe Street, New York.

BLADES. Finest quality. Factory prices, postpaid. Ace Blades, Buffalo, N. Y.

EXCELLENT Opportunity selling our complete line of brushes, largest commissions. Write for sales plan. Wire Grip Sanitary Brush Company, 2300 5th Ave., New York.

EDUCATIONAL AND INSTRUCTION

YOU, Too, can have your own profitable, lifetime business. Operate a collection-credit bureau. Capital unnecessary. Free literature. Cole Associates, Syracuse, N. Y.

STEADY Job—good pay. Be an expert meat cutter. Sound, essential business. People must eat. Demand for trained meat cutters greater now than ever before. Intensive, short course, actual practice makes you a fully qualified, experienced, union meat cutter (union card guaranteed—furnished free) on completion of course in six weeks. Job help. Pay after graduation. Write for details. We have no salesmen. National School of Meat Cutting, Dept. U-3, Toledo, Ohio.

AIR Conditioning—Electric refrigeration. Rapid growth creates big demand for trained men. Earn up to \$35-\$50 weekly. Write for free facts. Utilities Engineering Institute, 404 North Wells, Dept. 101, Chicago.

"UNCLE Sam" jobs. Many 1940 appointments expected. Start \$105-\$175 month. Prepare for next examinations. Common education usually sufficient. Particulars—list positions, free. Write today. Franklin Institute, Dept. W3, Rochester, N. Y.

INVENTIVE Minded can become independent. Explanation free! F. Higbee, Cantil, Calif.

WATCH Repairing is steady profitable work. Experts always in demand. You can learn watchmaking trade at home, spare time. New original instruction system. Script engraving course included. Write for free details today! Nelson Co., A-2001 Manhattan Building, Chicago.

AMAZE With extraordinary memory! Make learning easy! Remember names-dates-facts-ideas with incredible ease. "Super Memory" course tells how. Complete 7 lessons \$3.00. Details free. Info Co., Box 1122, Chicago.

READ Our war and oil ad under Business Opportunities, it's worth answering. Royal Keystone Enterprise, Berryville, Ark.

ELECTRIC Welding pays good money. Jobs everywhere. Our short course trains you. Write for information. Welding Company, 4100 Paul Street, Philadelphia, Penna.

STRONG Man course 10c. 60c dozen. Sid's System, Southgate, California.

LOCKSMITH Instructions. Lock picking, key fitting, etc. \$1.00 prepaid. Locksmith, Canadian, Texas.

CLAIM Adjusting. Excellent pay. Investigate tragic accidents, fires; outwit fraudulent claimants. Burns School, Keystone Building, Pittsburgh, Penna.

NEWSPAPER Jobs—Learn practical reporting, freelance journalism from experienced editors by mail. The Millers, 10 Bakersfield, California.

DRAFTING Jobs often pay \$175.00-\$500.00 month. Qualify now. Details free. Write Monroe Institute, PM-101, Alton, Illinois.

CHEMICAL, Electrical, mechanical books. Catalogue, stamp. Kraftsmen's Press, Coscob, Conn.

HOME Study and degree—Psychology, Metaphysics, Bible, Philosophy. Free catalog. College of Universal Truth, 20 East Jackson, Chicago.

BIG Pay trades you can learn in a few weeks. Decorating, paperhanging, graining, marbling, card writing. Enroll now. Booklet free. Chicago Painting School, 102 West Lake Street, Chicago, Illinois.

HIGH School French, English, expert mail tutoring, exam coaching; details, stamp. V. Doherty, 4821 47th, Woodside, N. Y.

HOW To secure a gov't job in the classified civil service. Railway postal clerk, \$1900 a year. Postal clerk, city mail carrier, \$1700. Other jobs, \$1260 to \$2100. Our method helps you pass exams. Men-women, age 18 to 50. Send for free book. Patterson School, 8C Mercantile Bldg., Rochester, N. Y.

MASSAGE, Hydrotherapy, dietetics, drugless therapeutics, chiropody, taught by mail. Evans Correspondence School, Montgomery, Ala.

LEARN Auto mechanics, body repairing, welding electricity, refrigeration. Diesel. Stevinson's, 2008A Main, Kansas City, Mo.

TELEGRAPHY Taught thoroughly. Railroad retirement act creating opportunities for new operators. Expenses low. Catalog free. Dodge's Institute, Hiatt Ave., Valparaiso, Ind.

SECRET Investigation. Experience unnecessary. Detective particulars free. George Wagner, M-2640 Broadway, N. Y.

PLAYS, STORIES, MANUSCRIPTS

HUMOR Pays! 44 cartoon idea markets, 15 cartoonists wanting gag ideas, 43 jokes, skits, short humor markets, 50 surprise "free money" markets. Selling tips. Instructions. All 50c. 50 paying poetry markets—10c. Market lists, services—all writing fields. Particulars free. Harry Bierman, M-1440 Broadway, New York, N. Y.

BECOME Better playwright through detailed constructive criticisms. Send \$1 with manuscript. Good ones published. National Play Publishers, Box 42, Kenmore, N. Y.

EARNEST, Ambitious student-poets expertly trained. Publicity help. Artistic penlettering, poetry, prose. Romatka, 25 West 3rd Street, New York.

SONGS Wanted—Completed manuscripts considered for publication. Poems if found suitable. Legitimate talent encouragement. Cinemat Music Publishing Company, Hollywood, California.

BEAUTIFUL Original poems written upon request. 25c. L. Krannick, Pekin, Illinois.

SHORT Stories revised, typewritten, marketed. Hursh, Box P-1013, Harrisburg, Penna.

CARTOONING, COMMERCIAL ART, SHOWCARD WRITING, SIGN PAINTING

HAVE Your own money making business. Learn show card writing, sign painting. Write for details. Begley Specialty, 1472P Broadway, New York.

CARTOONING, Sketching, etc.—46 lessons, 600 illustrations, including drawing paper, pens, pencils, \$1.00 complete. Fraba Service, Cashton, Wisconsin.

CARTOON Sales Guide Monthly. Two issues 25c (coin). Lavalette, West Virginia.

ART Magazine including directory art books—free! Send 10c postage. Art Headquarters, Doty Street, Madison, Wisconsin.

LEARN Cartooning for profit. Leon Gray School, Box 1901, Dallas, Texas.

BE A professional sign writer right from the start with Showcarder. No training necessary. Make signs that sell. Write Showcarder, 524½ North Prior Avenue, St. Paul, Minnesota.

AMATEUR Cartoonists, earn cash at home, copying and duplicating cartoons for advertisers. Ad-Service, Argyle, Wis.

LETTERING Patterns, free literature. Sample alphabet 5c. Display Letters, Box 28, Ft. Hamilton, Brooklyn, N. Y.

PEN And ink drawings. Let us draw your advertising and catalogue illustrations, from photos, copies or objects. Best work and fair prices. Heraldic Studios, 1914P Oakdale Avenue, Chicago, Ill.

ADVERTISING AGENCIES, LETTER WRITERS, FOR ADVERTISERS

LEARN Advertising at home. Easy practical plan. No text books. Common school education sufficient. Interesting booklet and requirements free. Page-Davis School of Advertising, 3601 Michigan Avenue, Dept. 3439, Chicago.

MAIL-ORDER Ad reaching 1,500,000 families throughout United States \$15.40 inch. Newspaper, magazine, rateguide—stamp. Chicago Advertising Agency, 20-P West Jackson, Chicago.

ADVERTISE: 24 Words, 149 newspapers \$6.50. Lists free. Advertising Bureau, 4515-C Cottage Grove, Chicago.

LETTERS Written to secure jobs. \$2. B. H. Allen, 122 S. Michigan, Chicago.

INCH Display advertisement 30 magazines, year \$24. Wood's Popular Services, Atlantic City, N. J.

FOUR-LINE Ad, 185 newspapers, \$5.28. Lists free. Fidelity Advertisers, W-3838 Washington, Chicago.

DIRECT-MAIL Advertising services. Sales letters that sell. Mailing lists. Omaha List & Letter Co., Box 2172, South Omaha, Nebr.

ADVERTISING Placed all magazines, newspapers, radio. Lowest rates. Free service. 54 page rate book free. Baker Advertising Agency, A-189 West Madison, Chicago. Successors to Ankrum. Established 28 years.

FREE—New Advertisers Rate Guide, 44 pages. Includes everything. Lowest rates. E. H. Brown Advertising Agency, 140 S. Dearborn, Chicago.

BUSINESS SERVICE

WASHINGTON, D. C., mailing address. Mailing Service, Suite 1204, 1343 H St. Northwest, Washington, D. C.

COLLECT Your bad debts. Merchants write Lamont Company, Beacon, New York.

RELIABLE Information, any subject \$1.00. Start profitable business making artificial marble, details 3c stamp. American Business Service, 79 Madison Ave., New York.

RUBBER STAMPS AND OFFICE SUPPLIES

CUSHION Stamps: 2 lines 25c, 3 lines 35c, signatures \$1.50. Stamp Works, Hastings, Nebr.

CUSHIONED, 3 Lines 35c. Stamp Works, Box 402, Youngstown, Ohio.

ORIGINAL, Cushion mounted. One, two lines, 25c; three 35c; four 45c; facsimile signatures \$1.50. Stamp Works, 814 Bradley, Peoria, Ill.

2 LINES 25c, 3 Lines 35c. Stamp Works, Auburn, Nebr.

TYPEWRITERS, DUPLICATORS, OFFICE DEVICES

PRINT Own post cards, stationery, circulars, etc. Miniagraph stencil duplicator complete with supplies \$2.95. Universal, 4106 West 22nd Place, Los Angeles, Calif.

MULTIGRAPH Lines (cast in five inch lengths), Box 4464, Philadelphia.

MULTIGRAPH, Electric, model 36, like new. \$95.00, 8041 Exchange, Chicago.

NEW Remington portable \$24.50. Free trial. Easy payments. Ruppenthal, Lawrence, Kansas.

NEW \$3.75 Automatic adding machine. Fully guaranteed. Bassett, Box 302-A, Altadena, California.

TYPEWRITERS, Adder, mimeograph, multigraph, addressograph. Send for free lists of machines that will help you at half price. Pruitt, 28 Pruitt Bldg., Chicago.

INCREASE Business now. "Excellograph" Rotary Stencil Printer reprints thousands everything you typewrite, handwrite, draw or trace. Colors. \$19.75 to \$44. Terms. Illustrated literature free to business or professional men. Pittsburgh Typewriter Supply, Department K-2, Pittsburgh, Penna.

PRINTING, MULTIGRAPHING, MIMEOGRAPHING, GUMMED LABELS

BOND Letterheads, envelopes, \$2.75 thousand. Samples. Anything quoted. Irelan Printing Co., Berkeley Heights, Route 7, Dayton, Ohio.

PRINTING Prices lowered. Excellent work. Floyd W. Hearn, Mt. Vernon, Ohio.

SOCIAL Printing, lowest prices, send for samples. Moulblow, 26 Chestnut, Rosebank, N. Y.

HAMMERMILL Letterheads, any color paper, ink; 300 8½x11, \$1.48 postpaid. 30 styles type. Free particulars. Woodruff's, 217A Lewis, Duluth, Minn.

ATTRACTIVE 2-Color shipping labels, business cards \$1.00 thousand. Quantities cheaper. Stickers, blotters, Hammermill bond letterheads, envelopes, displays, folders, etc. Cut prices. Prepaid. Free samples. Certified Printers, 708-C Madison, Chicago.

PRINTING. One dollar specials. Menten, 9313D Glenwood Road, Brooklyn, N. Y.

PRINTING—Lowest prices in America. Samples free. Pitz, Middle, Iowa.

EXPERT Typewritten reproductions, letters, pricelists, etc. 100 copies 8½x11—\$1.00. Additional hundreds 20c. Includes paper! Letter-Shop, Dept. P, Cedar Rapids, Iowa.

500 TWO-COLOR Stickers, 50c. Free catalog. Cott's, Spickard, Missouri.

125 8½x11 TWENTY Pound bond letterheads and 125 6¾ envelopes \$1.00 postpaid. Benneville, 907 West Roosevelt, Philadelphia.

1000 BUSINESS Cards \$1.00. Vellum, free cuts. Dixie Business Card Co., PM189 Jefferson, Memphis, Tenn.

200 6¾ ENVELOPES Neatly printed, \$1.00 postpaid. D. Matuska's, Girard, Ill.

PRINTING And mimeographing. Best prices. 150 envelopes \$1.00, 1000 letters mimeographed \$3.25. Printex, Vinton, Virginia.

QUALITY Printing, lowest prices. Free samples. M&M Printing, West Frankfort, Ill.

MULTIGRAPHING—500 Letters just as if typewritten. \$1.70 (20 lines). Multi-graphers, Ashland, Virginia.

1000 BUSINESS Cards post paid \$1.00. Superbo Print, Room 303, 815 So. Hill, Los Angeles, Calif.

PRINT Anything reasonable. Samples free. Hamilton Press, 4341 P. Meade, Chicago.

1000 NEAT Business cards \$1.00 postpaid. Taft Co., Box 5366, Chicago.

MIMEOGRAPHING, Printing, 250 letterheads 75c. Wickesser, Prospect St., Holyoke, Mass.

LETTERHEADS, Envelopes, statements, circulars, etc., 1000—\$1.75. Expert workmen. Stoddard's, Delmar, Iowa.

LETTERHEADS, Envelopes, statements, 6/9 circulars, 500 \$1.50. Franklin Press, 80 William, Nutley, New Jersey.

SHIPPING Labels—\$1.75 1000 up, postpaid. Samples free. Specialty Sales, 3064 5th, Chicago.

500 REGULAR Letterheads, envelopes, statements, billheads \$1.00, 5000 \$7.50. Carter, Box 52, Orange, Calif.

200 8½x11 BOND Letterheads, 200 6¾ envelopes \$1.00 postpaid. Franklin Printery, 2932 Pershing, Chicago.

50 SHEETS, 20 Envelopes, 25c postpaid. Western Stationery, Topeka, Kansas.

NEED Printing? Good work, service, low prices. Samples free. Lonelm Press, Paulding, Ohio.

BETTER Grade printing, free trade illustrations. Reasonable. Economic Press, Leonia, N. J.

500 ¾x2¼ FOUR Line gummed stickers, 25c. Moritz Printery, Saginaw, Mich.

PERSONAL Stationery. Exclusive styles. List. Flentge, 1564 Thacker, Des Plaines, Ill.

PRINTING OUTFITS AND SUPPLIES

PRESSES, New type that satisfies. Lists 3c. Landis, Richland, Penna.

CUTS To order, proofs, list, free. Moritz Printery, Saginaw, Mich.

ZINC Cuts, 2x3, 70c; 2x4, \$1.25. Cozatt, Danville, Ill.

NEW Type 29c font. Catalog dime. Box 123D, Jackson, Michigan.

SPECIAL—Six useful dance, business, fraternal cuts 50c. Republic, 7150 Cottage Grove, Chicago.

PRESSES \$4.00. Complete equipment. Send stamp. Bradshaw, 3214-P Huron, Chicago.

PRINT Your own cards, stationery, circulars, advertising. Save money. Easy rules furnished. Print for others, big profits. Junior outfits \$8.25, senior outfits \$16.55 up. Details free. Kelsey Presses, H-11, Meriden, Conn.

USED Presses, type, supplies, Lists 3c. Turnbaugh Service, Loysville, Penna.

BARGAINS—Presses, type, supplies. Send stamp. 159 Harvard, Cambridge, Mass.

HAND Presses, type and complete printers' supplies. Send stamp for catalog and new price list. P. Peiffer & Co., Newark, N. J.

PATENT ATTORNEYS

INVENTORS: Send immediately for your copies of our new free books, "Patent Protection" and "Suggestions on Selling an Invention." Sixty-eight pages of interesting facts. They tell how Patent Laws protect you; kind of sketch or model needed; simple steps to take without cost; how successful inventors have secured financial assistance; show interesting inventions; illustrate important mechanical movements. With books we also send free Evidence of Invention form to help establish date of disclosure. Prompt service, reasonable fees, special deferred payment plan. Strictest secrecy. Forty-two years' experience. Highest references. Write us today. The facts in our books are worth money to the man with a good invention. Address: Victor J. Evans & Co., Registered Patent Attorneys, 561-A Victor Building, Washington, D. C.

INVENTOR'S Universal Educator: contains 900 mechanical movements; 50 perpetual motions; instruction on procuring and selling patents and selecting an attorney, etc. Suggests new ideas. Price \$1 postpaid in U.S.A. Address Albert E. Dietrich, 511-B Colorado Bldg., Washington, D. C.

PATENTS. Gerald P. Welch, Registered Patent Attorney, Plankinton Arcade, Milwaukee, Wisconsin.

PATENTS—Trade marks. Preliminary advice, book and disclosure form free. Personal service. Irving L. McCathran, 1060 International Bldg., Washington, D. C. Registered Patent Attorney.

PATENTS—Before too heavy an outlay of time or money is made on an invention, a search of the Patent Office records should be made to determine as nearly as possible whether or not the same idea has been patented before. The cost of this search is small, while the value of the facts it uncovers is often considerable. We offer inventors and manufacturers a thorough, prompt, confidential search service—plus experienced counsel and assistance in every phase of patent and trade-mark practice. Write for our new free book containing valuable information relating to patent procedure. Clarence A. O'Brien, Registered Patent Attorney, Dept. OA1B, Adams Bldg., Washington, D. C.

PATENTS. Send for our new bulletin on patents. R. & S. Engineering Co., 17 East 42nd Street, New York City.

INVENTORS—Send for free booklet "Patent-Sense." Information based on 64 years experience. Lacey & Lacey, Dept. 5A, 635 F St., Washington, D. C.

INVENTORS—Before disclosing your invention to anyone send for form "Evidence of Conception"; "Schedule of Government and Attorneys' Fees" and instructions. Sent free. Lancaster, Allwine & Rommel, 411 Bowen Building, Washington, D. C.

"INVENTOR'S Guide," 100 mechanical movements, free; advises on patenting, selling inventions. Frank Ledermann, Tribune Bldg., New York.

L. F. RANDOLPH, 302-B Victor Bldg., Washington, D. C. Low cost. Book and information free.

PATENTS. Booklet free. Highest references. Best results. Promptness assured. Watson E. Coleman, Patent Lawyer, 724 Ninth St., Washington, D. C.

FOR INVENTORS

PATENTS—Before too heavy an outlay of time or money is made on an invention, a search of the Patent Office records should be made to determine as nearly as possible whether or not the same idea has been patented before. The cost of this search is small, while the value of the facts it uncovers is often considerable. We offer inventors and manufacturers a thorough, prompt, confidential search service—plus experienced counsel and assistance in every phase of patent and trade-mark practice. Write for our new free book containing valuable information relating to patent procedure. Clarence A. O'Brien, Registered Patent Attorney, Dept. OA1A, Adams Bldg., Washington, D. C.

AN Individual service for inventors. Developing models, manufacturing, dies, tools, special machinery. H & H Tool & Mfg. Company, C-308 E. 3rd St., Cincinnati, Ohio.

INVENTORS Attention: Have you a marketable patented article? Owner of factory will finance and manufacture on a royalty basis or consider partnership. State full details and description in first letter. Write Mr. Hammond, 340 E. Carlsle Ave., Milwaukee, Wis.

INVENTING Taught at your home by Trofimov School of Inventive Practice, Hanna Rd., Willoughby, Ohio.

WE Want new inventions. Write us. Box 1445, St. Louis, Mo.

CONTACTS Established during ten years mail order sales manager Sears Roebuck enables me sell patented or unpatented ideas. Get details. L. H. Fowler, Elmhurst, Ill.

INVENTIONS Wanted—Patented, unpatented. If you have an idea for sale write Hartley's, Inc., Box 928-E, Bangor, Maine.

INVENTORS: "Making Inventions Pay," our 32-page illustrated book, mailed upon receipt of 3c postage. Crescent Tool Co., Dept. Z, Cincinnati, Ohio.

I SELL Patents. Established in 1900. Charles A. Scott, 773PM Garson Ave., Rochester, N. Y.

WE Locate buyers meritorious patented, unpatented inventions. If will sell, reply immediately. Descriptive booklet free. Invention Reporter, 5A-11236 South Fairfield, Chicago.

INVENTORS—Send for 72-page book on patents. Reasonable terms. Conscientious treatment to inventors. L. F. Randolph, Registered Patent Attorney, 302-E Victor Bldg., Washington, D. C.

HAVE You a sound, practical invention for sale, patented or unpatented? If so, write Chartered Institute of American Inventors, Dept. 4-A, Washington, D. C.

INVENTORS: Profit by your invention. A practical talk to inventors by an experienced manufacturer. Our 68 page booklet "Mind vs. Matter" mailed upon receipt of 25c. Rex Engineering Co., Cincinnati, Ohio, Dept. D.

INVENTIONS WANTED

WILL Finance good invention, patented or not. Flecks, Warren, Ohio.

INVENTIONS Wanted, Blackstone Coin Packer Co., 208 King St., Madison, Wis.

ATTACHABLE Handprotector for knives, just allowed. Antony, 1364 East Fourth Street, Brooklyn, N. Y.

WANTED:—Ideas or inventions by manufacturer pertaining to painters equipment. P.O. Box 349, Oak Park, Ill.

INVENTIONS Of merit wanted for marketing. Send for "4-Points of Service" bulletin. R. & S. Engineering Co., Dept. SA-1, 17 East 42nd Street, New York City.

NATIONAL Service organization with main offices in New York, Cleveland, and Chicago, and representatives in many large cities, wants new products for clients. Invention meeting requirements will be commercialized at no cost to inventor, including such services as industrial design, engineering, market survey, merchandise analysis, etc. Only charge made is percentage of proceeds obtained from sale of invention. Submit only practical devices suitable mass production, patent granted or applied for. Enclose postage for return of models and other material. Designers For Industry, Inc., Merchandise Mart, Chicago, Illinois.

WANTED—Meritorious patented, unpatented inventions. Booklet free. Invention Reporter, 5B-11236 So. Fairfield, Chicago.

SMALL Inventions wanted by manufacturers. I'll help you sell your invention. Write for free circular. Stanley Hull, 7829-K Euclid Avenue, Cleveland, Ohio.

SIMPLE, Practical inventions wanted by manufacturers, patented or unpatented. For information write Chartered Institute of American Inventors, Dept. 4-D, Washington, D. C.

PATENTS FOR SALE

SELF Loading and dumping skip. Will load slack coal, concentrates, sand and gravel from dump, scientifically and economically. Elling Pederson, 134 E. 4th Street, Leadville, Colo.

HUMANE Rat and animal trap catches in droves, inexpensive to manufacture, 94 in three nights. W. C. Schryver, Polo, Ill.

PRECAST Hollow slab story high building units, walls, floors, roofs, partitions, other numerous advantages. J. E. Marston, Bralorne, B. C., Canada.

PATENTED Hand truck, handles 800 lbs. easier than carrying 100 lbs. Also pat. pend. metal slat for corn cribs. Hans Skreberg, Milan, Minnesota.

IMPROVED Ship steering device, patent pending. Improved lubricant washer cap, patent pending. Combination jack and automobile theft prevention device, patent pending. Improved dirigible head lights for vehicles, patent pending. Will sell outright or royalty. Write Ernest Forster, General Delivery, Newark, New Jersey.

MANUFACTURERS: For new products or profitable manufacturing opportunities, inquire. Invention Reporter, 5C-11236 So. Fairfield, Chicago.

SELL Your patent through a small classified ad in Popular Mechanics. Many inventors have found buyers in this way. Ask me for proof—I'll gladly send it to you. F. W. Johnson, Manager Classified Advertising, 200 E. Ontario St., Chicago.

MANUFACTURING

MANUFACTURING. Any material, any quantity, inventions developed. Milburn, Burlington, Kentucky.

HAND Wood-turning and carving. Any kind. Sample or sketch. Guaranteed. M. G. Day, 1039 Hamilton, Indianapolis, Indiana.

INVENTIONS Manufactured by an experienced company, in any quantity at low cost. Metal specialties, novelties, stampings, dies, and models. Free estimates. Our booklet "Mind vs. Matter" sent upon receipt of 25c. Rex Engineering Co., Cincinnati, Ohio, Dept. C.

INVENTIONS—Manufactured in any quantity at low cost by old established company. Stampings, metal specialties, dies, models, etc. Free estimates. Send for catalog. Crescent Tool Co., Dept. X, Cincinnati, Ohio.

SEE Our display advertisement on page 51A. R. & S. Engineering Co.

MACHINE Woodworking. Only complete book on machines and uses. \$3.25. Popular Mechanics, 200 E. Ontario St., Chicago.

MODELS AND MODEL SUPPLIES

MODELS—Blue prints made, models developed. Send us your ideas for estimates. Model Engineering, Osgood, Ind.

BUILD Miniature racing cars. List free. Northern Aircraft, Manitowoc, Wis.

STEAM Locomotives, 1/4" scale. Send 10c for descriptive folder. Little Engines, Box 15B, Wilmington, Calif.

ENGINE Catalogue castings, supplies, 25c. Howardco, A-2417 North Ashland, Chicago.

SHIP Model kits, 1000 fittings catalogue 10c. Polk's, 429 Seventh St., New York.

MINIATURE Boat and airplane supply catalog 5c. Selley, 1377 Gates Ave., Brooklyn, N. Y.

MODEL Boat construction kits. Racing hulls. Cruiser. Accessories. Free literature. St. Louis Model Boat Co., Clayton, St. Louis, Mo.

MODELS—Practical models put over your ideas. We develop models from the crude to perfect working devices. Your idea might have large commercial value. Services confidential. Bank references. Registered graduate engineers at your service. Send 25c for our 68 page booklet "Mind vs. Matter." Rex Engineering Co., Cincinnati, Ohio, Dept. B.

POWER Models. Electric railways, steam locomotives, steam and gasoline engines, all accessories, metals, tools. 84 page catalog 35c. Chas. Cole, Ventura, Calif.

SUBMARINE 24" Kit to build \$1.00. Spotts, 3925 N. Broad, Philadelphia.

MODEL Supplies for the inventor. Send 3c stamp for catalog. Pierce Model Works, Tinley Park, Ill.

MODEL Railroad Shop, Dept. PM, Dunellen, New Jersey. Catalog 10c.

STEAM Locomotives! 3/4" scale. Build one by "Easy Steps." Our illustrated catalog lists all needs. 25c. Little Engines, Box 15B, Wilmington, Calif.

BUILD Ship models, coach models, covered wagon. Complete kits \$1.00 to \$6.00. Fully shaped and finished redwood hulls, all parts cut to fit including masts and yards, sails, chain, wire, nails, string and other parts. Detailed drawings and full instructions. Send 3c stamp for catalog. Miniature Ship Models, Dept. R, Perkasie, Penna.

MODELS—Your ideas developed into practical working models. 30 years successful experience; thousands of satisfied customers. Confidential service guaranteed. Bank references. Send 3c postage for our large booklet—"Making Inventions Pay." Crescent Tool Co., Dept. Y, Cincinnati, Ohio.

RAILWAY Models. Catalog handbook 25c. Walthers, 247 E. Erie, Milwaukee.

BLUEPRINTS AND PLANS

BUILD Your own machine tools. Castings and blue prints at nominal cost. Send 10c for 2 color 28 page catalog, 34 prints covering 12 metal-working projects, \$1.50. 23 prints covering 6 wood-working projects, \$1.00. Lewis Machine Tool Co., Dept. M-1, 1000 Alhambra Ave., Los Angeles.

LOWEST Prices in country: drawings, tracings, blueprints made to order. Speedy confidential service. Imperial Designing Co., Box 611, Memphis, Tenn.

3 **ARTISTIC** Fullsize lathe patterns, includes table articles. 15c. David Tyson, Perkasie, Penna., Route 2.

HOME CRAFTSMEN

FOLDING Boat plans—Easy to build "Fold-Craft" kayak or row boat. Plans 50c each. Fold-Craft, 4015 N. Oketo, Chicago.

SILK Screen printing plates \$1.65 for 5" x 5" design. Do 10,000 imprints. Instructions. Larger plates quoted. Send your design desired size. Art work, supplies, extra. Remit with order. Warman's, Winchendon, Mass.

GET Free leathercraft instructions, prices of leathers, tools, projects. Make extra money. Beautiful gifts. Leather samples 5c. Wilder & Company, 1038 Crosby, Dept. 1F, Chicago, Ill.

SQUAREKNOTTERS! Make belts, handbags, etc. Quality cord samples with catalog, free. Beginners book, catalog and samples, 10c. Special! Regular \$1 book with 50c beginners outfit, all for \$1. P. C. Herwig Co., Dept. J-18, 121 Sands St., Brooklyn, N. Y.

MEXICAN Wood novelties easily made! 20 patterns and instructions 30c. 20 western silhouette patterns 30c. 10 evening project patterns 25c. Mexican Arts, Crafts, Eagle Pass, Texas.

22 FULL Size lawn ornament patterns 25c each. Strother, Box 383-AP, Belington, West Virginia.

LEADED Antique and colonial type lanterns. Various colors and designs, \$3.50 up. M. Ascheri, Lorain, Ohio.

VENETIAN Blinds, supplies, wholesale catalog 6c. Roberta, Box 260, Gloversville, New York.

FAST-SELLING Novelties, furniture, easily made. Catalog, hundreds illustrations, moneysaving prices, on materials, blueprints, wood-kits, construction sets, machinery, 10c. Woodcraft Service, Plainview, Minnesota.

PATTERNS—Lovely designs plywood novelties and novelty furniture—easy to make with jig saw. Largest line silhouettes. Lowest prices transfer decorations. 170 items superbly illustrated. Write Wo-M:t Shop, Ashburn, Georgia.

70 PATTERNS, 20 Lawn ornaments, 14 silhouette, 20 novelties, 16 lawn ornaments, 30c each set, all for \$1.00. Modern Woodcraft, Saginaw, Michigan.

"HEAT Treat" your own tools, dies, etc., with Ralksite, scientifically prepared new case hardening compound. Depth of hardness easily controlled. No special equipment needed. Gives a better case, quicker. Efficient, economical—saves time, money. Pound can \$1.00 postpaid. Send today: Ralksite Company, 372 Classon Ave., Brooklyn, N. Y.

VIOLIN-MAKING Instructions, patterns, kits, supplies. Chelsea Fraser, Saginaw, Mich.

MAKE It Yourself—Hundreds of practical and useful devices described in our big book. Plain instructions and illustrations show you how. Save money on things for yourself or make profit selling to others. 900 articles. 480 pages. 823 illustrations. \$3 postpaid. Popular Mechanics Press, Room (C39), 200 E. Ontario St., Chicago.

OLD GOLD, WATCHES, JEWELRY, PRECIOUS STONES

MINERAL Specimens and books on mineralogy, gem polishing, fossils. Catalog 5c. The Gem Shop, Box C797, Helena, Mont.

OPALIZED Woods, agates, jaspers, 25 specimens, some polished \$1.25. Jay Ransom, Aberdeen, Wash.

WATCHES—Elgin, Waltham, Bulova, ladies and gents, tremendous savings. Send postal for free catalogue. Lou Maltz, Dept. "S," 204 So. 8th Street, Philadelphia, Penna.

WATCHMAKERS' Tools, supplies. Watch parts. Lowest prices. Write for price list 43. Dean Company, 87 Nassau St., New York.

REBUILT Watches, guaranteed. Pontiac Watch Co., Box 576-P, Pontiac, Mich.

WATCHMAKERS' Materials—Tools, watches, jewelry bought, sold, exchanged. Ben Segal's, 5 South Wabash, Chicago.

AUSTRALIA'S Lovely opals. Illustrated catalogue free. Good selection \$5.00. Norman Seward, Melbourne, Australia.

HIGHEST Prices for old gold—Mail your teeth, watches, jewelry. 100% full cash value mailed day shipment received. Satisfaction guaranteed or articles cheerfully returned. Information free. Chicago Gold Smelting Company, 300-P Champlain Building, Chicago.

GOLD \$35 Ounce. Ship old gold teeth, crowns, jewelry, watches—receive cash by return mail. Satisfaction guaranteed. Free information. Dr. Weisberg's Gold Refining Co., 1500-Q Hennepin, Minneapolis, Minn.

5000 REBUILT Elgin, Waltham, Hamilton watches. Also ladies, gents wrist watches. Make big money! 12 size, 7 jewel, Elgin or Waltham, \$4.75; 16 size, 17 jewel, \$7.50. Send for free watch and diamond catalogue. The New York Jobbers, Dept. M, 74 Bowery, New York, N. Y.

HOW To identify and determine value of old precious metals. Where to buy. To whom to sell. Reliable and up-to-date information. Complete instructions only \$1 postpaid. Popular Mechanics Press, Room (C39), 200 E. Ontario St., Chicago.

FOR THE HOME

LET A clock turn on your heat before you get up. Free details. Homestead Furnace Clock Co., 155 Sunset Ave., Newark, N. J.

METAL Furniture in modified modern design, how to make, described in Shop Notes for 1937 only 50 cents postpaid. Popular Mechanics Press, Room (C39), 200 E. Ontario St., Chicago.

TOBACCO

GUARANTEED: Cigarette, pipe or chewing 5 lbs. \$1.00, ten, \$1.75. Pay when received. Pipe and box cigars free. Rives Tobacco Co., Paducah, Ky.

TENNESSEE Golden Heart natural leaf tobacco. Nature gave it its pleasing flavor. A-grade 15c per lb. Fancy 20c. Good Tobacco Company, Paris, Tenn.

RAZORS—RAZOR BLADES

"KEENEREDGE" Your blades. One produced 1175 shaves. Keeneredge, (\$1.00), Oblong, Ill.

FOR SALE—MISCELLANEOUS

SEND \$1.00 And receive genuine calf billfold with zipper. Pigskin \$2.45, morocco \$2.95, pinseal \$3.50, alligator \$5.00. Beautiful Christmas gifts. Tanners Leathercraft, 700 Broadway, Chelsea, Mass.

WANTED—MISCELLANEOUS

MERCHANDISE Foreign, domestic, for gift shop. Edwin Stovall, Douglas, Ga.

WANTED: Scrap copper, brass, aluminum, Starmetals, 4201 No. Sawyer, Chicago.

\$50.00 REWARD Paid for information leading to satisfactory proof of actual use of aeroplane type propellers on wind charging generators prior to 1924. Lessing Advertising Co., Des Moines, Iowa.

CASH For used microscopes, binoculars, slide rules, drawing sets, scientific instruments, tools, cameras, stop-watches. Write details. Elman's, 2302 Van Buren, Chicago.

PERSONAL

PLAQUES Make beautiful gifts. Photos 6c. Booklet tells how \$1.00. R. Edmondson, 441 E. Main St., Rochester, N. Y.

WIN Contest money! Free information from our staff of winners. Personal Contest Club, Station P, Brooklyn, New York.

COMPLETE Guaranteed course for improving vision without glasses \$1.00. Eyesight Improvement, Box 193, Hamilton, Ohio.

STAMMERING Scientifically corrected. Practical, home training. Normal Speech Mail Course, 236 Palmer, Grand Rapids, Mich.

INCREASE Earning power, achieve popularity, become irresistible. "Success" reveals how. 60c. Doherty, 4821 47th, Woodside, N. Y.

WIN Prize money: Booklet—"Successful Contesting"—shows how. 10c postpaid. Bulletin listing \$100,000.00 prizes included. World Publishers, 4515-B Cottage Grove, Chicago.

1059 WAYS To start a profitable business. Get Popular Mechanics book of modern formulas and methods for practical specialty manufacturing. Price only \$1.25 postpaid. Popular Mechanics Press, Room (C39), 200 E. Ontario St., Chicago.

MISCELLANEOUS

ALASKAN Gold nuggets, for gifts, or souvenirs, from a prospector, \$1.00, \$2.50 and \$5.00. M. Shimrock, Manley Hot Springs, Alaska.

DEPENDABLE Mechanical pencil. Name imprinted 25c. Take orders, charge 50c. Adcraft, Lacrosse, Wis.

CLASSIFIED Directory of swappers, traders, collectors, all over United States. 25c coin. Your articles listed free. Special Features Publishers, Austin, Texas.

WIN Money! Prizes! Sample contest magazine 10c. Butler, Braxton, Miss.

TREASURE Hunter with modern instruments wants work. Lange, Box 133, Columbus, Ind.

GOOD Eyesight without glasses. No drugs. Get my simple, inexpensive, new invention. Satisfaction guaranteed. Details free. Arthur Jacobson, Upsala, Minn.

READ Our war and oil ad under Business Opportunities, it's worth answering. Royal Keystone Enterprise, Berryville, Ark.

EMBOSSSED Signs made to order. Name plates, manufacturers' displays, Christmas signs, etc. Any color. Sample with your own copy 25c. Sign-O-Graf, 739 Cole, San Francisco.

PRIZE Contest money! You can win plenty! Stamp brings opportunity! National Contest Bulletin, (Dept. P.), Box 634 Grand Central Station, New York City.

SEND \$1.00 And receive Drexel Durlum Point Pen and Pencil set. Guaranteed for 5 years. Beautiful Christmas gift. Order today! Bellingham Pen, 700A Broadway, Chelsea, Mass.

LUMINOUS Paint shines in dark 25c. Formula 50c. Myers, Box 26, Niles, Mich.

LUMINOUS Paint sample, 10c. 50c. 75c sizes. Eastern, 185 Powell St., Brooklyn, N. Y.

RECEIVE Gigantic malls, magazines, samples. Your name in numerous mailing lists 10c. Charles Waltman, 460 Grand Street, New York.

FIRE Extinguisher for automobile, home, office \$1 postpaid. Universal, 4106 West 22nd Place, Los Angeles, California.

PRINT Your own pictures, 2 minutes (daylight) from any negative, on cards, stationery, cloth. Kit \$1.00. Box 291B, Iron River, Michigan.

HAND-WOVEN Ties \$1. Write for free sample of tie material and 32 colored pictures of patterns. Log Cabin Hand Weavers, 11 Post Road, Oregon City, Oregon.

COATS Of arms and crests, correctly painted in colors or black and white, from heraldic description or furnished copy, \$10.00 and up. Highest grade work. Heraldic Studios, 1914P Oakdale Avenue, Chicago, Ill.

TATTOOING Outfits, supplies, illustrated list free. Percy Waters, Anniston, Alabama.

REFINE Used oil without cost. Particulars. F. Gerwin, Fairview, Oklahoma.

SWAPPER'S Friend, R4, Saline, Michigan. Interests swappers, collectors, 50c year, sample 10c.

FOR Home, shop, office. Ten drawer cabinet, 14x33x44 inch drawers. Kit 75c. Finished cabinet \$1.50, 10c extra west Mississippi. Attractive dealer proposition. Taylorcraft, W. Howard, Hagerstown, Md.

10,000 MONEY-MAKING Formulas. Tells you how to make and sell almost everything under the sun; cosmetics, mucilage, anti-freeze solutions, battery solution, beverages, cheese, chewing gum, cleaning preparations, extracts, hair preparations, inks, bluing, leather polish, mirrors, perfumes, polishes, typewriter ribbons, carbon paper, washing powders, liquid soap, and hundreds of other profitable articles. \$4 postpaid. Popular Mechanics Press, Room (C39), 200 E. Ontario St., Chicago.

A COMPLETE SERVICE FOR INVENTORS

Specializing in:

- 1) PATENTS—patents obtained through registered patent attorney. Write for free details.
- 2) DESIGNING & DEVELOPING—of your ideas and inventions. Designs and technical plans prepared.
- 3) MODELS—built to "put over" your ideas. Can serve as samples. Experts in plastic materials.
- 4) DIES, TOOLS, patterns, castings, metal stampings, etc.
- 5) MANUFACTURING—in any quantities.

Write today for the R. & S. "4-Points of Service" bulletin. Also, bulletin describing development of actual case.

R. & S. ENGINEERING CO., 17 East 42nd St., N. Y. C.



LEARN CARTOONING!

Let a prominent cartoonist teach you this fascinating profession by mail. PERSONAL instruction, just like private tutoring. Recommended by America's foremost cartoonists. Write for free details.

DORMAN H. SMITH, Box C597, SAN RAFAEL, CALIF.



MONUMENT

\$900 UP WE PAY FREIGHT

Marble & Granite Memorials. Low Prices. Lettered. Guaranteed. Erecting service. Free Catalog & Samples. Write Us at once.

U. S. MARBLE & GRANITE CO. Oneco, Fla.



A AND N SUPPLY CO.

Bargains—Military, Sport Goods, Firearms, Clothes, Shoes, etc. Send 10¢ for new catalog, to be redeemed on first order.

EST. 1868 A & N Supply Co., 4772 Lester St., Richmond, Va.

GET INTO INDUSTRIAL DESIGNING and DRAFTING



Learn to make the drawings and blue prints with which all industry begins; learn also how to create new designs and new products. Learn how to improve and re-style old products so they have more "eye appeal", more selling power. Drafting is a very big field, but drafting with industrial designing is twice as big. Factories must continuously bring out new models, new products, and improved designs. You can learn both subjects right in your own home, in your spare time. You can be trained for better pay. I can prepare you just as I have trained many hundred successful students from 16 to past 50. I'll

train you thoroughly by applied instruction on actual work until you are holding a good paying position. Complete working outfit furnished without extra charge. Send coupon for FREE BOOK "Industrial Designing and Drafting". Engineer Dobe, Libertyville, Illinois.

Engineer Dobe,
Div. 3371
Libertyville, Ill.

Send for FREE BOOK

Please send me FREE BOOK on "Industrial Designing and Drafting", also please explain how you assist your graduates to good positions in these fields.

Name.....
Address.....
Town..... State..... Age.....

HOW TO MODERNIZE YOUR OLD RADIO

MIDWEST FACTORY-TO-YOU 20th ANNIVERSARY SPECIAL!

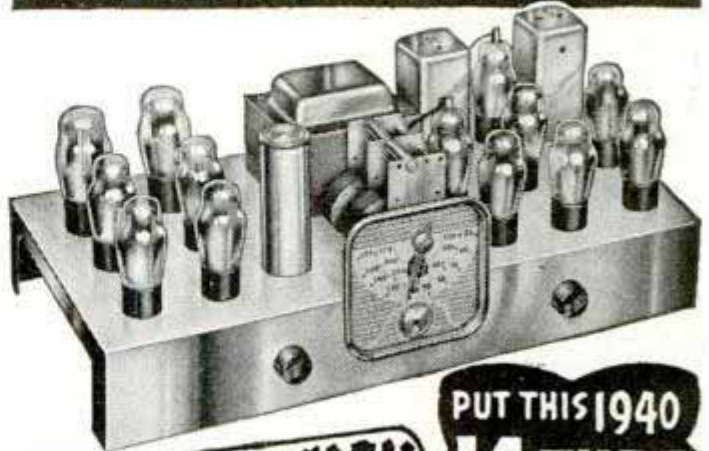

WITH TELEVISION ADAPTATION

Here's today's biggest radio value—the 1940 TELEVISION-ADAPTED Midwest—at sensationally low factory-to-you-price. Amazing foreign reception. Absolute satisfaction guaranteed on money-back basis. Other models from 5 to 17 Tubes, and up to 5 Wave Bands. Send 1c postcard for FREE 1940 catalog. (User-agents make easy extra money!) See Midwest's Answer to TRADE-INS!

PUT THIS 1940 14 TUBE CHASSIS IN YOUR PRESENT CABINET \$19.95 COMPLETE CHASSIS WITH TUBES AND SPEAKER

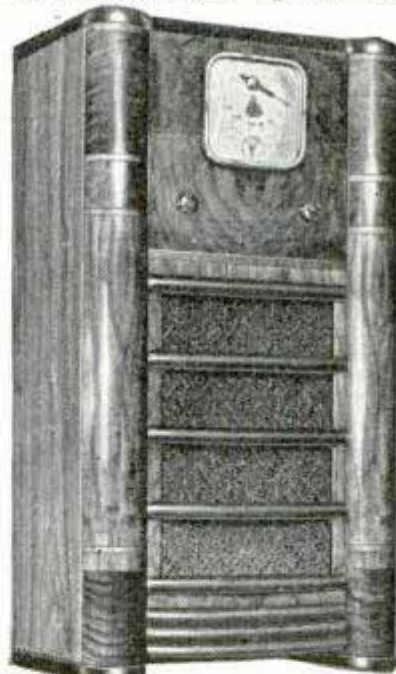

SAVE UP TO 50% 30 DAYS TRIAL EASY PAY PLAN

14-TUBE CONSOLE \$29.95 COMPLETE

MIDWEST RADIO CORPORATION Dept. 15-H Cincinnati, Ohio

PASTE COUPON ON 1c POSTCARD...OR WRITE TODAY!

MIDWEST RADIO CORPORATION Cincinnati, Ohio Dept. 15-H Name..... Address..... Town..... State..... Send me your new FREE catalog, complete details of your liberal 30-day Trial offer and factory - to - you prices. User-Agents Make Easy Extra Money. Check here [] for details.

Be An ARTIST!



LEARN TO DRAW

—at home in your spare time

The fascinating field of Art offers opportunity to both men and women. Trained Artists are capable of earning \$30, \$50, \$75 a week. We train you right at home for a successful career in—

COMMERCIAL ART ILLUSTRATING CARTOONING

For 24 years W. S. A. graduates have been "making good" in Art—WHY NOT YOU? No previous Art experience necessary—our instruction is practical and thorough. Write for Booklet—"Art for Pleasure and Profit," fully describes course and TWO BIG ARTISTS' OUTFITS included. Clip coupon—mail today.

FREE BOOK gives details!

Washington School of Art, Studio 121P
1115—15th St., N. W., Washington, D. C.

Yes! I am interested in learning to draw. Please send me your Free Book, "Art for Pleasure and Profit."

Name..... Age.....
Address.....
City..... State.....



Know Electricity as Experts Know It—and Get an Expert's Pay!

What about your future? Who is safe today? Surely not the man who is contented to stand still! Know your job thoroughly—prepare yourself for jobs ahead. To do just this thousands of men have used

The Croft Library of Practical Electricity

The Croft Library is a complete electrical educator. It is founded on practice—on 20 years of shirt-sleeve experience—on work as it is actually done. It is jammed from cover to cover with the kind of hard-headed facts you want. Written so that the beginner can easily understand it, yet so sound, so thorough, that it is the daily guide of 50,000 highly paid electrical workers and engineers. Croft tells you the things you need to know about motors, generators, armatures, commutators, transformers, circuits, switchboards, distribution systems—electrical machinery of every type—illumination in its every phase—the most improved methods of lighting—lamps and lamp effects, etc.—how to do a complete job, from estimating it, to completion.

**6 volumes, 2155 pages—New low price
No money down—Easy payments.**

Fill in and mail the coupon attached and we will send you the entire set of six volumes for ten days' Examination on approval. We take all the risk—you assume no obligation. If you decide to keep the books, send \$1.50 in ten days and the balance at the rate of \$3.00 a month. Send the coupon NOW and see the books for yourself.

EXAMINATION COUPON

McGraw-Hill Book Co., 330 W. 42nd St., New York

Send me for ten days' examination on approval the Croft Library of Practical Electricity. If satisfactory I will send you \$1.50 in 10 days and \$3.00 monthly until the price of \$16.50 is paid. If not wanted, I will return the books postpaid. (To insure prompt shipment write plainly and fill in all lines.)

Name.....
Home Address.....
City and State.....
Position.....
Name of Company..... P.M. 1-40

When writing please mention Popular Mechanics



We supply you 20 separate outfits of Electrical Equipment and Apparatus at no extra cost to help you learn Practical Electricity in your own Home Shop. No previous experience or advanced education necessary. Lifetime Employment Service. Write for Big Free Electrical Book Today! No obligation.

ELECTRIC INSTITUTE, Dept. 60-A. Hinsdale, Ill.



VOICE

100% Improvement Guaranteed

We build, strengthen the vocal organs—not with singing lessons—but by fundamentally sound and scientifically correct silent exercises... and absolutely guarantee to improve any singing or speaking voice of *least 100%*... Write for wonderful voice book—sent free. Learn WHY you can now have the voice you want. No literature sent to anyone under 17 years unless signed by parent.

**PERFECT VOICE INSTITUTE, Studio 1351
64 E. Lake St., Chicago**

Learn Public Speaking

At home—in spare time. Many overcome "stage-fright," gain self-confidence and increase earning power, this easy way. Write for free booklet, *How to Work Wonders With Words* and requirements.

**North American Institute, Dept. 1351
3601 Michigan Ave., Chicago, Illinois**



BE A LANDSCAPE ARCHITECT

Ambitious? Here's a profession for men and women. Year-round occupation—also interesting hobby! Home study course used by hundreds. Write for free booklet "Success thru Landscape Training." Write today.

**AMERICAN LANDSCAPE SCHOOL
6138 Grand Avenue Des Moines, Iowa**



Earn Cash at Home!

We paid M. M. \$1174 for exceptional cellar crop Snow-King mushrooms! We furnish materials; buy all crops. Big FREE picture book tells if your cellar, shed, barn, suitable. Est. 1902. Write today. United Co., 3848 Lincoln Av., Dept. 312, Chicago

M ECHANICS-WELDERS - COLLISION MEN

GOOD JOBS and Mighty GOOD PAY

Do you want to earn big money? If so let us know which of the following trades you prefer. You learn by doing. Practical work. Expert teachers. Low tuition. Personal attention. It will pay you to investigate AT ONCE. Just check the courses you'd like to take and mail today. You will receive full information, absolutely without cost or obligation. But don't delay.

Check the Trade You'd Like to Learn

- Complete Auto Mechanics (including Diesel)
- Auto Collision
- Metal Finishing
- Electric Arc and Acetylene Welding
- Spray Painting
- Body and Fender Bumping

Ask about our "Pay After Graduation Plan"

Name

Address

Mail the above at once to

MICHIGAN TRADE SCHOOL

Write for FREE FOLDER

3758 Woodward Ave. Detroit, Mich.

WELDERS WANTED!



ELECTRIC ARC—OXY-ACETYLENE
 Skilled Welders earn \$8 to \$15 a day. The demand now greater than the supply. Learn this highly paid trade in 3 weeks by actual shop work. One of America's leading schools. Established 1902. 7 floors of shops. Endorsed by welding industry. Limited number of students. 3 weeks course in Electric Arc or Acetylene Welding, including room and board, only \$105. Write or wire for reservation. Ask for "Welding Facts." State age. GREER COLLEGE, Dept. 110, 2024 S. Wabash Ave., Chicago

ARTISTS MAKE MONEY

Find out your ability. Send name, age, occupation and address for Free Vocational Art Test.
Federal Schools, Inc., 1140 Federal Schools Bldg., Minneapolis, Minn.

ITALIAN ACCORDIONS

HAND MADE. Very best. Lowest prices. Direct from Factory Representative. Send your name and address for FREE catalog.
ITALIAN ACCORDION COMPANY
 323 W. POLK ST., DEPT. P-9 CHICAGO, ILL.



TURN HOME WORKSHOP HOURS into EXTRA MONEY



Get the New 188 Page Book WHAT TO MAKE

Get this new book and turn happy home workshop hours into extra cash. 188 pages packed with instructions, plans, valuable data and pictures showing what to make and how to make it. Anyone who can use simple tools can work from this book and make it pay him a profit. Order today. Tells how to make—Breakfast Nook—Humidifier—Knee-hole Desk—Night Table—Twin Deck Beds—Modern Bedroom Furniture—Clocks—Plastic Candlesticks—Bob Sled—and more than a hundred other useful and saleable articles.

Only
50¢

POPULAR MECHANICS PRESS
 Dept. 140, 200 E. Ontario St., Chicago

MEN WANTED Your Opportunity in the AVIATION INDUSTRY

Prepare now to step into a waiting big pay position with your future assured. 35,000 trained men needed right now in America's fastest growing billion dollar industry, say authorities. \$200,000,000 worth of equipment now back ordered for lack of capable workers. It's your opportunity.

LEARN

- Sheet Metal Craftsmanship
- Aircraft Welding
- Airplane Mechanics
- Engine Mechanics
- Flight Engineering
- Aeronautical Engineering
- Instructor's Aeronautical Training

PRACTICAL INSTRUCTION
 It's easy to learn by the Sweeney System of practical instruction. You Learn By Doing in modern up-to-date shops under highly trained instructors—right at the crossroads of the nation's airways.

TRAINING FOR SUCCESS
 Over 57,000 men have come to Kansas City for Sweeney training in the past 32 years. There must be a reason. E. J. Sweeney, America's pioneer instructor, started to teach aviation in 1913. His successful unique methods have been imitated but never excelled—all unnecessary theory eliminated—training condensed into short, intensive courses that soon fit you for a good job.

SEND NAME TODAY
 Let Sweeney help you find your proper niche in Aviation. Our free vocational guidance should prove valuable to you as it has to countless others. Simply send name on coupon below for your free copy of booklet "Opportunities in Aviation" or write for confidential advice as to special opportunities in all branches of aviation.

Sweeney

AVIATION SCHOOLS
 101 Administration Bldg., Fairfax Airport, Kansas City, Kan.

The Original and Only Sweeney School in U. S. No Branches
SWEENEY AVIATION SCHOOLS, E. J. Sweeney, President
 101 Administration Bldg., Fairfax Airport, Kansas City, Kan.

Please send me your booklet and full information on opportunities in all branches of aviation.

Name.....Age.....
 Address.....
 Town.....State.....

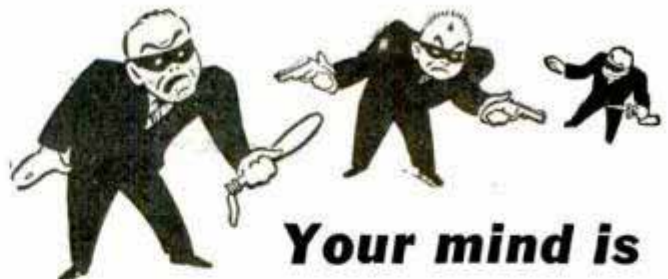

Your mind is BURGLAR-PROOF

● Gold may be stolen. Stocks and bonds may depreciate in value. But knowledge—the ability to hold a better, higher-paying position—never can be taken from you. Training endures through depression and prosperity.

Thousands of men in your industry—men you will have to compete with in the struggle for advancement—are training their minds for the future through the International Correspondence Schools. Will you watch them advance—or will you advance with them?

Whether or not you mail this coupon will help determine the answer to that question.

INTERNATIONAL CORRESPONDENCE SCHOOLS

BOX 5564-J, SCRANTON, PENNA.
 Explain fully about your course marked X:

- TECHNICAL AND INDUSTRIAL COURSES**
- | | | |
|--|---|--|
| <input type="checkbox"/> Agriculture | <input type="checkbox"/> Air Brake | <input type="checkbox"/> Managing Men at Work |
| <input type="checkbox"/> Air Conditioning | <input type="checkbox"/> Architectural Drafting | <input type="checkbox"/> Manufacture of Pulp and Paper |
| <input type="checkbox"/> Architecture | <input type="checkbox"/> Auto Engine Tune-up | <input type="checkbox"/> Marine Engines |
| <input type="checkbox"/> Auto Technician | <input type="checkbox"/> Aviation | <input type="checkbox"/> Mechanical Engineering |
| <input type="checkbox"/> Boilermaking | <input type="checkbox"/> Bridge Engineering | <input type="checkbox"/> Navigation |
| <input type="checkbox"/> Building Estimating | <input type="checkbox"/> Chemistry | <input type="checkbox"/> Patternmaking |
| <input type="checkbox"/> Civil Engineering | <input type="checkbox"/> Coal Mining | <input type="checkbox"/> Pharmacy |
| <input type="checkbox"/> Concrete Engineering | <input type="checkbox"/> Contracting and Building | <input type="checkbox"/> Plumbing |
| <input type="checkbox"/> Cotton Manufacturing | <input type="checkbox"/> Diesel Engines | <input type="checkbox"/> Practical Telephony |
| <input type="checkbox"/> Electrical Engineering | <input type="checkbox"/> Electric Lighting | <input type="checkbox"/> Poultry Farming |
| <input type="checkbox"/> Foundry Practice | <input type="checkbox"/> Fruit Growing | <input type="checkbox"/> Public Works Engineering |
| <input type="checkbox"/> Heating | <input type="checkbox"/> Heat Treatment of Metals | <input type="checkbox"/> Radio Operating |
| <input type="checkbox"/> Highway Engineering | <input type="checkbox"/> Locomotive Engineer | <input type="checkbox"/> Radio Servicing |
| <input type="checkbox"/> Machinist | <input type="checkbox"/> Management of Inventions | <input type="checkbox"/> R. R. Section Foreman |
| <input type="checkbox"/> Welding, Electric and Gas | | <input type="checkbox"/> R. R. Signalmen |
| | | <input type="checkbox"/> Refrigeration |
| | | <input type="checkbox"/> Sheet Metal Work |
| | | <input type="checkbox"/> Steam Electric |
| | | <input type="checkbox"/> Steam Engines |
| | | <input type="checkbox"/> Structural Drafting |
| | | <input type="checkbox"/> Structural Engineering |
| | | <input type="checkbox"/> Surveying and Mapping |
| | | <input type="checkbox"/> Telegraph Engineering |
| | | <input type="checkbox"/> Textile Designing |
| | | <input type="checkbox"/> Welding, Electric and Gas |
- BUSINESS COURSES**
- | | | |
|--|---|---|
| <input type="checkbox"/> Advertising | <input type="checkbox"/> Bookkeeping | <input type="checkbox"/> Grade School |
| <input type="checkbox"/> Business Correspondence | <input type="checkbox"/> Business Management | <input type="checkbox"/> High School |
| <input type="checkbox"/> Cartooning | <input type="checkbox"/> Civil Service | <input type="checkbox"/> Illustrating |
| <input type="checkbox"/> College | <input type="checkbox"/> Cost Accounting | <input type="checkbox"/> Lettering Show Cards |
| <input type="checkbox"/> College Preparatory | <input type="checkbox"/> Commercial | <input type="checkbox"/> Railway Postal Clerk |
| <input type="checkbox"/> Foremanship | <input type="checkbox"/> C. P. Accounting | <input type="checkbox"/> Secretarial |
| <input type="checkbox"/> French | <input type="checkbox"/> Spanish | <input type="checkbox"/> Salesmanship |
| <input type="checkbox"/> Sign Lettering | <input type="checkbox"/> Service Station Salesm'p | <input type="checkbox"/> Sign Lettering |
- DOMESTIC SCIENCE COURSES**
- | | |
|---|--|
| <input type="checkbox"/> Advanced Dressmaking | <input type="checkbox"/> Professional Dressmaking and Designing |
| <input type="checkbox"/> Foods and Cookery | <input type="checkbox"/> Tea Room and Cafeteria Management, Catering |
| <input type="checkbox"/> Home Dressmaking | |

Name.....Age.....
 Address.....
 City.....State.....
 Present Position.....
 Canadian residents send coupon to the International Correspondence Schools Canadian, Limited, Montreal, Canada. British residents send coupon to I. C. S., 71 Kingsway, London, W. C. 2, England

When writing please mention Popular Mechanics

"What do you look for first in a pipe Tobacco?"

we inquired at a bowling match...

COOLNESS SCORES
WITH ME FIRST IN
PIPE-SMOKING. THAT'S WHY
I CHOSE **PRINCE ALBERT**.
IT'S PLENTY **MILD**, YET
TASTY ENOUGH FOR
ANY MAN!

RIGHT YOU ARE! THERE'S
NO OTHER TOBACCO LIKE **P.A.**
FOR **SMOKING COMFORT**.
AND THAT CRIMP CUT
SURE **PACKS RIGHT**
FOR **EASY DRAWING!**

COOL SMOKING
IS NO. 1 WITH ME TOO—
PRINCE ALBERT STYLE.
NO MORE HOT,
FLAT-TASTING SMOKES
FOR ME!

IN RECENT LABORATORY "SMOKING BOWL" TESTS, PRINCE ALBERT BURNED

86 DEGREES COOLER

than the average of the 30 other of
the largest-selling brands tested... coolest of all!

PPIPE-SMOKERS get what they want in Prince Albert. That's why it's the world's largest-selling tobacco. Prince Albert's **COOL** burning assures your smoking pleasure—the rich taste and fragrance of those choice tobaccos is not destroyed by excess heat. That means **REAL SMOKING COMFORT** too! The "crimp cut" and "no-bite" treatment are also exclusive Prince Albert features. Enjoy them in your pipe today!

(Try P.A. in "makin's" papers too.)

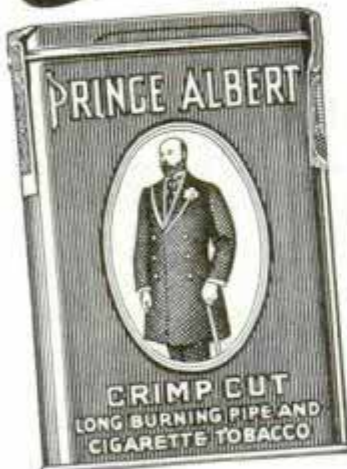

Copyright, 1939
R. J. Reynolds Tobacco Co.
Winston-Salem, N. C.

50 pipefuls of fragrant tobacco in
every handy tin of Prince Albert

Prince Albert

**THE NATIONAL
JOY SMOKE**



Popular Mechanics Magazine

REGISTERED IN U. S. PATENT OFFICE AND CANADA

WRITTEN SO YOU CAN UNDERSTAND IT

Vol. 73

JANUARY, 1940

No. 1

ARMY *ON* WHEELS



PART I

By R. Ernest Dupuy
Major, U. S. Field Artillery

West Point 24
TANKS on the ground, planes in the sky, pig boats under water; radio direction finders, mechanical fire-control computers, automatic rifles—it's a machine age in war as in peace.

Many of us are inclined to make the rash conclusion that war today is entirely an affair of machines—with robots taking the place of flesh and blood. Nothing could be farther from the truth. War is



Courtesy U. S. Army Signal Corps

New 75-mm. howitzer and, below, a light tank leaping off the ground in demonstration of its cross-country capabilities

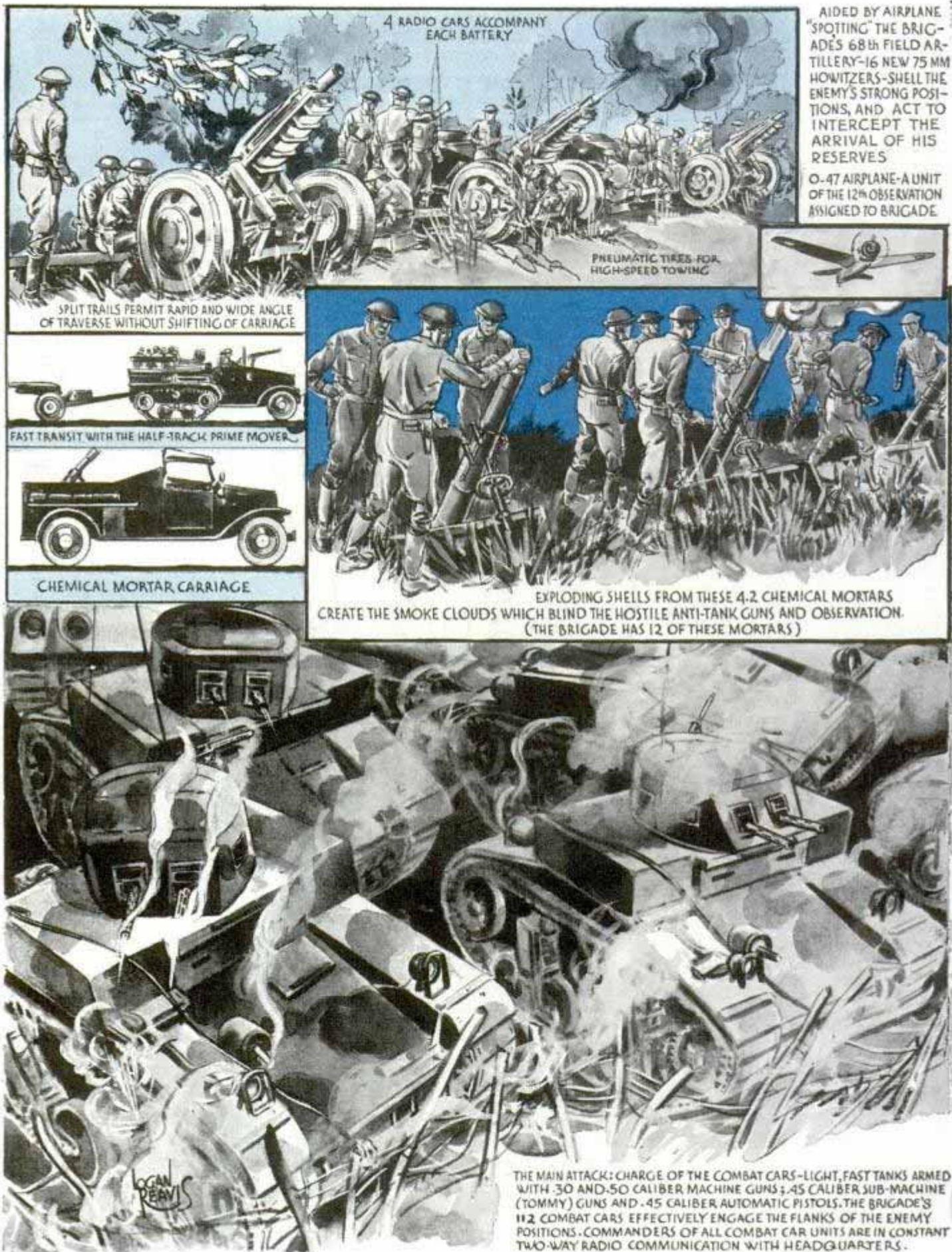

Mechanized forces which were unleashed against Poland have their counterpart in the Seventh Cavalry Brigade of the U. S. Army. Its equipment includes speedy, heavily armed and armored reconnaissance cars and tough "hell buggies"—combat cars. Drawings show how the brigade would use its equipment in battle

21221

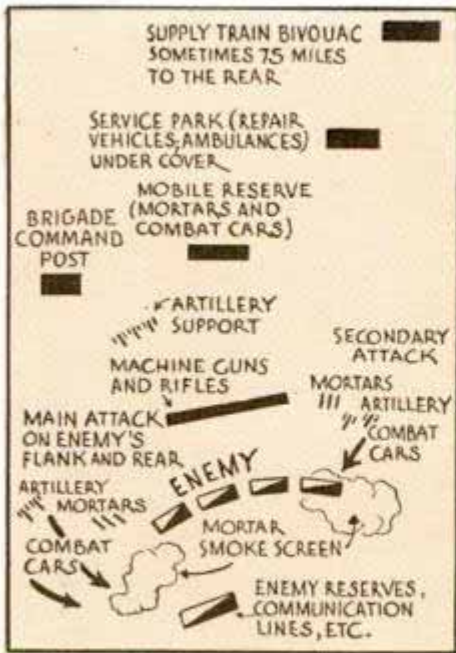

A TYPICAL ATTACK DEPLOYMENT

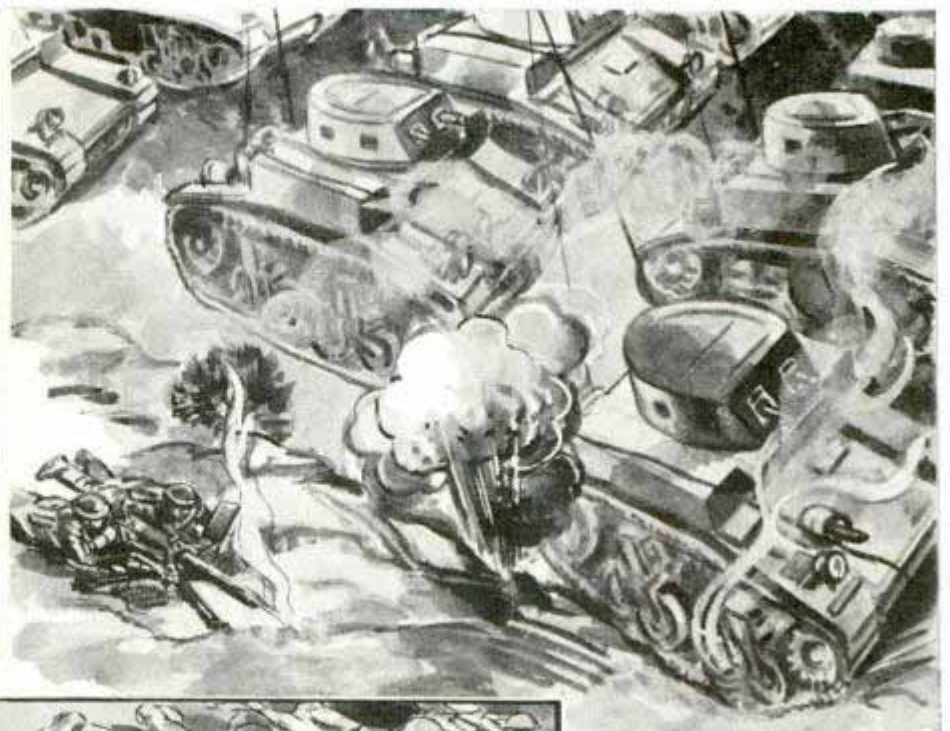

RAKING THE ENEMY WITH DIS-
MOUNTED MACHINE GUN FIRE,
WHILE THE COMBAT CARS ASSAIL
HIS FLANKS AND REAR.



PROTECTION OF FLANKS
OF THE MACHINE GUN-
NERS AND ARTILLERY-
MEN WITH THE GARAND
SEMI-AUTOMATIC RIFLES

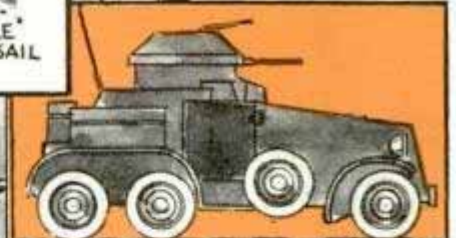

ARMORED CAR

LONG BEFORE THE MAIN
ATTACK THE ENEMY MUST
BE FOUND. THIS RECONNAIS-
SANCE IS THE OBJECTIVE OF
AIRPLANES, ARMORED
CARS AND SCOUT CARS
ASSISTED BY MOTOR-
CYCLE SCOUTS. THESE
LATTER ARE ALSO EXTEN-
SIVELY USED TO CARRY
MESSAGES. TWO-WAY
RADIO PERMITS INSTANT
CONTACT WITH HEADQUAR-
TERS BY ALL UNITS OF
THE BRIGADE.

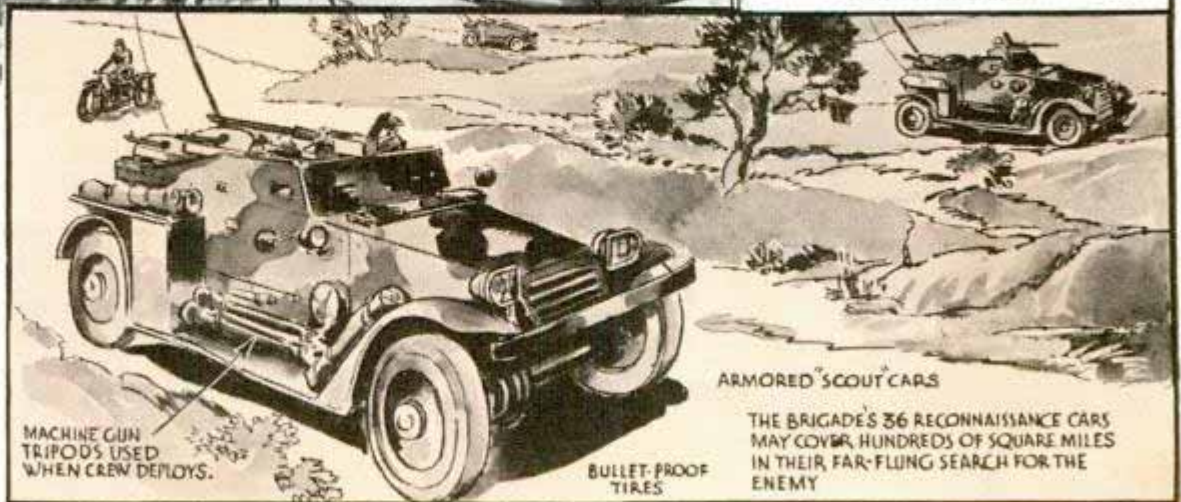

ARMORED SCOUT CARS

MACHINE GUN
TRIPODS USED
WHEN CREW DEPLOYS.

BULLET-PROOF
TIRES

THE BRIGADE'S 36 RECONNAISSANCE CARS
MAY COVER HUNDREDS OF SQUARE MILES
IN THEIR FAR-FLUNG SEARCH FOR THE
ENEMY

Additional drawings of the manner of attack employed by the Seventh Cavalry Brigade, which comprises a total of 650 vehicles and 2,280 officers and men. On this, and the page opposite, the vehicles are shown in close formation, but in a real battle they would attack in open ranks manner, reducing chances of damage from enemy fire



Courtesy U. S. Army Signal Corps



waged by men; men drive machines. Mars is simply utilizing the latest in mechanical developments as he has since the first caveman found that by rushing on his opponent, stick or stone in hand, he could do better than by walking slowly at him, barehanded.

That first caveman didn't know it but he was utilizing the basic elements of mechanics—force and motion. Ever since that time men have taken advantage of mechanical contrivances on land and sea.

Invention of the wheel was the first step toward the earliest form of tank, the chariot. The sling, the bow, the arbalest, the ballistae hurling great rocks, later gunpowder, ushering in firearms—all of these things are machines, some invented for use in war, others adapted to it from pacific uses.

And for each new invention in offensive, each improvement in the art of war, man in turn invented something to defend himself against it, from the shield of hide to the armor plate, from the

Top, rifleman ready to attack when smoke screen becomes effective, and, right, mechanized cavalry combat car. Center, new and old in army supply transport. At left is the supply truck of today, at right the escort wagon of World War days. Bottom, tanks operating in sham battle

simple shelter of a tree or hammock to the Maginot line and the Westwall.

Fire and movement, striking power and mobility are the aids mankind has been seeking since that first caveman's rock-implemented rush. The two things are diametrically opposed. The Roman short sword stopped the Greek phalanx, the British longbow the armored knights of France. The machine gun's stutter sounded the knell of cavalry's earth-shaking charge. Armor and armor-piercing projectiles have vied with one another since before the invention of steel. And now the perfection of the motor vehicle has brought into being the mechanized forces—troops that fight from moving vehicles, differing from the hide-armored, scythe-armed, arrow-shooting chariots of ancient history only in degree of human invention.

The fight between fire power and mobility has always brought about a compromise, for the fast-

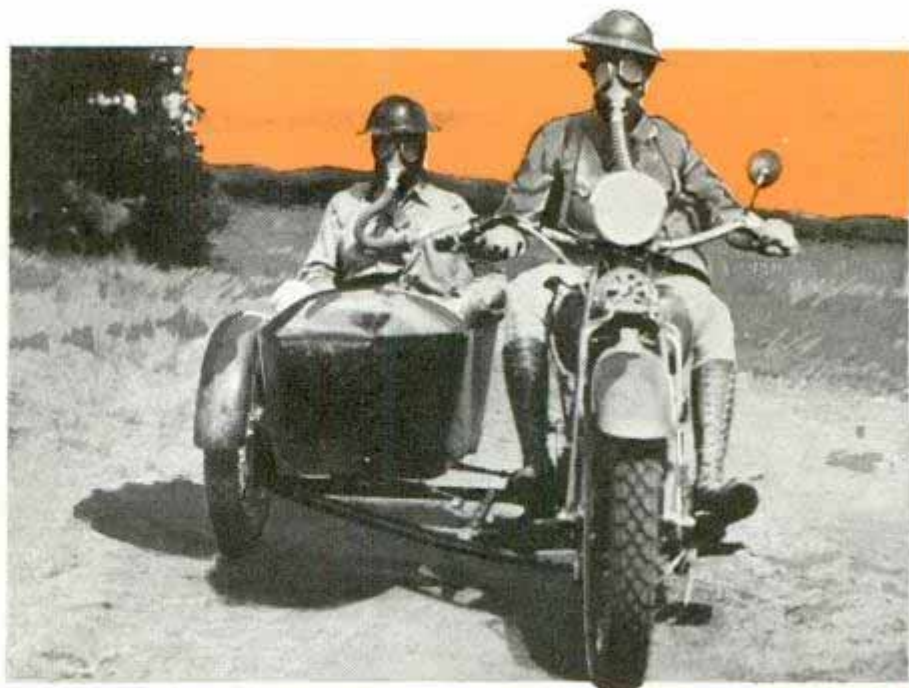

Type	Weight (tons)	Crew	Max. speed m.p.h.	Combat speed m.p.h.	Traction	Armament	Armor (thickness in inches)
Creeper	1/4-1/2	1	6-12	1-5	Track	1 machine gun	.25-.50 (front only)
Tankette	2-4	2	20-35	8-15	Track	1 machine gun or 1 cannon	.25-.63
Light tank	5-9	2-4	15-45	10-20	Track	1-3 machine guns or 1 cannon and 2 machine guns	.35-1.33
Medium tank	10-20	4-6	15-35	8-20	Track	1-2 cannon and 1-3 machine guns	.50-1.4
Amphibious	3.3-11.0	2-3	6-10 water 25-36 land	8-20	Propeller and track	1-3 guns	.35-.59
Half-track armored car	4-8	3-4	25-30	10-15	Wheels front, track in rear	1 cannon and 1-2 machine guns	.25-.50
Light armored car	4-8	3-4	35-60	25-40 on roads	2 or 4 wheel drive	1 cannon or 1 heavy machine gun and 2-3 light machine guns	.20-.35



Top, reconnaissance motorcycle entering gassed area. Center, types of tanks and cars in use, with essential operating data. Bottom, tank attempting to break through a barricade

er the movement, the less protection can be carried. Conversely, the heavier the protection, the more massive the weapon, the less the speed. In our own Civil War railroads were prime factors for mobility; so too in the Austro-Prussian war of 1866. By the time of the World War, fire power—the long range punch of artil-

(Continued to page 146A)

1,000 Lenses Take 120,000 Pictures a Second

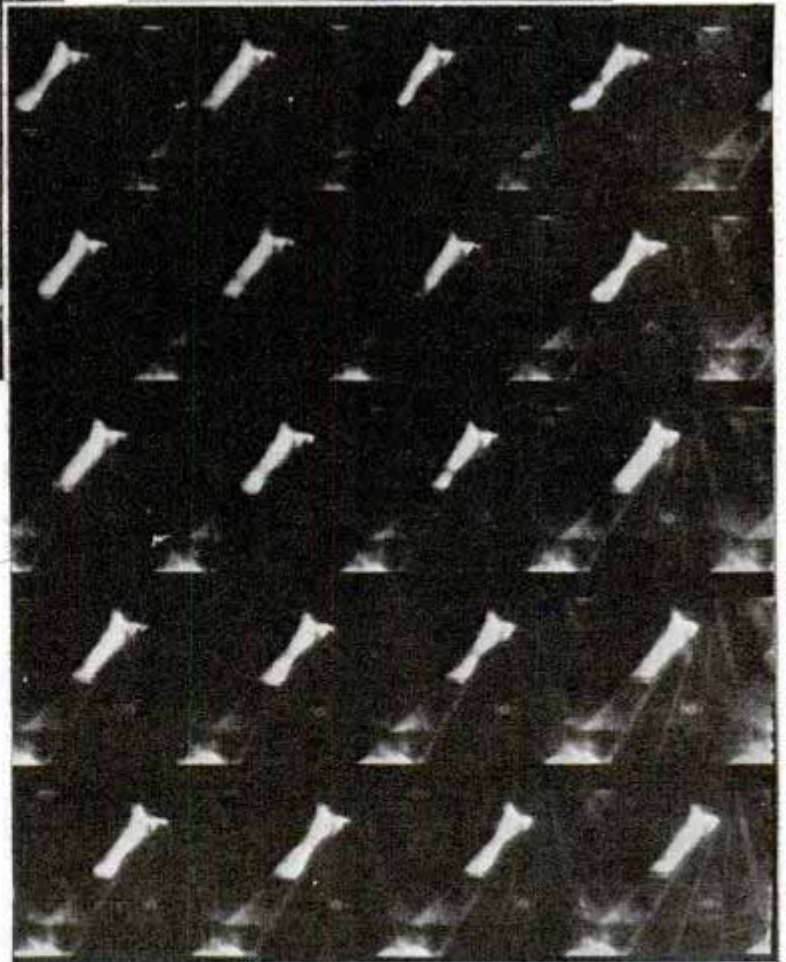
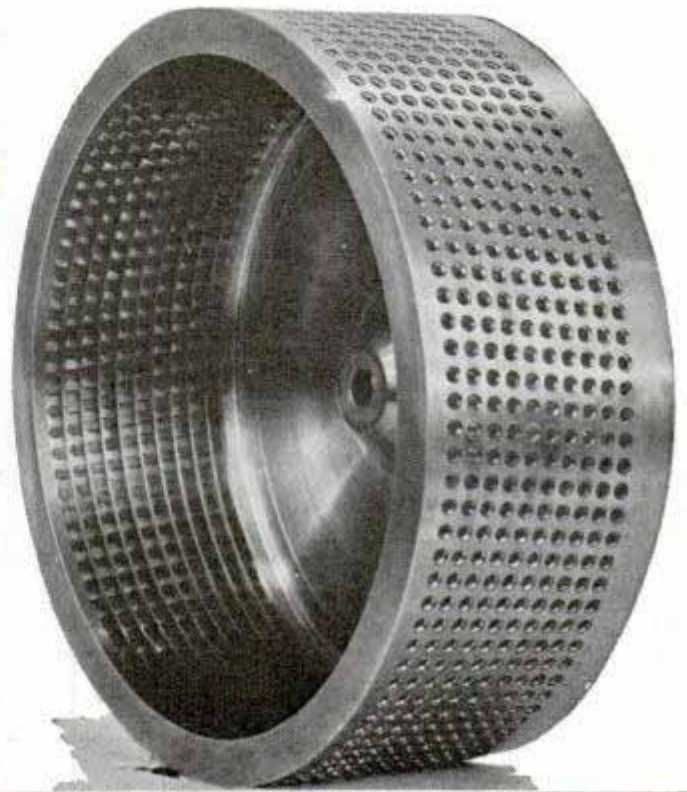
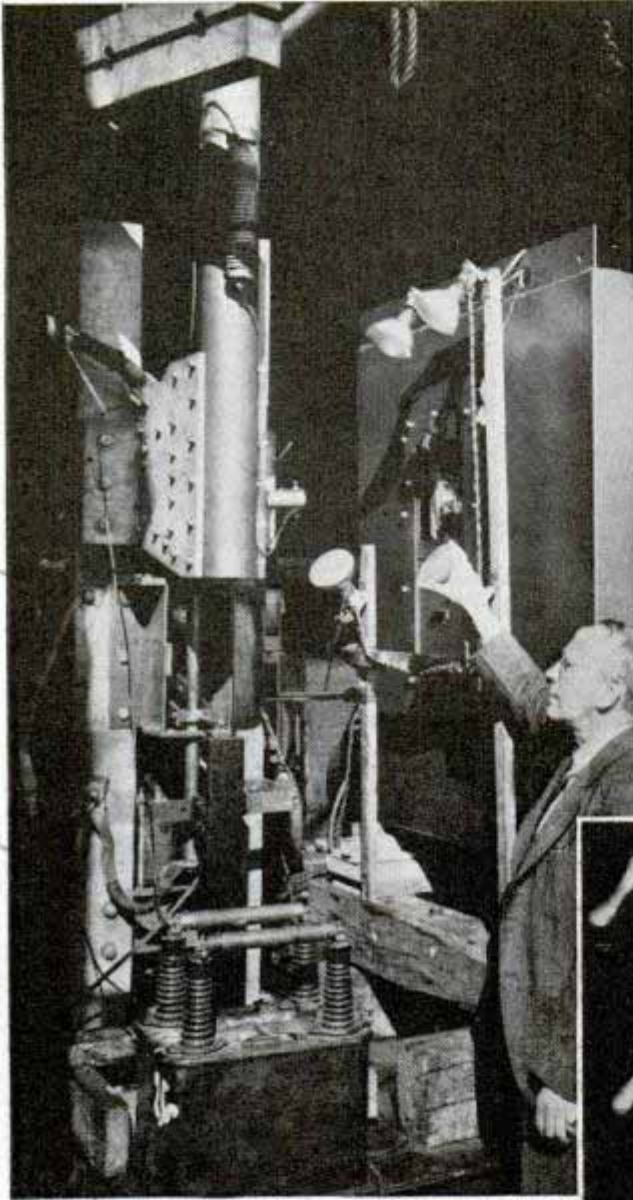

Pictures at the rate of 120,000 per second are made with a camera having 1,000 pinhole "eyes." Engineers of General Electric company devised the camera to help them study the behavior of arcs in circuit breakers and other electrical apparatus. Instead of glass lenses, the camera has 1,000 holes one-hundredth of an inch in diameter. Glass lenses, it was found, caused distortion in the pictures due to inter-reflection from the brilliant light of 5,000 to 50,000 ampere arcs, which is equal to the brilliancy of forty million watts in photo-flood lamps. The film, measuring four and one-half by forty inches, is placed around

Top, left, adjusting lights before camera is put into operation; right, drum perforated with a thousand pinholes that serve as lenses. Bottom, action of arc recorded on film studied by engineers to learn more about electricity's behavior

W. K. Rankin, Philadelphia Works

the inside of a metal drum encircled by ten rows of holes. These are so arranged that no two holes are exactly opposite each other and only one of them comes into photographic position at a time. A one-half horsepower motor turns the drum at 7,200 revolutions a minute, thereby permitting each of the pinhole openings to be exposed as fast as one-one-hundred-twenty-thousandths of a second. The drum rotates within a cylinder fourteen inches in diameter, and as each of the 1,000 pinholes passes a slot extending the width of the film, a picture is taken. Pictures are about one-third of an inch square.

1208
**Reel for Drying Fishing Line
 Is Wound Automatically**

\$ 3.50

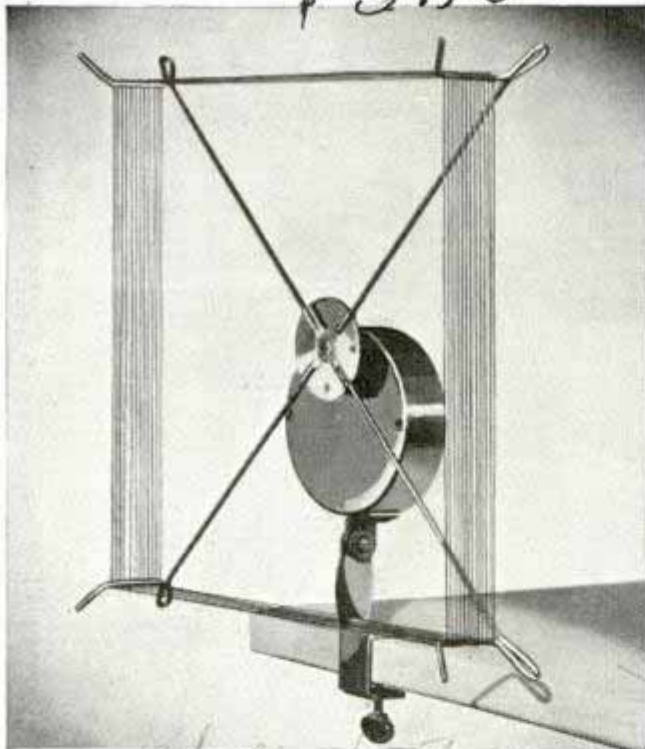

Wald speaking good
 Drying reel automatically winds fishline from casting rod and is reset for use when line is removed

With a self-winding reel on which to wind his fishline, a fisherman can dry the wet casting line quickly with little effort. A clamp with swivel mounting secures the winder to any vertical or horizontal surface. Hook the line on any of the wire spokes and press the button, and the reel automatically winds the wet line from your reel onto itself. In a few minutes the line is dry and can be rewound on the casting reel—and this automatically resets the drier for the next winding. The unit will handle 100 yards of silk casting line.

Chicago
 Eclipse Mfg. Co.

**Radio Time Is Regulated
 by Two-Way Clock**



I am trying national
to indicate C. Ballman
 Clock with two dials runs forward and backward to help in timing radio programs to the second

Split-second timing of radio programs is made easy by using an electrical clock that tells at a glance how long the program has been on the air and how much time is left. Actually it is two clocks in one. The dial of one moves clockwise to indicate elapsed time, and the other counter-clockwise to show the time remaining.

1143
**Streamline Tractor for Airport
 Has Six-Cylinder Engine**

Pennsylvania at Detroit
 Airport tractors have gone streamline to keep up with the design of modern airplanes. Their job is to haul the giant air liners about the hangars and air field. The new model is powered with a six-cylinder automobile engine. *Plymouth*

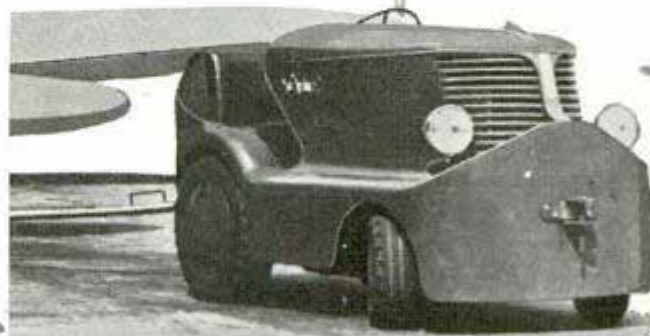

Larry Foto
 Airport tractor for hauling airplanes around hangars is streamlined for movement in close quarters

4531 Jacomy, Philo
 Yale & Towne Co.

18618
maly
15555 Holman Ave
Pasadena
Pasadena

FLYING



to learn his location. He had to stay in the dark, find the direction of the airport by instruments, and fly directly to it without one peek at the scenery. He was somewhere within a 40,000-square-mile area that had the field as its center, but it took only a couple of minutes for

Area above: Publishing Director
United Air Lines
Pasadena

FOR more than an hour Capt. C. R. Bowman had been flying blind at the controls of the "Mainliner." Canvas curtains were fastened securely around his side of the cockpit. He had flown off the field by instruments alone and since then he had banked the plane in turns, stalled it with and without power, and performed other maneuvers that the voice in his earphones dictated. By now he was completely lost. "Okay, Dick, let's go home."

Sitting in the co-pilot's seat, Assistant Flight Superintendent Bob Bergesen of United Air Lines' southern division gave Bowman his final order over the interphone. That didn't mean Bowman could unsnap his curtains and look over the side

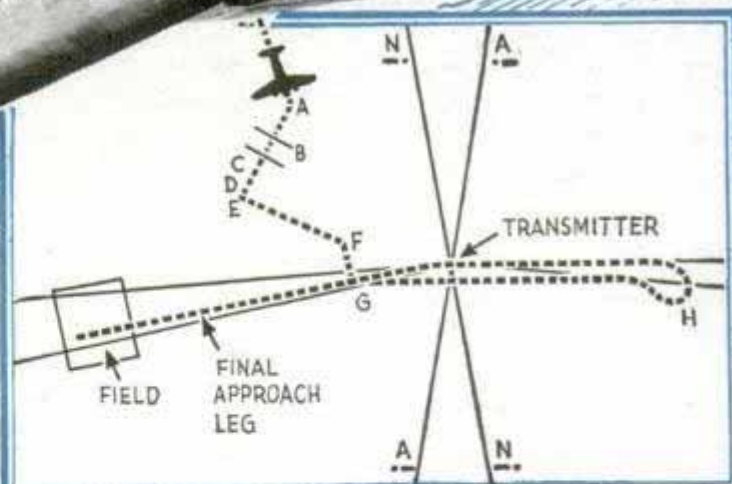

- A. Loop turned on, plane starts turn.
 - B. Null signal from station comes over loop.
 - C. Continues straight until signal returns.
 - D. Loop rotated for second null to indicate side station is on.
 - E. Loop rotated to "homing" position and plane turned to receive null on nose.
 - F. Heading of plane changed 45 degrees to intercept nearest leg.
 - G. Plane turns toward range station and flies across it to opposite leg.
 - H. Pilot makes 180-degree turn and flies back over range station, descending as he flies along final approach leg.
- Location procedure takes about three minutes at any reasonable distance from range station

Circle, pilot is curtained off while test flight is under way. Center, DC-5, sixteen-passenger transport. Below, how pilot finds airport while flying blind

"UNDER *the* HOOD"

C 0 5 1
0 1 5 1

United
H. W. DeWesse
Civil Service Commission

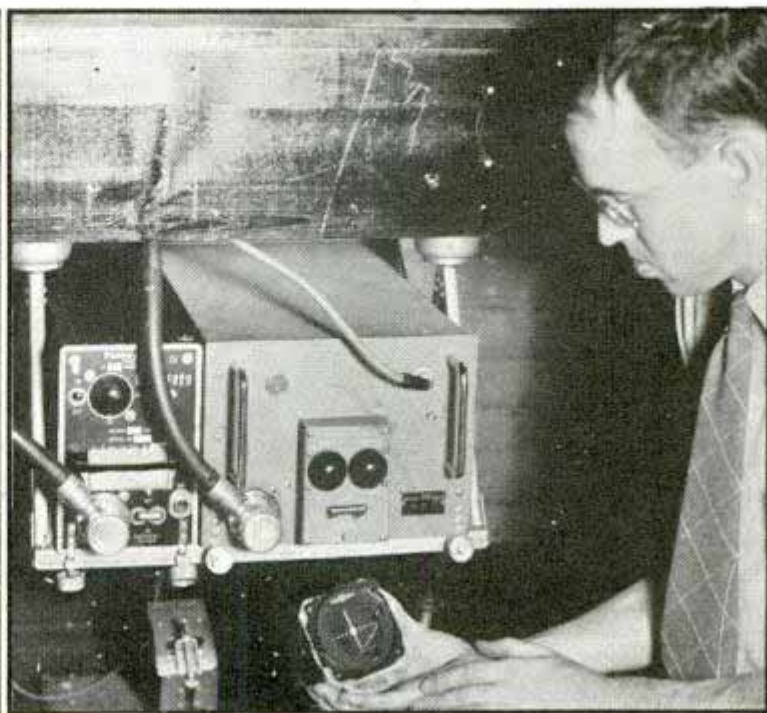

Left, Bennie Howard demonstrating throttles in DC-4. Right, instrument, in demonstrator's hand, has cross pointers which pilot follows in making landing. Below, special antenna, atop fuselage, makes possible uniform reception of radio signals required in making instrument landing

him to locate himself. Making sure that the directional radio loop was pointed fore and aft, he switched its circuit to his headphones and began a slow turn. When the repeated dots and dashes faded out he straightened his course. A few more adjustments to the loop showed him the direction to the nearest radio beam from the range station and he steered toward it. By now he had enough data to enable him to determine his exact geographical position.

All through the test Bowman had been flying by manual control. The image of his plane on the



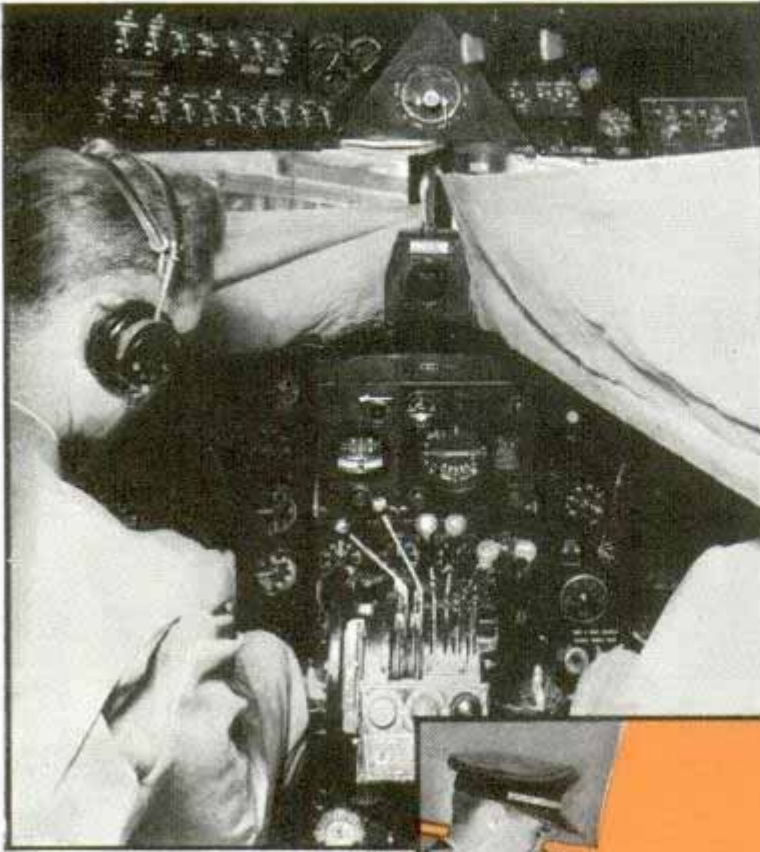

artificial horizon told him his position in the air and the altimeter gave him his height. The air speed, compass, rate of climb, and the bank and turn instruments supplemented the others. After he flew to the radio range station he was required to turn to the final approach beam that led to the field and descend along it until he reached a certain minimum altitude over the airport.

Every six months Captain Bowman and every other pilot in charge of an air liner must pass that test. The check pilot who gives the examination sits in the clear and can take charge of the airplane if other aircraft approach. Blind or instrument flying is common today when weather obscures landmarks, and the check flights that pilots make include combinations of

circumstances more severe than they would encounter on their regular runs. Aside from their tests the pilots spend considerable time "under the hood" to increase their proficiency.

United pilots are already practicing blind landings in anticipation of the time when they will land regularly with passengers in zero-zero weather, just as they practiced instrument flying for a long period before they carried passengers through heavy weather. R. T. Freng, flight director of United, has made more than 1,000 blind landings, each time guiding his plane directly to the field and putting it down gently on a 100-foot wide runway without seeing the ground.

Details of the instrument landing system, worked out by the Civil Aeronautics Authority at its Indianapolis experiment center, include a sharply defined directional radio beam that guides the plane to the runway



Top, how pilot's compartment is curtained off. Center, examining cartridge that contains reel on which trailing wire is unwound to diminish static. Bottom, nose of DC-4 opened to expose radio compass loop

8957

21213

and a "radio glide path" radiation from a separate transmitter that creates radio waves that gradually incline upward in a dishlike pattern from the field. As a forerunner to absolute blind landings pilots will be using this system this spring to assist them in making landings in limited visibility.

On the Douglas DC-4 transports that United has ordered for service in 1941, blind landings will be facilitated by the nose wheel of the aircraft's tricycle landing system. Landing this plane is already partly automatic. The job of steering it can be handed over to the automatic pilot, which also takes care of the ailerons, and all the human pilot has to do is control his rate of descent. The nose wheel forestalls any possibility of ground looping with the rudder control set.

Control surfaces are so large that booster controls are provided to help the pilot handle the plane. These planes will have sealed pressure cabins and two-stage engine superchargers so that passengers can be carried in comfort as high as 20,000 feet for greater speed on long flights. In the cockpits will be ground-to-plane radio teletypewriters to take down weather reports as they are broadcast, relieving the crew of the jobs of copying the signals. Terrain indicators that use a radio echo to measure the distance to the ground will be another new cockpit instrument. Another device will turn on a warning light to show the proximity of another airplane.

More and more, aviation is developing radio into one of its most useful servants. If a United pilot finds that static is so heavy that messages are not coming through he simply pushes a button and the interference falls away to a whisper. The button operates a reel in the tail cone, releasing a short trailing wire that discharges most of the static behind the ship.

(Continued to page 145A)

"Hoopcycle" Carries Rider and Motor in Rear Wheel



Motor and seat for rider are mounted inside hooplike wheel which is steered by handlebars attached to small front wheel

Fifty miles an hour and 250 miles on a gallon of gasoline are claimed for a motor-operated "flying wheel." Driven by a small gasoline engine mounted inside it, the hoop also circles the driver's seat. Steering is accomplished with handlebars attached to a small wheel at the front. The inventor, an automobile mechanic of Glendale, Calif., spent four years developing his idea.

Tilting Reflector Above Torch Lamp Softens Light for Portraiture

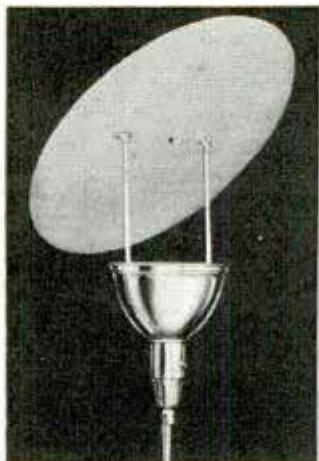

Softly glowing light, especially desirable for use in portraiture, is shed by a photographer's lamp now available. Indirect lighting is achieved by a flat-surfaced tilting reflector mounted above the standard of a torch type lamp. This can be adjusted to any angle so the light will be cast wherever desired. Remove the reflector, and the unit serves as a floor lamp.

The Halderson Co.

L. T. New York
 J. H. Chicago
 C. E. L. T. New York
 L. T. New York

"Frozen" Model Reveals All Points of Stress

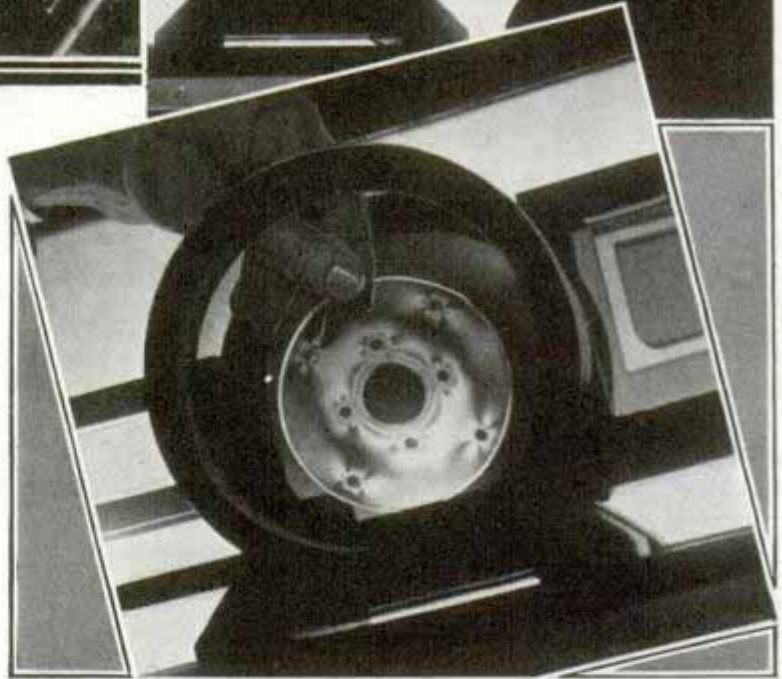

Top, left, placing Bakelite test piece in polariscope; right, pattern reveals stresses in crane hook, and, below, in disk

Machine parts that must withstand heavy strains are made safer through a testing process developed by a research engineer of the Westinghouse laboratories. A transparent Bakelite model of the part to be tested is placed in an electric oven and subjected to a load such as the full-size part must endure, then the heat is turned on. For an hour the test piece "cooks" at about 240 degrees Fahrenheit, reducing the Bakelite to an elastic condition in which deformation of the piece results, due to the stresses which are exerted on it. The load is left on as temperature is lowered, thus "freezing" the deformation when the material returns to the solid state. To the unaided eye the sample appears unchanged after its heat and load treatment. Here is where polarized light comes in. The investigator cuts a slice through the model and places it in a polariscope, resembling a giant magic lantern. Polarized light,

which vibrates in only one plane instead of scattering like ordinary light, is passed through the Bakelite slice. As these light rays come out they are captured by an analyzer and form a picture of the stress lines in the model. By studying these lines, the engineer sees where the greatest stresses will occur in the part he is designing.

Two-Way Facsimile Unit for Planes Offers Rapid Communication

Two-way facsimile communication is possible for airplanes, automobiles and small boats with a transmitter weighing only twenty-five pounds. With the light-

weight unit in an army plane, the pilot can fly over enemy lines, mark information on a prepared map, then place it in the scanner and immediately send it to every bat-

Mr. Zublas. Petenyi
 G. Bell...
 1039

Service Bureau
 Ad: 24
 1251

Finch Telephone Laboratories
 27 111 57 41

Demmer... of W. Va. is French.

tery which can reach the objective by gunfire. Complete secrecy is obtained by using any of the present "scrambled" radio methods which can be decoded only in pre-arranged facsimile receivers. Jamming of the air with distorting signals on the same wave length has little effect on facsimile transmission, since this results merely in graying the background but does not obliterate the intelligence which is superimposed upon it. In peacetime, airplanes and ships could use the facsimile system to exchange weather maps and other information with ground stations.

J 1152

Giant Streamline Loud Speakers Broadcast Music in Park

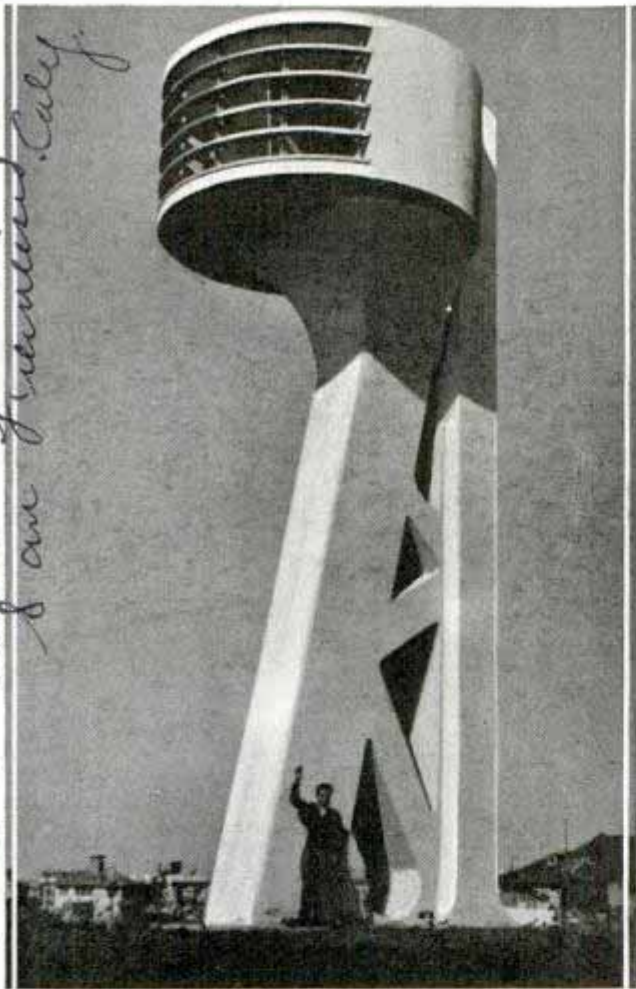

One of two streamline loud speakers erected in San Francisco to broadcast music and announcements

Two giant loud speakers facing each other from opposite ends of a park in San Francisco, Calif., add a touch of modern design to the surroundings with their streamline construction. The towering public-address units broadcast music and announcements to holiday throngs.

Arch. Herb L. Trumbull 1831 Polk St. San Francisco, Calif.

J 1207
Stop Signal Worn on Sleeve of Driving Jacket



at auto show
Driving jacket with word "stop" outlined in bright reflectors makes hand signal easier to see at night

One of the latest fads for motorists is a driving jacket with the word "stop" outlined in brilliant red reflectors on its left sleeve. It adds safety to hand signaling since drivers coming from behind can see the outstretched arm more easily when their lights shine on the red reflectors.

J 1164

Motorcycle with Fluid Drive Starts without Jerk

Using an oil or fluid drive, instead of gears, for transmitting power from engine to wheel, a motorcycle is started smoothly without jerking. New in design, the vehicle carries either a one or a two-cylinder engine on the front fork. Standard straight-side pneumatic tires and drop center rims are used.

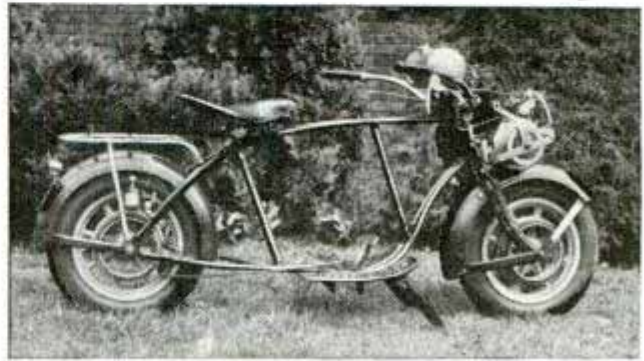

No jerking is noticed when this motorcycle starts because gears have been replaced by fluid drive

Chas. E. Miller Corp.

American Brass & Steel Co. 450. 4th Ave. New York Products Co.

1065 Cnr. 2. U. Cleaves
145 W. 46 th. New York

TESTING *the* WARSHIPS

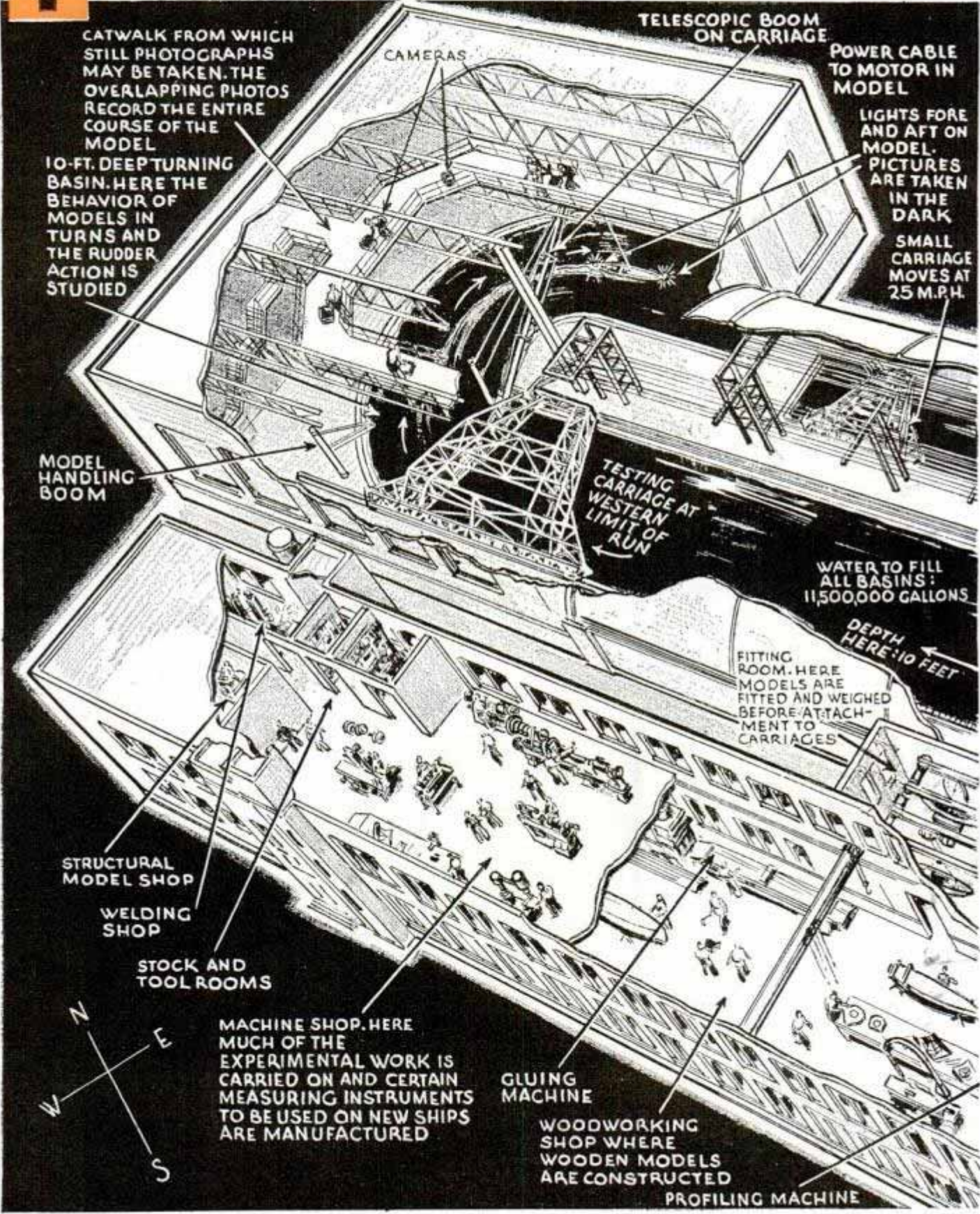

Shown here is the \$3,500,000 basin being built by the navy at Carderock, Md., for testing seaworthiness of scale models of America's future battleships, torpedo boats, other naval craft and merchant ships. Self-propelled models with lights mounted fore and aft will be photographed to show up defects in maneuverability. More than 250 persons will be employed at the basin

David W. Taylor model basin

of TOMORROW

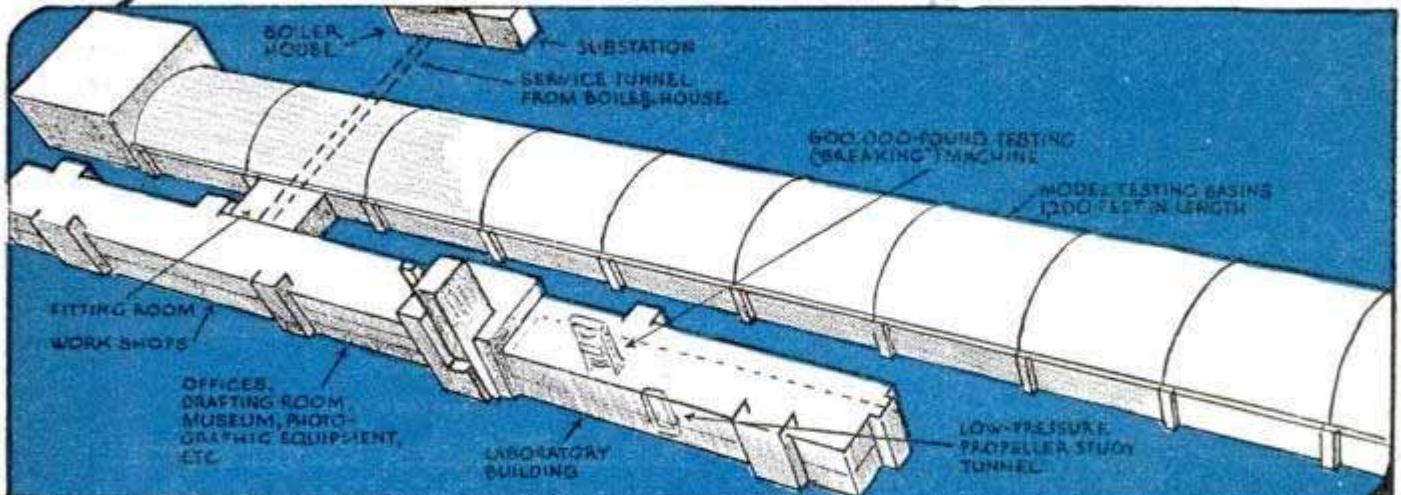

GENERAL ASPECT OF DAVID W. TAYLOR "MODEL BASIN"

EXPANSION JOINTS FACILITATE ADJUSTMENT OF ROOF TO THERMAL CHANGES

HIGH-SPEED BASIN 10 FEET DEEP PERMITS SPECIAL SPEED TESTS AS OF MOTOR TORPEDO-BOAT MODELS

ALUMINUM PAINTED ROOF REFLECTS SUN'S RAYS AND AIDS IN PREVENTING OVERHEATING OF INTERIOR

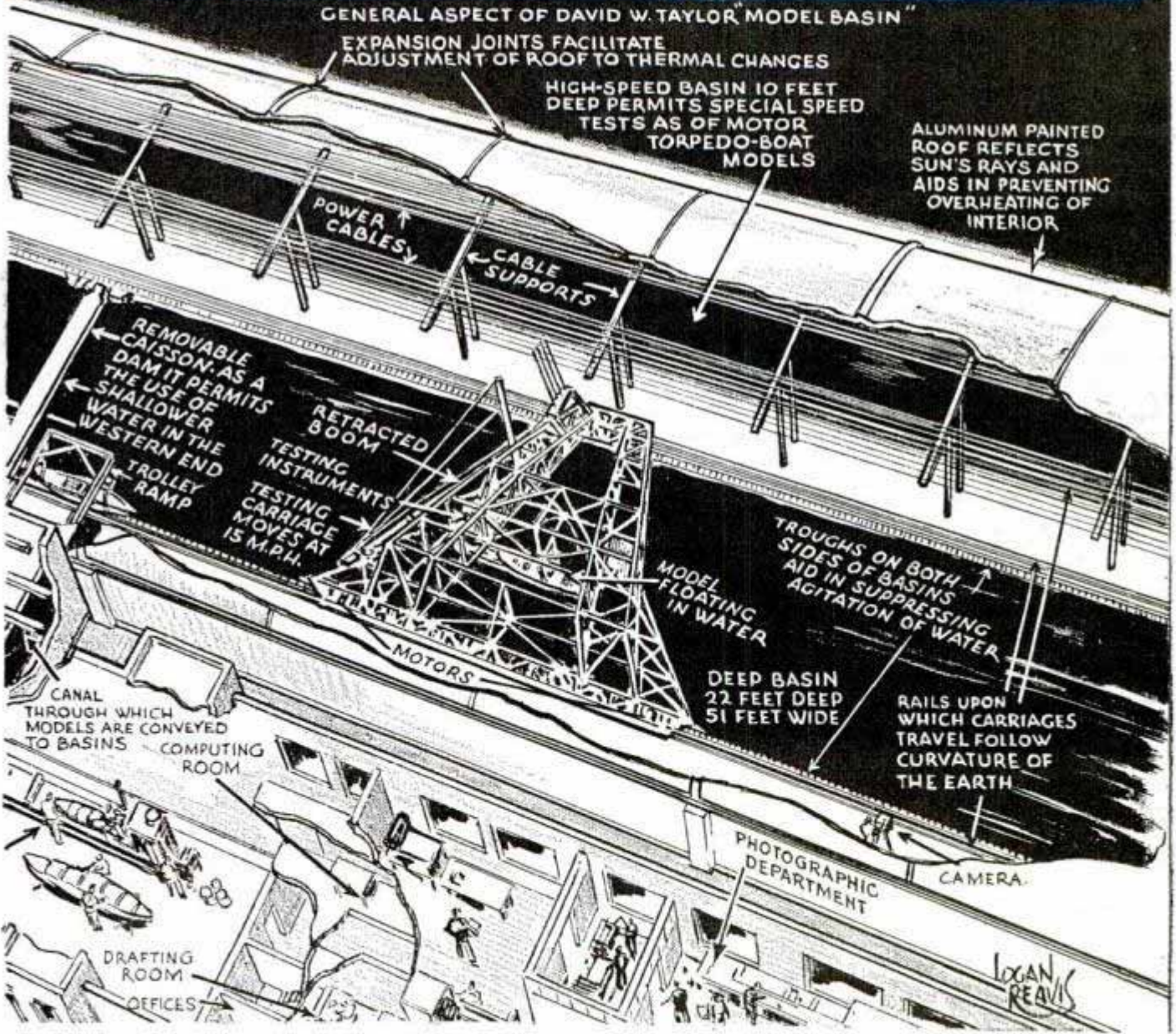

Because extreme precision is essential for tests in the 1,200-foot basin, it is air conditioned and draftless, heavily insulated and the temperature is maintained between sixty and seventy degrees. The rails on which the towing carriages ride are even adjusted to the earth's curvature. The tests are recorded on delicate instruments and wave patterns are photographed

2-118-0
16

Socks Are Mended by Patch "Vulcanized" over Hole

Lewis & Cinger
45th and West 40th Ave
Cleveland

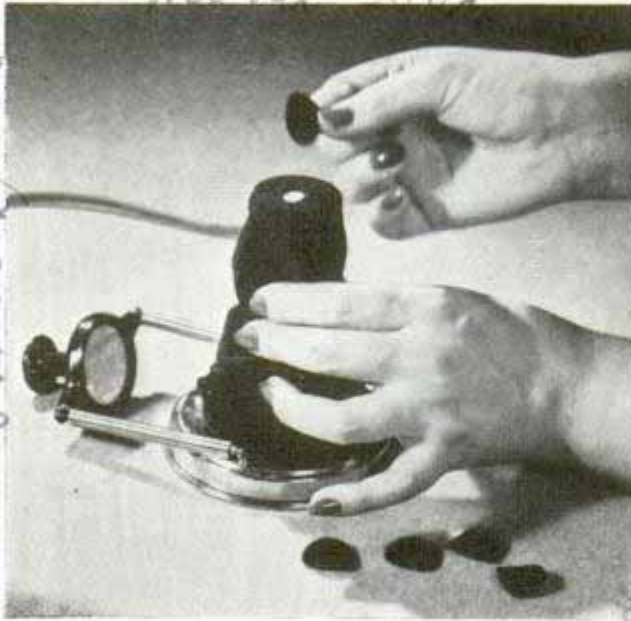

Small patch held in hand is "vulcanized" over hole in stocking by special heating device

Socks can be mended without darning by a process similar to that of vulcanizing patches on auto inner tubes. A patch is placed over the hole and then a heating device is applied. This results in a finished mend without any lumpiness like that which sometimes appears in darning.

Built by Preston Tucker
Tucker Infy. Co. of Flint, Mich.

Four-Gun Anti-Aircraft Tank Fires 5,220 Shots a Minute

Intended as a defensive arm against low-flying aircraft on ground-strafting missions, an arc-welded combat car is equipped with three machine guns and a cannon. The automatic cannon fires at the rate of



High-speed bulletproof auto with rotating turret on top is designed to combat low-flying airplanes

Simon Electric Co
12818 Coll Road
Cleveland Ohio

120 shots per minute and three thirty-caliber machine guns fire 5,100 shots, making a total of 5,220 shots a minute. With a motor of 200 horsepower, 114 miles an hour is possible. Designed by an American builder, the tank is arc welded of bulletproof armor plate to eliminate rivets. The welds themselves are bulletproof. The turret rotates freely to give complete firing range, and glass two and one-half inches thick gives full visibility. Mounted on bulletproof tires, the new mobile unit has little difficulty traveling through mud, sand and broken ground.

Kit for Building Target Pistol Requires Only Hand Tools

parts list 7 B. P. 2-00
1/264 \$15.00

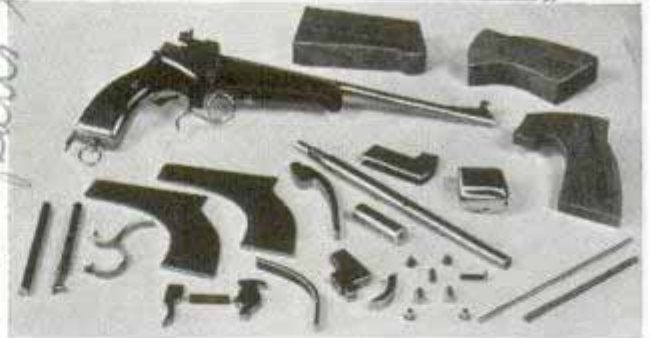

Top, designer sights target pistol; below, complete homemade pistol and parts from which it is made

Sportsmen who want to build a target pistol in the home workshop can follow blueprints worked out by a Wisconsin man, using hand tools for all except the turning of the barrel, which requires a lathe or grinder. This shop hobbyist has shot down toy balloons a quarter mile distant with his homemade pistol. It is a .22-caliber weapon with twelve and one-quarter inch barrel. A pistol that might cost \$100 and more in a gunshop may be built at home for about fifteen dollars. The complete kit of parts is available in roughed-out form or ready for assembly.

The Selmer-West Co
12818 Coll Road
Cleveland Ohio



Wall Disney Productions 2719
Hyperion Ave. Hollywood Calif.
New York - 1270 Sixth Ave.

COLOR-SHOOTING in FAIRYLAND



Building the story of "Pinocchio" for the colorful motion-picture version of the fairy tale, members of story crew study sketches for a proposed sequence



© Walt Disney Prod.

Noise-makers shaking buckshot in rubber balloons to produce sound effects for Monstro, the whale. Left, animator checks his own expression in mirror in drawing wondering expression on J. Worthington Foulfellow

all, he's only a color cartoon having a furious time in a three-by-five-foot pool. And that he got his start as a model with synthetic ribs which could breathe if the stunt man was there to pump his lungs full.

Fairyland is back in Hollywood again. Even before "Snow White and the Seven Dwarfs" had rung up new box-office records, Walt Disney and his staff were sitting up nights reading fairy tales and thinking up ways

of bringing them to life in livelier and more colorful vein than ever. Several technical problems were solved before "Snow White" went on the road, but it was too late for changes and the lessons learned then will benefit fairyland's second full-length Technicolor production, "Pinocchio."



ACROSS the screen you'll watch a whale of terrifying size swim lazily, his powerful muscles undulating in blue-black waves along his back.

When he goes into a fit of rage and lashes up mountainous seas with that gargantuan tail you'll forget that, after

X 907 19



© Walt Disney Prod.

Music for the picture is produced by composer (left, above) who checks score with air of Movieola at right. Sound effects man splashing paddle in soapy water (right). Disney multiplane camera which makes possible new techniques in motion pictures

Dimensional models of not only characters but various properties in the picture were created for the animators to use in making up the cartoons of which the motion picture is composed. These models were regular little figurines designed, sculptured and cast in the studio's character model department, and painted in the same colors in which they were to appear on the screen. These models enabled the animator to obtain a more concrete idea of what the characters would look like from every angle.

In connection with the creation of the character of Pinocchio himself, actual puppets were created by the model department for the use of the animators responsible for the live marionette hero of the famous story. These animators took lessons from the fellow worker who created the puppet. A well-known puppeteer before joining the studio, he showed them how to make Pinocchio go through all

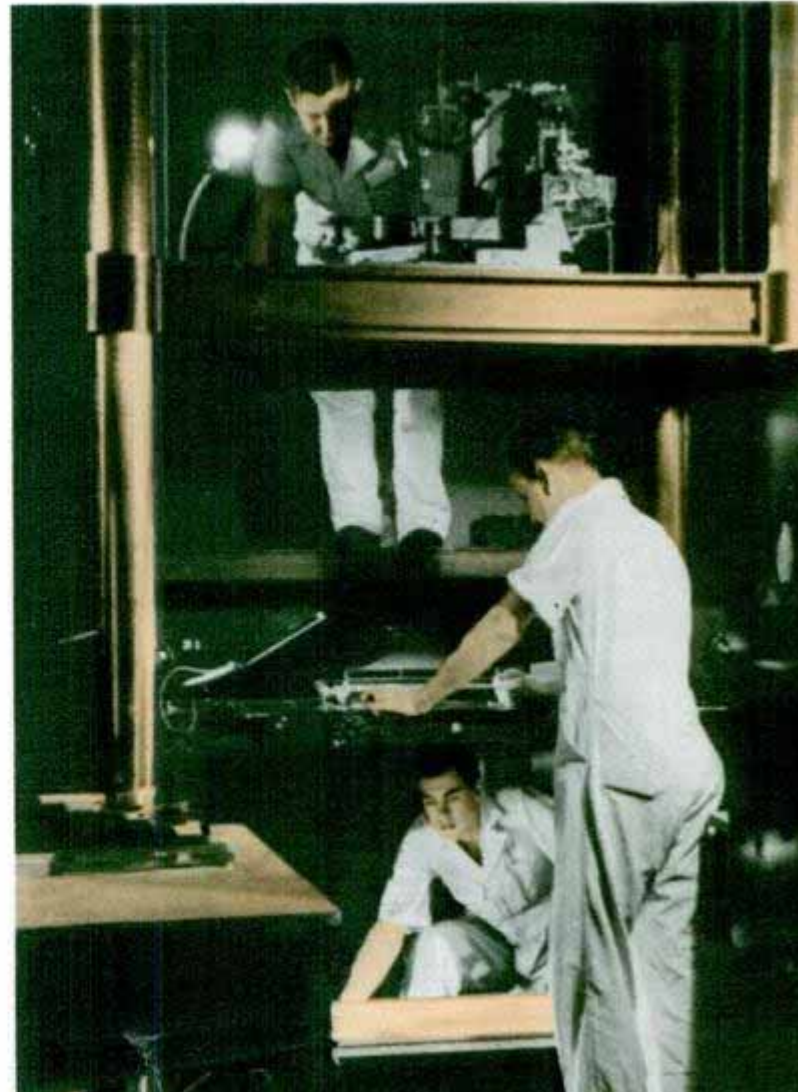



© Walt Disney Prod.

2909

26



Colors for "Pinocchio" came from paint laboratory in which more than 200 new types and shades have been produced since the making of "Snow White." This brings the total number of colors and shades up to more than 2,000

Checking up on recording equipment on sound stages must be frequent in order that music, sound and dialogue be as nearly perfect as possible. The technician is shown checking board responsible for one complete sound stage set-up in the Disney studio

21 2709

sorts of antics. This was necessary because although, in the story, the puppet is alive, he is still wooden, and therefore cannot move as a real boy would move.

Other properties which helped the animators included a little stagecoach perfect in every respect, even to the tiny lamps which were lighted by means of hidden batteries; and the wagons used by Stromboli, the puppet master in the picture. Motion pictures were shot of all these vehicles as they were trundled over miniature roads—bumps and all. These movies were used by the animators for study and inspirational aids. For the illusion of weight, the little coach and wagons were weighted with pieces of lead. The bumps in the "road" were made of sponge. This combination gave the exact appearance of heavy vehicles, while the miniature springs rocked them from side to side in a realistic way as they hit the sponge bumps.

In the story of "Pinocchio," the puppet is created by an old woodcarver named Geppetto, whose quaint old house is overflowing with toys, musical gadgets, clocks, pipes and furniture to delight the hearts of young and old. Many of the objects drawn for this animated production had their actual inspiration in counterparts which came out of the character model department.

One clock shows a mother with a small boy turned over her knee. One of his hands is caught in a jam pot. As the clock strikes, she spansks him and he cries.

Those who saw "Snow White" marveled at the

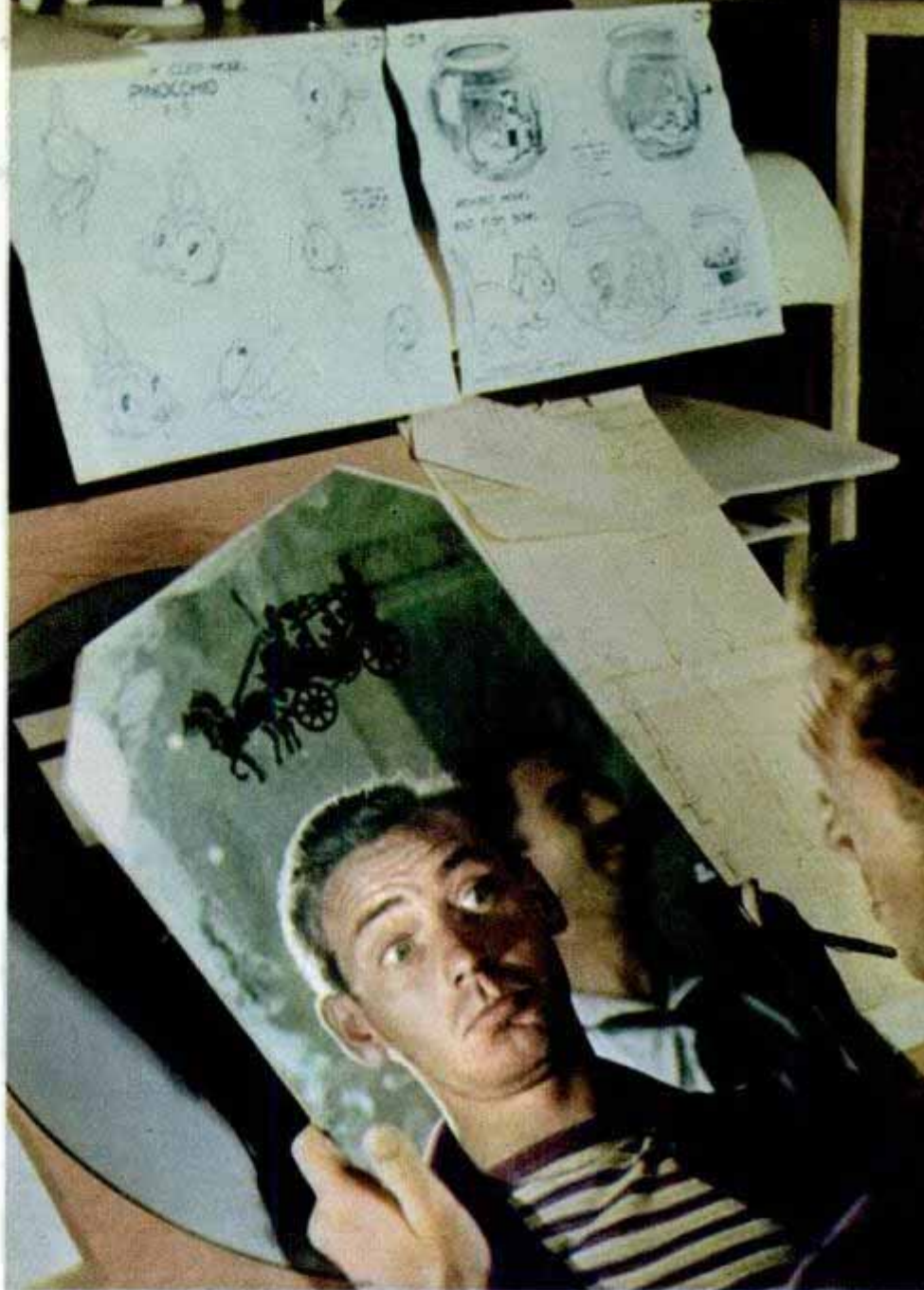

© Walt Disney Prod.

Making faces at himself, the animator attempts to catch coy expression to pin on Cleo, the goldfish. Below, cutter synchronizing a scene from the fairy tale, seeing that picture, dialogue and sound are all "on the nose"



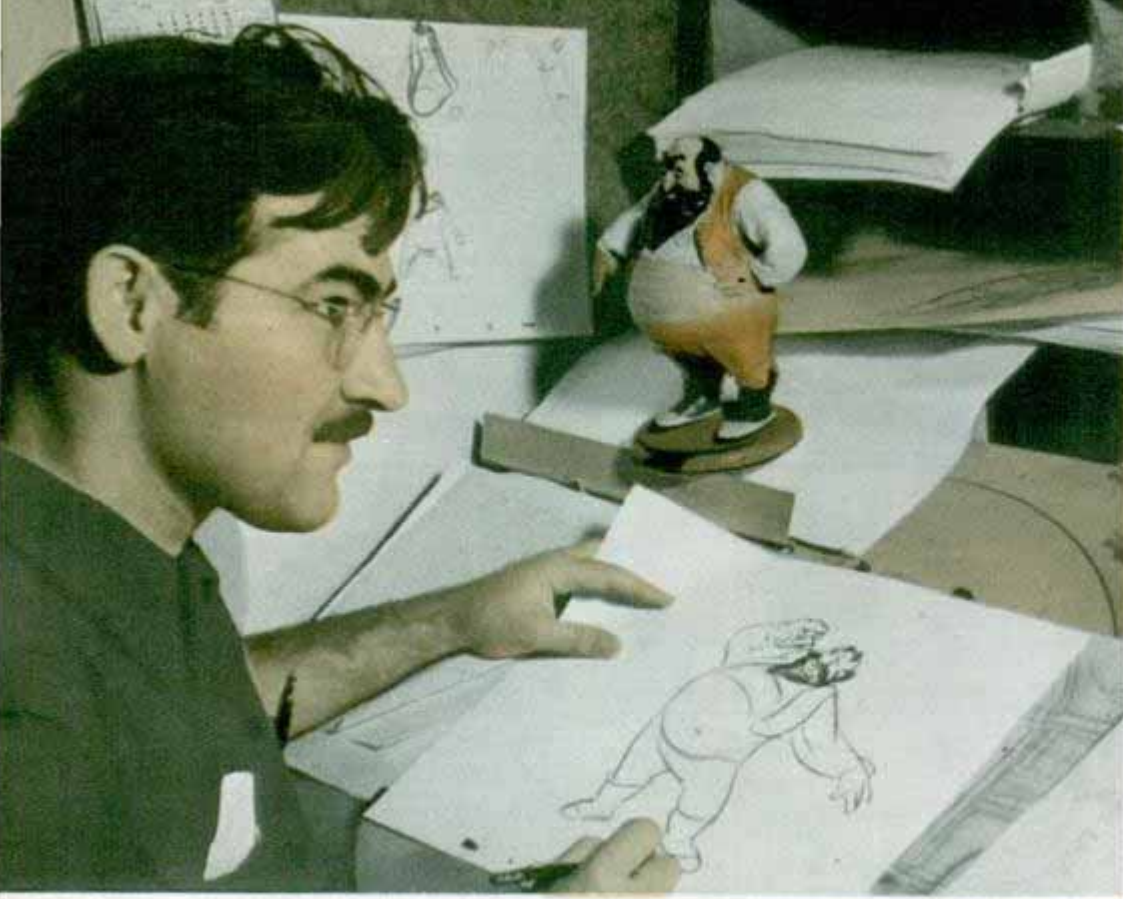

27

Models helped animators produce sketches for the movie. Bottom of page, sound men hard at work producing various weird effects that were found necessary at some stages in "Pinocchio." Note the devices employed by the sound men

© Walt Disney Prod.

2909 realism of the shadows, the highlights on jewels, and on shiny objects, the mists, the dusts, and the water. All such inanimate but highly important things are the responsibility of the special animation effects department. In "Pinocchio," for the first time in the field of animation, audiences will see the warm glow of a lighted match against a man's face as he lights his pipe. They will see underwater effects that look for all the world like super-special marine photography. They will see the Blue Fairy step from a dazzling brilliance of light. They will see that three-story whale rippling under the water. Animation-effects men spent months around the Pacific ocean in all kinds of weather, photographing and sketching the sea in all of its moods. They also studied the exotic and colorful under-water gardens which can be seen plainly from glass-bottomed boats off Catalina Island.

The creation of Monstro the whale lay rather equally between the regular

character animators, the effects animators, and the layout men. For months they experimented with some way to fix up Monstro so that his big bulk took on depth, perspective and highlighting. The whale was first drawn in pencil on regular animation paper. Then the drawing was traced to a special type of colored paper and the highlights rendered in chalks. From this point, the drawing went through a tracing-dyeing-photographing process on a newly developed type of sensitive film. In this way, subtleties of highlights and perspective were obtained, as well as nuances and shades of coloring impossible with regu-



2909

23

lar paints. Whale models created within the studio also helped the animators and layout men with their project. A miniature whale skeleton some five feet long was made, which the artists could twist and turn at will. The model department fashioned a rib cage and lungs which could be pumped to simulate actual breathing. Clay models were made and painted in oil so that the artists could study probable highlights and light changes on Monstro's skin.

The layout men discovered the illusion of great size could only be carried out by paying minute attention to perspective. They drew



© Walt Disney Prod.



Pinocchio being given final touches in inking and painting department (top). Overhead shot of crew on stage for combined sound effects and organ recording (center). Working model clock employed as a prop to produce a novel, humorous touch in the movie



© Walt Disney Prod.



Melding the movie (top) by using control board for dialing music, dialogue and sound up and down, as desired. Below, Walt Disney holding Pinocchio, the puppet hero of the picture, on his knee

2909
 him to approximate the scale of a three-story building. Wherever possible, the whale filled up most of the camera field. Although the largest capacity of sound ever put on film was recorded for sequences when Monstro churns up the sea in a fit of rage, the water effects were made in a tank with the relatively small dimensions of three feet by four feet by five feet. Swishing ordinary water around in this tank didn't do at all, because the sound coming over the play-back machine didn't give the effect of several tons of blubber thrashing in an ocean. The desired "heavy" tone was accomplished after one of the ingenious members of the sound effects crew suggested that they play with soapy water. Several boxes of soap powder were poured into the tank at one time, and as the suds mounted toward the ceiling of the recording room, the crew, garbed in swimming trunks, attacked the water with stirring rods and similar instruments.

When Monstro reached his peak of activity, the entire range of sound frequency was employed which, of course, meant a delicate balancing of the frequencies. The fullest amplification of sound was obtained on one occasion by stretching a screen across a framework. Above the screen was

(Continued to page 128A)

7 11 79

Floyd Bennett Airport
Brooklyn N.Y.

Sky Writers Play Tick-Tack-Toe with Smoke



Hangar # 6,

Andy Stinis and Dave de Blasio, sky-writing pilots (above), were getting nowhere with tick-tack-toe in idle hours on the ground at Floyd Bennett airport so they decided to go "upstairs" and try their luck. Below, taking off for the biggest game ever played

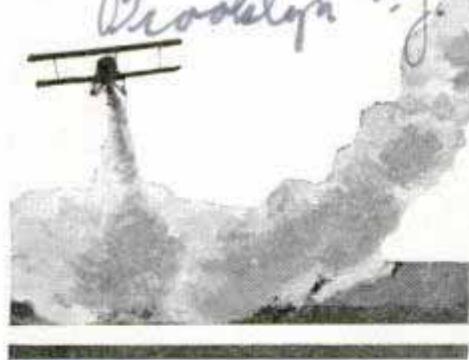

Brooklyn N.Y.

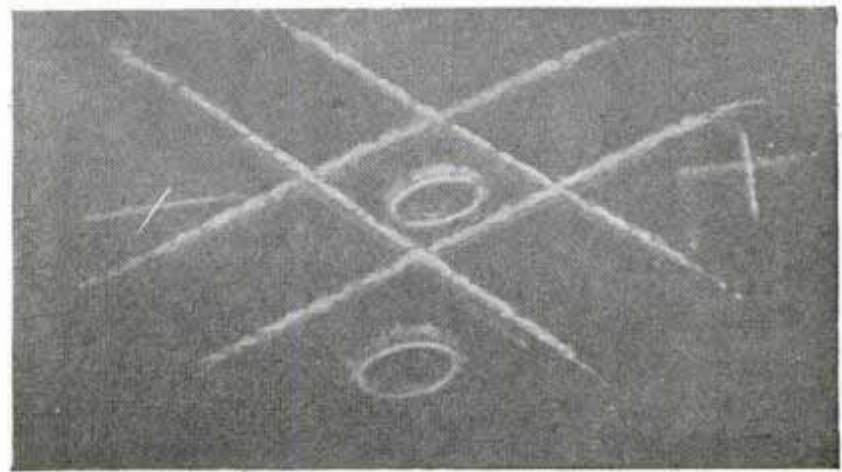
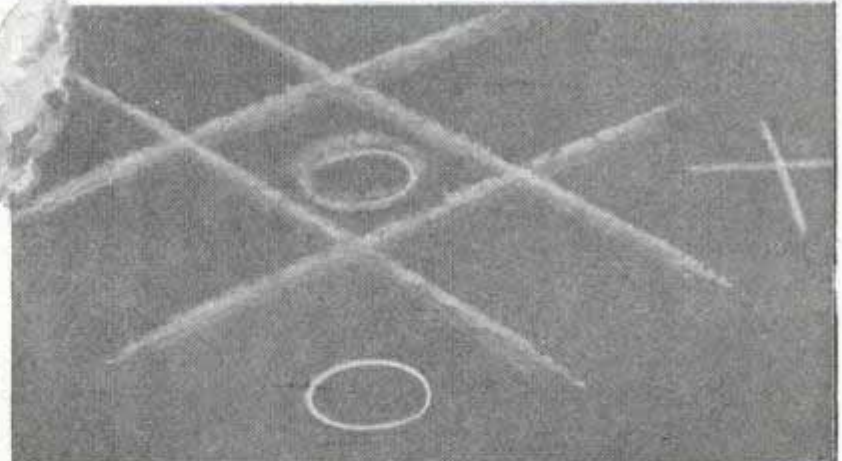
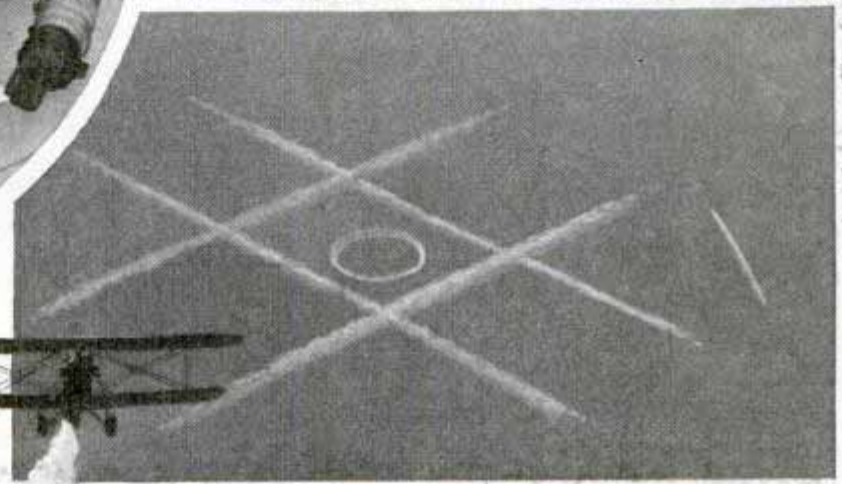
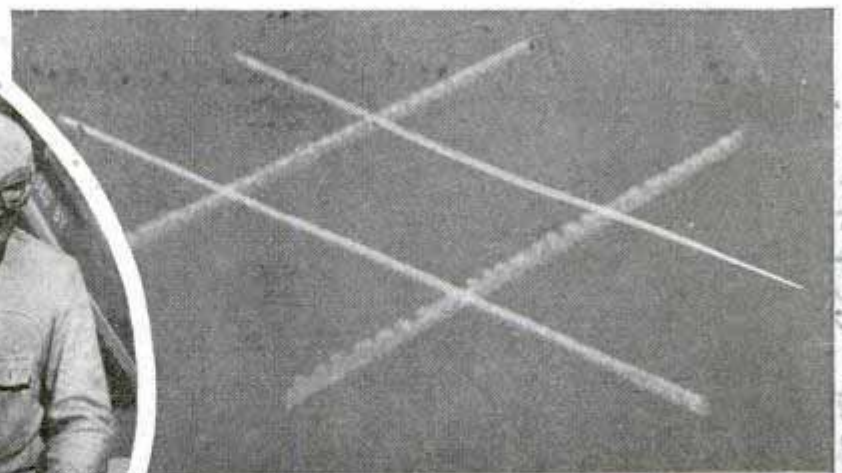

Using planes for pencils and the blue sky for a scribbling pad the two pilots fight a tick-tack-toe duel. It's not as simple as it looks, for the flier can't see the "board" without climbing above or dropping below it, they must work fast before smoke falls apart, and each line must be 100 feet or more above the last, lest propeller blast disperse previous smoke lines. In bottom scene Dave, apparently confused by twisting maneuvers at high altitude, has just put his "X" in the wrong corner and Andy has only to write another "O" to complete the diagonal and win. During the game the framework drifted twenty miles from starting point

Cosmic Rays Filmed in Plane 28,900 Feet above the Earth

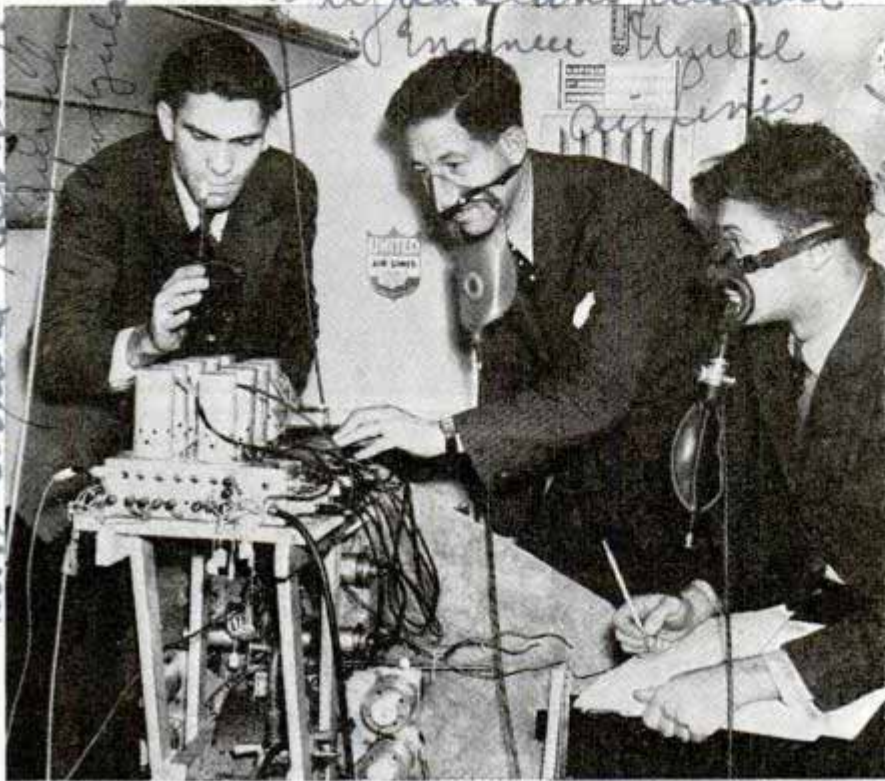

Wearing oxygen masks in rare atmosphere at 28,900 feet, scientists photograph cosmic-ray tracks in Wilson cloud chamber installed in plane.

Five and one-half miles above Chicago, a twin-engined United Air Liner took three scientists on a cosmic-ray hunt the other day. They not only captured the tracks of the cosmic rays on photographic film but established an altitude record of 28,900 feet for transport planes of that type. Outside, the temperature was thirty degrees below zero. Inside, crew and researchers wore oxygen masks. At intervals they operated the photographic equipment, and found a cosmic-ray count at 28,900 feet, ten times that at sea level. The apparatus used was the glass-walled Wilson cloud chamber, which produces an artificial cloud in expanding air. The cosmic ray shooting through the air smashes molecules into ions, which, in the artificial cloud, form nuclei for droplets of moisture that mark the track of the rays, which can be filmed under brilliant lights.

World's Weather Getting Hotter, Widespread Records Show

The world is becoming a warmer place in which to live, according to records for the last twenty years gathered from many parts of the globe. An official of the U. S. weather bureau cites the records at Portland, Ore., where seventeen years in the

last twenty have been warmer than usual. During the same period Washington, D. C., had seventeen years of warmer-than-normal weather, and nineteen of the last twenty years in Cape-town, South Africa, have been warmer than normal.

Hard-Rubber Toe for Football Shoe Helps Kicker

Football wars may be won henceforth by armor-plated toes. Too often for the comfort of coaches the extra point after touchdown has been the difference between defeat and victory. In autumn practice sessions Coach George Munger of the University of Pennsylvania found his kickers could boot the ball between the goal posts ninety-eight per cent of the time, but when they traded the heavy shoes of practice for the light, fast shoe of game time they weren't so expert. The remedy was found in a hard-rubber toe with a blunt, corrugated face. It is tossed out to the kicker from the bench just before the play.



Football player fitting hard-rubber toe over shoe before attempting field goal. Notice the blunt face

Reference: Prof. Arthur H. Compton, United States of Chicago
Science Service 11/3/39
Walter Dean Research Engineer Chicago
Pratt and Whitney
Science Service 25. United States of Chicago
Mr. Barbara / 10/25/39
Manual from
29
Washingt. D.C.

21148

Fourteen-Inch Guns Guard Panama Canal

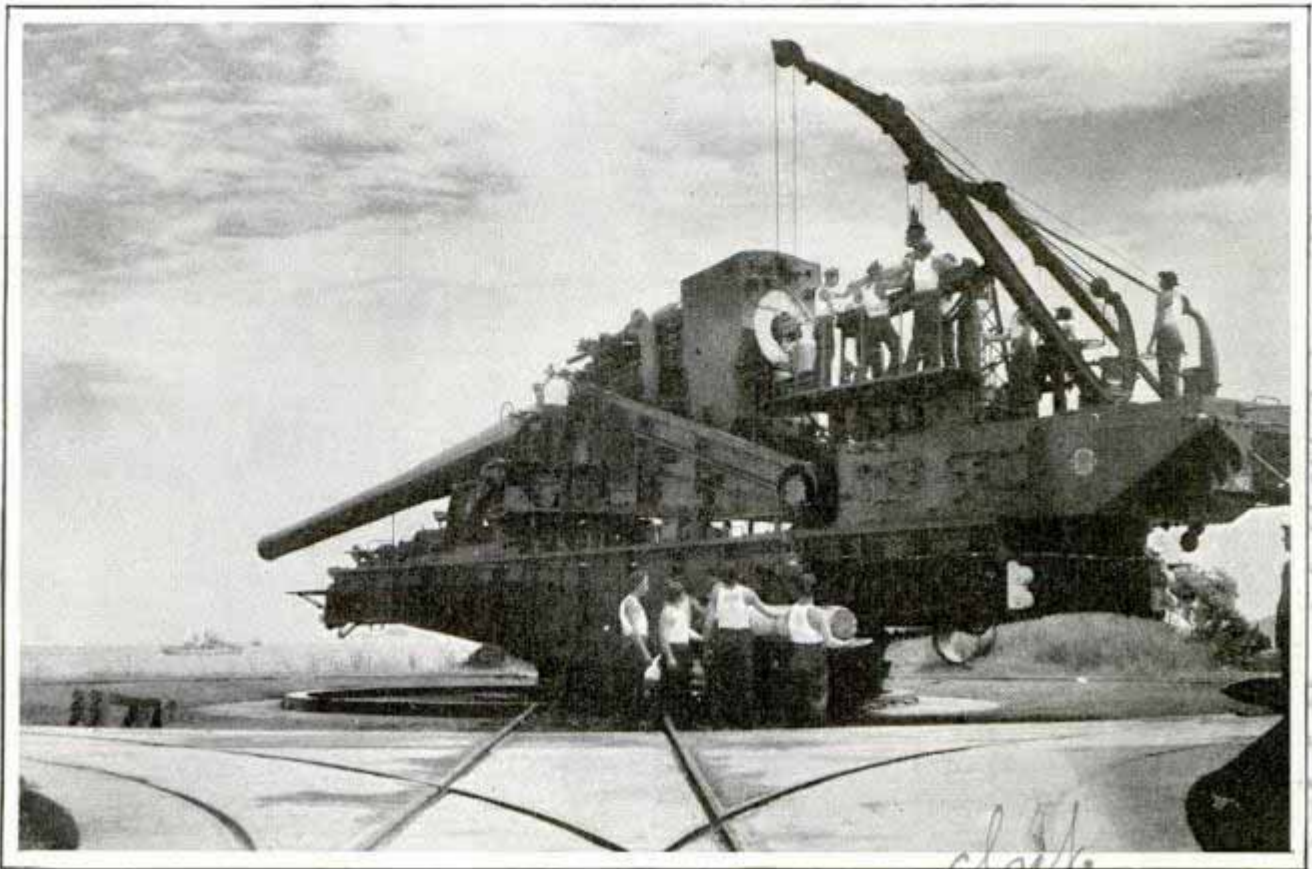

One of the fourteen-inch guns shown in loading position at Panama canal. Shells that can be hurled thirty miles in any direction are loaded by derrick mounted on gun carriage

Looking out over the Pacific ocean to threaten any possible invader, fourteen-inch guns stand guard at the Panama canal, vital lifeline of the United States.

Capable of hurling projectiles thirty miles, the giant rifles can be aimed in any direction. Shells are loaded by a derrick mounted on the rear of the gun carriage.

Self-Cooled Air Conditioner Equals 100 Tons of Ice Daily

Borrowing an idea from the household refrigerator, Westinghouse engineers have built a compact air-conditioning compressor unit with a cooling capacity equal to the melting of 100 tons of ice in twenty-four hours. Like that of the home electric refrigerator, the new "V-16" compressor is hermetically sealed. It has a water-cooled condenser, and is much more compact than earlier models because the refrigerant gas is used to cool the compressor motor as well as the air.



Compressor of air-conditioning unit is cooled by its own refrigerant gas

Mr. Norman E. Stinson, Jr.
10555 Halman Ave
Los Angeles, Calif.



OUTWITTING

Air Raid Warning Service - Frank Eley, Sautera,
California Edison Co. 601 W. 5th St. Los Angeles, Calif.

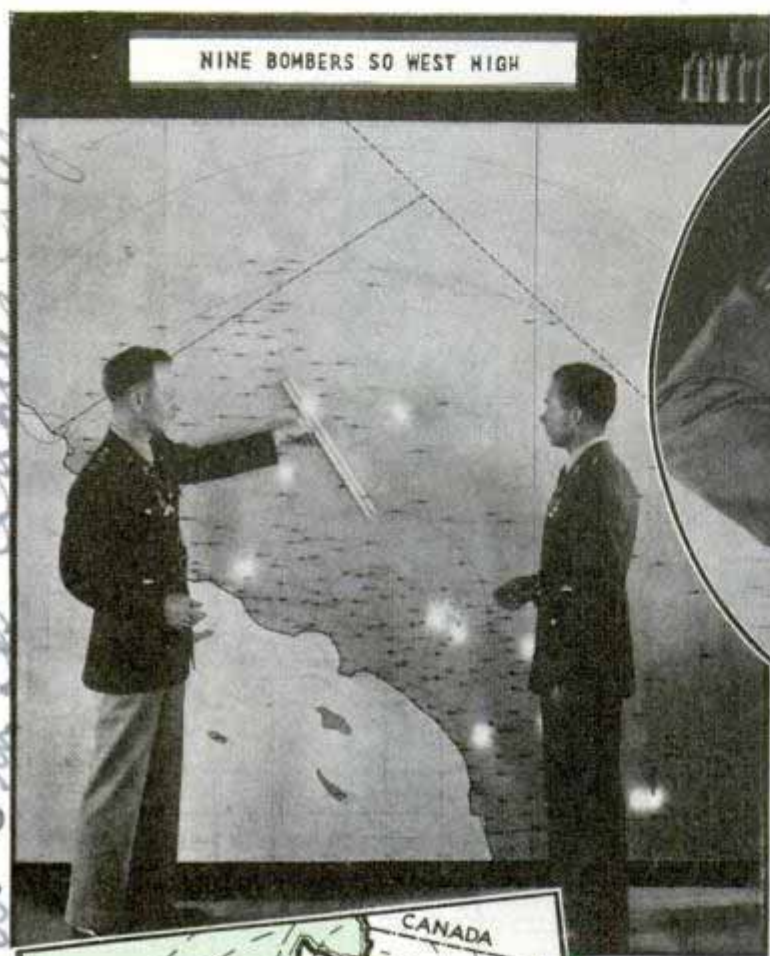

Left, map with light circuits to show locations reporting enemy planes. Note translucent screen overhead. Right, plotting course of planes from observers' reports. Below, map shows four message centers to which reports of enemy planes are phoned or radioed



A FLIGHT of planes representing enemy aircraft had been ordered to attack an unknown target in southern California and the defending forces had mobilized to track down the planes.

At the nerve center of the defense network in Alhambra groups of army officers and civil technicians were watching the operation of their latest idea, the new aircraft warning service. From the long telephone table a bell jingled six times and an operator lifted his receiver. "Message center, go ahead," he said.

"Flash flash 5 Ventura 215 seen Ventura 9 large bomber multiple motor monoplane southeast high 10:58 that's all."

Nine enemy bombers headed southeast had been spotted high above Ventura by a civilian observer. Checking the words on a chart in front of him, the message clerk passed the sheet to an army officer who had the job of plotting the course of the flight. On a large map at one end of the big room a red light that marked the loca-

Major Lesaslie Chan-
Capt. A. A. Hopkins,
Sheriff's Office

2898

the AIR RAIDERS

508 N. Loma St. Los Angeles



tion of the report flashed on and details of the message appeared on a moving tape on a translucent screen overhead.

By now other dispatches were coming in over the battery of phones. Teletype machines were chattering and operators at the radio posts were taking down other messages. On the big map another red light showed the latest location of the planes and the path along which they had passed was marked by bulbs that glowed more dimly.

Looking at the map and the charts in front of him, the plotting officer made his decision. "Probable objectives are Douglas airplane factory and the oil refineries at the harbor. Warn Santa Monica to ex-

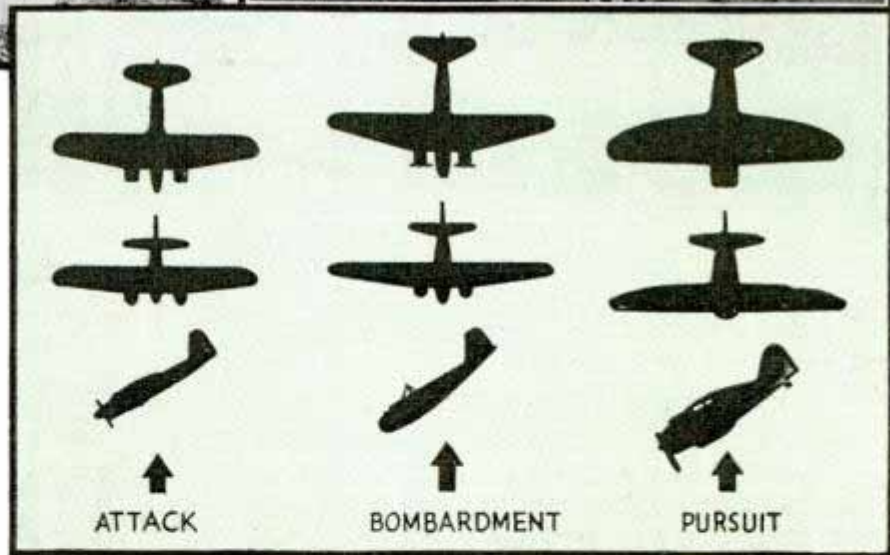

Left, camouflaged anti-aircraft gun ready for enemy bombers. Right, watching cathode-ray tube that shows visual sound track of planes passing over robot listening post far away in mountains. Below, profile charts of military aircraft are issued to civilian observers to facilitate identification of planes

pect hostile aircraft at 11:15," he ordered. The defending squadrons at adjacent airports had already been warned by radio and now special air-raid signals were transmitted to civil authorities over the civil advisory circuits. In each town involved authorities were "alerted" for pos-

March Field Calif. B Battery



the sound of the invading planes as they passed overhead and transmitted it along a 66,000-volt power line as carrier current to the message center. The cathode tube gave a visual sound track of the flying planes, permitting detection and identification of the type at long distance. Ultimately the robot listening post may be improved to report the altitude, direction of flight and even the number of planes that it "hears."

For three days last summer the Pacific coast frontier was

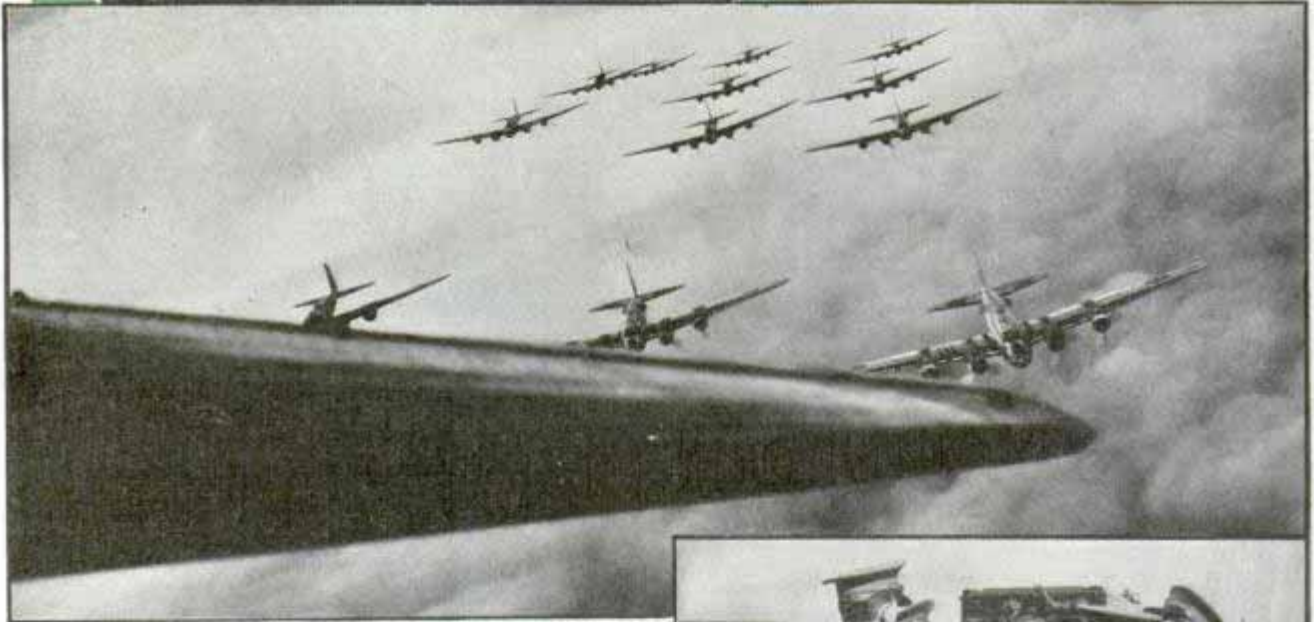

sible fire suppression, rescue of trapped civilians and evacuation.

At a table beside the map a sergeant was watching a cathode-ray tube. Suddenly the glowing line on the face of the tube began to waver. "Formation passing over robot listening post number one," the sergeant reported and at the same time the room was filled with the sharp roar of airplane motors from a loud speaker below the tube.

The huge mechanical ears that the army uses to detect distant airplanes require from eight to ten men to operate and in the recent California tests an untended robot ear was tried out for the first time. Guarding a lonely mountain pass more than 100 miles away, the ear picked up



Circle, control board with switches by which lights showing position of enemy raiders can be flashed on map. Center, army bombers in test raid. Bottom, army men group around mechanical device that figures angle at which anti-aircraft gun should be fired

in a state of military preparedness. General Air Corps maneuvers gave the aircraft warning service a chance to prove its efficiency. Message centers at Seattle, Portland, San Francisco and Alhambra easily kept track of the flights from the reports flashed in by hundreds of special civilian observers who used a vast network of communication lines. On an average two minutes elapsed from the time an observer first saw the planes until he contacted the message center.

The warning service was developed in conferences between army authorities and officials of the Southern California Edison company after it was realized that in an emergency valuable time might be lost in creating a network to report the presence of enemy airplanes. The present organization consists of trained men in the employ of public utilities and other agencies, and is ready for instant operation at any time without diverting men from their usual duties or commandeering public channels of communication.

In the southern California test area a territory as large as New England is protected by men at 245 reporting stations. For the last three summers, the first two times in secret, drills were held to test the observers in speed and accuracy. Nucleus of the warning system is the Edison company's 6,500 miles of private telephone lines and 17,000 miles of light and power lines that crisscross the area and extend far into the mountains. Interconnected with these are the communication circuits of other utilities. Telegraph company line-men, station agents of the major railways, mountain lookouts of the forest service, lighthouse keepers along the coast, and navy observation stations on offshore islands all link together to form a voice, teletype, and radio network around Los Angeles that would be extremely difficult to penetrate without detection.

As organized, the warning service is merely an organization to warn the army and the population of incipient attack. At the message center are the facilities for throwing switches for a blackout as protection against night air raids although authorities are undecided about the value of a blackout in a highly electrified community. A general power cut-off would result

(Continued to page 151A)

21244.
**Electric Manicure Set
 Is a Fast Worker**

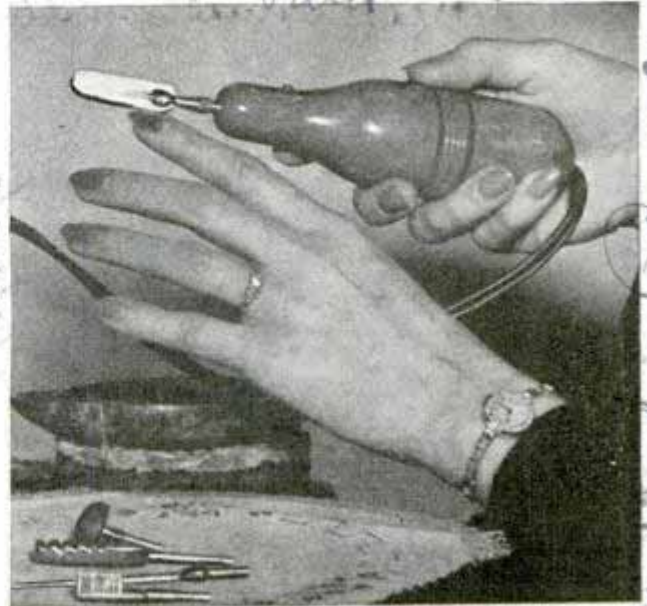

In addition to manicuring, this electric tool has been used by a jeweler for cleaning and polishing

Brush, nail file, emery bar and massager are combined in an "electric manicurist" invented by an Idaho man. Working somewhat on the principle of the electric shaver, it is four and one-half inches long and one and one-half in diameter, and besides its manicuring duties has been put to work by a jeweler cleaning rings and watches, and polishing and sanding surfaces.

1237
**Deadly Mines Washed in by Sea
 Are Set Off by Coast Guard**

Mines laid in the sea by Europe's belligerent nations frequently drift to Dutch beaches, where they are a deadly menace if not destroyed. It is one of the wartime duties of Holland's coast guard to watch the shores and shallows for these spheres and blow them up.



Smoke in right background marks explosion of one mine, while another, at left, awaits its turn

27059

Robot Sells Air-Mail Stamp, Stationery and Map

Address: Louise Campbell



Using air-mail machine which does practically everything except write the letter

Complete materials for an air-mail letter are delivered by a machine invented recently. Stamp, stationery and air-mail map are turned out by the robot for the price of the present air-mail stamp. The machine also contains an electrically operated motion-picture reel which depicts various phases of aviation news.

Preservative for Rubber Latex Solves Storage Problem

Rubber latex, which is subject to rapid decomposition, now can be kept in good condition during transportation and storage by means of a chemical preservative, consisting of sodium pentachlorophenate with a small amount of ammonia added. Lack of such a preservative has been a serious problem to both importers and exporters of latex, since eighty per cent of the world's supply is produced in British Malaya and Netherlands East Indies and

must be shipped thousands of miles. In 1937, 100,000,000 pounds of liquid latex were shipped into the United States. This development makes it possible to maintain a reserve of the highly perishable material for use in the event of interruption of the supply by warfare on the seas.

Rotary Planer for Drill Press Finishes Wood Surface

Wood surfaces can be planed to a smooth finish on the drill press with a rotary planer. It is a die cast disk with three high-speed tool-steel cutting knives, and fits into the chuck of any powered woodworking drill press. Any size plank that can be moved on the drill-press table can be handled and the tool will plane a plank two feet by eight inches in twenty-five to thirty seconds. Blades are adjusted with feeler gauges so they extend .002 below the center face of cutter body, and it is recommended that the drill-press depth gauge be set to take a cut one-thirty-second of an inch or lighter. A patented set-screw arrangement holds the cutting blades securely so it is impossible for them to get out of adjustment while in operation.



Planing piece of wood in drill press. Inset shows new tool with its three cutters held by set screws

I and F. James Roberts Hollywood, Cal. Box 1596

same as Berry tool Co. Architects Ology Kerkhof

2291 Scott St Detroit, Mich

Monsanto Chemical Co. St. Louis Mo

X-Ray Camera Photographs a Beating Heart

Stereoscopic photographs of a beating heart and of lungs in the process of breathing are taken with a giant automatic X-ray camera, developed by Westinghouse engineers. Controlled by a double-trigger electric "gun," the robot releases charges of 100,000 volts of electricity, stopping action to one-sixtieth of a second, with perfect safety to the subject. Pressing the larger trigger raises the voltage to the point at which it is set for operation and operates five relays to make the apparatus ready for taking X-ray pictures. The smaller trigger starts another series of four electric relays, which in turn cause the film to be exposed and then quickly adjusts the apparatus to the



Automatic X-ray camera releases charges of 100,000 volts of electricity when trigger is pressed to make split-second pictures of beating heart

proper angle of view for the second part of the stereoscopic picture. When this action is completed the circuit automatically resets itself for another pair of pictures.

Covered Bridge Moved by Tractor to Its New Location

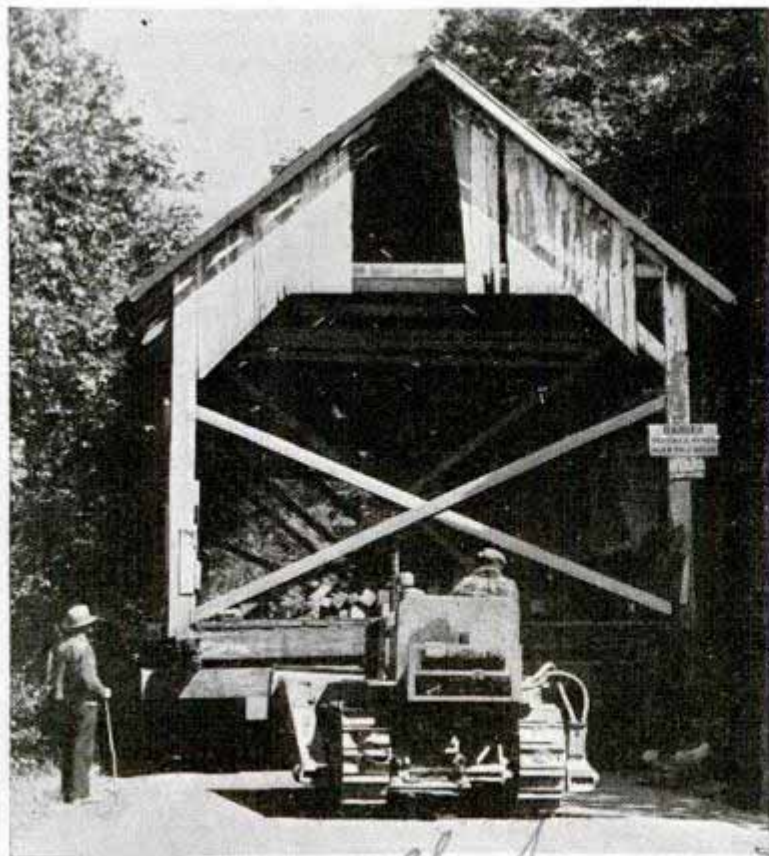

Tractor hauling old covered bridge through park to new location in order to preserve its rustic beauty for posterity

Sentiment forestalled the destruction of an old covered bridge in the west when its removal became necessary to make way for a modern bridge. As a result of protests by citizens, the historic structure was towed by tractor to a near-by park where it will spend its days in retirement spanning a small creek.

Doctor Finds Length of Life Depends on Shape of Body

How long you'll live depends somewhat on the shape of your body, two scientists found after a study of body shapes. Early deaths from heart and kidney ailments were indicated by large abdominal girths and chests that were unusually large or small. Cancer was more prevalent in men overweight or underweight, and in diabetic persons the weight and girths were larger than average.

J. W. Long Island City

Technician

Samuelin may hospital

Chauncey Cook

Dr. Ray Palmer
Director Pres. Hospital

21091

10/29/39

1241

Raymond

club

Allen Canyon, at

BLIND

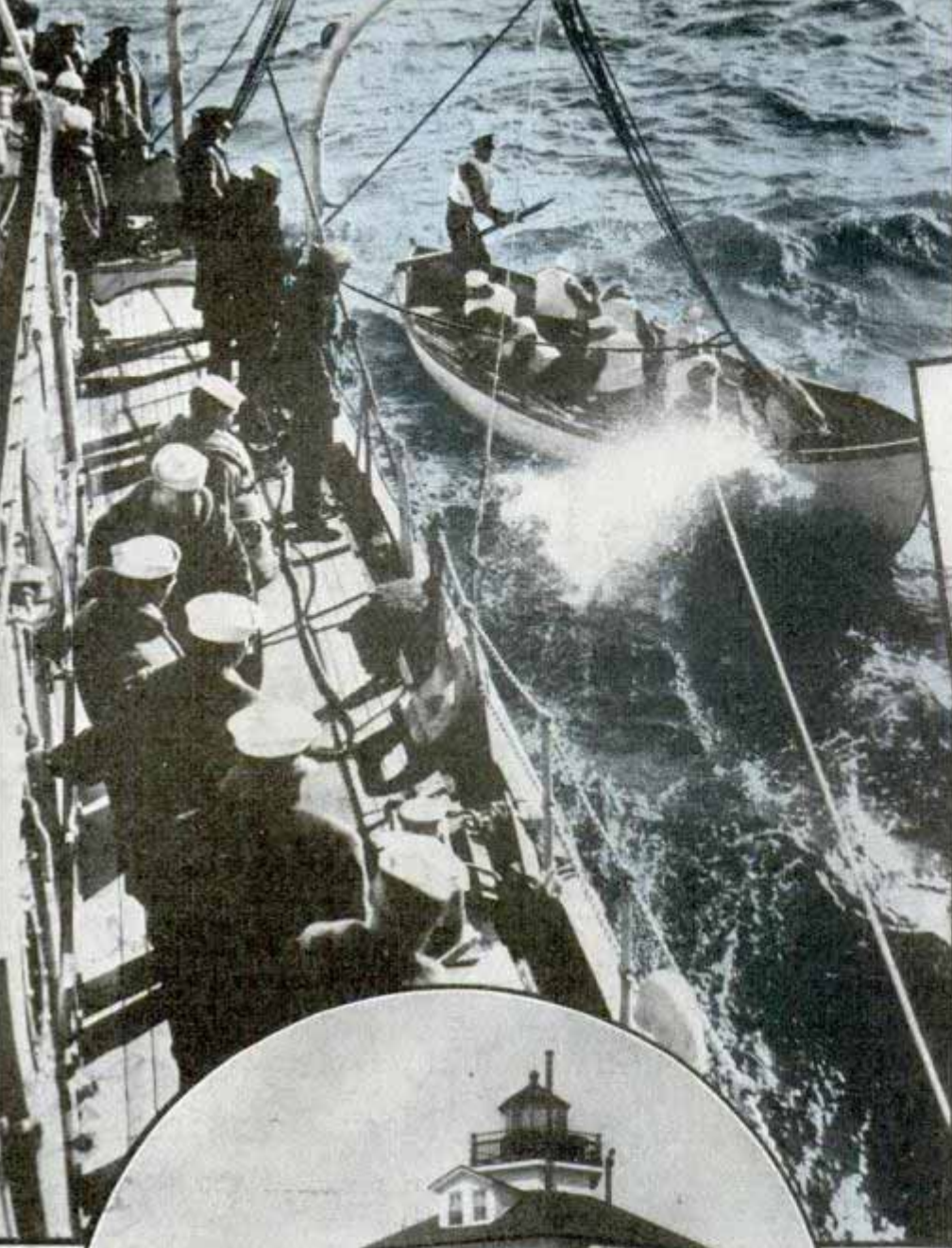

Left, boat drill on the high seas; above, checking an ocean liner's position with the bearing repeater. In the circle below is the Drum Point lighthouse on the shore of Chesapeake Bay



WINTER surrounds a liner off Nantucket. Winter and fog. There's something eerie about the cold gray wall of vapor that swirls about the bridge, blotting out the bow, condensing in opaque droplets on the windows of the wheelhouse. Through a cleared circle made by

the revolving wiper, the watch officer peers ahead anxiously. The captain paces the open bridge wing, staring intently into that gossamer wall—seeing nothing.

A jet of steam spouts from a pipe on the forward funnel as the deep-throated whistle blares its fog warning in ghostly, minute-spaced wails. Fog at sea! A thousand passengers, twenty million dollars worth of ship and cargo, in one's charge; and a high-speed schedule to be maintained. And here we are making a landfall, approaching a busy harbor after two days of dead-reckoning navigation, unable to check position by sun and stars.

Blind man's buff, with the ship's captain "It," with a thousand souls forfeit to Davy Jones should the game be lost. Do we exaggerate the peril? Hardly! There have

Com. Herbert V. Webb,
4322 Second Road, North
Arlington, Va.

2994

MAN'S BUFF

been nearly 40,000 collisions and groundings due to fog since the World War. There have been more than 40,000 lives lost. Fog still is the greatest natural peril at sea.

Dead reckoning places our position 200 miles east of Cape Cod; but without a sextant shot for two days, that's merely an intelligent guess, what with wind and current knocking holes into the best of calculations.

Sparks crackle in the

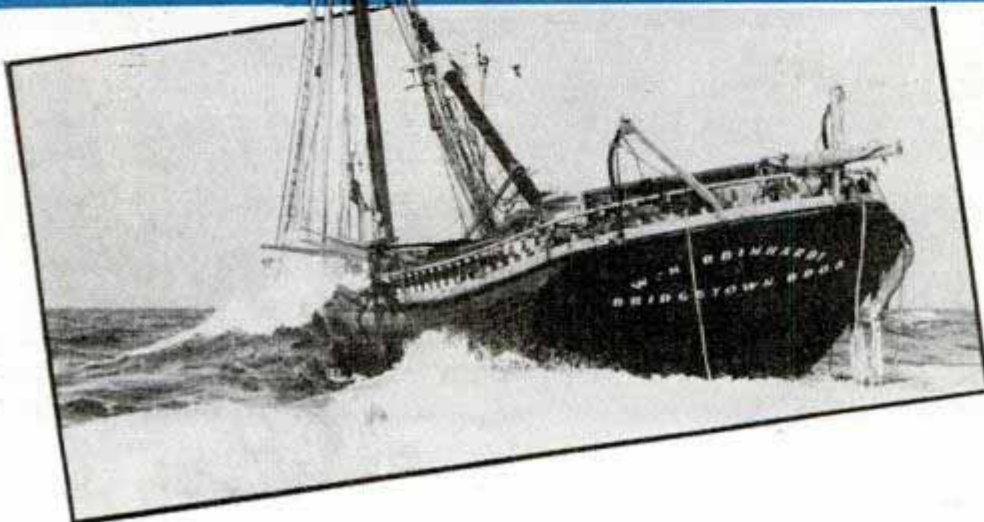
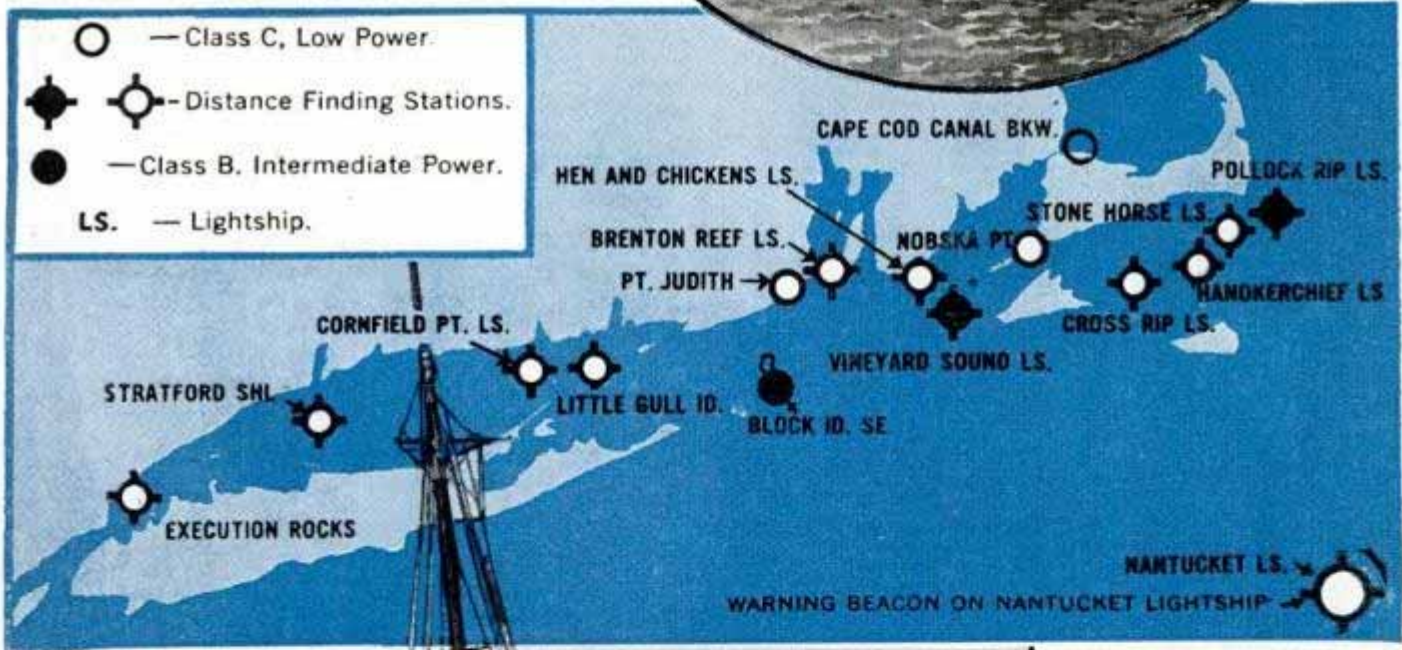
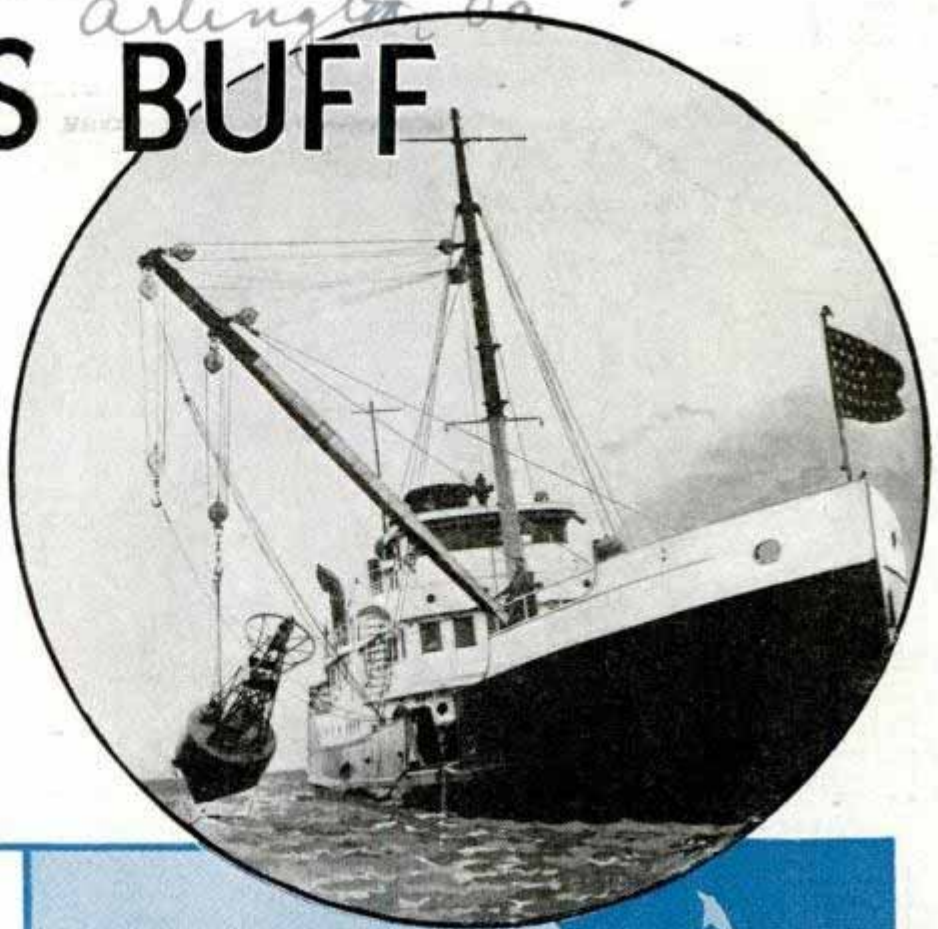

At top, a U. S. lightship tender on the Great Lakes places a lighted bell buoy in position. The map in center shows the position of lighthouses and lightships between Cape Cod and Long Island, with the famed Nantucket lightship in lower right corner. Bottom, breakers pound the "W. N. Reinhardt" to pieces after its crew has been brought ashore safely by breeches buoy with aid of Coast Guard



Top, placing acetylene gas tank in lighted whistle buoy; as buoy rises on wave, air is drawn in at whistle; as it sinks, rising water compresses air and forces it out through whistle. Diagram shows how air currents affect foghorns. Below, Coast Guard lifeboat in surf, and Ambrose lightship at New York harbor entrance

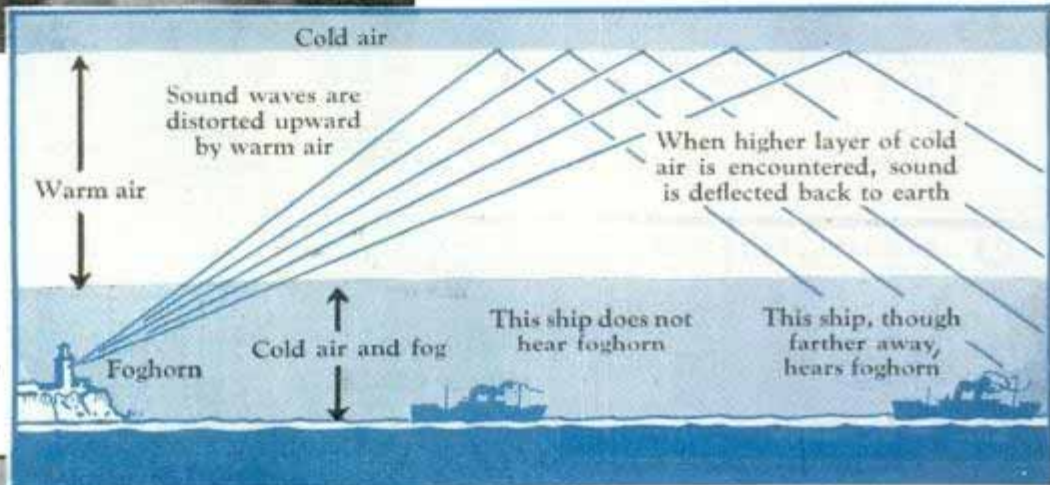

radio shack, as the captain requests bearings from the U. S. Navy. The naval radio stations along shore get into communication, and each takes a radio-compass bearing on the ship, phoning the results to the central station. Rays are drawn on a chart from each of these stations at the obtained bearings, and the ship is informed of the latitude and longitude at which these rays cross.

But these bearings show your captain to be nearly fifty miles off his plotted course, and he has no confidence in the report. He knows

how fallible is the radio compass, depending on the far from perfect human ear. For the radio compass gives no direct reading. The operator must swing a loop antenna over a compass card, until the signal fades out. Noting this bearing, he swings the loop in the opposite direction, marking the next fade-out point. The bearing is the difference between the two fade-out readings. An error of two or three degrees is normal on such readings, ten degrees is not unusual. At 200 miles, a ten-degree error will cause a mistake in fix of thirty-four miles.

In the captain's mind, he is still playing blind man's buff, still doesn't know where he is. So he uses his own equipment to get radio-beacon bearings from the nearest lightships and lighthouses maintained by the Coast Guard.

2994

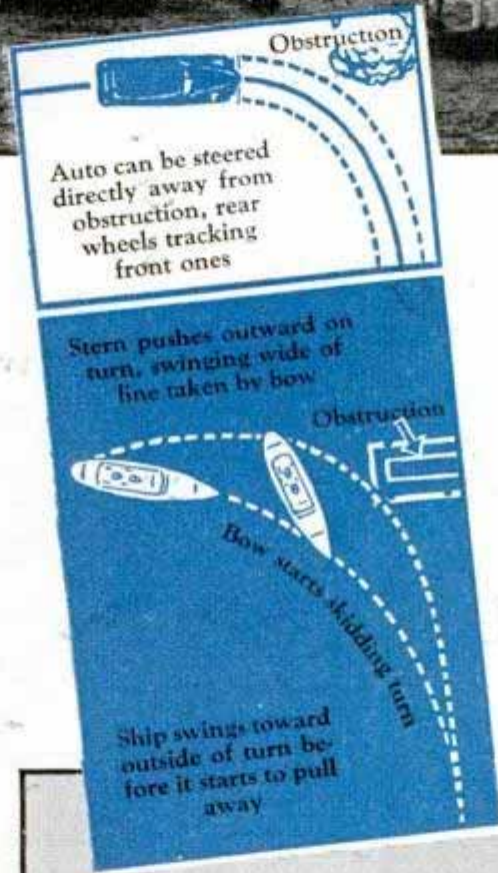
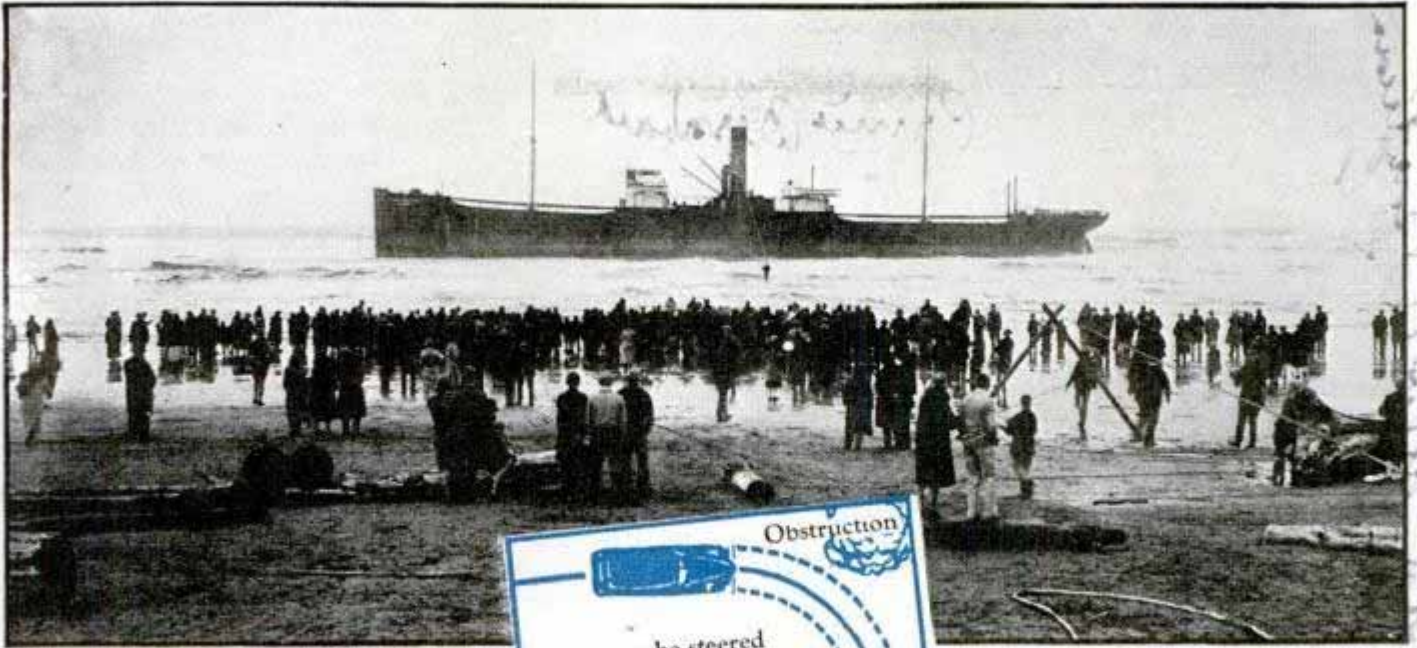

The radio beacons broadcast dot and dash signals. The ship picks these up with its own loop antenna, mounted over a gyrocompass repeater, and the captain plots his own position by cross bearings. This system is subject to the same errors as the navy's; but at least the navigator knows any errors will be his own.

Until a few years ago it was the practice of ships approaching New York from Europe to steer directly on the radio beacon of Nantucket lightship. But in 1934 the S.S. "Washington" headed too accurately for that beacon and ran down the lightship in the fog; carrying away part of her superstructure. A few weeks later the "Olympic" cut the lightship squarely in two as it loomed suddenly out of the fog. Seven of the lightship's crew perished. The Nantucket was soon replaced, equipped with an auxiliary beacon to sound a warble note on the same frequency as a warning

that ships were approaching too close.

Practically all lightships, and many lighthouses, are equipped with the standard distance-finding device—a foghorn synchronized with the last note of the radio beacon. The transmission of radio waves being practically instantaneous, while the speed of sound through air is comparatively slow,

(Continued to page 138A)

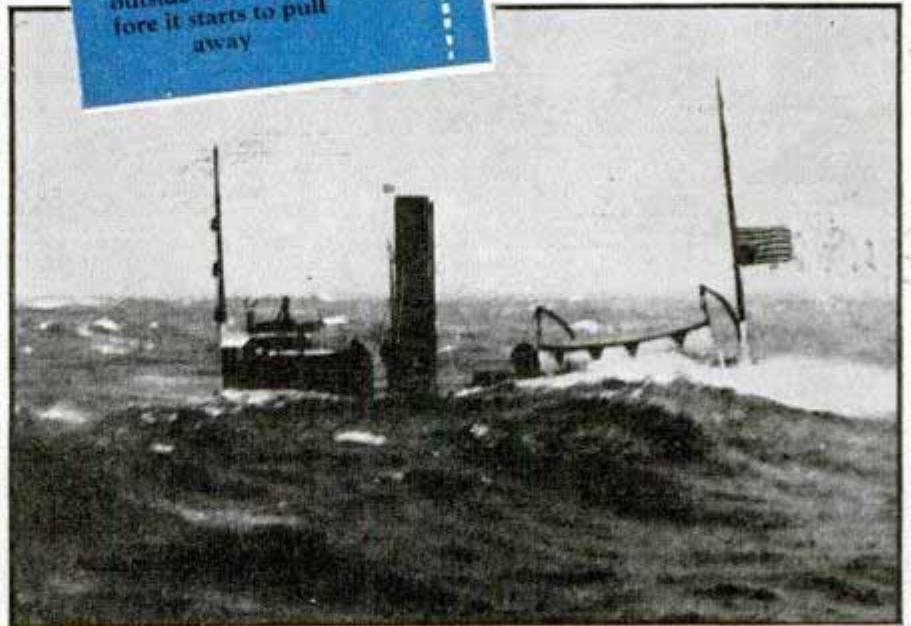

Top, breeches buoy saves crew of steamer beached in fog. Diagram shows difficulty of ship avoiding collision as stern swings wide. Tug flying distress flag, bottom, was assisted into New York harbor by Coast Guards

Diamond rd 2

Watertight Diesel Tractor Speeds Lifeboat Launching

Princ Bernhard



Watertight tractor, top, speeds launching of lifeboat by hauling it into water on track-type trailer as shown in lower picture

Made completely watertight by sealing it with special metal coverings, a Diesel tractor operates in water as long as the level is below the air intake and exhaust pipes, which extend upward. Rubber hose keeps sea water out of the steering clutch and main clutch levers, and no water can enter the drive or transmission housings. The tractor is used by the coast guard of the Netherlands for speedy launching of lifeboats.

National Park Visitors Increase by a Quarter Million

Visitors to the twenty-five national parks numbered 6,804,216 persons during the season ending last September, an increase of nearly a quarter of a million, or three and one-half per cent, over 1938. Popular also were the sixty-three national monuments where travel increased from 2,313,630 in 1938 to 2,566,452 in 1939. A decrease in the number of visitors to national military parks and cemeteries was shown, due

to the seventy-fifth anniversary celebration at Gettysburg national military park and cemetery in 1938, skyrocketing the figure there to 1,554,234 compared with 608,125 in 1939. The grand total of visitors to all units of the federal park system during 1939 was 15,454,367, a drop of 779,321 from the 1938 total—16,233,688.

Overshoes Fit in 'Capsule' in Handle of Umbrella

There's protection from top to toe in an umbrella that has been nicknamed the "umbrubber" because it carries a pair of rubbers, ready for a rainy day. They are made of special lightweight material and pack away in twin containers of plastic that form the handle of the umbrella.



At the first sign of rain you merely twist the lid of the umbrella handle and out come the overshoes

Halstead and Gravenstein

Handwritten notes:
- Top left: *Mr. Sondrian, managing director, Regmatul line van Nieuw, Longden*
- Top right: *Deveke & Co. Technische Bureau de Ruyterkade 113 Amsterdam - Centrum, Holland*
- Middle left: *National Park Service, Dept. of Interior, Washington, D.C.*
- Middle right: *Calypso tractor*
- Bottom right: *56th, New York*

210888. safe Cabinet des.

Remington - Rand Inc.

Fiery-Furnace Test Proves Safe Can 'Take It'

marretto il bed

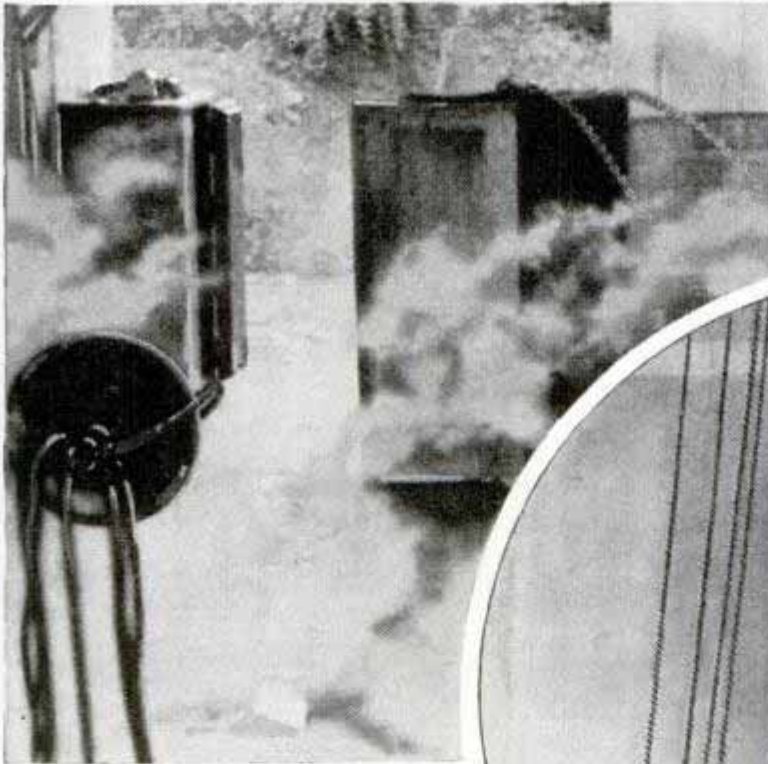
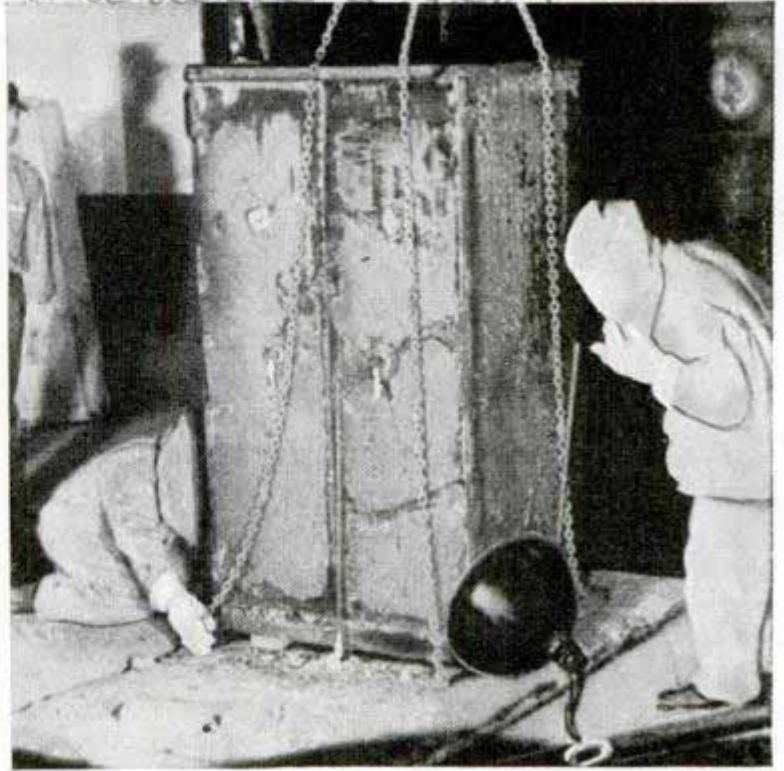

Above, left, rolling a big steel safe into gas furnace for flame test. Right, asbestos-clad men attach chains for drop test after safe has been tortured with heat for one hour. Below, the safe is hoisted for its thirty-foot plunge, the laboratory equivalent of a three-story fall in a burning building. Left, dust flies as it crashes down on a solid concrete block

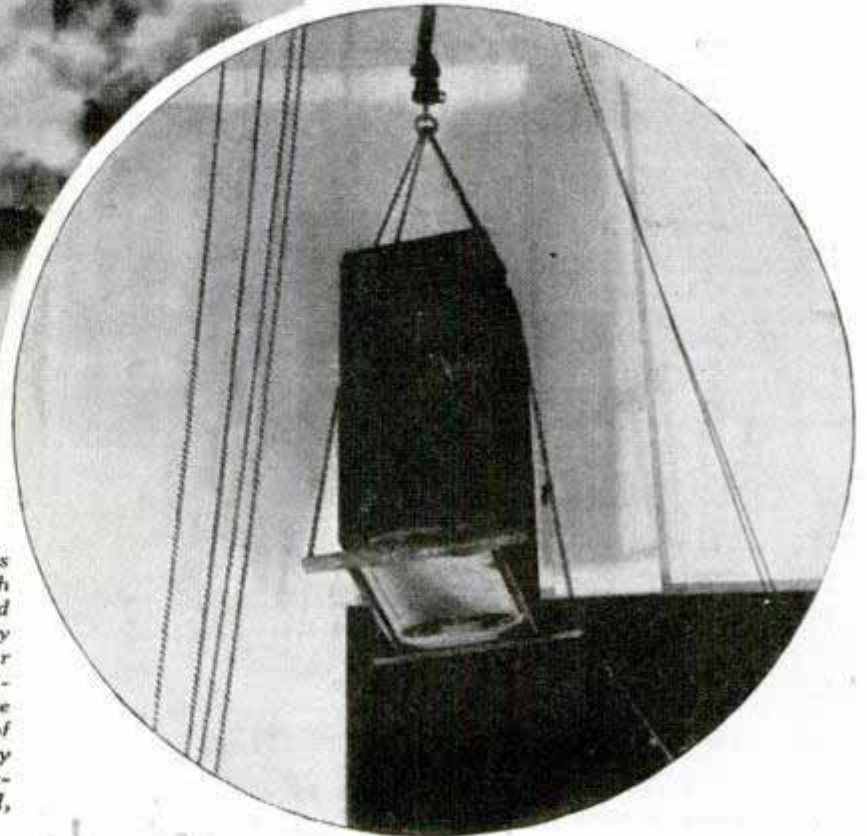

Before a safe manufacturer calls his steel box "fireproof" he puts it through a terrific ordeal. The safe is rolled into a furnace, sealed with fire clay and subjected to roaring gas flames for an hour. Redhot, it is rolled out, allowed to drop thirty feet to a concrete block, then given another hour of 1,700-degree heat. Chilled suddenly with water, it is broken open. If papers inside have not been scorched, the safe has passed its test

21053

Soviet aircraft battery

The MECHANICS of

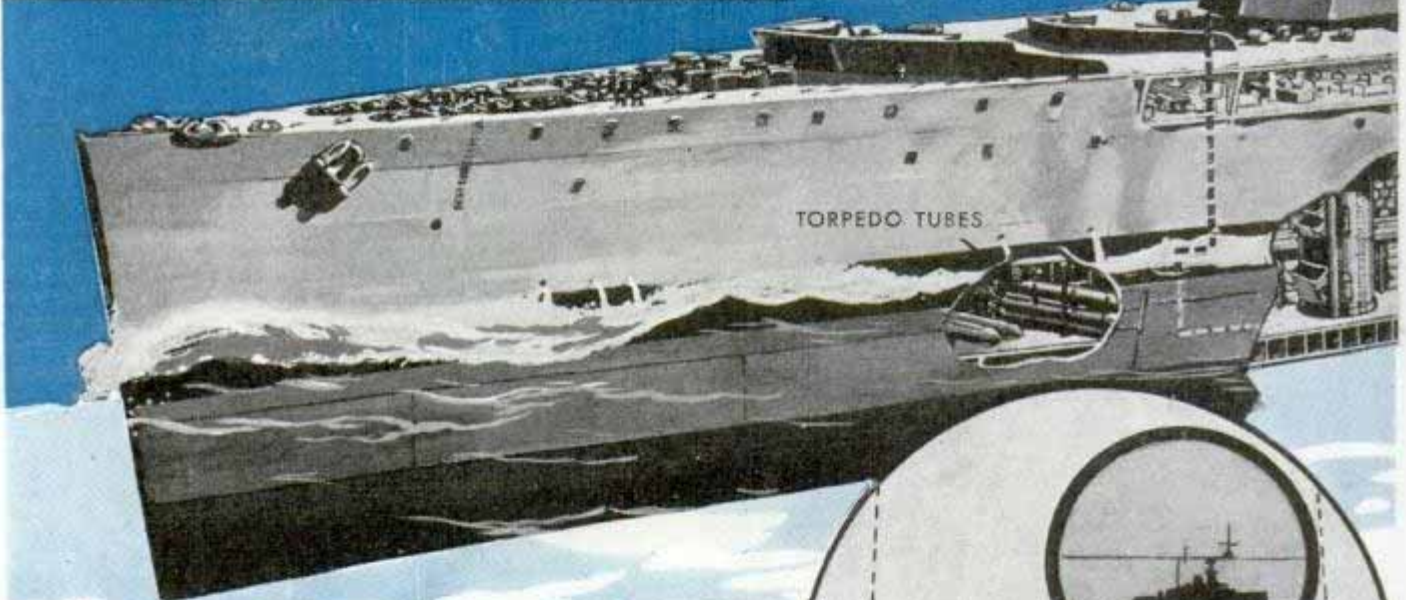
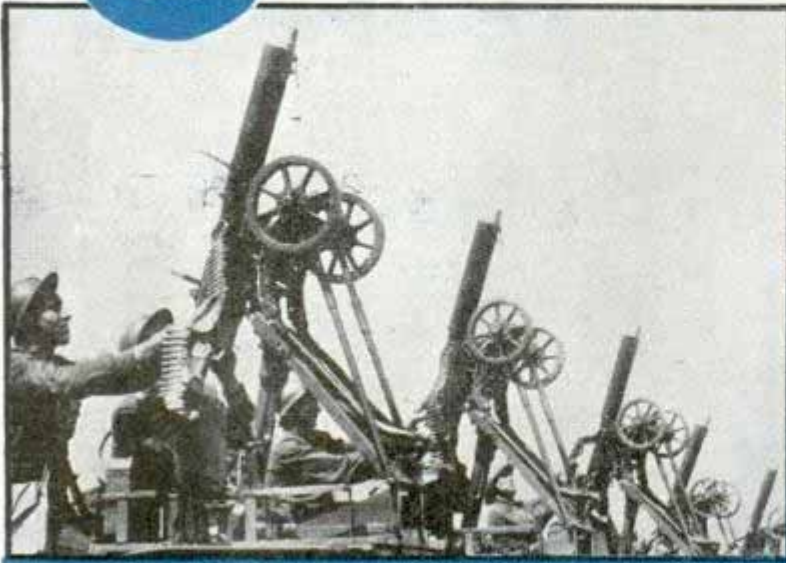

Mighty engines of warfare have been unveiled by nations involved in the new European conflict, as well as by countries that may be drawn into the struggle. Many, many anti-aircraft batteries, such as the one pictured at top of page, are found in Soviet Russia's red army

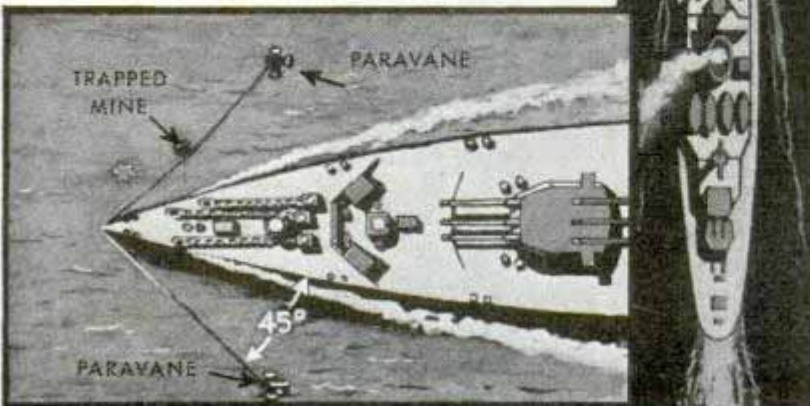
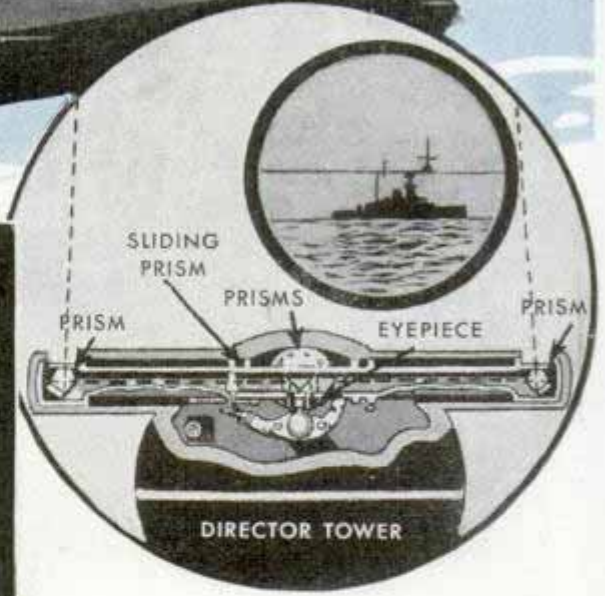

Bottom, left, how ship employs paravanes to avoid striking mines. Center, actual size of battleship as seen from bombing plane at 6,000 feet. Circle, above, diagram of range finder, with inset view of what it sees. When the two images coincide, the range is mathematically calculated with help of sliding prism

Chris

21053









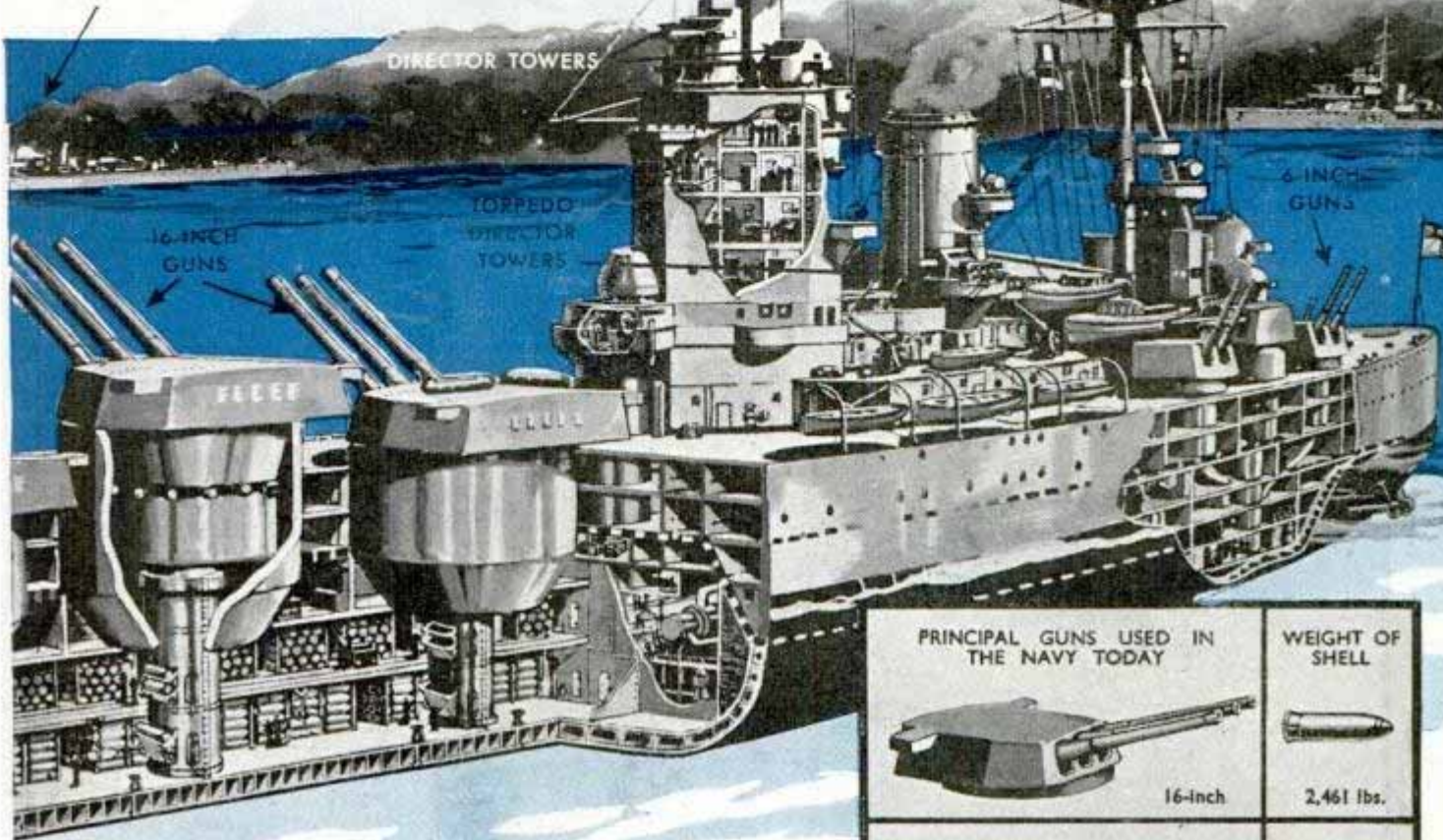





MODERN WARFARE

DESTROYERS LAYING PROTECTIVE SMOKE SCREEN

FIRE CONTROL TOP



How a mighty British battleship goes into action is shown on this and the page opposite. Decks are cleared and sixteen-inch guns firing, while destroyer lays protective smoke screen. Right, naval weapons and weight of shells. Bottom of page, range and trajectory of modern sixteen-inch naval gun and shell. The shell has a muzzle velocity of 1,800 miles an hour and a rate of fire of one round a minute. The sixteen-inch gun is the largest believed practical for warships to mount, under present methods of construction

PRINCIPAL GUNS USED IN THE NAVY TODAY		WEIGHT OF SHELL	
	16-inch		2,461 lbs.
	15-inch		1,920 lbs.
	8-inch		256 lbs.
	6-inch		100 lbs.
	4.7 A.A.		50 lbs.
	Multiple pom-pom		2 lbs.

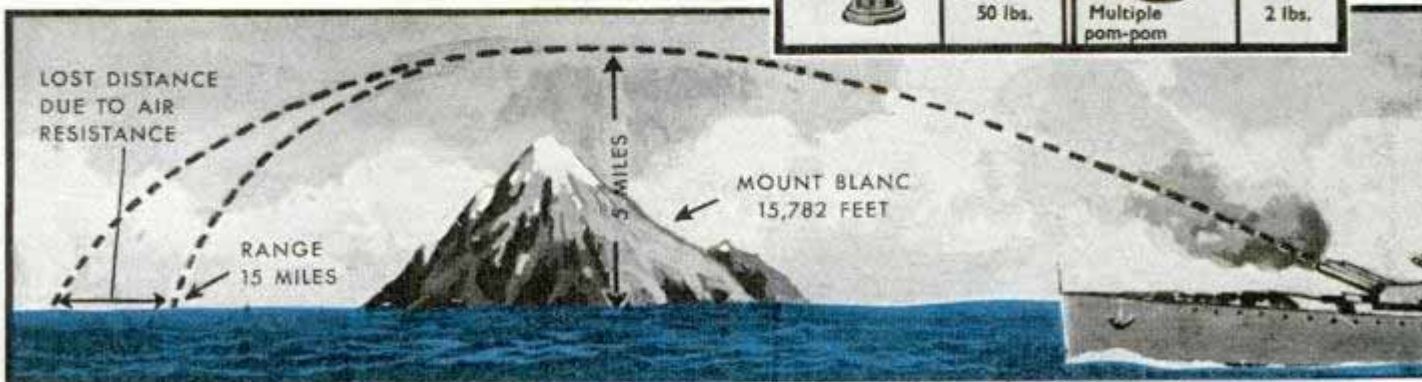

Club

21053

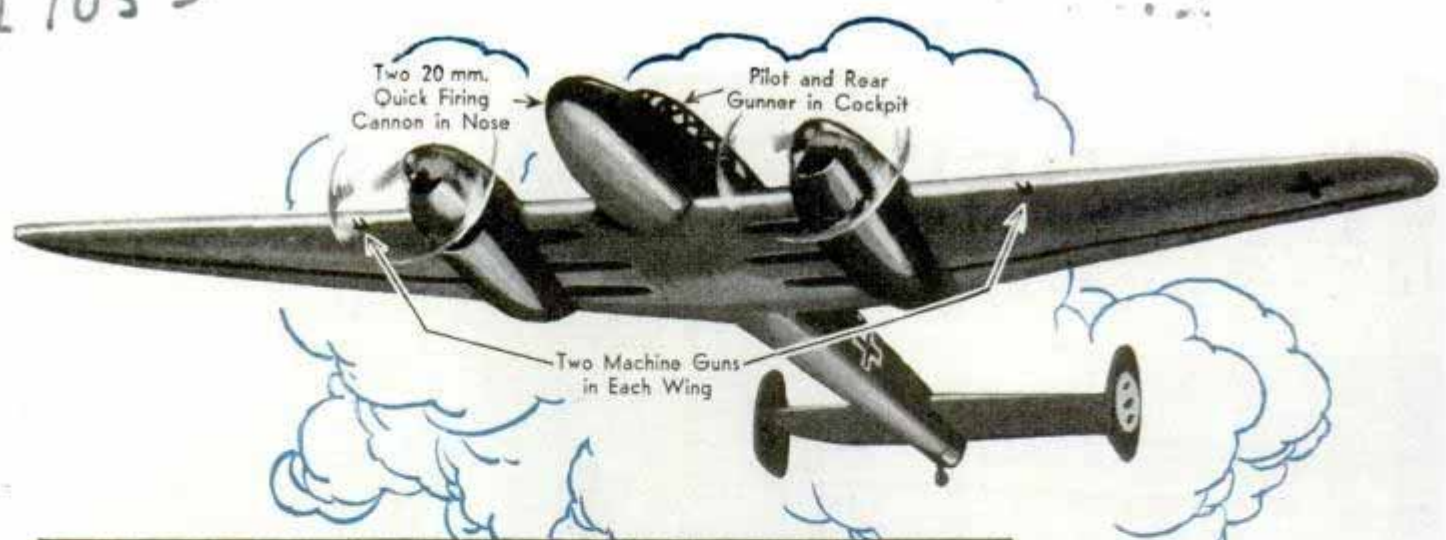

Top, drawing of long-range combat plane reported as designed to escort German raiding bombers. Its purpose is to fight off small pursuit ships. Speed is around 380 miles per hour and the range about 1,200 miles, with two 1,160-horsepower engines delivering the power. Left, British airmen, dressed in heavy uniforms and carrying machine guns of latest type. Bottom of page, left, British soldiers, wearing gas masks, atop a modern war tank

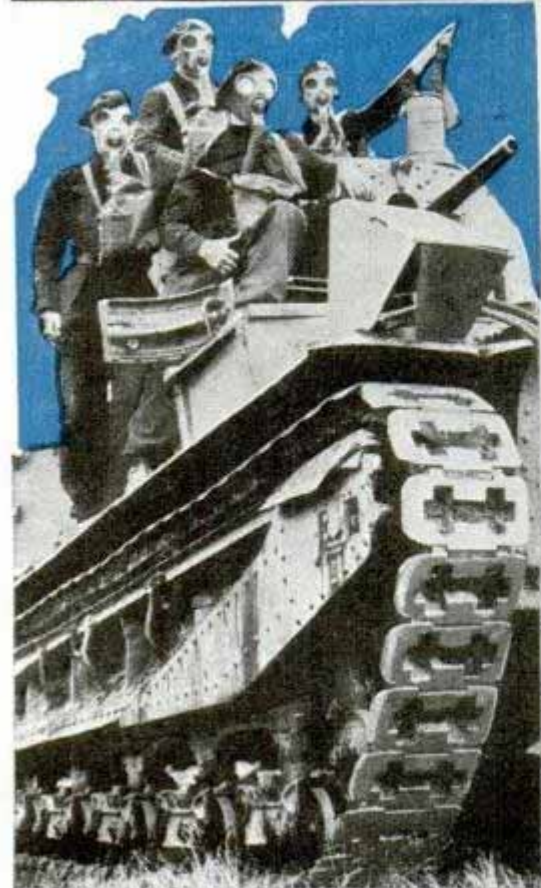

Bottom, center, massive air-raid shelter, built to protect 2,000 people, on Germany's western frontier. Right, German torpedo boat with two tubes for discharging deadly loads at enemy shipping. The torpedo boats operate from a "mother ship"



club

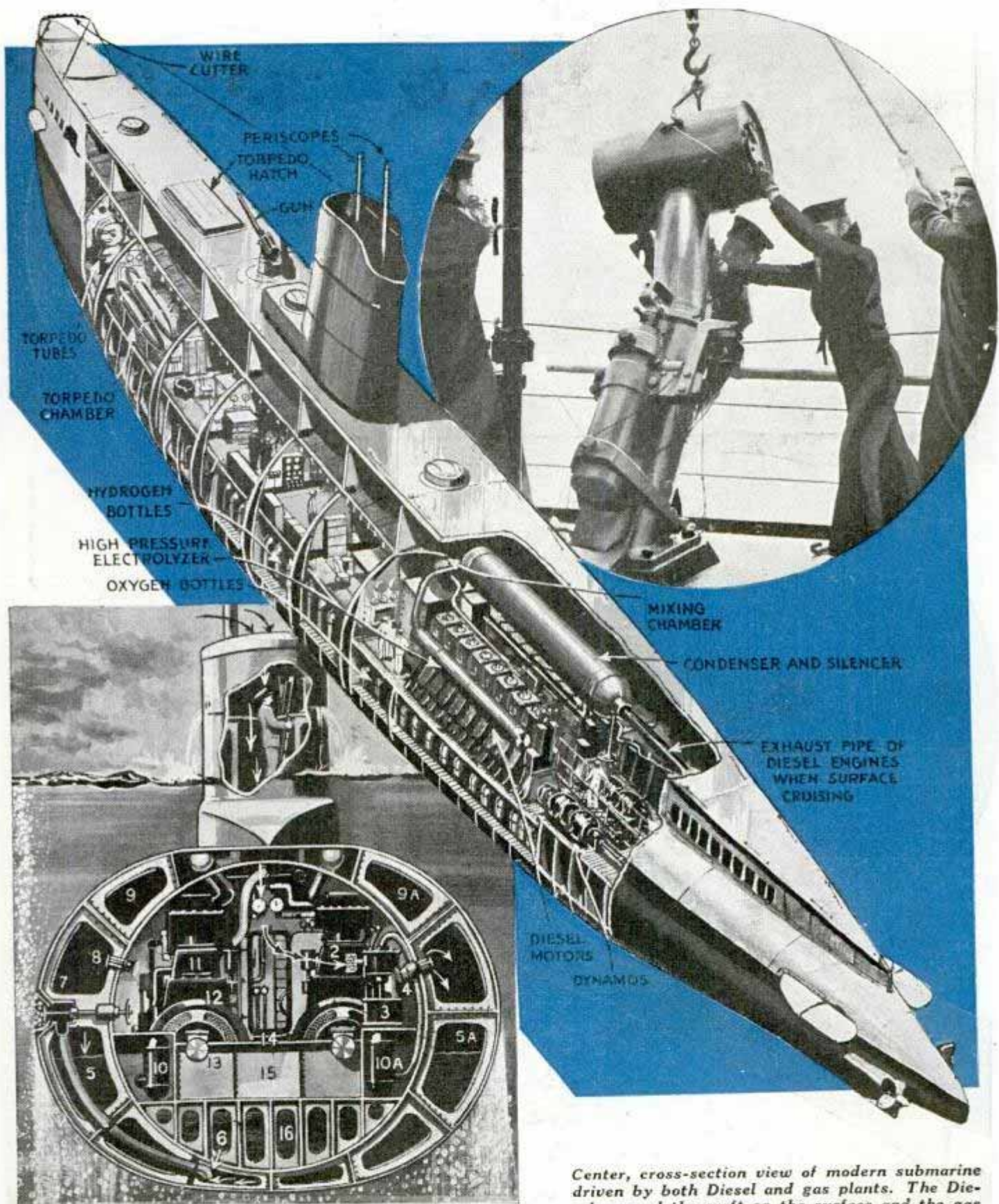

- This sketch shows how a modern submarine returns to the surface:
1. The submarine breaking the surface with the conning tower hatch opened to admit pumping outside air.
 2. Air inlet.
 3. Air pump forcing air into the tanks without using compressed air bottles.
 4. Three-way blowing valve.
 5. 5A. Air forcing water out of external ballast tanks.
 6. Water tail-pipe.
 7. Flooding valve open for ejecting water.
 8. Air vent valve to relieve pressure in tanks when emptied.
 - 9, 9A. Special anti-rolling tanks.
 - 10, 10A. Compressed air bottles. Used only for blowing the tanks sufficiently to raise conning tower above the water.
 11. Diesel engines.
 12. Main electric motors. Used also for driving auxiliary motors for pumps.
 13. Propeller shaft.
 14. Watertight door (open).
 15. Battery tank.
 16. Internal ballast tanks used for maintaining positive buoyancy.

Center, cross-section view of modern submarine driven by both Diesel and gas plants. The Diesels propel the craft on the surface and the gas engines when it is submerged, eliminating peril of batteries ordinarily used for underwater cruising. Bottom, how a submarine rises to the surface. Circle, top of page, members of British ship's crew heaving a depth charge over the side. The charge automatically explodes from the pressure of water at a certain depth—the depth at which an enemy submarine may be riding according to calculations

Handwritten signature: H. S. Pittern 43

2-105-37

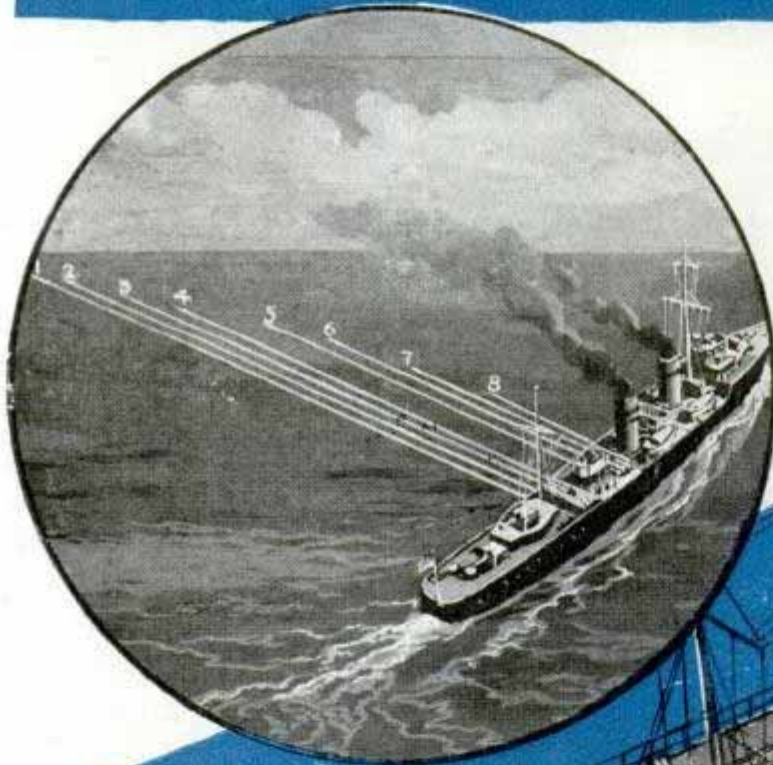
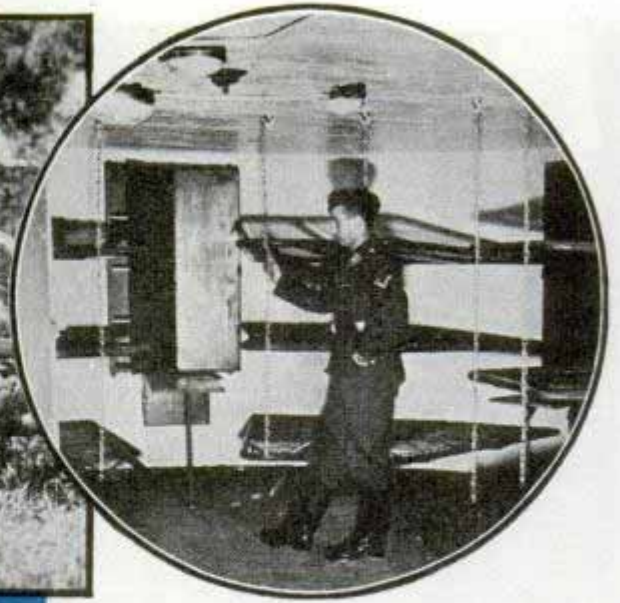

Above, left, cycle scouts of Soviet army in action similar to that accompanying the invasion of Poland by the Russian forces. Right, underground barracks of Germany's Siegfried line. When not manning their guns pointing toward France, men of the garrison dwell in dugouts like this one, deep in the earth

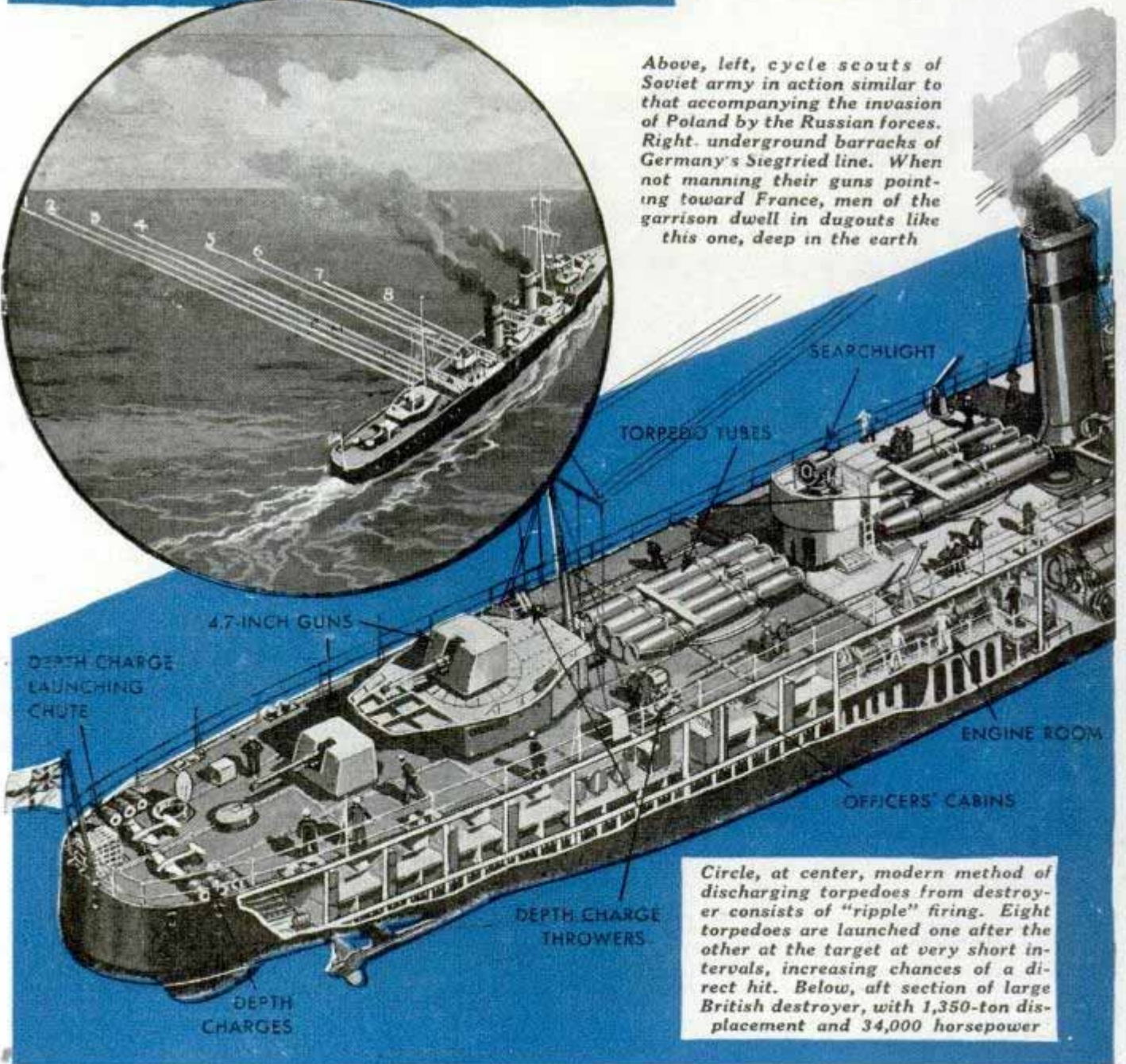

Circle, at center, modern method of discharging torpedoes from destroyer consists of "ripple" firing. Eight torpedoes are launched one after the other at the target at very short intervals, increasing chances of a direct hit. Below, aft section of large British destroyer, with 1,350-ton displacement and 34,000 horsepower

Jan 1940
2-105-37
clw

2106.3

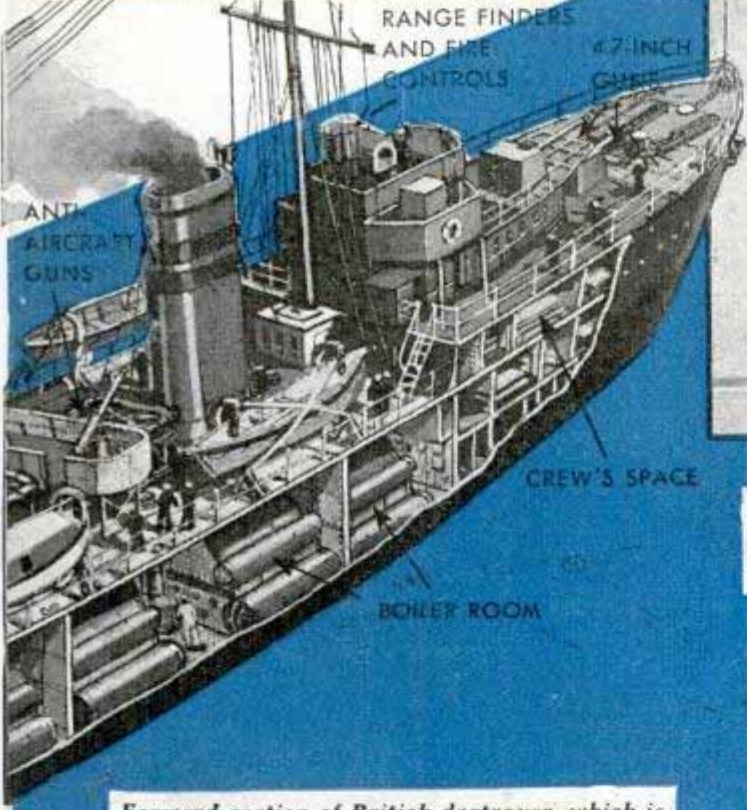
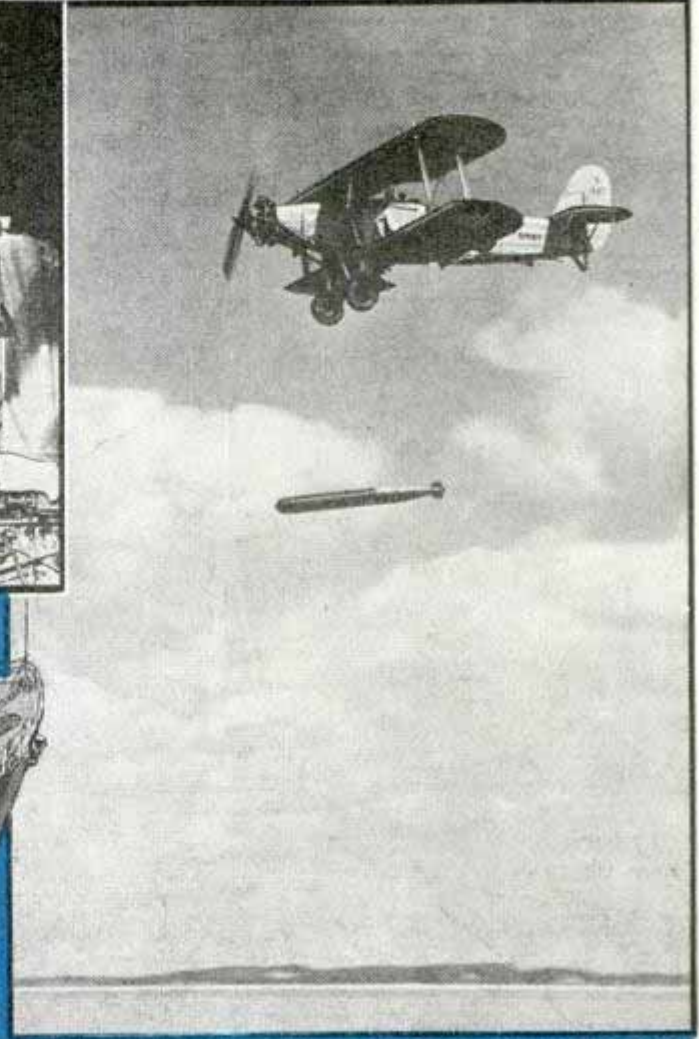
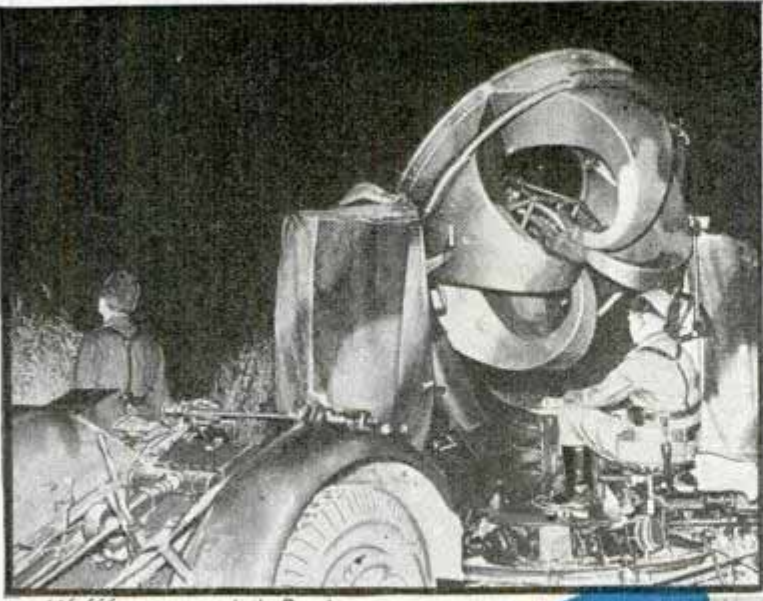

RANGE FINDERS AND FIRE CONTROLS
 #7-INCH GUN
 CREW'S SPACE
 BOILER ROOM

Top, left, latest type of German searchlight used on the western front in anti-aircraft defense work. Right, British plane releasing a torpedo powerful enough to sink a battleship, if properly placed

Forward section of British destroyer, which is equipped not only with torpedoes and 4.7-inch guns, but also carries powerful depth charges, such as that shown at right in cutaway drawing. The destroyer straddles a submarine in the water beneath it and releases depth charges dead astern and also about forty yards to starboard and port. Bottom of page, section of a deadly twenty-one inch torpedo

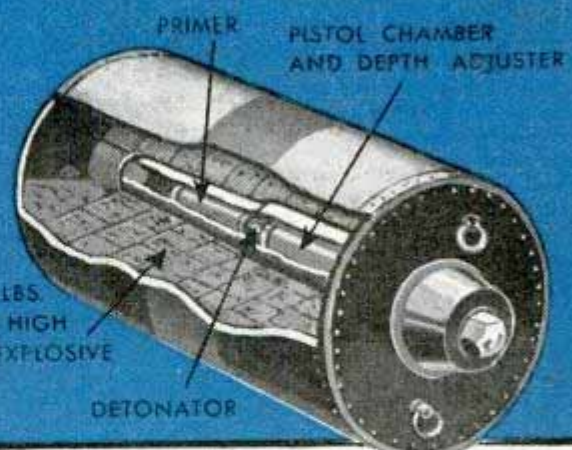

PRIMER
 PISTOL CHAMBER AND DEPTH ADJUSTER
 300 LBS. OF HIGH EXPLOSIVE
 DETONATOR

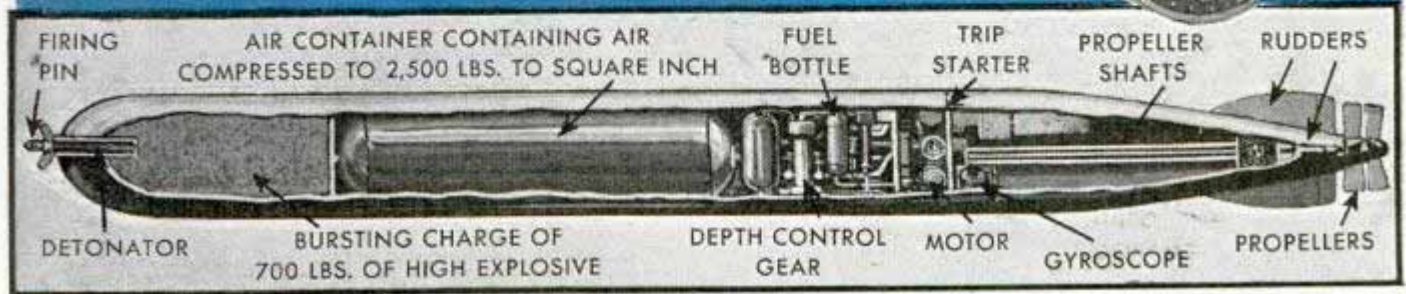

FIRING PIN
 AIR CONTAINER CONTAINING AIR COMPRESSED TO 2,500 LBS. TO SQUARE INCH
 FUEL BOTTLE
 TRIP STARTER
 PROPELLER SHAFTS
 RUDDERS
 DETONATOR
 BURSTING CHARGE OF 700 LBS. OF HIGH EXPLOSIVE
 DEPTH CONTROL GEAR
 MOTOR
 GYROSCOPE
 PROPELLERS

alw.

9.70.53

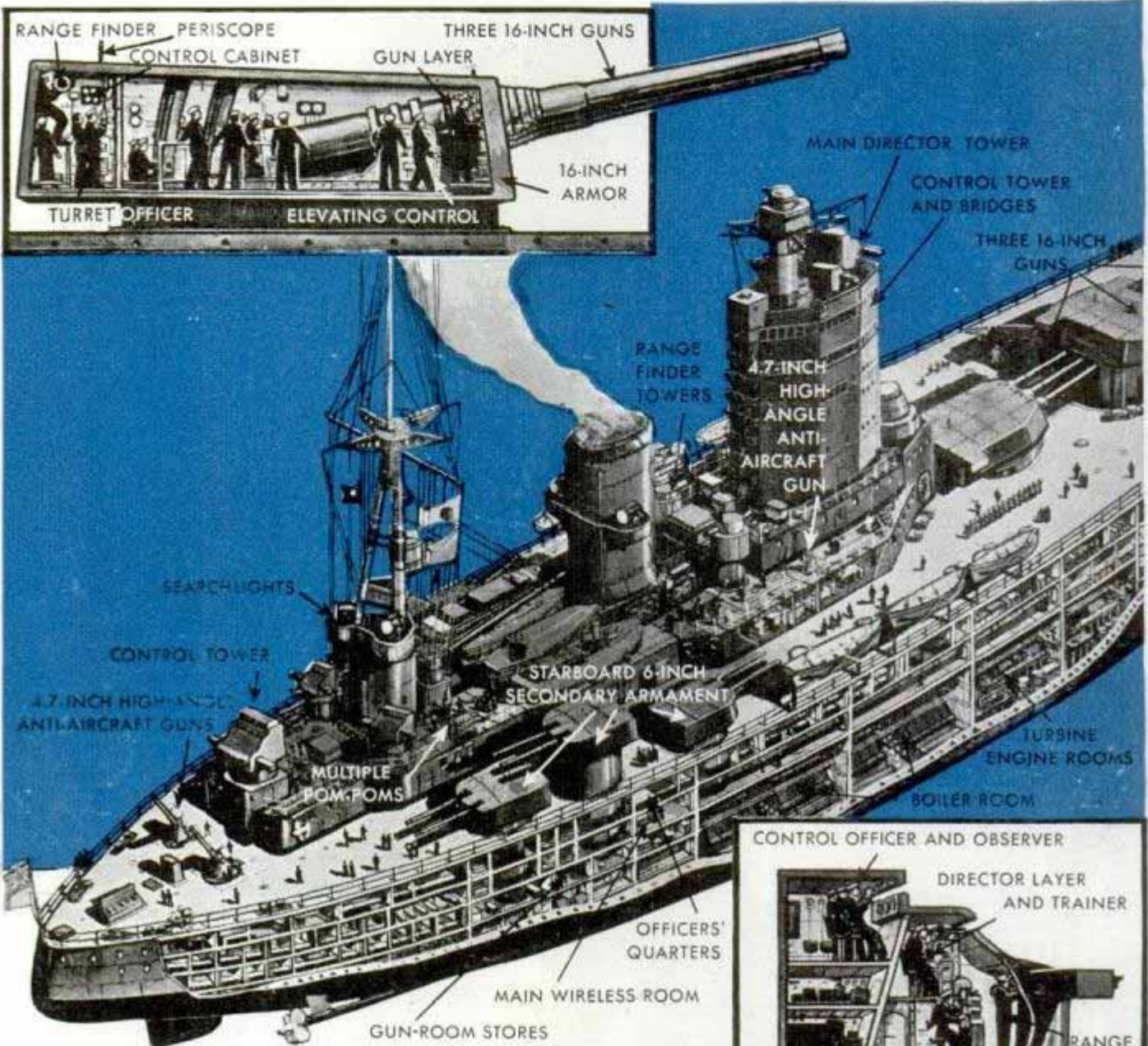

Aft on mighty British floating fortress, showing offensive and defensive weapons and equipment. Displacement is approximately 34,000 tons and the vessel carries nine sixteen-inch guns. Top of page, turret and guns on the battleship. Right, main control tower. Bottom of page, left, British soldier firing new anti-tank rifle which discharges high-velocity bullets that easily penetrate steel plating on tanks, disabling them. Ordinary rifle bullets have no effect on tanks. Right, German air squadron taking on load of bombs. Note bomb in foreground, ready to be placed in the racks



clad

2 1053

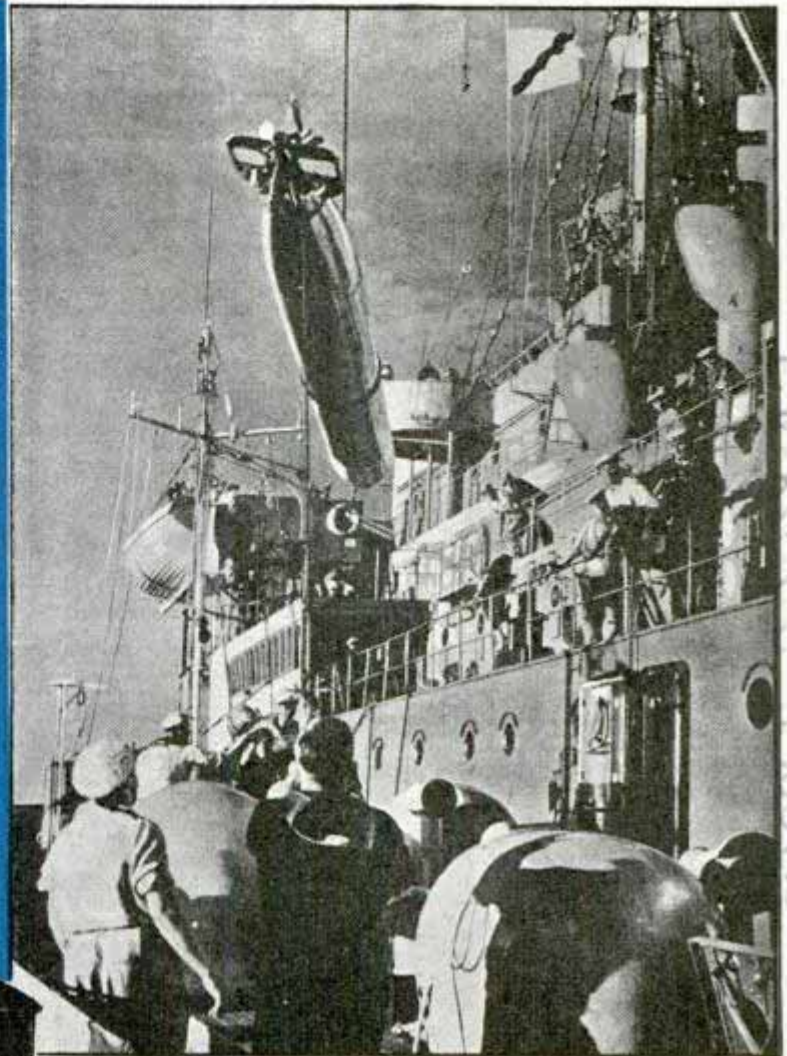
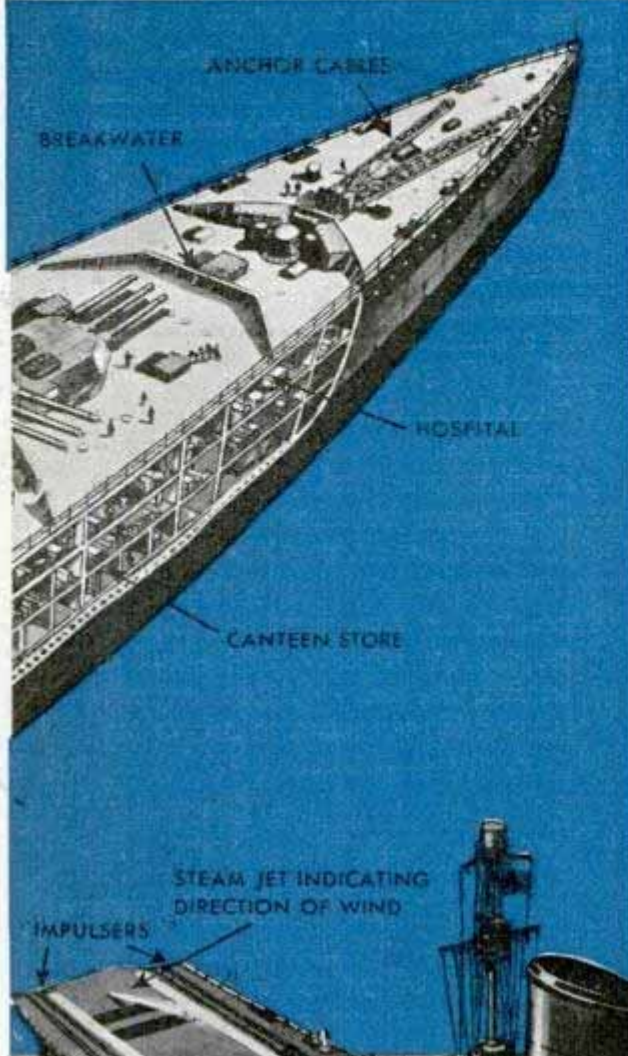

Above, unloading torpedo from German "mother ship" to torpedo boat. Left, forward on British battleship. It steams at twenty-three knots

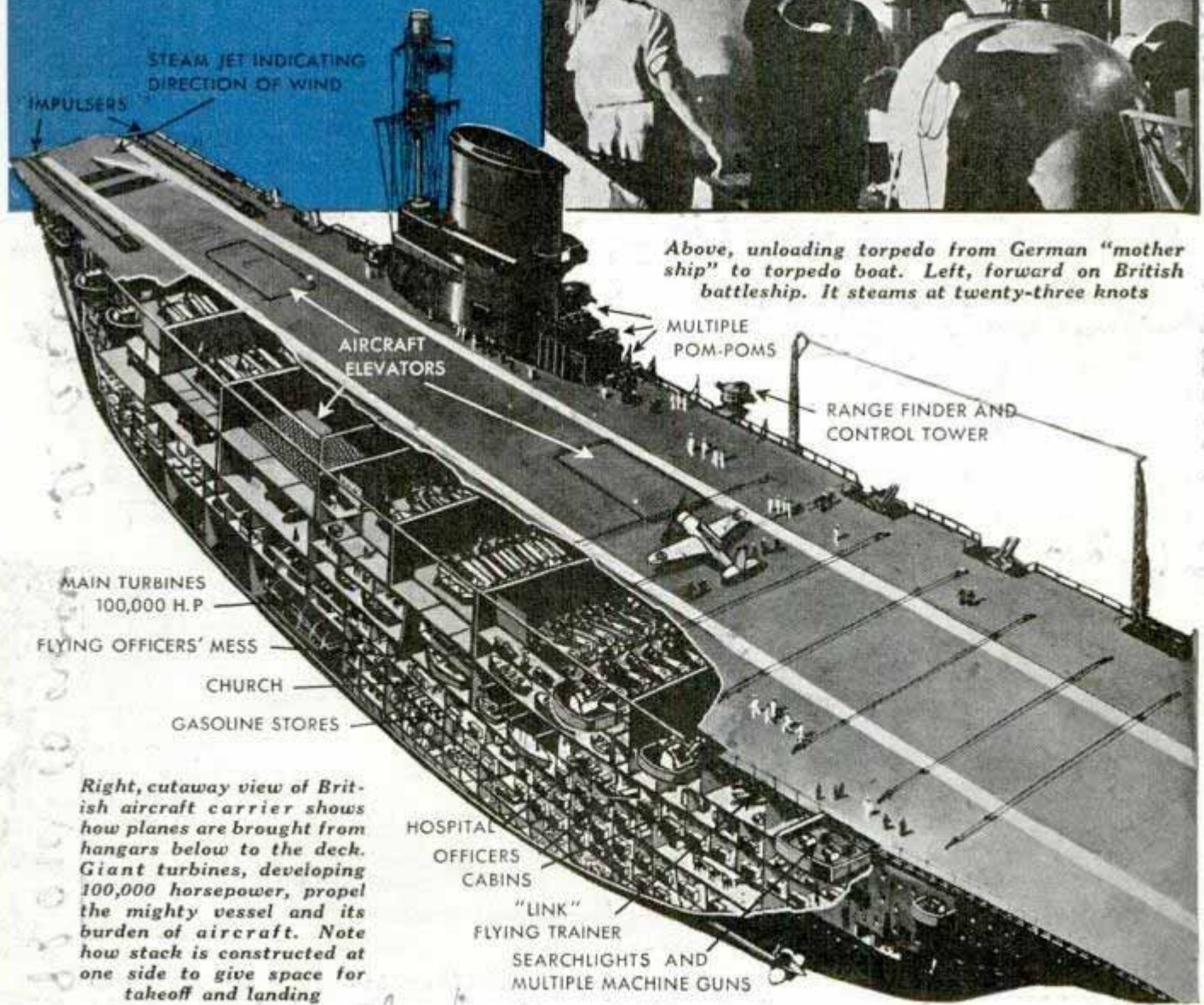

Right, cutaway view of British aircraft carrier shows how planes are brought from hangars below to the deck. Giant turbines, developing 100,000 horsepower, propel the mighty vessel and its burden of aircraft. Note how stack is constructed at one side to give space for takeoff and landing

abnd

21138.

"Bouncing" Iron Ball Dashes Gambling Machines to Bits



Giant iron ball is lifted high above doomed slot machines by electric magnet whence it descends to smash them to bits

Slot machines are threatened by a new kind of ball game introduced by Los Angeles police in their drive against gambling devices. Confiscated machines are piled up and a huge iron ball is raised high above them by an electric magnet. Then the current is cut off and the ball descends with devastating effect.

Lustrous Stainless Steel Like Precious Metal

Stainless steel with a surface as lustrous as gold, silver or platinum, has been produced by processes discovered at Massachusetts Institute of Technology. This was one of the results of research to make steel resistant to all known sorts of corrosion, and was achieved by adding to the chemical bath a little titanium tetrachloride, the metal that produces smoke for warfare. Steel is ren-

dered corrosion resistant in salt water, it was found, if stainless steels are exposed to air for some hours, or if they receive treatment by an oxidizing solution directly after the pickling operation. Salt-water corrosion is cut down more than eighty per cent by adding minute amounts of silver, resulting also in a great improvement of the rolling and machining properties of the metal. For cold-rolling, a thin film of silver is electroplated on the steel. This prevents rollers from marring the surface and the silver alloys with the steel to make a corrosion-resistant surface. These discoveries tend to remove the handicap in the use of a stainless steel on naval vessels where it is subjected to sea water.

Display Rack on Wheels Rolls Tires In and Out

To save himself the time and effort consumed in carrying tires in and out of his store every day for display purposes, one dealer designed a rolling rack mounted on pneumatic tires for ease in handling. On this movable stand he displays about forty used tires and it can be wheeled quickly to any part of the lot where the stock may be shown to best advantage.



Rackful of tires on wheels can be moved in and out of shop easily or placed to best display advantage on outdoor lot

Developed by: Herbert H. Biggs, John C. Wolff, Robert S. Williams, Eugene L. Stange and Robert S. Williams

General Tire

Quaker Co., Akron, Ohio

20 W. 10 Ave. St. Ann, Mo.

Same Service

Used by P. S. Norris + Son Inc.

'Air Traffic Cop' in Tower Guides Air Liners

Built on filled-in land at a cost of more than \$53,000,000, the new North Beach air terminal in New York is located within a twenty-minute cab ride from the Grand Central area. On the roof of the administration building is a booth for the "traffic cop of the air" who controls airplane traffic, and from there emanate the radio directional beam signals which guide the giant transports to the field. There are four runways ranging from 3,532 to 6,000 feet long, and space is provided for fifteen big transport planes to be loaded or unloaded at a time. Accommodations also are offered



Tower from which "traffic cop of the air" gives "stop and go" signals to pilots of transport planes using new airport at New York

East river. They will be hauled from the water by special cars running on tracks which extend under water onto the ramp across a service field and into the hangar.

Merry-Go-Round Baby Scooter Anchored to Safety Zone

Restricted to movement within a five-foot circle, a baby's exerciser and walking-trainer permits the toddler to ride forward or backward in merry-go-round fashion

without danger of injuring himself. It is anchored by a pivoted rod to a weight resting on a non-slip rubber base. A safety-belt around the baby's waist slides up and down, permitting him to stand up or sit down comfortably.

Non-tip scooter anchored to weight is confined within circle where baby may learn to walk in safety. Belt that fastens about him permits sitting or standing in comfort

\$ 5-95



'Leaded' Steel Saves Time in Machining Metal

Adding small amounts of lead to batches of steel is the latest trick of industry to turn this metal into a product that can be cut faster on lathes and milling machines, thus bringing lower production costs. In mass-production operations this also results in less wear in cutting tools and dies, and fewer breakdowns. Recent tests made by metallurgists show that the tensile strength of "leaded" steel remains virtually the same as steel not so treated.

Loring in Court. Resister key

Shis and Loughlin... 155

2 1176
JWA

2 1130

same since 10/19/34

2 1235

Frimble Maryland
134
Robbins and
Casper

21001 Mr. James McQueeny

9 E 45th Kansas City Mo

The WONDERS of

City of Los Angeles' observation car



Top to bottom, view is too bright so passenger turns knob to sight comfort level and then to cut off view entirely. Polaroid is the secret. Right, you can see through several thicknesses of Polaroid if optical "slots" are parallel, but not when slots are crossed, as in fold at right

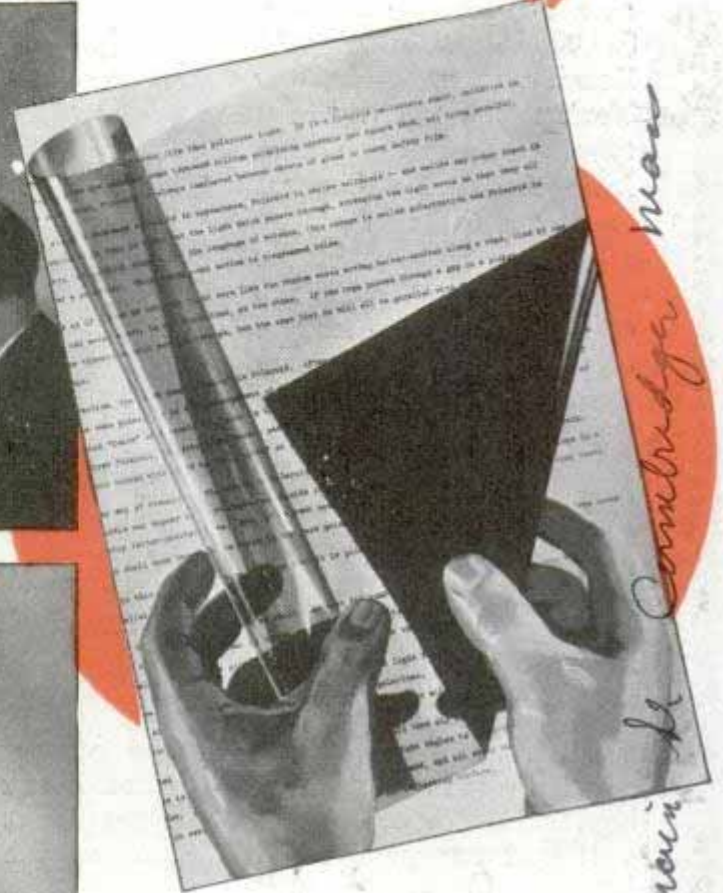

By James McQueeny

BYPASSING light through what is known as a polarizer, its vibrations can be combed and rearranged so they'll vibrate in planes parallel to each other, instead of at right angles and, generally, in every direction.

The material performing this amazing operation is a thin, transparent film—Polaroid light control material. Because of it, polarized light, once merely a scientific oddity, gives promise of doing for applied optics what the vacuum tube did in applied electricity. Many careers are being mapped out for it. Non-glare reading lamps and anti-glare sun glasses are sales leaders in their fields. By placing a bottle between two sheets of the Polaroid material, a glass manufacturer can tell if it's been correctly annealed to prevent internal strain; heat content

man Cambridge Polaroid Corp. 420 main St

Polaroid Corp
285 Columbus Ave - 2/100/
Boston Mass
730 Main St
Cambridge
Mass

POLAROID GLASS

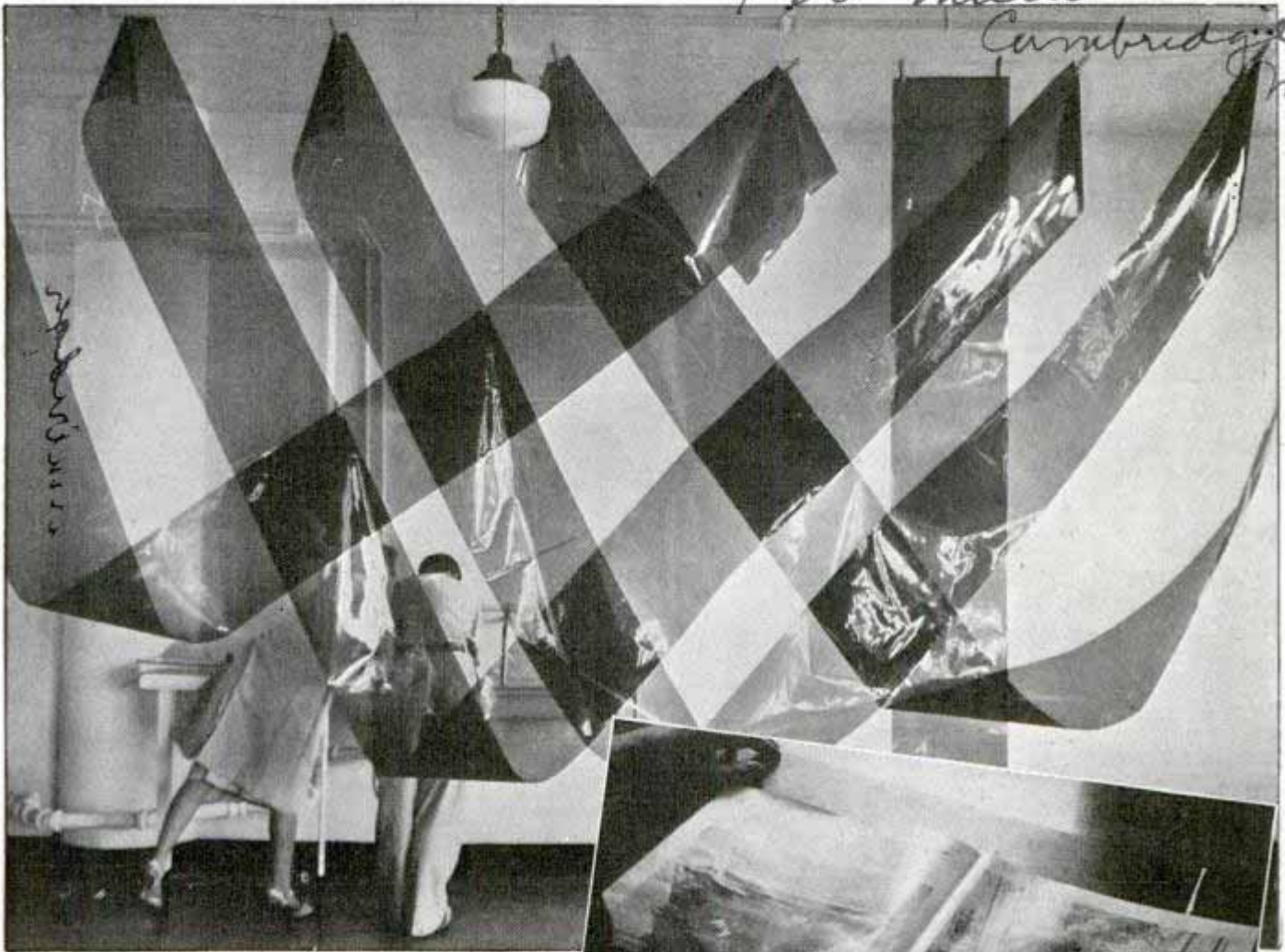

Polaroid strips (top) are transparent unless two are crossed at right angles. Right, comparative views showing how Polaroid sheet eliminates reflected glare on magazine pages.

of coal samples may be measured in a similar fashion and so can the wearability of cotton fabrics.

The jeweler has made the versatile substance his ally in the detection of clever imitation jewels. An engineer can determine in advance how efficiently the members he's designing will carry their actual service loads. He makes a transparent Bakelite or celluloid model of the part, places it between Polaroid disks in an optical system;

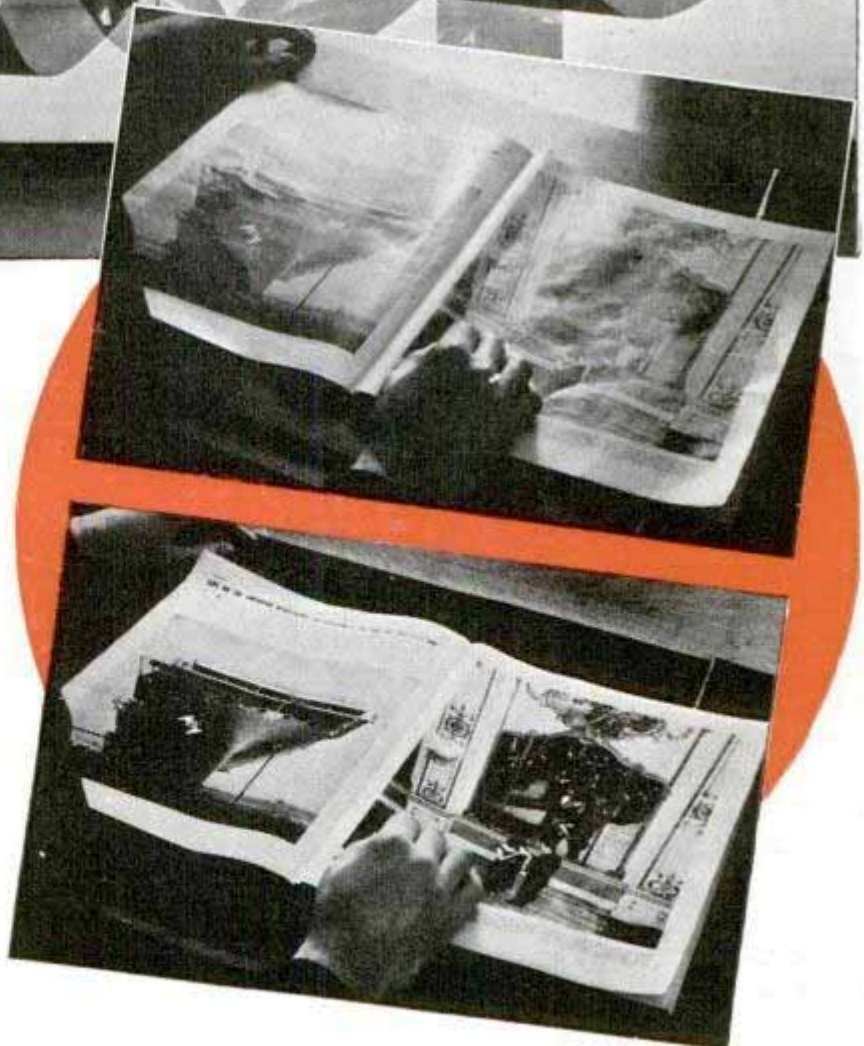

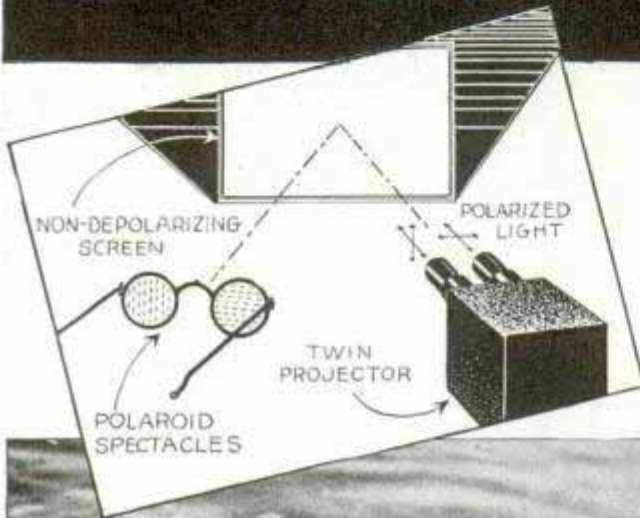
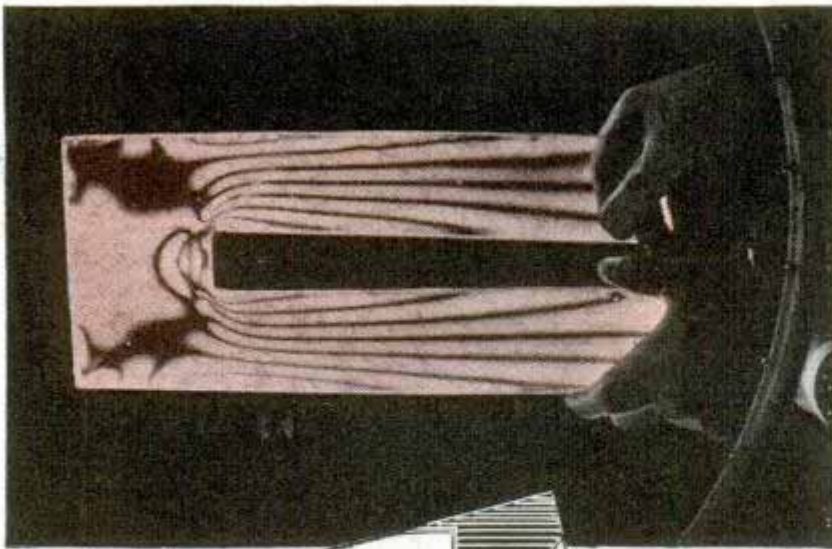

applies forces to the model corresponding to actual service conditions. Strains appear as a map of light and dark bands in the specimen, and from this he can calculate strain at every point in the model, and in turn, predict the behavior of the full-size metal parts in service.

Insurance doctors use it in probing cases of those who claim loss of vision from accidents. Marksmen find it eases eyestrain when applied to gun sights, and the long lights in architectural offices now are being covered with it to take the glare from drafting tables.

A partial solution to the highway death toll, at least the number caused by glaring

headlights, is furnished by Polaroid glass. After two years of intensive testing, automotive engineers predict the windshield in front of the driver, and headlight glasses on all new cars, will be of the new material with installations being made available for cars already in use.

Significant uses for Polaroid glass in photography are many. Through it scientists are photographing the sun to study the structure of the sun's corona. Glare from glass or water ceases to be a problem to the photographer whose camera is equipped with a filter of this material and by means of a small device containing two pieces of the wonder film, one over the other, home-movie makers find they can turn out "fades" between shots that have a professional touch. Recent works of Charles S.

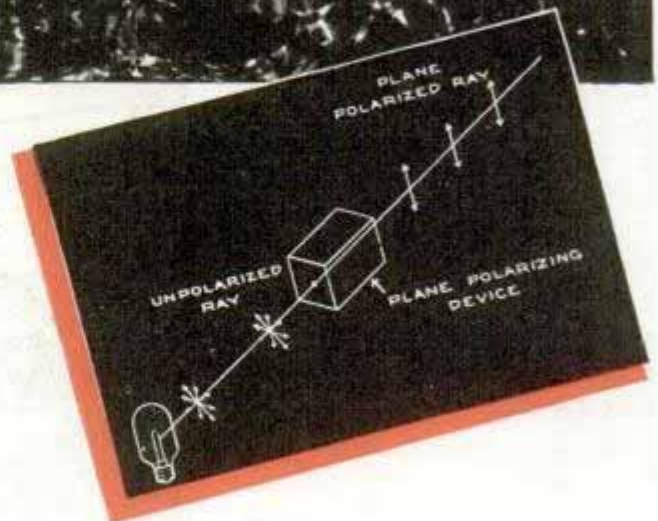

Polaroid sheets reveal strain (top) on transparent model under pressure. Below, principle of Polaroid three-dimensional pictures. Center, how water looks to fisherman before and after putting on Polaroid glasses. Note the fish. Bottom, how polarization affects light rays

Foster, famed microphotographer, have convinced amateur and professional researchers that Polaroid glass is the open-sesame to hitherto inaccessible explorations.

With a thickness of only three-thousandths of an inch, a piece of this flexible cellulosic sheet might be mistaken for Cellophane. For protection, it's always sandwiched between sheets of glass or safety film. Embedded in a square inch of it are some thousand billion sub-microscopic crystals, each having polarizing properties yet all lying parallel so they perform as a single crystal. Their effect is to absorb vibrations along one of their axes. There's no perceptible change in light that is passed through the crystal-studded matrix but it can be called upon to do scores of tasks ordinary light can't. The behavior of the altered light may be studied best with a second Polaroid sheet. Many of the applications involve the use of two sheets.

Polarization isn't new. Scientists have known and understood the principle for years. The big difficulty has been in finding an economical, convenient means of getting the job done. Polaroid material accomplishes in a more practicable fashion what a Nicol prism or what other cumbersome, expensive polarizers do. Then too, it's not limited in aperture or field of view, and is easy to adjust in an optical system.

Place a piece of Cellophane between two polarizing sheets and there appears, as if by magic, a combination of striking, yet harmonious colors. These are created by the withdrawal of certain spectral components of white light by the interference of light vibrations occurring at the second sheet. Consequently, display signs now are fashioned by cutting or stamping Cellophane into the designs wanted. Layers of Cellophane are then added until the

(Continued to page 130A)

Family Rides "Pedalmobile" When State Bans Gasoline



Write World
Family of five turned to this foot-powered vehicle for transportation when Italy limited use of gasoline to emergencies

Milare
Many innovations in bicycles have been produced in Italy as a result of rigid conservation of gasoline. One of the latest vehicles carries a family of five, four of whom do the pedaling.

1127 Army Automobile for Roughest Road Can Climb Steep Slopes

Having proved its ability in the war in Spain, an army car that can travel over the worst roads has been adopted by the German army. Chain driven, the vehicle climbs slopes of forty-five degrees and on level ground can attain a seventy-mile-an-hour speed. Tires have special tread to grip muddy ground, and the body is set up high to give clearance in passing over ridges.



Acme
Sturdy auto of German army travels rough terrain, climbs forty-five degree incline, and attains seventy-mile speed

*Built by Krupp.
Second Parliament firm*

Self-Launching Boat Runs on Beach to Load

Shipper and navigator

Jack Benson, Oceanide, Ore.



Boat equipped with wheels can go ashore where there is a sloping beach to pick up load of passengers and then launch itself again into deep water for a round-trip pleasure ride

Three wheels mounted on a pleasure boat give the craft amphibian characteristics. On a sloping beach she can ride out of the water to take a load of sixteen passengers, drive them over the surf to deep water for a boat trip and return them to the beach. No dock or pier is needed. Powered by a 110-horsepower engine, on

land the ship is driven by two front wheels, and by a paddle at the rear while in shallow water. Twin propellers give the boat a speed of about eight miles an hour in deep water. A rubber-tired wheel at the stern is encased in the rudder so the same controls may be used in steering the boat whether it is on land or at sea.

Seaplane Bases Dot the Map with Ports for Private Flier

at Beulah, Mich

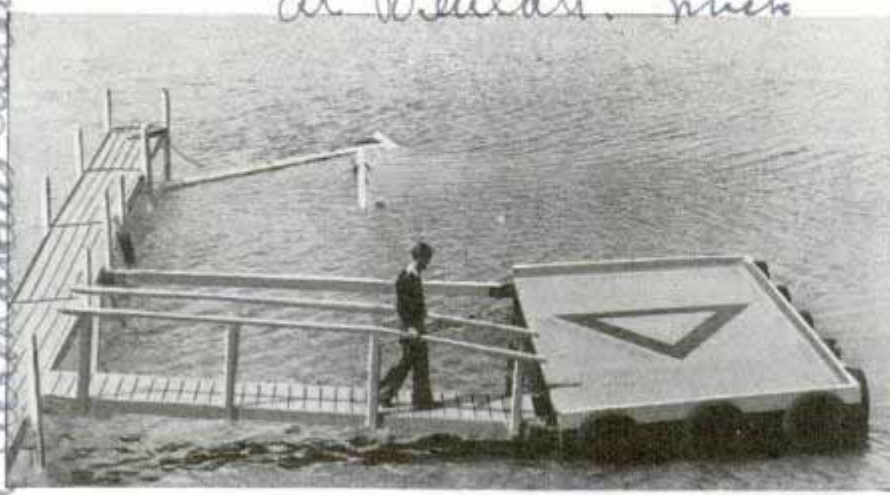

To facilitate and encourage use of private seaplanes, floating bases like this are being established on lakes and rivers throughout U. S.

It won't be long before you can fly your private seaplane from Norfolk to Long Beach and find a convenient floating base at safe intervals across the country. Seaplane flying by private owners, lagging behind land planes at the start, is now fast-growing and the government is building a network of bases at strategic points on rivers and lakes throughout the

*Ref: Harry Bartholomew, Oceanide, Oregon
Chief, Airport System, Washington
and Director, Aullon*

states. Every town or city with adjoining water has a potential port with little initial cost or maintenance expense. The standard float consists of a twenty by twenty-two foot lumber floor with oil-drum floats anchored in the water and connected with shore by catwalk piers. Several of these units can be combined if larger mooring is necessary.

21140
Lightweight Air-Brush Motor Combined with Compressor

Combined in one unit, an electric motor and compressor weighing only twelve pounds produce pressure to operate an air brush for either home or professional jobs of painting with enamel, lacquer and other materials. The air gun, furnished with

about \$10.00



Lightweight motor and compressor combined in one unit operates air brush handy for shop or home use

a glass liquid container, is readily adapted for use in refinishing furniture, which is tedious when performed with a brush. Easily carried by its handle, the unit is mounted on a firm base and includes a receptacle for the gun. Ten feet of connecting hose and an electric cord are supplied, and the motor operates on 110 volts a.c. or d.c. The sprayer is also useful for spreading insecticides.

Send return postage to our Bureau of Information to learn the name of the maker of any device described in this magazine.

Crosswalk Is Painted White to Reduce Accidents



Wide strip of white to mark crosswalk over highway silhouettes pedestrians so motorist can see them

Pedestrians crossing a street are seen quicker by motorists if the crosswalk is painted white, according to one test at a dangerous intersection. The strip is visible to drivers from a great distance and persons walking on it are silhouetted against the bright background.

91217
"Shock Absorber" Helps Angler Land Big Fish on Light Pole

Deep-sea fishermen along the California coast are using a "shock absorber" to take big fish with a light pole. It is an ordinary wooden jig with a strong spring inside it that can stand fifty pounds pressure, taking the initial shock off the line.

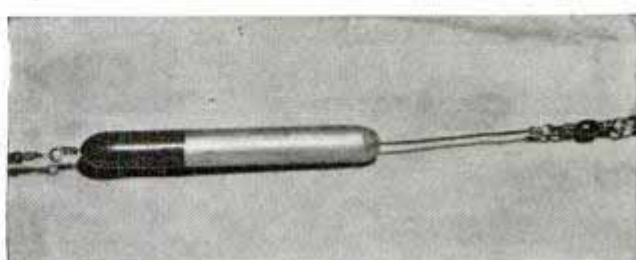

Strong spring in wooden jig withstands fifty-pound shock, so big fish can be caught with light pole

Jegging Joe

Comb. Sam. Bramfaha
1941 Newlee Sh. Monterey, Calif.

4278 91st St. Los Angeles, Calif.

2 102 0. Cont. R. Cle. W. H. Miller
4547 S. Serrano Ave.
Los Angeles

LIFESAVERS for OLD

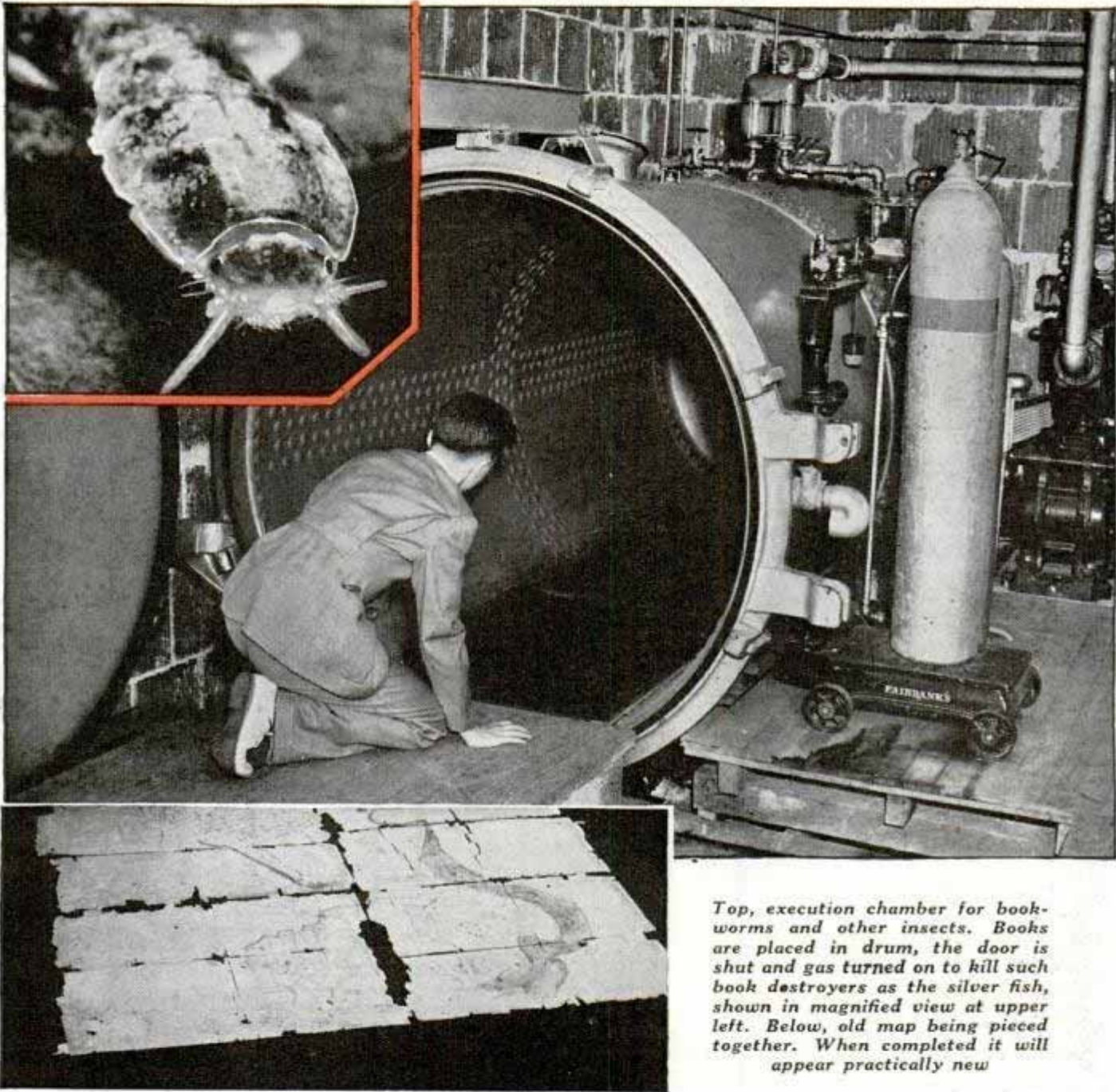

Top, execution chamber for book-worms and other insects. Books are placed in drum, the door is shut and gas turned on to kill such book destroyers as the silver fish, shown in magnified view at upper left. Below, old map being pieced together. When completed it will appear practically new

RESTORING old, worn manuscripts to good condition, kicking out book-worms and seeing that no more get in is a job for a scientific laboratory whose staff has been especially trained. One of the finest manuscript repair laboratories is at the Huntington Library at San Marino, Calif., which houses some of the world's most valuable books and manuscripts.

All newly received books and manuscripts are first "gassed." This is done in a gigantic steel drum, the poisonous gas be-

ing pumped in under high pressure to insure its penetrating into the eggs of worms or other destroying pests. From the gas chamber, the manuscripts go to the repair laboratory. Those which are wrinkled or creased are flattened with the aid of a controlled-humidity stretching table. Weighted lines are clamped to all sides of a manuscript, thereby applying an even pressure. During this process, the manuscript is kept damp by a special humidifying process which prevents moisture from actually

27020
Capt. R. B. Hazelden

BOOKS

touching the manuscript, as this would cause the ink to run. Desks with neon-illuminated glass tops, giant presses able to exert a pressure of many tons, special map-piecing tables, binders, all form part of the equipment by which trained workers transform a faded, torn, and crinkled piece of vellum into a page which looks almost as new as it did centuries ago when it was written; a page from which the bookworms have been banished by a gas attack.

(Continued to page 144A)

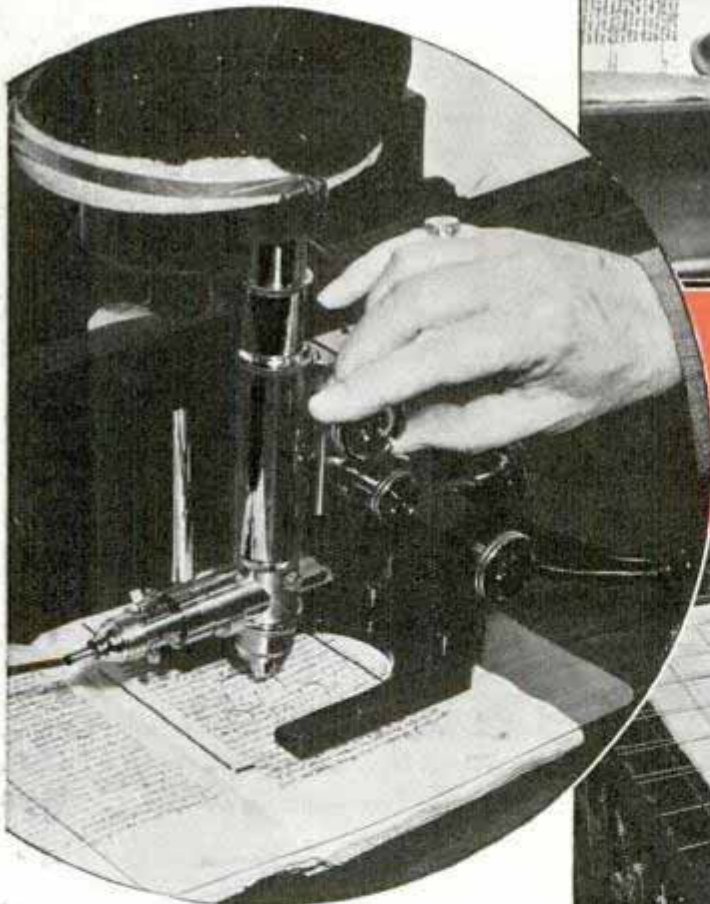
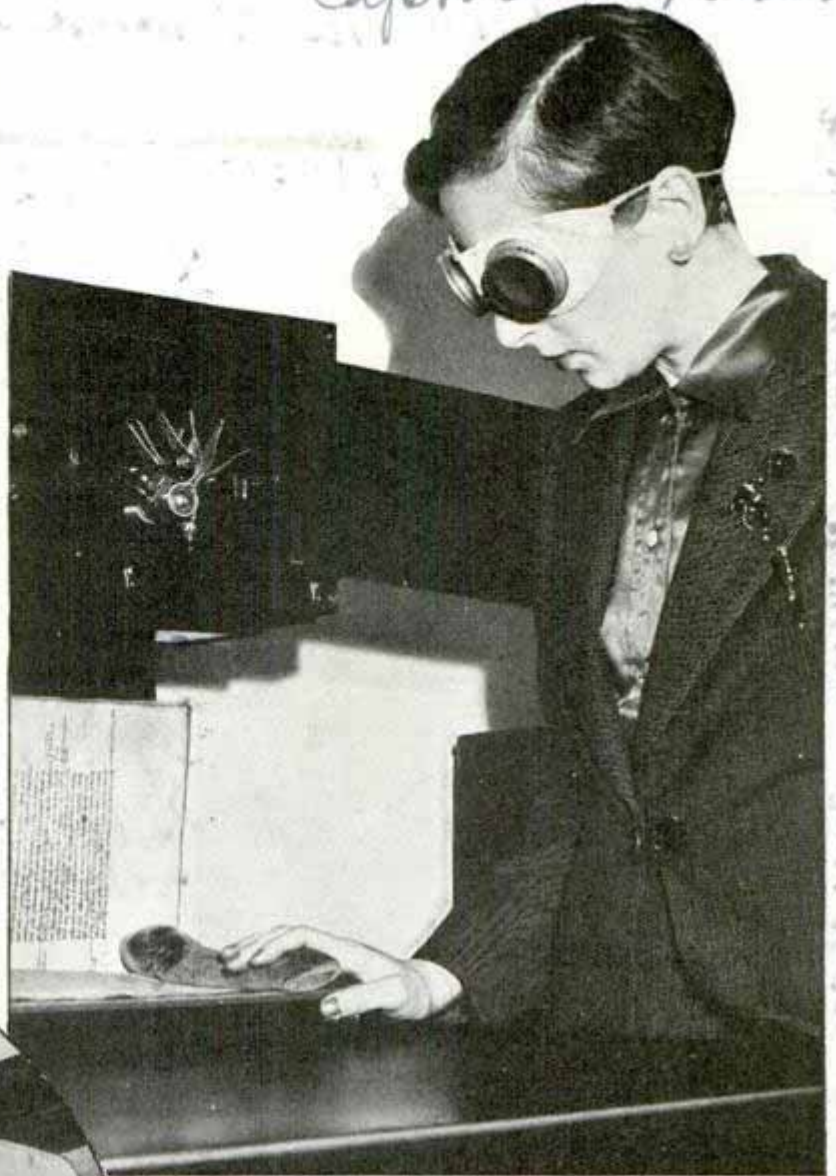

Top, old manuscript under ultraviolet light. Circle, robot being used to analyze shade of ink used in old manuscript. Right, "stretching table" which applies uniform pressure to edges of manuscript aids in restoration of creased pages

I. M. Mr. John C. Keill

5118 N. Broad St., Phila.

Near-Blind Can See Better with Telescopic Glasses

see Circ. 194d 525



Telescopic mounting for spectacle lenses helps near-blind to see well enough to perform normal work

Near-blind persons are helped to see for normal work with telescopic glasses. Held together by rods a little more than an inch long, two lenses instead of only one are used for each eye. They are said to permit more normal perspective than thick lenses.

Airplane Tires Used as Springs Cause Truck to Float on Air

"Doughnut" airplane tires act as a pneumatic cushion in a system designed to replace mechanical springs on trucks and pleasure cars. In a truck installation, four of these small balloon tires were placed on each side to keep the truck, loaded or empty, floating on air, with the result that spinning of rear wheels on dry surfaces



Four airplane tires on each side cushion truck load on air, improving traction and reducing tire wear

was eliminated and the inventor estimated road wear on tires would be reduced as much as twenty-five per cent.

Soil-Testing Kit for Gardeners Helps Prescribe for Plants

Before planting seeds or bulbs or nursery stock you can determine the suitability of the soil for those particular plants, or its deficiency in nitrogen, potash or phosphorus, by using a simple soil-testing kit. Anyone can make the tests without previous knowledge of earth chemistry, and can change the degree of acidity or alkalinity as desired by adding the right amount of aluminum sulphate or ground limestone. A pamphlet of directions shows the acid or alkaline preferences of common flowers and vegetables. Other tests will show what fertilizer is needed.

Artificial Lung Worn Like Vest Leaves Arms and Legs Free



Small size artificial lung, leaving arms and legs free, has "window" to permit observation of chest

Permitting arms and legs of a patient to remain free for any necessary treatment, an emergency lung developed by General Tire and Rubber company covers only the chest of infantile paralysis victims whose chest walls have been rendered useless for breathing. Sealed at the edge by a pneumatic rubber ring, the "lung" exhausts air between itself and the patient's body.

Transistor Body Co. employed at 43rd Avenue of Pennsylvania Philadelphia

9117 3

Judby's deal Gesting Substation South Suburb. Mass. 555 Huntington Ave. Boston Collins, 555

Sold by Warren &

A recent Wright Co. Wilmington, Del.
 POPULAR MECHANICS
 21213.

thereby expanding his chest and inducing breathing at a normal rate. Doctors or nurses can observe the action through the transparent material. The electric pump, operated by a quarter-horsepower motor, is provided with a lever which also permits the "lung" to be operated by hand. Its low cost, as compared with the larger "iron lung," makes it available for the smallest hospitals as well as for ambulances.

Twin-Unit Electric Cooker Fits on a Table Top



You can cook dinner right on the table in trailer, cottage or camp with this two-burner electric stove

When there is no room for a full-size stove, a table-top electric cooker solves the problem. There is a tiny range available with either one or twin burners, which are individually controlled for low, medium or high temperatures. The top of the cooker is made of stainless steel, making it easy to keep clean. The small unit is especially suited for installation in kitchenette apartments, camp cottages or trailers.

Bit to Drill Holes of Various Sizes Is Set by "Dialing"

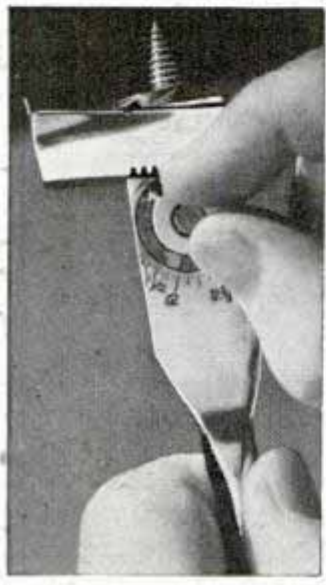

You can drill holes of various sizes by "dialing" an expansive bit now on the market. Available in two sizes—five-eighths to one and three-fourths inches, and seven-eighths to three inches—the micrometer bits are claimed to be accurate within one-thousandth of an inch. A set screw

prevents any slipping of the adjustment, and a gauge on the back of the dial shows depth of the hole during the drilling.

'Painting' Made of Beans and Corn Shows Pilgrim Scene

Dried beans and corn supplied all the color needed for painting an unusual "picture" of "Pilgrim Exiles" which was exhibited at a state fair in Connecticut. Thousands of beans in their natural shades provided a variety of colors, and corn was used to give an added touch of yellow and white.



Artist used only colored beans and corn in "painting" this Pilgrim picture which was exhibited at Connecticut state fair

made by William Cook

Samson's Limited Cookery Range 1700

*Original Service
Oct. 26
American Chemical Society*

Buoys Mark Lanes in Sea Cleared by Mine Sweeper



dist.
Sailor holding string of marker buoys of type laid by mine sweeper to guide vessels through mine-infested waters

When a lane in the ocean has been swept clear of death-dealing mines, it is indicated by marker buoys, so vessels may follow the safe course. British mine sweepers, working in coveys, use paravanes to cut the cable holding hidden mines in position, in order to clear areas for ocean shipping.

Robot Chemist Analyzes Solution and Draws Graph of Results

Complex chemical substances can be analyzed today by a robot that works faster and more accurately than any trained human chemist. The only help it needs is an assistant to "feed" it chemical solutions. It reduces to an automatic, mechanical process the electrometric titration method

now commonly followed by hand, the chemist adding small amounts of reagents to a solution and watching the voltage as the solution's current flows. The robot chemist does this by itself, adding reagents and recording the voltage on a graph after each "dose" of reagent. Not only is human labor saved but the element of human error is eliminated and the recorded graph of the chemical substance can be depended upon.

Floodlight Attached to Camera Can Follow Action

Action pictures indoors are captured more easily when light and camera are teamed up to follow the action. A photoflood gun that is attached to the camera makes this possible. The camera is mounted on an arm between two floodlight reflectors, so that aiming the camera aims also the lights, and the photographer needs no extra hands. There is also a single-lamp gun carrying still or movie camera on its arm.



Making indoor movies with photoflood lights attached to camera so that lights can follow the action

How Chemical Co. Midland

1258

275 up

1206

Portland, Ore. 1925 N.E. Smith

91021.

C. W. Elston, Hall of Justice, Los Angeles, Calif.

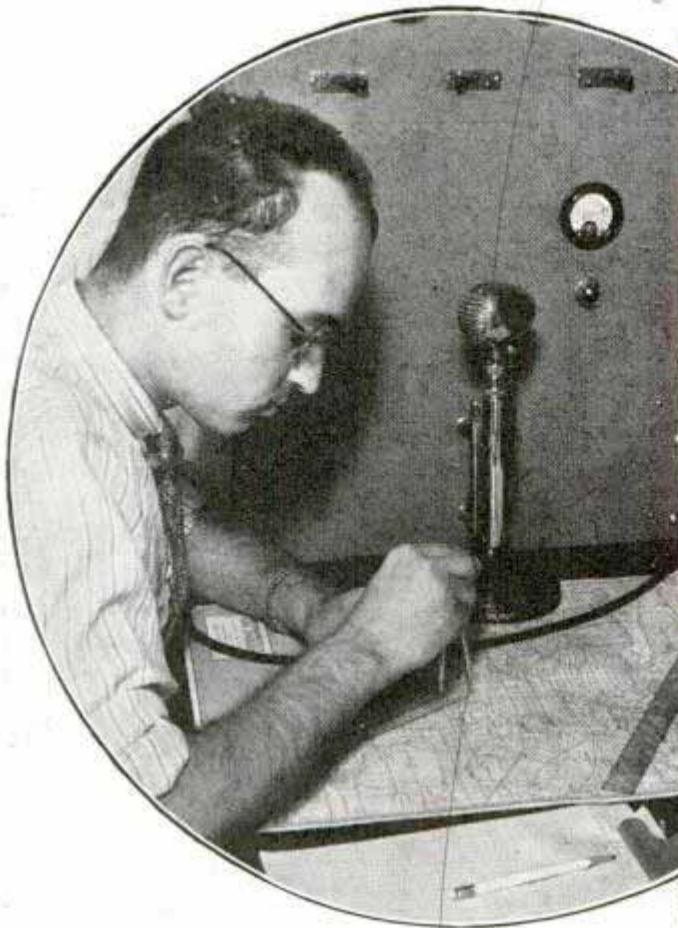

TRAPPING the RADIO SPIES

Scouting through the short waves with his high-frequency receiver, a radio deputy in the sheriff's office of Los Angeles county suddenly ran onto a message that didn't make sense. He copied it down. It was in code, and there was no signature.

It was just the sort of message he was seeking, and during the next few weeks a constant watch was kept on that frequency. Other messages were recorded. Decoded, they helped bring about the arrest of a group of spies who were stealing naval secrets and selling them abroad.

During a flood in southern California a couple of years ago the existence of an illegal short-wave radio station that had been in communication with a foreign capital was disclosed when the operator, in fear of the rising waters, broadcast an SOS that brought deputy sheriffs to his rescue.

Spies are busy in the United States today and they have turned to short-wave radio as a means of communication that is fast and fairly safe and secret. A direc-

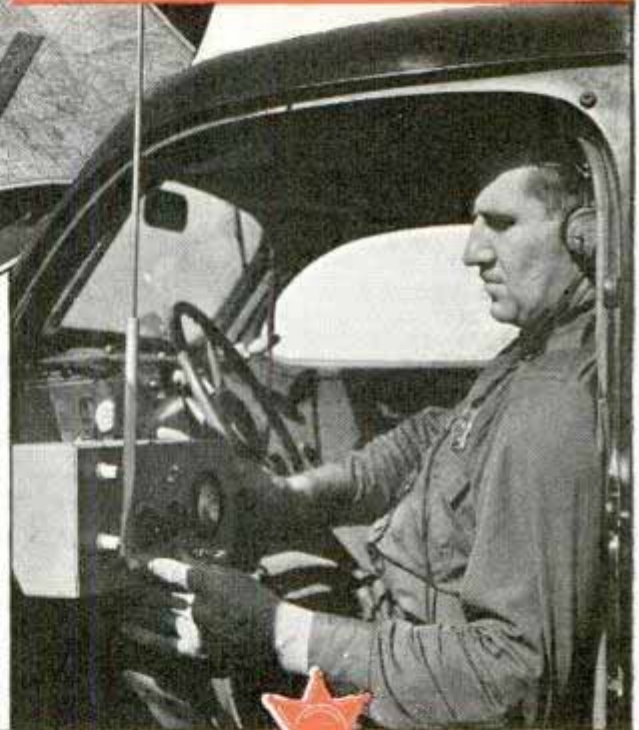

Top, tracing short-wave signals on map by triangulating bearings from several patrol cars. Center, field intensity meter helps find station by measuring strength of signals. Below, deputy sheriff hunting transmitting antenna, with car pointed in direction of strongest signals

Capt. Thomas E. Stevenson, Jr. 10555 Wilman Ave Los Angeles 61

2 10 21



Top, talking on directional beam over parabolic antenna. Right, rotating beam antenna on sheriff's station finds direction of other transmitters. Bottom, mobile transmitter and power supply

tional antenna hidden in an attic and a transmitter that can be carried in a suitcase are all the equipment that a foreign agent needs. He can cross an ocean and a continent with no more power than is needed to light an electric bulb.

It is estimated that there are several thousand unlicensed short-wave radio transmitting stations in the United States. Most of these are amateur "bootleg" stations operated in the five or two-and-a-half meter bands by enthusiasts who haven't bothered to apply for federal licenses or can't pass the required tests. Having no call letters, a bootleg operator frequently uses the signature of a bona fide amateur station and it is through this deception that he is apt to be caught. Other bootleg stations are used for such illegal activities as

the broadcasting of horse-race results from tracks when such announcements are forbidden to gamblers. A tiny mobile set hidden in an automobile at the race track is all that is required.

One of the advantages of radio in espionage is that with directional transmitting aerials, dot and dash messages or conversation can be made almost completely secret. By turning his antenna in the right direction a spy can communicate with a foreign nation, yet other stations a few miles behind or to one side of the transmitter can't pick up the signals. Automobiles containing powerful transmitters can

broadcast while driving at high speed although in such cases the message radiates in all directions, because a large directional antenna can't be mounted on a car. Using a portable apparatus that he can carry under one arm, a spy can talk from a cliff to a ship at sea, employing an ultra-high frequency beam only a few centimeters in wave length that confines the radio waves like the beam of a searchlight. Only a receiver in the direct path of the beam can pick the signals up.

So grave are the possibilities that many law-enforcement bodies have been co-operating

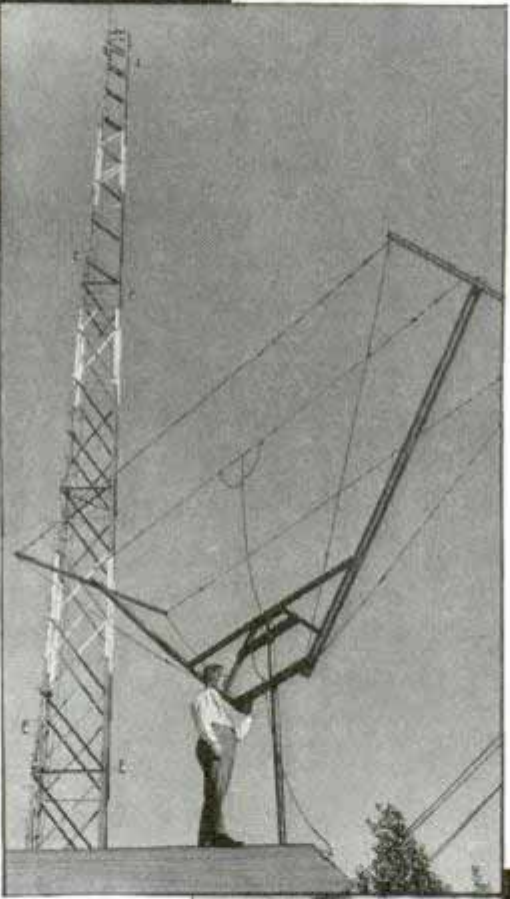

with army and navy intelligence units, standing watch over short-wave channels and working out methods of apprehending illegal operators. In Los Angeles county, Lieut. Charles W. Ellison, in charge of the communications department of the sheriff's office, at the orders of Sheriff Eugene W. Biscailuz, is training his staff in counter-espionage work and in tracking down illegal stations. Standard police radio equipment instead of special direction-finding sets serve the purpose.

"Surprising as it seems," says Lieut. Ellison, "a patrol car equipped with a two-way radio and a fish-pole antenna is a perfect direction-finder. Radio reception



Radio car finds direction of short-wave station by rotating on grease rack, top. Center, recording high-speed signals, to be played back slowly for decoding. Bottom, tiny beam transmitter sends signals twenty to thirty miles

is usually best when the car is pointed directly toward or directly away from the transmitting station. If we are trying to find the location of an unknown station the car's radio is tuned to it and the driver then turns the car until the signals come in strongest. At that point the car is in a direct line with the transmitter, although there is no immediate way to tell whether the station is in front or in back of the car. The next step is to drive in the general

(Continued to page 122A)

2 1115.

Gas Bag on Roof of Auto Holds Fuel for the Car



Coal gas, taking the place of gasoline as auto fuel, is carried in large bags on top of cars in London

Rationing of gasoline in England has brought back the gas-bag car, familiar in London and other British cities during the world war. Coal gas used in place of gasoline is stored in a bag on top of the car and piped to the engine through a hose.

2 1167

"War Tape" on Paris Windows Introduces New Art

Forced to plaster their plate-glass windows with paper tape to keep them from



Dress shop in Paris with its plate-glass windows protected by tape arranged in decorative design

shattering under bombardment, Paris merchants have created a new kind of advertising art. By arranging the strips in attractive designs to represent the kind of merchandise carried, shopkeepers create effects which sometimes enhance the appearance of their establishments.

2 1216.

"Wipeoff" Disks for Movies Produce Trick Effects

Amateur moviemakers can produce professional effects with inexpensive disk attachments just made available. There is a celluloid "fadeout" disk that ranges gradually from opaque to transparent, and a

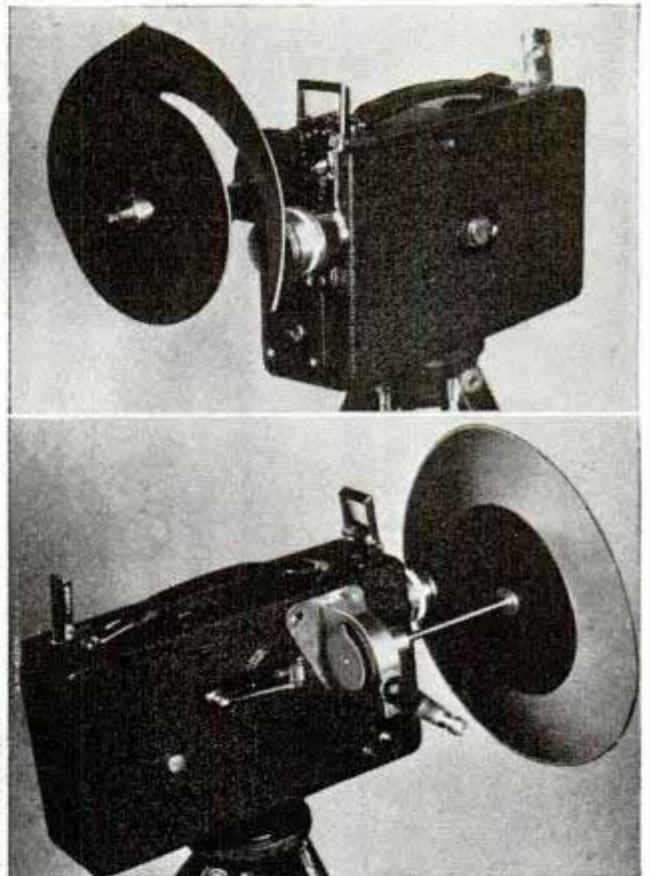

"Wipeoff" and "fadeout" disks attached to movie camera rotate when a button is pressed

"wipeoff" disk that wipes the scene from left to right or vice versa. The equipment is mounted on the camera with a detachable frame counter and back crank. Pressing a button automatically turns the disk while the camera is operated normally.

Names and addresses of manufacturers and dealers in articles described in this magazine will be furnished by our Bureau of Information upon request accompanied by stamped, self-addressed envelope.

21129

Wesper Aircraft Corp, Pa.
Luck Haren, Pa.

Plane Light Changed by Man in Automobile

Perched precariously in a speeding automobile, a ground crew member changed the port running light of a seaplane seeking to establish an endurance mark. Soaring dangerously low to complete the hazardous maneuver, the pilots managed to guide the craft within reach of the car traveling fifty miles an hour.

Mechanic stretches to reach airplane wing light that needed changing, as pilots lowered their ship flying at speed of car racing fifty miles an hour across sands.



Jack London, Jr.

Wes Aircraft Corp, Pa.
Luck Haren, Pa.

Floating Conveyor Hose on Sea Pumps Cargo to Tanker



Seagoing tankers are filled in record time with the aid of a hose light enough to float on the surface of the water, yet strong enough to withstand high pumping pressures. Using such a hose, 1,000 feet long, 3,000,000 gallons of cargo were loaded into a ship, ready to sail, in eighteen hours.

Hose lying snakelike on surface of water loads cargo from shore into tanker in record time

F. Goodrich Co.

London Cars Wear Slotted Masks on Headlights as Raid Protection

Automobiles driven in London must wear hoods over their headlights at all times as a precaution against air raids. The mask emits diffused light downward through three horizontal slits, and is placed on all lamps. Permanent installation is ordered to supersede the former temporary screening methods.



Fitting three-slot hood over automobile headlight

☐ Inquiries as to makers of articles described in Popular Mechanics, will be answered by our Bureau of Information upon receipt of return postage.

21148

2 10.48

Cont. Wallace D. Morris

5902. Magnolia Ave

Chicago



TRICKS of the

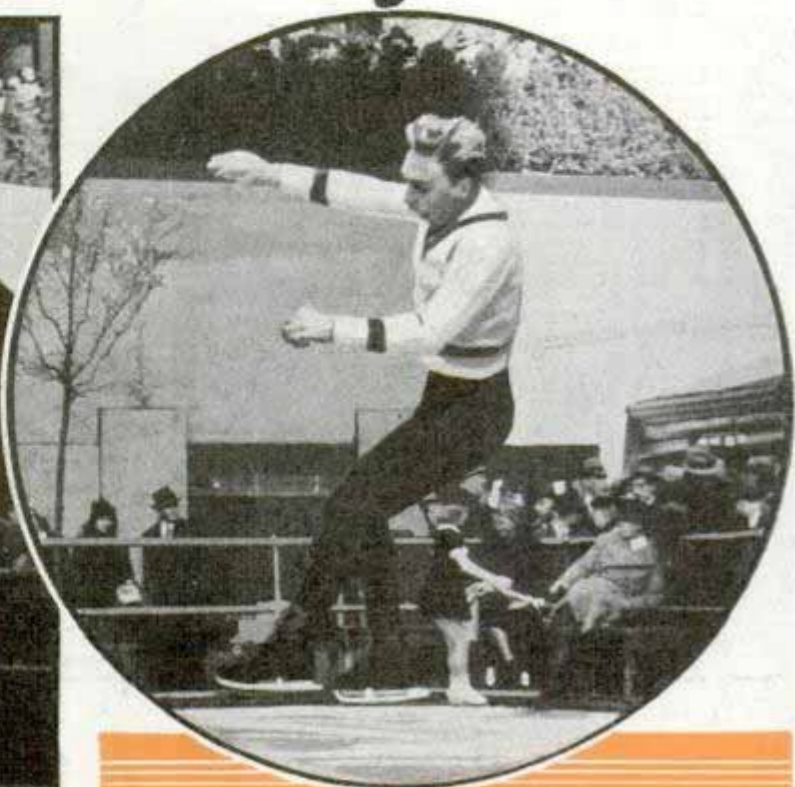

Eric and McChug
By Lewis A. Elkin

(Senior Instructor, Chicago Figure Skating Club)

244 E. Pearson St. Chicago

OUT on the ice you see a skater cutting graceful and intricate figures. It looks simply perfect—and perfectly simple—but there is more to “big league” ice skating than greets the eye. Top-flight skaters, with memories of years of assiduous training, practice, and many unpremeditated bumps on the ice, are fully aware of what it takes to become a champion.

No matter whether a person becomes an expert figure skater, or merely acquires enough ability to skate simply and pleasurably, a few fundamental rules of procedure govern in all cases, and at all times. First, remember that in order to move along on the ice, and to acquire speed, skating must be done on the edge of the skate blade. With that essential habit acquired, the next thing to learn and remem-

Ollie Haupt, Jr., one of America's outstanding figure skaters starts Axel Paulsen jump (top, left). Circle, Haupt in air, using his arms to help him twirl. Bottom, Audrey Peppe starting forward-outside spiral

J. 10 48

FIGURE SKATERS

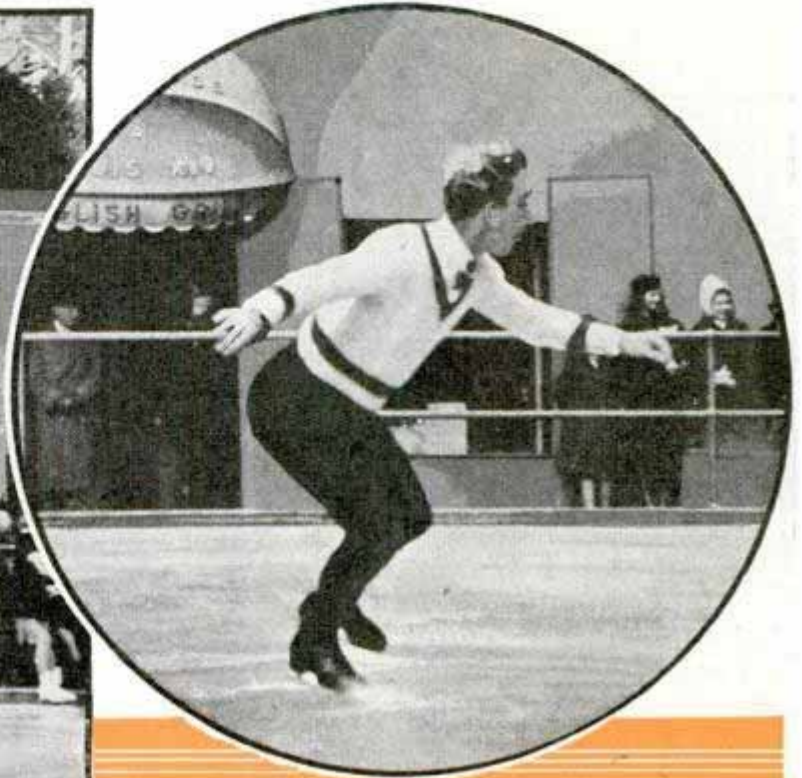

Top, Haupt nearing end of Paulsen jump and then landing. (Photos courtesy St. Louis Post-Dispatch.) Bottom row, Miss Peppe, member of U. S. Olympic team, continuing and completing forward outside spiral (Photos courtesy Sun Valley, Idaho.)

ber is to lean to one side. This latter becomes instinctive, almost, when the edge of the blade is used. Skating on the blade edge, and leaning, tend to make the skater progress in curves, rather than in a straight line. Simple curves, when worked up, become the beautiful figures that form much

of the repertoire of the champion skater.

A skate blade is identified in four sections, or edges, the forward outside edge, the forward inside edge, the back outside edge, and the back inside edge. The figure skater employs all these edges, and he who hopes to become proficient should be-



gin by acquiring stability and balance on the four edges. The problem that besets the beginner is that of keeping in motion on one foot, while the other foot is preparing to shove him along. Fear of falling prompts him to put both feet down together. But you can't skate that way.

Do it this way: start with the outside edge of either foot. The body is leaned to the side of that starting foot, known as the skating foot, but is kept otherwise erect, with the skating knee well bent. The free leg, and the arm on that side, go naturally to the rear as you make your first stroke. And remember that you skate on the edge of the blade by leaning the whole body—not by turning the ankle. After pushing off, you are apt to begin to lose your balance. To offset this, come down on your free foot, so that it becomes the skating foot, and shove off with what was the skating foot, but which now becomes the free foot. This is the basis of all skating. In a short time—only a few minutes for some—foot follows foot to the ice in instinctive rhythm, the distance covered in each stroke is longer, the

speed greater, the balance more sure, and you begin to get the pleasure of skating.

This is ideal form for the skater: the body erect, the arm on the skating side in front of the body, with the forearm and hand parallel to the ice as nearly as possible. The other arm and shoulder blade should be held well back—not rigidly, but gracefully. Hands should be below the waist, controlled but relaxed, the palms downward.

The same basic principles apply to skating backward as to skating

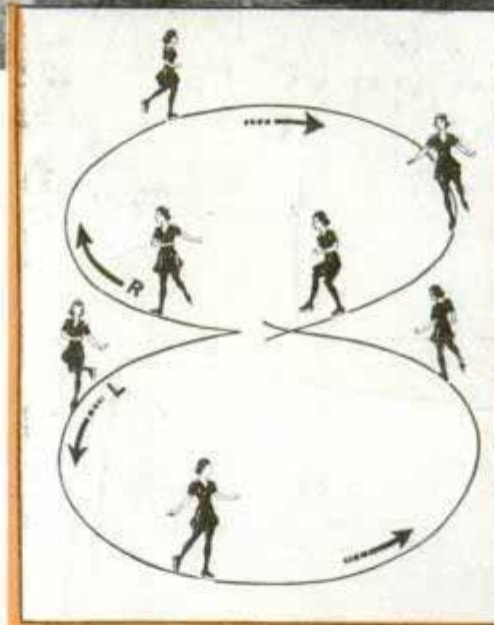

Top, Miss Peppe in midst of splits jump. Center, how forward outside eight is executed. Right path followed on a loop, forward outside. (R and L indicate right and left foot)

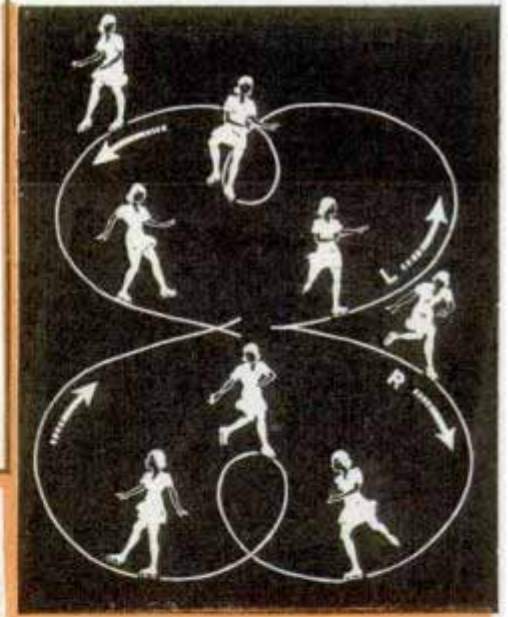

forward. Only the direction of propulsion is reversed. Plain skating, both backward and forward, is a necessary foundation before the skater can begin to learn the figures that make up what might be termed "specialty" skating, but which is the thing that marks those who advance to the enviable status of "champions."

Professional or "champion" ice skating is arduous, too. Karl Schafer, who held the championship for men in Europe from 1929 to 1937, has been quoted as losing as much as two pounds in weight during a five-minute exhibition.

Once a skater reaches top form—cham-

27048

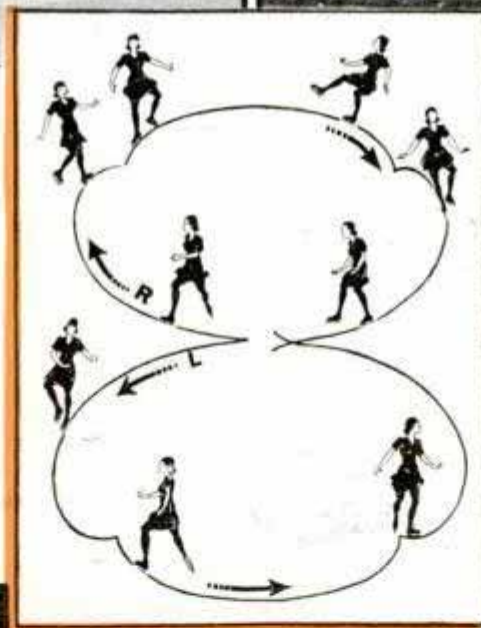
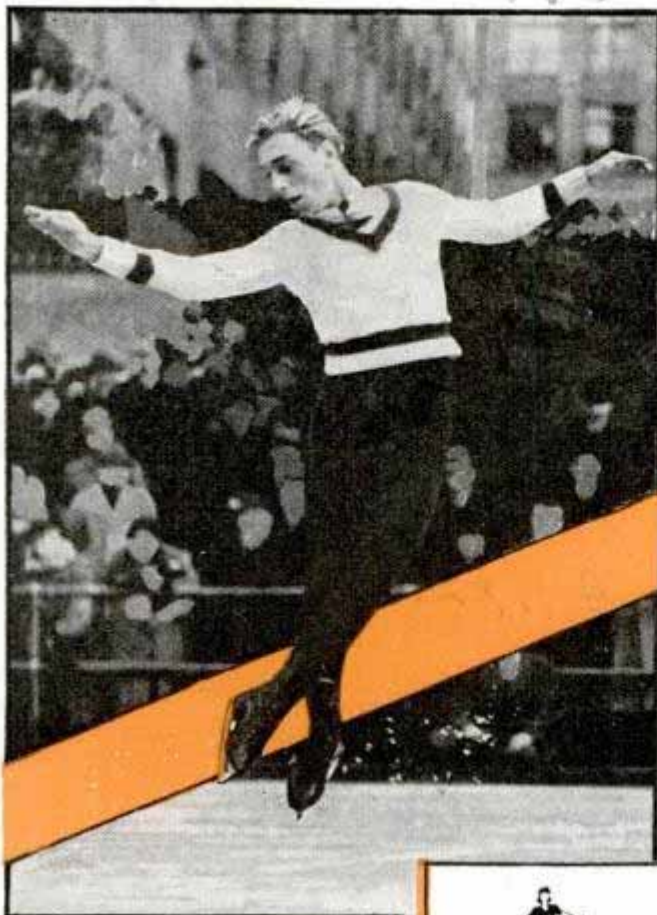

pionship form, so to speak—he or she cannot expect to stay at or near the top on less than two hours of practice a day. It is not uncommon for a topnotcher to practice a full hour on one figure that he is trying to perfect. So, for school figures and free skating a two-hour average every day must be on the cards.

Top, left, Haupt, skating backward, performs mazaruka jump. Right, perfect form in the stag jump by Haupt. (Photos courtesy St. Louis Post-Dispatch.) Center, diagram of the forward outside double three, R and L indicating right and left foot. Bottom, Miss Peppe concluding Axel Paulsen in graceful swing (Photo courtesy Sun Valley, Idaho.)

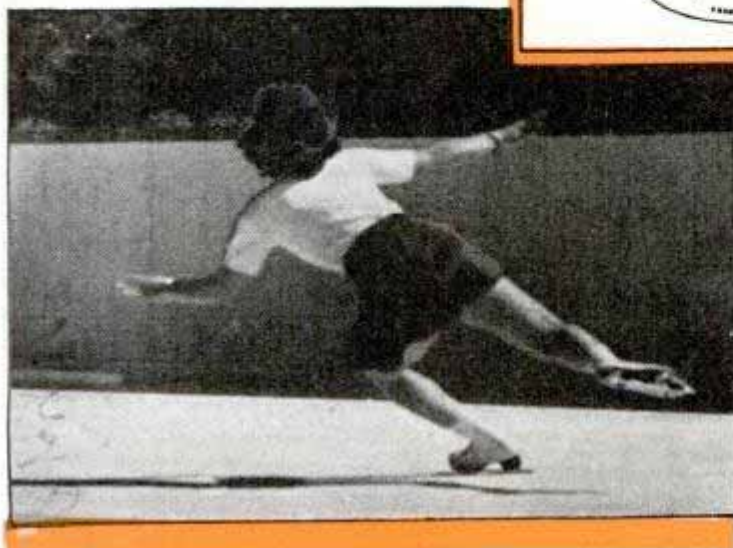

Near the head of the list of qualities with which the competent skater must be endowed is the gift of co-ordination—co-ordination of mind and muscle, of arms

and legs, of the body as a whole. If you want to test your own co-ordinative endowments, try this: let both your arms hang beside your body. Then rotate one of them in one direction, in the same plane as it was when hanging loose, at the same time rotating the other arm in the opposite direction. If you can do that, your co-ordinative ability is good.

Like any other active sport, skating calls for good stomach muscles. Those who eventually attain better than average abil-

(Continued to page 118A)

2/16/35. Mr. Donald Willey c/o P. Over State Co
 10130 Jackson St. Louisville, Ky

Rail Crossing Gate Swings to Release Trapped Auto

despite outside temperatures that run as high as 120 degrees by installing an auto cooler that uses Dry-Ice to lower the interior temperature. One patented container, filled with twelve pounds of Dry-Ice, is installed in a window opening, the glass window being rolled up to hold the unit in place. Outside air entering a small port in the container passes over the Dry-Ice and is delivered into the car at a temperature of about fifty degrees, resulting in a general drop of as much as thirty degrees. On some desert routes motorists may rent a filled container which may be refilled along the way, and then turn it in at a station at the end of the crossing.



Pushing railroad gate to prove it really will swing to release trapped motorists as sign indicates

Motorists who find themselves trapped on railroad tracks inside gates recently installed at Louisville, Ky., can push their way through, since the arms can be swung outward. A pressure of twenty-five pounds will open the gate. Bells and lights go into action five or six seconds before descent of the gate arms, giving traffic time to halt, but if a car is trapped, the driver can get it off the track by nosing it against the gate.

9/11/32. —————
Speech Is Timed to the Second by Radio Readometer



Manuscript or music is rolled through Readometer at proper speed so radio program will end on the second

9/10/34 —————
"Dry-Ice" Automobile Air Cooler for Hot-Desert Driving

Tourists who drive over the hot deserts of the western states remain comfortable

Kool-A-Kar # 2,142,895

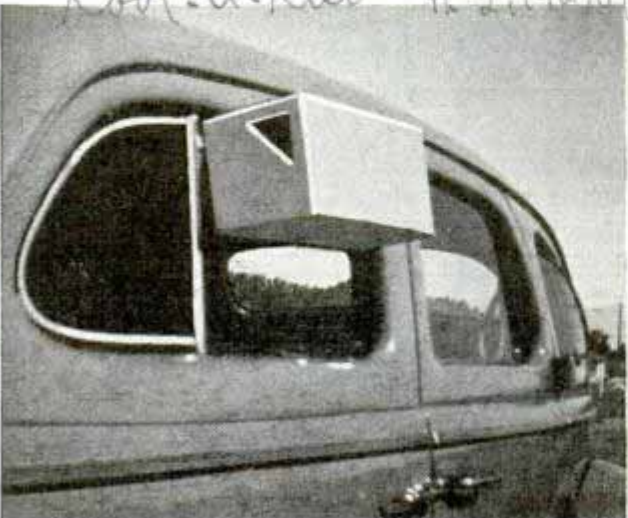

Carton of Dry-Ice mounted in automobile window picks up and cools hot outside air before it enters car

In radio broadcasting, where programs literally are scheduled to the second, it is a major problem to regulate speeches, announcements, dramatizations or orchestration so they will fit the exact allotted time. This is being accomplished uniformly by using a Readometer which feeds the matter to be broadcast across the face of the machine at the correct speed. It con-

Cole's Readometer Co
 308 W. Washington

motor of air-dc (C.) Las Vegas Nevada
 412 S. main (N.)

C. Sprague

sists of two rollers to which the manuscript or music is attached, and as the paper rolls along a pointer helps the speaker keep his eye on the line of print, where a light is provided for ease of reading. With this instrument, a speaker can make use of his full paid-for broadcasting time without exceeding it, and it also eliminates the need for a "fill-in" between programs.

21125
"Cool" Light Glows Inside Ice without Melting It

To demonstrate the "coolness" of a newly developed fluorescent light, a sign was frozen solidly in a cake of ice and burned continuously without causing it to melt. The light was designed for use in freezing rooms of a modern cold-storage plant, where a temperature of thirty degrees below zero prevents efficient operation of ordinary fluorescent lamps, and incandescent lamps would create too much heat. Solution of the problem was found in the development of this special fluorescent-tube light, and extensive tests under frigid conditions proved its success.

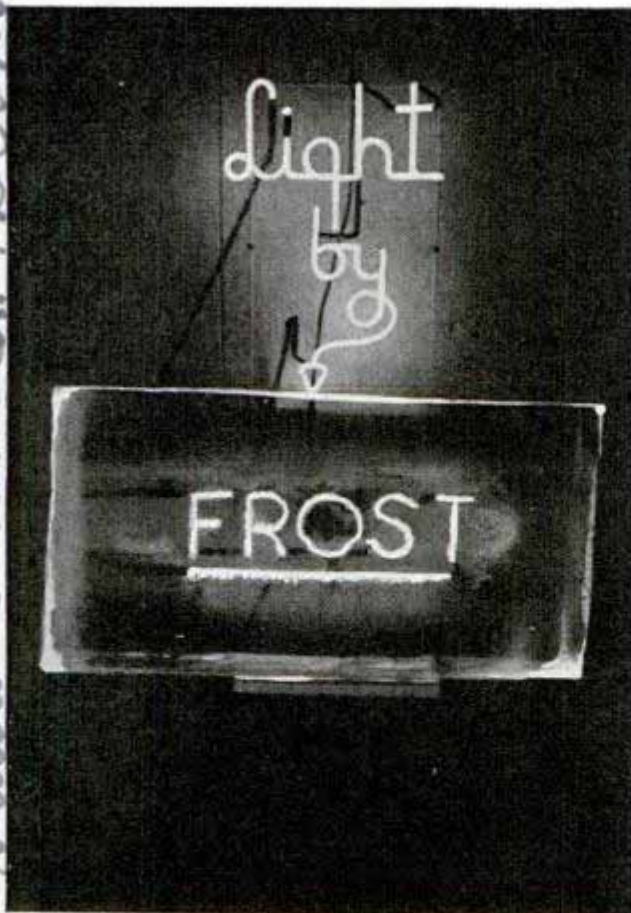

Fluorescent sign frozen in cake of ice proves its lack of heat and its efficiency for use in cold rooms

Clifford Seriman

21154
Ball Bearings for Oil Well Save Casing and Tubing

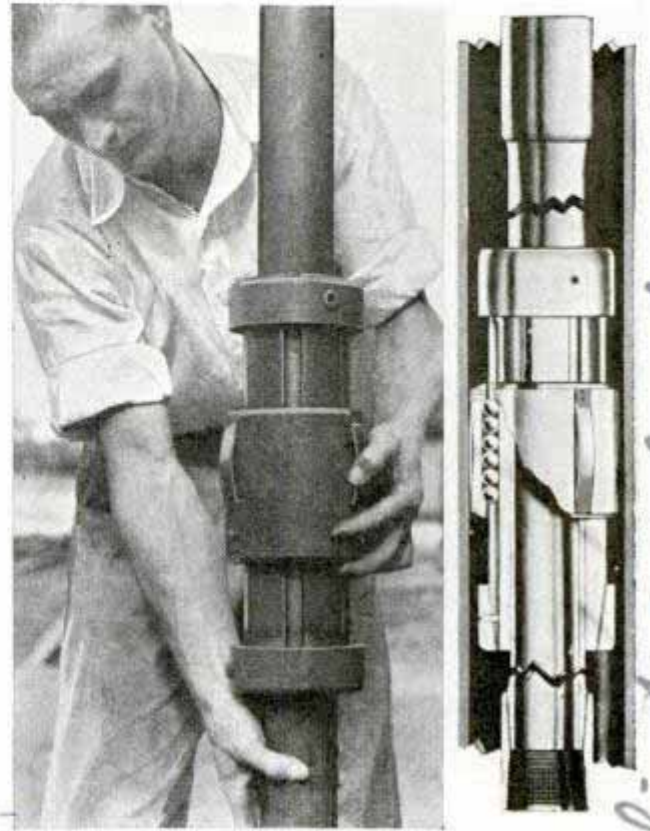

Left, oil-well connection. Right, cross-section showing location of ball bearings

In pumping wells, especially those more than 5,000 feet deep, a breathing action causes the inner string of pipe, or tubing, to rub against the well casing. A new device with ball bearings allows several inches of vertical movement in the well without appreciable friction, thus retarding wear on casing and tubing collars.

21223
Electric Eye Sees Death Approach in Time to Prevent It

Warning of the approach of death is given by a photoelectric eye, designed at Ford hospital in Detroit, Mich., which reacts to changing color of the skin and blood of a patient. It will be used in surgical operations where anesthetics or sedatives have been administered, as its signal allows time to give life-saving oxygen. Blood grows darker, due to loss of oxygen, upon the approach of death, and this is what actuates the photocell. A strong light is placed behind the ear, and the electric eye picks up rays passing through, thus detecting changes in the blood color.

Chicago Tribune
10/20/39

to Aurora News Co. 4 S. Archer St. Aurora, Ill.

21154
21125
21223
Wetzel Tubing Co. - Des Moines, Ia.

2973

Cont. Co. with Muller
457 S. Serrano Ave.
Los Angeles Calif



“PAINTING” LIVE

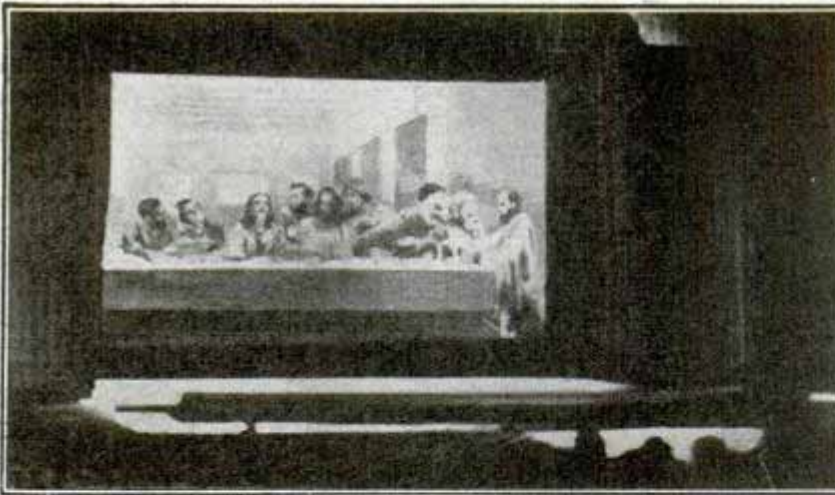

Top, left, Roy M. Ropp adjusting gilt globe for "The Races of Man" presentation. Right, cotton glued to pitcher and bowl looks like milk. Bottom, left, "The Last Supper" reproduction. Right, glassware glued to tablecloth to prevent sliding on tilted table in "The Last Supper"

BEFORE the audience appears one of the world's masterpieces of painting, every line and color just as a great artist created it. Only the painting is life sized, and the characters are actually living.

For a minute and a half the picture remains visible, then vanishes. A few moments pass, and another world-renowned work of art appears. Next comes a piece of famous sculpture. Then other paintings.

Finally da Vinci's immortal "Last Supper" is spread before the audience, its power, reality, and unbelievable feeling of "depth" bringing an awestruck whispering from the crowd.

Painting with people sounds a little like a miracle—until you see it done. And even then, you have to shake yourself to make sure you haven't dreamed that the great masterpieces of the world's finest painters

Laguna Beach, Calif. ...

The ...

9993



PICTURES

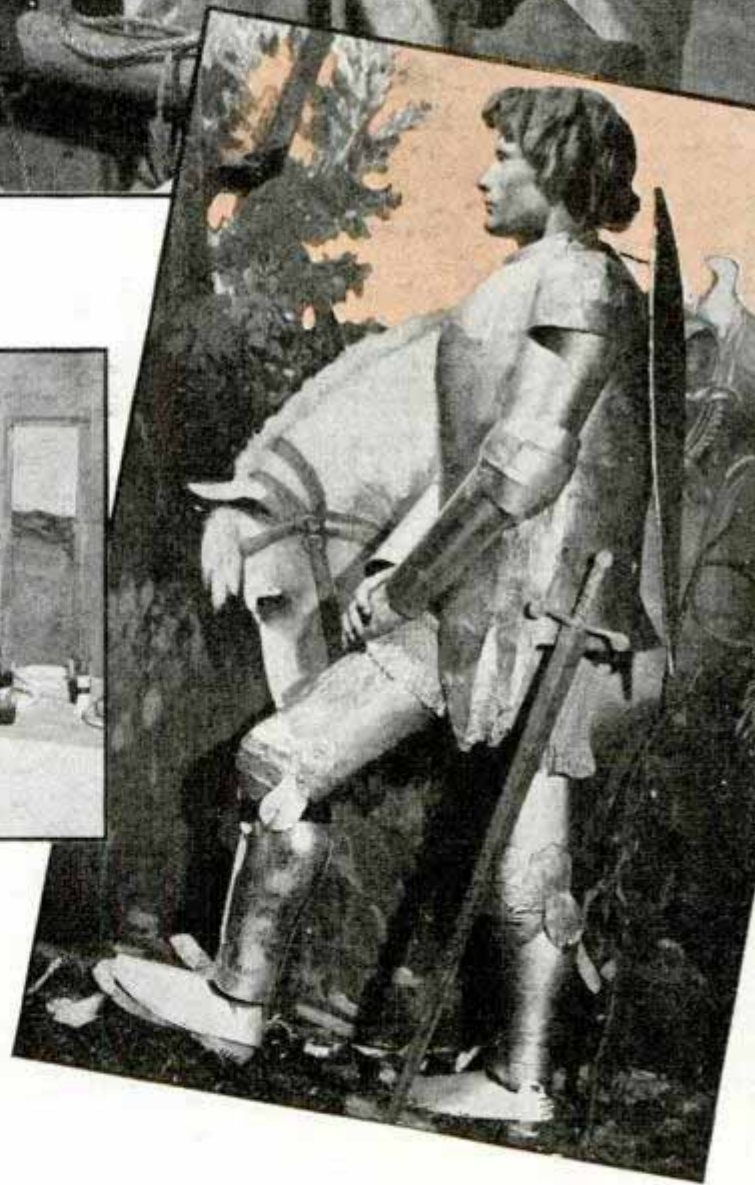
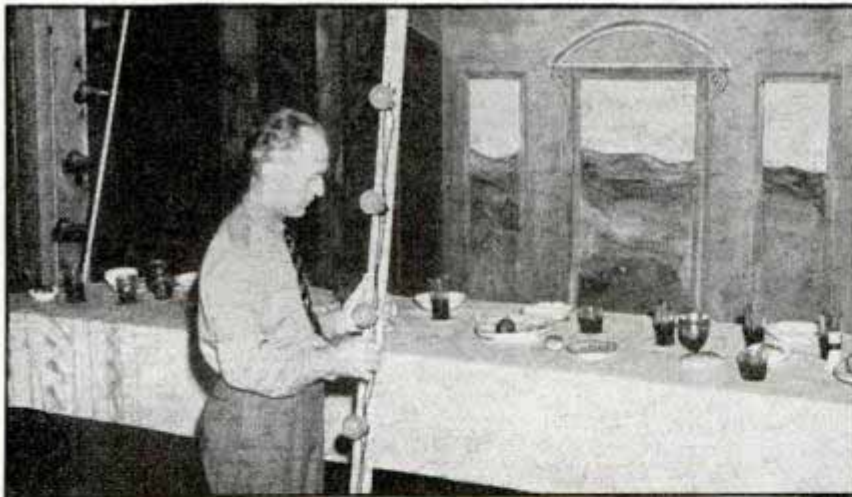

haven't walked right out of their frames.

Behind this seeming magic is the artistry and mechanical ingenuity of Roy M. Ropp of Laguna Beach, Calif., whose living masterpieces form part of the annual Festival of the Arts which is held in that city.

For six months before the annual festival, Ropp culls through copies of hundreds of the world's great paintings, selecting those which are best suited for reproduction in his unique manner. This year he chose forty-four paintings and started the seemingly impossible task of solving the

Top, living models presenting Renouf's "A Helping Hand." Below, left, preparing setting for "The Last Supper." Right, reproduction of Watt's immortal painting, "Sir Galahad." The model is living, the horse is painted on background

2973

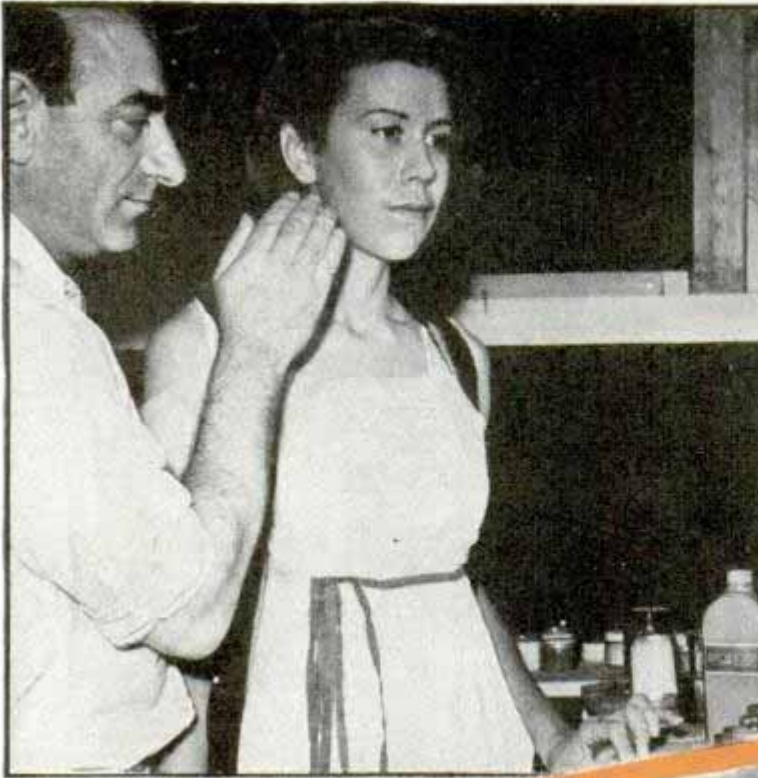

men understood the situation. But when they realized what it was all about, they agreed to become statuary for a night.

In the vast majority of cases the models are secured from citizens of Laguna and near-by towns. Often, it is the magic of makeup and costuming which turns the trick. The highly masculine character of Velasquez' "Alessandro del Borro" was played by a woman, certain features of whose face had suggested to Ropp that she might play the part. Makeup and costume did the rest.

One of the most difficult mechanical as well as artistic prob-

mechanical and artistic problems and finding the proper models.

Noticing a resemblance between the face of a local garage owner and that in Frans Hals' most famous work, Ropp obtained his consent to play "The Laughing Cavalier." A Laguna octogenarian plays Whistler's "Mother." Ropp was once unable to find three physically perfect men to play parts in one of the pieces of statuary which are displayed on the same program with the paintings. The statuary in question, Malvina Hoffman's "The Races of Man," was to be given with the aid of a specially modeled golden globe of the world, and a revolving pedestal. He was about to cancel this number, when he saw three young men walking along the street. They were the exact type he wanted. It took quite a bit of explaining before the young



Top, the magic of makeup is important in recreating masterpieces. Center, living reproduction of Whistler's painting of his mother has a striking resemblance to the original. Bottom, reproduction of a piece of sculpture with a living model during Pageant of the Masters

2973

2117

6012

lems is to properly blend the living models and constructed sets with the painted background. Correctly judging where the set should end and the background begin is important in securing the feeling of "depth."

For instance, in Watt's famous painting, "Sir Galahad," a knight in shining armor stands beside the head of his horse, while in the background are massive oak trees. In reproducing this picture only the knight and a narrow strip of leaf-strewn ground are real, the trees and the horse being skillfully painted on a backdrop. The armor is made from papier-mache.

In Renouf's "A Helping Hand," a large part of an old rowboat was used in the foreground, the rear of the boat being so skillfully blended into the painted background that only a few feet away it was impossible to tell where the two joined.

In one picture it was necessary to show milk being poured from a pitcher into a bowl. The scene was to be held for ninety seconds, but a pitcher of the relative size painted by the artist wouldn't hold enough milk to pour that long. After days of experimentation, it was discovered that a strip of ordinary cotton glued to the pitcher at one end and the bowl at the other created the desired effect perfectly.

Such pictures as "Birth of the Flag" by Henry Mosler, which shows Betsy Ross and her daughters sewing on the first Old Glory, require elaborate costumes and makeup. The costumes are made by members of the association presenting the living pictures. Many of the characters must wear wigs. As no standard wigs will give the specific effects intended by the great artists, it is necessary to create a special wig for each character. The wig for the "Blue Boy," adapted from a theatrical wig, is so perfect that even when

(Continued to page 141A)

Braille Globe for the Blind Helps Follow War Events



Globe with pins outlining sea coasts and boundaries of countries enables blind to trace them in following events of war

Blind people can keep posted on the progress of events in Europe with the aid of a Braille globe designed for that purpose. Boundaries of the various countries are read by following with the fingertips a line of pins projecting above the map.

Motor-Oscillated Electric Disk Heater Distributes Warmth in Room

Quick, even distribution of heat from the common disk-type electric heater is accomplished by an oscillating heater introduced recently. A quiet-running motor turns the heater alternately right and left.

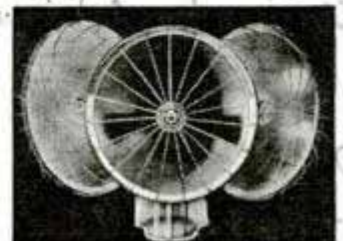

J.A. Smith Mfg Co NY
Price \$11.95

Marysville
1-1-41

Braille, distributor of America
N. Vermont, 1-1-41

Flash Bomb Lights City for Air Cameraman

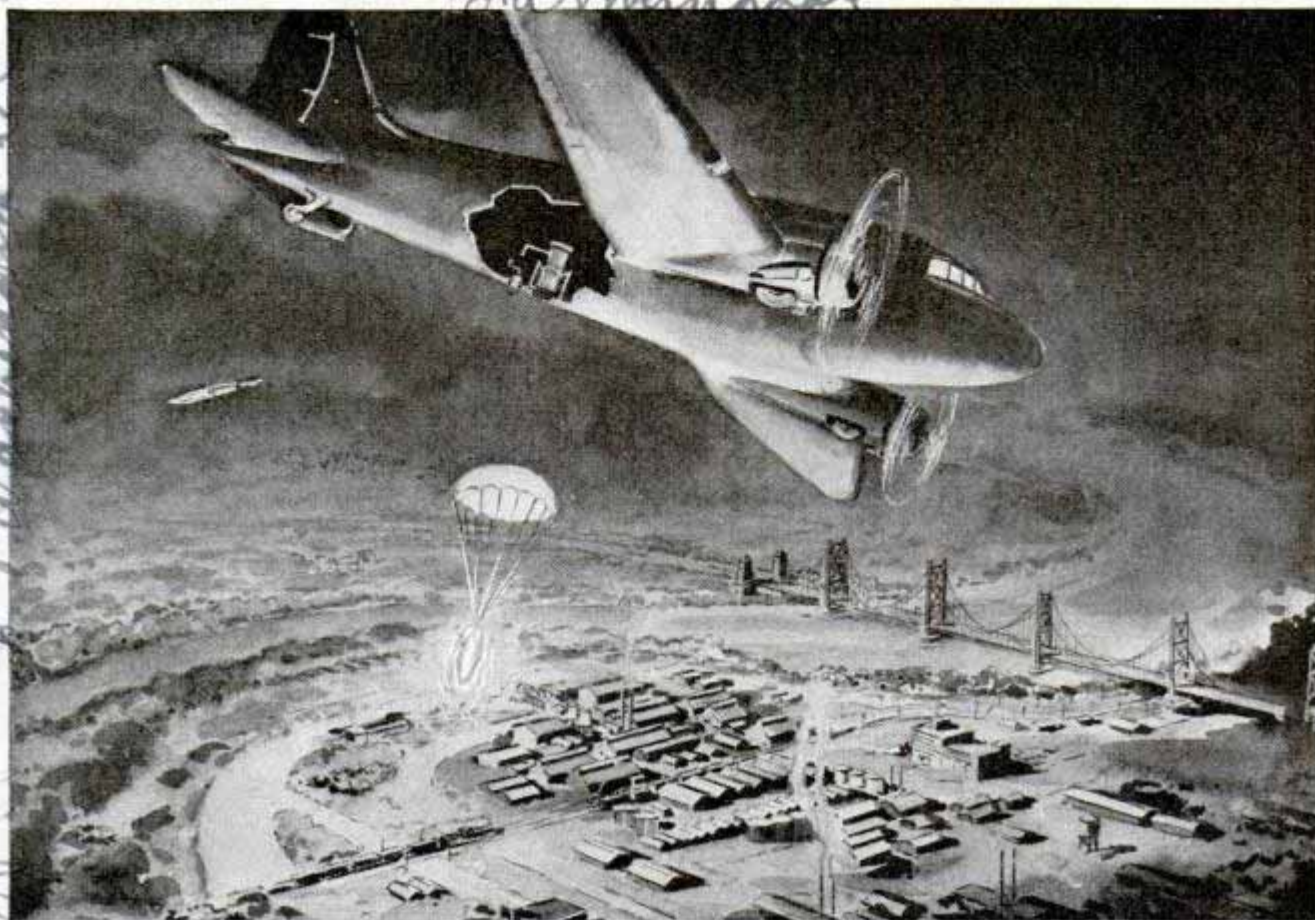

Flashlight bomb suspended by a parachute, at top, illumines terrain below and its light automatically releases shutter of camera shown mounted in cutaway portion of plane



Photos U. S. Army Air Corps Lower photos show San Diego and an airport photographed at night, and army's aerial flash-bomb equipment

Automatic flash bombs that set off an automatic camera shutter make aerial photography at night as simple as in broad daylight. After twelve years of experiments the U. S. Army Air Corps has developed a bomb that is dropped by parachute, exploding when the parachute opens

at a safe distance from the airplane. The bomb floods the terrain below with a brilliant light, sufficient to bring out in sharp detail the ground within view of the camera with an exposure of one twenty-fifth second at f3.5. The shutter is automatically tripped when the light reaches a photo-

War Dept. Office Chief of Army Corps

Illustrated London News 8/19/39

electric cell in the camera. Besides its value to military photography, the flash bomb can be used for aerial pictures of shipwrecks and accidents at night, or to illuminate a target for artillery or for aerial observation flights.

295/
**Giant 170-Ton Iron Casting
Big Enough to House Auto**

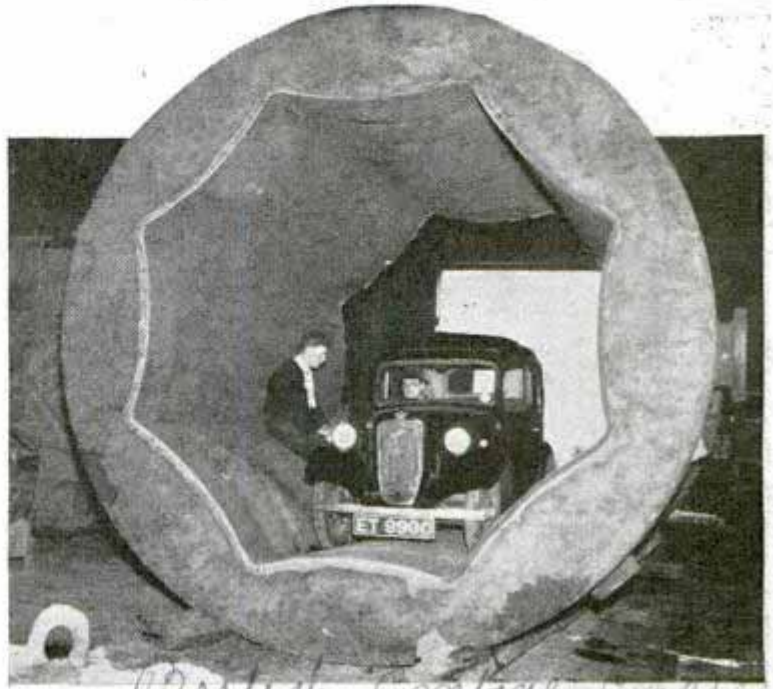

Automobile was driven into casting with plenty of clearance to demonstrate enormous size of 170-ton piece of molded iron

One of the largest castings ever produced in England was recently completed at the English Steel Corporation, Vickers Works, Sheffield. Into its production went 170 tons of molten iron. An automobile was driven through the mold easily in demonstration of its unusual size.

212/4
Surgical Tool Has an 'Eye' to Light Way into Wound

Surgery has a new tool that "sees" its own way into a wound where life is in danger and use of the knife might be fatal. It is the peritoneoscope, a slender instrument with a telescope and electric lamp at its end, and forceps that can clamp off a bleeding artery or pluck out a fragment of bullet or shell. It can be thrust into the tiny opening made by a bullet without enlarging the surface wound. It can be inserted through a needle-size opening through the skin and tissues to drain an internal abscess or sample a bit of tissue suspected of cancer. Surgeons hope that many an abdominal operation can be avoided by using the new instrument.

2113/
Robot "Doctor" Shows Pulse Count and Blood Pressure

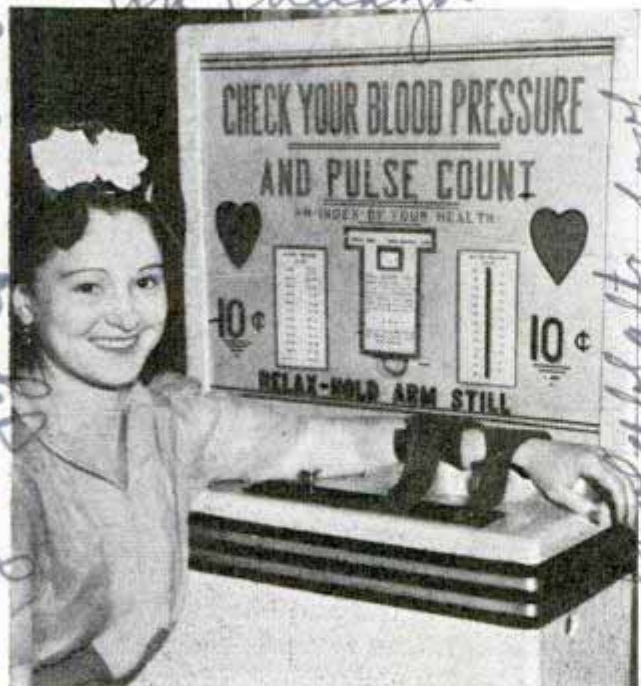

Blood pressure and pulse count are measured by a coin-in-the-slot machine, known as the robot "doctor." The "patient" places his arm in position on the machine and an attendant helps him strap it in place. Then a dime is inserted and the doctor automatically conducts a test and reports its findings.

2115/
Dripless Flowerpot Reservoir Prevents Souring of Soil

Soil will not sour in a flowerpot that has a reservoir into which moisture drains. A perforated disk above the reservoir retains the soil, but roots extend through to absorb water as needed.



Vending machine that sells information about your blood pressure and pulse count for ten cents

Dally mfg Co 2640 Belmont Avenue Chicago Ill. 16

Write Roy C. Burns

George Korb, Inc. Inc. 207 Pennsylvania

2997

W. U. Smith
Harvard Blvd
Los Angeles, Calif

"HAMS" CIRCLE GLOBE

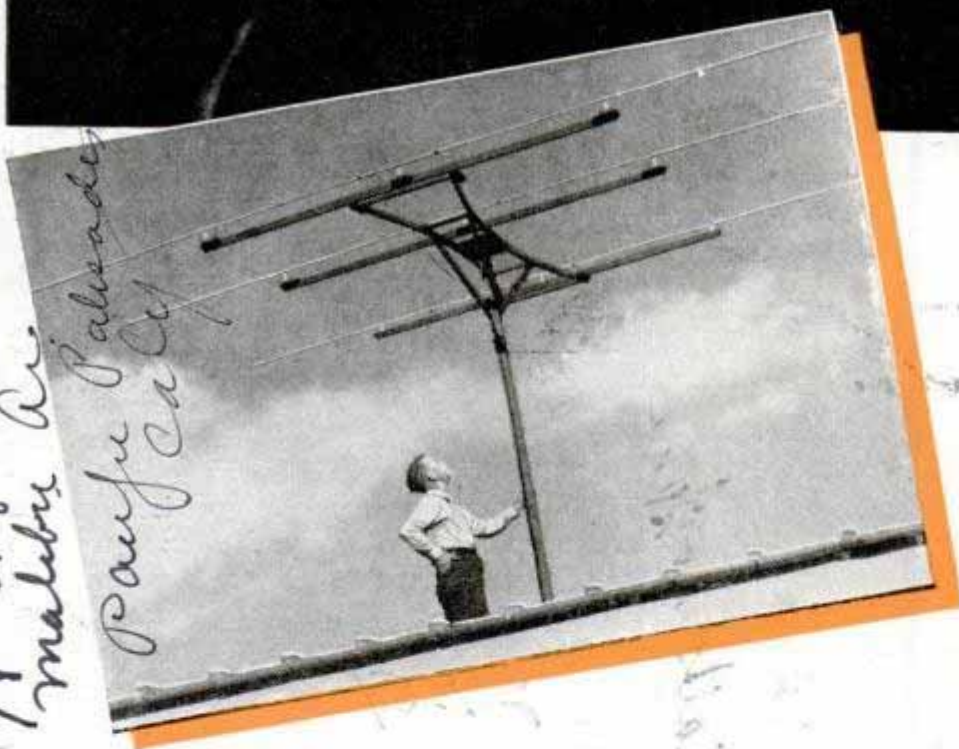
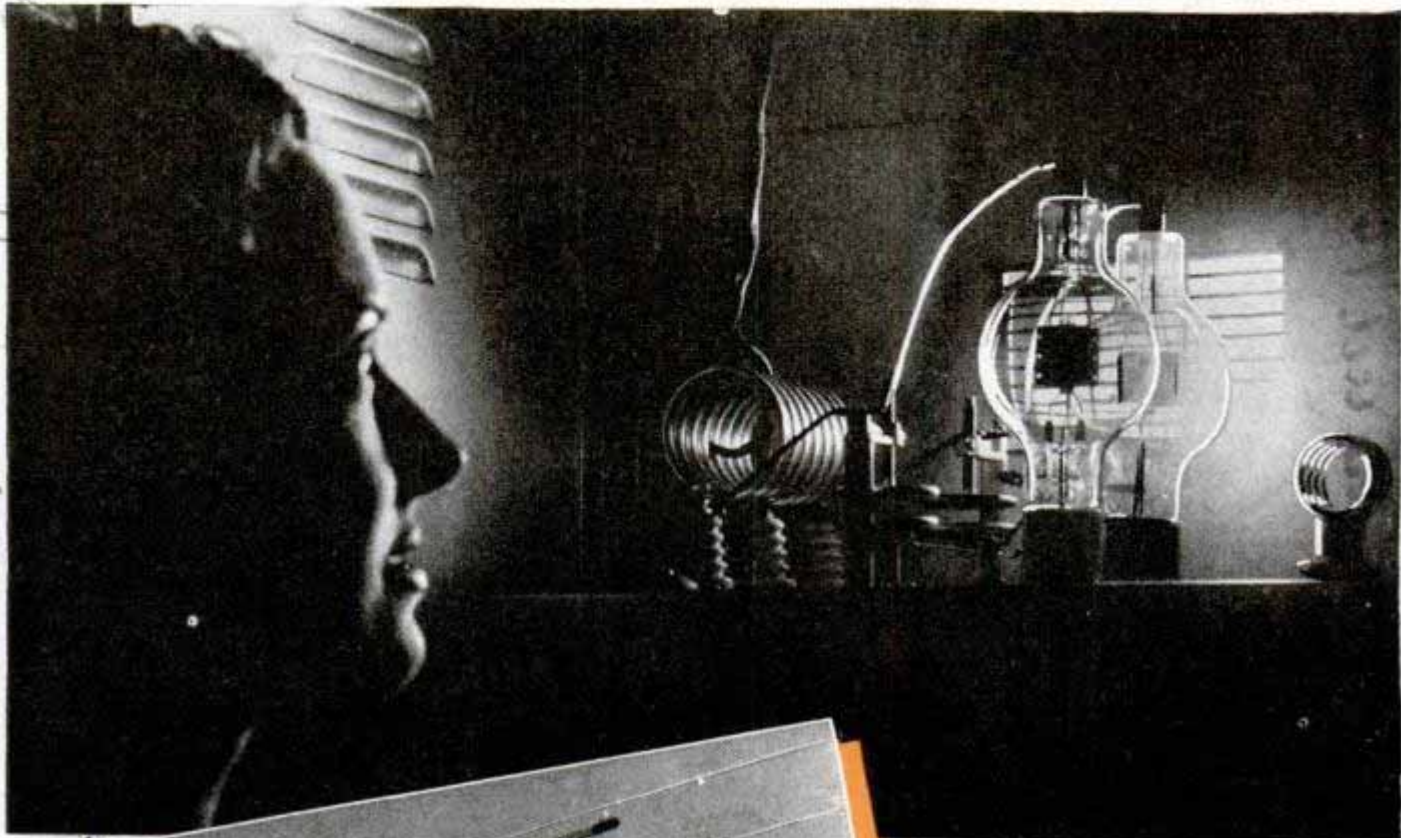

Final amplifying stage of one-kilowatt transmitter built by amateur and (left) rotary beam antenna for ten-meter transmitter

to the recent perfection of the three-element rotary-beam antenna that acts as a reflector and directs nearly all transmitted waves in one direction. It delivers a signal improvement in the desired direction amounting to 100 times more than was possible with earlier types

FIFTEEN years ago not even five times the power of today's biggest broadcast station was enough to insure daytime radio communication across the continent, but today an amateur with a five-watt set can talk coast to coast. His transmitter consumes no more power than a Christmas-tree bulb. With a twenty-five-watt transmitter he can reach friends in any part of the world when conditions are good. This tremendous gain in efficiency is due in part

of aeriels. Very little energy radiates away in undesired directions. It likewise increases ability to pick up distant signals when used as a receiving antenna. The beam aerial consists of three parallel metal rods, usually of dural or stainless-steel tubing, the lengths and spacings of which must conform to a formula worked out by J. N. A. Hawkins of W6AAR from theoretical research performed by George Brown. The antenna is supported horizontally in

Cont. Thomas E. Stinson, Jr.
18618
Malibu, Calif
10518
Pacific Palisades
Pacific Calif

5050
5050
5050

J. 997.

with "RIFLE" ANTENNA

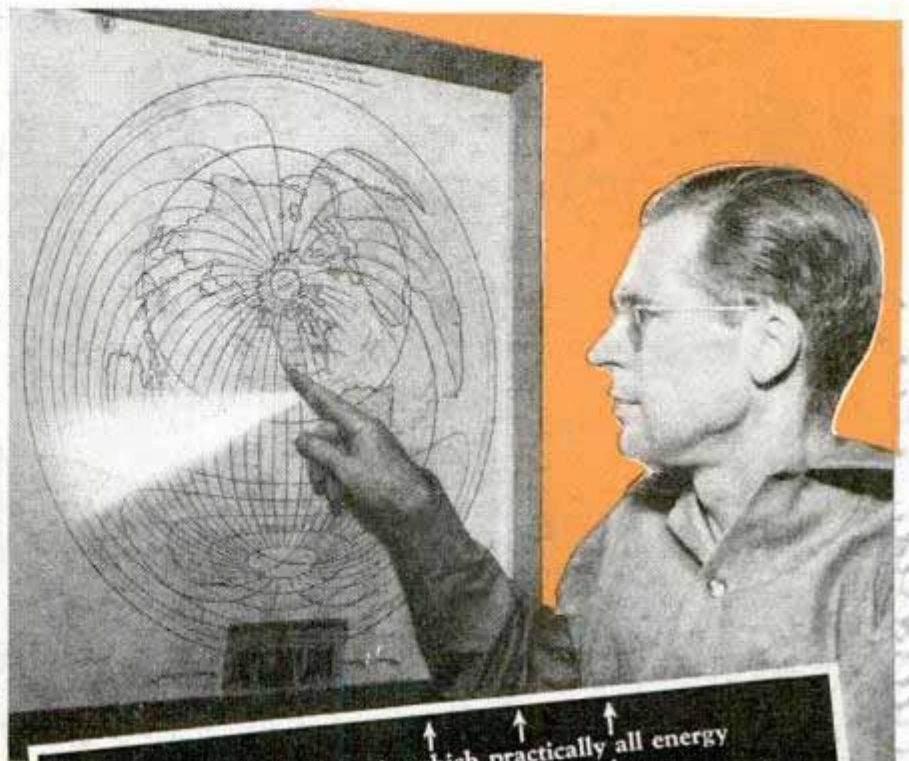
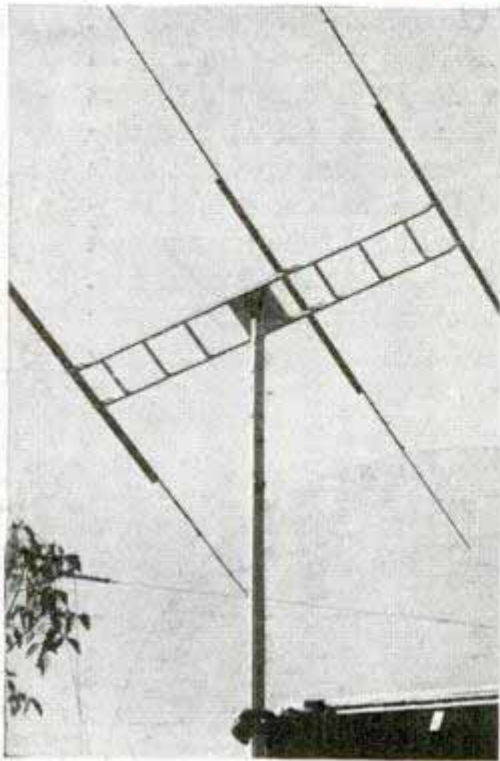

the air. The central rod is a radiator, the rear element is a reflector, and the front element is a director. The reflector absorbs and re-radiates back signals broadcast from the radiator, the time delay that occurs permitting the re-radiated power to reinforce signals then being broadcast from the radiator rod. The direc-

(Continued to page 126A)

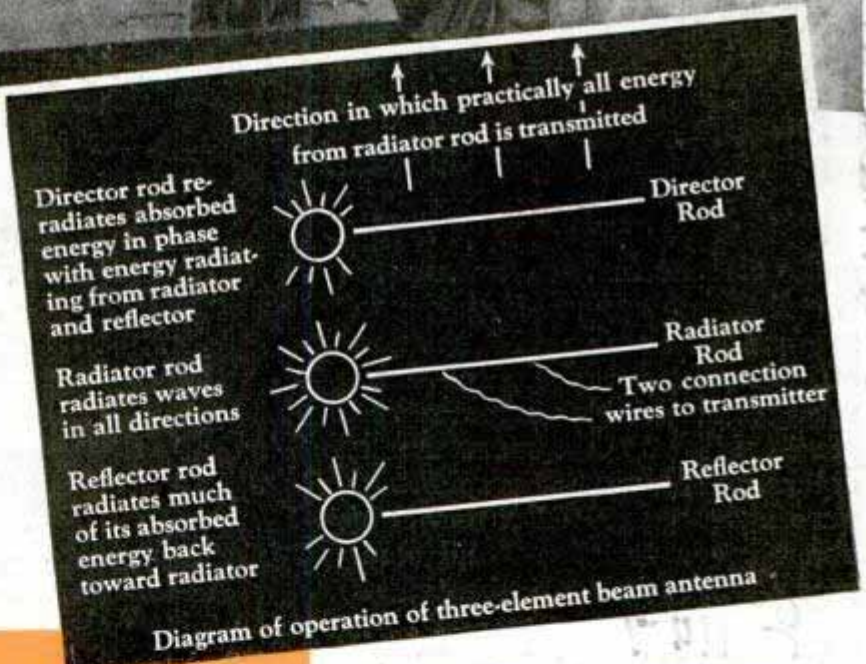

Top, left, ladder is antenna framework. Right, light behind map shows direction antenna is pointing. Center, how antenna works. Bottom, amateur at "mike," and diagram of how antenna transmits energy

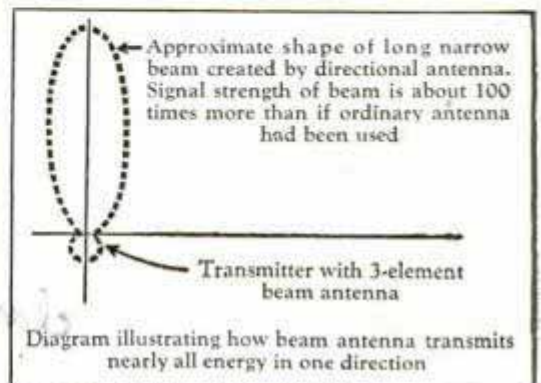

and Howard C. Scott
res. mech metallurgist.

1124.

Steel Made Diamond-Hard in 'Blanket' of Gas

J. P. Esray, research engineer

Mr. A. A. Bates
Chemical
and metallurgical lab.

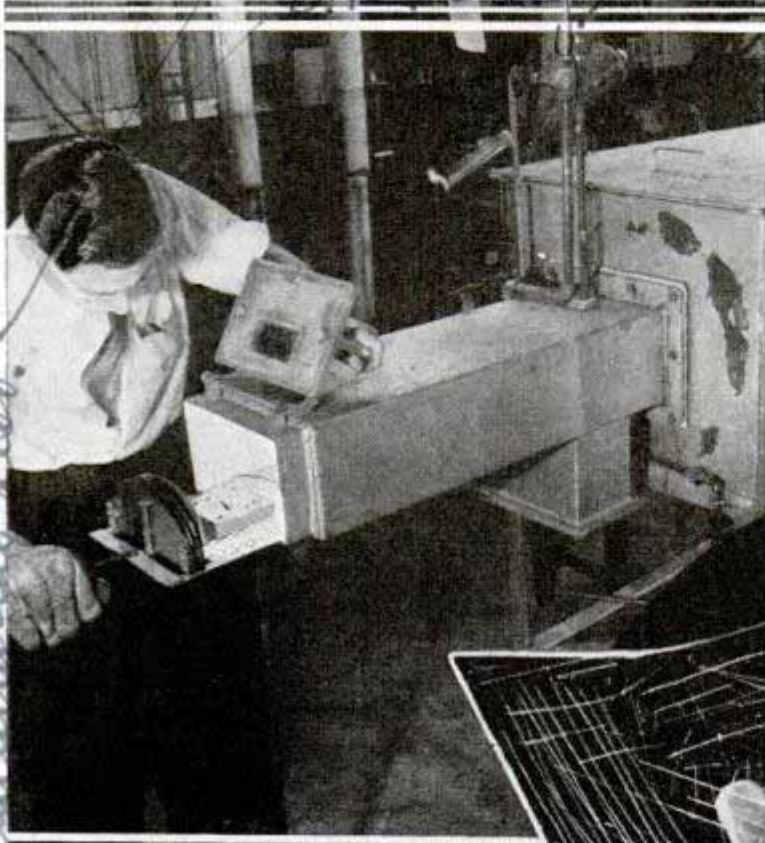

high as 2,000 degrees Fahrenheit before it cools in an air-cooled tunnel. There is no quenching in oil or water, which would distort or mar the metal. Steel pieces approach diamond hardness in their finished form with a bright surface and without the expense and delay of additional machining. Delicate steel springs retain their brilliant finish despite the intense heat treatment.

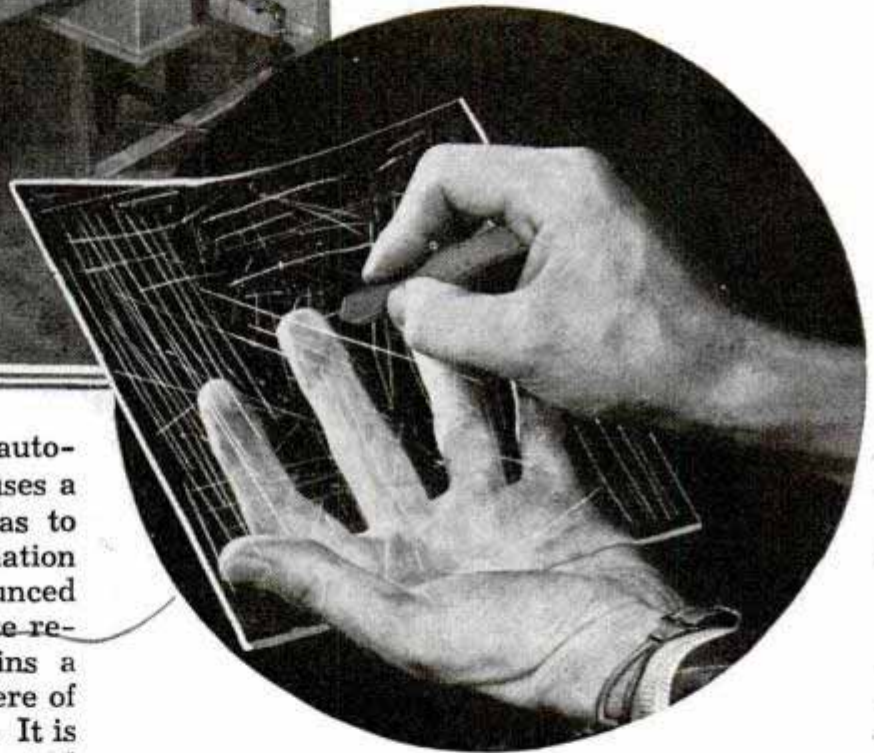

Steel is hardened in an automatic electric furnace that uses a "blanket" of oxygen-free gas to prevent distortion and formation of scale. The furnace, announced recently by the Westinghouse research laboratories, maintains a delicately balanced atmosphere of pure hydrogen and nitrogen. It is about seven feet long, and steel passing through it is heated as

Above, removing steel die from furnace. Right, steel so nearly approaches hardness of diamond it can scratch glass

1147

Ninety-Two-Ton French Tank Is New Monster in War

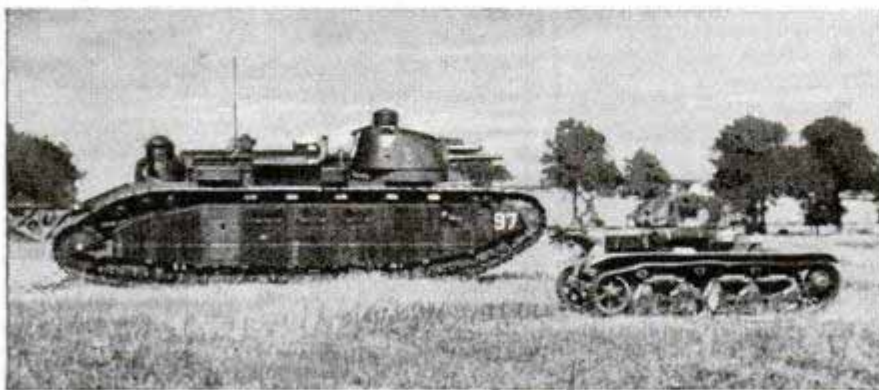

One of the French army's most powerful weapons is a huge tank weighing ninety-two tons. Its gigantic proportions dwarf the "baby" tank weighing twelve tons.

Photo, News of the Day
"Baby" tank weighing twelve tons is dwarfed by ninety-two-ton monster. Both are used by the French army

Send return postage to our Bureau of Information to learn the name of the maker of any device described in this magazine.

*Write to Hazel Dell, North
709 Thiel St N.E.
Fort Dodge, Iowa
said name of inventor not given*

Plates Attached to Grader Speed Road Work

Highway maintenance may be speeded by a set of four portable toothed plates that can be attached to the blade of a road grader in ten or fifteen minutes. The plates are adapted to two types of teeth, one for loosening gravel on rough road, the other for removing ice from slippery highways. Use of the equipment is said to speed up road maintenance and reduce the costs.



Inspecting special toothed blades attached to road machine. Two types are used, one for loosening gravel, the other for removing ice

Old Locomotive Hauled on a Truck to Railroad Station



When the Southern Pacific railroad wanted to place the old locomotive "C. P. Huntington" in front of the station in Sacramento to help celebrate the city's centennial, it called upon a moving specialist. The once proud giant was hauled to the spot on motor trucks and there unloaded. In its better days of service the 43,500-pound engine, built in 1843, operated between Sacramento and Promontory Point, Utah.

Here is how historic locomotive was loaded on truck and hauled to station where it took part in celebrating centennial

Extension Shield on Automobile Sun Visor Cuts Glare to a Minimum

Your sun visor can be increased in area to provide greater protection against the sun and wind while driving by adding to it a shield that may be extended and unfolded when needed. It is attached to the visor by means of snap fasteners, and since it weighs but eight ounces the burden will not cause the bracket to sag. When not in use the extension shield slides behind the regular visor.

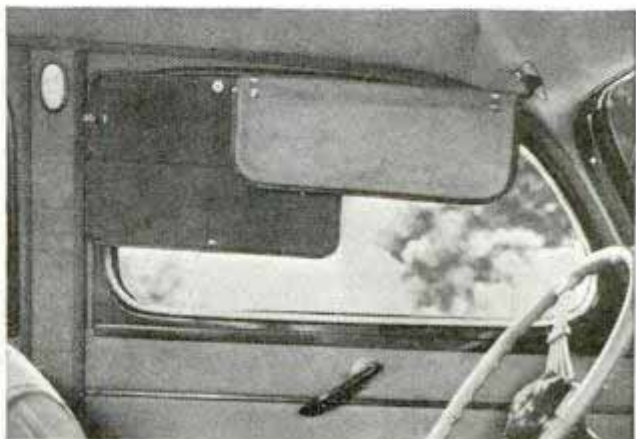

Shield extending to left of regular automobile visor is attached with snap fasteners

Send return postage to our Bureau of Information to learn the name of the maker of any device described in this magazine.

21145.
21133
Send to: Essential Store - Rubber Co. Akron, Ohio
Des Moines, Calif.

*Serafin Sales Co.
123 E 7th St*

2995 cont. smile (Schneidmayer)
108-9-E. 66th St. N.Y.
New York City



COLLEGE for SEALS



One of Capt. Spiller's seal

Left, seal applauding. It's a trick that has to be taught. Right, ready for graduation. Below, difficult "one-hand" stand by an educated seal

"GIVE the average seal a 'college degree' and he'll be worth a great deal more than he would be as an expensive fur coat, besides which he'll pay for his education for many years to come."

So says Mark Huling, president of Seal College, who, at Kingston, New York, is scientifically educating seals to become versatile performers, musicians, acrobats and comedians. The demand for educated seals during the past few years has increased to such proportions that after a year's training under Huling's supervision, a seal worth from \$100 to \$200 when caught, has a value of from \$3,000 to \$4,000 when it graduates. Especially talented seals have been worth \$5,000.

Seal College, a large wooden structure, contains many scientific devices, some of which are worthy of a school for human beings. There is a large swimming pool, for example. Lined with concrete, fed with a constantly

2995.



flowing stream of fresh water and equipped with springboards, it has replaced the old-time bathtub and small tank which trainers previously used. Near by is a miniature stadium capable of seating about 200 people so that the pupil, during the course of his training, becomes accustomed to spectators who invariably collect when he performs. The seal "dormitories" are of concrete, and spotless.

Huling's pupils, which are mostly caught in the Pacific near Catalina Island, are of the type known as California sea lions. They have long supple necks, lithe bodies and a considerable amount of nervous energy which makes them among the best fitted for performers. Sometimes they are temperamental, too. In their native haunts they are accustomed to feeding themselves on live fish, so

Left, seal ready for a comedy turn, for which it has a natural flair. Right, this big fellow didn't go to college but he learned to jump for a fish dinner. Below teaching one of the pupils to play a tune on the horns. The trick is teaching the sequence in which each horn is to be blown

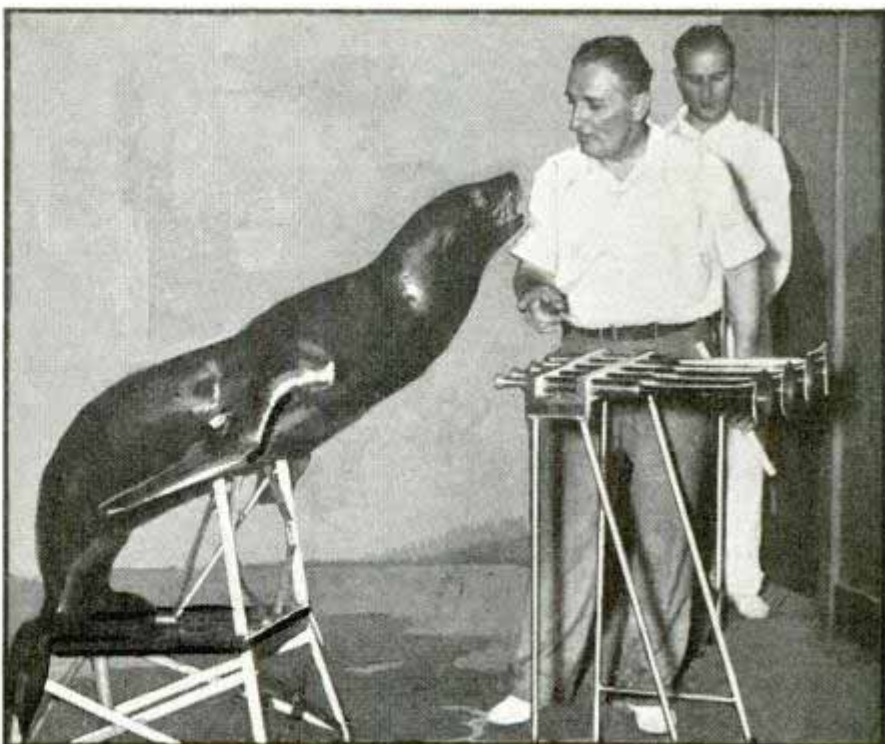

Al Huling

Capt. Dolana Pebois

2995

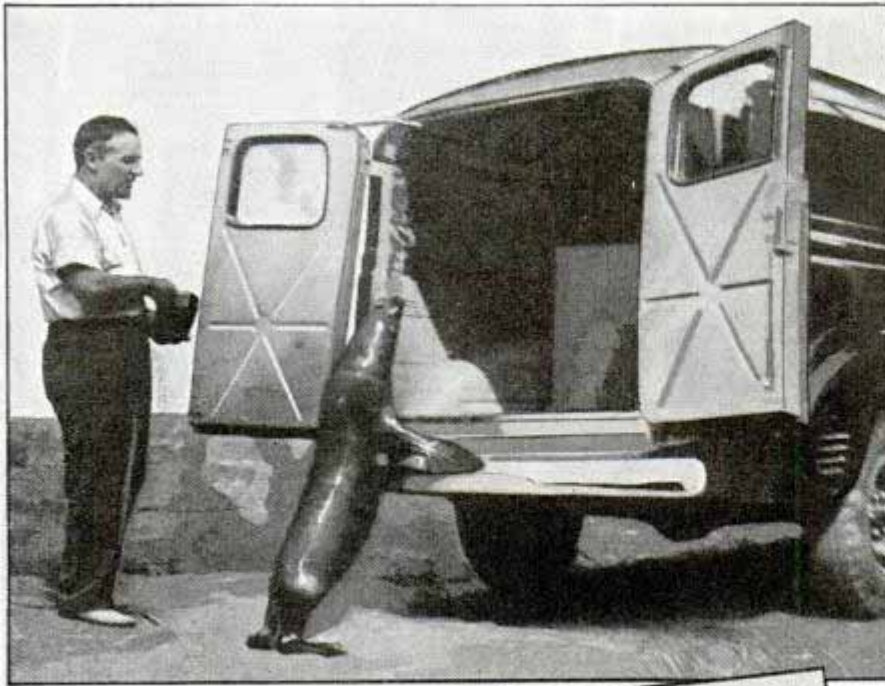

some of those shipped to Seal College go on a hunger strike for several days after they arrive, refusing to be fed by Huling or his assistants.

Each student gets from eight to ten pounds of fish a day. He also gets a snack before and after he goes through each stunt and will not perform otherwise.

"A seal gets just about one half hour of instruction every day," says Huling. "He learns readily and what he learns he

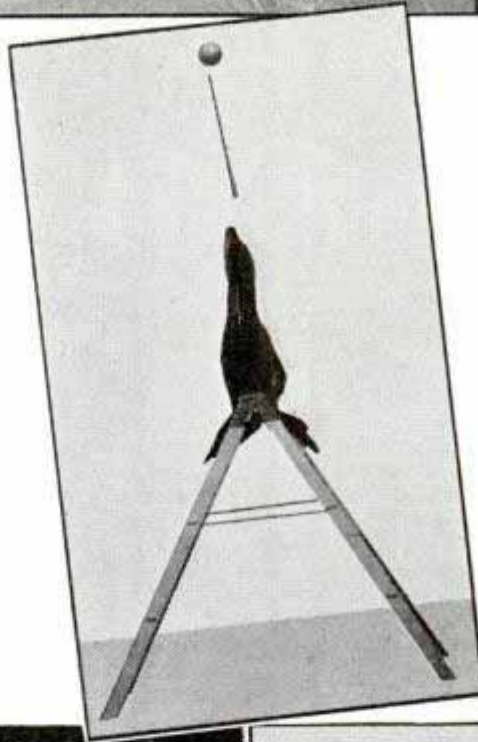

never forgets. An intelligent seal may remember from fifteen to twenty tricks and after he has become used to the routine of the college he can learn them at an average of about one a week.

"The first thing we teach a pupil is to take things in his mouth. Then comes balancing. After that comes clapping. This last looks like a natural gesture and a great many people think that it is, but it really must be taught, which isn't as simple as one might think. After a seal has learned these rudimentary tricks, he is ready for more complicated ones and may specialize in one of the several courses given."

Thirty years ago, according to Frank Wirth, one of America's foremost bookers of animal acts, the seal became popular as a novelty act and its popularity has persisted. In order to continue to be a "novelty" however, the seal has had to add considerably to its repertoire. As a result, even old troupers are sent back

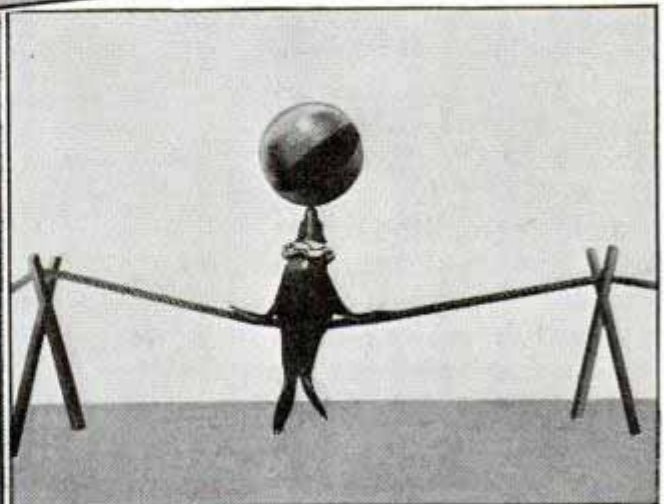
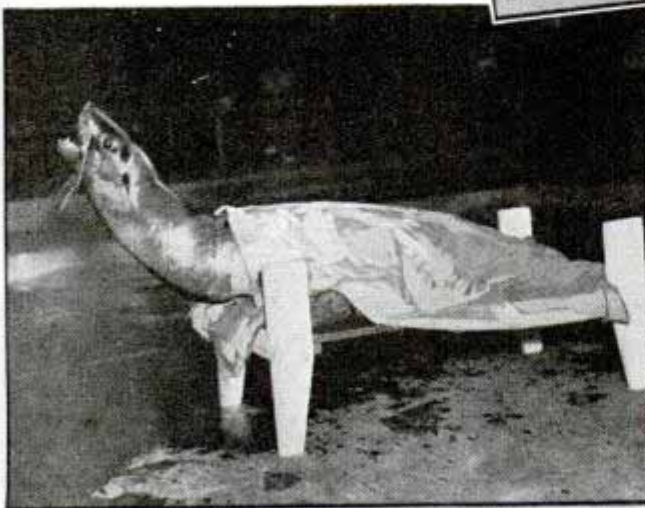

Top, seal graduate leaving "college" in specially equipped car. Center, doing a difficult balancing act. Bottom. left, seal in a "bedroom" scene. Right, doing combination balancing and acrobatic act

to school every once in a while for a post-graduate course. Since a seal lives as long as a human being, in some cases even longer, some of the performers that got by with simple tricks three decades ago are still taking courses occasionally with various trainers to brush up on their routines.

One of the most popular branches of study at Seal College is music and Huling and his assistants can teach a pupil to play the chorus of a song on the horns by blowing them.

"Some people think that a seal is actually musical and can distinguish the various notes," he says. "This is not so. The student is taught to remember the sequence by which he must blow, not the notes themselves. Incidentally there are two ways of blowing, by the mouth and the nose. Inasmuch as a seal puts his mouth around a horn when he blows by the former method, for fast choruses we teach him merely to exhale through his nose as this is much swifter.

"Sometimes one of my pupils will show temperament. Noise does not seem to affect them, except the sound of clapping, which they realize is applause and which they continually seek. Colors in motion do affect them occasionally and I have known a pupil to slip up in his routine when a woman in a brightly colored dress took her seat and distracted his attention after a performance had started."

One odd example of temperament in Huling's recollection was that exhibited by Alf, a seal which had graduated with honors. Alf had an extensive repertoire of tricks and went through every one of them faultlessly during rehearsals. When there was an actual performance, however, for some reason or other he cut a simple balancing stunt out of his routine. One night he played in a theater in which the first row of seats was so far back from the stage that he couldn't see the audience in the darkened house. Thinking he was at a rehearsal, he went through his entire repertoire without a flaw. When the lights went up, he saw the audience and heard their applause, then seemed to realize his mistake. Never thereafter did he cut out a trick during his performance.

Advanced students at Seal College sometimes specialize in difficult balancing tricks

(Continued to page 142A)

Portable Talking Projector Tells Sales Story



Tiny talking projector tells sales story in word and picture for prospect in his own office

To present a complete sales story, there is now available a talking projector which can be taken right into the prospect's office. Slide films are shown on the screen and a reproducer does the talking. Electrically operated, the unit is light in weight and easily carried in a compact case.

Gas Masks to Protect Dogs Fit All Sizes and Breeds

Dogs have not been overlooked in war-torn Europe. The French society for the protection of animals is providing gas masks to fit all sizes and breeds of dogs so the pets may be protected against possible gas attacks from enemy airplanes.



Dog wearing gas mask as protection against possible gas attacks from enemy airplanes in France

21135
 Clyde A. May, Chief Engineer of Seal
 Sales Engineers, Chicago
 N. Michigan Ave. Chicago
 5410
 J. 1137
 Paris, France.

Dr. Samuel S. Meyer
58 E Washington
Chicago

Model Homes Rotate on Shelf Offering 'Paint Prescriptions'



Home owners select model house most nearly resembling their own, choose most appealing paint combination and obtain prescription for the paint

Cleveland Color Center

More than a thousand color combinations for the home are suggested in a display of 400 miniature houses mounted on revolving tables in a paint manufacturer's "color clinic." The home owner can look over model houses resembling his own, visualize the decorative effects of various combinations of colors on both the exteriors and the interiors, and then obtain "prescriptions" for the paints preferred.

923 Included

Diseased Eyes Are 'Spot-Welded' to Restore Sight

Increasingly good results have been reported in restoring sight by a kind of electrical "spot-welding" where a detached retina is threatening blindness. The retina depends for its nourishment on tissue called the chorioid, and when, through in-

jury or disease, it becomes detached from the chorioid, it cannot function properly. If not treated, the retina may eventually peel off the chorioid, and blindness results. Eyesight is being saved for better than one out of three patients by applying tiny needles carrying an electric current to the chorioid, without puncturing it. The electric cauterization produces an adhesive inflammation between the chorioid and the retina, causing the retina to become reattached.

Handcuffs on Belt Prevent Attack on Officer

Prisoners handcuffed in the usual way sometimes have used the shackles as a bludgeon in a two-handed smash to subdue the officer and escape. It was to prevent such misuse of handcuffs that a detective invented a belt to which they are fastened. The belt is locked about the captive's waist, making it impossible for him to swing his hands.



Handcuffs fastened to belt around prisoner's waist prevent use of shackles in assailing officer

Detective Emmett El Kersas Cincinnati

The Bladden Co., 107 S. Lodi St., Cleveland, Ohio

Service Service ad. 12

Reported by American Police & Surgeons

27106 Page designed by -
Schweitzer Bros.
Brookshill, N.J.

Glider's Two-Way Radio Guides Crew in Car

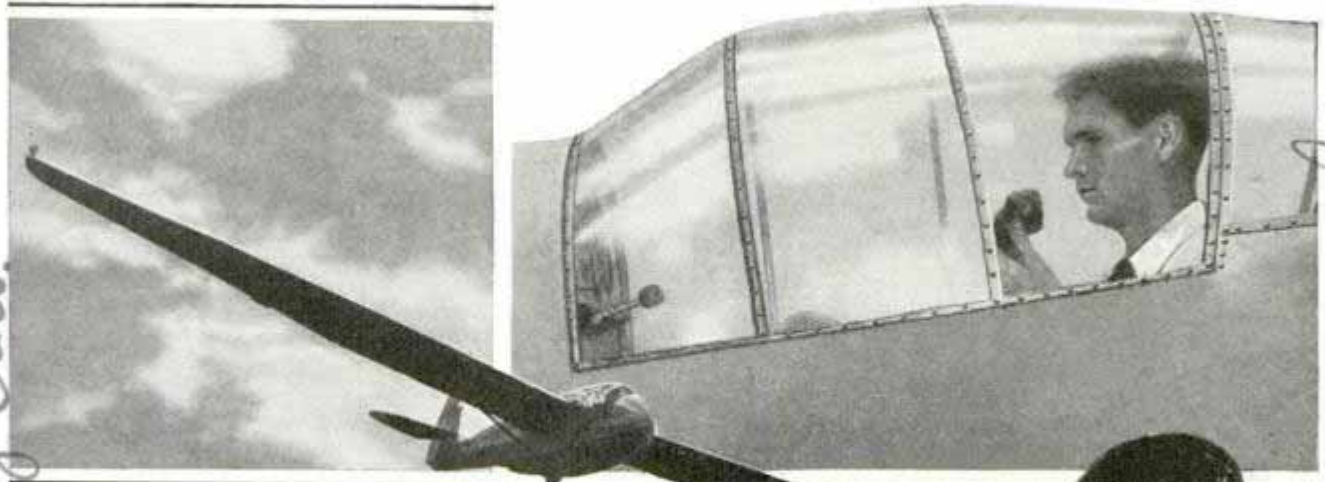

Two-way radio enables a ground crew to track down the metal two-seater sailplane owned by one gliding club. The sailplane, on endurance flights, may travel several hundred miles from starting point and a special lightweight radio working on five-meter wave length guides the crew following in an auto also equipped with the two-way radio. Above, sailplane in the air and pilot giving instructions on radio to crew on ground



Above, testing radio before the sailplane takes off. Left, circle, operator in auto receives pilot's message giving location of sailplane. Below, ground crew arrives at point where the aircraft has landed and the pilot approaches the car. The radio is also valuable for instruction purposes on local flights, such as warning beginner pilots of obstacles in their path. The two-way radio weighs twelve pounds, including batteries



Jack Brookhart, winner
State Glider

and Soaring Club

Asst. Chief

Radio - Transceiver Sabogalones

and Soaring Club
Chamberlain

G-928. Conk. Under max well.
20 Sherman Ave
Giverson d 27

FLOATING

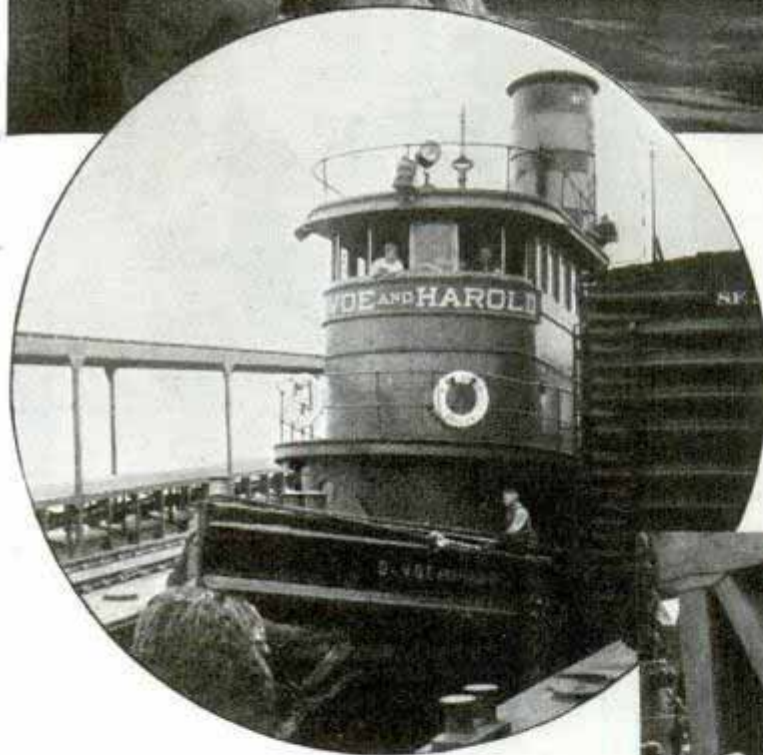
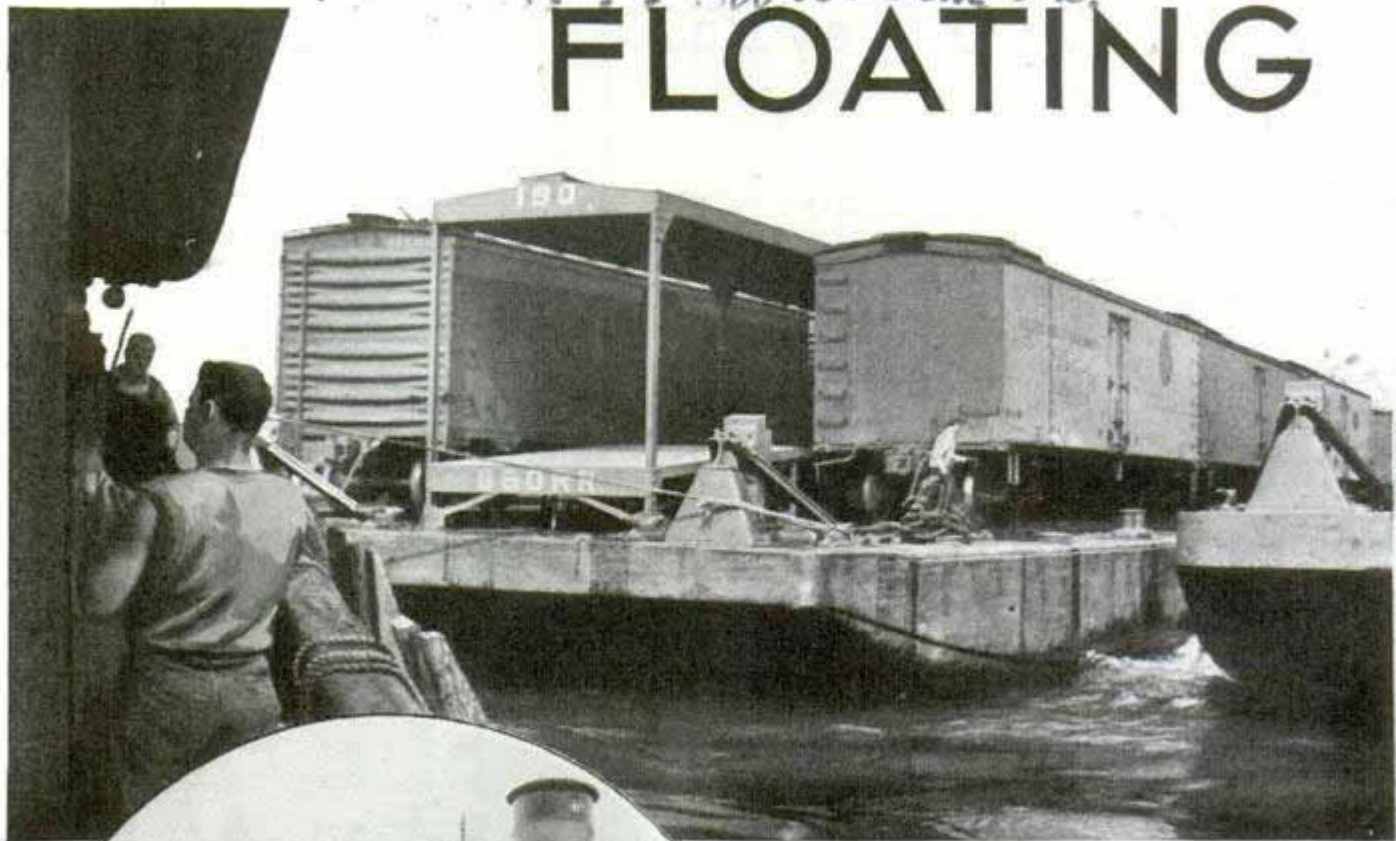

North river, over from Staten Island and points on down the Jersey shore, all bound for Manhattan. The cars are on long, narrow boats, from twelve to twenty cars to a boat. Between each pair of boats is a tug. With the expert ease of long experience, the tug gently lays the boat alongside the

WHEN New York's business day is over, hundreds of motor trucks come snorting out of the side streets and form long lines, each leading to a wharf on the water front. Each driver knows exactly where he belongs. Laborers by the thousand wheel hand trucks out of storage rooms and stand waiting. Soon, beyond the usual harbor activity, comes a wave of something greater, more extensive, and finally dim shapes moving across the water assume the outlines of boxcars—freight cars, coming down the Hudson, across the

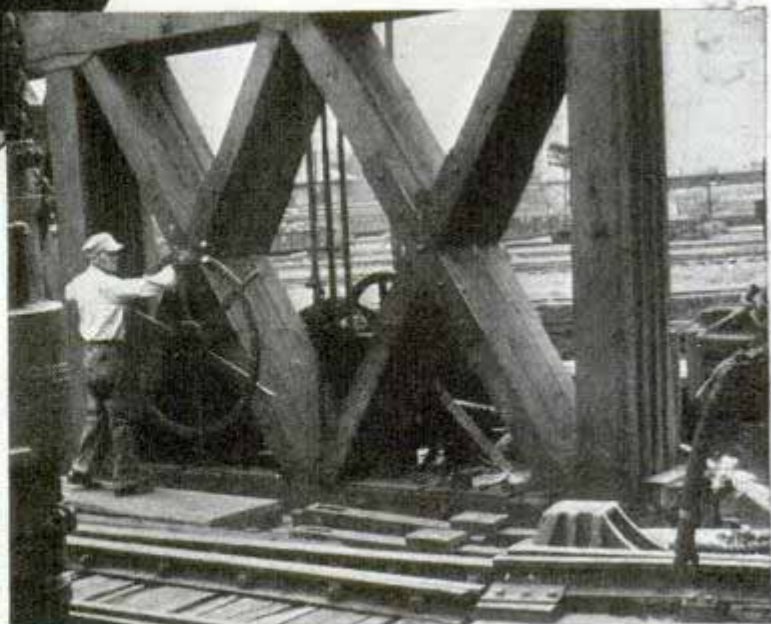

Top, snaking car float out of line without disturbing those next to it. Circle, tug's pilot house is high enough to overlook tops of cars. Bottom, lining up tracks on bridge and car float

2928

FREIGHT YARDS

Right, captain in pilot house has a clear view of all operations. He does his own steering. Circle, casting off the towing bridle. Bottom, the first job each morning is to round up and return all car floats emptied of their freight during the night. The car-float system solves the problem of how to get freight cars into New York without having extensive freight yards, which are out of the question because of lack of space

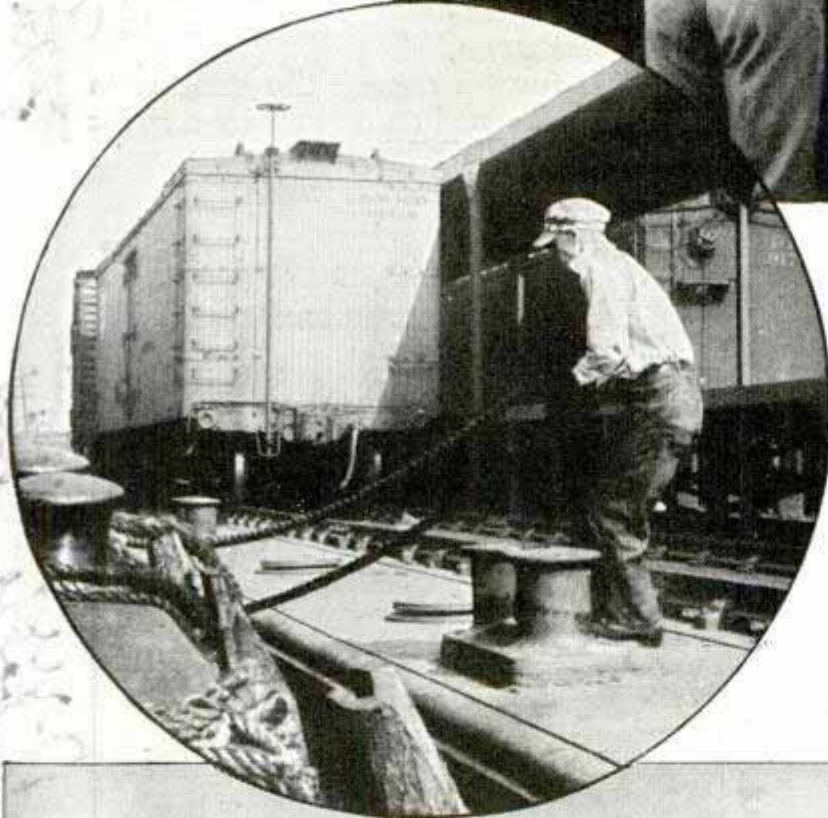
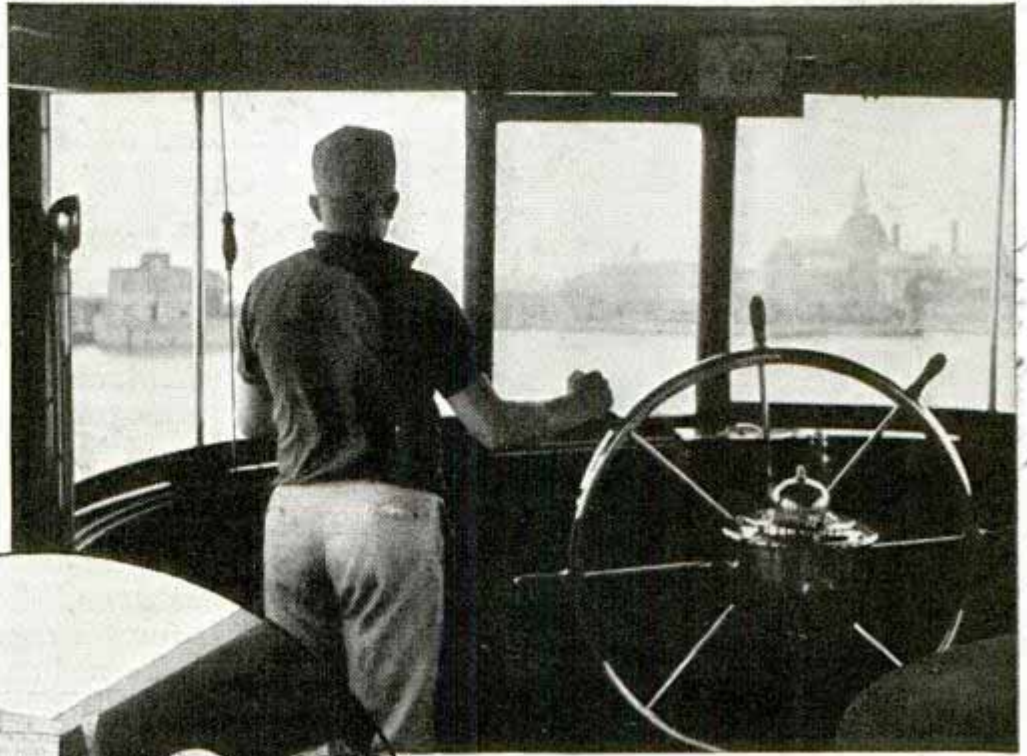

wharf, slides out of the middle and nudges the other craft alongside the first. Hardly has the first tug retired before another arrives. The boats, or car floats, as they are called, fit together like tiles in a floor. The seagoing freight yard has arrived—and it is the answer to New York's problem of lack of space on the island for the vast freight yards that would be required to serve the city.

(Continued to page 124A)



*I. W. Watson Arnola
Northville, N. Y.*

21099
**Electric Photoprint Drier
Circulates Warm Air**



Speeds
Your photographic prints would not face danger of scorching in this drier that circulates warmed air

Photographic prints are dried within fifteen minutes without danger of scorching or burning in a drier that circulates warmed air. Even if prints are allowed to remain in the chamber over night they will suffer no ill effects from overheating.

21097
**Multiple-Broom Snow Sweeper
Clears Skating Rink**

Snow is swept off a skating rink at Northville, N. Y., with a homemade clean-



Chemical Culture Company
Pushed forward by hand, sled sweeper brushes snow to one side with its twelve brooms on endless chain

er that is pushed by hand over the ice like a sled. A two-cycle engine rotates an endless chain of stout brushes which throw snow sidewise as they travel across the ice at the lower level, and then are sent back over the top for another sweep.

21100
**Colored Safety Lights on Sled
Guard Children at Night**

Red and green running lights are installed on some sleds as a protection for children who go coasting on streets used by automobile traffic. Besides warning drivers of the presence of children, the lights furnish enough illumination to see ahead. Turned on and off by a slight twist of the lens, the lamps are mounted on brackets and have plastic lenses.

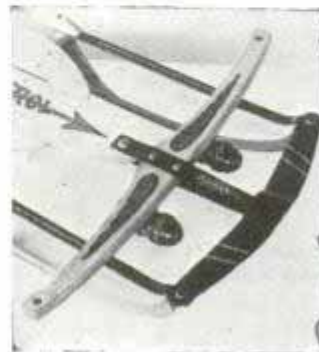

21119
**"Wick" in Soilless Flowerpot
Lifts Chemicals to Roots**



Pointing to capillary feeder that "lifts" chemicals to soilless flowerpot. Complete assembly at right

Amateur water-culture experimenters sometimes find that mineral solutions of their chemical gardens get out of balance and the plants may wither and die. Now a

*Ernest W. Breading
Montebello, Calif.*

*General Electric Corp.
2125 Spanght Circle
Chicago*

*S. J. Allen & Helen
Greenwood Phil.*

*Ernest W. Breading
Montebello, Calif.*

"foolproof" flowerpot is available which automatically regulates the amount of chemicals fed to a plant's roots by a capillary feeder working on the principle of a kerosene lampwick. The pot is divided into two compartments, the lower half containing the minerals in solution and the upper half holding the roots of the plant in pure silica gravel or other inert material. Between these two separate compartments is the capillary feeder which carries the solution from the storage tank to the roots, making the process self-regulating. The chemical garden requires refilling only at intervals of from ten days to six weeks, and plants do not need to be repotted like the old-style dirt pots to allow for root expansion. The pots are made in various sizes and shapes, like window boxes, urns, and hanging baskets.

Camera "Gun" Trains Fliers without Wasting Ammunition

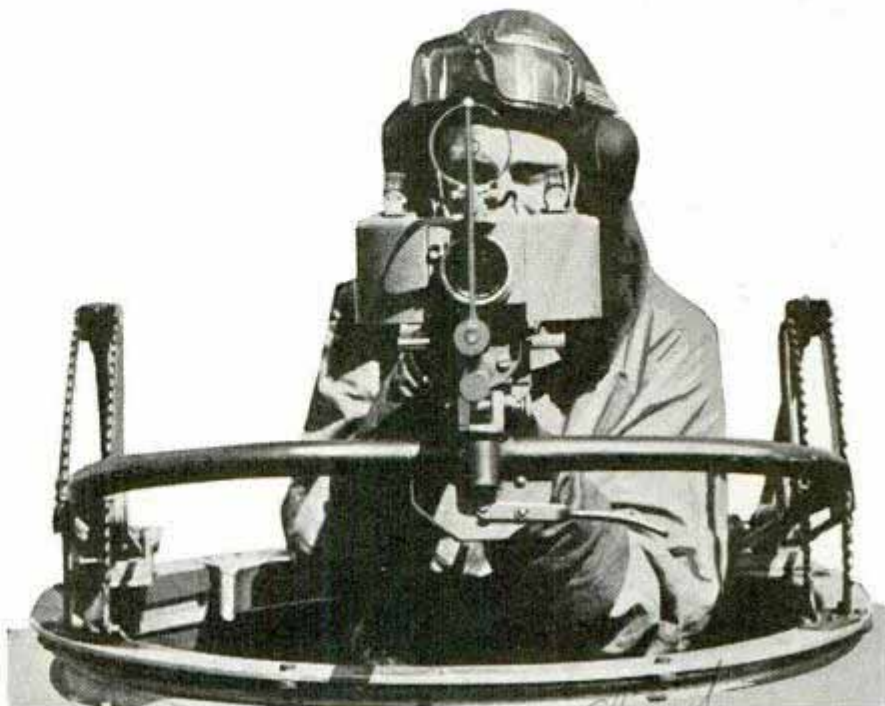

Marksman on British bomber practicing with camera "gun" that saves ammunition by shooting pictures of target instead of using bullets

Aerial gunners of the British air force test their marksmanship with a camera gun instead of bullets. When the pupil fires the gun, he merely clicks the shutter to record a picture of the target. This supplies instructors with information of the pupil's ability, and conserves ammunition.

'Trailer' Run by Its Own Motor Is an Overnight Sleeper

Built in the form of a trailer, a motorized "club car" has sleeping accommodations

comparable to a train drawing room for four persons and a separate room for the driver. It is intended primarily for long-distance non-stop transportation, and not simply for overnight stops, since one person can drive while the other rests. Tanks carry fuel for a 400-mile trip. With an interior headroom of six feet, the car is equipped with table and seats, washroom and toilet facilities. The driver's cab seats four people easily. Shorter than many motor cars, the vehicle is about the width of a small size trailer. It is light in weight and easy to handle on the road. The car has a top speed of seventy-five miles an hour and can cruise at fifty-five or sixty.



Motorized "trailer" for long non-stop runs has sleeping quarters for four, and permits one to drive while the other rests

Wi
li:
Ea
Ta

Club Car steering and drive mech.
Search rear engine
Stout Engineering Laboratories, Inc.
2124 S. Telegraph Road

J. 8 45

Com. Tom White 0508 48,
Alameda, Calif

KEEPING *the*

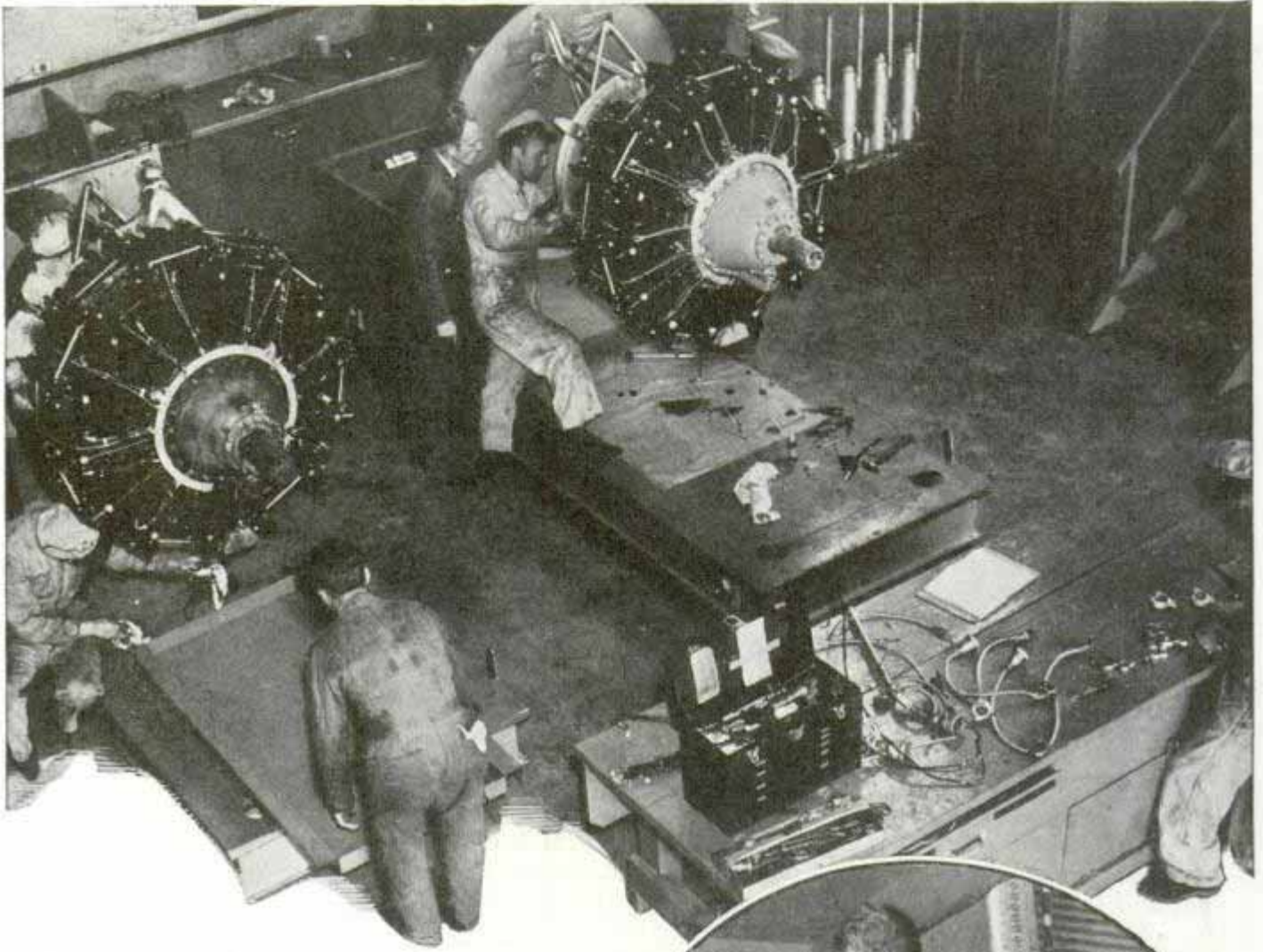

WITH passengers and mail aboard, the new giant Clipper pokes her nose out of her Treasure Island base, taxis into San Francisco bay, and heads west. Then with a mighty roar, her four engines lift the forty-one-ton ship clear of the water, out through the Golden Gate and off for Hong Kong. Her first stop is Honolulu, 2,410 miles away, the longest scheduled hop in commercial, transoceanic flying.

Back of this departure lies a routine of checks and counterchecks, tests and retests that lays bare all but the unpredictable in flight failure—the mechanical as it relates to engine performance, the structural as it concerns the huge, seventy-four-passenger ship itself and the scientific from the angle of intricate flight and navigation instruments.

This rigid system of checking and testing is all the more important be-

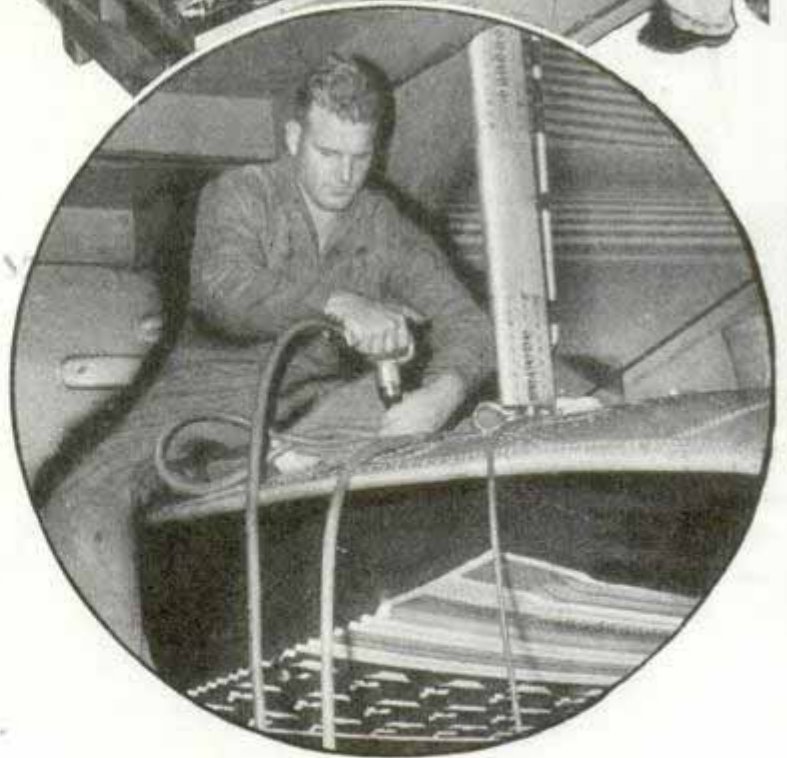

Taking down engines (top) for shipment to rebuilding plant. Circle, mechanic riveting reinforcement in place on Clipper's hydro-stabilizer, which is subject to great shock in landing on water.

Brownsville Texas

SEA BIRDS *Flying*

cause, being seaplanes, the clippers have no emergency landing fields every hundred miles or so, on which to "sit down"; therefore, they must be right in every respect, especially before taking off on a hop equal to one-tenth of the circumference of the globe.

The Treasure Island home of the clippers is one of the world's finest air marine terminals. It is here the monster planes come roaring in from the Orient, discharge mail and passengers, then submit to the all-revealing checks and tests. Every maintenance operation is carried on here, except for complete motor rebuilding. The first step is getting the

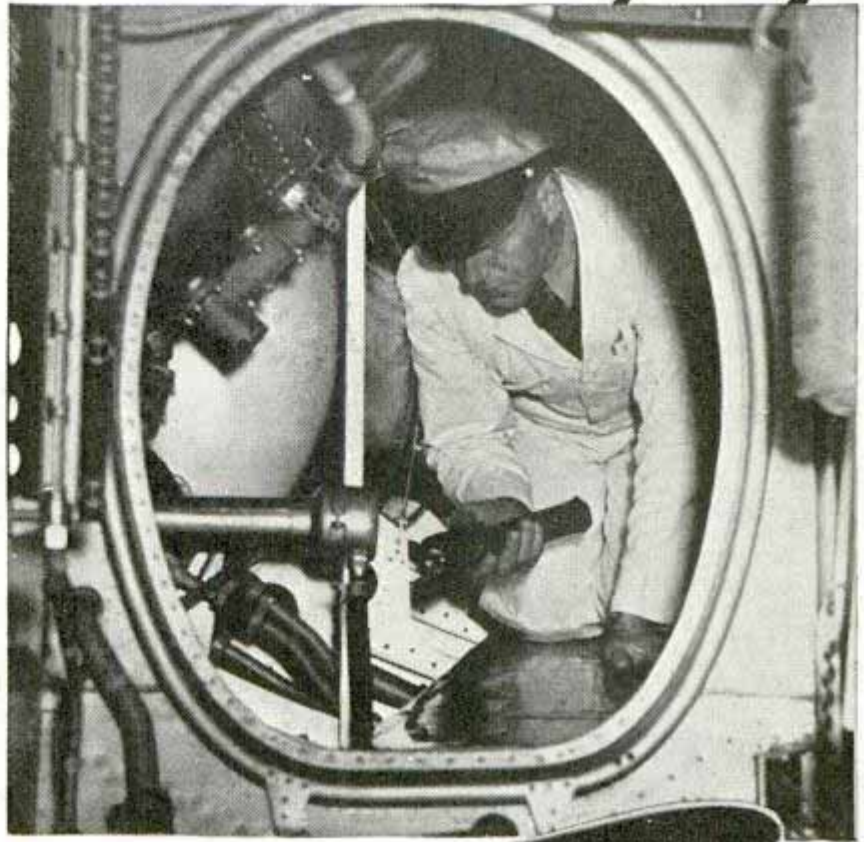

Engineer in position to work on engine in flight (top) and Clipper being brought to land on cradle similar to that of a marine railway (bottom). This is first step in the maintenance routine

Clipper out of water. This is done by maneuvering the ship over a submerged cradle running up an inclined track to the land level, similar to the marine railway at a shipbuilding plant. The clipper rests on a wheeled framework on the level deck

of the cradle; and as powerful electric motors bring the elevator and its forty-one-ton load even with the shore, the ship rolls off in tow of a tractor and is parked in the hangar, ready for inspection. This is done following every round trip to China.



building record of every engine is kept as carefully as the case history of a hospital patient. And just to make doubly sure that no ship is afflicted with complete failure of a power unit for more than one hop, spare engines and skilled mechanics are stationed at Honolulu, Midway, Wake and Guam.

One of the major divisions of clipper maintenance work is carried on in the accessory overhaul shop, where many of

(Continued to page 114A)

Left, inspecting water rudder. Below, testing bubble sextant; wheeling lofty platforms into place for servicing, and Clipper just leaving the water



Out of the hands of the captain and crew, the ship is taken over by a drove of highly skilled technicians, each assigned a definite job. First, out come two alternate engines, No. 1 and No. 3; upon return from her next round trip, Nos. 2 and 4 will come out. The two engines removed are shipped to the Brownsville, Tex., engine rebuilding depot, for complete overhaul; this means that after two round trips the entire power plant has been rebuilt. Each engine bears the shop number, the number denoting its position when mounted—whether No. 1, 2, 3, or 4—and its serial number which is given to all clipper engines throughout the entire system. A maintenance, repair and re-

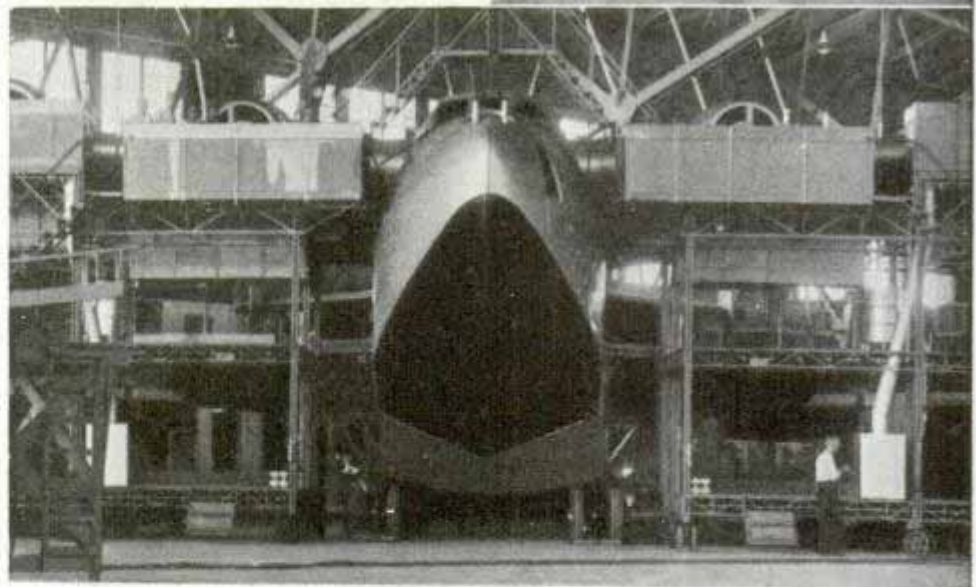

Open-Air Sightseeing Car Popular for Parties

Unexpected was the popularity of a fresh-air streetcar and a bus, with their roofs and upper sides removed, which have been introduced in Cincinnati, O. These vehicles are now in demand for observation trips and special parties. The car floor slopes upward toward the rear and no windshield is needed, for the car travels at a leisurely pace. Colored lights decorate the car.

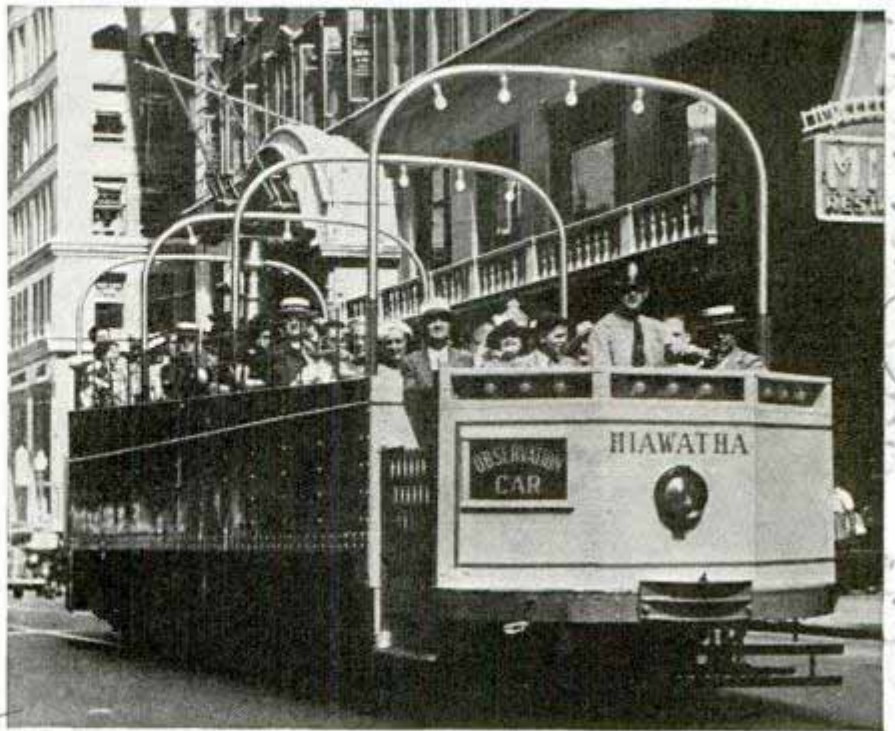

Roofless observation streetcars, festooned in colored lights, are enjoyed by sightseers and can be chartered by excursion parties

Electric Eye Draws Molten Glass from a Fiery Furnace



One stage in the production of optical glass involves "cooking" it at an exact, controlled temperature, and to insure its removal from the annealing oven at the right instant a photocell has been installed on the handling machine, which rolls back and forth on special heat-resisting tires. The crucible, weighing two tons, is carried by tongs at the end of a nine-foot arm.

Truck controlled by "electric eye" rolls back from fiery furnace at exact instant two-ton crucible of optical glass must be withdrawn

Three-in-One Trowel for Garden Pulls Weeds and Furrows the Soil

All the tasks in planting a home garden can be performed with a trowel that includes several unusual features. At the point there is a V-shaped slot for pulling weeds and cutting roots. Two claws on each side make furrows for seeds. Then, for measuring the exact depth when planting, the surface of the tool is calibrated.



M. Johnson, 1232-16th St. Santa Ana, California

Truck made by Wentworth and driven 123 N. E Oregon Portland Ore

Fire Truck Goes Streamline with Inclosed Body and Cab

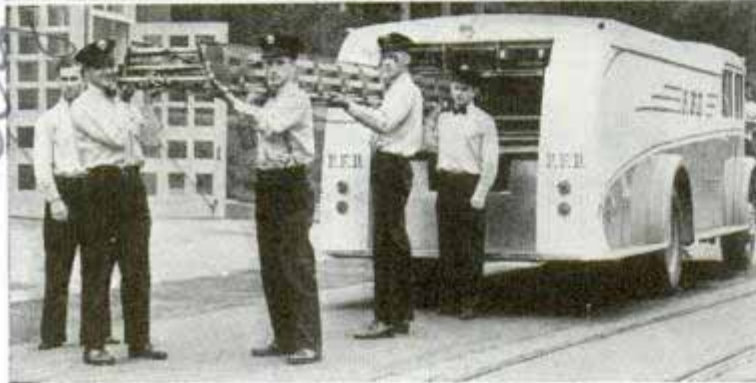

Above, the streamline fire truck. Below, firemen removing ladders through rear door of the inclosed body

Gone is the red fire engine, with firemen clinging to its sides. The latest fire truck is painted white, its crew rides in a cab up front and the ladders and other equipment are housed in the inclosed body. A life net is carried in the top. Powered by a "pancake" motor installed beneath the floor, the truck has a 250-gallon booster pump and a 200-gallon water tank. Equipment is removed through a wide door at the rear of the body.

Community Workshop Rents to Craftsmen

Craftsmen who want to follow their hobby but lack room and tools at home can rent the space and equipment in a community workshop in San Francisco. It is a commercial "build-it-yourself" establishment equipped to enable anyone to build a wide variety of things from toys and tiny plane

models to full-size boats and automobile trailers. Both power and hand tools are maintained and builders can do their own welding, painting, drafting and designing. Although not operated as a school, the shop offers an extensive library, in addition to expert advice from master mechanics and the mutual exchange of ideas with fellow craftsmen. Down the middle of the work floor are power-driven bandsaws, rip saws, jointers, drills and lathes, while smaller tools are obtained from the tool-room. Rental fees are based on the amount of space and type of tools used, size of the project, and space needed for materials.

Flying Merry-Go-Round Is Driven by Propeller

Children of one man in England enjoy riding on a homemade flying "gondola" built for them in their own back yard. The gondola is suspended from a boom attached to a central post and it is driven by a twenty-three inch wooden propeller mounted as on an airplane, a one-horsepower engine supplying the power.



Homemade flying merry-go-round, erected in back yard, is driven like an airplane by a one-horsepower engine

Commissioner G. Earl Riley Portland Ore

City

San Francisco

England

Public Workshop... Maurice Chats



The CRAFTSMAN

Attractive GRILLE-DOOR CASE protects books from dust

By GEORGE E. BASICH

USING a few hand tools, a bit of ordinary craftsmanship and inexpensive materials, this attractive 95-volume bookcase with grilled doors, may be built for the living room, den or study. As you see from Fig. 1 it makes a neat job when finished. Seasoned white pine is used in its construction. This wood finishes nicely with walnut stain and oil-rubbed varnish. Select the best pieces of stock for use on the outside of the case. Less choice material with checks and discolorations may be used for shelving. To begin with, cut two sides 50 $\frac{3}{4}$ in. long and the bottom shelf 35 in. long from $\frac{3}{4}$ -in. stock. The latter should be about $\frac{1}{4}$ in. narrower than the sides as this will save the trouble of rabbeting it later, since the plywood backing

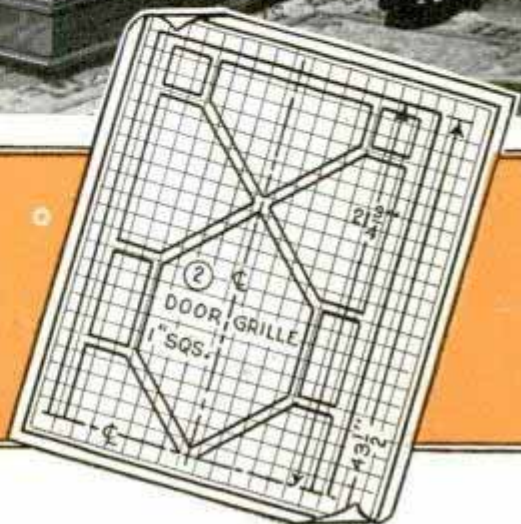
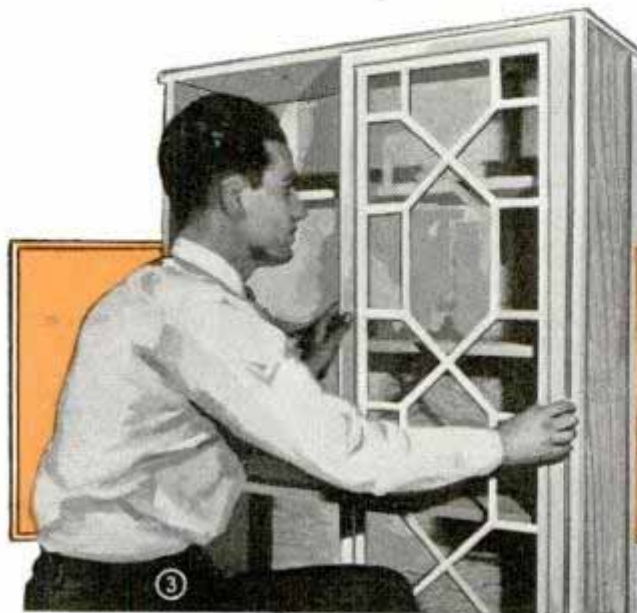

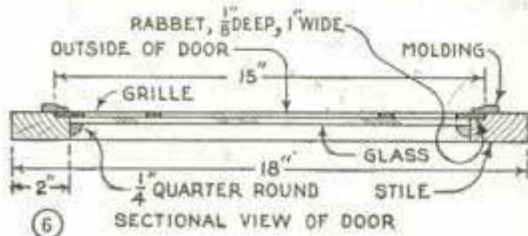
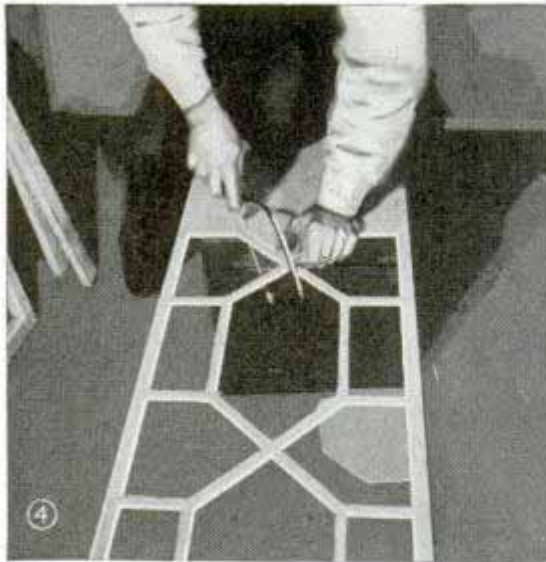

can extend down the full $\frac{3}{4}$ in. The top, since it overlaps the sides, is $1\frac{1}{2}$ in. longer than the bottom shelf. Rabbits are cut on each end, $\frac{3}{4}$ in. wide and $\frac{1}{2}$ in. deep. The sides fit into this rabbet and the joint is covered with a stock molding as you see in Fig. 5. On the back edges of the top and the sides, cut a rabbet $\frac{1}{4}$ in. deep and $\frac{1}{2}$ in. wide for the plywood back. Assemble the four pieces with finishing nails. The bottom shelf is placed $3\frac{3}{4}$ in. from the bottom ends of the sides. The front apron is mitered to the sides below the bottom shelf as you see in Fig. 5. With the apron in position, put on the plywood backing, nailing it every 3 in. with box nails. Then screw the four rubber-tired casters in place. Aluminum angle stock with $\frac{5}{8}$ -in. legs is used to support the shelves. Drill three holes into the leg of each 10-in. piece and fasten to the sides with small screws. Cut the shelves from $\frac{3}{4}$ -in. stock and fasten with screws driven up from the underside through the angles. Each shelf is braced against sagging in the center by screws driven through the plywood back. Put on the molding as indicated in Fig. 5. Use brads, sink with a nail set, and fill the holes with plastic wood. Sand and stain the wood with walnut oil stain, and wipe with cheesecloth to the desired shade. Apply a mixture of shellac,

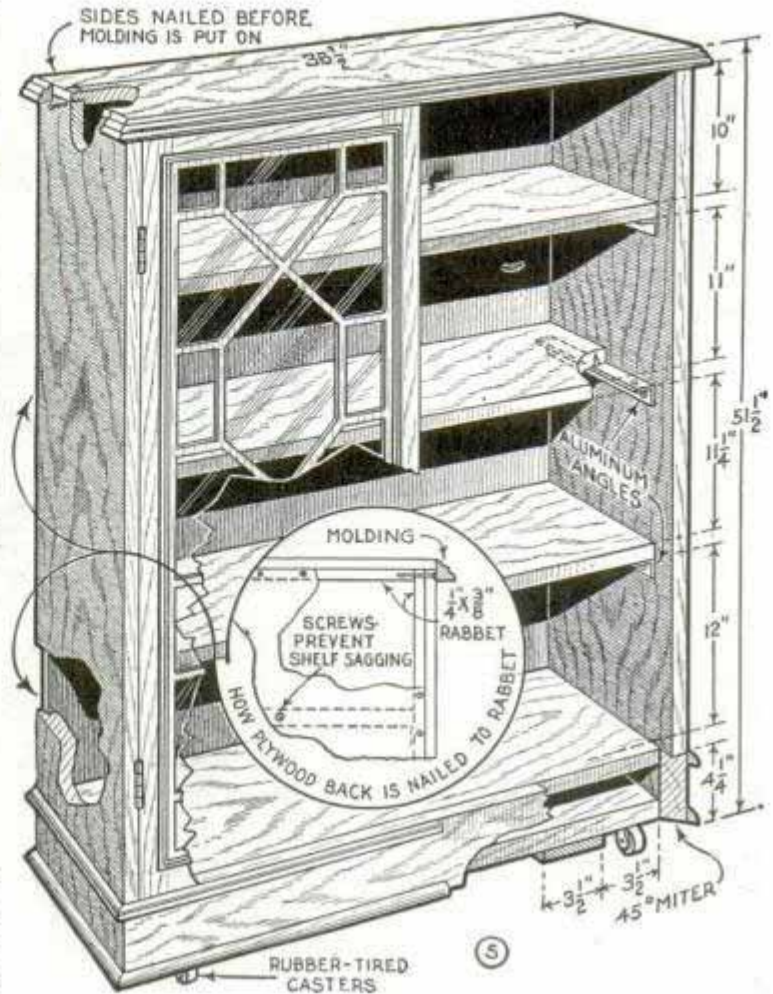

one part, and alcohol, one part, to prevent the stain from coloring the varnish. Two coats of varnish are sufficient, the final coat being rubbed with oil and pumice. This gives a smooth, non-glossy finish.

Fig. 6 shows a cross-sectional view of the door. Joints are plain butt, fastened with dowels and glue. The width given makes allowance for trimming to fit after assembly. Cut four pieces 47 in. long for the vertical stiles and four top and bottom pieces $17\frac{5}{8}$ in. long. The rabbet for the grille is $\frac{1}{8}$ in. deep and 1 in. wide. Lay out the design for the grille from Fig. 2 and start cutting at the top with an ordinary coping saw as in Fig. 4. The joint between the grille and the door is covered with molding. Fit the doors as in Fig. 3 and put on the hinges. To prevent the doors from swinging inward too far, place two small blocks at the top and bottom. On the inside of the left door, fit an elbow catch. The lock and escutcheon plate go on the other door. After fitting, remove the doors and cut the quarter round which holds the glass. Then take off all hardware and finish the doors as you did the case.

Wheeled "SNACK SHACK"

rolls to profit spots

STATIONED at any spot where refreshments can be sold, this gay-colored booth will pay you dividends. Balloon-type pneumatic wheels equipped with roller bearings and sturdy axles are used. Framing is covered at the bottom and roof with hard-pressed board. From the counter to the roof the covering is wire-glass to offer weather protection without shutting off the light. There is a door at the rear and two of the front frames are fitted with removable or hinged sash through which customers are served.

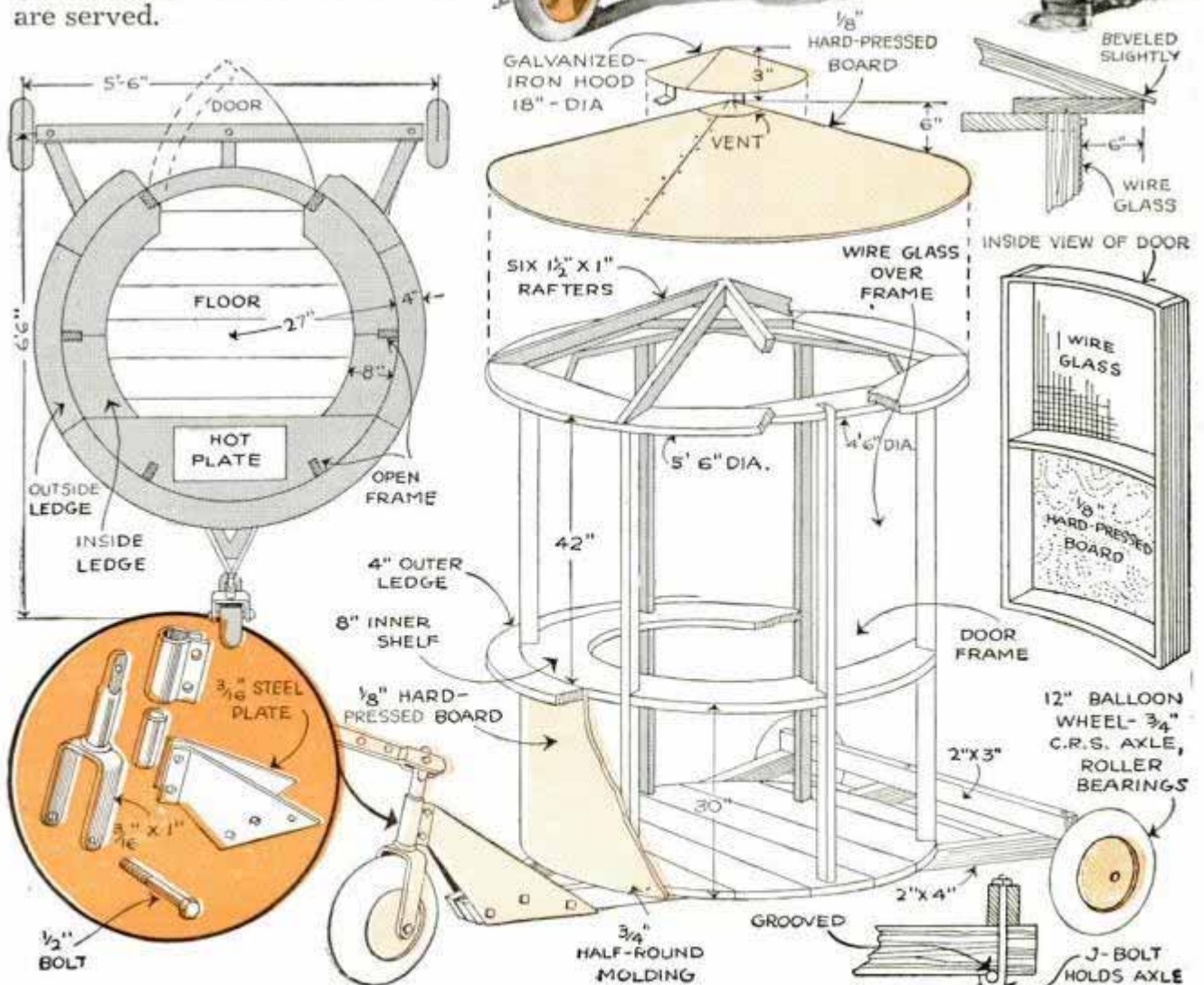

Two Men Can Roll Logs Easily on Rubber Tires



Two old tires mounted on clincher rims having valves in the inner tubes that do not project beyond the rims will save work when moving heavy logs. The ends of the log are inserted through the tires as indicated. By gripping the tops of the tires, the workmen can keep a more upright position and the log rolls easily.

Tile in Center of Furnace Grates Improves Fuel Combustion

One home owner claims that he gets better combustion of fuel in a hand-fired furnace if a section of ceramic tile is set on

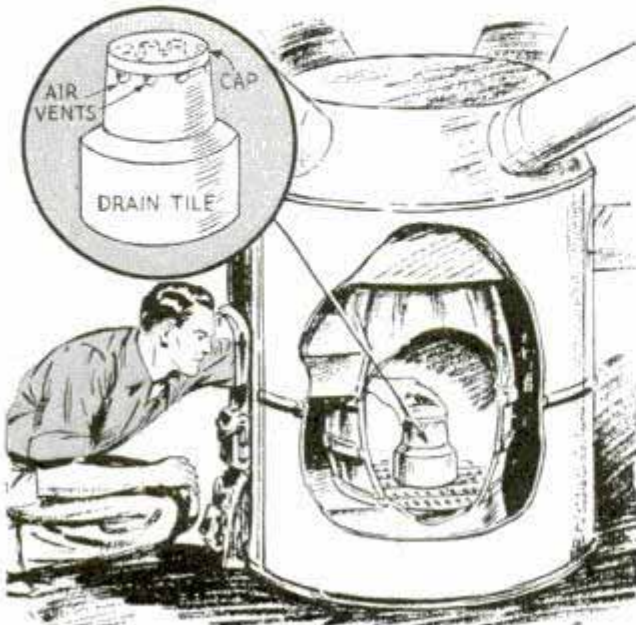

the grates as indicated. Fuel is piled up around the tile, which brings air up through the center and disperses it into the fuel through vents filed in the upper edge of the tile. A ceramic cap prevents fuel from falling inside the tile.

—M. B. Birge, Hinsdale, Ill.

Glass Tubing Bent by Heating with Resistance Wire

Having a number of glass tubes to bend to a U-shape, one craftsman used resistance wire, such as the element from an electric heater. The wire was threaded through the tube, connect-

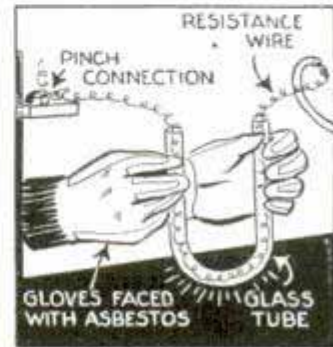

ed to the current, and the glass bent slowly as soon as it was hot enough. Gloves faced with asbestos were worn so that the tubing could be bent in the hands.

Calendar on Pencil Saves Time

You can have a perpetual calendar right on your automatic pencil where it is always at hand. Just attach a small calendar sheet to the pencil with rubber cement and cover it with transparent adhesive tape to protect the paper.

Then make a small brass band to fit snugly on the pencil and indent it as indicated to represent the days of the week. At the first day of each month, move the band so that the day of the week corresponds to the day of the month, and the rest of the figures will represent the correct calendar reading for that particular month.

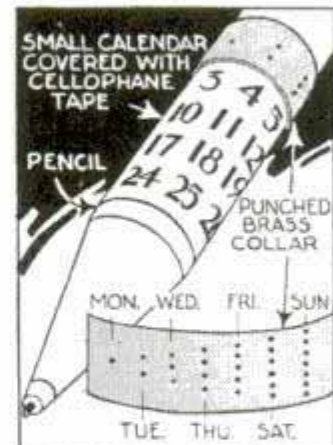

Triangular pieces of thin felt cemented to the underside of oilcloth where it contacts the table corners will help to prevent it from cracking.

Sturdy Construction in This Six-Piece Stand

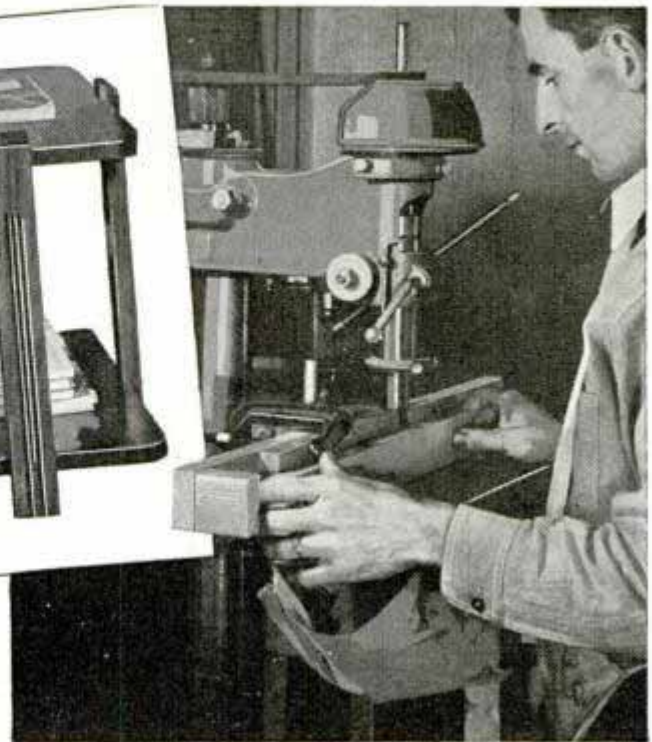
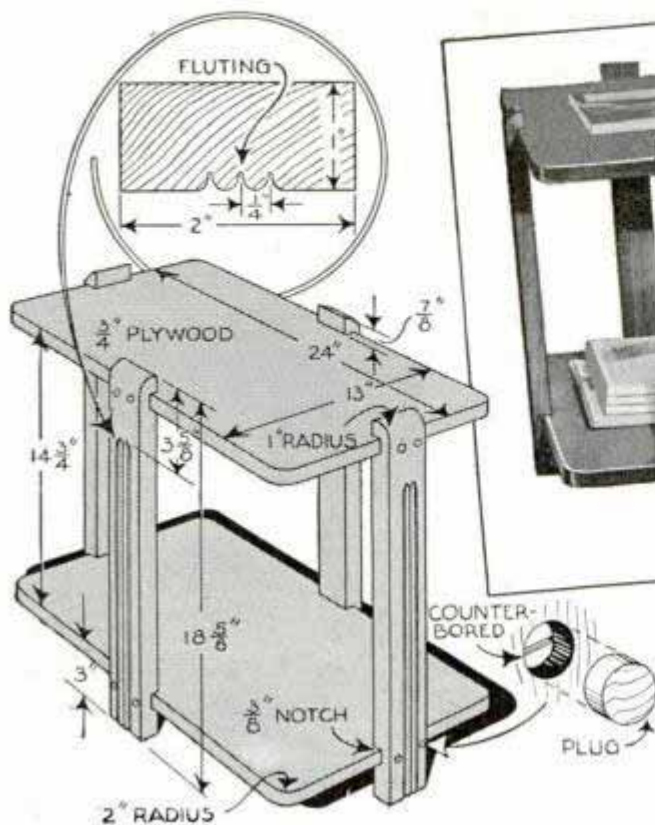

Just six pieces of walnut or whatever wood you desire—that's all the material required for this modern magazine stand. Four $\frac{3}{4}$ by 2-in. strips, stop-beaded on the outer faces and grooved to take the shelves, serve as legs. Beading is done with a beading cutter on the drill press as shown. Shelves can be $\frac{3}{4}$ -in. plywood or the solid stock. If you use the latter you will have to dowel and glue together several narrow

strips to build up a single piece of the required width. Either way the assembly of the stand is the same. First see that the shelves are exactly the same size, then counterbore the legs for small screws. Spread glue in the grooves, center the legs on the length and width of the shelves and screw them in place. Plug the screw holes with matching wood plugs. Finish a walnut stand with filler, shellac and wax. Close-grained woods can be enameled or stained and varnished, as desired.

Motor-Switch Control on Scroll Saw Located Above Table

As the nature of work done on a scroll saw requires that it be stopped and started frequently, this switch control, which is located above the table within easy reach, is handy. The control is a length of piano wire run through a piece of copper tubing and connected to the switch lever. A hardwood bracket supports the control on the arm of the saw. If desired, a number of holes can be bored in the top of the bracket and it will also serve as a container for saw blades.

—Dick Cole, Los Angeles, Calif.

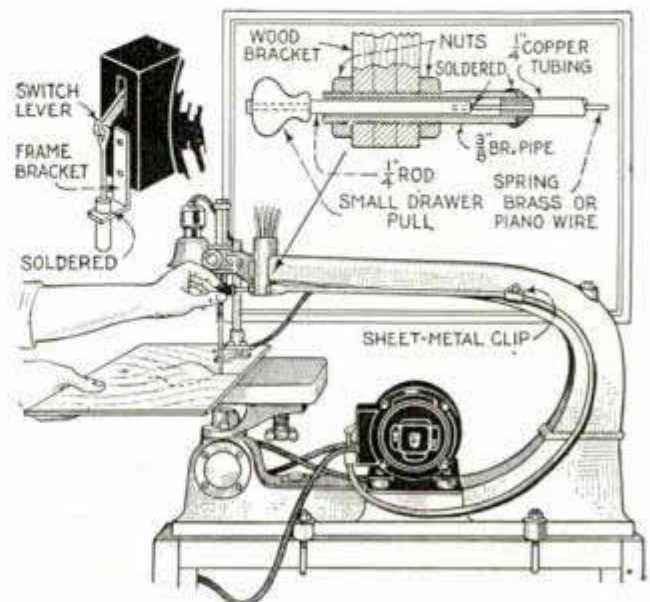

☞ Glass baking dishes that have become brown can be cleaned by soaking them in a strong solution of borax and water.

Winter on SLEDS and

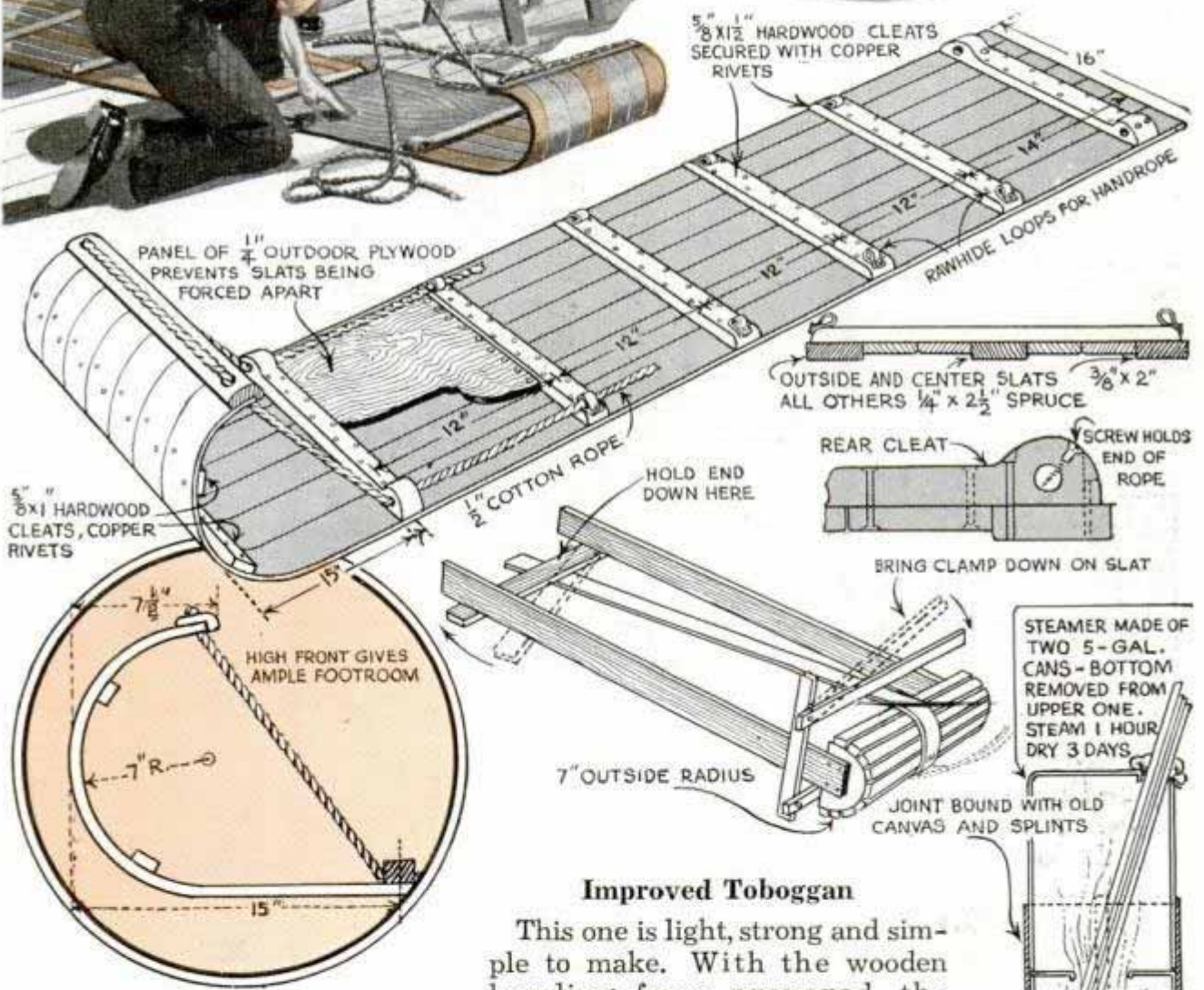
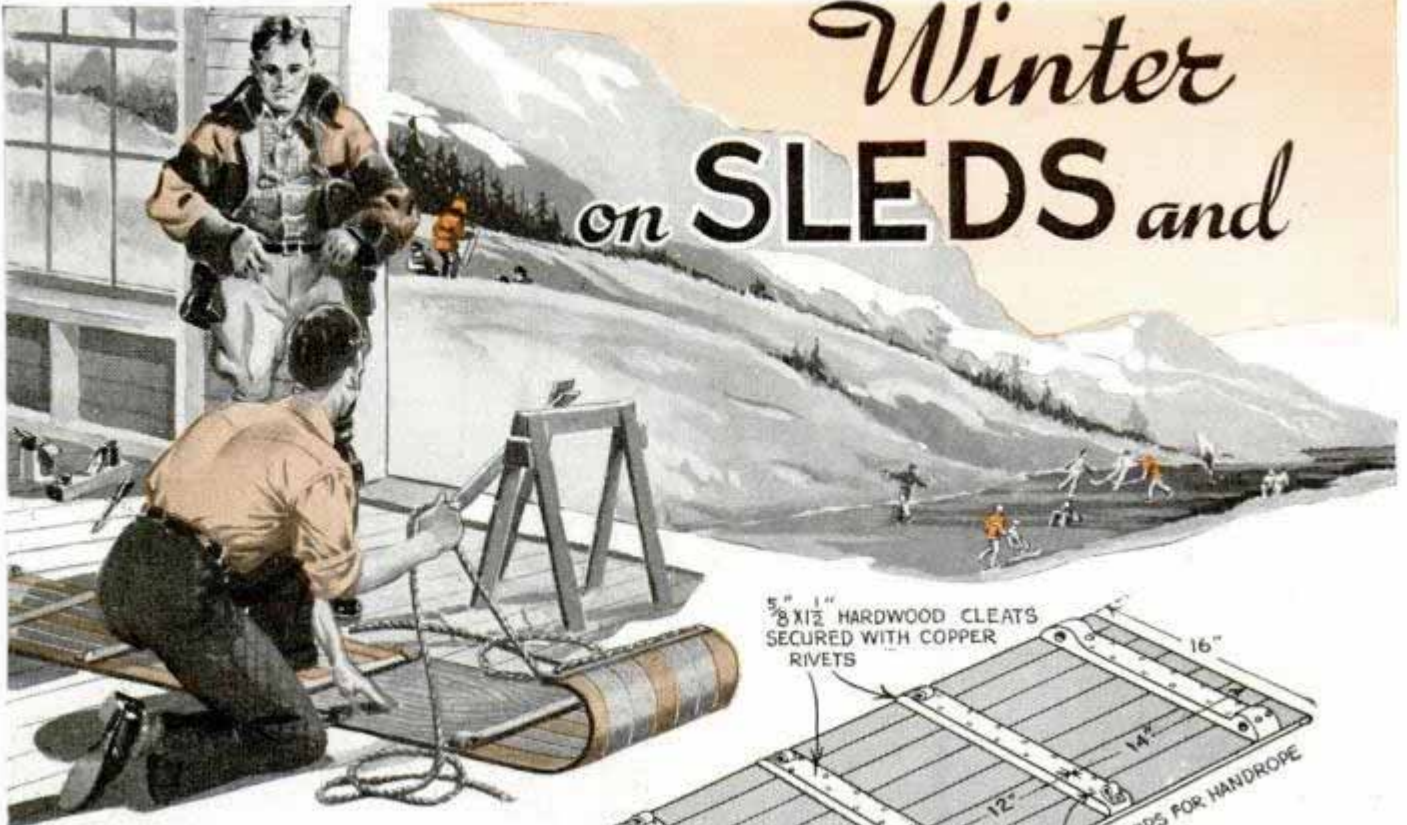

Improved Toboggan

This one is light, strong and simple to make. With the wooden bending form prepared, the steamed slats will all be curved uniformly. The center and outside slats are thicker than the others, which helps to keep the toboggan on its course. In order that these thicker slats can be bent the same as the others the forward ends are planed down to 1/4 in. for a dis-

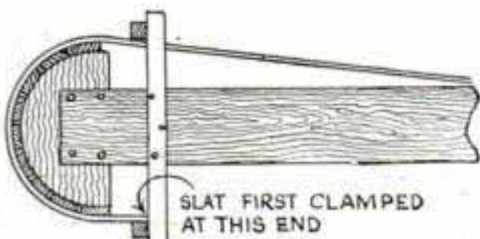

Thrills SLIDES



tance of 24 in. Then the thickness gradually increases along the next 12 in. of length. All cleats are fastened with copper rivets, the heads being countersunk flush on the bottom. This is much better than screws, which have a tendency to loosen soon. A rectangular panel of plywood is riveted down between the two forward cleats. This forestalls the trouble of having the toboggan knocked askew by the occasional experience of bumping

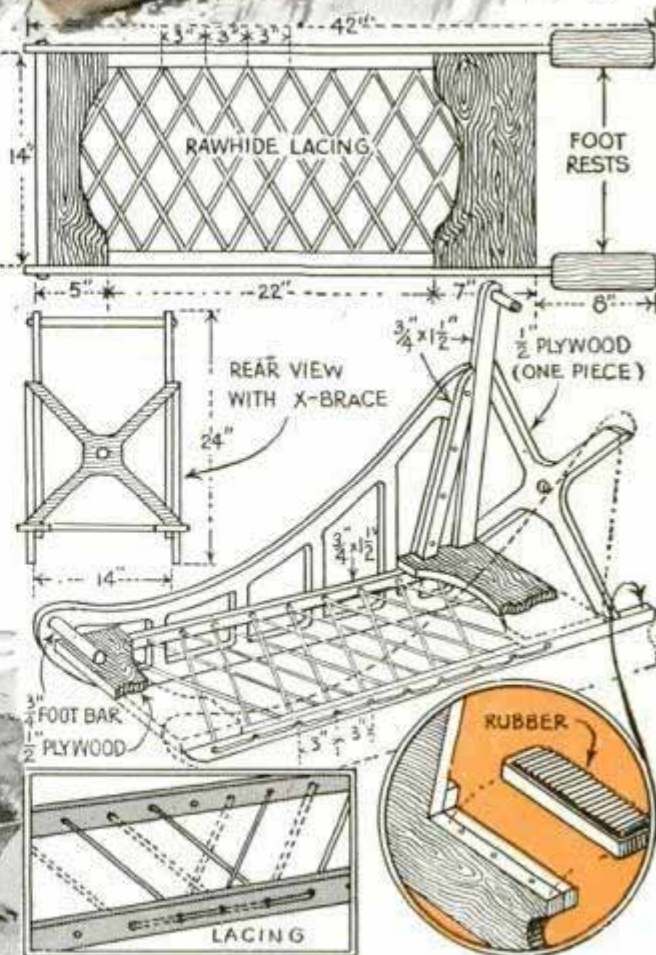
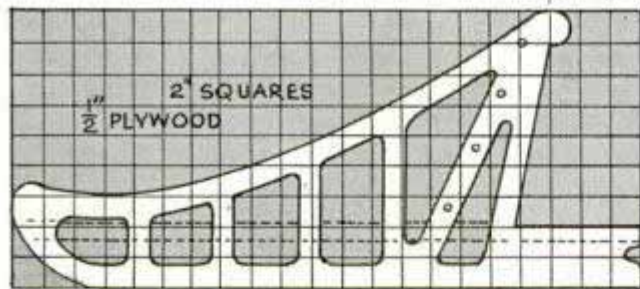

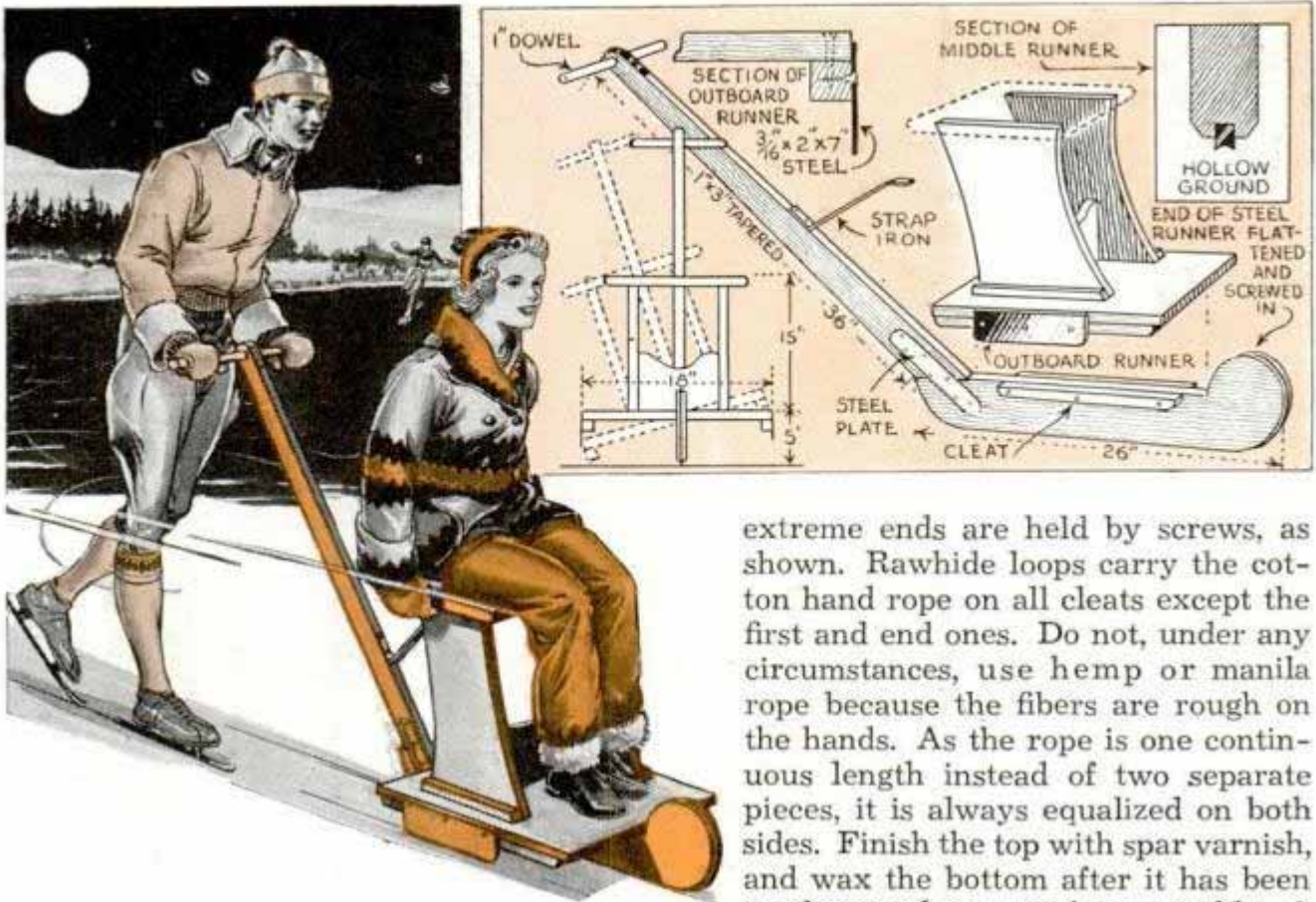

extreme ends are held by screws, as shown. Rawhide loops carry the cotton hand rope on all cleats except the first and end ones. Do not, under any circumstances, use hemp or manila rope because the fibers are rough on the hands. As the rope is one continuous length instead of two separate pieces, it is always equalized on both sides. Finish the top with spar varnish, and wax the bottom after it has been sandpapered as smooth as possible. A pleasing effect is obtained by staining alternate slats mahogany or walnut.

Eskimo Sledge: The design of the little sledge shown on the second page of this article was adapted from a real eskimo komatik and has been so modified that construction is not only very simple, but light and exceptionally strong. The sides are scroll-sawed from 1/2-in. waterproof plywood, with inner frame pieces to support the rawhide lacing and the handle bar. On a plywood panel 18 by 42 in. lay out the side frame as shown in the squared detail, and saw two identical pieces. Then install the reinforcing frame members. The two former are drilled 1/4 in. for the rawhide lacing at 3-in. intervals. Join the two sides with the plywood gussets at the ends and the X-brace, after which the wooden handle bar and foot bar are installed. Use brass screws where required, and apply casein waterproof glue to all joints. Footrests are screwed to the projections of the runners and rubber runningboard matting is cemented on. Flat iron is secured to the runners with countersunk screws, and bent around the ends. Lace the rawhide thongs tightly in the manner indicated, on bed and back, and when in use, cover with blanket or pad.

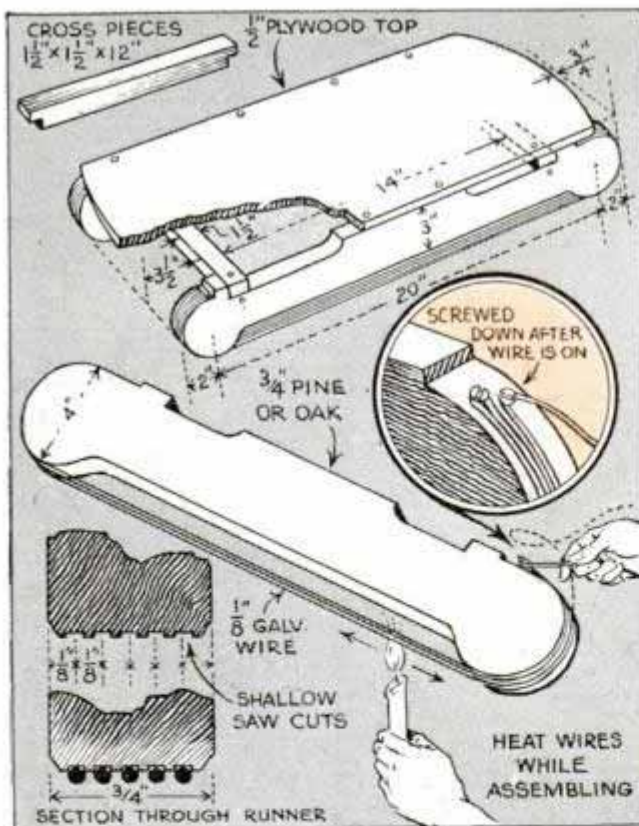

into a tree stump or some other unplanned obstacle. Casein glue should be used under all cleats. Before installing the hand rope, stretch it by attaching to the garage rafters with a weight through a pulley. The

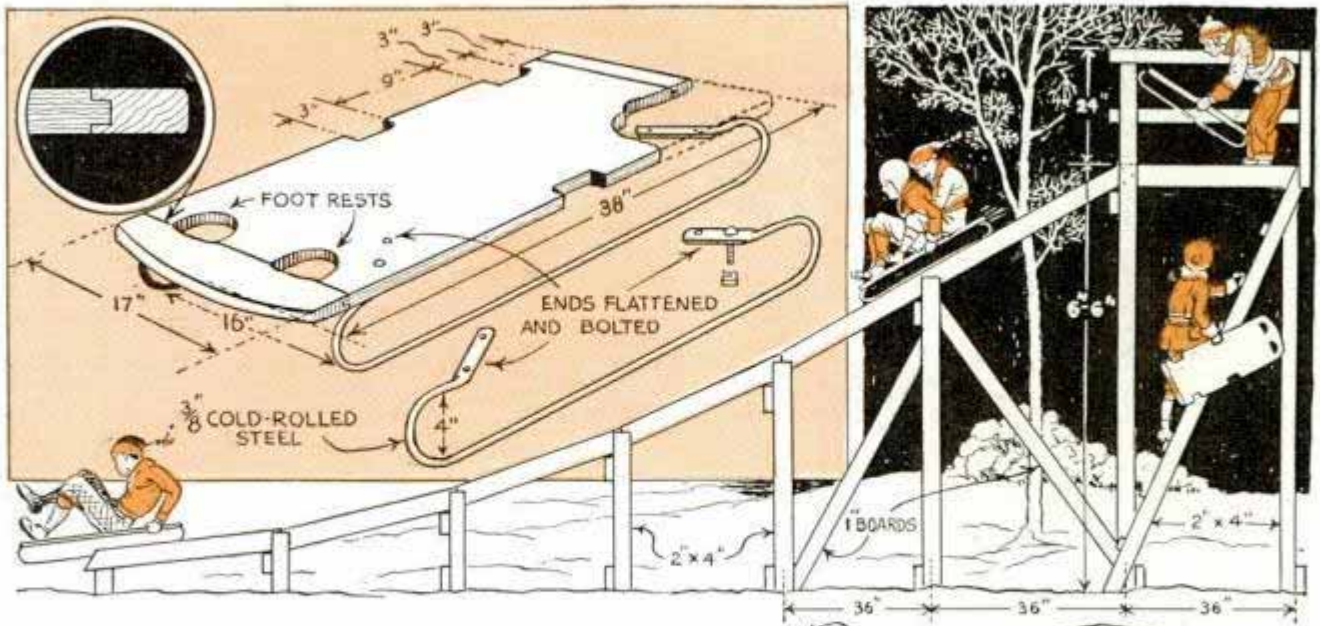

While the original Eskimo komatik of driftwood and bone is unpainted, a child will appreciate a lively color. A dog can be humanely hitched to this sledge when a boy helps push behind, and the latter can have his ride when going down inclines.

Scandinavian Ski-Jack: The tricky little ice sled on which the rider has a seat requires no practice to balance after it is once under way, and a minimum of effort is required to push it because the single runner is narrow and hollow-ground. Short outboard runners prevent capsizing in an emergency but do not interfere on the straightaway when it is riding on the middle runner. It literally "turns on a dime" because the sled can be tilted up on its heel by bearing down on the handle. Ordinary pine is used. Assemble with galvanized screws and casein waterproof glue. Note that the square-section main runner, which is cold-rolled steel, lays in a groove half its depth. The ends of the runner are flattened and screwed to the wood.

Wire Runners on Sleds: Sleds used on hard-packed snow or on ice can be provided with multi-strand wire runners. In order to stretch the wire taut, it is heated while being fitted to the runner. The runners have circular ends the edges of which are notched with circular saw cuts 1/8 in. between centers. Into these notches the wire lies when drawn up and brought around the screw heads at the ends.

Ice Tracks on Back-Yard Slides: Minimum friction enables riders to get up considerable speed and a long ride, if ice tracks are provided on a slide the frame-

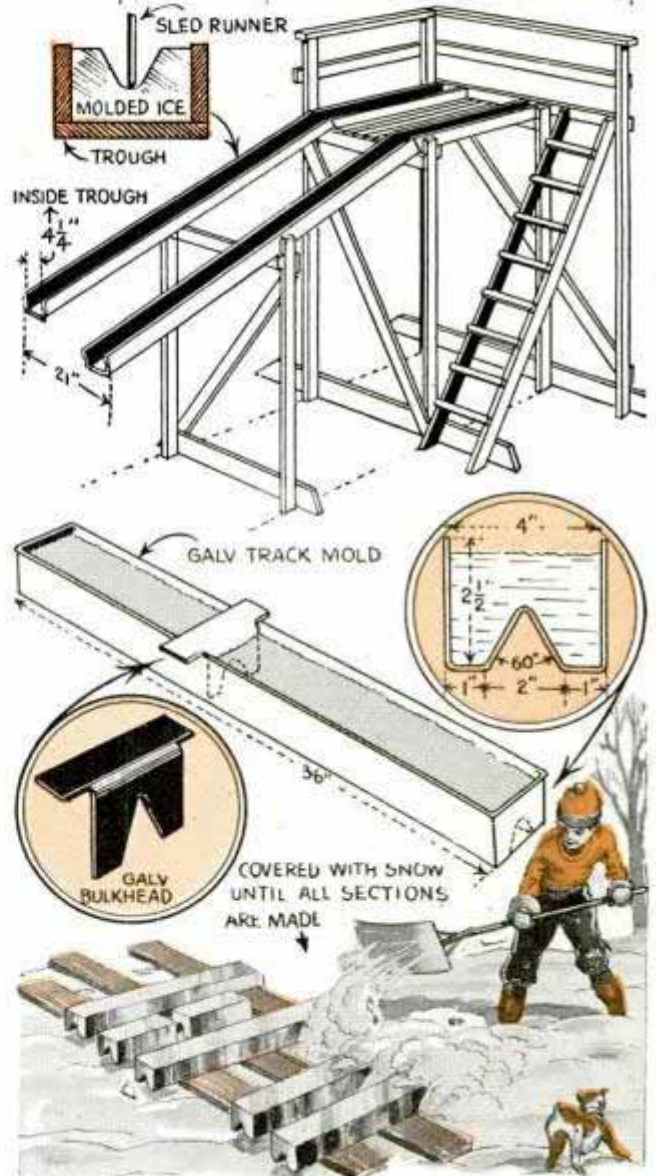

work of which is wood. The tracks are frozen in galvanized troughs, and old lumber from a wrecking yard will do for the structure, using 2 by 4-in. uprights, 1-in.

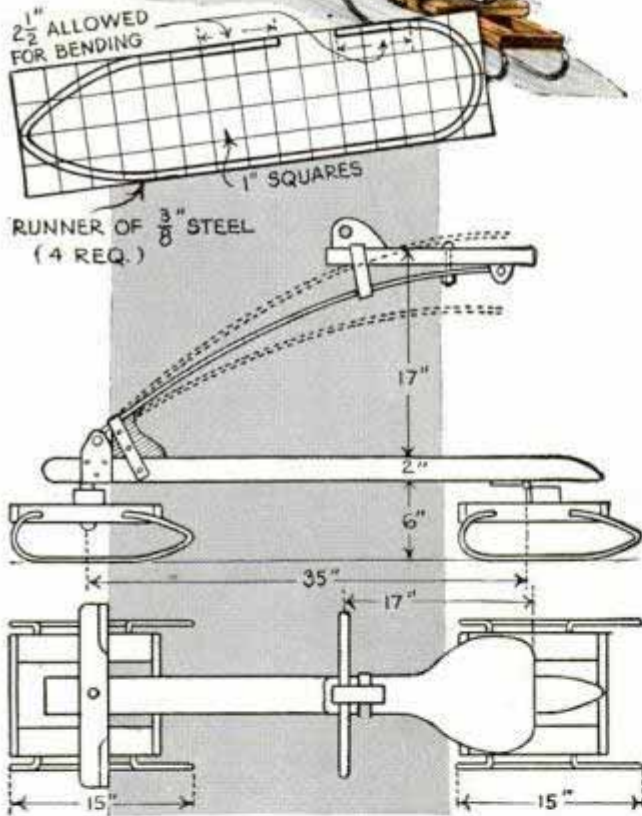
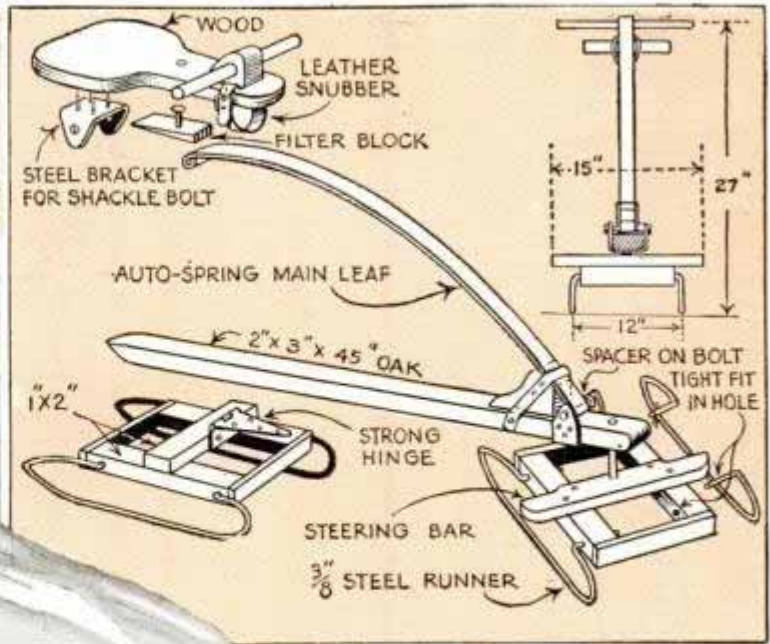

stock for diagonal braces and the troughs in which the ice tracks are laid. For molds, make one or more galvanized sheet-iron troughs to the dimensions shown. A local tinsmith can bend them to this shape easier and cheaper than you can do it yourself.

With four troughs in sub-zero weather, sufficient rails can be made in a few nights. When one is removed from the mold by pouring hot water over the bottom, lay it face down on old boards and cover with snow, in a shaded spot, until enough rails

are made to complete the job. Beginning at the bottom, lay the rails in the wooden troughs, end to end toward the top. Should they have a tendency to slide in thawing weather, nail a small cleat to the trough at each joint. In daytime cover them over with burlap and they will last through considerable mild weather. If an extra cold night comes after they are laid, turn a fine spray from the hose over them. Sleds for this slide are made wider than standard size to give ample stability and also a low center of gravity. Runners are bent from steel rod and permit a certain amount of side movement to accommodate themselves to inequalities in width of the track. Notches are made for handholds.

Galloping "Jockey Bob": On the single-passenger bobsled very little effort will start the "saddle" in a galloping motion. Having acquired a main leaf of an auto spring and about 10 ft. of $\frac{3}{8}$ -in. steel rod, the remaining material can be found among odds and ends. Bend the runners, after heating in a forge or with a blowtorch, as in the squared diagram, and insert the ends in holes in the sled frames. They should be driven to a tight fit and as a further precaution, cotter pins should be driven through holes in the ends. A strong hinge permits rocking motion in the rear sled, and several washers on the kingpin permit a certain amount of latitude forward. A good grip is supplied by the short, wooden handle bar, and a leather snubber prevents the seat from rearing backward. Steering is done with the feet.

Adjustable Cradle to Handle Heavy Bottles

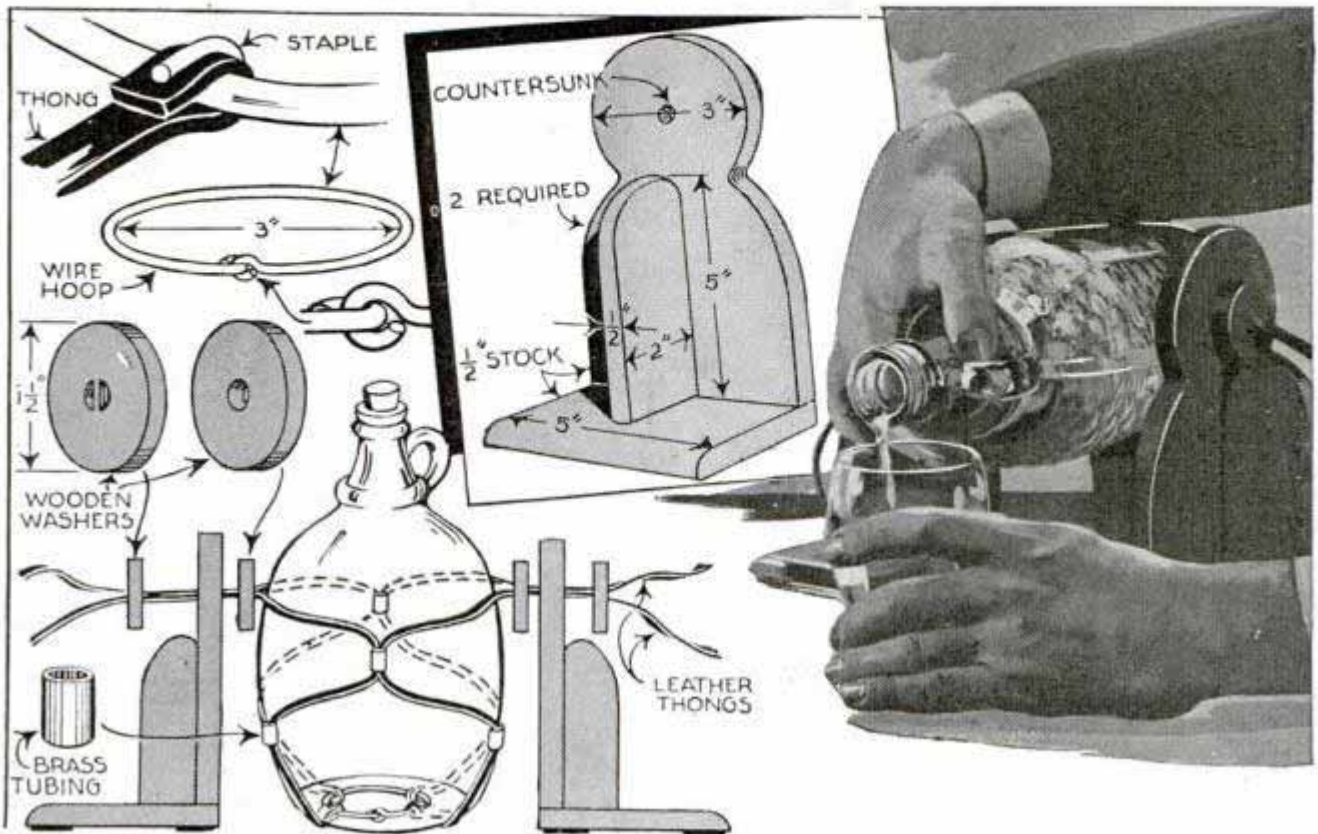

This ornamental cradle permits easy pouring from large bottles, especially when they are on shelves, making it unnecessary to lift them down. It is also useful on a dining table for handling water carafes. Made of $\frac{1}{2}$ -in. wood, the cradle may be

finished with stain, paint or varnish. One long rawhide thong, such as a shoelace, and four $\frac{1}{2}$ -in. sections of brass tubing are used to make the bottle sling, which may be adjusted in a moment by tightening or loosening the thongs.

Tricks with "Charged" Toy Balloons That Defy Gravity

Toy balloons that dive for the ceiling, cling to your hair, move up and down an umbrella and do many other things contrary to gravity will amaze your friends who are not familiar with the laws of static electricity. Rub an inflated balloon briskly on a rug. Then toss it gently near the ceiling. It will make a sudden spurt for the ceiling and cling there. Or, prove that a balloon will defy gravity by moving along a cotton umbrella at will. Toss two balloons into the air, walk under them and as they cling to your hair prove you are a master juggler. The balloons will not take a strong static charge in humid air. The best time is a dry fall or winter day.

☛ When washing painted woodwork with soap and water, a tablespoonful of baking soda sprinkled into the water will help.

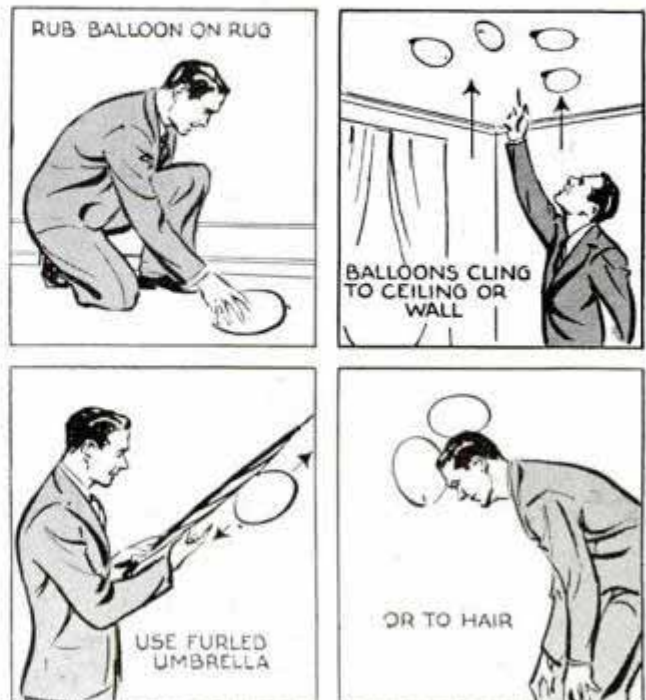

Pencil Eraser and Prick Punch Make Plumb Bob

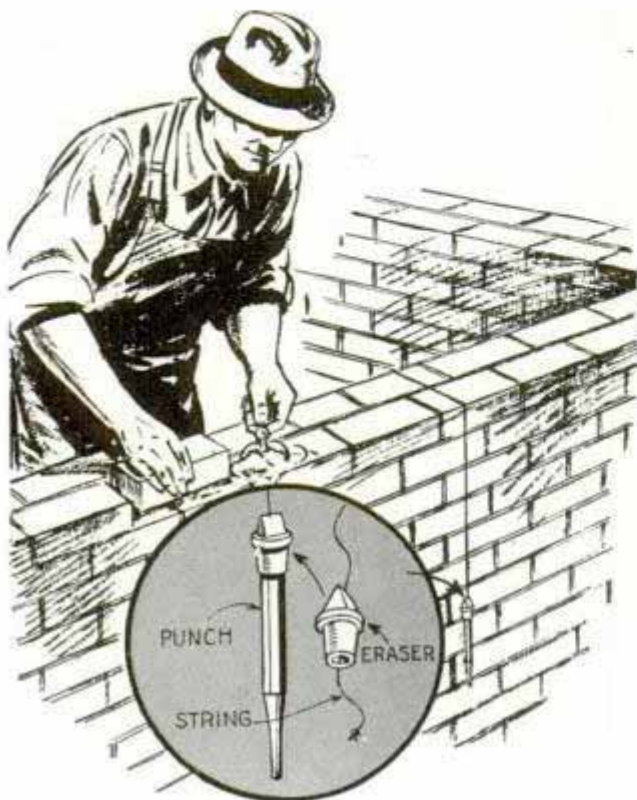

An emergency plumb bob that will give practical and dependable service may be made from a slip-on pencil eraser and a prick punch. A stout line is knotted and threaded through the eraser, which is then fitted over the end of the punch.

Motor Cord Wound on Reel to Keep It Off Floor

When shop machines are located near an electrical outlet, the excess motor cord can be wound on this reel or cleat to keep it off

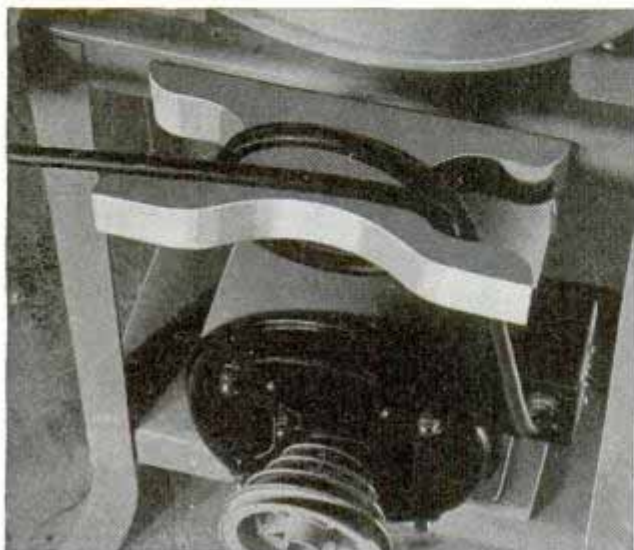

the floor. Made of wood, the reel may be fastened in any position on the machine where it does not interfere with work.

Non-Scratch Feet for Boxes

Book ends, small boxes or pieces of bric-a-brac that are placed on polished tables can be kept from scratching the surfaces by sticking pieces of felt to their bottoms. Felt corn plasters of the type shown are handy for this, and come in several sizes. Just moisten the pads and stick them in place.

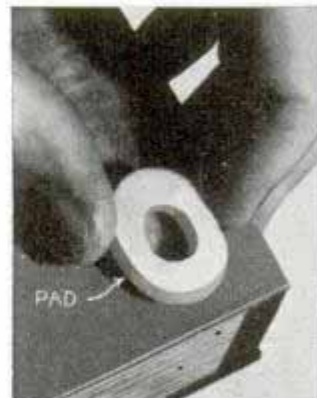

—Daniel Reynolds, Pontiac, Mich.

Coiled Strap Is Good Polisher

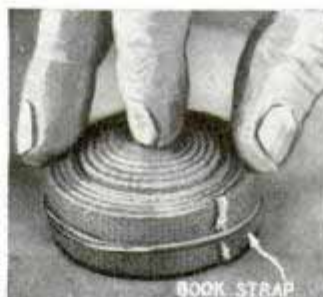

You will find that a coiled web book strap is better than a cloth when using cleaning and polishing compounds. Snap a rubber band around the strap to keep it coiled, and dish the center by pushing the coils down slightly. This provides a small well to hold the powder on the surface of the work.

Typewriter Oiled with Dropper

Instead of using a small oil can to lubricate your typewriter, try a medicine dropper. You can reach all of the bearings easily and oil will not drop on the machine, which often happens when you turn up a can to do the job.—E. T. Robinson, Broadacre, O.



☛ If showcard color rubs off when dry, mix a small amount of glue or mucilage with it.

"Cat" Doorstop Reached Without Stooping

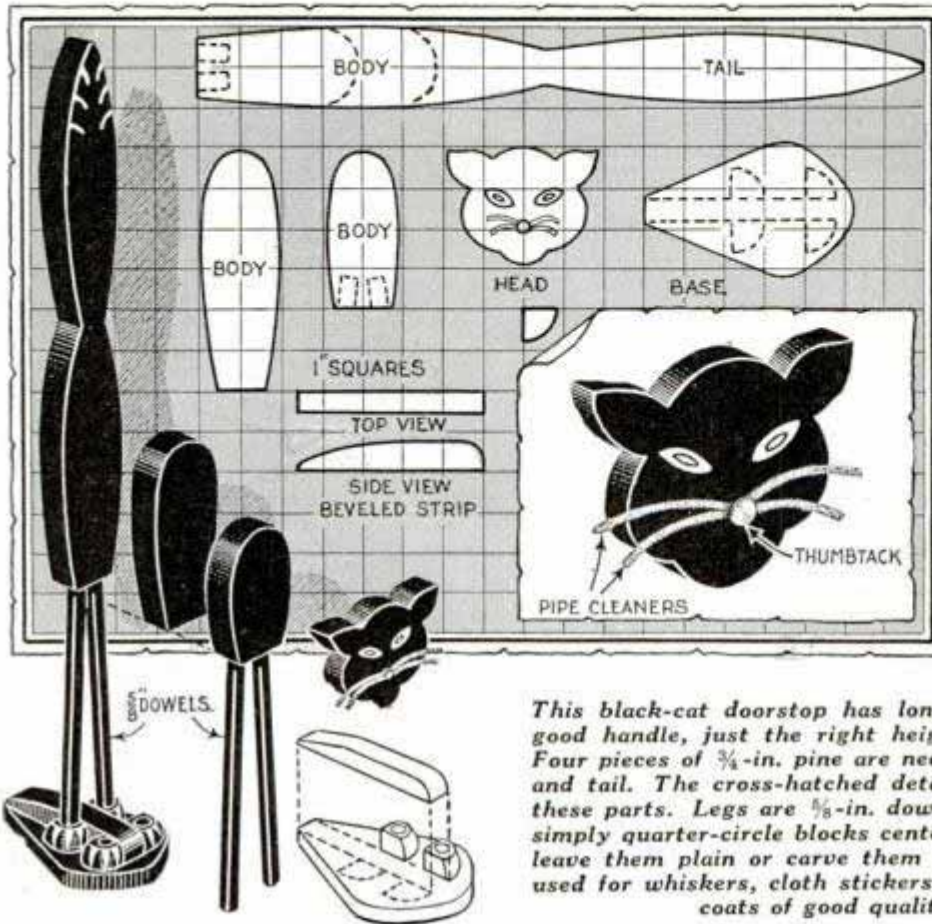

This black-cat doorstop has long legs and its tail provides a good handle, just the right height to reach without stooping. Four pieces of $\frac{3}{4}$ -in. pine are needed for the body and the head and tail. The cross-hatched detail gives the size and shape of these parts. Legs are $\frac{1}{8}$ -in. dowels, 9 in. long, and the feet are simply quarter-circle blocks center-drilled for the legs. You can leave them plain or carve them if you wish. Pipe cleaners are used for whiskers, cloth stickers for the eyes. Finish with two coats of good quality flat black paint.

Notch Is Filed in Jaw of C-Clamp to Hold Rod or Pipe

It is easy to adapt an ordinary C-clamp for holding pipe or rods. On a small clamp, just file or grind a V-shaped notch in one

jaw. A piece of angle iron welded onto the jaw of a large clamp takes the place of the notch. A convenient jig to hold pipe while welding it can be made by welding two clamps to lengths of bar or channel iron.

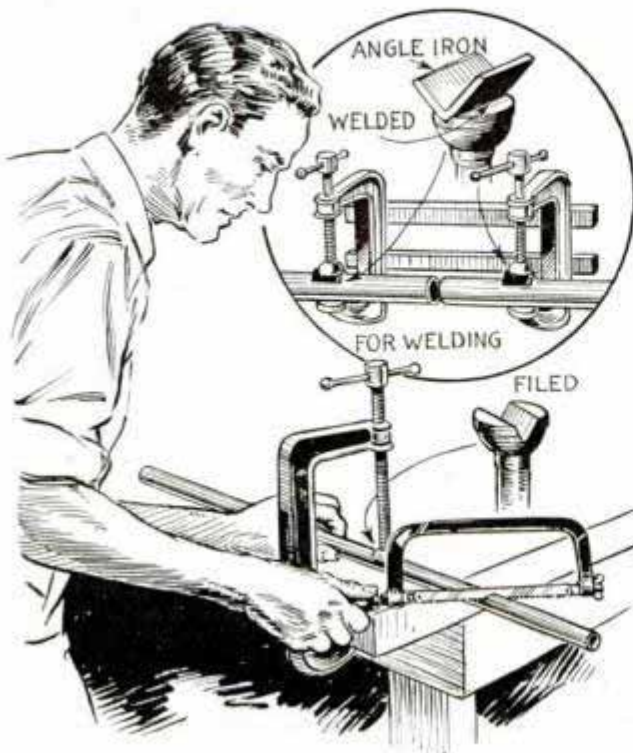

Rod-Coupling Weights Stop Hum of Chimney Guy Wires

When a customer complained that long guy wires on the pipe extension of a chimney made a constant humming in a high wind, one tinsmith overcame the trouble by inserting weights of pump-rod couplings at the points indicated. These tended to break harmony of the vibrations and stopped the noise.

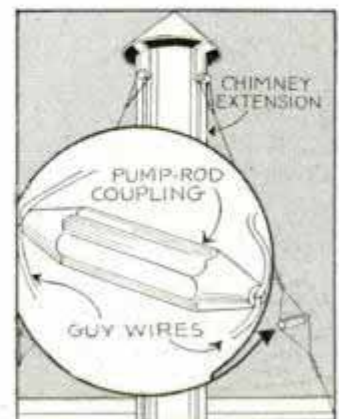

Swedish SUPPER CART

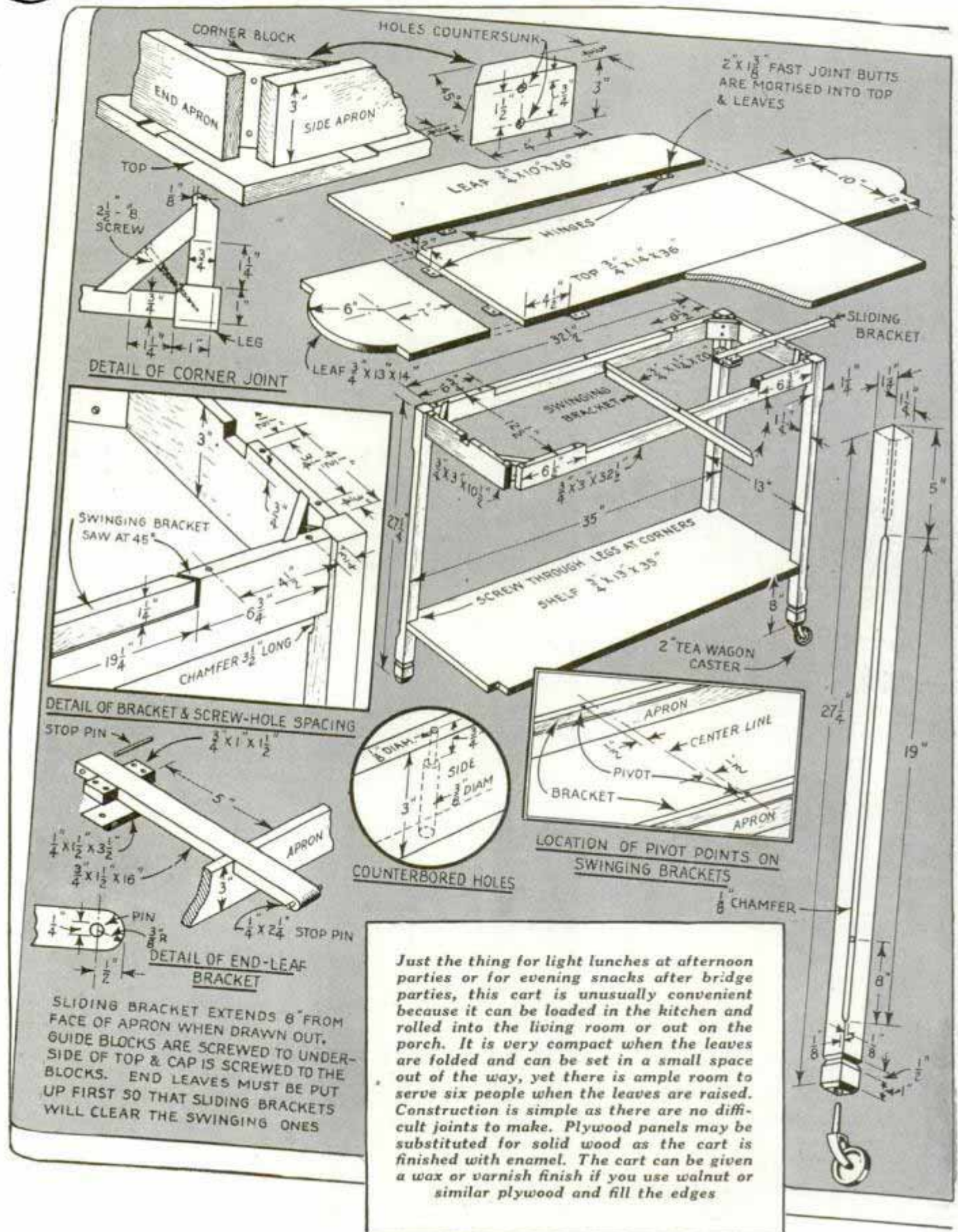

has four drop leaves

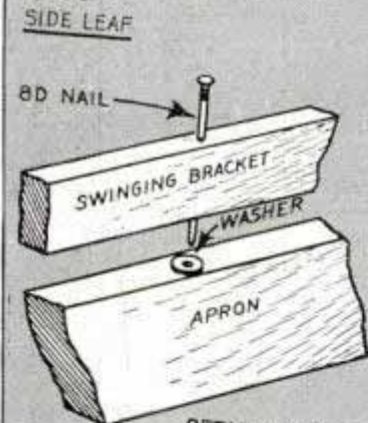
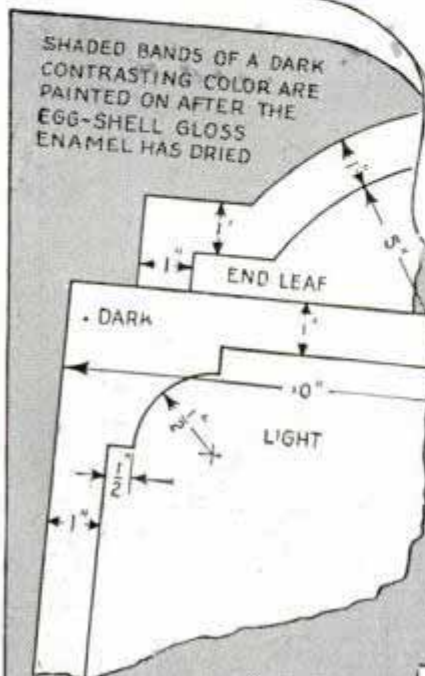

DETAIL OF PIVOT

MATERIAL LIST (Birch or Gum)

- 4 Pcs. 1 1/4 x 1 1/4 x 27 1/4 in. for legs
- 1 Pc. 3/4 x 14 x 36 in. for top
- 2 Pcs. 3/4 x 10 x 36 in. for side leaves
- 2 Pcs. 3/4 x 13 x 14 in. for end leaves
- 2 Pcs. 3/4 x 3 x 32 1/2 in. for side aprons
- 2 Pcs. 3/4 x 3 x 10 1/2 in. for end aprons
- 1 Pc. 3/4 x 13 x 35 in. for shelf
- 4 Pcs. 3/4 x 3 x 4 in. for corner blocks
- 2 Pcs. 3/4 x 1 1/4 x 20 in. for swinging brackets
- 2 Pcs. 3/4 x 1 1/2 x 16 in. for sliding brackets
- 4 Pcs. 3/4 x 1 x 1 1/2 in. for guide blocks
- 2 Pcs. 1/4 x 1 1/2 x 3 1/2 in. for caps
- 4 2-in. Tea wagon casters. (Rubber tired)
- 8 Wood screws—2 1/2 in. No. 8 for corner blocks
- 4 Wood screws—2 in. No. 8 for shelf
- 12 Wood screws—7/8 in. No. 6 for guide and cap
- 16 Wood screws—1 1/4 in. No. 6 for top

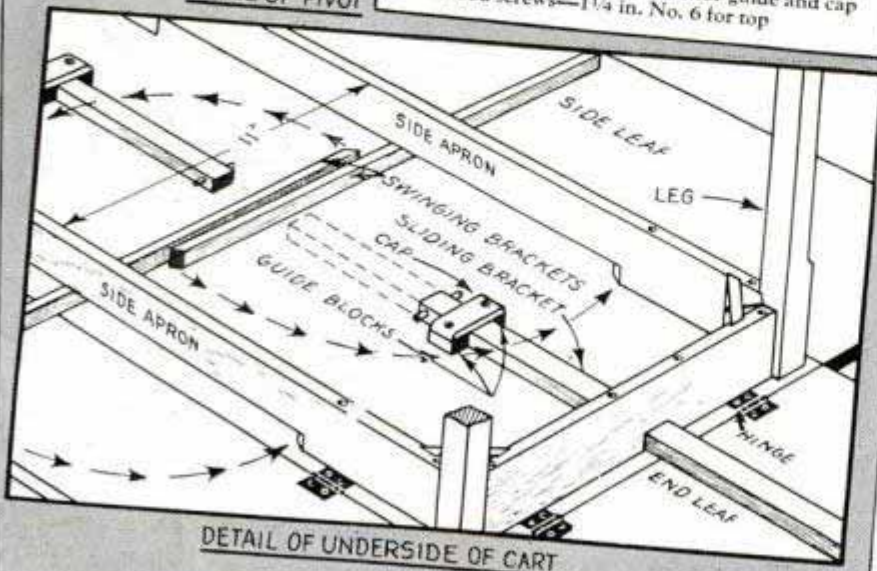

DETAIL OF UNDERSIDE OF CART

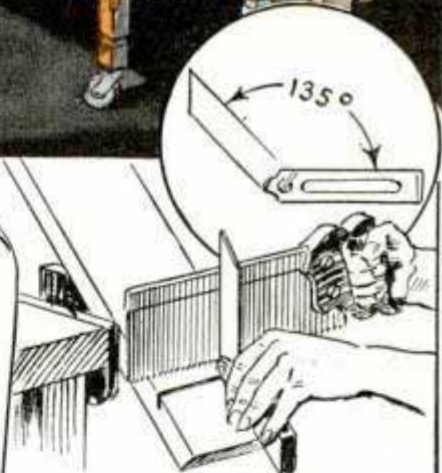

DADOS FOR CORNER BLOCKS ARE SAWED, THEN CHISELED TO DEPTH

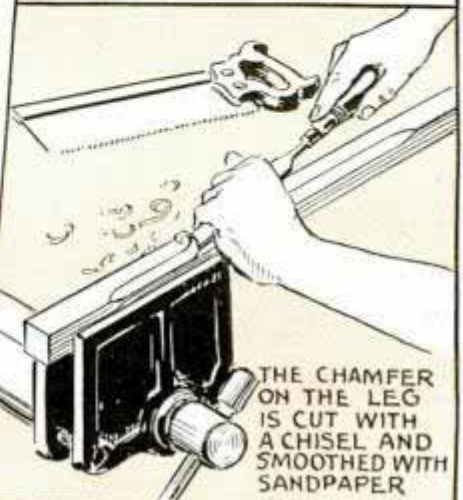

THE CHAMFER ON THE LEG IS CUT WITH A CHISEL AND SMOOTHED WITH SANDPAPER

Cardboard Under Thumbtacks Makes Them Easy to Remove



Slip small pieces of cardboard underneath thumbtacks and you can remove them by pulling up on the cardboard instead of pulling them with your fingernails which are likely to break. Cardboard pieces 1 in. square are about the right size.
—Robert Bowers, Springfield, Ohio.

Motor Used on Several Machines Controlled by Portable Switch

Owners of home workshops who have only one motor and move it along the bench to operate different machines, will find this portable switch handy. It can be moved from machine to machine and

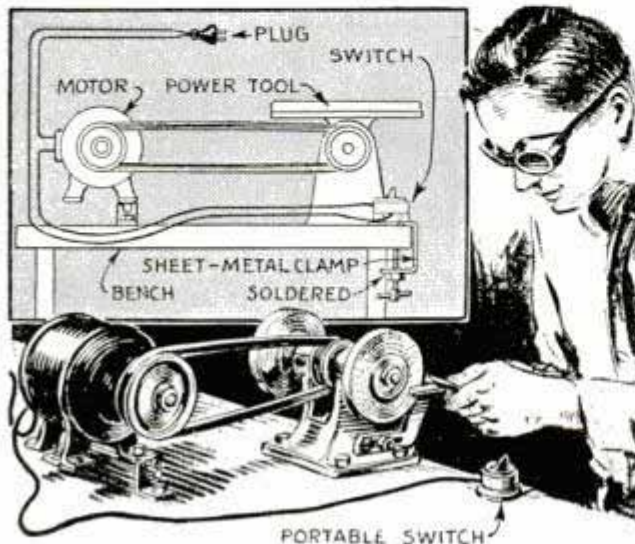

clamped to the bench top to give instant control over the motor. The switch is mounted on a C-clamp shaped from heavy sheet metal, the screw of the clamp being a bolt driven through a nut soldered to the lower end of the clamp.

—Jack La Londe, Portland, Ore.

Time Switch Operates Appliances in Your Home

Here is a simple time switch that anyone can make to turn on a radio, toaster, electric iron or coffee percolator at a given time. All you need is an alarm clock and a mercury switch. If desired, the latter can be made from a small phial. This is attached to a strip of heavy brass, which is

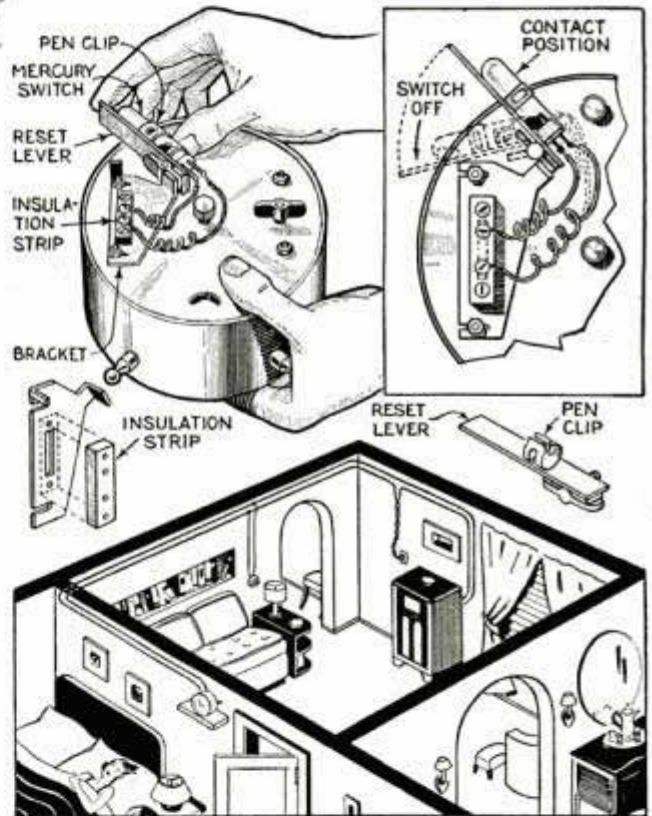

in turn soldered to the alarm winding key after the latter has been removed. In use, the alarm is wound just enough to tip the switch, after which further winding is unnecessary as resetting the switch by pulling down the arm winds the alarm. A stop pin must be soldered to the back of the clock to check movement of the arm after the switch has been tipped. The switch can be used to turn off an appliance by simply reversing the position so that the mercury flows away from the electrodes when the alarm tips the switch.

Basement tanks supply FUEL OIL TO HEATER

An electrically driven pump automatically maintains the oil level in the heater tank

WITH this automatic method of keeping the oil tank on a stove constantly supplied, there's little chance of the tank running dry. Also there's no danger of the tank overflowing in the event the float might develop a leak or the switch would fail, as an overflow line of greater diameter than the supply line is provided to carry oil back to the tank or tanks in the basement. A gear-type pump is used and it is run by a $\frac{1}{8}$ or $\frac{1}{4}$ -hp. electric motor. In the reservoir on the stove, a float operates a toggle-type electric switch, which in turn controls the motor and hence the oil supply. The whole arrangement is clearly shown in Figs. 1 and 2.

The discharge line from the pump to the heater tank is made of copper tubing as this is easily bent to pass through the floor and through a notch cut in the quarter round as in Fig. 2. A short length of muslin rolled to form a tube is attached to the end of the feed line as shown. This prevents splashing of the fuel oil as it is pumped into the tank. A short length of oil-resistant rubber hose is inserted in the intake line from the supply tanks to the pump and in the feed line to the heater. In addition, the pump and motor are mounted on a sponge-rubber pad to prevent noise.

Fig. 2 shows how the motor is switched off and on automatically as the oil level in

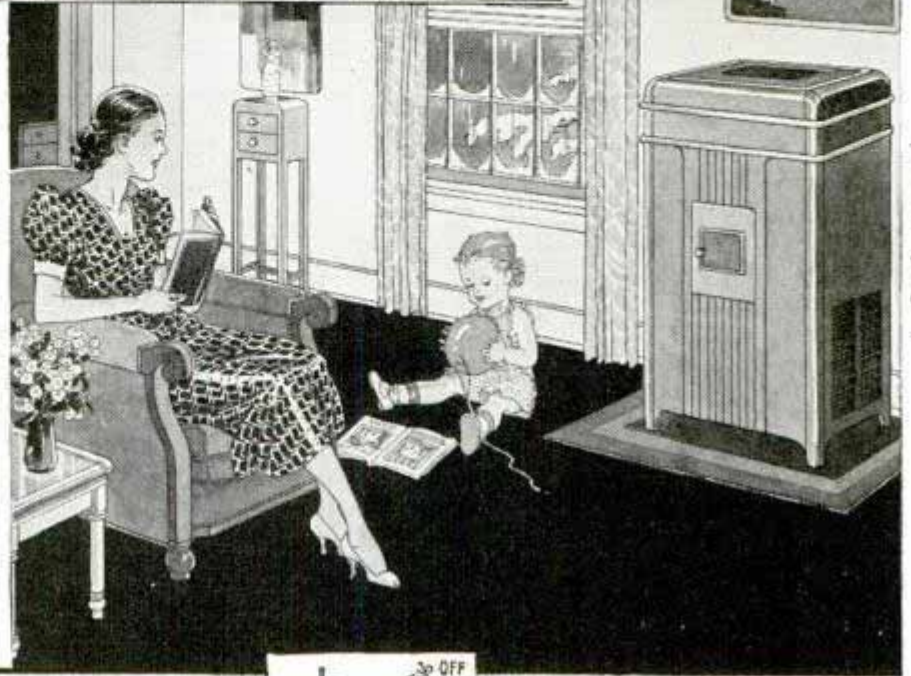

Woburn Electrical Supply Co.

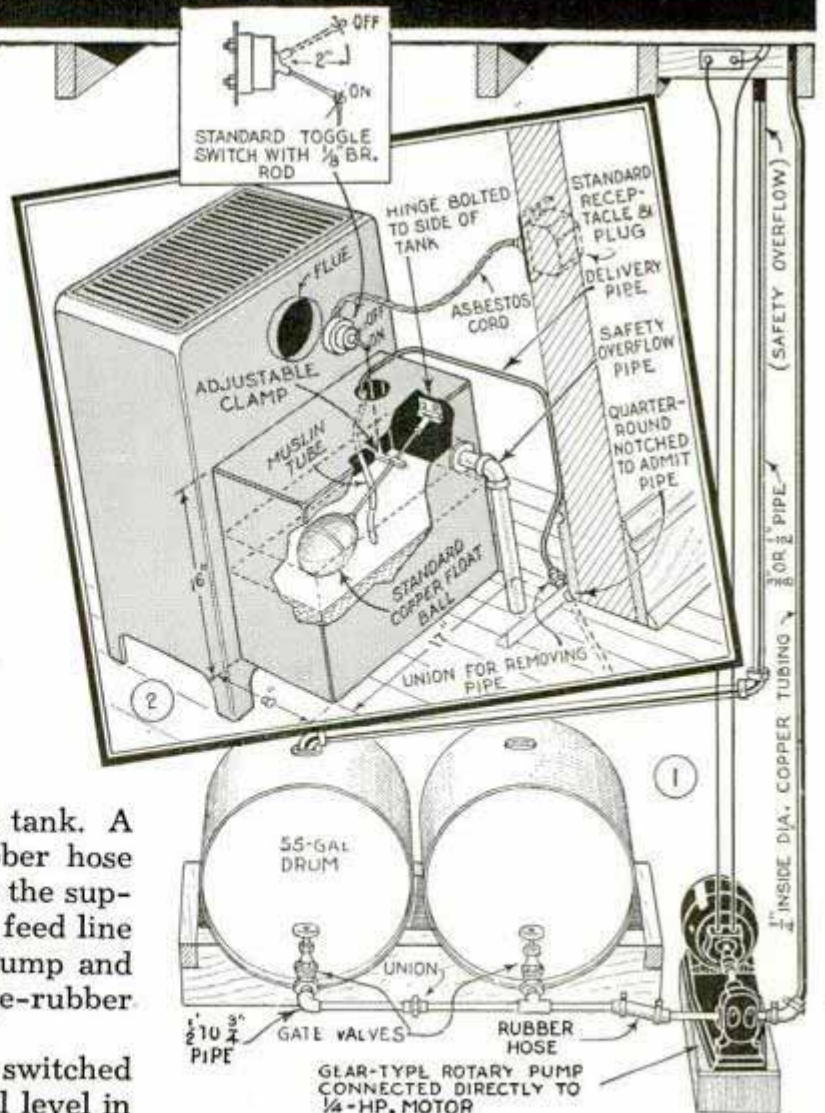

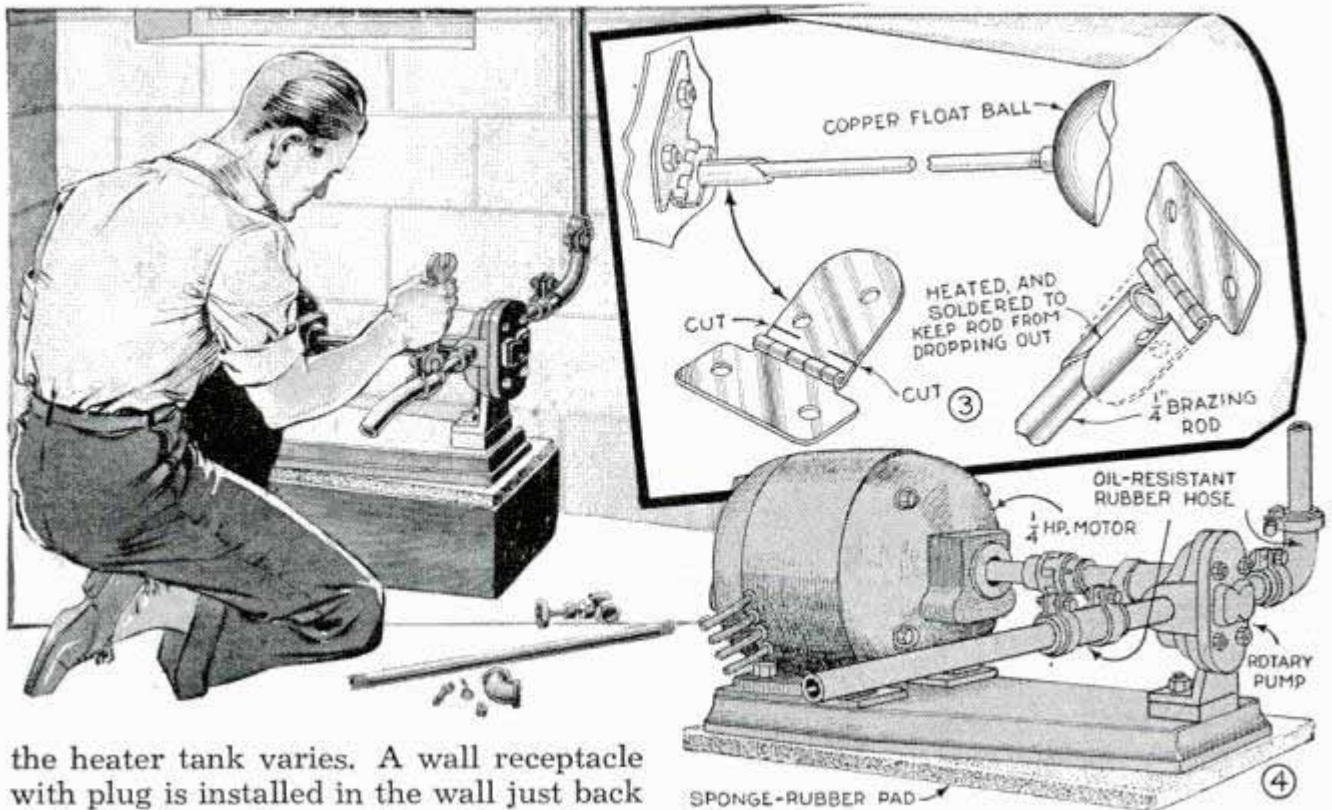

the heater tank varies. A wall receptacle with plug is installed in the wall just back of the heater and connections through armored cable are made to the current supply and the motor. A double-pole toggle switch is mounted securely on the back of the heater and the switch handle is extended with a short length of $\frac{1}{8}$ -in. brass rod as shown. The switch so fitted is

linked to an ordinary copper float ball as in Fig. 2. The float is hinged to one end of the heater tank as indicated in Figs. 2 and 3, taking care that the hinge works freely. An asbestos cord and plug leads from the switch to the wall receptacle.

Saw Mandrel Made Inexpensively from Generator Parts

A ball-bearing mandrel for a homemade circular saw can be assembled at little cost by using the armature shaft from an old-

car generator. The pulley end of the shaft and end plate of the generator housing can be used without alteration. The other end of the shaft will have to be turned down to take the saw blade and to fit the bearing in the end plate of another generator. If both ends of the shaft extend through the plates, you can use them by simply turning down the shaft so that the bearing can be moved in to allow for the saw. In assembling the mandrel, the plates are bolted to blocks on the underside of the saw table as indicated, being sure that the plates are in perfect alinement to avoid binding.

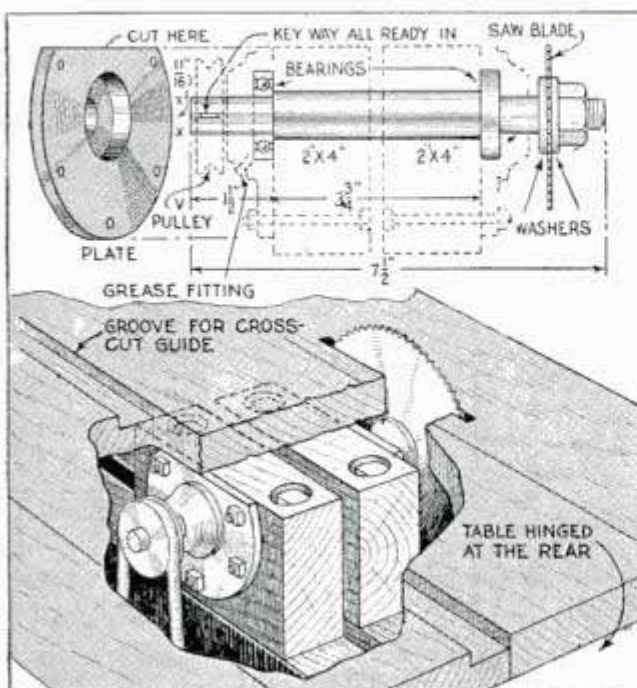

☛ If you have an idea that might be used for a short article in these pages, send it to the Homecraft Editor. Inclose a snapshot or drawing and give all the necessary information in as few words as possible. To be accepted, material must be of general interest and different from any we have published previously.

This Child's Clothes Rack Invites Neatness

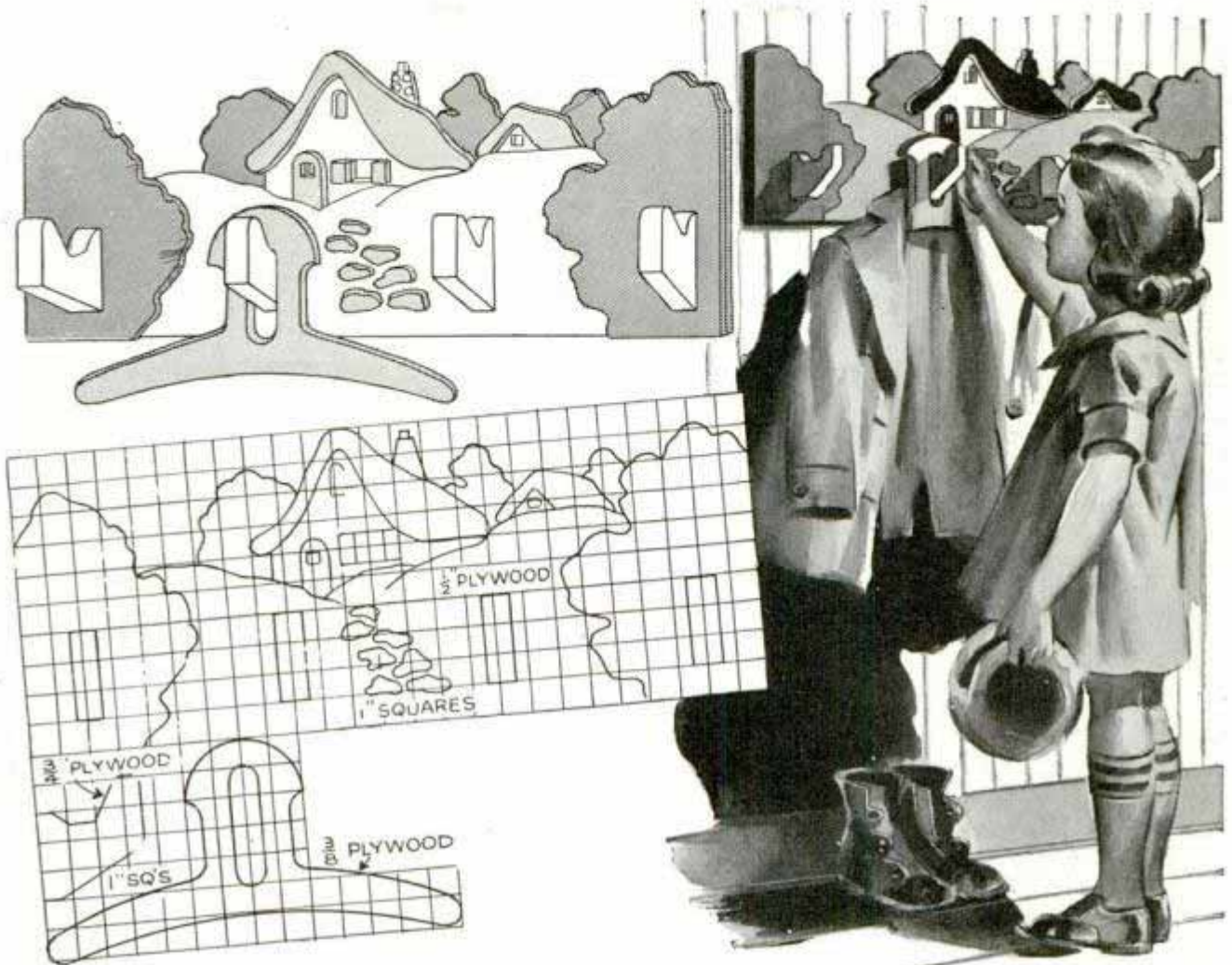

Hung within easy reach in the children's room or in the hall, this brightly colored clothes rack keeps tiny wraps in order and always ready for use. To make it, you cut the main part of the rack from $\frac{1}{2}$ -in. plywood. This includes the whole outline as you see it above except the tree overlays at

the ends. The latter and the flagstone overlays at the center are cut from $\frac{1}{4}$ -in. plywood and glued in place. Hooks for the hangers are simply notched blocks of $\frac{3}{4}$ -in. stock fastened with screws driven through from the back. Finish with enamel in cream, orange and green.

Bench Vises Serve as Clamps to Assemble Mitered Work

For holding mitered work while assembling it, two dime-store bench vises of the clamp-on type are just the thing. One is clamped to the side of a bench and the other at the end as indicated. Due to play in the vise clamps, they can be twisted to one side slightly and clamped in the proper position to hold work cut to form hexagon, octagon and other shapes.

☛ Flies and small insects that often infest house plants can usually be destroyed by spraying the plant with a suds made of washing soap.

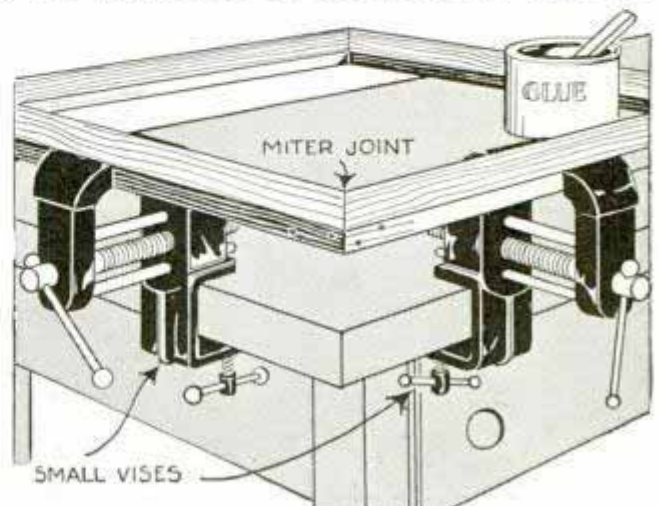

Inner-Tube Holder Keeps Pencils on Drawing Board

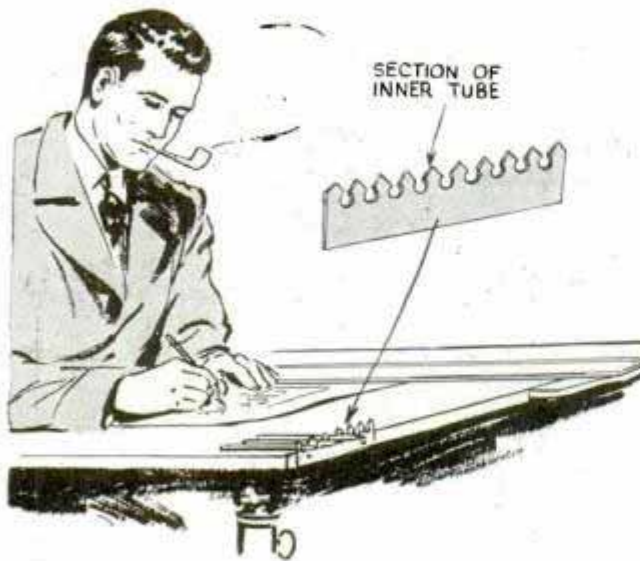

Simple and practical, this pencil holder for a drawing board is made from a strip of inner tube. It is cut as indicated and is tacked to the upper edge of the board. Pencils are held against accidental dislodgment, but are removed easily.

Choke Coil Changes Tone of Bell for Use with Two Doors

By simply installing a small choke coil in the circuit to one push button, you can use one doorbell for both the front and back doors of your home. The electrical resistance provided by the coil causes the bell to ring softly when the back-door

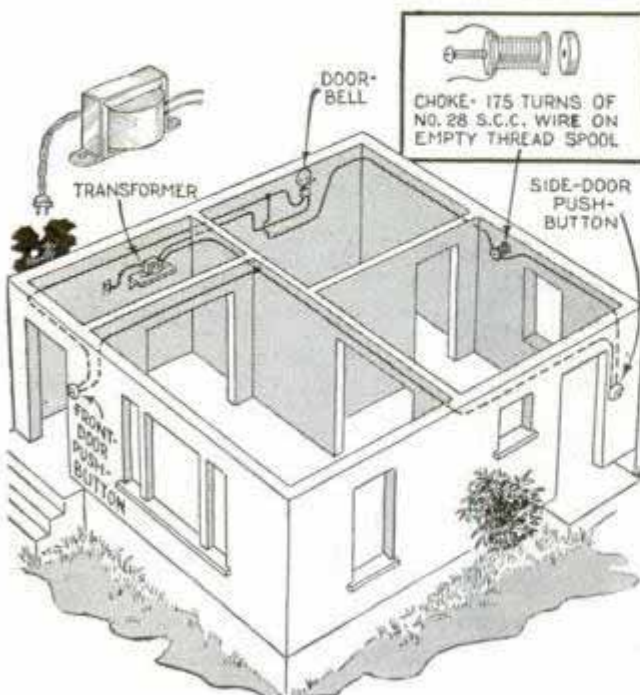

push button is closed, while the absence of any resistance in the circuit to the other push button allows the bell to ring loudly. The coil is made by winding No. 28 single-cotton-covered wire on an empty thread spool. The number of turns will vary according to the output of the transformer. One home owner used a 14-volt radio transformer and found that 175 turns of wire on the choke gave the tone desired.

Electric Light Aids in Soldering

When soldering a leak in a pail or other container, time can be saved if you place an electric light under the pail. Light will show the leak so a quick soldering job can be done. —H. Arrall, Newburyport, Mass.



Label Wire Around Tree Coiled to Protect Bark

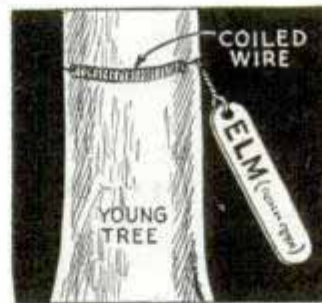

If you leave the labels on shrubs and small trees when transplanting them, coil the label wires as shown. This allows the wire to stretch as the growing tree or plant increases in diameter so that the bark will not be injured.

—A. S. Wurz, Jr., Rockyford, Alta., Can.

Rubber Hose Shields Level Glass in Tool Chest

If a carpenter's level is stored with other tools, slit a short piece of garden hose and slip it over the glass to protect it against breakage. A piece of $\frac{3}{4}$ -in. hose is just the right size.

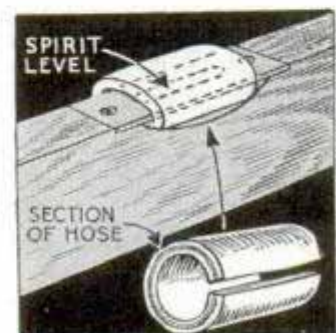

Healthy HOUSE PLANTS

Secrets of success with succulents

By Robert Clarence Stahler

ALL-SEASON window gardens of succulents, those hardy slow-growing plants native to the hot, arid regions of the world, lend to your living room the charm of colorful foliage the year 'round. Properly cared for, they thrive in the warm and comparatively dry atmosphere of heated rooms where other seasonal plants sometimes wither and die. Caring for them is the very simplest procedure; just a small pot partly filled with gritty soil, and an occasional watering. True succulents should not be confused with the ordinary varieties of cactus plants. Succulents are generally classified in groups and all exhibit a striking variety of foliage, both in oddity of form and in brilliance of coloring. The aloe group alone can furnish more than enough specimens to complete a window garden. However, for the sake of variety try to collect a few plants from other groups such as Echeveria, Euphorbia, hart's-tongue,

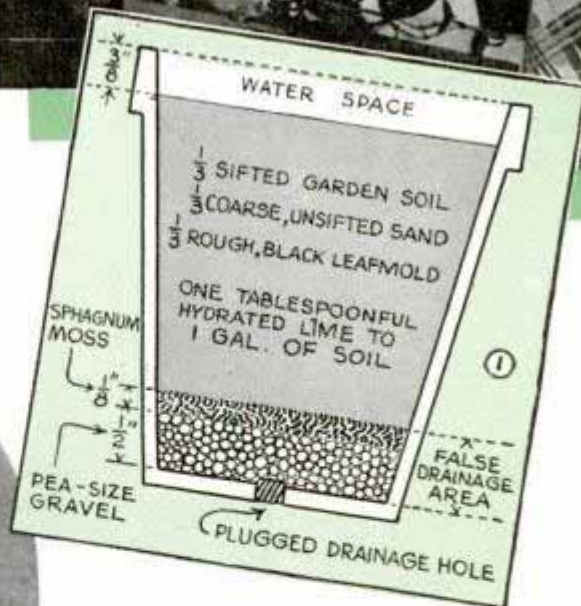

Crassula, Kalanchoe, ice plants, Sansevieria. True succulents thrive best in a soil of the composition shown in Fig. 1, but will do very well in a mixture of half garden soil (sifted) and unscreened coarse sand, with the lime content the same as in Fig. 1. Don't use manures or fertilizers in your soil mixture, and avoid a clay soil.

When potting, have the soil damp, but not

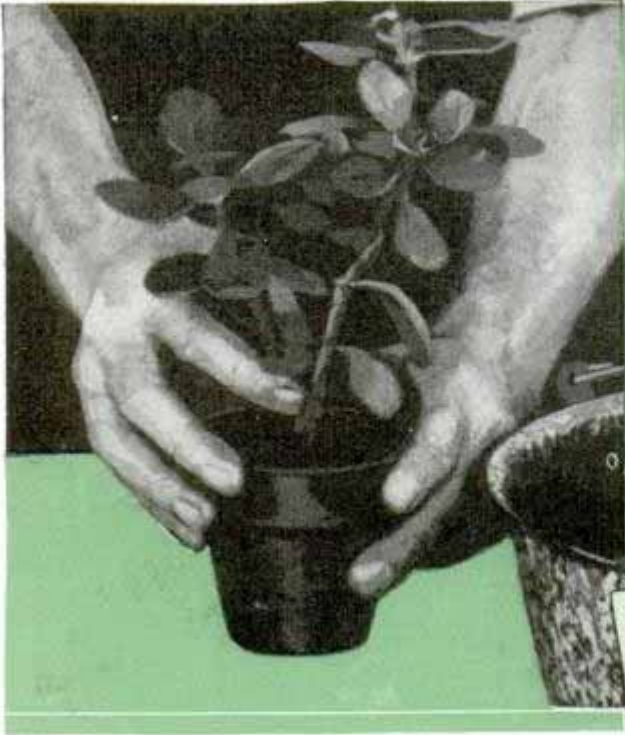

wet. Large pots will not do; 2, 2½, 3, and 3½-in. pots are the rule, with an occasional 4-in. size for very large specimens. Plug the drainage holes and follow the drainage details and water space given in Fig. 1. This is important. Rot is the chief enemy of succulents. They cannot abide a wet, boggy soil.

After providing the required drainage, potting procedure is as shown in Figs. 1, 2, and 3. Thumb the soil down somewhat firmly as in Fig. 2, but avoid packing it too hard. Loose soil in pots brings about a boggy condition. After potting, fill water spaces one-third full. Most succulents thrive without repotting or without new soil for about two years. They may be repotted at any time except when in bloom. Late fall and winter is the dormant season, though some plants may continue to grow. Do not attempt to force these resting plants into active growth by over-watering. To do so is to invite rot. Give the soil of the resting plants a slight dampening—water space one-third full—every week or ten days. Fill water spaces of growing plants every ten days or two weeks. No hard and fast rule for watering can be laid down. Size of pots, room temperature and humidity all have a bearing on the intervals of watering. Soil in glazed or decorated pots will remain damp for several days, whereas soil in common clay pots will evaporate its moisture through the pot walls in about 24 hours. This does

not mean you should apply water every day, for succulents can absorb water from soil that appears bone dry. Should a plant droop, or, as succulents are more likely to do, shrink slightly, water thoroughly.

In late February dormant plants will begin to wake up. From now on do not allow the soil to dry out, but at the same time do not overwater. Remember that while the top soil seems dry, that at lower levels may be sufficiently damp. Choose, if possible, the morning of a sunny day for the watering routine, and always use water at

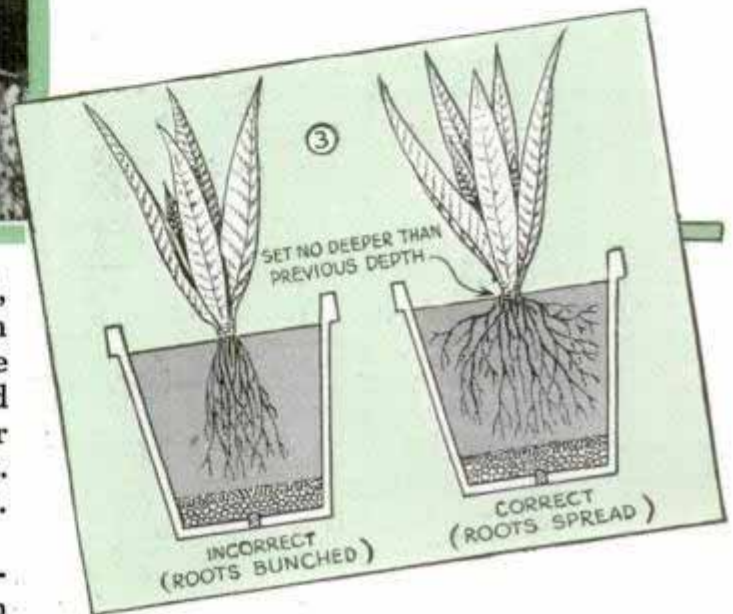

about living-room temperature. Avoid locating your plants over a hot-air register or radiator. They tolerate a wide range of humidity, but like all indoor plants dislike drafts, cannot stand freezing temperatures. A window in a cooler part of the home would, of course, be their choice, but is not essential; succulents thrive in temperatures higher than living-room average. If you locate your garden in an east window, a curtain is unnecessary. A south window radiates too much heat during early fall and spring, but such a location is ideal if a curtain of fine mesh hangs between the window and the plants. Although succulents occasionally send forth beautiful blooms, their charm lies in their foliage. Keep it clean. Once a month carry the plants to the bathtub and wash them carefully with mild warm soapsuds. Go over the stems and leaves, using the fingers or a small sponge instead of a rag. After washing a plant, spray off with lukewarm water.

X750 Tom-Thumb TRELLISES

improve indoor gardens.

THESE tiny trellises add the atmosphere of an outdoor garden to groups of potted plants kept indoors during the winter months. Wire, a few large corks, small dowels or skewers and several strips of pine are all the materials you need to make up the ones shown below. In any case they should not be too large but should be kept in proportion to the size of the pots and plants. Although trellises usually look best painted white, other colors or combinations may be used.

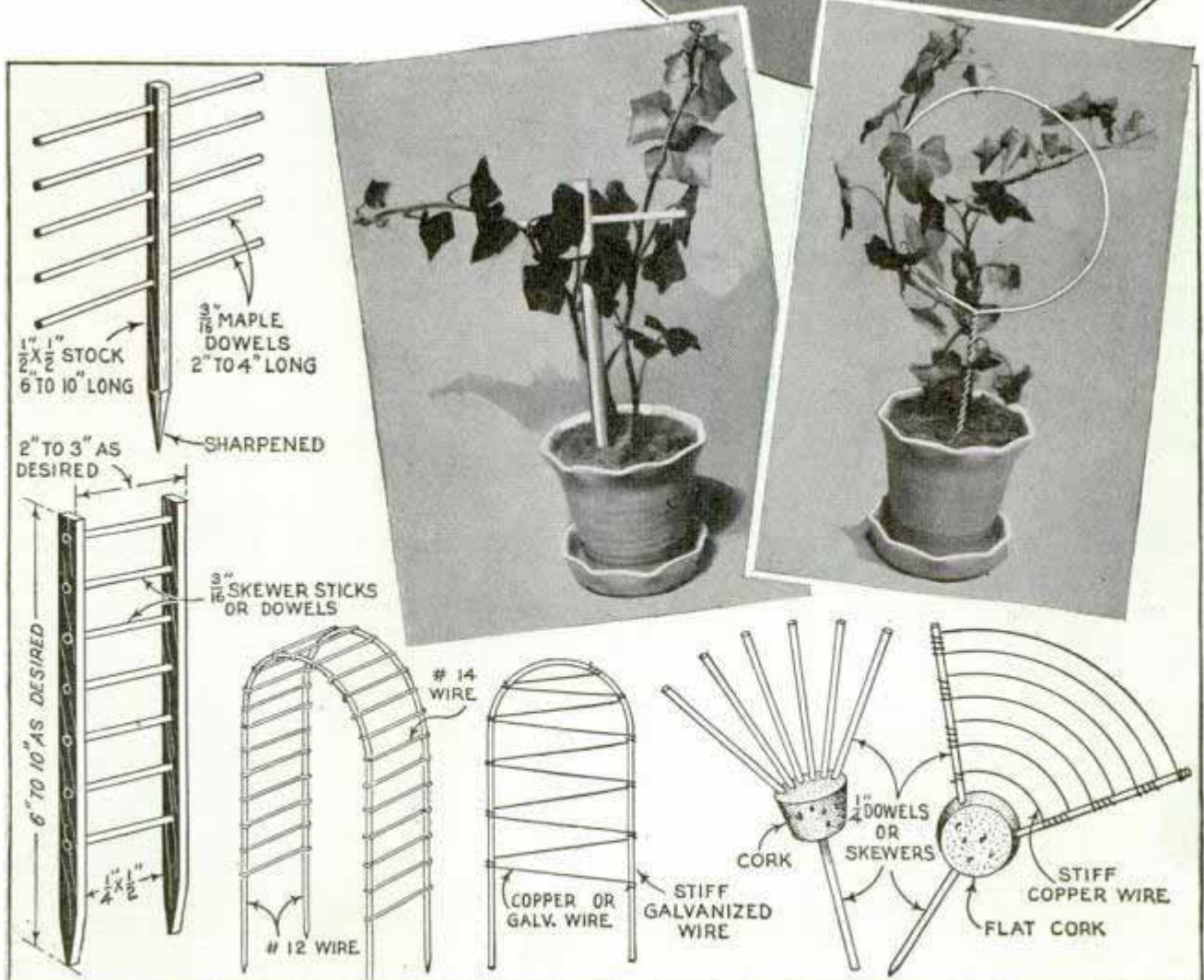

Scrub Brush Is Handy Stroker for Long Belt Sander

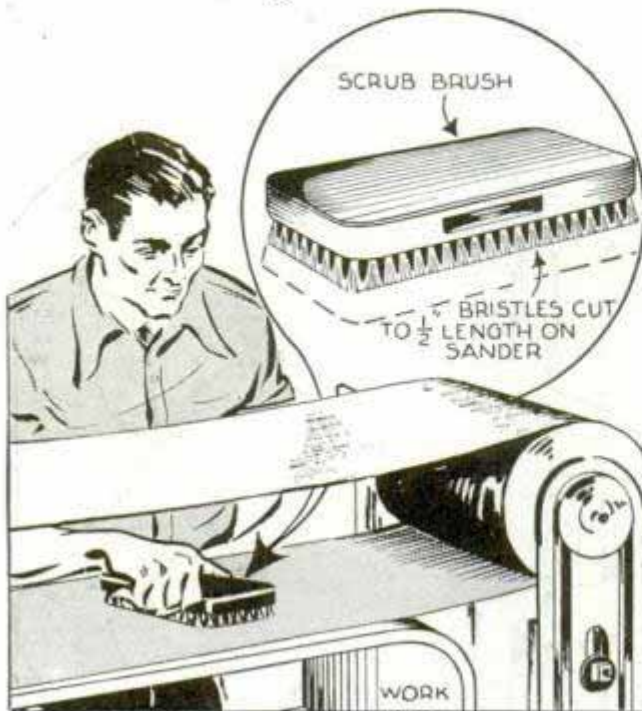

Easy handling and minimum wear on a sanding belt are the features of this simple stroker, which is nothing more than a scrub brush. The bristles are cut to a length of $\frac{1}{2}$ in. by holding them against the abrasive side of the moving belt.

Rubber Around Umbrella Handle Prevents Slipping

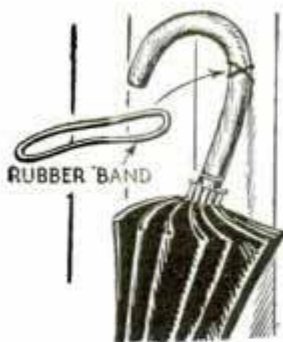

The tendency of umbrellas to fall when leaned against smooth surfaces may be overcome by twisting a rubber band around the handle. Friction will tend to hold the umbrella in place.

Old Brake Rods Truss Ladder

Having a long ladder in which the rungs loosened so that it tended to sway sideways, I trussed it with lengths of brake rods and turnbuckles as shown.

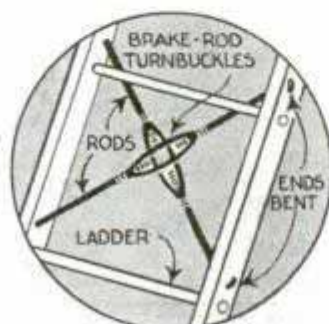

The ends of the rods were run through holes drilled in the ladder sides and bent over to keep them from pulling out. Then the turnbuckles were tightened.

—A. H. Waychoff, Phoenix, Ariz.

Sandpaper Washers Keep Knobs Tight on Drawers

To prevent wooden knobs of cupboards or dresser drawers from loosening, cut twin washers from medium sandpaper as indicated, fold them in the center and slip them over the knob bolt or screw. When the knob is tightened against the washers, the abrasive surface will hold it securely.

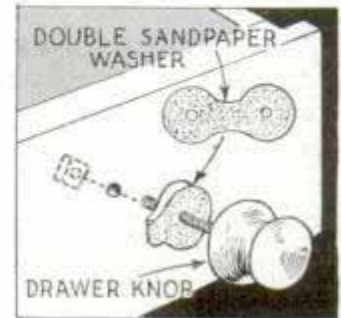

Scratch-Pad Binder Holds Sheets and Permits Easy Tearing

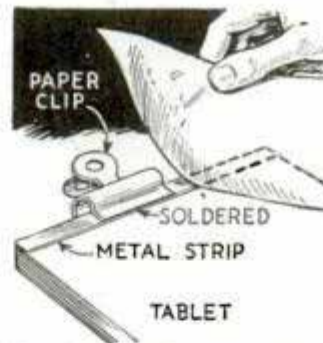

If you have some odd pieces of stationery on hand and would like to make them into a scratch pad, a strip of metal soldered to one jaw of a spring paper clip makes a good binder. This not only provides a means of holding the pages together, but the metal strip serves as an excellent tearing surface.

This not only provides a means of holding the pages together, but the metal strip serves as an excellent tearing surface.

Key Held in Lock by Metal Strip

Of the many methods of preventing a key from being pushed out of a lock so that a skeleton key can be inserted to enter from outside, the method shown is one of the most effective. A strip of thin steel is bent to a U-shape at one end, given a half twist and inserted into the lock as indicated.

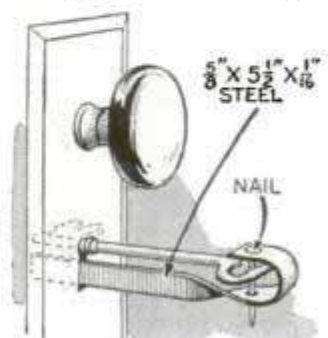

A strip of thin steel is bent to a U-shape at one end, given a half twist and inserted into the lock as indicated.

Animated Squirrel Toy Performs Realistically

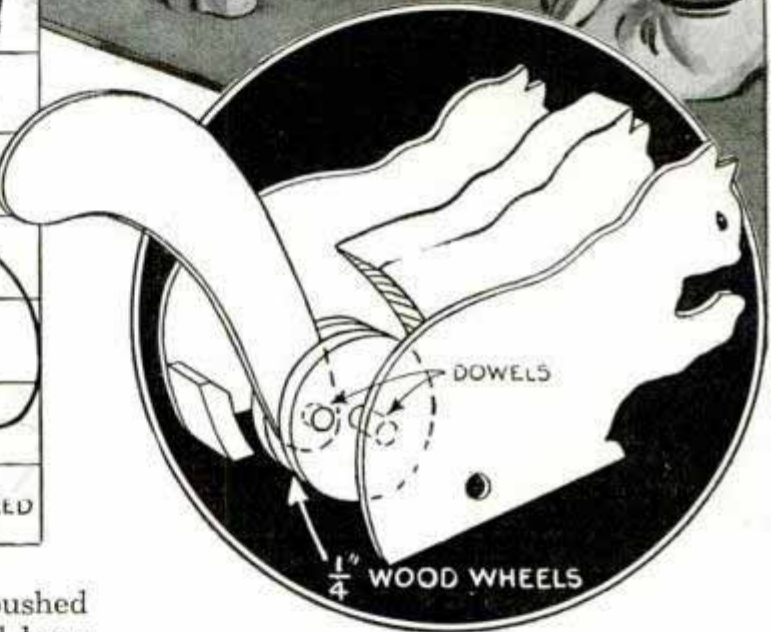
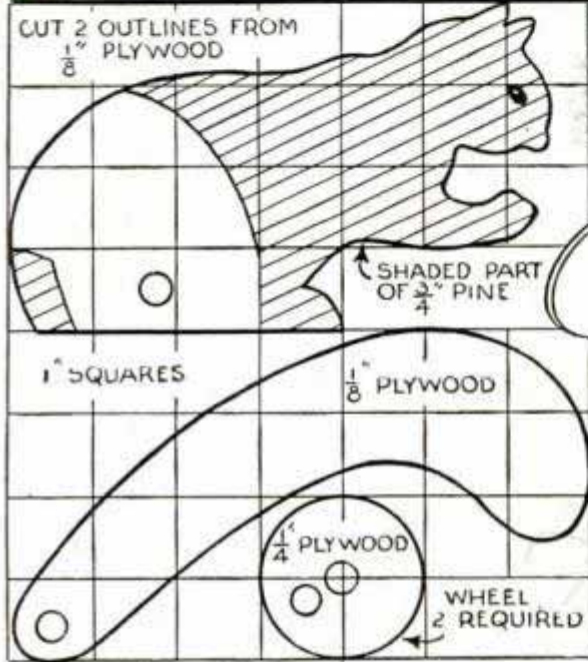

Merrily flipping its tail as it is pushed over the floor, this squirrel toy will be a prized possession of your small child. The two sides are cut from thin wood and are glued to a spacing block shaped and cut out, as indicated in the squared detail, to accommodate the tail-actuating mechanism. This consists of two wooden wheels

or disks having the tail piece pivoted slightly off center between them. Short dowels glued into the centers of the wheels project through holes in the side pieces to serve as an axle.

—Hazel F. Showalter, Davenport, Nebr.

Rotary Mercury Switch for the Experimenter's Workbench

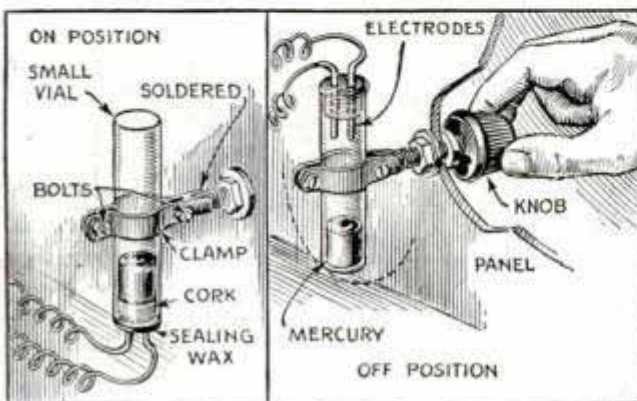

An electric switch of the rotary type that is suitable for use on currents up to 110 volts can be made from a small glass vial as indicated. The switch must be connected with flexible lead wires so that it can be turned easily.

—Neil H. McKay, Jr., Fontana, Calif.

Ⓞ Much time will be saved if you put cheese, that is to be grated, through the food chopper, using a fine cutter.

"WHIZZ" a Fast

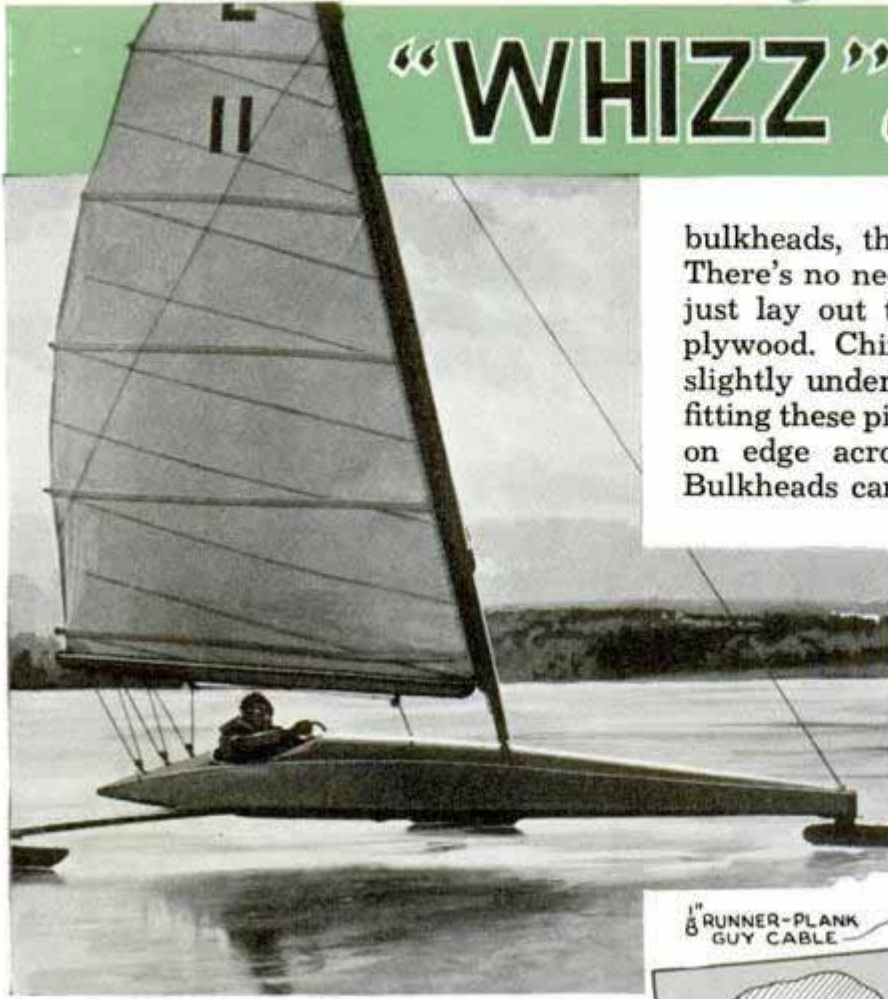

bulkheads, the smaller ones are made. There's no need to make paper patterns—just lay out the outlines directly on the plywood. Chine and sheer notches are cut slightly undersize and finished later when fitting these pieces. Place a 2 by 4-in. plank on edge across a couple of sawhorses. Bulkheads can be fastened temporarily to

IN BUILDING this ice yacht, you start by carefully going over the drawings to get acquainted with all constructional details. The six bulkheads, dimensioned in Fig. 5, are cut out of a $\frac{5}{8}$ by 24 by 72-in. panel of fir plywood. Centers of all bulkheads except No. 4 are cut out and from the cutout stock of the larger

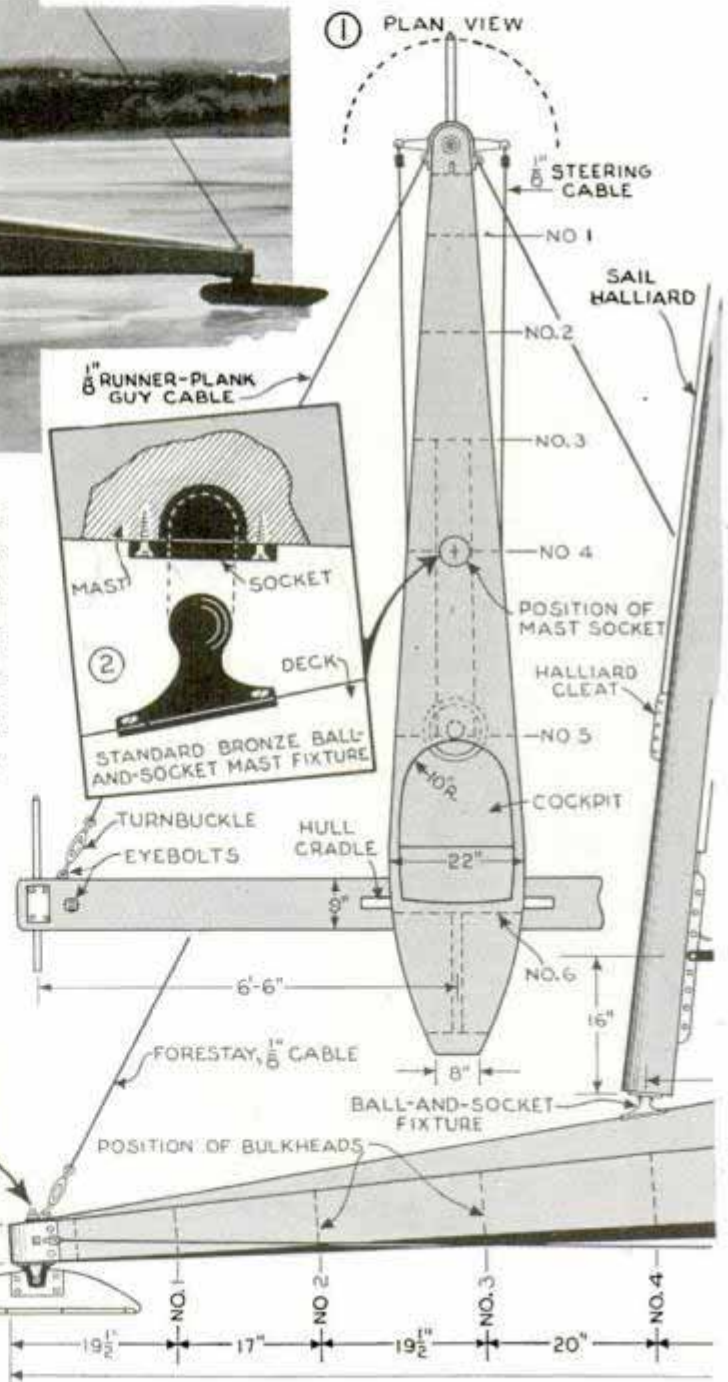
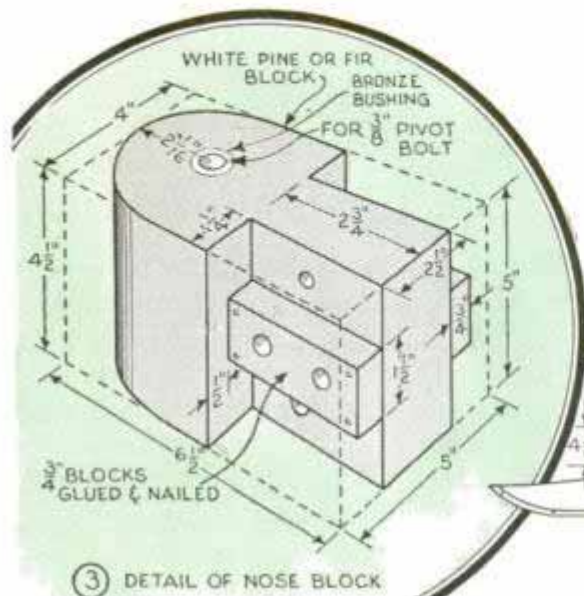

Class-E ICE YACHT..

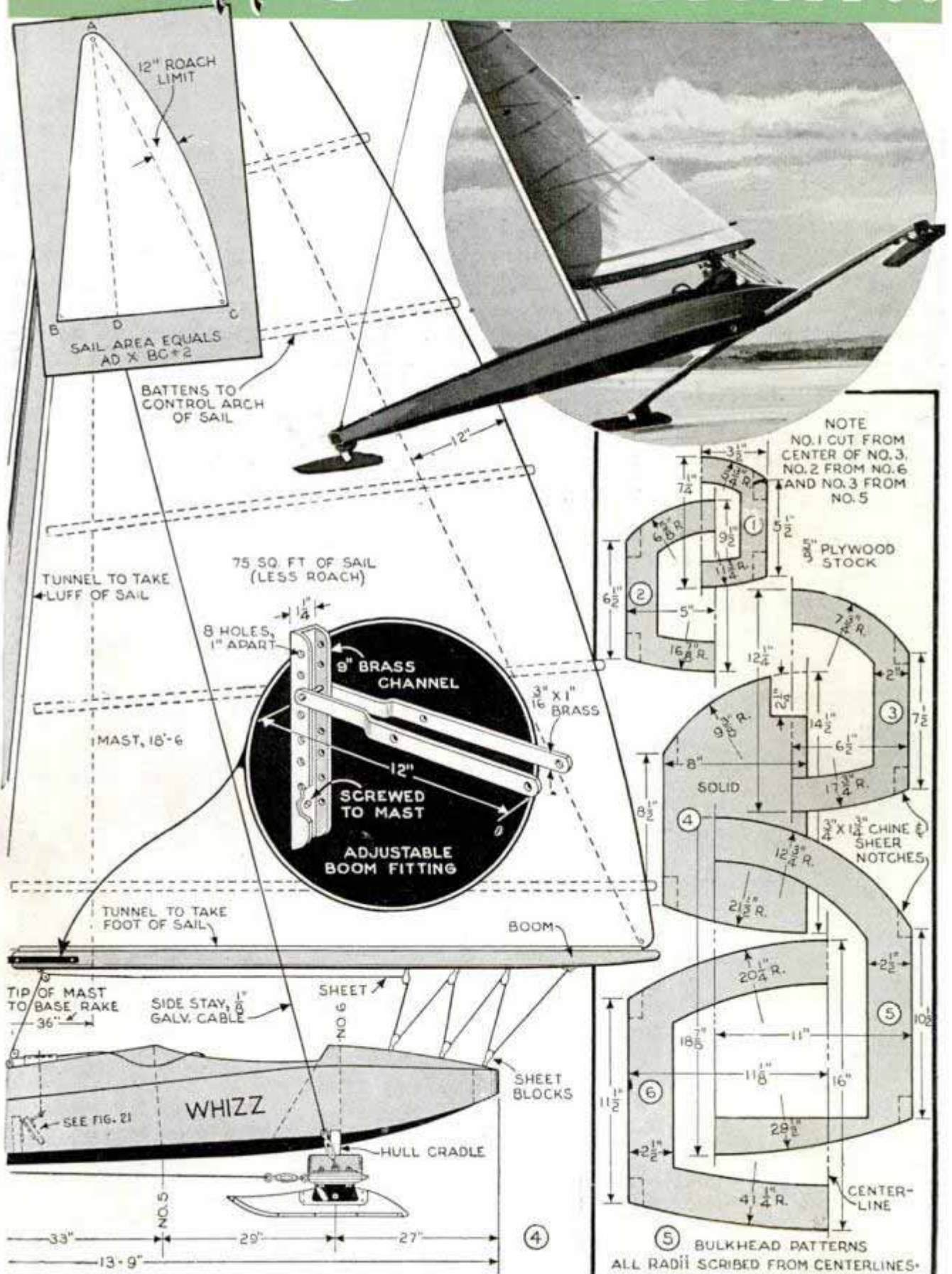

this plank while assembling the hull framework. Center-to-center spacing of the bulkheads is given in the side view, Fig. 4. Begin assembling by fastening the nose block, Fig. 3, to the plank with a lag screw inserted through the pivot hole. Then toenail bulkhead No. 5 to the plank in its correct location, after which a light straightedge is laid across the top of both nose block and bulkhead to determine the bevel to which the outer edges of the bulkhead should be cut in order to conform to the longitudinal taper of the hull.

After locating and beveling the intervening bulkheads, the chine and sheer battens of $\frac{3}{4}$ by $1\frac{3}{4}$ -in. spruce are fitted, casein-glued and screwed in the nose-block rabbets and bulkhead notches, using No. 10, $1\frac{1}{2}$ -in. f.h. brass or galvanized screws. Allow the sheer and chine pieces to extend all the way back. Next, the oak mast support is glued and screwed in place. The top edge of this piece is crowned slightly to conform to deck contour. Framework is continued aft. A 1-in. oak cleat, glued and screwed to the lower face of bulkhead No. 6, is bored to take two carriage bolts as shown in Fig. 10. Unlike the others, this bulkhead is not fastened directly to the plank, but is supported tem-

porarily about $1\frac{1}{2}$ in. above the top edge of the plank to maintain the sweep of the hull. The natural curve of the battens when fastened at this point will bring the bulkhead in true position. After fastening the tail block in place, a $\frac{3}{4}$ -in. center brace is fitted between the bulkhead and tail block.

Now for the side planking: The shaded portion of the pattern in Fig. 9 represents the shape of the side planking 39 in. from the tail of the hull, the lines being straight from this point forward. The centerline of your paper pattern, which is made accordingly, is laid directly over a centerline struck on the planking and the curved outlines traced off. After the planking is cut to shape, first, temporarily fasten it in place to the battens for a test fit before permanently fastening with casein glue and No. 7 1-in. brass screws, spaced about 4 in. apart. The batten edges should come about flush with the planking.

Before the deck and bottom covering are

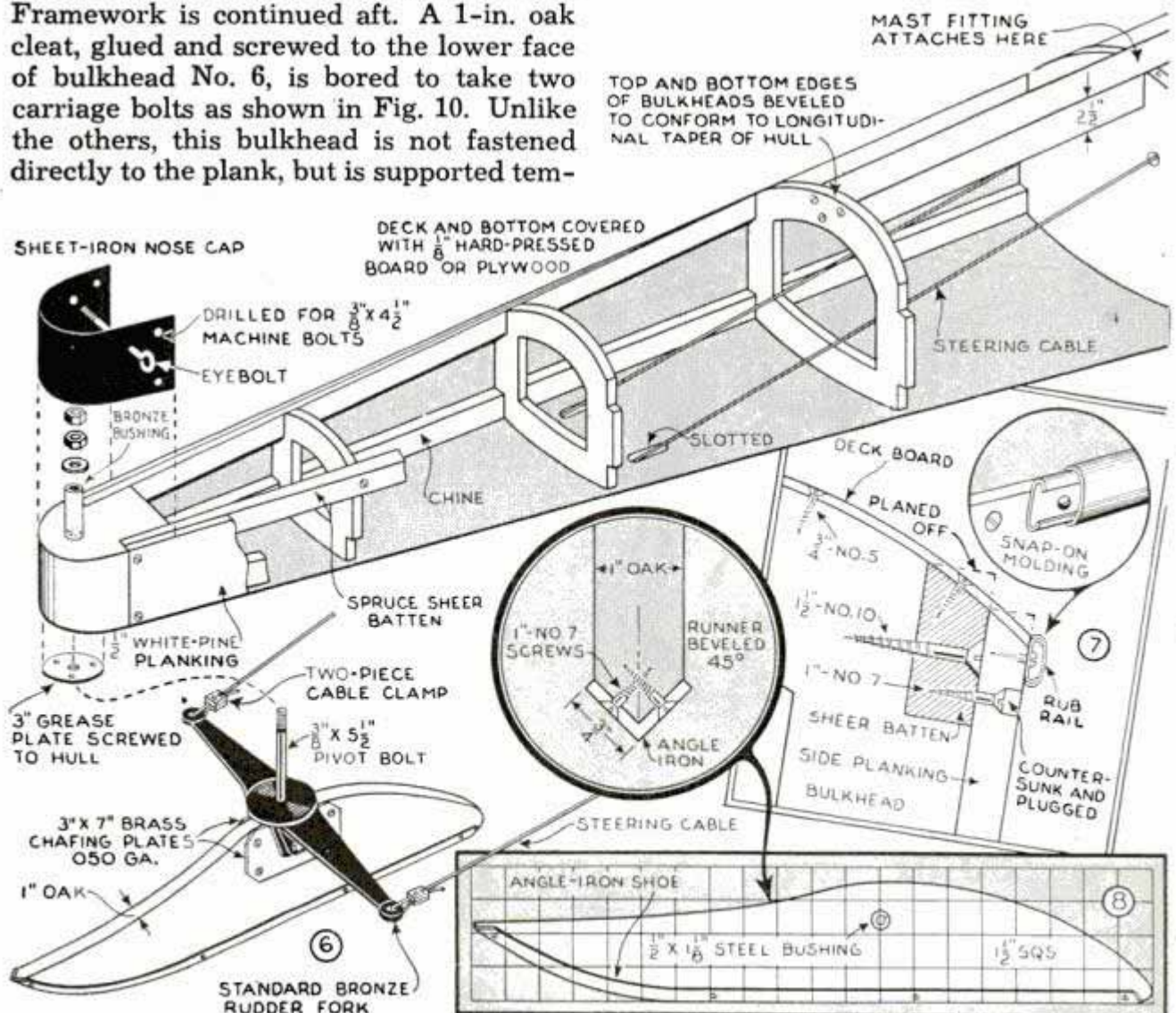

applied, the edges of battens and planking must be planed off so that they will be flush and on the same angle as the bulkheads. See Fig. 7. Also, the cockpit floor and back are fitted. And, don't forget the bolts in the cleat on bulkhead No. 6, nor the counterbored hole for the steering-wheel pivot bolt. Paper patterns of the deck and bottom to guide in cutting the hard-pressed board can be made by laying

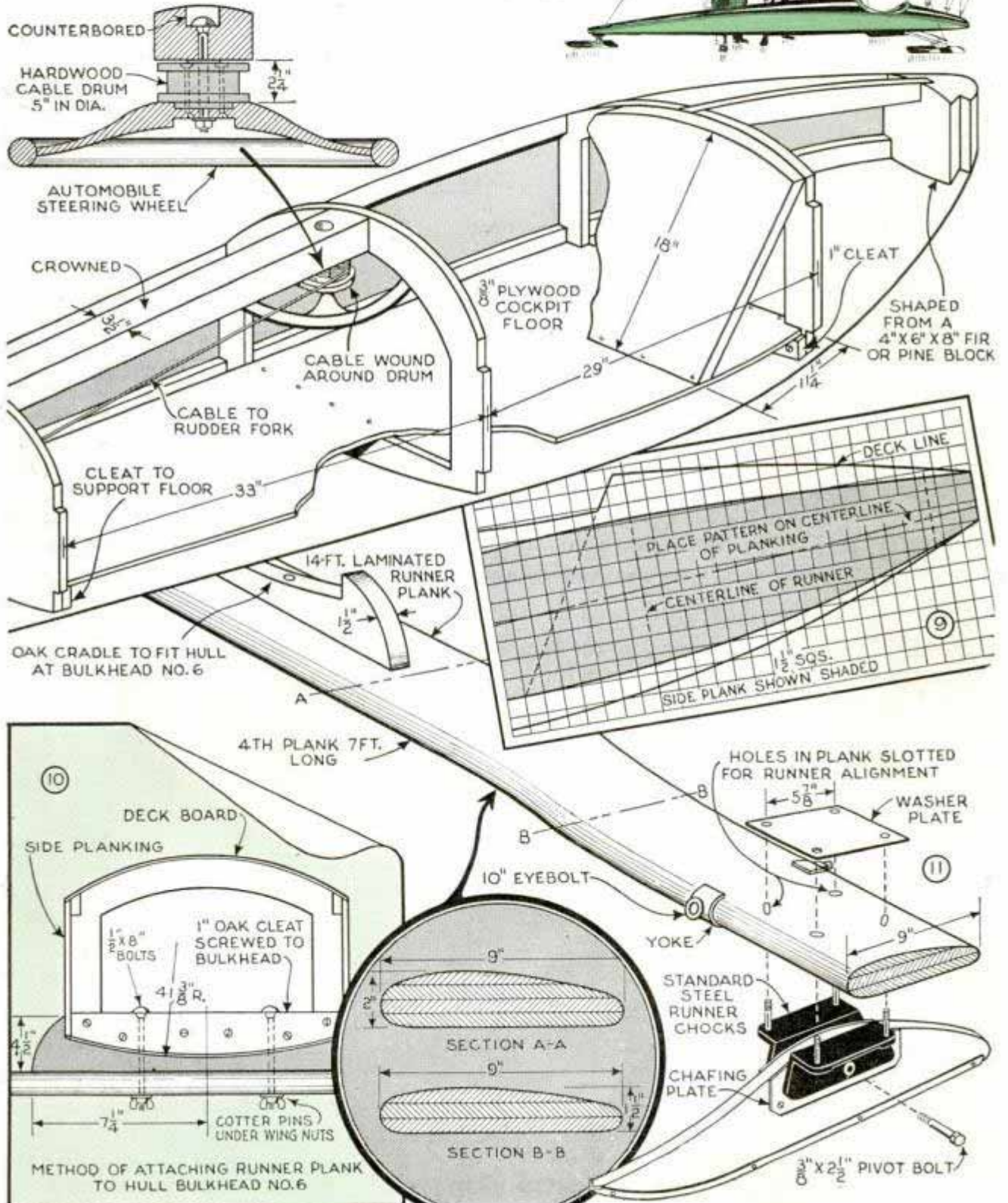

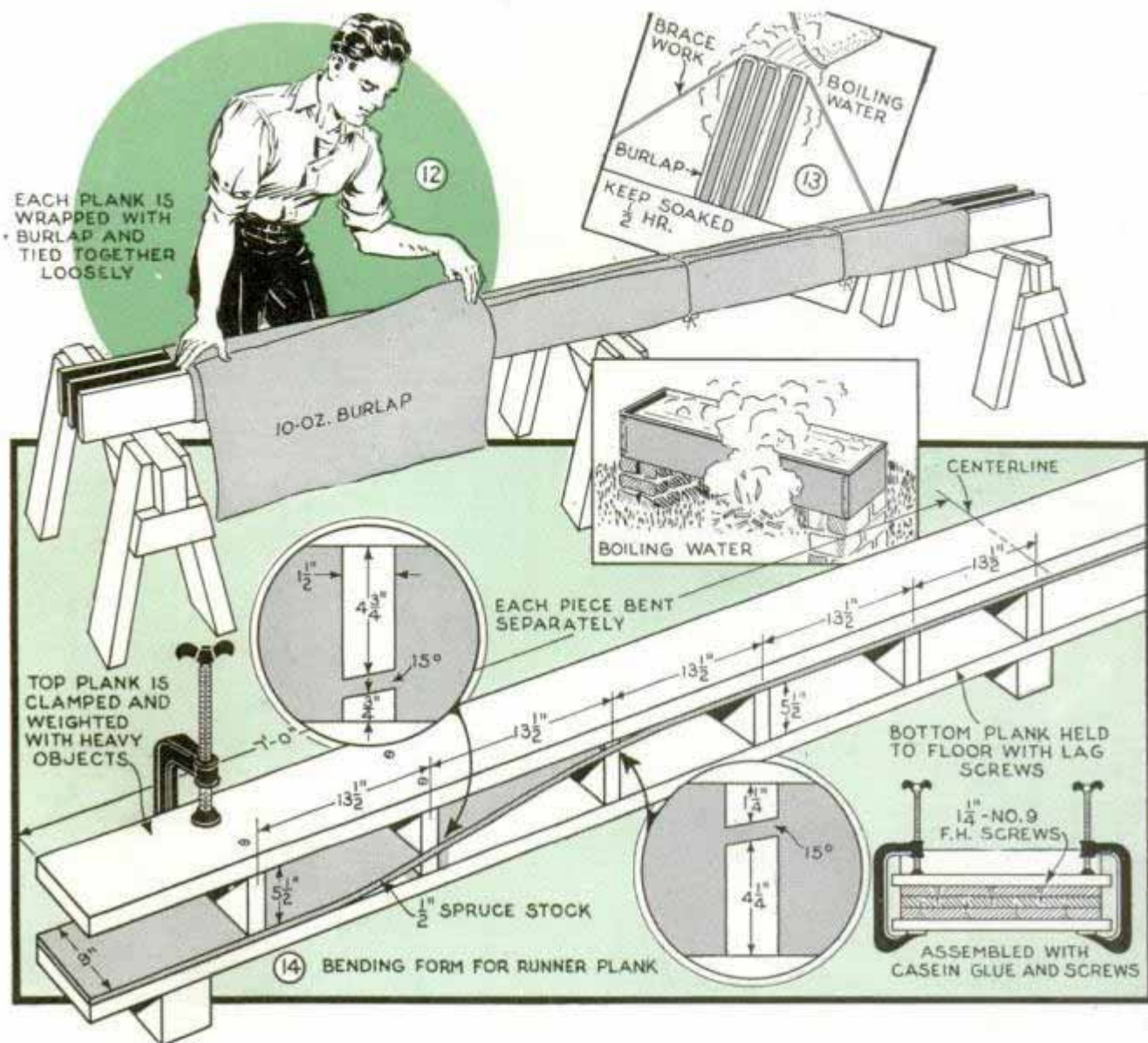

large sheets of heavy wrapping paper over the framework, fastening it here and there with thumbtacks. Use No. 5, 3/4-in. brass screws spaced 3 in. apart for fastening the covering. After trimming the edges flush with the side planking, a 1/2-in. standard rub-rail molding is attached over the joint.

The runner plank, Fig. 11, comes next. It is built up from four pieces of 1/2-in. spruce to give spring action. Figs. 12, 13 and 14 show how the pieces are wrapped loosely with burlap and steamed before being clamped separately in a wooden form until thoroughly dry. When each piece has been bent, the three upper planks are glued, clamped and screwed solidly together with No. 8, 1 1/4-in. brass screws, after which a fourth auxiliary plank, 7 ft. long, is screwed to the bottom side at the center. The complete assembly is then shaped as shown in the sectional detail of Fig. 11. For ease in transportation the run-

ner plank is made quickly detachable from the hull by means of an oak cradle cut and bored to receive the two projecting bolts at bulkhead No. 6, as in Fig. 10. Cotter pins through the bolts prevent the wing nuts from working off. The runners, cut and shaped from 1-in. oak as in Fig. 8, are pivoted in standard runner chocks, shown in Figs. 6 and 11. The bronze rudder fork, Fig. 6, bears on a 3-in. grease plate screwed to the bottom of the hull. Rear runner chocks are bolted to the runner plank in slotted holes to permit runner alignment. The 1/8-in. galvanized side stays stretched from eyebolts fitted through the edge of the runner plank and nose block are fastened with small cable clamps and drawn taut with turnbuckles, as in Fig. 1.

Choice of two types of mast and boom construction is given in Figs. 15 to 20 inclusive. The one in Fig. 17 is simpler than the Swedish type of mast shown in Fig. 19.

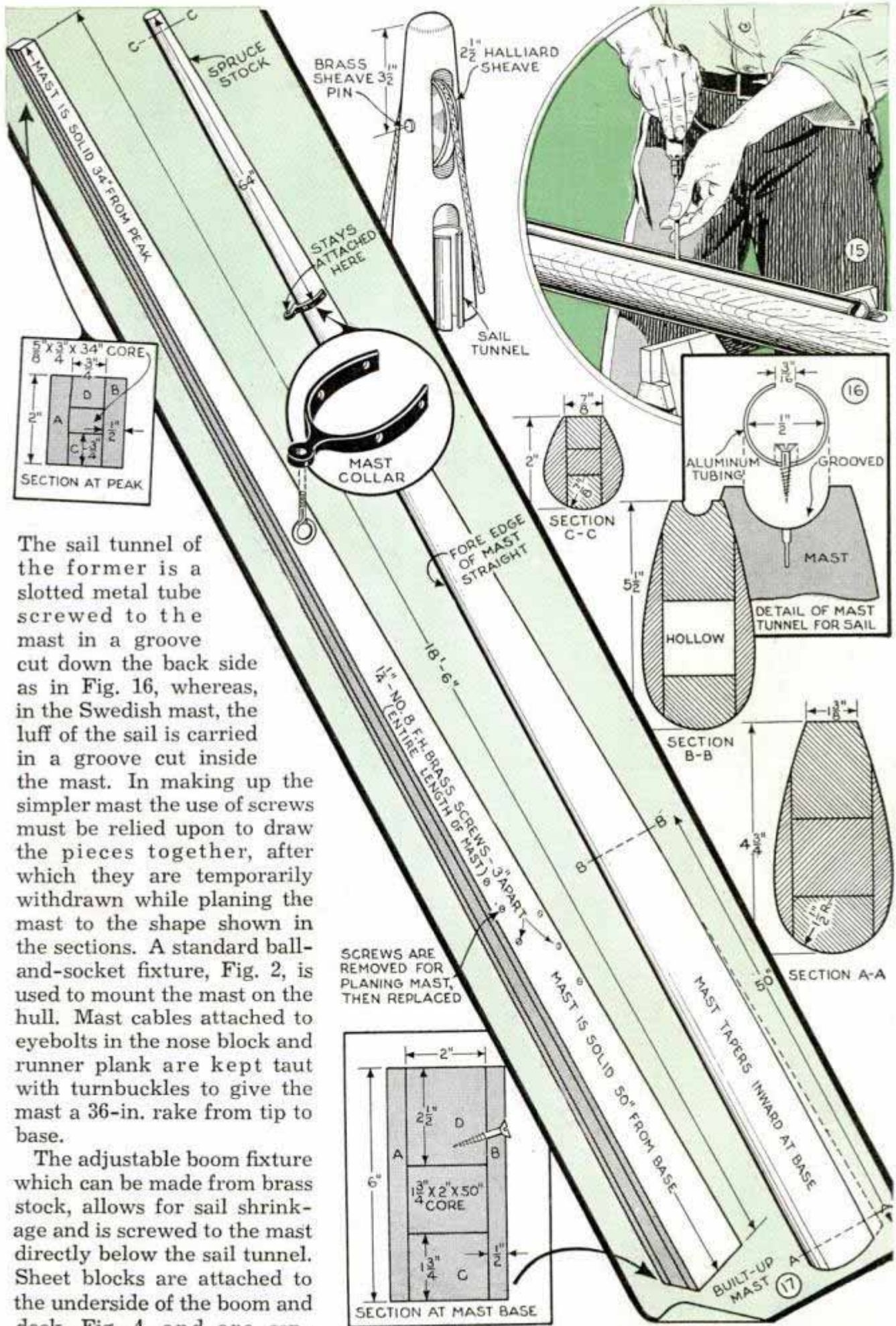

The sail tunnel of the former is a slotted metal tube screwed to the mast in a groove cut down the back side as in Fig. 16, whereas, in the Swedish mast, the luff of the sail is carried in a groove cut inside the mast. In making up the simpler mast the use of screws must be relied upon to draw the pieces together, after which they are temporarily withdrawn while planing the mast to the shape shown in the sections. A standard ball-and-socket fixture, Fig. 2, is used to mount the mast on the hull. Mast cables attached to eyebolts in the nose block and runner plank are kept taut with turnbuckles to give the mast a 36-in. rake from tip to base.

The adjustable boom fixture which can be made from brass stock, allows for sail shrinkage and is screwed to the mast directly below the sail tunnel. Sheet blocks are attached to the underside of the boom and deck, Fig. 4, and are con-

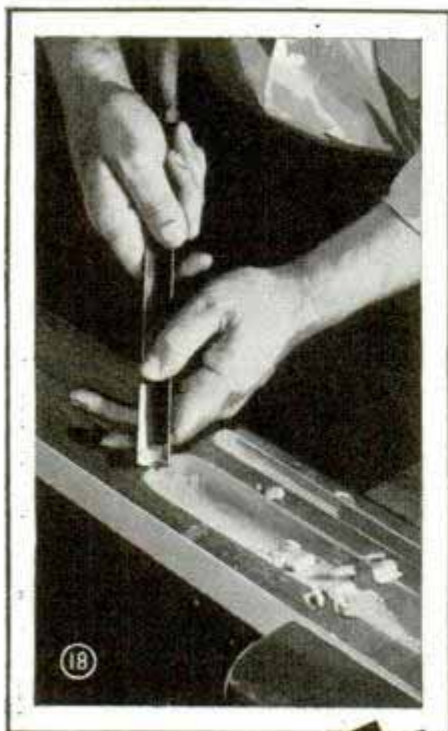

- LUMBER REQUIREMENTS**
- 1 pc. Fir plywood 5/8 x 24 x 72 in.—Bulkheads
 - 1 pc. Fir 5 x 5 x 7 in.—Nose block
 - 1 pc. Fir 4 x 6 x 8 in.—End block
 - 4 pcs. Spruce 3/4 x 1 3/4 in. x 14 ft.—Sheer and chine battens
 - 2 pcs. White pine 1/2 x 11 3/4 in. x 14 ft.—Side planking
 - 1 pc. Hard-pressed board or plywood 1/8 x 30 in. x 14 ft.—Deck board
 - 1 pc. Hard-pressed board or plywood 1/8 x 24 in. x 14 ft.—Bottom
 - 1 pc. Oak 2 1/2 x 3 1/2 x 36 in.—Mast support
 - 1 pc. Fir plywood 5/8 x 20 x 24 in.—Seat back
 - 1 pc. Fir plywood 3/8 x 24 in. x 6 ft.—Cockpit floor
 - 1 pc. Oak 1 x 3 x 40 in.—Floor cleats
 - 1 pc. White pine 3/4 x 3 x 30 in.—Deck brace
 - 1 pc. Oak 1 x 5 x 16 in.—Hull cradle
 - 1 pc. Oak 2 1/2 x 6 x 6 in.—Cable drum
 - 3 pcs. Spruce 1/2 x 9 in. x 14 ft.—Runner plank
 - 1 pc. Spruce 1/2 x 9 in. x 7 ft.—Runner plank
 - 1 pc. Oak 1 x 6 in. x 8 ft.—Runners
- Mast and Boom (built-up type)**
- 2 pcs. Spruce 1/2 x 6 in. x 18 1/2 ft.—Sides
 - 2 pcs. Spruce 2 x 2 1/2 in. x 18 1/2 ft.—Filler strips
 - 2 pcs. Spruce 1 3/4 x 2 in. x 18 1/2 ft.—Filler strips
 - 1 pc. Spruce 1 3/4 x 2 x 50 in.—Core strips
 - 1 pc. Spruce 1 x 1 x 36 in.—Core strips
 - 1 pc. Spruce 1 1/4 x 3 in. x 9 1/2 ft.—Boom
- Mast and Boom (Swedish type)**
- 2 pcs. Spruce 1 1/2 x 6 in. x 18 1/2 ft.—Mast
 - 2 pcs. Spruce 3/4 x 3 in. x 9 1/2 ft.—Boom

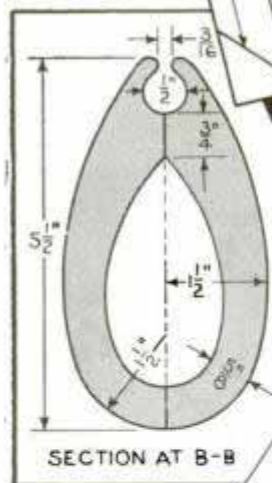
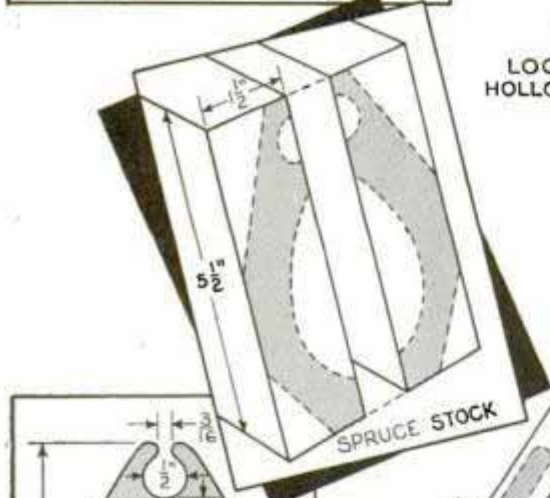

LOCATIONS OF HOLLOWED SECTIONS

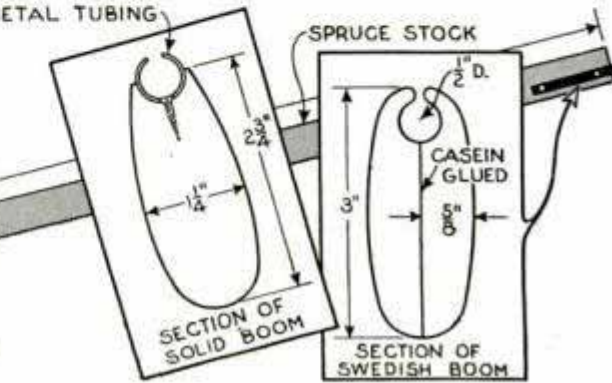
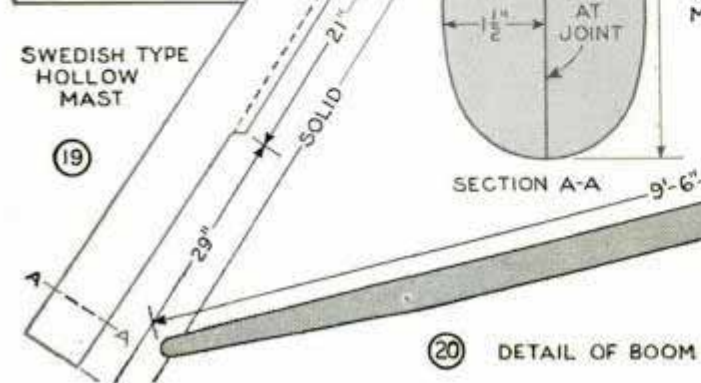

trolled by a pedal, Fig. 21, which eliminates holding the sheet continuously by hand. It is recommended that the sail be purchased from a dealer. The steering cables are fastened to the cross-piece on the front runner with cable clamps, and a turnbuckle should be installed at a convenient point so that the cable can be kept taut without the necessity of removing the cable clamps.

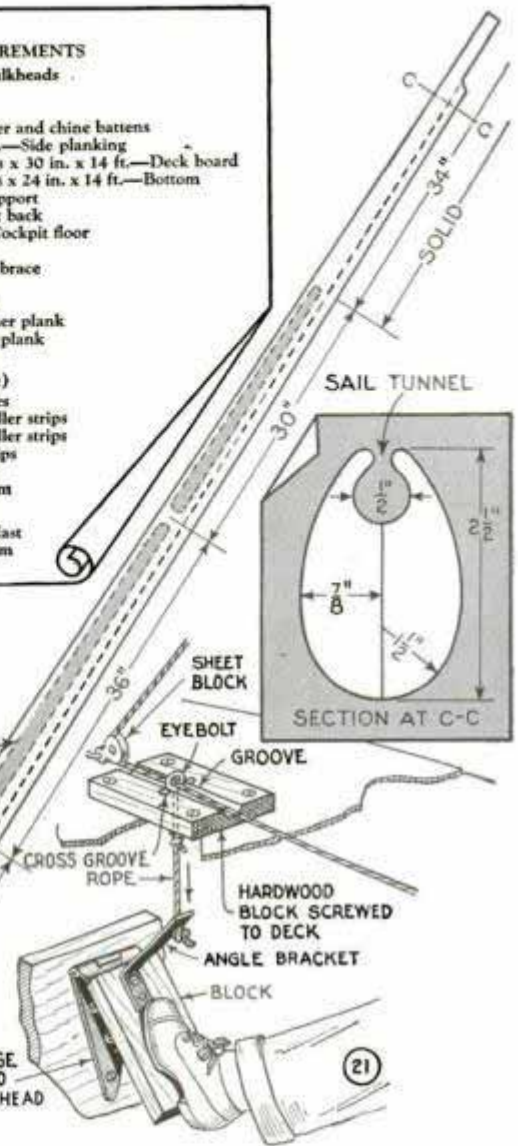

Cool Handle on "Mushroom" Photo Lamp

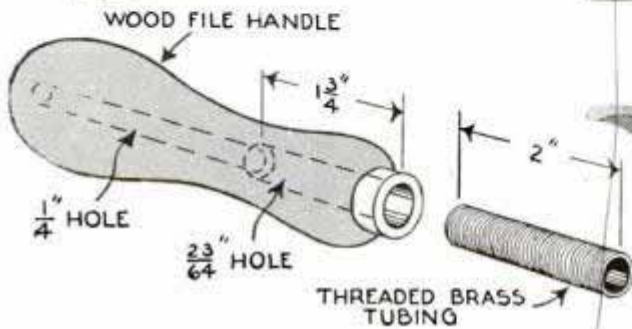
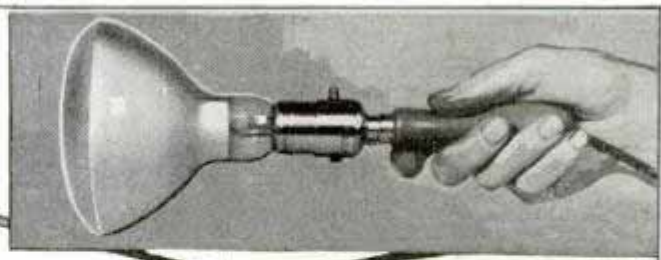
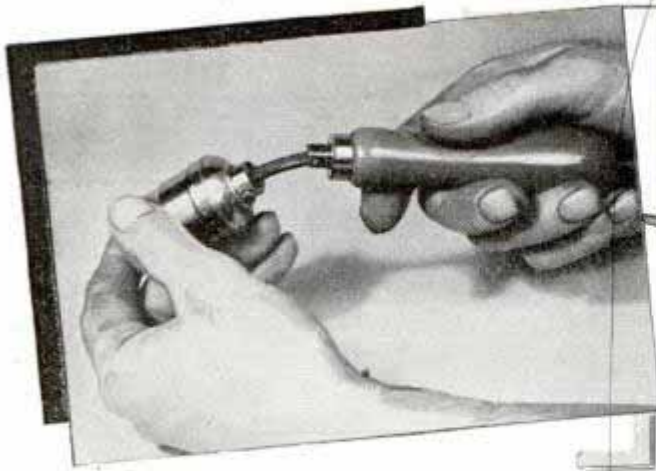

Photoflood lamps of the new R-2 type, in which the reflector and lamp are combined, cannot be held comfortably by the socket due to the heat. A cool holder on the socket can be provided by using a wooden file handle. A hole is drilled lengthwise through the center to take a threaded brass tube or a $\frac{1}{4}$ -in. pipe nipple, which can be purchased at a dime or hardware store. Turn the nipple into the

file handle to project about $\frac{1}{4}$ in. Then screw a push-switch socket onto the nipple, assemble the socket and connect a cord and plug through the handle.

Eyes Formed on Rods and Wire with Aid of an Old Gear

When you want to form an eye on a small rod or a piece of heavy wire, use an

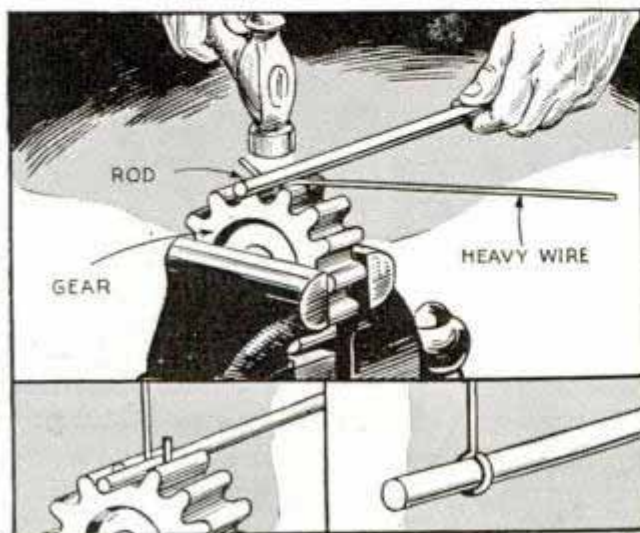

old gear clamped in a vise as a former. To shape the eye, lay the work across two teeth of the gear and force it down between them with an iron rod and a hammer as shown. This shapes part of the eye, which is completed by bending the projecting end of the work around the rod as in the lower left-hand detail. You can make chain links and do similar work in the same way. If you pick up several old gears having the teeth spaced differently, you can form eyes of various diameters.

☞ You will find that rectangular-shaped doilies provide a much wider space on your dining table for silver and glasses than the round or oval ones.

Safety Pin Keeps Thread Spool Close at Hand



When sewing large work such as quilts, a blanket pin is just the thing for keeping a spool of thread at hand. The pin is run through the spool and fastened to the work. This allows the spool to turn as thread is unwound, yet keeps the spool from rolling off on the floor.

Improved Lathe Gear Holder

Assembled from a piece of heavy sheet metal and a couple of bolts, this lathe gear holder will do away with the inconvenience of replacing the gears on a single spike, or serve as a space saver for the

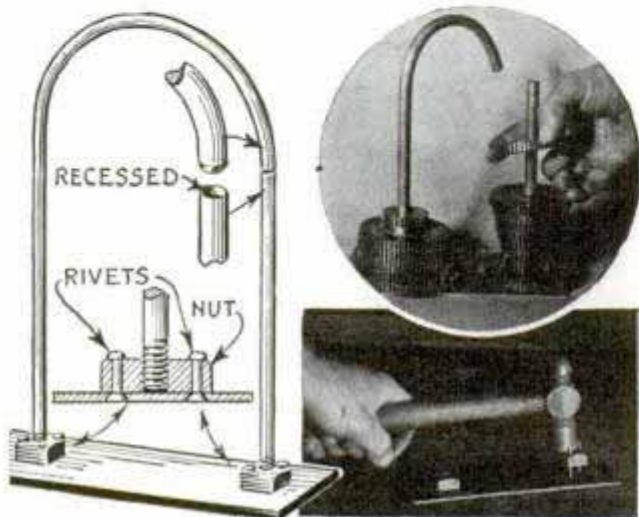

machinist who keeps his lathe gears on separate pegs. Two threaded nuts are riveted to a metal base, the dimensions of which vary according to the size and number of gears for which the holder is intended. One upright member is a headless bolt long enough to hold all of the gears and the other is a longer bolt bent into an arc as shown. The end of the short bolt is recessed and the long bolt is rounded to fit into it. In using the holder, you move the gears from side to side until the desired gear is reached, then swing the handle over and remove it.

Spring Locks Type in Galley

To keep type in position in a galley, one printer uses a length of clock spring. This is sprung into place so that the edges bear tightly against the galley sides. The spring is especially useful for locking the type in position for taking galley proofs and for storing.

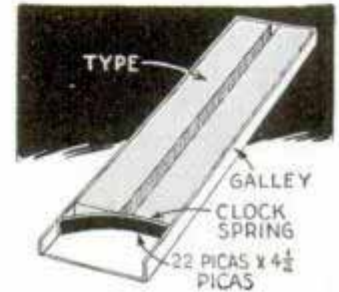

Tar Holds Work on Faceplate to Turn Rosettes

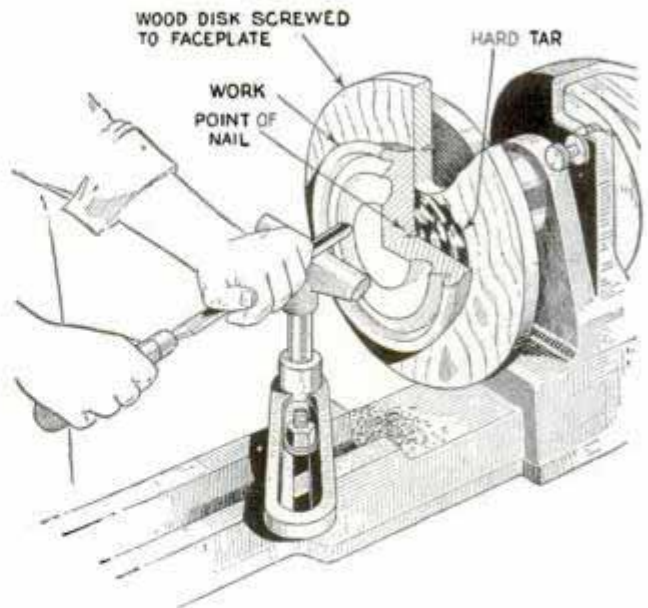

Stock for turning thin decorative pieces can be held on a lathe faceplate with tar. First screw a disk to the faceplate and put a point in the center for centering the work to be turned, making a small indentation

in the back of the work to take the point. Then start the lathe and hold a piece of hard tar against the disk. Heat caused by friction will soon soften the tar so that some adheres to the disk. Hold the work against the faceplate with the lathe still rotating for a few seconds and then let it go and it will stick tightly to the disk. After the turning has been done, the work can be separated from the disk with a chisel, which is tapped lightly with a hammer.

—L. Malecki, Chicago.

Portable "Kitchen" Made from Orange Crate

Living in a rooming house where there were no facilities for cooking, one girl made herself a portable "kitchenette" from nothing more than an empty orange crate and a wide board. The board was screwed to one end of the crate to serve as a table top on which were set an electric hot plate, toaster, coffee percolator, etc. An electric cord for plugging into a wall outlet was run through a fuse box on the side of the crate to a multiple outlet box on the table top for plugging the various accessories. Painting the top and covering the crate with cloth, with a curtain in front, completed the job. Dishes and silverware were stored on the shelves of the orange crate.

—H. Small, Kansas City, Mo.

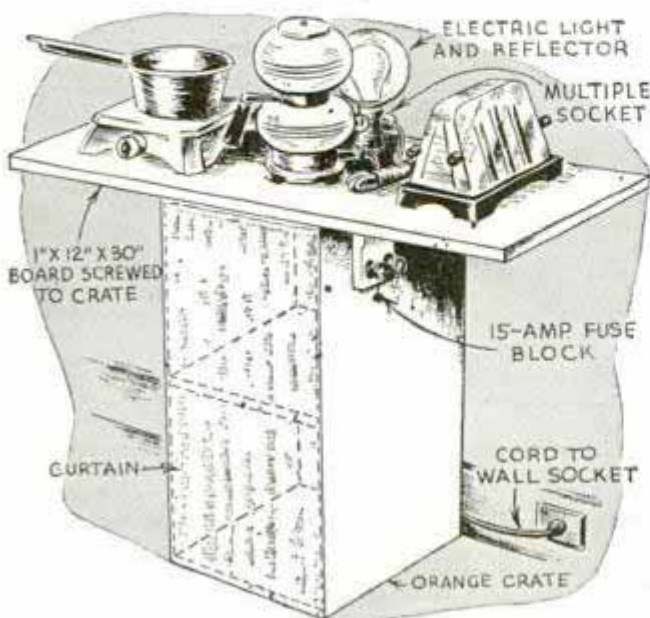

Ash Tray Clamped to Lamp Always at Hand When Reading



Regardless of how a room is decorated, one or more bridge or reading lamps are usually located near a comfortable chair or davenport, which is the ideal location for an ash tray. The one shown was turned from walnut, to take a glass tray, and clamped to the lamp standard by means of a wood bracket. After filling the pores of the wood with paste filler, apply two coats of good varnish, then rub down with oil and pumice.

Silencing Noisy Sink Drain

Sink drains that are noisy because of a long fall from the strainer to the water in the trap can be silenced by inserting a twisted strip of sheet aluminum into the drain as shown. The strip keeps the water from splashing in the trap and can be removed easily for cleaning.



☐ If your linoleum is soiled badly, a little kerosene added to the wash water loosens the dirt, and makes washing easier.

Solving HOME

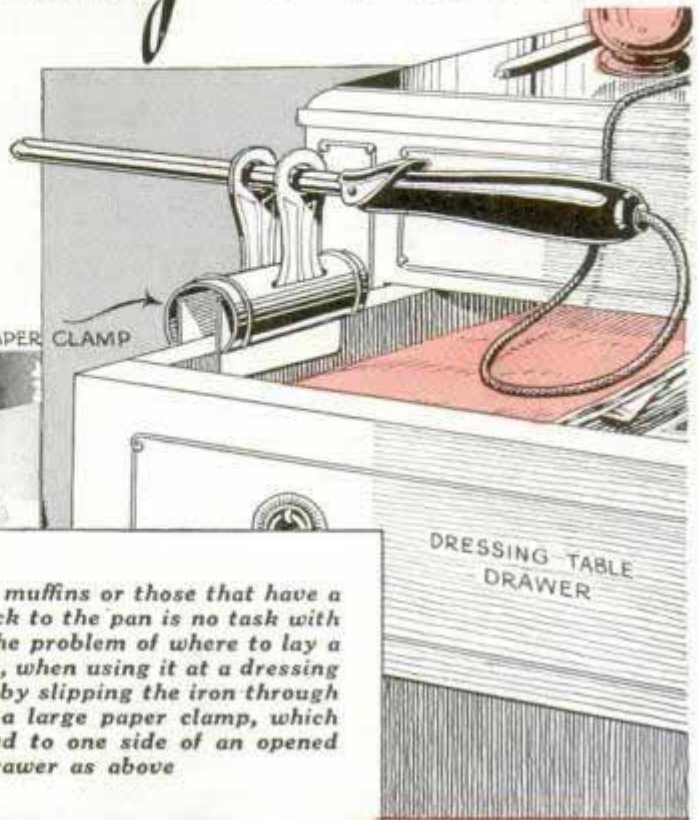

Removal of hot muffins or those that have a tendency to stick to the pan is no task with these tongs. The problem of where to lay a hot curling iron, when using it at a dressing table, is solved by slipping the iron through the handles of a large paper clamp, which has been clipped to one side of an opened drawer as above

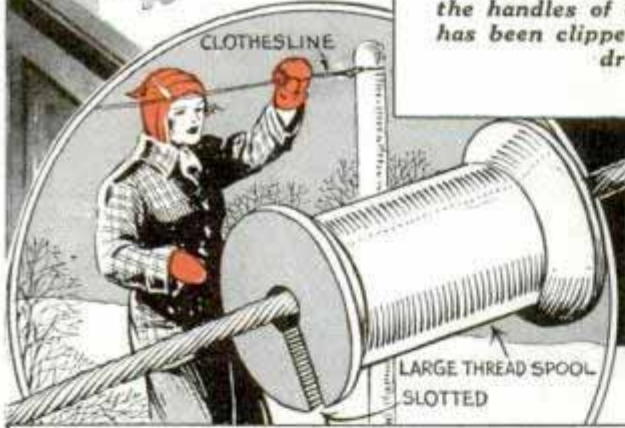

Cleaning ice from an outdoor wire clothesline in winter is easy if you use an empty thread spool slotted as above

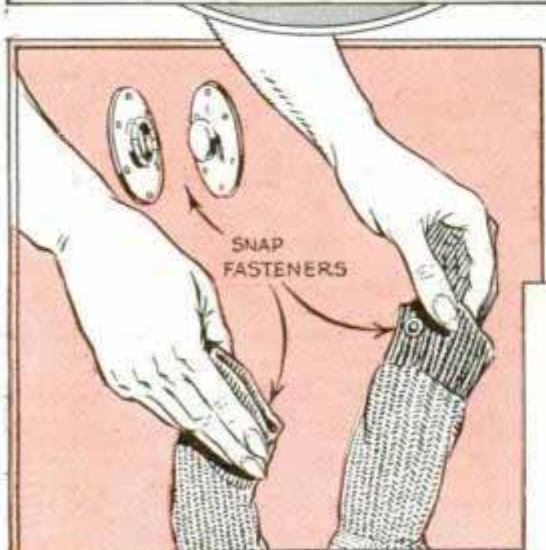
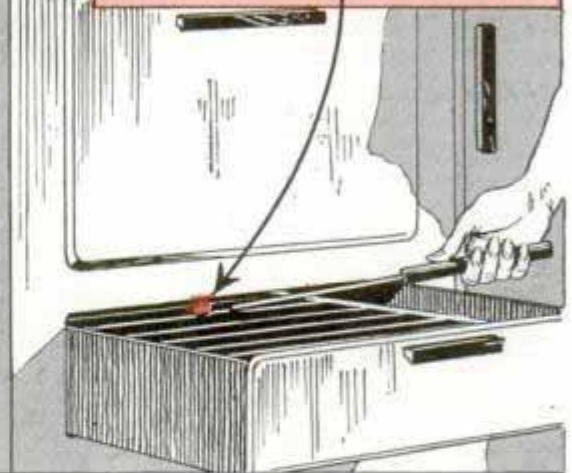
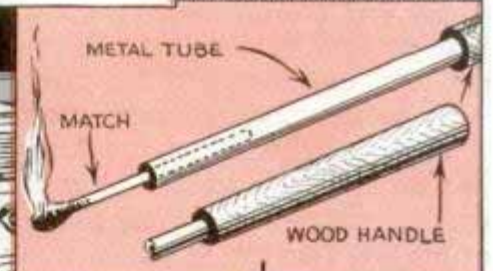

To keep children's stockings in pairs while washing and drying them, use snap fasteners. Sew half of a fastener to one stocking of each pair as at the left. This saves time in sorting after they have been laundered. A small metal tube to take a match snugly in one end, and a wood grip in the other end, is handy for lighting an oven of a gas stove. The tube keeps your fingers away from the flame

PROBLEMS

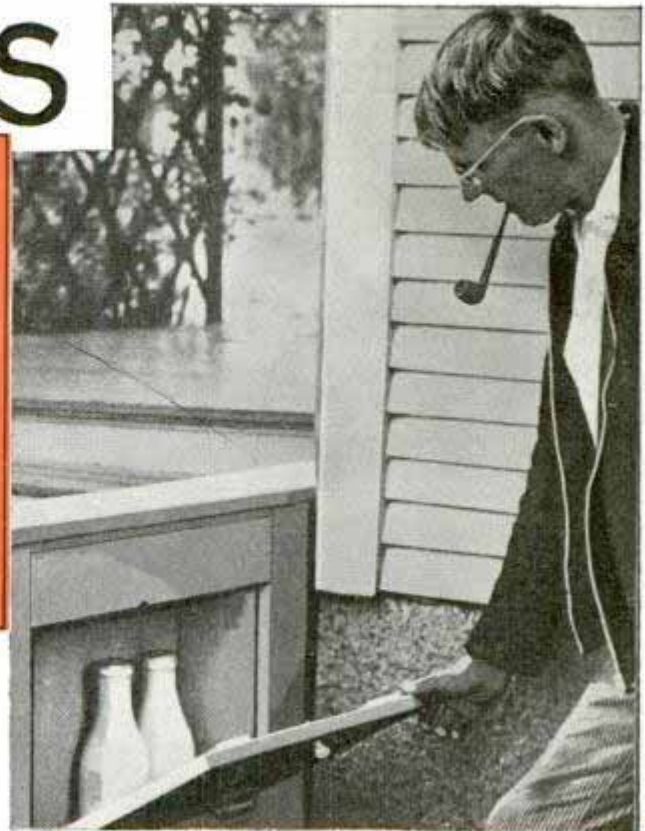
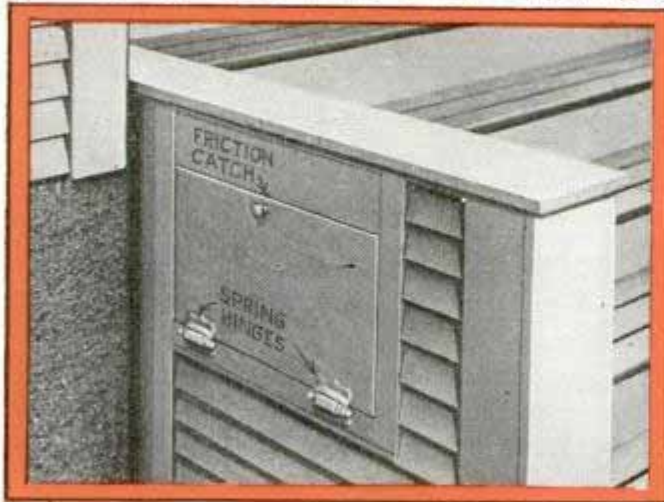

There is no worry about cats and dogs getting at your milk in the morning if you have a cabinet built into the porch steps as above. A door pivoted over the cabinet opening with spring hinges and fitted with a friction catch prevents the milkman from leaving it open

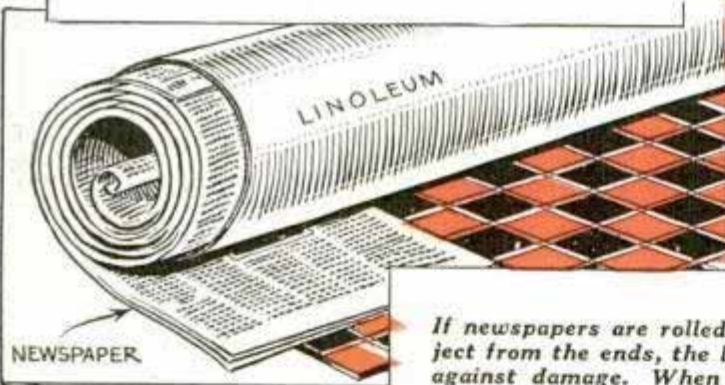

If newspapers are rolled with linoleum to project from the ends, the latter will be protected against damage. When the shut-off valve to your home water supply is hard to get at, use a pole with nails in the end to operate it as at the right

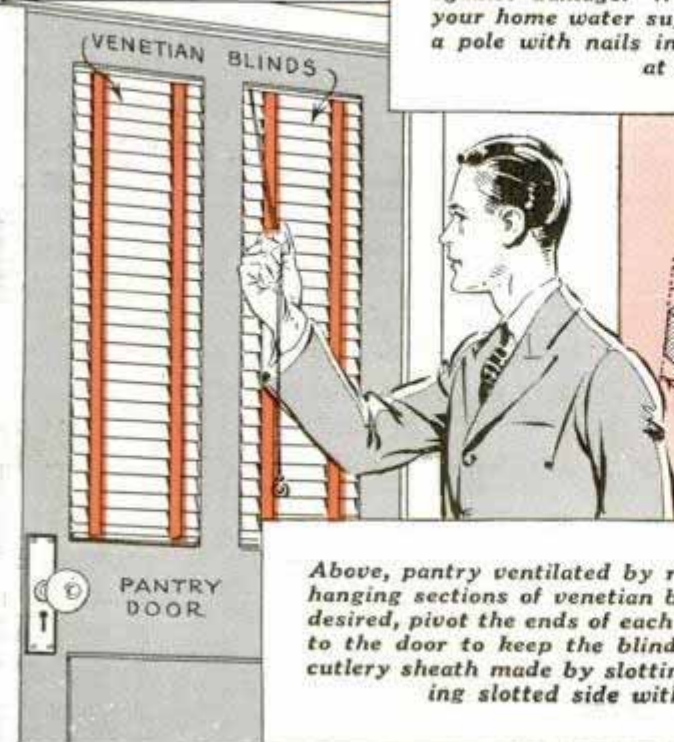
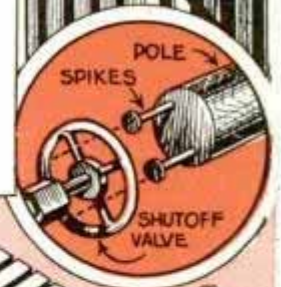

Above, pantry ventilated by removing door panels and hanging sections of venetian blinds in the openings. If desired, pivot the ends of each lower slat of the sections to the door to keep the blinds from swinging. Right, cutlery sheath made by slotting wood block and covering slotted side with thin plywood

Extra Binding Posts on Terminal of Small Transformer

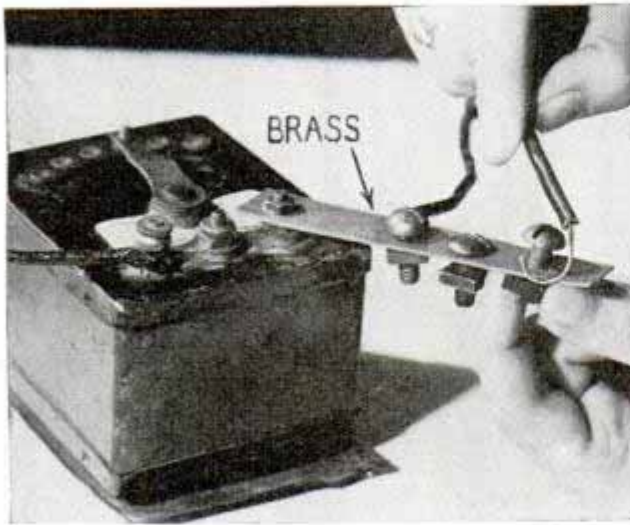

In experimental work where it is sometimes necessary to attach several wires to one binding post of a small transformer or

battery, drill several holes in a strip of brass and fasten it to the terminal. This will enable you to attach the wires individually with small bolts in the holes of the strip so that they can be connected or removed as desired without disturbing the others.—W. Dennis, Riverside, N. J.

Pocket Rule and Glass Tumbler Provide Emergency Graduate

A graduate for emergencies, especially for measuring comparative quantities of liquids, may be made by fastening a pocket ruler to the side of a glass tumbler with two rubber bands.

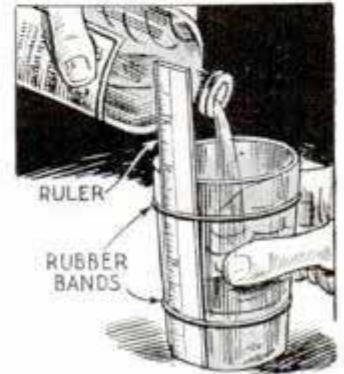

A Masterpiece in Ship Models

Do you want a model of one of the most outstanding warships in history? If so, build the "Sovereign of the Seas." Complete information on the construction of this ornately decorated, and highly picturesque model, 34 in. long and 26 in. high over all, is given in our blueprints 828 to 835 incl., priced at \$1.50 per set. Descriptive text in bound book, \$1.00 additional.

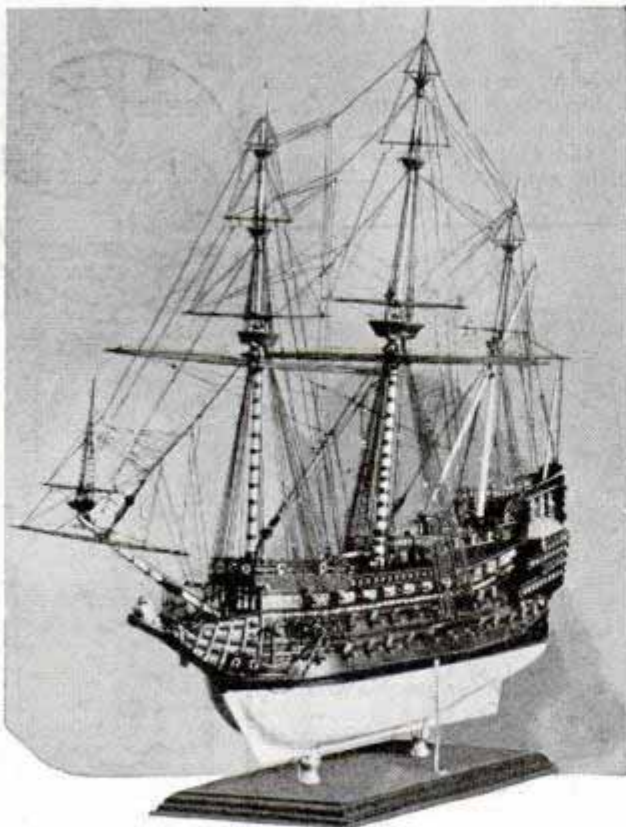

OTHER WORTH-WHILE MODELS

"Flying Cloud" Clipper Ship—709-714A: No collection is complete without a clipper. Complete with full-size lift templates—\$1.25. Descriptive data in book form \$1.25 extra.

"Half Moon"—717-718A: Model of boat used by Dutch Seaman, Henry Hudson—\$1.00.

"Sea Bee"—905 to 968: 32 in. speed boat for circular race courses. Powered by midget gas engine—\$1.00.

Viking Ship Model—888: Used by Norsemen in early explorations. 14-in. hull—25c.

"Santa Maria"—759: Simplified design of Columbus' flagship. About 18 in. long—25c.

"U.S.S. Pensacola"—863 and 864: Midget design of 10,000-ton treaty cruiser—50c.

Prairie Schooner—728: Model is quaint reminder of covered-wagon days. Wagon without top, 8 3/4 in. long—25c.

Model Colonial Cannon—735: Perfect 10-in. miniature of guns used during days of 1776. Turned brass and wood—25c.

Any six of these blueprints (not projects) will be sent postpaid upon receipt of \$1.00

Blueprint Department, Popular Mechanics Magazine, 200 E. Ontario St., Chicago



Radio

"A" and "B" ELIMINATOR for Portable Sets

IT IS no longer necessary to put away your portable battery-operated vacation receiver when winter comes. At home or in a.c. power locations, you can remove the dry batteries, substitute this inexpensive "A" and "B" eliminator, and operate the set at a negligible cost.

This compact battery eliminator is suitable for use with any standard portable set which employs 1.4-volt tubes. Operating from the 115-volt 60-cycle a.c. power source, it supplies the required filament and B-voltage for the circuits, providing at all times the same hum-free performance as obtained with new dry batteries.

Assembly and circuit details are given in Figs. 1 and 2; the parts are available in kit form from radio supply houses. When assembled in the metal container, there is nothing to adjust, merely attach the regular set battery plugs and insert the line plug in your electric-light socket. Operating cost is estimated at about eight cents per month, if used for three hours each day. Improved transformer, hum-filtered dry-disk rectifier and high-capacity electrolytic filter condensers make this efficient compact lightweight unit possible.

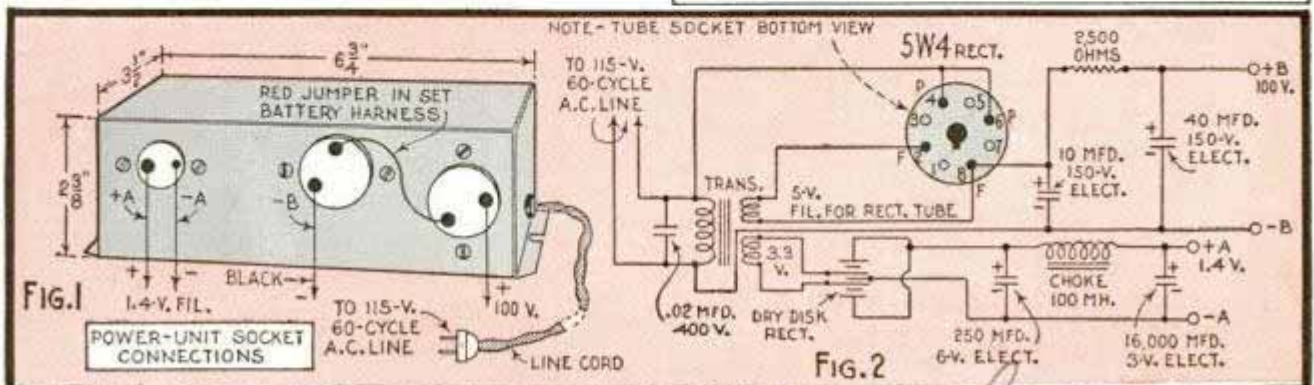
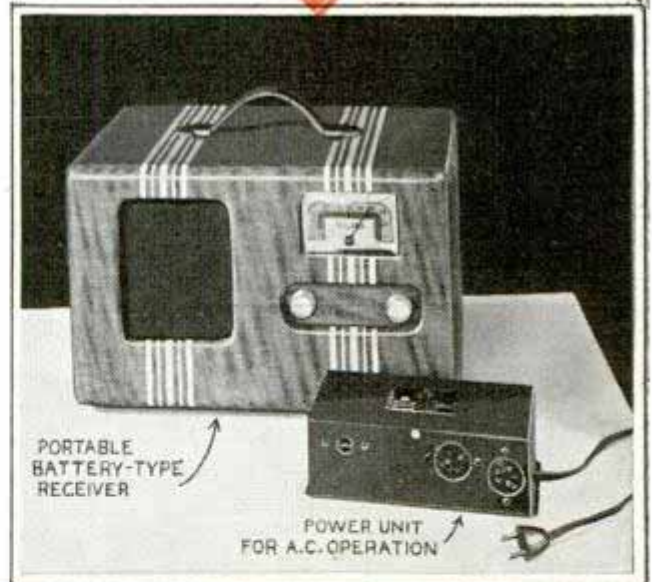

*Electro Product Laboratory 135
549 W. Randolph Street*

Do not use. Costs obsolescent.

How to Build an Inexpensive

By Harry A. Fore

FOR many years treasure-finder enthusiasts have tried to make use of beat-frequency circuits for detecting small metal objects. Theoretically the idea is fine. In actual practice, however, such instruments have not proved entirely satisfactory because the body, or hand, of the operator, and surrounding vegetation, produce such tremendous changes in capacitance that any effect due to changes in the inductance caused by metal objects within the field, is completely masked.

The "Chilson"-type metal-detecting device to be described enjoys all the theoretical advantages of the beat-frequency instrument without any of the disadvantages caused by extraneous capacity effects, and is adjustable to zero beat. This highly efficient little instrument was designed for locating buried metallic objects; it is also suitable for exploring masonry and walls for hidden metal objects, and tracing out pipes. It employs only a single loop unit connected to a metal box containing the instrument. The circuit is easily adjusted for zero signal, or near-zero signal, and metal brought into the field of the loop sets up a sort of "clucking" sound in the headphones. When correctly adjusted, this clucking noise will be heard when a large sheet of any metal is brought within 5 ft. of the exploring coil unit. If a good adjusting job has been done the signal will change from zero beat to a slow clucking sound when a 3-in. square piece of sheet metal is brought within 12 in. of the loop. A coin as small as a dime, when held within a few inches of the center of the loop, will cause the signal to appear.

Although the metal instrument cabinet and drilled base are available, construction details are given



Commercial instruments made by Proddak Co 1031 Broadway Los Angeles

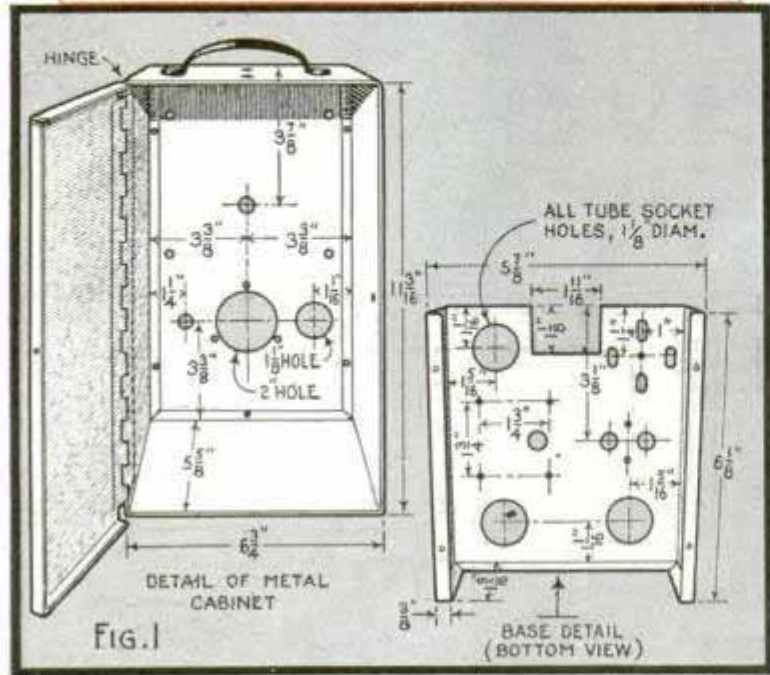
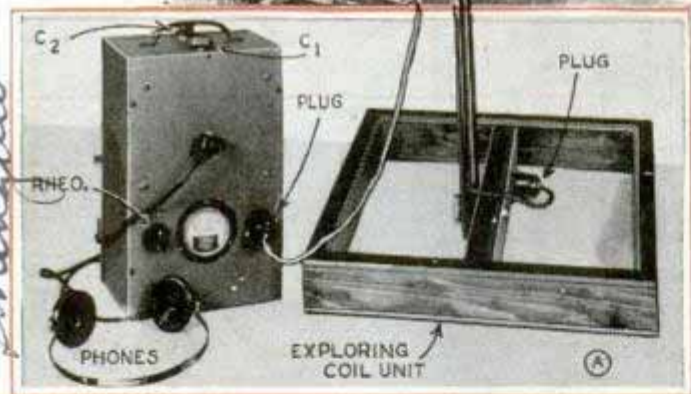

similar

TREASURE FINDER

in Fig. 1 for those who wish to make their own. The simplified wiring diagram, Fig. 2, shows all connections under the base and includes all leads running up to the parts mounted on top of the base and those mounted on the back of the front panel and top of cabinet. All parts are standard except three special foundation units, namely, the r.f. coupling coil, complete exploring coil unit and a.f. choke. Although these three parts are special, they only cost the builder about \$15.75, and the manufacturer has made them available either direct, or through several large mail-order radio-parts houses. The double filament circuit-control phone jack is a "Yaxley" type. A good

(Continued to page 133A)

Left, old cannon balls and other relics recovered at Fort Ticonderoga, N. Y., with this type of instrument

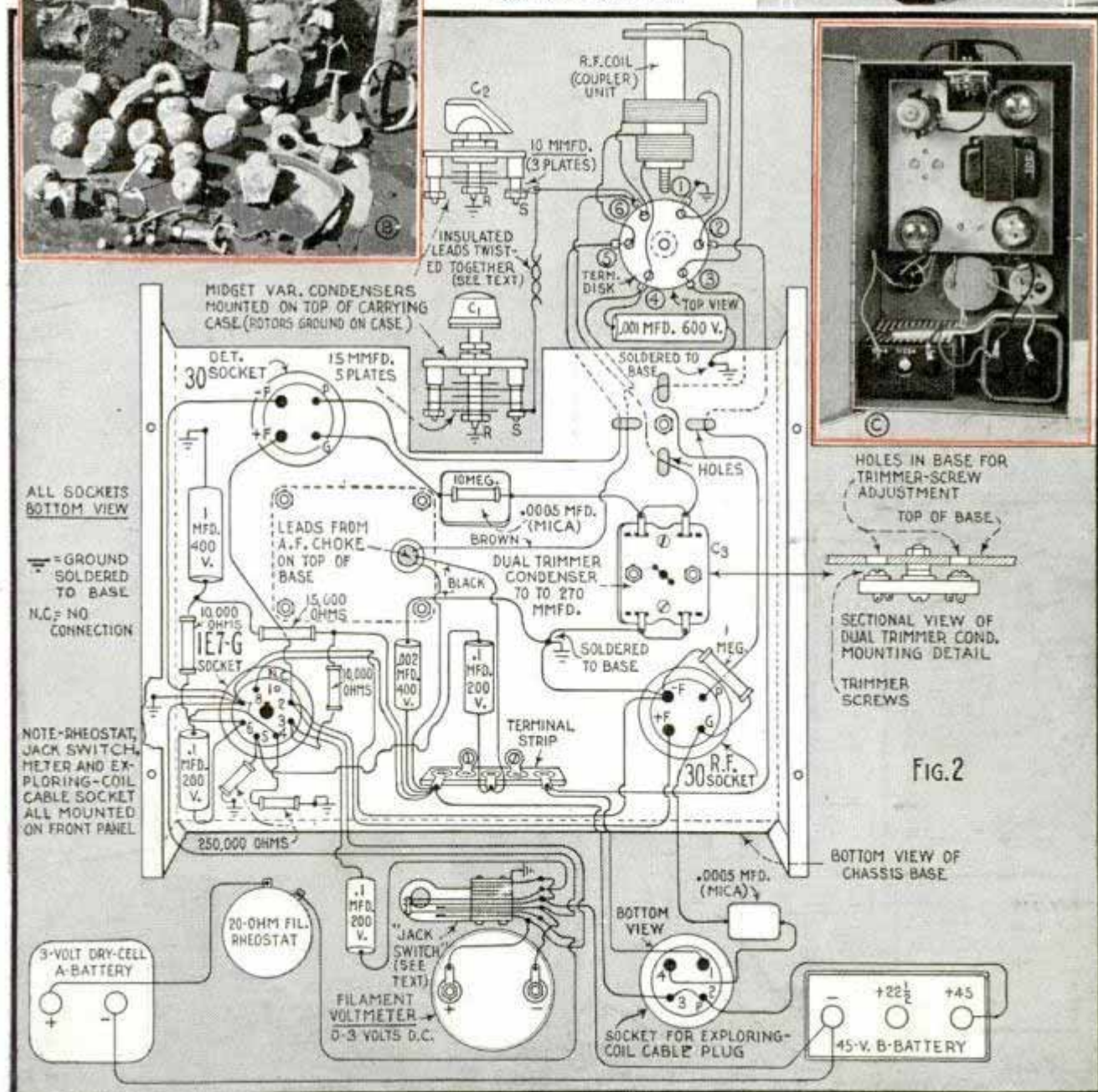

Welden Hgg. Van Buren Chesay

Improved Di-Pole Television Antenna System



BECAUSE of the wide range of television frequencies and the low intensity of the signals, your television antenna must be more efficient than those used for ordinary broadcast and short-wave reception.

Recent tests indicate that stronger "video" (sight) and sound signal pickup is possible by means of an easily installed antenna system specially designed for television requirements. Instead of using metal rods to form a di-pole, or "curtain-rod," type of antenna commonly used for television reception, this antenna consists of two 64-in. weatherproofed wooden rods each covered with a shield of finely woven enameled-copper braid. Leads from these pickup areas are permanently connected with a low-loss transmission line as indicated in Fig. 1; the complete installation is shown in the photo below.

A reflector antenna of similar type, erected directly behind and parallel to the braided di-pole, greatly increases the signal strength and, when properly placed prevents multiple images. Servicemen use a simple portable telephone between set and antenna locations to determine best position for the di-pole and reflector. Fig. 2 shows the operating principle of television.

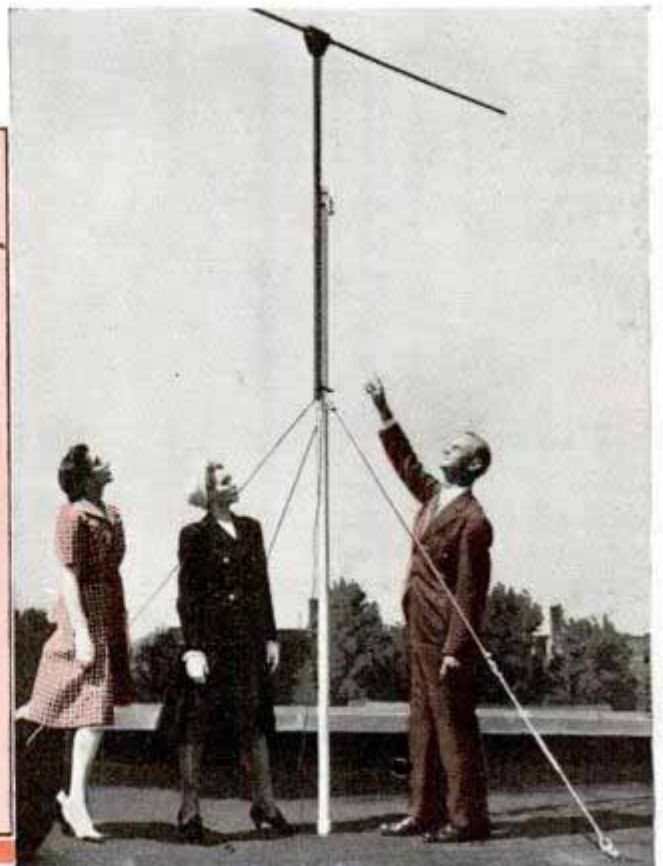
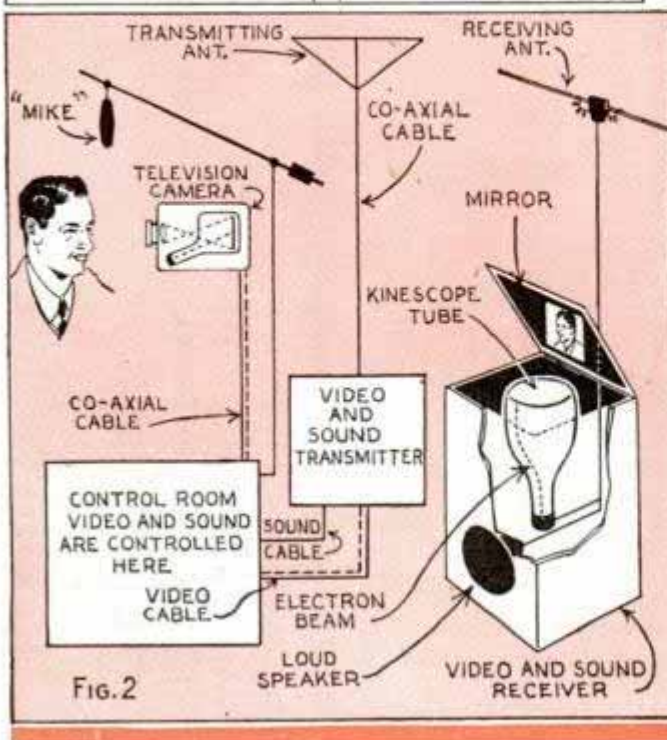
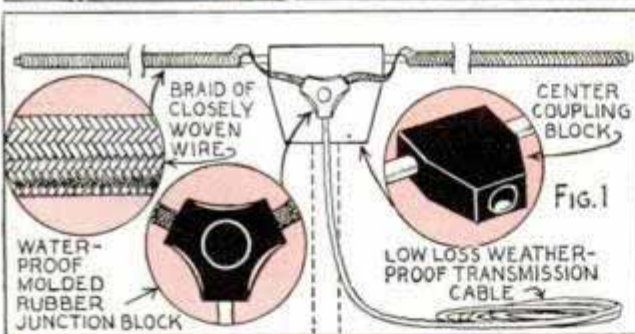

Ward Products Corp
Ward Bldg
Cleveland Ohio

Electronic Laboratories
Chas. 17 2nd Ave. New York 11
Cincinnati Ohio

Practical RADIO SUGGESTIONS

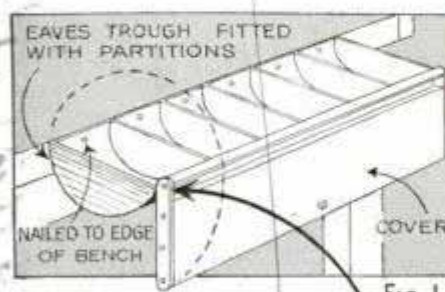
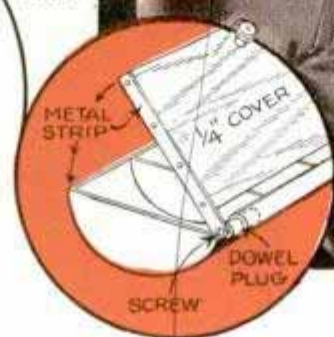

FIG. 1
This handy bin for screws, nuts and small radio parts is made from a short length of 3 1/2-in. eaves trough divided into a number of separate compartments by fitting and soldering semi-circular pieces of tin as illustrated in Fig. 1. Fastened to the end of the workbench, the contents are quickly accessible. The cover is optional



Sketch Fig. (A) shows an easily installed "pneumatic" telescoping auto antenna which is independent of ignition and vacuum systems. It is raised or lowered by means of the pneumatic dash control; (B), portable high-voltage vibrator power-supply unit of heavy-duty design operates either on storage-battery or 110 volts a.c.

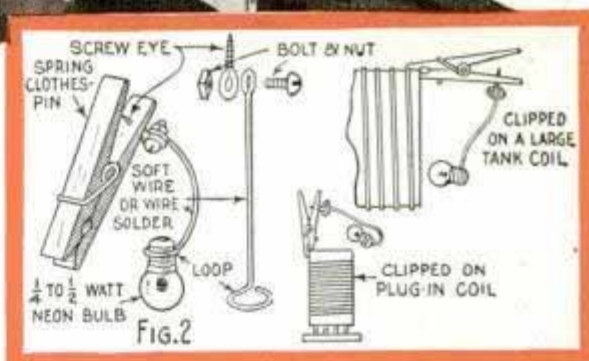
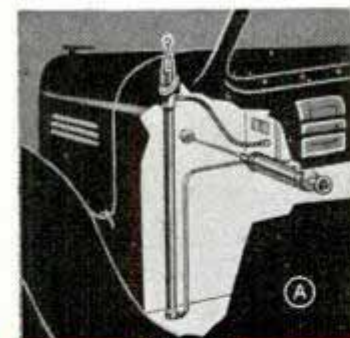
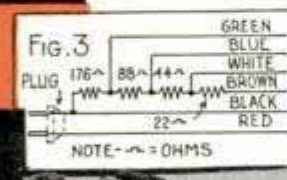
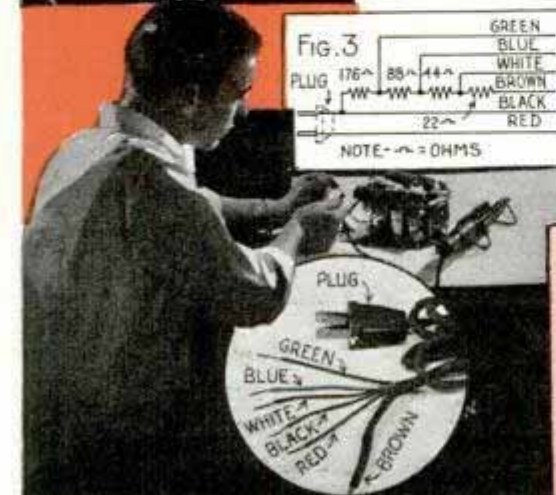
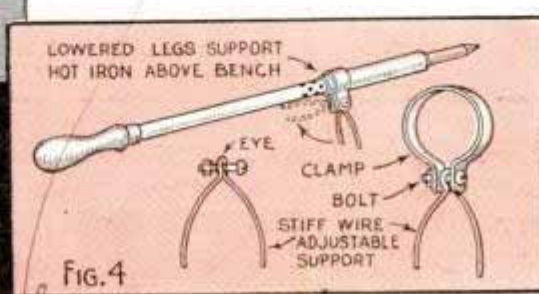

Fig. 2, spring clothespin and a short piece of flexible wire make a handy adjustable clip for holding a small neon bulb in any desired position to check resonance in amateur tank circuits. Fig. 3, and photo at lower left, show a universal line cord that enables experimenters and servicemen to add or change tubes in a.c.-d.c. sets by merely changing the line-cord resistor connection. This single cord may be used as a service replacement for all a.c.-d.c. receivers specifying line-cord resistors



Plug-in relays of the type shown in photo (C) permit the use of low-powered tubes such as type-30 or 71-A to control heavy-duty loads in photo-cell-operated devices; a simple solution for the "hot-iron" problem is detailed in Fig. 4



Sigma Instrument Co
Palmetto, Mass
139

Fourteen-Inch Television Tube for Home Receivers



This giant cathode-ray tube is now probably operating in a television receiver located in some home in or near New York City. The photo shows the tube receiving its Bakelite base with the various connections which this skillful laboratory worker is soldering to respective contact members. Rounded sides add strength to bulb.

Tiny Dual-Purpose Receiver



With the radio switch turned off, this combination unit appears to be, and actually is, an electric clock with its entire dial or face looking like the lower half of

the dial as seen in the photo; black ring blocks out the dial readings.

Modern Set Fits Old Consoles

Now you can modernize your old radio by installing this up-to-date receiver which is designed to fit into most types of consoles. It includes an "organ-fonic" tone filter of resonating pipes, organ-key tone control and built-in antenna.

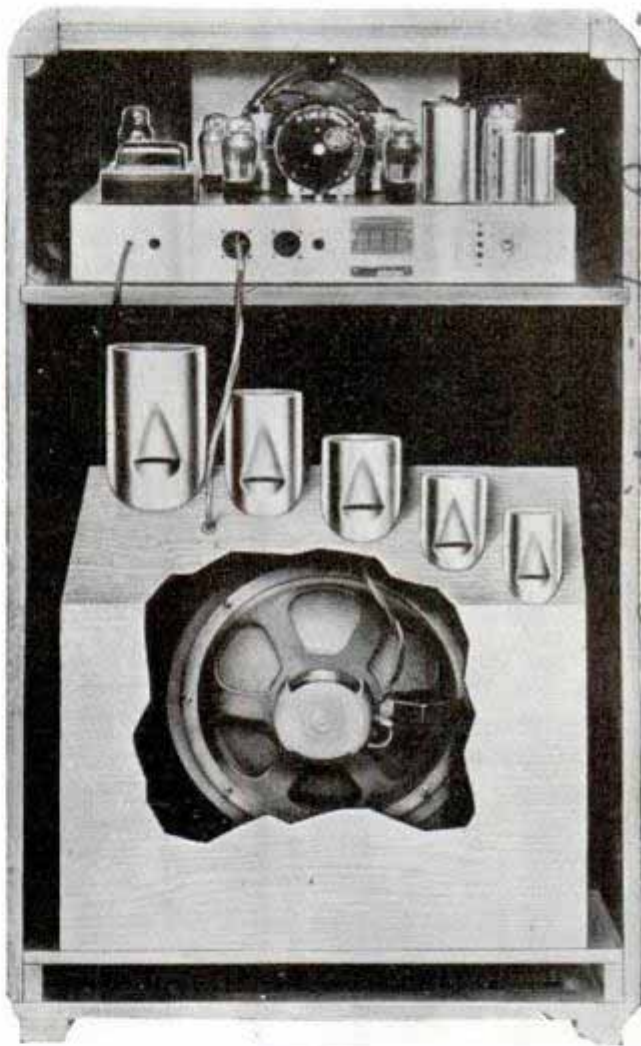

Blueprints covering radio construction articles in this and past issues are available for 25 cents each. Original material lists, with names of manufacturers and dealers, can be obtained from our Radio Department upon receipt of postage.

NEXT MONTH—How to Build a Two-Band Flashlight-Battery Receiver. This new model of one of our most popular low-cost sets for beginners covers broadcast programs and a short-wave band. Also **Home-Recorder Assembly for Amateurs.** Practical suggestions for making and playing your own records at home.

Majestic Radios and Television Corp. 2600 W. 50th St. Chicago, Ill.

Midwest Radio Corp. 909 Broadway, Cincinnati, Ohio



SHOP NOTES

"ELECTRIC HAND" *in the shop*

Easy-to-make electromagnet picks objects from hard-to-reach places and releases them on the bench

PICKING up small steel brads and screws, cleaning steel turnings from hard-to-reach places inside a lathe bed and compound rest, and setting tiny steel screws in difficult assemblies—these are jobs easily done with this little electromagnet which operates on 110 to 125-volt, 60-cycle alternating current. An ordinary horseshoe-type permanent magnet cannot reach some of these places and it will not release the things it picks up.

The assembly diagram below illustrates construction. One winding in the center represents the coil which, of course, is much larger and more compact than is shown. The core of the magnet is a piece of $\frac{1}{4}$ -in. round soft iron rod, $6\frac{1}{8}$ in. long. If a $\frac{1}{4}$ -in. bolt of sufficient length can be found, it will serve the purpose by cutting off the head. One

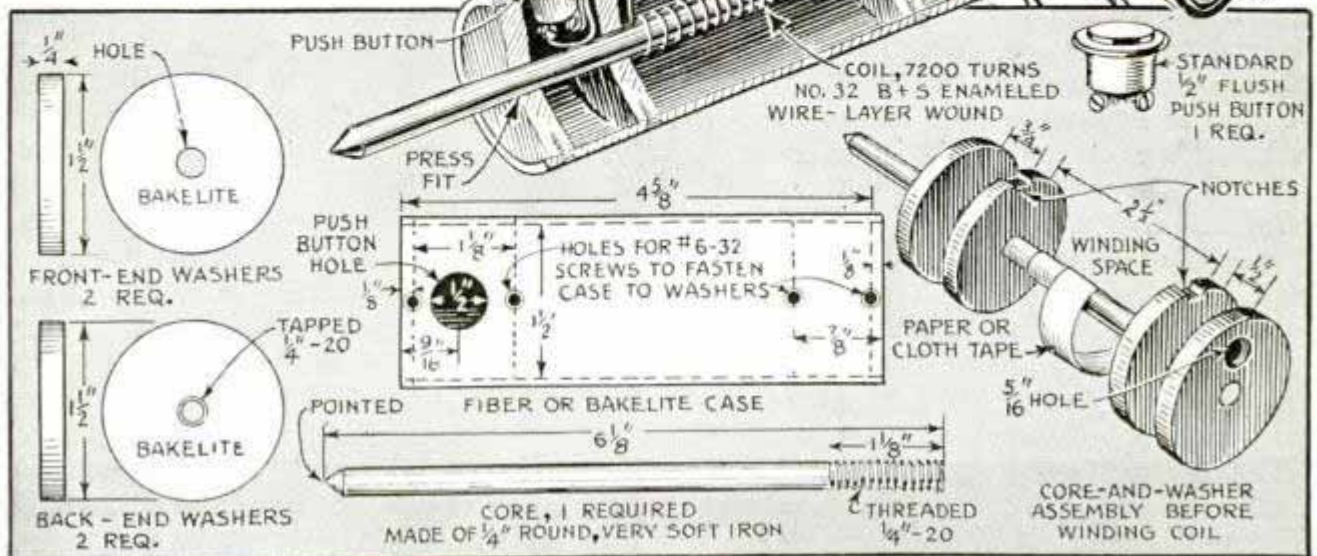
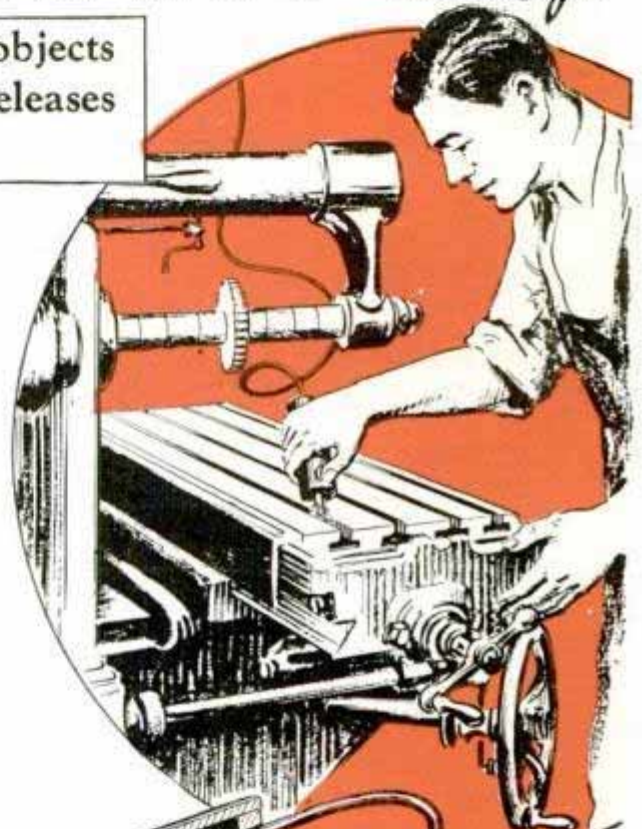

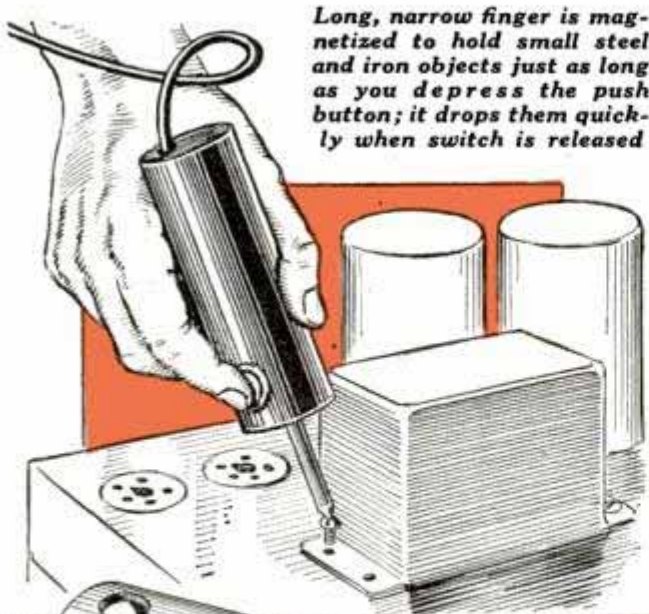

Long, narrow finger is magnetized to hold small steel and iron objects just as long as you depress the push button; it drops them quickly when switch is released

a 1-ft. length of the wire through the hole in the back coil washer and fasten it temporarily. Chuck the core in the lathe or in a hand drill, and proceed to wind the coil, keeping the turns tight and close together. Coat each layer thinly with insulating varnish before going further. As the winding progresses, the layers will become more and more uneven. This can be corrected from time to time by covering the coil with a layer of thin paper. When the coil is completed, cut the wire leaving a length of 1 ft. to extend for connections. Cover the coil with several layers of paper, which you wrap tightly, varnishing between each layer. Lay the switch wire on the coil, set

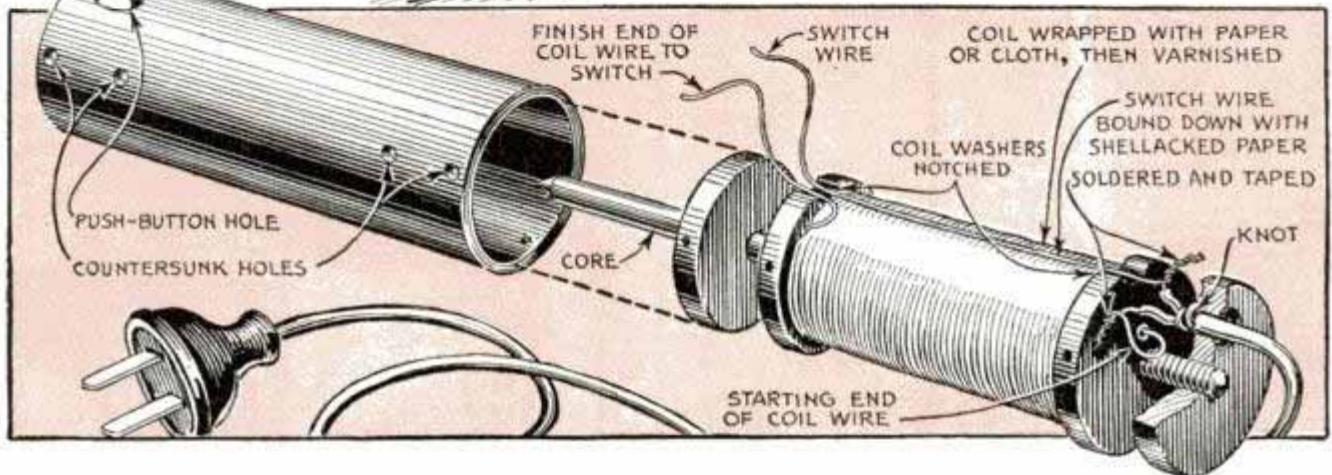

end of the rod is sharpened to a point while the other end is threaded as indicated in the drawing. Four Bakelite washers are cut from an old radio panel which is $\frac{1}{4}$ in. thick. To make them, drill a $\frac{3}{16}$ -in. hole in four pieces, slip them on a threaded bolt, drawing nuts tightly against them to lock them in place. Then mount the assembly in a lathe and turn the pieces down to size. The two washers for the front end are reamed to $\frac{1}{4}$ in., while the two for the other end are tapped to turn on the thread. Be sure to notch the edge of the washers and drill lead-in holes near the centers for the coil wires before assembling on the core. The rear washer has a $\frac{5}{16}$ -in. hole in it to admit the supply cord. Coat the core with insulating varnish and a layer of thin paper or cloth, tightly wound. After this is dry, push the front washers into place and screw on the rear ones. Adjust the space between the coil washers to $2\frac{1}{2}$ in.

The magnet winding consists of 7,200 turns of No. 32 B & S enamel-coated copper magnet wire, wound in layers. Draw

it in the washer notches and bind it down with tape or another layer of paper.

The case is a Bakelite or fiber tube $1\frac{1}{2}$ in. inside diameter and $4\frac{3}{4}$ in. long. Holes are drilled in it as shown. Drill the push-button hole and then drill and countersink the fastening screw holes.

To assemble the magnet in the case, pull the cord through the hole in the rear washer, knot it on the inside and solder one of the wires to one of the wires from the magnet. Cover the connection with tape, and with silk thread bind securely to the core. Then the other lead wire is similarly soldered to the switch wire and well taped and tied. You can now slip the case on from the front end and pull the front wire through the switch hole. Using the fastening drill holes in the case as guides, drill and tap holes in the washers for No. 6-32 screws to fasten the case in place. Connect the switch to the front wires. Carefully insulate the two connections. A little piece of asbestos bound in place with thread will do this quite well.

Christmas-Tree Display to Attract Shoppers

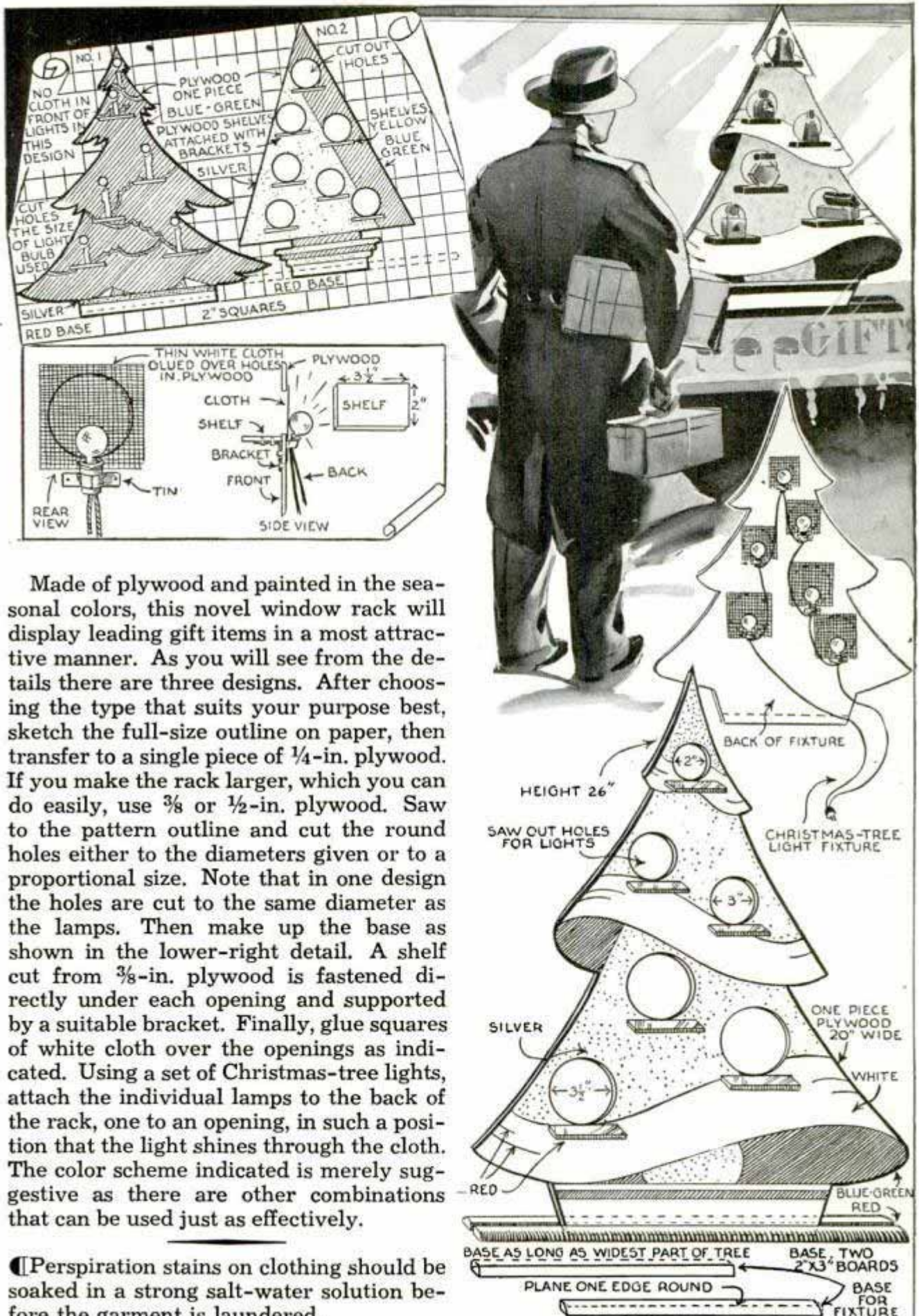

Made of plywood and painted in the seasonal colors, this novel window rack will display leading gift items in a most attractive manner. As you will see from the details there are three designs. After choosing the type that suits your purpose best, sketch the full-size outline on paper, then transfer to a single piece of $\frac{1}{4}$ -in. plywood. If you make the rack larger, which you can do easily, use $\frac{3}{8}$ or $\frac{1}{2}$ -in. plywood. Saw to the pattern outline and cut the round holes either to the diameters given or to a proportional size. Note that in one design the holes are cut to the same diameter as the lamps. Then make up the base as shown in the lower-right detail. A shelf cut from $\frac{3}{8}$ -in. plywood is fastened directly under each opening and supported by a suitable bracket. Finally, glue squares of white cloth over the openings as indicated. Using a set of Christmas-tree lights, attach the individual lamps to the back of the rack, one to an opening, in such a position that the light shines through the cloth. The color scheme indicated is merely suggestive as there are other combinations that can be used just as effectively.

Ⓛ Perspiration stains on clothing should be soaked in a strong salt-water solution before the garment is laundered.

Substitute for Focusing Cloth in the Photo Studio

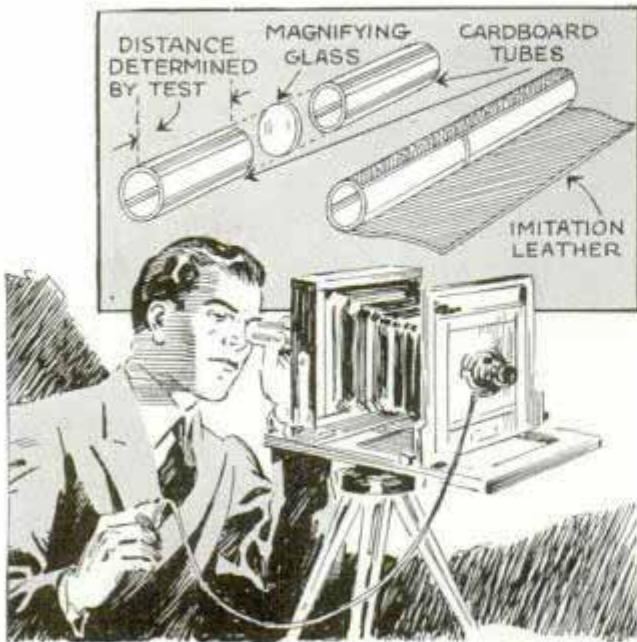

This focusing tube is easier to handle than a cloth and it magnifies the image on the ground glass so that focusing is done quickly and accurately. To assemble the tube, two fiber or cardboard tubes are placed end to end with a small magnifying glass between them, after which they are rolled on a piece of imitation leather or similar material that has been coated with glue. The leather holds the parts together to form a tube with the glass near the center. The variable factor in the dimensions of the tube is the length from the ground glass to the magnifying glass. To determine this distance, hold the glass at a point where the image on the ground glass will be in sharp focus. Then cut one of the tubes to this length. The other tube does not matter as it merely keeps out light.

—Joseph Raszinski, Chicago.

Wheel Operates Vise Quickly

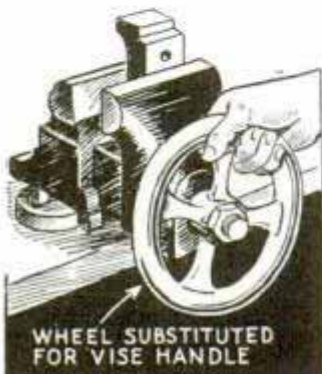

At an assembly bench where the worker has to use a bench vise, time can be saved by replacing the vise handle with a large wheel. This permits the vise to be opened or closed much more

rapidly. If the wheel is fairly large, the worker will be able to apply sufficient leverage for most work of this type.

Pitchfork and Shovel Racks from Auto Casing

One farmer cuts sections from an old auto casing and nails them up to hold forks, shovels, garden rakes, etc. Two or three nails through the back side and a slot cut in the front as shown, is all that is required to make these handy holders.

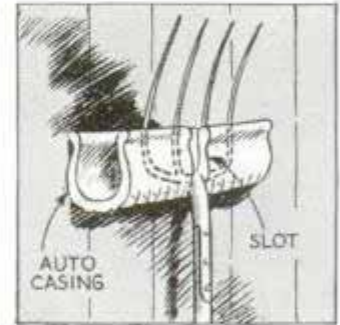

Holder Supports Test Tubes

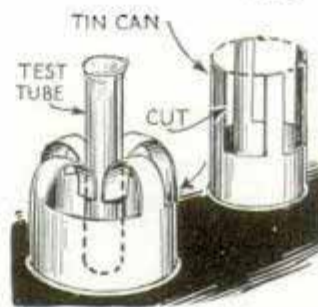

When you want to set down a filled test tube, a holder made from a tin can, as indicated, will support it and help to prevent accidental spilling of the contents.

Binder Wheel Fitted with Legs Provides Farm Forge

With an old binder bull wheel for a start, it is easy to make a good forge. The wheel is supported on flat-iron legs, and the spokes are imbedded in concrete, which is covered with fire clay if this is available. The hub of the wheel is left open and becomes an inlet for the air blast, which can be furnished by a blower either hand or power driven.



Dog for Turning Square Stock

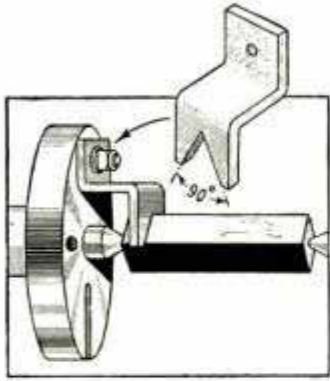

This is a simple lathe dog that can be used to turn various sizes of square stock, making it unnecessary to change dogs each time the stock is changed. The dog is a piece of heavy flat iron bent as indicated, and a V-notch cut in the end to straddle one edge of the work. The other end of the dog bolts to the faceplate.

Rigid Support for Mailbox

With the increased use of large mailboxes on rural routes so that parcels may be inclosed during bad weather, a more substantial type of support is usually needed. The one shown in the photo has proved successful and consists of two old auto-tire rims riveted to four pipe legs, which are bent as indicated and set firmly in the ground. If desired, the entire assembly can be set on the ground so that it can be moved to one side when the road maintainer comes along.



Small Hand Taps Used in Lathe with Special Wrench

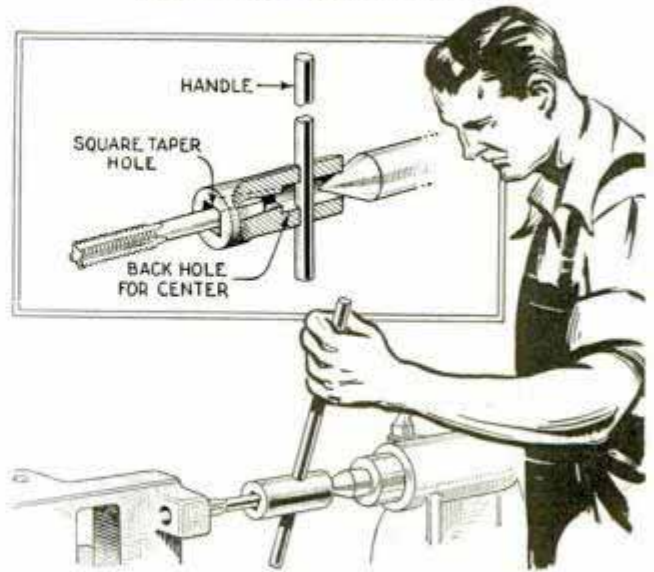

Here is a wrench that enables you to use small hand taps in a lathe and keep them in alignment. As shown, it is a piece of round steel with a tapered square hole in one end to take the squared ends of the taps, and a round hole in the other end to take the lathe tailstock center. The tapered square hole permits the wrench to be used on taps of various sizes without making adjustments.

Adapting Large Micrometer to Small Work

Having a 2-in. micrometer, which was used only occasionally, one shop owner

fitted it with a 1-in. adapter for smaller work. A piece of steel was cut to the shape shown, and rounded on the back edge to fit the mike frame. The piece was then drilled and reamed at the upper end to fit the mike spindle, and at the lower end to take

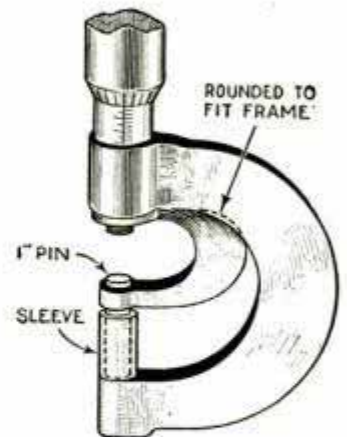

a pin, a sleeve being made to fit tightly on the pin. To use the adapter, the spindle is withdrawn to clear the frame, and the adapter slipped in place. When the spindle is brought down and the sleeve is pushed over the anvil, the adapter is locked securely in place.

from **PATTERN**

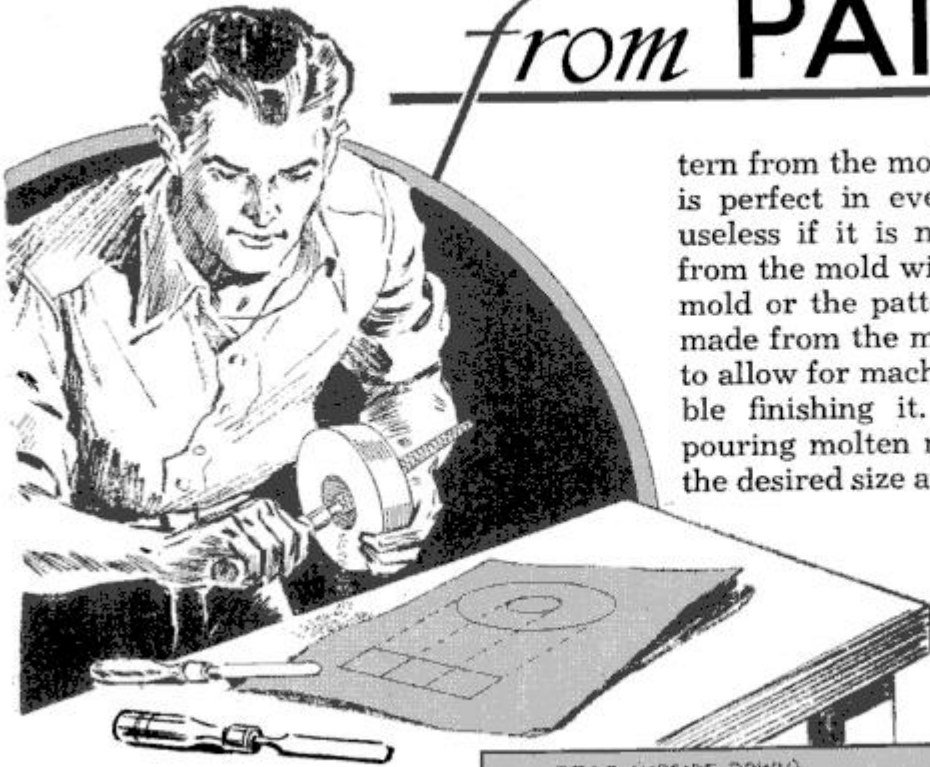

tern from the molder's viewpoint, one that is perfect in every other respect is still useless if it is not possible to remove it from the mold without breaking either the mold or the pattern. If the rough casting made from the mold has insufficient metal to allow for machining you will have trouble finishing it. Castings are made by pouring molten metal into a sand mold of the desired size and shape, Fig. 4. The sand

is retained in a box open at the top and bottom which is called the "flask." The latter is made in two sections, the lower of which is called the "drag" and the upper the "cope." These are fitted with guides and cleats or dowels to permit accurate realignment of the two sections. The first steps required in making a mold from a one-piece pattern are shown in Figs. 1

PART I

Tells how castings are made in the foundry in sand molds—how to make your own patterns—what woods to use—where to use fillets—how to make draft and shrinkage allowances with 'shrink' rule

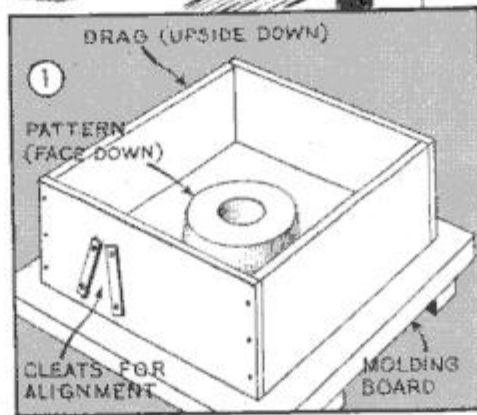

HOW often have you attempted to make up some metal part of stock materials and finally found that a casting would be much better for the purpose? Then, why not make a pattern and have a casting made from it that will be just what you want? Unless the casting required is complicated in detail or unusual in shape, the pattern needed will be a very simple affair. There's no need for fancy woods or elaborate equipment. Just a piece or two of pine and a few hand tools will serve the purpose where only one or two castings are to be made from the same pattern. However, it is necessary that the latter be laid out and constructed very carefully, for any errors in the pattern will be reproduced in the casting.

The pattern for a casting is simply a form or device from which a mold can be made that will produce a casting of the desired shape and size. Looking at the pat-

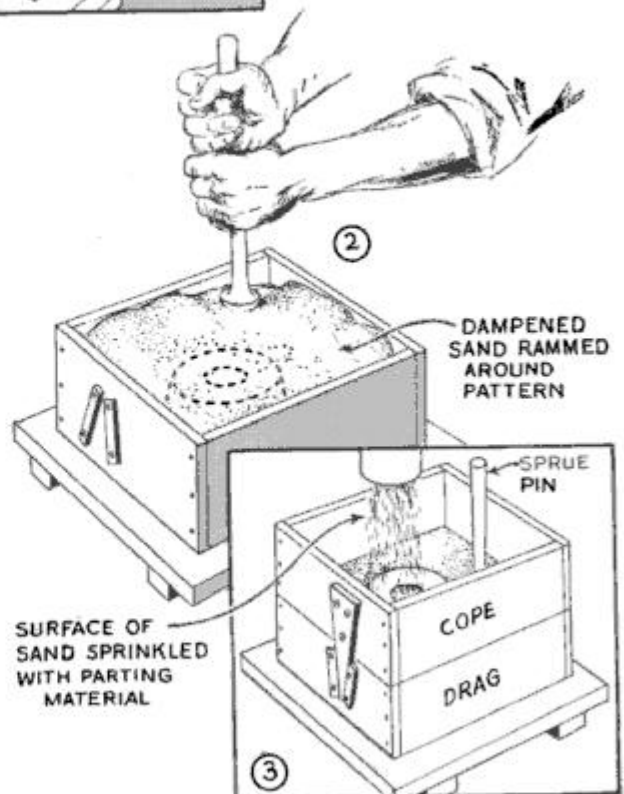

to CASTING

to 3. First the pattern is laid face down on the molding board, with the drag inverted around it. The sand, properly dampened, is rammed around the pattern until the drag is filled to the top and struck off level with a straight edge. The drag is then turned right side up on the bottom board and the surface is sprinkled with a parting material to prevent sticking. At the same time the second half of the pattern, if it is in two pieces, is set in place. The cope is set on the drag, a sprue pin is placed to form a pouring hole in the cope, and the latter is rammed with sand. It is then lifted off and the pattern is removed from both halves of the mold. After a pouring hole and gate for the metal are cut in the sand as in Fig. 5, the cope is replaced as in Fig. 6. This, in brief, is the common procedure. The pattern is invariably larger than the finished casting, and in all cases it is necessary that it be made with tapered sides, or "draft" as it is commonly called. This provision on the pattern makes it easy to remove from the mold without breaking up the print as in Fig. 7. Fig. 8 shows the same pattern constructed with the proper draft. The amount of draft that must

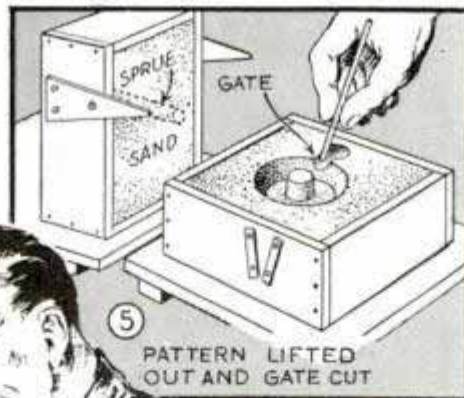

COPE REPLACED ON DRAG,—READY FOR POURING



be provided depends on the type of the mold and the location. Where possible, the pattern is made with the draft all running in one direction from the parting line, as at A in Fig. 9. In this case, and for the outside of the pattern, the amount of draft is generally $\frac{1}{8}$ in. to the foot, as in Fig. 10. Note also in this illustration that on the side of a casting, where a hollow pattern is used, considerably greater draft is required. Generally a draft of $\frac{1}{16}$ in. to the inch is specified. If the opening is less than 1 in. in diameter, draft of $\frac{1}{8}$ in. to the inch must be allowed. Where this amount of draft cannot be tolerated on an inside surface, it is necessary to use a solid pattern and form the hole with a core. This will be explained in the second article of this series.

Another important provision with regard to draft applies to those cases where a pattern cannot be made in one piece, but is made in two pieces with

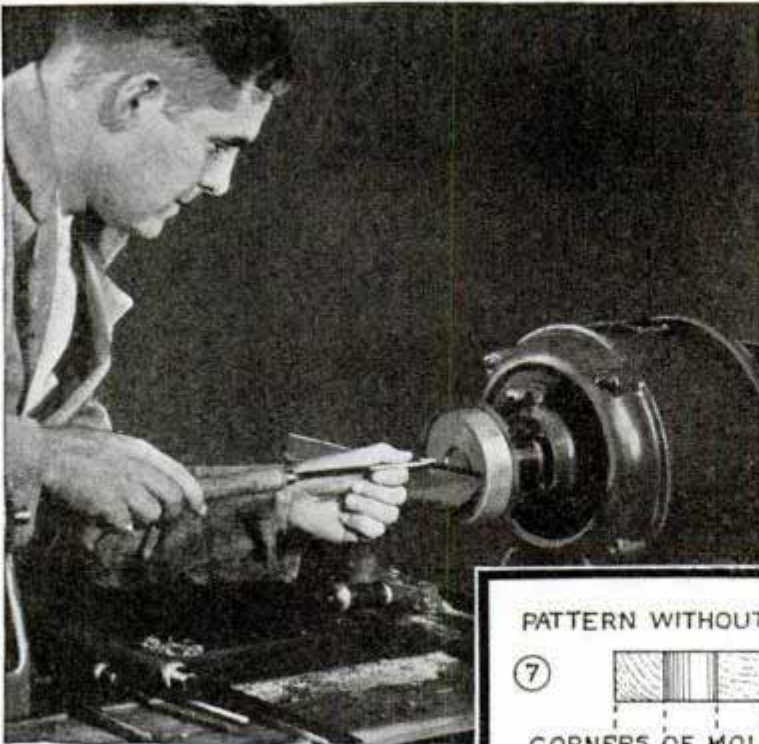

draft running in both directions from the parting surface, as shown in Fig. 9, B. Here it is necessary to double the draft on the section of the pattern that extends into the cope or upper section of the mold. This provision is made to assure easy parting of the pattern from the mold when the cope is lifted off the drag and the pattern is removed.

The second important characteristic that affects the pattern size is shrinkage. All castings shrink after solidification, the amount of shrinkage depending on the metal from which they are made. It is, therefore, necessary to make the pattern and mold somewhat larger so that the casting will shrink to the desired dimensions. Table I gives the approximate shrinkage for various common metals. To get this shrinkage accurately you simply lay out the pattern with a shrink rule instead of an ordinary rule. A shrink rule has each foot increased by $\frac{1}{8}$ in., if for iron, and by $\frac{3}{16}$ in., if for brass, and all subdivisions elongated proportionately. This saves the time necessary to calculate the shrinkage allowance on each dimension.

A third allowance which must frequently

be made is that for finish. The surface of a casting is naturally rough and somewhat irregular, and if two castings must be fitted together accurately, or if extreme accuracy is necessary for any other reason, the surface will have to be machined down to the finished size. Generally an allowance of $\frac{1}{16}$ in. is made for each finished surface on small castings, although for larger castings in which irregularities may be greater, a larger allowance for finish is needed. One more thing and you're ready to lay

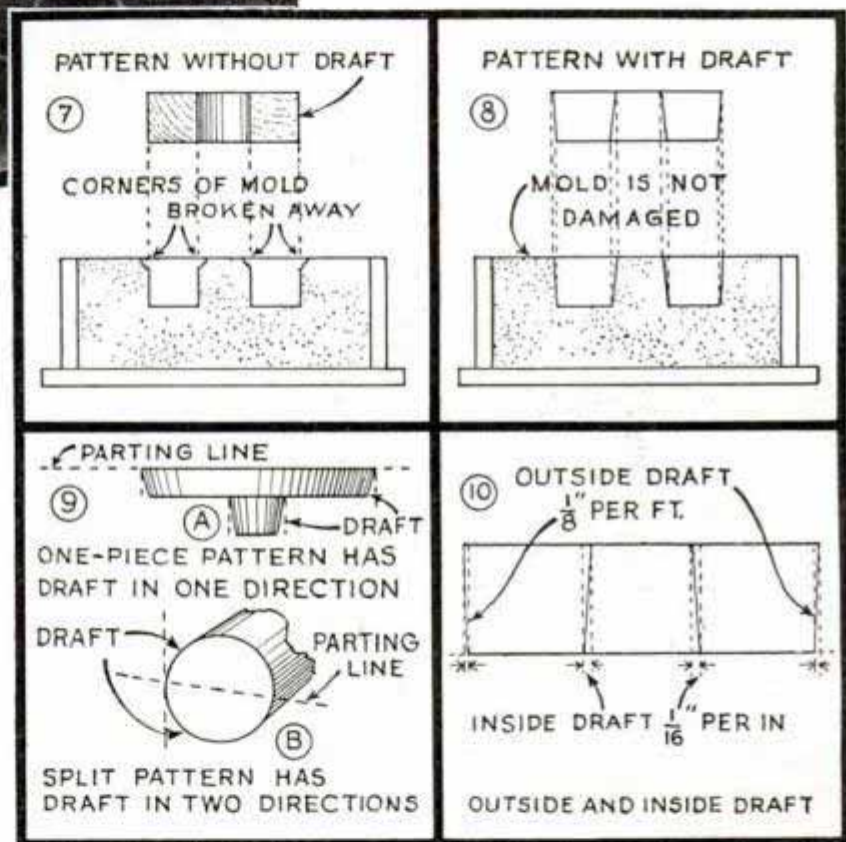

out the pattern. Wherever wood parts of a pattern join at right angles a fillet is necessary, Figs. 12, 13, and 14. Triangular leather fillets are obtainable ready-made in a variety of sizes and are easy to apply with glue. On small patterns such as those used for model parts, beeswax is usually better. It is simply pressed into place then worked to a true radius with a spherical-ended tool as in Fig. 14. The tool must be heated slightly at intervals.

The best way to lay out the pattern is to make a mechanical drawing of the part to be made as in Fig. 15. Locate the surfaces to be finished and use the symbol "f" to

denote them on the drawing. This will help in remembering to make the proper finish allowances. Patternmaking woods should be well dried and seasoned. Redwood is sometimes used, also cherry, mahogany, or maple when the pattern will be subject to repeated use. For ordinary work, clear white pine will do very well. Where gluing is necessary use a hide glue applied hot, as in Fig. 11. If possible the layout should be made directly on the wood that is to be used for the pattern. The pattern should be planned in advance so that, if possible, the draft is all in one direction from the parting line. With this



TABLE I
Approximate Shrinkage of Castings

Cast iron1/8 in.
Brass3/16 in.
Aluminum1/4 in.
Zinc5/16 in.
Copper3/16 in.
Lead5/16 in.
Malleable iron1/8 in.
Steel1/4 in.

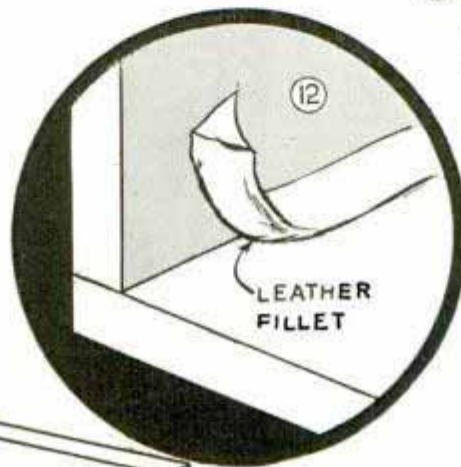

in mind, the layout is made, using a shrink rule for all dimensions and marking all lines with a sharp knife. It is best to start all measurements from the center line of the pattern, rather than from an edge; and to lay out any holes first before

laying out edges. The steps in laying out a pattern for a simple bracket are shown in Figs. 16, 17, and 18.

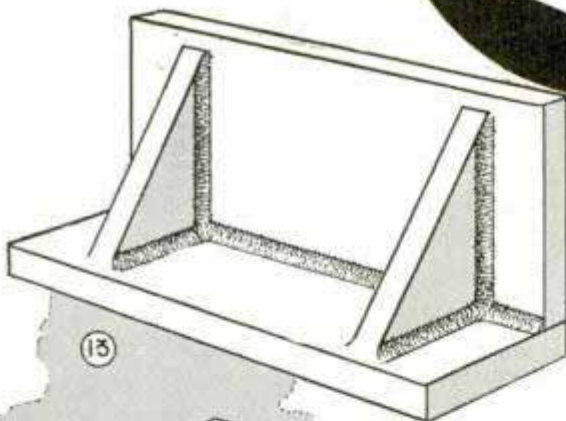

When the layout is completed, the excess wood can be removed by sawing and the pattern finished with chisels and gouges. Cylindrical or other round sections, of course, may be turned in a lathe. The work should be finished to exact size very carefully. The quality of the finish, especially on small wood patterns, is very important. All surfaces of the wood which come in contact with the sand must be glass-smooth before applying shellac. Where hand tools are used to cut away waste it is necessary to use care when you approach the finish dimensions or you may cut too deep and spoil the pattern. It is essential that surfaces worked down with edge tools be left as smooth as possible so that sanding will be reduced to the minimum. Slight cavities or shallow cuts made inadvertently under the finish dimensions can be filled with woodturner's cement or wood putty. Have your tools razor-sharp so that you can cut with or across the grain without

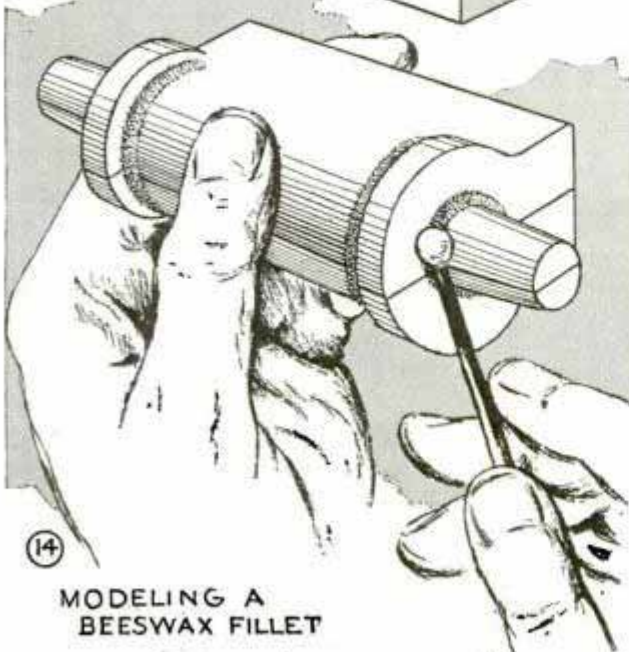

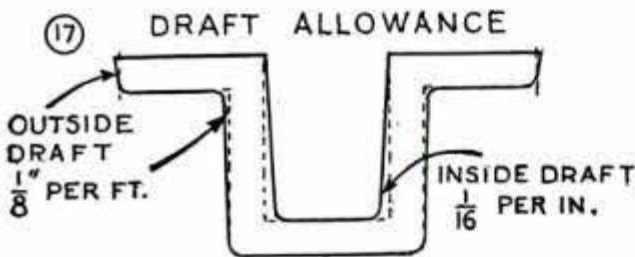
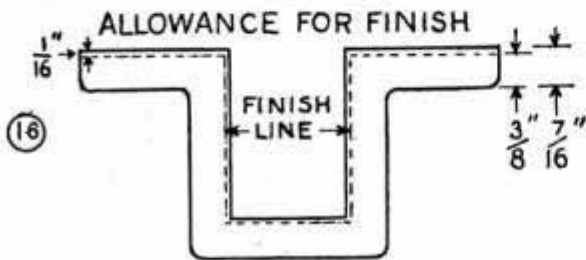
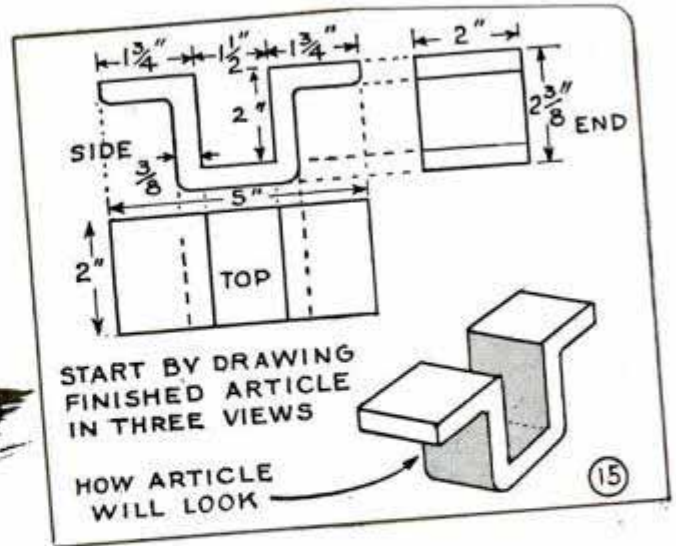

LAYOUT ON WOOD MADE WITH AID OF SHRINK RULE

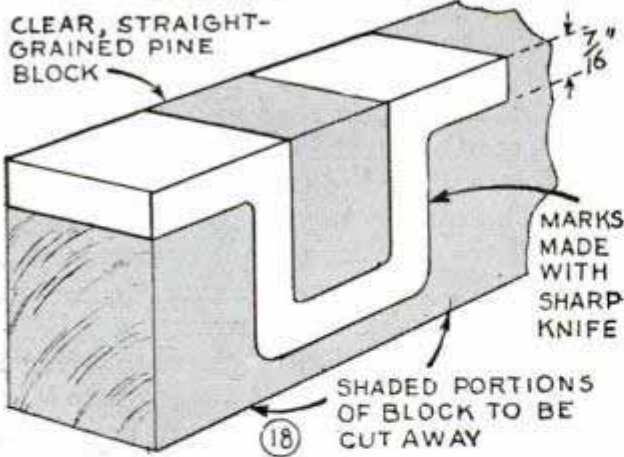

raising deep splinters. Sometimes a fine rasp is better than a chisel or gouge on the cross grain. The disadvantage of the rasp for general work is that it raises the fibers of the wood and leaves a rather rough surface which requires considerable sanding to smooth up. Lathe-turned patterns can be finished ready for shellacking with a minimum of hand work, of course. Some-

times small patterns are simply sanded and then dipped in melted paraffin to finish. Although not approved practice, this method frequently serves very well. In any case when the carving is finished, the pattern is sanded carefully with No. 0 or finer sandpaper and, as is the common practice, given two or three coats of orange shellac to protect it from moisture.

(To be continued)

Hog Trough from Oil Drum

Here is a hog trough that is cheap, can be emptied and cleaned easily, and that will not burst if liquids freeze in it. Made from half an oil drum, it is pivoted at the corners between stakes driven firmly into the ground. In this position, it is easy to overturn for emptying. After cutting the drum in half, it is a good idea to bend the edges over or round them with a file to avoid injuring the hogs.

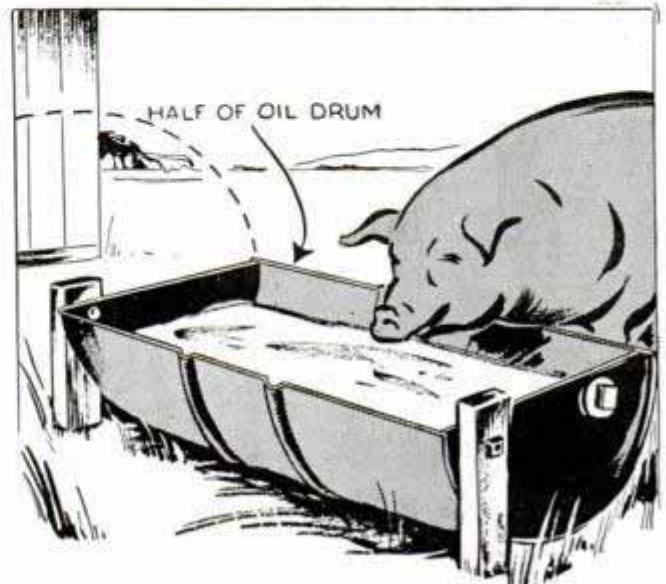

Jig Sets Boring-Bar Fly Cutter to Close Limits

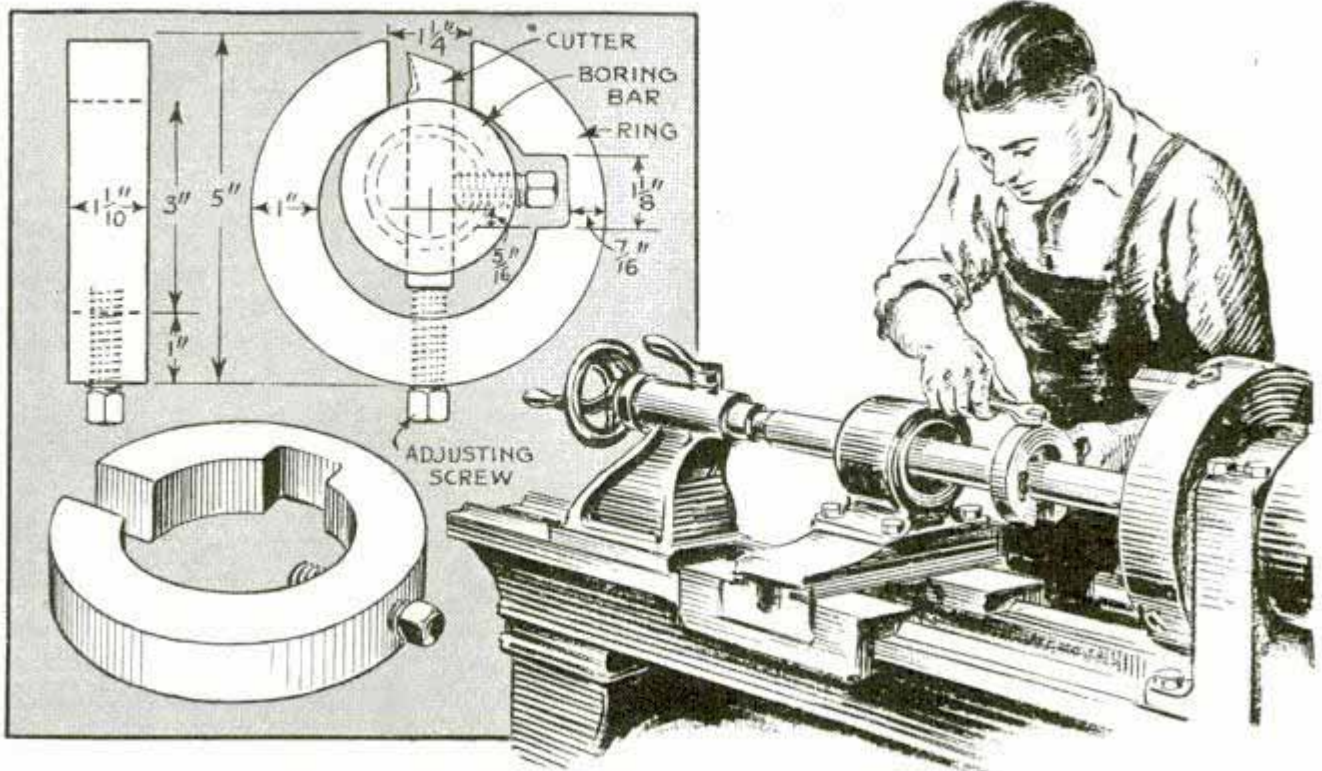

On jobs of boring either small or large-diameter holes to close limits with a boring bar when it is difficult to set the tool out for the finish cuts, especially where the cutter must be moved only a few thousandths, you'll save time by using this simple tool-setting jig. Whatever the size of your boring bar the general dimensions of the jig should be proportional to those given above. Turn and bore the ring from mild

steel and slot and groove it to provide space for slipping it over the cutter and the head of the set screw holding the cutter in place. In this position, the adjusting screw of the jig bears against one end of the cutter as shown. This makes it easy to move the tool to exactly the finish dimension required by simply turning down the adjusting screw with a wrench.

—W. P. Davies, Topeka, Kans.

Folding Rack Lengthens Pickup Truck to Haul Lumber

One lumber dealer reduced delivery costs on small orders by using this rack on a pickup truck, making it unnecessary to drive his large trucks for less than ½-ton loads. The rack will accommodate boards up to 18 ft., and will enable the truck to handle a load of over 600 ft. of lumber averaging 14 ft. in length. As shown, the rack is pivoted to the truck body and gives it an over-all length of 11 ft. When the truck is not used for hauling lumber, the rack is folded inside the body out of the way.—P. Walker, Wautoma, Wis.

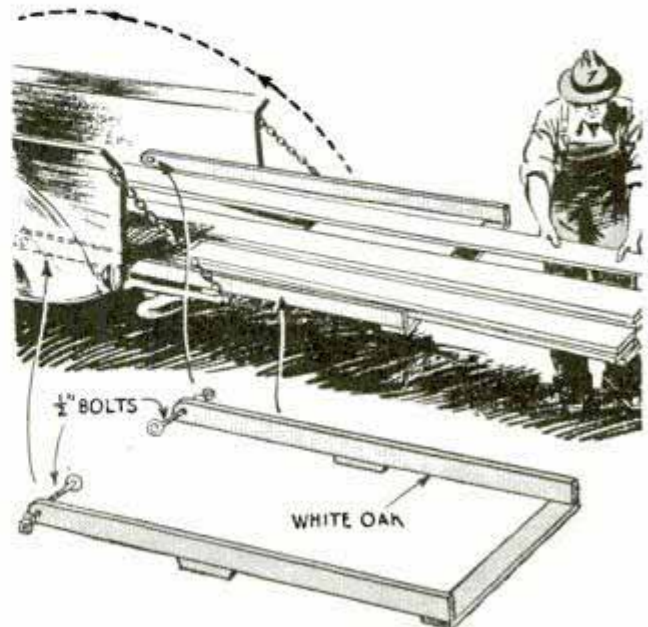

☐ When you clean tinware, rub it with a wadded piece of moistened newspaper and washing soda and then polish it with a dry piece of the paper.

Lug Wrench to Remove Nuts with a Hammer

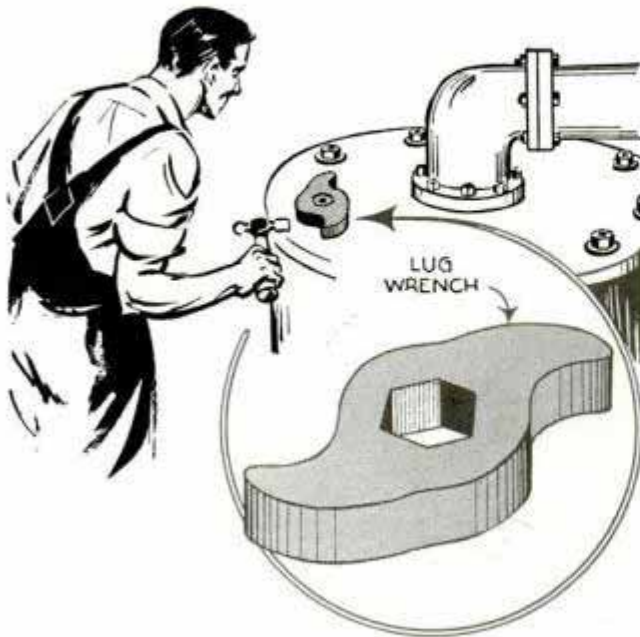

Having many large nuts to remove, I use this lug-type wrench and strike it with a hammer to loosen them. I find that the impact of the hammer on the lug is often more effective in loosening a tight nut than the leverage of a wrench. After the nut has been loosened, it can be turned off rapidly by rotating the lug with the hand.

—Chas. H. Willey, Penacook, N. H.

Block of Salt Kept on Platform by Projecting Peg

Cattle can be kept from pushing rock salt off a platform, which is provided to

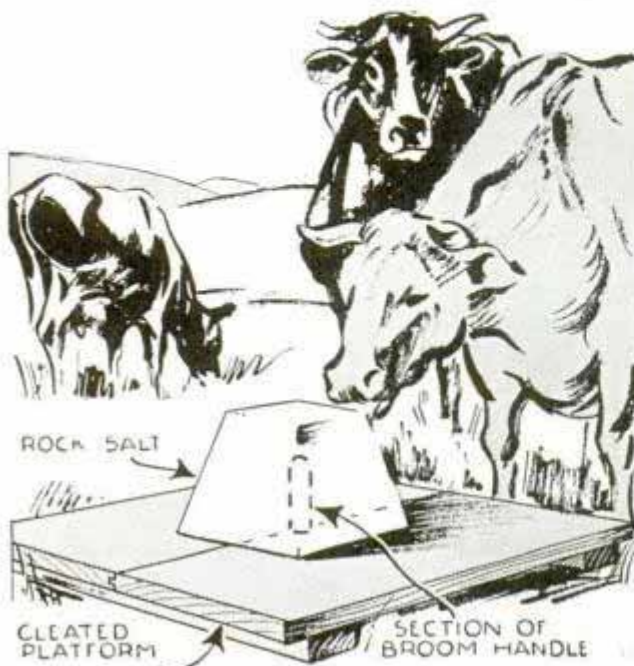

keep it off the ground, by slipping the salt over a peg projecting from the platform. An old auger will serve for making a hole in the salt to take the peg.

Waxed-Paper File Stops Drying of Mimeograph Stencil

I have kept mimeograph stencils for many months in filing wrappers lined with waxed paper like the one shown, without them drying out. The paper is fastened to the wrapper with staples or glue at the corners, and an index tab is attached to one edge.

—W. F. Horan, Plainfield, N. J.

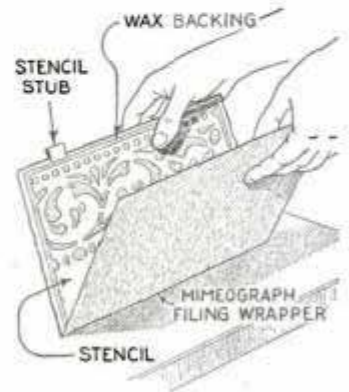

Metal Domes on Large Ledgers Make Handling Easy

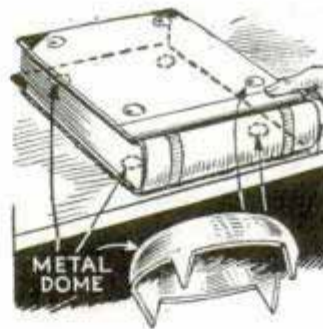

Heavy ledgers that are hard to slide on and off shelves can be handled easier if metal domes or furniture glides are fastened near each corner of the covers. The domes

provide only four small points of contact on the shelf, thus reducing friction so that the ledger can be moved easily.

Rubber Band Holds Can Handle Upright for Grasping

A Wisconsin beekeeper who found it annoying to pull up the wire handles on cans of honey when moving them about, avoided the trouble by snapping rubber bands around the handles. These support the handles, but allow the cans to be stacked.

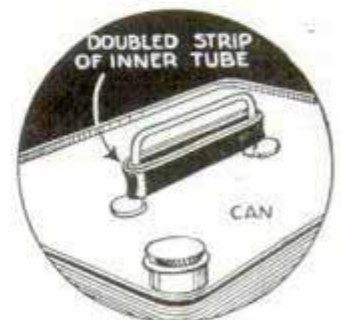

Mini-Camera Focuser Aids Taking Close-Ups

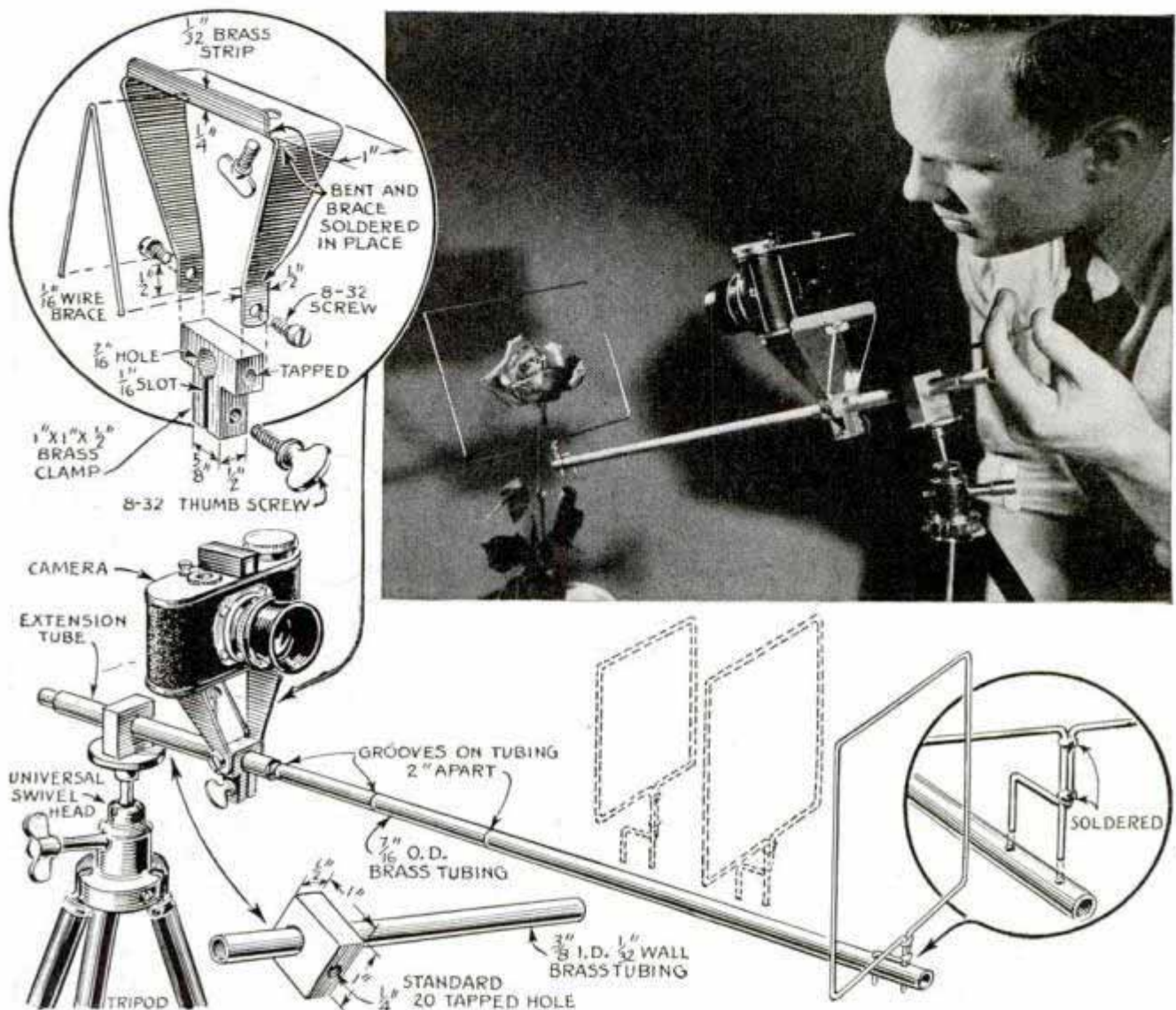

When photographing small objects with a miniature camera fitted with a supplementary copying or portrait lens, you can save yourself the time of taking measurements under 3 ft. for exact focusing by using this quick-acting focusing frame which attaches to the universal head of any tripod. The telescoping tube you see in the details carries both the camera and the wire focusing frames. The latter are for the purpose of framing the subject and centering it at a given distance from the lens. Grooves turned or filed on the extension tube give these distances for each of the three frames. However, as the accessory lens has a definite focal length it is necessary to determine this accurately beforehand. Place the camera on a table, set the lens at minimum distance and attach the supplementary lens. Then open the back of the camera and insert a piece

of ground glass in place of the film. With the shutter set on "time" and a small object in front of the lens, move the camera back and forth until the image focuses sharply on the ground glass. Then measure and record the distance. By re-setting the distance scale on the camera you can vary the number of inches between the lens and the object when the latter is in sharp focus. This will give you the distance settings for the three frames. Sizes of the frames will also vary. Each one should be sufficiently large so that no part of it is included in the field of the lens, otherwise it will appear in the picture.

☞ To clean hairbrushes without loosening the bristles, wash them in luke-warm soapsuds to which a few drops of common household ammonia have been added; then place them in an open window to dry.

Shield over Implement Tongue Keeps Reins from Tangling

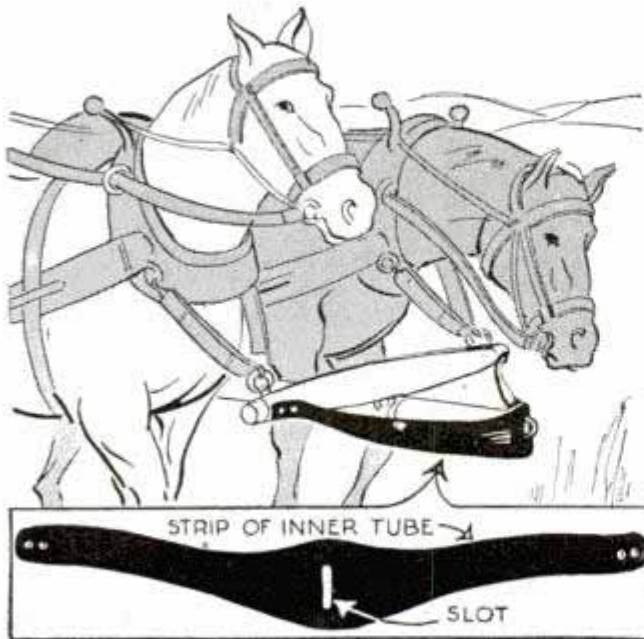

Reins are likely to get under the end of an implement tongue when horses lower their heads unless a shield is provided to avoid this trouble. Such a shield is made easily by stretching a strip of inner tube over the end of the tongue and nailing the ends to the neckyoke as indicated.

Simple Rack Displays Groceries and Vegetables

Made entirely of inexpensive plywood, this rack is just the thing to display groceries and fresh vegetables in a store. It

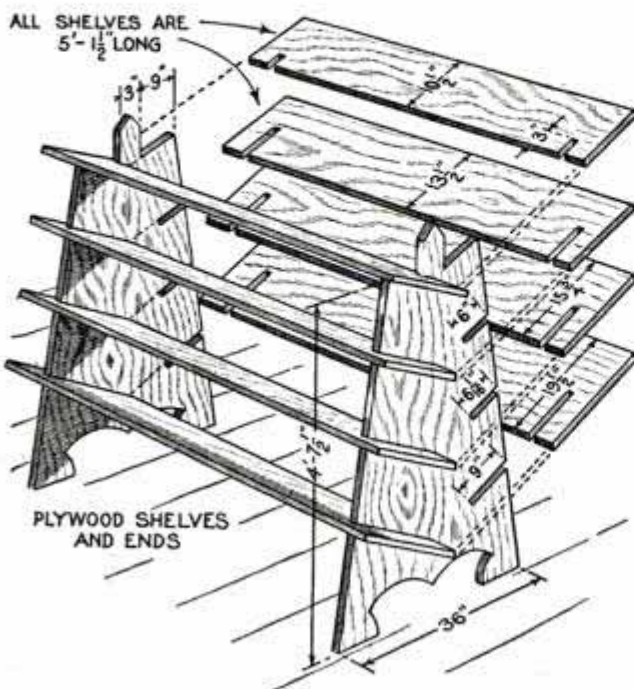

can be made any size desired by varying the dimensions given, and will be found especially useful in self-service stores. Or, it can be made smaller for home use.

Extension Stops on Two Valves Prevent Using Both at Once

In a factory where it was necessary to make certain that two valves could not be opened together, and that one would be closed before the other was opened to avoid incorrect mixtures in a tank, the simple arrangement shown in the drawing was found effective. The nuts on the valve

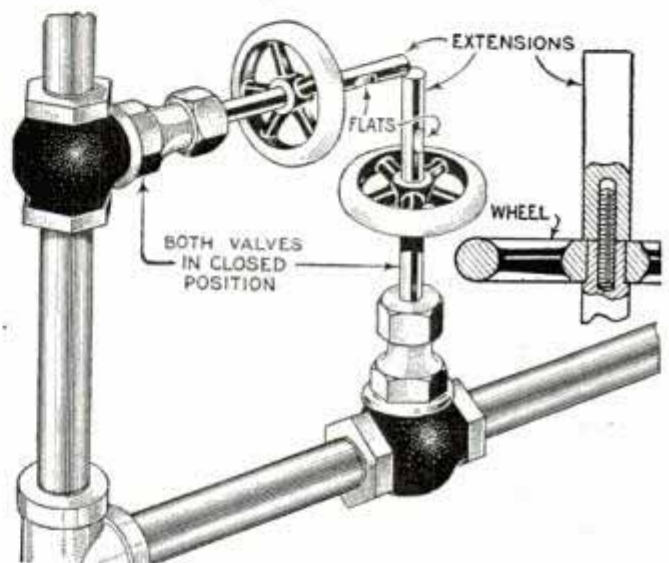

stems were removed and two extension pieces screwed on, which just cleared each other when the valves were closed. Then, when one of the valves was opened, it was impossible to open the other one as the extension piece was in the way.

Attached Rubber Bands Save Time in Handling Blueprints

By permanently attaching rubber bands to blueprints, a contractor saved time because the bands could not be misplaced when a print was unrolled. Strips of adhesive tape held the bands in place.



☐ Aluminum muffin pans provide good trays for starting seedlings.

The RIGHT WELD

in the right place

WHEN to use the electric arc and oxy-acetylene flame for welding need not be a puzzling problem. Just remember that the arc is faster and enables you to minimize distortion, while the gas flame can be varied to control hardness of the weld. In many cases, however, either method produces results that are quite similar, thus making the choice a matter of convenience. Ordinary assembly work and repair jobs on wrought iron and mild steel, Figs. 1, 2 and 3, permit the use of either method. On other jobs, the form or thickness of the pieces at the point of weld, the kind of metal and the results desired often make one method better than the other.

Special Shapes: In welding special shapes where distortion or warping must be kept at a minimum the electric arc is better as the weld can be finished before the surrounding metal has been heated excessively. For example, in building up a broken gear tooth, Fig. 7, speed is necessary to minimize distortion. The tooth is built up as rapidly as possible with the electric arc, after which the finished weld is machined or otherwise finished.

Hardness of Steel Welds: With the oxy-acetylene torch, a reducing flame—one with an excess of acetylene gas—can be used to control hardness of the weld. In this case, some of the excess gas is broken

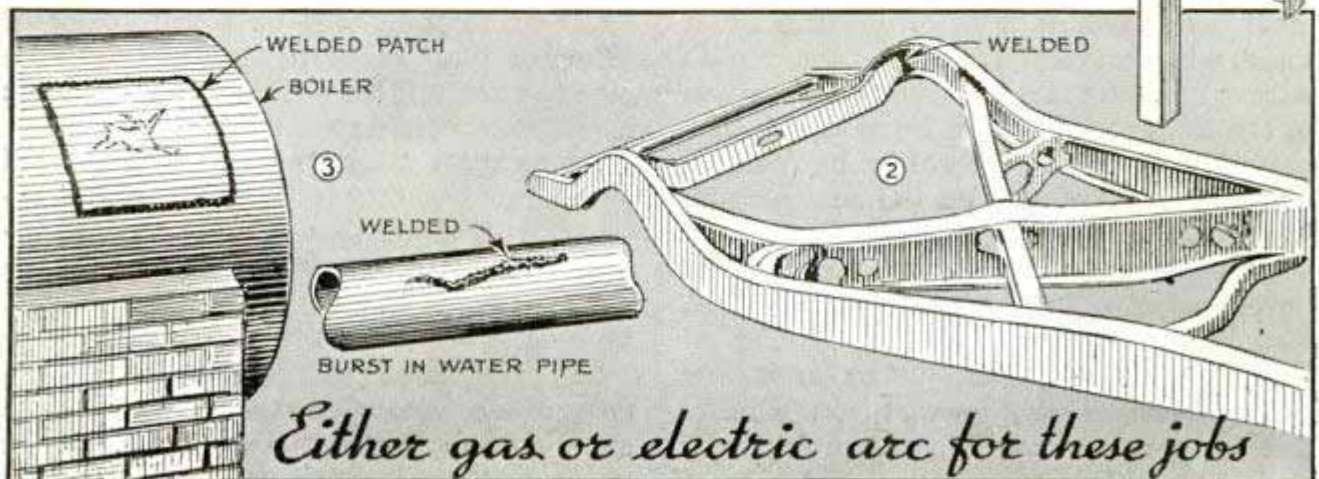
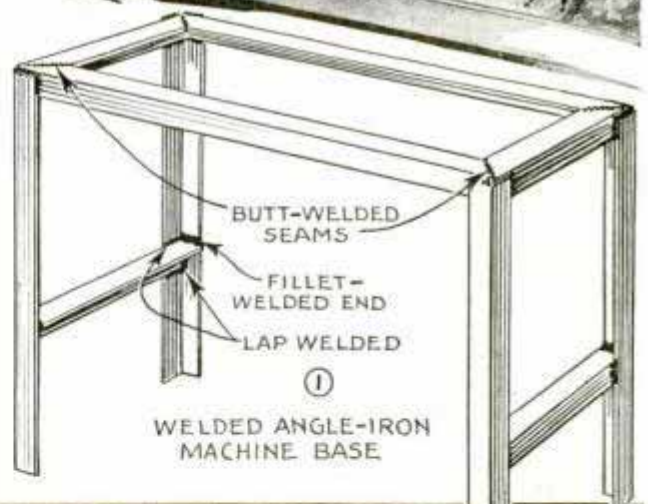

Either gas or electric arc for these jobs

The electric arc minimizes distortion

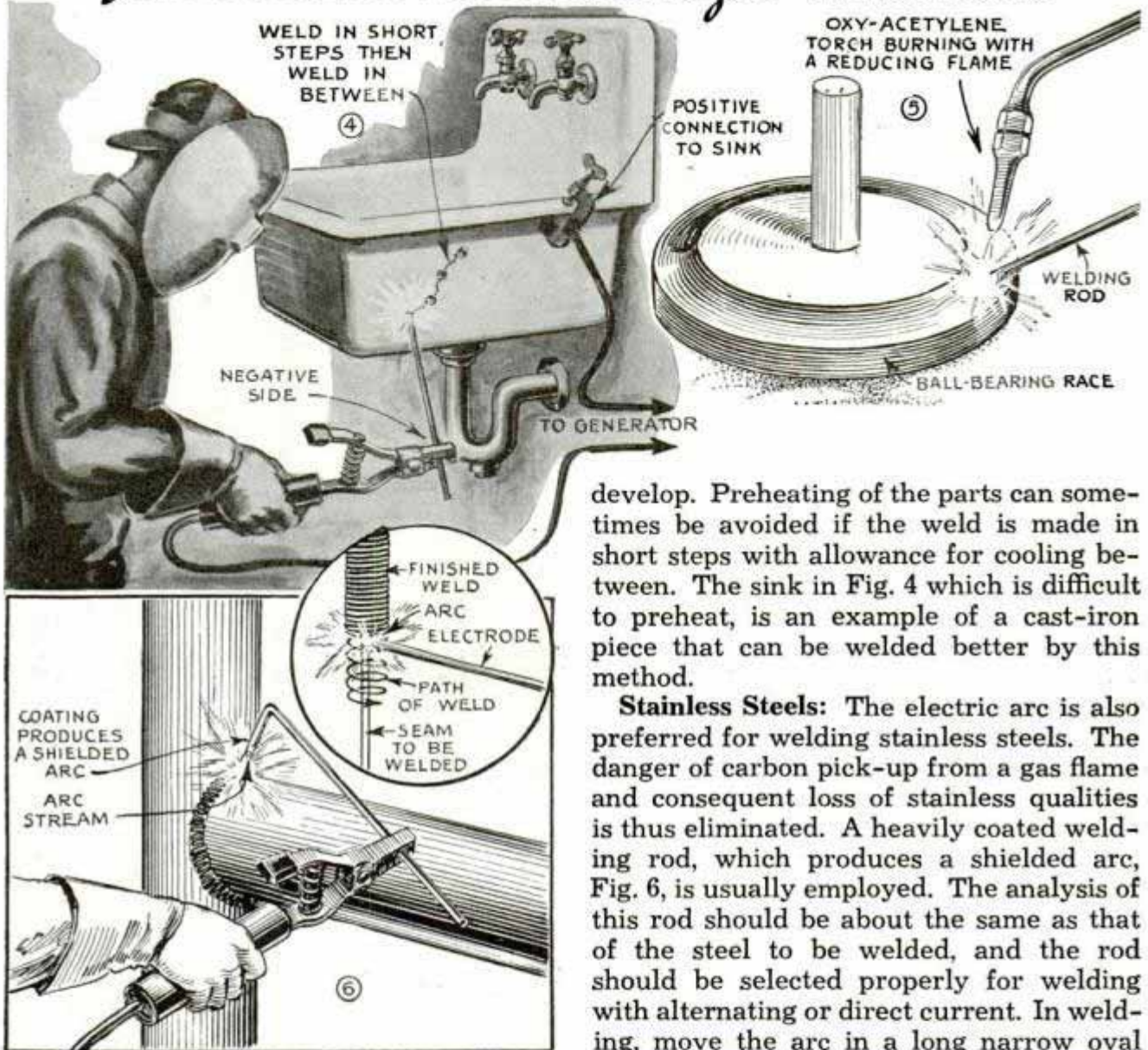

down into carbon, which passes into the molten iron of the weld. This metal then becomes high-carbon steel and will be much harder and more brittle when it is cold, which is desirable in welding hard steel, as shown in Fig. 5. On the other hand, when an oxidizing flame or one with excess oxygen is used, some of the carbon in the weld metal will be burned out. The resulting weld will be softer but with a larger amount of slag on the surface, and will have a tendency to be pitted and coarse-grained. With reasonable care, however, jobs like the automobile fender, Fig. 8, can be welded successfully.

Cast Iron: The faster electric arc is better than gas welding on cast iron. Cracks due to uneven expansion of the cast iron and the weld metal are not so likely to

develop. Preheating of the parts can sometimes be avoided if the weld is made in short steps with allowance for cooling between. The sink in Fig. 4 which is difficult to preheat, is an example of a cast-iron piece that can be welded better by this method.

Stainless Steels: The electric arc is also preferred for welding stainless steels. The danger of carbon pick-up from a gas flame and consequent loss of stainless qualities is thus eliminated. A heavily coated welding rod, which produces a shielded arc, Fig. 6, is usually employed. The analysis of this rod should be about the same as that of the steel to be welded, and the rod should be selected properly for welding with alternating or direct current. In welding, move the arc in a long narrow oval along the seam to keep the metal molten long for gas bubbles to escape. Stainless steel expands greatly upon heating and the strains produced around a welded joint in this metal are considerable. If the piece is annealed after welding to remove these strains, the joint will be much stronger. When a direct-current arc is used, the electrode should be positive and the work negative, reversing the usual procedure.

Aluminum: This metal can be welded satisfactorily either by gas or by the electric-arc method. Gas welding on aluminum is more convenient, however, as the metal has a very low electrical resistance. In nearly all cases, preheating of aluminum parts before welding is essential when using the oxyacetylene torch, as the metal expands and contracts greatly with heat changes. Care should be taken not to pre-

Gas welding controls hardness

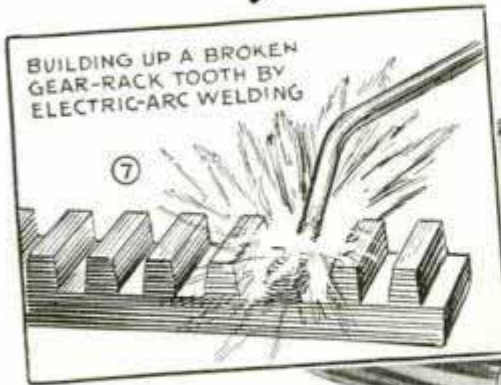

heat over 800° F. as aluminum becomes very weak at temperatures above this point.

There are several methods that can be used for preheating aluminum to be welded. An open forge may be the only means available, or perhaps a gas burner is handy. The latter method is convenient when welding a cracked aluminum crankcase, which, as shown in Fig. 9, has been placed over both burners. As the determination of exact temperature of a casting may be impossible with apparatus available, you can tell approximately the correct welding temperature by simply touching a stick of ordinary solder to the metal at the welding location. Just as soon as the solder melts when it contacts the aluminum, the piece is hot enough to commence welding. Aluminum and its alloys have a sharp melting point and collapse readily into a very fluid pool around the torch flame. This may cause difficulty in welding as the molten pool can become deep enough to blow through and run off while the rod is still solid. Technique in handling the torch and rod will help, but the use of welding rods of the same alloy as the metal to be welded—cast rod for cast aluminum, duralumin for duralumin, etc.—will tend to eliminate this difficulty.

Copper, Bronze, and Brass: Since the electrical resistance of this class of metals is very low, gas welding is again slightly more satisfactory than welding with the electric arc. Results are the same, however, by either method, when the work is done correctly. Copper, bronze, and brass do not expand excessively when heated but the molten metal is very fluid. This

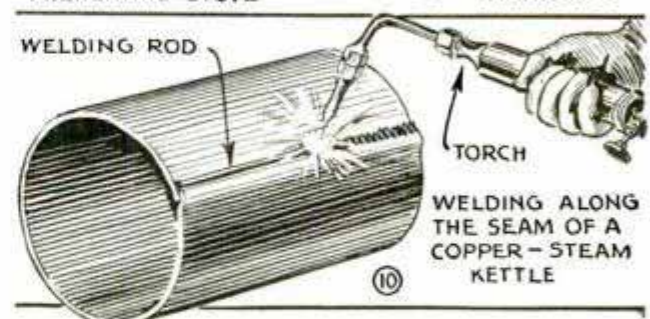
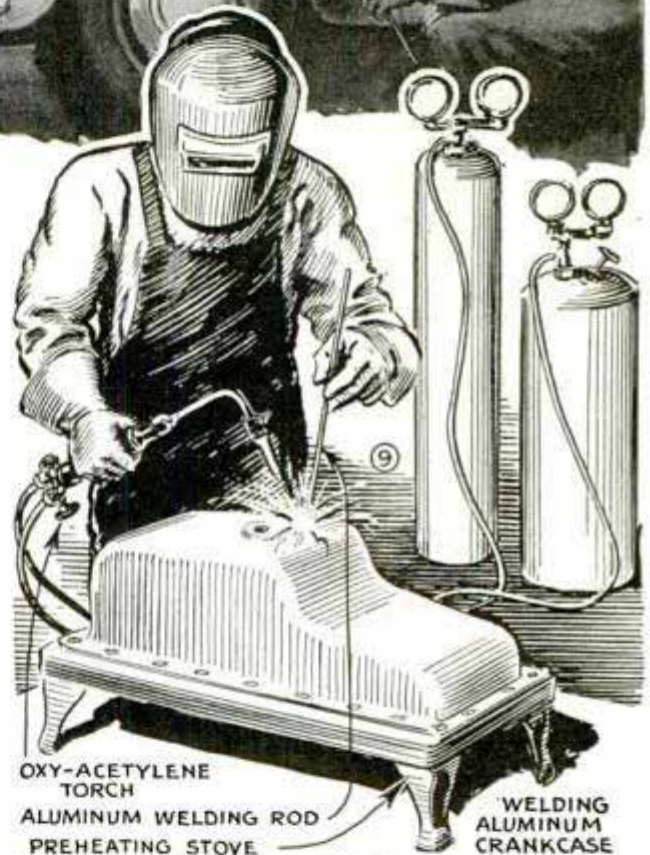

makes for faster fusion and often the welding can be done by simply laying a piece of welding rod along the joint or seam and flowing it in place with the torch, Fig. 10. Copper and its alloys conduct heat readily, and it is often difficult to keep the weld hot enough. Preheating the pieces will save gas and allow the welding to proceed faster.

Mounted Policeman Marks Cars without Dismounting

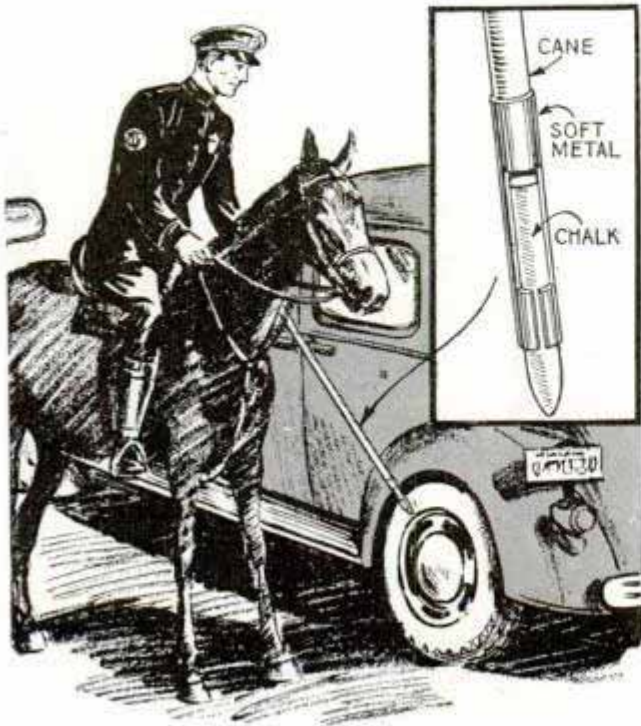

By using chalk on a long handle, a mounted policeman can mark the parking time on car tires without getting off his horse. The handle, which may be an ordinary wood cane, has a short metal tube fitted on the end to take the chalk, one side of the tube being cut out as indicated so that the chalk can be moved down as the end wears off.

Silencing Noisy Brake Rod

Noise caused by a brake rod vibrating against the starter and exhaust pipe on my car was silenced with a sponge-rubber ball. A hole was made in the ball with an ice pick so that it could be slipped over

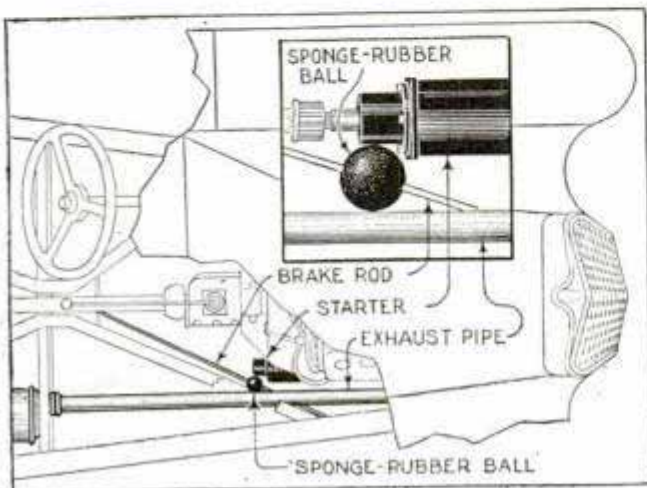

the rod, locating the ball in a position to contact the starter housing when the rod vibrated.—Woody Harmon, Fairbanks, Ind.

Flexible Garage Doorstop from Radiator Hose

In a public garage, where doorstops were lost or thrown about so that they were not at hand when needed, one mechanic made a supply of them from discarded pieces of radiator hose. Each piece was flattened and riveted at one end to make an elastic wedge.

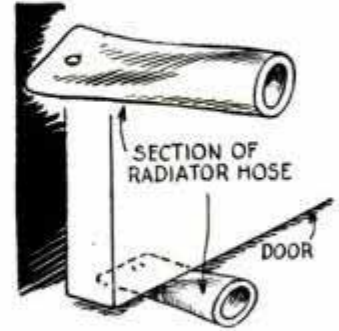

Truck Tailboard Chain on Pulley Easy to Operate

Instead of running the chain that holds the tailboard through the usual screw eye or over a hook, use a pulley of the type

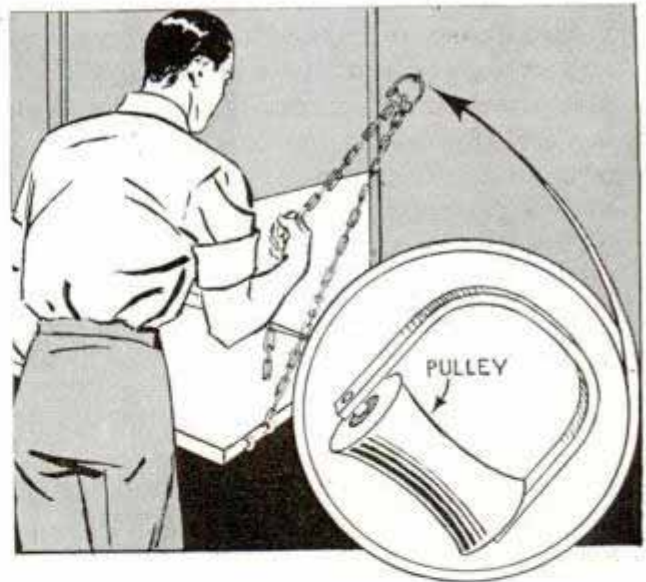

shown. This makes it easy to pull up the chain as the board is raised, and the chain end can be fastened in the usual manner.

Uses for Soap on Your Car

Besides cleaning your hands, there are several uses for soap around your car. Soft soap or shaving cream applied to the edges of vacuum cups on coat hangers, ash

trays, etc., will make them stick tightly. Maybe there is a squeak around the windshield or other part of the car that is caused by two metal parts rubbing slightly. Shaving cream worked between the contacting surfaces will stop the noise. If it is coming from the floor of the car, an application of yellow laundry soap will silence it.

—C. E. Packer, Chicago.

Paper Clip Provides Guide for Striping Brush

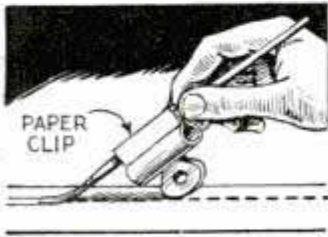

Having an occasional job to touch up with paint where a fender or part of a body had been repaired, one mechanic found that a paper clip

of the type shown provided a good guide for his striping brush. The jaws of the clip are clamped over the brush, which is then adjusted to any angle desired.

Jiggling Reflectors Get Attention of Motorist Behind Truck

Red glass reflectors soldered to small coil springs, which are fastened to the rear of a truck body, will vibrate and tend to attract the attention of an approaching motorist quicker than those that are attached rigidly to the body. The wire from which the springs are made should be of a small diameter so that the weight of the reflectors will cause them to flex at the slightest movement of the truck.

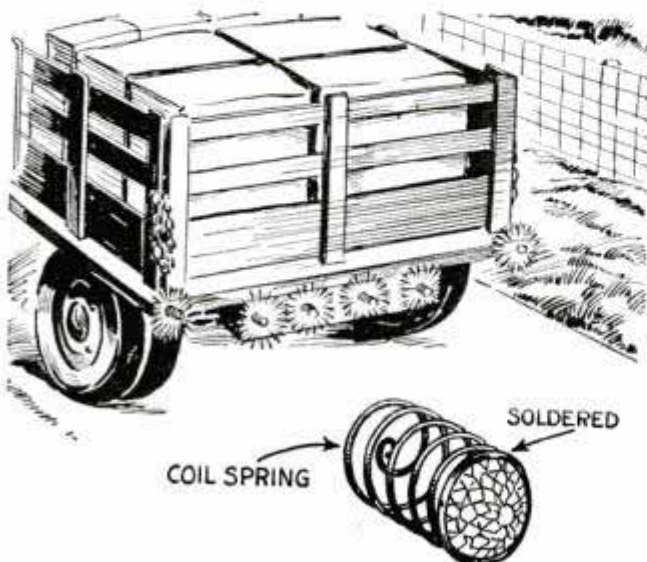

Pointer Tests Valve Springs by Comparison

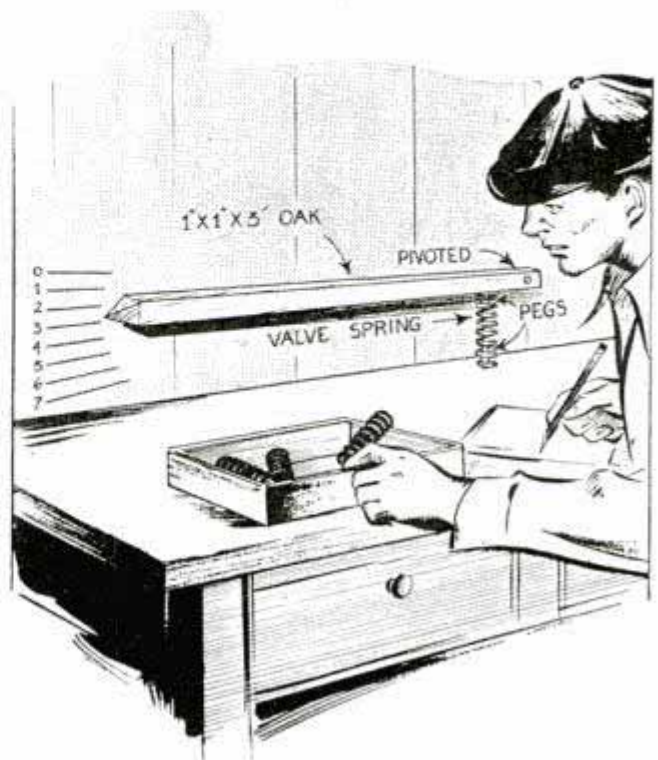

To test the strength of valve springs in approximate comparison with that of a new one, an auto repairman pivoted an oak pointer to the wall over his workbench. A peg in the underside of the pointer and one in the bench top support the spring upright for the test, which is made by allowing the weight of the pointer to compress the spring. The zero mark of the scale at the end of the pointer was determined by using a new valve spring, and the remaining marks were made to indicate comparative loss of strength of old springs.

Acidproof Battery-Tag Holders

Short pieces of garden hose, with one end slit as indicated, provide good tag holders for customers' cards on batteries in a charging room. Ordinary size hose fits snugly over most battery posts and the card may be inserted securely in a slot where it will be conspicuous and the number read easily.

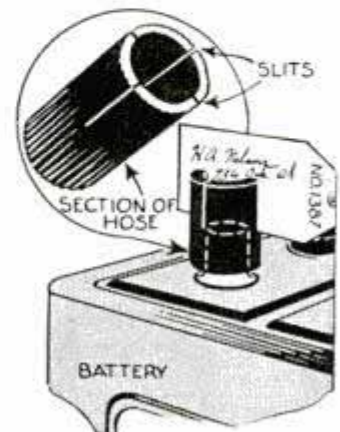

Perforated Hose Washes Car Tops

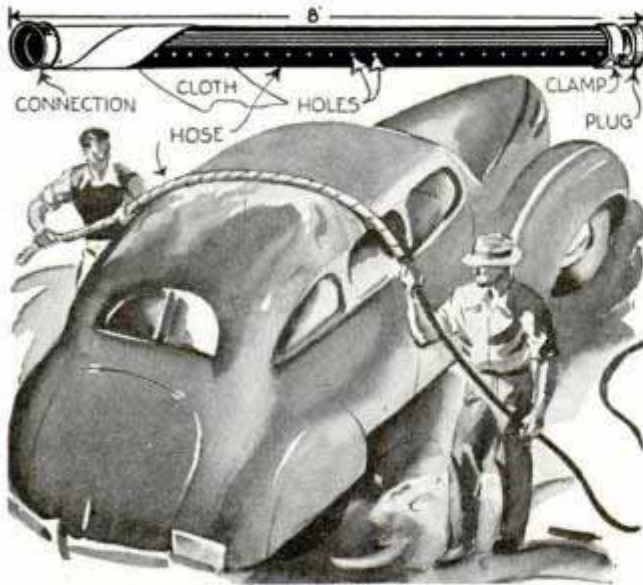

Late-model cars that have no running boards give car washers a problem because

there is no place to stand to reach the top. To overcome this trouble, one washer uses a length of garden hose, which has small holes punched in it about 1 in. apart to emit water. The hose is plugged at one end and is wrapped with soft cloth.

Brush Cleans Oil Holes

To clean out oil holes so lubricant may be applied freely, solder a bent mucilage brush on the oil-can spout. The bristles of the brush may be manipulated to clean a hole before the oil is applied.

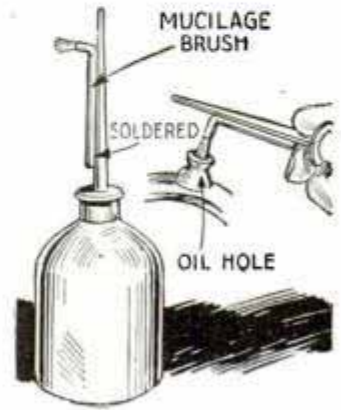

Twelve Woodwork Hobby Plans—a \$1 Gift

A winning Christmas gift that keeps "growing" in results

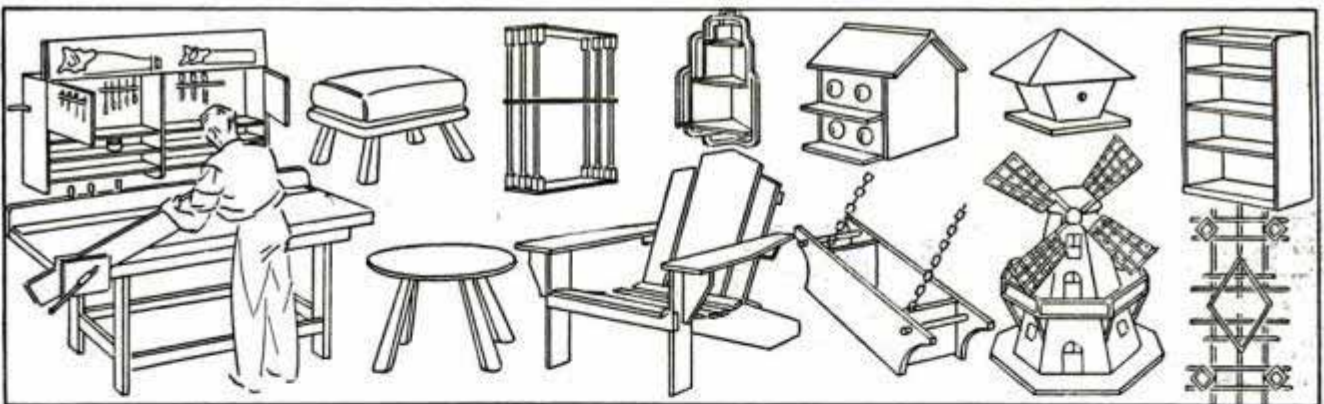

Special Offer

Here's a real bargain assortment of Craftplans for making simple, useful articles with hand tools; things needed in and around every home. Complete detailed drawings give size and position of every part—also material list and easy-to-understand instructions how to proceed step by step.

Ideal Christmas Gift

For hubby or junior who likes to make things; for the man or boy who wants and should have a worthwhile hobby, what small gift is more appropriate than this collection of Craftplans? If you want a larger gift, just add a kit of good quality tools.

What the Craftplans Include

Sturdy woodwork bench; handy wall tool cabinet; colonial coffee table; cushioned footstool; two small wall shelves; an eight-compartment martin house; five styles of wren houses; four-shelf open bookcase; garden chair; window flower boxes; three trellises and a miniature Dutch windmill for the garden.

To Get This Selection of Plans

Fill out the coupon and remit \$1 and this surprise package will be sent to you prepaid. The above-listed Craftplans are the only ones available. For a selection of other subjects send 3 cents for our catalogue of 25-cent plans.

POPULAR MECHANICS MAGAZINE
200 E. Ontario St. Chicago

Enclosed find \$1.00 remittance for your
SPECIAL CRAFTPLAN ASSORTMENT

Please check I am a subscriber
 I buy at newsstand

Name _____
Use Pencil
Address _____
City _____ State _____

FAMOUS
**HANKEE
HANDYMAN**

HOME . . . HOBBYIST TOOLS

25¢

IT RATCHETS

**YANKEE
HANDYMAN
No. 2H**

Needed in the kit of every hobbyist. Wanted in every home. Useful to man, woman, boy. "It Ratchets!" Makes easy work of driving or drawing small screws. Simply set for right or left ratchet. Then just move handle to and fro. You get genuine "Yankee" quality for only *Twenty-Five Cents*. Length 4 1/4"

Look For
"Yankee" Handyman
Displays At Dealers
New
Amazing
Values

\$1²⁵

\$1⁰⁰

"YANKEE"—famous for Fine Mechanics' Tools, also makes "Yankee" Handyman Tools for Home and Hobbyist. New speed, greater ease, handier for you—driving screws, boring holes! "Yankee" Handyman Screw Driver **No. 133H**—with *Spring in Handle*, \$1.25, is ideal drill. **No. 33H**, without spring in handle, only \$1.00.

To bore holes for screws, countersink, etc., with either **No. 133H** or **No. 33H**, buy these "Yankee" Accessories. Sold separately, or in Pak:

"Yankee" Chuck and 3 Drills Set, 39c

"Yankee" Drill 5/64"
"Yankee" Drill 7/64"
"Yankee" Drill 9/64"

"Yankee" Countersink Each 25c

"Yankee" 5/32" Blade for small screws Each 12c

Accessory Pak No. 330H

Complete Set Accessories On Card, 75c.



To change No. 133H or No. 33H into a drill, remove screw driver blade.

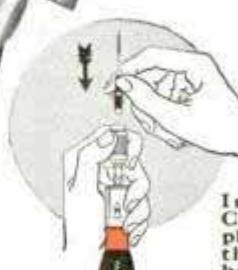

Insert "Yankee" Chuck-and-Drill in place of blade. You then are ready to bore small holes.

North Bros. Mfg. Co., Philadelphia, U. S. A.

"YANKEE" GIFT BOXES

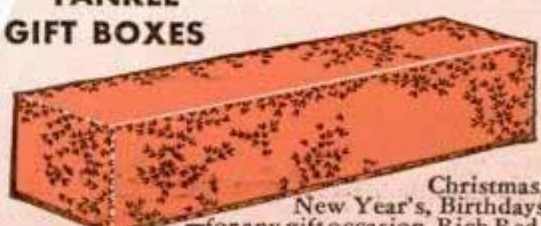

Christmas, New Year's, Birthdays —for any gift occasion. Rich Red-and-Gold "Yankee" Gift Boxes, containing "Handyman" **No. 33H** for \$1.00... Or, **No. 133H** for \$1.25—with *Spring* in handle. At Hardware Dealers.

Keeping the Sea Birds Flying

(Continued from page 94)

the units making up the nerve center of the craft are inspected and serviced, such as generators, magnetos, starters, spark plugs, propeller governors, gasoline meters, five different kinds of pumps and countless other accessories. New equipment, too, is examined and subjected to rigid tests. Of equal importance is the maintenance of the giant, three-blade propellers. An entire shop is given over to the care of this equipment, which is a highly mechanized unit. Each propeller is completely dismantled after every trip, the blades removed and the mechanism overhauled, cleaned, checked and lubricated. Known as variable-pitch propellers, their

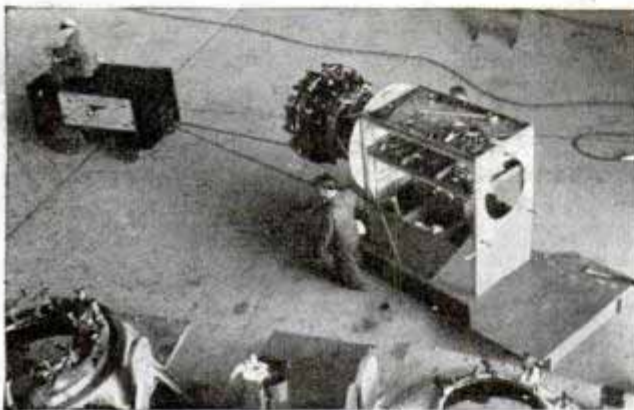

Moving one of the 1,500-horsepower engines, of which the Clipper is driven by four

blades are pitched so the angle of attack may be changed in flight. On taking off, the pitch is reduced to develop more power; for straightaway flying, the angle is increased for better efficiency.

As the over-all length of the new Clipper is 109 feet, this means that some of the control cables are close to 100 feet long, which calls for more time and greater care in checking and inspecting the controls of these big ships than any others yet built. Control cables for the ailerons, rudders, wing flaps and elevators are gone over and tested for a service far more demanding than that required of a land plane whose average length of hop is approximately 1,000 miles.

Even the body, or fuselage, is checked, such as port covers and soundproofing panels, which are inspected, cleaned and repaired if necessary. The sea wings, or hydro-stabilizers—short, stubby, under-

(Continued to page 116A)

1 What \$14 camera gives me KODACHROME transparencies?

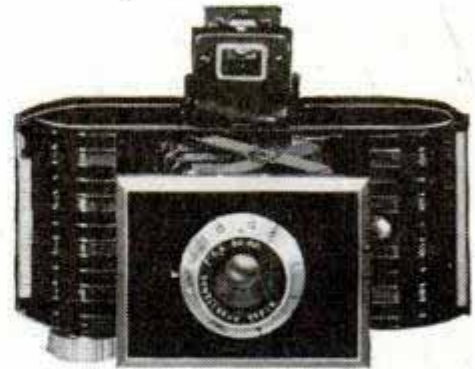

KODAK BANTAM (f/5.6). No extra equipment; just load with Kodachrome (full-color) Film . . . Through modern photofinishing methods, Bantam (f/5.6) also leads to black-and-white pictures 2 3/4 x 4 inches . . . Kodak Bantam, with Kodak Anastigmat f/5.6 lens, \$14; with Kodak Anastigmat Special f/4.5 lens, \$22.50.

2 What camera recently announced is equipped with that great new Supermatic shutter?

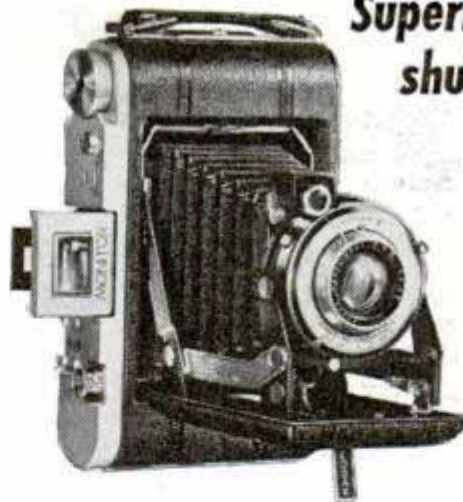

KODAK MONITOR SIX-20 (f/4.5 Special). The Supermatic is Eastman's new high-precision between-the-lens shutter, that is unsurpassed anywhere in accuracy. 9 speeds to 1/400 second. Other features: Kodak Anastigmat Special f/4.5 lens, new-type body shutter release, double-exposure prevention, automatic film stop. Price, \$42.50.

Only
EASTMAN makes
the KODAK

PHOTO FAN'S CHRISTMAS-BUYING QUIZ...

3 What great miniature is a sensational value at its present price?



KODAK BANTAM SPECIAL. Super-precise Kodak EKTAR $f/2.0$ lens. $1/500$ Compur-Rapid shutter. Coupled range finder. For black-and-white and Kodachrome full color. Price, \$87.50 with field case.

5 What movie camera is justly known as the "economy movie maker"?



CINÉ-KODAK EIGHT is the "economy home movie maker." Thoroughly capable, it gives 20 to 30 black-and-white movie scenes—each as long as the average newsreel scene—on a roll of film costing \$2, *finished, ready to show*. For color movies, load with Kodachrome Film. Price, \$29.50. At your dealer's... Eastman Kodak Co., Rochester, N. Y.

4 What 35 mm. miniature offers high precision at modest cost?

KODAK 35 ($f/3.5$). Gives you what you must have for dependable black-and-white and Kodachrome (full-color) photography. Precise, long-lasting construction. Special $f/3.5$ lens. Accurate $1/200$ shutter. Double-exposure prevention. Automatic shutter setting. Exposure counter. Price, \$33.50.



GREATEST VALUES IN YEARS

(Continued from page 114A)

wings—come off regularly, every third round trip, for inspection and painting. These wings are built to absorb much of the shock of landing; also, they stand a terrific beating when taking off in a strong cross-wind, and when lying alongside a dock or pontoon, which sometimes results in sprung plates or pulled rivets.

The maintenance of instruments for both flying and navigation requires the services of sixteen highly specialized workers. Each class of instrument has its own shop. For flying, there are the air-speed indicator, the tachometer for counting engine revolutions, the bank-and-turn indicator and the artificial horizon. Perhaps the instru-



Giant propeller on test stand for checking after its mechanism has been serviced thoroughly

ment calling for the greatest care and precision on the part of the inspector is the automatic pilot. This maintains not only directional flight, but altitude as well, such as ironing out bumps. Among the navigation instruments are the compass, drift indicator, chronometers, radio direction finders, and the sextant. And every scientific instrument, for both flying and navigating, is removed, overhauled and checked after every round trip to the Orient.

Complete maintenance work at Treasure Island is divided between 125 scientific and mechanical experts; and after each one has finished and inspected his own work, the general inspector goes over the whole ship for a recheck of every detail. The net result is summed up in the test flight. For example, consider a ship that arrived on Tuesday and is scheduled to depart next Wednesday, eight days later. On the fol-

lowing Tuesday all shop work is completed; the ship is fueled and oiled, but before launching there is an engine "run-up"; that is, engines are run for two hours, part of the time at full throttle, part at low speed.

While this is going on, the compass is being compensated, as when the captain of a steamer adjusts his compass by swinging his vessel. Once more in the water, the crew and captain go aboard for a four-hour "cruise to nowhere," the men taking the time for routine drills, such as making emergency landings and abandoning ship exactly as if passengers were aboard.

The purpose of this four-hour shake-down cruise is to make sure everything is in order for the flight to Hong Kong. But if any performance detail is in doubt, if the skipper doesn't like the sound of that No. 4 engine, the detail is attended to overnight. With everything in perfect order, the ship is moored and stands by ready to take aboard her passengers the following day.

But just suppose something does go wrong with an engine or its fuel or oil line, while in mid-flight. Immediately the engine is cut off, while the engineer crawls out through the wing to make repairs. If necessary, a four-engine ship can fly indefinitely on three power units; even on two it will maintain level flight.

Energy in Handful of Uranium Could Drive an Ocean Liner

There is enough atomic energy in eight pounds of uranium to drive a great liner like the "Queen Mary" across the Atlantic ocean. Of course, it won't happen very soon, for the neutron bombardment that releases atomic energy is turned loose only in laboratory cyclotrons. Experimentally, thirteen grams of metallic uranium were exposed to neutrons and the temperature rise was measured. It was found that each uranium atom split liberated 175,000,000 electron volts of energy; splitting 155 billion uranium atoms would warm a gram of water one degree centigrade; a little more than a half pound of uranium would boil 386,000 tons of ice water. And so it was computed that the energy in eight pounds of uranium would equal that of the 6,300 tons of fuel oil carried in the "Queen Mary's" bunkers.

Mr. Malcolm C. Henderson Princeton

IT'S
SMOOTH GOING
WITH

Velvet

HARVEY NILSEN
Sun Valley, World's Fair
Professional
Ski-Jump Champion

...the fine old aged-in-wood mildness of Kentucky Burley tobacco that cools your pipe and warms your heart... extra good taste of pure maple sugar flavor.



**Packs easy in a pipe
rolls smooth in a cigarette**

*for Better
Smoking
Tobacco*

.. say VELVET

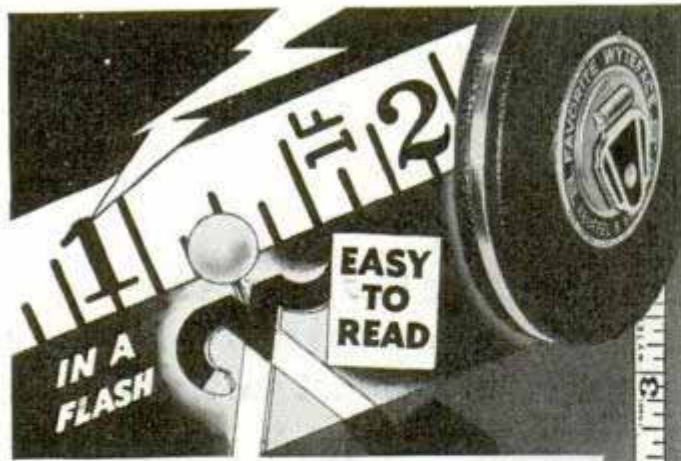

Black-on-white markings! In a flash, you read them—in poor light or good light—with minimum chance of error! This improved steel tape has a smooth, crack-proof, white surface—bonded to the steel—protecting it from rust. It's hard to kink, hard to curl. It's easy to clean—and good for a long life. 25, 50, 75, 100 ft. lengths. Get a free sample of the line and illustrated folder. Mail the coupon today!

K&E FAVORITE WYTEFACE STEEL MEASURING TAPES

LOOK FOR THIS DISPLAY



KEUFFEL & ESSER CO. . . Est. 1867
Dept. 104, Hoboken, N. J.

Name.....
Address.....
City.....State.....

NEW STREAMLINE BENJAMIN AIR RIFLES WITH LEVER HAND PUMP



BENJAMIN

HARD ACCURATE SHOOTING WITH CHAMBERED AIR
You can use new models BENJAMIN AIR RIFLE WITH LEVER HAND PUMP anywhere, for practice firing or just plinking around the house or camping, fishing, hunting, etc., at lowest cost. Shooting force is adjustable depending on AIR PRESSURE—amazing maximum power and accuracy—will penetrate to 1'. Hair trigger firing without lunge or recoil. Single Shot BB \$7.50. Repeater BB \$9.00. Rifled Cal. 22 or 177 Single Shot \$8.50. Ask your dealer all about them or write for complete specifications—targets and blueprints FREE if requested. We also make a complete line of BENJAMIN AIR PISTOLS for target and small game. WRITE TODAY. BENJAMIN AIR RIFLE CO., 895 MARION ST., ST. LOUIS, MO. U. S. A.



FREE! JUST OUT! AMERICA'S MOST BEAUTIFUL Nursery and Seed BOOK

FIRST QUALITY GUARANTEED STOCK FROM AMERICA'S LARGEST Direct-To-You Nurseries. Plan your garden right from this helpful new book of choicest flowers, fruits, seeds, shrubs, roses, etc. Free gift offers and planting guide for customers. Low prices. Write to-day. INTER-STATE NURSERIES, 3710 E. St., Hamburg, Iowa



Build this Smith Compressor

We will furnish complete instructions with a

Smith Compressor Head and Accessories

With a Ford Motor and shop facilities you can easily assemble a Smith Air Compressor. You'll have a smooth performing, efficient compressor. Sixty cubic feet a minute capacity—all the power you'll need to operate rock drills and paving breakers. Here's a way to save money. Write for complete information.

GORDON SMITH & CO. Inc.

410 College St., Bowling Green, Ky.

Tricks of the Figure Skaters

(Continued from page 69)

ity usually start at a tender age, too. The child who takes first steps in figure skating between the ages of four and six has a distinct advantage over those who start later. Not only is he a proficient skater by the time others are just taking it up, but he also, if properly instructed, has nothing to unlearn—no bad self-taught skating habits that must be replaced with the proper routine, and only done by painstaking practice.

Consider for a moment the insecure footing of a skater. It is only a thin blade of steel in contact with a sheet of ice, and there hardly could be a more slippery combination. It is obvious, then, that exhibition skaters do wonders, under those circumstances, and their accomplishments are proof of real skill and agility. A skilled skater, leaping from one foot, can do a double Salchow or a double back loop jump, both of which are two complete turns in the air, and land properly on one foot. Most skating jumps are made from but one foot.

There is no average length of time required for a novice to acquire skill on the ice. The requisite asset above all others is natural ability—in other words, muscular control and that matter of co-ordination spoken of above. The soundness of instruction weighs heavily, coupled with which is the matter of an adequate amount of the proper instruction. Then comes practice, and more practice. From personal experience I know what it is to put in from five to seven hours a day at it, part of the time being devoted to rope-skipping, limbering up and stretching exercises, manipulations by a masseuse, and general conditioning exercises.

Skating being the thing of grace, rhythm and motion that it is, lots of things can be and are done on skates. To pass the tests and earn the medals of the United States Figure Skating Association, the seeker of ice laurels must skate various "school" figures, beginning with circles, and running through threes, change of edges, double threes, loops, brackets, counters, rockers, one-foot eights, three-change-three, double-three-change-double-three, loop-change-loop and bracket-change-bracket. All figures are done commencing on either

right or left foot, forward and backward.

If the seeker of medals can do all these figures in a series of seven tests, to the satisfaction of judges duly qualified by the U. S. F. S. A., the aspirant crosses his fingers, makes sure his rabbit's foot is in his pocket, and heads into the eighth or championship test. Here, if he can execute, commencing on alternate feet for each figure, the backward three-change-three, backward and forward double-three-change-double-three, backward and forward loop-change-loop, and backward and forward bracket-change-bracket, again to the satisfaction of the judges, he has won approximately half the U. S. F. S. A. gold or "champion" medal. The possessor of a gold "champion" medal is not a champion, in the ordinary sense of the word. The medal simply means that he has attained a definite high degree of skating ability.

With his gold medal partly won, as above, the skater wins it in its entirety by giving an exhibition of "free" skating, doing spirals, dance steps, jumps, spins, spread-eagles, and other maneuvers alive with a dash of sparkle and whatever inventive skill he may give to them. It's nice work if you can do it—and do it fast. Men are required, in passing this final test, to do five minutes of continuous free skating; women, four minutes.

Of the free-skating specialties, the jumps deserve the most prominence, because of their innate difficulty. I would rate the various jumps as follows, beginning with the least difficult: 1. Three or waltz jump; 2. Salchow jump; 3. Back loop jump; 4. Splits jump; 5. Lutz jump, and, 6. Axel Paulsen jump. There are minor variations of these jumps that are given different names, but they are only slight departures from the basic forms.

Oddly enough, the three-jump, the least difficult of them all, usually wins the greatest applause from non-skating audiences, when properly done, due to the height attained by the skater in the air in executing it. The three or waltz jump consists of jumping off with one foot, making a half turn in the air, and landing on the other foot. The true skater always skates on one or the other of the edges of the blades of his skates, thus gaining maneuverability, or, in other words, control, due to the knifelike pressure of the skate edge against

(Continued to page 120A)

MEGOW'S MODEL AIRPLANES

SOARING *Eagle* 

Sensational new gas-powered model climbs quickly to great height,

\$295

soars long and glides to level landings. 3-unit construction . . . fuselage, wing and tail sections . . . easy to build, transport and operate. Finished propeller on all sizes. Special puncture-proof rubber wheels on the Class C size.

By mail, postage 20c

MEGOW'S RUBBER-POWERED MODELS



at 25c. Korda's 1939 Wakefield International Champion, \$1.00.

Megow models are the easy kind to build and fly. Many special features—Motor Hum Device—and Turned Nose Cowlings whenever design permits. Scores of big, colorful flying models at \$1.00. 30-inch flying models at 50c, and 24-inch flying models

SHIP MODELS

Authentic, romantic, historical types. The HISPANIOLA made famous by Stevenson's "Treasure Island", shown here. Length 17 in., beam 3 in. Complete plans and materials, ready-carved hulls. \$2.00 plus 15c postage.



HO-GAUGE FREIGHT CARS and ACCESSORIES



Each car an individual scale model, accurate and colorful. Kits complete with trucks, brake cylinders and wheels. Wheels insulated for 2-rail operation, couplers automatic. 26 types, 50c each, plus 10c postage. Also stations, signal bridges, water tanks, and all accessories.



Big new catalog just issued! Shows scores of model airplanes, model ships and HO-Gauge Railroads. Send 5c postage for your copy.

Megow's Dept. PM, Howard & Oxford Sts. Phila., Pa. or 217 N. Desplaines St., Chicago or 718 Mission St., San Francisco

WORLD'S LARGEST MANUFACTURERS
of Model Airplanes, Ships and HO-Gauge Railroads

21048
(Continued from page 118A)

IT'S NEW-Sensational! ELECTRIC WOOD CARVING

AN EXCLUSIVE HOME FOUNDRY ACHIEVEMENT!
Just plug in a amazing new tool and carve wood by electricity! Set No. E-102; 5 plaques, 3 interchangeable tools: stain brush and sand paper. \$2.



\$2.00

Electric Casting Set
Exciting new war molds! Casts 3 large figures; electric casting ladle; vise; 12 pigs metal; smoking torch; 2 bottles paint; 2 brushes. Fully equipped electric casting set No. A-104. \$2.



"WONDER PEN" Electric Wood-Burning
New improved pen with ivory bakelite handle and white cord and plug; 12 plaques including book-ends; finishing liquid, water colors, brushes, etc. Complete set No. B-102. \$2.



ELECTRIC METAL-TAP
Complete metal-tap set, includes electric tapper with cord and plug, 1 large airplane plaque mounted on cork with a real thermometer, 4 coaster plaques also mounted, and 6 other assorted plaques. With these you can create useful objects as well as beautiful pictures. In beautifully litho'd box. Big value. \$2.
Set No. C 103.

SAND PEN DRAWING SET
Includes 12 containers of various colored sand, 8 sand drawing pens filled with different color sands, one bottle glue and 1 brush, and 20 picture-plaques 8x6 1-4 in., many printed in two colors. In a colorful box, Big value at \$2.



SEND FOR BIG FREE CATALOG
32 pages of new homecraft sets and supplies! Many Xmas gift ideas!
Home Foundry Mfg. Co.
3124 W. Fifth Avenue
Chicago, Ill. Dept. P-1

1/2 PRICE! MFRS. ORIG. GENUINE UNDERWOOD

10 DAY TRIAL
SEND NO MONEY!



BUY YOUR UNDERWOOD No. 5 DIRECT FROM US AND SAVE OVER \$60.00 on the mfrs. original price—on easy terms too—only 10¢ a day. Greatest rebuilt typewriter bargain ever offered!
Think of it! This genuine full-sized Underwood has all standard improvements—keyboard, back spacer, 2 colors, tabulator etc. Made to sell at \$102.50—yours for only \$38.90 cash while they last, or buy on easy terms (\$42.90 term price). Mail coupon NOW for 10-day trial!

EASY TERMS 10¢ a day

INTERNATIONAL TYPEWRITER EXCHANGE
231 West Monroe St., Chicago, Ill., Dept. 101.
Send Underwood No. 5 (F. O. B. Chicago) at once for 10-days' trial. If I am not perfectly satisfied I can return it express collect. If I keep it I will pay \$3.00 a month until I have paid \$42.90 (term price) in full.
For quick shipment give references and occupation

Name.....Age.....
Address.....
Town.....State.....

the ice. Also, this makes for more graceful patterns that he may cut as he weaves and glides.

To do the Salchow jump, the skater takes off from the inside back edge of one skate. Then he does a complete revolution in the air, landing on the outside back edge of the other skate.

The back loop jump is like the Salchow, but a bit more difficult. Here the skater takes off and lands on the same foot.

With the Lutz jump things begin to get difficult in earnest. The jump is done from a strong outside back edge, by simultaneously putting the toe of the free foot in the ice and using it as a lever to assist in counter-rotation, the jumper landing on the back outside edge of the foot used originally as a lever. Thus when he lands he has done a full turn in the air, and comes down facing in the same direction as that in which he started.

Then comes the Axel Paulsen, one and a half turns in the air. You take off from one foot, landing, one and a half turns later, on the other foot. Still greater skill is demanded by the double Salchow and double loop, performed the same as the Salchow and back loop, but each adding an extra revolution in the air. It is easy to read, but don't be misled.

Spins are something else. There are one-foot spins, two-foot spins, sit-spins, change-foot spins and cross-foot spins, done on either edge of the skate or the toe of the skate. All call for practice, and the novice soon learns that as he draws his arms in toward his body he calls into play one of the factors of motion, known as centripetal force. This force builds up the speed of his spin.

Ice skating is a supreme sport, and he who gains proficiency at it gets keen personal enjoyment out of it. In this respect it is perhaps more so than is the case in some other athletic activities, such as baseball and football, where the spectator reaps the most pleasure from the exhibition.

Our Bureau of Information keeps on file the names and addresses of makers of, and dealers in, all devices described in the pages of Popular Mechanics Magazine. We are glad to furnish this information to our readers upon request, accompanied by stamped, self-addressed envelope.

Made \$279.50

on my first job in my



Own NEW Business!..

How would YOU like to own your own business and make \$3.00, \$5.00 or even \$6.00 or more in an hour? How would you like to be able to start making a pocketful of money the VERY FIRST DAY?

Here is a NEW FIELD for live wire men, and we want a man like you in every locality. You don't need special training—you don't need a lot of money. We can start you in this business where you will be your own boss and where money comes faster and easier

No Rent to Pay

Your home is your office, therefore you have no extra rent to pay. TAKE THE MACHINE TO THE JOB and do the work in your customer's home, then collect your money the same day. Think of these amazing opportunities. Barrett says "Made \$28.00 in 8 hours—on another job made \$5.00 an hour." Hanson wrote "Have all I can do." Corson says "Got my money back the first month."

Earn a Home—Earn a Car—Earn Big Pay

Even in spare time you can earn a lot of money with this new invention. If you want a new car, if you need extra money to buy a home or if you want to pay yourself a handsome salary, get into this fascinating money making business NOW. The work is easy to do, opportunities are almost limitless and you should be able to take in big profits the VERY FIRST DAY. Send the coupon for FREE BOOK telling you how you can have a business of your very own.

"Have just made \$40.00 for 7 hours' work with my Deterger cleaning wrestling pads for high school athletic department. The coach said that this was the only method of doing a satisfactory job."

R. D. McGowan.

"My profits with the Deterger have been more than satisfactory. One job paid \$18.00 for 7 hours' work, another \$28.00 for 8 hours and my customers report 'Looks like new', 'Just wonderful', etc."

J. W. B.

"Many of my jobs run from \$35.00 to \$50.00, for work which I can do in one day without any extra help. Besides every customer has become a booster for me."

A. F. Nash.

"Have often made as high as \$57.00 in a single day. My best profit for one week was \$270.75."

E. R. Williams.

FREE VON SCHRADER MFG. CO., 551 Pl., Racine, Wis. Send me (without obligation) your free booklet telling me how I can own my own business and become financially independent and how I can pay for the DETERGER on easy terms.

Name.....

Address.....

City.....State.....

than from an ordinary job. This business is NEW but letters are already pouring in, telling of tremendous profits earned the very first week. Our new electric furniture cleaning machine washes any kind of upholstered furniture right in your customer's home. Think of the millions of pieces of furniture which need cleaning. There are thousands and thousands of customers everywhere; hotels, clubs, hospitals, public institutions of all kinds, as well as homes, are all your prospects. They are ready to PAY BIG for this service. One of our men reported making \$150.00 by cleaning automobile interiors alone. Here is a vast field with tremendous opportunities.

Customers All Satisfied...

Your customers are always satisfied. They send their friends to you and thus business should roll in and help you to make still more money. REMEMBER the work is done in your customer's home. This makes everybody happy. YOU don't have to cart the work back and forth and YOUR CUSTOMERS can use the furniture almost as soon as it is cleaned. Our machine does a beautiful job, makes stains and blemishes disappear as if by magic.

Guarantee

Every machine is made in our own factory and we fully guarantee the quality of materials and workmanship, we also help you get started and make it possible for you to earn a lot of money. The entire outfit comes to you ready to use.

Easy Terms

The price is very reasonable and a down payment brings everything to you complete. The balance you can pay just a few dollars monthly. From the very day you receive the machine you should be able to start making money.

OWN YOUR OWN BUSINESS. Let us help you start now. Send the coupon above for FREE BOOK "Your Own Business, Profits Instead of Wages" NOW.



VON SCHRADER MFG. CO., 551 Pl., Racine, Wis.

BURN YOUR NAME ON TOOLS
WITH THE **ARKOGRAF**

PROTECT YOUR TOOLS FROM THEFT
Write with electricity any name or design on the hardest and finest tools and instruments, or any metal, like writing on paper with pen or pencil. Complete Outfit \$3.50—Prepaid Anywhere. Interesting illustrated circular free. Write today. Agents wanted. ARKOGRAF PEN CO., 3927 S.E. Stark St., Portland, Ore.

AMAZING POWER for model planes, model boats, model cars

Brown JUNIOR MOTORS

Model D. \$12.50. Complete, ready-to-run. Precision-made by world's largest builder of model gasoline motors. Other models up to \$21.50. Every motor guaranteed. Weight, bare, 6 1/2 oz. Dept. 6, Junior Motors Corp., 2545 N. Broad St., Phila., Pa.

HOW TO WORK IN Wood

LEARN the latest knack, e. g. how to finish 35 kinds of imported woods and domestic woods. - Up to date advice for EXPERTS; also detailed directions for BEGINNERS, showing how to make beautiful furniture the first week—and—

Up-to-date-bargains
123 special "deals"; about 300 furniture and scroll saw patterns showing exact price of materials. Bargains in woods, machinery, hardware, miscellanies of all kinds for craftsmen.

SEND ONLY 10c (currency or stamps) TO
CRAFTSMAN WOOD SERVICE CO.
2729 S. Mary St., Div. 3371 Chicago, Illinois

136 PAGES Only 10¢

Print Your Own MAKE MONEY PRINT FOR OTHERS

Cards, Stationery, Advertising, Labels, Paper, Circulars, Tags, Movie Titles, etc. Save money and time. PRINT FOR OTHERS, BIG PROFITS. Do popular raised printing like engraving with any of our presses. Junior Outfit \$8.25, Senior Outfits \$16.55 and up. Pays for itself in a short time. Easy rules sent. Recreation as well as money maker. Have printcraft for a hobby. Lowest priced practical printing press made—sold only direct from factory. Write for free catalog and all details. **KELSEY PRESSES, W-37, Meriden, Connecticut**

for HOME CRAFTSMEN

SENSATIONAL NEW Flexible SHAFT TOOL!

EASY TO HOLD—EASY TO USE

Here's new skill, new ease for home craftsmen! **FOREDOM TOOLS** afford complete freedom of operation—definitely controlled power at your finger tips. You can work in hard-to-reach places with professional precision. See illustration. Motor suspends from swinging wall bracket. You hold pencil-size, lightweight hand-piece which can be grasped close to its end for easy control. Accessories interchange almost instantly. Hundreds of uses: grinding, polishing, drilling, milling, engraving, sharpening, slotting, stone-cutting, rust-removing, sawing, carving, cleaning, sanding, scratch-brushing, etc., etc. Since 1922 **FOREDOM TOOLS** have been quality-tested and proven by thousands of expert craftsmen the world over. Here's what you get: 1. High grade universal motor (operating on both AC and DC). 2. Flexible shaft assembly. 3. Hand-piece as described. 4. 50-piece accessory set. 5. Swinging wall bracket—complete portable workshop for only **\$14.95**

YOURS ON 10-DAY FREE TRIAL

Order this Model 45 **FOREDOM Flexible Shaft Workshop** today. Enclose check or M. O. for \$14.95; or, if you prefer, we'll ship C. O. D. Try it for 10 days. If not completely satisfied, return the set and we'll refund your money at once. Catalog of this and other **FOREDOM TOOLS** free.

•**FOREDOM ACCESSORIES:** 300 to choose from. Most complete line available. Also accessory sets, all priced amazingly low. **SPECIAL OFFER:** 35-piece set including mandrels, brushes, Sanders, stone, etc., in convenient holder, postpaid in U. S., only 60 CENTS. Circular free.

DEALERS: Write for our special offer.

FOREDOM ELECTRIC CO., Dept. 110
27 Park Place New York, N. Y.

\$9.245
*and up

Auto-Glide

Truly LOW COST TRANSPORTATION

Only 1/3¢ per mile—That's the AUTO-GLIDE! Swift, thrilling rides to work, school, deliveries, pleasure. Powerful, trouble-free Cushman engine. Dependable.

WRITE! today for free folder, or see dealer for demonstration, models. Act NOW!

THE CUSHMAN MOTOR WORKS
Dept. D-1 Lincoln, Nebr.

The Gift that Leads

The Hull Auto Compass is a leader in popularity as a Christmas gift . . . and leads motorists over the most difficult routes without a lost mile. Comes in attractive holiday package. Streamlined Bakelite case, genuine sapphire bearing, built-in compensator. Only \$2.95.

See it at your dealer.

HULL MANUFACTURING CO., P.O. Box 246-D1, WARREN, OHIO

Send for **NEW SHIP MODEL CONSTRUCTION KIT**

15¢, coin or stamps, brings you NEW 36-pg. catalog with attractive full-page illustrations, authentic models of historic ships and racing sail boats, with full details of Construction Kits for all models. Remember, for precision-shaped hulls and FINISHED fittings, its

MARINE MODEL CO. 174 WORTH ST. NEW YORK
DEPT. M 11

Saw-Filing

Pays up to \$2 or \$3 an Hour in Spare Time

A FOLEY Automatic Saw Filer files hand, circular and band saws better than the best hand filer. Cash business, no canvassing, no eyestrain. No experience needed. Louis P. Wadovick, Ohio, says, "I have filed 764 saws in spare time and have earned \$850.00 in carpenter work due directly to my saw filing contacts." Send coupon for **FREE PLAN**, no obligation.

FOLEY MFG. CO., 116-40 Foley Bldg., Minneapolis, Minn.

Send Free Plan on Saw Filing business.

Name.....
Address.....

21021
Trapping the Radio Spies

(Continued from page 63)

direction indicated, tune in on the signals again, and measure their intensity with a field-strength meter in comparison with their intensity at the original location. If the signals are stronger the car is on the right track. If they are weaker, the car turns back in the opposite direction.

"Another method is to spot patrol cars at locations miles apart. Each driver takes the direction toward which his car is



Portable receiver for short-wave beam messages; antenna rod is adjusted for different wave lengths

pointed when the signals are strongest and these directions are triangulated on a map, the point at which the lines converge indicating the location of the transmitter.

"But locating a subversive radio station isn't always as simple as that. A spy station could confine its transmissions to periods so short there isn't time for the cars to swing in a circle to measure the signal strength. We have an answer to that. If we can anticipate the time at which a message is to be sent we can place cars on hydraulic grease racks at gasoline stations in different parts of the county. Raised on a pivot, a car can be swung rapidly while the radio operator finds the direction in

2-10-21
 which the signals sound loudest. Plotting the directions reported by the different cars supplies the answer."

Trapping radio spies is not a major function of the sheriff's communication department in peacetime and such methods have been used mainly to find amateur stations that are infringing on the sheriff's wave length and interfering with official messages.

"Few people appreciate the extent to which foreign nations have been using radio to learn conditions and important military information about this country," remarks an official in another branch of radio surveillance. "An amateur short-wave operator in the United States may, in conversing with an amateur abroad, unwittingly pass on information that the foreign amateur immediately turns over to his government. A foreign vessel offshore, taking advantage of the anonymity of radio may disguise itself with the call letters of an innocent amateur station and converse with amateurs here on the chance of learning something important. Amateur operators are warned to be on guard. These suggestions may seem far fetched, but the actual facts are otherwise."

This kind of radio espionage has been made to work the other way. Trusted amateur operators in this country, properly coached, have deliberately passed on misinformation to foreign amateurs who seemed to have a more than natural curiosity about some subjects. With Europe at war and amateur radio activity in the belligerent countries ended there is not so much prying over the ether waves, although it is not impossible that some amateur stations in warring nations may occasionally assume the call letters of amateurs in neutral countries to carry on conversations with amateurs here.

If the United States should become involved in war all amateur radio transmission, as in the last war, would be forbidden. In such a case some or all of the 50,000 American amateurs may be asked to spend all available time guarding the short wave lengths so that illegal messages may be detected. Attached to Lieut. Ellison's department in Los Angeles county is a small band of advanced amateur operators, chosen for patriotism, ability and availability, on call for work that would include such listening duties in time of emergency.

for SAFETY'S SAKE "PUT A NoRoL ON YOUR CAR"



Avoid
Accidental Roll Back ...

NoRoL

HOLDS CAR on UP-HILL STOPS

--leaves right foot free for accelerator

Don't be a brake pedal jockey! Put a NoRoL on your car and get away from a lot of leg fatigue as well as excessive wear and tear on clutch and drive mechanism.

NoRoL gives you a "third foot"—doing brake duty against back-roll on inclines, while right foot is left free for accelerator duty. Eliminates fatigue and frazzled nerves when you are driving in congested traffic on hilly roads and streets . . . Does away with chance of back-roll on up-hill start . . . Prevents unnecessary wear on clutch facings . . . Also lessens chances for clashing of transmission gears.

Easily installed . . . Built to last . . . Does not interfere with operation of brake pedal, clutch pedal or accelerator.

HERE'S HOW IT WORKS

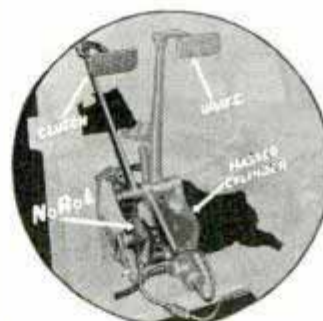

[Illustration shows a NoRoL installation . . . Actually is out of sight. Does not alter appearance of car.]

When stopping on any incline, no matter how steep, you simply apply the brake and disengage the clutch in the usual manner. An automatic check retains the hydraulic pressure in the braking system which was developed when brakes were applied. This hydraulic pressure holds the brakes applied as long as the clutch pedal is held depressed, enabling the driver to take his foot off the brake pedal and use it for accelerator duty . . . Thus making it unnecessary to keep his right foot on the brake pedal while the car is stopped. It's like having a "third foot."

When ordering a new car, specify that it come complete with a NoRoL. Available for new models of—

BUICK	DE SOTO	LASALLE	PLYMOUTH
CADILLAC	DODGE	NASH	PONTIAC
CHEVROLET	GRAHAM	OLDSMOBILE	STUDEBAKER
CHRYSLER	HUDSON	PACKARD	INTERNATIONAL
	WHITE, MACK and others		

Also available for many 1936, 1937, 1938 and 1939 makes of cars and trucks having hydraulic brakes.

Many Models Only \$12.00 Installed
SEE YOUR CAR DEALER—or write us

N 39-12

Wagner Electric Corporation

(Manufacturers of Lockheed Hydraulic Brakes)
 6400 Plymouth Avenue, St. Louis, Mo., U. S. A.

Send FREE BOOKLET and details on NoRoL.

NAME _____

ADDRESS _____ CITY _____

STATE _____ MAKE AND MODEL OF MY CAR IS _____

2.928

Floating Freight Yards

(Continued from page 89)

Hardly have the car floats been moored till the seals are broken, car doors swung open and gangplanks hooked over the sills. Men start heaving the crates of fruit and vegetables onto hand trucks. These are promptly wheeled to the platform where the motor vehicles are backed. As one truck departs, another slides into its place. As the crew unloads the first row of cars onto hand trucks another group unloads the outer row onto the platform which runs down the center of the float. With the first row of cars empty, the doors are opened and the truckers go on through, and speedily whisk away the stacks of crates and baskets which are still being piled out of the cars. The air is heavy with the smell of melting ice, celery, tomatoes and oranges.

As soon as the cars on one float have been unloaded, the tug returns and snakes that float out of the line, and shoves a loaded one into its place. The wharf is almost a quarter mile long and a number of tugs are busy at once, all moving, but never seeming to get in each other's way. On their stacks are familiar symbols, Erie, B. & O., New Haven, C. N. J., and others. These tugs all belong to railroads and are in reality floating switch engines.

Along New York's water front are 157 miles of wharf. The activity is being repeated at intervals around the entire island. It is not uncommon for a single wharf to handle 250 cars between ten at night and seven in the morning, unloading them, distributing the merchandise to the waiting trucks, and having it all hauled away, the refuse swept up and the pavement washed by nine o'clock.

The newer car floats are made of welded steel and are streamline. Rectangular in shape, the underwater structure offers minimum drag, and they can be handled in close quarters as easily as an automobile in a parking lot. There are two distinct types, the terminal float, which runs up to a dock for the cars to be unloaded, and the transfer float which runs from one railroad to another. The cars are taken off bodily by a switch engine and hauled by rail to their destination. The terminal float has only two tracks, and is often roofed over; the transfer float is longer, heavier and has

MAKE BIG MONEY At Home!

New Invention Electroplates by Brush

Plates GOLD SILVER COPPER TIN CADMIUM NICKEL

Easy as painting

No Tanks, Liquids, Generators DOES SAME WORK AS BIG OUTFITS

Millions of old auto-parts, and all kinds of old, worn articles in homes, stores, offices, factories everywhere can now be electroplated with a permanent brand-new sparkling coat of metal—by *electrolysis*—with the stroke of a brush. Easy as painting—no dismantling—plates right on the spot. Any electric light socket or car battery. Weighs only a few pounds. Take it anywhere—ready for instant use.

Quick, Easy Way to Start Your Own Business

MAKE BIG PROFITS AT ONCE

Amazing low price and magic-like demonstration brings you thousands of orders for plating from garages, radio shops, bicycle shops, machine shops, home work shops, factories, offices, janitors, doctors, dentists, jewelers and farmers, homes, stores, etc.—with big profits for you! List of plating charges furnished; also reports of remarkable daily earnings.

2-MINUTE DEMONSTRATION WITH SAMPLE AMAZES EVERYBODY

Send today for FREE Sample and amazing profit details and bona fide reports of big steady earnings! Also, 3-way proven sure money-making plan. Get started at once on this permanent, profitable business. No competition. Simply mail name on penny post card—NOW! Be the exclusive Warner Nu-Way Electroplater in your community.

WARNER NU-WAY ELECTROPLATER CO.
360 N. Michigan Ave., Chicago, Ill. Dept. 5-W

FREE SAMPLE PROVES CLAIMS



60 POWER TELESCOPE . . . \$2.19

NEW! Three telescopes in one. 3 different magnifications. 20 power for ultra-bright images with 40 and 60 power for extra long range. Guaranteed to bring distant objects, people, sports events, ships, moon, stars, etc., 60 times as close.



Most powerful made for anywhere near the money. Closes to one foot in length. Multiple lens system. 30 mm. objective lens. 5 sections. Directions included for using as a compound 4 lens microscope. American made. Prompt shipment guaranteed. We pay the postage. Only \$2.19. Catalog of Microscopes, Binoculars, Telescopes FREE on request. **BROWNSCOPE CO., Dept. 41, 5 W. 27th St., New York, N. Y.**

FREE BOOK ON FILING! 28 pages of detailed information on use and care of files, packed with complete instructions, scores of photos. The complete book for every file user. Write today. Nicholson File Company, 22 Acorn St., Providence, R. I., U. S. A.

A FILE FOR EVERY PURPOSE

ITCH STOPPED QUICKLY

Use **D.D.D.** Prescription

Quick relief from itching of eczema, rashes and other externally caused skin troubles

35c bottle, at druggists, proves it or money back

2928

three tracks and no roof. These floats are all sufficiently stable and seaworthy to withstand a long trip in rough water, and they ride much easier than many passenger vessels.

Of the 700 tugs operating in New York harbor, one-fourth of them belong to the railroads.

Getting the cars onto the floats is serious business. High and low tide often makes a six-foot difference in water level. Light and heavy loads make a difference in float level. A complex structure, known as a bridge, is used. It is a hinged section of track, which may be raised and lowered to match the deck of the incoming float. When the float is in position, it is securely moored by hawsers, and gigantic drawbolts are slid into sockets, like dowel pins, joining float and bridge into a single rigid unit. Then as the float rises and falls, the hinged bridge moves with it. On the larger floats a hydraulic jack must be used to level the float so the drawbolts can be inserted. Locomotives never roll on the bridges or floats. The switch engine always pushes a string of cars ahead of it, and stays well back on the solid earth.

In the month of October alone, one railroad, with its five tugs, moved 4,959 loaded cars from the Jersey City yards to Manhattan unloading terminals. The total for all of the roads for one year falls just a few cars short of a million. With this staggering volume, one would think it sufficient, yet it is but part of the railroads water borne traffic. There is the ship to rail business, the rail to barge coal handling, the movement of bulk and less than carload lots between terminals and warehouses, and the special delivery and emergency dispatch of rush orders and scheduled business. It is a complicated business structure and calls for many pieces of special equipment, such as special delivery boats to carry last minute deliveries to out-bound steamers, refrigerated and heated floating warehouses to house perishable commodities in summer and winter while they are being transferred from ship to rail, or from one terminal to another.

Names and addresses of manufacturers and dealers in articles described in this magazine will be furnished by our Bureau of Information upon request accompanied by stamped, self-addressed envelope.

Gifts
FOR MEN
OF ALL AGES!

Man to man—what gift can beat a Christmas-packaged Stanley Tool? Useful, lasting, different! Help the ladies decide what to give you . . . show them this page and check the tools you want.



"The aristocrat of hammers" — Stanley 100 Plus. 16 oz. or 13 oz. \$2.00

Stanley Screw Driver Set — 4 popular sizes, composition handles. \$1.70



Screw Driver with Jack-knife in handle! Brand new! \$1.00



Famous Stanley "Pull-Push" Steel Rule with 6 foot flexible-rigid blade. \$1.25

"Stanloid" Chisel Set — 3 distinctive chisels with composition handles. \$4.80



Socket Chisel Set — 3 with hickory handles. \$3.00

Also planes, soldering irons, hand drills and tool chests.

THEY'RE WAITING AT YOUR HARDWARE STORE!

TRADE **STANLEY** MARK

STANLEY TOOLS

DIVISION OF THE STANLEY WORKS

New Britain, Conn.

Prices slightly higher West of Missouri River

MANUFACTURING OPPORTUNITIES



NOW IS THE TIME TO CASH IN on the growing building industry. Make a new and better building material—one that cuts building costs at every step—the kind your builders demand and are waiting for.

WE EQUIP YOU with a Line Production Machine—Raw materials enter at one end—finished products emerge from the other—You make new, scientifically designed building units in more than 40 beautiful colors—You operate with 1 to 3 men who produce a volume selling up to \$200. per day. INVESTIGATE NOW. Send for "4 Keys to Success." It tells how manufacturers already established are making outstanding progress. Write today while your territory is still open.

W. E. DUNN MFG. CO.

600 W. 24th St. Holland, Mich.

CLAMPS

The biggest need in most home workshops is more good clamps—clamps for gluing, holding, drawing-up and for setting-up work. They are the extra hands for the 1-man shop. Don't spoil or delay work for want of clamps. From over 40 types of clamps we have selected these as the first for homecraft use.

ADJUSTABLE CLAMP CO.

"The Clamp Folks"

421 N. Ashland Ave., Chicago, U. S. A.



PONY Miniatures 9 types 1" to 2 1/2" cap. Not torn but fine tools with 100 uses.

PONY "50" Fittings go on ordinary 1/2" pipe. Any length. Send \$3.00 plus postage (6 lbs.) for fittings for "50" Clamps. Also "Pony" No. 52 Fittings for 1/4" pipe—2 sets for \$2.00 plus postage.

Catalog FREE Ask your Dealer



Jorgensen Handcrew Genuine "Jorgensen" Handcrew grip at all angles, never slip, split or loosen. All sizes. Send \$3.20 plus postage (7 lbs.) for 2 No. 1. Handcrew—open 6".



WRITE for big illustrated FREE Circulars!

BIG MONEY Assembling NEW BOAT!

Make big money on each 20-lb. Mead KI-YAK you easily assemble at home from complete "cut-to-fit" Kit at amazing LOW COST! Seaworthy, Fast! Snappiest thing afloat. (Complete Sailing Rig, a few dollars extra.) Also 2 other portable paddle-sail models AND 2 portable outboard motor, sail, oars models. Finished Double Blade Paddle or Oars now INCLUDED with your KI-YAK. Write for Free Circulars, low Factory-To-You-prices!

MEAD GLIDERS, 15 S. Market, Dept. B-10, CHICAGO, ILL.

FREE "BETTER RESULTS WITH GLUE"



Send post card for booklet, "Better Results with Glue," containing many useful hints about mending, model making and home workshop jobs. Address: McCormick Sales Co., 402 Light St., Baltimore, Md.

at hardware, drug and 10c stores; also in cans from 1/4-pint to 1 gallon

NOW ONLY \$4.95

REAL ENGINE VALUE

Over 7,000 GHQ Gas Engine Kits were sold at \$8.50. Over 15,000 sold last year. Now is your chance to buy the *New Improved* kit for \$4.95. Absolutely complete with coil, plug, etc. For boats, planes, etc. All parts guaranteed. Send only \$1.—Shipped Express Collect for balance same day. Send 3c for new 12-page illus. catalog. **DEALERS WRITE.**

All parts finished. Only a screwdriver needed. 1 1/2 H.P. Average assembly time 30 minutes.

GHQ MOTORS, 40B East 21 St., New York, N. Y.

2997

"Hams" Circle Globe

(Continued from page 79)

tor rod likewise absorbs radiation and re-radiates the power in phase to boost the strength of the radio waves traveling in its direction. As many as five elements instead of the usual three may be used to collect the power broadcast from the radiator and direct it as a powerful beam in one direction.

The Hawkins' formula for the radiator rod is: length in feet equals 477 divided by the station frequency in megacycles; reflector: length in feet equals 492 divided by the frequency in megacycles; director: length in feet is 458 divided by the frequency in megacycles. For a station transmitting on 28.8 megacycles, in the ten-meter band, the radiator is sixteen feet six and one-half inches long, the reflector is seventeen feet one inch long, and the director is fifteen feet eleven inches long. Spacing between the radiator and reflector is ten per cent of a wave length, or forty-one inches for 28.8 megacycles, and the distance between the radiator and the director is fifteen per cent of a megacycle or sixty-one and one-half inches for 28.8 megacycle transmission.

With an aerial calculated from this formula amateurs on the east coast are able to communicate with Japan, using twenty-five watts or more, and amateurs on the west coast can reach across the continent and the Atlantic to work voice stations in Europe and Africa. Scientific measurements of "radio echoes" indicate that signals from many small stations actually travel all the way around the world.

In order to be able to rotate their aerials in any direction amateurs use special antenna supports. The aerial rods are usually mounted on a lightweight wooden framework strong enough to withstand high winds. The whole structure is revolved by means of an electric drive, a satisfactory combination consisting of an electric washing-machine motor attached by means of a V-belt to a gear box that in turn is connected to a worm and wheel drive such as may be obtained from the steering mechanism of a 1932 Chevrolet automobile. The electric drive is operated by remote control from the transmitting panel. Such an antenna may be built for twenty dollars and up or at a minimum cost of fifty dollars if an electric drive is used.

\$200 My First Week



... Now in my OWN Business.

Would you, too, like to own a business where you could take in \$200 your first week as did L. A. Eagles in Madison, Wisconsin?

We want a reputable, honest man in each county. This man need not have any special experience or more than ordinary ability, but he must be honest and courteous.

Such a man we will start in business for himself. You can make far above average profits in the rug-washing business—a high-grade business all your own. Many earn \$125 to \$200 per week—some considerably more.

NO SHOP NECESSARY

The rug-washer finishes rugs like new on the customer's floor. Anyone can run it. Electricity does the work. A quick, thorough and highly-efficient method that restores the natural beauty of floor coverings.

There are hundreds of customers—in your vicinity and nearby towns. The business grows steadily. Simply wash a few rugs or carpets. These customers tell others and also give you their future work. Soon you will have a prosperous year-around business. Send coupon for booklet explaining everything.

"Profits Pay for Home"

Harry Hill built and paid for a home from rug-washer profits. His first day's business was \$86. Another man writes, "Made \$70 in 13 hours." A. L. Miller says, "Have had rug-washer 6 years—have earned as high as \$92 a day." M. O. Malmin earned 3 times the cost of his machine the first two months. You, too, can enjoy a large income.

VON SCHRADER MFG. CO., 101 PL., RACINE, WIS.

Free Book!
MAIL COUPON now

VON SCHRADER MFG. CO.
101 Pl., Racine, Wis.

Send at once (no obligation) your free booklet illustrating rug-washer and telling how I can own my own permanent business; how I can earn large profits at prices below other methods; how I can become financially independent in a short time; and how I can pay on easy terms.

Name.....
Address.....
City..... State.....

"Never a Complaint"

C. J. White says: "\$100 business in six days—never a complaint." That is the nicest part of this business—every customer is more than satisfied. Stains and blotches disappear and vivid colorings and freshness in faded floor coverings come back.

EVERY MACHINE GUARANTEED

You take no risk. These machines have been manufactured since 1918 and are used by the United States Government and by many of the world's largest hotels. They are fully GUARANTEED.

EASY TERMS

The complete equipment is inexpensive. A reasonable down payment brings everything to you and the balance is paid monthly. From the start, you have your own business—one that is profitable and of which you can be proud.



MAIL COUPON Today

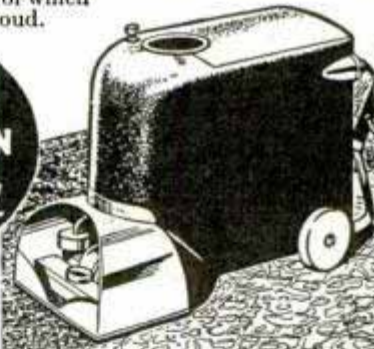

OTTAWA LOG SAW \$39

BIG BOOK FREE



PUTS THIS OTTAWA to work for you. MAKE MONEY! Wood is valuable. Does more than 10 men. Easily operated. Falls trees—saws limbs. Use 5-hp. engine for other work. Write for FREE Book.

SAW 10 TO 20 CORDS A DAY

OTTAWA MFG. CO.
2727 Wood St., Ottawa, Kans.

BIG NEW STREAMLINED LATHE

AT SENSATIONAL BARGAIN PRICE



Imagine! This extra heavy wood lathe, steel bed 48" long, at low prices. Heavy duty head stock, 4-step cone pulley for V-belt. No. 2 Morse Taper Centers. Sealed ball bearings. 6" face plate screws onto spindle. Tool rest 10" long. Complete line of accessories at amazing low prices. Write today for free catalog describing Blue Star full line precision woodworking machinery. Factory-to-you prices. Not sold through agents. Act at once!

Swings 10 inches

BLUE STAR PRODUCTS, 601 Gate Street, Fairfield, Iowa

IT'S THRIFTY TO INSTALL NEW CHAMPION SPARK PLUGS

New Adding Machine Fits Vest Pocket!



Adds, subtracts and multiplies up to one billion. Weighs only 4 ounces. Not a toy—strong guarantee. Absolutely accurate, very fast. Sells to offices, stores, homes—wherever figures are used. Write quick for FREE AGENTS sample offer and Money-Making Plan.

VE-PO-AD, Dept. 201, 303 W. Monroe St., Chicago

Costs only \$2.95

KINKADE GARDEN TRACTOR

and Power Lawnmower

A Practical Power Plow and Cultivator for Gardeners, Suburbanites, Florists, Truckers, Nurserymen, Fruit Growers

Low Prices - Easy Terms

American Farm Machine Co.
1058 33rd Av. SE. Minneapolis, Minn.



Catalog Free

COMET MODEL AIRPLANES

10c • 25c • 50c • \$1



Ryan S-T Kit No. LI-30 in.—50c

BIG, NEW CATALOG
Shows hundreds of models, including gas models, motors. Send 6c stamps.

BIG wingspans—big values! 16-in. models only 10c—giant 25-in. models, 25c; super-detailed models, working shock-absorbing landing gear and other features, 50c and \$1.00! Every model tested for flyability! Get them at your dealers!

ZIPPER Gas Model
Champion gas model of all time—designed by Carl Goldberg! Outstanding winner in events throughout the country! Climbs 2000 ft. per min.; many amusing new features! 54-in. span—postage 25c, \$3.95 none if ordered from dealer.

What a Climb!

COMET MODEL AIRPLANE & SUPPLY CO.
129 W. 29th St., Chicago—Dept. P-1—688 Broadway, New York

HANDEE Hobbies

Get more out of life. Make things with our easy working plans. 75 new, intriguing projects for the home, gifts or to sell—models of ships, planes, houses; engraved glassware, trays, mirrors; statuettes, book ends, etc. Portfolio of 12 plans, 25c.

TOOL OF 1001 USES

A tool shop and power house in one. Plugs in any electric socket. Grinds, drills, polishes, cuts, carves, routs, saws, sands, sharpens, engraves, all materials. Write for FREE 64-page catalog. Shows Handees \$10.75 up.

CHICAGO WHEEL & MFG. CO.
108 S. Aberdeen St.
Chicago, Illinois



A
GIFT
HE'LL
LIKE

IT COST ME MONEY TO FORGET!

The "Automatic Memory" Won't Let You Forget

Memindex—the famous memory method and personal systematizer, is credited by thousands of successful persons with speeding their rise to the top. Memindex keeps all data on handy, cleverly indexed and dated cards—today's always visible. Fine leather POCKET CASE organizes your daily memos—handsome DESK TRAY keeps permanent records for you. No transcribing. Worth 1000 times its small cost to salesmen, business and professional men, hobbyists and social leaders.

SPECIAL OFFER Free dated cards for the remainder of 1939, with all orders for 1940 Memindex.

FREE Booklet: "Memory On Cards" WRITE:
Wilson Memindex Co., 161 St. Paul St., Rochester, N. Y.



Pocket Case

HOLD-E-ZEE AUTOMATIC GRIP SCREWDRIVERS

Hold, start and set-up screws in unhandy places. Gripper instantly released by spring action, sliding up out of way when not in use. Finest materials throughout, chrome vanadium blades; many have transparent, insulating unbreakable handles. (Illustrated.)



No more expensive than ordinary screw drivers. Models for recessed-head screws. Handiest ever. Get one today. At auto-supply, hardware or electrical stores.

UPSON BROS., INC. 86 EXCHANGE ST. ROCHESTER, N. Y.

Send FOR MY NEW BARGAINGRAM No. 242

A monumental work—lists thousands of STILL Cameras—New and Used... apparatus galore—Slide Projectors—Gigantic Book Section... Chemicals, etc. etc. Also Cine Catalog No. 240—Both FREE.

Bass CAMERA CO.

179 W. MADISON ST., CHICAGO, ILL. DEPT. P



WORLD'S LOWEST PRICED ADDING MACHINE

IDEAL XMAS GIFT GUARANTEED ACCURATE. Not a toy. Operates with only a finger flick. Adds, subtracts, multiplies, divides. Counts up to a million. Pays for itself over and over. Ideal Gift—for Business, Income Tax and School use. MONEY BACK GUARANTEE. Send name and address. Pay postman only \$2.50 plus postage. (Send full cash if outside U. S.) Money back in 10 days if not delighted. AGENTS WRITE.

VEST POCKET SIZE
FREE TRIAL

ONLY \$2.50
TOTAL COST
SEND NO
MONEY

Calculator Machine Company, (Mfrs.), Dept. 101, P. O. Box 1118, Chicago, Illinois

Color-Shooting in Fairyland

(Continued from Coloroto Section)

placed a phonographic pickup, which was connected to the screen by a small piece of wire. By pounding on the screen with drumsticks, the vibration was transmitted into the phonographic pickup and then amplified and reproduced through a large horn, at which point it was picked up by the microphone.

While the sound effects department was at work, the musicians were working on the background score for the production. The first rough music tracks were recorded by piano, to give an idea of the type and theme of music for various sequences. After all sequence changes were made, the score was recorded by organ and Novachord. Because there were so many places in the picture where strange, comic or eerie sounds of music were required, the music department frequently called in small orchestral groups and used them for experimenting in arrangements. After the desired result was worked out, the full recording orchestra was called in. Among the scenes which called for more than "every-day" music were those in connection with the whale, the sounds of musical toys and music boxes, and the theme music surrounding the "Blue Fairy."

Cameras considered the last word when "Snow White" was filmed have been improved or replaced by new types. Among the most important is a type of universal camera crane, a development whereby instead of using a vertical method of shooting, as on the original Disney multiplane camera, the camera dollies into a scene or away from it, on the same principle as motion-picture photography in a live-action studio. The backgrounds which can be used on this camera are twice as big as those which could fit in the original multiplane setup.

Dirt, dust and lint, long the bugaboo of the inking, painting and camera departments were vanquished by having the employes of these departments wear lint-proof smocks and coveralls while working. In the camera department two innovations were set in: one is an electronic method of cleansing the celluloids of all foreign matter. The other is a device whereby anyone entering the camera rooms is treated to specially routed air blasts guaranteed to remove all dust and lint from clothes.

Six Tools in One!

This latest model Delta 11" Drill Press is almost a complete workshop in one tool. It will, of course, perform all metal drilling usually required around your home shop, taking drills up to $17/32$ " in diameter. It takes all standard wood bits up to $1/2$ " shanks and can be used for drilling holes up to 2" in diameter with multi-spur bits. With the addition of special Delta attachments it can be used efficiently: for making square end mortises from $1/4$ " to $1/2$ " width and of any length—for numerous routing operations—for shaping—for sanding both curved and straight work—and for many jobs of surface grinding. No wonder this quality tool offered at a surprisingly low price is being used and endorsed in thousands of home shops and small industrial plants all over the country!

Many Special Delta Features on this 11" Drill Press

Here is the only 11" drill press made with both the Self-Aligning Drive and a Free Floating Spindle—a combination that assures years of accurate service. Has numerous other quality features including precision construction, Tilting Table with locating pin, Graduated Quill and Adjustable Pointer for depth boring and drilling, Stop Rod and nuts for repetition drilling and self-sealed ball bearings requiring no lubrication for their entire life. For full details, send for latest Delta catalog.



\$25.95
(less motor)

NEW TIME PAYMENT PLAN



The complete line of Delta quality metal and wood-working tools is now available on liberal extended terms through established Delta dealers. Send coupon for latest Delta catalog and list of Delta dealers who can supply you with Delta tools on terms to suit your convenience.

Send for CATALOG...

The latest Delta Catalog gives you full information on the complete Delta line of low cost tools for home shops, small shops and industry. (Also send 10c for new Project Book No. 6 crowded with new and "out of the ordinary" things to make.

Delta Manufacturing Co. Dept. A140
600-634 E. Vienna Ave., Milwaukee, Wis.
Send me the latest new 1940 Delta Catalog and list of Delta Dealers nearest me. I enclose 10c (stamps or coin) for which please send me the new Delta Project Book No. 6.

Name.....

Address.....

City.....State.....

Check here if you are a Delta user now.

DELTA MANUFACTURING CO.
600-634 EAST VIENNA AVENUE
MILWAUKEE, WISCONSIN

THE GIFT HE'LL LIKE Best AND USE Longest



100 TOOLS in ONE

The genuine Dremel Moto-Tool is the ideal gift for a craftsman's Christmas. Grinds, polishes, sharpens, drills, engraves, etc., etc. Saves time, cuts cost, does finer work. Owners find it the handiest tool in the home or shop... use it daily. Same tool as used on precision jobs in factories. **OVER 25,000 R.P.M.**—the speed necessary to conserve cutters, do fine work. Has oil-less (oil sealed) bearings... dynamically balanced armature, vibrationless, 110 v. universal (AC-DC)... has built-in cooling fan.

Model One MOTO-TOOL Only \$9.85

Modern Craftsman's Kits
KIT No. 1 with 23 high grade accessories and Model 1 Moto-Tool in hard-wood case. **\$17.50**
KIT No. 2, same as above with Master Model 2 Moto-Tool. **\$23.50**

6 oz. Model 1 Moto-Tool complete with chuck and $\frac{1}{8}$ " collet, only **\$9.85**.
Master Model 2 faster, heavier, more powerful, with chuck and $\frac{3}{8}$ " collet only **\$16.50**.

AMERICA'S Newest HOBBY!

Make dull moments delightful, creative, educational. Turn your spare hours into cash. Master the fascinating new art of plastic carving, now made easy for all with **Moto-Tool NICK-NACK Carving Kit**. Make useful, colorful giftware, toys, statuary, costume jewelry from marble-like new plastic substance. Work out original designs of your own in wood, glass, metals... like things sold in stores at 4 to 5 times manufacturing cost. Enjoy this new hobby just for fun... or start a profitable home-work business.



Kits Include 24-Page Book "How to Make 41 Projects"

JUNIOR Kit with No. 1 Moto-Tool (25,000 r.p.m.), 17 accessories, plastic materials, for 10 projects—in beautiful wood case, only **\$17.85**.
MASTER Kit with factory type No. 2 Moto-Tool (27,000 r.p.m.), 23 accessories and plastics for 20 projects—in beautiful wood case as shown, only **\$24.85**. Big project book goes with both Kits.

10-DAY MONEY BACK

See genuine Dremel Moto-Tools Craftsman's Kits and New Nick-Nack Carving Kits at better dealers or order direct from factory on 10-day money back trial. Include remittance with order and we pay postage—or send only \$2.00 and pay postman balance plus postage.

NOTICE!

Motor-in-Hand Tool Owners
 Big Carving Project Book, exactly as furnished in kits, sent separately, for only **\$1 Post-paid**.

CATALOG of Dremel Tools, kits, equipment, and special combination offers **FREE**.
DREMEL MFG. CO., Dept. MK110-A, Racine, Wis.

NEW Grinding Attachment

For 8" to 16" Metal Lathes. Build it Yourself.

At last, a precision grinder within your means. You save 2/3 by finishing our semi-machined castings on your own lathe. HURON handles both internal and external grinding. Accuracies to .00025". Mirror finish easily obtained. Grinds cutters, sharpeners, mirrors, hard or soft, holes, lathe safes, pistons, bushings, shafts, hard or soft, holes, lathe cutters. Sharpens reamers, milling cutters. Does eccentric drilling; laps; polishes; scores of other uses, for home workshops, garages, machine shops. Write for **FREE** illustrated folder and full information.



Semi-Machined Castings Only **\$5.95**

Huron Machine & Tool Co., Dept. B-1, Yale, Mich.

A GARDEN TRACTOR THAT Plows!

HERE'S YOUR GARDEN TRACTOR—The Black Hawk plows and cultivates, does belt work and many other jobs—all on a couple gallons of gas a day! Powerful, rugged, easy to handle. Enclosed gears. 1 1/2 horsepower. You'll want to own it because it saves money, increases income for hundreds of farmers, gardeners, truck gardeners, poultry farms, others.

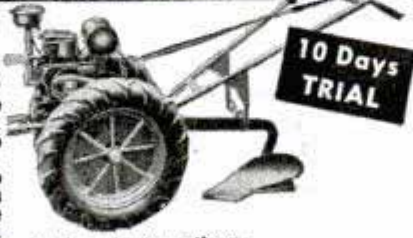

10 Days TRIAL

LOW FACTORY-TO-YOU PRICE
 This "economy champion" is sold direct to you at rock bottom factory price. Send post card today for free catalog giving complete details and prices.
THE OHIO CULTIVATOR CO., BOX 140, BELLEVUE, OHIO

SEND FOR FREE CATALOG

The Wonders of Polaroid Glass

(Continued from page 53)

desired colors are attained. A turn of one of the Polaroid disks and the color scheme can be made to change smoothly to the complementary color arrangement, four times during each rotation. In fact, with a more complex mechanical setup, endlessly changing color schemes become possible.

The first full-scale mural, eighteen feet wide and thirty-six feet high, was built for a motor-car manufacturer to show the car of the future glowing in ever-changing, subtly-blended colors—colors seen only in a butterfly's wings, a sea shell, and in a film of oil on water. The mural operates only at night. No colors are used, the entire effect being produced from revolving disks of Polaroid film.

Several months ago, the motion-picture industry was startled by a colored film Loucks and Norling made for the Plymouth company in which the illusions of depth and roundness are preserved by substituting two-eyed vision for one-eyed vision. In principle, at least, this approach to stereoscopy is a familiar one. Most of our impressions of distance and of space, optical experts say, arise from the fact we see simultaneously with two eyes. The view seen by one eye is always slightly different from that seen by the other. Through life-long experience, our brains are trained to interpret the differences between the two views in terms of space and distance.

The camera, therefore, used in making stereoscopic colored pictures looks upon a scene just as a pair of human eyes would. Two pictures are shot simultaneously, eye distance apart, by means of an attachment affixed to the camera. The two views are then recorded side by side on a single film. When shown, the two views are projected on the same screen, one over the other, by means of a similar device which reverses the taking technique. Each image is polarized by projection through Polaroid disks. The disks are set in such a way that the right-eye image reaches the screen polarized horizontally while the left-eye image reaches the screen polarized vertically.

Supplied with spectacles having special Polaroid lenses, set at corresponding angles, the spectator sees one image with the left eye, the other with the right; each eye

21001
 45 W. 55th Street
 New York City

21001
 sees one picture and one picture only. That's all there is to the procedure—the left eye sees what the left eye would see if it were present at the scene of the action, the right eye sees what it would see. The brain converts these impressions into a feeling of depth and true realism.

One of the most popular applications of the single Polaroid sheet is in dealing with glare. If you look at a non-metallic surface, your eye gathers two kinds of light—the diffuse light with which it sees color and detail and the mirrorlike reflection of the light source—glare. This specular reflection, as it is called, is largely, sometimes wholly, made up of vibrations that are parallel with the reflecting surface—therefore, highly polarized. The diffuse light on the other hand is substantially unpolarized. Thus, by looking at the surface through Polaroid material, the glare virtually can be removed without greatly changing the relative brightness of the diffuse light. Ordinary sun glasses, on the other hand, reduce the intensity of diffuse light and unwanted glare equally but the Polaroid ones can discriminate between them, absorbing the reflected light, transmitting the other.

The eyestraining glare of the desk top or the word-obscuring dazzle of the slick magazine page can be precluded by Polaroid. The light reflected from these surfaces is polarized horizontally, making it impossible for these vertical ribbons of light to deflect off the horizontal desk top or printed page in the form of glare.

Light filters made of this material do for the camera what Polaroid glasses do for the eye. The polarizing material, cemented between optical plates, and mounted in a lightweight metal cell, fits in front of the camera lens. One type Pola-screen is suitable for photography both in Kodachrome and black and white. With such an attachment, a photographer making a shot of, say, a store window can subdue oblique reflections. If he takes particular pains in selecting his camera angle, reflections virtually can be eliminated. Or, in shooting a picture in a direction at right angles to the sun, faces, buildings, trees, and other objects can be made to stand out against a blue sky by using one of the special filters to darken the latter. Copy and reproduction work can be improved appreciably by Polaroid attachments on lens and lights.

"We've tried them all
 and we recommend
CASCO for
 permanent gluing!"

—says Albert Constantine, Jr. of Albert Constantine & Son, Inc., 797 East 135th Street, New York, a leading supplier of fine woods for home craftsmen, cabinet makers, manufacturers of furniture, musical instruments, etc.



● Take a tip from wood experts and get clean, permanent, professional glued joints with these 5 advantages of CASCO GLUE:

1. RESISTS HEAT, MOISTURE. Sets chemically, withstands humidity changes in heated homes.

2. UNIFORM STRENGTH. Processed by laboratories with 30 years' experience in adhesives. Proved on many of industry's toughest gluing jobs.

3. USED COLD. CASCO spreads easily, sets at full strength without heating!

4. EASY TO MIX. No mess. Just add water and stir.

5. ECONOMICAL. CASCO is in powder form, all glue...no preservatives. 1 lb. makes 1½ quarts full strength glue for 65¢. At hardware stores 10¢ to 65¢.

For fastening felt, cork, fabric, leather — to metal, plastics, glass, etc., use the new **CASCO FLEXIBLE CEMENT!** Large tube, 25¢ at hardware stores.

FREE! Home Workshop Handbook



Helps woodworkers from beginner to Master Craftsman. Contains a list of free and low-cost booklets offered you by leading experts on Tools, Finishes, Sharpeners, Cabinet Woods and Veneers, Project Plans and Workshop Clubs. First book with all this information. Mail coupon now for your copy.

CASEIN COMPANY OF AMERICA
 350 Madison Ave., Dept. PM-140
 New York, N. Y.

Yes, send me your free "Home Workshop Handbook"

Name _____

Address _____

Save 2c, stick coupon on penny postcard

Welding Business Earns \$150 to \$300 for You Each Month



"BUILD-YOUR-OWN"

Just couple your own engine to this unit, mount it on chassis and you have money making advantage of a portable welder at a saving of \$100 to \$500.

30 DAY'S TRIAL AT HOBART'S RISK AND EASY "PAYS FOR ITSELF" TERMS

Free! VALUABLE BOOKLETS ON WELDING. CHECK YOURS AND MAIL THE COUPON TODAY.

- How to "Build-Your-Own"
- New Profits in Arc Welding
- New Arc Welding Catalog

New low prices make this profitable welding service available to everyone. Opens doors to big pay jobs that carry real profit. Hobart Welders are easier to operate, faster, guaranteed to bring you quality welding business . . . extra profits will pay for welder without expense to you.

NO INVESTMENT TERMS—PROFITS PAY FOR IT

Extra earnings and savings possible with Hobart Welders make it easy to own without expense. You can even rent a new Hobart and later purchase it without loss. Coupon brings details.



HOBART
THE FASTEST SELLING ARC WELDER ON THE MARKET TODAY

HOBART BROS., BOX M-140, TROY, OHIO
Gentlemen: Send me information on () Build Your Own Welder () Electric Drive Welder () 30 Days Trial, Easy Terms () Rental Plan. Also send me the free books I've checked.

Name.....
Address.....

FLEXIBLE . . .

transparent, waterproof

- Holds permanently on china, glass, wood, metal, leather, paper, fabrics. Not affected by heat, cold, moisture. Dries quickly. Ideal for model making, as well as for mending.





DUCO CEMENT

"GIFTMAKER, SR." \$150 PRIZE CONTEST

(Outside U.S.A. \$5.40; C.O.D. \$5.10)

New 24" LATHE

\$490

POST PAID

Free Catalog:

A heavy duty, smooth running wood lathe at a remarkable price. 32" long, 7" high. Turns pieces 4 1/2" in diameter by 24". Fully adjustable. 2-speed. Weighs 10 lbs. Long and short tool rests. OILLESS bushings. Satisfaction guaranteed or money back.

Free Catalog describing \$150 prize contest (1st prize, \$25; 2nd, \$15; 3rd, \$10; 41 other cash and merchandise prizes). Cat. illustr. complete power tool line: Jig Saw, \$1.50; Jointer, \$6.50; Shaper, Circular Saw with oilless bearings, \$3 each; Drill Press, \$2.50; 9 1/2" Lathe, \$2; Sander, \$1; etc. Sold direct only. Order today or send card for Catalog.

J & H Metal Products Co. 5 Commercial St. Rochester, N. Y.

Full Size, Cut-to-Shape Paper BOAT PATTERNS

and master blueprints enable you to build at 1/3 cost. Newest designs by naval architect. Cruisers, runabouts, sloops, snipe, outboard boats, sailing canoe (Kayak), etc., 7 1/2 ft.-38 ft. Low prices. Rush 10c (coin) for latest catalog. Send \$1 for "HOW TO BUILD BOATS" book, postpaid.

CLEVELAND BOAT BLUEPRINT CO.
Station A-667, Cleveland, O.

TRAILER PARTS

Largest, most complete stock of trailer parts and equipment in America. Lowest prices, quick delivery. Marvel is the pioneer in trailer accessories with a reputation for highest quality products, refrigerators, stoves, etc. Send 10c in coin for 40 page illustrated catalog.

MARVEL TRAILER PARTS CO.
19001 Celestine Ave. Detroit, Mich.

Sani-Flush

SAFE • NOT CAUSTIC

CLEANS OUT AUTOMOBILE RADIATORS

POWER TOOLS AT LOWER COST

also Model Makers and Accessories

FREE CATALOG

1219 Shawnee St., Freeport, Ill.

How Thousands Are Gaining 10 to 25 Lbs.

New thousands of skinny fellows can say goodbye to "scarecrow" bones, jittery feeling and lack of pep. For with these easy-to-take Ironized Yeast tablets many have put on 10 to 25 lbs., gained new pep and strength—quick. If you too need Vitamin B and Iron to build you up, get Ironized Yeast tablets from your druggist today.

PINS 30¢ RINGS \$1.50

Finest quality. Over 300 artistic designs. Write for our attractive free catalog and select a beautiful pin or ring for your class or club.

Dept. N, METAL ARTS CO., Inc., Rochester, N. Y.

FREE CATALOG

GERSTNER Tool Chests

"For the Man Who Cares"

Toolmakers, Machinists and other exacting mechanics will choose their Chests in 1940 from our Free Catalog.

GERSTNER TOOL CHESTS
440 Columbia St. Dayton, Ohio

MYSTIC MIKE

WIRELESS OUTFIT

IT'S LIKE HAVING YOUR OWN BROADCASTING STATION

AN ORIGINAL, UNIQUE, ENTERTAINING CHRISTMAS GIFT!

This set enables you to do YOUR OWN BROADCASTING from any part of your home, office, store, etc. NO WIRES CONNECTED TO RADIO. Simply plug this unit into any AC or DC electric socket, speak or play music into the microphone, and it will be picked up by ANY RADIO ANYWHERE within the same building. Has variable frequency control for easy radio dialing. Use it for entertaining, auditions, rehearsals, public address system—in fact it can serve you in hundreds of ways. ORDER TODAY!

FREE

WRITE FOR BULLETIN P-1

OLSON MFG. CO., 362 Wooster Ave., Akron, Ohio

Complete Set With Microphone and Tube

\$3.95

ADD 15¢ POSTAGE

MONEY BACK GUARANTEE

Tear out this ad, write name and address in the margin, mail \$3.95 or order C. O. D. and we will send outfit at once.

Inexpensive Treasure Finder

(Continued from page 137)

pair of 4,000-ohm headphones should be used for maximum results.

When wiring the instrument, refer to photos A, B, C, D and E, as these all show actual views of the various stages of construction; the schematic circuit diagram appears in Fig. 3. Avoid loose connections, and use insulating sleeves of "spaghetti" tubing freely throughout the circuit wiring to prevent the possibility of accidental shorts. Make all soldered connections

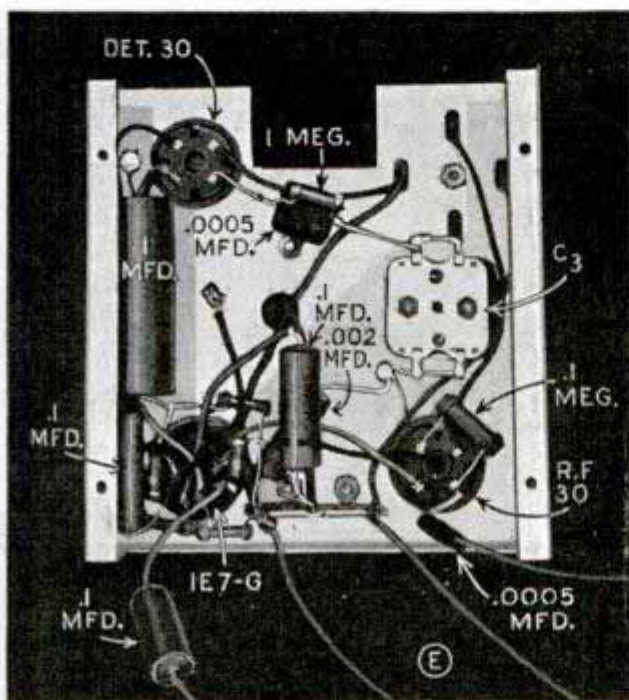

carefully, with rosin-core solder. The battery leads should have a definite color code. A detailed list of materials can be obtained from Popular Mechanics radio department without charge.

Handle the r.f. coil unit carefully so that the two fixed coils are not moved from their established positions; be particularly careful to avoid injury to the delicate leads connecting the movable middle coil. Note the separate twisted insulated hookup leads loosely coupling the variable condensers C₁ and C₂. For a better coupling it is suggested that these leads terminate in single interlocked loops, rather than being merely twisted together.

After assembly, install batteries, insert tubes and plug in the headphones. Adjust rheostat to show exactly 2 volts on the voltmeter. Set C₁ and C₂ so that the plates are about half way in. Carefully move the

(Continued to page 135A)

FREE ALLIED'S 204 PAGE
RADIO AND
CATALOG PARTS

OVER 15,000 RADIO ITEMS
AT RADIO'S LOWEST PRICES



60 SET VALUES!

Radio's greatest values—new "Knights" for every purpose. 60 models, 4 to 12 tubes, newest features, "Air-Magnet," Gemloid Dials, etc.—latest portables, electric phonographs, phono-radios, etc., at sensational prices. SEE ALLIED'S CATALOG NOW.

Learn Radio
"BUILD YOUR OWN"

ALLIED RADIO BUILDERS' HANDBOOK
ALLIED RADIO CORP.

Build your own radio receiver, transmitter, transceiver—learn while you build! Dozens of new, low-cost Kits—beginners to most advanced—are shown in ALLIED's big, new Radio Catalog. Write us first for Free matched parts lists to build any circuit. Learn Radio quickly—enjoy this great hobby! ALLIED serves you best at lowest cost!

RADIO BUILDERS' HANDBOOK—A new and different book on radio; tells how to select circuits, read diagrams, build sets, etc. Easy to understand. Packed with valuable data. Latest revised edition. **10c** Only. Order by coupon below.



SENSATIONAL P. A.

3 complete new "Knight" lines—"Economy," "Standard," and "Deluxe"—14 new systems (with built-in phono!), 6 to 70 watts, remarkable values!—and latest accessories, recording equipment, etc.—low priced, also available on new Time Payment Plan!

5 BIG BOOKS IN 1!

ALLIED's new Catalog is really 5 Super books in 1, offering every radio need for dealer, serviceman, amateur, sound man and builder! Write for this Catalog today—save money on Everything in Radio! It's Free—just SEND COUPON to—

ALLIED RADIO

833 W. Jackson Blvd. Dept. 5-A-O
Chicago, Illinois

RUSH your FREE 1940 Radio Supply Catalog.

ENCLOSED IS 10c for your NEW Radio Builders' Handbook.

Name.....

Address.....

City..... State.....

New-Type Cheap OIL BURNER INVENTED Sweeping the Country!

COOK and HEAT Without Coal or Wood
 In Your Present Stove or Furnace—
HOTTER—No Drudgery, Dirt or Ashes—More Heat Quick at SMALL COST.

OVER 40,000 SOLD

Beats any cheap burner ever gotten out for low cost, perfect performance. Burns cheap oil a new way, without pre-generating or clogging up. Quick intense heat by **Simple Turn of Valve.**

GUARANTEED

30 DAYS' TRIAL

Prove its efficiency, convenience and economical operation.

Write Immediately for FREE BURNER OFFER TO AGENTS

AGENTS Salesmen BIG MONEY

F. Silver says: "I can dispose of 250 HEAT KINGS before this year ends." Sample Burner FREE to producers. Write us now for agents' offer.



Slips Into Any STOVE RANGE or FURNACE

Quick HEAT At Turn of Valve!

who will demonstrate and take orders. Write quick, be first to learn how to make REAL MONEY right now, spare or full time—mail 1c postcard today.
UNITED FACTORIES, A-751, Factory Bldg., Kansas City, Mo.

FREE RADIO CATALOG

ALL YOUR RADIO NEEDS

Your nationally known radio favorites at lowest prices. Sets, parts, supplies, etc.
BURSTEIN-APPLEBEE CO. 1012-14 McGEE ST. KANSAS CITY, MO.

NEW Electric PRESSER

HANDIEST AID FOR BUSY, THRIFTY WELL GROOMED MEN

Do your own Pressing this modern way, at home, in office or when traveling. Easy to use. No wet cloth, board or bother. Plug in any socket and it's ready to press pants, collars, sleeves, lapels, dress pleats. And man, what it does to crumpled ties! It presses them into crisp newness before you can say Jack Robinson.

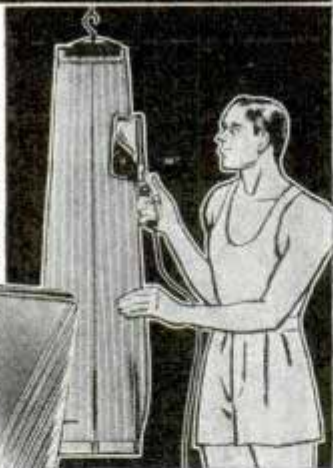

\$1 Post-paid Money Back Guarantee.

AN IDEAL XMAS GIFT

a gift any man or boy will appreciate. Each Empire presser is fully guaranteed. Comes complete with cord, plug, and simple directions.
DEALERS—Over 750,000 sold to date. Order now to take care of growing demand everywhere.

EMPIRE ELECTRIC CO., Dept. PM 817 Main Street, Cincinnati, Ohio

PM-1

Enclosed is \$1.00 for an Empire. If not satisfied, I will return it and my money will be refunded.

Name.....

Address.....

When writing please mention Popular Mechanics

SAVE THAT CHAIR!



DON'T THROW FURNITURE, mirrors, glassware, etc. away... repair them with Rogers Glue—makes them as good as new... Rogers Glue is ready to use and works quickly—stays put longer because it is stronger. Sells 10c and up in tube, jar or can at hardware stores only or send 10c for full size jar and you receive a Free Project Book giving new ideas, new plans for making useful articles—to Dept. B. ROGERS GLUE COMPANY Gloucester, Mass.

ROGERS
the best LIQUID FISH GLUE

ELIMINATE FORD BRAKE TROUBLES

Your Ford Car is listed in the so-called lower priced class but has more brake lining area and larger drums than the others, in fact as much or more brake area than all but the higher priced cars. You can have safe, sure, unflinching mechanical brakes. Install easily yourself our Simplex Floating Wedges to center the shoes for mechanical assurance with hydraulic performance. A set of four, one for each wheel, all for \$1.75. All models 1928 to 1938—Send for circular.
SIMPLEX WEDGE EXCHANGE, Dept. PM-1, 613 Jefferson St., Ottawa, Ill.



Money Making Pay Raising BOOKS Catalog FREE

Send Name and Address Today

Selected books covering all trades, office helps, home workshop, spare time work, hobbies, etc. Learn how to earn more. Write today.



Popular Mechanics Press
 DEPT. 140
 200 E. Ontario Street
 CHICAGO



Build a BOAT FOR PLEASURE OR PROFIT



Shows EXACTLY HOW TO BUILD 15 DIFFERENT BOATS

EASY—LOW COST with POPULAR MECHANICS BOAT BOOK

This is the new edition with 42 added pages, 6 new boats, and conversion of Ford motor for marine use. Full directions and details for cabin cruiser, racing, hydroplane, outboard runabout, sail boats, kayak, sled type—15 boats in all. Also sectional boat to carry on car.

Build a boat at home! You can do it. Just the kind you've wanted—power, sail, or row boat. The "Boat Book" shows you how in simple step-by-step directions. Specially prepared for those with limited tools, little skill and money. Build boats to sell for profit too. Book tells how.

GIVES PLANS, METHODS AND MATERIALS

SEND NO MONEY

Write for new edition of Boat Book today! Sent anywhere. Pay postman \$3.00 plus small C. O. D. fee. Outside U. S. and possessions remit with order. Money refunded if not satisfied.

Actual working plans and photos of real boats under construction makes building easy. Hundreds of pictures. No chance for mistake. Includes also, navigation and pilot rules, handling sailing craft, boat kinks, boating terms. Everything a boat enthusiast should know. Size 7x10 inches. 312 pages. Fine cloth binding.

POPULAR MECHANICS PRESS—Dept. 140 200 East Ontario St., Chicago

(Continued from page 133A)

adjustable middle coil on the r.f. unit to about mid-position. Plug in the loop-unit cable and set the loop edgewise on a table, at least 6 ft. away from all metallic objects. A strong oscillatory tone should now be heard in the headphones.

The next step is to adjust the dual trimmer C₃ by means of a long insulated screwdriver inserted through the holes in the top of the base, and reconcile this adjustment with the correct placing of the adjustable middle coil previously referred to. Adjust

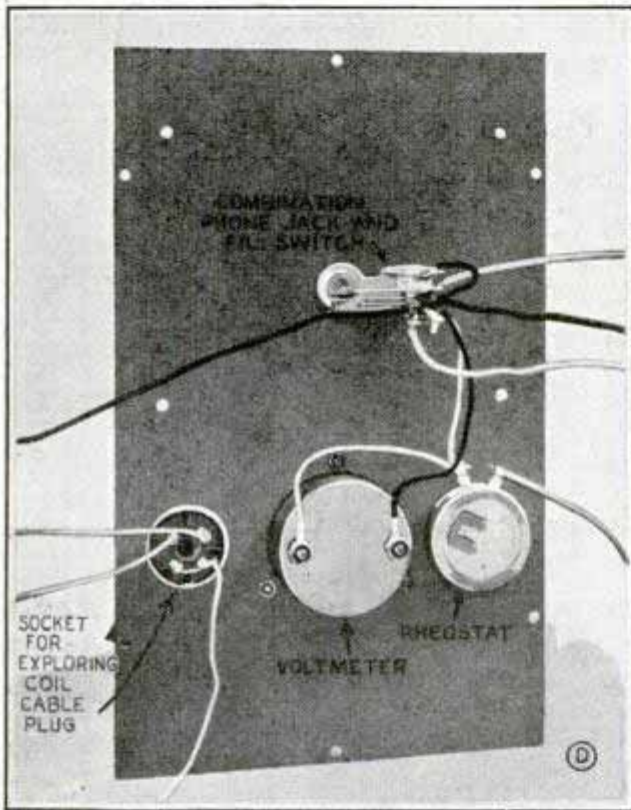

the trimmer screws one way or the other until the signal tone drops to zero frequency. Tighten this trimmer slightly more to bring the low-frequency signal tone again into action. When the movable coil has been placed correctly by trial, it will be found possible to control the audible clucking note through a satisfactory range of from zero to several hundred cycles per second by a slight adjustment of the vernier control C₁; make this adjustment with the cover of the cabinet closed. Note that when adjusting the middle coil, a rather violent oscillation is heard when the fingers are placed on the coils; this is normal.

If C₃ and the movable coil have been adjusted correctly, you can now set the instrument for zero, or near zero, signal and make the test with metals previously re-

(Continued to page 136A)

BUILD IT YOURSELF...



SEND FOR FREE
1940 RADIO
CATALOG!

Build a radio that really does things! Send for this great FREE catalog of build-it-yourself kits, parts, tools, etc. Save time and money! Here in one handy 188-page book is everything you'll need.



RUSH COUPON
for your FREE copy. Full of great values in radios, amateur equip't and Public Address. Use it as your buying guide.

LAFAYETTE RADIO
100 Sixth Ave., New York, N. Y.

Radio Wire Television Inc.
Dept. 7A-100 Sixth Ave., New York, N. Y.
Rush FREE 1940 Radio Catalog No. 78

**WORLD'S
FINEST
RADIO
CATALOG
FREE**

NAME

ADDRESS

CITY STATE

MADE \$1025.00

in 9 Months
with the

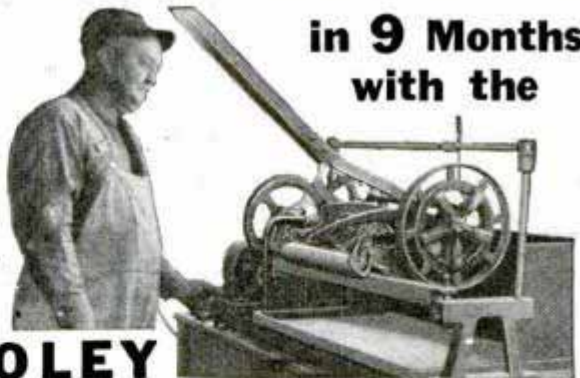

FOLEY LAWN MOWER SHARPENER

"A substantial increase in grind jobs each year, proves beyond any doubt that Foley Grinders do very satisfactory work. We have ground 723 mowers since February 1 to date, November 9. Our total receipts on lawn mower service alone during that period has grossed us \$1,025.00. The prevailing price of grinding and adjusting service is \$1.00 and \$1.25—repairs and parts extra."—W. A. Tulip, Phoenix, Ariz.

You Too Can Make Big Money

Free plan tells you how to start. The Foley Lawn Mower Sharpener turns out perfect work quickly and easily, no experience needed. Simply put the mower in the machine and turn on the power. Uses same system as lawn mower factor is. Sharpens all sizes and types in 15 or 20 minutes.

Special Offer: Attachment for grinding axes, hatchets, knives, etc., included FREE with Foley Lawn Mower Sharpener on our Special Offer, brings you business the year around. Send coupon today.

FOLEY MFG. CO. 107-40 Foley Bldg., Minneapolis, Minn.

Send Free Plan for making money sharpening lawn mowers, and Special Offer on the Foley Lawn Mower Sharpener.

Name

Address



Here's Power for FARM, ROAD, BELT and SHOP WORK!

BUY AT LOW FACTORY PRICES

● The newly developed, fully tested Master DU-ALL is the lowest priced riding tractor on the market today. It is a complete, all-purpose machine—fully equipped and powered for practically all tractor jobs. It cultivates, plows, hauls, runs belt equipment and does nearly all farm and workshop power jobs. Engine is air-cooled. Auto-like gear shift has three speeds forward and reverse. Idles to one mile per hour; speeds up to 7 miles per hour. Plant clearance, 16 inches. Turning radius, 5 feet. Rear wheel tread, is adjustable from 17 to 30 inches between tires. Burns kerosene or fuel oil. Air or steel tires. Has tool control, convenient hitches and cultivating depth gauge. "Factory-to-you" selling plan makes this the biggest tractor bargain of the year. Mail coupon for full facts and low factory price!

● This complete 4-wheel tractor costs little more than many walking-type garden tractors. Investigate low price!

Master
SHAW
DU-ALL
ALL-PURPOSE TRACTOR

10-DAY TRIAL OFFER—All Shaw Models can be tried for 10 days on your own place without risk. Mail coupon now for full details of this offer. See for yourself that you can actually get efficient, economical tractor power at unbelievable low cost.



SHAW
DU-ALL
GARDEN TRACTOR

● The popular and famous line of Shaw Du-All Garden Tractors is now offered at record-breaking low prices—as low as \$136.50. 2, 3, 4 or 5 H.P. riding and walking models do most field and belt work. Equipped with many superior, exclusive Shaw features. Get catalog and list of low factory prices. Mail coupon!

AGENTS:

Get full facts about liberal agent and dealer proposition, now being offered to qualified men. Mail coupon for details, low prices, discounts and terms!

SHAW MFG. CO.,
4501 Front St., Galesburg, Kan.;
5812 G. Magnolia Ave., Chicago, Ill.;
130 G W. 42nd St., New York, N. Y.;
668 G No. 4th St., Columbus, Ohio

Send FREE information checked below about Shaw DU-ALL Tractors.

Low Factory Prices, Catalog, 10-Day Trial offer and all details about the new Master and Garden Tractor Models.

Liberal proposition for agents and dealers.

Name

Address

Town

State

WET BASEMENTS!

Amazing new Seal-Seep method, anyone can use. Applied to inner masonry wall and floor surfaces; no digging. Guaranteed permanently effective. Agents write for unusual earnings opportunity. Details FREE.

National Seal-Seep Co., Dept. 192, Cincinnati, O.

Waterproof
Your Own
Save up to
\$100 to \$150

FREE CLUB & CLASS PIN CATALOG SHOWING OVER 300 DESIGNS

300 SMART DESIGNS!

Knit your class or club closer together with pins or rings. Bastian has been the leading maker for 45 years. Clean cut, quality work. Write today for 1940 Catalog.

BASTIAN BROS. CO. Dept. 72, Rochester, N.Y., \$140

SpeedWay DRILL \$7.95 GRINDER \$5.95

KIT \$14.95

ROUTER \$3.95

GRINDER \$9.95

STAND \$3.95

QUALITY TOOLS
... products of SpeedWay, for 30 years leading manufacturers of electric tools. Specially wound high torque 110V universal 1000 motors. Improved design, correct speeds. 1000 RPM Drill with die cast handle has 1/4" capacity in steel. 20,000 RPM Hand Grinder has speed essential for efficiency and collets for both 1/8" and 3/32" arbors. Drill and Grinder sold singly or together with 5 accessories in fitted Steel Kit. Stand takes either drill or grinder. Router frame converts grinder into router. Bench Grinder is complete with motor. Write for Circulars. SpeedWay Mfg. Co., 1842 S. 52nd Ave., Cicero, Ill.

EASY PROFITS IN PAINT SPRAYING

Paint walls, ceilings, screens, furniture, radiators, machinery faster, better! 1/4 H. P. motor 110 Volt 60 Cycle AC, complete with Spray Gun, 15 ft. hose. Weighs only 44 lbs. Carry anywhere. FULLY GUARANTEED. Only \$31.15 f. o. b. Chicago. \$5 Deposit, Balance COD, or SEE YOUR DEALER. Circular FREE. Get started making money NOW!

Ideal Automatic Pump Co. Dept. PM-1, 801 Washington, Chicago \$31.15 Complete

When writing please mention Popular Mechanics

SPARE TIME MONEY . . .

There's a big demand for the many hand-tooled articles you can make with the Enseo Leathercraft Set. Easily learn to make good money in your spare time. Complete outfit including tools, leathers, patterns, etc., and full instructions, only \$2.00—on sale at leading Department Stores or order direct and pay postman on arrival. \$2.50 outside U. S.

LEATHERCRAFT

Free When ordering direct, clip name of your Department Store to this ad, and we will include with your set, one extra free project. Illustrated catalog 10c.

E. A. SWEET CO. Dept. A-30 Binghamton, N. Y.

Earn \$150 to \$300 EXTRA PROFIT MONTHLY with New A.C. Arc Welding

LIBERAL TRIAL TO PROVE IT... START WITHOUT INVESTING "PAY OUT OF THE PROFITS" TERMS

Get the bigger profits that come from high quality arc welding with this new Hobart A.C. Welder. Use on 220 volt circuit. Simple to operate; unusually low operating cost... will handle hundreds of repair and construction jobs. Thirty adjustments of current and voltage gives you the right heat for every job.

ONLY \$12.50 MONTHLY

For as little as \$12.50 monthly you get everything you need to start a profitable welding business... including head shield, electrode holder, electrodes, cables, etc. You try this new A.C. Welder for 10 days on your own work at our risk, to prove how profitable it is. Write for free booklet and complete details.

HOBART BROS. CO., Box M-1481, TROY, OHIO

FREE! "New Profits in Arc Welding" Ask for it!

Check this ad and MAIL TODAY FOR COMPLETE INFORMATION

I'M SO HAPPY NOW
THAT CHARLES IS
DOING SO WELL IN HIS
NEW BUSINESS



**MADE \$217
in 10 DAYS
WASHING WALLS**

● Newly invented machine washes walls 6 times faster and better than by hand.

Charles Steele made \$217.00 the first 10 days. We want more men like him to go into business for themselves. Customers everywhere — homes, schools, offices, stores, churches, lodge halls, hotels all have walls that need washing. You don't rent a store or office; you operate this business from your home. On a job paying you \$10 your cost is 20c. Write for complete facts on new Von Schrader Wall Deterger which washes paint perfectly and postpones repainting many years.

Howard James writes: "I landed a \$40.00 job the first day."

J. A. Crosby says: "I have several jobs to start on Monday, thanks to your help."

Cliff Brown writes: "I got a contract in a public school which will more than pay for my machine in the next few days."

VON SCHRADER



Easy Payments

It takes only a few dollars to get started in this new money-making profession. No experience necessary. The total price is so small and the payments so easy that anyone with ambition should get started NOW.

**SEND FOR FREE
INFORMATION**

MANUFACTURING CO.

771 PL. RACINE, WISCONSIN

BUILD YOURSELF A MIDGET CAR



WE SPECIALIZE IN WHEEL SETS, ENGINES, ETC. for building Cars, Scooters, Trucks, etc. We carry only the best at the lowest prices. Send 10c for parts catalog and plans for three Midget Racers, Scooters and other vehicles. It pays to use only reliable plans and parts—We guarantee satisfaction. **Build-Your-Own-Devices, 536 North Parkside, Dept. PM-3, Chicago**

A Midget Car or Scooter outfit is an ideal Xmas gift

Ideal Xmas Gift for Home Craftsmen

BRONZE FOUNDRY



in your own workshop allows you to design and build your own GASOLINE ENGINES, STEAM ENGINES, STATUARY, ART OBJECTS, SPECIAL TOOLS, NEW INVENTIONS, ETC. You can also make forgings and case harden steel. Your shop is not complete without a **FOUNDRYETTE**. Three sizes are available capable of making bronze castings of 1½, 3, and 6 pounds weight, aluminum, copper, brass, etc., in proportion to specific gravity. Economically priced. Domestic gas supply and required for operation. Write for circular.

110 volt 60 cycle energy
KANSAS CITY SPECIALTIES CO.
Box 6022, Dept. P-3

Kansas City, Mo.

HANDEE

Tool of 1001 Uses

A GIFT HE'LL LIKE

A Whole Tool Shop in Your Hand

Smooth, steady power at your finger tips. Uses 300 accessories to grind, drill, polish, rout, cut, carve, sand, saw, sharpen, engrave, etc. Plugs in any AC or DC socket, 18,000 r.p.m. 16 oz.

Get A Demonstration

at Hardware, Tool or Dept. Stores, or order on 10-Days Money-Back Trial. **\$10.75** post-paid with 3 Accessories . . . De Luxe Model, 25,000 r.p.m. 12 oz. **\$18.50** with 6 Accessories.

Chicago Wheel & Mfg. Co., 108 S. Aberdeen St., Chicago, Ill.



Save
Hours
of Hand
Work

FREE 64-PAGE CATALOG

Complete information on Handee Products and their wide application in crafts work and industry all over the world.

2994 Blind Man's Buff

(Continued from page 37)

the distance from ship to radio beacon may be computed by measuring the time interval between radio and aural signals. Dividing the seconds of interval by five gives roughly the distance in miles.

The trouble is that frequently the fog-horn is not heard, even by the best of ears. For the very difference in air temperature that causes fog also distorts sound waves upward. These same waves may be deflected later back to earth by a higher layer of cold air, so that a ship five miles from a

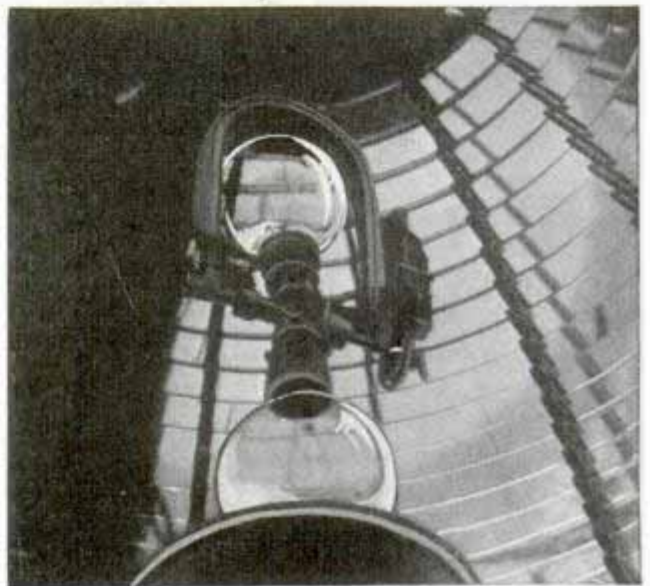

Lens of the Cape Henry lighthouse on the Virginia coast, guarding the entrance of Chesapeake Bay

lighthouse might hear the fog signal, while a vessel a mile away might miss it.

Sound waves are subject to other disturbances. The edge of a fog bank, intervening between ship and source of sound, deflects waves that strike it at an obtuse angle. Wind always distorts sound waves, confusing the direction of the source. The reason is that sound waves spread in a circle, like ripples from a stone dropped into a pond. Wind distorts this circle into an ellipse. Since the apparent source of sound is at right angles to the front of the wave, a listener may mistake the source by as much as seventy degrees.

To overcome the idiosyncrasies of sound through air, several lightships transmit submarine distance-finding signals. The Fire Island and Ambrose lightships transmit with an underwater bell; the Nantucket has a submarine oscillator. Such signals are not subject to distortion, and their

2994
 speed is uniform at 4,800 feet a second. However, it takes a costly installation in the ship's hull to receive such signals; few except the most modern liners carry it. The "Olympic" did, but it did not prevent her running down the Nantucket.

Having felt her way along by radio and sound to Ambrose lightship at the entrance to New York harbor, our captain picks up the Sandy Hook pilot, who guides ships through the narrow channels of our busiest port. And the channels are narrow. The broad expanse of water you see from the Staten Island ferry is a delusion, for most of it is less than ten feet deep. Even Ambrose Channel is but forty feet deep—and a thousand yards wide. The pilot must keep the ship within this channel, must avoid other ships, and the countless ferries, tugs, and lighters in the harbor.

To follow the channel in fog, he must feel his way by compass and watch the buoys anchored along the channel boundaries, half a mile apart. Each may be identified by a number on the side, by the individual flashing interval for its light, and by its distinctive bell or gong, trumpet or whistle—all sounded by wave action. A deep-toned bell or whistle can be heard for miles, yet the ear has trouble ascertaining its direction even when close at hand. A shrill, high-pitched tone has excellent directional qualities, but can be heard a very short distance.

Navigation and piloting in fog must be done entirely blind, except for the few unobscured yards permitted by the fog. And this short visual distance is not enough, for a ship must proceed at a reasonable rate of speed to remain manageable. Except for ferries, tugs, and a few other vessels with an extremely high ratio of power to size, a ship cannot maintain steerage-way and be stopped in less than four or five times its own length. Neither can a large ship be maneuvered quickly to avoid collision. It will continue on its original course for a considerable period after the rudder has turned it in the new direction, skidding or drifting on the turn. Then too, a ship cannot turn directly away from danger, as can an auto, or other vehicle with front steering. In making a right turn, a ship's rudder actually pushes the stern to the left, instead of tracking the bow in the new direction. You can illustrate this prin-

(Continued to page 140A)

AT LAST!

A COMBINATION HI-SPEED WOOD PLANER and FINISHER

FITS ANY
 DRILL PRESS
\$7.50
 COMPLETE

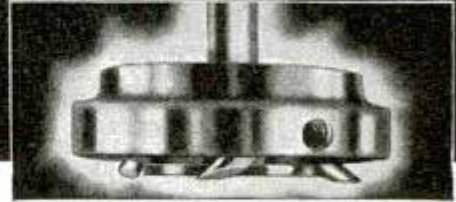

ELIMINATES HAND PLANING AND SANDING
LIGHTNING FAST—SAFE—ABSOLUTELY ACCURATE!

No workshop is complete without this sensational, time-saving, mechanical hi-speed wood planer and finisher. Requires no sanding for added smoothness. Accurate to within .001 inch. Planes every type of wood, plastics and similar materials without scratching, marking, gouging or checking. Parallels and surfaces with amazing speed—30 seconds for planing 2 ft. x 8 in. board with 1/16" cut or less. Knots, hard grains and surrounding surfaces finished to agate smoothness. No experience or skill required. A lifetime tool. Works in any table or pedestal woodworking drill press. Indispensable for cabinet and pattern makers, carpenters, millwrights and home work shop enthusiasts.

HERE'S OUR MONEY BACK FREE TRIAL GUARANTEE

We will send our new Hi-Speed Planer any place in the U.S.A. for a five day free trial. If you are not 100% sold on its all around usefulness, just return it, getting your full refund. Try it and be convinced. Send check or money order for \$7.50 introductory offer. We prepay shipping. Or order C.O.D. and we will ship parcel post collect.

FREE DESCRIPTIVE LITERATURE. DEALER OPENINGS

Berry Tool Company, 303 Architects Bldg., Detroit, Mich.

BERRY HI-SPEED ROTARY WOOD PLANER

PUSH-BUTTON CONTROLLED GAS TANK LOCK



A new invention "ELECTRIC HAMMER ACTION" obsoletes all other gas caps. Eliminates troublesome keys. Stops loss of gas and caps. Features PUSH-BUTTON CONTROL FROM DASH—STREAMLINE DESIGN. Exclusive territory grants going fast. Write immediately for distributorship proposition.

SNAP-UP GAS CAP CO.

DEPT. T.

ASHLAND, KY.



CASH PAID Why not get ready now to spend spring, summer, fall outdoors gathering insects—butterflies, moths. I buy hundreds of kinds for collections. Good cash prices paid. Some \$1 to \$7. Easy. Simple. Send 10c (not stamps) for **Illustrated Prospectus** before sending any insects. Write today. **Hurry!**
MR. SINCLAIR, DEALER IN INSECTS,
 Dept. 72, Box 1830, San Diego, Calif.

Stoves AT FACTORY PRICES!



New FREE Catalog

New designs, new features. Nearly 170 Styles and Sizes of Heaters, Ranges, Furnaces. Up to 18 months to pay for stoves, 3 years for furnaces. Write today for **FREE CATALOG**. 30 days **FREE TRIAL**—24 hour shipments.

Kalamazoo Stove & Furnace Co.
 391 Rochester Ave.

Kalamazoo Michigan
 Over 1,500,000 Satisfied Users
 40 Years in Business

A Kalamazoo
 Trade Mark Registered **Direct to You**

Write today for
FREE CATALOG

2994

(Continued from page 138A)

High Quality Driver Tilting Arbor Saw

CRASHES
MEDIUM PRICE
FIELD!

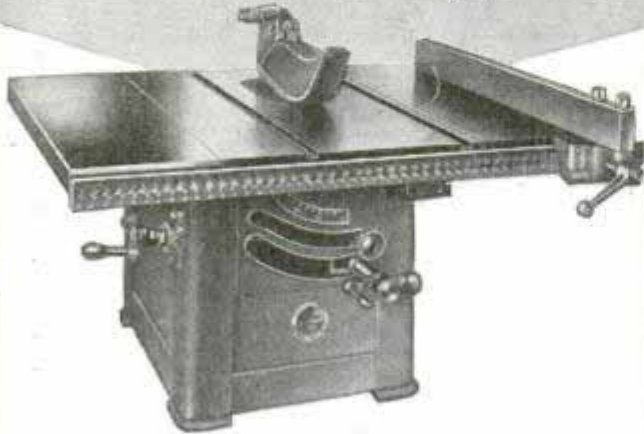

"Some day I'm going to own a fine Tilting Arbor Saw!" Your friends have said it . . . you've said it. For sheer all-around usefulness and convenience, this tool has always stood out. And now you can . . . without sacrifice of quality, Driver engineering has achieved one economy after another, to bring a high quality Tilting Arbor Saw within reach of everyone's pocketbook!

FEATURES: famous Texrope multiple-belt drive. Also furnished with gear drive. 8" or 10" blade. New "Gun-carriage" raising-lowering-tilting mechanism works smoothly, accurately . . . can't jam.

See it at your Driver dealer's—and get the price. Then you'll agree—*Driver engineers have made news again!*

COUPON below puts your name on list for new 1940 Driver Catalog showing many new models, improvements. Fill in and mail now!



DRIVER Engineered POWER TOOLS

Walker-Turner Co., Inc.
110 South Ave., Plainfield, N. J.

Put me down to receive one of the big 1940 Driver Catalogs just as soon as it is off the press!

Name.....

Address.....

CAMERA BOOK

FREE!



Illustrates latest methods in Photography and Home Movie Making, for fun and profit. Offers hundreds of amazing money-saving bargains in still and movie Cameras, Lenses, Films, etc. Used equipment accepted in trade. Satisfaction guaranteed or money back with 10-day trial privilege.

WRITE FOR FREE BARGAIN BOOK!
CENTRAL CAMERA CO., 230 S. Wabash, Dept. A-16, Chicago, U.S.A.

ciple with your own car. If parked alongside another car, you can turn your wheels and move forward directly away from it. But if you cut your wheels to back away, the front end of your car (now the rear) will move toward the other car before you start to move away from it.

With sound so unreliable, with ships so hard to manage in the visual distance permitted by fog, some method needs be found to increase that visual distance. Science has long been at work on the problem, but with little success. Sodium vapor and neon lamps have been tried, but they increase visibility in fog by a few feet only. Dr. W. J. Humphreys of the U. S. Weather Bureau says 300 feet of dense fog so refracts visual rays that the direction of their source becomes indistinguishable.

He suggests the shorter waves, heat waves invisible to the human eye but easily detected by a visually recording thermocouple. Such a receiver would pick up rays from a heating element in lighthouses and buoys; engines of another ship would emit more than enough heat rays to stimulate the thermocouple. Such equipment, already perfected in the laboratory, awaits commercial exploitation. Efforts to disperse fog have met with failure, though successful in the laboratory. Electrical induction, for instance, will dissipate fog within a few feet of the charged wire. It is manifestly impossible to string a network of highly charged wires over a harbor. Electrified sand, dust, or water, sprayed from an airplane, will cut a swath through fog; but the fog will close in again immediately unless enormous quantities are sprayed—a ton a minute per acre. Fog particles will condense and fall as rain when the temperature becomes low enough; or will evaporate with enough heat. It would take a ton of coal a minute per acre to furnish enough heat to evaporate a fog, if distributed evenly.

"Yes," Dr. Humphreys declares, "we know how to dissipate fog—in the laboratory. I know how to carry a stone too, yet I wouldn't attempt to walk off with the Washington monument. It's one thing to know how to do something; quite something else to figure out a practical means of doing it."

Meanwhile, the game of blind man's buff goes grimly on.

9973
 "Painting" Live Pictures

(Continued from page 75)

seen close up it still appears to duplicate exactly the hair on the figure in Gainsborough's masterpiece.

Of all the living masterpieces, da Vinci's "Last Supper" is the most startling. The original, now faded and blurred, is on the wall of a chapel in Milan. But Ropp's living reproduction has all the drama and brilliance which must have characterized the painting at the moment when da Vinci's brush finished its work. In recreating this painting it was found that the audience was unable to see the top of the table behind which the apostles sit. So Ropp slant-



Girl making wig for Gainsborough's "Blue Boy" is guided by copy of the famous painting

ed the table toward the audience. So cleverly was the illusion created that the table looks flat—yet all of its top is clearly visible. But with a slanted table, the cups, plates, bread and fish, which da Vinci painted, would slide off. Ropp solved this problem by gluing all the plates and cups, even the bread and fish, onto the tablecloth.

So the Pageant of the Masters goes on, accomplishing with artistry and ingenuity the seemingly impossible task of displaying great paintings and pieces of sculpture that, in all reality, live.

Our Bureau of Information keeps on file the names and addresses of makers of, and dealers in, all devices described in the pages of Popular Mechanics Magazine. We are glad to furnish this information to our readers upon request, accompanied by stamped, self-addressed envelope.

Guaranteed for
18,000
 MILES

Only
29¢
 EACH

Double Check
 W/ DOUBLE POWER
 SPARK PLUGS

You'll buy gas less often after you install Double Check Spark Plugs, because there's *no loss in firing*. Turn on the ignition—step on the gas—and *FLASH*—you're off to a lightning start.

Longer and parallel side-electrodes are the secret of Double Check's ability to *get every atom of power and speed from your car*. Gap adjustment lasts twice as long.

Double Check Spark Plugs—in design and construction are patterned after multiple electrode plugs used in aeroplanes. *Here's Double Power—at less than half price!* Guaranteed to be highest quality obtainable!

ORDER A COMPLETE SET TODAY
MAILED POSTPAID—NO EXTRA CHARGE
ANYWHERE IN THE UNITED STATES

SEND CHECK OR MONEY ORDER
 A complete set for 4-cylinder cars, only \$1.16; 6-cylinder cars, \$1.74; 8-cylinder cars, \$2.32. Designed in the correct heat range for your car, truck or tractor. Be sure to specify make, year and model of car.

DEALERS: Sell Double Check Spark Plugs in your territory. Write for details.

The **PEP BOYS**
 MANNY, MOE & JACK
 General Offices and Warehouses
 10th St. & Somerville Ave., Philadelphia, Penna.
 1122-24 W. Washington Blvd., Los Angeles, Calif.

Get ALL the Facts About
Atlas Shop Equipment



SEND FOR YOUR **FREE**
1940 ATLAS CATALOG

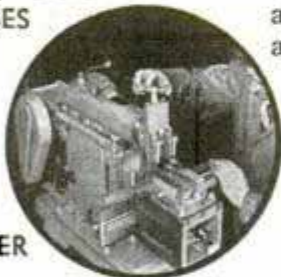

LATHES

DRILL
PRESSES

SHAPER

Every shop man should have this big new 72 page book at hand for quick reference during the busy months ahead.

It's crammed full of interesting machining operations, equipment close-ups, shop views, construction details, and many helpful machine tool facts.

Fill out and mail the coupon below today—you'll enjoy and value this catalog all year.

ATLAS PRESS CO.

143 N. Pitcher St.
Kalamazoo, Mich.

ATLAS PRESS CO., 143 N. Pitcher St., Kalamazoo, Mich.

Please send me your 1940 Catalog on 10" Metal Lathe
 6" Metal Lathe 7" Metal Shaper Drill Presses Arbor
Presses; and name of nearest Atlas Dealer.

Name.....

Address.....

City and State.....

2995 College for Seals

(Continued from page 85)

or in comedy, the latter being in particular demand these days. Huling points out that the balancing tricks are much more difficult than those demanded of performers of former years. One of the hardest is to balance a glass of water and roll over without spilling it. Another is to roll a small ball back and forth on a grooved stick.

As for comedy, complete little routines of the vaudeville sketch type are being taught in this course. "Seals are real comedians," says Huling, "and their droll appearance gives them a natural advantage as far as getting laughs are concerned. Right now I am teaching one pupil to say his prayers, get into bed and pull up the covers, then 'wake up' and start scratching himself with a flipper. After he has mastered this, I will teach him to go through some antics in a bathtub. Then the two stunts will be combined in one routine and the student will be able to give a thoroughly ludicrous imitation of a person taking a bath and going to bed. Tricks such as these, burlesquing actions of human beings, have a sound theatrical psychology and are sure fire with audiences.

"Curiously enough when a pupil has thoroughly mastered a difficult trick, he must be taught to 'unmaster' it a bit. Veteran showmen know that a stunt will be more appreciated by an audience if it is made to appear very hard. A proficient student will go through a really difficult trick so fast that it seems easy to the casual onlooker. And so he must be taught showmanship, and the knack of doing things more slowly."

When one of the students leaves Seal College, he does so in his own specially equipped car, designed by Mr. Huling. The car contains a miniature tank of fresh water and is spacious enough for the seal to exercise in while en route, instead of being confined in a small cage as formerly.

"The seal car is but one of the many scientific improvements which we have added recently," said Mr. Huling. "As the need for new apparatus and equipment develops we will originate it along scientific lines. Any animal with a value that can be increased as greatly in a year's time as the seal's certainly warrants the best and I believe that Seal College is a long step in this direction."

IF YOU WANT THE LADIES TO LIKE YOU



Clip this Coupon

20 FREE SHAVES

Lambert Pharmacal Co., Dept. 139, St. Louis, Mo. Please send me free and postpaid your large sample tube of Listerine Shaving Cream; Listerine Brushless Cream. (Check whichever is desired.)

Name _____ Address _____
City _____ State _____

Make Your Hobby and Spare Time Pay You EXTRA MONEY

Here are selected books to help you cash in on your hobby, earn extra money or establish a profitable business of your own. Pay postman or remit with order for pre-paid delivery. Money refunded if not satisfactory, if returned in 3 days.

ORDER UNDER MONEY-BACK PLAN

- A SMALL BUSINESS OF YOUR OWN.** Gives 1000 ways for a man with little or no capital to build a modest dependable business. \$1.00.
- MAKING AMATEUR PHOTOGRAPHY PAY.** Turn your prints into extra money. Tells what to take, where to submit and how to sell pictures. \$1.00.
- TURN SCRAP INTO MONEY.** Shows how to build power plants, 110 volt motors and generators, wind power plants and other electrical apparatus from old auto parts. \$1.00.
- HOME AND WORKSHOP FORMULAS (HENLEY).** 10,000 opportunities to make and save money through the use of these tested recipes, formulas and processes, etc. Tells how to make salable preparations of all kinds. 883 Pages. \$4.00.
- A LIVING FROM THE LAND.** The information that thousands of people have, who are seeking security and productive uses for their leisure time, want and need. \$1.50.
- SHOE REPAIRING.** Practical and simplified instruction on modern

- shoe repair methods. Helps you save money on your own work and make money repairing for others. \$1.00.
- AUTOMOBILE BODY AND FENDER REPAIRS.** Covers thoroughly, the best paying end of the auto repair business. Prepares for regular job or good source of extra, spare time money. \$3.00.
- PAINTING AND DECORATING.** Use this book for complete study or to pick up extra money on spare time jobs. Includes estimating and cost figuring. \$1.50.
- HIGH SCHOOL SELF TAUGHT.** Complete four year high school course in one volume. Broaden your knowledge and increase your income with high school subjects. 1000 Pages. \$2.39.
- BUSINESS COLLEGE SELF TAUGHT:** Here's your practical training for business all in one handy volume. 15 courses covering all essential subjects taught in a modern business college. Over 1000 pages. Cloth. \$2.39.

POPULAR MECHANICS PRESS
Dept. 140, 200 E. Ontario St., Chicago

EARN MORE MONEY WITH CONCRETE

Now you can start a profitable business of your own! Never before have such great opportunities existed in this fascinating field of concrete. It is simple and easy to use. Make things you before thought impossible. No previous experience! Little competition! Learn how you can make money in double-quick time! Send for Free details now!

POPULAR MECHANICS PRESS, 635 St. Clair Street, Chicago, Illinois

In answering advertisements always write name and full address clearly.

WOODWORKERS NEW BARGAIN BOOK 10¢

Yes, rock-bottom prices! On EXTRA FINE woods, tool Send 10c for NEW 1940 BARGAIN BOOK. Learn how much you can SAVE. Forty-one sensational NEW offers solely to prove the HIGH QUALITY of woods that have made the name CONSTANTINE famous for 112 years. Think of it! On some special lots at less than \$5.00 you actually save up to \$14.81! Send 10c for Bargain Book TODAY—WHILE SPECIAL STOCKS LAST!

ALBERT CONSTANTINE AND SON, INC., 793-C, E. 135th St., N. Y.

Power Pays a Big Profit with a Red Universal Tractor

You plow, disc, cultivate, mow, haul, do belt work, for about 33c a day. Safe, trouble-free long life. New plow lift—new reverse. Hundreds used. Save by buying from maker. Two weeks trial—satisfaction guaranteed. FREE colorful catalog. Write today.

PIONEER MFG. CO. DEPT. V-10, WEST ALLIS, WIS.

Save Fuel This Winter!

Equip your hot-air furnace with a thermostat and electric damper control. Automatically keeps temperature of your home at any point desired. Turns the draft on and off as needed. Does away with Over and UNDER-heating. Helps to reduce colds. Pays for itself in fuel saved. Easy to install. Takes only a few minutes. The equal of equipment selling at double the price. Satisfaction guaranteed or your money back. Send today for FREE circular. Modern Automatic Circulator Co., 2262 Gratiot Ave., Detroit, Mich.

WRITE for CIRCULAR

FREE WHOLESALE CATALOG

260 pages chock-full of tested fast sellers, for salesmen, dealers and operators. New, big 1940 issue, just off the press. Describes many plans for boosting sales, one of which may add \$3 to \$15 a day to your earnings. It illustrates carded goods, automobile accessories, household necessities, office specialties, wearing apparel—over 4500 first quality items at low wholesale prices. Cost about 35c, FREE, while stock lasts. Get your copy by mailing your request for it, now.

SPORS COMPANY 11-39 Elm St., LeCenter, Minn.

NOW! Plug in your FARM or PORTABLE RADIO

PORTA-POWER converts 1½ and 2 Volt Battery Radios into ALL-ELECTRIC. Designed for RCA, ZENITH, PHILCO, SENTINEL and 95% of all battery radios. Modernizes farm radios where High-Line is now in or coming. Makes Portable Radio economical home set year around. 100 hours cost less than 5c. Just plug in light socket—BATTERY EXPENSE STOPS. Supplies A & B power from 115 Volt, 50-60 Cycle. Uses conventional tube and Mallory rectifier circuits adequately filtered. Fits all battery compartments. Thousands in use. Quickly pays for itself. **100% GUARANTEE.**

Order NOW! Enclose \$7.50 for 1½ Volt UNIT. 2 Volt requires service man to install. Send his name, address and \$9.95. Agents and service men wanted.

TEL-RAD COMPANY 333 N. Michigan Ave. Chicago, Ill.

1½ VOLT \$7.50 2 VOLT 9.95

Save Your **TIME** and **TEMPER**

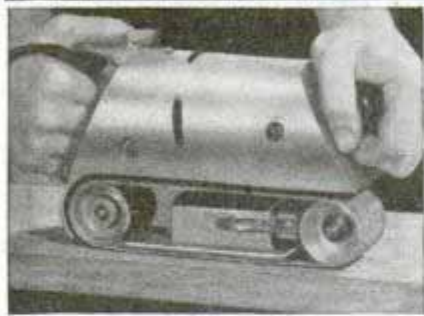

Do Sanding this **EASIER BETTER** way with

Portable Electric Sander

Sands, Grinds, Buffs, Polishes, Sharpens Tools, Removes Paint and Varnish!

Try **GUILDSANDER** just once... and you never will go back to monotonous, slow, exasperating hand sanding again.

You can do **EXPERT** sanding—no experience needed. Use the handy **GUILDSANDER** anywhere, in any position—weighs only 9 lbs. High speed abrasive belt works on wood, wall board, metal, stone, plastics or compositions. Gives a smooth, straight-grain finish—no swirls. Takes off paint and varnish in a jiffy, without scraper or messy removers. Operates on AC or DC. Quality guarantee. See **GUILDSANDER** at your hardware or tool supply store—or write us for full information.



SYRACUSE GUILD TOOL CO. 1740-1C No. Salina St. Syracuse, N. Y.



BOATS-AQUAPLANES
BUILD OR BUY NOW FOR SPRING

SKIFF, 12 ft. carries six, weight 110 lbs., handles 10 H.P. outboard. Ready to use, not necessary to soak. **AQUAPLANE**, new type, hollow, fast, light. Send for **COMPLETE** construction blue prints and instructions, each \$1.00. All materials can be secured in local lumber yards. Crafts can be shipped knocked down or completed at exceptionally low cost.

MARTIN & ROBERTS, INC.
P.O. Box 136 Gulfport, Miss.

Write FOR FREE

big, 24-page magazine filled with pictures and stories of thrilling, exciting motorcycle events—and literature on the snappy, new 1940 Harley-Davidsons, "World's Champion Motorcycles." Write now! Harley-Davidson Motor Co., Dept. P, Milwaukee, Wisconsin.

HARLEY-DAVIDSON MOTORCYCLES



Reg. \$5 BRIARS

\$1

Straight Grain Irregulars

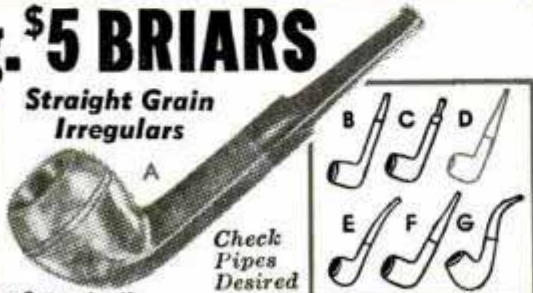

Check Pipes Desired

Every Pipe Guaranteed! Imported Corsican briars treated to give you the coolest, mellowest smoke ever. Every one with scientific moisture control unit for a clean, dry smoke. Gift boxed.

HOUSE OF BARCLAY 545 Fifth Ave. [WE PAY POSTAGE] New York, N.Y. [On Prepaid Orders]

Please send me.....pipes at \$1 each.
Name.....
Address.....
Cash M. O. Check C.O.D.

21020
Lifesavers for Old Books

(Continued from page 57)

Mysteries surrounding old manuscripts are solved with the aid of a color-distinguishing robot which automatically analyzes the color of ink used in old documents. Combining an electric eye, a microscope, filters, radio amplification, and a current recorder, the mechanism was designed by Captain R. B. Haselden.

His color-distinguishing robot was designed to aid the human eye in analyzing the color of small opaque objects such as pen strokes. The writing to be analyzed is

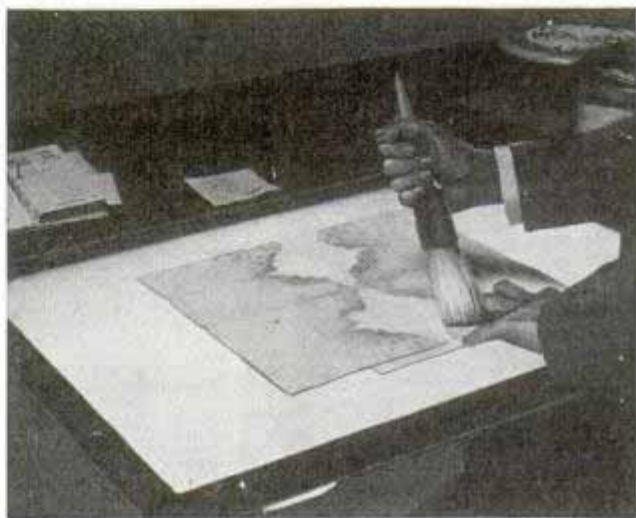

Glass table top, illuminated from beneath, aids in the patching of manuscript fragments

placed under a microscope. At the eyepiece of the microscope is a photoelectric cell. Before reaching this cell the light passes through a color filter. Color filters are provided which cover the entire range of the spectrum. The light which passes through the filter and reaches the cell sets up an electric current which is amplified by radio tubes, and finally recorded on a meter. By noting the difference in the strength of the electric current when different colored filters are used, the exact shade of the ink can be determined with far greater accuracy than could be done by the human eye. By using ultraviolet light, a complete manuscript may be found written under the one being examined. As the lambskin or "vellum" used by ancient authors was often scarce, they made a practice of washing the writing off a discarded document and using the vellum again. Although the original writing is invisible under any normal illumination, ultraviolet light makes it clearly visible.

295 J
Flying "Under the Hood"

(Continued from page 11)

Because of radio a pilot no longer needs to watch the ground to keep track of his position. Airway marker beacons of several kinds tell him of his progress along an airway and if he desires he can take intersecting bearings on several radio stations with his rotatable loop. With such bearings he can fix his position instantly. The directional loop is one of the most valuable instruments on the plane and pilots practice with it constantly. One recent innovation is an automatic direction finder that consists of two loops that revolve at con-



Big DC-4 warming up for night flight. A smaller ship of same type will be used in transport service

stant speed, the mean of their readings being transferred to a dial that shows the bearing of a particular ground station no matter in what direction the airplane is turned.

Valuable as the radio beams along the airways are now they are to become even more dependable shortly when new ultra high-frequency transmitters are installed. The purpose of the new installations is to eliminate static and multiple and bent courses, delivering clear reliable signals to aircraft under all conditions. Present radio range stations transmit four beams, one in each quadrant, and the plan is to replace each of these with two short-wave transmitters that emit two beams each. The idea is to avoid the congestion of four-way traffic at one point. In the future each leg of a radio range station is to be identified by a special signal that shows its direction from the transmitter. Another proposal is that the present ground control radio stations at major airports be equipped with re-broadcast equipment so that pilots of incoming air liners can talk with one another to arrange their order of approach.



Caught with a Speed Graphic by Robert C. Chick

GRAFLEX and SPEED GRAPHIC
 ★ Prize-Winning Cameras ★
 ★ Praise-Winning Gifts ★

You can make no finer gift choice—for yourself or any other picture-taker—than a Graflex or Speed Graphic Prize-Winning camera. American-made by master craftsmen they are the first choice of those who strive for better pictures.

The great versatility of these cameras is winning prizes and recognition for owners everywhere. Choose from your Dealer's selection of Graflex and Speed Graphic cameras and accessories.

Now Available on Easy Payments at Graflex Dealers Everywhere!

National GRAFLEX



Because it features full vision focusing, focal plane shutter speeds to 11500 and an f.3.5 Bausch & Lomb Tessar lens, this camera has been called the finest of American-made miniature reflexes. Makes ten album-size pictures on each 8-exposure film. Price..... **\$87.50**

2 1/4 x 3 1/4 Miniature SPEED GRAPHIC



One of the most popular of all cameras! Small, compact, it has all recognized Speed Graphic features plus new and advanced ones including built-in focal plane shutter flash synchronization and parallax correcting tubular view finder. Price (dependent upon lens selected) **\$111.00** from.....

Accessories, coupled range finder (illustrated) \$27.00

2 SPLENDID PHOTOGRAPHY BOOKS

"Graphic Graflex Photography" by Morgan and Lester. Out in January! Buy gift certificates now. Exchange them later. **\$4.00** Only.....

"Photographic Enlarging" by Franklin I. Jordan, F. R. P. S. A gift any hobbyist will appreciate. In attractive gift box. **\$2.50** Only.....

New York City Display Rooms: 50 Rockefeller Plaza

FREE CATALOG and GIFT GUIDE

Send for free catalog of Graflex and Speed Graphic American-made, Prize-Winning Cameras and Accessories and free Graflex Annual Gift Guide. Paste coupon—or write your request—on penny post card, if you wish. Polmer Graflex Corporation, Dept. PM-3, Rochester, N. Y.



FOLMER GRAFLEX CORPORATION
 DEPT. PM-3, ROCHESTER, N. Y., U. S. A.

Please send me your free Graflex catalog and free Graflex Gift Guide.

NAME _____
 ADDRESS _____
 CITY _____ STATE _____





NEW! BORMAN PNEUMATIC Air-Cushioned HEELS

A NEW PATENTED DISCOVERY for
HEALTH—SAFETY—and ECONOMY

Sixteen hours a day on your feet—are they hours of comfort? Borman Pneumatic Air-Cushioned Heels are scientifically designed with air pocket to absorb the shock of every step—preserve energy and reduce fatigue. They're non-skid. Air pocket compresses and grips, even on oily or slippery surfaces. Anatomically correct—not flat any more than your own heel. Made of highest quality rubber for dress, work, or safety shoes. Will outlast soles and often the shoes themselves. Eliminate run-down heels. "Walk Miles With Smiles." Order a pair today. Send outline of heel size and 85c. 2 pairs for \$1.10. Specify black or brown. Curiosity seekers will not be answered. Bonafide distributors wanted.

You actually walk on
a cushion of air!

Borman Pneumatic Heel Co., Dept. A, 1945 W. Fullerton, Chicago, Ill.

Wonderful PIPE Invention

A 16" Smoke in a 6" Pipe

The coolest, sweetest, driest smoke you ever enjoyed! Smoke cooled by heat-radiating shank as it travels 12 spiral inches around "Thermal" (filter). No "slugs", soggy bowls, sour shanks. Finest briar, friction finish, no varnish. Removable Bowl, Shank, "Thermal", all easily cleaned. Send \$5.00 for model pictured, on money-back guarantee, or write for literature. SALESMEN—make real money with Smokolator.



Dillon Smokolator

TIMM - McCURDY, Inc.

6010 W. National Ave.
MILWAUKEE, WIS.



BUILD WITH DOENUTS

Build your wheelbarrows, hand trucks, midget autos, lawn mowers, portable painting rigs, spraying equipment, boat dollies, etc., with the original patented Musselman Doenut Wheels. They absorb surface obstructions, eliminate jolts and handle larger loads much easier. Size 10" x 2.75" and 12" x 3.30". Furnished with Cadmium plated steel disc wheel with adjustable ball bearings. Send 10c postage for illustrated literature unless you are a rated manufacturer.

MUSSELMAN PRODUCTS CO.
6225-R St. Clair Ave., Cleveland, Ohio



Better Tools—Lower Prices GET BALKO'S 1940 CATALOG!

THE CATALOG OF EVERYTHING IN POWER TOOLS, SPRAY EQUIPMENT, MODEL SUPPLIES, ELECTRIC MOTORS, Metal Lathes, accessories, Artist Air Brushes, Spray Guns, Elec. Bench Grinders, Grinding Wheels, Lathe Chucks, Micrometers, Pulleys, V Belts, Carving Tools, Compressors. BALKO'S complete stocks and fast service save you time and money. Send a 5c stamp today for your big new copy.

BALKO ELECTRIC TOOL & SUPPLY CO.
605 W. Washington, 1-A, Chicago, Ill.

NEVERSLIP PULLEY

Transmits more power with less belt wear; unaffected by weather. No pulley covering, no belt dressing required. Replace troublesome pulleys with NEVERSLIPS. All sizes. Money-back guarantee. Ask for NEVERSLIP Pulleys on ALL power machinery you buy. Write for folder and prices.
ROSENTHAL CORN HUSKER CO.
Box 16-140 Milwaukee, Wisconsin



FREE TRAILER BUILDERS' GUIDE AND CATALOG



NEW EDITION
WORLD'S BEST LINE OF TRAILER AXLES, HITCHES AND PARTS—Complete house trailer working blue prints only 50c. WRITE TODAY FOR THIS NEW FREE CATALOG.

HAMMER BLOW TOOL COMPANY, DEPT. 101, WAUSAU, WIS.

ENGINES

A real money maker for farm or factory. Uses Cheap fuels. Pays for itself out of savings. Costs Less to Own—Less to Operate.

LOG SAWS

Make Money—Start a wood sawing business—turn spare timber into cash. Cash or Terms—Engine and Saw Catalog.

WITTE ENGINE WORKS
1741 OAKLAND AVE.
KANSAS CITY, MO.

21221 Army on Wheels

(Continued from page 5)

lery, the deadly hail of the machine-gun bullet—combined to halt mobility. Then came the tank, as compromise, for it combined to a certain degree mobility and fire power or striking power. Today an improved tank, with increased mobility as well as increased fire power, is in the field. And already its Nemesis has appeared—the anti-tank gun.

Last September, Poland was eliminated as a combatant because the German invasion disrupted the entire economic structure of the nation; destruction of Polish armed forces was of secondary importance and a logical conclusion once the industrial heart of the nation was penetrated. This was accomplished by use of mechanized forces which, being mobile, dashed ahead at top speed, and, having fire power or punch, brushed aside local resistance. Foot troops, infantry, able to hold the terrain dominated by the mechanized thrust, followed fast. And foot troops, armed men on the ground, are the decisive factors in war.

Perhaps the most brief, the most illuminative word-painting of what this all means is the homely language of General Nathan Bedford Forrest, of the Confederate Army, who expressed all the principles of war in this remark—"Git thar fustest with the mostest men."

This can be done in two ways—by using transportation to get troops onto the field of battle, when they must then dismount and fight on the ground, or by using the vehicles not only for transport, but as actual fighting platforms. Today we call the first motorization the second mechanization. The words do not mean the same thing. The basis for mechanization is of course the cross-country vehicle, which by one of several ingenious devices, most of them adaptations of the so-called Caterpillar tread, or endless-chain track, can cover ground which an ordinary wheeled vehicle cannot cross.

Mechanization began with the World War tank, a cumbersome armored tractor which lumbered across country at the pace of walking infantrymen, protecting them in its advance, crushing machine-gun nests, knocking down barriers, crossing ditches and trenches. Today tanks, both light and medium, which can in theory make forty miles an hour or more, are still

(Continued to page 148A)

World's Smallest
NOV! Real RADIO
 BEAUTIFUL — PLASTIC — CABINETS



Midget radio fits your pocket or purse. Weighs only 4 ozs. Small as cigarette package! Receives stations with "clear" natural tone. "PATENTED FIXED CRYSTAL"—NO UPKEEP—only one moving part. "TUBELESS, BATTERYLESS," ENTIRELY NEW PATENTED DESIGN. Has enclosed geared luminous dial for perfect tuning. Many owners report amazing reception and distance.

ONE YEAR GUARANTEE

Sent completely ready to listen with instructions and Tinyphone for use in homes, offices, hotels, boats, in bed, etc. **TAKES ONLY A SECOND TO CONNECT—NO ELECTRICITY NEEDED! SEND NO MONEY!** Pay postman only \$2.99 plus postage on arrival or send \$2.99 (Check, M. O., Cash) and yours will be sent complete postpaid. A most unusual value. **ORDER NOW! MIDGET RADIO CO., Dept. P-1, Kearney, Nebr.**

MAN IN EACH TOWN
To Plate Auto Parts

Reflectors, Bicycles, Fixtures, Mirrors, by late method. Simple plan of manufacturing at home starts you IN **GOOD PAYING BUSINESS.** Write today for **FREE** particulars and proofs.

GUNMETAL CO. Decatur, Ill.
 Ave. M

BUILD ARC WELDER FROM OLD GENERATOR

WE SHOW YOU HOW
 For light or heavy work. 75-200 amps. 35c brings complete PLANS. 100 other generator changes. **LEJAY MFG., 1347 LeJay Bldg. Minneapolis Minn.**



WHEN YOU BUY FLASHLIGHT BATTERIES DEMAND "EVEREADY" FRESH DATED BATTERIES

The word "Eveready" is the registered trade-mark of National Carbon Co., Inc.

NO-KO-RODE BATTERY TERMINAL PROTECTORS

Simple—efficient—will outlast average battery and give 100% protection against dangerous corrosion. Sold through agents; distributors. Retail 50c set. Write for quantity prices. Sample set 35c. postpaid. **NO-KO-RODE MFG. CO., Dept. N, 924-Fifth St., N.W., WASHINGTON, D. C.**

Earn Cash at Home!

M.M. EARNED \$174 at Home!

We paid M. M. \$1174 for exceptional collar crop Snow-King mushrooms! We furnish materials; buy all crops. Big **FREE** picture book tells if your cellar, shed, barn, suitable. Est. 1908. Write today. **United Co., 3848 Lincoln Av., Dept. 300, Chicago**

BUILD YOUR GRANDFATHER CLOCK

SIMPLE BLUEPRINT SYSTEM 25c

The Simple Sensible Red-i-Kut way as thousands have. DIME brings PLANS and sixty picture "HOW" Book pricing many fine brass weight Westminster, tube chime, electric and battery movements showing nine beautiful colonial grandfather cases. **WHY WAIT LONGER? KUEMPEL CHIME CLOCK CO., Bldg. 36, Guttenberg, Iowa.**



In answering an advertisement with a coupon, be sure to write name and complete address clearly. Sometimes advertisers are unable to respond to inquiries due to lack of complete information.

Start a Profitable Business of Your Own
 Get the New Book • Just Published

MONEY Formulas MAKING



Here is the book you need to put yourself into a good paying spare time or full time business of your own. Shows how to make, package, and sell saleable articles of all kinds. Gives practical and tested formulas for household, auto and shop products. Tells how to make cleaning products, polishes, soaps, rubber, glass adhesives, cement, lacquers, pharmaceuticals, food products, cosmetics, photography accessories, and hundreds of other products. Order today. Pay postman on delivery or sent postpaid for \$4.35. Money back if not satisfied.

GIVES EVERY FACT YOU NEED

Hundreds of good paying businesses have been built on products made from simple recipes. Opportunities in this field exist everywhere.

POPULAR MECHANICS PRESS
 Dept. 140, 200 E. Ontario St., Chicago

WORLD'S NO. 1 SKIER

Hannes Schneider, greatest skier in the world, helped design the new Northland Skis. Schneider has used Northland's exclusively for two years and considers them the finest skis he ever owned. For 30 years Northland has been making skis champions use—at prices you can afford. Start skiing right! Use Northlands!



FREE! Send for illustrated folder.

NORTHLAND SKI MFG. COMPANY

World's Largest Ski Manufacturers
 95 Merriam Park St. Paul, Minnesota

READY CUT HOMES

\$416 and up. Freight paid. Save \$500 or more. Buy direct. Modern production methods prevent waste in material and assembly time. 75 home plans to select from, including 10 new feature 1940 designs. All modern, practical, distinctive, complete. Simple plans for easy assembly. Includes all lumber, insulation, roofing, bronze weather stripping, built-in features, attractive one-panel doors, latest hardware, nails, lath, paint, varnish. Also, summer cottages, garages, tourist cabins, etc. Information and plans for FHA Financing requirements on request. For new 1940 full color catalog, with floor plans, send 25 cents to Dept. Mill and Bay International Co., City, Mich.

NEW COLOR CATALOG FOR ONLY 25c



Write with Electricity

NEW MODEL ELECTROGRAF

Writes easily on the hardest metals or tools. Positively identifies your tools, protects against theft. Absolutely permanent. Requires few seconds only—anyone can operate. Pays for itself. A Money Maker. **Order yours today—two for \$3.00 P.P. to agents** If M. O. or check accompanies order, we pay postage. **AGENTS: Write today for our proposition.**

\$1.98 POSTPAID

NATIONAL LABORATORIES, Portland, Ore.



COOK and HEAT Without Coal—No Drudgery or Ashes

NEW TYPE OIL BURNER at **Amazingly LOW PRICE**

QUICK HEAT at TURN of VALVE

Slips Into Any Stove, Furnace

Why shovel coal and ashes? Why not enjoy just the heat you want at turn of valve—quick, steady, regulated heat? Here's one of the latest oil burners patented—with an ingenious new feature which gives better combustion, assuring maximum heat with less oil consumption. Changes cheap oil into one of the quickest, hottest fires known—will not clog up, no cups or wicks, no pre-generating—different.

SENT ON 30 DAYS TRIAL Try it—see for yourself before deciding. Prove it ends drudgery of coal and ashes—enjoy quick regulated heat at turn of valve—see the economy of the cheapest of oil fuels—and it must satisfy you or you need not keep the burner.

SAMPLE BURNER for AGENTS

Write quick—a 1c postcard will do—for **SAMPLE BURNER** at no-money-cost offer that brings you a sample burner for demonstration. Startling low price makes sales easy. Write quick—be first in your locality—write today.

JUST SEND NAME

ATLAS BURNER CO.
 290-A Rockhill Theatre Bldg. Kansas City Missouri

Write your name and address in the margin, clip and mail, or send penny postcard.

New RUBBER MAT MAKER *Invention*



Starts you in Business for Yourself on "Shoestring"
Makes Mats in 10 Min.
150% to 200% Profit

The revolutionary Phoenix Rubber Mat Maker (pat. pend.) enables you to start and build a permanent, profitable, all-year business on an investment so small that it may be earned the first week. Make Phoenix live rubber mats in color patterns—today's most-talked about mat value! No experience needed—“easy as playing checkers”.

Excellent spare-time money maker with big full-time expansion possibilities. Sell homes, clubs, stores, public buildings, hospitals, funeral directors, etc., at prices competitors can't meet! 150% to 200% profits. Act quick. Send 10c today for complete money-making facts and samples of materials. "\$50 a week and independence".

PHOENIX RUBBER CO., 9205 Detroit Ave., Cleveland, Ohio, U. S. A.

21221

(Continued from page 146A)

the basic vehicles of mechanized forces. We say "in theory" because in fact a vehicle of this type crossing rough terrain is limited more by the human element than by its traction. One must remember that in action the driver, completely enclosed, has most limited vision. How fast would you drive your auto, on the road, if your only observation was through narrow eye-slits? Multiply this by the obstacle-dodging necessity of cross-country driving, and you will realize that only under most exceptional circumstances, on smooth ground, could extreme speed be kept up.

The heavy tank or "land battleship," is a special weapon for special circumstances, such as a break-through on a stabilized front, and has been discarded by some nations. Armor used on tanks covers only the vital parts, and is not all-round, hence tanks are more vulnerable on top and bottom. Again we see the conflict between the two opposed factors of mobility and fire power. It might be possible to build a tank which would be impervious to anything but heavy artillery projectiles; when you do this, however, you instantly slow up its speed out of all proportion. A nearly motionless tank cannot carry out its mission.

Light, medium and heavy tanks have two uses—accompanying, that is, moving with their infantry and assisting its forward movement; and leading, that is, to charge and clear the way for infantry.

Tanks have certain basic limitations: their noise, which can be heard a mile or more away, and which, inside the vehicle is terrific, limiting communications and preventing the crew from locating anti-tank guns by ear; poor vision of crews; distinctive appearance; ineffectiveness of their fire at any but the most limited ranges, because of poor vision and eccentricity of motion; limitations of ammunition supply; terrific strain on the crews, and sensitivity to terrain. Deep mud and sand, and stump land are serious obstacles. Steep-sided ditches, felled trees, pits—like elephant traps—in roads and artificial obstacles like concrete pyramids, will break up tank attacks.

Most tanks can cross ditches five to six and one-half feet in width and can ford streams up to three feet in depth if the bottom be firm. Mines, portable affairs which weigh about five pounds, detonated by contact, can be sown in fields which

Free! BOOK OF PHOTO VALUES



Everything for the photographer! Latest-type cameras, supplies, complete developing and printing equipment. Make money on your prints. Have the necessary equipment. Order at home. Save time and money. This catalog has helped thousands — amateurs and professionals. Get the guide to the buys in photography. Send for your FREE copy of catalog No. 79 today.

LAFAYETTE CAMERA DIVISION
Radio Wire Television Inc.
 DEPT. 7AC — 100 SIXTH AVENUE, NEW YORK, N. Y.

WOOD WORKERS

BUY DIRECT...SAVE BIG MONEY ON EVERY NEED!

Send today for our valuable book, listing the most complete line of foreign and domestic plywood and veneers available anywhere including Waterproof plywood. Because we are Direct Mill Representatives our prices afford big savings. You can't afford to buy elsewhere before seeing our amazing offers. Send 10c to cover cost of postage and mailing catalog. 10c refunded on 1st order. Write today, and save money.

Beck Plywood & Veneer Co. Chicago, Ill.
 Dept. PM-1 1302 N. Halsted St.

BUILD TRAINS—

AIRPLANES — SHIPS — GAS MODELS — RACE CARS, etc.

Low priced C-D quality Kits by the master model designers. Passenger loco 50c, Switcher 50c, 27 diff. freight Cars, ea. 10c, Gas Models, \$2.50, and up, 3 Foreign race cars, 3 Indianapolis winners, ea. 10c. Hundreds of others and thousands of supplies. Add 15c for pack. & post. all orders, or part shipment deducted. Catalog only 10c.

Cloudster Gas Model Kit \$2.50

Cleveland Model & Supply Co. Inc.
 4508-DS Lorain Ave. Cleveland, Ohio, U.S.A.



Earn MONEY Make Color-glazed Concrete Products

MAKE color-glazed concrete pottery, tiles, walls. New, low cost, patent method. No molds. Use only sand, cement, cheap materials. Basement waterproofing. Other projects. Booklet, cost data, details, 10c.

NATIONAL POTTERIES COMPANY
 Room 6, 13 W. 26th St., Minneapolis, Minn.

RADIOS..SAVE UP TO 50%



DEAL DIRECT — FACTORY PRICES
 Many models to choose from at wholesale prices. AC-DC midsets \$4.98. Portable and battery sets \$8.98 up. Car sets \$11.75 up. Also consoles, all-wave etc. Samples at 50% off. Send for FREE 1940 bargain catalog giving details of 10 day FREE trial and agent's proposition and discounts. No obligation, write today. **GOLDENTONE RADIO CO., DEPT. PM, DEARBORN, MICH.**



Q 1221

might be perfect avenues of approach. Heavy woods are tank obstacles, but sparse woods may work to their advantage as tanks can push over trees up to six inches in diameter, and scattered trees may provide cover for them to creep up within charging distance.

But of all anti-tank weapons artillery is the most to be feared. To understand this we must visualize the penetrative power of projectiles in armor plate. The following approximate tabulation may help:

Weapon	Caliber (inches)	Rate of fire in combat rds. per min.	Penetration (inches) at 100 yards distance
Rifle	.30	10	.35
Automatic Rifle	.30	40	.35
Light Machine gun	.30	250	.35
Heavy Machine gun	.50	100-150	.80
20 mm. Anti-tank Rifle	.79	10	1.25
37 mm. Cannon	1.45	10-20	1.30
47 mm. Cannon	1.85	10-20	2.00
75 mm. Cannon	3.00	6	Direct hit probably fatal to any tank

The figures given above are based on a direct hit with ninety-degree angle of incidence, that is, with the bullet meeting the armor plate squarely. However, one must remember that absolute destruction of the tank is not the essential object of anti-tank fire. The shot that knocks off a tread or otherwise cripples the progression of the vehicle is sufficient.

To assume that the tank is not a dangerous weapon, however, is erroneous. The tank is a highly dangerous and highly important weapon, since it provides for the attacker an increase of mobility and an additional striking power crushing through defensive works which would otherwise hold up the infantry. It is an essential member of the combat team.

Insofar as the infantry are concerned, the tank, used either as an accompanying weapon or as the spearhead of an attack, must be considered by both attack and defense. Its use as either or both depends upon national doctrine, terrain and tactical situation. Some countries, for instance Germany and Russia, contend that the hammer-blow, in advance of the infantry, is the true role of the tank. Others, among them France, hold that tanks should move side by side with the foot troops.

(Concluded next month)

FUN FOR YOU!



PLAY LATEST HITS!

Even If You Can't Read a Note!

Surprise friends at your next party or social. Play latest hits, popular songs, swing—even if you can't read music. Lots of fun, good times, popularity for you. A real musical instrument. Used by swing bands. Very easy to play!

10 DAYS' TRIAL
TONETTE makes you popular, welcome at homes, parties, dances. Try for 10 days without risk. Fun guaranteed or money back. The perfect gift.

SEND NO MONEY

Just pay postman when delivered or you can safely send only \$1.00, saving small P. O. charges. FREE: Lesson Charts sent free with TONETTE. No C.O.D. outside U.S.A. Mail Coupon or ask dealer to get TONETTE for you.

MONEY-BACK GUARANTEE

TONETTE CO., Dept. 48, 30 E. Adams, Chicago
Rush TONETTE and free lessons on 10 day trial-money back guarantee.

I will pay postman I enclose \$1.00

Name.....
Address.....

MAIL COUPON TODAY!

MYSTERIOUS DEVICE WELDS BRAZES AND SOLDERS ANYONE CAN OPERATE

Now, an electric welding, brazing and soldering Torch, complete with power unit, goggles and supplies. Works INSTANTLY off any light socket. Does a thousand and one repair jobs at amazingly LOW COST on aluminum, iron, steel and other metals. Indispensable for Auto, Body and Fender Repairs, and home repairs—shop, factory, farm, engineer, janitor, sheet metal, radio and bicycle repairs. Anyone can handle without previous experience with our simple TO-DAY HOME TRIAL instructions. Write at once for Special Introductory Low Price Offer. Try 3 in 1 Electric Torch for 10 days at our risk, or get one free by helping to introduce it. ELECTRO-TORCH CO., 2613-F5 Michigan Ave., Chicago

OWN X-ACTO, World's Keenest Knife for Hobby & Craft. NOW Only 50c OVER 100,000 IN USE!

X-ACTO, invaluable where surgeon scalpel-keen cutting efficiency is required. Perfect for Model-Hobbyists, Stencil and Mat Cutting, Photo Retouching, etc. Blades speedily changeable. Buckleproof. Money Back Guarantee.

50c for new, improved Durable aluminum X-Acto with blade. 2 types: No. 1—delicate work; No. 2—Heavy Duty. Specify type desired. Dealers Wanted. (See Gas-Airplane or Skin catalog.)

POLK'S MODEL CRAFT HOBBIES
PM-1, 429 7th Av., N. Y. C.
Card brings complete X-ACTO, pay 50c on arrival, plus C.O.D. (Postpaid if coin or stamps accompanies order.) If \$1 bill more convenient to mail, you get X-ACTO with 6 blades, your choice. Order now!

SEND NO MONEY

Calling All Cars

A MYSTERIOUS DISCOVERY SAVES UP TO 30% ON GASOLINE or Costs Nothing to Try



Stop wasting Gas!—trim dollars off gas bills—get more power—quicker pickup—faster acceleration! **AUTO OWNERS everywhere praise VACU-MATIC!** Proven so efficient, it is guaranteed to satisfy, or the trial costs you nothing.

Automatic Supercharge Principle Vacu-matic is entirely different! It operates on the supercharge principle by automatically adding a charge of extra oxygen, drawn free from the outer air into the heart of the gas mixture. It is entirely automatic and allows the motor to "breathe" at the correct time, opening and closing as required. Saves up to 30% on gas costs, with better motor performance.

AGENTS Get Yours FREE

FOR INTRODUCING. Here's a splendid opportunity for unusual sales and profits. Every car, truck, tractor owner a prospect. Send name and address now for big money making offer and how you can get yours Free. **The Vacu-matic Co., 7617-482 W. State Street, Wauwatosa, Wis.**

Decidedly Unusual . . . THURSTON'S 1940 CATALOG OF "HARD-TO-GET" MATERIALS

For Homecrafters, Schools, Institutions, Antique, Novelty and Cabinet Shops

A few of the items we show: Chest hardware, locks, hinges, supports, casters, copper trim, etc., also mides, overlays, etc. Finishing materials, glue, stains, varnish, wax, flint and garnet papers, rubber sanding blocks, stick shellac, burning-in knives, etc. Upholstery supplies and coverings. Complete line of electrical findings for lamp manufacture, also cluster and indirect fixtures. Chair cane, wovens and in strands, spine, rods, fibre cord, etc. Trays for smoking stands and glass liners. Large line electric and spring clock movements, with and without dials. Complete line Venetian Blind hardware, tapes and cords. Table slides and leaf supports. Tea wagon wheels and casters. Wood dowels, also dowel screws, dowel centers, wood screw hole buttons. Excellent line card table leg supports. Bed hardware of every description. Desk pens, complete with funnel and fastening, without base. Water transfers, inlays, small moldings, etc. Furniture glides and casters, office chair spiders, wood legs and K. D. chair frames. Small box hardware of every description. Large selection pulls, knobs, handles, hinges, locks, catches, etc. Perforated steel panels, chair braces, revolving chair fixtures, rocker springs, candlestick sockets, bill board clamps, banquet table equipment, many sizes braces, corner irons, hanger bolts. Step ladder braces, plaster strips, sliding track and sheaves. Typewriter desk hardware, binowings, mirrors, nut bowl hardware. Bar pins for novelties. Catalin Plastics. Crib hardware, swivel top table fixtures, sectional bookcase hardware, clamp nails, electric pens for burning, etc., etc. Send 10c cash or stamps.

THURSTON SUPPLY COMPANY, Dept. P. M., ANOKA, MINN.



YOU CAN MAKE MORE MONEY

in the Composition Novelty Manufacturing Business. Reports of \$100 a week or more are not unusual. Our Big 32-page Book explains and illustrates the secrets of this profitable money-making business. It's yours for only 10c. Send for it today! **STEWART'S STUDIO, Dept. PM-14, 2927 Wilcox St., Chicago, Ill**

DO YOU

WANT a new business profession of your own, with all the trade you can attend to? Then become a foot correctionist, and in a few weeks earn big income in service fees,—not medical nor chiropody—easy terms for home training, no further capital needed, no goods to buy, no agency. Established 1894. Address Stephenson Laboratory, 1 Back Bay, Boston, Mass.

MONEY for MEN ALL FREE

THE PLASTEX Industry needs manufacturers on small scale and for big production of X-mas Tree Ornaments, Art Goods and Novelties in Plastex and Marble imitation. Experience unnecessary. 1/2c material makes regular 10c store sellers. Rubber moulds furnished for speed production. Small investment brings big returns. **BIG CHAIN STORE** orders now being placed by us. Ambitious men have chance for real prosperity. Our FREE booklet will interest and benefit you. **PLASTEX INDUSTRIES, Dept. P, 1085 Washington Ave., New York, N. Y.**

BUILD THE DESTROYER PRESTON

CARVED HULL Included! Complete Kit \$2.50 Post Paid

24" Super Detail Model

Catalog—10c

IDEAL AEROPLANE & SUPPLY CO., Inc., 26 W. 19 St., New York

Makes perfect building easy

TRAILER BUILDERS BUYERS OWNERS TRAILER

Send 25c for this Big Book Today

Over 100 pages! Beautifully Printed and Illustrated! Trailer Suggestions and Ideas galore! Catalog shows America's greatest line of Trailer Parts and Equipment at lowest prices. Everything from wheels to top. Rush 25c today. Satisfaction positively guaranteed!

TRAILER SUPPLY CO. Box 438-A WAUSAU, WIS.

BUILD IT YOURSELF

The Jim Dandy Cabin Cruiser

The Trailer that has everything. Classy! Boomy. Easy to build in any size with my simplified Plans and Instructions—Price \$1.00. Rush dollar bill today to **JIM DANDY Box 125-A WAUSAU, WIS.**

FREE

—World's Fair Edition "Toys That Buzz With Action." Shows in color new All-Electric Erectors as exhibited at New York World's Fair. Write A. C. Gilbert Company, 12 Erector Square, New Haven, Conn.

CAPTURE THE COLOR OF LIFE!

YOUR OWN MOVIES! ONLY 10c A DAY!

NATIONALLY ADVERTISED 8MM and 16MM Movie cameras, projectors. For home, business, church, school, club. **MONEY BACK 10 DAY TRIAL.** Payments as low as 10c A DAY. Satisfied customers throughout the world. FREE details. WRITE TODAY. Don Elder's Home Movies, Dept. N-1, 738 Boylston St., Boston, Mass.

BUILD MODEL COACH

18th Century Coach. Complete Kit, drawings, wood, metal, upholstery, enamel, etc. Heavy cutting done. Also 32" scale model racing yacht ENTERPRISE. Send 3c stamp for FOLDER and LOW PRICES on both models.

K. C. Model Supply, 2716 Summit St. Kansas City, Mo.

All Your Snapshots in Natural Colors!

AMAZINGLY BEAUTIFUL!

Any size roll developed and 8 prints **25c** Natural Color Reprints **3c** each.

Natural Color Photo Service, Dept. C-54, Janesville, Wis.

ELECTRIC EYE

Build your own from our kit of parts, or buy complete electric eye. Kit consists of caesium photo cell, sensitive relay, amplifier tube, chassis and resistors with diagram. Price \$5.00. Complete electric eye relay assembled in metal case \$9.50. Literature on other types of electric eyes sent on request.

ELECTRONIC PRODUCTS COMPANY
6th and Prairie Sts., St. Charles, Illinois

CATCH FISH!

minnows, eels, mink, muskrat, with our folding galvanized Steel Wire Traps. **Walton's Automatic Hooks** are so constructed that when a fish gives the slightest pull on the bait the upper hook reaches down and gets a hold that holds him. 3 for 50c. Write for descriptive catalog of Traps, Hooks, Lures, and other specialties. **Walton Supply Co., 3567 Junata Ave., St. Louis, Mo.**

HANDY TAPS and DIES . . .

Accurate—carefully hardened and tempered. Complete range of sizes at your local five and ten cent store

HENRY L. HANSON, WORCESTER, MASS

A DEPENDABLE STEAM ENGINE for boat models up to 36" in length. Model SE-3, a two cylinder, slide-valve type. Bore 5/16", Stroke 1 1/2", Length 7", Width 3", Height 3 1/2". Price complete ready to run with burner and propeller . . . \$3.00 Postage extra, shipping weight 1 1/2 lb.

SHAWNEE ENGINE CO. Box 162, Station D, Cincinnati, Ohio

BUILD THESE PROJECTS

For garden or lawn. Easy to build. Easy to sell. Detailed Blueprints Model B-25 Dutch Windmill 50c; Model OM-60 Old Mill, 85c. Lawn Figure Patterns—Sunbonnet Girl, Dutch Boy, Tulip Girl, Holland Pair, 35c each, all 4—\$1.00. Catalog illustrating many models, send 10c today.

CRAFTSMAN'S MODEL CO., Dept. P-36, 2030 N. 41st St., Milwaukee, Wis.

CASH IN ON SPARE TIME

\$30 WEEKLY OR MORE EARN. Grow mushrooms HOME. Cellar, shed suitable. We buy 35c lb. Year round business, **\$270** made by Mr. B. in few weeks **SPARE TIME.** Guaranteed materials. Established 1931. Write for **FREE BOOK.**

WASHINGTON MUSHROOM INDUSTRIES, Dept. 601, 2019 2nd Seattle, Wash.

Outwitting the Air Raiders

(Continued from page 31)

in serious stoppage in steel mills, petroleum refineries and airplane factories.

The idea of the aircraft warning service is an outgrowth of an older plan intended to organize emergency assistance in time of stress. Unknown to most of the inhabitants, a major disaster plan has been prepared for Los Angeles city and county and for a number of other cities and counties in the west. In case of any such major catastrophe as a devastating earthquake, an uncontrollable pestilence, or a destructive air raid, a behind-the-scenes rescue and rehabilitation organization will immediately begin to function.

The plan coordinates into a large efficient organization much of the public and private resources of the area. The American Red Cross, fraternal organizations, law-enforcement bodies and fire departments, ex-service men and other groups, all have been furnished with stand-by orders as to what each member should do. The efficiency of such a plan depends on its details and the emergency council of Los Angeles county has tried to foresee every possible contingency. Golf courses, parks, race tracks and other open areas adjacent to dense population centers are listed as possible refugee camps, the availability of uncontaminated water and the furnishing of medical supplies to the refugee centers has been studied, and the location of food supplies has been noted.

Chests of maps have been prepared, available only in time of a major disaster, that show all public utility lines and pipes in the area and the location of all key valves and switches that might be needed for shutting down or furnishing electricity, water, and gas. Members of the emergency organization have written instructions as to the location of supplies of motor fuel, lubricating oil and construction equipment. Arrangements have been made for drafting airplanes and boats. The larger fleets of taxicabs, automobiles and trucks are listed. Portable emergency illumination and public-address systems would be furnished by motion-picture studios. Armored cars would be available from bank-messenger concerns. Alternative methods of communication have been prepared in case the ordinary systems should fail.

SWAY-CHEK

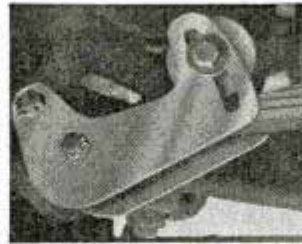

Checks —
WIND-WANDER
CURVE-SWAY
LOAD-ROLL

Now Available for FORDS
 MERCURYS, LINCOLN-ZEPHYRS

If you appreciate **real roadability** you will get a great ride thrill out of SWAY-CHEK. By checking front and rear "shackle shift" without impairing spring action, SWAY-CHEK promotes **positive steering response, bee-line steadiness and lack of load-roll.**

SWAY-CHEK is especially appreciated when driving in high winds, along crowned roads, around sharp curves and with heavy loads. With this advanced accessory on your FORD, MERCURY or LINCOLN-ZEPHYR you will enjoy an added sense of stability, handling ease and safety.

QUICKLY INSTALLED WITHOUT SPECIAL TOOLS
 Simple, illustrated directions for installing SWAY-CHEK come with each set. A pair can be attached within an hour in your own garage or any repair shop with ordinary tools.

SHIPPED DIRECT WITH MONEY-BACK GUARANTEE
 SWAY-CHEK will be sent **postpaid** anywhere in U. S. A. upon receipt of your order with remittance. Or you may order C. O. D. and pay shipping charges. If not delighted with results, return SWAY-CHEK within ten days for refund of full purchase price. Free booklet on request.

PRICES: Front Set for 1935-39 FORDS..... \$5.95
 Complete Front & Rear Set for 1935-39 FORDS 9.95
 Rear Set for 1940 FORD-85s and MERCURYS (already equipped with front end stabilizer)... 5.95
 Rear Set for 1938-40 LINCOLN-ZEPHYRS... 9.75
 (All prices subject to change without notice)

MAIL YOUR ORDER TODAY, stating Car and Year, to

THE BELFLEX CORP.
 2012 Sylvania Ave., Toledo, O.



AGENTS WANTED
 Make big money installing SWAY-CHEK on the many Ford-built cars in your community. Write for proposition.

Miles Ahead in
Power
 and Performance

Drill Champion
 ELECTRIC DRILL

The ideal drill for all-around service. Light. Compact. Powerful motor has great overload cap. Drills steel or wood. Usable with accessories for grinding, cleaning, etc. Has Jacobs chuck, 10 ft. cable. Guaranteed.

\$19.95



Cap. . . . 1/4" steel
 Speed . . . 2000 r.p.m.
 Length . . . 12 in.
 Weight . . . 4 lbs.

FREE TRIAL: Try the Drill Champion in your shop. We ship C.O.D.; you pay \$19.95 on del. Keep tool 10 days; if not satisfied return it. Your money refunded at once.

FREE ACCESSORIES: Send check or M. O. with order and we ship 1 wire brush, 1 sanding disc, 1 polish disc **AT NO EXTRA COST!**

INDEPENDENT PNEUMATIC TOOL COMPANY
 602 W. Jackson Blvd., Chicago, Illinois

{ } Send 1/4" Drill Champion () 110 volts () 220 volts
 { } Enclosed find check (or M. O.) for \$19.95.
 Send 1/4" Drill Champion and FREE accessories.

NAME _____
 ADDRESS _____
 CITY _____ STATE _____

South Bend 9" WORKSHOP *Precision* Lathes

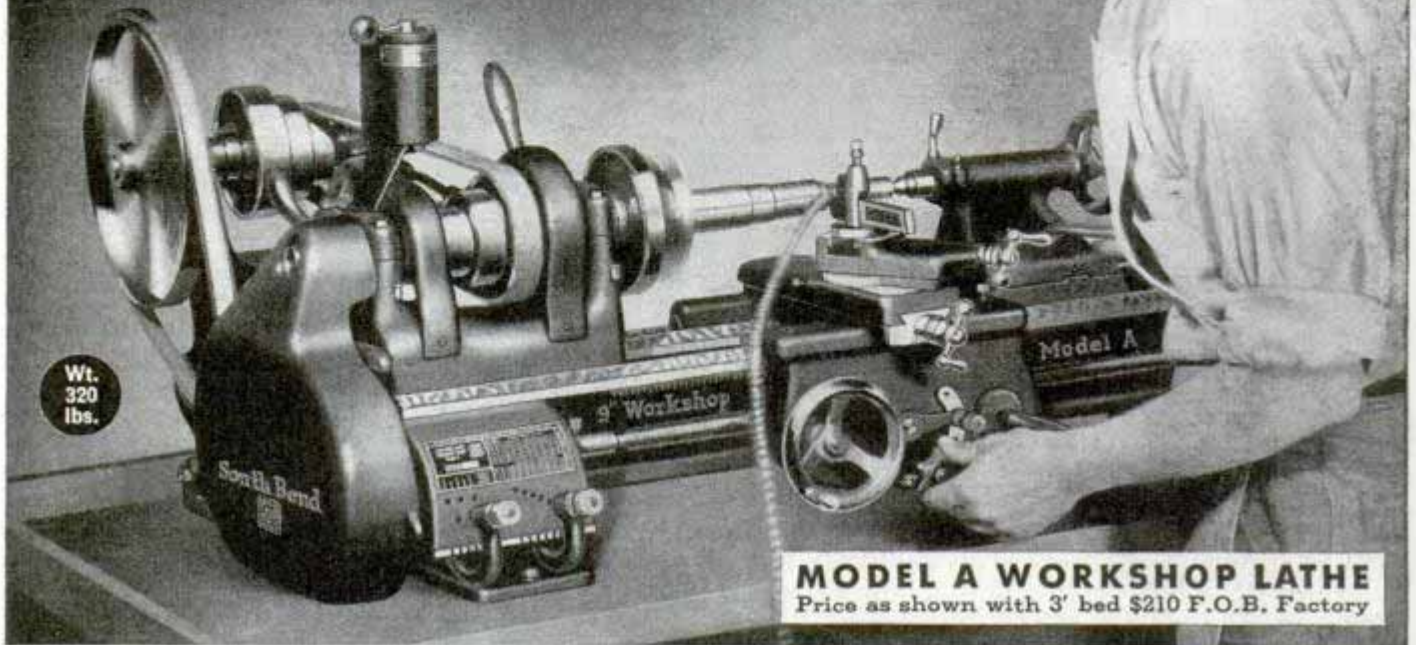

Wt.
320
lbs.

MODEL A WORKSHOP LATHE
Price as shown with 3' bed \$210 F.O.B. Factory

Three Models

Prices Start at \$95

Time Payments If Desired

To meet the requirements of every type of shop, South Bend 9-inch Workshop Back-Gearred, Screw-Cutting Lathes are now made in three models; with bench or floor legs; motor drive or countershaft drive.

MODEL A has full quick change gear mechanism, making all threads and feeds instantly available, also automatic apron with friction clutch for operating power cross feeds and power longitudinal feeds. This is a practical lathe for light manufacturing and accurate tool work.

MODEL B has plain change gear equipment for threads and feeds, also automatic apron with friction clutch for operating power cross feeds and power longitudinal feeds. This lathe is recommended for laboratory and instrument work.

MODEL C which we have been manufacturing for over five years has lead screw and half-nut power longitudinal feeds. This popular model is the same as Models A and B, except that it does not have the gear box and the friction clutch in the apron.

Send Coupon for this New Catalog

Complete information on Models A, B and C in 3', 3½', 4', and 4½' bed lengths, Sent Free Postpaid.

SOUTH BEND LATHE WORKS,
601 E. Madison St., South Bend, Ind., U.S.A.
Please Send Catalog No. 50 Free.

Class of Work.....

Name.....

Address.....

City.....State.....

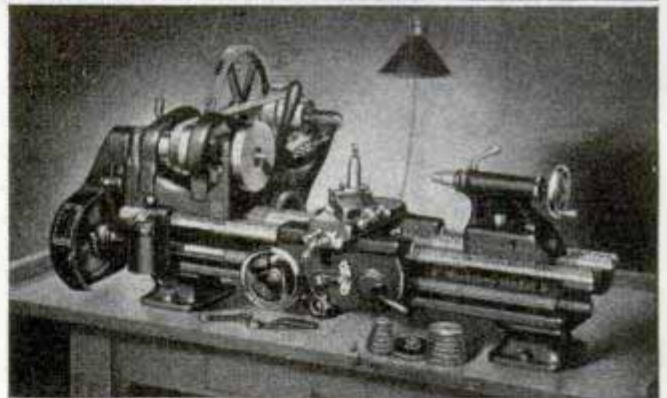

MODEL B WORKSHOP LATHE
Price as shown with 3' bed \$160 F.O.B. Factory

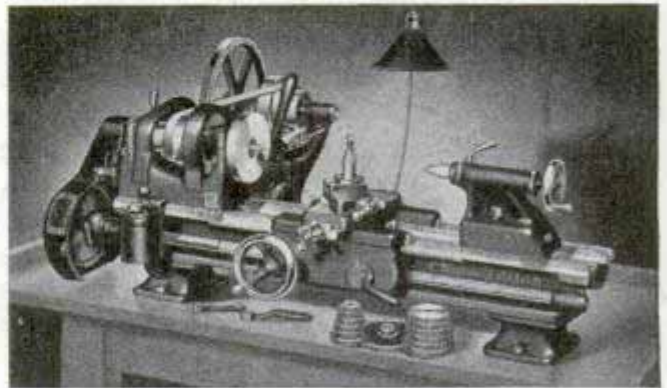

MODEL C WORKSHOP LATHE
Price as shown with 3' bed \$127 F.O.B. Factory

South Bend Lathe Works 601 East Madison Street
South Bend, Ind., U. S. A.



Cables

are the "LIFE-LINES" of your car . . . they need

Authorized CERTIFIED RE-WIRING Service

The performance of the electrical units on your car depends on the condition and quality of the cables that carry the "juice." Battery, starting motor, coil, generator, lights, and the rest . . . none can perform right if the wires that serve them are worn-out, undersize, or of poor quality. If you want to avoid hard starting, increased gasoline consumption, insufficient illumination and dangerous "shorts," go to a station that provides Packard Authorized CERTIFIED RE-WIRING Service. You will get better service—and here's why . . .

1. Certified Re-Wiring assures EXPERT service.

Any station that displays the Authorized CERTIFIED RE-WIRING Service sign—or any station where the mechanic possesses an Authorized CERTIFIED RE-WIRING Service Certificate—is prepared to service the wiring on your car according to the latest service instructions. The mechanic who does the work knows how to locate faulty wiring with accurate instruments. He can "spot" trouble in the electrical system, and is trained in the proper replacement procedure.

2. Certified Re-Wiring assures QUALITY cable for replacements.

Packard cable is original equipment on more cars than all other brands of cable combined; it is practically the unanimous choice of drivers in the Indianapolis Speedway classic, having been used by 119 of the 120 "money winners" during the last twelve years, including all first-place winners. When you have your wiring checked at a service station displaying the Authorized Certified Re-Wiring Service sign, all *necessary* replacements will be made with high-quality PACKARD cable of the proper gauge. Always insist on Packard cable.

WINTER WARNING. Undersize or corroded battery cables and loose connections are the cause of many starting difficulties. Replace with No. 1 gauge PACKARD battery cables for sure starting.

SPECIAL TO DEALERS, MECHANICS. See your Packard jobber for information on Authorized Certified Re-Wiring Service. Packard Electric Division, General Motors Corporation, Warren, O.

Packard
REG. U. S. PAT. OFF.
TRADE MARK

THE STANDARD WIRING EQUIPMENT OF THE AUTOMOTIVE INDUSTRY

*"Thanks
to Uncle Sam*

—tobacco's better than ever!

... and Luckies always take the better grades!" says Ray Oglesby, tobacco auctioneer for 8 years.



BENJAMIN HAWKS of North Carolina shows Auctioneer Oglesby his fine tobacco seedlings—grown by new U. S. Government methods.

RAY OGLESBY in action. Among *independent* tobacco experts like this famous auctioneer, Luckies are the 2-to-1 favorite over all other brands.

Copyright 1939, The American Tobacco Co.

Q. WHY HAVE TOBACCO CROPS BEEN BETTER?

A. Because, even though crops vary with weather conditions, Uncle Sam's new methods of improving soil, seed and plant-food have done a fine job.

Q. Do Luckies buy this better tobacco?

A. Yes, indeed — *independent* experts like Ray Oglesby tell you that Luckies always *have* bought the choicer grades of each crop. In fact, that's why Mr. Oglesby has smoked Luckies for 11 years.

Q. Do other tobacco experts prefer Luckies, too?

A. Among these skilled auctioneers, buyers and warehousemen, Luckies are the 2-to-1 favorite.

Try Luckies a week. You'll find them easy on your throat, for the "Toasting" process takes out certain harsh irritants found in all tobacco. You'll also know why . . . **WITH MEN WHO KNOW TOBACCO**

BEST—IT'S LUCKIES 2 TO 1



Have you
tried a
LUCKY
lately?