

HOW THE BIG GUNS HIT THE MARK

# POPULAR MECHANICS

MAGAZINE



... SO YOU CAN UNDERSTAND IT

DEC.  
25 CENTS

SEE PAGE 855





# MOOSE HUNTER FIGHTS FOR LIFE IN RAGING TORRENT!

J. V. KIRSCH  
Palmer, Alaska



① "I bagged a giant moose, the dressed meat weighing 982 pounds," writes Mr. Kirsch. "Starting back to camp at dusk, we foolishly decided to ford Willow Creek, a very fast mountain stream. We figured the 150-pound packs of moose meat would keep our feet on the bottom.

② "We were wrong! When the water reached my chest, I was swept from my feet and trapped beneath the foaming mountain torrent! Wedged against a rock, and held down by the current and my heavy load, I couldn't budge! I thought I was done for!



③ "I had been carrying my lighted flashlight in one hand, and still held it. And just in time, one of the packers located me by its beam! He rushed in, seized my pack rope and managed to drag me ashore. I most certainly wouldn't have lived to enjoy that moose meat if those 'Eveready' fresh DATED batteries had failed me. (Signed) J. V. Kirsch"

NOTE: An "Eveready" flashlight with "Eveready" batteries, will normally continue to burn under water. Try it!



**FRESH BATTERIES LAST LONGER... Look for the DATE-LINE**

NATIONAL CARBON COMPANY, INC., 30 EAST 42ND STREET, NEW YORK, N. Y.  
Unit of Union Carbide UCC and Carbon Corporation



# LOOK AT ITS SIZE, STYLE AND LUXURY—



## IT'S HARD TO BELIEVE *that's* A LOW-PRICED CAR

### NEW LUXURY EVERYWHERE

1. **MAGNIFICENT STYLING**—new grace and distinction in every detail.
2. **BIGGER CAR** throughout — 117" wheelbase—wider seats!
3. **THE LUXURY RIDE!** New appointments, new chassis engineering—entirely new ride formula.

**T**HE 1940 Plymouth has the most astounding *luxury* and *quality* ever built into a low-priced car!

There's a luxurious new feel to the big Floating Power engine—*Superfinished* in vital parts for longer life. Steering post gear shift, front coil springs are standard *on all models* ...new engineering, designing, throughout.

Be sure you take Plymouth's *Luxury Ride!*  
MAJOR BOWES, C. B. S., THURSDAYS, 9 TO 10 P. M., E. S. T.  
SEE THE NEW LOW-PRICED 1940 PLYMOUTH  
COMMERCIAL PICK-UP AND PANEL DELIVERY!

# 1940 PLYMOUTH *The Low-Priced Beauty with the LUXURY RIDE*



IT'S  
A THRIFTY THING...  
THE TELEPHONE



Americans have the world's best bargain in telephone service. It's good and it's cheap. Nowhere else do people get so much service and such good and courteous service at such low cost.

### **THRIFTY**

According to Webster, *thrifty* means "...Evinced thrift... Characterized by economy and good management... Serviceable; useful..."

**BELL TELEPHONE SYSTEM**



*When writing to advertisers please mention Popular Mechanics*



# Popular Mechanics Magazine

H. H. WINDSOR, Founder

H. H. WINDSOR, Jr., Editor and Publisher

December, 1939

Vol. 72, No. 6

## IN THIS ISSUE

Treasure Hunting Up-to-Date . . .	801
Sharpshooting at Unseen Targets . . .	808
Clear Track Ahead . . . . . Coloroto	
The Golden Age of Sound . . . . .	828
Exploring a Tropical Wonderland . . .	834
War Machines of Land, Sea and Air . . .	840
Ambulance for Crippled Ships . . . . .	850
Accident Sleuths of the Highway . . . . .	860
Public Enemy Number Zero . . . . .	866
Dinner Time at the Zoo . . . . .	872
The Challenge of the Supercharger . . . . .	882
The Movies Join the Army . . . . .	888
Heroes of the Coast Guard . . . . .	892

(Continued on next page)

## Wonders of Polaroid Glass

**P**OLAROID has started a revolution. Possessed of a magic ability to tame light waves, it has brought motion pictures to the threshold of a three-dimension era and opened an enchanting new world to the amateur and commercial cameraman. Through Polaroid the microphotographer sees mysterious patterns in crystals; a drop of chemical melts into colors of a butterfly's wing. A jeweler tests gems under Polaroid, an engineer studies the stresses in a bridge girder. Your own life inevitably will be affected by this versatile material, whose story is told in the January issue.

## Outwitting the Air Raiders

**N**INE enemy bombers are spotted in the California sky. Observers telephone warnings; lights flash on a headquarters map plotting the raiders' course. A wavering line on a cathode-ray tube signals passage of the planes over a robot listening post. An article next month describes the network of men and machines ready to protect us from attack by air.

## Next Month

**W**HEN the Clipper sweeps down from the sky after a 2,410-mile flight from Hawaii it goes right to Treasure Island's hospital. Two of the four motors may be shipped to Texas for complete rebuilding. Every propeller is dismantled. The under wings that take the shock of the waves come off for inspection and painting every third trip. Sixteen specialists go over every flight and navigation instrument. That's how they keep the sea birds flying, as described in next month's issue.

## Filming Fairyland

**A**CROSS the screen swims a whale of terrifying size, lashing up mountainous seas with its powerful blue-black tail. You forget for a moment that it's only a cartoon whale rampaging in a three-by-five pool. For Hollywood is shooting Fairyland again; and Walt Disney and his staff have learned a lot about color between "Snow White" and the new "Pinocchio," as you'll find when you read the January Coloroto section with eight pages of color pictures.

## Blind Man's Buff

**F**OG hangs a ghostly curtain over the bridge of a liner off Nantucket, blotting out even the bow. A thousand passengers, a \$20,000,000 ship depend on the captain. Without sun or stars he hunts blindly by dead reckoning, by radio, for New York harbor. A story in January gives a thrilling account of how pilot and master fight fog, the peril that has taken 40,000 lives in twenty years.



# GET ON THE SAFE SIDE WITH THIS



## COLD WEATHER AHEAD

### PYROIL CAN SAVE YOU MUCH TROUBLE

Whether you're driving a new car this fall or the same "old faithful," treat it with Pyroil, now! Pyroil will put your car on the *safe side* for coming cold weather. It can save you from many operation troubles from now on. How? . . . The few ounces of Pyroil you put in crankcase and gasoline tank travel quickly to every vital area. There — on valves, guides, pistons, cylinders, bearings, shafts — the super protective oiliness film contained in Pyroil is spread. This special Pyroil film *clings* to the metal. It is an extra shield against many possibilities of damage. More than your regular lubricant. For while Pyroil is essentially a lubricant it is entirely different from your regular lubricant.

Pyroil dissolves gum, removing hard carbon that chokes your motor. Thus it frees your motor giving it more pep and power for the cold weather job ahead. Pyroil combats dangerous "engine varnish." It disperses sludge. Frees rings. Prevents corrosive damage (acid wear) to delicate, polished surfaces. Your favorite station or garage will service your car with Pyroil today. Try it. Be delighted like thousands of others

the world over. See coupon below. Manufactured and Guaranteed by Pyroil Company, W.V. Kidder, Founder, 512 Pyroil Bldg., LaCrosse, Wisconsin, U. S. A.

**DISTRIBUTORS:**  
CHECK AND MAIL  
COUPON FOR FRANCHISE FACTS.



ADD  
MERELY  
OUNCES TO  
GAS TANK &  
CRANKCASE

**PYROIL COMPANY**  
512 Pyroil Bldg., LaCrosse, Wisconsin

I'd like to know all the facts of how Pyroil will put my car on the "Safe Side" for this winter. Please send me your Free Booklet, "Questions and Answers," which tells me everything.

Send details of your plan for Distributors.

Name.....  
Address.....  
City..... State.....

## (Contents—Continued)

### AUTOMOTIVE

Fender guard on bumper serves as feeler.....	806
Venetian blinds for automobile.....	807
Fluid drive and automatic transmission.....	826
Steel tank transferred from rail to trailer.....	849
Self-packing garbage truck.....	854
Expanders seal piston ring in groove and gap.....	858
Ceramic filter cleans fuel of particles.....	865
Steam roller's big wheels ride soft soil.....	877

### AVIATION

Aerial mine field guards against plane raids.....	855
Upside-down plane lands on its back.....	857
Homemade oxygen mask used in race.....	858
Nonsstop plane handles mail on "rural" route.....	859
Portable radios in planes latest travel service.....	880

### FARMS

All-crop harvester cuts and threshes.....	838
Tulip harvester digs 20,000 bulbs an hour.....	865
Spray for reddening apples.....	891
Three-nozzle poison sprayer kills weeds.....	896

### HOUSEHOLD

Plate with well in center holds cup.....	804
Revolving stand for kitchen tools.....	805
Roller for stretching curtains.....	848
Pocket comb and brush combined in one.....	854
Mixer dial shows speed for each food.....	856
Automatic "on-and-off" switch for hot plates.....	864
Four-in-one tool for kitchen.....	870
Venetian window awning controlled from indoors.....	870
Rotating brush cleans teeth.....	876
Exhaust fan outside of window cools house.....	890
Portable fire escape fits any window.....	895

### MODELS

St. Patrick's cathedral has electric lights.....	807
Speedway for baby midgets.....	815
Streamliner and village built out of doors.....	853
Pendulum keeps model plane on even keel.....	858
Planetarium has two thousand parts.....	871

### PHOTOGRAPHY

Making photographic Christmas cards.....	813
Lights and screen unit in case.....	833
Store front is giant likeness of camera.....	838
Shatterproof photoflash bulb.....	848
Robot deep-sea camera shoots blind.....	858
Polarizing filter pivoted on camera lens.....	863
"Double-barrel" telescope takes two photos.....	871
Mirror "rights" film image for editing.....	877

### RADIO AND ELECTRICITY

Basic musical pitch on continuous broadcast.....	853
Portable grade-crossing signal.....	856
Low-cost Diesel electric generator.....	870
"Talkies" of big war events recorded.....	876
Tiny reeds rival twenty-six bell carillon.....	886
"Camera-case" portable receiver for hikers.....	935
Progressive 4-tube set for experimenters.....	936
Building portable low-cost sound system—Part II.....	938
Helpful radio hints.....	939
A.C. set with clock and built-in antenna.....	940
Sound effect kit for junior experimenters.....	940
Test set in rack and panel assembly.....	940
Wireless remote control for radio-phonograph.....	940

### SCIENCE AND INDUSTRY

Air blast circuit breaker resembles gun.....	806
Stratosphere air is boiling hot.....	838
Cast-iron paving blocks.....	839
Half brain is good as whole one.....	863
Fabrics made water-repellent by chemical finish.....	864
Giant funnel gauges sky heat.....	865
Refrigerator to run 450 degrees below zero.....	876
Electroformed iron molds.....	880
"Telescope" finds flaws inside pipes.....	881
Robot weather observer to aid in forecasts.....	886
Plants help prospectors find minerals.....	890
Sunshine "canned" and shipped to distant spot.....	890
Three face shields in one unit.....	896

### SPORTS

Rubber fins increase swimmer's speed.....	838
Power meter tests football players' strength.....	863
Windshield for bike rider gives dust protection.....	864
Six-man baseball played on triangular field.....	881
Skater towed by motorcycle in sports thriller.....	887
Fishhook with safety catch avoids snags.....	896

(Continued to page 6A)





*What this*  
*new* **DELCO** *battery offers*

**MORE POWER . . .** this new Delco battery makes good the *promise of power* you get from its rugged, substantial appearance. Within its husky case of genuine hard rubber are larger plates and more active material; it teems with extra power for sure starting in zero temperatures—extra capacity for lights, radio, heater and other accessories—extra stamina to assure long and dependable service.

**GREATER DEPENDABILITY . . .** the new Delco is designed to give a long life of usefulness. It is built entirely by Delco-Remy. That means careful selection of the materials used . . . absolute control of every manufacturing operation . . . frequent tests and checks throughout production. The time-tested Delco-Remy reputation for dependability assures you that this powerful new Delco is an *economical investment*.

**QUICKER STARTING . . .** the new Delco battery has been designed particularly for that purpose. It provides more than ample cranking power to snap modern high-compression engines into life—engines so hard to turn over that hand cranks are not provided with the cars they power. For absolute peace of mind during the long winter months, you need the *assurance of sure, quick starting* that this more powerful Delco gives you.

**See your Delco battery dealer today . . .** have him check your present battery and tell you how many months of service you can expect from it according to the Battery Life Expectancy Chart. Then take a look at the powerful new Delco battery that fits your particular make of car . . . and ask about replacing your present battery with the new Delco. There's a Delco battery dealer near you—see him today!

*Replace with a*  
*Delco battery*

**Delco-Remy**

MANUFACTURER OF DELCO-REMY  
 STARTING, LIGHTING, AND IGNITION  
 KLAXON HORNS • DELCO BATTERIES  
 AUTOMATIC CARBURETOR CONTROLS.



DELCO-REMY PRODUCTS AND GENUINE PARTS ARE AVAILABLE AT UNITED MOTORS SERVICE STATIONS EVERYWHERE...WHEREVER YOU SEE THIS SIGN.

**World's Largest Manufacturer of Automotive Electrical Equipment**

*When writing to advertisers please mention Popular Mechanics*





## P. W. RESETS BATHROOM FIXTURES

You can quickly and easily reset loose bathroom fixtures, loose tiles, seal unsightly cracks around bathtubs and sinks with water-proof Plastic Wood. At Paint, Hardware, 10¢ Stores. Try it!



# PLASTIC WOOD



## WASHING MACHINES NEED 3-IN-ONE

HEAVY BODY 3-IN-ONE Oil works wonders on Washing Machines and Electric Refrigerators. It instantly penetrates the tightest bearings and moving parts. Lubricates—guards against rust. Get it at Hardware, Drug, Grocery, 10¢ Stores.

Ask for

**HEAVY BODY**

# 3-IN-ONE Oil



## (Contents—Continued)

### TOOLS

Lamp changer on pole reaches high ones .....	853
Wrench turns two nuts at once .....	870
Welding vise with double swivel .....	877
"Frozen" nuts removed with hammer-punch tool .....	886
Roots cut from sewers by steel rod .....	887

### MISCELLANEOUS

Portable drinking fountain .....	804
Sound system for home movies .....	804
Animated sign shows speeding train .....	805
Copyholder and lamp combined .....	806
Weather a military secret in Europe .....	806
"One-lick" forest fire fighting .....	816
Wheat stored under lake in Switzerland .....	816
Automatic electric pencil sharpener .....	825
Fertilizer forced into earth with compressed air .....	825
Violin tuned by sight with homemade instrument .....	825
Stunt man's leap revealed by camera .....	833
Elastic glass is tough and durable .....	839
Man needs sixty-pound bite for steak .....	839
Pusher for handling barrels saves time .....	848
Giant masterpiece in glass will be preserved .....	849
Making bottle-cap baskets is profitable hobby .....	854
Newspaper made fireproof by liquid compound .....	856
Paint with charcoal base is preservative .....	856
Hydraulic-drive Diesel engine hauls load smoothly .....	857
Robot counter never makes an error .....	857
Exercising "swing" on wheels .....	864
Polish tube built into brush .....	876
Building tomorrow's world today .....	878
Safety shower with thermostatic control .....	880
Pipes and cigarettes form a tabletop army .....	885
Restaurant built of 10,000 shells .....	891
Small air tank supplies diver for thirty minutes .....	891

## Craftsman and Shop Notes

### AUTOMOTIVE

Armature rack from old pistons .....	958
False studs hold crankcase while starting screws .....	958
Memo pad clipped to sun visor .....	958
Tag avoids excessive greasing of clutch bearing .....	958
Auto fan exhausts paint fumes .....	959
Blotter aids in cutting inner-tube patches .....	959
Nut holder on wheel wrench .....	959
Switch prevents driving car with brakes set .....	959
Tailboard in luggage carrier to load packages .....	959
Truck cover carried in housed roller .....	959
Swinging platform helps load trucks in alley .....	960

### FARMS

Adjustable roller gate passes various animals .....	943
Humane whip has report of firecracker .....	944
Protecting eggs against soiling .....	944
Eccentric clamp on wagon holds reins .....	946
Keeping chicks off water fountain .....	952

### HAND TOOLS

Cleaning threads of nuts .....	908
Improvised tap for soft materials .....	917
Slot in sawhorse to support saw .....	924
Toothbrush handle to clean plated parts .....	924
Cutting slots in center of screw heads .....	927
Fulcrum on hammer always at hand .....	927
V-block holds round work for drilling .....	943
Handle to hold small blades while grinding .....	945
Double point on pencil aids in sawing .....	952
Rubber feet keep brush clean .....	952

### HOME IMPROVEMENTS

Friendly hearth fits new living rooms .....	903
Mail boxes housed in stone columns .....	908
Window boards to admit fresh air .....	929
Tire railings on gateway through hedge .....	930

### HOUSEHOLD

Linoleum inlays make attractive breadboards .....	899
Plywood kitchenware .....	901
Repairing crack in stove .....	902
Keeping medicine dropper on bottle .....	908
Tightening clothesline .....	912
Loosening steam-radiator valves .....	918
Pipe leak repaired with hose .....	918
Repairing ball valve in bathroom flush tank .....	922
Pine-cone winter gardens .....	923
Cart to move heavy ash cans .....	929
Spoon bent over glass to dispense medicine .....	929
Solving home problems .....	932

(Continued to page 8A)



# When jobs are looking for men -that's news!



## ..... NOW IS THE TIME! .....

**R**IGHT now, in many lines there is a search for really good men—managers, leaders—men who can take charge of departments, businesses, branch offices, and set things humming.

As always, there are not enough ordinary jobs to go 'round—but rarely before in the history of American business, has there been so much room at the top!

Ordinarily, there would be plenty of men to fill these jobs—men in junior positions who have been studying in spare time. But most men have been letting their training slide during these dark years of depression . . . "What's the use?"—You have heard them say. Perhaps there has been some excuse for sticking to any old kind of a job one could get the past few years—but the door is wide open for the man with ambition NOW!

And don't let anyone tell you that "Opportunity Only Knocks Once"—that's one of the most untruthful sayings ever circulated. Opportunities flourish for every American

every day of his life.

Far more to the point is to be ready—be prepared—to make yourself interesting to the big-time employer—and. LaSalle offers you a short-cut method of qualifying for opportunity jobs in accounting, law, traffic, executive management, and kindred occupations.

LaSalle Extension is 30 years old—over 30,000 students enroll annually—60 American firms each employ 500 or more LaSalle-trained men—surveys show that average LaSalle students attain good salary increases after graduation—nearly 10% of all C. P. A.'s in the U. S. A. are LaSalle alumni.

Why not find out what LaSalle has done and is doing for men in your position? Send and get the facts; see what LaSalle can do for you personally!

There's no question about it—jobs are looking for trained men—the time has come for you to qualify for future prosperity. Mail this coupon today!

LASALLE EXTENSION UNIVERSITY, A Correspondence Institution. Dent. 1264-R. Chicago

Kindly send me your free booklet on the business field I have checked—and tell me

- Business Management
- Business Correspondence
- Business English
- Traffic Management
- Salesman
- Accounts

This One



4ATU-B7K-H12K

Name.....

Address.....

**LASALLE EXTENSION UNIVERSITY** A CORRESPONDENCE INSTITUTION

When writing to advertisers please mention Popular Mechanics



Here's  
what a **ROBOT!**  
"thinks" with



**W**HEN you see a **Robot** obey its inventor's commands to rise, walk, talk, sing, and smoke, you wonder what kind of imitation brain it has.

The New Merriam-Webster tells you that the **Robot's** "gray matter" is made of **Selenium**, and its chemical relatives, which also make possible all the other modern marvels achieved with the photocell, or "electric eye." And the same kind of information which "*The Supreme Authority*" gives on **Selenium** is also furnished on the other 91 elements known to the world of chemistry!

**For scientific information, turn first to the NEW MERRIAM-WEBSTER!**

Send for **FREE BOOKLET**, "The New Merriam-Webster: What It Will Do For You."

G. & C. MERRIAM CO.,  
Dept. 299,  
Springfield,  
Mass.



WEBSTER'S  
NEW INTERNATIONAL  
DICTIONARY  
Second Edition  
MADE IN U.S.A.

LOOK FOR THE  
CIRCULAR  
TRADE-MARK  
Copyright,  
1939, by  
G. & C.  
Merriam Co.

Webster's  
New International  
Dictionary  
Second Edition

## (Contents—Continued)

### MODELS AND MODELMAKING

Removing connecting pins from toy-train track.....	914
Small drill for model makers .....	922
Lighted case displays your model .....	947

### OFFICE

Paraffin waterproofs rolls of paper tape .....	917
Desk calendar and paper-clip box combined.....	927
File marker of cardboard .....	952

### PHOTOGRAPHY

Bracket for camera speed-flash mechanism.....	909
Deflector on photo lamp gives indirect light.....	913
Handy film holder for home movies .....	914
Take your own picture .....	915
Adjustable wire brace to steady camera tripod.....	918
Darkroom cabinet has everything at hand.....	925
Novel backgrounds super-imposed on prints.....	945

### POWER TOOLS

Wiper for lathe ways .....	902
Painted line helps adjust lathe tool rest.....	913
Junior's new hand press .....	919
Sharp taps and dies .....	941
Lathe centers from drills .....	942
Reversible lathe dog saves time.....	946
Brush cleans lathe-spindle threads .....	950
Milling-machine cutter set with aid of paper .....	950
Wood joints with power tools .....	953

### TOYS AND NOVELTIES

Novel cigarette tray of metal and plastic .....	909
Forehead writing is fun at parties .....	916
Lung tester enlivens parties .....	924
Santa pops out of chimney as toy moves.....	931

### WOODWORKING

Holding balsa wood to cut it .....	900
Sanding bow to smooth curved work .....	900
Wood stains applied with shoe dauber .....	902
Turning chisel has high-speed steel tip .....	908
Duplicating irregular lines from layout board.....	912
Spoon used as sanding block .....	922
Cushioning C-clamps to protect work .....	930

### MISCELLANEOUS

Merry Christmas in wood .....	897
Buffing and polishing wheels of paper .....	898
Swing spout dispenses liquids from large can.....	900
Clip holds paint paddle in pail .....	902
Slotted washer opens ink and paint tubes.....	902
Neat way to paste scrapbook .....	907
Chair-side magazine case .....	910
Bottle caps removed with screw eye .....	912
Magnifying glass on pencil always at hand .....	912
Simple speed reducer for light work .....	912
Solder locks small nuts in place .....	914
Worn broom improved by sawing off straws .....	914
Banana stems remove vermin from hen house.....	917
Chicken wire on gate keeps children off.....	917
Nuts and washers kept on can-opening key.....	918
"Spider" holds bolt in cement .....	918
Cork aids in driving slender nail .....	922
Craft with coconut shells .....	923
Drawer under wheelbarrow stores small tools.....	928
Hose keeps thread from unwinding on spool.....	928
Reflectors on baby carriage warn night drivers.....	928
Bobby pin serves as marker on thermometer.....	930
Drawer pulls from bottle caps .....	930
Level to hang large pictures straight .....	930
Sheet-metal stand supports Christmas tree securely.....	931
Balancing pole on stepladder prevents falling.....	934
Slit in hunter's glove aids in shooting .....	934
Spiral rack displays jewelry boxes .....	942
Lens of flashlight protected by vacuum cup.....	944
Locking nut on pulley shaft .....	944
Adapting grease cups for pressure gun .....	946
"Treading" sidewalks to provide safe footing.....	946
Chairs fastened to floor with door hooks.....	950
Insulating vise to hold work while soldering.....	950
Artist's studio easel is adjustable .....	951
Patches on postman's gloves to sort mail .....	952
Holding paint cans on top of stepladder .....	960

### IMPORTANT NOTICE

It is the intention of this magazine to provide its readers with information regarding the latest developments in the mechanical arts. We take no responsibility as to whether the disclosures contained in our articles are covered by patents and advise readers to investigate this subject before making, using, or selling any of the products, machines, or processes described, in order to avoid possible liability for patent infringement.





**I can't hire  
the man  
who says:  
"I CAN DO  
ANYTHING!"**

"There's no room in my business—or in most others—for the jack-of-all-trades. What we're looking for is men who are trained to do one thing, and do it well!

"That's why we pay special attention to applicants who are I.C.S. graduates. We know they're ambitious, intelligent, able to concentrate—and we know that the International Correspondence

Schools provide their students with sound, practical, modern training!"

More than 4,000,000 men have studied I.C.S. courses. Today, many are business and industrial leaders. Where will you be five years from today? This coupon will bring you complete information on an I.C.S. course in your field. Check it—and mail it—right now!

## INTERNATIONAL CORRESPONDENCE SCHOOLS

BOX 5559-J, SCRANTON, PENNA.

★ Without cost or obligation, please send me a copy of your booklet, "Who Wins and Why," and full particulars about the subject *before* which I have marked X: ★

### TECHNICAL AND INDUSTRIAL SUBJECTS

- |   |   |   |  |   |
|---|---|---|--|---|
| <input type="checkbox"/> Agriculture                  | <input type="checkbox"/> Air Brakes               | <input type="checkbox"/> Contracting and Building | <input type="checkbox"/> Manufacture of Pulp Paper | <input type="checkbox"/> Sanitary Engineering       |
| <input type="checkbox"/> Air Conditioning and Cooling | <input type="checkbox"/> Cotton Manufacturing     | <input type="checkbox"/> Diesel Engineering       | <input type="checkbox"/> Marine Engineering        | <input type="checkbox"/> Sheet Metal Work           |
| <input type="checkbox"/> Architectural Drafting       | <input type="checkbox"/> Electrical Engineering   | <input type="checkbox"/> Electric Lighting        | <input type="checkbox"/> Mechanical Drafting       | <input type="checkbox"/> Steam Electric Engineering |
| <input type="checkbox"/> Architecture                 | <input type="checkbox"/> Fire Bosses              | <input type="checkbox"/> Auto Electric Technician | <input type="checkbox"/> Mine Foreman              | <input type="checkbox"/> Steam Engineering          |
| <input type="checkbox"/> Auto Technician              | <input type="checkbox"/> Fruit Growing            | <input type="checkbox"/> Aviation                 | <input type="checkbox"/> Patternmaking             | <input type="checkbox"/> Steam Fitting              |
| <input type="checkbox"/> Boilermaking                 | <input type="checkbox"/> Heating                  | <input type="checkbox"/> Bridge Engineering       | <input type="checkbox"/> Pharmacy                  | <input type="checkbox"/> Structural Drafting        |
| <input type="checkbox"/> Building Estimating          | <input type="checkbox"/> Heat Treatment of Metals | <input type="checkbox"/> Chemistry                | <input type="checkbox"/> Poultry Farming           | <input type="checkbox"/> Structural Engineering     |
| <input type="checkbox"/> Civil Engineering            | <input type="checkbox"/> Highway Engineering      | <input type="checkbox"/> Coal Mining              | <input type="checkbox"/> Public Works Engineering  | <input type="checkbox"/> Surveying and Mapping      |
|   | <input type="checkbox"/> House Planning           |   | <input type="checkbox"/> Radio                     | <input type="checkbox"/> Telegraph Engineering      |
|   | <input type="checkbox"/> Machinist                |   | <input type="checkbox"/> R. R. Locomotives         | <input type="checkbox"/> Telephone Work             |
|   | <input type="checkbox"/> Management of Inventions |   | <input type="checkbox"/> R. R. Section Foreman     | <input type="checkbox"/> Toolmaking                 |
|   |   |   | <input type="checkbox"/> R. R. Signalmen           | <input type="checkbox"/> Ventilation                |
|   |   |   | <input type="checkbox"/> Refrigeration             | <input type="checkbox"/> Welding, Electric and Gas  |
|   |   |   |  | <input type="checkbox"/> Woolen Manufacturing       |

### BUSINESS SUBJECTS

- |  |  |  |  |   |                                  |
|--|--|--|--|---|----------------------------------|
| <input type="checkbox"/> Accounting              | <input type="checkbox"/> Advertising                 | <input type="checkbox"/> College Preparatory | <input type="checkbox"/> Grade School Subjects | <input type="checkbox"/> Railway Postal Clerk   | <input type="checkbox"/> Signs   |
| <input type="checkbox"/> Bookkeeping             | <input type="checkbox"/> Cost Accounting             | <input type="checkbox"/> C. P. Accounting    | <input type="checkbox"/> High School Subjects  | <input type="checkbox"/> Salesmanship           | <input type="checkbox"/> Spanish |
| <input type="checkbox"/> Business Correspondence | <input type="checkbox"/> First Year College Subjects | <input type="checkbox"/> Foremanship         | <input type="checkbox"/> Illustrating          | <input type="checkbox"/> Secretarial Work       |                                  |
| <input type="checkbox"/> Business Management     | <input type="checkbox"/> French                      |  | <input type="checkbox"/> Lettering Show Cards  | <input type="checkbox"/> Stenography and Typing |                                  |
| <input type="checkbox"/> Cartooning              | <input type="checkbox"/> Civil Service               |  | <input type="checkbox"/> Managing Men at Work  | <input type="checkbox"/> Traffic Management     |                                  |

### DOMESTIC SCIENCE SUBJECTS

- |   |   |  |
|---|---|--|
| <input type="checkbox"/> Advanced Dressmaking | <input type="checkbox"/> Home Dressmaking                       | <input type="checkbox"/> Tea Room and Cafeteria Management, Catering |
| <input type="checkbox"/> Foods and Cookery    | <input type="checkbox"/> Professional Dressmaking and Designing |  |

Name..... Age..... Address.....

City..... State..... Present Position.....

Canadian residents send coupon to International Correspondence Schools Canadian, Limited, Montreal, Canada  
British residents send coupon to I. C. S., 71 Kingsway, London, W. C. 2, England



**FELLOWS-YOU'VE SEEN ALL THESE DIESELS---**

POWER PLANT  
CONTRACTING  
DIESEL-ELECTRIC  
AIRCRAFT  
MARINE  
AUTOMOTIVE

*but*

**WHAT ARE YOU DOING ABOUT THEM?**

★ ★ Everywhere you look you can see Diesels forging ahead—new types for trucks, busses, trains, boats and general industry. You've seen the ads of world-known firms announcing their entry into Diesel—magazines making Diesels the subject of their feature articles. Never before has there been greater activity in this field. ★ ★ But are you connecting your future with the inevitable growth of this great industry? ★ ★ Find out about it—start doing so by sending for free copy of March of Diesel, and data on Hemphill Diesel training. Use coupon now.

**HEMPHILL DIESEL SCHOOLS**

- All communications concerning enrollment in any of the Hemphill Diesel Courses should be sent to one of the following addresses:
- NEW YORK . . . . . 31-26 Queens Blvd., L. I. C.
  - CHICAGO . . . . . 2014 Larrabee Street
  - MEMPHIS . . . . . 417 Monroe Avenue
  - LOS ANGELES . . . . . 2120 San Fernando Road
  - VANCOUVER, B.C. . . . . 1363 Granville St.

**HEMPHILL DIESEL SCHOOLS** (use nearest address)

Please send data on your Diesel courses, also free copy of illustrated booklet "March of Diesel."

Name \_\_\_\_\_ Age \_\_\_\_\_

Street \_\_\_\_\_

City \_\_\_\_\_ State \_\_\_\_\_ M-42-P

Applications for enrollment will be accepted from English speaking students residing in foreign countries. Write for special terms.

**GET IN THE SWING**  
*with Slingerland . . . DRUMS*  
**GUITARS**  
**MANDOLINS**



**GENE KRUPA — World's Greatest Swing Drummer uses Slingerland**

**WONDERFUL VALUE**  
**EASY PAYMENTS**

Compare the value—tone and power in Slingerland "Radio King" drums, banjos, guitars, mandolins, marimbas or bugles—before you buy. Guaranteed more for your money. Acclaimed the tops in smooth

tone, easy playing, rich power by world's leading musicians. Easy payments, 5-days free trial. See at your dealers.

Write for free special information on how to organize drum and bugle corps. Free Catalog—mention instrument wanted.

**SLINGERLAND DRUM CO.**  
1330 Belden Avenue Chicago, Illinois



**LEARN WATCH REPAIRING**



**AT HOME** You can learn by our modern and original system of instruction every part of the Watch Repairing Trade at home. You can earn money while learning and prepare yourself for a well paying position or start in business after completing our course of instruction. Good watch repairers are in demand and generally earn very good salaries. For particulars apply to the Wisconsin School of Watch Repairing 524 E. Mason St., MILWAUKEE, WIS.

**ELECTRICAL ENGINEERING**

Condensed ONE-YEAR residence course combines theory with practice in well-equipped laboratories. High employment record. Suburban campus; modern buildings; dormitory. 47th year. CATALOG. Give age.

**BLISS ELECTRICAL SCHOOL**  
122 Takoma Ave., Washington, D. C.

**AVIATION APPRENTICES**



AIRMINDED YOUNG MEN INTERESTED IN TRAINING FOR ENTERING THE WELL PAID FIELD OF AVIATION AS APPRENTICES—Write immediately, enclosing stamp.

**MECHANIX UNIVERSAL AVIATION SERVICE CO.**  
Wayne County Airport, Box 857, Dept. E, Detroit, Mich.

**EARN THE DEGREE**

Doctor of Psychology (Ph.D.), Philosophy, Divinity. General Courses—Art, Business, etc. A Correspondence Institution Chartered by State of Washington. Send for 32-page FREE Bulletin at once. No Obligation. Temple Bar College, Dept. 2-R, 1520 Thirteenth Avenue Seattle Washington, U.S.A.

**CARTOONING PAYS WELL**

Exclusive instruction by a famous cartoonist makes it easy to learn at home. Write for Free Booklet describing details of the course.

**NATIONAL SCHOOL OF CARTOONING**  
439 Penton Bldg. Cleveland, Ohio



*Learn Write.*

Begin Today. Write for our Free Book, "How to Become a Good Penman." It contains specimens and tells how others learned to write in spare time. Your name elegantly written on a card if you enclose stamp for postage. Write today. The Tamblin School of Penmanship, Dept. 8, Ridge Bldg., Kansas City, Mo.



# Training Counts in Every Field



International News Photos

## You Must Know What to Do When Signals are Called

To play the game—whether on the football field or in the bigger jobs of business and industry—you must know what to do when the signals are called. To make the team a player must be above average—and you must be above average to meet the demands of employers for the better paid positions.

Your own ability to hold the better jobs depends entirely on the preparation you have made to accept the **opportunities offered every month in the year** in the active fields of today such as Air Conditioning, Diesel Engineering, Drafting and Design, etc. Men in these fields and others with preparation as accountants and in merchandising are being advanced into such openings as department heads, managers, foremen, superintendents, traveling auditors, etc.

Your opportunity today simply means being **ready** for the good jobs looking for good men—your chance for a worthwhile position depends on whether or not you will prepare to meet the demands of employers all over the country who are offering the big jobs to men who can handle them!

Without training a man is no more valuable at 40

than at 30, is old at 50. But the doctor at 40 or 50 is a better doctor than he was at 30—and it's the same with men trained in other fields—executives, draftsmen, engineers, merchants, architects **are young at 40, at 50**—and still have many good pay years ahead. Promotion, higher pay, reward properly trained men!

American School, an educational institution incorporated "not for profit," has used for over 40 years a direct and practical method for preparing men to handle the **bigger jobs in business and industry.**

American School graduates hold important positions as engineers, accountants, experts, draftsmen, managers, etc., or successfully operate their own business. Thousands of our High School graduates have entered colleges, universities, normal schools, etc., have attained success in business or industry.

Find out how American School can help YOU, the difference it may make in your entire future **success and happiness!** Mail coupon today for **free** Bulletin and early lesson in field of your choice. No obligation on your part.

**American School, Dept. G945, Drexel Ave. at 58th St., Chicago**

Cut Along This Line

### Try a Lesson Yourself—No Obligation

**American School, Dept. G945, Drexel Ave. at 58th St., Chicago**

I have checked the line of work in which I would like a good job. Please send me without expense or obligation on my part a copy of your Bulletin and an early lesson in the field I have selected.

- |  |   |   |
|--|---|---|
| <input type="checkbox"/> Air Conditioning                | <input type="checkbox"/> Electrical Engineering         | <input type="checkbox"/> Law                    |
| <input type="checkbox"/> Architecture                    | <input type="checkbox"/> Diesel Engineering             | <input type="checkbox"/> Liberal Arts (College) |
| <input type="checkbox"/> Automotive Engineering          | <input type="checkbox"/> Drafting and Designing         | <input type="checkbox"/> Mechanical Engineering |
| <input type="checkbox"/> Automobile Repairing            | <input type="checkbox"/> Electric Refrigeration         | <input type="checkbox"/> Merchandising          |
| <input type="checkbox"/> Bookkeeping and Cost Accounting | <input type="checkbox"/> Heating, Ventilating, Plumbing | <input type="checkbox"/> Private Secretary      |
| <input type="checkbox"/> Business Management             | <input type="checkbox"/> Professional Accounting        | <input type="checkbox"/> Radio and Television   |
| <input type="checkbox"/> Civil Engineering               | <input type="checkbox"/> Incl. C. P. A. Coaching        | <input type="checkbox"/> Salesmanship           |
| <input type="checkbox"/> Aviation                        | <input type="checkbox"/> High School                    | <input type="checkbox"/> Shop Practice          |
| <input type="checkbox"/> Contracting, Building           | <input type="checkbox"/> Highway Engineering            | <input type="checkbox"/> Steam Engineering      |



Name.....Age.....Occupation.....

Street.....City.....State.....

When writing to advertisers please mention Popular Mechanics





**J. E. SMITH**  
President  
National Radio  
Institute  
Est. 25 Years

## I will train you at home for RADIO and TELEVISION

### I TRAINED THESE MEN



**\$10 TO \$20 A WEEK  
IN SPARE TIME**

"I repaired many Radio sets when I was on my tenth lesson. I really don't see how you can give so much for such a small amount of money. I have made an average of \$10 to \$20 a week—just spare time."—**JOHN JERRY**, 1529 Arapahoe St., Denver, Colo.

**OWNS SHOP, MAKES  
\$3,000 A YEAR**

"Before taking your Course I earned about 17 1/2 cents per hour as a truck driver. When I had completed 20 lessons I started service work. During the last year I have made about \$3,000 in Radio. I now own my own shop."—**EARL KELLY**, 306 W. Calhoun St., Magnolia, Ark.



**SALARY INCREASED \$1,800  
YEAR IN RADIO**



"I have been regularly employed in radio since my graduation. I have been Chief Engineer of three broadcast stations and at present time am Chief Engineer of WJOD. My salary has increased \$1,800 per year since entering Radio and credit is given you for your excellent training."—**JULIUS C. VESSELS**, Station WJOD, Chattanooga, Tenn.

Radio is a young, growing field with a future. It offers you many good pay spare time and full time job opportunities. And you don't have to give up your present job, go away from home, or spend a lot of money to become a Radio Technician. I train you right at home in your spare time.

#### Jobs Like These Go To Men Who Know Radio

Radio broadcasting stations employ engineers, operators, technicians and pay well for trained men. Radio manufacturers employ testers, inspectors, foremen, servicemen in good-pay jobs with opportunities for advancement. Radio jobbers and dealers employ installation and servicemen. Many Radio Technicians open their own Radio sales and repair businesses and make \$30, \$40, \$50 a week. Others hold their regular jobs and make \$5 to \$10 a week fixing Radios in spare time. Automobile, police, aviation, commercial Radio; loud-speaker systems, electronic devices, are newer fields offering good opportunities to qualified men. And my Course includes Television, which promises to open many good jobs soon.

#### Why Many Radio Technicians Make \$30, \$40, \$50 a Week

Radio is already one of the country's large industries even though it is still young and growing. The arrival of Television, the use of Radio principles in industry, are but a few of many recent Radio developments. More than 28,000,000 homes have one or more Radios. There are more Radios than telephones. Every year millions of Radios get



**Set Servicing**  
pays many Radio  
Technicians \$30,  
\$40, \$50 a week.  
Others hold their  
regular jobs and  
make \$5 to \$10  
extra a week in  
spare time.



**Loud Speaker System** building, installing,  
servicing and operating is another growing  
field for well trained Radio Technicians.

**FIND OUT ABOUT THIS TESTED WAY**



# Technician

## \$40, \$50 A WEEK

out of date and are replaced. Millions more need new tubes, repairs, etc. Over 5,000,000 auto Radios are in use and thousands more are being sold every day. In every branch Radio is offering more opportunities—opportunities for which I give you the required knowledge of Radio at home in your spare time. Yes, the few hundred \$30, \$40, \$50 a week jobs of 20 years ago have grown to thousands.

### Many Make \$5 To \$10 a Week Extra In Spare Time While Learning

The day you enroll, in addition to my regular course, I start sending you Extra Money Job Sheets which start showing you how to do actual Radio repair jobs. Throughout your Course I send plans and directions which have helped many make from \$200 to \$500 a year in spare-time while learning.

### You Get Practical Experience While Learning

I send you special Radio equipment; show you how to conduct experiments, build circuits illustrating important principles used in modern Radio and Television receivers, broadcasting station and loudspeaker installations. My 50-50 method of training gives you both printed and actual work with Radio parts—makes learning at home interesting, fascinating, practical. I ALSO GIVE YOU A MODERN, PROFESSIONAL, ALL-WAVE RADIO SET SERVICING INSTRUMENT to help you make more money fixing Radio sets while learning and to equip you with a professional instrument for full time work after you graduate.



### Find Out What Radio Offers You

Act today. Mail coupon for my 64-page book, "Rich Rewards in Radio." It points out Radio's spare time and full time opportunities and those coming in Television; tells about my course in Radio and Television; shows many letters from men I trained, telling what they are doing and earning. Read my money back agreement. Find out what Radio offers you. Mail coupon in envelope or paste on a penny postcard—NOW.

J. E. SMITH, PRES., DEPT. 9NP, NATIONAL RADIO INSTITUTE, WASHINGTON, D. C.



Broadcasting Stations employ operators, installation, maintenance men and Radio Technicians in other capacities and pay well.

THIS  
Free Book  
HAS HELPED  
HUNDREDS OF MEN  
MAKE MORE  
MONEY



## Mail this to get 64 page book FREE

J. E. SMITH, President, Dept. 9NP  
National Radio Institute, Washington, D. C.

Dear Mr. Smith:

Send me FREE, without obligation, your 64-page book "Rich Rewards in Radio" which points out Radio's opportunities and tells how you train men at home to be Radio Technicians. (Write plainly.)

Name..... Age.....

Address .....

City..... State.....



Automobile Radio is another new Radio field—selling, installing, servicing. One million or more auto owners will install radio sets within the next year.

## TO BETTER PAY



**ACTUAL WORK ON  
ACTUAL ELECTRICAL  
MACHINERY**

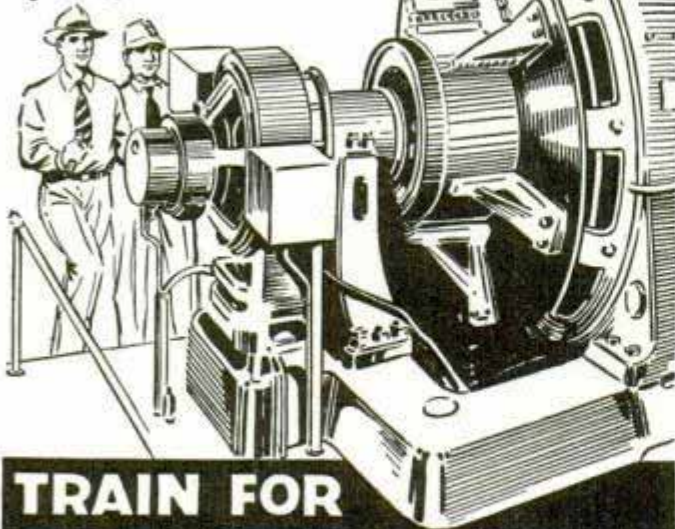

**TRAIN FOR  
ELECTRICITY  
12 WEEKS SHOP TRAINING**

**PAY TUITION  
AFTER GRADUATION**

Are you sick and tired of just getting by—holding a small-pay unskilled job or worse, yet out of work most of the time.

It's bad enough for a fellow to be in this position today but it's worse to look ahead at the years before you and realize the future looks pretty dark. A lot of fellows just sit back and say they never got the "breaks"—others realize they must make their own "breaks" and they climb out of their apparently hopeless condition.

Now Electricity offers opportunities and a real future to the fellows between 16 and 40 years of age, who will prepare themselves by training for them.

**LEARN BY DOING**

Here in my school you can get 12 weeks practical "Learn by Doing" shop training that can prepare you for your start in this field. Here at Coyne you work on motors, generators, dynamos — you do house wiring, wind armatures and do actual work on many other branches of electricity, and because this training is practical training you don't need advanced education or previous experience.

**I Make This Training Easy to Get**

You don't have to put out a lot of money to enroll in my school. You can pay most of your tuition in 12 monthly payments — beginning 60 days after you graduate. And if you need part time work to help out with expenses while you train in my shops, my employment department will help you — and we will give you lifetime employment service after you graduate.

Get my big free book NOW. Study the dozens of pictures. Read all the facts about Coyne actual shop training. Coyne Employment Service, my "Pay Tuition After Graduation Plan" and big opportunities in electricity. Mail coupon today for your FREE copy.



H. C. LEWIS, President  
COYNE ELECTRICAL SCHOOL,  
500 S. Paulina St., Dept. 99-72, Chicago, Ill.  
Please send me your big Free Opportunity Book and all the facts about Coyne training.

NAME.....  
ADDRESS.....  
CITY..... STATE.....

**Easy to Play**  
THE SMALLEST, LIGHTEST, FULL-VOLUMED 90 BASS ACCORDION EVER DESIGNED. IT'S THE NEW SOPRANI AMPLIPHONIC MIDGET

● Think of it! 34 treble, and 90 bass keys, beautiful tone, amazing volume. See and try this wonderful new Soprani at your dealer's, or write for FREE booklet.

**SOPRANI, INC.** Dept. 1229  
630 S. Wabash, Chicago, Ill.

**FREE BOOK**

**LAW STUDY AT HOME**  
Legally trained men win higher positions and bigger success in business and public life. Greater opportunities now than ever before. Big corporations are headed by men with legal training.

**More Ability: More Prestige: More Money**  
We guide you step by step. You can train at home during spare time. Degree of LL. B. Successful graduates in every section of the U. S. We furnish all text material, including 14-volume Law Library. Low cost, easy terms. Get our valuable 48-page "Law Training for Leadership" and "Evidence" books FREE. Send for them NOW.

**LaSalle Extension University, Dept. 1264-L Chicago**  
A Correspondence Institution

**Regain Perfect Speech, If You STAMMER**

Every stammerer should have the new 304 page book "Stammering, Its Cause and Correction." Sent free to stammerers. It describes the Bogue Unit Method for the scientific correction of stammering and stuttering. Method successfully used at Bogue Institute for 38 years—since 1901. Endorsed by physicians. Write for full information. No obligation. Benjamin N. Bogue, Dept. 1309 Circle Tower, Indianapolis, Indiana.

**PHOTO-ENGRAVING TASOPE' SINCE 1931**

Cash in on pictures! Learn quickly at home or in our residence school. Make halftones, line cuts for the trade. Qualify for interesting, good pay job. We show you how and supply complete low-cost engraving plant. Small investment. Easy terms. Particulars free!

**THE AURORA SCHOOL OF PHOTO-ENGRAVING**  
Dept. PM-11 Tasope' Bldg. Aurora, Mo.

**Minstrels** Comedy Stunts Plays Songs

Unique First Parts for complete show with special songs and choruses. Make-up. Catalog Free.

**T. S. Denison & Co., 203 N. Wabash, Dept. 19, Chicago**

**CARTOONING**

FREE TRIAL LESSON! Cash in on your sense of humor—AT HOME—BY MAIL. Have fun! Make money! No experience needed to start. Write today for FREE LESSON, mailed postpaid. No obligation.

**MOON Gag-Cartoon School, Dept. A, Fall Creek, Wis.**

**GET THIS FREE SUIT AS A BONUS — AND MAKE UP TO \$12.00 IN A DAY!**

Let me send you a fine wool Union Tailored suit FREE as a bonus. Pay no money. Just follow simple plan I send you, earn up to \$12 in a day showing to friends. No experience needed—no house-to-house canvassing.

Send for Samples — FREE OF COST

Write today for FREE details, ACTUAL SAMPLES and "sure-fire" money-getting plans. Send no money.

**H. J. Collin, PROGRESS TAILORING CO., Dept. A-216, 500 South Throop Street, Chicago, Illinois.**

When writing please mention Popular Mechanics



# IMAGINE THEIR JOY WHEN THEY FOUND THEY COULD PLAY



**LEARNED QUICKLY AT HOME**  
I didn't dream I could actually learn to play without a teacher. Now, when I play for people they hardly believe that I learned to play so well in so short a time.  
\*H.S.C., Calif.



**SURPRISED FRIENDS**  
My friends are surprised at the different pieces I can already play. I am very happy to have chosen your method of learning. \*B. F., Bronx, N. Y.

This easy-as-ABC way!



**PLAYS ON RADIO**  
I am happy to tell you that for four weeks I have been on the air over our local radio station. So thanks to your institution for such a wonderful course. \*W. H. S., Alabama.

## What Instrument Would You Like to Play?

JUST name your instrument and we'll show you how you can learn to play it—quickly, easily, in spare time at home. Never mind if you don't know one note of music from another—don't worry about "special talent". And forget all you've ever heard about music's being hard to learn.

The truth of the matter is that *thousands now play who never thought they could!* Yes, men and women everywhere have discovered this amazingly easy way to learn music at home. Now they are enjoying the thrilling satisfaction of playing the piano, violin, guitar, saxophone or other favorite instruments. Some of them are playing in orchestras and over the radio; others are teaching music, making money in spare or full time. And thousands are having the time of their lives playing for their own enjoyment and the entertainment of their friends.

**LEARN TO PLAY BY NOTE**  
Piano Guitar  
Violin Saxophone  
Organ Mandoline  
Tenor Banjo  
Hawaiian Guitar  
Piano Accordion  
Or Any Other Instrument

No tedious study and practice, no tiresome exercises. You learn to play *by playing*—start right in with the melody of a simple tune! It takes only a few minutes a day; the cost is trifling. Does it sound too good to be true? Mail the coupon and get the **FREE PROOF!**

### FREE DEMONSTRATION LESSON AND BOOKLET

Fascinating illustrated booklet answers all your questions; free demonstration lesson shows how method works. Just mail coupon. (Instruments supplied when needed, cash or credit.) \*Actual pupils' names on request. Pictures by professional models. U. S. School of Music, 712 Brunswick Bldg., N. Y. C., N. Y.

**U. S. SCHOOL OF MUSIC**  
712 Brunswick Bldg., New York City, N. Y.

I am interested in music study, particularly in the instrument indicated. Please send me your free illustrated booklet, "How to Learn Music at Home" and the Free Demonstration Lesson.

Name.....  
Address.....  
Instrument..... Have you Instrument?.....

## You CAN GET IN AVIATION

Like hundreds of successful graduates SPARTAN Training following standard College or University planned curriculum will give YOU Aviation training that will qualify for positions now open. Advantages: Factory affiliation building ALL-METAL Commercial and Military Airplanes. Unequaled year-round flying weather and country. GOVERNMENT APPROVED. All courses Mechanical and Flight. Write for Illustrated Catalog.

**HOME OF THE DAWN PATROL**  
J. D. GREEN, Director, Dept. PM-26, TULSA, OKLAHOMA

**SPARTAN SCHOOL OF AVIATION**

## MECHANICAL DENTISTRY AT HOME!

*Learn* To make Crowns, Plates, Bridgework, etc., for Dentists. Easy practical way to learn mechanical dentistry at home in spare time. FULL EQUIPMENT OF TOOLS AND MATERIALS INCLUDED WITH COURSE. Low tuition. Easy terms. Write for FREE BOOK about this money making profession that is not affected by machine age.

McCARRIE SCHOOL OF MECHANICAL DENTISTRY  
207 N. Broad St., Dept. 751, Philadelphia, Pa.

## BE A PASSENGER TRAFFIC INSPECTOR

Write for Free Booklet describing our 20 yrs. experience placing Men (19-50) as Railway and Bus Traffic Inspectors—jobs that pay up to \$135 per mo. plus expenses to start. Easy, home-study course trains you in spare time. STANDARD BUSINESS TRAINING INSTITUTE, Div. 212, Buffalo, N. Y.

## RADIO ENGINEERING

broadcasting, aviation and police radio, servicing, marine and Morse telegraphy taught thoroughly. 48 weeks' engineering course equivalent to three years' college radio work. School established 1874. All expenses low. Catalog free.

Dodge's Institute, Ada St., Valparaiso, Ind.

## Learn TAXIDERMY

from a Museum Staff Taxidermist. Complete Course of Five Books--BIRDS, ANIMALS, GAME-HEADS, FISH, TANNING

Send for FREE Sample of Lesson

Chicago School of Taxidermy  
P.O. Box 343 Dept. 15 Chicago, Ill.

## Be a Civil Engineer!

Learn—Quick Reference Way

It's Paying Big Right NOW

Cyclopedia of Civil Engineering 7 great volumes. 2,800 pages. 1,600 illustrations. New revised edition by twelve of America's greatest engineers. Includes: Surveying, bridges, railroads, steel structures, municipal engineering, water supply, road building, etc.

Spanish Covers Flexible Grain Gold Stamped Shipped Free

For Examination Slide Rule

Be prompt and we will include a brand new, circular slide rule to carry in coat pocket. Invaluable in solving all kinds of engineering problems.

**Earn \$3000 a Year—and Up!**

"Civil engineers are wanted NOW. Enormous amounts are being spent in all kinds of public works and not a dime is spent until the Engineer has prepared plans. Then He must direct the work. It's a big job and there are not enough men to go around. Everywhere you go, you see road work going on—water and sewer systems being built—vast projects of all kinds. Here is Your Opportunity to get the necessary training right at home. These books are complete and simply written so anyone can understand them. Start now on our FREE examination plan. Mail the coupon without obligation."

**AMERICAN TECHNICAL SOCIETY**  
Dept. C915 Drexel at 58th St. Chicago

**American Technical Society**  
Drexel at 58th St., Dept. C915, Chicago

I want to examine the CIVIL ENGINEERING Cyclopedia for 10 days. I will gladly pay the few cents express, but I am to pay nothing for the 7 big volumes if I return them within 10 days. If I wish to keep them I will send you \$2 after the 10 days, then \$3 a month until advertising price, \$29.80 is paid. Send latest Edition and Slide Rule.

Name.....  
Address.....  
(Attach letter stating age, occupation, employer's name and address and that of at least one business man as reference.)





**Start \$1260 to \$2100 a Year  
Get Ready Now for 1940  
Examinations**

**Railway Postal Clerks**

Railway Postal Clerks get \$1,900 the first year regular, being paid on the first and fifteenth of each month. (\$79.17 each pay day.) Their pay is automatically increased yearly to \$2,450. Advance may be had to Chief Clerk at \$2,700 a year. (\$112.50 each pay day.)

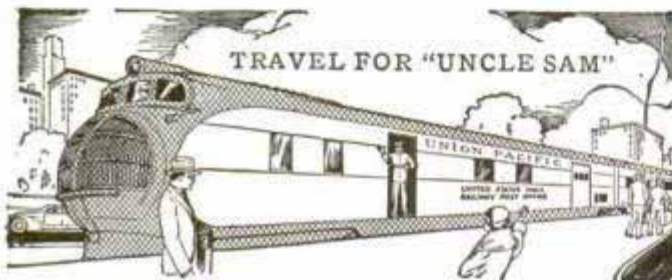

**3 Days On—3 Days Off—Full Pay**

Railway Postal Clerks on long runs usually work 3 days and have 3 days off duty or in the same portion. During this off duty their pay continues just as though they were working. They travel on a pass when on business. When they grow old, they are retired with a pension.

**City Mail Carriers, Post Office Clerks**

Clerks and Carriers now get \$1,700 the first year on regular and automatically increase \$100 a year to \$2,100 and \$2,300.

**GOVERNMENT  
CLERK**



**File Clerk—Clerk**

Open to Men—Women 18 to 50. Entrance salary \$1250—\$1440 Year. Appointments as File Clerks and Clerks in the Departments at Washington, D. C., are made from this examination.

**Many Other Positions**

Many other positions are obtainable. Those wishing these positions should qualify at once.

**Get Free List of Positions**

Fill out the following coupon. Tear it off and mail it today—now, at once.

This investment may result in your getting a big-paid government job.

FRANKLIN INSTITUTE, Dept. S173, Rochester, N. Y.

Rush to me, entirely free of charge (1) a full description of U. S. Government Jobs; (2) Free copy of illustrated 32-page book, "U. S. Government Positions and How to Get Them"; (3) List of U. S. Government Jobs; (4) Tell me what to do to qualify for one of these jobs.

Name.....

Address.....

Use This Coupon Before You Mislaid It. Write or Print Plainly.

When writing please mention Popular Mechanics

**EASIER than EVER**



**To Master, this New 1940 P-A**

● Just touch a key and blow normally; you can't miss. So easy, and such beautiful tone. Nothing to compare with these new P-A Saxes, Clarinets, Trumpets, and other P-A instruments. Fully guaranteed; your success assured. See your music dealer or write direct for beautiful free book. No obligation. Easy terms. Greatest fun, easiest with P-A. Write today sure.

1975  
**PAN-AMERICAN**  
1203-A 81dg. Elkhart, Indiana

**TRI-STATE COLLEGE**

**B. S. Degree in 2 Years**

World famous for technical 2-year courses in Civil, Electrical, Mechanical, Chemical, Radio, Aeronautical Engineering, Business Administration and Accounting. Special preparatory department for those who lack required high school work. Short diploma courses (36 weeks) in Surveying, Drafting, Low tuition. Low living costs. Students from every state and many foreign countries. 56th year. Graduates successful. Enter September, January, March, June. Write for catalog. 4129 College Ave., ANGOLA, IND.



**PLAY A SAW!**

Produce wonderful music in 5 days... quickly play popular and classical numbers. No notes to read, no dreary practice — success guaranteed. Since 1924 thousands of my students have amazed friends, starred in shows and broadcasting orchestras. Without obligation, write for 5 DAY TRIAL OFFER now.

**MUSSEHL & WESTPHAL**  
134 W. Water St., Fort Atkinson, Wis.

**Learn PHOTOGRAPHY at Home**

Splendid opportunities. Prepare in spare time. Easy plan. No previous experience needed, common school education sufficient. Send for free booklet "Opportunities in Photography", particulars and requirements.

American School of Photography  
3601 Michigan Ave., Dept. 1359, Chicago, Ill.



*Learn How to Write*

Write for my Free Book, "HOW to BECOME an EXPERT PENMAN," which shows how others became experts by my Method. Supplies furnished to students. Your name elegantly written on a card if you enclose stamp. Write Today. T. M. TEVIS, Box 25K, CHILLICOTHE, MO.



**SUCCEED IN LANDSCAPING**

Send for FREE book with full details about landscape training. Study at home, earn while learning. Profitable, healthful career; interesting hobby; men, women. Give age, occupation.

**AMERICAN LANDSCAPE SCHOOL**  
6129 Grand Avenue Des Moines, Iowa

**NEW YORK SCHOOL OF MECHANICAL DENTISTRY**

Learn how to make Crowns, Bridges, Plates in this OLDEST Laboratory Center. Practical training. Day, Eve. Easy terms. Ask for free Catalog P and tool offer. N. Y. SCHOOL of MECHANICAL DENTISTRY, 125 W. 31 St., N. Y. C.

**MAKE MONEY AT HOME**

**RUBBER MOLDS** Low as 6¢ EA.

Amazing rubber mold-making outfit makes perfect flexible molds of plaques, ash trays, book-ends, etc. Molds cost from 6c to 25c each. Each mold makes hundreds of novelties and gifts to sell up to \$1.00 apiece! No experience necessary. Quick and easy. Start profitable business in your home... sell to stores, gift shops, friends, resorts, road stands, by mail. Full or spare time. "Molders Handy Book" and list of buyers FREE. Write

**SO-LO WORKS**  
Dept. B-827 Cincinnati, Ohio







# EXTRA MONEY

Yes, you can make extra money right at home, and have real fun doing it. We show you how, we furnish everything necessary on an easy basis.

**COSTS NOTHING** to learn about our plan, all details are given you free. Write today for idea book full of colored pictures telling all about our methods which have made money for so many people. Learn how easy it is to make up to \$10 to \$25 in a week in the most delightful home work you can imagine. Write Now—It's FREE!

**FIRESIDE INDUSTRIES, Dept. 66-W, Adrian, Mich.**

## AN AVIATION CAREER OFFERS YOU GREAT FUTURE!



Demand for trained aircraftmen is increasing and already exceeds supply. Curtiss-Wright Tech, Aviation's foremost school, is located on Grand Central Air Terminal in heart of the aircraft industry and specializes in training MASTER MECHANICS and AERONAUTICAL ENGINEERS. (No flying involved.) Graduates are obtaining immediate employment. Write for details NOW. Dept. PM-12.

**CURTISS - WRIGHT TECHNICAL INSTITUTE**  
Glendale (Los Angeles) California



## Auto-Diesel

Master a real trade. Auto Mechanics, Diesel Mechanics, Arc Welding, Acetylene Welding, etc. Let us train you to be an expert Auto-Diesel Mechanic and help you get a good job. The cost to you is reasonable. Learn on modern equipment with tools under experienced instructors. Real shop work. Steam heated buildings. Room and board in our steam heated dormitory. We pay your fare to Nashville. For free catalog write

**Nashville Auto-Diesel School, Dept. 75, Nashville, Tenn.**

## Learn Public Speaking

At home—in spare time. Many overcome "stage-fright," gain self-confidence and increase earning power, this easy way. Write for free booklet, *How to Work With Words* and requirements.

**North American Institute, Dept. 1359  
3601 Michigan Ave., Chicago, Illinois**

STATEMENT OF THE OWNERSHIP, MANAGEMENT, CIRCULATION, ETC., REQUIRED BY THE ACTS OF CONGRESS OF AUGUST 24, 1912 AND MARCH 3, 1933, of Popular Mechanics Magazine, published monthly at Chicago, Ill., for October 1, 1939.

State of Illinois, County of Cook, ss.

Before me, a notary public in and for the state and county aforesaid, personally appeared H. H. Windsor, Jr., who, having been duly sworn according to law, deposes and says that he is the Editor of the Popular Mechanics Magazine and that the following is, to the best of his knowledge and belief, a true statement of the ownership, management, etc., of the aforesaid publication for the date shown in the above caption, required by the Act of August 24, 1912, as amended by the Act of March 3, 1933, embodied in section 537, Postal Laws and Regulations, printed on the reverse of this form, to wit: First. That the names and addresses of the publisher, editor, managing editor and business manager are: Publisher, Popular Mechanics Co., 200 East Ontario St., Chicago, Ill.; Editor, H. H. Windsor, Jr., 200 East Ontario St., Chicago, Ill.; Managing Editor, L. K. Weber, 200 East Ontario St., Chicago, Ill.; Business Manager, Willis S. Brown, 200 East Ontario St., Chicago, Ill. Second. That the owner is: (If owned by a corporation, its name and address must be stated and also immediately thereunder the names and addresses of stockholders owning or holding one per cent or more of total amount of stock. If not owned by a corporation, the names and addresses of the individual owners must be given. If owned by a firm, company, or other unincorporated concern, its name and address, as well as those of each individual member, must be given.) Popular Mechanics Company, 200 East Ontario St., Chicago, Ill.; Estate of Lina B. Windsor, Deceased, 200 East Ontario St., Chicago, Ill.; H. H. Windsor, Jr., 200 East Ontario St., Chicago, Ill.; L. H. Windsor, 200 East Ontario St., Chicago, Ill. Third. That the known bondholders, mortgagees, and other security holders owning or holding 1 per cent or more of total amount of bonds, mortgages, or other securities are: (If there are none, so state.) None. Fourth. That the two paragraphs next above, giving the names of the owners, stockholders, and security holders, if any, contain not only the list of stockholders and security holders as they appear upon the books of the company but also, in cases where the stockholder or security holder appears upon the books of the company as trustee or in any other fiduciary relation, the name of the person or corporation for whom such trustee is acting, is given; also that the said two paragraphs contain statements embracing affiant's full knowledge and belief as to the circumstances and conditions under which stockholders and security holders who do not appear upon the books of the company as trustees, bond stock and securities in a capacity other than that of a bona fide owner; and this affiant has no reason to believe that any other person, association, or corporation has any interest direct or indirect in the said stock, bonds, or other securities than as so stated by him. H. H. Windsor, Jr., Editor. Sworn to and subscribed before me this 24th day of September, 1939. J. GRAHAM, Notary Public. (My commission expires June 16, 1940.)



THERE YOU ARE, THAT'S INVISIBLE INK THE KIND SPIES USE!

HERE'S ANOTHER SWELL EXPERIMENT IN THE MANUAL... LET'S TRY IT!

THESE CHEMCRAFT OUTFITS SURE ARE WONDERFUL!

**FUN ADVENTURE THRILLS**

Boys, you just can't imagine anything that will give you more real enjoyment than a Chemcraft Outfit. Fun—in doing the many fascinating experiments that amaze your friends—adventure and thrills in producing the chemical reactions and delving into the secrets and mysteries of science. And with the fun and thrills you are also securing practical knowledge in chemistry, the science that is utilized every day in the laboratories of great industrial companies for the development of new products. Chemcraft Outfits contain no dangerous substances and the manuals describe fully how to perform hundreds of amazing experiments.

# CHEMCRAFT

REG. U. S. PAT. OFF.

## CHEMICAL OUTFITS

Chemcraft Outfits are accurate—scientific—and contain many exclusive features. Only Chemcraft gives you **Chemical Magic, Alcohol Lamp Blow Torch for Glass Blowing, a Spectroscope, an explanation of chemical Formula and Symbols, larger boxes finished in two-tone duo-form, and many other features found only in Chemcraft.** See Chemcraft Outfits at your favorite store, priced \$1 to \$25. If they cannot supply you with your choice you may order direct from us.



**Outfit No. 1**—Just think —160 dandy experiments, 22 chemicals and pieces of apparatus, including test tube rack and spring test tube holder. The finest beginner's outfit. Price \$1.00.

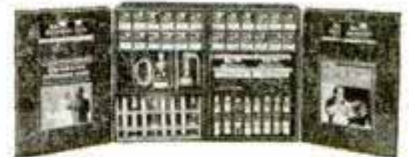

**Outfit No. 5**—Contains 62 chemicals, pieces of apparatus and equipment with special alcohol lamp blow torch for glass blowing and heating. Manual explains over 450 fine experiments with additional manual on Glass Blowing and construction of Home Laboratory. Packed in stand-up laboratory-type cabinet with hinged doors, size open 37 x 13 3/4 inches. Price \$5.00.

### MAIL COUPON FOR FREE BOOK "EXPERIMENTS IN CHEMISTRY"

It's a real treasure house of entertainment and information. Tells how to do more than 40 thrilling experiments in Chemistry, Microscopy, Physics, Biology, Electricity, etc. Also helps you to construct a laboratory work shop in your own home and explains how you may join the Chemcraft Science Club. Don't miss this fascinating book.



**The Porter Chemical Company**  
45 Prospect Ave., Hagerstown, Md.

Please send me your free book "Experiments in Chemistry."

Name .....

Address .....

City ..... State .....





## MACHINE SHOP MEN

Learn to set up and run ANY kind of machine; **MAKE MORE MONEY NOW** by learning quickly **HOW TO DO THINGS** which usually take years of study and practice. The demand for **SKILLED men** is **ALREADY** far ahead of the supply, then what **WILL IT BE** a month or two from now?

**Needed NOW!**

**Bigger Pay** Don't miss this chance to qualify for promotion, don't miss this Big Opportunity which is yours almost for the asking. Seven Big Books chockful of important mechanical facts told simply and clearly. Over 2600 pages, nearly 2700 illustrations cover every subject fully, including Tool Making, Pattern Making, Foundry Work, Mechanical Drawing, Forging, Machine Shop Practice and Management, and hundreds of other subjects.

**7 Big Books Sent FREE** for examination. Yes ALL of these books will be sent to you for examination. Decide in your own home or place of business whether or not you want to keep them, check up on any facts you want to. Note their great **MONEY MAKING** value, then, if you want them, pay on the easiest kind of payments. Send **NOW** and we will include a year's consulting membership in the American Technical Society without extra charge.  
American Technical Society, Dept. 5919, Drexel at 58th St., Chicago.

American Technical Society, Dept. 5919, Drexel at 58th St., Chicago.  
You may send me the 7 big NEW books for free examination. I will pay the few cents delivery charges only, unless I decide to keep them in which case I will send \$2.00 in ten days and \$3.00 per month until the total price of only \$29.80 is paid. If I return them in 10 days I will owe you nothing. Because I send now, you agree to give me a membership in the American Technical Society entitling me to Free consulting privileges with any of your experts for one year.  
Name.....  
Address.....  
Please attach a letter stating age, occupation, employer's name and address and that of at least one business man as reference.



## Learn this Profitable Profession

**in 90 Days at Home**

Hundreds of men and women of all ages 18-50 make \$10.00 to \$20.00 in a single day giving scientific Swedish Massage and Hydro-Therapy treatments. There is a **big demand** from Hospitals, Sanitariums, Clubs, Doctors and private patients as well as opportunities for establishing your own office. Learn this interesting money-making profession in your own home by mail, through our home study course. Same instructors as in our **NATIONALLY KNOWN** resident school. A diploma is awarded upon completion of the course. Course can be completed in 3 to 4 months. High School training is not necessary. Many earn big money while learning.



### Anatomy Charts & Booklet FREE

Enroll now and we will include uniform coat, medical dictionary, patented reducing roller and Hydro-Therapy supplies without extra cost. The reducing course alone may be worth many times the modest tuition fee.

Send coupon now for Anatomy Charts and booklet containing photographs and letters from successful graduates. These will all be sent postpaid—FREE.

THE College of Swedish Massage (Successor to National College of Massage) Dept. 964—30 E. Adams St., Chicago.  
You may send me **FREE** and postpaid, Anatomy Charts, booklet containing photographs and letters from graduates, and complete details of your offer.

Name.....  
Address.....  
City..... State.....

## I'LL TRAIN YOU AT HOME IN SPARE TIME to MAKE GOOD MONEY in RADIO and TELEVISION



**Easy to Start . . . Earn While You Learn**  
Wake up! Get ahead! You fellows with ambition can make a wonderful success in Radio and Television through my new, practical, home training. I teach you in your spare time through interesting experiments with real equipment. Every essential phase of Radio, Television, Electronics, Facsimile, Radio Set Repair and Installation is covered. You get Personalized help. No previous experience needed. So practical—so understandable—so simplified is this training that any man with average education can grasp the money-making knowledge quickly and easily. You will be ready for a business of your own . . . or to hold down a good-paying job. My **BUSINESS BUILDERS** show you how to make profits while learning.  
**BIG FREE BOOK!** Get complete details in new catalog "HOW TO MAKE MONEY IN RADIO". Write Sprayberry Academy of Radio, 210-M, University Place, N. W., Washington, D. C.

- YOU GET**
- 146 RADIO PARTS
  - RADIO TOOLS
  - ALL WAVE ALL PURPOSE ANALYZER

## VOICE

**100% Improvement Guaranteed**  
We build, strengthen the vocal organs—not with singing lessons—but by fundamentally sound and scientifically correct silent exercises . . . and absolutely guarantee to improve any singing or speaking voice at least 100% . . . Write for wonderful voice book—sent free. Learn WHY you can now have the voice you want. No literature sent to anyone under 17 years unless signed by parent.  
**PERFECT VOICE INSTITUTE, Studio 1359**  
64 E. Lake St., Chicago

## GET INTO THE BAKING BUSINESS!

National Baking Institute announces a new home study course in commercial baking. Baking now America's fifth industry in wages. Nearly a depression-proof business. Good field for ambitious men. Common school education sufficient. Send for free booklet "Opportunities in Commercial Baking" and requirements.  
**National Baking Institute**  
3601 Michigan Ave. Dept. 1359 Chicago, U. S. A.



## ENGINEERING DEGREE IN TWO YEARS

B. S. Degree courses in engineering: Electrical, Civil, Chem., Mechanical, Radio or Aeronautical. 1 yr. Mech. Drafting. Approved by Civil Aeronautics Authority, participation in Pilot Training Program. Large industrial center. Prep courses without extra charge. Earn board if desired. Low tuition. Enter December, March, June, September. Write for Catalog.  
239-A E. Washington Blvd., Fort Wayne, Ind.  
**INDIANA TECHNICAL COLLEGE**

## NEW WAY TO CHOOSE A CAREER

**LET SCIENCE PICK A JOB FOR YOU!**  
TODAY, getting a job or choosing a career is no longer a hit-or-miss task. Science can now accurately determine for you, in advance, just what type of work or profession you are best suited for. **FREE** No money. Send your name on a penny postcard for your own personal Occupational Adjustment Test absolutely free. Why waste time or money groping aimlessly when new scientific methods show you proven steps to success? Write at once for details and **FREE** Adjustment Test!  
Vocational Guidance Institute, Dept. A-112, Greenway Sta., Tucson, Ariz.

## PARKS AIR COLLEGE

PARKS AIRPORT EAST ST. LOUIS, ILL.

Offers **YOU COLLEGE** and **PROFESSIONAL TRAINING** Majoring in **AVIATION**

Accredited by the Illinois Superintendent of Public Instruction. U.S. approved as a Commercial Ground and Flying School and Mechanics' School. Accredited by and cooperating with the United States Army Air Corps in giving flight and mechanical training. Open to high school graduates. **FOUR** courses lead to B.S. degrees in Professional Piloting, Aviation Operations, Maintenance Engineering, Aeronautical Engineering. **SEVENTEEN TRAINING PLANES** are used in professional flight training which prepares graduates for airline flight operations. 74% of graduates enter air transportation in North and South America. 76,000 hours flight training given, 1800 hours being flown monthly. **FACULTY** of 48 specialists in various fields of aviation. 1569 graduates. Enrollment limited to a total of 300 commercial aviation students. Total enrollment 415. 100-acre airport, 18 buildings devoted to school purposes exclusively. Dormitories and dining hall at the College. Winter Term January 8. Send postcard for new 64-page catalog.  
**13th YEAR** Registrar, Dept. PM-12  
**PARKS AIR COLLEGE, East St. Louis, Ill.**



# "Hi Fellers! I'M GETTING A GRETSCH DRUM THIS CHRISTMAS!"



You'll never forget the thrill of owning your first real drum... a GRETSCH DRUM... the kind that big-name drummers play, stars like Bernie Mattinson, Billy Gladstone, O'Neil Spencer. Drums that big band leaders prefer above all others. Here's a present for you ambitious chaps that leads to a money-making career later. No tedious lessons necessary; playing a drum comes naturally to any *regular* boy! Cultivate a hobby *today* that can make *big* money for you tomorrow.

Send penny postcard for FREE DRUM Catalogue and full information about EASY-PAYMENT Plan and FREE TRIAL through your GRETSCH dealer. Address Dept. PM-120.

**EASY TO PLAY  
★  
EASY TO PAY**

**The FRED. GRETSCH MFG. CO.**  
Musical Instrument Makers Since 1883  
60 BROADWAY, BROOKLYN, N. Y.

GRETSCH also offers SUPER VALUES in Guitars, Saxophones, Trumpets, Trombones, Accordions. Send for FREE catalogue. Mention instrument.

## LEARN PHOTOGRAPHY

Our staff of noted experts will teach you Commercial, News, Portrait, Advertising, Natural Color or Motion Picture photography. For pleasure or career. Wonderful opportunities. Personal Attendance and Home Study courses. Free booklet.

**from Experts**

**NEW YORK INSTITUTE OF PHOTOGRAPHY**  
10 West 33 Street (Dept. 49) New York City

## ANY BOOK IN PRINT!



Delivered at your door. We pay postage. Standard authors, new books, popular editions, fiction, reference, medical, mechanical, children's books, etc.—all at guaranteed savings. Send card now for Clarkson's 1940 Catalog.

**FREE** Write for our great illustrated book catalog. A short course in literature. The buying guide of 300,000 book lovers. The answer to your Christmas gift problem. **FREE** if you write **NOW—TODAY!**

**CLARKSON PUBLISHING COMPANY**  
Dept. PM5—1255 So. Wabash Ave., Chicago, Ill.

## Correspondence Courses in RADIO and ELECTRICAL ENGINEERING

LOW AS \$25



**ELECTRICAL ENGINEERING.** Get good grasp of wide electrical field. Modern. Very understandable. Theory made easy.  
**RADIO ENGINEERING.** Extra fine course in radio, public address, photo-electric work. Trains you to be super-service man, real vacuum tube technician. Tuition ONLY \$25. either course. Deferred payment plan. Experiment kits furnished.  
**FREE** Write for free copies of school catalogs, student magazines, etc.

**FREE LINCOLN ENGINEERING SCHOOL.** Box 931-P12, Lincoln, Nebr.

## SURE ROUTE TO HAPPY-LAND

MAIL TODAY SURE

**J. C. DEAGAN, Inc., Dept. 3459**  
1770 Berteau, Chicago

Without cost or obligation, tell me about the easy-to-play DEAGAN MARIMBA... its sensational rise in the music world... the fun it provides at parties... the opportunities for radio, stage and dance-band fame.

**EASY TO PLAY**

Name—Please PRINT  
Address

## ARE YOUR Chances

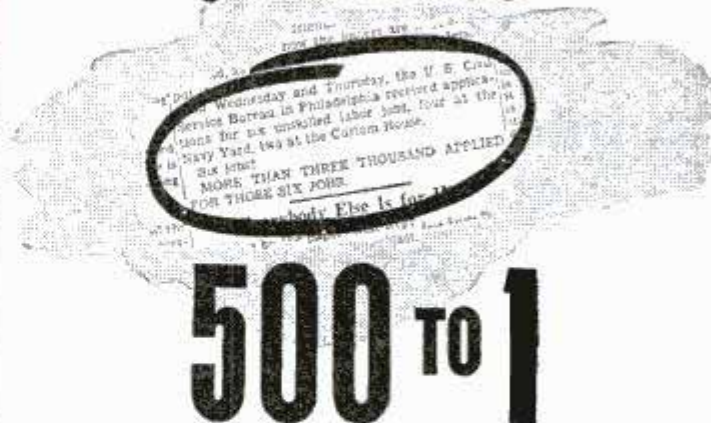

**SIX JOBS**—three thousand applicants! That's what the *untrained man* is up against! That's what *you're* up against—unless you get the sound, essential training you need.

Fortunately, you *can* get it—if you're willing to face the facts of your own case. For nearly 50 years, men in your position have turned to the International Correspondence Schools.

I. C. S. provided them with a sound program of spare-time study—texts prepared by outstanding authorities—personalized, intelligent instruction.

Clip the coupon. Check the subject you are interested in mastering. Mail it—today. That simple act may be your first step to a brighter future!

## INTERNATIONAL CORRESPONDENCE SCHOOLS

BOX 5560-J, SCRANTON, PENNA.

Explain fully about your course in the subject marked X:  
**TECHNICAL AND INDUSTRIAL SUBJECTS**

- |   |  |   |
|---|--|---|
| <input type="checkbox"/> Agriculture                  | <input type="checkbox"/> Air Brakes                | <input type="checkbox"/> Manufacture of Pulp Paper  |
| <input type="checkbox"/> Air Conditioning and Cooling | <input type="checkbox"/> Marine Engineering        | <input type="checkbox"/> Mechanical Drafting        |
| <input type="checkbox"/> Architectural Drafting       | <input type="checkbox"/> Mechanical Engineering    | <input type="checkbox"/> Navigation                 |
| <input type="checkbox"/> Architecture                 | <input type="checkbox"/> Patternmaking             | <input type="checkbox"/> Pharmacy                   |
| <input type="checkbox"/> Auto Electric Technician     | <input type="checkbox"/> Plumbing                  | <input type="checkbox"/> Poultry Farming            |
| <input type="checkbox"/> Auto Technician              | <input type="checkbox"/> Aviation                  | <input type="checkbox"/> Public Works Engineering   |
| <input type="checkbox"/> Boilermaking                 | <input type="checkbox"/> Bridge Engineering        | <input type="checkbox"/> Radio                      |
| <input type="checkbox"/> Building Estimating          | <input type="checkbox"/> Chemistry                 | <input type="checkbox"/> R. R. Locomotives          |
| <input type="checkbox"/> Civil Engineering            | <input type="checkbox"/> Coal Mining               | <input type="checkbox"/> R. R. Section Foreman      |
| <input type="checkbox"/> Contracting and Building     | <input type="checkbox"/> Cotton Manufacturing      | <input type="checkbox"/> R. R. Signalmen            |
| <input type="checkbox"/> Diesel Engineering           | <input type="checkbox"/> Electrical Engineering    | <input type="checkbox"/> Refrigeration              |
| <input type="checkbox"/> Electrical Engineering       | <input type="checkbox"/> Electric Lighting         | <input type="checkbox"/> Sheet Metal Work           |
| <input type="checkbox"/> Foundry Practice             | <input type="checkbox"/> Fruit Growing             | <input type="checkbox"/> Steam Electric Engineering |
| <input type="checkbox"/> Heating                      | <input type="checkbox"/> Heat Treatment of Metals  | <input type="checkbox"/> Steam Engineering          |
| <input type="checkbox"/> Highway Engineering          | <input type="checkbox"/> House Planning            | <input type="checkbox"/> Structural Drafting        |
| <input type="checkbox"/> Machinist                    | <input type="checkbox"/> Management of Inventions  | <input type="checkbox"/> Structural Engineering     |
| <input type="checkbox"/> Managing Men at Work         | <input type="checkbox"/> Welding, Electric and Gas | <input type="checkbox"/> Surveying and Mapping      |
|   | <input type="checkbox"/> Woolen Manufacturing      | <input type="checkbox"/> Telegraph Engineering      |
|   |  | <input type="checkbox"/> Telephone Work             |
|   |  | <input type="checkbox"/> Welding, Electric and Gas  |
|   |  | <input type="checkbox"/> Woolen Manufacturing       |

### BUSINESS SUBJECTS

- |  |  |   |
|--|--|---|
| <input type="checkbox"/> Advertising             | <input type="checkbox"/> Bookkeeping         | <input type="checkbox"/> High School Subjects         |
| <input type="checkbox"/> Business Correspondence | <input type="checkbox"/> Business Management | <input type="checkbox"/> Illustrating                 |
| <input type="checkbox"/> Business Management     | <input type="checkbox"/> Cartoonying         | <input type="checkbox"/> Lettering Show Cards         |
| <input type="checkbox"/> C. P. Accounting        | <input type="checkbox"/> Civil Service       | <input type="checkbox"/> Railway Postal Clerk         |
| <input type="checkbox"/> Cost Accounting         | <input type="checkbox"/> College Preparatory | <input type="checkbox"/> Salesmanship                 |
| <input type="checkbox"/> Foremanship             | <input type="checkbox"/> College Subjects    | <input type="checkbox"/> Service Station Salesmanship |
| <input type="checkbox"/> Foremanship             | <input type="checkbox"/> French              | <input type="checkbox"/> Signs                        |
| <input type="checkbox"/> Grade School Subjects   |  | <input type="checkbox"/> Spanish                      |
|  |  | <input type="checkbox"/> Stenography and Typing       |

### DOMESTIC SCIENCE SUBJECTS

- |   |  |
|---|--|
| <input type="checkbox"/> Advanced Dressmaking | <input type="checkbox"/> Professional Dressmaking and Designing      |
| <input type="checkbox"/> Foods and Cookery    | <input type="checkbox"/> Tea Room and Cafeteria Management, Catering |
| <input type="checkbox"/> Home Dressmaking     |  |

Name..... Age.....  
Address.....  
City..... State.....

Present Position.....  
Canadian residents send coupon to the International Correspondence Schools Canadian, Limited, Montreal, Canada. British residents send coupon to I. C. S., 71 Kingsway, London, W. C. 2, England.



# INVENTORS

*Act Now* TO PROTECT  
YOUR INVENTION WITH U.S. PATENT

## Small Ideas May Have Large Commercial Possibilities

Inventions do not have to be complicated to be profitable when Patented. The 5c and 10c stores flourish on simple Patented products which are commercially successful. The zipper, safety pin, thumb tack, paper clip, collar button—all are simple yet familiar inventions—brought their inventors rich rewards. If you have a Patentable invention—act to protect it. Send for our FREE 48-Page Book that tells you how.

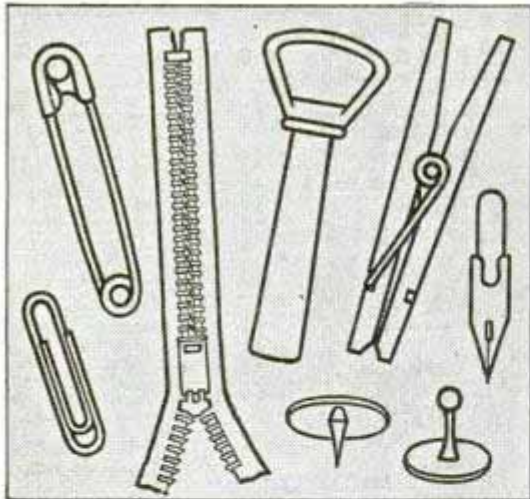

CLARENCE A. O'BRIEN

Dept. 9M1 Adams Building, Washington, D. C.  
Registered Patent Attorney before U. S. Patent Office

## Free Book TELLS IMPORTANCE OF QUICK ACTION—HOW TO OBTAIN PATENT AND MARKET INVENTIONS

If you have invented something, if you're interested in inventing something, you need our new 48-page book that gives the entire Story of Patents. It tells you for the first time about new phases of invention, how others succeeded, how the patent laws protect you, how to market your invention, where to obtain finances, how to form a company, partnership, or arrange for royalties from your invention's sale.

### PRACTICAL BENEFITS OF THIS BOOK

You will find 6 complete pages illustrated with simple inventions that have succeeded in six different fields of industry. Over 100 illustrations are in this book. You will read the stories of ten (illustrated) of America's most famous inventors. You will find an experienced and thorough survey of market conditions affecting the inventor—showing the possibilities for commercial invention today. Entire chapters are devoted to the value of a patent in promoting the final success of your invention. The importance of quick action in applying for patent is stressed—facts revealing danger of delay are emphasized.

If you expect to realize profits from your invention you must protect it with a U. S. Patent. Otherwise you may find that all your time and labor have been lost, because it often happens that other inventors are working on the same invention. If you have an invention, or an ambition to invent—get the information on obtaining patent AT ONCE!

### FREE RECORD OF INVENTION FORM

When you send for our FREE BOOK, we include, also Free, our specially prepared Record of Invention blank, on which you can quickly make and date a sketch and description of your invention. This "disclosure" as it is called, may be absolutely invaluable as evidence for you, should your rights ever be contested. Be sure to get it and use it.

# CLARENCE

REGISTERED PATENT ATTORNEY before U. S. Patent Office



*for  
Quick  
Action*

**SEND  
TODAY**



**GET FREE 48-PAGE BOOK**  
and Free Form for Recording Your Invention

**MAIL COUPON NOW**  
**TO CLARENCE A. O'BRIEN**  
*Registered Patent Attorney*  
BEFORE U. S. PATENT OFFICE

Clarence A. O'Brien, Dept. 9M1, Adams Building, Washington, D. C.  
Please send me your Big, Free 48-Page Book for Inventors and your Specially Prepared Record of Invention form. This request does not obligate me.

Name.....

Address.....

City.....

State.....

(Please write or print plainly).

*You Can Patent*  
**MACHINERY, ARTICLES, DESIGNS, FORMULAS, ETC., IF NEW**

**IMPROVEMENTS IN**  
**MACHINERY, ARTICLES, DESIGNS, FORMULAS, ETC., IF NEW**

Every year thousands of Patents are granted. Very few, however, represent the discovery of entirely new principles. Most of them provide new methods of doing some every-day thing in a better way—changes for greater efficiency, usefulness, adaptability, or beauty in some previously Patented thing. These IMPROVEMENTS are patentable if new, and actually represent new inventions. These improvement Patents offer large chances for profit if commercially useful. The business world wants improved products and services.

#### FINISHED DRAWINGS NOT NECESSARY

Our Big Book tells you how you can start immediately to apply for Patent Protection even if you haven't finished models or drawings available now. It will tell you how we can prepare the specifications and finished drawings necessary in the form prescribed by the Patent Office—so as to secure for you full Patent Protection. Mail Coupon for Our Big Book TODAY.

#### OUR SERVICES TO YOU

We are Registered Patent and Trade-Mark Attorneys, serving Inventors all over the United States and abroad. Our Organization is complete. We have Draftsmen, experienced Searchers and Attorneys to serve your interests.

We can act as your legal adviser in all Patent Matters. Our complete service is described in Our Big Book. Mail Coupon for it NOW.

#### REASONABLE FEES—CONVENIENT TERMS

Don't worry about finances. Our fees are very reasonable—we can arrange convenient terms of payment. It is our custom to permit clients to pay for our services in installments as the application progresses in our office. See our Big Book for fees in obtaining Patent. It explains our arrangements clearly. Send for it NOW.

#### GET FREE BOOK—MAIL COUPON NOW

If you have an invention in the making—if you simply have the crude elements of an invention in mind—you should have our Big FREE BOOK without delay. It will guide you every step of the way—from the preliminary search stage to the issuance of the final patent grant. This book contains twenty-five chapters describing in plain man-to-man language the story of obtaining a patent and marketing an invention. This book is absolutely FREE—just tear off the above coupon or write us a letter or postcard TODAY!

**CLARENCE A. O'BRIEN**

Adams Building, Dept. 9M1, Washington, D. C.  
Registered Patent Attorney before U. S. Patent Office

**A. O'BRIEN**

**Dept. 9M1, Adams Building . . . . . WASHINGTON, D. C.**



# POPULAR



# INVENTIONS

2915  
**O**F PARTICULAR interest while nations are at war is a newly patented submersible aircraft which would serve the dual purpose of scouting enemy ships from the air and then diving into the water and torpedoing them. The craft would have wings which could be folded against

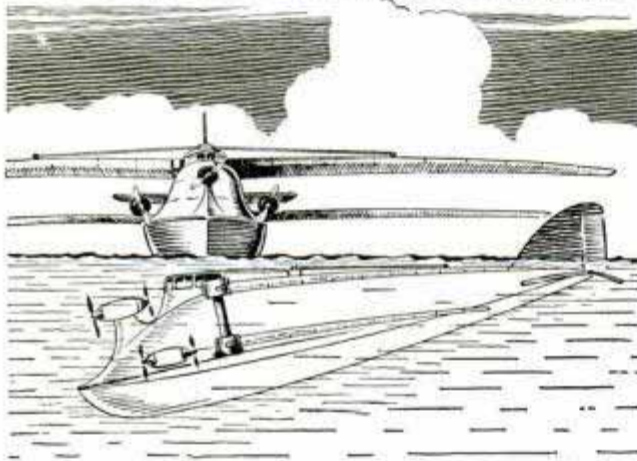

the hull during operations beneath the water's surface. The power plant would turn propellers for operations in the water and air screws in the air. In theory, the craft would be a flying boat, taking off and alighting on the water. When its commander desired to dive, the wings would be folded, the hull made watertight and machinery adjusted for submarine work.

**R**EADING would be made more enjoyable by a recently patented indicator that gives a positive indication of the page number and the line of the page where the reader has left off while reading a book. It has an elongated strip with a fold at one end to engage the



upper end of a page and a slot lengthwise for engaging and guiding a numbered indicator up or down the page to the last line read. The indicator also provides the reader with information of the month, date and page where the reader discontinued.

**H**ANDY for the automobile repair shop lacking space for a permanent installation is a newly patented portable wheel-aligning machine. It consists of a pair of supports for the wheels, a crossbar which provides a fixed reference, a pair of aliner heads adapted for mounting to move with the wheels, and bars to indicate the angular position of the wheels. When not in use the machine may be stored in a small space.

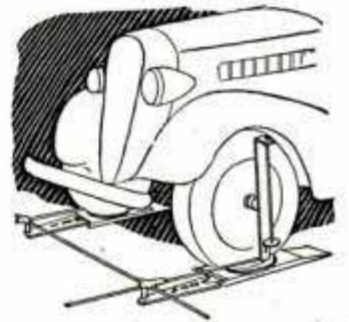

**M**ORE comfort for the trailer traveler is the objective of a folding wall construction method patented recently. The patent covers an expansible building on wheels, with a permanent central section, an extensible roof section, an extensible floor section and an outer wall section. These various extensible sections may be moved on tracks to expand the trailer into a considerably larger structure, thus giving more space for the traveler to cook, eat and sleep on the road.

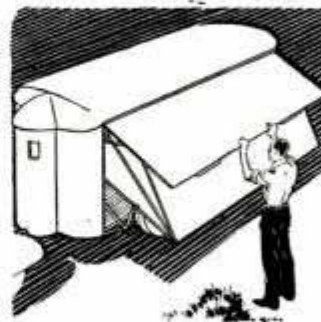

(Continued to page 24A)



**Briar Hill STOKERS** — FOR PARTICULAR SMOKERS

ONE MATCH AND YOUR PIPE STAYS LIT

PATENTS PENDING

GENUINE IMPORTED BRIAR • NO BREAK-IN

NO SOGGY HEEL • NO BITE • NO RELIGHT

**Briar Hill** The **IDEAL GIFT PIPE** FOR NEW SMOKING PLEASURE

THIS PIPE REALLY STAYS LIT

Why give "just another pipe" when you can get the pipe that makes all others obsolete. It's converting a nation to new smoking pleasures and making pipe smokers of thousands who have said they couldn't smoke a pipe. It eliminates those petty annoyances . . . stays lit . . . burns all the tobacco . . . leaves no soggy heel. Every puff is cool, dry and velvety.

Choose your gift pipes from the shapes below. Order one for yourself too. Don't go hunting or fishing without one. **\$1.50 EACH**

The Briar Hill "Pioneer" is a fine pipe. Genuine imported briar . . . unexcelled in workmanship and smoking qualities fitted with the Briar Hill Stoker.

YOUR OWN PIPE can be fitted with a Briar Hill Stoker. Put a ONE DOLLAR BILL with your pipe BOWL and mail to us. (Pack it well . . . do not mail the stem.)

See our full page ad in December Popular Science.

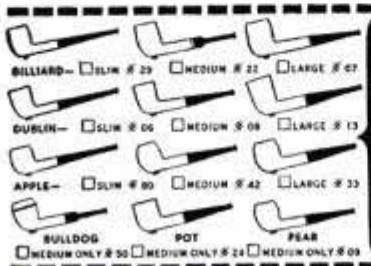

BE SURE TO CHECK YOUR CHOICE

**BRIAR HILL CORP.** MILLERSBURG, OHIO

Enclosed is \$..... Send Briar Hill "Pioneer" Stoker pipes checked at left.

Enclosed is \$1.00 and my favorite pipe. Please "fix it so it will stay lit."

Send Briar Hill chart of full size illustrations.

Name .....

Address .....

City and State.....

12-39-P.M.

**Learn THE GREER SHOP WAY!**

**WELDING** **BE A TRAINED MAN**

**AIR CONDITIONING**

**DIESEL**

**BODY AND FENDER**

**AUTO**

**MACHINE SHOP**

You can earn more if you learn a trade—qualify quickly the easy **JOB-SHOP** way. Big shops—lots of equipment—experts teach you. Established 37 years. Employment help. Write **TODAY** for FREE information and special offer.

**GREER SHOP TRAINING, INC.**  
2024-6 S. Wabash Ave., Chicago, Ill.



**LEARN CARTOONING!**

Let a prominent cartoonist teach you this fascinating profession by mail. PERSONAL instruction, just like private tutoring. Recommended by America's foremost cartoonists. Write for free details.

**DORMAN H. SMITH, Box C597, SAN RAFAEL, CALIF.**

**Best Poultry Paper 6 BIG ISSUES 10¢**

Helps Increase Poultry Profits. Send coin or stamps. 50 cents for 3 years or 10 cents for 6 months trial. Agents wanted. **American Poultry Journal**  
532 So. Clark Street Chicago, Illinois

**CASH IN ON SPARE TIME**

**\$30 WEEKLY OR MORE EARN.** Grow mushrooms HOME. Cellar, shed suitable. We buy 30c lb. Year round business.

**\$270** made by Mr. B. in few weeks **SPARE TIME.** Guaranteed materials. Established 1931. Write for **FREE BOOK.**

**WASHINGTON MUSHROOM INDUSTRIES, Dept. 601, 2019 2nd Seattle, Wash.**

**MYSTERIOUS DEVICE WELDS BRAZES AND SOLDERS ANYONE CAN OPERATE**

Now, an electric welding, brazing and soldering Torch, complete with power unit, goggles and supplies. **Works INSTANTLY off any light socket.** Does a thousand and one repair jobs at amazingly **LOW COST** on aluminum, iron, steel and other metals. **Indispensable** for Auto, Body and Fender Repairs, and home repairs—shop, factory, farm, engineer, janitor, sheet metal, radio and bicycle repairs. Anyone can handle without previous experience with our simple **10-DAY HOME TRIAL** instructions.

Write at once for Special Introductory Low Price Offer. Try 3 in 1 Electric Torch for 10 days at our risk, or get one free by helping to introduce it. **ELECTRO-TORCH CO., 2513-FN Michigan Ave., Chicago**

**Start a Profitable BUSINESS of Your Own**

**Get the New 450 Page Book MONEY MAKING FORMULAS**

Fortunes have been made from a single formula like thousands in this money-making book. Modern, up-to-the-minute. Contains valuable information on how to make, package and sell cosmetics, household, auto, shop and other articles of all kinds. Nothing like it elsewhere. Rush postcard for free, illustrated circular.

**GET INTO INDUSTRIAL DESIGNING and DRAFTING**

Learn to make the drawings and blue prints with which all industry begins; learn also how to create new designs and new products. Learn how to improve and re-style old products so they have more "eye appeal", more selling power. Drafting is a very big field, but drafting with industrial designing is twice as big. Factories must continuously bring out new models, new products, and improved designs. You can learn both subjects right in your own home, in your spare time. You can be trained for better pay. I can prepare you just as I have trained many hundred successful students from 16 to past 50. I'll train you thoroughly by applied instruction on actual work until you are holding a good paying position. Complete working outfit furnished without extra charge. Send coupon for **FREE BOOK "Industrial Designing and Drafting"**. Engineer Dobe, Libertyville, Illinois.

**Engineer Dobe, Div. 3379 Libertyville, Ill. Send for FREE BOOK**

Please send me **FREE BOOK** on "Industrial Designing and Drafting", also please explain how you assist your graduates to good positions in these fields.

Name .....

Address .....

Town..... State..... Age.....

Always write your name and full address clearly when answering advertisements.





**Know Electricity as Experts  
Know It—and Get an Expert's Pay!**

What about your future? Who is safe today? Surely not the man who is contented to stand still! Know your job thoroughly—prepare yourself for jobs ahead. To do just this thousands of men have used

**The Croft Library of  
Practical Electricity**

The Croft Library is a complete electrical educator. It is founded on practice—on 20 years of shirt-sleeve experience—on work as it is actually done. It is jammed from cover to cover with the kind of hard-headed facts you want. Written so that the beginner can easily understand it, yet so sound, so thorough, that it is the daily guide of 59,000 highly paid electrical workers and engineers. Croft tells you the things you need to know about motors, generators, armatures, commutators, transformers, circuits, switchboards, distribution systems—electrical machinery of every type—illumination in its every phase—the most improved methods of lighting—lamps and lamp effects, etc.—how to do a complete job, from estimating it, to completion.

**6 volumes, 2155 pages — New low price  
No money down — Easy payments.**

Fill in and mail the coupon attached and we will send you the entire set of six volumes for ten days' Examination on approval. We take all the risk—you assume no obligation. If you decide to keep the books, send \$1.50 in ten days and the balance at the rate of \$3.00 a month. Send the coupon NOW and see the books for yourself.

**EXAMINATION COUPON**

McGRAW-HILL BOOK CO., 330 W. 42nd St., New York

Send me for ten days' examination on approval the Croft Library of Practical Electricity. If satisfactory I will send you \$1.50 in 10 days and \$3.00 monthly until the price of \$16.50 is paid. If not wanted, I will return the books postpaid. (To insure prompt shipment write plainly and fill in all lines.)

Name.....

Home Address.....

City and State.....

Position.....

Name of Company..... P.M. 12-39

**MECHANICS**

**KNOW  
YOUR  
CAR**

**You Need  
this  
Book**

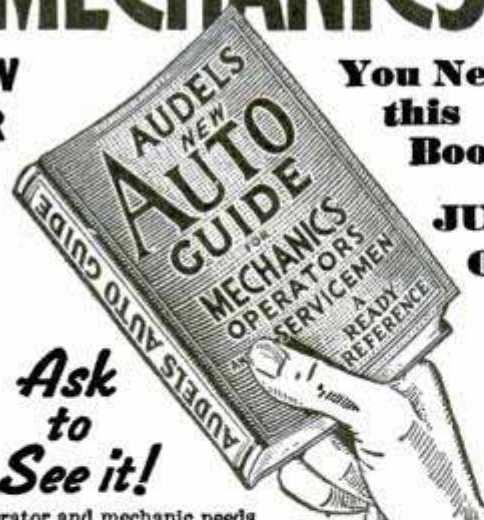

**JUST  
OUT!**

**Ask  
to  
See it!**

Every operator and mechanic needs AUDELS NEW AUTO GUIDE. This book saves time, money and worry. Highly endorsed. It presents the whole subject of auto mechanics: 1—Basic principles, 2—Construction, 3—Operation, 4—Service, 5—Repair. Easily understood. Over 1500 pages—1540 illustrations showing inside views of modern cars, trucks and buses with instructions for all service jobs. Diesel Engines fully treated, fully illustrated. To Get This Assistance for Yourself Simply Fill in and Mail Coupon Today.

**4 COMPLETE • PAY ONLY \$1. A MONTH ←**

THEO. AUDEL & CO., 49 WEST 23rd STREET, NEW YORK Please send me postpaid AUDELS NEW AUTOMOBILE GUIDE (\$4) for free examination. If I decide to keep it, I will send you \$1 within 7 days; then remit \$1 monthly until purchase price of \$4 is paid. Otherwise, I will return it to you promptly.

Name .....

Address .....

Occupation .....

Reference .....

PM

29/3

**POPULAR INVENTIONS**

(Continued from page 22A)

**H**ANDY for the gardener is an anti-weed gun patented recently. It may

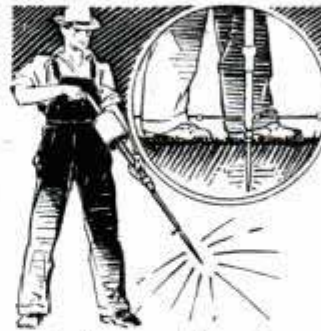

be used for spraying in open air to kill plants above the ground; then it may be employed to attack the roots of weeds by forcing its point to the desired depth in the soil

and depressing the pump plunger to apply poison chemical. The gun weighs eight pounds and holds a gallon and a half.

**L**OWERING a disabled plane to the ground by parachute is not a new idea,

but a recently granted patent indicates that inventors are hard at work on the problem of preventing crashes. The latest invention in the field calls for attachment of a parachute to the plane, with a guide tube on each side of the fuselage for opening or closing the parachute. In an emergency the chute would be spread quickly by means of operating cords.



**F**OR taking curves smoothly, a newly patented device permits banking of the

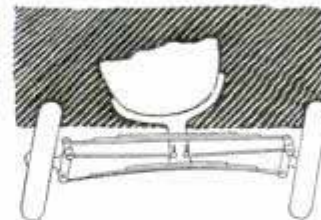

wheels without altering the horizontal position of the automobile's body. It consists of a pair of spread-apart axles complete with leaf springs and connections for controlling the action without danger. The wheel banking device might be especially useful in auto racing.

Due to the fact that many of the devices described in this department are still in the patent office stage and are not on the market, Popular Mechanics Magazine cannot undertake to supply further information regarding them.





**FREE BOOK TELLS HOW YOU CAN LEARN TO MOUNT BIRDS and ANIMALS**

**BE A TAXIDERMIST—Learn by Mail**

Easy home lessons teach you quickly how to MOUNT BIRDS, ANIMALS, GAME-HEADS, FISH—to TAN LEATHER, FURS. Save your hunting trophies. Have a home museum. It's thrilling! Taxidermy is wonderful. FUN, A PLEASURE HOBBY AND A MONEY MAKER:—Investigate! Get this strange FREE BOOK. **EXTRA MONEY:**—Earn in your spare time. Sell your mounts; and do work for other sportsmen. Students report \$30 to \$75 and more per month. Big demand. Fine prices. If you want REAL PROFIT from spare time WRITE TODAY. **FREE BOOK**—with 100 photos of wild game. Tells about Taxidermy and how YOU can learn, easily, quickly. Old reliable school. 275,000 students. — STOP this minute and TEAR OUT THIS AD NOW as a reminder; then write; get the free book. You will be delighted, AMAZED. RUSH postal or letter and learn how to have more FUN, FASCINATION, PROFIT. State your AGE.

Northwestern School of Taxidermy, Dept. 3379 Omaha, Neb.

**FREE TRIAL LESSON**

**FREE TRIAL LESSON IN DRAFTING**

More good jobs now in Drafting. Learn AT HOME in spare time (or at our Chicago School). Send postcard for FREE TRIAL LESSON and see how easy to learn and get a good job.

**CHICAGO TECHNICAL COLLEGE**  
S-200 Tech Bldg., 118 E. 26th St., Chicago, Ill.

**STUDY ENGINEERING AT HOME**

**Earn a Degree at Home**

From A Chartered Institution Of Higher Learning Employers Demand Degree Men For Key Positions

88 Degree Courses in Electrical, Mechanical, Civil, Structural, Diesel, Architectural, Drafting, Automotive, Aeronautical, Radio, Refrigeration, Air Conditioning, Highway, Mining, Geology, Petroleum, Marine, Industrial, Chemical Engineering, Arts, Sciences, Philosophy, Psychology; Chemistry; Education; Business Training; Law; etc.

McKinley-Roosevelt Graduate College, 4750-G Sheridan Road, Chicago

**HOW**

**How to Win Fortune, Happiness by a Book**

Money not essential to begin business or develop a winner. Too much money, unless earned by experience, usually means failure. Success develops itself. Marconi, Carnegie, automobile, telephone, telegraph, camera all started from **BOOKS**. Read **HOW**. Learn to get ahead in **sure, inexpensive way**. For free **HOW GUIDE**, write your name and address on postcard, mail today to

**R. & R. Co., 641 H. St., Melrose, Massachusetts**

**MONROE COLLEGE OF OPTOMETRY**

**Be a Doctor of Optometry.** Test eyes. Fit Glasses to improve sight. An uncrowded profession. College not operated for profit. We help to provide part time employment. Days, Evenings. Next semester begins Feb. 14. Write for Bulletin.

164 North Wacker Drive Chicago, Illinois

**Own A Profitable Greaseless DOUGHNUT BAKESHOP Start In Your Kitchen!**

Who else wants to enjoy profits from this amazing new business you can start in your own kitchen? New electrical invention turns out delicious, different Brown Bobby Doughnuts. Everybody wants them! Stores eager to sell for you. Big daily profits possible selling production of one machine at wholesale only. We supply equipment and tested money making plans. This is your chance. Send No Money. Rush postcard for FREE details.

**BROWN BOBBY CO., 620 N. Michigan Ave., Dept. D-1812 CHICAGO, ILL.**



**REAL JOBS OPEN FOR TRAINED AUTO MECHANICS**



**LEARN QUICK! 8 WEEKS practical SHOP TRAINING!**

**AUTO, DIESEL and AVIATION mechanics**

I'll train you quickly, correctly for this fascinating work, paying up to \$60 a week! Based on 25 years' experience knowing how to train men well, in the 2 biggest, best schools of their kind in the world. You learn with real tools, on real equipment, a complete, practical course in Auto, Diesel and Aviation Mechanics, so you can step out of low-pay jobs into a career in the biggest field of opportunity in America today!

**SPECIAL LOW RATE**

**SPECIAL LOW TUITION RATE IF YOU ACT NOW!**

Again McSweeney leads in real value. If you write at once we will reveal a special new low tuition rate that will amaze you, and on easy terms it makes it easy for you to train AT ONCE for a big-pay job! Write TODAY for details!

**McSWEENEY MEN MAKE GOOD!**

25 years' success means something to you! Read how others have succeeded with McSweeney training: "Just got thru writing income tax check. Money spent at your school was best thing I ever did"— Lee Grant, O.; J. W. Wiggins, Okla., says before we trained him he had no income, now has own business, money in bank and to spend! G. B. Park, Ind., says "Your training fitted me to handle any job in auto field." These men were trained in our fine big schools, best of their kind anywhere!

**TWO FINE BIG SCHOOLS**



DETROIT

**FREE BOOK!**



Send now for your copy of my big book giving all the facts and announcement of amazing new low tuition rate for short time only—but you must write at once!



KANSAS CITY

Address nearest school:

**McSWEENEY TRADE SCHOOL**  
Dept. D-7, Detroit, Mich., or Kansas City, Mo.  
Without cost or obligation send me your big FREE book.

NAME.....  
STREET.....  
TOWN..... STATE..... AGE.....

When writing please mention Popular Mechanics





# DRAFTING

**BOOKS SENT FREE!**

**ON APPROVAL**  
**5 VOLUMES BRAND NEW EDITION**  
 Only 15 minutes a day with these WONDER BOOKS can prepare you for a good drafting job in less than a year. Mechanical and architectural drafting from simple straight lines to important complex plans. *A step at a time!* Built especially for beginners, for men with only grammar schooling. Drafting room practice, PLUS ENGINEERING, made easy and clear. Includes complete information on blue print reading for building and machine trades.

**Big Field Big Demand Big Pay**  
 Competent draftsmen are urgently needed right now in all building and manufacturing lines at \$30.00 to \$75.00 a week. That's just the beginning—FOR DRAFTSMEN HAVE THE BEST CHANCES FOR ADVANCEMENT. Pleasant, fascinating work, easy to learn and do. Learn quickly with these books—send coupon for a set and see for yourself.

*A year's consulting membership in the American Technical Society now given to all readers of this famous cyclopedia of drafting. Many say that it is worth more than the cost of the books.*

Complete set of drawing instruments if you send for these drafting books NOW. These instruments are made of the finest of German silver, are absolutely accurate and are packed in velvet lined leatherette pocket case. Real \$10 value, but included with these books.

**AMERICAN TECHNICAL SOCIETY**  
 Dept. D919, Drexel at 58th St., Chicago, Ill.

## For Beginners or Experts

Written, so you can understand every word, by 22 well known engineers and architects. De-Luxe flexible binding, nearly 2,000 pages, 1546 blueprints, charts and diagrams; prepares you for a good drafting job in mechanical or architectural lines. Sent for 10 days' free use if you mail coupon immediately.

## These Instruments Included



American Technical Society, Dept. D919, Drexel at 58th St., Chicago, Ill.  
 Send for 10 days' trial. New 5 volume set of drafting. I will pay the few cents delivery charges. If I wish, I may return books in 10 days and owe you nothing but if I decide to keep them, I will send \$2.00 after 10 days, then only \$3.00 a month until \$24.80, the advertising price, is paid. Send latest edition and include drawing instruments and Membership Certificate.

Name.....  
 Address.....  
 Attach letter stating age, occupation, employer's name and address and that of at least one business man as a reference.

# MECHANICS-WELDERS - COLLISION MEN

## GOOD JOBS and Mighty GOOD PAY

Do you want to earn big money? If so let us know which of the following trades you prefer. You learn by doing. Practical work. Expert teachers. Low tuition. Personal attention. It will pay you to investigate AT ONCE. Just check the courses you'd like to take and mail today. You will receive full information, absolutely without cost or obligation. But don't delay.

### Check the Trade You'd Like to Learn

- |   |   |
|---|---|
| <input type="checkbox"/> Complete Auto Mechanics (including Diesel) | <input type="checkbox"/> Electric Arc and Acetylene Welding |
| <input type="checkbox"/> Auto Collision                             | <input type="checkbox"/> Spray Painting                     |
| <input type="checkbox"/> Metal Finishing                            | <input type="checkbox"/> Body and Fender Bumping            |

Ask about our "Pay After Graduation Plan"

Name.....  
 Address.....

Mail the above at once to

**MICHIGAN TRADE SCHOOL** Write for FREE FOLDER  
 3758 Woodward Ave. Detroit, Mich.

When writing please mention Popular Mechanics

# CLIMBING AHEAD THESE DAYS IS tough going...

... BUT... consider the hundreds of men now in Aviation who started their careers with Aero I.T.I. training. You may be right where these men once were—wondering how to get ahead faster. If so, you owe it to yourself to find out about the training that has placed so many men in the rapidly expanding Aviation industry. During one 60 day period 126 Aero I.T.I. trained men were placed with one aircraft plant alone!

**Find Out** about Aero I.T.I. training. Choice of three courses in Aircraft Mechanics, two in Aeronautical Engineering. You can take full-time courses at the school, or start your training at home. For full details, write NOW

**AERO INDUSTRIES TECHNICAL INSTITUTE**  
 5253 West San Fernando Road • Los Angeles, California

# LAW

STUDY AT HOME for Personal Success and Larger Earnings. 28 years of successful student guidance assures expert instruction. LL.B. Degree awarded. All text material furnished. Easy payment plan. Send for FREE BOOK—"Law and Executive Guidance," at ONCE.

**AMERICAN EXTENSION SCHOOL OF LAW**  
 Dept. T-12, 620 N. Michigan Ave., Chicago, Ill.

# Write and Speak MASTERLY ENGLISH



Learn correct English with Sherwin Cody's new invention. No rules to memorize. Like a fascinating game. Spare-time study, 15 minutes each day, quickly gives you command of English. Send for free book, "How You Can Master Good English in 15 Minutes a Day." Write today.  
**SHERWIN CODY SCHOOL OF ENGLISH**  
 512 Searle Bldg. Rochester, N. Y.

## WANT A GOOD PAY JOB?

Learn Tool and Die Making, Machinist Trade, Screw Machine work. Earn as much as \$50-\$60 per week. Learn by actual work in one of America's best equipped shops. Training supervised by experts. State certified. Day-Evening classes. Enter any time. Low tuition fee, employment help. Write **FREE** NOW for booklet "Practical Machine Shop Training."

**ALLIED SCREW MACHINE CO., Inc.**  
 (School Division)  
 Dept. PM-12603-9 W. Lake Street, Chicago, Ill.



# CARTOON YOUR WAY TO SUCCESS!



**DON'T COPY - LEARN TO ORIGINATE!**  
 RAYE BURNS will teach you HOW to CREATE ORIGINAL CARTOONS at home that you can SELL! Course has 26 lessons and 600 illustrations. \$2.85  
 Send name and address for free details. Only....

**RAYE BURNS SCHOOL, Dept. M-6, Box 2194, CLEVELAND, OHIO**

# How To Secure A Government Position

In the Classified Civil Service! Railway Postal Clerk, \$1900 a year regular. Postal Clerk, City Mail Carrier, \$1700 regular. Other attractive positions paying \$1260 to \$2100 a year. Our tested method helps you pass examinations. Men—Women, age 18-50, send for our FREE BOOK explaining requirements TODAY.

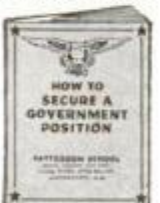

**PATTERSON SCHOOL, 812 Mercantile Bldg., Rochester, N. Y.**  
 Send, without obligation, free book "How to Secure a Government Position."

Name..... Age.....  
 Address.....



**NOV!** *World's Smallest*  
Real **RADIO**  
BEAUTIFUL — PLASTIC — CABINETS



Midget radio fits your pocket or purse. Weighs only 4 ozs. Small as cigarette package! Receives stations with clear natural tone. "PATENTED FIXED CRYSTAL" — NO UPKEEP — only one moving part. "WIRELESS, TURBLESS, BATTERYLESS." ENTIRELY NEW PATENTED DESIGN. Has enclosed geared luminous dial for perfect tuning. Many owners report amazing reception and distance.

**ONE YEAR GUARANTEE**

Sent completely ready to listen with instructions and Tinyphone for use in homes, offices, hotels, boats, in bed, etc. **TAKES ONLY A SECOND TO CONNECT—NO ELECTRICITY NEEDED! SEND NO MONEY!** Pay postman only \$2.99 plus postage on arrival or send \$2.99 (Check, M. O., Cash) and yours will be sent complete postpaid. A most unusual value. **ORDER NOW! MIDGET RADIO CO., Dept. P-12, Kearney, Nebr.**

**FOR MEN WHO WANT TO LEARN A PROFITABLE TRADE**

*Complete*  
**DIESEL TRAINING**

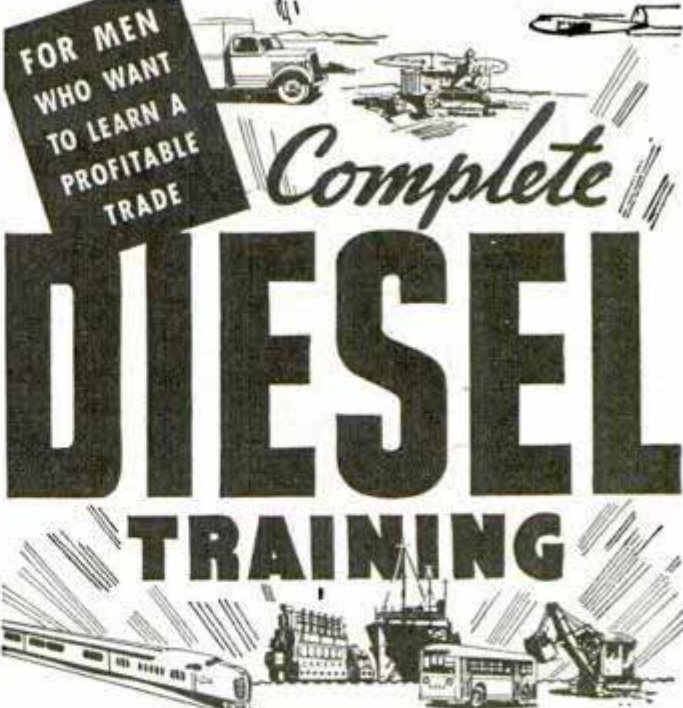

**NO MATTER WHERE YOU ARE OR WHAT YOU DO —we have a training plan for YOU!**

IF you are sincerely ambitious and interested in making good in the Diesel field, be sure to immediately investigate our flexible training plan that will fit your circumstances. A Plan for every Man. A Plan for those seeking immediate shop training as well as for those who cannot give up their present employment and income. For 34 years National Schools, a recognized leader in the field of trade education, has helped wide-awake men to success. This million-dollar trade school will supply you with a sincere, honest statement of facts of what you should do to quickly get into the profitable Diesel Industry. No exaggerations—no misstatements; and a definite plan to fit you.

**Write Today for Full Details**

**WE ARE DEFINITELY INTERESTED IN HELPING MEN OF LIMITED INCOME AND "BLIND ALLEY" JOB HOLDERS.**

Mail the coupon below. Find out how you can get the finest in Diesel training without delay. See how this great trade school operates and makes its facilities available to every ambitious man. Actual work in modern training shops, a part of every man's instruction. Shop methods time-tested for 34 years. Fascinating, efficient preparation. Get the facts.

**NATIONAL SCHOOLS**

LOS ANGELES, CALIF.

Complete Training in Diesels and Gas Engines.

Oldest Trade School in West

MAIL COUPON FOR FREE LITERATURE

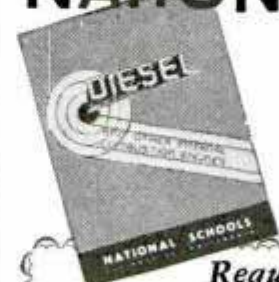

*Request for Free Literature*

NATIONAL SCHOOLS (established 1905) Dept. 12-PMA  
4000 South Figueroa Street, Los Angeles  
Please send me, without obligation, your FREE Literature and information.

NAME \_\_\_\_\_ AGE \_\_\_\_\_  
ADDRESS \_\_\_\_\_ CITY \_\_\_\_\_ STATE \_\_\_\_\_

**FREE WHOLESALE CATALOG OF 4000 BARGAINS FOR SALESMEN—DISTRIBUTORS**



It has 260 pages, chock-full of unusual values. It contains selling plans; order stimulators; tested fast selling articles to dealers, stores and direct to the consumer. A new revised issue is just off the press. Cost about 25c. FREE, while stock lasts. Send for your copy, Today.

**SPORS CO., 10-39 Elm St., LE CENTER, MINN.**

**S AGENTS 300% Profit SIGN LETTERS**

For Store Fronts and Office Windows. Anyone can put them on. Free Samples. Liberal Offer to general agents.

**METALLIC LETTER CO., 438 N. Clark St., Chicago**

**LEARN MONEY-MAKING CARTOONING**

by America's most famous method. Hundreds of successes! Start today—soon draw for pay. Rush 10c for details and big Picture Chart to test your ability (state age).

**THE LANDON SCHOOL, 1039 National Bldg., Cleveland, Ohio**



**PLUMBERS & STEAM FITTERS**  
Audels Plumbers and Steamfitters Guides

**4 Vols. \$6**



A practical, illustrated, Reference Library and Study-Course for Master Plumbers, Journeymen and Apprentice Steamfitters, Gas Fitters and Helpers, Sheet Metal Workers, Draughtsmen, Master Builders, Engineers and all Building Trade Students. This valuable set of handy, pocket-size Guides explains in practical concise language and well-done illustrations all the principles, advances and short cuts of the Plumbing and Heating trade—based on modern practice. Contains careful, detailed instructions on how to figure and estimate various jobs. Use FREE COUPON below to examine, without obligation, this valuable work.

on how to figure and estimate various jobs. Use FREE COUPON below to examine, without obligation, this valuable work.

**INSIDE TRADE INFORMATION ON:**  
Soldering, tinning. Joint wiping, bending, beating. Pipe—iron—steel, threading. Mathematics, tables, physics. Materials—iron, steel, copper, brass, lead, tin, antimony, etc. Sheet metal—galvanized—plate. Sanitation, syphonage, tanks. Drainage, sewage, purification. Fixtures—bath—kitchen. Pipe fittings, soil pipe, tools. Laying out work. Roughing. Screwed fittings, flanges, joints. Pipe bending, examples. Elbows. Heating, ventilation, air conditioning, refrigeration. Water supply, mains, wells, tanks. Gas-fittings. Sheet metal work, problems, methods. Braising, heating, lead burning. Welding, various welds, methods. Blacksmithing, forges, tools. **Air Conditioning.**

**THEO. AUDEL & CO., 49 W. 23rd St., New York City**

Mail Audels Plumbers Guides, 4 vols., on 7 days' free trial. If O. K. I will remit \$1 in 7 days, and \$1 monthly until \$6 is paid. Otherwise I will return them. No obligation unless I am satisfied.

Name \_\_\_\_\_  
Address \_\_\_\_\_  
Occupation \_\_\_\_\_  
Reference \_\_\_\_\_ P. M.





Learn by pre-tested Training

# RADIO *plus* TELEVISION



**A flexible Training Plan to fit your immediate needs**

National Schools offer optional training planned to fit your present circumstances. You can master Radio, Television, Sound and allied trades by National's exclusive plan. Actual shop and studio training; also complete training if you cannot give up your present employment and income. A definite plan to fit your needs.

## FREE LITERATURE

Explains National's pre-tested plan; how you can master Radio, all branches, Sound-Recording, Public Address & Communication Systems, Broadcasting, Television. This interesting literature sent post-paid, without obligation to you.

**NATIONAL SCHOOLS**  
Los Angeles (EST. 1905)

Request for **FULL DETAILS**

NATIONAL SCHOOLS, Dept. 12-PMR  
4000 S. Figueroa St., Los Angeles, Calif.

NAME \_\_\_\_\_ Age \_\_\_\_\_

ADDRESS \_\_\_\_\_

CITY \_\_\_\_\_ STATE \_\_\_\_\_



# AUTO

BOOKS SENT FREE

on approval. Just mail the coupon and we'll send you a set of these remarkable auto books, just off the press. Whether you are a mechanic or helper, expert or apprentice, auto owner or driver, if you're interested in knowing all about automobile mechanics, take advantage of this **FREE OFFER**.

### GET A BETTER JOB

A better job—in the gigantic auto industry. **BIGGER PAY**—a chance to go into business for yourself and get a share of the huge profits, are waiting for any man who even half tries to improve himself. Learn auto engineering with these wonder books a new way—without studying or memorizing. Simply use the **JIFFY INDEX** to look up the answer to any auto problem. Built by eleven of America's greatest automobile engineers, and written in simple language so you can understand it. Very newest cars, all covered.

**[ FREE Privilege of consulting Automobile Engineers of American Technical Society for one year without cost if you mail coupon immediately ]**

Send promptly and we will include a Brand New **EXTRA** volume with over 300 pages including **ALL 1939** cars with wiring diagrams and data sheets on each.

### CAN YOU FIX IT?

These wonder books tell step by step **HOW** to take out "play" in differential — to kill the shimmy in steering—to set **TIMING**—how to put your finger instantly on engine trouble and then the quick expert way to **FIX** it. Newest improvements fully covered. Equal to a complete trade course at less than a fourth the cost.

**6 BIG VOLUMES**  
Brand New Edition  
2500 pages, 2000 illustrations, wiring diagrams, etc., including Marine Engines, Aviation Motors, Diesel engines, etc. De Luxe edition, Gold-stamped flexible binding.

**AMERICAN TECHNICAL SOCIETY,**  
Drexel Ave. & 58th St., Dept. A919, Chicago, Ill.  
I would like to see the new 6-volume edition of your **AUTO BOOKS**. I will pay the few cents delivery charges only, but if I choose to, I may return them express collect. If after 10 days use I prefer to keep them, I will send you \$2 and pay the balance at the rate of only \$3 a month, until \$24.80 is paid. Please include free membership and extra Volume No. 7, as per your offer above.  
Name \_\_\_\_\_  
Address \_\_\_\_\_  
City \_\_\_\_\_ State \_\_\_\_\_  
Attach letter stating age, occupation and name and address of employer and that of at least one business man as reference.

## ARREST HIM, OFFICER! I'LL HAVE COMPLETE FACTS ON THE OTHER FELLOW TONIGHT!



Secret Service Operator No. 38 is on the job . . . FOLLOW HIM through all the excitement of his chase after the counterfeit gang. Write **NOW** for

### FREE Confidential Reports No. 38 Made to His Chief!

It may open your eyes to the great opportunity for YOU as a well paid Finger Print Expert. The kind of work you'd like. Excitement! Travel! Thrills! A **REGULAR MONTHLY** salary. **REWARD MONEY**. Graduates of this school **HEAD 47%** of all

Identification Bureaus in U. S. ! Write for Free Reports, Finger Print Book, low prices. Easy Terms Offer.

Literature will be sent only to persons stating their age.

**INSTITUTE OF APPLIED SCIENCE**  
1920 Sunnyside Ave., Dept. 1359 Chicago, Illinois

## FREE CATALOG 25,000 BARGAINS in BOOKS

Our 45th Annual 320-Page Bargain Catalog of new Books of all Publishers lists 25,000 titles—Fiction, Juvenile, History, Scientific, etc. Illustrated, Indexed. Used by schools, colleges, libraries, and thousands of individuals. Write today for this new 1940 catalog, "Bargains in Books."

**THE BOOK SUPPLY COMPANY, Dept. 131**  
564-566 WEST MONROE STREET - - - CHICAGO, ILLINOIS

Established 1902

# New York Electrical School

Ask for free illustrated booklet

44 West 17th St., N. Y. C.

## AUDELS Carpenters and Builders Guides

4 vols. \$6



**Inside Trade Information** for Carpenters, Builders, Joiners, Building Mechanics and all Woodworkers. These Guides give you the short-cut instructions that you want—including new methods, ideas, solutions, plans, systems and money saving suggestions. An easy progressive course for the apprentice and student. A practical daily helper and Quick Reference for the master worker. Carpenters everywhere are using these Guides as a Helping Hand to Easier Work, Better Work and Better Pay. To get this assistance for yourself, simply fill in and mail the **FREE COUPON** below.

### Inside Trade Information On:

- How to use the steel square—How to file and set saws—How to build furniture—How to use a mitre box—How to use the chalk line—How to use rules and scales—How to make joints—Carpenters arithmetic—Solving mensuration problems—Estimating strength of timbers—How to set girders and sills—How to frame houses and roofs—How to estimate costs—How to build houses, barns, garages, bungalows, etc.—How to read and draw plans—Drawing up specifications—How to excavate—How to use settings 12, 13 and 17 on the steel square—How to build hoists and scaffolds—skylights—How to build stairs—How to put on interior trim—How to hang doors—How to lath-lay floors—How to paint.



**THEO. AUDEL & CO., 49 W. 23rd St., New York City**

Mail Audels Carpenters and Builders Guides, 4 vols., on 7 days' free trial. If O.K. I will remit \$1 in 7 days, and \$1 monthly until \$6 is paid. Otherwise I will return them. No obligation unless I am satisfied.

Name.....

Address.....

Occupation.....

Reference..... P.M.



*To make money on your idea..*  
**PROTECT your INVENTION**  
 WITH A UNITED STATES GOVERNMENT  
**PATENT!**

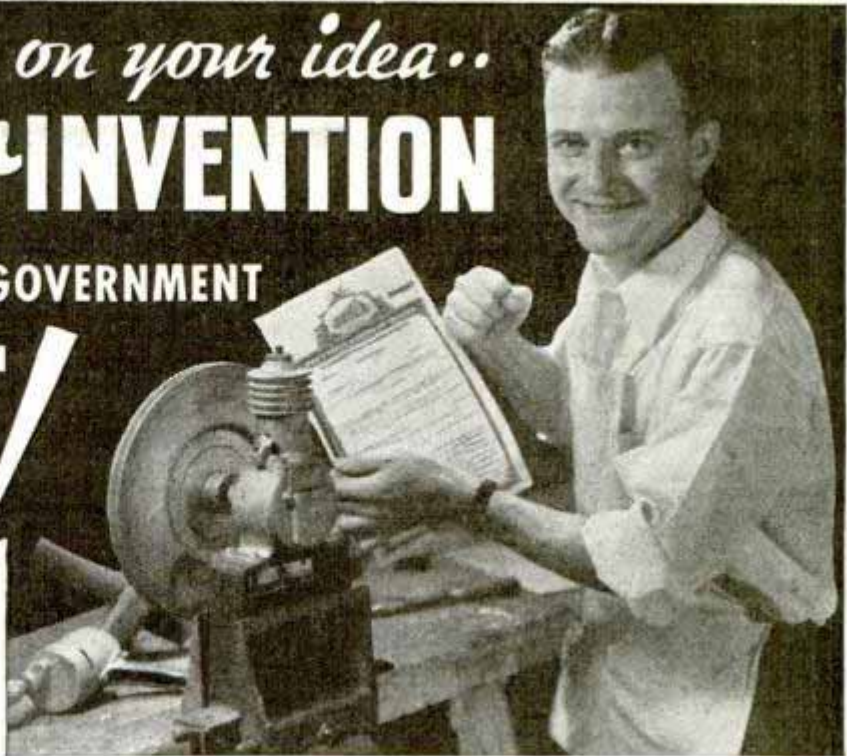

**Y**OU want to cash in quickly on that original idea you have . . . the idea that others haven't thought of yet! Both the U. S. Supreme Court and the Patent Office have made it clear that you need the assistance of a competent patent attorney in order to safeguard your chances for success in this field. Victor J. Evans & Company has helped thousands of inventors . . . creative-minded people, just like you, who have entrusted their ideas to our specialized knowledge throughout the past 41 years. **EVERY CASE THAT COMES INTO THIS OFFICE IS PREPARED IN STRICTEST CONFIDENCE!** Get these big books into your hands . . . they'll answer every patent question you need to know! At no cost, of course.

**LEARN HOW U. S. GOVERNMENT PATENT LAWS PROTECT YOU!**

Here are two big, fact-packed books that come quickly to the point and tell you exactly what to do to get the patent or trademark . . . and how to do it . . . and **WHEN** to do it! They answer every one of those questions that are right now on the tip of your tongue! Then they go ahead and tell you important **facts** you **have** to know before your patent application can even be considered! Best of all, we're going to send you, with these books, a confidential **EVIDENCE OF INVENTION FORM** that may help later to establish your claim to priority. What does this information cost you? **NOT A SINGLE PENNY!**

**HOW WE CAN HELP YOU!**

It's one thing to think out an original invention . . . but it's entirely another to take the necessary steps, so that you can safely commercialize it. And that's just where we step in. We're your guiding hand, leading you past many dead-ends and pitfalls directly to U. S. Government Protection of **YOUR INVENTION!** **The booklets illustrated on this page show you how to go about it!** Make your start **NOW** . . . before tonight! Delay may be dangerous, as at this very minute someone a thousand miles away may be writing to Washington to get a patent on an invention that is almost identical with yours. If he gets there first . . . he will have a definite advantage over you in interference proceedings and **YOUR WORK MAY BE WASTED!**

SEND FOR THE BOOKLETS and EVIDENCE OF INVENTION FORM **Right Now** . . . while the thought is fresh in your mind!

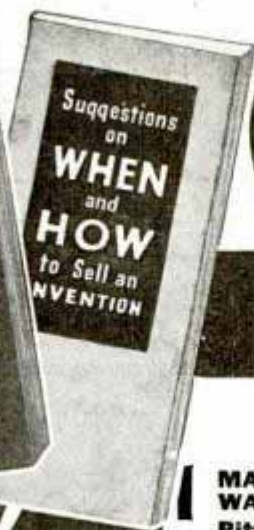

**VICTOR J. EVANS & Co.**

**REGISTERED PATENT & TRADEMARK ATTORNEYS**

**MAIN OFFICE: 112-P, VICTOR BUILDING WASHINGTON, D. C.**  
**Pittsburgh Office: 514-N, Empire Building**

Rush by return mail **FREE** copies of your books, "Patent Protection" and "How and When to Sell an Invention," also important **EVIDENCE OF INVENTION FORM**. I want to know if I can quickly and safely commercialize my invention.

Name.....

Address.....

City or Town.....

*Get Started!*  
**SEND IMMEDIATELY TO WASHINGTON FOR THESE FREE BOOKS!**



# PATENTS

Booklet Free Highest References  
Promptness Assured Best Results

Send drawing or model.

## ALL BUSINESS GIVEN PROMPT AND PROPER ATTENTION

Listed Patent Lawyer in the latest editions of the Rand-McNally Directory of Bankers and Bank-Recommended Attorneys, published by Rand-McNally & Co., Chicago, Ill.; The Baggott & Ryall Directory of Guaranteed Attorneys, published by Legal Directory Corporation, Boston, Mass.; American Lawyers Annual, Cleveland, Ohio; Bankers Service Legal Directory, published by Bankers Service Co., Boston, Mass.; Eyre's Law List, 9 Park Place, New York City; Snow-Church Directory Co. Lawyers List, published in New York City, and the Central Guarantee Co., Bankers and Lawyers Directories, 630 Fifth Avenue, New York City.

**WATSON E. COLEMAN,**  
REGISTERED PATENT LAWYER

Victor Building, 724 Ninth Street, N. W.  
**WASHINGTON, D. C.**

### INVENTORS PATENT YOUR IDEAS SEND FOR FREE BOOK



#### HOW TO OBTAIN A PATENT

Written by a Former Member of the Examining Corps (1922-24) of the U. S. Patent Office. If you want to profit by your idea, you should take steps to apply for a U. S. Patent at once. Your first step is to get this Free Book. This interesting illustrated book contains valuable information you should have. It tells you fully how to obtain a patent on your idea in the quickest way. With this Free Book you will also receive a "Record of Invention" form on which you can easily record your idea. Personal and Confidential Service: Your case will be personally handled only by a Registered Patent Attorney who is also a Former Member of the Examining Corps of the U. S. Patent Office. All communications confidential.

MAIL COUPON TODAY for FREE PATENT BOOK and RECORD OF INVENTION Form.

**CARL MILLER**  
REGISTERED PATENT ATTORNEY  
FORMER MEMBER EXAMINING CORPS U. S. PATENT OFFICE

Woolworth Bldg., 35th Floor, Dept. 129A, New York City  
MILLER BUILDING, Dept 129A, WASHINGTON, D. C.

Please send me your Free Book, "How to Obtain a Patent," and your "Record of Invention" form.

NAME.....

ADDRESS.....

NEW BENJAMIN AIR PISTOLS  
WITH MULTIPLE LEVER  
HAND PUMP FOR TARGET-  
SMALL GAME-CAMPING-ETC.



Guaranteed-Accurate-Practical-Economical-Safe-Clean-Quiet. Adjustable Force-Amazing Maximum Velocity. No smoke or fumes. Bolt Action-Hammer Fire-Hair Trigger-Safety Lock-Hand Pump. Single Shot BB \$8.50; Single Shot cal. 177 or 22 with rifled barrel \$8.50; BB 8-Shot \$10.00; Holster \$2.00. Also a complete line of Benjamin Genuine Compressed Air Rifles for BB and cal. 177 or 22. No license required from dealer or factory. Ask for complete specifications and Free Targets. BENJAMIN AIR RIFLE CO., 890 Marion St., St. Louis, Mo., U.S.A.

### PATENTS Mail Coupon for FREE BOOKLET

of cost and other useful information about patents. Registered patent attorney and former Patent Office Examiner.

**EUGENE H. PURDY**

1423 International Building Washington, D. C.

NAME.....

ADDRESS.....

### PATENTS—TRADE MARKS

All cases submitted given personal attention  
Form "Evidence of Conception" with instructions  
for use and "Schedule of Government  
and Attorneys' Fees"—FREE!

**LANCASTER, ALLWINE & ROMMEL**  
Patent Law Offices

412 Bowen Bldg. Washington, D. C.



### GEARS

In Stock — Immediate Delivery

Gears, speed reducers, sprockets, thrust bearings, flexible couplings, pulleys, etc. A complete line is carried in our Chicago stock. Can also quote on special gears of any kind. Send us your blueprints and inquiries.

Send 10c for Complete Catalog No. 10  
**CHICAGO GEAR WORKS**  
440-48 N. Oakley Blvd. CHICAGO, ILL.

### INVENTORS

Small ideas may have large commercial possibilities. Write us for FREE Book, "Patent Guide for the Inventor" and "Record of Invention" form. Delays are dangerous in patent matters. Free information on how to proceed. **CLARENCE A. O'BRIEN & HYMAN BERMAN,** 707 Adams Building, Washington, D. C.

**INVENTORS** who derive largest profits know and heed certain simple but vital facts before applying for patents. Our book, Patent-Sense, gives those facts; sent free. Trade Marks—Copyrights.  
**LACEY & LACEY, Est. 1869, 635 F St., N. W., Dept. 5, WASHINGTON, D. C.**



### BUCHSTEIN'S FIBRE LIMB

Correctly fitted. Strong, light, neat, cool, soothing. Braces for all deformities. On terms.

**D. BUCHSTEIN CO.**  
610 3rd Ave. South, Minneapolis, Minn.

### RUPTURED?

Get Relief This Proven Way

Why try to worry along with trusses that gouge your flesh—press heavily on hips and spine—enlarge opening—fail to hold rupture? You need the Cluthe. No leg-straps or cutting belts. Automatic adjustable pad holds at real opening—follows every body movement with instant increased support in case of strain. Cannot slip whether at work or play. Light. Waterproof. Can be worn in bath. Send for amazing FREE book, "Advice To Ruptured" and details of liberal truthful 60-day trial offer. Also endorsements from grateful users in your neighborhood. Write:  
**CLUTHE SONS, Dept. 31, Bloomfield, New Jersey**

### To PROTECT YOUR INVENTION Use this coupon, NOW

Delays are dangerous and may be very costly. My personal service assures prompt action, strict confidence, and a minimum of expense. I suggest that you send me a model or drawing, or sketch and description of your invention, and \$5.00. I will make a search and report

promptly as to its patentability and send you a copy of my 72-page booklet. Or, if you prefer to read my booklet first, mail the attached coupon at once. I will also send my "Record of Invention" form. (Over 38 years experience as a Registered Patent Attorney.)

**L. F. Randolph, 302-D Victor Bldg., Washington, D.C.**

Please send me at once, free of charge, your 72 page booklet and "Record of Invention" form.

Name.....

Address.....

### A PERSONAL CONFIDENTIAL PATENT SERVICE



# Inventors—Get Patent Facts!

- How to obtain a patent . . .
  - How you can commercialize your patent . . .
  - Why you need a patent . . .
  - Correct way to proceed and costs . . .
- Answers in Free Books



Our 64th Year!

## Your Ideas May Be Worth Money

If you have already constructed a device, or merely have an idea on paper . . . now is the time to give it the protection you have the right to enjoy. Read patent facts sent to you free of charge, and without obligation. You can feel perfectly sure in dealing with this reputable firm. Write today—just request our free booklets and special "Certification and Invention" form. Prompt service and best results.

**C. A. SNOW & CO.**  
Registered Patent Attorneys Since 1875  
1912 Snow Building Washington, D. C.

**LACO**  
Oil Heater



## Still MORE HEAT at Still Lower Cost!

Know what is INSIDE the oil heater you buy—that's the part that really counts! Inside the New LACO are TWO unusual units—(1) LACO's wonder "2-stage" heater, that produces a surprising volume of heat from little low-priced oil, and (2) LACO's newly improved INNER HEATING UNIT, which has made a record for low cost heat! This unit is built with large-surfaced walls of heavy steel—these walls become intensely hot! Air moves up through and around the hot unit . . . delivers an extra volume of slow-moving, moist, heated air into the room. The outer cabinet is of heavy auto-body steel, electrically welded into a solid unit. Fully guaranteed!

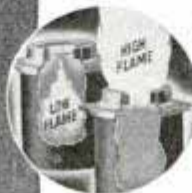

HI-LO 2-STAGE BURNER

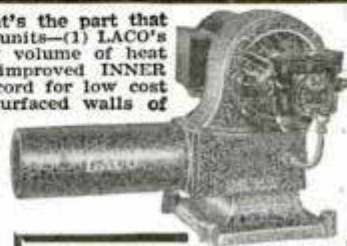

LACO's 1940 "Gun-Type" for furnaces has new refinements that make it the greatest buy in LACO history, at the Very Low Price! Send name today for new folder, and the money-saving price.

**WRITE!** See your LACO dealer or send for free folder, prices.

**DEALERS** Money-making opportunity. Low prices, big discount.

**LACO OIL BURNER CO.,** 1129 Union Ave., Griswold, Iowa

## Inventions Wanted Patented or Unpatented

We have been successfully selling inventions, patented and unpatented, since 1924. Write for proof, and tell us what you have for sale.

**Chartered Institute of American Inventors**  
Dept. 4, Barrister Building, Washington, D. C.

## STOP Your Rupture Worries!

Why suffer with that rupture? Learn about my truss invention for reducible rupture. Automatic air cushion assists Nature to close the opening—has relieved thousands of men, women and children. No obnoxious springs or hard pads. No salves or plasters. Sent on trial to prove it. Beware of imitations. Never sold in stores. Write today for confidential information free in plain envelope. **Brooks Company, 457-B State Street, Marshall, Michigan**

## LET ME PROVE I CAN MAKE YOU A NEW MAN

I changed myself from a 97-lb. weakling to winner of title, "World's Most Perfectly Developed Man." Let me prove that my secret of Dynamic Tension will give you powerful muscle, smashing strength, a handsome build. All I ask is a 7 DAY TRIAL. Write for my 48-page FREE BOOK. **CHARLES ATLAS, Dept. 8M, 115 East 23rd St., New York City.**



**SEND FOR MY FREE BOOK**

# U. S. GOVERNMENT JOBS

Railway Postal Clerks



Many Other Government Jobs  
Mail Carriers—Clerks—File Clerks—  
Post Office Clerks—Stenographers, Etc.

**START \$1260 to \$2100 Year**  
Mail Coupon Before You Lose It

FRANKLIN INSTITUTE, Dept. S195,  
Rochester, N. Y.

Sirs: Rush to me without charge—copy of 32-page book, "How to Get U. S. Government Jobs," with list of positions and full particulars telling how to qualify for them.

Name.....

Address.....





## High School Course at Home

### Many Finish in 2 Years

You can complete this simplified High School Course as rapidly as your time and abilities permit. Equivalent to resident school work—prepares you for entrance to college. Standard H. S. texts supplied—Diploma. Credit for H. S. subjects already completed. Single subjects if desired. High School education is very important for advancement in business and industry and socially.

### College Entrance

During the past 14 years, our High School graduates have been admitted to 531 different Universities, Colleges, Junior Colleges and Normal Schools—80% of them without entrance examination. Course also prepares for teachers' certificate and pre-professional examinations.

### Business—Industry

To get and hold a good position in Business today you must be able to write clear, accurate letters and reports—do figuring involving Algebra and Geometry—talk intelligently on matters requiring a knowledge of Geography, History, and Economics.

In Industry—Mechanical and Engineering lines—you must have at least an elementary knowledge of Physics and Chemistry—be able to figure quickly and accurately—know something of Mechanical Drawing and blueprints—and be able to talk and write accurately and clearly on both your work and ordinary topics of conversation.

Our High School course meets the preparatory educational requirements for Business and Industry.

### An Educational Institution

The American School was chartered in 1897 as an educational institution, not for profit—and is exempt from paying Federal income tax, like the best resident colleges and universities.

### Don't Be Handicapped—Complete Your Training Now

Be a High School Graduate! Prepare yourself for promotion in Business and Industry—for the Professions, College Entrance and social success. No matter what line you may select, High School training will prove invaluable to you! Our moderate fees cover all instruction, standard textbooks and Diploma. Easy monthly terms. Get ahead in life. Start your training NOW!

#### 20 Other Courses

Over 150 noted Educators, Engineers, and Business Men helped prepare our special instruction material, which is used by many resident schools and colleges, U. S. Navy, and Province of Manitoba, Canada. We offer you quality training at home for the best-paying lines of Industry and Business, as listed in the coupon.

tion in Business and Industry—for the Professions, College Entrance and social success. No matter what line you may select, High School training will prove invaluable to you! Our moderate fees cover all instruction, standard textbooks and Diploma. Easy monthly terms. Get ahead in life. Start your training NOW!

Mail coupon for information about line that interests you  
**American School, Drexel at 58th, Chicago**

**American School, Dept. H-945, Drexel at 58th, Chicago**

Tell me how to train for success in line checked. No obligation.

- |  |  |
|--|--|
| <input type="checkbox"/> Accounting & Auditing   | <input type="checkbox"/> Diesel Engineering    |
| <input type="checkbox"/> Architecture & B'lding  | <input type="checkbox"/> Drafting & Design     |
| <input type="checkbox"/> Automotive Engin'ring   | <input type="checkbox"/> Liberal Arts          |
| <input type="checkbox"/> Business Management     | <input type="checkbox"/> Private Secretary     |
| <input type="checkbox"/> Commercial Aeronautics  | <input type="checkbox"/> Hi'er Ac't'g (C.P.A.) |
| <input type="checkbox"/> Electrical Engineering  | <input type="checkbox"/> Highway Engin'ring    |
| <input type="checkbox"/> Electrical Refrigerat'n | <input type="checkbox"/> Mechanical Eng'ring   |
| <input type="checkbox"/> Air Conditioning        | <input type="checkbox"/> Radio & Television    |
| <input type="checkbox"/> Civil Engineering       | <input type="checkbox"/> Salesmanship          |
| <input type="checkbox"/> Complete Law            | <input type="checkbox"/> Steam Engineering     |

Name.....  
 Address.....

Always write your name and full address clearly when answering advertisements.

# MAKE POULTRY PAY YOU A GOOD LIVING FOR LIFE



**POULTRY RAISING PAYS GOOD PROFITS FOR THOSE WHO KNOW ITS SECRETS**

Healthful, interesting occupation for whole or part time in country, village or city suburbs. Open to young and old. Win independence of low wages, uncertain employment, uncongential labor, with a Poultry Business of your own.

### PROVED METHODS BRING SUCCESS FROM START

Harry M. Lamon, nationally known Poultry Expert, former Senior Poultryman U. S. Dept. of Agriculture, quickly trains ambitious men and women for Poultry Success from start. His famous Home Study System, endorsed by thirty leading Agricultural schools. Fascinating study, easy to learn, complete in every detail, shows valuable success secrets used by leaders, how they avoid losses. How to start in small way. Make business grow from sale of Poultry, Eggs and Baby Chicks. Big, ever increasing demand. Or prepare for a good job in large poultry plant. Established nearly twenty years—a multitude of graduates attest the success of his time-tested methods.

Mr. Lamon has prepared a big 32-page book "How To Raise Poultry for Profit", chock full of money-making poultry facts. He offers to send it Free to anyone interested in learning the splendid money-making opportunities in Poultry Raising. If you are "at sea" on your future, send for this Free Book today.

Address: Harry M. Lamon, President,

**NATIONAL POULTRY INSTITUTE**  
 Dept. 50-D Adams Center, N. Y.

### FREE BOOK TELLS HOW

A multitude of poultry-raisers large and small are making money in this most interesting and profitable occupation.

Whether you have ever kept chickens or not—whether you have ten hens or ten hundred, you should read this FREE BOOK. It's yours for the asking.



**DIESEL** Maximum training minimum time; practical and theoretical. Modern equipment, experienced teachers. Personal instruction. 40th year. Catalog free. Residence course in three months.  
**FINLAY ENGINEERING COLLEGE, 10th & Indiana, Kansas City, Mo.**

# Now! FIND OUT HOW TO WIN SUCCESS

*Money, Friends, Popularity*

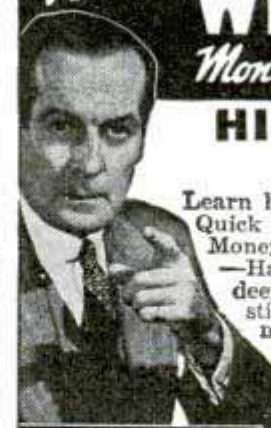

## HIDDEN POWERS

**DEEP WITHIN YOU AFFECT YOUR FUTURE**

Learn how to get the things you want... Quick Advancement in Business—More Money—a Better Job—Greater Popularity—Happiness—SUCCESS. Hidden Powers deep within you may be waiting to be stirred to light. Properly directed they may make all your dreams come true. Any man of average intelligence has it within himself to progress far beyond his present condition. **FIND OUT HOW!** The secrets of making money, choosing a job, winning friends, securing SUCCESS are revealed. Don't let yourself get into a rut or be satisfied with unpleasant work at poor pay. Make the most of yourself! Write at once for FREE Self Analysis Chart, at no cost or obligation to you. Mail coupon today.

**FREE Self Analysis CHART**

**SELF STUDY FOUNDATION, INC.**  
 30 N. Michigan Ave., Dept. K-12  
 Chicago, Illinois

Please send me free of charge instruction for self-analysis of my capabilities and tell me how I can "Get Set For Success."

Name..... Age.....  
 Address.....  
 City..... State.....



# AVIATION WANTS MORE LINCOLN TRAINED MEN



Now is the time to get into Aviation! Airlines, Airports, Airplane Factories now expanding, must have thousands more trained men. Graduates of this **Lincoln Government Approved School** are regularly stepping into good-pay positions in Aviation!  
**BE A SKILLED WELL PAID PILOT.** Learn here to fly fast modern airplanes. 15 Training Planes; 5 types, provide wide piloting experience. Your training here is Government Approved every step of the way. Prepares you for your official Government Rating as Private, Limited Commercial or Commercial, (Transport) Pilot.



**BE AN AVIATION MECHANIC or AERONAUTICAL ENGINEER.** Learn Airplane and Engine Maintenance, rebuilding and repair; Airplane Design and Construction; Aircraft Sheet-Metal or Welding. We teach you. Big demand for skilled mechanics. Big money paid! 106 Lincoln Graduates recently placed in good positions.  
**EMPLOYMENT SERVICE GIVEN.** We assist Graduates in locating positions. Now offering part-time employment for board and room while in training.  
**MAIL COUPON NOW** for complete information.  
**LINCOLN AIRPLANE & FLYING SCHOOL**  
 5612 AIRCRAFT BLDG., LINCOLN, NEBRASKA

**LINCOLN AIRPLANE & FLYING SCHOOL**  
 5612 Aircraft Bldg., Lincoln, Nebraska.

I'd like to get into Aviation. Please send complete information about Lincoln Training.

NAME..... AGE.....

ADDRESS .....

CITY..... STATE.....

## JOBS in DIESEL REFRIGERATION and AIR CONDITIONING

We Mean YOU fellows from 18 to 50, feeling blue, wondering what success feels like! Get in one of the real opportunity fields of today - Diesel Engines or Air Conditioning and Automatic Refrigeration. Train in your spare time to be a Technician, Service or Repair man. Send a card or letter stating which opportunity field you are interested in. No cost or obligation.

**NATION INSTITUTE, INC.**

Dept. 1239 - - - Muncie, Indiana

## TURN HOME WORKSHOP HOURS into EXTRA MONEY



Get the New 188 Page Book **WHAT TO MAKE**

Get this new book and turn happy home workshop hours into extra cash. 188 pages packed with instructions, plans, valuable data and pictures showing what to make and how to make it. Anyone who can use simple tools can work from this book and make it pay him a profit. Order today. Tells how to make—Breakfast Nook—Humidifier—Knee-hole Desk—Night Table—Twin Deck Beds—Modern Bedroom Furniture—Clocks—Plastic Candlesticks—Bob Sled—and more than a hundred other useful and saleable articles.



**POPULAR MECHANICS PRESS**  
 Dept. 1239, 200 E. Ontario St., Chicago

## EARN MORE MONEY WITH CONCRETE

Now you can start a profitable business of your own! Never before have such great opportunities existed in this fascinating field of concrete. It is simple and easy to use. Make things you before thought impossible. No previous experience! Little competition! Learn how you can make money in double-quick time! Send for Free details now!  
**POPULAR MECHANICS PRESS, 633 St. Clair Street, Chicago, Illinois**



## There's MONEY IN ARC WELDING!

**U. S. Manufacturers** desire men to learn Electric Arc Welding and get practical experience under actual production conditions in the laboratories of the School of Engineering. Moderate training Fee. Accepted applicants will be fully trained until ready to pass rigid test and assisted in securing employment.

**ARC WELDING** presents one of the outstanding opportunities for steady income and future success. Welding is growing rapidly, replacing large and intricate castings, rivets, nuts, bolts, screws. It is commonly used in assembling cranes, hoists, bridges, structural steel work, etc. No limit to the application of welding to industry, increasing durability and reducing manufacturing costs. There is a decided shortage of properly trained Welding Operators, Technicians and Welding Engineers. Why be content with ordinary work, hit and miss jobs and low pay when in a short time you can become a trained Specialist in Welding?

## MILWAUKEE SCHOOL of ENGINEERING

*Institute of Electrotechnics*

PM 1239 North Broadway and E. State, Milwaukee, Wis.

Send Free Booklet "ARC WELDING, World-Wide Dawn of a Gigantic Industry." Also tell me how I can become an Arc Welding Operator in 3 1/2 mos. ... Air Craft Welder (6 wks.) ... Welding Technician (4 months) ... Welding Engineer (1 year) ... Send details of student Loan Plan ... Earn Part Expense Plan ... Name ... Age ... City ... State ... (If interested in other courses, check here. Refrigeration and Air Conditioning Technician (3 mo.) ... Radio and Television Service Man (6 Mo.) ... Commercial Radio Engineer (1 Yr.) ... Electrical Engineer B.S. Degree (4 yrs.) ...

PM-1239



## MONEY IN RABBITS—CAVIES

**WE BUY** and put you in touch with other markets. Catalog and copy of magazine 10c. Or send 25c for Book Catalog and Price List and Year's Subscription to the AMERICAN SMALL STOCK FARMER.  
**OUTDOOR ENTERPRISE CO., BOX 919, NEW CITY, N. Y.**

# BROOKLYN YMCA TRADE SCHOOL



- Unlimited Instruction** until you have mastered every part of Course without additional charge.
- Full Shop Equipment**  
 Unexcelled Instruction  
 Fireproof Dormitories.
- Special Privileges. Check your interests** on coupon to receive free literature.
- Mechanical Pre-Engineering
  - Diesel Engines
  - Diesel Pre-Engineering
  - Aeronautical Pre-Engineering
  - Aviation Mechanic
  - Auto Mechanic
  - Refrigeration
  - Television and Radio Mechanic
  - Architectural-Mechanical Drafting
  - Machinist
  - Armature Winding
  - Oil Burner
  - Welding
  - Talking Pictures
  - Air Conditioning
  - Die Making
  - Electrical

## MAIL COUPON

1117 Bedford Ave., Dept. P.M.  
 Brooklyn, New York City, N. Y.

Name.....

Address.....

When writing to advertisers please mention Popular Mechanics



# Business Demands Accountancy

## —because Accountants Command Business

**A**CCOUNTANTS are usually in demand—at better than average earnings.

But today—more than ever before—the competent accountant finds his services at an increasing premium.

In the depression, business tightened up the reins and is watching costs—prices—every move—striving to operate on that basis of close control so essential to profits.

Then too, progressive business is building now for future prosperity—laying plans for expansion, for new processes, new markets—getting ready for the opportunities of the next ten years.

### The Home Study Way to Accountancy Success

Thousands upon thousands of men have trained for Accountancy with LaSalle—at night—at home.

Their success—their progress—is a matter of record.

Whether their goal was a C. P. A. degree or advancement in business, our files are full of letters reporting income increases far out of line with the time and cost investment.

Note for instance, these four cases chosen out of many more we might cite. (Names on request.)

F. F. A. was a railroad yard clerk at \$112 a month when he began accountancy training with LaSalle. Five years later, his income was 500% larger and he was a Certified Public Accountant and attorney. F. C. was 22 years of age and general all-around man in an Arkansas lumber yard at \$75 a month. Five months later, his firm made him manager at \$125, and ten months later promoted him to a larger yard at \$250 plus a commission on sales.

O. D. always thought stories about LaSalle training were fairy tales until the training helped him—a clerk at \$75 a month—move up in six months to \$125, and within four years to \$250. He became General Auditor of a large national organization—with his income more than seven times his starting salary.

As an assistant bookkeeper in a great Western bank, C. F. H. looked forward to slow progress. But LaSalle accountancy training speeded up his climb to Assistant Trust Officer and to a salary increase of 400 per cent.

### These Men Won Success in Ordinary Times—You Will Profit By Unusual Times

Remarkable as is the success of these men—you will have an advantage over them—you will be entering accountancy when unusual business conditions work with you for success.

Present conditions not only call for more capable accountants—but offer unusual opportunities for both quick and permanent success. The accounting student of 1940 will face real opportunity in 1941 and the accounting leaders of 1945-50 will be largely determined in 1940-1941.

### —If You Can Qualify

Ask yourself three questions:

1. Are you ambitious?
2. Have you determination?
3. Can you see and grasp an opportunity?

If you have determination; if you are ambitious; if you can take advantage of circumstances—*prove it* by investigating. A three-cent stamp, sixty seconds time, and the coupon below will bring you full information regarding Accountancy training and the opportunities to which such training leads. Then you can judge intelligently.

## LaSalle Extension University

### A Correspondence Institution

Dept. 1264-HR

CHICAGO

Opportunities in Accountancy—Check below and we will send you a free copy of "Accountancy, the Profession that Pays," also information about our new training in Higher Accountancy, all without obligation.

#### Higher Accountancy

Other LaSalle Opportunities: If more interested in one of the other fields of business indicated below, check that:

- |  |  |  |
|--|--|--|
| <input type="checkbox"/> Business Management | <input type="checkbox"/> Law: LL.B. Degree     | <input type="checkbox"/> Business Correspondence |
| <input type="checkbox"/> Expert Bookkeeping  | <input type="checkbox"/> Commercial Law        | <input type="checkbox"/> Stenotypy               |
| <input type="checkbox"/> C. P. A. Coaching   | <input type="checkbox"/> Industrial Management | <input type="checkbox"/> Modern Salesmanship     |
| <input type="checkbox"/> Railway Accounting  | <input type="checkbox"/> Modern Foremanship    | <input type="checkbox"/> Business English        |
| <input type="checkbox"/> Traffic Management  |  |  |
| <input type="checkbox"/> Effective Speaking  |  |  |

Name.....Age.....

Present Position.....

Address.....

When writing to advertisers please mention Popular Mechanics





# CLASSIFIED

## Advertisements



Advertisements in this section, 35 cents per word, each insertion, minimum 10 words, payable in advance  
To be inserted under proper classification in January issue, copy should be in our office November 8th

January issue on sale December 1st

Popular Mechanics Magazine, 200 East Ontario Street, Chicago, Illinois

## YOU'LL PROFIT

By reading and answering the classified ads in this section. Hundreds of opportunities to make and save money.

Mr. F. W. Johnson,  
Popular Mechanics,  
Chicago, Illinois

Dear Sir: My first advertisement appeared in Popular Mechanics 15 years ago this month. Since then I have tried almost every kind of publication including the farm and the women's publications, the mail order magazines and a variety of others. For several years yours is the only publication in which I have carried an advertisement the year round. This alone gives you an idea of what I think of your magazine as compared with the others. The others wear out after a while but yours seems to have an inexhaustible supply of new readers.

Yours truly,

(Original letter on file in our office)

YOUNG PHOTO SERVICE

### AUTOMOBILES—MIDGET CARS

**AUTOMOBILE Superchargers** \$3. Guaranteed mileage increase 20%; power 10%. University of Detroit test. Any car; give make, year. Wrench installs 15 minutes. John Hanley, Manufacturer, 5719 Loraine, Detroit, Mich.

**NEW Fifth edition Automobile Racing Book.** Tells how to build dirt track bodies, frames, engines. Records, superchargers, rules, formula, plans, stock conversions, roadster racing, fast Fords. \$1.00 postpaid; \$1.15 C.O.D. Ray Kuns, Department 12, Madisonville, Cincinnati, Ohio.

**MIDGET Cars, supplies, kits, wholesale.** Plans 50c. Catalog 10c. Derby Midgets, Woodstock, Illinois.

**DIESELS — Automotive — mechanical books.** Catalogue. Stamp. Kraftsmen's Press, Coscob, Conn.

**MIDGET Racecars, sportcars, motor-scooters.** New bargain lists—over 130 used motors, midgets, parts—20c. Catalog new kits, parts, plans, 10c. Circulars on request. Shipps Midgets, Box 543-H, Zanesville, Ohio.

**MIDGET Racers, two-passenger autos.** Midget motorcycles, motorscooters, bicycles. Motors, wheels, parts, plans. New handbook catalog, 90 illustrations, 20c. Midwest, Box 1959-P, Chicago.

**AUTOMOBILE Mechanics** who want business or earn extra money write for samples and details of nationally distributed Self-Locking Triple-X Piston Rings. Eliminate re-boring. Guaranteed life of car. Franchise valuable. Some territories open. Triple-X Co., 3801 South Racine, Desk R, Chicago.

**ALUMINUM Alloy pistons, automotive, aviation, diesel, industrial, marine, midget, model, motorcycle, outboard.** Finished or semi. Judson Mfg. Co., Hedge and Gillingham, Philadelphia, Penna.

**GASOLINE Saving device, \$1.00.** Ford V8's 1934-1939. Chevrolet 1935-38. Walert Co., 3429 N. 10th St., Milwaukee, Wis.

### AUTO SUPPLIES AND EQUIPMENT

**AUTOMOBILE Seat covers, Washable linen.** All cars. Coupes \$1. Coaches, sedans \$1.98 postpaid. Universal, 2808 - 12th Ave., Los Angeles, California.

**MECHANIC'S Work bench, 3" maple top \$10.00.** Block Corporation, Petoskey, Michigan.

**BARGAINS—Compressors, welders, battery chargers, car washers, attractively priced.** Terms, trial. Write for bargain list. Hobart Automotive Supply, Box M-1295, Troy, Ohio.

**ANTIFREEZE.** Similar to Prestone. Formula 30c. Practical Methods, St. Paul, Minn.

**FACTORY Expert rebuilds carburetors,** like new, \$3.95. Prompt service. 8041 Exchange, Chicago.

**FREE Wholesale bargain catalogue, auto supplies, tires, tubes, equipment, tools.** For dealers only. American, 1189 Bedford Ave., Brooklyn, N. Y.

**1939 IGNITION Supercharger \$1.25.** E. G. Sales & Mfg. Co., New York.

**PLATING Outfits for auto parts.** Connect to a battery. No tanks used. Free particulars and proofs. Gunmetal Co., Ave. J, Decatur, Ill.

**CRANKCASE Oil refiner.** Inexpensive construction, operation. Plans, specifications. \$1.00. Technical Laboratories, East Haven, Conn.

### AUTO TRAILERS

**BUILD The famous, low-cost Jim Dandy Cabin Trailer.** Complete plans and instructions 50c. Plans to build the beautiful, streamlined Jim Dandy Cabin Cruiser, \$1.00. Trailer Builders Manual and catalog of trailer parts, supplies and equipment—over 100 interesting, illustrated pages, 25c. Order today. Satisfaction guaranteed. Trailer Supply Co., 411-A Jackson St., Wausau, Wisconsin.

### MOTORCYCLES, BICYCLES, MOTOR SCOOTERS AND SUPPLIES

**"WHIZZER" Bicycle motor.** Quiet, dependable, 4-cycle, 1 3/8 h.p., motorcycle type crankcase. Bicycle structure not weakened. Center of gravity unchanged. Spring motor suspension eliminates vibration. Anyone can install thirty minutes. Further information write Breene-Taylor Engineering Corp., Los Angeles, Calif.

**BUILD Power scooters, midget cars.** We supply tires, wheels, motors. Lowest prices. Send 10c for plans, etc. Build-Your Own Devices, Dept. 12-A, 536 North Parkside, Chicago.

**MOTORIZED Vehicles, scooters, airplanes.** How to build. Large book \$1.00. Circular free. Hamm Products Co., 162 High St., Oshkosh, Wis.

**NEW Push-A-Bike outboard motor for your bicycle.** Complete with pneumatic tire. Ready to attach. Richburn Company, Aurora, Missouri.

**SEND 10c For catalog new and used parts.** Bootz, 622 East Grand, Des Moines, Iowa.

**1.3 H.P. Engines suitable for scooters, cars, boats, at only \$14.95.** Clearvue Company, Dayton, Ohio.

**SAVE 60%.** Build own Comet scooter. We supply parts, tires, engines. Literature, drawing, 10c. Hurry! Comet Cycle Company, Box 3032, Madison, Wisconsin.

**BICYCLE Parts, tires, accessories.** Money-saving catalog 10c. Capital Cycle, 3251 N. Capitol, Indianapolis, Indiana.

**MOTORCYCLE Parts and accessories,** new and used, for all motorcycles. Write for prices. Henderson list 10c. Triangle, 1111 Washington, Chicago.

**REBUILT Motorcycles.** All makes genuine parts and service. Special generator and armature repairing. Send 15c for illustrated bulletin. Western-Harley Davidson Distributor, 914 East 15th, Kansas City, Mo.

**MOTORSCOOTERS.** Midget cars! Easily built. Complete plans and literature on wheels, tires, motors, etc. 10c. Honsakers, Masontown, Penna.

**ALLOY Pistons \$3.00—Harley, Indian, Henderson, Excelsior, Cleveland.** Cylinder grinding, rings, bearings, gaskets, chains, sprockets, helmets, goggles, accessories, parts new and used for less. Catalogue and wings pin 10c. Ballak, 1115 Chestnut, St. Louis, Mo.

**MOTORCYCLES.** Reconditioned. New, used, parts and accessories. All makes. Large stock. Bargains. Illustrated catalogue, 15c. Indian Motorcycle Sales, Kansas City, Mo.

**INSIDE Dealer prices.** Overstocked, all models. Indians and Harleys. Rebuilt, guaranteed. Dime brings latest list. Crandall-Hicks, Boston, Mass.

**RECONDITIONED Motorcycles.** New—used parts for all makes. Authorized Harley-Davidson dealer. Whitman Motorcycle & Supply Co., 405-9 Southwest Blvd., Kansas City, Mo.

**MOTORCYCLE Bargains, lowest prices,** bargain sheets for stamp. Motorcycle accessories. Rochester Harley Davidson Corp., 129 W. Main St., Rochester, N. Y.

**MOTORCYCLE Cylinder boring \$2.00.** Aluminum pistons, stock or racing, all models, (dealers supplied). New and used Indian parts. Used motorcycles. Stamp brings list. Phila. Indian, 1635 Hunting Park, Philadelphia, Penna.

### AVIATION

**SNOWSLED Builders.** Convert your own engines. Complete conversion for Henderson or Indian \$10.00; aircooled A Ford kit \$29.95. Blueprints included. Heath Company, Benton Harbor, Mich.

**AIRCOOLED Ford.** Powerful aircraft, snowsled engines, complete \$92.50. Conversion instructions available. Lightning Aircraft, St. Paul, Minnesota.



**BUILD** And fly your own motorcycle powered monoplane at home. Easy, cheap. 90 mph. maximum. Tested plans, only \$1.00. Rush, Aerotech, Box 7320, Pittsburgh, Penna.

**AVIATION'S** Pocket sized encyclopedia with over 600 questions and answers, photos of oldest, most recent, smallest, largest planes! Written by nationally famous instructor and pilot, only 10¢ coin! Leonard Schrader, Dept. 106, Nauvoo, Ill.

**PROPELLERS** For airplanes, ice sleds, snow sleds, boats, dehydrators, fans, frost-fighters, Hubs, countershafts, faceplates, snow sled skis. World's largest propeller catalog, 10¢. Banks Propellers, Hangar No. 4, Love Field, Dallas, Texas.

100 AIRPLANES, \$50 Up. Catalogue 25c. Aircraft Directory, Athens, Ohio.

**PRACTICAL** Course in flying, 29 chapters, illustrated, \$1 complete. Aircraft Directory, Athens, Ohio.

**AVIATION** Apprentices — Air-minded young men interested in training for entering aviation as apprentices see ad on page 10A.

**LEARN** Aviation at Lincoln! Exceptional employment opportunities now in aviation. 83 more Lincoln School graduates step into good-pay positions! This Lincoln government approved school of aviation would like to prepare you for immediate employment as pilot or airplane and engine mechanic or as aeronautical engineer. We assist graduates in locating positions. Part-time employment for board and room while in training. Write today for complete information. Lincoln Airplane & Flying School, 2005 Aircraft Building, Lincoln, Nebraska.

**PROPELLERS** Attractively priced, leading with three blade airliners, more efficient for sleds, aeroplanes, boats, also supplies, information free. Standard Propeller Company, Ft. Worth, Texas.

**LEARN** To fly free. Folder, dime. Ohmeyer, Box 391, Hempstead, N. Y.

**PROPELLERS** For airplanes, sleds, ice-sled blueprints, supplies. Catalog dime. Lorenzen Propellers, Niles, Michigan.

#### BATTERIES, GENERATORS, ETC.

**EDISON** Storage batteries for light-power systems. Non-acid. Odorless. Fifteen year life. Five year unconditional guarantee. Bargains in complete lighting systems. Low prices. Free illustrated literature. "See-Jay" Battery Co., 82 Sterling Ave., Yonkers, N. Y.

12 VOLT Heavy duty generators \$8.50. Save money on new, used automotive electrical parts; free catalog. State Ignition, 52 Cullerton, Chicago.

**LEARN** Facts about storage batteries. Earn large income. Send \$1.00 for particulars. Sta-Hi Battery Service Co., 407 Bannock, Boise, Idaho.

50-1/2 HORSE, Repulsion induction, 110-220 volt, heavy duty motors, 3400 speed, \$9.75. Also generator bargains. Electrical Surplus Company, 1885 Milwaukee, Chicago.

**EDISON** Lifetime storage batteries for light and power. Eliminates acid battery diseases. Long guarantee. All kinds rebuilt generating plants, motors, and miscellaneous articles at bargain prices. Free interesting literature. T. Hawley Smith Co., Croton Falls, N. Y.

#### ELECTRICAL SUPPLIES—EQUIPMENT

**BANKRUPT** Public address apparatus, speakers, amplifiers, at salvage sale. 70% discount. Send for list. Electrical Salvage Company, Lincoln, Nebraska.

**ELECTRIC** Eye, with wiring diagram, instructions, literature, catalog, \$1.00 postpaid. Photobell, Dept. 87, 123 Liberty Street, New York.

**DEALERS** Sell electric motors, furnace fans, blowers, unit heaters, exhaust fans, parts wholesale catalog 10c. Cmco, 1111 Washington, Chicago.

**MAGNET**, Alnico, new wonder alloy lifts 50 times own weight. \$1.00. Advance, P.O. Box 861, Minneapolis, Minn.

**BARGAINS**—Arc welders, also motor generator. Write for new bargain list telling needs. Hobart Bros., Box M-1297, Troy, Ohio.

**ELECTRIC** Engraver, engraves all metals deeply, dollar. Hudson Bros., East Syracuse, N. Y.

**PRICELIST** Free. appliances; home workshop tools. Mailorder Electric, 713 South Dearborn, Chicago.

**ELECTRO-SCRIBE**: Electric pencil. Writes-engraves all metals \$1.00. Health lamp: Dual ray—ultra violet—infra red. Promotes Sun-Tan Vitamin "D." Automatic—ac-dc current, \$3.90. Details, Beyer Mfg. Co., 4515-H Cottage Grove, Chicago.

#### AIR CONDITIONING

**AIR** Conditioning course drastically reduced. Literature free. Supreme Publications, 3727 West Thirtieth, Chicago.

#### WELDING AND SOLDERING

**REBUILT** a.c. d.c. Arc welders, all sizes; engine governors, idlers. Terms. Low prices. Guaranteed. Service Co., 3732 Cedar Ave., Cleveland, Ohio.

**ELECTRIC** Arc welders, cheap. Free literature. Holkerson Service, Canton, Kas.

75-200 AMPERE Arc welders from Dodge generators. Complete plans 35c. 100 other generator changes. LeJay Manufacturing, 347 LeJay Building, Minneapolis, Minn.

**WELDING** Equipment, list dime. Adastik Bros., Grand Rapids, Mich.

D.C. Arc-welder plans \$1.00 each. (Three for \$2.00.) Build it yourself without re-winding armature. 25-200 amperes from (Delco, Fairbanks Morse, Phelps, etc.) farm light plant generators. 25-600 amperes from d.c. motors salvaged from vehicles, mules, etc. 25-200 amperes from (Northeast Dodge) automobile starter generators. Welders Club, AB-3432 M-Mart, Chicago. (Special notice: Money back via dollar merchandise certificates.)

#### ENGINES, MOTORS, DYNAMOS

**MOTORS**, 1/4 H.P. General Electric, etc. \$3.50, guaranteed. Larger sizes. List 10c. A. C. Motors, 3008 Bailey, Philadelphia, Penna.

**BARGAINS**—Plating generators, motor generator sets, also arc welders. New low prices for large and small shops. Trial—easy terms if desired. Hobart Bros., Box M-1296, Troy, Ohio.

**MAKE** Money, rewind auto generators, washing machine motors, construct arc welder. 10¢ brings particulars. Catalog material. Ernest Knight, LaSalle, Illinois.

**AIR** Compressors 1 3/4 x 1 1/2, \$6.00; 2x2, \$7.00; 2 1/2 x 2, \$8.00. Free catalog. National, 1915 South State Street, Chicago, Ill.

600 NEW Diagrams, tables, and controller connections for electricians. Contents includes two and three phase: All circuits to twelve path, multi-lead, dual voltage, multiple speed windings. Single phase: Circuits for repulsion induction, split phase, capacitor, series, etc. Data for rewinding and reconnecting. Important tables. Satisfaction guaranteed or remittance refunded. Literature on request. Prepaid \$2.75. Dept. Y, Educational Advancement Company, Lakewood, New York.

**SMALL** Elect. motors, with flexible shafts \$3.25 postpaid. McConnell, 1619 Edgewood, Racine, Wis.

**RELIABLE** Motor winding books; in business 21 years. Lessons, connecting diagrams, winding data. Introductory data selection. \$1.00. Motor Data Co., Box 7631, Kansas City, Missouri.

**ALTERNATING**, 1/2 Horse, 110 volt, induction motors. Rebuilt, guaranteed, \$7.25. Wilmot Auto Supply, 2247 St. Paul Ave., Chicago.

**THREE** To ten KVA alternating generators. Motors, converters. State your needs. Queen City Electric, 519 South California, Chicago.

**REFINE** Used oil without cost. Particulars. F. Gerwin, Fairview, Oklahoma.

**BARGAIN**—1/2 Hp. motors, 60 cycle, 1 phase, 110 volt, like new, guaranteed, \$7.40. Send check to Erie Electric Motor Co., 120 Church, Buffalo, N. Y.

#### MACHINERY, TOOLS AND SUPPLIES

**DIAMOND** Pointed grinding wheel dressers. First time at \$1.00. Mounted in steel holder 7/16" x 6". Philip Sinz Company, 56 West 45th Street, New York, N. Y.

**BROWN** & Sharpe cams made to order, light experimental and jobbing machine work. J. A. Makara, 11 Kingsland Ave., Harrison, N. J.

**POWER** Drill press \$5.95. 6 inch bench saw \$9.95. Circular, Ebel-Binder, 1825 Queen City, Cincinnati.

**TAILSTOCK** Turret rough castings blue prints \$3.50. Milburn, Burlington, Ky.

**SURPLUS** Stock and reprocessed standard line power tools. Send for new price list. Bill Bailey, Box 326, Columbus, Ohio.

**FOR** 9" South-Bend lathes. Milling attachments, universal movement \$9; threading dial indicators \$3; 6" four jaw chucks \$9.50. Unique Manufacturing Co., 4807 North 31 Ave., Omaha, Nebr.

**MILLING** Attachment for South Bend workshop lathes. Closing out, \$7.00. Guaranteed. Alexander, 1516 Webster, Omaha, Nebraska.

**CLUTCH** From auto parts 1/2 to 20 h.p. No machine work. Plans \$1.00. Archer, Middleboro, Massachusetts.

**CONCRETE** Building block machines and molds. Easy payments. Catalog free. Concrete Machine Co., 5129 South Compton Ave., St. Louis, Mo.

**TREMENDOUS** Surplus of factory tools selling out. Drills, taps, files, hacksaws, etc. Send for free lists, include six cents postage. Travers Tool Co., 264 Jackson Ave., Long Island City, N. Y.

**DRILL** Grinding attachment fits bench grinder, hand or power turned. Handles sizes 3/16 to 1 1/4". Price \$7.85. Descriptive literature on request. Tractor-Lite Co., Sidney, Iowa.

14" x 6" GREAVES Klusman cone head engine lathe, quick change. No. 0 Cincinnati miller, cheap. Write for particulars. Cincinnati Machinery & Supply Co., 221 E. Second St., Cincinnati, Ohio.

#### BOATS, OUTBOARD MOTORS, ETC.

**BOAT** Plans, building instructions by famous architects. 300 designs, all types—outboard, inboard, sail—cruisers, runabouts, racers, utilities, etc. Compiled in book form containing up to 43 plans each at \$2.00 and \$3.00 per book. Free catalog. Motor Boating, 574 Madison Ave., New York.

**BUILDING** Plans 15' keel knockabout—plywood, November Rudder 35c. Catalog boat plans free. Rudder, 15 Murray St., New York.

**FOR** Sale. Motorized iceboat, airplane covering. Past. Mr. Bachelder, 954 Randolph Ave., Milton, Mass.

**SEE** Our ad on page 134A. Cleveland Boat Blueprint Co.

**BOAT** Plans—any type. State requirements. Tredwell Lyle, Sarasota, Florida.

**FORD-ZEPHYR** Marine conversions. Catalog 10c. Lehman Engineering Company, Dept. D, Newark, N. J.

**MARINE** Power—Easily convert any Ford motor (domestic and foreign) with Osco parts and kits. Complete catalogue 25c (coin). Osmithson, 3644 Lawrence St., Philadelphia, Penna.

**ASSEMBLE** Your own boat. Our finished knock-down frames and materials save you 2/3 builder's cost. All types and sizes. Send 25c for big catalog. Brooks Boat Co., Inc., D4, Saginaw, Mich.

**USE** "Welch Hull Seal Cement" for a leaky boat. 1/2 gallon \$2.00; quart \$1.00; postpaid. Welch Boat Company, Station K-1, Milwaukee, Wisconsin.

**OUTBOARDS**—Save 1/2. Good used parts, all makes and models. Bargains rebuilt motors. Crandall Hicks Co., 959 Commonwealth, Boston, Mass.

**BOAT** Designers are highly paid professionals. Complete course by mail. Catalog. Westlawn, Montville, N. J.

#### SPORTING GOODS, GUNS, FISHING TACKLE, ARCHERY

**SEND** For free illustrated catalog of Lawrence leather belts, holsters, gun cases and other sporting equipment. George Lawrence Company, Portland, Oregon.

**TRAPPERS**: Catch foxes, minks easily. Methods free for stamp. Everette Sherman Whitman, Mass.

**ARCHERY** Supplies, catalogue free. Instruction book 50c. Archery, 2209a East 75th, Chicago.

**TRAP** Fox or coyote: Bunch system gets the sly furbearers. Results or no pay. Q. Bunch, Welch, Minn., Box K.

**BARGAINS!** Gun catalog 5c. ski catalog 5c. J. Warshal Sons, First-Madison-PM, Seattle, Wash.



**GOLF Clubs.** Five club matched set \$2.50. Lincoln Surplus, 123 Galena, Freeport, Ill.

**BOWS And arrows.** Construction book 50c. Catalogue of materials free. Chester Brown, 617 South State, Chicago.

**HUDSON Bay blankets,** complete camping, hunting, outdoor equipment. Catalog. Howe Fur Company, Coopers Mills, Maine.

**BOWS, Arrows, raw materials.** Beautiful catalog (over 125 pictures) and "Essentials of Archery" a handbook on making bows and arrows 35c. Everyone intending to make their own should have this manual. Instruction folder and catalog 10c. L. E. Stemmler, Queens Village, N. Y.

### FIELD GLASSES, TELESCOPES, MICROSCOPES

**FREE Instructions.** Make powerful telescope. Small cost. Jamer, Manorville, N. Y.

**TELESCOPES, Microscopes, binoculars;** 1940 bargain catalog free. Brownscope Co., 5 West 27th Street, New York.

**TELESCOPE Mirrors and parabolizing.** Frazine, 1016 North 17th Ave., St. Petersburg, Fla.

### ANTIQUES, RELICS, INDIAN GOODS, CURIOS

**REPTILES:** Chameleon, newt, 25c. Curios: Resurrection plant, 10c. Postpaid. Free catalogue. Quivira Specialties Co., Winfield, Kansas.

**OLD Pistols, guns, knives, relics.** We buy, sell, trade. R. Wootton, 514 N. State, Chicago.

**FIVE Spears \$1.00.** Good arrowheads 5c. J. Townsend, Delmont, Penna.

**35 GENUINE Indian arrowheads, \$1.00.** Catalog. George Holder, Glenwood, Ark.

**NAVAJO Indian rugs.** Make beautiful lasting holiday gifts. Price list. W. E. Severn, 1509 Grand Ave., Phoenix, Arizona.

**ALASKA Indian beaded hair seal moccasins \$2.25 per pair postpaid.** Suitable Xmas gift. Perry M. Hern, Skagway, Alaska.

**CHINQUILLA'S Indian Craft Museum.** Handiwork of all Indian tribes. Jamaica, N. Y.

**ARROWHEADS!** Glacial boulder beauties. Rainbow variations. Don McKillop, Regina, Sask.

**INDIAN Relics, coins, bills, gems, crystals, curios, etc.** Illustrated catalog 5c. 100 ancient arrowheads \$3.00. H. Daniel, Hot Springs, Ark.

**SWORDS, Rapiers, pistols, daggers, armor list 10c.** Robert Abels, 860A Lexington Ave., New York.

**INDIAN Relics, beadwork, coins, curios, minerals, old glass.** Catalog 6c. Indian Museum, Northbranch, Kansas.

### TAXIDERMY

**LEARN By mail to mount birds and animals, tan skins, make leather.** Old reliable school teaches, easily, quickly, at low cost. Over 250,000 students. Rush postal for free 48 page book. Northwestern School of Taxidermy, 775 Elwood Bldg., Omaha, Nebr.

**WOLF Rugs, open mouth \$12.50 prepaid.** Strange. Taxidermist, Clarkston, Wash.

**GLASS Eyes, taxidermists', furriers supplies.** Big catalog free. Elwood Company, 222 Smith Bldg., Omaha, Nebr.

**TAXIDERMY Supplies—Quality artificial eyes, teeth, genuine Jonas head forms, Tools, materials, etc.** Everything for the progressive taxidermist. Send 10c for big illustrated catalogue. Jonas Bros., 1049 Broadway, Denver, Colo.

### DOGS, PETS, BIRDS

**ST. BERNARDS—Manitou's famous puppies bring Xmas joy.** Literature containing twelve colored pictures of our stock free. Manitou's St. Bernard Kennels, Watrous, Sask., Canada.

**JONES Dog hulls will stop running fits or your money refunded.** Dealers wanted. J. M. Jones, 724 West Trade St., Charlotte, N. C.

**PUPPIES.** Norwegian Elkhounds, Scotties, wires, blue foxes. Write. Envilla Ranch, Havre, Montana.

**SPORTSMEN:** 200 Pointers, setters, straight cooners, combination hunters, rabbit and fox hounds. Reasonable. List free. Ramsey Creek Kennels, Ramsey, Illinois.

**RACCOONS.** Blacks \$20.00, greys \$15.00 each. Information with order. Peter Fleming, Horicon, Wisconsin.

**SAINT Bernard puppies, beauties, reasonable.** Paramount Kennels, North Hatley, Quebec.

**BOSTONS!** Easy monthly payments! Circulars, (dime). "Sentree," Royal Oak, Michigan.

**GREAT Danes—Dependable guards, companions—Pups \$25.00. Pictures free.** Kalm Danery, Stone-Mountain, Georgia.

**LIVING Xmas gifts are finest—Saint Bernard puppies.** Dime brings photographic prospectus. Royal Kennels, Chazy, N. Y.

**BEAUTIFUL Pure white police dogs.** Ansonia Kennels, Mose, N. Dak.

### POULTRY AND FARM SUPPLIES

**LEADING Turkey magazine, devoted exclusively to turkey raising.** Explains newest methods. \$1.00 a year. Turkey World, Desk 59, Mount Morris, Illinois.

**MAKE Money with poultry.** Read America's leading poultry magazine for latest information. Three years \$1.00; nine months 25c. Poultry Tribune, Dept. E-93, Mount Morris, Ill.

### TREES, SHRUBS, ROOTS, HERBS

**JUST Out! World's greatest "Herbalist Almanac."** Beautifully illustrated in natural colors. Contains over 200 old-fashioned herb medicine recipes for home use. 10c postpaid. Worth dollars! Botanics, 145 W. 112th St., Chicago.

### FARMS AND FARM LANDS

**FARMS That pay in the Great Northern Railway agricultural empire, Minnesota, North Dakota, Montana, Idaho, Washington, Oregon.** Fertile black soil, high production crops, grain, fruit, vegetables, feed and livestock. Many kinds of farms for selection. Write for book on state you prefer. E. B. Duncan, Dept. 1257, G. N. Ry., St. Paul, Minn.

**GOVERNMENT Land—10c acre up.** Information all states 25c. Nat. Tax Service Bureau, 600A Majestic Bldg., Detroit.

**115 ACRES \$2000;** 16 cattle, horses, machinery, poultry, hay, corn, oats, vegetables included; attractive 7-room home, cow barn, granary, horse barn; only mile village; income last year nearly equals selling price; grand opportunity, part down; page 12 free catalog supplement. Strout Realty, 255-P 4th Ave., New York City.

**LIVE in New Hampshire!** Mrs. Bertha Hayes, Real Estate, Barrington, New Hampshire.

**FLORIDA Tax deed lands.** Good fruit and farm land. Ten acres \$60.00, \$5.00 down, \$5.00 month. Many others. Florida Tax Deed Service, 8007T Nebraska, Tampa, Florida.

**40 ACRES.** Near White River, unimproved; poultry land, \$175, \$5 down, \$5 monthly. Free list and literature. Hubbard, 216 Grossman Bldg., Kansas City, Kans.

**GOOD Farms available.** Washington Minnesota, Idaho, western Montana, Oregon. Dependable crops, favorable climate. Write for impartial advice, literature and list of typical bargains. Specify state. J. W. Haw, 119 Northern Pacific Ry., St. Paul, Minn.

### PROFITABLE OCCUPATIONS

**HOW To earn money at home!** Big, free book tells inside story—How hundreds are earning cash raising mushrooms in cellars, sheds. Cash paid for all raised. Write today. United, 3848 Lincoln Ave., Dept. 64, Chicago.

**BUILD With rock for beauty.** Kinks that count, explains how. \$2.00. Chester A. Read, Route 2, Pulaski, Va.

**"RUBBER Molds."** Make them yourself. Formulas, instructions 25c. Ideal Service, 1614, Park Ridge, Ill.

**BUSINESS Proposition resilvering mirrors, autopaarts, reflectors, making chipped glass signs.** Write Sprinkle, Plater, 288, Marion, Indiana.

**STANDARD Rabbit Journal, Milton, Penna.** Year 50c, sample dime, supplies.

**10,000 FORMULAS—900 Page volume,** most amazing value in years. \$1.50 postpaid. Ideal Book Shop, 713 Park Ridge, Ill.

**WHERE To sell cancelled postage stamps for cash.** Information 15c. Shray, 511 Broadway, Joliet, Ill.

**READ Our war and oil ad under Business Opportunities, it's worth answering.** Royal Keystone Enterprise, Box 192, Berwyn, Ark.

**205 MONEymaking Opportunities.** Start own business. Home, office, etc. Particulars free. Stamford, 3762-c Broadway, New York.

**RAISE Mink.** Dime for general information. Lommans Fur Farm, Spangler, Penna.

**\$30 WEEKLY.** Grow mushrooms. Cellar shed. We buy 35c lb. Mr. B. made \$270 spare time. World's largest company of its kind. 40 page book free. Mushrooms, Dept. 701, 2019 Second, Seattle, Wash.

**MEN—Women, operate "Specialty Candy Factory" home, all or spare time.** Steady income. (Our 31st year.) Hillyer Ragsdale, Inc., Drawer 62, East Orange, N. J.

**MONEY in rabbits and cavies.** We buy and put you in touch with other markets. Catalog and copy of magazine 10c. Or send 25c for book catalog and price list and year's subscription to the American Small Stock Farmer. Stahl, Box 1, Holmes Park, Mo.

**EARN Money in your spare time taking subscriptions to Popular Mechanics.** Unlimited possibilities, every family a prospect. Easy to sell. Bonus paid in addition to liberal commission. Send postcard for further details today. Circulation Dept., Popular Mechanics Magazine, 200 E. Ontario St., Chicago.

### BOOKS, PERIODICALS, PICTURES, POSTCARDS

**EXCELLENT Profits taking subscriptions—2500 magazines.** Agents confidential catalog, complete starting supplies free. Pines, B-581 Monroe, Brooklyn, N. Y.

**REAL Comic post cards.** Send 25c for ten. Henry N. Kost, Liberty, N. Y.

**"SOUTH America Needs You" booklet on how to apply for employment, 25c coin.** South American Assn., 2020 Nicollet, Minneapolis, Minn.

**SEND 10c (Refundable) for catalog listing 250 books at bargain prices.** Box 4161, Orlando, Florida.

**BOOKS—At 100% savings.** Catalog 3c. Specialties, Box 293, Waterbury, Conn.

**BOOK Bargains!** Catalogues free. Write: Old Prof's Book Shop, B16 Arcadia Court, Pontiac, Mich.

**SECRET Of psychic power.** Key to real success. 15 cents. Staver Brothers, 1645 So. Weadock, Saginaw, Michigan.

### MAGIC TRICKS, PUZZLES, JOKER NOVELTIES

**AMAZE And mystify!** Catalog 500 pocket-parlor tricks 10c. Professional catalog 10c. Lyle Douglas, Station A-5, Dallas, Texas.

**HOUSE Of 1000 mysteries!** Professional magic! Pocket tricks! Jokes! Puzzles! Novelties! Two big surprise catalogs! Both illustrated! Both for 20c! Lawson Vick Co., Dept. P14, Queens Village, N. Y.

**AMAZING, Curious novelty with catalogue, 10c.** Walnut Specialty, Everett, Mass.

**ENTERTAIN With magic!** Catalog 500 easily learned tricks 10c. Professional catalog 10c. Lyle Douglas, Station A-5, Dallas, Texas.

**FREE Magic age indicator.** Mailmart, Box 27, Grand Central, New York, N. Y.

**USED Magical apparatus bought and sold.** Waldmann, 332 East 77, New York.

**500 MAGIC Tricks in wonderfully illustrated catalog only 10c!** Professional catalog 10c. Lyle Douglas, Station A-5, Dallas, Texas.

**\$100 WORTH Of tricks for 50c.** Professional secrets exposed! Now you can perform the magic that has thrilled large audiences. Send 50c today. P.O. Box 120, Arkansaw, Wis.



**BE A magician.** Large professional magic catalogue of latest tricks 25c. Cash paid for complete Tarbell magic courses. Write, Ireland, C-109 North Dearborn, Chicago.

**MAGICIANS' Headquarters** (professionals and amateurs). Enormous stock, tricks, books, supplies, etc. Clever book, "Modern Magic" and latest mammoth 200 page professional catalogue, 25c. Kanter's 1309 Walnut, Philadelphia.

**MAGIC.** Mind reading, easily learned. Particulars free. Browne, Box 272, Duluth, Minn.

**LEARN Ventriloquism.** 3c stamp brings particulars. Smith, 801 Bigelow, Peoria, Illinois.

**LARGE Magic catalog** 25c. Hundreds of tricks. Chicago Magic Company, 2300 N. Mason Avenue, Chicago.

**EARN Money** in any crowd. Call names of strangers, tell unspoken questions. Professional course mind reading, spirit writing, etc., \$1. Henderson, Box 341, San Bernardino, Calif.

**WORLD'S Largest magic shop** professional catalog, 25c. Holden, 220 W. 42nd St., New York.

### GAMES—ENTERTAINMENT

**PLAYS,** Operettas, musical comedies, complete minstrel first-parts with song programs, blackface skits, vaudeville acts, monologs, dialogs, recitations, juvenile plays and songs, musical readings, entertainments, make-up goods. Catalog free. T. S. Denison & Co., 203 N. Wabash, Dept. 11, Chicago.

**MONEY Makers** for organizations. Bingo games, punch cards, wheels, etc. Catalog. WarNovCo, Conimicut, R. I.

**SELL Your game!** Particulars 3c stamp. Trend Games, Highland Park, Ill.

**HOW To chalk talk—Complete instruction** in this fascinating form of entertainment, by a famous professional. Shows how to draw trick pictures, arrange a program. 52 original illustrations showing how pictures are started and completed—all sure-fire hits. Includes humorous talk for delivery while drawing. Postpaid, \$1. T. S. Denison & Company, 203 N. Wabash, Dept. 66, Chicago, Illinois.

### OLD STAMPS WANTED

**I WILL Pay \$100.00 each** for 1924 1c green Franklin stamps, rotary perforated eleven (up to \$1,000.00 each unused). Send 6c for large illustrated folder showing amazing prices paid. Vernon Baker, 444PM-12, Elyria, Ohio.

### STAMP COLLECTING

**FREE! Xmas present to you!** Any 15 stamps you select from our Xmas approval. Just send names, addresses 2 active collectors, size your collection and 3c postage. Ranger Stamp Co., Dept. B, Box 2547, Dallas, Texas.

**FREE.** Three sets: Four beautiful new Bolivia (animals), complete set Czechoslovakia (legionnaires), scarce set Ecuador (Olympics). Send 3c postage today and request our famous U. S. and foreign "Four Star Approvals." Kessels, Tucson, Ariz.

**ANNOUNCEMENT.** We will send free the new, enlarged edition of what we believe to be the most interesting book ever written about stamps. Title "Famous Stamps and Their Stories." Size: 60 pages. Illustrations: over 300. Binding: deluxe. Printed on fine paper. It is so elegant in appearance that it will grace any library. Did you know that Abraham Lincoln was an honorary citizen of the Republic of San Marino and that his portrait is on two stamps of that country? Did you know that Columbia issued the largest stamps in the world and that Switzerland has a stamp which is sold only from a traveling omnibus? These and hundreds of other stamps are fully illustrated and their stories told. Nothing like it has ever been attempted. This book is more fascinating than fiction, more thrilling than a movie and more instructive than years of study. We will send it free for 5c mailing expenses but only to really serious approval applicants, together with a fine approval selection. Approval Headquarters, Globus Stamp Company, 268 - 4th Avenue, New York City, Dept. 201.

**SENSATIONAL Combination offer!** Big packet 105 all different including Greenland (new country), Congo, Manchukuo, Costa Rica triangle, air-mails, commemoratives, giant diamond-shaped stamp, \$4 United States; complete set United States telegraphs, cataloging 20c, scarce set Siberia cataloging 50c. Packet British colonies including Gwalior, Hyderabad, Burma (new country), jubilee and coronations. Total catalog price over \$3.00! Everything for only 5c to approval applicants! World-Wide Stamp Company, Department 600, Camden, New York.

500 MIXED, Bi-colors, colonials, etc., 10c. Approvals. Macek, Madison, Illinois.

**COLUMBUS Crossing Atlantic.** Set to approval applicants for postage. Vincent Lee, 4 Ayr, Brookline, Mass.

**GERMANY Latest mint comrade issue,** 12 stamps, complete 65c. Scott's 1940 catalogue \$2.20 postpaid in U. S. only. Admiral Stamp Co., 125-21 Hillside Ave., Richmond Hill, N. Y.

U. S. Mint, Pulaski, 1c Pan-American Pitcher, Penn. 45c, with 5c parks free. McClay, Altadena, California.

**FREE—20 U. S. commemoratives,** air-mails, old issues, etc., all different, to approval applicants enclosing postage. George Hagedorn, 1821 Rutland, Cincinnati, Ohio.

**FINE Approvals,** freshly filled books and sheets. Tell me what you want and I will send it. Milton Skinner, 306 East Fourth, Long Beach, Calif.

**RIOT Of colors packet includes 2 large multi-colored Ecuador Constitutions, 3 Philippines (Rizal), 3 beautiful triangles, plus stamps from Andorra, Monaco, Senegal, Ivory Coast, Futuna, Angola, Estonia, Oceania, Tunisia, Ukraine, Cape Verde, Kouang Techeu, New Caledonia, Victoria. This bizarre assortment of over 20 different stamps containing pictorials and commemoratives will be given as a premium to collectors who send only 5c for our big value 100 different packet. McLoughlin, North Ave., Meriden, Conn.**

**5 BEAUTIFUL Sets and packet plus 2 premiums for 3c with approvals.** Mailmart, Box 27, Grand Central, New York, N. Y.

**NEW Stamps!** 30 different colorful used foreign latest issues—25c. W. Torgesen, Tenneck, N. J.

**A REAL Bargain.** 200 all different foreign and 60 different U. S. stamps—our pamphlet on "How to Make a Stamp Collection Properly" and our big bargain list of sets, packets and album—all for only 18c. Queen City Stamp & Coin Company, Room 36, 604 Race Street, Cincinnati, O.

**CANNIBALAND—British Solomon Islands,** genuine Baden, Liberian Bongo, fantastic Manchukuo, Cayman Islands beauty, \$5 U. S., bizarre Negri Sembilan, Turks Caicos. Everything 3c with approvals. Viking, 1-Z Hanson Place, Brooklyn, N. Y.

**UNITED States stamps on approval.** Big discounts. Free premiums. Stamp Co., 452 Broadway, Albany, New York.

**50 STAMPS Free with approvals.** Leo, 853 North Martel, Los Angeles, California.

100 U. S. 2c 1894 1899 triangles, 30c. Archibald Parker, 236 Brackett, Portland, Maine.

**NUDE Duchess (Spain), Hindenburg zeppelin,** 5c approvals. Shultes, Berne, N. Y.

**UNPICKED Mixture:** 40c pound. 100 U. S. revenues on documents—10c! (700—50c.) Vanvoorhis, Hyndman, Penna.

**GAMBLE.** Huge auction purchases broken into \$1.00 lots. Enormous value. Worldwide testimonials. Hughes, Queens Rd., Bournemouth, England.

**21 FRENCH Colonies, pictorials, sets of 5 each (105) for 35c.** French, 241 Euclid, Cleveland.

**MAKE Money selling stamps.** Erickson, 736 Cottage, Saint Paul, Minnesota.

**50 FREE Iraq, Iran, etc. Postage 1c.** Album 3c. Bullard, 268 Northampton, Boston, Mass.

**ATTRACTIVE Wholesale approvals.** References. Fuld, Dickmann Building, St. Louis, Missouri.

**BEAUTIFUL Rumanian packet.** 3c. Approvals. Ward, Box 592, Vancouver, Wash.

**YEMEN—5 Varieties 5c with approvals.** LeDuc, Saint Petersburg, Florida.

**RUSSIAN Mint set free with price-lists.** Lester, 1214 N. 8th St., Philadelphia, Penna.

**1199 DIFFERENT Stamps postpaid \$2.00.** Acc. 5403 Beeman, Dallas, Texas.

**PRECANCEL Approvals, 5 different** presidentials for 3c to applicants. Gierhart, Baltimore, Ohio.

**MEXICAN Revolution issue and 100 foreign stamps 3c approval applicants only.** Quality Stamps, Englewood, Colorado.

**1000 MIXED Foreign 25c.** Well worth sorting for values. Plaza Stamp Co., Santa Fe, N. Mex.

**MEXICAN Dollar bill and 100 different** foreign stamps 10c. Nagles, 346 North 12th, Reading, Penna.

**TWENTY Commemoratives only 5c.** Approvals. Lucas, Five Broadway, New York.

**THOUSANDS Of unusual stamps,** correctly numbered, mounted by country, 1c to 5c. Poy, 100 Ray St., Freeport, N. Y.

**15 OBSOLETE U. S. 5c approvals.** LaJolla Stamp Co., LaJolla, Calif.

**APPROVALS—Write for particulars.** (Lobdell), 625 So. 18th, Salem, Oregon.

**BUILD Collections new way.** 100 to 500 stamps every week. Year's membership details, 115 different selected stamps 25c. Pacific Stamp, 312 Wheeler St., Seattle.

**175 U. S. commemoratives, etc., 10c.** 500 25c. P. O. Box 457, Newark, N. J.

**U. S. commemoratives—42 different, 25c.** Crystal Stamp Co., Racine, Wis.

**U. S. mission mixture, 50c pound.** Stamps, Box 64, Racine, Wis.

**STAMP Collections wanted.** Cash paid. N. Barcus, 3787 Longfellow, Detroit, Mich.

**1000 WORLDWIDE Stamp mixture 25c.** Monjar, 1542 Waverly, Cincinnati, Ohio.

**STAMP Catalogue free!** New revised edition. Giant fifty-page quarterly listing albums, supplies, Canadians, Newfoundland, United States, new issues, foreign and pictorials. Illustrations galore! Empire Stamp Company, Dept. PM, Toronto, Canada.

**25 TRANSCAUCASIA 10c.** Approval applicants only. Walt Sochor, 114 Glenwood Ave., Merchantville, New Jersey.

**43 DIFFERENT Czechoslovakia, 3c with** approvals. Pearce, 2833 NW13, Oklahoma City, Oklahoma.

**(FIRST) Stamps 10 countries 3c.** Approvals. Post-Zegel, Windham, N. Y.

**1000 GOOD Mixed 25c.** Includes valuable prize packet. DeMers, Box 1033, Milwaukee, Wisconsin.

**25 DIFFERENT Airmails or 50 different** U. S. postage 12c. Perforation gauge free. Arthur McFadden, Mt. Rainier, Md.

**WRITE For sample selection "Yellow** Jacket Approvals." Buckey, Ludlow Building, Dayton, Ohio.

**FIFTY Different U. S. ten cents.** Mampe, 4204 No. Wolcott, Chicago.

**50 ANIMALS, Railroads, ships, maps,** etc. 10c with approvals. Buchanan, Box 40, College Point, N. Y.

**FREE 50 Different stamps if you re-**quest approvals, 3c postage. World Stamp Co., Flint, Mich.

**SHEPARD Stamp News, one year 10c.** 180 North Wacker Drive, Chicago.

**FREE! World's smallest triangle.** Bolivia triangle, bicolored diamond, jubilee, Devils Island, Congo, Danzig, Tunisia, Soudan, West Indies, Southseas, Asia, Africa, Mozambique, Br. Cols., pictorials, commemoratives, airmails, bicolours, perforation gauge, millimeter scale. Postage 3c. Approvals. Davidson, 2297-6E, Salt Lake, Utah.

**NEWS.** If interested in knowing how to operate a stamp business, get "System Suggestions." Complete information, 50c. Threlfall, Box 6811-D, Philadelphia.

**UNBELIEVABLE! Collection United** States 225 different stamps. Scotts value over \$10.00. Guaranteed satisfaction. Send \$1.00. Franklin, 225 Franklin, Rochester, N. Y.

**U. S. 6c 1918 Airmail used, catalogue** 75c for only 25c. U. S. or foreign approvals with each order. W. C. Phillips, 750 Main St., Hartford, Conn.

**BRITISH Colonies: 100 different 25c,** 20 mint 45c. Guay's, 5628 Elgin, Pittsburgh, Penna.



**WORLD'S Fair** beauty together with packet of over 200 different stamps including scarce Belgian train commemorative (cat. value 25c), jubilees, coronation, etc. Only 5c to approval applicants. Ensign Stamp Co., Box 295-M, Gardner, Mass.

**15 AIRMAILS**, 5c With approvals. Harworth, 4968 Victoria Dr., Vancouver, Canada.

**YOU Like** clean, inexpensive approvals? We have them and to new applicants we will send 50 different beautiful large sized mint pictorials for only 5c. Acme Stamp Company, Dept. 1, Box 101, Westmount, P.Q., Canada.

**DISGUSTED?** Try my approvals, 1/4c up. Bargains galore, premiums with purchase. Viscusi, 4, Scotia, N. Y.

**SEE For yourself!** 20 different commemoratives. Also U. S. packet. Everything 3c with bargain approvals. Dolve, Box 406D, Minneapolis, Minnesota.

**WARTORN Poland** bargain collection. 100 different only 15c. Sterling Supplies, Toronto 9, Ont.

**FINE Used U. S. army-navy** 16c. bi-centennial 16c. parks 35c, 100 different pre-cancels 20c. Peter Wetterquist, Rockford, Ill.

**50 FREE Iraq, Iran, etc.** Postage 1c. Album 3c. Bullard, 268 Northampton, Boston, Mass.

**\$10.00 STAMP Free** to approval applicants. Foote, 309 Greeley, Webster Groves, Missouri.

**STAMP Dealers!** Philatelic printing. Samples free. Keelerprint, 3822-W Ogden, Chicago.

**WORLD'S Fair Ecuador, Greenland, Albania, Nigeria, Monaco, Andorra, New Mauritania, Miquelon, etc.** This fascinating collection, over 50 countries, 5c with approvals. Stamp Service, 53-E, Webster Avenue, Brooklyn, N. Y.

**1000 U. S., superior grade,** 25c. Steiber, 306 E. 139th, Bronx, N. Y.

**"DEVILS Island"**—Beautiful set of five stamps from this famous French penal colony. Set portraying historic Grecian Acropolis, famous Corinth Canal. Set of 10 commemorating foundation of Rome. Plus package stamp-mounts, watermark detector, stamp-longs, and stamp-wallet with perforation gauge. All for 10c. Approvals. Bison Stamp Company, Lackawanna, N. Y.

**BIG Packet free!** Scarce Hindenburg zeppelin which exploded mid-air. World's smallest triangle. Indo-China air-mails. Eagle and lion in mortal combat on new Italian East African. Mozambique giraffe. Liberian antelope. 55-year old Eastern Roumelian! Canadian coronation and silver jubilee. Giant diamond-shaped stamp. Holy Lands packet. These and many more in this thrilling package to approval applicants only 5c. B. Fitts Co., Framingham, Mass.

**U. S. 1879 Issue!** Scarce 6c Lincoln stamp cataloging \$1.25 for only 5c to approval applicants. Write today! Pricelist free. Curhan Stamp Company, Gloucester, Mass.

**TIBETAN Stamp free!** Genuine Tibet stamp free with "complete country" collection (White Russia), stamps from Armenia, Azerbaijan, Burma, Tannou Touva and Ukraina. Only 5c to approval applicants. Cactus Approvals, Box 1870-B, Tucson, Arizona.

**FREE!** Nine desirable airmails. Approvals. Barker, 714 Market, San Francisco.

**FREE!** Two coronation sets. Postage 3c. Roberts, 312F Shearerbig, Bay City, Mich.

**LIECHTENSTEIN Stamps.** Beautiful, scarce, valuable. 50 different 50c, 100 different 4c. Mrs. Muller-Flury, Schaan, Liechtenstein.

**SIX Big items!** (1) Airmail packet: giant and midjet airmail stamp, zeppelin stamp, etc. (2) Postal zoo packet: tiger, kangaroo, kiwi, etc. (3) Triangle and diamond-shaped stamps. (4) Stamps picturing locomotion of mail, by dog sled, camel, locomotive, airplane. (5) Kings and dictators packet: Mussolini, Kemal Ataturk, murdered czar, etc. (6) Strange lands packet: Greenland (new country!), Djibouti, Manchukuo, Palestine, etc. All for 5c to approval applicants! Maynard Sundman, Dept. 6, Bristol, Conn.

**10,000 VARIETIES 1c each!** Gordon Davison, Box 568, Manchester, N. H.

**150 GOOD Mixed foreign stamps,** 3c. Elvin Stanton, Niantic, Conn.

**CANNON!** Set of stamps showing cannon, firing squad, cavalry charge and 200 other different stamps, only 10c to approval applicants. L. H. Reich Stamp Co., 4647 Kenmore, Chicago.

**FREE U. S. \$1, \$2, \$4 and \$5 stamps.** Unbeatable U. S. approvals. Nelson, 369 1/2 Robert Street, St. Paul, Minn.

**300 DIFFERENT 20c; 1000 75c; 2000 \$2.50.** Fred Onken, 630 79th St., Brooklyn.

**1000 MIXED U. S., 15c.** Foreign approvals. Premiums. Lee, Bridgeport, N. Y.

**UNITED States stamps on approval.** Commemorative, airmails, 19th Century issues, parcel post, revenues, etc. Bargain lists with each selection. We have an extensive stock, correctly classified, reasonably priced. Southern Stamps, Box 70A, Miami, Florida.

**SILVER Jubilee souvenirs.** Third set of twenty beautiful stamps issued by Irish Hospitals' Trust, Dublin. Specimen sheet free of charge to all writing to Mr. J. O'Sheehan, Department P.M. 13, Earlsfort Terrace, Dublin, Ireland.

**QUEEREST Stamp packet:** Mozambique, Japan, China, Soruth, Albania, many others—5c to approval buyers. R. M. Stamp Co., Box 230P, Port Chester, N. Y.

**ASK For my famous 1/2c approvals.** Olivo Alvos, Guadalupe, Calif.

**APPROVAL Sheets.** One to three cents. Frederick B. Driver, 2009 Finance Bldg., Philadelphia, Penna.

**FREE—Choose any country 10c packet—** 5c postage—approvals. Victoria Stamp Co., London, 4, Canada.

**WHOLESALE Dealer's catalog.** Illustrated. Postage 5c. Frank's, 4900 Chalmers, Baltimore, Md.

**"HOW To Make Money in Stamps" 50c** a copy. Walters, Milburn Ave., Maplewood, N. J.

**FREE—Irish-U. S. constitutional and Will Rogers set** to approval applicants. Charles Cleveland, 806 North Humphrey, Oak Park, Illinois.

**SIX Dollars for 9c! 300 different stamps** (cat. price \$6) only 9c with approvals. Tatham Stamp Co., Springfield-30, Mass.

**THREE Sets for three cent stamp!** Jack Reed, Houtzdale, Penna.

**FREE—From every continent, 155 different airmails, triangle, commemoratives, pictorials, many U. S. and others, with 1c approvals.** Send 5c for postage and handling. Ace Stamps, Euclid Arcade, Cleveland, Ohio.

**40,000 VARIETIES First quality stamps** available on approvals 1/4c up. Representative selection on request. Adults only. PKeigwin Stamp Co., Vineland, N. J.

**UNITED States—45 different, gauge, hinges, pricelist 10c.** No approvals. Seidenberg, Baroda, Mich.

**WHOLESALE Supplements to dealers** for 10c postage. Hundreds of bargains. Grossman Stampco, 102 West 42nd, New York.

**GIANT Packet 200 all different** from Africa, South America, Asia, South Sea Islands, etc. Includes world's smallest stamp: triangle and diamond-shaped stamps; animal stamps. Nicaragua "Will Rogers" airmail; many others. Also packet 17 different United States (cataloging 50c)—all obsolete, including \$4 denomination, commemoratives, etc. Total catalogue price over \$5.00! Everything for only 5c to approval applicants! Mystic Stamp Company, Dept. 80-N, Camden, New York.

**50 DIFFERENT, Fine U. S. including** perforation gauge, 10c with approvals. The Stamp Shop, 809 Holland Bldg., St. Louis, Mo.

**PENNY Approvals, that satisfy.** Neil Gronberg, Box 5441-P, Philadelphia, Penna.

**AIRMAILS And commemoratives, 25 different, including Columbians, Panama-Pacific, Edison, Zeppelin, etc., only 5c** with exceptionally fine United States and foreign approvals. Marco Stamp Co., Box 888, San Francisco, Calif.

**UNITED States illustrated looseleaf catalog.** \$1.00. Send postage for free United States price list, precancel list. Stanley Gibbons, 38-P Park Row, New York.

**200 DIFFERENT 10c. Big 50% approvals.** Covert Stamp, 39 State, Rochester, N. Y.

**BRAZIL, 50 Different 10c with bargain approvals.** Davis, Silver Lake, Ind.

**ASK For our wonderful one cent approvals.** Prospect Stamp Co., 225 Broadview, Toronto, Canada.

**WEEKLY Stamp magazine, thirteen weeks, 10c.** Stamp Journal, Kalamazoo, Mich.

**STAMP Dealers, your ad here will bring** wonderful returns. Ask me for proof. F. W. Johnson, Manager, Classified Advertising, Popular Mechanics Magazine, 200 E. Ontario St., Chicago.

#### RARE COINS

**OLD Money wanted.** Will pay \$100.00 for 1894 dime, S. mint, \$50.00 for 1913 Liberty head nickel (not buffalo). Big premiums paid for all rare coins. Send 4c for large coin folder. May mean much profit to you. Numismatic Co., Dept. 20, Fort Worth, Texas.

**TAX Tokens—Complete official current set (21) fifty cents.** Illinois provisionals twelve \$1.00. Harco, 312 W. Harrison, Albuquerque, New Mexico.

**10 CANADIAN Coins and medal \$1.00.** Park Coin Shop, Winnipeg.

**INDIAN Head penny.** Coin list 10c. Charles Banker, Salina, Kansas.

**GET Profit and pleasure in collecting** old coins. Send 10c for 56 page illustrated coin catalog. You'll be delighted with it. Send for it now. B. Max Mehl, 370 Mehl Building, Fort Worth, Texas. Largest rare coin establishment in U. S. Established 39 years.

**JEFFERSON Nickels, 1938, P-D-S mints,** uncirculated, set of three 25c. Selling price list free. Ace Stamp, Euclid Arcade, Cleveland, Ohio.

**15 DIFFERENT Coins 25c.** Otto Oddehon, Overland Station, St. Louis, Mo.

**COIN Collectors' illustrated catalog** of coins, books and accessories 10c. James Randall, 407 South Dearborn, Chicago.

**COIN Collectors—Read "The Numismatist."** Monthly magazine containing news and features on coins, medals and paper money. Published by The American Numismatic Association. Six months trial subscription \$1.50; sample copy 30c. Write for descriptive circular. Room 228, 99 Livingston St., Brooklyn, N. Y.

**BRILLIANT Uncirculated 1939 S. or D.** Lincoln cent with new price list 10c. Monterey Money Mart, Beverly Hills, Calif.

**1939-S UNCIRCULATED Cent and catalog** 10c. Landon, 901 Lucerne, Los Angeles.

**RARE U. S., foreign coins, war medals.** Catalogue 10c. Mengelle, Colorado Springs, Colo.

**COMMEMORATIVE Half dollars, Lincoln, Stone Mountain, Oregon, Texas, Cleveland, Kentucky, San Diego, Long Island, \$1.50 each.** Illustrated catalogue No. 14, 25c. Norman Shultz, Salt Lake, Utah.

**FREE! Foreign coin, banknote, and large illustrated coin catalogue.** Send 4c postage. Coin approvals sent. Tatham Coinco, Springfield-125, Mass.

**\$5 TO \$500 Each paid for hundreds of** old or odd coins. Keep all until posted. Many very valuable. Send 10 cents for illustrated Coin Value Book, 4x6. Guaranteed buying and selling prices. 31 years in business. Coin Exchange, Box 5, Le Roy, N. Y.

#### HOBBIES AND COLLECTIONS

**ACTUAL Foreign (now getting scarce)** and U. S. airline baggage stickers. Send 25c for package of 15. International Baggage Sticker Exchange, 41 East 42nd Street, New York City.

**MATCH Book cover album mounts 600** without paste. Information 3c. Adams Sales, Dept. 25, State Tower, Syracuse, N. Y.

**EXCHANGE Your duplicate stamps,** match covers, etc. with collectors everywhere. Dime brings list. (Mention Hobby.) Secretary, Box 2166, Denver, Colo.

**UNUSED Book match covers, 100 all** different. \$1.00. Free list. Charles Edelman, 1311C East 84, Cleveland, Ohio.



## PHOTO FINISHING

**ROLL** Developed, 8 beautiful enlargements 2 to 8 times larger, deckled edge, 116 or smaller. 25c coin. Reprints 3c each. Ace Photos, 258 Astor Sta., Boston, Mass.

**35MM. Special.** Developed and enlarged to 3 1/4 x 4 1/2. Extra glossy prints \$1.30. Any 6 or 8 roll 25c. Free enlargement coupons. All work guaranteed. Kelso, Box 549-B10, Inglewood, California.

**CHRISTMAS.** Photographic, greeting cards 20 for \$1.00. Sample, 10c! 20 reprints 25c! Reprints \$1.00! Rolls developed, 2 prints of each negative 25c! Quality guaranteed—prompt service! Free mailing containers, price list. Mercury Studios, G-109 N. Dearborn, Chicago.

**HIGHEST** Class photo finishing. We use fine grain developer. Any size roll developed and printed and two enlargements 25c. One dozen reprints and two enlargements 36c. Try us once. Helen Art Photo Service, Albany, New York.

**DOUBLE-QUICK** Service! Roll developed 16 Velox prints; or 8 prints 2 enlargements 25c. Chicago Photo Lab., Box 3, South Chicago, Illinois.

**20 (116) SIZE** Or smaller reprints 25c, 50 for 50c. Any 6 or 8 exposure roll film developed and two prints each negative 25c. Send for free mailing envelope, price list. Star Photo Service, J-20 W. Jackson Blvd., Chicago.

**TECHNIFINISH—35mm.** 36 Exposure rolls fine grain developed and perfectly enlarged to 2 3/8" x 3 3/4" glossy prints, 75c. New exclusive methods and equipment make this low price possible. Cartridge reloaded with Eastman Plus X. 25c. One day service. Satisfaction guaranteed or money back. Write for postpaid mailing bags and information. Technifinish Laboratory, 109-A Lexington, Rochester, N. Y.

**TWO** Rolls developed, printed, 35c trial. Modern Photo, Plaistow, New Hampshire.

**YOUR** Favorite film enlarged 15c. from photos 10c extra. Greene Service, 11 St. Marks Place, New York City.

**MOTION** Picture studio technicians—Process your rolls in our laboratory. Eight Beautitone prints and two Artone professional enlargements—25c. Latest design photo Christmas cards. Sample 10c. Holylints, P-1350, Hollywood, California.

**35MM. ROLLS** Developed free. 3 1/4 x 4 1/2 enlargements, 36 exposures \$1.00, 18 exposures 60c—reprints 4c. Send roll and money today. Minipix, Dept. 512, 100 N. LaSalle, Chicago.

**FREE—Beautiful** 8x10 enlargement and coloring information if you send negative and 10c postage. Lifetone, K-39, Des Moines, Iowa.

**SPECIALIZING** 35mm. Rolls fine grain developed, 36 enlargements 3 1/2 x 5 \$1.00. Cartridge reloaded 35c. Photoshop, Linton, Ind.

**SIX** Copies any photo, proof, drawing, 25c. Photo Laboratories, Yakima, Wash.

**OIL** Coloring photographs a fascinating hobby or profitable business. Learn at home by easy simplified method. Previous experience unnecessary. Send for free information and requirements. National Art School, 3601 Michigan Avenue, Dept. 3439, Chicago.

**COMPLETE** Developing—printing outfits \$2.95. Cromwell's, 204 Griffin, Atlanta, Ga.

**BEAUTIFUL** Photographic Christmas cards, 75c dozen. Send 10c and negative for sample. Hench Studios, Harrisburg, Penna.

**PHOTO** Mill. Immediate service! No delay! Roll developed, carefully printed and choice of two beautiful 5x7 professional enlargements, one tinted enlargement, or eight reprints—for 25c coin. Reprints 2c each. The Photo Mill, Box 629-12, Minneapolis, Minnesota.

**20 REPRINTS** 25c. 100—\$1.00. Roll developed 16 prints 25c. 5x7 enlargements 10c. 3—25c. Nordskog, 4 Maywood, Illinois.

**FREE—Roll** developed only plus beautiful photographic Christmas card from best negative if you include this ad with 10c postage. Filmcraft, J-39, Des Moines, Iowa.

**35MM. SUPER X.** 20 exposures 25c. Send empty cartridge. Filmshop, Linton, Ind.

**8x10 ENLARGEMENTS** In album \$4.50 doz. Send negatives. McKinney, 6941 Ozark, Chicago.

**FREE** Photographic Christmas card from best negative if you include stamp. 20 reprints 25c; 100—\$1.00. Roll developed, three prints each, 25c. Or, 16 prints and two beautiful enlargements 25c. Lifetone, G-39, Des Moines, Iowa.

**FILM** Developing bargains! Hurry! Save! Write for free safety mailers and details. Modern Studios, Dept. PM, LaCrosse, Wis.

**QUALITY** Since 1889—one day service. Roll developed, 2 Brilliantone prints each negative 25c. 8x10 enlargement coupon, 16 reprints 25c. 20 Photographic Christmas Cards from your negative \$1.00; 50—\$2.00. Willard Studios, Box 3535-A, Cleveland, Ohio.

**PHOTOGRAPHIC** Christmas folders, cards, calendars. Write for circular or send negative and 25c for samples. Ideal Photos, Box 2255, Paterson, N. J.

**EIGHT** Silvertone gloss enlargements or eight prints and two enlargements, 25c. Mayfair, Box 261-K, Toledo, Ohio.

**ROLL** Developed, 8 prints all enlarged to double size, 25c. 16—50c. Enlarged reprints 4c. Artcraft Studios, Box 3582-A, Cleveland, Ohio.

**20 REPRINTS** 25c. 100 Reprints \$1.00. Rolls developed, 2 prints each negative, 25c. New Photosnaps, Kirksville, Missouri.

**ENLARGEMENT** From each picture on your roll 25c. Lifelike enlargements bringing out the best in your pictures. High quality, fast service, low price, an unbeatable combination. Cut Rate Photos, Dept. B-4, Janesville, Wisconsin.

**PROFESSIONAL** Overnight service. Developed, printed, 2 enlargements, 25c. Fotoservice, 1942 Marlow, Toledo, Ohio.

**TWO** Prints from each picture on your roll 25c. Your pictures will speak volumes when finished by our expert craftsmen. One day service. Nineteen years experience. Lens Photos, Dept. J-4, Janesville, Wisconsin.

**ROLL** Developed 8 prints and two enlargements 25c. Beautiful photographic Christmas cards or calendars from your negatives, 4 for 25c; 17, \$1.00, envelopes included. Young Photo Service, 405-C, Albany, N. Y.

**BETTER** Photo finishing. Eight exposure rolls developed and printed 25c. Moore Studios, Alstead, New Hampshire.

**BETTER** Colored enlargements, 5x7, 25c. Catlin Film Service, Catlin, Illinois.

**EMBOSS** Christmas cards, including envelopes, from your own negative 60c dozen. Minimum 4 for 25c. Film Capitol Service, Box 504, Rochester, New York.

**LARJARGRAPH** Reprints: Five 5x7 enlargements 25c. Cardinal Photos, Summit, N. J.

**FOR** The discriminating amateur—Rolls developed 2 prints each, 25c. Reprints 3c. Superior workmanship. Same day service. Paramount Co., 327 E. 92nd St., New York.

**IMMEDIATE** Service! Better pictures. Sixteen guaranteed prints from roll, 25c. One colored or two plain enlargements and 8 guaranteed prints, 25c coin. Special Coupon for 8x10 enlargement given with every 25c worth Kodak finishing. Any 36 exposure, 35 mm. film fine-grain developed and each good negative enlarged to 3x4 prints for only \$1.00. 3x4 reprints, 4c each. One day service. Details and mailers free on request. American Studios, Dept. 22, LaCrosse, Wis.

**ROLL** Developed, 16 guaranteed prints, 25c. Smart Photo, Winona, Minnesota.

**PROMPT** Service—Guaranteed work. Two beautiful portrait type doubleweight enlargements, eight neverfade gloss prints, each roll 25c. Dubuque Film Service, Dubuque, Iowa.

**PROMPT** Service—Quality work; 2 beautiful doubleweight gloss enlargements, 8 guaranteed neverfade prints each roll, 25c. Excel Photos, Dubuque, Iowa.

**ROLLS** Developed, two prints each and two free enlargement coupons, 25c; reprints, 2c each; 100 or more, 1c. Summers' Studio, Unionville, Mo.

**THREE** Prints each good negative in roll 25c. Reprints 3c. Fred D. Eastman, Bode, Iowa.

**LIFE** Photo finishing lasts a life time. Roll developed, 8 prints, 2 enlargements 25c. Reprints 1 1/2c. Life Photos, Hutchinson, Kansas.

**16 PRINTS** With roll 25c. 16 reprints 25c. Rex Photo, Ogden, Utah.

**ONE** 6 1/2 x 8 1/2 Wide border embossed enlargement or one 5x7 hand colored enlargement with each roll developed and 8 prints 25c. 36 exposure roll developed and 36 3 1/4 x 4 1/2 enlargements \$1.35. 18 exposure roll 75c. Vidor, 321-P Hennepin, Minneapolis, Minn.

**ROLL** Developed and 8 beautiful Velox glossy prints 25c coin or stamps. Reprints 3c each. Fotoprint Service, Roanoke, Va.

**TWO** Glossy enlargements, 1 colored with roll 25c. Arbor Service, 10, Joliet, Ill.

**CANDID** Special, 35mm. rolls enlarged to 3 1/4 x 4 1/2, \$1.00. 18mm. rolls 60c. 3 1/4 x 4 1/2 reprints 3c. Brown Photo Company, 1910-61 Emerson, Minneapolis, Minn.

**GUARANTEED.** Roll developed, 16 prints 25c. 20 prints 25c. Quality Photo, Hutchinson, Kansas.

## CAMERAS, PHOTO SUPPLIES

**MEXICO?** Wanted: your name and address for literature and prices of finest German cameras, binoculars, movies. Foto Mantel, Apartado 1459 Ven. Carranza 11, Mexico City, No. 105.

**CAMERAS** And supplies. Free illustrated catalog listing everything photographic—still and movie cameras, films, lenses—at tremendous savings. Hundreds of bargains, new and used. All guaranteed. We take your old camera or equipment in trade. Write now for your free copy of our newest money-saving bargain book—just out! Limited edition. Hurry! Central Camera Co., (Photographic Headquarters since 1899), 230 S. Wabash, Dept. L-16Z, Chicago, Ill.

**MAKE** Money in photography. Learn quickly at home. Easy plan. Previous experience unnecessary. Common school education sufficient. Interesting booklet and requirements free. American School of Photography, 3601 Michigan Avenue, Dept. 3439, Chicago.

**CAMERAS,** Enlargers, on time. See advertisement under Motion Pictures, Gull's.

**FROM** The great stocks of Bass, you can buy any camera, lens, at bargain prices. Write. All cameras carry 14-day money back guarantee. 30 years of leadership. Dept. AG, Bass Camera Company, 179 W. Madison St., Chicago, Illinois.

**MAKE** Money with your camera. New book tells how. 46 pages, 50c. Popular Mechanics Press, Room (C39), 200 E. Ontario St., Chicago.

**FREE—Guide** to everything photographic. New 1940 camera catalog—handbook just issued. 84 pages containing over 2000 items, 300 pictures. Latest camera models, new prices. New accessories—enlargers, lens, dark room needs, movie cameras, etc. Also used camera bargains. Liberal allowance for your old equipment. Send for free catalog today. Abe Cohen's Exchange, for 30 years "The House of Photographic Values," Dept. C2, 142 Fulton St., New York, N. Y.

**STUDIO** Backgrounds revolutionize your pictures. Professional results. Cost few dollars, can make hundreds! Write for free literature. No-Stitch Mfg. Co., Long Island City, New York.

**MAKE** Photographic Christmas cards as easily as contact prints! Our negative assortment includes 10 Christmas greetings and 8 decorations with complete instructions. Paper negatives \$1.00. Film negatives including 4 seasonal photographs \$2.00. Merit Photo Service, Blomfield, N. J.

**CAMERA** Repairing. Bellows made to order, shutters repaired. Bellows made to fit all standard cameras! United Camera Co., Inc., A-1515 Belmont, Chicago.

**ENLARGER** \$1.59. Enlarges eight times size of small negatives. Fully guaranteed. Paramount Sales Company, 89 Dudley Street, Boston, Mass.

**HAVE** You a camera? Send ten cents for recent number of our big magazine, showing how to make better pictures and earn money. American Photography, 116 Camera House, Boston, 17, Mass.

**CAMERAS** Films, paper 25% to 35% discount. Paramount Photo Division, 327 East 92nd St., New York.

**MAKE** Photography Pay. New book. \$1.00. Popular Mechanics, 200 E. Ontario St., Chicago.



### MOTION PICTURES AND SOUND EQUIPMENT

**BARGAINS!** Life of Christ, talking, singing. Short subjects. Portable projectors. Western Films, 1018 S. Wabash Avenue, Chicago.

**NEWS Photos!** Film local events, make money. 35mm. cameras \$49 up; 16mm. \$5.99 up; 35mm. auditorium projectors from \$37.50; sound \$169.50; 16mm. projectors \$49.50; sound \$98.50. Pressflash cameras: \$4.49, \$5.95, \$8.59. Xmas Bargainnews free. Mogull's, 64 West 48th, New York.

**MOVIE Title sets—100 wood letters and centering guide. Exceptional angles possible. \$2.50 complete. Kramark, Inc., 26 West 19th Street, New York.**

**CHRISTMAS Movie, 100 ft., 16mm. \$1.75, 50 ft., 8mm. 89c. Free bargain lists. Home Movies, Box 216, Easton, Penna.**

**TITLES; Request 16-8mm. catalogue. Orbit, 6404 Sunset, Hollywood, Calif.**

**8MM-16MM. Varieties. Arts. Home Movies, Box 82, Cincinnati, Ohio.**

**BARGAINS! Silent 35mm. films. Projectors. Demsey, 1223 Berkley, Youngstown, Ohio.**

**UNUSUAL 8mm. Movies, 60c up. List 3c. Import, 392Y, Elmira, N. Y.**

**BARGAIN Prices on all film—fit any projector. Waldo Films, Box 524, Cincinnati.**

**EXCHANGE Your 16mm. films. Complete information 3c. Arnett, 445 Weber, Piqua, Ohio.**

**PARTS Repair sales, rentals. World Film Enterprises, 630 9th Ave., New York.**

**35MM. Bargains—Westerns, comedies. Jersey Films, 2075 Richland, Lakewood, Ohio.**

**HOME Movie and still equipment. Victor Film Service, Litchfield, Minn.**

**WAR Films, 10% discount. 8-16mm. lists. Paragon, Box 453, Meriden, Conn.**

**SAVE! Catalogue! Bulk film! Write! Penn-Craft, Box 423-ML, Williamsport, Pennsylvania.**

**FREE! Write for Cinescreen Magazine. Latest film news. Movies of movie stars! Bailey Films, Dept. Y-3, 1651 Cosmo, Hollywood.**

**TITLE Film, 100' \$1.00. Title literature free. Cine Shop, 1812B Piedmont, Charleston, W. Va.**

**35MM. SOUND Silent bargains. Lists. Calderara, 5119 South St. Louis, Chicago.**

**8-16-35MM. SILENT. Sound, complete subjects \$3. Odd reels \$1.40. Lists. Norman's, 2120 Strauss, Brooklyn, New York.**

**8MM-16MM. Bargains. Free catalog. Movie Shop, 838 Broadway, Bayonne, N. J.**

**7-16MM. SOUND Projectors—\$145.00. Roshon, State Theatre, Pittsburgh, Penna.**

**GENERA Movie films (fresh stock) for all cameras. Save 50%. Free bargain circulars. Genera Company, Davenport, Iowa.**

**35MM. SOUND Films, projectors, amplifiers. S.O.F. DeVry, complete \$150.00. Kirk, 374 Driving Park, Rochester, New York.**

**8-16MM. FILMS. Latest release European war. Actual bombing by land-sea-sky. Lowest prices. Many other subjects. Films rented everywhere. Trades accepted. Free illustrated catalogue (with sample film 10c). Garden Exchange, 317 West 50th, New York.**

**8MM., 16MM. and 35mm. films, bargain lists 3c. Clifford Hoffman, 57 Broad, Albany, N. Y.**

**FILM: Art sample, 10c; others, lists free. Goodwill Company, Jackson, Tenn.**

**CASH For late "Filmo" 16mm. movie projector. Box 616, Mount Horeb, Wis.**

**16MM. VELOTEX. Perfect outdoor film, 100 ft. rolls \$1.95 including free processing. Sample free. Velotex Laboratories, 600-G, Gary, Indiana.**

**BEADED Screens easily made! Free directions, with beads covering 4'x5', \$1.00. Finest, \$1.25. Gard, Box 418-P, Madison Square Station, New York.**

**"SANTA CLAUS Is Coming." A real Christmas film for your children. Charlie Chaplin in "The Property Man." It's funny! 16mm. 200 ft. \$4.50, 8mm. 100 ft. \$2.50. Buy for yourself or Christmas giving. Royal Home Movies, 42T Melrose, Boston, Mass.**

**TITLES From Hollywood. 8 and 16 mm. 25 stock backgrounds, up to 8 words, 4 for \$1. Crown Titles, 1150 No. La Brea, Hollywood, Calif.**

**16MM. SOUND. Silent, 8mm. films, equipment, supplies, reasonable. State requirements. Send for price list. Nu-Art Films, Inc., 145 West 45 St., New York City.**

**TALKIE Shorts \$3.00 reel. Programs rented \$7.50 two nights. Simpson, 1275 South Broadway, Dayton, Ohio.**

**16 35MM. Films. List 5c. Bedner, 5300 S. Talman, Chicago.**

**MONEY Maker! "The World's Greatest Passion Play." 16mm. and 35mm. Sound or silent. Purchase or rent, superior than Oberammergau play. Write Hemenway Film Co., 37F Church Street, Boston, Mass.**

**BASS Says: Write to Cine headquarters for 66-page Cine Bargaingram No. 240. 8mm., 16mm., 35mm. silent and sound. Equipment to gladden the heart of amateur or professional, including the famous 16mm. sound on film RCA camera, exclusive distributors. Write for copy of this great book, it's free, to motion picture headquarters for 30 years. Dept. A. Bass Camera Company, 179 W. Madison St., Chicago, Illinois.**

**BARGAINS! 8mm., 16mm., free literature. Elder, P-739, Boylston, Boston, Mass.**

**GUARANTEED 8MM. 24-hour reversal processing. Double 8mm., 45c. Single, 25c. Univex 15c. Eso-S. 3945 Central, Kansas City, Missouri.**

**MOVIE Film. Develop yourself. Univex, Eastman, etc. Chemical samples 15c. Raw film wholesale. Lake Camera Exchange, Gary, Ind.**

**15% TO 25% Discount on still or movie cameras. Free circular. Paramount Co., 327 E. 92nd St., New York City.**

### RADIOS, SUPPLIES, INSTRUCTION

**TUNE In world wide radio stations. Thrilling hobby. Radex Magazine helps you with complete world stations lists, articles. Regularly 25c. Introductory price 15c copy. Radex, Teaneck, N. J.**

**BATTERY Radios—\$8.95 up. 1½-6-volt. Home agents wanted. Catalog free. Marco, P. Kansas City, Mo.**

**RADIOS \$4.95 Up. All types. Save to 50%. Agents user proposition. Catalog free. Autocrat-A, 3855 N. Hamilton, Chicago, Ill.**

**TELEVISION—Tubes, disks, motors. Arthur Pohl, 4829 Merritt, Detroit, Mich.**

**RADIOS Wholesale. All makes. Wilson Radio, 2509 N. 3rd, Milwaukee.**

**RADIO Engineering, broadcasting, aviation and police radio, servicing, marine and Morse telegraphy taught thoroughly. All expenses low. Catalog free. Dodge's Institute, Ames St., Valparaiso, Ind.**

**SEND For free giant money saving radio and phonograph record catalogue. United Radio Company, 1000-M, Newark, N. J.**

**MUSIC AND MUSICAL INSTRUMENTS**

**HAWAIIAN Guitar taught new easy method. World's finest home study course. Honolulu Conservatory, Dept. 10, 2108 Payne Avenue, Cleveland, Ohio.**

**JAZZ Piano lessons. Radio styles. Erskine, 810 East 14th St., Oakland, Calif.**

**SONGWRITERS—Agents, new sales plan. National Music-D, 532 Sixteenth, Oakland, Calif.**

**SONGWRITERS: Send for free booklet giving truth about songwriting opportunities. Allied Music, Dept. L3379, Carew Tower, Cincinnati, Ohio.**

**SONGWRITERS, Verse or music. Brilliant opportunity. Write immediately. Vanburen, B-23, Rockhaven, Kentucky.**

**MUSICAL Setting, radio publication free. Do not send material. Write first to Norman Spencer, Music Publisher, Studio PM, 145 W. 45th St., New York City.**

**SONGWRITERS—Marketing, composing. Free booklet. Write today. Songwriters Institute, 1234-C Broadway, New York.**

**SONGWRITING And selling secrets. Instructive book \$1. Liberty Books, Syracuse, N. Y.**

**PLAY Swing guitar. Hot licks. Orchestration. Every chord. \$1.00. Distributor, 903 Ninth St., S. E., Roanoke, Va.**

**MUSIC Composed to words. Rhyming pamphlet on request. Phonograph recording of completed songs. Send poem for consideration. Keenan's Studios, Dept. PM, Box 2140, Bridgeport, Conn.**

**SONGWRITERS—Send original poems—America's finest service. Variety, Dept. H, Salem, Indiana.**

**MUSICIANS! Learn modern music arranging. Complete 10-lesson course, \$1.00. Guaranteed. Melodic Music Methods, P.O. Box 1297, New Orleans, La.**

**SONGWRITERS! Outstanding, amazing offer. Hibbeler, C-5, 2157 N. Avers, Chicago.**

**DUO-FLEX Reeds for clarinets, and saxophones eliminate your reed troubles. Write for circular. Duo-Flex Reeds, 1204 1st Ave., Evansville, Ind.**

**PIANO By ear. Free booklet. Day-V-Way, Woolworth Building, Dearborn, Michigan.**

**SONGS—Arranged, revised by arranger "If I Had My Way"; "Carolina Moon"; others. Send for details. Harold Potter, 1619(P) Broadway, New York.**

**SIMPLIFIED Swing courses! Accordion, saxophone, clarinet, trumpet. Write Swingmaster, 1259-N Bender, East Cleveland, Ohio.**

**MUSIC Composed to words. Wonderful proposition. Bauer Bros., Oshkosh, Wis.**

**WRITE Songs. Big money and reputation. Write for information. J. Gordon Pub. Co., 201 N. Hoyne Ave., Chicago.**

**WANTED! Lyrics, melodies for songs. We arrange, publish, sell. Superior Song Studios, Passaic, N. J.**

**SONGWRITERS: Send your poem today for immediate consideration. Richard Brothers, 24 Woods Building, Chicago.**

**SONG Writers. Send for publishing agreement. McKinley Music Publishers, 1501 E. 55th St., Chicago.**

**SONG Poems wanted. Free examination. Send poems to McNeil, Master of Music, 510-PM So. Alexandria, Los Angeles, Calif.**

**PIANO. Self instruction. Play within an hour. \$1.00. Popular Mechanics, 200 E. Ontario St., Chicago.**

### BUSINESS OPPORTUNITIES

**FORDS Portable Hammermill operators make regularly weekly net earnings, \$50, \$75, \$100 and more. Fords' exclusive molasses impregnator gives operators big competitive advantage. Equipment may be purchased 25% down, balance from earnings. Write for particulars about this safe, sure, profitable year-round business. Myers Sherman Company, 1428 12th, Streator, Illinois.**

**127 WAYS To make money, in home or office, business of your own. Full particulars free. Elite Co., 214 Grand St., New York.**

**START A letter shop. Fifteen lessons \$1, postpaid. Literature free. Ostlin Letter Service, 1334 - 7th Ave., Moline, Ill.**

**SELL Auction, bankrupt clothing bargains from home, store or auto. Experience unnecessary. Shoes 15c pair. Men's, boys' suits, overcoats 75c. Dresses 25c. Wholesale catalog free. Bargains galore. Superior Jobbing, 1250-PJ Jefferson, Chicago.**

**HOW And where to obtain capital fully explained, free particulars. Star Service, Wapakoneta, Ohio.**

**BIG Money installing burglar alarms! Homes, stores, etc. Simple illustrated instructions. One dollar. Universal, 2808 12th Ave., Los Angeles, Calif.**

**"RUBBER Molds." Make them yourself. Formulas, instructions 25c. Ideal Service, R-12, Park Ridge, Ill.**

**POPCORN Machines, caramelcrisp, crispettes, cheese coat, potato chips. Long Eskins, 2035-M High St., Springfield, Ohio.**

**QUICK Income! Fast-growing business creates lasting independence; no canvassing. Service, Drawer 339-5, Butte, Mont.**

**EARN Steady income with "route" of peanut, gum and amusement machines. Small capital required. Robbins Co., 1141P DeKalb Avenue, Brooklyn, New York.**

**M. M. Earned \$267 three weeks, raising mushrooms in cellar! Exceptional, but your cellar, shed perhaps suitable. We buy crops. Book free. United, 3848 Lincoln Ave., Dept. 62, Chicago.**



**COLLECT** Accounts by mail. \$2.00 brings sufficient forms and instructions to start your own profitable business. The Collector, Box 265, Zanesville, Ohio.

**AMBITION** Isn't enough. But action will build your own business. Be independent. Easy to begin, steady, not selling. Your time is biggest investment. Write Hilco Products, St. Cloud, Minn.

**MAKE** Pine needle pillows. Sell downtown shops. 900% profit! 10c instructions. Pine Pillows, Box 148, Rhinebeck, N. Y.

**ANNOUNCING** New home study course in commercial baking. Good field for ambitious men. Nearly depression proof business. Common school education sufficient. Send for free booklet "Opportunities in the Baking Industry" and requirements. National Baking Institute, 3601 Michigan Avenue, Dept. 3439, Chicago.

**OPERATE** Phonographs, legitimate amusement, vending machines. Amount invested governs profits. Box 1591, Rockford, Illinois.

**SELL** Beautiful fur coats, capes, scarfs and boleros to your friends and make 100% profit. Free catalogue. Fox Fur Co., Ensley, Ala.

**BIGGER** Profits! Make, sell single ingredient products. Formula catalog free. H. Kinford, Wayne, Penna.

**FORMULAS**—Fast selling products. Guaranteed. Laboratory tested. Lowest prices. Catalog free. Kemico, 511, Park Ridge, Ill.

**FREE** Literature describing many money making plans. Brown Publishing Co., 610 So. Broadway, Los Angeles, Calif.

**MAIL** Order business on 25c capital. Instructions 25c coin. Kermen, Box 694, Pocatello, Idaho.

**FASCINATING**, Profitable "Fixit" service taught. Houlgate, Station C, Pasadena, California.

**YOUR** Own business! Selling by mail. Details free. Maples, 3418 South Marshfield, Chicago, Illinois.

**FORMULAS**—List 10c. Decrette, 3516 Old Frederick Road, Baltimore, Maryland.

**BUSINESSES** For sale. Many addresses. Dime brings three catalogues. Kashfinder, Wichita, Kansas.

**TURN** Tin cans into money at home. Big profits. 25c easy instructions mailed. H. Chaney, 1116 East 16th Street, Jacksonville, Fla.

**WANTED** Local purchase agents. Chautauqua, 25 Chestnut St., Jamestown, N. Y.

**CAPITAL** Raised by simple methods. Financing explained. Send \$1.00 for ten money raising plans. Executive's Promotion Service, Washington, D. C.

**POSITIONS** Abroad! We tell you where they are, how to get them. Write today for reliable, accurate information. A. Julius, Amarillo, Texas.

**205 WAYS**, Start own moneymaking business. Select line not overcrowded. Particulars free. Stamford, 3762-b Broadway, New York.

**WIN** Money! Prizes! Sample contest magazine 10c. Butler, Braxton, Miss.

**ELITE** Collection of business plans, contains 127 tested plans and scores of formulas. Start own business; home, office. Particulars free. Elite Co., 214 Grand St., New York.

**START** Profitable business at home. Make concrete statuary, garden furniture, vases, bird baths, etc. No machinery. Pays big profits. Experience not required. Write at once for interesting literature. Popular Mechanics Press, 641 St. Clair St., Chicago.

**YOU'LL** Like resilvering mirrors, auto-parts, reflectors, making chipped glass signs. Write Sprinkle, Plater, 127, Marion, Indiana.

**BIG** Profit in mold making and plaster casting. Foolproof rubber. Tremendous market. Simple interesting work. \$1.50 on every dime invested. 24 page instructive booklet 3c stamp. Plastic Arts, 711 Neely, Muncie, Indiana.

**PROFITABLE** Home business. Easily started. Steady profits. Details 10c. Home Service Bureau, Box 4079, South Edmonton, Canada.

**CASH** Newspaper clippings. Details. Galvin (D724), 207 E. 84, New York City.

"THE Lord is Coming." Get proofs. Sheal, 263, Duluth, Minnesota.

**BIG** Money in candy, make and sell candy for Christmas. Ten basic formulas. \$1.00. Ward Tome, 3468 W. 25 St., Cleveland, Ohio.

**MAKE** Household product of 100 uses. Sell by mail or agents, spare time. Information free. Ribot, 620 East 62nd, Chicago.

**MAKE** \$50-\$100 Weekly! Show talkies in theatreless communities. We furnish everything! Experience unnecessary. Free catalogue (with sample film 10c). Garden Exchange, 317 West 50th, New York.

**START** Mail order book business new way. Method thoroughly proven. Substantial supply source. Help in getting started. Circular free. E. P. Pendleton, Whittier, Calif.

**POSTCARD** Addressed Excello Sales, Shreveport, Louisiana, brings best proposition ever received.

**MAKE** Your own rubber molds. Details free. June, 101-B Beech, Holyoke, Mass.

**INCREASE** Your income. Countless spare time opportunities, magazine. Sample 10c. Katz, 4254 North Kimball, Chicago.

**ADVERTISE**. Sell by mail. Write: Goodall Agency, 628 Montgomery, San Francisco.

**MAKE** Artificial marble. Novelties, floors, pottery. Cement secrets. Brilliant sample 3c. John A. Payn, 945 Grande Vista Avenue, Los Angeles, Calif.

**WANT** More money? "Successful Selling Methods Revealed!" 25c. Luty, 9821 DeQuindre, Detroit.

**WONDERFUL** Sparetime business. Pays amazing profits. Unusual opportunity. Investigate this new moneymaker. Box 1892, Wichita, Kansas.

**SELL** By mail! Inspiring, constructive, instructive literature. Jay, 1127-p East 61st, Chicago.

**COMPILE** And publish books without capital. Dignified business. Stamp for details. Washer, 2825 Downer, Milwaukee.

**WAR** And oil. War equipment must have oil in exceedingly large quantities. You should know how to save and make money concerning oil at this time. We show you how to cash in. Legitimate. This is for you and you. For 25c coin. Royal Keystone Enterprise, Box 192, Berryville, Ark.

**AFTERNOONS** Free! Work home. \$50,000 reported made (exceptional—full-time). Also war-time business plan! Expect surprise! National-D, BX1240, San Bernardino, California.

**RADIOS**; Motors; home workshop tools. Mailorder Electric, 719 South Dearborn, Chicago.

"20,000,000" **MOTORISTS** Your prospective customers. Make, buy, sell. Hire salesmen, agents. Free particulars. Original, P.O. Box 1792, Houston, Texas.

**205 MONEYMAKING** Opportunities. Start own business. Home, office, etc. Particulars free. Stamford, 3762-a Broadway, New York.

**AMBITIONS** Realized! Extra income, better jobs. Fascinating hobbies, happiness! Stamp for plans. Seekay, Augusta, Maine.

**STEADY** Job, if mechanically inclined. Easy work, good money, own boss. Connan, 508 S.W. Second, Portland, Oregon.

**HANDY** Men—Earn money home operating Community "Fix-It" Shop. Stafford, Makanda, Illinois.

**MANUFACTURE** New garden tool at home. Big market. Dollar brings three tools postpaid. Particulars free. McElmoyl, Groveville, N. J.

**BELTS**, Suspenders, make'm and make money! Dandy Christmas gifts! Materials supplied. Sample belt 25c. Arto Leather, 400 Joseph Ave., Rochester, N. Y.

**PUBLISH** A magazine at home. Sample magazine dime. Devine, M820 Wrightwood Ave., Chicago, Ill.

**BUSINESS** Opportunities! Catalog free. National Opportunity Catalog, 4101 S. 38 Avenue, Minneapolis, Minn.

**DON'T** Buy formulas before reading November's big free Formula Messenger! Miller's Chemical Laboratories, Tampa, Florida.

**PROFIT** With new products. Make, sell, repeat. Analysis. Research. Guaranteed formulas. Biggest catalog free. Nominal prices. Gibson Laboratory, Chemists, BD-1142 Sunnyside, Chicago.

**OPERATE** Profitable "route" four compartment vendors. Small investment. Penny King, 1233 Chouteau, St. Louis.

**LUMINOUS** Paint—Shines in dark. Made easily. Sells quickly. Big profits. Formula, moneymaking instructions, \$1.00. Generous sample, details, 10c. Gordon Laboratories, 1265-D Broadway, New York.

**SIGNS** And showcards easily painted with letter patterns. Write for free sample. John Rahn, D1330 Central Ave., Chicago.

**SOAP** Making. Learn at home. No machinery needed. Posera, T-4545 Bartlett, Milwaukee, Wisconsin.

**AMAZING** Profits "Building Home Coolers." Entirely new business. Unlimited possibilities. Enormous demand. Experience not required. Tremendous opportunity to build big paying business. Write today. Helm Mfg. Co., Decatur, Texas.

**WANT** More business! 2c daily opens individual New York branch office. Co-operative Mail Service, 126 Lexington Ave., New York.

**SALESMEN**—Our electric frankfurter grill sells on sight, exclusive territory. Write Miracle Appliance Company, Cresona, Penna.

**DON'T** Write—Personal contacts get better results. Confidential agent will perform any service in Chicago—business, personal, unusual. Moderate fee. Matthews, Box 268, Chicago.

**EXTRA** Dollars for you. Make-sell. Fragrantly tenacious synthetic perfume. Manufacturing instructions \$1.00. Perfumer, 8830 Betty Way, Los Angeles.

**START** Your own business. Local or mail order. Particulars, 3c stamp. Tumbled, Box 214, Newport, Arkansas.

**BE** Your own boss. 25c brings valuable booklet of opportunities. Circular for stamp. Otto, Box 864, Sequim, Wash.

**WE** Help start you in business, furnishing outfits and instruction, operating "Specialty Candy Factory" home. Men-women, opportunity to earn good steady income, all or spare time. (Our 31st year). Booklet free. W. Hillyer Ragsdale, Inc., Drawer 4, East Orange, N. J.

**\$30 WEEKLY**. Grow mushrooms. Cellar, shed. We buy 35c lb. Mr. B. made \$270 spare time. World's largest company of its kind. 40 page book free. Mushroom, Dept. 701, 2019 Second, Seattle, Wash.

**AMBITIOUS** Men—Make \$8 daily. New profession. Start immediately. No canvassing. No selling. Kenneth N. Cooke, Box 42, Sarnia, Ontario.

**MAIL** Order business is your opportunity. Many began small, now earn thousands yearly. No personal contact. Boundless opportunities. Have had over 30 years experience; will help you succeed. Send 25c for valuable booklets, none free. B. Breniser, 257 S. 21st, Philadelphia.

**WANTED**—Factory representatives for complete Turkish bath outfit for home use. Light, streamlined, compact. Retail \$9.95. Write today for our proven sales plan. Perspirator Mfg. Co., First and Utah, Toledo, Ohio.

**COLOR** Concrete with chemicals. Stucco-Rock. Cement artistry. Benches. Washingwells. Spin concrete pottery. Miniature castles, waterfalls, coldglaze, water-paints, marbling. Sample 10c. Hollywood Cement-Craft, 8527 Wonderland, Hollywood, California.

**LEARN** Account collecting. Good income; quick results. Interesting folder free. National Collectors Association, Newark, Ohio.

**EARN** Extra money at home. Increase your income at home by new, simple Wentworth Tempera Color method. We instruct you and supply you with work. Write today for free booklet. Wentworth Pictorial Co., Ltd., Dept. 3, Hamilton, Ont.

**GOOD** Paying business, plating auto parts, reflectors, bicycles, bath fixtures, mirrors, by late method. Small investment brings big returns. A permanent respectable business in your own community. Free particulars and proofs. Gunmetal Co., Ave. H, Decatur, Ill.

**100 PROFITABLE** Mail order and local plans. Gilbert Supply, 1107 Broadway, New York.

**MAKE** Money by mail, the way we do. Free information. Maywood, P-1107 Broadway, New York.



**MANUFACTURE** From Phospholene. Cleaning fluid 1c gallon; bleach 2c gallon; hand soap 2c pound; and ten fast sellers. Sample 25c. Details free. Western, 401 Climax Bldg., Cleveland, O.

**ADVERTISERS!** 1,600,000 Mail order circulation. Inch advertisement, \$15.40. "Get results." 20 newspapers, 18 words, \$6.50. Diener-Dorskind, 1474P Broadway, New York.

**LIQUID Marble**—anyone can make! Colorful, glazed! Moulded, brushed, spray'd. Rubberlastic moulds. Composition flooring. Big money in these! Particulars free. Marbleizing Service, Edwardsville, Ill.

**SUCCEED** With your products. Make-sell. Formulas. Accurate analyses. Catalog free. B. Thaxly Company, Washington, D. C.

**I WANT** To send you proof of the wonderful pulling power of Popular Mechanics Magazine's classified pages. What's your proposition? Write me today. F. W. Johnson, Manager Classified Advertising, 200 E. Ontario St., Chicago, Ill.

**DELAWARE** Charters: Complete service \$35. Submitted forms. Chas. G. Guyer, Inc., Wilmington, Del.

**SELL** By mail. Books, novelties. Bargains! Big profits! Particulars free. E. Elco, 438 N. Wells, Chicago.

**CHARTERS:** Delaware; best, cheapest; free forms. Colonial Charter Co., Wilmington, Del.

**WHERE** To buy at lowest wholesale prices. Information free. Yorena, Box P-312, Bayonne, N. J.

**1001 WAYS** to Use Concrete. Send for large free illustrated folder describing new Popular Mechanics book covering every known use of concrete for the home, farm, building, business and industry. Popular Mechanics Press, Room (C39), 200 E. Ontario St., Chicago.

### MONEYMAKING OPPORTUNITIES

**TELEPHONE** Repair service offers unusual money making opportunity for energetic men in farm communities. Start your own service, we furnish instructions and materials at low prices. Ideal sideline for radio, electric or hardware stores. Write today about county agency. Farm Telephone Repair Company, Rogers Park Station, Chicago.

**MAKE** Shell novelties. Big demand as souvenirs. Sample and instructions 35 cents coin. The Treasure Chest, Ocean-lake, Oregon.

**BE A** professional scrapbooker. Big fees. Unlimited opportunities. Can be done at home. No competition. No capital needed. Write to Scrapbookers Guild, 59 Park Place, New York, N. Y.

**BETTER** Than a job—No selling. Full or spare time. Profits roll in day, night. Free—complete details. Automatic, 2427 West Fullerton, Chicago.

**FROZEN** Food. Make money in this fast growing new industry. Send 25c complete information. Earl F. Starkey, Sierra Madre, Calif.

**OPPORTUNITY!** Want it? We have it! Send for exceptional offer! Jules, 440½ Park, Salt Lake, Utah.

**YOU'LL** Like resilvering mirrors, auto-parts, reflectors, making chipped glass signs. Write Sprinkle, Plater, 287, Marion, Indiana.

**LOOKING** For business opportunities? Home work offers? Samples? Catalogs? Your name listed with thousands of dealers, manufacturers 25c. Schuman, 1715-A South 16, Milwaukee, Wis.

**MILLION** Articles. Buy wholesale. Valuable directory 10c. Ideal Service, D-12, Park Ridge, Ill.

**POSITIONS** Abroad! Write for free reliable information. C. Julius, Amarillo, Texas.

**FREE**—Combination pen and pencil for 10 minutes time. Dept. PM, Veltex Company, Birmingham, Ala.

**"PORT** Of Opportunities" published monthly—offering latest self employment; ideas; plans; schemes. \$1.00 year, copy 10c. Farm & Home Industries, 66 Seneca, Gardenville, N. Y.

**OPPORTUNITY** Mail. Your name listed 10,000 directories, 25c. Wayne Herald, Fairfield, Ill.

**WORK** Mornings home. Big money. No canvassing. Unique plans. Campbell's, 3231 Dupont North, Minneapolis, Minn.

**AMAZING** Discovery—Make original etchings, your own greeting cards, book plates, Easy! Supply others. Inexpensive—practical. Get your part of 25 million yearly sales. Have independent business of your own. Write now. Etchcrafters, 10 W. Eager St., Baltimore, Md.

**NEW!** Money making secrets, gets the orders. Write now, 10c refunded. Modern Specials, Box 6346-M, Pittsburgh, Penna.

**MONEY** By mail, new mailorder opportunities free. Harvey Teeple, Decatur, Indiana.

**205 MONEYMAKING** Opportunities. Start own business. Home, office, etc. Particulars free. Stamford, 3762-a Broadway, New York.

**MAKE** Sell latest winter auto necessity. Write Acme Service, Copley St., Auburn, New York.

**"HOLLAND-INN"** Hamburgers, hotdogs offer possible fortune. Particulars, including "genuine" barbecued frankfurters formula 25c. Refundable. Davis, Box 1484-PMX, Clarksburg, West Virginia.

**AFTERNOONS** Free! Work home. \$50,000 reported made (exceptional—full-time). Also war-time business plan! Expect surprise! National-E, BX1240, San Bernardino, California.

**ANALYSIS.** Research. Newest guaranteed formulas. Biggest catalog free. Nominal prices. Gibson Laboratory, Chemists, CS-1142 Sunnyside, Chicago.

**AMATEUR** Cartoonists, earn cash at home, copying and duplicating cartoons for advertisers. Ad-Service, Argyle, Wis.

**BE** Funny, make money. Learn gag writing. Stamp brings information. Don Uish Studios, B-443 Wrightwood, Chicago.

**FREE** Questionnaire helps you get jobs, home work, agencies, etc. Unobligated. Write, Bridger, New Windsor, Illinois.

**INCREASE** Your income, free literature. Ace Publisher, 60C, Maspeth, N. Y.

**MEN-Women**, operate "Specialty Candy Factory" home, all or spare time. Steady income. (Our 31st year.) Hillyer Ragsdale, Inc., Drawer 63, East Orange, N. J.

**READ** Our war and oil ad under Business Opportunities, it's worth answering. Royal Keystone Enterprise, Box 192, Berryville, Ark.

**WANT** Money? Wonderful plan; no investment. Write P.O. Box 1928, Hollywood, California.

**NEW** Work for men and women. Excellent fee basis makes good income all or part time. Easily learned by anyone who can type and is neat. Complete instructions 25c. Free circular. E. O. Pendleton, Whittier, Calif.

**COLLECT** 50c From each person wearing eye glasses. Queen City Chemical Company, 724 W. Trade St., Charlotte, N. C.

**BETTER** Yourself. Present position—new job—or your own business. Advance, prosper, succeed. Startling free details. Write, Manager, VR Mfg. Company, Detroit Lakes, Minnesota.

**BUYERS** Guide—Also latest money making opportunities. Wetzel, Valhalla, N. Y.

**BOOKKEEPERS**—Increase income with inexpensive new bookkeeping service. Bobertz, 3701 East Hancock, Detroit.

**GOOD** Paying business, plating auto parts, reflectors, bicycles, bath fixtures, mirrors, by late method. Small investment brings big returns. A permanent respectable business in your own community. Free particulars and proofs. Gunmetal Co., Ave. N, Decatur, Ill.

**MOULDS**, Guaranteed, for casting toy soldiers, Indians, trappers, warships, sinker moulds, 244 kinds. Send 5c for illustrated catalogue. Henry C. Schiercke, 645 Spencer, Ghent, N. Y.

**RAISE** Earthworms for profit. Information free, stamp appreciated. Bureau Zoological Research, 106A Broadway, Peoria, Ill.

**WHOLESALE** Sources. 500,000 articles. Free directory. Maywoode, 1107 Broadway, New York.

**1059 WAYS** to start a profitable business. Get Popular Mechanics book of modern formulas and methods for practical specialty manufacturing. Price only \$1.25 postpaid. Popular Mechanics Press, Room (C39), 200 E. Ontario St., Chicago.

### FORMULAS, PLANS, ETC.

**LESS** Than 5c hundred pounds to make garden fertilizer material at home. Complete report and step-by-step directions 50c. Western Research, RFD 1, Box 210, Mill Valley, California.

**GUARANTEED** Formulas—New fast sellers. None better. Lowest prices. Catalog free. Kemico, 410, Park Ridge, Ill.

**FORMULAS** 5c. Biggest formula value. List free. 565 Dunfermline St., Pittsburgh, Penna.

**SINGLE** Ingredient formulas! Quickest way to bigger profits! Catalog free. G. Kinford, Wayne, Penna.

**10,000 MONEY-MAKING** Formulas, secrets, recipes for making almost anything. 900 page book \$1.50 postpaid. Catalog 3c. Adams-Brown Company, Chestnut Hill, Massachusetts.

**CHAMPION** Wall paper cleanser. No water hand soap. Mending fluid. All three formulas \$2.00. Mack McLeod, West Branch, Mich.

**DON'T** Buy formulas before reading November's big free Formula Messenger! Miller's Chemical Laboratories, Tampa, Florida.

**ANALYSIS.** Research. Newest guaranteed formulas. Biggest catalog free. Nominal prices. Gibson Laboratory, Chemists, BD-1142 Sunnyside, Chicago.

**3 GOOD** Formulas with instructions for making gold, silver, gun-metal mirrors, \$1.00. Don't buy cheap formulas. Nashville Mirror Plating Co., 427 Broad, Nashville, Tenn.

**FREE** Formula catalog. You'll be surprised. Western Chemical, Salem, Oregon.

**REAL** Manufacturing formulas. Lists free. Cummings, Chemist, Gordon Avenue, Syracuse, N. Y.

**FORMULAS** For live selling products. Palmer Specialties, Sandwich, Ill.

**THAXLY** Formulas for perfect products. Accurate analyses. Catalog free. B. Thaxly Company, Washington, D. C.

**FORMULAS.** Latest money makers. Literature free. Belfort, 4042 N. Keeler, Chicago.

**ELITE** Formulas and plans; make and sell your own products. Descriptive booklet free. Elite Co., 214 Grand St., New York.

**FORMULAS**—All kinds. Real money-makers. Lowest prices. Catalog free. Clover Formulary, P-12, Niles Center, Ill.

### CHEMISTRY

**FREE** Catalogue. Chemistry, mineralogy, biology, microscope, telescopes. Tracey Laboratories, Evanston, Illinois.

**CRUCIBLE** Amateur chemical magazine. Sample copy 10c. Crucible, Box 294, Jamaica, N. Y.

**CHEMICAL.** Electrical, technical books. Catalogue. Stamp. Kraftsmen's Press, Coscob, Conn.

**LEARN** Chemistry: 40-lesson course \$10, formerly \$145. Money-back guarantee. Particulars free. Lawes, 128 E. 23rd, New York.

**CHEMICALS,** Laboratory, glassware, apparatus. Send 3c for catalog CP1. Biological Supply Company, 1176 Mt. Hope Avenue, Rochester, N. Y.

**CHEMICALS** In 5c quantities. Catalog 5c. Fleischer's Laboratories, Everett, Mass.

**SPECTROSCOPE** For quick chemical analysis \$2.50. Kutting Sons, Campbell, California.

**FREE** Chemistry catalog. Supplies at 5c! Equip complete laboratory. Send 3c for postage. Kemkit Scientific Corp., 397P Bridge St., Brooklyn, N. Y.

### HELP WANTED

**BIG** Money taking orders; shirts, ties, hosiery, underwear, pants, jackets, rain-coats, uniforms, etc. Sales equipment free! Experience unnecessary. Nimrod, 4922-BG Lincoln, Chicago.

**STEADY** Work—Good pay. Reliable man wanted to call on farmers. No experience or capital required. Pleasant work. Home every night. Make up to \$12 a day. Wonderful new proposition. Particulars free. Write McNess Co., Dept. 329, Freeport, Illinois.



M. M. Earned \$267, three weeks, raising mushrooms in cellar! Exceptional, but your cellar, shed perhaps suitable. We buy crops. Book free. United, 3848 Lincoln Ave., Dept. 63, Chicago.

**SALARIED Positions**—\$2500 yearly and up. Let us find one for you. Write for valuable information. Executive's Promotion Service, (16), Washington, D. C.

**\$30 WEEKLY.** Grow mushrooms. Cellar, shed. We buy 35c lb. Mr. B. made \$270 spare time. World's largest company of its kind. 40 page book free. Mushrooms, Dept. 701, 2019 Second, Seattle, Wash.

#### AGENTS WANTED

**WEAR** Fine hose I send without cost with outfit while taking orders for amazing new hosiery. Replacement guaranteed against holes, snags, and runs. Rush name and hose size. Wilknit, S-37, Greenfield, Ohio.

**SELL** The best fibre house broom made; new low prices; 100% profit. Fibro Brush Mfg. Co., 1268 Stanford Ave., St. Paul, Minn.

**500% PROFIT** With new perfected (1940) quick-action, no flint, automatic gas lighter. Retail 25c. Sample 10c. New Method Co., Box PMH-83, Bradford, Penna.

**WORLD'S Fastest** money maker. Sell 50c packs of razor blades for 5c. Tharp, 914 Lexington, Cumberland, Md.

**MERCHANTS** Wall signs. Cost 1c, sell 10c. Samples 15c. Richards, 127-M E. New York St., Indianapolis.

**NOW**—Direct factory representatives wanted. New profit plan on nationally known, guaranteed electric refrigerators. Write today. Gennett and Sons, Dept. C, Richmond, Indiana.

**WANTED**—Distributors, jobbers, for attractive carded merchandise priced right. Aspercol Products, 2613-15-17 38 Ave., Oakland, Calif.

**SELL** Artistic oil painted personal portraits. Portraiture, 2637 Evergreen, Chicago.

**BIG** Money taking orders; shirts, ties, hosiery, underwear, pants, jackets, raincoats, uniforms, etc. Sales equipment free! Experience unnecessary. Nimrod, 4922-AN Lincoln, Chicago.

**"KEENEREDGED"** Blades shaves smoother. Guaranteed sample "Keeneredger" \$1.00. Keeneredger, Oblong, Ill.

**MAGNETIC** Sponge draws dirt from clothing. Used like brush. Saves dry-cleaning. Slick discovery. Samples sent on trial. Write "Inventor," 113 Kristee Bldg., Akron, Ohio.

**AGENTS**—300% Profit selling gold leaf letters; stores and offices. Free samples. Metallic Letter Co., 438-B North Clark, Chicago.

**SURE-FIRE** Deal. Housewives grab it. \$1 household necessity, now 69c. Give genuine Delifite salad bowl without charge. Big profit for you. 200 other fast-sellers. Free to reliable man—\$6 worth goods to start. Zanol, 6138 Monmouth, Cincinnati, Ohio.

**POLMET** Polishing cloth removes tarnish from metals without the use of liquid, paste or powder. Agents say it sells like "hot cakes." Retail 25c. Sample free. Gale & Co., Inc., 15 Edinboro St., Boston, Mass.

**STEADY** Profits: New improved wax furniture polish. Private brands; your name. P.O. Box 247, Newport, R. I.

**AGENTS**—Opportunity make money; book containing 127 successful business plans; home-office; send for free introductory booklet. Elite Co., 214 Grand St., New York.

**MAKE** Extra money selling new plastic beverage bottle cap every home uses. Send 15c for sample. Metaloplastics, Inc., Port Washington, N. Y.

**DANDY** Seller. Good profits. Details free. Societe Cent Quarante, Valley City, N. Dak.

**BUSINESS** Proposition resilvering mirrors, autoparts, reflectors, making chipped glass signs. Write Sprinkle, Plater, 128, Marion, Indiana.

**CAR-OWNERS** To put up our signs. Fine offer for anyone traveling. (Not for kids.) Get details. Atlas Sign Works, 7941 Halsted, Chicago.

**AUTOMOBILE** Mechanics who want business or earn extra money write for samples and details of nationally distributed Self-locking Triple-X Piston Rings. Eliminate re-boring. Guaranteed life of car. Franchise valuable. Some territories open. Triple-X Co., 3801 South Racine, Desk RA, Chicago.

**WANTED**—Purchasing agents, no experience or money required, write and mail 3c stamps for application to Purchasing Mgr., 176 N. Halsted St., Chicago.

**MAN** Wanted to supply Rawleigh's household products to consumers. We train and help you. Good profits for hustlers. No experience necessary. Pleasant, profitable, dignified work. Write today. Rawleigh's, Dept. L-53-PPM, Freeport, Ill.

**205 WAYS.** Start own moneymaking business. Select line not overcrowded. Particulars free. Stamford, 3762-b Broadway, New York.

**FOREIGN** Like souvenir auto plates. China, Egypt, India, \$1. Agents wanted. Lingles Shop, Dept. PM, Anna, Ill.

**EXCELLENT** Sparetime profits taking subscriptions—2500 magazines. Confidential agents catalogue, complete starting supplies free! Pines, A-581 Monroe, Brooklyn, N. Y.

**SELL** New, used clothing from home, auto, store. Men's suits 96c. Overcoats 66c. Dresses 21c. Ladies coats 42c. Hundreds big bargains. Catalog free. S&N, 440-A East 31st, Chicago.

**NEW** 10c Seller. Costs 1c. Western, 432 Climax Bldg., Cleveland, Ohio.

**EX-O-LENE** Anti-knock power compound. More mileage, power, speed, pep guaranteed. Thermo Exolene, Peoria, Ill.

**READ** Our war and oil ad under Business Opportunities, it's worth answering. Royal Keystone Enterprise, Box 192, Berryville, Ark.

**TIES:** Wonderful proposition. Free swatches. Eureka, 307 West 38th, Manhattan.

**SELL** Fascinating Jitterpups and carded merchandise. Dixie Supply, Rosslyn, Va.

**FAST** Selling perfume novelties. Big profits. Vassar, 332-P Washington, Hoboken, New Jersey.

**AMAZING** Manufacturing formula. Fast selling repeater. Make at home. Large profits. Complete selling plans. Details free. Shennery Laboratories, 1788 Madison, New York.

**MOTORS:** Drills; appliances; grinders. Mailorder Electric, 715 South Dearborn, Chicago.

**\$ FOR** Your spare time! No investment! Experience unnecessary! New items! Tremendous sales appeal! Buyers everywhere! Convince yourself! Deluxe outfit free! Union Specialty, 1775-P Broadway, New York.

**MEXICAN** Curios sell on sight. Large profits. Free particulars. Samples 10c stamps. Marquez-PQ, Apartado 1176, Mexico City.

**EARN** Extra money taking magazine subscriptions. Lafayette Agency, Sea Cliff, N. Y.

**WAR** Maps—24x36 pictorial. Big profits, easy sales. Sample 25c. Premium Promotions, 1181 Broadway, New York City.

**AGENTS** Wanted. "Magic Box." Fast seller. Sample 30c. Money refunded if not satisfied. Speedy Specialty Co., Box 184, Venice, Calif.

**SENSATIONAL** Device cuts, trims own hair. Also manufacturing formulas. Plaza Laboratories, T, 1561 North Clark, Chicago.

**PROFIT** With new products. Make, sell, repeat. Analysis. Research. Guaranteed formulas. Biggest catalog free. Nominal prices. Gibson Laboratory, Chemists, BD-1142 Sunnyside, Chicago.

**500% PROFIT.** Gold and silver colored sign letters. Offices—stores. Large sizes, 1c. Free samples. Modernistic, B-3000 Lincoln Ave., Chicago.

**DRESSES** 10c. Hats 40c. Shoes 50c. Many other bargains—Used merchandise. Free catalog. Send name on postcard. Fairmount, 160PM, Monroe Street, New York.

**SELL** 50 Assorted Christmas cards with name \$1. Costs 50c. Free sample offer. Other profitable sellers. Nickel's Press, 4617 Loughborough, St. Louis, Mo.

**AGENTS** Make big profits on food products, bargain deals. Low wholesale prices. Rush name for trial outfit offer. Ho-Ro-Co, 2810-T Dodier, St. Louis, Mo.

**COLLECT** Your bad debts. Merchants write Lamont Company, Beacon, New York.

**500% PROFIT!** Transfer sign letters for windows, offices, trucks, signs. Colors: gold, silver, red, many combinations. Auto monograms. Easily applied. Neonite, Akron, Ohio.

**AGENTS:** Smash go prices! Santos coffee 12c lb. 4-oz. vanilla 8½c. Razor blades 10 for 8½c. 100 sticks chewing gum 12c. Christmas cards, 21 in box, 14c. 150 other bargains. Premiums. Experience unnecessary. Carnation Company, PO, St. Louis, Mo.

**AGENTS**—To mail our literature. Good profits. Home business. Maywood, 1105-1107 Broadway, New York.

**DO** You want agents for your proposition? Your ad in this space will place your message before hundreds of men seeking fast-selling products. My folder "How to Secure Agents" is filled with proof. I'll gladly send you a copy free. F. W. Johnson, Manager Classified Advertising, Popular Mechanics Magazine, 200 E. Ontario St., Chicago.

**SUCCEED** With your products. Make-sell. Formulas. Accurate analyses. Catalog free. B. Thaxly Company, Washington, D. C.

**ENGRAVED** Name plates, numbers, signs, etc., easily sold, profits large. Brett Bros., Winthrop, Mass.

**BIG** Money applying initials on automobiles. Easiest thing today. Free samples. Also, sideline salesmen for short order decalcomania name plates. "Ralco," 1305 Washington, Boston, Mass.

**BIG** Money applying initials on automobiles. Write for particulars and free samples. American Letter Company, Dept. 40, Dunellen, New Jersey.

**MANUFACTURE** Specialties, hire agents yourself. Big money. Free literature. Gilbert Supply, 1107-P Broadway, New York.

**REVOLUTIONARY** Window cleaning tool. Good Housekeeping approval. Only ten \$2.25 sales daily to housewives, factories, schools, stores will make you \$350.00 monthly. Carter Products Corp., 900 Front Ave., Cleveland, Ohio.

**FREE** Sample—Amazing cleaner; sells homes, taverns, everywhere. Big profit—fast repeater. Betco, 5007 Irving Park, Chicago.

**AGENTS:** Stamping names on pocket-key protectors. Sample check with your name, address, 25c. Stamping outfits. Emblem checks, check-fobs, name plates. Hart Mfg. Co., 303 Degraw St., Brooklyn, N. Y.

**10,000 MONEY-MAKING** Formulas. Tells you how to make and sell almost everything under the sun; cosmetics, muclage, anti-freeze solutions, battery solution, beverages, cheese, chewing gum, cleaning preparations, extracts, hair preparations, inks, bluing, leather polish, mirrors, perfumes, polishes, typewriter ribbons, carbon paper, washing powders, liquid soap, and hundreds of other profitable articles. \$4 postpaid. Popular Mechanics Press, Room (C39), 200 E. Ontario St., Chicago.

#### HIGH-GRADE SALESMEN

**BIG** Daily profits, extra cash bonuses. Represent large manufacturer. Show complete line tailored shirts, neckwear, hosiery, underwear direct to wearer. Experience unnecessary. Part or full time. Handsome outfit free. Write. Tell us something about yourself. Packard Corporation, Dept. F446, Terre Haute, Ind.

**DID** You make \$50 last week? Does your job offer you real future? If not, why not start a wholesale business of your own? Start with little as \$2.50. Handle line 200 nationally advertised 5c-10c products. Show merchants new plan for increasing sales and profits. Handle everything from your home at start. Chance to operate one of our Silver Fleet service trucks. Facts free. World's Products Co., Dept. 10-M, Spencer, Ind.

**SELL** Printing at cut prices. 2,000 business cards \$1.50; 1,000 envelopes or statements, etc. \$1.75; 25 printed sales books \$1.50; 1,000 process embossed cards \$1.50; 2,000 two-color labels, free holder \$1.50; 2,500 printed handbills \$1.75. One-third comm. Free outfit. Bargain Prtg. Co., 189-F W. Madison, Chicago.



**SALESMEN, Distributors.** 200 items, brushes, mops, marvelous magnetic brush—exceeds vacuum cleaner. Big profits. Neway Brush Co., Hartford, Conn.

**SELL** Complete line business necessities—over 1000 items. 50% savings to every merchant. Experience unnecessary. Samples free. Commissions advanced. Northwestern. 625-RM Jackson, Chicago.

**BIG Commissions**—selling to stores celluloid pricing tickets, metal shelf moulding. To restaurants, menu covers, signs. P. Pricing Press, 124 White St., New York.

**NATIONALLY Known business service.** "Bad times" spell "good times" for alert salesmen. Easy seller. Repeats. A. C. L., 107 Pleasant, Baltimore, Maryland.

**PERFUMES, Wholesale to stores.** Pickwick, 501 Meville, Rochester, New York.

**SALESMEN:** America's finest sideline. 40% comm. daily. 725 fast selling repeat items. Every business uses and must buy. No investment. Sales portfolio free. David Lionel Press, 312 So. Hamilton, Dept. NM, Chicago.

**WRITE** For new free catalog fast-selling numbers, carded merchandise, razor blades, aspirin, pocket combs, etc. National Supply Company, Richmond, Virginia.

**\$3,000 PROFIT** In six months by Foster. Over \$6,000 in one year by Felton. Over \$30.00 daily for 90 days by D. F. F. All selling our special tool set to garages. Exclusive territory. Mesco, Beaver City, Neb.

**NEW Reflector type lawn numbers.** Every home owner wants one. Write now. Numberlites, Box 403, Springfield, Illinois.

**ADVERTISING** Book matches offer liberal earnings—full, spare time. Experience unnecessary. Factory direct. Low prices for fine quality, quick deliveries, help get orders; faster repeats. All business firms prospects. Free outfit, instructions. American Match & Printing Co., Dept. 612, 4822 South Trumbull Ave., Chicago.

**OPENINGS!** Call on all dealers with new trade-stimulator plans. It's "hot." \$3 commission on each \$5 sale. Big repeat commissions. No investment. Sales kit free. Universal, 2222 Diversey, Dept. C512, Chicago.

**CLEAR** Up to \$10 daily. Offer deluxe family Bible—\$1.95. Experts say worth \$5. Average \$1 profit. Size, 8 3/4 by 11 3/4. Every home, church a prospect. Amazing value makes fast sales. Westcraft, Dept. 212, Racine, Wis.

**ADVERTISING** Book matches—calendars. Lowest prices. Big cash commissions. New outfit free. Gem Match, 76PM West Washington, Chicago.

**LOCAL Agents** wanted to earn bonus suits and demonstrate to friends. Up to \$12 in a day easy. Experience unnecessary. Valuable demonstrating equipment, actual samples absolutely free. H. J. Graves, 1300 Harrison, Dept. A-817, Chicago.

**AGENTS** Earn 100% fast selling new style menu covers all dining places. Sample full particulars. Write Crystal-Vu Binder Company, Camden, N. J.

**DISTRIBUTORS** Line best auto specialties going. Small investment required. 100 South 11th, Hiawatha, Kansas.

**DRESSES** 10c. Hats 40c. Shoes 50c. Many other bargains—used merchandise. Free catalogue. Send name on postcard. Fairmount, 162PM Monroe Street, New York.

**CALENDARS**—Beautiful complete line, all sizes, including jumbos. Samples free. Also Christmas cards. Fleming Calendar Company, 6539 Cottage Grove, Chicago.

**EARN 65c** On every dollar! Sell Christmas twenty-one piece superfine, religious or magicked assortments. Three sample boxes \$1.00 postpaid. Personal imprint Christmas folders, wreaths, wrappings, calendars. Illustrated circular service. Popular sellers! Catalog free! Elfko, 440 North Wells, Chicago.

**BLADES.** Finest quality. Factory prices, postpaid. Ace Blades, Buffalo, N. Y.

**NEW Specialty**—Sells every business and professional man. Four \$15 sales daily pay \$280 weekly. Farrell cleared over \$1,000.00 monthly. Write, F. E. Armstrong, President, Dept. PM, Mobile, Ala.

**EXCELLENT** Opportunity selling our complete line of brushes, largest commissions. Write for sales plan. Wire Grip Sanitary Brush Company, 2300 5th Ave., New York.

## EDUCATIONAL AND INSTRUCTION

**"HOW To Break and Train Horses"**—A book every farmer and horseman should have. It is free; no obligation. Simply address Beery School of Horsemanship, Dept. 11012, Pleasant Hill, Ohio.

**AIR Conditioning**—Electric refrigeration. Rapid growth creates big demand for trained men. Earn up to \$35-\$50 weekly. Write for free facts. Utilities Engineering Institute, 404 North Wells, Dept. 19Z, Chicago.

**SELLING** Real estate brings largest commissions. Open own office. Learn how through home study in easy lessons prepared by real experts. Entire course only \$10.00. Morrison School of Real Estate, 100 N. La Salle Street, Desk 9, Chicago.

**EARN More**—Improve yourself—Learn bookkeeping. Only \$1.00 for up-to-date, interesting, self-instructive book. M. J. Butler, Publisher, 6709-D Cregier, Chicago.

**YOU, Too,** can have your own profitable, lifetime business. Operate a collection-credit bureau. Capital unnecessary. Free literature. Cole Associates, Syracuse, N. Y.

**BOOKKEEPING.** Trial lesson \$2.00. New simple approach will amaze you. Business Arts Institute, 220 8th Ave., San Francisco, California.

**INVENTIVE** Minded can become independent! Explanation free. Don Higbee, Cantil, Calif.

**ELECTRIC** Welding pays good money. Jobs everywhere. Our short course trains you. Write for information. Welding Company, 4100 Paul Street, Philadelphia, Penna.

**WATCH** Repairing is steady profitable work. Experts always in demand. You can learn watchmaking trade at home, spare time. New original instruction system. Script engraving course included. Write for free details today! Nelson Co., M-2001 Manhattan Building, Chicago.

**BECOME** Practical scientific investigator. Modern illustrated course. Thorough training by former agent U. S. secret service. Particulars free. International Secret Service Institute, PM-129, Hoboken, N. J.

**GET** A government job, Men-women. \$105-\$175 month. Prepare immediately for examinations. Full particulars, free. Write today. Franklin Institute, Dept. T3, Rochester, N. Y.

**HOME** Study and degree—Psychology, Metaphysics, Bible, Philosophy. Free catalog. College of Universal Truth, 20 East Jackson, Chicago.

**MATHEMATICS.** Arithmetic, algebra, geometry, trigonometry, calculus, sciences, engineering, accounting, statistical, actuarial mathematics. Mondell, Institute, 230 West 41st, New York.

**LEARN** Watchmaking. Material to start \$1.00. Wholesale tool-material-watch catalog 5c. Instruction book \$3.50. Stewart's, 721 Olive, St. Louis, Mo.

**BIG** Pay trades you can learn in a few weeks. Decorating, paperhanging, graining, marbling, card writing. Enroll now. Booklet free. Chicago Painting School, 102 West Lake Street, Chicago, Illinois.

**CIVIL** Service examination books. Postal \$2.00, storekeeper-gauger \$1.10. No experience required. Many others. Free information. Write today. Pergande, Publishers, Milwaukee.

**YOU, Too,** can have your own profitable, lifetime business. Operate a collection-credit bureau. Capital unnecessary. Free literature. Cole Associates, Syracuse, N. Y.

**LEARN** Electricity in 25 weeks. Complete course \$12.95. Details free. Radcliffe's, 1015 High, Petersburg, Virginia.

**DRAFTING** Jobs often pay \$175.00-\$500.00 month. Qualify now. Complete details free. Write today. Monroe Institute, PM-12, Alton, Illinois.

**WRITE** For newspapers—gain pleasure, good pay and perhaps fame. Full time or free-lancing (part time). Hundreds of stories, articles, ideas are needed in every issue. We successfully coach you by mail. 45 years newspaper experience—plenty of contacts for placing graduates. The Millers, Dept. 10, Bakersfield, Calif.

**HIGH** School French, English, expert mail tutoring, exam coaching; details, stamp. V. Doherty, 4821 47th, Woodside, N. Y.

**DRAFTING.** Blueprint reading, architectural, airplane, mechanical, electrical, naval architecture, structural. Mondell Institute, 230 West 41st, New York.

**READ** Our war and oil ad under Business Opportunities, it's worth answering. Royal Keystone Enterprise, Box 192, Berryville, Ark.

**HOW** To secure a gov't job in the classified civil service. Railway postal clerk, \$1900 a year. Postal clerk, city mail carrier, \$1700. Other jobs, \$1260 to \$2100. Our method helps you pass exams. Men-women, age 18 to 50. Send for free book. Patterson School, 8C Mercantile Bldg., Rochester, N. Y.

**LEARN** Air conditioning—America's next big industry. Thousands of opportunities. Get your start with complete book by E. W. Riesbeck, \$3.50 postpaid. Popular Mechanics Press, Room (C39), 200 E. Ontario St., Chicago.

**MASSAGE, Hydrotherapy, dietetics, drugless therapeutics, chiropody,** taught by mail. Evans Correspondence School, Montgomery, Ala.

**LEARN** Auto mechanics, body, repairing, welding electricity, refrigeration. Diesel. Stevinson's, 2008A Main, Kansas City, Mo.

**TELEGRAPHY** Taught thoroughly. Railroad retirement act creating opportunities for new operators. Expenses low. Catalog free. Dodge's Institute, Hiatt Ave., Valparaiso, Ind.

**SECRET** Investigation. Experience unnecessary. Detective particulars free. George Wagner, M-2640 Broadway, N. Y.

**BOY** Mechanic—Famous library of 3 volumes covers the building of almost everything a boy might want to make. Actually covers 3,000 different articles. Each volume 460 pages, fully illustrated. Cloth. Price \$2 each or set of 3 vols.—\$5 postpaid. Popular Mechanics Press, Room (C39), 200 E. Ontario St., Chicago.

## PLAYS, STORIES, MANUSCRIPTS

**MAKE** Money writing for radio. Stamp brings details. Writer, 2265 Delaware, Buffalo, N. Y.

**AMBITIOUS** Student-poets expertly trained. Publicity help. Romatka, 25 West 3rd Street, New York.

**POEMS, Free criticism.** Ratcliffe, 512 1/2 Florida, Vallejo, California.

**BE** A writer—"Writer's Handy Guide" just out tells how to write—where to sell. \$1 postpaid. Manuscripts edited, revised, typed. Jewel Guild, 330 S. Wells, Chicago.

**SHORT** Stories revised, typewritten, marketed. Hursh, Box P-1013, Harrisburg, Penna.

**RADIO.** Stage plays wanted for publication. Readings free. Details. Box 42, Kenmore, N. Y.

**ORIGINAL** Poems, songs wanted for publication, radio. Westmore Music Corporation, Dept. 33G, Portland, Ore.

## CARTOONING, COMMERCIAL ART, SHOWCARD WRITING, SIGN PAINTING

**BE** A professional sign writer right from the start with Showcarder. No training necessary. Make signs that sell. Write Showcarder, 524 1/2 North Prior Avenue, St. Paul, Minnesota.

**HAVE** Your own money making business. Learn show card writing, sign painting. Write for details. Begley Specialty, 1472S Broadway, New York.

**QUICK** Method sign painting. Particulars 10c. Straley, 1017 Mulberry, Springfield, Ohio.

**CARTOON** Sales Guide monthly. Two issues 25c coin. Lavalette, W. Va.

**LEARN** Chalk talking. Quick easy method \$2.98. Marland Haines, Bloomfield, Indiana.

**LEARN** Cartooning, lettering, etc. Free information. Murray Service, 1799 East 100th, Cleveland, Ohio.

**ANIMATED** Cartooning taught days, evenings. New York state licensed. Mondell Institute, 117 West 42nd, New York.

**AMATEUR** Cartoonists, earn cash at home, copying and duplicating cartoons for advertisers. Ad-Service, Argyle, Wis.

**ART** For advertisers! Drawings, lettering, etc. Gill Art Service, Huntsville, Alabama.



**LETTERING** Patterns, free literature. Sample alphabet 5c. Display Letters, Box 28, Ft. Hamilton, Brooklyn, N. Y.

**CARTOONING**, Sketching, etc.—46 lessons, 600 illustrations, including drawing paper, pens, pencils, \$1.00 complete. Fraba Service, Cashton, Wisconsin.

**PEN And ink drawings**. Let us draw your advertising and catalogue illustrations, from photos, copies or objects. Best work and fair prices. Heraldic Studios, 1914P Oakdale Avenue, Chicago, Ill.

**MAKE Art Pay**. Advanced art students, \$1.00. Popular Mechanics, 200 E. Ontario St., Chicago.

#### ADVERTISING AGENCIES, LETTER WRITERS, FOR ADVERTISERS

**LEARN Advertising** at home. Easy practical plan. No text books. Common school education sufficient. Interesting booklet and requirements free. Page-Davis School of Advertising, 3601 Michigan Avenue, Dept. 3439, Chicago.

**INCH Display advertisement** 30 magazines, year \$24. Wood's Popular Services, Atlantic City, N. J.

**ADVERTISE Profitably**: \$15 reaches 5,000,000 Sunday newspaper readers with 24-word ad. Newspaper, magazine, mailing-list ratebook, free. Chicago Advertising Agency, 20-PA West Jackson, Chicago.

**ADVERTISE**: 24 Words, 149 newspapers \$6.50. Lists free. Advertising Bureau, 4515-C Cottage Grove, Chicago.

**FOUR-LINE Ad**, 185 newspapers, \$5.28. Lists free. Fidelity Advertisers, W-3838 Washington, Chicago.

**INCH, 3 Times**, 50 magazines, \$3.00. Albert Service, 6-M North Dearborn, Chicago.

**ADVERTISE**: 24 Words, 200 newspapers, \$5.72. Lists free. Midwest Advertising Agency, Columbus, Ohio.

**DIRECT-MAIL Advertising services**. Sales letters that sell. Mailing lists. Omaha List & Letter Co., Box 2172, South Omaha, Nebr.

**ADVERTISING** Placed all magazines, newspapers, radio. Lowest rates. Free service. 54 page rate book free. Baker Advertising Agency, A-189 West Madison, Chicago. Successors to Ankrum. Established 28 years.

**FREE—New Advertisers Rate Guide**, 44 pages. Includes everything. Lowest rates. E. H. Brown Advertising Agency, 140 S. Dearborn, Chicago.

#### BUSINESS SERVICE

**LOS ANGELES Address**. Daily forwarding, contacts made, information furnished, \$1.50 monthly. Universal, 2808 - 12th Ave.

**NEW York city**, mail address; business, personal; reforwarded; \$2 monthly. Wiesen, 151-M West 40th.

#### RUBBER STAMPS AND OFFICE SUPPLIES

**2 LINES 25c. 3—35c.** Cushioned. Stamp Works, Centerport, N. Y.

**ORIGINAL**, Cushion mounted. One, two lines, 25c; three 35c; four 45c; facsimile signatures \$1.50. Stamp Works, 814 Bradley, Peoria, Ill.

**2 LINES 25c. 3 Lines 35c.** Stamp Works, Auburn, Nebr.

#### TYPEWRITERS, DUPLICATORS, OFFICE DEVICES

**MULTIGRAPH** Large, automatic, printing model, \$125.00, with Davidson \$175.00. 8041 Exchange, Chicago.

**NEW \$3.75 Automatic adding machine**. Fully guaranteed. Bassett, Box 302-A, Altadena, California.

**TYPEWRITERS**, Adder, mimeograph, multigraph, addressograph. Send for free lists of machines that will help you at half price. Pruitt, 28 Pruitt Bldg., Chicago.

**OFFICE Machines**, typewriters, adding machines, duplicators, etc., 29 different makes, care and operation of. Only book on subject. 384 pp. illus. \$2.50 postpaid. Popular Mechanics Press, Room (C39), 200 E. Ontario St., Chicago.

**INCREASE Business now**. "Excellograph" Rotary Stencil Printer reprints thousands everything you typewrite, handwrite, draw or trace. Colors, \$19.75 to \$44. Terms. Illustrated literature free to business or professional men. Pittsburgh Typewriter Supply, Department K-2, Pittsburgh, Penna.

#### PRINTING, MULTIGRAPHING, MIMEOGRAPHING, GUMMED LABELS

**500 REGULAR Letterheads**, envelopes, statements, billheads \$1.00. 5000 \$7.50. Carter, Box 52, Orange, Calif.

**1000 BUSINESS Cards—Vellum or thinplate** \$1.50 postpaid. Complete sample folio for stamp. Thornber Press, 2166 Sixth, San Diego, California.

**40 CHRISTMAS Cards**, 250 envelopes, letterheads, 95c. Samples, illustrations. Schneider, 949-B West 68th, Chicago.

**LETTERHEADS**, Envelopes, 125 each \$1.00 postpaid. Smith Printery, Hollandale, Wisconsin.

**200 8½x11 BOND Letterheads**, 200 6¾ envelopes \$1.00 postpaid. Franklin Printery, 2932 Pershing, Chicago.

**125 8½x11 TWENTY Pound bond letterheads** and 125 6¾ envelopes \$1.00 postpaid. Benneville, 907 West Roosevelt, Philadelphia.

**MULTIGRAPHING—500 Letters** just as if typewritten, \$1.70 (20 lines). Multigraphers, Ashland, Virginia.

**COMBINATION Special—500 Hammermill letterheads**, statements, envelopes, \$4.00. Also personal stationery. Adkins, Union, N. Y.

**1,000 TWO-COLOR Shipping labels**, 4x2½—\$1.75. 10,000 3x6 circulars, \$4.95. Letterheads, envelopes, typewritten letters, cards, etc. Okayprint, Martins Ferry, Ohio. Samples.

**50 SHEETS**, 20 Envelopes, 25c postpaid. Western Stationery, Topeka, Kansas.

**1000 NEAT Business cards** \$1.00 postpaid. Taft Co., Box 5366, Chicago.

**PRINT Anything—20 Xmas folders**, name printed 50c. Investigate. Hamilton Press, 4341P Meade, Chicago.

**100 LETTERHEADS**, 50 Envelopes printed 50c. Dealers wanted. Beasley, Stapleton Station, New York City.

**200 COPIES 8½x11**, Mimeographed \$1.25. Dougherty, 243 Washington, Phillipsburg, N. J.

**100 BUSINESS Cards**, printed, 25c postpaid. Lain, Printer, La Crosse, Wis.

**ATTRACTIVE Printing**, attractive prices. Catalog. Cettel, 348-B West 47th, New York.

**FANCY Gift stationery**. Great for Christmas. 100 initialed sheets, 50 printed envelopes in cabinet, \$1.00. Staver Brothers, 1645 So. Weadock, Saginaw, Michigan.

**6x9 CIRCULARS**, Envelopes, letterheads, postcards, \$1.89, quantities. Typewriter letters, slips, labels lowest prices. Samples. Goodprint, Harrisonburg, Va.

**NEED Printing?** Good work, service, low prices. Samples free. Lonelm Press, Paulding, Ohio.

**BETTER Grade printing**, free trade illustrations. Reasonable. Economic Press, Leonia, N. J.

**ILLUSTRATE** Freely without cuts. Write for details and prices on photo-offset printing. Roberts Service, 250 W. 49th St., New York.

**HAMMERMILL Letterheads**, any color paper and ink, 300 8½x11, \$1.48 postpaid. 30 type styles available. Free particulars. Woodruff's, 217A Lewis, Duluth, Minn.

**500 ¾x2¼ FOUR Line gummed stickers**, 25c. Moritz Printery, Saginaw, Mich.

**500—2x3½ GUMMED Labels**, blotters, or cards—50c. Robey, East Lansing, Mich.

#### PRINTING OUTFITS AND SUPPLIES

**BORDER Font**, catalog and bargain list 25c. Daemicke, 6452 Kenwood, Chicago.

**PRESSES**, Type, cabinets, supplies. Catalogue for stamp. Lincoln Press, 220-B Hartwell, Fall River, Mass.

**BARGAINS**, Presses, type, List 3c. Exchange, D-15, 54 Liberty, Meriden, Conn.

**PRESSES**, Type, supplies, list free. Catalog ten cents. Model Press Co., York, Penna.

**GENUINE ATF foundry display type** in words, lines, sorts. Box 4464, Philadelphia, Penna.

**PRESSES**, New type that satisfies. Lists 3c. Landis, Richland, Penna.

**PRESSES \$4.00**. Complete equipment. Send stamp. Bradshaw, 3214-P Huron, Chicago.

**PRINT Your own cards**, stationery, circulars, advertising. Save money. Easy rules furnished. Print for others, big profits. Junior outfits \$8.25, senior outfits \$16.55 up. Details free. Kelsey Presses, H-11, Meriden, Conn.

**SNAPPY Cuts**, best art work. List free. Moritz Printery, Saginaw, Mich.

**USED Presses**, type, supplies. Lists 3c. Turnbaugh Service, Loysville, Penna.

**BARGAINS—Presses**, type, supplies. Send stamp. 159 Harvard, Cambridge, Mass.

**HAND Presses**, type and complete printers' supplies. Send stamp for catalog and new price list. P. Peiffer & Co., Newark, N. J.

#### PATENT ATTORNEYS

**INVENTORS**: Send immediately for your copies of our new free books, "Patent Protection" and "Suggestions on Selling an Invention." Sixty-eight pages of interesting facts. They tell how Patent Laws protect you; kind of sketch or model needed; simple steps to take without cost; how successful inventors have secured financial assistance; show interesting inventions; illustrate important mechanical movements. With books we also send free Evidence of Invention form to help establish date of disclosure. Prompt service, reasonable fees, special deferred payment plan. Strictest secrecy. Forty-one years' experience. Highest references. Write us today. The facts in our books are worth money to the man with a good invention. Address: Victor J. Evans & Co., Registered Patent Attorneys, 113-P Victor Building, Washington, D. C.

**DIETERICH & Rutley**, Registered Patent Lawyers, 511B Colorado Building, Washington, D. C. Booklet on patents sent free.

**ASSISTANCE** In selling patents obtained through me. Overnight personal service to midwest inventors. Booklet free. Arthur Sturges, Registered Attorney United States Patent Office, 401 Neville Block, Omaha, Nebraska.

**INVENTORS—Send for free booklet "Patent-Sense"**. Information based on 64 years experience. Lacey & Lacey, Dept. 5A, 635 P St., Washington, D. C.

**INVENTORS—Before disclosing your invention** to anyone send for form "Evidence of Conception"; "Schedule of Government and Attorneys' Fees" and instructions. Sent free. Lancaster, Allwine & Rommel, 411 Bowen Building, Washington, D. C.

**PATENTS**. Protect your idea by securing free "Proof of Invention" folder. Exceptional personal service. Established 1906. E. E. Vrooman, 871 Woodard Bldg., Washington, D. C.

**"INVENTOR'S Guide"**. 100 mechanical movements, free; advises on patenting, selling inventions. Frank Ledermann, Tribune Bldg., New York.

**L. F. RANDOLPH**, 302-B Victor Bldg., Washington, D. C. Low cost. Book and information free.

**PATENTS**. Booklet free. Highest references. Best results. Promptness assured. Watson E. Coleman, Patent Lawyer, 724 Ninth St., Washington, D. C.

#### FOR INVENTORS

**INVENTOR'S Universal Educator**: contains 900 mechanical movements; 50 perpetual motions; instruction on procuring and selling patents and selecting an attorney, etc. Suggests new ideas. Price \$1 postpaid in U.S.A. Address Albert E. Dietrich, 511-B Colorado Bldg., Washington, D. C.

**MEETING**, Exhibit and sale of inventions, December 5th to 8th. Write Inventors of America, Hotel Leamington, Oakland, Calif.

**CONTACTS** Established during ten years mail order sales manager Sears Roebuck enables me sell patented or unpatented ideas. Get details. L. H. Fowler, Elmhurst, Ill.



**INVENTIONS** Developed. Reasonable, confidential, reliable. Hugo Zschau, 1952 Humboldt, Chicago.

**INVENTIONS** Wanted—Patented, unpatented. If you have an idea for sale write Hartley's, Inc., Box 928-E, Bangor, Maine.

**INVENTION** Sales Bulletin describing over 500 inventions, showing how we sell inventions, patented or unpatented, with booklet and particulars free. Patentee System, 9443 Pleasant, Chicago.

**INVENTORS:** "Making Inventions Pay," our 32-page illustrated book, mailed upon receipt of 3c postage. Crescent Tool Co., Dept. Z, Cincinnati, Ohio.

**I SELL** Patents. Established in 1900. Charles A. Scott, 773PM Garson Ave., Rochester, N. Y.

**WE** Locate buyers meritorious patented, unpatented inventions. If will sell, reply immediately. Descriptive booklet free. Invention Reporter, 5A-11236 South Fairfield, Chicago.

**INVENTORS**—Send for 72-page book on patents. Reasonable terms. Conscientious treatment to inventors. L. F. Randolph, Registered Patent Attorney, 302-E Victor Bldg., Washington, D. C.

**HAVE** You a sound, practical invention for sale, patented or unpatented? If so, write Chartered Institute of American Inventors, Dept. 4-A, Washington, D. C.

**INVENTORS:** Profit by your invention. A practical talk to inventors by an experienced manufacturer. Our 68 page booklet "Mind vs. Matter" mailed upon receipt of 25c. Rex Engineering Co., Cincinnati, Ohio, Dept. D.

### INVENTIONS WANTED

**INVENTIONS** Wanted suitable national distribution. Albert Burns, La Salle Hotel, Chicago.

**INVENTORS:** Sell your idea quickly—Patented or unpatented through our triple placement service. Complete information 10c. National Inventors Service, Box 404, Chicago.

**WANTED**—Meritorious patented, unpatented inventions. Booklet free. Invention Reporter, 5B-11236 So. Fairfield, Chicago.

**SMALL** Inventions wanted by manufacturers. I'll help you sell your invention. Write for free circular. Stanley Hull, 7829-K Euclid Avenue, Cleveland, Ohio.

**SIMPLE.** Practical inventions wanted by manufacturers, patented or unpatented. For information write Chartered Institute of American Inventors, Dept. 4-D, Washington, D. C.

**CASH** For inventions patented or unpatented. Stamp appreciated. Mr. Ball, 9441-A Pleasant, Chicago.

### PATENTS FOR SALE

**OUTRIGHT** Or royalty. Quick adjusting wrenches, pipe and monkey. Have won merit award. John W. Doege, 1008 - 3rd St. S. E. Cedar Rapids, Iowa.

**DENTAL** Floss holder. Spring grip. Quick change. Patented. Geo. A. Landis, 1510 C Street, Hoquiam, Wash.

**PIE-DIVIDER.** Chain store article. Fest, 1565 W. 23rd St., Los Angeles.

**SELF-ADJUSTING** Hose supporter for men. Outright or royalty. O. L. Risinger, 441 - 31st Ave., San Francisco, Calif.

**MY** U. S. and Canadian patent on soot collector. Outright or royalty. Wm. Nulle, 832 5th Ave. N. E. Aberdeen, S. D.

**FIGURE** Toy: Simple, inexpensive toy which may simulate any squat figure, human or animal. Jasper Likes, P.O. Box 273, Long Beach, Calif.

**PATENTED** New marble skill game. Cheap to manufacture. Reasonable. B. L. Fisher, General Delivery, Oklahoma City, Oklahoma.

**PATENTED** Folding cot. Write Fred Jaspersen, 900 Railway Exchange, Chicago.

**INVESTIGATE** This new old mine. The tire wrapping removing device. Outright or royalty. Andrew Doros, 230 Caspian St., Elizabeth, N. J.

**NEW** Principle electric coffee maker. Place coffee grounds and cold water in machine. First cup coffee ready about one minute. All automatic, no watching, stirring or preheating. Virgin field, L. Abbate, 3327 Pierce Ave., Chicago, Ill.

**PAPER** Stapling machine. Patented. Retail about 25c. Can be merchandised through dime stores, school supply stores, mail order, etc. Repeat business on staples. L. Abbate, 3327 Pierce Ave., Chicago, Ill.

**MANUFACTURERS:** For new products or profitable manufacturing opportunities, inquire. Invention Reporter, 5C-11236 So. Fairfield, Chicago.

**SELL** Your patent through a small classified ad in Popular Mechanics. Many inventors have found buyers in this way. Ask me for proof—I'll gladly send it to you. F. W. Johnson, Manager Classified Advertising, 300 E. Ontario St., Chicago.

### MANUFACTURING

**MANUFACTURING.** Any material, any quantity, inventions developed. Milburn, Burlington, Kentucky.

**STAMPING** Press \$35. Floating dies, cheapest home production. Free circular. Baum's Metal Specialties, Kansas City, Mo.

**HAND** Wood-turning and carving. Any kind. Sample or sketch. Guaranteed. M. G. Day, 1039 Hamilton, Indianapolis, Indiana.

**INVENTIONS** Manufactured by an experienced company, in any quantity at low cost. Metal specialties, novelties, stampings, dies, and models. Free estimates. Our booklet "Mind vs. Matter" sent upon receipt of 25c. Rex Engineering Co., Cincinnati, Ohio, Dept. C.

**INVENTIONS**—Manufactured in any quantity at low cost by old established company. Stampings, metal specialties, dies, models, etc. Free estimates. Send for catalog. Crescent Tool Co., Dept. X, Cincinnati, Ohio.

**METAL** Furniture in modified modern design, how to make, described in Shop Notes for 1937 only 50 cents postpaid. Popular Mechanics Press, Room (C39), 200 E. Ontario St., Chicago.

### MODELS AND MODEL SUPPLIES

**CARVED** Hull ship model kits. Ship and yacht model fittings; model yacht sails. Illustrated catalog 20c. A. J. Fisher, 1002-M Etowah Ave., Royal Oak, Mich.

**SHIP** Kits 1000 fittings catalog 10c. Airplanes, engines catalog 5c. Polk's, 429 Seventh Ave., New York.

**ENGINE** Catalogue castings, supplies, 25c. Howarco, A-2417 North Ashland, Chicago.

**SUPPLIES.** Engines, pumps. Catalogue 10c. Erraymesco, 28-P North Clinton, Chicago.

**POWER** Models. Electric railways, steam locomotives, steam and gasoline engines, all accessories, metals, tools. 84 page catalog 35c. Chas. Cole, Ventura, Calif.

**SUBMARINE** 24" Kit to build \$1.00. Spotts, 3925 N. Broad, Philadelphia.

**MODEL** Supplies for the inventor. Send 3c stamp for catalog. Pierce Model Works, Tinley Park, Ill.

**MODEL** Railroad Shop, Dept. PM, Dunellen, New Jersey. Catalog 10c.

**STEAM** Locomotives!  $\frac{3}{4}$ " scale. Build one by "Easy Steps." Our illustrated catalog lists all needs. 25c. Little Engines, Box 15B, Wilmington, Calif.

**BUILD** Ship models, coach models, covered wagon. Complete kits \$1.00 to \$6.00. Fully shaped and finished redwood hulls, all parts cut to fit including masts and yards, sails, chain, wire, nails, string and other parts. Detailed drawings and full instructions. Send 3c stamp for catalog. Miniature Ship Models, Dept. R, Perkasio, Penna.

**SPEED!** Model power boats! Racing hull construction kits. All classes. Engines, accessories. Cruiser kit. Free literature. St. Louis Model Boat Co., Clayton, St. Louis, Mo.

**MODELS**—Your ideas developed into practical working models. 30 years successful experience; thousands of satisfied customers. Confidential service guaranteed. Bank references. Send 3c postage for our large booklet—"Making Inventions Pay." Crescent Tool Co., Dept. Y, Cincinnati, Ohio.

**MODELS**—Practical models put over your ideas. We develop models from the crude to perfect working devices. Your idea might have large commercial value. Services confidential. Bank references. Registered graduate engineers at your service. Send 25c for our 68 page booklet "Mind vs. Matter." Rex Engineering Co., Cincinnati, Ohio, Dept. B.

**MODELS** Made of your ideas. Inventions manufactured. Write for estimates. Model Engineering, Dept. C, Osgood, Ind.

**PASSENGER** Locomotive (Hudson type), model lithographed in colors, size 10x46 in. Every part shown and numbered. Invaluable for study. \$1 postpaid. Popular Mechanics Press, Room (C39), 200 E. Ontario St., Chicago.

### BLUEPRINTS AND PLANS

**BUILD** Your own machine tools. Castings and blue prints at nominal cost. Send 10c for 2 color 28 page catalog. 12 complete metal-working projects and 34 prints, \$1.50. 6 wood-working projects and 23 prints, \$1.00. Lewis Machine Tool Co., Dept. M-12, 1000 Alhambra Ave., Los Angeles.

**3 ARTISTIC** Fullsize lathe patterns, includes table articles. 15c. David Tyson, Perkasio, Penna., Route 2.

### HOME CRAFTSMEN

**CRAFTSMAN'S** Work bench, 3" maple top. Write for illustrations. Michigan Maple Block Co., Petoskey, Michigan.

**LAWN** Ornaments—easy to make. 20 full-size patterns, birds, animals, etc., 25c; Dutch boy, Dutch girl, sprinkling girl, fox terrier, Scottie bulldog, 15c each, any two 25c; Dutch windmill, 36 inches high 25c. Entire collection, 27 patterns, \$1.00 postpaid. Wickman Co., 746 Brooklyn Ave., Dayton, Ohio.

**WOODWORKER'S** Bench vise. Material costs 25c. Screw type, 10" jaws. Send 25c, in coin, for instructions. The Craftshop, Box 296, Wheaton, Ill.

**CARVED** Drawer-pulls for your cabinets \$1.00. Schumacher, Westhampton Beach, N. Y.

**FOLDING** Boat plans—Easy to build "Fold-Craft" kayak or row boat. Plans 50c each. Fold-Craft, 4015 N. Oketo, Chicago.

**VENETIAN** Blinds, supplies, wholesale catalog 6c. Roberta, Box 260, Gloversville, N. Y.

**GET** Free leathercraft instructions, prices of leathers, tools, projects. Make extra money. Beautiful gifts. Leather samples 5c. Wilder & Company, 1038 Crosby, Dept. 12F, Chicago, Ill.

**MEXICAN** Wood novelties easily made. Our 20 patterns and instructions 25c. 20 cowboy silhouette patterns 25c. 10 lawn ornament patterns 15c. Mexican Arts, Crafts, Eagle Pass, Texas.

**MAKE** Your own tubular door chimes. Complete instructions, drawings 25c. Beautiful Christmas gift. Thomas, 254 Westwood, Birmingham, Michigan.

**LEADED** Antique and colonial type lanterns. Various colors and designs, \$3.50 up. M. Ascherl, Lorain, Ohio.

**ENLARGE** Drawings and patterns accurately, quickly. A jigsaw necessity. Guaranteed. \$1.25. Pantagraph, 86-11 Boulevard, Rockaway Beach, New York.

**PATTERNS**—Plywood novelties, silhouettes. Also transfer decorations, 170 items illustrated. Write Wo-Met Shop, Ashburn, Georgia.

**MONEYMAKING** Christmas projects. Dime brings illustrated catalog, hundreds illustrations novelty blueprints, wood-kits, construction sets. Woodcraft Service, Plainview, Minnesota.

**70 PATTERNS.** 20 Lawn ornaments, 14 silhouette, 20 novelties, 16 lawn ornaments, 30c each set, all for \$1.00. Modern Woodcraft, Saginaw, Michigan.

**HARDWOODS.** Cabinetwoods, plywoods. Send for free catalog. White Brothers, Fifth and Brannan Streets, San Francisco, California.

**22 FULL** Size lawn ornament patterns 25c coin. Strother, Box 363-AV, Belington West Virginia.



**KNOCKDOWN** Furniture, lumber, veneers. Illustrated catalog 10c. Gles-Kendall Co., Decatur, Alabama.

**MAKE It Yourself**—Hundreds of practical and useful devices described in our big book. Plain instructions and illustrations show you how. Save money on things for yourself or make profit selling to others. 900 articles. 480 pages. 823 illustrations. \$3 postpaid. Popular Mechanics Press, Room (C39), 200 E. Ontario St., Chicago.

### OLD GOLD, WATCHES, JEWELRY, PRECIOUS STONES

\$1.25 POSTPAID 25 Beautiful Oregon gem cutting agates. Helena Jones, Florence, Oregon.

**WANTED:** False teeth. We pay high as \$10 for full sets. Any condition. We buy crowns, bridges, jewelry, gold, silver. Goods returned if price is not satisfactory. Western Metal Co., Bloomington, Illinois.

**REBUILT** Watches, satisfaction guaranteed. Pontiac Watch, Box No. 576P, Pontiac, Michigan.

**BULOVA,** Gruen, Elgin, Waltham wrist and pocket watches for ladies and gents. Positively lowest wholesale prices. 1940 styles now available. Write for free money making wholesale catalogue. Norman Rosen, Wholesale Jeweler, Dept. P.M., 801 Sanson Street, Philadelphia, Penna.

**WATCH** Parts, tools, supplies. Write for price list 43. Dean Company, 87 Nassau Street, New York.

**AGATES,** Gems, minerals. 20 gemstones \$1.00. Pricelist free. Hill, Route 7, Salem, Oregon.

**WATCHMAKERS'** Materials—Tools, watches, jewelry bought, sold, exchanged. Ben Segal's, 5 South Wabash, Chicago.

**AUSTRALIA'S** Lovely opals. Illustrated catalogue free. Good selection \$5.00. Norman Seward, Melbourne, Australia.

**HIGHEST** Prices for old gold—Mail your teeth, watches, jewelry. 100% full cash value mailed day shipment received. Satisfaction guaranteed or articles cheerfully returned. Information free. Chicago Gold Smelting Company, 300-P Champlain Building, Chicago.

5000 **REBUILT** Elgin, Waltham, Hamilton watches. Also ladies, gents wrist watches. Make big money! 12 size, 7 jewel, Elgin or Waltham. \$4.75; 16 size, 17 jewel, \$7.50. Send for free watch and diamond catalogue. The New York Jobbers, Dept. M. 74 Bowery, New York, N. Y.

**GOLD** \$35 Ounce. Ship old gold teeth, crowns, jewelry, watches—receive cash by return mail. Satisfaction guaranteed. Free information. Dr. Weisberg's Gold Refining Co., 1500-Q Hennepin, Minneapolis, Minn.

**HOW** To identify and determine value of old precious metals. Where to buy. To whom to sell. Reliable and up-to-date information. Complete instructions only \$1 postpaid. Popular Mechanics Press, Room (C39), 200 E. Ontario St., Chicago.

### FOR THE HOME

**AMAZING** Furnace lighter. Starts fires in 3 minutes without wood, paper. Lorain Furnace Lighter Company, Lorain, Ohio.

**MY** Hand-turned woodenware make beautiful, lasting Christmas gifts. Send stamp for price-list. James Brown, Painesville, Ohio.

**SOUVENIR** And postcard 25c coin postpaid. Bruce Wolfe, 613 N. Main, Room 350 Lee Inn, Kansas City, Mo.

**HOMEMADE** Drill press, belt sander, forge and 328 other practical shop articles in Shop Notes, Vol. 31, only 50c postpaid. Popular Mechanics Press, Room (C39), 200 E. Ontario St., Chicago.

### TOBACCO

**GUARANTEED:** Cigarette, pipe or chewing 5 lbs. \$1.00, ten, \$1.75. Pay when received. Pipe and box cigars free. Rives Tobacco Co., Paducah, Ky.

**"KOOLPUF,"** The scientific pipe. Free literature. Lockco, 1476, Washington, D. C.

**DRYBOL** Pipes have concealed water tight trap. Saliva and nicotine controlled. Assures smokers real enjoyment. No more "wet heel." \$1.00 each. The Drybol Company, 154 Nassau St., New York, N. Y.

### SURVEYING INSTRUMENTS

**GUARANTEED** Factory rebuilt transits and levels for rent (with purchase option) or sale (cash or terms). Order now before prices advance. We will repair, trade in, or buy your old instruments. Ship prepaid for estimate and valuation. Write for List M-412 and complete information to Warren-Knight Co., 136 N. 12th St., Philadelphia, Penna.

### FOR SALE—MISCELLANEOUS

**SEND** \$1.00 And receive genuine calf billfold with zipper. Pigskin \$2.45, morocco \$2.95, pinseal \$3.50, alligator \$5.00. Beautiful Christmas gifts. Tanners Leathercraft, 700 Broadway, Chelsea, Mass.

### WANTED—MISCELLANEOUS

**OLD** Newspapers, magazines, documents, scrap books, diaries, soldier letters, envelopes. Before 1870, write what you have. Mathewson's, Jackson, Ga.

**CASH** For used microscopes, binoculars, slide rules, drawing sets, scientific instruments, tools, cameras, stop-watches. Write details, Elman's, 2302 Van Buren, Chicago.

### PERSONAL

**STAMMERING** Scientifically corrected. Practical, home training. Normal Speech Mail Course, 236 Palmer, Grand Rapids, Mich.

**ELECTRIC** Presser \$2.00, guaranteed. Inquire Mases, 152 86 Street, Rockaway Beach, N. Y.

**YOUR** Eyes trained to overcome weakness, astigmatism, nearsightedness without glasses. Complete guaranteed course \$1.00. Eyesight Improvement, Box 193, Hamilton, Ohio.

**SAVE** Your hair. New discovery. Write D-116 Church, Foxchase, Philadelphia.

**INCREASE** Earning power, achieve popularity, become irresistible. "Success" reveals how. 60c. Doherty, 4821 47th, Woodside, N. Y.

**DANDRUFF?** Fungicide kills germs causing disease. Large tube, \$1.00. Clorell Co., St. Louis, Mo.

**WIN** Prize money: Booklet—"Successful Contesting"—shows how. 10c postpaid. Bulletin listing \$100,000.00 prizes included. World Publishers, 4515-B Cottage Grove, Chicago.

**MODERN** Refrigeration. New industry needs trained men for installing, servicing, repairing. If you seek a new field with larger opportunities get latest book by Althouse and Turnquist. \$5 postpaid. Popular Mechanics Press, Room (C39), 200 E. Ontario St., Chicago.

### MISCELLANEOUS

**FOR** Sale. Lockable ash trays, unstealable. For hotels, night clubs, etc. Price 75c each, plus postage. Shipping weight 16 oz. T-E Lockable Tray Co., Grapeville, Penna.

**MONOGRAMMED** Book matches. 150 with your initials in silver on solid black stock, black stems, red heads. Send three initials desired with \$1.00. Shipped postpaid. Chicago Match Co., 4014 Parker Ave., Chicago, Ill.

500 **ADVERTISING** Pencils \$5.00. Samples 5c. Adcraft Company, Lacrosse, Wis.

**EMBOSSSED** Signs made to order. Name plates, counter displays, Christmas signs, etc. Any color. Sample with your own copy 25c. Signograf, 739 Cole, San Francisco.

**MATMAKERS** Learn latest wire fastening, improves appearance. \$1.00. Morse, Union Place, Yonkers, N. Y.

**LUMINOUS** Paint shines in dark 25c. Myers, 26, Niles, Mich.

**EYESIGHT** Quickly improved. Use my simple, inexpensive, new invention. Satisfaction guaranteed. Neither glasses nor drugs. Details free. A. E. Jacobson, Upsala, Minnesota.

**OROSCOPE** Detects hidden metals. Patented. Send stamp. Oroscope, Hot Springs, N. Mex.

**ARC** Welding, procedure handbook of design and practice. Latest world standard authority, 819 pages, illus., only \$1.50 postpaid. Popular Mechanics Press, Dept. (C39), 200 E. Ontario St., Chicago.

**LIKE** Receiving letters? Interesting letter from Yukon. "Land of the Klondyke." 25c (coin). With five scenic photographs 50c. Sourdough Dave, Dawson, Yukon, Canada.

**AN** Ideal gift: "Pen, pencil and knife set." All three articles matched perfectly. Self filling fountain pen fitted with durium stainless point, latest filigree band, lever filler with pencil to match, expel and repel movement with compartment containing extra leads, eraser. Both blades in knife are made of highgrade tempered steel that will hold its edge. Each set packed in attractive gift box, \$1.00 postpaid. Gustafson, Box 531, Rockford, Illinois.

**FOR** Home, shop, office. Ten drawer cabinet. 1 1/4 x 3 3/4 x 4 3/4 inch drawers. Kit 75c. Finished cabinet \$1.50, 10c extra west Mississippi. Attractive dealer proposition. E. Taylor, W. Howard, Hagerstown, Md.

**MECHANICAL** Information for inventors, experimentalists, model builders, students, mechanics, regarding materials, shop practice, formulas, manufacturing methods, sources of supply, etc. Send 10c for 225 mechanical facts and our plan. J. C. Irwin, 316 8th Ave., So. Minneapolis, Minn.

**BULL** Fight playing cards by Ruano Llopiz. Send one dollar. Mexican curios. Anything from Mexico. Fernando M. de Oca, Apartado 2686, Mexico City, Mexico.

**PECANS,** 10 Lbs. large paper shells \$2.20. Shelled Spanish peanuts 13c lb.; runners unshelled 11c lb. Georgia cane syrup \$1 gallon. All express prepaid. Request quantity prices. Brennan & Co., Fitzgerald, Ga.

**BUYERS** Club. Anything cut rate. Free source directory. Universal Service, Box 522, Binghamton, New York.

**TURN** Scrap into money. Convert old auto generators into A.C. generators for auto radio, camp and home lighting, power and other uses. Complete book \$1 postpaid. Popular Mechanics Press, Room (C39), 200 E. Ontario St., Chicago.

**READ** Our war and oil ad under Business Opportunities, it's worth answering. Royal Keystone Enterprise, Box 192, Berryville, Ark.

**CHROMIUM-PLATE** Without electricity! Metal finish applied with brush. Generous sample bottle 35c, prepaid. D & H Distributing Company, 106 N. Bellvue, Hastings, Nebraska.

**FOR** Free literature and magazine, address: Goat World, Vincennes, Indiana.

**REVEALING** Book—How to Sway a Person's Mind. Learn high-pressure methods that place a person in a position which compels him to do as you wish. Not a book on salesmanship. \$2.25 complete. Two-day money-back guarantee. Order now. Herman Hatcher, 100 No. La Salle St., Suite 712-A, Chicago.

**EXOTIC** Christmas gifts for mother, wife, daughter, sister, sweetheart. Genuine Mexican sterling silver filigree, bracelets, sets, guaranteed. Send \$2.00 for sample. Flores, Vallarta 1994, Guadalajara, Jalisco, Mexico.

**INFORMATION.** Any subject. Moderate fee. International Research, 2737 Francis Ave., Los Angeles.

**HAND-WOVEN** Ties \$1. Write for free sample of the material and 32 colored pictures of patterns. Log Cabin Hand Weavers, 11 Post Road, Oregon City, Oregon.

**COATS** Of arms and crests, correctly painted in colors or black and white, from heraldic description or furnished copy. \$10.00 and up. Highest grade work. Heraldic Studios, 1914P Oakdale Avenue, Chicago, Ill.

**TATTOOING** Outfits, supplies, illustrated list free. Percy Waters, Anniston, Alabama.

**REFINE** Used oil without cost. Particulars. F. Gerwin, Fairview, Oklahoma.

**SWAPPER'S** Friend, R4, Saline, Michigan. Interests swappers, collectors. 50c year, sample 10c.

**REFINISH** Your car. Instruction book treats all phases of painting and refinishing autos and trucks. Written for the man who wants to renew his own car, but covers also the business end of refinishing for the professional. \$1.65 postpaid. Popular Mechanics Press, Room (C39), 200 E. Ontario St., Chicago.





THIS VALUABLE BOOK

**FREE**

**LEARN CARTOONING AT HOME IN SPARE TIME**

Send for this FREE book containing money-making tips, cartooning charts, idea creating methods, list of cartoon buyers, and other valuable information. Read about the money-making opportunities in one of the most fascinating of all professions—CARTOONING. With this booklet we will include a complete portfolio describing our easy Course in Cartooning and explaining our new Marionette Method of Instruction. We will also tell you how to get the Cartoonists' Exchange Laugh Finder FREE of extra cost. This amazing device actually helps create and originate humorous ideas. Send name at once and mention your age.

**CARTOONISTS' EXCHANGE**

Dept. 912 Pleasant Hill, Ohio

**ENGINEERING**

**DEGREE IN TWO YEARS**

TECHNICAL AND APPLIED COURSES. Nonesentials omitted. TIME AND MONEY SAVED. Degree 2 yrs., diploma 1 yr. Electrical, Mechanical, Architectural, Structural, Civil, Aeronautical, Highway. All courses include Air Conditioning, Electric Refrigeration and Diesel. Short intensive courses 3 and 4 months in Electricity, Power Plant, Diesel-Electric, Electric Refrigeration, Drafting. Extensive modern equipment. LOW TUITION. Part-time work for room and board. Thousands of successful graduates in U. S. and foreign lands. Approved by Industry, endorsed by educators, recommended by alumni. One and two-year courses start in Sept., short courses open year round. 40th YEAR. Residence courses. Catalog free.

**FINLAY ENGINEERING COLLEGE**

1001 Indiana Avenue Kansas City, Mo.

**EARN A DEGREE AT HOME**

From A Chartered Institution Of Higher Learning  
Employers Now Demand College Graduates With Degrees

88 Degree Courses in Art; Sciences; Philosophy; Education; Psychology; Public Health; Sociology; Physics; Chemistry; Pol. Science; Theology; Law; Business Training; Accounting; Statistics; Adv.; Sales; Agriculture. Electrical, Mechanical, Civil, Structural, Diesel, Architectural, Mining, Drafting, Automotive, Aeronautical, Radio, Refrigeration, Highway, Marine, Air Conditioning, Geology, Petroleum, Industrial, Chemical Engineering. Founded 1908. 170 p. Catalog Free. McKinley-Roosevelt Graduate College, 4750-F Sheridan Road, Chicago

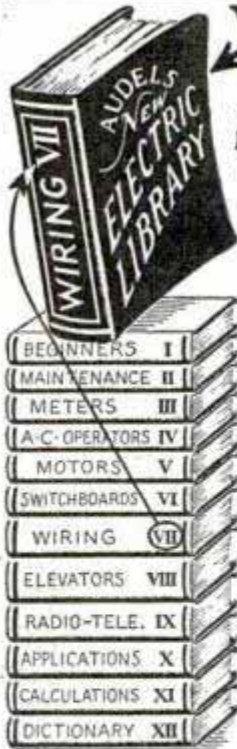

**WIRING**

**VOL. VII AUDELS NEW ELECTRIC LIBRARY—A MASTER BOOK ON WIRING**  
728 PAGES, 1200 ILLUSTRATIONS. \$1.50

House and Power Wiring  
Diagrams—Problems  
and Calculations

fully explained in clear practical language, easy to use and understand including helps and hints for all electrical workers that will save time, trouble and money.

**AUDELS NEW ELECTRIC LIBRARY—**  
A progressive Home Study and Reference Course in applied electricity. Easy to understand. Questions and answers plainly written for a complete working knowledge of modern electrical practice, necessary to every electrician, engineer, mechanic and student.

**LEARN THE AUDEL WAY!** You ask the question—Audels New Electric Library gives the answer—9500 simplified outlines, graphic illustrations and precise explanations covering Construction, Operation and Machine Maintenance.

**BOOK A MONTH PLAN—**Order the volume that interests you—today! We will send that volume on 7 days' free trial. If the book helps you, send us \$1.50. If it does not help you, mail book back to us.

**FREE EXAMINATION COUPON**

Theo. Audel & Co., 49 W. 23rd St., New York City  
Mail Vol. VII on 7 days free trial. If O.K. I will remit \$1.50 otherwise I will return it. Also please send further information about the Electric Library—no obligation unless I am satisfied.

Name .....  
Address .....  
Occupation .....  
Reference .....PM

**HOW TO MODERNIZE YOUR OLD RADIO**

**MIDWEST FACTORY-TO-YOU 20th ANNIVERSARY SPECIAL!**

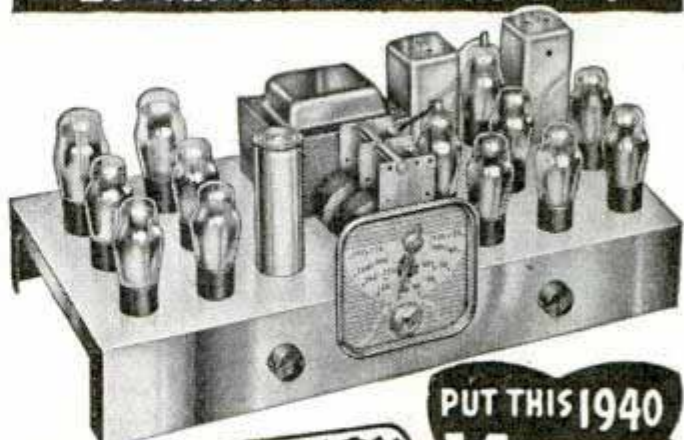

**WITH TELEVISION ADAPTATION**

Here's today's biggest radio value—the 1940 TELEVISION - ADAPTED Midwest—at sensationally low factory-to-you-price. Now enjoy exciting foreign reception. Absolute satisfaction guaranteed on money-back basis. Send 1c postcard for FREE 1940 catalog. (User-agents make easy extra money!)  
See Midwest's Answer to TRADE-INS!

**PUT THIS 1940 14 TUBE CHASSIS IN YOUR PRESENT CABINET**  
**\$19.95**  
**COMPLETE CHASSIS WITH TUBES AND SPEAKER**

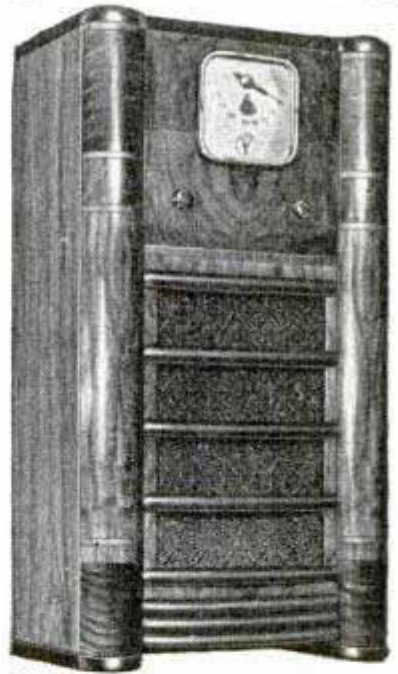

**SAVE UP TO 50%**  
**30 DAYS TRIAL**  
**EASY PAY PLAN**

**14-TUBE CONSOLE**  
**\$29.95**  
**COMPLETE**

**MIDWEST RADIO CORPORATION**  
Dept. 15-G Cincinnati, Ohio

PASTE COUPON ON 1c POSTCARD...OR WRITE TODAY!

**MIDWEST RADIO CORPORATION**  
Cincinnati, Ohio  
Dept. 15-G  
Name.....  
Address.....  
Town..... State.....  
Send me your new FREE catalog, complete details of your liberal 30-day Trial offer and factory - to - you prices.  
User-Agents Make Easy Extra Money. Check here [ ] for details.

Always write your name and full address clearly when answering advertisements.



**"IT WAS LIGHT IN A WILDERNESS OF DARKNESS TO ME"**



● "I was stuck. A wife and three kiddies—and the same old pay envelope. I couldn't see a thing ahead except the same old grind. Then one day I read an I. C. S. ad. The coupon fascinated me. A new idea struck home—it was light in a wilderness of darkness to me! Today, because I mailed that coupon two years ago, I am a trained man—making a trained man's pay!"

Nearly fifty years ago, the International Correspondence Schools were established to provide sound educational facilities to men unable to attend resident schools. Over five million dollars has been spent in preparing textbooks and keeping them up-to-date. Today, you'll find I. C. S. graduates holding leading positions in every field of business and industry.

**INTERNATIONAL CORRESPONDENCE SCHOOLS**

BOX 5561-J, SCRANTON, PENNA.

Explain fully about your course in the subject marked X:  
**TECHNICAL AND INDUSTRIAL SUBJECTS**

- |   |  |   |
|---|--|---|
| <input type="checkbox"/> Agriculture                  | <input type="checkbox"/> Air Brakes                | <input type="checkbox"/> Manufacture of Pulp Paper  |
| <input type="checkbox"/> Air Conditioning and Cooling | <input type="checkbox"/> Marine Engineering        | <input type="checkbox"/> Mechanical Drafting        |
| <input type="checkbox"/> Architectural Drafting       | <input type="checkbox"/> Mechanical Engineering    | <input type="checkbox"/> Navigation                 |
| <input type="checkbox"/> Architecture                 | <input type="checkbox"/> Patternmaking             | <input type="checkbox"/> Pharmacy                   |
| <input type="checkbox"/> Auto Electric Technician     | <input type="checkbox"/> Plumbing                  | <input type="checkbox"/> Poultry Farming            |
| <input type="checkbox"/> Auto Technician              | <input type="checkbox"/> Public Works Engineering  | <input type="checkbox"/> Radio                      |
| <input type="checkbox"/> Boilermaking                 | <input type="checkbox"/> R. R. Locomotives         | <input type="checkbox"/> R. R. Section Foreman      |
| <input type="checkbox"/> Bridge Engineering           | <input type="checkbox"/> R. R. Signalmen           | <input type="checkbox"/> Refrigeration              |
| <input type="checkbox"/> Building Estimating          | <input type="checkbox"/> Sheet Metal Work          | <input type="checkbox"/> Steam Electric Engineering |
| <input type="checkbox"/> Chemistry                    | <input type="checkbox"/> Steam Engineering         | <input type="checkbox"/> Structural Drafting        |
| <input type="checkbox"/> Civil Engineering            | <input type="checkbox"/> Structural Engineering    | <input type="checkbox"/> Surveying and Mapping      |
| <input type="checkbox"/> Coal Mining                  | <input type="checkbox"/> Telegraph Engineering     | <input type="checkbox"/> Telephone Work             |
| <input type="checkbox"/> Contracting and Building     | <input type="checkbox"/> Welding, Electric and Gas | <input type="checkbox"/> Woolen Manufacturing       |
| <input type="checkbox"/> Cotton Manufacturing         |  |   |
| <input type="checkbox"/> Diesel Engineering           |  |   |
| <input type="checkbox"/> Electrical Engineering       |  |   |
| <input type="checkbox"/> Electric Lighting            |  |   |
| <input type="checkbox"/> Foundry Practice             |  |   |
| <input type="checkbox"/> Fruit Growing                |  |   |
| <input type="checkbox"/> Heating                      |  |   |
| <input type="checkbox"/> Heat Treatment of Metals     |  |   |
| <input type="checkbox"/> Highway Engineering          |  |   |
| <input type="checkbox"/> House Planning               |  |   |
| <input type="checkbox"/> Machinist                    |  |   |
| <input type="checkbox"/> Management of Inventions     |  |   |
| <input type="checkbox"/> Managing Men at Work         |  |   |

**BUSINESS SUBJECTS**

- |  |  |   |
|--|--|---|
| <input type="checkbox"/> Advertising             | <input type="checkbox"/> Bookkeeping           | <input type="checkbox"/> High School Subjects         |
| <input type="checkbox"/> Business Correspondence | <input type="checkbox"/> Illustrating          | <input type="checkbox"/> Lettering Show Cards         |
| <input type="checkbox"/> Business Management     | <input type="checkbox"/> Railway Postal Clerk  | <input type="checkbox"/> Salesmanship                 |
| <input type="checkbox"/> Cartooning              | <input type="checkbox"/> C. P. Accounting      | <input type="checkbox"/> Service Station Salesmanship |
| <input type="checkbox"/> Civil Service           | <input type="checkbox"/> Cost Accounting       | <input type="checkbox"/> Signs                        |
| <input type="checkbox"/> College Preparatory     | <input type="checkbox"/> Foremanship           | <input type="checkbox"/> Spanish                      |
| <input type="checkbox"/> College Subjects        | <input type="checkbox"/> Grade School Subjects | <input type="checkbox"/> Stenography and Typing       |

**DOMESTIC SCIENCE SUBJECTS**

- |   |  |
|---|--|
| <input type="checkbox"/> Advanced Dressmaking | <input type="checkbox"/> Professional Dressmaking and Designing      |
| <input type="checkbox"/> Foods and Cookery    | <input type="checkbox"/> Tea Room and Cafeteria Management, Catering |
| <input type="checkbox"/> Home Dressmaking     |  |

Name..... Age.....  
Address.....  
City..... State.....

Present Position.....  
Canadian residents send coupon to the International Correspondence Schools Canadian, Limited, Montreal, Canada. British residents send coupon to I. C. S., 71 Kingway, London, W. C. 2, England.

## QUICK CASH IN NEW POTATO CHIPS

**START AT HOME**

Here's your chance—a money-making business of your own. Turn potatoes into cash by making new kind of Potato Chips with my improved outfit. Makes delicious, superior, "NON-GREASY" Chips at low cost. A few hours' practice does it. Begin anywhere—city, village, town. Potatoes cheap and plentiful. Wholesale or retail. Steady year-round business. Groceries, markets, restaurants, taverns, do the retailing for you. **WE HELP START YOU IN BUSINESS** Great quantities of Chips are eaten daily. Profit large—unusually so. You can start this money-making business on a "next to nothing" outlay of cash. Write for Potato Chip Booklet.

LONG-EAKINS COMPANY, 1228-S High St., Springfield, Ohio

## Learn To MOUNT BIRDS

**Tan SKINS, Make Up FURS**

Be a Taxidermist. Double your hunting fun. We teach you at Home. Mount Birds, Animals, Pets, Heads and Fish. Save your hunting trophies; decorate home and den. **MAKE MONEY.** Mount and Krome-tan for others. Big sparetime profits. **INVESTIGATE TODAY.** **FREE BOOK with 100 game pictures.** 48 pages. Hunters, get yours! It's **Now Free.** Send postal card **TODAY -- This Minute!** State your AGF **NORTHWESTERN SCHOOL OF TAXIDERMISTRY, Dept. 3379 Omaha, Nebr.**

## TOOL & DIE MAKING DESIGNING

Machinists Trade. Not a correspondence course. Practical shop training in the world's industrial center. Write today for full information. **NATIONAL SCHOOL OF MECHANICAL TRADES** Dept. 12 628 W. Lake St. Chicago, Ill.

## ARTISTS MAKE MONEY

Find out your ability. Send name, age, occupation and address for Free Vocational Art Test. **Federal Schools, Inc., 12139 Federal Schools Bldg., Minneapolis, Minn.**

## DIESEL

Get BETTER training. Realize Adcox advantages. Located in Pacific Northwest, a Diesel center. Established 28 years. Modern equipment, expert instructors. Close cooperation for YOUR success. Earn room and board while learning. Send for free book, "What Every Man Should Know About Diesel". Dept. 18. Home study and resident courses. **L. L. ADCOX TRADE SCHOOL** Portland Oregon

## The Lost Word

**THE KEY TO SECRET WISDOM**

"Like a bolt from the heavens, the word was spoken and from the reverberations of its sacred syllables, came the creation of the Universe"—so relates an old, old legend. Through the ages men have searched in vain for this lost word. In its stead they found keys to a secret wisdom. They learned how to unlock the hidden possibilities slumbering within everyone... startling, unused powers that make for a greater life.

**This Sealed Book—FREE**

A sealed book by the Rosicrucians, reveals the plan whereby you may obtain this wealth of knowledge leading to the greater joys and rewards of living. For free copy without obligation, write Scribe R.H.X.

**The ROSICRUCIANS**  
SAN JOSE [AMORC] CALIFORNIA  
NOT a religious organization





**NEW models  
EASIER TO PLAY**

Find out about these sensational new Conn Band Instruments. Many wonderful, exclusive features! Today, *more than ever*, Conns are the "choice of the artists." You'll advance faster and take more pride in a genuine Conn—made by the world's largest manufacturer. See your dealer or write us for Home Trial, Easy Payment offer. Mention instrument.

**C. G. CONN, LTD.**  
1231 Conn Bldg., Elkhart, Ind.

**CONN**  
BAND INSTRUMENTS

**WRITE FOR FREE BOOK**

**FREE OUTFIT  
Brings Quick Profits**

Profits your very first day and all year 'round with my Proven Plan and big OUTFIT given FREE to reliable persons. Outfit includes large assortment of full size packages. Distribute home necessities—over 200 fast selling, quick repeating, nationally known products—guaranteed to satisfy! Full or part time. Liberal credit plan. Old reliable company. Write quick for my Free Offer.



**E. J. Mills, 9666 Monmouth Ave., Cincinnati, Ohio.**

**DENISON'S  
PLAYS**

Musical Comedies, Operettas, Vaudeville Acts, Minstrels, Comedy Songs, Make-up Goods.  
Catalog Free

**60 YEARS OF HITS**

**T. S. Denison & Co., 203 N. Wabash, Dept. 9, Chicago**

**Earn Cash at Home!**

**N.M. EARNED \$1174 at Home!**

We paid M. M. \$1174 for exceptional cellar crop Snow-King mushrooms! We furnish materials; buy all crops. Big FREE picture book tells if your cellar, shed, barn, suitable. Ed. 1908. Write today. United Co., 3848 Lincoln Av., Dept. 310, Chicago

**Learn to play..**

Easy lessons at home. Inexpensive. 132-page Music Dictionary FREE when you enroll. Stop lessons when you like. Money back guarantee. Write for free details. Hamann Institute, 2016 N. 24th Place, Dept. R-12, Milwaukee, Wis.

Hawaiian Steel Guitar  
Spanish Guitar  
Piano

**\$5, \$10, \$15 FOR ONE DRAWING**

**Be an ARTIST!**

**Learn at home in your spare time**

Train to be an Artist and become your "own boss." Our practical method has trained men and women of all ages since 1914. **COMMERCIAL ART, CARTOONING, and DESIGNING** all in one complete course. Trained Artists are capable of earning \$30, \$50, \$75 a week. No previous Art experience necessary. **FREE BOOK, "Art for Pleasure and Profit"** describes course and **TWO ART OUTFITS** included. Mail coupon today.

**FREE BOOK gives details!**

Washington School of Art, Studio 1212M  
1115—15th St., N. W., Washington, D. C.

Yes! I am interested in learning to draw. Please send me your Free Book, "Art for Pleasure and Profit."

Name.....Age.....  
Address.....  
City.....State.....

**Be a modern  
SHOE SERVICE  
Expert!**

**Complete Training in...  
SHOE REPAIRS  
DYEING  
FOOT ANATOMY  
SHOE CORRECTION  
MERCHANDISING  
SALESMANSHIP  
ADVERTISING**

**MAIL COUPON NOW!**

**New Business College Course fits you to earn up to \$50.00 A WEEK in depression-proof career**

Here's opportunity! Don't be satisfied with small-pay, no future jobs. The modern Shoe Service course of the National Shoe Service Institute will fit you for a steady, pleasant, big-pay career... even teaches you how to be successful in your own business! Train under capable instructors. Course includes merchandising, salesmanship, advertising. Two years of high school qualifies you.

Mail coupon today. Learn of the opportunities awaiting you. Special Low Tuition offers.

**NATIONAL Shoe Service INSTITUTE**  
P. O. Box 5503, Chicago, Ill.

Send cost and details of complete Shoe Service Business Course.

Name.....  
Street.....  
Town.....State.....

**This MACHINISTS' Home-Study Course helps men get ahead**

Newly assembled—specially priced—these five recent books give you the practical facts on modern machines, up-to-date methods, you need to advance in machine shop work. Take advantage of the other man's experience as found in books, to solve your problems, increase your efficiency, with

**The NEW AMERICAN MACHINISTS' LIBRARY**

5 volumes—2014 pages—1853 illustrations  
(A combined home-study course and reference library)

This library of machine shop practice was written for practical men. It gives you the best methods for every kind of machine shop work. It fully explains lathes, drills, and other machine tools and their operation; automatic screw machines, speeds and feeds, gear design and production, punch and die work, metal surfacing, etc., etc. Plainly written—completely illustrated—the best kind of help to the machine shop man who wants to advance himself.

**No money down—special price—easy payments.**

**EXAMINATION COUPON**

**McGRAW-HILL BOOK CO., 330 W. 42nd St., New York**

Send me for ten days' examination the new American Machinists' Library. If satisfactory I will send you \$1.50 in 10 days and \$3.00 monthly until the price of \$16.50 is paid. If not wanted, I will return the books postpaid. (To insure prompt shipment write plainly and fill in all lines.)

Name.....  
Home Address.....  
City and State.....  
Position.....  
Name of Company..... PM-12-39

When writing please mention Popular Mechanics



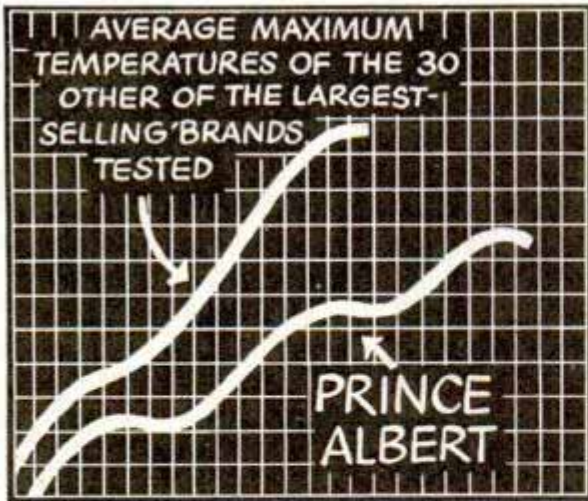

Chart showing how much cooler Prince Albert burned compared to the average of the 30 other of the largest-selling brands recently tested for cooler smoking



In Recent Laboratory "Smoking Bowl" Tests, Prince Albert Burned

**86 DEGREES COOLER**

than the average of the 30 other of the largest-selling brands tested — coolest of all!

SCIENTISTS at a nationally known independent laboratory tested to find the COOLEST-SMOKING TOBACCO, and the results are no surprise to millions of smokers. Automatic smoking and heat-registering machines found that Prince Albert smokes coolest—as above. Say good-bye to parching, "bitey" smokes. P.A.'s cooler, milder smoking lets rich, full body come through EXTRA EASY ON THE TONGUE. Prince Albert's choice, "no-bite" tobacco is "crimp cut." ("Makin's" fans, that's a "pointer" to you too!)

OL' JUDGE ROBBINS SAYS:



LET COOL-SMOKING P.A. PUT NEW JOY IN YOUR PIPE!

**50**

pipefuls of fragrant tobacco in every handy tin of Prince Albert

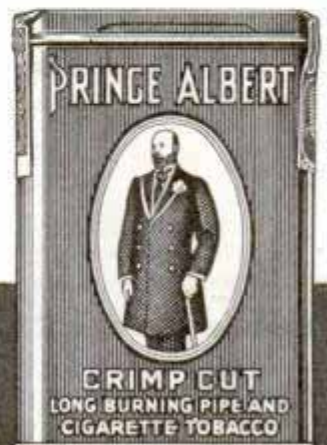

Copyright, 1939, R. J. Reynolds Tobacco Co., Winston-Salem, N. C.

*Prince Albert* THE NATIONAL JOY SMOKE



# Popular Mechanics Magazine

REGISTERED IN U. S. PATENT OFFICE AND CANADA

WRITTEN SO YOU CAN UNDERSTAND IT

Vol. 72

DECEMBER, 1939

No. 6

## TREASURE HUNTING UP-TO-DATE

By L. A. Hawkins

Executive Engineer,  
General Electric Research Laboratory

*J. 1112*  
**A**MERICAN industry has undergone profound changes in the past fifty or sixty years. Automatic machine tools have increased productive efficiency enormously; standardization and mass production have become the rule, yielding superior products at far lower costs; the role of engineering has

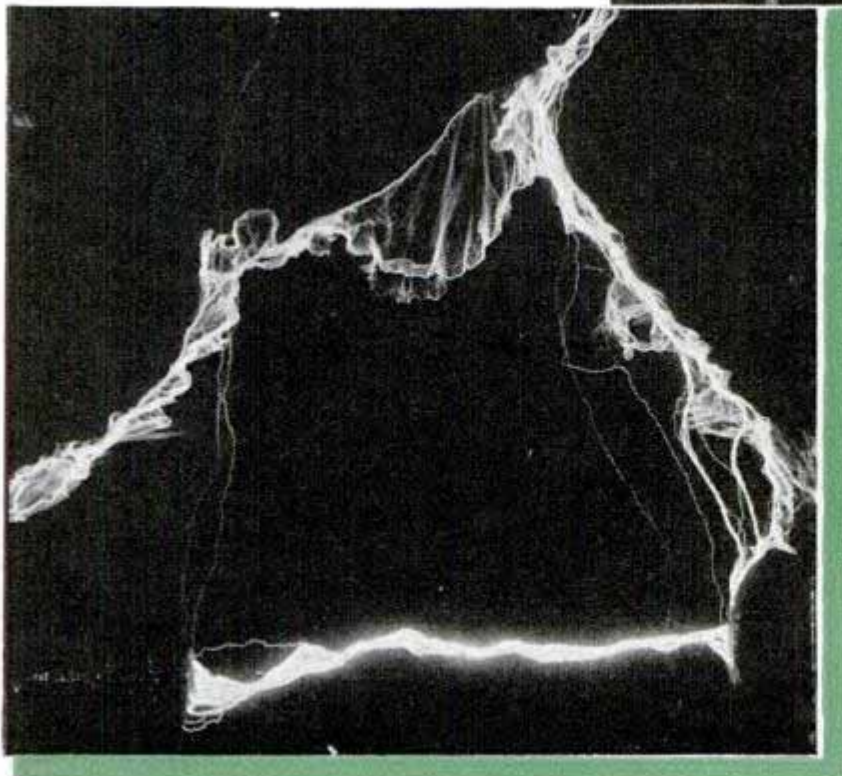

*Mr. C. Langford*  
While engineers put electricity to work, researchers try to find what it is and why it behaves as it does. Above, studying an arc; left, a camera "freezes" lacy pattern of nine-foot arcs between revolving pinwheels



William A. Suggles

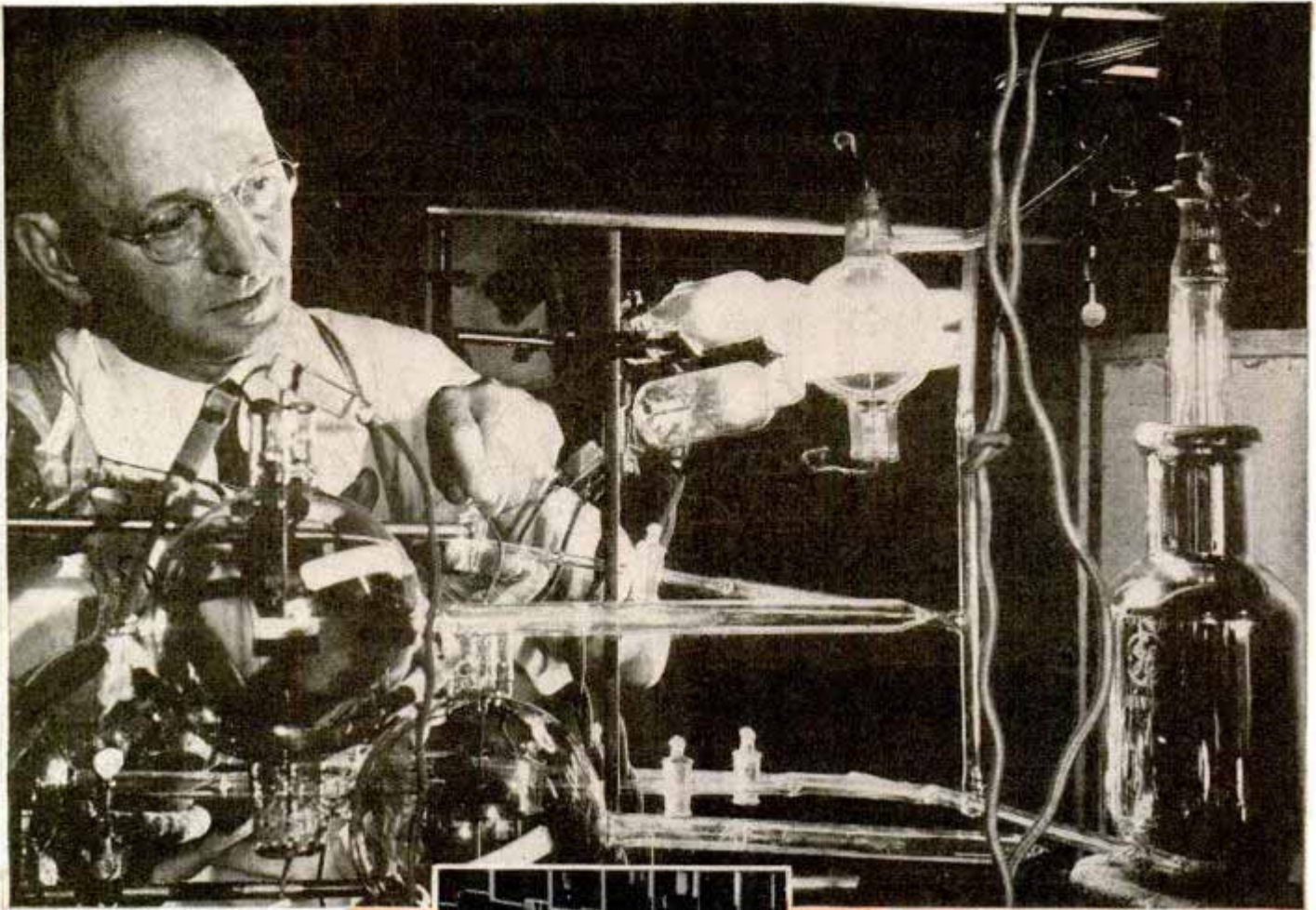

*Man's nearest approach to perfect vacuum is removal of all but one ten-billionth of air in X-ray or radio tube, above. Center, scientist watches activities in one of the new bulbs. Bottom, million-volt X-ray machine*

increased greatly in importance and has led to a much higher degree of technical specialization.

But no other change is likely in the long run to have a profounder effect on the character of industry than that which is being wrought by industry's domestication of science in its own research laboratories.

This change began less than forty years ago and came into wide operation only in the last two decades. It is since the last war that research has become generally recognized as an essential function of industry.

Scientific facts are the basis for invention and engineering development, but

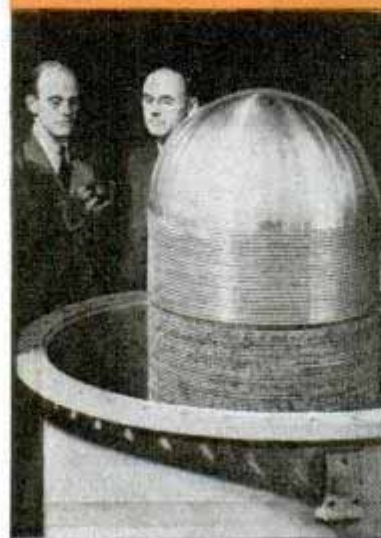

the inventors and engineers of the last century had, as their only source of such facts, the sporadic results of unorganized researches. But even so, the experiments of scientists, working single-handed and often with the most meager equipment, had laid the foundations for a number of new industries, of which none was growing more rapidly and promising more for the future, as the century closed, than the electrical industry.

It was Faraday's great discovery of electromagnetic induction in 1831 which made possible the development of the generators, transformers and motors with which in "the gay nineties," the young profession of electrical engineering was building its rapidly growing systems for the generation,





distribution and utilization of electric light, heat and power.

Some of the industry's leaders had the vision and wisdom to perceive that if such important development had sprung from sporadic scientific efforts in the past, much more could be expected from organized, cooperative endeavor, adequately supported with equipment and material. To this perception the industrial research laboratory owed its creation.

The General Electric company was a leader in this movement. Its research laboratory was started in 1900. Today the National Research Council lists 2,000 industrial research laboratories.

Research is the systematic search for new facts by experiment, but research is of two kinds. One kind seeks new facts about a particular thing for a definite end. It is such research which leads to new and better materials, new, improved and lower-cost products, increased productive efficiency, new or

(Continued to page 150A)

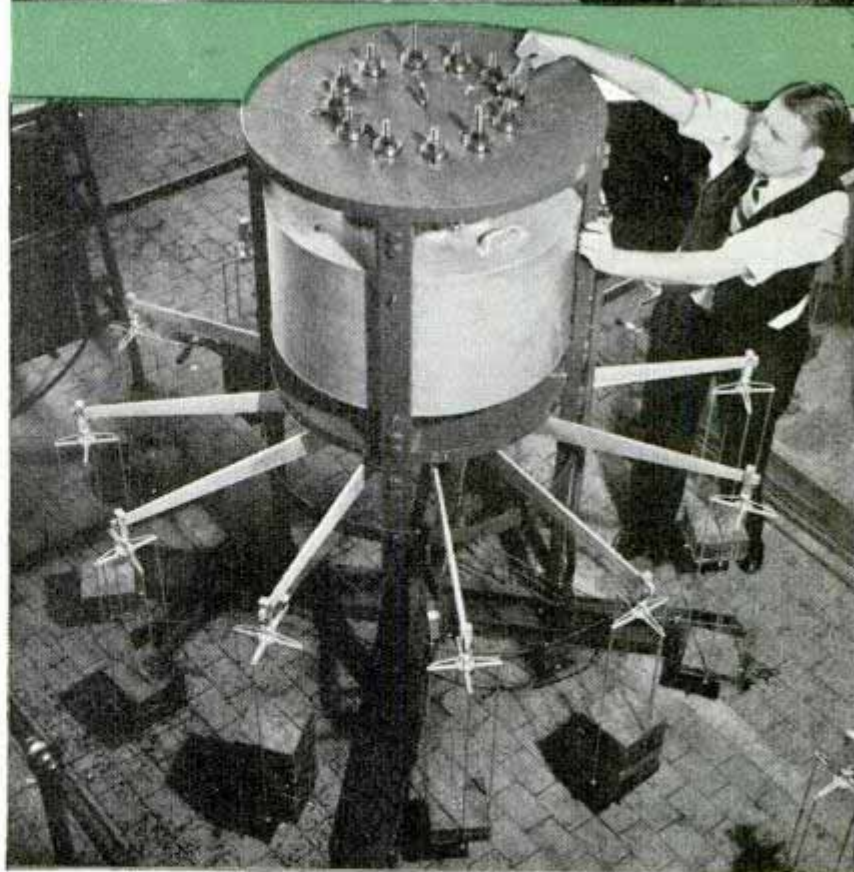
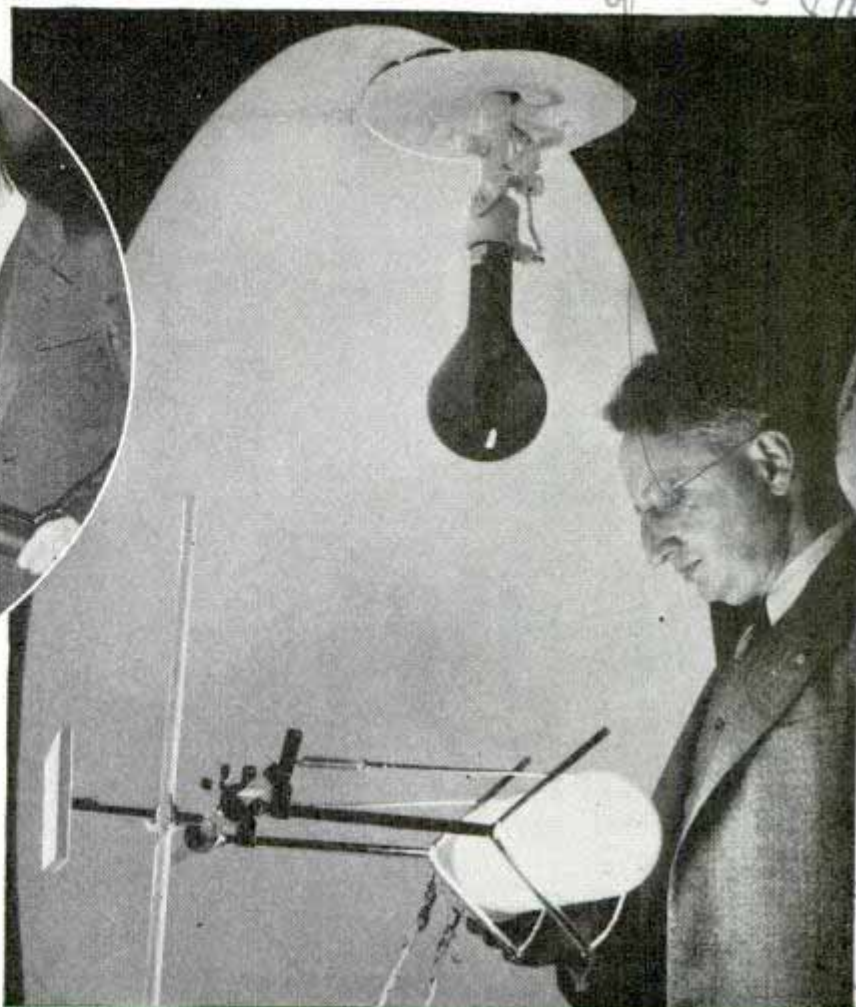

Top, left, inspecting high-power X-ray tube; right, measuring light output of sodium-vapor lamp. Bottom, twelve steel rods for turbines are given breakdown test in an electric furnace



**Cup Is Kept from Skidding  
by "Well" in Plate**

*Omaha, Neb*



*Cup sits tight in "well" of non-skid glass plate even when it is tilted at sharp angle*

If you experience difficulty in balancing a plate and cup on your knee at those informal luncheons, you may welcome a plate that permits one-hand control of the food and beverage. Skidding of the cup is prevented by a "well" rising in the center of the glass plate into which either a cup or tumbler will fit.

*21036*

**Sound System for Home Movies  
Carried in Compact Case**

Sound effects and music for home-movie presentations are available in a three-in-



*Loud speaker is in upper part and amplifier below*

*4928 Newton Ave  
S. Minneapolis*

one unit which includes dual turntables, amplifier and loud speaker built into a portable carrying case weighing less than forty-five pounds. The speaker and a fifty-foot extension are contained in the upper portion of the case, and there is space for a microphone and small stand. Either ten or twelve-inch disks may be played. Pick-up arms are equipped with pilot lights to aid in finding record grooves in darkened projection rooms. For split-second synchronization of sound effects, push-button cutoffs are provided.

*21050*

**Portable Drinking Fountain  
Holds Five Gallons**

More sanitary than the old-fashioned water jug is a portable drinking fountain



*Portable drinking fountain replaces the old water jugs at athletic fields and construction jobs*

that has the appearance of a fire extinguisher. A few strokes of the pump build up enough air pressure in the compression chamber to force water out of the fountain when the valve is released. It holds about five gallons and ice may be added to the water if desired.

*Hobbs Mfg. Co.  
North St. Paul, Minn.*

*Western Supply Co., 561  
Washington Blvd.*

*George R. Culbertson Co.,  
Specialized Sound Equipment*



*21011 Wash. D.C. 1917*  
**Cylinders Impart Motion to Scene on Sign**  
*Los Angeles Calif.*

Motion is imparted to advertising signs by illuminated cylinders revolving behind them. The scene itself is painted on Lumarith, an acetate cellulose plastic material which passes light, in back of which is slipped a shield to mask the part of the picture not to be animated. Also made of Lumarith, the cylinders have designs painted on them and synchronized to create natural action in the

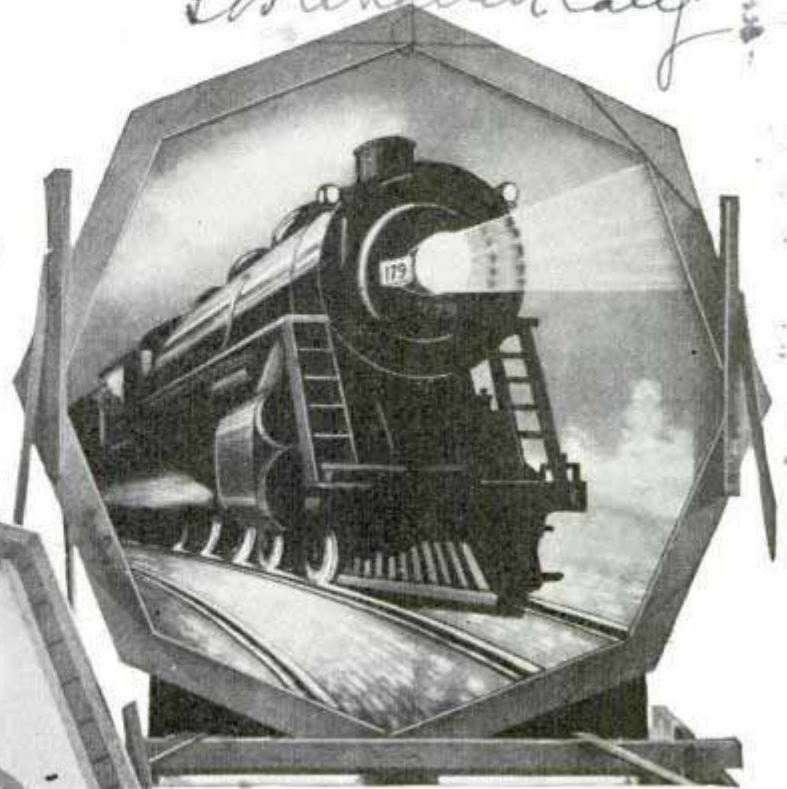

*Left, light shining through rotating cylinders imparts backward motion to tracks, ballast, steam and smoke in train scene above*



scene. Electric bulbs within the cylinders cast lights and shadows on the picture as they revolve. In one scene depicting a train, the light action of the tracks actually goes backward to create the illusion of a locomotive speeding toward the onlooker. The painting can be taken off the frame and rolled up like a rug for shipment.

*21024*  
**Rotating Stand for Kitchen Tools Holds Various Utensils**

Various kitchen tools can be installed interchangeably in a handy stand that eliminates the need of holding the tools with both hands. The basic unit comprises a juice extractor, an egg beater and an enameled bowl that sets on a revolving base. A potato ricer and a food chopper also fit the standard pedestal.

Names and addresses of manufacturers and dealers in articles described in this magazine will be furnished by our Bureau of Information upon request accompanied by stamped, self-addressed envelope.

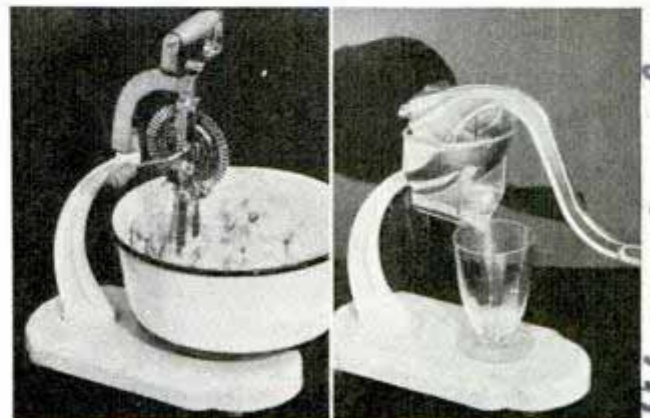

*Standard base is used to hold food mixer (left) with bowl on rotating stand, and juicer (right)*

*Universal*  
*Landers, Frary and Clark, New Britain*



# Lamp and Copyholder Unit Saves Typist's Eyes



Typist is assured of good illumination from copyholder lamp. Line spacer is operated by hand

Light is shed right where it is needed by a lamp mounted directly on a typist's copyholder to lessen eyestrain. The holder itself is adjustable to any angle and it has a hand-operated line spacer. The light switch is located at the front, and there is a convenient holder at the base for pencils.

# Fender Guard on Auto Bumper Serves as Feeler in Traffic

Mounted at the outer ends of front and rear bumpers, fender guards signal the driver as soon as they come in contact

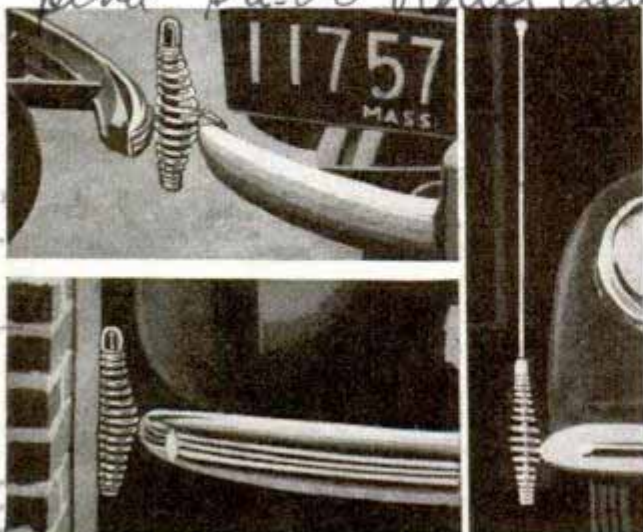

Two views at left show how "feeler" guards fenders. Right, clearance guides can be added if desired

with another vehicle. Roller and spring action cause the guards to slide off of objects without damage, and the slightest jar is felt immediately in the steering wheel. The purpose is to prevent interlocking of bumpers in traffic and parking as well as to protect fenders and headlamps. The guards can be attached easily to the front and rear bumpers of any car.

# Circuit Breaker Like Big Gun Blows Out Arc with Air

Resembling the barrel of an anti-aircraft gun, an exhaust muffler is part of a pneumatic circuit breaker developed by General Electric which uses a blast of air, built up under pressure, to interrupt the circuit and break the arc. It is designed for 15,000-



Circuit breaker set up in unusual position. Base contains mechanism and long barrel serves as muffler

volt service at interrupting ratings up to 1,500,000 kilovolt-amperes, and is capable of protecting electric equipment in commercial installations which previously were limited to oil-type circuit breakers.

# Weather Is a Military Secret to Countries at War

Information about the weather, of immense value in war, is guarded by warring nations as a military secret. In Britain, for instance, the publication or broadcasting of weather data—even of local thunder-showers—is strictly forbidden. Since

Vertical handwritten notes on the left margin: "Aries Wagon Co. 1036 E. Grand St. Washington, D.C. \$2.00 Roller Action" and "Diagram of the device" (partially visible).

Handwritten number "9975" above the circuit breaker title.

Handwritten signature "Schenectady NY" above the circuit breaker image.

Handwritten number "9114" above the weather title.



Sept. 28, 1930

weather regularly moves from west to east, the geographical position of the western powers of Europe gives them the advantage of knowing what sort of weather is in store for Germany to the east. Advance knowledge of storms, cloudiness, fog and rain has been a deciding factor in the success or failure of air raids, major offensives, or naval engagements. This is particularly true in chemical warfare which is notoriously dependent on wind direction and the probability of rain.

## Lighted Model of Cathedral Has Stained-Glass Windows

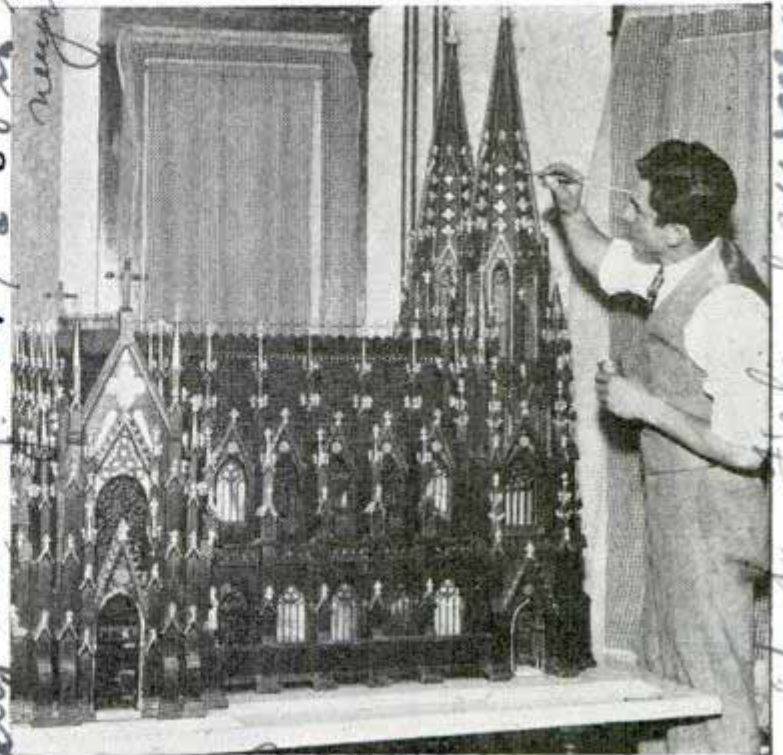

Builder brightening up some high lights in model of cathedral fitted with stained-glass windows and interior lighting

## Venetian Blinds for Auto Reduce Glare and Heat

Venetian blinds for the automobile are now available, made to fit any type of square or curved windows. The flexible cord which controls the setting of the slats is operated by one hand, so that the driver can easily adjust the angle of the slats or drop the blind quickly for hand signaling. Besides reducing sun glare, the blinds keep the car interior cooler in summer. The blinds are made in sizes and shapes to fit any car.

Fitted with electric lights and stained-glass windows, a miniature of St. Patrick's Cathedral in New York City is the product of a three-year hobby. Into the five-and-one-half foot model went 16,352 pieces of boxwood all carefully fashioned.

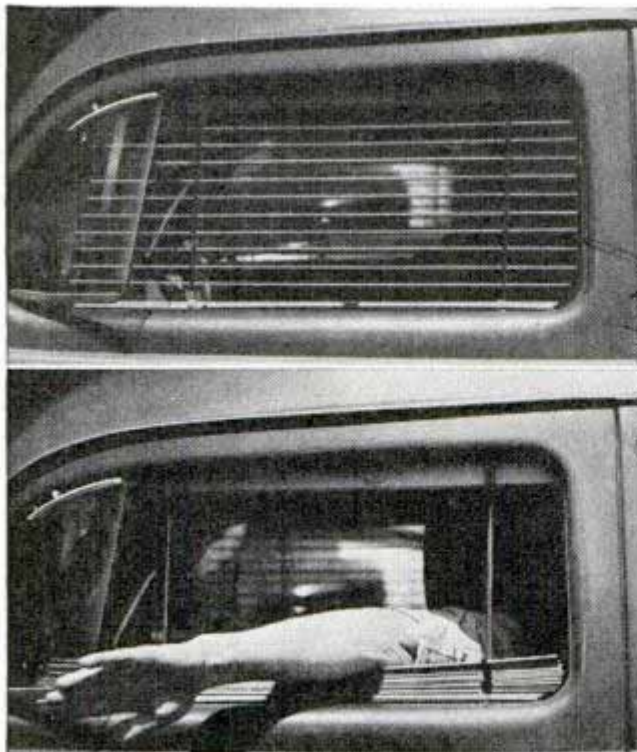

Blinds raised to shut out sunlight and heat (top) can be lowered quickly with one hand for signaling

## Many Stars Are Nearer Earth Than Hitherto Believed

More than 5,000 stars nearest the earth, including many visible to the naked eye, are only half or a third as far away as previously believed, according to Prof. Jan Schilt, of Columbia University, who has found a small systematic error which changes the calculations made by the method of parallaxes. This involves sighting the angle of the star at intervals six months apart and then computing its distance by trigonometry. It is now suggested that tides and waves in the earth's atmosphere, caused by the moon's pull and sunlight above the earth, bend the beam of light from the star. Because of the systematic nature of the new correction, recalculation can be made without taking new observations of each star. The discovery does not affect more remote stars.

Hubb. Huff Co. 16 21

829  
Fella Runney

built by Peter Lynam  
manhattan  
Dunthorpe  
Abner



7 982 C.M.R. 4322 Second Road Hotel  
Arlington, Va.

# SHARPSHOOTING

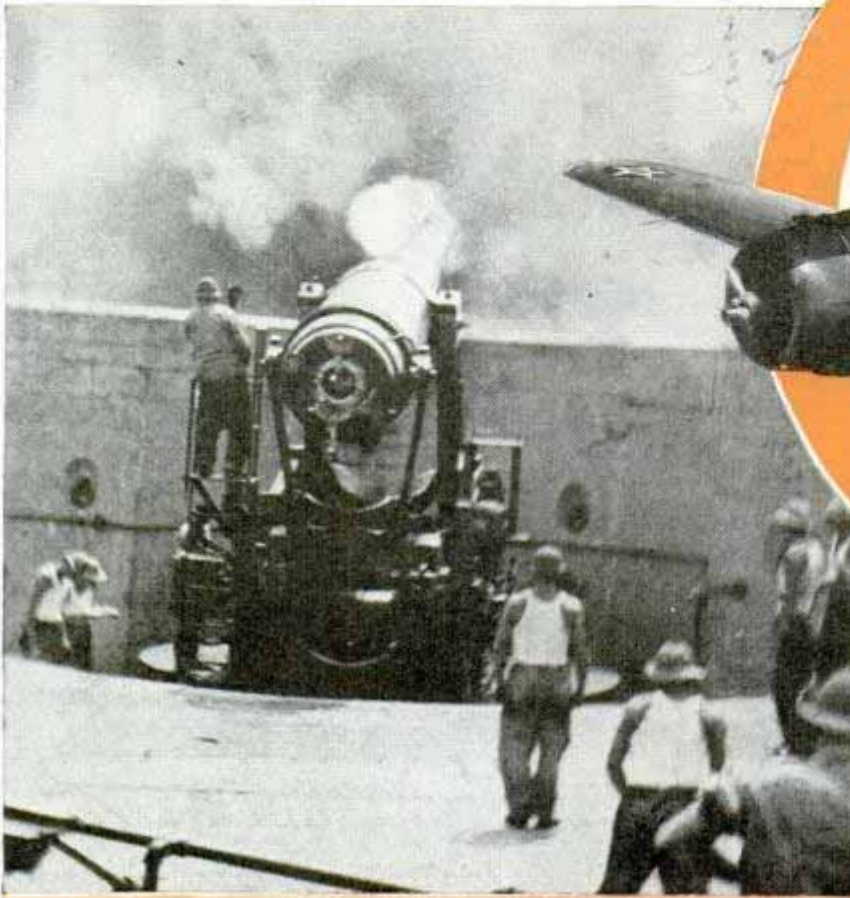

**S**UPPOSE you were behind a hill with your gun, while a man on top of the hill told you over the phone where the game was, and you tried to hit it without ever seeing it at all.

A ridiculous futility, you say, but that sort of shooting is everyday work to the artilleryman. It is seldom that the men who fire the guns ever see what they are shooting at.

Your coast-defense gunner has the easiest job of all, for the permanent installation of these guns permits a long and accurately plotted base line, and a wealth of specially calibrated instruments simplify the problem.

And the problem needs simplifying, for the effective range of a big seacoast gun is twenty-six miles. Its normal target will be a battleship moving thirty miles an hour. The gunners' view will be blocked completely by fortifications, even when mist, smoke screens or distance do not conceal the ship.

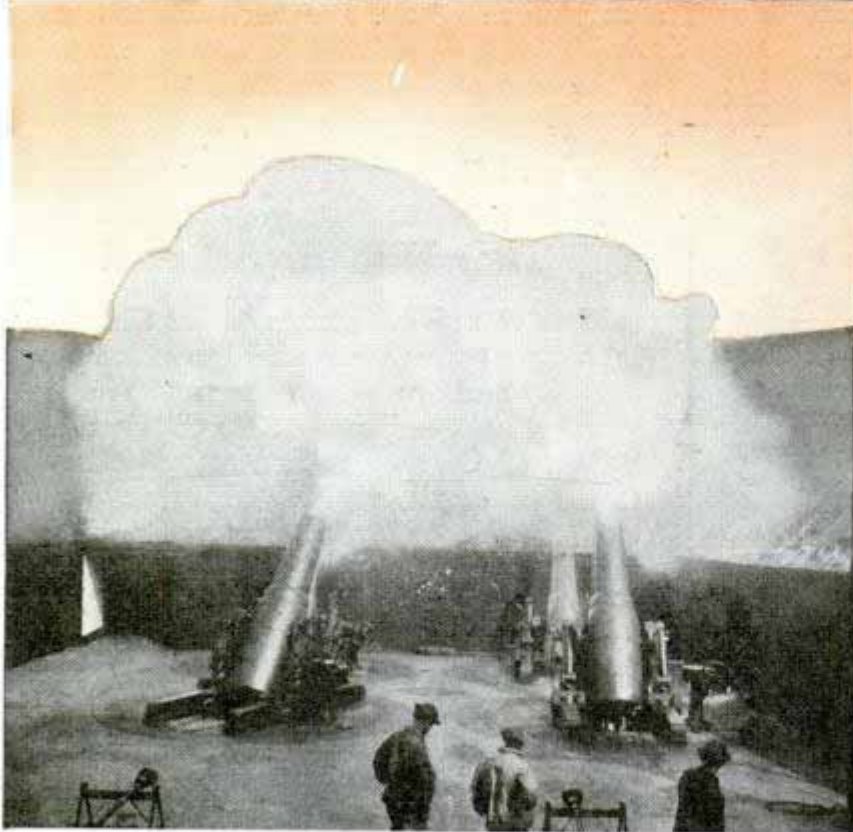

*Top, left, ten-inch disappearing gun at instant of firing. Bottom, battery of coast-defense mortars firing. Note projectiles in air. Upper right, observation plane used for artillery spotting which enables the gunners to fire accurately at targets they cannot see*



2982

# *at* UNSEEN TARGETS

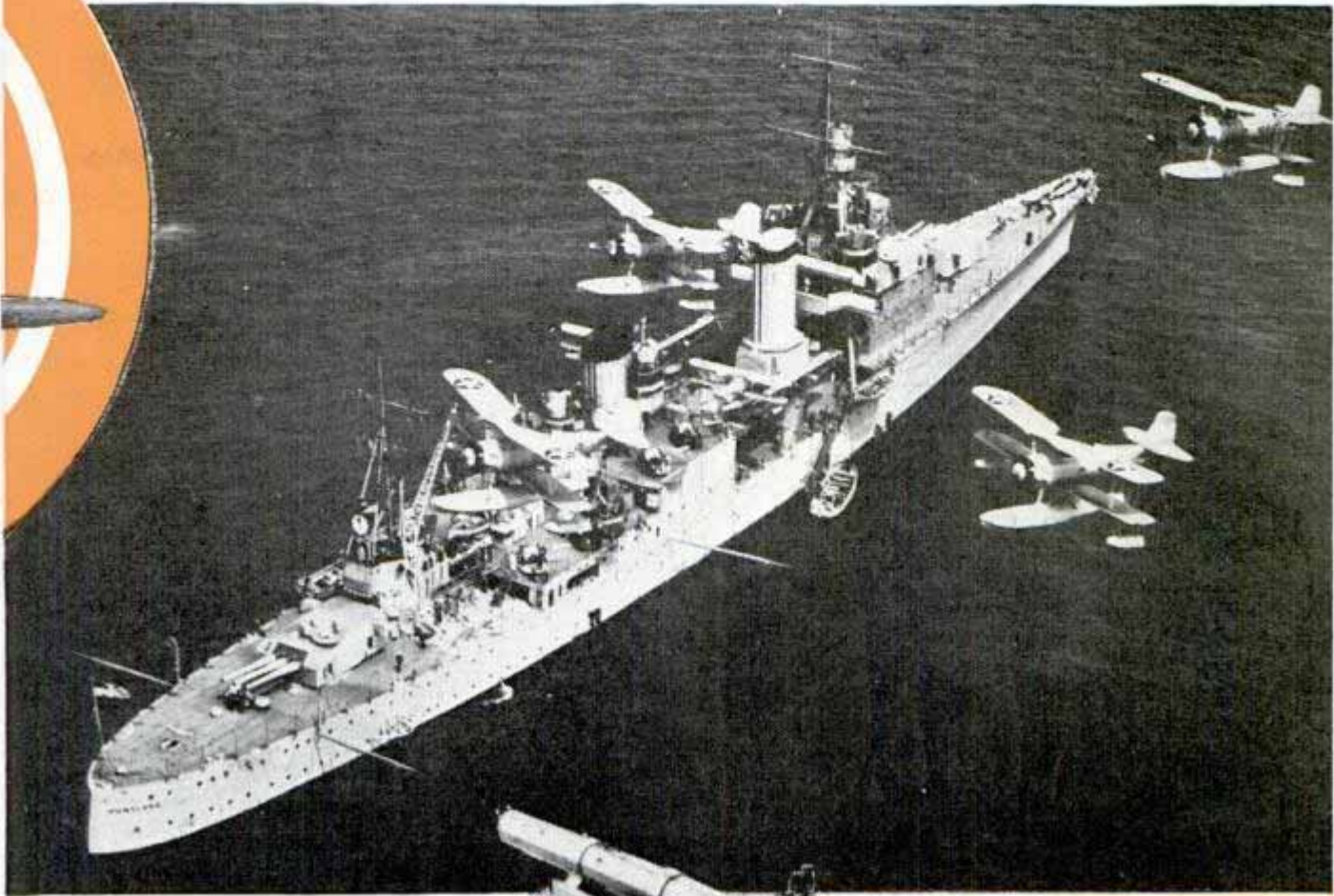

To score hits, the gunners must be furnished with the ship's direction, distance, course and speed. And the gunner cannot aim where the ship is at the moment, for it takes more than three minutes for the huge projectile to reach its destination at extreme range, during which time the ship will travel a mile and a half. At these long ranges there are many things to be considered that the hunter need never worry about—the so-called "variables," that cause the shell to deviate from its normal trajectory. In a vacuum that trajectory would be a symmetrical curve, but air resistance slows down the shell so that it falls at a much greater angle than it arises. The altitude attained



*Top, observation planes flying above the U.S.S. cruiser "Portland." Bottom, new 4.5 field piece, with split trail, ready for firing. Note that the gun is mounted on a carriage which facilitates rapid movement as the attacking force advances on the enemy*



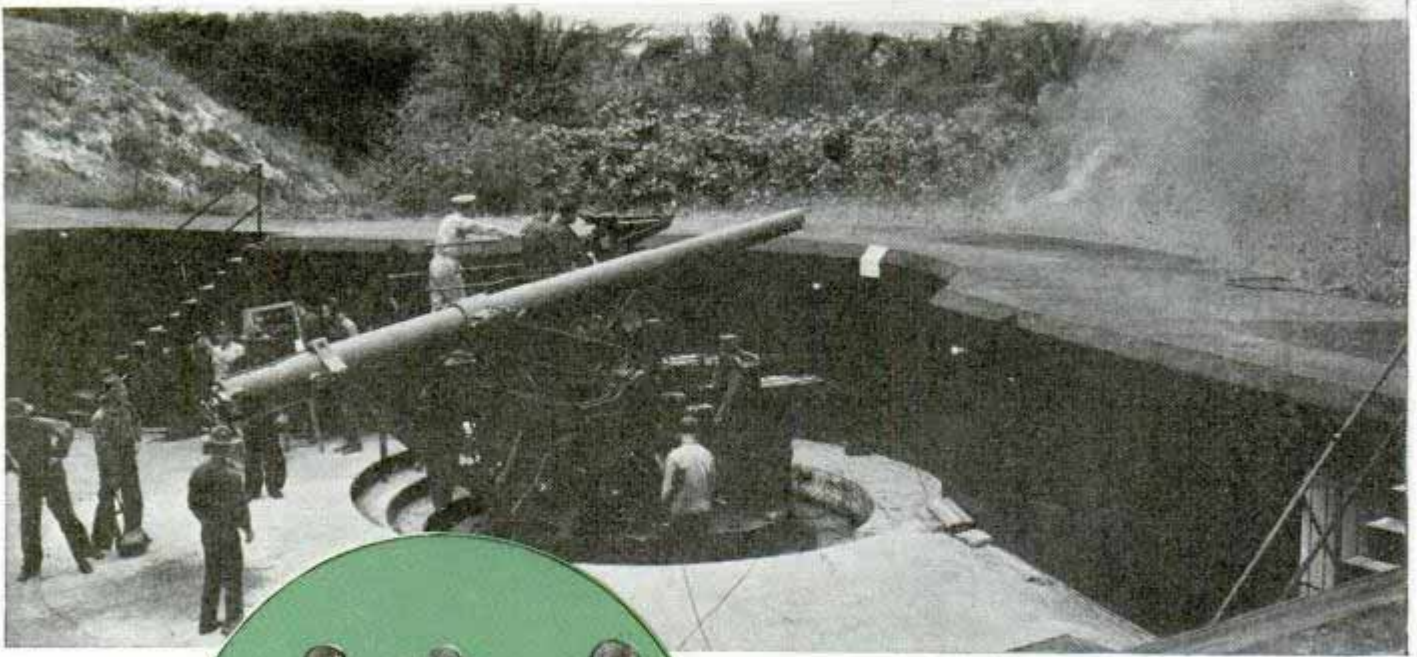

by a sixteen-inch shell at maximum range is more than twelve miles, so not only must the density of the air at sea level be computed, but the varying densities of all the higher layers of air that the shell must pass through. Barometer and humidity readings are always possible at sea level, and the higher readings may be obtained by airplane or balloon in peacetime. But during war it seldom will be possible to obtain such readings when needed, so tables of averages, based on sea-level readings, must be used. This factor is far from trifling, for air density can cause a fifteen-per-cent possible error—one and three-fourths miles at maximum range.

The velocity and direction of wind, from sea level to stratosphere, must also be known or estimated, for a twenty-mile wind will carry a shell a full mile off its course during the three minutes it is in the air. The wind might vary from ten miles an hour at sea level to eighty miles an hour at the top of the trajectory; so these varying forces must be computed ac-

ording to the length of time they affect the shell.

And at those long ranges, the earth can no longer be considered a stationary flat object. Both its curvature and rotation must be allowed for. A gun firing north, for instance, must be aimed 175 yards east of the target at maximum

range, else the earth will have rolled the target out from under the descending shell. Rising or falling tide will also affect range, by changing the elevation of the target in relation to the gun.



*Top, six-inch disappearing gun immediately after firing. Note that recoil mechanism is returning gun to loading position. Circle, optical range finder, being used here for anti-aircraft fire, also is used for practically all naval gunnery. Bottom, sixteen-inch coast-defense gun in action*



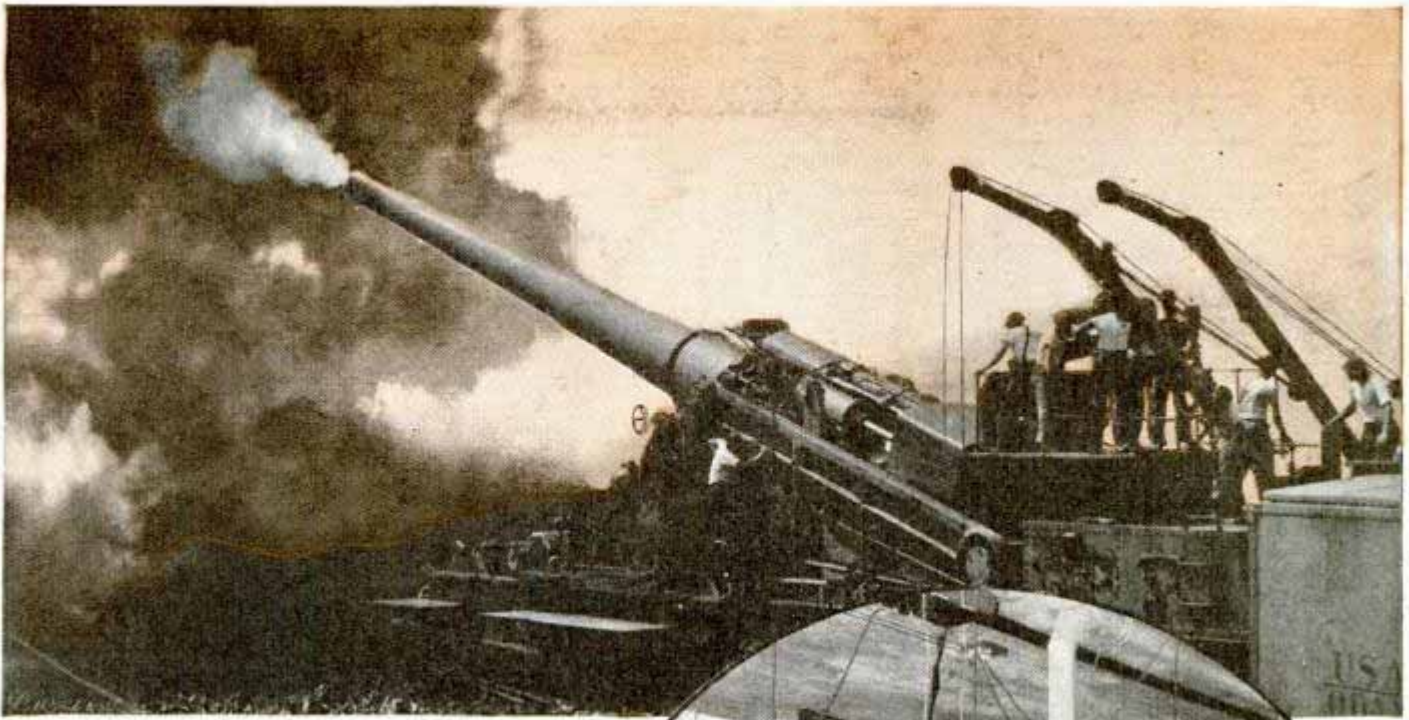

Powder temperature is another variable. Warm powder burns faster than cold, a change of ten degrees causing a difference of 300 yards in the distance the same amount of powder will hurl a shell. These huge projectiles, weighing more than a ton, will vary a few pounds too, thus varying the distance which a standard charge of powder will hurl them.

(Continued to page 144A)

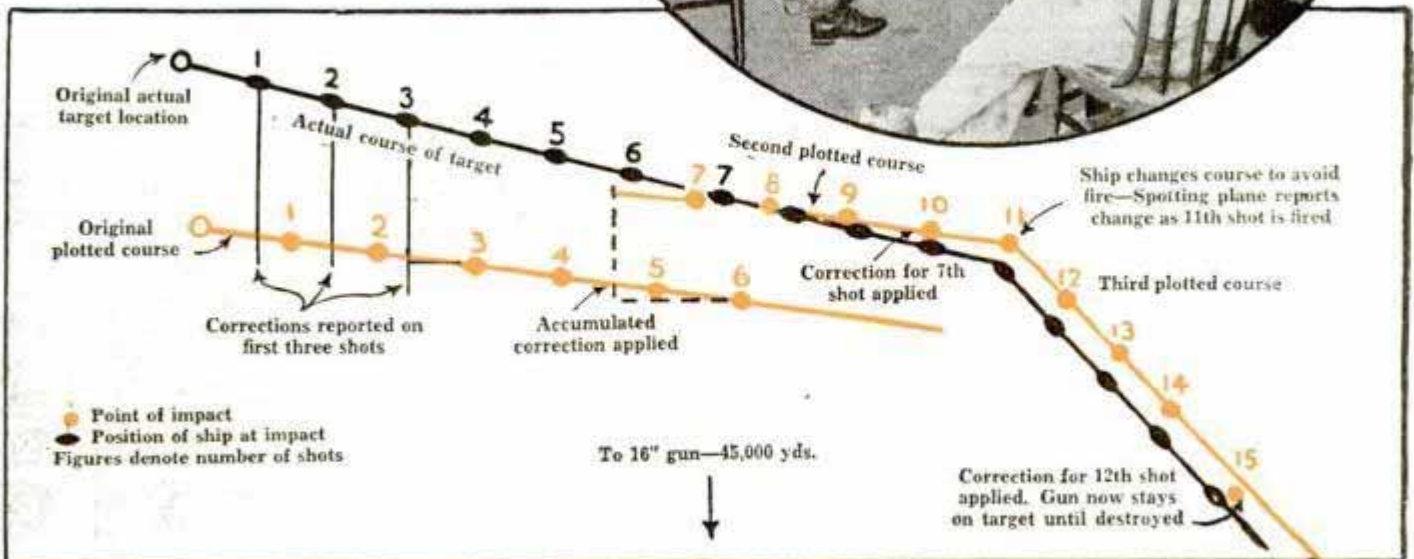

Top, firing a sixteen-inch railway gun. The crew depends almost entirely upon aerial target location and spotting. Circle, plotting room of coast artillery battery with plotting board in use. Bottom, how spotting places gun on target, causing destructive hits after several shots have been fired



## Portable Scaffold on Wheels Towed to Job as Trailer

*Roadway Trailer Co.  
14-57 Broadway  
Albany N.Y.*

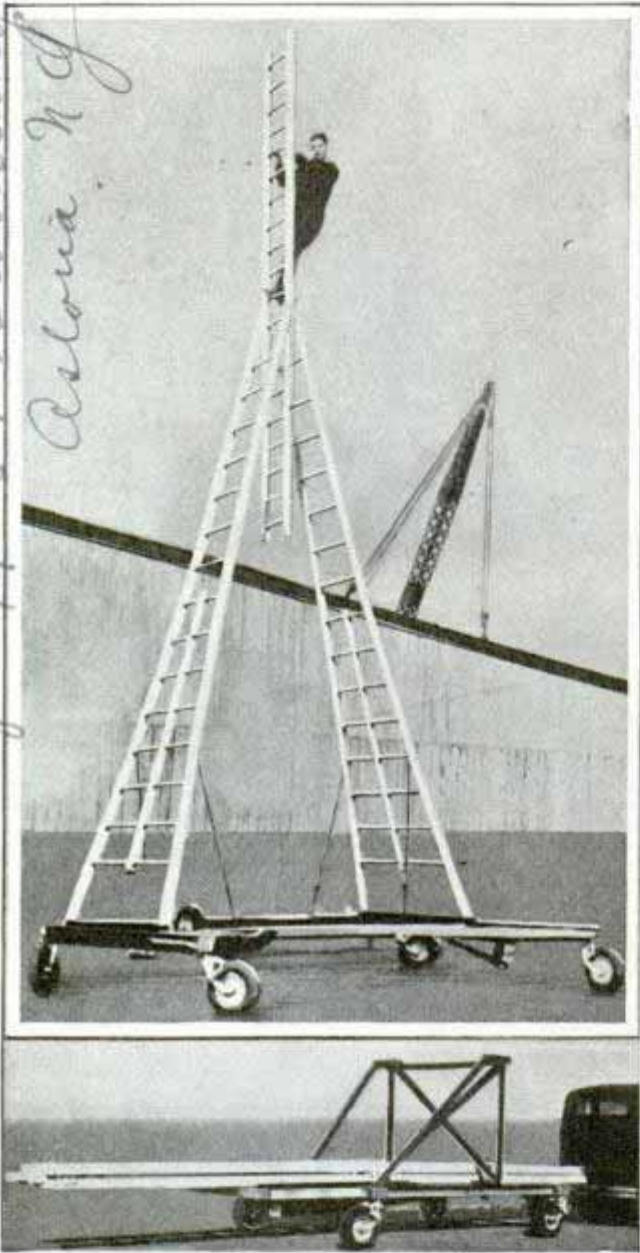

*Scaffold ladders are quickly erected, or folded as shown below for towing to the next job*

Scaffolding equipment that serves as its own trailer when towed from job to job is built on a four-wheel chassis for quick and easy portability. Capable of reaching heights up to fifty feet, its group of extension ladders may be fitted together in various positions such as leaning, straight up, towers to support a railed platform on top, and scaffolds upon which planks may be laid, the parts being tied in place with sectional braces, telescopic pipes and long eye hooks. Ladders are aluminum or wood for ease in handling, and other parts are steel. The two long axles with their

wheels, mounted on the sides of the oblong chassis, can be removed and placed across the narrow ends to make a broad, non-tip base for the tall structure. All four swivel wheels may be locked in the best position to provide stability, and a fifth wheel also can be lowered for additional steadiness.

*J 1085*

## Lock Washer Pre-Joined to Bolt Is Mechanics' Timesaver

Mechanics can save the time wasted in putting lock washers on screws by using a pre-assembled unit that is ready for application. The proper type and size washer is held securely on each screw so it cannot come off. They are especially handy for insertion in places hard to reach.



*J 1092*

## Loud Speakers on Motorcycles Help Police Direct Traffic

Loud speakers now being installed on motorcycles of the London police force, while intended primarily for the normal duties of directing traffic and pedestrians, are used also to give alarm in case of air-raid warnings and to help people locate shelters. The microphone is attached to the handlebars, and the loud speaker is fitted in front of the vehicle.

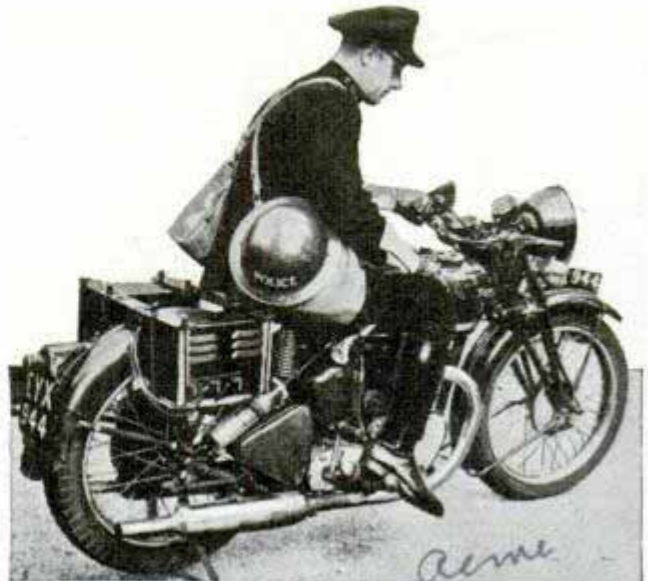

*Loud speaker mounted in headlight's place is used by London motorcycle cop to direct traffic*



Cashman Road Rochester, N.Y.

# SNAP Your Own CHRISTMAS CARDS

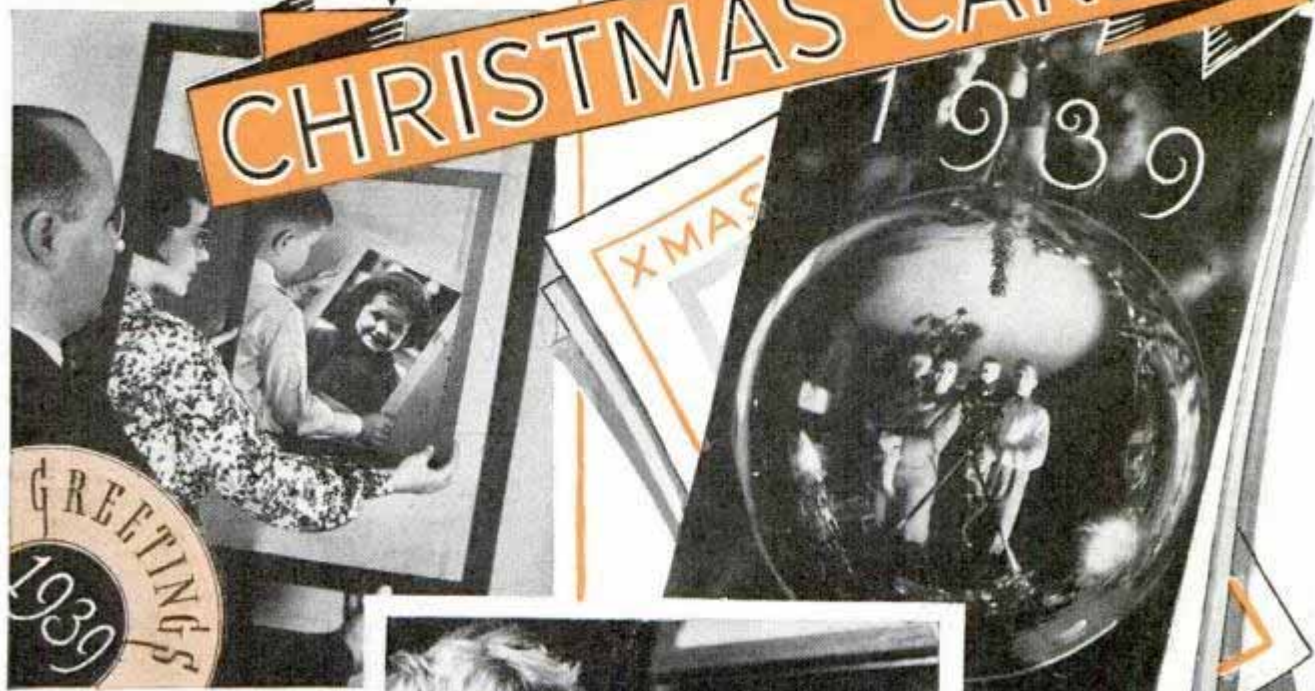

For a really original Christmas card, put your camera to work. It can make anything from the family-portrait and house-in-the-snow scenes to the distinctive cards shown here. Composite, above, was made by photographing each person holding a card and pasting one on top of another



Family's reflection in Christmas-tree decoration, top, was snapped with camera with double-extension bellows, focusing on ground glass. Left, blackboard greeting in playroom. Below, an "over-the-typewriter" shot

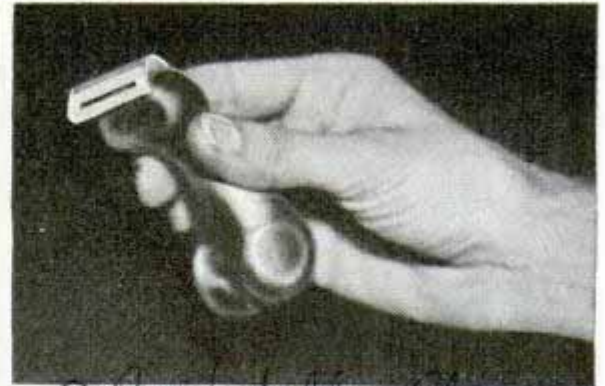

Table-top pictures offer a variety of ideas for clever holiday greetings. A model billboard was used for the card above, with enlargements and Christmas message pasted on it





# Everyday Articles Redesigned for Comfort



*9 Rockefeller Plaza*  
 Designing ordinary articles to fit the needs of the human body is being accomplished by Angelo Bisenz of New York. Above, safety razor shaped for easier handling

Designer Bisenz with pen which he says will improve penmanship and eliminate writer's cramp. He calls this kind of designing "formagenics" and hopes to increase the utility of ordinary articles

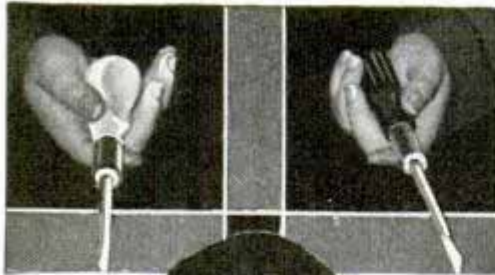

Center, formagenic glass, plate and spoon. Just above, new design in doorknobs. Center, left, formagenic screwdriver compared to old style. Bottom, Bisenz working on formagenic hairbrush. Note sketch of brush and unusual handle. The formagenic screwdriver has grips fitting the fingers instead of ordinary straight grooves on the handle. Fitting articles with nonslip handles will prevent many accidents, the designer contends. He plans to extend his work into the furniture, housing, automotive and many other fields



Chas. Charlie M...  
6362 Hollywood Blvd.  
Hollywood, Calif.

2 10 39

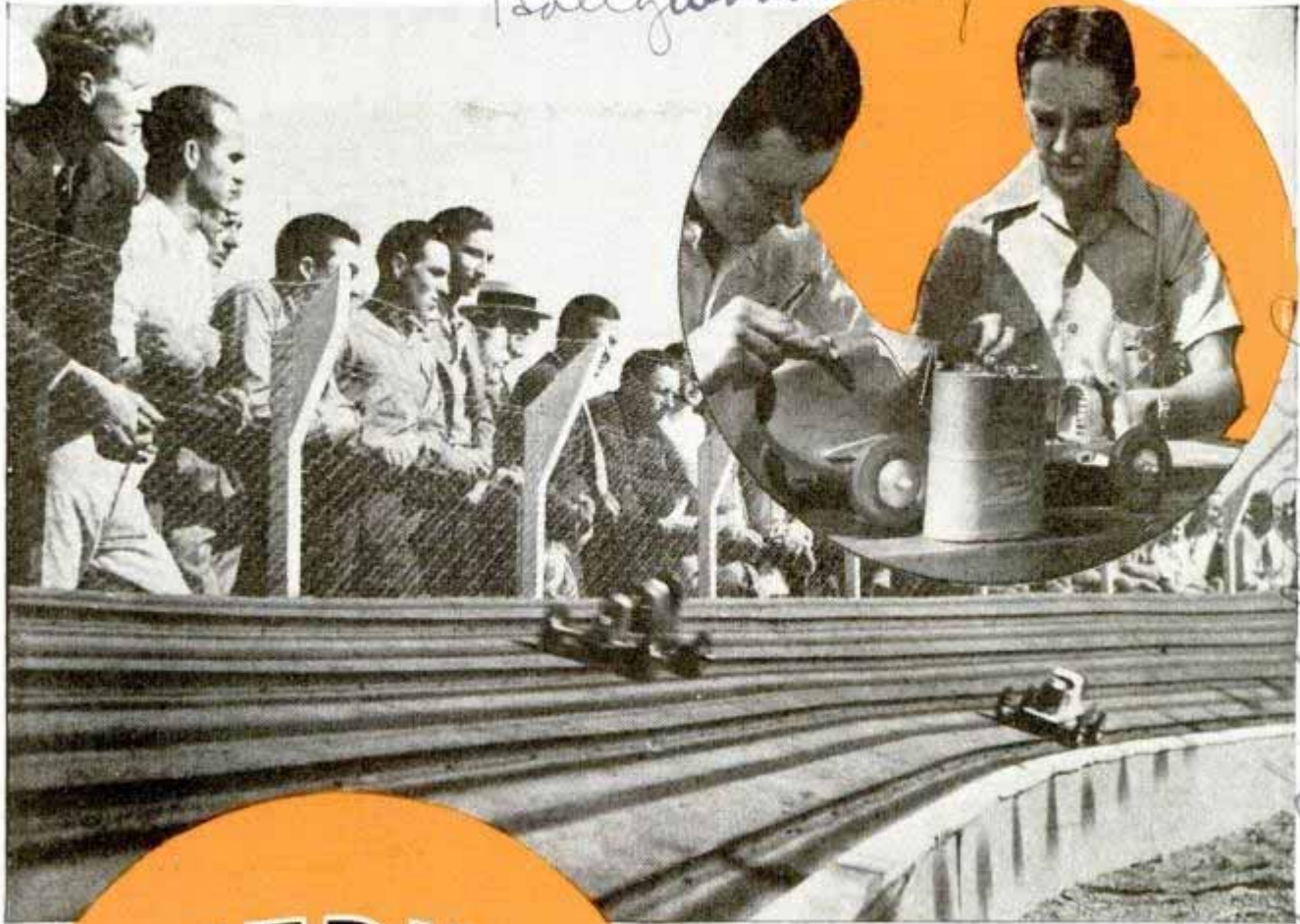

The Model Race Car  
Speedway, Los Angeles, Calif.

# SPEEDWAY for BABY MIDGETS

Designed for model racing cars, a new speedway in California is one-sixteenth of a mile long. There are four rails around the track and each car has a device with two small bearings that run against the rail. Thus, the car is guided as it travels at speeds around sixty miles an hour as centrifugal force keeps it on the speedway. Four cars may run in each event, each running against time. A wire rod protruding from the left side of each car is the ignition switch. Lowering a wire across the track trips the switch on any car which the race officials desire to stop

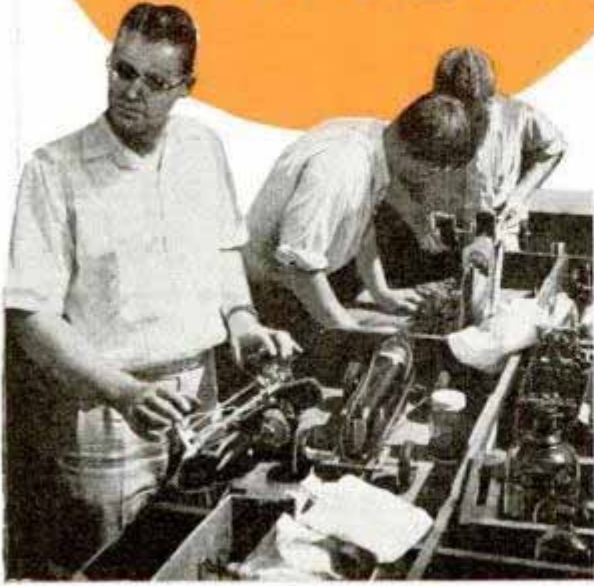

Top, spectators at the speedway. Circle, owners adjusting cars. Bottom, left, owners in the pits. Right, wire across track trips ignition switch of any car. Each racer weighs ten pounds, costs about \$60



# Wheat Stored under Lake for Wartime Needs

Right, wheat dumped into compressor pipes is forced into tank shown below. Sketch, at bottom, right, illustrates the tank submerged in lake.

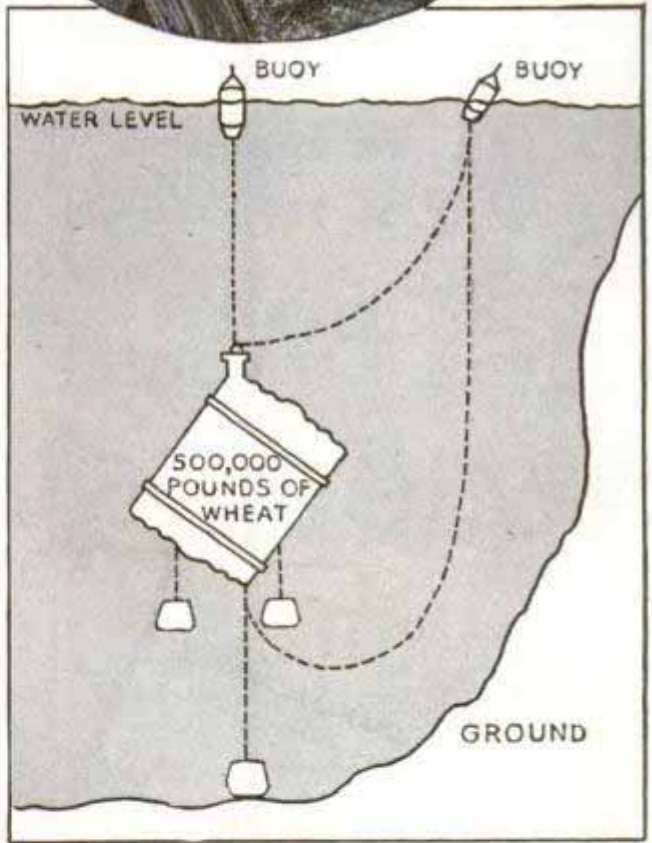
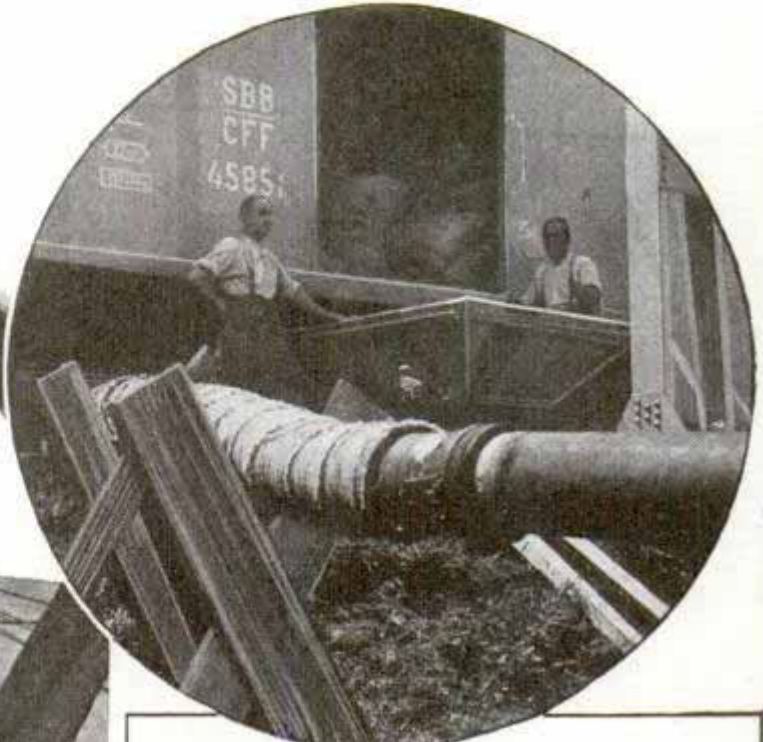

As a precaution against the possibility that a war blockade may interfere with imports of food, Switzerland is storing wheat at the bottom of her deep mountain lakes. The grain, forced into a tank of 500,000 pounds capacity, is expected to remain unspoiled under water for years.

*Black Star Publishing Co. 4-20 Lexington Ave. New York*

## "One-Lick" Forest Fire Fighters Clear a Lane Quickly

Cutting fire lanes in a forest by the "one-lick" method now being adopted is accomplished about three times as fast as by any other manual system. Formerly each man, equipped with ax, rake and shovel, covered one sector of the line. Now the fire fighters are divided into crews of axmen,

rakers and shovelers. As the axmen advance each takes just one stroke at any tree or brush; if that does not clear it the man behind takes the second. After the axmen come the hoe and rake squad, and they are followed by the shovel crew, each taking his turn at the line.

*Dept. of Agriculture. Release No. 1110 Oct 8, 1939*



# CLEAR TRACK AHEAD

817

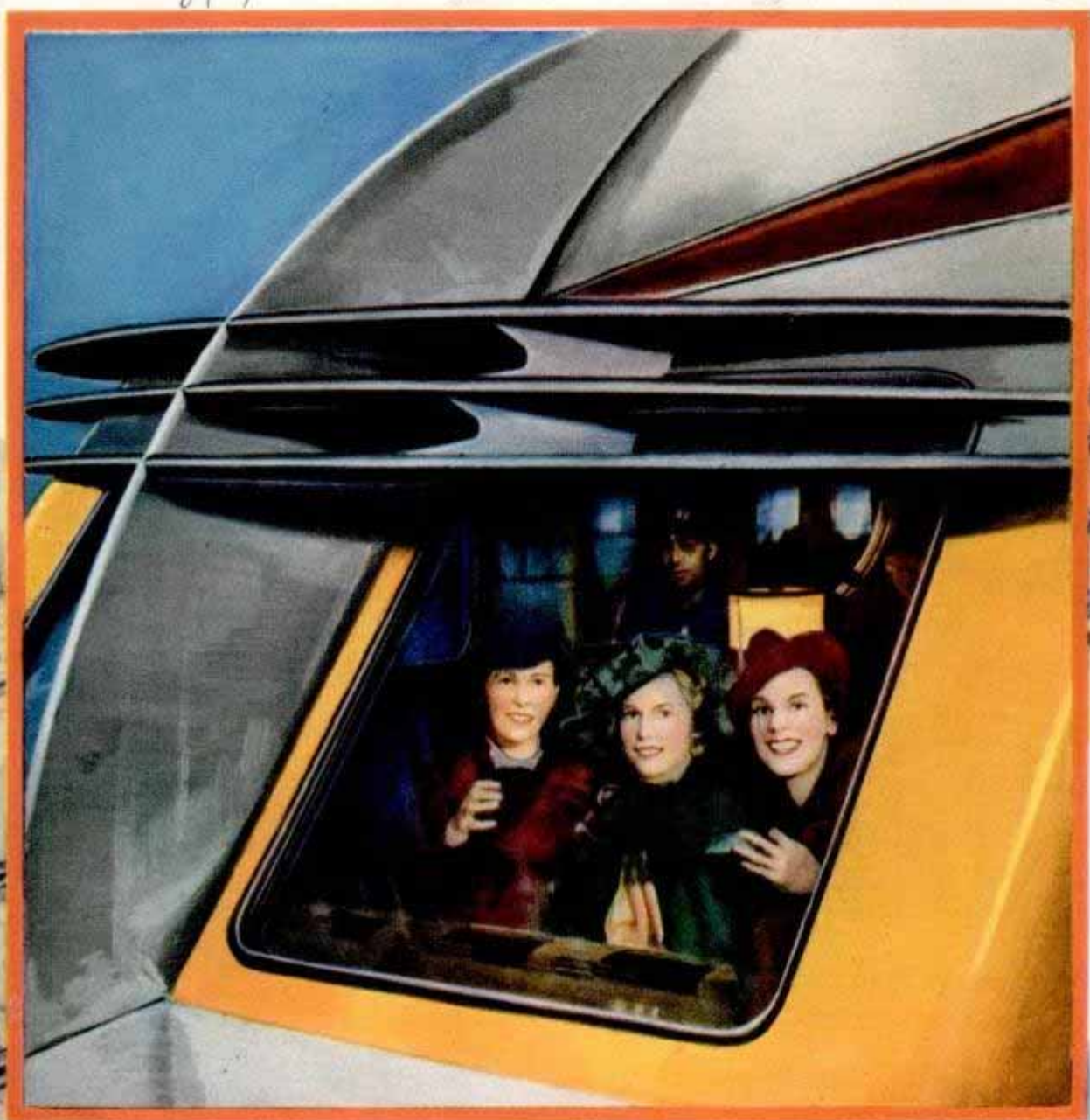

Comfort and speed are being combined in the modern train. Top, unusual rear end of one of the streamline coaches. Below, the New York Central's majestic "Twentieth Century Limited"





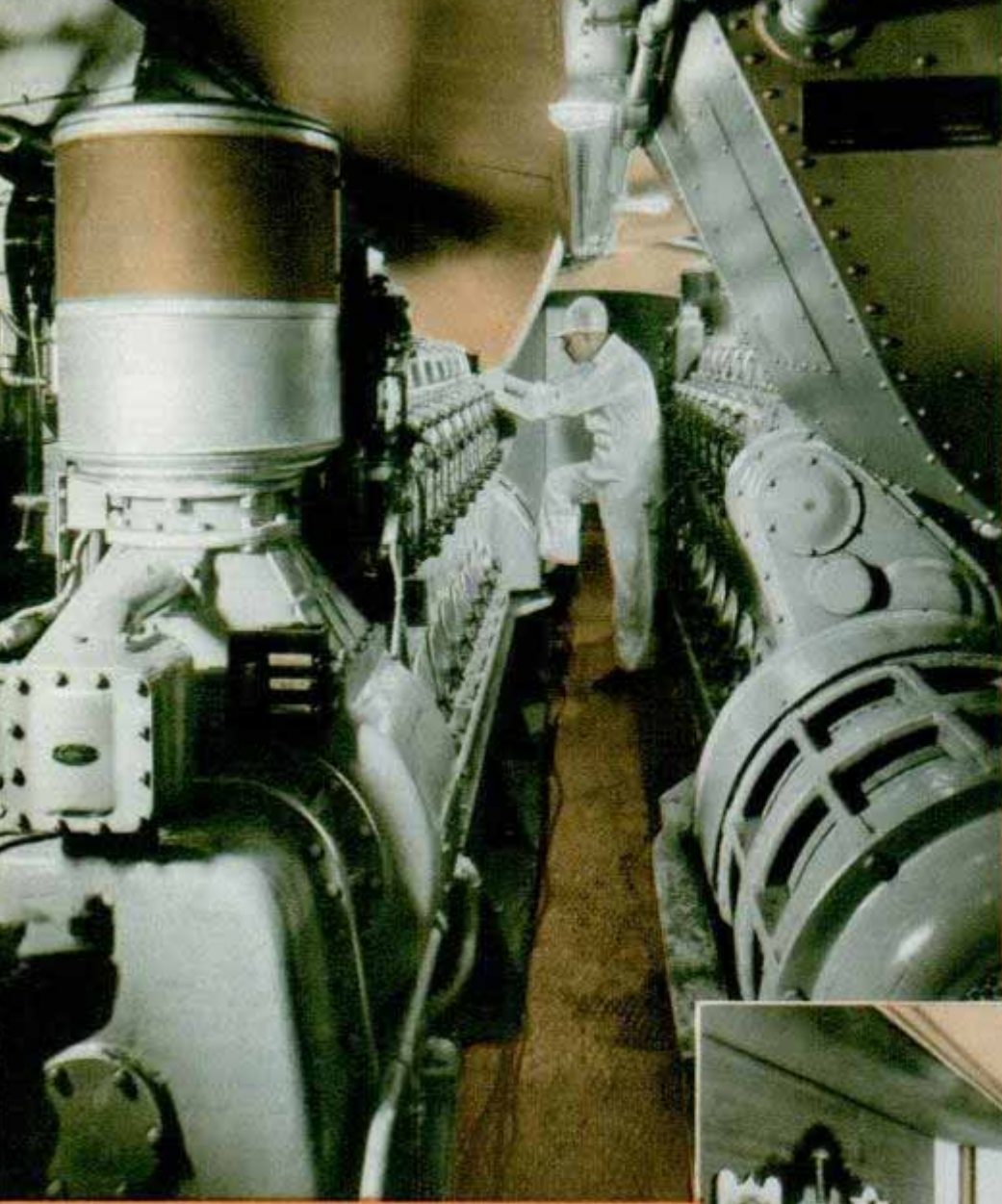

g  
 Diesel power, believed by some railroad operators to offer economical means of driving the super-trains, is illustrated at left. Here is the engine room of the "City of Los Angeles"

De luxe service is fast becoming common on American lines. Below, the interior of dining car used on the Pennsylvania Railroad, looking toward buffet and pantry end of car

*Built by Budd  
 Mfg Co. Phila  
 Styled by Raymond  
 Loewy*



818  
 By F. E. Williamson  
 President, New York Central Railroad

**M**AN'S age-old struggle to conquer time and distance has reached its present astonishing approach to fulfillment through the discoveries and the resulting marvels achieved by modern science. This is particularly true in the case of the railroads.

To cite one example, the streamline lightweight trains which have captured the imagination of America and in a way have started what it is hoped will be a renaissance of rail passenger travel have been made possible largely by recent developments in metallurgy. Protracted and laborious research in the mills and laboratories has resulted in the creation of numerous new alloy steels and other metals which have lent themselves to novel uses. Even ten years

ago many of these were either unknown or their production commercially was impracticable for varying reasons, one of these being, in some instances, the factor of cost. To show how fully the use of these new alloys has entered into the production of the modern train, I might say that lightweight high-tensile steel and at least six alloys were used importantly in the new Twentieth Century Limited.



## Rails—1850 to 1938

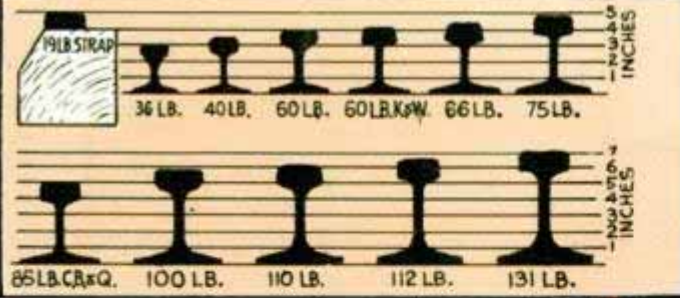

*Burlington*  
 Advancement in rails is illustrated in chart (above). Right, control cab of a streamliner's power car. Note telephone (at left) on which driver may communicate with other trainmen. Below, double-decker coach which is operated by the Pennsylvania Railroad in New York suburban territory has exceptional passenger capacity



*Long Island*  
 Such advances as these have been, in great part, the result of constant research and experiment, both in the field of theory, of day-by-day practice and in technical scientific laboratories. Too little has been realized by the public of the ceaseless efforts in this direction made both by the railroads themselves, as well as by the great equipment companies which serve them. Yet for many years, both branches of the industry have been engaged in intensive experimentation, often jointly, in an effort to create better equipment and facilities and to do this,

if possible, at a lesser expense. So great has been the volume of equipment and so high the safety and service standards involved and so vast the expense that even when better materials or methods have been found and tested, changes from the old to the new often have had to be necessarily slow. Rapid wholesale replacement has not been economically feasible. After all, a steam locomotive is built for a useful life of at least twenty years and costs \$60,000 to \$145,000 or more. Hence, important though these changes may be, often they have lacked spectacular ap-







820 J 740  
Progress of American railroads is demonstrated in these photographs of the latest locomotives. Left, giant steam-electric power car which the Union Pacific had built for service on long runs



Steam power is not lagging in the railroad parade. Left, we see the Pennsylvania's "Broadway Limited," which has streamline coaches fitted with close-fitting vestibules and curving "skirts"



Awe-inspiring are such trains as this, the Baltimore and Ohio's "Royal Blue," pictured here with a streamline "Bullet" steam locomotive substituting for Diesel-electric power car





9948 821

Colorful to a degree never dreamed of in the early days of railroading is the Seaboard Railway's "Orange Blossom Special" (above). The Illinois Central's "Green Diamond" (right) averages a mile a minute



Zephyr trains, of which the "General Pershing" (pictured at left) is the latest, provide fast service on the Burlington. These streamliners, built of stainless steel, are propelled by Diesel engines

Modernized steam locomotives get the call to drive many of the nation's fast trains. Right, the Southern Pacific's "Day-light" rounds curve on a section of double-tracked line

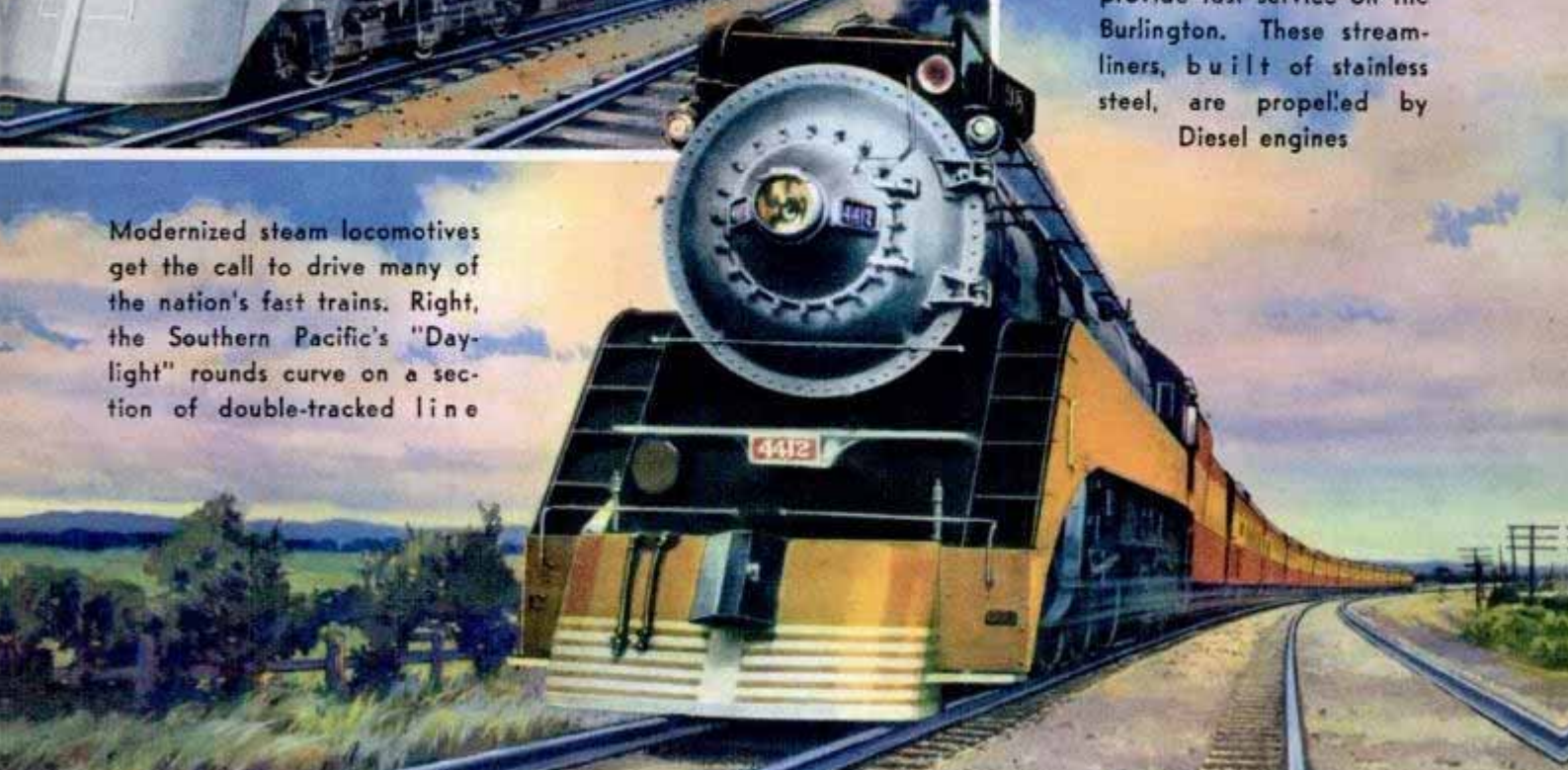





Strength, without an increase in weight, is achieved by fastening "fluting" (top photo) to the gleaming surface of Budd-built stainless steel cars. Below, attractive interior of tavern coach on Seaboard's "Silver Meteor." Some of America's foremost designers participated in styling today's trains

82 11  
peal and thus have met with meager public appreciation.

For many years the railroad industry has participated in both creative and applied research to improve its service and at the same time reduce its expenses. As examples of recent creative research I might mention the development of new means for detecting fissures in steel rails, as well as the development of methods looking toward the greater prevention of fissures; a ten-year program on air brakes which resulted in the development of a new and much more effective freight triple valve; the development of efficient systems for air conditioning passenger cars—11,027 cars already have been equipped with air-conditioning systems and this work is being expanded as finances permit; and the locomotive booster, a valuable auxiliary to increase a locomotive's power temporarily for starting or on grades.

The test departments of the railroads are chiefly concerned with applied research. Applied research results in greater efficiency, economy and safety in daily operations. It is, in essence, a constant search for better equipment, materials, supplies and processes, particular emphasis being laid on those factors that make for safety.

Among other subjects selected by the railroads for intensive research are the effect of fatigue on rolling stock axles; boiler feedwater studies, which include the testing of compounds designed to prevent caustic embrittlement; the development of disk-type driving wheels for locomotives; development of a device to indicate proper selection





823  
 and use of the cut-off necessary to produce the maximum drawbar pull and horsepower available in the locomotive at all incidental speeds and to avoid waste of fuel and power by the use of longer cut-offs; the development of roller bearings on both wheels and driving journals; the development of new automobile loading devices; the development of container cars and containers; drop-type couplers in combination with the steel pilot; experiments with longer rails and substitutes for the wood tie.

Literally hundreds of other subjects have been investigated. Much of this research has produced concrete results, making possible improved and safer service. As an example, in 1938, the railroads established a new record in fuel efficiency in freight service. In that year, to haul 1,000 tons of freight and equipment one mile required only 115 pounds of fuel, against 172

8748

Luxury on rails is the objective which most operators have reached, and the photo above illustrates the point. Like a finely furnished home is this observation lounge which is a feature of the "Silver Meteor." Below, trucks of the Milwaukee Road's streamliner "Hiawatha" embody such innovations as coil springs, hydraulic shock absorbers, rubber mountings and roller bearings that free the cars from jars, jolts and sideways

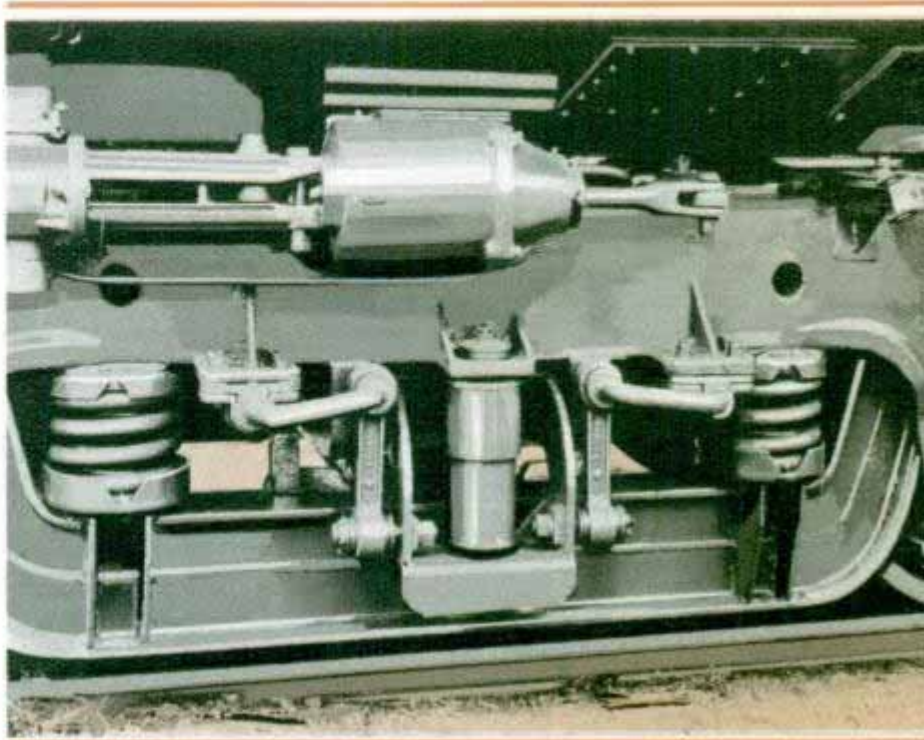



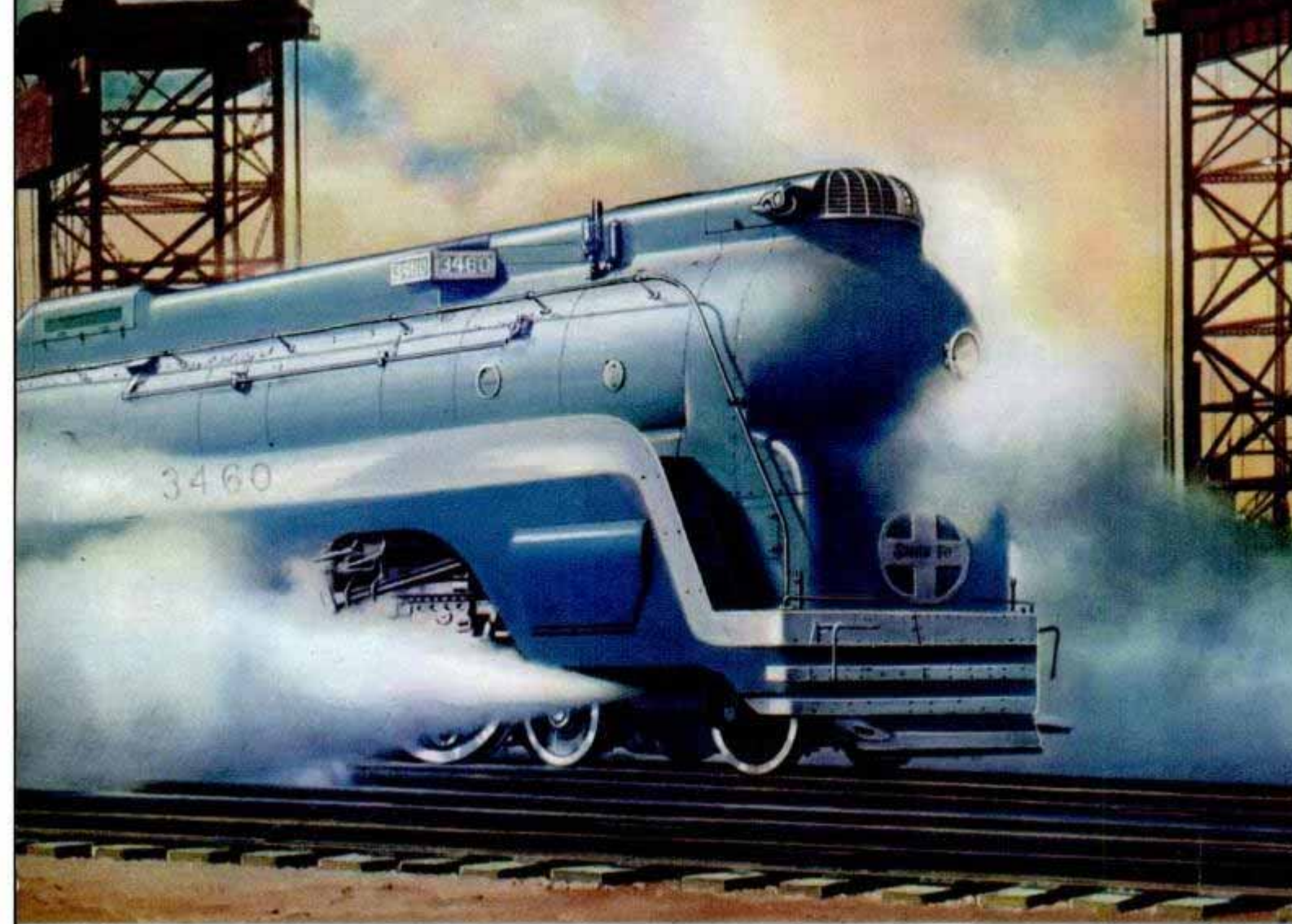

824

Speed is visible in every line of this steam locomotive, used by the Santa Fe to pull its high-speed train, the "Chief," between Chicago and the west

9748

pounds in 1920, a reduction of thirty-three per cent. In passenger service, fuel efficiency in 1938 improved twenty-one per cent, against 1920, a passenger train car being hauled one mile with fourteen and nine-tenths pounds of fuel.

Another result of research has been the increase, with safety, of regularly scheduled operating speeds both in freight and passenger service. In 1932, there were only a handful of trains operated at an average speed of more than sixty miles an hour. In 1938, 48,164 miles were being covered at speeds of sixty to eighty miles an hour and even higher. In six years this mileage increased about twenty-four times. Today, the United States has more high-speed trains than any other country.

Railroads differ from most other industries in that they do not make things to sell to consumers—they purchase things and utilize them in combination to produce service. Every year they buy

more than 70,000 items of equipment, materials and supplies. It is only natural, therefore, that the makers of these items should engage in research to improve and perfect their products and that the railroads should often be a partner in this work, but always a beneficiary of it.

Ceaselessly railroad research goes on day after day. At Purdue University there is a railroad laboratory, maintained for years by the Association of American Railroads, where draft gear, couplings and brake shoes are under test continuously, and at the University of Illinois, in a laboratory operated jointly by the Association of American Railroads and the steel companies, steel rails undergo tests. In Maryland, Indiana and Illinois special track installations have been under study to determine their performance under traffic.

The problem of reducing in both  
(Continued to page 128A)



1836 Market St. Phila

# Tuning a Violin by Sight with 'Dancing' Wire

With a simple tuning device invented by a Philadelphian, any amateur can tune a violin by using his eyes instead of his ears to check the pitch. The tuner consists of a rigid steel frame rather like a hacksaw holder, with a piano wire stretched across it. A screw at one end permits

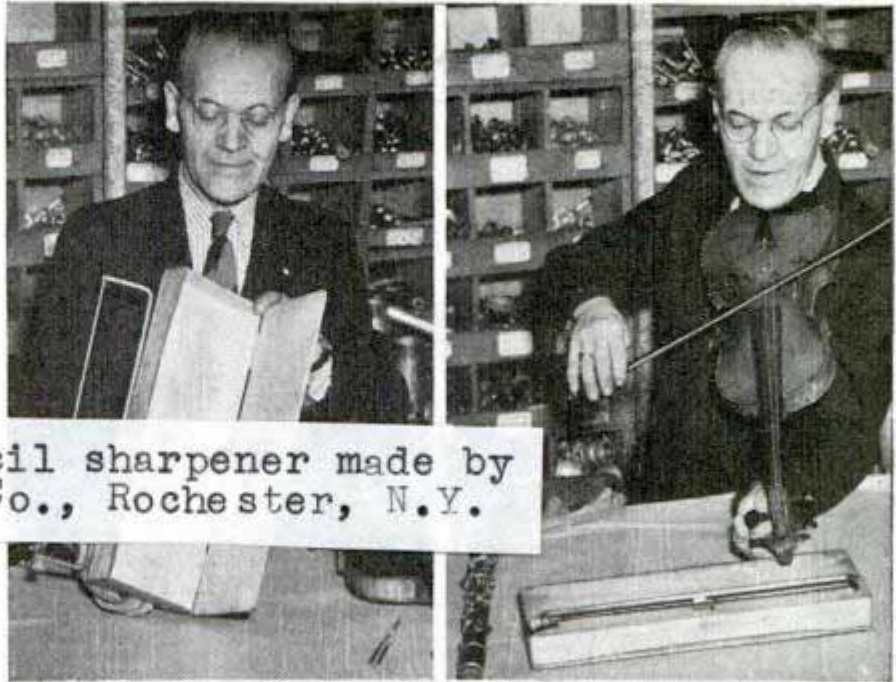

Suggest Electric pencil sharpener made by E. A. Smith Mfg. Co., Rochester, N.Y.

screw is adjusted until the piano wire vibrates and a "washer" on the wire dances violently, indicating the wire is in pitch with the tuning fork. The tuner is mounted on a wooden sound box. To set a violin in exact pitch, it is held against the sound box and the tuning nut of the proper string

Left, sound box with tuning wire stretched on steel frame; right, tuning violin by holding it against sound box and watching vibration of wire

manipulated until the wire of the tuning device vibrates. It can be used similarly to tune any string or wind instrument.

21058

# Fertilizer Is Forced into the Earth with Compressed Air

Introduction of fertilizer into the soil is facilitated by a system employing ground

drills and compressed air. After the earth has been drilled, the fertilizer is forced beneath the surface with the aid of air-pressure machines, thus enabling workers to nourish roots deep in the ground.



One worker drills hole while the other forces fertilizer deep into the soil

# Self-Starting Pencil Sharpener

Pencils are sharpened automatically by an inexpensive electric grinder that starts itself and stops as soon as its work is done. Inserting a dull pencil through the opening at the top sets the tiny motor going. Then as the lead is ground to a fine point, the current shuts off automatically.



Used at Westlake Park

(not on market yet)

21058  
Friedman on Modeler. 11365  
North Hollywood Calif Ventura Blvd.



# Wheel Is Spun at 100 Miles to Check Its Balance

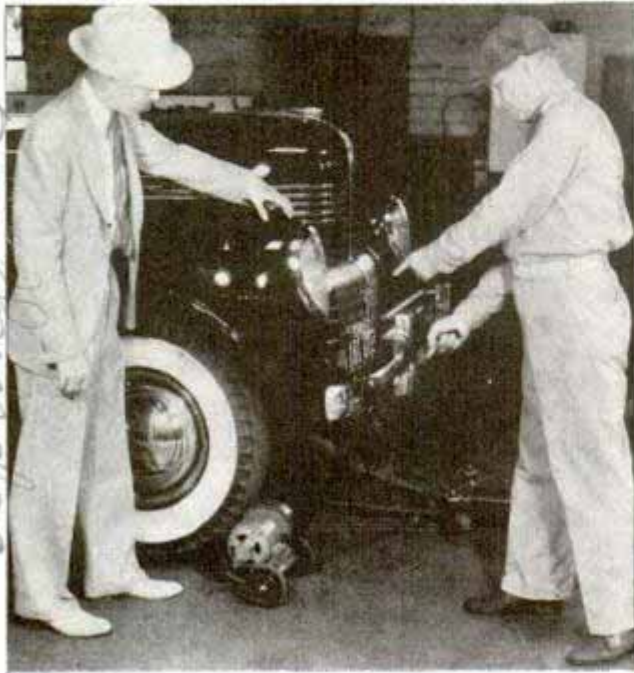

Checking balance of auto wheel by rotating it at high speed. An electric motor supplies the power

Automobile wheels are checked for shimmy or unbalanced condition in three to five minutes by spinning them at high speed. Operated by an electric motor, a rotating wheel is set in contact with the raised tire, quickly accelerating it to the equivalent of eighty or 100 miles an hour. If the wheel is not correctly balanced, the body and frame will vibrate under the test.

# Simplified Typewriter Keyboard Increases Speed of Typist

Increased speed in typing is claimed for a radically new arrangement of the type-

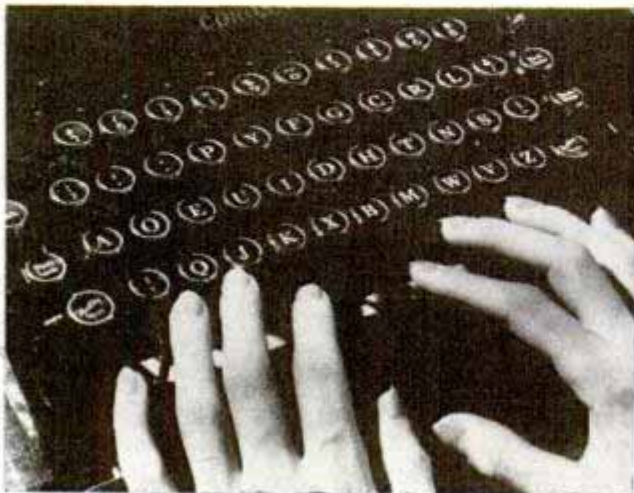

Keyboard arrangement that speeds typing

writer keyboard that distributes the work more evenly between right and left hands. For instance, with the standard keyboard more than 2,700 words must be typed with the left hand alone, while on the new keyboard there are but sixty-nine common words, most of them monosyllables, typed with the left hand. Since touch typists return and rest their fingers on the "home" or second row from the bottom, it is arranged so seventy per cent of all key stroking is done on this row, which helps to lessen fatigue. Operators trained on the standard keyboard can learn the simplified arrangement in a short time. Manufacturers of standard typewriters will furnish the new keyboard if requested.

# Rubber Mats Are Made at Home with Set of Simple Tools

It requires only a few simple tools to assemble rubber door mats in various designs at home. A complete outfit includes a designing and construction board, wire



Mats of various designs can be made at home with complete set of simple tools supplied in kit form

benders and cutters, and a tool for closing sleeves over the wire ends. Standard size mat links are supplied in black, white, red, orange and blue, and wires come in suitable lengths. To construct a mat, the rubber links are placed on the board in the desired design, wires threaded through the links, protruding wire ends pinched down, and metal sleeves closed over them.

Waverly Mfg. Co. Springfield, Ill.  
All standard typewriter makes will service without extra charge  
Complete outfit - \$20.50

Uvovak Univ. d Washington, Seattle, Wash

91086

ad - Jan. 44

Cleveland, Ohio 1-18-46  
F. J. Bunnell

Involving Rubber Co 9205 Detroit Ave



# Automatic Drive Car Has No Clutch Pedal

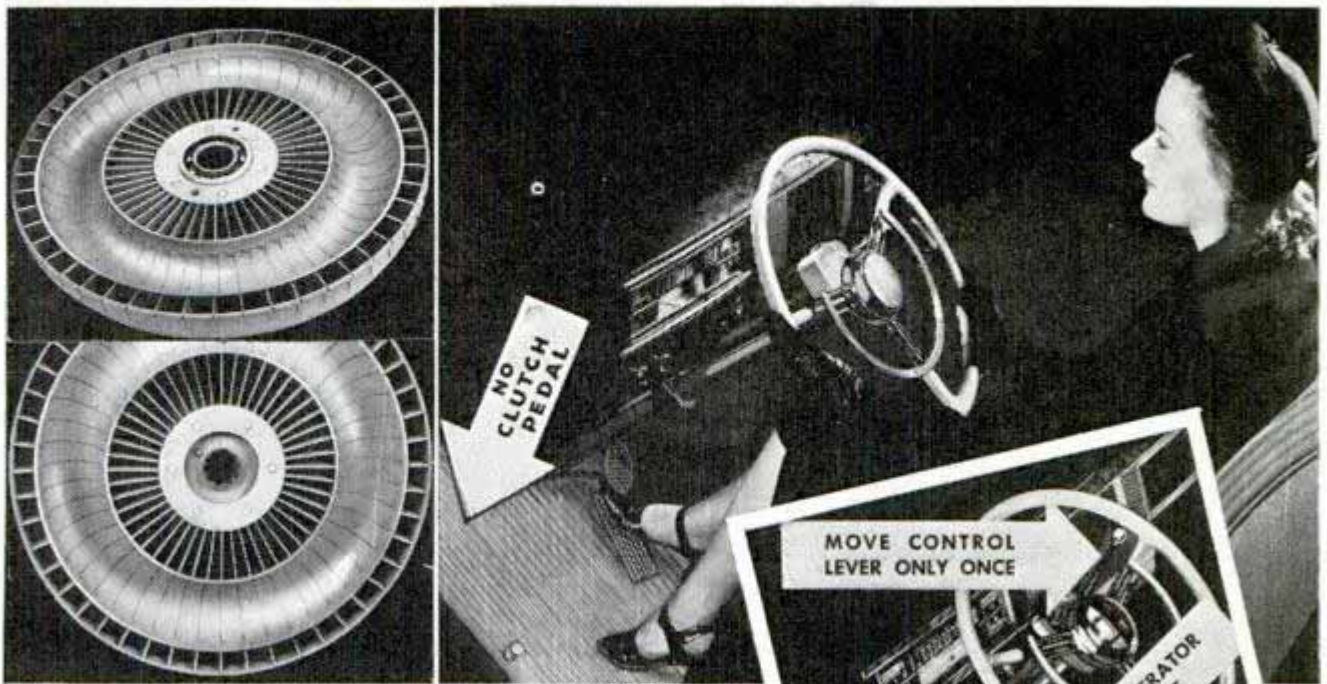

Automobile control is simplified by the "Hydra-Matic Drive" offered at extra cost on the 1940 Olds. It consists of a liquid flywheel and an automatic transmission, the combination of which eliminates clutch and clutch pedal. To get the car under way, you start the engine, move the lever under the wheel from "neutral" to "high" and step on the accelerator. The car changes gears as speed increases.

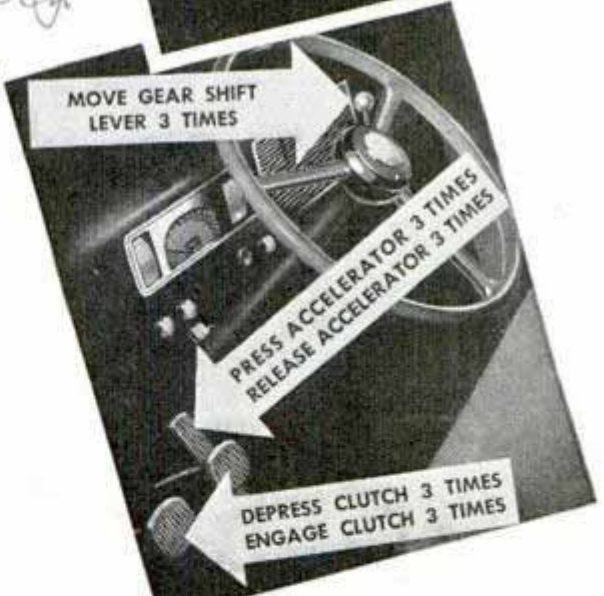
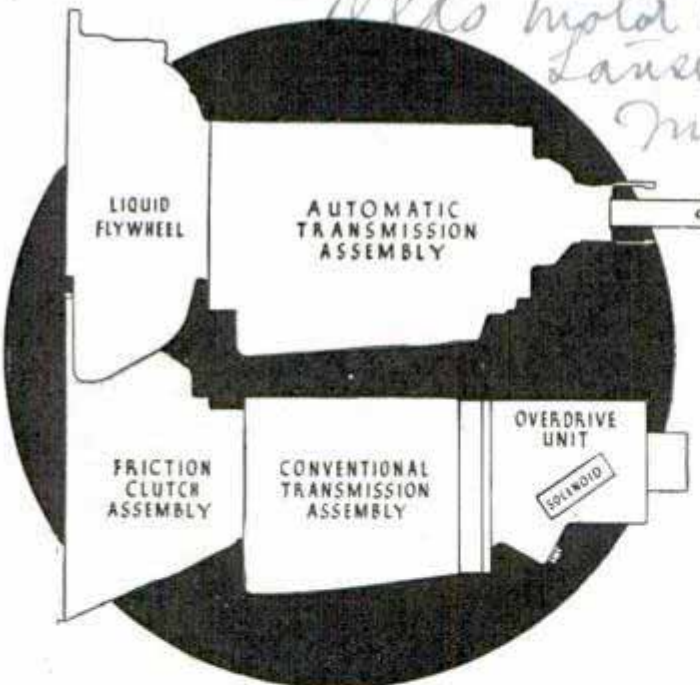
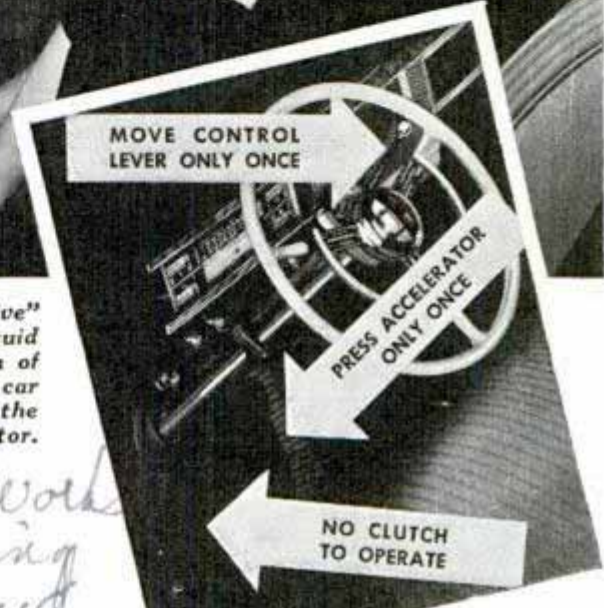

Top, left, parts of liquid flywheel. Right, car has no clutch pedal. Center, left, drawing comparing "Hydra-Matic" with conventional drive to which overdrive has been added. Right, two photo-diagrams illustrating drive ease of "Hydra-Matic" system (top) compared with multiple operations required by conventional drive. Bottom of page, photo of the new Olds. Use of a fluid flywheel reduces wear, eliminates crankshaft vibration from passing to the transmission and cushions application of power to the rear wheels, thus relieving rear axle gears of considerable strain. Oil is the medium employed between engine and transmission.





Cont. Thomas G. Stinson, Jr., 10555 Holman  
Ave - Los Angeles



# The GOLDEN AGE of



Top, left, testing hearing ability; right, measuring sound reflected into "mike" from insulated wall. Below, tuning fork shows efficiency of spring clip for "floating" wall

By Vern O. Knudsen, Ph.D.

Professor of Physics,  
University of California, Los Angeles

WHEN nature developed our ears as instruments to warn us of danger she didn't foresee our present noisy civilization and failed to provide us with "ear-lids" with which we could shut out objectionable sounds. We would be healthier

and happier if she had. At a meeting of boilermakers seventy-five out of 100 men couldn't understand their speaker because of occupational deafness, a malady caused by exposure to incessant sound.

Noise is sometimes stimulating but most of us work and think best in quiet surroundings. Part of the acoustical engineer's job is to reduce noise levels and insulate against machines that we use, and part of his job is to devise protection for the ears similar to the

protection that dark glasses afford the eyes.

These objectives are being rapidly accomplished. The golden age of sound is not far in the future and it promises a richer and more comfortable life for all. Magnificent new music undreamed of in the past is a likelihood, better aid for those who are hard of hearing is a certainty, and relief from unwanted racket is assured.





# SOUND

## VARIOUS NOISE LEVELS

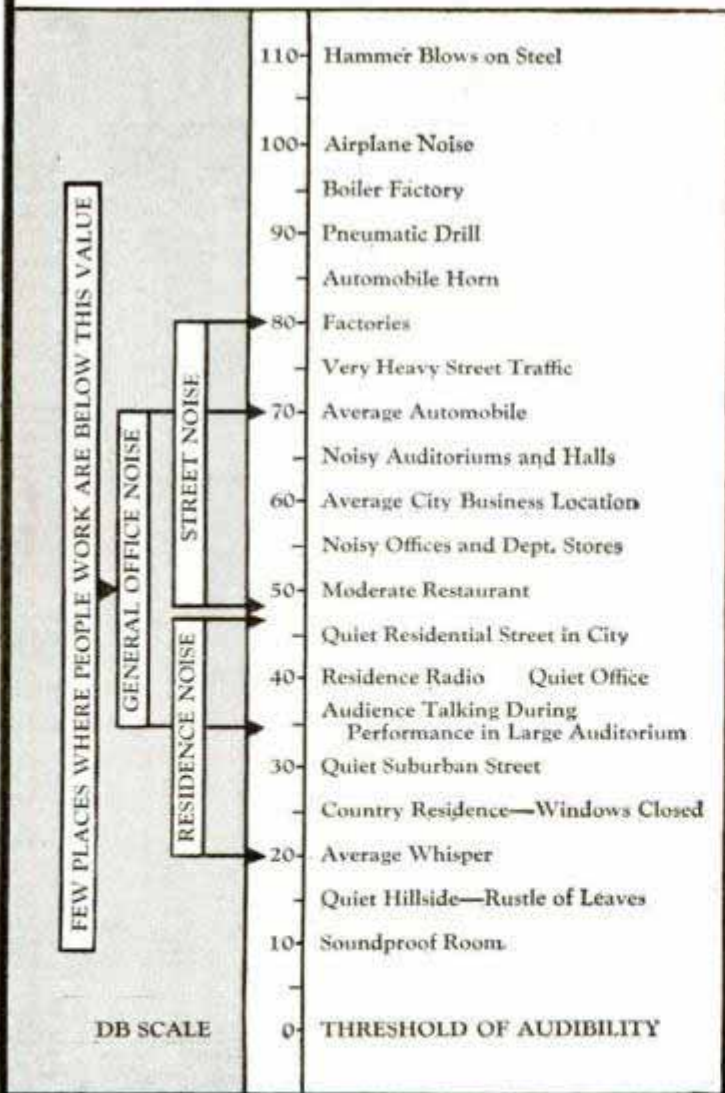

Upper left, experimenting with hearing aid; right, measuring sound transmission in gas. Various gases humidity and temperature all affect the distance sound travels. Below, decibel scale of common sounds

The last ten years, with their many developments in radio and talking motion pictures, have materially increased our knowledge of sound. Much has been learned respecting the insulation of buildings and rooms against noise and vibration. Bothersome reverberations from hard walls first led us to drape blankets on the walls of a radio studio with the result that the room was "dead," especially for the higher-pitched tones, and sounds were flat and uninteresting. In a modern radio studio the walls and their insulation are carefully chosen with the idea of permitting some reflection of sound. This gives brilliance and interest to music and speech.



1 to 11 pairs 60¢ per pair

To produce models by Mini Safety Appliances Company, Braintree, Massachusetts

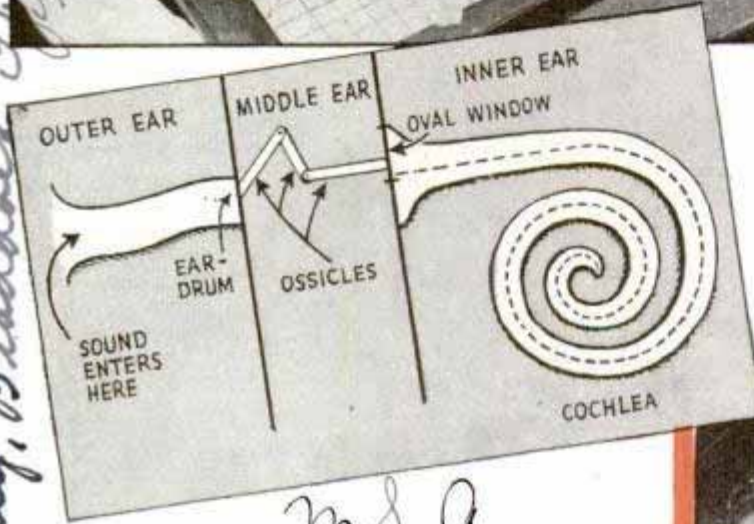
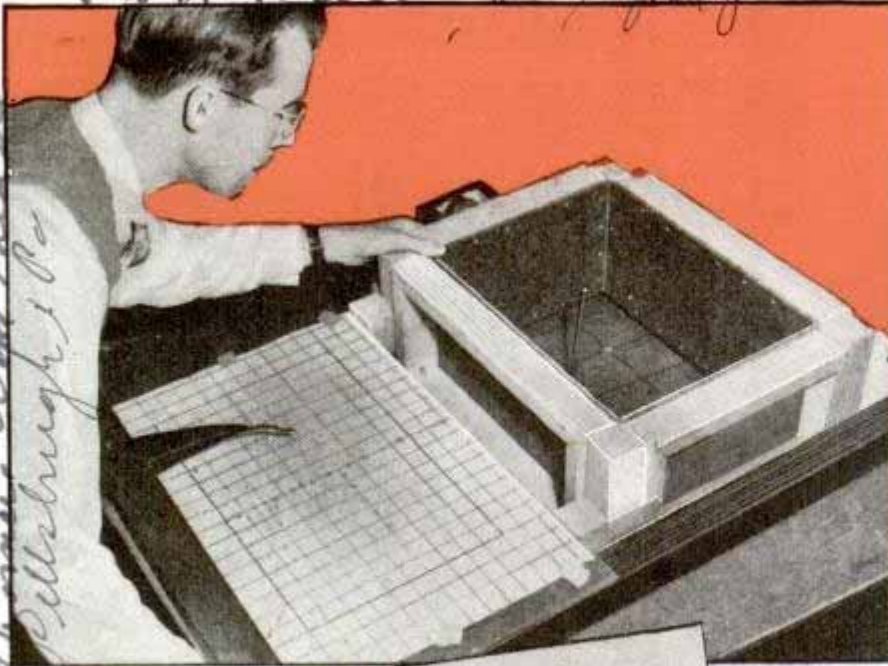

*m.s.a.*

Needless noise is a nuisance that impairs the hearing of millions of factory workers and that robs city dwellers of quiet and sleep. Nervousness and ill health are aggravated by it. While suffering from the noise in a modern hospital the writer devised an "ear defender" that protects the ears from bothersome sounds. The ear defender is a scientifically designed plug that is inserted in the ear canal; it consists of a soft rubber tube having an outer plug of heavy metal separated by an air space from an inner plug of soft rubber.

Simple wax or rubber stoppers in the ears reduce noise to about one-fifth its original loudness. The new ear defenders reduce sounds to about one-tenth their loudness, an average insulation of from forty to forty-five decibels. A roaring airplane motor becomes no louder than the noise in a restaurant. Restaurant noise is reduced to a whisper. I carry a set of the plugs with me to sleep soundly on trains

and to help me concentrate when a loud radio is being played in the next room.

Such ear defenders are not a cure-all for some factory workers because the insulation is only against air-borne sounds. The bones of the body conduct some noise and also conduct sub-audible vibrations. Workers exposed to such vibrations should sit or stand on insulating cushions.

One odd thing about wearing ear defenders in the presence of loud continuous noise is that they do not interfere with understanding conversation. This is because a speaker whose ears are unprotected normally raises his voice above the background noise in order to be understood, and his voice still remains

(Continued to page 132A)



Top, high-frequency sound measurements show noisiest areas in model room; center, diagram shows how bones in ear transmit sound. Bottom, sound is reduced to 1/10,000 strength by trap in air duct



# Old Wagon Wheels Made into Trim Furniture



Above, flowerpot and book ends made of wagon-wheel parts. Upper right, seat and footrest. Below, trim glass-covered table with book shelf beneath

From old wagon wheels, hubs and other parts, a Californian fashions beautiful hardwood coffee tables, flowerpots, book ends, center tables, mailboxes, seats, footrests, lamps and other useful items for the home. First he dismembers the wheel, removing all spokes and prying loose the rim. Then each part is tested. All rotten wood is dressed off with a sander and then the pieces are reassembled. If he is making a center table, the salvage materials consist of one heavy wheel with a four-inch rim

and two large hubs, one of which is sawed in half, leaving the spokes all on one side. Spokes of both hubs are then cut to about eight inches in length and the full hub and two half hubs are fitted together. The end without spokes is used to support the surface of the table, the end with the spokes is used as the base. The full hub goes between the two and its spokes serve as a center shelf. The surface of the table generally is a circular piece of plate glass which fits on top of the large wheel.

Jack Sahr, 11119 Ventura Blvd.



# Automatic Garage Speeds Up Car Service

De luxe parking is offered to guests who drive their own cars to Rockefeller Center. Six floors of the New York skyscraper,

three of them below the street level and three above, have been turned into an air-conditioned garage, providing room for 800 automobiles. Sealed throughout and with no open windows, the entire space is maintained at uniform temperature and the air-purifying system eliminates gas fumes and dirt. For washing cars a special soap is applied through a brush fed by a hose, followed by a shower bath to rinse them. Motorists open entrance doors automatically by driving over contact plates. Firehouse poles between floors are used by the attendants.

Top, right, attendant sliding pole holds ticket in his mouth; left, hose-fed brushes. Bottom, left, auto under shower; right, doors opening as car rides over contact plates

© Halbran

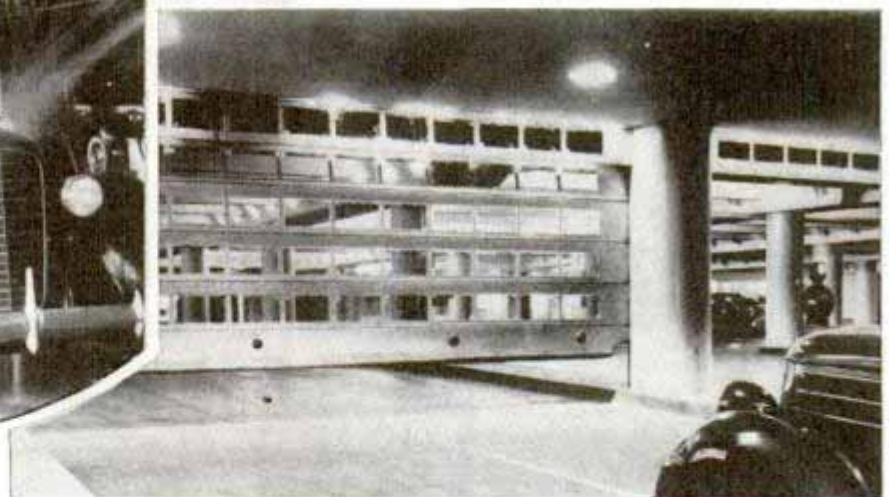
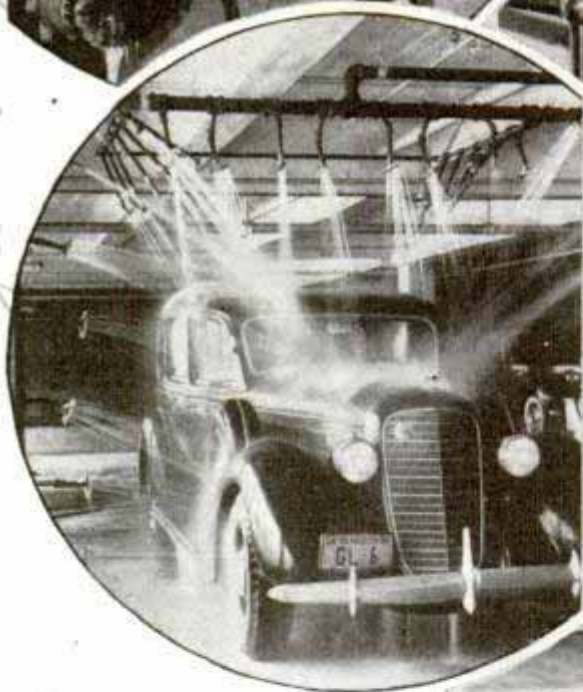

## Forest Fire Every Two and One-Quarter Minutes Is U. S. Average

During the calendar year 1938 there were 232,229 forest fires in the United States, or an average of one every two and one-quarter minutes, according to a summary by the forest service of the U. S. department of agriculture. These fires combined to burn over 33,815,100 acres—an area almost as great as that of Arkansas—and caused damage estimated at \$36,888,460.

Ninety-one per cent of the acres burned over were on unprotected private land, and the remaining nine per cent were on land under federal, state or private protection. Of 659,202,090 acres of land needing protection, 158,883,850 acres of private lands are unprotected. Statistics show that 82.7 per cent of fires on protected lands were caused by man, 8.6 per cent by lightning.

2 W 5  
Cmk. Andrews H. Halbran 8747-83rd St  
Jackson Heights N.Y.

21142



How Stunt Man Leaps Is Revealed by Camera

Leaping from a window more than forty feet above street level into a truck is one of the thrillers in a recent movie. How a stunt man, substituting for the principal actor, made the jump without injury is revealed by photos snapped by several photographers shooting from different points of vantage. At \$500 per jump, it was a one-take affair for the motion picture and the whole cast was jittery, but the stunt man, Loren Riebe, made a beautiful leap from a third-story window, shot outward and down at the "X" marked on the fabric-covered top of the truck, crashed through and landed on a pile of mattresses. He didn't even suffer a sprain. The stunt man was traveling 516.27 feet per second as he went through the canvas top of the vehicle. Stunt men frequently make leaps from forty feet or more in the air, but the landing place—a truck roof eighteen feet out from the wall of the building, made this job more hazardous than usual.

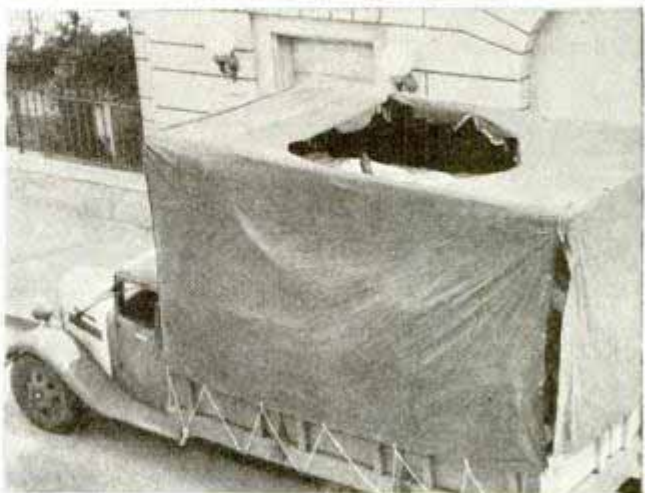
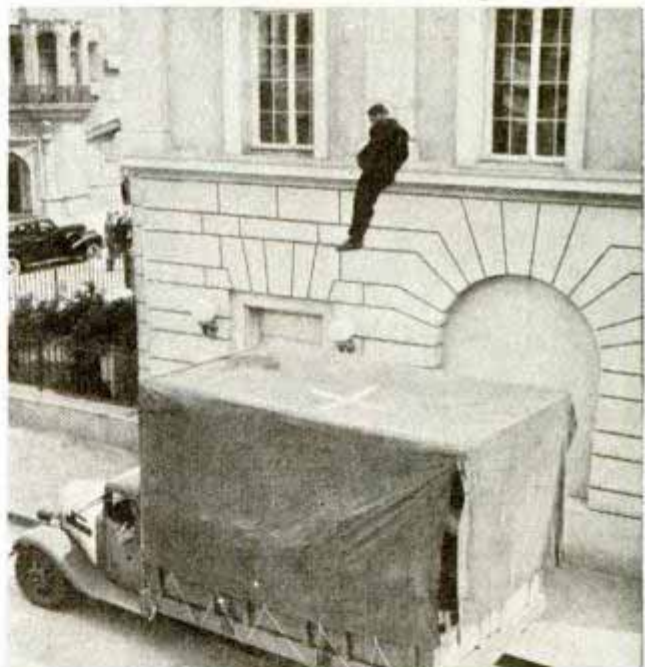

Series of pictures reveal how stunt man of movies hit the mark in leap from third floor of building

2 1049  
 "Jack-in-the-Box" Photo Lights Lift to Almost Eight Feet

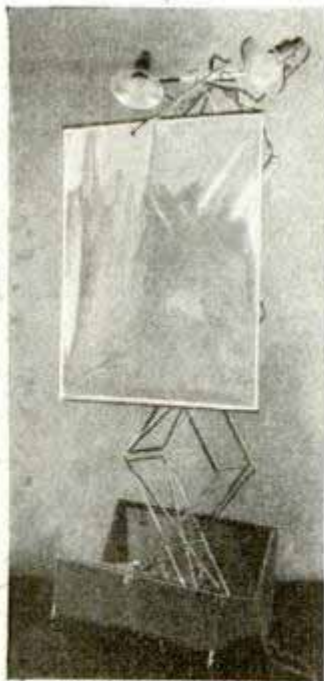

Capable of being raised from floor level to any height up to ninety-four inches, a set of photographic lights and a diffusing screen are packed in a carrying case that forms a base for the unit when in use. A lifting device stops at any intermediate point without fastening. The two lamps can be separated horizontally from eleven to thirty-six inches,

and there are adapters for smaller flood-lamps. Casters on the case facilitate moving the unit about. When the case is closed for carrying it measures nine by ten by thirty inches. It weighs twenty-three pounds.

Co. a Assoc. Corp.  
 N.Y.



# Exploring A TROPICAL

C. B. Perkins  
Herpetologist, San Diego  
Zoo

1908/1909 Holly wood Blvd  
L.A.



De Witt Meredith, U.S.G.S.

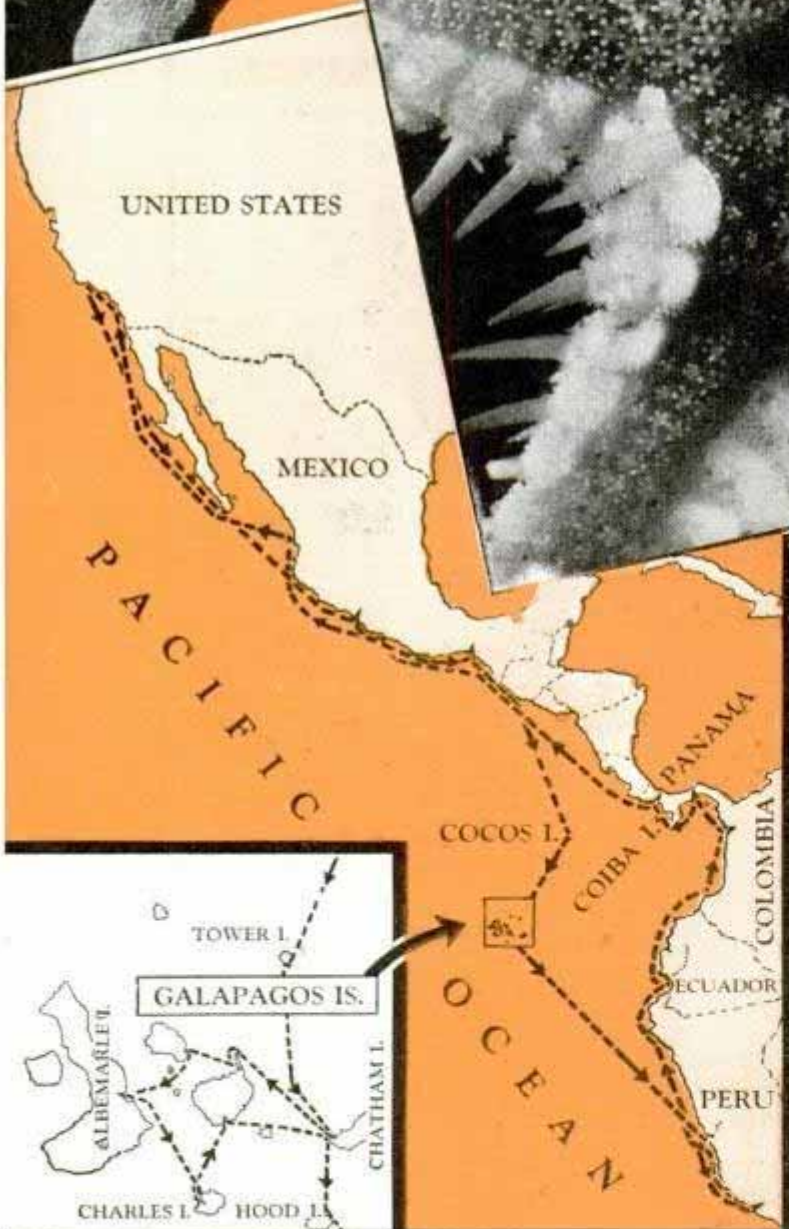

Top, a scientist makes acquaintance of a land iguana in the Galapagos. Below, map of recent cruise. Right, underside of sea star showing tentacles extended, and sea urchin (circle) with poisonous spines

BIRDS that stand over their nests to shade their eggs and keep them cool, queer forms of life dredged up from the sea that resemble mushrooms armed with teeth, birds the size of turkeys that appear to have been freshly plucked and that are actually babies, larger than their parents—these are some of the odd specimens collected on voyages of the "Velero III," the scientific exploration ship of the Allan Hancock Foundation for Scientific Research at the University of Southern California.

Blue-faced boobies of the Galapagos Islands are the birds that protect their eggs

Capt. Thomas F. Stinson, Jr.  
12555 Idomina Ave. Los Angeles



2029

on San Salvador Archipelago

# WONDERLAND

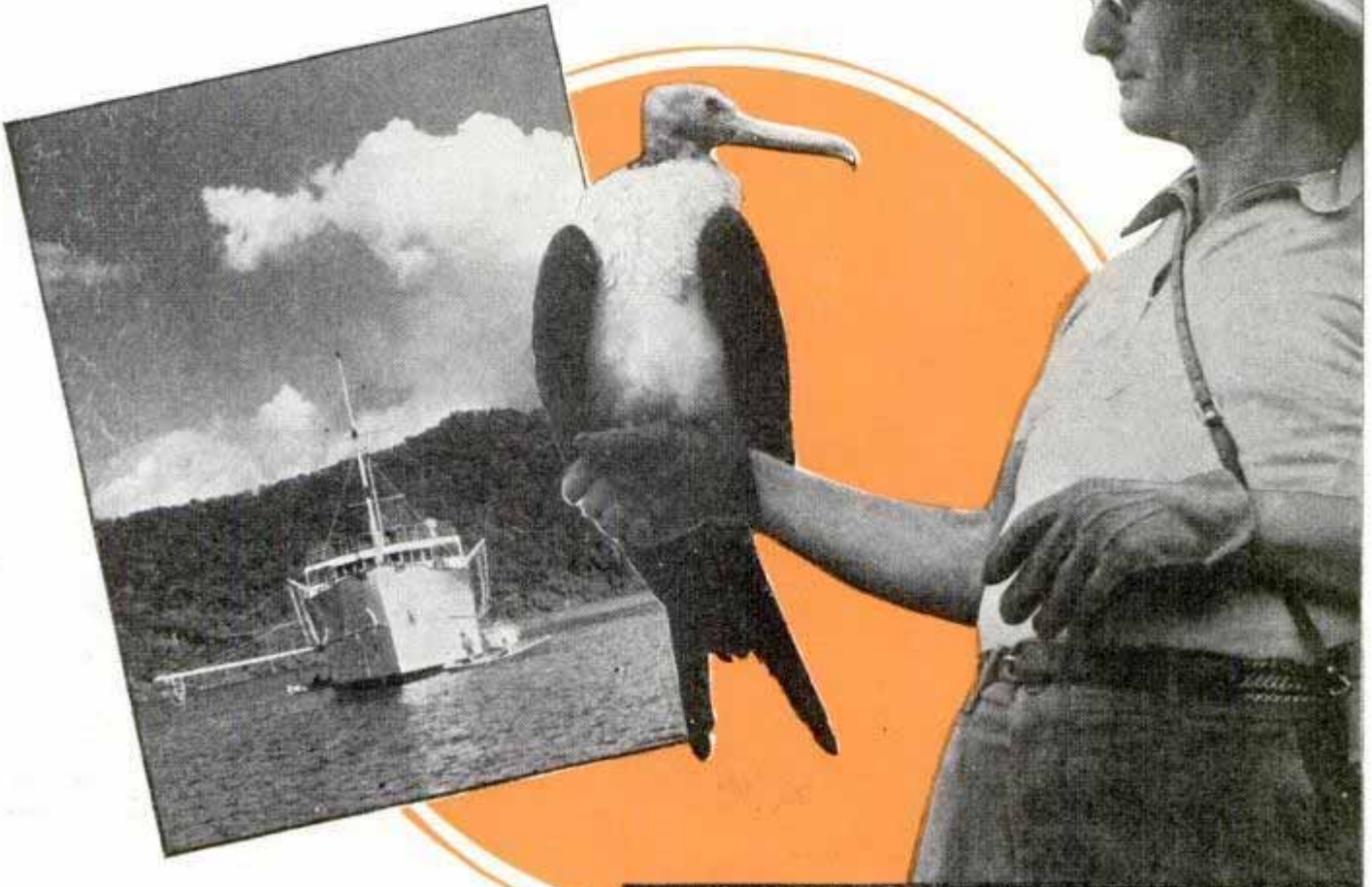

from the intense midday sun. The strange mushroomlike forms from the sea bottom are a new mystery to scientists who are still trying to decide whether the specimens belong to the animal or vegetable kingdom. The large naked birds are young tropical pelicans that are so well fed by their parents that they temporarily outstrip them in size.

In the tropics the scientists on the "Velero III" cruise for miles through patches of ocean turned bright red by countless microscopic plankton. At night they read newspapers by the glowing phosphorescent light of the disturbed water in the ship's wake. Visiting Cocos Island, they hunt for new species of marine life instead of searching for the legendary pirate treasures supposed to be buried there. Along the coasts of Guatemala and San Salvador their passage is lit by the ruddy



Photos courtesy Allan Hancock Expeditions  
 Top, the "Velero III," exploration cruiser, at anchor in tropical Port Utria, Colombia. Right, Capt. Allan Hancock, master of the ship and expedition director, with a young man-o'-war bird.  
 Below, collecting freshwater fish on Cocos Island

Mr. George S. Myers, Costa Rica 835

Water Boat

San Francisco



on Tiburon Island, Mexico



*port Uthia Columbia*  
**Seri Indian chief, top, applies "makeup" with ten-cent-store mirror presented by visitors on Tiburon Island. Center, rare porpoise with ducklike bill. Below, examining haul from dredge**

glow of smoldering volcanoes. They anchor in uncharted coves off Ecuador and Colombia to study native tribes.

The scientists visit the Bird Islands off Peru that are glistening white in the sun when the bird population is out fishing at sea and that appear to be black masses later when the vast flocks of birds return and cover nearly every square foot. To the scientific world the tropical Pacific is a zoological and botanical wonderland only partially explored. Both on land and in the depths of the sea new and unusual forms of life are still being discovered. In the jungles and arid wastes are fish-eating bats, um-

brella ants, and rare reptiles. The toad fish that walks on the bottom of the sea with five-toed fins, rare black shrimp and club-footed sea urchins are only a few of the strange forms of marine life.

Not only because of their interest in exploring the unknown but because of the expectation that some of the research will contribute directly to the welfare of mankind, faculty members of the University of Southern California and distinguished scientists of other institutions are engaged in a comprehensive study of lonely areas in the eastern Pacific. They carry on their work from a ship built especially for research, presented to the school by Cap-



tain Allan Hancock of Los Angeles, who serves as navigator and director of the expedition. Among the institutions that have participated in the voyages are the United States National Museum of Washington, D. C., the Field Museum of Chicago, and the University of Michigan. Each year, with college students as part of the crew, at least one voyage is made into the tropics. The "Velero III" is a sturdy 198-foot



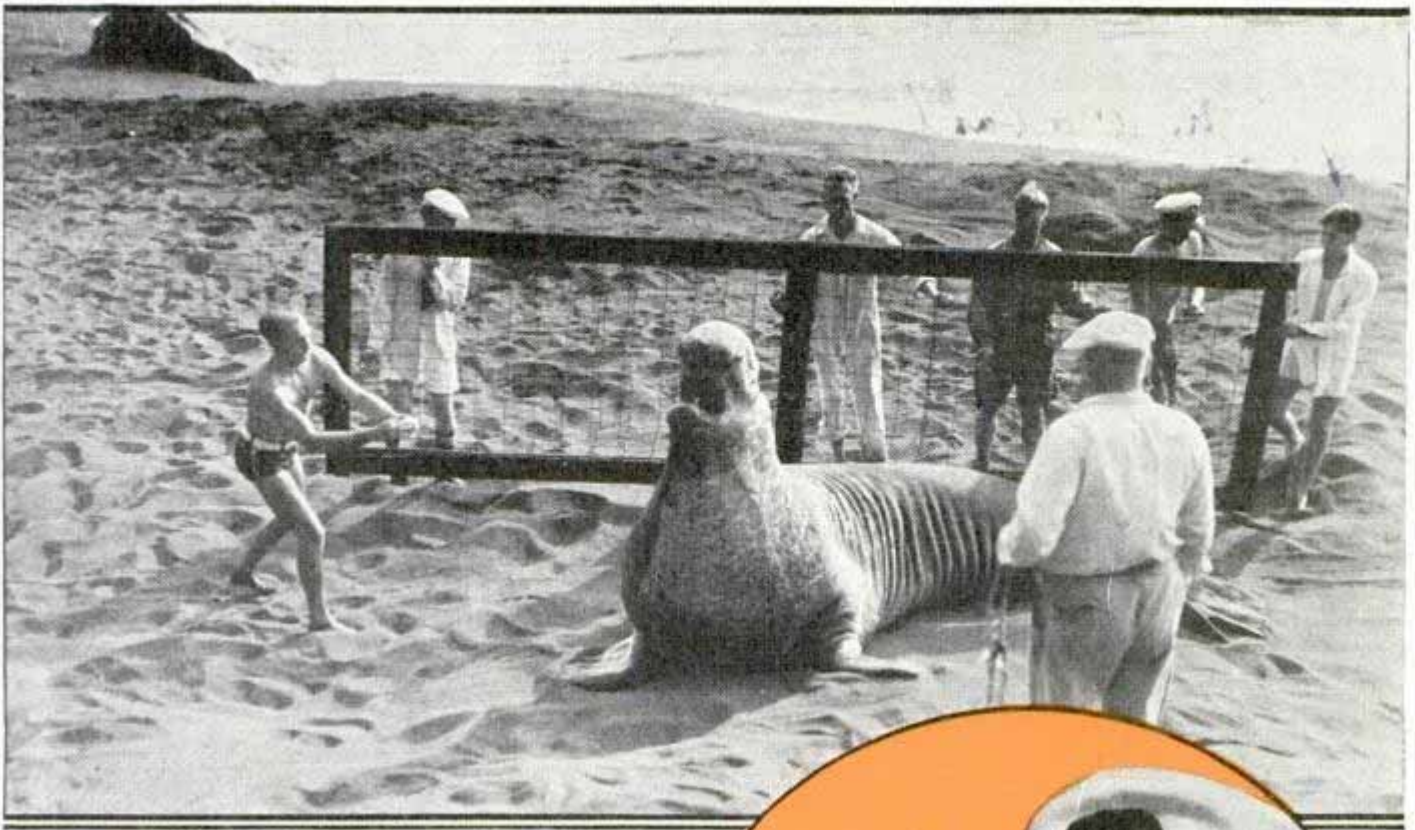

Diesel cruiser carrying fuel for a 10,000-mile voyage. The vessel is a floating laboratory with work-rooms where specimens may be studied, air-conditioned storage rooms, photographic darkrooms, heating and cooling systems for maintaining the proper temperatures for specimens brought back alive. The ship carries four power launches and skiffs for landing on rugged coasts.

Specimens collected range from microscopic organisms to 1,200-pound "pug-nosed" Peruvian sea lions brought back for zoos. Motion pictures are made of strange animals. In the tropics the photographers keep their film in refrigerators because of the heat and humidity. For close-ups of animals and birds they can usually walk right up to their subjects, which are not afraid of humans.

Archaeological notes are made ashore, geography and chemistry of the sea are studied, and salinity and temperature data at various locations and depths are gathered for the Scripps Institute of Oceanography. Parts of the sea bottom along the west coast of Central America are shifting because of earth disturbances, and the ves-



*Top, crew of the "Velero III" net a big bull sea elephant on Guadalupe Island, Mexico, then buoy it out to sea and hoist it aboard ship for San Diego. It weighed 3,000 pounds. Below, Captain Hancock is navigator of the expedition vessel*

sel charts the latest changes with its electric fathometer.

With so many fields under investigation, discoveries are made on every trip. On one voyage Dr. Hubert Lyman Clark of Harvard University found evidence of the odd life cycle of one brittle starfish that starts life with six radial arms and can break into two separate animals with three arms each, after which each half grows two additional

(Continued to page 130A)



### Rubber Fins Worn on Feet Increase Swimmer's Speed



Swimmer almost doubles his speed in water by flipping these large fins to duplicate action of tail of fish

Artificial fins, like those used by fast swimming natives of the South Seas, are about to become available to swimmers in this country. The fins are made of rubber and are attached to the swimmer's ankles. Swimmers wearing rubber fins can travel through the water at almost double the speed of a fast crawl-stroke swimmer.

### Harvester Cuts and Threshes in One Operation

Operated from a power takeoff of a one-pow size tractor, a new all-crop harvester cuts and threshes at the same time, combining the work of binding, shocking and threshing into a one-man job. Amply large

Model 40.



Versatile streamline combine, with forty-inch cut, can be adjusted to handle more than 100 grains, peas and seeds

for the average farm, the streamline machine features a forty-inch cut, wide bar cylinder, and rubber shelling contacts with simple adjustments for more than 100 grains, peas and seeds. With it farmers can harvest valuable seed, like soybeans, clover, alfalfa, vetch and grasses of every kind, thus encouraging the growth of legumes and grasses that help build soil fertility, soak up rainfall and stop erosion.

### Giant Likeness of Small Camera Forms Store Front

Camera fans are attracted to a Los Angeles store front constructed in the likeness of a miniature camera. To complete the



Store front, in likeness of miniature camera with all attachments, displays photographic accessories

advertising stunt all the attachments of standard cameras have been added, including a lens, shutter, view finder, film winder and dual range finders. Especially interesting is the lens, which serves as a show window in the day and as a screen for projection of amateur movies at night.

### Stratosphere Boiling Hot Meteor Tracks Indicate

At about thirty-eight miles above the earth's surface, temperatures have been found to reach 212 degrees Fahrenheit, the boiling point of water. This discovery was made by Dr. Fred L. Whipple,

Oliver Churchill 198 d. Los Palmas Los Angeles

\$345.00 job La Porte club

Alis. Chalmers, La Porte d'ind

Science Service, Sept 13

The Classroom, 5376



Cambridge  
Mass

27000

Harvard astronomer, who uses a new type of "meteor speedometer" which tells temperatures in the stratosphere from tracks made in the sky by shooting stars. A fan blade revolving in front of a telescope-camera breaks at measured intervals the path of any meteor that flashes across the field of view. Two such thermometers, located twenty-four miles apart, give an accurate measurement of the meteor's height, brightness, velocity and deceleration. Ordinary room temperature of sixty-eight degrees Fahrenheit was indicated at the seventy-mile height.

21078

### Cast-Iron Blocks for Pavement Made with Low-Grade Ore

With an eye toward the creation of an outlet for vast quantities of low-grade ores in iron ranges of the state, the University of Minnesota has developed a cast-iron paving block that can be manufactured from ores containing up to forty-five per cent of oxides, not generally suitable for steel making. The hollow blocks, six by six inches square and one and five-eighths inches high, are laid on concrete after it has set. Irregularities on the iron paving surface permit rapid drainage and help to remove the film of water from auto tires.

Minneapolis



Laying cast-iron blocks in section of highway. Inset shows close-up view of their construction

School of Mines

### Verglyte plastic Glass Bends and Stretches Without Cracking

see May 1940-1909



Showing how sheet of elastic glass bends without cracking. Belt and suspenders are of new material

Elastic glass, which will not scuff or crack in bending or stretching, is being used for making garters, belts and braces. It yields comfortably to body pressure, then eases back to its original shape. In its natural color the material is transparent, but it can be produced in translucent colors. Like ordinary glass, the elastic variety does not deteriorate, will not support combustion, is unaffected by water, perspiration and alcohol, and it cleans easily.

21110

### Man Needs a Sixty-Pound Bite to Tackle a Tough Steak

It takes a sixty-pound biting pressure to bite through a tough beefsteak, but fortunately man has the jaw pressure for the job. The power of the human jaw was demonstrated recently by Dr. Ralph H. Boos of Minneapolis before a dental convention. He used a gnathodynamometer, an instrument which measures biting power. He showed that normal biting pressure for a man is sixty to sixty-five pounds, for a woman, twenty-five to thirty pounds.

Chicago Tribune 9/29/3

Vertical text on the right margin: Carbide & Carbon Chemical Co 19 E 42, Nyl  
Duchobain & Furoni Chem  
243



g 10 22. Wide world.

# WAR MACHINES

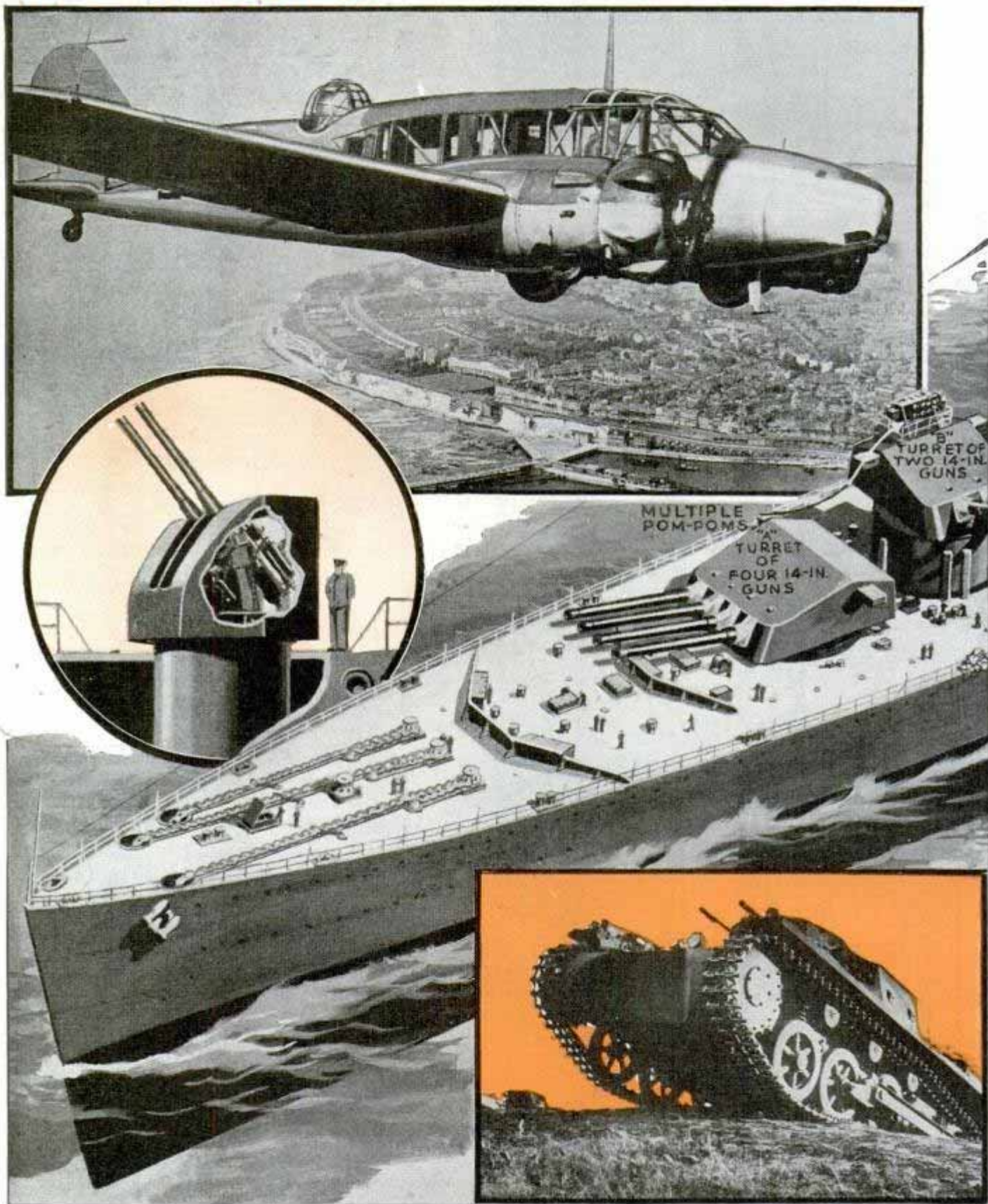

Outbreak of war in Europe turned loose fighting machines far more terrible in striking power, far stronger in defense than any hitherto used. On these pages are some of the modern instruments of battle. At top, a British bombing plane. Left, 5.25-inch guns in twin turret on Britain's newest battleship (center); guns can be elevated to sixty-degree angle. Bottom, latest high-speed German tank



# of LAND, SEA and AIR

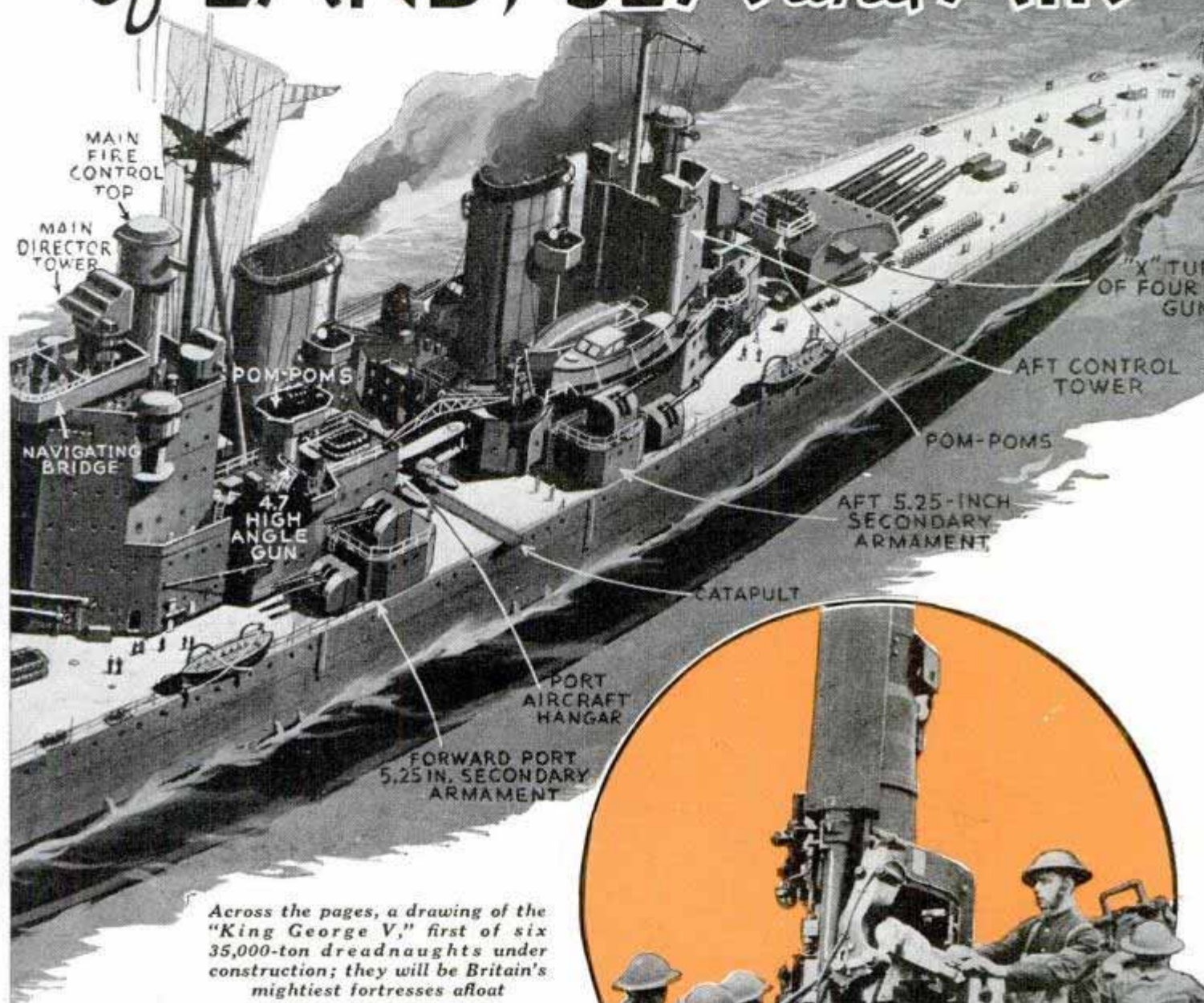



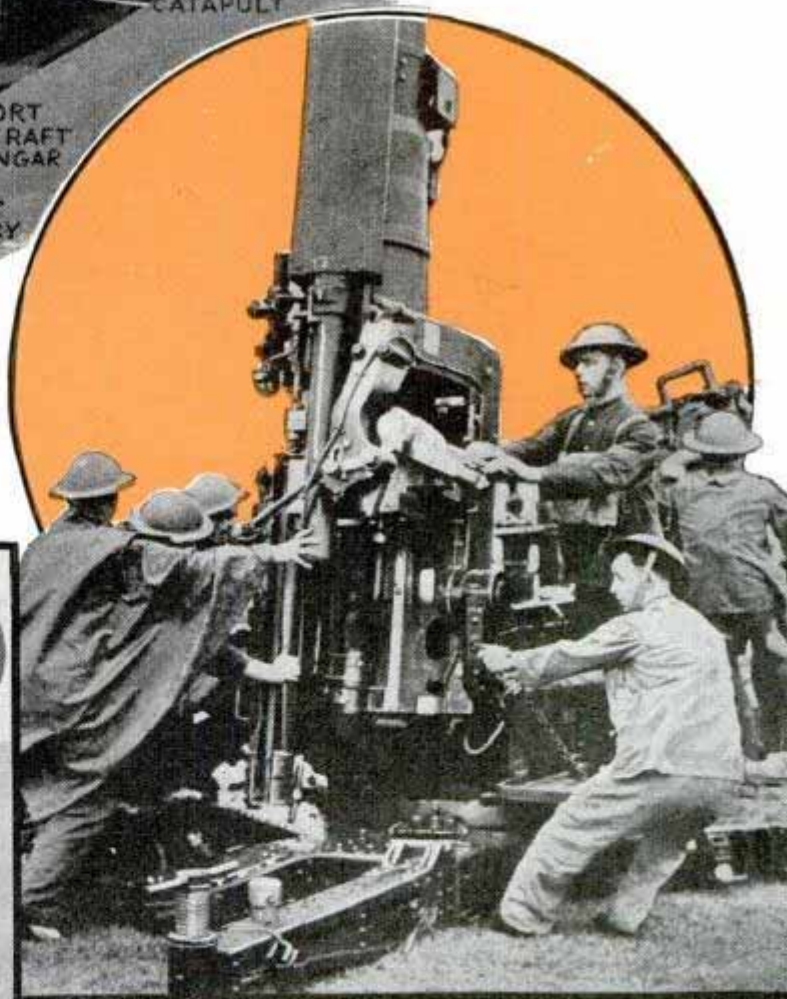







Across the pages, a drawing of the "King George V," first of six 35,000-ton dreadnaughts under construction; they will be Britain's mightiest fortresses afloat

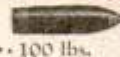

No big gun at all but an aircraft spotter, the range finder at left is a "big brother" of the focusing device on your camera. Above, anti-aircraft crew mans its highly mobile 3.7-inch gun, which can be pointed skyward at an angle of nearly ninety degrees



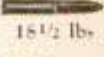

 <p>9.2-INCH COAST DEFENSE GUN</p>	 <p>320 lbs.</p>
<p>RANGE 20,000 YARDS</p>	
 <p>8-INCH HOWITZER</p>	 <p>250 lbs.</p>
<p>RANGE 18,000 YARDS</p>	
 <p>6-INCH HOWITZER</p>	 <p>100 lbs.</p>
<p>RANGE 15,000 YARDS</p>	
 <p>60-POUNDER (5-INCH) GUN</p>	 <p>60 lbs.</p>
<p>RANGE 15,000 YARDS</p>	
 <p>18-POUNDER (3.3-INCH) GUN</p>	 <p>18 1/2 lbs.</p>
<p>RANGE 8,000 YARDS</p>	
 <p>2-POUNDER ANTI-TANK GUN</p>	 <p>2 lbs.</p>
<p>RANGE 3,000 YARDS</p>	

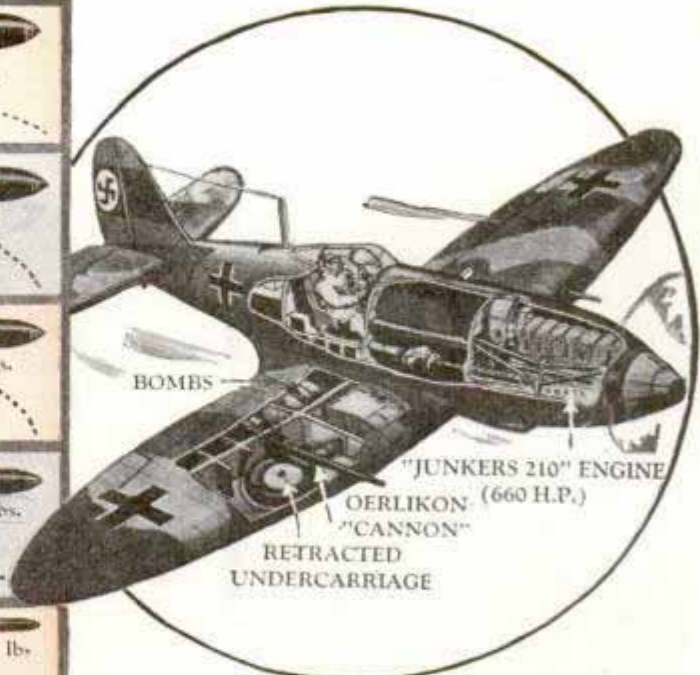

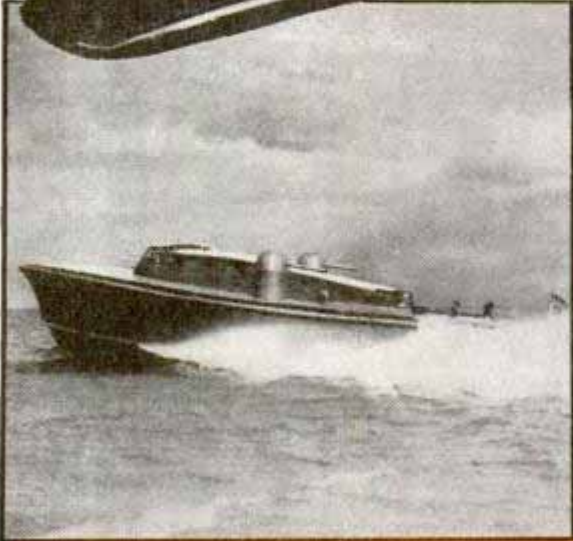
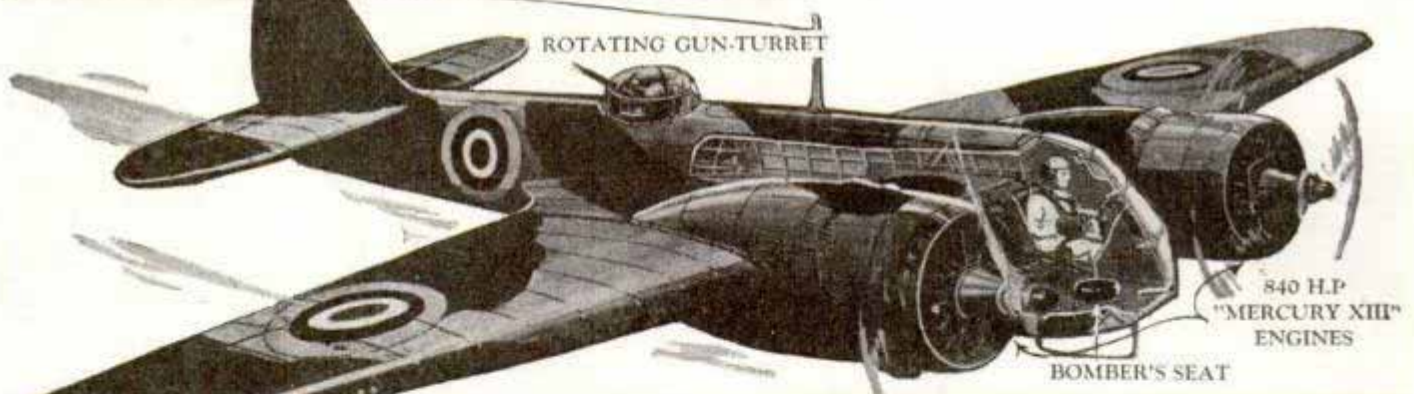

Approximate firing ranges of some of the principal types of army guns are shown at left. Heavily armed German single-seat bomber above can fly 685 miles at 276 miles an hour



Ample glass area gives crew of British plane (center) clear visibility in all directions. Below, left, forty-two-knot British boat carries four torpedoes, depth charges and armor-piercing guns in turrets; center, another torpedo boat with anti-aircraft gun; right, big German gun hidden in brush



EFFECTIVE RANGES OF CANNON AND MACHINE GUNS COMPARED

-  ..... Machine Gun—Approximately 30 yards
-  ..... 20 mm. Cannon—Approximately 100 yards
-  ..... 37 mm. Cannon—Approximately 230 yards

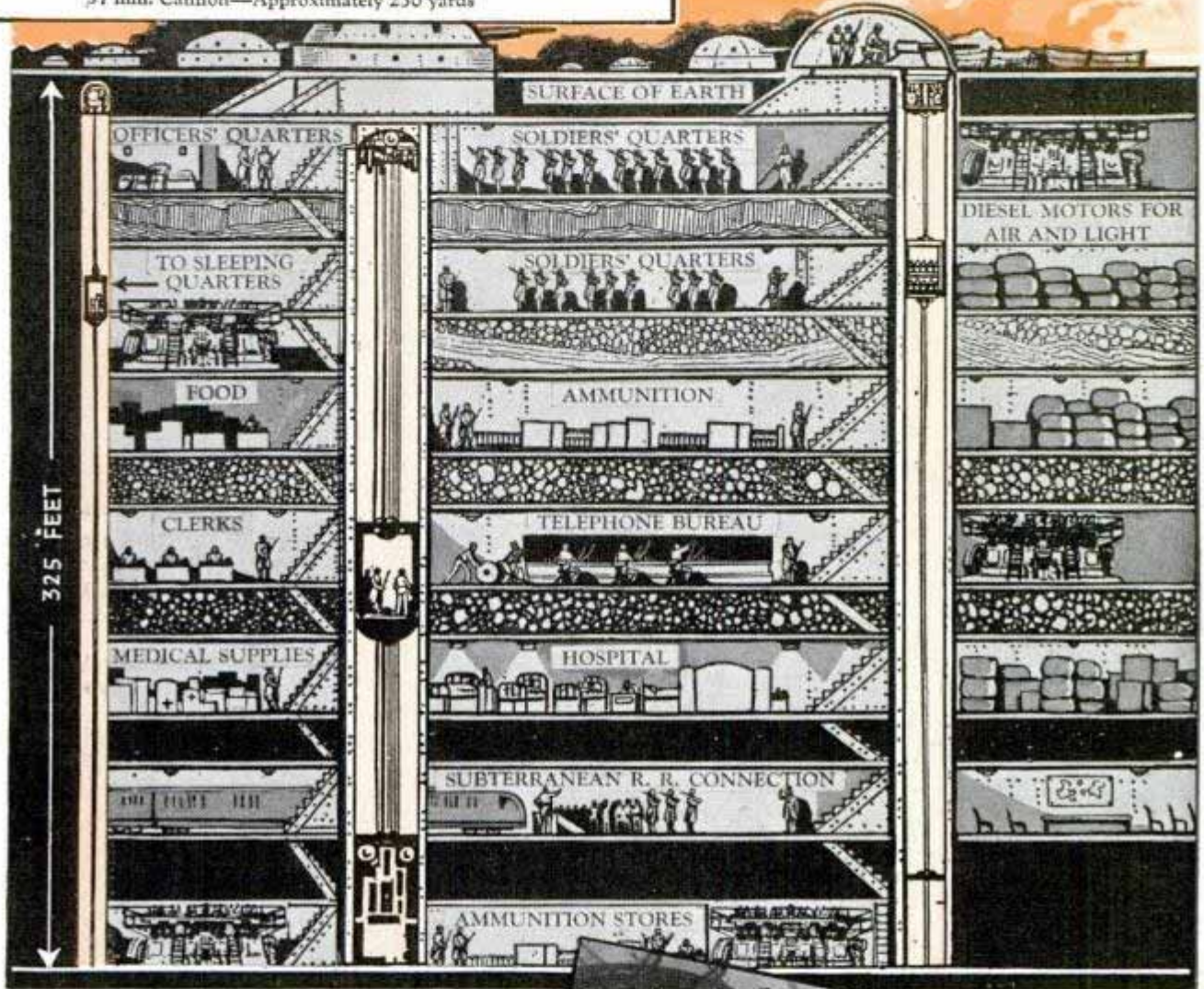

Airplane guns have relatively short effective range, indicated at top, but cannon shells explode on impact with highly destructive effect. Underground forts of Maginot Line protecting eastern France are sketched in cross section above

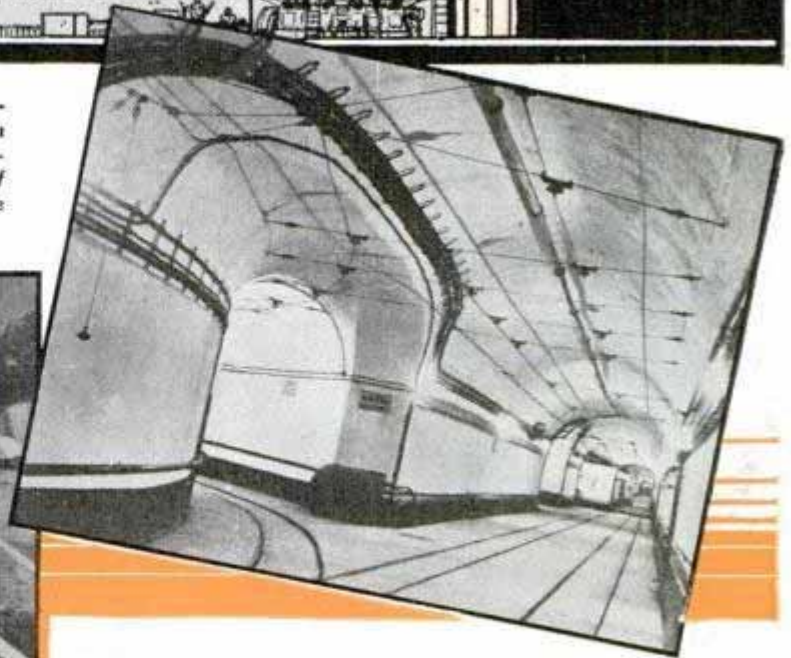
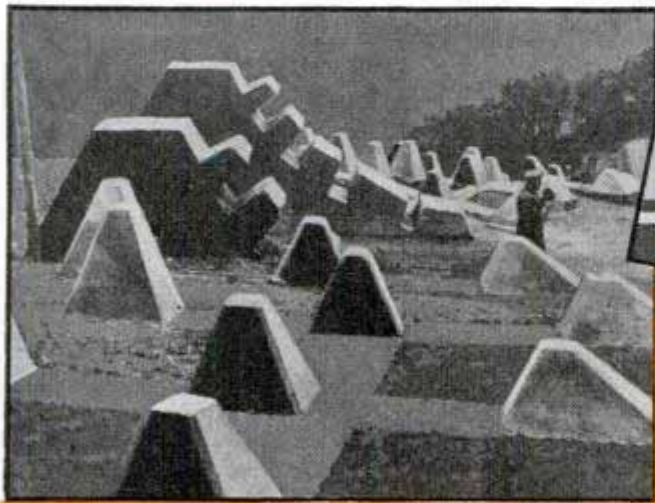

Electric railway 100 feet underground serves Maginot Line, above. Left, concrete traps built to keep enemy tanks from piercing Germany's Siegfried Line



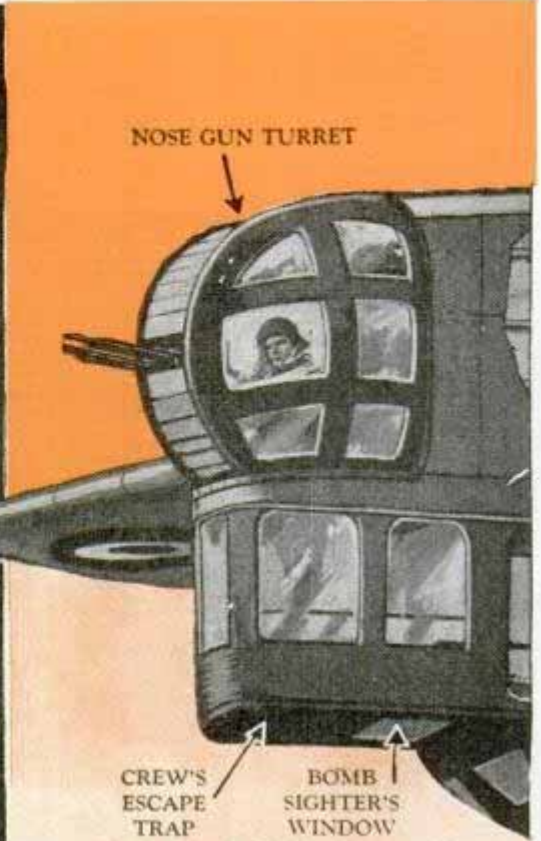
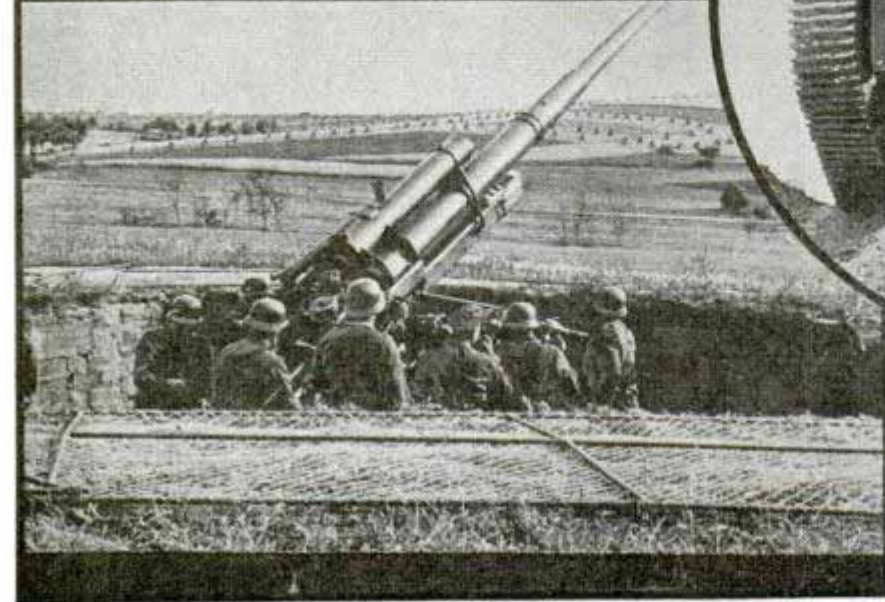
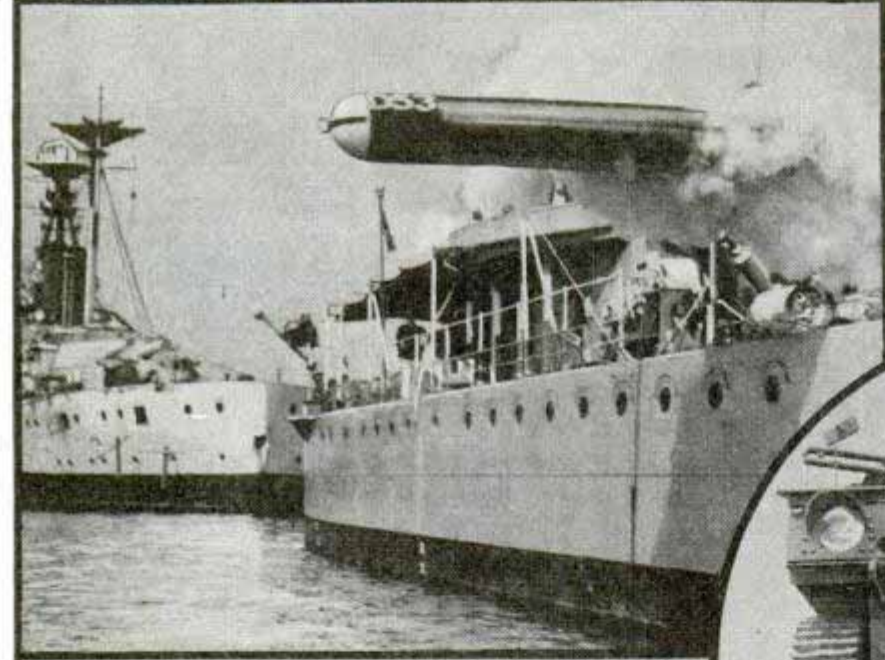

*Mechanization of war has introduced hundreds of armored tanks, tractors and trucks such as the light tractor below, attached to British artillery unit*



*Left, top, powerful batteries of German cruiser in action. Center, the camera "stops" a torpedo as it is launched from a British warship; modern torpedoes travel a mile a minute and are deadlier in aim than those of world war days. Bottom, anti-aircraft gun on Siegfried Line fires over field*



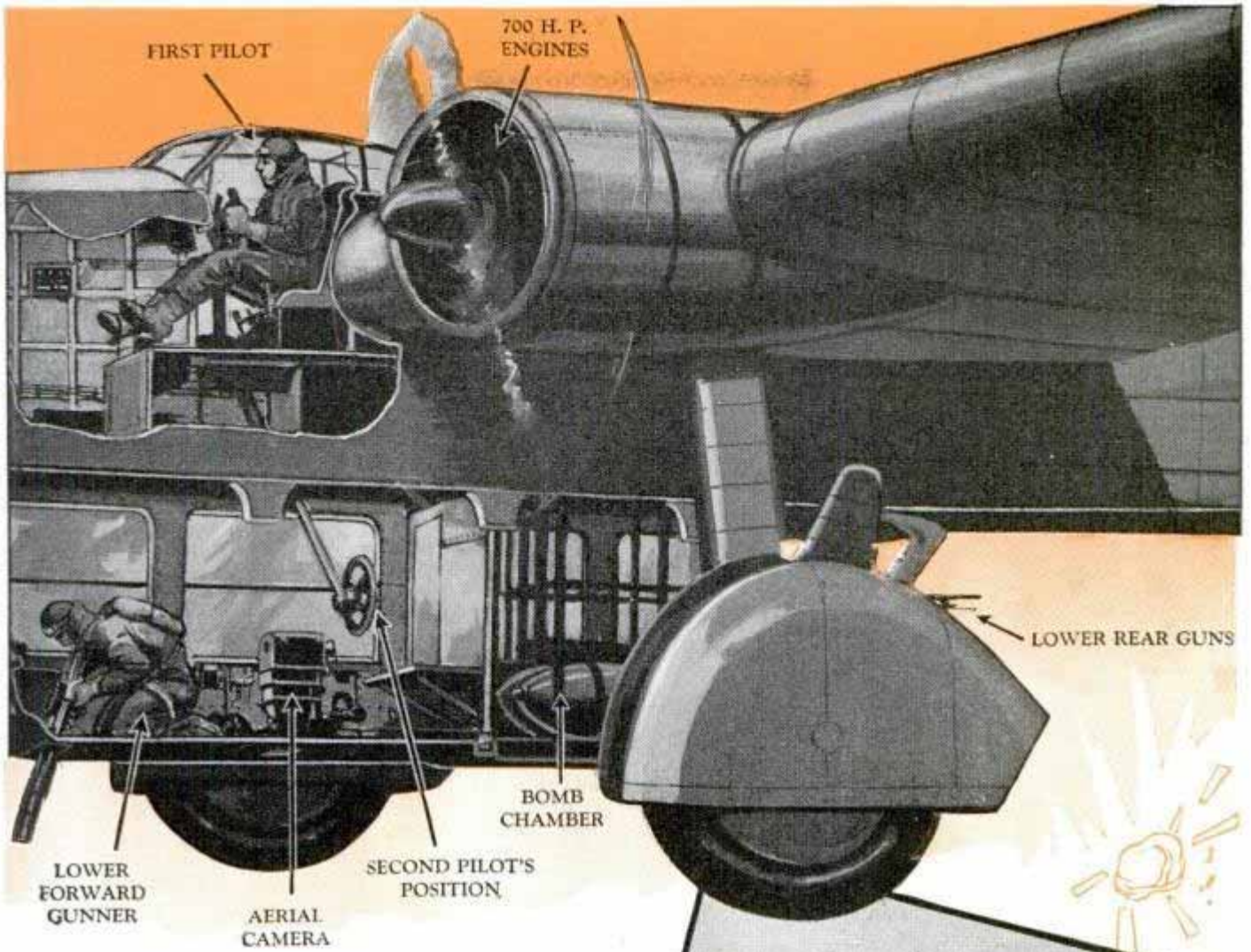

*Twin-motored French heavy bomber, above, is a double-deck sky fortress carrying a pilot and two gunners on each level, an aerial camera mounted in the floor amidships and a rack of 1,100-pound bombs in a chamber between the wheels. These are released by levers thrown by bomber sighting through window in floor of nose (see opposite page). The gunners can fight off planes from any angle*



*Above, infantry team ready to go into action with three-inch light mortar which fires forty shots a minute. Left, giant searchlight with which German troops in trench on "West Wall" spot enemy aircraft on night raids*

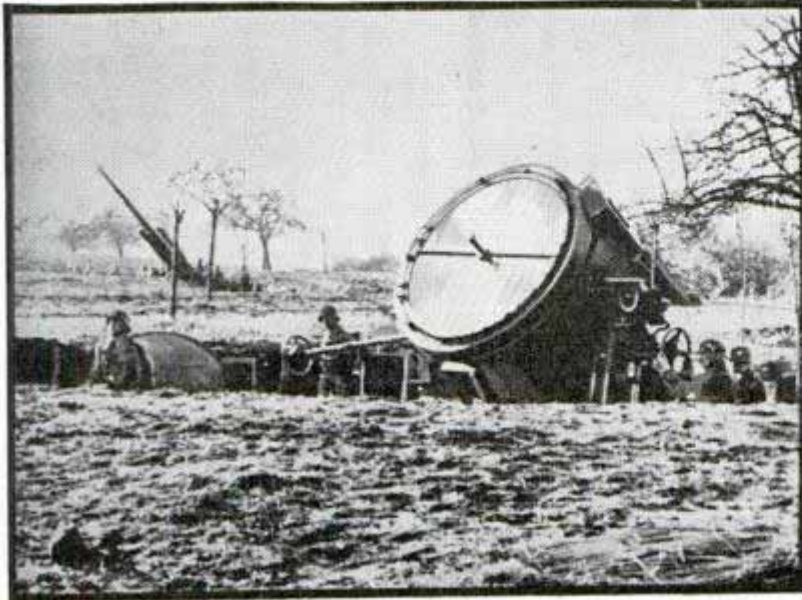



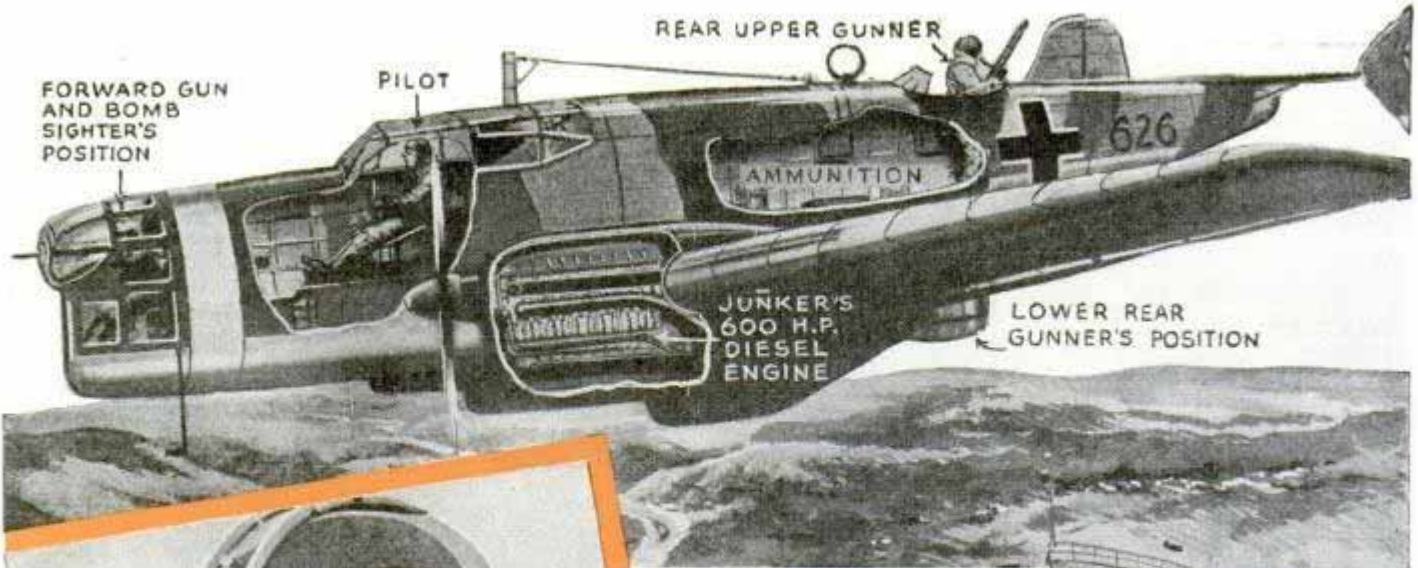

*Germans have pioneered with Diesel aircraft engines; heavy bomber above is powered by two 600-horsepower Diesels. It has an automatic pilot to relieve the human pilot for other duties, and a directional radio loop. Left, airplane detector at a listening post on Germany's western front*

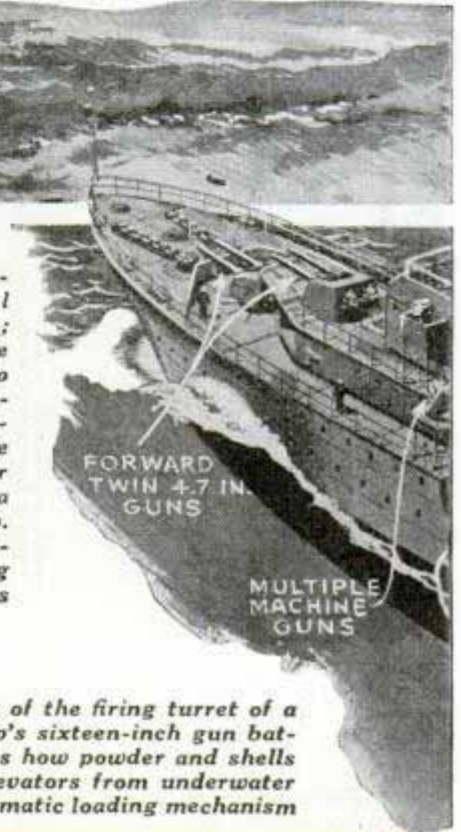

*Cutaway drawing of the firing turret of a modern battleship's sixteen-inch gun battery, below, shows how powder and shells are hoisted on elevators from underwater magazines to automatic loading mechanism*

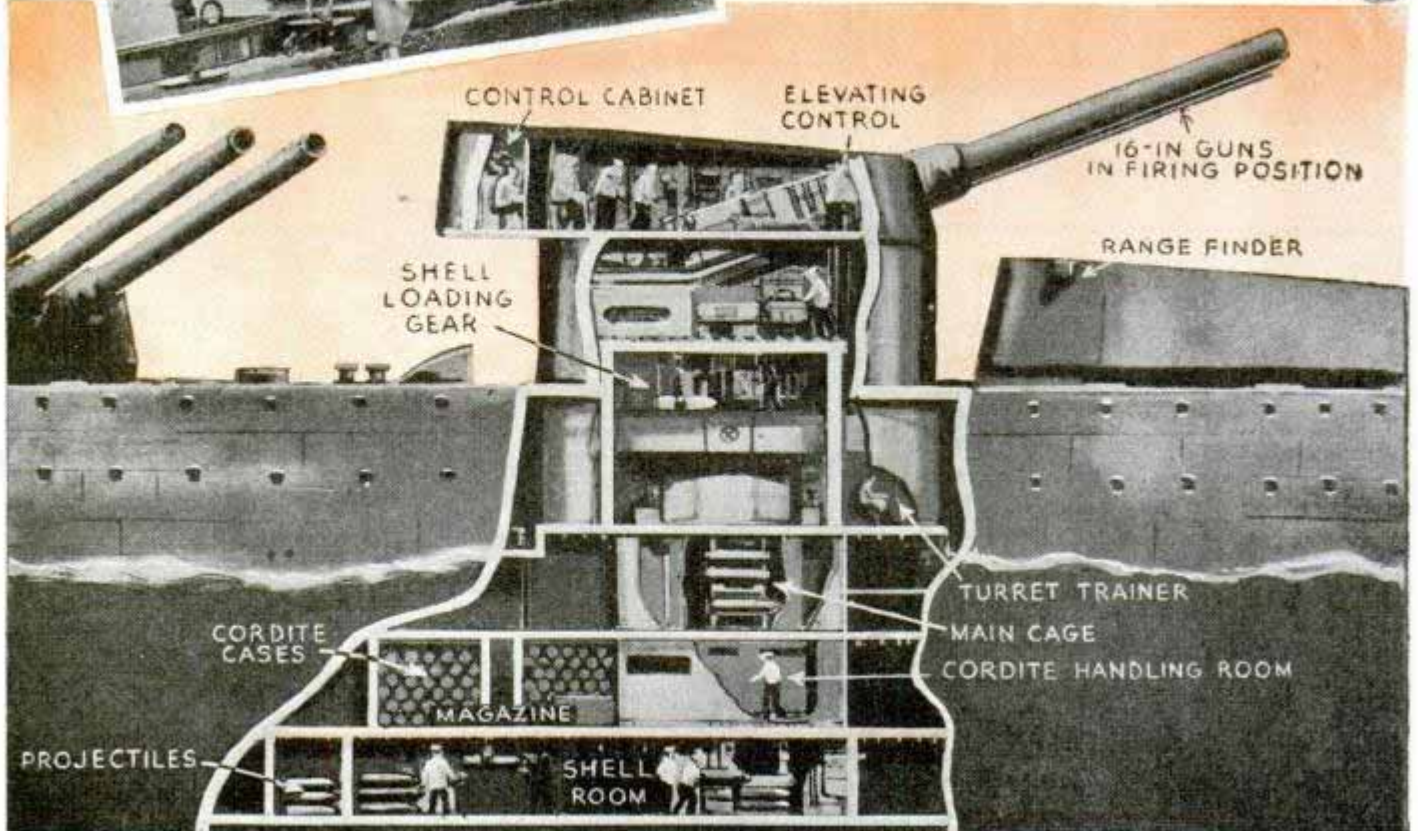



2/022

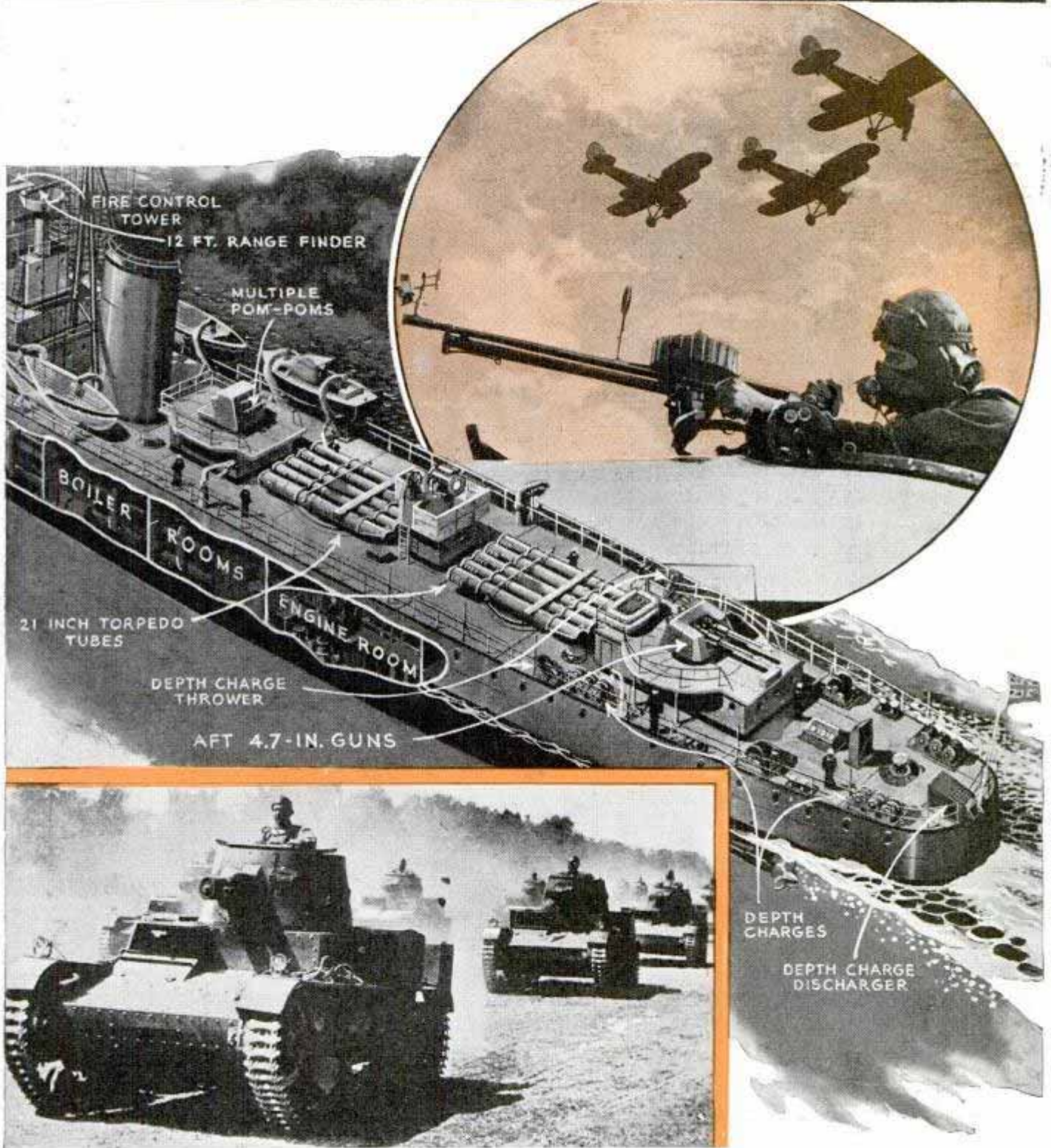
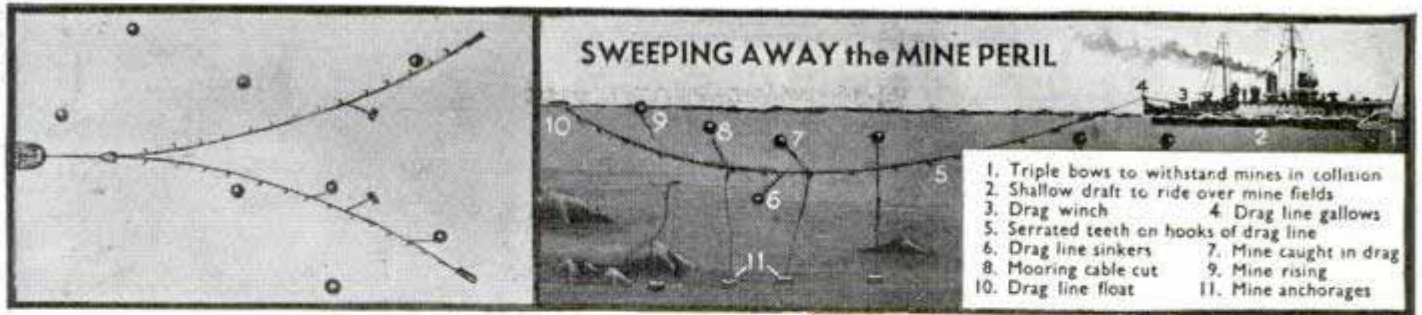

*Drawings at top show how a mine sweeper operates. In circle, war birds fly in formation above an aerial machine gunner. Center, a British destroyer, greyhound of the seas; 40,000-horsepower turbines drive it at forty miles an hour or better. For armament it carries ten 21-inch torpedo tubes and six 4.7-inch guns, depth charges and anti-aircraft pompoms. Bottom, light tanks in mass advance*



# Pusher for Handling Barrel Saves Time and Effort



Barrel "goad" equipped with four rollers pushes and steers the heavy containers with minimum of effort

Filled barrels and drums can be handled easily by one man using a pusher now on the market. It consists of a wooden handle, at the end of which are arms equipped with four rollers, or casters, which revolve with the movement of the barrel. Thus, the barrel can be pushed along the floor or other surface with minimum effort. Since the rollers turn as the barrel rolls, it is easy to steer the barrel or drum to the position desired.

# Roller for Stretching Curtains Helps Avoid Spiked Fingers

Painful injuries to fingers can be avoided when stretching curtains on the barbed-type frames if a rubber roller now on the market is used. This porous wheel takes

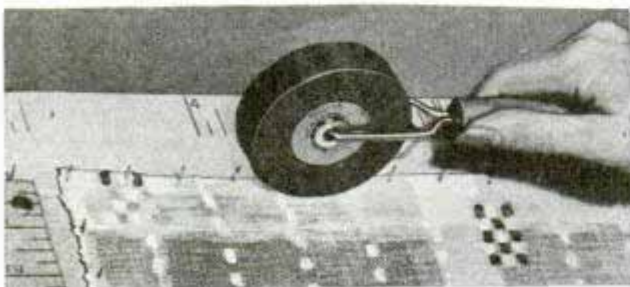

Rolling down edge of curtain over sharp pointed barbs of-stretcher with hand out of harm's way

over the hand's task of pressing the edge of the curtain over the sharp points, permitting the housewife to keep her hands away from the "danger zone." It is claimed that the soft rubber does not stick to the curtains and the tiny spikes can pierce it indefinitely without damaging the roller.

# Shatterproof Photoflash Bulbs Wear Safety Jackets

Bursting and shattering of photoflash bulbs, a hazard to photographers, is prevented by the development of transparent "safety jackets" for the glass which make it shatterproof. Both the inside and outside of the glass bulb are coated with a heavy but invisible wall of film, forming a tough skin to keep the glass from flying apart. To demonstrate its toughness a bulb was dashed full force against a wall. Although the glass cracked and dented, it did

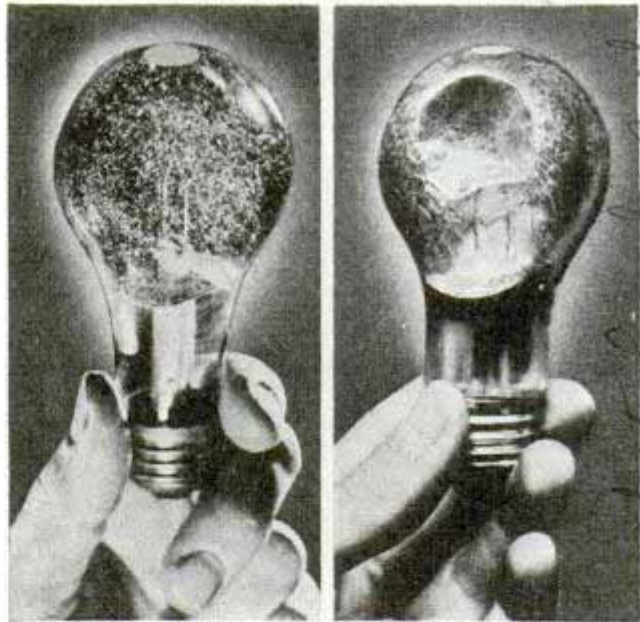

Left, unused bulb with shatterproof glass, and, at right, same bulb after being dashed against wall

not shatter, and every bit remained sandwiched within the clear safety jacket. The bulbs have two other improvements—a blue spot which automatically turns pink if a defect develops before using, and the bulb cannot be flashed accidentally by contact with other bulbs or by outside electrical current or static.

Send return postage to our Bureau of Information to learn the name of the maker of any device described in this magazine.

Milwaukee Graepage Co. 3020 W. Cass Ave. 2958

Carroll H. Prooklym

Wabash Photo Lamp Corp.

Chicago Curtain Stretcher 3701 S May



## Giant Masterpiece in Glass Will Be Preserved

Described as the largest single piece of glass in the world, the experimental 200-inch telescope disk poured at Corning Glass Works as a preliminary to production of the giant mirror for Mt. Palomar, Calif., observatory will be preserved. It has just been placed in a steel-ribbed framework built in the form of an observatory at Corning, N. Y. Before the Mt. Palomar mirror was ground, it was the same size as the experimental disk.

*Installing giant piece of glass in framework shaped like observatory. The glass will be preserved as reminder of work done on 200-inch mirror to be used at Mt. Palomar observatory*

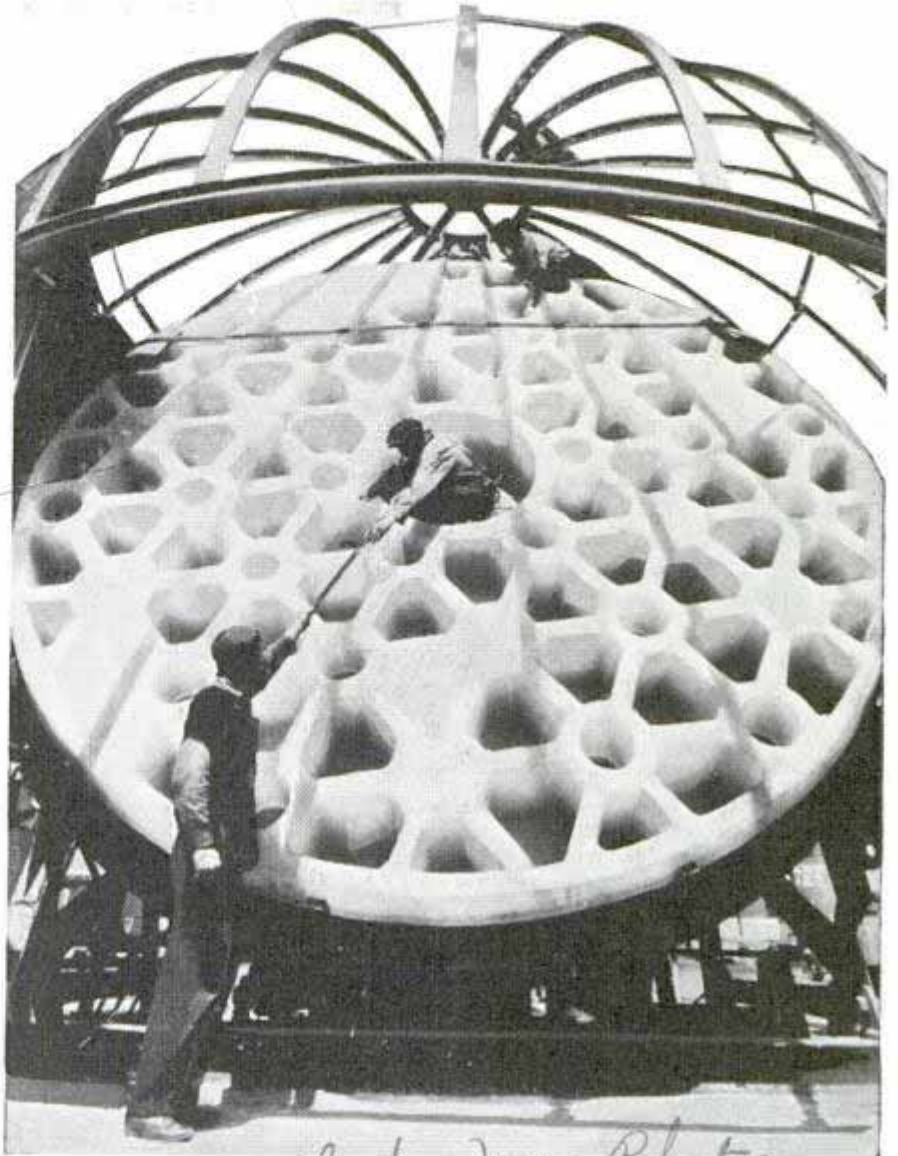

## Push Button Shifts Huge Tank from Rail Car to Trailer

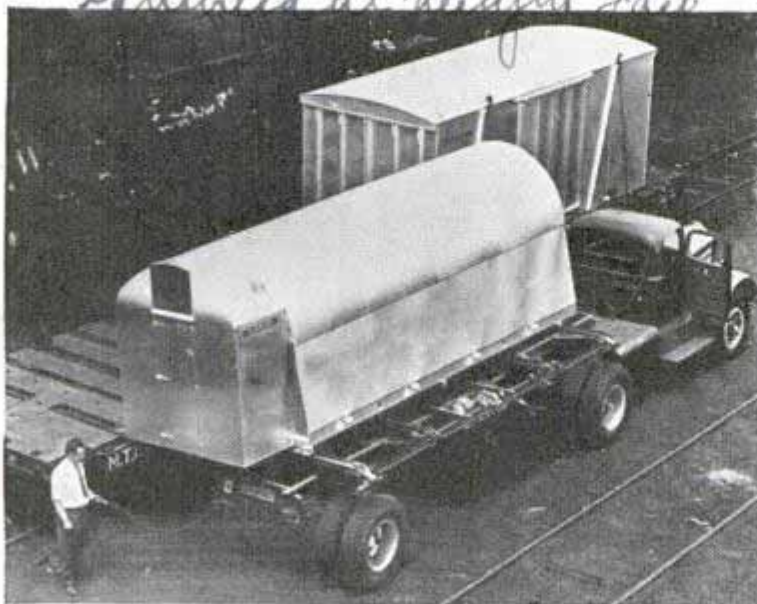

*Laden with 4,000 gallons of milk, the big steel tank above is shifted from flatcar to highway trailer at touch of a button*

To facilitate long-haul transportation by railroad and short-haul movement on the highways, a tank that can travel on flatcar or trailer has been developed. These steel containers can be built in any shape to accommodate the commodities to be carried. In the first public exhibition of this system a 4,000-gallon tank loaded with milk was transferred from a railway car to a highway trailer in ninety seconds, the interchange being operated by a push-button control.

Send return postage to our Bureau of Information to learn the name of the maker of any device described in this magazine.

*Developed by W. F. Fitch, President*



10555 Holman Ave  
Los Angeles

# AMBULANCE

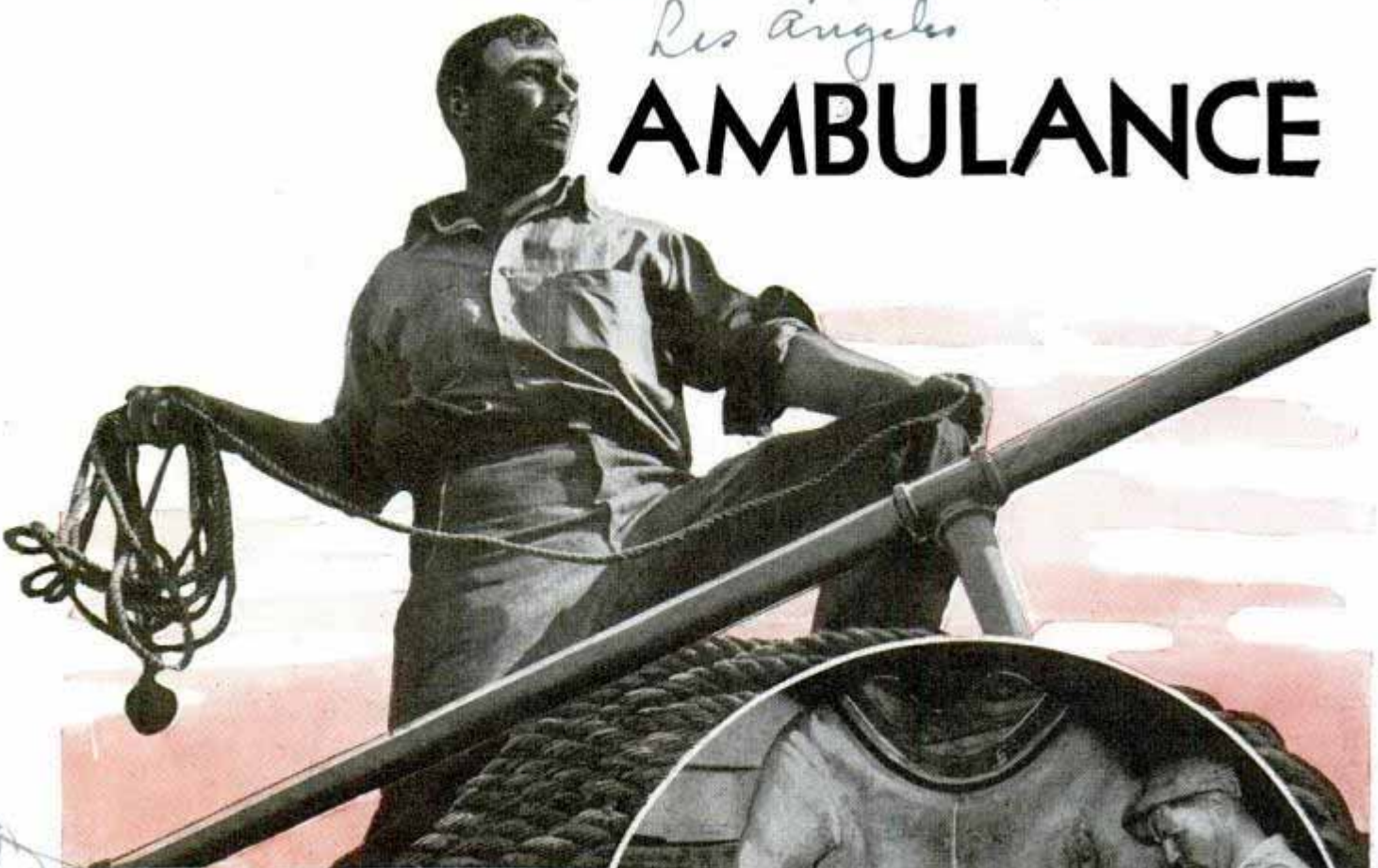

Above, tossing a line from the "Retriever" to disabled vessel. Right, inspecting rubber diving suit for leaks; below, salvagers sinking pontoon alongside sunken hull

**P**LOWING through the big seas of a storm, skirting close to dangerous reefs, or poking her nose into desolate bays, the salvage tug "Retriever" is a welcome sight when a ship piles up on the west coast.

She is apt to be found anywhere between Panama and California on her way to a rescue. Large ships rarely get into trouble and most often the "Retriever's" task is to salvage a big yacht or some husky tuna clipper that has gone ashore or is pounding on the rocks.

Recently the ship left Los Angeles for a fast run to the Galapagos Islands, 2,600 miles away. Repairs had to be made to the intermediate shaft of a tuna clipper. The job finished, the rescue boat was well on its return when new orders came in by radio. "Yacht 'Sans Peur' on the rocks off Espiritu Santo Island in the Gulf of California," came the message. "Needs your assistance." Captain E. D. Brown got in touch with the

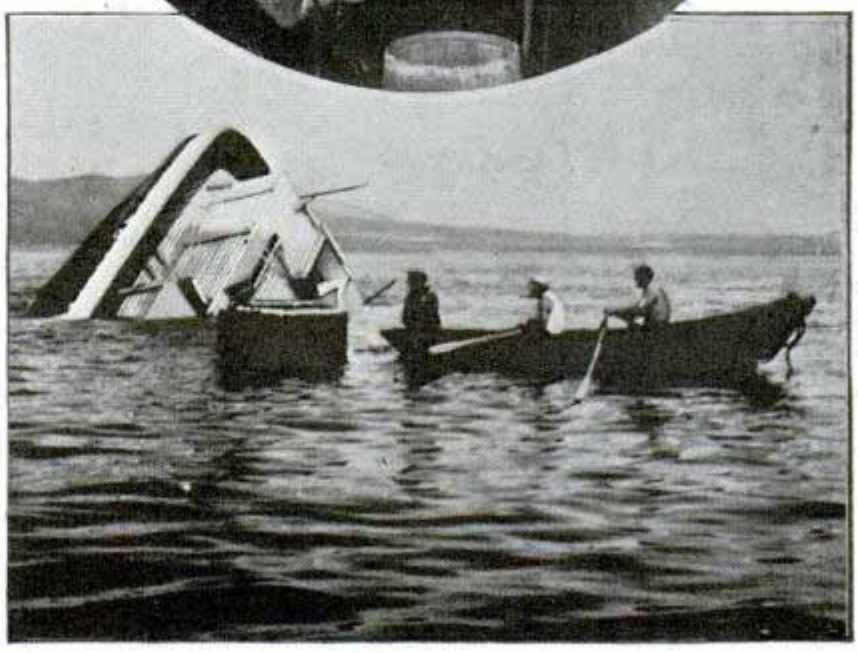

of tug Retriever Harbor Island, Galapagos  
Terminal Island, Calif



# *for* CRIPPLED SHIPS

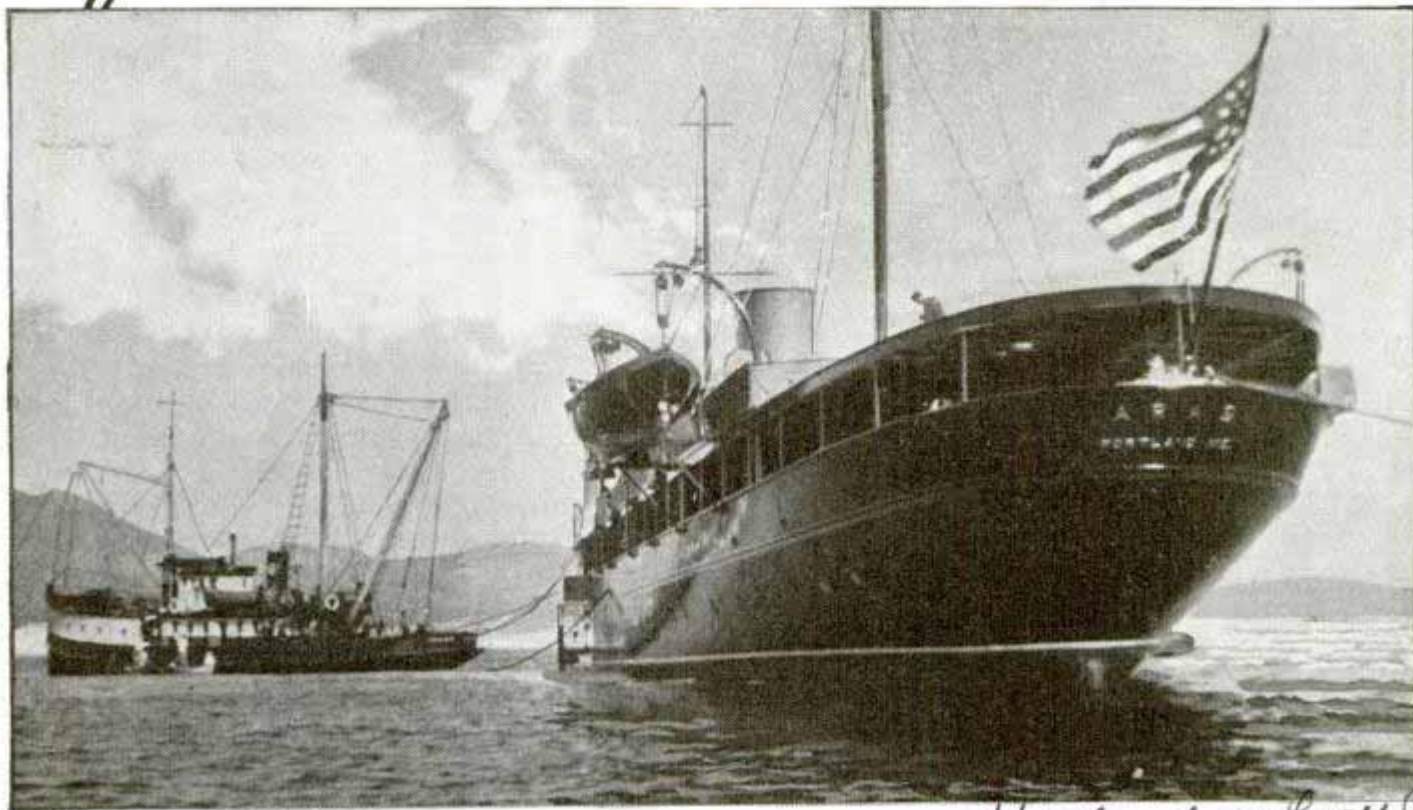

*off island on Lavee California*

yacht by radio, then called Los Angeles back to order his diver, who wasn't on board, to meet him at a Mexican port.

The "Sans Peur" was a 200-foot steel English vessel and her captain had gotten her off the rocks and she was anchored, partly flooded, off a beach where she was safe unless heavy weather set in. The hull had opened up under water but Brown and his crew made her watertight again. The diver plugged the

**Top, "Retriever" moored alongside big steel yacht which she has refloated after patching hull. Bottom, long-range radio set used in rescue work and a wrecked tuna clipper being raised from bottom after divers have mended holes in her side**





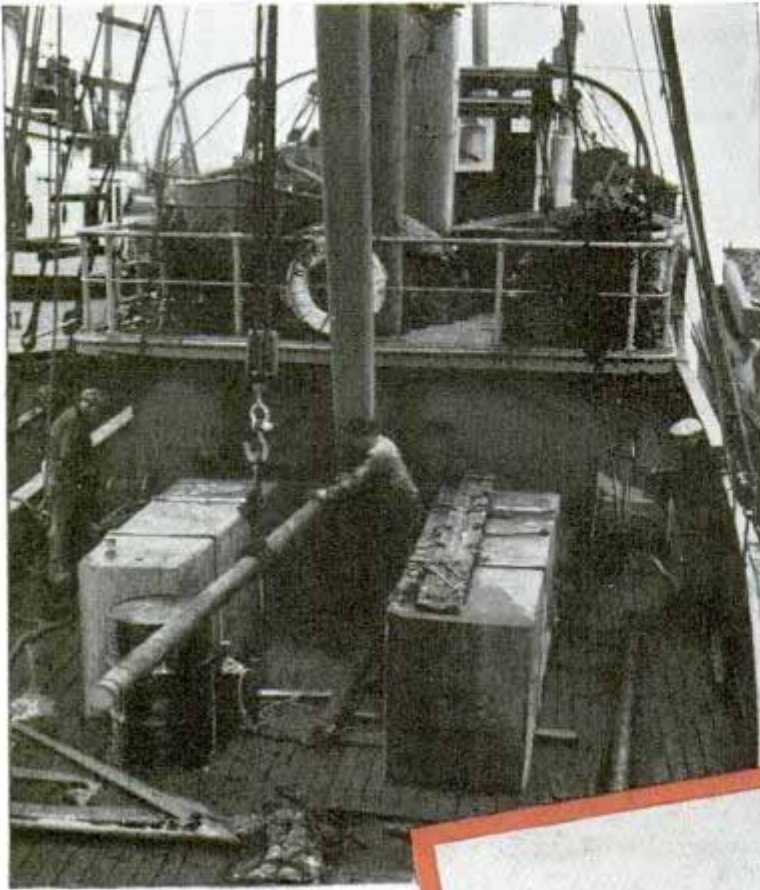

When the ship is in port at Los Angeles and a first-aid call comes in it takes less than half an hour to rally the crew. Buck Scougale, first mate, lives close by. Diver Dan Boom and his tender, H. W. Stroele, are called by phone. Harold Keith, engineer and radio operator, usually is on board. Half a dozen experienced seamen complete the crew.

Salvage laws are not what they used to be and it is no longer true that an abandoned ship becomes the property of anyone who boards her. Almost always the title rests with the owners until they renounce it, after which ownership

(Continued to page 122A)

cracks with wooden wedges driven securely into the seams. The ship was pumped out and a big concrete poultice was applied inside to the damaged area. Then she was able to reach a shipyard under her own power.

The "Retriever" is an old ex-army tug, 100 feet long. Her original steam engine has been replaced with a 350-horsepower Diesel. On her way to a rescue job she may be loaded down with salvage gear until she looks like a floating junkshop. Pumps, diving gear, beach cables, towing hawsers, air compressors and pontoons clutter up her decks. In the machine shop down below the crew can manufacture nearly anything they may need, from a "pudding patch" of two by twelve timbers, canvas and oakum, to the steel bolts that a diver may have to fit into holes that he cuts in the side of a wreck to hold the patching material tight against the damaged hull.

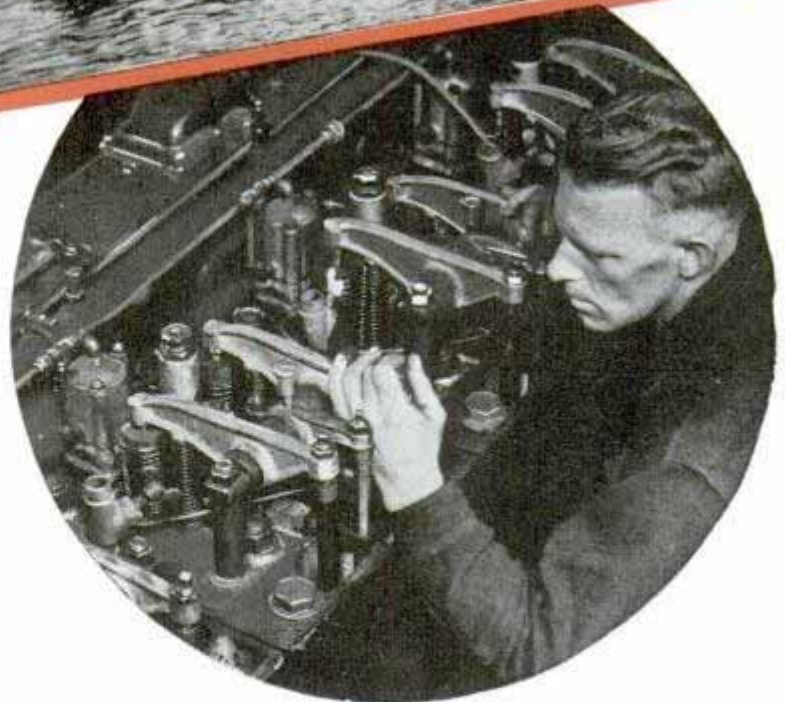

Deck of salvage ship, top, is crowded with every rescue gear useful in emergencies. Notice extra fuel tanks. Wrecked boat in center, with decks awash, was patched, pumped out and towed 1,000 miles to port. Below, valve assembly of Diesel engine



21056

*Sup't. Pomona City Schools  
and S. Howard, Pomona  
Recreation Dept. Pomona Calif.*

# Model Railroad and Village Built Out of Doors

Built and operated out of doors, a model railway system with 220 yards of road has tiny ties laid on actual roadbed, following a scale of one-half inch to the foot. Automatic block signals and switches are of the most modern type, and the train is completely equipped inside. Copying one of the transcontinental trains, two model fans of Pomona, Calif., spent seven months at their hobby, making everything themselves even down to patterns and castings from which the smallest parts were fashioned. They chose as the setting a miniature town and included Indian pueblos and other scenic features that are so realistic as to deceive even the camera.

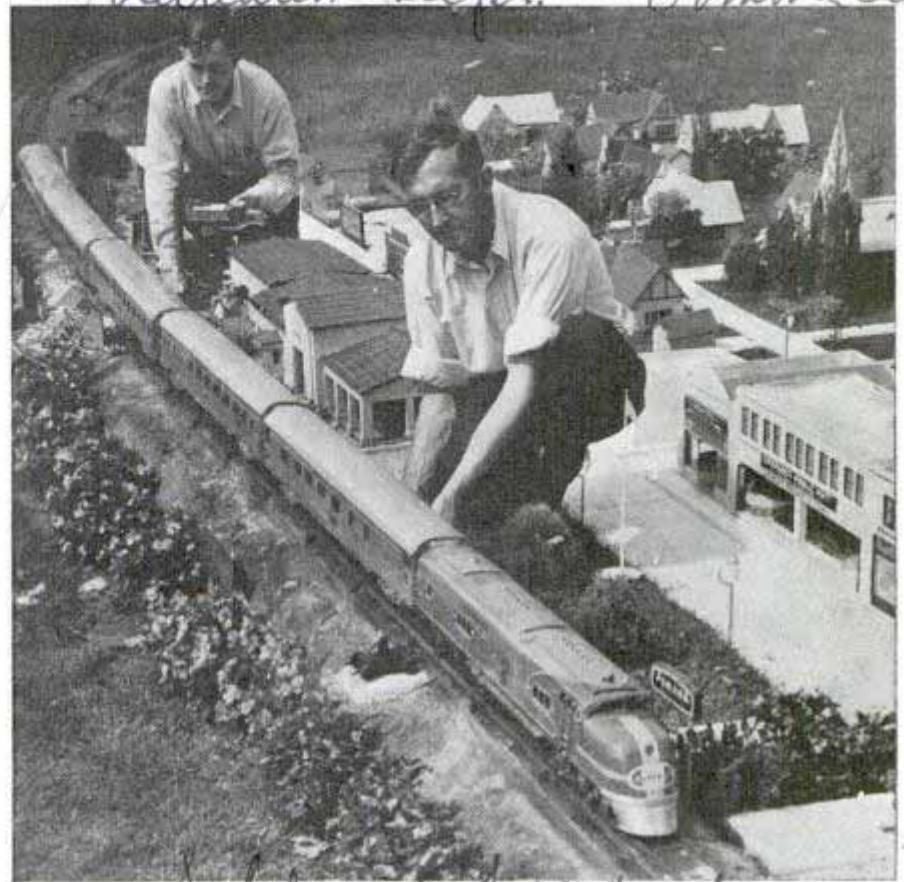

*Sorbelman & graduate*  
Model builders making adjustments in their miniature town complete with tiny streamliner operated by switches and running on 220 yards of track

*2752*

# Electric Bulb Changer on Long Pole Reaches High Ones

Electric-light bulbs in ceilings and other places out of reach without a ladder, can be changed in safety with a pole that has

a suction cup at one end for gripping the lamp. One cup is designed to hold bulbs of many different sizes, and a string attached to its edge is pulled to release the lamp when secured in the socket.

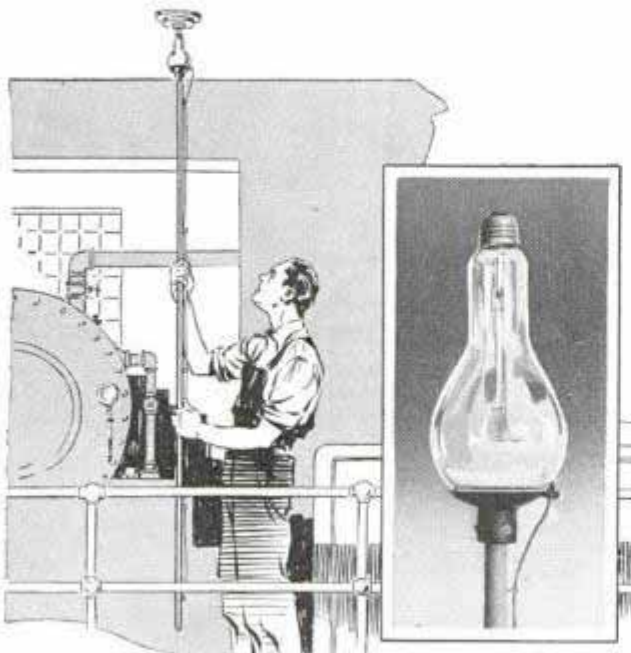

Bulb changer easily reaches burned-out lights in ceiling. Inset shows suction-cup arrangement

*21060*

# Radio Helps Keep Bands Tuned by Broadcasting Musical Note

The musical note A above middle C is now kept on the air by the national bureau of standards in a continuous radio broadcast over station WWV with a frequency of five megacycles, so there is no longer any excuse for ill-tuned instruments. Interruptions occur only during short periods when the bureau uses the same frequency for other broadcasts, and every ten minutes the call letters of the station are given to insure identification. The accuracy of the pitch as transmitted—440 cycles per second—is better than one part in ten million, far beyond any musical requirement.

*Suction Cup Lamp Changer 2752*

*Science Service*







# Aerial Mine Field Guards Against Plane Raids

BALLOON  
FIVE FT.  
IN DIAMETER



WIRE  
40 FT.  
LONG

BOMB

## THE AERIAL MINE

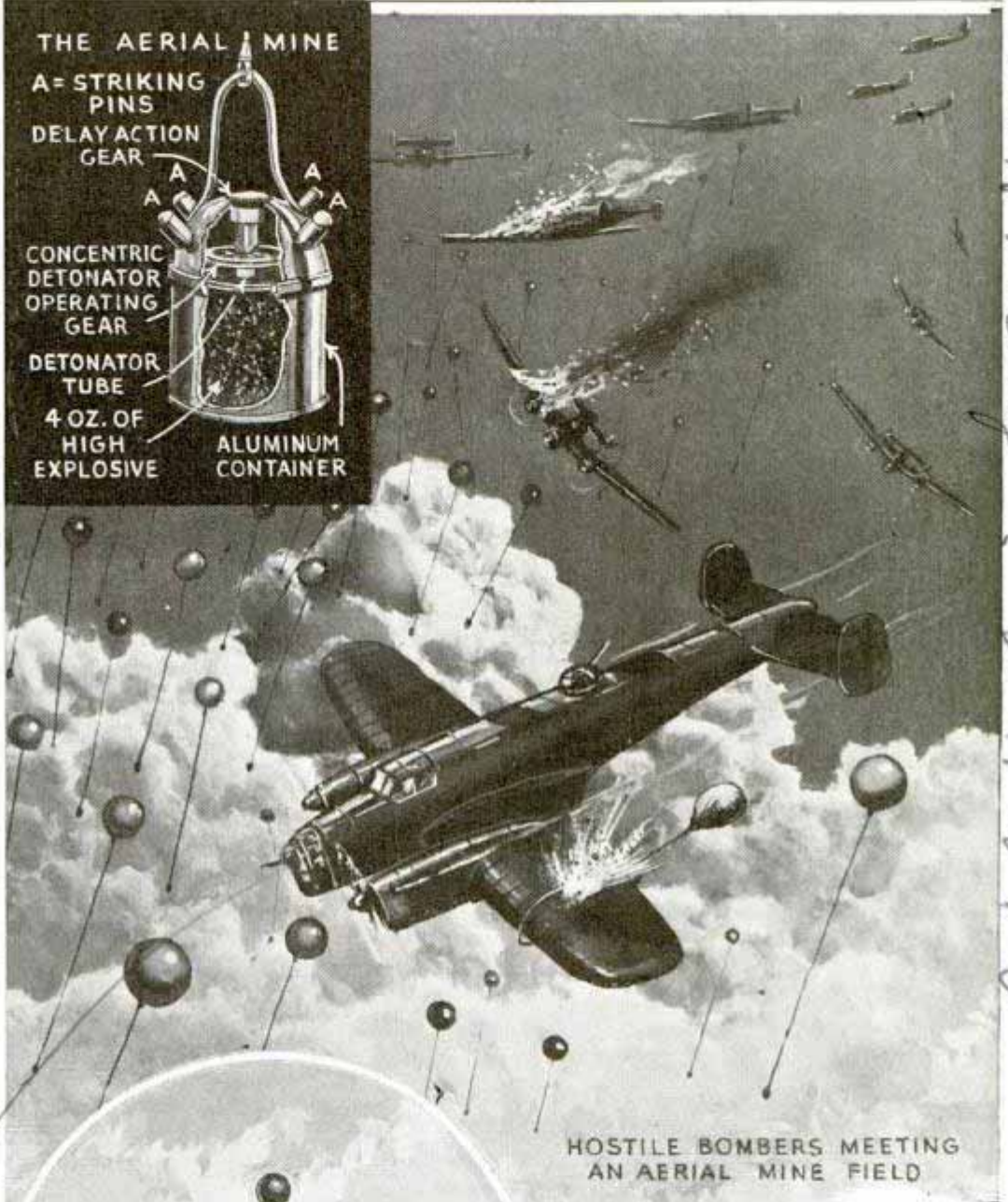

HOSTILE BOMBERS MEETING AN AERIAL MINE FIELD

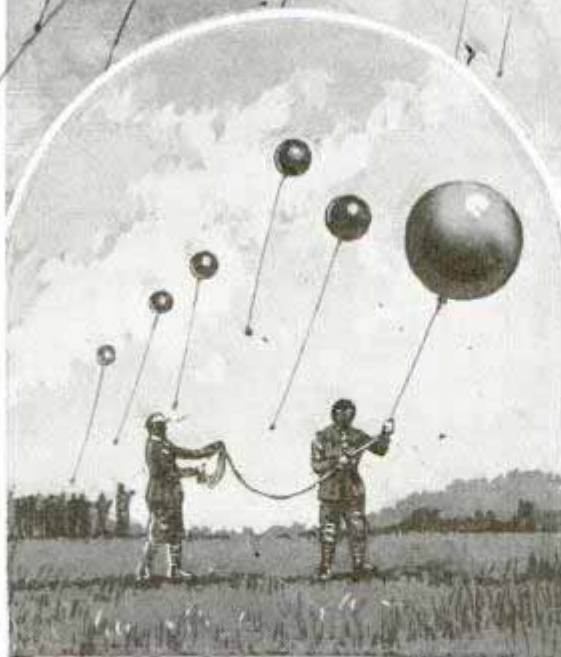

TWO MEN CAN RELEASE THE MINE BALLOONS AT THE RATE OF ONE EVERY 30 SECONDS

Here's how the aerial mine field, invented for protection of England against enemy air raiders, is intended to be used. Hundreds of hydrogen-filled balloons, each five feet in diameter, are sent aloft, perhaps to 30,000 feet, with small bombs suspended by long wires. Aircraft striking one bomb would be damaged severely, perhaps disabled. It is claimed the balloons can be regulated to float at the altitude desired. Cost of the aerial mine is said to be small, thus permitting its use in large numbers for the protection of cities and military objectives

Cont. L.S. H. Davies - Simms Hillside Road, Ewell, Surrey, England



# Mixing Speed Is 'Tuned In' by Dialing Name of Food

*Chicago Flexible Shaft Co. Roosevelt Road and Central Ave. Chicago*



Close-up of dial, in inset, shows how names of food are lettered opposite numbered speeds to guide cook

Whatever the food to be mixed, the housewife simply "tunes in" to the correct speed by dialing its name printed on the automatic selector of an electric mixer now on the market. Whether the task is creaming the butter and sugar for a cake, blending salad dressing or whipping potatoes, the proper mixer speed for it is plainly indicated on the dial.

*21032*

## Paint Resistant to Decay Has a Charcoal Base

*Kar-Com Seal*

Objects of ancient civilizations, which have passed down to us in a good state of preservation, indicate that charring is one of the oldest forms of preserving wood known to man. With a formula recently developed it is possible to char many building materials, including metals, concrete, brick, plaster, roofing, canvas, paper and all types of wood. The base of the product, which has about the same consistency and covering qualities as paint, is

*21033 4/10/4*

*as in Menzies Products 106 S. Hedman Av. W.*

charcoal obtained by burning hardwood to 800 degrees Fahrenheit. It is black and can be applied easily with a brush or a sprayer, and when applied it forms a hard, permanently bonded, non-porous, flat black coating of carbon resistant to moisture, fungi, salt, termites and acids.

*2983*

## Newspaper Is Made Fireproof by Liquid Compound

Any inflammable material such as wood, newspapers, silk cloth and straw hats can be made fireproof, it is claimed, by treatment with an odorless, colorless and tasteless fluid



invented by an Italian chemist. His compound has a mineral base dissolved in water, and when approached by flames the treated material gives off a gas which forms a protective layer between the substance and the fire. Besides being given a fireproof "life" of eight to ten years, substances so treated are made thirty per cent more resistant to ordinary wear and tear, the inventor says.

*21028*

## Portable Grade-Crossing Signal Is Operated by Wireless

Useful for emergency or temporary installations, a portable railroad-crossing signal operated by radio may be moved to

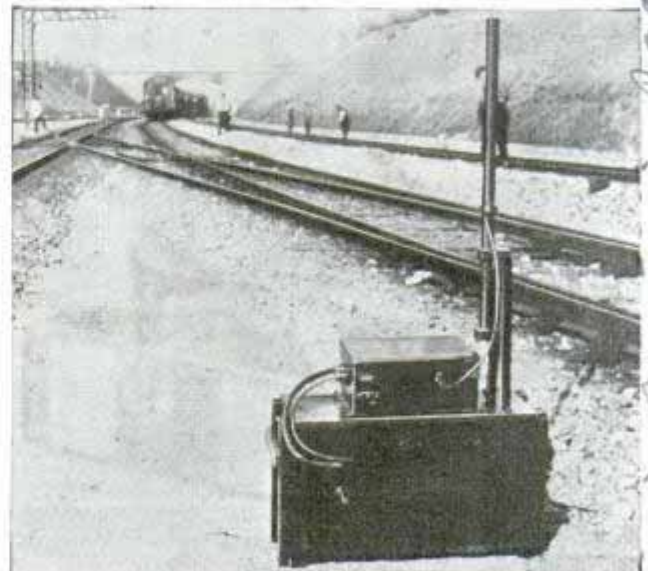

Wireless warning signal can be moved along track

*Perth, British Columbia. Electrician, Lowell. 55. True wireless, 2011 Sargent*



any section of the track to protect workers as well as pedestrians and motorists. At one end is a transmitter radiating a constant signal on a five-meter wavelength. A radio receiver at the other end operates a relay which is normally held closed by the regular signal. As soon as reception is interrupted, the relay opens and sounds a loud horn to warn that a train is approaching. Each set is carried in a small case mounted on top of a larger one containing a six-volt battery. They are shifted along the track as a section gang progresses.

21023  
**Hydraulic-Drive Diesel Engine Hauls Heavy Loads Smoothly**

Three loaded coal cars were pushed up a five-per-cent grade from a standing start, halted midway of the climb and then resumed the ascent in a demonstration recently of the smooth power of a Diesel switching engine equipped with a hydraulic torque converter. As many as 107 empty cars were handled with ease on a three-per-cent grade by the six-cylinder Diesel locomotive. The new hydraulic transmission consists of an American designed hydraulic torque converter and hydraulically engaged and disengaged gear sets, the shifting being accomplished by a lever at the operator's control stand. The converter, with only two moving parts, runs in an oil bath with sufficient clearance between the rotating parts to avoid wear, and since there is no mechanical connection between engine and transmission, the power delivery is smooth and devoid of road shocks.

**Coin Counter and Sorter Never Makes Mistakes**



Coins poured into hopper are sorted and then counted as they clink along into the right money sack

Millions of coins are counted each year by a complex machine that never makes an error. The money-counter handles all the tolls paid on the San Francisco-Oakland Bay bridge. More than \$5,000,000 a year paid by motorists clinks through the machine which shakes it in the hopper, sorting the coins into sacks and recording the total of each denomination.

21011  
**Upside-Down Stunting Airplane Lands Safely on Its Back**

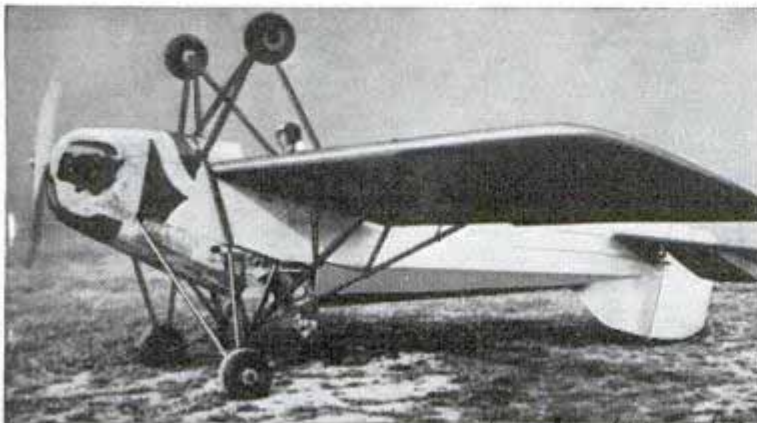

Stunt plane with twin pilots and twin sets of landing wheels can turn turtle in air and make three-point landing on back

You really see double when you look at a topsy-turvy plane designed for stunt flying. Besides the conventional landing gear and cockpit, the ship has an extra set of landing wheels on its back and a cockpit where a second pilot "sits" head downward. The plane can turn over in the air and land on its back.

☐ A Philadelphia violin maker has made a bow of 150 stainless-steel "hairs" 1/2,000 inch in diameter.

Carp. Hamilton Ohio

Toll Serge John Prof...

Berkeley Calif  
 703 Santa Barbara Ave

Michael Murphy  
 Saint Fil...

Joseph Primavera  
 130 S. 8th Phila



# Mask Made of Rubber Bulb and Football Bladder



*Andy Arnold Photos*  
Pilot wearing his homemade oxygen mask made of rubber bulb and football bladder

By joining together a football bladder and a rubber bulb, with a valve between them, Art Bussy, racing pilot, designed a homemade oxygen mask which he used in the 1939 Bendix air race. The bulb, of the type used with battery hydrometers, was formed to fit over his mouth and nose, and the valve permits escape of exhaled air. Oxygen under pressure is fed gradually into the bladder and from there it is inhaled with ease.

# Expanders Seal Piston Rings at Wall, Groove and Gap



An unbroken oil seal in the cylinder is claimed for a multi-piece piston ring. Seven expanders force it against the wall, and also spread the ring in the

groove to insure a snug fit. Another expander, wedge-shaped, pushes against the gap in the ring to keep it closed at that point so oil will not seep through, at the same time preventing rotation of the ring. Inside each expander is a coil spring that takes up normal wear automatically.

# Camera Snaps Deep-Sea Scenes at Depth of Two Miles

Photographs two miles down in the ocean have been snapped with a massive, automatic deep-sea camera and lighting arrangement invented by Prof. E. Newton Harvey of Princeton University. The submarine device has two windows of extra strong glass to resist the two-ton per square-inch pressure encountered at that depth. The camera looks through one window and a beam of light is projected through the other. A timer operates the electric lamp and camera at predetermined intervals, and a motor winds the film.

# Model Plane Kept on Even Keel by Pendulum Hung Beneath

Annoyed by frequent "crackups" that all but wrecked his tiny plane, a model builder designed an "anti-dive" pendulum that keeps the frail craft on even keel in the air and brings it down invariably to a

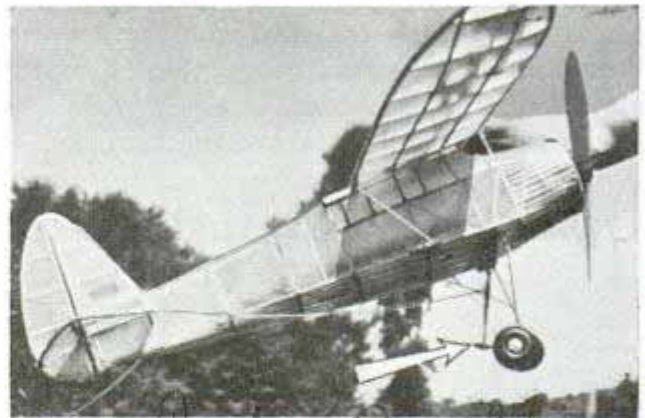

*Andy Arnold*  
Arrow points to pendulum which swings under model plane, automatically keeping it on even keel

perfect landing. The pendulum is suspended in a ball socket under the fuselage. If the plane goes into a dive, the pendulum swings forward and pulls on control lines leading to the elevators, thereby righting the ship. Cross controls similarly prevent too steep a bank or turn.

*Work - Oute Products Co. cl no. Ed Carsten's  
148 - 44th St. Toledo, Ohio  
211 Warrensburg, Mo.*



# Nonstop Plane Handles Mail on 'Rural' Route

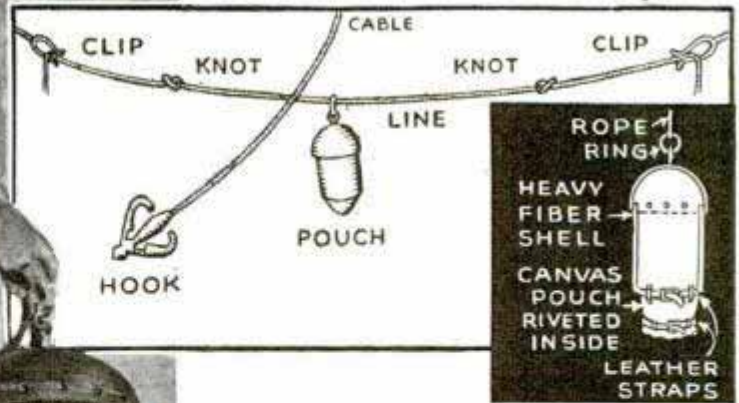
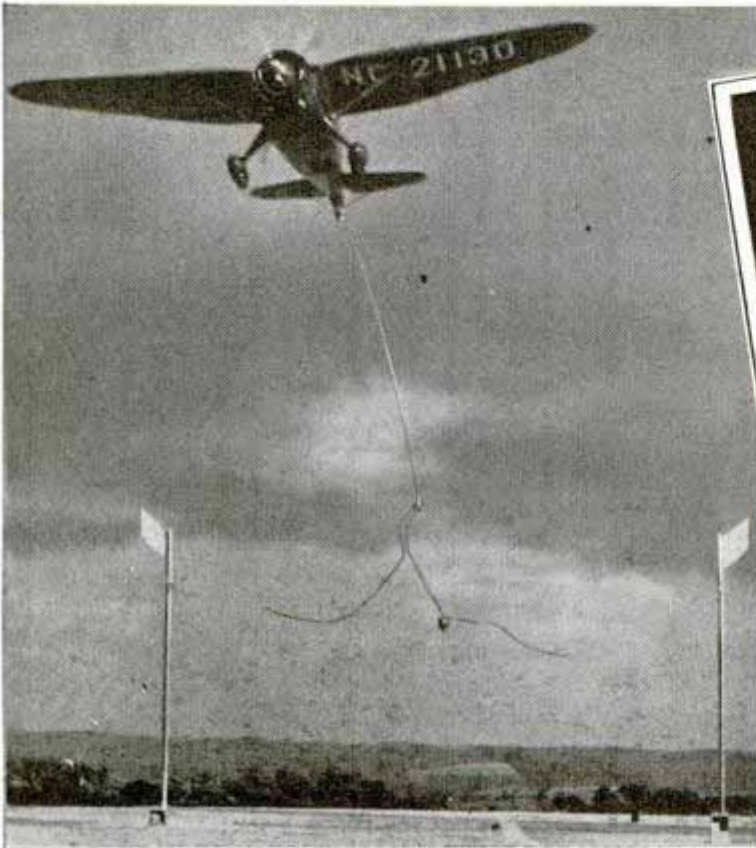

Communities inaccessible by rail or located in rugged country are being served by nonstop planes that pick up and deliver mail. At each point on the modern "rural" route, the plane drops a pouch and picks up another suspended on a line between two tall poles. A grappling iron let down by the pilot engages the line so the mail bag may be hauled into the plane. Top, left, dropping pouch and picking up another. Right, the grappling iron. Center, sketch of pickup system. Bottom, left, mail clerk emptying pouch to take letters by auto to the post office



2749

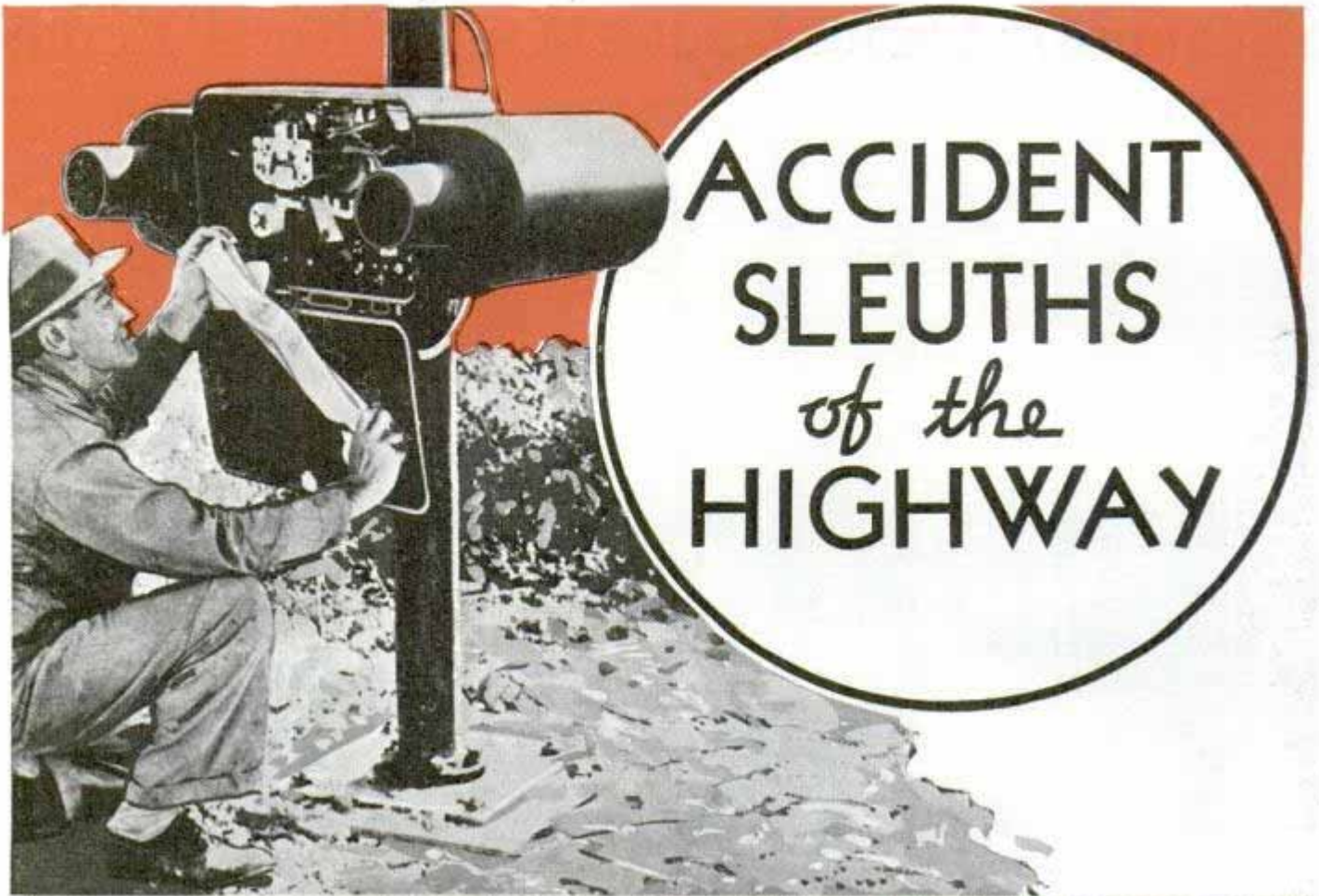

Top, automatic recorder registers flow of traffic on tape. Below at left, narrowed center island allows extra lane for left-turn traffic; right, reflector fins outline curb at night

THEY'RE fighting highway accidents today with pencil and paper and cameras—and getting results. Preventive medicine for traffic tragedies rides in the same patrol car with first aid for the victims of the latest collision.

No sooner does word of an accident reach the police radio dispatcher than he's at the microphone directing the nearest

By James McQueeney *Kansas City, Mo*  
*431 W. 60th Terrace* squad car to the scene. Then he gives the order: "Accident Investigation Car No. 3 proceed to Sixth and Main—motor car crash."

Upon their arrival, the investigators, trained in first-aid methods, treat the injured. Then out come cameras and report sheets to translate the accident onto film and paper. Their scientific report is the backbone of the new science of saving lives





in the streets and highways. Until a year or so ago, an air of hopelessness hung over the motor-death problem. Statisticians calculated that one child in three was born to be killed or seriously injured by a motor car. But last year the motor-death graph, instead of continuing its upward trend of the last two decades, shot downward. Fatalities dropped from 39,643 to 32,000; the appalling injury toll and financial loss from accidents showed corresponding decreases. A few cities and states, not the entire country, were responsible for the change. In virtually every instance, the scientific accident report figured prominently.

No better example of its worth can be cited than in New Jersey. On the far-flung federal system of highways, the average daily volume is 1,700 to 1,800 motor vehicles, yet in New Jersey, over Route 25, from the Holland Tunnel, via the Newark airport through Eliz-



*Traffic commissioner puts reenacted highway accident under microscope, top. Below, warning at danger spots is a preventive*





the maximum safety for a minimum of expenditure. His first step was to select four typical stretches of roadway ranging from three and three-tenths to twelve miles in length as "accident laboratories." Twenty-four-hour accident patrols were launched, three men alternating every eight hours, riding back and forth continuously, over five-mile stretches; traffic counters were stationed at strategic locations to record traffic volumes and establish ratios of accident rate and traffic flow. Cruising back and forth along the sections assigned to them, the investigators are prepared to swing into action at the crunch of a fender. Their reports are a study in completeness; the time of the accident, condition of cars and drivers, weather, road conditions—all data pertinent to analysis of the cause of the crash. The report is submitted to safety engineers who analyze the contributing factors and classify the crash under one of several types.

(Continued to page 121A)

abeth and the Woodbridge Clover Leaf, an average of 60,000 vehicles travel every day. Last summer, a record flow of 102,000 cars passed a check point between Newark airport and Elizabeth during a twenty-four-hour period.

Owing to this congestion, an average of four persons were killed and twenty-four sent to hospitals every day in 1937. It would have taken many millions to make New Jersey's highways accident-proof. Only limited funds were available, however, so E. Donald Sterner, highway commissioner, set about to provide



*When accident investigation car is on emergency call, operator darkens its light on board, top. Center, interviewing driver after crash. Below, patrol cars spotted on Kansas City map*



*Washington Ave and 168 N. Seward*  
**Half Brain as Good as Whole One  
 Surgery Finds**

Removal of brain tumors by surgery has brought out the paradox that half a brain is as good as a whole one and much better than three-quarters. Actual improvements in personality have been noted in persons after removal of one of the two frontal lobes in the forebrain, seat of human intelligence, according to a report of Prof. Byron Stookey, brain surgeon of the Neurological Institute of New York City. Such persons were found to make quicker decisions than when the whole brain was functioning. However, when one of the two frontal lobes was only partly removed the operation was followed by emotional instability, listlessness and indifference.

*Chicago Tribune 10/29/37*  
**Players Test Their Strength  
 with Football Power Meter**

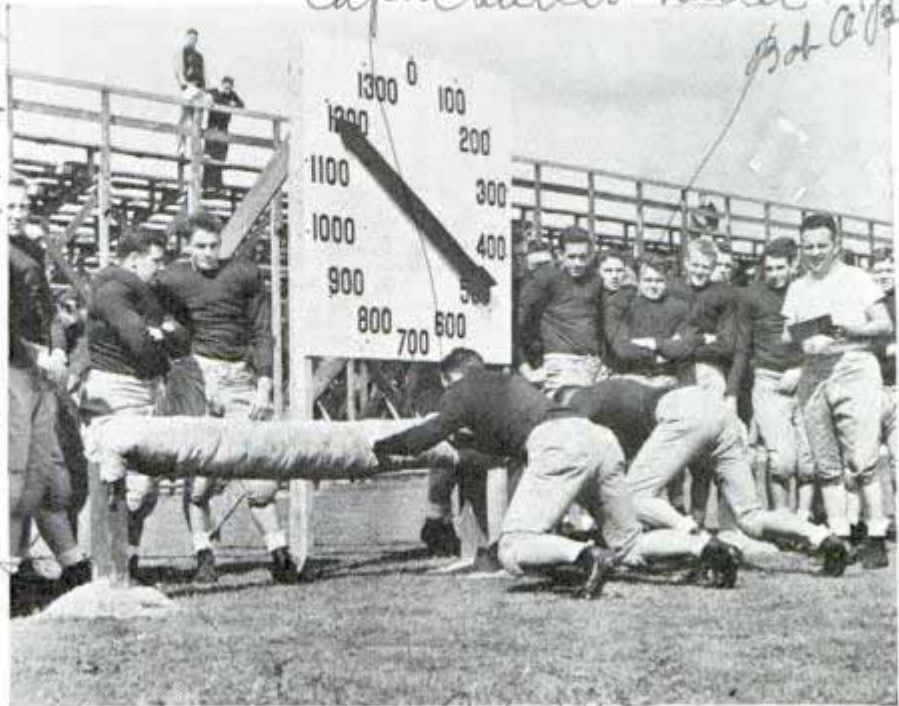

*acme*  
 Football players bucking against power meter to test their blocking strength. Pointer on numbered dial indicates amount of force used.

*Hanover, N. H.*  
 Football players of the Dartmouth team demonstrate their strength by pushing against a "power meter" that registers the amount of force applied. The coach thus can test the power of his men either individually or in groups to obtain information that may be of value in preparing the lineup.

*2 10 29*  
**Polarizing Filter on Lens Pivot Is Sighted over Camera**



Photographer looks through polarizing filter to adjust it, then swings it in front of camera lens

Accurate adjustment of a polarizing filter for cameras is possible with a pivot mounting attached to the lens. The polarizing screen is free to turn in a collar, which is pivoted on a clamping ring that, in turn, fits over the camera lens. This assembly permits the screen to be pivoted from its position in front of the lens to a point above the camera, where the photographer may look through it and turn the screen until the desired angle is obtained. Then when the polarizing screen again is swung in front of the lens its angle is the same.

Our Bureau of Information keeps on file the names and addresses of makers of, and dealers in, all devices described in the pages of Popular Mechanics Magazine. We are glad to furnish this information to our readers upon request, accompanied by stamped, self-addressed envelope.

*E. Leitz, Inc.*  
*1 number*



# Windshield for Bike Rider Gives Dust Protection

*Bronco & Co*



Bicycle rider is protected from wind, rain and dust by windshield mounted on handlebars

Protection against wind, dust and rain is provided by a neat windshield that fits on the front of the bicycle. In addition to reducing wind resistance with its curved surface, it saves the rider's clothing from dust and dirt tossed back by vehicles ahead.

## Automatic "On-and-Off" Switch Controls Electric Burner

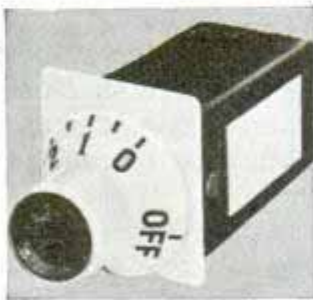

Variable heat control for electric hot plates and top-of-stove burners is afforded by a switch that turns the current off and on intermittently. Matching the flexibility of a gas-stove burner, the switch can be regulated to supply any amount of heat from a low simmering point to the burner's

*No. 11 Sagel Knave*

highest capacity. It is not intended for ovens since it does not regulate the exact temperature, but merely varies the power input by opening and closing the electric circuit for specific time intervals. The longer the "off" and the shorter the "on" periods, the lower the input will be, and consequently the less intense will be the heat. Any degree of heat desired for cooking is selected by turning a knob.

## Fabrics Made Water-Repellent by Chemical Finish

Clothing can be made water-repellent permanently by a chemical that withstands laundering and dry cleaning and that cannot be removed by any known solvent. Use of the chemical, an ammonium compound, for coating the clothing of armies is seen as one possibility. The clothing will not become heavy with rain or perspiration, yet the chemical does not close the pores of the fabrics, allowing evaporation of perspiration which helps to keep the body cool.

## Exercising "Swing" on Wheels Is Rowed Back and Forth

Exercising is made a pleasure by the invention of a rowing machine that travels as you row. It is a four-wheeled scooter attached to the ceiling by giant rubber bands. The operator pulls himself back and forth by grasping the two bars, and at the end of each swing the machine comes to a smooth stop.



When bars are pushed and pulled in rowing fashion, exercising "swing" is propelled back and forth

*Inv. Chris. Carsten*

*Internat. M. Co  
712 Beacon St.  
Boston  
St. Joseph  
Albany, N.Y.*

*Jelan*

*21044*

*2980*

*Wilmington, Del.  
in France*

*Bluelath*



Carter Carburetor Co 2838 N. Spring Ave. Chicago Ill

91008.  
**Ceramic Filter For Auto Cleans Fuel of Particles**

Foreign matter may be removed from gasoline by using a new ceramic filter developed for automotive engines. The makers claim that it will keep out particles fifteen times smaller than those visible to the eye. A top thumb nut clamping feature facilitates cleaning of the bowl or changing the cartridge. Pulsations in the line are cushioned, assuring an even flow of gasoline to the carburetor.



2700.  
**Big Funnel Gauges Sky Heat and Helps the Weatherman**

see Nov. 1938 - 696

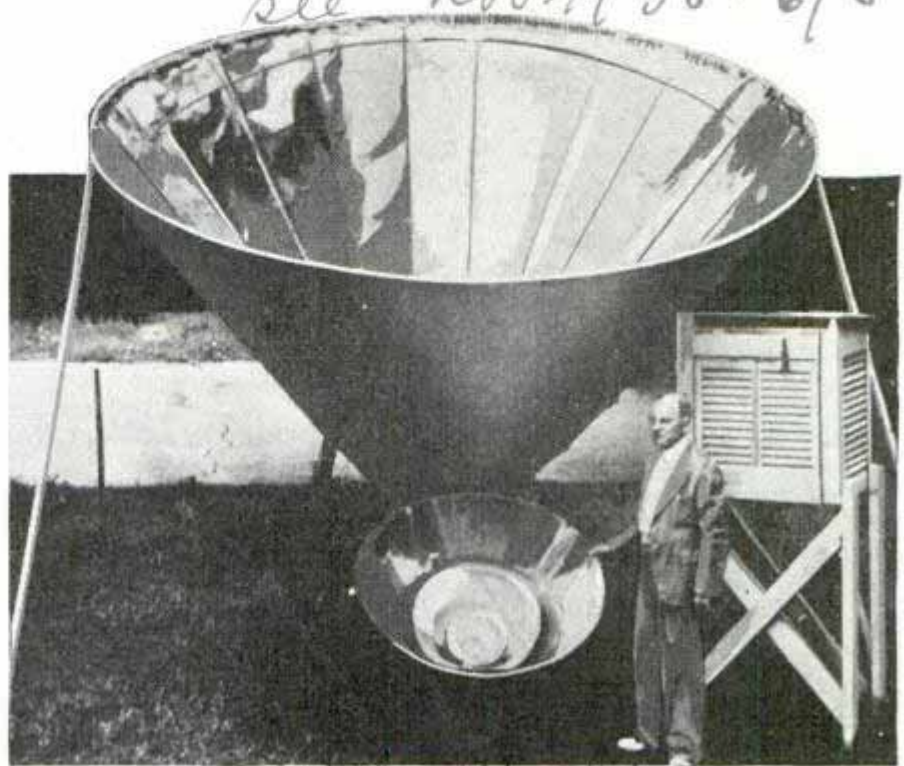

Inventor is shown with giant funnel with which he claims the temperature of a drop of water one mile up can be measured

Devised to measure the temperatures high above the earth, a giant funnel-like instrument has been developed as an aid to the weatherman. By concentrating the light of the sky on a "cascade" of mirrors, the inventor, Dr. C. H. Heck, claims that he can detect changes in temperature in the upper atmosphere which make possible the prediction of the weather for the next twenty-four hours.

2965  
**Tulip Harvester and Crew Dig 20,000 Bulbs per Hour**

Operated by a crew of seventeen men, including the tractor driver, a tulip harvester handles 20,000 bulbs, or about eighty full boxes, in an hour. Standing along the sides of the twenty-three foot machine, men sort the valuable bulbs as they are carried toward the rear by endless belts. It rides on four sets of wheels, and the front section is articulated for convenience in steering at the ends of rows.



Men standing on running boards sort tulip bulbs as tractor-drawn harvester digs and moves them along on endless belt at rate of 20,000 an hour

Built by Moore Machine Shop, members of the...

for Vaughan Seed Co. 601 W. Jackson. Chicago



2762

# PUBLIC ENEMY

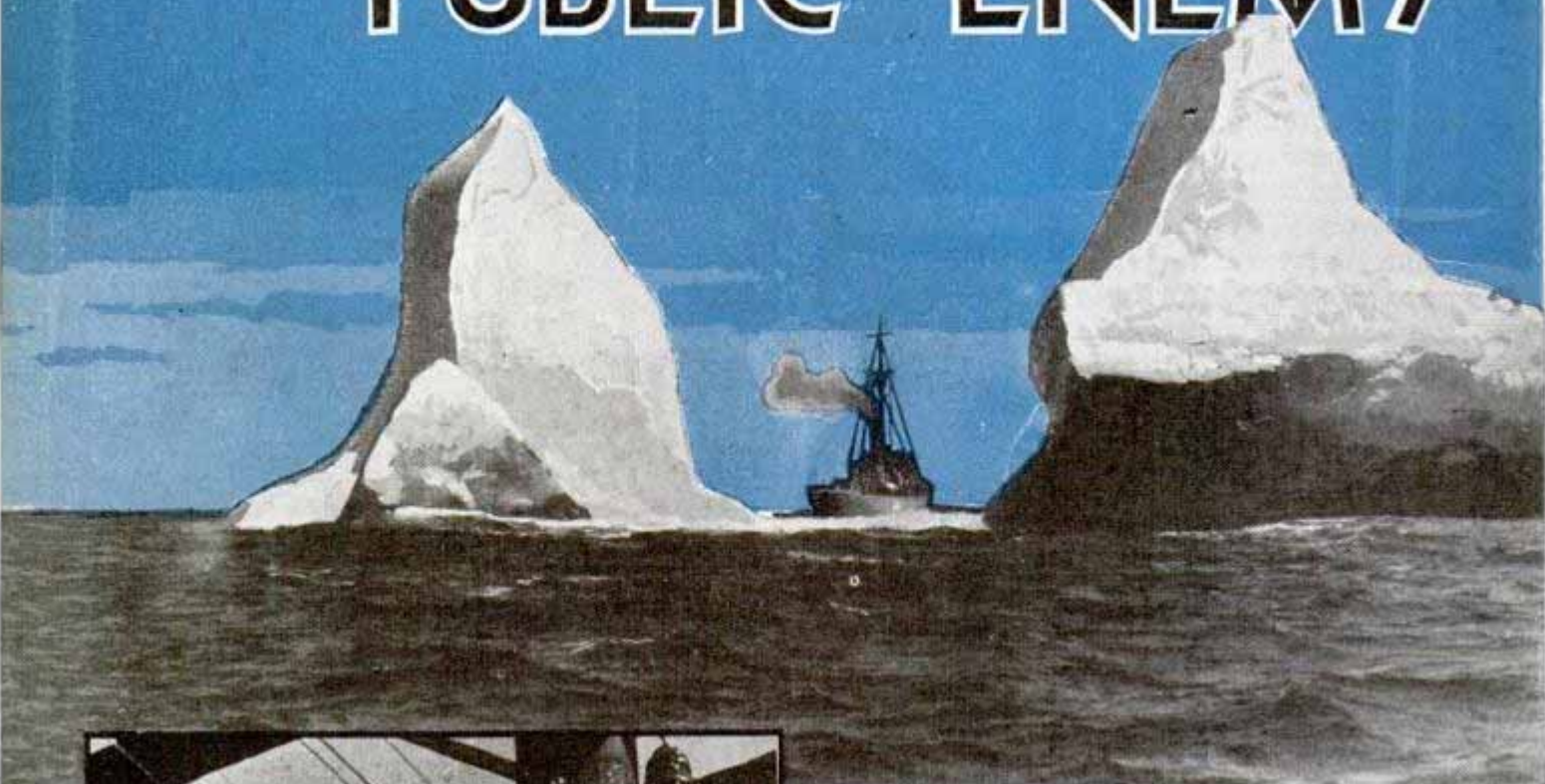

201 N. W. 1st St. - 1st Floor

**W**HEN Arctic winds sweep down from the north, when the mercury plunges toward zero, when the weather man predicts snow or sleet or extreme cold, it means battle to thousands of men.

Our modern civilization is a tender thing, of delicately adjusted nerves and arteries. Block those nerves and arteries, block the means of transportation and communication, and disaster is close at hand. Cold weather, with its ice and sleet and snow, attacks us first through those nerves and arteries; and an army must be mobilized to fight it. That weather report you read in your evening paper is the mobilization order. "Colder," it says, "and snow or sleet." You dismiss it with a shrug, but down in the railroad terminal and freight yards grim-faced men are gathering. At the first flurry of snow, gas or oil heaters are lighted under switches and men patrol them with broom and pike. No ice or snow must be permitted to clog them so they will not open and close properly. Semaphore signals must be watched, for a coating of glaze or sleet will freeze them so they will not move. Often it is necessary to place watchmen at each of thousands of signals, to prevent their freezing by working them periodically by hand.

Winter's end marks the beginning of work for the International Ice Patrol. Coast-guard cutter, top, guards icebergs in north Atlantic shipping lane. Below, a lineman strings temporary wires after storm

Chesapeake Potomac Telephone



Mr. Herbert V. Webb, Apt. 3  
Buckingham Apts. 4322  
Second Road N., Arlington,  
Va.

# NUMBER ZERO

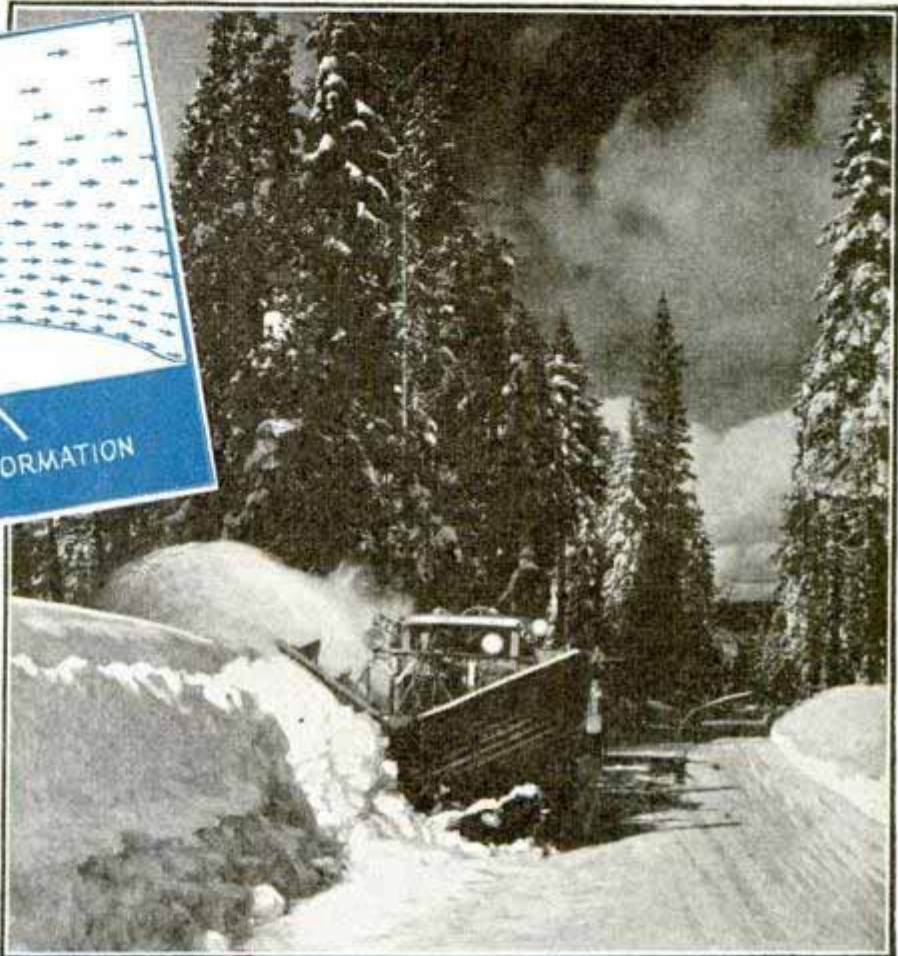
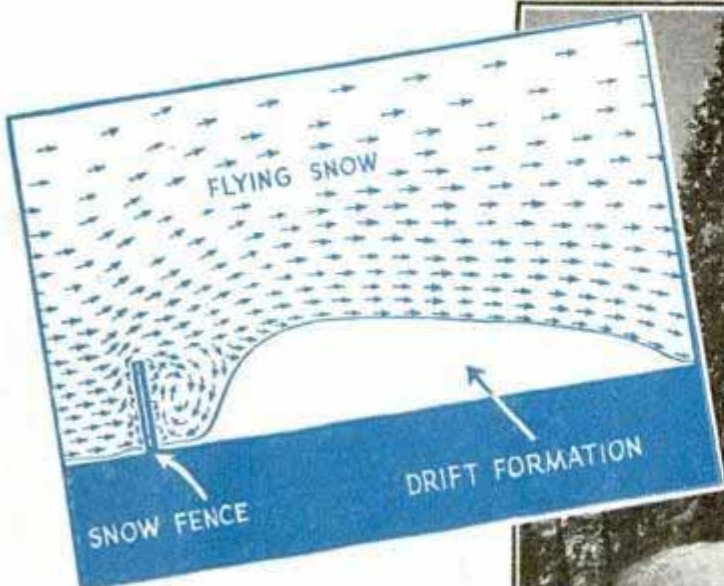

How snow fence controls formation of drifts (upper left); snow-plow clearing road in Sierras (right), and seven-inch deposit of wet snow on three-sixteenths inch electric-light wire (below). The snow weighs approximately fourteen ounces to the foot

Railroad men believe the way to lick a storm is to keep on top of it. Instead of waiting until snow is deep enough to stall a train, locomotives equipped with flangers are sent out to keep the tracks open; while great rotary plows stand by in case the snow gets too deep for the flangers. It is seldom that a mere snowfall can get ahead of them, but when high wind accompanies the fall, drifts several feet deep often pile up in a few minutes. In such cases snow trains are necessary—rotary plows pushed by two or more locomotives, with other cars for workmen and their tools. These men follow the train on foot, shoveling away loose snow from the tracks after a channel is plowed through the drifts.

Where drifts occur regularly, millions of dollars are spent to forestall them. In the mountain states snowsheds are built. In flat country one



Springfield Mo



*Worcester Mass.  
Nov. 26-29, 1921*

*2762*

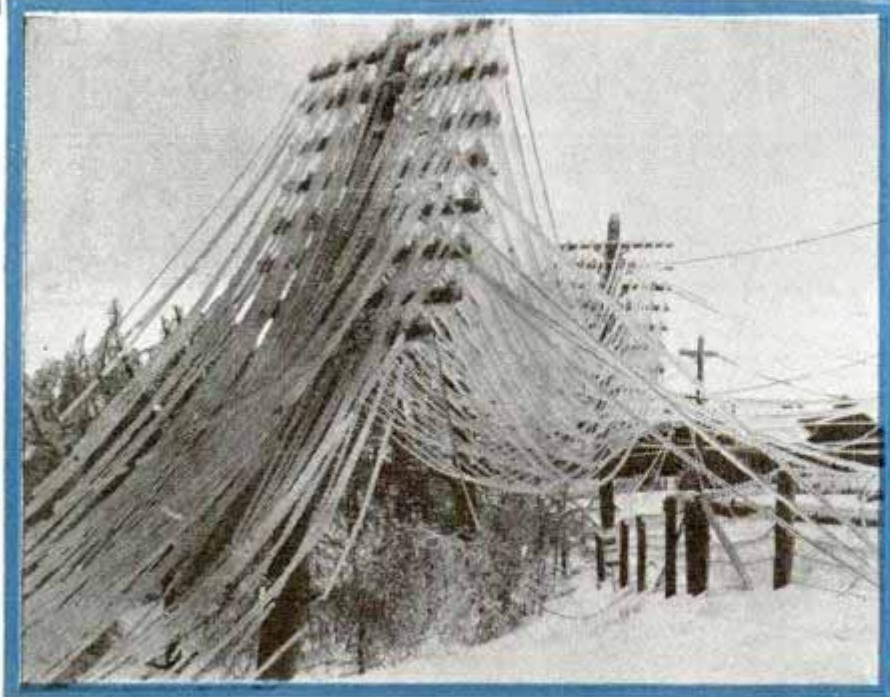

or slush tracked in by autos. Sometimes this can be cleared by pouring kerosene in the slot and igniting it, with a plow following to push away the resultant slush. In severe cases it is necessary to tear up all the plates along miles of line and clean the slot with hand tools.

But even when the transit company clears its own lines, its troubles are not over. Car-line streets are often the only ones open, and are quickly blocked by motor traffic stalling on the tracks, while the demand for

may see thousands of miles of snow fence erected beside the track. But despite these precautions, drifts have been known to pile up higher than a locomotive in two or three hours. The railroads spent nearly fourteen million dollars last year fighting snow and ice.

Street railways have the same problem, complicated by several other factors. Overhead wires collect icicles and glaze that prevent contact of the trolley. Special scrapers must replace trolley wheels to clear the wires. In Washington and New York, where the underground conduit system is used, the slot fills with drifting snow,

street cars trebles because most auto owners leave their cars at home during the storm. Automotive traffic also tends to pack the snow so hard on the tracks that it causes derailments. However, traffic is seldom tied up more than a few hours. In one heavy Chicago snowfall 1,111 miles of car track and 154 miles of bus routes operated all during the storm, and normal schedules were restored within twenty-four hours. But it took 1,500 snow fighters to lick the fifteen-inch fall, assisted by 220 plows and sweepers.

Seventeen million dollars is the annual cost of keeping our 217,000 miles of main

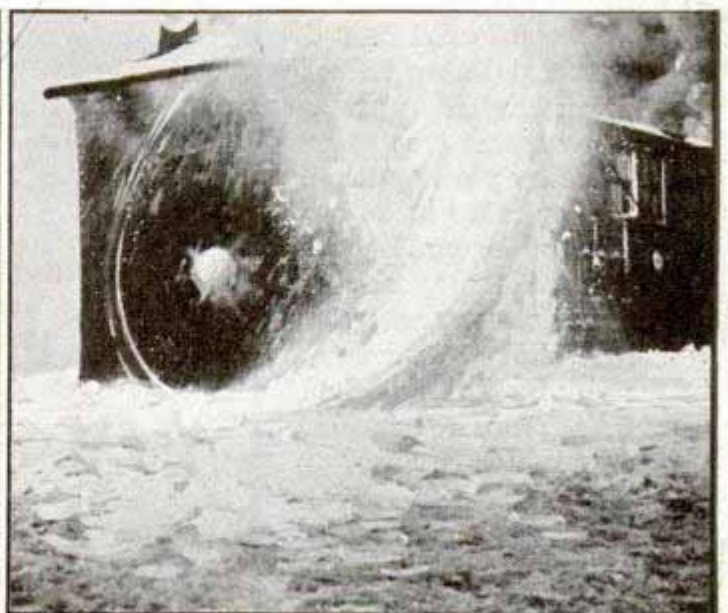

*Ice three inches thick weighing 800 pounds per wire coated lines in Massachusetts storm, top. Below, rotary plows fling high a shower of snow to clear a highway in Oregon and a Minnesota railway*

*mana Sly L.A.P.*



296.2

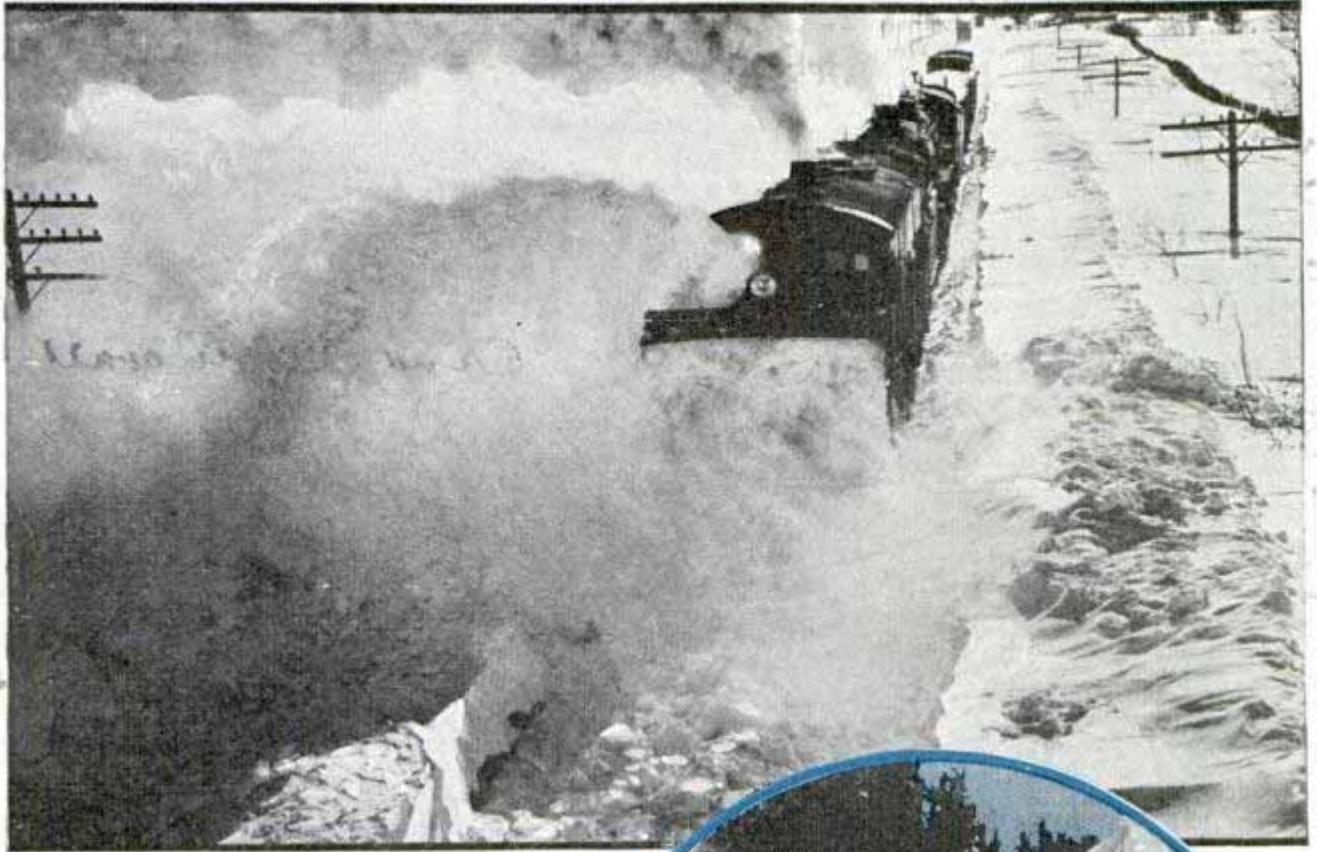

highways open during the winter months. In one mountain pass 469 inches of snow fell last year; yet that pass was kept open to motor traffic during all but a few hours of the season. In the mountainous state of Washington, snow-removal activities are directed by radio, the central office dispatching snow fighters to the scene of

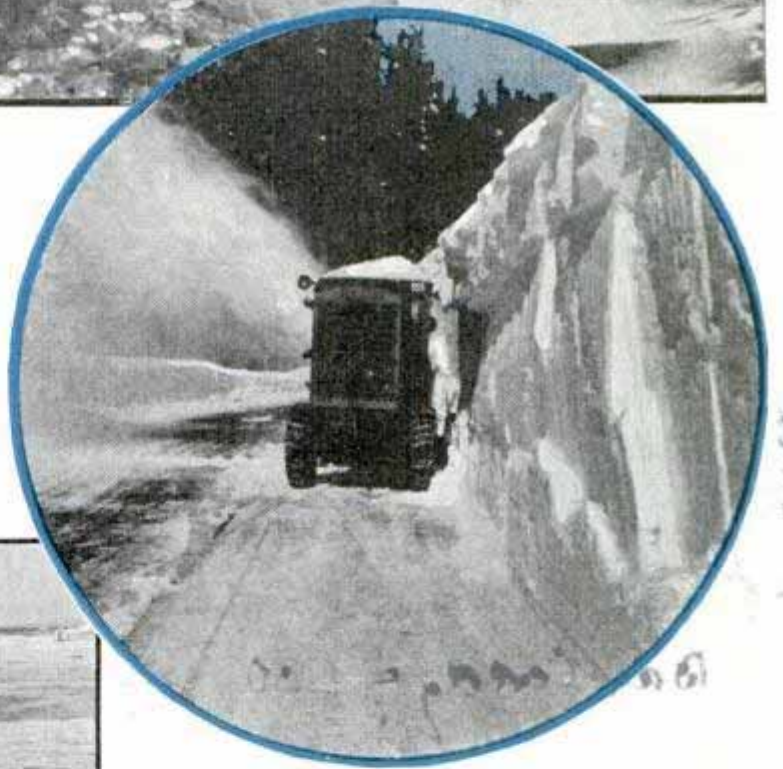

Top, snow train clearing Milwaukee Railroad line; center, digging canyon through mountain pass. Below, cutter rescues ships frozen in Detroit river ice

battle by means of two-way radio installed on plows and trucks.

A large part of this highway snow battle is fought in the summer, and by engineers rather than plow drivers and shovel men. Road grades are being raised above adjacent ground, slopes are flattened, cuts are reshaped, to provide windswept surfaces. Trees and shrubs are planted as snow barriers, miles of snow fence are erected. Wider ditches are dug and roads are cambered to provide better drainage.

(Continued to page 126A)

Jahona



# Venetian Window Awning Controlled from Indoors



Adjusting the vanes of the outdoor Venetian-type awning by a chain inside the window

Protection from the sun without cutting off light and air is afforded by a Venetian-type awning just introduced. Hung outside the window, its vanes can be controlled from inside the house by a pull chain. The vanes and all parts are of metal, eliminating any expense for replacement.

## Four-in-One Tool for Kitchen Has Opener in Handle

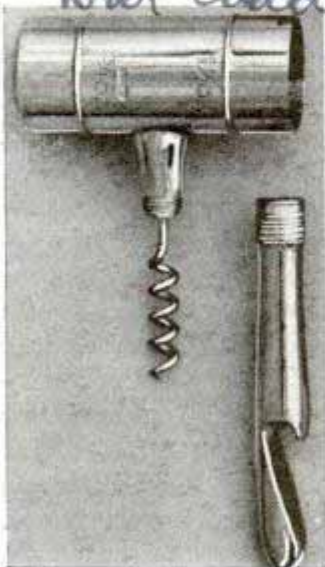

Combining an ice hammer, cap remover, corkscrew and jigger, a four-in-one accessory for the kitchen is now on the market. For use as a measuring cup in cooking, the head of the tool holds a full two ounces and is marked on the outside for measuring one and one-

half ounces, one ounce, and three-fourths ounce. The closed end of the cup is weighted and rounded to serve as an ice hammer. All pressed-on bottle caps are easily removed with the handle, and when a corkscrew is needed the handle is unscrewed.

## Diesel Electric Generating Unit Delivers Low-Cost Power

Electric power at about one cent a kilowatt-hour, with all operating costs except depreciation included, is produced by a Diesel driven generator just developed by the Caterpillar Tractor company. Intended for use on the farm, in logging or construction camps, airports, sports arenas and the like, this low-cost generating unit is quickly installed. The first such generator sold was put to work lighting a midget-auto race track, and was in service twenty minutes after it was delivered, furnishing current to twelve 1,000-watt lamps at a cost of about 10.4 cents an hour. All electrical equipment needed is built in, except the circuit breaker.

## Wrench for Dual Wheel Work Turns Two Nuts at Once



Handy two-in-one wrench which speeds up work on truck and bus tires

Repair work and tire changes on dual wheels of automotive vehicles may be speeded up by using a combination wrench that turns two nuts at the same time. Operated by one man, it removes the outside hex and the inside square nut at once. It also can be used for "spinning" nuts on or off and for general service work.

*J. C. Russell Co. Cleveland Ohio*  
*10 2 40th St New York*  
*2978*  
*Bar Caddy \$1.00*  
*W. B. & Co. 10 2 40th St New York*

*10 34*  
*16 and 20 Milwaukee*  
*21006*  
*Portland, Oregon*  
*Milwaukee*  
*5 + 6 Standard Wrench*



79, 2 Warner & Company Co. Cleveland, Ohio.

# 'Double-Barrel' Telescope Takes Two Photos

Having two large and two smaller tubes, a camera telescope, known technically as a "double astrographic camera," which will be used in studying the Milky Way, was completed recently for Lick Observatory atop Mt. Hamilton, Calif. The two main tubes, each fifteen feet long and twenty inches in diameter, are used only for making photographs. A third tube, equipped with a ten-inch lens, is the "guiding telescope," and the fourth one, having a three and one-half inch lens, is the "finder" used for the preliminary location of the instrument. Two seventeen by seventeen-inch photographs can be taken simultaneously with the telescope, making it possible to get identical pictures with blue stars bright on one negative and red stars bright on the other. Or it can make dupli-

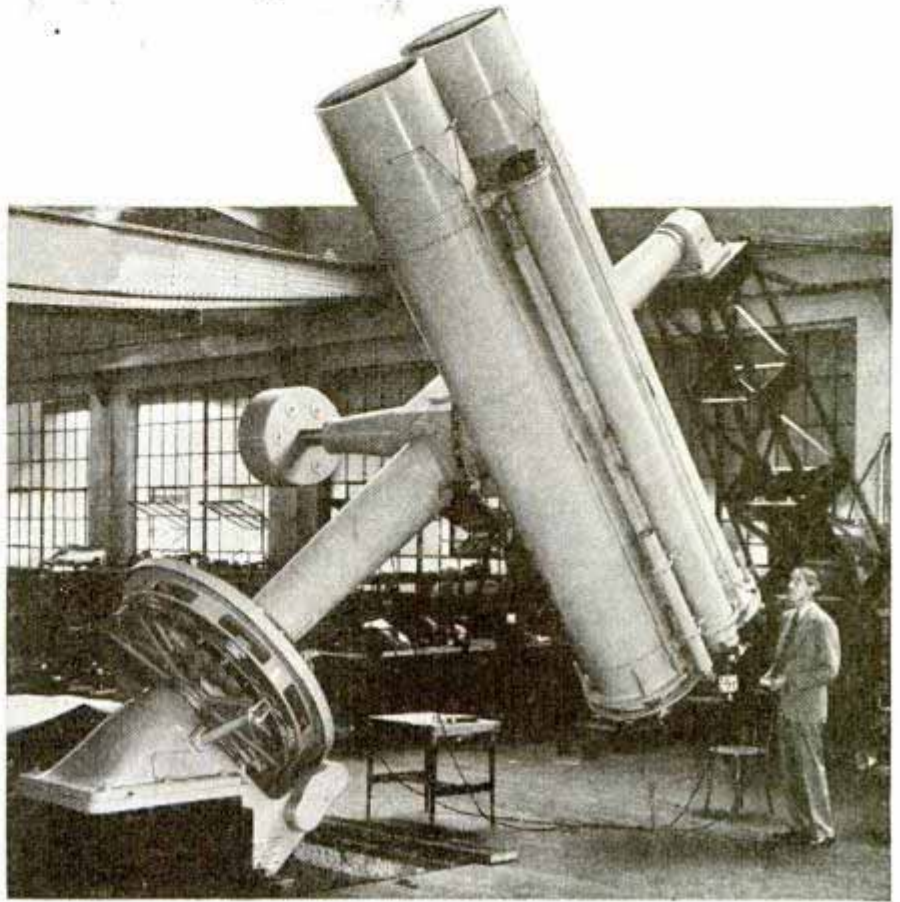

Twin cameras of double-barrel telescope can make two identical photographs of stars. Instrument is used in making study of Milky Way

cate negatives of each picture. All four tubes with their counterweights, weighing four tons, are on a single axis or mounting.

# Tiny Model of Planetarium Has Two Thousand Parts

An exact reproduction of the projector used in Hayden Planetarium in New York

City is the result of three years of patience and expert workmanship. Containing more than two thousand parts, all hand made of brass and copper, the twenty-pound model is built to a scale of one to eleven. The original, a Zeiss Planetarium instrument, weighs two tons. Connected to a one-sixteenth inch driveshaft, a tiny motor revolves the projector completely in forty-five seconds.

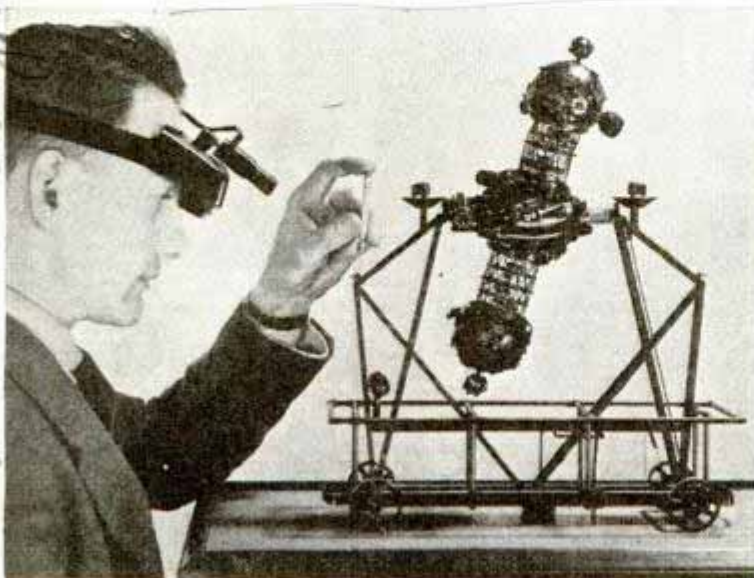

Builder putting finishing touches to miniature planetarium

More energy from solar heat could be obtained in the state of New Mexico alone than now comes from all the coal, oil, and water consumed in the United States annually for generating heat, light and power, says Dr. C. G. Abbot, an authority on solar radiation.

Emp. Emil A. Berg, 131 Lincoln Road, Brooklyn, N.Y.

Smithsonian Institution, Washington, D.C.

Model by Ernest Heise. Compressed Air (1930)



20 729

Mr. & Mrs. W. Miller  
457 S. Serrano Ave.  
Los Angeles, Calif

# DINNER TIME at the

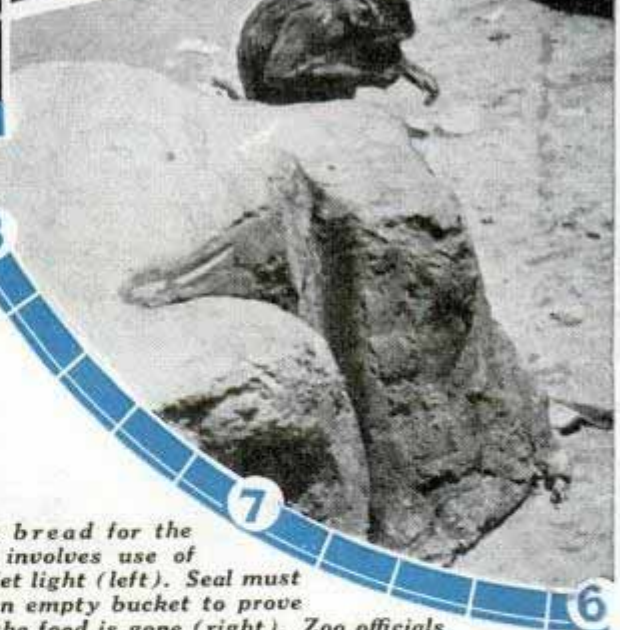
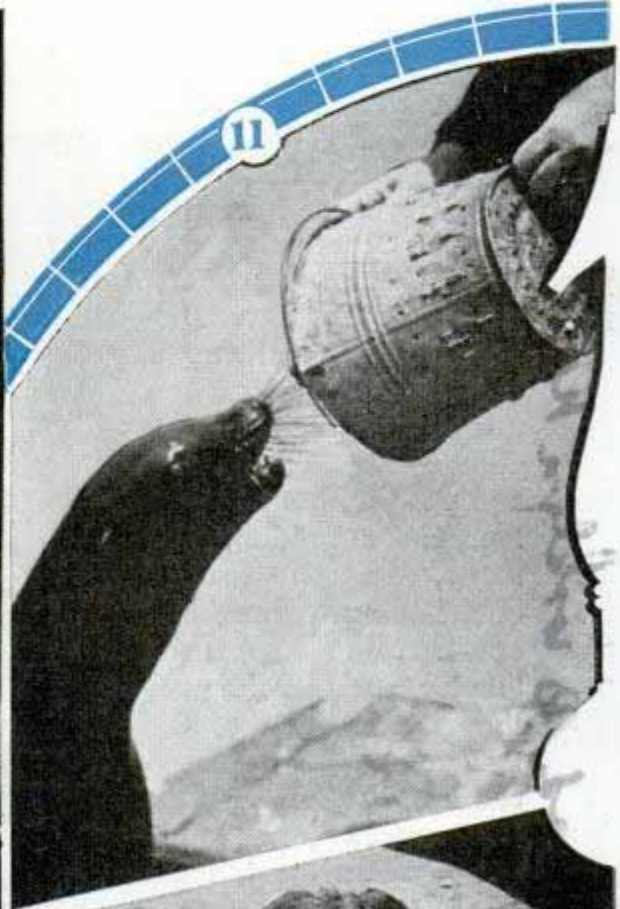

**A**FTER many years of research, the staff of the Griffith Park Zoo at Los Angeles has worked out a scientifically accurate method of feeding animals which has cut the death rate to such a surprising degree that zoos throughout the world are studying the system. But there's one hitch in the system worked out by Superintendent Byron C. Gibson. That's the Sunday diet the animals get from zoo visitors.

Such items as bath towels, pearl breastpins, ping pong balls and bottles of poison are obviously not conducive to animal well being. But even such traditional tidbits as peanuts, popcorn and carrots are often dangerous to the health of the inhabitants of the cages. That's the reason for the innumerable little signs, "Do Not Feed the Animals."

There are a lot of people who claim that their right to feed the animals is guaranteed by the Constitution, or words to that

*Treating bread for the animals involves use of ultraviolet light (left). Seal must be shown empty bucket to prove that all the food is gone (right). Zoo officials must watch monkey's diet carefully (below)*

effect. It would do such people a lot of good to take a peep behind the scenes and see a few of the problems of modern zoo feeding.

For instance, you've got to be sure that the baby octopuses arrive promptly on Friday morning. You see, baby octopuses



# ZOO

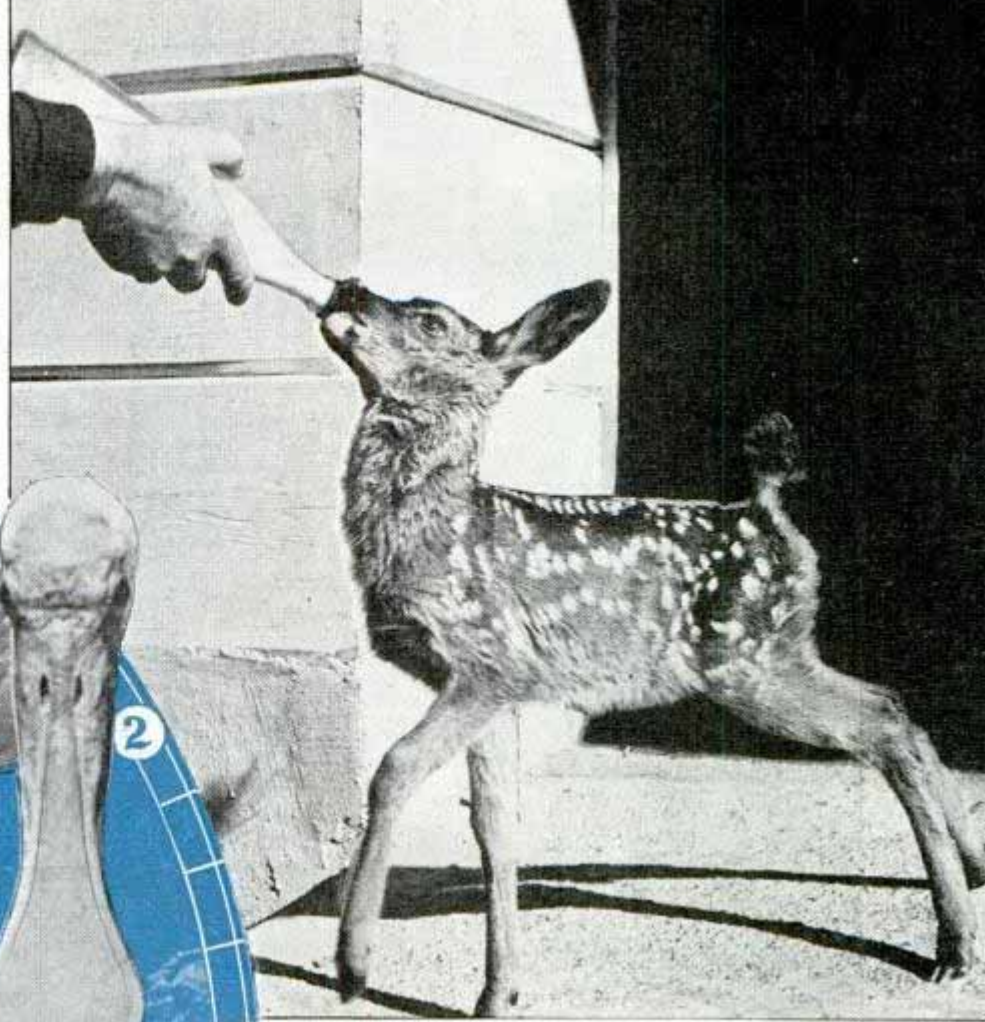
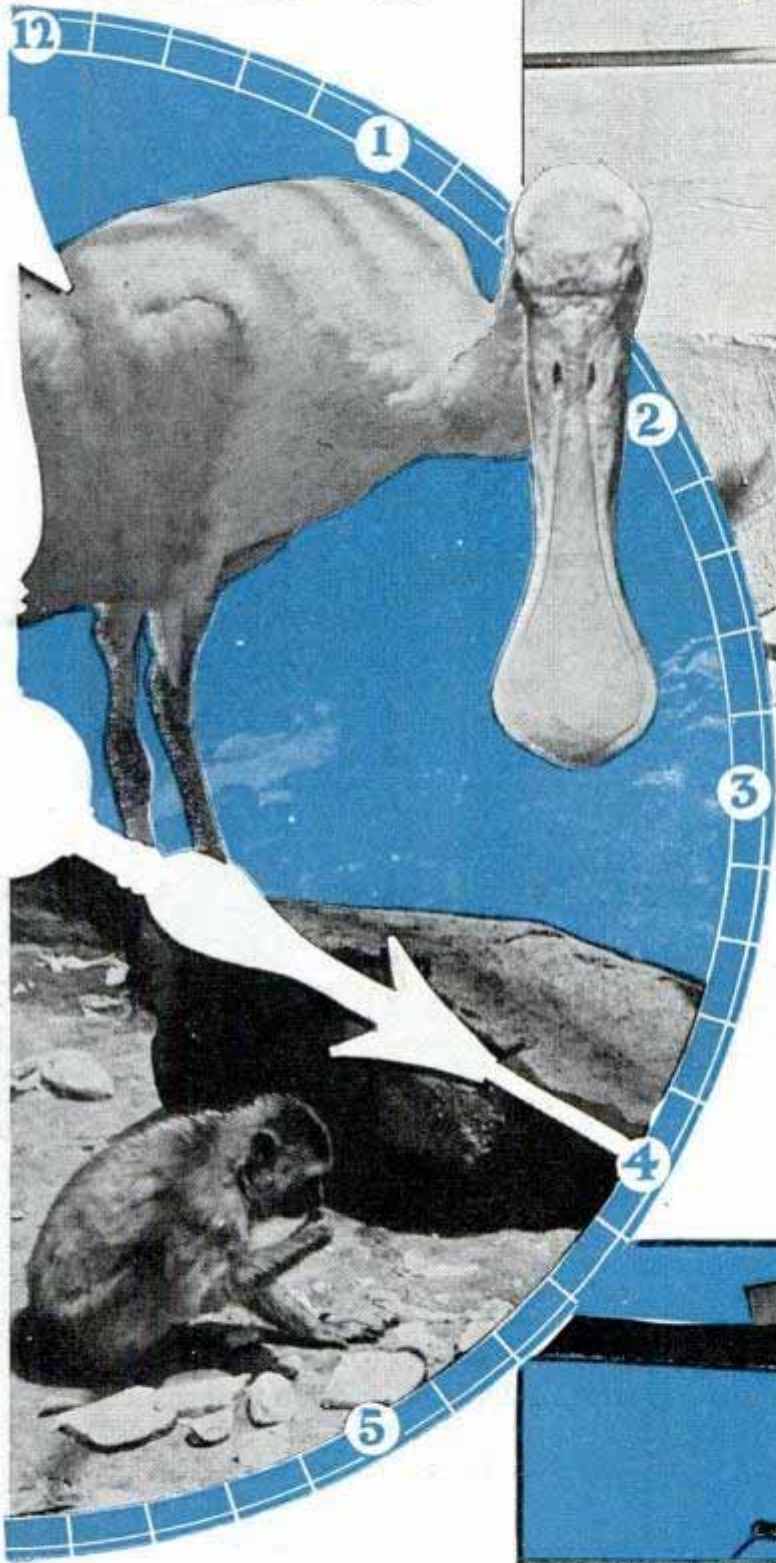

contain a high percentage of iodine, and seals need iodine. If they don't get their octopuses regularly, they become listless, lose weight, and present a pretty sorry appearance. One day as the seals' special bucket was being filled with octopuses, a wildly excited zoo attendant dashed into the feed house.

"Somebody's thrown a pearl breast-pin into the seal tank," he yelled, "and the pin's open! I saw it!"

A split second later the feed house

Upper part of circle, rare spoonbill feeds unless he gets his shrimp. Top, warm milk is fed week-old fawn. Bottom, right, private dinner buckets are reserved for more particular animals

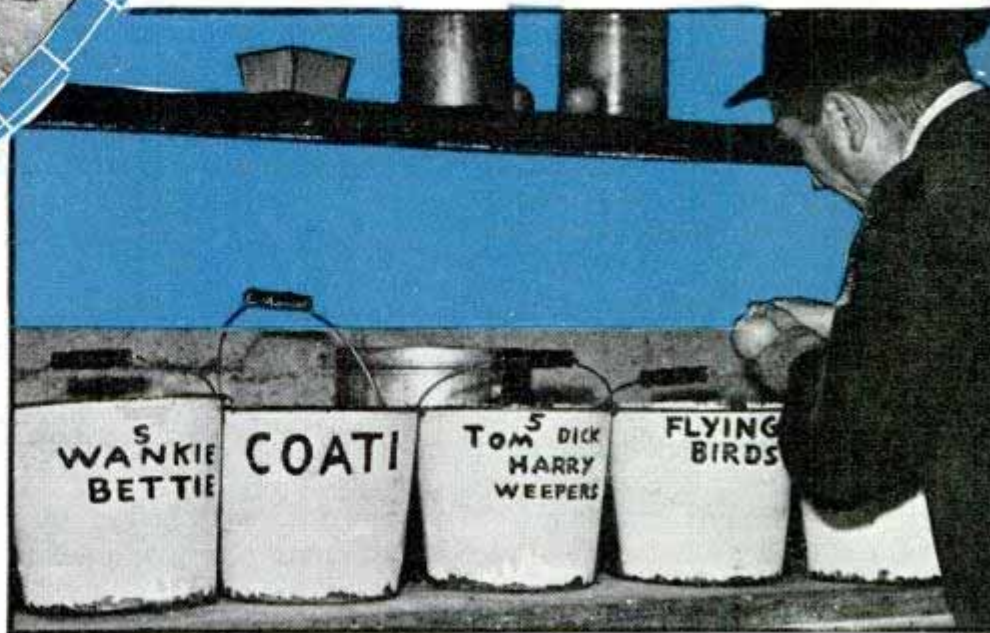



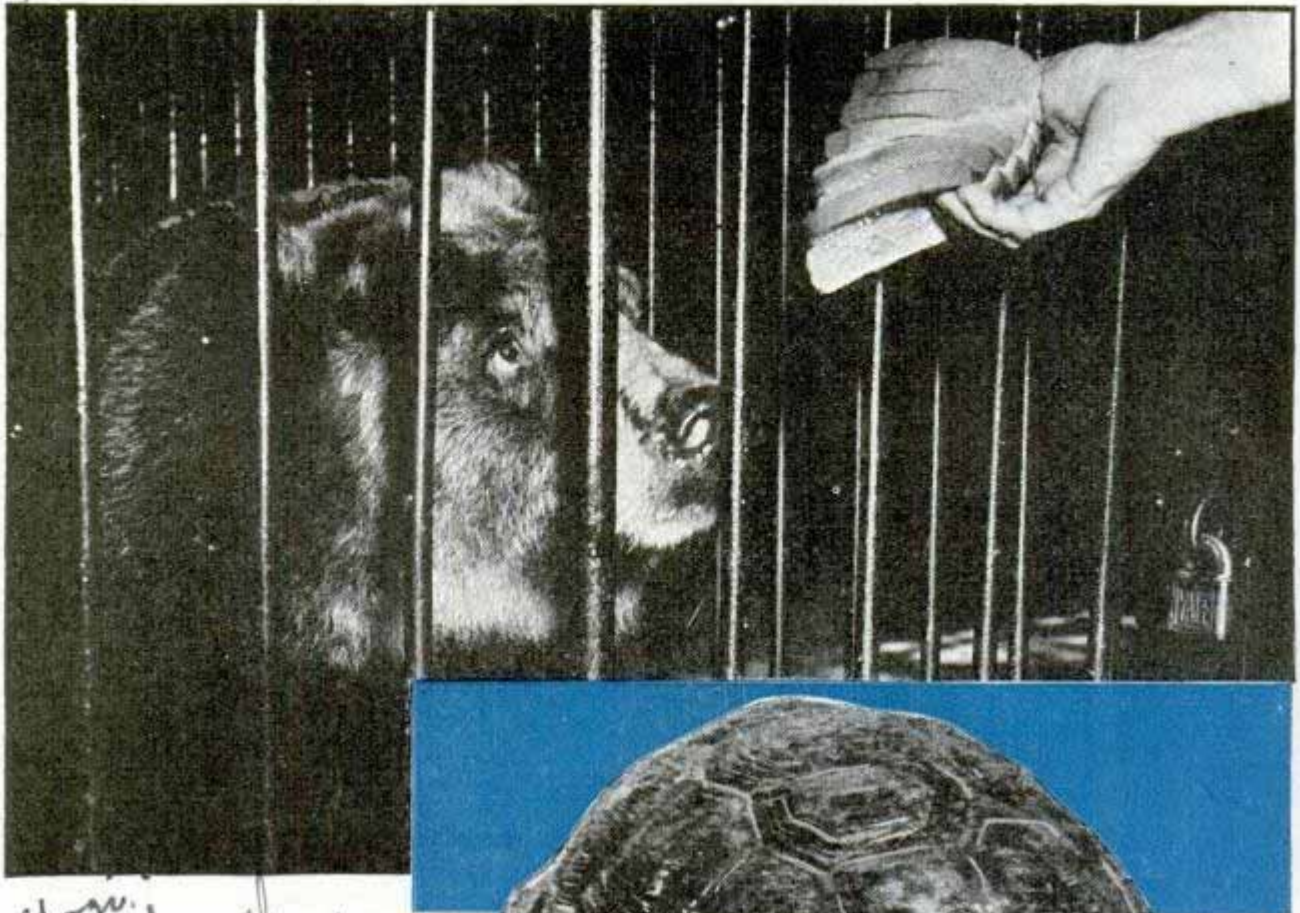

"Yogi  
Dwarf  
Kodiak  
bear"

Above, dwarf bear getting her bread, but she doesn't like it. Below, gopher tortoise nibbling a fresh piece of cactus—rather a prickly dinner



was empty. Gibson, yelling orders in all directions, was first to reach the pool. He called the seals, Flip and Flop, which responded to his familiar voice, and slithered up the bank. There they were captured and hustled away. In the meantime, valves had been opened, and the group watched the water ebb from the tank. When the bottom of the huge tank came into sight, one of the assistants spotted the pearl pin—and it was open. If it had not been for the quick work on the part of the staff, the pin eventually would have been spotted by one of the seals and gulped down, the open point perhaps causing death.

But such dramatic occurrences aren't as important as constant scientific study of the reactions of various animals to different foods. One of the most recent advances in this field has been in the realm of vitamins. To insure a high vitamin content,

much of the food is treated with ultraviolet or infrared light. A recently developed extract which is twenty-five times stronger than cod-liver oil is fed to all animals. When a bear cub becomes listless and refuses to eat, it is fed honey sandwiches treated with ultraviolet light and impregnated with the vitamin extract.

Some birds change color if certain elements are absent from their diets. The "spoonbill," with a bill twice the length of its head, loses its delicate pink color if it doesn't get enough luminous shrimp. These shrimp are found in the Mediterranean—but that's a long way from Los Angeles.

"The only way I can keep enough shrimps on hand," Gibson declares, "is to



2729

Byron C. ...

haunt the waterfront until I find the captain of a ship who will bring me a load of shrimps on his next voyage. Once in a while the shrimp run low, and the new load doesn't arrive on time. Then I don't dare look at the spoon-bills and flamingos for fear they're beginning to fade."

Monkeys are not only particular about their food, but they also have the human trait of demanding constant change. The same food combination can't be used more than three days. They even get tired of bananas. When a monkey gets off its feed, it has to be intrigued with all sorts of tidbits. One of the most effective is raw peanuts. Roasted peanuts are never fed to the animals, because cooking destroys much of the vitamin content.

A particularly difficult feeding problem occurs whenever

(Continued to page 130A)

*Top, syringe used by zoo superintendent to feed milk and eggs to a lioness. Below, seal must get his octopus every Friday. Bottom, left, dwarf bear pushes bread to one side, then enjoys the lettuce and carrots*



"Flaps"



### 'Talkies' of Big War Events Recorded for Students



Giant recording platter on which words and voices of statesmen are recorded along with events of war

Momentous events of 1939 are preserved for future students who will be able to hear them repeated by playing big phonograph records. Not only the words, but the determined voices of leading European statesmen were recorded by General Electric's short-wave station during the crisis, and then rebroadcast.

### Rotating Brush Cleans Teeth and Massages the Gums

Thumb pressure on the lever of a mechanical toothbrush starts it rotating, ef-



Squeeze a lever with your thumb and this toothbrush spins, cleaning teeth and massaging gums

fectively cleaning the teeth while it gives the gums a beneficial massage. The brush is non-electric, its powerful little motor in the handle keeping the brush spinning for more than a minute on one winding.

### Polish Tube Built into Brush for Easy Shoeshining

Introducing a new way of shining shoes, a device now on the market combines a tube containing polish for fifty shines and a brush for applying the polish. The outfit is built to fit the hand. A turn of a small key releases sufficient polish to the brush



Turning key at top of brush feeds shoe polish from tube and permits application without soiling hand

for a quick, satisfactory shine. The user's hands do not come in contact with either the brush or the polish, thus eliminating the nuisance of soiling the fingers. Empty tubes may be replaced in the handle.

### "Coldest" Refrigerator to Run at 450 Degrees Below Zero

As the result of discoveries announced recently, the world's coldest refrigerator, operating at 450 degrees below zero, Fahrenheit, is in prospect. It would run on compressed helium, which when liquefied produces the coldest cold known to man, only a few degrees above absolute zero. At 450 degrees below zero all lubricants are frozen solid, so this difficulty was met by doing away with lubricants in the heli-

Zeebee Rotating Tooth Brush Co. Bell Telephone Co.

Shubert Corp.

E. Frankley, East Orange, N.J.

Alma Perme 9/7/39

1030

1009

1025

1042



Prof. ... Column  
Mass. Institute of Technology  
Cambridge, Mass. 02139

um engine and replacing the conventional engine piston with a flexible diaphragm of stainless steel. The diaphragm is sealed at its edges by a copper gasket between two steel plates, and expansion of the helium occurs between the diaphragm and one of the plates. Two or three such engines will be used in consecutive stages in refrigeration, since it is impractical to try to reach extreme low temperatures in one step down the temperature scale.

21068

### Two-Swivel Welding Vise Holds Work at Angle

Faster and more accurate welding is said to be possible when a vise with a double-swivel arrangement is used, as it holds the work



Welding vise with double-swivel arrangement turns at any angle required by work

in the best position for doing the job. Although designed especially for welding, the vise, which is mounted on the workbench, can be converted easily into a regular swivel vise for ordinary work.

The Leonard-Stephan

### Steam Roller Rides Soft Soil on Wheels Twelve Feet Tall

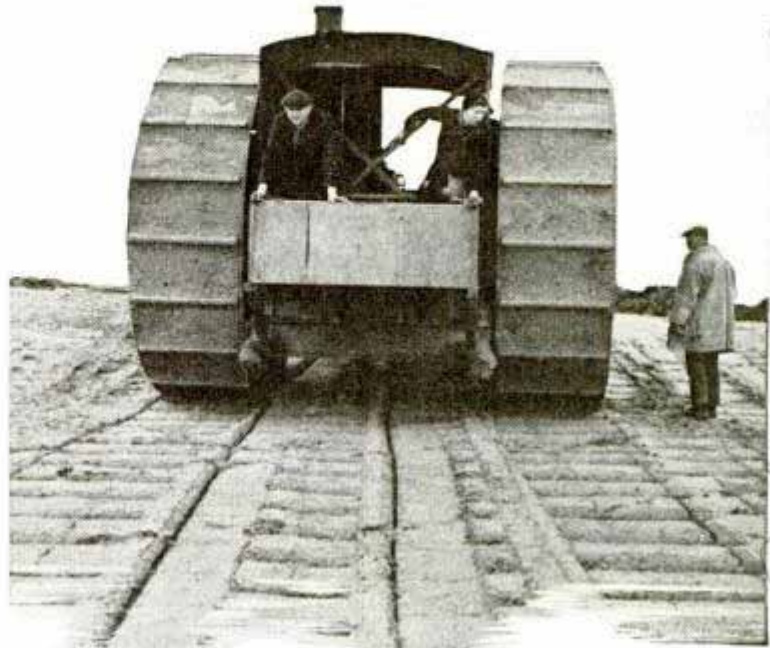

© British Press Combine

Twenty-ton steam roller is equipped with twelve-foot wheels to keep it from sinking into soft soil on wall of reservoir

Because the ordinary steam roller sank into soft soil, special wheels were designed for a twenty-ton roller used in building the wall around a new reservoir in England. The new wheels, twelve feet in diameter for the rear and six feet for the front, were large enough to keep the machine from bogging.

### Magnifier and Mirror for Movie Films "Rights" the Image for Editing

To help movie fans in editing their films, a magnifying glass that may be attached to any editing machine is equipped with a mirror for reversing the image into upright position to make it easily readable. Only two screws are used in fastening it.



Movie film images and lettering "righted" by mirror for editing

Alldredge in charge of works at Alberton, North Essex, England  
291 Madison  
2903  
All movie blue-prints in movie of Blvd. 6628. San Dimas, Calif. 91111  
P.O. Box 1000, Hollywood, Calif.



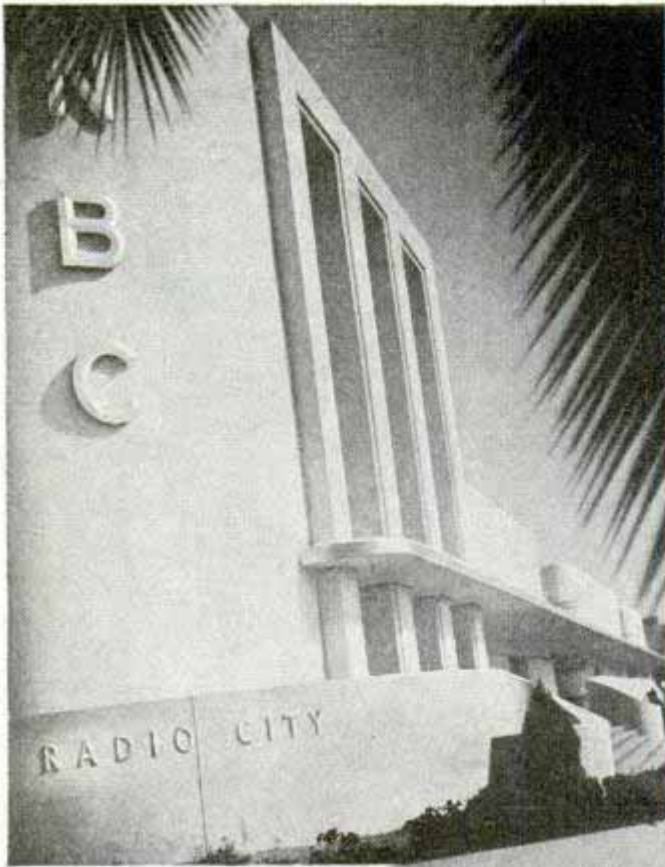

# Building TOMORROW'S WORLD TODAY



*The world of tomorrow is here. You need not travel to a world's fair to see it. True, it had a start in Chicago's 1933 exposition and gained impetus in fairs of '39, but industry is already at home in the future, in buildings shaped to perform functions efficiently instead of following tradition. Top, Hollywood studios of N.B.C., made of tinted concrete with aluminum canopy. Center, research laboratories of American Rolling Mills have porcelain enamel, stainless steel and glass walls. Below, simple lines characterize Campana company plant at Batavia, Ill.*

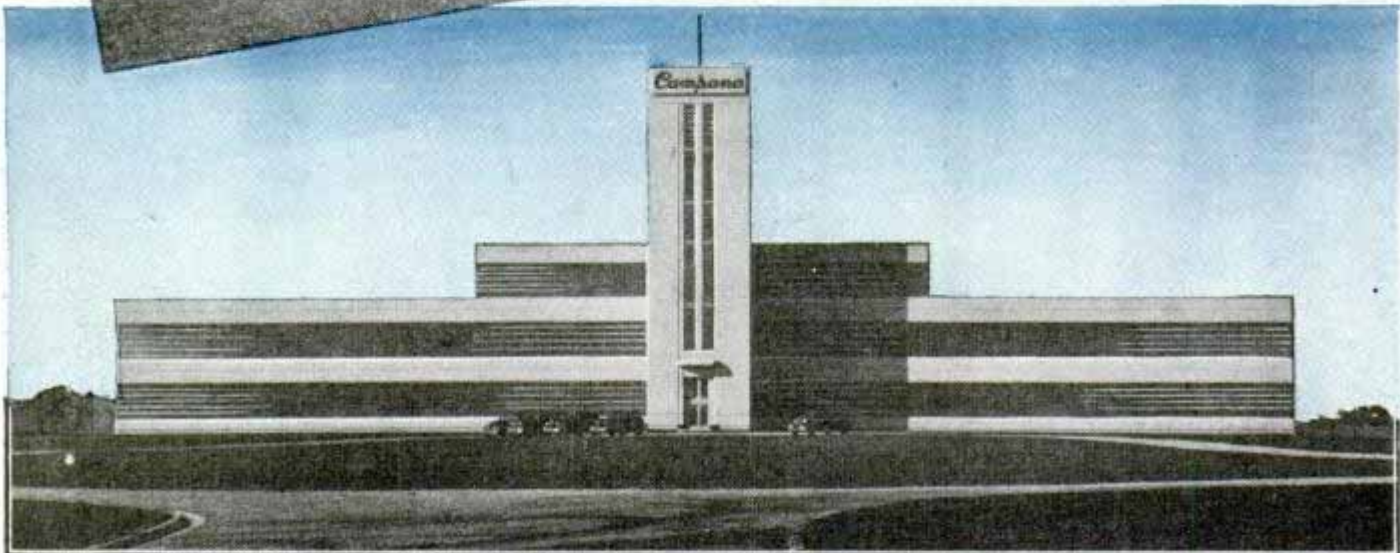



21055

Answer to  
Pa J. Cahoon  
Lake Forest, Ill.

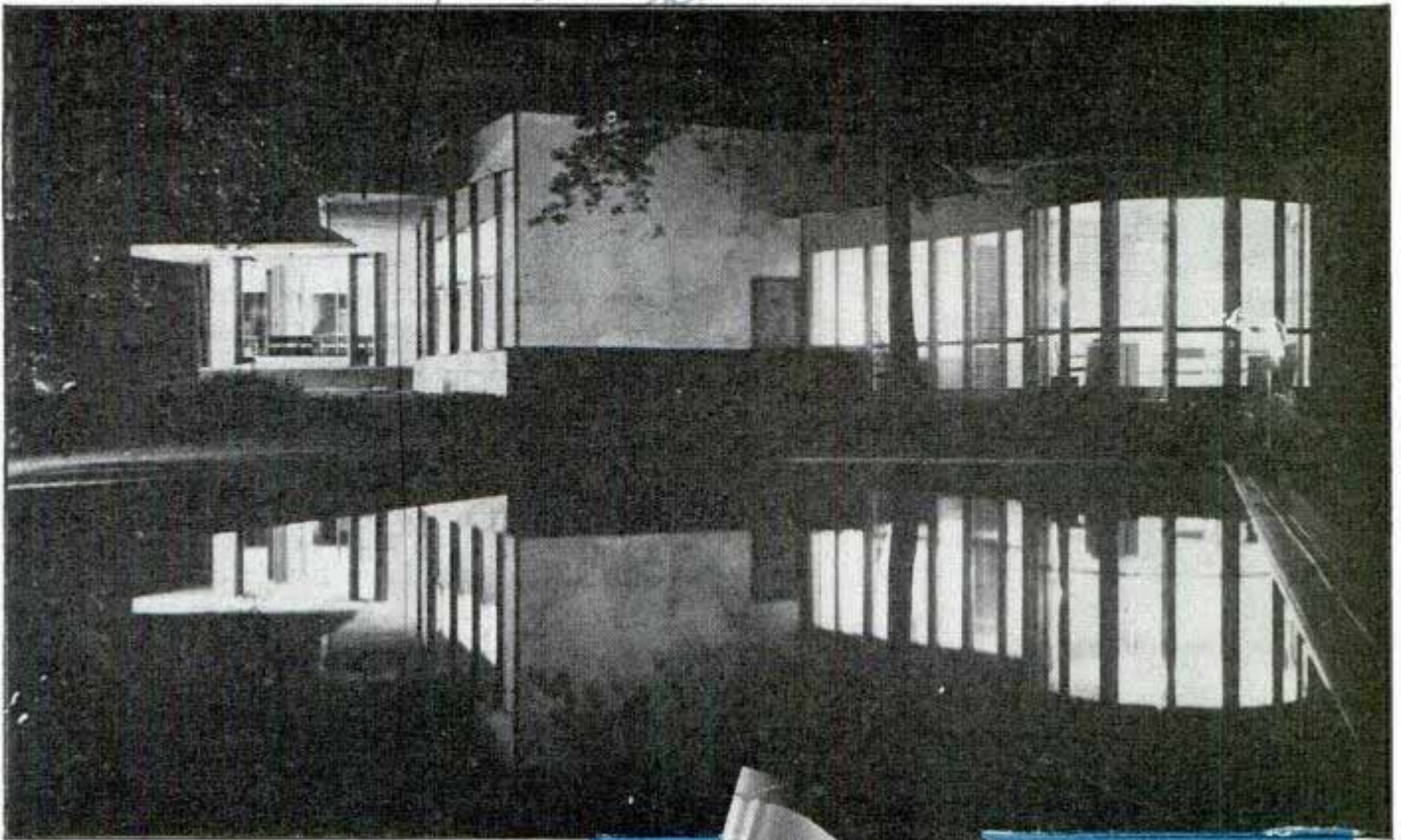

Above, night view of home designed by Architect George F. Keck, Chicago, in answer to demand for a "house of day after tomorrow." Right, living room, with dining table against window. The house has exterior Venetian blinds, rubber-tile floors, and is arranged for minimum housekeeping effort

612 N Michigan

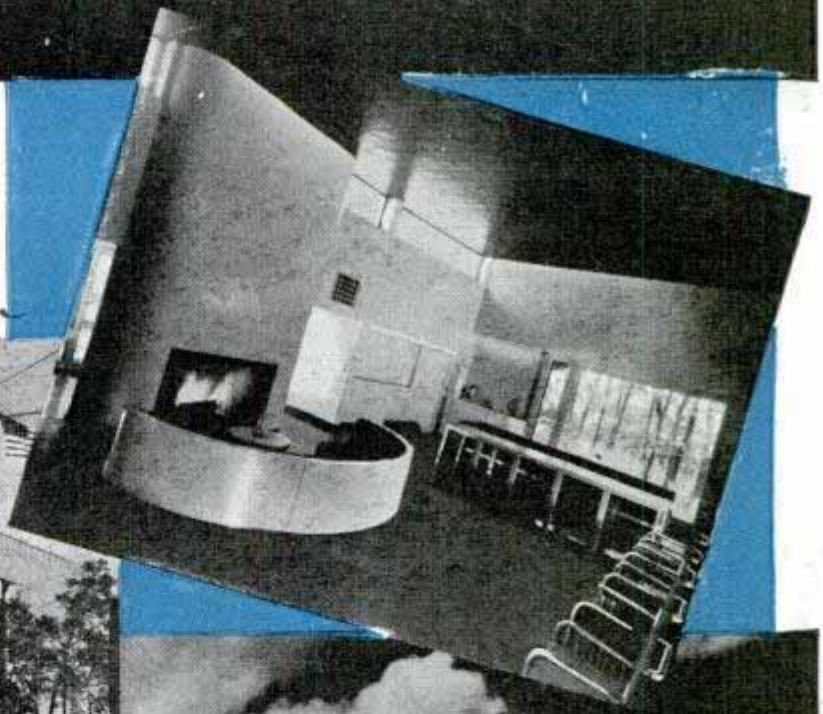

Windows are abolished in the modern store and factory. Scientific lighting, often with the new fluorescent tubes and with daylight coming through glass-block walls, saves maximum space for sales display and machinery. Environment is under complete control, air-conditioning systems providing optimum "weather" for work. Above, windowless Sears, Roebuck & Co. store in Baltimore. Right, model of factory just completed for Church & Dwight, soda manufacturers









*20. Mr. Harry J. Wild  
805-a Eichelberger  
St. Louis, Mo*

# Six-Man Baseball Played on Triangular Field

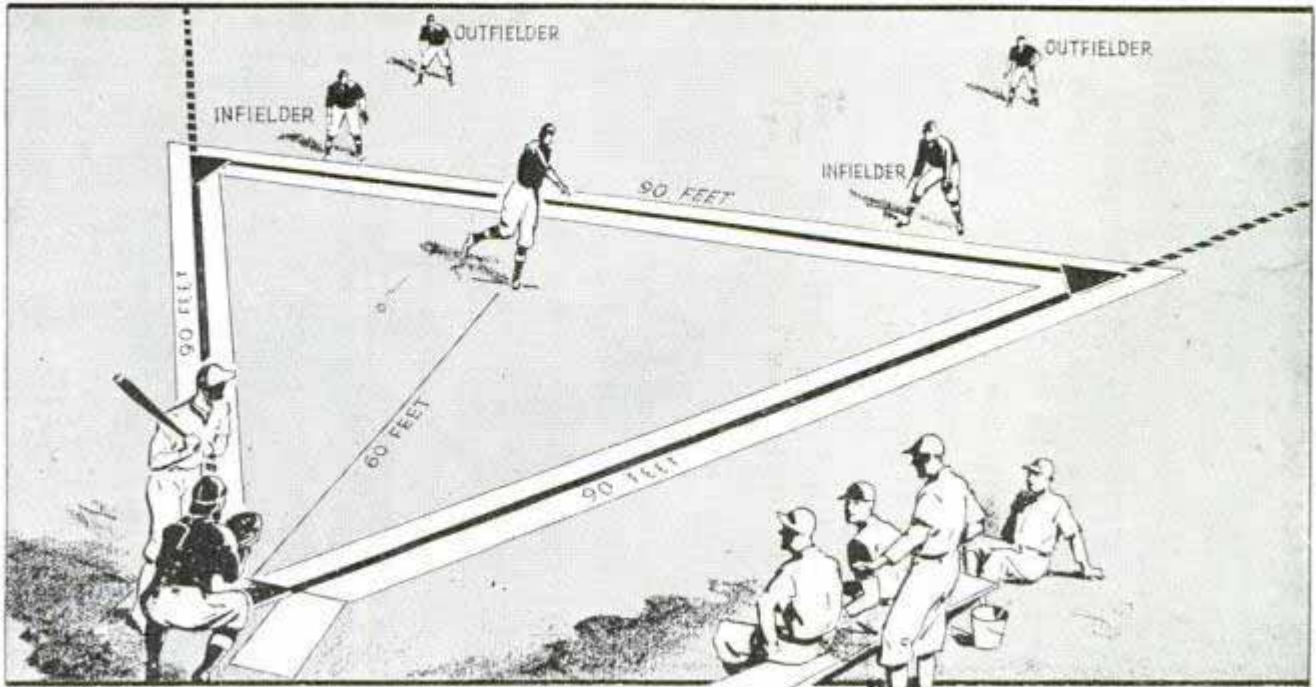

*Faster baseball games, requiring only six-man teams, are played on three-cornered "diamond." Two outfielders and two infielders have no less ground to cover, and players come to bat more often*

*Chester Nebr.*

Already proving popular in some localities, a six-man-team adaptation of baseball developed by Stephen Epler, who five years ago originated six-man football, is especially suited to small-town schools having a limited student enrollment. Six-man baseball requires a smaller playing field and less equipment than its big brother, and permits wider flexibility of the rules. Each team is composed of six players—two infielders, two outfielders, a pitcher and a catcher. Instead of four bases, the "diamond" is composed of three, including home plate. Bases are equal distances apart—ninety feet when a hard ball is used—and they are located at the cor-

ners of an equilateral triangle. A full game is six innings, and two strikes, instead of three, retire the batter. Foul balls are counted as half-strikes, and the hitter is called out on four fouls. Three balls, instead of four, give a base on balls. A player removed from the game may reenter in the following inning, but only when his team takes the field on defensive. These regulations may be varied, but, played in this manner, six-man baseball is so fast that a full game can be completed during the ordinary school recreational period. Players have a turn at bat more frequently, and must be more accurate since they hit into a sixty-degree angle instead of ninety.

## "Telescope" Looks Inside of Metal Pipe to Locate Flaws

Inspection of the inside of newly manufactured metal pipes is accomplished with an instrument resembling a telescope. Through a series of special lenses and reflectors, and aided by a light, the adjustable eyepiece can be focused on any point in the entire 360 degrees of the pipe's interior surface. By magnifying defects, the instrument helps an inspector detect small cracks, slivers or pits, and their exact locations are determined by calibrations on a revolving barrel.

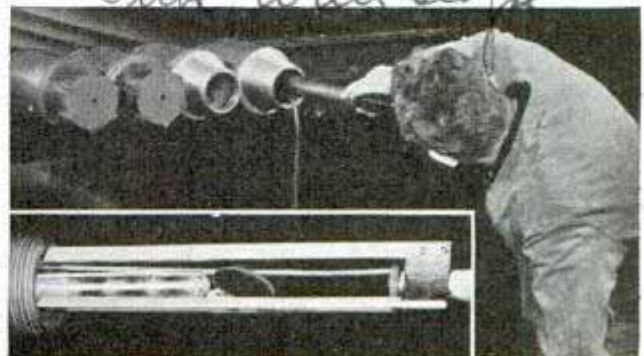

*Looking for flaws inside metal pipe with illuminated "telescope" that magnifies tiny imperfections*

*2967  
Jones and Laughlin Steel Corp  
Pittsburgh, Pa*



20967. *W. Thomas S. Dumas, Jr.*  
 5555 Hollywood Ave.  
 Los Angeles, Calif

# The CHALLENGE

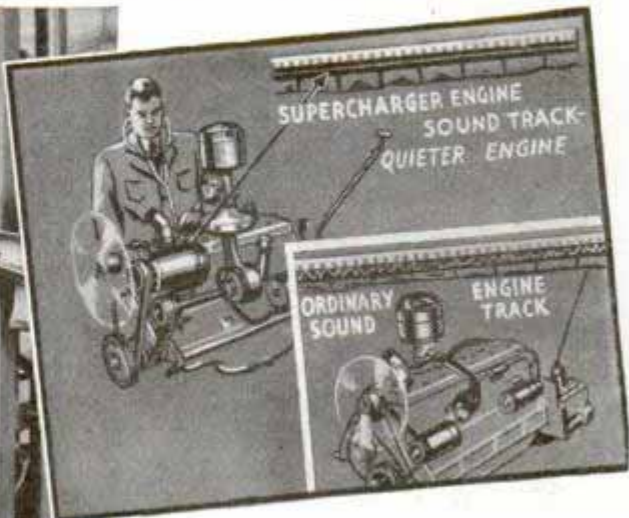
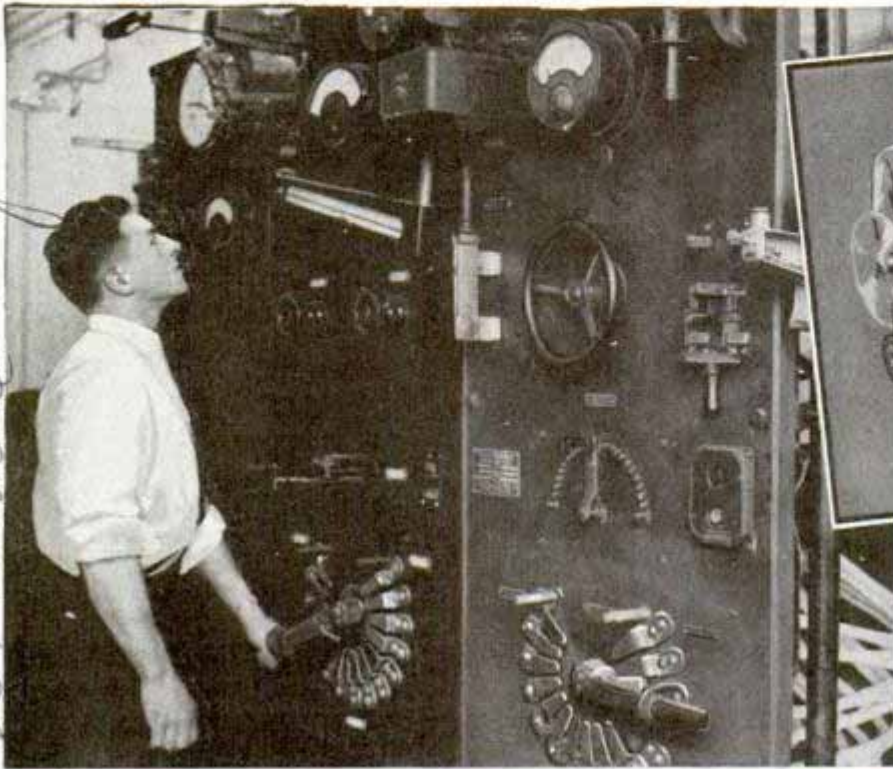

Engineer at panel of dynamometer (top, left) which shows results of engine test. Right, test reveals how supercharger smooths out engine performance. Below, installing fuel tanks on test car for road run

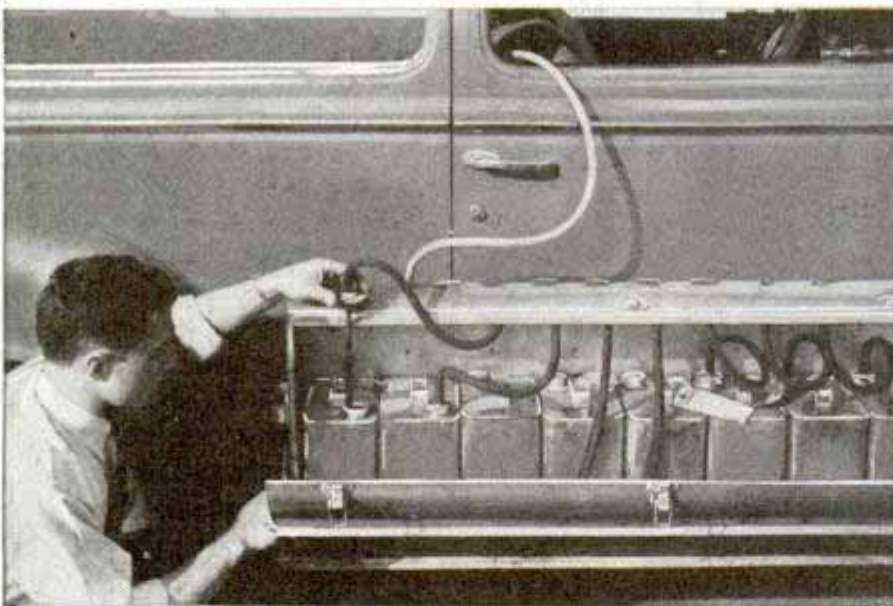

that performs as well as today's engines?

They visualize small supercharged power plants that will use much less fuel but that will give just as much speed and acceleration as the engines of today. Supercharging is expected to be the next important step toward greater engine efficiency but first the engineers have a number of problems to solve.

Superchargers are already in use on some truck and bus engines.

One accessory manufacturer

**P**UT a supercharger on a race car and it goes faster than ever before. Take the superchargers off a long-range flying boat and it can no longer carry enough load to pay for its trip. Put a supercharger on your car or truck and you ought to get more power and economy.

In that case why aren't all cars equipped with superchargers? Automotive engineers reply: "Do you need more power than you already have or would you prefer a smaller, much more economical engine

turer has designed a supercharging unit for Fords. Graham-Paige broke the ice in the stock-car field by using as standard equipment a supercharger that rotates at up to 40,000 revolutions per minute and that forces the fuel-air mixture into the combustion chambers at five pounds per inch above atmospheric pressure. The supercharged engine develops additional horsepower and operates on a gas mixture so lean that it would not keep an ordinary engine running.

San Bernardino Laboratory  
 Whyl Corodene Corp

*McCulloch Engineers*



# of the SUPERCHARGER

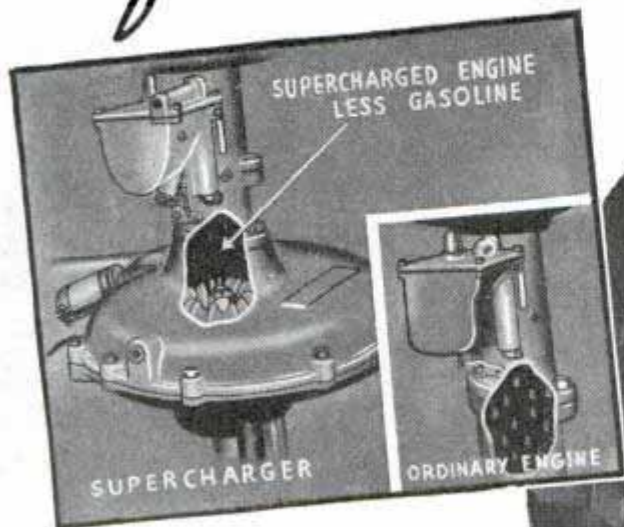

Every one has heard that only a small percentage of the total power in a gallon of gasoline is put to work in an ordinary engine. To some extent the amount of power extracted from the fuel depends on the degree to which the fuel charge is compressed in the cylinder, and one way of obtaining this effect is to force the fuel into the combustion chambers under pressure. Supercharging is a sort of



Top, left, showing why supercharged engine uses less fuel. Circle, attaching analyzer to car's exhaust pipe. Center, supercharger action results in better fuel mixture. Bottom, truck and trailers carrying 60,000-pound load on a test run

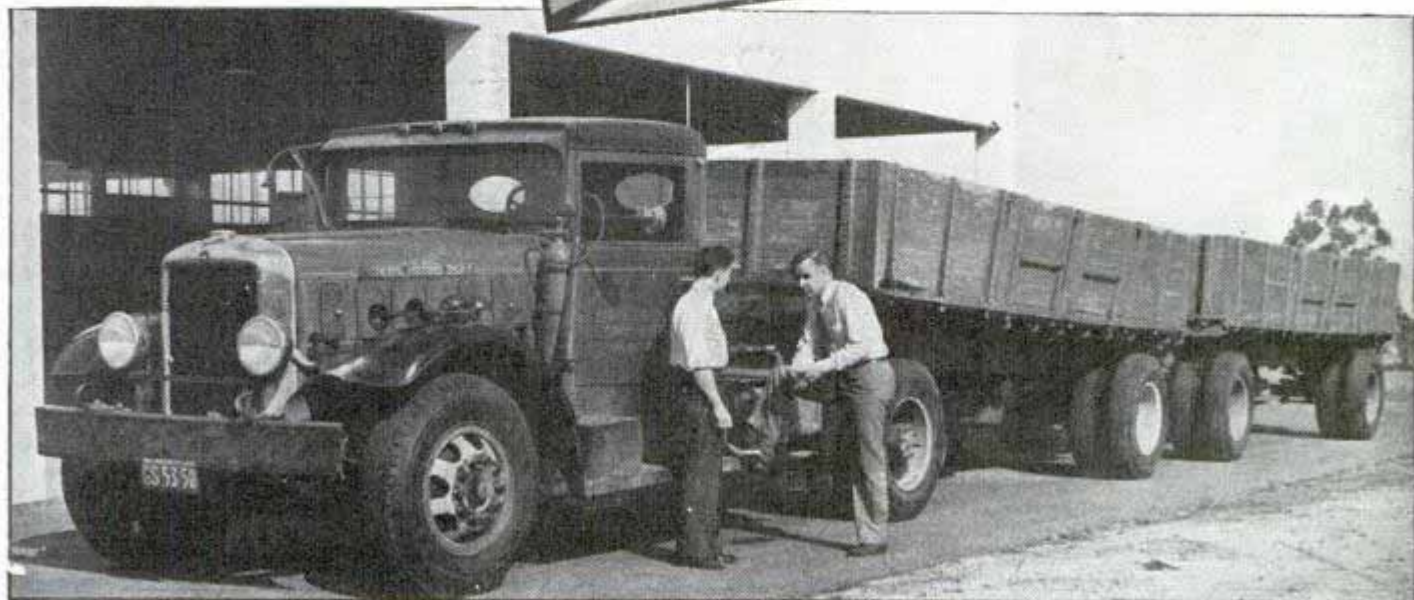



2769  
884

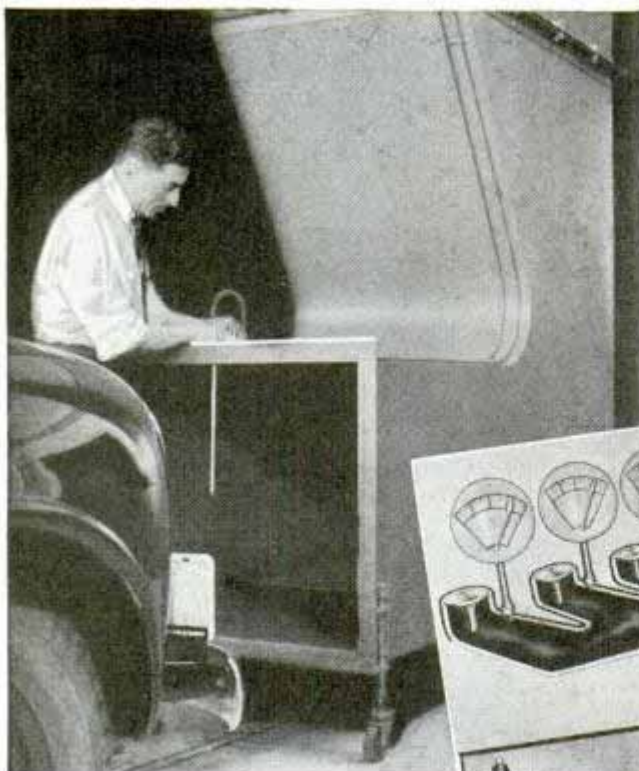

Top, wind tunnel in front of car on dynamometer test. Right, supercharger equalizes fuel mixture for all cylinders. Below, baffles inside wind tunnel direct air flow

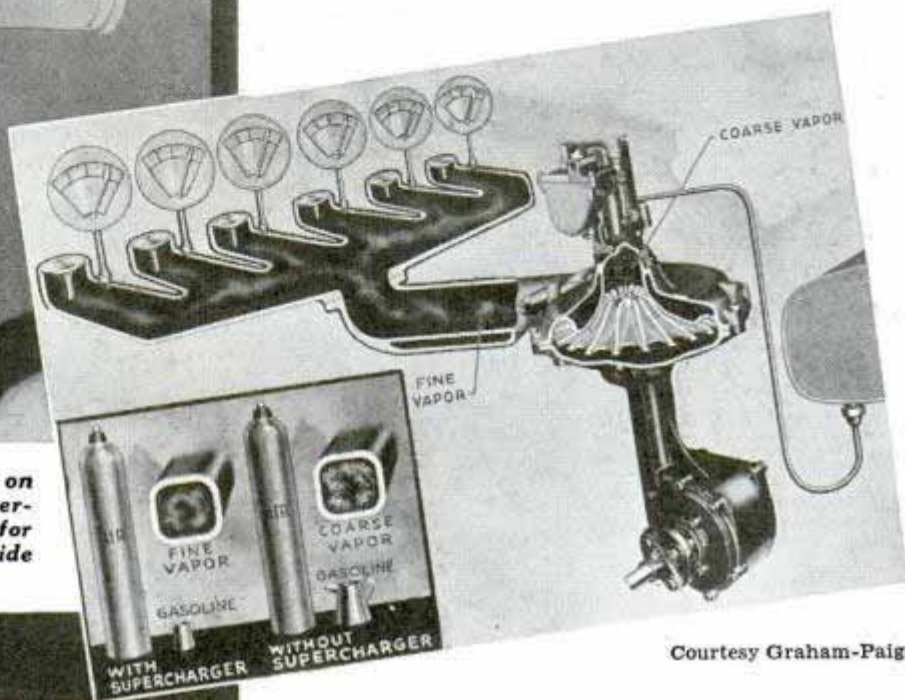

Courtesy Graham-Paige



Courtesy Ethyl Gasoline Corp.

forced artificial respiration. It pumps a much heavier fuel and air charge into the combustion chambers than would be forced in by atmospheric pressure alone. The result is a more powerful thrust against the piston. In theory, supercharging is not economical but a number of factors make it possible to lean down the carburetor

mixture and gain considerable economy. One of these factors is the mixing and vaporizing action performed by the vanes of the supercharger. The raw gasoline and air are stirred into a much more homogeneous mixture than is done by the carburetor alone. Better atomization and more even distribution result.

One interesting development in preparing the fuel for ignition is a device that creates supersonic waves in the intake manifold. These silent sound waves aid in the atomization of the fuel by jarring the fuel particles apart and keeping them in suspension during their journey to the combustion chambers. The waves are above the audible range of hearing and are created by a small slotted bronze ball, inside a metal cage in the manifold, that floats free in the air and that spins at a terrific rate because of the blast action of the fuel charge being drawn past it. This "power ball" is claimed to produce better mileage and performance, cooler operation, and less carbon in several popular makes of cars. *men and power*

Since the benefits of supercharging make it a logical step in automotive progress and because the right kind of fuels for such engines need study, the Ethyl Gasoline Corporation is conducting an intensive investigation of supercharging at its research laboratory in Detroit. A stock eight-cylinder engine is used in the tests, attached

(Continued to page 116A)

4400 S. San Pedro

*off 28 W. Olympia*  
*San Pedro, Calif.*



# Pipes and Cigarettes Form a Tabletop Army

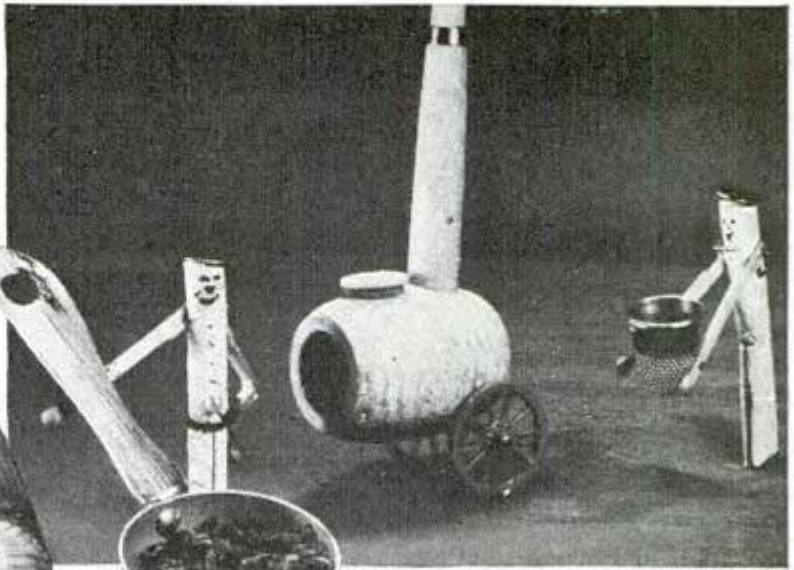
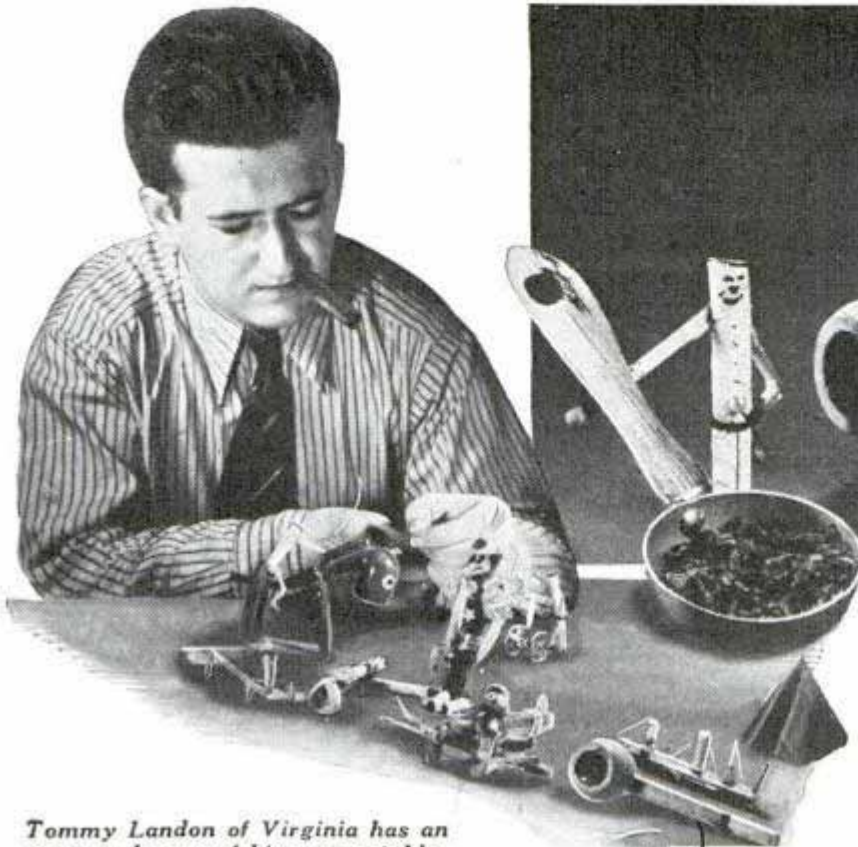

Even a toy army must eat, so the miniature field kitchen rolls up to camp with a mobile oven that you recognize as a corn-cob pipe on wheels. Cigarette soldiers with matches for arms ladle spinach out of an ashtray, and the troops step up to get their hearty thimbleful of rations at mess time

Tommy Landon of Virginia has an army and navy of his own, a tabletop force built by his father, Jeff Landon. They call it the "Fags' Army and Navy" because the big guns are pipes and cigarettes, soldiers and sailors are cigarettes and matches. Mr. Landon is shown above with army, air and fleet units

*no address*

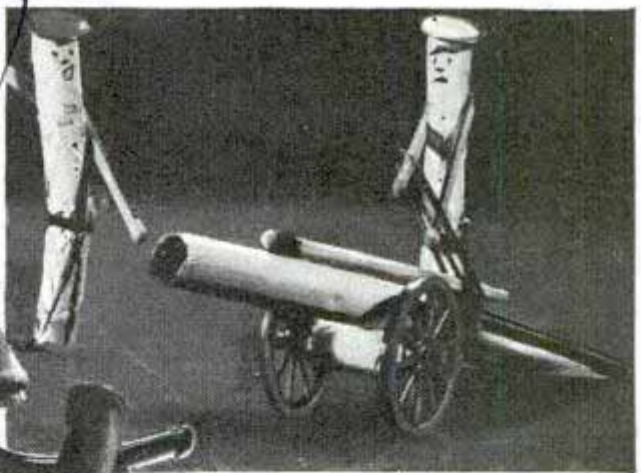

While a gunner in the "Fags' Army" at bottom, trains his combination pipe-and-cigarette cannon on the enemy, another artilleryman stands ready with a pipe cleaner to clean the muzzle before the next shot. Safety matches shield the gunner, and a glass ashtray serves as emplacement. A field artillery crew is seen above, the officer wearing a pin for a sword. At left, a cavalryman prepares to take his horse over a fence

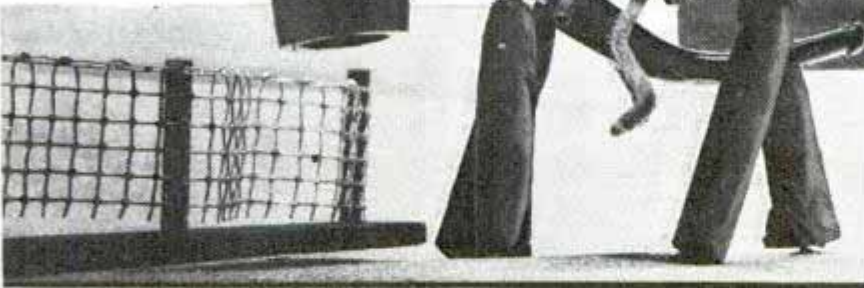



# Tiny Reeds Rival Giant Carillon's Bell Music

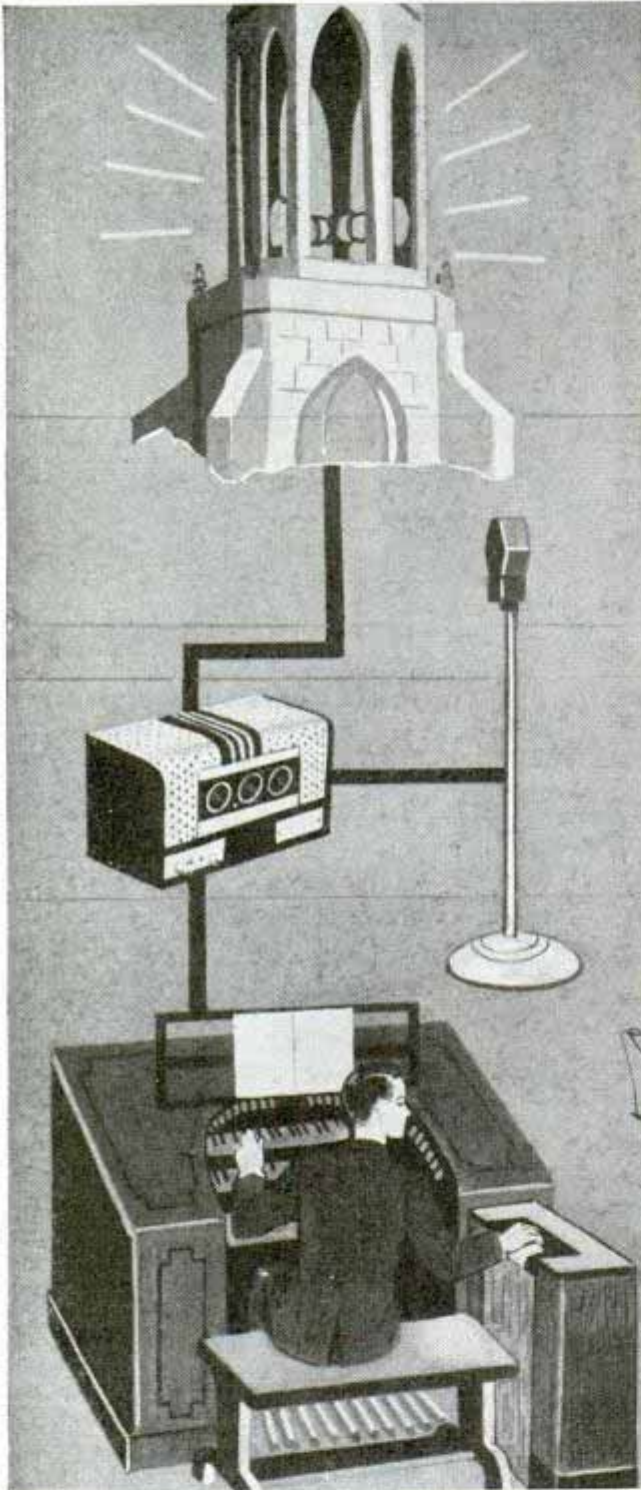

Bell notes that rival the tones of a carillon of twenty-six giant bells are produced by little hammers tapping slender metal reeds, the entire system being housed in a cabinet no larger than the ordinary home radio console. Operating a two-octave keyboard produces the music of dancing electrons induced in magnetic coils by the vibrating reeds, whence they are amplified in radio tubes and conducted to a loud-speaker. The electronic tones may be controlled in volume and their music aimed in any direction. Another instrument, a five-note Westminster chime, may be operated from a clock to peal at fifteen-minute intervals. Both systems, developed by RCA Manufacturing company, are designed for use in churches, schools and parks.

*Camden NJ*

## Tool Loosens "Frozen" Nut with a Few Hammer Blows

Nuts that are "frozen" or are located where it is impossible to get leverage with a wrench, can be loosened easily with a few hammer blows on a starter now on the market. Made of tough forged, heat-treated and tempered vanadium steel, the starter has a projecting lug with broad face to form a solid foundation for a punch, being reversible for tightening nuts in hard-to-reach places. The set of fourteen starters fits all sizes of standard hexagonal nuts measuring from three-eighths to one and one-quarter inches on the flat. Each starter has twelve angled recesses, so it is shifted only a short distance from one recess to the next as hammering progresses.



*Duro Metal Products Co.*

*2649 N. Eldorado*

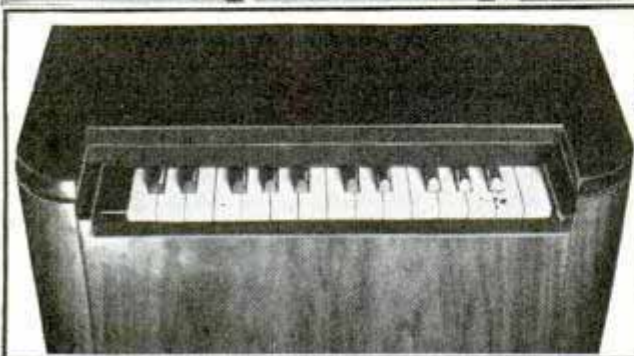

How electric carillon is used with organ amplifier and public-address system. Below, view of keyboard

*21044*

## Small Robot Weather Observer to Aid in Forecasts

Better weather forecasting with the aid of a ring of robot weather outposts in Alaska and northwestern Canada is in

*Science Service 917 130*



Mr. K. O. Lange  
 Harvard Observatory 2987  
 Blue Hill Station  
 Millis, Mass

## Skater Towed by Motorcycle in the Latest Sports Thriller

prospect. A tiny automatic weather observer and radio transmitter which works for six months without attention has just been developed. It is designed for the measurement and radio transmission of figures on hourly air pressure, temperature, humidity, wind direction and velocity and sunshine data. The goal of immediate research is the spotting of the robot in isolated locations in the Far North where much of the nation's weather originates. Thus, with the robot weathermen properly placed, there is no reason why the world pattern of weather could not be learned hourly. In actual operations over oceans, the robot apparatus could be serviced by weather ships comparable to lighthouse tenders. On land, routine visits would be worked out.



*Wed. World*  
 Skijoring on skates, with motorcycles as the means of towing, is illustrated here. A special track makes the sport safer

Roller skatejoring is the latest sports thriller. The skaters wear special skates with rubber wheels. Towed by motorcycles, they attain speeds up to thirty-five miles per hour on smoothly surfaced tracks specially built for the purpose. The sport was inspired by skijoring.

## Roots Are Cut from Deep Sewers by Spinning Steel Rod

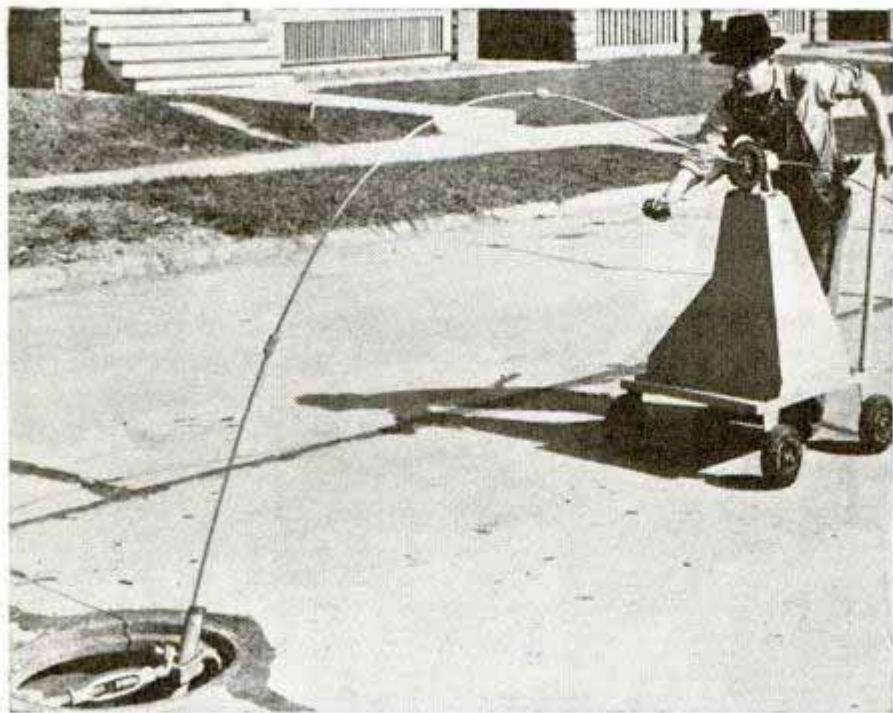

"Fishing rod" used by workman angling for tree roots which have crept into sewer. Sharp cutting tool turned by crank severs the growths

Little tree roots that creep through cracks into sewers often grow to large size and seriously obstruct the passage. To chop them off, a cutter mounted at the end of a long steel rod is lowered through the manhole and unreeled. The apparatus is carried on a rubber-tired cart.

(Names and addresses of manufacturers and dealers in articles described in this magazine will be furnished by our Bureau of Information upon request accompanied by stamped, self-addressed envelope.

*General Sewer Machine Co. Inc.*

*General Sewer Machine Co. Inc. Akron, Ohio*

i:  
W.



Head  
Brayton

Cont. John L. County, Bar 665 Apex Station,  
Washington, D.C.



# The MOVIES



TO ITS bombs, airplanes, battleships, field artillery and other fighting equipment, America is about to add motion pictures. The Signal Corps of the U. S. Army plans, in substance, visual instruction of troops via the movie method. In addition to familiarizing rookies with the method of reading military maps it gives them a definite visualization of the objective they are working toward in any maneuvers programs in which they participate.

In other words the fledgling soldier who now learns elementary military movements under the personal supervision of a hard-boiled sergeant soon will be permitted to see those movements executed with machinelike precision on the screen to the accompaniment of staccato barks from commanding officers. Likewise budding artillerymen will be able to view batteries of artillery guns in action, the positions and tech-



*Shooting scene showing how infantry defends itself with machine guns against low-flying planes (top). Filming military movements (center) and the building of bridge (bottom). Fledgling soldiers are shown films like this to aid in training*



2969

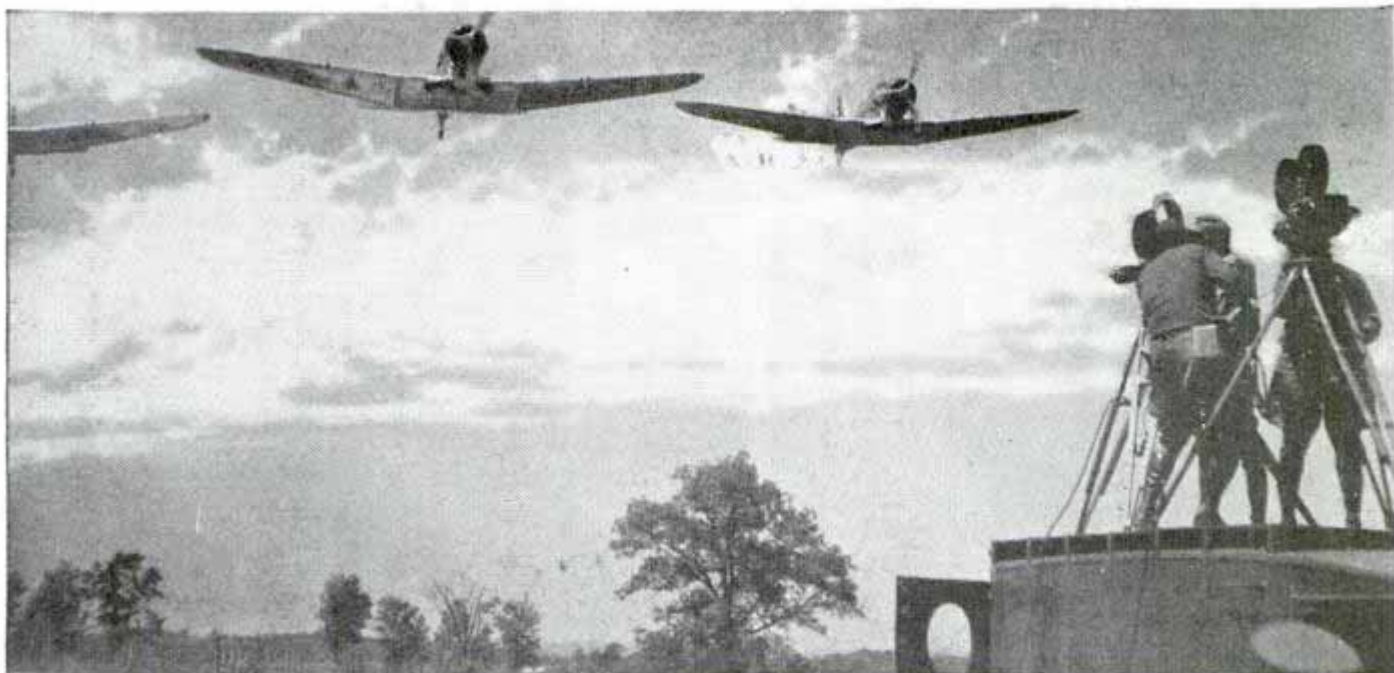

# JOIN *the* ARMY

niques of gun crews and other important details.

The Signal Corps, after almost twenty years of experimentation, is ready to do a complete job on this method of training soldier personnel, so that in case of emergency this country would have a complete program of thousands of training films ready for instructing in every depart-

(Continued to page 141A)

*Top, scene like this is flashed on screen to show rookie pilot how to handle plane in formation. Circle, ready to film take-off at Wright Field. Bottom, proper bayonet procedure is taught young soldiers more easily by movie method*





*Mr. Rectifying  
Equip. Co.*

890

*Soren Palmquist  
University, Lund, Sweden*

*2902*

### Exhaust Fan on Window Cools the Entire House

*Thompson Welding Tubes*



*Fan mounted outside of window draws air from house fast enough to make complete change once a minute*

If you live in a rented house unequipped with an attic ventilator, you can fit the place with an exhaust fan which involves no alteration to the house and remains completely portable. The fan is mounted outside a window, by supporting it on an outside structure or wall bracket. A canvas duct connects the fan with the window. When windows are opened and the fan turned on, enough air is drawn out of the house to make a complete change in every room per minute. The breeze created on the lawn has enough force to keep away mosquitoes and other flying pests.

*21013*

### Plants May Help Prospectors Find Elusive Minerals

Leaves and young twigs of deep-rooted plants have been found to contain evidence of the presence of mineral wealth. Substances in the ground, dissolved in soil

*Science Service*

water, are taken up by the plant roots and concentrated in the leaves. Two Swedish scientists have reduced this plant material to ash and subjected it to examination under a carbon arc, breaking up the light with a spectrograph and recording it as lines on a photographic plate. An abundance of any given element in the ash is indicated by strong and pronounced lines characteristic of that element. The method should prove valuable in the search for metals like nickel and molybdenum. Having established presence of a mineral in the plant, geologists endeavor to trace to its source the water that brought the telltale traces of mineral elements to the trees.

*21005*

### Sunshine "Canned" and Shipped for Release at Distant Spot

Sunshine, which had been absorbed by luminescent powder and "canned" by being frozen in liquid air has been transported by airplane 1,000 miles and released in one of science's most spectacular feats, the achievement involving the "canning" of Florida sunlight and its release in New York. It started with the exposure of a slender glass tube containing luminescent powder to sunshine for several hours. Then the tube was placed in a vacuum flask of liquid air and flown to New York. There the tube was dipped into a beaker of water, to hasten thawing out of the

*Samuel S. Baber, Lighting Engineer,  
Westinghouse  
Englewood*



*Lamp 262  
Blomfield  
R. J.*

*Scientist holding glass tube of luminescent powder, in which sunshine may be trapped*



"frozen" sunshine. Feebly the tube began to glow, then in a few moments it was giving off a brilliant illumination in a darkened hall as the solar energy was released after nearly twenty-four hours imprisonment. In absorbing light energy, scientists believe the luminescent powder undergoes a temporary change in physical structure. The theory is that the outermost orbits of electrons, which make up the molecules and atoms of the powder, are distorted or literally moved from one energy level to another when excited by impinging light, thus imprisoning some of the light. In that position the powder is frozen at some 300 degrees below zero in the liquid air. Warming the powder in water causes the electrons to return to normal position and give out the light energy they held.

*2772. Taylor, Havtger Co. 138th Infantry Missouri National Guard St. Louis, Mo*

## Small Air Tank Supplies Diver under Water Thirty Minutes



Two views of air tank which permits diver to remain under water for long periods. Left, ready to dive. Right, on bottom of pool

Sufficient air for twenty-five to thirty minutes is supplied by a small tank designed for underwater swimming. It is made of a compressed-air cylinder, some valves and part of an inner tube. The tank may be refilled at any auto service station. Air is admitted to the inner tube by a control wheel at the top of the cylinder. From the inner tube the air is taken into the mouth through a valve.

*21019*

## Restaurant Built of 10,000 Shells Advertises Sea Foods



Appropriate exterior for this sea-food cafe in Los Angeles consists of 10,000 abalone shells

Ten thousand sea shells form the walls of a Los Angeles restaurant which specializes in sea foods. Placed with the concave side out, the beautiful abalone shells make an attractive exterior and call attention to the sea-food menu.

*21043*

## Spray for Reddening Apples to Speed Up Sales

Apples coming to market in the near future probably will be reddened by a new chemical spray. It will be a natural glow, not a makeup job. The natural red color of apples is due to a pigment known as idaein and the new chemical stimulates the formation of the pigment. It not only intensifies the color of naturally red apples, but induces a slight blush on yellow apples, thus making them more attractive.

*U.S. D. W. Mustgast and D. J. Duncan Agricultural Experiment Station Sacramento, California*

*The Sea Shell, Alab. Pasadena, Calif.*



# HEROES *of*

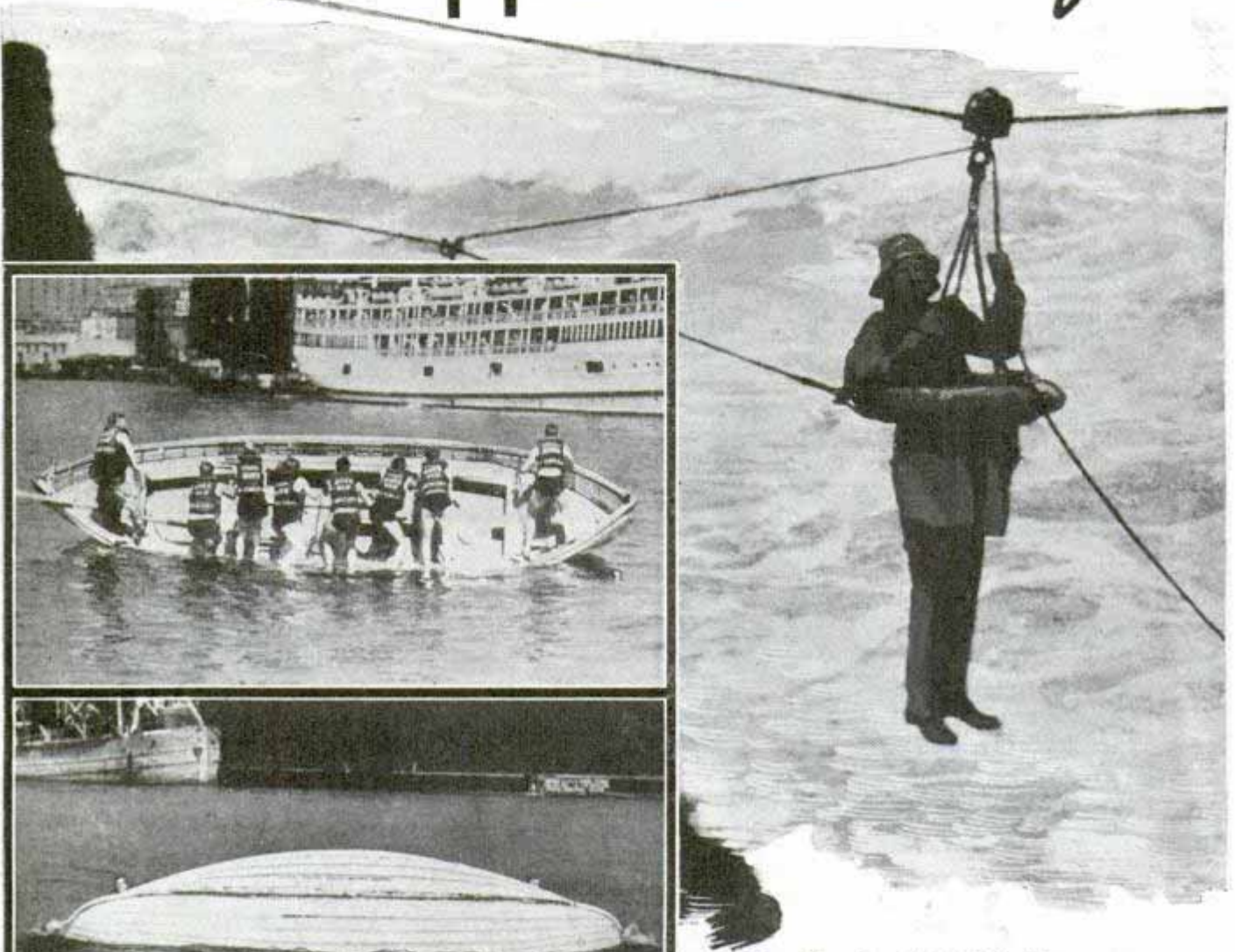

By Roderick M. Grant

**Y**OU seldom hear of heroes in the coast guard. Not that there aren't plenty—the service is full of them. But heroism is everyday, bread-and-butter stuff in this lifesaving business.

When you sign up for the coast guard you contemplate a pleasant summer at the seaside, lots of swimming and boating and a dash of adventure when a rescue is necessary. Well, you get that, but you also get your weekly stint of swabbing down the station, dreary hours of flag communications drill and rowing practice and such tiresome events as resuscitation and frostbite training—with maybe some frostbites of your own—and infantry drill.

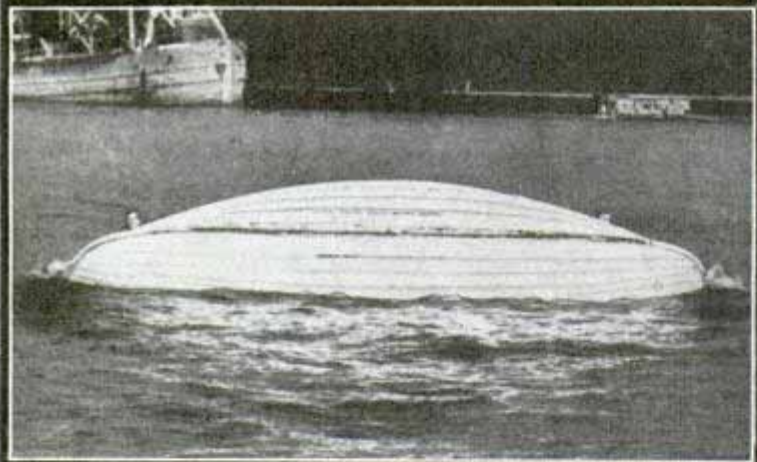
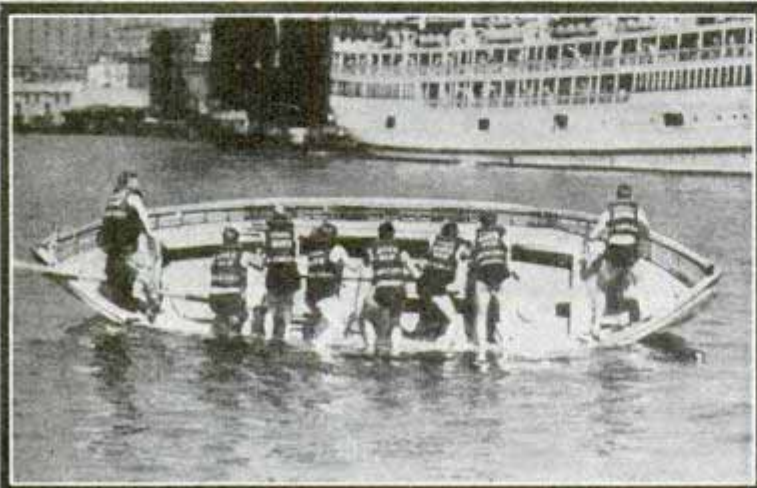

*Coast guardsmen drilling on approved method of righting a boat after it has been upset (see strip at left). Right, the breeches buoy, with which the coast guard has effected many rescues. This method is especially useful in transferring men from a grounded ship to shore*



# *the* COAST GUARD



Thousands of lives are saved every year by coast guardsmen at the many stations that outline the lakes and seashores. Not one of those men would admit anything heroic about his work, least of all Chief Boatswain John O. Anderson, who has just gone ashore after thirty-nine years in the service. Most of that time he was chief of the "Old Chicago" station.

On the night that John Anderson became a hero a sixty-mile gale was blowing on Lake Superior. The mercury cringed at the eighteen-degree mark and spray froze on the nose of the little steamer "H. E. Runnels" as it poked its prow out of the harbor of Grand Marais, Mich., at 2:30 a.m. on an early November morning. Eight miles out the ship ran into a blinding blizzard. The cap-



*Top, coast guard rescue boat returning from search for fishermen lost in ice fields on Great Lakes. Bottom, breeches buoy drill, with the guardsmen hoisting shore props to tighten the line*



Hall Point

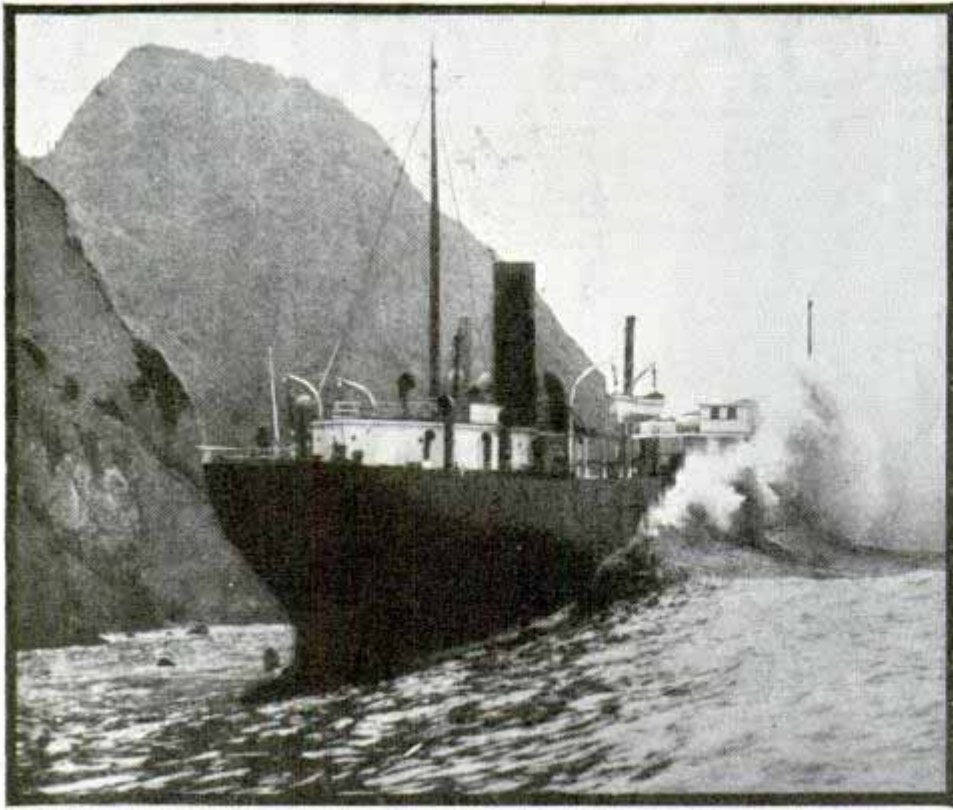

Steamship "Coos Bay" stranded off California coast (top). Crew of thirty-five was rescued by means of breeches buoy and lifeboats. Center, shooting a line to stranded ship. Right, bottom, coast guard beach patrolman

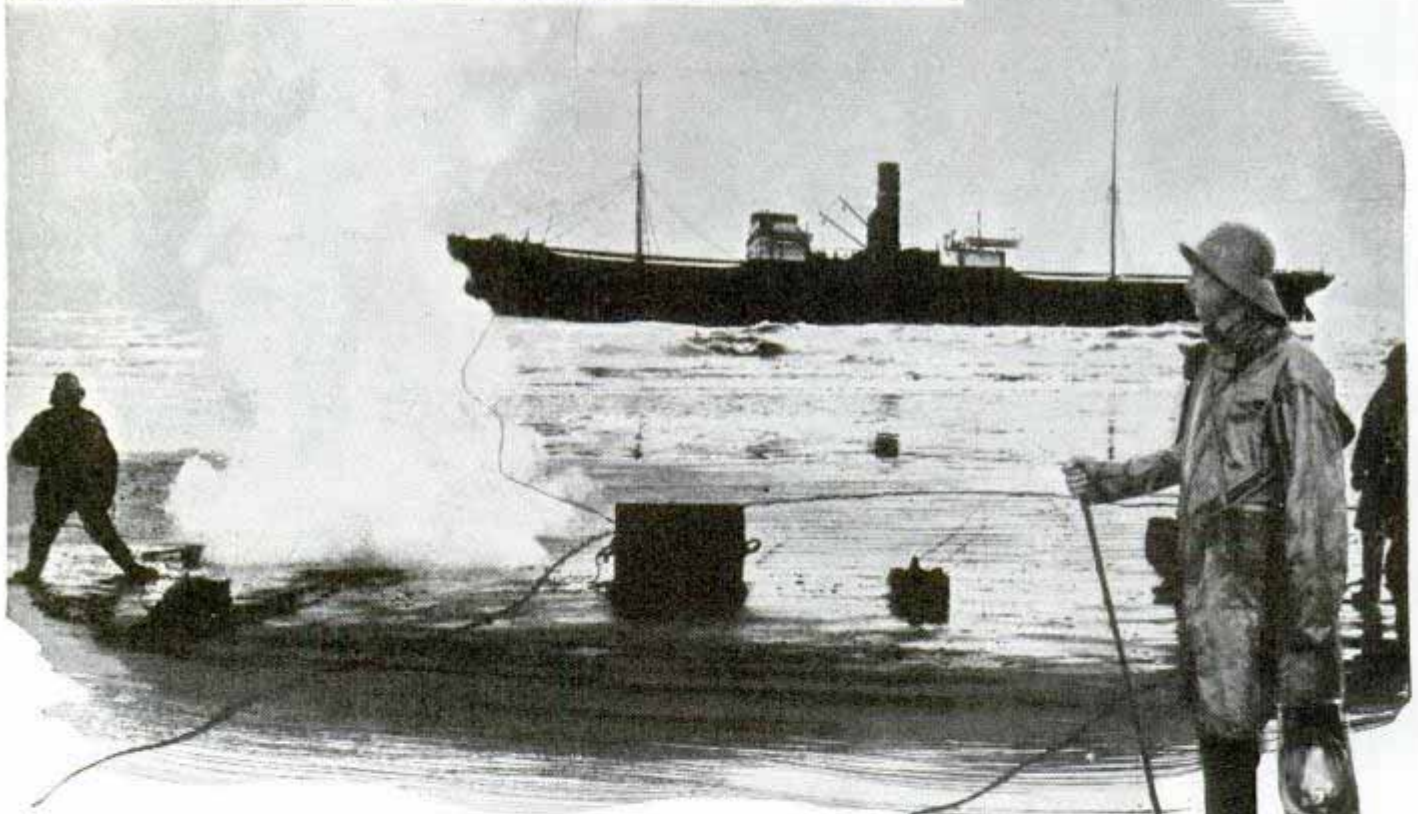

tain wheeled around to regain the safety of the harbor and wait out the storm. Feeling her way in the blackness the "Runnels" missed the harbor entrance, then backed five miles out into the lake and tried again. As she fought toward port a second time the steering gear gave way, and with an emergency gear rigged up of block and tackle for hand steering, the ship plowed shoreward, once more missed the entrance and went hard aground a half mile off shore.

Coast guards had sighted the steamer a half hour before she struck. The chief of the Grand Marais station was absent on leave but luck had



brought to port that day Keeper John Anderson, on leave from the Chicago station. Anderson took command of the rescue. The beach gun was set up, and one well-aimed shot sent a whip line over the bowsprit of the "Runnels." The sailors made it fast, and the guardsmen prepared to send the breeches buoy out—but water swiftly froze on the pulley and fouled it. Rescue by breeches buoy was abandoned.

No one but a coast guardsman would have ventured into the surf that was pounding the beach, but there were seventeen men out there waiting for help. Lashing the forward end of the boat to the line stretching to the wreck, Anderson and his crew shoved the surfboat into the twenty-foot waves. Halfway out the lashing gave way, and the men tried the oars. Blades were as useless as matches in this blow. They made fast to the line again, bow and stern, and slowly hauled themselves by hand to the steamer. One by one, four men slid down the line into the surfboat.

Turning their backs on the biting gale the guardsmen pulled for the beach. Suddenly a towering wave swept over the small boat, washed overboard every man. Fortunately all wore life belts, and all managed to make shore. But three of the crew were through for that day. Wrapped in blankets, they were cared for at the station while the rescue went on.

Back to the wreck went Anderson and crew three more times, bringing six men ashore, then five, finally shoving off for the last trip to rescue the master and chief engineer of the "Runnels." By now only Anderson and Mate Christoffson of the Grand Marais post were fit for the final trip, and four fishermen volunteered to help. They took off the captain, then it was the chief engineer's turn. He was a big hulk of a seaman weighing 315 pounds. Twice Anderson was swept overboard in trying to rescue him, and it was ten long minutes before he pulled the big fellow aboard with a boathook—ten minutes of paralyzing struggle in and out of a plunging lifeboat that might at any minute capsize or crash against the steamer.

Just as the surfboat rode a breaker high up on the beach and spilled out eight exhausted men, almost solid blocks of ice, a tremendous wave split the "Runnels"

(Continued to page 118A)

## Portable Metal Fire Escape Anchors to Any Window

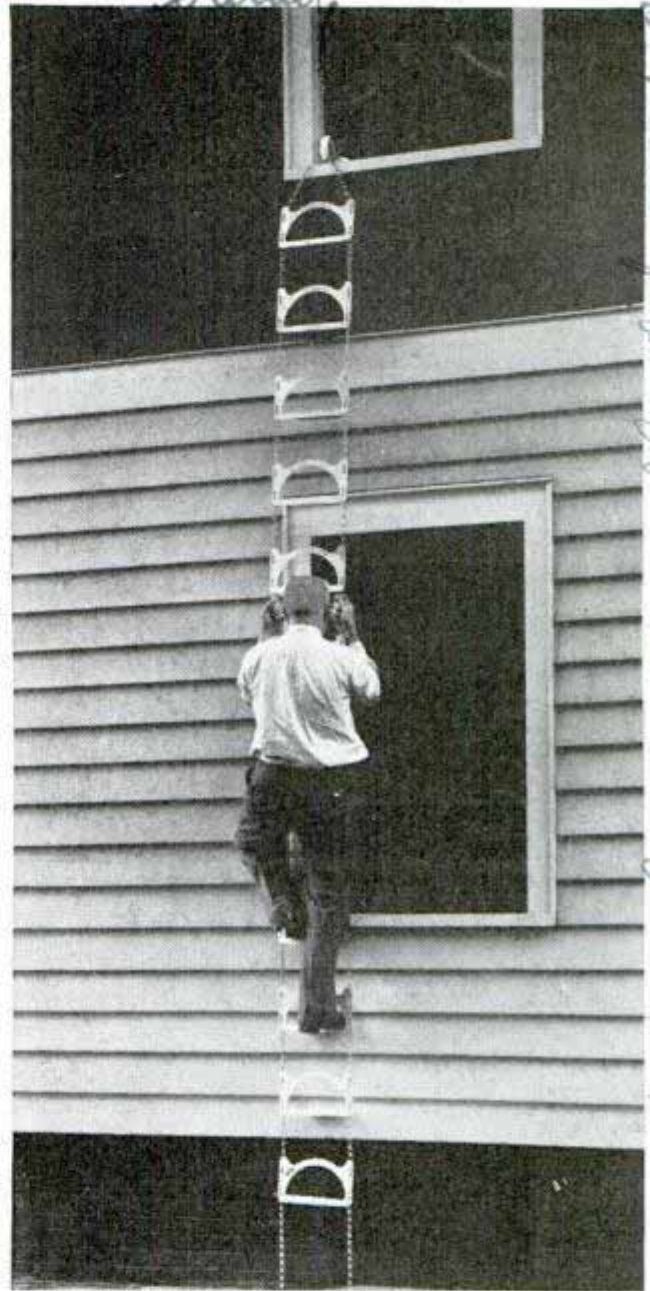

Climbing down from second-story window on metal fire escape that is anchored quickly to any sill

In case of fire or other emergency a folding metal ladder will convert any window into a point for escape to safety. An anchor at the top holds it to the window sill, and its load capacity is 1,800 pounds. Strung on a chain in the fashion of a rope ladder, metal treads four by nine and one-half inches assure a positive level footing. A sixteen-foot ladder is available for two-story buildings, and there is a twenty-four-foot one for three stories.

□ An Arizona copper mine has been air conditioned to a depth of 4,000 feet.

Magna Copper Mine



2949  
896

Lewis retd. 4/21/48  
POPULAR MECHANICS

## Sprayer with Three Nozzles Is Carried on Back



© British Press Combine

Chemical in tank carried on gardener's back is forced out through nozzles in pipe near ground

*Used in England*

Weed-killing chemicals are spread over lawns evenly by a hand-operated apparatus consisting of a long pipe equipped with three nozzles that extend close to the ground. A supply of poison is carried in the tank on the gardener's back.

## Three Face Shields in One Unit Are Interchangeable

Three different types of industrial face shields, each for a special type of work, are interchangeable in one unit which is now



Three face shields to suit different types of work are interchanged on a single headband for workman

on the market. A screen is used for babbitting and protection from heat, while a clear Plastacele window is sufficient for spot, flash and gun welding, buffing, polishing, wire brushing and similar operations. These two guards afford all-around vision. To have complete protection for acetylene welding, burning and scarfing, the workman uses a fiber mask with a built-in window. Any of these shields can be buttoned on the headband quickly. Absorbent leather sweatbands, with wool-felt backing, keep perspiration out of the eyes.

## Fishhook with a Safety Catch Is Set by Jerking Line

To prevent snagging on logs and weeds a Wisconsin man has invented a sliding safety catch that guards the point of the fishhook until the fish takes the bait. The

*Pat # 2,123,598 20 cents*

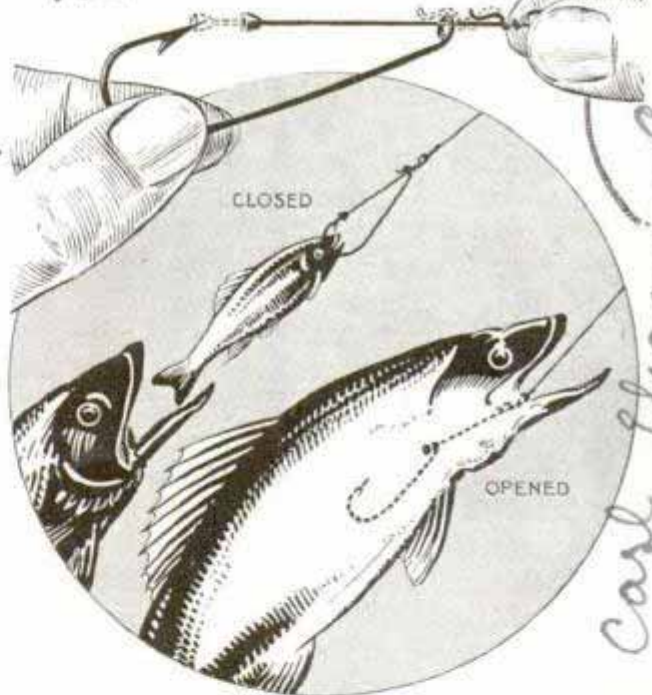

Drawings show how the guard over point of fishhook is withdrawn by jerk after fish swallows bait

tiny funnel-shaped guard rests over the point. When the fisherman feels a tug on the line and is ready to "set" the hook a simple jerk releases the guard and the fishhook opens and makes the catch.

Names and addresses of manufacturers and dealers in articles described in this magazine will be furnished by our Bureau of Information upon request accompanied by stamped, self-addressed envelope.

*Mr. Messrs. Elmer...  
The Boyer...  
6500 Antioch...*

*Carl Pearson & Co.  
Clymer, Wis.*





# The CRAFTSMAN

Craftsmen Wood Service  
2727 S. Mary

## Say MERRY CHRISTMAS

## in WOOD

Thin veneer in rare stock lends itself to overlays, cutouts, or it can be carved

YOUR Christmas cards will be different and outstanding from the general run of paper cards if you use thin veneer in imported woods available at craftsmen's supply houses. The cost of veneer for this purpose is not high—probably not any more than you would normally spend for a good grade of paper cards. The fact that they are made entirely in your hobby shop adds to their personal character.

If you have a scroll saw, it's an easy matter to stack a number of pieces of veneer in a pad and make the same cutout on all the pieces as in Fig. 1. The design is traced on the top one. After cutting out the pieces,

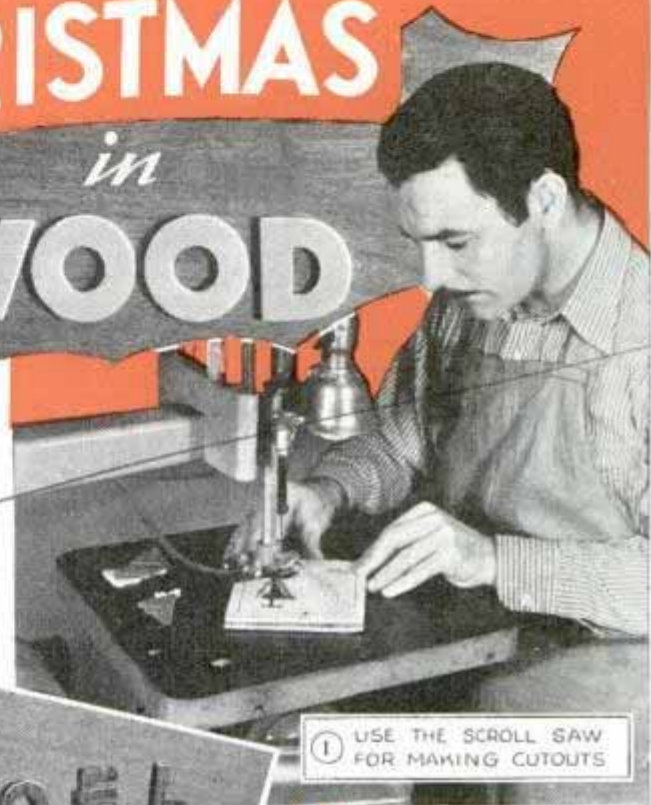

① USE THE SCROLL SAW FOR MAKING CUTOUTS

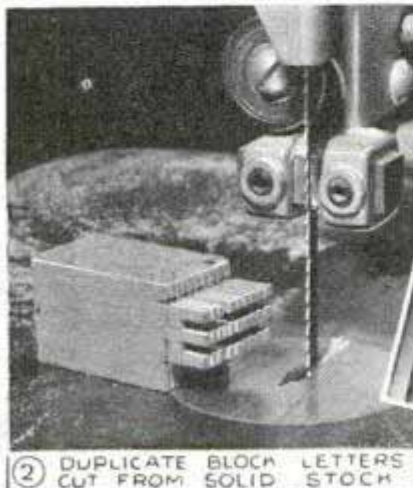

② DUPLICATE BLOCK LETTERS CUT FROM SOLID STOCK



they are glued to a solid backing of contrasting veneer. Or, you can saw out letters for words to be glued to veneer cards. A number of duplicate letters can be cut out from solid stock either on a scroll or band saw. See Fig. 2. When cutting duplicate pieces in this way, the stock is held together securely by means of pins driven through the waste portion, or the pieces are rubber-cemented together. The latter method permits you to pull the



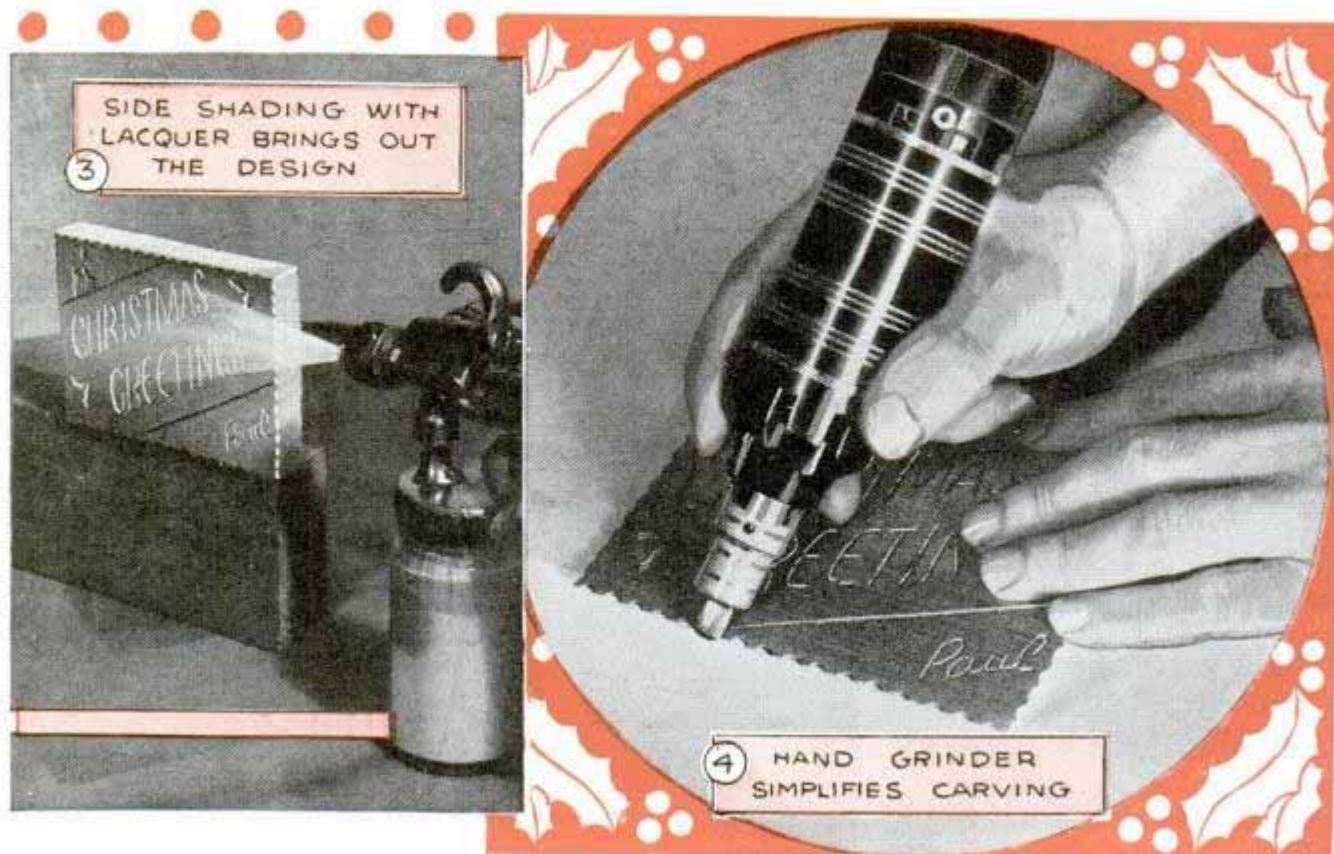

sawed pieces apart easily, after which the cement is rubbed off.

A third type of card is one on which the wording is carved. Of course, each card is done separately and the whole job will take more time than the production methods already suggested. If you have a motorized hand grinder, light carving of letters does not involve much more work or

skill than writing, as you can see from Fig. 4. On carved work, beautiful effects can be obtained by means of side shading, Fig. 3, with a small paint-spray gun.

Besides the few suggestions given, these methods of making Christmas cards offer unlimited possibilities in obtaining varied effects, dependent entirely on the ingenuity and skill of the designer.

## *Inexpensive Buffing and Polishing Wheels Made of Paper*

If a buffing or polishing wheel is not available all you need to make one is a couple of old pulp magazines. Remove the covers and draw a circle of the desired size on an outside sheet. Use tin shears to rough out the wheel, cutting fairly close to the line. Then clamp it between a couple of boards and drill the shaft hole. Put the assembly on the shaft, using mucilage between the sheets near the core to keep them together. Then start the motor and turn the circle to size with a chisel. For a permanent wheel, put the sheets on a hollow metal mandrel that will slip over the buffer shaft. Thread the outer surface for nuts to clamp the paper in place.

☐ You can slice fresh bread easily with a sharp knife that has been heated.

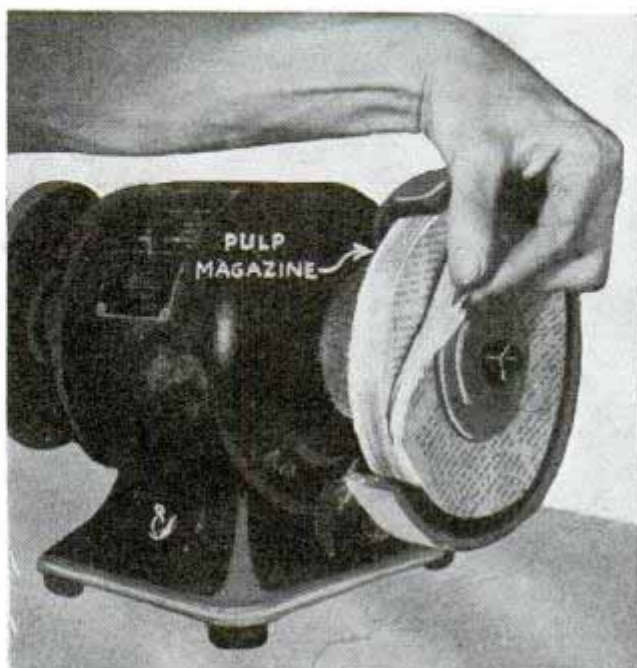



# LINOLEUM INLAYS

*make attractive breadboards*



Colorful breadboards of linoleum with contrasting linoleum inlays are useful and decorative additions to modern kitchens. They are easy to make and various colors of linoleum available permit unlimited combinations. Besides the inlay designs given here, you can find any number of suggestions for inlays from the pages of catalogues and magazines, or you can purchase suitable inlays from stores that sell linoleum. The boards consist of plywood with linoleum cemented to both sides, the edges of the boards being bound with linoleum strips cemented and bradded in place.

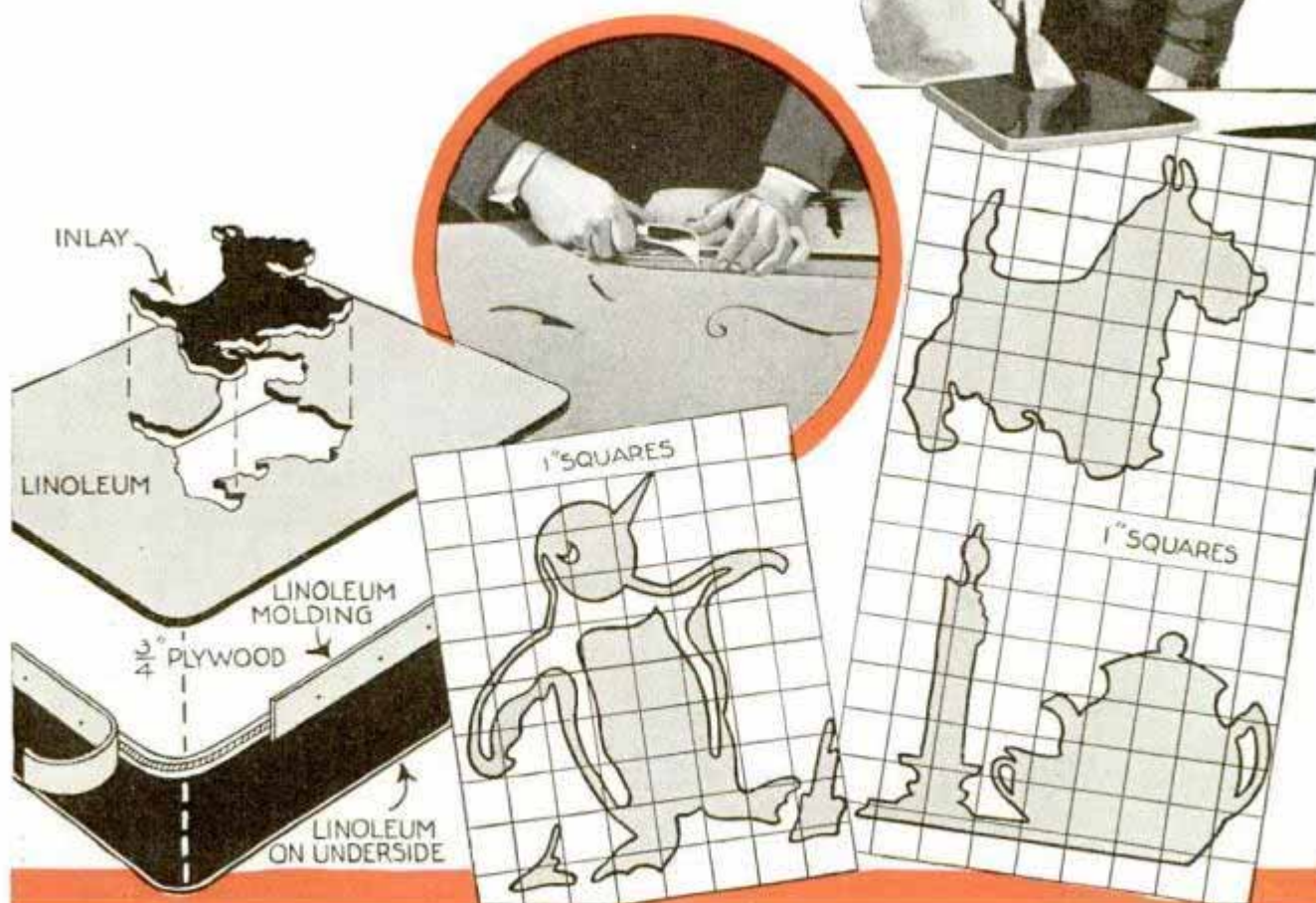



## Sandpaper Clip Helps to Hold Balsa Wood While Cutting

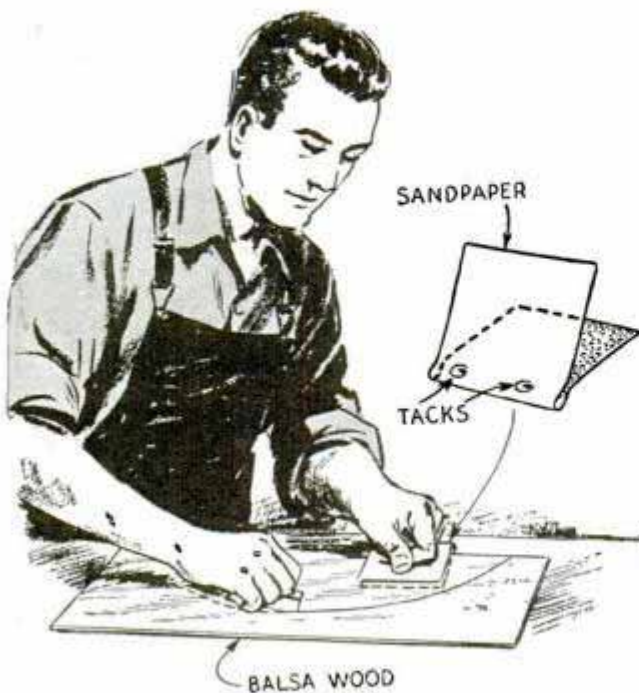

Difficulty of holding thin strips of balsa wood on a board or table for cutting along pattern lines, led one man to devise a simple vise for the purpose. This consists of a folded piece of sandpaper, which is attached to the board with thumbtacks. The balsa is slipped between the abrasive surfaces, and the pressure of a finger holds it firmly while the blade is being operated to do the cutting.

## Swing Spout Dispenses Liquids in Large Cans

When filling small containers from large cans of honey, molasses, heavy oils or other thick liquids, lifting may be avoided by attaching a swinging spout to the screw

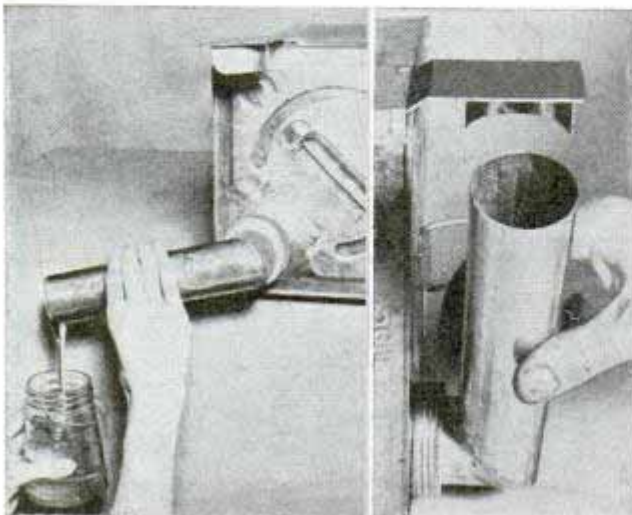

cap of the large can and placing the can on a flat surface. A hole should be cut in the top of the screw cap and a tin spout, 2 in. in diameter, soldered over the hole so that when the spout is in an upright position the lid will be screwed on tightly. A cap, to keep out dust, or other foreign matter, is slipped into a raised strip soldered to the side of the can. To fill a container the spout is lowered until the liquid runs out.—Benj. Nielsen, Aurora, Nebr.

## Sanding Bow for Curved Work

A bow to take a strip of abrasive cloth will facilitate sanding irregular-shaped work. The bow consists of a length of thin flat iron bent to a wide U-shape, with short pieces of iron bolted to each end to clamp the ends of the abrasive cloth. In use, the cloth is held against the object to be sand-

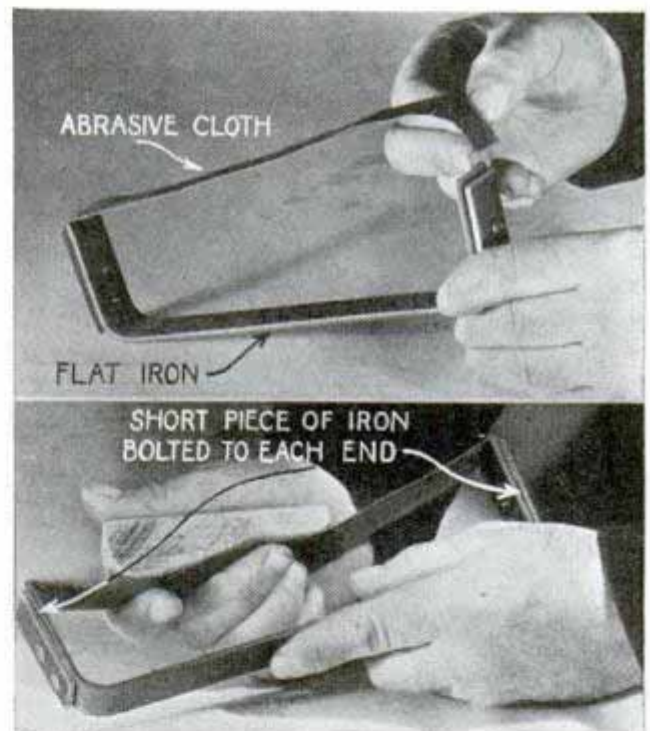

ed and it is pressed into the low spots with the fingers, as shown in the lower photo. Sanding is accomplished, of course, by pulling the bow back and forth. If desired, a wood handle can be attached to the bow with small bolts.

—Merle Terrill, Portland, Ore.

☐ Before washing porcelain tubs and sinks, wipe them with a cloth dampened with kerosene, which will cut the dirt and grease and reduce the amount of scouring necessary to clean them.





# Plywood KITCHENWARE

IT'S just like pouring coffee to dispense soap chips and beads from these containers. The one with a spout is for soap beads, while the other with a pivoted lid, which is opened like an old-time syrup pitcher, has a larger opening for chips. Both containers are made of  $\frac{1}{4}$ -in. plywood, and are assembled with small brads. The holder for salt and pepper shakers at the bottom of the page has a teapot motif to carry out the kitchenware idea.

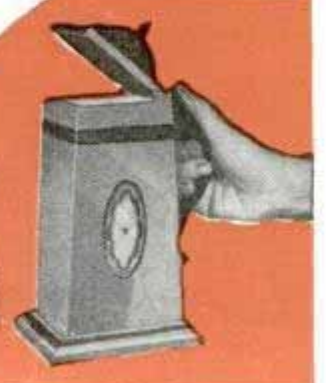
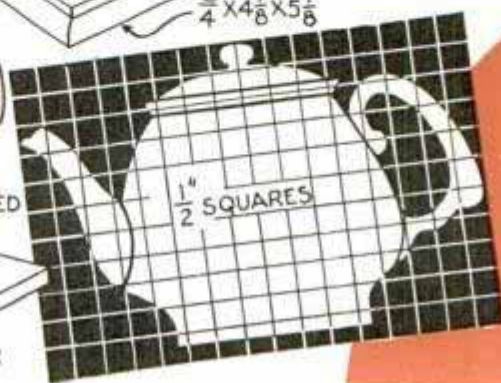
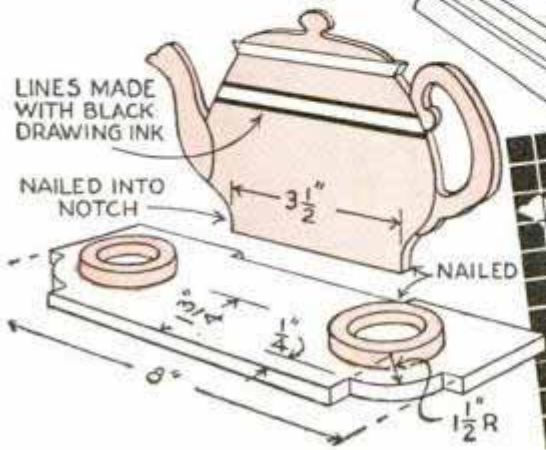
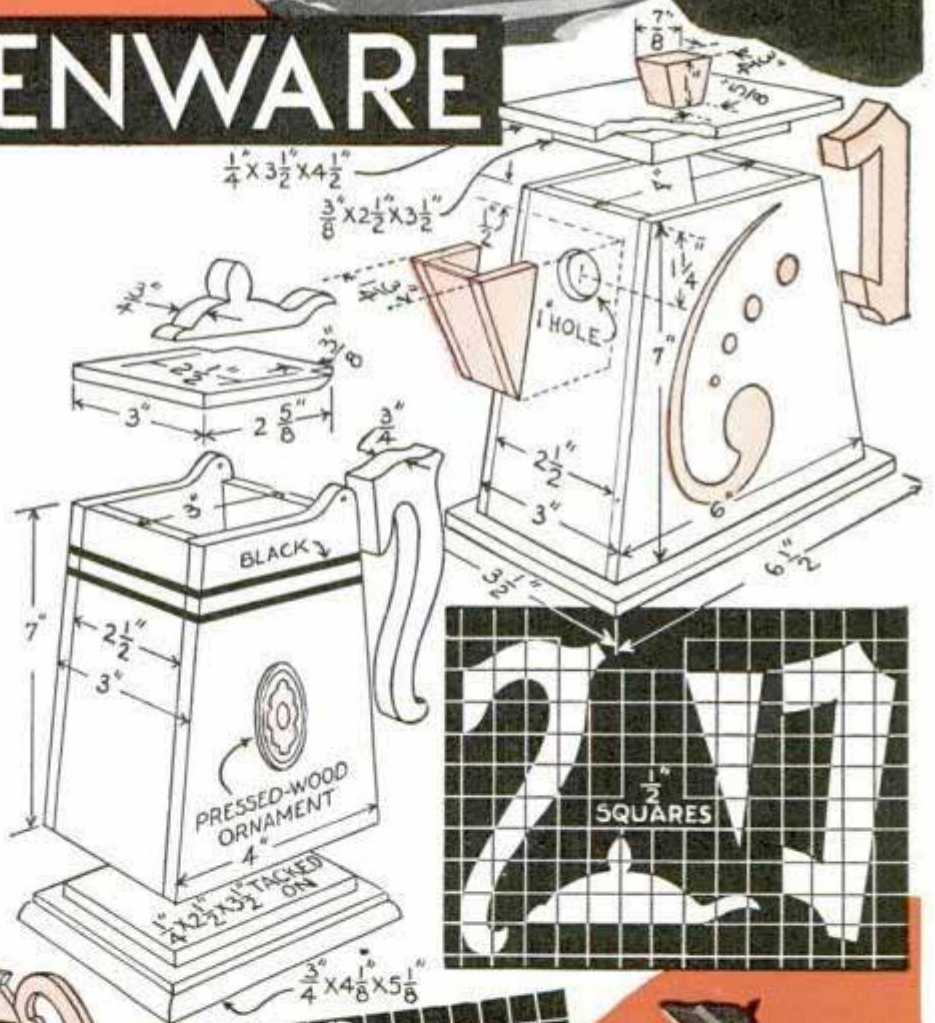



### Stains Applied to Wood Turning with Shoe-Polish Dauber



A shoe-polish bottle fitted with a dauber provides a handy receptacle for wood stains. I find the bottle more convenient than the original stain can, as the applicator is always at hand and there is no loss of time in cleaning or caring for a brush.

—G. E. Hendrickson, Argyle, Wis.

### Wiper Cleans Ways on Lathe

After having a chip of tool steel work under the tailstock of my home-workshop lathe and scratch the way, I added a wiper

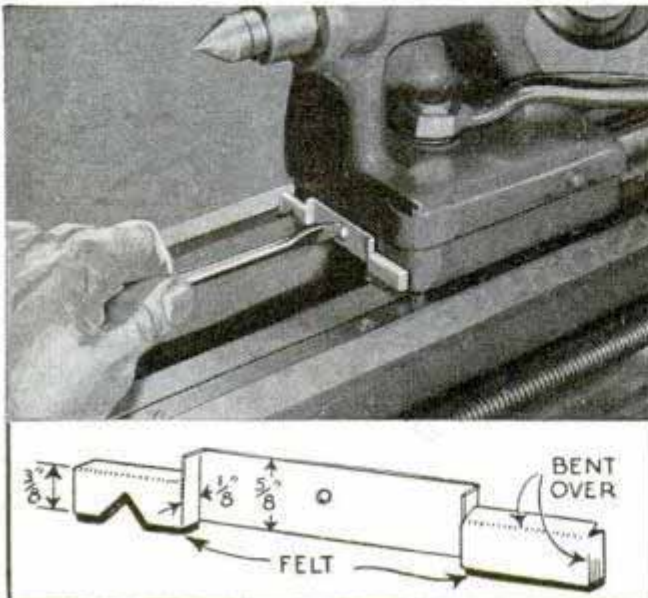

to the tailstock to avoid such damage. The detail gives the dimensions, some of which are omitted because these vary with the size and type of lathe. A hole is drilled in the center of the wiper, and the tailstock base is drilled and tapped to receive a clamp screw. This permits the wiper to be removed by loosening this one screw.

—Burl Knutson, Bismarck, N. D.

### Slotted Washer Opens Tubes of Ink or Paint

Printers and painters who use inks or paints in collapsible tubes will find a slotted washer handy for removing the screw caps. After slotting the washer, bevel the severed ends to sharp edges so they will tend to bite into the cap when pressed over it.



### Repairing Crack in Stove

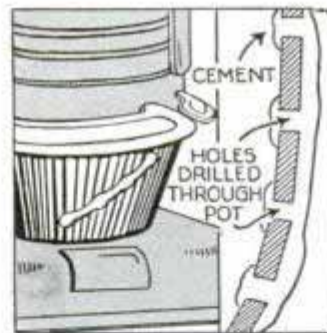

Cleaning a crack in a stove fire pot so cement will bond to it to form a good repair is simplified by drilling holes through the pot at the crack as indicated. Bright metal is

exposed inside the holes so the cement makes a good bond. Holes at each end of the crack tend to prevent further damage.

### Clothespin Holds Paint Paddle

To keep a paint paddle from interfering with the brush, a painter uses a clothespin clip as shown. One side of the bail is removed and inserted through the pin so that it rests horizontally on the edge of the pail.





# FRIENDLY HEARTH

*fits new living rooms*

Portable fireplace in bone white has recessed shelf for books and bric-a-brac, and can be moved to any wall space for varied effects

By WAYNE C. LECKEY

DESIGNED to harmonize with the furnishings of most rooms, this fireplace and mantel combination provides space for a radio, books and decorative knickknacks in the small home or apartment. It's easily moved when you want to rearrange the furnishings. Soft wood, such as white pine used together with fir plywood is suitable for constructing the fireplace as the finish is to be enamel. Referring to Fig. 1, shape two blocks which make up the corners of the frame. This is done on a circular saw with the table tilted to  $45^\circ$  as in Fig. 3. Fig. 2 gives the successive steps. A compass set to a 4-in. radius is used to scribe a guide line on each end of the pieces, although planing the pieces round is not done until after they have been glued in place. The two corner pieces are now joined with a cross-rail doweled and glued 2 in. up from the lower end. A couple of clamping blocks to hook over the corners will enable you to draw the joints up squarely with a bar clamp. While the glue

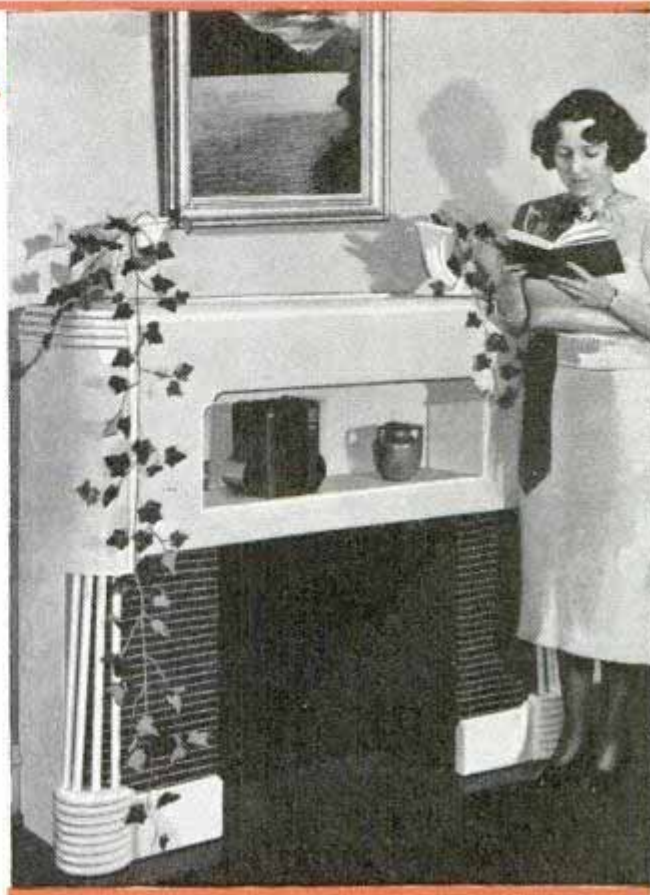

is drying, the plywood sides of the frame can be cut. One edge is rabbeted to fit snugly in the corresponding groove in the corner piece, Fig. 1. Here, as before, each side must be cut as a right or left-hand member. A portion of the rabbeted edge is removed flush with the shoulder and sanded smooth. If the fireplace is to fit closely against the wall, make a pattern of

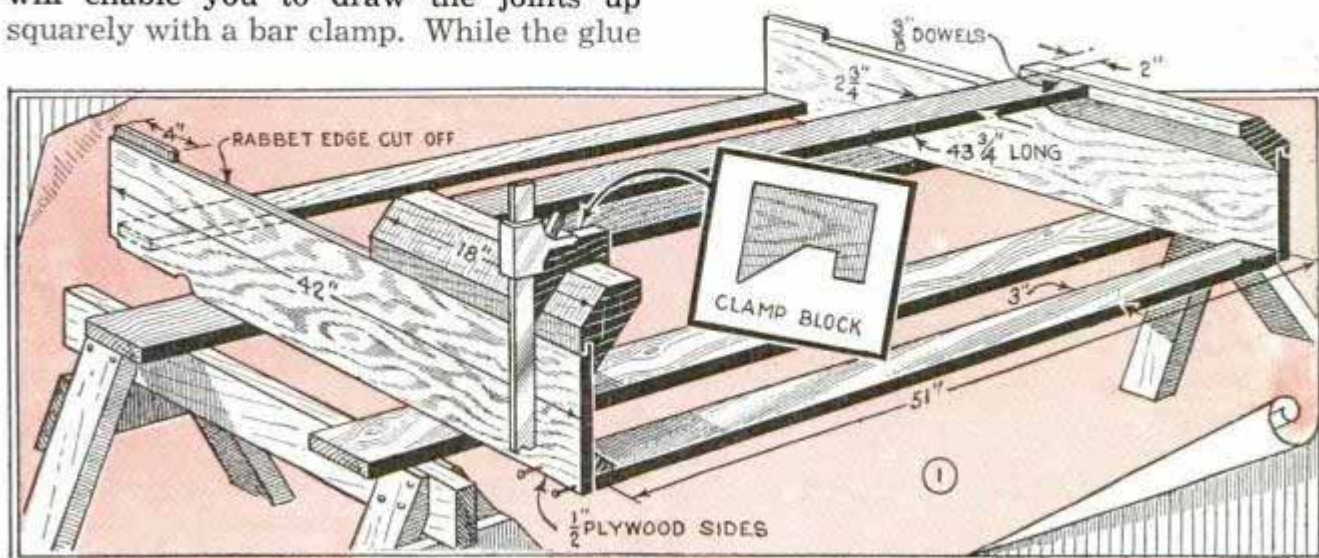



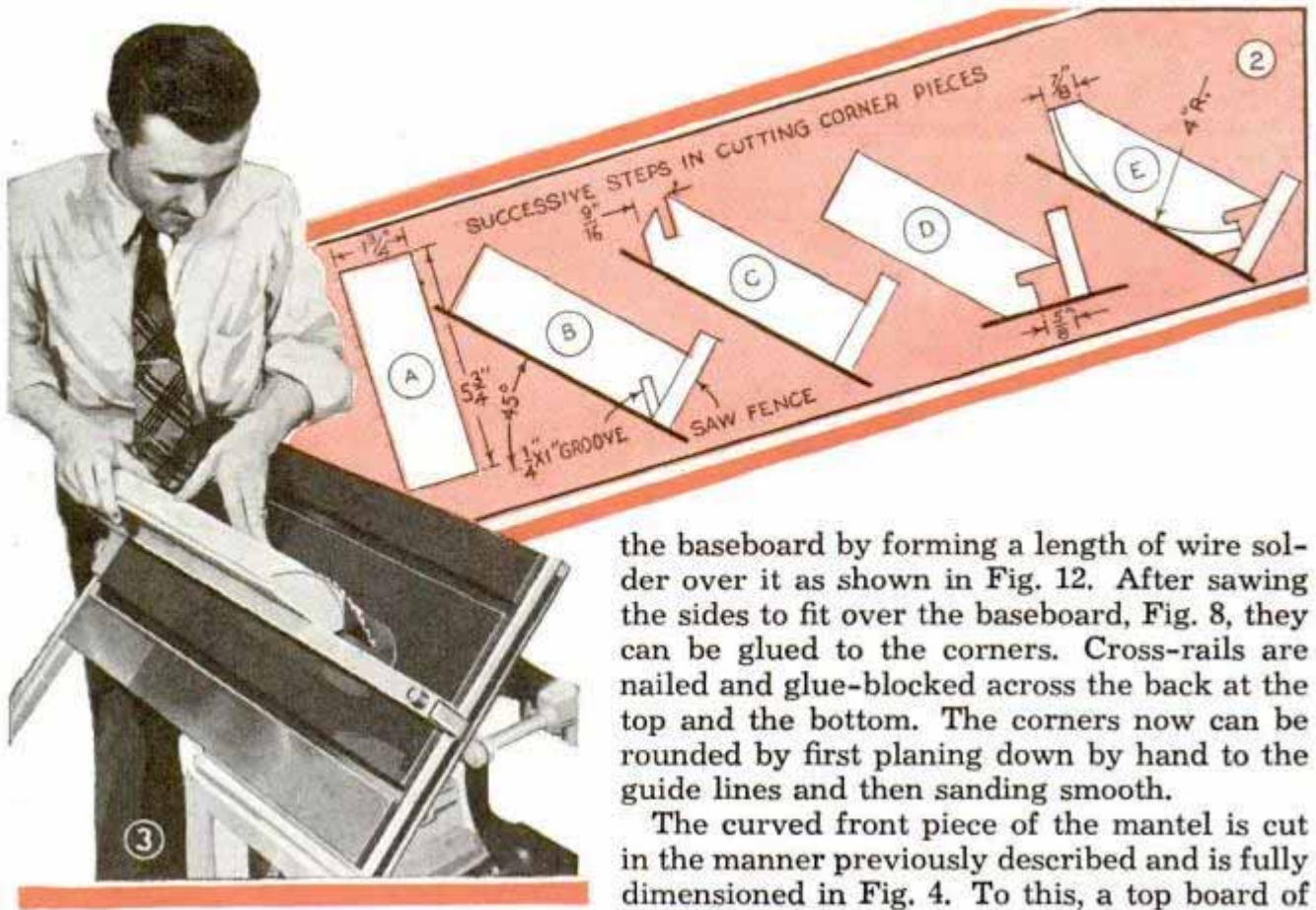

the baseboard by forming a length of wire solder over it as shown in Fig. 12. After sawing the sides to fit over the baseboard, Fig. 8, they can be glued to the corners. Cross-rails are nailed and glue-blocked across the back at the top and the bottom. The corners now can be rounded by first planing down by hand to the guide lines and then sanding smooth.

The curved front piece of the mantel is cut in the manner previously described and is fully dimensioned in Fig. 4. To this, a top board of plywood is rabbeted and glued as before, using several clamps and blocks to pull up the joint. While this is drying, the 1/4-in. plywood panel which covers the front can be cut to size as in Figs. 5 and 11. The top edge is rabbeted to fit

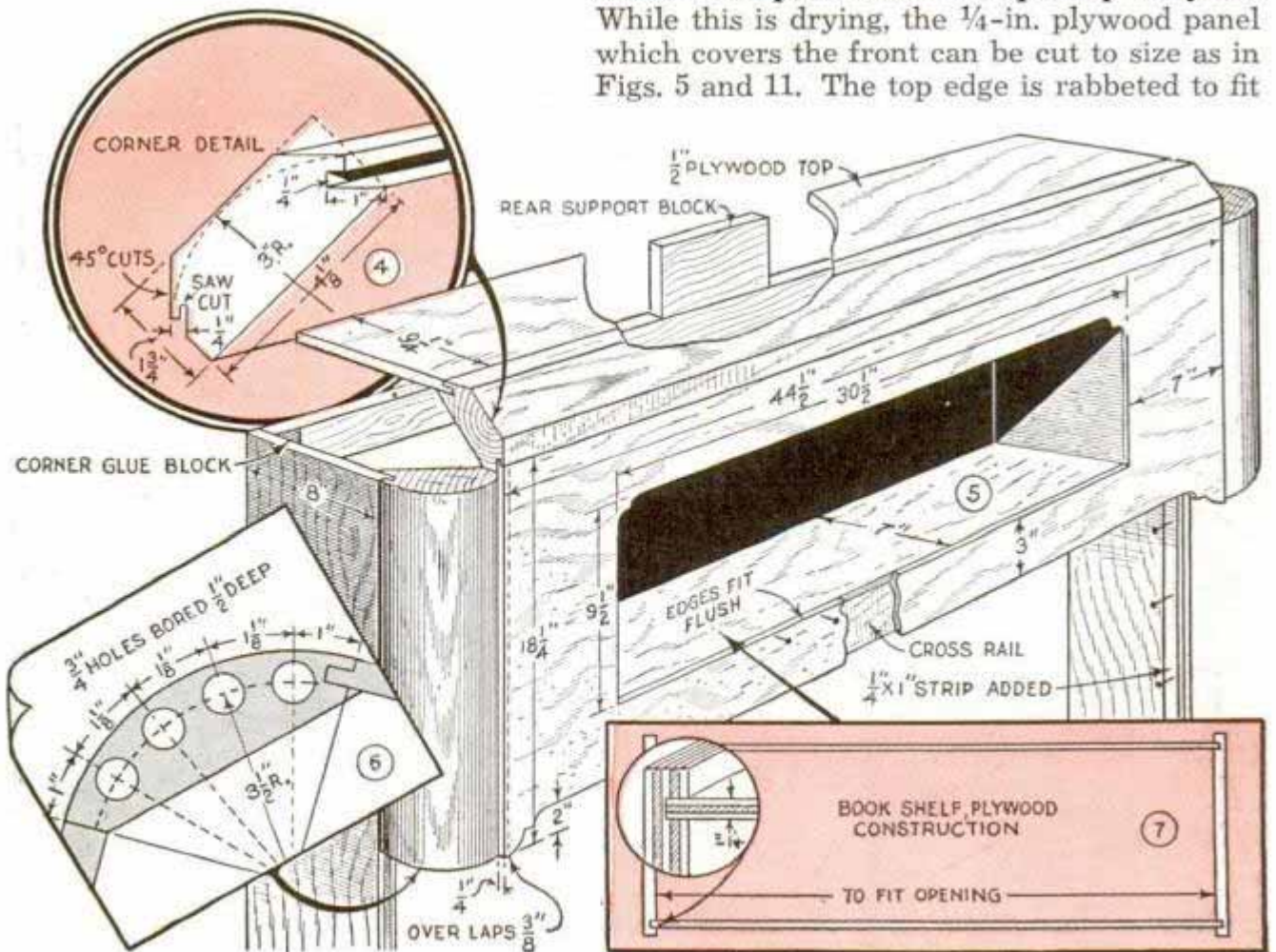



snugly. The opening for the bookshelf can be cut on a bench saw by bringing the work down gradually over the rotating blade. This is then glued and bradded in place, allowing it to over-lap the corners  $\frac{3}{8}$  in. When this has been done, the top unit, previously clamped, is glued to the extending rabbet of the front. A scrap block glued to the center of the rear cross-rail supports the top at the back. The corner is then formed round as before.

Made to fit flush with the edges, a box-like framework, Fig. 7, is glued and bradded to the opening to form the bookshelf. The assembly is now turned up-side-down and, using a ratchet brace, four  $\frac{3}{4}$ -in. holes are bored in the lower end as shown in Fig. 6. What appears to be a solid shaped block at the top corners is simply four pieces glued together in layer fashion as in

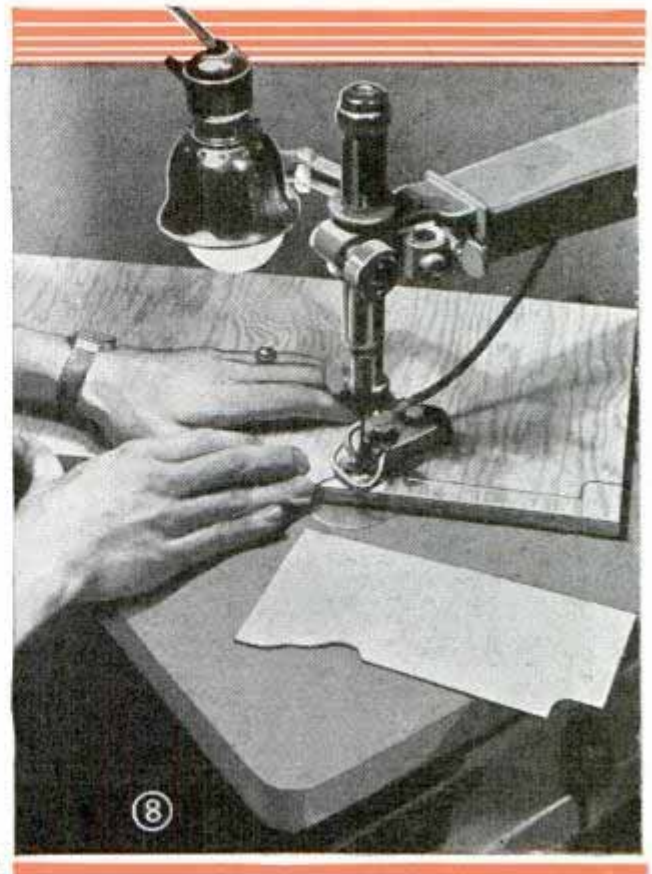
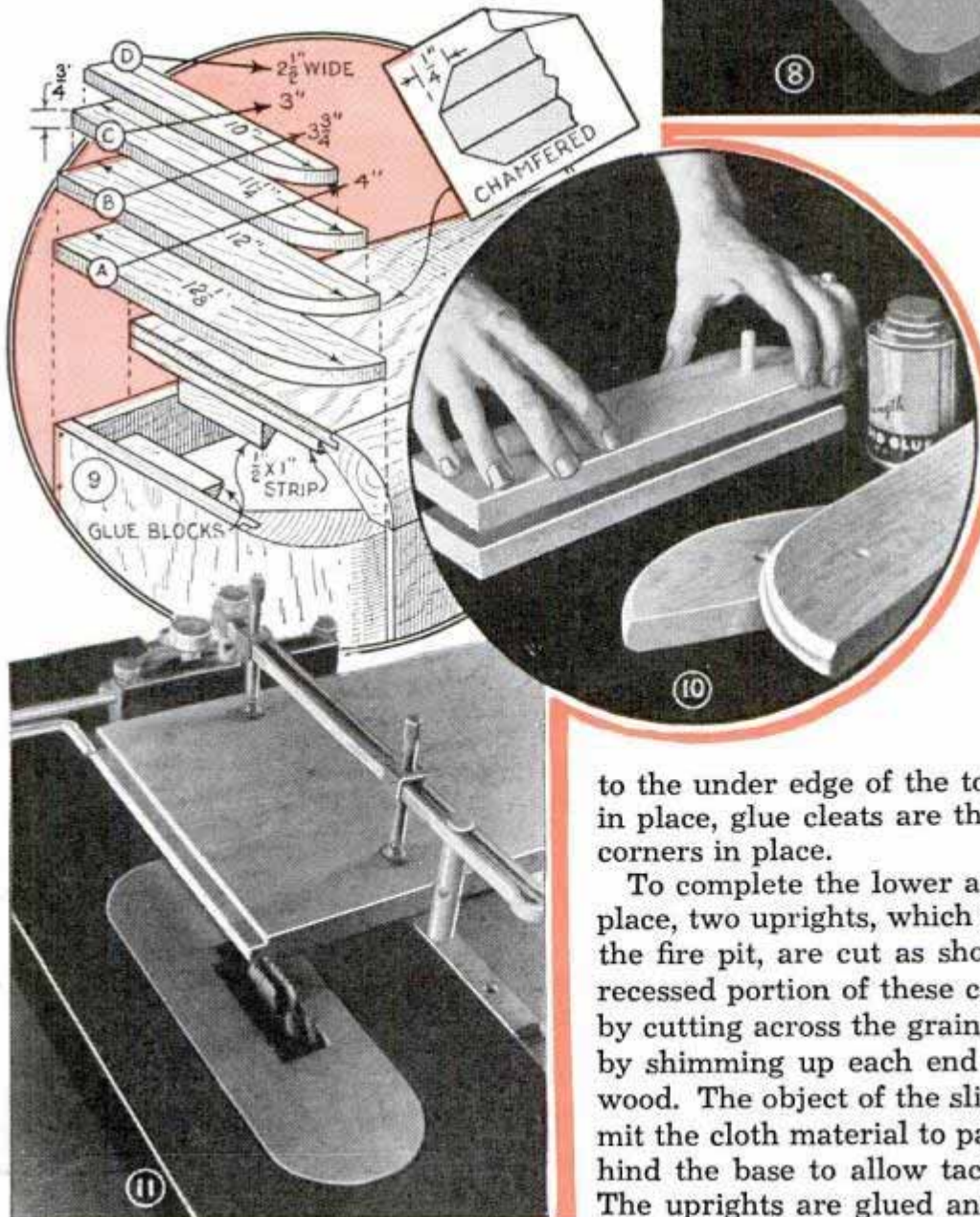

Fig. 9. These are cut separately to size and the outer edges chamfered. Short dowels passing through the pieces will prevent them shifting when gluing together, Fig. 10. Prior to gluing the assembled block in place at the corner, a narrow strip first should be glued

to the under edge of the top, Fig. 9. With this in place, glue cleats are then used to hold the corners in place.

To complete the lower assembly of the fireplace, two uprights, which form the opening of the fire pit, are cut as shown in Fig. 13. The recessed portion of these can be formed either by cutting across the grain with a dado saw or by shimming up each end with thin pieces of wood. The object of the slight recess is to permit the cloth material to pass between and behind the base to allow tacking from the rear. The uprights are glued and screwed from the





back in the position shown and are joined at the bottom with angle cut pieces which in turn are nailed to the back cross-rail, Fig. 15.

To form the shaped, built-up corners, Fig. 18, first make a cardboard templet by enlarging the pattern given in Fig. 17. Each right and left-hand corner block requires eight pieces cut to this shape from  $\frac{3}{4}$ -in. pine, the outer edges being chamfered. The disk which is to be at the top of the stack should be cut as detailed in Fig. 17. These parts are then glued and nailed together. When dry, a shoulder is formed on each block by cutting back the corners at 45 degrees. A groove to take the tenon on the side piece is run in one shoulder cut while the other is bored to receive two short dowels in the base member. Using the templet previously made as a guide, bore the holes in the top of the blocks at a slight inward angle. The blocks now can be glued at their respective cor-

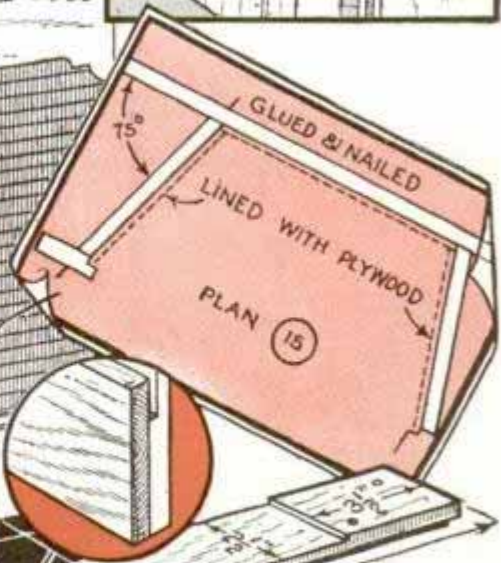
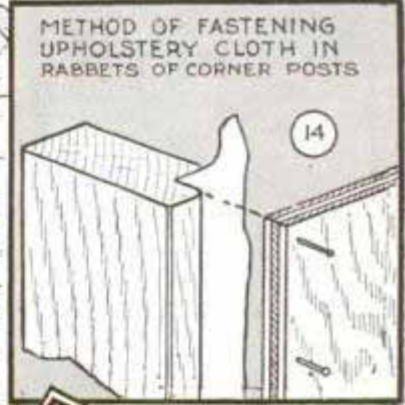
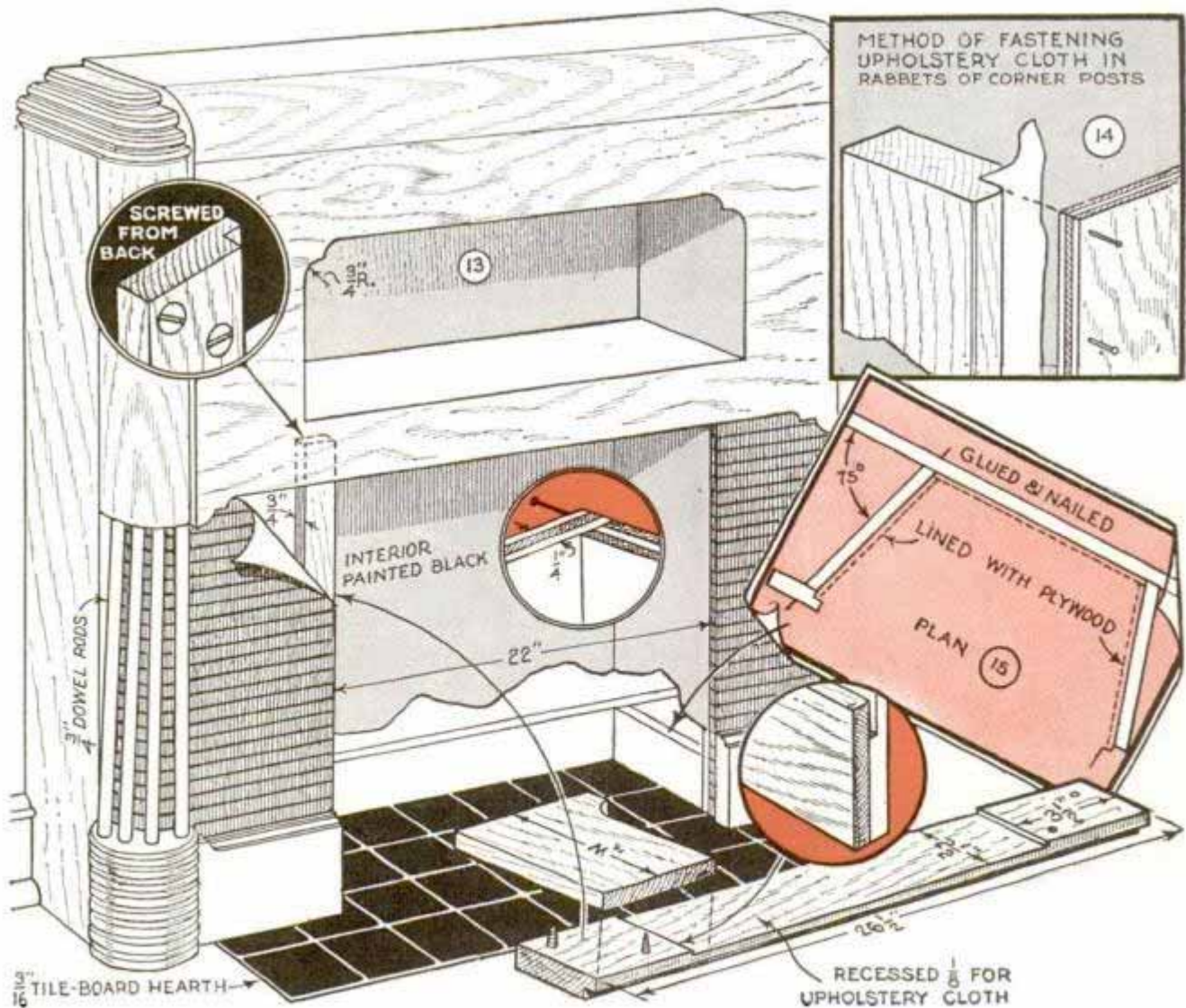

$\frac{3}{16}$  TILE-BOARD HEARTH

RECESSED  $\frac{1}{8}$  FOR UPHOLSTERY CLOTH



ners, inserting the  $\frac{3}{4}$ -in. dowels at the same time.

To fit the upholstery cloth which forms a grille behind which a speaker baffle may be placed, first work the material in the recess at both top and bottom and bring around the rabbet cut as shown in Fig. 14. Over this, the side panels which line the interior of the opening are placed and bradded to the rabbet cut, neatly concealing the raw edge of the material. From then on it is merely a matter of stretching the cloth around behind the dowels, making it curve at the corner by inserting a cardboard form as shown in Fig. 19. This extends the full height of the opening and is held securely by nailing into the corner blocks. Finishing bone white, Fig. 16, completes the fireplace. Apply two or three coats as required, allowing the enamel to dry well between coats.

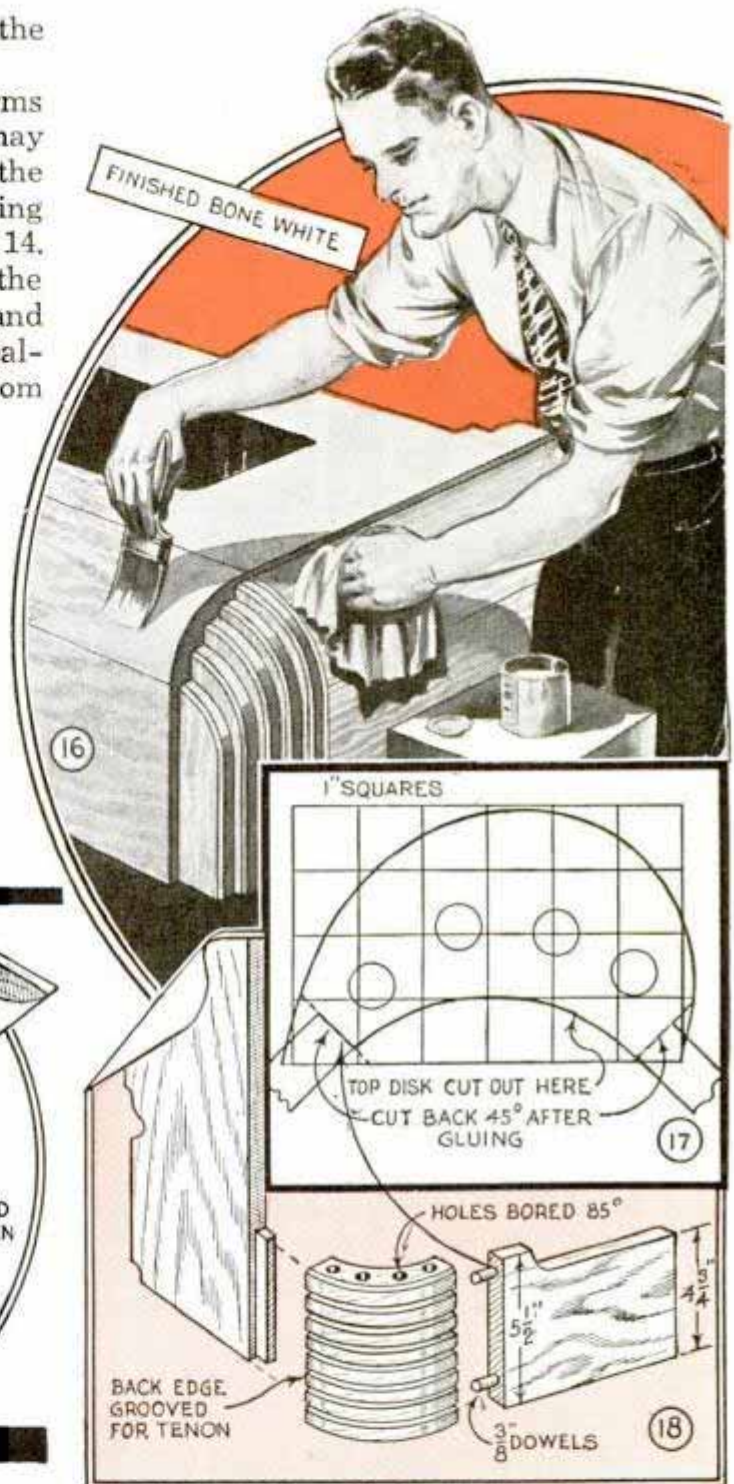
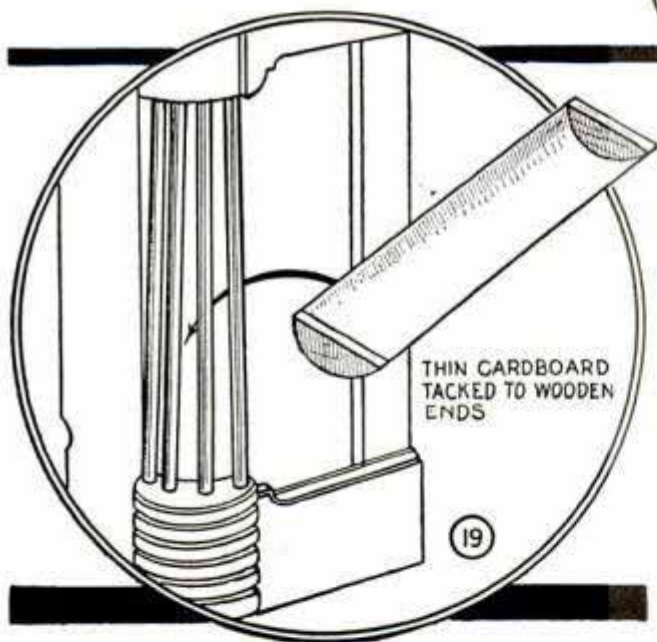

## Clippings Pasted This Way Assure a Neater Scrapbook

The "scrap" appearance of a scrapbook can be eliminated by doing away with puckered edges where the paste has shrunk the clipping, and the print from the other side of the paper has "bled" through. Instead of using a mucilage dauber or paste brush for the job, get a roll of brown gummed paper. Place the clipping in position on the page. Hold it firmly with the left hand, using the first and third fingers. Then, with the right hand, moisten a piece

of the gummed paper and slide it underneath the edge of the clipping with the sticky side upward. Apply a little pressure with the second finger of the left hand on the clipping over the gummed paper and at the same time withdraw the latter so that some of the adhesive will be transferred to the underside of the clipping. Then press the clipping firmly in place, for which purpose the back of a spoon will be found useful.



## Turning Chisel for Tough Jobs Has Tip of High-Speed Steel

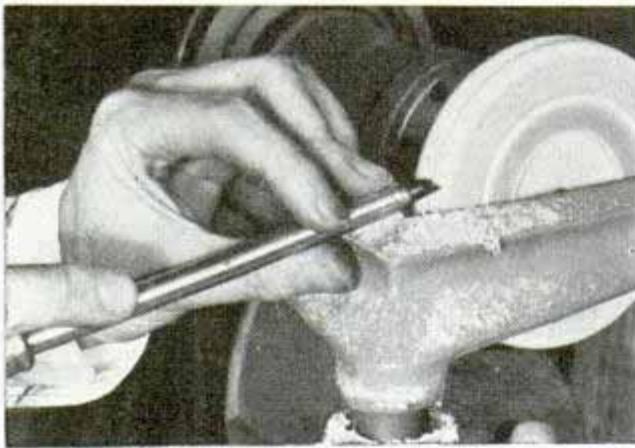
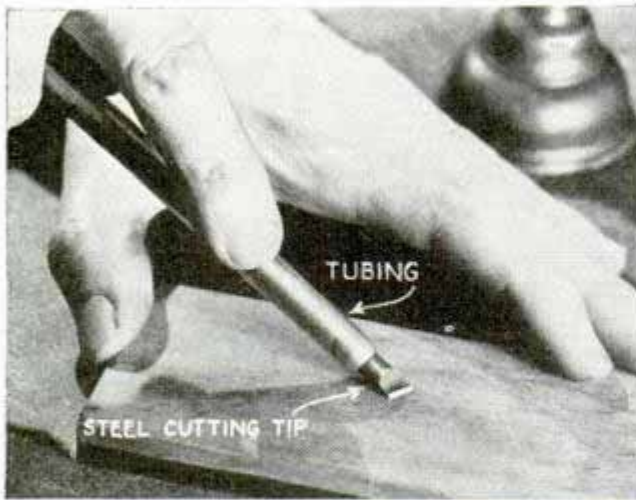

A wood-turning chisel that will hold an edge under such adverse conditions as overheating or the striking of a hidden nail can be made by fastening a piece of high-speed steel in the end of a soft-steel bar or rod. A short metal-turning lathe bit provides a good cutting tip. The rod or bar is drilled in the end to take the tip, which is soldered or brazed in place. Fitting a suitable handle to the chisel completes the job.

—Walter E. Burton, Akron, Ohio.

## Pin Keeps Medicine Dropper Handy on Bottle



To have a medicine dropper handy at all times, bend a common pin as shown and slip it over the glass tube of the dropper, under the rubber bulb. The projecting point is

easily forced into the bottle cork and holds the dropper where it will not be overlooked or broken. If not too large, the pin will not interfere in any way with the suction of the bulb.

## Cleaning Internal Threads

Dirt and grit that collect in internal threads, especially those of a nut, can be removed easily with a piece of steel wire pointed at the ends and bent as indicated. In use, compress the wire ends and "screw" them into the nut to be cleaned.



—Ivan J. Stretten, Detroit, Mich.

## Mail Boxes Hidden in Columns Flanking Porch Steps

One city home owner embedded two rural mail boxes in stone columns that flanked his porch steps. The large boxes provided ample storage space for mail and were well hidden from view. If desired, one box can be used for incoming mail and the other for outgoing mail. Or, magazines and newspapers can be put in one and first-class matter can be put in the other.





## Colorful Cigarette Tray of Metal and Plastic

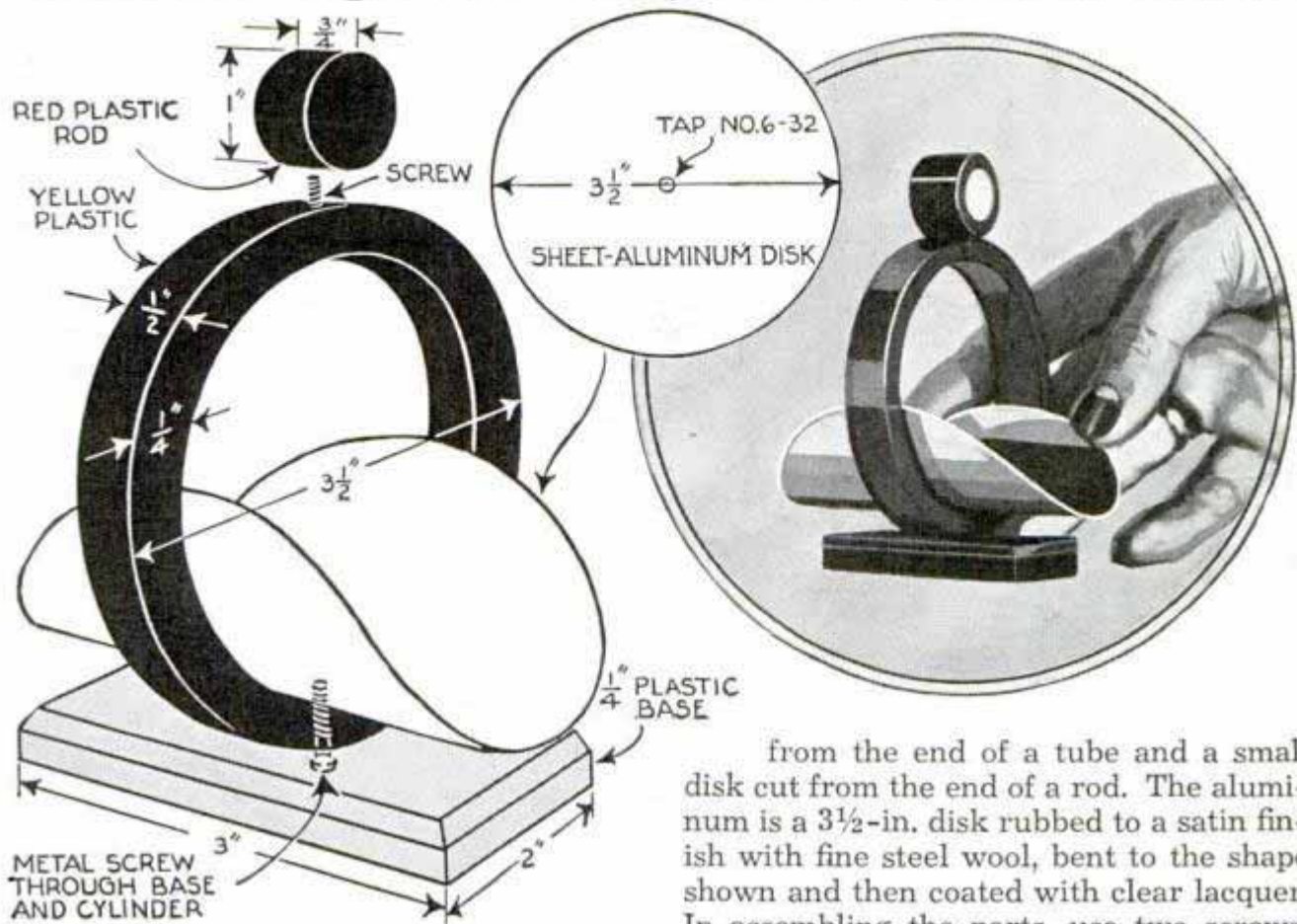

Here's a snappy little cigarette tray in which brightly colored plastics are contrasted with aluminum rubbed to a satin finish. Three pieces of plastic are used; a flat piece for a base, a large ring sawed

from the end of a tube and a small disk cut from the end of a rod. The aluminum is a 3½-in. disk rubbed to a satin finish with fine steel wool, bent to the shape shown and then coated with clear lacquer. In assembling the parts, use two screws, which are tapped into the lower side of the ring, and into the lower side of the plastic disk. The bottom screw is also driven into a hole tapped in the aluminum disk.

—H. R. Wallin, New York.

## Camera and Flash Mechanism Held on Tripod by Bracket

When using a small camera that has but one tripod-screw socket in the base, with a speed-flash device incorporating a small battery case, synchronizer and reflector, this sheet-metal bracket enables you to attach the assembly to a tripod. The bracket is slipped over the tripod screw under the camera, and the flash mechanism is attached to the other end of the bracket. Thus, the entire assembly is tilted with the camera as one unit.—B. M. Ikert, Chicago.

☞ If dirt becomes ground into a waxed floor, rub the spots with a cloth moistened with gasoline or turpentine until the wax coating is removed. Then wash the floor with alcohol and wax it to restore the polish. If the varnish is removed, apply white shellac before waxing again.

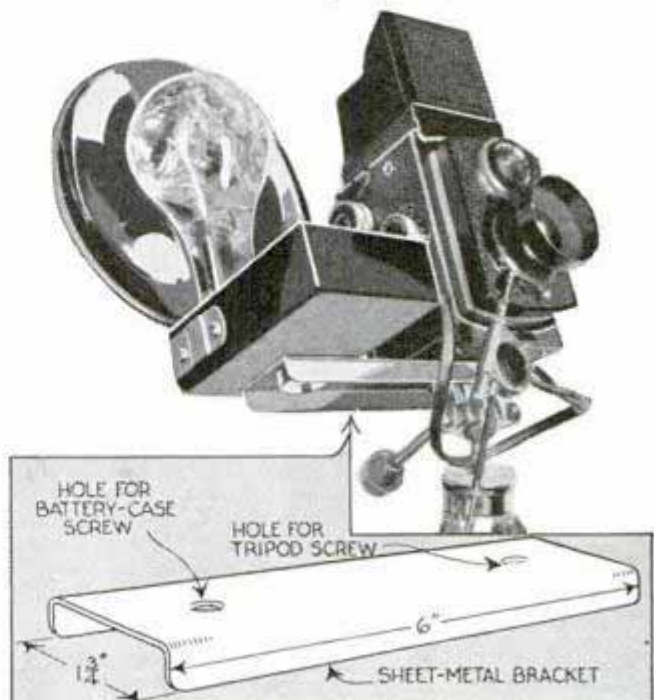



# Chair-side MAGAZINE CASE

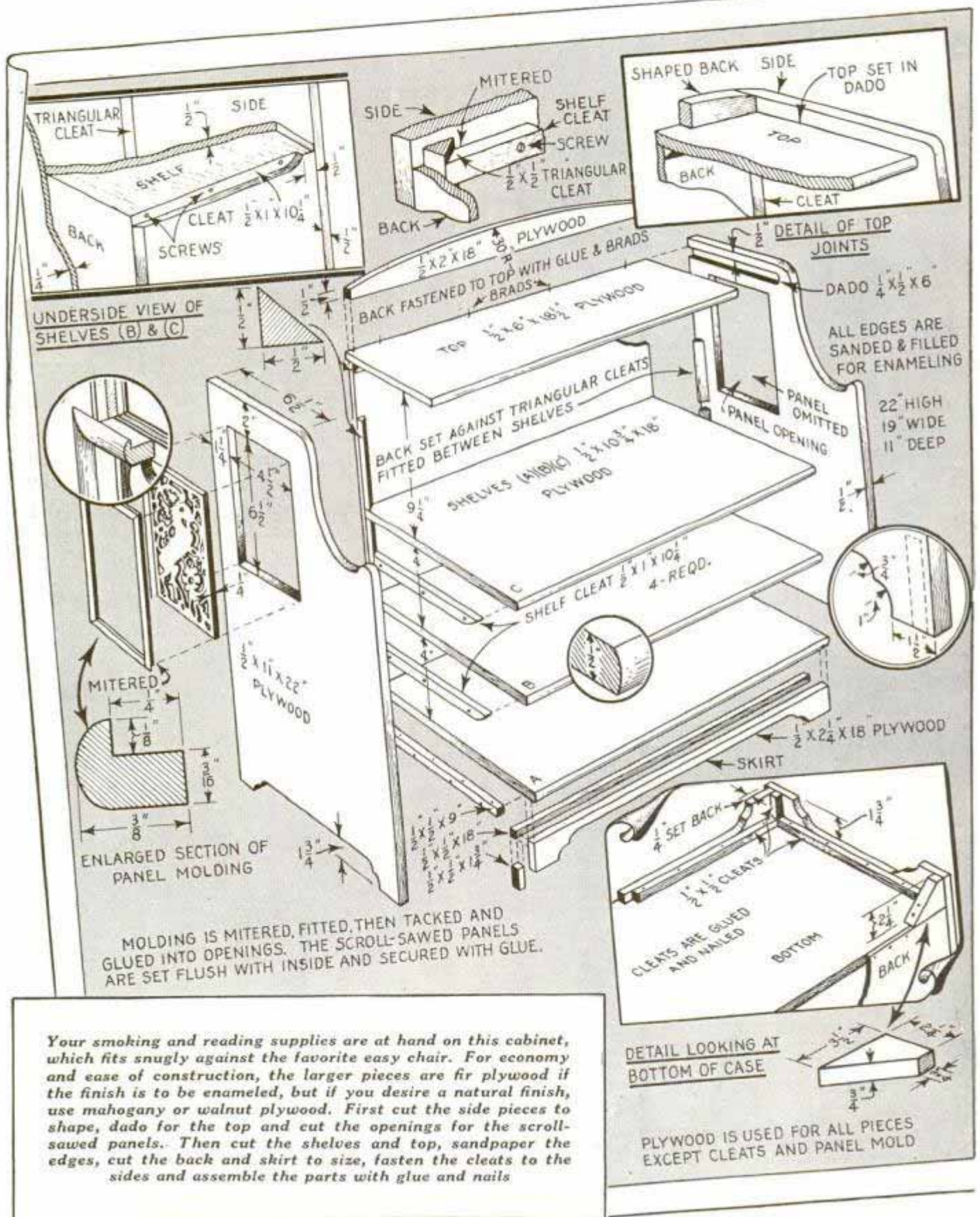

Your smoking and reading supplies are at hand on this cabinet, which fits snugly against the favorite easy chair. For economy and ease of construction, the larger pieces are fir plywood if the finish is to be enameled, but if you desire a natural finish, use mahogany or walnut plywood. First cut the side pieces to shape, dado for the top and cut the openings for the scroll-sawed panels. Then cut the shelves and top, sandpaper the edges, cut the back and skirt to size, fasten the cleats to the sides and assemble the parts with glue and nails.



# has cut-out panels

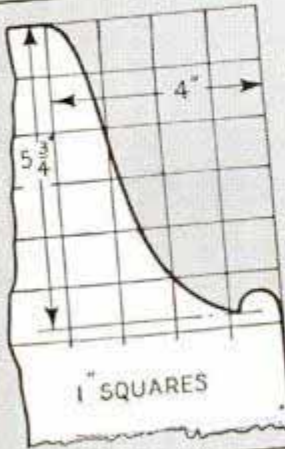

DETAIL OF  
SIDE PANEL

## MATERIAL LIST

- 2 Pcs.  $\frac{1}{2}$  x 11 x 22 in. fir plywood—Sides
- 3 Pcs.  $\frac{1}{2}$  x 10 $\frac{3}{4}$  x 18 in. fir plywood—Shelves
- 1 Pc.  $\frac{1}{2}$  x 6 x 18 $\frac{1}{2}$  in. fir plywood—Top
- 1 Pc.  $\frac{1}{2}$  x 2 x 18 in. fir plywood—Shaped rail
- 1 Pc.  $\frac{1}{2}$  x 2 $\frac{1}{4}$  x 18 in. fir plywood—Skirt
- 1 Pc.  $\frac{1}{4}$  x 18 x 18 $\frac{3}{4}$  in. fir plywood—Back
- 2 Pcs.  $\frac{1}{4}$  x 4 $\frac{1}{2}$  x 6 $\frac{1}{2}$  in. fir plywood—Panels
- 2 Pcs.  $\frac{1}{2}$  x  $\frac{1}{2}$  x 9 in. white pine—Shelf cleats
- 1 Pc.  $\frac{1}{2}$  x  $\frac{1}{2}$  x 18 in. white pine—Front cleat
- 4 Pcs.  $\frac{1}{2}$  x  $\frac{1}{2}$  x 1 $\frac{3}{4}$  in. white pine—End cleats
- 4 Pcs.  $\frac{1}{2}$  x 1 x 10 $\frac{1}{4}$  in. white pine—Shelf cleats
- 2 Pcs.  $\frac{1}{2}$  x  $\frac{1}{2}$  x 9 $\frac{1}{4}$  in. white pine—Triangular cleats
- 4 Pcs.  $\frac{1}{2}$  x  $\frac{1}{2}$  x 4 in. white pine—Triangular cleats
- 1 Pc.  $\frac{1}{2}$  x  $\frac{1}{2}$  x 18 in. white pine—Molding
- 48 linear inches of 5 16 x  $\frac{1}{8}$  in. white pine—Molding

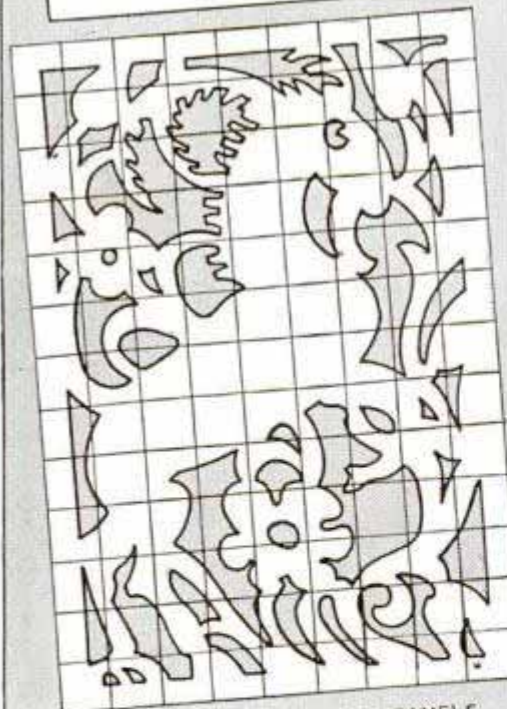

DETAIL OF SCROLL-SAWED PANELS  
 $\frac{1}{2}$ " SQUARES 2 REQ'D.

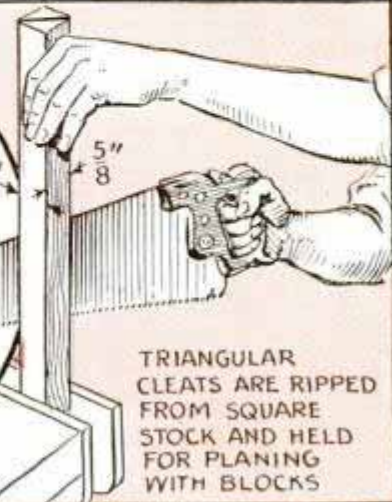
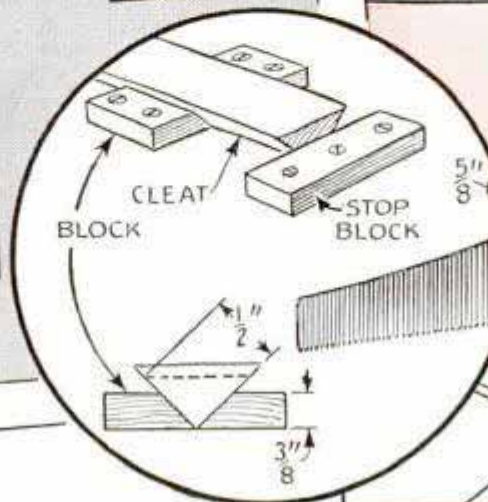
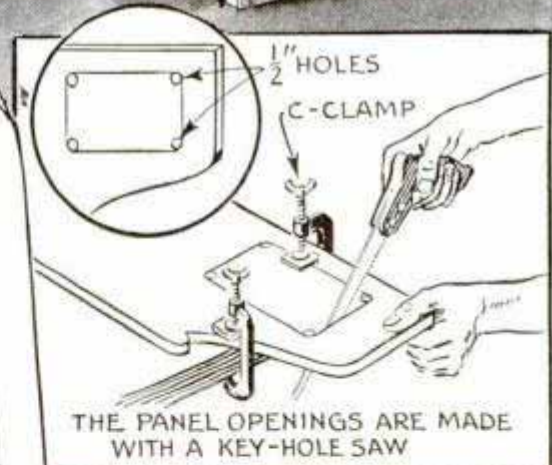
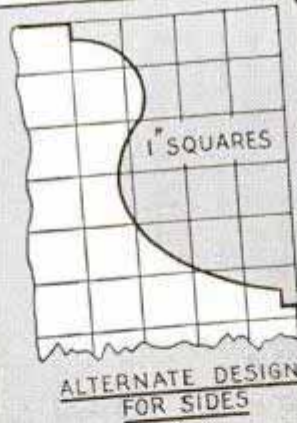



## Clothesline Stretched and Held by Tent-Rope Tightener



To simplify stretching and fastening a rope clothesline, bore two holes through the ends of a 6-in. length of broomstick and slip the rope through these in the same manner as a tent-rope tightener. The loop thus formed in the rope may be slipped over the line hook in the support of the post and the tightener pulled along the rope to give it the proper tension. Striking the stick where the line passes through it will release it easily.

## Friction-Drive Speed Reducer Handles Light Work

All you need for this speed reducer is a couple of jack shafts with bearings, two step pulleys and belt, a sanding disk and an 8-in. V-pulley. The parts are assembled as indicated and will give speeds ranging from 250 to 5,000 r.p.m. The V-pulley is lagged with a baby-carriage tire to provide a friction surface against the sanding disk. The motor base should have slots for the anchoring bolts so that it can

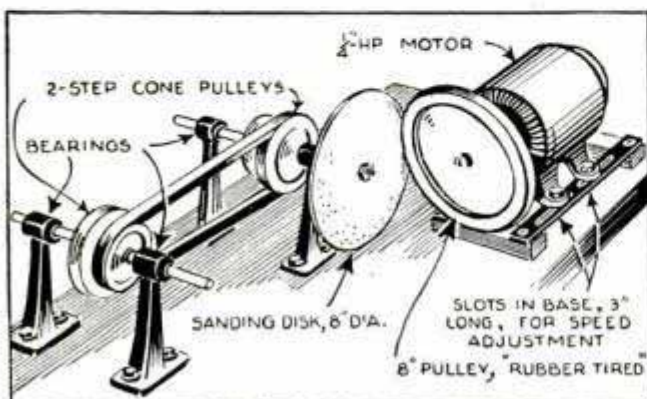

be moved at right angles to the sanding disk to get the desired speeds. Care must be taken in assembling the reducer as any misalignment will cause excessive vibration.—C. F. Travis, Verdun, Quebec, Can.

## Magnifying Glass on Pencil Always at Hand

When small print in a 'phone directory or other book that you consult often and make notes from is difficult for you to read, use this magnifying glass. It is a very small one, which is soldered to a piece of tubing of a size to slip over the end of the pencil used in jotting down the notes.

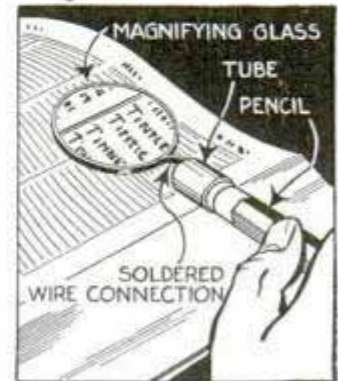

## Screw Eye Removes Bottle Caps

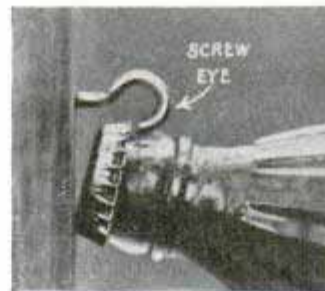

If you are on a picnic and have forgotten a bottle-cap remover, one can be improvised from a screw eye. Usually a screw eye can be found in some of the car tool kits. Open the eye as indicated and drive the screw into a board. If a file or stone is available, bevel the end of the eye so it will slip under the edge of the cap.

## Duplicating Irregular Line from Layout Board

When there is an odd-shaped line on a layout board that must be duplicated the job can be simplified by using small brads. These are placed with their heads on the line to be duplicated as shown. Then the work to which the line is to be transferred is pressed down firmly on the brad heads. This will transfer the line accurately.—Ed Isakson, Oakland, Calif.

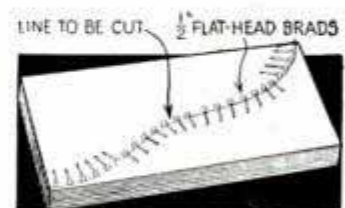



## Deflector on Photo Lamp Gives Indirect Light

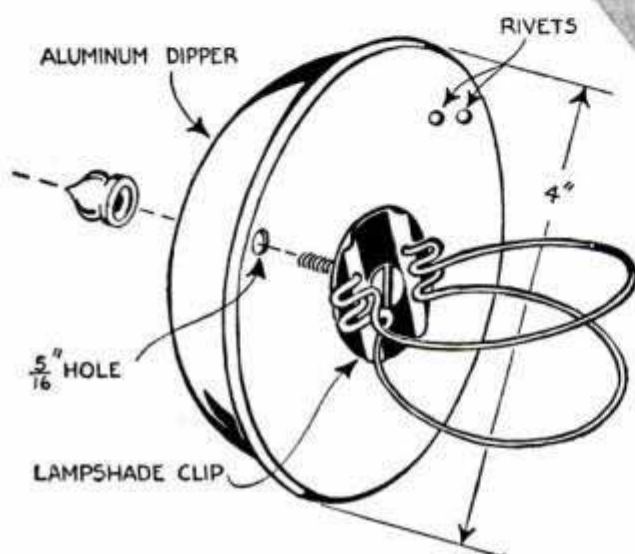
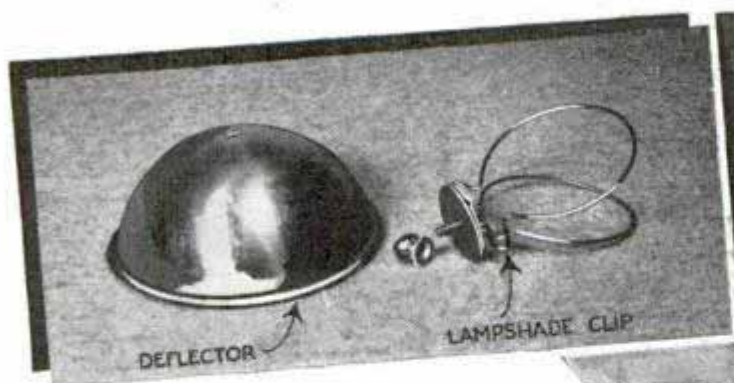

You can have a photo lamp that gives soft, indirect light by using this inexpensive slip-on deflector on your regular photoflood lamp. The deflector is nothing more than the bowl part of a ten-cent aluminum dipper, which is fitted to a clip of the type used in fastening a small lampshade to a bulb. The dipper should be about 4 in. in diameter and  $1\frac{3}{4}$  in. deep. Deflectors are most effective when used in conjunction with

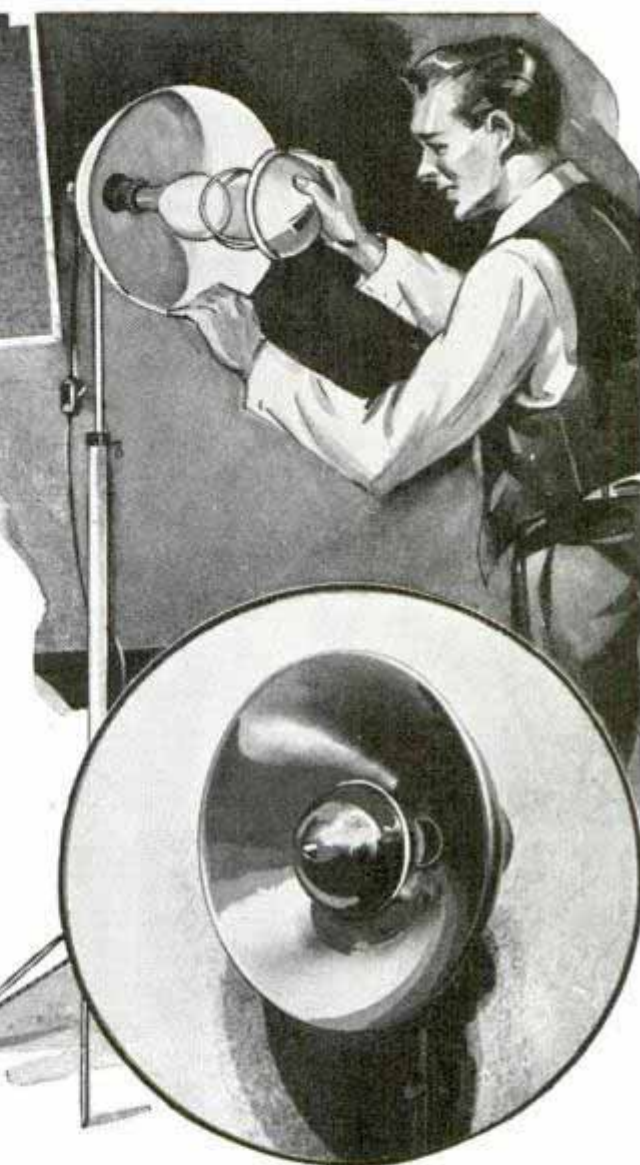

photoflood lamp reflectors that measure 10 in. or more in diameter. On reflectors smaller than this, there is not enough surface area to reflect the light properly.

—Arthur Trauffer, Davenport, Ia.

## Painted Line Aids in Adjusting Height of Lathe Tool Rest

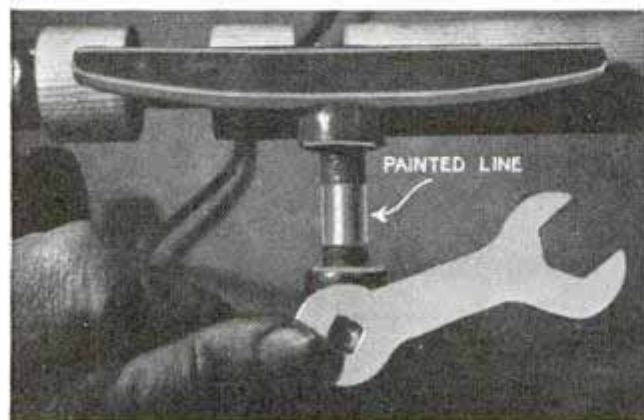

To save time in setting the tool rest of a woodworking lathe at the correct height above the centers, I painted a line or band on the post of the rest. A glance at the space between the lower edge of the line and top surface of the post socket casting indicates the height of the rest above the lathe centers. To paint the line, set the rest so that the top is exactly in line with the centers and apply the paint, using the top of the socket casting as the lower limit of the line.—W. C. Wilhite, Carlinville, Ill.



## Handy Film Holder for Editing and Titling Home Movies



You will find this holder just the thing for home movie film when titling or editing it. Several 1-in. openings are made in a piece of stiff cardboard, which is then bent down around the edges so that when it is set in a box it is supported above the bottom. For 16-mm film, about  $\frac{5}{16}$  in. of the cardboard edge should be bent down, while about  $\frac{3}{16}$  in. will do for 8-mm film. Most any box will serve as a container, although a metal one is preferred as the film can then be stored in it. Cigarette tins are just the right size for the smaller film.

## "Push Rod" Removes Pins in Toy-Train Track

When the connecting pins in the ends of a toy-train track become forced into the hollow rails, this push rod is handy to remove them. It is a length of small steel

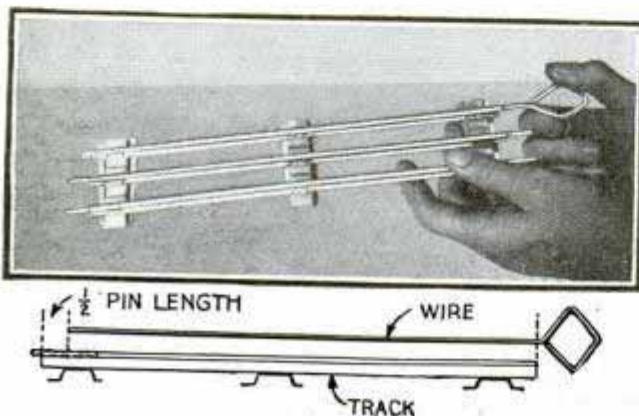

rod of size to slip into the hollow rail easily. One end is formed into a handle. The straight portion equals the length of a rail less one-half the length of a pin. Then when the rod is used to push out a pin it will automatically stop when half of the pin projects from the rail end.

## Small Nuts Are Locked on Bolts by a Drop of Solder

If you have trouble keeping nuts tight on a child's wagon or doll carriage, just draw them up tightly and put a little solder on the first couple of threads above the nuts. This will keep them from loosening,

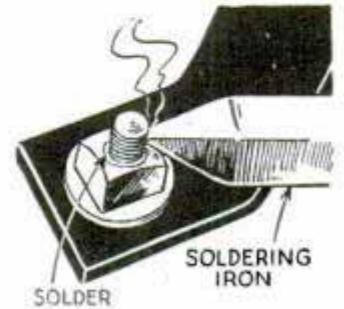

and the solder can be removed with a pointed tool if it is necessary to remove the nuts.

## New Brooms from Old Ones

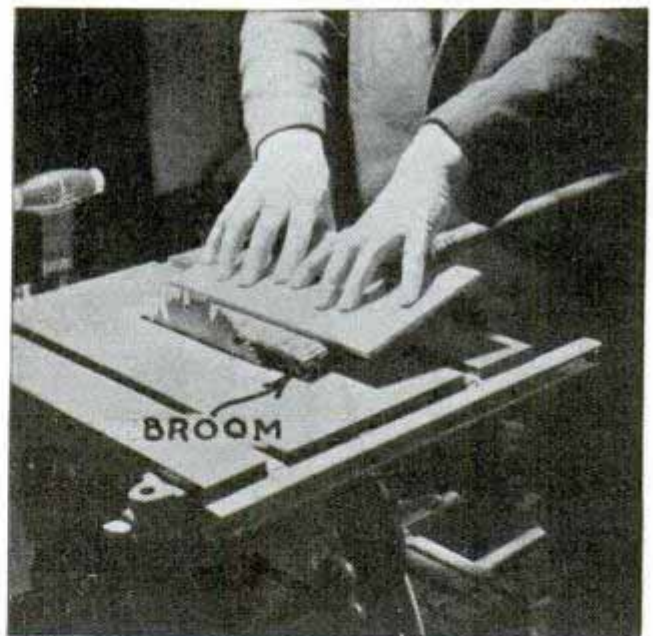

Old brooms that have worn at an angle can be sawed off straight to provide stiff brooms for shop use. To do this, set your circular saw for a deep cut so that the teeth will not push upward on the straws as the broom is moved over it. Use a wood block to compress the straws as shown in the photo.—Philip S. Maingery, Montreal West, Quebec, Can.



# Take Your OWN PICTURE

Self Portraits Easily Taken  
with Aid of a Floor Lamp  
and Small Mirror



MIRROR

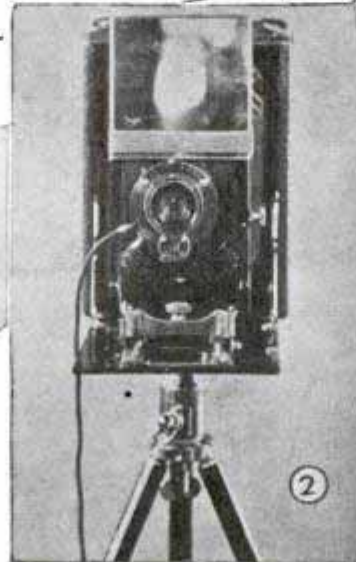

2



1

By J. MODROCH

THERE are certain aids and accessories right in your own home that can be used to good advantage in making successful self portraits. For example, one of these is a common bridge lamp. By tilting the shade of the lamp you can center it accurately on a line with the camera lens, as in Fig. 1, by sighting through it. The shape and size of most shades approximate closely the size and general proportions of one's head. It has adequate mass and the desired roundness on which to play the beams of photo lamps for the purpose of gauging the proper lighting. Focusing is made easy when the lamp is lighted. Of course, it is essential that, before removing the lamp and substituting yourself, the exact position of the shade with relation to markings on floor and along the side lines should be noted. Then when you take your position as the subject, you will have a means of checking accurately on assumed pose with the position formerly held by the lamp.

A small mirror, secured to the camera

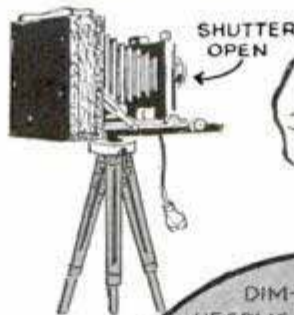

SHUTTER OPEN



SAFE-LIGHT MARKING POSING POSITION

3

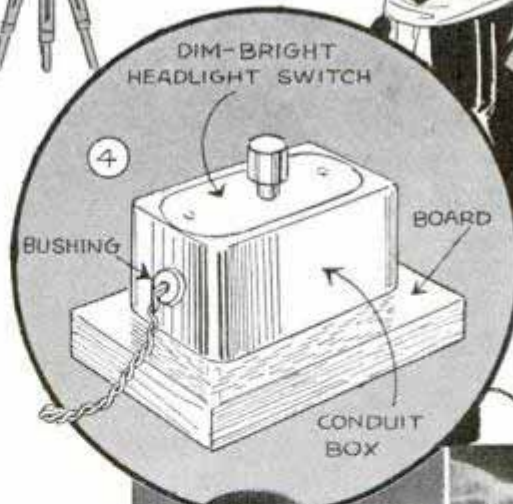

DIM-BRIGHT HEADLIGHT SWITCH

4

BUSHING

BOARD

CONDUIT BOX

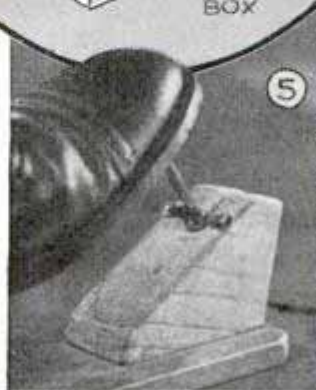

5

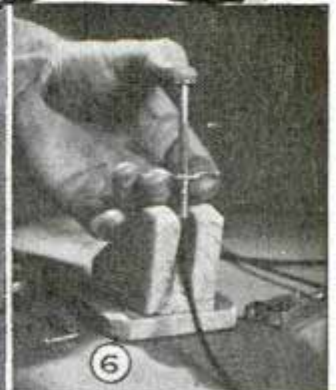

6





front with a rubber band, as shown in Fig. 2, will materially assist in composing the picture and setting facial expression. Say you are about to make a head-and-shoulder portrait of yourself. First, compose a picture of the lamp shade by viewing it on the ground-glass, or in the view finder. Then adjust the mirror on the camera so that the image of the shade will be centered in the glass when sighted through the shade, as in Fig. 1. Now, after placing yourself in the position of the lamp, it is only a matter of centering your own image in the mirror to be assured that the finished photo will turn out as you composed the "stand-in" picture.

Releasing the camera shutter once you are posed can be done by employing either a delayed-action mechanism or an extension cable release operated with your foot as in Fig. 5. While delayed-action mechanisms are built into certain types of shutters, attachments that do the same job may be used with most shutters of standard make. It is necessary, however, when using delayed action in self-portraiture, to assume the pose quickly after setting the timer going, since the shutter will be released in a few seconds at most. This is

sometimes a disadvantage and can be overcome by using an extension cable release. The latter are regularly sold in lengths up to 10 ft. and can be run along the floor out of camera range to your hand or foot as in Figs. 5 and 6. Practically every portrait, including even full-figure shots, can be composed with a hand or foot hidden, free to depress plunger of extension cable as in Fig. 7. Another method of controlling exposure requires that the pose be assumed in a room totally dark except for the faint glow of a negative-developing safelight, Fig. 3. With the camera shutter open, the lights are turned on by means of a foot or hand-operated switch, Fig. 4,

governing the exposure by the length of time the lights are on. This method cannot be recommended for poses in which the eyes will appear prominent in the finished picture. A red safelight can be used if camera is loaded with orthochromatic film, but a green light of very low intensity must be used with panchromatic film.

### Forehead Writing Gives Fun at Your Party

At your next party when the fun begins to slow down, you can pep up the evening





by having your guests practice forehead writing. Give each one a pencil and a strip of paper about 2 in. wide and 6 in. long. Then have them hold the paper across their foreheads and write their names. The result will be mysterious scribbling that usually can be deciphered only by viewing the writing with a mirror. When looked at in reverse, the person's name appears quite distinctly.

### Improved Tap for Soft Material

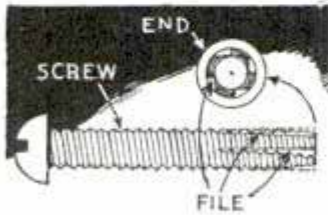

When a hole has to be tapped into wood or other soft material for a screw with an odd thread for which there is no tap at

hand, you can make a tap for the purpose from one of the screws. The screw is held in a vise and flutes are filed as shown, being sure that the cutting edges are the leading edges of the flutes. Undersize holes must be drilled to start the tap, and the end of the latter must be tapered to the hole size to facilitate starting.

—Earl Pagett, Coffeyville, Kan.

### Lice in Chicken House Removed with Aid of a Banana Stem



Owners of a few chickens will find that banana stems are an aid in protecting them against lice and mites. When the stems are hung against the walls and roosts, the vermin are attracted to them from cracks and crevices where they usually gather. Each morning the vermin should be removed from the banana stem and destroyed.

□ An effective way to prevent cut worms from bothering plants in either vegetable or flower gardens is to surround each plant with a row of ordinary kitchen matches, stuck into the ground with the heads down.

### Gate Shielded to Prevent Child from Swinging on It



If you have small children who like to swing on a yard gate, stretch chicken wire tautly across both sides. This tends to prevent them from getting their feet on the lower cross member. If the wire is painted the same color as the gate, it will be much less noticeable.

### Paraffin Waterproofs Paper Tape in Open Dispensers

Rolls of gummed paper tape used in open dispensers are often ruined by having water splashed onto the sides so that the glue sets and will not allow the tape to be removed. If a bar of paraffin is rubbed over the sides of the rolls, the wax will serve as a protection against water without affecting the adhesive surface of the tape.





### Rubber Bulb Loosens Thermostat in Radiator Air Valve

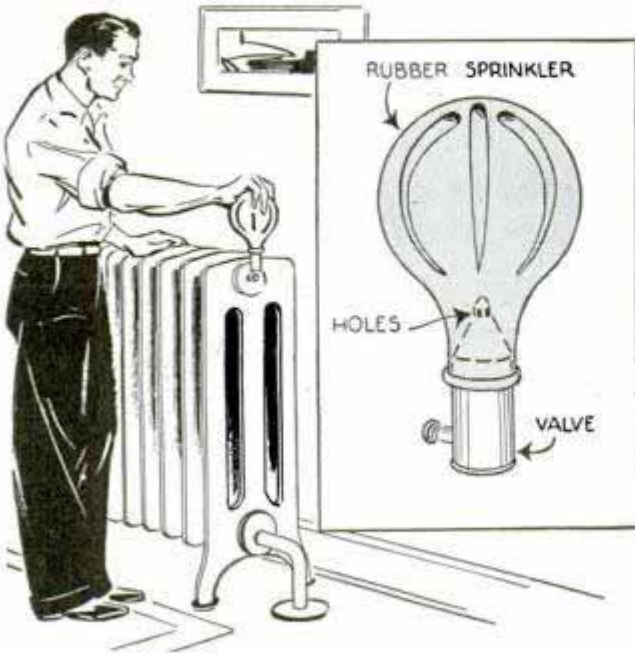

Tiring of frequently calling the superintendent of our building to loosen a stuck radiator valve, I found that it could be repaired with a rubber bulb such as used for sprinkling clothes. I just slipped the mouth of the sprinkler over the upper end of the valve and repeatedly pressed the bulb. This forced air in and out of the valve so that it would start working.

—H. G. Gunther, Sunnyside, L. I., N. Y.

### Tin-Can "Spider" Holds Bolt in Cement Form

When a bolt must be set in cement and difficulty is experienced in supporting it with a crosspiece, cut a tin can to form a "spider" as shown, and use it to hold the

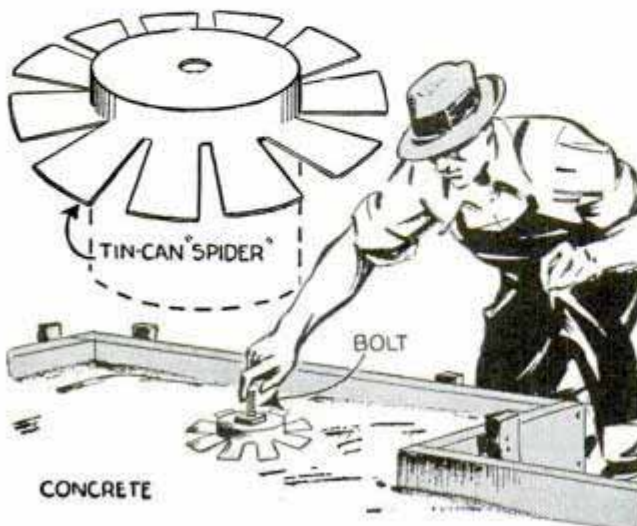

bolt in the position that is desired. If necessary, the tin may be left in place after the job is completed.

### Camera Tripod Steadied on Floor by Adjustable Wire Brace

Here is a simple brace for the legs of a tripod, and it is adjusted instantly to spread the legs as desired. Several screw eyes are driven into the legs, to take a length of stiff wire, which has hooks bent on the ends. After adjusting the legs as desired, drop the wire into two of the screw eyes.

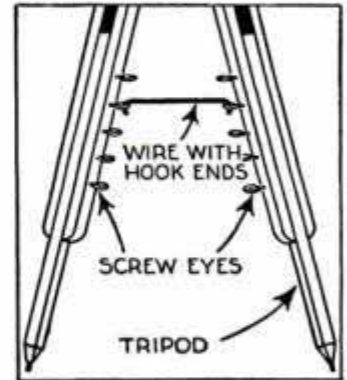

### Nuts and Washers on Can Key Are Easy to Find

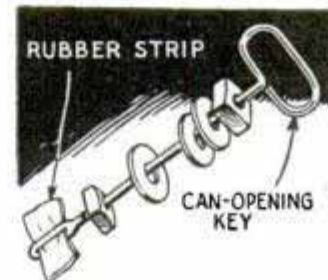

Instead of keeping nuts and washers loosely in a drawer where it is difficult to find the size wanted, collect a few can-opening keys, sort the nuts to size

and slip them over the keys. A rubber strip inserted in the eye at the end of each key will keep the nuts in place, yet they can be pulled off or slipped on over it and held conveniently for use when needed.

### Emergency Repair for Pipe

If one of your plumbing pipes suddenly develops a leak, it can be repaired temporarily with a piece of garden hose. Use a 2-in. length and slit it along one side. Slip this over the leak and hold it in place with a hose clamp. Place the clamp directly over the leak. Sometimes, it may be necessary to use more than one clamp.

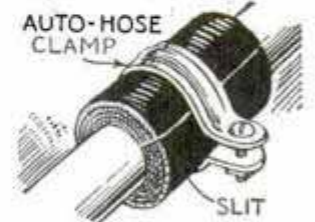

—Cornelius T. Greydanus, Paterson, N. J.



# Junior's New HAND PRESS

Light in weight and accurate in operation. Chase is built in the bed to hold type or cuts

**P**ORTABILITY is the thing you will like about this little printing press. A complete self-contained unit, it weighs less than 30 lbs., and is ready for work wherever you set it down. The roller, Fig. 2, is made from a length of steam pipe, known to steam fitters as a 5 by 9-in. nipple, unthreaded. Cut wood hubs to make a press fit inside the pipe, and with the shaft in place and bearing against the tailstock of the lathe, work the pipe up and on the hub which has been mounted on the faceplate. Then center the opposite hub on the tailstock center. Of course, if a metal lathe with sufficient swing is available, turning down the cylinder will take only a few minutes, but even on a wood lathe a good job can be done with nothing more than a coarse square file as in Fig. 1. To start, keep the speed down below 200 r.p.m. When the irregularities are removed, raise it to 500 r.p.m. and for the final polish with emery cloth,

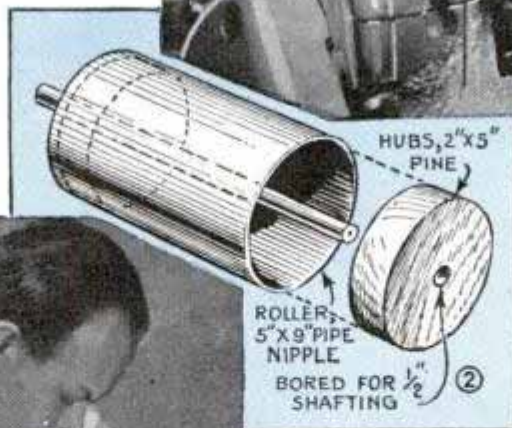
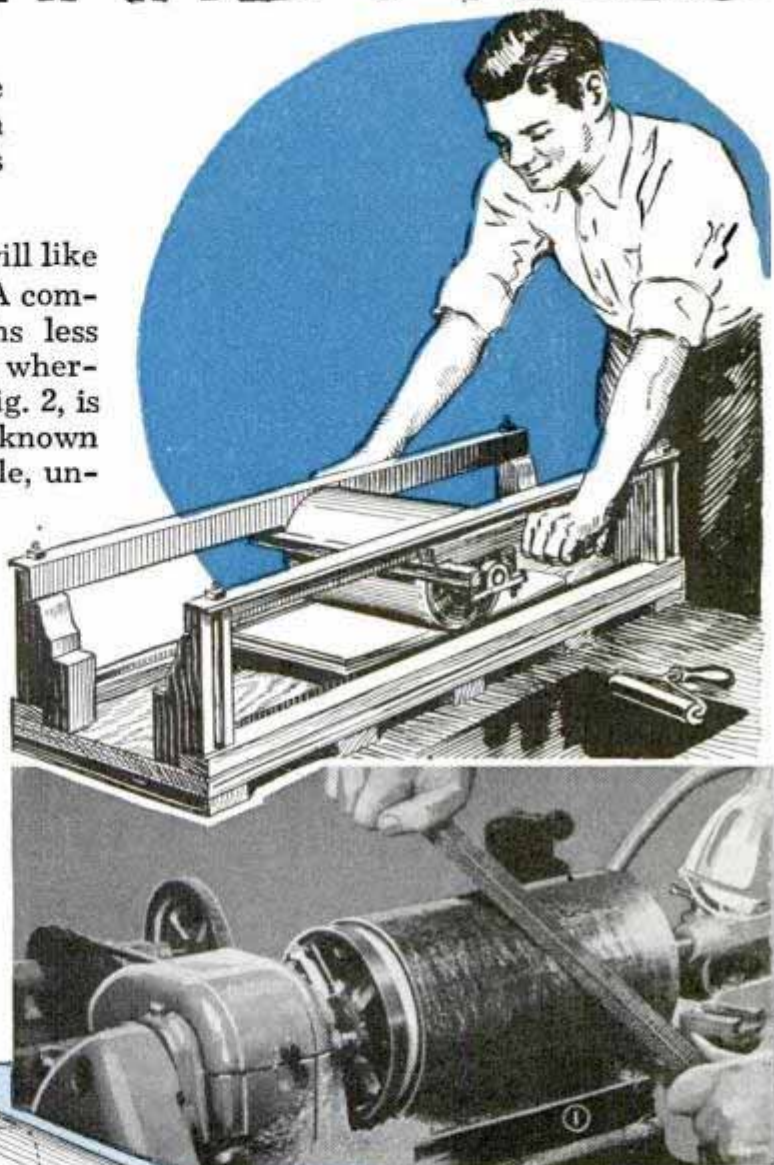

800 r.p.m. is not too fast. The bed must be rigid and flat. Use a piece of  $1\frac{3}{16}$ -in. birch plywood for a base and reinforce it with battens of maple. The five bottom battens, Fig. 6, are secured with casein glue and screws.

Pencil the location of each batten on the bottom of the panel, size the marked strip with glue and let it soak in for several minutes. Coat again, spread glue on the batten and press together with a rotary motion to force out air bubbles. Clamp in place and drive in three screws. Wipe off excess glue with a damp cloth. Holes must be bored to the body size of the screw in the battens, and countersunk, but let the





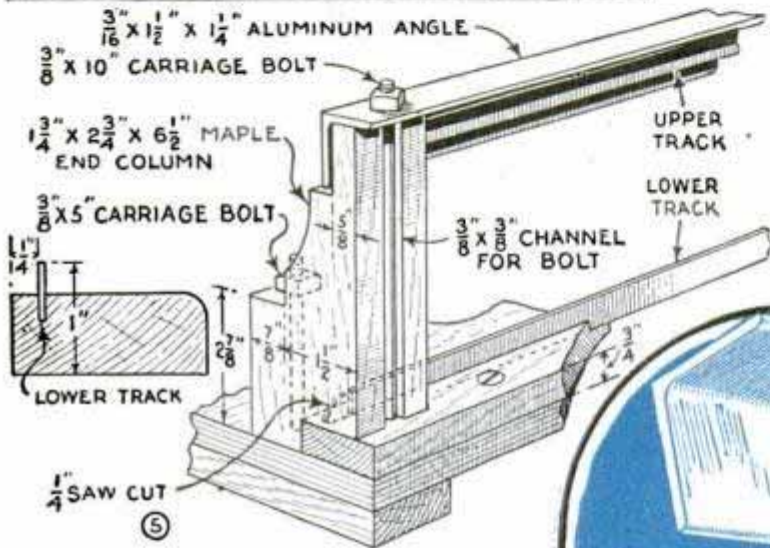

screw thread cut its own way into the plywood.

The compartment in which the cuts are placed is called a chase, Figs. 6 and 9. To make this, the two rails are mortised and end pieces set in place, Fig. 6. This assembly is squared, clamped, then glued and screwed down as a unit. For additional strength, drive glued dowel pins around the circumference of the chase as indicated.

The steel track is the type used in show-cases with heavy sliding doors. A length of 1/2 by 1/16-in. by 12 ft. will be needed. Run a cut the entire length of each rail with a planer saw blade, Figs. 5 and 8, but insert a piece of track only 34 in. long. The ends are held in place by the columns which will be installed later. Varnish the assembled bed, using a thin, penetrating marine varnish to seal the wood and prevent absorption of moisture.

The end columns, Figs. 3 and 5, must be identical and of the exact dimensions indicated. Do not glue these down, and don't tighten the bolts all the way until after the

press is assembled. Aluminum angles are used for upper-track supports. The track, in this case, is rabbeted into a maple strip as in the circular detail, Fig. 6, and is anchored to the angle by machine screws threaded into it. Positive dimensions on the truck are impossible, for the measurements depend entirely upon the sheaves and pillow blocks. Select ball-bearing sheaves and bronze, one-piece pillow blocks, following the general details of Fig. 7. As you see, the truck assembly, including the roller, is comparatively light yet it is so arranged that the four compression springs, Figs. 6 and 7, exert more than 120 lbs. pressure at the point of contact between cut and paper. This assures uniform printing.

In assembling, tighten the nuts on the stove bolts, Fig. 7, and set the complete roller and truck unit on the lower track. Slip the angles in place, Fig. 3, and bolt them down. Oil the pillow blocks and sheaves, and coat the surfaces of the aluminum angles lightly with dry graphite.

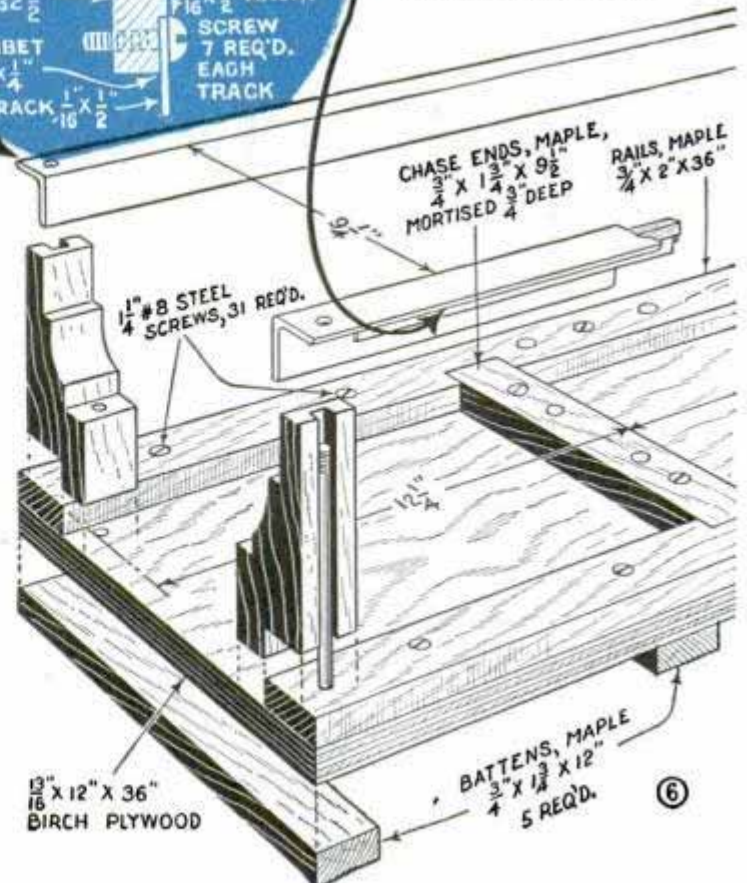
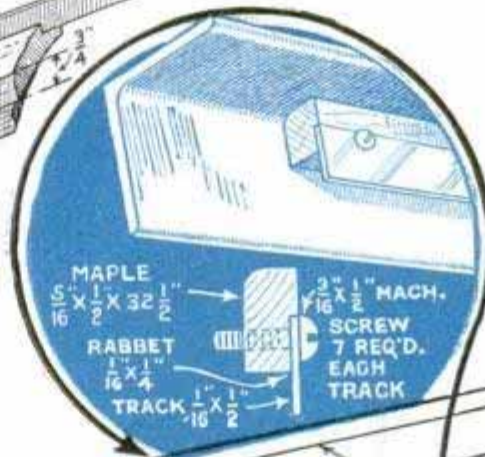



The first requisite for printing is the proper ink and a roller for applying. Wood cuts take a different grade of ink than metal type, so specify the use when purchasing. Squeeze some ink on a sheet of glass, Fig. 4, and roll it out till it contacts the roller for better than a complete revolution. Before printing, the cuts must be locked securely in the frame. Cut an assortment of maple fillers and two pairs of wedges, Fig. 9, and arrange these about the cut so that when you drive the wedges tight the cut will be locked in both directions. The cut is inked by contact with the charged printing roller. Rub in both directions and cornerwise to make sure the entire surface is evenly coated. Use thin cardboard sheets for an impression pad.

The actual impression requires reasonable skill. With the paper in contact with the cut and the pad in place, advance the roller until it rises from the lower rails and rests on the pad. Now pull toward you slowly until the roller drops to the rails again. Lift the pad carefully and peel the paper from the cut.

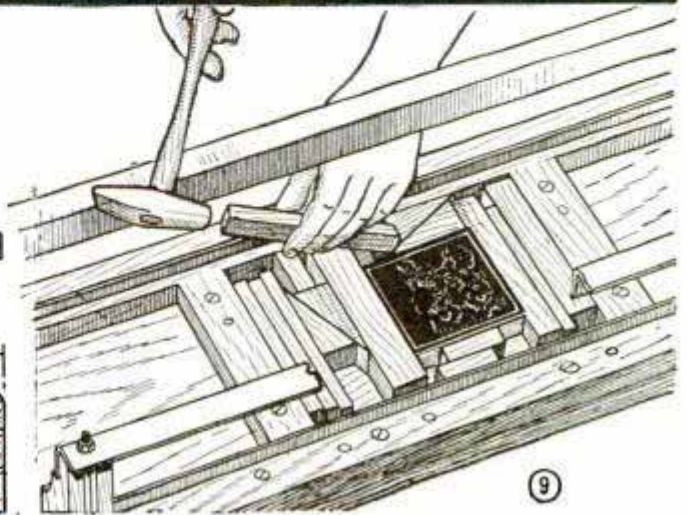
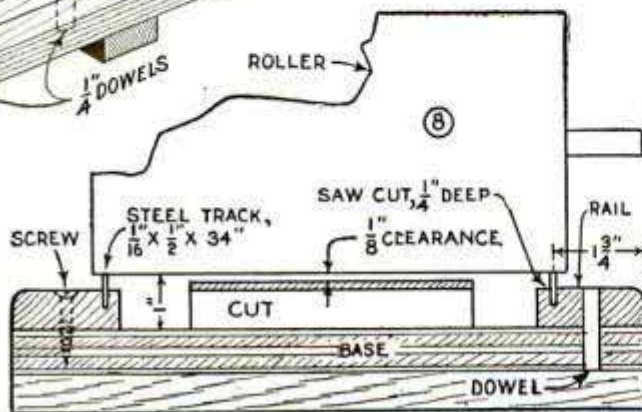
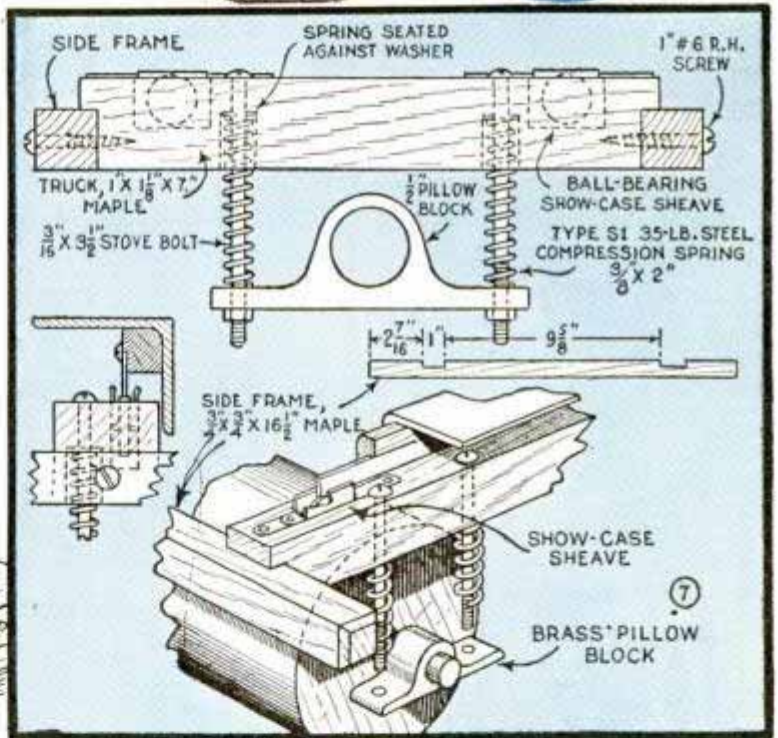
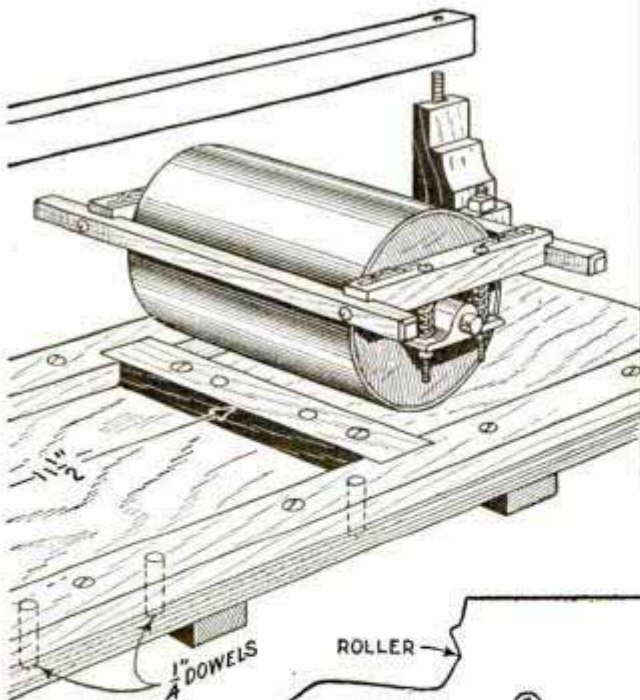



### Flexible Linkage in Flush Tank Lets Ball Valve Seat Correctly



If the ball valve in your bathroom flush tank sticks, the trouble may be caused by the linkage between the ball and the trip lever. This sometimes binds and prevents the ball from dropping. I replaced the original linkage in my tank with a key chain. This is very flexible and prevents any possibility of binding.

—DeL. C. Jones, Columbia, S. C.

### Drill to Use in Model Making Assembled from Scrap Parts

This handy drill for use in making model ships, planes, etc., is constructed easily. A 7-in. length of 1/8-in. brass or steel rod is used for the shaft, and a spiral, removed

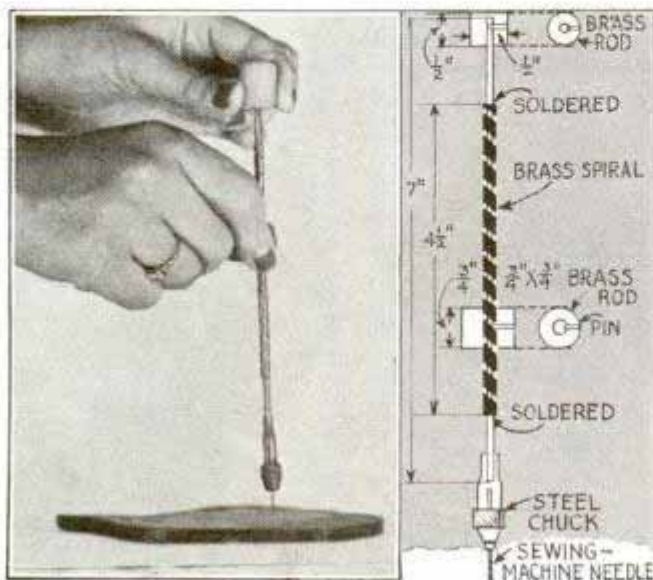

from an automatic lead pencil, serves as a rotating device, which is soldered at the ends to the brass shaft. A finger grip, which rotates the drill when moved up and down the spiral, is made from a 3/4-in. length of brass rod. This has a hole drilled through the center so it will slide loosely over the spiral, and is fitted with a pin, which extends slightly into the center of the hole to engage the spiral. The chuck is one removed from a small pin drill. Drill bits are made from steel sewing needles.

### Sanding Block for Curved Work from Teaspoon

I have found that small, irregular-shaped work can be finished easily and quickly with an old spoon having the bowl covered with a piece of sandpaper.



with a piece of sandpaper. The sandpaper is cut so that the ends can be folded over the edge into the bowl of the spoon. The handle is held in the hand while one finger presses down on the ends

of the sandpaper, which rest in the hollow of the bowl. If the spoon is held on edge, sanding grooves will be easier.

—Harvey Paisley, Edmonton, Can.

### Cork Aids in Driving Thin Nail

Difficulty of driving a slender finishing nail into hardwood without it bending can be avoided with a cork. Just drive the nail through the cork and into the wood. After the nail has been started well into the work, the cork is pulled off over the head and the driving of the nail completed.

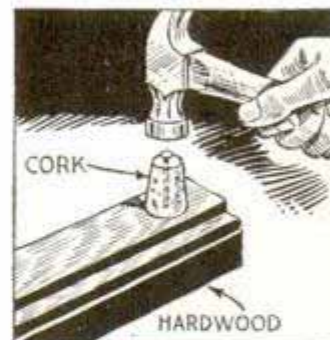

—James F. Ferguson, Oregon, Ill.

☞ An alarm clock will save much waiting and worrying when baking. Undivided attention then may be given to other duties.



# CRAFT *with* COCONUT SHELLS

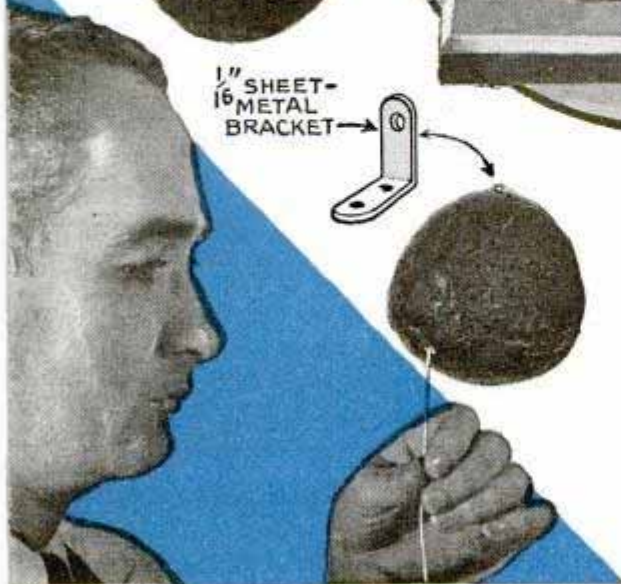
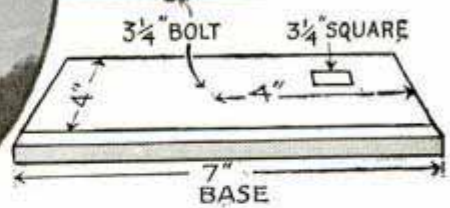
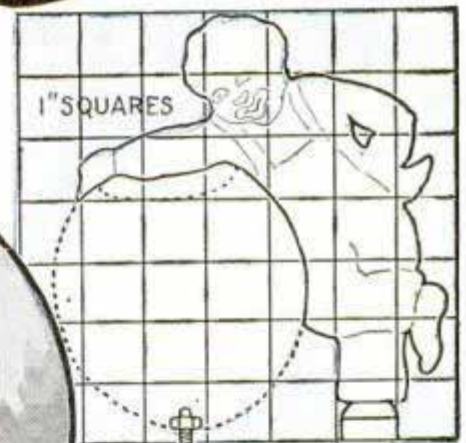
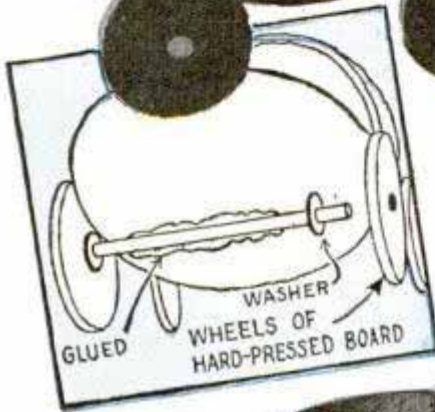
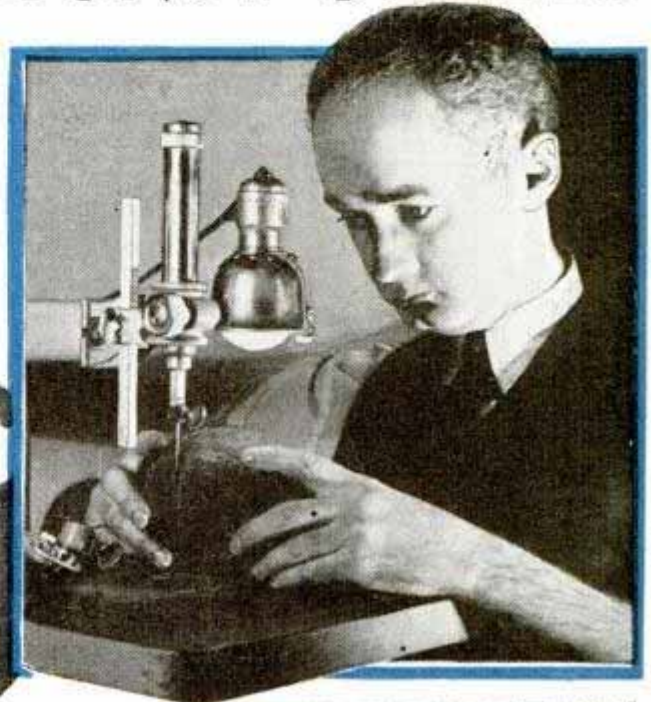



## Sawhorse Slotted to Hold Saw When Not in Use



Cut a long slot in the cross member of one of your sawhorses and drop your saw in it when not in use. The saw is always at hand, and it cannot fall down, which might damage the teeth.

—Guy Wheeler, Eureka Springs, Ark.

## Toothbrush Handle Scrapes Plated Parts

When you want to remove dried grease from plated parts, such as those on a car, use an old toothbrush handle. It is tough enough to scrape off the grease, yet is soft

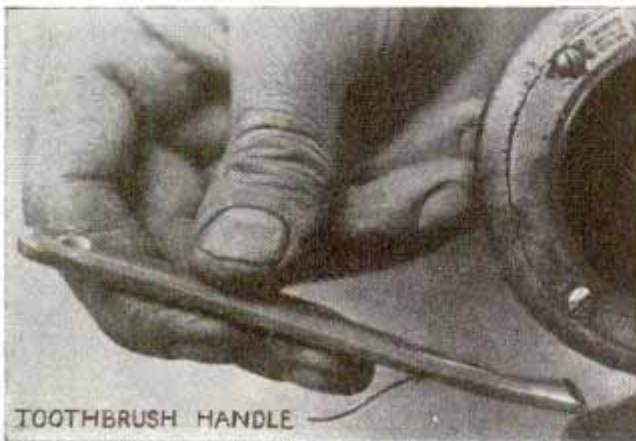

enough to avoid scratching the metal. The end of the handle can be shaped with sandpaper as desired, to clean grooves, recesses, etc.

## “Lung Tester” for Fun at Party Will Mystify Your Friends

Here is a lung tester that will provide a barrel of fun, and enable you to show the superiority of your lungs over those of your friends. The tester consists of a small phial floating upside down in a ½-pint flask filled with water. There must be just enough air trapped in the phial to barely float it. A rubber tube is connected to the flask by means of a short glass tube through the stopper. The explanation offered to the uninitiated is that by blowing through the tube he can compress the air



in the phial, force in more water and cause the phial to sink. Anyone attempting this will find his lungs unequal to the task. As a matter of fact, no amount of blowing will have any effect, as the rubber tube is plugged. The only way to sink the phial is to compress the air in it by squeezing the flask in the hands, thereby slightly bending in the sides of the glass. By pretending to blow in the tube and simultaneously squeezing the flask, anyone can sink the phial.—Dale Kelly, New York, N. Y.



Everything at hand in this

# DARKROOM CABINET



By FLOYD MIX

**S**TRUCTURALLY this is one of the simplest cabinets to assemble, for there are no difficult joints to fit. You will notice from the material list, that the whole thing is made of fir plywood. To start construction, the ends and partitions are cut to size, 28 by 30 in., from  $\frac{3}{4}$ -in. stock. These pieces are then shaped and floor-supporting cleats are attached as shown in Fig. 5. To keep the ends and partitions in an upright position and evenly spaced from top to bottom while assembly progresses, a couple of 6-ft. lengths of scrap lumber are tacked to each of the side edges. Fitting the top of the cabinet, which is simply a piece of  $\frac{3}{4}$ -in. plywood 30 by 72 in. in size, comes next. If the cabinet, Fig. 1, is to receive but little handling, just screw the top securely to the four upright members. Should you desire a cabinet that will stand frequent moving and a great deal of abuse, it

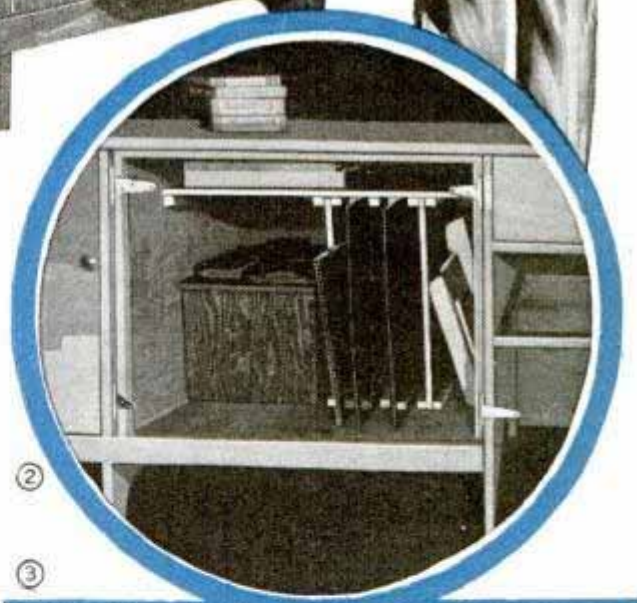



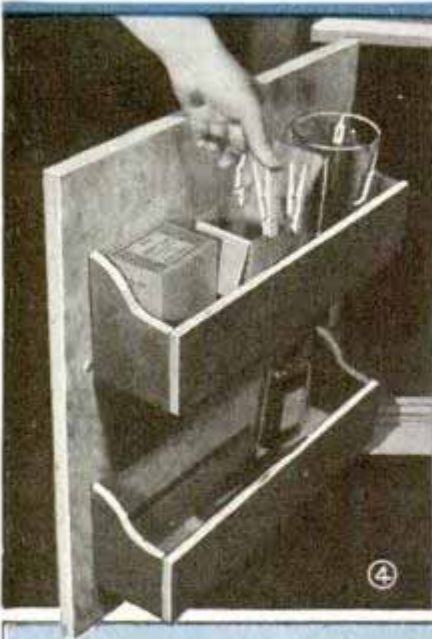

is well to strengthen the joint between the top and the upright members by adding cleats of the type used to support the floor. The cleats should be screwed and bolted to the upright members and the top fastened to the cleats in a similar manner. For the back of the cabinet,  $\frac{1}{4}$ -in. plywood is satisfactory, and for the floor,  $\frac{1}{2}$ -in. stock is recommended. In putting this on, make sure all joints are tight so the cabinet won't be a "dust trap" when completed. The stretchers and drawer runners are made from  $\frac{3}{4}$ -in. plywood and the drawers, including the bottoms, from  $\frac{1}{2}$ -in. plywood.

The interior of the two compartments, Figs. 2 and 3, should be arranged to accommodate the equipment you have at hand, care being taken to see that the section for the ferrotype plates in the center compartment is just the right size to keep the plates in an upright position between the 1 by 1-in. strips. The doors, which are  $\frac{3}{4}$  in. in

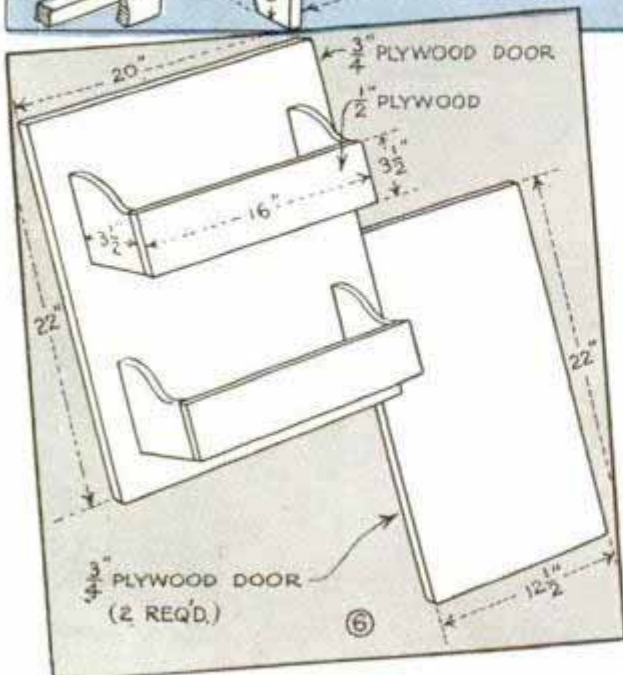
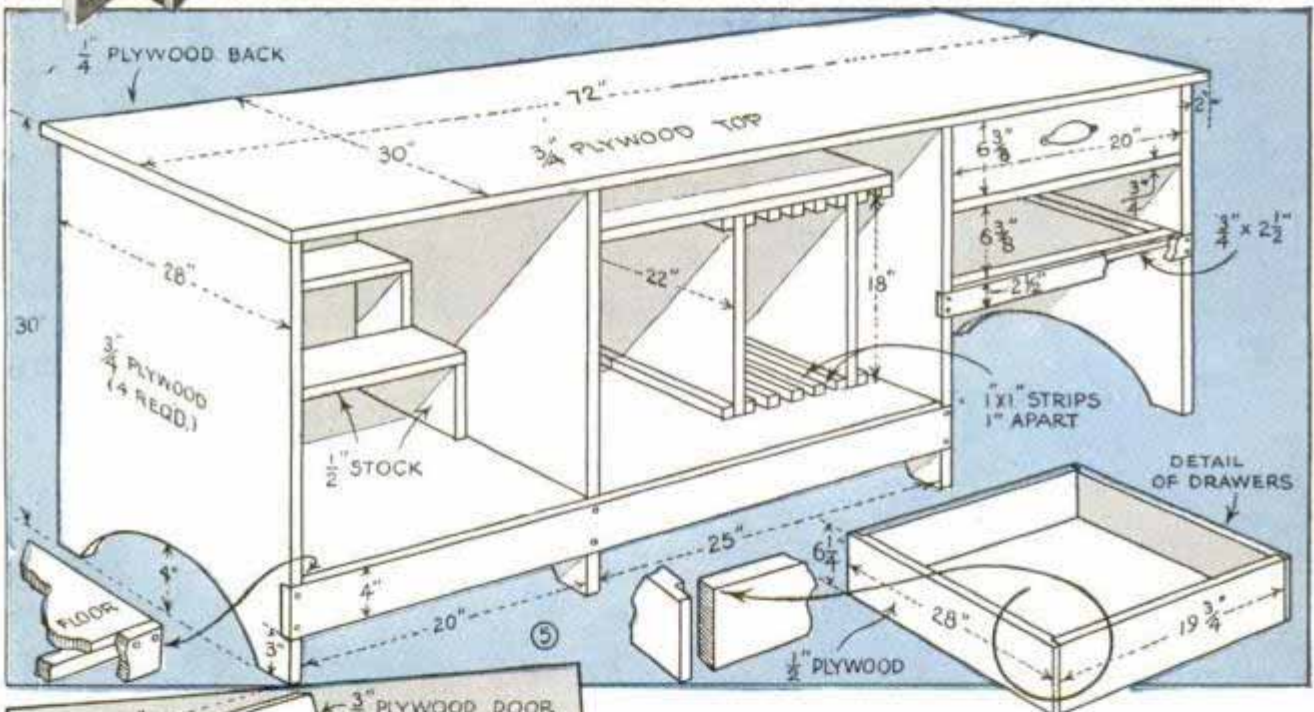

thickness, are shown in Figs. 4 and 6. You'll find the door pockets a handy place to keep negative-drying clips, squeegee and other small items which are used frequently. Pieces of  $\frac{3}{4}$  by 1-in. stock serve as door jambs. Adding door pulls and catches completes the cabinet—all except the finishing of the wood. The finish on the original cabinet consisted of a coat of shellac and two coats of high-grade gray enamel.

#### MATERIAL LIST

Fir plywood is used throughout

- 1 pc.  $\frac{3}{4}$  x 36 x 72 in.—top and stretchers
- 2 pcs.  $\frac{3}{4}$  x 30 x 60 in.—ends and partitions
- 1 pc.  $\frac{3}{4}$  x 24 x 48 in.—doors
- 4 pcs.  $\frac{1}{2}$  x 30 x 48 in.—drawers and floor
- 2 pcs.  $\frac{1}{2}$  x 24 x 48 in.—shelving and door pockets
- 1 pc.  $\frac{1}{4}$  x 30 x 72 in.—back
- Misc.—Hinges, door and drawer pulls, door catches,
- 1 pt. shellac, 1 qt. enamel, nails and screws.



## Desk Calendar and Paper-Clip Box Combined

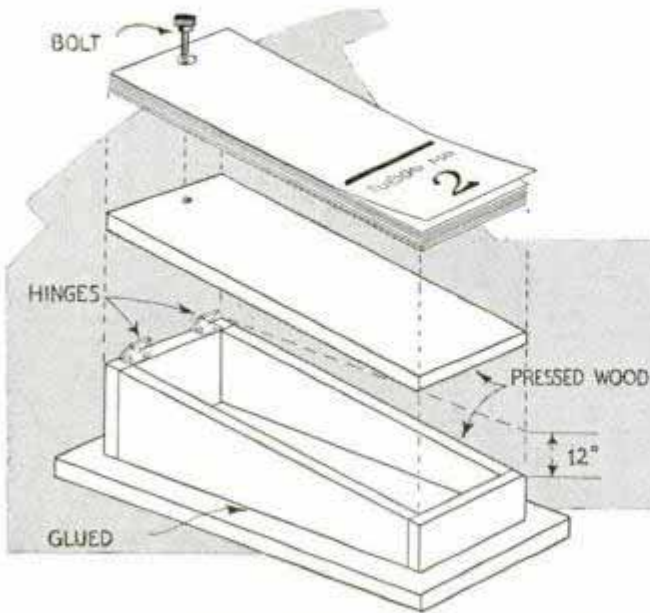

Paper clips, rubber bands, and similar items are always at hand in this box, which also holds your calendar and memo pad. The box is of suitable size to accommodate whatever pad you use, and it can be made of thin wood, plywood or hard-pressed

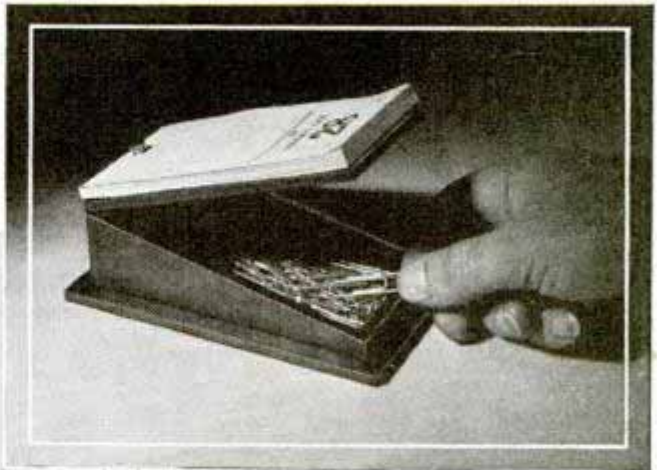

board. Simply glue the four sides to the bottom, then cut them at an angle of about  $12^\circ$ . In hinging the top, hammer the hinge pins lightly to provide sufficient friction to hold the top open. The calendar pad is attached to the top with a small bolt and knurled brass nut as shown.

—Kenneth Murray, Colon, Mich.

## Vise Jaws Guide Hacksaw to Slot Screw Head in Center

Workmen who occasionally have to make a special screw can assure slotting the head exactly in the center by clamping the screw in a vise and using the jaws to guide the hacksaw blade. In doing this, sheet-

metal clips of the same width as the vise jaws are used, and a slot is cut exactly in the center of one. The slot serves as a guide in locating the screw in the center of the vise jaws. In use, the saw is operated so that the blade just touches the clips at opposite ends as indicated.



## Block Fastened to Hammer Head Aids in Pulling Nails

Shaped as shown and screwed to the end of a hammer, a hardwood block is always at hand when pulling nails. The block does not interfere with the regular use of the tool, and enables you to pull a nail in a tight place where it would be exceedingly difficult to place a fulcrum block with the hands.



Edward P. Herlihy, Chicago.



## Red Reflectors on Baby Carriage Are Safety Factor at Night

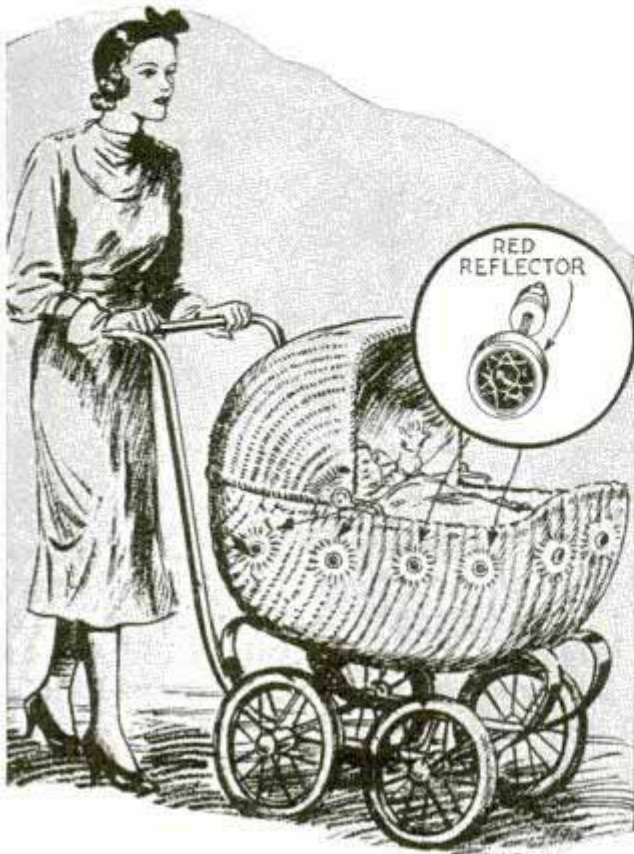

One mother who often took her baby out in its carriage early in the evening, put red reflectors on the carriage so that motorists could see her if she crossed a street. After the reflectors have been put on, the projecting ends of the bolts should be filed flush with the nuts, and two or three layers of tape put over them to avoid damaging the baby's clothing. If possible, countersink the nuts and then tape over them.

## Pine-Cone Winter "Gardens"



Taking advantage of the habit of pine cones to open when dry and close when damp, you can use them to grow green plants in winter. First sand off the bottoms so that they will set level, or drive a nail through a wood disk into the bottom of each cone.

Then set them in saucers of water and sprinkle grass seeds or seeds of small flowers over them. When the cones close, the seeds will sprout and produce a luxuriant growth that will completely hide the cones.

## Hose Slipped over Thread Spool to Prevent Tangling

A spool of thread carried in a camp kit may be prevented from unwinding or untangling by slitting one side of a short piece of garden hose and slipping it over the spool in the manner indicated. If you want to hold the end of the thread in position for instant location, cut another slit a short distance through one edge and pull the end of the thread into it.

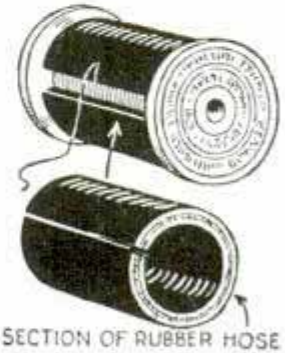

If you want to hold the end of the thread in position for instant location, cut another slit a short distance through one edge and pull the end of the thread into it.

## Drawer under Wheelbarrow Stores Hand Tools

When using a wheelbarrow around your home, a drawer fastened to the barrow as indicated provides a place to carry small hand tools that you may need. Lengths of angle iron screwed to the barrow frame and to the sides of the drawer provide strong slides that work easily if greased.

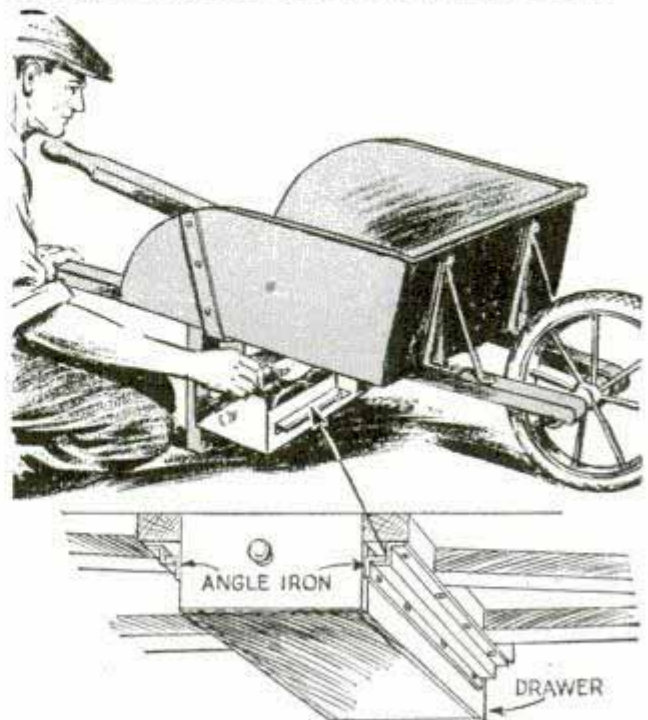



# Room Aired Through Window Check Rail

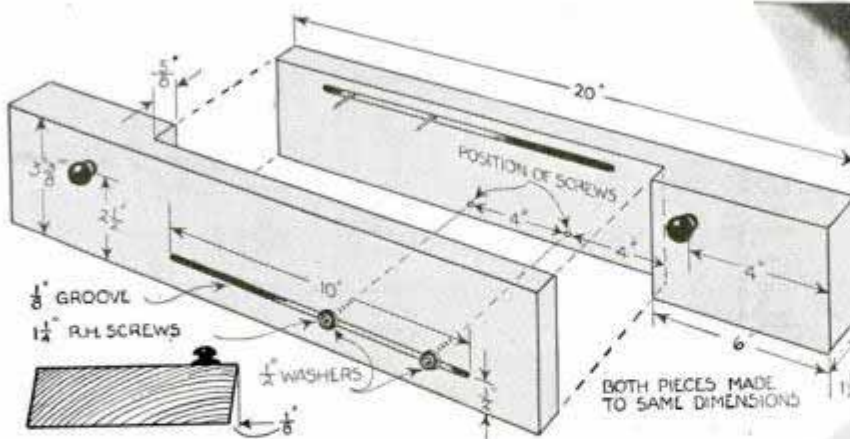

During stormy weather when it is usually necessary to keep windows closed to exclude rain or snow, these adjustable draft stops permit them to be raised so that air enters through the check rails. Also, air entering through the check rails tends to avoid direct drafts on the floor or at head level. Each stop consists of two pieces of wood cut and assembled as shown in the detail. Notice that the upper and lower edges of each piece are beveled slightly to correspond with the bevel of the lower sash member and the slope of the window sill,

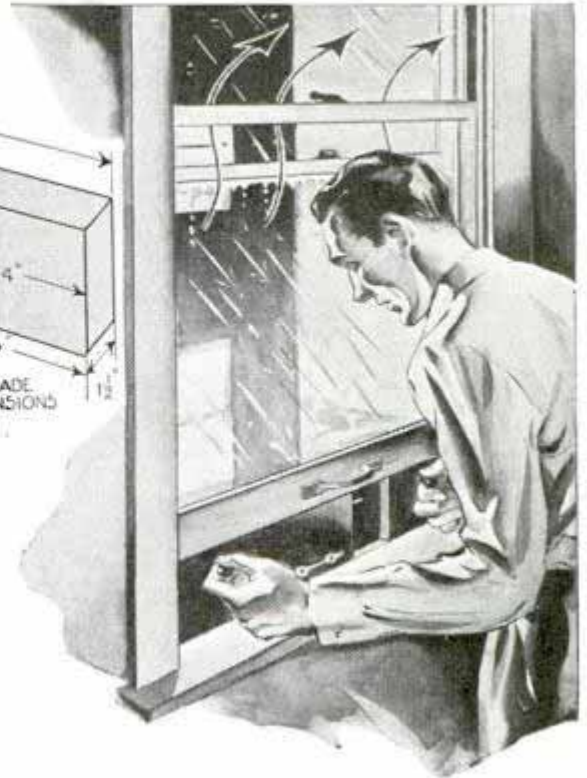

thus providing a tight fit at these points to exclude air. Drawer pulls are used on the stops for handholds.

—A. E. Hughes, London, Ontario, Can.

## Small Cart to Move Ash Can up Steps Saves Heavy Lifting

Instead of carrying a heavy ash can up basement stairs, take a little time and assemble this simple cart for the job. It con-



sists of a couple of tricycle wheels, a short, wide board and an old lawnmower handle. A piece of angle iron at the bottom enables you to load the can easily, and a couple of wood blocks on each side of the board keep it from rolling sideways.

—A. L. Mills, Chicago.

## Bent Spoon Hooks over Tumbler for Dispensing Medicine

To hold a spoon steady for mixing or dispensing medicine from a dropper without spilling, use an inexpensive one and bend the handle so that it fits over the rim of a glass tumbler. Also, when a spoon is used in this way, it need not be laid on a table to soil the linen.

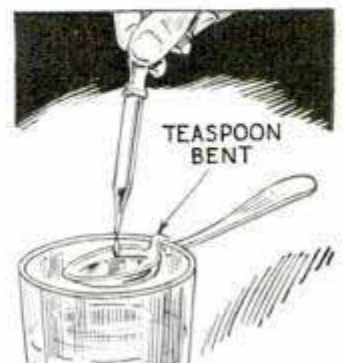



## Special Level to Hang Pictures Straight on Wall



You can save time when hanging large pictures if you use this level. After the picture has been hung, just slip the level under the lower edge and adjust it until straight. Two small boards are nailed together at right angles and a small spirit level is sunk into the top edge of one of them. A drawer handle screwed to the side of the assembly facilitates using it.

—Opie Read, Jr., Chicago.

## Gateway Through Lawn Hedge Fitted with Tire Railings

Cut in two at the sides and painted white, two old auto tires were used to make the

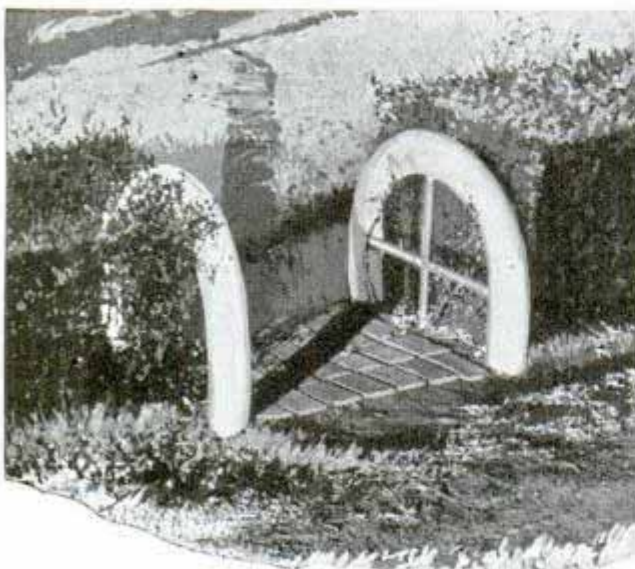

decorative railings on this hedge gateway. The ends of the tires are spread and slipped over the ends of stakes, which support them vertically. Crossed lattice strips fill the open centers of the tires to improve appearance.

## C-Clamp Has Removable Pads to Protect Furniture

If C-clamps have to be used on finished work, the surface can be protected by forcing hollow rubber balls of suitable size over the ends of the clamps. The balls will hold themselves firmly in place, and if left

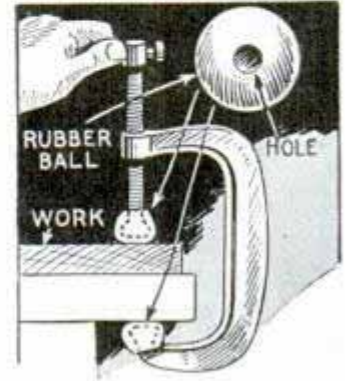

on the clamps, will save much time looking for suitable material to put on each side of the work to protect its finish.

## Bobby Pin Marks Readings of Thermometer

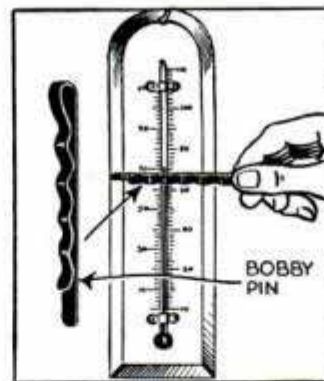

Desiring to mark a temperature reading on a thermometer so that he would not have to remember it when the next reading was taken, one man used a bobby pin as a marker. The pin

can be slid along the thermometer tube as desired without removing it.

## Bottle Caps Serve as Drawer Pulls

When in need of a drawer pull, one can be made from a composition bottle cap. Cut away part of one side as shown and drill a hole in the top for a screw to attach it to the drawer.

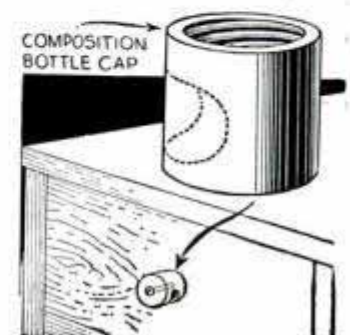



# Santa Pops Out of Chimney as Toy Moves

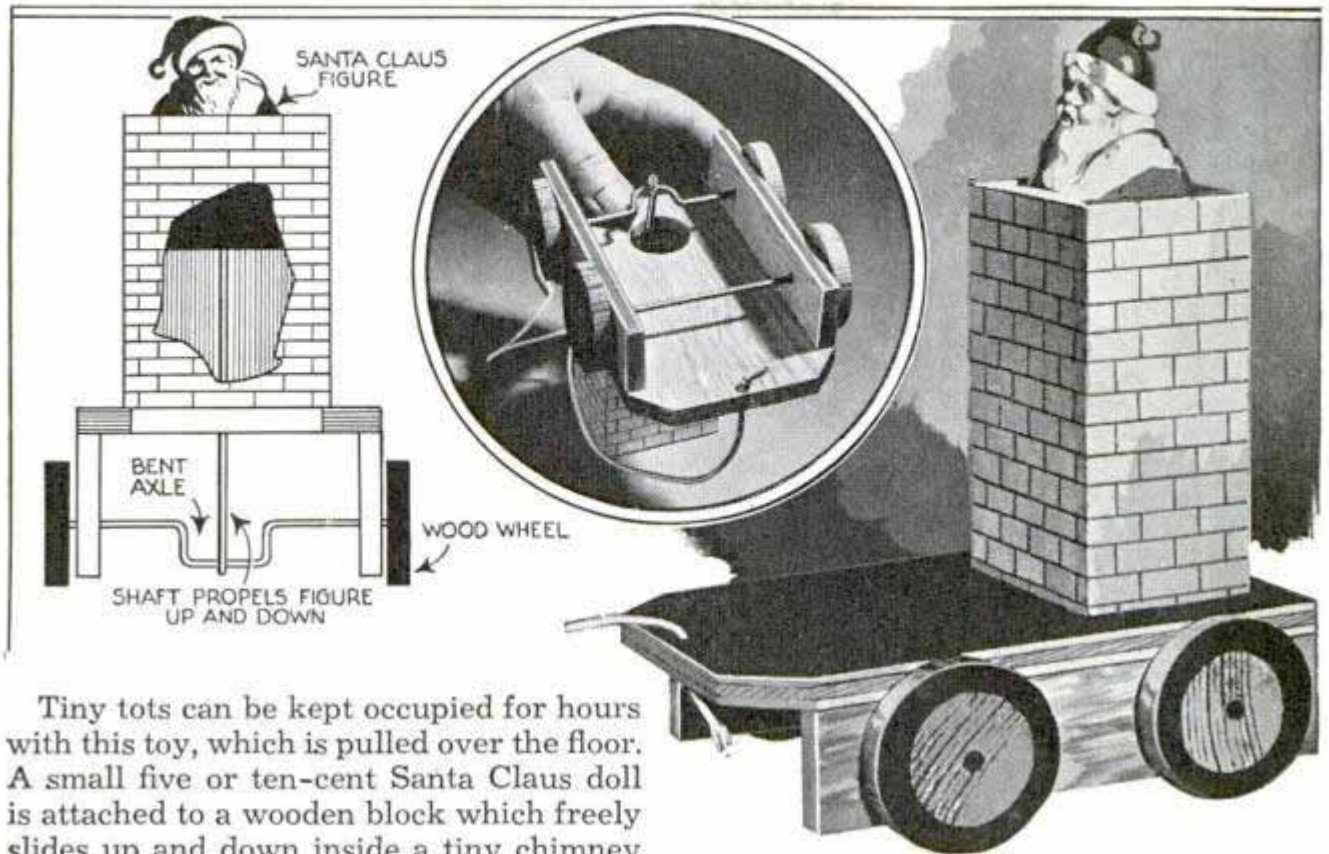

Tiny tots can be kept occupied for hours with this toy, which is pulled over the floor. A small five or ten-cent Santa Claus doll is attached to a wooden block which freely slides up and down inside a tiny chimney mounted on a four-wheeled cart of plywood. Each pair of wheels has a stiff wire axle, the rear one having its center portion bent to a crank shape for attachment of a

wire connecting rod that activates the piston. A hole is bored in the floor of the cart to provide sufficient clearance for the connecting rod.

## Sheet-Metal Stand Will Support Christmas Tree Securely

Sturdy and inexpensive, this Christmas-tree stand can be made from a piece of heavy sheet metal 1 or 2 ft. square, depending on the size of the tree. First measure the diameter of the tree at the base and make a circle this size in the center of the square. Then draw lines from each corner of the metal to the center of the circle and cut these lines up to the circle. Then bend each side up at a right angle as shown by the dotted lines. Nails are driven through the center of the base into the end of the tree and also through the vertical pieces of metal into the trunk, which will hold the tree securely. A coat of paint improves the appearance of the stand.

—Bess Livings, Batavia, Ill.

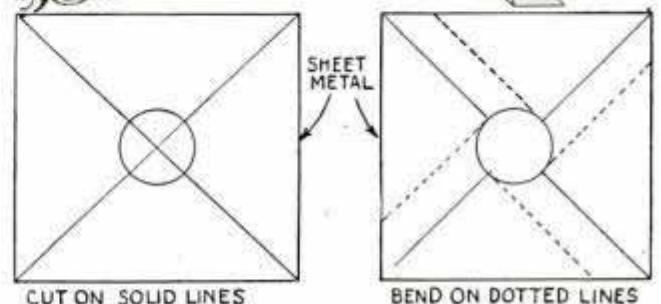
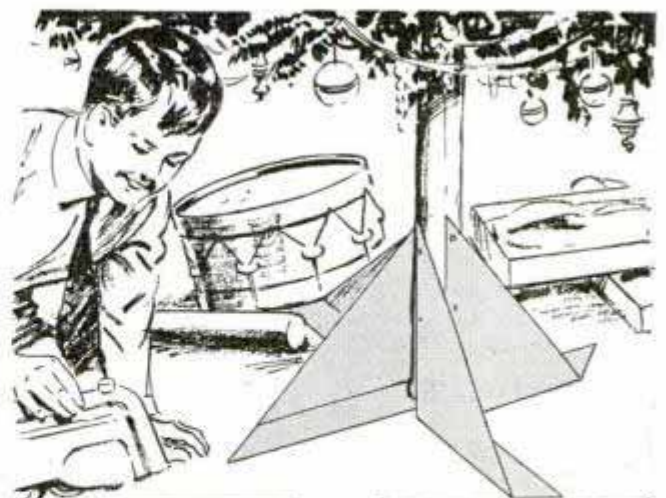

Ⓛ Small washable rugs should not be run through a wringer as this is likely to cause them to lose their shape, just hang them on the line dripping wet.



# Solving HOME

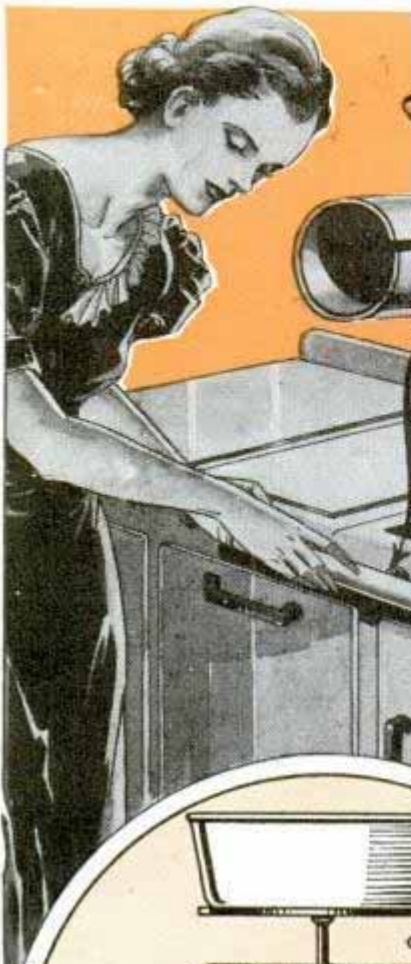

Very small children in your home can be kept from turning the cocks of a gas stove by slitting a cardboard mailing tube along one side and slipping it over the cock handles. It takes only a second to put on or remove the tube

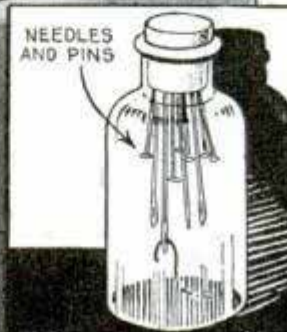

Needles can be carried safely if stuck in a cork inside a small bottle

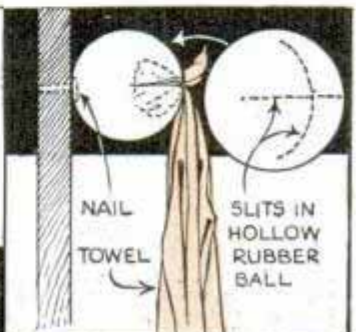

A hollow rubber ball slit on one side provides a good towel rack

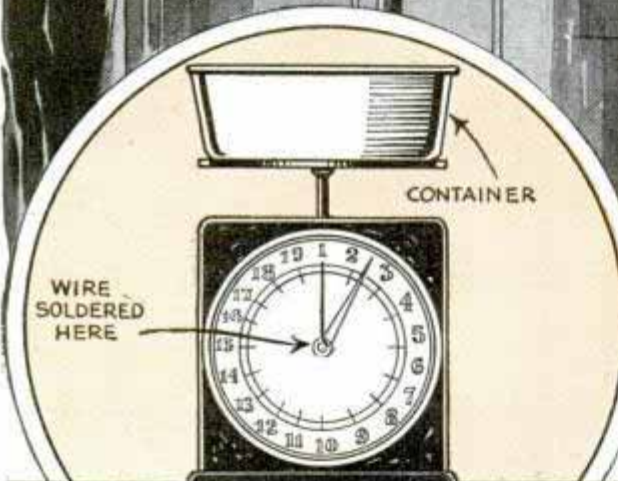

When using the same container to weigh various commodities, a wire soldered to the scale shaft and set at zero allows for the weight of the container

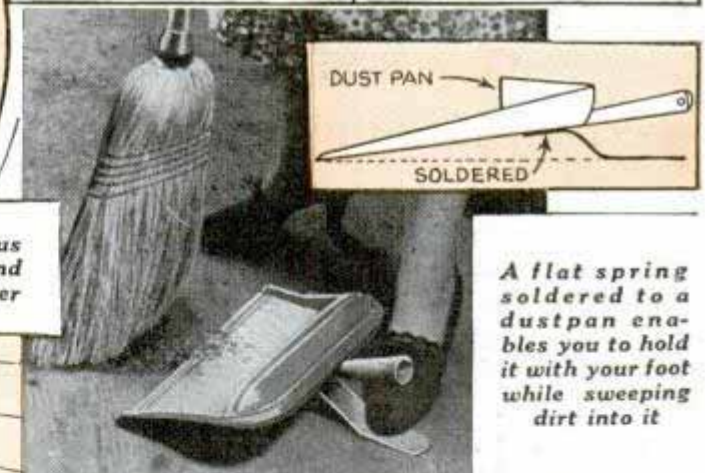

A flat spring soldered to a dustpan enables you to hold it with your foot while sweeping dirt into it

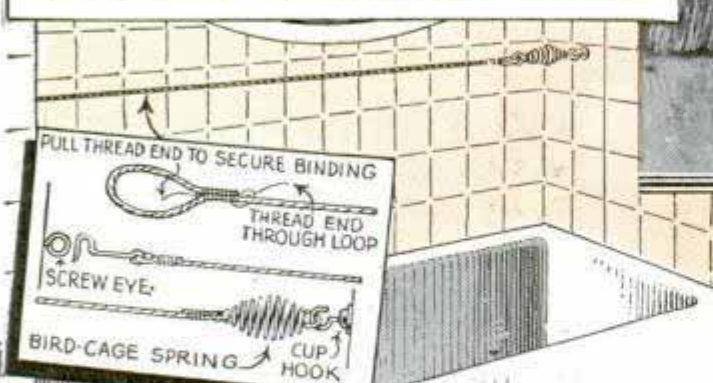

Stretched above a bath tub, the garment line at the left has a small spring at one end which makes it easy to put up. To hold a washboard at a convenient angle in a large tub, remove the paint from a pair of metal bottle caps and solder them in the bottom of the tub. Then set the ends of the washboard legs in them

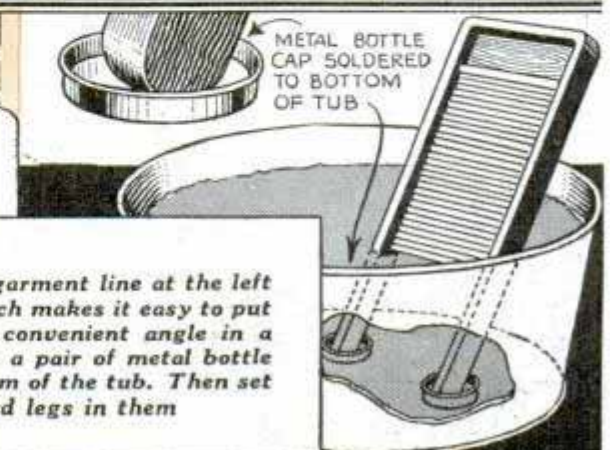



# PROBLEMS



Anyone who has undertaken the job of making a stand or support for a Christmas tree knows that it is not the simple thing it would appear to be. However, an old auto steering wheel is just right. Simply trim the end of the tree trunk with a sharp knife to fit snugly in the wheel hub

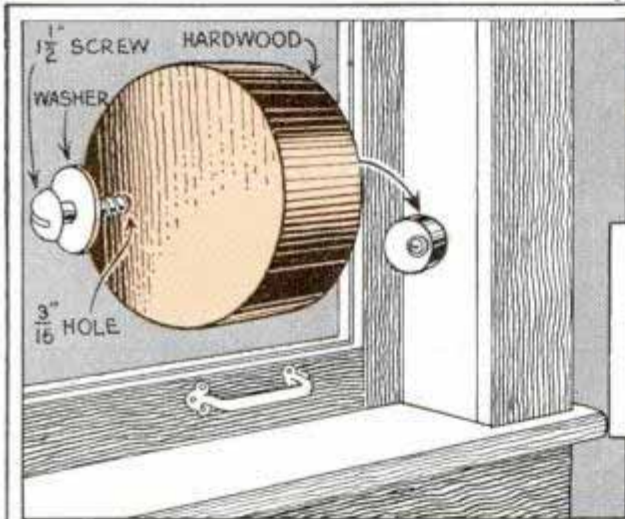

You can easily silence a rattling window or door with a small cam made from a disk of hardwood. The cam is fastened to the frame with an "off-center" screw as indicated

If the plug of your electric razor pulls from the lamp socket too easily, loop the cord and hook it over the socket key as shown at the right

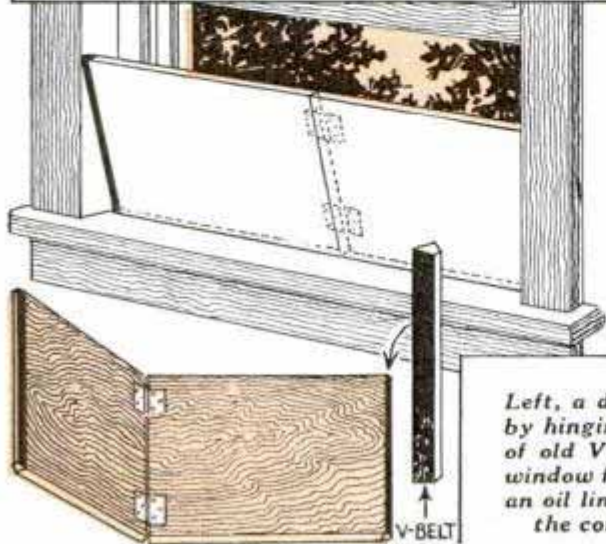
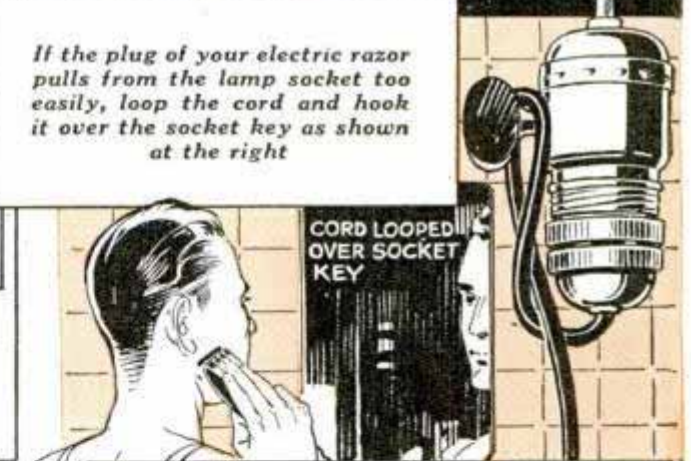

Left, a deflector for an open window can be made by hinging two boards at the center. Nail a length of old V-belt to the ends to prevent marring the window frame. Right, when the string used to pack an oil line becomes tightly wedged in the nut, heat the connection over a flame to char the packing

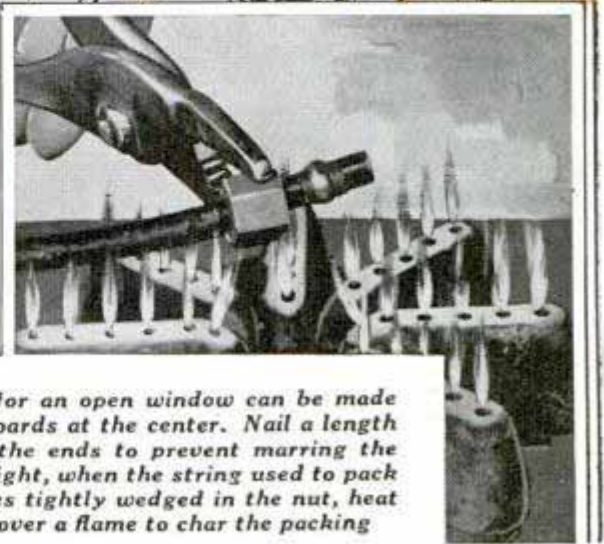



## Balancing Pole on Stepladder Helps Prevent Falls

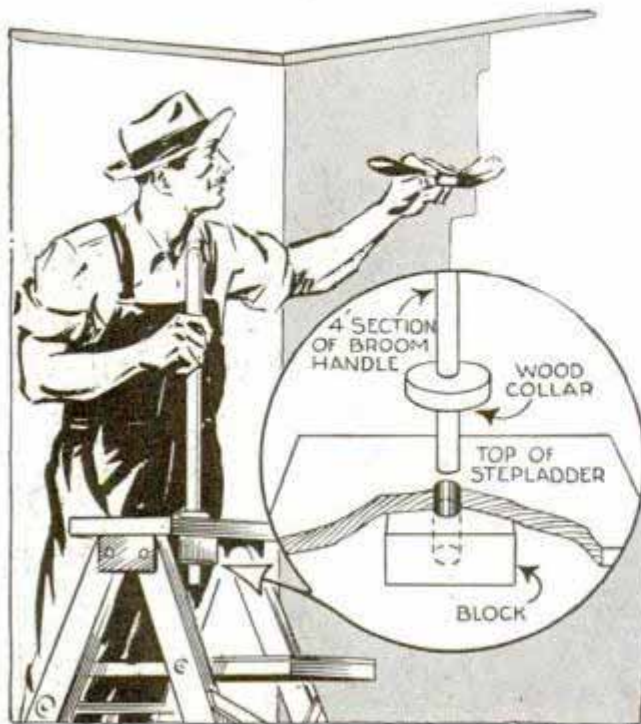

Women and others who occasionally use a stepladder around the home and are afraid of overbalancing when working from near the top of the ladder will find this pole solves the problem. It is a length

of broom handle with a wood collar near one end, which is inserted through a hole in the top of the ladder, a block being nailed underneath to reinforce it.

## Finger Slit in Hunter's Glove Aids When Shooting

Annoyed by the inconvenience of firing a rifle quickly with a gloved trigger finger, a sportsman cut a slit in the glove finger and turned it inside to leave the index finger of his hand uncovered. As the reversed glove finger rested on the back of the hand, it did not interfere in any way with shooting.



☐ If the juice from an apple pie runs over in the oven while cooking, shake salt on it; this causes the juice to burn to a crisp so that it can be removed.

## A Hundred Simple Ways to Save Money

New Handyman's Reference Guide Shows How!

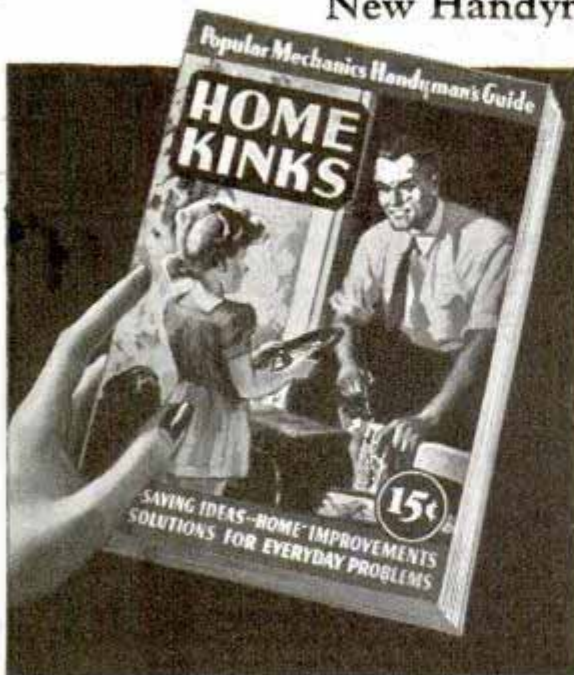

This 96-page book gives you over a hundred practical ideas of great value in solving, simply and inexpensively, many of the everyday mechanical problems that arise in every home. Also shows many ways of reducing costs and eliminating waste. Contains complete details on refinishing floors and furniture; hanging wall paper; cutting heating losses; curing leaky faucets and making other minor plumbing repairs; protecting clothes, rugs and fabrics against moth damage; curing wet and leaky basements—all this besides numerous shortcuts and simple kinks of great value to make things handier around the average home

Write for "Home Kinks"—a copy will be sent to you upon receipt of 15 cents

Popular Mechanics Magazine, Book Dept., 200 East Ontario Street, Chicago, Ill.



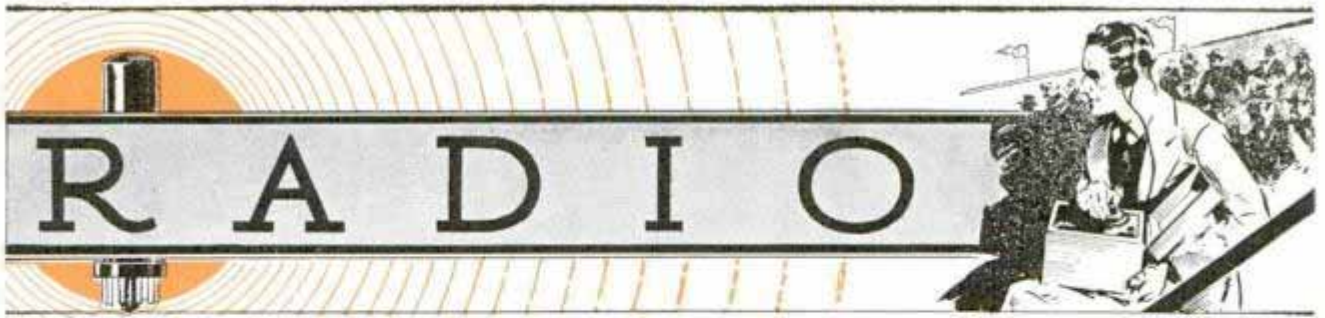

# "CAMERA-CASE" *Portable Receiver*

ALMOST as easy to carry as a camera or a pair of field glasses, this personal radio for pedestrians plays anywhere, is ideal for hikes and a handy companion at any sporting event. It enables the user to hear the broadcaster's comments while watching the action at a race or game. Completely self-contained, it consists of a 4-tube superheterodyne with a 4-in. permanic-type speaker. A multi-turn non-directional antenna is concealed in the shoulder strap, and the tuning range is from 550 to 1,575 kc. The set is quite sensitive and brings in a wide range of stations with good volume. Within the case, shown in photos Figs. 1 and 2, are two batteries—one 80-volt "B" battery and one 2-cell "A" battery which is claimed to have a useful life of from 75 to 100 hours.

The set is contained in an extremely compact case, covered with imitation leather, 5 by 8¼ by 4 in. It weighs less than 5 pounds, and is provided with rubber feet so that it may be placed anywhere.

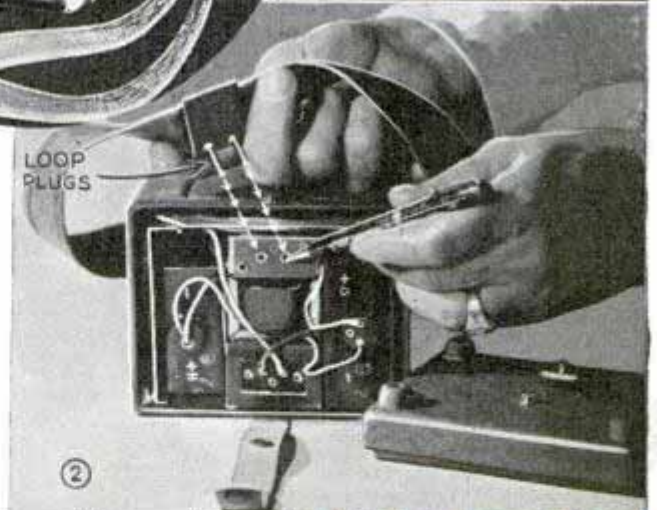
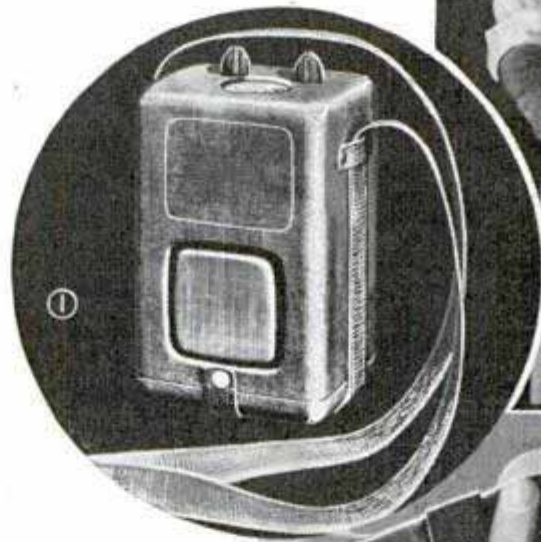

*Salvia ref. E  
4545 Augusta Blvd*



# PROGRESSIVE

By M. N. Beitman

PLANNED especially for students and experimenters, this 4-tube set provides a practical means for learning radio work by "actual doing." In a later article the reader will be told how to convert this very same set to a 6-tube 3-band receiver and use every part originally purchased. This economical feature has been worked out

carefully at the suggestion of prominent teachers for use by progressing radio classes in public-school shops. Both this set and the larger one to follow in an early issue, are complete in every detail, have good tone quality, distance-getting ability and provide excellent radios for the home when completed.

Separate chassis bases are employed for the power supply and the radio set itself, as detailed in Figs. 1 and 2; the speaker is also a separate unit housed in a standard metal cabinet. The power-supply unit is of standard design for 110-volt, 60-cycle operation. However, transformers for other line-supply voltages and frequencies can be obtained if required. Since a permanent-magnet type speaker is recommended, a separate filter choke and a single dual-eight mfd. electrolytic are

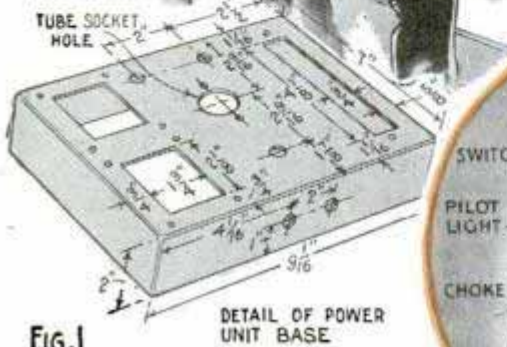

Fig. 1  
DETAIL OF POWER UNIT BASE

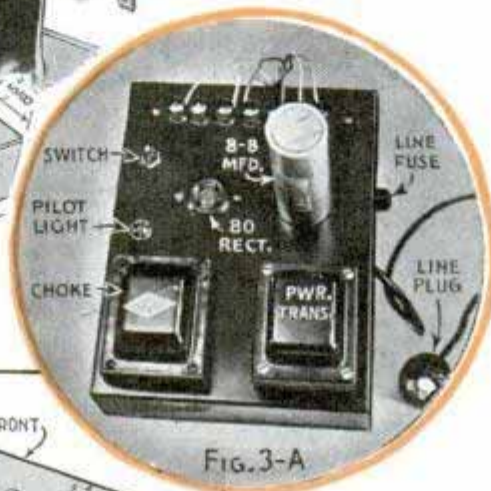

Fig. 3-A

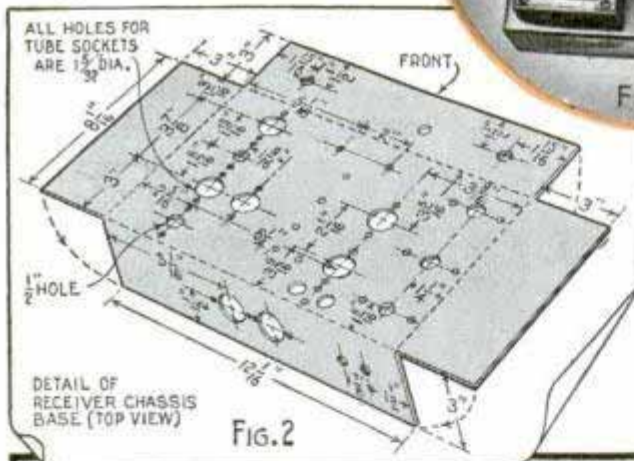

Fig. 2

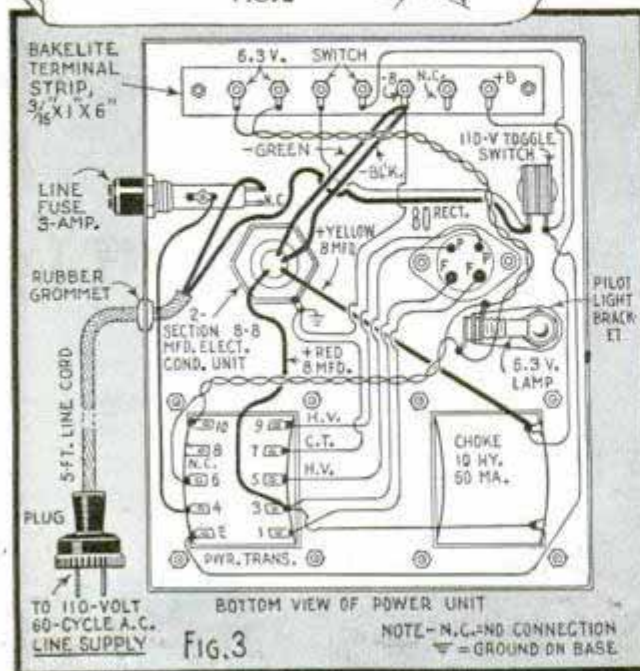

Fig. 3

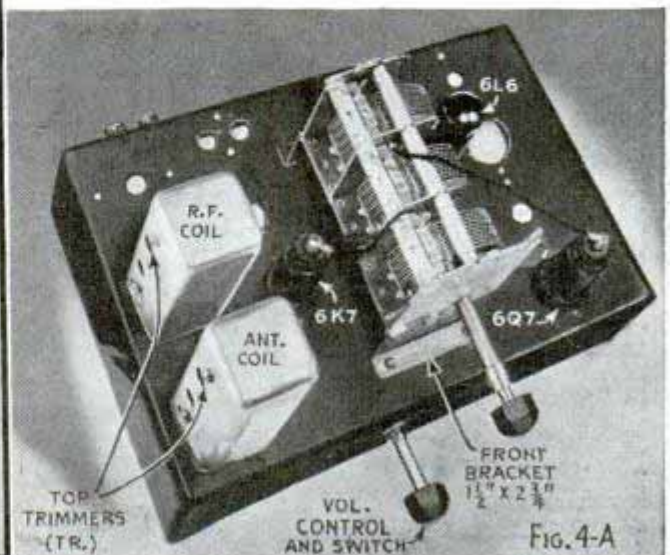

Fig. 4-A







# Building a Portable Low-Cost Sound System

## PART II



AFTER completing the wiring of the chassis base, as detailed in Fig. 2 in Part I of this article, which appeared in the November issue, we are now ready for the portable case that houses the amplifier, phonograph motor and pickup. It is made of pine wood and is designed so that the amplifier may be operated and controlled with the case closed, if desired.

All case dimensions are clearly shown in Fig. 4. Two  $\frac{1}{16}$ -in. pieces are required for the bottom and top of lid; other case material may be  $\frac{1}{16}$ -in. plywood. Please note that the chassis base is mounted on  $\frac{5}{8}$ -in. strips to raise it to the proper height to center the shafts of the various controls which extend through the cutout in the right end of the case, as shown in photo Fig. 2-E. Details for this recessed end construction are given in the insert sketch that appears in Fig. 4. The shafts of the

controls should be cut to the proper length so that the knobs do not extend beyond the end of the case.

Photo Fig. 2-D shows the amplifier unit installed in the case and the various internal speaker and microphone plugs inserted in their respective jacks and sockets. The a.c. supply-line input connec-

(Continued to page 142A)

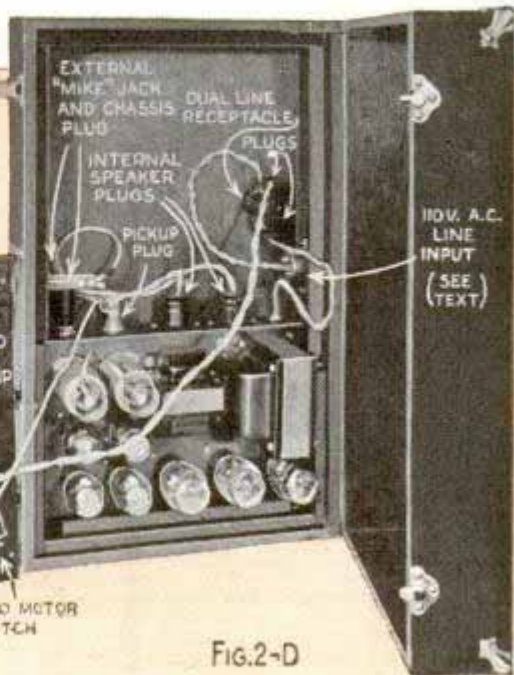
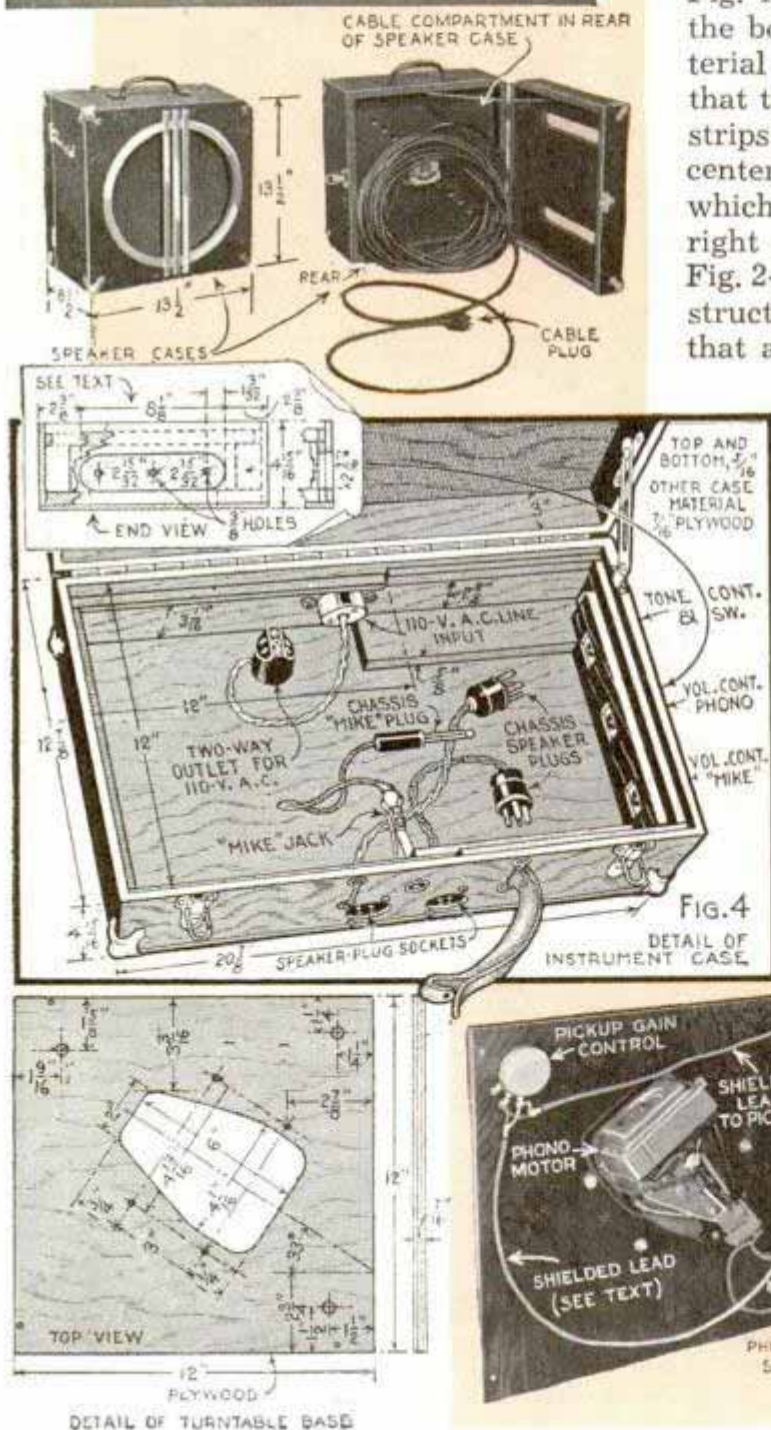

FIG.2-D



Messner mfg. Co.  
Mr. Carmel, d. l.

# Helpful RADIO HINTS

Make your midget broadcast receiver more selective by using a loop instead of the usual 15 or 20-ft. length of "roll-up" antenna wire. With loop detailed in Fig. 1, signals may not be quite as loud but they become directional; when the edge of loop is pointed at the desired station, unwanted signals from stations at right angles to it are eliminated. About 50 feet of "roll-up" type antenna wire is wound on the loop frame, the correct amount being best determined by trial; loop ground connection is optional

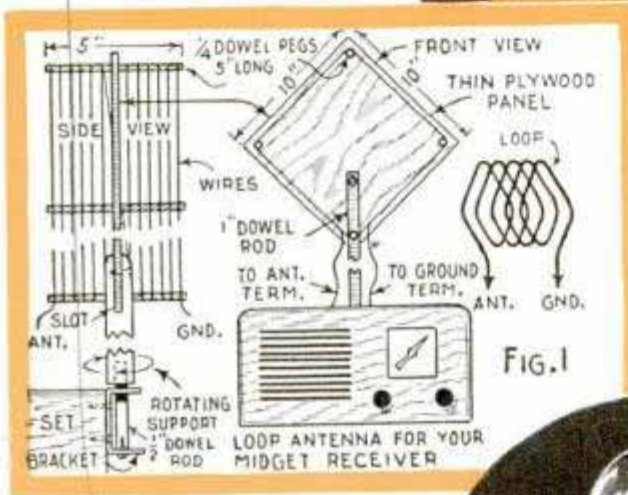

Sketch Fig. 3 and photo, illustrate one of several useful applications of a compact easily installed a.c. operated photocell relay burglar-alarm now available to experimenters and servicemen. This device consists of a light source, photocell and amplifier all mounted in a compact unit. The light beam is reflected by an adjustable auto-type mirror and is practically invisible; any break in the light beam, over distances up to 30 feet, works the relay that can be connected to operate either a chime, bell or light at a remote point

Photo (A), insulated caps for exposed terminals of high-voltage tubes provide protection against accidental shock. Fig. 2, small wave trap available for each of the amateur bands covering respectively 20, 40, 80 and 160 meters to prevent interference with broadcast reception. Two or more units may be connected to the same receiver for eliminating interference on as many different frequencies

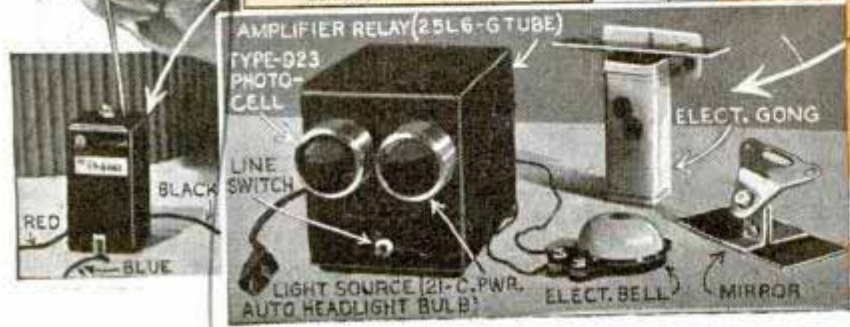
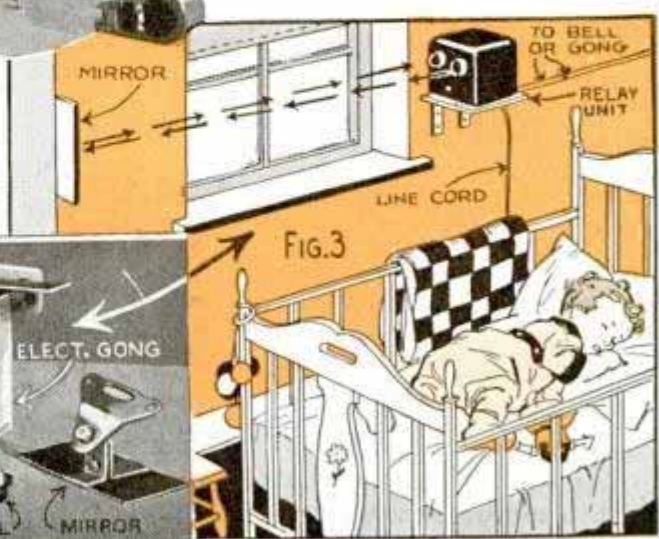
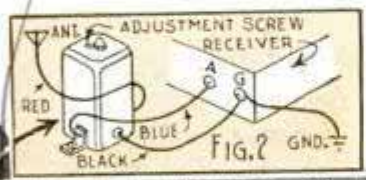

Warner Products Co.  
W. Ohio, Cheung  
1019 W. State

National Co. 61 Sherman



### Junior Sound-Control Studio for Experimenters



Many sound effects commonly employed by broadcasting stations, and recording studios, may be duplicated by means of this electrical kit which allows the youngsters to experiment with home recording and small public-address amplifiers.

### Test Set in Panel Assembly

Ready for installation with other radio workbench equipment, this improved rack



and panel assembly has all jacks and controls out in front and immediately accessible to the serviceman.

### Electric Clock in Receiver

A five-tube a.c. set with an electric clock and built-in antenna is now available in a small table model 9½ in. high, 10 in. wide and 5½ in. deep. No external ground or antenna is required thus making the set easily portable for room to room use.



### "Wireless" Radio-Phono Control

Now you can control remotely either radio or records in a radio-phonograph by means of a small remote-control box without wired connections. Volume and record-changing are included.



Blueprints covering radio construction articles in this and past issues are available for 25 cents each. Original material lists, with names of manufacturers and dealers, can be obtained from our Radio Department upon receipt of postage.

**NEXT MONTH—How to Build an Inexpensive Metal Locator.** A simple, portable beat-frequency instrument of improved design, that anyone can build and operate. Also—An "A" and "B" Eliminator for Portable Battery Receivers. This compact unit enables owners of portable battery sets to operate them on 60-cycle a.c. lines.

*Service & instruments direct  
404-4th Ave New York*

*1501 Ocean Ave  
Detroit Mich*  
*Telephon Corp*  
*Philed Radio & Photo*





# SHOP NOTES

## Sharp TAPS and DIES...

By GEORGE DESCHENES

CONSIDERING the relative size of their cutting edges, taps and dies remove more stock than other metal-cutting tools. The reason for this is that the lead is positive in the case of taps and dies, whereas with a drill or reamer the feed is almost completely controlled by the operator. With such limitations in view, adjustable dies are preferable to non-adjustable ones, especially in cases where it is necessary to cut a thread slightly under or over size.

If adjustable dies are not available, but you do have one or more sets of non-adjustable dies, it is possible to alter these, this being recommended for dies of the cheaper variety. To make a die adjustable, it is first slit with a cutoff grinding wheel that has a  $\frac{1}{16}$ -in. thickness, as illustrated in Fig. 1. The location of the slit in relation to the spot on the periphery of the die depends on whether the die has four or five cutting surfaces. The next step is to grind the 90-degree compound angle by holding the die with the slit at about a 45-degree angle against a wheel with a sharp corner. Also, make it a habit

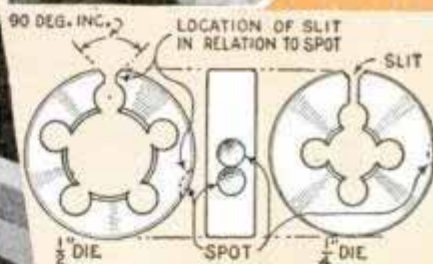
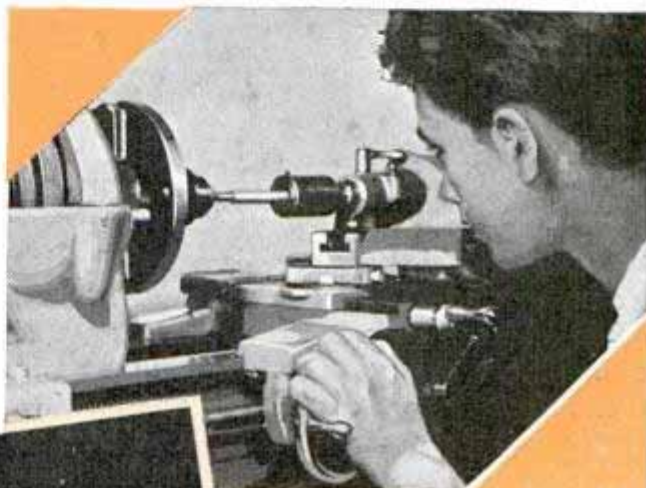

### ① Slitting the die

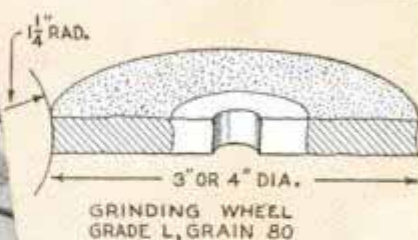

### ② Chamfering tap

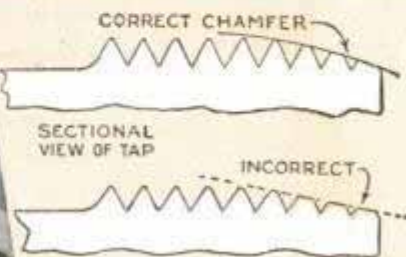

### ③ Grinding flutes

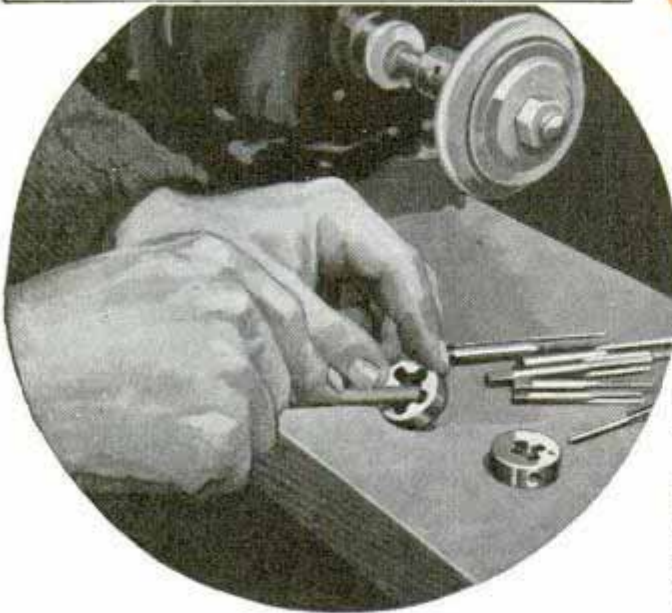

④ *Hone with round slipstone*

to touch up the chamfers of your dies with a small round oilstone, as in Fig. 4. Do this often and see how much better they will cut. Before using dies, always be sure to clean them with a wire brush as in Fig. 5. When using dies in a lathe, it is best to provide a special holder that fits the tailstock and seats the dies securely and accurately. This is much better than holding the dies against a tailstock pad.

Chamfers are the chief point of attention on taps. Chamfers must be kept to their original outline as much as possible. This is best done, without special equipment, as shown in Fig. 2, using a grinding wheel of

⑤ *Clean dies before using*

the size given. An equal amount of stock is removed from each chamfer by feeding to the wheel with a slight oscillating movement and in such position that the required clearance will result. With a little practice on discarded taps, you soon will become proficient in getting an outline as that shown in Fig. 3. Occasionally, you should also grind the flutes of all taps by starting at the back rather than at the front. The wheel used should be of the same size as the one shown in Fig. 2, with the face dressed to the exact contour of the flutes. Apply light pressure, traversing down and up, and be careful not to round the cutting edges. The conventional bench grinder is best adapted to this work. A 3-in. wheel at 3,450 r.p.m. has the same surface speed as a 6-in. wheel at 1,750 r.p.m. The smaller diameter wheel is usually best.

## Spiral Rack of Wallboard Displays Small Jewelry Boxes

Jigsawed on a spiral line, a single disk of wallboard can be telescoped to form a novel rack on which small items of merchandise, such as jewelry boxes, can be displayed attractively. The disk is supported on a metal hat stand, adjusted for proper height and placed up through the center of the spiral.

### Lathe Centers from Drills

Broken taper-shank drills can be ground easily to provide good lathe centers in less time than they can be made from rough stock. Just put the drill in one of the lathe-center holes and grind it to shape, taking care, of course, not to heat it and anneal the metal.

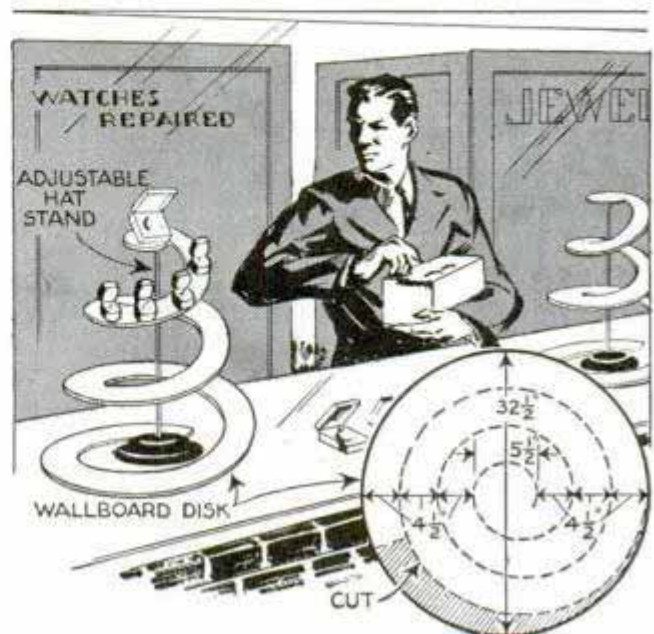



## V-Block Holds Round Work to Drill the Ends

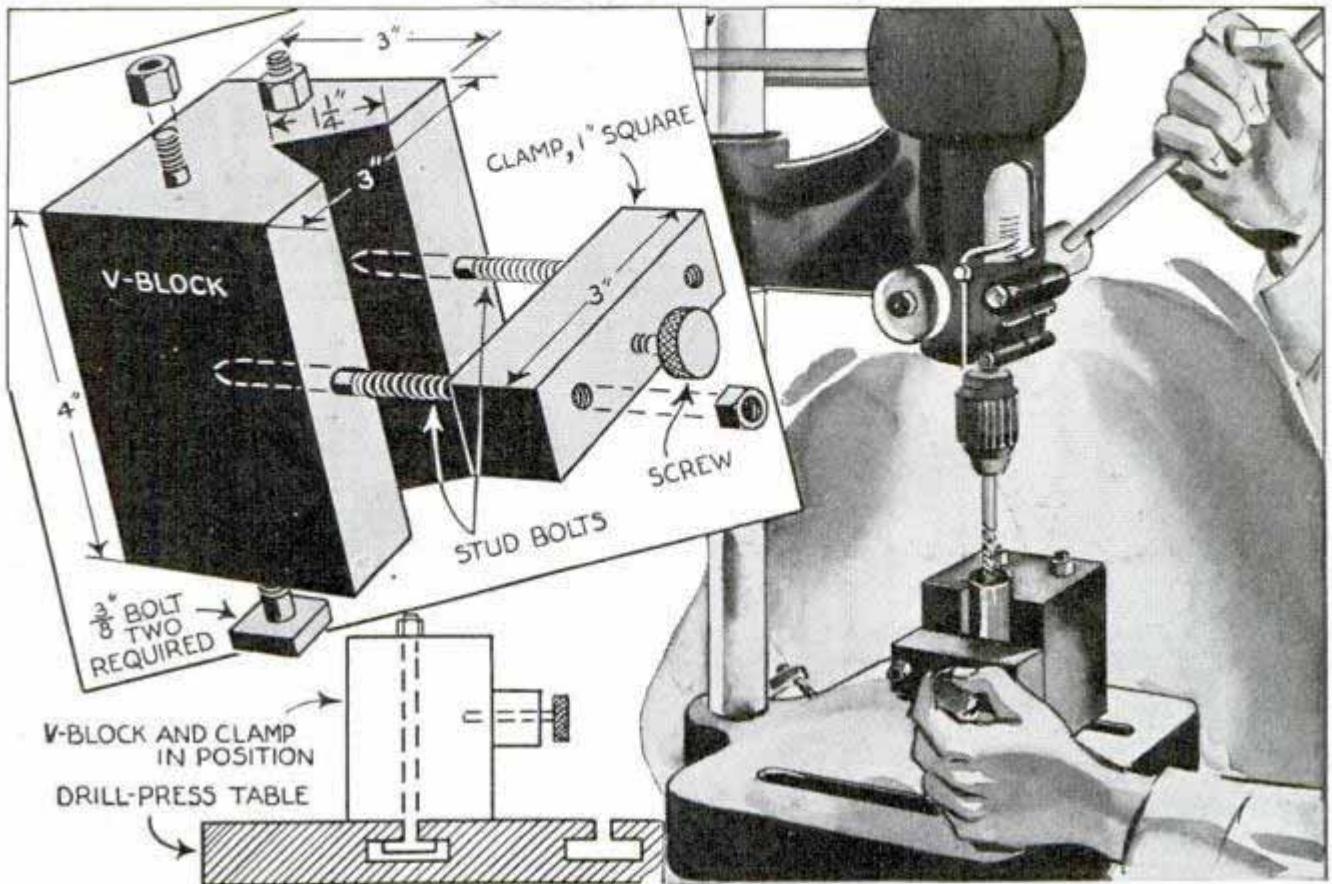

Drilling holes in the ends of short rods, pins, bushings, etc., is simplified with this V-block. Long, slender bolts passing through the block fit into slots of the drill-press table and hold it securely in place. A clamping bar holds work in the V-groove of the block, the bar being secured by stud

bolts driven into holes tapped on each side of the groove. When the work to be drilled is smaller in diameter than the depth of the V-groove in the block, it can be held by means of a thumbscrew tapped in the center of the clamp bar.

—Truman Greenwalt, Litchfield, Ill.

## This Roller Gate Is Adjustable to Pass Various Animals

Desiring a gate that could be adjusted to let animals of various sizes pass, and keep out others, a farmer made the one shown. It consists of two vertical rollers mounted on cross members between two posts. Both members are drilled to vary the spacing of the rollers, the upper member being removable to make the adjustment. The rollers are lengths of pipe filled with concrete, the shafts that project from the ends being centered in them before pouring the concrete.

☐ An easy way to remove grease spots on wallpaper is to cover the spot with a paste made of cornstarch and water. When dry, brush off, and the stain in most cases will be gone.

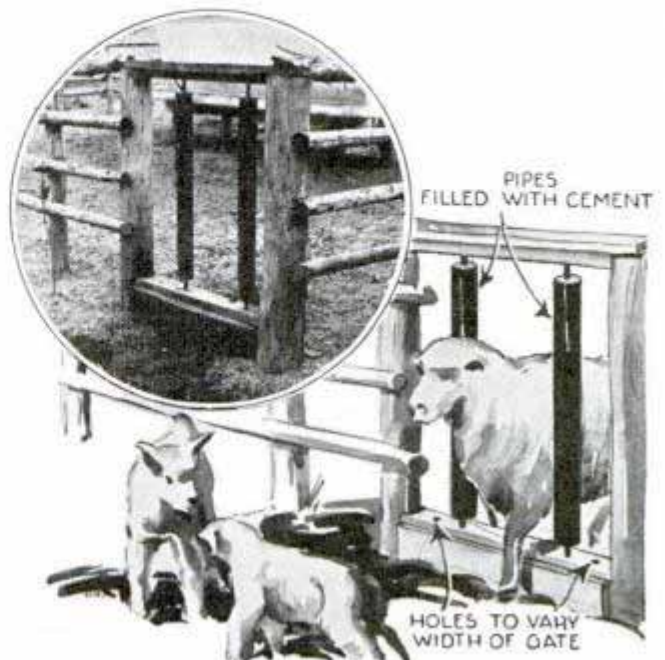



## Humane Whip to Drive Cattle Has Loud Report

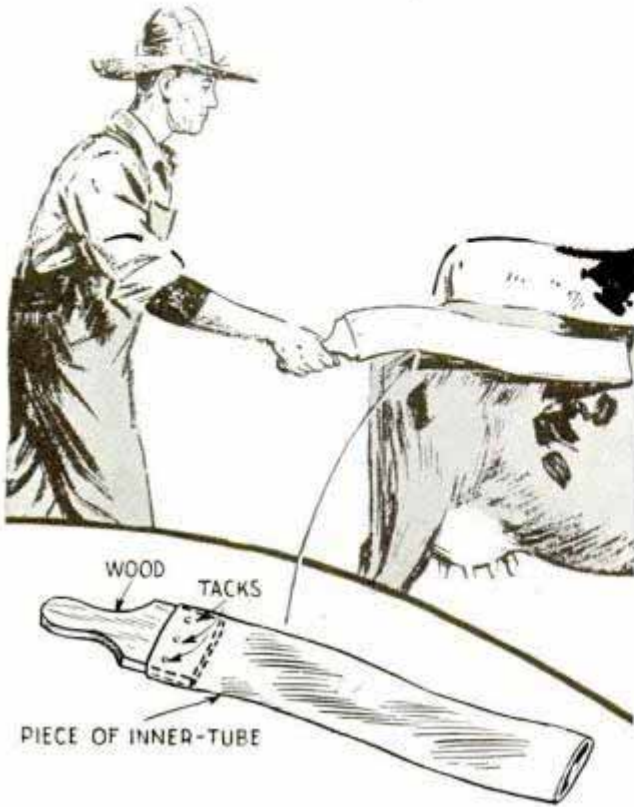

To avoid injuring or bruising livestock in his shipping yards, one Wisconsin stock buyer insists that all driving be done with whips made of inner tubes. The tube sections are mounted on board handles, cut as indicated, and are tacked in place to seal the end of the tube. When the whip is slapped against an animal it makes a loud report that startles the beast and produces the same effect as a painful blow. The closest investigation of slaughtered animals has shown no bruise or injury.

## Locking Nut on Pulley Shaft

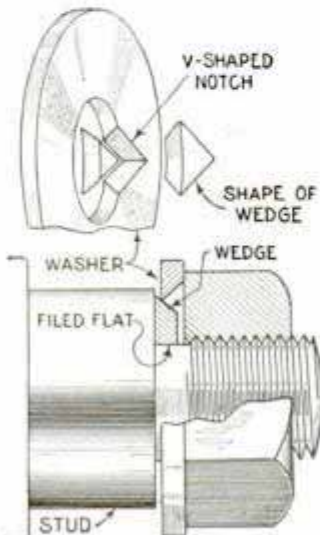

A nut that repeatedly worked loose on the end of an idler-pulley shaft was locked tightly in place as indicated. A V-shaped piece was cut out of the washer under the nut, holding the hack saw at an angle to bevel the edges. Then a flat was filed on the

shaft close to the shoulder. When the washer was placed with the narrow side of the notch against the shoulder, the wedge slipped in between the shoulder and washer. Tightening the nut forced the wedge against the flat portion of the shaft and locked the assembly.

## Lens of Flashlight Protected by Vacuum Cup

Finding that the lens of a flashlight carried in his tool bag was damaged by metal articles, a mechanic slipped a small vacuum cup over the lens before placing the light in the bag. The removal and replacement of the cup take only a second.



## Chaff Trough at Hens' Nest Prevents Soiling Eggs

Hens tracking mud into their nests during rainy weather cause considerable loss of revenue for the owner, as once the eggs are soiled it is difficult to clean them to bring top prices. To prevent this as far as possible, one poultryman places a shallow trough in front of the nest and fills it with chaff or sawdust. This helps to clean the feet of the fowls. Also, the chaff clings to the mud not removed from hens' feet and prevents it from marking the eggs.

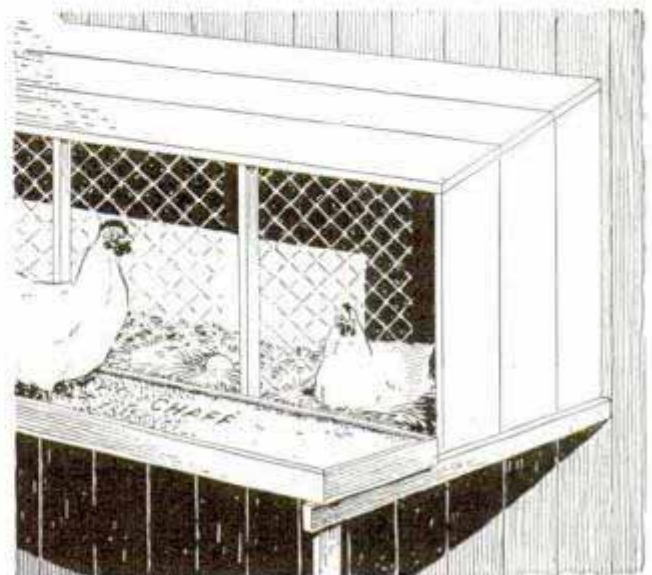



## Novel Backgrounds Superimposed on Prints

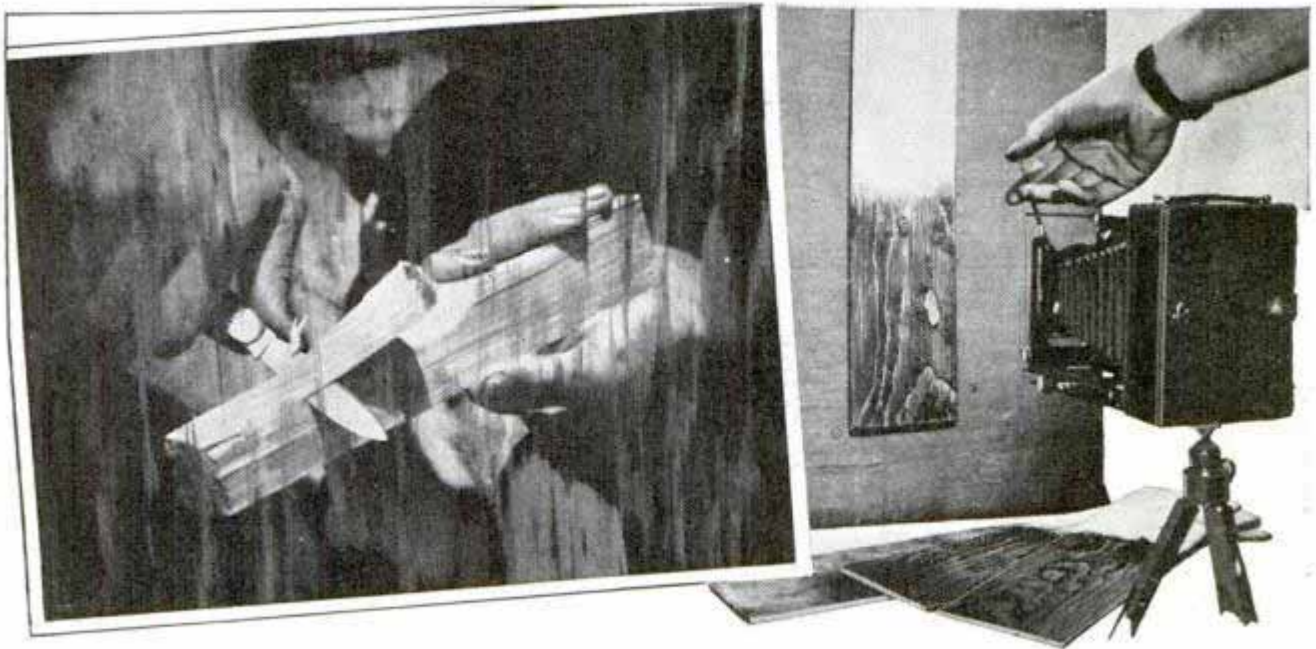

A texture negative under the picture negative in the printer—that's what turns the trick in this process. Using texture negatives from such surfaces as leather, wood, stone, lace, a frosty window or a leaf, you can turn out some very striking contact prints or enlargements for your album. Above, you see the results. This example was made by simply photographing a stained-wood surface, and is particularly

suitable for a photo of whittling. The texture negative should not be hard or contrasty. A thin one is better. It is well to make texture negatives of several different surfaces so that you can control the process and also select a suitable texture. In contact printing, the texture negative is placed beneath the picture negative, while in projection printing the two negatives are placed in the holder face to face.

## Small Cutting Tools Clamped to Handle for Easy Grinding

Small cutting blades, such as spokeshaves, plane irons and scrapers are so difficult to grip while sharpening them that it is almost impossible to obtain a correct edge. Also, there is always danger of injuring the hands when holding the blades against a grinding wheel. To avoid this trouble, fasten the blades to a piece of wood with a C-clamp to provide a handle on which you can get a good grip for holding the blades at the angle desired. The thumbscrew of the clamp should be placed uppermost so that it will not interfere if you support the tool on a rest, and the blade should be clamped to the underside of the handle.

—A. F. Lantz, Bramber, Nova Scotia, Can.

☞ To clean dry floor mops, first soak them in warm water to which a generous amount of salt has been added, then wash them in warm, soapy water and rinse well.

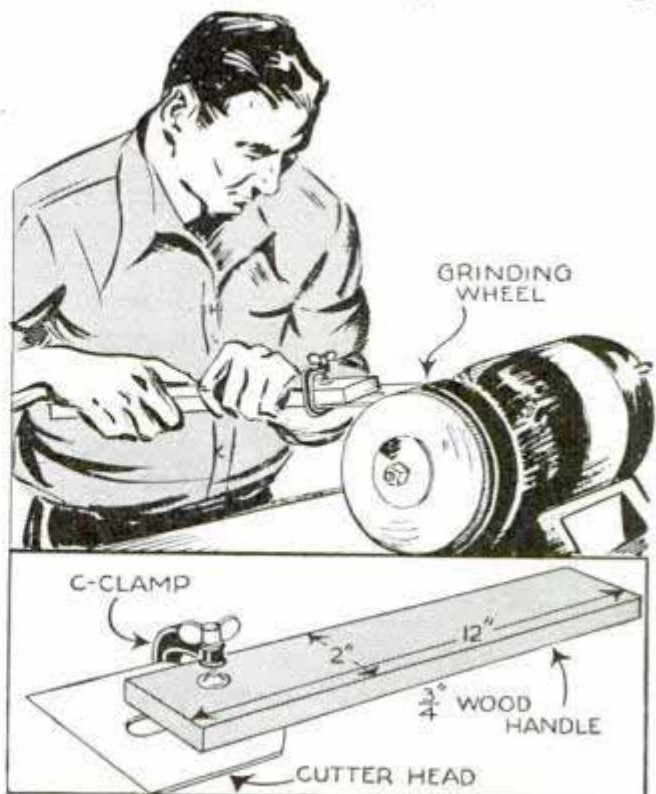



### Sloping Sidewalks "Treaded" to Provide Safe Footing



One contractor who specialized in laying sidewalks and often had to build them on sloping ground always roughened the surfaces to provide a safer footing for those who used them. To do this, he used a wood roller covered with rubber matting, which was run over the concrete while it was soft. This left an impression of the matting in the concrete. Matting with almost any design will do. If the concrete has a tendency to adhere to the rubber, coating it with cylinder oil at frequent intervals will prevent this trouble.

### Reversible Lathe Dog Saves Time

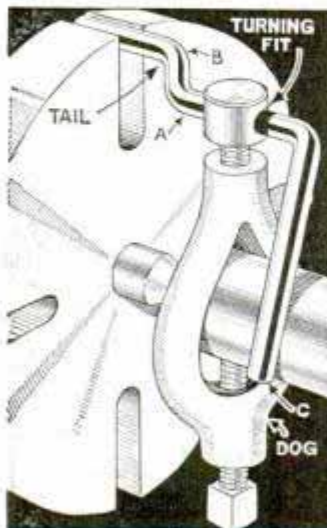

Time can be saved by using this dog when facing work to length or doing other short jobs on the ends of bars, as it does not have to be removed each time the work is turned end for end. Just slide it along the work and reverse the tail. The dog consists of a regular lathe dog with

the tail cut off and the end tapped for a large cap screw, the head of which is

drilled to take the new tail. This is made from a steel rod bent as shown, the bends A and B being made after the rod has been pushed into the screw head. To reverse the tail, just lift it at C and turn it over.

—H. Moore, Leeds, England.

### Compression Cups Are Adapted to Use Pressure Gun

Machines and farm implements that are equipped with compression grease cups can be lubricated with a pressure gun by simply providing each cup with a grease fitting.

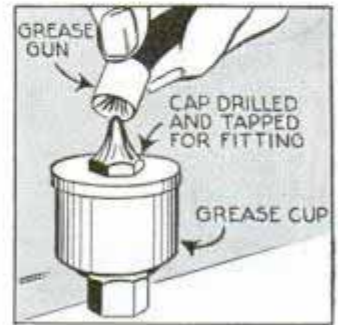

After each cap has been screwed down tightly, a grease gun can be used in the regular way.

—D. E. Wyatt, Richfield, N. C.

### Clamp on Wagon Grips Reins When Team Is Unattended

When using a team and wagon on jobs where the reins must be released temporarily at times, one farmer uses an eccentric clamp on the side of the wagon box to hold them. The clamp is made from a couple of wood blocks as indicated and keeps the reins where they are handy to reach. Furthermore, the eccentric action makes it easy to attach or remove the reins.





# LIGHTED CASE *displays your* MODEL

Sealed to exclude dust, and fitted with fluorescent lamp to illuminate the interior without glare or shadow

By Alexander Maxwell

**I**N THIS model case, soft, white glow of a fluorescent light is easy on the eyes, and it can be reflected until all shadows are nullified, making your ship stand out in bold relief against a background of pure white.

Dimensions are given for a case to fit the Greek trireme ship model described in past issues of *Popular Mechanics*, but they may be altered easily to fit any of the popular-sized models. Mahogany finished natural gives a rich effect. Cutting and fitting is done with a circular saw fitted with a planer blade. Keep the blade razor sharp. This is done by dressing the teeth with a slipstone as they start to dull. On long cuts, rub paraffin on the blade for side lubrication. The model must fit the case with about 2 or 3 in. clearance all around, except the top, where the tips of the mast come level with the door frame. The various members, Figs. 4, 7, and 8, are cut to maximum dimensions, then rebated as indicated. Dimensions are frequently repeated, so one setting of the rip gauge will do for a number of cuts. Fit each joint as finished, Fig. 3, and save the waste stock to be used as fillers for securing the window glass, Figs. 4 and 6.

The door frame, Fig. 7, is assembled first, and the rest of the case built around it. Cut the glass, fit the wood to it and fasten with screws and casein glue. This automatically holds the frame square until the glue sets. The end frames, Fig. 2, include parts D, E, F, G and H. The front joints

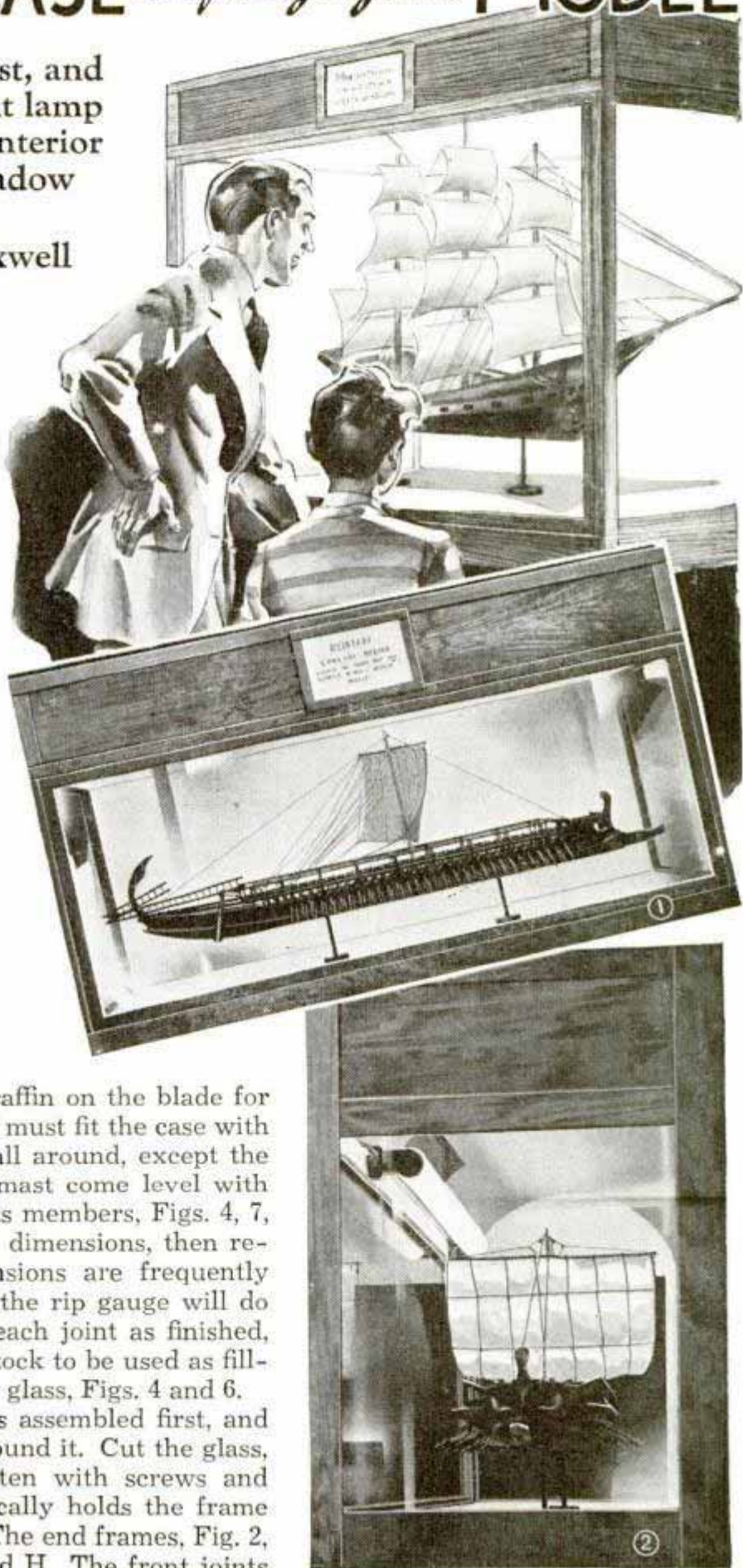



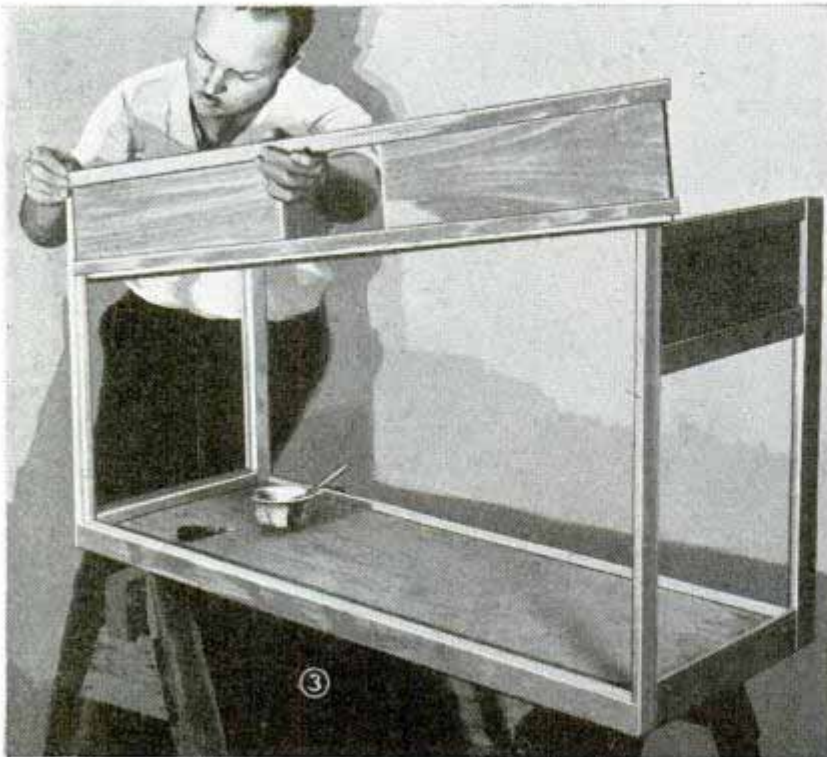

both C and CC to the end frames. C and D, Fig. 6, are cross-screwed, so no screws will appear on the front, Fig. 7. The bezel, Fig. 1, brings the usual printed matter up to eye level and tastily displays it with back lighting.

Mahogany is soft and scratches easily, so handle carefully and sand with No. 3-0 garnet paper after assembly. Finish sanding with No. 5-0 paper, which imparts a velvety luster. Whisk with a dry paintbrush and follow with a damp cloth. Dress down the raised grain with No. 5-0 paper, let the dust

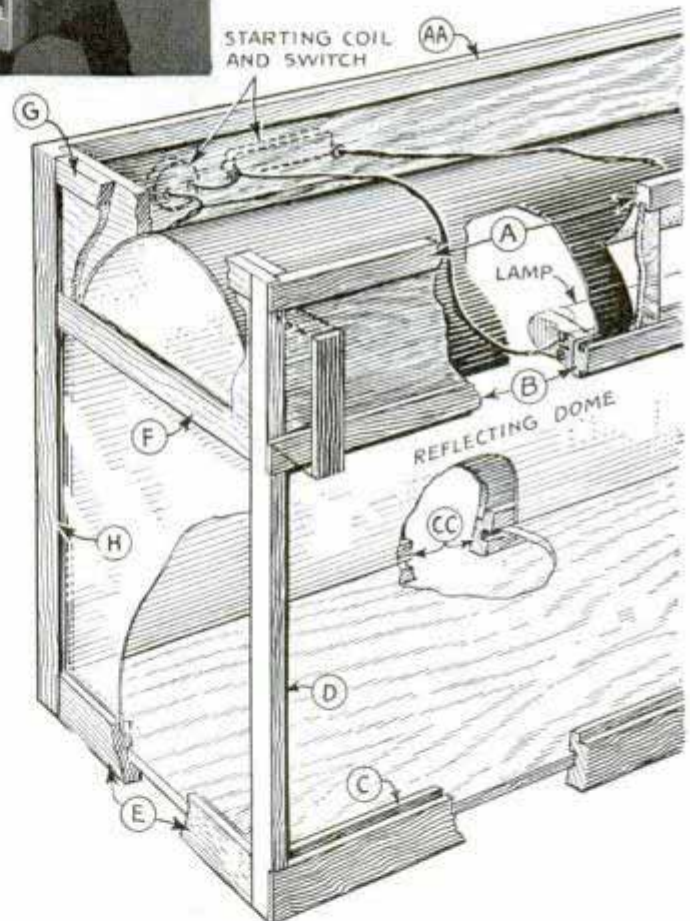
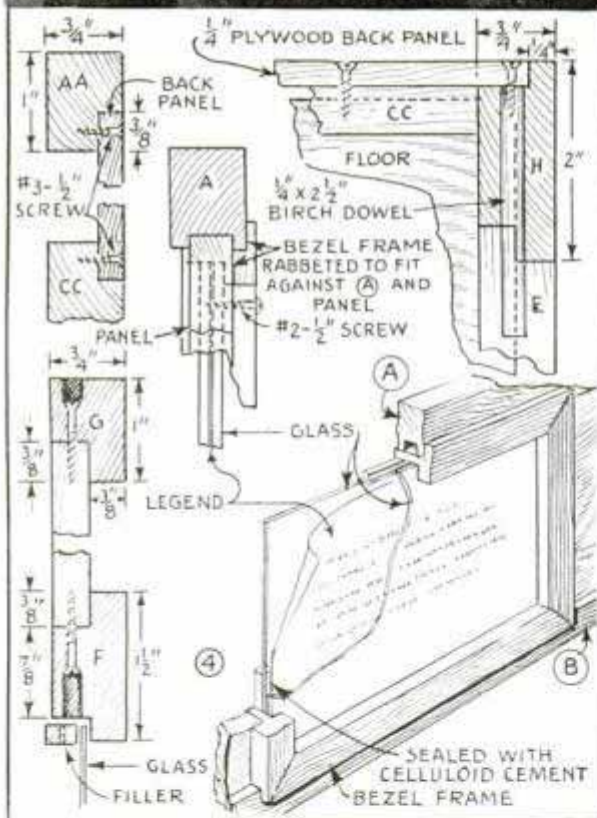

are screwed, those on the back doweled, Figs. 4 and 6, because there are no screws long enough available. Secure with clamps until dry. The plywood panels between G and F are glued and screwed with four No. 2,  $\frac{3}{4}$ -in. screws, top and bottom. Drill No. 60 holes in panels to keep screws from bulging the veneer. Using your door frame as a gauge, cut and fit piece C, and follow with CC. Slide the floor in place and fasten

settle overnight and apply clear Bakelite varnish with a camel's-hair brush. Rub with No. 3-0 steel wool, give a second coat and rub that with wet or dry sandpaper. Buff the work with a felt pad dipped in dry rottenstone, then wax and polish. The back and top of the cabinet are  $\frac{1}{4}$ -in. plywood panels painted black.

The reflecting dome is bent to shape, screwed to B, Fig 9, and held with two



pattern blocks screwed to G, Fig. 7. Bend the iron first, then cut blocks to fit the natural curve. Spring pressure holds the metal against CC and floor. Calk the seams with marine glue and paint right over it. Flat white, casein cold-water paint has a reflection almost as much as silver, making the light from a single bulb bathe your ship on all sides. Three or more coats will be needed. Mix in a teacup and use a wide brush, well loaded. Make one stroke do,

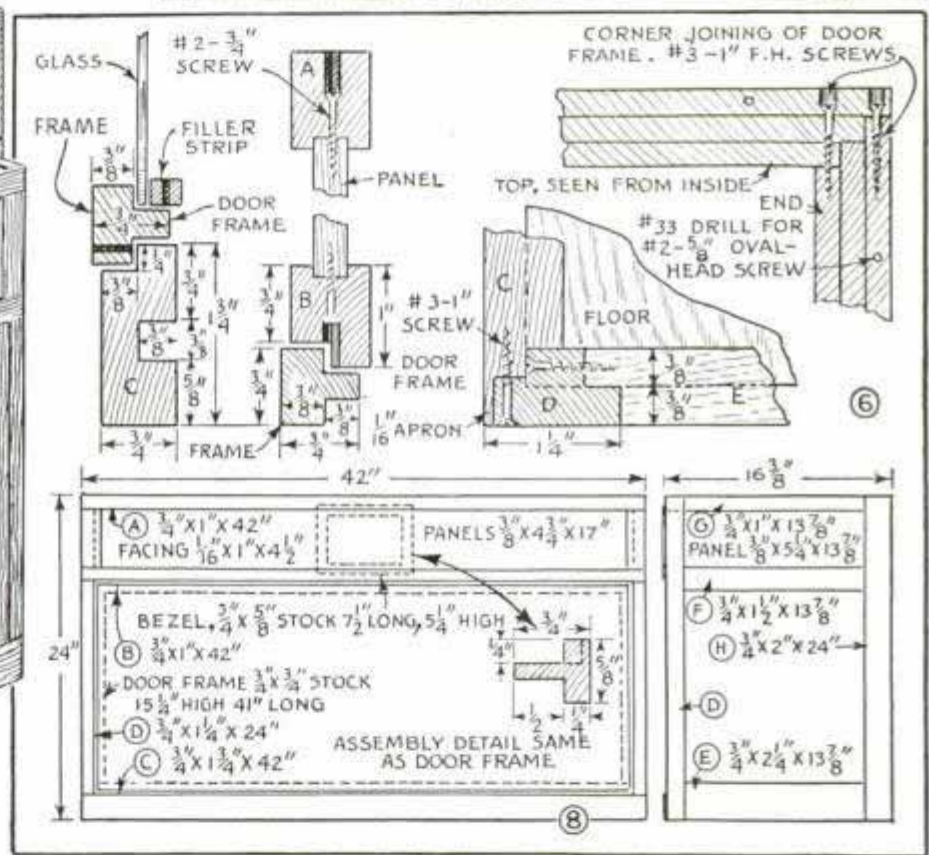
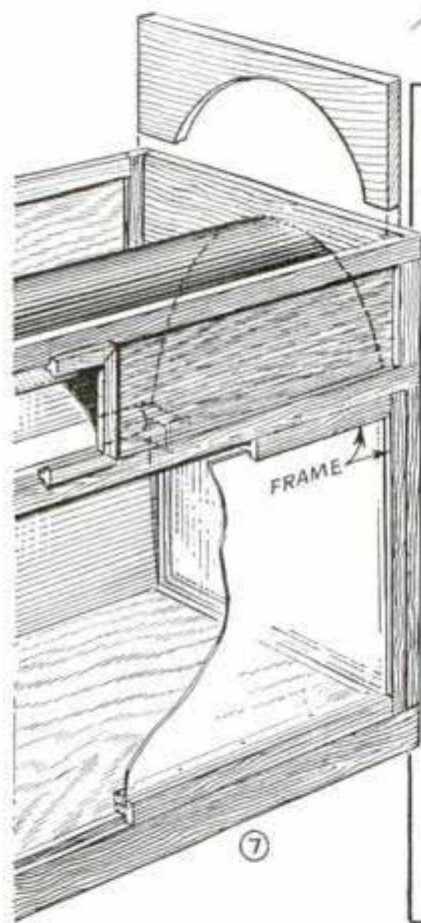

for the second only lifts the one under it. When dry, apply the next coat, Fig. 5. Cover the entire inside of the case. Use a type T-12, 24-in. fluorescent lamp. Mount it on the back of B, Fig. 2. In addition you will need a starting coil and switch, which are mounted outside, on the back of the case, as in Fig. 9. The lamp is wired as shown in Fig. 10. Solder all connections. White light is preferable, but a number of color tints are available for special effects. Screw down the lid, without glue, spacing the screws closely and laying felt around the edges for a dust seal. When the ship is in place, insert the door and screw it down, taking care that the screwdriver does not slip. The life of the bulb is 1,500 hrs. and there should be no need to open the case short of that time.

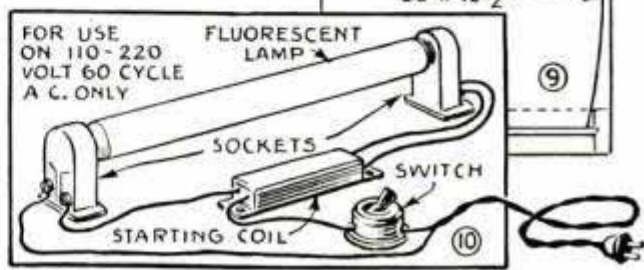
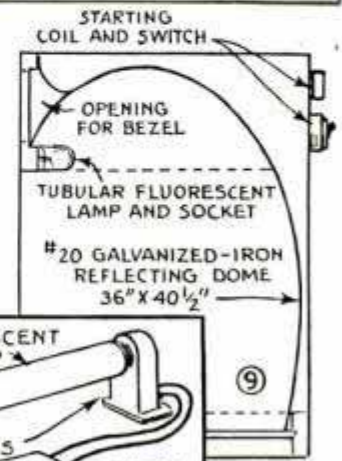



## Insulating Vise Jaws Hold Work While Soldering It

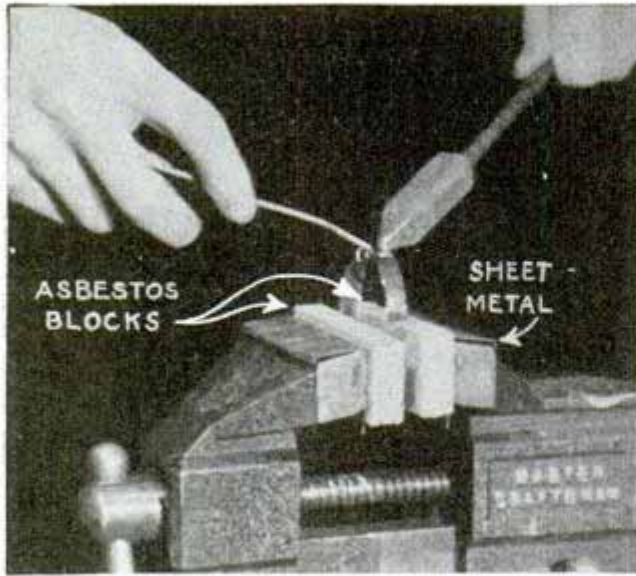

Often it is convenient to grip a small piece of work in a vise to solder it, but the vise jaws rob the work of heat so fast that the job is difficult to do. In such cases, blocks of asbestos used as auxiliary vise jaws will solve the problem. If you have much of this type of work to do, cement the blocks to pieces of sheet metal shaped to slip over the vise jaws. The metal will hold the blocks in place when the vise is opened.—T. H. Taylor, Seattle, Wash.

## Milling-Machine Cutter Set with Aid of Paper

When it is necessary to make an accurate cut with a milling machine to depth from a surface of the work, considerable skill and care are required in determining just

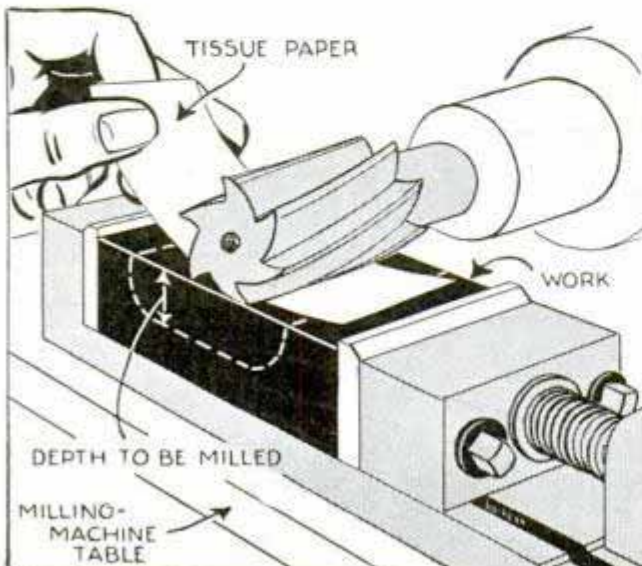

the instant the edges of the milling cutter touch the work. The drawing shows how a thin strip of tissue paper may be used to simplify setting the cutter. The strip is held in the fingers with one end between the cutter and the surface of the work and the machine table gradually raised until the cutter pulls the paper. This will indicate the cutter is within approximately .001 inch of the surface. The cutter then may be set to the proper depth according to the dial on the machine hand-feed wheel. The method also may be used for setting an end mill, etc.

—Peter F. Rossmann, Kenmore, N. Y.

## Chairs in Shops Latched to Floor by Screen-Door Hooks

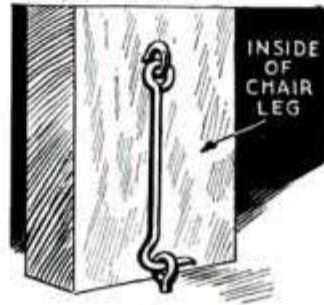

Chairs in barber shops, beauty parlors and other public places can be fastened to the floor with screen-door hooks so that they can not be moved about by the people that use them. The hooks are placed on the inside surface of the front legs and engage with screw eyes driven into the floor. This method of fastening the chairs makes it easy to move them for cleaning the floor.

—Archie J. Maus, Spokane, Wash.

## Toothbrush Cleans Threads Better Than Cloth

Before screwing a chuck or faceplate on a lathe spindle, I find a discarded toothbrush handy for cleaning the threads on the spindle. Also, the brush is better than a cloth for cleaning the internal threads of the chuck and faceplate as the bristles reach the spaces between the threads and do not leave lint as does a cloth.—S. A. Schaffer, Ford City, Pa.

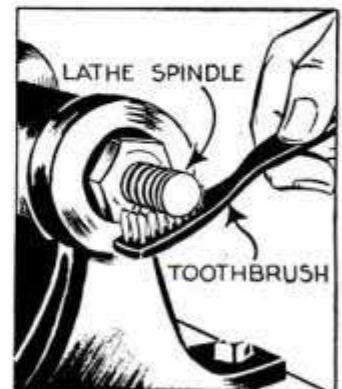



# Artist's STUDIO EASEL

*is adjustable for height*

Artists and sign painters always can have their work at a convenient height with this easel, which is made of flooring at small cost. A piece of plywood or hard-pressed board slides in the grooves of the side rails and a shelf to hold the work is attached to this sliding panel by means of angle brackets. The assembly is adjusted to suitable height with a rope which fastens to a cleat on one of the side rails, and slides through a screw eye or small pulley fastened to the top cross member. A separate strip of flooring serves as rear leg. It is hinged to the top cross member while a length of furnace chain prevents it from slipping back too far. A couple of large L-hooks can be driven into the side rails near the bottom to hold a maul stick. Also, a box to accommodate tools and accessories is screwed to the side rails in the position indicated

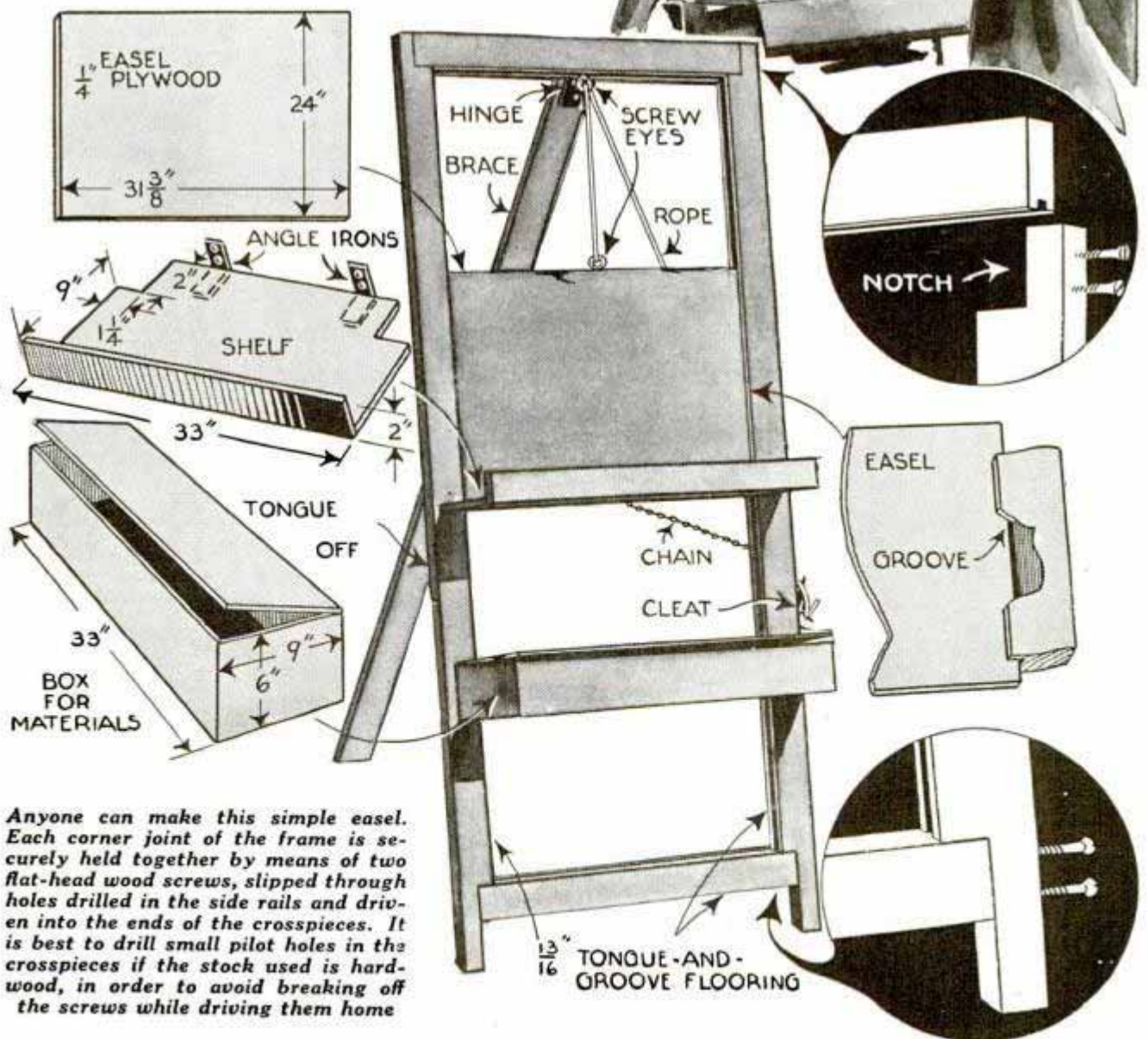

Anyone can make this simple easel. Each corner joint of the frame is securely held together by means of two flat-head wood screws, slipped through holes drilled in the side rails and driven into the ends of the crosspieces. It is best to drill small pilot holes in the crosspieces if the stock used is hardwood, in order to avoid breaking off the screws while driving them home



### Cardboard 'Clothespin' Is Marker in Letter Files

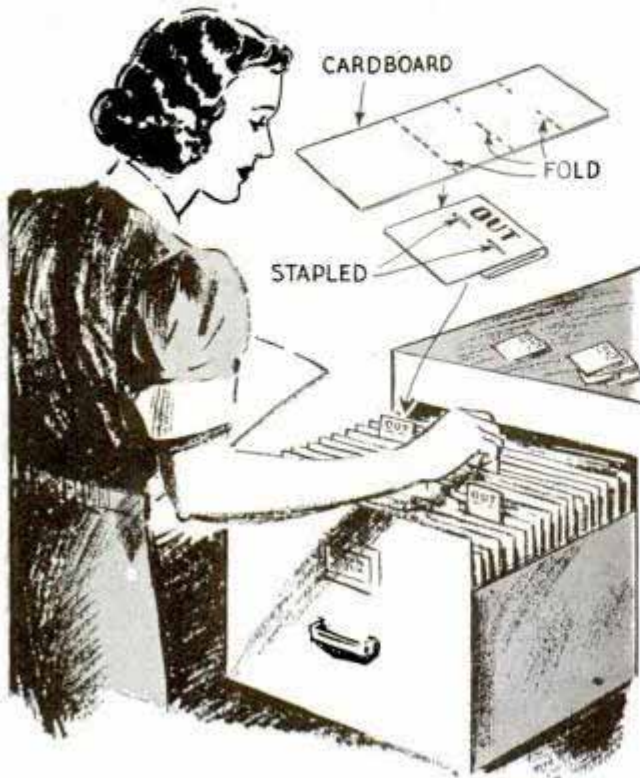

An office manager employs folded strips of thin cardboard to mark places in filing cabinets where papers have been removed temporarily. These are stapled as indicated so that they can be slipped quickly over the file dividers, or over the edges of papers adjoining those that were removed.

### Roosting of Chicks on Fountain Avoided by Funnel

One poultryman places a small, tin funnel on the top of his chicks' water fountain to keep them from roosting on top of it. If a

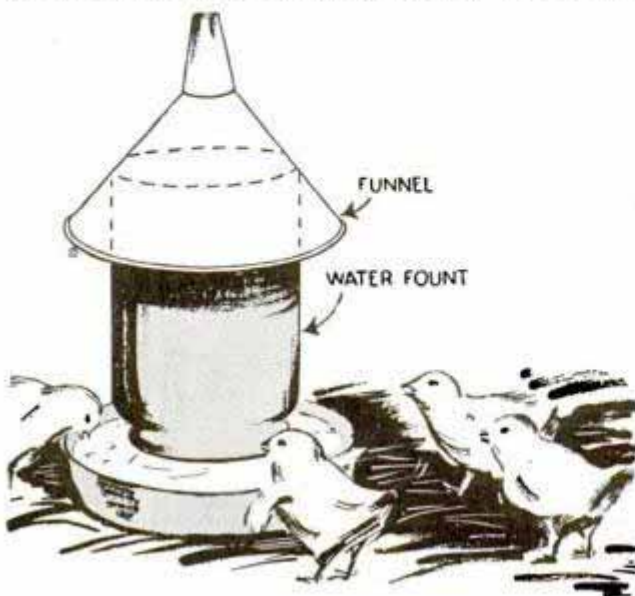

number of fountains are to be protected, coil springs from auto cushions could be used in a similar way.

### Postman Has Tire Patches on Gloves to Sort Mail

Tire patches cemented to the thumbs and index fingers of his gloves are used by a mail carrier in Tempe, Ariz., to sort the mail while on his route without baring his hands when it is bitterly cold. The rubber surfaces of the patches enable him to pick out letters and papers without them slipping out of his hands



### File Cuts Double Point on Pencil

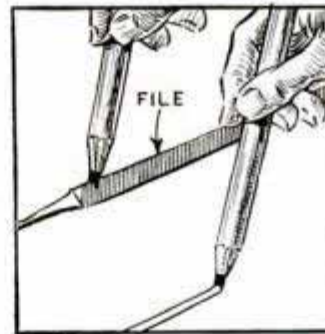

A Wisconsin carpenter claims that it is easier to cut a board accurately if the pencil is pointed to make a double line. By sawing between the lines the markings are always

visible and the saw is easily guided accordingly. The pencil is kept sharpened for this purpose with a three-cornered file.

### Rubber "Feet" Keep Brush Clean When Laid Down

To keep the bristles of his bench brush from being soiled or bent out of shape when laid down, one laboratory worker tacked a short length of small rubber hose across the back of the brush. The hose supported it with the bristles upward, and was flexible, to avoid scratching anything with which it came in contact





# WOOD JOINTS

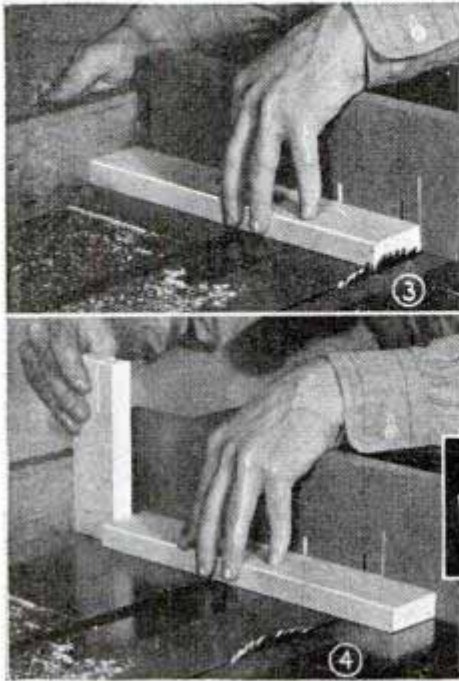

## with POWER TOOLS

**C**UTTING wood joints with power tools differs from hand methods not only in the use of power but also in the greater use of mechanical methods to set off dimensions. This principle, faster and more accurate than cutting to a pencil line, is illustrated especially well

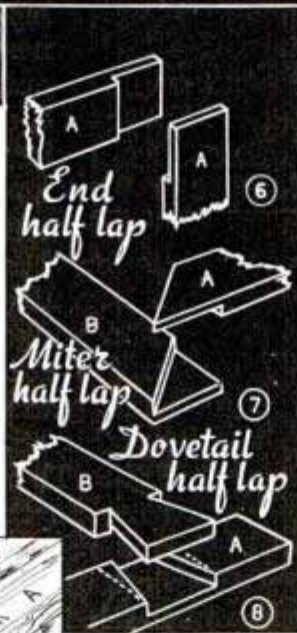

in the case of the halved or half-lap joint.

**Halved Joints:** Most common of these is the end half lap, Fig. 6. Both pieces are identical; either part is cut first. Set the saw to depth. Check by cutting from each side of a scrap piece. Set the shoulder cut by placing the end of the work against the saw blade and setting the fence at the opposite end, as in Fig. 3. A scrap piece of stock used as a setting-out block will locate the shoulder cut exactly, Fig. 4. When the cut is to be made in the middle of the work, as in the case of the middle half lap, Fig. 5, the setting-out block is a scrap of the stock ripped down the center and nailed back together, as in Fig. 2. Fig. 1 shows this block in use. The first cut is set to a pencil mark and a stop block is clamped to the miter gauge. Fitting the setting-out block in place, as shown, then locates the second cut, after which successive cuts across the work will remove excess material.

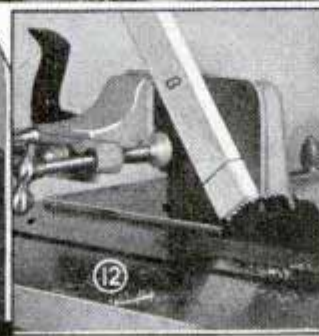
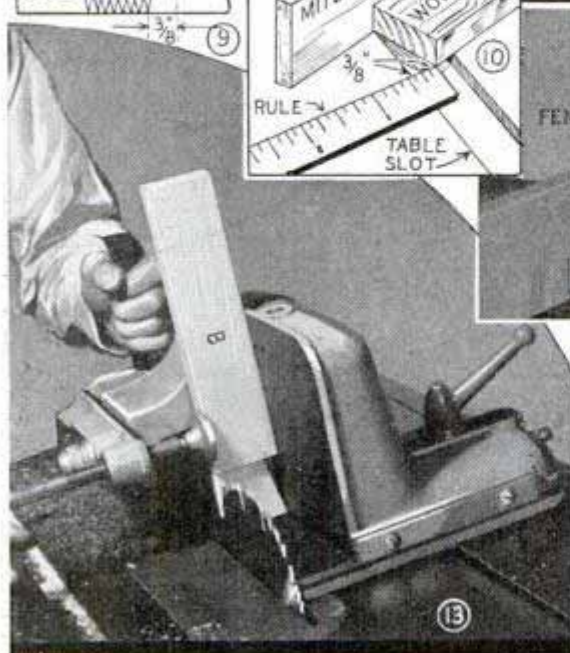
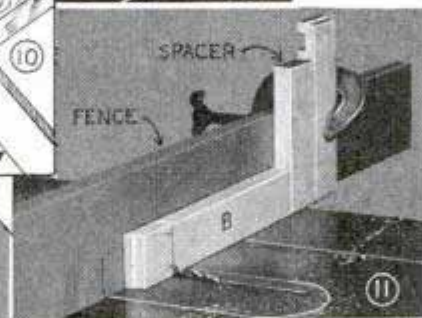
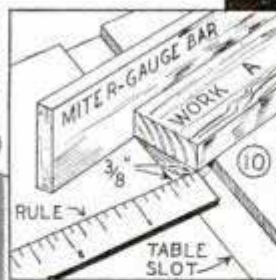
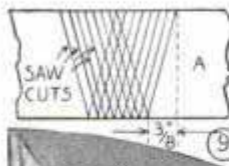



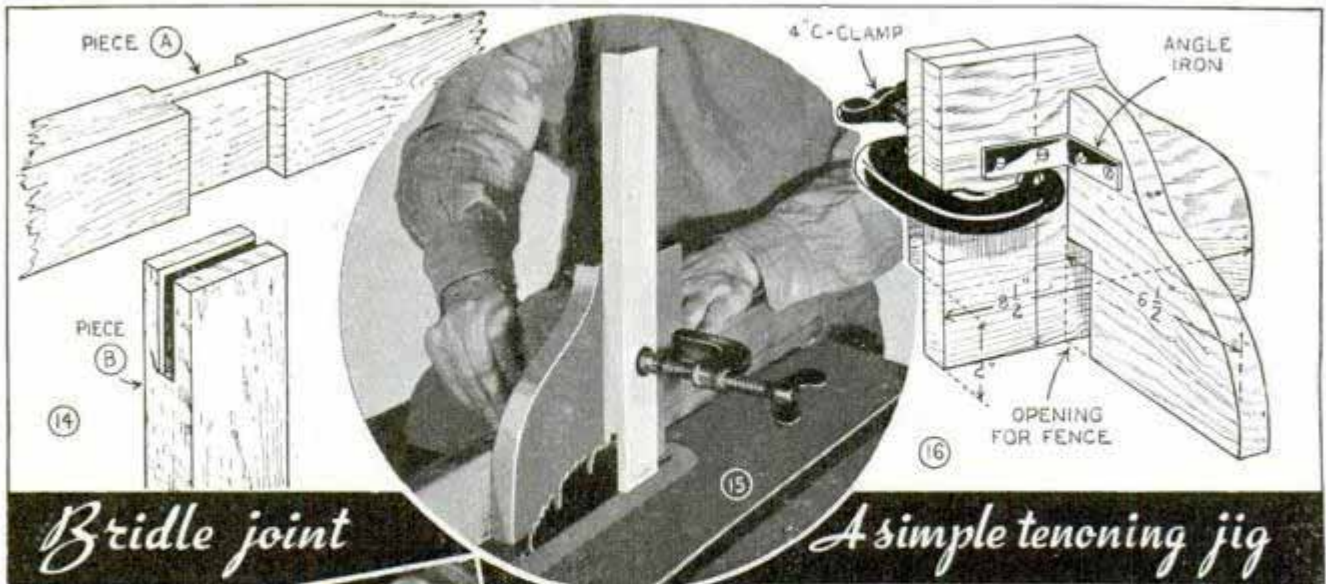

*Bridle joint*

*A simple tenoning jig*

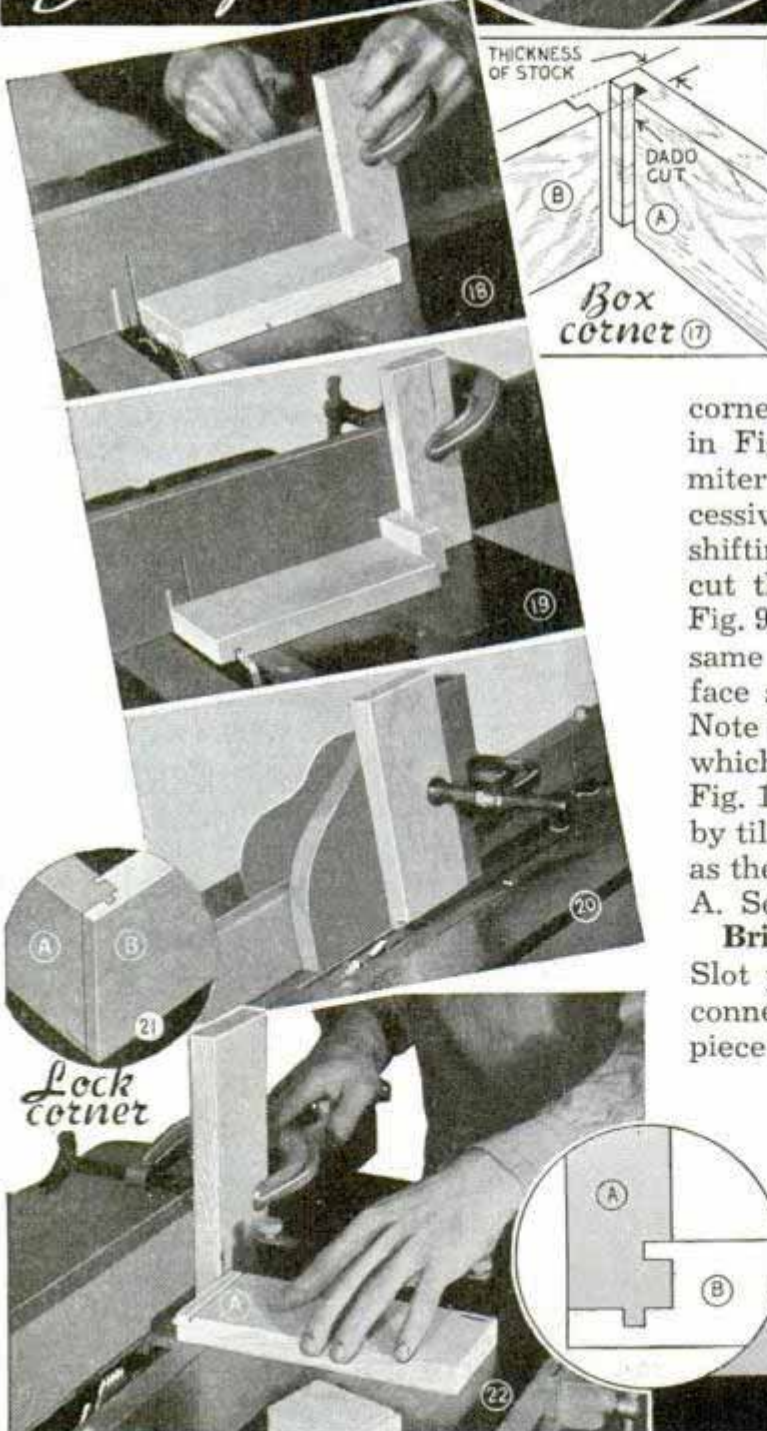

*Box corner*

*Lock corner*

*Successive steps*

The mitered half lap, Fig. 7, is cut in the same manner as the end lap except that the miter gauge is used at 45 degrees as required. In cutting the dovetail half lap, Fig. 8, start with piece A. If the stock is  $\frac{3}{4}$  in. thick, the depth of cut will be  $\frac{3}{8}$  in. Swing the miter gauge until a dimension taken at the corner of the work equals  $\frac{3}{8}$  in., as shown in Fig. 10. Note how many degrees the miter gauge is swung, and then make successive cuts to remove excess material, shifting the gauge to the opposite side to cut the other side of the opening, as in Fig. 9. To cut piece B, leave the saw at the same depth and cut shoulders from the face side and edges, as shown in Fig. 11. Note the saw cut at the end of the work, which is used to set the face cheek cut, Fig. 12. The slanting cheek cuts are made by tilting the saw table to the same setting as the miter gauge was set in cutting piece A. See Fig. 13.

**Bridle Joint:** This is shown in Fig. 14. Slot piece B first, using a single saw in connection with the tenoning jig, then cut piece A in the same manner as for a middle half-lap joint. See Fig. 15. Details of the tenoning jig used for all joint work are shown in Fig. 16.



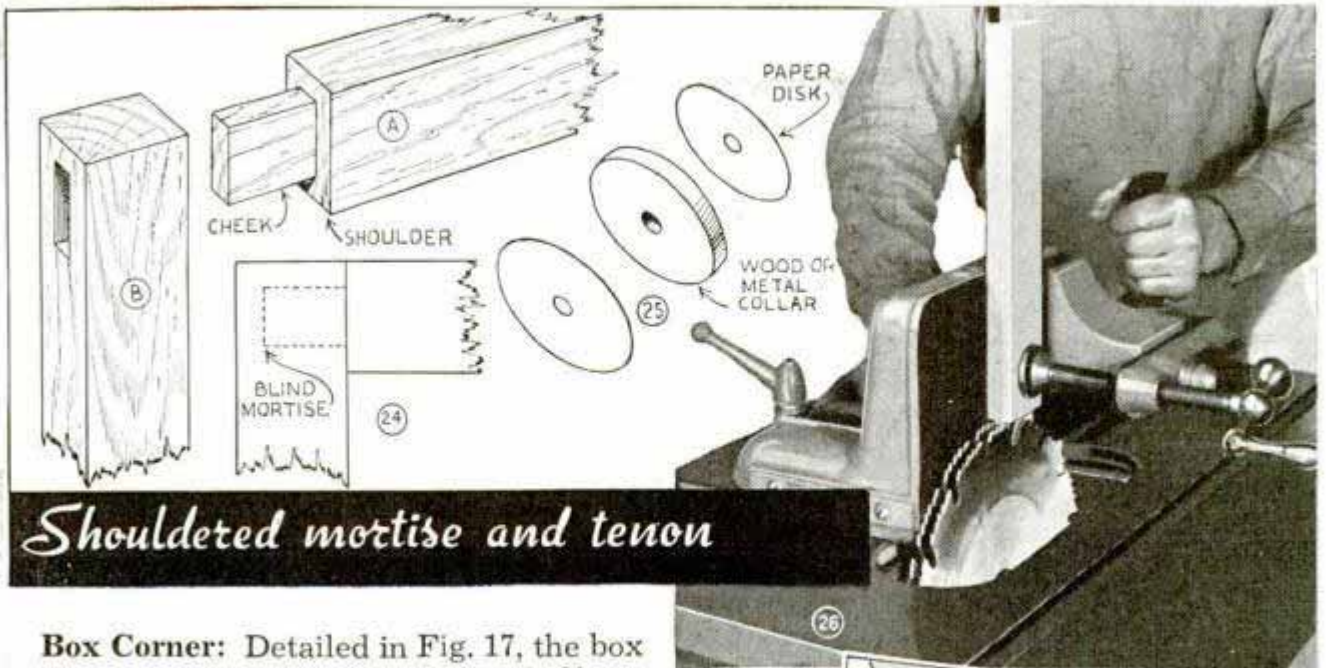

*Shouldered mortise and tenon*

**Box Corner:** Detailed in Fig. 17, the box corner is cut with the dado head,  $\frac{1}{4}$  in. being the usual standard for  $\frac{3}{4}$ -in. stock. Set the work against the side of the saw and clamp a stop block to the miter gauge, as in Fig. 18. A scrap piece of the stock sets the dado cut, as in Fig. 19. With the saw set at the same depth, cut the rabbet in piece B. This operation is shown in Fig. 20. The work is moved until the remaining tenon fits the groove in piece A.

**Lock-Corner Joint:** Fig. 21 shows this joint. It is cut with a single dado saw,  $\frac{1}{8}$  in. thick. The saw is set to a depth of  $\frac{3}{16}$  in. and the first and second cuts are made on piece A. The third cut on piece A is of such a depth as to leave a tenon the same thickness as the dado saw ( $\frac{1}{8}$  in.). Fig. 22 shows this cut being made. The first cut on piece B is set in  $\frac{1}{8}$  in. from the edge, and is carried across until the groove fits the first piece. The final cut on piece B cuts the tongue to the right length and also cuts the groove for the tongue at the end of the first piece. See Fig. 23 for successive steps in forming a lock-corner joint.

**Milled Corner:** This is an excellent box or drawer joint. Notice in Fig. 27 the dimensions marked DD (double dado). If a  $\frac{1}{4}$ -in. thick dado combination is used, these dimensions would be  $\frac{1}{2}$  in. Place the ten-

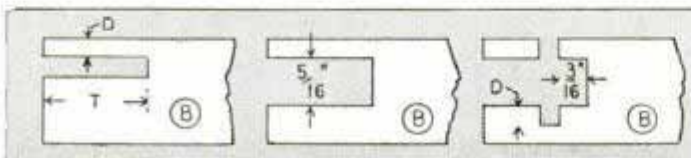
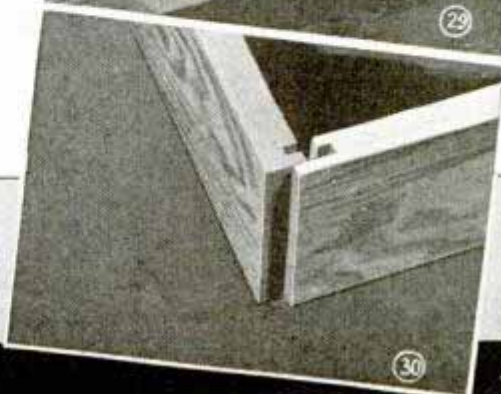
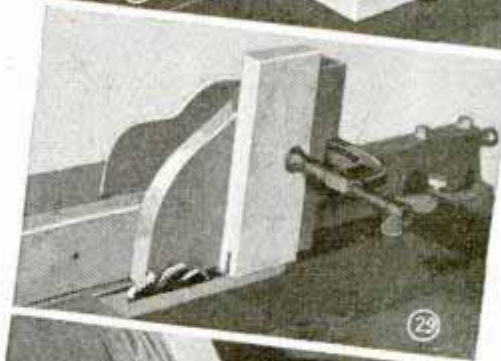
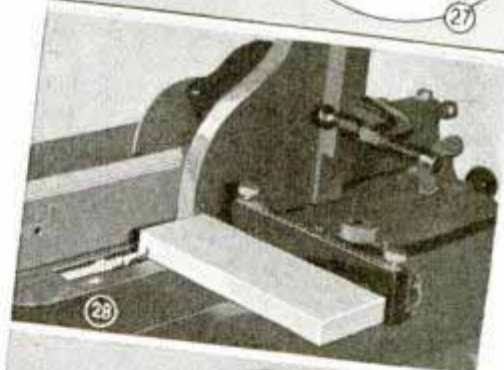
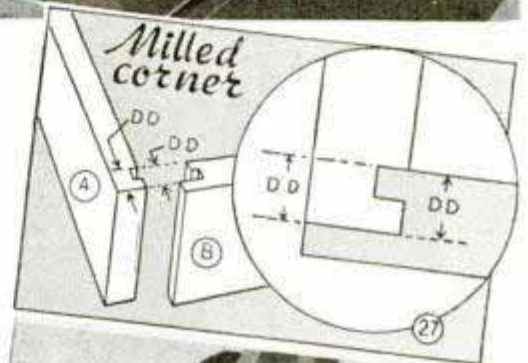

*in making lock corner joint*



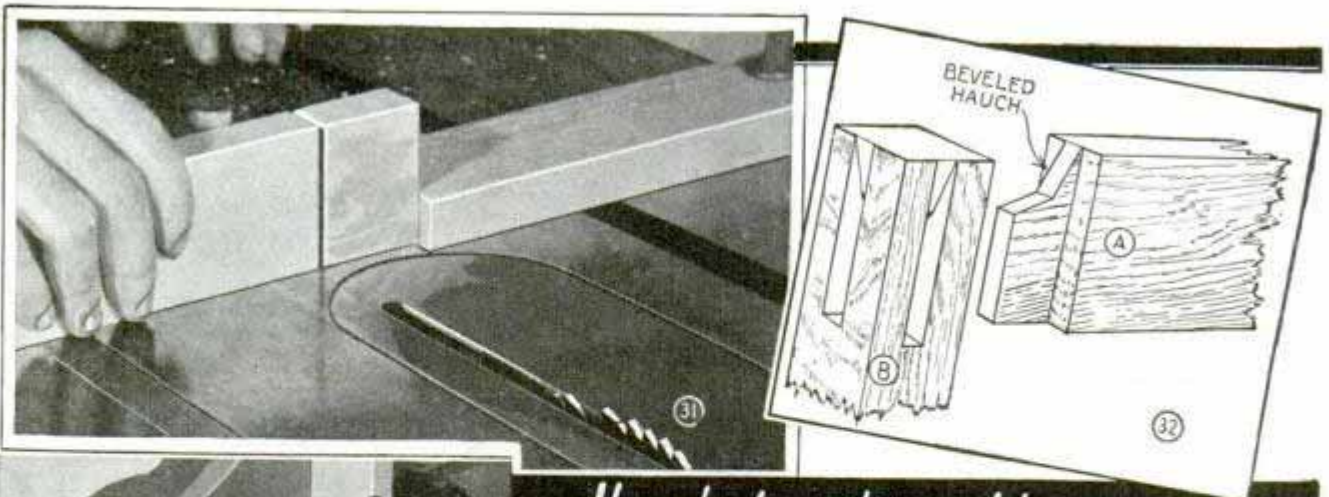

### *Haunched mortise and tenon*

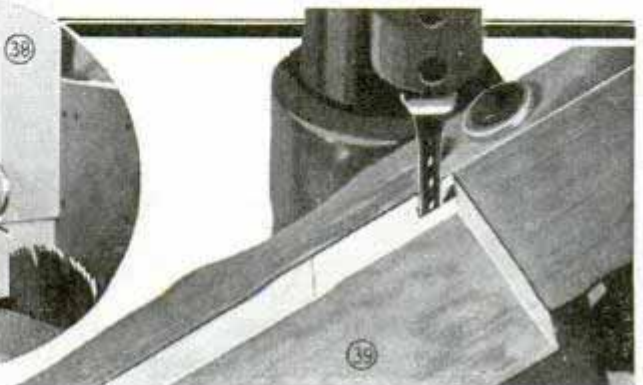
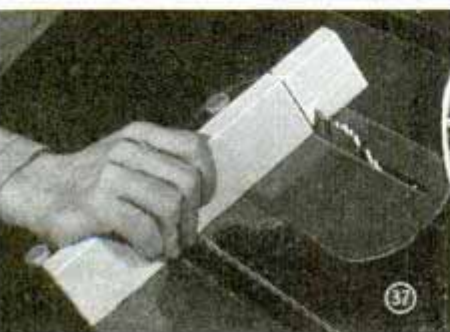
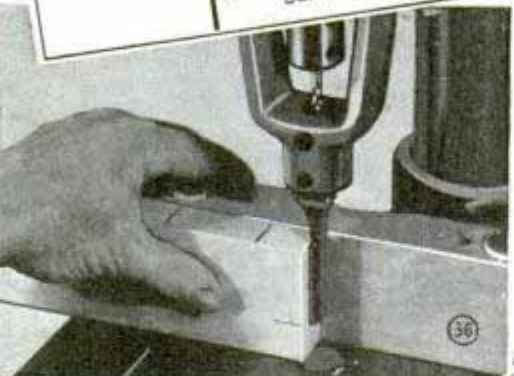
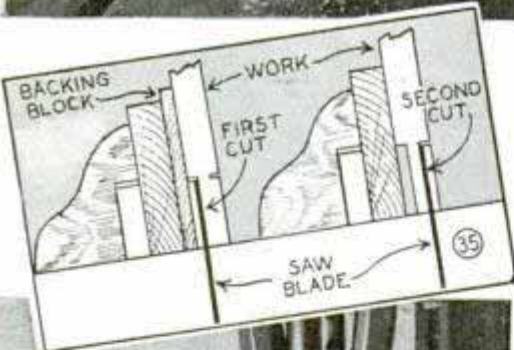
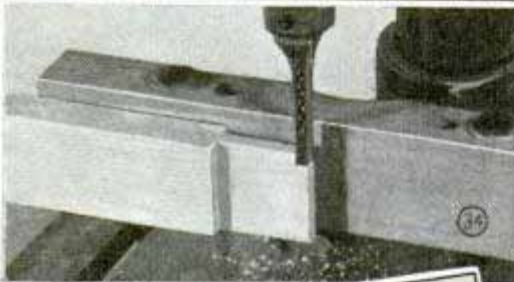
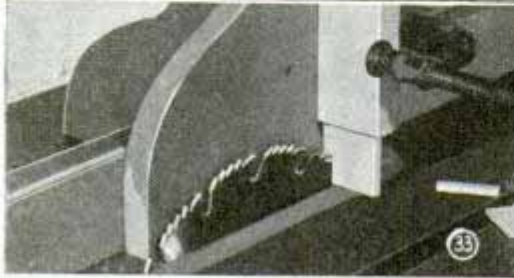

oning jig over the saw fence and use it as a stop block, making the adjustment so the dado cut will be  $\frac{1}{2}$  in. from the end of the work, as in Fig. 28. Make the cut, completing piece A. Now, without moving the fence, place piece B in the tenoning jig, Fig. 29, and cut the slot. The joint, fitted together, will look like Fig. 30.

**Mortise-and-Tenon Joints:** A typical example is the shouldered mortise and tenon shown in Fig. 24. Start by making the shoulder cuts, as in Fig. 31, cutting in on all four sides. Next, cut the cheeks, making all cuts on the inside, Fig. 33. An optional method of cutting the tenon is shown in Fig. 35. This makes use of a backing block of a thickness equal to the width of the tenon plus the thickness of the saw blade. After the first cheek cut, the backing block is removed and the second cheek cut is made, keeping the same face side of the work against the jig. Another method is to use two saws with a spacing collar, as in Fig. 26. The collar, Fig. 25, plus paper disks, spaces for loose or tight tenons. When cutting mortise for any mortise-tenon joint check the fence setting by nibbling off a corner of the tenon, Fig. 34, and then set the chisel to the proper depth, as in Fig. 36.

**Haunched Tenons:** These can be either square or beveled. The cutting of a beveled hauch is shown in Fig. 32. Make the shoulder cuts first, tilting the



table to shoulder the hauch, as in Fig. 37. Then make the cheek cuts, as in Fig. 38. In cutting the mortise, tilt the drill table for the hauch, checking by holding the tenon in place against the fence. Make the angle cuts first, as in Fig. 39, then level the table and cut the rest of the mortise.

### Nut Holder on Wheel Wrench

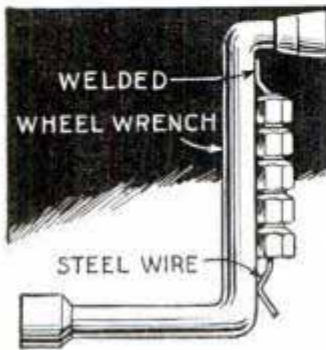

Wheel nuts will not be lost when removed if they are slipped under a short length of spring wire, which has been brazed to the wrench as indicated. The wire should be of a good quality so that it

will not bend out of shape when the nuts are slipped on it.—E. Hanson, Argyle, Wis.

### Auto Fan Exhausts Paint Fumes from Spray Booth

Desiring to economize on equipment for my paint-spraying shop, I rigged up an exhaust fan to remove paint fumes from the spraying booth by using an auto fan, which was driven by the belt that run the compressor. The drawing shows the arrangement. A model-T Ford fan was used.

—Walter Cox, Dundas, Ontario, Can.



### Tailboard on Luggage Carrier Aids in Loading Packages

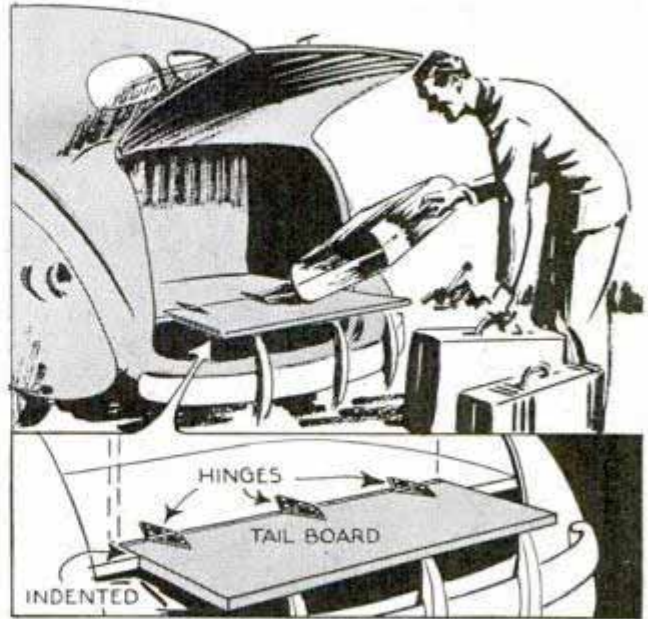

Bumper guards do not interfere when loading heavy luggage into your car trunk if the latter is provided with a tailboard, which folds down over the guards as shown. The board tends to provide a platform from the trunk to the edge of the bumper. The front edge of the shelf over the spare tire in the trunk is cut away an amount equal to a little more than the thickness of the board, which is then hinged in place as indicated. After the trunk has been loaded, the board is raised up against the luggage.

### Wet Blotter or Cardboard Used in Cutting Tire Patches

Sheet rubber for repairing inner tubes may be cut to the desired shape much more easily, and without sticking to the shears, if the sheet is first placed upon a moist blotter or piece of heavy cardboard as shown. When shaping the patch, cut through both the rubber and blotter.

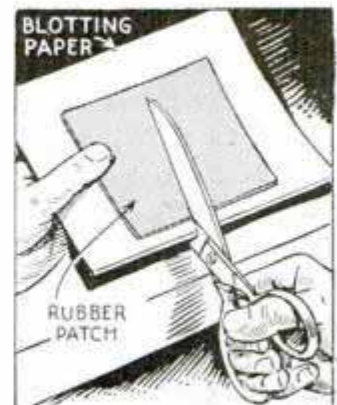

Paint can be removed from window glass with a strong solution of washing soda.



### Spring Clips Keep Memo Pad on Sun Visor

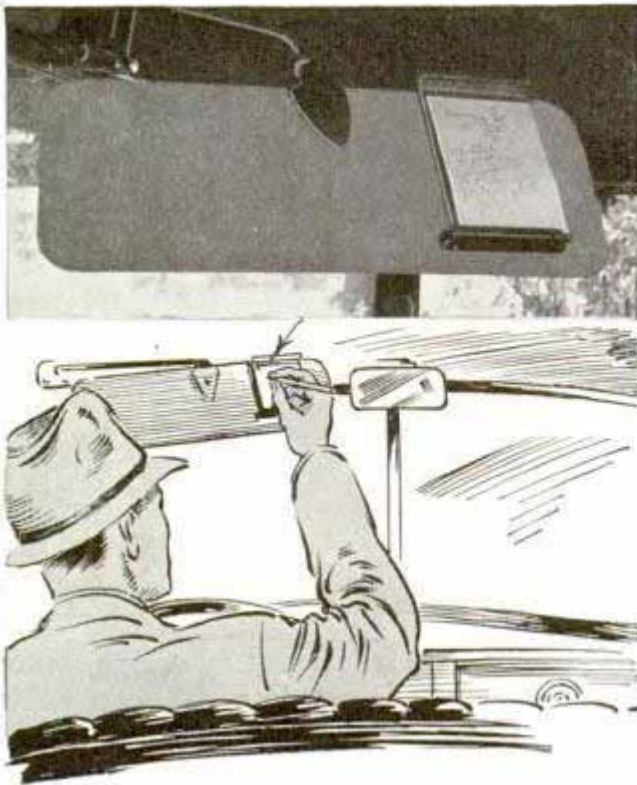

Mounted on the back of the glare visor in a car, a couple of spring clips furnish a handy place to keep a road map or a pad of memo paper. A pad, mounted as shown, is instantly available to the driver of the car without stopping.

—K. S. Anderson, Fort Mills, P. I.

### False Studs Support Crankcase When Starting Cap Screws

The problem of holding a crankcase in place while starting the cap screws is solved with a couple of studs of the type shown. A long slot is cut in each one to take a length of spring wire bent as indicated to slip in a hole in the top of the

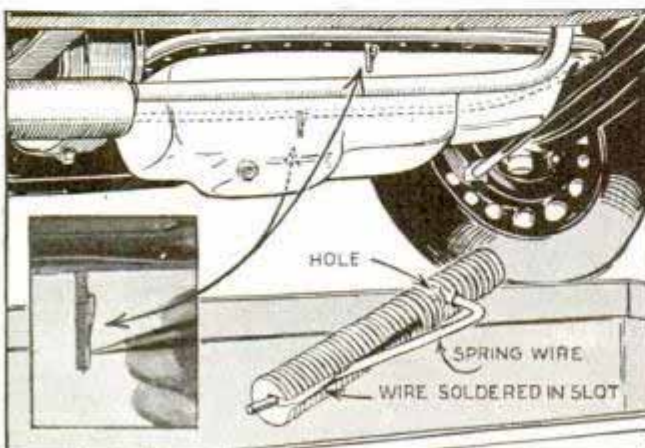

stud. In use, the studs are started in holes in opposite sides of the motor. Then the case is slipped over them, the spring wires providing shoulders that support it.

### Excessive Greasing of Clutch Bearing Avoided by Tag

As the clutch throw-out bearings on most cars require lubrication only once in several thousand miles, greasing is often over-done, causing grease to get on the clutch facings and result in grabbing. To

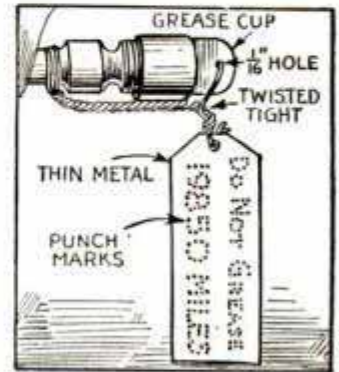

avoid this trouble, one motorist attached a tag to the grease cup showing at what mileage the bearing should be lubricated.

### Handy Rack Holds Armatures While Testing Them

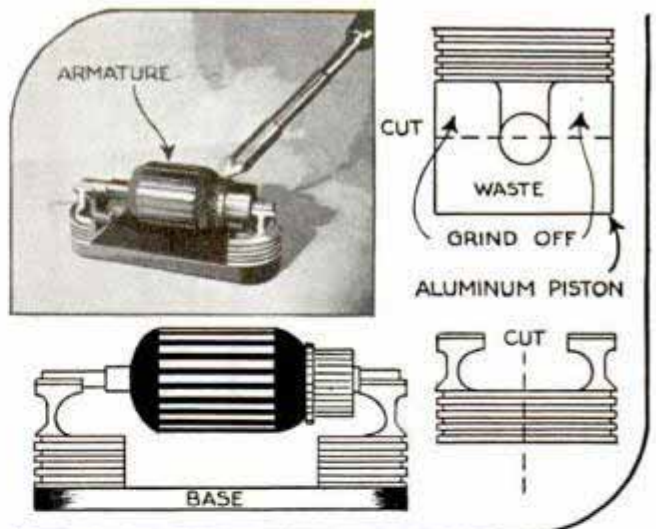

By cutting down a discarded aluminum alloy piston, as shown, you can make a useful rack for holding auto generator and starting-motor armatures for testing or other work. Cut the piston in two along the center line of the wrist-pin holes and then bisect the top portion. Grind away the excess metal at the sides of the holes and drill two screw holes in each half. Make a wooden base from 1-in. stock and cut the ends to conform to the curvature of the piston.



# Housed Cover Quickly Unrolled over Truck

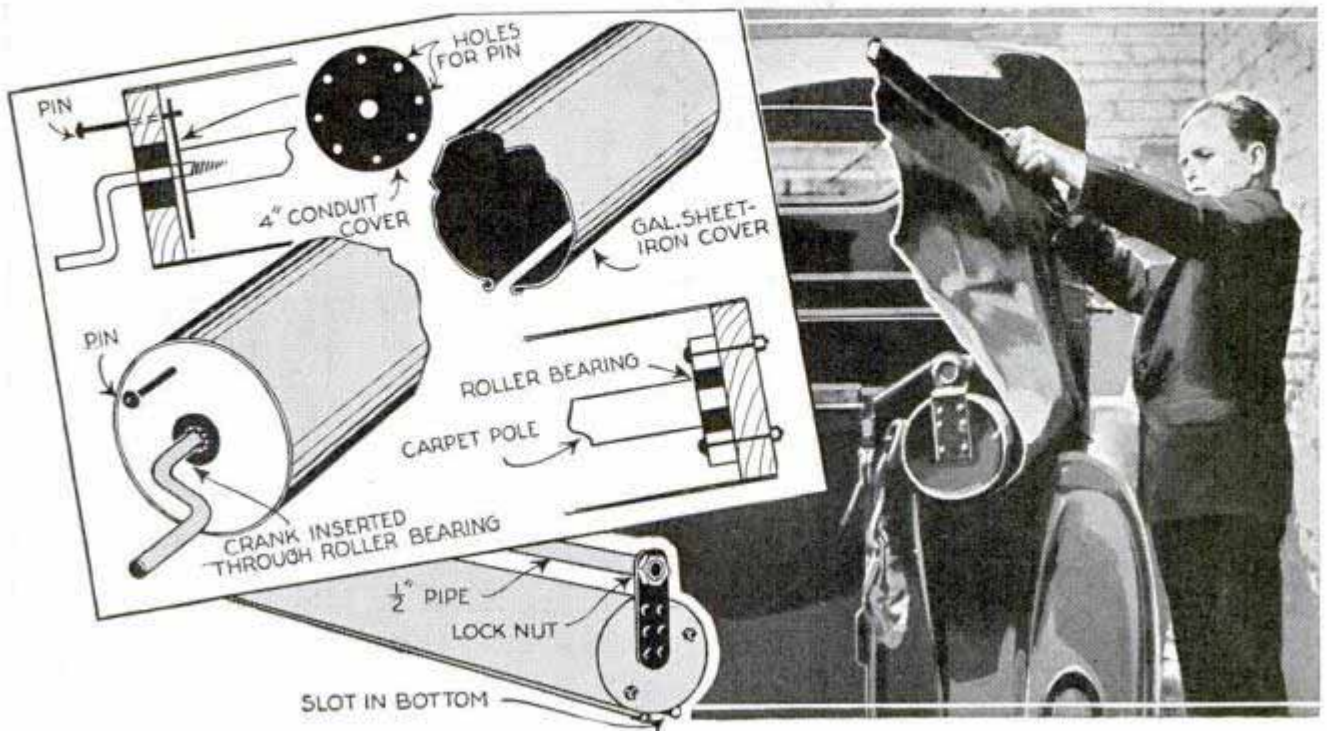

Here is a tarpaulin for your pick-up truck that can be pulled over the load in a jiffy; it is unrolled from a container fastened right on the side of the truck body. The container is a large sheet-metal tube having the ends closed with wood disks. Bearings in the disks carry a section of carpet or rug pole on which the tarpaulin

is wound, a slot being provided along the bottom side of the tube to admit the tarpaulin. A crank is provided at one end for winding, as indicated, and a metal disk, such as a conduit cover, is made fast to the end of the pole to take a pin as shown, to keep the tarpaulin from unrolling.

—J. H. Dunnewin, Grand Rapids, Mich.

## Switch Opens Car Ignition Circuit When Brakes Are Set

A motorist who damaged his emergency brake by driving away without releasing it, wired his ignition circuit so that the

motor could not be started until the brake was released. This was done by putting a stoplight switch in the circuit between the battery and the ignition switch, the stoplight switch being connected to the brake lever so that it opened the circuit when the brake was set, and closed the circuit when the brake was released. The circular detail shows how the switch was mounted by means of a piece of sheet iron fastened under bolt heads in the transmission. Be sure that wires leading to the switch do not rub against any metal.

—Oliver D. Messner, Akron, Ohio.

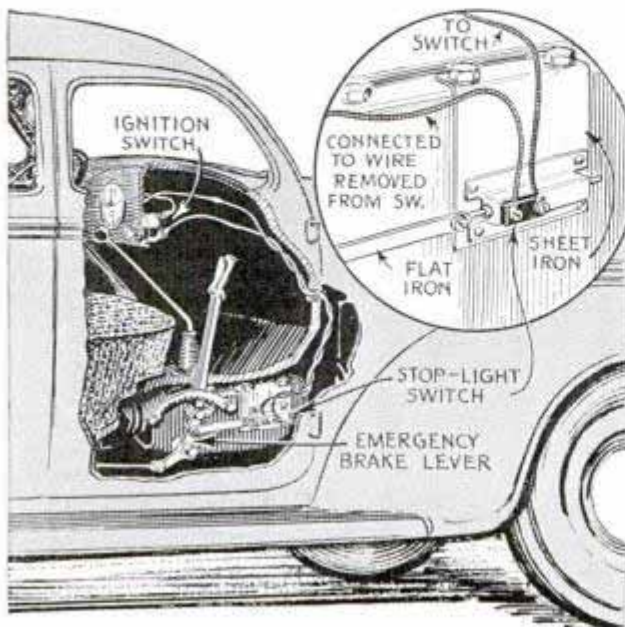

When installing a clutch you can center it easily with a hardwood pilot. Insert the pilot through the clutch plate into the flywheel, tighten the clutch cover, then remove the pilot and the transmission will slide in place.



## Swinging Platform Saves Space When Loading Trucks

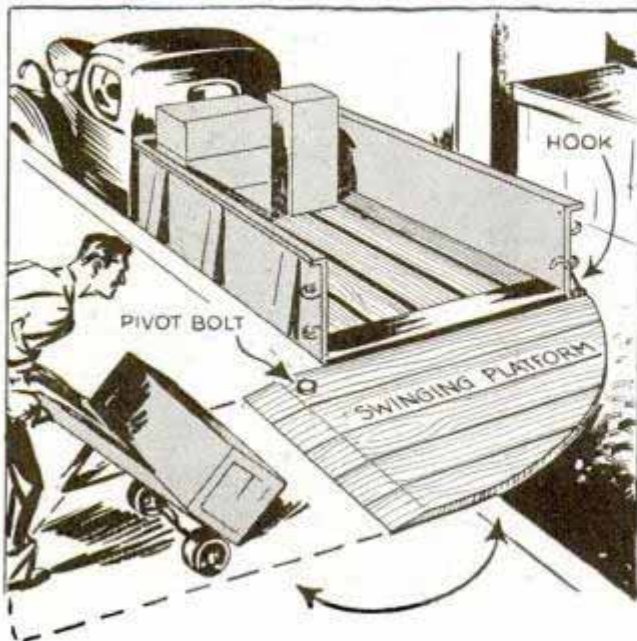

This novel, swinging platform was designed by a produce merchant to allow trucks to be loaded in a narrow alley with-

out congesting other traffic. The platform is pivoted to the regular loading platform, and is provided with a stout hook so that it can be attached to the trucks. It is made of heavy planks assembled with iron rods.

## Paint Cans Kept on Stepladder by Rods Through Top

To keep small paint cans from sliding off his stepladder when moving it from place to place on a window-sign job, one artist bent two lengths of  $\frac{1}{4}$ -in. rod as indicated, and slipped them into holes in the top step. In use, the rods are merely lifted and dropped so that the extending hooks engage the rims of the cans.

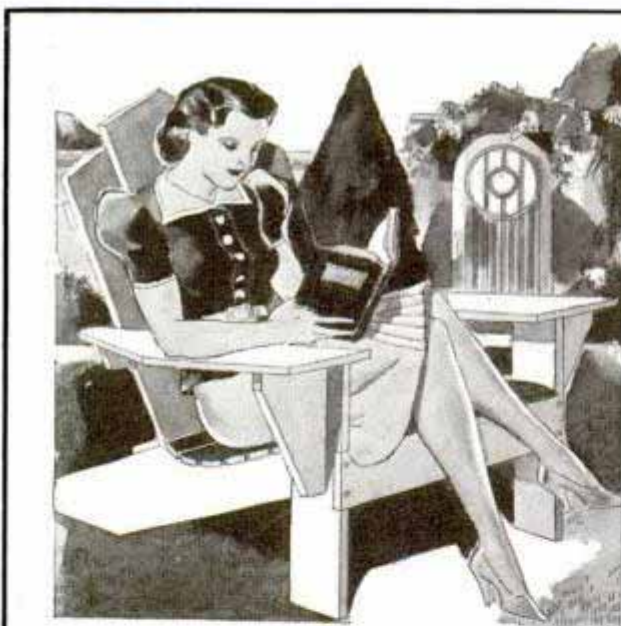
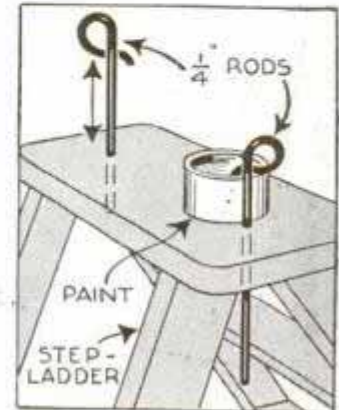

## Starting Early on Your GARDEN CHAIR

Curved, slatted seat of this style assures comfort, and varied color scheme adds charm to the garden

**AN EARLY START:** Now is the time to get your garden furniture in shape for next season. Making a set of these handsome chairs during winter months assures having them at hand when many outdoor jobs will require your time.

**VARIED COLOR SCHEME:** Along the trend of vari-colored kitchenware, so popular, these chairs can be given a two-tone effect or each of them a different, vivid color, providing life and sparkle in the garden before most flowers are in bloom.

**ONLY HAND TOOLS NEEDED:** Anyone having a few hand tools can build these chairs without any difficulty. Ripping boards to exact widths is avoided as the plans call for stock sizes of lumber. Most of the joints are screwed together to obtain rigidity and long life.

**FULL DETAILS IN CRAFTPLAN:** Besides showing all parts and their complete dimensions, Craftplan No. 3010 shows just how parts are assembled even to the smallest details, such as the screw sizes, and the size holes to drill for them to avoid splitting stock. Craftplan also contains full instructions how to proceed step by step. Just fill out the coupon and remit ten cents and the Craftplan will be forwarded to you.

POPULAR MECHANICS MAGAZINE  
200 E. Ontario St Chicago

Enclosed find 10 cents for Craftplan No. 3010—  
Garden Chair

Please check  I am a subscriber  
 I buy at newsstand

Name \_\_\_\_\_

Use pencil

Address \_\_\_\_\_

City \_\_\_\_\_

State \_\_\_\_\_



# Snap this "shot" tonight



**With the new fast Kodak Super-XX Film, you can take just as good pictures indoors at night as you have taken outdoors in the sun**

**B**EDTIME storytelling, baby in his bath, a festive family dinner . . . all those long-wished-for indoor pictures are easy to take—now that there's Kodak Super-XX, about four times as fast as ordinary film. Using any camera at all that loads with Kodak Super-XX—even a \$1 Baby

Brownie—you get the same interesting snaps indoors that you get outdoors.

All you need besides camera and film are two or three Photoflood lamps in Kodak Handy Reflectors. (Photoflood lamps are inexpensive, and they last long enough for you to take dozens of snapshots.) A helpful booklet (illustrated) not only gives you the few simple directions you'll need, but suggests picture opportunities, and contains much useful information. It's FREE at your dealer's . . . Eastman Kodak Company, Rochester, N. Y.

**HERE'S ALL  
YOU  
NEED . . .**





“Have you ever noticed that Camels burn longer and give you more smoking?”

ASKS VAN CAMPEN HEILNER  
FAMOUS GAME AND FISHING AUTHORITY

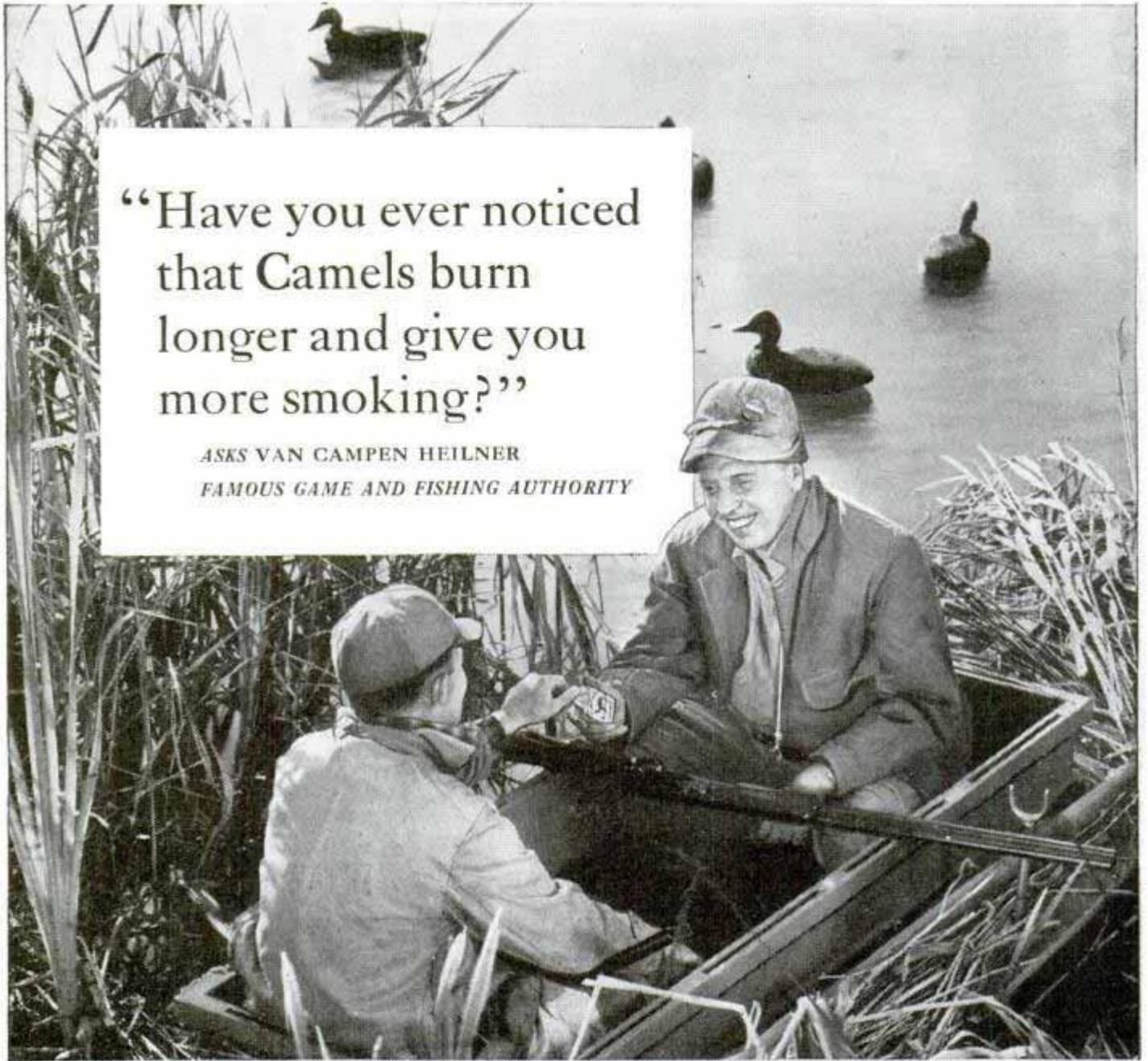

Above, “VAN” waiting in the duck blinds for the “zero hour.” Explorer, sportsman, scientist, conservationist, author of the authoritative, new “A Book on Duck Shooting,” Heilner knows the waterfowl flyways from California to Maine, Alaska to Mexico, and those of Europe too. “VAN” has been a Camel smoker for 18 years.

YOU can tell a lot about a cigarette by whether it burns fast or slowly. Camel cigarettes are noted for their long burning. In fact, they burned longer, slower *than any other brand tested*, in recent scientific studies. Van Campen Heilner, the famous American authority on wild game, points out an interesting angle to this. “Camels give *more smoking* because they burn so slowly,” he says. “And I think the way those choice tobaccos

burn is a very good way to judge the *quality* of cigarettes too. I notice this about Camels—I can smoke them steadily and they still taste smooth and cool, and my mouth feels fresh—and there’s no throat irritation. Camels are mild, flavory. They give more pleasure per puff—and more puffs per pack.” Turn to Camels. Get extra smoking per pack—topped off with the delicate taste of choice quality tobaccos. For contentment—smoke Camels!

# CAMELS—

When writing to advertisers please mention Popular Mechanics



Whatever price you pay per pack, it's important to remember this fact: By burning 25% slower than the average of the 15 other of the largest-selling brands tested—slower than *any* of them—CAMELS give a smoking *plus* equal to

**5**  
EXTRA SMOKES  
PER PACK!



Cigarettes were compared recently... sixteen of the largest-selling brands... under the searching tests of impartial laboratory scientists. Findings were announced as follows:

**1** CAMELS were found to contain MORE TOBACCO BY WEIGHT than the average for the 15 other of the largest-selling brands.

**2** CAMELS BURNED SLOWER THAN ANY OTHER BRAND TESTED—25% SLOWER THAN THE AVERAGE TIME OF THE 15 OTHER OF THE LARGEST-SELLING BRANDS! By burning 25% slower, on the average, Camels give smokers the equivalent of 5 EXTRA SMOKES PER PACK!

**3** In the same tests, CAMELS HELD THEIR ASH FAR LONGER than the average time for all the other brands.

Don't deny yourself the pleasure of smoking Camels, the quality cigarette *every* smoker can afford.

MORE PLEASURE PER PUFF...  
MORE PUFFS PER PACK!

PENNY FOR PENNY  
YOUR BEST CIGARETTE BUY!

Copyright, 1939  
R. J. Reynolds  
Tobacco Company  
Winston-Salem, N. C.

*Long-Burning Costlier Tobaccos*

When writing to advertisers please mention Popular Mechanics



# Challenge of the Supercharger

(Continued from page 884)

to a dynamometer and fitted with a carburetor that is kept under pressure and that is connected to a compressed-air tank that furnishes an air supply of any desired pressure. The engine had an original compression ratio of five and five-tenths to one and developed eighty-two horsepower at 4,000 revolutions per minute on seventy-eight octane fuel. When supercharged to an intake manifold pressure of ten inches of mercury and with the compression ratio reduced to four and twenty-five hundredths to one, the engine developed sixty-three per cent more power on the same fuel. With the same amount of supercharging and with its original compression ratio, using gasoline of an octane value of ninety, the engine showed a power increase of ninety-six per cent over its unsupercharged performance. Except at low engine speeds, fuel consumption with the engine supercharged was materially less than with the engine unsupercharged. The test figures indicate that positive induction will permit smaller, more economical engines that will still deliver enough power for fast get-aways and high-speed driving. One problem that arises in supercharger installations is that the ordinary supercharger is geared directly to the engine and that it is most efficient at wide-open throttle. At low engine speeds the supercharger contributes little additional power, and gasoline consumption mounts. The "power cost" of turning the supercharger over at low engine speeds is greater than its advantages. Automotive engineers are hunting for some way to make the supercharger efficient at all speeds.

Other problems that the engineers are working on are the sturdier crankshafts needed in supercharged engines, valve materials that will stand up under the higher exhaust temperatures, and spark-plug materials that are efficient over the wider heat range. The possibility of driving the supercharger from a small turbine operated by the exhaust gases is one intriguing idea.

Because laboratory tests of many kinds don't always prove themselves on the open highway, the Ethyl Gasoline Corporation recently opened an experiment station at San Bernardino, Calif., where new automotive materials and designs are tested

under actual operating conditions. The station is adjacent to mile-high mountains and sub-sea level areas. Freezing temperatures at high altitudes and the blistering heat of the desert only a few miles away provide a wide range of driving conditions. On the level surfaces of dry lakes in the desert, cars can be driven wide open as long as they will hold together. About twenty vehicles ranging from passenger cars to heavy trucks and trailers hauling 60,000 pounds gross load are used continuously in the test work. One truck alone has consumed 72,000 gallons of fuel in tests so far.

Drivers and engineers, working in shifts, are apt to drive a passenger car 1,000 miles per day for eight months or more. Each car is equipped with special instruments and with burettes for measuring fuel consumption. The old way of comparing the performance or economy of two different gasolines was first to make a test run with one fuel and then repeat the test over the same route while using the second fuel. But with this method the atmospheric pressure, humidity, or road conditions might change between runs and the results would not be strictly comparable. This is avoided at the San Bernardino station by testing both kinds of fuel in the same engine at the same time. Two separate fuel systems are used. Fuel from one tank runs through its own carburetor and manifold system to three cylinders of a six-cylinder engine and the other fuel feeding through a separate system supplies the other three cylinders. This allows the engineers to make scientific comparisons between an unknown fuel and a test fuel under actual operating conditions.

To a great extent the San Bernardino laboratory is a proving ground for the engines that we will be driving three or four years from now. Spark plugs, valve materials, fuels, carburetors, and new designs of intake manifolds and combustion chambers are tried out. Supercharging pressures and compression pressures are studied. Not many years ago valves had to be ground every 6,000 miles or so, today 25,000 miles at least are expected between valve grinds, and some of the tests at San Bernardino suggest that in the future valves will last for the life of the car.



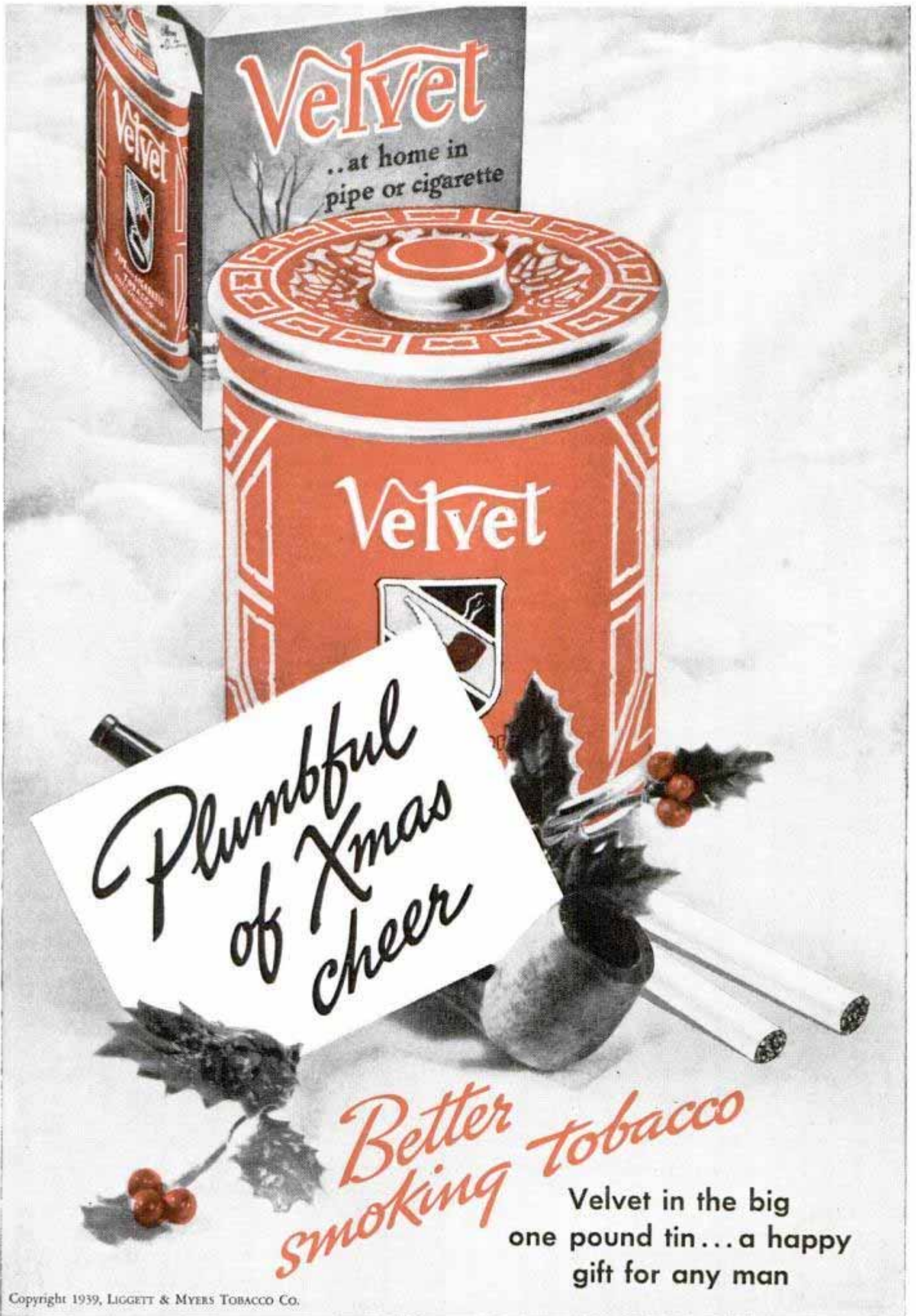

**Velvet**

...at home in  
pipe or cigarette

**Velvet**

*Plumbful  
of Xmas  
cheer*

*Better  
smoking tobacco*

Velvet in the big  
one pound tin... a happy  
gift for any man



# Heroes of the Coast Guard

(Continued from page 895)

amidships, but its crew of seventeen and their rescuers were safe on shore.

So a coast guardsman on vacation became a hero. Chief Boatswain Anderson and the five who accompanied him on the last rescue trip—including Christoffson, who also made all four trips—were awarded the Congressional medal for heroism.

Glamorous to read about, this hero stuff. Maybe that's why coast-guard careers are in such demand. You can't get rich in the service, yet there are enough applications on file to fill the coast-guard stations for perhaps ten years. That doesn't mean recruiting is closed. It's a competitive service, and the best men win. To start with, you must be between eighteen and twenty-five years old and a citizen of the United States, with a high-school education. You must prove you can swim, undress under water, qualify for rescue work and carry a victim on your back for fifty yards in the water, and retrieve a twelve-pound weight under twelve feet of water. Then, there's navigation to learn, signaling by flag and by lights, firearms drill and so on and on.

At the "Old Chicago" station the weekly routine includes motorboat drill on Monday, oars on Tuesday, code communications Wednesday, beach gun or surfboat or infantry drill Thursday, resuscitation, frostbite treatment and fire drill Friday—and Saturday is housecleaning day. The surfboat drill is a sort of vestigial reminder of earlier days; oars are virtually obsolete for actual lifesaving work but practice is kept up for emergencies, for exercise and for fun. One of the big events in the guardsman's year is the inter-district surfboat race, an elimination contest in which six-man crews from stations throughout the country participate, manning heavy nonsinkable twenty-six-foot boats.

When John Anderson was a youngster of seventeen looking forward to a coast-guard career, a strong arm and an iron back really meant something, for there were no gasoline engines in the service then. A fellow had to row or stay ashore. Today the rescue work is motorized. Fast speedboats are ready to race to the scene if waters are calm. Heavy, sturdy boats that can do only ten or twelve miles an hour stand by for squall duty. These big, self-bailing boats might capsize in a vio-

lent storm, but hang on tight—there are several hundred pounds of lead in the keel and the ship will right itself.

Weekly arms practice at the lifesaving station means not only target shooting with sidearms but firing the beach gun, which flings a nineteen-pound projectile carrying a line to the distressed ship, and the smaller rifle which is carried on the power boat and shoots a lighter line.

Next thing to be added to the curriculum will be rescue drill with two-way telephones. Fifteen stations on the Great Lakes are tuned in on the emergency frequency at all times to catch distress signals, and even lifeboats may be equipped with telephones to facilitate communication between boat and headquarters while on duty.

Chief Anderson has been credited with saving more than 4,700 lives. Only a dozen or so of those rescues stand out as thrilling adventures. And when you're out on a job you're not thinking that you're a hero—you're thinking that your back aches and your arms are throbbing, the frozen spray is drilling your face like needles, you haven't enough strength to climb in if the boat turns over again, and it would be nice to have a cup of coffee.

There wasn't an ounce of glamour in it that cold morning when the Chicago crew was sent after a drifting army scow. The routine report of the chief tells the story:

"At 3 o'clock Sunday morning lookout reported ship adrift and tumbling in waves half mile off the lake shore. Wind between fifty-five and sixty miles an hour. Sea billowing waves from twenty to twenty-two feet high. With eight men put out in lifeboat 'Storm Warrior.' Got contact with derelict at 3:30 a.m. Got towline aboard derelict. Force of wind and waves made towing impossible. Scow and lifeboat bounded over high sea with no control possible. Lifeboat crashed at mid-starboard against bow of scow. Stove in lifeboat. Gap two feet square. Had to plug with jackets—even underwear—of crew. Buffeting of lifeboat and scow continued. One crew-man's leg caught in towline slack and when it tightened suddenly, leg almost amputated. Signaled for aid. Tug came out, took us all in tow. Returned to station without further mishap."



*Greatest Thrill on Wheels...*

# PUSH-BUTTON RAILROADING!

Look what Lionel Trains now do—ELECTRICALLY!

WANT TO LOAD A COAL CAR? I'LL DO IT! PRESS BUTTON AND I'LL FILL IT TO THE BRIM!

I WHISTLE WHILE I WORK—LOUD & LONG, OR SHORT & SHARP  
WOO-OO-WOO-OO

WHAT'S BECOME OF OUR LOAD OF COAL? PRESS BUTTON...AND PRESTO...CAR TILTS, UNLOADING COAL WHEREVER YOU SAY

HERE'S A NEAT TRICK, PRESS THAT BUTTON AND WE'LL UNCOUPLE—ELECTRICALLY!

I CAN TILT—ELECTRICALLY AND ROLL OFF THE LOAD OF LOGS

SIDE OF CAR, LIFTS—BARRELS TUMBLE OUT

THIS IS TOPS! PRESS BUTTON! CAR DOOR OPENS, OUT POPS FREIGHT

Look what roars your way this Christmas... push-button railroading! Lionel's greatest thriller! Trains not just starting, running, stopping but the whole world of railroading going through its paces—at your finger's command. Freight cars that load, tilt, unload—automatically! Cars that couple and uncouple—at your finger's command. Switches that click open and shut... train lights that snap on and off... gates that lower and rise automatically... the built-in locomotive whistle that screams—why, it's unbelievable what these new 1939 Lionel wonder trains can do!

**GET THE INSIDE STORY**

See How Push-Button Railroading Works. Just clip and fill in the coupon printed here and rush it to us. We will mail to you—pronto—a copy of the big, 1939, 52-page, full-color Lionel catalog.

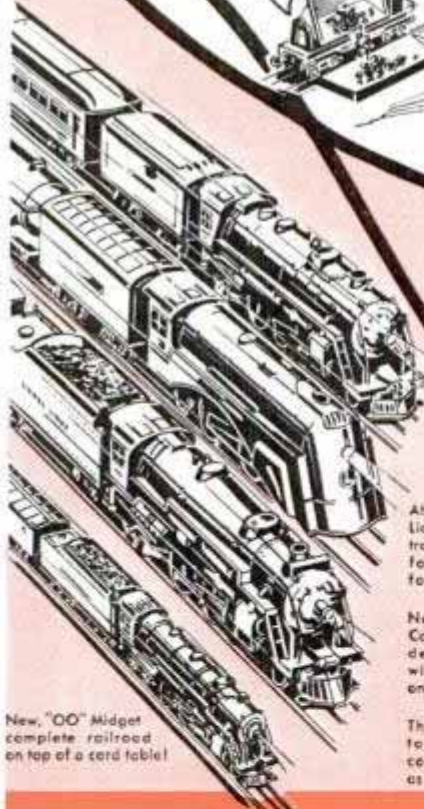

At top, one of the Lionel "027" feet train tracks, transformer and all, for only \$9.95

Next, "O" gauge Commodore Vanderbilt freight, with transformer, only... \$12.95

Third, Super detailed model in complete outfits as low as \$20.25

New, "OO" Midget complete railroad on top of a card table!

# LIONEL

The Lionel Corporation, Dept. AX  
15 East 26th Street, New York, N. Y.  
Please send me the new 1939, 52-page, full-color Lionel Catalog. Enclosed is 10c (for postage and handling).

Name \_\_\_\_\_  
Address \_\_\_\_\_  
City \_\_\_\_\_ State \_\_\_\_\_

Copyright 1938—The Lionel Corporation



# FOR ANTI-FREEZE FACTS- LOOK BEYOND THE LABELS

*... a message for men  
with a technical slant*

Engineers of the Army, Navy, Utilities and the Automotive Industry have long advocated the use of "Prestone" brand anti-freeze ... the original anti-freeze with an ethylene glycol base.

The general public, too, has become well acquainted with the superiority of "Prestone" anti-freeze. It has been used in more cars than any other brand of anti-freeze ever made.

But not everyone knows *why* "Prestone" anti-freeze is so vastly superior. For "Prestone" anti-freeze is *far more* than highly refined and purified ethylene glycol. It contains other *vitaly important* elements.

To make ethylene glycol adaptable to cooling system service required years of exhaustive research by National Carbon Company, Inc. It required millions of the most murderous miles of test driving an anti-freeze can undergo.

Out of this research and testing were developed *exclusive* ingredients that fortify ethylene glycol—curb leaking, foaming and rust-clogging—and make "Prestone" anti-freeze *unlike any other product in the field!*

"Prestone" brand anti-freeze contains NO alcohol ... NO glycerine. It will not boil off. One filling lasts all winter long. There's no danger from fumes ... or from fire ... no danger of harm to your motor. Absolutely odorless. "Prestone" anti-freeze is *guaranteed in writing*. See your dealer today.



The word "Prestone" is a registered trade-mark of National Carbon Co., Inc.

# "PRESTONE" ANTI-FREEZE



# Accident Sleuths of the Highway

(Continued from page 862)

Working in cooperation with the accident investigators is a camera car with a platform on top from which motion pictures are made of traffic flows and average tendencies on the part of drivers. These pictures are likewise studied and their findings incorporated into future designs.

"In this way," explains Commissioner Sterner, "the principal causes of the majority of accidents on each type of road can be ascertained. This, in turn, permits various preventives to be prescribed, such as



*Camera car of accident laboratory films traffic movements while observer counts passing cars*

divided highways, white reflecting curbs, traffic signals, and highway lighting.

"Where an existing road is to be widened, or divided, these studies carried on before and after the construction changes enable us to determine the effect on the number and type of accidents produced by the corrective measures. When the surveys are completed, we'll be in a position to predict the proper type of safety features required in other roads of similar characteristics to provide the utmost in safety."

Although still in the experimental stage accident laboratories have become a significant factor in checkmating highway tolls. A seven months' check of a stretch of Route 25 when the New Jersey program was begun showed eight persons killed, 234 injured in 261 accidents, of which 134 occurred at night. Traffic on this section averages over 50,000 vehicles a day. After the installation of precast safety islands, reflecting curbing, and modern highway

lighting the investigators made a second survey covering the same seven months a year later. Despite a greater volume of traffic, the number of accidents was reduced from 261 to 160, the number of injured from 234 to 149 and the number killed from eight to none.

Trained accident investigators have become important cogs in the safety machinery of virtually all the larger cities, including Providence, Lincoln, Columbus, New Haven, Oakland, Louisville, Syracuse, New York City, Detroit and Kansas City.

In the city, the accident report is spotted on a large city map by a colored pin—a white one for an accident in which there's been no fatality or injury, green for a crash involving a non-fatal injury, red marking a death.

When four pins show up at any point on the map during a six-month period, the reports are hauled out, and a map showing the details of the four crashes together with location of traffic control equipment, road conditions, obstructions to visibility, and other points is prepared. From experience, safety engineers have learned that seventy-five per cent of accidents occur during one-twelfth of the day, so the location under study is checked to learn its peak accident time. The map and data may point to a functional weakness in the street. A sharp curve may need straightening or a passenger zone must be constructed. If, however, no engineering defect is apparent, attention is focused on the motorists' habits. They may be going too fast for conditions. The fault may be indifferent observation of stop signs and signal lights, failure to give signals, making improper turns, or parking dangerously.

As soon as the cause of the accidents is determined, law officials try to eradicate it by selective enforcement. This amounts to concentrating traffic police at the danger spots. Usually, motorists are warned first of violations of traffic laws at these danger spots. "Repeaters" usually draw a ticket, a jail term, or suspension of driving privileges. Selective enforcement has even cut down the number of collisions at spots where some major alteration, say, under and over passes, must eventually be added.

(Continued to page 122A)



(Continued from page 121A)

2749  
 In a number of cities as much as eighty per cent of the motor vehicle enforcement activities is concentrated on danger zones. For example, the 300 state police in Texas couldn't cover intensively the 22,000 miles of highway. They've done the next best thing, building their network of enforcement around the reports of the accident investigators. And they've made it work. Deaths on the thirty-mile stretch between Dallas and Fort Worth were cut from twenty-four to four in a year. On nineteen other experimental stretches, the 1938 toll was pared to 134 from 315.

The causes of some accidents aren't always readily apparent. At one intersection in Kansas City, four accidents occurred within a few months. The city's traffic engineer, T. J. Seburn, got out a copy of the spot map for the previous six months, found no accidents had taken place at this intersection. He prepared a collision map, went out to study the location and put his finger on the cause: a clump of shrubs in one corner of a parkway was robbing drivers of visibility as they approached the corner. From November to April when the shrubs were bare, the obstruction was negligible, hence the absence of accidents. He had the

bushes set back some distance and since then no crashes have been reported.

Scientific reporting of accidents brought about another traffic innovation in Kansas City. The city's motor toll for 1937 and 1938 showed 140 deaths, 105 of them at night, and ninety of them pedestrians. A close study made it clear that the big majority of night accidents were occurring on through streets that had a maximum speed limit of thirty-five miles per hour. In the light of these findings, a night speed limit of twenty-five miles per hour was put in effect, and six months later the city's motor toll was eighteen, as contrasted with forty-two for the same period the year before.

"When engineers first began building bridges," says Seburn, "they didn't know much about stress or strain. By making thorough investigations of projects as engineering progressed they were able to arrive at certain conclusions that removed the guesswork from bridge building. That's what we're trying to do in traffic work. Because of the human element present, traffic engineering will never become the exact science that bridge building has, but as soon as we learn what causes accidents the better we'll be able to meet the challenge our roads and highways present."

## 2338 Ambulance for Crippled Ships

(Continued from page 852)

passes to the insurers. Salvage operations are conducted on a cost plus or bid basis with the owners.

Hauling ships off the rocks and towing disabled vessels to port may seem an adventurous occupation but it doesn't appeal that way to the men on the "Retriever." "Adventure?" one of them asks. "There's not much adventure in spending three solid days doing nothing but unload fish that have been dead too long. That's what happened when we patched up the 'Sea Tern.' She had gone ashore on the Mexican coast. Her ice machine was broken down and she had 120 tons of tuna on board. They were more than ripe by the time we got there and we had to throw them overboard by hand, fish by fish. The vessel had a big hole stove in her. We put on a wood and canvas patch, pumped the water out, and towed her in."

When the "Olympia," another tuna clipper, blew up on the other side of Cape San Lucas in the Gulf of California it looked like a hopeless job. Three men were killed when the engine room exploded, the deck and deckhouse were blown to splinters, and a big hole torn in the bow. The ship sank in sixty feet of water, but the "Retriever" brought her home. The crew sank large steel pontoons alongside the wreck and the diver secured them in place with a sling under the hull. Compressed air was fed into the pontoons and the wreck slowly rose. Then the salvors patched the hole in the bow, pumped the ship out, and towed it home.

Not long ago a tuna clipper capsized, the sea washed her in toward the beach and opened up her deck seams. When Captain Brown got to the wreck it was partly un-

(Continued to page 124A)



**HELLO BOYS- the sensational new ERECTORS ARE ABLAZE WITH LIGHTS**

**THEY'RE COLOSSAL! THESE ALL-ELECTRIC ERECTORS- 4-speed Electric engine- Electric lights- Electro magnet**

**DEVELOPED AT THE GILBERT HALL OF SCIENCE**

SEE THIS UNUSUAL STUNT WITH STEEL- WATCH THE POWERFUL ELECTRO MAGNET GRAB UP GIANT GIRDERS BEFORE IT TOUCHES THEM

HERE'S ANOTHER NEW FEATURE- AN ENGINEER'S SHACK THAT YOU CAN PUT ELECTRIC LIGHTS IN. ERECTOR IS JUST LIKE REAL ENGINEERING

NOW YOU CAN PUT BLAZING ELECTRIC LIGHTS IN YOUR ERECTOR MADE MOTOR CARS, AIRPLANE BEACON, RAILROAD TRAINS AND DOZENS OF OTHER MODELS

ERECTOR'S NEW ELECTRIC ENGINE IS SUPER-OVER. IT HAS 2 SPEEDS FORWARD- 3 SPEEDS BACKWARD AND A GEAR SHIFT LIKE AN AUTOMOBILE

THIS IS THE BABY I WANT- THE NO. 8 1/2 ERECTOR. GEE! IT'S GOT EVERYTHING. I'M GOING TO ASK DAD TODAY

ME, TOO!

**BOYS!** Leading toy stores are showing a sensational new kind of Erector this year. An Erector that makes model-building more fun than the movies—more exciting than a football game. Because Erector has gone *all-electric*.

Now, for the first time, you can build a revolving airplane beacon with a real electric searchlight—construct electrically lighted railroad trains, Ferris wheel, airplanes, motor cars—erect electric bridges that open and close—make mighty cranes that grab up steel girders by electro-magnetic power.

You can build all the engineering marvels you see on this page—and 100 more—with one Erector set. Put dazzling electric lights on them. Make them buzz with action with the new 4-speed Erector electric engine. There are more blood-tingling thrills in the new All-Electric Erector than in a dozen ordinary toys. Tell Dad that Erector is your No. 1 choice of Christmas presents.

## The Sensational New **ALL-ELECTRIC** **ERECTOR**

As exhibited at the New York World's Fair

Get a load of the No. 8 1/2 All-Electric Erector. Crammed with exciting electrical and structural parts. Electric lights—110 volt electric engine with 4 speeds and automobile-type gear shift—powerful electro-magnet. Also, polished steel boiler shell—big red wheels—steel girders and red, yellow and blue structural plates—gears and pinions—a total of 18 lbs. of up-to-the-minute parts for building over 100 colossal, engine-driven, electrically lighted engineering marvels. Price \$12.95; other Erectors from \$1.00 to \$29.95.



A. C. Gilbert, Founder of the Gilbert Hall of Science—the home of Erector, American Flyer Trains, Gilbert Chemistry Sets, Kaster Kit and other Gilbert scientific wonders.

**FREE — WORLD'S FAIR EDITION** "Toys That Buzz with Action" 20 color pages—over 100 illustrations Hello Boys! This exciting book has full color pictures and descriptions of the new All-Electric Erectors as exhibited at the New York World's Fair. Don't lose a minute in sending for a free copy. Mail coupon or post card.

### RUSH COUPON OR POST CARD

Mr. A. C. Gilbert, The A. C. Gilbert Company  
13 Erector Square, New Haven, Conn.  
You bet I want your World's Fair Edition  
"Toys That Buzz with Action." Please rush.  
(Offer good only in U. S. A. and Canada).  
Name.....  
Street.....  
City.....State.....



(Continued from page 122A)

der water and he put suction lines aboard to pump her out. It didn't work; the pumps couldn't keep up with the leaks. Then Brown had an idea. There were a few sacks of rice in the wreck and the rice had swollen up in the sea water, just the sort of thing that an experienced salvage man wants in such a case. The crew scattered the rice in big handfuls in the water at the points where the sea was leaking in. The rice filled the cracks and stopped the inflow of water enough for the pumps to win the battle.

Nearly every salvage job is different but they all have one thing in common—every job is dangerous. No one on the "Retriever" has ever been hurt although the men have had many narrow escapes. The west coast is an inhospitable shore with few safe harbors. Along the Mexican coast hurricanes are apt to strike in the summer and in the winter the local "chubasco" storm is a big hazard. This queer storm generally strikes at night, out of a clear sky. The only warning is a play of lightning on the horizon, followed by a tremendous wind.

The men on the salvage tug live hard and work hard but occasionally they have time for sport. "Ever catch a flying fish with nothing but a big soup strainer?" asks Captain Brown. "They are good eating. Down at the Galapagos, when we want some, we shine a light on deck at night and they come swimming around the boat. You can scoop them up out of the water with a soup strainer borrowed from the galley.

"Sometimes in calm weather we run into a big school of turtles sunning themselves on the surface. If we want a change of menu we shoot one from deck and put a skiff over the side to haul it in. We'll have turtle soup that night and turtle meat as well."

The "Retriever" herself lost her rudder one time 350 miles offshore and Brown had his own rescue to handle. He did it by slinging a two-ton anchor over the stern at the end of a long line suspended from an overhead boom. Then he rang the engine room for full speed ahead. The anchor trailed out astern and created a drag. When the boom was held amidships, the anchor was right in the wake and the ship steered straight ahead. By hauling the boom to starboard the anchor was pulled to the right and the ship turned in the

same direction. To change course to port, the boom was swung to the left.

One strange rescue the "Retriever" made happened when a big wooden purse seiner was rammed off Huntington Beach, twenty miles down the coast from Los Angeles harbor. The vessel was cut clear to the center line and the hole was too large to patch. The stern was awash and the bow was resting on the bottom, the heavy engines holding her down. Brown passed a tow rope around the stern and dragged the boat home under water, the bow bumping along the bottom all the way.

One of the most unusual rescues in Brown's experience happened one September when he sighted a small power cruiser wallowing out of control in the sea ten miles off the coast. There was a man on board the power cruiser and he wanted a tow to port but first, he called, he would like something to eat.

"What's the matter?" Brown shouted back. "Can't you wait a couple of hours?" "I've been adrift since last May," came the faint reply, "and I'm down to a handful of dried beans." After he was fed he explained what had happened. He lived in Alaska and the previous spring he had started out in his boat from Dutch Harbor to Juneau. Half way there his engine broke down. He started to drift and kept on drifting, the currents carrying him down toward Hawaii and then setting him over toward the mainland. He had been at sea for 117 days, had drifted across seven or eight steamer lanes but had sighted only two distant ships in all that time. His engine couldn't be repaired with the tools he had on board, his rudder had broken, and when he tried to rig a sail the small mast snapped off. He had lived frugally on the small stock of provisions on board and caught drinking water off the roof of the cabin every time a rain squall struck. In his 3,000-mile drift he weathered severe storms and came out of his remarkable experience with nothing worse than a big hunger.

Between rescues the "Retriever" lives a varied life, towing barges up the coast to San Francisco and Seattle or acting as tender to square riggers sailed for the motion pictures. But always the ship is ready for a salvage call whether it is ten miles or 3,000 miles away.



# Start Quick...But DON'T SACRIFICE:



- ✓ ENGINE PROTECTION
- ✓ ENGINE CLEANLINESS
- ✓ ENGINE ECONOMY

Get All Good Qualities  
with MOBILOIL ARCTIC

**Q**UICK STARTS—*sure!* But car engines demand safety *after* warm-up, too! “Double-range” Mobiloil Arctic flows fast for easy starts, yet retains its rich film... resists wear, carbon, sludge, for *Balanced Protection!* Get Mobiloil Arctic (SAE 20-20W)...or Mobiloil Arctic Special (SAE 10-10W) where *sub-zero* weather is usual. SOCONY-VACUUM OIL CO., INC.

## HOW AN EXPERT WINTERPROOFS YOUR CAR

1. **DIRTY OIL DRAINED.** Crankcase flushed; refilled with Mobiloil Arctic for *Balanced Protection!*
2. **RADIATOR** cleaned with Mobil Radiator Flush; protected with Mobil Freezezone.
3. **THICK GEAR OIL REPLACED**—with Mobiloil Winter Gear Oil for easy, cold-weather shifting.
4. **CHASSIS PROTECTED.** Winter Mobilgrease helps protect vital parts against wear.



WINTERPROOF TODAY AND CHANGE TO...

# MOBIL OIL ARCTIC





*J. J. J.*  
Public Enemy Number Zero

(Continued from page 869)

Telegraph, telephone and power companies must also mobilize their forces; but theirs is a defensive battle, for there is little they can do about snow or ice until a break has occurred in their lines. With extreme cold these utilities have little worry, for dry or wind-driven snow has no effect on wire lines. But let the temperature hover around the freezing point, with precipitation but no wind, and there is trouble. Wet snow can build up around a thin wire to the size of a water main. Wires in Springfield, Mo., a few years ago, accumulated a deposit seven inches in diameter, weighing fourteen ounces to the foot. Many wires came down, carrying poles with them.

When the upper air is above freezing so that rain falls, while the ground temperature is below thirty-two degrees, we have an ice storm. The rain freezes on everything it touches, especially metal. If the air is still, the ice coating may become several inches thick. And ice is heavy. Telephone wires in a sleet storm in Worcester, Mass., received a three-inch deposit of ice, which weighed 800 pounds per wire between poles. Wires and poles came down.

The utility companies can only watch for the break, testing lines constantly to make sure they are open. When one goes out, the distance to the break is ascertained with a Wheatstone bridge, which measures resistance. A trouble-shooting truck, or a motor car if the lines parallel the railroad, is dispatched to the scene of the break. A simple interruption can be repaired in a few minutes. If a whole section of pole line goes out at once, the problem is greater. Tangled wires must be cut down, poles removed and the circuit restored by running twisted pairs between undamaged points, stringing them along the ground, fastening them to fences, trees, anywhere—anything to restore service. When all wires go down, so that a community is isolated, a portable emergency radio telephone may be used to bridge the gap.

But the most thrilling battles come when zero clamps down hard, when lakes and rivers and harbors freeze. Then the Coast Guard is besieged with calls for assistance. A cutter is wanted to break a channel, to

Millions of miles of

## TOUGH TEST

driving in every type of car  
...under every type of condition... prove "Prestone"  
Brand anti-freeze the  
world's most dependable  
winter protection. It contains  
NO alcohol. NO glycerine.  
One filling lasts all winter!

(SEE PAGES 120a and 131a)

## TEST-O-LITE

Tests Everything Electrical  
From 100 to 550 Volts

A real necessity for electricians and home because it has 1001 uses. Equipped with a Neon light which tells instantly where trouble lies in electric circuits, fuses, cut-outs, motors, radios, all kinds of electric appliances, etc. Tells A. C. from D. C. Far superior to ordinary clumsy test bulb. Fountain pen size with clip for carrying in vest pocket. Lifetime guarantee.

**PATENTED**

**L. S. BRACH MFG. CORP.**  
55 Dickerson St., Newark, N. J.

APPLIANCES  
MOTORS  
FUSES

\$1.50 At Electrical Stores or Post-paid



**AMAZING POWER** for model planes, model boats, model cars

## Brown JUNIOR MOTORS

Model D, \$12.50. Complete, ready-to-run. Precision-made by world's largest builder of model gasoline motors. Other models up to \$21.50. Every motor guaranteed. Weight, bare, 6 1/2 oz. Write Dept. G, Junior Motors Corp., 2545 N. Broad St., Phila., Pa.

## BUILD YOUR OWN RAILROAD!

### FREE BOOK

TELLS ABOUT NEW THRILLING HOBBY!

The fun of creating and building a model railroad system and the excitement of operating it are two good reasons why you should get the facts on this fascinating new hobby right away! Send for free booklet which tells why you'll like it and explains how easy it is to get started. A 75-car plan drawing is included free—write for yours today!

**SCALE-MODELS, INC.**  
1515 So. Wabash Ave., Chicago, Ill.

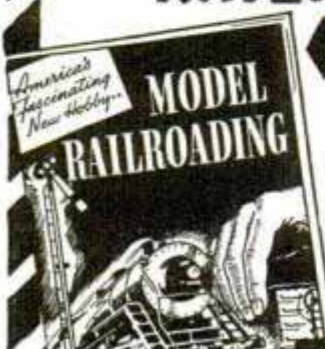



clear a harbor, so that ships laden with food and fuel may be brought to city dwellers, so that fishermen may be freed from ice, so that medical attention may reach some isolated community. If wind and tide are right, it is sometimes possible to clear a harbor of ice in twenty-four hours. The cutter starts at the outer edge of the field and rams it, breaking off triangular sheets small enough to drift through the narrowest passage. Then when wind and tide are right, the cutter begins at the lower end and pushes the sheets to seaward until the central part of the harbor is free. At high water the cutter works along the margins, loosening shore ice, which the ebb tide carries away.

But when conditions are adverse, the same cutter might spend a week breaking a single channel only twenty miles through heavy ice. This strenuous work is an emergency measure, done only when it is impossible to break up the ice field and move it out.

The Coast Guard has two types of ships designed especially for this work. The first, the regular type cutter, has a spoon-shaped keel at the bow. If the ice is too thick to break aside, powerful engines push the bow on top the ice, so that the weight of the ship can break the sheet downward. The other type, designed especially for ice breaking, is hardly more than a large tug of extremely sturdy construction, and with powerful engines. This ship has a sharp reinforced bow, with ballast tanks forward, and a bulging projection a few inches below the water line. Charging an ice field, the projection rides on top the ice and breaks downward, while the true keel cuts with a forward motion. The combined action cuts with a sort of scissors motion.

Another form of ice work is the freeing of vessels that have frozen in at their moorings or in open water. This happens frequently to small fishing craft.

Winter's end finds the ice patrols preparing to set forth to guard the shipping lanes, so the battle against Public Enemy Number Zero is never ended.

Names and addresses of manufacturers and dealers in articles described in this magazine will be furnished by our Bureau of Information upon request accompanied by stamped, self-addressed envelope.



**\$495** By mail,  
postage

New gas model that flies swiftly to high altitudes . . . soars long and glides to level landings. Build one and be in line for BIG CASH PRIZES to be offered contest winners using Megow models. 3-unit construction . . . quick-detachable wing and tail sections fly off undamaged in collision, and give easy access to ignition unit. Quickly built fuselage. 6 ft. wingspan. 8 oz. wing loading. Uses any 1/5 h.p. motor. The best-performing, most beautiful model airplane you ever saw.

### KORDA'S WAKEFIELD INTERNATIONAL CHAMPION



With a flight record of 43 minutes and 29 seconds, this supreme rubber-powered model won not only the famous \$500 Wakefield trophy but the all-time world's record. Kit, manufactured exclusively by Megow's, contains not only all necessary materials but Korda's official plan. \$1.00 at your dealer's or by mail, 10c extra for postage.

### SHIP MODELS



Authentic, romantic, historical and modern types. MAYFLOWER, shown here, length 17½ in., printed deck-piece construction with carved hull. Complete plans and all materials, \$3.00 plus 15c for postage. Many other famous models, all popular sizes and prices, shown in new catalog. Ready-made parts and supplies.

### HO-GAUGE FREIGHT CAR KITS 50c

Each a scale model, realistic, accurate and colorful. Kit complete with trucks, brake cylinders and wheels. Wheels insulated for 2-rail operation. Couplers automatic. Gondola, hopper, tank and refrigerator cars and cabooses. 50c each. By mail, 10c postage.



Big, new catalog just issued! Shows scores of model airplanes, model ships and HO-Gauge Railroad cars. Send 5c postage for your copy today!



**Megow's**

Dept. PM.  
Howard & Oxford Sts.  
Philadelphia, Pa.

217 N. Desplaines St.,  
Chicago

718 Mission St., San Francisco

WORLD'S LARGEST MANUFACTURERS  
of Model Airplanes, Ships and HO-Gauge Railroads



2748

# Clear Track Ahead

(Continued from Coloroto Section)

freight and passenger service the dead weight of passenger and freight cars has received considerable attention. By the use of high-tensile steel, alloys and aluminum, the weight of the new streamline trains has been reduced materially. Box-cars made of alloy steel and weighing approximately 8,000 pounds less than the previous standard cars are undergoing tests.

In steam-locomotive construction remarkable improvements have been made. Their net effect has been to increase the tractive power while maintaining or reducing weight and fuel consumption. The extension of engine runs from 100 miles to more than 500 has made for permanent

economies in shop and maintenance work. On road and laboratory tests in air-brake equipment alone, more than \$2,000,000 has been expended. From these tests has been evolved an air brake which requires only eight seconds from the time the engineman operates the brake valve until the brakes are set on the last car, as much as a mile and a half away. Tests are continuing, in an effort to develop still better brakes for use on high-speed passenger runs.

Today, the Association of American Railroads has 173 committees of technical experts constantly studying all phases of railroad operation to increase efficiency, effect economy and promote safety.

As one result of all this research, the operating cost of producing a ton-mile of freight went down from \$10.78 in 1921 to \$6.75 in 1935, a decrease of approximately forty per cent, while at the same time, the average speed of freight trains was increased sixty-one per cent. In 1938 the average distance per freight train per day was 398 miles, against 247 in 1920, including all delays en route. Because of this, California fruit growers are now four days nearer the Eastern seaboard than formerly, with service from Florida and Texas also bettered.

The railroads, today, move a ton of freight one mile at an average cost of less than one cent, the lowest rate in the world. Surely this could not have been accomplished if railroad managers were sleeping at the switch.



Above, "face" of newest Diesel streamliner, North Western's "400." Below, Southern Pacific cab-front locomotive





# It never drinks too much!

**New Safety-Fill Construction in Willard "H-R" Battery gives you and your car greater protection**



## HERE'S HOW SAFETY-FILL WORKS

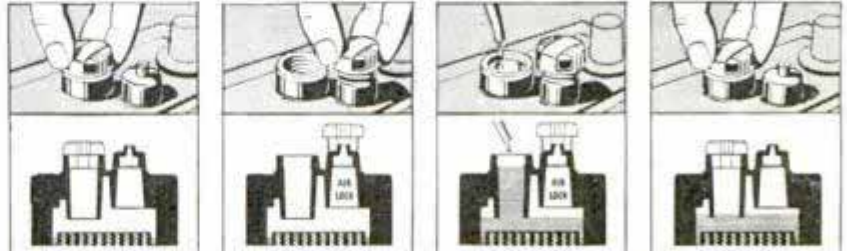

To fill the battery, unscrew filler-cap as usual.

PLACE CAP ON SAFETY-FILL VENT, forming air lock in breather-chamber.

Add water till visible. Air lock controls amount that can be added.

Remove cap from SAFETY-FILL vent and solution drops to correct level.

*Overfilling a storage battery means trouble!* If it is located under the hood, just ONE overfilling can cause expensive and dangerous acid-corrosion.

Willard's new *Safety-Fill* development prevents overfilling—protects the vital parts of your motor and wiring system from acid-spray, and stops the current losses and starting failures caused by corroded cables and terminals.

You can get *Safety-Fill*, AT NO INCREASE IN PRICE, in Willard's newest "powerhouse" battery, the "H-R." Capable of cranking *six cars at one time*, this remarkable battery also has Willard Thread Rubber Insulators between its plates to guard against short circuits and assure you of extra long battery life.

See this new "H-R" Battery TODAY! It's the battery your car really needs!

WILLARD STORAGE BATTERY COMPANY  
Cleveland • Dallas • Los Angeles • Toronto

The  
**Willard "H-R"**

with

**SAFETY-FILL**

A Willard development

**STOPS**  
DANGEROUS  
CORROSION

**Ask for it by name at your Willard Dealer's**



## Exploring a Tropical Wonderland

(Continued from page 837)

arms and becomes an adult starfish having five radial arms. Investigation of marine parasites is a field in itself, the size of which is indicated by the fact that there are several hundred different parasites that live on shellfish alone, including tiny crabs that live and grow side by side with an oyster inside its shell.

Scientific discoveries are adventures in themselves but the scientists on the "Vele-ro III" share other kinds as well. Once they rescued a crew of fishermen trapped in the doldrums at sea without food or water. On another occasion five men were rescued from a capsized sailboat.

But the normal routine of an exploration party is long hours of hard work. Each member has his program mapped out and even when the ship is under way he is busy classifying the specimens collected at the last stop. One subject of present scientific interest is the marine life of the cold Humboldt current that sweeps up from Antarctica along the coast of Peru. Part of the equipment on the ship is a deep-sea dredge attached to 7,000 feet of plow-steel cable that is used for bringing to the surface the tiny crustaceans and other forms of life that exist on the bottom.

Ashore the scientists lead a rough life. In spite of skilled boatmen a skiff is sometimes swamped in the surf. Climbing over slippery rocks or wading in shallow water, a collecting party may be submerged by a giant comber. Inland the botanists and ornithologists struggle through long stretches of cactus or slash their way through jungle growths. A day's hike may take them across miles of broken lava and thorny brush. Often they find specimens that make even the toughest trips worth while.

On several cruises parties from the "Vele-ro III" have visited the uncivilized Seri tribe of Indians who live on Tiburon Island in the Gulf of California. Said to have been cannibals in the past, they live in crude brush shelters and feed on fish and small animals. More recently one of the expeditions brought back an excellent photographic study of the San Blas Indians of southern Panama, a tribe that has had few contacts with civilization and that rarely allows its women to be photographed, believing that the camera steals the souls of those whose pictures are taken.

## Dinner Time at the Zoo

(Continued from page 875)

one of the lions refuses to eat. Once a young lioness was intentionally poisoned by some visitor. For three weeks the lioness was kept alive on a diet of raw eggs and milk, which Gibson administered with the aid of a large syringe. When the lioness would open her mouth to growl, Gibson would jump forward, jab the point of the syringe between her teeth, and squirt in some eggs and milk. When the lioness finally began to eat regularly again, he counted his fingers twice, and went to see if the baby boa constrictor was getting enough white mice. The mice, incidentally, are killed before they are fed to the snakes.

Only government-inspected beef is fed to the animals. Eggs, milk and vegetables are also of the best quality, and rigorously inspected to insure against infection.

One of the most prized animals in the Griffith Park Zoo is Yogi, a dwarf Kodiak bear captured in Siberia and valued at \$12,000. Yogi is very partial to carrots. But too many carrots aren't good for bears. Therefore, her meal consists of a mixture of carrots, lettuce, and vitamin-treated bread. Bread, however, is a sort of bear spinach, and Yogi doesn't think much of it. So she sorts out the bread and piles it to one side, as a silent gesture against a balanced diet.

Monday is fast day for most of the animals. This is due to Sunday over-feeding by visitors who don't believe in signs. The other six days of the week feeding begins at ten a.m. Food is prepared in the feed house by two dieticians under Gibson's supervision. Mechanical choppers, grinders, and mixers speed up the work. A huge icebox is filled with whole beefs, iced fish, and beef hearts. Each type of animal has its own special bucket. Certain monkeys and other animals have individual buckets labeled with their names. Unusual types of food, such as the dried shrimps, which are difficult to obtain, are kept under lock and key.

The problem of furnishing food for the zoo isn't always simple, but it's an interesting one—in which science and ingenuity combine to keep the animals looking their best for the benefit of the people on the outside looking in.



**LAST WINTER "PRESTONE"  
ANTI-FREEZE SAW MOTORISTS  
THROUGH MORE THAN 24 BILLION  
MILES OF CAREFREE DRIVING!**



**Here's why "Prestone" anti-freeze is the world's  
largest selling brand of winter protection**

**1** It is made with highly refined and purified ethylene glycol. To this ethylene glycol are added *exclusive* fortifying ingredients that were developed after years of laboratory research and millions of miles of the most torturous test driving an anti-freeze can undergo. These *exclusive* ingredients curb leaking, rust clogging and foaming. They are *vital* to a perfect anti-freeze.

**2** One filling of "Prestone" brand anti-freeze lasts all winter long. There's NO replacing. "Prestone" anti-freeze gives off NO dangerous fumes... is NOT a fire hazard. It contains NO alcohol... and will not boil off. *Guaranteed in writing.* See your dealer today.

**NEW  
LOW PRICE!** **\$2<sup>65</sup>**  
PER GALLON



**"PRESTONE" ANTI-FREEZE**

The words "Prestone" and "Eveready" are registered trade-marks and identify products of National Carbon Company, Inc.



# The Golden Age of Sound

(Continued from page 830)

louder than the background noise to the ears of a person wearing ear defenders. On the other hand a person wearing the defenders can hardly speak loudly enough to make himself understood by an unprotected person in a noisy place because he doesn't realize how loudly he must shout in order to be heard.

It is estimated that several million people in the United States are noticeably deficient in hearing. Heredity, age, damage from infections, or exposure to great noise deadens the sensitivity. If you tested your

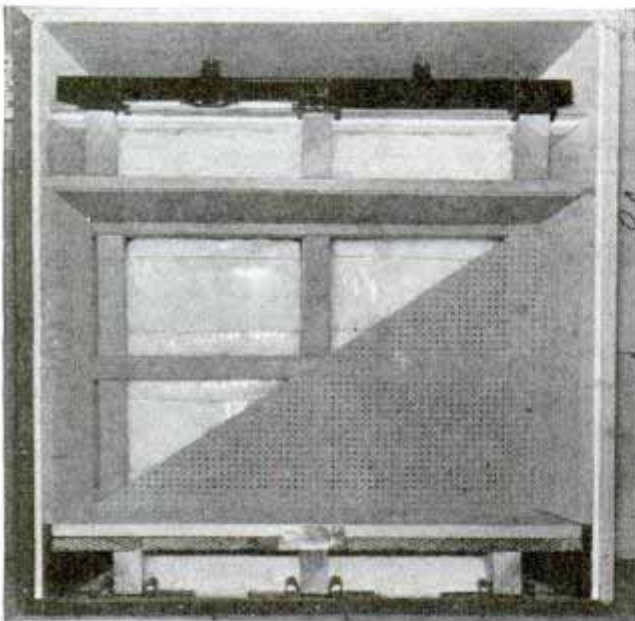

Cut-away representing radio studio where ten types of sound-absorbent materials and devices are used

hearing at the telephone exhibit at either world fair last summer you unwittingly participated in a giant survey being made to discover the extent and degree of deafness in the population, a study that is important to society as well as to telephone engineers.

Incidentally, the belief that animals have much keener hearing than humans is erroneous. The hearing of most animals is remarkably similar in range and sensitivity to the human ear although animals have the advantage of not wearing shoes and so are better able to detect sound vibrations through the ground.

Everyone is partly deaf because no human ear is tuned high enough to detect some of the sound vibrations that are created in nature. After twenty years of age we slowly begin to lose our hearing in the

upper tones. As age advances vowels can still be heard but consonants are increasingly harder to understand. High-pitched words such as "thin" and "fine" are hard to catch by the partially deaf although they still understand "low" or "gore" or other low-pitched sounds.

It is a peculiarity of sound that low-pitched tones drown out or mask high-pitched tones. This characteristic is carried over in the amplifiers that are used as aids for the hard of hearing with the result that even though speech is made louder for them they still have trouble hearing the higher notes that are required for complete understanding. This difficulty is overcome in a new English system that employs two channels and delivers all low notes to one ear and all high notes to the other. The result is that each ear hears one band of frequencies without interference. This device, a boon to the deaf, is the outcome of an old stunt of telephone engineers who sometimes divide speech up electrically and divert all the low notes to one ear and all the high ones to the other. Each ear hears distorted sound yet the brain, receiving sound from both ears at the same time, assimilates the sound waves into normal intelligible speech.

Improved as it has been, the telephone is not yet a perfect instrument and the fact that we hear so well over it is partly due to the training our ears have received. Some high and some low notes are muffled by the mechanism and some others are over-emphasized. People not accustomed to the telephone are apt to have difficulty until they train an ear to interpret the sounds, a thing that you can test for yourself by placing the receiver to the other ear than the one you usually use.

Otologists are learning that a person's two ears are likely to be quite different in tone perception and sensitivity. In the future a person who is hard of hearing will not be restricted to a simple amplifying system for only one ear but will be able to equip himself with a small portable double outfit that has been adjusted to fit the individual needs of each ear just as individual glasses are ground to fit the peculiarities of each eye. Hearing aids for both ears

(Continued to page 135A)

U.S. Agent - Charles H. Lehman



FAMOUS

# YANKEE HANDYMAN

## TOOLS FOR THE HOBBYIST

GET "Handyman" tools for your workshop. New speed, greater ease—driving screws, boring holes! "Yankee" Handyman Screw Driver No. 133H—with *Spring in Handle*, \$1.25, is ideal drill. No. 33H, without spring in handle, only \$1.00.

To bore holes for screws, ream, etc., with Handyman No. 133H or No. 33H, buy these "Yankee" Accessories. They fit Driver in place of blade. Sold separately, as below or in Pak:

"Yankee" Chuck and 3 Drills, Set, 39c.

"Yankee" Drill 5/64"

"Yankee" Drill 7/64"

"Yankee" Drill 9/64"

"Yankee" Countersink, Each 25c.

"Yankee" 5/32" Blade for small screws, Each 12c.

Accessory Pak No. 330H Complete Set on Card, 75c.

Big News! Genuine "Yankee" quality now yours in a small screw driver for **Twenty-five Cents!** "It Ratchets!" Gets the best of tiny screws . . . saves time, temper. Simply turn to and fro. Adjust ratchet to drive or draw screw.

### IT RATCHETS

YANKEE  
HANDYMAN  
No. 2H

# 25¢

Length, 4 1/16".

Look for "Yankee" Handyman Displays at Hardware Dealers

### "YANKEE XMAS PACKAGES"

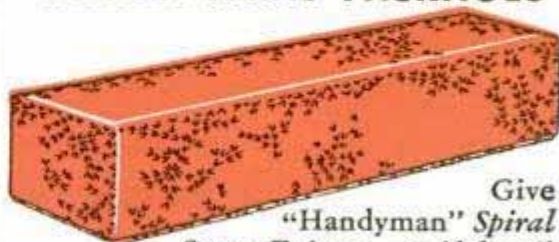

Give "Handyman" Spiral Screw Drivers—a gift for all year 'round. Just \$1.00 for No. 33H. Only \$1.25 for No. 133H—with *Spring* added in handle. Packed in Red-and-Gold Gift Boxes. At Hardware Dealers. North Bros. Mfg. Co., Philadelphia, U. S. A.

\$1.00

\$1.25



**BOYS!**  
NEW REPEATING 500 SHOT Air Rifle

Write for **FREE** Catalog

**3 WAYS TO GET THIS Carbine FOR CHRISTMAS!**

- 1 AT YOUR DEALER**... tell Dad to get "No. 108 CARBINE"—tell him which Dealer has it.
- 2 IF NO DEALER NEAR YOU**, send \$2.50 to us, we'll mail your new Lightning-Loader Carbine postpaid.
- 3 SECRET PLAN**—we'll help you get a Carbine for Christmas—the fastest-loading air rifle in history! Write us stating your own name, address—also name, address of person most likely to give you a Carbine for Christmas. Enclose 3c stamp. That's all you do—so do it now! Hurry!

**DAISY MANUFACTURING COMPANY, 1112 UNION ST., PLYMOUTH, MICH.** Higher in Canada

**only \$2.50 and it's yours**

**Get a DAISY AIR RIFLE For Christmas!**

**1/2 MFRS. ORIG. PRICE!**

**GENUINE UNDERWOOD No. 5**

**10 DAY TRIAL**

**SEND NO MONEY!**

BUY YOUR UNDERWOOD No. 5 DIRECT FROM US AND SAVE OVER \$60.00 on the mfrs. original price—on easy terms too—only 10c a day. Greatest rebuilt typewriter bargain ever offered! Think of it! This genuine full-sized Underwood has all standard improvements—keyboard, back spacer, 2 colors, tabulator etc. Made to sell at \$102.50—yours for only \$38.90 cash while they last, or buy on easy terms (\$42.90 term price). Mail coupon NOW for 10-day trial!

**EASY TERMS 10¢ a day**

**INTERNATIONAL TYPEWRITER EXCHANGE**  
231 West Monroe St., Chicago, Ill., Dept. 1201.

Send Underwood No. 5 (P. O. B. Chicago) at once for 10-days' trial. If I am not perfectly satisfied I can return it express collect. If I keep it I will pay \$38.90 a month until I have paid \$42.90 (term price) in full.

For quick shipment give references and occupation.

Name.....Age.....  
Address.....  
Town.....State.....

**BIG MONEY Assembling NEW MEAD KI-YAK at Home!**

MEAD'S complete cut-to-fit KI-YAK Kit easily assembled for pleasure or profit! Portable. Seaworthy. Light. Fast. Highest quality. Low cost. 3 models 20 lbs. to 45 open a new world of sport for you both in sailing, paddling. Also 2 portable Outboard Models. Finished double-blade paddle or Oars now INCLUDED with your KI-YAK. Rush 10c coin for big circulars, low Factory-To-You prices!

Finished DOUBLE PADDLE or OARS now INCLUDED with your KI-YAK... Hurry!

**MEAD GLIDERS, 15 S. Market, Dept. B-129, Chicago**

**FREE "BETTER RESULTS WITH GLUE"**

Send post card for booklet, "Better Results with Glue," containing many useful hints about mending, model making and home workshop jobs. Address: McCormick Sales Co., 402 Light St., Baltimore, Md.

**IRON GLUE 10¢** at hardware, drug and 10c stores; also in cans from 1/4-pint to 1 gallon

**MAN IN EACH TOWN To Plate Auto Parts**

Reflectors, Bicycles, Fixtures, Mirrors, by late method. Simple plan of manufacturing at home starts you IN GOOD PAYING BUSINESS. Write today for FREE particulars and proofs.

**GUNMETAL CO. Decatur, Ill.**  
Ave. M

**BOAT BLUEPRINTS & PATTERNS**

Full size paper patterns! Newest designs by naval architect. Cruisers, runabouts, sloops, snipe, outboard boats, sailing canoe (Kayak), etc., 8 ft.-38 ft. Low prices. Rush 10c (coin) for latest catalog. Send \$1 for "HOW TO BUILD BOATS" book, postpaid.

**Cleveland Boat Blueprint Co., Station A-667, Cleveland, O.**

**Earn MONEY Make Color-glazed Concrete Products**

MAKE color-glazed concrete pottery, tiles, walls. New, low cost, patent method. No molds. Use only sand, cement, cheap materials. Basement waterproofing. Other projects. Booklet, cost data, details, 10c.

**NATIONAL POTTERIES COMPANY**  
Room 6, 13 W. 26th St., Minneapolis, Minn.

**SOFT WATER MAGIC WORDS**—that are bringing big profits to Webb Salesmen!

The Webb Portable Water Softener gives every housewife, soft water in an endless flow for washing dishes, laundry, bath, shampoo and every home purpose. Softens hardest water instantly at the turn of the faucet. Provides healthful drinking water equal to many expensive bottled waters.

**ALSO WEBB IMPROVED CHLORINE FILTER**  
Removes chlorine and odor and taste—big demand!

**Distributors Salesmen FREE SALES PLAN**  
100% profit—simple home demonstration sells it easily. Leads to larger sales. Write today for free literature and full details of the Webb NO RISK TEST OFFER and FREE Sales Plan.

**NO RISK TRIAL OFFER!**

WEBB MFG. CO. Dept. P129 1813 Baltimore Ave. Kansas City, Mo.

**Print Your Own MAKE MONEY PRINT FOR OTHERS**

Cards, Stationery, Advertising, Labels, Paper, Circulars, Tags, Movie Titles, etc. Save money and time. **PRINT FOR OTHERS, BIG PROFITS.** Do popular raised printing like engraving with any of our presses. **Junior Outfit \$8-25, Senior Outfits \$16.55 and up.** Pays for itself in a short time. Easy rules sent. Recreation as well as money maker. Have printercraft for a hobby. Lowest priced practical printing press made—sold only direct from factory. Write for free catalog and all details. **KELSEY PRESSES, W-37, Meriden, Connecticut**

**EXCELSIOR**



2843  
(Continued from page 132A)

are also desirable because binaural listening improves the sense of sound localization, reduces room reverberation, and increases the ability to focus attention on desired sounds.

Recently a subject with only four per cent of standard hearing ability was tested with various kinds of hearing aids. Using a portable aid of the common micro-telephone type his articulation was twenty-one per cent. With a portable vacuum-tube type his articulation was increased to forty-five per cent and with the laboratory high-quality amplifier there was an increase to sixty per cent. When this uniform amplification was modified to conform to his special needs his articulation reached seventy-two per cent. The indications are that the present imperfect listening devices for the hard of hearing are going to be replaced by aids that in most cases will allow them to hear only a little less perfectly than people with normal hearing. Unfortunately, this does not suggest that any amplifying system will be of any use to those who have suffered a complete loss of hearing because of inner ear or nerve atrophy.

The realm of music is expanding to new horizons with the development of electro-musical instruments that provide composers and musicians with almost unlimited control over timbre and harmonics. Not only can these "tone generators" of the vacuum-tube type imitate the best individual instruments but they can combine the effects of many kinds of instruments in an orchestration. One hope is that such sounds of nature as the breaking of waves and the murmuring of trees will be made available to musicians and that the newly created sounds will be made definitely musical by the use of filters that select tonal bands that form harmonic series. Modern acoustics can and should furnish the musical artist with new tone colors and new sound effects which a Wagner could utilize to enhance the beauty and emotional interest of music.

☐ Popular Mechanics Magazine can furnish the name and address of the maker of, or dealer in, any article described in its pages. If you wish this information, write to the Bureau of Information, inclosing a stamped, self-addressed envelope.

Do you want  
**ALL-WINTER RADIATOR  
PROTECTION FOR ONLY \$1.50?**



**H**ERE'S the way many car owners do it every year! They put in a couple of quarts of Du Pont "Zerone" early in the season for protection against rusting and the sudden cold snaps they know will come.

When winter gets down to real business, they add enough "Zerone" to protect them to lower temperatures. A total of six quarts, put in as needed, can protect a car with an average size cooling system for the entire winter. And six quarts of "Zerone" cost only \$1.50! Just one gallon protects an average size cooling system (15 quarts) to 1°. Five quarts would protect it to -12°; six quarts to -27°!

You may need a little more or less, depending on the condition and capacity of your car radiator and the severity of winter in your neighborhood. But the unusual efficiency of Du Pont "Zerone" will save you real money.

"Zerone" in a clean cooling system prevents rust and corrosion, which reduce operating efficiency. It gives better dissipation of engine heat, avoids power losses. Protect your car with "Zerone" this very day! It's only \$1.00 a gallon, 25¢ a quart.



**DU PONT**  
THE COMPANY

ONLY

\$1 A GALLON

**ZERONE**  
*Anti-Rust* ANTI-FREEZE



WHERE WINTER PROTECTION

MUST NOT FAIL...

"Prestone" brand anti-freeze gets the job! It's used on airplane carriers... in anti-aircraft guns... in railroad signals, and in more cars than any other brand of anti-freeze. One filling lasts all winter!

(SEE PAGES 120a and 131a)

# CLAMPS

The biggest need in most home workshops is more good clamps—clamps for gluing, holding, drawing-up and for setting-up work. They are the extra hands for the 1-man shop. Don't spoil or delay work for want of clamps. From over 40 types of clamps we have selected those as the first for homecraft use.

ADJUSTABLE CLAMP CO.

"The Clamp Folks"  
421 N. Ashland Ave., Chicago, U. S. A.



**PONY Miniatures** 9 types 1" to 2 1/2" esp. Not toys but fine tools with 100 uses.

**PONY "50" Fittings** on ordinary 3/4" pipe. Any length. Send \$3.00 plus postage (8 lbs.) for fittings for two "50" Clamps. Also "Pony" No. 52 Fittings for 1/2" pipe—2 sets for \$1.50 plus postage.

Catalog FREE Ask your Dealer



**Jorgensen Handcrew**  
Genuine "Jorgensen" Handcrew grip at all angles, never slip, split or loosen. All sizes. Send \$3.20 plus postage (7 lbs.) for 2 No. 1 Handcrew—open 6".



# HOLD-E-ZEE

## Automatic Grip Screwdrivers

Hold, start and set-up screws in unhandy places. Gripper instantly released by spring action, sliding up out of way when not in use. Finest materials thru-out, chrome vanadium blades; many have transparent, insulating, unbreakable handles. Models for recessed-head screws. No more expensive than ordinary screwdrivers. At auto-supply, hardware or electrical stores.

UPSON BROS., INC.  
86 Exchange St.  
Rochester, N. Y.



# BIG NEW STREAMLINED LATHE

## AT SENSATIONAL BARGAIN PRICE



Swings 10 inches

Imagine! This extra heavy wood lathe, steel bed 48" long, at low prices. Heavy duty head stock, 4-step cone pulley for V-belt, No. 2 Morse Taper Centers. Sealed ball bearings, 6" face plate screws onto spindle. Tool rest 10" long. Complete line of accessories at amazing low prices. Write today for free catalog describing Blue Star full line precision woodworking machinery. Factory-to-you prices. Not sold through agents. Act at once!

BLUE STAR PRODUCTS, 612 Gate Street, Fairfield, Iowa

# FREE CLUB & CLASS PIN CATALOG SHOWING OVER 300 DESIGNS



## 300 SMART DESIGNS!

Knit your class or club closer together with pins or rings. Bastian has been the leading maker for 45 years. Clean cut, quality work. Write today for 1940 Catalog.



BASTIAN BROS. CO. Dept. 71, Rochester, N.Y.

# LAUX 771-D WOOD WORKERS! YOUR GLUE PROBLEMS SOLVED!

Better wood working results with Laux 771-D Casein Glue! Low stain, water resistant—safe on delicate woods. Guaranteed for model making, mending, home workshop jobs. Money back if not satisfied. Made by world's largest manufacturers of water resistant glue. Money saving 16-ounce can 65c postpaid anywhere in U. S.

I. F. LAUCKS, INC., Dept. A, Portsmouth, Va.; Seattle, Wash.

# EASY PROFITS IN PAINT SPRAYING



Paint walls, ceilings, screens, furniture, radiators, machinery faster, better! 1/4 H. P. motor 110 Volt 60 Cycle AC, complete with Spray Gun, 15 ft. hose. Weighs only 44 lbs. Carry anywhere. FULLY GUARANTEED. Only \$31.15 f. o. b. Chicago. \$5 Deposit. Balance COD, or SEE YOUR DEALER. Circular FREE. Get started making money NOW!

Ideal Automatic Pump Co. Dept. PM-12, 801 Washington, Chicago \$31.15 Complete

# RADIOS.. SAVE UP TO 50%



DEAL DIRECT—FACTORY PRICES  
Many models to choose from at wholesale prices, AC-DC midsets \$4.99. Portable and battery sets \$8.98 up. Car sets \$11.75 up. Also consoles, all-wave etc. Samples at 50% off. Send for FREE 1940 bargain catalog giving details of 10 day FREE trial and agent's proposition and discounts. No obligation, write today. GOLDENTONE RADIO CO., DEPT. PM, DEARBORN, MICH.



10 DAY TRIAL \$4.95 EACH in lots of 3 R.C.A. LIKE NONE

# Your HAIR

## IS IT THINNING OR FALLING OUT?

If your hair is causing you this kind of trouble and it is due to poor blood circulation in the scalp, rent a Crosley XERVAC and try home treatments with this amazing machine. It is designed to help correct just such conditions of the scalp as the lack of proper blood circulation.

# Rent a CROSLY XERVAC

Write for free particulars, how you can rent a brand new machine, the same type now used in many barber shops and scalp clinics, for a small rental fee per month, without any obligation to buy. The Crosley XERVAC operates on the principle of alternate vacuum and pressure, known to be effective for forcing fresh, stimulating blood into the deep-rooted blood vessels. Very compact, easy to use. Now that you can rent one you can get its benefits on easiest of terms. Write for details of home rental plan.

THE CROSLY CORPORATION  
Dept. M-10 Cincinnati, Ohio



# Saw-Filing

Pays up to \$2 or \$3 an Hour in Spare Time

A FOLEY Automatic Saw Filer files hand, circular and hand saws better than the best hand filer. Cash business, no canvassing, no eyestrain. No experience needed. Louis P. Wadlowick, Ohio, says, "I have filed 764 saws in spare time and have earned \$850.00 in carpenter work due directly to my saw filing contacts." Send coupon for FREE PLAN, no obligation.



FOLEY MFG. CO., 1216-9 Foley Bldg., Minneapolis, Minn.

Send Free Plan on Saw Filing business.

Name.....  
Address.....



## Progressive Receiver

(Continued from page 937)

It would not be practical to try to cut these extra holes after any parts are mounted. These chassis bases are available, formed and drilled, from several large radio parts houses, if desired. Both the antenna and r.f. coils have four leads that are not employed in this 4-tube set, as indicated in the simplified wiring diagram of the re-

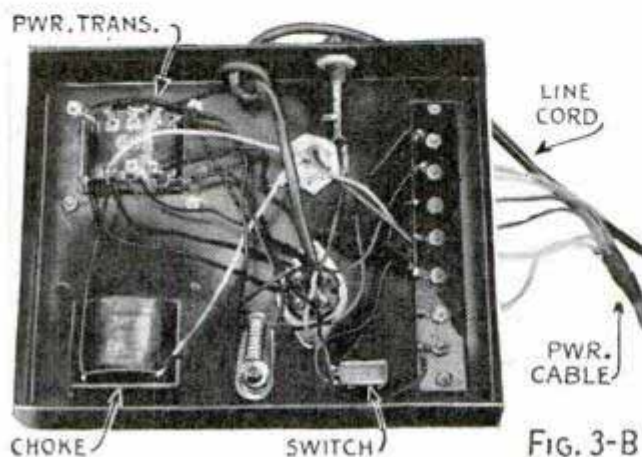

FIG. 3-B

ceiver, Fig. 4. These leads are merely twisted up and the ends taped, until required for the large set; the third section of the tuning condenser is also reserved. The coils are "General" types, the numbers of which appear on the diagram.

Metal tubes are used as they require no additional shielding and are the types com-

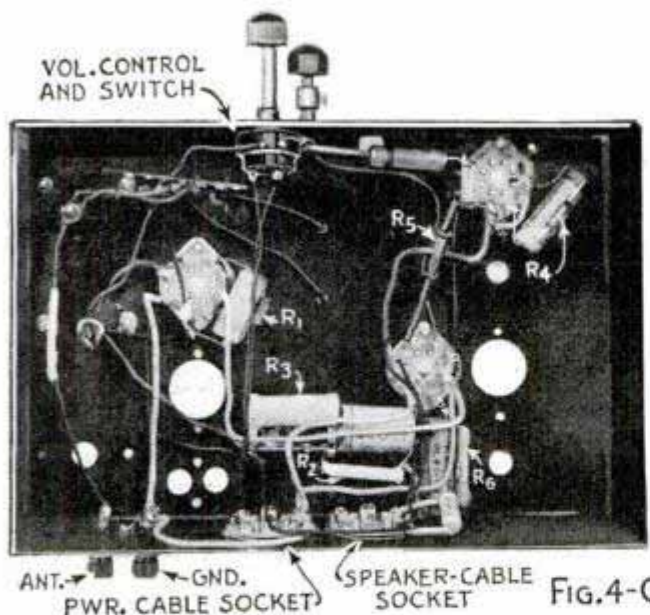

FIG. 4-C

monly employed in commercial receivers. Although this 4-tube circuit is a standard t.r.f. variety, it will be noted in schematic circuit diagram Fig. 5 that a type-6Q7 tube

(Continued to page 138A)

FIND LIFE DULL?  
SAVING ANY MONEY?  
THIS **FREE** BOOK  
is what you need!

It's packed full of ideas—new sources of pleasure, new ways to profit. Do you find life dull . . . uninteresting? Thrill to building a radio of your own. Get stations in far-away lands. This book has all the parts you need, in handy builder's kit complete with instructions. It's easy—and fun!

**LIKE TO HAVE FRIENDS?** Become a radio amateur. Make friends all over the world. This book offers a complete line of nationally advertised amateur equipment at surprisingly low prices.

**CAUGHT IN A RUT?** Get into radio servicing, or Public Address sales and installation. Earn good money full time or spare. This book can supply you with everything you need—complete stock of radio parts, tubes, tools, equipment. Special section on sound systems. Save money on everything you buy!

GET THIS 1940  
**FREE** Radio Catalog

See what's in it for you. If you're looking for a hobby, a sideline or a profitable career — you need this 188 page guide. For your **FREE** copy, tear out and mail this coupon NOW. . .

*Free Xmas Number*

Here's a special catalog crammed with Christmas values. All the latest type cameras, complete equipment and supplies. New 1940 radios, modern household appliances, educational toys—excellent gift suggestions at money-saving prices. The coupon brings you both catalogs **FREE**. Mail it

Radio Wire Television Inc. WHOLESALE RADIO SERVICE CO., Inc.

**LAFAYETTE RADIO**

NEW YORK, N. Y. CHICAGO, ILL. ATLANTA, GA.  
100 SIXTH AVENUE • 901 W. JACKSON BLVD. • 265 PEACHTREE ST.  
BOSTON, MASS. • BRONX, N. Y. • NEWARK, N. J. • JAMAICA, L. I.  
110 Federal St. 542 E. Fardham Rd. 24 Central Ave. 90-08 166th St.

Radio Wire Television Inc.  
Dept. 7M9—100 Sixth Ave., New York.

Rush **FREE** 1940 Radio Catalog No. 78   
Rush **FREE** Xmas Catalog No. 79

NAME \_\_\_\_\_  
ADDRESS \_\_\_\_\_  
CITY \_\_\_\_\_ STATE \_\_\_\_\_

**FREE!**  
a double  
**XMAS**  
**GIFT**

PASTE COUPON ON PENNY POSTCARD



(Continued from page 137A)

**"If only I could have had that new  
RCA ELECTRONIC LAB  
when I was young!"**



Here, for the first time, is a complete electronic laboratory with which you can build many thrilling, fascinating electrical devices—and at the same time, learn something about an art which may hold a profitable, exciting future for you.

Ask your dad what he'd have given to have owned one of these great new RCA Electronic Labs when he was a boy. He'll tell you—"Plenty!"

And no wonder! For with an RCA Electronic Lab you can spend scores of thrilling, funfull evenings building many exciting electronic devices. Your own announce system, which you can use for talking through the family radio from an adjoining room. Or your own telegraph practice set on which you can practice code. Or your own radio. In addition, you can build a mystifying Magic Relay, too—and with it you'll have laughs galore performing stunts that will amaze your family and friends.

Sounds simple, doesn't it? And it is. You receive complete instructions, making everything easy to build. The parts in the RCA Electronic Lab are genuine—and may be used over and over again. And every minute you use this Lab you're learning more and more about electronics—gaining knowledge of a great art that you may some day wish to make your own profession.

By all means see the RCA Electronic Lab at your RCA Victor dealer's—or any place where toys are sold. Two models, priced from \$7.50 f. o. b. Camden, New Jersey.

For finer radio performance—RCA Victor Radio Tubes

Trademark "RCA Victor" Reg. U. S. Pat. Off. by RCA Mfg. Co., Inc.

**Put on your own radio dramas with sound effects!  
SEE NEW RCA SOUND CONTROL STUDIO**



By-Products Division, RCA Manufacturing Company, Inc. Camden, N. J. A Service of the Radio Corporation of America

is used as a triode power detector, the diodes not being connected. A type 6K7 is employed in the r.f. stage and the 6F6 in the output stage delivers 3 watts of audio power. A detailed material list for this 4-tube set can be obtained from Popular Mechanics radio department without charge. Any good permanent-magnet dynamic speaker with the correct output transformer will work nicely. A table-type cabinet, or console, may be used to house

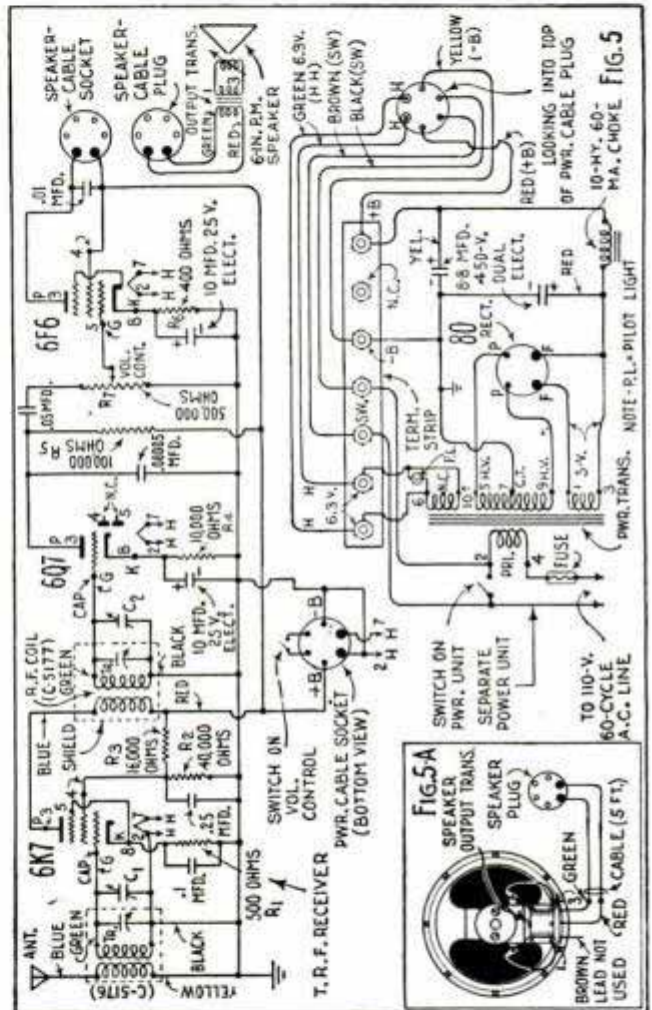

both the receiver and speaker if preferred; an airplane-type dial with universal scale is recommended. Photos Figs. 3-B and 4-C are underside views of the completed power unit and receiver chassis.

To balance this set, tune in a good powerful local station at about 1,400 kc. Reduce the volume until the program is barely audible. Now turn the set in the position indicated in photo Fig. 4-A and adjust the top trimmers with a small screwdriver until maximum volume is obtained. Any good indoor or outdoor antenna may be used. The blueprint number of this 4-tube set is R-273.



**Boys! HOW MANY OF THESE CHEMICAL SECRETS DO YOU KNOW?**

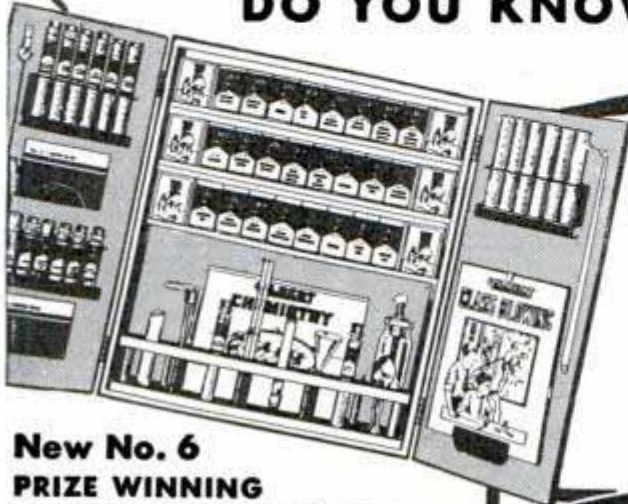

Do you know how to write messages in magic ink, make a chemical weather flag, change the color of flowers, make your own paints, sparklers, soda water? These are only a few of the hundreds of scientific secrets that a Gilbert Chemistry Set puts at your finger tips. Gilbert Chemistry Sets are the kind boys win fame with. Look for the words "Developed at the Gilbert Hall of Science." Also, see the new Gilbert Microscopes—the sets that reveal Nature's innermost secrets and colors.

**\$200.00 Annual Awards** — Mr. Gilbert will award \$100.00 in cash to the boy doing what he considers the most important research in Chemistry, Microscopy or Electricity in 1940—and \$10.00 each to the ten boys doing the next most important research. Mail coupon for full details.

**New No. 6 PRIZE WINNING CHEMISTRY LABORATORY**

Big blue wooden cabinet forms Laboratory over 2 ft. long with 5 feet of test tube racks and shelf room. 63 chemicals and pieces of apparatus, including glass blowing equipment, 2 books by noted Yale professors describing over 400 exciting experiments. Price \$5.00. Other Gilbert Chemistry Sets \$1.00 to \$15.00. See them at your nearest toy store.

**Free "THE FUN OF EXPLORING SCIENTIFIC SECRETS"**

Big 20-page book crammed with color pictures of latest developments of Gilbert Hall of Science as exhibited at New York World's Fair. Mail coupon or 1¢ post card.  
The A. C. Gilbert Co., Gilbert Hall of Science  
Room 209, New Haven, Conn. (offer good only in U. S. A. and Canada)  
Name.....  
Street.....  
City..... State.....

**SOLVES THE Gift PROBLEM**  
The Hull Streamline Auto Compass is an attractive, practical answer to the Christmas gift problem . . . and solves the problem of directions for motorists. Streamlined Bakelite case, super-visible dial, genuine sapphire bearing, built-in compensator. Available in black or mottled brown. Attractive gift package.  
Only \$2.95 at your dealer.  
Write for Literature.  
**HULL MANUFACTURING CO.**  
P. O. Box 246-D20, WARREN, OHIO

**NEW Grinding Attachment**  
For 8" to 16" Metal Lathes. Build it Yourself.  
At last, a precision grinder within your means. You save 2/3 by finishing our semi-machined castings, on your own lathe. HURON handles both internal and external grinding. Accuracies to .00025". Mirror finish easily obtained. Grinds valves, pistons, bushings, shafts, hard or soft. Holes, lathe centers, Sharpen reamers, milling cutters. Does eccentric drilling; lags; polishes; scores of other uses, for home workshops, garages, machine shops. Write for FREE illustrated folder and full information.  
**Huron Machine & Tool Co., Dept. B-12, Yale, Mich.**

Semi-Machined Castings Only \$5.95

**IS IT SPLIT? WE'LL FIXIT!**  
SAYS GLUEKY  
Apply Rogers Glue—place splinter, joint, or pieces in position—clamp . . . then chipped, splintered, and broken articles will look and remain like new when repaired with Rogers Glue . . . **incredibly** strong. Sells 10c and up in tube, jar or can at hardware stores only or send 10c for full size jar plus free project book giving new ideas, new plans for making useful articles to Dept. A  
**ROGERS GLUE COMPANY, Gloucester, Mass.**

**ROGERS**  
the best LIQUID FISH GLUE

**WOMEN KNOW WHY THIS FREE OFFER WORKS!**

FREE SHAVING CREAM SAMPLE? WHAT'S THE IDEA?  
WELL, WHY NOT? YOU'RE ALWAYS GROUSING ABOUT HOW SHAVING HURTS YOUR FACE. — THIS LISTERINE SHAVING CREAM MIGHT BE THE ANSWER.

HONEY, YOU'RE A GENIUS! THIS CREAM'S THE NUTS! MY FACE FEELS LIKE A MILLION — SMOOTH AND COOL AS A BABY'S.  
GUESS I KNOW HOW TO PICK WINNERS! — IT'S A LAMBERT PRODUCT.

BILL TELLS HIS FRIENDS  
I'M TELLING YOU! — YOU CAN'T BEAT LISTERINE SHAVING CREAM! — SAVES CASH TOO — ONE 35¢ TUBE LASTS THREE MONTHS.  
LISTERINE, EH? — UNDERSTAND THEY MAKE A SWELL BRUSHLESS CREAM TOO.

**20 SHAVES FREE**

**CLIP THE COUPON** → Lambert Pharmacal Co., Dept. 125, St. Louis, Mo. Please send me free and postpaid your large sample tube of  Listerine Shaving Cream;  Listerine Brushless Cream. (Check whichever is desired.)  
Name..... Address.....  
City..... State.....



# SMOOTH-ON No. 1

dependable in repair work  
as water in making steam

SMOOTH-ON No. 1 derives its unequalled usefulness primarily from easy application, from quick setting into solidified iron, and from expansion in doing so. Where this last can be utilized with wedging action, as between the walls of a crack, under a clamped plate or between threads or flange faces, the combined adhesion and expansion into all voids, lock the solid metallic filling into place and produce lasting tightness. Leaks stopped with Smooth-On No. 1 are therefore permanently sealed, stripped threads can be made to hold perfectly, and loose nuts can be made to stay locked—all with minimum effort and at low cost. Smooth-On repairs also avoid the delay and expense for a professional mechanic.

The SMOOTH-ON HANDBOOK, filled with practical advice and information, explains all Smooth-On compositions and their uses, contains simple instructions with working diagrams for proper application under any conditions, and is a repair guide that every home owner and handy man should have. Study its contents and keep

a can of Smooth-On in your work bench. You will then be prepared to stop many common nuisances and in case of a sudden leak or crack, you will have a life-saver.

Return the coupon for your copy of the booklet, and buy Smooth-On in 7-oz. or 1 or 5-lb. can from your hardware store or from us.



Write for FREE BOOK



Do it with SMOOTH-ON

SMOOTH-ON MFG. CO.,  
574 Communipaw Ave.,  
Dept. 37,  
Jersey City, N. J.

Please send Smooth-On Repair Book.

Name .....

Address .....

12-39 .....

## A Junior for Junior



Synco Junior Jig Saw . . . The best bet for a Christmas Gift. The safest, most practical saw ever made to make models, toys, furniture or games. Junior will spend countless hours in rapturous enjoyment making things with his own hands.

**\$4.95** Give him a Synco Jr., the first step toward a pleasurable, profitable, safe hobby. See them at your dealers. Send for catalog A.

NEW YORK OFFICE - - 200 FIFTH AVE.

SYNCO DEVICES INC. 747 BEAUBIEN ST. DETROIT

**NOW ONLY \$5.00 REAL ENGINE VALUE**

Over 7,000 GHQ Gas Engine Kits were sold at \$8.50. Over 10,000 sold last year. Now is your chance to buy the *New Improved* kit for \$5.00. Absolutely complete with coil, plug, etc. For boats, planes, etc. All parts guaranteed. Send only \$1.—*Shipped Express Collect for balance same day. Send 3c for new 12-page illus. catalog. DEALERS WRITE.*

All parts finished. Only a screwdriver needed. 1.5 H.P. Average assembly time 30 minutes.

GHQ MOTORS, 40B East 21 St., New York, N. Y.

**BURN YOUR NAME ON TOOLS WITH THE ARKOGRAF**

**PROTECT YOUR TOOLS FROM THEFT**  
Write with electricity any name or design on the hardest and finest tools and instruments, or any metal, like writing on paper with pen or pencil. **Complete Outfit \$3.50—Prepaid Anywhere**. Interesting illustrated circular free. Write today. Agents wanted. ARKOGRAF PEN CO., 3927 S.E. Stark St., Portland, Ore.

**WOODWORKERS NEW BARGAIN BOOK 10¢**

The 1940 Constantine Catalog makes available most complete source of fine woods. Packed with valuable useful facts, some not previously published. Gives free housing details of our new educational motion picture for woodworkers. All who work with woods need it. Send 3c stamp or coin today.

ALBERT CONSTANTINE AND SON, INC.  
7918 East 135th St. New York, N. Y.  
The Craftsman's Headquarters for Fine Woods

**CAMERA BOOK FREE!**

Illustrates latest methods in Photography and Home Movie Making, for fun and profits. Offers hundreds of amazing money-saving bargains in still and movie cameras, lenses, films, etc. Used equipment accepted in trade. Satisfaction guaranteed or money back with 10-day trial privilege. **WRITE FOR FREE BARGAIN BOOK!**

CENTRAL CAMERA CO., 230 S. Wabash, Dept. L-16, Chicago, U.S.A.

**Work Faster Make More Money with the Red UNIVERSAL TRACTOR**

With this practical machine and attachments you can do all field and belt work hours faster at the low cost of 33c per day. Many units pay for themselves the first season. Unusually easy to handle and operate. Absolutely safe. Hundreds of users. Buy direct at low factory price. Two weeks' trial—satisfaction guaranteed. Write for colorful, free catalog.

PIONEER MFG. CO. Dept. V-129 West Allis, Wis.



## The Movies Join the Army

(Continued from page 889)

ment—soldiers and civilians alike. Under the new plan short films of one and two reels would be made on a large scale. For the most part they would be sixteen-millimeter, amateur size, sound films that would show every type of military drill and would be made available immediately for every army training unit.

In charge of the training film program is a staff of Hollywood trained technicians who work in a tiny laboratory in the Army War College grounds. These experts run a highly efficient motion-picture producing plant containing the most modern equipment including finest sound apparatus, a couple of expert animation artists, plus a corps of directors, actors, projectionists and mechanics.

According to Major R. T. Schlosberg, U.S.A., who directs the movie unit, "The use of animated cartoons is one of the most effective methods in this ultra-modern system of education. Functional processes of equipment and precise operation of weapons can be demonstrated effectively in this manner. For example, a complete picture of what occurs inside the recoil mechanism of a big gun can be illustrated visually by no other method."

The army also maintains a training film unit, based at Fort Monmouth, N. J., in charge of Major M. E. Gillette. This unit is charged with the preparation of scenarios and the photographic and editorial work in connection with the completion of the finished training film.

Raw materials for an army movie cost from \$600 to \$700 a reel, depending on the number of retakes. When a movie has been filmed it goes through about the same general procedure in the army as it would in Hollywood. Developed, cut, edited and assembled, it will then be shown in a projection room with walls and ceilings soundproofed, while army officers, seated in red-leather chairs, look on with critical eye. Copies of each movie are sent to the various corps area headquarters.

The Signal Corps made hundreds of thousands of feet of film during the world war. This material, together with subsequent additions, probably constitutes the largest and most valuable collection of historical movies in the government service.

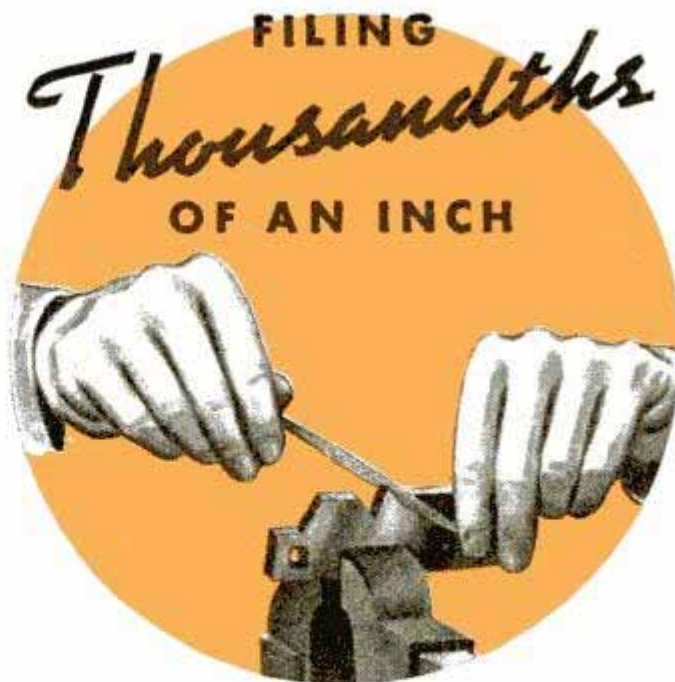

## Calls For NICHOLSON X. F.

Knurled Handle

### NEEDLE FILES

12 DIFFERENT SHAPES  
IN A WOODEN BOX  
THAT BECOMES  
A BENCH STAND



If you're one of industry's craftsmen, you need these files for fine tool and die-making, for jewelry and silverware manufacture. And you *home* craftsmen need them too, for fashioning tiny parts of models, for other delicate work. If you're a gunsmith or sportsman, you'll find them invaluable for remodeling or changing sights, speeding up actions, reducing trigger pulls.

Sets of 12 files in assorted shapes come in 4", 4¾", 5½" or 6¼" lengths. And in any one of these cuts: Nos. 0, 2, 4, 6 (No. 6 is finest). If your hardware dealer can't supply you, write us direct. Specify length and cut you wish. 6¼" length, No. 2 cut, is most popular for general use. Nicholson File Company, 22 Acorn Street, Providence, Rhode Island.

SHOWN ACTUAL  
SIZE -- NICHOLSON  
X. F. NEEDLE FILE  
(FLAT) 4" LONG,  
NO. 2 CUT

A FILE FOR EVERY PURPOSE

# NICHOLSON

PIONEERS IN  
QUALITY PRODUCTION

75<sup>th</sup>  
ANNIVERSARY  
YEAR



# 5 Radio Books in 1

## Free THE CATALOG WITH EVERYTHING IN RADIO!



60 new Knight sets for every purpose, 4 to 12 tubes, newest features, "Air Magnet," etc. — latest portables, new electric phonographs, phono-radios, — all sensational values!

3 complete, new lines — "Economy," "Standard," and "Deluxe" — 14 new systems, 6 to 70 watts, new beauty and performance! — "mikes," recording equipment at lowest prices. New Time Payment Plan!

Most complete amateur listing in all radio! — all latest receivers, Rotary Beam, Television equipment, all standard lines at lowest prices. — or New lower-cost Time Payment Plan!

Over 15,000 parts for every purpose, latest tubes, tools, books, etc., at lowest prices! Latest Test Equipment, Rider Voltbyst, etc. Dozens of new kits, diagrams and projects!

Special section of super-bargains! Smashing values in BRAND NEW standard radio parts, sets, cabinets, headphones, and accessories of all types. Don't miss these super-values!



**DEALERS SAY:** "The new Knight Sets are a scoop. Those remarkably low prices can't be beat! Your catalog is invaluable for supplies of all kinds!"

**SERVICEMEN SAY:** "Your 1940 Catalog is the best ever! Bigger listings than ever before, with all the repair parts for every Service requirement!"

**P. A. MEN SAY:** "Thanks for the complete range of great new P. A. systems. Your "Choice of 3 Systems" serves every P. A. purpose!"

**AMATEURS SAY:** "That big new Ham Section takes the prize! The full dope on all the newest gear and everything a Ham might want! Thanks for a real catalog!"

**BUILDERS SAY:** "You sure know what a Builder wants! More kits, diagrams and projects than ever, in your 1940 catalog! It's a honey!"

**FREE  
SEND  
COUPON**

**ALLIED Radio Corporation**  
Dept. 5-M-0, 833 W. Jackson Blvd.  
Chicago, Illinois

RUSH me your FREE 204-page Radio Catalog.

Name .....

Address .....

City..... State.....

## Portable Low-Cost Sound System

(Continued from page 938)

tion is made by means of a recessed-type plug and receptacle indicated in photo Fig. 2-D. This socket is connected to a dual receptacle plug screwed to the bottom of the case to provide a convenient means for supplying power to the amplifier and phonograph motor, both of which are operated with independent switches.

The mounting panel detail for the phono turntable shows the location of all mounting holes, and dimensions for the phonomotor cutout to meet the requirements of

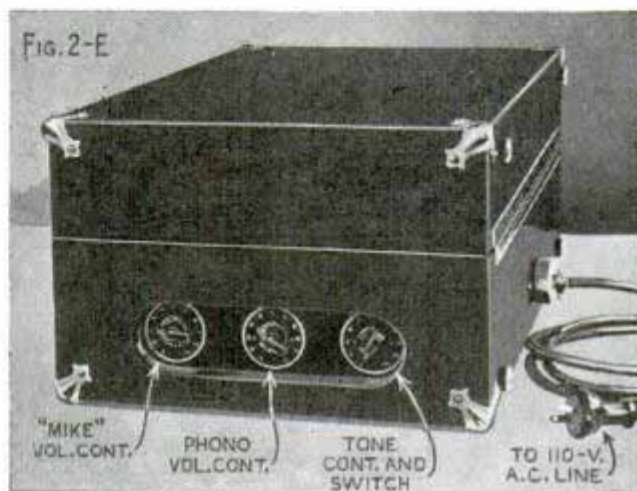

the one specified. These dimensions may be altered to suit any other type that the builder may prefer. The motor switch and auxiliary pickup gain control are also mounted on this panel in the manner shown in the photo. Soft rubber washers are used on the motor mounting screws above and below the panel to cushion the motor and turntable assembly. External connections for two 12-inch, permanent-magnet type loudspeakers with 15-ohm voice coils, and a microphone, are provided by the sockets and microphone jack mounted in the front of the case directly under the carrying handle. Sixty feet of heavy 2-conductor rubber-covered cable is provided for each speaker, the cables terminating in 4-prong plugs with connections made to the large prongs. The cables are coiled in the rear of the speaker cases when not in use. Speaker cases may be of the homemade variety shown, or similar ones are available from radio parts houses. They are provided with handles to make them easily portable. The large instrument case weighs approximately 36 pounds. Blueprint number for this article is R-272.



# Powerful New DELTA SHAPER

It's here at last—and arousing tremendous interest among power tool users everywhere. This new Delta unit offered at a surprisingly low price is a basically improved shaper—a powerful, smooth-running accurate tool that gives you heavier, faster cuts than the ordinary light shaper. It will shape, form or mould any form of work from the smallest mouldings to heavy production work.

## Many Special Advantages

Some of its new features are: 1. Large Husky Spindle; 2. Exceptionally Big Table; 3. Long Spindle and Spindle Travel; 4. Large Sealed-for-life Bearings; 5. Powerful V-Belt Drive; 6. Interchangeable Spindles; 7. Fully Adjustable Fence; 8. Strong, Welded Cabinet. Every man interested in power tools should get the full details on this remarkable machine.



## NEW LOW COST DELTA GRINDER AND BUFFING HEAD

Has 6" x 1/2" wheels, easily removable cast iron guards, adjustable tool rests and a quality heretofore not found in low-cost grinders. May be driven from back or bottom. New Delta Buffing Head is similar to grinder except that guards and rests are eliminated. Has 1/2" threads so that many standard attachments can be used such as scratch wheels, wire brushes and chucks.

No. 3100 Delta Bench Grinder . . . \$5<sup>75</sup>

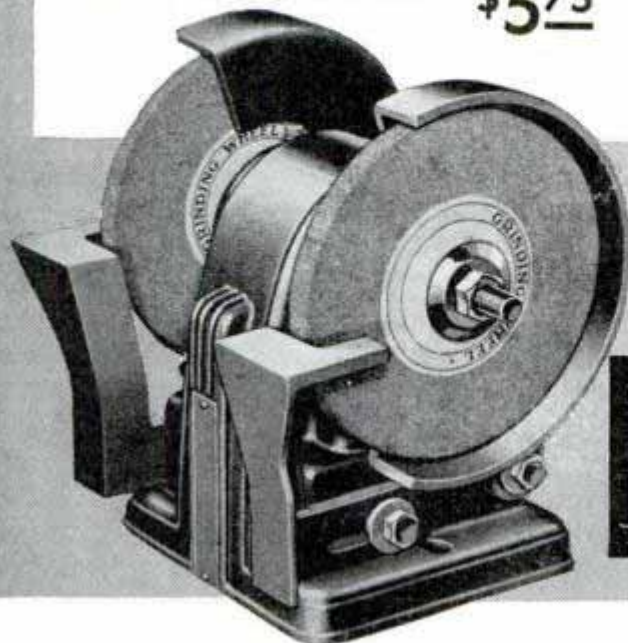

## SEND FOR CATALOG

The latest Delta 1940 Catalog gives you full information on the complete Delta line of low cost tools for home shops, small shops and industry. (Also send for new Project Book No. 6 crowded with new and "out of the ordinary" things to make. Has scores of diagrams, photographs and working drawings. Send 10c with coupon for Delta Project Book No. 6 and Delta Catalog.)

Delta Manufacturing Company, Dept. A1239  
600-634 E. Vienna Ave., Milwaukee, Wis.

I enclose 10c for new Delta Project Book No. 6 and new 1940 Delta Catalog of Power Tools.

Name .....

Address .....

City.....State.....

## DELTA Mfg. Co.

600-634 E. Vienna Avenue  
MILWAUKEE, WIS.

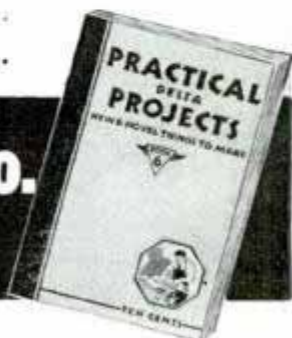



Now CASCO does  
every gluing job!



**MODEL-BUILDERS, CAMERA FANS** and household handymen choose the new CASCO FLEXIBLE CEMENT because it sticks *all* surfaces *quickly*. Fastens felt, cork, fabric, canvas, leather—to metal, wood, plastics, plaster, even glass! Contains *casein* for strength, and *rubber* to absorb shocks and expansions of widely dissimilar materials.

**WOODWORKERS, BOAT-BUILDERS**, men who make heavy-duty, weight-bearing *wood* joints use CASCO POWDERED CASEIN GLUE for its *permanent* bond. Easy to mix, used cold, and economical, it's the master workshop glue!

CASCO adhesives are already proved through years of industrial use by leading U. S. manufacturers. CASCO's moisture- and heat-resistant joints give your handiwork the permanence it deserves.

CASCO Flexible Cement, large tube—25c... Also in pint and quart cans. Casco Powdered Casein Glue—10c to 65c—at hardware stores.

## FREE! Home Workshop Handbook

Helps woodworkers from beginner to Master Craftsman. Contains a list of free and low-cost booklets offered you by leading experts on Tools, Finishes, Sharpeners, Cabinet Woods and Veneers, Project Plans and Workshop Clubs. First book with *all* this information. Mail coupon *now* for your copy.



CASEIN COMPANY OF AMERICA  
350 Madison Ave., Dept. PM-1239  
New York, N. Y.

Yes, send me your free "Home Workshop Handbook"

Name \_\_\_\_\_

Address \_\_\_\_\_

Save 2c, stick coupon on penny postcard

## Sharpshooting at Unseen Targets

(Continued from page 811)

So that the gunner can hit the invading ship, all these things must be figured out for him. Range and direction are simple problems in trigonometry and a clever device called a plotting board has been developed to solve these problems automatically and instantly.

A coast-defense fort will have base-end stations, perhaps several miles away, on either side of the guns. Usually they are placed on some high point of ground that permits observation many miles to seaward. These stations will be at known distances from the guns, and will be connected to the plotting room by telephone.

Observers at each station pick up the enemy ship with their telescopes, which are mounted over a graduated dial. Hav-

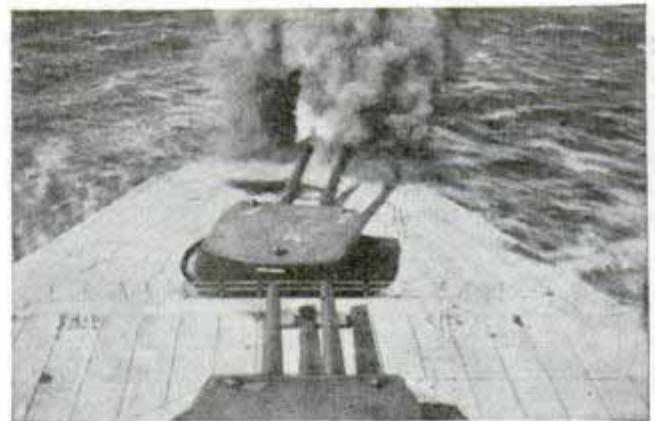

With decks cleared for action, forward turret of cruiser hurls two shells at enemy

ing the ship spotted at the cross hairs, they read the dial pointer and phone the azimuth reading to the plotting room, where a miniature range is laid out on the plotting board. This board is a semi-circular table, graduated around its edge, and equipped with three arms, which are placed in the same proportional relationship to each other as are the two base-end stations to the guns. As the observers report the azimuths from their stations to the target, men set the arms of the plotting board to those same angles. This causes the third or gun arm to automatically point to the azimuth that the target is from the gun; while at the same time the movement of the plotting arms causes a slide on the graduated gun arm to indicate the range. Actual distance and direction from gun to target are thus read at a glance.

But this information is not enough for



2982  
 the gunner. A man sits at the range correction board, making adjustments for all the variables that affect range, so that when the actual range is called out to him, he need only set that range on the board to read off the corrected range, which the board automatically computes. Another man operates the deflection board, adjusting the variables that affect lateral direction. Then by setting the actual direction on the board, he can read the corrected azimuth instantly.

In the meantime the observers at the base-end stations track the moving target, reporting the changed azimuths every minute, or other interval in which it is desired to fire the guns. After four or five such reports, the plotting officer has a line of four or five dots on the plotting board, which show him the course and speed of the ship. This enables him to plot the point where it will be at the instant he desires to have the guns fired. Next he consults a slide rule to show him how far the ship will travel while the projectile is in the air, and sets this distance off on the plotted course. This gives him the set-forward point—the point where the guns are to be aimed. The correction is applied to this range and azimuth, and the information is transmitted to the guns by phone or visual indicator.

When the first shot is fired, the base-end observers' job changes. They now watch for shell splashes, and report the angle, read by a scale etched on the telescope lens, between the splash and the target. The plotting crew set these two angles on the spotting board, which automatically computes the error for that shot, in both distance and direction.

The officer at the plotting board makes these corrections in computing future set-forward points, and this procedure continues until the target is destroyed. Often ten or more shots are fired before the target is hit; but with three or four projectiles on their way at once from the same gun, spotting corrections cannot be applied until that number of shots intervene.

While this method of spotting and target location is the most accurate possible, it probably will never be used in a future war; for a modern fleet would be concealed from the shore by a smoke screen, laid down by destroyers or airplanes.

(Continued to page 147A)

# Better Sanding\*

## 10 Times Faster

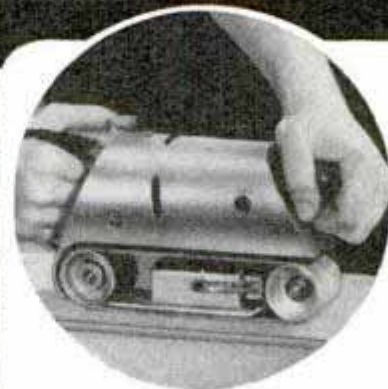

this  
**EASY  
 WAY**

### PORTABLE Guild Sander ELECTRIC

Now—save time, save tedious labor . . . get a satin-smooth job that is a delight to the eye, a joy to the touch. With Guild-Sander you can do the job **10 TIMES FASTER**, a hundred times easier.

The fast-cutting abrasive belt—quickly changed to any degree of fineness—gives a straight-grain finish. No cross-swirls, no gouges. It makes you an expert, even without practice. Useful on 1,000 jobs. Works on wood, wall board, metal, stone or plastic—on either flat or curved surfaces.

GuildSander is a precision tool—at a price you can afford—with a *written guarantee*. Runs from any light socket. Weighs only 9 lbs.—handy in any position. Try it at your hardware dealer's, or write us for complete details.

1000 USES  
 Sands-Grinds  
 Planes-Polishes  
 Buffs-Sharpens  
 Removes Paints,  
 Varnishes, Etc.

A POPULAR  
 PRICED  
 PRECISION  
 TOOL  
 Equal in every-  
 thing but size to  
 big-shop sanders  
 at double the  
 price.

RECOM-  
 MENDED  
 BY  
 Carpenters,  
 builders, cabinet  
 makers, home  
 craftsmen, boat  
 owners, millwork  
 shops, painters,  
 decorators,  
 novelty manu-  
 facturers, manual  
 training schools  
 and others.



"It is a wonderful tool and does work in a very few minutes which would require hours, and possibly days, to do by hand." *Ira W. Parker, Markesan, Wis.*

**SYRACUSE GUILDTOOL COMPANY**  
 1740-12C North Salina Street  
 SYRACUSE, NEW YORK





Don't put anti-freeze in a radiator that will clog up and overheat. Flush out rust, sediment, scale and sludge with 10c worth of Sani-Flush (25c for the largest trucks and tractors).

It's easy to do yourself. Just pour in Sani-Flush. Run the engine, drain, flush and refill (*directions on the can*). Or, if you prefer, ask your garage or service station to do the job for you with Sani-Flush. Sani-Flush cannot injure motor or fittings. It keeps radiators clean and cool. Saves power and fuel. You'll find Sani-Flush in most bathrooms for cleaning toilets. Sold by grocery, drug, hardware, and five-and-ten-cent stores. 25c and 10c sizes. The Hygienic Products Company, Canton, Ohio.

## Sani-Flush Safe NOT CAUSTIC

KEEPS RADIATORS CLEAN

**BUILD YOURSELF A MIDGET CAR**

WE SPECIALIZE IN WHEEL SETS, ENGINES, ETC. for building Cars, Scooters, Trucks, etc. We carry only the best at the lowest prices. Send 10c for parts catalog and plans for three Midget Racers, Scooters and other vehicles. It pays to use only reliable plans and parts—We guarantee satisfaction. **Build-Your-Own-Devices, 536 North Parkside, Dept. PM-2, Chicago**

A Mid-get Car or Scooter outfit is an ideal Xmas gift

## NEURITIS Relieve Pain in Few Minutes or Money Back

To relieve the torturing pain of Neuritis, Rheumatism, Neuralgia or Lumbago in a few minutes, get NURITO, the fine formula, used by thousands. No opiates. Does the work quickly—must relieve cruel pain to your satisfaction in a few minutes—or your money back. Don't suffer. Don't delay. Ask your druggist today for trustworthy NURITO on this guarantee.

## Amazing Quick Relief For Acid Indigestion

YES—TUMS bring amazing quick relief from indigestion, heartburn, sour stomach, gas caused by excess acid. For TUMS work on the true basic principle. Act unbelievably fast to neutralize excess acid conditions. Acid pains are relieved almost at once. *TUMS are guaranteed to contain no soda. Are not laxative. Contain no harmful drugs. Over 2 billion TUMS already used—proving their amazing benefit. Get TUMS today. Only 10¢ for 12 TUMS at all druggists.*

You never know when or where  
**Always Carry FOR ACID INDIGESTION**

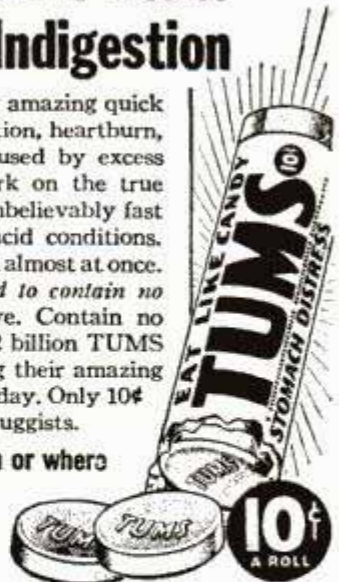

**SpeedWay DRILL \$7.95 GRINDER \$5.95**

**ROUTER \$3.95** **KIT \$14.95** **STAND \$3.95** **GRINDER \$9.95**

**QUALITY TOOLS**

... products of SpeedWay, for 30 years leading manufacturers of electric tools. Specially wound high torque 110V universal speed motors. Improved designs, correct speeds, 1000 RPM Drill with die cast handle has 1/4" capacity in steel. 20,000 RPM Hand Grinder is speed essential for efficiency and rollers for both 1/4" and 3/32" arbors. Drill and Grinder sold singly or together with 5 accessories in fitted Steel Kit. Stand does either drill or grinder. Router Frame converts grinder into router. Bench Grinder is complete with motor. Write for Circulars. **SpeedWay Mfg. Co., 1842 S. 52nd Ave., Cicero, Ill.**

**CHRISTMAS CARD PRINTER KIT**

ONLY \$1.50 COMPLETE

INCLUDES: SILK FRAME..ORGANDY.. STENCIL..TACKS..TAPE..& SQUEEGE COMPLETE AS SHOWN

**VEL-SUEDE FLOCK KIT**

ONLY \$3.30 COMPLETE

KIT INCLUDES: GUN... 3 COLORS... BINDER.. 3 COLORS VEL-SUEDE.. BRUSH

**SPECIAL COMBINATION... BOTH KITS SHOWN ABOVE... \$4.50**

**JORDAN AIR & SUCTION PUMP CO. CATALOG WRITE TODAY**  
P-9 BRYANT BLDG. KANSAS CITY, MO. DETAILS

**LEVEL STOVES, PLUMBING, CLOCKS, etc.**

New Aluminum Clear shaped level. Won't tear pocket. 9" long. Shows plumb level. 45°, 1/2°, 1°, pitch. Grooved Bottom. Only \$1.25.

**BEAUTIFUL CHROME ALUMINUM POCKET LEVEL**

Clips to Vest pocket like a fountain pen. Always handy. Accurate. Pitch graduations on level vial. Only 75c. Order direct or from your dealer. Send 10c for catalog. Empire Pattern accuracy level, used by good craftsmen everywhere.

**EMPIRE LEVEL MFG. CO., Dept. P-5**  
717 S. 6th St., Milwaukee, Wis.

**OTTAWA LOG SAW \$39 BIG BOOK FREE**

PUTS THIS OTTAWA to work for you. MAKE MONEY! Wood is valuable. Does more than 10 men. Easily operated. Falls trees—saws limbs. Use 5-hp. motor for other work. Write for FREE Book.

**OTTAWA MFG. CO.**  
2627 Wood St., Ottawa, Kans.

**TRAILER PARTS**

Largest, most complete stock of trailer parts and equipment in America. Lowest prices, quick delivery. Marvel is the pioneer in trailer accessories with a reputation for highest quality products, refrigerators, stores, etc. Send 10c in coin for 40 page illustrated catalog.

**MARVEL TRAILER PARTS CO.**  
19020 Celestine Ave. Detroit, Mich.

When writing please mention Popular Mechanics



2982

(Continued from page 145A)

In that case it would be necessary to locate the target and adjust fire by aerial observation. The plane would first fly on the far side of the enemy ship, and radio the compass bearing of the ship from two prominent landmarks on shore. Lines would be drawn on the chart from these landmarks, at the designated angles, the location of the target being where these lines cross. The airplane observer would then determine the course of the ship, and would estimate its speed; then when the firing commenced, he would observe the splashes, reporting their location with regard to the target.

Naval gunners have exactly the same problems in firing the big guns aboard the battleships; but with added complications. For not only is the enemy ship moving, but



Four shells explode as one within a few feet of towed target, recording a hit

so is the ship from which the guns are fired. And a ship permits of no long base line from which accurate triangulation is possible. Instead, an optical range finder, with a base of only thirty feet, must be used. This instrument is so designed that when a true image of the target appears in the eyepiece, range and direction may be read direct from a scale. This information is set on an amazingly intricate machine called a director, along with data on the variables, and the courses and speeds of both ships. The director automatically and instantly computes set-forward points, and by an electrical hook-up, aims the turret guns, which may all be fired together at a touch of the gunnery officer's finger.

The roll and pitch of a ship in a heavy sea adds another complication. It readily can be seen that the guns must be aimed in

(Continued to page 149A)



*Be Your Own Boss*  
**GET INTO AIR CONDITIONING**

Work out of your home—in spare time—newspaper and phone book ads work for you. Make winter air conditioners so cheap they sell themselves. \$20 and a little work will start you in business. No books—no studying—just assemble and sell. Easy sales—quick profits, easy work.

**A YEAR'S PAY IN 4 MONTHS**

Boreli made \$3600 gross—Forkes made \$1200 gross—Whitlow \$1700 gross—Walters made \$6800 gross—Wilson made \$2300—Knudson made \$500 gross. You can make \$500 to \$5000 gross in 6 months. Don't wait! Get in the money now!

**INSTALL**



**COAL BLOWERS**

A coal blower operated by a thermostat gives you everything a stoker provides except underfeeding of coal! Your cost is \$12.99. You sell it for \$29.95 installed! The cheapest stoker is \$150 so you save your customer \$120. Save their cost in 3 months. Cut doctor bills. 90% of all homes need them. Cash in now! Coal companies will help you!

No. A1 Complete automatic heating unit with 110V, 60C electric motor driven blower, thermostat, mounting plate, stackstat, B-X and full instructions..... **\$12.99**

You can make a real income with this unit.

**INSTALL**



**FURNACE FANS**

Every furnace needs a furnace fan to bring hot air up quickly, before heat is lost, and to force it into far, cold corners. **Cuts fuel bills up to 20%!** Saves replacing old furnaces! Cost you \$14.99. You sell it for \$29.95 installed! A quiet torrent of air! All furnace heated homes are real prospects because they pay for themselves in a few months! Make money on it. NOW!

No. A2 Complete automatic 12 inch, 110V, 60C Electric motor driven furnace fan, Thermostat, B-X and full instructions for easy installation..... **\$14.99**

You always make money when you save people money!

**INSTALL**

**FURNACE AIR CONDITIONERS**

Filtered forced air is the sign of a modern furnace. You can make every furnace modern for \$39.95 installed, by using our \$27.63 unit. A silent tornado of clean, hot air penetrates every cold corner providing comfort and fuel savings, lower decorating and cleaning bills.  
No. A3 Complete 110 V, 60 C, electric motor driven furnace filter unit complete in cabinet with Edgeseal filter pad..... **\$27.63**  
No. A4 Thermostat for automatic control of above, line voltage..... **\$4.25**  
**This is a tremendous profit opportunity for ambitious men.**

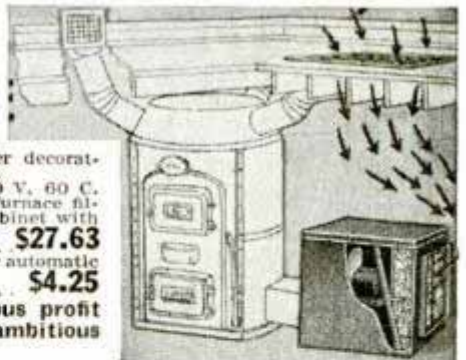

**INSTALL A UNIT IN YOUR HOME NOW!**

**BLUE PRINTS FURNISHED WITH EACH ORDER**

**AIR CONDITIONING HEADQUARTERS,**

912-918 W. Ohio St., Chicago, Ill., U. S. A.

Show me the way to earn a year's pay this winter in my own business and rush me the items ordered below:

Sets	Description	Price Prepaid	Total
.....	No. A1 Automatic heat package.....	U. S. A. \$12.99	.....
.....	No. A2 Automatic furnace package.....	14.99	.....
.....	No. A3 Furnace air conditioner.....	27.63	.....
.....	No. A4 Line voltage thermostat.....	4.25	.....
.....	Catalog, circulars and prints .25 (Free with order)		
	\$10 UNIVEX 8 MM MOVIE Camera only \$5.95 with any order.		
	I am enclosing \$.....cash. Balance \$.....C.O.D.		
	Name.....Address.....		
	Town.....State.....		

**WIN INDEPENDENCE - ORDER NOW!**



# THOUSANDS REJOICE AS THEIR SKINNY BODIES FILL OUT

SKINNY MEN HAVE NO ATTRACTION FOR MOST GIRLS



Posed by professional models

## AMAZING GAINS OF 10 TO 25 LBS. IN A FEW WEEKS REPORTED BY MEN AND WOMEN EVERYWHERE

THOUSANDS of thin, rundown, nervous men and women who had tried several other tonics without apparent results—who could hardly look at food, slept poorly and were always tired and jittery—report gains of 10 to 25 pounds in a few weeks, wonderful new pep, fine appetite, sound sleep, steady nerves—through simply taking these amazing little Ironized Yeast tablets.

The reason is simple. Scientists have discovered that great numbers of people are skinny, puny, tired and shaky only because they don't get enough Vitamin B and iron from their daily food. Without these two vital substances you may lack appetite and not get the most body-building good out of what you eat.

But now you get these exact missing substances in these scientifically made, easy-to-take little Ironized Yeast tablets. So it's easy to see how, with their aid, so many almost hopeless people have easily put on the naturally attractive pounds they so long wished for—have gained new strength, new pep, new friends and new joy in life.

### Try them on money-back test

Get Ironized Yeast tablets from your druggist today. If with the first package you don't eat better and FEEL better, with much more strength and pep—if you're not convinced that Ironized Yeast will give you the normally attractive flesh, new energy and life you have so long wished for, the price of this first package will be promptly refunded by the Ironized Yeast Co., Atlanta, Ga.

Only be sure you get the genuine Ironized Yeast, and not some cheap inferior substitute which does not give the same results.

### Special offer!

To start thousands building up their health right away, we make this special offer. Purchase a package of Ironized Yeast tablets at once, cut out the seal on the box and mail it to us with a clipping of this paragraph. We will send you a fascinating little book on health, "Facts About Your Body." Remember, results with the first package—or your money refunded. At all druggists, Ironized Yeast Co., Inc., Dept. 5312, Atlanta, Ga.

**TUNE IN ON JOHN J. ANTHONY'S GOOD WILL HOUR.** See your local newspaper for exact time and station.



## new POWER JOINTER

only **6.50** postpaid (Outside U. S. A. \$7; C. O. D. \$6.75)

"The Jointmaker"

## AMAZING VALUE

### FREE CATALOG!

describing \$150 Prize Contest (1st prize \$25; 2nd \$15; 3rd \$10; 41 other cash and merchandise prizes). Cut. Illustr. complete power tool line: Jig Saw, \$1.50; Shaper, Circular Saw with oilless bearings, \$2.50; Drill Press, \$2.50; Sander, \$1; completely equipped lathe, \$2.00 and \$4.00. Sold direct only. Order today or send card for Catalog.

\$150 PRIZE CONTEST

Just think of it, a real "power jointer" at this astonishingly low price! "The Jointmaker" performs every jointing operation (planes, cuts angles, rabbets, etc.) smoothly and quickly. Weighs 8 lbs.; is overall 4 1/2" high by 8 1/2" wide by 4 1/2" long; has 4 3/4" wide table with tempered carbon steel knives set in solid safety-type cylinder with automatic without tools. Frame and justable cast iron.

Guarantee: Satisfaction or full refund if returned within 5 days.

J. & H. Metal Products Co. 5 Commercial St., Rochester, N. Y.

## NEW KIND OF MAN'S SHOE

The new sensation in men's shoes — The Chippewa Clipper. It zips on and off in a "jiffy". Right now is the right time to get into a dignified and highly profitable shoe business of your own with this fast seller, and a complete line of almost 250 styles of dress, work and sports shoes. Prices as low as \$1.98 a pair. Free 10-second demonstrator sells super-comfort air-cushion shoes like magic.

Manufacturer established 35 years wants salesmen. No experience needed. Write for complete sales kit. It's free!

MASON SHOE MANUFACTURING CO. Dept. E-45, Chippewa Falls, Wis.



ZIPS ON AND OFF

SALESMEN WANTED BIG PAY EVERY DAY

## BUILD THE SCHOONER BLUENOSE

Complete Kit

\$2.50

Post Paid

Makes perfect building easy



### CARVED PINE HULL

Metal Anchor, Steering Wheel, Lifeboats, Anchor Chain, Casks, Masts, Dowels, Lacquer and Cement.

Complete hobby catalog, 10c

IDEAL AEROPLANE & SUPPLY COMPANY, INC. 26 W. 19th St., New York

## TRAILER BUILDERS · BUYERS · OWNERS

TRAILER Send 25c for this Big Book Today

Over 100 pages! Beautifully Printed and Illustrated! Trailer Suggestions and Ideas galore! Catalog shows America's greatest line of Trailer Parts and Equipment at lowest prices. Everything from wheels to top. Rush 25c today. Satisfaction positively guaranteed!

TRAILER SUPPLY CO. Box 433-A

WAUSAU, WIS.



## BUILD IT YOURSELF

### The Jim Dandy Cabin Cruiser

The Trailer that has everything. Classy! Roomy. Easy to build in any size with my simplified Plans and Instructions—Price \$1.00. Rush dollar bill today to JIM DANDY Box 125-A WAUSAU, WIS.

## "PEPY" GASOLINE ENGINE GOVERNOR



Make your Auto, Truck or Tractor Motor into a steady, even power unit for all kinds of work. Fits any make of engine. Money back guaranteed. Price, postpaid, \$9.50

Harris Machy, Co., 505 30th Ave., S. E., Minneapolis, Minn.

## BUILD YOUR GRANDFATHER CLOCK

The Simple Sensible Red-i-Kut way as thousands have. DIME brings PLANS and sixty picture "HOW" Book pricing many fine brass weight Westminster, tube chime, electric and battery movements showing nine beautiful colonial grandfather cases. WHY WAIT LONGER?

KUEMPEL CHIME CLOCK CO., Bldg. 35, Guttenberg, Iowa.



## ENGINES

A real money maker for farm or factory. Uses Cheap fuels. Pays for itself out of savings. Costs Less to Own—Less to Operate.



## LOG SAWS

Make Money—Start a wood sawing business—turn spare timber into cash. Cash or Terms—Engine and Saw Catalog.

WITTE ENGINE WORKS 1745 OAKLAND AVE. KANSAS CITY, MO.



(Continued from page 147A)

relation to the surface of the earth, rather than the ever-changing angle of the deck, else ranges become meaningless. To compensate for roll and pitch, the navy has perfected a mechanical device which corrects for the ship's motion at the instant of firing. These marvelous devices are among the navy's most guarded secrets; no one ever being permitted to see them except those entrusted with their operation.

The fleet carries its own observation planes, either on carriers or on catapults of the fighting ships, to locate the enemy and to adjust fire by observing the splashes.

The problem of field artillery that accompanies the mobile army is simpler in well-mapped country, for with gun and target accurately located on a map, the direction and range can be read directly, using a protractor and map scale.

But maps suitable for fire-control purposes are available for only a small portion of the earth's surface. And without such maps, every artillery problem becomes a complicated computation in trigonometry, for field artillery cannot carry the cumbersome and delicate instruments used by the navy and coast artillery to solve their problems mechanically.

*21107*  
**Alarm Clock for Flyer Rings Bell When Rental Period Is Up**

Pilots who rent planes by the hour from one operator at Floyd Bennett field can no longer offer good excuses for staying in the air beyond the time limit. In the cockpit of each airplane is a "flying time" alarm clock that rings a bell as soon as the specified rental time is up. Four control knobs are used for marking fifteen, thirty, forty-five and sixty-minute periods.

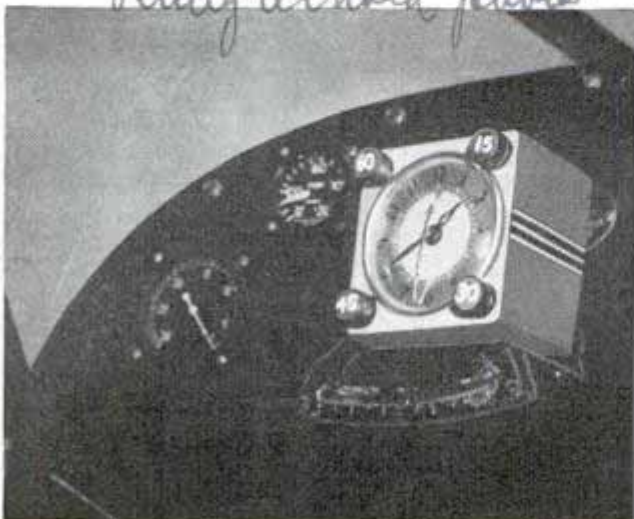

*Dr. Archie Baxter*



**motorcycle to "FUNLAND"**

**W**HEN you own a 1940 Harley-Davidson Motorcycle, every day brings you new exciting adventures. Its zooming power and streamlined beauty constantly open new gateways to fun! You're always "all set" to go places — see new sights — make new friends — and share their thrill-filled fun at tourist trophy races, rallies, gypsy tours, endurance runs, hillclimbs and other sport-packed motorcycling events.

See your Harley-Davidson dealer at once — learn about the great times members of motorcycle clubs are having — and get details of his Easy Pay Plans. Mail the coupon NOW!

**WINS "JACK PINE" 15th Consecutive Year!**

Again in 1939, the 500-Mile National Jack Pine Endurance Championship — toughest of all motorcycle tests — goes to Harley-Davidson! All classes — A & B Solo and Sidecar, Dealer and Club Teams!



**FREE** — This big 24-page magazine filled with pictures and stories of thrilling, exciting, motorcycle events.



**HARLEY-DAVIDSON**  
 WORLD'S *Champion* MOTORCYCLE

**SEND COUPON NOW**  
 HARLEY-DAVIDSON MOTOR CO.  
 Dept. P, Milwaukee, Wisconsin

Send FREE copy of "ENTHUSIAST" motorcycling magazine and literature on your new 1940 models. Stamp is enclosed for mailing cost.

Name.....  
 Address.....



9 1112.  
Treasure Hunting Up-to-Date

(Continued from page 803)



It's Prest-O-Lite's  
Amazing New  
**SILVER JUBILEE** Hi LEVEL  
WITH 7 REMARKABLE FEATURES

WHAT a battery—and what a PRICE! Fiberglas insulation! 51 big powerful plates! Rugged construction that means no power leakage! Plenty of punch for winter starts! All these features, PLUS the Prest-O-Lite HiLevel principle that makes it necessary to water this battery only 3 times a year under normal usage. See your Prest-O-Lite dealer NOW—save time and money with this new Prest-O-Lite SILVER JUBILEE Battery.

PREST-O-LITE BATTERY CO., INC., INDIANAPOLIS, INDIANA  
Manufacturing Plants at: Indianapolis, Niagara Falls, Oakland,  
Oklahoma City, Toronto

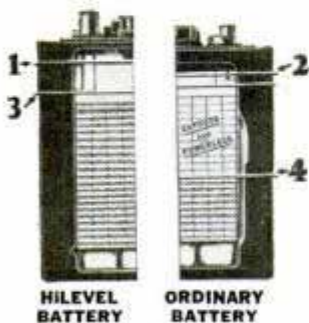

**HOW HiLEVEL  
FEATURE WORKS**

- ① FILLING LEVEL of Hi-Level Battery. (Note extra height.)
- ② FILLING LEVEL of ordinary battery.
- ③ By the time the fluid in a HiLevel Battery drops to here, (note plates are still covered)...
- ④ ...in an ordinary battery it falls to here, leaving a large part of the plate surface exposed and powerless.

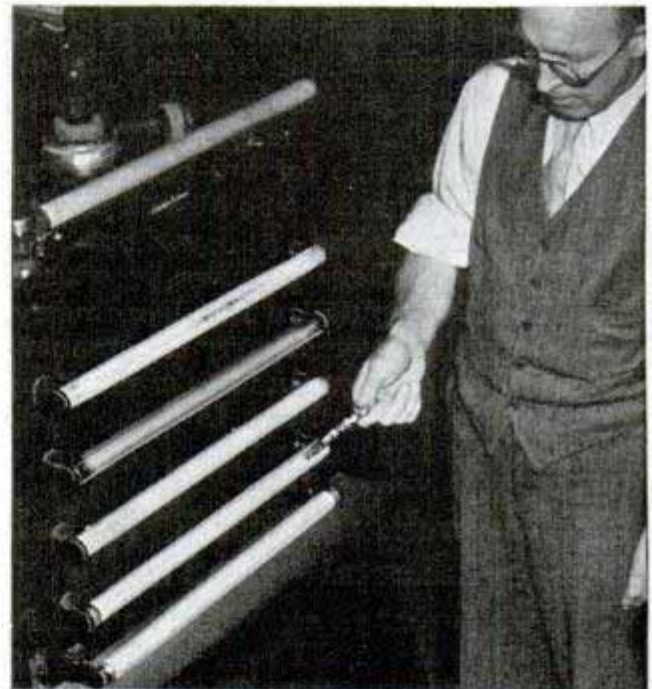

Fluorescent lamps, one of the newest products of research, offer high light output from low wattage

suspected possibility of radically new developments, and opening new fields for industrial activity.

But like all pioneering, such research is a gamble. From its very nature it is impossible to foresee what the practical results, if any, will be, or in what field they may find application. It therefore follows that an industrial company, however large, if its field of interest is narrow, can hardly justify a large amount of fundamental research. It is only when a company's interests are many and diverse that it has a fair chance of cashing in commercially on research in pure science.

Such is the case with the General Electric company, and this fact was realized by its leaders in 1900. When, therefore, it started its research laboratory in that year,

(Continued to page 152A)







# Action! Color! Night Shots!

**AT 1/3 THE PRICE OF FOREIGN SPEED CAMERAS!**  
 Now you can take thrilling, split-second *action* pictures! By night, as well as by day—in color, as well as black-and-white! The sensational new Mercury embodies every important feature of the expensive foreign-made speed cameras!

**CHECK FEATURES:** 1/1000th second focal plane shutter! Tricolor deep-focus f3.5 lens! Built-in flash synchronizer! Automatic film transport (double exposures impossible!) Interchangeable lenses! Helical focusing mount! Quick-action, simplified controls! Uses economical UniveX 35 mm. film that cuts your negative costs in half! (Color shots 5¢ each!) See it today! Many dealers feature easy-payment terms.

**PROOF!** Unbiased tests show that the Mercury has the most accurate shutter speed of any candid under \$500! All UniveX Cameras are 100% American-Made.



**\$25**  
**TRICOR Deep-focus f3.5 Lens!**

Universal Camera Corp. **FREE**  
 Dept. M-65, New York City  
 Please send free illustrated booklet describing the many features of the new UniveX Mercury Super-Speed Candid.

Name \_\_\_\_\_  
 Address \_\_\_\_\_  
 City \_\_\_\_\_ State \_\_\_\_\_

## 1/1000<sup>th</sup> Second **MERCURY**

**ACE**  
 LATHE TOOL SET  
**\$14.50**

**Be permanently tooled-up for every operation on your Metal Cutting Lathe**

The ACE Set is complete—there's nothing more to buy. Drop forged by the manufacturers of cutting tools used by 96 per cent of the plants and shops in industry, they are correctly designed, are of special steel, are finely finished, are stronger—will last a lifetime. You can cut easier, faster and more accurately with ACE TOOLS.

At your Hardware Store—Circular FREE.

**ARMSTRONG BROS. TOOL CO.**  
 "The Tool Holder People"  
 368 N. Francisco Ave., CHICAGO, U.S.A.

3 Turning Tools, 2 Cutting-off Tools, Knurling Tool, Barling Tool, Threading Tool, High Speed Steel Cutters and Blades, and 2 Wrenches in Filled Steel Case.

**THE GIFT HE'LL LIKE BEST AND USE LONGEST**

**100 TOOLS in ONE**

The genuine Dremel Moto-Tool is the ideal gift for a craftsman's Christmas. Grinds, polishes, sharpens, drills, engraves, etc., etc. Saves time, cuts cost, does finer work. Owners find it the handiest tool in the home or shop... use it daily. Same tool as used on precision jobs in factories. Over 25,000 r.p.m. (the speed necessary to con-

Only **\$9.85** POST PAID

serve cutters, do fine work. Has oil-less (oil sealed) bearings... dynamically balanced armature, vibrationless. 110 v. universal (AC-DC)... has built-in cooling fan.

6 oz. Model 1 Moto-Tool complete with chuck and 1/8" collet, only \$9.85. Master Model 2, faster, heavier, more powerful, with chuck and 1/8" collet only \$16.50.

**10-DAY MONEY TRIAL BACK**

See genuine Dremel Moto-Tools and complete kits at better dealers or order direct from factory on 10-day money back trial. Send only \$5.00 with order. We ship C.O.D. for balance.

**DREMEL MFG. CO., Dept. M119-M, Racine, Wis.**

**DO YOU** want a new business profession of your own, with all the trade you can attend to? Then become a foot correctionist, and in a few weeks earn big income in service fees,—not medical nor chiropody—easy terms for home training, no further capital needed, no goods to buy, no agency. Established 1894. Address **Stephenson Laboratory, 1 Back Bay, Boston, Mass.**

**KROMER PRACTICAL FLEXIBLE SHOULDER BRACE** for correct carriage and posture. Wear it at work or play. Free booklet on "Design Yourself and Your Personal Condition" with each brace. Enclose normal chest measurement. 35c postpaid.

**KROMER BRACE CO., 430 N. Water St. Milwaukee, Wis.**

**IT'S LIKE HAVING YOUR OWN BROADCASTING STATION**

**CLEAR TONE!**  
 PERFECT CARRYING QUALITY

**MYSTIC MIKE WIRELESS OUTFIT**

Now! This perfected Mystic Mike Wireless Outfit, with variable frequency control, enables you to do your own broadcasting from any part of your home, office or store WITHOUT the use of any interconnecting wires, NO WIRES CONNECTED TO RADIO. Simply plug this unit into any AC or DC electric socket; speak or play music into the microphone and your voice, or the music, will be picked up by ANY radio ANYWHERE within the same building. Use it at home for entertaining, auditions, rehearsals. Use it in your office or store as a public address system. In fact, it can serve you in hundreds of ways. Order today. Immediate delivery.

**FREE BULLETIN P-12**

**WRITE FOR OLSON MFG. CO., 362 Wooster Ave., Akron, Ohio**

**COMPLETE SET WITH MICROPHONE AND TUBE**

**\$3.95**

**MONEY BACK GUARANTEE**

Tear out this ad, write name and address in the margin, mail \$3.95 or order C. O. D. and we will send outfit at once.



2 11/2

(Continued from page 150A)

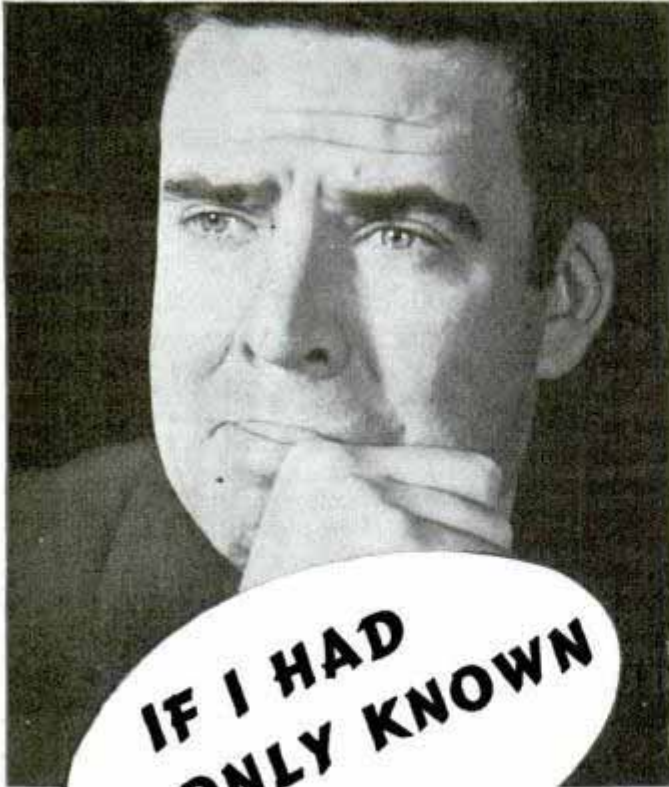

## IF I HAD ONLY KNOWN

Do you know that every fire insurance policy states that if fire occurs the insured shall furnish a complete inventory of the damaged and undamaged personal property? If you should have a fire tonight, it would be almost impossible to recollect tomorrow everything that was missing.

Get this free Household Inventory Booklet. It helps you make a complete list *before fire strikes!* It suggests objects frequently forgotten. It lists rooms one by one. Make an inventory right away and keep it in a safe place. It will save you work, worry and dollars and cents if you should have a fire. Send the coupon. It costs nothing. No obligation.



**THE AMERICAN INSURANCE GROUP**  
Dept. 2813, 15 Washington St.  
Newark, N. J.

Without charge or obligation, please send me your Household Inventory Booklet.

Name *M* \_\_\_\_\_

Street \_\_\_\_\_

City \_\_\_\_\_ State \_\_\_\_\_

the primary purpose was to conduct research of a fundamental nature in the electrical field, in the hope that new facts might be discovered which would suggest new and profitable developments.

While the pressure of other work, such as giving assistance on specific problems arising in the company's engineering and manufacturing activities, and the development usually necessary to translate a newly discovered fact into a form utilizable by other departments, has restricted the amount of fundamental research the laboratory has been able to carry on, a strenuous and unremitting effort has been made from the beginning to keep as much fundamental work in progress as possible.

And it has paid.

As an example, consider the extremely fundamental work on atomic and molecular reactions done by Dr. Irving Langmuir of the G. E. laboratories. Prof. N. K. Adams of University College, Southampton, England, after describing the "apparently obtruse academic character" of Langmuir's work, said in an article last April: "Yet the reward of this type of research, carried out thoroughly where the technical staff have the ability to apply its results, is far greater than that of the type of research ordinarily allowed in industry, and it has placed the American General Electric company in a commanding technical position in their industry."

The results of two purely academic studies by Langmuir, one on the rate of evaporation of tungsten from a hot filament, and the other on the mechanism of the loss of heat from a small heated wire in air, when combined, pointed unexpectedly to a radically new and highly important development—the gas-filled vacuum lamp, which has replaced the vacuum type in all but the very smallest sizes, doubled lighting efficiency with the higher wattage lamps, enabled the incandescent lamp to compete successfully with the arc in street and projection lighting, and made possible the economic adoption of higher lighting levels wherever artificial light is used.

From the second of the two researches mentioned above came also a new method of welding, with flames of atomic hydrogen, which made easy the fabrication of metal parts such as the evaporator of the



9 11 2

electric refrigerator, which otherwise would have been difficult and costly.

Another research, the purpose of which was simply to resolve the apparent contradictions in the observations of other experimenters on the so-called "Edison effect," led to the discovery of the space charge law, and pointed the way to the development of the high-power, high-vacuum tubes which made radio broadcasting possible. It also gave the lead to the development of a radically new design of X-ray tube, the Coolidge tube, which has superseded all other types and has greatly extended the reliability and power range of X-ray technique.

Langmuir's later work, on the mechanism of adsorbed films, has opened up a



Monel-metal gasoline storage tank being fabricated by the atomic-hydrogen welding process

wholly new branch of chemistry, two-dimensional or surface chemistry, brought him the Nobel prize, given us more efficient radio tubes, brought revolutionary changes in the froth-flotation process of ore separation, yielded a better understanding of the mechanism of lubrication, led to the production, not yet commercial, of non-reflecting glass, given the biophysicist and biochemist a new and fruitful technique for studying the proteins, which constitute much of our bodily tissue and control most of our vital functions, and cast much new light on the size and shape of molecules, the forces that bind their atoms together, and the reactions between molecules. While much of this new knowledge has as yet found no application in the company's work, its scientific importance is very great.

(Continued to page 155A)



Caught with a Speed Graphic by Robert C. Chick

## GRAFLEX and SPEED GRAPHIC

### ★ Prize-Winning Cameras ★ ★ Praise-Winning Gifts ★

You can make no finer gift choice—for yourself or any other picture-taker—than a Graflex or Speed Graphic Prize-Winning camera. American-made by master craftsmen they are the first choice of those who strive for better pictures.

The great versatility of these cameras is winning prizes and recognition for owners everywhere. Choose from your Dealer's selection of Graflex and Speed Graphic cameras and accessories.

Now Available on Easy Payments  
at Graflex Dealers Everywhere!

### National GRAFLEX



Because it features full vision focusing, focal plane shutter speeds to 1/500 and an f.3.5 Bausch & Lomb Tessar lens, this camera has been called the finest of American-made miniature reflexes. Makes ten album-size pictures on each 8-exposure film. Price..... **\$87.50**

### 2 1/4 x 3 1/4 Miniature SPEED GRAPHIC



One of the most popular of all cameras! Small, compact, it has all recognized Speed Graphic features plus new and advanced ones including built-in focal plane shutter flash synchronization and parallax correcting tubular view finder. Price (dependent upon lens selected) **\$111.00** from.....

Accessory coupled range finder (illustrated) \$27.00

### 2 SPLENDID PHOTOGRAPHY BOOKS

"Graphic Graflex Photography" by Morgan and Lester. Out in January! Buy gift certificates now. Exchange them later. **\$4.00** Only.....

"Photographic Enlarging" by Franklin I. Jordan, F. R. P. S. A gift any hobbyist will appreciate. In attractive gift box. **\$2.50** Only.....

New York City Display Rooms: 50 Rockefeller Plaza

### FREE CATALOG and GIFT GUIDE

Send for free catalog of Graflex and Speed Graphic American-made, Prize-Winning Cameras and Accessories and free Graflex Annual Gift Guide. Paste coupon—or write your request—on penny post card, if you wish. Folmer Graflex Corporation, Dept. PM-3, Rochester, N. Y.



FOLMER GRAFLEX CORPORATION  
DEPT. PM-3, ROCHESTER, N. Y., U. S. A.

Please send me your free Graflex catalog and free Graflex Gift Guide.

NAME \_\_\_\_\_  
ADDRESS \_\_\_\_\_  
CITY \_\_\_\_\_ STATE \_\_\_\_\_





# GIFTS FOR MEN!



**Gift Set No. 301**

Waterproof Match Box and Coat Compass. Postpaid, \$1.75

**60¢ to \$5**



**Gift Set No. 305.** Woodcraft Knife with Staghorn Handle, Waterproof Match Box and Coat Compass. Postpaid, \$5.00.

No gift you can make will bring greater pleasure. Every true sportsman knows the name "Marble's" stands for highest quality.

In addition to the two Gift Sets shown above, we recommend the following:

- No. 181 Marble's Waterproof Match Box. Postpaid, 60c.
- No. 182 Marble's Coat Compass, stationary dial. Postpaid, \$1.25.
- No. 082 Marble's Coat Compass, revolving dial. Postpaid, \$1.50.
- No. 187 Marble's Wrist Compass, with leather strap. Postpaid, \$1.50.
- No. 60 Marble's Sport Knife, 4 in. blade, leather handle with leather sheath. Postpaid, \$1.50.
- No. 2 Marble's Safety Axe. All steel handle. Blade protected by folding guard. Postpaid, \$3.25. No. 6, wood handle, \$2.25.
- No. 304 Gift Set like No. 305 shown above, but knife has leather handle. Postpaid, \$4.00.

Order direct if your Dealer does not carry the items you want.

**MARBLE ARMS & MFG. CO.**

578 DELTA AVE. GLADSTONE, MICH., U. S. A.



## FREE BREATH-TAKING 48-PAGE BOOK AMERICAN FLYER TRAINS

Brings you advance news on American Flyer 15 sensational new features. Gigantic double-header freight . . . first talking railroad station that automatically stops your train, produces true-to-life sound effects and starts your train again . . . the only never-fail automatic couplers . . . new uncouplers that uncouple cars with speed and realism . . . new remote control electromatic loading and unloading crane . . . new Lucite block signal system . . . automatic and remote control whistle and other exclusive features. Mail coupon or post card. American Flyer Trains, 513 Erector Square, New Haven, Connecticut.

Name.....  
 Street.....  
 City..... State.....

## Your Photo Made Into PICTORIAL STATUETTE

Special Introductory Offer only **25¢**

Amazing Bargain. Beautiful, novel Pictorial Photo Statuette made from any photo of child, adult, group or pet. Six inches high on fine bronze-tone base. Formerly 98c. Now special at 25c to introduce our service. Send photo film with 25c coin or stamps. Money-back guarantee. Film returned with order. Details on Hand-Painted, Natural Color Photo Statuette sent FREE. Send order today.

FORMERLY SOLD AT 98¢



**HARTLEY STUDIOS**

Dept. 2 Janesville, Wisconsin

**\$13.95**  
Full Set



## MICROMETERS

Six piece set, in velvet lined leather case. Special price, only \$13.95. Precision machined in one thousandths, up to 4" outside and 3/4" inside measurements. Guaranteed accurate, easy to read and adjust. Satisfaction guaranteed or money back. This is your opportunity to get one at a Bargain Price if you act now. Shipped prepaid on receipt of remittance. On C.O.D. shipments, send deposit of \$2.00.

FREE FOLDER

MICRO PRODUCTS, 529 E. Jefferson Ave., Detroit, Mich

## Build SCALE-PERFECT SHIP MODELS!



NEW CATALOG, 36 pgs., contains full-page illustrations of many historic ship models and racing sailboats; describes complete Construction Kits, including precision-shaped hulls, FINISHED FITTINGS, for building ACCURATE scale models. Send 15¢, coin or stamps, for catalog.

**MARINE MODEL CO.** 174 WORTH ST. DEPT. M11 NEW YORK



## FREE TRAILER BUILDERS' GUIDE AND CATALOG—NEW EDITION

WORLD'S BEST LINE OF TRAILER AXLES, HITCHES AND PARTS—Complete house trailer working blue prints only 50¢. WRITE TODAY FOR THIS NEW FREE CATALOG.

HAMMER BLOW TOOL COMPANY, Dept. 112, Wausau, Wis.

**FROZEN FOOD** Make money in this fast growing new industry. You can build freezer and storage cabinets for own use or sale. New construction amazingly simple. Buy parts wholesale. Send 25c for complete information. **SIERRA MADRE ENG. CO.,** Box 282, Sierra Madre, California

## New Adding Machine Fits Vest Pocket!..

Adds, subtracts and multiplies up to one billion. Weighs only 4 ounces. Not a toy—strong guarantee. Absolutely accurate, very fast. Sells to offices, stores, homes—wherever figures are used. Write quick for FREE AGENTS sample offer and Money-Making Plan.

VE-PO-AD, Dept. 199, 303 W. Monroe St., Chicago



**HANDY TAPS and DIES...** Accurate—carefully hardened and tempered. Complete range of sizes at your local five and ten cent store  
**HENRY L. HANSON, WORCESTER, MASS.**

## ELECTRICITY

ANYWHERE

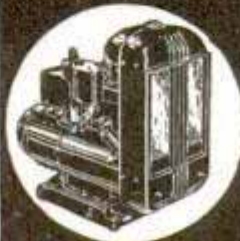

ONAN ELECTRIC PLANTS furnish 110 Volt, 60 Cycle, A. C. Current same as City Power Lines for Farms, Camps, Construction Jobs and Emergency Service in Hospitals, Schools, Theatres, Public Buildings. **SAVE PROPERTY**, even LIVES in case of Power Line Failure. Thousands in use in all parts of the World. Operate Lights, Radios, Water Systems, all Appliances, Models 350 to 50,000 Watts, 12, 32 and 110 Volt D. C.—110 or 720 Volt A. C. Also Combination A. C.-D. C. Units. Manual, Full-Automatic and Self-Starting Types. Shipped COMPLETE—READY TO RUN, \$99 and up. Write for details.

**D. W. ONAN & SONS**

1040 Royalston Ave. Minneapolis, Minn.



(Continued from page 153A)

While Langmuir has been responsible for more fundamental research than any other member of the staff, others have contributed in various fields. Studies of crystals, their magnetic properties along different axes, and the factors controlling their orientation, pointed the way to the recent development of highly superior silicon steel strip, which has materially reduced the weight, size and cost of distribution transformers.

Studies of the dielectric properties of gases under pressure have led to the use of gas of the Freon type, at forty-five pounds pressure, instead of oil in a recently built million-volt transformer for X-ray use, with enormous saving in weight.

Fundamental studies of arc characteristics have shown the great effect in extinguishing arcs producible by suitably arranged cooling surfaces, and have led to improvements in air circuit breakers.

Studies of the mechanism of "creep," the slow yielding of metal under stress at high temperature, have made possible the development of alloy steels more than twice as resistant to high-temperature stress as those before available.

Many new facts have so far found no application, but the search for more goes on. Whether or not some new development, leading to a great new industry like broadcasting, is to appear in the near future, nobody knows. We do know that, if it comes, it will have had its origin in fundamental research.

### CIGARET JUMPS OUT OF CLOCK WHEN DIAL IS TURNED

Cigaretts are dispensed one at a time at the top of a clock that is mounted on a leather case. It holds a full pack of twenty. When the dial is turned an inner-spring mechanism causes a cigaret to pop out.



Send return postage to our Bureau of Information to learn the name of the maker of any device described in this magazine.

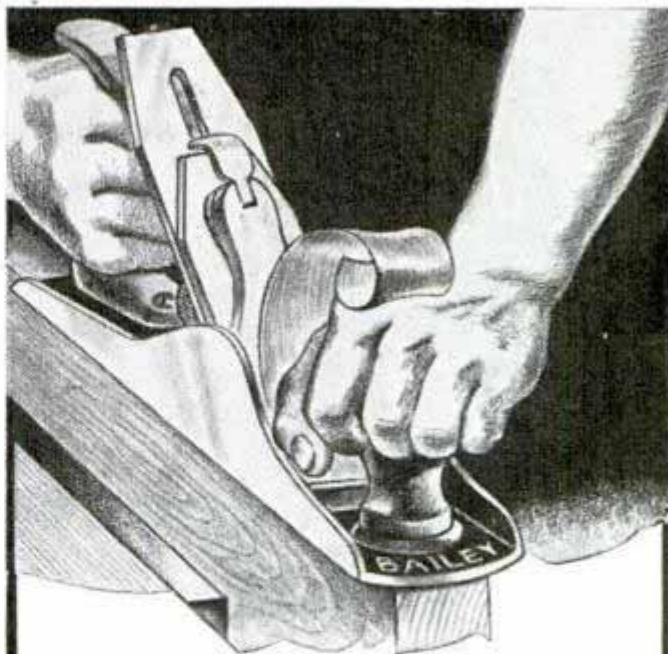

## STANLEY PLANES

*The Choice of All Woodworkers*

For over 70 years, Stanley "Bailey" Planes have been a Number One tool in the tool kits of woodworkers everywhere.

Today there is a Stanley Plane for every conceivable purpose . . . from simple smoothing to elaborate decorative cuts. To give you an idea of the variety of planes available from Stanley - there are 121 different ones described in Stanley Tool Catalog No. 34. Send for a copy of this catalog.

### Two Leaders in Their Class

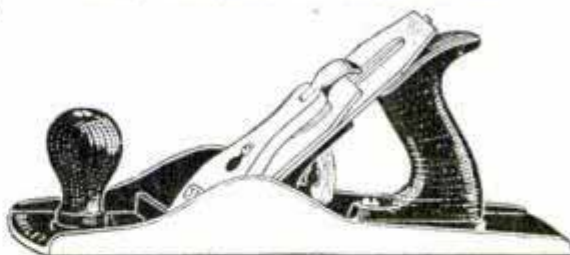

No. 5 Stanley "Bailey" Jack Plane. The most popular plane in the world. 14" long - cutter 2" wide. There are ten other sizes of this plane.

No. 118 Stanley Block Plane. Companion to the famous No. 5 Jack Plane. All steel parts make it practically unbreakable. Minimum number of parts. Lowest cutting angle. Go to your hardware store.



## STANLEY TOOLS

Division of The Stanley Works, 105 Elm St., New Britain, Conn.

**THE TOOL BOX OF THE WORLD**



*Good times coming!*



### Snap them with G-E MAZDA PHOTO LAMPS

Thanksgiving, Christmas, birthdays... there'll be lots of good times in *your* home this Fall. And every one of them says "Time for pictures!" *Take them*, indoors or at night... and get good, clear shots with G-E MAZDA Photo Lamps.

### GET READY NOW

FOR ACTION, and shots you can't re-take, be sure to get the new G-E MAZDA Photoflash lamps... No. 11 . . . . . **15¢**

(It pays to buy the handy holiday package of six, so you'll be ready for several pictures . . . . . only 90c.)

FOR DOZENS of snaps with new super type film, or for home movies, get G-E MAZDA Photoflood lamps.

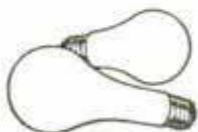

- G-E NO. 1 PHOTOFLOOD . . . . . **20¢**
- G-E NO. 2 PHOTOFLOOD . . . . . **40¢**

**GENERAL ELECTRIC**  
MAZDA PHOTO LAMPS

### Garden Gate of Welded Tools Designed by Mechanic

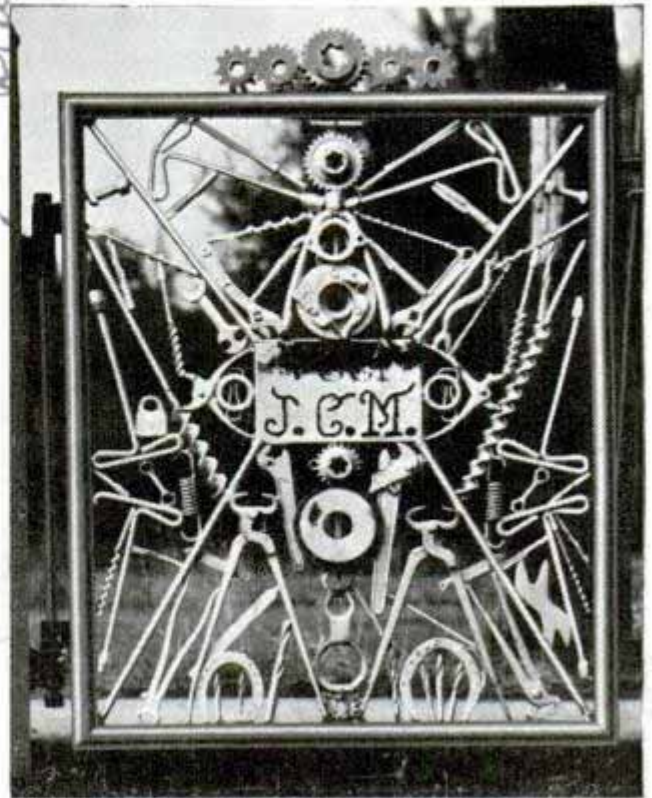

Tools, gears, horseshoes and other metal objects were welded together to make this garden gate

Symbolizing the trade of its designer, a garden gate constructed by an airplane mechanic consists of an assortment of wrenches, drills, pliers and other tools welded together. These instruments were discarded as unfit for use in the shop. To complete the gate's design, other odds and ends of metal such as horseshoes, bottle openers and gears were added.

### Large Vanadium Mine in U. S. Assures Ample Supply

Within the space of a few years, the United States has leaped from among the smallest to the largest producer of vanadium, a metal that is in great demand both in war and peace. In 1936 only sixty-three tons were produced, but by 1938 the total jumped to 732 tons. The change was brought about by the development of a mine tucked away in a wild and lonely section in southwestern Colorado, sixty miles from the nearest railroad. It is believed there is enough ore to keep the plant going for 100 years. By its effect of increasing the toughness and "springiness" of steel, vanadium has become well-nigh indispensable in the manufacture of automobiles, and has many direct uses in war.

*2 1098*  
*2 1161*  
*Mr. J. C. Messersmith, Faber, Calif.*  
*Gene Sime*

*Vanadium Corp.*



# The One BIG New Engineering Feature in the 1940 Cars!

**NO GEARS TO SHIFT**

**NO CLUTCH TO PRESS**

**SAVES HALF THE EFFORT OF DRIVING**

ALL YOU DO TO DRIVE IS THIS YOU ELIMINATE

1 STEER

2 STEP-ON-IT

3 STOP

SHIFTING

CLUTCHING

## HYDRA-MATIC DRIVE

*A Combination of Liquid Coupling and Fully Automatic Transmission*

For years it's been coming! Today it is here! For 1940, Oldsmobile introduces what automotive engineers have long been working toward—a completely automatic drive. Here's a combination of a closed-circuit, turbine-type liquid coupling and a hydraulically operated, four-speed automatic transmission based on two planetary gear sets hooked up in series. It's

the sensation of the automobile industry! See your Olds dealer. Try an Olds with Hydra-Matic Drive. Get free illustrated booklet.

### How It Works

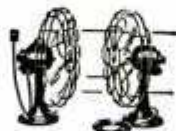

Face two electric fans toward each other. Start one, and the motion of the air will run the other. The same thing happens in the liquid coupling of Hydra-Matic Drive, except that oil takes the place of air.

*More Than Just a Fluid Flywheel*



Ordinary fluid couplings add a fluid flywheel and an over-drive to a conventional clutch and transmission. Hydra-Matic Drive eliminates both clutch and sliding gears.

# OLDSMOBILE



**AMERICA'S BIGGEST MONEY'S WORTH**

**BIGGER and BETTER in EVERYTHING**

*When writing to advertisers please mention Popular Mechanics*



# Quiz

**Q.** What anti-freeze has proved itself in more automobiles than any other brand ever made?

**A.** "Prestone" Brand anti-freeze—America's most popular winter protection. Contains NO alcohol...NO glycerine. Lasts all winter!

(SEE PAGES 120a and 131a)

## RENEW OLD BUILDINGS WITH PLASTIC STUCCO

### STUCCO SPRAYING MACHINE

It fuses a plastic mixture to any masonry surface. It water-proofs and fills all cracks. It can be applied in any thickness desired and in 30 colors. Fully proven by over thirteen years actual use under all conditions and every climate.

**BIG EARNINGS.** Operators report costs of 2c and up per sq. ft. and sell up to 7c. Machine covering capacity up to 1000 sq. ft. per hour soon pays for itself. Make money by supplying the big waiting market for renewing both old and new buildings with permanent color at low cost. Get the facts. Send for books, "Proven Business Opportunity." Write today.

**COLORCRETE INDUSTRIES, Inc.**  
570 Ottawa Ave., Holland, Michigan

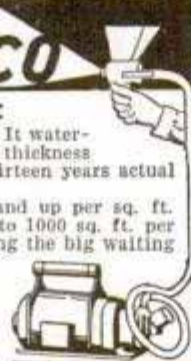

## AMERICA'S Newest Hobby

Make dull moments delightful, creative, educational. Turn your spare hours into cash. Master the fascinating new art of plastic carving, now made easy for all with **Moto-Tool NICK NACK Carving Kit**. Make useful, colorful giftware, toys, statuary, costume jewelry from marble-like new plastic substance. Work out original designs of your own in wood, glass, metals...like things sold in stores at 4 to 5 times manufacturing cost. Enjoy this new hobby just for fun...or start a profitable home-work business.



### NOTICE

**Kits Include 24 Pg. Book "How to Make 41 Projects"**  
JUNIOR Kit with No. 1 Moto-Tool (25,000 r. p. m.), 17 accessories, plastic materials for 10 projects in highly finished wood case, only \$17.85. MASTER Kit with factory type No. 2 Moto-Tool (27,000 r.p.m.), 23 accessories and plastics for 20 projects in highly finished wood case as shown, only \$24.85. Big project book goes with both Kits. See Moto-Tool "Nick-Nack" Kits at your dealers, or order direct. Send remittance and we pay postage—or send \$2.00 and pay postman balance plus postage. Write for circular. **DREMEL MFG. CO., Dept. K-119-M, Racine, Wis.**

**Moto-in-Hand Tool Owners!** Carving Project Book, exactly as furnished in Kits, sent separately, for only \$1 Postpaid.

## Decidedly Unusual... THURSTON'S 1940 CATALOG of "HARD-TO-GET" MATERIALS"

For Homecrafters, Schools, Institutions, Antique, Novelty and Cabinet Shops

A few of the items we show: Chest hardware, locks, hinges, supports, casters, copper trim, etc., also midgets, overlays, etc. Finishing materials, glue, stains, varnish, wax, flint and garnet papers, rubber sanding blocks, stick shellac, burning-in knives, etc. Upholstering supplies and coverings. Complete line of electrical findings for lamp manufacture, also cluster and indirect fixtures. Chair cane, woven and in strands, spline, reeds, fibre cord, etc. Trays for smoking stands and glass liners. Large line electric and spring clock movements, with and without dials. Complete line Venetian Blind hardware, tapes and cords. Table slides and leaf supports. Ten wagon wheels and casters. Wood dowels, also dowel screws, dowel centers, wood screw hole buttons. Excellent line card table leg supports. Bed hardware of every description. Desk pens, complete with funnel and fastening, without base. Water transfer, inlays, small moldings, etc. Furniture glides and casters, office chair spiders, wood legs and K. D. chair frames. Small box hardware of every description. Large selection pulls, knobs, handles, hinges, locks, catches, etc. Perforated steel panels, chair braces, revolving chair fixtures, rocker springs, candlestick sockets, bill board clamps, banquet table equipment, many sizes braces, corner irons, hanger bolts. Step ladder braces, pillar strips, sliding track and sheaves. Typewriter desk hardware, binowings, mirrors, nut bowl hardware. Bar pins for novelties. Catalin Plastics. Crib hardware, swivel top table fixtures, sectional bookcase hardware, clamp nails, electric pens for burning, etc., etc. Send 10c cash or stamps.

**THURSTON SUPPLY COMPANY, Dept. P. M., ANOKA, MINN.**

## KEEP YOUR TOOLS SHARP!

Oilstone your cutting edges in a fraction of the time—and with a fraction of the effort—required by hand.

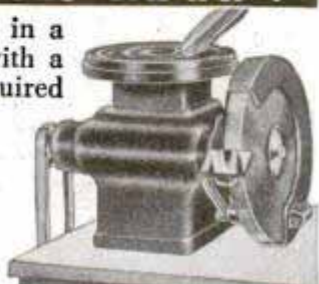

### The TOOL DRESSER

Revolving Oilstone and Emery Wheel combined. SEE YOUR DEALER Literature Free.

**CLAUSING MFG. CO. - OTTUMWA - IOWA**



## Better Tools—Lower Prices GET BALKO'S 1940 CATALOG!

THE CATALOG OF EVERYTHING IN POWER TOOLS, SPRAY EQUIPMENT, MODEL SUPPLIES, ELECTRIC MOTORS, Metal Lathes, accessories, Artist Air Brushes, Spray Guns, Elec. Bench Grinders, Grinding Wheels, Lathe Chucks, Micrometers, Pulleys, V Belts, Carving Tools, Compressors. BALKO'S complete stocks and fast service save you time and money. Send a 5c stamp today for your big new copy.

**BALKO ELECTRIC TOOL & SUPPLY CO.**  
605 W. Washington, A-12, Chicago, Ill.



## Bass 30 ARGUS

**BUILT-IN PHOTOFLASH SYNCHRONIZER**  
Coupled range finder... accurate from 3 feet to infinity. F:3.5 "Cinar" lens... 1/5th to 1/300 sec. speeds. Uses 35mm movie film, Model C3, complete... \$30.25  
Send for Bass Bargaingram—mention still or cine.

**BASS CAMERA CO. DEPT. P**  
179 W. MADISON ST., CHICAGO, ILL.



## A LASTING GIFT

Toolmakers and machinists will prize their Gerstner Chests for long years to come. Free Catalog.  
**GERSTNER TOOL CHESTS**  
439 Columbia St. Dayton, Ohio

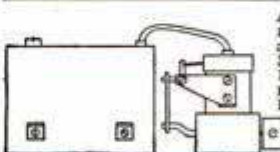

A DEPENDABLE STEAM ENGINE for boat models up to 36" in length. Model SE-3, a two cylinder, slide-valve type. Bore 5/16", Stroke 1 1/4", Length 7", Width 3", Height 3 1/2". Price complete ready to run with burner and propeller... \$3.00 Postage extra, shipping weight 1 1/2 lb.

**SHAWNEE ENGINE CO.**  
Box 162, Station D, Cincinnati, Ohio

## For Your Class or Club



Pins, rings and emblems. Over 300 designs. Finest quality. Reasonable prices from 30c up. Write today for our attractive, free catalog.  
**Dept. N, METAL ARTS CO., Inc., Rochester, N. Y.**

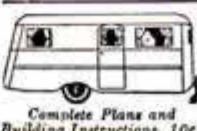

## FREE TRAILER PARTS CATALOG

We'll save you money on—axles, springs, wheels, couplers, windows, sinks, water pumps, brakes, refrigerators, beds, lamps, inside and out, 6V lamps, furniture, jacks—everything. Special discount to mfrs. **NATIONAL TRAILER EQUIPMENT CO. Successors to Kar-A-Van Industries, Inc.** Dept. P. 714 W. Wisconsin Ave., Milwaukee, Wis.

Complete Plans and Building Instructions. 10c



**"Carving" Made Out of Butter  
Depicts Kitchen Scene**

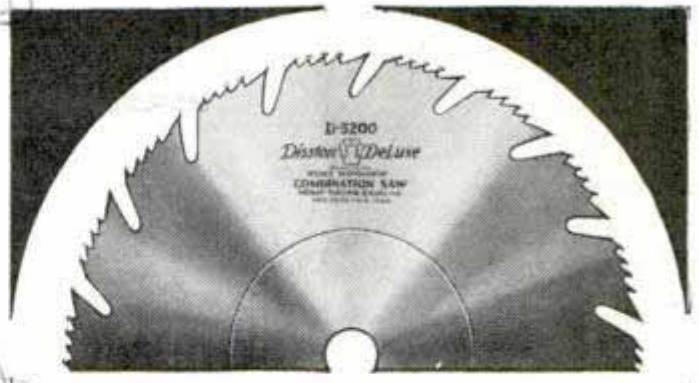

Table and figure of housewife were carved from 400 pounds of butter and exhibited at Kansas fair

Butter provided the material for the sculptor who carved in full size a common kitchen baking scene. Four hundred pounds of the dairy product were used in the figure which was exhibited by a creamery company at a Kansas fair in Topeka.

**Plants Bred with Wonder Drug  
Yield "Giant" Seeds**

Taller corn yielding more bushels to the acre, fluffier cotton bolls and bigger and juicier peaches and pears are some of the plants of the future that may result from modern breeding with the aid of colchicine. These possibilities were first demonstrated by Dr. A. F. Blakeslee of Carnegie Institution, who applied the method to a few plants ranging from radishes to phlox. Today there are probably hundreds of experimenters at work in the field, breeding more than a dozen different plants. In its purified form colchicine is a crystalline powder, and so powerful is it that it can be used only in a diluted solution. When this is injected into a plant or sprayed on its surface, the seeds it bears are apt to produce giants—plants that look like their parents but are much bigger and breed true to their new big size. The process may be repeated with the new generations, doubling and redoubling their size.



**Saws of Craftsmanship**

Let Disston Steel, Disston workmanship, smooth finish, accurate fitting, sharp teeth that hold their cutting edge, prove how these circular saws can help you do better work . . . even on the most intricate jobs. Ask for "Disston De Luxe" at your dealer's.

**Cross-cut; Rip; Combination**  
 6" (1/2" hole) \$2.70    8" (1/2", 5/8", 3/4" hole) \$3.50  
 7" (1/2" hole) \$3.10    10" (5/8", 3/4" hole) \$4.50

**Hollow Ground Combination**  
 6" (1/2" hole) \$4.30    8" (1/2", 5/8", 3/4" hole) \$5.40  
 7" (1/2" hole) \$4.90    10" (5/8", 3/4" hole) \$6.90

These prices apply only to United States; for others, write Henry Disston & Sons, Ltd., Toronto, Canada.

**and the  
Hint of the Month**

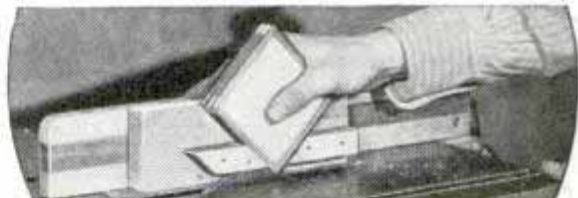

Jig for cutting mortise slots in mitred corners for inserting veneer strips to make feather joint. Holds work at correct angle and gives cut of proper depth. Temporary block inside frame lets you hold work firmly.

**and a New Edition  
FREE BOOK**



New Disston Saw, Tool and File Manual, better than ever! 48 pages; hints like one above; also tells how to joint, set and sharpen saws, how to choose and use all kinds of saws and tools.

**MAIL COUPON**

Henry Disston & Sons, Inc.  
1211 Tacony  
Philadelphia, U. S. A.

Name .....

Address .....

*1911 Washington, D.C. - Lambert's Lte.*



# If You Want to Be A BETTER CRAFTSMAN



Get the Right Saw For the Job

Often the finished job that looks best comes from knowing which saw to use, rather than better handling of the tools. A single hand saw is not an all-purpose tool. A rip saw does its particular job better than a cross cut would, and vice versa, while several others are each best for certain work. The right saw is an Atkins, and which type to use is explained in a helpful booklet. Send 10c for the "How To Do It Book."



E. C. ATKINS AND COMPANY  
426 So. Illinois St., Indianapolis, Ind.  
Dept. M-12

# ATKINS Silver Steel SAWS

## BUILD MODEL COACH

18th Century Coach. Complete Kit, drawings, wood, metal, upholstery, enamel, etc. Heavy cutting done. Folder-3c. Send \$1.00—balance of \$5.50, c.o.d. Guar. value.  
K. G. Model Supply, 2714 Summit St. Kansas City, Mo.



# IT'S NEW-Sensational! ELECTRIC WOOD CARVING

AN EXCLUSIVE HOME FOUNDRY ACHIEVEMENT!

Just plug in amazing new tool and carve wood by electricity! Set No. E-102; 5 plaques, 8 interchangeable tools; stain, brush and sandpaper. \$2.



## Electric Casting Set

Exciting new war molds! Casts 3 large figures; electric coating ladle; vise; 12 pigs metal; smoking torch; 2 bottles paint, 2 brushes. Fully equipped electric casting set No. A-104, \$2.

## "WONDER PEN" Electric Wood-Burning

New improved pen with ivory bakelite handle and white cord and plug; 12 plaques including book-ends; finishing liquid, water colors, brushes, etc. Complete set No. B-102, \$2.

SEND FOR BIG FREE CATALOG  
32 pages of new homecraft sets and supplies! Many Xmas gift ideas!  
**Home Foundry Mfg. Co.**  
3124 W. Fifth Avenue  
Chicago, Ill. Dept. M-12

# STRANGE MAGNETIC SPONGE CLOTHES BRUSH

REVOLUTIONARY invention. **DRAWS** dirt out of fabrics. No messy bristles. No dust. Uses no electricity. **500 AGENTS WANTED.** **SAVES DRYCLEANING** keeps clothing spic-and-span. Also cleans hats, drapes, upholstered furniture, etc. Long lasting. **Low priced.** Instantly grips attention wherever shown. **HOT SELLER FOR AGENTS.** Hustlers cleaning up big money.  
**SAMPLE OFFER** Samples sent on trial to the first person in each locality who writes. No obligation. Get details. **Be first—send in your name TODAY!**  
**KRISTEE CO., 677 Bar St., Akron, Ohio**



## UNIQUE HEATING METHOD! Investigate SUPERFEX

The only oil heater with patented, adjustable shutters that direct warm, radiant heat rays out and down... no fans or blowers needed. **FREE booklet.**  
**PERFECTION STOVE COMPANY**  
7194-C Platt Ave. • Cleveland, Ohio

## Chucks for Small Lathes

Lowest Prices Ever Offered

3 INCH	\$4.25
4 INCH	\$5.50

Four-jaw independent as shown. A quality tool, accurately made. Send draft or money order. If not entirely satisfied, return chuck in five days and we will refund your money.  
6" Chuck, \$9.75. 8", \$18.50. 10", \$23.75.  
**JOHN L. ALEXANDER**  
428 Superior St. Detroit, Mich.

## Auto-Glide

\$9.245  
UP, F.O.B. Factory

**CUTS TRANSPORTATION COSTS WAY DOWN!** Ride an AUTO-GLIDE for a dime where it would cost a dollar to drive a car! Thrill to its 35 miles per hour speed, easy handling, convenient parking. Use it for deliveries, business, school, sport!

**WRITE!** See your dealer or send for free folder showing several models. Send NOW!  
**THE CUSHMAN MOTOR WORKS**  
DEPT. C-12 LINCOLN, NEBR.

# IT'S THRIFTY TO INSTALL NEW CHAMPION SPARK PLUGS

## Calling All Cars

A MYSTERIOUS DISCOVERY  
**SAVES UP TO 30% on GASOLINE**  
or Costs Nothing to Try

Stop wasting Gas!—trim dollars off gas bills—get more power—quicker pickup—faster acceleration! **AUTO OWNERS everywhere praise VACU-MATIC!** Proven so efficient, it is guaranteed to satisfy, or the trial costs you nothing.

**Automatic Supercharge Principle**  
Vacu-matic is entirely different! It operates on the supercharge principle by automatically adding a charge of extra oxygen, drawn free from the outer air into the heart of the gas mixture. It is entirely automatic and allows the motor to "breathe" at the correct time, opening and closing as required. Saves up to 30% on gas costs, with better motor performance.

**AGENTS Get Yours FREE**  
FOR INTRODUCING. Here's a splendid opportunity for unusual sales and profits. Every car, truck, tractor owner a prospect. Send name and address now for big money making offer and how you can get yours Free.  
**The Vacu-matic Co., 7617- 477 W. State Street, Wauwatosa, Wis.**



**Coin-in-Slot Gasoline Pump  
at Self-Service Station**



Self-service gasoline pump permits motorist to fill his own tank without awaiting help from attendant

Motorists do not have to wait for an attendant at a self-service filling station where the gasoline pump is operated by dropping a coin in the slot. Should the pump be empty, coins are returned automatically. The plan is to install the vending machines at rural stores, yards of large industrial plants, and other locations where attendants cannot be on the job constantly.

21675

**"Costume Jewels" of Stone Age  
Show High American Culture**

America had a Stone Age society just as cultured as Europe's. At least, the early Americans of 12,000 to 20,000 years ago, at the end of the Ice Age and beginning of Stone Age culture, wore "costume jewelry." Two decorated bone heads have been found in a camp site of prehistoric Folsom men near Ft. Collins, Colo., and Dr. Frank H. H. Roberts, Jr., of the Bureau of American Ethnology, says the artistic decorations, the red and yellow paint, and the variety of tools and weapons indicate that America's earliest known culture must have compared favorably with the Stone Age society in Europe at the same time.

Washington, D.C.

**NEW 1940 FREE CATALOG READY SOON!**

**BOICE-CRANE**  
"shop tested"  
**MACHINES**

**21 MODELS**  
Boice-Crane completely equips your shop. Every widely used type of machine included in our 1940 line. *Saws, Lathes, Band-Jig Saws, Drill Presses, Jointers, Sanders, Planers, Shapers.*

**ADVANCED DESIGN**  
Boice-Crane consistently stays a step ahead with valuable and practical improvements. It's just one of the extra values all our users get.

**NEW CATALOG**  
New Boice-Crane 1940 Catalog ready in just a few weeks. See for yourself why men who know really good tools buy Boice-Crane and nothing else!

**USE COUPON**  
If you include 10c we send 16 pg. Metal Spinning Instruction Book. You'll enjoy this lathe craft!

**WRITE NOW FOR YOURS!**

**BOICE-CRANE CO. Dept. 2129 Toledo, Ohio**  
Catalog FREE. If Spinning Book wanted, send 10c.  
Name.....  
Address.....  
City.....State.....

**SHIFTING FOR CAPITALS IS  
EASIER WITH FLOATING SHIFT**



A Corona feature for years ...makes typing easier... saves energy. Other helpful aids: Piano-key Action ...Speed Booster...Touch Selector...make Coronas the "best buy in portables." 3 models: Silent... Sterling... Standard. Mail coupon for folder today.

**\$1.00 A WEEK TO OWN A CORONA**  
Plus small down payment

**FREE DEMONSTRATION AT ALL DEALERS**

**SPEEDLINE CORONA**

L C SMITH & CORONA TYPEWRITERS INC  
Desk 12, 723 E. Washington Street, Syracuse, New York  
Please send me free folder describing Speedline Coronas.  
Name.....  
Address.....  
City.....State.....



# MAKE BIG MONEY

## At Home! New Invention Electroplates by Brush

Plates  
GOLD  
SILVER  
COPPER  
TIN  
CADMIUM  
NICKEL  
Easy as  
painting

**No Tanks, Liquids, Generators DOES SAME WORK AS BIG OUTFITS**  
Millions of old auto-parts, and all kinds of old, worn articles in homes, stores, offices, factories everywhere can now be electroplated with a permanent brand-new sparkling coat of metal—by electrolysis—with the stroke of a brush. Easy as painting—no dismantling—plates right on the spot. Any electric light socket or car battery. Weighs only a few pounds. Take it anywhere—ready for instant use.

**Quick, Easy Way to Start Your Own Business**

**MAKE BIG PROFITS AT ONCE**  
Amazing low price and magic-like demonstration brings you thousands of orders for plating from garages, radio shops, bicycle shops, machine shops, home work shops, factories, offices, janitors, doctors, dentists, jewelers and farmers, homes, stores, etc.—with big profits for you! List of plating charges furnished; also reports of remarkable daily earnings.

**2-MINUTE DEMONSTRATION WITH SAMPLE AMAZES EVERYBODY**  
Send today for FREE Sample and amazing profit details and bona fide reports of big steady earnings! Also, 3-way proven sure money-making plan. Get started at once on this permanent, profitable business. No competition. Simply mail name on penny post card—NOW! Be the exclusive Warner Nu-Way Electroplater in your community.

**WARNER NU-WAY ELECTROPLATER CO.**  
360 N. Michigan Ave., Chicago, Ill. Dept. 5-T

**FREE SAMPLE PROVES CLAIMS**



## HANDEE Hobbies

Get more out of life. Make things with our easy working plans. 75 new, intriguing projects for the home, gifts or to sell—models of ships, planes, houses; engraved glassware, trays, mirrors; statuettes, book ends, etc. Portfolio of 12 plans, 25c.

**TOOL OF 1001 USES**

A tool shop and power house in one. Plugs in any electric socket. Grinds, drills, polishes, cuts, carves, routs, saws, sands, sharpens, engraves, all materials. Write for FREE 64-page catalog. Shows Handees \$10.75 up.

**CHICAGO WHEEL & MFG. CO.**  
108 S. Aberdeen St.  
Chicago, Illinois



A GIFT HE'LL LIKE



When writing please mention Popular Mechanics

## This Beautiful SANTA CLAUS STATUE IS YOURS FOR ONLY \$2.95

attractively finished in bright lacquer colors  
**AND** We tell you how to make them and color them at a cost of only a few cents each.  
**1000% PROFIT!**

Think of it. Your cost of manufacture will be only a few cents each and you sell them for \$2.95 each. Here is an opportunity to make some real money.

**EVERY HOME A PROSPECT!**  
**EVERY STORE**

At Xmas everyone will want a Santa Claus. It makes a beautiful table piece for the home—an excellent display piece for the store window or counter. You can easily sell hundreds, or even thousands if you get busy now.

**GET STARTED NOW!**

But, don't wait. Xmas is coming and mighty fast. Order your SANTA CLAUS today! Also ask for our 32-Page Book offering many other money making opportunities. It's only 10c Postpaid.

**Stewart's Studio Dept. PM-9**  
2927 Wilcox Street, Chicago, Ill.

Santa Claus  
11 1/2" x 7" x 6"



## SAVE GAS EVERY DAY YOU DRIVE WITH THE



## Gasmaster

**MILEAGE GAUGE and TROUBLE INDICATOR**

Thousands now on cars, giving owners MORE MILES PER GALLON OF GAS. Installs on any car in 15 minutes. Ask your auto supply dealer or sent postpaid, in U. S. A., on receipt of \$2.00.

**SPEEDOMETER SERVICE CO., Inc., 281 Central Ave., Newark, N.J.**

## The Super MAGIC WAND WELDER for HOUSE CURRENT!

**WELDING!** The most sensational tool in 20 years. Super Magic Wand Welder weighs about one pound, easy to handle! No generators, no transformers, no batteries, no special wiring! Just plug into ANY LIGHT SOCKET! With this rugged tool anyone can weld iron, steel, bronze, brass, lead, aluminum, or ANY metal.

**FREE!** With every Super Magic Wand Welder you get a full kit of welding supplies. Bronze, steel and aluminum welding rods; welding flux, pair of genuine "Protectosite" glare-proof goggles. Also complete instructions and money-making ideas! All for \$4.98. Test for 10 days if not satisfied Money Refunded. We ship by RETURN MAIL. Push your orders today! Yes! Agents wanted.  Sent C.O.D. plus postage!  I enclose \$4.98 Ship Postpaid, PATENT SPECIALTIES COMPANY, Dept. P-1, Teaneck, New Jersey

**COMPLETE ONLY 4.98 WITH FULL SUPPLIES**



**AT LAST!** All Your Snapshots in Natural Colors!  
**AMAZINGLY BEAUTIFUL!**  
Any size roll developed and 8 prints **25c** Natural Color Reprints 3c each.  
Natural Color Photo Service, Dept. C-54, Janesville, Wis.

## POCKET TYPEWRITER AMAZING NEW INVENTION

Carry with you everywhere. Weighs only 2 oz. Easy to operate. Practical for adults—thrilling for children. Order yours now. Agents wanted. **50c**  
**METZGER CO., 665-A Barry Ave., Chicago, Ill.**

## \$ CHRISTMAS MONEY \$

There's a big demand for the many hand-tooled articles you can make with the Esco Leathercraft Set. Make your own Xmas Gifts and easily learn to make good money in your spare time. Complete outfit, including tools, leathers, patterns, etc., and full instructions, only \$2.00—on sale at leading Department Stores or order direct and pay postman on arrival. \$2.50 outside U. S.

## LEATHERCRAFT

Free When ordering direct, clip name of your Department Store to this ad, and we will include with your set, one extra free project. Illustrated catalog 10c.  
**E. A. SWEET CO., Dept. A-29 Binghamton, N. Y.**



**Gas Lighter for Coal Furnace  
Kindles Fire without Wood**

*Rockwell 8.5.75*

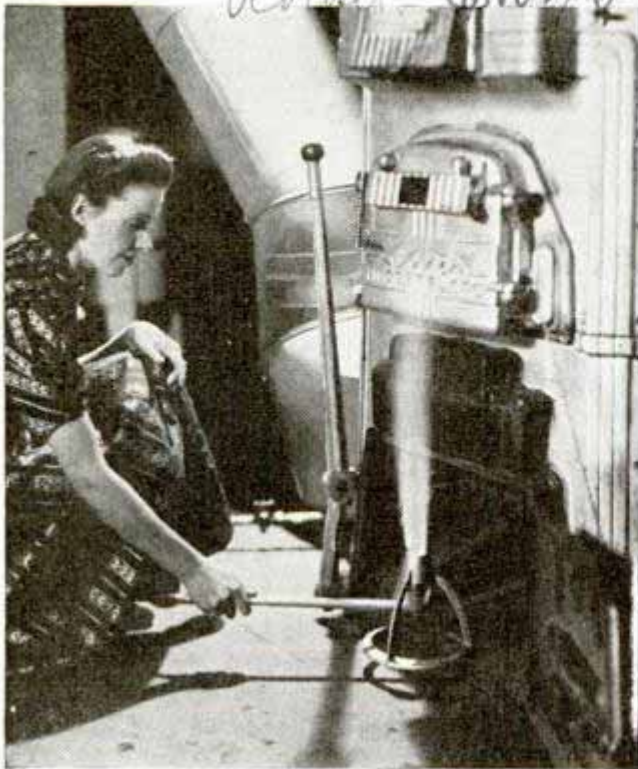

**Blazing gas torch for starting furnace fires is shoved under grate by means of its long handle**

Kindling a fire is as easy as lighting a water heater if you have a gas furnace lighter now on the market. No wood, paper or charcoal is needed. Turn on the gas, strike a match, set the lighter under the grate, and in a few minutes you have a blazing coal fire. Then the fire starter is withdrawn in safety by its long handle, and the gas turned off. Flexible metal tubing connects with any gas outlet, usually at the hot-water tank.

*21174*

**Candy Glows with a Faint Light  
When Dropped in Liquid Air**

Crystalline candy wafers and ordinary ice emit a faint glow of light when dropped in liquid air. This glow, called triboluminescence, can also be produced by grinding the wafers in a chemical mortar. Scientists believe this phenomenal radiation is caused by the cracking of the candy or ice by sudden, severe chilling and the consequent production of frictional electricity. The amount of light varied with different flavors, wintergreen producing the most brilliant glow. Candy that had first been subjected to ultraviolet rays gave off stronger light.

*Mr. Frances S. Wick  
Massachusetts College of Podiatric Medicine*

for SAFETY'S SAKE "PUT A NoRoL ON YOUR CAR"



Avoid  
Accidental Roll Back...

**NoRoL**

**HOLDS CAR on UP-HILL STOPS**

--leaves right foot free for accelerator

Don't be a brake pedal jockey! Put a NoRoL on your car and get away from a lot of leg fatigue as well as excessive wear and tear on clutch and drive mechanism.

NoRoL gives you a "third foot"—doing brake duty against back-roll on inclines, while right foot is left free for accelerator duty. Eliminates fatigue and frazzled nerves when you are driving in congested traffic on hilly roads and streets... Does away with chance of back-roll on up-hill start... Prevents unnecessary wear on clutch facings... Also lessens chances for clashing of transmission gears.

Easily installed... Built to last... Does not interfere with operation of brake pedal, clutch pedal or accelerator.

**HERE'S HOW IT WORKS**

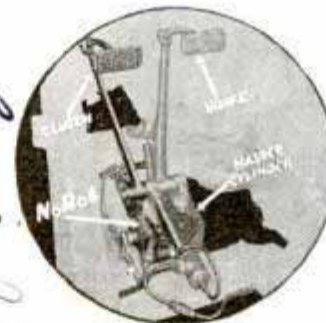

When stopping on any incline, no matter how steep, you simply apply the brake and disengage the clutch in the usual manner. An automatic check retains the hydraulic pressure in the braking system which was developed when brakes were applied. This hydraulic pressure holds the brakes applied as long as the clutch pedal is held depressed, enabling the driver to take his foot off the brake pedal and use it for accelerator duty... Thus making it unnecessary to keep his right foot on the brake pedal while the car is stopped. It's like having a "third foot."

Illustration shows a NoRoL installation... Actually is out of sight. Does not alter appearance of car.

When ordering a new car, specify that it come complete with a NoRoL. Available for new models of—

- |                        |         |            |               |
|------------------------|---------|------------|---------------|
| BUICK                  | DE SOTO | LASALLE    | PLYMOUTH      |
| CADILLAC               | DODGE   | NASH       | PONTIAC       |
| CHEVROLET              | GRAHAM  | OLDSMOBILE | STUDEBAKER    |
| CHRYSLER               | HUDSON  | PACKARD    | INTERNATIONAL |
| WHITE, MACK and others |         |            |               |

Also available for many 1936, 1937, 1938 and 1939 makes of cars and trucks having hydraulic brakes.

**Many Models Only \$12.00 Installed  
SEE YOUR CAR DEALER—or write us**

N 39-12

**Wagner Electric Corporation**

(Manufacturers of Lockheed Hydraulic Brakes)  
6400 Plymouth Avenue, St. Louis, Mo., U. S. A.

Send FREE BOOKLET and details on NoRoL.

NAME \_\_\_\_\_  
ADDRESS \_\_\_\_\_ CITY \_\_\_\_\_  
STATE \_\_\_\_\_ MAKE AND MODEL OF MY CAR IS \_\_\_\_\_





**LAFAYETTE**

# FREE new CAMERA CATALOG

Here's everything you need in photography. All the nationally advertised candid, still and home-movie cameras. Complete line of up-to-date accessories and supplies, including tripods, exposure meters, enlargers, easels, lighting equipment, hundreds of dark room aids. Prices bed-rock low. Buy by mail—save time and money. Get your copy of the Guide to the "Buys" in photography. It's FREE—a whole bookful of smashing values! Mail coupon at once.

**LAFAYETTE CAMERA**

NEW YORK  
100 SIXTH AVENUE

CHICAGO  
901 W. JACKSON BLVD.

ATLANTA  
245 PEACHTREE STREET

BOSTON • BRONX  
NEWARK • JAMAICA

LAFAYETTE CAMERA DIV. Radio Wire Television Inc.  
Dept. 7MC9-100 Sixth Ave., New York.  
Rush New FREE Camera Catalog No. 79

Name.....

Address.....

City..... State.....

**CAMERA CATALOG FREE**

PASTE COUPON ON PENNY POSTCARD

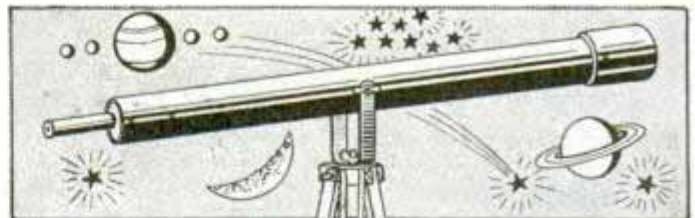

## 100 POWER TELESCOPE COMPLETE LENS KIT only \$1.95

Make your own high powered telescope in one evening of easy work. All optical parts completely finished for 6 ft. long refracting telescope. Kit contains 3" diameter 75" F. L. ground and polished objective lens and 2 astronomical eyepieces 50X and 100X. Here is your chance to own a high powered telescope and study the mountains and craters on the moon, the ringed planet Saturn, the moons of Jupiter, double stars, and hundreds of other interesting sights. Complete kit with full directions for mounting, only \$1.95 postpaid. Send money order now for immediate delivery.

BROWNSCOPE CO. Dept. 412 5 W. 27th St., New York

## BIG MONEY-MAKERS THAT WORK

### EIFEL-GEARED PUERENCH KIT-7" & 8 1/2"

"Pocket Machine Shops" that do the work of \$50 worth of other tools. Amazingly Quicker, Better... Easier!

- Now of ALLOY Steel—65% Stronger! • NEW PLANT... Quadrupled Capacity.
- Now have your Own Business in a New Selling Case. Full-time men making \$1,500 to \$4,000 Yearly... Part-timers in proportion. We need Many More!

Mail Your Address Today (on a post card will do) Get FREE—this 6-Edge End-&-Angle Screw-driver and 101-Picture Manual of Mechanics, with...  User Offers: or, with...  DISTRIBUTOR, Territory, Demo, and SELLING Kit Offers!

AMERICAN PUERENCH CORP'N ZPM-4611 N. RAVENSWOOD AV. CHICAGO, ILL.

## NEW OIL BURNER SENSATION

**COOK HEAT with CHEAP OIL** SLIPS INTO ANY STOVE, RANGE or FURNACE. One of latest oil burner patents—will not clog up—no cups or wicks—different. Even heat, much or little by turn of valve—better cooking, baking, heating.

**at Amazing LOW PRICE**

**30 DAYS' TRIAL** Write today for NO-RISK offer. Try it before deciding—see how it SAVES in fuel, ends drudgery and ashes of coal.

**SAMPLE BURNER FOR AGENTS** Write quick for SAMPLE OFFER that brings you one for demonstration. A money maker—big season now. Act quick—send no money, just your name, address. ATLAS BURNER CO., 290-P Rockhill Theatre Bldg., Kansas City, Mo.

## PUSH-BUTTON CONTROLLED GAS TANK LOCK

NO KEYS—ELECTRICALLY OPERATED FROM DASHBOARD. FULLY GUARANTEED. NOW USED AS STANDARD ACCESSORY BY GRAHAM, County franchises granted. Appoint sub-agents. Write immediately to:

SNAP-UP GAS CAP CO. DEPT. O. ASHLAND, KY.

## FREE RADIO CATALOG

**ALL YOUR RADIO NEEDS** Your nationally known radio favorites at lowest prices. Sets, parts, supplies, etc. BURSTEIN-APPLEBEE CO. #1012-14 McGEE ST. KANSAS CITY, MO.

## FACTORY MODERNIZED VACUUM CLEANERS

**FEATURING:** Premier, Hoover, Royal, Eureka, Universal, G. E., Electrolux, 30 Other Makes

Factory Modernized by Re-New

• Full Year Guarantee • Immediate Delivery

**RE-NEW SWEEPER CO.** 9591 Grd. River Ave., Detroit, Mich.

World's Largest Independent Vacuum Cleaner Rebuilders Est. 1916

# TOUCHDOWN COMING UP



**Fun and Thrills!**

All American **ELECTRIC FOOTBALL**

**FELLOWS,** All-American Electric Football offers a chance to match your "wits" and "strategy" against all comers—what's more it can't be beat for *action and thrills!*

You and your opponent are Coach, Quarterback, Line, Ends, Backfield, and Cheering Section of your respective teams! The player who knows smart football and who can outmaneuver his opponent will control the yardage of the miniature football as it goes up and down the gridiron... but the uncertainty of the game often gives the losing player a "fighting chance" and he may sweep down the field for a "touchdown" or a "smashing last-minute victory!"

Game comes complete, ready to play, with Miniature Football, Timing Device, Lights, and Batteries.

Be the popular owner of the champion of games—All-American Electric Football! 1940 MODEL, \$2. Postpaid.

## SIGN AND MAIL COUPON TODAY

**ELECTRIC GAME CO., Inc.**  
10 Bridge Street, Holyoke, Mass.

Enclosed find \$2. Send POSTPAID one Electric Football Game.

Name.....

Address.....



- 120 miles per gal.
- 30 miles per hour
- Moto-Clutch
- Kick Starter
- Automotive Brake
- Finger Tip Controls
- 1½ H. P. Motor

# SCOOTO BIKE

## \$79<sup>50</sup>

CONVERSION  
UNIT  
COMPLETE

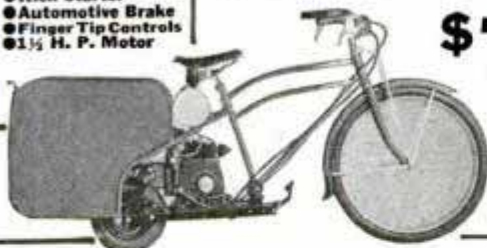

HERE is the newest way to put a power unit on your bicycle that gives 30 MILES PER HOUR ON LESS THAN ¼ A GALLON OF GAS. Finger tip control. 1½ H. P. motor with floating mount, air cleaner, oil pump

and integral clutch and brake. Large package space. Or you can buy complete Scooto-Bike as illustrated for \$99.50. See your Bicycle Dealer today.

MOTO-SCOOTO MANUFACTURING CO.  
8454 South Chicago Ave., Chicago, U.S.A.

## NOW a DYNAMIC HEAVY DUTY INDUSTRIAL WELDER

Works Off 110-Volt Light Socket. This marvelous Dynamic Power Welder does the work of much higher priced types. It is easily portable. WELDS Cylinder Blocks, Burners, Fenders, Tanks, Farm Machinery, etc. Will also solder and braze on the lightest material. Works on iron, steel, tin, brass, copper and all other metals. Men without previous experience can make as much as \$5.00 on a one hour repair job. In a year's time a Dynamic Welder Costs You LESS THAN 5 CENTS A DAY. Instructions Free—Open a welding shop now. AGENTS—Make big profits selling to garages, factories, janitors and machine shops. Write today for our 10-DAY TRIAL OFFER. DYNAMIC WELDER CO. 2226-KE Silvertown Road Chicago, Illinois

for Only \$19<sup>50</sup>



### BUILD

TRAINS—AUTOS—AIRPLANES—SHIPS—GAS MODELS—ALSO CAMERAS, etc.

Low priced C-D quality Kits by the master model designers. Passenger loco 50c, Switcher 50c, 27 diff. freight Cars, ea. 10c, Gas Models, \$2.50, and up, 3 Foreign race cars, 3 Indianapolis winners, ea. 10c. Hundreds of others and thousands of supplies. Add 15c for pack. & post. all orders, or part shipment deducted. Catalog only 10c.



Cloudster Gas Model Kit \$2.50

Cleveland Model & Supply Co. Inc.  
4508-C97 Lorain Ave. Cleveland, Ohio, U.S.A.



## Monuments \$9. Up

Best Quality Marble and Granite. Big Saving. Free Lettering. Guaranteed. Erected if desired. Write for Catalog and samples.

U. S. MARBLE & GRANITE CO., A-18, Oneco, Fla.

## ITALIAN ACCORDIONS

HAND MADE. Very best. Lowest prices. Direct from Factory Representative. Send your name and address for FREE catalog. ITALIAN ACCORDION COMPANY 323 W. POLK ST., DEPT. P-9 CHICAGO, ILL.



## 1940 SHOP NOTES

World's Biggest 50c Worth

Get Shop Notes for 1940! May easily be best investment of your entire lifetime. Contains 384 money-making, time-saving ideas. Kinks, short cuts for mechanics, farmers, home workshop fans, handy men—214 pages, and 762 illustrations. Thousands wait for this book every year. Only 50 cents. 1939 and 1940 Shop Notes sent postpaid for \$1.00. Popular Mechanics Press, Dept. 1239, 200 E. Ontario St., Chicago.



Now Ready

for everyone who uses tools.

## Money Making Pay Raising BOOKS Catalog FREE

Send Name and Address Today Selected books covering all trades, office helps, home workshop, spare time work, hobbies, etc. Learn how to earn more. Write today.



Popular Mechanics Press  
DEPT. 1239  
200 E. Ontario Street  
CHICAGO

In answering advertisements always write name and full address clearly.

# To... MECHANICALLY MINDED MEN:—

You are invited to attend our special Display and Demonstration of 1940 Atlas Shop Equipment

ATLAS DEALERS OF AMERICA

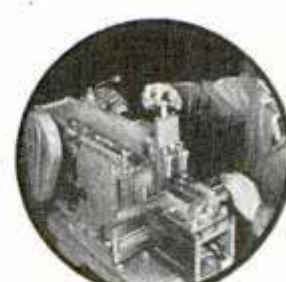

YOUR Atlas Dealer has ready for your inspection the finest metal-working shop equipment we have ever produced—all set up and waiting for you to put it through its paces.

Make it a point to visit him soon. See for yourself—and operate—the new Atlas F-Series 10" Lathes. Use the automatic power cross feed (standard equipment), and make all the power and precision tests you want to. Note the smooth performance of Atlas Drill Presses with their floating drive design. And be sure to get the facts about the economical Atlas 7" Bench Shaper.

Whether you use machine tools in your business or home shop, you'll find everything you want at sensible low prices in modern new 1940 Atlas Equipment. See it at your dealers. Send for complete catalog.

SEND FOR FREE 1940 CATALOG



ATLAS PRESS CO.  
1243 N. Pitcher St.  
Kalamazoo, Mich.

ATLAS PRESS CO., 1243 N. Pitcher St., Kalamazoo, Mich.

Please send me your 1940 Catalog on  10" Metal Lathe  
 6" Metal Lathe  7" Metal Shaper  Drill Presses  
 Arbor Presses and the name of nearest Atlas Dealer.

Name.....  
Address.....  
City and State.....



# New Ranger Power Cycle READY!

AGENTS & DEALERS  
WANTED! HURRY!

**\$79.50**

For Power  
Unit

F. O. B.  
Chicago



## MOTORIZE YOUR BIKE IN 20 MINUTES!

Now you can motorize your bicycle in 20 minutes with Mead's sensational new Ranger Power-Wheel Unit—only \$79.50 F. O. B. CHICAGO—OR—buy Power-Wheel Unit already attached to a brand new 1940 Mead Bike—the best bike! Economical—120 miles per gallon! Reliable. Guaranteed Briggs & Stratton 1 1/2 h.p. motor. Clutch. Kick starter. Roomy package carrier. Ride dirt cheap to school . . . to work . . . weekend trips. Thrilling . . . fast . . . yet safe!

### EASY TERMS FINANCED

Easy Terms available in most States. Pay as you ride with the money you can earn delivering packages, etc. Write quick for color folder while this SPECIAL LOW PRICE, Special Easy Terms offer lasts!

(Dealers! Write for available territories, wholesale prices!)

### 1940 RANGER BICYCLE CATALOG FREE

Ready! Mead's great new Bicycle Catalog listing 44 different styles, colors and sizes of famous Mead Rangers and Mead bicycles . . . Write!

**Mead CYCLE COMPANY** Write us today  
DEPT D-1, CHICAGO for free folder



ETERNAL LITE

NO  
BATTERIES

## GOOD BYE TO BATTERIES! GENERATES OWN "JUICE"

NO MORE BATTERIES TO BUY—A never-failing Eternal supply of current with brilliant, continuous light. The "PARKER" is "always there"—anytime—anywhere—today, to-morrow or ten years hence. Battery failures now banished forever. A gentle press gives a continuous light of brilliant duration—Plenty of power—plenty of reserve.



General Electric  
Monnet

REPAY'S ITS COST MANY TIMES. Ideal for Autos, Boats, Airplanes, Homes, Camping, Fishing and all emergencies. A quality product made in U. S. A., sturdily built—beautifully designed. Bakelite Case—Chrome trimmed.

Get yours TO-DAY on our MONEY-BACK trial.  
Makes Ideal Christmas Gift

**PARKER MFG. CO., 2024 N. Clark St. Chicago, Ill.**

- Send C.O.D. I will pay Postman \$2.25 plus few cents postage.
- I enclose \$2.25 send Parker Lite postage prepaid.

NAME.....

ADDRESS.....

## SHELDON Back Geared Screw Cutting PRECISION LATHES \$108

F. O. B. CHICAGO



**SHELDON  
MACHINE CO.  
INC.**  
1621 North  
Milbourne Ave.  
Chicago, U.S.A.  
Write for  
Catalog

The SHELDON "METALWORKER" is a sturdy, full sized, full weight, back geared, screw cutting, 10" precision lathe, built to industrial standards with hob-cut change gears, heat treated and ground spindle, hand scraped V-way, etc., etc. 10 1/2" swing, 1 1/16" hole thru spindle, 20" center distance, 3/8" lead, complete with compound rest, tool post, change gears, face plate, centers and wrenches (as illustrated), less motor drive \$108.00 F. O. B. Chicago.

Write for FREE Bulletin on Sheldon Lathes, drives, attachments and tools. Easy Payment Plan and names of local dealers.

## FREE ELECTRICITY

Wind driven 6-12-32-110 Volt Lighting Plants. Send 10¢ for New Copyrighted Manual describing Wind Generators, Propellers, Batteries, Plans and Instructions for building. All Electricians and those wanting Free Electricity send for this information today.

**WESCO, 8 Terminal, Minneapolis, Minn.**



### CATCH FISH!

minnows, eels, mink, muskrat with our fishing guaranteed Steel Wire Traps. Walton's Automatic Hooks are so constructed that when a fish gives the slightest pull on the bait the upper hook reaches down and gets a hold that lands him. 3 for 50¢. Write for descriptive catalog of Traps, Hooks, Lures, and other specialties. Walton Supply Co., 3507 Junata Ave., St. Louis, Mo.



### ELGIN & WALTHAM WATCHES

Send for new illustrated watch and jewelry catalog. Many attractive buys. Make extra money, too From **\$3.50**

**PLYMOUTH JEWELRY EXCHANGE**  
163 Canal St., Dept. M, New York



## A AND N SUPPLY CO.

Bargains—Military, Sport Goods, Firearms, Clothes, Shoes, etc. Send 10¢ for new catalog, to be redeemed on first order.

EST. 1868

A & N Supply Co., 4772 Lester St., Richmond, Va.

**Earn Cash at Home!**

**M.M. EARNED \$1174 at Home!**

We paid M. M. \$1174 for exceptional cellar crop Snow-King mushrooms! We furnish materials; buy all crops. Big FREE picture book tells if your cellar, shed, barn, suitable. Est. 1908. Write today. United Co., 3848 Lincoln Av., Dept. 311, Chicago

**1 BUYS 60 WELDING ELECTRODES**

60 pieces, assorted sizes, of famous AGILE AC ELECTRODES. WILL NOT STICK OR "FREEZE". Easiest for unskilled welders, hobbyists and students. Sent post-paid, anywhere in U. S., or possessions. Send cash, money order or check. **AMERICAN AGILE CORP.** Dept. A—5804 Hough Ave., Cleveland, Ohio.

Always write your name and full address clearly when answering advertisements.

# Stoves AT FACTORY PRICES!

**SALE CATALOG—FREE**

Nearly 200 Styles and Sizes of Heaters, Ranges, Furnaces at **FACTORY PRICES**. Easy Terms. Write today for **FREE CATALOG**. New styles, new features—24-hour shipments.

**Kalamazoo Stove & Furnace Co.,**  
391 Rochester Avenue  
Kalamazoo Michigan  
Over 1,400,000 Satisfied Users  
39 Years in Business

**"A Kalamazoo Direct to You"**

Write for **FREE CATALOG**

When writing please mention Popular Mechanics









*"You can earn*  
**\$150 to \$300**  
*extra profit monthly*  
*with this*  
**HOBART**  
**WELDER"**



**30 Days Trial**  
 in your shop on your own work to prove it  
 SEND for complete details

**Get Into Arc Welding With Dependable, Long Life HOBART 40-Volt Equipment**

You can now build a big paying business of your own with a new "Simplified" Hobart Arc Welder. Prices are the lowest in arc welding history . . . low enough to allow even the smallest shops to own one of these new welders. Extra profits will pay for it in a short time. And remember, there must be a good reason why Hobart is the fastest selling arc welder on the market today. Arc welding is today's profit opportunity . . . don't miss it!

**Remote Control** This is an important feature you get at no extra cost with Hobart. It lets you control your welder from any working point. Saves time, temper and eliminates the need for a helper on overhead or concealed work.

**Easy to Operate** Hobart Welders have "Simplified" operation. This means faster welding—with the right current for every job. Hobart is simplified, so any of your men can weld easily and successfully. The mystery and uncertainty of obtaining correct welding current settings are removed.

**60% Extra Capacity** Over old style 25-Volt Welders . . . necessary for welding with the new coated rods. Automatic reactance lets you handle light welder work without losing the arc. Users don't understand how they got along with old style welders after trying this new Hobart. Furnished in ELECTRIC DRIVE, GASOLINE ENGINE DRIVE, or GENERATOR ONLY.

**"Pays-for-Itself"** Terms You have 30 days trial at our risk to prove that extra earnings and savings obtainable with this improved welder makes it easy for you to own a Hobart with practically no cash outlay.

**"Build Your Own"** Let us tell you how you can build your own portable electric welder by using Hobart generator and coupling to your own engine and chassis. This equipment lets you operate any place, especially on the profitable outside jobs. Check coupon for detailed information.

**HOBART** One of the World's largest builders of Arc Welders

HOBART BROS. CO., Box M-129, Troy, Ohio

Tell me more about—

- Building My Own Portable Welder
- Complete Gas Engine Drive
- Electric Drive Welder
- Send FREE Book on "New Profits in Arc Welding"

Name.....

Address.....

Interested in  30 DAYS TRIAL  EASY TERMS

Own this PROFIT MAKER for only \$20 MONTHLY

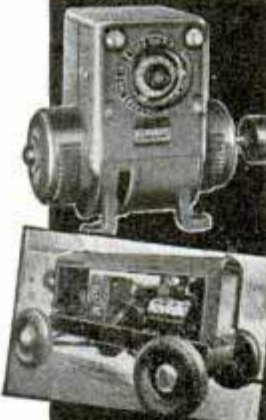

Build Your Own Arc Welder with above Hobart unit SAVES YOU \$300 to \$500

Use this Coupon to get FREE Arc Welding Book



*New Fields of Usefulness*  
**for DURO GRINDERS**

have been opened to model makers and craftsmen by the first practical Lathe and Drill Press Attachments for Hand Grinders. The famous Heavy Duty Grinder insures an abundance of power and sustained high speed to make those parts used in modelmaking that were formerly made by hand or else purchased at exorbitant prices. 42 watts output provides the necessary power for continuous work without stalling—24,000 R.P.M. insures smooth, finished cuts that do not require sanding. For full information send for literature describing the complete line of Duro Grinders and Accessories.

Made By the Manufacturers of America's Finest and Most Complete Line of Power Driven Machinery.  
**DURO METAL PRODUCTS COMPANY**  
 Dept. B-12 2657 N. Kildare Ave., Chicago, Ill.

**DURO Grinders**



SEND FOR NEW FOLDER



**Wood WORKERS**  
*Here it is!*



only 10¢

HERE is Harold Hunt's 1940 Catalog for Wood Workers. You NEED this book. UP TO DATE BARGAINS, including 123 special "deals."

136 pages, 24 pages of color.—About 300 furniture and scroll saw patterns showing, with each pattern, total cost of material required—2 pages of metal trim mouldings for modern designs.

Also, HOW TO WORK IN WOOD.—latest ideas for experts, also detailed directions for beginners showing how to make beautiful furniture the first week. Send only 10¢ (silver or stamps) to

**CRAFTSMAN WOOD SERVICE CO.**  
 Dept. 3379 S. Mary Street Chicago, Ill.

**POWER GRINDER Complete Only \$2.95**



Powerful 110 volt, AC, DC, rebuilt, variable speed MOTOR which originally sold for much more, has lever on side to adjust speed from 5000 to 10000 revs. per minute. Can be used for routing, drilling, grinding, polishing, carving and a multitude of other uses.

INCLUDED—30 piece Arbor Tool Set in Selector Box. Set consists of extra mandrels, routing burrs, all shapes and sizes and types of grind stones, polishing brush, buffing wheels and various grades of sand paper and emery discs.

Quantity LIMITED—RUSH \$1.00—Balance C. O. D.—Fully Guaranteed.

**Philadelphia Machinery Co., Dept. A2, 118 N. 6th St. Philadelphia, Pa.**

**50 PIECE UNIVERSAL ARBOR TOOL SET 95¢**  
 WILL FIT YOUR HAND GRINDERS . . .

Indispensable to Jeweler, Laboratory, Model Maker and Home Craftsman. The ideal outfit for fine accurate grinding, sanding, routing or carving. Includes 12 grindstones with brass centers in assorted sizes, 5 bakelite cut-off wheels, 5 assorted engraving, routing or carving burrs, 2 polishing buffs, 2 bristle polishing brushes, circular and cup shape, 3 mandrel arbors, 20 assorted sanding discs of emery, garnet, mud, fine, medium and coarse.

Send Coin or Money Order \* Shipment Prepaid  
**Philadelphia Machinery Co.** Dept. P. M., 118 N. 6th St., Phila., Pa.



# Sweeping the Country!

# NEW-TYPE CHEAP OIL BURNER INVENTED!



**COOK and HEAT**  
*without* **COAL or WOOD** In Your Present Stove or Furnace

**MORE HEAT AT SMALL COST—NO DIRT OR ASHES**  
**QUICK HEAT AT TURN OF VALVE**

An Amazing New-Type Oil Burner Which Experts and Users Say BEATS ANY CHEAP BURNER EVER GOTTEN OUT FOR LOW COST, EFFICIENT PERFORMANCE. Burns Cheap Oil a NEW WAY Without Pre-generating or Clogging Up. READ BELOW HOW YOU CAN TEST THIS REMARKABLE SUPER FLAME OIL BURNER in Your Own Home or Business FREE OF RISK.

**OVER 40,000 SOLD**

Why burn coal or wood with its dirt and drudgery of building and feeding fires? Why carry ashes and get uneven, slow-starting heat, when you can burn cheap oil a NEW WAY and get MORE HEAT at SMALL COST—and have QUICK HEAT regulated to any degree desired by a simple turn of a valve?

Your present coal or wood stove, heating stove or furnace can be fitted easily and quickly with our Super Flame "HEAT KING." Nothing like it on the market—the lowest priced efficient oil burner—Positively guaranteed NOT TO CLOG OR STOP UP. Has a record of over 11 years constant use without ever needing any cleaning. Simple—safe—economical—no electrical connections—no moving parts to wear out—all unnecessary parts eliminated. Burns 95% air and 5% cheap oil and the result is QUICK, CONVENIENT, EFFICIENT HEAT by simply turning valve. What an Engineer of National Reputation Says:

"Combustion principles of the Heat King are simple, efficient, excellent—assures economical oil consumption and maximum amount of heat. Tests made on burner with one year's hard service prove there was no evidence of dirt or residue within the burner or any carbon deposit on any interior parts. There are no

nozzles or tins to "choke up" or stop up with sediment, scale, etc."—C. W. Lovelace—K. C., Mo.

**WHAT USERS SAY:**

There are fifteen oil burners of different kinds here but Heat King is cheapest and best—J. R. Goldthorp—Washington. I get more heat from your burner than I ever had from coal, wood or anything else I ever burned in my furnace—W. C. Nicholson—Ind. My wife and her mother say they have reduced their coal bill fifty percent since they put your oil burner in—W. S. Collins—Pa. Your oil burner is the poor man's friend—L. Gradner—N. C.

**30 DAYS' TRIAL Satisfaction Guaranteed**

If you want QUICK, efficient heat with the convenience of gas at small cost in cooking and heating you may try the "HEAT KING" Oil Burner AT OUR RISK. Write now for full information—Prove that it ends drudgery and dirt of coal or wood; prove its efficiency, convenience and economical operation. You must be satisfied under our liberal guarantee or YOU PAY ABSOLUTELY NOTHING FOR THE BURNER.



**Slips Into Any STOVE RANGE or FURNACE**

**— QUICK HEAT on or off AT TURN of VALVE**

**FREE SAMPLE to Agents**

and salesmen who will demonstrate and take orders. Send no money—just sign and mail coupon for 1c postcard will do. You can't lose for here's a revolutionary cheap new type oil burner that is safe, economical and efficient. So mail coupon quick, be first in your locality to learn how satisfactory oil heat can really be and how you can MAKE REAL MONEY spare or full time. Mail Coupon or 1c postcard today—NOW.

**AGENTS SALESMEN DISTRIBUTORS— BIG MONEY**

Startling low price puts this amazing new-type oil burner within the reach of everyone. No wonder so many homes, small business firms, oil filling stations, etc., are buying it—no wonder salesmen and distributors are breaking records in sales. All YOU have to do is to bring it to the attention of prospects and show how it gives QUICK HEAT, HOTTER, MORE CONVENIENT, WITHOUT DIRT AND ASHES, and how economical it is in operation—then, reap BIG CASH PROFITS. It sells fast because low-priced, cheap to operate, efficient.

**WHAT SALESMEN SAY:**

"Greatly pleased with installations. Installed one when weather was 10 degrees below zero. Kent house well heated and owner is still raving about the wonderful burner. I can dispose of 250 "HEAT KINGS" before this year ends. —F. Silver—Canada.

Heat King satisfactory in demonstration to one of the largest oil companies—W. DeJeffer—Ohio.

I am a plumber, have installed all kinds of oil burners, but I never knew before there was such a thing to get that much heat out of oil. There is money in selling them—W. C. Nicholson—Ind.

If you want to earn good money and own your own business, it's hard to beat the "HEAT KING" as a money maker. SAMPLE BURNER FREE TO PRODUCERS. Write us now for agents' offer. Act quick—be FIRST in your locality—MAIL COUPON at right or 1c postcard today—NOW.

**MAIL COUPON**

UNITED FACTORIES, P-751, Factory Building, Kansas City, Mo.

Without cost or obligation, rush full particulars of generous FREE TRIAL OFFER on the wonderful "HEAT KING" Oil Burner.

Name.....  
 Address.....  
 City.....  
 State.....

Check here if you also want to know how to make money in sales agency of your own and details of FREE sample burner to producers. This does NOT obligate in any way.

**UNITED FACTORIES P-751 Factory Building Kansas City, Mo.**

*When writing to advertisers please mention Popular Mechanics*



## ZIM JAR OPENER

**Opens anything that wears a cap**  
 Practical, new patented wall fixture—always handy, swings down out of the way when not in use. ZIM quickly and easily opens jars (including Mason jars) glasses, bottles, cans with screw caps, pry-up caps, friction caps, vacuum caps, crown caps. (Also tightens screw caps).



**PREVENTS BREAKAGE—CUTS LOST TEMPER, ETC.**

IN GAY  
 NEW COLORS  
**\$1.25**  
 IN CHROMIUM  
**\$1.35**

Nothing to break or get out of adjustment. Lasts a lifetime. Your choice of black or red with white trim, green with ivory trim, cream with black trim, or all chromium. Send for ZIM in shade to match your kitchen color scheme. Sent postpaid for only \$1.25 in cash, check or money order. **ORDER YOURS AT ONCE.** The newest, most convenient kitchen item on the market. Modern Streamline styling. Makes attractive Xmas gift any housewife will be proud to own. Approved by Good Housekeeping.  
**ZIM MFG. CO.**  
 Dept. P. M. 12, 3047 W. Carroll Ave., Chicago, Ill.

## NEW STREAMLINE BENJAMIN AIR RIFLES



**HARD ACCURATE SHOOTING WITH CHAMBERED AIR**  
 You can use new models BENJAMIN AIR RIFLE WITH LEVER HAND PUMP anywhere, for practice firing or just plinking around the house or camping, fishing, hunting, etc., at lowest cost. Shooting force is adjustable depending on AIR PRESSURE—amazing maximum power and accuracy—will penetrate to 1". Hair trigger firing without lunge or recoil. Single Shot \$7.50. Repeater \$9.99. Rifled Cal. 22 or 177 Single Shot \$8.50. Ask your dealer all about them or write for complete specifications—targets and blueprints FREE if requested. We also make a complete line of BENJAMIN AIR PISTOLS for target and small game. **WRITE TODAY.**  
**BENJAMIN AIR RIFLE CO., 895 MARION ST., ST. LOUIS, MO., U. S. A.**

## Wind Electric Plant

**Build Your Own—We Show You How.**  
 Easily made from old auto generator. Dime brings complete plans and Big NEW catalog of 500 electrical items, 100 other generator changes to 6, 12, 32, 110 volt Plants, Motors, Welders, Electrical Fencer. Write today.  
**LEJAY MFG., 1447 LeJay Bldg., Minneapolis, Minn.**

## NEW Electric PRESSER

**HANDIEST AID FOR BUSY, THRIFTY WELL GROOMED MEN**

Do your own Pressing this modern way, at home, in office or when traveling. Easy to use. No wet cloth, board or boiler. Plug in any socket and it's ready to press pants, collars, sleeves, lapels, dress pleats. And man, what it does to crumpled ties! It presses them into crisp newness before you can say Jack Robinson.

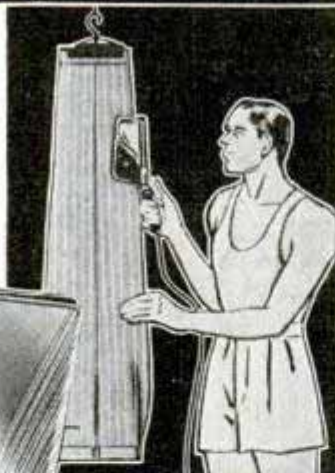

**\$1** Post-paid Money Back Guarantee.

**AN IDEAL XMAS GIFT**

Material slides between two electrically heated pressing blades. Saves time, money, wear on clothes. Don't let another day go by without an Empire. And, remember it's a gift any man or boy will appreciate. Each Empire presser is fully guaranteed. Comes complete with cord, plug, and simple directions. **DEALERS—Over 750,000 sold to date. Order now to take care of growing demand everywhere.**

**EMPIRE ELECTRIC CO., Dept. PM 817 Main Street, Cincinnati, Ohio**

Enclosed is \$1.00 for an Empire. If not satisfied, I will return it and my money will be refunded.

Name.....  
 Address.....

PM-12

When writing please mention Popular Mechanics

## ARCADE Low Cost POWER TOOLS



### Compare These Prices

Drill Press, 15" high, \$5.30; Disc Sander, 8 1/4", \$5.00; Jig Saw, 10" throat, \$5.30; Belt Sander, 4"x4" drums, \$8.00; Shaper with oilite bronze bearings, \$16.50; Shaper with ball bearings, \$20.50; Lathe, 8" Swing, 30" between centers, \$9.50; Band Saw, 10", \$18.00; Bench Saw, 6" blade, \$11.00; Bench Saw, 8" blade, \$22.50. Prices west of Rockies slightly higher. Other Bench Tools, Model Makers and Accessories at low prices . . . all quality built for long service and accurate workmanship. If dealer cannot supply, order direct. Write for FREE CATALOG

**ArCADE Mfg. Co., 1219 Shawnee St., Freeport, Illinois**

## WEATHER STRIP YOUR WINDOWS

**Save Money! Make Money Too!**



Now! You can weather strip your own home yourself, easily, quickly, without special tools and at half the cost. New all-metal INTERLOCKING E-Z-ON WEATHERSTRIP keeps out cold, dust, rain and wind seepage. Stops rattling and heat loss. Will not rust or corrode, nothing else like it, lasts the life of the building. Cuts fuel bills—increases comfort. Weather condition your home now! Surprisingly low cost. Write today for full particulars, or send \$1.00 for complete E-Z-ON window set and sure money-making plan telling how to start your own weatherstrip business, full or part time. Valuable territories still open. Act now! Money back guarantee.

**ROBERT N. BALTZ & CO., INC.**  
 156M W. Adams St. Chicago

## Sell Advertising BOOK MATCHES

**WORLD'S LARGEST "DIRECT-SELLING" BOOK MATCH FACTORY**

Offers you a money-making connection in profitable year-round business. Experience unnecessary. Full or spare time. All business firms prospects. MATCHCORP's new, faster-selling features; high quality, low factory prices; quick deliveries; bring easier orders. Repeats boost earnings. Kit, full instructions, FREE. Write today!  
**MATCH CORPORATION OF AMERICA**  
 3433-43 W. 48th Place, Dept. M-12, Chicago, U. S. A.



## SHAW GARDEN and ALL-PURPOSE TRACTOR



Low "FACTORY-TO-FARM" Prices. 2 to 8 Horsepower Models. Walking and Riding Types. **WRITE FOR 10 DAY TRIAL PLAN and BIG FREE CATALOG.**  
**SHAW MFG. CO., 4512 Front St., Galesburg, Kans.**  
 5812G Magnolia Ave., Chicago, Ill.; 139G W. 42nd St., New York; 658G North 4th Street, Columbus, Ohio

## WANTED MEN PAST 40

If you are past 40 and desire extra money we can help to make your full or spare time profitable. Business pleasant and profitable. Operate from your home. Call on merchants, shops, schools, churches, auto, truck and bus owners, farmers, lodges, public institutions, etc. Large manufacturer of approved first-aid fire extinguishers, fire alarms, recharges, etc. Write details about your past experience, etc. Address **FYR-FYTER COMPANY, DEPT. 90-48, DAYTON, OHIO**

## Alkalize with Alka-Seltzer

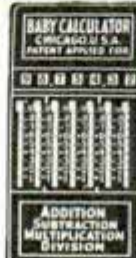

## WORLD'S LOWEST PRICED ADDING MACHINE

**GUARANTEED ACCURATE.** Not a toy. Operates with only a finger flick. Adds, subtracts, multiplies, divides. Counts up to a million. Pays for itself over and over. Ideal Gift—for Business, Income Tax and School use. **MONEY BACK GUARANTEE.** Send name and address. Pay postman only \$2.50 plus postage. (Send full cash if outside U. S.) Money back in 10 days if not delighted. **AGENTS WRITE. CALCULATOR MACHINE COMPANY (Mfrs.), Dept. 112, P. O. BOX 1118, CHICAGO, ILLINOIS.**

**ONLY \$2.50**  
 VEST POCKET SIZE  
 FREE TRIAL  
 TOTAL COST  
 SEND NO MONEY



## Hannes Schneider Uses Northland's

Hannes Schneider, world's No. 1 skier, helped design Northland's spectacular FIS model skis. Combining the most modern design, beautiful workmanship and super-hickory wood, Northland's FIS skis are the finest you can buy. Northland skis are available in other models — all prices. See the *Best in Skis* when you buy.

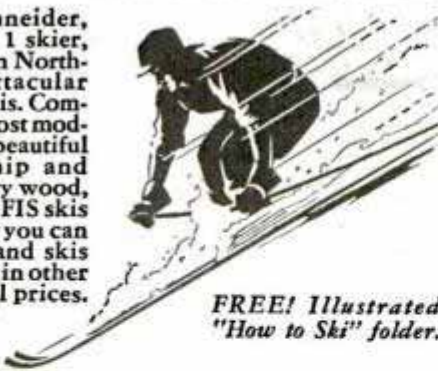

FREE! Illustrated "How to Ski" folder.

## NORTHLAND SKI MFG. COMPANY

World's Largest Ski Manufacturers

95 Merriam Park

St. Paul, Minnesota

## POWERlite

### AMERICA'S FINEST— MOST POWERFUL ELECTRIC LANTERN

80 to 100 HOURS LIGHT  
On One 6-Volt Dry Battery

● TWO LIGHTS on a double action switch. 800 ft. spot beam from front reflector; broad floodlight from top. Handle reverses. Unbreakable lens. 6½" high. At sport, hardware, electrical dealers or write for literature.

DELTA ELECTRIC COMPANY \$3<sup>35</sup>  
300 W. 33rd St., MARION, INDIANA Less Battery



Buy Only a GENUINE DELTA

## TYPEWRITER Brand NEW!

Only \$19.95 and up

10-Day Trial—Easy Terms. Guaranteed Brand New latest HEMINGTONCA DET model only \$19.95 during this sensational sale. Also Royal, Corona and famous Featherweight Portables at real money-saving prices. Also standard full size office models rebuilt and fully guaranteed at ½ saving. SEND FOR BIG FREE CATALOG IN COLORS.



10c  
A  
DAY

International Typewriter Exch., 231 W. Monroe St., Dept. P-1201, Chicago

### CAPTURE THE COLOR OF LIFE! YOUR OWN MOVIES! ONLY 10c A DAY!

NATIONALLY ADVERTISED 8MM and 16MM Movie cameras, projectors. For home, business, church, school, club. MONEY BACK 10 DAY TRIAL. Payments as low as 10c A DAY. Satisfied customers throughout the world. FREE details. WRITE TODAY.

Don Elder's Home Movies, Dept. N-12, 739 Boylston St., Boston, Mass.



## DOENUT WHEELS

DOENUTS, developed and patented by the originator of the air-wheel, absorb more surface obstructions and eliminate jolting. Protect wood and concrete floors. Do not sink in sand or soft ground. Cadmium plated die wheel with adjustable ball bearings. Size 10"x2.75" with cap. of 225 lbs. per wheel and 12"x3.50" with load cap. of 325 lbs. per wheel. Ideal for wheelbarrows, painting rigs, spraying equipment, textile trucks, dish trucks, boat dollies, food carts, or most any portable unit that rolls. Handle same loads with less than half the labor. Send 10c postage to cover cost of mailing literature.

MUSSELMAN PRODUCTS CO.  
6225-Q St. Clair Avenue, Cleveland, Ohio

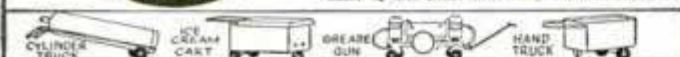

## High Quality Driver Tilting Arbor Saw

CRASHES  
MEDIUM PRICE  
FIELD!

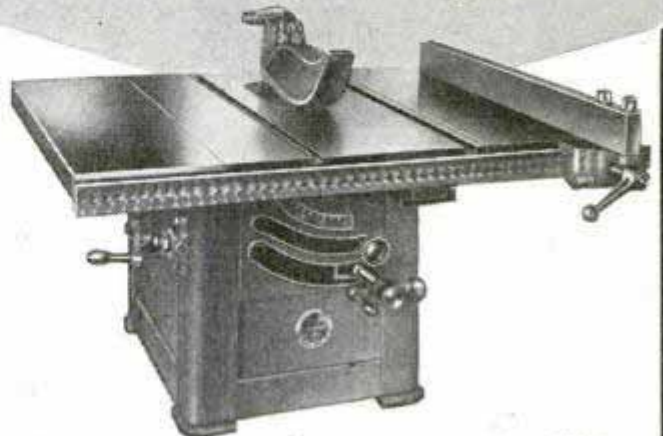

"Some day I'm going to own a fine Tilting Arbor Saw!" Your friends have said it . . . you've said it. For sheer all-around usefulness and convenience, this tool has always stood out. And now you can . . . without sacrifice of quality, Driver engineering has achieved one economy after another, to bring a high quality Tilting Arbor Saw within reach of everyone's pocketbook!

**FEATURES:** famous Texrope multiple-belt drive. Also furnished with geared drive. 8" or 10" blade. New "Gun-carriage" raising - lowering - tilting mechanism works smoothly, accurately . . . can't jam. See it at your Driver dealer's—and get the price. Then you'll agree—Driver engineers have made news again!



**COUPON** below puts your name on list for new 1940 Driver Catalog showing many new models, improvements. Fill in and mail now!

## DRIVER Engineered POWER TOOLS

Walker-Turner Co., Inc.  
1129 South Ave., Plainfield, N. J.

Put me down to receive one of the big 1940 Driver Catalogs just as soon as it is off the press!

Name.....  
Address.....

## WOOD WORKERS

BUY DIRECT...SAVE UP TO

33%

Send today for our valuable book, listing the most complete line of foreign and domestic plywood and veneers available anywhere. Because we are Direct Mill Representatives our prices afford savings up to 33%. You can't afford to buy elsewhere before seeing our amazing offers. Send 10c to cover cost of postage and mailing catalog. 10c refunded on 1st order. Write today, and save money.

BECK PLYWOOD & VENEER CO.  
Dept. PM-12 1302 N. Halsted St. Chicago, Ill.



# FOR ACCURATE WORK . . . . . YOU NEED A PRECISION LATHE

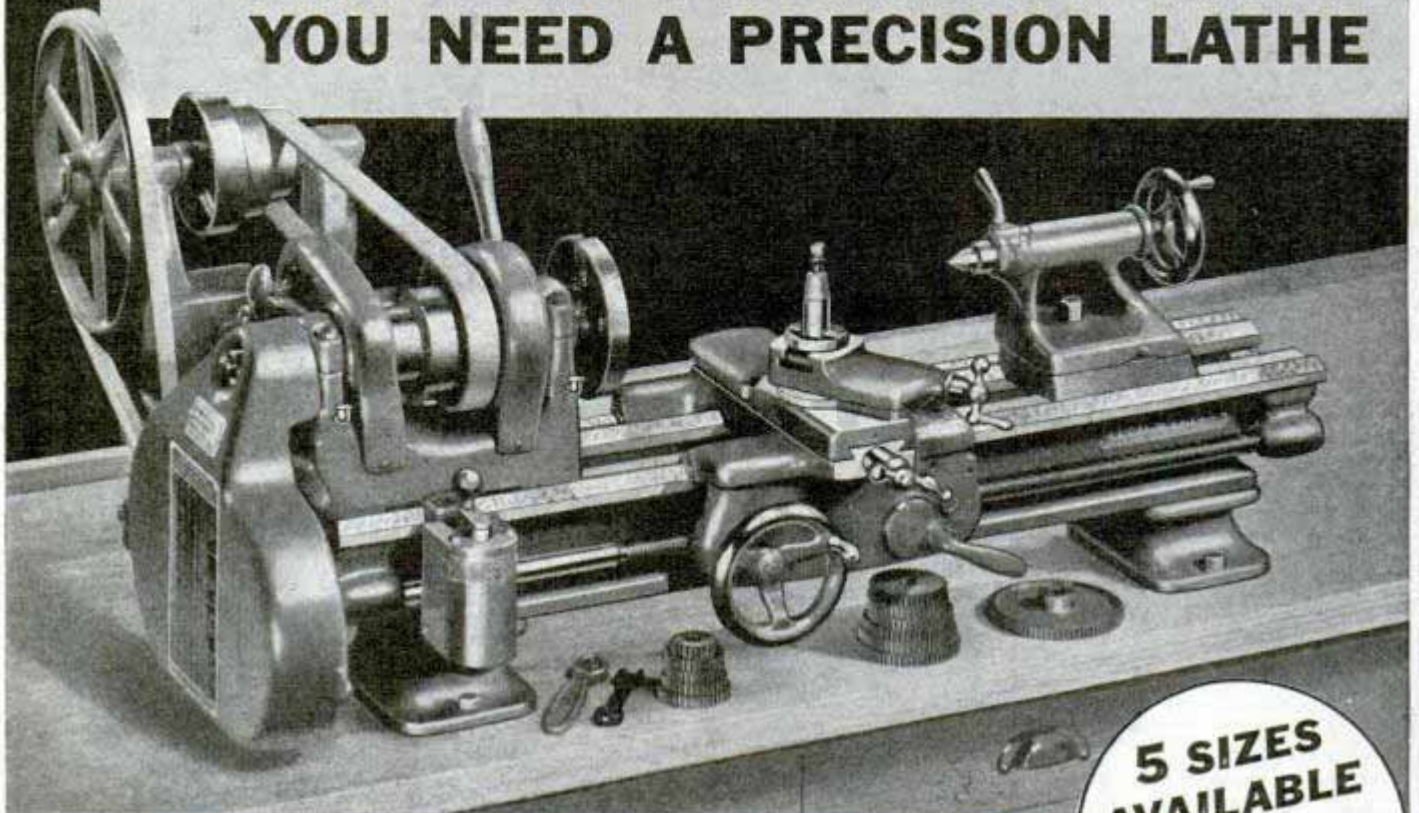

No. 415-YC, 9 1/4" Swing by 3' bed Workshop Model C Bench Lathe with Motor Drive as shown. Shipping Wt. 320 lbs. (Easy Payments If Desired)

**\$127**

**5 SIZES  
AVAILABLE**  
—  
9", 11", 13", 14 1/2"  
and 16"  
Swing

**O**NLY good shop equipment has the precision accuracy demanded in modern manufacturing plants, tool rooms, laboratories, machine shops and repair shops. South Bend Lathes are designed and built to assure this precision and to simplify the most difficult metal working jobs.

Features include: heavy semi-steel lathe bed with hand-scraped V-ways, heat treated alloy steel head-stock spindle, precision machine-cut gears, ball thrust bearing on spindle, all steel and iron construction.

### A CHRISTMAS SUGGESTION

The 9" South Bend Workshop Lathe is a superb gift for any man or boy mechanically inclined. It is a tool which any shop owner will proudly exhibit to his friends.

## SOUTH BEND LATHE WORKS

648 East Madison Street  
South Bend, Indiana, U.S.A.

**SOUTH BEND LATHE WORKS**  
648 E. Madison St., South Bend, Ind., U.S.A.

- No. 46-B—9" Workshop Lathe Catalog, Free  
 No. 34-LB—How to Run a Lathe, 25c

Size of Lathe Interested In.....

Name.....

Address.....

City.....State.....



### PRICES OF POPULAR SIZES

Size and Type of Lathe	Price Counter- shaft Drive	Price* Pedestal Motor Drive	Price* Underneath Motor Drive
9" x 3' Quick Chg. Gear	\$358	\$431	\$486
9" x 3' Q. C. G. 1" Collet	458	543	598
11" x 4' Quick Chg. Gear	466	549	625
13" x 5' Quick Chg. Gear	571	685	781
14 1/2" x 6' Qk. Chg. Gear	714	844	964
16" x 8' Quick Chg. Gear	868	998	1129

\* Includes 3 phase, 60 cycle, 220 volt, A.C.  
Instant Reversing Motor and Switch.

### SHOP REFERENCE BOOKS

**Catalog No. 46-B**—Describes and prices 9" Workshop Lathe in 3', 3 1/2', 4', and 4 1/2' bed lengths. Features and Construction illustrated in detail show why this lathe gives satisfactory service.

**How to Run a Lathe**—Complete reference book on lathe practice and shop work shows how easy it is to operate a lathe. 128 pages, 350 illustrations. 25c postpaid.



# SOUTH BEND Precision LATHES



# New Goodrich Battery

SO POWERFUL IT STARTS 2 CARS AT  
THE SAME TIME *AT 10° BELOW ZERO!*



Look! These New Goodrich Glasstex Mats are so porous that you can blow smoke right through them!



## Read How Miracle Glass Mats *DOUBLE\* BATTERY LIFE!*

• If you're one of the millions who have to drive in cold winter weather—here's good news. It's all about the new Goodrich *Glasstex* Battery that is so powerful that not just one but TWO motors can be started from it at the same time at 10° below zero! Just imagine, then, how much faster this new Goodrich Battery will start *your* car in cold winter weather when it has only *one* motor to turn!

To keep vital power-producing material in the plates from being lost—Goodrich "packs" this battery with the unique *glass mats*. These miracle mats do "double duty" by holding this valuable material in the plates *twice as long*—by being so porous they allow a full, free flow of the battery acid. See your nearest Goodrich Tire and Battery Dealer or Goodrich Silvertown Store now about this guaranteed Goodrich Glasstex Battery.

\*Proved by life tests made in accordance with specifications of The Society of Automotive Engineers.

THE B. F. GOODRICH CO.

Akron, Ohio

Los Angeles, Calif.

# Goodrich GLASSTEX Battery

Trade Mark Registered U. S. Patent Office



*Wishing you  
more pleasure*



*Always welcome...* CHRISTMAS CHESTERFIELDS IN ATTRACTIVE GIFT CARTONS