

The 1940 CARS

POPULAR MECHANICS



MAGAZINE

WRITTEN SO

REG'D. TRADE MARK, GREAT BRITAIN, NO. 410426

PAT. OFF.

NOV.

25 CENTS



SEE PAGE 654

PROBIL

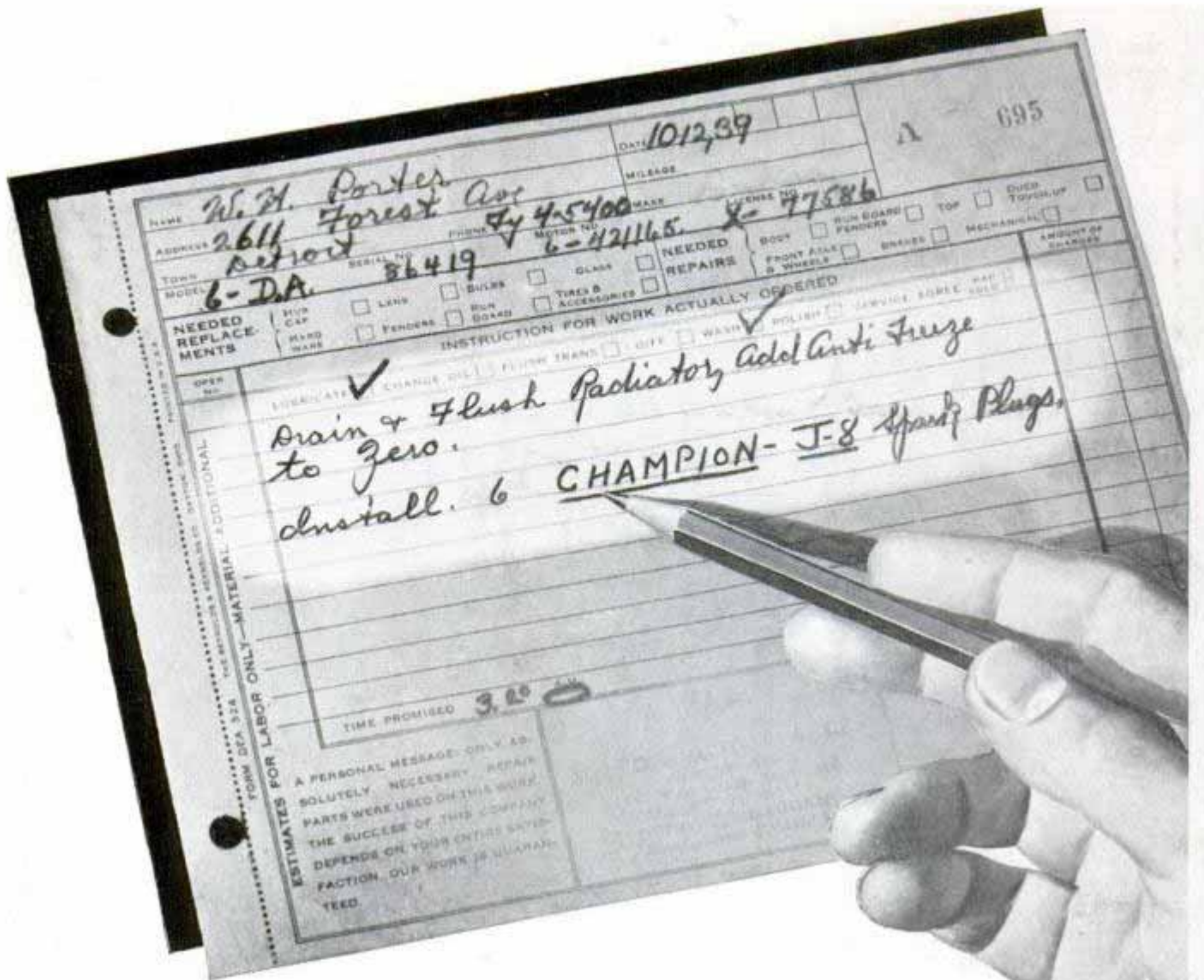

Cold Weather and Hard Starting Hold No Fears for Mr. Porter

It is the simple, inexpensive and well-rewarded practice of thousands of motorists to protect their cars against hard starting by installing new sets of Champion Spark Plugs just before cold weather sets in.

The advantages of installing new Champions *now* are manifold, and quickly apparent to the driver. They insure quick starting in coldest weather; they forestall heavy drain on the battery occasioned by hard starting; they also minimize the dangers from crankcase dilution due to excessive use of the choke—automatic or manual—which is

usual in cold weather starting and through the warming up period.

Thus it will be seen that a new set of Champion Spark Plugs is cheap insurance against temper-trying delays and needless expense. Furthermore, the savings in gas and oil quickly pay for the cost of a new set of Champions.

Insist on Champions by name, to be sure that you get the spark plugs champions use. Dependable dealers everywhere sell dependable Champions.

CHAMPION

SPARK PLUGS

IT'S THRIFTY TO INSTALL NEW SPARK PLUGS—Demand CHAMPIONS

***YOU NEVER SAW
SUCH STYLE AND ROOM
IN ANY LOW-PRICED CAR***

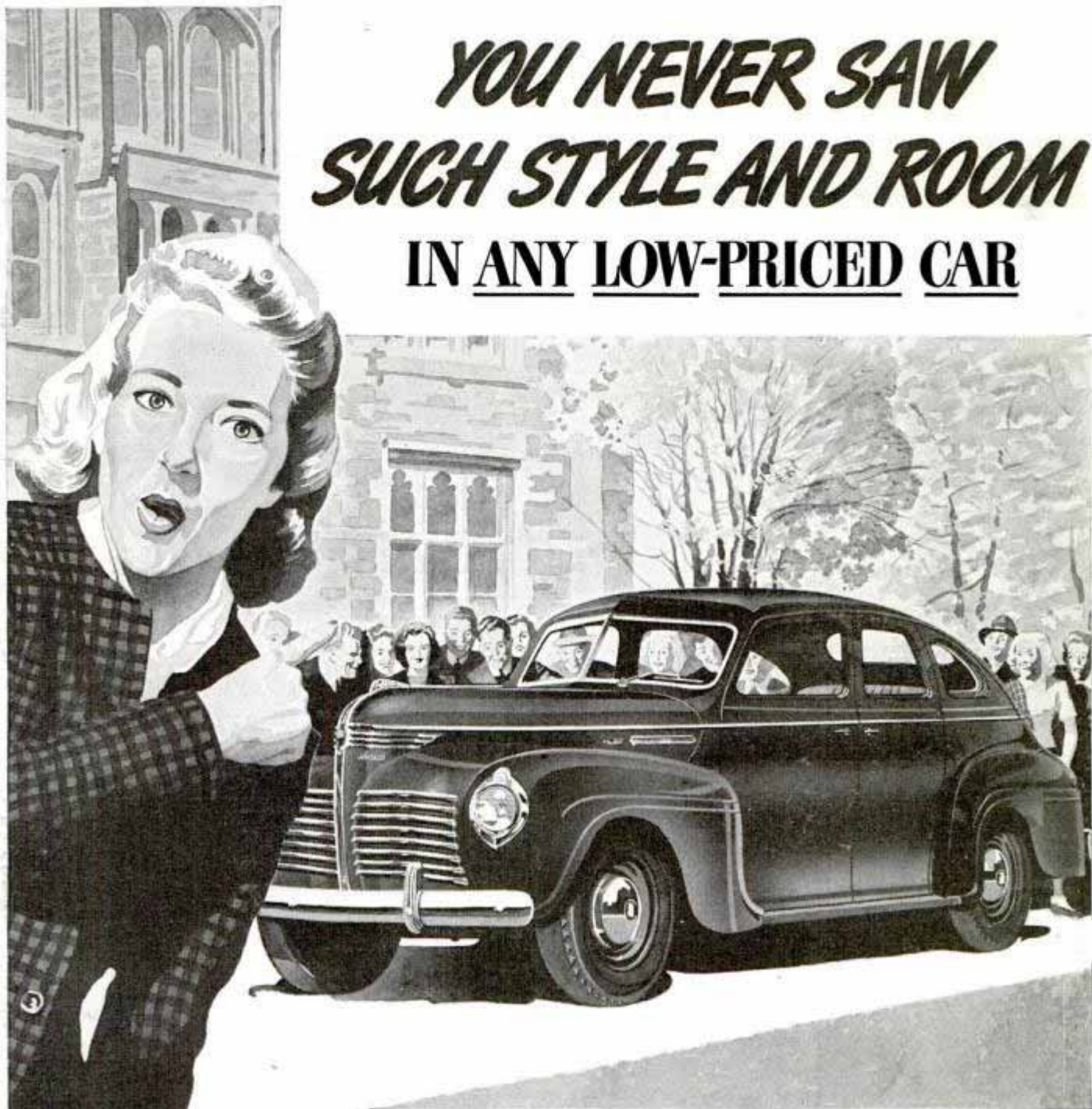

And never such luxury!
The 1940 Plymouth is the
low-priced beauty with the
Luxury Ride! New Sealed
Beam Headlights give 50-
65% more road lighting...
rear doors are full width at
the bottom...Steering Post
Gear Shift is now standard
equipment on all models!

NEW luxury, new quality, new bigness, new
value stand out in the 1940 Plymouth!
Notice the new *spaciousness*...enjoy the luxu-
rious feel of the big Floating Power engine—
Superfinished for long-life smoothness!

It's the low-priced beauty with luxury looks
and luxury performance. Shifting is a luxury,
too. And the famed hydraulic brakes have
Superfinished drums. Try the *Luxury Ride!*

TUNE IN MAJOR BOWES, THURS., C.B.S., 9-10 P.M., E.S.T.

***THE LOW-PRICED BEAUTY with THE LUXURY RIDE
1940 PLYMOUTH!***

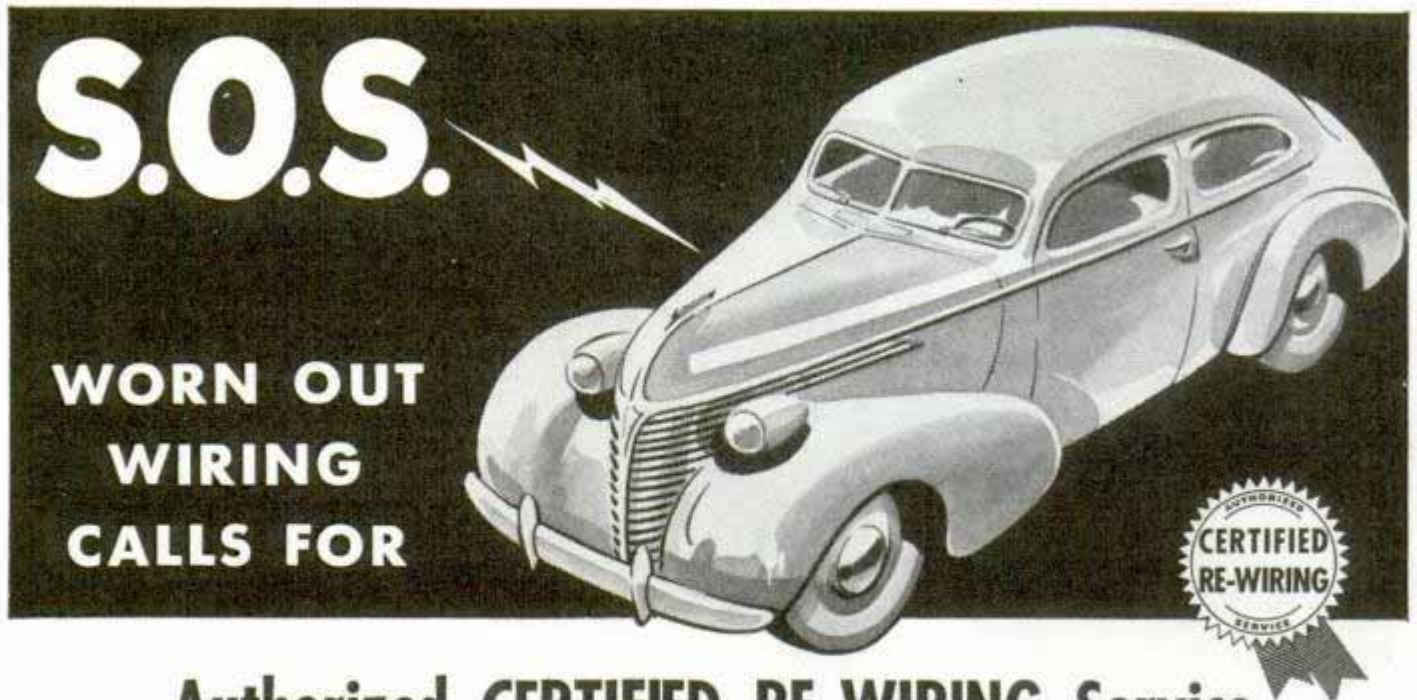

Authorized **CERTIFIED RE-WIRING** Service

If you have driven 15,000 to 20,000 miles without any attention to the wiring on your car, the chances are it is sending out an S.O.S. for **CERTIFIED RE-WIRING** Service. The symptoms to look for are loss of pep and power, hard starting, reduced gas mileage, insufficient illumination from headlamps, and poor accessory performance.

These troubles cannot be fixed by hit-or-miss methods. The way to be *sure* that your wiring system will be scientifically checked and put in A-1 shape, with high quality

cables of the correct gauge and construction, is to go to a station that provides Authorized **CERTIFIED RE-WIRING** Service. This is your assurance that the mechanic who services your car is thoroughly trained in the proper checking and replacement procedure, and that all needed replacements will be made with Packard Cable—the standard wiring equipment of the automotive industry. Drive in to an Authorized **CERTIFIED RE-WIRING** Service Station today!



LOOK FOR THIS SIGN. This sign identifies the Authorized **CERTIFIED RE-WIRING** Service Station. Since many garages are prepared to provide Certified Re-Wiring Service, but have not yet received their signs, you can ask to see the mechanic's Certified Re-Wiring Certificate, which proves he has passed his Certified Re-Wiring examination and is prepared to provide expert electrical service. Insist on genuine Packard Cable for all replacements.

AUTOMOTIVE MECHANICS: *Don't miss out on the opportunity to become a Certified Re-Wiring expert. Any Packard jobber salesman will tell you how to get the Certified Re-Wiring Manual, examination blank and your Certified Re-Wiring Certificate. Or write direct. Have the owner or manager of your place of business get in touch with his Packard jobber today. Packard Electric Division, General Motors Corporation, Warren, Ohio.*

Packard
REG. U.S. PAT. OFF.
TRADE MARK

THE STANDARD WIRING EQUIPMENT OF THE AUTOMOTIVE INDUSTRY

Popular Mechanics Magazine

H. H. WINDSOR, Founder

H. H. WINDSOR, Jr., Editor and Publisher

November, 1939

Vol. 72, No. 5

IN THIS ISSUE

No "Blind" Driving in 1940 Cars	641
The Band Steals the Show	648
Shooting from the Clouds	Coloroto
Keeping the Iron Horse on Time	668
With the Diving Navy—Part II	674
Explorers of Space	680
Angling for Better Billiards	690
Doing It the Easy Way	696
Don't Take It So Hard	706
Disaster College for Sea Captains	712
Every Policeman a "G-Man"	722
Hunting Birds with a Camera	732

(Continued on next page)

Exploring the Tropics

DOWN among the islands of the tropical Pacific you'll meet baby pelicans that are bigger than their parents and haven't a feather to wear. You'll read magazines after dark by the light of the phosphorescent sea. You may chance upon fish-eating bats and umbrella ants and a fantastic collection of rare birds and animals that consider you a curiosity and will walk right up to your camera, unafraid. "Exploring a Tropical Wonderland," a feature in the December issue, takes you with a shipload of students and scientists on one of the Allan Hancock expeditions among the jungle isles and atolls of the Pacific.

Shots in the Dark

HITTING a running deer a few hundred yards away is no easy job, but suppose you were told where the game was and you had to hit it without seeing it? Ridiculous, you say, but that sort of shooting is everyday work to the artilleryman. It is seldom that Uncle Sam's gunners see the targets at which they fire—with surprising accuracy. Read how they do it in next month's story, "Sharpshooting at Unseen Targets."

Next Month

WHAT about a supercharger for your car? Supercharging a racing automobile steps up its speed higher than ever. A trans-oceanic flying boat couldn't carry a pay load if deprived of its superchargers. Would your car develop more power or operate more economically if you could feed it gas and air at higher atmospheric pressures? An article in December tells what research engineers are accomplishing in their efforts to "soup up" the family sedan and the ten-ton truck.

Golden Age of Sound

NATURE might have provided us with "earlids" to shut out objectionable sounds had she foreseen our noisy civilization. She didn't, so it's up to the acoustical engineers; and already they prophesy a golden age of sound in which unwanted racket will cease, the deaf will hear and magnificent new music will be created—music already foretasted in the new electric and vacuum-tube instruments. Read a professor's forecast of this golden age next month.

Clear Track Ahead

AMERICAN railroads haul a ton of freight for less than a cent a mile, moving it forty per cent faster than a few years ago. A new air brake in eight seconds applies car brakes a mile and a half back of the engine. Next month F. E. Williamson, president of the New York Central, tells how research is keeping our railroads on top of the world. Look for the eight-page Coloroto section.

(Contents—Continued)



115,000 HARD MILES OF SERVICE WITHOUT NEW RINGS OR GRINDING VALVES

OUR FORD V-8 DELIVERY HAS RUN 54,000 MILES WITHOUT ONE CENT OF REPAIRS

IN 3,000 MILES PRACTICALLY ALL CARBON WAS REMOVED, GAS MILEAGE INCREASED, MOTOR HAD MORE POWER AND RAN COOLER

THESE RESULTS, SAY USERS, ARE DUE TO THE USE OF PYROIL

On all sides, good word arises on the performance of 'Pyroil'. "I have used Pyroil in my car since it was new and I am very pleased with the way it has kept my motor in condition," says one. Another: "I like the smooth performance Pyroil gives my car." A passenger bus line: "We are adding Pyroil to our equipment. We feel grateful to any product that will give us added protection from trouble."

Many-year users of Pyroil are good judges of its efficiency and value. We tell you Pyroil keeps engines clean. Reduces hard carbon. Prevents corrosive wear. Disperses gum and sludge. Frees rings and valves. Defeats engine "varnish." Saves you money. Users tell you Pyroil has done these things for them.

You can enjoy the many benefits of Pyroil from today on if you will ask at your favorite service station or garage for a trial treatment. Merely a few ounces in gas tank and crankcase at a trivial few cents' cost. Then, just see what a difference there is in your car's performance. Do this today! Manufactured and Guaranteed by Pyroil Company, W. V. Kidder, Founder, 511 Pyroil Bldg., LaCrosse, Wisconsin, U.S.A.

A FREE BOOKLET telling you all about Pyroil—plus copies of interesting original letters from users, sent to you without obligation. Mail the coupon below.

DISTRIBUTORS:

CHECK AND MAIL COUPON FOR FRANCHISE FACTS.



ADD MERELY OUNCES TO GAS & OIL

PYROIL COMPANY,
511 Pyroil Building,
LaCrosse, Wisconsin, U. S. A.

Send FREE copy of your booklet "QUESTIONS AND ANSWERS ABOUT PYROIL." Also letters from users.

Send details of your plan for Distributors.

Name _____

Address _____

City _____

State _____

AUTOMOTIVE

Runabout for shopping has plywood body.....	652
Lawn rickshaw saves walking.....	683
Portable tester for car batteries.....	685
Police car marks tires to check parking.....	686
Police car warns drivers to dim lights.....	688
Tractor mower has two sickle bars.....	688
Rear unit converts hike into motor scooter.....	689
Accelerator for left foot attaches to right pedal.....	694
Electric curb feeler guards auto in parking.....	695
Auto signal arm has built-in light.....	716
One-man fire department on trailer.....	721
One-horsepower "safety trainer" auto for children.....	726
Obstacle race tests the driver.....	728
Foot pump inflates auto tire quickly.....	730

AVIATION

Derelict airplane finds job chasing mosquitoes.....	694
Fuel analyzer shows pilot if mixture is balanced.....	726
Guns mounted in airplane's "pants".....	735
70,000 licensed pilots by end of 1941.....	736

BOATS AND BOATING

Towboat lowers pilot house under bridge.....	678
Speedboat with airplane cockpit.....	701
Submarine camouflage adopted by Germany.....	703
Liquid-type marine compass has floating dial.....	705

CONSTRUCTION

Glass building block with light diffuser.....	679
Tiles with built-in draining keep dry.....	700
Metal cleats space roofing nails evenly.....	716

FARMS

Tractor pulls tanks on wheels to water orchards.....	683
Offset tractor allows clear view of row crop.....	703
Sod shaver drawn by tractor.....	725
Electric tractor for hotbeds.....	731

HOUSEHOLD

Jar sealed by suction cap easy to close.....	678
Self-locking corner shield.....	679
Stove-top bun warmer.....	684
Fan on lawn mower blows cooling breeze.....	685
Crib spring may be raised and lowered.....	702
Glass mailbox has top and bottom openings.....	704
Lamp on memo pad lights when using pencil.....	710
Crib is cabinet, bath and dressing table.....	716
Pianos in tweeds and leather.....	720
Sink, stove, refrigerator and cabinet in one.....	727
Fire extinguisher discharged like gun.....	735
Oiled-silk cap keeps dust off books.....	736

PHOTOGRAPHY

Movie camera on gunstock gives steady aim.....	652
Spiral-slotted reel for cut film.....	688
View meter helps take artistic pictures.....	702
Shadow lingers behind on tricky screen.....	711
Movie test for drunken drivers eliminates trials.....	720

RADIO AND ELECTRICITY

"Cold" super light for television.....	678
Street lamp blends mercury and incandescent light.....	679
"Eye chart" tests television camera.....	684
Whirligig traps and measures lightning bolt.....	705
Vacuum tube lasts more than eleven years.....	730
Short-wave diathermy for livestock.....	736
Pocket-type vacuum-tube hearing aid.....	775
How to build a portable sound system.....	776
Electrical substitute for a large baffle.....	778
Practical radio suggestions.....	779
Frequency standard for amateurs and service men.....	780
High-fidelity three-unit receiver in kit.....	780
Lens enlarges size of television image.....	780
Portable microphone holder leaves both hands free.....	780

RAILWAYS

Railroad trestle opened for 200-inch disk.....	689
Phone at crossing reports if track is clear.....	701
Streamliner has "earlaps" to blow smoke away.....	717
Diesel train for Pikes Peak cuts time.....	727

SCIENCE AND INDUSTRY

Blind spot in eye charted in visual test.....	653
Atmosphere shields earth from meteorites.....	678
Weekly weather cycles linked to sunspots.....	684
Chicago built on coral reefs.....	685
Bell of new alloy rings clear when hot.....	686
Diamonds fall from sky with meteors.....	689

(Continued to page 6A)

The Ride of Your Life Waits for You IN ANY 1940 HUDSON

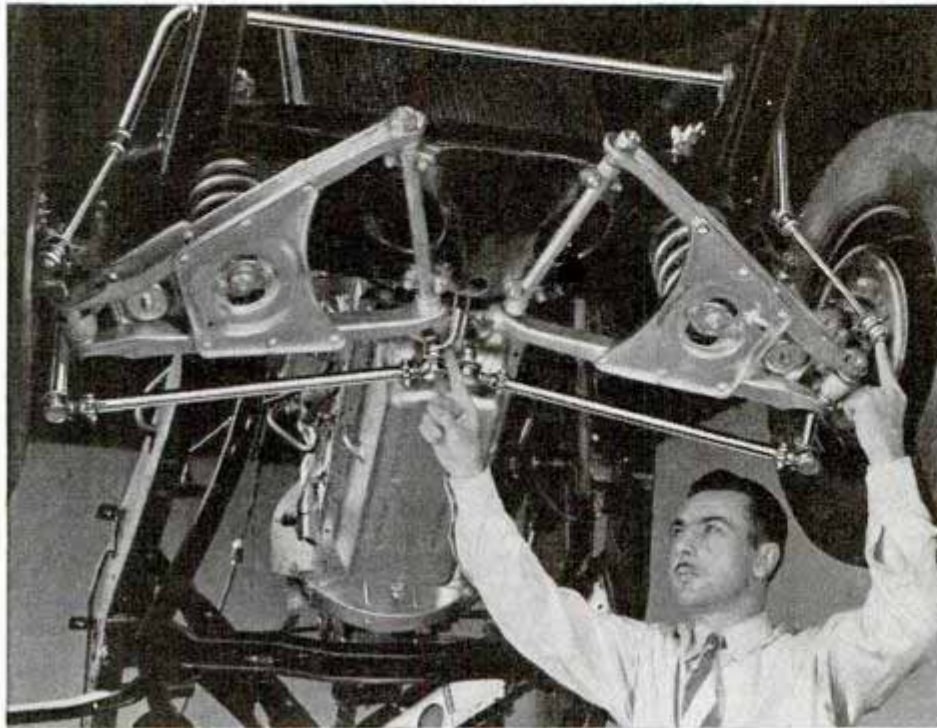

(At left) An engineer points out two of the features of Hudson's new independent front wheel suspension that are new to the industry!

His left hand indicates Hudson's own Auto-Poise Control—a patented invention that automatically helps keep wheels straight, even if a tire blows! For the first time, finest independent front wheel coil springing is given the benefits of *positive wheel control!*

His right hand indicates Hudson's Center-Point Steering, most accurately designed system known . . . used up to now only on very costly cars. Sweetest handling, easiest riding car you ever drove!

Now . . . in the Lowest Price Field . . . a Car that Looks, Rides and Drives like Twice the Money

Today, for a rock-bottom price, you can own a car that makes heads turn to see more of its beauty. A car with more roominess, more genuine luxury, more power, than the lowest price field has ever seen before. This car is the new Hudson Six, most amazing lowest priced

car ever built, pictured below. And its crowning wonder is that you'll find it one of the most economical of all cars . . . in gas, in oil, in every way. Visit the nearest Hudson showroom . . . see and drive the new Hudson . . . before you buy any 1940 car!

Car shown is new Hudson Six DeLuxe Touring Sedan, \$806*

NEW LOWER PRICES
STARTING AT

\$670

*delivered in Detroit, equipped to drive: including Federal taxes, not including state and local taxes, if any. Low time payment terms, with new Hudson-C. I. T. Plan. Prices subject to change without notice.

AMERICA'S SAFEST CARS are now AMERICA'S SMARTEST



NEW HUDSON SIX • NEW EIGHT AND SUPER-SIX • NEW COUNTRY CLUB SEDANS

**NAME IT...AND I'LL
STICK IT!**



**New kind
of cement
hailed by hobbyists!**

• "Just the cement I've waited for," say home craftsmen, model builders and camera fans.

Proved by ten years' industrial use, Casco Flexible Cement is now available in handy tubes for workshop, home, school and office.

Bonds a wide variety of surfaces—metal, paper, glass, wood, plastics—a new, quicker, cleaner way. Forms a *flexible* bond that resists heat, moisture, expansions, even shocks!

Large tube 25c at Hardware Stores.



FOR HEAVY DUTY WOOD GLUING

...on furniture, cabinets, boats, etc... use Casco Powdered Casein Glue. Easy to mix. Used cold. Resists moisture, heat and rough usage. 10c to 65c at Hardware, Paint and Lumber Dealers.

FREE! Home Workshop Handbook

Helps woodworkers from beginner to Master Craftsman. Contains a list of free and low-cost booklets offered you by leading experts on Tools, Finishes, Sharpeners, Cabinet Woods and Veneers, Project Plans and Workshop Clubs. First book with *all* this information. Mail coupon *now* for your copy.



CASEIN COMPANY OF AMERICA
350 Madison Ave., Dept. PM-1139
New York, N. Y.

Yes, send me your free "Home Workshop Handbook"

Name _____

Address _____

Save 2c, stick coupon on penny postcard

(Contents—Continued)

Energy of ultraviolet shown by light meter.....	695
Fifth skin pigment discovered.....	704
Hundred million billion suns in our range.....	716
Giant 280-ton lathe turns 120-ton casting.....	721

SPORTS

Two bikes and tandem carry five.....	653
Swiss hornet game played with ten-foot club.....	699
Automatic life jacket keeps wearer afloat.....	701
Reel flashes tiny light when fish bite.....	720
One shaft and club heads is golfer's outfit.....	730
Polo played on motor scooters.....	731

TOOLS

Hand-powered pike pole "jack".....	700
Flameless electric paint burner.....	710
Clamp for small work has viselike grip.....	726

MISCELLANEOUS

Giant floating sign shot into air.....	652
Phosphorus "flower" hides army maneuvers.....	678
Rubber band flips newspaper to reader's home.....	684
Tablets slip from box one at a time.....	686
Relief carving of General Grant tree.....	694
Collapsible metal ladder for emergency fire escape.....	695
Non-electric dry shaver.....	700
Vacuum cleaner trap catches usable scrap.....	702
Electric sterilizer purifies air with dry mist.....	704
Doll with flexible legs stands or sits.....	710
Spindle has safety flap on point.....	710
Miniature roller coaster that runs.....	711
Artificial respiration meter.....	717
Compass and camera show oil-well slant.....	717
Stretcher between two bikes forms ambulance.....	725
List slides into phone base when not in use.....	730

Craftsman and Shop Notes

AUTOMOTIVE

Electrical test units detect auto faults.....	795
Fitting brake lining to turned drums.....	797
Extra cylinder-head gasket stops exhaust blowouts.....	798
How to clean valve stems.....	798
Pressure lubrication of car springs.....	798
Racing cold motor burns moving parts.....	798
Removing wheel with aid of pipe.....	798
Cotter keys aid in repairing tires.....	799
Creeper seat for working on tires and brakes.....	799
Cylinder taper measured with feeler gauge.....	799
Testing valve seats for fit.....	799
Adjustable lamp on free-air hose standard.....	800

FARM

Pan provides good bird feeder.....	764
Chimney cap provides automatic feeder for poultry.....	786
Rubber stop holds halter rope without tying.....	786
Tile provides good holder for stock salt.....	788
Tumbling barrel mixes stock feed.....	788
Feed trough from planter wheel.....	792
Planter wheel serves as hog feeder.....	794
Sack on turkey's wing prevents flying.....	794

FURNITURE

Novel wall case for books.....	737
Cutting upholstery material to make straight seams.....	742
Writing cabinet folds flush with the wall.....	743
Dual and single-purpose types in small tables.....	744

HAND TOOLS

Cushioning handle of nail clipper to protect fingers.....	748
Comb used as compass.....	752
Shield for scribe point.....	769
Doorknob handles for ends of files.....	783
V-block from halved generator shell.....	784
Well in bench holds oil to lubricate centers.....	784
Sharpening pointed tools with two files.....	786
Clamp jig to make washers.....	792
Thimble on glass cutter protects finger.....	792
Shielding file tang to protect hand.....	800

HOUSEHOLD

Clothespin prevents spoon from slipping into pan.....	739
Hairpin holds button while checking for location.....	740
Package of pins cut for easy removal.....	740
Pencil eraser on garment hook holds hat.....	742
Colonial floor lamp.....	750
Improvised reel for skeining yarn.....	762

(Continued to page 8A)

WHICH OF THESE MEN IS YOU?



Is This You?

OR

Is This You?



1. "My name is Stark. I'm never late mornings. I get back promptly from lunch—often work overtime cheerfully. I carefully do every single job they give me and in six years I have done each job so many times that I'm letter-perfect! Only one little raise so far, but some day I ought to get a good one. I'm probably the steadiest, most loyal employee in the whole office. One of these days the boss will realize that I'm the best man who ever worked on this job. Then I'll show these other fellows a thing or two!"

2. "My name is Baker. I've only been here a year, but the jobs they give men like Stark and me are too easy. In three months I saw I could never get far ahead on routine work like this. So I began to look for ways to increase and improve the work in my department. I'm taking home-study training that's helping me a lot. My boss heard about it and complimented me. Next month I'm going to be made Assistant Department Head at 40% more money. After that—well, we'll see. But you can bet I'm still studying!"

DON'T you recognize both these men in your office? One is a slow plodder—the other an energetic go-getter. Stark thinks of himself—Baker, of his company.

Stark runs along comfortably in a rut—*hopes* for a big raise. Baker pulls himself out of ruts—*gets* a big raise. And goes right on training for *another* one!

It's men like Baker who turn to LaSalle business training because of what it *gets* them! And they know it gets them *plenty* because the proof is plain to read in the grateful letters—and the successful lives—of thousands of LaSalle graduates.

You too can join the ranks of the "comers" like Baker if you'll "train on the

job you've got—to get the job ahead!" It all depends on you—the height of your ambition and your readiness to investigate, then study systematically and seriously.

The LaSalle Success Road is cleared and ready for earnest adults—has been traveled for thirty years. Its first sign-post has always been a man's name on a coupon like the one below.

It costs absolutely nothing to send such a coupon. But sending it may mean the turning-point in your whole life. Mail it! At least *find out* about LaSalle's road to better jobs—more money—success! There's no time like *NOW!*

LASALLE EXTENSION UNIVERSITY, A Correspondence Institution
Dept. 1164-R CHICAGO

I am ambitious like Baker. Tell me how I can prepare for larger success—and send me your free booklet on the field I have checked below:

Executive Management Law: LL.B. Degree Salesmanship
 Accounting Traffic Management

Name.....Age.....

Position.....

Address.....



This One

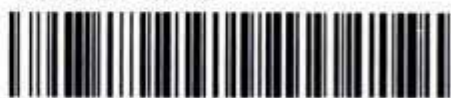

BPAC-LF6-WWJ2

LaSalle EXTENSION UNIVERSITY
A CORRESPONDENCE INSTITUTION

TIME SAVING ALONE

may urge repair with

SMOOTH-ON No. 1



INFINITELY more vexing than the repair of a cracked heater, leaky joint, opened seam, or loosened part are the annoyance and possible damage before proper working conditions are restored.



A—Sealing crack in a heater with Smooth-On

Usually a leak can be stopped, a loose part tightened, or a crack patched with Smooth-On without taking anything apart. The Smooth-On is easily applied without heat or special tools, solidifies quickly, and makes a seal or joint that has the strength and durability of the adjacent metal. Any householder or handy man can do the work quickly, at big savings, and with full assurance of an efficient and permanent repair.

The instructions and working diagrams in the SMOOTH-ON HANDBOOK cover much emergency and common repair work, and afford a reliable guide for getting dependable results. Get a free copy of this booklet, keep it for quick reference and see that there

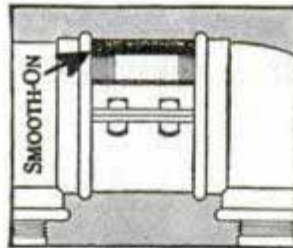

B—Stopping leak at pipe threads

is a can of Smooth-On No. 1 in your workbench. With these precautions, you will be well prepared when the unexpected happens.

Buy Smooth-On No. 1 in 7-oz. or 1 or 5-lb. can from your hardware store or if necessary from us.



Write for
FREE BOOK



Do it with **SMOOTH-ON**

Dept. 37,
SMOOTH-ON MFG. CO.,
574 Communipaw Ave.,
Jersey City, N. J.

Please send Smooth-On Repair Book.

Name.....

Address.....

11-39.....

(Contents—Continued)

Cards stored in box underneath bridge table.....	769
Sewing cabinet with modern lines.....	771
Solving home problems.....	772

OFFICE

Ash tray on curtain rod slides under desk.....	763
Finger holes simplify use of cardboard files.....	792
Vacuum cup on stamp-pad lid prevents slipping.....	794

PHOTOGRAPHY

Cork holds film under water faucet.....	748
Camera lens masks to get photomontages.....	753
Drip-proofing your darkroom sink.....	793

POWER TOOLS

Keen edges on jointer knives.....	781
Tinplate track made in rolling mill.....	787
"Stroker" belt sander.....	789

STORE AND SHOP

Fulcrum block attached to crowbar.....	754
Price tags fastened to dishes with paper clips.....	784
Rubber grip on hand stamp.....	788
Mousetrap holds orders on hand truck.....	792

TOYS AND NOVELTIES

Furniture glides provide bearings for toy wheels.....	754
Starting early on the doll house.....	756
Speedy "mono coaster".....	763
Support for miniature trees.....	764
Stiff swing seat for little tots.....	770

WOODWORKING

Bench top veneer press set up quickly.....	748
Small flashlight aids in turning bowls.....	748
Tidbit tray of copper.....	749
Disk sander has quick-change abrasive surfaces.....	762
Razor altered to cut sheet veneer.....	764
Abrasive fastened on sanding drum with stapler.....	770
Rugged bench spring clamp has many uses.....	770
Swinging arms on sawhorse support wide work.....	788

MISCELLANEOUS

Vase holder hand wrought in copper.....	739
Re-knurling handlebar grips.....	740
Rifle target from tin cans.....	740
Rubber boots suspended in coat hangers.....	740
Snow-man refreshment booth used all year.....	741
Nail kit from spool and metal boxes.....	742
Old car tires fire green brush piles.....	742
Small parts rack from sturdy spool.....	742
Rubber guard for compass point.....	743
Thumb loop avoids dropping electric razor.....	743
Phonograph and cabinet for child.....	749
Envelope cleans small tacks from magnet.....	752
Paper clip extends for use in key purse.....	752
Rubber belt strap supports top of boots.....	752
Rule supports data sheet on workbench.....	752
Sanding block permits instant change of paper.....	753
Cartridge pouch slips on trouser belt.....	754
Shield on acid-bottle stopper.....	754
Window in pocket to see watch.....	754
Attractive model house conceals mailbox.....	755
Beach pebbles assure action of salt shaker.....	755
Antproof hanger for lunch box.....	762
Signs clamped to trees with auto casing.....	762
Tax-token purse from rubber ball.....	764
Mount that trophy for your den.....	765
Metal ladder rungs stand hard use.....	768
Bracket supports paint bucket on picket fence.....	769
Concrete incinerator resembles hollow stump.....	770
Wooden feet support stepladder on soft ground.....	771
Shock-absorbing feet for large boxes.....	774
Thumbtack puller made from empty cartridge.....	774
Super locked on beehive with sash fasteners.....	784
Diagonal bracing strengthens roof framing.....	785
Pad to wipe soldering iron clamped on blowtorch.....	785
Rubber strap holds tool kit on stepladder.....	786
Coil spring on head of T-square holds pencils.....	792
Glass tumbler seals bottle mouth.....	794
Protecting bulb of laboratory thermometer.....	794

IMPORTANT NOTICE

It is the intention of this magazine to provide its readers with information regarding the latest developments in the mechanical arts. We take no responsibility as to whether the disclosures contained in our articles are covered by patents and advise readers to investigate this subject before making, using, or selling any of the products, machines, or processes described, in order to avoid possible liability for patent infringement.



"SHOP PRACTICE & HOME STUDY - brother, they go together!"

● "I work in the shop every day. And a couple of hours every evening, I study. Study what? I don't mind telling you — an I. C. S. Course! Take it from me, shop practice and home study go together. When you combine them, you're headed for more pay and a brighter future!"

The International Correspondence Schools are proud that over 600 American schools, colleges and universities use textbooks prepared by the I. C. S.! And I. C. S. instruction is a *personal* relationship between student and instructor. The coupon will bring you detailed information.

INTERNATIONAL CORRESPONDENCE SCHOOLS

BOX 5557-J, SCRANTON, PENNA.

★ Without cost or obligation, please send me a copy of your booklet, "Who Wins and Why," and full particulars about the subject *before* which I have marked X: ★

TECHNICAL AND INDUSTRIAL SUBJECTS

- | | | | | |
|---|---|---|--|---|
| <input type="checkbox"/> Agriculture | <input type="checkbox"/> Air Brakes | <input type="checkbox"/> Contracting and Building | <input type="checkbox"/> Manufacture of Pulp Paper | <input type="checkbox"/> Sanitary Engineering |
| <input type="checkbox"/> Air Conditioning and Cooling | <input type="checkbox"/> Cotton Manufacturing | <input type="checkbox"/> Diesel Engineering | <input type="checkbox"/> Marine Engineering | <input type="checkbox"/> Sheet Metal Work |
| <input type="checkbox"/> Architectural Drafting | <input type="checkbox"/> Diesel Engineering | <input type="checkbox"/> Electrical Engineering | <input type="checkbox"/> Mechanical Drafting | <input type="checkbox"/> Steam Electric Engineering |
| <input type="checkbox"/> Architecture | <input type="checkbox"/> Electric Lighting | <input type="checkbox"/> Fire Bosses | <input type="checkbox"/> Mechanical Engineering | <input type="checkbox"/> Steam Engineering |
| <input type="checkbox"/> Auto Electric Technician | <input type="checkbox"/> Fruit Growing | <input type="checkbox"/> Heating | <input type="checkbox"/> Mine Foreman | <input type="checkbox"/> Steam Fitting |
| <input type="checkbox"/> Auto Technician | <input type="checkbox"/> Heat Treatment of Metals | <input type="checkbox"/> Highway Engineering | <input type="checkbox"/> Navigation | <input type="checkbox"/> Structural Drafting |
| <input type="checkbox"/> Aviation | <input type="checkbox"/> House Planning | <input type="checkbox"/> Machinist | <input type="checkbox"/> Patternmaking | <input type="checkbox"/> Structural Engineering |
| <input type="checkbox"/> Boilermaking | <input type="checkbox"/> Management of Inventions | | <input type="checkbox"/> Pharmacy | <input type="checkbox"/> Surveying and Mapping |
| <input type="checkbox"/> Bridge Engineering | | | <input type="checkbox"/> Plumbing | <input type="checkbox"/> Telegraph Engineering |
| <input type="checkbox"/> Building Estimating | | | <input type="checkbox"/> Poultry Farming | <input type="checkbox"/> Telephone Work |
| <input type="checkbox"/> Chemistry | | | <input type="checkbox"/> Public Works Engineering | <input type="checkbox"/> Toolmaking |
| <input type="checkbox"/> Civil Engineering | | | <input type="checkbox"/> Radio | <input type="checkbox"/> Ventilation |
| <input type="checkbox"/> Coal Mining | | | <input type="checkbox"/> R. R. Locomotives | <input type="checkbox"/> Welding, Electric and Gas |
| | | | <input type="checkbox"/> R. R. Section Foreman | <input type="checkbox"/> Woolen Manufacturing |
| | | | <input type="checkbox"/> R. R. Signalmen | <input type="checkbox"/> Refrigeration |

BUSINESS SUBJECTS

- | | | | | | |
|--|--|--|--|---|----------------------------------|
| <input type="checkbox"/> Accounting | <input type="checkbox"/> Advertising | <input type="checkbox"/> College Preparatory | <input type="checkbox"/> Grade School Subjects | <input type="checkbox"/> Railway Postal Clerk | <input type="checkbox"/> Signs |
| <input type="checkbox"/> Bookkeeping | <input type="checkbox"/> Cost Accounting | <input type="checkbox"/> C. P. Accounting | <input type="checkbox"/> High School Subjects | <input type="checkbox"/> Salesmanship | <input type="checkbox"/> Spanish |
| <input type="checkbox"/> Business Correspondence | <input type="checkbox"/> First Year College Subjects | <input type="checkbox"/> Foremanship | <input type="checkbox"/> Illustrating | <input type="checkbox"/> Secretarial Work | |
| <input type="checkbox"/> Business Management | <input type="checkbox"/> French | | <input type="checkbox"/> Lettering Show Cards | <input type="checkbox"/> Stenography and Typing | |
| <input type="checkbox"/> Cartooning | <input type="checkbox"/> Civil Service | | <input type="checkbox"/> Managing Men at Work | <input type="checkbox"/> Traffic Management | |

DOMESTIC SCIENCE SUBJECTS

- | | | |
|---|---|--|
| <input type="checkbox"/> Advanced Dressmaking | <input type="checkbox"/> Home Dressmaking | <input type="checkbox"/> Tea Room and Cafeteria Management, Catering |
| <input type="checkbox"/> Foods and Cookery | <input type="checkbox"/> Professional Dressmaking and Designing | |

Name..... Age..... Address.....

City..... State..... Present Position.....

Canadian residents send coupon to International Correspondence Schools Canadian, Limited, Montreal, Canada
British residents send coupon to I. C. S., 71 Kingsway, London, W. C. 2, England



Be an ARTIST!

You can prepare for an Art Career, at home in your spare time this practical way
Trained Artists Are Capable of Earning \$30, \$50, \$75 a Week

YOU can develop your ability to enter the fascinating, profitable field of Art. It's actually fun to learn at home the proven W.S.A. way. No previous Art experience is necessary.

Commercial Art, Cartooning and Designing ALL in ONE Course!

W.S.A. has been successfully training men and women for Art careers since 1914. Many trained Artists are now making good money in their own art studios, or drawing for newspapers, publishers, stores and advertising agencies. **TWO ARTISTS' OUTFITS INCLUDED** with course. Mail coupon for details in **FREE BOOK**.



FREE BOOK gives details!

Washington School of Art, Studio 1211M
 1115—15th St., N. W., Washington, D. C.
 Yes! I am interested in learning to draw. Please send me your Free Book, "Art for Pleasure and Profit."
 Name..... Age.....
 Address.....
 City..... State.....



DO YOU WANT \$36.50 A WEEK?

U. S. Government Jobs

START \$1260 TO \$2100 A YEAR

MEN — WOMEN

Paid Vacations
Common education usually sufficient
Mail Coupon Today—SURE

FRANKLIN INSTITUTE
 Dept. R195
 Rochester, New York

Gentlemen: Rush to me, FREE of charge, list of U. S. Government big pay positions. Send me FREE 32-page book describing salaries, hours, work, vacation, and giving full particulars on how to qualify for a position.

COUPON
 Name.....
 Address.....

Always write your name and full address clearly when answering advertisements.

GET IN THE SWING with Slingerland . . . DRUMS



GENE KRUPA — World's Greatest Swing Drummer uses Slingerland

GUITARS MANDOLINS

WONDERFUL VALUE EASY PAYMENTS

Compare the value—tone and power in Slingerland "Radio King" drums, banjos, guitars, mandolins, marimbas or bugles—before you buy. Guaranteed more for your money. Acclaimed the tops in smooth world's leading



tone, easy playing, rich power by musicians. Easy payments. 5-days free trial. See at your dealers.

Write for free special information on how to organize drum and bugle corps. Free Catalog—mention instrument wanted.

SLINGERLAND DRUM CO.
 1330 Belden Avenue Chicago, Illinois

AN AVIATION CAREER



OFFERS YOU GREAT FUTURE!

Demand for trained aircraftmen is increasing and already exceeds supply. Curtiss-Wright Tech, Aviation's foremost school, is located on Grand Central Air Terminal in heart of the aircraft industry and specializes in training MASTER MECHANICS and AERONAUTICAL ENGINEERS. (No flying involved.) Graduates are obtaining immediate employment. Write for details NOW. Dept. PM-11.

CURTISS-WRIGHT TECHNICAL INSTITUTE
 Glendale (Los Angeles) California

TAKE THE NEW RADIO EXAMS IN YOUR STRIDE



Let A. R. Nilson, internationally known author, train you for 1st or 2nd class radio telephone operator's license and radio telegraph operator's permit. New, low-cost home-study courses described in FREE booklet "What The Modern Radioman Must Know." Write for a copy of circular PM-11 now!

POLICE AIRCRAFT FORESTRY BROADCAST

NILSON RADIO SCHOOL 51 East 42nd St. New York, N. Y.



FOLLOW THIS MAN

Secret Service Operator No. 38 is on the job! Running down dangerous Counterfeit Gang. Tell-tale finger prints in murdered girl's room.

Free The Confidential Report Operator No. 38 made to his chief. Write for it. Earn a Regular Monthly Salary

YOU can become a Finger Print Expert at home, in your spare time, at small cost. Write for confidential full report and details. Literature will be sent only to persons stating their age.

INSTITUTE OF APPLIED SCIENCE
 1920 Sunnyside Ave. Chicago, Ill. Dept. 1358

Learn PHOTOGRAPHY at Home

Splendid opportunities. Prepare in spare time. Easy plan. No previous experience needed. common school education sufficient. Send for free booklet "Opportunities in Photography", particulars and requirements.

American School of Photography
 3601 Michigan Ave., Dept. 1358, Chicago, Ill.

Regain Perfect Speech, If You STAMMER

Every stammerer should have the new 304 page book "Stammering, Its Cause and Correction." Sent free to stammerers. It describes the Bogue Unit Method for the scientific correction of stammering and stuttering. Method successfully used at Bogue Institute for 38 years—since 1901. Endorsed by physicians. Write for full information. No obligation. Benjamin N. Bogue, Dept. 1398 Circle Tower, Indianapolis, Indiana.

Training Counts in Every Field



International News Photos

You Must Know What to Do When Signals are Called

To play the game—whether on the football field or in the bigger jobs of business and industry—you must know what to do when the signals are called. To make the team a player must be above average—and you must be above average to meet the demands of employers for the better paid positions.

Your own ability to hold the better jobs depends entirely on the preparation you have made to accept the **opportunities offered every month in the year** in the active fields of today such as Air Conditioning, Diesel Engineering, Drafting and Design, etc. Men in these fields and others with preparation as accountants and in merchandising are being advanced into such openings as department heads, managers, foremen, superintendents, traveling auditors, etc.

Your opportunity today simply means being **ready** for the good jobs looking for good men—your chance for a worthwhile position depends on whether or not you will prepare to meet the demands of employers all over the country who are offering the big jobs to men who can handle them!

Without training a man is no more valuable at 40

than at 30, is old at 50. But the doctor at 40 or 50 is a better doctor than he was at 30—and it's the same with men trained in other fields—executives, draftsmen, engineers, merchants, architects **are young at 40, at 50**—and still have many good pay years ahead. Promotion, higher pay, reward properly trained men!

American School, an educational institution incorporated "not for profit," has used for over 40 years a direct and practical method for preparing men to handle the **bigger jobs in business and industry**.

American School graduates hold important positions as engineers, accountants, experts, draftsmen, managers, etc., or successfully operate their own business. Thousands of our High School graduates have entered colleges, universities, normal schools, etc., have attained success in business or industry.

Find out how American School can help YOU, the difference it may make in your entire future **success and happiness!** Mail coupon today for **free** Bulletin and early lesson in field of your choice. No obligation on your part.

American School, Dept. G845, Drexel Ave. at 58th St., Chicago

-----Cut Along This Line-----

Try a Lesson Yourself—No Obligation

American School, Dept. G845, Drexel Ave. at 58th St., Chicago

I have checked the line of work in which I would like a good job. Please send me without expense or obligation on my part a copy of your Bulletin and an early lesson in the field I have selected.

- | | | |
|--|---|---|
| <input type="checkbox"/> Air Conditioning | <input type="checkbox"/> Electrical Engineering | <input type="checkbox"/> Law |
| <input type="checkbox"/> Architecture | <input type="checkbox"/> Diesel Engineering | <input type="checkbox"/> Liberal Arts (College) |
| <input type="checkbox"/> Automotive Engineering | <input type="checkbox"/> Drafting and Designing | <input type="checkbox"/> Mechanical Engineering |
| <input type="checkbox"/> Automobile Repairing | <input type="checkbox"/> Electric Refrigeration | <input type="checkbox"/> Merchandising |
| <input type="checkbox"/> Bookkeeping and Cost Accounting | <input type="checkbox"/> Heating, Ventilating, Plumbing | <input type="checkbox"/> Private Secretary |
| <input type="checkbox"/> Business Management | <input type="checkbox"/> Professional Accounting | <input type="checkbox"/> Radio and Television |
| <input type="checkbox"/> Civil Engineering | <input type="checkbox"/> Incl. C. P. A. Coaching | <input type="checkbox"/> Salesmanship |
| <input type="checkbox"/> Aviation | <input type="checkbox"/> High School | <input type="checkbox"/> Shop Practice |
| <input type="checkbox"/> Contracting, Building | <input type="checkbox"/> Highway Engineering | <input type="checkbox"/> Steam Engineering |

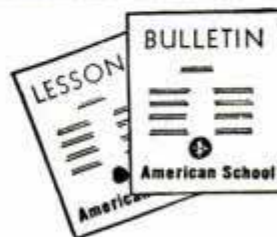

Name ----- Age ----- Occupation -----

Street ----- City ----- State -----

When writing to advertisers please mention Popular Mechanics

I Jumped from \$18 a week to \$50
--A FREE BOOK STARTED ME TOWARD THIS
Good Pay in Radio
--- HERE'S HOW IT HAPPENED
 by S.J.E. (NAME AND ADDRESS SENT UPON REQUEST)

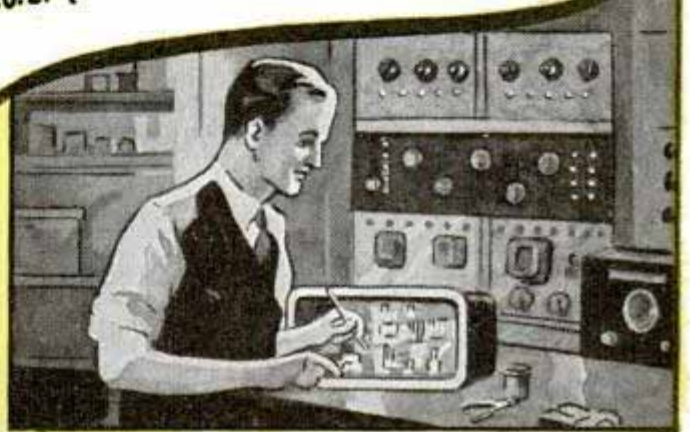
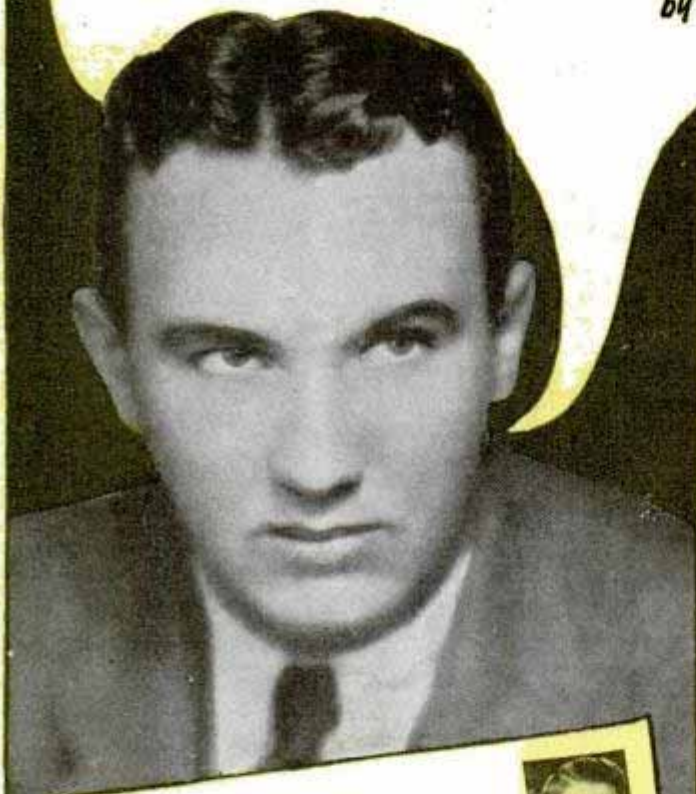

"When I finished training I accepted a job as serviceman with a Radio store. In three weeks I was made service manager at more than twice what I earned in the shoe factory."

Be a RADIO

Find out How I Train

RADIO IS A YOUNG, growing field with a future, offering many good pay spare time and full time job opportunities. And you don't have to give up your present job to become a Radio Technician. I train you right at home in your spare time.

Why Many Radio Technicians Make \$30, \$40, \$50 a Week

Radio broadcasting stations employ engineers, operators, station managers. Radio manufacturers employ testers, inspectors, foremen, servicemen in good-pay jobs. Radio jobbers, dealers, employ installation and service men. Many Radio Technicians open their own Radio sales and repair businesses and make \$30, \$40, \$50 a week. Others hold their regular jobs and make \$5 to \$10 a week fixing Radios in spare time. Automobile, police, aviation, Commercial Radio; loudspeaker systems, electronic devices are other fields offering opportunities for which N. R. I. gives the required knowledge of Radio. Television promises to open good jobs soon.

Makes \$50 to \$60 a Week

"I am making between \$50 and \$60 a week after all expenses are paid, and I am getting all the Radio work I can take care of, thanks to N.R.I."

H. W. SPANGLER
126½ S. Gay St., Knoxville, Tenn.



Over \$1,000 Before Graduating

"Before completing half the N. R. I. Course I was servicing sets, and I made \$1,000 to \$1,200 before graduating. I am doing Radio service work for myself now."

ASHLEY G. ALDRIDGE
1228 Shepherd St., Petersburg, Va.



\$10 to \$25 a Week in Spare Time

"I am now making from \$10 to \$25 a week in spare time while still holding my regular job as a machinist. I owe my success to N. R. I."

WM. F. RIPP
611 Green Street, Bridgeport, Pa.





"I had an \$18 a week job in a shoe factory. I'd probably be at it today if I hadn't read about the opportunities in Radio and trained at home for them."



"The training National Radio Institute gave me was so practical I was soon ready to make \$5 to \$10 a week in spare time servicing Radio Sets."

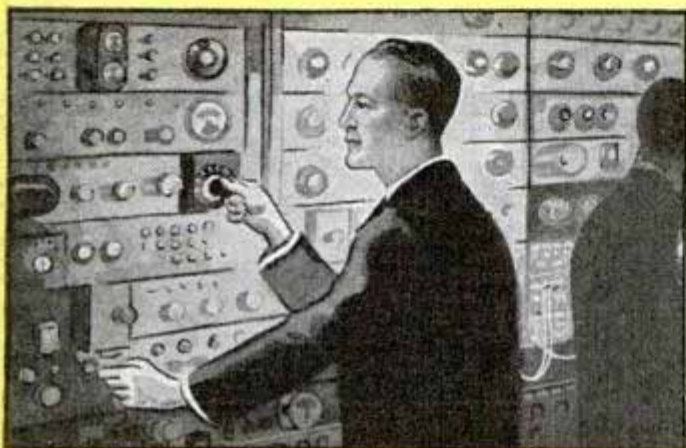

"Eight months later N.R.I. Employment Department sent me to Station KWCR as a Radio operator. Now I am Radio Engineer at Station WSUI."



"N. R. I. Training took me out of a low-pay shoe factory job and put me into Radio at good pay. Radio is growing fast."

Technician You at Home



**J. E. SMITH, President
National Radio Institute
Established 25 Years**

He has directed the training of more men for the Radio Industry than anyone else.



Many Make \$5, \$10 a Week Extra in Spare Time While Learning

The day you enroll, I start sending you Extra Money Job Sheets which start showing you how to do Radio repair jobs. Throughout your training I send plans and directions which have helped many make \$200 to \$500 a year in spare time while learning. I send special Radio equipment to conduct experiments and build circuits. This 50-50 training method makes learning at home interesting, fascinating, practical. I ALSO GIVE YOU A MODERN, PROFESSIONAL ALL-WAVE, ALL-PURPOSE SET SERVICING INSTRUMENT to help you make money fixing Radios while learning and equip you for full time work after you graduate.

Find Out What Radio Offers You

Act Today! Mail the coupon for my 64-page book, "Rich Rewards in Radio." It points out Radio's spare time and full time opportunities and those coming in Television; tells about my course in Radio and Television; shows many letters from men I have trained, telling what they are doing and earning. Read my money back agreement. MAIL COUPON in an envelope or paste on a penny postcard—NOW!

**J. E. SMITH, PRESIDENT
DEPT. 9MP, NATIONAL RADIO INSTITUTE
WASHINGTON, D. C.**

**MAIL THIS NOW
Get 64 Page Book Free**

**J. E. SMITH, President, Dept. 9MP,
National Radio Institute, Washington, D. C.**

Dear Mr. Smith: Send me FREE, without obligation, your 64-page book "Rich Rewards in Radio" which points out Radio's opportunities and tells how you train men at home to be Radio Technicians. (Write Plainly.)

NAME.....AGE.....

ADDRESS.....

CITY.....STATE.....

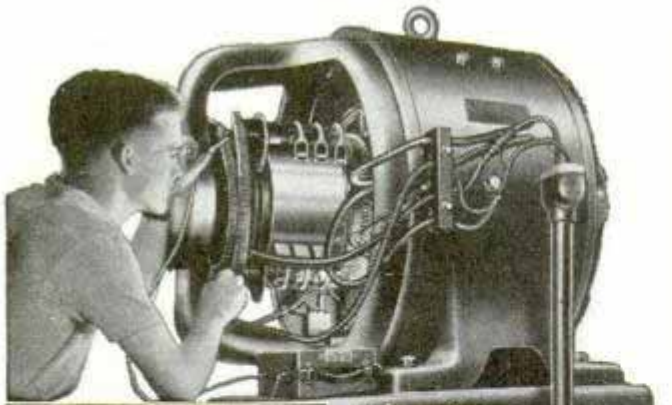

**TRAIN FOR
A GOOD PAY JOB IN
ELECTRICITY
ON REAL MOTORS, GENERATORS, ETC.**

12 WEEKS'
"Learn by Doing" Training
Right Here in Coyne Shops

I'LL FINANCE YOUR TRAINING

Send coupon now and I'll tell you all about my quick, easy way to train for your start for a better job and a real future in the giant field of ELECTRICITY. I'll not only tell you about my training but I'll tell you how you can get this training without laying out a lot of money. You can get training first by making a small down payment—then start paying for most of it in easy monthly payments starting 60 days after your regular training period is over. My training—plus my unusual offer—is your chance to get started towards a real job and a real future. Don't dream about better pay and a good job—prepare now to get it.

QUICKER, EASIER WAY

Here in my big COYNE Chicago training shops you are trained on real electrical machinery and equipment—not by correspondence or embarrassing reciting but by actual **Practical work**. First you are told how to do a thing—Then you are shown how to do it—Then you do the work yourself under the guidance of expert instructors. By my method of instruction you **don't** need previous experience or advanced education.

PART TIME WORK WHILE TRAINING
EMPLOYMENT SERVICE AFTER GRADUATION

If you are short of money and need part-time work to help pay for your room and board while training, our Employment Department will help you get a part time job. After graduation, we will give you **FREE** Lifetime Employment Service.

GET THE FACTS

Don't let lack of money keep you from sending the Coupon NOW. My Big **FREE** COYNE Book is full of facts and photographs which tell you about COYNE Practical Training and how you can get this training **first**, and pay for it later. It shows you how **easy** it is to learn by the COYNE method. It will also tell you about my part time work plan—about my graduate employment service, lifetime membership privileges and many other facts you will want to know. **Don't** delay—mail coupon **TODAY**.

Training in DIESEL, Electric Refrigeration and Air Conditioning—NO EXTRA COST

MAIL THIS COUPON TODAY

H. C. LEWIS, President, COYNE ELECTRICAL SCHOOL
500 S. Paulina St. Dept. 89-72 Chicago, Ill.
Please send me your Big Free Book and details of your "Pay Tuition After Graduation Plan" and other plans to help a fellow get ahead.

NAME.....

ADDRESS.....

CITY.....STATE.....

When writing please mention Popular Mechanics

**BOEING SCHOOL PREPARES FOR
TOP JOBS**

Boeing School training, in 11 thorough ground and flying courses, commands world-wide respect from air executives. Separate courses for college and high school graduates. Enter any quarter, limited enrollment, 30 full-time instructors, unexcelled equipment. 85% of graduates employed. Big demand for trained pilots and meteorologists. U. S. - approved school. Owned and operated by United Air Lines. Ask for Bulletin. 7119 Hangar 5, Airport, Oakland, California.



SCHOOL OF AERONAUTICS

LEARN PHOTOGRAPHY

Our staff of noted experts will teach you Commercial, News, Portrait, Advertising, Natural Color or Motion Picture photography. For pleasure or career. Wonderful opportunities. Personal Attendance and Home Study courses. Free booklet. **from Experts**

NEW YORK INSTITUTE OF PHOTOGRAPHY
10 West 33 Street (Dept. 49) New York City

Succeed in Landscaping
Send for FREE Book on Landscape Training



Full details about this profitable career for men or women. Study at home in leisure time. Successful graduates receive large fees. Some students earn \$5, \$10, \$15 while learning. Pleasant work; initiative rewarded. Write today, giving age and occupation.

AMERICAN LANDSCAPE SCHOOL
6114 Grand Ave. Des Moines, Ia.



TRI-STATE COLLEGE

B. S. Degree in 2 Years

World famous for technical 2-year courses in Civil, Electrical, Mechanical, Chemical, Radio, Aeronautical Engineering Business Administration and Accounting. Special preparatory department for those who lack required high school work. Short diploma courses (36 weeks) in Surveying, Drafting. Low tuition. Low living costs. Students from every state and many foreign countries. 56th year. Graduates successful. Enter September, January, March, June. Write for catalog. 4119 College Ave., ANGOLA, IND.

**CARTOON YOUR WAY
TO SUCCESS!**



DON'T COPY - LEARN TO ORIGINATE!
RAYE BURNS will teach you HOW to CREATE ORIGINAL CARTOONS at home that you can SELL! Course has 26 lessons and 600 illustrations. **\$2.85**
Send name and address for free details. Only....

RAYE BURNS SCHOOL, Dept. M-5, Box 2194, CLEVELAND, OHIO

Stop Slamming Doors
AMAZING MONEY MAKER!



Kant-Slam Door Check is an amazing invention that closes all doors silently and automatically. Closing speed easily adjusted by turning screw at top of check. Holds doors open when wanted open. Operates on hydraulic principle. Low priced. Permanent. Easily installed in ten minutes. Never needs attention. **A Real Demonstrator Furnished Every Agent.**

You get orders quickly demonstrating actual sample on easy to carry miniature door. Every office, factory, store, institution, and public building needs a Kant-Slam for every door. Rush name and address for details of amazing money-making opportunity. **KANT-SLAM DOOR CHECK CO.**
FREE Demonstrator to Workers Dept. R-53, Bloomfield, Ind.

AIRCRAFT
MINING
MARINE
POWER PLANT
AUTOMOTIVE
CONTRACTING
FARMING
DIESEL-ELECTRIC

You've heard about

ALL THESE DIESELS

**-but...
have you
connected
them with
Your Future?**

HAVE YOU GIVEN THE DIESEL
FIELD ANY REAL THOUGHT?

You have seen the full page newspaper and magazine ads on new type Diesels. You have read frequent news items on the rapid, ever-expanding adoption of Diesel power. You have seen many magazine articles on the spectacular growth of the Diesel industry. But have you connected any of them with your own future?

Investigate for yourself . . . get your free copy of the pictorial "March of Diesel" . . . find out about Hemphill Diesel training. You can start right at home and finish in the Hemphill Schools shops. Send the coupon NOW.

HEMPHILL DIESEL SCHOOLS

All communications concerning enrollment in any of the Hemphill Diesel Courses should be sent to one of the following addresses:

NEW YORK . . . 31-26 Queens Blvd., L.I.C.
CHICAGO 2014 Larrabee Street
MEMPHIS 417 Monroe Avenue
LOS ANGELES . . . 2120 San Fernando Rd.
VANCOUVER, B.C. . . . 1363 Granville St.

Applications for enrollment will be accepted from English speaking students residing in foreign countries. Write for special terms.

Hemphill Diesel Schools (use nearest address)

Please send data on your Diesel courses, also free copy of illustrated booklet "March of Diesel."

Name _____ Age _____

Street _____

City _____ State _____ m-41-p

ELECTRICAL BOOKS

shipped FREE



10 BIG BOOKS

BRAND NEW RADIO SECTION
PUBLIC ADDRESS SYSTEMS COVERED

Here's great news for anybody interested in Electricity. BRAND NEW edition of Applied Electricity including Diesel Electric Plants brought right down to date with every NEW Electrical subject fully covered. 10 big Volumes and all shipped FREE for examination.

For Beginners and Experts

Over 3000 pages—hundreds of illustrations—the most complete work of its kind ever published. Dynamos, motors, power stations, radios, television, everything electrical explained clearly so anyone can understand them.

BIG FIELD! Big Demand! Big Pay!

Men who understand electricity are urgently needed right now in thousands of industries. Autos, airplanes, machine shops—practically every industry depends on electricity and men who know this subject make big money. Pleasant, fascinating work, easy to learn and do; learn quickly with these books. Send coupon for a set for FREE examination and see for yourself.

SEND NOW [A year's consulting membership in the American Technical Society now given to all readers of this famous Cyclopaedia of Electricity. Many say, "That's worth more than cost of books."]

AMERICAN TECHNICAL SOCIETY
Dept. E819, Drexel at 58th St. Chicago

American Technical Society, Dept. E819, Drexel at 58th St., Chicago
Send for 10 days' free use, BRAND NEW 10 volume set of Electrical Engineering. In return for mailing this coupon promptly, send certificate of membership in the American Technical Society entitling me to full consulting privilege for one year. I will pay the few cents delivery charges on the books. If I wish I may return them in 10 days and owe you nothing, but if I keep them I will send \$2.00 after 10 days, then \$3.00 a month until the total price of only \$29.80 is paid.

Name

Address

City State

Please attach letter stating age, occupation and name and address of employer and at least one business man as reference.

Learn this Profitable Profession



in 90 Days at Home

Hundreds of men and women of all ages 18-50 make \$10.00 to \$20.00 in a single day giving scientific Swedish Massage and Hydro-Therapy treatments. There is a big demand from Hospitals, Sanitariums, Clubs, Doctors and private patients as well as opportunities for establishing your own office.

Learn this interesting money-making profession in your own home by mail, through our home study course. Same instructors as in our NATIONALLY KNOWN resident school. A diploma is awarded upon completion of the course. Course can be completed in 3 to 4 months. High School training is not necessary. Many earn big money while learning.

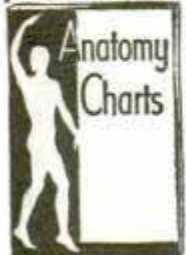

Anatomy Charts & Booklet FREE

Enroll now and we will include uniform coat, medical dictionary, patented reducing roller and Hydro-Therapy supplies without extra cost. The reducing course alone may be worth many times the modest tuition fee.

Send coupon now for Anatomy Charts and booklet containing photographs and letters from successful graduates. These will all be sent postpaid—FREE.

THE College of Swedish Massage (Successor to National College of Massage)
Dept. 864—30 E. Adams St., Chicago.

You may send me FREE and postpaid, Anatomy Charts, booklet containing photographs and letters from graduates, and complete details of your offer.

Name

Address

City State

How to Speak and Write MASTERLY ENGLISH

EVERY time you speak or write you show just what you are. Mistakes in English reveal you as a person who lacks education and refinement. Stop making mistakes in spelling, punctuation, pronunciation. Increase your vocabulary.

WONDERFUL INVENTION

Only 15 minutes a day with Sherwin Cody's new invention—and you can actually SEE your English improve. His method develops correct language-habits which banish fear of mistakes.

FREE BOOK ON ENGLISH

Lack of language power may easily be costing you hundreds of dollars every year. Learn what Mr. Cody can do for you. It costs nothing to find out. Mail a postal card or letter this very minute for free book, "How You Can Master Good English in 15 Minutes a Day." Address SHERWIN CODY SCHOOL OF ENGLISH, 511 Searle Building, Rochester, N. Y.



Sherwin Cody

SCHOOL OF ENGLISH

LEARN WELDING



Both Electric Arc and Acetylene by practical Shop-Plan method in a few short weeks. No textbooks. You learn by doing. Finest equipment. Low tuition. Pay-After-Graduation-Plan. Illustrated literature free. Write today.

MICHIGAN TRADE SCHOOL
3757 Woodward, Detroit, Mich.

Write for FREE FOLDER

YOU CAN GET IN AVIATION

Like hundreds of successful graduates SPARTAN Training following standard College or University planned curriculum will give YOU Aviation training that will qualify for positions now open. Advantages Factory affiliation building ALL-METAL Commercial and Military Airplanes. Unequaled year-round flying weather and country. GOVERNMENT APPROVED. All courses Mechanical and Flight. Write for Illustrated Catalog.

HOME OF THE DAWN PATROL
J. D. GREEN, Director, Dept. PM-25, TULSA, OKLAHOMA

SPARTAN SCHOOL OF AVIATION

ENGINEERING

DEGREE IN TWO YEARS

TECHNICAL AND APPLIED COURSES. Necessentials omitted. TIME AND MONEY SAVED. Degree 2 yrs., diploma 1 yr. Electrical, Mechanical, Architectural, Structural, Civil, Aeronautical, Highway. All courses include Air Conditioning, Electric Refrigeration and Diesel. Short intensive courses 3 and 4 months in Electricity, Power Plant, Diesel-Electric, Electric Refrigeration, Drafting. Extensive modern equipment. LOW TUITION. Part-time work for room and board. Thousands of successful graduates in U. S. and foreign lands. Approved by Industry, endorsed by educators, recommended by alumni. One and two-year courses start in Sept., short courses open year round. 40th YEAR. Residence courses. Catalog free.

FINLAY ENGINEERING COLLEGE
1001 Indiana Avenue Kansas City, Mo.

LAW

STUDY AT HOME
Legally trained men win higher positions and bigger success in business and public life. Greater opportunities now than ever before. Big corporations are headed by men with legal training.

More Ability: More Prestige: More Money
We guide you step by step. You can train at home during spare time. Degree of LL. B. Successful graduates in every section of the U. S. We furnish all text material, including 14-volume Law Library. Low cost, easy terms. Get our valuable 48-page "Law Training for Leadership" and "Evidence" books FREE. Send for them NOW.

LaSalle Extension University, Dept. 1164-L Chicago
A Correspondence Institution

CARTOONING

FREE TRIAL LESSON! Cash in on your sense of humor—AT HOME—BY MAIL. Have fun! Make money! No experience needed to start. Write today for FREE LESSON, mailed postpaid. No obligation.

MOON Gag-Cartoon School, Dept. A, Fall Creek, Wis.

Yes! WITH HOOVER UNIFORMS!

Big earnings for ambitious men and women in new uncrowded field with famous nationally-advertised Hoover line of smart, exclusive Uniforms for restaurants, fountains, hotels, taverns, stores, offices, doctors, dentists, etc. Not house-to-house. No experience—no money needed to get into this new, big-income business. Mail postcard now for beautiful new Uniform Style presentation, actual samples and money-making equipment—sent FREE.

HOOVER 251 West 19th Street Dept. JJ-9 New York

HE STUMBLED ONTO A GOLD MINE!



Wandering over the barren hills, penniless and ragged, our hero kicks up a nugget of pure gold. Wealth . . . fame . . . and the Only Girl in the World!

It happens in the story books—but not in Life! In this modern competitive world, the rewards go to the man who is trained for a better position.

Today, nearly 100,000 ambitious men are actively studying with the International Correspondence Schools—getting the essential knowledge and training they need for success in life. They learn through methods perfected during 48 years of I.C.S. experience. They study texts so authoritative that 24 State universities have adopted them. An I.C.S. representative keeps in touch with each of these students—assists and encourages him in reaching his goal.

These are the men you will be competing with tomorrow! Instead of watching them advance in life, why not join them—and advance with them! Mail the coupon—right now!

INTERNATIONAL CORRESPONDENCE SCHOOLS

BOX 5558-J, SCRANTON, PENNA.

★ Without cost or obligation, please send me a copy of your booklet, "Who Wins and Why," and full particulars about the subject before which I have marked X: ★

TECHNICAL AND INDUSTRIAL SUBJECTS

- | | | | | |
|---|---|---|--|---|
| <input type="checkbox"/> Agriculture | <input type="checkbox"/> Air Brakes | <input type="checkbox"/> Contracting and Building | <input type="checkbox"/> Manufacture of Pulp Paper | <input type="checkbox"/> Sanitary Engineering |
| <input type="checkbox"/> Air Conditioning and Cooling | <input type="checkbox"/> Cotton Manufacturing | <input type="checkbox"/> Diesel Engineering | <input type="checkbox"/> Marine Engineering | <input type="checkbox"/> Sheet Metal Work |
| <input type="checkbox"/> Architectural Drafting | <input type="checkbox"/> Diesel Engineering | <input type="checkbox"/> Electrical Engineering | <input type="checkbox"/> Mechanical Drafting | <input type="checkbox"/> Steam Electric Engineering |
| <input type="checkbox"/> Architecture | <input type="checkbox"/> Electric Lighting | <input type="checkbox"/> Fire Bosses | <input type="checkbox"/> Mechanical Engineering | <input type="checkbox"/> Steam Engineering |
| <input type="checkbox"/> Auto Electric Technician | <input type="checkbox"/> Fruit Growing | <input type="checkbox"/> Heating | <input type="checkbox"/> Mine Foreman | <input type="checkbox"/> Steam Fitting |
| <input type="checkbox"/> Auto Technician | <input type="checkbox"/> Heating | <input type="checkbox"/> Heat Treatment of Metals | <input type="checkbox"/> Patternmaking | <input type="checkbox"/> Structural Drafting |
| <input type="checkbox"/> Aviation | <input type="checkbox"/> Highway Engineering | <input type="checkbox"/> House Planning | <input type="checkbox"/> Pharmacy | <input type="checkbox"/> Structural Engineering |
| <input type="checkbox"/> Boilermaking | <input type="checkbox"/> House Planning | <input type="checkbox"/> Machinist | <input type="checkbox"/> Poultry Farming | <input type="checkbox"/> Surveying and Mapping |
| <input type="checkbox"/> Bridge Engineering | <input type="checkbox"/> Management of Inventions | <input type="checkbox"/> Management of Inventions | <input type="checkbox"/> Public Works Engineering | <input type="checkbox"/> Telegraph Engineering |
| <input type="checkbox"/> Building Estimating | | | <input type="checkbox"/> Radio | <input type="checkbox"/> Telephone Work |
| <input type="checkbox"/> Chemistry | | | <input type="checkbox"/> R. R. Locomotives | <input type="checkbox"/> Toolmaking |
| <input type="checkbox"/> Civil Engineering | | | <input type="checkbox"/> R. R. Section Foreman | <input type="checkbox"/> Welding, Electric and Gas |
| <input type="checkbox"/> Coal Mining | | | <input type="checkbox"/> R. R. Signalmen | <input type="checkbox"/> Ventilation |
| | | | <input type="checkbox"/> Refrigeration | <input type="checkbox"/> Woolen Manufacturing |

BUSINESS SUBJECTS

- | | | | | | |
|--|--|--|--|---|----------------------------------|
| <input type="checkbox"/> Accounting | <input type="checkbox"/> Advertising | <input type="checkbox"/> College Preparatory | <input type="checkbox"/> Grade School Subjects | <input type="checkbox"/> Railway Postal Clerk | <input type="checkbox"/> Signs |
| <input type="checkbox"/> Bookkeeping | <input type="checkbox"/> Cost Accounting | <input type="checkbox"/> C. P. Accounting | <input type="checkbox"/> High School Subjects | <input type="checkbox"/> Salesmanship | <input type="checkbox"/> Spanish |
| <input type="checkbox"/> Business Correspondence | <input type="checkbox"/> First Year College Subjects | <input type="checkbox"/> Foremanship | <input type="checkbox"/> Illustrating | <input type="checkbox"/> Secretarial Work | |
| <input type="checkbox"/> Business Management | <input type="checkbox"/> French | | <input type="checkbox"/> Lettering Show Cards | <input type="checkbox"/> Stenography and Typing | |
| <input type="checkbox"/> Cartooning | <input type="checkbox"/> Civil Service | | <input type="checkbox"/> Managing Men at Work | <input type="checkbox"/> Traffic Management | |

DOMESTIC SCIENCE SUBJECTS

- | | | |
|---|---|--|
| <input type="checkbox"/> Advanced Dressmaking | <input type="checkbox"/> Home Dressmaking | <input type="checkbox"/> Tea Room and Cafeteria Management, Catering |
| <input type="checkbox"/> Foods and Cookery | <input type="checkbox"/> Professional Dressmaking and Designing | |

Name..... Age..... Address.....

City..... State..... Present Position.....

Canadian residents send coupon to International Correspondence Schools Canadian, Limited, Montreal, Canada
British residents send coupon to I. C. S., 71 Kingsway, London, W. G. 2, England

DANGER GO SLOW

...WHEN

Read
This

THERE'S no other product like "Prestone" anti-freeze. It contains NO alcohol... NO glycerine. It's made with highly refined and purified ethylene glycol. But it took far more than ethylene glycol to make "Prestone" brand anti-freeze the world's finest winter protection!

In "Prestone" anti-freeze, ethylene glycol is fortified with *exclusive* ingredients developed after years of laboratory research and millions of miles of the toughest test driving an anti-freeze can undergo. These ingredients curb leaking, foaming, rust clogging,

It takes years of experience to make a great anti-freeze. Beware of new and untried preparations.

And think twice before you spend even a dollar for a gallon of alcohol base anti-freeze. (Regardless of brand name dollar-a-gallon anti-freezes usually contain alcohol.) Alcohol boils away... has to be replaced. "Prestone" anti-freeze will not boil away. One filling lasts all winter long.

Remember: "Prestone" anti-freeze has proved itself in more cars than any other brand of anti-freeze ever made!

GUARANTEE

"National Carbon Company, Inc., specifically guarantees that 'Prestone' brand anti-freeze, if used according to printed directions, in normal-water cooling systems, will protect the cooling system of your car against freezing and clogging from rust formations for a full winter; also that it will not boil away, will not cause damage to car finish, or to the metal or rubber parts of the cooling system, and that it will not leak out of a cooling system tight enough to hold water."

This famous "Prestone" anti-freeze guarantee says plenty—and says it in writing for your protection. That's another big reason for the popularity of "Prestone" anti-freeze.

**NEW
LOW
PRICE** \$ **2.65**
per gal.

GOOD NEWS—"Prestone" anti-freeze is now sold at only \$2.65 per gallon—the lowest price in history! See your "Prestone" anti-freeze dealer today. He'll protect your car as specified by the official chart. Then smile with "Prestone" anti-freeze... let others boil!



The words "Prestone" and "Eveready" are registered trademarks and identify products of National Carbon Co., Inc.

GET "PRESTONE" ANTI-FREEZE...

TRADE-MARK

YOU BUY AN ANTI-FREEZE!



"PRESTONE" ANTI-FREEZE will never fail you no matter how long or cold the winter. When you put it into your car you can forget about costly freeze-ups. There's no replacing. You're *safe!*



MANY ANTI-FREEZES are made with alcohol. But their brand names don't say so. These anti-freezes may boil away, require replacing. "Prestone" anti-freeze is not made with alcohol—does not boil off.



"PRESTONE" ANTI-FREEZE ends all your worries about rust. It protects your car from rust-clogging that chokes up the cooling system... causes overheating. And "Prestone" anti-freeze does not foam.



NO DANGEROUS FUMES from "Prestone" anti-freeze—no fire-hazard. "Prestone" anti-freeze cannot harm car finish or the metal and rubber parts of your cooling system. Absolutely odorless!

AND FORGET WINTER WORRIES!

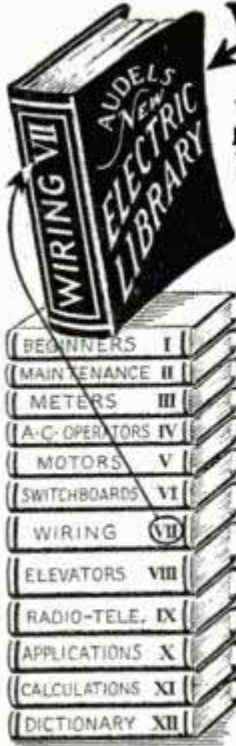

← WIRING

VOL. VII AUDELS NEW ELECTRIC LIBRARY—A MASTER BOOK ON WIRING
 728 PAGES, 1200 ILLUSTRATIONS. \$1.50
House and Power Wiring
Diagrams—Problems
and Calculations

fully explained in clear practical language, easy to use and understand including helps and hints for all electrical workers that will save time, trouble and money.

AUDELS NEW ELECTRIC LIBRARY— A progressive Home Study and Reference Course in applied electricity. Easy to understand. Questions and answers plainly written for a complete working knowledge of modern electrical practice, necessary to every electrician, engineer, mechanic and student.

LEARN THE AUDEL WAY! You ask the question—Audel's New Electric Library gives the answer—9500 simplified outlines, graphic illustrations and precise explanations covering Construction, Operation and Machine Maintenance.

BOOK A MONTH PLAN—Order the volume that interests you—today! We will send that volume on 7 days' free trial. If the book helps you, send us \$1.50. If it does not help you, mail book back to us.

FREE EXAMINATION COUPON
 Theo. Audel & Co., 49 W. 23rd St., New York City
 Mail Vol. VII on 7 days free trial. If O.K. I will remit \$1.50 otherwise I will return it. Also please send further information about the Electric Library—no obligation unless I am satisfied.

Name

Address

Occupation

Reference



AUTO

BOOKS SENT FREE

on approval. Just mail the coupon and we'll send you a set of these remarkable auto books, just off the press. Whether you are a mechanic or helper, expert or apprentice, auto owner or driver, if you're interested in knowing all about automobile mechanics, take advantage of this **FREE OFFER**.

GET A BETTER JOB

A better job—in the gigantic auto industry. **BIGGER PAY**—a chance to go into business for yourself and get a share of the huge profits, are waiting for any man who even half tries to improve himself. Learn auto engineering with these wonder books a new way—without studying or memorizing. Simply use the **JIFFY INDEX** to look up the answer to any auto problem. Built by eleven of America's greatest automobile engineers, and written in simple language so you can understand it. Very newest cars, all covered.

FREE Privilege of consulting Automobile Engineers of American Technical Society for one year without cost if you mail coupon immediately

Send promptly and we will include a Brand New **EXTRA** volume with over 300 pages including **ALL 1939** cars with wiring diagrams and data sheets on each.

CAN YOU FIX IT?
 These wonder books tell step by step **HOW** to take out "play" in differential — to kill the shimmy in steering—to set **TIMING**—how to put your finger instantly on engine trouble and then the quick expert way to **FIX** it. Newest improvements fully covered. Equal to a complete trade course at less than a fourth the cost.
6 BIG VOLUMES
 Brand New Edition
 2500 pages, 2000 illustrations, wiring diagrams, etc., including Marine Engines, Aviation Motors, Diesel engines, etc. De Luxe edition, gold-stamped flexible binding.

AMERICAN TECHNICAL SOCIETY,
 Drexel Ave. & 58th St., Dept. A819, Chicago, Ill.
 I would like to see the new 6-volume edition of your **AUTO BOOKS**. I will pay the few cents delivery charges only, but if I choose to, I may return them express collect. If after 10 days use I prefer to keep them, I will send you \$2 and pay the balance at the rate of only \$3 a month, until \$24.80 is paid. Please include free membership and extra Volume No. 7, as per your offer above.
 Name

Address

City

State

Attach letter stating age, occupation and name and address of employer and that of at least one business man as reference.

GET THIS GUIDE TO BUSINESS SUCCESS

BRIEF BUSINESS ENCYCLOPEDIA

only \$1.00 NET

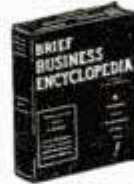

America's Largest Educational Book House

Tells how to make contacts for jobs. Where and what types of jobs are open to you. Steps leading to promotion . . . to success in business and in your personal business affairs. How to answer "want ads". Finding employment. Getting along with people. Investing your money. How to buy wisely. Better business letters. The successful salesman, etc., etc.
 For the first time a guide to business success written from **YOUR SIDE** as a worker . . . your side as a consumer! Hundreds of business success secrets told in this amazing book. 478 pages of easy-to-read information on getting ahead in the business world . . . 292 illustrations of standard business forms, business activities, statistical tables, charts; Dictionary of Business Terms.

FREE GIFT BOOK with every purchase as long as gift supply lasts! Rush us your order for **Brief Business Encyclopedia** **RIGHT NOW** . . . get your free gift copy—2 books for price of 1—! If you act promptly.

WILCOX & FOLLETT CO.
 Dept. C M 1255 So. Wabash Ave. Chicago, Ill.



BE A RAILWAY WRITE TRAFFIC INSPECTOR TODAY

Ambitious Men—Here's YOUR Opportunity

Qualify as Railway and Bus Passenger Traffic Inspector by our easy, home-study course and on completion we will help place you at up to \$135 per month, plus expenses, to start, or refund tuition. You'll like the work. Write for Free Booklet describing our 20-years' experience in training Men. **STANDARD BUSINESS TRAINING INSTITUTE** Div. 211, Buffalo, N. Y.

LEARN WATCH REPAIRING



AT HOME You can learn by our modern and original system of instruction every part of the **Watch Repairing Trade** at home. You can earn money while learning and prepare yourself for a well paying position or start in business after completing our course of instruction. Good watch repairers are in demand and generally earn very good salaries. For particulars apply to the **Wisconsin School of Watch Repairing** 524 E. Mason St., MILWAUKEE, WIS.

LEARN MECHANICAL DENTISTRY



Be A Dental Technician

Learn how to make Crowns, Bridges, Plates in this oldest school, licensed by the State of New York. 5,000 feet up-to-date equipment. Day and Evening Sessions. Easy terms. **Write NOW** for free catalog P and tool offer.

N. Y. School of Mechanical Dentistry 125-127 West 31st Street, Dept. 9, New York City



CARTOONING PAYS WELL

Exclusive instruction by a famous cartoonist makes it easy to learn at home. Write for Free Booklet describing details of the course.

NATIONAL SCHOOL OF CARTOONING 439 Penton Bldg. Cleveland, Ohio

AVIATION APPRENTICES



AIRMINDED YOUNG MEN INTERESTED IN TRAINING FOR ENTERING THE WELL PAID FIELD OF AVIATION AS APPRENTICES—Write immediately, enclosing stamp.

MECHANICAL UNIVERSAL AVIATION SERVICE CO. Wayne County Airport, Box 857, Dept. E, Detroit, Mich.



Your VOICE!

100% Improvement Guaranteed
 or Tuition Refunded!

You to be sole judge! Strengthen and master your voice—not with singing lessons—but by scientific **silent exercises**, successfully taught for over a century. **Marvelous success with DEFECTIVE Voices.** Write for Free Voice Book, **Learn WHY and HOW** you can now have the voice you want. If under 17, we require parent's signature. With 100% improvement guaranteed—will you faithfully follow instructions? If so, **WRITE: Perfect Voice Institute, Studio 1358, 64 E. Lake St., Chicago**

When writing please mention *Popular Mechanics*

PATENT and MARKET YOUR INVENTION

How
**SUCCESSFUL
INVENTORS DO IT!**

This
**FREE
BOOK
TELLS HOW**



IF there is a reliable formula followed by successful inventors, it is (1) a good invention, (2) a good patent, (3) a good market. To make the formula work, in this modern age of competition, point No. 2, effective patent protection, is the real connecting link between companion points No. 1 and 3.

NATION-WIDE MERCHANDISING SELLS NEW PRODUCTS BY THOUSANDS

Many times inventors say, "It's such a simple gadget—is it worth a patent?" Inventors who say this have little conception of modern merchandising methods. New gadgets are not "peddled" today from town to town. Mass production takes them over and turns them out immediately on a big scale. Nation-wide sales agencies put them quickly in stores all over the country. If a manufacturer takes your invention the wheels of mass production start rolling and—almost overnight—the new commodity or novelty is "on sale" from coast to coast. That's the modern American way. New production methods, salesmanship, advertising and promotion do not wait for public demand—they create it! Modern business makes pennies of royalty pile quickly into dollars of profit—profit that must be protected by worthwhile patent.

BE SURE TO PROTECT YOUR RIGHTS

The U. S. A. is the greatest open market for new inventions in the world. Here commercial striving is so keen that the unprotected invention, if it has public acceptance, is quickly "eyed" and may become the prey of eager competition. Worthwhile manufacturers won't bear the production costs and sales expense of promoting a new invention unprotected by patent. A good, strong patent not only opens the road to marketing your invention, but closes it to would-be chiselers who may seek to reap the rewards of your creative efforts.

LET US HELP YOU WITH YOUR PATENT

During the past twenty years we have helped great numbers of inventors secure their U. S. Patents. We know the pitfalls and how to avoid them. We have trained, experienced patent draftsmen and registered patent attorneys ready to serve you—and each one, when he undertakes to handle your case, realizes that he is personally responsible to contribute the fullest individual effort possible.

FREE RECORD OF INVENTION FORM MAKES IT EASY

When you send for our **FREE BOOK**, we include, also Free, our specially prepared "Record of Invention" blank on which you can quickly make and date a sketch and description of your invention. This "disclosure", as it is called, may be absolutely invaluable as evidence for you, should your rights ever be contested. Be sure to get it and use it.



MAIL COUPON NOW!

If you have an invention in the making—if you simply have the crude elements of an invention in mind—you should have our Big **FREE BOOK** without delay. It will guide you every step of the way—from the preliminary search stage to the issuance of the final patent grant. This book contains twenty-five chapters describing in plain man-to-man language the story of obtaining a patent and marketing an invention. This book is absolutely **FREE**—just tear off the attached coupon or write us a letter or postcard **TODAY!**

CLARENCE A. O'BRIEN and HYMAN BERMAN

706 Adams Building, Washington, D. C.
Reg. Patent Attorneys Before U. S. Patent Office
Please send me at once your Big Free 48-Page Book, "Patent Guide for the Inventor" and your specially prepared "Record of Invention" form. This request does not obligate me.

Name

Address

(Please write or print plainly)



LAFAYETTE RADIO

ADVANCE IN RADIO IT'S FUN

GET THIS FREE 1940 CATALOG

SAVE AS YOU GO!

There's fun, thrills, big money in radio today. Send for this FREE book that shows what is new and how to save. Read about the 1940 Lafayette receivers—the line that's years ahead in styling and performance. A model for every purse and purpose, from the new miracle portables to magnificent phono-radio combinations.

ARE YOU MECHANICALLY INCLINED?

You'll get an even bigger kick out of a radio you build. Our bed-rock low prices on parts, tubes and equipment cut the cost of world-wide reception to a fraction. Special Build-it-Yourself kits to guide you. Hundreds who started experimenting in this way now hold important high-salaried jobs in radio. For the amateur, the catalog contains a complete line of receivers, transmitters and parts—nationally advertised names.

EARN MONEY FULL TIME OR SPARE

Interested in radio repairing? In selling sound systems? Here's how to buy famous equipment at low, money-saving prices. Here's how to save time because now you can order "everything in radio" from one source. Send for a copy of this big FREE 188 page catalog today. See Lafayette's triple line of sound systems—streamlined for eye-appeal, priced right for popular appeal.

Act at once! Mail coupon below and get the world's most complete, up-to-date radio catalog. It's FREE! Simply paste coupon on penny postcard. Do it now!

Radio Wire Television Inc.
formerly WHOLESALE RADIO SERVICE CO., Inc.

LAFAYETTE RADIO

NEW YORK, N. Y. CHICAGO, ILL. ATLANTA, GA.
100 SIXTH AVENUE • 901 W. JACKSON BLVD. • 265 PEACHTREE ST.
BOSTON, MASS. • BRONX, N. Y. • NEWARK, N. J. • JAMAICA, L. I.
110 Federal St. 542 E. Fordham Rd. 24 Central Ave. 90-08 166th St.

Radio Wire Television Inc.
Dept. 7L9—100 Sixth Ave., New York, N. Y.
Rush FREE 1940 Radio Catalog No. 78

Name.....
Address.....
City..... State.....

Free! 1940 RADIO CATALOG

PASTE COUPON ON PENNY POSTCARD

When writing please mention Popular Mechanics



CLIMBING AHEAD
THESE DAYS IS *tough going...*

... BUT... consider the hundreds of men now in Aviation who started their careers with Aero I.T.I. training. You may be right where these men once were—wondering how to get ahead faster. If so, you owe it to yourself to find out about the training that has placed so many men in the rapidly expanding Aviation industry. During one 60 day period 126 Aero I.T.I. trained men were placed with one aircraft plant alone!

Find Out about Aero I.T.I. training. Choice of three courses in Aircraft Mechanics, two in Aeronautical Engineering. You can take full-time courses at the school, or start your training at home. For full details, write NOW

AERO INDUSTRIES TECHNICAL INSTITUTE
5253 West San Fernando Road • Los Angeles, California

ELECTRICAL ENGINEERING
Condensed ONE-YEAR residence course combines theory with practice in well-equipped laboratories. High employment record. Suburban campus; modern buildings; dormitory. 47th year. CATALOG. Give age.

BLISS ELECTRICAL SCHOOL
121 Takoma Ave., Washington, D. C.

LAW STUDY AT HOME for Personal Success and Larger Earnings. 28 years of successful student guidance assures expert instruction. LL.B. Degree awarded. All text material furnished. Easy payment plan. Send for FREE BOOK—"Law and Executive Guidance," at ONCE.

AMERICAN EXTENSION SCHOOL OF LAW
Dept. T-11, 620 N. Michigan Ave., Chicago, Ill.



Auto-Diesel

Master a real trade. Auto Mechanics, Diesel Mechanics, Arc Welding, Acetylene Welding, etc. Let us train you to be an expert Auto-Diesel Mechanic and help you get a good job. The cost to you is reasonable. Learn on modern equipment with tools under experienced instructors. Real shop work. Steam heated buildings. Room and board in our steam heated dormitory. We pay your fare to Nashville. For free catalog write

Nashville Auto-Diesel School, Dept. 75, Nashville, Tenn.

PHOTO-ENGRAVING TASOPE' SINCE 1931

Cash in on pictures! Learn quickly at home or in our residence school. Make halftones, line cuts for the trade. Qualify for interesting, good pay job. We show you how and supply complete low-cost engraving plant. Small investment. Easy terms. Particulars free!

THE AURORA SCHOOL OF PHOTO-ENGRAVING
Dept. PM-10 Tasope' Bldg. Aurora, Mo.

How To Secure A Government Position

In the Classified Civil Service! Railway Postal Clerk, \$1900 a year regular. Postal Clerk, City Mail Carrier, \$1700 regular. Other attractive positions paying \$1260 to \$2100 a year. Our tested method helps you pass examinations. Men—Women, age 18-50, send for our FREE BOOK explaining requirements TODAY.



PATTERSON SCHOOL, 811 Mercantile Bldg., Rochester, N. Y.
Send, without obligation, free book "How to Secure a Government Position."

Name..... Age.....
Address.....

HE Mailed This Coupon

J. G. O'BRIEN
Atlas Champion
Cup Winner

This is an ordinary snapshot of one of Charles Atlas' Californian pupils.

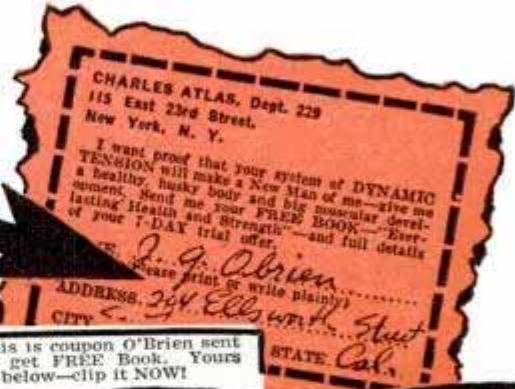
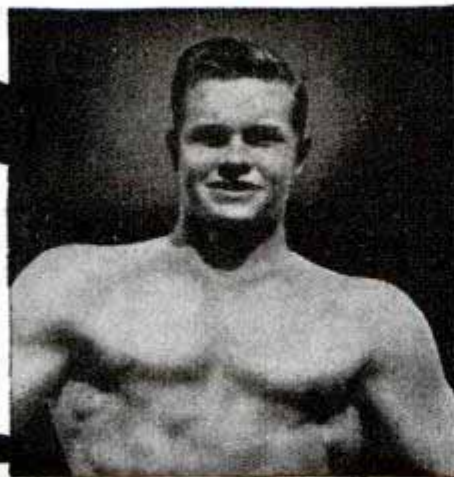

This is coupon O'Brien sent to get FREE Book. Yours is below—clip it NOW!

...and Here's the Handsome Prize-Winning Body I Gave Him!

J. G. O'BRIEN saw my coupon. He clipped and mailed it. He got my free book and followed my instructions. He became a New Man—and also won one of my Atlas-Champion, Sterling Silver Cups for his physical improvement. NOW read what he says:

"Look at me NOW! Dynamic Tension WORKS! I'm proud of the natural, easy way you have made me an 'Atlas Champion'!"

J. G. O'Brien

Let Me Prove I Can Make YOU a New Man!

Would you like to have a handsome build—greater physical development—a strong, muscular body? Then listen to this:

I, myself, was once a skinny weakling of 97 lbs. I didn't know what real health or strength were. I was afraid to fight, ashamed to be seen in a swimming suit.

Then I discovered the secret that changed me into "The World's Most Perfectly Developed Man," the title I won twice and have held ever since, against all comers. My secret is Dynamic Tension.

It is a natural method. Its purpose is not only to give you the powerful, rippling muscles you'd like to see in your own mirror, but also—for those whose systems are sluggish from lack of proper exercise—to help them tone up their entire body, inside and out.

Accept My 7-Day Trial Offer

Do you want a better build? Are you dissatisfied with your present physical development? All I ask is a 7-DAY TRIAL. Just one week! In even that short time you will notice your chest hardening and filling out with solid muscle—or the 7-Day

Trial will cost you nothing. Surely this is proof enough that by continuing with my "Dynamic Tension" method I can make you a New Man—give you bodily power and drive, and put you in magnificent physical condition which wins you the envy and respect of everyone.

FREE BOOK

Let me show you the results produced for other men! I'll send you FREE my famous book, "Everlasting Health and Strength." It shows actual photos. Write your name and address carefully on coupon. Mail to me personally today. I'll rush your free copy to you AT ONCE! Charles Atlas, Dept. 8L, 115 East 23 Street, New York, N. Y.



An untouched photo of Charles Atlas, twice winner of the title, "The World's Most Perfectly Developed Man."



SILVER CUP BEING GIVEN AWAY
This cup 14 in. high will be awarded to pupil making greatest physical improvement in next 3 months.

CHARLES ATLAS
Dept. 8L, 115 East 23rd Street,
New York, N. Y.

I want the proof that your system of Dynamic Tension can help make me a New Man—give me a healthy, husky body and big muscle development. Send me your FREE book, "Everlasting Health and Strength," and full details about your 7-DAY Trial Offer.

Name
(Please print or write plainly)

Address

City..... State.....

REAL JOBS OPEN

FOR TRAINED AUTO MECHANICS



LEARN QUICK!
8 WEEKS
practical SHOP
TRAINING!

AUTO, DIESEL *and* AVIATION *mechanics*

I'll train you quickly, correctly for this fascinating work, paying up to \$60 a week! Based on 25 years' experience knowing how to train men well, in the 2 biggest, best schools of their kind in the world. You learn with real tools, on real equipment, a complete, practical course in Auto, Diesel and Aviation Mechanics, so you can step out of low-pay jobs into a career in the biggest field of opportunity in America today!

SPECIAL LOW RATE

SPECIAL LOW TUITION RATE IF YOU ACT NOW!

Again McSweeney leads in real value. If you write at once we will reveal a special new low tuition rate that will amaze you, and on easy terms it makes it easy for you to train AT ONCE for a big-pay job! Write TODAY for details!

McSWEENEY MEN MAKE GOOD!

25 years' success means something to you! Read how others have succeeded with McSweeney training: "Just got thru writing income tax check. Money spent at your school was best thing I ever did"—Lee Grant, O.; J. W. Wiggins, Okla., says before we trained him he had no income, now has own business, money in bank and to spend! G. B. Park, Ind., says "Your training fitted me to handle any job in auto field." These men were trained in our fine big schools, best of their kind anywhere!

TWO FINE BIG SCHOOLS



DETROIT



KANSAS CITY

FREE BOOK!



Send now for your copy of my big book giving all the facts and announcement of amazing new low tuition rate for short time only—but you must write at once!

Address nearest school:

McSWEENEY TRADE SCHOOL

Dept. C-7, Detroit, Mich., or Kansas City, Mo.

Without cost or obligation send me your big FREE book.

NAME.....

STREET.....

TOWN..... STATE..... AGE.....

When writing please mention Popular Mechanics

PARKS AIR COLLEGE

PARKS AIRPORT EAST ST. LOUIS, ILL.

Offers YOU COLLEGE and PROFESSIONAL TRAINING
Majoring in AVIATION

Accredited by the Illinois Superintendent of Public Instruction. U.S. approved as a Commercial Ground and Flying School and Mechanics' School. Accredited by and cooperating with the United States Army Air Corps in giving flight and mechanical training. Open to high school graduates.

FOUR courses lead to B.S. degrees in Professional Piloting, Aviation Operations, Maintenance Engineering, Aeronautical Engineering.

SEVENTEEN TRAINING PLANES are used in professional flight training which prepares graduates for airline flight operations. 74% of graduates enter air transportation in North and South America. 76,000 hours flight training given, 1800 hours being flown monthly.

FACULTY of 48 specialists in various fields of aviation. 1569 graduates. Enrollment limited to a total of 300 commercial aviation students. Total enrollment 415.

100-acre airport, 18 buildings devoted to school purposes exclusively. Dormitories and dining hall at the College.

Winter term January 8. Send postcard for new 60-page catalog. Registrar, Dept. PM-11

13th YEAR PARKS AIR COLLEGE, East St. Louis, Ill.

SELL FOOD

Everybody must buy food. Own profitable neighborhood route. Complete outfit, including large assortment regular full size packages—FREE to reliable persons. No experience needed. Make money at once. Weekly profits grow as you expand route of regular users. Handle nationally known line 200 guaranteed, daily necessities; fast sellers; quick repeaters. Fascinating all year 'round business. Liberal credit plan. Old reliable company. Write now for my Free Offer. No obligation. E. J. MILLS, 8057 Monmouth Ave., Cincinnati, Ohio.



COMPLETE OUTFIT FREE



U. S. Manufacturers desire men to learn Electric Arc Welding and get practical experience under actual production conditions in the laboratories of the School of Engineering. Moderate training Fee. Accepted applicants will be fully trained until ready to pass rigid test and assisted in securing employment.

ARC WELDING presents one of the outstanding opportunities for steady income and future success. Welding is growing rapidly, replacing large and intricate castings, rivets, nuts, bolts, screws. It is commonly used in assembling cranes, hoists, bridges, structural steel work, etc. No limit to the application of welding to industry, increasing durability and reducing manufacturing costs. There is a decided shortage of properly trained Welding Operators, Technicians and Welding Engineers. Why be content with ordinary work, hit and miss jobs and low pay when in a short time you can become a trained Specialist in Welding?

MILWAUKEE SCHOOL of ENGINEERING

Institute of Electrotechnics

PM 1139 North Broadway and E. State, Milwaukee, Wis.

Without obligation send Free Booklet "The Dawn of a Gigantic Industry and Its Outstanding Opportunities." Also tell me how to become a

- | | |
|---------------------------------|--|
| Welding Operator (3 mo.)..... | Refrigeration and Air Conditioning Technician (3 mo.)..... |
| Gas Welder (6 wks.)..... | Air Cond. Engr. (1 yr.)..... |
| Welding Technician (6 mo.)..... | Radio, Television (6 mo.)..... |
| Welding Engineer (1 yr.)..... | Commercial Radio Engineer (1 yr.)..... |
| Electrical Engineer | |
| B. S. Degree (4 yrs.)..... | Earn Part Expense Plan..... |
| Student Loan Plan..... | |

Name..... Age.....
 City..... State.....

Briar Hill STOKERS
FOR PARTICULAR SMOKERS

ONE MATCH AND YOUR PIPE STAYS LIT

PATENTS PENDING

GENUINE IMPORTED BRIAR

NO SOGGY HEEL • NO BITE • NO RELIGHT • NO BREAK-IN

Briar Hill DECLARES **WAR** ON TOBACCO **Waste.**

THINK WHAT IT COSTS TO THROW AWAY 1/3 OF THE TOBACCO YOU BUY. -- THAT IS WHAT YOU ARE DOING WHEN YOU SMOKE A CIGARETTE--

WASTE Cigarette

SMOKE. -- WHEN YOU SMOKE A CIGAR -- YOU THROW AWAY 1/3 IN THE BUTT THAT BECOMES WET AND BITTER. LIKEWISE WHEN YOU SMOKE AN ORDINARY PIPE YOU WASTE 1/3 OF YOUR TOBACCO

WASTE Cigar

IN THE SOGGY HEEL YOU KNOCK OUT AND YOU BURN MORE MATCHES THAN TOBACCO TRYING TO KEEP IT LIT.

WASTE Tobacco

YOU CAN STOP THIS EXPENSIVE WASTE --

BY SMOKING A BRIAR HILL STOKER PIPE you eliminate all the objections to pipe smoking, it burns *all* the tobacco and **YOUR PIPE STAYS LIT.**

BRIAR HILL STOKERS not only save you 30% and more of your tobacco purchases but actually give you the *longest—driest—coolest—mildest* and *sweetest* pipe smoke you ever had from any pipe, regardless of its cost, or name, whether domestic or foreign. The bowl will not burn out. It's good from the start—does not need to be "caked". The **BRIAR HILL** is a "one match pipe". There's no finger pushing to keep the fire against the tobacco—the stoker packs the tobacco **UP**—you don't push it down with your finger.

Think of it! You save enough tobacco to **smoke 4 months out of every year for nothing.**

YOUR OWN PIPE, if in good condition, can be equipped with a "BRIAR HILL" STOKER—custom fitted by expert workmen. Just fill out the coupon below, put a **ONE DOLLAR** bill with your pipe and mail it to us. (Pack it well for mailing.) Your modernized pipe will be returned to you promptly, postpaid. (We do not change your stem or filter.)

If you prefer **A NEW PIPE**, send \$1.50 for the **BRIAR HILL "PIONEER"**, a pipe of genuine imported natural briar, fitted with the **BRIAR HILL STOKER**, unexcelled in workmanship and smoking qualities regardless of price or name, whether domestic or foreign and *equipped to smoke either with or without a standard filter.*

NO AGENTS

- BILLIARD**— SLIM # 29 MEDIUM # 22 LARGE # 07
- DUBLIN**— SLIM # 06 MEDIUM # 08 LARGE # 13
- APPLE**— SLIM # 80 MEDIUM # 42 LARGE # 33
- BULLDOG** MEDIUM ONLY # 50 **POT** MEDIUM ONLY # 24 **PEAR** MEDIUM ONLY # 09

BE SURE TO CHECK YOUR CHOICE

BRIAR HILL CORP., MILLERSBURG, OHIO

- I am enclosing \$1.00 and my favorite pipe. Please modernize it with a "BRIAR HILL" STOKER.
- I am enclosing \$1.50. Please send postpaid one BRIAR HILL "Pioneer" Model Stoker Pipe. Style and size marked at left. (Please mark first and second choice)
- Please mail pipe literature showing shapes and models available.

NAME _____

ADDRESS _____

CITY AND STATE _____

(PLEASE PRINT NAME PLAINLY)

11-39 P. M.

Be Your Own MUSIC Teacher

LEARN AT HOME

by wonderful improved method. Simple as A. B. C.—a child can learn it. Your lessons consist of real selections instead of tiresome exercises. When you finish one of these delightfully easy lessons, you've added a new "piece" to your list. You read real notes, too—no "numbers" or trick music. Method is so thorough that many of our 700,000 students are band and orchestra LEADERS. Everything is in print and pictures. First you are told what to do. Then a picture shows you how to do it. Then you do it yourself and hear it. In a few short months you become an excellent musician—the life of every party.



Free Book and Demonstration Lesson

You may quickly become a fine player through the U. S. School home study method. If interested, mail coupon today for Free Book and Free Demonstration Lesson, which explain all. Please mention your favorite instrument. Instruments supplied when needed, cash or credit.

U. S. School of Music, 711 Brunswick Bldg., N. Y. C., N. Y.

U. S. School of Music, 711 Brunswick Bldg., N. Y. C.
 I am interested in music study, particularly in the instrument checked below. Please send me your free illustrated booklet and free Demonstration Lesson.

<input type="checkbox"/> Piano	<input type="checkbox"/> Accordion	<input type="checkbox"/> Clarinet	<input type="checkbox"/> Banjo
<input type="checkbox"/> Violin	<input type="checkbox"/> Saxophone	<input type="checkbox"/> Trumpet	<input type="checkbox"/> Ukulele
<input type="checkbox"/> Guitar	<input type="checkbox"/> Mandolin	<input type="checkbox"/> Trombone	<input type="checkbox"/> Other Instrument

Name
 Street
 City State

This MACHINISTS' Home-Study Course helps men get ahead



Newly assembled—specially priced—these five recent books give you the practical facts on modern machines, up-to-date methods, you need to advance in machine shop work. Take advantage of the other man's experience as found in books, to solve your problems, increase your efficiency, with

The NEW AMERICAN MACHINISTS' LIBRARY

5 volumes—2014 pages—1853 illustrations
 (A combined home-study course and reference library)

This library of machine shop practice was written for practical men. It gives you the best methods for every kind of machine shop work. It fully explains lathes, drills, and other machine tools and their operation, automatic screw machines, speeds and feeds, gear design and production, punch and die work, metal surfacing, etc., etc. Plainly written—completely illustrated—the best kind of help to the machine shop man who wants to advance himself.

No money down—special price—easy payments.

EXAMINATION COUPON

McGraw-Hill Book Co., 330 W. 42nd St., New York

Send me for ten days' examination the new American Machinists' Library. If satisfactory I will send you \$1.50 in 10 days and \$3.00 monthly until the price of \$16.50 is paid. If not wanted, I will return the books postpaid. (To insure prompt shipment write plainly and fill in all lines.)

Name
 Home Address
 City and State
 Position
 Name of Company PM-11-39

When writing please mention Popular Mechanics

It's Lots of Fun to PLAY the DRUMS

...and EASY, too!



Step out in front! Be entertaining... popular... sought-after by friends. Start to play a GRETSCHE DRUM. Begin a BIG MONEY career—be an ace drummer like O'Neil Spencer, with John Kirby's Band. O'Neil and thousands of others have won success on radio, stage and screen using GRETSCHE equipment. EASY TO PLAY—no difficult lessons. Buy GRETSCHE DRUMS, on NEW EASY-PAYMENT plan.

O'NEIL SPENCER

EASY TO PLAY * EASY TO PAY

Send penny postcard for FREE DRUM catalogue and full information about EASY-PAYMENT plan and FREE TRIAL through your GRETSCHE dealer. Address Dept. PM-110

The FRED. GRETSCHE MFG. CO.

Musical Instrument Makers Since 1883

60 BROADWAY, BROOKLYN, N. Y.

GRETSCHE also offers SUPER VALUES in Guitars, Saxophones, Trumpets, Trombones, Accordions. Send for FREE catalogue. Mention instrument.

Learn To MOUNT BIRDS



TAN SKINS—MAKE UP FURS

Be a Taxidermist. We teach you at Home. Mount Birds, Animals, Pets, Heads, Fish. Save your hunting trophies. Decorate home and den. Make Money. Mount and tan for others. Fun and Profit! Don't delay. WRITE TODAY—NOW—for FREE BOOK with 100 game pictures. Hunters, get your copy. It's Now Free. Send post card. State your AGE. N. W. SCHOOL OF TAXIDERMISTRY, Dept. 3378, Omaha, Nebr.

MAKE MONEY in new Kind of CONCRETE Business

START YOUR OWN SPARE TIME OR FULL TIME BUSINESS



Here's a world beating opportunity to start a profitable business right at home, making salable articles of all kinds from concrete. Make garden furniture—bird baths—statuary—vases and hundreds of other products from both the conventional and the new colored concretes. All these things are in big demand. Little or no capital needed.

256 PAGE BOOK TELLS HOW

Get "1001 Ways to Use Concrete" the amazing new book that covers the whole field of making money in concrete work. Explains all methods and materials, trade secrets, simple equipment you can make—gives 146 short cuts to extra profits. Hundreds of pictures and sixteen full-colored plates. It's the key to a new and growing industry, that you can use now.

SEND NO MONEY. Pay Postman

Price, complete \$4.95. Postpaid upon receipt of remittance. If you live in the U. S. or possessions you may pay postman on delivery, plus few cents charges. Money back if not satisfactory. Order now and get started at once.

POPULAR MECHANICS PRESS
 Dept. 1139, 200 E. Ontario Street, Chicago

Free DIESEL Training

.... FOR ONE FULL WEEK AN AMAZING OFFER

Come to the Adcox School for one week's *Free Training*. Use our equipment. Test our instructors. Talk to Adcox students and Adcox graduates. Find out all about the Diesel opportunities in the Northwest, and how the Adcox School trains and helps its students. We are so confident that one week in our school will open your eyes to opportunities you never dreamed existed in these depressing times that we are willing to put all of our equipment and all of our instructors at your disposal for one week *Free!*

Prove to yourself by your own investigation that the Pacific Northwest is the place for you to get started in Diesel, and that the Adcox School is the best school in which to train for Diesel. Remember, you are the Judge.

VALUABLE DIESEL BOOK FREE

We have just received from the publishers a new supply of that popular book, "What Every Man

Should Know About Diesel," by John Harrington, well-known engineer and inventor. If you would like to have a copy of Mr. Harrington's book, print your name and address plainly in the coupon below and send it to us right now, before the limited supply is gone, and we will send you a copy *Free!*

We believe you will find it the most interesting Diesel book you have ever read. We will also include complete information about the Adcox *Free Trial Training* offer. If more convenient, use postal card. Request Book No. 25A.

DIESEL BOOK FREE

Mr. L. L. Adcox, Pres. L. L. Adcox Trade School
237 N. E. Broadway, Portland, Oregon.

I'll be glad to read Mr. Harrington's book. Please send me a Free copy.

Name.....Age.....

Address.....

Town.....State.....

NOW a DYNAMIC HEAVY DUTY INDUSTRIAL WELDER

Works Off 110-Volt Light Socket. This marvelous Dynamic Power Welder does the work of much higher priced types. It is easily portable. **WELDS** Cylinder Blocks, Bumpers, Fenders, Tanks, Farm Machinery. Will also solder and braze on the lightest material. Works on iron, steel, tin, brass, copper and all other metals. Men without previous experience can make as much as \$3.00 on a one hour repair job. In a year's time a Dynamic Welder Costs You **LESS THAN 5 CENTS A DAY**. Instructions Free—Open a welding shop now. **AGENTS**—Make big profits selling to garages, factories, janitors and machine shops. Write today for our 10-DAY TRIAL OFFER. **DYNAMIC WELDER CO.** 2226-HX Silvert 1 Road Chicago, Illinois



Learn to Write

Begin Today. Write for our Free Book, "How to Become a Good Penman." It contains specimens and tells how others learned to write in spare time. Your name elegantly written on a card if you enclose stamp for postage. Write today. **The Tamblin School of Penmanship, Dept. 8, Ridge Blvd., Kansas City, Mo.**



MECHANICAL DENTISTRY AT HOME!

To make Crowns, Plates, Bridgework, etc., for Dentists. Easy practical way to learn mechanical dentistry at home in spare time. **FULL EQUIPMENT OF TOOLS AND MATERIALS INCLUDED WITH COURSE.** Low tuition. Easy terms. Write for **FREE BOOK** about this money making profession that is not affected by machine age.

MCCARRIE SCHOOL OF MECHANICAL DENTISTRY
207 N. Broad St., Dept. 750, Philadelphia, Pa.

I'LL TRAIN YOU AT HOME IN SPARE TIME TO MAKE GOOD MONEY in RADIO and TELEVISION



Easy to Start . . . Earn While You Learn

Wake up! Get ahead! You fellows with ambition can make a wonderful success in Radio and Television through my new, practical, home training. I teach you in your spare time through interesting experiments with real equipment. Every essential phase of Radio, Television, Electronics, Facsimile, Radio Set Repair and Installation is covered. You get Personalized help. No previous experience needed. So practical—so understandable—so simplified is this training that any man with average education can grasp the money-making knowledge quickly and easily. You will be ready for a business of your own . . . or to hold down a good-paying job. My **BUSINESS BUILDERS** show you how to make profits while learning.

BIG FREE BOOK! Get complete details in new cat-in-RADIO". Write **Sprayberry Academy of Radio**, 210-L University Place, N. W., Washington, D. C.

YOU GET

146 RADIO PARTS

RADIO TOOLS

ALL WAVE ALL PURPOSE ANALYZER

NEW BENJAMIN AIR PISTOLS WITH MULTIPLE LEVER HAND PUMP FOR TARGET-SMALL GAME-CAMPING-ETC.



Guaranteed-Accurate-Practical-Economical-Safe-Clean-Quiet. Adjustable Force-Amazing Maximum Velocity. No smoke or fumes. **Bolt Action-Hammer Fire-Hair Trigger-Safety Lock-Hand Pump.** Single Shot BB \$8.50. Single Shot cal. 177 or 22 with rifled barrel \$8.50; BB 8-Shot \$10.00; Holster \$2.00. Also a complete line of Benjamin Genuine Compressed Air Rifles for BB and cal. 177 or 22. No license required from dealer or factory. Ask for complete specifications and Free Targets. **BENJAMIN AIR RIFLE CO., 850 Marion St., St. Louis, Mo., U.S.A.**

BROOKLYN YMCA TRADE SCHOOL



- Unlimited instruction until you have mastered every part of Course without additional charge.
- Full Shop Equipment
- Unexcelled Instruction
- Fireproof Dormitories.
- Special Privileges. Check your interests on coupon to receive free literature.
- Mechanical Pre-Engineering
- Diesel Engines Oil Burner
- Diesel Pre-Engineering
- Aeronautical Pre-Engineering
- Aviation Mechanic Welding
- Auto Mechanic Talking Pictures
- Refrigeration Air Conditioning
- Television and Radio Mechanic
- Architectural-Mechanical Drafting
- Machinist Tool and Die Making
- Armature Winding Electrical

MAIL COUPON

1117 Bedford Ave., Dept. P.M.
Brooklyn, New York City, N. Y.

Name.....

Address.....



Know Electricity as Experts Know It—and Get an Expert's Pay!

What about your future? Who is safe today? Surely not the man who is contented to stand still! Know your job thoroughly—prepare yourself for jobs ahead. To do just this thousands of men have used

The Croft Library of Practical Electricity

The Croft Library is a complete electrical educator. It is founded on practice—on 20 years of shirt-sleeve experience—on work as it is actually done. It is jammed from cover to cover with the kind of hard-headed facts you want. Written so that the beginner can easily understand it, yet so sound, so thorough, that it is the daily guide of 50,000 highly paid electrical workers and engineers. Croft tells you the things you need to know about motors, generators, armatures, commutators, transformers, circuits, switchboards, distribution systems—electrical machinery of every type—illumination in its every phase—the most improved methods of lighting—lamps and lamp effects, etc.—how to do a complete job, from estimating it, to completion.

**6 volumes, 2155 pages—only \$16.50
No money down—Easy payments.**

Fill in and mail the coupon attached and we will send you the entire set of six volumes for ten days' Examination on approval. We take all the risk—you assume no obligation. If you decide to keep the books, send \$1.50 in ten days and the balance at the rate of \$3.00 a month. Send the coupon NOW and see the books for yourself.

EXAMINATION COUPON

McGraw-Hill Book Co., 330 W. 42nd St., New York

Send me for ten days' examination on approval the Croft Library of Practical Electricity. If satisfactory I will send you \$1.50 in 10 days and \$3.00 monthly until the price of \$16.50 is paid. If not wanted, I will return the books postpaid. (To insure prompt shipment write plainly and fill in all lines.)

Name.....
Home Address.....
City and State.....
Position.....
Name of Company..... P.M. 11-39

MECHANICS

KNOW
YOUR
CAR

You Need
this
Book

JUST
OUT!

Ask
to
See it!

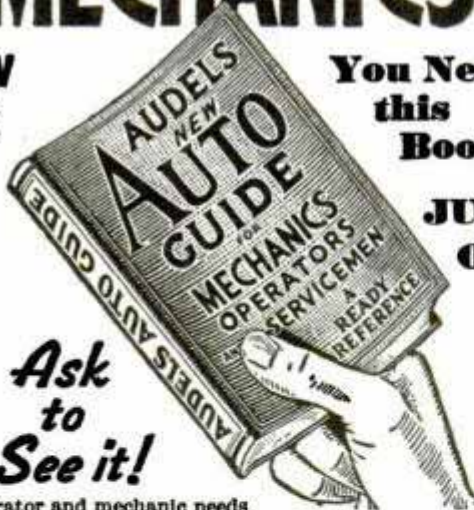

Every operator and mechanic needs AUDELS NEW AUTO GUIDE. This book saves time, money and worry. Highly endorsed. It presents the whole subject of auto mechanics: 1—Basic principles, 2—Construction, 3—Operation, 4—Service, 5—Repair. Easily understood. Over 1500 pages—1540 illustrations showing inside views of modern cars, trucks and buses with instructions for all service jobs. Diesel Engines fully treated, \$4 fully illustrated. To Get This Assistance for Yourself Simply Fill in and Mail Coupon Today.

4 COMPLETE • PAY ONLY \$1. A MONTH ←

THEO. AUDEL & CO., 49 WEST 23rd STREET, NEW YORK
Please send me postpaid AUDELS NEW AUTOMOBILE GUIDE (\$4) for free examination. If I decide to keep it, I will send you \$1 within 7 days; then remit \$1 monthly until purchase price of \$4 is paid. Otherwise, I will return it to you promptly.

Name.....
Address.....
Occupation.....
Reference..... P.M.

When writing please mention Popular Mechanics

MAKE POULTRY PAY YOU A GOOD LIVING FOR LIFE



POULTRY RAISING PAYS GOOD PROFITS FOR THOSE WHO KNOW ITS SECRETS

Healthful, interesting occupation for whole or part time in country, village or city suburbs. Open to young and old. Win independence of low wages, uncertain employment, uncongenial labor, with a Poultry Business of your own.

FREE BOOK TELLS HOW

A multitude of poultry-raisers large and small are making money in this most interesting and profitable occupation.

Whether you have ever kept chickens or not—whether you have ten hens or ten hundred, you should read this FREE BOOK. It's yours for the asking.

PROVED METHODS BRING SUCCESS FROM START

Harry M. Lamon, nationally known Poultry Expert, former Senior Poultryman U. S. Dept. of Agriculture, quickly trains ambitious men and women for Poultry Success from start. His famous Home Study System, endorsed by thirty leading Agricultural schools. Fascinating study, easy to learn, complete in every detail, shows valuable success secrets used by leaders, how they avoid losses. How to start in small way. Make business grow from sale of Poultry, Eggs and Baby Chicks. Big, ever increasing demand. Or prepare for a good job in large poultry plant. Established nearly twenty years—a multitude of graduates attest the success of his time-tested methods.

Mr. Lamon has prepared a big 32-page book "How to Raise Poultry for Profit", chock full of money-making poultry facts. He offers to send it free to anyone interested in learning the splendid money-making opportunities in Poultry Raising. If you are "at sea" on your future, send for this Free Book today.

Address: Harry M. Lamon, President,
NATIONAL POULTRY INSTITUTE
Dept. 50-C Adams Center, N. Y.

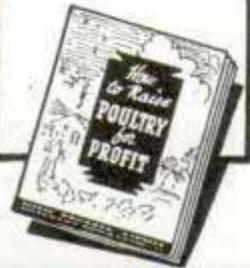

QUICK CASH IN NEW POTATO CHIPS



START AT HOME

Here's your chance—a money-making business of your own. Turn potatoes into cash by making new kind of Potato Chips with my improved outfit. Makes delicious, superior, "NON-GREASY" Chips at low cost. A few hours' practice does it. Begin anywhere—city, village, town. Potatoes cheap and plentiful.

Wholesale or retail. Steady year 'round business. Groceries, markets, restaurants, taverns, do the retailing for you. **WE HELP START YOU IN BUSINESS** Great quantities of Chips are eaten daily. Profit large—unusually so. You can start this money-making business on a "next to nothing" outlay of cash. Write for Potato Chip Booklet.

LONG-EAKINS COMPANY, 1128-S High St., Springfield, Ohio

1940 SHOP NOTES



Now Ready

World's Biggest
50c Worth

Get Shop Notes for 1940! May easily be best investment of your entire lifetime. Contains 384 money-making, time-saving ideas. Kinks, short cuts for mechanics, farmers, home workshop fans, handy men—

for everyone who uses tools. 214 pages, and 762 illustrations. Thousands wait for this book every year. Only 50 cents. 1939 and 1940 Shop Notes sent postpaid for \$1.00. Popular Mechanics Press, Dept. 1139, 200 E. Ontario St., Chicago.

WANT A GOOD PAY JOB?

Learn Tool and Die Making, Machinist Trade, Screw Machine work. Earn as much as \$50-\$60 per week. Learn by actual work in one of America's best equipped shops. Training supervised by experts. State certified. Day-Evening classes. Enter any time. Low fee, employment help. Write NOW for FREE booklet "Practical Machine Shop Training."

ALLIED SCREW MACHINE CO., Inc.
School Division:
Dept. PM-21603-9 W. Lake Street, Chicago, Ill.



PATENT and SELL your INVENTION

A Simple Recipe for Inventive Success

PROBABLY the simplest recipe for inventive success would be this: First, a practical, useful invention; second, a good strong Patent; third, a buyer or a market. The inventor needs all three to get anywhere. Lacking any one, he is likely to get nowhere. The recipe is simple. Working it out isn't so simple. That is why inventors—and others inventively inclined—have found the two books shown here so helpful. We've gone into each part of the recipe carefully. Exactly what is an invention? We tell you. What is a strong patent? We tell you. How can I go about finding a buyer? We tell you.

Many Questions Answered

But there's much more. For example, just how an Application for a Patent is made; how an inventor can safeguard himself with dated sketches as he goes along; how the pertinent Patent Office records are checked to see what other inventors may have done along the same line; how some successful

inventors have secured financial backing; simple ways to contact manufacturers; and many other points.

41 Years in the Business of Helping Inventors

The world needs, can use and will pay for practical, useful inventions. Manufacturers are on the alert for new articles, or improvements that will help them increase sales. Maybe you have one. Maybe not. These books will help you in deciding that. From that standpoint alone, they are valuable.

For more than 41 years, it has been our business to help inventors. We answer your questions and supply complete information about Patent procedure, costs, steps to take, kind of sketch or model needed, and much more. Our staff is made up of experienced Registered Patent Attorneys, Draftsmen, Searchers. Fees are reasonable—deferred payments arranged. Whether your idea is large or small, finished or still in the rough stage, you should have the facts both about Patenting and Selling. The information which we give you—based on long experience with thousands of inventors—is yours for the asking. No need to delay. These two books of facts may save you time, trouble, money, even later disappointment. Return the coupon—or write us a confidential letter—today.

115 Mechanical Movements Shown

In our book "Patent Protection" you will find illustrated 115 different mechanical movements. Maybe you'll find just what you need to work out some of your own ideas. Many other interesting pictures are shown in this book. Both books and an "Evidence of Invention" form sent to you FREE the same day we hear from you.

VICTOR J.
EVANS & Co.

REGISTERED PATENT ATTORNEYS

MAIN OFFICE: 112-M, VICTOR BUILDING
WASHINGTON, D. C.

Pittsburgh Office: 514-N, Empire Building

Send me FREE copies of your books, "Patent Protection" and "When and How to Sell an Invention."

Name.....

Street and No.....

City or Town.....State.....

These 2 books tell you
how to go about it ..
Both Sent FREE >

PATENTS

Booklet Free Highest References
Promptness Assured Best Results

Send drawing or model.

ALL BUSINESS GIVEN PROMPT AND PROPER ATTENTION

Listed Patent Lawyer in the latest editions of the Rand-McNally Directory of Bankers and Bank-Recommended Attorneys, published by Rand-McNally & Co., Chicago, Ill.; The Baggott & Ryall Directory of Guaranteed Attorneys, published by Legal Directory Corporation, Boston, Mass.; American Lawyers Annual, Cleveland, Ohio; Bankers Service Legal Directory, published by Bankers Service Co., Boston, Mass.; Eyre's Law List, 9 Park Place, New York City; Snow-Church Directory Co. Lawyers List, published in New York City, and the Central Guarantee Co., Bankers and Lawyers Directories, 630 Fifth Avenue, New York City.

WATSON E. COLEMAN, Victor Building, 724 Ninth Street, N. W.
REGISTERED PATENT LAWYER WASHINGTON, D. C.

INVENTORS PATENT YOUR IDEAS SEND FOR FREE BOOK

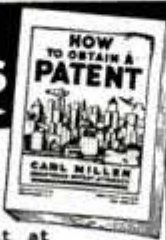

HOW TO OBTAIN A PATENT

Written by a Former Member of the Examining Corps (1922-24) of the U. S. Patent Office. If you want to profit by your idea, you should take steps to apply for a U. S. Patent at once. Your first step is to get this Free Book. This interesting illustrated book contains valuable information you should have. It tells you fully how to obtain a patent on your idea in the quickest way. With this Free Book you will also receive a "Record of Invention" form on which you can easily record your idea. Personal and Confidential Service: Your case will be personally handled only by a Registered Patent Attorney who is also a Former Member of the Examining Corps of the U. S. Patent Office. All communications confidential.

MAIL COUPON TODAY for FREE PATENT BOOK and RECORD OF INVENTION Form.

CARL MILLER
 REGISTERED PATENT ATTORNEY
 FORMER MEMBER EXAMINING CORPS U. S. PATENT OFFICE

Woolworth Bldg., 35th Floor, Dept. 119A, New York City
 MILLER BUILDING, Dept 119A WASHINGTON, D. C.

Please send me your Free Book, "How to Obtain a Patent," and your "Record of Invention" form.

NAME.....
 ADDRESS.....

G E A R S

In Stock — Immediate Delivery

Gears, speed reducers, sprockets, thrust bearings, flexible couplings, pulleys, etc. A complete line is carried in our Chicago stock. Can also quote on special gears of any kind. Send us your blueprints and inquiries.

Send 10c for Complete Catalog No. 10

CHICAGO GEAR WORKS
 769-773 W. Jackson Blvd. CHICAGO, ILL.



PATENTS Mail Coupon for FREE BOOKLET

of cost and other useful information about patents. Registered patent attorney and former Patent Office Examiner.

EUGENE H. PURDY

1422 International Building Washington, D. C.

NAME.....
 ADDRESS.....

To PROTECT YOUR INVENTION — Use this coupon, NOW

Delays are dangerous and may be very costly. My personal service assures prompt action, strict confidence, and a minimum of expense. I suggest that you send me a model or drawing, or sketch and description of your invention, and \$5.00. I will make a search and report

promptly as to its patentability and send you a copy of my 72-page booklet. Or, if you prefer to read my booklet first, mail the attached coupon at once. I will also send my "Record of Invention" form. (Over 38 years experience as a Registered Patent Attorney.)

L. F. Randolph, 302-D Victor Bldg., Washington, D. C.

Please send me at once, free of charge, your 72 page booklet and "Record of Invention" form.

Name.....
 Address.....

A PERSONAL CONFIDENTIAL PATENT SERVICE

PATENTS—TRADE MARKS

All cases submitted given personal attention
 Form "Evidence of Conception" with instructions for use and "Schedule of Government and Attorneys' Fees"—FREE!

LANCASTER, ALLWINE & ROMMEL
 Patent Law Offices

412 Bowen Bldg. Washington, D. C.

New Ideas now Salable Before Patenting

Practical, useful inventions may now be safely marketed without patenting expense. Write for proof that we successfully sell both patented and unpatented inventions.

Chartered Institute of American Inventors
 Dept. 4, Barrister Building, Washington, D. C.

INVENTORS who derive largest profits know and heed certain simple but vital

facts before applying for patents. Our book, Patent-Sense, gives those facts; sent free. Trade Marks—Copyrights.
LACEY & LACEY, Est. 1869, 635 F St., N. W., Dept. 5, WASHINGTON, D. C.

ALBERT E. DIETERICH
THEODORE H. RUTLEY

REGISTERED PATENT LAWYERS

512 B Colorado Bldg. WASHINGTON, D. C.

Booklet on Patents sent free

In answering advertisements always write name and full address clearly.

RUPTURED?

Get Relief This Proven Way

Why try to worry along with trusses that gouge your flesh—press heavily on hips and spine—enlarge opening—fail to hold rupture? You need the Cluthe. No leg-straps or cutting belts. Automatic adjustable pad holds at real opening—follows every body movement with instant increased support in case of strain. Cannot slip whether at work or play. Light. Waterproof. Can be worn in bath. Send for amazing FREE book, "Advice To Ruptured" and details of liberal truthful 60-day trial offer. Also endorsements from grateful users in your neighborhood. Write:
CLUTHE SONS, Dept. 31, Bloomfield, New Jersey

Start a Profitable Business of Your Own
Get the New Book • Just Published

MONEY Formulas MAKING



Here is the book you need to put yourself into a good paying spare time or full time business of your own. Shows how to make, package, and sell saleable articles of all kinds. Gives practical and tested formulas for household, auto and shop products. Tells how to make cleaning products, polishes, soaps, rubber, glass adhesives, cement, lacquers, pharmaceuticals, food products, cosmetics, photography accessories, and hundreds of other products. Order today. Pay postman on delivery or sent postpaid for \$4.35. Money back if not satisfied.

GIVES EVERY FACT YOU NEED

Hundreds of good paying businesses have been built on products made from simple recipes. Opportunities in this field exist everywhere.

POPULAR MECHANICS PRESS

Dept. 1139, 200 E. Ontario St., Chicago

TURN HOME WORKSHOP HOURS into EXTRA MONEY



**Get the New 188 Page Book
WHAT TO MAKE**

Get this new book and turn happy home workshop hours into extra cash. 188 pages packed with instructions, plans, valuable data and pictures showing what to make and how to make it. Anyone who can use simple tools can work from this book and make it pay him a profit. Order today. Tells how to make—Breakfast Nook—Humidifier—Knee-hole Desk—Night Table—Twin Deck Beds—Modern Bedroom Furniture—Clocks—Plastic Candlesticks—Bob Sled—and more than a hundred other useful and saleable articles.



POPULAR MECHANICS PRESS
Dept. 1139, 200 E. Ontario St., Chicago

558 HELPFUL BOOKS Send for FREE CATALOG



Selected books on 50 subjects to help you earn more, get a better job, make money in business for yourself, cash in on a hobby. Send name and address today.
POPULAR MECHANICS PRESS
Dept. 1139, 200 E. Ontario St., Chicago

THOUSANDS HAVE WAITED FOR THIS BOOK

**What to Make
Only 50¢**

Get this new book and turn happy home workshop hours into extra cash. 188 pages packed with instructions, plans, valuable data and pictures showing what to make and how to make it. Anyone who can use simple tools can work from this book and make it pay him a profit. Order today. Sent postpaid for only 50 cents.

POPULAR MECHANICS PRESS
Dept. 1139-A, 200 E. Ontario St., Chicago

TRAVEL - for 'UNCLE SAM'

RAILWAY POSTAL CLERKS
Men 18 to 35

**\$1900 First year regular
MANY OTHER GOVERNMENT JOBS**

Mail Carriers—File Clerks—Stenographers—Typists, etc.
Grade School Education Usually Sufficient
\$1260 to \$2100 First Year

MEN—WOMEN
Mail Coupon immediately—today sure.



**GET A
U. S. GOVERNMENT
JOB**



COUPON

FRANKLIN INST., Dept. R173, Rochester, N. Y.

Gentlemen: Rush to me, without charge, 32 page book with list of U. S. Government big paid positions. Advise me also regarding salaries, hours, work, vacation, etc. Tell me how to qualify for a position.

Name.....

Address.....

HOW to Protect and capitalize on your INVENTION



Get these **FREE BOOKS** of "IDEA" Opportunities

Is your idea patentable? Has it commercial possibilities? Those are the things you want to know—and interesting information on these questions can be found in our books "How We Protect You" and "Suggestions on How to Commercialize Your Invention." We will send you these absolutely FREE—together with our Certification of Invention form, if you mail the coupon below NOW!

OUR EXPERIENCE GUIDES YOU

You can feel perfectly sure in dealing with this reputable firm. C. A. Snow & Co. has been securing patents of every description for 63 years. Save time and expense now by getting advice based on our long patent experience.

C. A. SNOW & CO.
Registered Patent Attorneys Since 1875

MAIL NOW FOR
FREE BOOKS

1911 SNOW BUILDING, WASHINGTON, D. C.

Gentlemen: Please send me—without cost or obligation—your FREE books, "Suggestions on How to Commercialize Your Invention," and "How We Protect You." Also Certification of Invention form.

Name.....
Street and No.....
City or Town..... State.....

SURE ROUTE TO HAPPY-LAND MAIL TODAY SURE



**J. C. DEAGAN, Inc., Dept. 3453
1770 Berteau, Chicago**
Without cost or obligation, tell me about the easy-to-play DEAGAN MARIMBA... its sensational rise in the music world... the fun it provides at parties... the opportunities for radio, stage and dance-band fame.

EASY TO PLAY

Name—Please PRINT

Address

POPULAR INVENTIONS



SOMETHING new in the bicycle field—a power-saving hub—has been patented recently. When the power is applied, an internal gear arrangement carries the static pressure of the load forward of the hub's center, giving the road wheel an immediate start. In exact proportion as the road wheel meets opposition, from the gradient

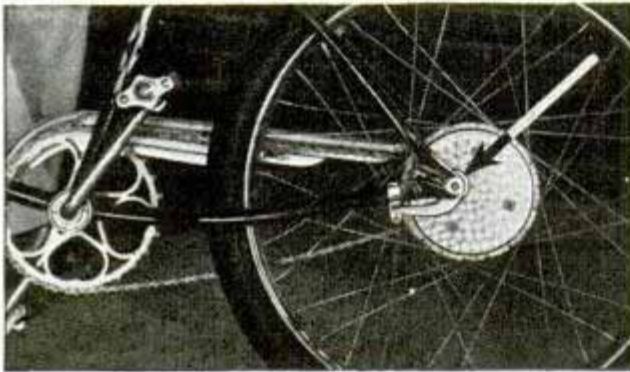

or other means, the load is brought still farther forward. The inventor claims that the power required to move the load within the hub is much less than that needed to turn the road wheel by torsion at its center; also that when the load is so shifted in the traveling direction, it has the effect of a moving wheel, resulting in quicker getaway and easier propulsion than if the wheel is moved in the usual manner.

INCREASED safety on the highway is the purpose of a newly patented center road-dividing guard. Curved guard rails, supported by spring steel legs, separate the lanes of the road, thus keeping automobiles, trucks and buses from meeting head-on or side-

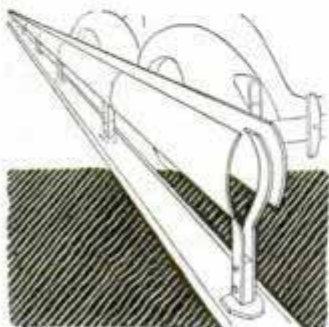

swiping each other. The plates, which present an outward curved surface to the vehicle, are spread slightly. Under impact, the plate struck by an auto is forced inward and against the companion plate, which helps to absorb the shock. The guard occupies little space.

GREATER speed and more protection from dirt and mud picked up by the front wheel are provided by a shield for a pedal car. Patented recently, the pedal car closely resembles a bicycle, except that it has two rear wheels, between which the seat is mounted. The shield forms a body, then extends upward to form a wind barrier. The shield is streamline, enhancing the appearance of the sports vehicle.



SERVICING a tire on an automobile fitted with the low-hanging modern fender and wheel skirt would be easy if a newly patented fender were adopted. The fender has two sections, one permanently attached to the side of the car, the other constructed to swing open on a hinge at the rear end to expose the wheel. A recess in the two sections contains a light for illuminating the wheel, and a pocket in the lower edge of the swinging half may be used for storing tire-servicing tools.



(Continued to page 34A)

A Sensational New Business

That May

Sweep You to Riches

This is undoubtedly the most amazing money-making opportunity ever offered to the readers of this—or any other—magazine. It tells how any ambitious, level-headed man can quickly establish a remarkable new kind of business that may pay a steady net cash profit of \$40.00 a day—a business that offers unlimited opportunity, rapid expansion—a business in which you can employ others to work for you and run your daily profits up as high as you want them to go—a business that may make many men independently wealthy within the next few years.

HERE, briefly, are the "high-spots" of this thrilling new business that should create "fortunes" for those with the vision and foresight to get in on the ground floor now:

- 1** An utterly new product with a natural, staple demand and big repeat business, yet one that has all of the appeal of a novelty.
- 2** Requires no house-to-house canvassing or selling. You simply manufacture. Every store, tavern, club, or any establishment where any sort of food is handled are your immediate customers.
- 3** Starting with one unit alone you have a capacity to enable you to make \$42.00 profit a day selling at wholesale.
- 4** An amazing product that can be manufactured by special secret process by only one mill in the country. This mill, one of the largest of its kind, manufactures the product exclusively for us and our operators. No one else can make it or buy it. This means your protection from cut-throat price competition.
- 5** All year around business; no slack seasons.
- 6** Tremendous natural demand in every community, whether large or small.
- 7** Absolutely no experience needed to be successful.
- 8** No expensive equipment needed. Your whole investment will be less than your first week's potential income.

This is truth; not fiction—fact; not theory. To the best of our knowledge, no other business in America offers one-tenth the opportunity for profit and independence.

Vision Turned to Reality

A short time ago, this amazing money-making product was nothing more than a dream—today it is a reality.

It is a practical, tried out, thoroughly tested business!

Every detail has been perfected—complete and tested plans of operation worked out—all necessary equipment ready to turn over to those who are prepared to develop this new "gold mine."

No Selling—No Canvassing

Do not confuse this new product with anything you have ever heard of before. It is not a potato chip, not candy, not a cheese chip, not a paste preparation—but a natural product that comes from the sky, from the ground, and from the air. It is not like anything you ever saw or heard of, or imagined. The simple truth about it is stranger than your wildest dream. And you can be the first to supply this great demand.

\$100.00 a Week, Net, to Start

According to accurate figures, the very minimum of the first operation should produce a net cash profit of at least \$100.00 a week. Since it is possible to make \$42.00 a day, you can see that it would take only two and a half days of full operation to make a profit of \$100.00. This, we figure to be a minimum. We would not be interested in appointing men who could not make at least that much every week. Then, as demand increases, other men can be put to work for you and you can double, triple or quadruple your weekly profit as steady repeat business develops.

No Expensive Equipment

Ordinarily a proposition as big as this would require the purchase of expensive equipment with which to manufacture this remarkable new product. But in this case our manufacturing process has been so simplified that we can furnish you with everything you need to start off making a profit the very first day—all for an investment of \$150.00.

No Experience Needed

Absolutely no experience is required to quickly become successful in this thrilling and fascinating new business. We tell you how to start—how to establish yourself quickly—how to operate the business the very day you are ready to go. We furnish all necessary plans, systems and equip-

ment. Any man with ordinary intelligence and a real desire to succeed is bound to make money.

Small Town or Big City

Another feature that makes this business unlike any other is that it can be operated anywhere. No matter where you live—in the smallest town or the largest city—you can establish yourself practically over night and start enjoying an independent income at once. From the foregoing facts, you can readily see that this is not a business for the timid operator who is satisfied to make a bare living, but for the wide-awake, aggressive go-getter who wants to see his energy and enthusiasm produce the greatest possible results in the shortest possible time.

Facts Sent Free

To all such men, we request permission to mail an unusual and complete presentation. After you have read the amazing facts and figures in this presentation, then you can decide whether or not an initial investment of \$150.00 is too much to ask for a complete business that can bring back that investment in the first three days of operation, and then continue to pay as much as \$252.00 a week net profit for one man operation, and up to as high as a thousand a week net profit to those men who have the ability to organize and direct other men.

Act Quickly

There is no time to lose. Today this proposition is new. Tomorrow it will be a little older—next week a little older still. So get the facts without a moment's delay. It's the newcomers in any enterprise of this sort—the "ground floor operators"—who always reap the richest rewards.

There is no coupon on this ad. We do not want to hear from coupon clippers. If you don't agree that this is worth a letter—or a telegram—you are not the man for the business.

So write or wire today—without the slightest cost or obligation—and get the information that can make you independent for life.

KING K. CO. Dept. K-311
620 N. Michigan Ave.
CHICAGO ILLINOIS

**For Your OPPORTUNITY
NOW - Get into**

**Industrial Designing
and DRAFTING**



There is a vast field of opportunity for you if you are trained in both Drafting and Industrial Designing. Nearly every industry can use men who not only know how to make drawings and blue prints—but who can actually help design new products and improve old ones. Training in Industrial Designing makes you a better draftsman—and a working knowledge of drafting makes you a more effective Industrial Designer. Now Engineer Dobe offers to train you in your spare time in both fields at the same time—quickly, easily, by his practical, easy "Work-Job" Method.

**A New Fast Growing Field
Crowded with Opportunity**

Manufacturers want men with ideas. Factories must continuously bring out new models, new products, and improved designs. Products must be re-styled and improved year after year, season after season, in order to keep up with competitors and demands of the public. Because this field is so large there is a need of trained, skilled designers. The Dobe combination method is ideal for men going into drafting or designing. Extremely valuable for executives, too.



**I'LL TRAIN YOU AT HOME
BY THE WORK-JOB METHOD**



Engineer Dobe

I can prepare you just as I have trained many hundred successful students from 16 to past 50. No previous experience or special inventive ability needed. High school education replaced by work experience. I'll train you thoroughly by applied instruction on actual work in both Drafting and Industrial Designing, until you are competent . . . yes, until you are holding a good paying position. Complete working outfit furnished without extra charge.

SEND FOR FREE BOOK

"Industrial Designing and Drafting."

Mail the coupon for FREE details as to how you can learn Industrial Designing and Drafting. Engineer Dobe, Libertyville, Ill.



ENGINEER DOBE, Div. 3378
Libertyville, Ill.

Please send me FREE BOOK on "Industrial Designing and Drafting" also please explain how you assist your graduates to good positions in these fields.

Name Age.....
Address
Town..... State.....

POPULAR INVENTIONS

(Continued from page 32A)

FOR enlarging its capacity, convertible furniture has been patented recently.

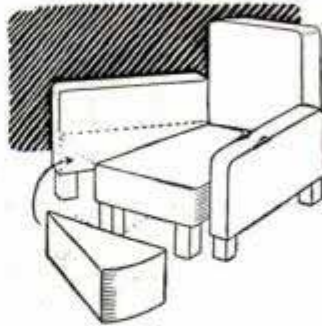

One piece consists of an upholstered chair with the usual side arms, at least one of which is arranged to swing away from the seat portion. Thus, an extra seat section, constructed in triangular

shape, may be inserted into the space and the swinging arm pushed into place against it. The extra seat is built the exact height of the regular seat. When the extra seat section is not required, it may be used as a foot and leg rest.

PRACTICALLY everything for the camper's culinary needs is incorporated into a handy kit patented recently. It contains plenty of pots, pans, plates and food storage utensils, all packed in a con-



venient container. At the top is a two-burner camp stove which folds for packing when not in use. The unit is expected to find considerable use among campers and picnickers. It probably will go on the market soon.

(Continued to page 55A)

Helps You **EARN MORE**

SAVES TIME and MONEY

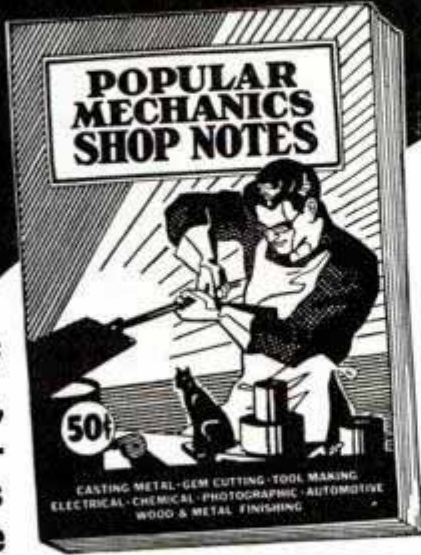

Thousands of Money-Making, Time and Labor-Saving Ideas You Can Use

Shop Notes will help you on your job—on home repairs—on the farm—in hundreds of different ways—will make money for you and save you time and money.

If you do machine shop work of any kind, sheet-metal work, painting, carpentry, auto repairing, farming, concrete work, plumbing, electrical work, welding, building, glass work, general repairing, tool-making, poultry raising, masonry or home repair work, you need the Shop Notes Library.

NOW READY—

SHOP NOTES for 1940

214 Pages • 384 Articles • 762 Illustrations

Just published—the world's biggest 50 cents' worth. Packed with new shop kinks, short cuts, helpful ideas, time and labor saving methods you can use. Here are just a few of the many subjects covered:

- | | |
|---|--------------------------------------|
| Novelty Paint Finishes | Building and Using a Wattmeter |
| Auto Mechanics | Cementing Glass, Metal and Celluloid |
| Drill-Vise Milling Unit | Making Precision Machine Tools |
| Density Meter for Separation | Tricks of Soldering |
| Negatives | Universal Photo Enlarger |
| Modern Plant Stands | Wood Finishing |
| Hand Loom Weaves Cane Webbing | Paint Spraying |
| High-Speed Cutting with Abrasive Wheels | Negative Dryer |
| Motorized Lawn Mower | Making Silk Stencils |
| Making Choke Coils | Tap and Die Holders |
| Gem-Cutting Bench | Correct Centering |
| Tractor Built from Old Car Parts | Motorized Garage Doors |
| Making Unit Castings | |

Special BARGAIN OFFER

7 SHOP NOTES VOLUMES While Present Supply Lasts \$2.98

Start your Shop Notes Library now. We will send seven issues, (approximately 400 articles in each) now in print, including the new 1940 Shop Notes and those published in 1932-1935-1936-1937-1938 and 1939—7 Shop Notes in all—for only \$2.98. Single books 50 cents each. Offer withdrawn when present supply is sold. Order today and avoid disappointment. If you have earlier years, rush order for 1940 Shop Notes. Money refunded if not satisfied.

Mail Coupon.... Pay Postman

**POPULAR MECHANICS PRESS, DEPT. 1139
200 East Ontario St., Chicago**

- Send 7 Volumes Shop Notes Library as offered. I enclose \$2.98
 Send C. O. D. I will pay postman price and small amount of postage.
 Send 1940 Shop Notes at once. Remittance for 50 cents enclosed.

Name.....
 Address.....
 City.....State.....

*C. O. D. applies to U. S. and possessions only. If you reside elsewhere, remittance must accompany order.

When writing please mention Popular Mechanics

FOR MEN WHO WANT TO LEARN A PROFITABLE TRADE



Complete DIESEL TRAINING



NO MATTER WHERE YOU ARE OR WHAT YOU DO —we have a training plan for YOU!

If you are sincerely ambitious and interested in making good in the Diesel field, be sure to immediately investigate our flexible training plan that will fit your circumstances. A Plan for every Man. A Plan for those seeking immediate shop training as well as for those who cannot give up their present employment and income. For 34 years National Schools, a recognized leader in the field of trade education, has helped wide-awake men to success. This million-dollar trade school will supply you with a sincere, honest statement of facts of what you should do to quickly get into the profitable Diesel Industry. No exaggerations—no misstatements; and a definite plan to fit you.

Write Today for Full Details

WE ARE DEFINITELY INTERESTED IN HELPING MEN OF LIMITED INCOME AND "BLIND ALLEY" JOB HOLDERS.

Mail the coupon below. Find out how you can get the finest in Diesel training without delay. See how this great trade school operates and makes its facilities available to every ambitious man. Actual work in modern training shops, a part of every man's instruction. Shop methods time-tested for 34 years. Fascinating, efficient preparation. Get the facts.

NATIONAL SCHOOLS

LOS ANGELES, CALIF.

Complete Training in Diesels and Gas Engines.

Oldest Trade School in West

MAIL COUPON FOR FREE LITERATURE

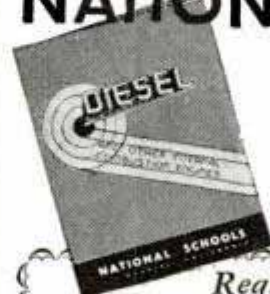

Request for Free Literature

NATIONAL SCHOOLS (established 1905) Dept. 11-PMA
 4000 South Figueroa Street, Los Angeles
 Please send me, without obligation, your **FREE** Literature and information.

NAME _____ AGE _____
 ADDRESS _____ CITY _____ STATE _____

FREE! Send For
ALLIED'S
1940 RADIO
CATALOG

204 PAGES — 15,000 ITEMS

EVERYTHING AT LOWEST PRICES



NEW SETS
 60 new Knight sets for every purpose—4 to 12 tubes, newest features, "Air Magnet," Gem-loid Dials, etc.—latest portables 1-tube electric phonographs, 5, 7, 11-tube phono-radios — all sensational values! All priced amazingly low.

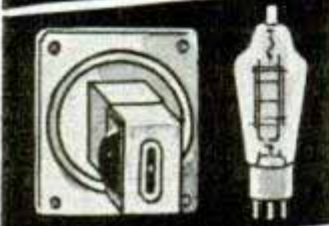

NEW BIG PARTS SECTION
 15,000 radio items—everything in Radio in one big book! Parts for every purpose, tubes for all radios, latest books, tools, etc.—at lowest prices! Latest Test Equipment — Rider Volt-Ohmyst, etc. Newest Kits, diagrams and projects.



NEW HAM GEAR
 Complete Amateur Equipment —latest receivers, Sky rider "Defiant," etc., Rotary Beam, Television Equipment, all standard lines—at lowest prices. Most complete Ham section in Radio. Investigate ALLIED'S convenient New Time Payment Plan!



NEW P.A. SECTION
 3 completely new lines—"Economy," "Standard," "Deluxe"—14 new systems, 6 to 65 watts, new styling and performance—new "mikes," latest recording equipment at lowest prices. Ask for ALLIED'S New Time Payment Plan.

BIG BARGAIN SECTION



KITS—We supply matched kits for building any circuit described in any magazine. Write for Free Parts Lists.

Free SEND COUPON

ALLIED Radio Corporation,
 833 W. Jackson Blvd.,
 Chicago, Ill., Dept. 5-FL-0

Send your new FREE 1940 Catalog.

NAME.....

ADDRESS.....

When writing please mention Popular Mechanics

1 Year Gov't Approved Course
LEADING TO AN A. & E. LICENSE OR TO SPECIALIZATION IN FACTORY PRODUCTION OF MODERN AIRPLANES

Luscombe trained men are employed with leading Aviation Enterprises throughout the U. S. Practical training under experienced instructors, limited enrollment, strict supervision and modern methods have been the means of placing over 90% of our graduates.
 Details will be gladly sent upon request.

LUSCOMBE
SCHOOL OF AERONAUTICS
 DEPT. M, WEST TRENTON, N. J.

TELEVISION
and SHORT WAVE HANDBOOK
 By F. J. Camm. (\$3.00). Just out. All latest discoveries. Hundreds of diagrams. 300 pages. Every branch of television and short wave completely covered. Indispensable guide for expert or beginner. Send no money. Pay postman \$3 plus postage. Money refunded if not satisfied.

FORTUNY'S Publishers
 67 W. 44th St., New York

EARN A DEGREE AT HOME
From A Chartered Institution Of Higher Learning
—Employers Now Demand College Graduates With Degrees
88 Degree Courses in Art; Sciences; Philosophy; Education; Psychology; Public Health; Sociology; Physics; Chemistry; Pol. Science; Theology; Law; Business Training; Accounting; Statistics; Adv.; Sales; Agriculture; Electrical, Mechanical, Civil, Structural, Diesel; Architectural, Mining, Drafting, Automotive, Aeronautical, Radio, Refrigeration, Highway, Marine, Air Conditioning, Geology, Petroleum, Industrial, Chemical Engineering. Founded 1908. 170 p. Catalog Free. McKinley-Roosevelt Graduate College, 4750-F Sheridan Road, Chicago

White Right
WONDERFUL INVENTION.
 Corrects your writing in few days, big improvement within few hours. No failures. Complete set, with instructions, only \$2. Returned if not satisfied after ten days' practice. Sent C.O.D. if preferred.
PERFECT PENMANSHIP CO., 35, St. Louis, Mo.

\$2

DON'T CHOOSE YOUR LIFE · WORK BLINDLY
USE THE "INDIVIDUAL VOCATIONAL SURVEY"
 to determine the occupation in which your natural ability, personality, and characteristics should bring your greatest success. Proven scientific guidance toward a better job at small cost.
FREE No money. Send name for your own personal Occupational Adjustment Test absolutely Free. Postcard will do.
 Vocational Guidance Institute, Dept. A-111 Greenway Station, Tucson, Ariz.

Learn Short-Method Arithmetic

Simplified system used by "master minds" on stage, accountants, bankers, etc. Easy to learn. Add columns of figures short-cut method; multiply 4 figures by 4 figures without using old-fashioned multiplication; use sight method of proving addition, division, etc. Learn horsepower calculation, how to use slide rule, micrometer. Complete illustrated course only \$1.00, postpaid. Satisfaction or refund. Amaze your friends with your mental wizardry! Free details —mail coupon TODAY.

FREE

NELSON CO., L-300 Manhattan Bldg., Chicago, Ill.
 Send free details about "Short-Method Mental Arithmetic" without obligation on my part.

Name.....
 Address.....
 City..... State.....

÷
 X
 =
 +
 ✓



EASY to play

With an easy playing Conn band instrument, you can be ready for band or orchestra in 4 to 6 weeks. A sure road to popularity if you start on a Conn. Choice of the world's greatest artists. Magnificent tone. Many exclusive features—yet they cost no more.

Ask to see the marvelous new models now being displayed by Conn dealers.

WRITE FOR THIS NEW FREE BOOK

Home trial. Easy payments. Write us for free book on whichever instrument interests you most. Mention instrument.

C. G. CONN, LTD., 1131 CONN BLDG. ELKHART, IND.



MUSEUM TAXIDERMAY

Learn this fascinating ART under PERSONAL Direction of a Professional, Museum Staff Taxidermist in one of the World's Largest Museums.

Five Complete Books
 BIRDS--MAMMALS--GAME HEADS & RUGS
 FISH & REPTILES--TANNING

Write for FREE Sample Lesson
CHICAGO SCHOOL OF TAXIDERMAY
 P. O. Box 343, Dept. 14, Chicago, Ill.

GET INTO THE BAKING BUSINESS!

National Baking Institute announces a new home study course in commercial baking. Baking now America's fifth industry in wages. Nearly a depression-proof business. Good field for ambitious men. Common school education sufficient. Send for free booklet "Opportunities in Commercial Baking" and requirements.



National Baking Institute
 3601 Michigan Ave. Dept. 1358 Chicago, U. S. A.

EARN THE DEGREE

Doctor of Psychology (Ph.D.), Philosophy, Divinity. General Courses—Arts, Business, etc. A Correspondence Institution Chartered by State of Washington. Send for 32-page FREE Bulletin at once. No Obligation. Temple Bar College, Dept. 2-R, 1620 Thirteenth Avenue Seattle Washington, U.S.A.

RADIO ENGINEERING, broadcasting, aviation and police radio, servicing, marine and Morse telegraphy taught thoroughly. 48 weeks' engineering course equivalent to three years' college radio work. School established 1874. All expenses low. Catalog free.

Dodge's Institute, Ada St., Valparaiso, Ind.



Best Poultry Paper 6 BIG ISSUES 10¢

Helps increase Poultry Profits. Send coin or stamps, 50 cents for 3 years or 10 cents for 6 months trial. Agents wanted. American Poultry Journal 532 So. Clark Street Chicago, Illinois

Prepare at Home for JOBS in



With this expert drawing outfit—drafting table, drawing board, superior drawing instruments . . . all sent without additional cost, you are all set to learn **DRAFTING AT HOME**. **FREE TRIAL LESSON** shows how easy. Mail coupon.

THIS DRAWING OUTFIT YOURS

DRAFTING

The draftsman's work comes first. When business improves . . . and it is improving . . . there is new construction work, new buildings, new machines, repairs and reconstruction work. All these must first be laid out on paper. So the **FIRST** man that must be hired is the **DRAFTSMAN**.

Drafting Is Well-Paid Work

Drafting is clean, interesting professional-type work. It pays well to start . . . offers real opportunities for promotion. You need no previous training or experience . . . no special talent—to learn Drafting. It is one of the steadiest employment fields. No machine ever did the Draftsman's work . . . and no machine can be invented. So your job is *always secure*.

Learn AT HOME

in your spare time (or at the College in Chicago) by the fascinating, easy, step-by-step plan originated by this 36-year old school for Draftsmen.



Sample this easy-lesson system of learning Drafting. Send postal card or this coupon. No charge now or later for this **FREE LESSON**. Prove to yourself how easy it is to learn Drafting by the C. T. C. method in your spare time right in your **OWN HOME**.

CHICAGO TECHNICAL COLLEGE

P-200 Tech Bldg., 118 E. 26th Street, Chicago, Illinois

Please send me **FREE Trial Lesson** in **DRAFTING** and show me how I can prepare for good positions in spare time **AT HOME**.

Name.....Age.....

Address.....

P. O.....State.....

GOOD SALARY

FINE CAR

**To the man who wants to enjoy
an ACCOUNTANT'S CAREER**

A NICE HOME

BANK ACCOUNT

IF you're that man, here's something that will interest you.

Not a magic formula—not a get-rich-quick scheme—but something more substantial, more practical.

Of course, you need something more than just the desire to be an accountant. You've got to pay the price—be willing to study earnestly, thoroughly.

Still, wouldn't it be worth your while to sacrifice some of your leisure in favor of interesting home study—over a comparatively brief period in your life? Always provided that the rewards were good—a salary of \$2,000 to \$10,000?

An accountant's duties are interesting, varied and of real worth to his employers. He has *standing!*

Do you feel that such things aren't for you? Well, don't be too sure. Very possibly they *can* be!

Why not, like so many before you, investigate LaSalle's modern Problem Method of training for an accountancy position?

Just suppose you were permitted to work in a large accounting house under the personal supervision of an expert accountant. Suppose, with his aid, you studied accounting principles and solved problems day by day—easy ones at first—then the more difficult ones. If you could do this—and if you could turn to him for advice as the problems became complex—soon you'd master them all.

That's the training you follow in principle under the LaSalle Problem Method.

You cover accountancy from the basic Elements right up to Accountancy Systems. Later, you choose from twelve post-graduate electives, including C. P. A. coaching.

As you go along, you absorb the principles of Auditing, Cost Accounting, Business Law, Organization, Management and Finance.

Your progress is as speedy as you care to make it—depending on your own eagerness to learn and the time you spend in study.

Will recognition come? The only answer, as you know, is that success *does* come to the man who is really *trained*. It's possible your employers will notice your improvement in a very few weeks or months. Indeed, many LaSalle graduates have paid for their training—with increased earnings—before they have completed it! For accountants, who are trained in organization and management, are the executives of the future.

Write For This Free Book

For your own good, don't put off investigation of *all* the facts. Write for our free 48-page book, "Accountancy, The Profession That Pays." It'll prove that accountancy offers brilliant futures to those who aren't afraid of serious home study. Send us the coupon *now*.

Over 1700 Certified
Public Accountants among
LaSalle alumni

LASALLE EXTENSION UNIVERSITY

A CORRESPONDENCE INSTITUTION

4101 S. Michigan Ave., Dept. 1164-HR, Chicago, Ill.

I want to be an accountant. Send me, without cost or obligation, the 48-page book, "Accountancy, The Profession That Pays," and full information about your accountancy training program.

Name.....

Address..... City.....

Position..... Age.....

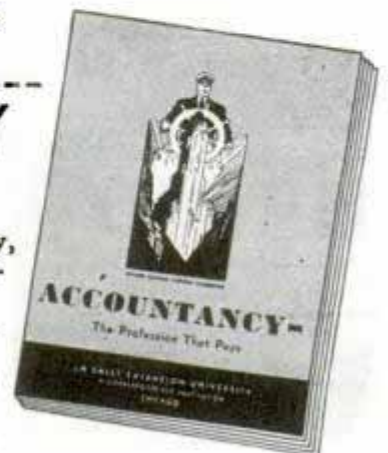

When writing to advertisers please mention Popular Mechanics

**WORLD'S
BEST
WANT AD
MEDIUM**

CLASSIFIED

Advertisements



Advertisements in this section, 35 cents per word, each insertion, minimum 10 words, payable in advance

To be inserted under proper classification in December issue, copy should be in our office October 8th

December issue on sale November 1st

Popular Mechanics Magazine, 200 East Ontario Street, Chicago, Illinois

YOU'LL PROFIT

By reading and answering the classified ads in this section. Hundreds of opportunities to make and save money.

Mr. F. W. Johnson, Mgr.,
Classified Advertising,
Popular Mechanics Magazine,
200 E. Ontario St., Chicago, Ill.

Dear Mr. Johnson:—I am informing you that the first ad we placed in the classified section of your magazine appeared in the November issue of 1935, and from that day up to the present time, we never missed an issue in the last three years and a half. The results are wonderful, the percentage of orders to the inquiries are the largest we ever received from any magazine, regardless of circulation.

(Original letter on file in our office)

Respectfully yours,
STAR SERVICE.

AUTOMOBILES—MIDGET CARS

ALUMINUM Alloy pistons, automotive, aviation, diesel, industrial, marine, midget, model, motorcycle, outboard. Finished or semi. Judson Mfg. Co., Hedge and Gillingham, Philadelphia, Penna.

NEW Fifth edition Automobile Racing Book. Tells how to build dirt track bodies, frames, engines. Records, superchargers, rules, formula, plans, stock conversions, roadster racing, fast Fords. \$1.00 postpaid; \$1.15 C.O.D. Ray Kuns, Department 11, Madisonville, Cincinnati, Ohio.

AUTOMOBILE Superchargers \$3. Guaranteed mileage increase 20%, power 10%. University of Detroit test. Give car make and year. Install yourself 15 minutes. John Hanley, Manufacturer, 5719 Loraine Ave., Detroit, Mich.

GASOLINE Saving device, \$1.00. Ford V8's 1934-1939. Chevrolet 1935-38. Walert Co., 3429 N. 10th St., Milwaukee, Wis.

MIDGET Cars, parts. Plans 50c. Catalog 20c. Derby Midget Co., Woodstock, Illinois.

PHOTOGRAPHS, World's finest automobiles. Handbook 10c. Automobiles, Box 534, Saint Cloud, Minnesota.

CHANGE Ford motor into fast pumping air compressor. Instructions \$1.00. Tuck, 73 Shirley, Pontiac, Mich.

AUTOMOBILE Mechanics who want business or earn extra money write for samples and details of nationally distributed Self-Locking Triple-X Piston Rings. Eliminate re-boring. Guaranteed life of car. Franchise valuable. Some territories open. Triple-X Co., 3801 South Racine, Desk P, Chicago.

AUTOMOTIVE—Technical books. Catalog for stamp, Kraftmen's Press, Coscob, Conn.

MIDGET Parts, plans, kits. Catalog 10c. Midgets, Box 543-H, Zanesville, Ohio.

MIDGETS! Racecars, sportcars. Latest bargain lists—over 130 used motors, midgets, parts—20c. Shipp's Midgets, Box 543-H, Zanesville, Ohio.

MIDGET Racers, two-passenger autos. Midget motorcycles, motorscooters, bicycles. Motors, wheels, parts, plans. New handbook catalog, 90 illustrations, 20c. Midwest, Box 1959-F, Chicago.

AUTO SUPPLIES AND EQUIPMENT

BARGAINS—Compressors, welders, battery chargers, car washers, attractively priced. Terms, trial. Write for bargain list. Hobart Automotive Supply, Box M-1195, Troy, Ohio.

MODERNIZE 1937-38 and 39 Ford and Mercury cars with new Fabriform Remote Gear Shift. Agents wanted. 4900 Cecelia Street, Bell, California.

FACTORY Expert rebuilds carburetors, like new. \$3.95. Prompt service. 8041 Exchange, Chicago.

GAS Stations construct, easy. Low-cost driveway signal. Plans, instructions postpaid \$1.00. U-Build-It-Labs, 2648 N. W. 22 Ave., Miami, Florida.

AUTOMOBILE Mechanics wanted to sell Vermiculite! Request details. Devereaux, Box 212, Battle Creek, Mich.

CRANKCASE Oil refiner, inexpensive operation. Plans, specifications, \$1.00. Technical Laboratories, East Haven, Conn.

CARBURETORS For Chevrolet 1932-'38. Brand new. \$6.20. Popular make. Manufacturers Automotive Supply, 1104 So. Sacramento, Chicago.

FREE Wholesale bargain catalogue, auto supplies, tires, tubes, equipment, tools. For dealers only. American, 1189 Bedford Ave., Brooklyn, N. Y.

1939 IGNITION Supercharger \$1.25. E. G. Sales & Mfg. Co., New York.

RE-REFINE Crankcase drainings, request information. Zelball, Mount Holly, N. J.

ACETYLENE Welding outfits, \$32.95; electric welders, \$74.95. Easy-payment plan. Box 331, Hamilton, Ohio.

PLATING Outfits for auto parts. Connect to a battery. No tanks used. Free particulars and proofs. Gunmetal Co., Ave. J, Decatur, Ill.

AUTO TRAILERS

BUILD The famous, low-cost Jim Dandy Cabin Trailer. Complete plans and instructions 50c. Plans to build the beautiful, streamlined Jim Dandy Cabin Cruiser, \$1.00. Trailer Builders Manual and catalog of trailer parts, supplies and equipment—over 100 interesting, illustrated pages, 25c. Order today. Satisfaction guaranteed. Trailer Supply Co., 411-A Jackson St., Wausau, Wisconsin.

MOTORCYCLES, BICYCLES, MOTOR SCOOTERS AND SUPPLIES

MOTORCYCLE Parts and accessories, new and used, for all motorcycles. Write for prices. Henderson list 10c. Triangle, 1111 Washington, Chicago.

MOTORSCOOTERS! New low prices! Build Comet scooter. Order parts, engines, tires from Comet Cycle Co., Box 3032, Madison, Wisconsin. Literature, drawing 10c.

MOTOR Marvel ready! Mead's sensational new Ranger Scooter goes 120 miles per gallon, 35 m.p.h., ride, rent or sell for profit, pleasure. Dealers, agents write for special introductory offer, easy terms, free circular. Hurry! Mead Cycle Company, Dept. C-1, Chicago.

REBUILT Motorcycles. All makes genuine parts and service. Special generator and armature repairing. Send 15c for illustrated bulletin. Western-Harley Davidson Distributor, 914 East 15th, Kansas City, Mo.

MOTORSCOOTERS, Midget cars! Easily built. Complete plans and literature on wheels, tires, motors, etc. 10c. Honsakers, Masontown, Penna.

BUILD Power scooters, midget cars. We supply tires, wheels, motors. Lowest prices. Send 10c for plans, etc. Build-Ur-Own Devices, 5238 Lake, Chicago.

ALLOY Pistons \$3.00—Harley, Indian, Henderson, Excelsior, Cleveland. Cylinder grinding, rings, bearings, gaskets, chains, sprockets, helmets, goggles, accessories, parts new and used for less. Catalogue and wings pin 10c. Ballak, 1115 Chestnut, St. Louis, Mo.

YOUR Money's worth at Knuth's. The best buys in reconditioned Harleys. Just think! Fully equipped police specials 37 - 80's only \$250.00. 36 - 80's for \$220.00. Many other bargains. Send 6c for bulletin. Knuth's, 2491 Fondulac, Milwaukee, Wis. "Everything for the motorcyclist."

MOTORCYCLES, Reconditioned. New, used, parts and accessories. All makes. Large stock. Bargains. Illustrated catalogue, 15c. Indian Motorcycle Sales, Kansas City, Mo.

INSIDE Dealer prices. Overstocked, all models. Indians and Harleys. Rebuilt, guaranteed. Dime brings latest list. Crandall-Hicks, Boston, Mass.

RECONDITIONED Motorcycles. New—used parts for all makes. Authorized Harley-Davidson dealer. Whitman Motorcycle & Supply Co., 405-9 Southwest Blvd., Kansas City, Mo.

MOTORCYCLE Bargains, lowest prices, bargain sheets for stamp. Motorcycle accessories. Rochester Harley Davidson Corp., 129 W. Main St., Rochester, N. Y.

MOTORCYCLE Cylinder boring \$2.00. Aluminum pistons, stock or racing, all models, (dealers supplied). New and used Indian parts. Used motorcycles. Stamp brings list. Phila. Indian, 1635 Hunting Park, Philadelphia, Penna.

SMALL Business of Your Own. 1000 tried and proven methods. \$1.00. Popular Mechanics, 200 E. Ontario St., Chicago.

AVIATION

LEARN Aviation at Lincoln! Exceptional employment opportunities now in aviation. 83 more Lincoln School graduates step into good-pay positions! This Lincoln government approved school of aviation would like to prepare you for immediate employment as pilot or airplane and engine mechanic or as aeronautical engineer. We assist graduates in locating positions. Part-time employment for board and room while in training. Write today for complete information. Lincoln Airplane & Flying School, 2005 Aircraft Building, Lincoln, Nebraska.

AVIATION'S Pocket sized encyclopedia with over 600 questions and answers, photos of oldest, most recent, smallest, largest planes. Written by nationally famous instructor and pilot only 10c coin! Leonard Schrader, Nauvoo, Ill.

PROPELLERS For airplanes, sleds, boats, hubs, countershafts, snow sled skis. Catalog 10c. Banks Propellers, Hanger No. 4, Love Field, Dallas, Texas.

IDENTIFY Yourself with aviation! Send thin dime for huge new illustrated catalog listing 1308 exclusive personal aviation items, jewelry, gadgets, etc., at attractive prices. Send dime today to Karl Ort, Dept. 42, York, Penna.

AIRCOOLED Motors, 80 horsepower, \$75. Aerodisc blueprints, 25c. Allison Aircraft, Lawrence, Kansas.

JUST Out—A practical course in flying, 29 chapters, illustrated, complete, Only \$1.00. Aircraft Directory, Athens, Ohio.

AVIATION Apprentices — Air-minded young men interested in training for entering aviation as apprentices see ad on page 20A.

AIRPLANES \$30 To \$375, located everywhere. Send 25c for complete catalogue. Used Aircraft Directory, Athens, Ohio.

PROPELLERS, Attractively priced, leading with three blade airliners, more efficient for sleds, aeroplanes, boats, also supplies, information free. Standard Propeller Company, Ft. Worth, Texas.

GRADUATE Airplane mechanic. Ten weeks, \$1.00 week. Graduates with leading concerns. Free catalog. United Air School, Elgin, Ill.

LEARN To fly free. Folder, dime. Ohmeyer, Box 391, Hempstead, N. Y.

PROPELLERS For airplanes, sleds, ice-sled blueprints, supplies. Catalog dime. Lorenzen Propellers, Niles, Michigan.

GET Into aviation. Pilots earn up to \$6000 a year! Airplane mechanics and aeronautical engineers also get big pay! Prepare at this Lincoln government approved school. Write for complete information. Lincoln Airplane & Flying School, 2004 Aircraft Bldg., Lincoln, Nebraska.

A. C. GENERATORS

PRACTICAL Changes for automobile generators. See our advertisement at bottom of page 139A. Autopower.

BATTERIES, GENERATORS, ETC.

NEW 110 A.C. auto fanbelt generators for movies, amplifier, neon signs, \$16.00 up. LeJay Manufacturing, 147 LeJay Building, Minneapolis, Minnesota.

WINDING Data 200 late automobile armatures \$1.00. Sabina Armature Works, Sabina, Ohio.

ELECTROPLATING—Motor generators or belt drive attractively priced. Easy terms, trial. Hobart Platers, Box M-1192, Troy, Ohio.

12 VOLT Heavy duty generators \$8.50. Save money on new, used automotive electrical parts; free catalog. State Ignition, 52 Cullerton, Chicago.

EDISON Storage batteries for light-power systems. Non-acid. Odorless, fifteen year life. Five year unconditional guarantee. Bargains in complete lighting systems. Low prices. Free illustrated literature. "See-Jay" Battery Co., 82 Sterling Ave., Yonkers, N. Y.

EDISON Lifetime storage batteries for light and power. Eliminates acid battery diseases. Long guarantee. All kinds rebuilt generating plants, motors, and miscellaneous articles at bargain prices. Free interesting literature. T. Hawley Smith Co., Croton Falls, N. Y.

50-½ HORSE, Repulsion induction, 110-220 volt, heavy duty motors, 3400 speed, \$9.75. Also generator bargains. Electrical Surplus Company, 1885 Milwaukee, Chicago.

REWOUND Auto generators give 110 volts a.c. for lighting outfit. Complete instructions in Shop Notes for 1937 only 50 cents postpaid. Popular Mechanics Press, Room (C39), 200 E. Ontario St., Chicago.

ELECTRICAL SUPPLIES—EQUIPMENT

BUILD Wind light plant. Complete plans and valuable catalog 10c. Welders, electric fencers. LeJay Manufacturing, 447 LeJay Building, Minneapolis, Minn.

BARGAINS—Arc welders, also motor generator. Write for new bargain list telling needs. Hobart Bros., Box M-1197, Troy, Ohio.

ELECTRO-SCRIBE: Electric pencil writes—Engraves all metals \$1.00. Health lamp: Dual ray—ultra violet—infra-red. Promotes Sun-Tan-Vitamin "D." Automatic—ac-dc. current, \$3.90. Details. Beyer Mfg. Co., 4515-H Cottage Grove, Chicago.

TWO Telephone microphones, \$1. Electric counter, \$1. R. White, 11030 Hermosa, Chicago.

ELECTRIC Engraver, engraves all metals deeply, dollar. Hudson Bros., East Syracuse, N. Y.

REPAIRING Electrical appliances and 330 other money making shop kinks in Vol. 31, Shop Notes, only 50c postpaid. Popular Mechanics Press, 200 E. Ontario St., Chicago.

ELECTRIC FENCING

MAKE Electric fence from old automobile coil. Complete plans 10c. No extras to buy. LeJay Manufacturing, 947 LeJay Building, Minneapolis, Minn.

WELDING AND SOLDERING

D.C. Arc-welder plans \$1.00 each (three for \$2.00). Build it yourself without rewinding armature. 25-200 amperes from (Delco, Fairbanks Morse, Phelps, etc.) farm light plant generators. 25-600 amperes via d.c. motors salvaged from vehicles, mules, etc. 25-200 amperes from (Northeast, Dodge) automobile starter generators. Welders Club of America, AB-3432 M-Mart, Chicago, Illinois. For sale: Welding books, vehicle motors, etc. (Super-fine and semi-flexible welding cable, low as 5c per foot.)

ACETYLENE Welding generators, latest type. \$25.00. Johnson Generator Co., Brookfield, Missouri.

DEMONSTRATORS, Electric arc welders. Money-saving prices. Used by the government. Trial and terms guaranteed. Hobart Welders, M-1193, Troy, Ohio.

EMERGENCY Arc-welding via storage batteries. Plans 10c. Welders Club, AB-3432 M-Mart, Chicago.

GOOD Practical tested plans for arc-welding and spot welding transformers. Also rectifier and power transformers, 75c to \$2.50. Write Hal Hubertz, Engineer, 412 S. Hoyne, Chicago, Illinois.

ENGINES, MOTORS, DYNAMOS

MAKE Money, rewind auto generators, washing machine motors, construct arc welder. 10c brings particulars. Catalog material. Ernest Knight, LaSalle, Illinois.

AIR Compressors 1½x1¼, \$6.00; 2x2, \$7.00; 2½x2, \$8.00. Free catalog. National, 1915 South State Street, Chicago, Ill.

600 NEW Diagrams, tables, and controller connections for electricians. Contents includes two and three phase: All circuits to twelve path, multi-lead, dual voltage, multiple speed windings. Single phase: Circuits for repulsion induction, split phase, capacitor, series, etc. Data for rewinding and reconnecting. Important tables. Satisfaction guaranteed or remittance refunded. Literature on request. Prepaid \$2.75. Dept. Y, Educational Advancement Company, Lakewood, New York.

BARGAINS—Plating generators, motor generator sets, also arc welders. New low prices for large and small shops. Trial—easy terms if desired. Hobart Bros., Box M-1196, Troy, Ohio.

WINDING Data 200 motors, growlers, test transformers \$1.00. Sabina Armature Works, Sabina, Ohio.

1.2 H.P. Engines suitable for scooters, cars, boats, at only \$14.95. Clear-View Co., Dayton, Ohio.

SMALL Elect. motors, with flexible shafts \$3.25 postpaid. McConnell, 1619 Edgewood, Racine, Wis.

RELIABLE Motor winding books; in business 21 years. Lessons, connecting diagrams, winding data. Introductory data selection, \$1.00. Motor Data Co., Box 7631, Kansas City, Missouri.

PRICELIST Free. Motors; drills; grinders; electrical appliances; clocks. Home workshop tools. Mailorder Electric, 713 South Dearborn, Chicago.

ALTERNATING, ½ Horse, 110 volt, induction motors. Rebuilt, guaranteed, \$7.25. Wilmut Auto Supply, 2247 St. Paul Ave., Chicago.

THREE To ten KVA alternating generators. Motors, converters. State your needs. Queen City Electric, 519 South California, Chicago.

MOTOR Winding data. Introductory selection single and three phase, \$1.00. Motor Data Co., Box 7631, Kansas City, Mo.

REFINE Used oil without cost. Particulars. F. Gerwin, Fairview, Oklahoma.

BARGAIN—½ Hp. motors, 60 cycle, 1 phase, 110 volt, like new, guaranteed, \$7.40. Send check to Erie Electric Motor Co., 120 Church, Buffalo, N. Y.

REWINDING Motors and 330 other valuable articles in Shop Notes, Vol. 31—50 cents postpaid. Popular Mechanics Press, Room (C39), 200 E. Ontario St., Chicago.

MACHINERY, TOOLS AND SUPPLIES

BARGAINS—Motors, grinders, electric drills, saws, vises, blowers, gas and oil burners. Paramount Engrs., Lincoln, Nebraska.

CLUTCH From auto parts ½ to 20 h.p. No machine work. Plans \$1.00. Archer, Middleboro, Massachusetts.

FREE: Wholesale tool booklet. Featuring power tools, sprayers, electric drills, taps, reamers, micrometers. Homecraft Supply, 236 Neptune Ave., Brooklyn, New York.

BARGAINS, Demonstrators, electric arc welders, guaranteed, 30 days trial and terms. Write Hobart Welder Exchange, Box M-1194, Troy, Ohio.

BARGAIN List on repossessed and sacrificed standard lines power tools and light machinery. Bill Bailey, Box 326, Columbus, Ohio.

GIANT Ten pound hardware kit. Four boxes full of screws, bolts, nuts, washers, gears, springs, rivets, brackets, etc. Over 1000 parts—price \$1.98—worth \$7.50. Satisfaction guaranteed. Manufacturers Screw, 211-W Illinois, Chicago.

DRILLS ½" AC-DC, \$14.95, ¾" \$13.95. Levine, 1625 So. Seventh Street, Philadelphia, Penna.

ATTACH Power to your lawnmower. We furnish parts. Lonmpower, 347 North Crawford, Chicago.

CONCRETE Building block machines and molds. Easy payments. Catalog free. Concrete Machine Co., 5129 South Comp-ton Ave., St. Louis, Mo.

TREMENDOUS Surplus of factory tools selling out. Drills, taps, files, hacksaws, etc. Send for free lists, include six cents postage. Travers Tool Co., 264 Jackson Ave., Long Island City, N. Y.

FREE Catalog of electric motors, grinders, drills, paint spray equipment, pumps, work shop machinery, blowers and exhaust fans. Sutton Electric Co., 767 Granby, Norfolk, Va.

PLASTICS, Brass, aluminum, Dowmetal, monel, stainless steel, gears, etc. Catalog 10c. Hobby Supply House, Box 2014, Pittsburgh, Penna.

DRILL Grinding attachment fits bench grinder, hand or power turned. Handles sizes 3/16 to 1¼". Price \$7.85. Descriptive literature on request. Tractor-Lite Co., Sidney, Iowa.

14" x 6' GREAVES Klusman cone head engine lathe, quick change. No. 0 Cincinnati miller, cheap. Write for particulars. Cincinnati Machinery & Supply Co., 221 E. Second St., Cincinnati, Ohio.

BOATS, OUTBOARD MOTORS, ETC.

BRONZE Sailboat hardware for sailboats, to eighteen feet. Deck hardware polished. Beautiful set fully complete with bronze stay cables, thirty-nine pieces in all, direct from the manufacturer. Save fifteen dollars. Distinctive figure-head and cockpit fitting included. Price \$25.00. The Taunton Brass Foundry, Taunton, Mass.

BOAT Plans—any type. State requirements. Tredwell Lyle, Sarasota, Florida.

BUILD Electric outboard from old automobile generator. Operates with car battery. Smooth—quiet. Plans 10c. LeJay Manufacturing, 547 LeJay Building, Minneapolis, Minn.

BUILD A boat by the Welch System. Materials for building; equipping or repairing boats. Use Welch Ready Cut Parts. Send 10c for catalog showing boats of many types; boat hardware; propellers; marine paints. Welch White Cap marine motors. Welch Boat Company, Station K-1, Milwaukee, Wisconsin.

EASY Build Kayaks—outboards. Complete kits. Twenty models. Catalogue. Kayak Boat, 154 East 129th, New York.

MAKE Your own sails, sailkits complete materials including blueprint 100 square feet \$4.75. Catalogue 10c. Alans, 98 Chambers, New York City.

SEE Our ad on page 134A. Cleveland Boat Blueprint Co.

OUTBOARD Motors. \$25.00 buys new 1.2 h.p. magneto ignition, weight 17 lbs. Troll fishing or pleasure motor. Dime for catalogue with parts, prices and operating instructions. Outboard, 305 Atlantic Ave., Boston, Mass.

OUTBOARD Motors. All makes of used motors and parts. Outboard Headquarters, 315 Atlantic Ave., Boston, Mass.

FORD-ZEPHYR Marine conversions. Catalog 10c. Lehman Engineering Company, Dept. D, Newark, N. J.

MARINE Power—Easily convert any Ford motor (domestic and foreign) with Osco parts and kits. Complete catalogue 25c (coin). Osmithson, 3644 Lawrence St., Philadelphia, Penna.

ASSEMBLE Your own boat. Our finished knock-down frames and materials save you 2/3 builder's cost. All types and sizes. Send 25c for big catalog. Brooks Boat Co., Inc., D4, Saginaw, Mich.

USE "Welch Hull Seal Cement" for a leaky boat. 1/2 gallon \$2.00; quart \$1.00; postpaid. Welch Boat Company, Station K-1, Milwaukee, Wisconsin.

OUTBOARDS—Save 1/2. Good used parts, all makes and models. Bargains rebuilt motors. Crandall Hicks Co., 959 Commonwealth, Boston, Mass.

BOAT Designers are highly paid professionals. Complete course by mail. Catalog. Westlawn, Montville, N. J.

SPORTING GOODS, GUNS, FISHING TACKLE, ARCHERY

FREE Catalog—Sportsmen's all-steel cabinets for guns, shells, tackle, rods, clothing. Lowest factory prices. 10 days trial offer. Send no money. Write today. No obligation. Farrell Steel Cabinet Company, 2500-PM East 75th Street, Chicago.

TREASURE Finders? Read Goldak advertisement on page 134A.

TRAP Fox or coyote: Bunch system gets the sly furbearers. Results or no pay. Q. Bunch, Welch, Minn., Box K.

BARGAIN Catalog. 10,000 new and used guns and other merchandise. Send stamp. Klein's, M-508 South Halsted, Chicago.

BARGAINS! Gun catalog 5c, ski catalog 5c. J. Warshal Sons, First-Madison-PM, Seattle, Wash.

GOLF Clubs. Five club matched set \$2.50. Lincoln Surplus, 123 Galena, Freeport, Ill.

BOWS And arrows. Construction book 50c. Catalogue of materials free. Chester Brown, 617 South State, Chicago.

BOOMERANGS. Genuine Australian return type. New, fascinating. No skill needed. Two styles, \$1.50 and \$1.00 postpaid, with throwing instructions. J. H. Byrnes, Box H, Palms Sta., Los Angeles, Calif.

BOWLING Shoes. Agents wanted. Write Smith's Shoe Manufacturers, Park Ave. and Wallace, Philadelphia, Penna.

HUDSON Bay blankets, complete camping, hunting, outdoor equipment. Catalog. Howe Fur Company, Coopers Mills, Maine.

BOWS, Arrows, raw materials. Beautiful catalog (over 125 pictures) and "Essentials of Archery" a handbook on making bows and arrows 35c. Everyone intending to make their own should have this manual. Instruction folder and catalog 10c. L. E. Stemmler, Queens Village, N. Y.

FIELD GLASSES, TELESCOPES AND MICROSCOPES

TELESCOPES, Microscopes, binoculars; 1939 bargain catalog free. Brownscope Co., 5 West 27th Street, New York.

TELESCOPES, Reflectors, complete mirror making outfit, 4" \$2.25, 6" \$2.95. Pyrex; 6" \$4.50, 8" \$6.75. Catalog, Wolf, 129 Amboy Street, Brooklyn, New York.

ASTRONOMICAL Telescopes, binoculars, cameras, microscopes; bought, sold, repaired. Send 10c for list of instruments desired. Rasmussen, Box 294, Amsterdam, N. Y.

FREE Instructions for the asking. Make efficient 100 power terrestrial and astronomical telescope. Finished lenses \$1.39 set. Jamer, Manorville, N. Y.

TELESCOPES—New, used, \$5.00 up; amateur kits, aluminizing, parts, accessories, mounts, books, maps, microscopes, binoculars, scientific instruments. Send 10c for catalog, interesting articles. American Telescope Laboratories, Department 11A, P.O. Box 2528, Hollywood, Calif.

ANTIQUES, RELICS, INDIAN GOODS

MOUNTED Curios: Gardike head 35c, rattlesnake rattle 12c, postpaid. Free catalogue. Quivira Specialties Co., Winfield, Kansas.

I BUY And sell Indian relics, 100 illustrations, identification chart and catalogue 25c. Glen Groves, 6601 Oshkosh, Chicago, Illinois.

ALASKA Indian beaded hair seal mocassin \$2.25 per pair postpaid. Suitable Xmas gift. Perry M. Hern, Skagway, Alaska.

CHINQUILLA'S Indian Craft Museum. Handiwork of all Indian tribes. Jamaica, N. Y.

100 GOOD Indian arrowheads \$3.00. Catalog. George Holder, Glenwood, Ark.

ARROWHEADS! Glacial boulder beauties. Rainbow variations. Don McKillop, Regina, Sask.

INDIAN Relics, coins, bills, gems, crystals, curios, etc. Illustrated catalogue 5c. 100 ancient arrowheads \$3.00. H. Daniel, Hot Springs, Ark.

SWORDS, Rapiers, pistols, daggers, armor list 10c. Robert Abels, 860A Lexington Ave., New York.

INDIAN Relics, beadwork, coins, curios, minerals, old glass. Catalog 6c. Indian Museum, Northbranch, Kansas.

TAXIDERMISTRY

GLASS Eyes, taxidermists', furrers' supplies. Big catalog free. Elwood Company, 222 Smith Bldg., Omaha, Nebr.

TAXIDERMISTRY Supplies—Quality artificial eyes, teeth, genuine Jonas head forms. Tools, materials, etc. Everything for the progressive taxidermist. Send 10c for big illustrated catalogue. Jonas Bros., 1049 Broadway, Denver, Colo.

DOGS, PETS, BIRDS

GREAT Danes—Dependable guards, companions—Pups \$25.00. Pictures free. Kalm-Danery, Stone-Mountain, Georgia.

LIVING Xmas gifts are finest—Saint Bernard puppies. Dime brings photographic prospectus. Royal Kennels, Chazy, N. Y.

SPORTSMEN: 200 Pointers, setters, straight cooners, combination hunters, rabbit and fox hounds. Reasonable. List free. Ramsey Creek Kennels, Ramsey, Illinois.

DOGS For sale. All breeds. Jack Flockner, Box 7720, Sharpsburg, Penna.

BOSTONS! Easy monthly payments! Circulars, dime). "Sentree," Royal Oak, Michigan.

COCKER Spaniels. Beautiful, healthy, merry puppies. Town Clerk, Oakham, Massachusetts.

HUNTING Hounds: Cheap. Trial. Literature free. Star Kennels, B6, Herrick, Ill.

BEAUTIFUL Pure white police dogs. Ansonia Kennels, Mose, N. Dak.

POULTRY AND FARM SUPPLIES

LOW Prices on Davis Chicks for fall broilers. Now hatching. Write for prices. Can make immediate delivery. Davis Poultry Farm, Route 34, Ramsey, Indiana.

WRITE For fall prices on Salem chicks. Our champion Rocks are making profits for hundreds of broiler raisers. Priced low. Prompt shipment. Salem Hatchery, Box 81, Salem, Indiana.

MAKE Money with poultry. Read America's leading poultry magazine for latest information. Three years \$1.00; nine months 25c. Poultry Tribune, Dept. E-93, Mount Morris, Ill.

TREES, SHRUBS, ROOTS, HERBS

JUST Out! World's greatest "Herbalist Almanac." Beautifully illustrated in natural colors. Contains over 200 old-fashioned herb medicine recipes for home use. 10c postpaid. Worth dollars! Botanica, 145 W. 112th St., Chicago.

FARMS AND FARM LANDS

FARMS That pay in the Great Northern Railway agricultural empire. Minnesota, North Dakota, Montana, Idaho, Washington, Oregon. Fertile black soil, high production crops, grain, fruit, vegetables, food and livestock. Many kinds of farms for selection. Write for book on state you prefer. E. B. Duncan, Dept. 1157, G. N. Ry., St. Paul, Minn.

FLORIDA Tax deed lands. Good fruit and farm land. Ten acres \$70.00. \$5.00 down, \$5.00 month. Many others. Florida Tax Deed Service, 8007P Nebraska, Tampa, Florida.

125 ACRES \$1800; Cost \$5500. Bldgs. all A-1, shaded 10-room house, beautiful views, 60 ft. barn, other bldgs.; fertile soil, spring water, sugar maples, timber; 1 1/2 miles to village; terms arranged, quick action necessary; in free catalog supplement. Strout Realty, 255-P 4th Ave., New York City.

LIVE In New Hampshire. Real estate of all kinds. Mrs. Bertha Hayes, Barrington, New Hampshire.

40 ACRES. Near White River, unimproved; poultry land. \$175, \$5 down, \$5 monthly. Free list and literature. Hubbard, 216 Grossman Bldg., Kansas City, Kans.

GOOD Farms available. Washington Minnesota, Idaho, western Montana, Oregon. Dependable crops, favorable climate. Write for impartial advice, literature and list of typical bargains. Specify state. J. W. Haw, 119 Northern Pacific Ry., St. Paul, Minn.

FARM MACHINERY AND SUPPLIES

GARDEN And all purpose tractors at factory price. Shaw Du-All 2 to 8 horsepower, riding or walking types. Does plowing, discing, harrowing, cultivating; mows lawns, cuts weeds, does hauling; runs belt machinery. Air or steel tires. Thousands in use. 10 day trial. Write for free catalogue. Shaw Mfg. Co., Dept. PM-11, Galesburg, Kansas.

FORDS Portable Hammermill operators make regularly weekly net earnings, \$50, \$75, \$100 and more. Fords' exclusive molasses impregnator gives operators big competitive advantage. Equipment may be purchased 25% down, balance from earnings. Write for particulars about this safe, sure, profitable year-round business. Myers Sherman Company, 1428 12th, Streator, Illinois.

PROFITABLE OCCUPATIONS

RAISE Mink. Dime for general information. Lommans Fur Farm, Spangler, Penna.

BUSINESS Proposition resilvering mirrors, autoparts, reflectors, making chipped glass signs. Write Sprinkle, Plater, 288, Marion, Indiana.

FINEST Strain of Alaskan minks. Feed free. Kmiecik, 1104 Natalie, East St. Louis, Ill.

HOW To earn money at home! Big, free book tells inside story—How hundreds are earning cash raising mushrooms in cellars, sheds. Cash paid for all raised. Write today. United, 3848 Lincoln Ave., Dept. 61, Chicago.

"RUBBER Molds." Make them yourself. Formulas, instructions 25c. Ideal Service, 1613, Park Ridge, Ill.

TREASURE Finders? Read Goldak advertisement on page 134A.

\$30 WEEKLY. Grow mushrooms. Cellar, shed. We buy 35c lb. Mr. B. made \$270 spare time. World's largest company of its kind. 40 page book free. Mushroom, Dept. 701, 2019 Second, Seattle, Wash.

ANNOUNCING New home study course in commercial baking. Good field for ambitious men. Nearly depression proof business. Common school education sufficient. Send for free booklet "Opportunities in the Baking Industry" and requirements. National Baking Institute, 3601 Michigan Avenue, Dept. 3438, Chicago.

SELL By mail. Make own wonder product. Write Springer, 8723 Union, Chicago.

EXCELLENT Opportunity helping unemployed find work. Write Vocational Advisors, Parkway, Washington.

RAISE Rabbits. We pay to \$7 for young. Catalogues 10c. Rabbitries, Bowling Green, Ky.

MEN—Women, operate "Specialty Candy Factory" home, all or spare time. Steady income. (Our 31st year.) Hillyer Ragsdale, Inc., Drawer 62, East Orange, N. J.

\$2.00 INVESTMENT Starts profitable local business. Free details. L. Waldo, Sturgis, Mich.

205 MONEYMAKING Opportunities. Start own business. Home, office, etc. Particulars free. Stamford, 3762-c Broadway, New York.

MONEY In rabbits and cavies. We buy and put you in touch with other markets. Catalog and copy of magazine 10c. Or send 25c for book catalog and price list and year's subscription to the American Small Stock Farmer. Stahl, Box 1, Holmes Park, Mo.

BOOKS, PERIODICALS, PICTURES, POSTCARDS

SECRET Of psychic power. Key to real success. 15 cents. Staver Brothers, 1645 So. Weadock, Saginaw, Michigan.

OCCULT Teaching, incense. Maha Devajata, 532 West 47th Street, Chicago.

BIG Sparetime profits taking subscriptions—all magazines. Pines, B-583 Monroe, Brooklyn, N. Y.

RELIABLE. Authorized subscription service. Complete list, all periodicals, 3c. Greylock Agency, Williamstown, Mass.

GAMES—ENTERTAINMENT

SELL Your game! Particulars 3c stamp. Trend Games, Highland Park, Ill.

MONEY Makers for organizations, bingo games, punch cards, wheels, etc. Catalog. Warnovco, Conimicut, R. I.

MAGIC TRICKS, PUZZLES, JOKER NOVELTIES

CLEVER Card tricks 10c. Lists free. Rafferty, 724 W. 47th St., Chicago.

MAGIC, Occult, books; novelties. Sample, catalogs 10c. Eastern City Sales, Delaware Bldg., Chicago.

ILLUSTRATED Magic catalog 10c. Davis Co., 1618 St. Paul St., Philadelphia, Penna.

MAGIC. Mind reading, easily learned. Particulars free. Browne, Box 272, Duluth, Minn.

MAGICARDS For Christmas, sensational. Send stamp. 82-29 60th Road, Elmhurst, New York.

HOUSE Of 1000 mysteries! Professional magic! Pocket tricks! Jokes! Puzzles! Novelties! Two big surprise catalogs! Both illustrated! Both for 25c! Lawson Vick Co., Dept. P13, Queens Village, N. Y.

BE A magician. Large professional magic catalogue of latest tricks 25c. Cash paid for complete Tarbell magic courses. Write, Ireland, C-109 North Dearborn, Chicago.

LEARN Ventriloquism, 3c stamp brings particulars. Smith, 801 Bigelow, Peoria, Illinois.

FREE Tricks! Join Magicians' Fraternity! Monthly magazine, sample 10c. International Magicians, Mt. Morris, Illinois.

LARGE Magic catalog 25c. Hundreds of tricks. Chicago Magic Company, 2300 N. Mason Avenue, Chicago.

EARN Money in any crowd. Call names of strangers, tell unspoken questions. Professional course mind reading, spirit writing, etc., \$1. Henderson, Box 341, San Bernardino, Calif.

WORLD'S Largest magic shop professional catalog, 25c. Holden, 220 W. 42nd St., New York.

OLD STAMPS WANTED

I WILL Pay \$100.00 each for 1924 1c green Franklin stamps, rotary perforated eleven (\$1,000.00 if unused). Send 6c for large illustrated folder showing amazing prices paid. Vernon Baker, 444PM-11, Elyria, Ohio.

STAMP COLLECTING

COSTA Rica airs special—No. 303-4, 310, 314; catalog 60c. Our price 18c. Approvals, references. Ann's Stamp Shop, 432 N. Leclaire, Chicago.

ECUADOR Commemorates both fairs! We offer 4 beautiful mint stamps commemorating each fair, total 8 stamps only 5c to bargain approval applicants. \$1.00 Chinese stamp free to first 100 applicants. Gladstone Stamps, 5800 Markham, Chicago.

ARMY Navy sets complete 10c. Approvals. Welker, 1320 Liverpool, Pittsburgh.

TIBETAN Stamp free! Genuine Tibet stamp free with "complete country" collection (White Russia), stamps from Armenia, Azerbaijan, Burma, Tannou Touva and Ukraina. Only 5c to approval applicants. Cactus Approvals, Box 1870-B, Tucson, Arizona.

SENSATIONAL Combination offer! Big packet 105 all different including Greenland (new country), Congo, Manchukuo, Costa Rica triangle, air-mails, commemoratives, giant diamond-shaped stamp, \$4 United States; complete set United States telegraphs, cataloging 20c, scarce set Siberia cataloging 50c. Packet British colonies including Gwalior, Hyberabad, Burma (new country), jubilee and coronations. Total catalog price over \$3.00! Everything for only 5c to approval applicants! World-Wide Stamp Company, Department 600, Camden, New York.

THE World in a packet. An outstanding value! 100 stamps from 100 different countries, including Abyssinia, Afghanistan, Brunel, Falkland, Samoa and others from Africa, Asia, South America, West Indies, etc. Our pamphlet which tells "How to Make a Stamp Collection Properly," together with our large bargain list of albums, packets, sets, etc. All for only 20c. Queen City Stamp Co., 604 Race St., Room 36, Cincinnati, Ohio.

MEXICAN Dollar bill and 17 different air-mail stamps 10c. Nagles, 346 N. 12th, Reading, Penna.

FREE! Nine desirable airmails. Approvals. Barker, 714 Market, San Francisco.

FREE! Scarce Hindenburg zeppelin air-mail set. Request approvals. Riedell, Greensburg, Penna.

1-2-3c APPROVALS. Doty, 5032 So. Gramercy, Los Angeles, Calif.

FREE! Two coronation sets. Postage 3c. Roberts, 312F Shearerbig, Bay City, Mich.

BEAUTIFUL Roumanian packet, 3c. Approvals. Ward, Box 592, Vancouver, Wash.

HINDENBURG Zeppelin, Spain nude duchess, 5c approvals. Shultes, Berne, N. Y.

PRIZES Weekly to subscribers. Kawchief Stamp Journal, 25c year, sample for postage. Lawrence, Kansas.

CANNIBALAND—British Solomon Islands, genuine Baden, Liberian Bongo, fantastic Manchukuo, Cayman Islands beauty, \$5 U. S., bizarre Negri Sembilan, Turks Caicos. Everything 3c with approvals. Viking, 1-Z Hanson Place, Brooklyn, N. Y.

OFFER From Africa: Send dollar for 100 all different South Africa. Amazing value. Blum, Box 1669, Capetown.

LIECHTENSTEIN Stamps. Beautiful, scarce, valuable. 50 different 50c, 100 different \$4. Mrs. Muller-Flury, Schaan, Liechtenstein.

SIX Big items! (1) Airmail packet: giant and midget airmail stamp, zeppelin stamp, etc. (2) Postal zoo packet: tiger, kangaroo, kiwi, etc. (3) Triangle and diamond-shaped stamps. (4) Stamps picturing transportation of mail, by dog sled, camel, locomotive, airplane. (5) Kings and dictators packet; Mussolini, Kemal Ataturk, murdered czar, etc. (6) Strange lands packet: Greenland (new country!), Djibouti, Manchukuo, Palestine, etc. All for 5c to approval applicants! Maynard Sundman, Dept. 6, Bristol, Conn.

NICARAGUA Will Rogers complete 5c with approvals. Davies Stamps, Lansford, Penna.

UNITED States mixture supreme, quarter pound 25c. Quality Stamps, Englewood, Colorado.

GIFT Edition stamp annual free—Sixty pages with hundreds of illustrations featuring Canadians, Newfoundlands, United States, colonials, foreign, supplies. Sent free. Gray Stamp Company, Dept. PM, Toronto, Canada.

10,000 VARIETIES 1c each! Gordon Davison, Box 568, Manchester, N. H.

100 DIFFERENT U. S. only 25c. Taylor, 261B Hawthorne, Haddonfield, N. J.

1000 MIXED Foreign 25c. Well worth sorting for values. Plaza Stamp Co., Santa Fe, N. Mex.

UNPICKED Mixture, 40c pound! 100 U. S. revenues on documents—10c! 100 different U. S.—15c! Vanvoorhis, Hyndman, Pennsylvania.

NICE Foreign approvals 1 to 5 cents each. References please. A. Anderson, 367 Fulton, Brooklyn, New York.

FREE. Any 10 stamps you select from our special approval selection Give names 2 active collectors and size your collection. Ranger Stamp Co., Houston, Texas.

PHILIPPINES—17 Different including pictorials 10 cts with approvals. Swedell, 3038 Harriet, Minneapolis, Minn.

150 GOOD Mixed foreign stamps, 3c. Elvin Stanton, Niantic, Conn.

CZECHOSLOVAKIA—100 Different 19c. Approvals. Niederstadt, 4727 West Beloit, Milwaukee, Wis.

100 DIFFERENT World postage stamps 3c. Wilfred Brophy, Galesville, Wis.

CANNON! Set of stamps showing cannon, firing squad, cavalry charge and 200 other different stamps, only 10c to approval applicants. L. H. Reich Stamp Co., 4647 Kenmore, Chicago.

50 STAMPS From 50 countries, 6c—approvals. Humphrey, 310 Cloverleaf, San Antonio, Texas.

POLAND 100 Different 25c; 200 Czechoslovakia \$1.30. Jem Stamps, Port Jefferson, New York.

FREE: Diamond and triangle stamps, 25 different foreign and French colony packet to approval applicants. Postage 3c. Klemann, Lockport, N. Y.

10 U. S. catalogue 75c, 5c, approvals. Link, Box 104, Louisville, Ky.

NEWFOUNDLAND 1898-1939. 25 different 25c. Approvals. Creevey, Berwick, Penna.

FREE! Set cataloging \$2.25. Approvals. Gramatan, Box 302, Mount Vernon, N. Y.

ONLY Mussolini stamp free to approval applicants sending 5c for 100 different National Co., Box 308, Red Lion, Penna.

U. S. and foreign penny approvals. Lenott Stamp Company, Dept. 2, Oxford, Maryland.

RUSSIA 1232-5 Catalogue \$2.00. With approvals 15c. Midwest, 2241-A East 71st, Chicago.

JUBILEES, Coronations, ships, war, airmails, commemoratives, Farleys 10c. Box 211, Malden, Mass.

(FIRST) Stamps 10 countries 3c. Approvals. Post-Zegel, Windham, N. Y.

FREE. U. S. \$1, \$2, \$4 and \$5 stamps. Unbeatable U. S. approvals. Nelson, 369½ Robert Street, St. Paul, Minn.

300 DIFFERENT 20c; 1000 75c; 2000 \$2.50. Fred Onken, 630 79th St., Brooklyn.

GIRAFFE, Lion, llamas, Czechoslovakia legionnaire, many others, 5c, approvals. Apex, 1933 SE. 45th, Portland, Oregon.

STAMP Dealers—Collectors! Philatelic printing. Samples. Keelerprint, 3822-W Ogden, Chicago.

THE European war. How it affects collectors. The European war will bring changes of greatest importance to all collectors. In normal times more than 70% of all stamps sold in the United States come from Europe. Everything will be different now. The regular supply of stamps will stop or will be tardy. Prices will constantly change and fluctuate. War issues, provisional stamps and occupation stamps will soon make their appearance. Some of these will be excellent buys and will advance in value rapidly; others will be plain trash. The question is: What to do about all this: How to form sound judgment: how to take the best advantage of this situation. We have written an informative pamphlet on the subject, the reading of which will be of greatest benefit to every collector. We will send it free for 3c mailing expenses together with a trial approval selection to new approval applicants, who will then, by virtue of being on our mailing list, get the full benefit from the war situation. To collectors not interested in our approval service, we will send it for 5c. Approval Headquarters, Globus Stamp Company, 268 - 4th Ave., New York City, Dept. 201.

ALBANIA—Going, going, gone! 11 different stamps—two complete sets. Only 5c to approval applicants. Kravat & Co., Dept. B3, 1925 Quentin Rd., Brooklyn, N. Y.

BEAUTIFY Your collection with this offer of 50 different large sized mint pictorials depicting gorgeous scenery, savage animals and peoples. All for 5c to new applicants to our clean inexpensive approvals. Acme Stamp Company, Dept. 1, Box 101, Westmount, P.Q., Canada.

APPROVALS That please. William Turbyfill, 513 West 29th, Norfolk, Virginia.

FREE Giant Russian stamps. No approvals. Schultze, 55R, Woodhaven, N. Y.

BOLIVIA Llamas set, postage 1c, approvals. Big Chief Stamps, 1521 Marsac, Bay City, Mich.

LARGE Pictorial stamps from British Colonies. 100 different \$2.00. Satisfaction guaranteed. Waldo, Box 266, Dallas, Tex.

1879 ISSUE! Scarce 19th century U. S. stamp cataloging \$1.25 for only 5c to approval applicants. Write today! Pricelist free. Curhan Stamp Company, Gloucester, Mass.

50 RAILROADS. Ships, maps, animals, etc. 10c with approvals. Buchanan, Box 40, College Point, N. Y.

SEE For yourself! 20 different commemoratives. Also U. S. packet. Everything 3c with bargain approvals. Dolve, Box 406A, Minneapolis, Minnesota.

FREE 25 Different Jugoslavia with approvals. Lincoln, 5535 May, Chicago.

1000 MIXED U. S., 15c. Foreign approvals. Premiums. Lee, Bridgeport, N. Y.

SETS For approval. Free premiums. Gottwirt, 1169 Lincoln Place, Brooklyn, New York.

NEW Will Rogers stamps with 25 others 10c. Buckey, 208 Ludlow, Dayton, Ohio.

BIG Package stamps 250 mixed with British colonials 5c to approval applicants. Washburn, 2224 Montana, El Paso, Texas.

175 BETTER U. S. commemoratives, etc., 20c. Lloyd Johnson, Hawarden, Iowa.

100 DIFFERENT Free! With big collection of attractive new sets, triangles, commemoratives, \$1.00. Schildhouse, Colonial Arcade, Cleveland, Ohio.

UNITED States! Britain and colonies! 50 different 10c; 100, 30c. Commemoratives! Airmails! Approvals. Firth Co., Sunderland, Mass.

BUY. Sell, trade through a national stamp society. Dues 75c yearly including 16-page weekly official organ. For information write Charles E. Winegar, Secretary, 816-PM So. Steele, Tacoma, Wash.

"REFRESHER Special" 15c with approvals. Cowles, 755 Anderson, Grantwood, N. J.

1000 WORLDWIDE Stamp mixture 25c. Monjar, 1542 Waverly, Cincinnati, Ohio.

UNITED States stamps on approval. Commemorative, airmails, 19th Century issues, parcel post, revenues, etc. Bargain lists with each selection. We have an extensive stock, correctly classified, reasonably priced. Southern Stamps, Box 70A, Miami, Florida.

AIRMAIL And animal triangle. Big packet of triangle, airmail, animals, airplane, commemoratives and big picture stamps from Asia, Africa and British colonies, with approvals only 5c. Bruin Stamp Co., Dept. 3, Mar Vista, Calif.

FREE! World's smallest triangle. Bolivia triangle, bicolored diamond, Danzig, Congo, Tunisia, Devils Island, approvals. Davidson, 2297-6E, Salt Lake City, Utah.

FREE Packet mint French colonials with penny approvals. McKay, 7200 Yale, Chicago.

1000 QUALITY Mixed United States 25c. (Free premium—coronation album without binder value 50c). Two pounds stamps \$1.00. (Complete album free, value \$1.00.) Halay, 452 West 58th, New York.

ZOOIE! Mystifying assortment hard countries—airmails and "queer" stamps—only 3c with approvals. You'll be delighted! Saxon Company, 408-A Jay Street, Brooklyn, N. Y.

SILVER Jubilee souvenirs. Third set of twenty beautiful stamps issued by Irish Hospitals' Trust, Dublin. Specimen sheet free of charge to all writing to Mr. J. O'Sheehan, Department P.M. 13, Earlsfort Terrace, Dublin, Ireland.

NEWFOUNDLAND, Canada, U. S., Mexico—"Four Star Approvals." Nothing like them! Write today. Specials to applicants: 1000 different stamps 88c. Three beautiful sets: Ecuador (Olympics), Nicaragua (Will Rogers), Czechoslovakia (Legionnaires) 12c. Kessels, Tucson, Arizona.

QUEEREST Stamp packet: Mozambique, Japan, China, Soruth, Albania, many others—5c to approval buyers. R. M. Stamp Co., Box 230P, Port Chester, N. Y.

ASK For my famous 1/2c approvals. Olive Alves, Guadalupe, Calif.

EXCHANGE Stamps, postcards. Universe, "Exchangers," Bry 226 pres. Paris, France. Particulars free.

APPROVAL Sheets. One to three cents. Frederick B. Driver, 2009 Finance Bldg., Philadelphia, Penna.

GRAND Gamble lots \$1.00. Quality—no junk. World's best source. Hughes, Queens Rd., Bournemouth, England.

NATIONAL Stamp News, published bi-weekly, 50c per year. Sample free. Box 6186, Washington, D. C.

FREE—Choose any country 10c packet—5c postage—approvals. Victoria Stamp Co., London, 4, Canada.

WHOLESALE Dealer's catalog. Illustrated. Postage 5c. Frank's, 4900 Chalmers, Baltimore, Md.

NAME On 1,000 mailing lists 25c. Wilborn, Station "H," Los Angeles.

"HOW To Make Money in Stamps" 50c a copy. Walters, Milburn Ave., Maplewood, N. J.

FREE—Irish-U. S. constitutional and Will Rogers set to approval applicants. Charles Cleveland, 806 North Humphrey, Oak Park, Illinois.

SIX Dollars for 9c! 300 different stamps (cat. price \$6) only 9c with approvals. Tatham Stamp Co., Springfield-30, Mass.

THREE Sets for three cent stamp! Jack Reed, Houtzdale, Penna.

FREE—From every continent, 155 different, airmails, triangle, commemoratives, pictorials, many U. S. and others, with 1c approvals. Send 5c for postage and handling. Ace Stamps, Euclid Arcade, Cleveland, Ohio.

40,000 VARIETIES First quality stamps available on approvals 1/4c up. Representative selection on request. Adults only. PKeigwin Stamp Co., Vineland, N. J.

UNITED States—45 different, gauge, hinges, pricelist 10c. No approvals. Seidenberg, Baroda, Mich.

WHOLESALE Supplements to dealers for 10c postage. Hundreds of bargains. Grossman Stampco, 102 West 42nd, New York.

GIANT Packet 200 all different from Africa, South America, Asia, South Sea Islands, etc. Includes world's smallest stamp; triangle and diamond-shaped stamps; animal stamps. Nicaragua "Will Rogers" airmail; many others. Also packet 17 different United States (cataloging 50c)—all obsolete, including \$4 denomination, commemoratives, etc. Total catalogue price over \$5.00! Everything for only 5c to approval applicants! Mystic Stamp Company, Dept. 80-N, Camden, New York.

50 DIFFERENT. Fine U. S. including perforation gauge, 10c with approvals. The Stamp Shop, 809 Holland Bldg., St. Louis, Mo.

100 DIFFERENT Hungary 7c, approvals. Hazett, 701P Fourth Baycity, Mich.

PENNY Approvals, that satisfy. Neil Gronberg, Box 5441-P, Philadelphia, Penna.

AIRMAILS And commemoratives, 25 different, including Columbians, Panama-Pacific, Edison, Zeppelin, etc., only 5c with exceptionally fine United States and foreign approvals. Marco Stamp Co., Box 888, San Francisco, Calif.

UNITED States illustrated looseleaf catalog, \$1.00. Send postage for free United States price list, precancel list. Stanley Gibbons, 38-P Park Row, New York.

200 DIFFERENT 10c. Big 50% approvals. Covert Stamp, 39 State, Rochester, N. Y.

BRAZIL, 50 Different 10c with bargain approvals. Davis, Silver Lake, Ind.

ASK For our wonderful one cent approvals. Prospect Stamp Co., 225 Broadway, Toronto, Canada.

WEEKLY Stamp magazine, thirteen weeks, 10c. Stamp Journal, Kalamazoo, Mich.

STAMP Dealers, your ad here will bring wonderful returns. Ask me for proof. F. W. Johnson, Manager, Classified Advertising, Popular Mechanics Magazine, 200 E. Ontario St., Chicago.

RARE COINS

OLD Money wanted. Do you know that coin collectors pay up to \$100.00 for certain U. S. cents? And high premiums for all rare coins? We buy all kinds. Send 4c for large coin folder. May mean much profit to you. Numismatic Co., Dept. 20, Fort Worth, Texas.

COMMEMORATIVE Half dollars: Lincoln, Texas, Cleveland, Long Island, \$1.19 each. Selling price list free. 36 page buying book 15c. American Coins, Box 3507, Cleveland, Ohio.

FREE Coin list. Keim, Box 103, Station A, Flushing, N. Y.

WILL Pay \$10.00 each for certain Lincoln pennies; Indianheads \$100.00; dimes \$700.00. Catalogue 10c. Federal Coin Exchange, Columbus, Ohio.

50,000 COINS, medals, papermoney, historical newspapers, Indian relics. Lists free. Nagy, 8-P South 18th, Philadelphia, Penna.

INDIAN Heads, 8 different, 25c. Paget, 546 Westfield, Rochester, New York.

INDIAN Cents 25 dates \$1.00. Hansan, 2342 Norton, Kansas City, Missouri.

INDIANHEAD Cents, eighteen different, 50c. Hussman, 211S 7th, St. Louis, Mo.

25 COINS, Bills, tokens, 25c. Otto Oddehon, Overland Station, St. Louis, Mo.

COIN Bargains. Catalogue and uncirculated coin—10c. I buy coins: Illustrated buying book—25c. Eugene Morrison, Reseda, California.

1939-S UNCIRCULATED Cent and catalogue 10c. Landon, 901 Lucerne, Los Angeles.

RARE U. S., foreign coins, war medals. Catalogue 10c. Mengelle, Colorado Springs, Colo.

COLLECTORS Illustrated catalog 10c. Includes books, supplies, coins of all kinds. James Randall, 407 South Dearborn, Chicago.

COMMEMORATIVE 1/8s, Five different, uncirculated, \$5.00; United States large cents, 1800, 1801, and 1802, \$1.00; packet 30 coins of 30 different countries \$1.00. Koeppl's Coin Shop, Eighth Corner Broadway, Los Angeles.

GET Profit and pleasure in collecting old coins. Send 10c for 56-page illustrated coin catalog. You'll be delighted with it. Send for it now. B. Max Mehl, 370 Mehl Bldg., Fort Worth, Texas. Largest rare coin establishment in U. S. Established 38 years.

COMMEMORATIVE Half dollars, Lincoln, Stone Mountain, Oregon, Texas, Cleveland, Kentucky, San Diego, Long Island, \$1.50 each. Illustrated catalogue No. 14, 25c. Norman Shultz, Salt Lake, Utah.

FREE! Foreign coin, banknote, and large illustrated coin catalogue. Send 4c postage. Coin approvals sent. Tatham Coinco. Springfield-125, Mass.

\$5 TO \$500 Each paid for hundreds of old or odd coins. Keep all until posted. Many very valuable. Send 10 cents for illustrated Coin Value Book, 4x6. Guaranteed buying and selling prices. 31 years in business. Coin Exchange, Box 5, Le Roy, N. Y.

HOBBIES AND COLLECTIONS

EXCHANGE Your duplicate stamps, match covers, etc. with collectors everywhere. Dime brings list. (Mention Hobby.) Secretary, Box 2166, Denver, Colo.

FREE Swap ads in Hobbyiana Magazine. Sample 10c. 1326 South 27th, Omaha, Nebr.

COLLECTING Match book covers fascinate young and old. Album preserves collection. Gives display. Information 3c. Adams Sales, Dept. 23, State Tower, Syracuse, N. Y.

HOLLYWOOD Match covers included collection 110 all different \$1.00. Cover-service, Fellows, Calif.

UNUSED Book match covers, 100 all different. \$1.00. Free list. Charles Edelman, 1311C East 84, Cleveland, Ohio.

PHOTO FINISHING

CHRISTMAS, Photographic, greeting cards 20 for \$1.00. Sample, 10c! 20 reprints 25c! 100 reprints \$1.00! Rolls developed, 2 prints of each negative 25c! Quality guaranteed, prompt service! Free mailing containers, price list. Mercury Studios, G-109 N. Dearborn, Chicago.

8 ENLARGEMENTS—Films developed plus 8 enlargements, 25c coin—116 or smaller. Enlarge Photo, Box 791, Dept. PMM, Boston, Massachusetts.

FILM Developing bargains! Hurry! Save! Write for free safety mailers and details. Modern Studios, Dept. PM, LaCrosse, Wis.

QUALITY Since 1889—one day service. Roll developed, 2 Brilliantone prints each negative 25c. 8x10 enlargement coupon, 16 reprints 25c. 20 Photographic Christmas Cards from your negative \$1.00; 50—\$2.00. Willard Studios, Box 3535-A, Cleveland, Ohio.

PHOTOGRAPHIC Christmas folders, cards, calendars. Write for circular or send negative and 25c for samples. Ideal Photos, Box 2255, Paterson, N. J.

MOTION Picture studio technicians process your roll film in our laboratory. Beautitone prints and two professional enlargements 25c. New and fascinating premiums. Hollytints, P-1350, Hollywood, California.

EIGHT Silvertone gloss enlargements or eight prints and two enlargements, 25c. Mayfair, Box 261-K, Toledo, Ohio.

PHOTO Mill. Immediate service! No delay! Roll developed, carefully printed and choice of two beautiful 5x7 professional enlargements, one tinted enlargement, or eight reprints—for 25c coin. Reprints 2c each. The Photo Mill, Box 629-12, Minneapolis, Minnesota.

ROLLS Developed—16 prints, 2 enlargements 25c. 25 reprints 25c. Trial. Filmcraft, River Grove, Illinois.

100 STAMP-SIZE Photos copied from any picture. \$1.00. Grove Studio, Coupeville, Washington.

ROLL Developed, 8 prints all enlarged to double size, 25c. 16—50c. Enlarged reprints 4c. Aircraft Studios, Box 3582-A, Cleveland, Ohio.

20 REPRINTS 25c. 100 Reprints \$1.00. Rolls developed, 2 prints each negative, 25c. New Photosnaps, Kirksville, Missouri.

35MM. Rolls developed free. 3 1/4x5 enlargements, 36 exposures \$1.00, 18 exposures 60c—reprints 4c. Send roll and money today. Minipix, Dept. 511, 100 N. LaSalle, Chicago.

ENLARGEMENT From each picture on your roll 25c. Lifelike enlargements bringing out the best in your pictures. High quality, fast service, low price, an unbeatable combination. Cut Rate Photos, Dept. B-4, Janesville, Wisconsin.

PROFESSIONAL, Overnight service. Developed, printed, 2 enlargements, 25c. Fotoservice, 1942 Marlow, Toledo, Ohio.

TWO Prints from each picture on your roll 25c. Your pictures will speak volumes when finished by our expert craftsmen. One day service. Nineteen years experience. Lens Photos, Dept. J-4, Janesville, Wisconsin.

DOUBLE-QUICK Service! Roll developed 16 Velox prints; or 8 prints 2 enlargements 25c. Chicago Photo Lab., Box 3, South Chicago, Illinois.

ENLARGEMENTS: Six doubleweight, guaranteed reprints, quarter. Bartels, 326 West 40th, New York.

ONE Day service—8 dated Lifetime prints and 2 doubleweight enlargements, 25c. Quality that pleases the most exacting kodaker. Satisfaction guaranteed. Super-tex Photo Service, Dept. M-4, Box 1166, Dallas, Texas.

QUICK Service—Quality work. Roll developed, 8 Velox prints, and two 5x7 double weight professional enlargements 25c. Finer Photo Service, Monroe, Wisconsin.

YOUR Favorite negative or picture enlarged lifelike 5x7. 15c. Promenade Photos, 30 East 20th, New York.

OIL Coloring photographs a fascinating hobby or profitable business. Learn at home by easy simplified method. Previous experience unnecessary. Send for free information and requirements. National Art School, 3601 Michigan Avenue, Dept. 3438, Chicago.

TWENTY Reprints 25c. Roll developed and two prints each negative, 25c. Send for free mailing envelopes, price list. Star Photos, 20 W. Jackson, Chicago.

FIRST Roll developed—Beautiful 5x7 enlargement and 16 prints, 25c. Dick's Photo, A-10, Louisville, Kentucky.

THE Modern Finishers, St. Paul, Minnesota, are the outstanding finishers in America for low prices with quality pictures. Our modern methods give quick service and bright guaranteed neverfade pictures. Roll developed, 16 modern tone prints, 25c coin. 16 modern tone reprints, 25c. Enlargement coupons. Join our thousands of satisfied customers by sending us your next roll or reprint order. Artistic Christmas cards. Sample from your negative 10c.

ROLL Developed 8 prints and two enlargements 25c. Beautiful photographic Christmas cards or calendars from your negatives, 4 for 25c; 17, \$1.00, envelopes included. Young Photo Service, 405-C, Albany, N. Y.

BETTER Photo finishing. Eight exposure rolls developed and printed 25c. Moore Studios, Alstead, New Hampshire.

BETTER Colored enlargements, 5x7, 25c. Catlin Film Service, Catlin, Illinois.

EMBOSS Christmas cards, including envelopes, from your own negative 60c dozen. Minimum 4 for 25c. Film Capitol Service, Box 504, Rochester, New York.

LARJARGRAPH Reprints: Five 5x7 enlargements 25c. Cardinal Photos, Summit, N. J.

FOR The discriminating amateur—Rolls developed 2 prints each, 25c. Reprints 3c. Superior workmanship. Same day service. Paramount Co., 327 E. 92nd St., New York.

PHOTOGRAPHIC Christmas cards. New style sensation. 20 for \$1.00. Sample 10c. Seascout Service, Box 52, Chelsea, Mass.

IMMEDIATE Service! Better pictures. Sixteen guaranteed prints from roll, 25c. One colored or two plain enlargements and 8 guaranteed prints, 25c coin. Special! Coupon for 8x10 enlargement given with every 25c worth Kodak finishing. Any 36 exposure, 35 mm. film fine-grain developed and each good negative enlarged to 3x4 prints for only \$1.00. 3x4 reprints, 4c each. One day service. Details and mailers free on request. American Studios, Dept. 22, LaCrosse, Wis.

ROLL Developed, 16 guaranteed prints, 25c. Smart Photo, Winona, Minnesota.

PROMPT Service—Guaranteed work. Two beautiful portrait type doubleweight enlargements, eight neverfade gloss prints, each roll 25c. Dubuque Film Service, Dubuque, Iowa.

PROMPT Service—Quality work: 2 beautiful doubleweight gloss enlargements, 8 guaranteed neverfade prints each roll, 25c. Excel Photos, Dubuque, Iowa.

ROLLS Developed, two prints each and two free enlargement coupons, 25c; reprints, 2c each; 100 or more, 1c. Summers' Studio, Unionville, Mo.

ONE 6 1/2x8 1/2 Wide border embossed enlargement or one 5x7 hand colored enlargement with each roll developed and 8 prints 25c. 36 exposure roll developed and 36 3 1/4x4 1/2 enlargements \$1.35. 18 exposure roll 75c. Vidor, 321-P Hennepin, Minneapolis, Minn.

THREE Prints each good negative in roll 25c. Reprints 3c. Fred D. Eastman, Bode, Iowa.

LIFE Photo finishing lasts a life time. Roll developed, 8 prints, 2 enlargements 25c. Reprints 1 1/2c. Life Photos, Hutchinson, Kansas.

ROLL Developed and 8 beautiful Velox glossy prints 25c coin or stamps. Reprints 3c each. Fotoprint Service, Roanoke, Va.

PROMPT Service! Rolls developed, two Velox prints each negative 25c. Hench Studios, Harrisburg, Penna.

TWO Glossy enlargements, 1 colored with roll 25c. Arbor Service, 10, Joliet, Ill.

CANDID Special. 35mm. rolls enlarged to 3 1/4x4 1/2, \$1.00. 18mm. rolls 60c. 3 1/4x4 1/2 reprints 3c. Brown Photo Company, 1910-61 Emerson, Minneapolis, Minn.

16 PRINTS With roll 25c. 16 reprints 25c. Rex Photo, Ogden, Utah.

GUARANTEED. Roll developed, 16 prints 25c. 20 prints 25c. Quality Photo, Hutchinson, Kansas.

QUICK Service—Rolls developed, 8 guaranteed prints; 2 enlargements; 25c coin. OK Photo Service, Ottawa, Kansas.

CAMERAS, PHOTO SUPPLIES

NEW Free photography book now ready—lists and illustrates hundreds of sensational new and used bargains plus valuable information on modern photographic methods, high-speed miniature candid cameras, precision lenses, night equipment, enlargers, darkroom equipment, movie cameras, screens, etc. Money-back guarantee. Liberal trade-in allowance on your old equipment. Get free book today. Write Central Camera Co., Dept. K-16Z, 230 South Wabash Avenue, Chicago, Ill.

MAKE Money in photography. Learn quickly at home. Spare or full time. Easy plan. Previous experience unnecessary. Common school education sufficient. Interesting booklet and requirements free. American School of Photography, 3601 Michigan Ave., Dept. 3431, Chicago.

CAMERAS, Enlargers, on time. See advertisement under Motion Pictures, Mougill's.

CAMERA Repairing. Bellows made to order, shutters repaired. Bellows made to fit all standard cameras! United Camera Co., Inc., A-1515 Belmont, Chicago.

ENLARGER \$1.59. Enlarges eight times size of small negatives. Fully guaranteed. Paramount Sales Company, 89 Dudley Street, Boston, Mass.

VICTOR Standard stereovicon, tripod model, with case and 300 "round the world" slides, complete \$65.00. Dept. AG, Bass Camera Company, 179 W. Madison St., Chicago, Ill.

NO More wasted film or unnecessary expense. Take pictures you can be proud of. Sell to magazines and newspapers. Make good money wherever you live. Easy, low-cost home study course shows you how! Free catalog. Universal Photographers, Dept. 10, 10 W. 33 St., New York City.

MAKE Money selling snapshots. Dime brings 152 page complete instruction book, buyers, real information. Fomo Publishers, Canton, Ohio.

FROM The great stocks of Bass, you can buy any camera, lens, at bargain prices. Write. All cameras carry 14-day money back guarantee. 30 years of leadership. Dept. AG, Bass Camera Company, 179 W. Madison St., Chicago, Illinois.

TREASURE Finders? See Goldak advertisement on page 134A.

HAVE You a camera? Send ten cents for recent number of our big magazine, showing how to make better pictures and earn money. American Photography, 116 Camera House, Boston, 17, Mass.

CAMERAS Films, paper 25% to 35% discount. Paramount Photo Division, 327 East 92nd St., New York.

MAKE Money with your camera. New book tells how. 46 pages, 50c. Popular Mechanics Press, Room (C39), 200 E. Ontario St., Chicago.

MOTION PICTURES AND SOUND EQUIPMENT

MOGULL'S Bargainews features: Monthly payments new-used cameras, projectors, enlargers, accessories, film. Free examination arranged. Perflex "44" (new) \$3.33 monthly! Filmo "8" (new) \$4.30; Cine-Kodak "8" 20 (new) \$2.64. Every make-model-still, movies on monthly terms. Specials in 16-35mm Soundfilm projectors. Trades accepted. Improve your equipment this convenient way! Mogull's, 64 West 48th, New York. Request Bargainews.

COMPLETE 16mm. Or 35mm. programs \$15.00 weekly. Colson Motion Picture Service, 2040 Chatterton Ave., New York City.

RAW Title film: clear, blue, yellow, inferno, amber, purplehaze—8mm. and 16mm.—100' \$1.00 postpaid. Laboratory Manual L-6, title specimens, 3c stamp. Cine Shop, 1812 Piedmont, Charleston, W. Va.

SOUND Or silent 16mm. films 400 ft. \$1.50 up. Lists free. Visual Products, 459 West 22nd Street, New York City, N. Y.

FOR Sale or rent—16mm. sound and silent features, cartoons, comedies. Waldo Films, Cincinnati.

16MM. SOUND. Silent, 8mm. films, equipment, supplies, reasonable. State requirements. Send for price list. Nu-Art Films, Inc., 145 West 45 St., New York City.

SILENT 35mm. Films, Projectors. Cheap. Demsey, 1223 Berkley, Youngstown, Ohio.

EARN \$17.50 Movie camera. Simple easy method. Industrial-A, Box 701, Sioux City, Iowa.

TALKIE Shorts \$3.00 reel. Programs rented \$7.50 two nights. Simpson, 1275 South Broadway, Dayton, Ohio.

FREE! Write for Cinescreen Magazine. Latest film news! Movies of movie stars! Bailey Films, Dept. Y-2, 1651 Cosmo, Hollywood.

SAVE! Catalogue! Bulk film! Write! Penn-Craft, Box 423-MK, Williamsport, Pennsylvania.

16 35MM. Films. List 5c. Bedner, 5300 S. Talman, Chicago.

OUTDOOR Film 100 ft. 16mm. \$1.98. 25 ft. double 8mm. 98c. Processing included. Free 16mm., 8mm. bargain lists. Home Movies, Box 216, Easton, Pennsylvania.

50—16MM. Sound projectors. Cheap. Roshon, State Theatre, Pittsburgh, Penna.

NOW You can get 16mm. titles with music at silent prices, professionally made. Catalogue free. Filmack, 841 South Wabash, Chicago.

GENERA Films in bulk for all movie cameras, 100 feet for Univex, \$1.00; 100 double 8mm., \$1.75; 16mm., \$1.35; 400 feet 16mm., \$4.25 postpaid. Sample for stamp. Process with our prepared powders. Promaders, Davenport, Iowa.

WAR in Europe. Actual scenes. Sensational developments European crises. Complete edition 16mm., 360 feet, \$8.75; 100 feet, \$3.50; 8mm., 180 feet, \$5.50; 50 feet, \$1.75. Order at once. Garden Exchange, 317 West 50th, New York.

16MM. VELOTEX. Perfect outdoor film. 100 ft. rolls \$1.95 including free processing. Sample free. Velotex Laboratories, 600-F, Gary, Indiana.

1000 FEET 35MM. 75c. Projectors, films, supplies. Calderara, 5119 South St. Louis, Chicago.

FILM: Art sample, 10c. Others, lists free. Goodwill Company, Jackson, Tenn.

FILMS For all projectors. Lists 3c. Clifford Hoffman, Albany, N. Y.

MONEY Maker! "The World's Greatest Passion Play." 16mm. and 35mm. Sound or silent. Purchase or rent, superior than Oberammergau play. Write Hemenway Film Co., 37 Church Street, Boston, Mass.

BASS Says: Write to Cine headquarters for 66-page Cine Bargaingram No. 240. 8mm., 16mm., 35mm. silent and sound. Equipment to gladden the heart of amateur or professional, including the famous 16mm. sound on film RCA camera, exclusive distributors. Write for copy of this great book, it's free, to motion picture headquarters for 30 years. Dept. A. Bass Camera Company, 179 W. Madison St., Chicago, Illinois.

8-16MM. Silent-sound. Complete rental library. Films shipped everywhere. Bargains in equipment, new-used. Free illustrated catalogue (with sample film, 10c). Garden Exchange, 317 West 50th, New York.

OLD Time movie, hit of 1903, "Great Train Robbery." 16mm., 300 ft. \$6.75. 8mm. 150 ft. \$3.50. Free list. Royal Home Movies, 42F Melrose St., Boston, Mass.

BARGAINS! 8mm., 16mm., free literature. Elder, P-739, Boylston, Boston, Mass.

GUARANTEED 8MM. 24-hour reversal processing. Double 8mm., 45c. Single, 25c. Univex 15c. Eso-S, 3945 Central, Kansas City, Missouri.

MOVIE Film. Develop yourself. Univex, Eastman, etc. Chemical samples 15c. Raw film wholesale. Lake Camera Exchange, Gary, Ind.

15% TO 25% Discount on still or movie cameras. Free circular. Paramount Co., 327 E. 92nd St., New York City.

JESUS Of Nazareth, 16mm. sound silent. Screenart, 729 7th Ave., New York City.

RADIOS, SUPPLIES, INSTRUCTION

RADIOS—\$8.95 Up. Chargers, fencers. Catalog free. Save to 50%. Marco-F, Kansas City, Mo.

ANY Radio diagram 25c. Specify manufacturer, model. Radio magazine free. Supreme Publications, 3727 West 13th, Chicago.

BATTERYMIZER Farm radio—\$8.95 (complete). Catalog free. Mission-F, Columbus, Kansas.

RADIOS \$4.95 Up. Buy direct. Factory prices; all types. Free catalog. 10 day trial agent user proposition. A. R. Co., 3855 N. Hamilton Ave., P.M.12, Chicago, Ill.

PLANS 18 Distance record crystal sets, with "Radiobuilder"—year, 25c. Laboratories, 7700-C East 14th, Oakland, Calif.

RADIO Engineering, broadcasting, aviation and police radio, servicing, marine and Morse telegraphy taught thoroughly. All expenses low. Catalog free. Dodge's Institute, Ames St., Valparaiso, Ind.

SEND For free giant money saving radio and phonograph record catalogue. United Radio Company, 1000-M, Newark, N. J.

MUSIC AND MUSICAL INSTRUMENTS

TUNE Your own piano. Easy method \$2.00 postpaid. J. Sullivan, Grant Street, Irwin, Penna.

MUSIC Composed to words. Rhyming pamphlet on request. Phonograph recording of completed songs. Send poem for consideration. Keenan's Studios, Dept. PM, Box 2140, Bridgeport, Conn.

SONGWRITERS, Verse or music. Brilliant opportunity. Write immediately. Vanburen, B-12, Rockhaven, Kentucky.

SONGWRITERS! Dance band makes phonograph record. Send melody and \$15.00. J. Richman, Carnegie Hall, New York.

SONGWRITERS—Send original poems—America's finest service. Variety, Dept. H, Salem, Indiana.

SONGWRITERS: Truth about song-writing opportunities. Rackets exposed. Send 10c for booklet. Allied Music, Inc., Carew Tower, Dept. E337B, Cincinnati, O.

POEMS Wanted. Work guaranteed. Publishing. Great Eastern, "D27," Thomaston, Maine.

SONGWRITERS—Marketing, composing. Free booklet. Write today. Songwriters Institute, 1234-C Broadway, New York.

SONG Poem writers, pleasing, sweet and catchy music composed to your words. Easier to publish. Wonderful opportunities. Verse and chorus \$8. Send your poem now. J. Vella, New Melody House, Habana Mackay, Queensland, Australia.

PHONOGRAPH Records twelve \$1.00. Paramount, 358 East Market, Wilkes-Barre, Penna.

MUSICIANS! Learn modern music arranging. Complete 10-lesson course, \$1.00. Guaranteed. Melodic Music Methods, P.O. Box 1297, New Orleans, La.

SONGWRITERS! Outstanding, amazing offer. Hibbeler, C-5, 2157 N. Avers, Chicago.

MUSICAL Setting—Radio publication—Free. Do not send material. Write first to Norman Spencer, Music Publisher, 145 W. 45th St., New York City.

WRITE Me for best offer. Grant, Box 4055, Miami, Fla.

1067 NAMES For new songs. It's the idea that counts. Many possible winners. Only \$1.00 postpaid. Wm. White, Vine-land, N. J.

POPULAR Dance orchestrations, 10—\$1.00. Silverman Music Mart, 3303 Lawrence, Chicago.

DUO-FLEX Reeds for clarinets, and saxophones eliminate your reed troubles. Write for circular. Duo-Flex Reeds, 1204 1st Ave., Evansville, Ind.

FIFTY Late phonograph records, \$2.50. Wurlitzer selective, amplified, 12 record phonographs, very cheap. Davis Sales Co., Syracuse, N. Y.

PIANO By ear. Free booklet. Day-V-Way, Woolworth Building, Dearborn, Michigan.

SONGS, Song poems, bought, published, best offer. Free information. Metro Music Publishers, 1204 Sutter, San Francisco.

SONGS—Arranged, revised by arranger "If I Had My Way"; "Carolina Moon"; others. Send for details. Harold Potter, 1619(P) Broadway, New York.

SIMPLIFIED Swing courses! Accordion, saxophone, clarinet, trumpet. Write Swingmaster, 1259-N Bender, East Cleveland, Ohio.

MUSIC Composed to words. Wonderful proposition. Bauer Bros., Oshkosh, Wis.

WRITE Songs. Big money and reputation. Write for information. J. Gordon Pub. Co., 201 N. Hoyne, Ave., Chicago.

WANTED! Lyrics, melodies for songs. We arrange, publish, sell. Superior Song Studios, Passaic, N. J.

SONGWRITERS: Send your poem today for immediate consideration. Richard Brothers, 24 Woods Building, Chicago.

SONG Writers. Send for publishing agreement. McKinley Music Publishers, 1501 E. 55th St., Chicago.

ORIGINAL Music composed to your words, \$5. 200 printed copies \$10. Reginald Belcher, Chatham, New Jersey. 30 years church organist.

SONG Poems wanted. Free examination. Send poems to McNeil, Master of Music, 510-PM So. Alexandria, Los Angeles, Calif.

PIANO, Self Instruction. Play within an hour. \$1.00. Popular Mechanics, 200 E. Ontario St., Chicago.

BUSINESS OPPORTUNITIES

NEW Framed feather pictures! Retail 69c. Sample 20c stamps. Dozen \$1.80 postpaid. Marquez-PBN, Apartado 1176, Mexico City.

EARN Steady income with "route" of peanut, gum and amusement machines. Small capital required. Robbins Co., 1141P DeKalb Avenue, Brooklyn, New York.

MAKE Big money at home! Sensational, new invention electroplates by brush—gold, silver, nickel, etc. Easy as painting. Does same beautiful, permanent plating as big tank outfits—easier, quicker, cheaper. Amazing low price. Portable—do work anywhere, right on the spot. Write for big quick-money-making plan and free sample that proves all claims. Warner Nu-Way Electroplate Co., Dept. 5-SC, 360 No. Michigan Ave., Chicago, Ill.

INVENTORS—Small ideas may have large commercial possibilities. Write us for free book, "Patent Guide for the Inventor" and "Record of Invention" form. Delays are dangerous in patent matters. Free information on how to proceed. Clarence A. O'Brien & Hyman Berman, 58-Z Adams Building, Washington, D. C.

OPERATE Movie shows in theatreless communities. Earn \$50.00 to \$100.00 weekly right away. No experience. We furnish projection equipment, talking film programs. Show you everything. Southern Visual, Dept. PM-1, 494 S. Second, Memphis, Tennessee.

EXTRA Dollars for you. Make-sell. Fragrantly tenacious synthetic perfume. Manufacturing instructions \$1.00. Perfumer, 8830 Betty Way, Los Angeles.

FORMULAS—Fast selling products. Guaranteed. Laboratory tested. Lowest prices. Catalog free. Kemico, 511, Park Ridge, Ill.

POPCORN Machines, caramelcrisp, crispettes, cheese coat, potato chips. Long Eakins, 2035-L High St., Springfield, Ohio.

GOOD Money raising mushrooms. Turn spare space—spare time into cash. Starting crop guaranteed. We buy all you raise. Get free book. Niagara Mushroom Co., Dept. B-11, Buffalo, N. Y.

YOU'LL Like resilvering mirrors, auto-parts, reflectors, making chipped glass signs. Write Sprinkle, Plater, 127, Marion, Indiana.

"RUBBER Molds." Make them yourself. Formulas, instructions 25c. Ideal Service, R-11, Park Ridge, Ill.

PACKAGE—Complete, proven business plans and magazines 25c. Lerner Novelty Co., 1658 Broadway, New York City.

PROFITABLE Mail order business. Complete instructions, samples, 10c refundable. Riegel, Kintnersville, Penna.

START Your own business. Local or mail order. Particulars, 3c stamp. Tumbsted, Box 214, Newport, Arkansas.

DRIVING Instructors make real money. Big demand. Complete instructions \$1.00. A. Novak, 1600 Denison, Cleveland, Ohio.

BE Your own boss. 25c brings valuable booklet of opportunities. Circular for stamp. Otto, Box 864, Sequim, Wash.

MONEY In "names!" Free instructions. Mailservice, 2231 McKinley, Berkeley, Calif.

CONVERT Tin cans into steel scrap and valuable tin by chemistry. Always a cash market for this material. Write today for process. 50 cents. H. D. Cater, 1601 East 14th Avenue, Denver, Colorado.

WATERLESS Soap business your opportunity. Complete instructions, \$1. Jerome Jones, Hollins, Alabama.

AMATEUR Cartoonists, earn steady, cash income, copying and duplicating cartoons for advertisers. Ad-Service, Argyle, Wisconsin.

EARN Money publishing. Copy and plan 10c. Blau, Mt. Vernon, Mo.

MAKE Money. Rubber mold making, plaster casting. 24 page instructive booklet, 3c stamp. Plastic Arts, 711 Neely, Muncie, Indiana.

AMAZING Manufacturing formula. Fast selling repeater. Make at home. Large profits. Complete selling plans. Details free. Shennery Laboratories, 1788 Madison, New York.

RUBBER Mold bargains. Stamp brings catalog. Colonial Arts, Derry, N. H.

BIG Profits. Experience unnecessary. Unique new item. Burns, Keystone Building, Pittsburgh, Penna.

WE Help start you in business, furnishing outfits and instruction, operating "Specialty Candy Factory" home. Men-women, opportunity to earn good steady income, all or spare time. (Our 31st year). Booklet free. W. Hillyer Ragsdale, Inc., Drawer 4, East Orange, N. J.

WANTED. Home movie representatives, small towns only. Adults. Details 10c. Import, 392, Elmira, N. Y. A "different" business.

205 **MONEYMAKING** Opportunities. Start own business. Home, office, etc. Particulars free. Stamford, 3762-a Broadway, New York.

FASCINATING Business or hobby. Learn electric arc welding at home. Free particulars. Welders Instruction Service, Wapakoneta, Ohio.

POSTCARD Addressed Excello Sales, Shreveport, Louisiana, brings best proposition ever received.

YOUR Own business! Easily started. Interesting booklet free. E. Kinford, Wayne, Penna.

HANDY Men—Earn money home operating Community "Fix-It" Shop. Stafford, Makanda, Illinois.

WANT More business? 2c daily opens individual New York branch office. Co-operative Mail Service, 126 Lexington Ave., New York.

SELECTED Opportunities, plans, formulas, each one a moneymaker. Proven successes. Details free. The Literary Guide, Walworth, New York.

\$30 WEEKLY. Grow mushrooms. Cellular, shed. We buy 35c lb. Mr. B. made \$270 spare time. World's largest company of its kind. 40 page book free. Mushrooms, Dept. 701, 2019 Second, Seattle, Wash.

FINANCIAL Independence obtainable by placing coin operated merchandise vending machines, out on percentage basis, no experience required, little capital needed, write for free details. Torr, 2047½ South 68th Street, Philadelphia, Pennsylvania.

AMBITIOUS Men—Make \$8 daily. New profession. Start immediately. No canvassing. No selling. Kenneth N. Cooke, Box 42, Sarnia, Ontario.

WORRIED About your future? Be independent. Own business, immense profits. Complete plan 50c. Write Gammell, Dedham, Mass.

10,000 **FORMULAS**—900 Page volume, most amazing value in years. \$1.59 postpaid. Ideal Book Shop, 712, Park Ridge, Ill.

CASH Newspaper clippings. Details free. Galvin, 207 E. 84, New York City.

HOW To get a job. Helpful booklet, questionnaire and life analysis \$1. Success, Box 31, Station D, Los Angeles, Calif.

THE Lord is coming! Get particulars. Sheal, 263, Duluth, Minnesota.

PROFIT With new products. Make, sell, repeat. Analysis. Research. Guaranteed formulas. Biggest catalog free. Nominal prices. Gibson Laboratory, Chemists, BD-1142 Sunnyside, Chicago.

MONEY For new or established businesses. New capital-raising plan; developed by lawyer; avoids disadvantages of partnerships, loans and security selling. Wholly legal. Neatly bound treatise—"The Founders Rights"—and complete set of forms for \$2.50. Price refunded if not as represented. Founders Rights System, P.O. Box 310, Atlanta, Ga.

MAIL Order business is your opportunity. Many began small, now earn thousands yearly. No personal contact. Boundless opportunities. Have had over 30 years experience; will help you succeed. Send 25c for valuable booklets, none free. B. Brenner, 257 S. 21st, Philadelphia.

LIQUID Plastics easily cast with Castone. Any color, machinable, no heat required. Information, samples, dime. Toledo Homecraft Supply, Box 156, West Toledo Station, Toledo, Ohio.

205 **WAYS.** Start own moneymaking business. Select line not overcrowded. Particulars free. Stamford, 3762-b Broadway, New York.

RECEIVE Stacks of mail. Your name listed in 10,000 directories 25c. Liberty Sales Service-A, Sheboygan, Wis.

SALTED Peanuts in shell! Patent and \$1.00 grew \$50,000; retired. Few wanted. Work home! Treatise-L, BX1240, San Bernardino, California.

EARN Extra money writing for publication. Simple method. Demand inexhaustible. Details free. Dona Veretts, 17 Grotton, Lowell, Mass.

MAKE Your own moulds. Sample mould and details 10c. June, 101-B Beech, Holyoke, Mass.

RECEIVE Lots of mail. Your name in 10,000 big mail directories, 25c. National, Argos, Indiana.

DON'T Sell! Make people buy! Learn big companies' way. Expert's manual \$1.00. Money-back guaranteed Specialty Selling Council, 185 Madison Ave., New York.

BELTS, Suspenders, make 'em and make money! Dandy Christmas gifts. Materials supplied. Sample belt 25c. Artel Leather, 400 Joseph Ave., Rochester, N. Y.

"PROSPERITY Pointers" sent free. Business of your own. Get next to "Unique opportunities for the wide awake." Diafas, Fillmore, N. Y.

WAR Time business plan! Supply something—certain class should have! Work home! Afternoons free! National, BX1240, San Bernardino, California.

ARTICLE Featured on cover old national magazine, August. Now have 35 licensed manufacturers, repeatedly bought by large oil companies, state institutions, stores, homes. Adopting new sales policy. Will appoint ambitious men exclusive territory. This is a solid business. Houseman, Inc., 630 Commerce, Shreveport, Louisiana.

NOTICE—Selling by mail is highly profitable, if you have a new, legitimate and good item. We have it. Our new valuable and different information folio is needed by millions, recent copyright. Not trash, bunk or schemes. Nothing like it. Large profit for mail dealers. Sample \$1.00. Particulars free. Royal Keystone Enterprise, Box 192, Dept. 11, Berryville, Ark. Copyright owner. Don't delay if you are interested in making money.

FREE—300 Wonderful business, mail-order and home work moneymaking offers. Lewis Company, 828-D Carpenter, Oak Park, Ill.

TREASURE Finders? Read Goldak advertisement on page 134A.

WANTED—Factory representatives for complete Turkish bath outfit for home use. Light, streamlined, compact. Retail \$9.95. Write today for our proven sales plan. Perspirator Mfg. Co., First and Utah, Toledo, Ohio.

COLOR Concrete with chemicals. Stucco-Rock. Cement artistry. Benches. Washingwells. Spin concrete pottery. Miniature castles, watermills. Coldglaze, water-paints, marbling. Sample 10c. Hollywood Cement-Craft, 8527 Wonderland, Hollywood, California.

LEARN Account collecting. Good income; quick results. Interesting folder free. National Collectors Association, Newark, Ohio.

QUICK Income! Fast-growing business creates lasting independence; no canvassing. Service, Drawer 339-5, Butte, Mont.

EARN Extra money at home. Increase your income at home by new, simple Wentworth Tempera Color method. We instruct you and supply you with work. Write today for free booklet. Wentworth Pictorial Co., Ltd., Dept. 3, Hamilton, Ont.

GOOD Paying business, plating auto parts, reflectors, bicycles, bath fixtures, mirrors, by late method. Small investment brings big returns. A permanent respectable business in your own community. Free particulars and proofs. Gunmetal Co., Ave. H, Decatur, Ill.

PROFITABLE Business. Personal, business stationery 50% profit. Garfield Art Studio, Crown Point, Ind.

100 **PROFITABLE** Mail order and local plans. Gilbert Supply, 1107 Broadway, New York.

NEWEST, Uncommon specialties sell best! I'll tell you how to easily make them, in an independent business yourself and have hundreds selling them for you. Miller's Chemical Laboratory, Tampa, Fla.

BE Rich. Make 900% profit bottle vanilla extract. Free labels. Tharp, 914 Lexington, Cumberland, Md.

MANUFACTURE From Phospholene. Cleaning fluid 1c gallon; bleach 2c gallon; hand soap 2c pound; and ten fast sellers. Sample 25c. Details free. Western, 401 Climax Bldg., Cleveland, O.

GIANT Mail, opportunities, added income, ideas. 68 page magazine 10c. Katz, 4254 N. Kimball, Chicago.

ADVERTISERS! 1,600,000 Mail order circulation. Inch advertisement, \$15.40. "Get results." 20 newspapers, 18 words, \$6.50. Diener-Dorskind, 1474P Broadway, New York.

PLASTEX Industries offers industrious men an opportunity to start a business of their own, manufacturing art goods, novelties, souvenirs, etc., in Plastex and marble imitation. 5c material makes \$1 articles. Rubber moulds furnished for speed production. Small investment brings big returns. You are just in time for big wholesale season now starting. Write for interesting booklet mailed free. Plastex Industries, Dept. A, 1085 Washington Ave., New York.

"SCHEMER" Magazine, Alliance, Ohio, (41st year) prints schemes, tips, opportunities, formulas; winners: \$10,000—\$25,000 reported. Year, \$1.00. Now get acquainted; trial six months only 30c.

MAKE Money by mail, the way we do. Free information. Maywood, P-1107 Broadway, New York.

LIQUID Marble—anyone can make! Colorful, glazed! Moulded, brushed, sprayed. Rubberlastic moulds. Composition flooring. Big money in these! Particulars free. Marbleizing Service, Edwardsville, Ill.

HOW And where to obtain capital fully explained, free particulars. Star Service, Wapakoneta, Ohio.

107 WAYS To make money, in home or office, business of your own. Full particulars free. Elite Co., 214 Grand St., New York.

SUCCEED With your products. Make-sell. Formulas. Accurate analyses. Catalog free. B. Thaxly Company, Washington, D. C.

I WANT To send you proof of the wonderful pulling power of Popular Mechanics Magazine's classified pages. What's your proposition? Write me today. F. W. Johnson, Manager Classified Advertising, 200 E. Ontario St., Chicago, Ill.

DELAWARE Charters: Complete service \$35. Submitted forms. Chas. G. Guyer, Inc., Wilmington, Del.

SELL By mail. Books, novelties. Bargains! Big profits! Particulars free. E. Eifco, 438 N. Wells, Chicago.

CHARTERS: Delaware; best, cheapest; free forms. Colonial Charter Co., Wilmington, Del.

WHERE To buy at lowest wholesale prices. Information free. Yorena, Box P-312, Bayonne, N. J.

A LIFETIME Business you can run at home! No selling. Grow giant, patented mushrooms, in cellar, shed. We pay cash for all you raise and supply everything necessary to start you in business. Write today for free book. United, 3848 Lincoln Ave., Dept. 59, Chicago.

ELITE Collection of business plans, contains 107 tested plans and scores of formulas. Start own business; home, office. Particulars free. Elite Co., 214 Grand St., New York.

1059 WAYS To start a profitable business. Get Popular Mechanics book of modern formulas and methods for practical specialty manufacturing. Price only \$1.25 postpaid. Popular Mechanics Press, Room (C39), 200 E. Ontario St., Chicago.

MONEYMAKING OPPORTUNITIES

MAKE More money! "Prosperity" shows how. Now 64 pages. Sample, dime. Size—more. 4917 N. Kostner, Chicago.

BETTER Yourself. Present position—new job—or your own business. Advance, prosper, succeed. Startling free details. Write, Manager, VR Mfg. Company, Detroit Lakes, Minnesota.

INCREASE Your income. We'll show you how. Particulars free. Ace Publishers, P.O. Box 170, Astoria, N. Y.

RAISE Rabbits, guinea pigs, white mice, for laboratory and other purposes. Big demand. Interesting, profitable work. Send stamp for particulars. Breeders Service Bureau, 201 Richardson, Hanover, N. H.

YOU'LL Like resilvering mirrors, auto-parts, reflectors, making chipped glass signs. Write Sprinkle, Plater, 287, Marion, Indiana.

MILLION Articles. Buy wholesale. Valuable directory 10c. Ideal Service, D-11, Park Ridge, Ill.

EARN Money, year round, inventing toys, games, novelties. Special markets. Booklet free. Hendrickson, Argyle, Wis.

MANUFACTURE. Sell furniture polish—Formula \$2.50. Linoleum cleaner polish \$3.00. Auto dry cleaner polish \$3.50. Three formulas \$7.50. Simmonds Co., Rt. 4, Box 3623, Sacramento, California.

APPLY For tropical positions. Write for list of companies with branches in Hawaii, Philippines, Panama, etc. World Tropics, Dept. C-1, Box 1243, Birmingham, Ala.

205 MONEYMAKING Opportunities. Start own business. Home, office, etc. Particulars free. Stamford, 3762-a Broadway, New York.

BUYERS Guide—Also latest money making opportunities. Wetzel, Valhalla, N. Y.

MAKE Money by mail. Steady income. Samples and particulars 10c. V. Messick, Box 217, Camden, New Jersey.

BOOK, 100 Opportunities, plans 25c. Literature 3c. Morelle, 130 N. State, Chicago.

START Your own business. Plans 25c and \$1.00. Ned Piermarini, 46 Lincoln Terrace, Leominster, Mass.

MAKE Cuts—Print greeting cards, book-plates, etc., without press. Instructions \$1.00. Paul Williams, Carmel, N. Y.

MAKE \$8.00 Daily. New profession. No selling. Write Garden Publishers, Adel, Georgia.

START Own mailorder business. Send 25c for big folio, "How to Sell by Mail," by expert. Benty, 1741 Melrose, Chicago.

ANALYSIS. Research. Newest guaranteed formulas. Biggest catalog free. Nominal prices. Gibson Laboratory, Chemists, GS-1142 Sunnyside, Chicago.

KEEP Dollars received supplying, by mail, satisfying employment information—millions jobless. We fill your orders. Stamp, details. Co-Operative Service, 77 Swan, Buffalo, New York.

PREPARE For artists job. Big pay. Simple for anyone. Illustrated course—nude figure drawing 50c postpaid. Hart Studios, 7939-P South Shore, Chicago.

900% PROFIT. We teach you. Stamp appreciated. Box 747, Muncie, Indiana.

BE Independent. Start mail order business. Over 100 ways. Particulars free. Campbell Service, 3231 Dupont, North, Minneapolis, Minnesota.

MONEYMAKERS! Barbecued frankfurters formula (dime). Sensational "Holland-Inn" hamburger proposition included. Davis, Box 1484-MP, Clarksburg, West Virginia.

BRAINS For you. 36 page magazine, plus opportunities 10c. Rab Publishers, Cincinnati.

FREE—Speedex candid type camera, carrying case, 2 rolls film, for two hours spare time. Postcard brings details. Veltex Company, Dept. MP, Birmingham, Alabama.

FREE—300 Wonderful business, mailorder and home work moneymaking offers. Lewis Company, 828-D Carpenter, Oak Park, Ill.

MAIL Order business that pays. John Rodakowski, Springfield, Oregon.

400 "UNIQUE Money making opportunities." Particulars free. G. Distas, Fillmore, N. Y.

TREASURE Finders? Read Goldak advertisement on page 134A.

BE A professional scrapbooker. Big fees. Unlimited opportunities. Can be done at home. No competition. No capital needed. Write postcard to Scrapbookers Guild, 59 Park Place, New York, N. Y.

BOOKKEEPERS—Increase income with inexpensive new bookkeeping service. Bobertz, 3701 East Hancock, Detroit.

GOOD Paying business, plating auto parts, reflectors, bicycles, bath fixtures, mirrors, by late method. Small investment brings big returns. A permanent respectable business in your own community. Free particulars and proofs. Gunmetal Co., Ave. N, Decatur, Ill.

"MONEY By mail"—Latest plans, formulas, ideas, opportunities. 25c. Roberts, 3705 East Hancock, Detroit.

BIG Mails of opportunities; imprints, new offers, mailorder propositions, sample mailing free. Harvey Teeple, Decatur, Indiana.

"100 TO 1" You will like these "unique and unusual" propositions. "3" real money makers. Details free. Original, Box 1792, Houston, Texas.

KEY Check stamping outfits. Emblem key checks, key rings. Catalog free. Sample name and address 25c. Social security plate name number 15c. Kemp & Company, 463-P East 178th St., New York.

MOULDS, Guaranteed, for casting toy soldiers, Indians, trappers, warships, sinker moulds, 244 kinds. Send 5c for illustrated catalogue. Henry C. Schiercke, 645 Spencer, Ghent, N. Y.

RAISE Earthworms for profit. Information free, stamp appreciated. Bureau Zoological Research, 106A Broadway, Peoria, Ill.

WHOLESALE Sources. 500,000 articles. Free directory. Maywoode, 1107 Broadway, New York.

ACCOUNTANTS And bookkeepers. Real profit from new type bookkeeping service. Write Asco, Box 1468, Springfield, Mass.

1001 WAYS to Use Concrete. Send for large free illustrated folder describing new Popular Mechanics book covering every known use of concrete for the home, farm, building, business and industry. Popular Mechanics Press, Room (C39), 200 E. Ontario St., Chicago.

FORMULAS, PLANS, ETC.

REAL Manufacturing formulas. Lists free. Cummings, Chemist, Gordon Avenue, Syracuse, N. Y.

FREE Formula catalog. Accurate analysis. Research. Western Chemical, Salem, Oregon.

GUARANTEED Formulas—New fast sellers. None better. Lowest prices. Catalog free. Kemico, 410, Park Ridge, Ill.

FORMULAS For live selling products. Palmer Specialties, Sandwich, Ill.

ONE Dollar for a formula that will clean the plates in your battery. It will take a charge in car or charger, will last three to six months longer. Cost about three cents per battery. Chandler Oil and Batteries, Box 214, Plainview, Texas.

PROFITABLE Formulas. Information free. Rochambeau Laboratory, 339 E. 19th, Paterson, N. J.

PRODUCTS Manufactured, bulk or packed. Write Manufacturing Chemist, P.O. Box 768, Waco, Texas.

ANALYSIS. Research. Newest guaranteed formulas. Biggest catalog free. Nominal prices. Gibson Laboratory, Chemists, BD-1142 Sunnyside, Chicago.

10,000 BIG-MONEY Formulas, processes, secret recipes. Huge 900 page book, \$1.50 postpaid. Catalog 3c. Adams-Brown Company, Chestnut Hill, Massachusetts.

FORMULAS—All Kinds. Real moneymakers. Lowest prices. Catalog free. Clover Formulary, P-11, Niles Center, Ill.

MAKE Chemical specialties without machinery or heat. Approved big sellers in daily demand. New plan tells how. Brown Company, 47 North Sixth, Reading, Penna.

10 FORMULAS 10c including "Traders Gold" the new marvel. Alma Company, Hunter, Ark.

HERE'S Headquarters for newest, tested, guaranteed highest quality formulas for every modern requirement. Analysis—research. Prices nominal. Miller, Chemist, Tampa, Florida.

REAL Moneymaker. Make, sell luminous paint. Simple, harmless. Formula, instructions \$1.00. Sample 10c. Gordon Laboratories, 1265-C Broadway, New York.

THAXLY Formulas for perfect products. Accurate analyses. Catalog free. B. Thaxly Company, Washington, D. C.

FORMULAS. Latest money makers. Literature free. Belfort, 4042 N. Keeler, Chicago.

ELITE Formulas and plans; make and sell your own products. Descriptive booklet free. Elite Co., 214 Grand St., New York.

10,000 MONEY-MAKING Formulas. Tells you how to make and sell almost everything under the sun; cosmetics, mucilage, anti-freeze solutions, battery solution, beverages, cheese, chewing gum, cleaning preparations, extracts, hair preparations, inks, bluing, leather polish, mirrors, perfumes, polishes, typewriter ribbons, carbon paper, washing powders, liquid soap, and hundreds of other profitable articles. \$4 postpaid. Popular Mechanics Press, Room (C39), 200 E. Ontario St., Chicago.

CHEMISTRY

FREE Catalogue. Chemistry, mineralogy, biology, microscopes, telescopes. Tracey Laboratories, Evanston, Illinois.

CHEMICAL—Technical books. Catalogue for stamp. Kraftmen's Press, Coscob, Conn.

JOIN—American Amateur Chemists Society. Journal, prospectus, 10c. Haslett, Mich.

CHEMICALS In 5c quantities. Catalog 5c. Fleischer's Laboratories, Everett, Mass.

SPECTROSCOPE For quick chemical analysis \$2.50. Kutting Sons, Campbell, California.

FREE Chemistry catalog. Supplies at 5c! Equip complete laboratory. Send 3c for postage. Kemkit Scientific Corp., 397P Bridge St., Brooklyn, N. Y.

CHEMICALS, Laboratory, glassware, apparatus. Send 3c for catalog CP1. Biological Supply Company, 1176 Mt. Hope Avenue, Rochester, N. Y.

HELP WANTED

M. M. earned \$267, three weeks, raising mushrooms in cellar! Exceptional, but your cellar, shed perhaps suitable. We buy crops. Book free. United, 3848 Lincoln Ave., Dept. 60, Chicago.

BIG Money taking orders; shirts, ties, hosiery, underwear, pants, jackets, raincoats, uniforms, etc. Sales equipment free! Experience unnecessary. Nimrod, 4922-BG Lincoln, Chicago.

STEADY Work—Good pay. Reliable man wanted to call on farmers. No experience or capital required. Pleasant work. Home every night. Make up to \$12 a day. Wonderful new proposition. Particulars free. Write McNess Co., Dept. 329, Freeport, Illinois.

SALARIED Positions—\$2500 yearly and up. Let us find one for you. Write for valuable information. Executive's Promotion Service, (16), Washington, D. C.

\$30 WEEKLY. Grow mushrooms. Cellar, shed. We buy 35c lb. Mr. B. made \$270 spare time. World's largest company of its kind. 40 page book free. Mushrooms, Dept. 701, 2019 Second, Seattle, Wash.

BIG Sparetime profits taking subscriptions—all magazines. Pines, W-583 Monroe, Brooklyn, N. Y.

AGENTS WANTED

A VALUABLE Gift—Watch, candid camera, dish set, or other gift of your choice—is yours in addition to doubling your money on easy selling of our 1939 master box of Christmas cards. This 80-piece box costs you 25c; sells itself quickly at 50c. Contains 16 artistic French-fold cards, 16 matching envelopes and 48 sparkling NipArt Christmas seals. Get free sample and our gift plan at once. Be first in your community. American Card Co., Box C-95, Lancaster, Penna.

\$1 STARTS You in business selling outstanding line ties, boxed novelties. Over 100% profit. Silk lined ties, \$1.50 dozen, sample 15c. Slide-On-Ready-Tied ties, \$2.50 dozen, sample 25c. Write today for descriptive wholesale catalog, prices, free sample materials. Philip's Neckwear, 20 West 22nd, Dept. P-3, New York.

MEN And women, big profits. See the brand-new Nifty Shoeholder. Nothing like it at any price. Holds any standard size shoe for cleaning, dyeing or polishing. Every home, shine parlor, barber shop and shoe store a prospect. Made of oak and steel. Postpaid sample with instructions, \$1.00. Nifty Shoeholder Co., 7280 Lindell, St. Louis, Mo.

POLMET Polishing cloth removes tarnish from metals without the use of liquid, paste or powder. Agents say it sells like "hot cakes." Retail 25c. Sample free. Gale & Co., Inc., 15 Edinboro St., Boston, Mass.

STEADY Profits: New improved wax furniture polish. Private brands: your name. P. O. Box 247, Newport, R. I.

YOU Ain't seen nothing till you've seen the patented Handynife. Sample 15c. (No postcards.) Paramount Specialties, 121-M East 27th, New York.

NEW Potato peeler. Sells like wild. Peels, shreds, slices, grates. Saves hands, time, food. Samples sent on trial. Rush name. Kristee, 112, Akron, Ohio.

WEAR Pine hose I send without cost with outfit while taking orders for amazing new hosiery. Replacement guaranteed against holes, snags, and runs. Rush name and hose size. Wilknit, R-37, Greenfield, Ohio.

NEW Inventions. New Products. Opportunities. Paramount Produx, 18834 Marx, Detroit.

ATLAS Window sign letters. Large sizes—penny each. Get beautiful samples. Atlas, 7943 Halsted, Chicago.

SELL New and used clothing from home, auto or store. Men's suits 96c. Shoes 8½c pair. Dresses 21c. Hundreds big bargains. Catalog free. S&N, 440-A East 31st, Chicago.

BIG Money—Applying gold initials on automobiles, luggage, etc. No experience needed. Samples free. Gold Letter House, Tyler, Texas.

500% PROFIT With new perfected (1940) quick-action, no flint, automatic gas lighter. Retail 25c. Sample 10c. New Method Co., Box PMH-82, Bradford, Penna.

BIG Money for you in small route business. Can be handled spare time from home. Equipment free. Operate on our capital. No experience needed. Earnings start at once. Don't answer unless sincere and dependable. Zanol, 6121 Monmouth, Cincinnati, O.

DRESSES 10c. Hats 40c. Shoes 50c. Many other bargains—Used merchandise. Free catalog. Send name on postcard. Fairmount, 160PM, Monroe Street, New York.

BEAUTIFUL Bird pictures handmade with genuine feathers. Sell on sight! Large profits! Free particulars. Samples 10c stamps. Marquez-PP, Apartado 1176, Mexico City.

BUSINESS Proposition resilvering mirrors, autoproducts, reflectors, making chipped glass signs. Write Sprinkle, Plater, 128, Marion, Indiana.

NEW! Amazing! Double action polish of thousand uses. Field unlimited. 25c for sample and plan. Glo-Kleen, 2444 N. 3rd, Milwaukee, Wis.

SELL Christmas signs. Write today. Special Kut Signs, Sidney, Ohio.

MEN! Sell the Automatic Gas Lighter. No flint or refill needed for 5,000 lights. Just hold over any gas jet or stove and it lights it. 15c each, \$1.20 dozen, \$5.04 six dozen, \$7.85 gross, \$15.50 two gross. A. Macaluso, 176 E. 106 St., New York City.

YOU Get \$5.00 cash for distributing 100 samples. 100% profits from sales and repeat orders. 10c brings full details. Earlrich and Co., Cedarville, Ohio.

LOWEST Prices—Reversible topcoats. Tremendous profits. Yale Clothing, Meriden, Conn.

SELL Charlie McCarthy clocks and carded merchandise. Dixie Supply, Rosslyn, Virginia.

BUILDERS Reel, many uses, fast seller. 200% profit. Sample dime. No-Ti Co., 3919 West Pine Blvd., St. Louis, Mo.

BIG Money taking orders; shirts, ties, hosiery, underwear, pants, jackets, raincoats, uniforms, etc. Sales equipment free! Experience unnecessary. Nimrod, 4922-AN Lincoln, Chicago.

CHRISTMAS Cards. Sell 50 imprinted \$1.00. Free samples. Lincoln Press, 220 Hartwell, Fall River, Mass.

PROFIT With new products. Make, sell, repeat. Analysis. Research. Guaranteed formulas. Biggest catalog free. Nominal prices. Gibson Laboratory, Chemists, BD-1142 Sunnyside, Chicago.

MILLION Dollar future! Sell this auto product. Tremendous possibilities! Millions interested. Guaranteed! Thermo Exolene, Peoria, Ill.

SENSATIONAL Device cuts, trims own hair. Also formulas. Plaza Laboratories, 1558 North Clark, Chicago.

205 WAYS. Start own moneymaking business. Select line not overcrowded. Particulars free. Stamford, 3762-b Broadway, New York.

SELL Religious statuettes set in shrine of preserved flowers. Ideal Christmas gift. Sample 50c. Large size \$1.00. Rice, 109-50 Merrick Rd., Jamaica, N. Y.

WATCH-DOG Tax collector prevents knocking down, makes customers want to pay sales tax. Box 108, Shelby, N. C.

NEW Improved gas station "service signals." Knipp, 1915 Florida, Long Beach, California.

BIG Sparetime profits taking subscriptions—all magazines. Pines, C-583 Monroe, Brooklyn, N. Y.

LATEST Sensation, perfumed Christmas folders. New self-selling plan free. sells all types Christmas cards. Reynolds Company, 5510 LeMoyné, Chicago, Ill.

MEN In factories and industrial plants sell watches cheap. Thomson, 474 Summer Ave., Newark, N. J.

SOMETHING New Jo Bo Rubber Bow Neckties. Article of real merit. Good sideline. Jo Bo Products Co., 3402 School St., Des Moines, Iowa.

SPARKLING Tinted Christmas signs, 11" x 14", cost 5c, sell 25c. Make Christmas money. Lowy, 8A West Broadway, New York.

SELL 50 Assorted Christmas cards with name \$1. Costs 50c. Free sample offer. Other profitable sellers. Nickel's Press, 4617 Loughborough, St. Louis, Mo.

NECESSITIES Are always in demand! Experience unnecessary to earn steady income supplying tremendous demand for customized shirts factory to wearer. Gigantic variety; one year guarantee; ninety sizes. Half price offer creates amazing values. Superior advantages eliminate competition. World's largest concern of its kind. Our sales force earns \$100,000.00 yearly. Get your share! Postcard brings you complete self-selling outfit free. Simply write orders. We deliver and collect. Write Dept. 404, Rosecliff-Quaker, 1239 Broadway, New York.

"CHRISTMAS Cards" Beauties. Big profits. Investigate. Hamilton, 4341-P Meade, Chicago.

MONOGRAMMING Automobiles real money maker. Write for samples. International Co., Box 9360, Philadelphia, Pa.

COLLECT Your bad debts. Merchants write Lamont Company, Beacon, New York.

HANDLE Exclusive territory for unique business service. Long profit. Real cooperation. Box 5411, Philadelphia.

SELL Artistic oil painted personal portraits! Portraiture, 2637 Evergreen, Chicago.

AGENTS Make big profits on food products, bargain deals. Low wholesale prices. Rush name for trial outfit offer. Ho-Ro-Co, 2810-T Dodier, St. Louis, Mo.

500% PROFIT! Gold and silver colored sign letters. Offices—stores. Large sizes, 1c. Free samples. Modernistic, B-3000 Lincoln Ave., Chicago.

CHRISTMAS Card box assortments selling like "wildfire." People who have never sold a thing in their lives are reaping harvests with our "New Champion" 21 folder assortment, including sensational "mystery card"—Biggest sales-puller of all time. Costs 50c—sell for \$1.00. Worth \$2.85. Also seven other bargain assortments, and personal imprinted cards. Write today. Samples on approval. Silver Swan Studios, 320 Fifth Ave., Dept. 74, New York.

AGENTS—Amazing new glass cleaner sells fast, repeats. Demonstrations reap big profits. Needed everywhere. Write Universal Utility, Gloversville, N. Y.

500% PROFIT! Transfer sign letters for windows, offices, trucks, signs. Colors: gold, silver, red, many combinations. Auto monograms. Easily applied. Neonite, Akron, Ohio.

AGENTS: Smash go prices! Santos coffee 12c lb. 4-oz. vanilla 8½c. Razor blades 10 for 8½c. 100 sticks chewing gum 12c. Christmas cards, 21 in box, 14c. 150 other bargains. Prelums. Experience unnecessary. Carnation Company, PO, St. Louis, Mo.

AGENTS—To mail our literature. Good profits. Home business. Maywood, 1105-1107 Broadway, New York.

SUCCEED With your products. Make-sell. Formulas. Accurate analyses. Catalog free. B. Thaxly Company, Washington, D. C.

ENGRAVED Name plates, numbers, signs, etc., easily sold, profits large. Brett Bros., Winthrop, Mass.

300% PROFIT Selling gold leaf letters for store windows; high grade letters 1½c each. Free samples. Metallic Co., 438-B North Clark, Chicago.

BIG Money applying initials on automobiles. Easiest thing today. Free samples. Also, sideline salesmen for short order decalcomania name plates. "Ralco," 1305 Washington, Boston, Mass.

REVOLUTIONARY Window cleaning tool. Good Housekeeping approval. Only ten \$2.25 sales daily to housewives, factories, schools, stores will make you \$350.00 monthly. Carter Products Corp., 900 Front Ave., Cleveland, Ohio.

AGENTS—Opportunity make money; book containing 107 successful business plans; home-office; send for free introductory booklet. Elite Co., 214 Grand St., New York.

STARTLING Invention—Pocket adding machine. Nationally advertised \$2.50. Whirlwind seller. Big profits. Baby Calculator Co., Box 1118, Chicago.

BIG Money applying initials on automobiles. Write for particulars and free samples. American Letter Company, Dept. 40, Dunellen, New Jersey.

MANUFACTURE Specialties, hire agents yourself. Big money. Free literature. Gilbert Supply, 1107-P Broadway, New York.

FREE Sample—Amazing cleaner; sells homes, taverns, everywhere. Big profit—fast repeater. Betco, 5007 Irving Park, Chicago.

AGENTS: Stamping names on pocket-key protectors. Sample check with your name, address, 25c. Stamping outfits. Emblem checks, check-fobs, name plates. Hart Mfg. Co., 303 Degraw St., Brooklyn, N. Y.

AGENTS! Men's suits \$1.53, pants 37c, dresses 15c, ladies' coats \$1.10. Other big bargains. Catalogue free. Roosevelt Mercantile, 566-AM Roosevelt Road, Chicago.

DO You want agents for your proposition? Your ad in this space will place your message before hundreds of men seeking fast-selling products. My folder "How to Secure Agents," is filled with proof. I'll gladly send you a copy free. F. W. Johnson, Manager Classified Advertising, Popular Mechanics Magazine, 200 E. Ontario St., Chicago.

HIGH-GRADE SALESMEN

AUTO Accessory men! Excellent sideline. Old reliable sparkplug company. Unusually liberal working plan. Irresistible dealer proposition. Protected territory. Write Reflex Sparkplug Co., 10905 Madison, Cleveland, Ohio.

ADVERTISING Book matches offer daily cash profits. Experience unnecessary. Full, spare time. Call on business places. Factory direct. Low prices for high quality, quick deliveries, bring easier orders; faster repeats. Free outfit, instructions. Match Corp. of America, 3433 West 48th Pl., Dept. E-11, Chicago.

BIG Commissions—selling to stores celluloid pricing tickets, metal shelf moulding. To restaurants, menu covers, signs. P. Pricing Press, 124 White St., New York.

OPENINGS! Call on all dealers with new trade-stimulator plans. It's "hot." \$3 commission on each \$5 sale. Big repeat commissions. No investment. Sales kit free. Universal, 6227 Broadway, Dept. C511, Chicago.

SELL Printing at cut prices. 2,000 business cards \$1.50; 1,000 envelopes or statements, etc. \$1.75; 25 printed sales books \$1.50; 1,000 process embossed cards \$1.50; 2,000 two-color labels, free holder \$1.50; 2,500 printed handbills \$1.75. One-third comm. Free outfit. Bargain Prtg. Co., 189-F W. Madison, Chicago.

SELL Xmas cards. 50 with name \$1. Unequaled. Also America's finest box assortment. Costs 50c. Sell \$1. Worth \$3. Sample on approval. National Greetings, Douglas Bldg., 3rd and Spring, Los Angeles, Calif.

SALESMEN: America's finest sideline. 40% comm. daily. 725 fast selling repeat items. Every business uses and must buy. No investment now or ever. Sales portfolio free. Willens, 2130 Gladys, Dept. MJ, Chicago.

DID You make \$50 last week? Does your job offer you real future? If not, why not start a wholesale business of your own? Start with little as \$2.50. Handle line 200 nationally advertised 5c-10c products. Show merchants new plan for increasing sales and profits. Handle everything from your home at start. Chance to operate one of our Silver Fleet service trucks. Facts free. World's Products Co., Dept. 10-L, Spencer, Ind.

SELL Complete line business necessities—over 1000 items. 50% savings to every merchant. Experience unnecessary. Samples free. Commissions advanced. Northwestern, 625-RG Jackson, Chicago.

RAWLEIGH Men make good money. Supply everyday household necessities to Raleigh routes of 800 family users. Ambitious men can make good earnings at start. We furnish everything but the car. Write today. Rawleigh's, Dept. K-A-PPM, Freeport, Ill.

DRESSES 10c. Hats 40c. Shoes 50c. Many other bargains—used merchandise. Free catalogue. Send name on postcard. Fairmount, 162PM Monroe Street, New York.

CALENDARS—Beautiful complete line, all sizes, including jumbos. Samples free. Also Christmas cards. Fleming Calendar Company, 6539 Cottage Grove, Chicago.

SALESMAN, Distributors; 200 items, brushes, mops, marvelous magnetic brush—excels vacuum cleaner. Big profits. Neway Brush Co., Hartford, Conn.

SALESMEN Sell harvest hats. Big commission. American Harvest Hat Company, St. Louis, Missouri.

AMAZING Invention—Low price makes Sheridan Toothpick Dispenser year's best seller, over 100% profit. Free sample offer. Write, Sheridan Specialty, 624 South Michigan, Chicago.

MAN Wanted—Trustworthy, steady worker. Manufacturer established 50 years will finance responsible man with complete stock of guaranteed food, farm and household necessities—you pay when sold. Mighty attractive proposition. Be your own boss. Pleasant outdoor work. Experience not necessary. No slack seasons or layoffs. Products well advertised on popular radio stations including WLW, Cincinnati, WSM, Nashville, WHO, Des Moines, and others—a big help to success. Write for no investment offer. McConnon and Company, Room M 66, Winona, Minn.

WE Need experienced salesmen for direct selling of our patented made to measure, form-fitted shirt. A beautiful fall and holiday line just assembled. Price range, \$2.00 to \$5.00. Very attractive proposition. Bona-Fit Shirt Co., Paterson, New Jersey.

BIG Sparetime profits taking subscrip- tions—all magazines. Pines, E-583 Monroe, Brooklyn, N. Y.

ADVERTISING Book matches—calen- dars. Lowest prices. Big cash commissions. New outfit free. Gem Match, 76-PM West Washington, Chicago.

PROFIT \$2.00 On fast \$2.50 sales to dealers. Valuable samples free. Aircraft Industries, Fort Worth, Texas.

\$3,000 PROFIT In six months by Foster. Over \$6,000 in one year by Felton. Over \$30.00 daily for 90 days by D. F. F. All selling our special tool set to garages. Exclusive territory. Mesco, Beaver City, Neb.

EARN 65c On every dollar! Sell Christmas twenty-one piece superfine, religious or magicard assortments. Three sample boxes \$1.00 postpaid. Personal imprint Christmas folders, wreaths, wrappings, calendars. Illustrated circular service. Popular sellers! Catalog free! Elfko, 440 North Wells, Chicago.

SELL Mexican novelties, Commission. Free samples. Marquez, Apartado 1176, Mexico City.

BLADES, Finest quality. Factory prices, postpaid. Ace Blades, Buffalo, N. Y.

NEW Specialty—Sells every business and professional man. Four \$15 sales daily pay \$280 weekly. Farrell cleared over \$1,000.00 monthly. Write, F. E. Armstrong, President, Dept. PM, Mobile, Ala.

EXCELLENT Opportunity selling our complete line of brushes, largest commissions. Write for sales plan. Wire Grip Sanitary Brush Company, 2300 5th Ave., New York.

ASPIRINS, Chocolate laxatives, under your name. Direct from manufacturer. Large, small quantities. Burton Lab., Cincinnati, O.

SALESMEN—Crew managers; rural magazine men to sell leading national publication. Small money but lots of it. Advancement. Write R. L. Harrington, 407 So. Dearborn, Chicago.

EDUCATIONAL AND INSTRUCTION

DRAFTING Jobs pay big, \$175-\$250 month not unusual. Learn easily at home. Experience unnecessary. Particulars free. Write Monroe Institute, PM-11, Alton, Ill.

LEARN Arc welding. Get information how you too can prepare yourself for a better job in our factory. Continental Welding, Manhattan Bldg., Milwaukee, Wis.

BECOME Expert piano tuner. Musical knowledge unnecessary. Highly paying. Uncrowded field. Fitzallen Associates, P.O. Box 16, Station J, New York.

BETTER Position? Tower your applica- tions above many competitors. Model, "Super-Prospectus" including Unfoldograph, Wheelograph, Ladderograph, Traitograph, 50c. Restpark, Willimansett, Mass.

START Own real estate office and earn largest commissions through home study in easy lessons by expert for city of Chicago and eleven other leaders at low cost of \$10. Write Morrison School of Real Estate, 100 No. LaSalle St., Desk 9, Chicago.

YOU, Too, can have your own profitable, lifetime business. Operate a collection-credit bureau. Capital unnecessary. Free literature. Cole Associates, Syracuse, N. Y.

WATCH Repairing is steady profitable work. Experts always in demand. You can learn watchmaking trade at home, spare time. New original instruction system. Script engraving course included. Write for free details today! Nelson Co., L-2001 Manhattan Building, Chicago.

ELECTRICAL Course \$9.95. Experimental outfit included. Radcliffe's, 1013 High, Petersburg, Virginia.

MEN—Women. Get U. S. government jobs. Commence \$105-\$175 month. Prepare immediately for next examinations. Experience usually unnecessary. Full particulars—list positions, free. Write today. Franklin Institute, Dept. S3, Rochester, N. Y.

BECOME Practical scientific investiga- tor. Modern illustrated course. Thorough training by former agent U. S. secret service. Particulars free. International Secret Service Institute, PM-119, Hoboken, N. J.

INVESTIGATORS Are in demand—Sec- ret investigation, travel, adventure, big money. Free particulars. Lee Detective School, F1523 West Pico, Los Angeles.

CLAIM Adjusting. Profitable, fascinat- ing. Authoritative course. Burns School, Keystone Building, Pittsburgh, Penna.

INDEPENDENCE Offered inventive minded. Explanation for stamp. C. Higbee, Cantil, Calif.

LOCKSMITH Course. Lock picking, key fitting, etc. \$1.00 prepaid. Locksmith, Canadian, Texas.

WELDING And machine shop practical training. Fine equipment. Low rates. Successful graduates. Dunn Welding School, 2033 NE Union, Portland, Ore.

BE Funny, make money. Learn gag writing. Tremendous demand. Personal instruction less than 10c weekly. Stamp brings information. Don Ullsh Studios, 443 Wrightwood, Chicago.

GOVERNMENT Jobs. Start \$1260-\$2100. List positions, full particulars free. Write today. Pergande, Publishers, Milwaukee, Wis.

MODERN "Short-Cut" arithmetic— swift, sure. Complete 50c coin or stamps. Arith-Magic, Dept. V, Maywood, Ill.

MAKE Money writing. I guide you, guarantee results. Details free. Slater, 612, Loew's State, Los Angeles.

GOOD Personality insures your success. Send for details. Park, 25 Union Park, Boston, Mass.

HOW To secure a gov't job in the classi- fied civil service. Railway postal clerk, \$1900 a year. Postal clerk, city mail carrier, \$1700. Other jobs, \$1260 to \$2100. Our method helps you pass exams. Men-women, age 18 to 50. Send for free book. Patterson School, 8C Mercantile Bldg., Rochester, N. Y.

ENROLL Now, decorating, paperhang- ing, graining, marbling, sign and pictorial painting. Catalogue free. Chicago Painting School, 102 W. Lake Street, Chicago.

WRITE For newspapers—gain pleasure, good pay and perhaps fame. Full time or freelancing (part time). Hundreds of stories, articles, ideas, are needed in every issue. We successfully coach you by mail. 45 years newspaper experience—plenty of contacts for placing graduates. The Millers, Dept. 10, Carmel, California.

MASSAGE, Hydrotherapy, dietetics, drugless therapeutics, chiroprody, taught by mail. Evans Correspondence School, Montgomery, Ala.

LEARN Auto mechanics, body, repairing, welding electricity, refrigeration. Diesel. Stevinson's, 2008A Main, Kansas City, Mo.

TELEGRAPHY Taught thoroughly. Rail- road retirement act creating opportunities for new operators. Expenses low. Catalog free. Dodge's Institute, Hiatt Ave., Valparaiso, Ind.

SECRET Investigation. Experience un- necessary. Detective particulars free. George Wagner, M-2640 Broadway, N. Y.

LEARN Air conditioning—America's next big industry. Thousands of opportunities. Get your start with complete book by E. W. Riesbeck, \$3.50 postpaid. Popular Mechanics Press, Room (C39), 200 E. Ontario St., Chicago.

PLAYS, STORIES, MANUSCRIPTS

SHORT Stories revised, typewritten, marketed. Hursh, Box P-1013, Harrisburg, Penna.

RADIO Stage plays wanted for publication. Readings free. Details. Box 42, Kenmore, N. Y.

ORIGINAL Poems, songs wanted for publication. radio. Westmore Music Corporation, Dept. 33G, Portland, Ore.

CARTOONING, COMMERCIAL ART, SHOWCARD WRITING, SIGN PAINTING

HAVE Your own money making business. Learn show card writing, sign painting. Write for details. Begley Specialty, 1472M Broadway, New York.

LEARN Cartooning, lettering, etc. Free information. Murray Service, 1799 E. 100th, Cleveland, Ohio.

ART For advertisers! Drawings, lettering, etc. Gill Art Service, Huntsville, Alabama.

CASH For your cartoons when you learn by our method. National Cartoon Features, Box 1901, Dallas, Texas.

ART Magazine including directory art books—free. Send 10c postage. Art Headquarters, Doty Street, Madison, Wisconsin.

CHALK Talks. Laugh producing program. \$1.00. Catalog 10c. Balda, the Cartoonist, Oshkosh, Wisconsin.

DRAWS Cartoons with new unique device. Complete instructions 25c. Cullen, Stepney Depot, Conn.

LETTERING Patterns, free literature. Sample alphabet 5c. Display Letters, Box 28, Ft. Hamilton, Brooklyn, N. Y.

CARTOONING, Sketching, etc.—46 lessons, 600 illustrations, including drawing paper, pens, pencils, \$1.00 complete. Fraba Service, Cashton, Wisconsin.

PEN and ink drawings. Let us draw your advertising and catalogue illustrations, from photos, copies or objects. Best work and fair prices. Heraldic Studios, 1914P Oakdale Avenue, Chicago, Ill.

LEARN Animated (movie) cartooning by mail. Hollywood trained instructors. Real movie methods. Write for free illustrated brochure. "Animated Cartooning"—Hollywood's sensational money-maker. Mondell Institute of Animated Cartooning, Dept. 101, 790 Broad, Newark, N. J.

MAKE Art Pay. Advanced art students. \$1.00. Popular Mechanics, 200 E. Ontario St., Chicago.

ADVERTISING AGENCIES, LETTER WRITERS, FOR ADVERTISERS

MAIL-ORDER Ad reaching 1,500,000 families throughout United States \$15.40 incl. Newspaper, magazine, rateguide—stamp. Chicago Advertising Agency, 20-P West Jackson, Chicago.

NEWSPAPER, Magazine, advertising; lowest rates; free lists. Fidelity Advertisers, G-3838 Washington, Chicago.

ADVERTISE—Sell by mail. Write Good-all Agency, 628 Montgomery, San Francisco.

ADVERTISE: 24 Words, 149 newspapers \$6.50. Lists free. Advertising Bureau, 4515-C Cottage Grove, Chicago.

INCH Display, 28 magazines, 3 months, \$3.00. Paramount Press, Atlanta, Missouri.

LEARN Advertising quickly at home. Easy practical plan. No text books. Common school education sufficient. Interesting booklet and requirements free. Page-Davis School of Advertising, 3601 Michigan Avenue, Dept. 343C, Chicago.

SELL Your product through agents, mail order. Advertise newspapers, magazines. Publishers' rates. Snappy layout your inch advertisement \$1. Martin Advertising Agency, 171M Madison Avenue, New York.

DIRECT-MAIL Advertising services. Sales letters that sell. Mailing lists. Omaha List & Letter Co., Box 2172, South Omaha, Nebr.

ADVERTISING Placed all magazines, newspapers, radio. Lowest rates. Free service. 54 page rate book free. Baker Advertising Agency, A-189 West Madison, Chicago. Successors to Ankrum. Established 28 years.

FREE—New Advertisers Rate Guide, 44 pages. Includes everything. Lowest rates. E. H. Brown Advertising Agency, 140 S. Dearborn, Chicago.

BUSINESS SERVICE

DELAWARE Corporations organized. Free information. Corporation Counselors, Lodge Building, Wilmington, Delaware.

LISTS of all United States manufacturers—5c per name. Stern, 6220 Ellis, Chicago.

RUBBER STAMPS AND OFFICE SUPPLIES

RUBBER Stamps minus rubber 1c per line. Signature 5c. Eveready Duplistamp, 1313 - 40th Street, Brooklyn, N. Y.

NAME And address stamp 25 cents. Sheridan, 441 Westchester Ave., New York City.

CUSHION Stamps. 1 line 25c, 2 lines 35c, signatures \$1.50. Stamp Works, Hastings, Nebr.

2 LINES 25c, 3 Lines 35c. Stamp Works, Auburn, Nebr.

2 LINES 25c, 3—35c. Cushioned. Stamp Works, Centerport, N. Y.

ORIGINAL Cushion mounted. One, two lines, 25c; three 35c; four 45c. Stamp Works, 814 Bradley, Peoria, Ill.

TYPEWRITERS, DUPLICATORS, OFFICE DEVICES

NEW \$3.75 Automatic adding machine. Fully guaranteed. Bassett, Box 302-A, Altadena, California.

MULTIGRAPH, Large, automatic, printing model, \$125.00, with Davidson \$175.00, 8041 Exchange, Chicago.

NEW Typewriters at half price. Free catalog. Richmond Service, 504 Broadway, Sterling, Ill.

INCREASE Business now. "Excellograph" Rotary Stencil Printer reprints thousands everything you typewrite, hand-write, draw or trace. Colors, \$19.75 to \$44. Terms. Illustrated literature free to business or professional men. Pittsburgh Typewriter Supply, Department K-2, Pittsburgh, Penna.

TYPEWRITERS, Adder, mimeograph, multigraph, addressograph. Send for free lists of machines that will help you at half price. Pruitt, 28 Pruitt Bldg., Chicago.

PRINTING, MULTIGRAPHING, MIMEOGRAPHING, GUMMED LABELS

250 ENVELOPES, 6 $\frac{3}{4}$, \$1.00, postpaid. Wilson, 953-A West 68th, Chicago.

500 TWO-COLOR Gummed stickers 25c. Oregon Printing Service, Gresham, Oregon.

TWO Color, 20 lb., white bond, water-marked letterheads \$3.65 M. Norris, B-135, Gillespie, Illinois.

LETTERHEADS, Statements, envelopes, 5000—\$5.95; 6x9 circular \$4.95. (Estimates.) Alpine Press, 325 East 88th, New York.

125 8 $\frac{1}{2}$ x11 TWENTY Pound bond letterheads and 125 envelopes \$1.00 postpaid. Benneville, 907 West Roosevelt, Philadelphia.

GUMMED Mailing labels. Unique, inexpensive. McPherson Stamp Works, Middletown, Conn.

500 LETTERHEADS 8 $\frac{1}{2}$ x11 \$1.00. Samples free. Michaels Service, E. Paterson, N. J.

RAISED 100 Letterheads and envelopes \$1.00. Perry Press, Albion, Maine.

LETTERHEADS, Envelopes, 125 each \$1.00 postpaid. Smith Printery, Hollandale, Wisconsin.

PRINTED Envelopes \$1.10 M. Letterheads, statements. Maloney Sales, 8 North Water, Rochester, N. Y.

INTRODUCING Arista bond printed stationery. 100 sheets, 50 envelopes printed your name, address in blue, only 50c. Samples free. Arista, 648 Broadway, New York.

300 8 $\frac{1}{2}$ x11 LETTERHEADS \$1.00 Postpaid. Other bargains. Universal Service, 203 Avon Avenue, Newark, N. J.

FANCY Gift stationery. Great for Christmas. 100 initialed sheets, 50 printed envelopes in cabinet, \$1.00. Staver Brothers, 1645 So. Weadock, Saginaw, Michigan.

THOMPSON Photo Offset Printing. Rockville Centre, N. Y. Illustrate advertising matter, cuts unnecessary, inexpensive, samples.

6x9 CIRCULARS, Envelopes, letterheads, postcards, \$1.89, quantities. Typewriter letters, slips, labels lowest prices. Samples. Goodprint, Harrisonburg, Va.

\$1.00 POSTPAID 125 Letterheads, 125 envelopes. Tucker, Box 65, Indianapolis.

200 8 $\frac{1}{2}$ x11 BOND Letterheads, 200 6 $\frac{3}{4}$ envelopes or 1000 3x6 circulars, 50 words, \$1.00 postpaid. Franklin Printery, 2932 Pershing, Chicago.

PERSONAL Christmas cards, Christmas letterheads. Samples. Riggs Press, Vevay, Ind.

500 LETTERHEADS, Envelopes \$1.00. Circulars 3x6, business cards 50c. Barence, 22a Fox, Worcester, Mass.

100 ENVELOPES Printed 2 colors 75c. Press, B-232, Rochester, N. Y.

NEED Printing? Good work, service, low prices. Samples free. Loneim Press, Paulding, Ohio.

2000 BUSINESS Cards \$1.50. General printing and estimates cheerfully given. Florence Printing, 270 Lafayette St., Manhattan.

NAME Address printed 100 5 $\frac{1}{2}$ x8 $\frac{1}{2}$ sheets, 50 envelopes, 50c postpaid. Free deal 30 50c business items. 24-hr. service. Beasley, Box 742-PM, Stapleton, N. Y.

1,000 2 $\frac{1}{2}$ x4 LABELS \$1.65; 6 $\frac{3}{4}$ Envelopes \$2.50. Paramount Press, Atlanta, Mo.

PRINTING, Multigraphing. Reasonable. Samples. Circle Press, 2911 Glenwood, Erie, Penna.

PRINT Anything. Lowest prices. Samples free. Hamilton Press, 4341-P Meade, Chicago.

LETTERHEADS, Envelopes, statements, 6x9 circulars, 1,000, \$2.95. Underhill, Beebe, Arkansas.

BETTER Grade printing, free trade illustrations. Reasonable. Economic Press, Leonia, N. J.

500 LETTERS Multigraphed exactly as if typewritten, \$1.70 (20 lines.) Multigraphers, Ashland, Virginia.

EXPERT Typewritten reproductions, letters, pricelists, etc. 100 copies 8 $\frac{1}{2}$ x11—\$1.00. Additional hundreds 20c. Includes paper! Letter-Shop, Dept. P, Cedar Rapids, Iowa.

1000 STICKERS, Four lines, 50c. Labels. Catalog. Cott's, Spickard, Missouri.

1000 BUSINESS Cards \$1.00 post paid. Superba Print, 912 Towne, Los Angeles, Calif.

ILLUSTRATE Freely without cuts. Write for details and prices on photo-offset printing. Roberts Service, 250 W. 49th St., New York.

HAMMERMILL Letterheads, any color paper and ink, 300 8 $\frac{1}{2}$ x11, \$1.48 postpaid. 30 type styles available. Free particulars. Woodruff's, 217A Lewis, Duluth, Minn.

500 3 $\frac{1}{2}$ x2 $\frac{1}{4}$ FOUR Line gummed stickers, 25c. Moritz Printery, Saginaw, Mich.

PRINTING OUTFITS AND SUPPLIES

FONT Of condensed Gothic type and bargain list 25c. Republic, 7150 Cottage Grove, Chicago.

BARGAINS, Presses, type. List 3c. Exchange, D-15, 110 Dexter, Meriden, Conn.

PRESSES, New type that satisfies. Lists 3c. Landis, Richland, Penna.

PRINT Your own cards, stationery, circulars, advertising. Save money. Easy rules furnished. Print for others, big profits. Junior outfits \$8.25, senior outfits \$16.55 up. Details free. Kelsey Presses, H-11, Meriden, Conn.

6x9 STEREOTYPE Caster \$2.50. Free mats. Green, 531 Broadway, Lawrence, Mass.

PRESSES \$4.00. Complete equipment. Send stamp. Bradshaw, 3214-P Huron, Chicago.

SNAPPY Cuts, best art work. List free. Moritz Printery, Saginaw, Mich.

USED Presses, type, supplies. Lists 3c. Turnbaugh Service, Loysville, Penna.

BARGAINS — Presses, type, supplies. Send stamp. 159 Harvard, Cambridge, Mass.

HAND Presses, type and complete printers' supplies. Send stamp for catalog and new price list. P. Peiffer & Co., Newark, N. J.

PATENT ATTORNEYS

INVENTORS—Before disclosing your invention to anyone send for form "Evidence of Conception"; "Schedule of Government and Attorneys' Fees" and instructions. Sent free. Lancaster, Allwine & Rommel, 411 Bowen Building, Washington, D. C.

PATENTS. Protect your idea by securing free "Proof of Invention" folder. Exceptional personal service. Established 1906. E. E. Vrooman, 871 Woodard Bldg., Washington, D. C.

"INVENTOR'S Guide," 100 mechanical movements, free; advises on patenting, selling inventions. Frank Ledermann, Tribune Bldg., New York.

L. F. RANDOLPH, 302-B Victor Bldg., Washington, D. C. Low cost. Book and information free.

PATENTS. Booklet free. Highest references. Best results. Promptness assured. Watson E. Coleman, Patent Lawyer, 724 Ninth St., Washington, D. C.

INVENTORS—Send for free booklet "Patent-Sense." Information based on 64 years experience. Lacey & Lacey, Dept. 5A, 635 F St., Washington, D. C.

INVENTORS: Send immediately for your copies of our new free books, "Patent Protection" and "Suggestions on Selling an Invention." Sixty-eight pages of interesting facts. They tell how Patent Laws protect you; kind of sketch or model needed; simple steps to take without cost; how successful inventors have secured financial assistance; show interesting inventions; illustrate important mechanical movements. With books we also send free Evidence of Invention form to help establish date of disclosure. Prompt service, reasonable fees, special deferred payment plan. Strictest secrecy. Forty-one years' experience. Highest references. Write us today. The facts in our books are worth money to the man with a good invention. Address: Victor J. Evans & Co., Registered Patent Attorneys, 113-M Victor Building, Washington, D. C.

INVENTORS—Time counts—Don't risk delay in patenting your invention. Write for new 48-page free booklet, "Patent Guide for the Inventor." No charge for preliminary information. Clarence A. O'Brien and Hyman Berman, Registered Patent Attorneys, 58-Z Adams Building, Washington, D. C.

ASSISTANCE In selling patents obtained through me. Overnight personal service to midwest inventors. Booklet free. Arthur Sturges, Registered Attorney United States Patent Office, 401 Neville Block, Omaha, Nebraska.

FOR INVENTORS

INVENTORS—Time counts—Don't risk delay in patenting your invention. Write for new 48-page free booklet, "Patent Guide for the Inventor." No charge for preliminary information. Clarence A. O'Brien and Hyman Berman, Registered Patent Attorneys, 58-Z Adams Building, Washington, D. C.

IDEAS Developed. Working models built. All kinds machine and electrical work. Low prices. Confidential service. Reao-Paul Engineering Co., 722 N. Gay St., Baltimore, Md.

WANT Inventions suitable national distribution. Roy C. Burns, LaSalle Hotel, Chicago.

GREAT Meeting and exhibit inventors and manufacturers December, 5-6-7-8. Write for details. Inventors of America, Hotel Leamington, Oakland, California.

INVENTIONS Wanted—Patented, unpatented. If you have an idea for sale write Hartley's, Inc., Box 928-E, Bangor, Maine.

SUCCESSFUL. Appreciative patentee, Miller, 2116 Ave. U, Brooklyn, N. Y., will supply name of his expert, reasonable attorney.

NEED Money or advice to promote your idea or invention—write us. Mid-West Industries, Joplin, Mo.

PROTECTION. You can fully protect your invention for two years at a total cost of only 68 cents. For complete instructions send \$1.00. Inventors Service Bureau, 624 South Michigan, Chicago.

INVENTION Sales Bulletin describing over 500 inventions, showing how we sell inventions, patented or unpatented, with booklet and particulars free. Patentee System, 9443 Pleasant, Chicago.

INVENTORS: "Making Inventions Pay," our 32-page illustrated book, mailed upon receipt of 3c postage. Crescent Tool Co., Dept. Z, Cincinnati, Ohio.

I SELL Patents. Established in 1900. Charles A. Scott, 773PM Garson Ave., Rochester, N. Y.

WE Locate buyers meritorious patented, unpatented inventions. If will sell, reply immediately. Descriptive booklet free. Invention Reporter, 5A-11236 South Fairfield, Chicago.

INVENTORS—Send for 72-page book on patents. Reasonable terms. Conscientious treatment to inventors. L. F. Randolph, Registered Patent Attorney, 302-E Victor Bldg., Washington, D. C.

HAVE You a sound, practical invention for sale, patented or unpatented? If so, write Chartered Institute of American Inventors, Dept. 4-A, Washington, D. C.

INVENTORS: Profit by your invention. A practical talk to inventors by an experienced manufacturer. Our 68 page booklet "Mind vs. Matter" mailed upon receipt of 25c. Rex Engineering Co., Cincinnati, Ohio, Dept. D.

INVENTIONS WANTED

DON'T Let your patent die. Thousands of buyers waiting. I sell inventions. Robert Clarke, Box 101, Station B, Toledo, Ohio.

INVENTIONS Of merit wanted for marketing. We design and build working models which put over your ideas. Write for "4-Points of Service" bulletin. R. & S. Engineering Co., Dept. M111, 17 East 42nd Street, New York City.

INVENTORS: Sell your idea direct. Eliminate brokers commissions. Twelve manufacturers and capital rating \$1.00. National Inventors Service, Box 404, Chicago.

WANTED—Meritorious patented, unpatented inventions. Booklet free. Invention Reporter, 5B-11236 So. Fairfield, Chicago.

SMALL Inventions wanted by manufacturers. I'll help you sell your invention. Write for free circular. Stanley Hull, 7829-K Euclid Avenue, Cleveland, Ohio.

SIMPLE. Practical inventions wanted by manufacturers, patented or unpatented. For information write Chartered Institute of American Inventors, Dept. 4-D, Washington, D. C.

CASH For inventions patented or unpatented. Stamp appreciated. Mr. Ball, 9441-A Pleasant, Chicago.

PATENTS FOR SALE

ATTENTION Invention buyers. Have practical invention for fruit picking, fishing, hunting, general uses. Also holdup-proof. Cashiers wicket. Cheap construction. Present system partly useful. Royalty or outright. J. Pankovich, 620 Barton, Hamilton, Canada.

EXPANDING Mandrel, open end, centerless, pneumatic operated, especially adaptable for machining shells and pistons. Patent pending. Paul Ash, 1124 West State Street, Milwaukee, Wisconsin.

MANUFACTURERS: For new products or profitable manufacturing opportunities, inquire. Invention Reporter, 5C-11236 So. Fairfield, Chicago.

SELL Your patent through a small classified ad in Popular Mechanics. Many inventors have found buyers in this way. Ask me for proof—I'll gladly send it to you. F. W. Johnson, Manager Classified Advertising, 200 E. Ontario St., Chicago.

MANUFACTURING

INVENTIONS Developed, manufactured in any quantities. Low cost. Metal specialties, stampings, dies, models built. Free estimates. Write for "4-Points of Service" bulletin. R. & S. Engineering Co., Dept. M 112, 17 East 42nd Street, New York City.

DIES, Stampings, models, tools. Complete service. Porsberg Engineering, Northfield, Ohio.

INVENTIONS Manufactured by an experienced company, in any quantity at low cost. Metal specialties, novelties, stampings, dies, and models. Free estimates. Our booklet "Mind vs. Matter" sent upon receipt of 25c. Rex Engineering Co., Cincinnati, Ohio, Dept. C.

INVENTIONS—Manufactured in any quantity at low cost by old established company. Stampings, metal specialties, dies, models, etc. Free estimates. Send for catalog. Crescent Tool Co., Dept. X, Cincinnati, Ohio.

MODELS AND MODEL SUPPLIES

MODEL Supplies for the inventor. Send 3c stamp for catalog. Pierce Model Works, Tinley Park, Ill.

MODEL Railroad Shop, Dept. PM, Dunellen, New Jersey. Catalog 10c.

BUILD Your own Marblehead model sailing yacht by the half-lift method. Simplifies construction. Keeps expenses down. Includes full-size station templates for 50"-800 yacht. Send 50c to Bruce-Milwaukee, 1307 Montgomery Building.

RAILWAY Models. Catalog handbook 25c. Walthers, 247 E. Erie, Milwaukee.

STEAM Locomotives! $\frac{3}{4}$ " scale. Build one by "Easy Steps." Our illustrated catalog lists all needs. 25c. Little Engines, Box 15B, Wilmington, Calif.

BUILD Ship models, coach models, covered wagon. Complete kits \$1.00 to \$6.00. Fully shaped and finished redwood hulls, all parts cut to fit including masts and yards, sails, chain, wire, nails, string and other parts. Detailed drawings and full instructions. Send 3c stamp for catalog. Miniature Ship Models, Dept. R, Perkasie, Penna.

MINIATURE Boat and airplane supply catalog 5c. Selley, 1377 Gates Ave., Brooklyn, N. Y.

POWER Models for railways, ships, accessories, tools, metals. Catalog 35c. Chas. Cole, Ventura, Calif.

ENGINE Catalogue castings, supplies, 25c. Howardco, A-2417 North Ashland, Chicago.

SPEED! Model power boats! Racing hull construction kits. All classes. Engines, accessories. Cruiser kit. Free literature. St. Louis Model Boat Co., Clayton, St. Louis, Mo.

MODELS—Your ideas developed into practical working models. 30 years successful experience; thousands of satisfied customers. Confidential service guaranteed. Bank references. Send 3c postage for our large booklet—"Making Inventions Pay." Crescent Tool Co., Dept. Y, Cincinnati, Ohio.

MODELS—Practical models put over your ideas. We develop models from the crude to perfect working devices. Your idea might have large commercial value. Services confidential. Bank references. Registered graduate engineers at your service. Send 25c for our 68 page booklet "Mind vs. Matter." Rex Engineering Co., Cincinnati, Ohio, Dept. B.

MODELS Made of your ideas. Inventions manufactured. Write for estimates. Model Engineering, Dept. C, Osgood, Ind.

BLUEPRINTS AND PLANS

BLUEPRINTS. "Microgrind" for drill press surface grinding 50c (casting \$1.00); "Triplirigid" boring bar 35c. Circular free. Craftsman's House, Avoca, Penna.

HOME CRAFTSMEN

MOTOR-IN-HAND Tool owners! 24-page book containing 41 designs for carving wood, plastics, \$1. Dremel Co., B119-L, Racine, Wisconsin.

SQUAREKNOTTERS! Make belts, handbags, etc. Quality cord samples with catalog, free. Beginners book, catalog and samples, 10c. Special! Regular \$1 book with 50c beginners outfit, all for \$1. P. C. Herwig Co., Dept. J-18, 121 Sands St., Brooklyn, N. Y.

22 FULL Size lawn ornament patterns 25c coin. Strother, Box 383-AY, Belington, West Virginia.

GET Free leathercraft instructions, prices of leathers, tools, projects. Make extra money. Beautiful gifts. Leather samples 5c. Wilder & Company, 1038 Crosby, Dept. 11F, Chicago, Ill.

20 **FULL Size** lawn ornament patterns 25c. Wickham, 744 Brooklyn, Dept. 75, Dayton, Ohio.

MEXICAN Wood novelties easily made. Our 20 patterns and instructions 25c. 20 cowboy silhouette patterns 25c. 10 lawn ornament patterns 15c. Mexican Arts, Crafts, Eagle Pass, Texas.

WOODWORKER'S Bench vice for 25c. Screw type. 10" jaws. Send 25c, in coin, for instructions. The Craftshop, Box 296, Wheaton, Ill.

AMERICAN Walnut wood noted for its beauty and scarcity at a reasonable price you can afford. Satisfaction guaranteed. No charge for cutting to special dimension. Write for prices. Henry Dambeck, R-2, B-111, Millville, N. J.

20 **LAWN** Ornament patterns, 20 novelty patterns, 14 silhouette patterns, 15 different lawn ornament patterns, 30c each, all \$1.00. Modern Woodcraft, Saginaw, Mich.

16 **OLD** West patterns 50c. Good Christmas numbers. Wilco, Box 109, Elizabeth City, N. C.

SAMPLE Osage cabinet wood. Stamp. Stuart Keneipp, Mt. Carmel, Ill.

MONEYMAKING Christmas projects. Blueprints, wood-kits, construction sets. Illustrated catalog 10c. Woodcraft Service, Plainview, Minnesota.

KNOCKDOWN Furniture, lumber, veneers. Illustrated catalog 10c. Giles-Kendall Co., Decatur, Alabama.

FOR THE HOME

FIREGUARD Furnace fuse—Protects furnaces. Prevents fires, easily installed. \$3.00 postpaid. Distributors wanted. Ramey Mfg. Co., Dept. M, Columbus, Ohio.

VACUUM Cleaners and parts. Write for bargain circular. Talley's, Charlotte, N. C.

LARGE Ships wheel ash tray \$1.25. Paper knife \$1.00. Both solid walnut, hand turned, inlaid with beautiful contrasting Minnesota hardwoods. Shattuck, Altura, Minn.

OLD GOLD, WATCHES, JEWELRY, PRECIOUS STONES

WATCH Parts, tools, supplies. Write for price list 43. Dean Company, 87 Nassau Street, New York.

AGATES, Gems, minerals. 20 gemstones \$1.00. Pricelist free. Hill, Route 7, Salem, Oregon.

WATCHMAKERS' Materials—Tools, watches, jewelry bought, sold, exchanged. Ben Segal's, 5 South Wabash, Chicago.

AUSTRALIA'S Lovely opals. Illustrated catalogue free. Good selection \$5.00. Norman Seward, Melbourne, Australia.

HIGHEST Prices for old gold—Mail your teeth, watches, jewelry. 100% full cash value mailed day shipment received. Satisfaction guaranteed or articles cheerfully returned. Information free. Chicago Gold Smelting Company, 300-P Champlain Building, Chicago.

5000 **REBUILT** Elgin, Waltham, Hamilton watches. Also ladies, gents wrist watches. Make big money! 12 size, 7 jewel, Elgin or Waltham, \$4.75; 16 size, 17 jewel, \$7.50. Send for free watch and diamond catalogue. The New York Jobbers, Dept. M, 74 Bowery, New York, N. Y.

GOLD \$35 Ounce. Ship old gold teeth, crowns, jewelry, watches—receive cash by return mail. Satisfaction guaranteed. Free information. Dr. Weisberg's Gold Refining Co., 1500-Q Hennepin, Minneapolis, Minn.

BULOVA, Gruen, Elgin, Waltham wrist and pocket watches for ladies and gents. Positively lowest wholesale prices. 1940 styles now available. Write for free money making wholesale catalogue. Norman Rosen, Wholesale Jeweler, Dept. P.M., 801 Sansom Street, Philadelphia, Penna.

HOW To identify and determine value of old precious metals. Where to buy. To whom to sell. Reliable and up-to-date information. Complete instructions only \$1 postpaid. Popular Mechanics Press, Room (C39), 200 E. Ontario St., Chicago.

TOBACCO

PAY When received. Good Red Leaf chewing or smoking 15 pounds \$1.00. Prompt shipment. Jim Ray, Ralston, Tenn.

LOOK! Try cheaper tobacco! Then taste our milder golden smoking or rich ripe chewing, four pounds, postpaid, \$1.00 Riverside Ranch, 201, Hazel, Kentucky.

"**COMMON** Sense"—If satisfied you will order again. Virginia's golden burley; 25 hands \$1.00, 60 hands \$2.00, postpaid. Graylodge, Alvarado, Va.

DRYBOL Pipes give smokers far greater enjoyment. Saliva and nicotine controlled. Simple, practical, serviceable, economical, healthful, standard design. \$1.00 each. Agents wanted. John McLaren, 154 Nassau Street, New York, N. Y.

GUARANTEED: Cigarette, pipe or chewing 5 lbs. \$1.00, ten, \$1.75. Pay when received. Pipe and box cigars free. Rives Tobacco Co., Paducah, Ky.

RAZORS AND RAZOR BLADES

"**KEENEREDGER**" Produces 1075 shaves per blade. \$1.00 prepaid. Keeneredger, Oblong, Ill.

100 **HIGH** Quality doubleedge blades, and new revolutionary patented razor, all for \$1.00 postpaid. Riordan Company, Box One, Linwood Station, Detroit, Michigan.

FOR SALE—MISCELLANEOUS

SEND \$1.00 And receive two beautiful neckties. Satisfaction or money refunded. Dolly, Box 1327, Washington, D. C.

WANTED—MISCELLANEOUS

WANTED. Novelties, pictures, gadgets, appealing to bars and taverns. Send details. Fritzel Laboratories, Pittsfield Bldg., Chicago.

CASH For used microscopes, binoculars, slide rules, drawing sets, scientific instruments, cameras, shotguns, golf sets. Write details. Elman's 2302 Van Buren, Chicago.

PERSONAL

DEAFNESS Is misery. Miller's artificial ear drums recommended. Free information. R. Miller, 801 Gramercy Drive, Los Angeles, California.

STAMMERING Scientifically corrected. Practical, home training. Normal Speech Mail Course, 236 Palmer, Grand Rapids, Mich.

POSITIONS Abroad—Romance, opportunity, adventure. If interested write Julius, Amarillo, Texas.

FINEST Printed personal stationery. Samples. Adkins Co., C601, Union, N. Y.

GENUINE Leather zipper billfolds \$1.00 postpaid. Tanners Leathercraft, 700 Broadway, Chelsea, Mass.

NERVOUS? Fears? Depressed? Afflicted? Free helpful information. Norman Ferngold, Psychologist, Office 15, 38 Shirley Street, Worcester, Mass.

WIN Prize money: Booklet—"Successful Contesting"—shows how, 10c postpaid. Bulletin listing \$100,000.00 prizes included. World Publishers, 4515-B Cottage Grove, Chicago.

TREASURE Finders? Read Goldak advertisement on page 134A.

YOUR Eyes trained to overcome weakness, astigmatism, nearsightedness without glasses. Complete guaranteed course \$1.00. Eyesight Improvement, Box 193, Hamilton, Ohio.

PAINS—Legs, hips, back, possibly compressed spinal cushions. Inventor with same trouble devised Spinolaxer, gives instant relief. Guaranteed. Not worn on body. Periodic use may eliminate trouble. \$4.85. Simmonds Co., Rt. 4, Box 3623, Sacramento, Calif.

EARN Money in your spare time taking subscriptions to Popular Mechanics. Unlimited possibilities, every family a prospect. Easy to sell. Bonus paid in addition to liberal commission. Send postcard for further details today. Circulation Dept., Popular Mechanics Magazine, 200 E. Ontario St., Chicago.

MISCELLANEOUS

EXOTIC Christmas gifts for mother, wife, daughter, sister, sweetheart. Genuine Mexican sterling silver filigree, bracelets, sets, guaranteed. Send \$2.00 for sample. Flores, Vallarta 1994, Guadalajara, Jalisco, Mexico.

SWAP Or sell articles you don't need for those you want. Send dime for Swapper's Guide listing articles from everywhere. Dept. PM, Swapper's Guide, Delphos, Ohio.

EMBOSSED Signs made to order. Name plates, window and counter displays. Any color. Sample with your own copy 25c. Signograf, 739 Cole, San Francisco.

HUMANE Rat and animal trap catches in droves, inexpensive to manufacture. 94 in three nights. W. C. Schryver, Polo, Ill.

AMAZING Climbing tomato! Bears 12 months! Yields 5 cases! 60c packet. N. S. W. Seed Co., Sydney, Australia.

PRIZE Contest money! You can win plenty! Stamp brings opportunity! National Contest Bulletin, (Dept. P.), Box 634, Grand Central Station, New York City.

PIRATE Treasure map agency opportunity. Copy map and details 50c. Goodacre, Box 73, Santa Barbara, California.

GOOD Eyesight without glasses. A new invention. Satisfaction guaranteed. Arthur Jacobson, Upsala, Minnesota.

WIN Prize contests. Sample magazine 10c. Box 39, Braxton, Miss.

2240 **WORDS** Article explaining four Voodoo ceremonies. \$1.00. Chas. Gray, Kingshill, Virgin Islands.

INFORMATION. Any subject. Moderate fee. International Research, 2737 Francis Ave., Los Angeles.

TEN Drawer cabinet kit. 1 1/4 x 3 3/4 x 4 3/4 inch drawers 75c. Finished cabinet \$1.50. 10c extra west Mississippi. Taylor, 120 W. Howard, Hagerstown, Md.

LUMINOUS Paint shines at night 25c. Myers, 26, Niles, Mich.

STOP! Your dollars are burning up, save them! Use boiler compound, \$2.50. Anthracite Boiler Compound Co., Scranton, Penna.

DYES. Beautiful shades. Any color. 10c package. Jalco, 14 Mechanics, Allston, Mass.

IRISH Family name book. Meanings, origins, clans, histories, coats of arms, crests, mottoes and Gaelic printed and written forms. 450 arms illustrations, 3550 names. \$2.00. O'Connor and Kelly, Box 5351, Chicago.

TREASURE Finders? Read Goldak advertisement on page 134A.

AMATEUR Tattooing outfits. Illustrated list free. Tatucco, 651 South State, Chicago.

HAND-WOVEN Ties \$1. Write for free sample of tie material and 32 colored pictures of patterns. Log Cabin Hand Weavers, 11 Post Road, Oregon City, Oregon.

ANY Three questions answered about New York or its inhabitants \$1.00. Reliable, confidential. Individual research. No guesswork or stock answers. Information Service, P.O. Box 149, Grand Central Annex, New York City.

COATS Of arms and crests, correctly painted in colors or black and white, from heraldic description or furnished copy, \$10.00 and up. Highest grade work. Heraldic Studios, 1914P Oakdale Avenue, Chicago, Ill.

TATTOOING Outfits, supplies, illustrated list free. Percy Waters, Anniston, Alabama.

REFINE Used oil without cost. Particulars. F. Gerwin, Fairview, Oklahoma.

SWAPPER'S Friend, R4, Saline, Michigan. Interests swappers, collectors, 50c year, sample 10c.

MAKE It Yourself—Hundreds of practical and useful devices described in our big book. Plain instructions and illustrations show you how. Save money on things for yourself or make profit selling to others. 900 articles, 480 pages, 823 illustrations, \$3 postpaid. Popular Mechanics Press, Room (C39), 200 E. Ontario St., Chicago.

Learn to MOUNT BIRDS

SEND FOR FREE BOOK!



LEARN AT HOME
Be a Taxidermist

Real FUN, great Hobby, sure spare-time profits. Save your hunting trophies. Mount BIRDS, ANIMALS, HEADS, FISH, TAN furs and hides. Mount common specimens into fine groups. Wild-game not needed. Easily, quickly learned. Investigate!

FREE BOOK Yes FREE. 100 pictures. Tells how YOU can be a Taxidermist, make a home museum, have fun and PROFIT from your HOBBY. Old reliable school, 250,000 successful students. Students earn BIG PROFITS mounting specimens for others. This strange FREE BOOK will interest and amaze you. Nothing like it—Send TODAY—this MINUTE—for YOUR Free copy. State your AGE.

N. W. School of Taxidermy, 3378 Elwood Bldg., Omaha, Neb.

ENGINEERING DEGREE IN TWO YEARS

B. S. Degree courses in engineering: Electrical, Civil, Chem., Mechanical, Radio and Television, or Aeronautical. 1 yr. Mech. Drafting. Intense, practical, thorough program. Large industrial center. Prep courses without extra charge. Earn board if desired. Low tuition and living costs. Enter December, March, June, September. Write for Catalog.

239-A E. Washington Blvd., Fort Wayne, Ind.

INDIANA TECHNICAL COLLEGE

LEARN MONEY-MAKING CARTOONING

by America's most famous method. Hundreds of successes! Start today—soon draw for pay. Rush 10c for details and big Picture Chart to test your ability (state age). THE LONDON SCHOOL, 1039 National Bldg., Cleveland, Ohio



Learn How to Write

Write for my Free Book, "HOW to BECOME an EXPERT PENMAN," which shows how others became experts by my Method. Supplies furnished to students. Your name elegantly written on a card if you enclose stamp. Write Today. T. M. TEVIS, Box 25K, CHILLICOTHE, MO.

Learn Public Speaking At home—in spare time. Many overcome "stage-fright," gain self-confidence and increase earning power, this easy way. Write for free booklet, *How to Work Wonders With Words* and requirements. North American Institute, Dept. 1358, 3601 Michigan Ave., Chicago, Illinois

Saw-Filing

Pays up to \$2 or \$3 an Hour in Spare Time

A FOLEY Automatic Saw Filer files hand, circular and band saws better than the best hand filer. Cash business, no canvassing, no eyestrain. No experience needed. Louis P. Wadowick, Ohio, says, "I have filed 764 saws in spare time and have earned \$850.02 in carpenter work due directly to my saw filing contacts." Send coupon for FREE PLAN, no obligation.



FOLEY MFG. CO. 1116A-9 Foley Bldg., Minneapolis, Minn.

Send Free Plan on Saw Filing business.

Name.....
Address.....

HOW TO MODERNIZE YOUR OLD RADIO

MIDWEST FACTORY-TO-YOU 20th ANNIVERSARY SPECIAL!

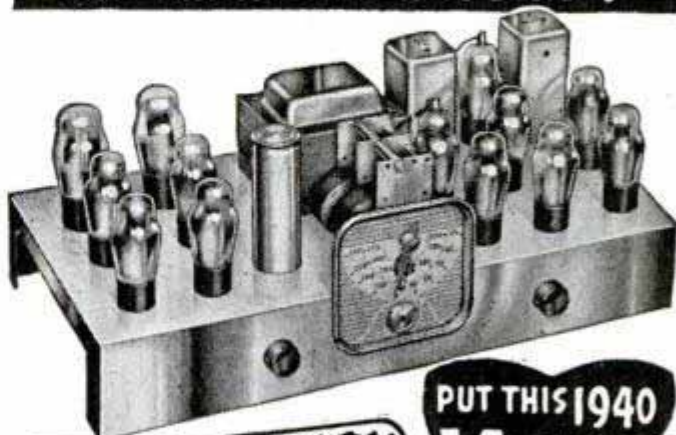

WITH TELEVISION ADAPTATION

Here's today's biggest radio value—the 1940 TELEVISION - ADAPTED Midwest—at sensationally low factory-to-you-price. Now enjoy exciting foreign reception. Absolute satisfaction guaranteed on money-back basis. Send 1c postcard for FREE 1940 catalog. (User-agents make easy extra money!)

See Midwest's Answer to TRADE-INS!

PUT THIS 1940 14 TUBE CHASSIS IN YOUR PRESENT CABINET

\$19.95
COMPLETE CHASSIS WITH TUBES AND SPEAKER



SAVE UP TO 50%
30 DAYS TRIAL
EASY PAY PLAN

14-TUBE CONSOLE
\$29.95
COMPLETE

MIDWEST RADIO CORPORATION
Dept. 15-F Cincinnati, Ohio

PASTE COUPON ON 1c POSTCARD...OR WRITE TODAY!

MIDWEST RADIO CORPORATION Cincinnati, Ohio Dept. 15-F
Send me your new FREE catalog, complete details of your liberal 30-day Trial offer and factory - to - you prices.
Name.....
Address.....
Town..... State.....
User-Agents Make Easy Extra Money. Check here [] for details.

Big Profits!

IN NEW PROFESSION

Start Earning At Home



No soliciting! No canvassing! We show you how to make big money decorating fast-selling Giftwares. We start you with a big \$10 Artist's Outfit. We supply you with \$150 worth of Giftwares free of extra charge and show you how to dispose of them without leaving your home. We give you 29 Tested Plans for making money. One Fireside Member says, "I made \$100 on furniture in one week." Another writes, "My sales were \$500 for 5 weeks. This is my first year." R. M. P., of Ill., says, "I did \$3,500 worth of business last year and over \$12,000 this year." D. W., New Mexico, reports, "I would not take \$1000 for my course."

No Experience Needed
You too may have a splendid income opportunity with Fireside. No tiresome study. You learn by doing. No artistic ability necessary. Our easy 3-Step Method makes the work easy to learn and easy to do and fits you to make good money practically from the start.

Quick Sales in Your Home
No need to leave the house to dispose of everything you make. Our new automatic salesman does all the selling for you. Designed to quickly find cash buyers for your Giftwares.

No Cost Plan
Mail coupon for Free Plan showing how to earn your course and Big Profits besides.

Fireside Industries
Dept. 66-S, Adrian, Mich.
Send me FREE Book on Home Decorating for a big steady income. Also details of plan that will pay for my course and give me big profits besides.

FREE!
Book on decorating at home for big money. Tells how to get big assortment of beautiful Giftwares free of extra charge.

NAME
ADDRESS
CITY STATE

When writing please mention Popular Mechanics

EASIER than EVER



To Master, this New 1940 P-A

● Just touch a key and blow normally; you can't miss. So easy, and such beautiful tone. Nothing to compare with these new P-A Saxes, Clarinets, Trumpets, and other P-A instruments. Fully guaranteed; your success assured. See your music dealer or write direct for beautiful free book. No obligation. Easy terms. Greatest fun, easiest with P-A. Write today sure.

1975
PAN-AMERICAN
1103 P-A Bldg. Elkhart, Indiana

FREE BARGAIN CATALOG of BOOKS

25,000 books of all publishers listed in our 45th Annual Bargain Catalog of 320 pages. Old-time favorites—latest "best sellers." Reference, Fiction, Juvenile, History, Scientific, etc. Supplying schools, colleges, libraries and thousands of individual customers. Send postcard today for our new 1940 catalog, "Bargains in Books."

THE BOOK SUPPLY COMPANY, Dept. 130
564-566 West Monroe Street, Chicago, Illinois

Correspondence Courses in RADIO and ELECTRICAL ENGINEERING LOW AS \$25

ELECTRICAL ENGINEERING. Get good grasp of wide electrical field. Modern. Very understandable. Theory made easy.
RADIO ENGINEERING. Extra fine course in radio, public address, photo-electric work. Trains you to be super-service man, real vacuum tube technician. Tuition ONLY \$25, either course. Deferred payment plan. Experiment kits furnished.
FREE Write for free copies of school catalogs, student magazines, etc.

FREE LINCOLN ENGINEERING SCHOOL, Box 931-P11, Lincoln, Nebr.



ITALIAN ACCORDIONS

HAND MADE. Very best. Lowest prices. Direct from Factory Representative. Send your name and address for FREE catalog.
ITALIAN ACCORDION COMPANY
323 W. POLK ST., DEPT. P-3 CHICAGO, ILL.

Learn to play..

Easy lessons at home. Inexpensive. 132-page Music Dictionary FREE when you enroll. Stop lessons when you like. Money back guarantee. Write for free details. **Hamann Institute, 3016 N. 24th Place, Dept. R-11, Milwaukee, Wis.**

Hawaiian Steel Guitar
Spanish Guitar
Piano

FREE →

"SCIENCE AND EXPERIMENT" magazine monthly to members! Cramped full of the most interesting, fascinating experiments in all sciences. Free prizes, apparatus, books, etc. Send postage, only 3c for free magazine and booklet.
SCIENCE AND EXPERIMENT MAGAZINE, 4931-N Hamlin Ave., Chicago

Earn Cash at Home!



We paid M. M. \$1174 for exceptional cellar crop Snow-King mushrooms! We furnish materials; buy all crops. Big FREE picture book tells if your cellar, shed, barn, suitable. *Est. 1908.* Write today, **United Co., 3848 Lincoln Av., Dept. 308, Chicago**



Save 3 Ways With New Improved LACO

Still MORE HEAT at Still Lower Cost!

INSIDE A Heater is where you find its real "works!" Inside the New LACO you find TWO great units—(1) LACO's proved "2-stage" heater, and (2) a patented, newly improved INNER HEATING UNIT! The unit's large-surface steel walls become intensely hot. Air moves upward and around the hot unit and through a special sloping flue . . . absorbs an immense load of heat . . . delivers extra volume of slow-moving, moist, heated air into the room. Beautiful outer cabinet of heavy auto-body steel, electrically welded into solid unit. Guaranteed.



WRITE See your LACO dealer or send for free folder, prices.
DEALERS Money-making opportunity. Low prices, big discount.
LACO OIL BURNER CO., 1119 Union Ave., Griswold, Iowa

FOR FURNACES Newest "Gun-Type" LACO. Special "Pressure Carburetor" feature transforms cheap oil to finest mist, produces extra-rich mixture. Get new folder, money-saving price.

POPULAR INVENTIONS

(Continued from page 34A)

INDICATIVE of the railroads' desire to speed up service to the shipper, the Pennsylvania Railroad has been assigned a patent covering a highway rail vehicle designed for carrying freight. It is a truck equipped with two pairs of rubber-tired wheels for travel on the highway and with two pairs of wheels for use on the standard tracks. Means of lowering the railroad

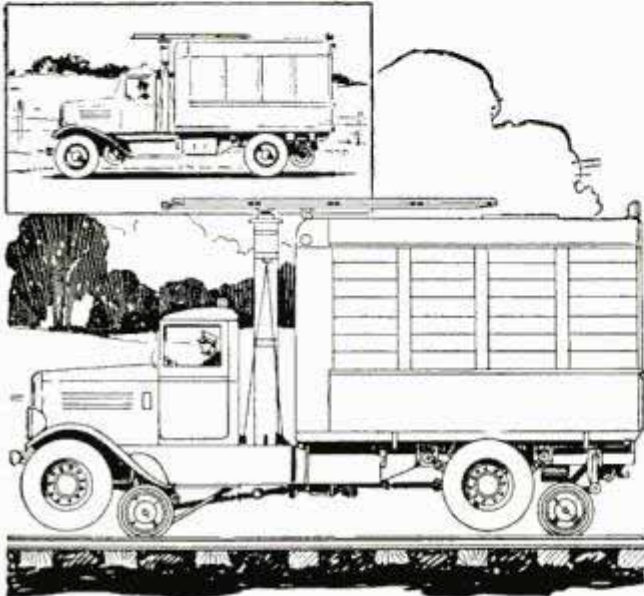

wheels into contact with the tracks and of elevating the highway wheels is provided. Freight would be picked up at the shipper's place of business by the truck traveling on the rubber-tired wheels and carried to the railroad, where the rail equipment would be employed to reach the town of destination. There the highway wheels again would be brought into use to carry the load direct to the consignee's door.

WHEN automobiles become old enough for the windows to rattle, a patented

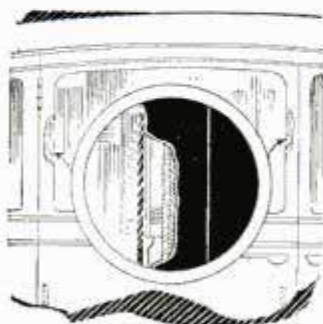

silencer is handy for preventing the window glass from creating annoying noises. The silencer is a clip that fits into a glass guide channel and exerts inward pressure against the guide channel. It has outwardly directed edges at one end and along three sides of the guide groove for engaging the casing.

(Continued to page 58A)



High School Course at Home

Many Finish in 2 Years

You can complete this simplified High School Course as rapidly as your time and abilities permit. Equivalent to resident school work—prepares you for entrance to college. Standard H. S. texts supplied—Diploma. Credit for H. S. subjects already completed. Single subjects if desired. High School education is very important for advancement in business and industry and socially.

College Entrance

During the past 14 years, our High School graduates have been admitted to 531 different Universities, Colleges, Junior Colleges and Normal Schools—80% of them without entrance examination. Course also prepares for teachers' certificate and pre-professional examinations.

Business—Industry

To get and hold a good position in Business today you must be able to write clear, accurate letters and reports—do figuring involving Algebra and Geometry—talk intelligently on matters requiring a knowledge of Geography, History, and Economics.

In Industry—Mechanical and Engineering lines—you must have at least an elementary knowledge of Physics and Chemistry—be able to figure quickly and accurately—know something of Mechanical Drawing and blueprints—and be able to talk and write accurately and clearly on both your work and ordinary topics of conversation.

Our High School course meets the preparatory educational requirements for Business and Industry.

An Educational Institution

The American School was chartered in 1897 as an educational institution, not for profit—and is exempt from paying Federal income tax, like the best resident colleges and universities.

Don't Be Handicapped—
Complete Your Training Now

Be a High School Graduate! Prepare yourself for promotion in Business and Industry—for the Professions, College Entrance and social success. No matter what line you may select, High School training will prove invaluable to you! Our moderate fees cover all instruction, standard textbooks and Diploma. Easy monthly terms. Get ahead in life. Start your training NOW!

20 Other Courses

Over 150 noted Educators, Engineers, and Business Men helped prepare our special instruction material, which is used by many resident schools and colleges, U. S. Navy, and Province of Manitoba, Canada. We offer you quality training at home for the best-paying lines of Industry and Business, as listed in the coupon.

Mail coupon for information about line that interests you

American School, Drexel at 58th, Chicago

American School, Dept. H-445, Drexel at 58th, Chicago

Tell me how to train for success in line checked. No obligation.

- | | |
|--|--|
| <input type="checkbox"/> High School Course | <input type="checkbox"/> Diesel Engineering |
| <input type="checkbox"/> Accounting & Auditing | <input type="checkbox"/> Drafting & Design |
| <input type="checkbox"/> Architecture & B'lding | <input type="checkbox"/> Liberal Arts |
| <input type="checkbox"/> Automotive Engin'ring | <input type="checkbox"/> Private Secretary |
| <input type="checkbox"/> Business Management | <input type="checkbox"/> H'ier Ac't'g (C.P.A.) |
| <input type="checkbox"/> Com'ercial Aeronautics | <input type="checkbox"/> Highway Engin'ring |
| <input type="checkbox"/> Electrical Engineering | <input type="checkbox"/> Mechanical Engin'ring |
| <input type="checkbox"/> Electrical Refrigerat'n | <input type="checkbox"/> Radio & Television |
| <input type="checkbox"/> Air Conditioning | <input type="checkbox"/> Salesmanship |
| <input type="checkbox"/> Civil Engineering | <input type="checkbox"/> Steam Engineering |
| <input type="checkbox"/> Complete Law | |

Name.....

Address.....

Diesel... *the NEW POWER*



The amazing performance of the Diesel powered Burlington Zephyr trains has opened a new era of power efficiency. Airplanes, automobiles, great industrial plants will soon be using these marvelously efficient engines. This means a new profession, a new trade for thousands of men. Learn Diesel operation, construction and repair NOW through our brand new quick reference cyclopedia, the only complete encyclopaedia on Diesel Engineering.

6 Big Books Shipped FREE

for examination. If you want to get into the most promising new field of the century, the liveliest, most up-to-date, most talked of profession, send for these books on our amazing free shipment minute. Over 2500 pages profusely illustrated and right up to the minute. Examine these books, read them, test them and if not thoroughly satisfied return them at our expense and you won't owe us one cent.

Brand New 1939 Edition

This brand new 6 volume edition of Diesel Engineering is the last word in Diesel information. Brought right up-to-date by a group of prominent engineers, makes it the final authority for beginners and experts alike. Six large volumes, handsome, durable binding. 2500 pages, covers Diesels from theory to design, electricity and its application through diesel power, in fact, all related subjects to help you master this NEW, BIG PAY profession.

AMERICAN TECHNICAL SOCIETY,
Drexel at 58th Street, Dept. 0819, Chicago, Ill.
You may send me the new 6 volumes on Diesel Engineering for ten days free examination. I will pay the few cents express only. Will examine the books and return them in ten days unless I decide to keep them, in which case I agree to send you \$2.00 in ten days and \$3.00 a month until the total price of only \$24.80 is paid.
Name
Address
City State

Please attach a letter giving age, occupation and the name and address of your employer and that of at least one business man as reference.

AUDELS Carpenters and Builders Guides 4 vols. \$6



Inside Trade Information for Carpenters, Builders, Joiners, Building Mechanics and all Wood Workers. These Guides give you the short-cut instructions that you want—including new methods, ideas, solutions, plans, systems and money saving suggestions. An easy progressive course for the apprentice and student. A practical daily helper and Quick Reference for the master worker. Carpenters everywhere are using these Guides as a Helping Hand to Easier Work, Better Work and Better Pay. To get this assistance for yourself, simply fill in and mail the FREE COUPON below.

Inside Trade Information On:

How to use the steel square—How to file and set saws—How to build furniture—How to use a mitre box—How to use the chalk line—How to use rules and scales—How to make joints—Carpenters arithmetic—Solving mensuration problems—Estimating strength of timbers—How to set girders and sills—How to frame houses and roofs—How to estimate costs—How to build houses, barns, garages, bungalows, etc.—How to read and draw plans—Drawing up specifications—How to excavate—How to use settings 12, 13 and 17 on the steel square—How to build hoists and scaffolds—skylights—How to build stairs—How to put on interior trim—How to hang doors—How to lay floor—How to paint.



THEO. AUDEL & CO., 49 W. 23rd St., New York City

Mail Audels Carpenters and Builders Guides, 4 vols., on 7 days' free trial. If O.K. I will remit \$1 in 7 days, and \$1 monthly until \$6 is paid. Otherwise I will return them. No obligation unless I am satisfied.

Name.....
Address.....
Occupation.....
Reference..... P.M.

Easy to Play

THE SMALLEST, LIGHTEST, FULL-VOLUMED 90 BASS ACCORDION EVER DESIGNED. IT'S THE NEW SOPRANI AMPLIPHONIC MIDGET

Think of it! 34 treble, and 90 bass keys, beautiful tone, amazing volume. See and try this wonderful new Soprani at your dealer's, or write for FREE booklet. Dept. 1129 SOPRANI, INC. 630 S. Wabash Chicago, Ill.

STUDY ENGINEERING AT HOME

Earn a Degree at Home
From A Chartered Institution Of Higher Learning
Employers Demand Degree Men For Key Positions
88 Degree Courses in Electrical, Mechanical, Civil, Structural, Diesel, Architectural, Drafting, Automotive, Aeronautical, Radio, Refrigeration, Air Conditioning, Highway, Mining, Geology, Petroleum, Marine, Industrial, Chemical Engineering; Arts; Sciences; Philosophy; Psychology; Chemistry; Education; Business Training; Law; etc.
McKinley-Roosevelt Graduate College, 4750-E Sheridan Road, Chicago

Established 1902

New York Electrical School

Ask for free illustrated booklet
44 West 17th St., N. Y. C.

DIESEL

Maximum training minimum time; practical and theoretical. Modern equipment, experienced teachers. Personal instruction. 40th year. Catalog free. Residence course in three months.
FINLAY ENGINEERING COLLEGE, 10th & Indiana, Kansas City, Mo.

ARTISTS MAKE MONEY

Find out your ability. Send name, age, occupation and address for Free Vocational Art Test.
Federal Schools, Inc., 11139 Federal Schools Bldg., Minneapolis, Minn.

TOOL & DIE MAKING DESIGNING

Machinists Trade. Not a correspondence course. Practical shop training in the world's industrial center. Write today for full information.
NATIONAL SCHOOL OF MECHANICAL TRADES
Dept. 11 628 W. Lake St. Chicago, Ill.

BUCHSTEIN'S FIBRE LIMB

Correctly fitted. Strong, light, neat, cool, soothing. Braces for all deformities. On terms.
D. BUCHSTEIN CO.
610 3rd Ave. South, Minneapolis, Minn.

MAKE MONEY AT HOME

RUBBER MOLDS

Low as 6¢ EA.

Amazing rubber mold-making outfit makes perfect flexible molds of plaques, ash trays, book-ends, etc. Molds cost from 6c to 25c each. Each mold makes hundreds of novelties and gifts to sell up to \$1.00 apiece! No experience necessary. Quick and easy. Start profitable business in your home... sell to stores, gift shops, friends, resorts, road stands, by mail. Full or spare time. "Molders Handy Book" and list of buyers FREE. Write
SO-LO WORKS
Dept. A-827 Cincinnati, Ohio



KNOWLEDGE
THAT HAS
ENDURED WITH THE
PYRAMIDS

A SECRET METHOD FOR THE MASTERY OF LIFE

WHENCE came the knowledge that built the Pyramids and the mighty Temples of the Pharaohs? Civilization began in the Nile Valley centuries ago. Where did its first builders acquire their astounding wisdom that started man on his upward climb? Beginning with naught they overcame nature's forces and gave the world its first sciences and arts. Did their knowledge come from a race now submerged beneath the sea, or were they touched with Infinite inspiration? From what concealed source came the wisdom that produced such characters as Amenhotep IV, Leonardo da Vinci, Isaac Newton, and a host of others?

Today it is known that they discovered and learned to interpret certain *Secret Methods* for the development of their inner power of mind. They learned to command the inner forces within their own beings, and to master life. This secret art of living has been preserved and handed down throughout the ages. Today it is extended to those who dare to use its profound principles to meet and solve the problems of life in these complex times.

This Sealed Book—FREE

Has life brought you that personal satisfaction, the sense of achievement and happiness that you desire? If not, it is your duty to yourself to learn about this rational method of applying natural laws for the mastery of life. To the thoughtful person it is obvious that everyone cannot be entrusted with an intimate knowledge of the mysteries of life, for everyone is not capable of properly using it. But if you are one of those possessed of a true desire to forge ahead and wish to make use of the subtle influences of life, the Rosicrucians (not a religious organization) will send you *A Sealed Book* of explanation without obligation. This *Sealed Book* tells how you, in the privacy of your own home, without interference with your personal affairs or manner of living, may receive these secret teachings. Not weird or strange practices, but a rational application of the basic laws of life. Use the coupon, and obtain your complimentary copy.

The ROSICRUCIANS

SAN JOSE

(AMORC)

CALIFORNIA



AMENHOTEP IV
Founder of Egypt's
Mystery Schools

Use this
coupon for
FREE
copy of book

SCRIBE S.Z.V.
The Rosicrucians (AMORC)
San Jose, California

Please send free copy of *Sealed Book*,
which I shall read as directed.

NAME.....

ADDRESS.....

CITY.....

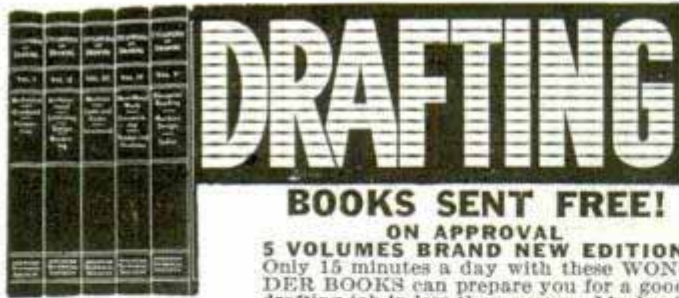

DRAFTING

BOOKS SENT FREE!

ON APPROVAL

5 VOLUMES BRAND NEW EDITION
Only 15 minutes a day with these WONDER BOOKS can prepare you for a good drafting job in less than a year. Mechanical and architectural drafting from simple straight lines to important complex plans. *A step at a time!* Built especially for beginners, for men with only grammar schooling. Drafting room practice, PLUS ENGINEERING, made easy and clear. Includes complete information on blue print reading for building and machine trades.

Big Field Big Demand Big Pay

Competent draftsmen are urgently needed right now in all building and manufacturing lines at \$30.00 to \$75.00 a week. That's just the beginning — FOR DRAFTSMEN HAVE THE BEST CHANCES FOR ADVANCEMENT. Pleasant, fascinating work, easy to learn and do. Learn quickly with these books—send coupon for a set and see for yourself.

A year's consulting membership in the American Technical Society now given to all readers of this famous cyclopedia of drafting. Many say that it is worth more than the cost of the books.

Complete set of drawing instruments if you send for these drafting books NOW. These instruments are made of the finest of German silver, are absolutely accurate and are packed in velvet lined leatherette pocket case. Real \$10 value, but included with these books.

AMERICAN TECHNICAL SOCIETY
Dept. D819, Drexel at 58th St., Chicago, Ill.

For Beginners or Experts

Written, so you can understand every word, by 22 well known engineers and architects. De-Luxe flexible binding, nearly 2,000 pages, 1546 blueprints, charts and diagrams; prepares you for a good drafting job in mechanical or architectural lines. Sent for 10 days' free use if you mail coupon immediately.

These Instruments Included



American Technical Society, Dept. D819, Drexel at 58th St., Chicago, Ill. Send for 10 days' trial. New 5 volume set of drafting. I will pay the few cents delivery charges. If I wish, I may return books in 10 days and owe you nothing but if I decide to keep them, I will send \$2.00 after 10 days, then only \$3.00 a month until \$24.80, the advertising price, is paid. Send latest edition and include drawing instruments and Membership Certificate.

Name.....
Address.....
Attach letter stating age, occupation, employer's name and address and that of at least one business man as a reference.

Learn by pre-tested Training

RADIO plus TELEVISION



A flexible Training Plan to fit your immediate needs

National Schools offer optional training planned to fit your present circumstances. You can master Radio, Television, Sound and allied trades by National's exclusive plan. Actual shop and studio training; also complete training if you cannot give up your present employment and income. A definite plan to fit your needs.

FREE LITERATURE

Explains National's pre-tested plan; how you can master Radio, all branches, Sound-Recording, Public Address & Communication Systems, Broadcasting, Television. This interesting literature sent post-paid, without obligation to you.

NATIONAL SCHOOLS
Los Angeles (EST. 1905)

Request for **FULL DETAILS**

NATIONAL SCHOOLS, Dept. 11-PMR
4000 S. Figueroa St., Los Angeles, Calif.

NAME _____ Age _____

ADDRESS _____

CITY _____ STATE _____

POPULAR INVENTIONS

(Continued from page 55A)

INTENDED as a means of fitting clothes accurately without the laborious measuring now necessary, a new system has been patented. It compares a person to be fitted with a garment to a standard pattern by superimposing a true outline of the

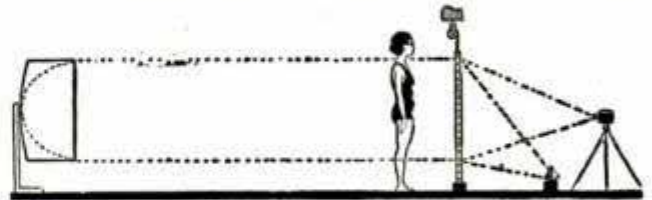

person by projecting light rays on a screen upon which is the standard pattern. With the person standing between the light source and the translucent screen, another light beam illuminates both the person's outline and the standard pattern.

DESIGNED to give any worker greater stability on a ladder, a step attachment for ladders has been patented.



The step is suspended from two hanger supports constructed to hook over a rung. Its outside edge rests on the legs at each side.

FOR renovating neckties, a newly patented device operates by electricity. It consists of a flat surface and an opposed rounded surface joined together in a shape that fits neatly into the tie. The form has water-absorbent means for holding water in suspension and an electrical heating element for producing steam.

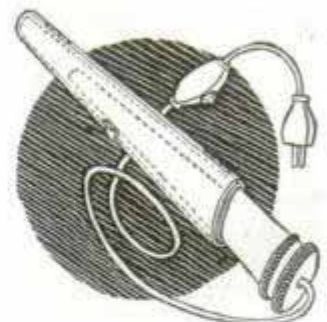

Due to the fact that many of the devices described in this department are still in the patent office stage and are not on the market, Popular Mechanics Magazine cannot undertake to supply further information regarding them.



THIS VALUABLE BOOK

FREE

LEARN CARTOONING AT HOME IN SPARE TIME

Send for this FREE book containing money-making tips, cartooning charts, idea creating methods, list of cartoon buyers, and other valuable information. Read about the money-making opportunities in one of the most fascinating of all professions—CARTOONING. With this booklet we will include a complete portfolio describing our easy Course in Cartooning and explaining our new Marionette Method of Instruction. We will also tell you how to get the Cartoonists' Exchange Laugh Finder FREE of extra cost. This amazing device actually helps create and originate humorous ideas. Send name at once and mention your age.

CARTOONISTS' EXCHANGE

Dept. 911 Pleasant Hill, Ohio

HOW TO MAKE MONEY

Thousands of publications buy MILLIONS of photos from free-lance camera owners every year. We show you *what* to photograph, *how* to do it, *where* to sell for biggest profits. Learn at home in spare time. Pay for course in easy monthly installments. No special camera needed. Write for FREE BOOK telling about this fascinating new field. **UNIVERSAL PHOTOGRAPHERS, Inc., Studio 711, 10 West 33rd Street, New York City.**

WITH YOUR CAMERA

Learn THE GREER SHOP WAY!

**WELDING
AIR CONDITIONING
DIESEL
BODY AND FENDER
AUTO
MACHINE SHOP**

BE A TRAINED MAN
You can earn more if you learn a trade—quickly the easy JOB-SHOP way. Big shops—lots of equipment—experts teach you. Established 37 years. Employment help. Write TODAY for FREE information and special offer.

GREER SHOP TRAINING, INC.
2024-6 S. Wabash Ave., Chicago, Ill.

In answering advertisements always write name and full address clearly.

Now! FIND OUT HOW TO WIN SUCCESS
Money, Friends, Popularity

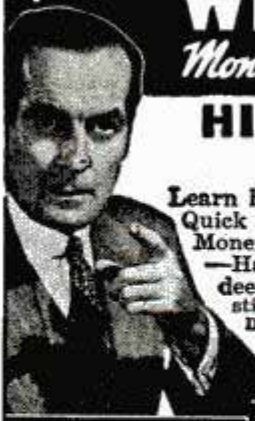

HIDDEN POWERS

DEEP WITHIN YOU AFFECT YOUR FUTURE

Learn how to get the things you want... Quick Advancement in Business—More Money—a Better Job—Greater Popularity—Happiness—SUCCESS. Hidden Powers deep within you may be waiting to be stirred to light. Properly directed they may make all your dreams come true. Any man of average intelligence has it within himself to progress far beyond his present condition. **FIND OUT HOW!** The secrets of making money, choosing a job, winning friends, securing SUCCESS are revealed. Don't let yourself get into a rut or be satisfied with unpleasant work at poor pay. Make the most of yourself! Write at once for FREE Self Analysis Chart, at no cost or obligation to you. Mail coupon today.

FREE Self Analysis CHART

SELF STUDY FOUNDATION, INC.
30 N. Michigan Ave., Dept. K-11
Chicago, Illinois

Please send me free of charge instruction for self-analysis of my capabilities and tell me how I can "Get Set For Success."

Name Age.....
Address
City State.....

WANTED MORE TRAINED PILOTS and MECHANICS for BIG PAY JOBS IN AVIATION



Want to get into Aviation? Now is your chance! 98 Graduates of this Lincoln Government Approved

School recently placed in good-pay positions in Aviation. More Lincoln Trained Men are wanted for positions with Airlines, Airports, Factories. **GOOD SALARIES PAID;** exceptional opportunities for advancement. **BE A PILOT, MECHANIC or AERONAUTICAL ENGINEER.** Prepare here for Government Rating as Private or Commercial (Transport) Pilot or for position as Airplane and Engine Mechanic; Aircraft Sheet-Metal man or Welder.

MODERN METHODS — MODERN EQUIPMENT



Fleet of 14 modern Training Planes; 12 Shops and Laboratories. School **APPROVED** by U. S. Civil Aeronautics Authority; by U. S. Army Air Corps and State Aeronautics Commission. 19 Years teaching Aviation. **GET INTO AVIATION NOW!** Train at Lincoln. Part-time employment for board and room while in training. We assist Graduates in locating positions. Get the Facts! **MAIL COUPON TODAY** for complete information.

LINCOLN AIRPLANE & FLYING SCHOOL
5611 Aircraft Bldg., Lincoln, Nebraska

I'd like to prepare for a position in Aviation. Send me complete information about Lincoln Training.

NAME.....
ADDRESS.....
CITY..... STATE.....

PLUMBERS & STEAM FITTERS
Audels Plumbers and Steamfitters Guides
4 Vols. \$6



A practical, illustrated, Reference Library and Study-Course for Master Plumbers, Journeymen and Apprentice Steamfitters, Gas Fitters and Helpers, Sheet Metal Workers, Draughtsmen, Master Builders, Engineers and all Building Trade Students. This valuable set of handy, pocket-size Guides explains in practical concise language and well-done illustrations all the principles, advances and short cuts of the Plumbing and Heating trade—based on modern practice. Contains careful, detailed instructions

on how to figure and estimate various jobs. Use FREE COUPON below to examine, without obligation, this valuable work.

INSIDE TRADE INFORMATION ON:

Soldering, tinning. Joint wiping, bending, beating. Pipe—iron—steel, threading. Mathematics, tables, physics. Materials—iron, steel, copper, brass, lead, tin, antimony, etc. Sheet metal—galvanized—plate. Sanitation, syphonage, tanks. Drainage, sewage, purification. Fixtures—bath—kitchen. Pipe fittings, soil pipe, tools. Laying out work. Roughing. Screwed fittings, flanges, joints. Pipe bending, examples. Elbows, heating, ventilation, air conditioning, refrigeration. Water supply, mains, wells, tanks. Gas-fittings. Sheet metal work, problems, methods. Brazing, heating, lead burning. Welding, various welds, methods. Blacksmithing, forges, tools. **Air Conditioning.**

THEO. AUDEL & CO., 49 W. 23rd St., New York City

Mail Audels Plumbers Guides, 4 vols., on 7 days' free trial. If O. K. I will remit \$1 in 7 days, and \$1 monthly until \$6 is paid. Otherwise I will return them. No obligation unless I am satisfied.

Name.....
Address.....
Occupation.....
Reference..... P. M.



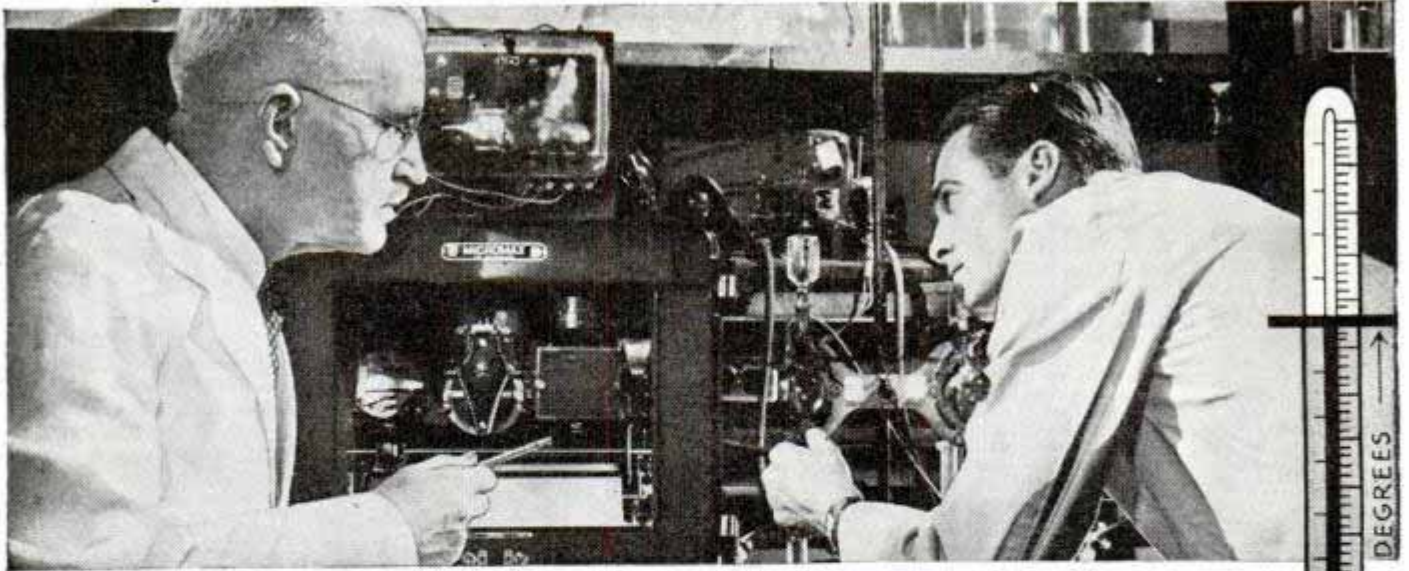

Experts of a nationally known laboratory observing the completely automatic finding and printing of pipe-smoke temperatures on Micromax, the scientific heat-recording device

The world's best- liked Tobacco **SMOKES COOLER** BY 86 DEGREES

than the average of the 30 other of the largest-selling brands tested—coolest of all!

SCIENTISTS who smoke a pipe feel as millions of men do about tobacco. They don't want *hot-burning*, "bitey" smokes, low in flavor. So a leading independent laboratory made impartial smoking-heat tests on 31 of the largest-selling brands. Completely automatic heat-recording equipment printed the results: **PRINCE ALBERT SMOKED 86 DEGREES COOLER** than the average of the others tested—*coolest of all!*

Just imagine what a difference of 86° can make in *your* smoking—in mildness, fragrance, grand taste . . . in **MOUTH COMFORT!** P.A.'s secret of cool smoking joy is in its choice, rich tobaccos . . . its famous "crimp cut" and "no-bite" process. Full-bodied smoking, yet **SO MILD**, because free from the effects on your mouth of excess heat. Put *your* pipe in the cool, mellow joy-circle of the world's largest-selling tobacco . . . *today!*

Copyright, 1939, R. J. Reynolds Tobacco Co., Winston-Salem, N. C.

**OL' JUDGE ROBBINS
SAYS**



TRY P.A.'S
**COOL-SMOKING
CRIMP CUT. ENJOY
ALL THE PLEASURE
OF RIPE, FULL-BODIED,
MELLOW SMOKING
TOBACCO!**

50 pipefuls of
fragrant tobacco in
every handy tin of
Prince Albert

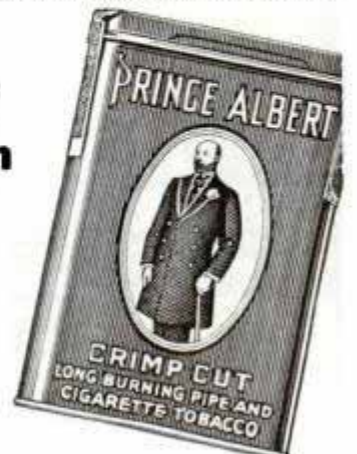

Prince Albert

THE NATIONAL JOY SMOKE

When writing to advertisers please mention *Popular Mechanics*

Popular Mechanics Magazine

REGISTERED IN U. S. PATENT OFFICE AND CANADA

WRITTEN SO YOU CAN UNDERSTAND IT

Vol. 72

NOVEMBER, 1939

No. 5

NO ²⁹³⁶ "BLIND" DRIVING IN 1940 CARS



Studebaker's "Champion," the LaSalle and the Chrysler, all with sealed beam lights

By Julian Leggett

FOR the first time in automotive history, the industry is making a concerted effort to eliminate "blind" driving from America's streets and highways, so we find the 1940 cars designed for greater efficiency of seeing. A new headlight system is introduced for greater safety from dusk to dawn; improved glass in windshields and windows offers greater visibility in both night and day operations. Other outstanding developments and trends include: Low-slung



2936

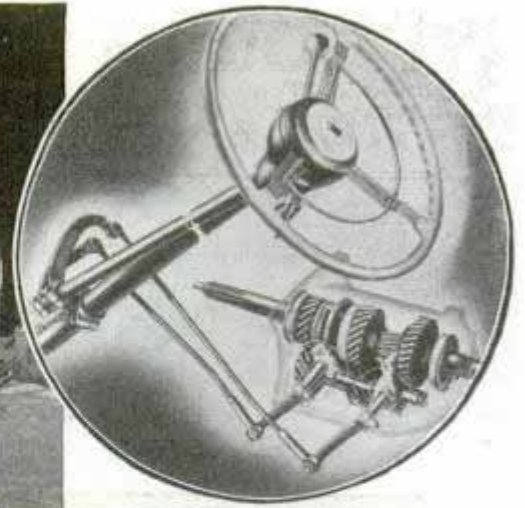

Left, four-door Willys sedan. Right, shifting levers on 1940 Cadillac and LaSalle are lengthened as aid to operating ease. The levers lead directly into transmission



Above, strip showing how the new Buick jack and supporting unit are used in removing wheel. Right, Pontiac's DeLuxe Eight four-door sedan on 120-inch wheelbase. It is powered by 100-horsepower L-head engine



Left, seats in cars with Fisher bodies have foam rubber and cotton pads superimposed on spring base. Below, LaSalle "Special," with "torpedo" body. Note projectile-like appearance. The car has no running boards, due to being built low. It has an unusually wide front seat

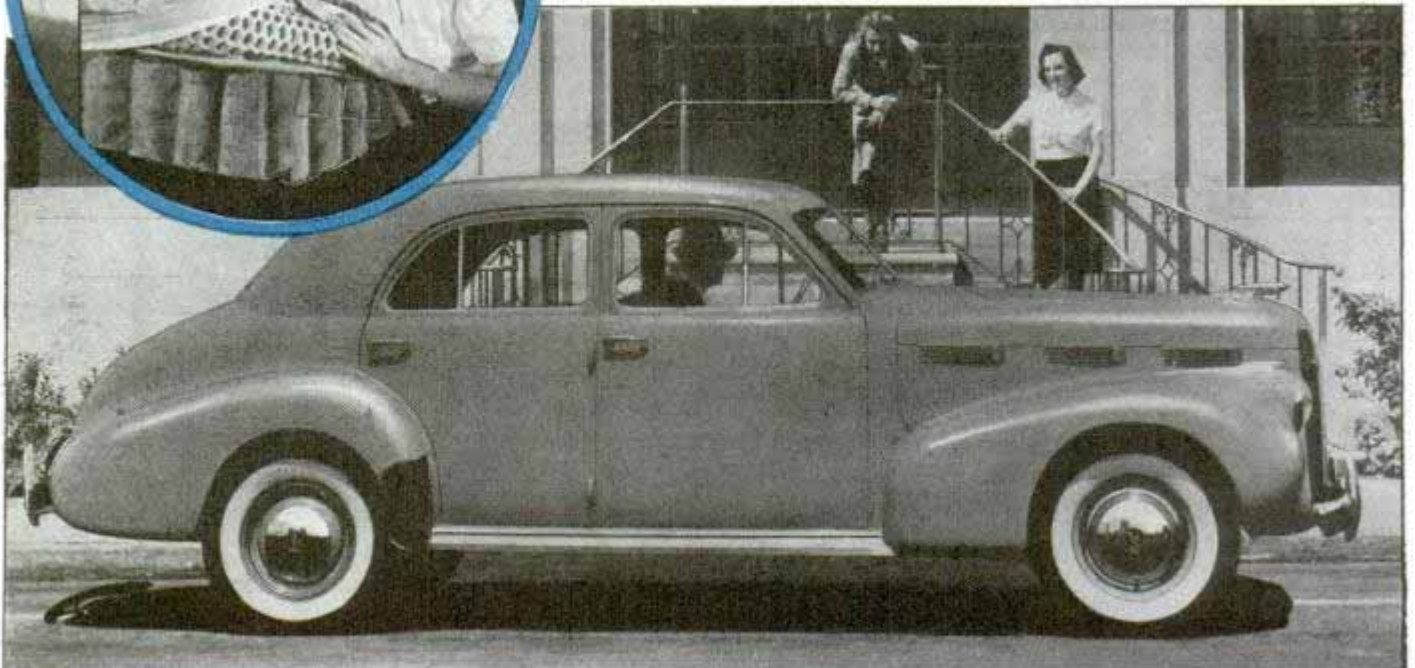

2936

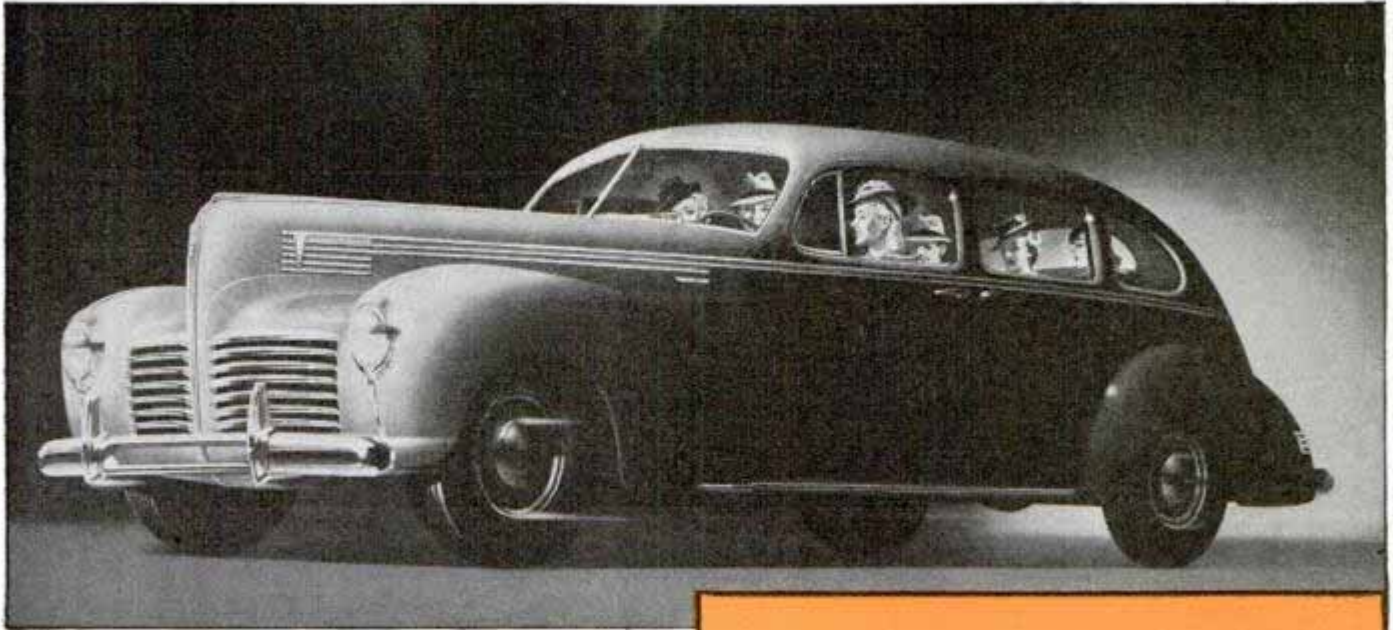

Above, Hudson's Country Club sedan. Running boards are optional. Right, sketch of Buick's air intake and under-seat heating system. Below, Chrysler "Royal," illustrating ease with which modern car transports six passengers

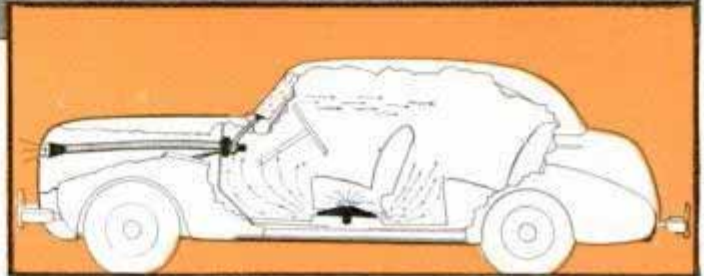

Circle, how Buick's antenna can be swung upward for improved reception by means of control inside car. Bottom, Cadillac "60 Special" for 1940 has more modish hood and front-end ensemble

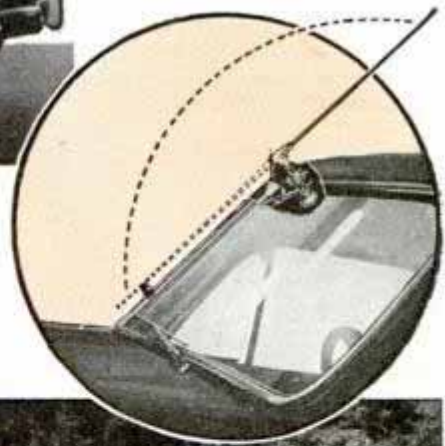

torpedo-shaped bodies that introduce a new conception of interior spaciousness; better heaters which control air temperatures and circulation within the car; longer wheelbases, achieved in most cases without increasing over-all length, and softer springing to make the ride more comfortable; a general movement to eliminate running boards and a hint that rear fenders may soon vanish into the body lines; exterior color schemes which permit such combinations as blue body and gray top; increased use of plastics, of which one manufacturer takes full advantage by turning out white instru-



Q 936

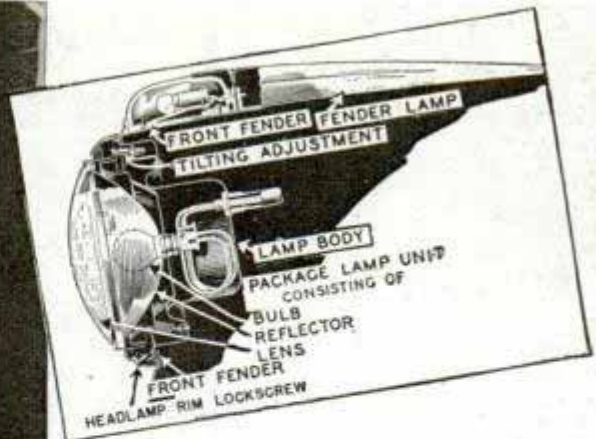
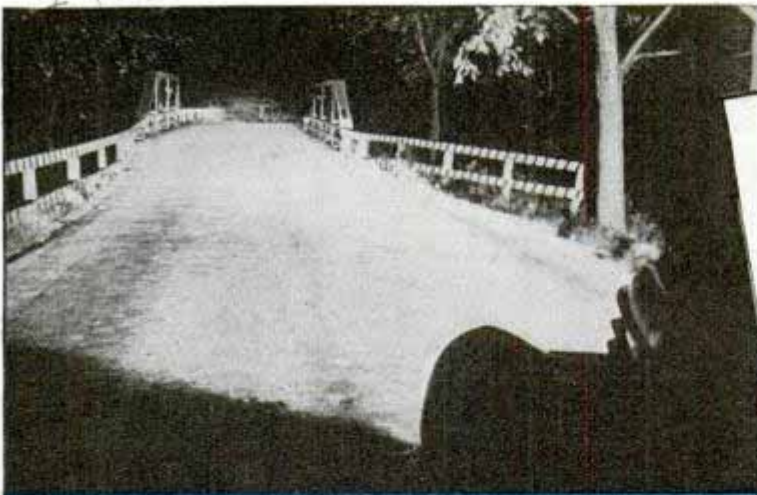

Top, Country Beam of new-type headlamps. Below, Traffic Beam. Note how approaching driver is guarded against glare. Top, right, sketch of headlamp, parking lamp and manner of mounting in fender



ment panel, steering wheel and interior trim; and extension of the use of directional signals, operated by steering-column lever.

The new headlamps, product of three years' cooperative work by auto and headlamp makers, collaborating with public authorities, are employed generally on the new models. Providing about fifty per cent more illumination than did previous headlights, the system is a valuable contribution to safety because inability of drivers to see clearly is held largely responsible for the fact that two-thirds of all fatal traffic accidents occur at night. The distinguishing feature is that the lamp is made as a permanently sealed unit, consisting of either metal or glass reflector, light source and lens, with each element adjusted to a fine

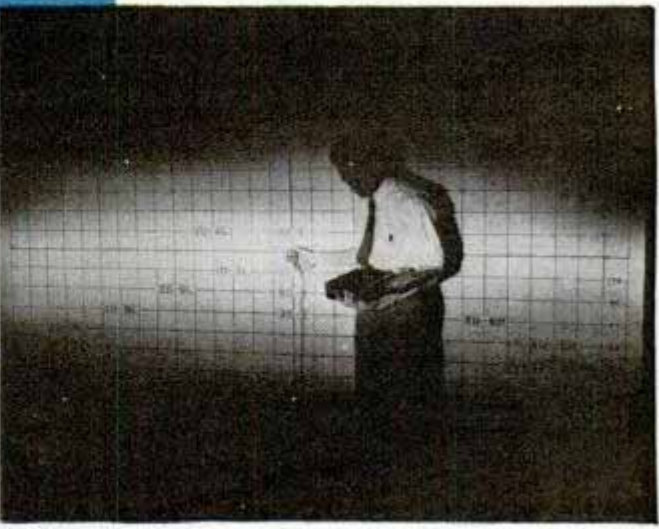
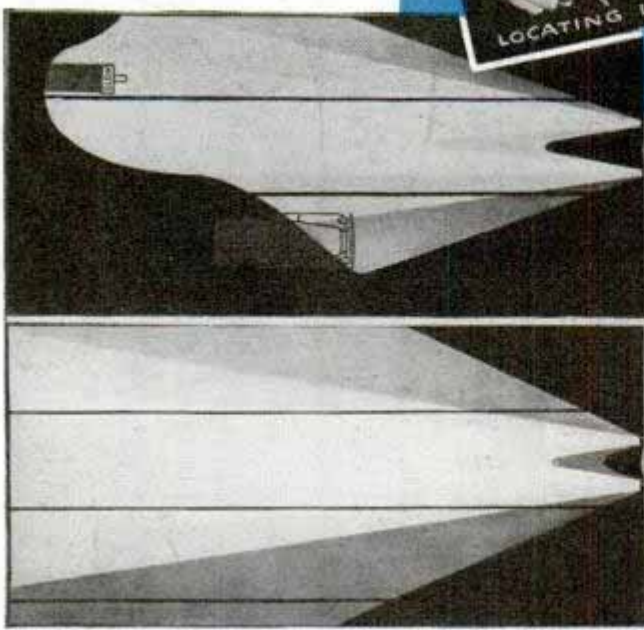

Inset (center), how lamp unit fits into housing. Bottom, left, sketch of illumination given by Traffic Beam (top) and Country Beam (below). Right, checking intensity of various parts of beam pattern with special meter at Nela Park laboratory of General Electric

2936



curves in light. You switch from one to the other beam with the familiar floor button and your instrument-panel switch has only two positions, one for parking and signal lights, the other for headlights.

Enlarging the driver's range of vision and eliminating distortion of images are accomplished by increasing glass area in windshield and windows, by cutting down pillar sections supporting the windshield, by replacing, in some cases, the divided rear window with a large, single piece of glass, and by using glass with greatly improved optical properties. General Motors cars using Fisher bodies have a high-test laminated safety plate glass which relieves eyestrain and affords greater accuracy of vision. Chrysler and other manufacturers offer glass



degree of precision at the factory. Dirt, dust and moisture cannot enter the unit, assuring freedom from filming, corroding and fogging and resulting in high efficiency throughout the life of the unit. All makes of the new lamp will fit any car equipped with the system. The owner will replace the entire unit when the bulb burns out, but the apparent increased cost is offset by using bulbs with longer-lived filaments.

Two beams are provided by the system. The first, a no-glare beam for use wherever there is movement of vehicles, is the Traffic Beam. The second, for use when the road is clear of traffic, is the Country Beam. Throwing its light a considerably greater distance than did former types, it bathes road shoulders, warning signs and



Top, engineer indicating Hudson Center-Point steering with right hand, and Auto-Poise Control connections to front wheel. Below, Buick with "torpedo" body. Right, Chrysler's white plastic instrument panel. Bottom, "One-Ten" Packard touring sedan which retains the distinctive Packard lines

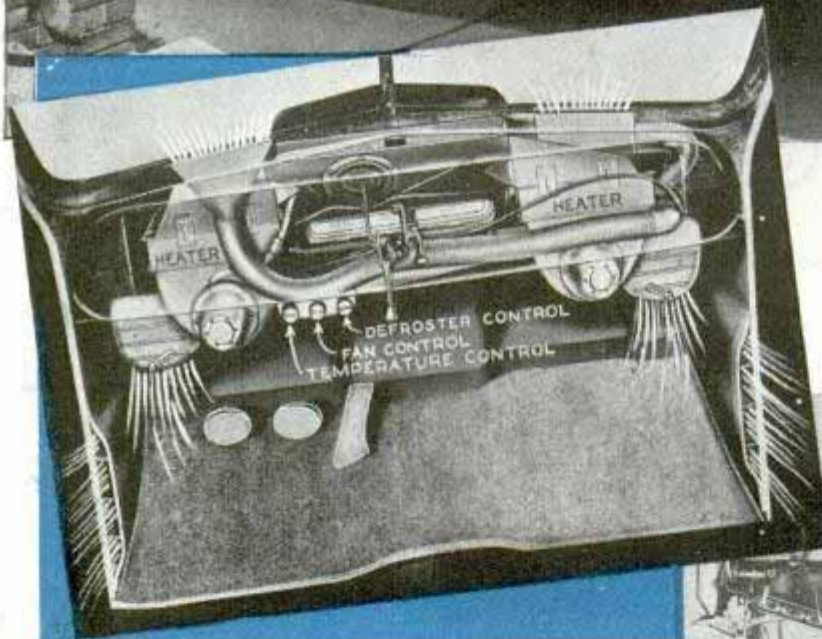

Above, the new Plymouth, which features eye-appeal and a more comfortable ride. Left, Chrysler Corporation's air-control system, with vents at side. Below, new type mountings between chassis and body reduce road noise in Pontiac. Bottom, Nash's four-door LaFayette on 117-inch wheelbase

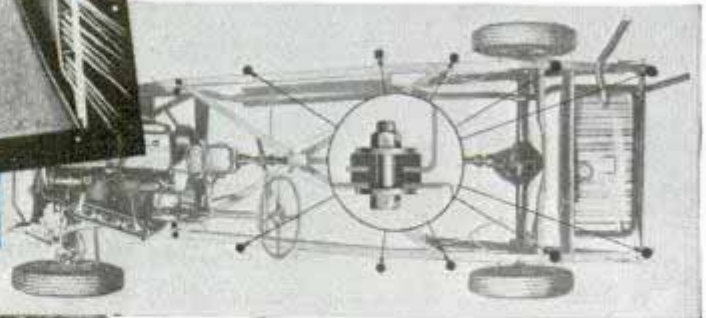

that is safer and tougher, as well as better optically.

The "torpedo" body, developed by Fisher Body for various divisions of General Motors, is smoothly streamlined, has no running boards, boasts an unusually wide front seat, and is equipped with such innovations as concealed door hinges, outside door locks on both front doors, new inside door locks,

293c

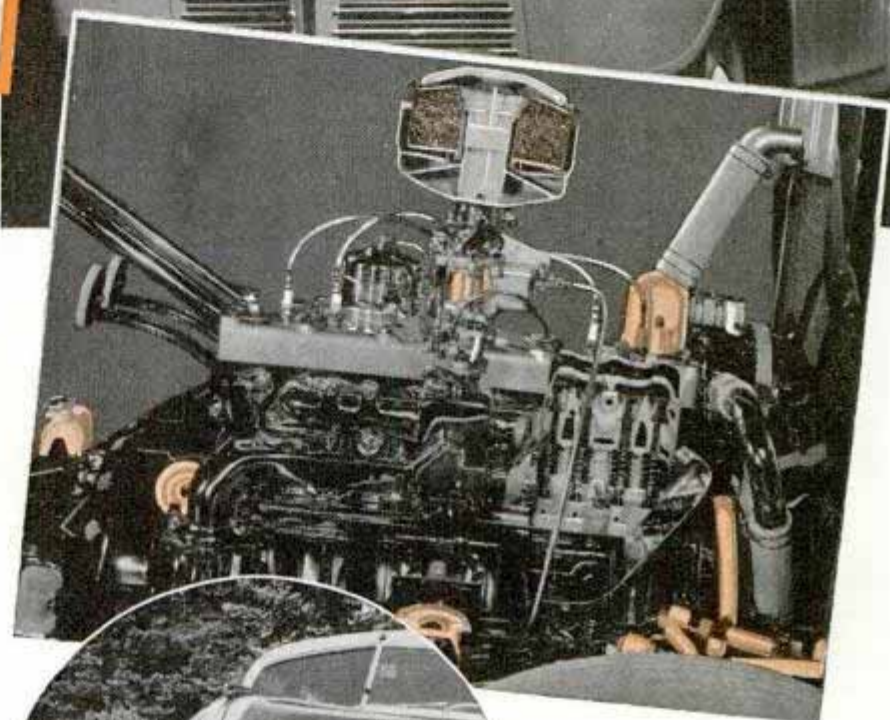

new door lock covers, upholstered folding center armrest in rear seat of sedan and chromium moldings on windshield, side and rear windows. Rear fenders approach the point of disappearing into the body. In the Pontiac, the "Torpedo Eight" has a two-inch longer wheelbase than the next car in the line, the floor is one inch lower, the over-all length is seven and one-half inches greater and windshield and rear window have larger glass area. The front seat is five inches wider, giving a space sixty inches wide for three passengers, plus

(Continued to page 142A)



Top, left, Pontiac's lowest-price car, the Special Six. Right, front-end view of new Plymouth. Below, cut-away of Plymouth's engine showing details of mechanism

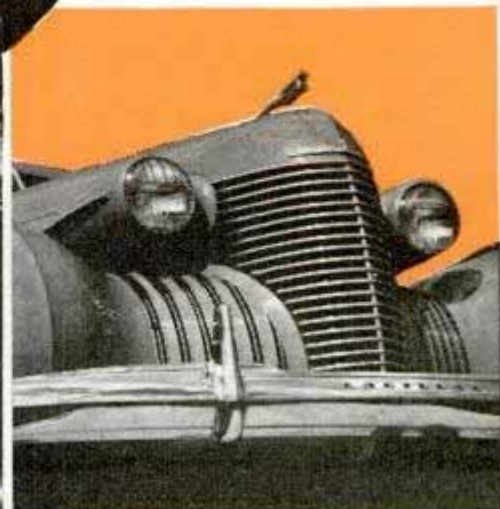

Circle (center), front end of the new Buick denotes strength. Bottom, left, nose of the Hudson touring sedan. Running boards are optional at no extra cost. Center, detail of Packard's front end. Right, grace of modern streamlining is exemplified in this view of Cadillac

8/18 cont James Mc Sweeney
 421 W. 60th Terrace,
 Kansas City, Mo

The BAND



Miss Le Har

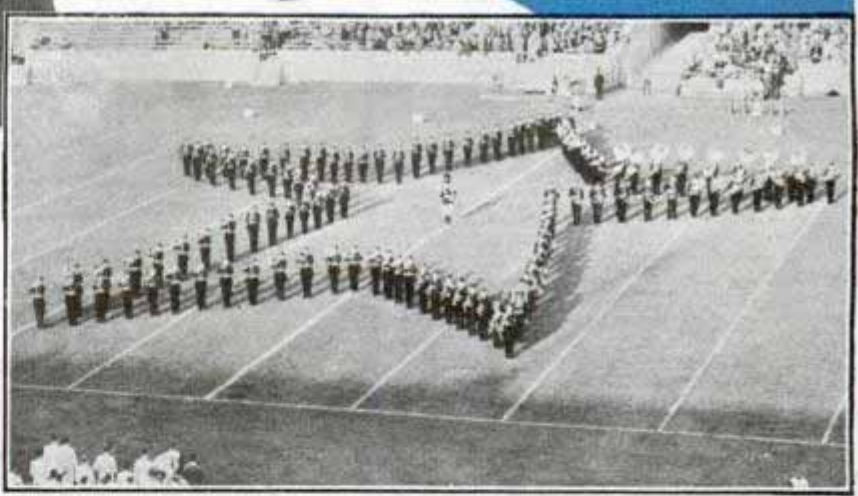
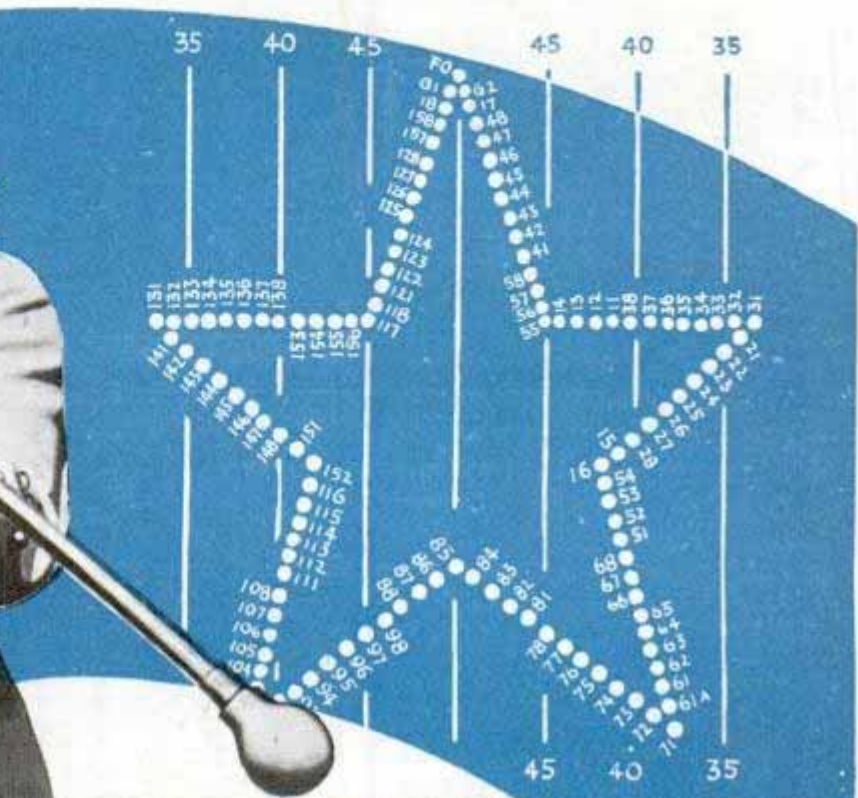

Top, left, photo taken at 1/1000th second shows how drum major twirls baton at high speed. Right, band's marching plan for formation of star, with each man's position shown. Below, Michigan's band forms the star

YEAR by year the band's gyrations in forming living flags, letters and intricate designs have grown more and more scientific. Today the crowd gets such a thrill from its displays that the teams must execute unusually spectacular plays to hold their place in the spotlight.

If you're lucky enough to get into the University of Illinois stadium on "Dad's Day," you'll see 350 musicians—Illini's entire musical strength, the concert group, and the first and second regimental bands rolled into one. On other occasions, a 175-piece football band holds forth.

When college bands first started entertaining football crowds, their efforts were confined to forming initials. Contrast these with some of Illini's best-remembered formations of the last few years—a cannon

from which "shells" were fired to form the word Army; the Army mule, and the word Ohio, which changed into Auto with the "O's" as wheels so it could roll down the gridiron; a stalk of corn that "grew" on the fifty-yard line in honor of the University of Iowa; a butterfly for the playing of an excerpt from "Madame Butterfly"; a flag with a "C" inside it, which waved as the band played "Wave the Flag for Old Chicago"; Notre Dame's "Irish Eyes"; an out-

L. 8/8

Ellis Carroll, Director
Butler Band.

STEALS *the* SHOW

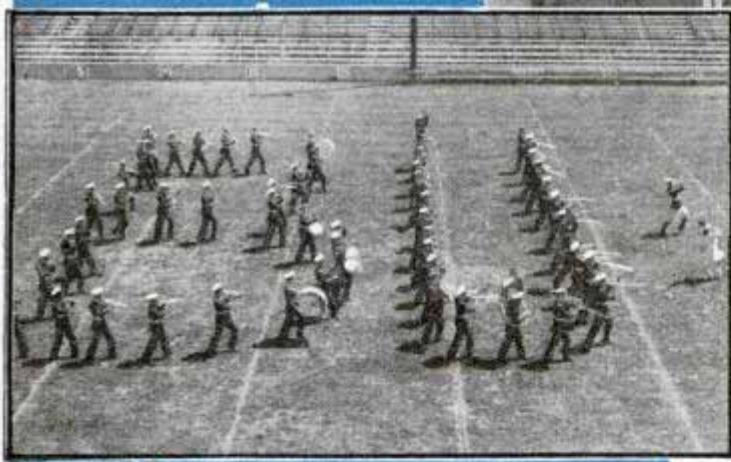
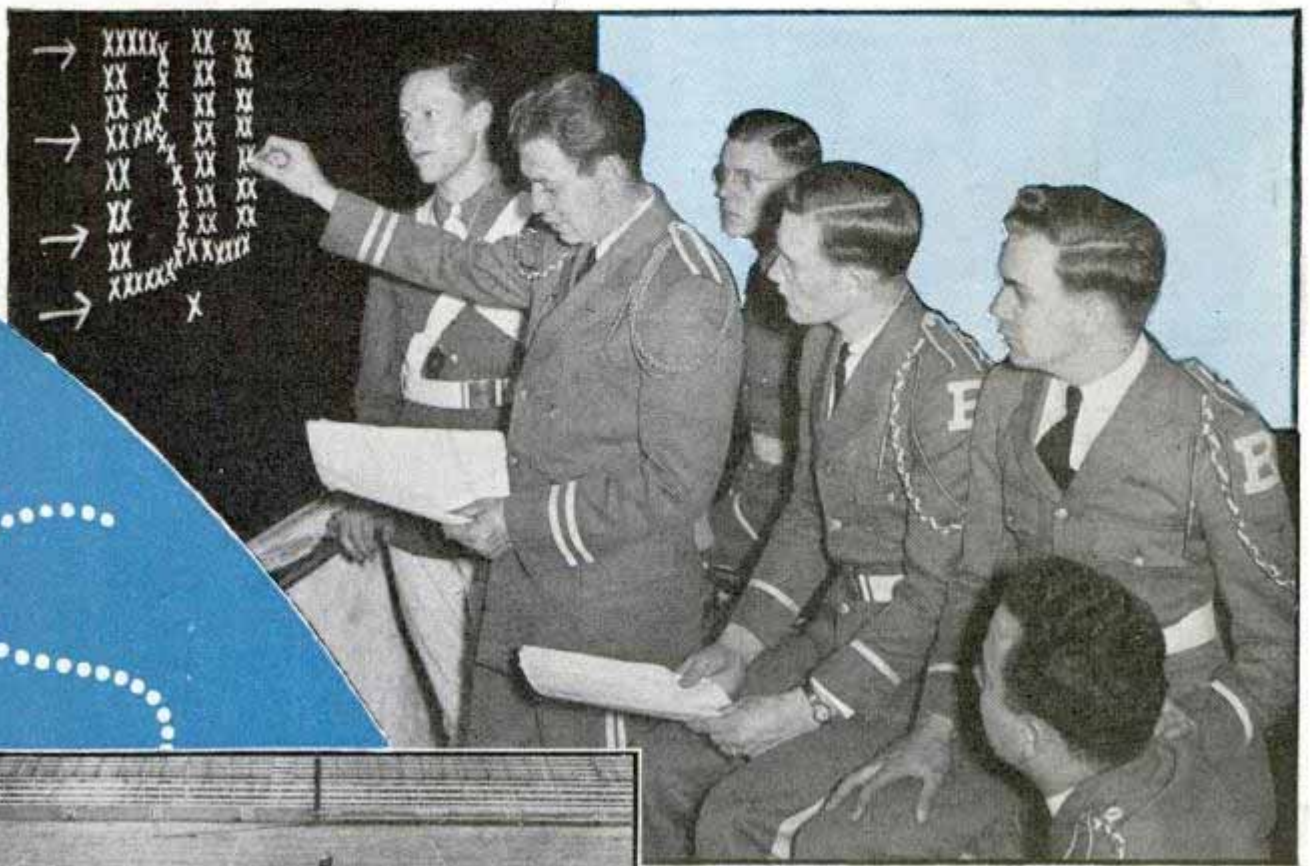

line of the state of Ohio with the Ohio river "flowing" to the music of "Beautiful Ohio," and a clock with a second hand that moved around, the time being told accurately.

For one of last year's appearances, Mark H. Hindsley, assistant director, worked out a formation in which the band proceeded to spell out "Music." A radio dial appeared



Top, diagramming formation while band's board of strategy looks on. Center, Butler band in B. U. formation marches down field. Bottom, Cornhusker band ready for the starting whistle

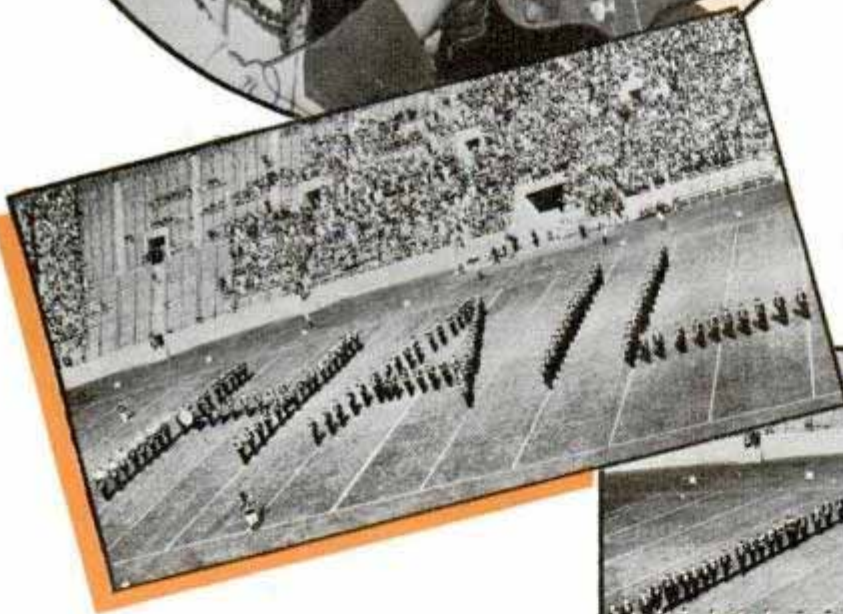
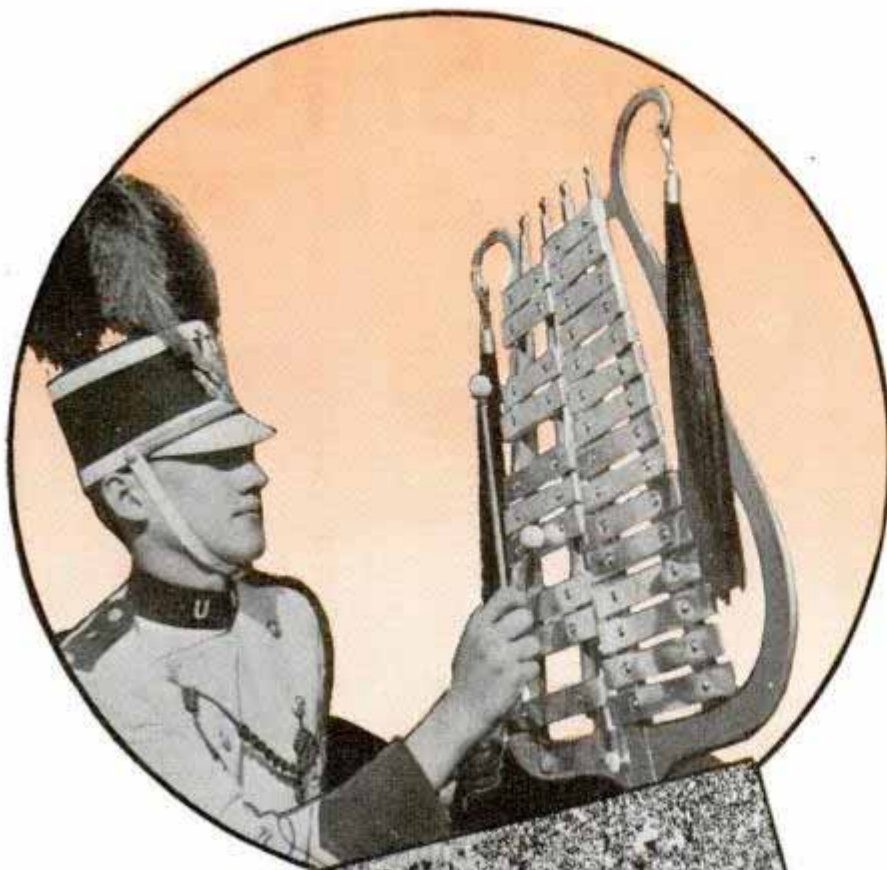

Top, glockenspiel is part of Nebraska band. Center, first word of tribute to alma mater. Bottom, moving letter as executed by Michigan band

in the center of the "S"—a large bass drum surrounded by smaller drums with a chrome baton as a pointer. As the dial moved around, excerpts from Wagner, Beethoven, Schubert, Liszt, and others were heard.

These formations are carried out without a single whistle or gunshot signal from the director, all marching cues being taken from the musical passages.

Staging an entire performance without the band coming to a halt or any of its members missing a note of music was

Michigan's idea. The Wolverines has long been known for its striking field mosaics—stars, horseshoes, covered wagons, windmills, clocks, and bicycles. Purdue's band started the letter formations and Indiana's famed military band perfected lightning switches from one word to another.

While playing host to Notre Dame, the Illini band once played "St. Patrick's Day" while spelling out Irish. Before concluding the piece, the middle "I" grew into a question mark, as if to inquire if the Irish of Notre Dame were all Irish! An entertainment highlight of the southern football circuit is the original fifty-piece swing band of Texas Christian. The ability of the Horned Frogs to jam and jive have won them a national

following. Their brand of swing, explains Don Gillis, the director, is written out note for note just as the conservative marches are. A swing arrangement seldom lasts more than three weeks so a corps of arrangers is kept busy turning out scores.

During the spring and summer months when the football coach is out rounding up grist for the football mills, the band director is giving auditions to musical hopefuls. Membership in Indiana's band is limited to ten seniors, twenty juniors, forty sophomores, and sixty freshmen, so Director

Frederick E. Green's task is largely one of selection.

The University of Nebraska, in addition to the 110-piece varsity band, maintains a large freshman band. Ordinarily, a player must spend a year on the freshman band before getting into the varsity. One joint display by the two bands is a colorful shield, outlined by the varsity musicians in brilliant scarlet and cream uniforms with the blue-and-white clad freshman players representing the stars and blue field.

Approximately 225 students report for band duty each year at University of Oklahoma. Once a player is admitted into the band, he must spend five to seven hours a week drilling and two to four hours more improving his music. On top of that there may be a few hours of private practice as many bands insist the players memorize their music so they can give their whole attention to singing and marching when they're on parade.

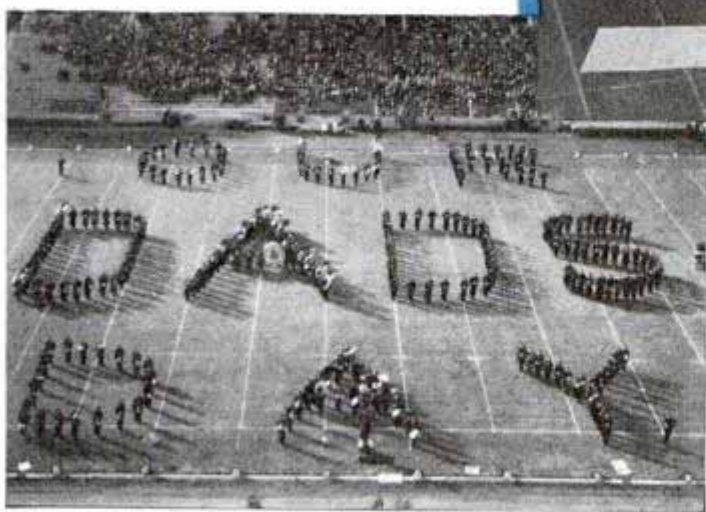

A marcher who is given to day-dreaming or has difficulty remembering his right from his left hand can wreak havoc with a display. Fifty thousand pairs of eyes are focused on the pageant. The players must have correct posture, carriage, and bearing. Tiptop physical condition is required to endure the rigors of continuous marching at a cadence varying from 150 to 210 steps per minute while playing for periods as long as thirteen minutes.

Ellis Carroll, director of the Butler Uni-

(Continued to page 141A)

Top, cornetists hit a high note. Center, planning maneuvers with toy soldiers and scale model field. Bottom, Illini's band pays a tribute to Dad's Day

Ed Michigan

Movie Camera on Gunstock Is Aimed Quickly



Taking steady aim with movie camera attached to gunstock for taking pictures from small boats

After trying with little success to take motion pictures of leaping fish from small fishing boats, whose unsteadiness eliminates use of a tripod, one photographer solved the problem by mounting his camera on a gunstock. When a fighting fish is hooked he can now get a steady aim for the picture, allowing his sea legs to take up the pitch and roll of the boat. The gunstock was specially made to fit the camera.

Gasoline Runabout for Shopping Has Plywood Body

Easy to handle in traffic, a small runabout, built for convenience in shopping, has a body of wood and plywood with glued joints to prevent squeaks and rattles. Storage space is provided in the rear cockpit which can be converted into a rumble seat. A small Willys engine drives the



Midget runabout with plywood body has space in back for luggage or extra seats and is easy to handle

lightweight car. All the accessories are inside the body to give a clean appearance, the gas tank being concealed and a small door in the rear giving access to the tank cap. Even the lamps are inclosed in the front grill. The hood opens from the front. The chassis is a 1933 model Willys automobile. Two openings on the side are ventilators, one for the driver's cockpit and the other for the engine.

Giant Sign Is Shot into the Air and Unfolded by Bomb

Giant-sized signs used in a new advertising stunt are shot 350 feet into the air by a mortar and unfolded by explosion of an aerial bomb. Weighing less than nine ounces, the signs are imprinted with im-



Lightweight sign in form of tire it advertises was shot into air by mortar and unfolded by aerial bomb

ages about fifteen feet high. The signs float in the air from two to ten minutes depending on the strength and direction of air currents. The aerial signboards are used at bathing beaches and other public places.

Built by Quentin Berg R. 22 57, North Canton, Ohio

3rd Ave. nearly all
Aerial Advertising Co. 409. 5met

Blind Spots in Eyes Are Charted by Vision Test

J. G. H. 3 American Optical Co. 200 Cambridge, Mass. Lloyd Stereo Comp. Louise Lomas



Blind spot in eye found by looking at black circle in chart and moving it slowly back and forth until cross disappears. Optical instrument, left background, examines field of vision

Did you know you have a blind spot in each eye? Here is how you can prove it. Close your left eye, look at the black circle on the chart in the illustration, and bring it slowly toward you. At a certain point the cross at the right will disappear. Repeat the same process with the right eye closed, and the left cross will disappear. These blind spots are points in the retina where the optic nerve connects with the eyeball. Everybody has them. If they become enlarged or distorted in size, or if other blind spots show up, some diseased condition is indicated. For exact measurement of blind spots a testing device has been developed which permits thorough examination of the visual field. The patient looks through lenses at a chart, one eye at a time, and then objects are placed within his field of vision on the chart and a diagram is prepared outlining the exact area he can see.

Five Ride on Three Bicycles Linked Together

Hook two bicycles side by side with a tandem at the rear and you have a bike built for five. At the seaside resort of Ostia, Italy, four of the girls riding the vehicle provide motive power, while the fifth, in the pilot seat, merely does the steering.



Four pedal and one steers bicycle built for five

Developed by - Ralph T. Lloyd in Cambridge

Dr. R. Lomas

Engineer G. J. ... 226 Oak ...
Clanville, d.H.

Streamliner Driven by Engine in Each Car

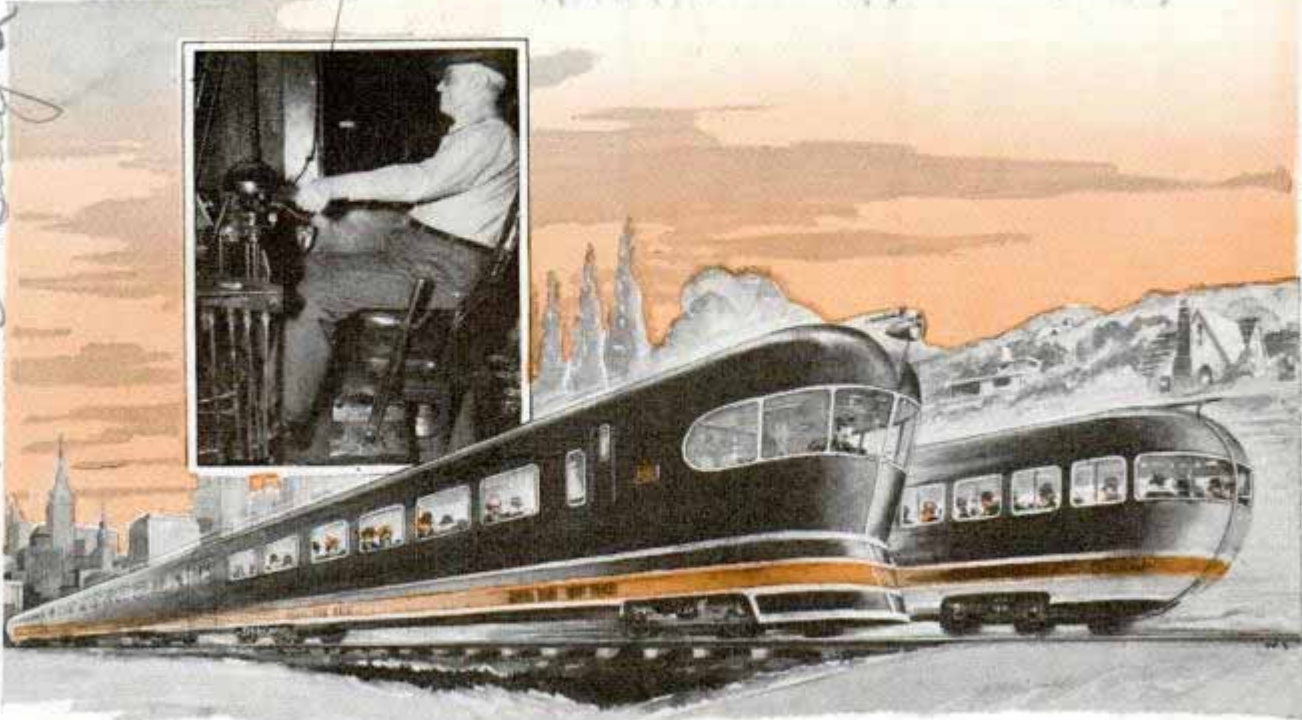

Sketch shows front and rear end designs of proposed train. Inset, driver at the controls of an earlier type car. Streamlining will be employed to the greatest degree recognized as practicable

Powered by a horizontally mounted gasoline or oil-burning engine in each car, the latest streamliner will offer speed and unusual flexibility on even secondary runs. The power necessary under any condition may be used. The engine will be installed beneath the floor of the car and its power transmitted through a geared transmission or a hydraulic torque converter operated by remote-control devices. An advantage of the engine-under-floor car is that the entire floor area may be utilized for rev-

enue. Another advantage is that passenger requirements may be fulfilled more accurately simply by adding one or more cars, each with its own engine, to the train as the passenger list increases. The front of the train is smoothly rounded, to reduce wind resistance, the lines being broken only by the "cowcatcher." Painted in striking colors, an articulated train of this type will present a pleasing appearance. It is designed by the American Car and Foundry company.

American Car and Foundry Co.
30 Church St. New York

2960

Torpedoes Are Launched in Pairs from Forward Tubes



Two torpedoes are launched simultaneously by motor torpedo boat of British navy during demonstration in English channel

Two torpedoes are launched simultaneously by Britain's latest type motor torpedo boat. Very fast, she carries two torpedo tubes, one on each side and pointing directly ahead, which let go their destructive agents when the ship has been maneuvered at full speed into the desired position.

□ A tube of pure nickel has been drawn with an outside diameter of .0026 inch, the width of a human hair, and an inside diameter of .0007 inch.

Wide World

Superior Tube Co.
Norristown, Pa.

Aug. 19, 1939
Business Week

J. G. G. and James G. Deeks,

205 Fourth Ave. Newark N.J.

Rotary Camera Takes Pictures on Disk Film

micro snapshot

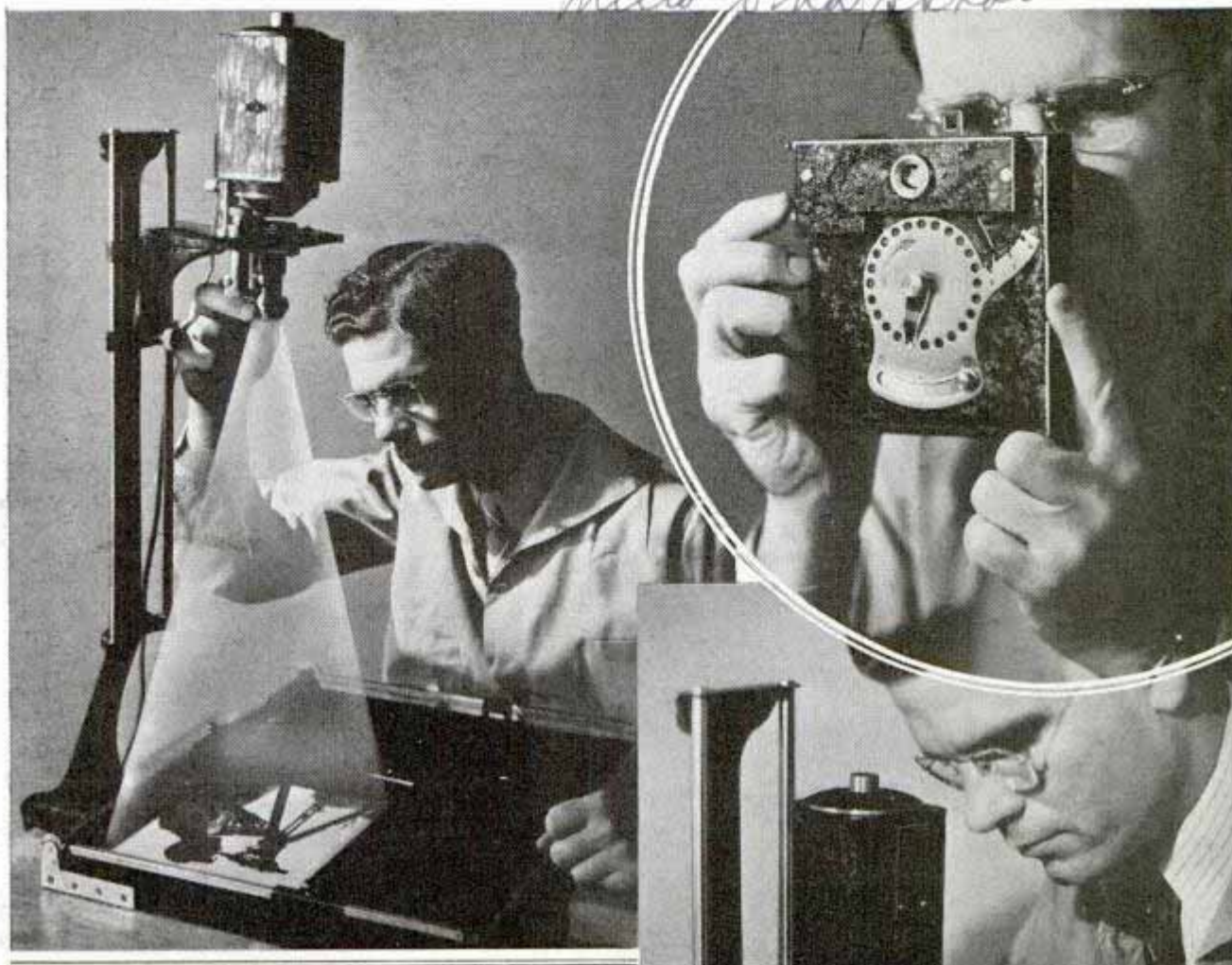

Above, using enlarging machine. Circle, focusing the camera. Right, removing disk film

Regarded by the inventor as offering the possibility of altering the future of photography, a rotary camera that takes twenty-four exposures on a circular film is being prepared for the market. From the negative film, enlargements up to eight-by-ten inches can be made with a rotary enlarger which also will be available. The camera is provided with time-exposure lever, snapshot lever, apertures adjustable for different sizes and a dial that controls movement of the film. Various grades of film will be supplied for all types of snapshot or time photography. The inventor claims that the disk film is much simpler to handle than ribbon or strip film. The enlarging machine plugs into any 110-volt, a.c. socket. A negative disk film is placed on a center spindle and the enlarger adjusted to the size desired. Simplicity of operation of the camera and enlarging machine is claimed by the inventor.



Air-Conditioner Filter Guard

Electric Filter Watchman
Immediate warning is given by a telltale light when it is time to change or clean the

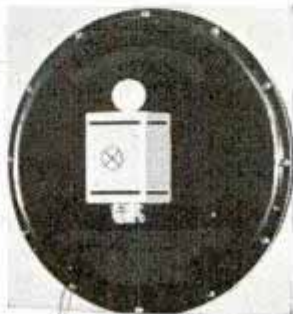

home air-conditioning filter. The filter guard is attached between the blower and filters. As soon as accumulated dust causes excess pressure to build up in the duct, the signal lamp flashes.

Simpler Controls Ltd. Westchester, N.Y. 706

Beetle-Back Car Is Fastest Thing on Wheels

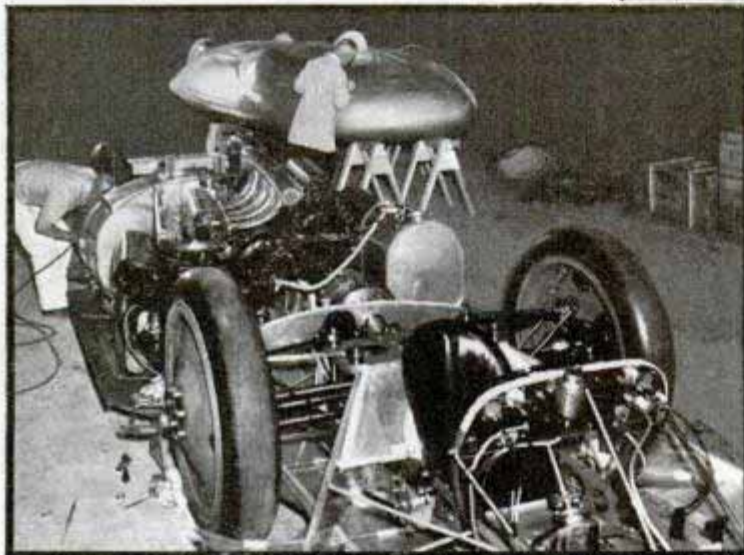
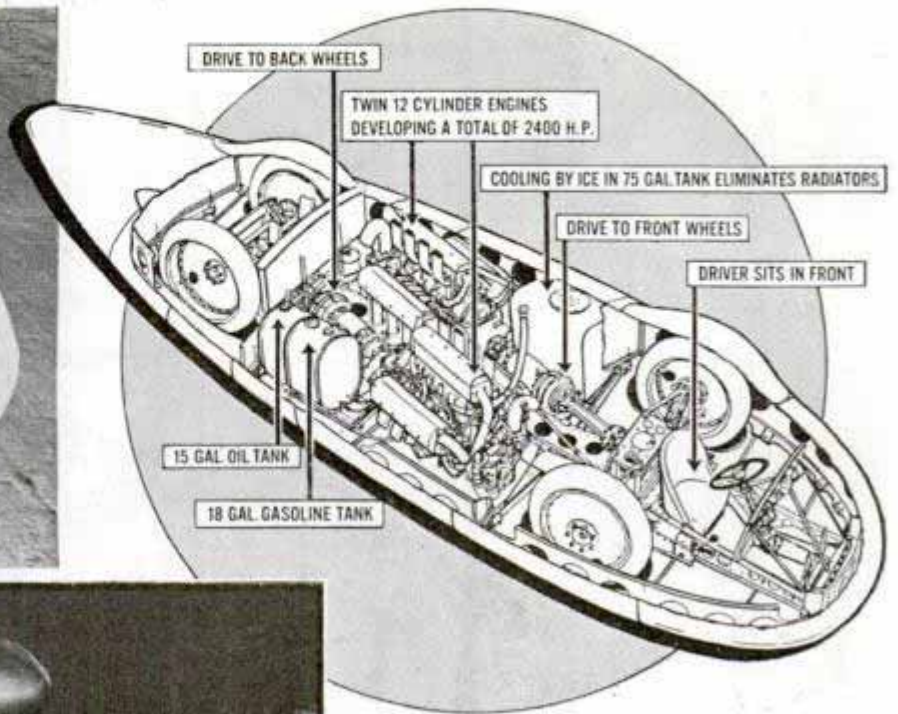

Above, left, streamline racer in which Cobb broke speed record is pictured from rear on Salt Bed course, and diagram, right, shows location of engines and other inner works of racer. Below, mechanics make final adjustments; body is in background

who pushed his "Thunderbolt" to 357.5 miles per hour. Three other international speed records on the straightaway were smashed in later attempts by Cobb, for five kilometers, ten kilometers and for ten miles. Cobb's automobile is unique

in its lack of a tail, which was considered unnecessary for a straight track. The \$100,000 speeder has two twelve-cylinder Napier Lion engines set off center between the front and rear wheels, the rear engine driving the front wheels, and the front engine driving the rear wheels, totaling more than 2,400 horsepower to move the three and one-half ton creation. The sleek body is regarded as the last word in streamlining. It has no radiator, ice in a seventy-five gallon tank being used to cool the engines.

Because many bridges as now built need all but one-sixth of their strength to support their own weight, Prof. J. B. Wilbur of Massachusetts Institute of Technology predicts future bridges will be built of aluminum, Cambridge, Mass

In colonial days men riding in ox-drawn wagons traveled at speeds of three or four miles per hour. Today, at least one man has traveled on land faster than six miles per minute. He is John R. Cobb, of London, who brought his racer, the "Railton Red Lion," to the Bonneville Salt Beds in Utah to establish new world's records. The course is ten miles long, with a run of about a mile and a half before entering the ten-mile stretch. Starting northward Cobb drove through the measured mile where time traps were set at 370.75 miles an hour—the fastest ever traveled by man—and then came back at 366.97 miles an hour. Officially, his average speed for the mile is computed at 368.85. In this same run a new record for the kilometer (five-eighths of a mile) was fixed at 369.74. Previous marks were held by Capt. George E. T. Eyston

Designed by Reid Railton, Built by J. Taylor

International Laboratory of Structural Analysis

Compressed Air
Jul 1930

650 American Civil Service
SHOOTING *from the* CLOUDS
657



Sighting his heavy aerial camera through the open window of an American Airlines flagship, Merle J. Oelke, the author, uses a lapel microphone and radio headset to direct his own pilot and that of the sky liner he is "shooting."

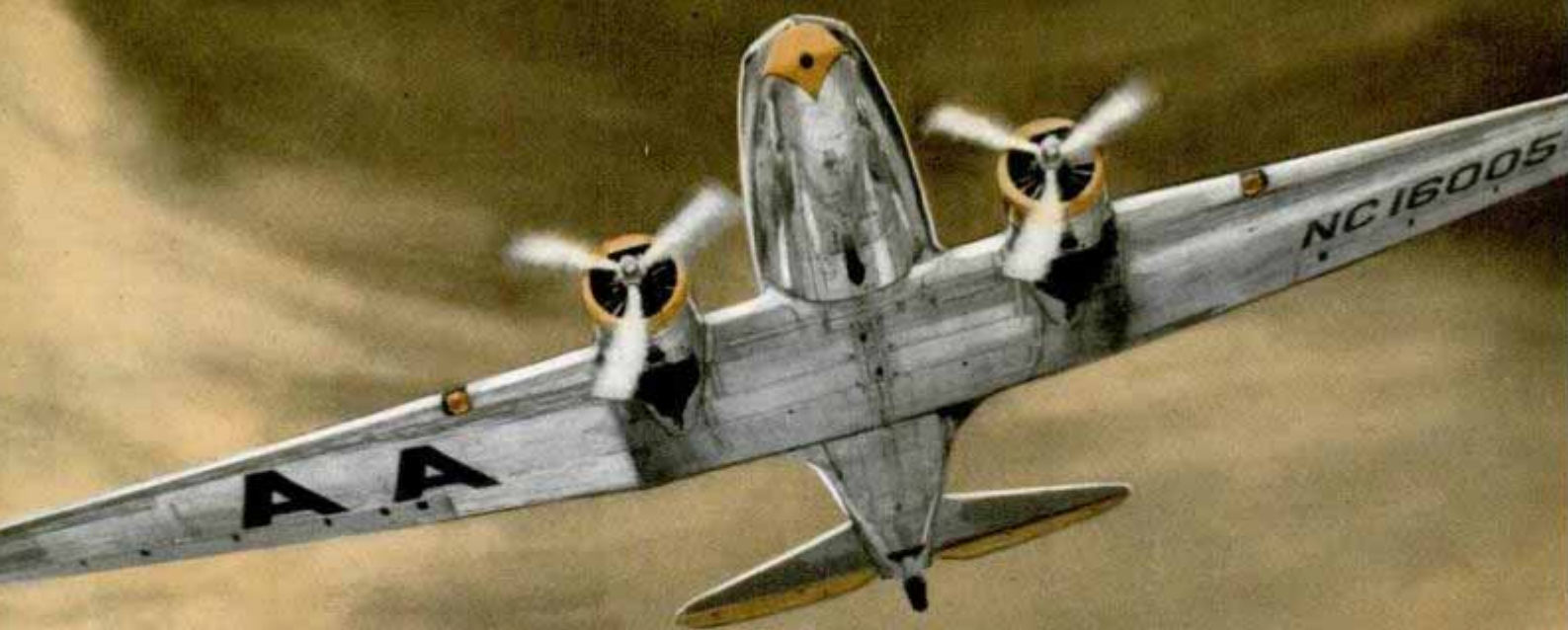

2630

Cameraman catches impressive view from runway, above, as a big one wheels over airport. Left, sunrise "on top," framed by window of Memphis-Fort Worth ship—a scene any passenger can film.

work of an air-line photographer.

Sometimes I wonder why I chose this profession. And then I remember a sunset above the clouds, a race to bring back air pictures of a train wreck, thrilling rides above Niagara Falls and Boulder Dam. I remember darkroom thrills as spectacular views of a city from the air sprang into life on film.

And there are the "interesting people you meet."

Usually things happen so fast in the sky that adventures are over before you know they're adventures. On one job out west we were so close to an unhappy landing that I get limp thinking about it, but at the time I was so preoccupied with the camera it didn't occur to me to be frightened. We had been sent to join a fleet of ships hunting for a missing plane in the neighborhood of Mt. Frazier, south of Bakersfield, Calif. Our mission

658
By **MERLE J. OELKE**
American Airlines Cameraman

CLUTCHING a thirteen-pound camera with both hands while you look through the open door of a plane bouncing in the up-drafts of a forest fire, playing hide-and-seek with the navy in a land plane drilling holes in the clouds thirty miles from shore, snapshotting a shy celebrity who calmly takes the camera away from you and ruins your film—it's all in the day's



2630

was to photograph the ground in the hope that the plane, hidden from the eye, might show up on an enlarged picture. Well, before climbing up high to photograph, we thought we'd take a look with our own eyes along the slopes of Mt. Frazier. We were skirting the leeward side of the mountain when I became conscious that we were losing altitude. Down, down we mushed until it seemed as if the trees were about to poke through the bottom of the plane. We were in the treacherous downdraft you always get in the lee of a mountain. Just about the moment I realized the helplessness of the pilot, he managed to ease out of that current and headed upstairs.

Since then, when someone wants an aerial shot of a mountain, I've always insisted on shooting from the

Malibar

652

Forest fire sweeps a California mountain, above. To get this picture the photographer had to maneuver to windward and stay high enough to avoid dangerous bumpy updrafts. Below, one sky transport snapped from another over Los Angeles.





660

Natural-color photo reveals murky waters of Chicago river meeting clear water flowing in from Lake Michigan. In background is Chicago's Merchandise Mart.

windward side. However, you can't always choose. Editors are very exacting. If it's a forest fire, they want the picture to show the smoke, the flames, the burned-over area, the threatened section, and any towns or people or roads in the path of the blaze. As for me, I want to point the camera away from the sun, I want to be on the windward side away from the smoke, and I want to be high enough to stay out of the bumpy air over the fire.

Once I filmed a forest and brush fire in California from a height of only 500 feet. The blaze was in a canyon less than a mile from the airport. We had seen the plume of smoke start up, and when the call came to get pictures we lifted the door off the plane and took off within a couple of minutes, headed directly for the fire. In less than a minute we were right over it. We could see men scrambling frantically up the canyon slopes, trying to reach safety at the

ridge. We bumped crazily in the hot-air blast rising from the flames. But down below thirty-five men were trapped in the encircling flames, and there was nothing we could do to save them.

You might think it a perfectly simple thing to poke a camera out the window of an airplane and snap a good picture. That's what I thought a few years ago, the first time I took a box Brownie 10,000 feet over San Diego, stuck it through the door opening and started pushing the lever that made the shutter click. Well, to begin, I pushed it too often—eight times for the roll of six, so a couple of them were double exposures. One was nothing but a blur, but I blamed the pilot for flying too fast. Another looked as though I had focused on the sun. The others showed part of the floor, wing struts and landing gear and hazy lines that I claimed were city streets. There were some beautiful clouds in the sky, but I can't prove it by my pictures.



661

2630

Even from the air the scene above is familiar, the New York world's fair dominated by Tylon and Perisphere. Below is the metropolis of southern California. It takes close coordination between pilots to pose the big sleeper plane against the desired background.

Los Angeles

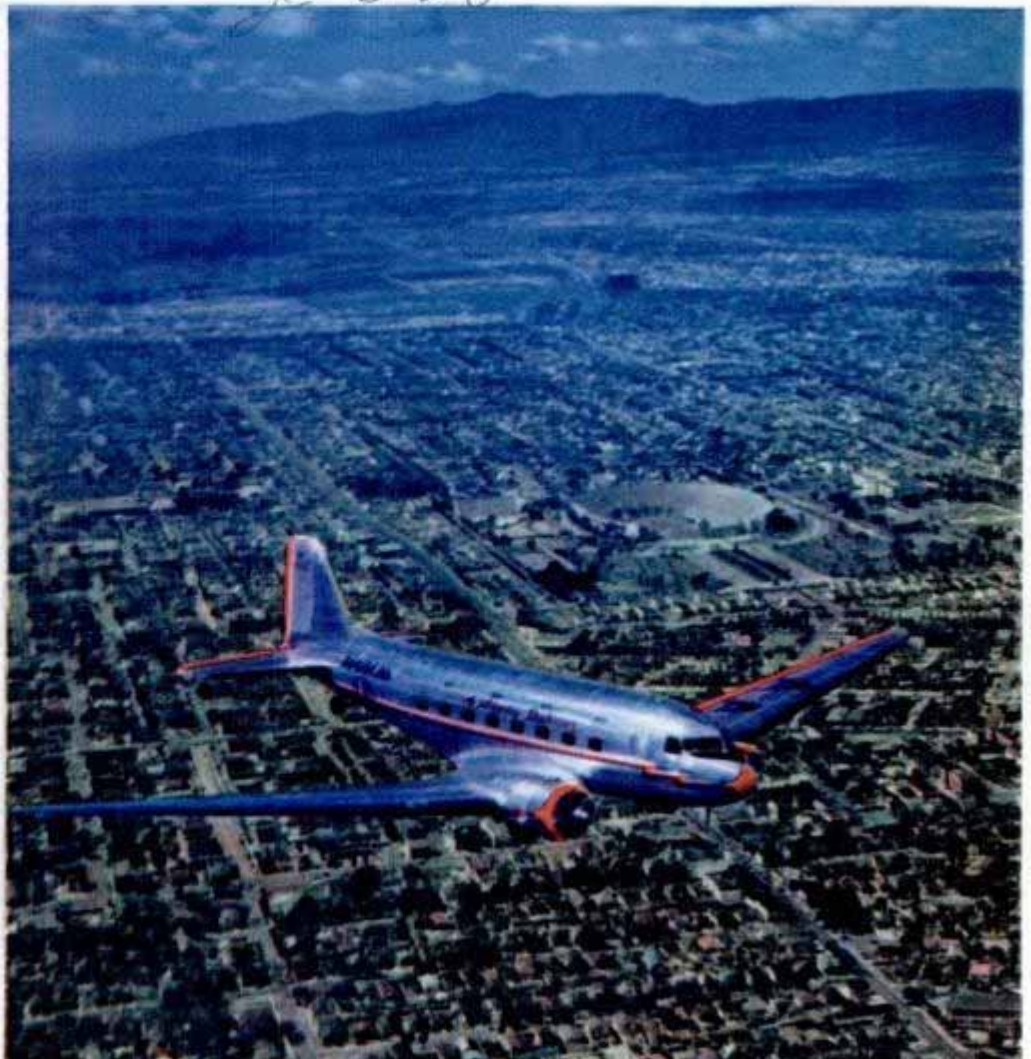

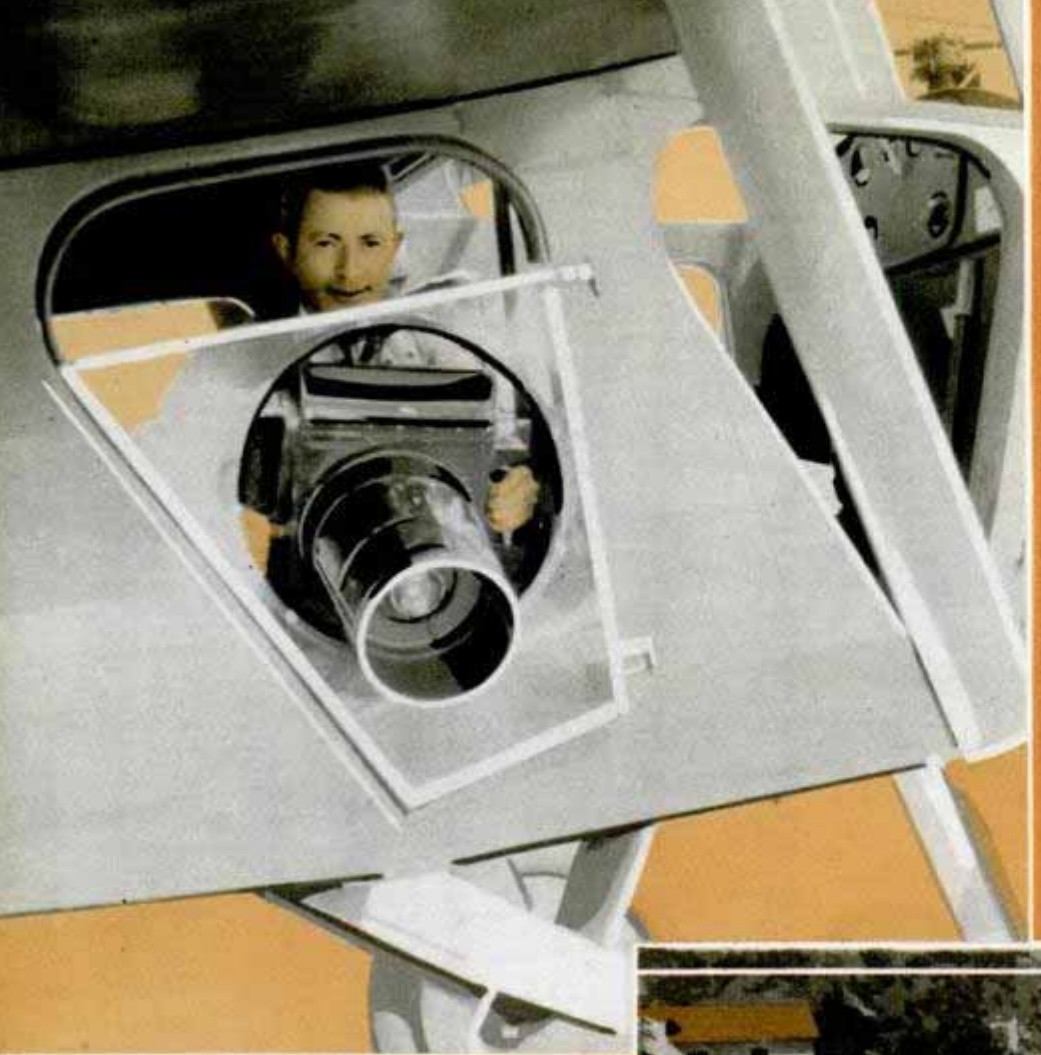

Oelke points his mosaic mapping camera out the side of the small cabin plane, left, which he likes for its maneuverability when vertical or steep angle shots are wanted. Below is one of his "news" pictures, a view of a railroad wreck taken "on the run" from low-flying plane and then rushed to newspapers.

662 9630

Live and learn. By years of trial and error I've picked up a few ideas about what to do and what not to do with a camera in the sky. In the first place, pick the right camera; for scenic photography from the air, I prefer a four-by-five camera with a good-quality lens of ten-inch focal length. With a lens of that length you've got to sight it like a rifle and hold it steady; if you thrust it outside the door or window the air blast will either rip it from your hands or blur the image badly. Nor can you rest it on the floor or window ledge; vibration would show up on the negative.

All this doesn't mean that you can't get a picture when you ride as a passenger in an air liner. You can, if you watch your moments. Shoot through the window at the sunlit clouds. Aim steeply downward at the patchwork





2620
 Top, air view of throng attending Easter service at Forest Lawn, Los Angeles; notice cars on serpentine road. Bottom, Oelke talks into microphone as he focuses on plane below.

663
 of fields, the slanting skyscrapers, the winding rivers. Watch for a chance to focus on the ground when the pilot is banking sharply, or while taking off or landing. Look out for reflections from the glass window. Shoot fast. Close to the ground you'll need shutter speeds of $\frac{1}{250}$ to $\frac{1}{500}$ second. Higher up, I shoot black and white pictures on the average at $\frac{1}{200}$ second at $f.8$, Kodachrome usually at $\frac{1}{100}$ second at $f.4.5$. But of course there can be no hard and fast rule; it depends on weather and speed and object and distance. To cut through haze I suggest a light yellow filter, which also produces beautiful cloud effects.

Ralph Hall is my favorite pilot when I'm after a news picture. He knows exactly how to stand the plane on its wing tip to get the wing out of the way of the lens. But when I go up with Hall I know I'm in for a ride. We usually take a high-powered Northrop cabin plane, and he

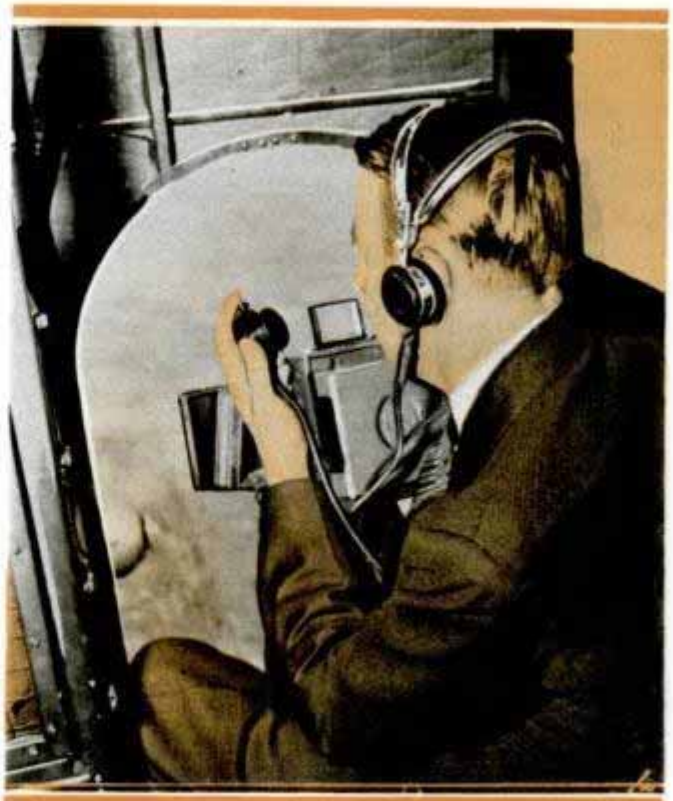



664
9630
Natural-color film brings out full beauty of Niagara's Horseshoe Falls. The liner had to lower its landing gear to slow down to pace of smaller plane carrying cameraman.

takes delight in going into a vertical bank that stands me on my head, perfectly helpless, with a thirteen-pound camera in my hands, centrifugal force increasing the weight about three times.

Photographing American Airlines flagships from another plane is a job calling for coordination. It takes a bit of maneuvering to get above and just ahead of the flagship and then to shoot at the right moment to take in a scenic background. I'll sit or lie in the open door of my air liner, sending messages up to the pilot by an assistant and trying to get the idea across to the other ship by waving my arms. Once the cooperation got entirely too good for comfort. I beckoned the other pilot to come closer and closer until I thought he was going to stick his wing right in my face and I waved frantically to pull away. Just the other day I went up in a Waco above Niagara Falls, where a flagship was to "sit" for its picture. Here was a nice

problem. The little Waco couldn't step faster than around two miles a minute. The Douglas liner was used to three miles a minute and more. We had to jockey around in the air above the gorge until I could sight the big ship right against the falls. Finally the Douglas solved it by throttling down to the lowest possible speed and then lowering its landing gear, which slowed it to 125 miles an hour. Meanwhile, several spectators called the airport to report a big plane flying over the falls with its landing gear down. And another time when I was circling above the Ford plant at Dearborn, Mich., waiting for a cloud to pass, the airport was bombarded with telephone calls about an "aviator lost over here. He just flies in circles."

Nowadays when I'm called upon to photograph another plane in the air I use a three-way radio instead of the hand signals. While I sight the camera,
(Continued to page 128A)

Camouflage Used on Tanks and Big Towers

War tanks used in Europe are being camouflaged to escape the eyes of air raiders. Camouflage is also being employed to hide important factories, munitions plants and powerhouses. The huge cooling towers of the electric generating works near Leicester, England, now closely resemble a clump of trees when viewed from a distance.

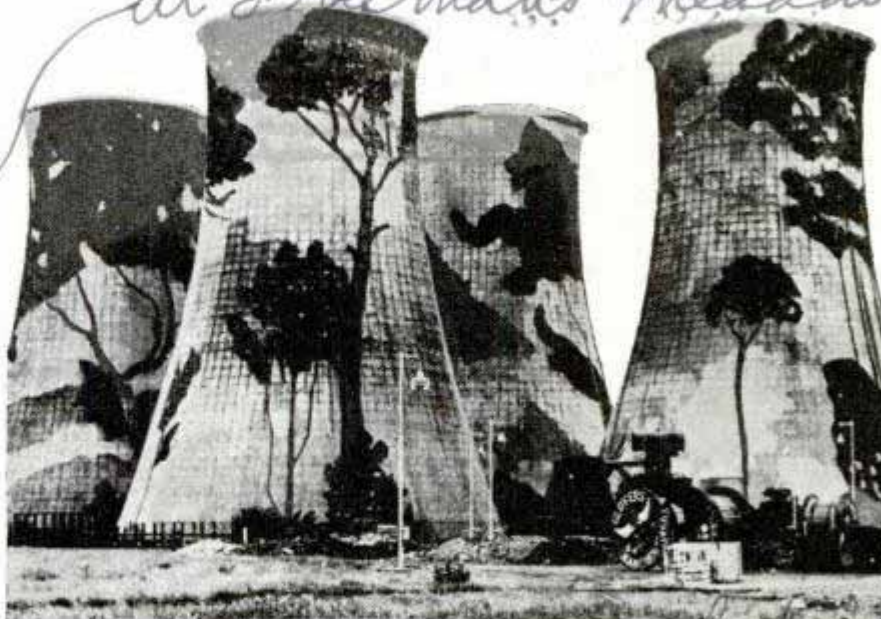

Boat Preservative Lasts Longer

A boat bottom preservative that will not dissolve in water, recently announced, was made possible by the discovery of new organic chemical compounds. When these were dissolved in suitable solvents, the product proved insoluble in both salt and fresh water, non-volatile, and incapable of leaching out or evaporating. Being in solution rather than in suspension, the toxic elements penetrate the wood itself giving lasting protection.



Two examples of camouflage in Europe. Top, cooling towers painted to resemble trees. Below, tank painted to blend with surroundings

Diesel-Powered Sightseeing Boat Offers Good Visibility



Sightseeing boat with open sides assures all-around vision for tourists

Tourists cruising on the sightseeing boat that operates on the lake at Norris Dam, Tenn., have an unobstructed view of scenery throughout the ride. Full visibility is also provided for the pilot who steers the Diesel powered ship from a glass inclosed cabin. Built low on a wide keel the sturdy vessel resists tilting and offers a safe ride to passengers on a sightseeing trip.

Built by Howard Ship Yards and Lock Co

Coltrin Chemical Corp 422 Alden St

2984

at Freeman's Meadow

International

210 33

2963

2963

KeyStone

Engine Adapted to Any Fuel in Few Minutes

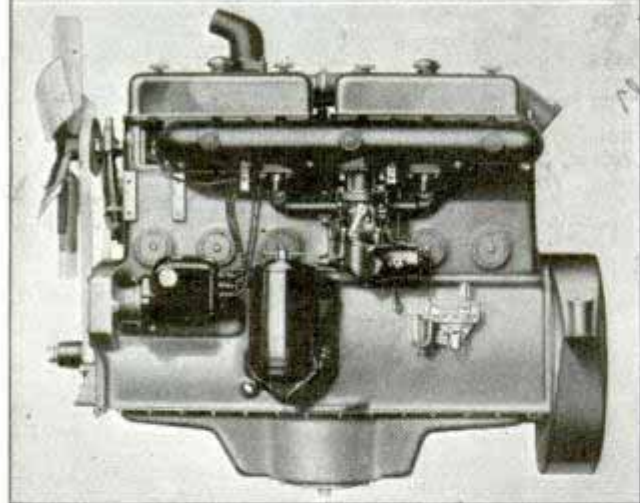
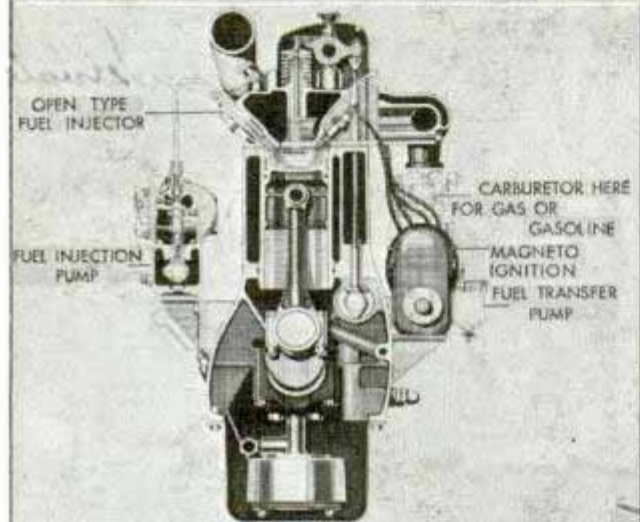
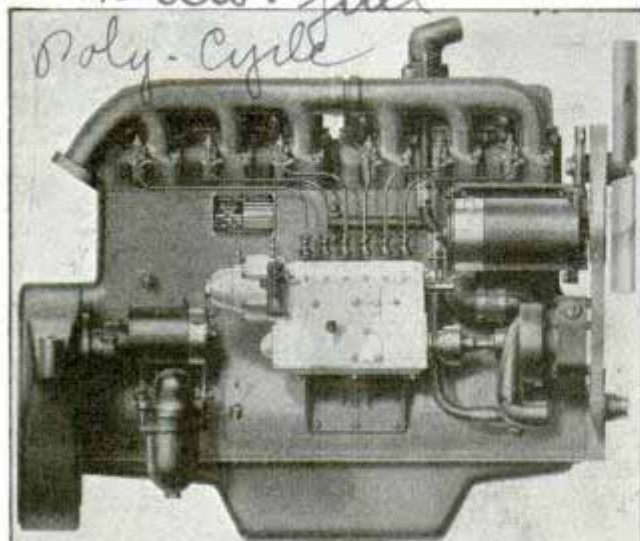

Engine fitted for oil (top) and for gasoline (bottom). Center, cross-section view

Gasoline, Diesel oil, butane and natural or artificial gas may be used in a multi-fuel engine that may be adapted to the various fuels in about twenty minutes. Change in fuel involves no modification of internal

parts, only the fuel system being altered. As an oil engine, it operates on the Hesselman principle, with fuel injection and spark ignition. The change to gasoline is made by closing the injector openings with plugs and fitting a carburetor in place of the air horn. The engine can be adapted to burn butane, natural gas or artificial gas by equipping it with a mixer in place of the carburetor. The engine, which is the valve-in-head type, weighs only a few pounds more, as an oil-burner, than as a gas or gasoline engine. The power plant, designed by Waukesha, is said to offer great possibilities for the fleet owner permitting a test of oil-burning vehicles without limiting the operation to territory where proper oil may be obtained easily. On long-distance jobs, the multi-fuel engine permits the vehicle to operate where any one of the fuels may be found.

"Spider" Plow Fights Forest Fire by Making Wide Trench

To speed part of the work of fighting forest fires, the U. S. department of agriculture forest service is using a spiderlike "plow" to cut lanes around burning areas. One operator with this machine can do the work of several men with shovels, throwing aside all vegetation, sticks and other inflammable material to form a fire break two and one-half feet wide. A five-horsepower outboard motor rotates the digger.



Pushing plow that cuts fire break wide enough to keep fires from creeping or leaping across

*Bender Aviation Corp
Marine Div 754
P.O. Box 1000, New York*

Air Cooler and Filter Adds Comfort to Driving

Relief from summer heat inside the automobile is offered by air coolers and filters operating on the evaporation principle. A step toward air conditioning, two designs are available for automobiles and trucks, and a third is homemade for use on trailers. The passenger car cooler is hung on the door without damaging the finish, and uses an airplane win-

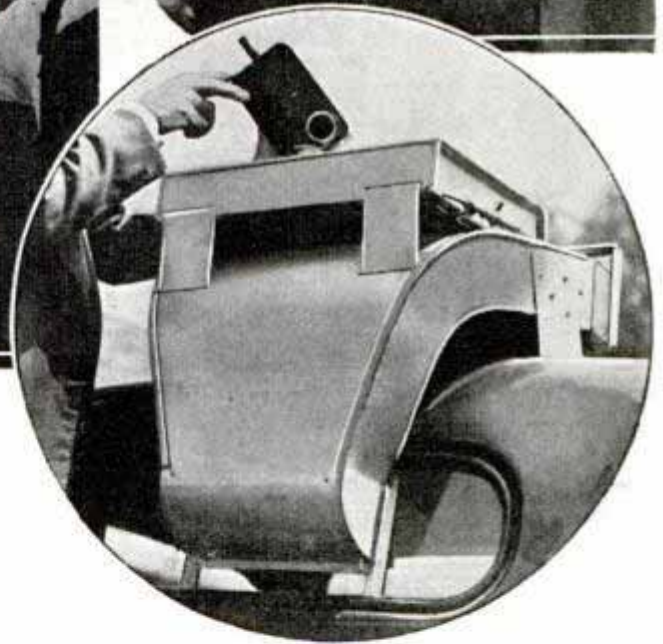
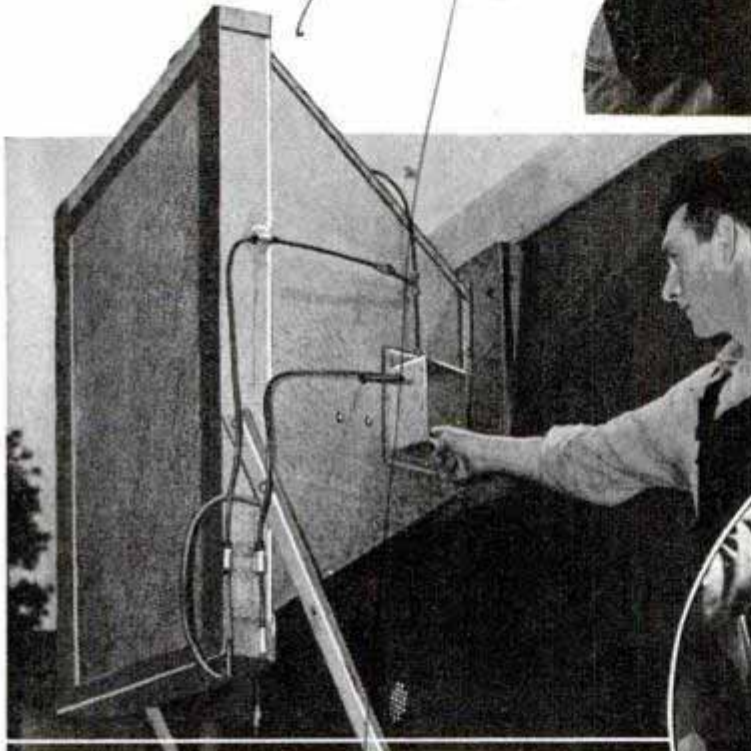

Above, homemade cooler for trailer. Right, manufactured unit on auto, top, and on truck, below

dow to close the opening. Air drawn through the unit by a fan passes through a fine mist where it is cooled by absorption of water and also is washed in one operation. Simply fill the water tank, turn on the switch, and cooling starts. The truck air cooler is placed on top of the cab and depends on motion of the vehicle to force air over a pad of dampened excelsior and then through the rear window. Dripping of water on the pad is controlled by the driver, a set of louvers controlling the air intake. A trailer owner constructed a funnel-shaped box to fit on the rear window of his trailer. Here again excelsior holds the water, and a blower fan in reverse position pulls outside air through the cooler and into the trailer. Water from

a tank inside the trailer is forced to a point where it drips into the excelsior. A regular automobile battery is the power source for operating both the water pump and air blower. Each of the units can be detached easily from the vehicle in the autumn when cooling is no longer needed.

Ⓢ A safer bullet for use in shooting galleries is made of spongy, fibrous lead that disintegrates when it hits, ending the hazard of flying fragments.

made by J.B. ... 1413 W. 30th St. ... Science Service ... D. W. Watson H. Woodford

J 891 ... Johnson ... place Cicero Ill. Coleman Steel Metal Wash 1950 ...

9 791
 Apr. 3, Buckingham Apts
 4322 Second Road, Phoebe

Keeping the IRON HORSE

Photos Western Union Telegraphy Co. Assn. of American Railroad & Transportation Workers Baltimore and Ohio R.R.

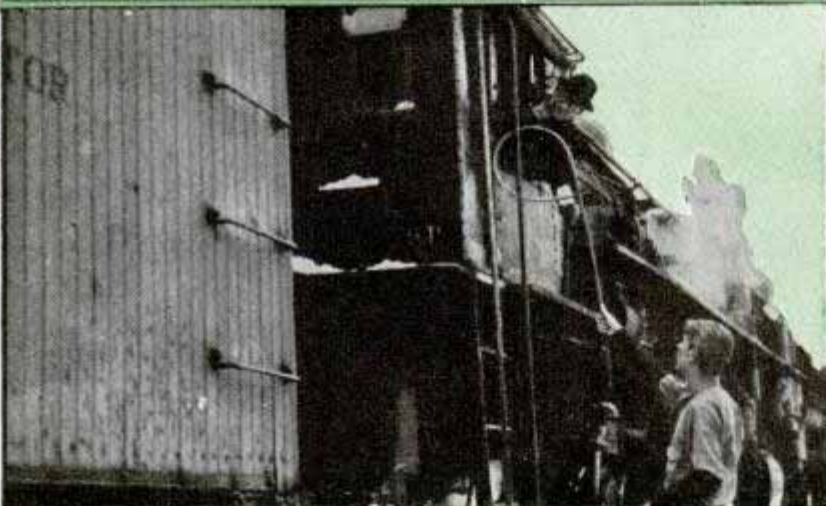
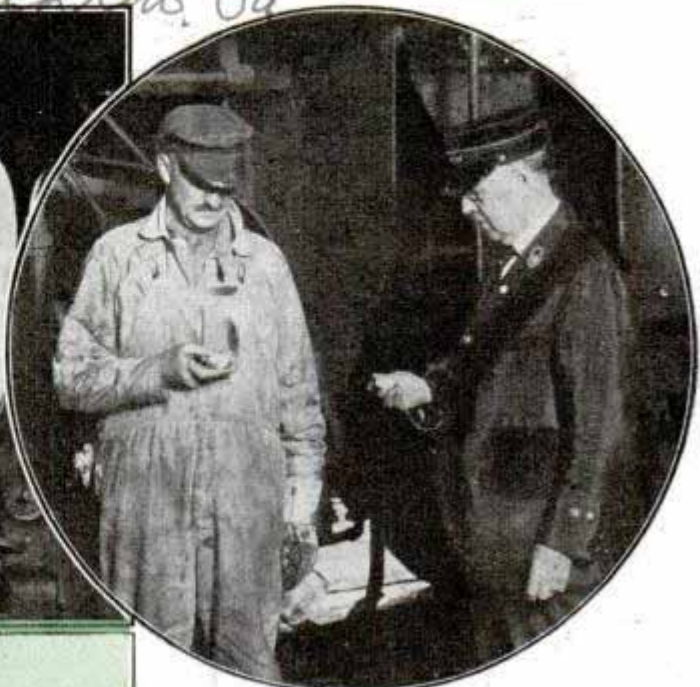

GOING home for Christmas? Jimmy Rice is. But his boss has told him he must work right up until closing time Friday. Jimmy's job is in Washington; his home 3,000 miles away in San Francisco. And Christmas comes on Monday.

Jimmy has counted his money—not enough for plane fare. So he has consulted railroad timetables and when he dashes for the train, he will wire his mother he will arrive at 7:52 Christmas morning.

Notice that "7:52." He didn't say he would get there in time for dinner, or at eight o'clock. The timetable shaved off those eight minutes, and he knows the train will do the same. He knows, too, that he will not get to Chicago until fifteen minutes before the San Francisco streamliner leaves from a different station. Close figuring here, but he can make it if the first train isn't late. His whole Christmas holiday

Signals as seen from cab of Diesel-electric locomotive, top, and engineer and conductor comparing watches. Below, passing orders to fireman of moving train, and signalmen at work in tower at Union station, Washington

Parsons
Chicago

on TIME

Norfolk and Western
2791

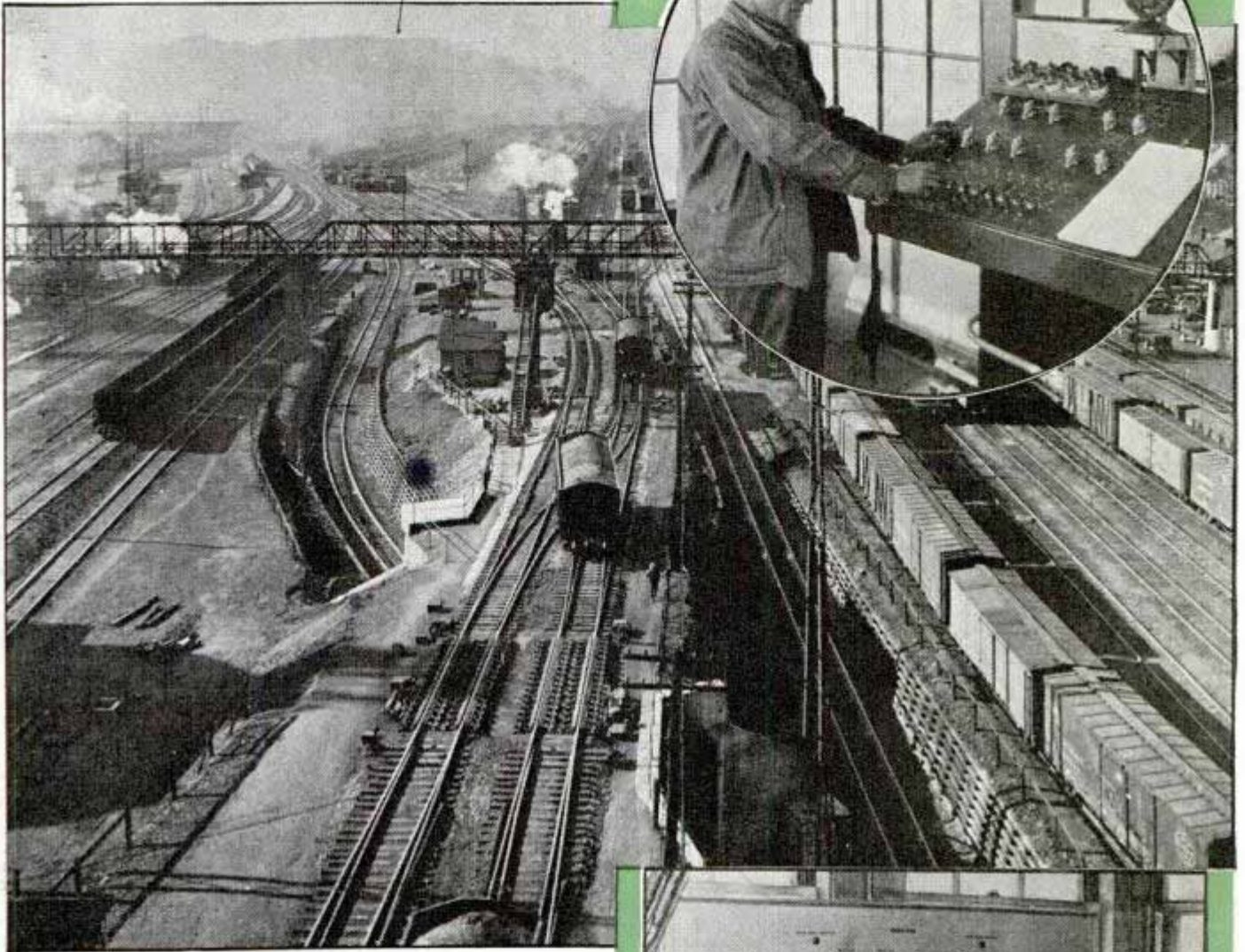

depends on that train being on time.

Millions of travelers every year lay business and holiday plans with implicit faith that those rows of figures in the timetable mean what they say. Seldom are they disappointed. For time is law to the railroad man.

Time to the railroad man is a thing of split-second, uniform accuracy. In every terminal, every dispatcher's office, every signal tower and telegraph office is a standard clock, checked and corrected each noon by telegraphic signals from the naval observatory at Washington, which in turn gets its time from the stars. Every railroad employe connected with the running of trains must check his watch with one of these standard clocks every day upon reporting for work. Once a month he

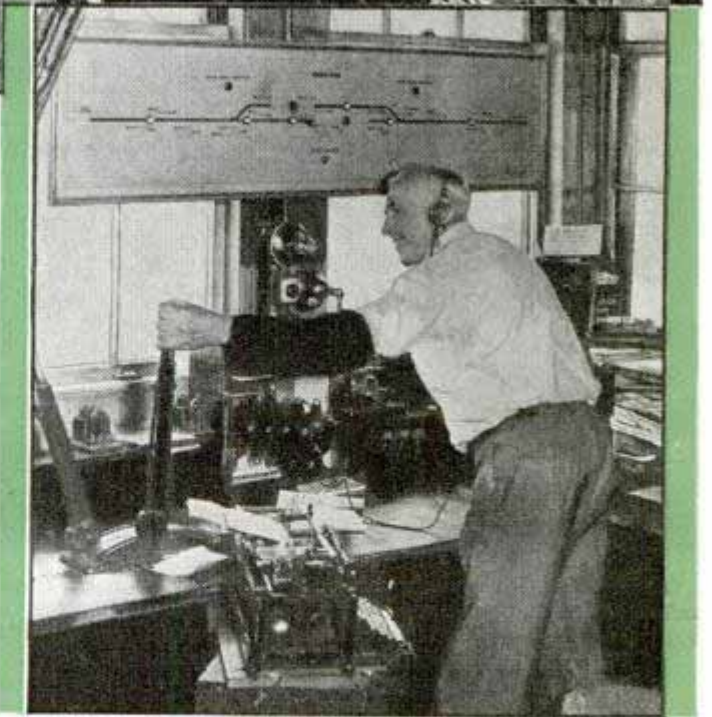

Hump yard, top, where freight cars are switched from track to track as they roll down hill, and control board in hump yard. Bottom, telegrapher working switches and signals for passing siding

2791
670

Traffic between North Lima and
Roachton.
B & O dispatcher at Deshler Ohio

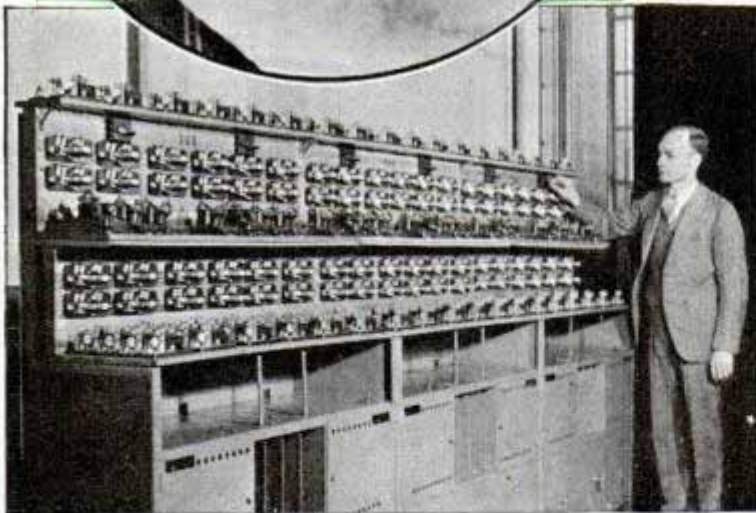
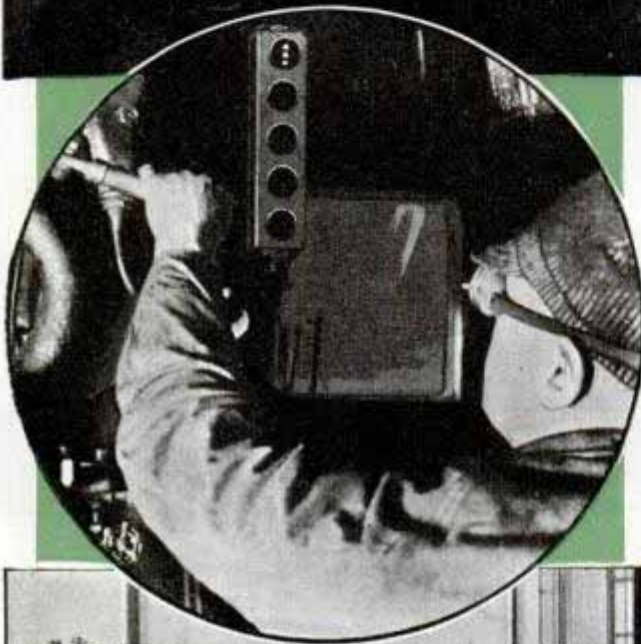
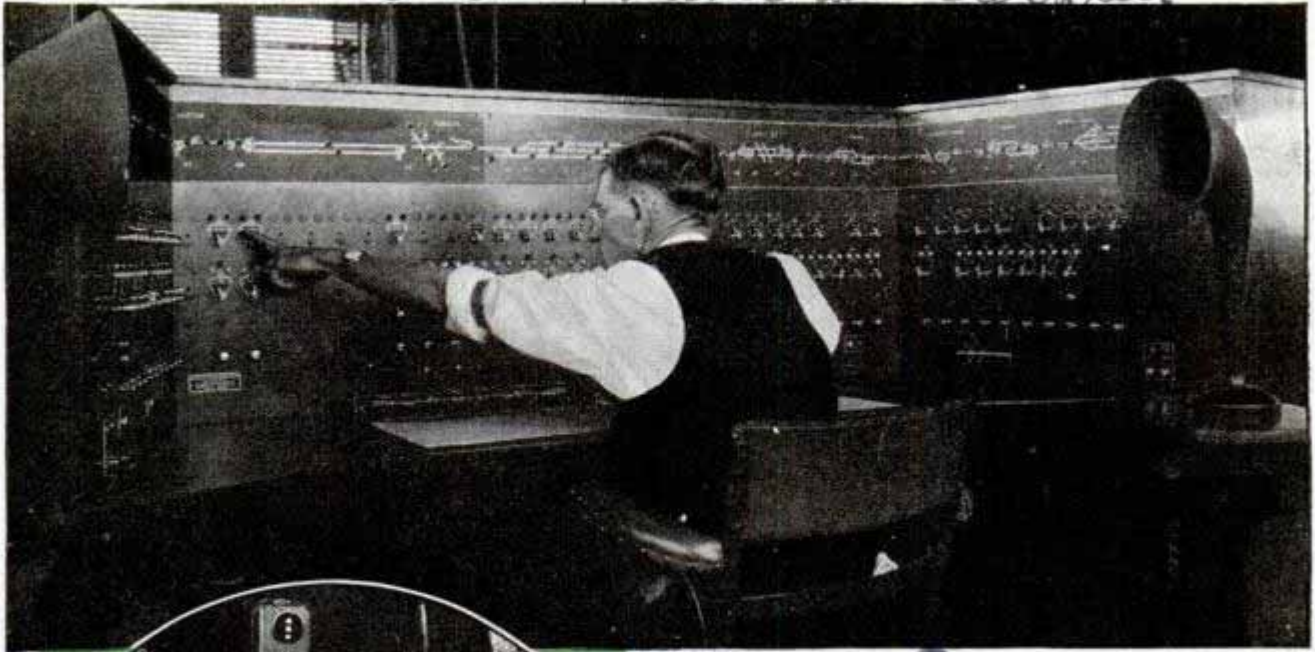

Dispatcher, top, at panel where signals and switches for many miles of track are operated. Cab installation, center, which repeats trackside signals. Bottom, apparatus which flashes correct time simultaneously to hundreds of points

Western Union

must take his watch to an official inspector for comparison, and twice a year for a thorough inspection.

And just any watch won't do. It must be a standard railroad watch of specified size,

with a minimum of twenty-one jewels—the product of any one of four American manufacturers selected on their reputation for making accurate timepieces. And a stemset watch is ruled out because the hands might accidentally be moved; a mishap impossible with the required lever set.

Now let's see how the railroads manage to get Jimmy across a continent—and on time. We see the engineer and conductor, standing beside the shiny locomotive, comparing their watches. One minute before the train is due to leave, the conductor turns a key switch in the platform box. This flashes a warning to the gateman who closes his gate, makes sure last-minute passengers get aboard. A light is also flashed in one of a row of numbered circles in the interlocking tower, informing the tower director that the train is ready to start. The director replies by pushing a button, which flashes on the second light at the gate.

This is a signal for the gateman to lock his gate. Doing this lights a second lamp in the platform box, and the third circle in the tower. Seeing both lights burning, the conductor consults his watch, and precisely on the dot gives the starting signal to the engineer. At that same instant the tower director orders a clear signal given, calls out to the leverman a route through the maze of terminal

(Continued to page 157A)

"Invisible" Light Guides Traffic in Blackouts

Designed to reduce the hazards and terrors of night air raids, during which whole cities are darkened for hours, an "invisible" light projector has been invented. The projector throws a narrow beam of light that is visible only when the observer is directly in its path. It is invisible to enemy airplanes. The light gun is useful as a guiding lamp for motor traffic. Since only one lamp is visible to the driver at a time, he knows that he is in the correct position on the road.



Above, using the beam projector as a signal device. Right, the light gun installed to guide motorists during blackouts



Torpedo with "Eye" Strikes Under Ship

Deadly in its attack against vessels is a torpedo invented by John Hays Hammond, Jr., which includes an electric "eye" that directs it against the bottom of the ship's hull and there explodes the charge. It is the answer to the use of "blisters" on warships that render submarines less effective against them. The purpose is to strike at the most vulnerable point of the hull—beneath the center of the ship. Running at a depth several feet below the ship's draft, the torpedo is caused to veer sharply upward when the light sensitive arrangement has passed into the shadow of the ship. At the same time mech-

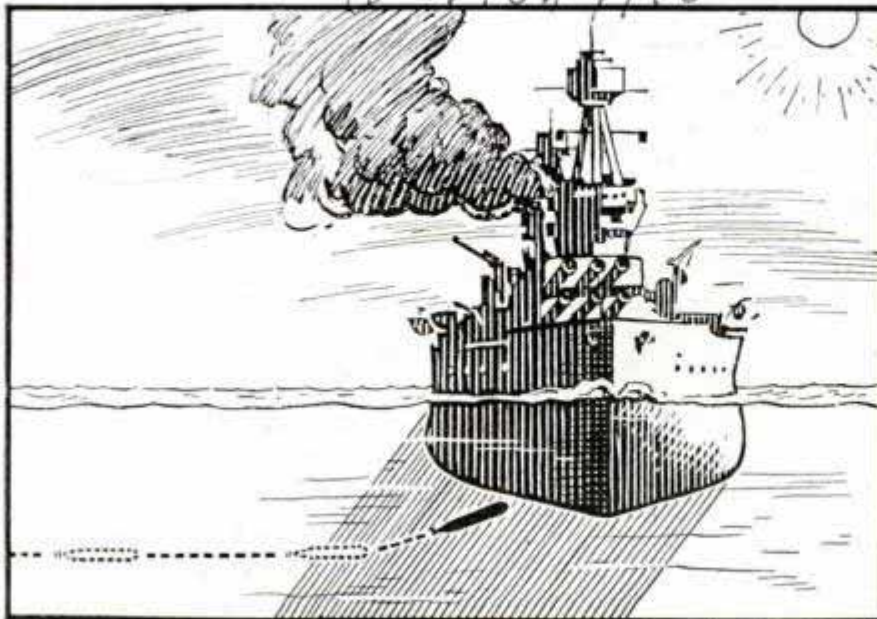

Torpedo entering ship's shadow is nosed upward by its light sensitive mechanism, as shown by drawing. Explosion occurs near center of vessel

anism is started operating to detonate the torpedo near or in contact with the hull of the craft. To prevent premature explosion in the event it passes beneath debris, a delay action circuit is incorporated so that the photocell must remain in the shadow a predetermined length of time before the mechanism will go into action. An important advantage in running torpedoes at a greater depth is the added difficulty to detect them, since air bubbles rising in their wake are farther behind.

2 1000

by Capt. J. D. Bunker

with intelligence full

Amsterdam, Holland

2 1015

Essex, Mass.

H 2 168-916

Seven-Year-Old Engine Breaks Water Record

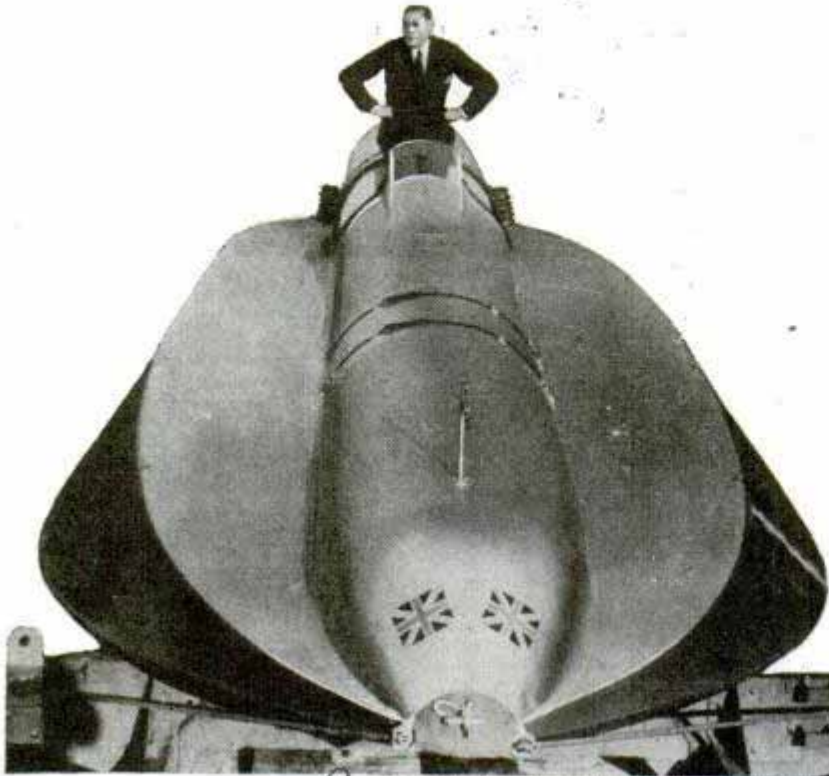

Coniston in Lancashire, England. Using a seven-year-old 2,500-horsepower Rolls Royce engine, he hit a top speed of 142.85 on the south run, and swung back over the route at 140.62. The achievement shattered his own previous record by 10.81 miles an hour. Sir Malcolm plans to equip his "Bluebird," which is a three-step hull design, with an engine capable of 200 horsepower more, for a future attempt to push the record still higher.

Above, Sir Malcolm Campbell in cockpit of his "Bluebird II." At right is powerful speedboat roaring over Lake Coniston in test run

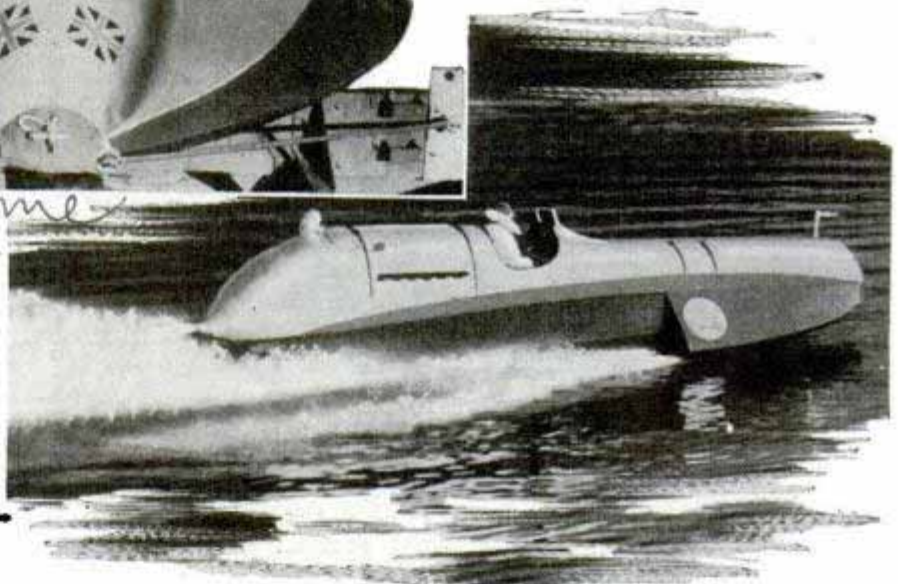

All water speed records were broken by Sir Malcolm Campbell when he drove his new twenty-seven foot "Bluebird II" at an average of 141.74 miles per hour over Lake

g 10 04

All-Purpose Fighting Tank Has Tractor Drive and Wheels



Here is the tank traveling over rough ground, with the tractor drive in contact with the surface

Equipped with wheels for smooth roads and a tractor drive for rough terrain, a German tank demonstrated recently is designed for use in mountainous country. While the tractor drive is in use, the wheels are held in elevated position. Fairly high speed can be attained when the wheels are lowered into contact with the road.

Six million big game animals inhabit the United States, it is estimated from figures of the last Bureau of Biological survey, deer leading with a total of five and one-third millions.

Washington, D.C.

8/27/39

Phosphorus 'Flower' Hides Army Maneuvers

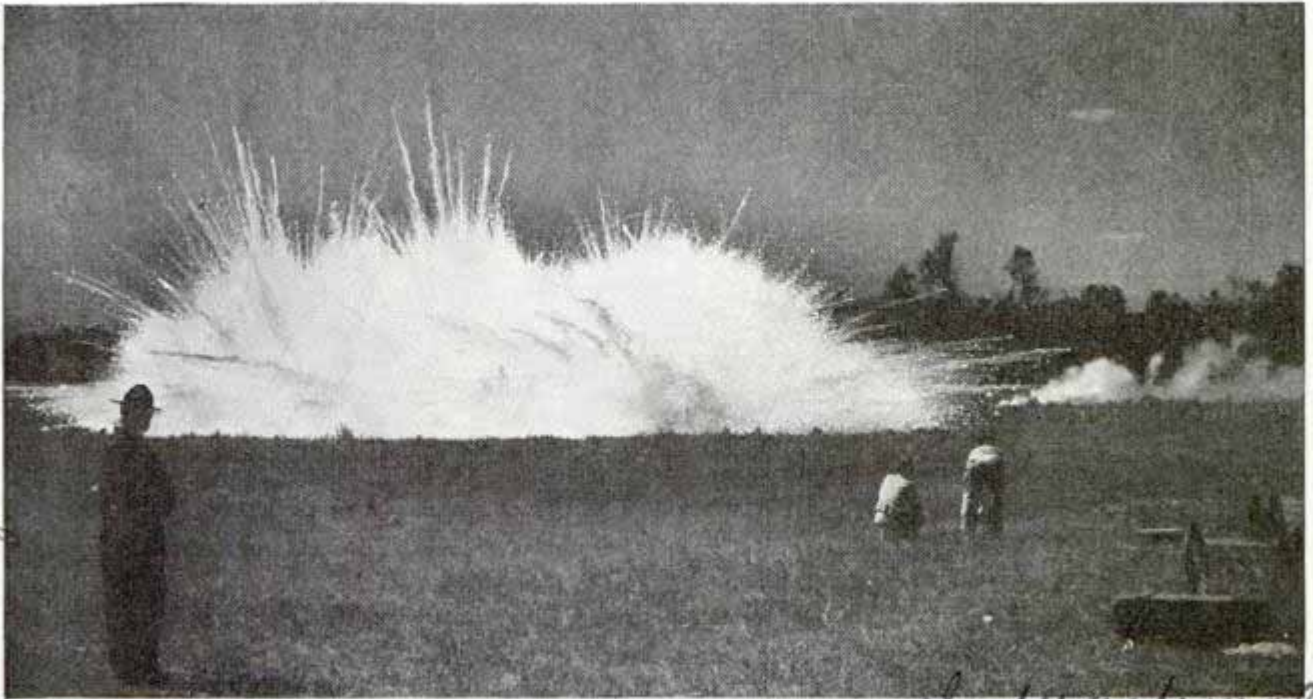

Screen of exploding phosphorus, "erected" by chemical warfare division like a giant, luminous wall, effectively conceals from view of enemy ground observers the movement of troops behind it

Chemical warfare has its defense aspects as well as its offensive power. At the Edgewood Arsenal in Maryland recently the chemical warfare division exploded a

quantity of phosphorus during troop maneuvers. It burst across the ground like a vast, luminous flower, effectively screening the movements of the soldiers from view.

Towboat Lowers Pilot House to Duck Beneath Bridges

Built for operation in the vicinity of Chicago where bridge clearances are limited, the towboat "Benwick" can duck under the bridges instead of waiting for them to be lifted. This is accomplished by mounting the pilot house on a rotary hydraulic elevator, powered by an electric oil-pumping mechanism installed inside the jack plunger. With this type of construction the pilot house may be raised to provide good visibility when navigating in open water and lowered below the clearance line to pass beneath bridges, saving the time it would take to slow down for them to open.



Pilot house, shown in "up" position for observation, can be brought down to clear low bridges by simply pressing button

Chemists have extracted a protein powder from whey, by-product of cheese, and whipped it with water to produce a substitute for egg whites.

Science Service
7/19/39

Sold by J. J. Stangel
Hardware Company

Resumpt by Abraham Lincoln Washington Bureau
6. ar ou

International
Edgewood
Rotary
Mynilow
Cable Monitor



Master Suter
William Badders

In the recompression chamber, left. Even before tenders pull off his suit, the diver starts breathing oxygen after reaching the surface. Below, groggy diver being helped to the recompression chamber after being brought to surface. Bottom, timer watching diver's elapsed time while man at loudspeaker telephone stands ready to order diver to come up

John Michalowski



Master Suter J. H. McDonald

FORTY FATHOMS DOWN

By Nat A. Barrows 195

Essex Ave. Wrentham
PART II Mass

THE ocean bottom 240 feet down is no place for a greenhorn. Only by long and careful training, gradually learning how to handle increasing amounts of pressure, can a man work at 240 feet and live to dive another day. A head-first tumble, a tear in the suit, a dose of carbon dioxide inside the "hat" and sudden, horrible death may overwhelm the hapless diver.

At 240 feet, the depth at which divers worked on the sunken "Squalus," off the New Hampshire coast, the pressure is so great that a cork will not float to the surface. Instead, it squeezes into a tiny hard pellet. A small piece of light wood turns into a toothpick. The ocean's crushing

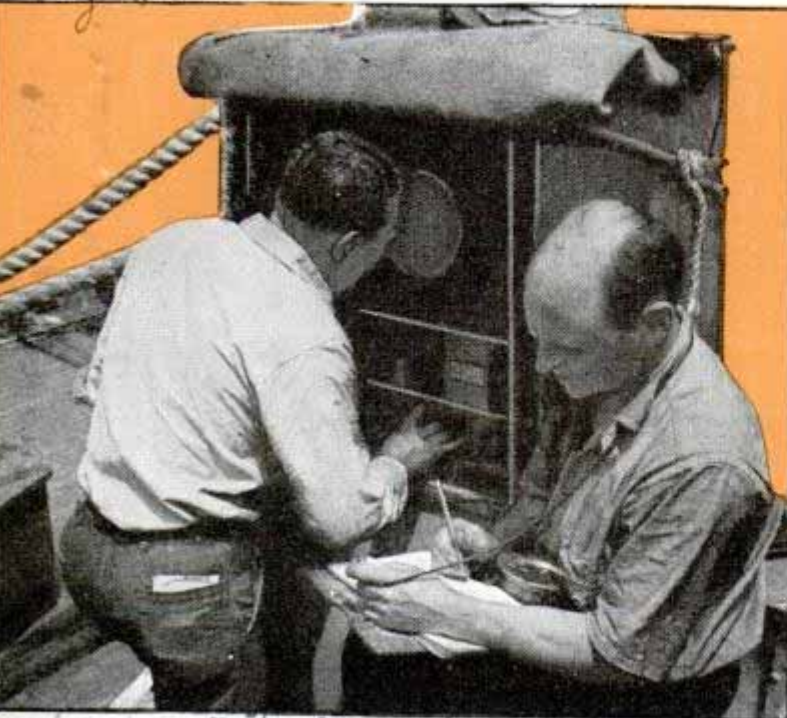

Fabian rapier separator

The diver's hat is a...
 The diver's hat is a...
 The diver's hat is a...

at Brooklyn Navy Yard: master diver. Arsen Crandall
 9805



Above, machine which blows air into pontoons used to raise submarine after they are sunk. Right, a master diver overhauling one of the salvage pontoons which was used to raise the "Squalus"

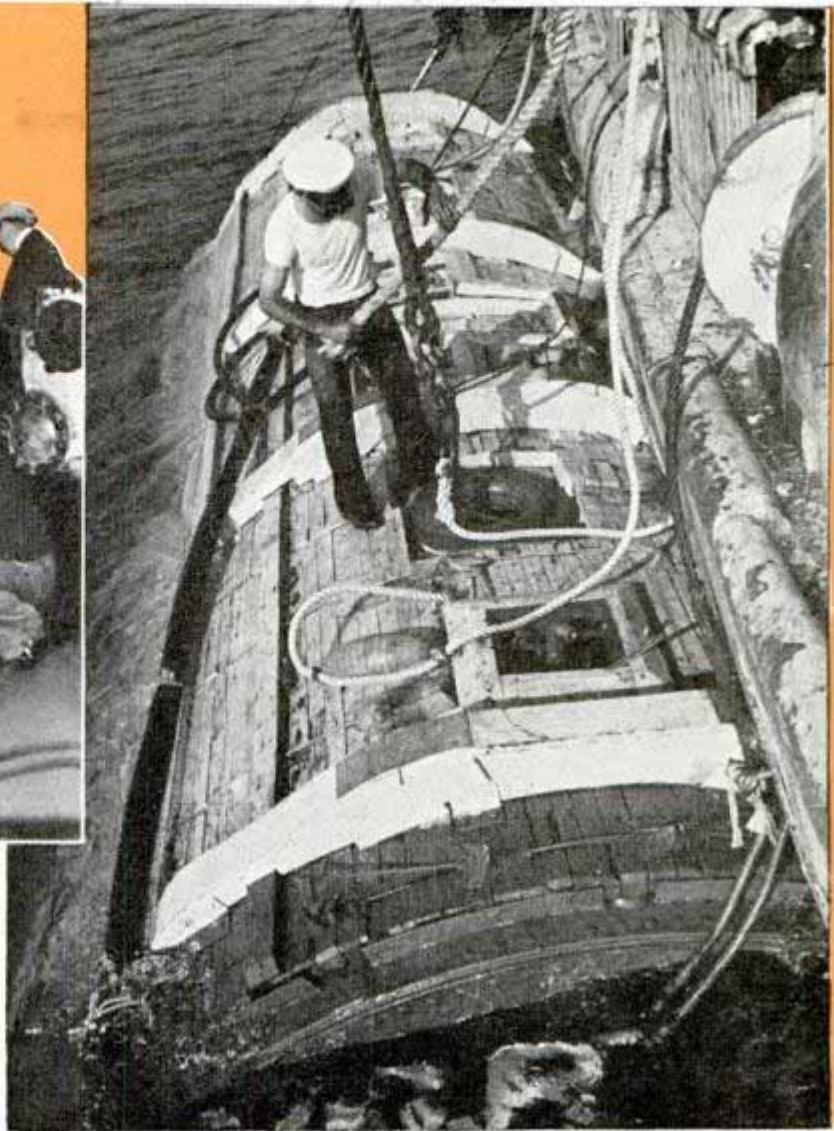

Squalus Salvage outfit.
 Fallen
 Commander: Insler, Salvage Officer.
 Reference: Lieut. Filson A.

with the **DIVING NAVY**

force, in fact, is enough to make a 1,450-ton submarine, the size of the "Squalus," actually one-eighth of an inch smaller all around the hull.

Yet, the trained diver, controlling his breathing pressure by the way his helmet and breastplate push or lift on his chest and shoulders, can stay down safely at such a depth as long as half an hour with compressed air, or considerably longer under helium-oxygen.

The fact that man, composed of eighty per cent water and fifteen per cent fat, can live even a split second 240 feet down is due, first of all, to his waterproof diving dress, which is today essentially the same as the suit brought out a century ago by the Englishman, Siebe. Without such a covering, a diver sliding down the descending line to 240 feet would become pulp

before he ever knew what had happened.

The suits used by the U. S. Navy, and throughout the world, are of rubber, faced with heavy, waterproof canvas. The saddle-shaped, metal breastplate fits the neck and rests on the shoulders, with an overhang well down the chest. To the breastplate the helmet is fitted, attached by an interrupted screw thread that makes the connection watertight. A snap safety lock keeps the helmet from unscrewing. The air-supply hose and the combined telephone cable and lifeline lead into the helmet, after crossing on the diver's chest and passing under his arms. The air-control valve is placed on the left, over the heart, to be used by the left hand as the diver needs more pressure.

"Away with the pressure—turn the control valve away from you; bring the pres-

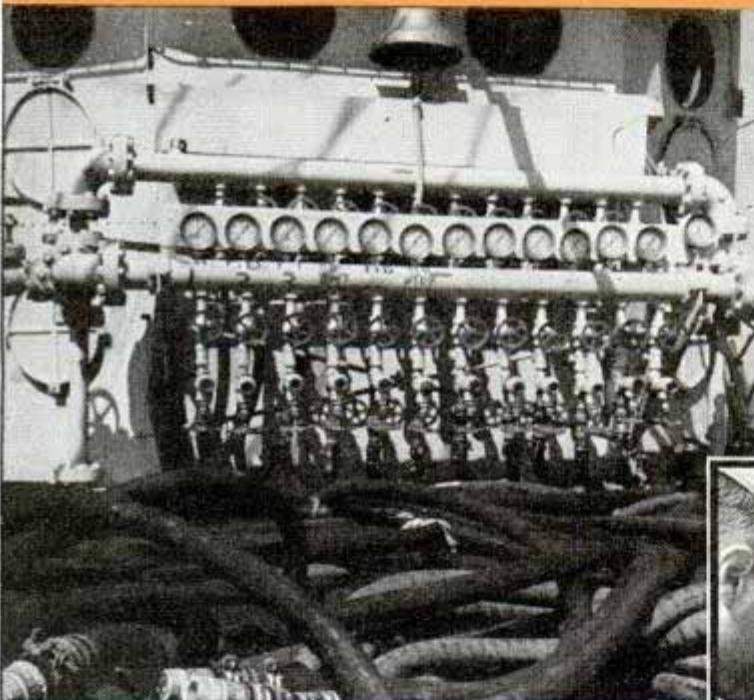
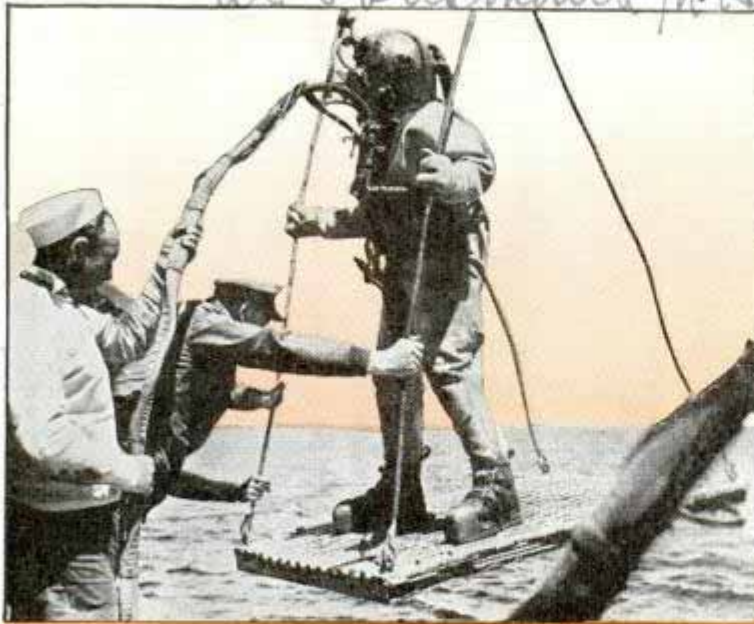

Diver, top, ready to descend to the "Squalus." Above, control board on "Falcon" from which air was shot down to pontoons. Right, adjusting diver's helmet

sure to you—turn the valve toward you," say the divers to shaky neophytes.

At the point where the air-supply line opens into the top of the helmet, an automatic non-return valve gives the diver a chance for his life in case the air line is ruptured or accidentally shut off. By closing the exhaust valve, at the right side of the helmet, the diver can keep enough air in his "hat" to insure some chance of life until the tenders haul him to the deck and rush him to the "iron doctor."

Ruptured air lines do happen, and it is a lucky diver who escapes without a serious case of the bends.

As a rule, the diver does not need to touch his exhaust valve often. It is adjusted so that pressure inside the helmet is slightly above pressure of the water. Thus, more pressure comes in the air hose than escapes through the exhaust vent.

If the carbon dioxide expelled by the diver begins to build up inside the helmet, exposing the man to the acute danger of unconsciousness, two remedies are available. Either the regular exhaust valve controlled by hand, or the button exhaust, controlled by a shove of the diver's chin may be used. This button is a handy affair when the diver has both hands occupied.

Protected by his suit and weighed down to keep from floating away, the diver working in great pressure depths is able to live because the increased pressure, introduced into the lungs by breathing, is evenly distributed throughout the body by the blood stream. In other words, the pressure inside the body is made to



balance the pressure of the ocean outside.

When the blood leaves the lungs under pressure it is saturated with the major gases—nitrogen, oxygen and carbon dioxide. The oxygen combines loosely with the blood hemoglobin and leaves but a small amount remaining in physical solution. It is the nitrogen-gas saturation in the blood that causes trouble. The body quickly and easily accommodates it-

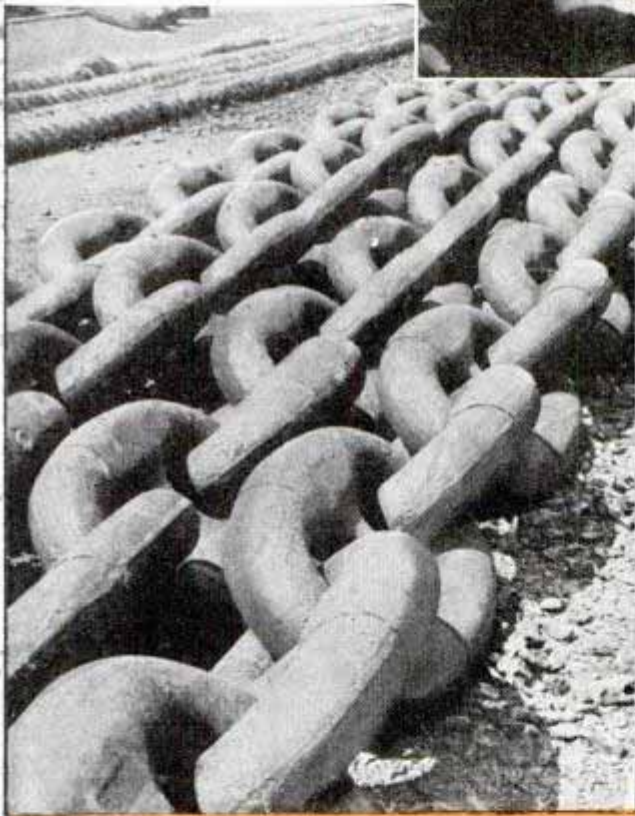

Chain used in "Squalus" salvage job. Each link weighs seventy-six pounds. Top, cutting one of the chain links, two and one-half inches thick

self to rapid changes of pressure, and to the subsequent high saturation of nitrogen.

But the elimination of this gas must be slow to keep it from forming bubbles before the blood stream can carry it off safely through the lungs. Since nitrogen makes up about seventy-five per cent of all the gases in the blood, it is the major problem in desaturating a diver after high pressure.

Unless the pressure is reduced gradually, the nitrogen gas turns into bubbles—and

the diver soon is screaming with agony as the racing bubbles pile up in the bloodstream bottlenecks at the joints and the base of the spine. Before scientists discovered the principle of nitrogen gas in saturation, divers died in terrible pain, or came up from the bottom paralyzed and blinded.

Today, with divers guided by exact decompression schedules, a case of the bends is rare, indeed, except after accidents. The use of oxygen masks has greatly shortened the time of decompression, since in breathing oxygen at a determined pressure the diver is taking in no nitrogen that has to come out of the system again, and the nitrogen already in the blood stream can continue to desaturate undisturbed. By shorter underwater decompression of divers, the diving platform is cleared for other divers, the danger of line fouling is lessened, and each diver is able to reach the warmth and security of the recompression chamber on the tender ship in less time.

Bends lurk always in the wake of deep-sea divers, even with the use of helium-oxygen instead of compressed air. Its dangers, however, are considerably lessened in these days of increased knowledge of how to handle divers.

A "blow-up" is one of the most serious accidents that can befall a diver working in deep water. If he gets too much pressure in his "hat," the diver balloons his suit. Then, unless he works cleverly and

(Continued to page 124A)

Q 881
678

General Electric Co
Schenectady, NY

"Cold" Light for Television Is Cooled by Water

consumed in the upper air, miles above us. These are seen only as luminous trails of shooting stars and meteors, most of the trails being so faint that they cannot be observed without a powerful telescope. The great majority of meteorites weigh from a few ounces to a fraction of a grain, but even a particle weighing less than a grain and moving with the speed of a meteorite would pass completely through a human being, explains Dr. Nichols.

Sally Eiler, movie actress



Water-cooled mercury arc lamp, small as cigarette, provides light with less heat for television studio

One of the problems of television engineers has been to provide double the studio lighting required by the movie cameras without creating unbearable heat on the "stage." The answer was found in water-cooled quartz mercury arc lamps that give twice as much illumination as a similar wattage of incandescent lamps but create only one-tenth as much heat. Three quarts of water per minute pass through the quartz jacket around the small lamp, taking away ninety per cent of the heat.

2895

Suction-Cup Seal for Food Jar Is Easy to Open and Close

Made possible by the invention of a unique sealing cap, food can be stored in airtight jars which are sealed by a simple tap with the hand. They are opened quickly by lifting the thin rubber edge of the lid with the fingers or a small object such as a toothpick, to admit air. Suction is created by a groove that circles the edge under the cap. A broad rim at the top of the jar forms a seat for the lid. The wide-mouthed containers and rubber covers are easy to wash and sterilize. When used as refrigerator sets they stop discoloration of fruits, prevent transfer of food odors, protect against spoilage, eliminate drying out,

merchandise mail

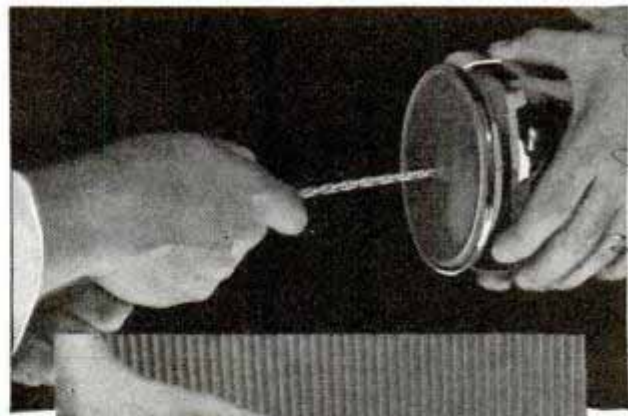

Suction ring seals cap onto broad rim of jar. Top, vacuum inside jar holds cover against strong pull

2990

Atmosphere Shields the Earth from Meteorite "Bullets"

Were it not for our atmospheric protection, we would have an aerial bombardment so severe that life could not exist except in the depths of the sea, declares Dr. W. H. Nichols, chief curator of geology at Field Museum of Natural History. The earth is daily the target of millions of meteorites, so small that they are completely

Science Service
Chicago

Chicago

Perfect Seal Sales Co. 1112
Chicago

and seal in the freshness and flavor of stored foods. They are ideal for the cold-pack method of preserving food, since it is not necessary to handle the hot jars when applying the tops. A vacuum inside the jar helps make a stronger seal, which may be so strong that a straight pull of more than 225 pounds is required to dislodge the cover—yet it lifts off easily if air is admitted under its edge.

897
Glass Block "Sandwich" Diffuses Light

Transmission of solar energy into buildings through the walls is reduced sharply by a new glass building block containing an interior screen of glass fiber. Eliminating glare from the sun results in a softer natural daylight, and the decrease in transfer of solar heat cuts down the cooling load in air-conditioned rooms. In the new design a glass-fiber sheet is sealed between two hollow glass squares, forming a light-diffusing screen in the center of the block.

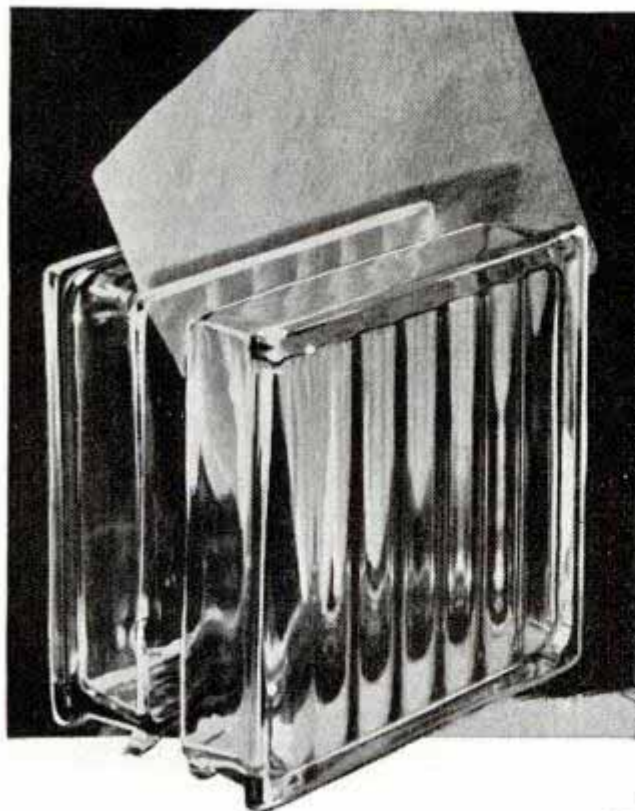

Glass-fiber sheet sandwiched between square glass "cups" diffuses sunlight and keeps out glare

2905 General Electric
 Schenectady, NY
Three-Eyed Electric Lamp Blends Two Types of Bulb

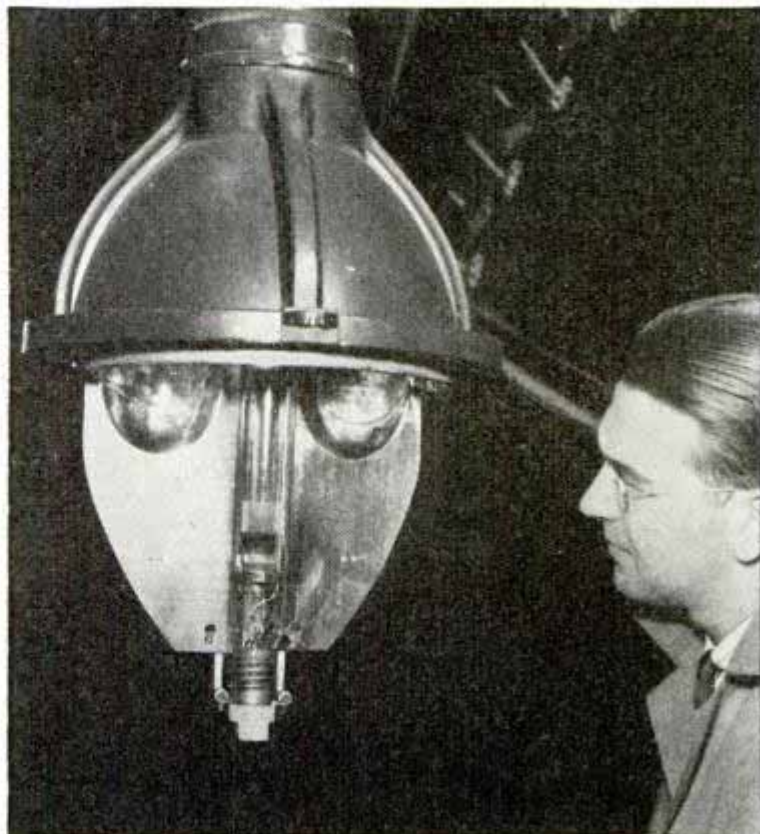

Two incandescent lamps and one mercury-vapor bulb are combined in one unit to produce this efficient street lamp

Incandescent and mercury-vapor bulbs blend their light in a three-eyed electric street lamp just developed. Flanking the 400-watt mercury lamp are two 200-watt incandescent lamps, producing together an effective light for outdoor use.

923
Self-Locking Shields for Corners Are Applied without Tools

No tools, nails or screws are needed to install a corner shield now on the market, as it is equipped with a spring steel clip having sharp points that hold it in place. Simply set the shield in the corner of a stair, drawer, shelf or cabinet and push it down firmly with the thumb. This locks it permanently in position and the maker claims it will not work loose.



Pittsburgh Plate Glass Co. Chicago - The Fair
 2222 Cass St. Pittsburgh Pa

George Pearson Lead Pipe, Pa.
 Wash. Co. Perryman, Md.
 C. S. Minneapolis
 Clever

2688

EXPLORERS OF

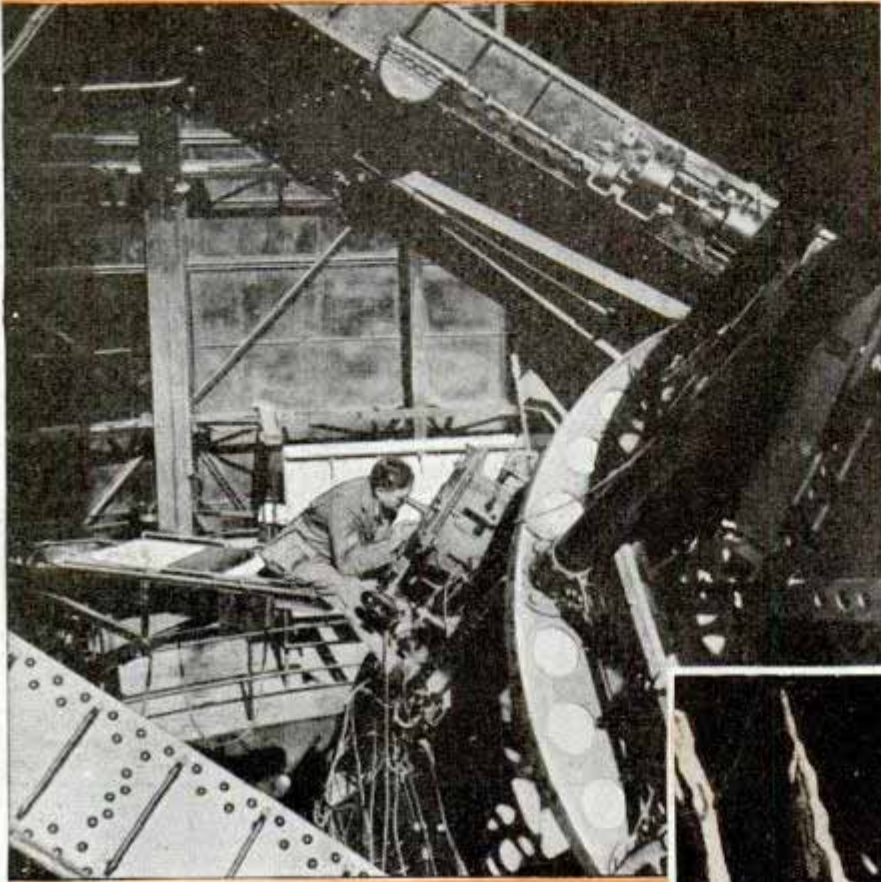

bring the moon visually to within twenty-four miles of our own world.

Already science knows enough about the moon to enable people to travel there—in imagination. By carefully assembling many facts already known about the lunar body and by dramatizing them with modern apparatus which includes scenic, sound and lighting effects scientists have made it possible to embark on a lunar expedition right in the center of New York City—at

By Emile C. Schnurmacher

108 E. 66th, New York City

ALMOST since the dawn of time, man has wondered about what was on the moon and in the stars. In imagination he has peopled the heavenly bodies with weird beings, incredible animals and grotesque foliage. Today his desire to roam the universe has at least been partially fulfilled. Only instead of leaving the earth to do so, science has reversed the process and brought the universe to the earth by means of the telescope and enacted dramas of the heavenly bodies in modern planetariums.

When Galileo devised his crude "optick tube" he discovered the four large moons of Jupiter, the phases of Venus, the spots on the sun and brought the mountains and craters of the moon to within 7,500 miles of the earth. Today with science's newest gift to the astronomer, a 200-inch telescope nearly ready for use, the promise is to

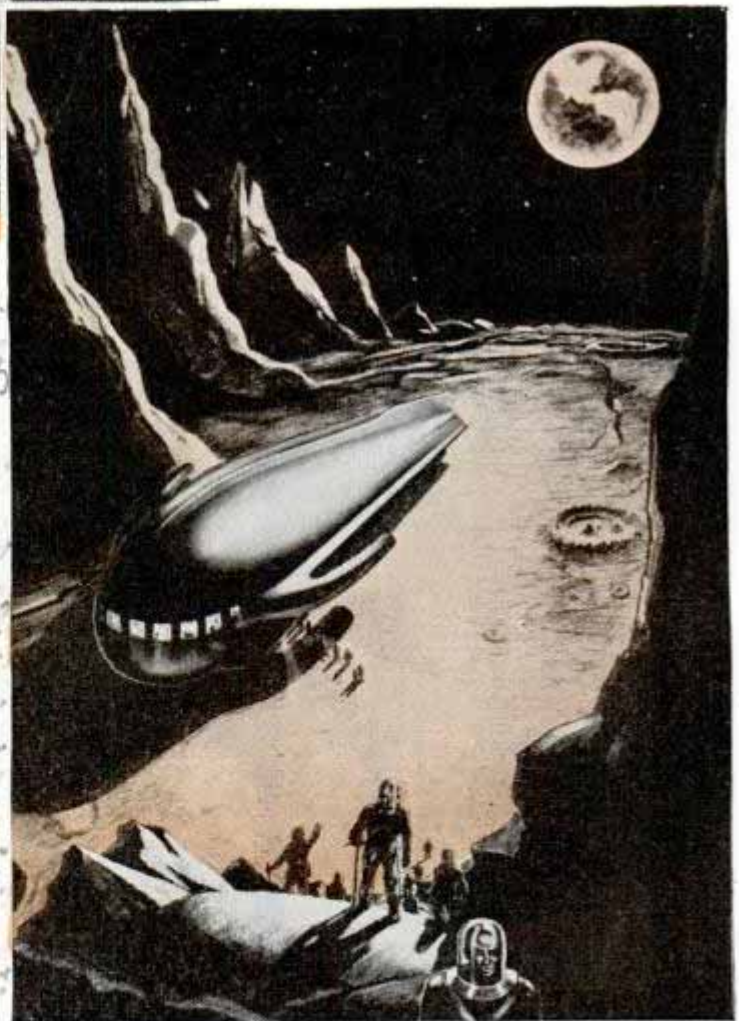

Observing the heavens through 100-inch telescope (top). Imaginary rocket ship after landing on surface of the moon. Note earth in sky

2608

SPACE



the Hayden Planetarium.

One such imaginary journey, an expedition "to observe an eclipse of the sun from the moon" took the planetarium staff, assisted by government workers under the direction of Professor William H. Barton, Jr., nearly three months to create and coordinate. Nearly 20,000 square feet of moon crater scenery had to be painted upon parchment which then had to be mounted in frames to obtain multiple lighting effects worked out by technicians. Several special projectors had to be built to faithfully reproduce the appearance of the earth as seen from the moon—its changing phases, the red halo at the time of eclipse and the faint illumination by moonlight.

The effect of a rocket ship soaring toward the moon at the rate of 250,000 miles a minute, the



Oxygen apparatus that might be required for exploring moon (top, left). This is from UFA movie. Right, Thomas Voter drawing of how earth's gravity might destroy moon, causing it to bombard earth. Bottom, eighty-two-inch telescope at McDonald observatory

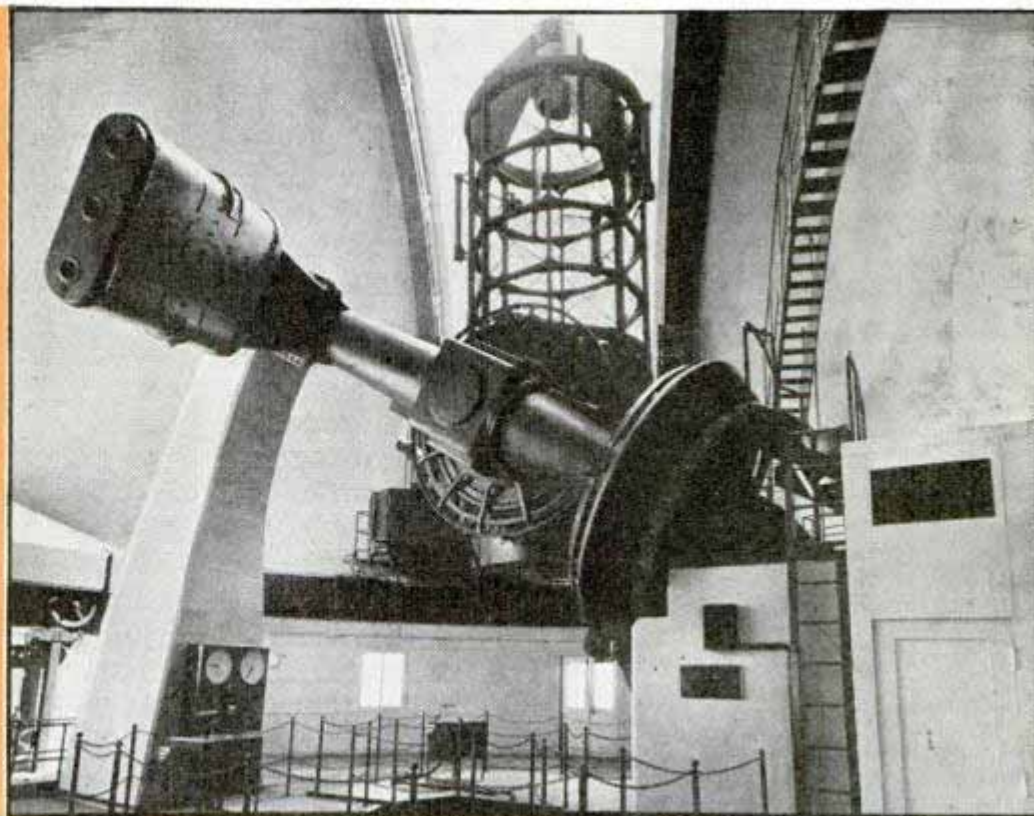



Above, imaginary representation of disintegration of the moon upon approaching earth too closely. Drawing is by Walter Favereau. Right, Howard Russell painting of earth as it probably appears from the moon. Bottom, Dr. Clyde Fisher of Hayden Planetarium

As the space ship reaches the moon, the spectators are taken for an imaginary cross-country flight over the craters, mountains, rifts and "seas" which form the fantastic lunar-landscape. Next the rocket lands and in a split second the explorers are transported from the cabin to a lunar crater on the moon, surrounded by tall white mountains glaring in blazing sunlight. Since this journey supposedly takes place on April 18th, 2144, the explorers see an eclipse of the sun from the moon which brings into play a series of spectacular lighting effects. Some of them show how the craters may have come into existence through meteoric bombardment or volcanic outbursts.

Because there is little, if any, oxygen on the moon the adventurous explorer is equipped with a light helmet as he leaves the protection of the ship. Immediately he finds himself in a strange world. There is a hushed, deadly stillness about him, for the moon has no atmosphere and since sound depends upon vibrations in the atmosphere, there is no sound. If he should chance to find some hardy species of plant life—and there are astronomers who believe that there may be a type of lichen adhering to the

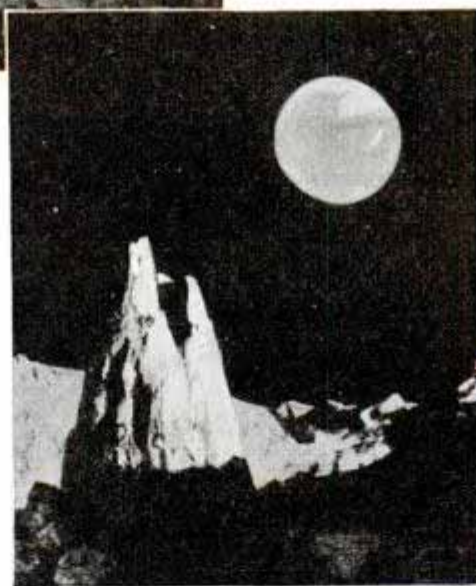

ultra-scientific craft in which the spectators make their imaginary journey, was a particularly obstinate problem which had to be surmounted by trick photography. Transformed into the control cabin of a super-space ship it is equipped with large, complicated control panels, with flashing lights and luminous dials and enormous wheels and gears such as a space rocket, the size of a battleship, might have. It "takes off" with a thunderous explosion followed by the hiss of combustion gases from the propulsion valves. As it whizzes in imagination toward the moon at the speed of 250,000 miles per minute, the lunar body seen through the windows in the control cabin looms larger and larger until it finally commands the entire view of the passengers.



crater walls, it would have no odor, for that too is carried by the atmosphere.

Stretching his legs after his long journey, the lunar explorer may run along with thirty-foot strides, for his "earthly" weight of 180 pounds has been reduced to thirty pounds, the moon having only one-sixth of the earth's gravity.

It is possible because of this low gravity too, that he may see great lava-formed mountain ranges two and three miles high, for some scientists believe that when numerous volcanoes erupted in the distant past, they shot their lava contents skyward for tremendous distances. Others believe that the craters on the moon may have come into existence through meteoric bombardment. Should the explorer chance to come upon any relics of a long dead race, he would probably find them in a perfect state of preservation and, should there have been any kind of intelligent being who once inhabited the moon, the dwelling he lived in would be exceedingly strange as measured by earthly standards. As there is no rain or snow to fall on the lunar body, a house would probably be roofless.

Leaving the moon and the year 2144 and projecting themselves millions of years into the future, scientists can predict, and show, from the safe vantage point of the planetarium, one of the possible roads to doomsday and the end of the world. Just what will be that end? The astronomers do not know but their various predictions based upon scientific observation, collated and dramatized by the planetarium, show several possibilities, always taking into consideration the uncertainties of the universe which, contrary to the popular belief, is not as "fixed as the stars."

One possible end of the world, millions of years from now, may be caused by the sun becoming

(Continued to page 122A)

Lawn "Buggy" Saves Steps and Travels Twice as Fast

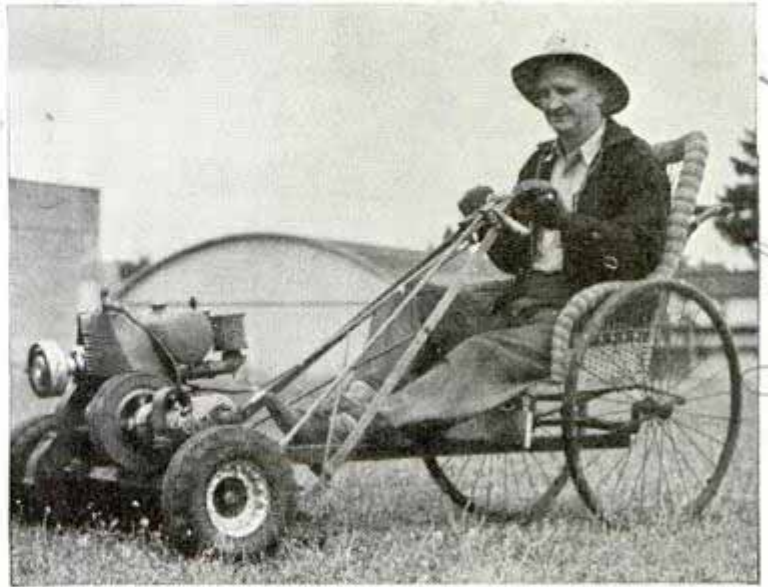

Wheel chair hitched to mower covers ground at double speed

With several acres of turf to mow in the football and baseball fields at University of Oregon, a grounds keeper has equipped his lawnmower with a seat, enabling him to travel six miles an hour, compared to three miles afoot. Material used in its construction consisted of an old-fashioned wicker wheel chair and some steel rods and wooden braces.

Tractor Pulls Portable Tanks on Wheels to Water Orchards and Fields

By using portable tanks on wheels, farmers have found a way of watering their orchards and fields. The mobile tanks are drawn by tractor. Fruit trees are moistened individually, with mulch being placed at the base of the trunk to conserve moisture.



Tractor-drawn water-wagon train being filled at a roadside tank

Used by Wm. H. Hurd
 602 1st St. N. C.

d.w. Mike Steadman

"Eye Chart" for Television Helps Get Sharp Image

Mary Murray

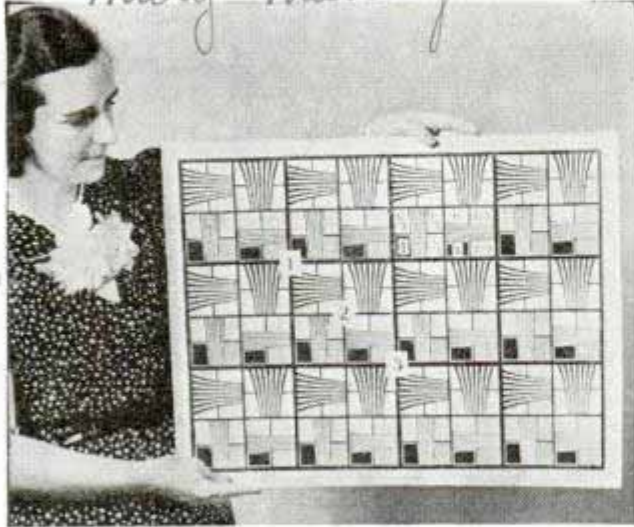

Chart used by General Electric engineers in adjusting television camera to obtain sharpness in images

Television cameras are given "eye tests" to obtain proper detail in the final images, in much the same fashion that human sight is measured. A chart with horizontal and vertical figures, instead of various sized letters, is placed before the television camera, and the accuracy and sharpness with which the figures register on a receiver indicate whether any changes or adjustments in the equipment are required.

Rubber Band Flips Newspaper from Car to Reader's Home

Throwing a newspaper from a sedan-type automobile to the customer's porch was the problem that an Indiana carrier solved by using pieces of inner tube. With



Newsboy speeds deliveries by propelling paper to customer's porch with "slingshot" on door of auto

a heavy piece of the rubber stretched across the window opening of the car, the carrier bends a folded newspaper over the rubber band and shoots it a hundred feet or more, in the manner of a slingshot, with great accuracy. Seldom is it necessary to stop the car, so sure is his aim.

Top-of-Stove Bun Warming Pan Vents Moisture through Lid

Cereals, crackers and bakery goods can be crisped and freshened in an aluminum bun warmer on the stove top. It has a small vent in the lid which can be opened to let moisture out when crisping is de-

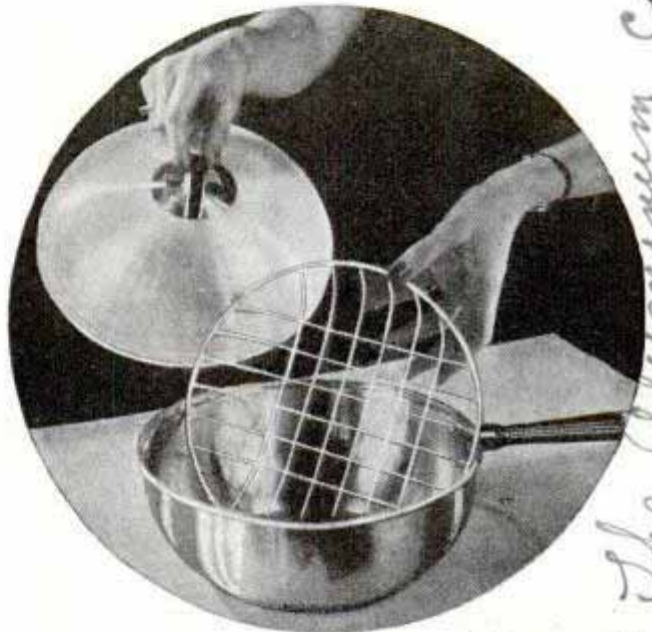

Wire basket in bun warmer keeps food from scorching, and vent in cover opens to let out moisture

sired, or closed if the moisture is to be retained in the food. There is a wire basket in the pan to hold the food. Potatoes can be baked in the utensil, saving the less economical oven heat.

Weekly Cycles in the Weather Are Linked to Sunspots

If your Sunday picnics are ruined week after week by rain, you can blame the sunspots. The nation's capital is one of the places that gets its weather by the week, so if it rains on Sunday it is likely to rain on several Sundays thereafter. The cycle is not exactly a week, but six days and eighteen hours, explains Dr. Charles G. Abbot, secretary of the Smithsonian Institution, and it amounts to just one-fourth

Washington, D.C.

914.
General Electric Co., Schenectady, N.Y.
9868
Comb. C. Saffer, Route 4, 306 3rd Avenue, Cleveland

9834
The Aluminum Cooking, Va. Glenoid Co. New Kensington, Pa.

the time it takes a group of sunspots to make a complete rotation around the sun. This indicates that the weather phenomenon may be connected in some way with sunspots, says Dr. Abbot. Since the period is one-fourth of a day less than a week, the rainy Sunday "curse" can be expected to shift forward one day in about a month—and that actually happened during June and July of this year. As a result of his study, Dr. Abbot predicted that June would have rainy Sundays and Tuesdays, and July rainy Saturdays and Mondays. In June maximum rainfall was on Tuesdays, and during July on Saturdays.

J 815
**Fan on Lawn-Mower Handle
 Blows a Cooling Breeze**

Why get hot at the summertime job of mowing the lawn? An English resident who wanted to keep cool at work transferred the blades of an old electric fan to the handle of the lawn mower. A pulley attached to the mower wheel and a few gear wheels put in the right places keep the fan blowing a pleasant breeze.



Fan blades on handle of lawn mower stir up breeze to cool worker while she pushes cutter under hot sun

**Portable Tester for Battery
 Checks Electric System**



Ills of battery and car's electric system show up quickly on this tester that hooks to terminals

Checking the car batteries takes no more time than the routine checking of oil and water when a portable tester just put on the market is used. It does not require removal of the battery. The leads are connected to the terminal posts and both the battery and the automobile's electric system are tested in one operation. It weighs ten pounds.

9986
**Chicago Built on Coral Reefs
 Millions of Years Old**

Studies of the bedrock in the Chicago region have revealed scores of coral-reef structures, some of which are as much as three miles in diameter, others being as small as thirty feet. Geologists explain that they were formed hundreds of millions of years ago, when warm seas covered interior North America, during the Silurian period of geologic time. A number of the reefs still rise well above surrounding land surfaces and can be examined where quarries and canal excavations have exposed the rock.

*Cont. Elton L. Carroll.
 402 W. Washington
 912*

*369 Lexington Ave
 New York City*

Tire Marker on Police Car Checks Parked Autos



Milwaukee Journal photo
Chalk stripe painted on tire by police car's automatic marker helps speed check of overtime parking

Officers riding in squad cars or on motorcycles can check the parking time of automobiles by equipping their machines with an automatic tire marker, thereby taking over the duties of patrolmen who do the work on foot. The device is controlled by a push button connected to the instrument board. Pressing the button causes the tire marker to extend outward from under the running board, and on releasing it the arm recedes to its original position leaving a chalk mark on the tire.

Pills Delivered One at a Time by Automatic Holder

One tablet at a time is delivered by a transparent pill box through its gravity chute when the cover is open. In this position the tablets are crowded back into a smaller closed compartment which has a

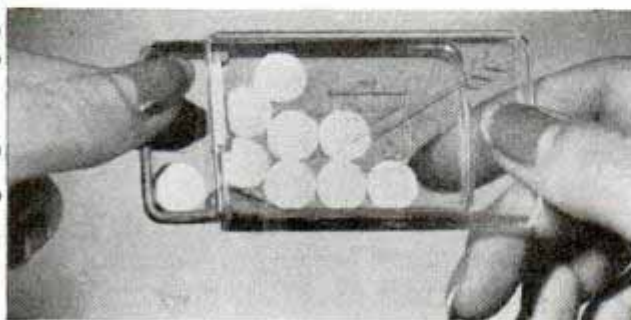

Transparent pill box permits only one tablet to be delivered at a time while cover is open

tiny slot through which they slide one at a time into the small opened part of the case which serves as a tray. When the cover is closed the interior of the box forms a single container. Made of non-breakable plastic, the pocket-size holder is refillable.

Bell of New Nine-Metal Alloy Rings Clear When Red-Hot

Two metal bells were heated bright red in an electric furnace at the Westinghouse research laboratories the other day. When they reached 1,100 degrees Fahrenheit they were pulled out. An engineer tapped one bell, of ordinary steel. There was only a dull thud, as if it were of concrete. He tapped the other. It rang with a brilliant

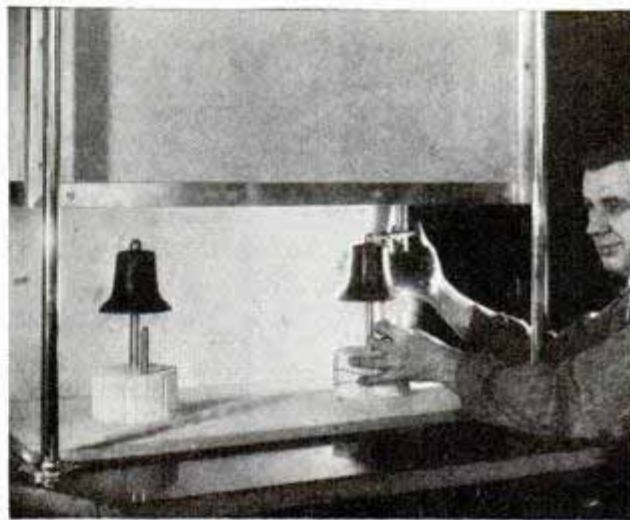

Heat dulled the ring of ordinary steel bell at left, but alloy bell rang clear when red-hot

tone. It was made of a new metal, dubbed "K-42-B," a combination of nine metals and the result of more than five years of experimenting in the hunt for a strong and heat-resistant alloy. It has proved its ability to stand up under temperatures as high as 2,912 degrees, 200 degrees hotter than the melting point of copper, and is stronger at 1,100 degrees than carbon steel is at room temperature. In it are the elements nickel, cobalt, chromium, titanium, iron, manganese, aluminum, silicon and carbon. Its originators foresee a future for "K-42-B" in the manufacture of dies, steam fittings and perhaps turbine blades.

☐ Rubber auto-license tags with metal numbers attached, invented in Germany, are claimed to do away with breakage and therefore remain readable longer.

Science Service

Vertical text on the left margin: 2253 Duane Building, 2917, 2921, 3912 Starbuck Ave, Milwaukee, Wis.

SAVING LIVES
with a
SURFBOARD

Ired Blessen



From Hawaii comes latest aid to seaside life-saving. The paddle board, adaptation of the surfboard, is being used by every lifeguard service in southern California

Dispatcher, circle, relays call for help to lifeguard, above, who spots the swimmer in distress. Right, another lifeguard sets off on paddle board, on which he can travel twice as fast as he could swim. Below, he paddles to catch a breaker after pulling the girl onto the board and starting shoreward

Isuara Peterson



Acme

Left, the rescue craft reaches shore, the lifeguards pick up the girl, using board as stretcher, and rush her to where artificial respiration may be applied. The lifeguards find the paddle board maneuvers more easily than a boat

'Dim' Sign Teaches Drivers to Lower Lights

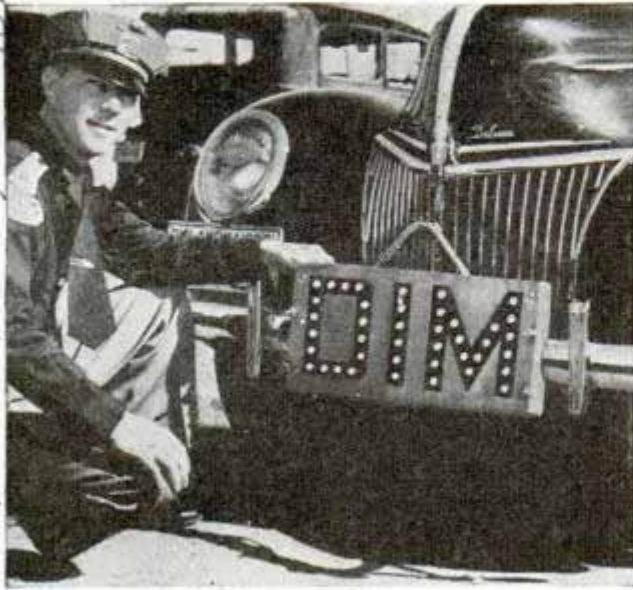

Motorists take the hint quickly and lower their bright headlights when they meet this police car

Motorists are reminded to dim glaring headlights when they meet one of the Oklahoma state highway patrol cars. On a panel in front is the word "Dim," spelled out in reflector buttons which catch and reflect high, blinding lights. Drivers usually lower their lights quickly.

Tractor Has Two Sickle Bars Run by Separate Motors

Two five-foot sickle bars, independently powered, are mounted on a tractor mower built for highway and airport use. The right-hand sickle bar is driven by a take-off from the tractor transmission and the



Both sickle bars, or either one separately, can be lowered by operator, each having its own power unit

left bar is operated by an air-cooled one-cylinder engine. Both bars are raised and lowered in two and one-half seconds by power, with ordinary shift levers as controls. The machine thus equipped can operate on congested center-strip parkways. The tractor has a six-cylinder engine and four-speed transmission ranging from three to forty-five miles an hour.

Spiral-Slotted Reel for Cut Film Protects Negatives in Tank

To keep photo negatives from rubbing against each other in the developing tank, and to assure that all parts of the negative are reached by the developing solution, a spiral-grooved reel for cut film and film pack is offered. The negative slips into one

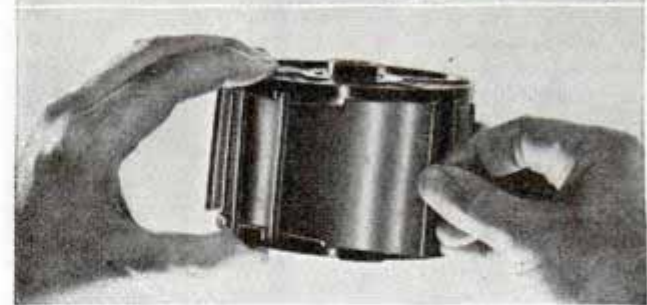

Top, spiral-slotted reel assembly. Note, below, how easy it is to insert negatives into slots

of the fanlike spiral slots and is protected from buckling or contact with other films. The reel is adjustable for negatives from thirty-five millimeters to two and one-half by three and one-half inches.

Found in gem mines of Brazil, a 350,000-carat topaz crystal, the largest ever known, has been added to the mineral collection of the Smithsonian Institution.

Washington D.C. 8/18/39

Harold A. Board, Oklahoma City, Okla. 111 N.W. 12 St. 2929
Curt. Harold A. Board, Oklahoma City, Okla. 111 N.W. 12 St. 2929
Doro Mfg Corp, 3042
Iceland Ice Machine Co

Elkay Photo Products Co. 303 Washington St. Newark N.J.

2901

Patd Reel only with tank 2.50

J 942.

Gap Cut in Railroad Trestle for 200-Inch 'Eye'

Too low to permit passage of the twenty-ton glass disk being transported to Mount Palomar, Calif., a railroad trestle was cut open by the removal of an entire track section. House-moving technique was used by workmen in handling the special cradle of steel which carried this disk, measuring 200 inches in diameter, the largest single piece of glass ever produced.



Section of railroad trestle removed to allow passage of giant glass disk on its way to observatory in California. Note how "cradle" is moved on rollers.

J 910.

International.

Bike and Scooter Are Combined in Handy Power Cycle

Remove rear wheel, pedals and sprocket of your bicycle, attach a motor-driven wheel and parcel carrier and you have a motorized delivery bike that will travel 120 miles on its one-gallon tank load of gasoline. The unit, just put on the market,

is easily installed on any bicycle frame or the complete motor bicycle can be obtained. The one and one-half horsepower motor drives the small rear wheel through chain and belt, with clutch and gas controls on the handlebars.

Congress unit \$79.50

Real Diamonds Fall from the Sky Meteor Analysis Shows

Diamonds fall from the sky, it has been proved by an X-ray examination of hard, black crystals in a specimen from the meteor crater in Arizona. The specimen was obtained by Smithsonian Institution and turned over to mineralogists of the geophysical laboratory of Carnegie Institution for examination. Although not of gem quality, the particles are good black diamonds of the kind used in industry, being even more valuable than medium-rate gems. Many years ago, when the presence of diamonds was suspected, futile efforts were made to drill into the meteor crater in the hope that a big diamond mass would be discovered. After going down for about 1,200 feet the drills hit material which they could not penetrate. Efforts to sink a shaft were defeated by striking water.

Washington D.C.

motor bike 79.50



Motor scooter mounted in place of rear wheel has handlebar control and powers handy delivery bike

*4/12/42
John J. & name
American Motor
816 W. Erie Street*

*Motor Scooter by
8440 S. Chicago Ave*

278. Mrs. James Mc Sweeney
 431 W. 60th Terrace,
 Kansas City, Mo

ANGLING

40 Brunswick - Balke Collyer Co
 618

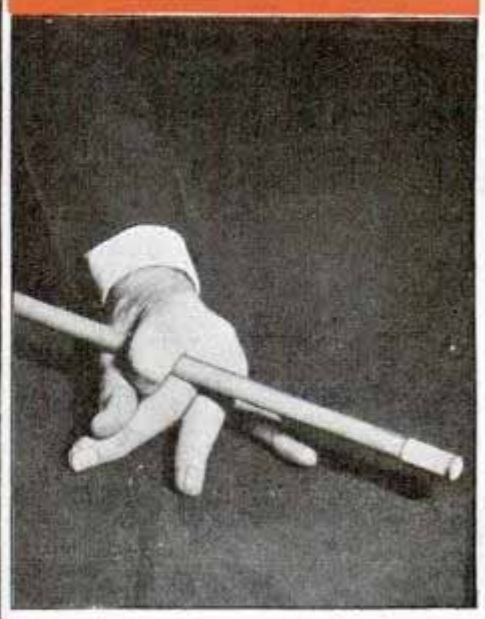
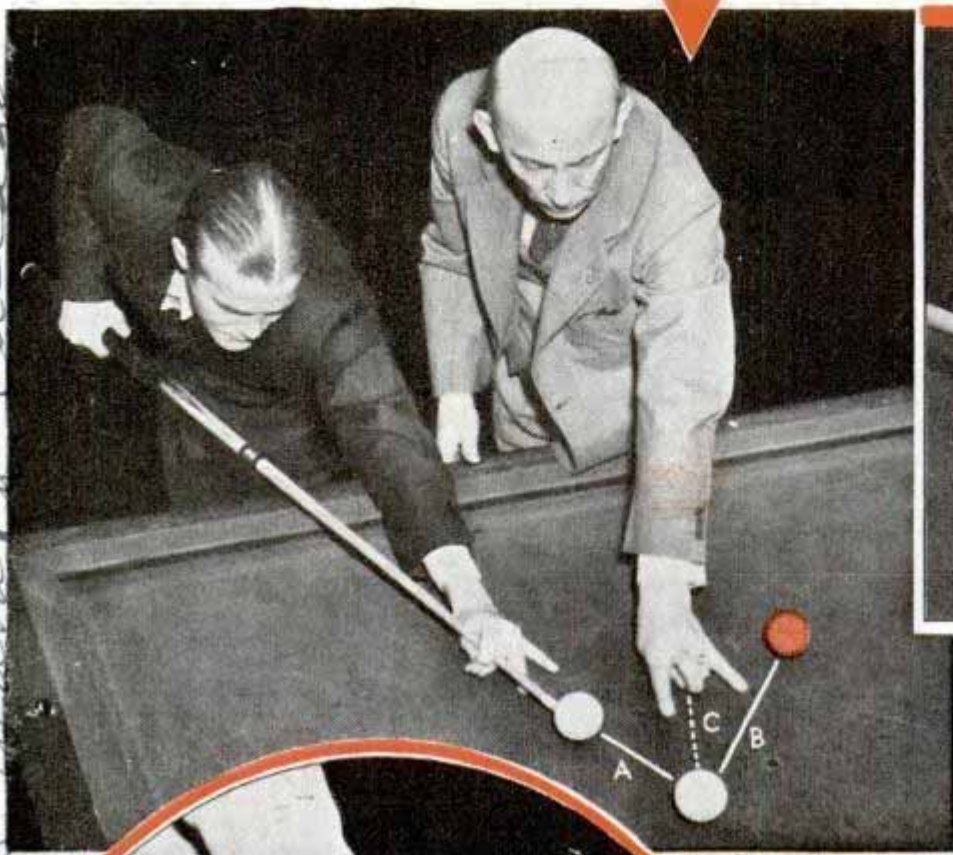

Left, showing how to divide triangle in making open draw shot. Above, general bridge. Circle, correct grip of cue. Note thumb and forefinger around cue



By Charles C. Peterson
 Famous Billiard Instructor

OF ALL the comebacks in sport, none has been more impressive than that of billiards. A few years ago, it was on the way out. Once only the recreation of royalty, billiards had slipped into disfavor. Certain

improvements in the table that abetted gambling had brought about its decline. With two strikes on it, the sport began beating back. Divorced from undesirable associations, it has really come into its own and now there are perhaps more people playing some form of billiards than any other game, with the possible exception of bridge.

Colleges have become incubators of interest. So rapid has been the game's rise in the field of higher learning that at University of Illinois and two or three eastern colleges, interfraternity billiards has been substituted for ice hockey. Intercollegiate billiards now occupies a place on the winter sports calendar. These competitions were started at the University of Wisconsin in 1931 when a scheme was developed whereby the game could be played by telegraph between schools through a key shot or chart system. Ten of the larger universities participated in the first straight rail tournament and its

for BETTER BILLIARDS

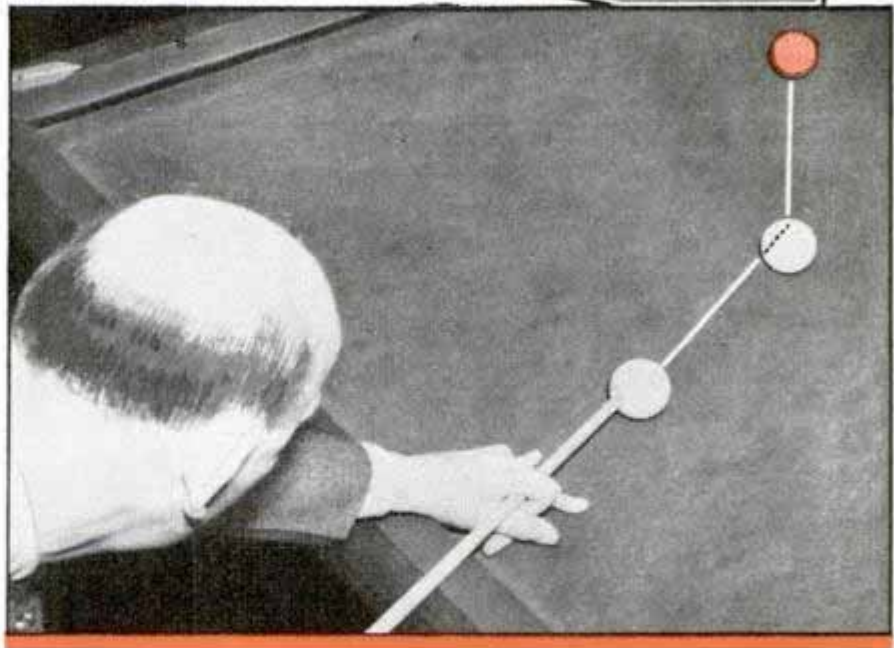
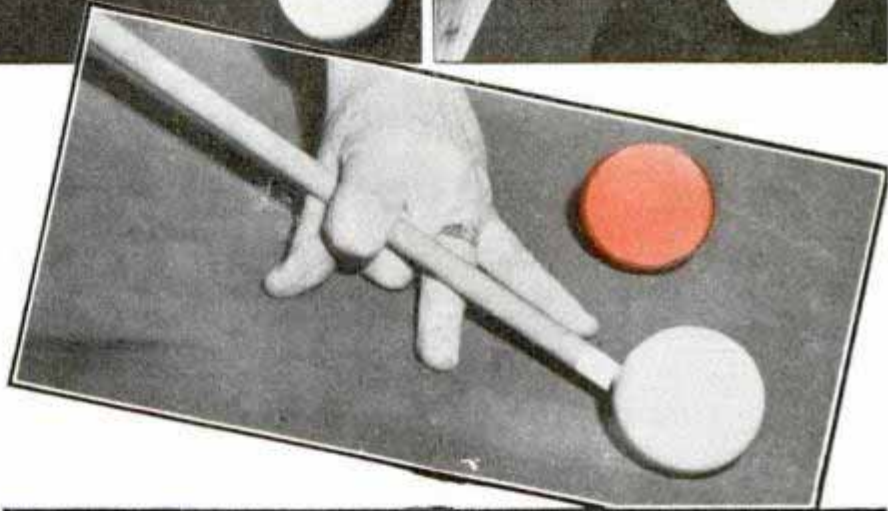
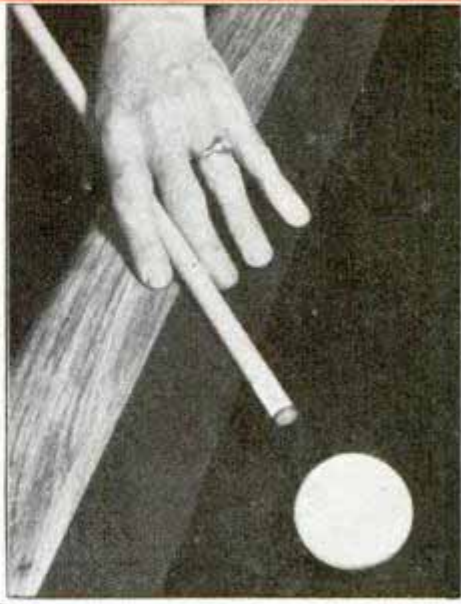
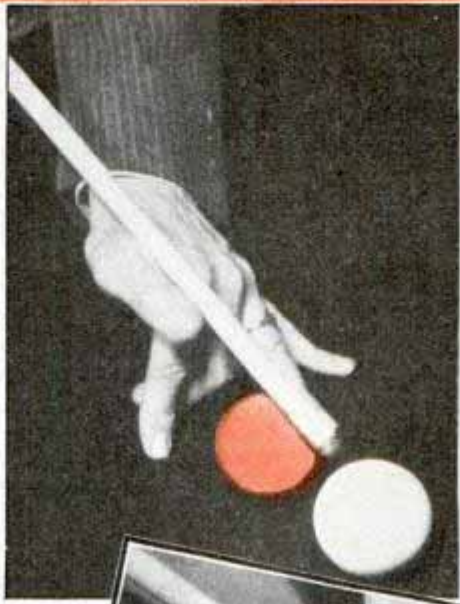
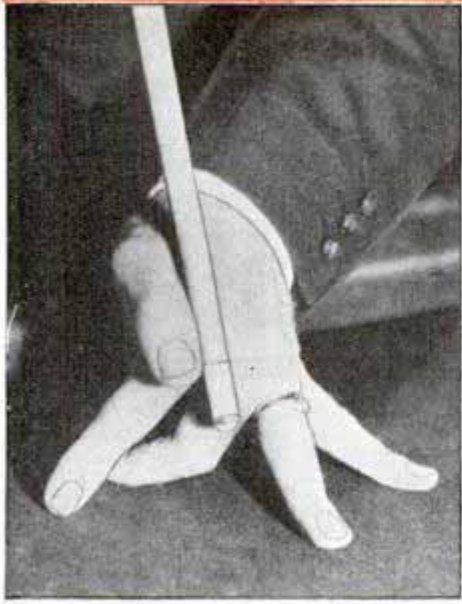

success paved the way for three-cushion and pocket-billiard championships. Six months out of every twelve are devoted to instructing university, college, and high-school students in the game. Before the present term draws to a close, group lessons will have been received by more than 70,000 students at 150 schools, ranging from the United States Military Academy at West Point to Santa Monica high school in California.

Billiards has the educational virtue of sharpening one's powers of both analyzation and visualization. The game handsomely rewards the novice who tackles the fundamentals with an undistracted mind. The player who grips the cue correctly, takes a flawless stance, and patterns his bridge along championship lines is well along the road to better billiards.

The most satisfactory way of gripping a cue

Top, left to right, firm masse bridge; correct bridge for masse over ball, and shot close to rail, with cue almost level. Center, covered bridge for draw shot. Bottom, follow shot. Draw straight line from first object ball to second object ball, then shoot cue ball in manner indicated



Left, top, author making masse shot. Center, sketch showing proper method of striking object ball with cue ball for various results. Bottom, squaring the angle. Player plays caroms from ball to ball in one and two cushion shots. Right, top, practice delivery of stroke on top of rail. Bridge rests firmly on rail with knuckle flat and leaving it that way

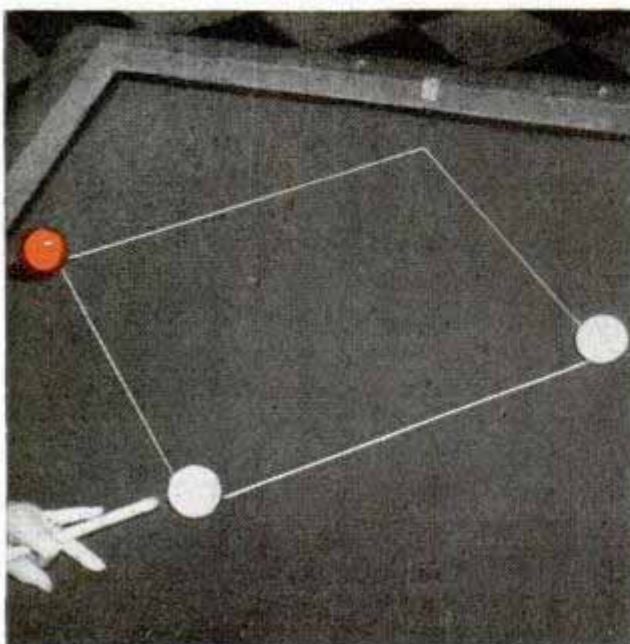
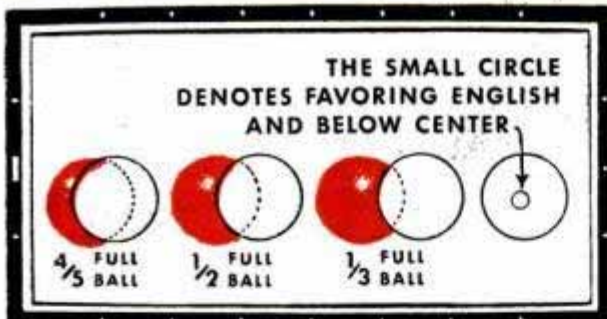

calls for only the thumb and first finger to touch the cue. This contact is light, just sufficient pressure to be firm. It is also essential that the cue be grasped, not at the extreme end, but as close to the balance point as possible. This makes for a shorter bridge and usually results in a smooth, even stroke with the level cue. By holding the cue at the extreme end, a pump-handle effect is produced, the cue point dipping down as it is drawn away from the ball and rising upon approaching it. Under such circumstances it becomes impossible to execute a good draw shot wherein the cue must be driven low and in a parallel line.

No two great players have precisely the same stance or position at the table. But there are certain points which all observe in taking a firm, yet graceful position. The player should face his shot squarely and then turn one half to the right—the body should be bent forward slightly, thus providing room for the right arm to swing without interference. The head should be over the cue, the latter being sighted as one does a gun. The left arm, of course, is extended with the hand resting upon

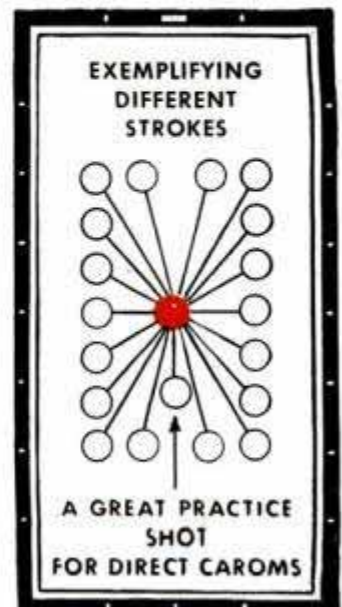

278



the table, forming a bridge. It is well to remember that the feet should be spread apart slightly to give firmness to the stance. The weight should be evenly distributed between the two feet. Where the pendulum stroke is used, the right forearm hangs almost perpendicularly. Avoid rigidity in your stance or the easy motion of the stroke will be curtailed.

No element of technique is of greater importance than a firm bridge. And this is best attained with what we call the tripod style. Because of the difference in fingers there are variations of the tripod bridge among champions but the basic design is easily recognizable in their games.

(Continued to page 128A)

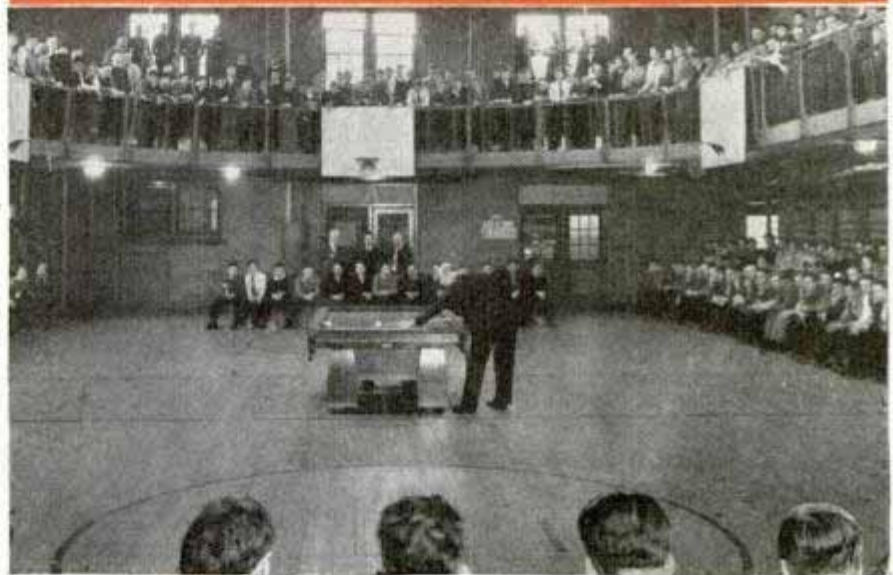
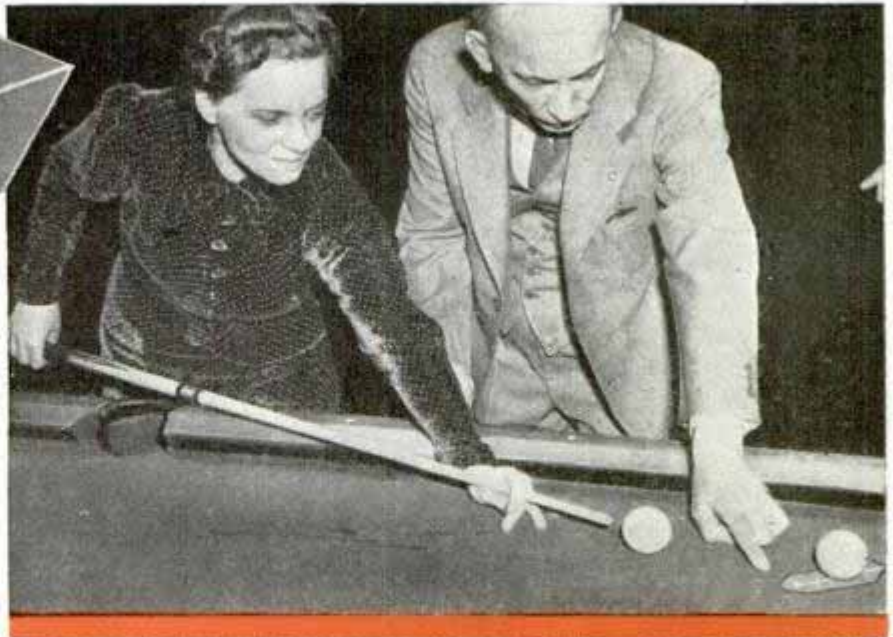

Top, left, handy little pointer. Right, novice may advance rapidly by using the pointer as shown. Below, pocket billiard exhibition given at school. Bottom of page, how certain shots should be made

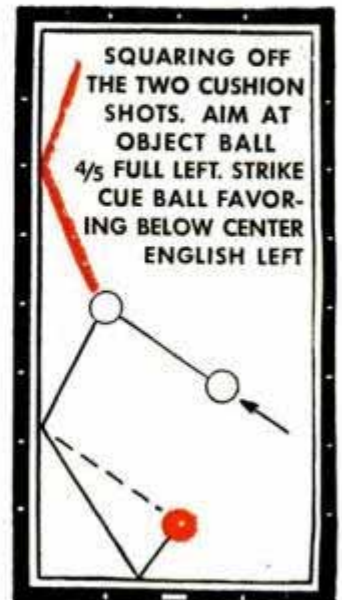
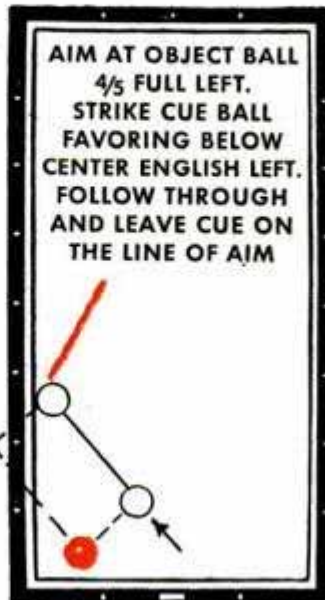
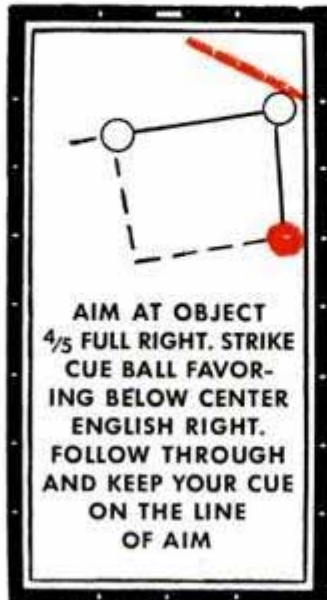
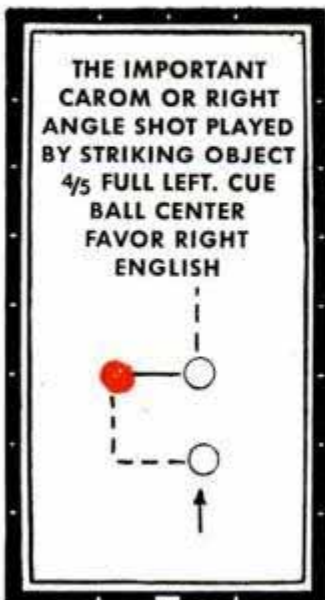

Derelict Airplane Finds Job Chasing Mosquitoes Away

Curtiss CX-9



Its flying days over, airplane finds comparatively easy job blowing insects from golf practice tee

Its wings and tail clipped, an ancient airplane has become a derelict—but it still holds a useful job. "Grounded" within a protective wire fence at a golf practice tee near Wold-Chamberlain airport at Minneapolis, the old engine turns at idling speed, its propeller fanning a breeze that wafts away mosquitoes and other insects attracted by the big floodlights.

Accelerator for the Left Foot Attaches to Right Pedal

For relieving right-foot fatigue in driving, an accelerator for the left foot may be attached to the standard accelerator pedal.

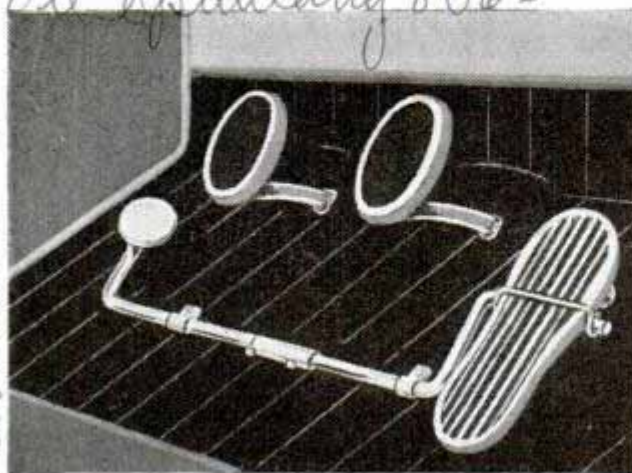

Small pedal at left may be used to control fuel flow in traffic or on hill

Thus, the driver may switch from one foot to the other when he begins to tire. In addition, the left-foot pedal may be used when it is desirable to keep the right foot on the brake pedal, ready for any emergency, such as operation of the automobile in heavy traffic. The left-side pedal does not interfere with the clutch.

Seven-Foot Carving of Big Tree Cut from Redwood Slab

Carved from a single redwood slab eleven feet long, four feet wide and two feet thick, a replica in relief of the famous General Grant tree has been in the making nearly six years. Finished, the carving is seven feet tall and eleven inches thick. Devoting 1,200 hours to the work, Victor



Famous General Grant tree carved in relief on slab of redwood required six years of painstaking work

Kerney faithfully reproduced the big tree even to the fire scars and other details. Known as a giant Sequoia, the tree, which stands in General Grant national park in California, is 267 feet high, with a maximum diameter of forty feet and four inches. Two hundred feet above the ground it measures twelve feet through.

*W. & S. Mfg Co. Chicago
3947 W. Lawrence
Emb. Sorden in mail
Princeton Ave. H. Paul
1893*

Marshay in Federal Bldg

Federal Bldg

Golden Gate Exposition

294

Matthew Sucheski

Energy of Ultraviolet Tested with Aid of Light Meter

With the help of a light meter, General Electric scientists have developed an easy and inexpensive way to measure the bacteria-killing energy of ultraviolet from germicidal lamps. Both short (ultraviolet) and long wavelengths are emitted by the lamps, and they have to be separated in determining the power of the short waves. It was known that ultraviolet causes cer-



tain materials to fluoresce, and also that quartz transmits the shorter wavelength whereas ordinary glass absorbs this energy. An appropriate fluorescing material, sandwiched between a

plate of clear quartz and one of ordinary glass, is the contrivance that solved their problem. Placing this over the sensitive cell of the familiar light meter, with the quartz side of the device toward the source of germicidal energy, causes the fluorescent material to emit light which the light meter records—but this measurement also includes the energy of the longer wavelengths which pass through. Now turn the glass side toward the lamp, and only the long wavelengths will pass. The difference between the two light meter readings serves as a measure of the germicidal energy.

Ladder Unfolds for Escape from Burning Building

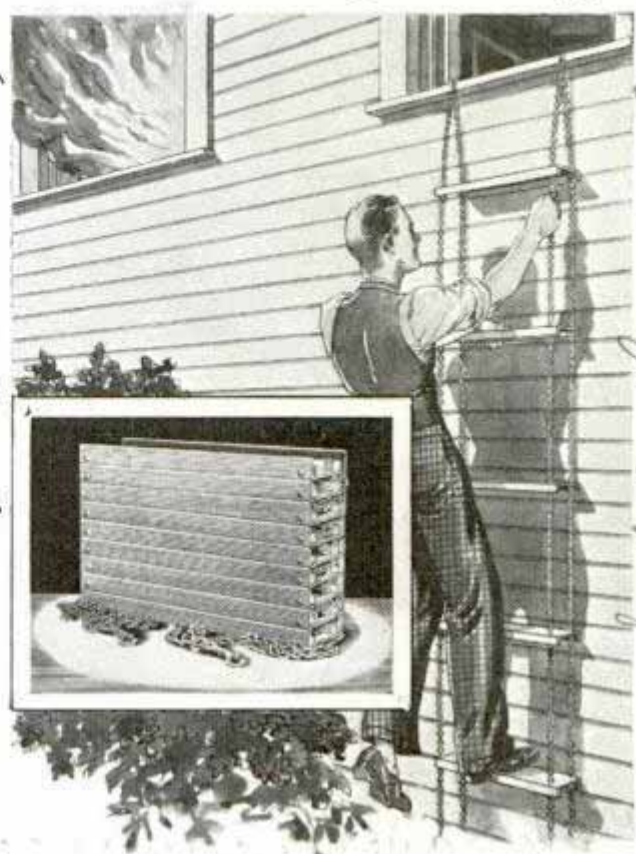

Climbing from burning building on collapsible ladder. Inset shows fire escape folded for storage

Any window is a safe exit from a burning building when it is equipped with a collapsible all-metal ladder just brought out. Made of lightweight aluminum alloy, the ladder folds into a small space for storage. In an emergency it can be attached quickly to the inside of any window and then lowered. The steps are corrugated.

Electric Curb Feeler for Auto Guards Side from Damage

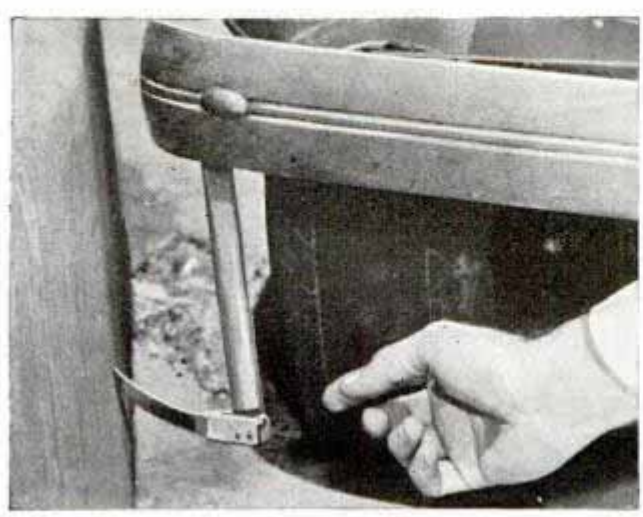

"Feeler" warns by flashing light before car strikes

To help automobile drivers avoid scraping against the curbing while parking, a "feeler" that signals a warning before the car strikes is now available. It is an L-shaped arm made of flexible clockspring steel, protruding about six inches beyond the side of the car, and when the horizontal part is bent, even slightly, it closes an electrical circuit to turn on a warning light on the instrument board. Both front and rear bumpers may be similarly equipped.

Send return postage to our Bureau of Information to learn the name of the maker of any device described in this magazine.

Rabb Mfg Co. 1621
21st Street

Josephine St.
Calif

Emergency Safety Ladder Co. 29 Covington, Va

2701

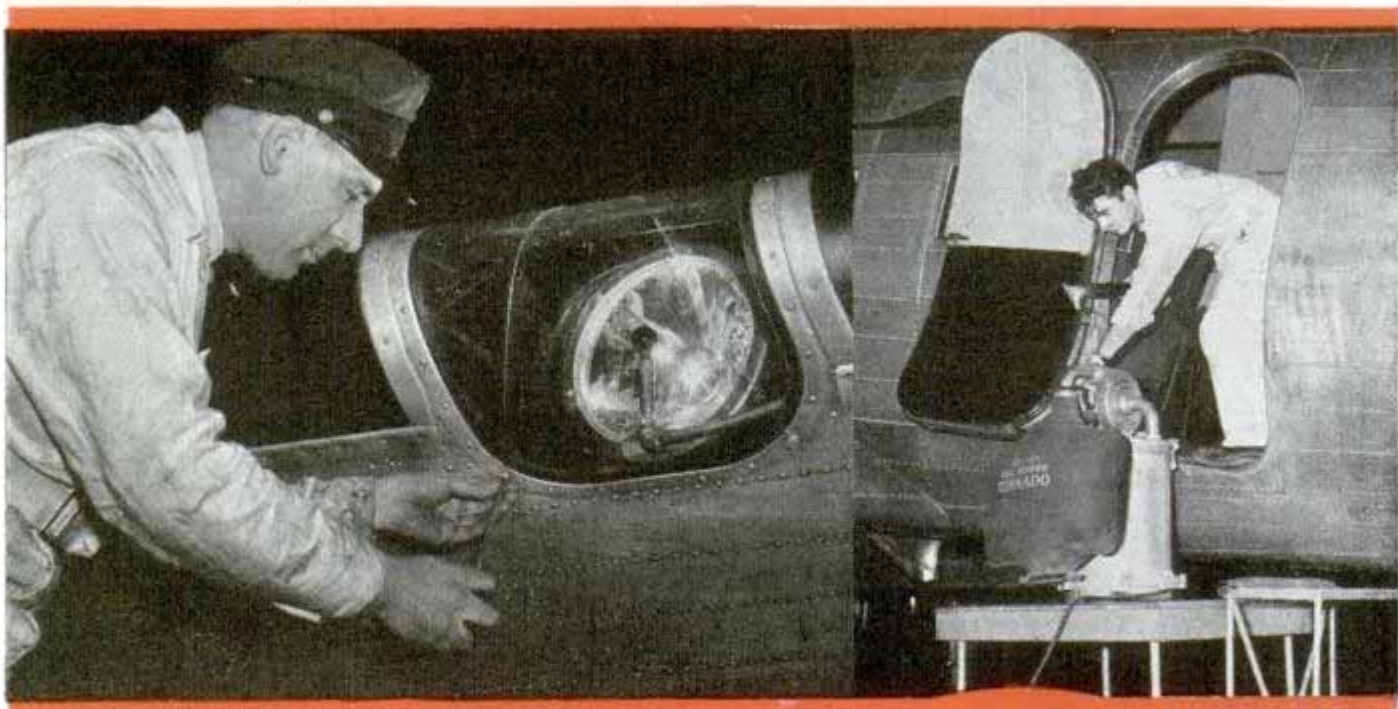

Above, a mechanic's idea of reinforcing wing landing lights with wire has saved much breakage. Top, right, "souped up" vacuum cleaner. Bottom, speed-control unit for Link trainer which applies "head" or "tail wind"

Westmain
 By Don Black *1901*
Shayer Ave. Los Angeles.

AROUND an airport you frequently hear the expression, "dumb mechanic," but close association with these fellows teaches respect for hangar brains.

Not long ago an executive was complaining because a mechanic spent too much time "trying to figure out the easy way to do things." About a week later this mechanic rushed up to the foreman all excited. "It works," he beamed, "works like a charm. Come and see."

Well, it used to take two men half an hour to put fresh oil into engine crankcases of an American Airlines' flagship being prepared for the overnight coast-to-coast flight. Each of the two motors required twenty-five gallons. That meant hoisting five-gallon cans up by hand and laboriously emptying them one at a time. With three outgoing transcontinental schedules daily, you can understand what this job would be.

What the mechanic did about it was to hook up the auxiliary batteries used for plane-engine starting to a small electric motor, a pump rigged out of spare parts and a couple of oil drums. For quick and positive control of the

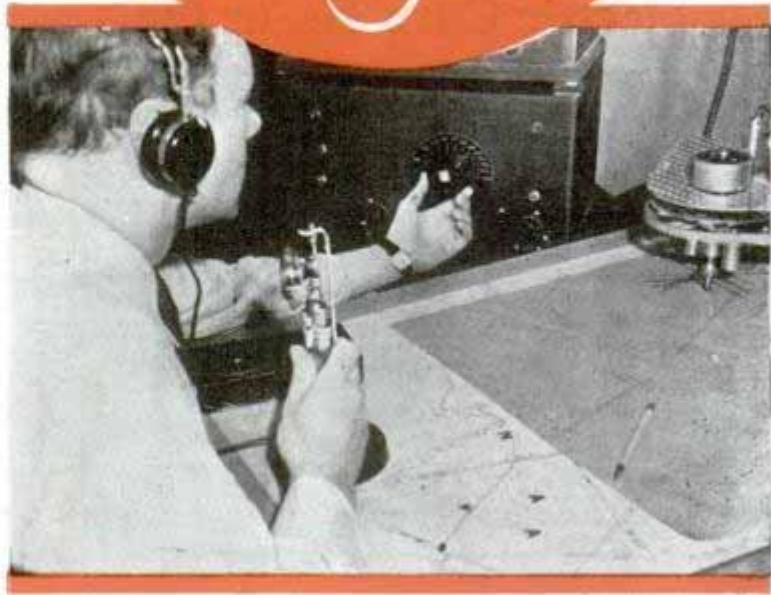
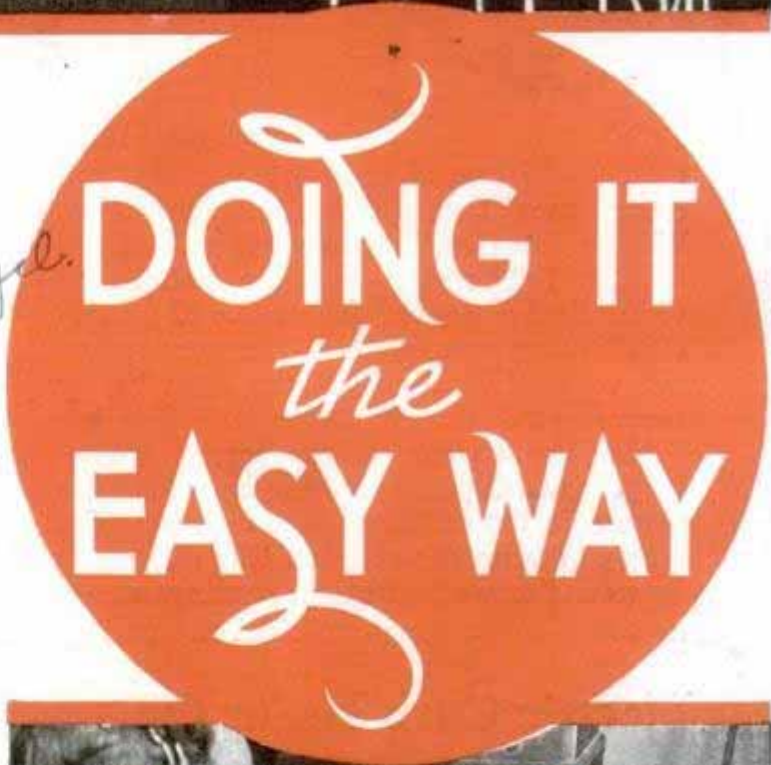

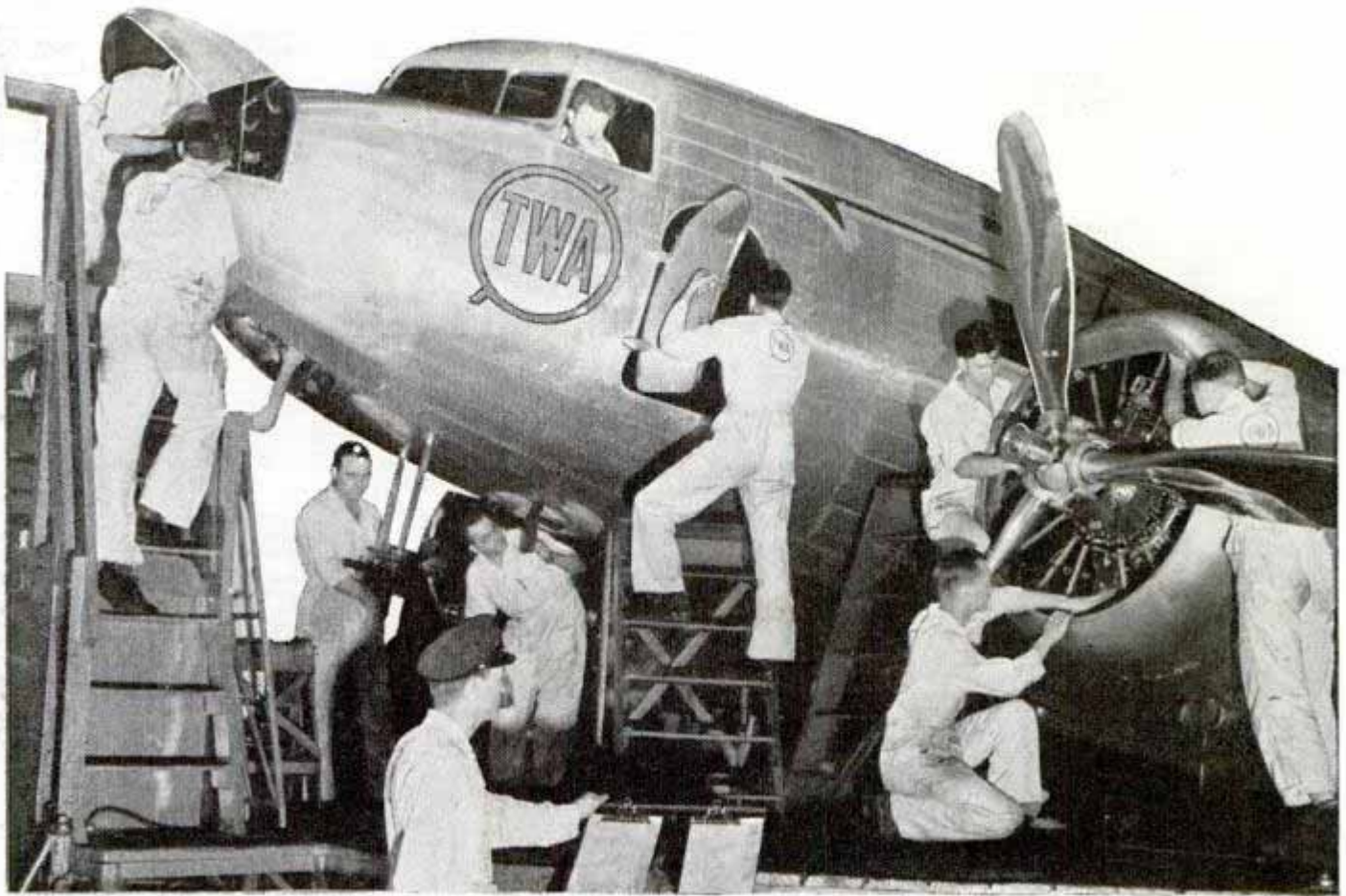

flowing oil, he fixed a switch at the hose nozzle and taped his wiring down the hose to the pump. Thereafter one man did the job in fifteen minutes flat, where it had taken two men exactly twice that long before. The final result was that the company saved \$821.25 a year in wages alone on that job.

That sort of thing happens almost every

day at shops of the line in Glendale, Calif. Also in the hangars of TWA, United Air Lines and Western Air Express at Burbank, near by.

James V. King, superintendent of maintenance for WAE, studied the \$4,000 catalogue price of a quick-change multi-frequency telegraph transmitter of 500-watt power and then declared, "My boys can

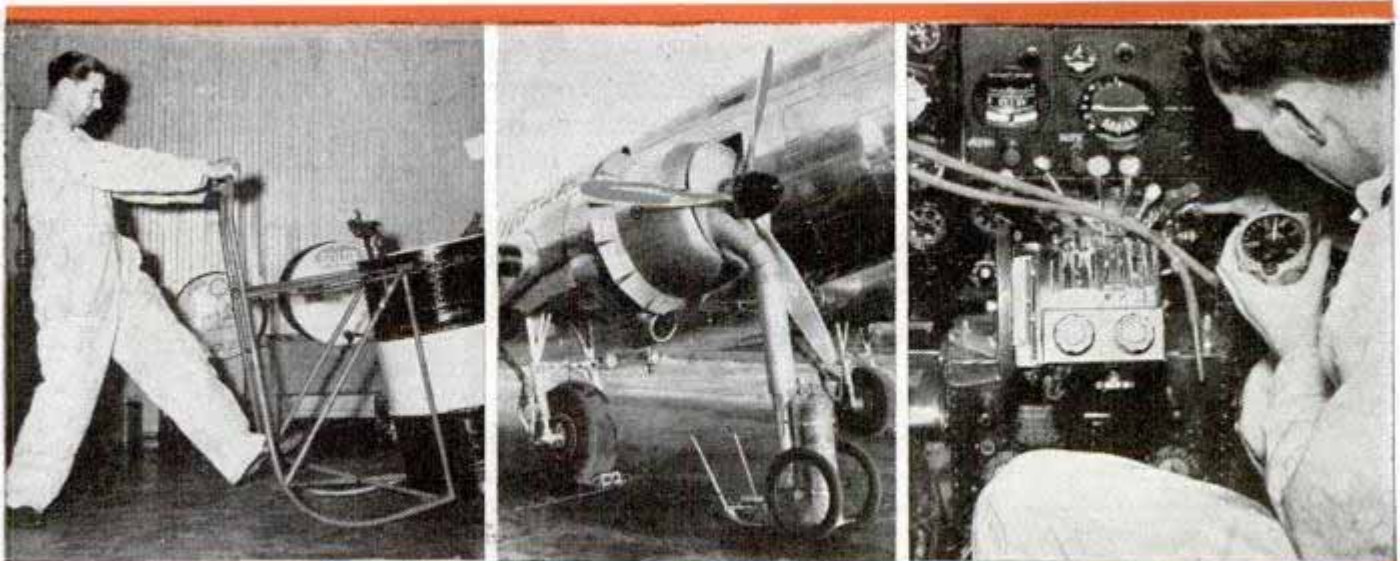

TWA
Top, mechanics swarming over plane. Bottom, a drum lifter, propane-gas heater used to warm cold motor quickly, and instrument man checking air-speed indicators with aid of "homemade" device.

TWA

*James King,
head of shop*

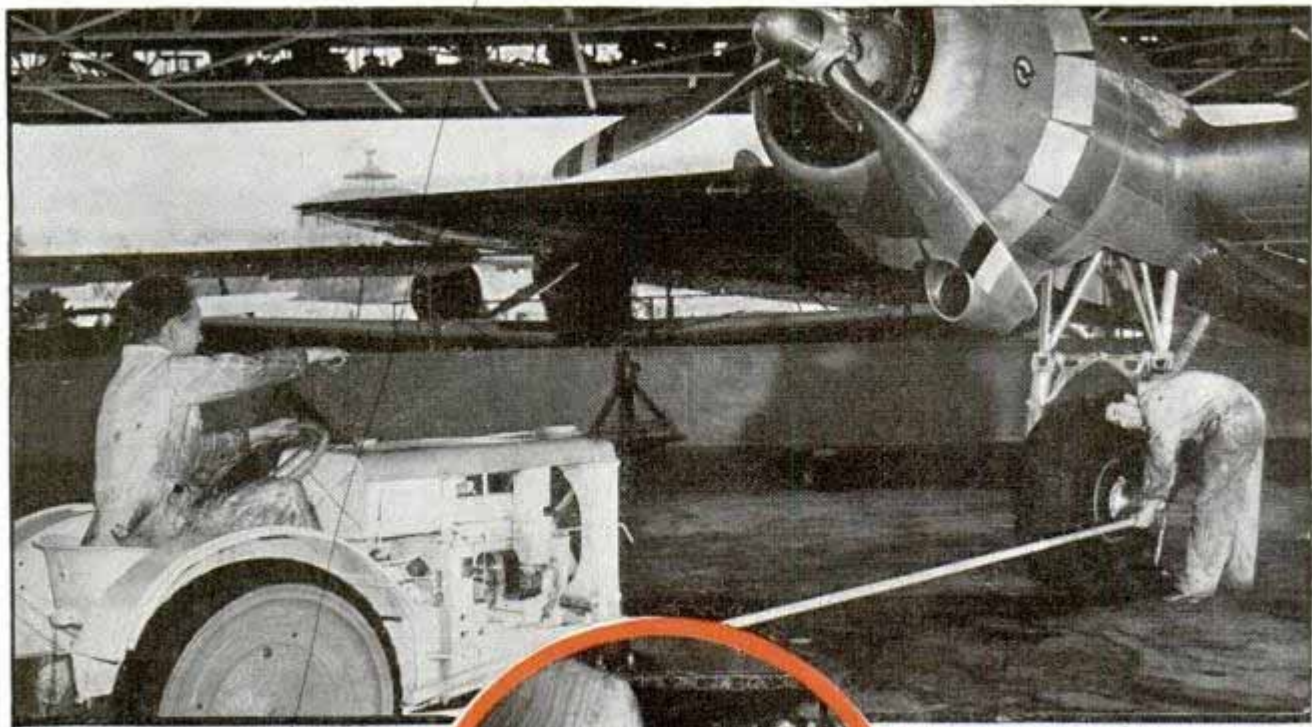

United
 "Push-pull rod," above, for avoiding tight corners in moving plane. Right, making inspection with flashlight and dental mirror. Below, leverage principle for removing tires

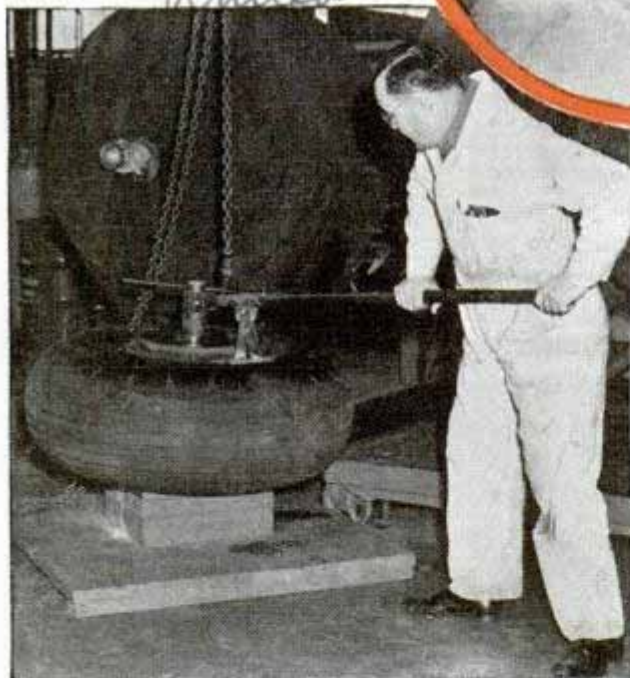

Another instance of how hangar brains solved a problem is found in the engine heater King's staff rigged up to save starting batteries and frozen fingers in severe winter weather. A homemade gadget, including an ordinary stovepipe and

elbow, it works so well that Pan American Airways now is using Jimmy's WAE specifications to build similar heaters for the Alaskan schedules. This outfit will raise the temperature of a motor with hot air from about zero to a point where these giant motors can be turned over by hand in about twenty minutes. The cost is only four cents an hour.

Another interesting invention is a constant manifold-pressure device for testing the automatic mixture control used by the big Douglas main liners. Still another is the apparatus devised to force a cleaning solution through the oil-radiator cleaner itself. Of equal interest is a manually operated speed control unit for the Link trainer which simulates actual flying conditions for pilots practicing blind flying on the ground under a hood.

Among the cleverest devices worked out by the mechanics are the three-step machines for reconditioning spark plugs.

(Continued to page 118A)

build one of these at a fraction of that price." And they did, from design to completion, at a cost of but \$250!

When Earl Kiernan, chief of the WAE radio department, needed a test device for adjusting the marker receiver, he built it at a cost of twenty-five dollars. The same apparatus was on the market for \$400.

Swiss Hornet Game Played with Ten-Foot Club



Wide World



Played at Emmemental

Resembling a combination of baseball and golf, the Swiss hornet game is played with a ten-foot, flexible club and a puck that makes a buzzing noise like a hornet as it flies through the air. The player bats the puck toward a field set off with numbered markers. In the field are "catchers" with bats that resemble oversized shovels, with which they try to stop the puck in flight. Should they succeed, the batter is out. Otherwise, he scores a point. Top, left, setting the puck. Circle, swinging. Below, fielders trying to stop the puck. Bottom, left, keeping score

in Bernese dialect



700
 2918. 255 Cuckwood Broadway
 London N.W. 2 Eng.

Hand-Operated Dry Shaver
 Lets You Shave in Car

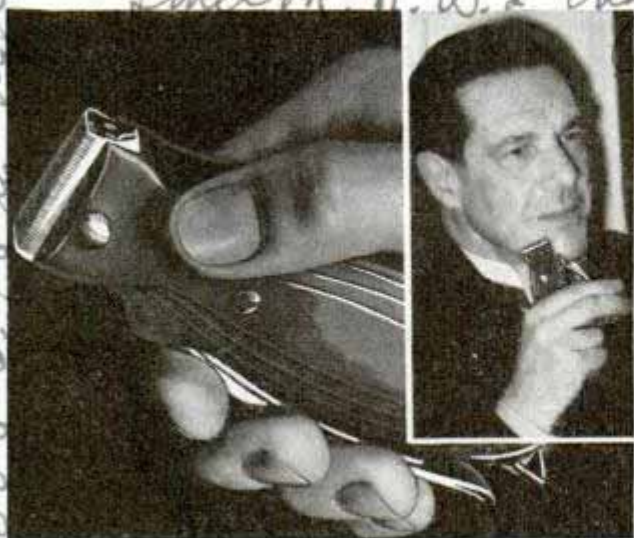

Pump lever of dry shaver with fingers to operate cutters, guiding razor over face as shown in inset

You can shave in your car, on the subway or at your office desk with a non-electric dry shaver just put on the market in England. Similar in appearance and in action to the electric models made by the same firm, it is operated by working a lever back and forth with a slight finger pressure. It is finding use among commercial travelers, motorists and vacationers.

One-Man Pike Pole Like Jack
 Equals Force of Six Men

Many applications are found in industry for a telescopic power pole, similar to pike poles used in logging, except that this one



One man can straighten leaning post with telescoping pike pole that is worked similar to auto jack

can be extended like a jack. Telescoping one into the other, two pieces of heavy iron pipe are powered by an easy working ratchet-lever hoist, or load binder, extending them from eight feet and two inches to eleven feet and seven inches. One man can operate the tool in straightening a leaning telephone pole or a tree, righting overturned vehicles, pushing over walls in the demolition of old buildings or shoring up the sagging sides of a building. Ordinarily it is operated with a flat base at one end and a sharp point at the other, but for logging it is equipped with sharp points at both ends. It is especially useful in breaking up log jams on river drives since the pole may be pre-set and then operated by remote control to pry loose the "key log" that holds the jam.

Tile Has Built-In Drain System
 to Keep Basement Dry

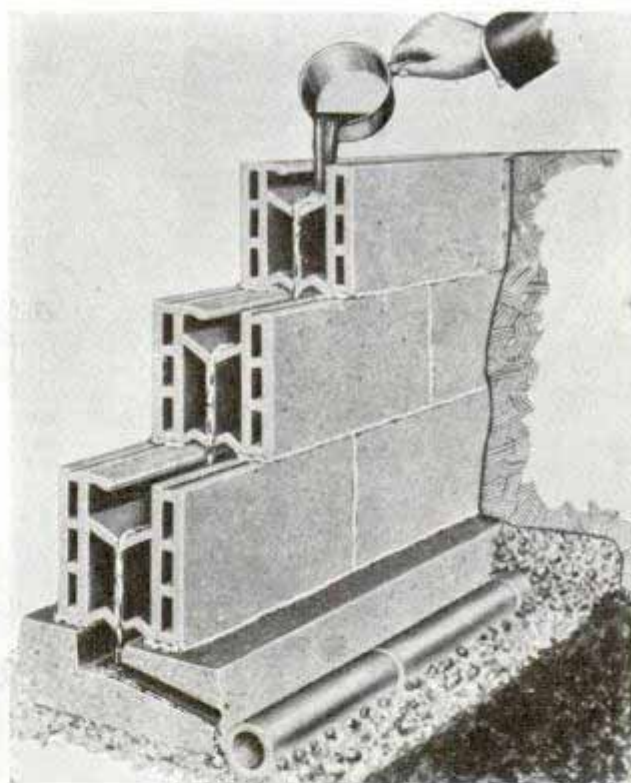

Cut-away section of wall shows how water runs down tile step by step and finally flows into drain pipe

Basements are kept dry by tile with a built-in drainage feature consisting of channels to guide water from the top to the bottom of the foundation and into a drain pipe at the base. Easy to keep clean, the tiles are furnished glazed or unglazed, and it is claimed they will not shrink or crack or require repairs or painting.

National Fireproofing Co., Dulton Bldg

Rolls Razor. Inc.
 305 E. 4th St. N.W.
 U.S.
 Collins Hart Co., Danville, Va.
 2934

Safety Phone for Farmers at Rail Crossing

Telephones are installed at a dangerous railroad crossing in England for the safety of farmers who drive cattle or haul crops over the tracks. When a farmer desires to use the crossing he rings the signalman for an all-clear signal, and after completing his crossing he again calls to inform him that the track is clear and that the gates have been shut. Instructions for using the phone are printed on a board near by. The farmers are provided with keys to the gates which are kept locked.

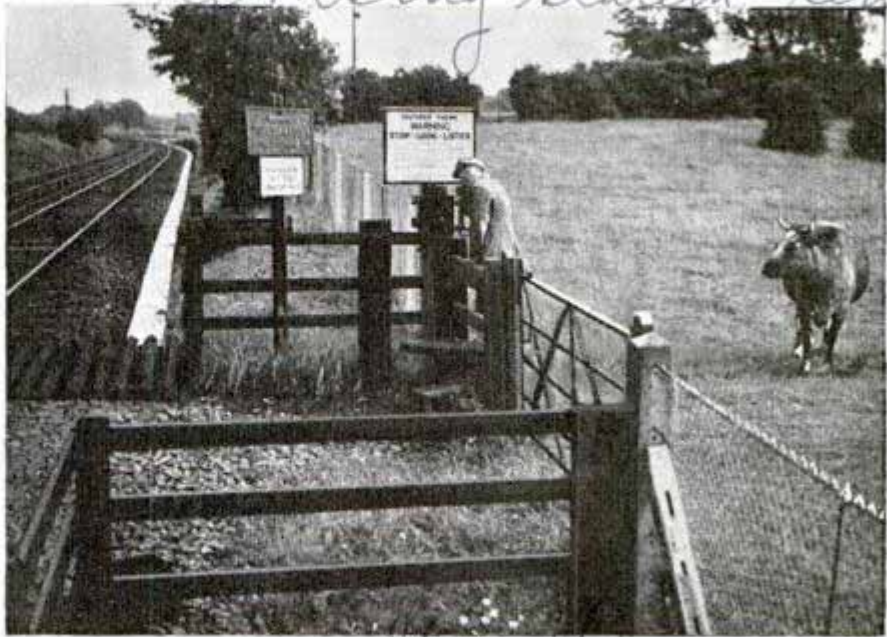

Farmer calling dispatcher at signal tower to learn if it's safe to drive cattle across tracks. Gates shut out cattle and unauthorized persons

Boat with Airplane Cockpit Navigates Shallow Water



Sixteen-foot speedboat supported by pontoons draws only two inches of water. Pilot's seat is like the open cockpit of an airplane

Christened "Voodoo," a powerful speedboat built recently for Chauncey Hamlin, Jr., a sportsman of Buffalo, N. Y., has an airplane-type cockpit for its pilot. The sixteen-foot boat is equipped with specially designed pontoons for support and draws only two inches of water. Its power plant is a 175-horsepower Lycoming engine.

Automatic Life Jacket Inflates Itself If Wearer Falls into the Water

Greater safety is the intent of a life jacket for participants in aquaplane and other water sports. When the wearer falls into the water, the jacket inflates automatically and keeps the wearer afloat indefinitely. The jacket was tried out recently by entrants in an aquaplane race from Catalina Island to the California coast.

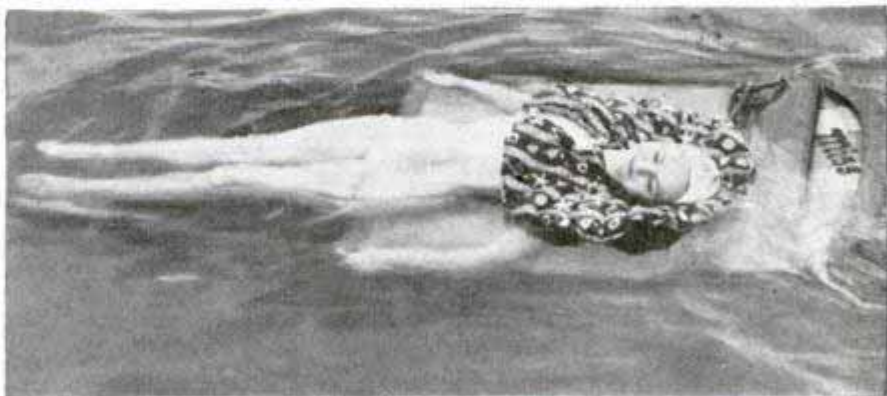

Life jacket resembles a bolero when deflated. It is intended to provide greater safety for participants in water sports

c/o Aquaplane Assn.
Huntington Beach, Calif.

Designed by Helen Miller 20 Cleveland Ave.

2940
702

5100 N. Ravenswood

Trap for Vacuum Cleaner Catches Usable Scraps

on two separate translucent plates contained in a leather case. First you adjust the meter so you view through it the picture area to be covered by the camera. You then arrange your position or the position of the objects so the principal and secondary subjects of interest are located at points designated by small circles on the meter. The result will be a balanced picture. The meter also serves as a monotone filter to help judge the lighting of pictures taken on black and white film.

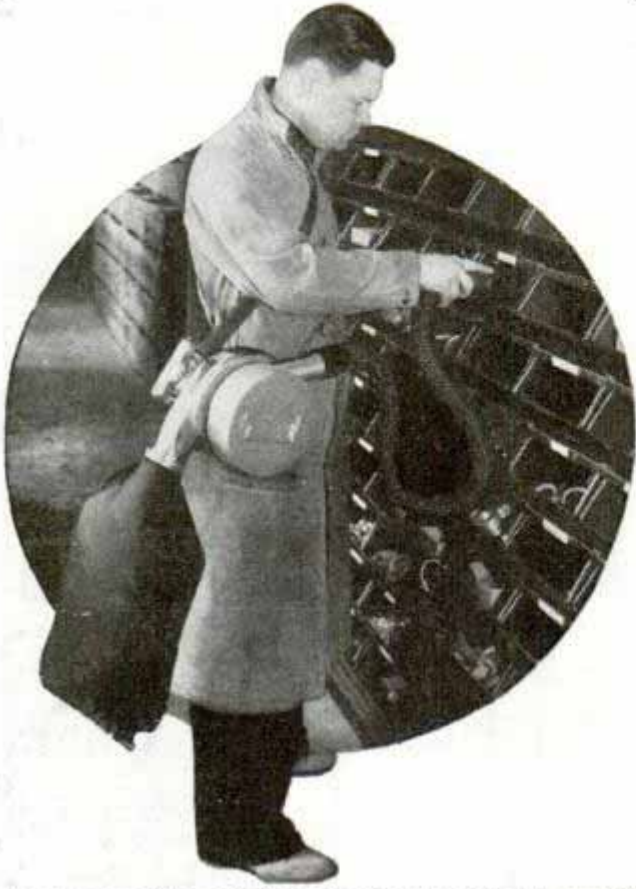

Heavy particles entering vacuum cleaner are caught in trap, later being unloaded free from dust and dirt

To salvage screws, nuts, bolts and other usable material in shops from dust and dirt picked up by vacuum cleaners, a special receptacle has been designed for attachment to cleaners and blowers. This serves as a trap, catching all heavy particles, which can be removed easily for inspection. Also, metal objects cannot reach the fan and cause damage.

Crib Serves as Dressing Table When Spring Is Raised

Greater convenience in caring for the baby is offered mothers by a crib equipped with special brackets that permit raising and lowering the spring. With the side down and spring in upper position, the crib may be used as a dressing table. Being at the same height it can be set alongside the mother's bed enabling her to care for the child without arising.

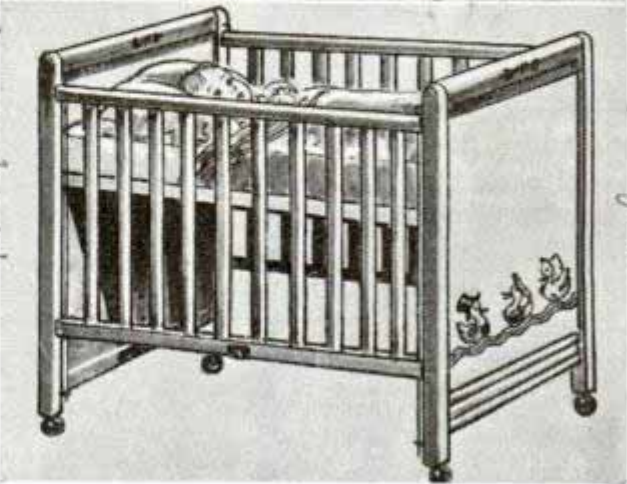
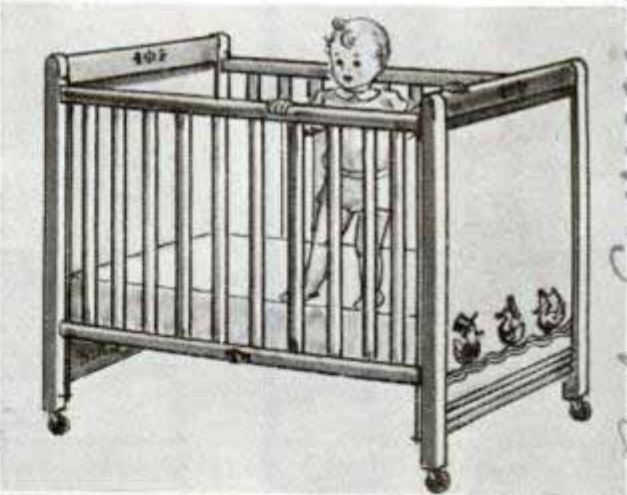

Top, with spring lowered, crib is safe place to sleep or play. Below, raised, may be used as table

Artistic Design in Every Photo Assured by Scene Viewer

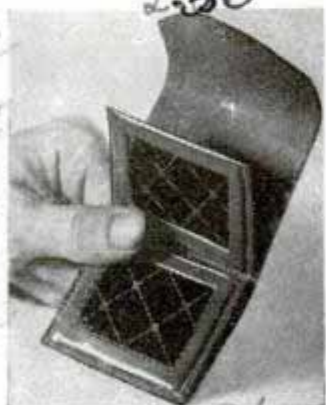

Photographers can check the artistic qualities of a picture before it is taken, by using a viewing meter that guides the position of the principal and secondary subjects of interest. Patented designs are engraved

Chicago Baby Carseat Co. Chicago
1801 S. Michigan

Levinas Photo Exhibitor, mfr. - Kroll Bros. Co.
4815 Cottage Grove Ave. 1801 S. Michigan

"Offset" Tractor Allows a Clear View of Row

Two lightweight tractors built for the small farm and for utility jobs around the big farm have just appeared on the market. One, built by Ford, has hydraulic controls which permit automatically controlling the implement to any desired depth in the ground regardless of surface irregularities. Tractor and unit implement are so closely coupled that they can work in corners and small irregular plots too small for horses. Tractor and tools are combined in one unit; for row crop cultivation, the cultivator can be attached in a few seconds without tools. The new International Harvester company tractor has an "offset" seat on the right, the motor being mounted forward at the left, so that the farmer has always a clear view of the row as he cultivates. In contrast with early tractors made by the same company, it weighs about 1,700 pounds, less than the weight of the flywheel of old-time implements.



Top, tractor with "offset" seat made by International Harvester; and, below, Ford tractor has hydraulic controls for close-coupled implement

Camouflage Guards Submarines by Matching Sea Colors



Difficult for enemy ships to see is this German submarine painted in war-time camouflage to blend its bulk with colors of surrounding waves

at Bremerhaven

During maneuvers of Germany's fleet in the Baltic sea, the defensive value of camouflage for submarines was demonstrated. When viewed at a distance, craft painted in these odd designs easily blend into the gray-green of surrounding water. Even if spotted by an enemy ship or plane, they would provide a most difficult target.

2869 Ferguson Sherman Mich. 6-1
 2 armall 5/5, 00 Cult. Vesim
 armall
 Ford

Electric Dry-Mist Sterilizer Purifies, Deodorizes Air

*London S.W.16.
England*



Dry mist from electric sterilizer floats in air, killing odors and bacteria, without leaving trace

An electric sterilizer intended for purifying and deodorizing the air of the home, sickroom or hospital room emits a bactericidal mist so fine and dry that it will not even fog a pane of glass. The unit, using house current, pulverizes liquid into super-fine particles that float in the air indefinitely without dampening effects. A cabinet model can be used to disinfect clothing, utensils and other articles, accomplishing its purpose within a few minutes. Loaded with an insecticide, it emits a fog that drives out pests and vermin without leaving perceptible odor or oil film.

Discovery of Fifth Skin Pigment Helps Diagnose Disease

Added to the hitherto known four skin pigments is "melanoid," recently discovered by use of a new optical instrument—the recording spectrophotometer—which makes possible speedy and precise analy-

ses of skin colors. Study of the many factors underlying variations in the color of human skin is enabling doctors to diagnose anemia more effectively than formerly and to watch closely the progress of their attempts to cure a patient. Melanoid is a diffuse form of melanin, a long-known skin pigment, and an abundance of these two results in a dark skin, whereas a lack of them gives a light skin. A third pigment, carotene, which is responsible for the hue in carrots, has never previously been recognized as a color component of the human skin. The other two pigments, producing a pinkish flesh tint, are the two forms of hemoglobin found in the blood, oxy-hemoglobin, and reduced or oxygen-free hemoglobin. All peoples, research has revealed, have these five color pigments.

Transparent Mailbox of Glass Is Emptied by Bottom Door

Visible from all sides, the contents of a glass mailbox can be seen by the householder without going outside. For convenience in inserting and removing letters, the box has openings at the top and bottom. A large spring clip above holds newspapers.



You can see from indoors whether there are letters in glass mailbox. Both cover and base are hinged

*Dr. E. A. Edwards, Harvard
Medical School, Cambridge, Mass.*

*George F. Collins Co.
Atlanta, Ala.*

No U. S. agent known

Patent Service 8/16/27

Mr. E. A. Edwards, Harvard Medical School, Cambridge, Mass.

Whirligig Traps and Measures Lightning Bolt



Left, lightning arrester that discharged lightning stroke captured by fifty-foot mast, center. Right, compass checks presence of magnetism in fulchronograph wheel



High atop the forty-two-story University of Pittsburgh Cathedral of Learning scientists set a trap for lightning, captured a bolt and metered its current and its fleeting life span. It was the first time natural lightning had been so analyzed. The whirligig magnetic surge recorder, called a fulchronograph because it measures both current and time, registered a lightning stroke lasting one-sixtieth of a second with a maximum crest of 21,000 amperes, while a newly developed lightning arrester no larger than a quart jar discharged the burden of the bolt without damage. Purpose of the experiments is to find means of protecting transmission lines from lightning. A fifty-foot steel mast on top of the 535-foot building is used to attract lightning. The fulchronograph is a motor and slotted aluminum wheel filled with magnetic steel fins that project from each side, rotating through two coils that carry the surge from the lightning bolt being measured. Current in the coils produces a magnetic field

proportional to the surge current at any instant, and the fin on the recording wheel which is passing in the field is magnetized according to the current carried by the stroke in time divisions as brief as forty millionths of a second.

2912.
\$196

Easy-to-Read Marine Compass



With its balanced, full floating dial in vertical position for convenience in reading, a liquid-type compass is designed for motorboats, sailboats and other small craft. Housed in a streamline brass case, the instrument fastens to any level surface.

Hull Mfg. Co.
Box 246, Warren

24-19

DON'T

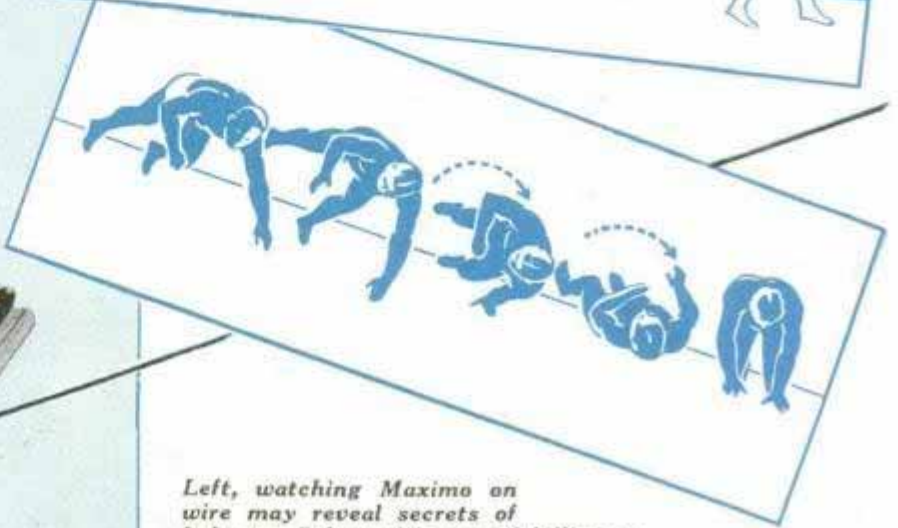

Left, watching Maximo on wire may reveal secrets of balance. Below, this way of falling on stairs may result in arm fracture. Above, right, how to roll without injury



AS LONG as you're going to fall, you may as well learn to do it properly so you won't break your neck.

There's no better place to study the technique of taking a tumble than at the circus. Next time you go, pay particular attention to the aerialists, wire-walkers, balancers, and clowns, and you'll pick up a few pointers that may save broken bones later.

Decorating the Christmas tree, hanging Junior's picture, or cleaning pantry shelves may not seem like very dangerous pursuits but last year 26,700 persons met their death while engaged in just such tasks. And an analysis of the 4,750,000 non-fatalities in homes shows a high percentage of them to be the result of persons tripping over loose rugs, doing nose-dives down the cellar steps, and stepping on the soap.

Likewise in industry, falls constitute the greatest work hazard and if it weren't for those who tumble out of haymows and off machinery, the mounting total of accidental deaths in agriculture could be drastically cut.

Cont. James Mc Greeny
431 W. 60th Street
Kansas City, Mo
2419

TAKE IT SO HARD

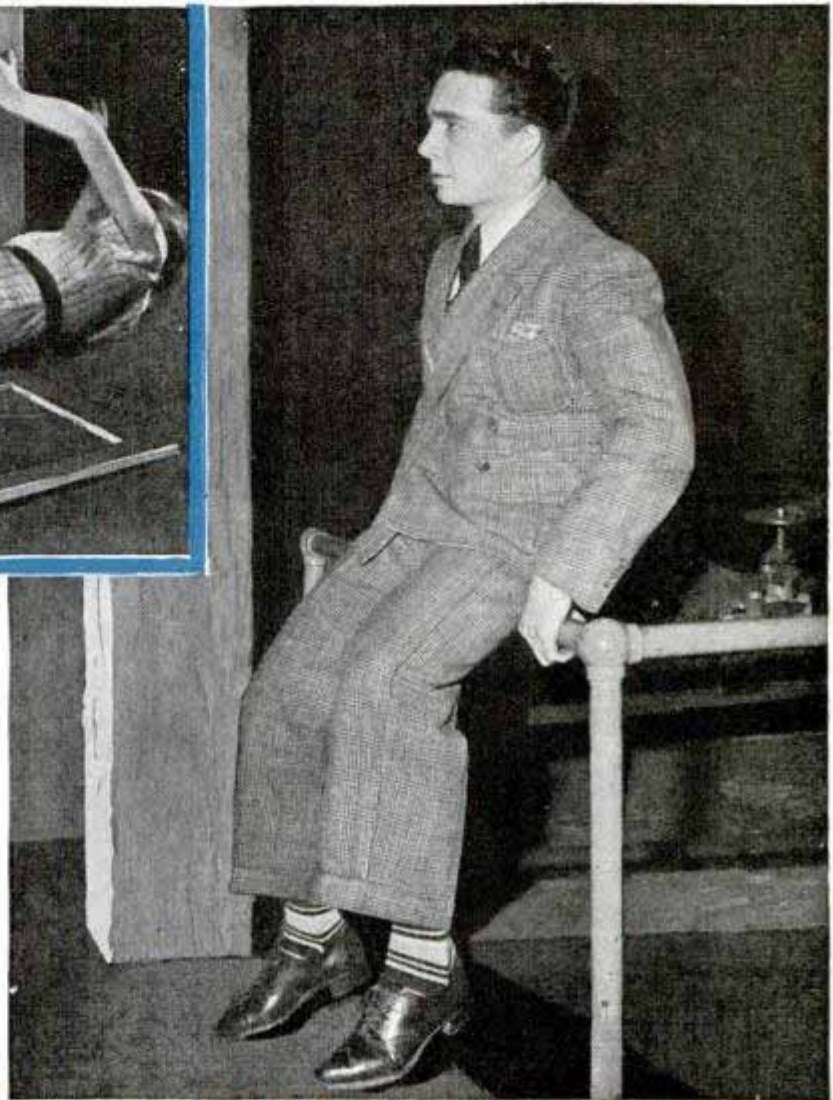
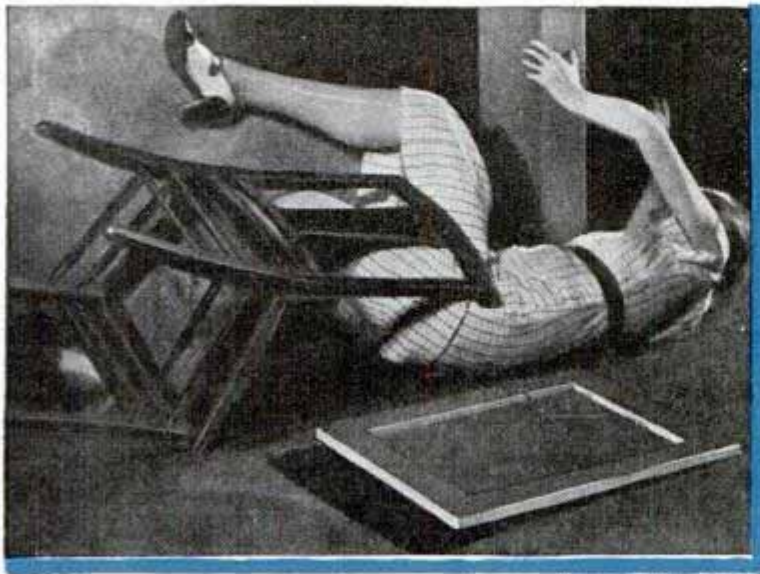

The proportionate number of deaths resulting from trapeze falls can't be compared with the number caused by collapsed stepladders; the bathtub looks like a deathtrap alongside the perch poles the circus daredevils use when the relative fatalities of the two are studied. The reason for this is simple. The performer knows what he's about whereas the picture hanger or bather doesn't. The former has schooled himself in the technique of the fall and knows how to make his body protect itself in an emergency.

Consider the clowns. You've seen Otto Griebeling start to break into a run, get tangled up in his floppy shoes and go sprawling on his face. His movements seem identical with those of the householder tripping over the handle of his son's wagon, only Griebeling doesn't suffer a wrist fracture or get his face scratched up as the latter is likely to do. How does a clown manage to escape injury? For one thing, he turns his head to either side and instead of going down with his full weight on his wrists he bends them slightly the instant he touches the ground so as to absorb the shock.



Top, left, picture hanger falls because she failed to test strength of the chair. Right, if you lose your balance on rail, turn fall into a swing (as illustrated below)

When the average person's heel slips on a banana peel or small rug on a highly polished floor, his legs shoot out from under him and he falls backwards after frantically flailing his arms in an effort to regain his equilibrium. His hospital chart is likely to mention something about a double



wrist fracture, a dislocated hip, or a brain concussion. In case you ever find yourself on the verge of taking off from a banana peel, Frank Conville, comedian, prescribes a safe way of handling yourself: "Pull back the leg taking the step and instead of forcing your body backward by clutching at thin air, jerk it forward, bend your knees and drop into a crouching position." It's axiomatic with performers, he says, to "go with the fall."

"Gravitation's impossible to beat," he explains, "so you've got to get around it as much as possible. The best way of doing this is to go with the fall, not fight against it. When you scramble wildly after losing your balance you are going against the fall, thus adding to the momentum. Remember—'go with the fall' and you're not likely to be injured."

When it comes to skidding on an ice-coated sidewalk, don't go down in a heap with all the weight on your wrists but

quickly tuck in your chin, draw in your breath so as to prepare your body for the jolt, and as you go down try to make a turn so the points of contact are your hip pad and the protected part of your shoulder. What is true of the slip also applies to the stumble. Instead of scrambling all over the place, flex your knee quickly and you'll find yourself in a position similar to that of a football player's on the line of scrimmage.

There's a sermon for the picture hanger as well as the person with a flair for falling in or out of the bathtub in the pulsating feats of the perch artist. Before he ever attempts any one-arm balances at some dangerous height, he is certain his equipment will sustain him, checking it carefully before every performance. That's not true



Top, bend wrists at moment of contact to ease shock and you'll avoid such injuries as are almost certain to result from putting out your arms (below). If you start to fall backward, put chin close to chest and make arch of your back (bottom)

of the usual person who, rather than make a trip out to the garage after a stepladder, will blithely hop up on a chair, box, or bookcase without ever pausing to measure its strength. Naturally, the hand balancer cannot afford to be careless about his work.

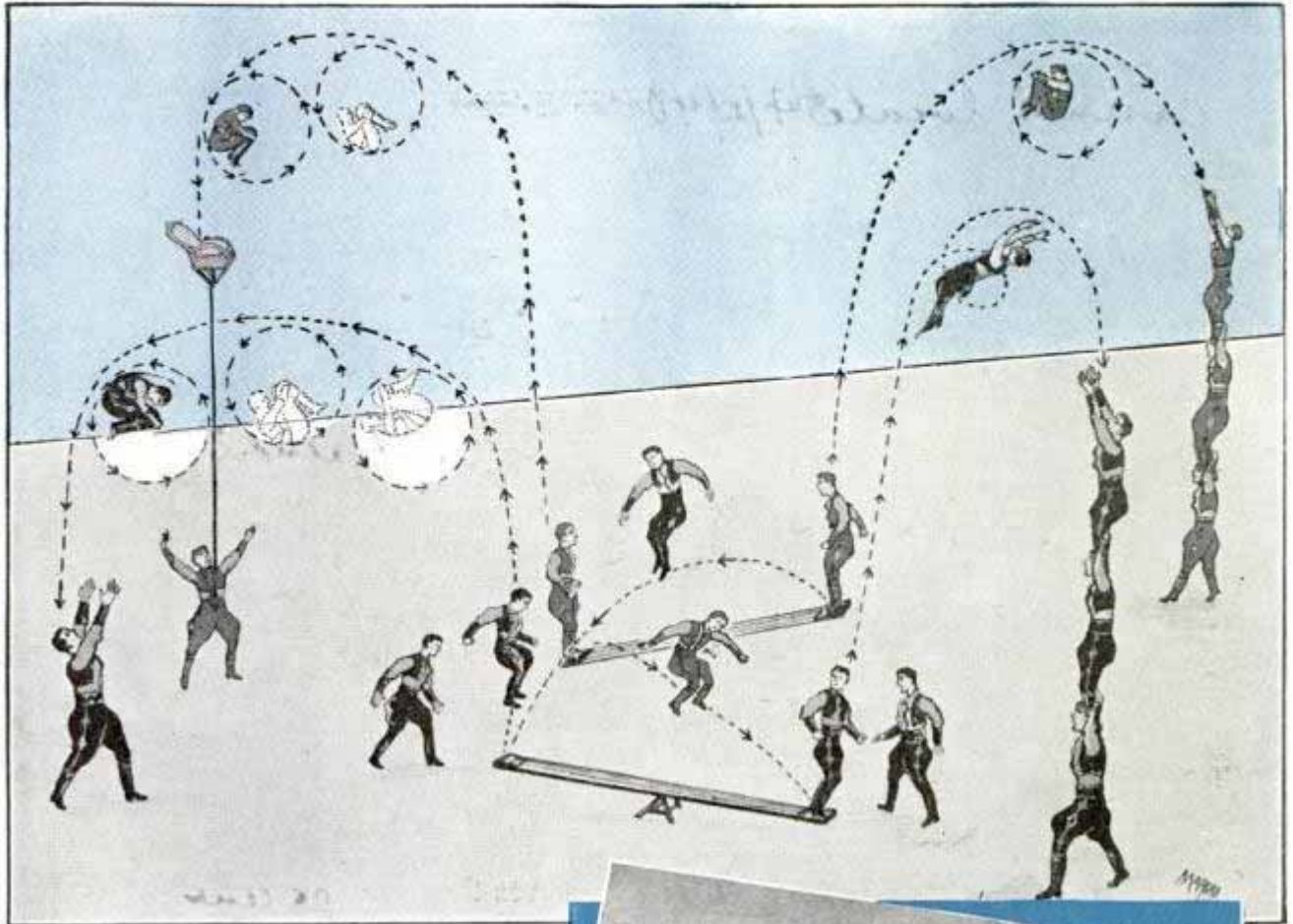

A false move may kill or maim him. He makes it a rule not to let go of his handholds until he's properly balanced. If a bather would hold onto the towel rack and the side of the tub until he was sure of his footing, his spine would never be endangered.

Every chair tipper goes too far occasionally and finds himself on the floor, sometimes with bruises and fractures. The way to preclude such upsets, according to Arzeno Selden who does his chair tipping ninety feet off the ground, is to project your body forward the instant you feel your balance slipping away. Instead of shooting out your legs, pull them back with all your might. The chair may topple but you won't as you'll be in a position midway between a crouch and an upright stance.

If you can't keep your basement stairs well lighted or free of toys, brooms, and scrub buckets, a few general tips on how to fall down them without having to be rushed

(Continued to page 137A)

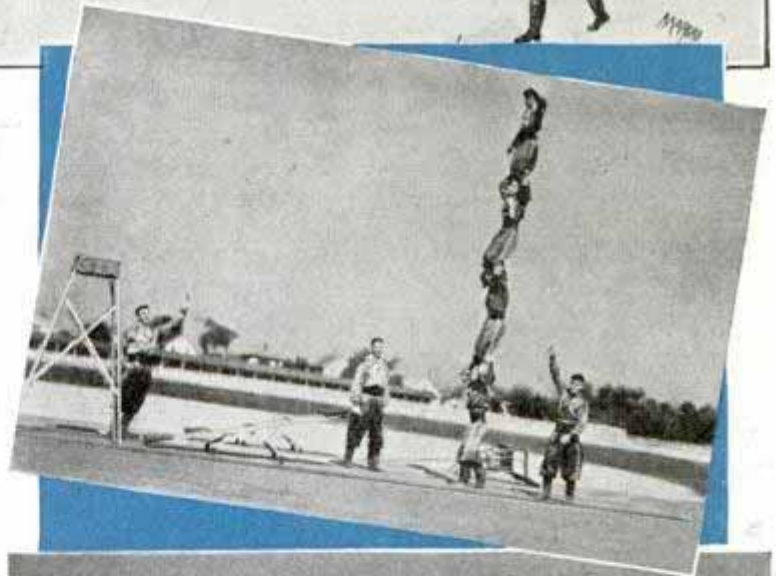

Two photos and drawing show how acrobats learn to regulate the speed of their turns in the air. This timing sense precludes many falls

Doll with Coiled Wire Legs Can Stand on One Foot

Carnival locate 4/2/48



High-kicking doll stands on one foot and holds other in its hand. Flexible legs and arms do the trick

Able to sit, stand and even hold one foot in the air, a doll now on the market is unbreakable. "Baby Snooks," as it is called, has arms and legs of hollow wire cable that may be bent into any desired form.

Flameless Electric Paint Burner Removes Surface Quickly

Before painting or decorating, the old surface—whether it is paint, varnish, putty, wallpaper or linoleum—can be removed

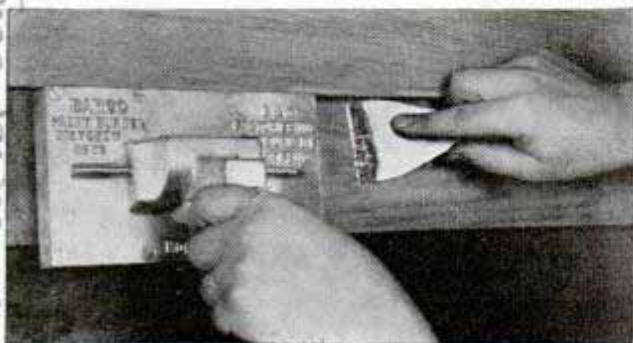

Scraper removes old paint with ease after it has been scorched by flameless electric burner

quickly and safely with a flameless electric burner just introduced. Operated like a flatiron, its aluminum surface heats rapidly and softens the old paint without harming material beneath. While one hand operates the burner, the other scrapes away the loosened paint. When removing linoleum or wallpaper, the surface is first moistened so that steam is generated.

Safety Flap over Paper Spindle Guards Hands from Injury

Old-fashioned spindles with their dangerous points sticking upward have been rendered harmless to hands and clothing by adding a flap to cover the tip. This safety top is hinged on a separate standard attached to the base, and it lifts up easily by inserting under it the paper to be placed on the stick-file.

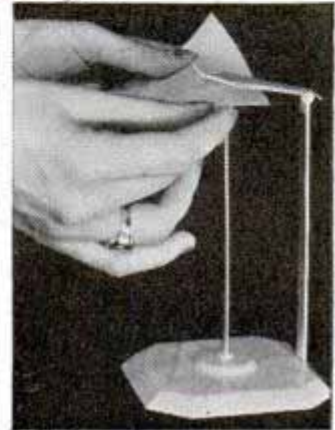

Lamp on Memo Pad Is Lighted When You Pick Up Pencil

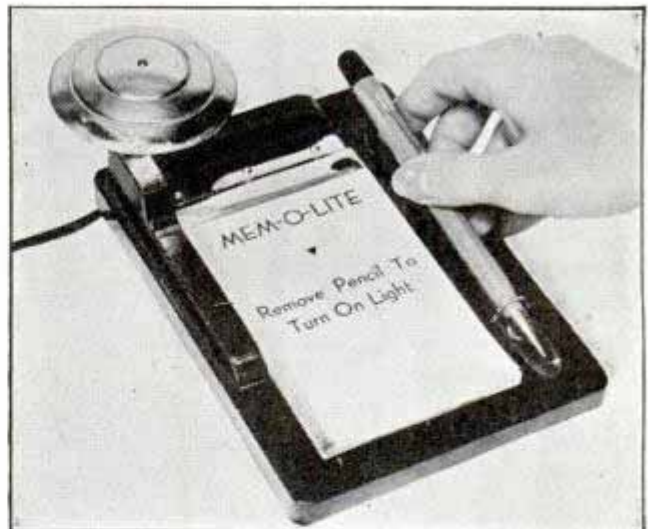

Pick up the pencil from this memo pad and you also automatically turn on electric lamp at top

When the pencil is picked up from its slot in the base of a memorandum pad, a small lamp is automatically turned on to flood the writing surface with light. The set uses house current and is handy for the telephone stand or bedside table.

*A. Stanley Brussel,
225 75th Ave., N.Y.C.*

*Box M. Factories, Inc.
3 Howard St. Auburn, N.Y.*

Shadow Lingers Behind on Tricky Screen

Walking away from your shadow may seem impossible, but that is just what a man of the General Electric company does, using a special screen. He first sits in front of the curtain, then gets up and walks away while his shadow remains sitting. The process is simple. The screen on which the shadow is cast is made of phosphorescent material that stores up light from a powerful spotlight. Only portions "charged" with light will glow, so when the house lights are turned off the screen continues glowing except the part which received no light because of the shadow. By turning on and off the red light of neon lamps, the shadow can be wiped out and brought back again. This is

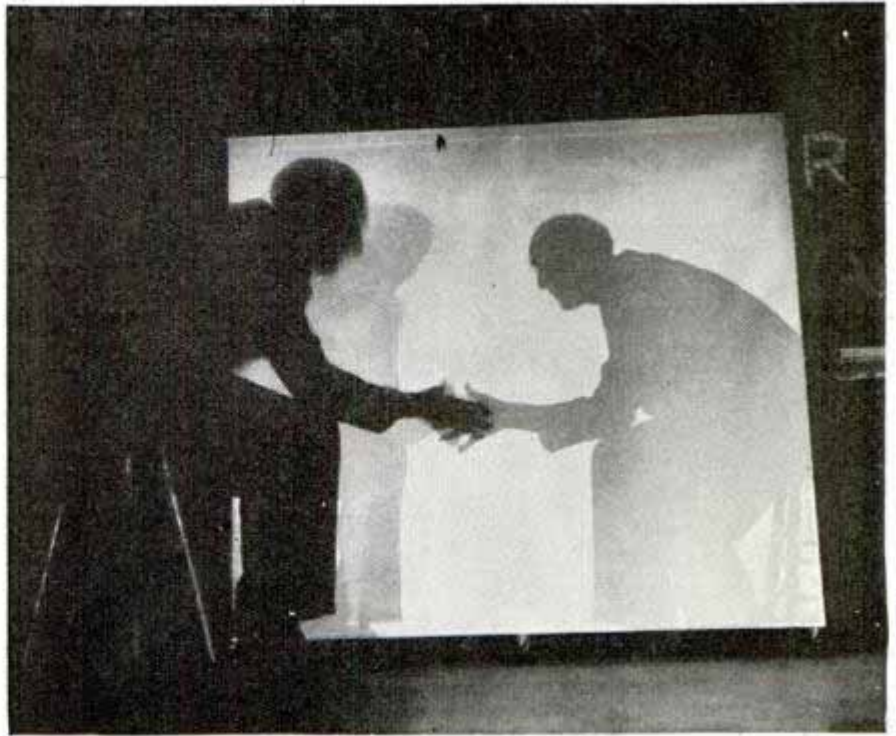

Shaking hands with own shadow that "froze" on phosphorescent screen. Part that received light remains luminous leaving shaded portion dark

because the red light does not "charge" the screen, and the phosphorescent light cannot be seen under the neon lamps.

Roller Coaster Model That Runs Built by High-School Boy

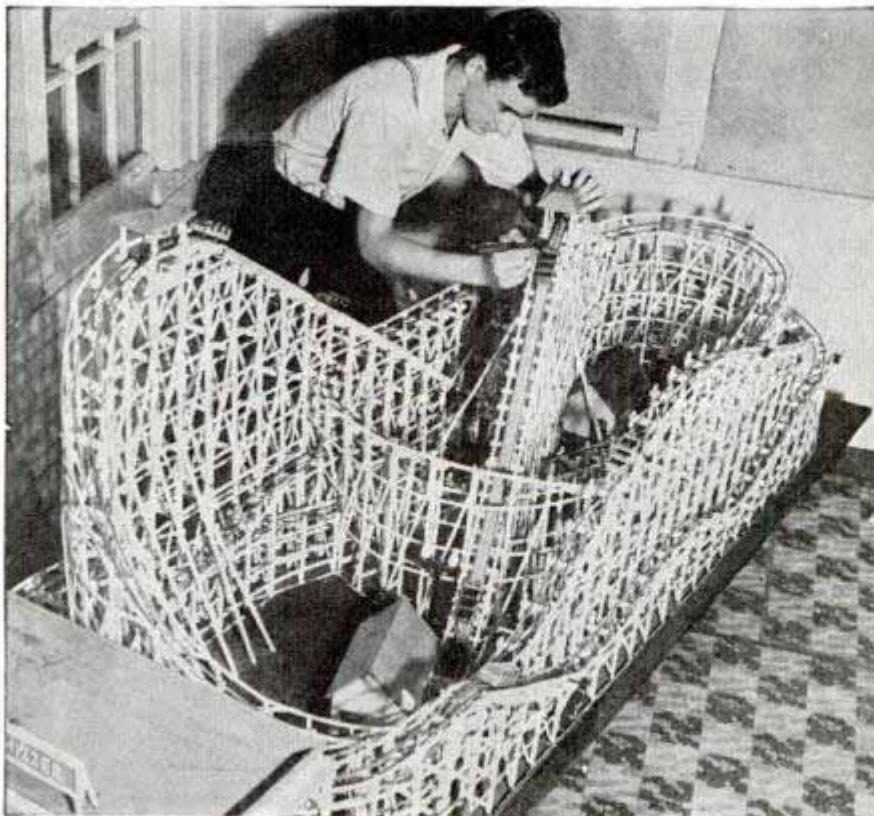

Builder adjusting chain that lifts cars to top of miniature roller coaster

Patience and painstaking work of an eastern high-school boy resulted in the completion of a miniature roller coaster like those used at amusement parks. The year and a half required in its building included many hours of study and experiment to be sure that the cars would not leave the rails on the banked turns and sharp dips of its sixty-five foot course. To start them on their mad dash cars are pulled to the top of the ride by a chain.

☐ Glass curbs installed on English highways are said to offer better visibility at night and in fog than curbs painted white.

*Home
C. W. Robert Weisil
West Coast Park*

*Public Safety
Aug. 1939*

Reference: Robert W. Horton Chief Maritime Commissioner of Washington D.C.

28 : Comdr. Thomas O. Emerson Jr
105 55 Holman Ave
Los Angeles, Calif

«DISASTER COLLEGE»



GATHERED in the wardroom of the ex-Coast Guard cutter "Northland," a group of sea captains and mates are taking an examination.

"Suppose," says Lieut. E. E. Hahn, Jr., "that you are first officer on a large passenger ship. Your captain died last night and now you are in command. Your ship is a modern luxury liner, one of the most fire-proof afloat, and you have a full passenger list. Tonight a small fire breaks out. What are you going to do?"

Details of this problem don't seem alarming but they were the circumstances under which fire swept through the "Morro Castle" and caused one of the great marine disasters of recent history.

Spherical blackboard on which problems are demonstrated (top) and students receiving Diesel repair instruction (bottom)

for

SEA CAPTAINS

"Suppose," asks Lieut. Hahn, "that you are weathering a heavy storm. One of the crew reports considerable water in the hold and more leaking in through the coal ports. What do you decide to do?" Again the question is a simple one but the wrong decision could cause another disaster like that of the "Vestris," from which tragedy the details of the question were taken.

Making the sea safer by

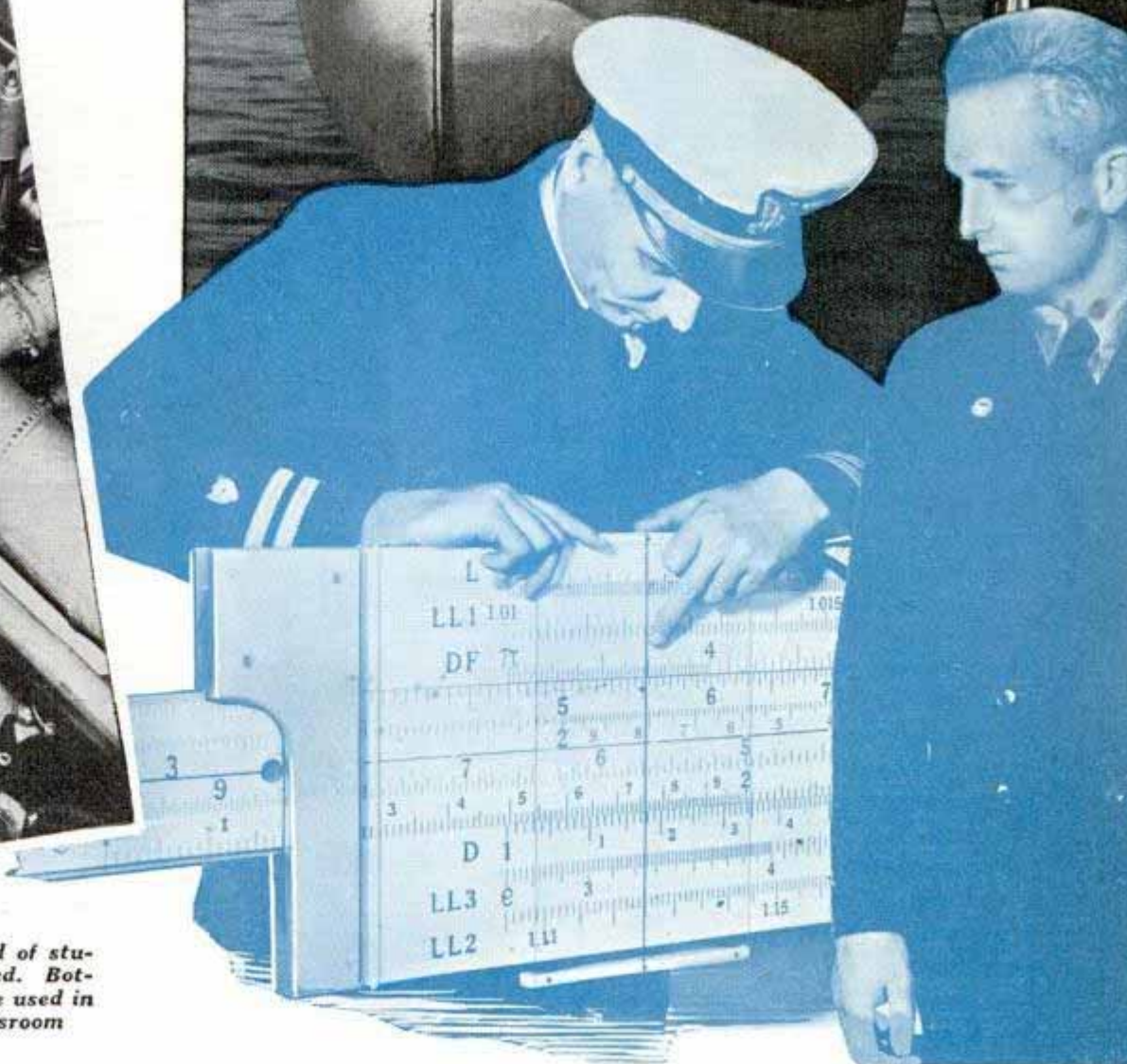
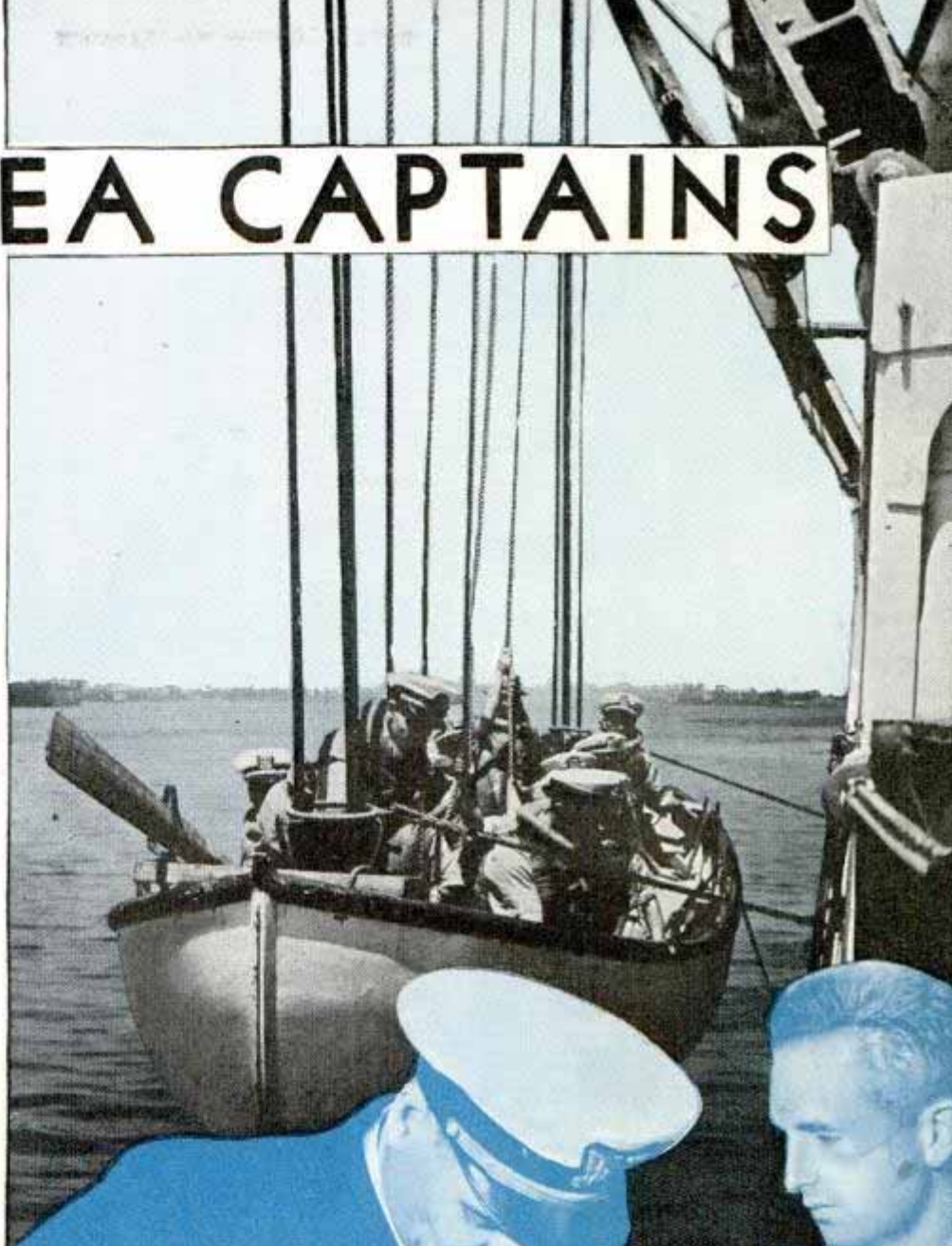

Right, top, boatload of students being lowered. Bottom, large slide rule used in the nautical classroom

2728

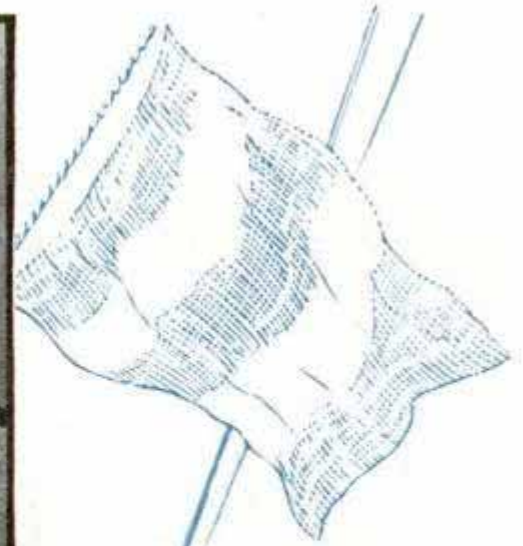
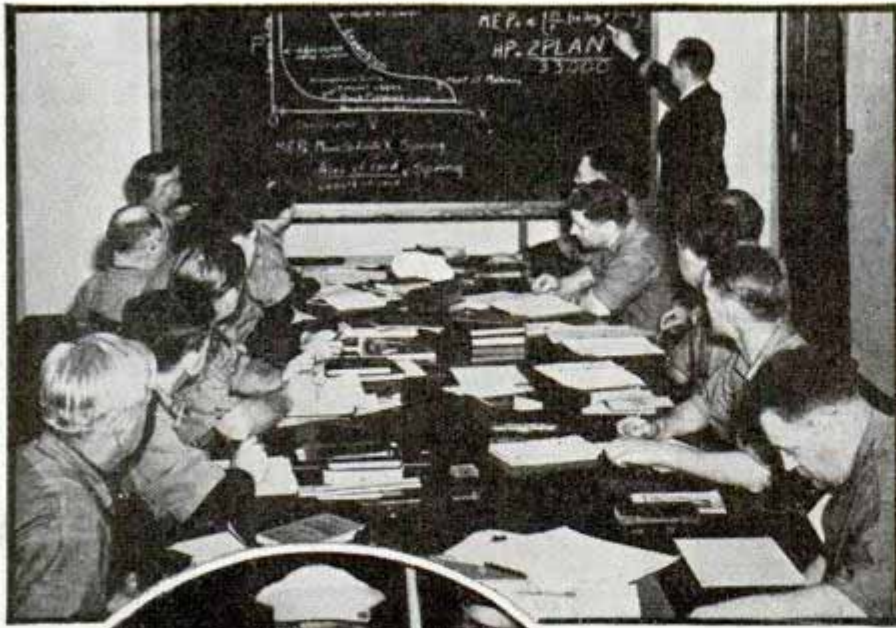

Top, engineering students at work. Circle, "marlinspike seamanship" being taught seaman. Right, instruction in use of signal flags. Bottom, ready to go over the side in boat

"taking shipwrecks apart" and studying the things that could have been done to prevent them is one of the subjects taught at the Maritime Service Training Station of the United States Maritime Commission at Government Island, Alameda, Calif.

Every shipwreck has a lesson in it, and at the school the officer students study each of the outstanding marine tragedies of the last several centuries. The "Vestris" and the "Eastland" sinkings might have been prevented if their officers had understood the proper loading and balancing of their ships. In the cases of the "Morro Castle"

and the "Titanic," lack of disciplined drill and organization helped contribute to the disasters. Sometimes captains hesitate to send an SOS until the last possible moment, delaying rescue work. Regular radio watches and the international ice patrol were begun as a result of the "Titanic" sinking. More recently, stricter discipline

see June 17 1929-39

and more frequent, thorough fire and boat drills have resulted from the "Morro Castle" fire.

Only men who have already been to sea can enroll in the schools of the Maritime Service. Young officers intent on rising to the top and grizzled sea dogs who have walked the bridge for a score of years sit side by side before the instructors. Often, in "disaster class," men who were present at the wrecks being discussed relate their experiences. Understanding of the causes of a disaster sharpens their interest in such subjects as cargo stowing and the distribution of weights.

The new training schools were established to increase the efficiency and skill of seagoing men and to help them advance in rank, as part of the program to return America to its former status among the leading maritime nations.

Officers who have plenty of practical experience but who do things by rule-of-thumb are taught theory and background in class. Only those who have served at sea seven months or more during the last two years on American ships of 500 gross tons or more and who are now unemployed can attend. During the three months of the course the students are provided with food, quarters, clothes, and are paid from \$36 to \$125 per month, depending on their rank. The men are allowed to return to school one month per year for more instruction.

At Government Island both the student officers and the unlicensed seamen students get plenty of classroom paper work, yet all hands turn out for the frequent and intensive drills in all kinds of emergency work. At the station you are apt to see the rare spectacle of a boat's crew of sea captains clambering into a lifeboat and getting it away smartly from the ship's side. No matter whether it is an abandon ship drill, a fire drill, use of the breeches buoy, or a drill in damage control, the idea is to do away with all confusion and to perform the drill with no conversation and a minimum of orders.

The Maritime Service is using Hoffman and Swinburne islands in lower New York Bay and the Coast Guard base at Fort Trumbull, New London, Conn., as its colleges on the Atlantic. On the Pacific its Government Island training center is in an

(Continued to page 116A)

Portrait on Stainless Steel Has Mirrorlike Depth



Portrait on circular piece of stainless steel has third dimension and will last longer than canvas

Mirrorlike depth of portraits and greater permanence than is possible with canvas are claimed for paintings made on stainless steel. The polished alloy background gives the third dimensional effect and will not crack nor rot. Metallurgists say such portraits will last at least 1,000 years.

Folding Cot for Beach or Camp Carried Like Suitcase

For lounging in the back yard, outings on the beach, and camping in tent or trailer there is a folding cot that packs in a suitcase. The duck cot is easily set up, and is available with steel-tube or hardwood frame. It weighs about fifteen pounds.



Top, cot holds grown person when unfolded, and fits in suitcase for carrying, as shown in circle

Electro Metallurgists Co. 20 E. 42nd St. New York

Pro-Tech-All Motor Signal

Pro-Tech-All Motor Signal

Baby's Crib Is Also Cabinet, Bath and Dressing Table



Mother saves many steps with baby's clothes handy in crib that combines bath, table and wardrobe

One piece of furniture that serves four purposes in the nursery is being introduced this year. It is a combination crib, baby's bath, wardrobe and dressing table. There are two large and two medium drawers in front, and a wardrobe section in the side for the baby's dresses.

Safety Auto Signal Flashes Light to Indicate Turns

Mounted on the auto door next to the driver, a signal arm has a built-in light to attract attention of other motorists. To swing out the arm to signaling position a

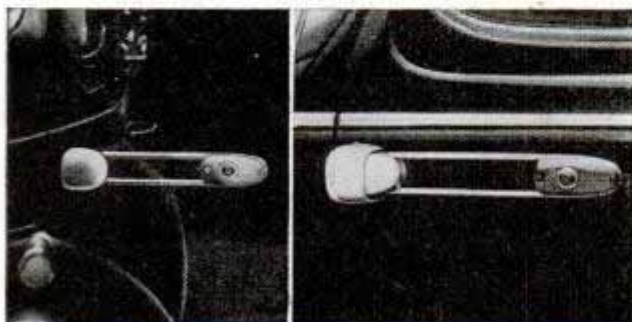

Left, auto turn signal extended gives light to rear of car, and, right, then folds back snugly on door

small knob inside the car is pulled; the bulb automatically flashes twice and then burns steadily while the signal remains extended. For installations small holes are drilled in the flange of the left front door and a simple electrical connection is made.

Hundred Million Billion Suns in Range of Telescopes

It is conservatively estimated that there are not less than one hundred million billion suns among the groups of stars that are within the range of present telescopes, according to Dr. R. S. Underwood, of Texas Technological College. Written as a number, this is the figure "one" followed by seventeen ciphers. This amounts to so many suns that, if they were reduced individually to the size of buckshot, they would fill a line of trucks strung end to end from Boston to San Francisco and folding back on itself about two hundred times, Dr. Underwood declared.

Metal Cleats Space Roof Nails at Uniform Intervals

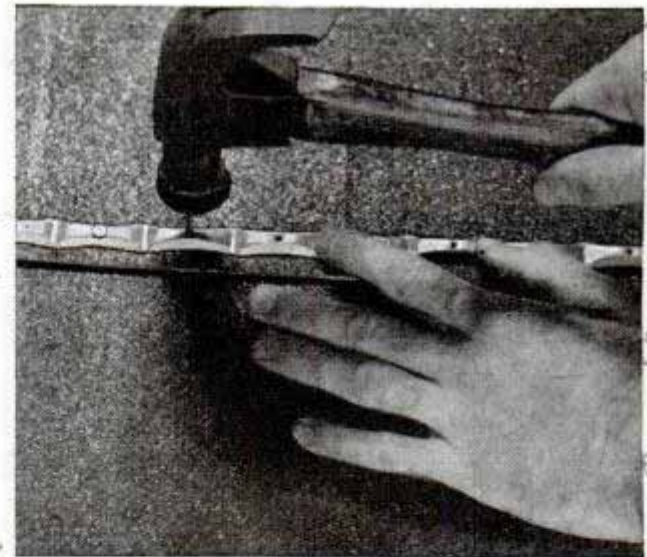

Roll roofing is held down firmly along entire edge by "endless" cleat with nail every inch-and-half

Metal cleats with nail holes one and one-half inches apart make it possible to space the nails evenly when applying roll roofing, and to fasten the roofing down continuously along the full length of the seam or edge instead of merely under the nail heads. The cleats are thirty inches long and can be overlapped with one nail through the end holes of the adjoining cleats.

Mallory Electric Co. Fullerton and Cloverdale / 39 Carlisle St. New York City

\$32.50

935

2529

Patent Service Aug. 12, 1939

Patent Service Chicago. Montgomery Ward

Regency 4432 S. Ashland Ave. Chicago

Streamliner's 'Earlaps' Blow the Smoke Away

Grotesquely unlike American streamliners, the newest locomotive of the State Railways of Germany has projecting fins like ear flaps to divert the smoke from its stack upward and away from the train. The engine has a top speed of 115 miles an hour and a cruising average of 100 miles an hour.

Camera and Compass Show Slant of Well

By lowering into the oil well a tiny camera, a calibrated scale and a magnetic compass, drillers now have a way of finding accurately the alinement of their wells far underground. The compass at all times indicates a fixed direction magnetic north, while the angle of the scale varies in accordance with the direction of the drill hole. The relative positions at known depths, as recorded by the camera, tell the experts exactly how the drill hole slants. The equipment is designed particularly for oil wells purposely drilled off the vertical to tap offshore pools on the California coast.



Smoke from streamliner is started upward and away from train by upturned fins that are worn on roof like a pair of earlaps

Meter for Artificial Respiration Shows Efficiency of Effort

As an aid in the training of rescue workers, a recording meter has been developed that gives a constant, visible check on the

efficiency of artificial respiration. While the resuscitation work goes on the graph shows the pounds of pressure applied by the operator at each stroke, and, on the opposite side of the chart, the volume of air expelled in cubic centimeters. A timing mechanism indicates the number of strokes and breaths per minute.

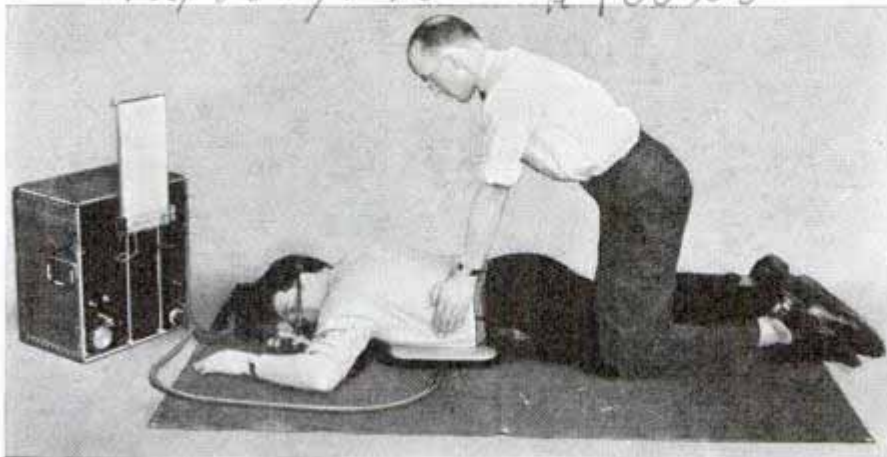

Meter records stroke pressure, volume of air expelled, and rhythm of breathing, to help train students of artificial respiration methods

One strand of grass that grew forty-eight feet long, sending down new roots every few inches from which blades shot up three feet high, was found in East Africa.

mine Safety Appliances Co. Tribune. 7/10/39
Pradock Thomas and West

2933
2866
2,155,136
\$400.00
W. G. Henderson, Fullerton, Calif.
John D. G. Henderson, Fullerton, Calif.

Q 678. Mr. Thomas G. Jensen Jr.
 10555 Hollywood Ave
 Los Angeles

Comb 8. Jr. Ryder, Santa Fe Rings
 560 S. Main St. Los Angeles

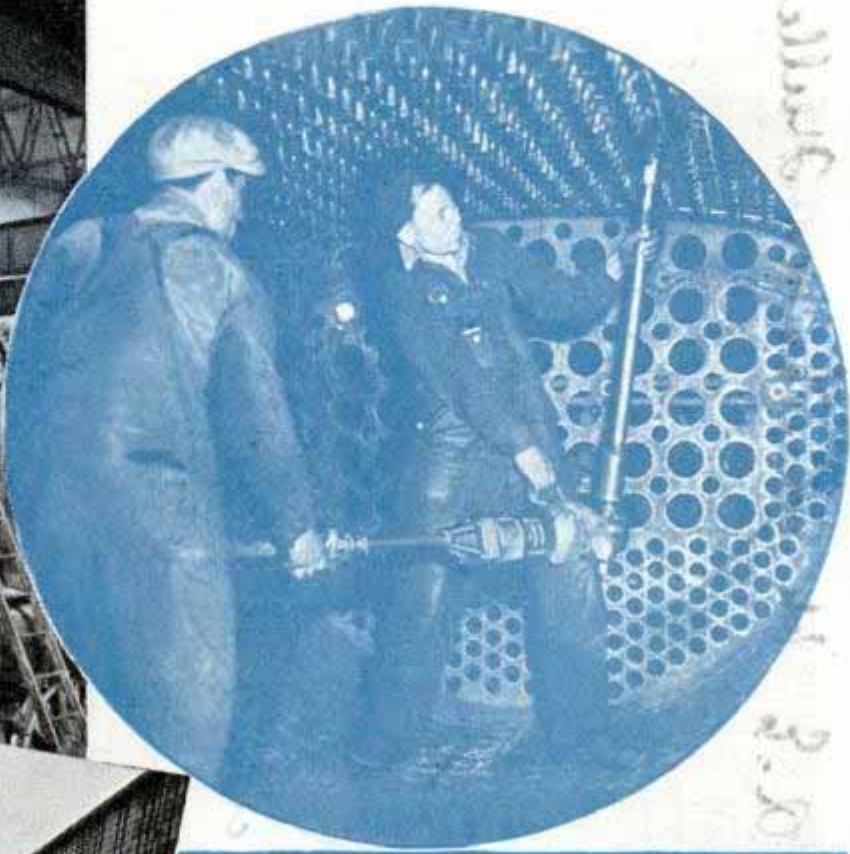
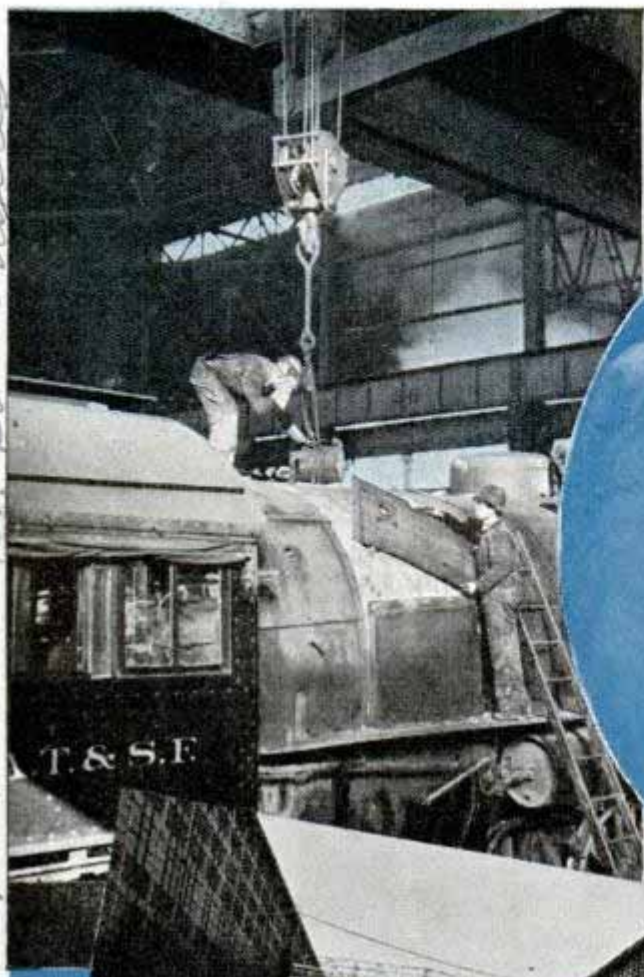

"HOSPITAL"



Keeping big locomotives at peak efficiency requires the services of an army of trained artisans, ranging from bricklayers to operators of specially designed lathes. Still hot from a run, the monster engine goes to the "hospital," or repair shops, for a light overhauling calling for about 3,500 man-hours of work. Above, new crown sheet being applied. Top, left, removing jacket and insulation. Center, transfer table hauls locomotive to stripping shop. Bottom, left, general view of hospital. Right, preparing to repack casing

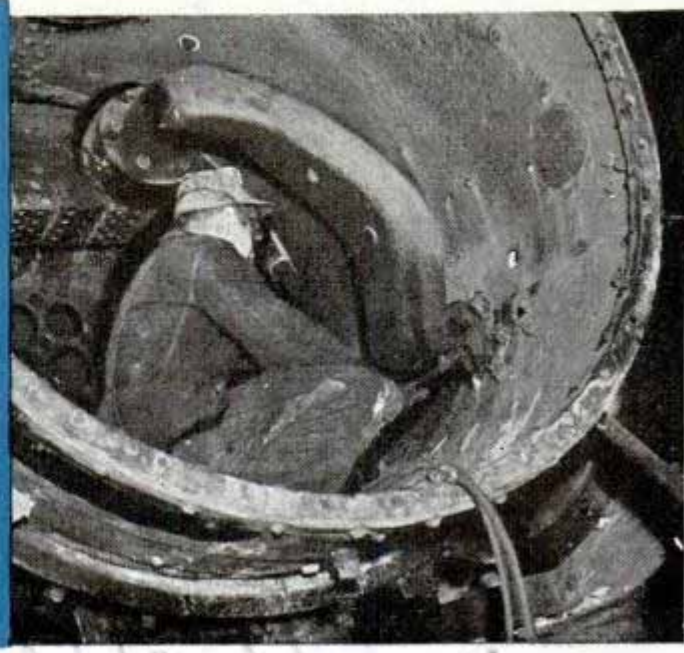

for

LOCOMOTIVES

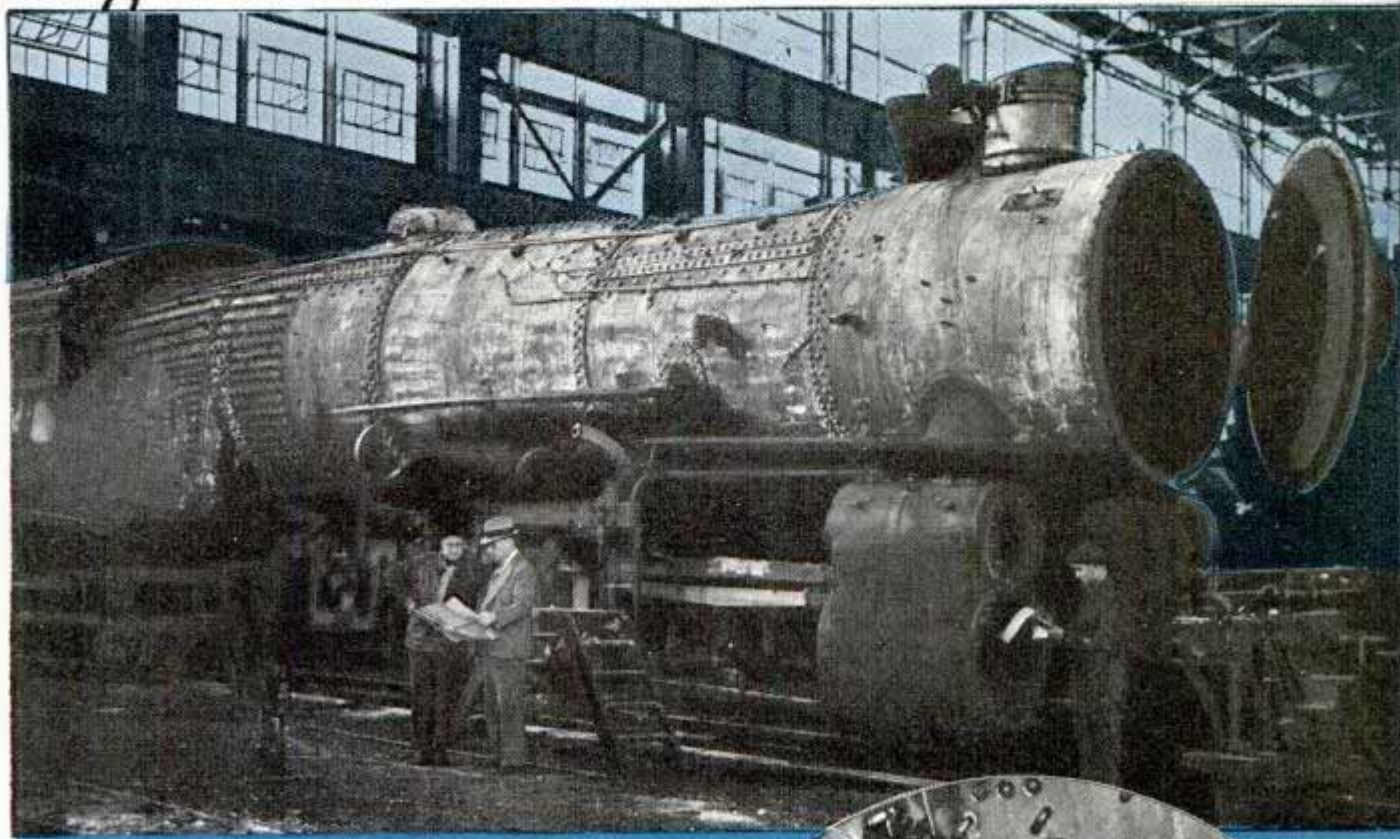

Whether the locomotive needs repairs or not, it has a general overhauling at the end of each year of service and at four-year intervals it is rebuilt from the tracks up. As a result a locomotive has a useful life of at least twenty years and some of the Santa Fe's engines have been operating steadily for thirty-five years. Above, stripping-down locomotive on the erecting floor

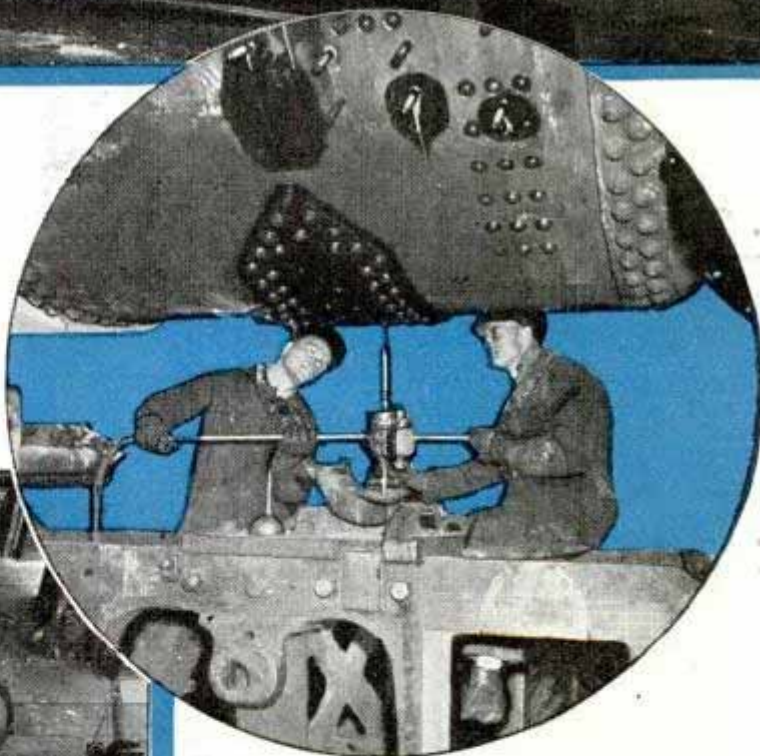

Light overhaul consists of removing 1,500-pound driving tires from wheels and turning down flat spots in lathe, grinding valves, replacing gauges and testing and adjusting every moving part. Circle, reinforcing boiler—drilling holes for "wind sheet tee iron" studs. Left, view from above as erecting floor workers assemble locomotive. Soon the "patient" will be roaring along the rails, hauling a dozen or more loaded passenger cars at speeds above sixty miles per hour

Tweed and Leather Pianos Set New Styles for Home



Piano sporting covering of blond oak and tweed is one of designs to match furniture in modern home

You'd hardly recognize the old piano in its smart new dress. Breaking away from the traditional styling of grands and uprights in mahogany and walnut and other standard finishes, it is appearing this year in shapes that conform with modern home furniture, in "blond" woods and with coverings of leather and tweeds.

Reel Warns When Fish Bites by Flashing Tiny Light

For the night angler, a device built into a fishing reel automatically signals when a fish bites by flashing a small light. The

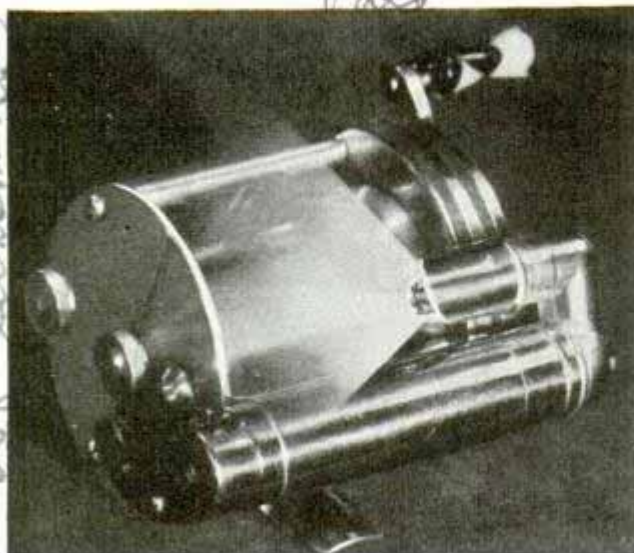

Small light at right flashes when there is a tug on the fishing line

tiny lamp also illuminates the reel spool to facilitate untangling of the line. The device consists of a small housing for midget battery built on the rear of the reel and an elbow which holds a light bulb directly behind the spool and to the handle side. A switch on the front plate of the reel makes it possible for the angler to illuminate his reel spool when desired, throws on the flasher for bait fishing or breaks the circuit entirely. The flasher is synchronized with the reel spool, flashing twice to one revolution of the crank.

Movie Test for Drunken Driver Eliminates Court Trials

There are fewer police court trials of motorists charged with driving while intoxicated since the police at Fresno, Calif.,



Intoxicated driver who can't walk the line is ready to admit guilt when confronted with movie of failure

began making film tests of drivers arrested. The motorist is asked to walk a straight white line while the movie camera films his performance. Of the first 100 drivers tested in this manner, eighty-six entered guilty pleas immediately, three were dismissed when the film showed they walked the line without stepping off, and the rest were held for trial.

Story of Clark Piano 648 Jackson Blvd. Chicago
899
U.S. Patent
Ill. K. & S. Co.
Ms. George Jennings
2806
Beland. Fresno
Police photo
dergh. Joe Brady
2809
Columbus, Ohio
S. Heziman, 688 Jackson St.

2878

Maschinenfabrik

Giant 280-Ton Lathe Turns 120-Ton Castings

Bielefeld, Westphalen, Germany

For machining and turning heavy castings or forgings weighing up to 120 tons, a giant lathe produced in Germany weighs 280 tons. Its centers are high enough to handle a casting nearly twelve feet in diameter if needed, and the distance between centers is twenty-six and one-half feet. Two large tool holders or carriages on opposite sides make it possible to take two cuts at one time; these can consist of the rough and finish cut, or both may be finish cuts of different diameters.

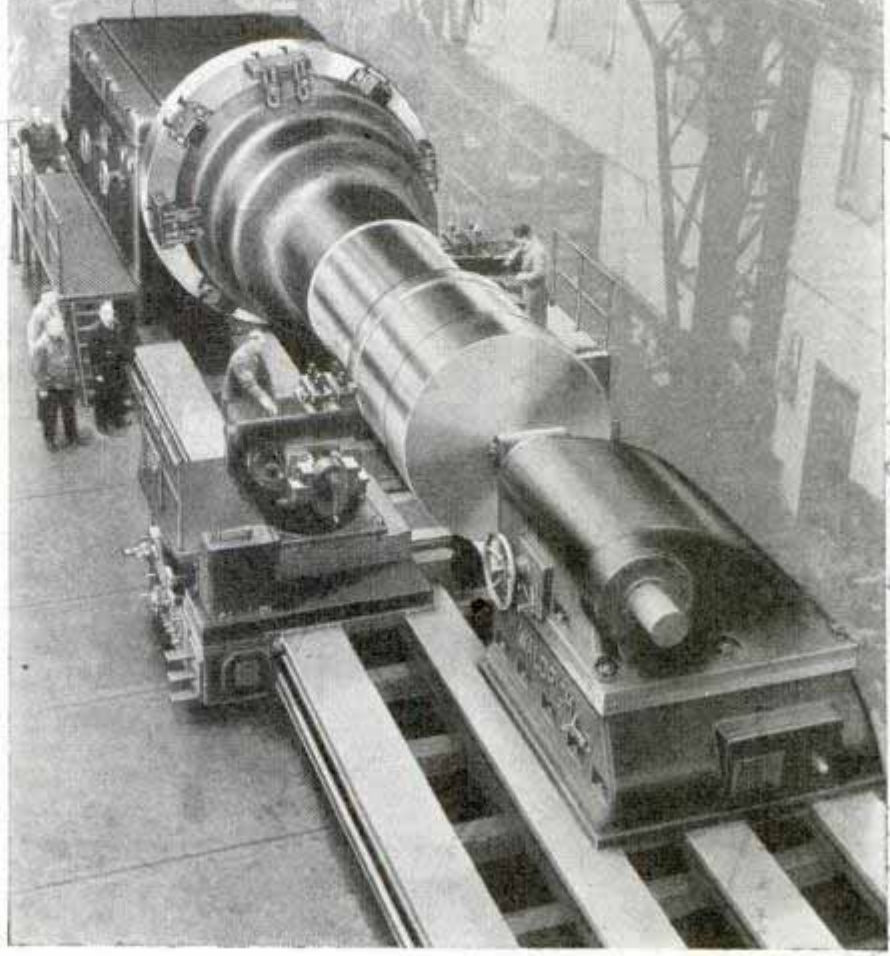

Photo shows giant lathe undergoing tests at factory. Having centers more than seventy-eight inches high, machine handles castings close to twelve feet in diameter and weighing 120 tons. Two cutting tools work at one time

No. 4 Sagittarian

One-Man Fire Department Is Mounted on Small Trailer

To afford protection against fire for rural points where there are no water

mains, a self-contained fire pump trailer is equipped with a ball-and-socket hitch that can be attached quickly to almost any passenger car. Having a low center of gravity and being well balanced, it may be towed at high speed on the road. Once at the fire, one man can maneuver the trailer into pumping position by hand, unreel the hose and start the pump. A four-cylinder engine pumps 150 gallons of water per minute at 100 pounds pressure, and it will deliver two streams at once if desired. Dirty water from ditches or creeks will not damage the mechanism. Included in the equipment are fire axes, extra nozzles, and a 500-foot reel of one and one-half inch, rubber-lined, cotton-covered hose in fifty-foot lengths. The engine is capable of fighting a fire 1,000 feet from the water supply if extra hose is available.

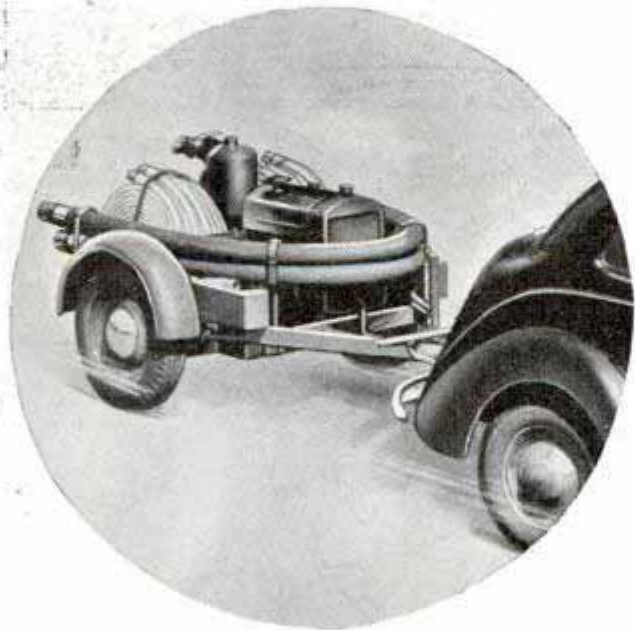

Complete with engine, pump, hose and axes, this trailer is an efficient one-man fire department

Within range of today's telescopes there are 100 million billion suns.

La Bour Co. Inc. Scientific Monthly
Chicago, Ill. April 1939

2561 - Cont. Herbert O. Webb
 Apr. 3. Buckingham Apts
 48 22 2nd Road North
 Every POLICEMAN
 Arlington Va

National Police Academy, Bureau of Investigation, Washington, D.C.

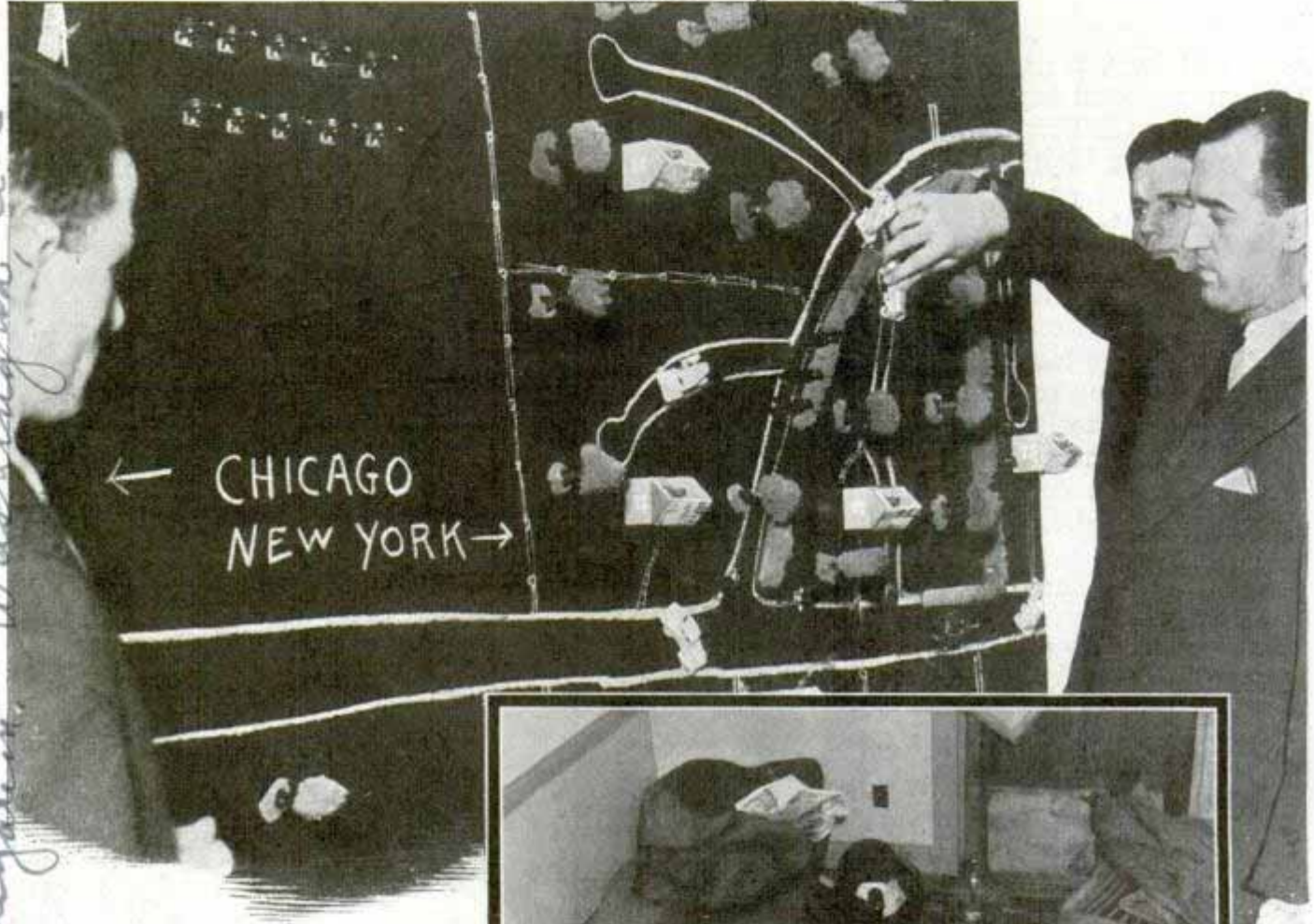

IT WAS murder, the district attorney said. What would you say? The dead man was slumped across the bed with a bullet hole in his head. There were no powder marks around the wound, no weapon in the room, no eyewitnesses. What else could you call it but murder? Yet you'd be wrong. For the investigator was a policeman of the old school, which often means no school at all. First on the scene, he picked up the fatal pistol, thrust it in his pocket. The cap, which the victim had pulled low over his head, and through which the fatal bullet had been fired, the policeman snatched off and threw carelessly behind the bed, then returned to the police station without informing anyone of his discov-

Top, planning a raid with models on magnetic blackboard at Bureau of Investigation's training school. Center, "rogues' den" where police students learn to gather clues in robbers' hideout. Bottom, Newark patrolmen practicing with submachine guns

Newark Police and Fire Academy Bldg.

a "G-MAN"

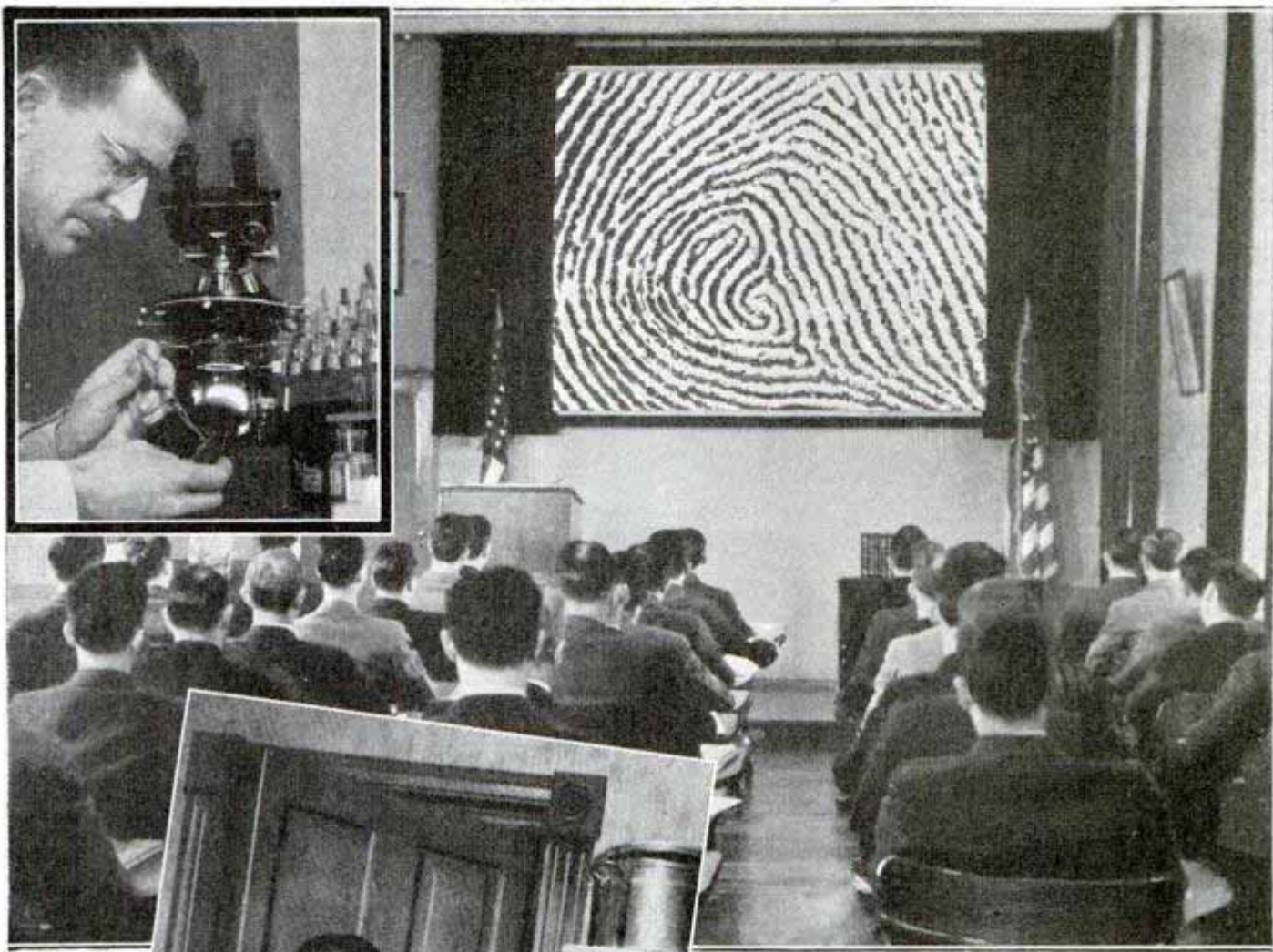

eries, leaving the district attorney with a supposed murder on his hands, and no clues.

But on that very day the first class of El Paso's police school was graduated. Two rookie officers from that class, trained in methods of the Federal Bureau of Investigation, volunteered to help the distraught district attorney. In short order they found the bullet-riddled cap, took a paraffin test of the victim's hand, proved he had recently fired a gun; thus definitely establishing suicide.

Elementary, my dear Watson! As elementary as the work of the officer was appallingly stupid!

We're not trying to prove how clever these young officers were, but to point out that the day of blundering, rule-of-thumb crime investigation is passing. J. Edgar Hoover's boys have taught us that it takes more than brawn and a badge to make a police officer. They've shown that training

Class at "G-men's" school attends lecture on fingerprint identification, top. Inset, working with comparison microscope in crime laboratory. Below, burglar takes his own picture as synchro-flash camera set by police is "fired" when he rifles money cabinet

*Capt. Johna Taylor
Hall Wayne, dnd*



shall return to their respective police organizations and impart the training they have received to their fellow officers. This small nucleus of graduates has already made instruction available to 76,668 policemen—which brings the goal well within sight.

Consider, for instance, what Captain Hubert E. Dax has already done with the Milwaukee police department. Graduating from the Academy in 1937, he has since then instructed



Student detectives examine "Oscar," the dummy, for clues to his murder, top. Center, pistol practice on marine corps range. Below tiny thread under microscope

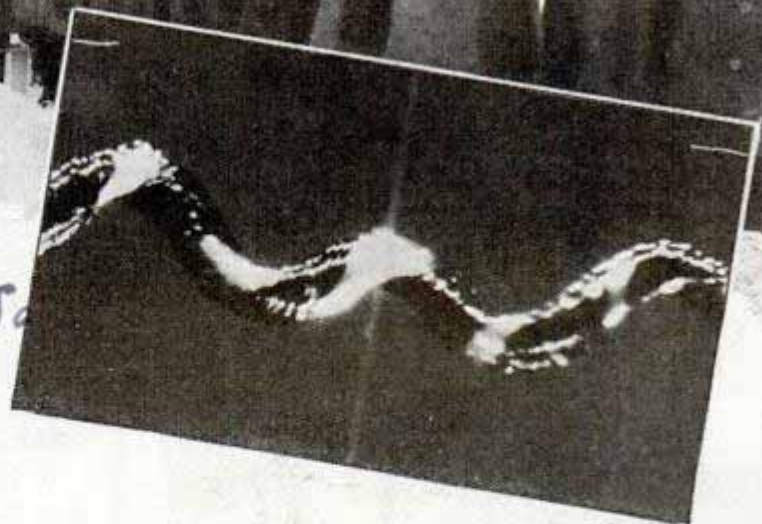

is necessary. Now they are providing that training—training that will eventually make every policeman a "G-man," in efficiency, though not in name.

The Bureau of Investigation's National Police Academy at Washington is only four years old, has graduated only 334 police officers. At first glance this seems a puny start toward so ambitious a goal.

But the bureau is not merely training police officers; it is training teachers. The idea behind the Academy is that graduates

the entire force in scientific methods of crime investigation.

For example:

Three girls were injured in an automobile accident. The two boys who had picked them up at a dance hall were unknown to them. They disappeared after the crash.

The abandoned car was quickly identified as having been stolen. No identifiable fingerprints could be found on the car. The only clue was a hat that one of the young thieves had dropped, and it bore no markings. But inside the hatband was a carefully folded piece of paper, obviously placed there to obtain a better fit. It was part of the front page of an old newspaper, and a portion of the address label was still attached. On it appeared:

“ owalski
 “ So 2d St.”

Routine checking did the rest.

Or take the case of a patrolman who observed a man loitering on the main business street at 2:30 a.m. He had in his possession a rusty old railroad spike. The policeman arrested him on suspicion, then went back and examined the doorways on his beat. He found one where the glass pane had been broken near the lock. On the floor inside he found bits of broken glass, which he carefully collected. He returned to headquarters with

(Continued to page 114A)

Tractor-Drawn Sod "Shaver" Cuts Strips with Disks on Sled



Shaving blocks of sod from a field with the tractor-drawn "harvester," which strips sod at any desired width or depth

Sod "harvesting" is accomplished with a special sled-mounted knife at an Indiana nursery. Hauled by a tractor, the cutter literally peels strips of sod from the ground. Two sharp, upright disks determine the width of the strip and a flat blade "shaves" the sod at the desired depth.

Dual Bicycle Ambulance Is Economical on Short Hauls



Test run with the bicycle ambulance. Rider on right-hand bike is in control

Designed as an economical substitute for the motor ambulance for short-distance work, a dual cycle ambulance has been tested in England. It consists of a stretcher mounted between two bicycles and is propelled by two persons. The rider on the right-hand bike has control of the vehicle, the left-hand rider simply helping to pedal. Thus the rider at the left is free to render first aid to the patient. The stretcher is removable from the machine. One advantage of the bicycle ambulance is that it can be lifted over shell holes or other obstructions. It can be taken apart or reassembled in a few minutes.

Popular Mechanics Magazine can furnish the name and address of the maker of, or dealer in, any article described in its pages. If you wish this information, write to the Bureau of Information, inclosing a stamped, self-addressed envelope.

One-Horsepower Safety Car Teaches Children to Drive



Safe driving practices are learned at early age with this English car driven by one-horsepower motor

Children in England are learning to drive an automobile almost as soon as they are able to walk. A miniature car that has all the controls of a full-sized automobile is on the market, and is called the "Junior Safety First Trainer" because it is used for schooling youngsters in safe driving methods at an early age. The one-horsepower motor drives it eight to ten miles an hour.

maker not known

*Charles R. Uugh, Ltd
Whitworth Works, Birmingham, Eng.*

portable vise that is adjusted quickly by a thumbscrew. The clamp is particularly handy where it is desired to secure two or more pieces in a constant position while working on them. Its jaws are one and one-half inches wide and they open about five-eighths of an inch. The vise can be used standing on end or lying sidwise.

Fuel Analyzer Shows Plane Pilot If Mixture Is Balanced

Doing a job not done heretofore by any single instrument, a new fuel analyzer tells the airplane pilot at a glance whether his fuel mixture is too rich or too lean. High-speed planes rising from one altitude to

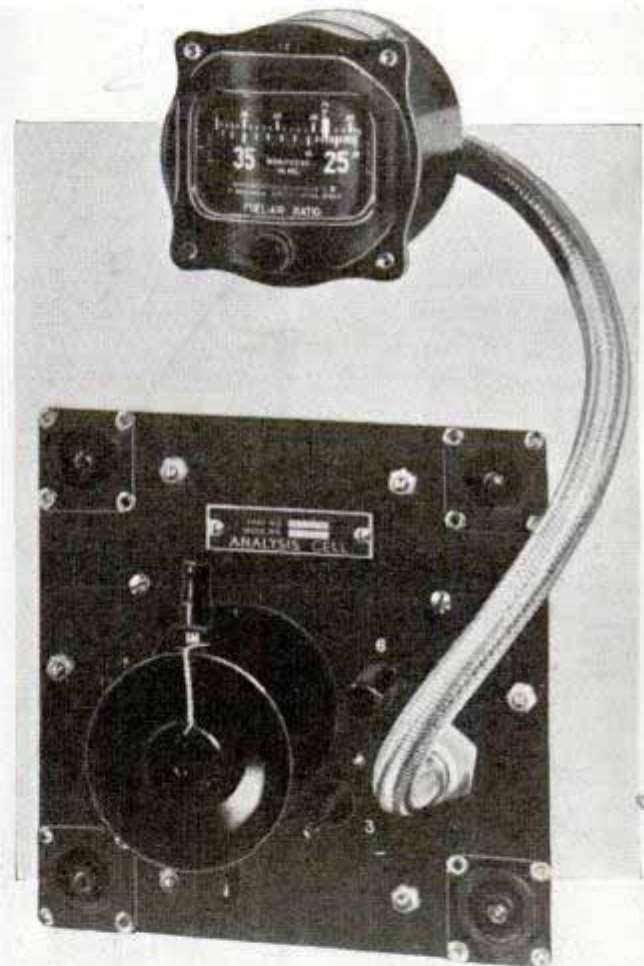

Indicator on instrument panel shows pilot whether fuel mixture is correct

Simple Clamp for Small Work Has Viselike Grip

Objects too small to be held in the hand while being toolled are gripped firmly by a

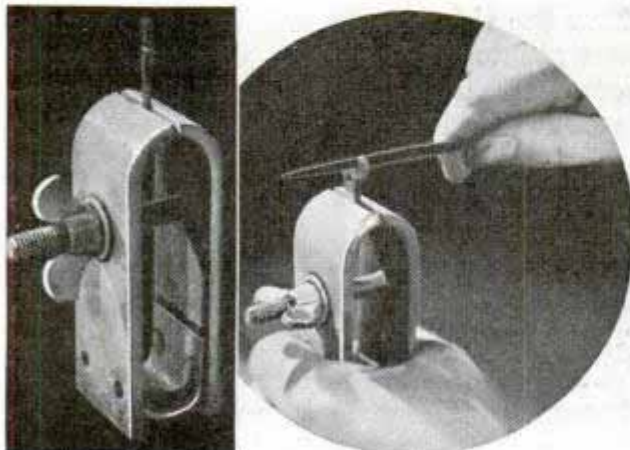

Hand vise holds piece in most convenient position

another where there is less oxygen obviously require more air in their engines for efficient operation. An analysis cell continuously determines the fuel-air ratio of the mixture by analyzing the exhaust gas from the engine. The result of this analysis is shown on an indicator located on the plane's instrument panel, enabling the pilot to make proper carburetor adjustments.

*Central Terminal
new oil City*

*John C. Petty
Belvidere Ill*

*Cambridge Instrument
Co. 3732 Island*

290. Luger & Products Corp. Michigan City, Ind. Cabriquette

Complete Kitchen in One Unit Is All-Electric

Everything needed for a complete kitchen is included in one unit that comprises a sink, electric stove, refrigerator, cabinet and cutlery drawer. An oven, too, may be installed if desired. When not in use the top is closed, concealing the fixtures and transforming the piece into a streamline sideboard. No door handles or knobs mar its appearance; doors and top are opened by pressing tabs. An electric lamp lights automatically when the top is raised and a concealed switch cuts off current to the burners when the top is closed.

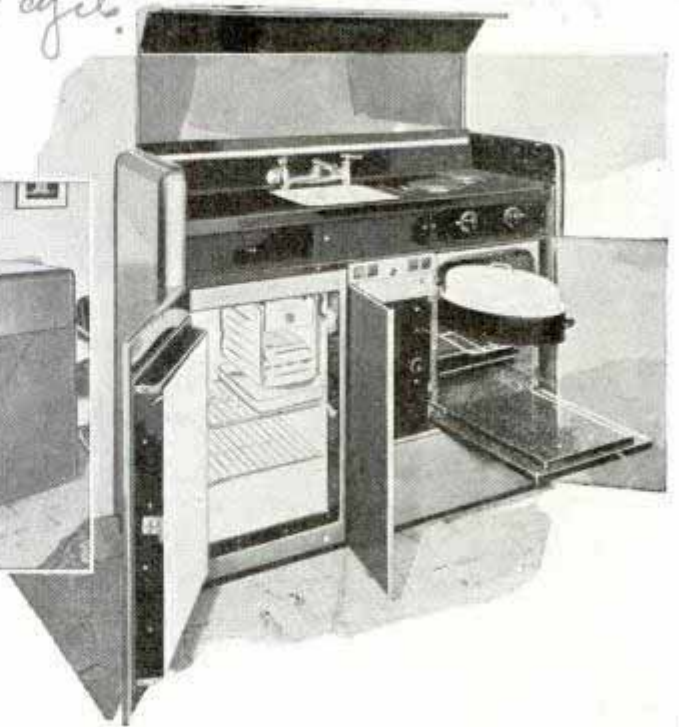

Sink, stove, oven, refrigerator and cabinet for pots and pans all combined in one piece saves steps for housewife. Inset, unit when closed

2863

Diesel Train for Pikes Peak Cuts Down Running Time

Powered by three 160-horsepower Diesel engines, a new locomotive pushes a fifty-two passenger observation car up Pikes Peak in one-third less time than that required by equipment previously used. Operating costs for the train, the first of a fleet to be placed in service on this scenic cog railway, are said to be about one-half those of trains it replaces. In places, the railway scales twenty-five per cent grades

in reaching the summit, 14,109 feet above sea level. Besides a double cog, mechanical hand brakes, air brakes and a "deadman" control, the new locomotive has a dynamic braking system. With this system, the electric traction motors that supply power to the cog through reduction gears while ascending the peak become generators during the descent. Resistance units absorb the electrical energy generated by the motors when the locomotive is on the downgrade, the speed being controlled by the number of coils brought into play. The fewer the units made available for absorption of electrical energy, the slower is the speed of the train.



Pikes Peak's new Diesel train pushing up one of the twenty-five per cent grades. Three 160-horsepower engines furnish the motive power

Mainton and Pikes Peak railroad

Diesel engine Dies General

2900 Cont André La Ferre
11 w. 42nd
New York

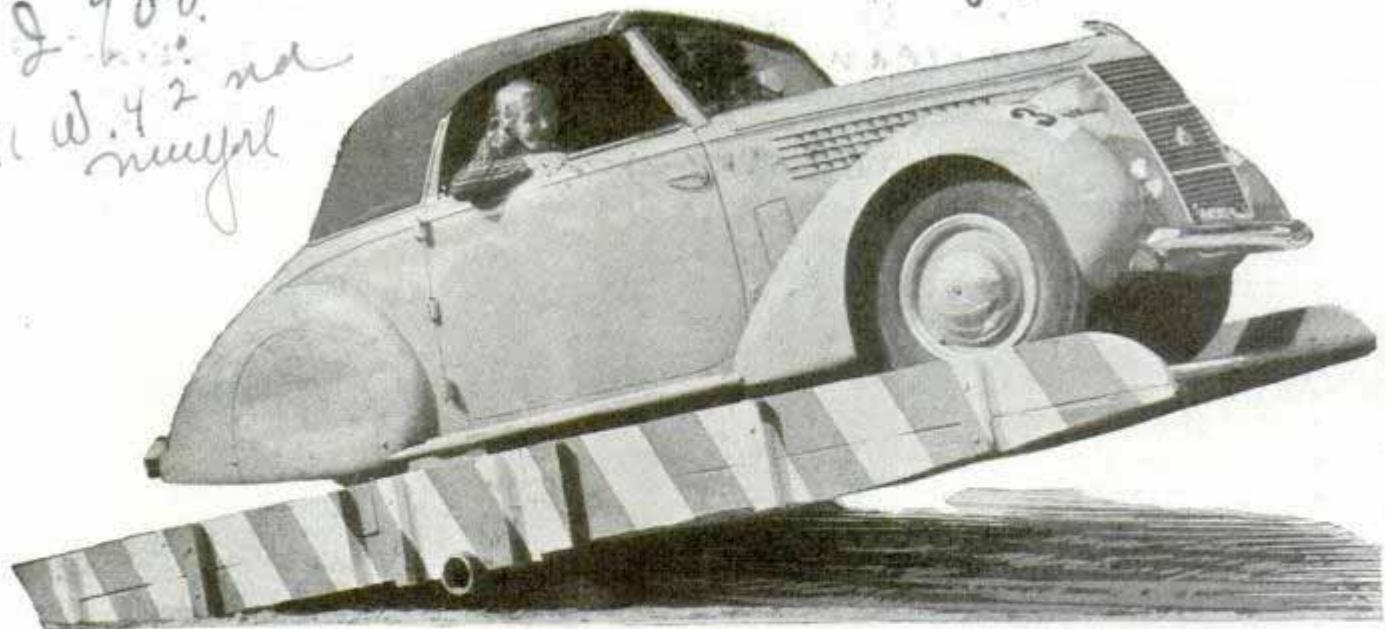

OBSTACLE RACE

Women drivers, teased by the men ever since cars were invented, are having the last laugh in Rome where the "automobile gymkana" is making experts of them. The gymkana consists of a maze of obstacles which would make even a New York taxi driver nervous. Negotiating such obstacles, it is claimed, teaches the cardinal rules of safe driving to participants. Top, driving over this teeter-totter helps the driver learn to keep control of the car under difficult conditions. Left, the shower-bath obstacle. If the driver strikes a hidden lever, the car gets a bath. Below, left, a quick stop was necessary as this traffic policeman was shunted in front of the driver. Below, right, picking up a plate of oranges and depositing them on another table requires accurate control of the car

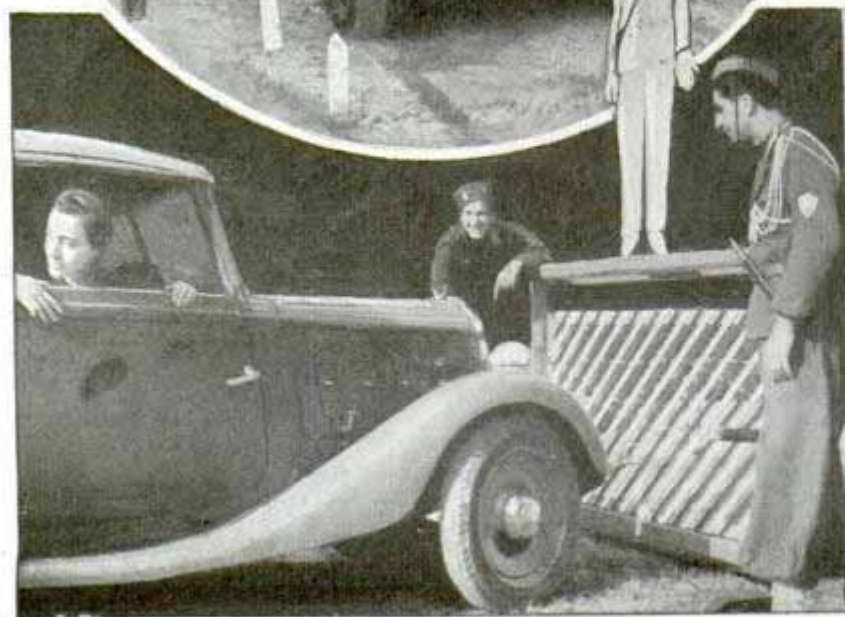

2900



TESTS *the* DRIVER

Each driver in the gymkana is accompanied by a woman companion who assists in accomplishing some of the stunts. Above, left, each occupant of the car is attempting to pick off a single balloon from a cluster hanging on each side of the track, without stopping or slowing down. This requires a deft touch on the part of the driver. Above, right, driving a zigzag course between rows of striped poles. Striking either a pole or one of the white stakes costs the driver a point



The stunt above requires an accurate eye. The driver stops her car, gets out and breaks an earthenware jar suspended from the cross piece. Then she must use care to avoid the broken pieces as she proceeds. Steady nerves are needed for the trick at the left. The driver stops her car and is given one try at putting the ball through the basket. Gymkanas, it is claimed, have improved the efficiency of Rome's women drivers thirty per cent during the past year

One Shaft and Club Heads Form Golfer's Outfit



Plenty of club heads but only one shaft—that's the latest outfit for the golfer

Intended as a substitute for the present heavy, cumbersome golf bag and clubs, a kit consisting of one shaft and a set of club heads is being introduced. The club head required for any shot may be attached quickly to the shaft by screwing it on. Contact of the club head with the ball does not loosen the head; instead, it serves to tighten the head because the golfer is hitting against the groove of the screw. The kit has slots on the side for five iron and two wood heads. A zipper device provides a compartment for the balls and small slots are convenient for carrying tees. The outfit weighs only about four pounds.

Vacuum Tube with Longest Life Lasts over Eleven Years

Longest-lived vacuum tube ever developed is the General Electric company's new mercury-vapor thyatron which will

serve, it is estimated, for nearly eleven and a half years continuously, night and day. Used to convert alternating into direct current, these tubes under test carry very high current, 175 amperes, and can be employed as commutators for direct-current motors such as in elevators and in experimental direct-current power transmission.

Phone List Slides into Base When Not in Use

One of the latest telephones has a number list built into its base. The list slides into the base when not in use. The phone is the automatic type and rings the number wanted when a switch on the base is set. It has provisions for ten call stations.



Foot Pump Inflates Auto Tire Quickly with Little Work

Requiring less time and labor for inflation of an automobile tire, a foot-operated pump is being offered to motorists. The cover of the pump is attached about its center to the plunger by means of a short rod. When the case is unlatched, a strong



Pumping up the automobile tire is easy with this new foot-operated pump

9883

Vacuum Tube with Longest Life Lasts over Eleven Years

Longest-lived vacuum tube ever developed is the General Electric company's new mercury-vapor thyatron which will

Peter and Russell, Chicago Springfield Club

Scene Service 7/29/34

The Shot Co. Chicago Ill. 32 S. Monroe Jefferson Chicago Ill. 5-1333

Developed by Dr. A.W. Hull. Edwards and Co. Milwaukee, Wisconsin 298

L. 8-7-35
Martchian, Moscow, Russia.
Electric Tractor for Hotbeds
Performs Multitude of Tasks

spring raises the hinged cover to an upright position, drawing back the plunger and preparing the unit for the pumping stroke. The hose is attached to pump and tire valve and the pumping is done by pushing the cover down with the foot as far as it will go and then releasing it. One hundred strokes inflate a 6.00x16 tire to thirty pounds pressure, compared to about 150 strokes of the ordinary hand pump. The foot pump will inflate tires up to ninety pounds pressure. The pump case has room inside for the hose, tube repair kit, tire iron and work gloves.

J 8 2 2
Motor Scooters Sub for Ponies on Polo Field

Motor scooters are the polo ponies of Marshall, Mich., where the game is played on the airport field. A bit faster than bicycle polo, the motorized sport brings occasional spectacular spills, but it's easy to jump off and the injuries to players are few.



Exciting moment in a polo game on the Marshall, Mich., airport, where speedy motor scooters are used instead of ponies. They're easy to maneuver

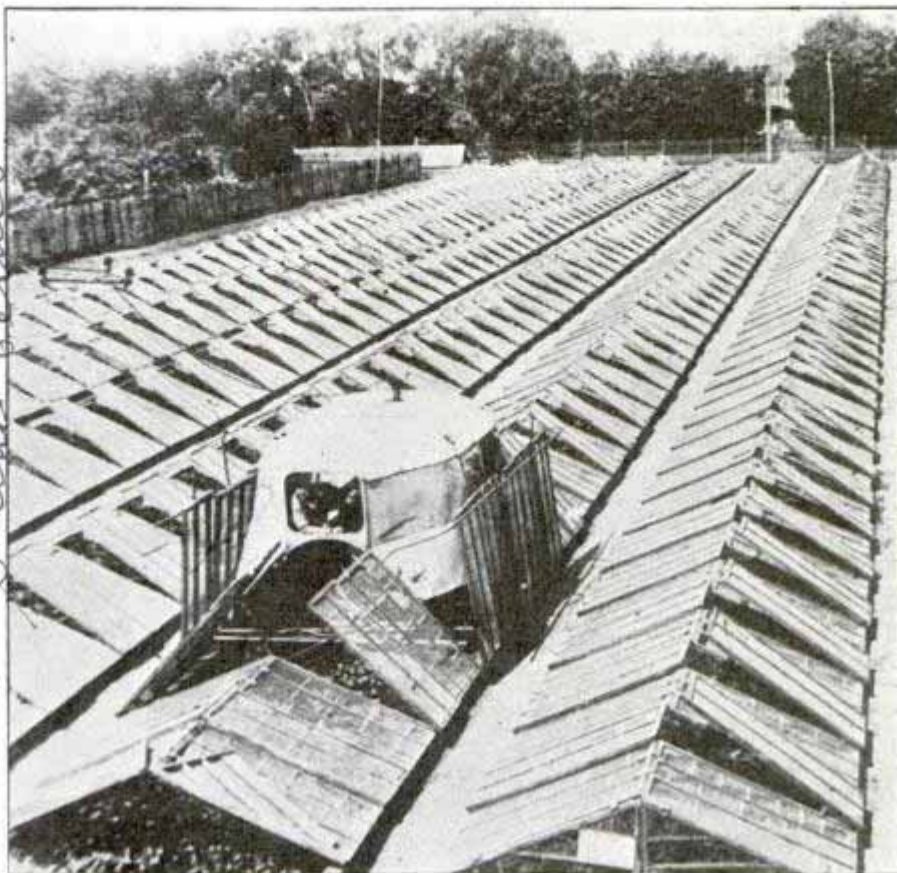

As it rides above row of hotbeds, this electric tractor thrusts out levers that open frames and then closes them after sowing or cultivating

More than a score of cultivating operations are performed by an electric tractor developed in Soviet Russia for working hotbeds. Driven by a three-kilowatt motor, it moves along the row of hotbeds, opening the glass frames by mechanical levers and then closing the frames as it moves on. By manipulating various levers in the cab, the operator can distribute soil, level it, mark out rows, sow vegetables, water them, weed, fertilize and cultivate plants, and do various other tasks. Tanks on the tractor carry water, chemical sprays and fertilizers. Use of the tractor is said to raise the yield of the hotbeds forty to eighty per cent.

them, weed, fertilize and cultivate plants, and do various other tasks. Tanks on the tractor carry water, chemical sprays and fertilizers. Use of the tractor is said to raise the yield of the hotbeds forty to eighty per cent.

□An increase of more than 6,000 pilots and 1,400 aircraft in a year brought the total of American licensed pilots to 26,144 and of aircraft to 11,160 on July 1, 1939.

Civil Aeronautics Authority, 7/16/39

G 643. Cont. Herbert V. Webb, Apr. 3
4323. Secoya Road N.
Ocala, Fla.

HUNTING

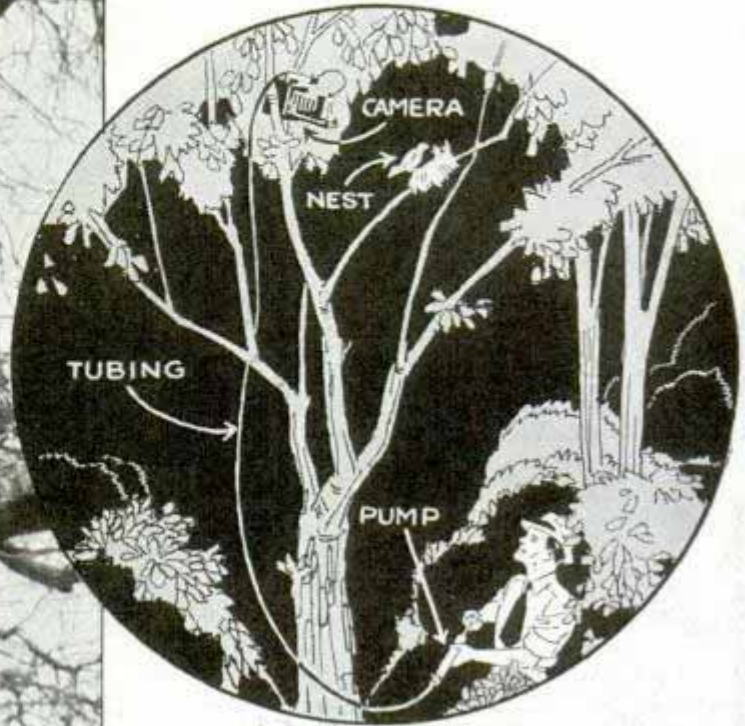

By William H. Lawrence

PATIENCE, ingenuity, and a spirit of exploration are the necessary ingredients for successful collecting of bird photographs.

The easiest and simplest way to start is with a feeding station. You will get better results in the winter and early spring, before an easy supply of the birds' natural food is available.

But birds are bashful. With the exception of chickadees and pigeons, I know of no species that will stay and feed while a man approaches and focuses his camera. There are three obvious solutions—the telephoto lens, the blind, and remote control of the shutter. The latter is preferred by many photographers.

It is possible to rig up a string trip for your shutter; but such a device is a makeshift at best. It frequently refuses to work when you want it to, or it will release the shutter unexpectedly while you are setting it up, thus spoiling a negative. It is possible to secure or make an electrical device for



Top, left, the author photographing young hawks in nest. Right, sketch of camera setup with remote control. Bottom, young crows begging the cameraman for food

Ref: William A. Lawrence, 1410 Decatur St. Washington D.C. #643

BIRDS with a CAMERA

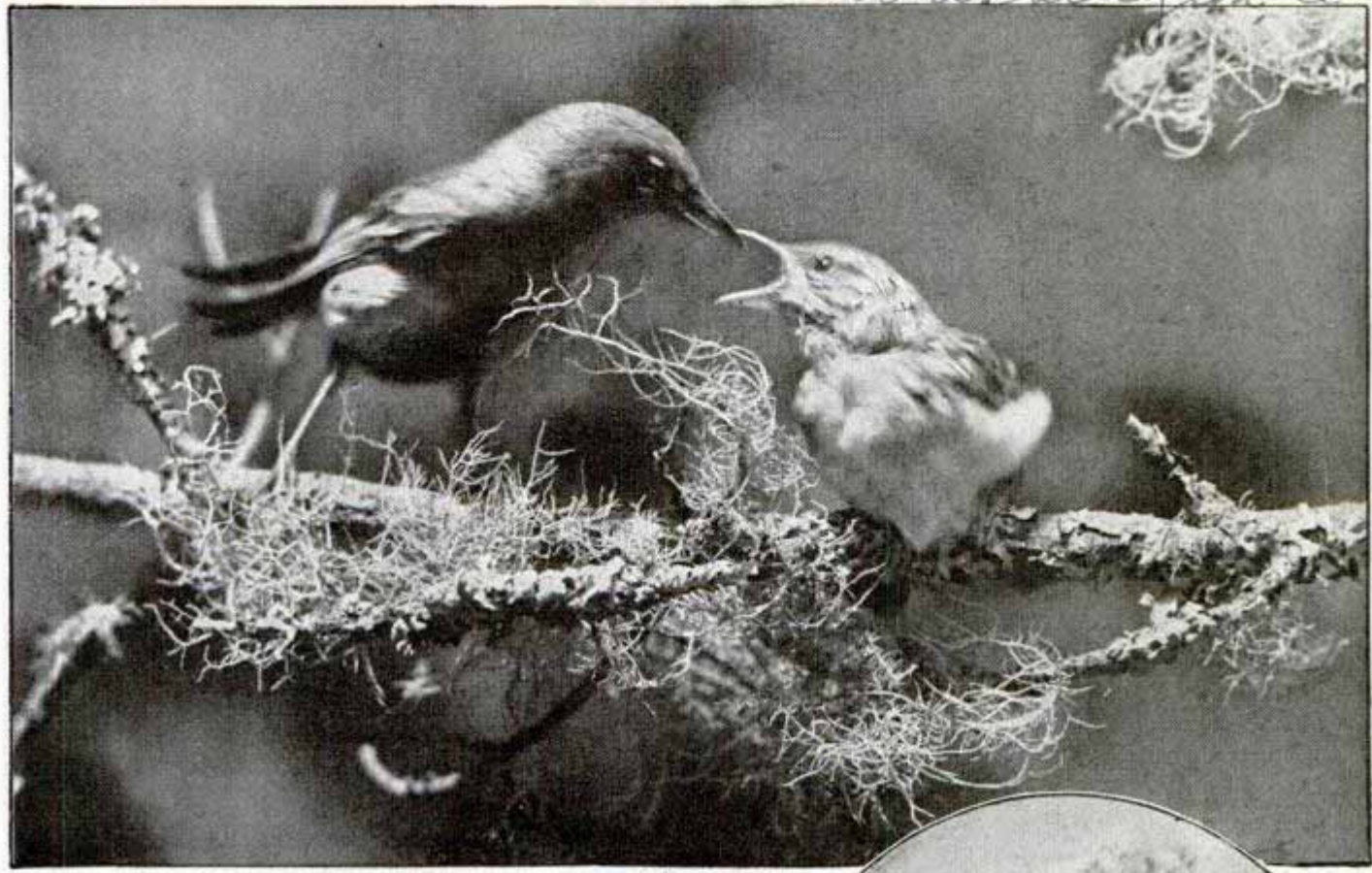

remote control, but most of those on the market are rather expensive and making one is an intricate job. Besides, the weight of the batteries, plus two lengths of wire, is a nuisance when roaming the woods.

One device that gives good results is cheap, easy to make, and practically fool-proof. It can be used on any camera equipped with a cable release. All you need is a kodak air release, a small block of wood and some screws, twenty feet or more of tubing, and a bicycle pump. The



Top, northern parula warbler feeding its young which photographer removed from nest before snapping picture. Circle, a good closeup. Bottom, parts necessary for remote-control camera hookup

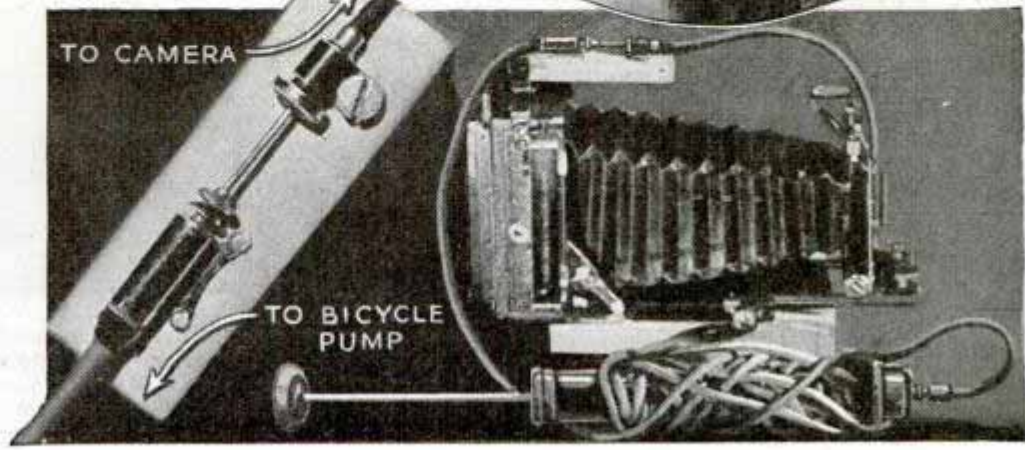

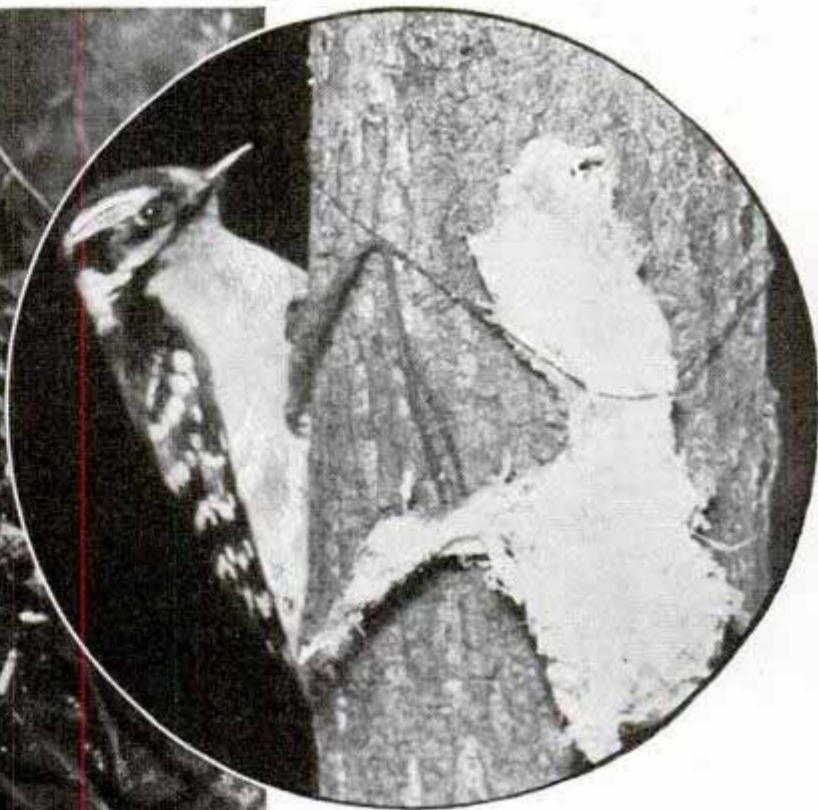

kodak air release, standard equipment before the development of the cable release, may be obtained at most camera stores. Being cheap to start with, and now obsolete, the price should be nominal. It should be hooked up to the cable release of your camera with screws and a wood block. One end of the tubing is attached to the air release, the other end is hooked up to the bicycle pump.



mounted on a tripod or otherwise securely fixed, is aimed at the station and the remote control is attached. Using a stick, or other convenient object, you determine where the subject will be in sharpest focus, then retire to the length of your control and wait quietly until a bird reaches the selected spot.

Suet will attract nuthatches, chickadees and

Now you are ready for the birds.
First, the feeding station is baited. This station need not be an elaborate affair. You may use the stump of a tree, since it forms a natural background for the photograph. A site should be selected where the sun will shine on the station, and where the immediate background will not be confusing. The camera,



Top, left, young great horned owl surprised on the nest. Circle, downy woodpecker lured into camera range with suet. Center, baby barn owl posing for the photographer, who had lowered the infant from nest and set it on a log, as shown in photo at bottom

2643

woodpeckers. Sunflower seeds are relished by titmice and nuthatches. Bluejays will be attracted to nut meats. Sparrows and snowbirds will eat any kind of small seeds.

Most birds do not fly directly to a station, but approach it gradually, flying from limb to limb. You can take advantage of this habit to get a more natural setting by placing a good-sized twig in a crack of the stump, focusing on the end of the twig rather than the station itself. Woodpeckers and nuthatches may be obtained in natural poses if suet is tied to a tree, the camera being focused on the bait.

To obtain portraits of the more bashful birds, more deception is sometimes needed. Many birds notice every detail of their surroundings, and will not approach a new object until they have become accustomed to its appearance. The camera, here today and gone tomorrow, frequently keeps these visitors away from the station. A trick to overcome such timidity is to rig up a dummy camera, on the spot to be occupied by the real one, and allow it to remain for several days before any photographing is attempted. Any box of the approximate size of the camera, and painted black, will do.

To conceal your own presence, construct a simple blind near the station and leave it for several days. This is nothing more than a piece of burlap on a broomstick spreader, weighted at the bottom and hung from near-by trees. Through this burlap a small hole is cut for observation at the most convenient point. Even the most timid of feathered friends can be fooled by these simple devices. Of course the station must be supplied with food for several days, to accustom the birds to looking for it there. Then, when you are ready to take pictures, you simply replace the dummy camera with the real one, lead the tubing under the blind, and wait. When the bird reaches the selected spot, a quick stroke of the bicycle pump trips the cable release.

After you have captured all of your regular visitors on celluloid, you will want to go farther afield, secure portraits of birds that do not frequent your station. Here time and your own ingenuity are your only limits; for any part of North America contains enough birds to keep you busy a lifetime. Your best chance of photographing birds who do not visit your station is to

(Continued to page 135A)

Gun in Plane Wheel 'Pants' Fired by Remote Control



Adjusting machine gun in undercarriage of airplane built in to give extra power when making an attack

Fighting airplanes of the Polish air force are given greater attack power by placing machine guns in the steel fenders, called pants, which cover the wheels. Firing of the guns is controlled from the cockpit.

2876

One-Hand Fire Extinguisher Is Worked Like Gun

Small fires that have not gained too great headway can be put out quickly with a lightweight extinguisher operated by one hand and aimed and discharged like a gun. When the trigger is pulled, liquid carbon dioxide is released, expanding rapidly into gas as it leaves the nozzle, blanketing the burning objects much like snow.



Extinguisher with pistol grip is light in weight so even a child can handle it in putting out fire

Walter Kidde & Co,
140 Cedar Street, N. J.

Ailing Livestock Given Short-Wave Treatment

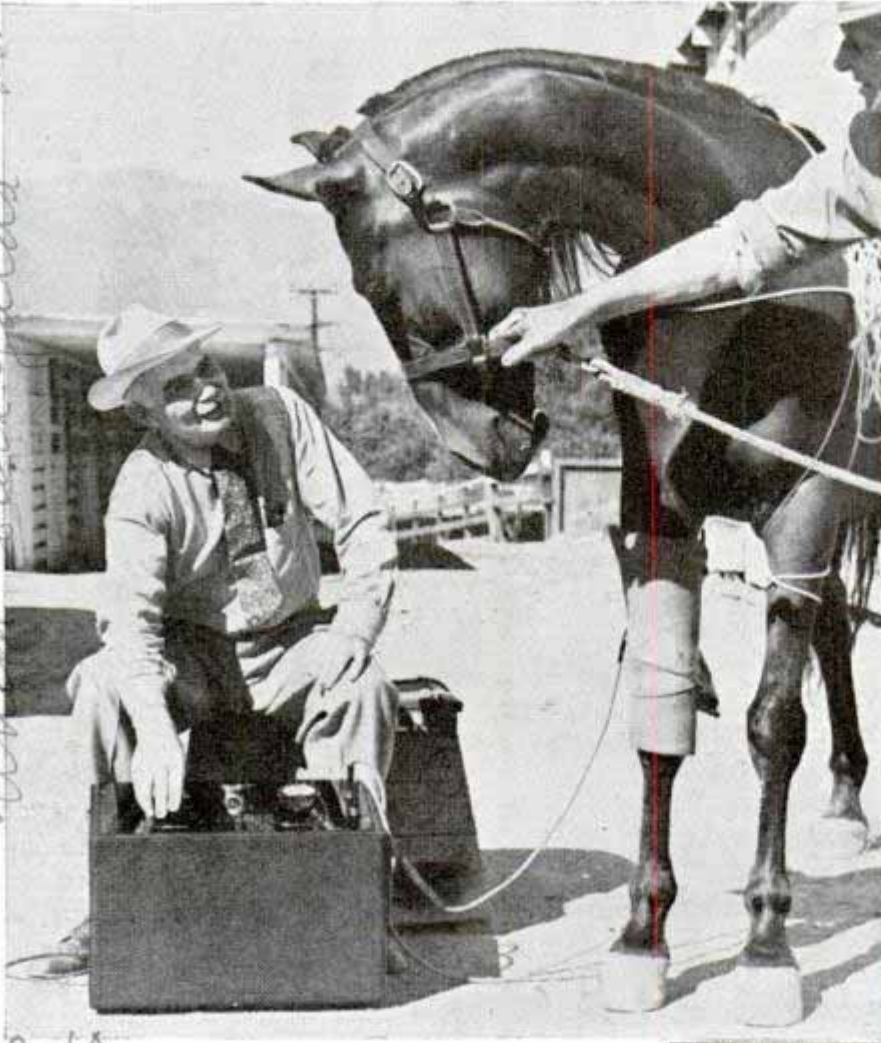

Short-wave diathermy is being used to treat diseased and injured livestock at several western ranches and animal hospitals. Radio transmitting sets operating on wave lengths varying from three to thirty meters are connected to rubber-clad applicator pads, and these are placed on opposite sides so that the waves will pass through the afflicted part of the body. First tried on ailing cattle, the short-wave heat treatments are now being applied to other animals.

At top, a race horse is given a dose of short-wave diathermy. Below, cattle become familiar with the transmitter



840
Dustproof "Beret" of Oiled Silk Keeps Books Clean on Shelf



Another new use has been found for those oiled-silk caps that cover dishes in the refrigerator and picnic lunches. Snapped over the top of a book, the elastic cap keeps out dust.

915
United States Will Have 70,000 Licensed Pilots by the End of 1941

There will be 70,000 licensed airplane pilots in the United States by the close of 1941, predicts Robert H. Hinckley, chairman of the Civil Aeronautics Authority. Already there are 26,144 certified pilots, 6,000 more than a year ago, and the normal

increase would bring the total to 43,000 by the end of 1941. But because of the current government student training program, under which 10,000 pilots will be trained each year, Hinckley expects the number to swell to 70,000 in a little over two years.

Science Service Aug 8, 1939

See at a... 5736... Los Angeles, Calif.
 Dr. C. E. Wiktor, Los Angeles
 County Logopedic Assn. Los Angeles
 79 Madison St. New York City
 Santa Fe Springs, Calif.

The



CRAFTSMAN

ENCIRCLE

Your Books

Novel, circular wall case keeps daily favorites at hand near your easy chair

By W. Keith Vining

HUNG at eye level this bookcase completes the furnishings of the livingroom or den. No need to be particular about the materials you use for it's finished in bright colors to complement the decorative plan of the room. A good grade of pine will do for the shelves and back while fir plywood can be used for the circular sides. The back is simply a disk consisting of a number of narrow strips of solid stock doweled and glued together. When the glue is dry, strike a circle of the required diameter as in Fig. 2 and saw away the waste. Then



1

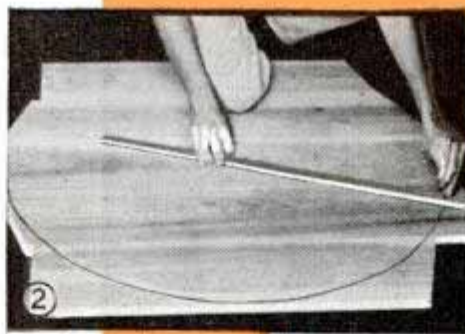

2



3



4

cut and space three shelves as in Figs. 3 and 7. Fit also the four vertical dividing pieces, Figs. 1 and 7. Cut these to approximate length but do not fasten them in place. The circular sides consist of two thicknesses of $\frac{3}{16}$ -in. plywood, each layer put on in two segments. The two segments of



the first layer join at the centerline of the center or "equatorial" shelf. The outer two join at the top and bottom. Spread glue between the inner and



be anchored firmly to the wall as in Fig. 8.

Finish the case before you put it up. First go over the whole thing with progressively finer grades of sandpaper until the surface is smooth. Fill the exposed edges of the plywood sides with paste wood filler, and sand smooth. Then finish with two coats of enamel. Over porous, absorptive woods such as those used, it will perhaps be better to apply an undercoater first. When dry, sand this lightly. Follow with the first coat of enamel, laying it on rather thin. Apply the second coat as it comes from the can brushing only enough to level the enamel.

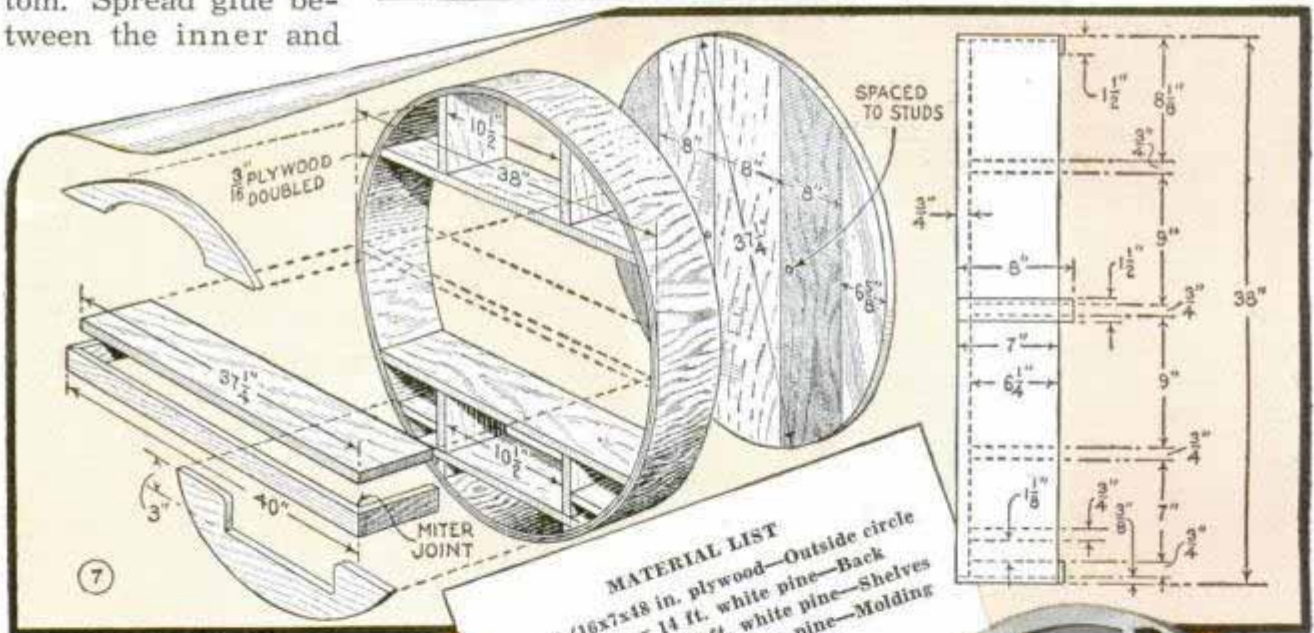

outer layers, Fig. 4, and fasten at the joints with very small screws, and to the back with a row of heavier flat-head screws or casing nails, the heads being sunk with a nailset and the holes puttied over. Now, you can fit the vertical divider pieces which partition the shelves, and finish screwing the latter to the back as in Fig. 5. Note that the center shelf is finished with a facing strip, which extends around the sides over the plywood, Figs. 6, 7 and 8. Holes in the back for 1/4-in. lag screws should be spaced carefully to come exactly on the centerline of the studs so that the bookcase can



Small Vase Holder Hand-Wrought in Copper

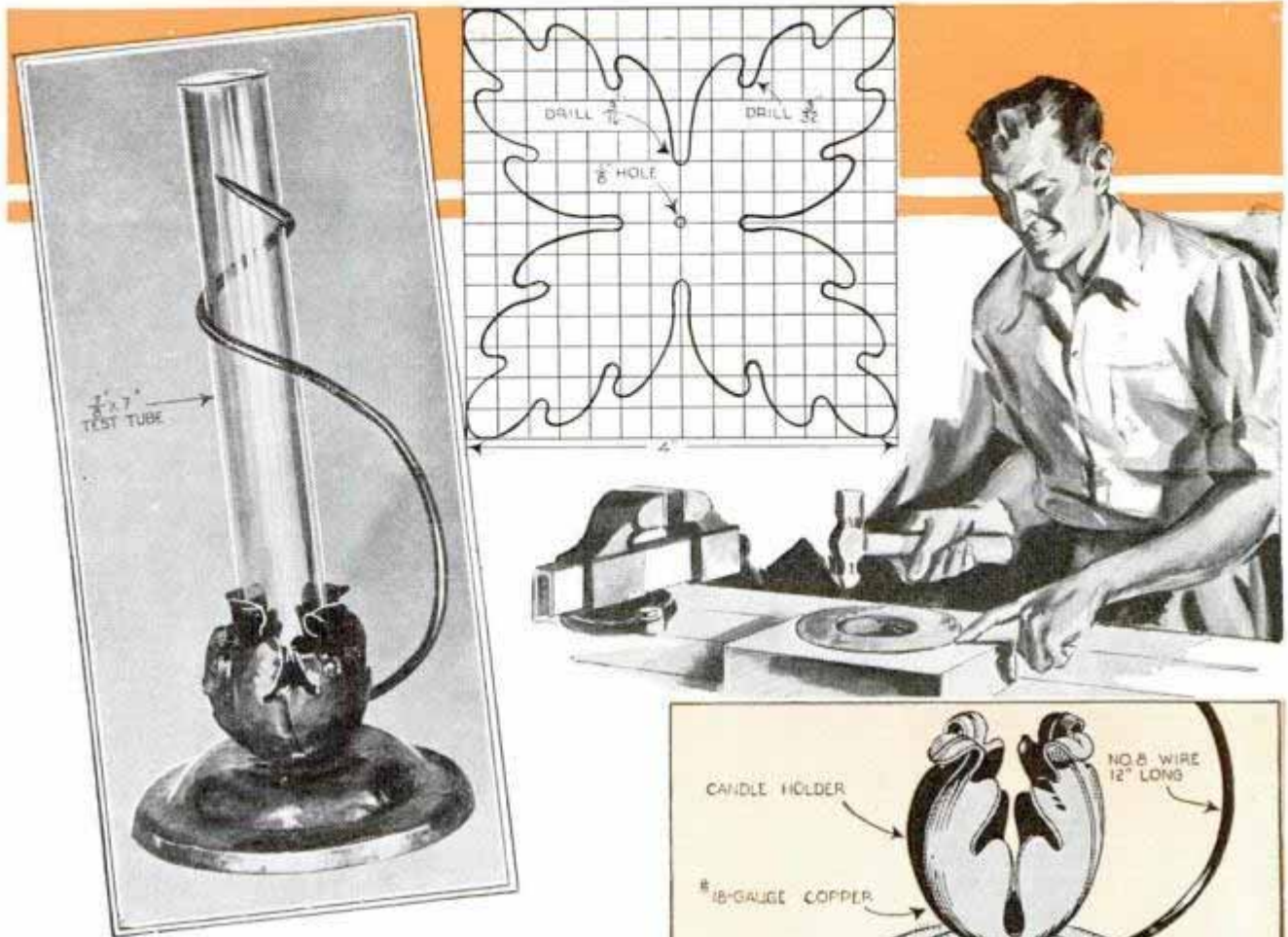

Made either singly or in duplicate this bud vase will serve a dual purpose as a vase for choice cut flowers or as a novel candle holder. The vase proper is simply a laboratory test tube as you see, and the base is purely a hand hammering job in soft copper. To use it as a candle holder, you remove the test tube. Hand hammering of the two parts which make up the base and holder requires frequent annealing of the metal. To form the reverse curves in the base you can use a block of hardwood recessed on the lathe to the depth and shape which the base is to be. Using this as an "anvil" it is easy to draw the metal to form by hammering. A medium size ball-peen hammer is best for this work. However, make sure that the ball peen is bright and smooth. Rust spots or other irregularities will mark the metal. When the two parts have been hammered and shaped they are riveted together with the support wire between as in the detail above. Polish bright and apply a coat of clear lacquer to prevent tarnishing.

—Dwight Adams, South Gate, Calif.

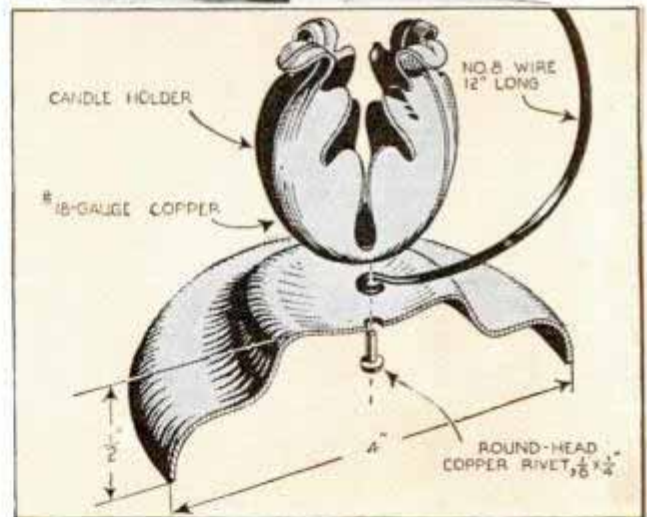

Clothespin on Stirring Spoon Keeps It from Slipping

A large stirring spoon can be prevented from slipping into a pan if an ordinary clothespin is slipped over the handle as indicated. A strip of adhesive tape wound tightly around the pin will hold it on the handle. In use, the clothespin rests against the side of the pan to keep the spoon from slipping.



Rubber Boots Hung Up Easily on Coat Hangers

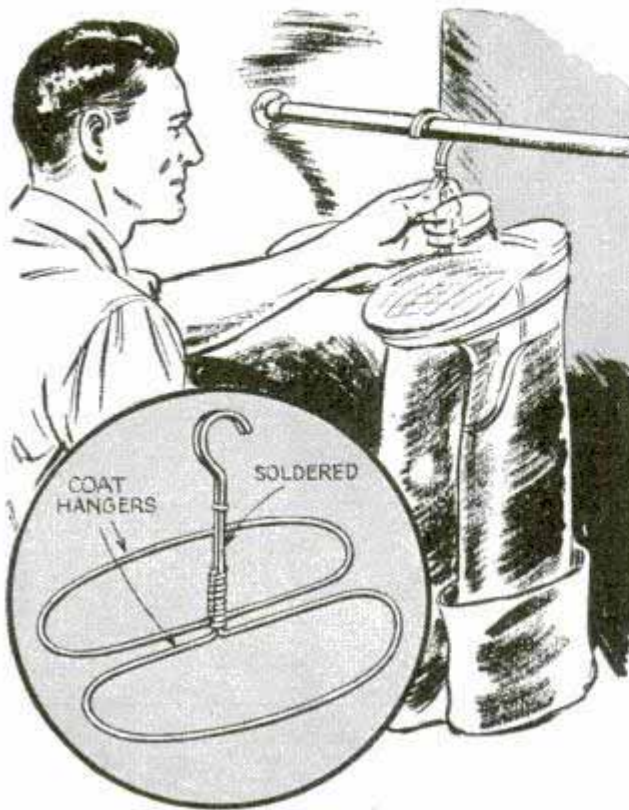

If you want to suspend your rubber boots in an inverted position so that they will not fold over and crack, bend a couple of coat hangers to the shape indicated and fasten them together with solder or wire. The boots are merely inserted through the two resulting loops in the hangers.

Tin Cans Threaded on Taut Wire Serve as Rifle Targets

Inexpensive rifle targets can be provided by simply stringing a number of tin cans

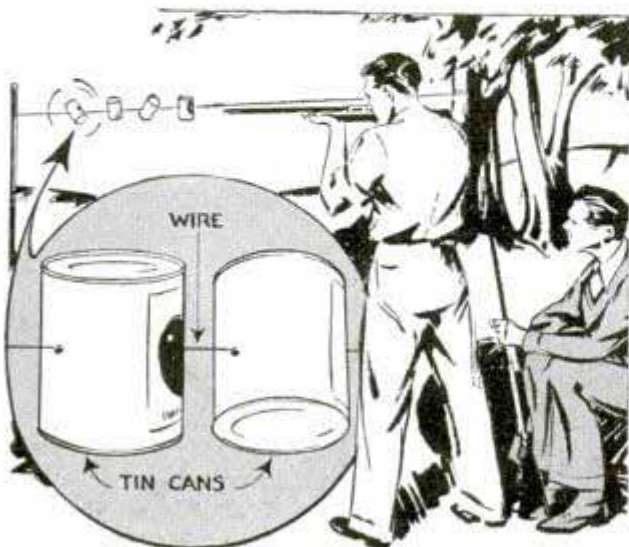

on a wire stretched tautly between a couple of posts or trees. If the cans are attached so that they are balanced, they will spin when hit from a suitable distance.

Hairpin Holds Button on Dress While Checking for Location

When the location of a button on a garment is critical, one seamstress slips a small hairpin through the button and cloth to hold it while checking to see if it is in the right place. If not, it is easy to pull out the hairpin and relocate the button before sewing it to the garment.



Package of Pins Cut into Strips and Rolled for Convenience

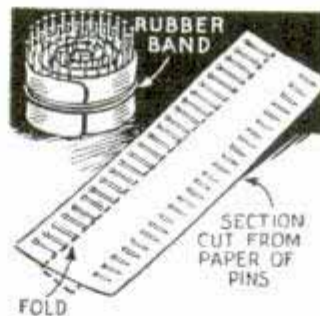

To make pins easy to remove from the original paper without folding and unfolding it repeatedly, one housewife cuts the paper into strips which are then

rolled as indicated and secured with a rubber band. This leaves the pin points protected but exposes the heads so that they may be removed easily.

Re-Knurling Handlebar Grips

When the knurling on the facings of motorcycle or bicycle rubber handlebar grips becomes worn so that the hands slip, the grips can be re-knurlled with a hack-saw blade.

Cuts are made in the rubber spirally around the grip in first one direction and then the other, as indicated.



Snow-Man Refreshment Booth Used All Year

In winter this genial snow man dispenses warming sandwiches, and in summer ice cream and cooling drinks. Despite the novel shape of the structure, construction is well within the scope of the amateur carpenter. First build a circular floor, 6 ft. in diameter, upon three stout sills. These can be used for skids in moving about. Framing is erected as in the perspective drawing. Install lath vertically up to where the curve of the roof begins. From there on, bend them around horizontally. Stretch wire, crisscrossed, over the lath so that the building paper to be applied next will not bulge inward. Over the paper lay 1-in. mesh chicken wire, and plaster over with stucco. The extended left arm is covered in the same manner, except the hand which has fly-screen instead of chicken wire, that being easier to bend around the stubby fingers. The right arm is built directly against the side of the structure, and a cane is fitted on. Waterproof plywood and galvanized iron are used for the hat, which is painted black, with white lettering. The door is made in halves so that the top serves as an awning when swung upward. A vent can be cut under the brim of the hat, protecting it from the rain or snow. With a window in the side opposite the door, ample light and ventilation are provided.

☞ Your dishcloth will be sweet and clean if it is scalded daily in a pan of water containing a teaspoonful of washing soda.

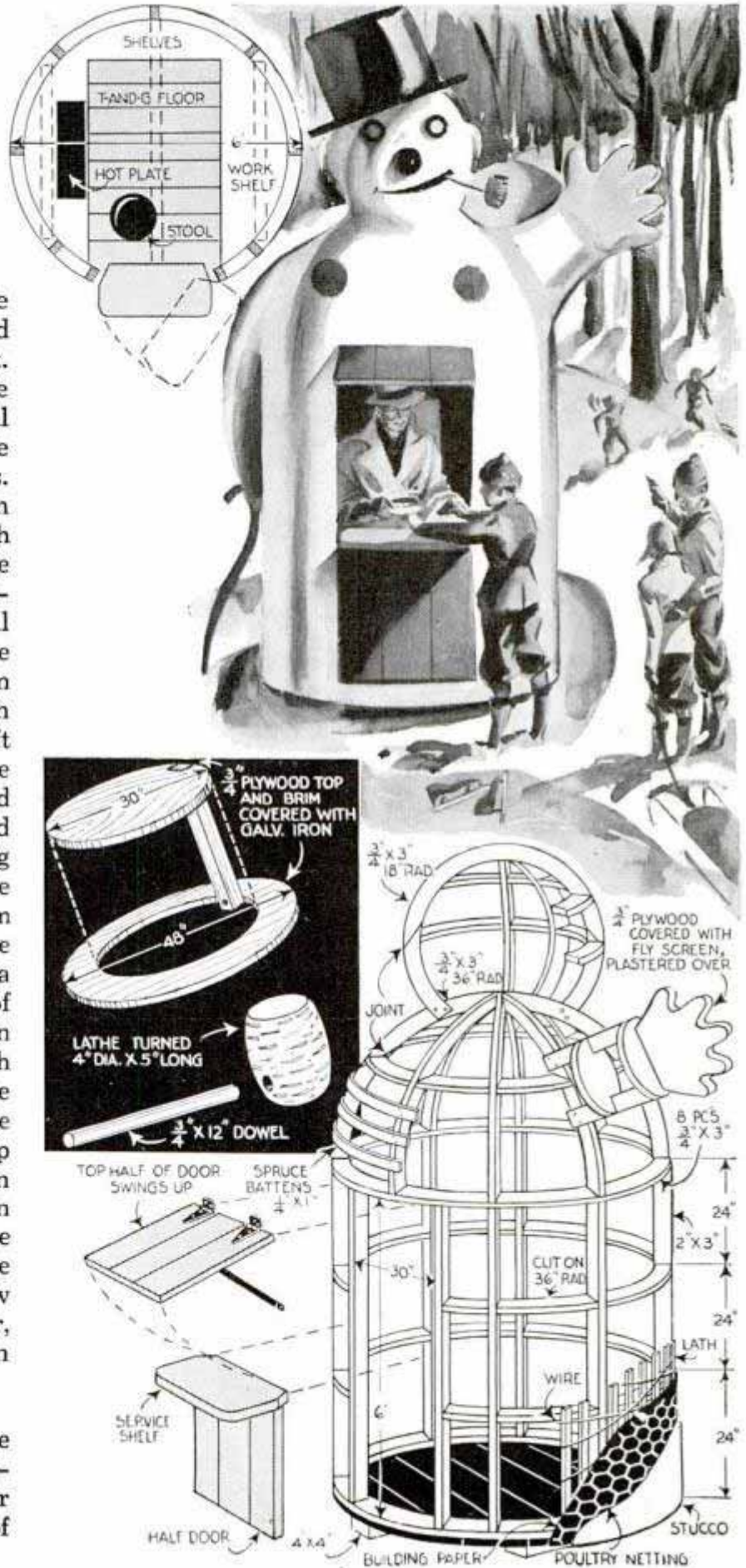

Old Auto Tires Give Intense Heat When Firing Brush Piles



The problem of disposing of old auto tires is solved on the western coast by timber workers who use them to fire brush piles. One large tire properly placed and ignited will give off such an intense heat that a green brush pile is easily fired.

—James Bashford, Tacoma, Wash.

Cutting Upholstery Material to Make Straight Seams

Unlike cloth upholstery fabric, the edges of leather and imitation leather material used for covering the tops of cushions, stools, benches, etc., must be cut and stitched slightly curved to make the welt seams run straight around the entire top

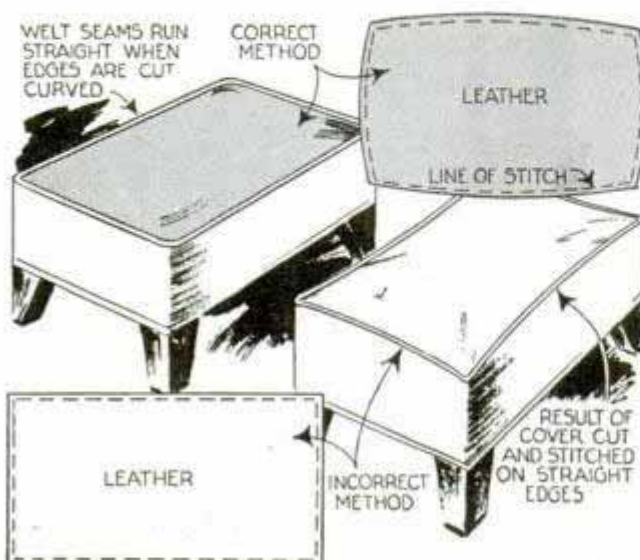

of the seat. If the edges are cut straight, the welt seams will bow in at the center on each side when the cover is stitched to the border and drawn into place.

Handy Household Nail Kit

By sawing two slots at right angles in the end of an empty thread spool and slipping it over the corners of four discarded typewriter-ribbon boxes, you will have a kit for carrying small nails or screws around the home. The spool may be attached to the boxes by small brads or glue.

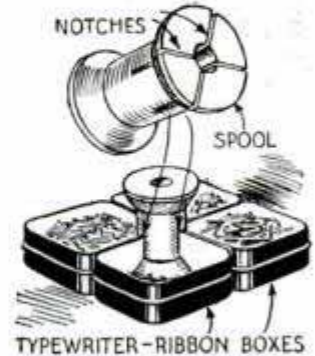

Pencil Eraser on Garment Hook Keeps Hat in Place

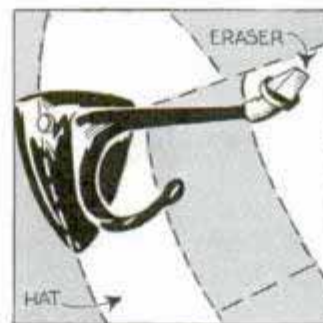

If you are in the habit of hanging your hat on a garment hook and it has a tendency to fall off easily, just slip a pencil eraser of the type shown over the end of the hook. There will

be sufficient friction between the rubber eraser and the hat to prevent slipping.

Tool Rack from Solder Spool

A rack for small chisels, punches, screwdrivers, etc., can be made easily by drilling holes concentrically through the rims of an empty wire solder spool. The rims of the spool are bent over on one side so that it can be attached to a wall or the back board of your bench.

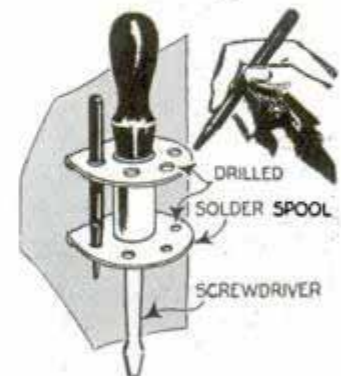

☛ A wet chamois will remove dog hair from upholstery without damaging the cloth.

Writing Cabinet Folds Flush with the Wall

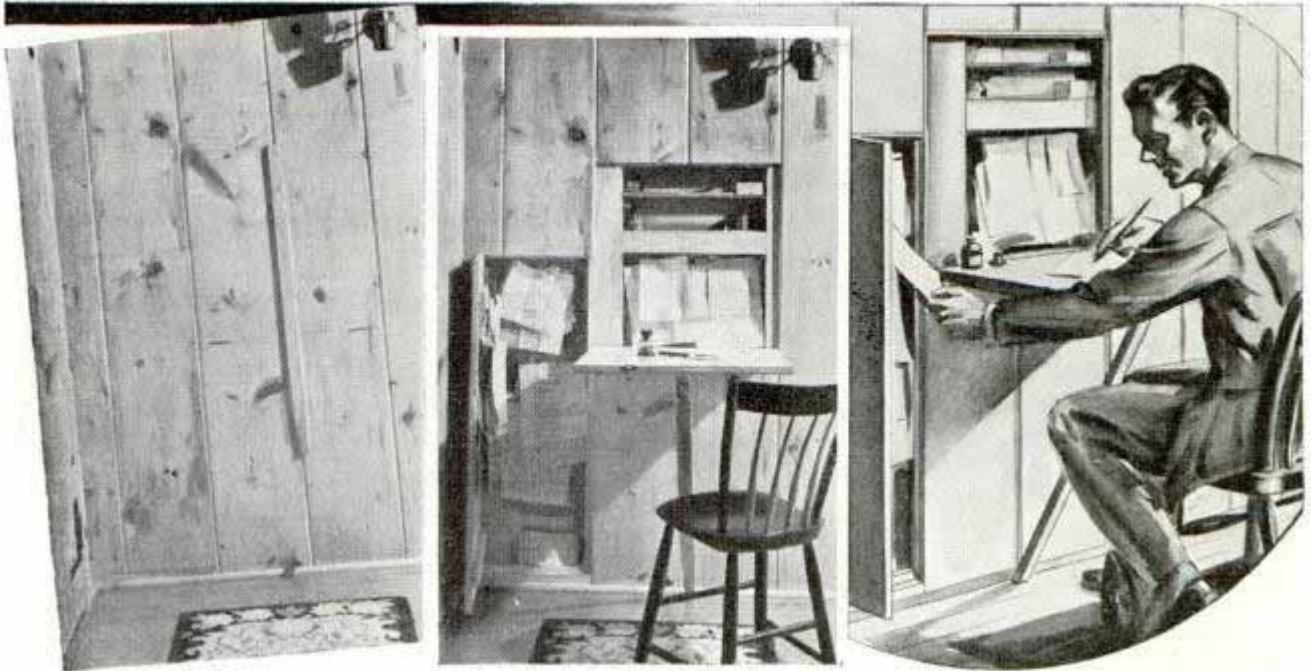

This handy writing desk and file compartment for letters and papers requiring periodic attention can be built into any wall paneled in solid wood. The desk recess can be any convenient size, although if this is larger than the space between the studding it will be necessary to put in headers. Both the desk and file compartments will have to be framed in and provided with back panels of matching wood, in this case knotty-pine paneling as you

see it in the illustrations. The hinged front, which provides a writing surface, is formed by doweling and gluing together two boards to give the required width. The edges are beveled to match the paneling. When dropped to the open position, the front piece is supported on a single leg which is hinged near the top edge. As you see from the left-hand illustration above, the desk and file compartment are almost invisible when closed.

Thumb Loop on Cord to Avoid Dropping Electric Razor

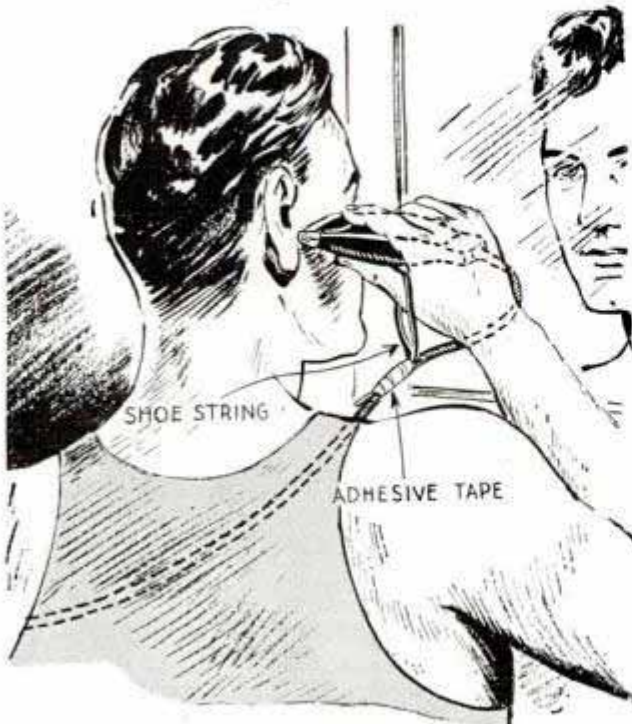

Have you ever had your electric razor slip out of your hand while shaving and drop to the floor? Breakage and other damage to the razor by having it drop on the floor or washbasin can be avoided by taping a looped shoestring to the razor cord to slip over the thumb while using the razor as indicated.

Guard for Points of Compass

A pencil eraser of the slip-on type provides a good guard for the sharp ends of a compass. The eraser is stretched over the points where it is held securely in place by its own elasticity.

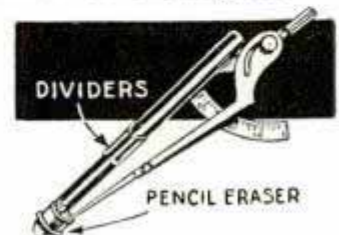

CHOICE *in*

Practical Designs in Modern Styling Offer Dual and Single-Purpose Types

By WAYNE C. LECKEY



INEXPENSIVE plywood combined with gleaming metal, lustrous plastics or glass makes any of these smart coffee tables, finished in either enamel or varnish, fit well among modern furnishings. They can be made easily in your own workshop.

Ideal for limited space is the dual-purpose table shown in Fig. 1, which, when made in duplicate, can be adapted readily as either an end table as shown, or the two

can be placed together to form a convenient coffee table as in Fig. 4. The top is cut from walnut-faced plywood with the edges painted to conceal the laminations of the stock. Also of plywood, the back with decorative pieces glued to the sides has a 16-in. length of standard 1 $\frac{3}{8}$ -in. closet pole stock flattened and doweled to its lower edge. The curved foot is formed by doweled an angle-cut block as shown in Fig. 3, to a 3 by 10-in. solid piece, which can be cut from the waste stock left from the curved center upright. To glue, a block is first cut as in Fig. 3, to hook a bar clamp over. After the glue has dried, the proper curve is laid out on the edge and band-sawed to line as in Fig. 12. If need be, this can be worked out by hand with a gouge, plane and sandpaper. The foot is then bored for a length of 1-in. chromium-plated tubing which is squared and plugged at both ends with a tight fitting, hardwood

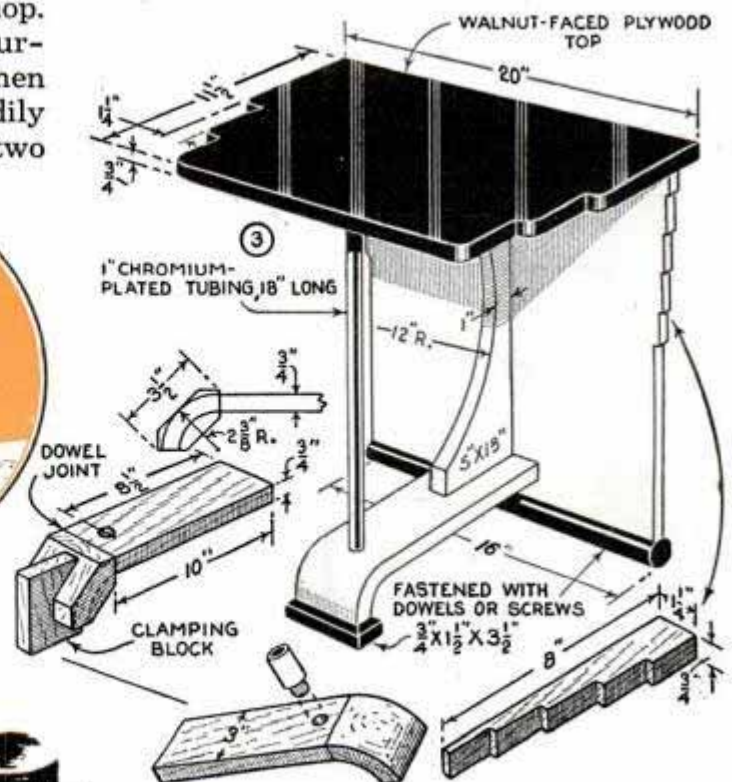

Small TABLES

dowel, Fig. 2. In fastening the top with dowels, allow it to extend $\frac{3}{4}$ in. over the back.

The table in Fig. 5 employs the same method of forming the legs, which are spaced equally and screwed to a circular top of $1\frac{1}{8}$ -in. solid stock. This you can build up from narrow widths of cheap material and veneer over with walnut. The lower circular shelf is slightly flattened where the legs join the edge. You can nail through the legs and cleverly conceal the nail heads by raising a chip with the grain and later gluing the chip back down over the head as shown in the detail, Fig. 5.

Angle-bent legs of 2-in. flat iron form the support for the thick circular top and bottom of the table shown in Fig. 6. These are drilled for attaching with bright-headed wood screws and are then chromium plated.

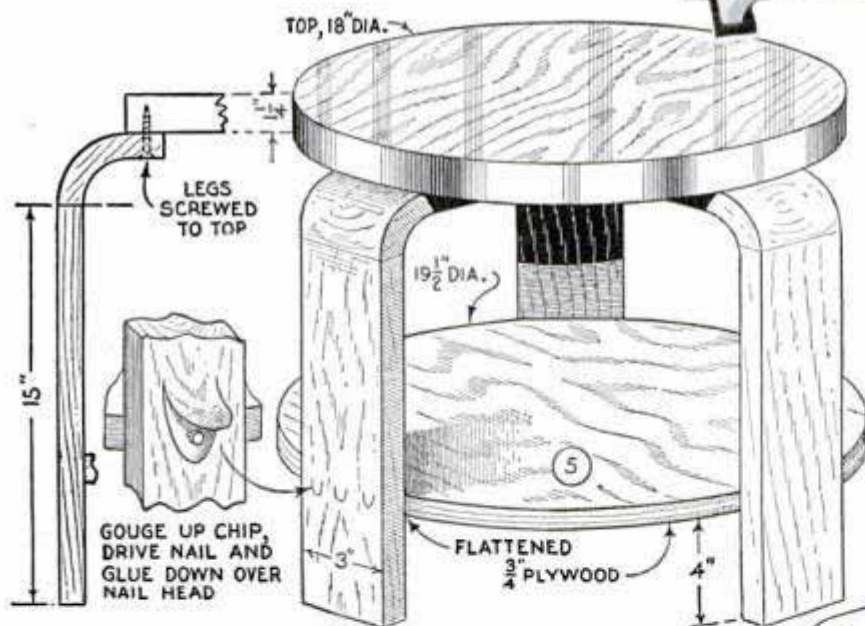

enameled, black top, the base, if desired, can be veneered with $\frac{1}{16}$ -in. sheet aluminum, soldering with aluminum solder to a band covering the edge.

Ultra modern is the table shown in Fig. 11, which is composed of a top and bottom of $\frac{1}{2}$ -in. plywood spaced apart with a 2-in. chromium-plated center column and three plate-glass vanes set in grooves routed in the surface. Assembly is made as shown in





of the glass. If you have an old round, beveled-edge mirror at hand, you can save on cost by building the table to fit. The wood surfaces done in bone white will give a pleasing appearance.

Utilizing standard $\frac{3}{4}$ -in. dowels for legs, the table in Fig. 9, has a "double" top made from two disks spaced 3 in. apart. If you have a shaper you can cut the circular tops for any of these tables by using a jig. After the disks have been bandsawed to the rough circle they can be placed on the jig and revolved past a straight-faced cutter, thus producing identical pieces. Both disks for the table in Fig. 9 are stacked and bored together to assure proper alignment of the holes, the holes in the top disk being bored blind. Fitted and

Fig. 10, with a tie bolt threaded at one end for a nut and washer. A base attached to the lower disk and fluted as shown in Fig. 11, is formed from twelve segments angle-cut at 75 degrees and glued and fastened together with corrugated fasteners. Over a layer of $\frac{1}{8}$ -in. felt, the top is covered with a circular mirror held in place with three or four stiff metal clips bent to hook over the edge

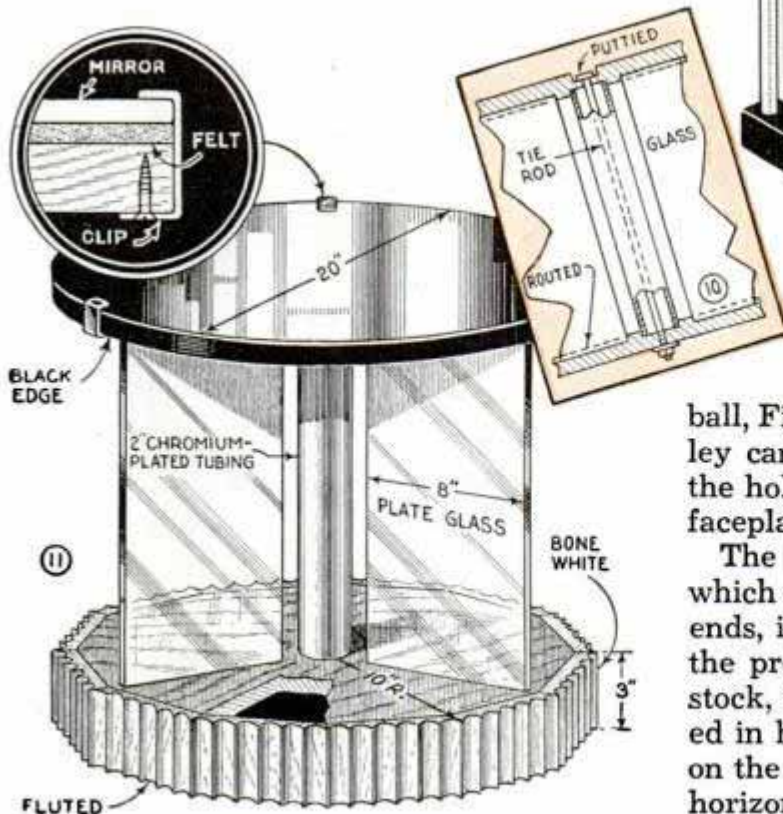
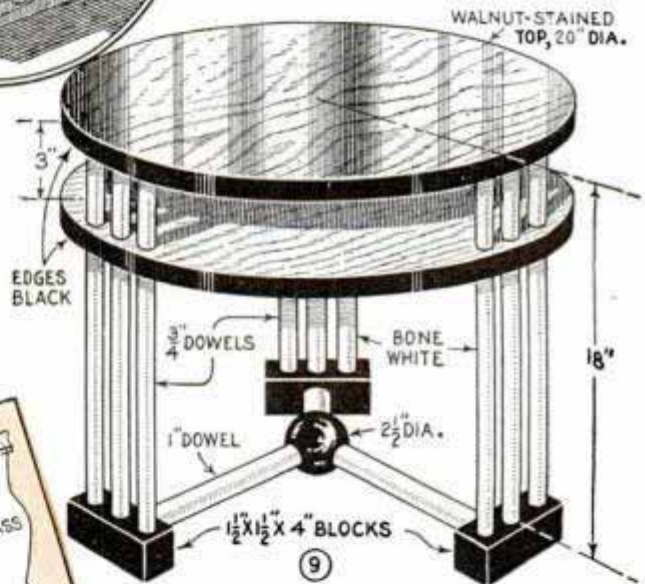

glued in square blocks at the bottom, the three sets of dowel uprights are connected with 1-in. round stretchers which terminate at the center in a $2\frac{1}{2}$ -in. turned ball, Figs. 7, 8 and 9. Your lathe index pulley can be used to advantage for spacing the holes while the ball is mounted on the faceplate.

The top of the table shown in Fig. 13, which appears to have pieces added at the ends, is actually one piece. Fig. 14 details the procedure in laying out the top. The stock, plywood is preferable, is first divided in half both vertically and horizontally on the underside of the work and then the horizontal line is bisected by striking an

arc from the corner as shown. Nails are then temporarily driven in at these three points around which a string is tied. Replacing the nail with a pencil, you can draw a perfect ellipse by keeping the string taut. After the top is cut to shape, draw an inner ellipse 1 in. in from the edge with a marking gauge. Using a fine blade, a section of this is jigsawed out to form part of the S-shaped base which is made up by doweling to upright and cross members. Using the inner ellipse line scribed on the top as a guide, paint the top black and the rest in bone white. A top of clear plate glass is used on the table shown in Fig. 15, fitted in notches cut in the four uprights which are formed from two pieces assembled at right angles with a half-lap joint.

Care in finishing has much to do with the beauty of any of these tables. Even where you use combinations of bone-white and black enamel irregularities in

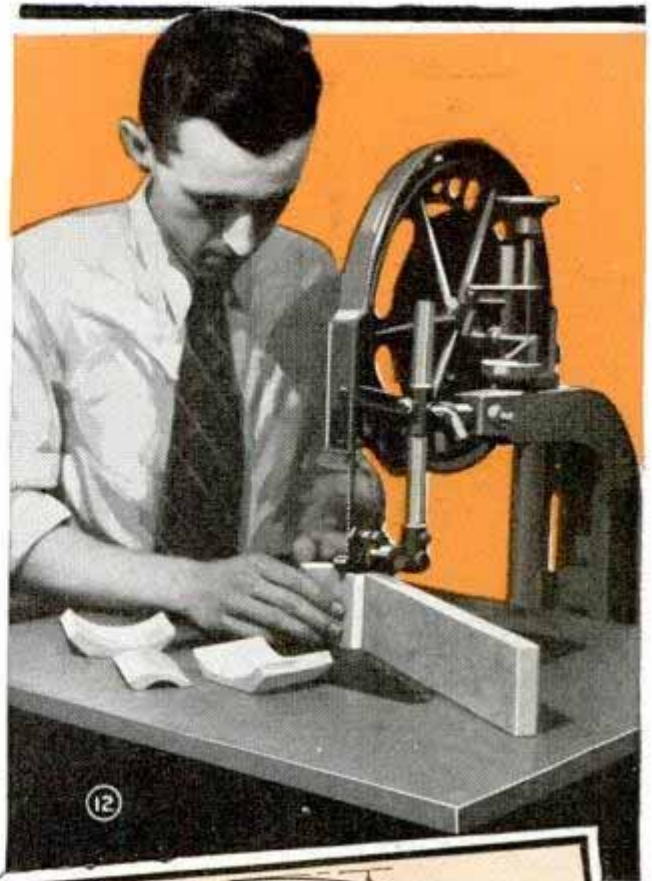

BLACK-ENAMELED TOP

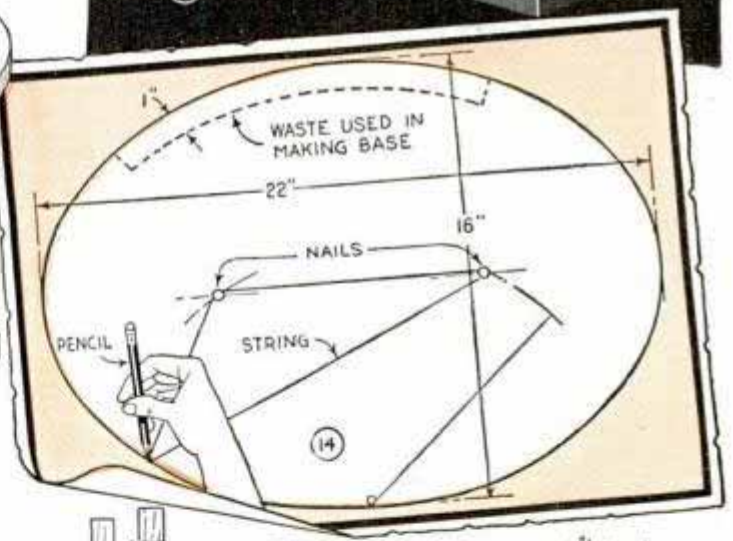
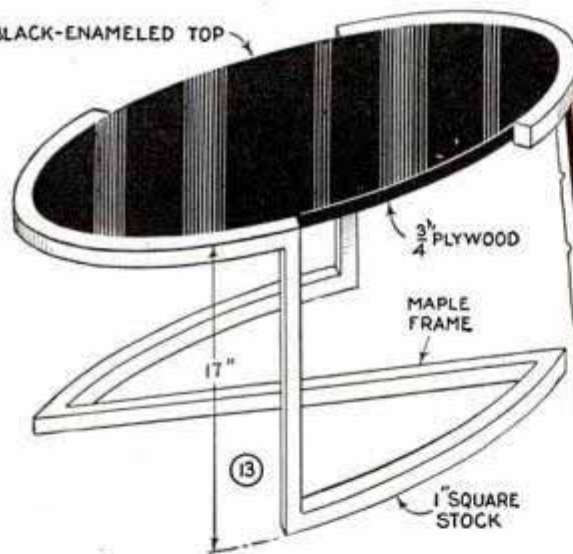

the surface will show through. The surfaces must be smooth and this means considerable hand work with sandpaper and a block. Use a medium coarse grade of sandpaper to start, then finish with a fine grit. When this can be done before the parts are assembled so much the better. It's always best to use an undercoater as a base coat under enamels. Avoid laying this on too thick. It is better to apply two thinner coats than to risk "piling" and "sagging" of the undercoater. When the latter is dry, sand it very lightly with fine paper, then lay on the first coat of enamel and when dry sand again lightly. The final finish coat should then level nicely in drying.

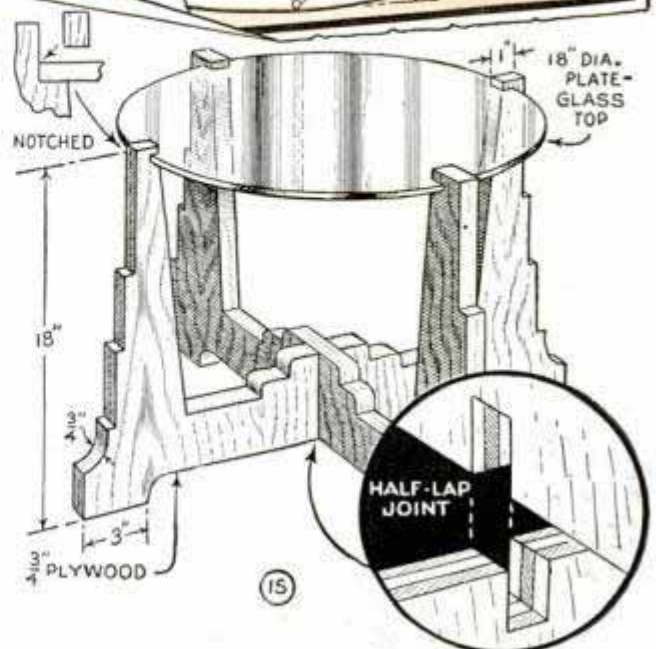

Cork Holder to Wash Photo Film under Water Faucet

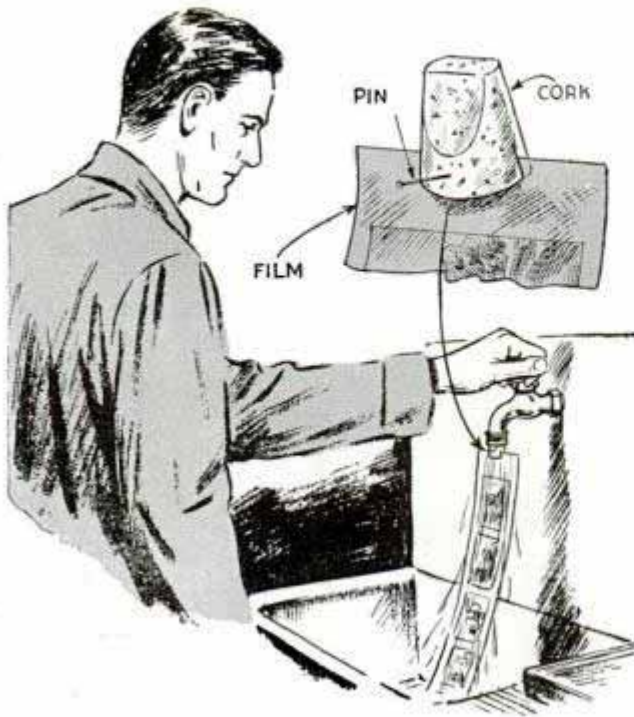

Here is a cork that will hold strips of film under a water faucet so that both sides will be washed efficiently. The cork is slotted at the wide end and opposite sides are flattened at the other. In use, the film is slipped into the slot and anchored with a pin through the margin, after which the cork is forced into the faucet and the water turned on lightly to flow down the back and front of the film.

Flashlight Aids in Turning Bowls

A small pencil-type flashlight is a great aid in boring deep bowls to a smooth finish. It is taped to the boring tool so that the beam of light spots at the cutting

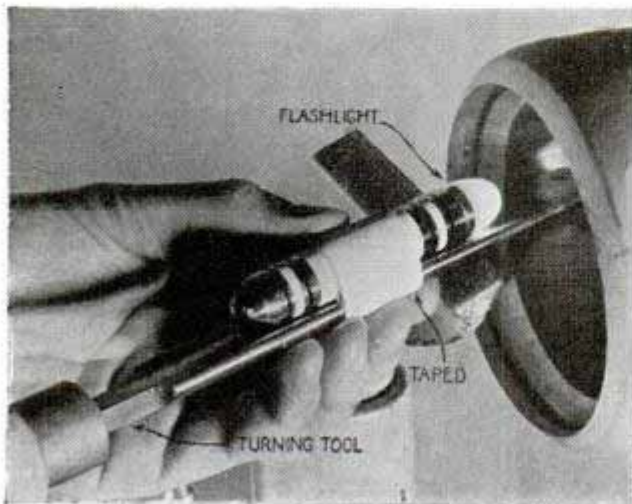

edge. This light shows up the defects in a manner that cannot be obtained with an outside beam.

Hose on Handle of Nail Clippers Avoids Pinched Fingers

Have you ever pinched your fingers between the handles of a nail clipper? If so, cut a piece of garden hose as indicated, and slip it over the handles. Besides cushioning the handles, the hose makes the tool self-opening, and easy to operate. If the hose is too large, a few wrappings of tape on the handle will make it fit tightly.

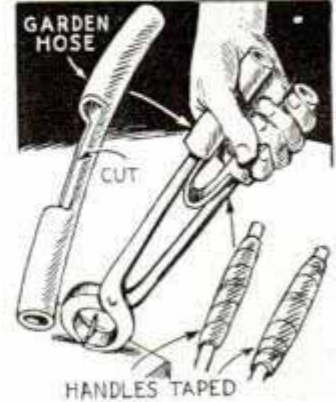

"Bench-Top" Veneer Press Set Up or Dismantled Quickly

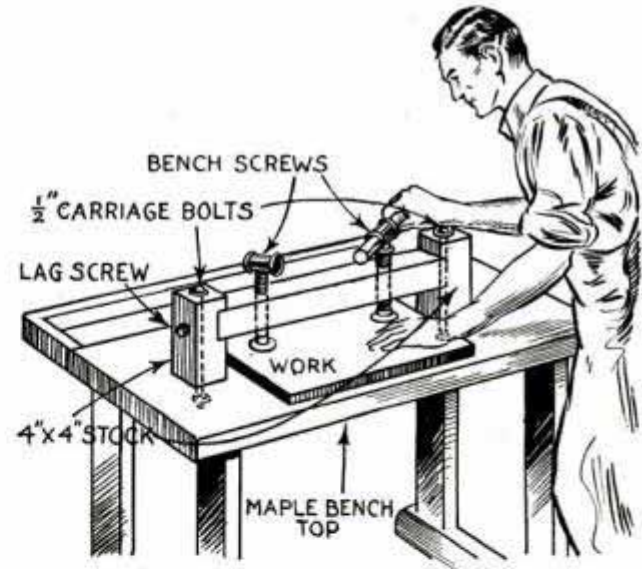

Using the flat, solid maple top of a shop bench to serve as a base, one manual training instructor made this simple press, which could be set up quickly for occasional jobs of veneering. As shown, several bench screws fitted into a sturdy 4 by 4-in. frame are used to apply pressure to the work. Holes for heavy $\frac{1}{2}$ -in. bolts, which extend through short vertical members, are drilled through the bench top for fastening the frames rigidly in place. Several units, spaced a short distance apart, can be used when the work varies in size.

Tidbit Tray of Curved Copper Has Wood Ends

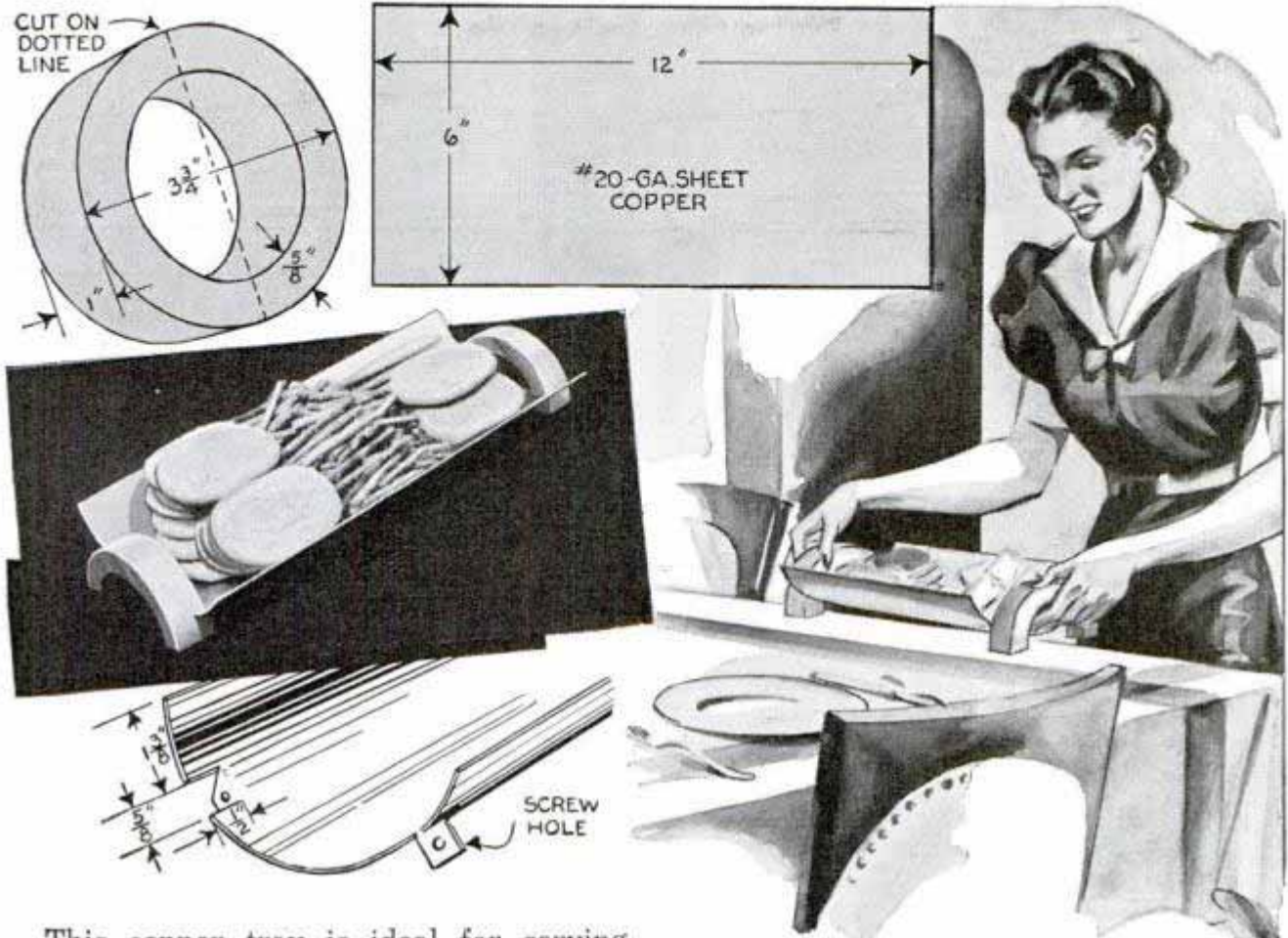

This copper tray is ideal for serving cookies, candy and other tidbits. It consists of a sheet of copper curved to a radius of 9 or 10 in., and two half-circular end pieces. The latter are halves of a wooden ring, each piece being grooved deeply to

take the ends of the copper. Two tabs formed at each end of the copper provide a means of attaching the circular ends with screws.

—Dale R. Van Horn, Lincoln, Nebr.

Old Phonograph Put in Small Plywood Cabinet for Child

Have you an old phonograph that has been discarded? If so, put it in a small cabinet, paint it in bright colors and present it to some child. The fun the child will get out of having its own phonograph will more than repay you for the two or three dollars cost. You can make up a cabinet of 1/2-in. plywood with butt joints fastened with screws. As the cabinet is painted, you can use inexpensive material. The cabinet shown stands 2 ft. high and has space for records and story books in the bottom.

—O. Evans Duemler, Pasadena, Calif.

☛ If candle grease spills on a highly polished wooden surface, heat a clean dust cloth and hold it over the grease until it becomes soft so that it can be wiped off.



COLONIAL FLOOR LAMP

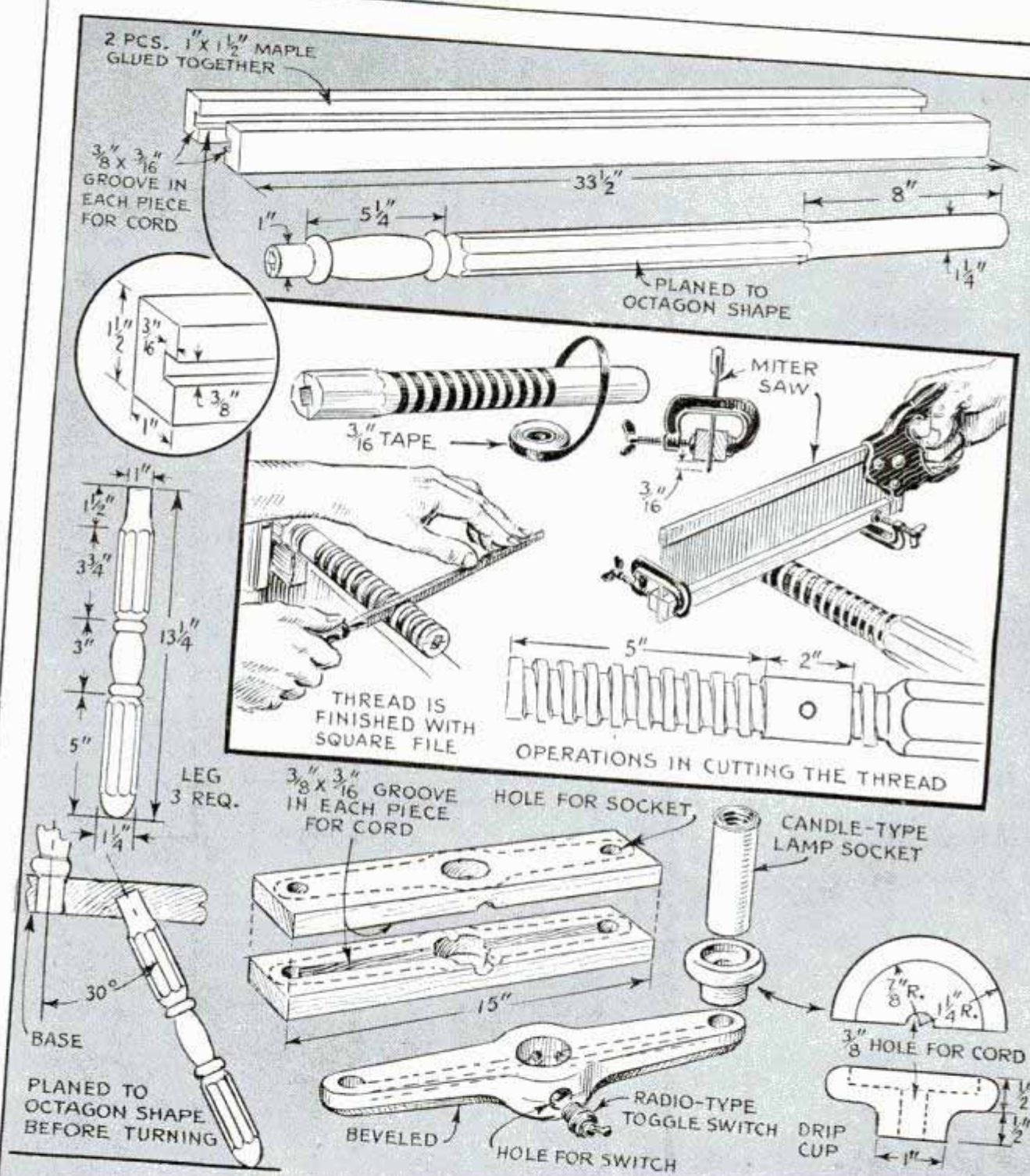

Although this lamp has a threaded column, the thread is for appearance only as the crossarm is pinned securely to a round section of the column so that the arm does not turn. As you see in the details above, the thread is laid out on the round stock then cut in with a saw and finished with a square file. The column is built up of two halves grooved at the center to take the cord. After gluing, the column is planed to the octagon shape, then turned down at the ends. Sand the turnings in the lathe so that you have them smooth before assembling. Finish in a honey color with stain, shellac and wax

has hand-cut screw

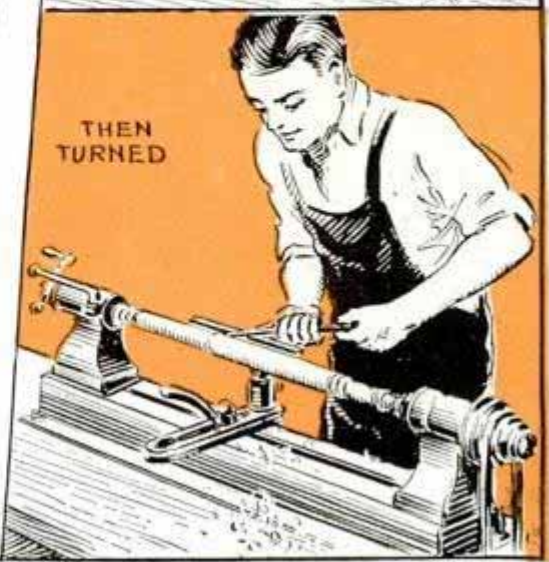
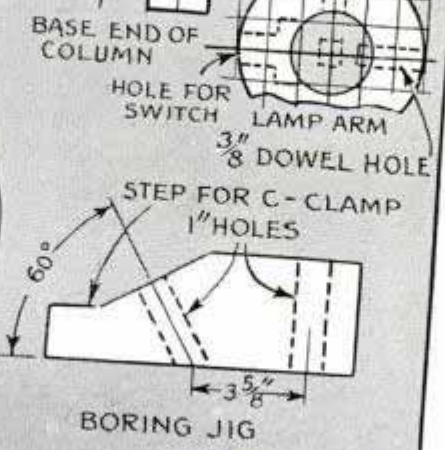
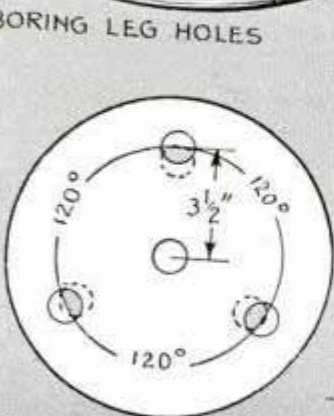
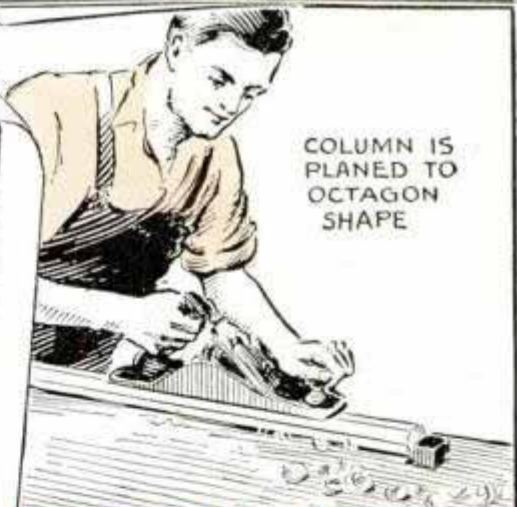
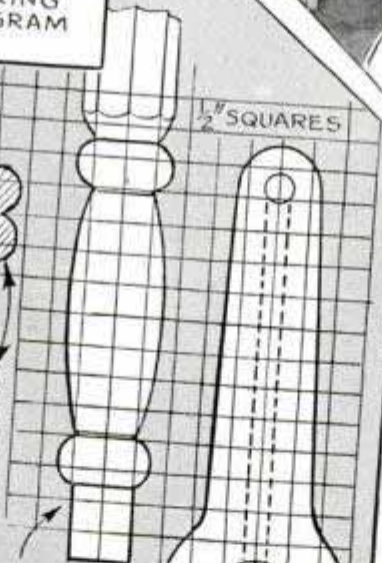
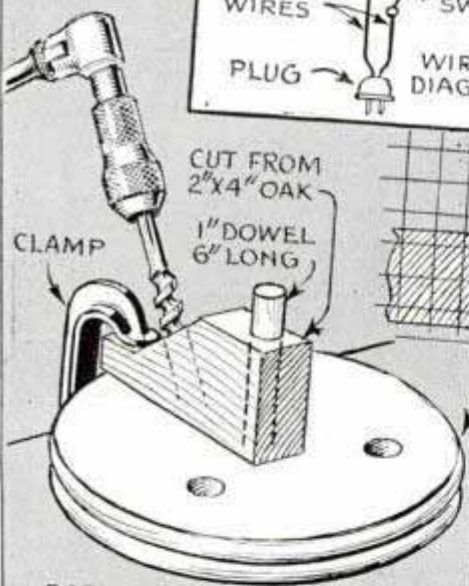
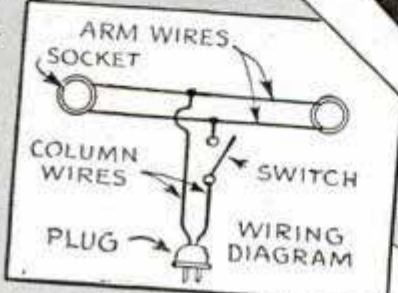
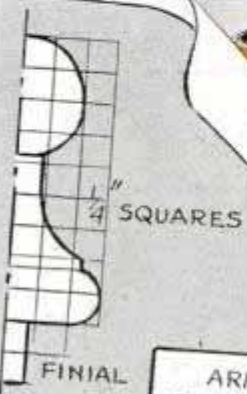

Rubber Straps on Trouser Belt Support Boot Tops



Fishermen, hunters and others who wear hip boots will find these rubber strap supports for the tops convenient, as they can be attached or detached in an instant without buckles or fasteners. The straps are cut from a discarded inner tube and engage the wearer's belt. The arrow-head ends of the straps are easily drawn through the loops of the boots to hold them up.

Folding Rule Holds Data Sheet on Bench for Reference

When working from a printed formula, clipping or drawing on a workbench, a folding rule provides a good emergency



support to hold it upright so that it can be read easily. Fold the paper over a piece of cardboard and insert it between sections of the rule as shown.

Envelope Removes Small Tacks from Permanent Magnet

Before using a permanent magnet to gather up small tacks or metal filings, slip it into a thin paper sack or envelope. The magnet will lose little of its power, and the paper can be removed to dislodge the metal.

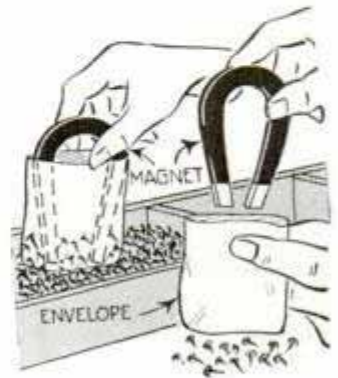

Extending Hook in Key Purse



PAPER CLIP

When a small key is carried in an ordinary key purse, the difficulty of inserting it into a lock because of the short hook on the purse can be overcome with an ordinary paper clip. This is merely fastened into the key eye and

the hook of the purse as indicated. Also, a paper clip may be used to identify a certain key in the dark.

Pocket Comb Used as Compass

Next time you need a compass and none is at hand, a pocket comb and a pencil will serve the purpose. Sharpen the pencil point to slip easily between the comb teeth. Then hook one end of the comb over a pin driven into the work and revolve the pencil to draw the circle. If the comb is to be used often for this purpose, drill a small hole through one end in which to insert the pin.

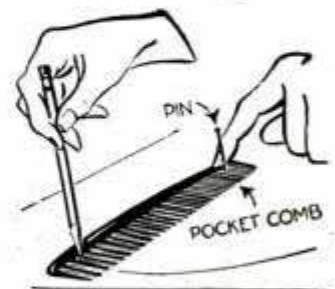

Camera Lens Masks to Make Photomontages

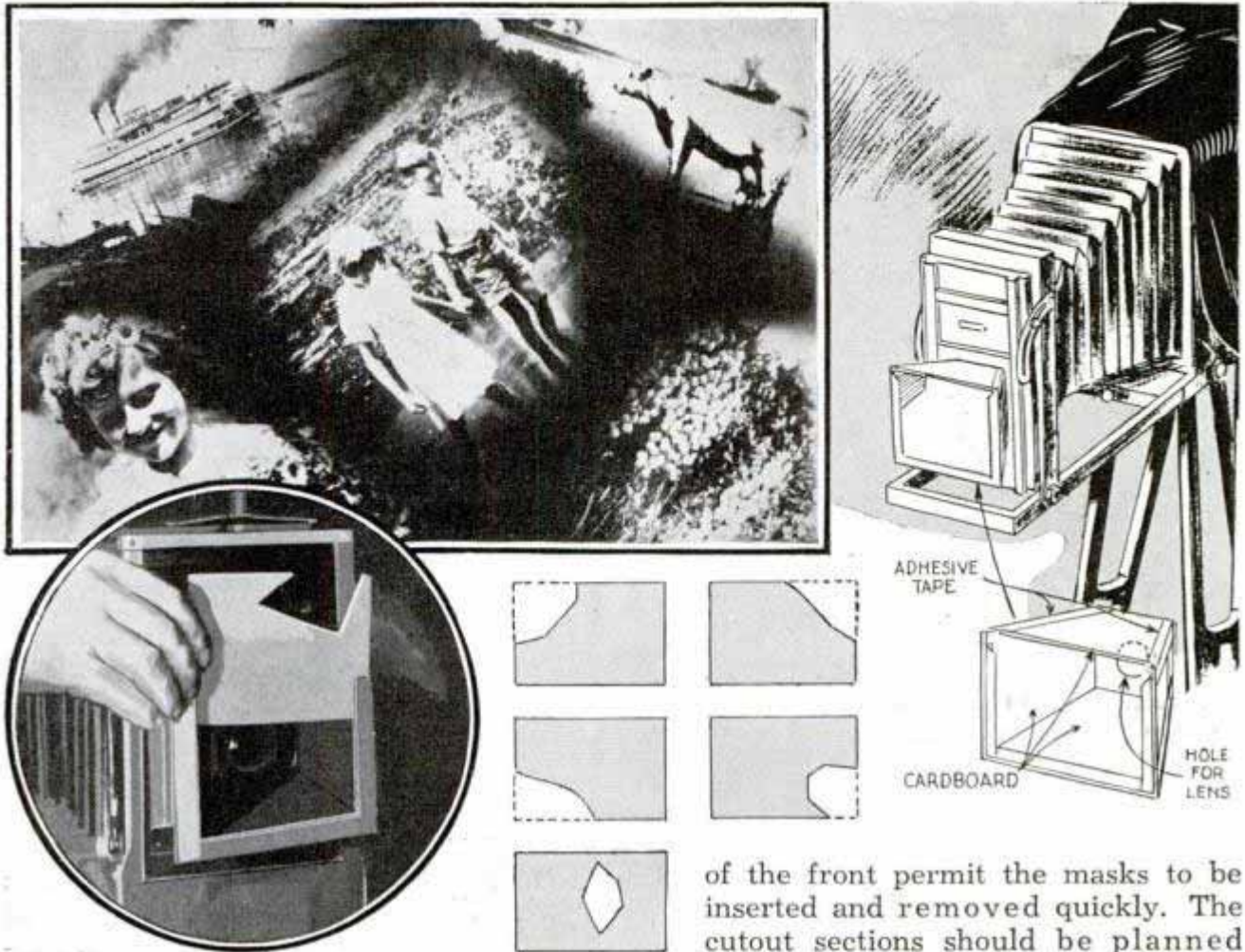

Photomontages—blended pictures on a single negative such as shown above—are easy to make by using lens masks with cutouts, so that portions of the negative can be exposed in sequence. A simple mask holder which fits over the lens may be assembled from pieces of cardboard taped together at the edges. Slides on each side

of the front permit the masks to be inserted and removed quickly. The cutout sections should be planned carefully so that exposures will not overlap, but will blend together at the edges, and so that the entire negative will be covered as you use the masks progressively. While simple cutouts as shown above will do, “saw-tooth” edges will give a more gradual blend. Uniform negatives can be obtained by taking the various pictures under similar lighting conditions.

Handy Sanding Block Permits Instant Change of Paper

To change the paper on this sanding block, you merely loosen the wingnut on the quick-acting hand grip, which holds one end of the paper. A slit cut at an angle across the top of the block holds the other end. Resiliency is provided by sheet rubber glued to the underside of the block. When making the block, allow sufficient clearance for both the screw and the bolt in the hand grip so that it can be tilted slightly. Standard 9 by 11-in. sandpaper sheets are cut to 2 by 9-in. strips to fit the block.—L. Schmitt, Chicago.

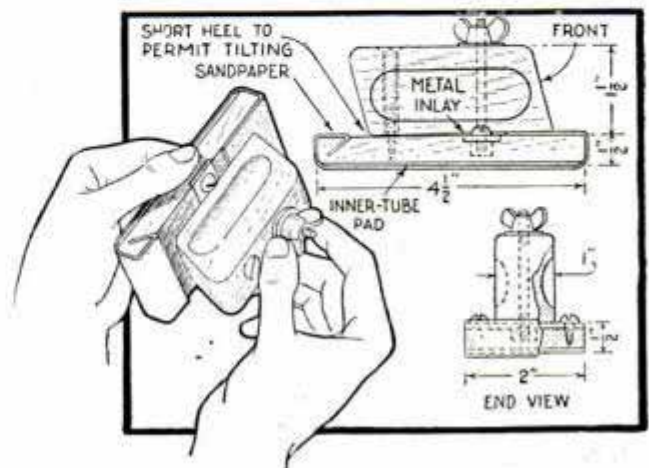

Window in Pocket to See Watch Without Removing It



One man who carries a pocket watch cut an opening on the inner side of his pocket and sewed a piece of transparent celluloid over it so that he could read the watch without removing it. This not only helped avoid dropping it, but enabled him to tell time by merely pulling back his coat.

Fulcrum Block Attached to Bar by a Length of Hose

To avoid carrying a fulcrum block about when moving heavy crates or machinery, slit a short piece of rubber hose and tack it onto the block. The hose may be opened

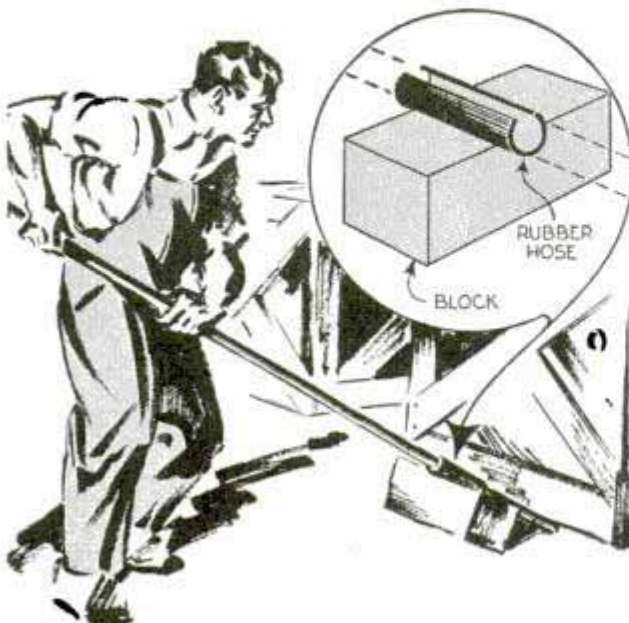

to engage the bar and will hold the block securely so that the operator need not stoop each time to move the fulcrum.

Furniture Glides Provide Bearings on Toy Wood Wheels

Pressed into each side of wooden wheels used on homemade toys, large nickel-plated furniture glides drilled through the center provide bearings and neat hub caps.

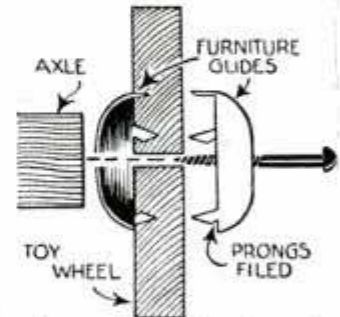

To assure that the holes in the glides will be in alignment and centered perfectly, drill the wooden wheel and the two glides through the center first. Then, using the same drill bit as an axle, slip the glides over each end and press the points into the wood.

Half Rubber Ball Is Shield on Acid-Bottle Stopper

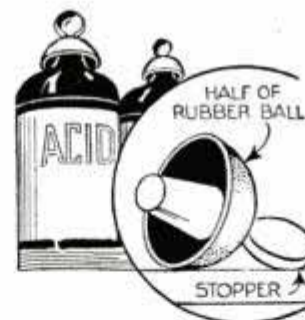

When a glass stopper is removed from an acid bottle and laid on a table or counter, it may be moist enough to damage the surface. If a hollow rubber ball is cut in half and

slit in the center to slip over the knob of the stopper, it will prevent the moist end of the latter from touching the table.

Cartridge Pouch Slips over Belt

While hunting or target practicing, this pouch is just the thing in which to carry cartridges. It is a rubber-lined tobacco pouch, with a strip of canvas or other cloth sewed on one side to provide a loop through which your trouser belt is slipped.

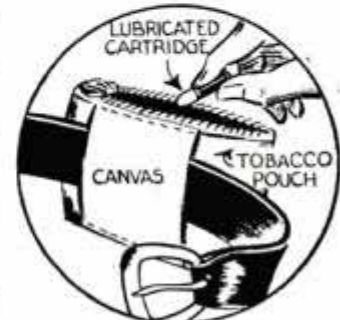

Attractive Model House Conceals a Mailbox

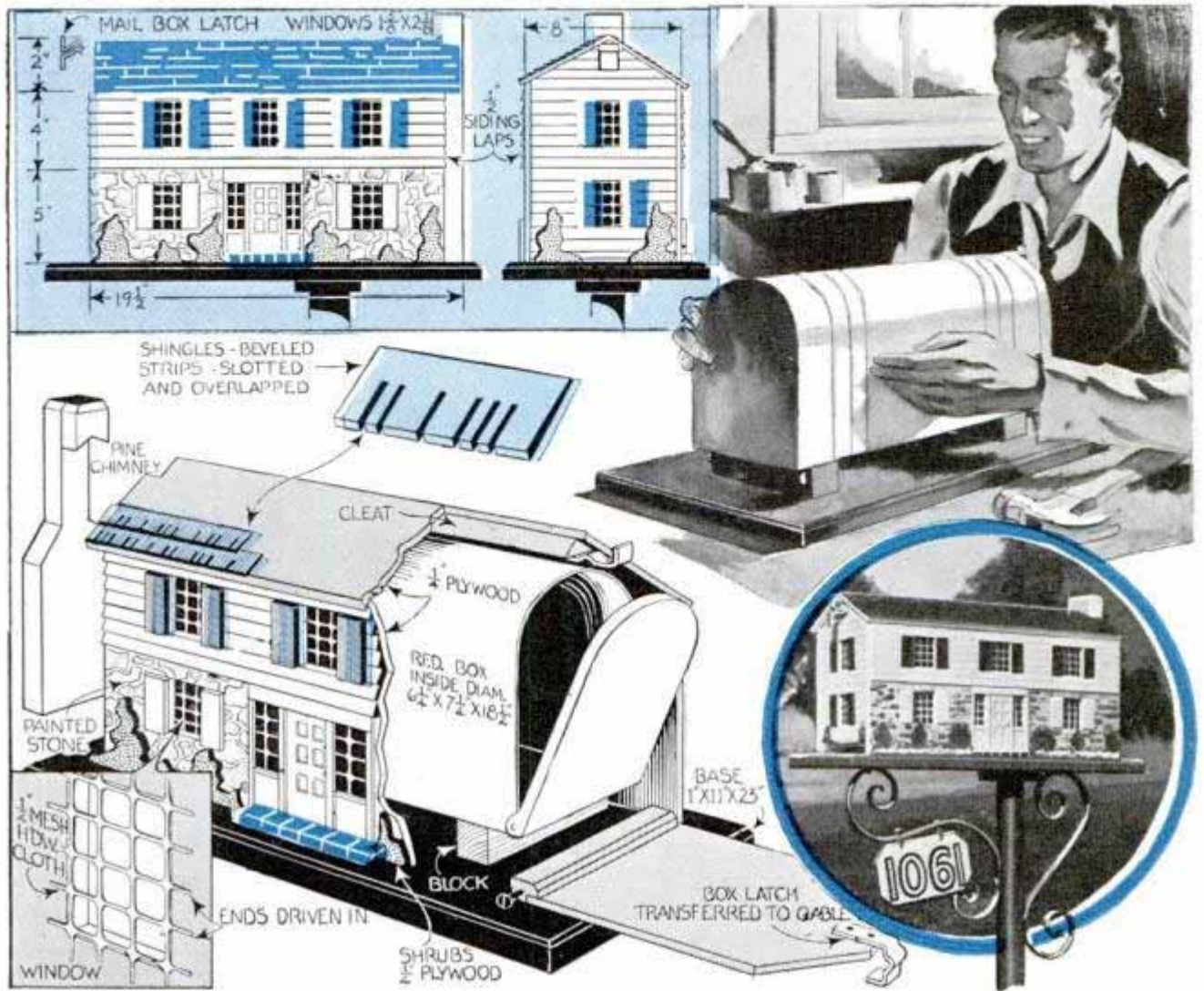

Patterned after the trim two-story colonial type featuring a combination of masonry and wide clapboards for the walls, this house model is designed to enclose the standard-size rural mailbox without altering the box in any way or making it inconvenient for the postman. Walls and roof boarding are of $\frac{3}{8}$ -in. plywood. The chimney and base are of solid stock. Two cleats, or blocks, attached to the base support the mailbox at the proper height. Imitation masonry is painted on the lower half of the walls as indicated. Siding is ripped from $\frac{1}{2}$ -in. stock into thin, beveled strips of uniform thickness. Shingles are made in the same way. Both are attached with small brads and glue. Note that one end of the house is hinged to the base to give ready access to the mailbox. Windows are made by cutting sections from hardware cloth, leaving the ends of the cut wires projecting about $\frac{3}{8}$ in. The ends are then

turned so that when the cloth is placed over the window opening the bent ends can be driven into the wood to hold the wire securely in place.

Beach Pebbles Assure Action of Salt Shaker



Campers who frequently have to pulverize their salt to keep it in condition to flow freely from the shaker, will find that much of this trouble can be avoided by dropping a few clean beach pebbles into the container. The pebbles tend to break the lumps of salt when the shaker is used.



Starting Early on the



Built of plywood, this roomy, substantial doll house in French chateau style may be wall-papered or painted inside; has "stucco" outside walls with "stone" corner trim, realistic celluloid window panes, a cozy fireplace, and it can be wired for tiny lights. Front door, under curved balcony, has a real latch and hinges. Entire front and back are removable for easy access to the interior

By Lowell R. Browne

A MODIFICATION of the clean-cut French chateau style of architecture presents a pleasing design for this doll house, Fig. 1. It has three bedrooms and bath in addition to upstairs hall, kitchen, dining room and a living room the full width of the house. All windows are fitted with sash, celluloid panes and shutters, and the front door has a real latch. Floors are in natural finish and each room is papered. If desired, the structure may be simplified considerably by eliminating the window sash, stair rail and treads, wallpaper, baseboards and casements, if a very simple shelter for dolls and furniture will suffice. With the exception of shingles, chimney and trim, construction is of $\frac{3}{8}$ -in. plywood throughout. Use only the best grade, sandpapered on both sides. Both front and back are detachable, Figs. 5 and 7, to give access to the rooms on each side of the house.

Walls and Partitions: Exact sizes of walls and floors are shown in Figs. 3, 4 and 6. First, second and attic floors are identical except for the stair-well cut in the second. Front and back are the same size, and if you care to go to the additional work, windows and a door may be cut in the back, to correspond to those in the front. To

standardize the work, the first and second floors are made the same height, although in full-size houses the second floor ceiling is usually lower than the first. Dimensions and location of the partitions are given in Fig. 6. Each partition has its individual letter to make it easier to follow assembly.

Assembling the Structure: The cut-away perspective drawing, Fig. 3, gives a clear picture of assembly of walls, floors, roof, cornices, etc. It is important that all walls, etc., be as square as possible. Join them with No. 3 flat-head screws after having applied casein glue to the joints. The screws should be countersunk. Note that upstairs partition "D" is directly over partition "B," hence it is impossible to put screws into both. The choice is given to the lower partition, with casein glue for the upper, aided by the weight on this member. Roof supports, "G" and "H" set down inside the cornice, and the chimney is not installed until the roof, before shingles are laid, is on. Cornices at the ends are slightly different in section from those in front and back, Fig. 8. This is due to the detachable front and back walls, which fit into a shallow rabbet along the top. The plywood roof rests directly upon the

Christmas DOLL HOUSE



cornice, and is screwed down upon the supports "G" and "H."

Detachable walls swing out from the bottom, and no catch is provided to hold them in as such devices are troublesome for very small children. Instead, a thin strip of rubber is cemented at each end on the lower corners. These tend to hold the wall in the proper position. Exact dimensions of the four pieces of plywood composing the roof sheathing are given in Fig. 16. These are beveled along the edges on the underside, taking a 45-degree angle along the horizontal edges, and less at the hips. It is inevitable that some trimming will be necessary at the latter joints unless one can cut the plywood "geometrically perfect."

For the imitation stone work on the corners of the building, scroll-saw a thick piece as shown in Fig. 7 with 1-in. notches $\frac{1}{2}$ in. deep. Then rip it into $\frac{1}{16}$ -in. strips. These in turn are lightly scored with a circular saw to indicate mortar joints between

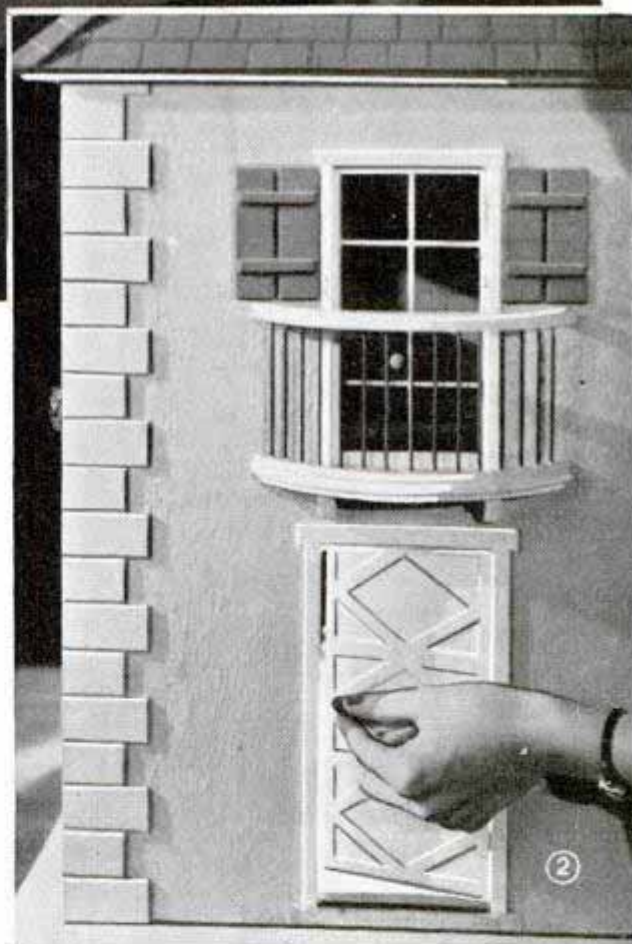

the blocks. Note that to preserve the same proportions on front and side walls, a strip the width of the plywood is ripped and glued to the edge. In gluing pieces together, it is understood that the wood is unpainted. Otherwise it will not hold se-

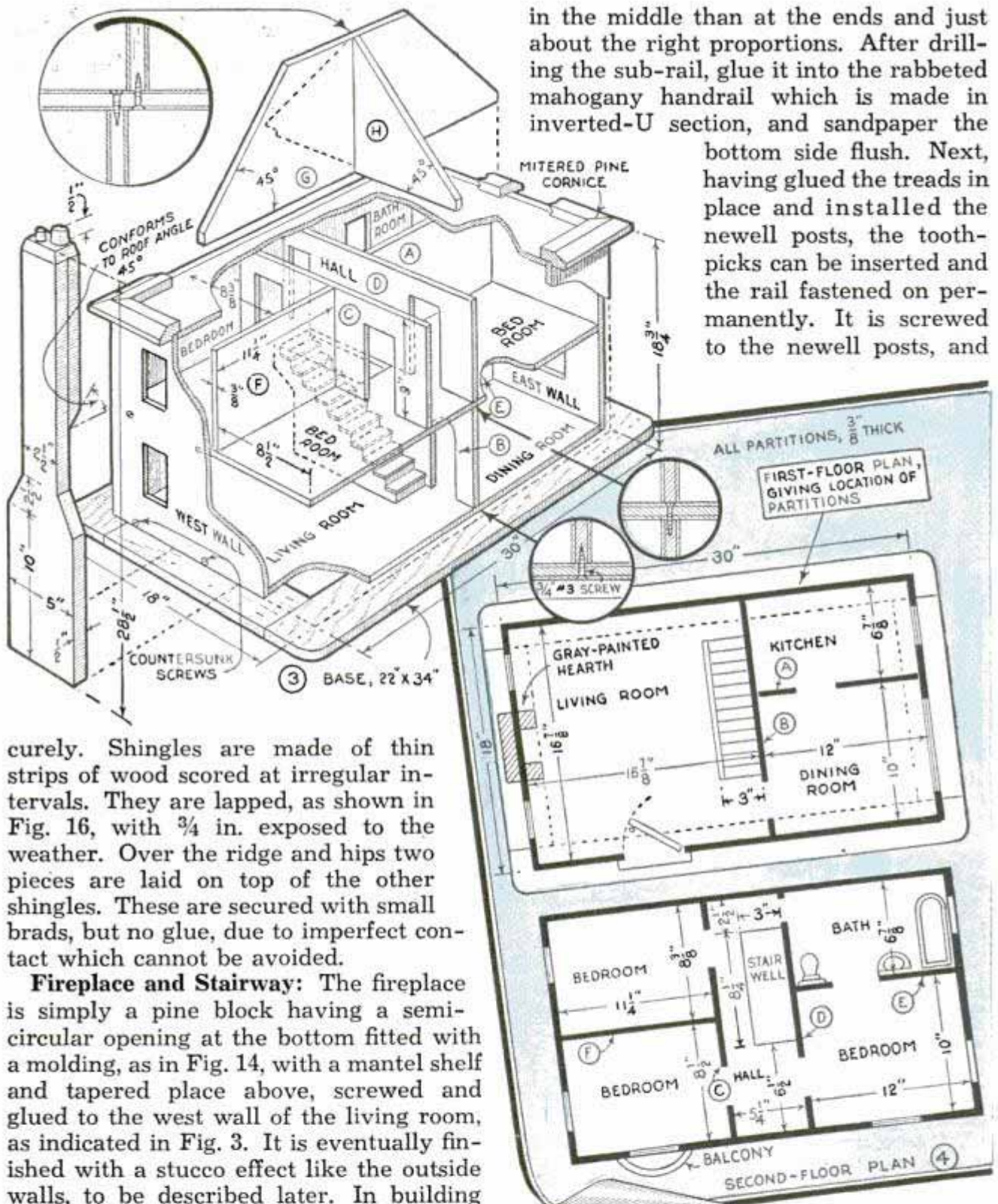

curely. Shingles are made of thin strips of wood scored at irregular intervals. They are lapped, as shown in Fig. 16, with $\frac{3}{4}$ in. exposed to the weather. Over the ridge and hips two pieces are laid on top of the other shingles. These are secured with small brads, but no glue, due to imperfect contact which cannot be avoided.

Fireplace and Stairway: The fireplace is simply a pine block having a semi-circular opening at the bottom fitted with a molding, as in Fig. 14, with a mantel shelf and tapered place above, screwed and glued to the west wall of the living room, as indicated in Fig. 3. It is eventually finished with a stucco effect like the outside walls, to be described later. In building the stairway, two side members are cut with the steps and joined with a piece of wood in between, as shown in Fig. 13. One wall is then screwed and glued to the partition "B." Before installing the stairway permanently, all the mahogany treads are made and an inner or sub-handrail is clamped over them, and each step is drilled through the latter for the spindle. Round, tapered maple toothpicks are just the thing for the spindles, as they are thicker

in the middle than at the ends and just about the right proportions. After drilling the sub-rail, glue it into the rabbeted mahogany handrail which is made in inverted-U section, and sandpaper the bottom side flush. Next, having glued the treads in place and installed the newell posts, the toothpicks can be inserted and the rail fastened on permanently. It is screwed to the newell posts, and

wood plugs are set over the countersunk screw heads. Before final assembly, all the white painting should be completed on the stairway walls and spindles, and mahogany treads and rail stained and shellacked. Construction of the stairway leaves a handy coat closet underneath, reached through a door in the rear.

Windows, Doors and Balcony: The original doll house shown in the illustrations

is fitted with complete sash and celluloid panes, a typical example being illustrated in Fig. 11. First a stop-batten is set inside the window opening and glued to the plywood. Casement pieces are lapped flush over this on the outside and a sill installed as shown. The sash is made of pine with the mullions rabbeted into the side, top and bottom members and mortised together where they cross. This makes the entire inner side flush and ready to receive the celluloid pane, which is cut as in Fig. 12

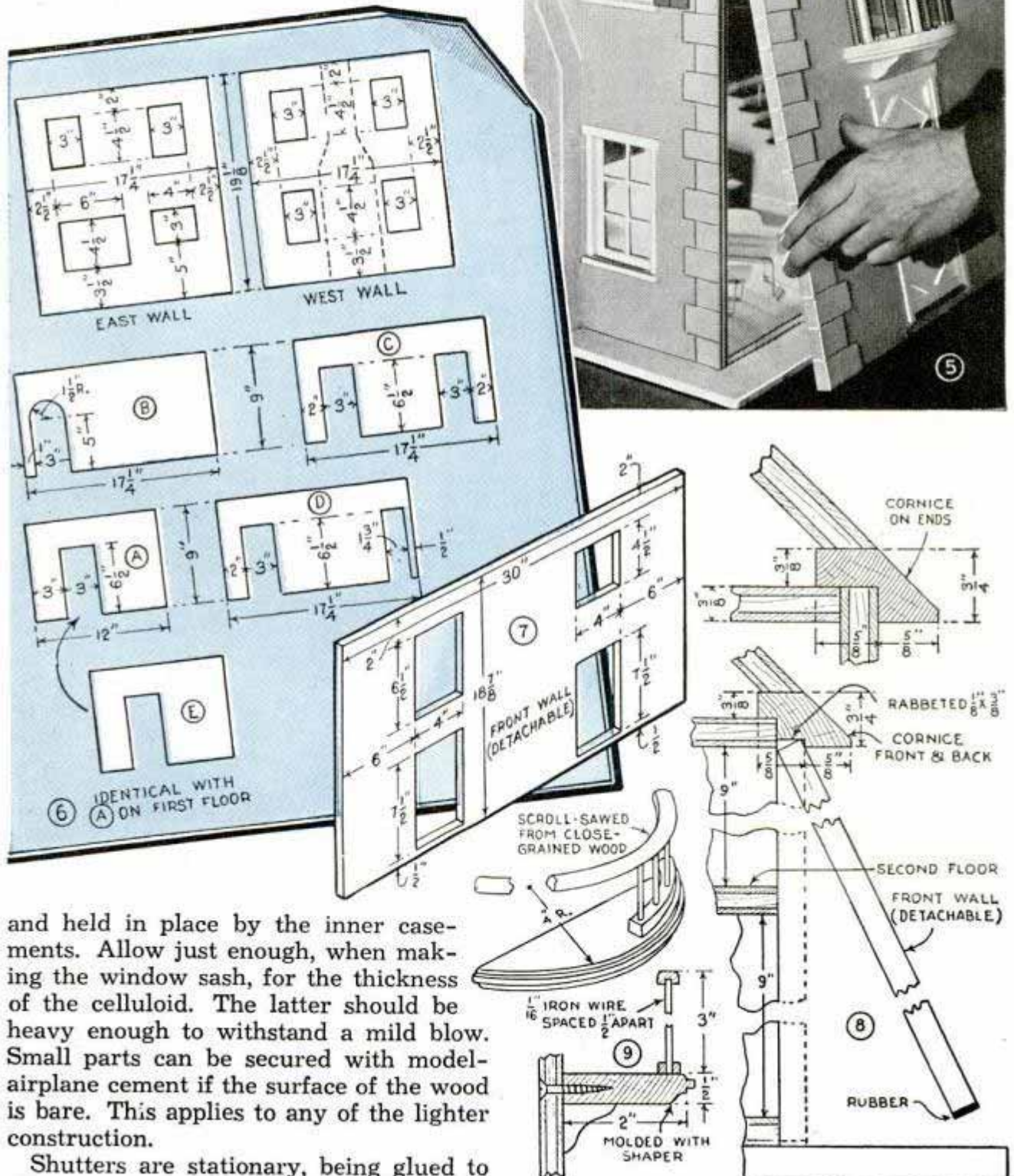
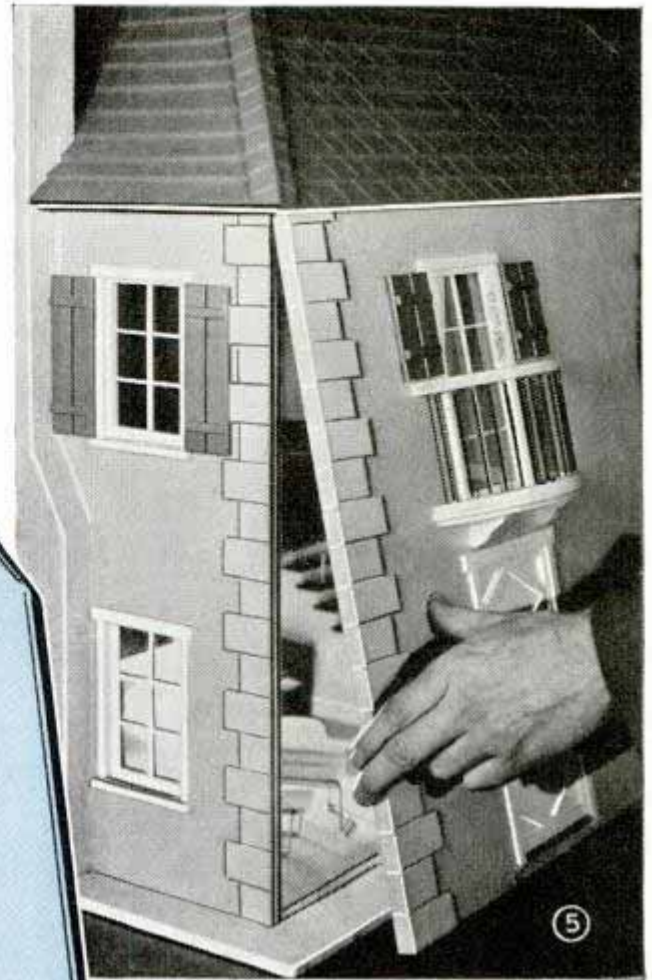

and held in place by the inner casements. Allow just enough, when making the window sash, for the thickness of the celluloid. The latter should be heavy enough to withstand a mild blow. Small parts can be secured with model-airplane cement if the surface of the wood is bare. This applies to any of the lighter construction.

Shutters are stationary, being glued to

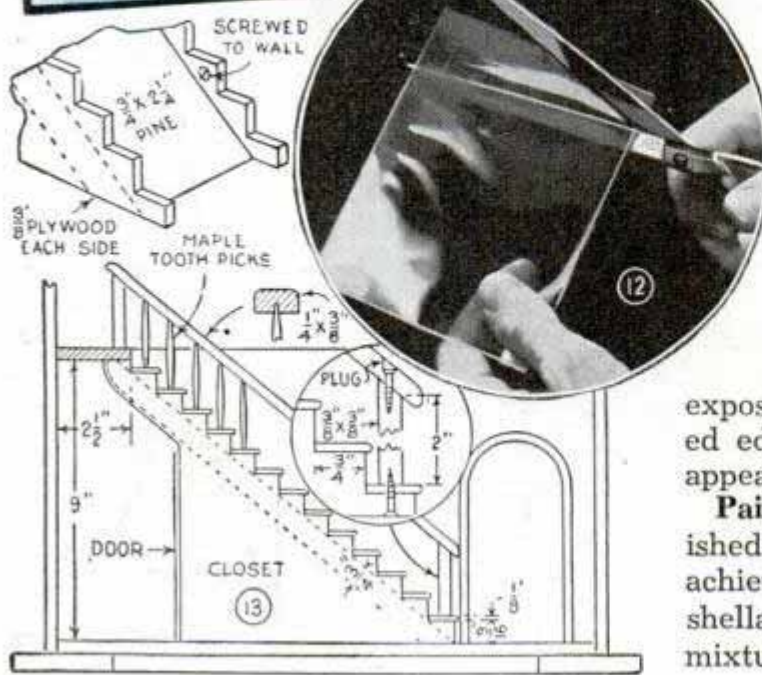
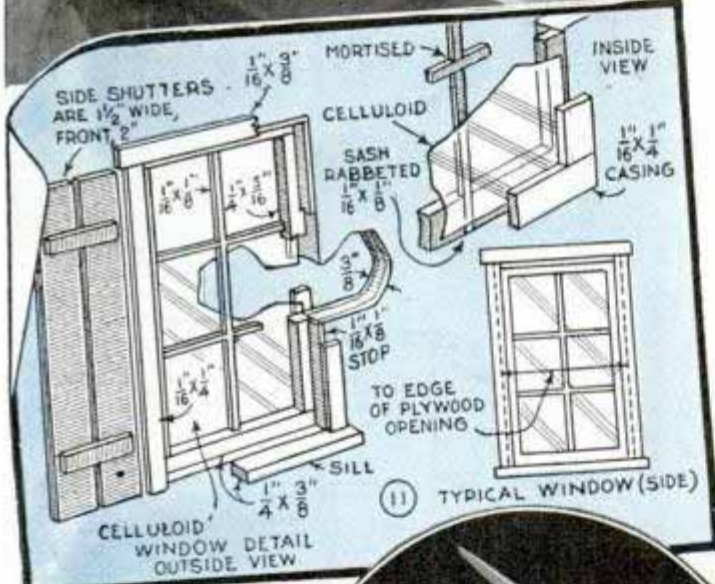
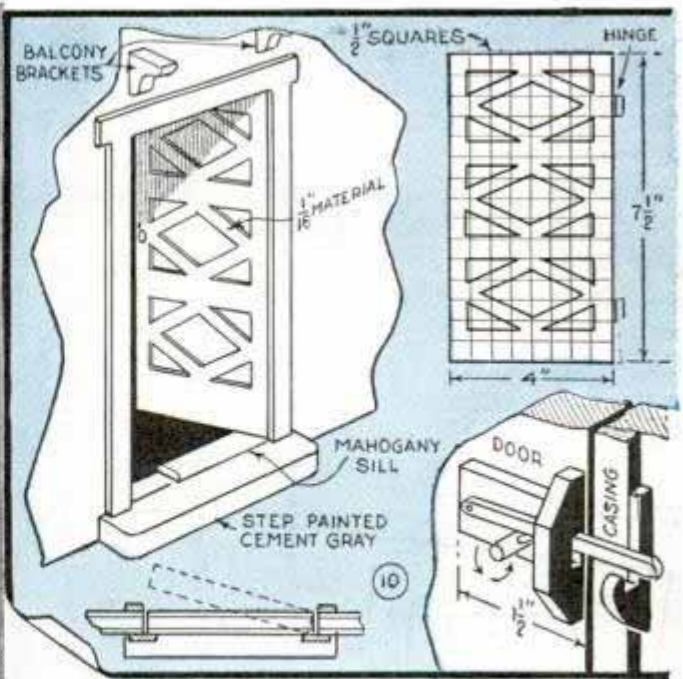

cleats secured to the house walls. The doorways between rooms are fitted with frames or trim, as in Fig. 14, and a neat baseboard is also installed in each room. The front door is hinged and swings inward in the standard arrangement, and is fitted with an all-wood latch operated from either side of the door, Figs. 2 and 10. The front of the door, which is plywood, is decorated with thin strips laid in the pattern of the squared diagram. A mahogany sill adds much to the realistic effect. In making the lock, see that all parts are loose enough so that the addition of paint will not cause them to bind. A substantial balcony over the door is simply made as in Fig. 9, and has a very pleasing effect. It is a curved base with handrail and iron spindles. The rail and corresponding piece at the base are scroll-sawed and clamped together for drilling. This work is done with the pieces reversed, that is, the upper rail on the bottom so that it can be drilled only half-way through. Thus no holes are exposed when the rail is in place. A molded edge to the balcony base adds to its appearance.

Painting: The original doll house is finished to resemble stucco, and this is achieved by painting with a mixture of shellac and dry plaster, Fig. 15. When the mixture has hardened, it is gone over with

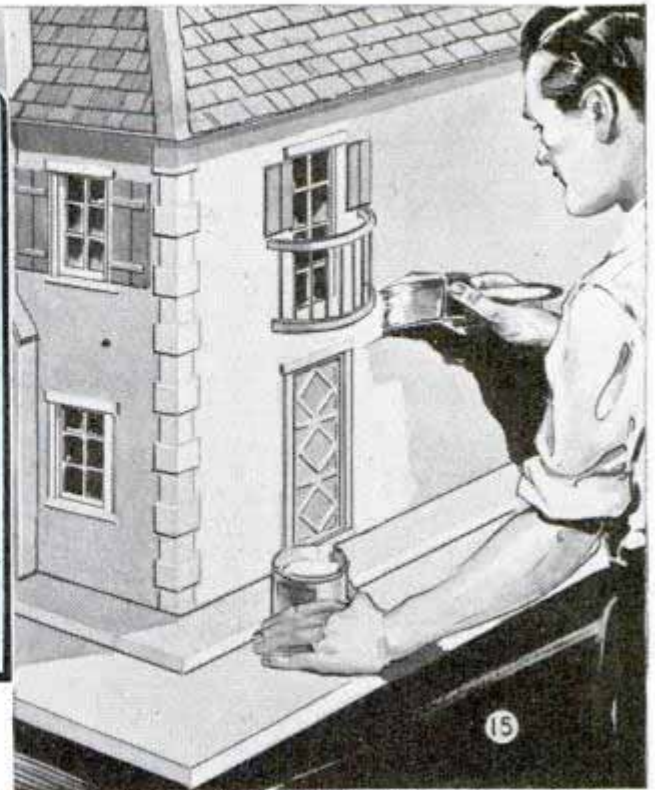
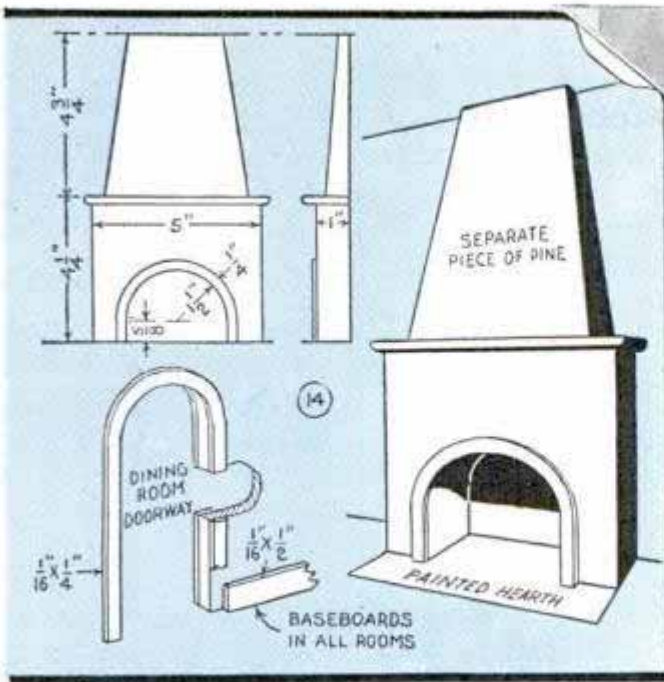

paint of whatever color you select. In this case, cream. The corner blocks are French gray; the roof green. Interior woodwork is white, with all walls papered. The paper was taken from a sample book, which cost nothing. For paste, a mixture of flour and water and a little alum was used. Window casements and balcony are white, with the spindles of the latter black. Floors are shellacked in natural wood, with oilcloth on the kitchen to resemble linoleum. If desired, electric lights can be installed as in Fig. 18, using a toy-train transformer and small, rubber-insulated wire. Tiny lamps and sockets for model-railroad installations are used in wiring the house.

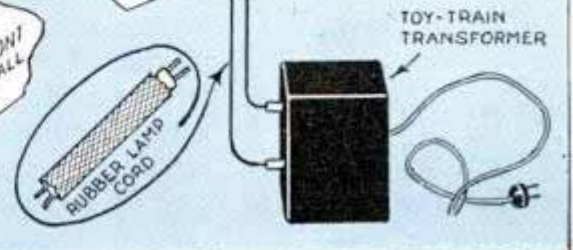
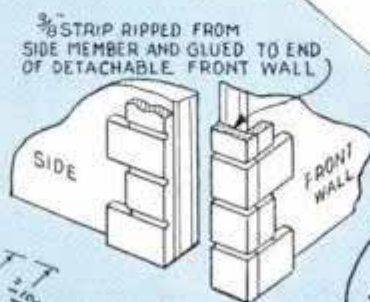
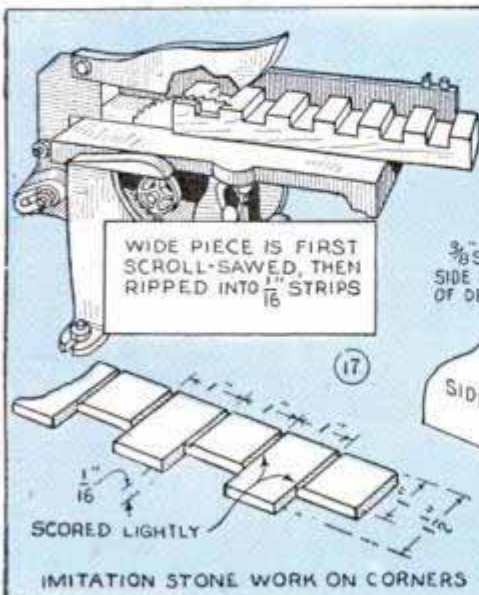
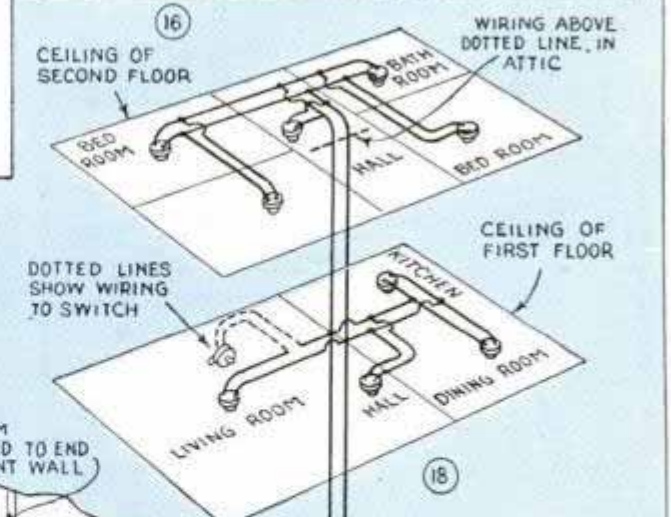
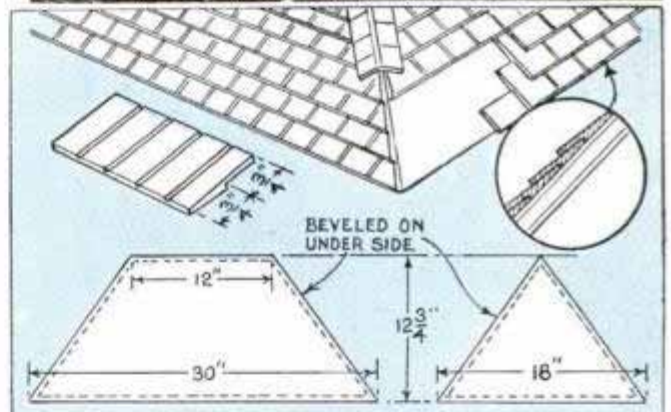

Temporary Signs Held on Trees with Sections of Auto Casing



If you want to fasten a few temporary signs to trees, you can do it by using sections of auto casing as clamps. These are nailed to the sign as indicated in the detail and have enough resiliency to grip the tree or other support without damaging it. When the signs are to be removed, just pull them off the supports.

Abrasive Surfaces on Disk Sander Changed Quickly

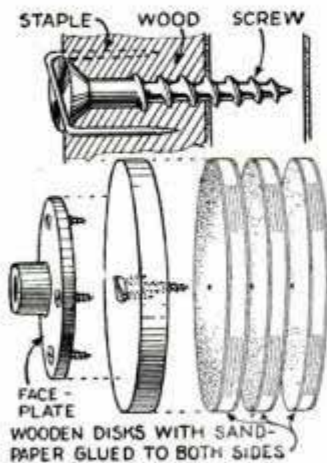

Amateur craftsmen who have small sanding jobs that require different grades of sandpaper, will find this lathe sander a timesaver as it has several quick-change abrasive surfaces. It consists of three or four wood disks, one of which is screwed to a faceplate. This disk has a wood screw projecting from its center for quick attachment of any one of the other

disks, which are faced on both sides with abrasive paper of different grits. The screw is kept from turning by a staple driven into the wood so that it straddles the screw head and rests in the slot.

—Harry S. Hayes, St. Paul, Minn.

Keeping Ants Out of Lunch Box

If you have had ants get in your lunch box, here is a hanger that will keep them out. It is nothing more than a length of heavy wire with hooks bent on both ends and a compression can lid soldered in the center. After you hang up the box as

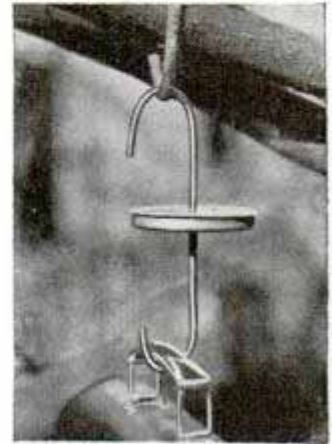

shown in the photo, fill the can lid with water. If ants crawl down the upper part of the hanger, they will not cross the water to reach the box.

Yarn Is Wound over Clothespins Clipped to Ruler

It is unnecessary to use the back of a chair for winding or measuring yarn into suitable skeins. A simpler method is to clip three clothespins on a wooden ruler as shown, the center one serving as a handle.



Trim 'Mono Coaster' Has Articulated Runner

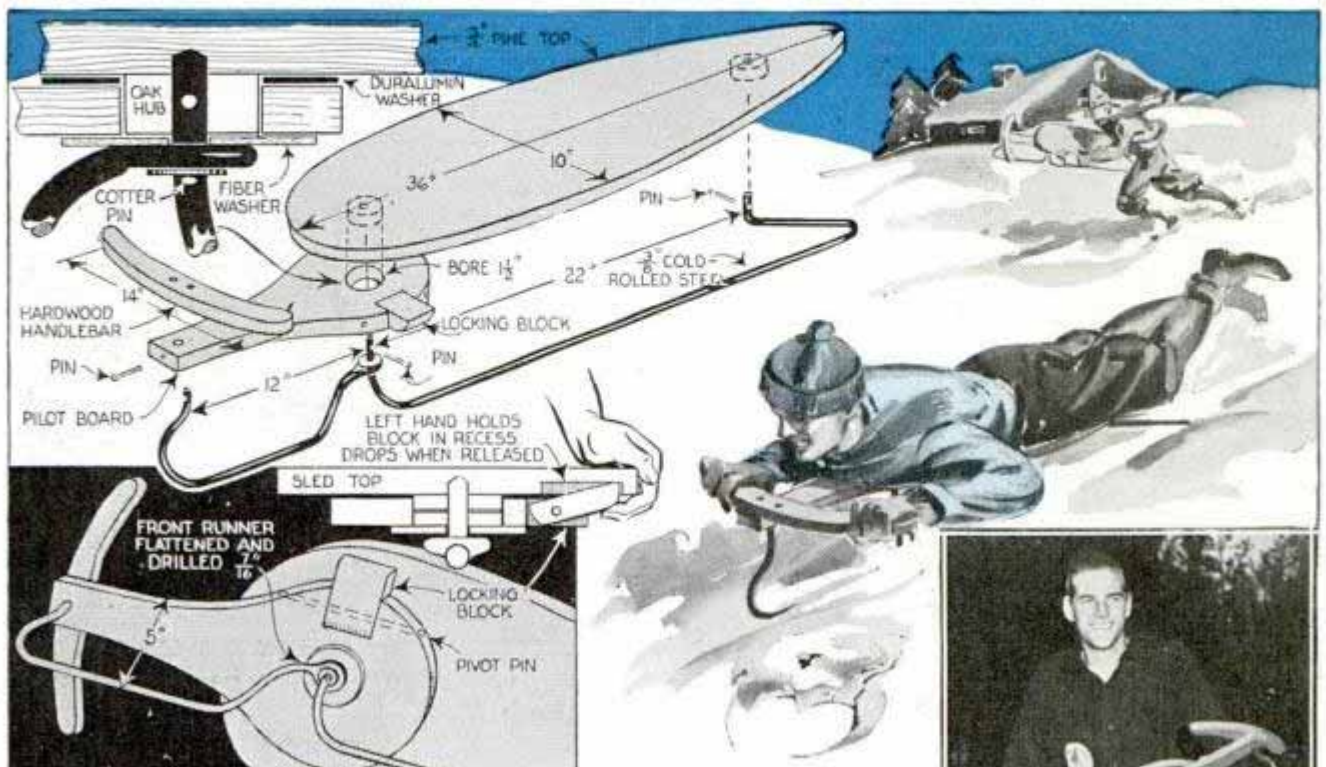

Designed for high speeds, this sled with its articulated forward steering runner is easy to maneuver. It steers and balances similar to a bicycle and is equipped with a simple steering-gear lock, which holds the runner straight ahead when the rider wishes to run and flop onto the sled while in motion. The sled is made unusually light without sacrificing strength, and it can be tucked under the arm for carrying. The top is a piece of white pine, oak or other hardwood being used for the pilot board and handlebar. Note that the rear end of the front runner is flattened and drilled to slip over the forward or pivot end of the rear runner. By drilling the hole $\frac{1}{16}$ in. oversize, a fair amount of play is permitted to take up some irregularities of the hill.

Ash Tray Fastened to Curtain Rod Slides under Desk Top

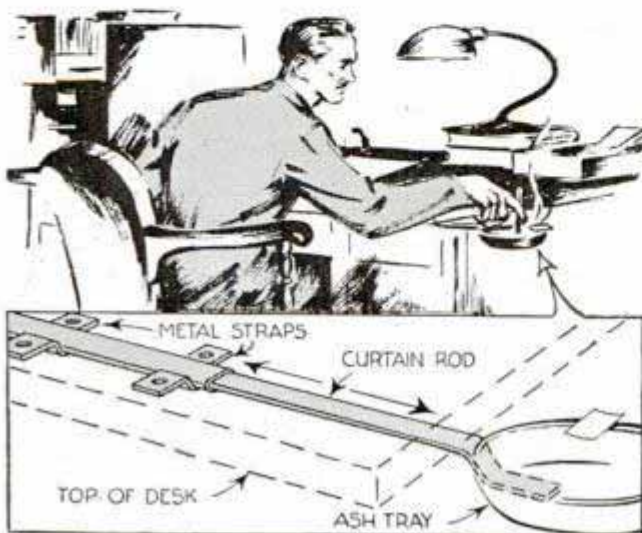

The inconvenience of having an ash tray on a desk while working is overcome by attaching the tray to a short section of telescoping curtain rod. This permits the tray to be pulled out when needed and pushed out of the way when not in use. The larger section of the rod is held in place by metal straps as indicated.

☞ To be effective against moths, it is necessary to keep cedar closets, chests and other containers for woollens tightly closed against possible entrance of the insects. Also, articles to be stored must be cleaned first to make sure they contain no eggs.

Sheet Veneer Is Cut Smoothly with Straight Razor Blade



Altering the blade of a discarded straight razor as indicated, and fitting it firmly in an old file handle makes a knife for cutting sheet veneer. After removing the blade from its handle, the end is broken off by placing it upright in a vise and striking it a sharp blow with a hammer, after which the severed end is ground to a bevel. The opposite end is ground straight to fit in the file handle.

Pan Nailed to Tree Trunk Is Good Bird Feeder

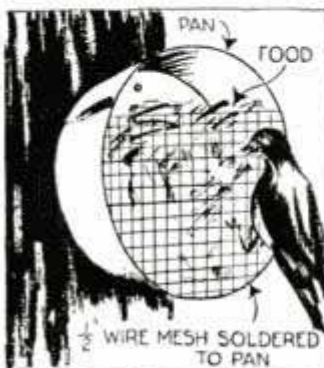

Desiring an inexpensive bird feeder of large capacity, one farmer nailed a pan to a tree and then soldered $\frac{1}{2}$ -in. wire mesh over the top as indicated, leaving the upper portion open so that the food supply

could be replenished. The feeder was kept filled with wheat heads. After picking the

wheat grains from the heads, the birds pulled the empty ones through the wire and dropped them so that they could get at the filled heads.

Tax Tokens Kept in Ball "Purse"

Shoppers in states where tax tokens are used will find this purse handy for the tokens as it keeps them from being mixed with small change in the pocketbook. The



purse is merely a hollow rubber ball slit along one side and a string attached for tying it to your shopping bag. To open the purse, squeeze the ball at the ends of the slit. When not in use, the ball is dropped into the bag.

Support for Miniature Trees

When making miniature scenery for model railroads, window displays and other purposes, a turkish towel stained green serves nicely as a lawn. To support miniature trees and shrubs firmly on such a lawn, one of the simplest methods is to use paper clips with one end bent sharply upward. This end is pushed through the towel and then into the stem which is to become the tree or shrub. The clips are out of sight, have a broad area and hold the trees firmly.

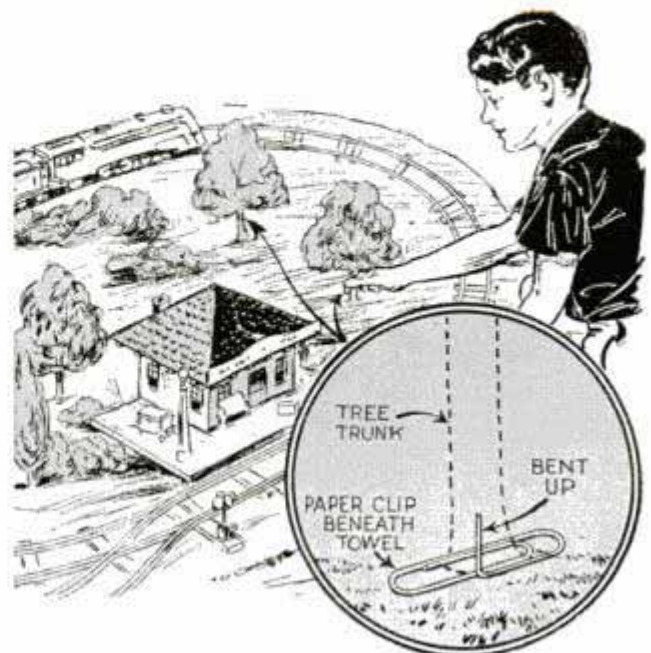



MOUNT *that* TROPHY *for your Den*

By John William Moyer

Staff Taxidermist
Field Museum of Natural History

AFTER you have finally secured a fine head from an elk, deer, or moose, why not mount it yourself? Like many other undertakings, the actual work of mounting a game head is much less difficult than it might appear in the beginning. The procedure is really very simple but you have to take special care with certain details. There are two methods you can follow and both are described here.

To begin with, do not allow the head to lie any longer than absolutely necessary before skinning, or the hair will slip. Get the carcass into a cool place and skin out the head without delay. In cutting the scalp from the body skin, be careful to leave the neck as long as possible and with a part of the brisket attached. After the head and neck have been severed from the carcass, removal of the scalp is begun by

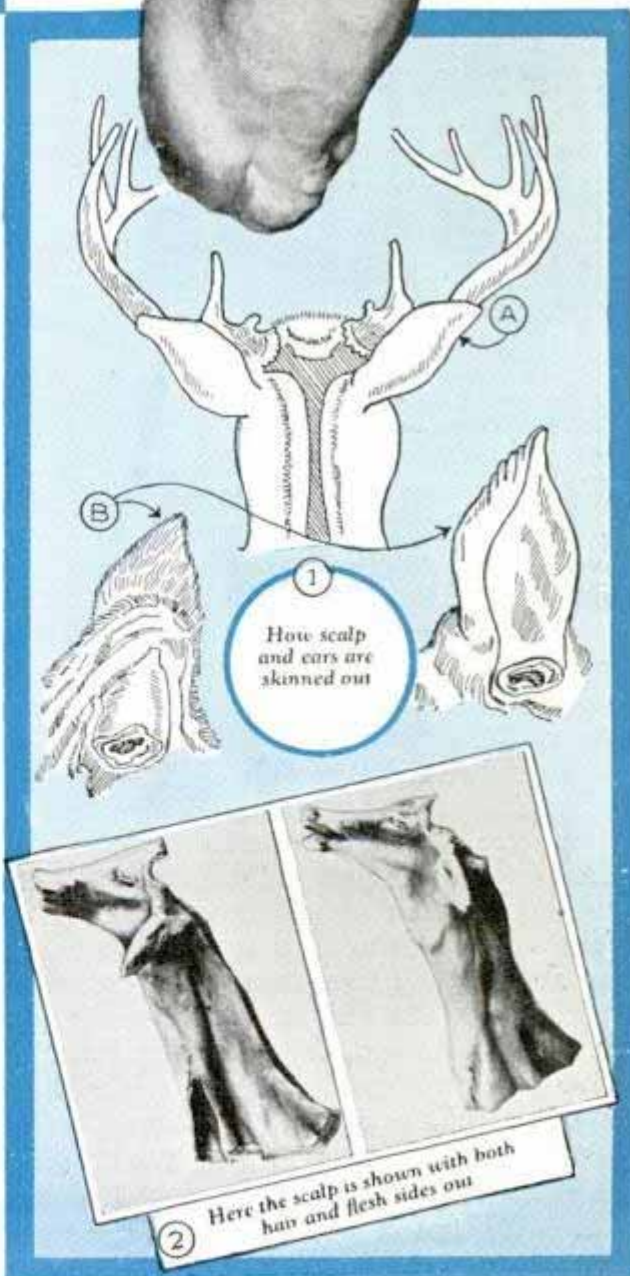



After skinning, the head is immersed in boiling water, which loosens remaining fragments of flesh

skinning directly up the center of the back, or nape, of the neck to the base of the skull as in the upper detail, Fig. 1. Then you make short branching cuts to the base of each antler and work the skin away from the top of the skull. Skin out the neck, and in removing the skin down over the face, use care around the ears, eyes, lips and nostrils. Cut the ears from the head, close to the skull and do not split open the eyelids any more than they are. The skin is then cut away from the skull, being very careful in separating it from the jaws and teeth. After the skin has been removed, the ears, Fig. 1 A, will have to be skinned out and the nostrils and lips split open. Do this now, or the salt will not act upon this part of the skin. In Fig. 1, details B show how the ears are skinned up the back to the tip to remove the cartilage. The latter is kept

and used later as a model for the artificial ears. Salt each ear thoroughly and turn it right side out. To produce a first-class job on any game head, the skin, or scalp, will have to be tanned. One can ship the scalp to a professional tanner, or can do the job himself by following directions given in the article on tanning in a previous issue. Fig. 2 shows the hair and flesh sides of a scalp after being removed from the skull and made ready for salting. Use common salt and see that all parts are well covered.

Cut away all muscles, eyes, tongue, brain, etc., from the skull, leaving only the antlers attached. Now place the entire skull in a tub of boiling water which will loosen the remaining flesh, allowing it to be removed very easily, Fig. 3. With a small piece of wire, fasten the jaws together, after all flesh has been cleaned from the skull.

Cut out a base roughly to the shape and size of neck from a 1-in. piece of wood and fasten the skull to this with two iron rods, as shown in Fig. 4. Allow the rods to hold the skull in the position wanted in the finished head. The head and neck can be straight or turned as desired. Cut and bend the rods to the same length as the neck skin. Now, with coarse excelsior, you build up a form on the rods and skull to model over. This is done by wrapping the excelsior around the neck

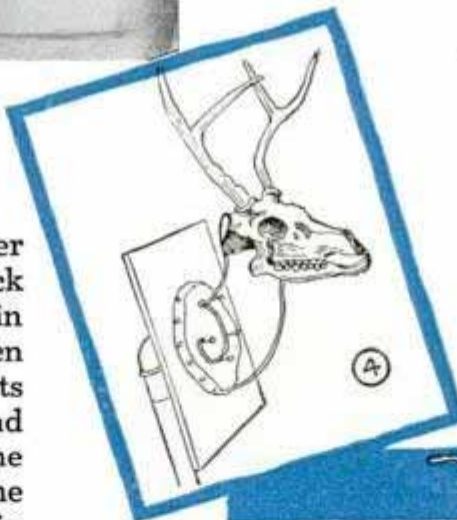

Neck is wrapped with excelsior to give the rough shape

and binding with heavy twine, as in Fig. 5. Keep this form smaller in size than the original head. Using fine-grade papier-mache, model over the rough form all of the muscles and other anatomy of the head you are mounting, Fig. 8. Build this up, layer by layer, to the correct size and shape. It may be necessary for you to study photographs, drawings and zoo animals to get this correct anatomy. Allow the mache to set and dry thoroughly, then shellac. This done, the modeled form is now ready for the tanned skin. Cut a pair of artificial ears from a piece of perforated lead, using the ear cartilage for measurements. The artificial ears can be fastened to the form, or inserted in the ear pockets of the scalp, using thin papier-mache to cement the skin to the ears. The scalp, after it has been tanned, is relaxed with warm, soapy water, to which carbolic acid has been added to the amount of $\frac{1}{2}$ teaspoonful to the gallon, Fig. 7. Brush well over the scalp and roll up, flesh



Finally, the scalp is drawn in place and sewed down the back of the neck

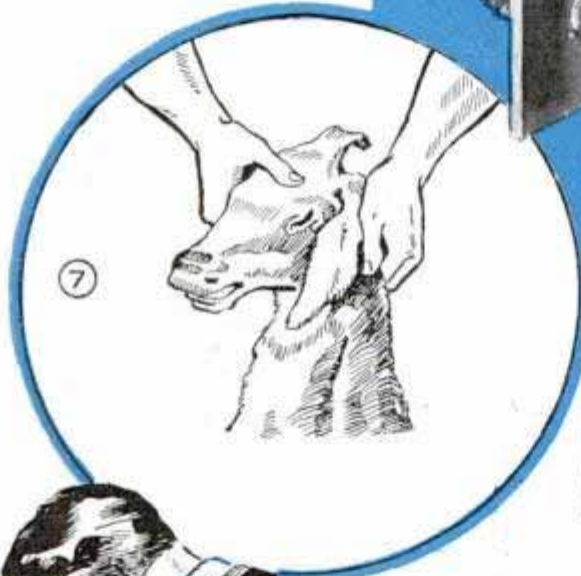

Modeling with papier-mache brings the head back to life-like form

side in, until pliable. It is now treated with a paste made by mixing arsenic powder (poison) with alcohol to a thin consistency. This prevents damage by moths and other insects.

The next step is to cover the model form with a thin coating of papier-mache ready to pull the skin over. The mache allows the skin to be adjusted into place and also holds it when set. Thicker papier-mache is used to model out around the lips and nostrils and at the base of the ears, forming the ear pockets. Glass eyes, of the proper color and size, are set into the eye sockets and held in place with the mache. Adjust the ears to the angle wanted and hold in position with heavy wires. Now start at the base of the neck and sew the skin together, as in Fig. 6.

Allow the skin to dry thoroughly, after which the hair is well combed and brushed, Fig. 9. The skin around the eyes, lips and nostrils can be painted with oil colors of the proper shade, and the antlers are cleaned and

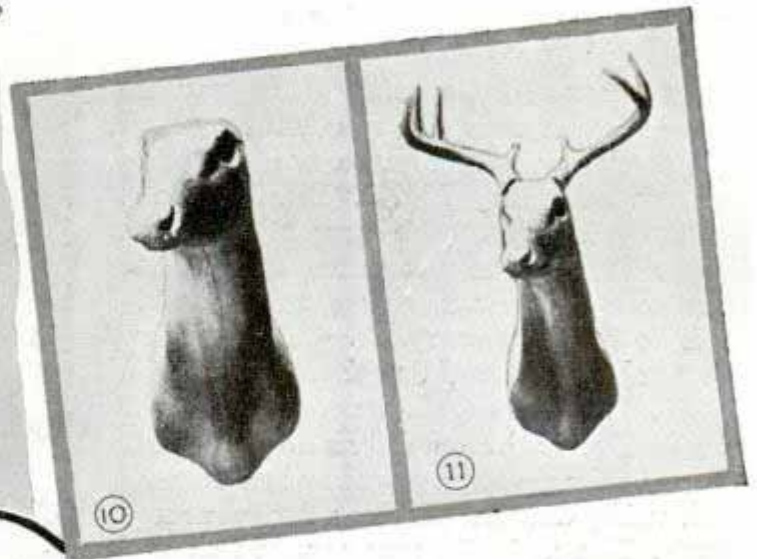

Ladder Rungs of Rods and Pipes Defy Weather and Hard Use

Make your ladder rungs of rods and pipes and severe climatic changes or hard usage will not affect them. Each rung consists of an iron rod threaded at both ends, or a long bolt slipped through a length of pipe. Large washers are placed under the nuts

oiled, using any light oil, rubbed on with a cloth and the surplus wiped off. Photo above Fig. 1 shows the completed head.

Now, if you wish to speed up the work of mounting your game head, there is another very satisfactory method. From any reliable taxidermy supply house, purchase what is known to the trade as a "head form" for the particular head you desire to mount. This head form is shown in Fig. 10. Be sure and send the correct measurements so the proper size form can be sent you. After the scalp is removed, saw off the antlers but leave them attached by a small section of the skull. They are now fastened to the head form, Fig. 11, with two screws driven into a small block of wood in the form. The latter is shellacked and the scalp, after being tanned and treated with the arsenic paste, is pulled over this form. Then the head, when thoroughly dry, is finished in the same manner as the one mounted by the first method.

☐ Your vacuum cleaner will be more efficient if the dust bag is emptied often. Never wash the bag as this will remove the filler that makes the fabric dustproof.

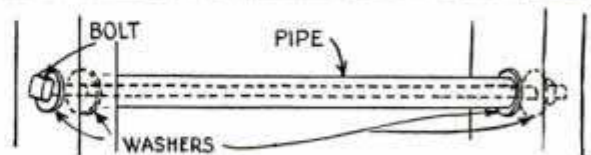
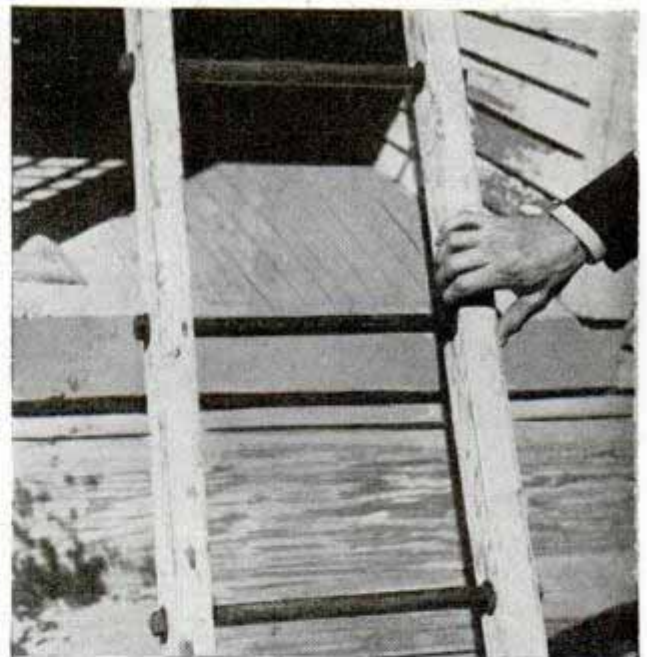

and at both ends of each length of pipe to protect the wood sides of the ladder. If the rungs loosen, just tighten the nuts on the ends of the rods, which will pull up the rungs against the sides.

Box Underneath Bridge Table Stores Cards



Cards, pencils, score pads, and ash trays are always at hand if you store them in a shallow box fastened to the underside of your card table as shown in the left-hand photo. It takes only a second to remove or replace the box as it is held between cleats by two short leather straps and a buckle, the ends of the straps being



fastened to the cleats with small nails. The box can be made easily from almost any kind of hardwood, and should be finished to match the finish of the table.

Simple Bracket Supports Paint Bucket on a Picket Fence

The inconvenience of stooping to dip his brush in a bucket of paint while finishing

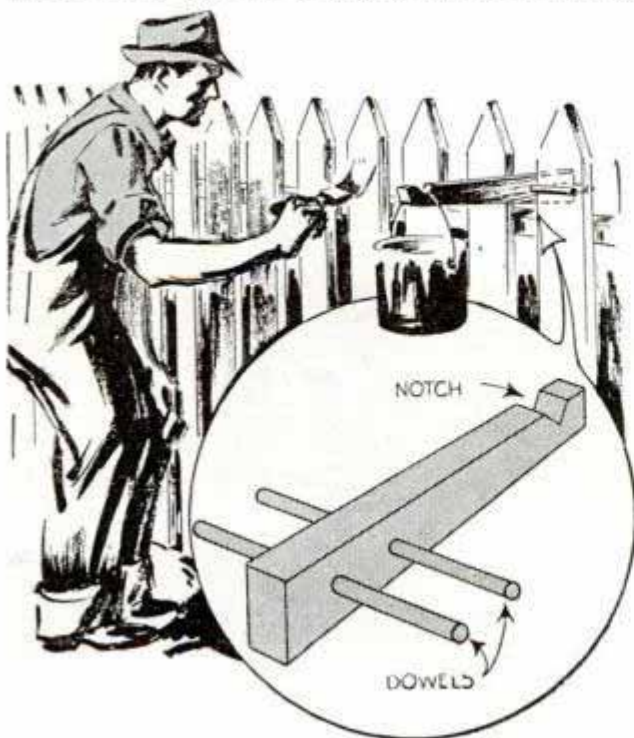

a picket fence was avoided by one man who made this removable bracket to support the bucket at a convenient height. The bracket consists of a length of wood with two dowels projecting from the sides at one end, the dowels being spaced to straddle two of the pickets as indicated. A notch near the free end of the bracket takes the bucket handle.

Wood Shield on Scriber Point

To protect the fine point of a scriber from becoming broken or dulled when not in use, make a small cap from a piece of soft wood. Drill a small hole part way through the cap from the small end so that it is a snug fit on the scriber.—Horace Taylor, Anderson, Ind.

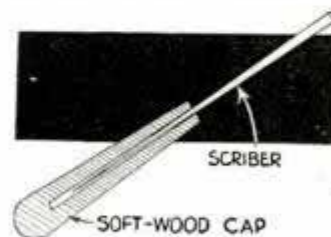

Office Stapler Fastens Paper on Sanding Drum

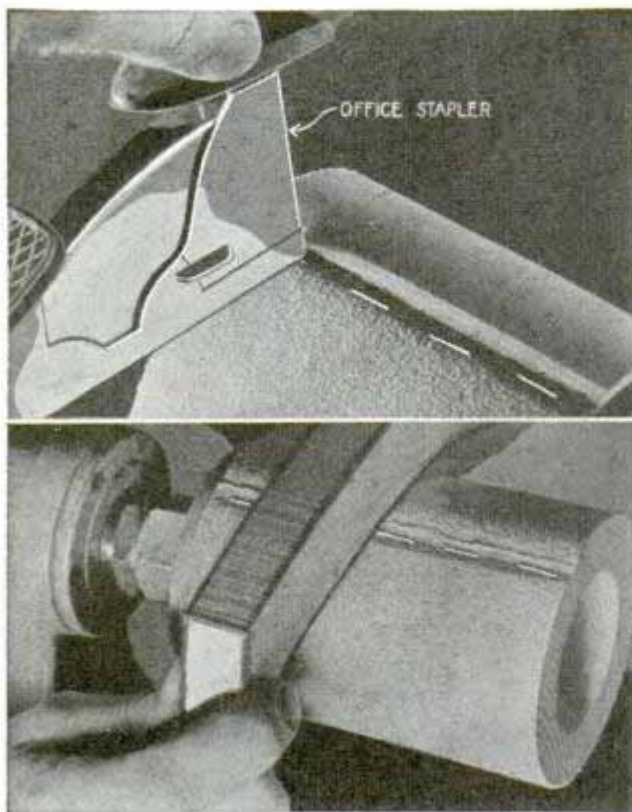

Here is an easy method of fastening sandpaper on softwood sanding drums. A V-groove is cut along the length of the drum and one end of the paper is fastened into this with a stapler of the type used in offices. Then the paper is wrapped around the drum and the other end is fastened. The paper should be wrapped in the direction opposite to that the drum rotates.

—Howard R. Heydorf, Missoula, Mont.

Park Incinerator Resembles Stump



Getting away from the usual square metal or concrete incinerators, the park officials of one city made a number of concrete incinerators that resemble hollow tree

stumps. To make the incinerator, an oil drum was first placed in the designated spot and loosely wrapped with fine poultry wire. Then several straight sticks were inserted between the netting and the drum and concrete mixed rather dry was packed

between the drum and sticks. After the concrete had set, the sticks were removed and the drum lifted out. Then the inside of the wire was plastered with cement and a hole was made on one side at the ground line for draft. The sticks formed deep grooves in the outside of the incinerator to resemble bark.

Spring Clamp on Bench Top Grips Thin Work

I find this rugged spring clip handy for holding thin work while gluing or assembling it. The clamp consists of a piece of spring steel bent to the shape shown and screwed to the bench top. A handle for opening the clamp is attached with small bolts as

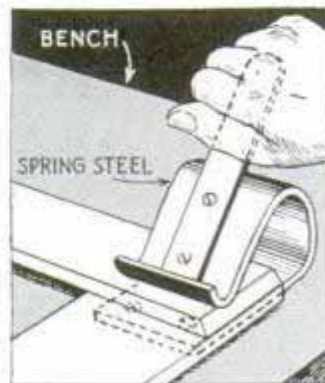

indicated.—C. H. Willey, Penacook, N. H.

Stiff Swing Seat for Children

For little tots who find it difficult to balance themselves on a rope swing, two pieces of wood shaped and screwed to the seat bottom as shown will keep the latter from tipping. The top ends of the wood pieces are attached by driving large-headed nails through the rope, as indicated.

—August Blume, Huntingburg, Ind.



Step-Top Sewing Box Has Drawer for Thread

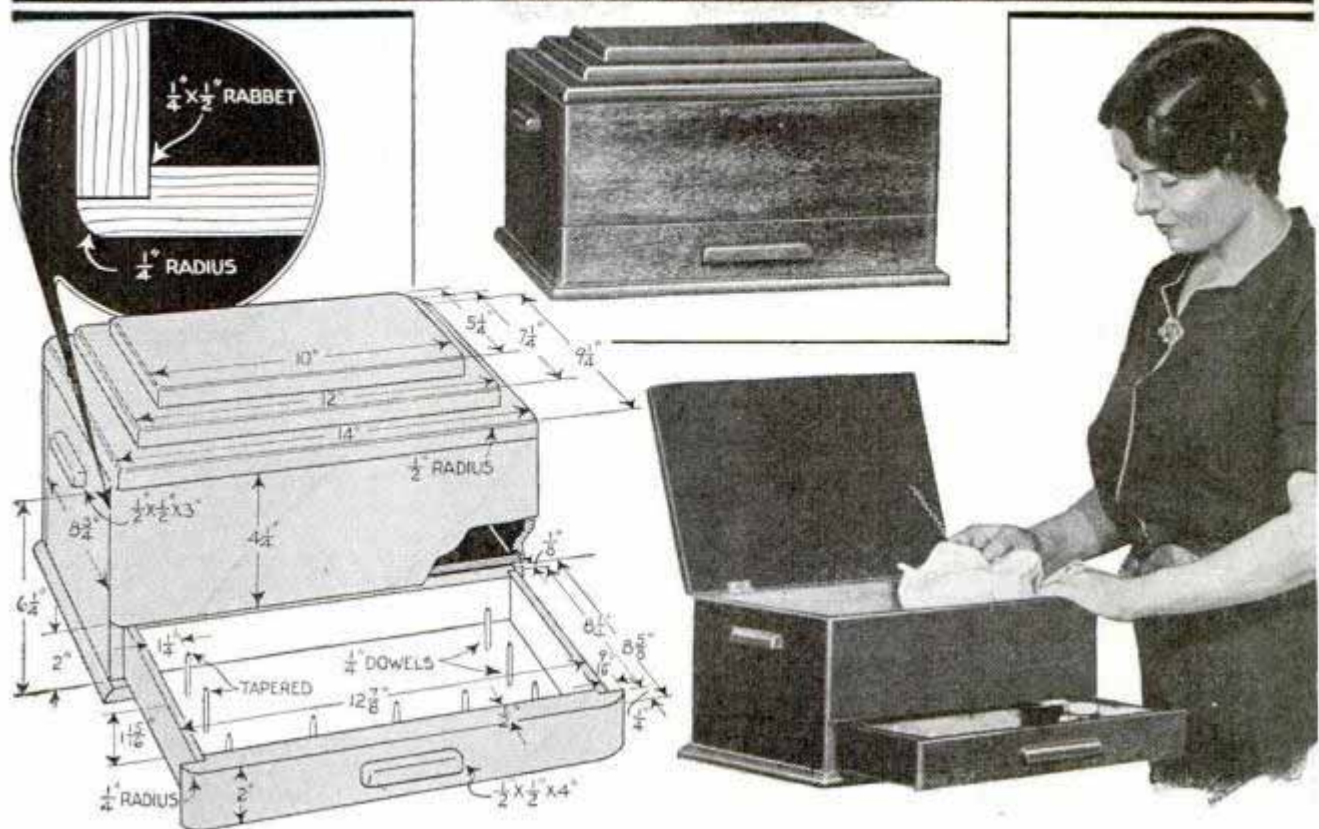

This sewing box is equipped with a compartment for holding fancy work or small pieces, and a shallow drawer in which spools of thread may be kept in orderly array on pegs. Mahogany is the best material for its construction, although any figured hardwood is suitable. The ends of the box fit into rabbeted sides and are grooved to take a shelf. After the edges of

the bottom have been rounded, the latter is fitted and nailed on. The lid and two step boards are rounded on the upper edges and the assembly is fastened to the box with small butt hinges. The drawer fits the opening with a clearance of about $\frac{1}{16}$ in. at the ends and top. Projecting ends of the drawer front form lips, which act as stops and give a neat appearance.

Hinged Wooden Feet Support Stepladder on Soft Ground

To prevent a stepladder from sinking into soft ground, fit the legs with folding feet of the type shown. These are made of

$\frac{3}{4}$ -in. wood of the same width as the legs. The feet are about 7 in. long and are fastened to the legs with strong hinges, the centers of the feet being recessed to take the hinges, which are fastened along the bottom of the legs. When not in use, the feet are folded back against the legs where they are fastened with $\frac{1}{4}$ -in. carriage bolts and wing nuts. The lower ends of the legs are then cut at an angle to set squarely on the floor. When folded down, the feet provide a firm base for the ladder on almost any surface.

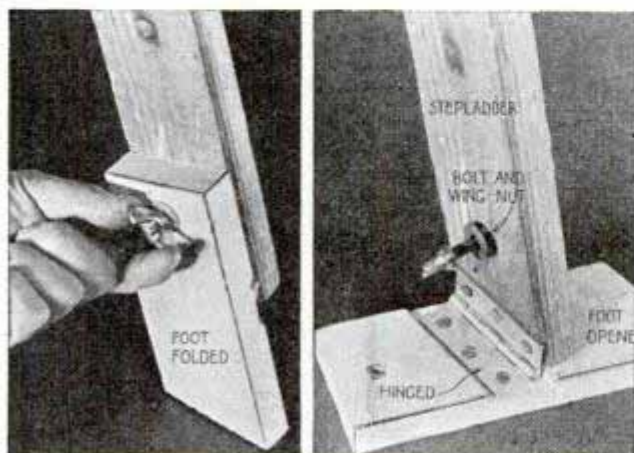

☞ To make your French-fried potatoes crisp let the raw potatoes stand in cold water for at least half an hour before frying.

Solving HOME



One housewife keeps a pad for lifting hot pans in a pocket which is sewed to her apron at the lower corner as above. An oil can cut as indicated below and hinged to a window sill serves as an outdoor cupboard for milk. It can be taken in through the raised sash



PAD IN POCKET SEWED TO BACK OF APRON

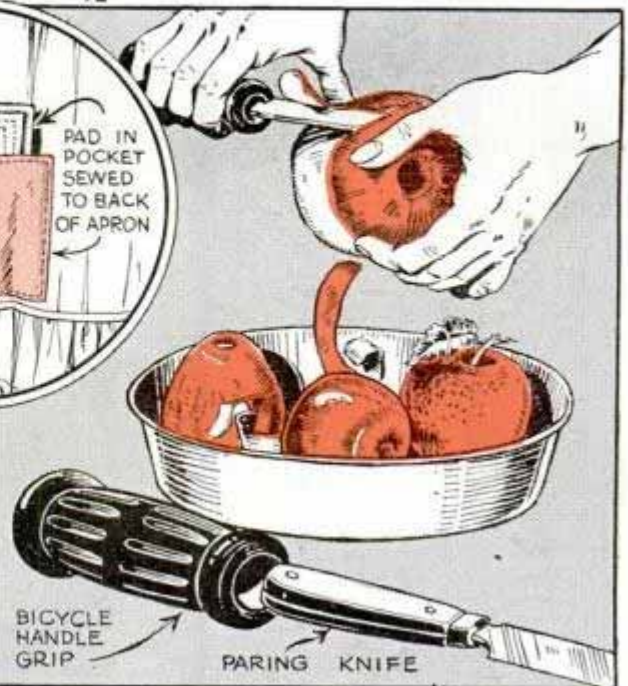

BICYCLE HANDLE GRIP

PARING KNIFE

When you have a lot of paring to do, slip a bicycle handlebar grip over the knife handle to reduce strain on the hand

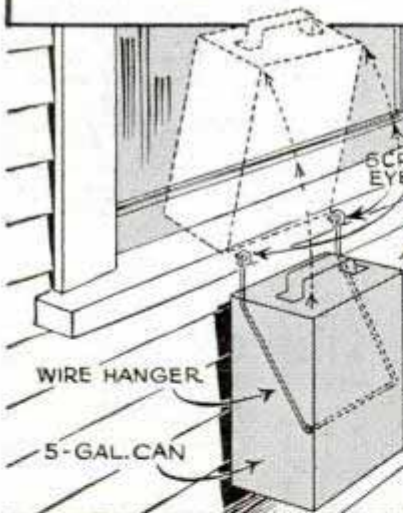

WIRE HANGER

5-GAL. CAN

SCREW EYES



TACK SOLDERED TO BOTTOM CENTER

CAKE TIN

A cake tin with a tack soldered to the bottom provides a "merry-go-round" holder for packages kept on a shelf. It can be turned to bring the desired article in front

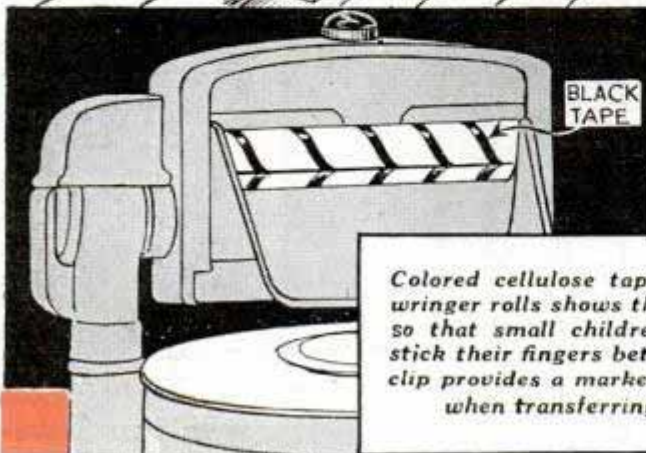

BLACK TAPE

Colored cellulose tape wound spirally on wringer rolls shows that they are rotating, so that small children are less likely to stick their fingers between them. A paper clip provides a marker for a tape measure when transferring measurements

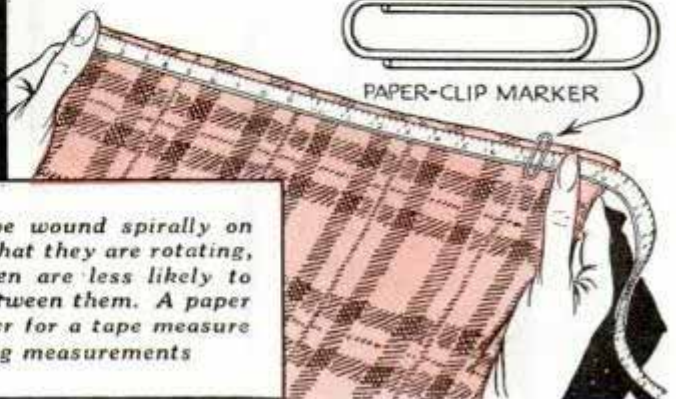

PAPER-CLIP MARKER

PROBLEMS



Leaky pipe unions of the type shown above can be repaired with a gasket cut from chamois skin. Make the gasket hole undersize as it will stretch. If you suspect the presence of rats or mice in your basement, a couple of handfuls of flour sprinkled on the floor in one corner as below, will show their tracks

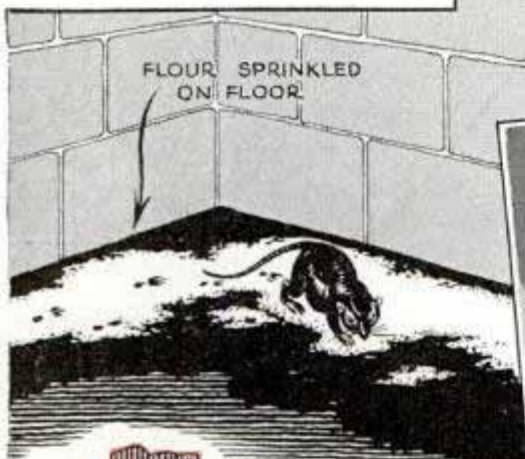

Instead of greasing the pin of a squeaky butt hinge, which may smear, dip a pipe cleaner in oil and with the pin out, swab the inside of the opening



A metal canopy from a ceiling light fixture provides a safe, decorative wall container for matches

Slip a hydrometer bulb over a smooth doorknob and you can turn it easily with wet hands

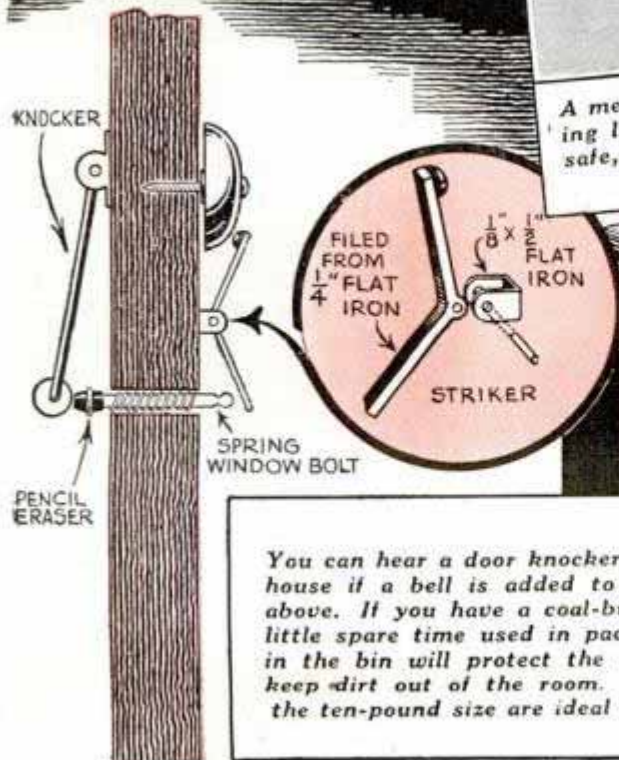

You can hear a door knocker throughout the house if a bell is added to it as indicated above. If you have a coal-burning heater, a little spare time used in packaging the fuel in the bin will protect the hands and help keep dirt out of the room. Paper sacks of the ten-pound size are ideal for the purpose



Short Pieces of Hose Provide Feet for Large Boxes



Fragile goods packed in large boxes can be protected against breakage from jars

and bumps by fitting the boxes with shock-absorbing feet. These are short pieces of garden hose cut on one side as indicated, and nailed to each corner of the box.

Thumbtack Puller on Pencil Made from Cartridge

A thumbtack puller that is always at hand on the end of a lead pencil is made easily from a 32-cal. cartridge that has been fired. The cartridge is slotted at the open end and pressed together slightly so that it will grip the pencil firmly. Then it is notched along the rim at the lower end with a three-cornered file so that it can be pushed under a tack head easily. Tipping the pencil to one side pries out the tack.

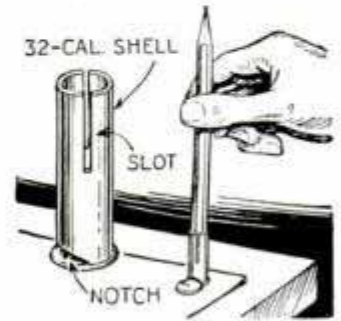

When tinting cloth be sure to hang it in the shade to dry. The basement will do if a shady spot is not available outside.

SAVE and MAKE MONEY by Knowing

how to solve everyday home problems

NEW REFERENCE GUIDE

for every practical home owner who wants simplified, usable information on making home repairs and improvements. Also shows many ways of reducing costs and eliminating waste. Contains complete details on refinishing floors and furniture; hanging wall paper; cutting heating losses; curing leaky faucets and making other minor plumbing repairs; protecting clothes, rugs and fabrics against moth damage; curing wet and leaky basements—all this besides numerous shortcuts and simple kinks of great value to make things handier around the average home

Write for "Home Kinks"—a copy will be sent to you upon receipt of 15 cents

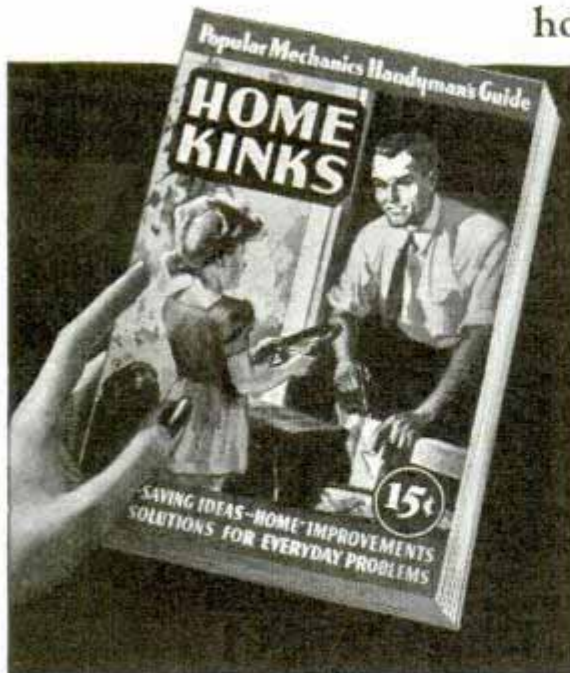

Popular Mechanics Magazine, Book Dept., 200 East Ontario Street, Chicago, Ill.



Radio

POCKET-TYPE *Vacuum-Tube Hearing Aid*

TINY radio tubes, little larger than a pencil in diameter and slightly more than 1 inch long, have recently enabled engineers to design a 4-stage vacuum-tube hearing aid, complete with crystal microphone, in a wearable container no bigger than a spectacle case.

Ordinary radio tubes have been used in table and group-type hearing-aid amplifiers with excellent results; now you can wear one that has sensitivity ample for operation under clothing, and only the ear piece is exposed to view.

The total electrical energy required is but a fraction of that necessary to operate the usual flashlight. The filaments of all four of these "Aurex-Ewing" type tubes together have a drain of just one-half that of a single type-199 "peanut tube" and, in spite of their tiny size, are claimed to have a useful life of more than 5,000 hours. A midget 45-volt B-battery is used. This has a compartment for the A-battery and is of handy pocket dimensions and weight.

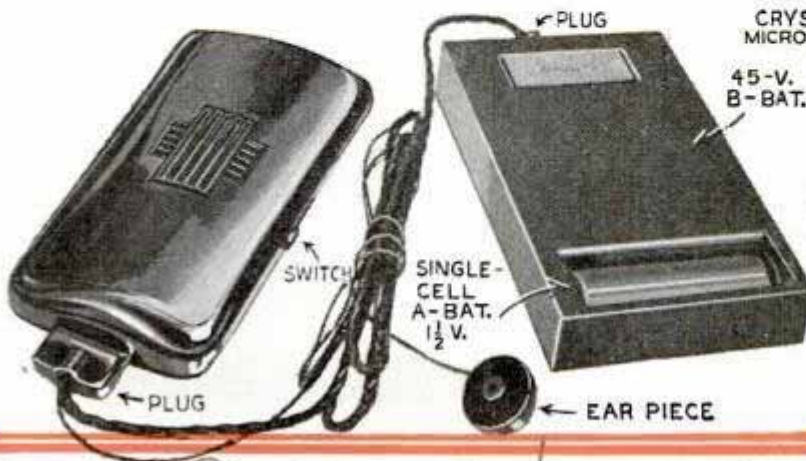
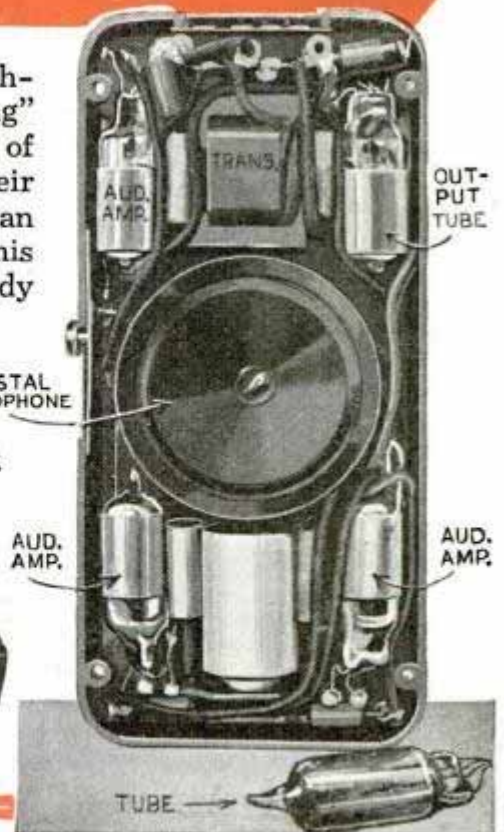
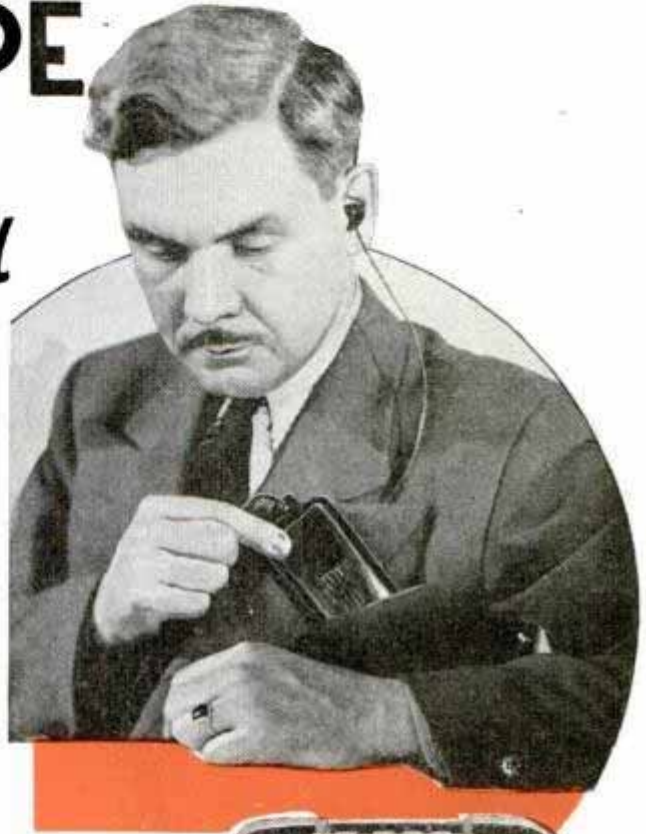

Aurex Corp., 1115

Dr. Franklyn Chicago 775

How to build a PORTABLE

By Fred Dingman

PART I

HERE is a "portable radio orchestra" that will bring you the world's finest dance music, when and where you want it. A complete 3-unit sound system suitable for fraternity and sorority parties, dancing clubs or lawn gatherings, it may also be used for public address and advertising. Operating two 12-in. permanent-magnet speakers with adequate volume for small halls or outdoor use, this general-purpose amplifier has an excellent undistorted output of about 10 watts.

Designed primarily as an inexpensive substitute for small dance orchestras at informal parties in a middle west university town, the builder supplies records and operator, and has had no difficulty in obtaining engagements

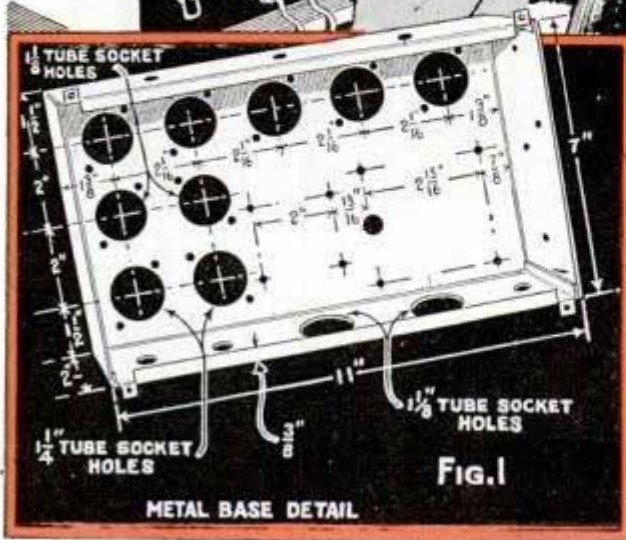

An Electrical Substitute for a Large Baffle



MOST radio experimenters and music lovers know that the frequency response at the lower end of the audio spectrum falls off even in the finest radio receivers. In other words, many of the low notes are missing. The actual bass response needed can be restored by using a very large speaker baffle, or a specially constructed speaker cabinet. The use of an ordinary tone control merely cuts off the high-frequency response and makes the base appear stronger, but this actually results in some distortion.

Many attempts have been made to correct this shortcoming electrically and a practical solution to the problem is offered by the M. R. Jones compensation circuit, simplified construction details of which are given in this article.

In order to bring out the low frequencies from 40 to 150 cycles, this circuit uses only two tubes and accomplishes a result electrically which is physically impossible except by means of a baffle at least 50 ft. square. This "imaginary infinite baffle" unit uses only a fraction of the incoming audio signal and this is fed to the type-6J7-GT tube in a special high-

(Continued to page 138A)

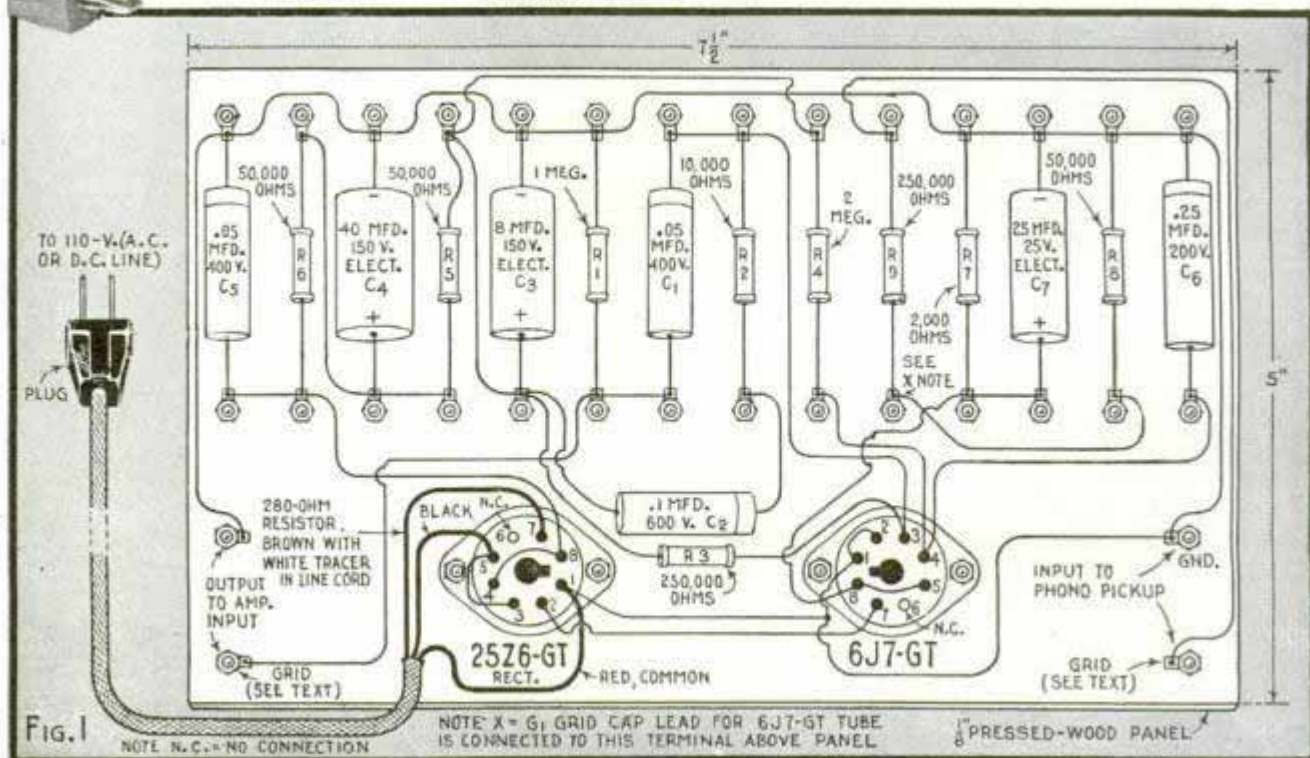
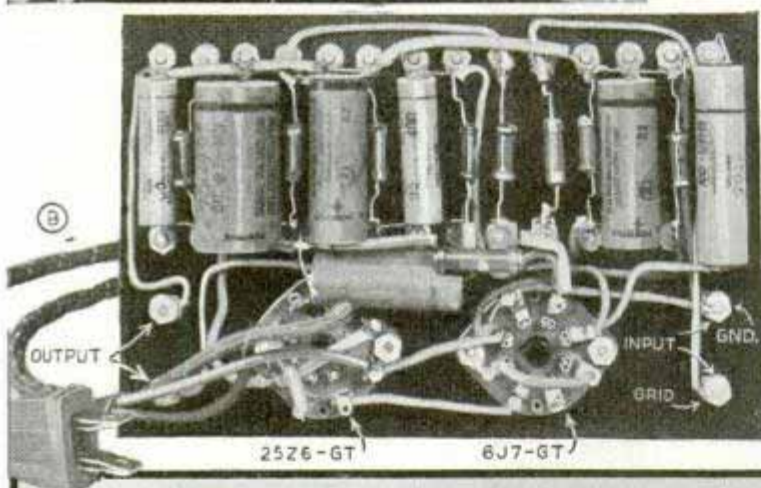
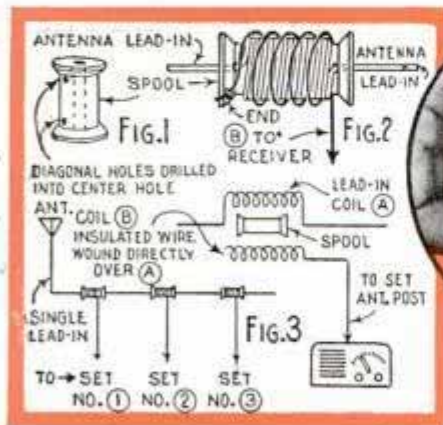

Fig. 1

NOTE: X = G₁ GRID CAP LEAD FOR 6J7-GT TUBE IS CONNECTED TO THIS TERMINAL ABOVE PANEL
NOTE: N.C. = NO CONNECTION

1/8" PRESSED-WOOD PANEL

Practical RADIO SUGGESTIONS



Winding details for homemade antenna set couplers

Right, receivers located in various rooms all operating on one efficient antenna; long, flexible insulated lead-in runs from room to room



Fig. 4 shows a handy aid for radio workers; this easily made gadget is a time and patience saver when trying to insert a machine screw through a nut behind some closely packed part of a radio chassis. Spring holds nut in position when plunger is released; tool also can be used when removing parts for repairs. Another useful tool for working on meters and other delicate apparatus may be made from a small pair of inexpensive tweezers as illustrated in Fig. 5. Fig. 6, auto set installation kink; gummed paper on underside edge of instrument board for pencil marks to locate bracket holes for drilling

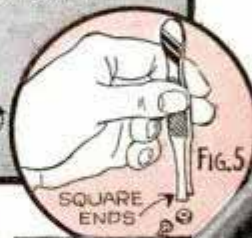
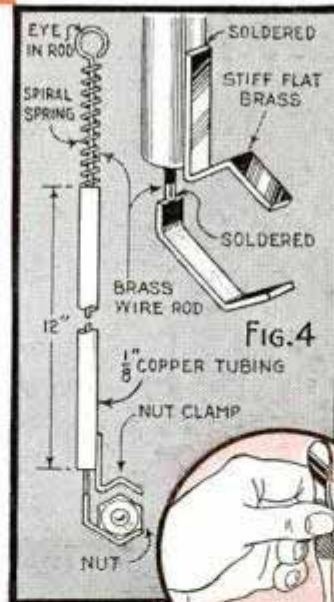

Figs. 1, 2 and 3 show the simple method by which a single antenna may be used to serve all of the receivers in your home; does away with makeshift antennas with no interference when sets are tuned to different stations. Coil (A) consists of 20 turns of the antenna lead-in wire on a large spool at each receiver. Coil (B) may be 20 or more turns with one end dead, for inductively coupling each set. A layer of friction tape is placed over the completed windings on the spools which may be mounted in or near each receiver. Below, soldering-iron stand with built-in cup for steel wool to clean tip

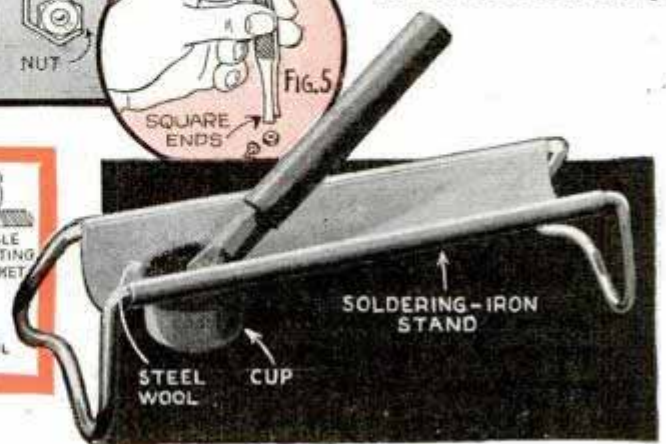
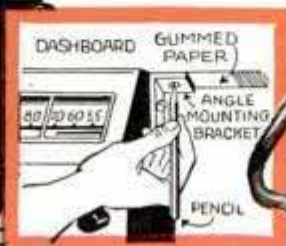

Portable Microphone Holder Leaves Both Hands Free



Gooseneck adjusts "mike" to any desired position

Designed to fit any modern microphone, this wearable holder brings the "mike" close to the mouth yet keeps it out of the line of vision; for window demonstrators or safe driving in mobile use.

High-Fidelity Set in Kit Form

Experienced builders can assemble this high-fidelity radio receiver so that the speaker, tuner and audio amplifier may be located at different points and remotely operated. Primarily intended for reproducing radio programs from local stations to the utmost of their frequency range.

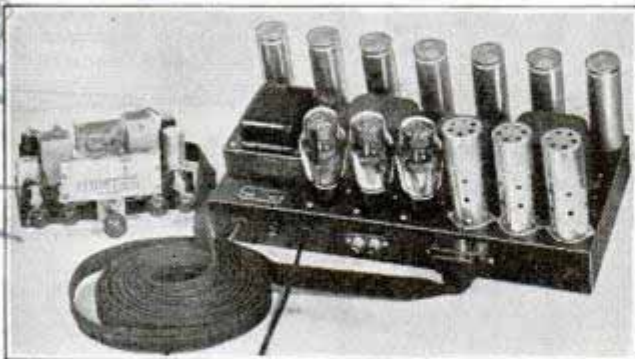

Four-Tube Frequency Standard

Four tubes serve as crystal oscillator, multivibrator, harmonic amplifier and power-supply rectifier in this low-cost frequency standard of interest to amateurs, servicemen and radio instructors.



Lens Enlarges Size of Image

This sight-and-sound set is equipped with a special lens which is built into the panel to magnify the television picture that



appears on the 5-in. "kinescope" tube. A shadow box housing the cathode-ray tube, obviates darkening the room and is claimed to add to the viewer's comfort.

Blueprints covering radio construction articles in this and past issues are available for 25 cents each. Original material lists, with names of manufacturers and dealers, can be obtained from our Radio Department upon receipt of postage.

NEXT MONTH—A Four-Tube "Progressive" Receiver for Students and Experimenters. Starting with a 4-tube t.r.f. set you learn radio work by actual "doing." A later article will show how to convert this same set to a 6-tube all-wave super, using every part originally purchased. Also—**Low-Cost Sound System, Part II**

Patent Engineering Corp. Machine Co. Wash. D.C. 1939

The Publicista Corp. 2611 S. ...
American Television Corp. 130 W. 56th St. New York



SHOP NOTES

Keen Edges on JOINTER KNIVES

FROM dull knives that hammer and ripple to razor-sharp edges that leave a satin-smooth surface is easy with any of the simple setups shown. Wherever practical, best results are obtained if the knives are ground while mounted in the jointer cutterhead. This can be accomplished without even removing the head from the jointer, by the method shown in Fig. 1. The arrangement here calls for a flexible shaft carrying a small grinding wheel. The solid

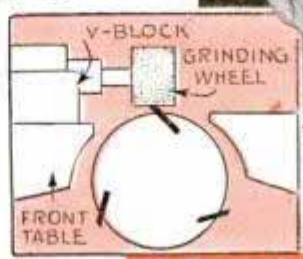
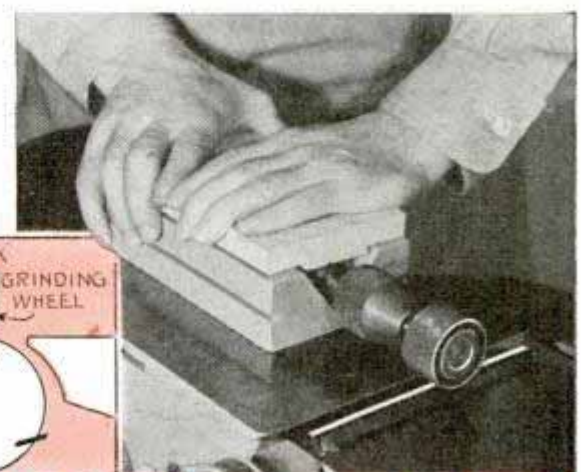

① Without removing the head

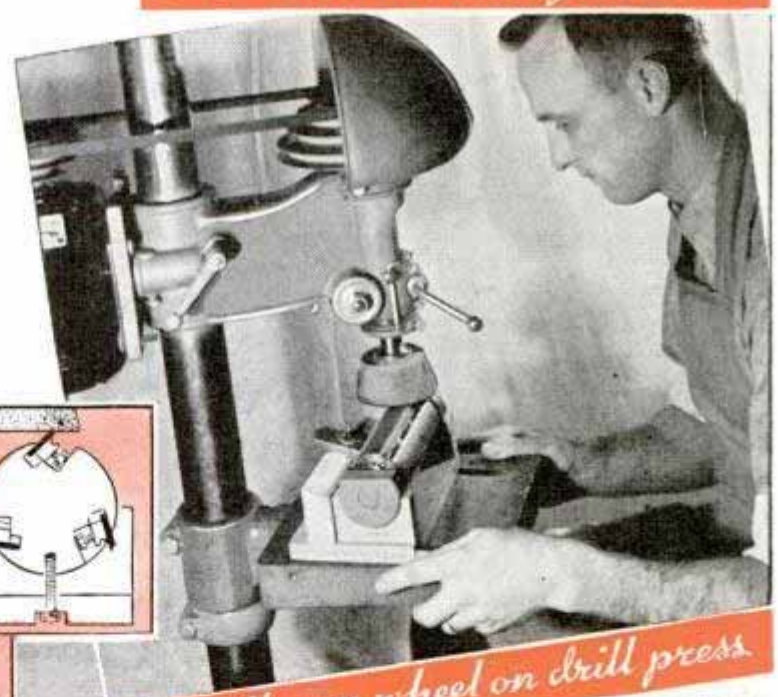

② With cup wheel on drill press

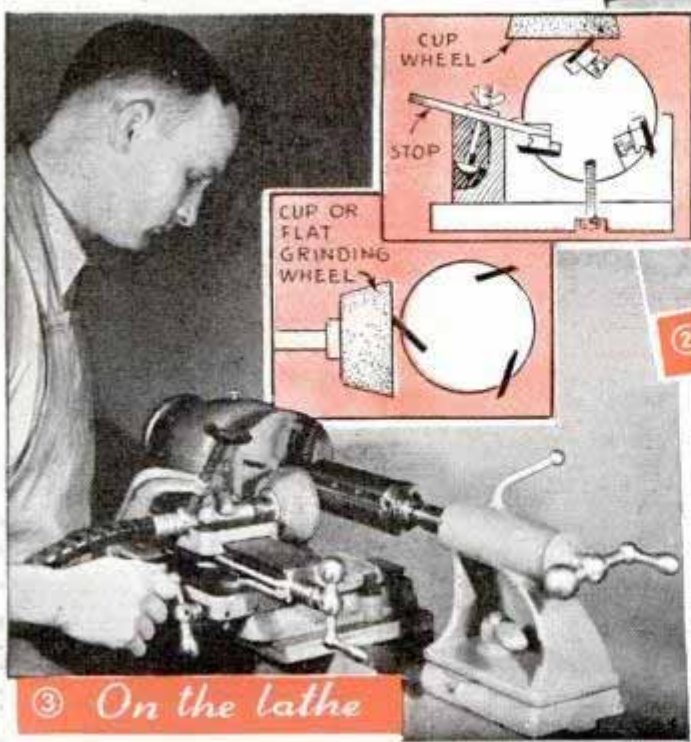

③ On the lathe

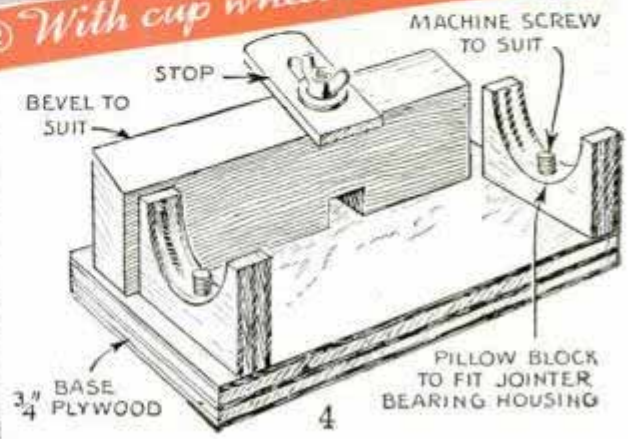

5 Knives ground singly on grinder

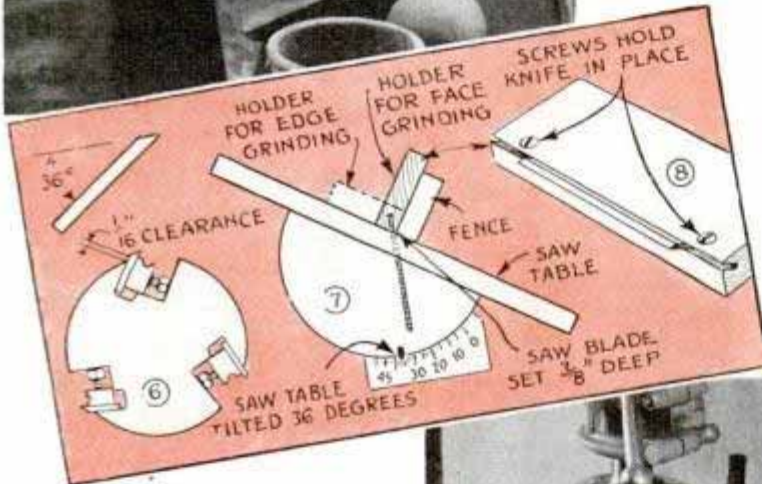

portion of the shaft is secured by means of a V-block. After adjusting the front table to the proper height, grinding is done by holding the V-block firmly against the table while moving the grinding wheel along the length of the knife. A clamp on the belt serves to hold the head immovable while each knife is ground in turn.

Fig. 2 shows grinding being done with a cup wheel on the drill press. A simple jig, the exact construction of which will vary for individual jointers, is made up, as shown in Fig. 4. A stop bar prevents the head from turning while grinding is being done, and also locates the knife to be ground at the proper position. If the drill

press is fitted with a column collar below the drill table, the jig can be clamped to the table and swung under the grinding wheel. Where a collar is not used, the jig would be pushed along the table.

A method whereby the knives are ground while mounted in the lathe is shown in Fig. 3. The slide rest provides a support for a flexible shaft and also permits feeding. The indexing head is used to bring each knife into place for grinding. Certain precautions must be taken in any method. First of all, high-speed steel knives should be ground dry, but slowly and with a very light cut. If you will jam the wheel (not running) lightly against the knife edge, you will set the cut quite nicely. Treat each knife exactly the same. Check all adjustments before you start to grind. Protect the jointer bearings by wrapping string or a rag around the shaft. Even though the bearings may be fitted with grease seals, these are not sufficient to prevent the entry of the fine grinding dust.

Some workers prefer to grind the knives singly. This can be done by using a wooden holder, made by running a saw cut along the edge or face of a block of wood

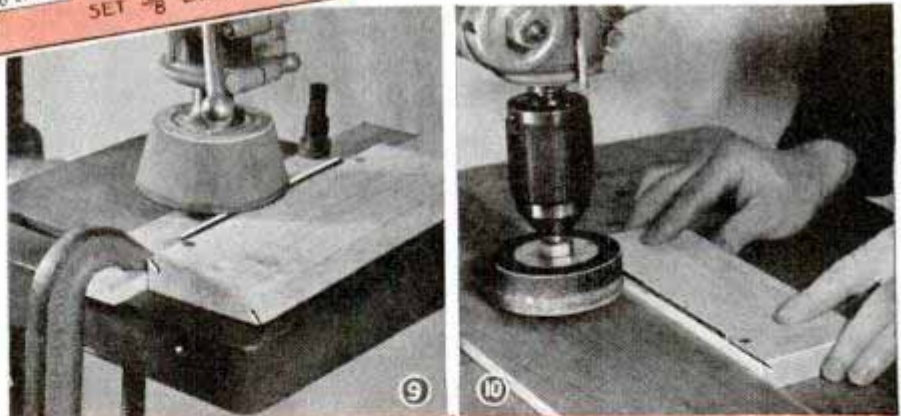

Face and edge-grinding single blades

and providing two screws to hold the knife, Fig. 8. If grinding is done on the grinder, the holder is straight, as can be seen in the inset, Fig. 5; if done in any other manner, the holder has an angle cut. This angle cut is made by tilting the saw table 36 degrees, as shown in Fig. 7, this being the same angle as the included point angle of the average knife, Fig. 6. A face-grinding operation on the drill press is shown in

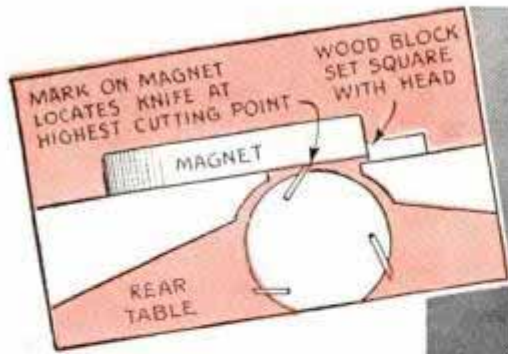

Fig. 9. Fig. 10 shows edge grinding. Both employ a straightedge clamped to the drill table, one to guide the work, the other to set the cut.

Whether knives are ground in the head or singly, it becomes necessary at times to reset the knives in order to maintain approximately $\frac{1}{16}$ in. back clearance, Fig. 6. Knife setting is ordinarily done with a straightedge, lining each knife level with the rear table of the jointer. A better method makes use of a magnet, as shown in Fig. 11, which not only supplies the straightedge but holds the knife in place while the screws in the locking bar are tightened. To use this method, clamp a block of wood across the front table to supply a stop for the end of the magnet. The block must be aligned exactly parallel with the slots in the joint-



⑩ Magnet holds knives level when resetting

er head. Now, place the magnet in position on the rear table, and locate on the magnet the exact spot where the knife is at its highest cutting point. Make an arrow at this point. Each knife is set to this mark, as shown in the photo. Finally, it must be remembered that grinding alone does not make a complete sharpening job. Go over each knife carefully with an oilstone in order to remove burrs and other slight imperfections that may have been caused by the grinding operation. Don't forget to draw up the nuts on the locking bars to an even tension.

Door-Knob Handles on Ends of Files Provide Good Grips

Ordinary door knobs provide good handles for files and help to eliminate accidental cuts and bruises when sharpening tools because the hand is above the work. In the upper detail, the file tang is bent upward, a slot being filed in the side of the tang to take the knob set screw. The lower left-hand detail shows a round file with a knob on the end opposite the tang. The set screw is turned into the file teeth where it will hold firmly. The right-hand detail shows the most convenient way of using a round file. The small end is heated and bent to the desired angle to take the knob.

—W. M. Mutschler, Lincoln, Nebr.

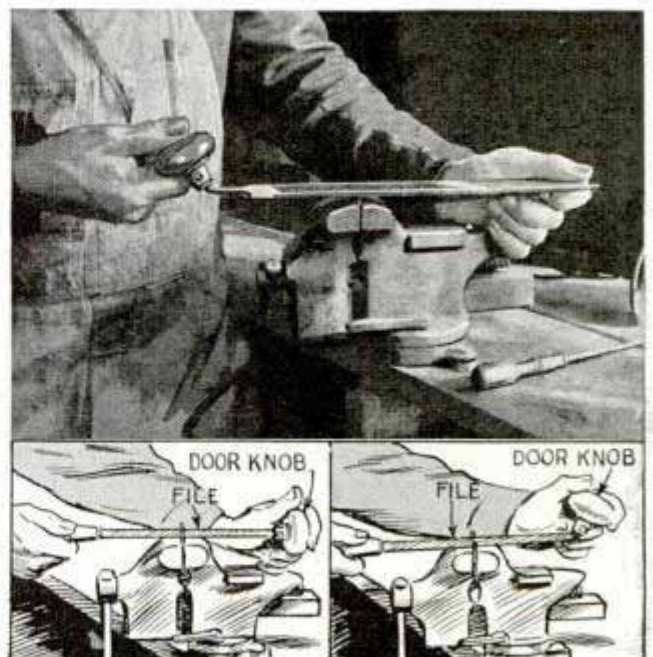

☞ A teaspoonful of vinegar added to the fat in which doughnuts are fried will prevent their absorbing too much grease.

Well in Lathe Bench Holds Oil to Lubricate Centers

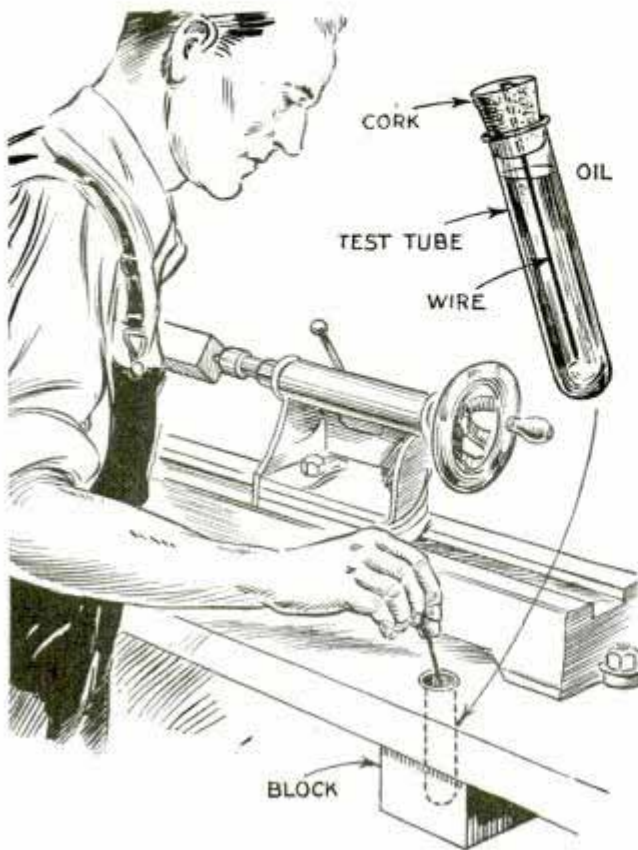

To have oil conveniently at hand for lubricating lathe centers, one machinist made a well in the bench near the lathe. The well consists of a hole drilled through the bench top and into a reinforcing block on the underside to take an ordinary test tube. This is fitted with a cork carrying a wire which projects into the oil and serves as applicator. If rough work around the bench is likely to break a glass test tube, use a short length of brass pipe with a cap screwed to each end.

V-Block from Halved Generator Withstands Hard Use

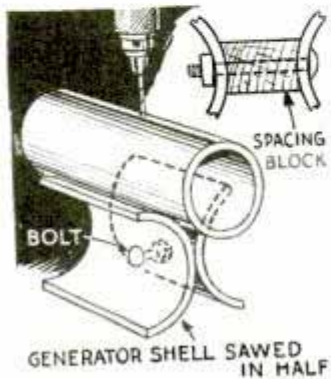

By sawing the shell of an old auto generator or starting motor in two and bolting the halves together as indicated, you have a useful and rugged V-block, which will serve efficiently for a wide range of

work diameters. Very large work may be held by removing the center bolt and interposing a wooden block between the halves. This spacing block must be shaped at the ends to fit the curvature of the shell. Turned on its side, the V-block is convenient for supporting a complete generator or motor for bench-repair operations or testing. By using two of the blocks, long work such as drive-shaft and rear-axle assemblies can be handled.

—W. C. Wilhite, Carlinville, Ill.

Price Tags on Spring Clips Grip Pottery

Attaching price tags to dishes, pottery and other hard, smooth surfaces is easy with paper clips of the type shown. The stem of the tag holder is soldered to the clip.

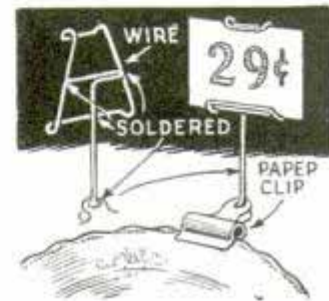

Super Locked on Beehive with Sash Fasteners

Instead of piling rocks and other weights on top of a beehive to keep the super from being knocked or blown off, use window-sash fasteners, which are neat and easy to use. One part of the fastener is screwed to the top edge of the hive and the other is fastened to the lower edge of the super.

—A. S. Wurz, Jr., Rockyford, Alta., Can.

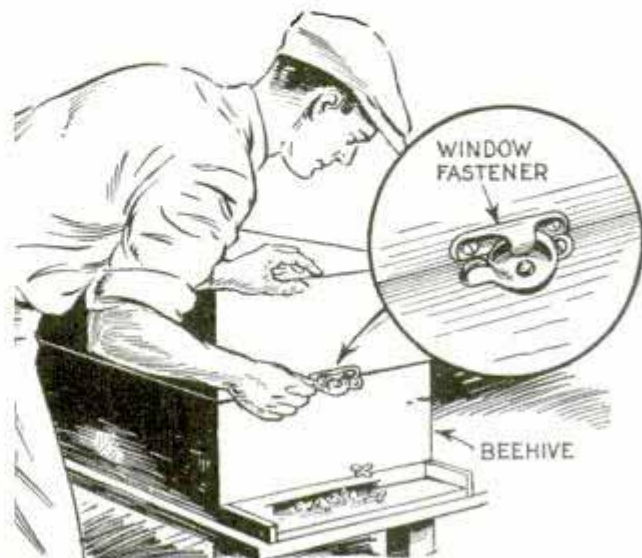

Diagonal Bracing Strengthens Roof Framing

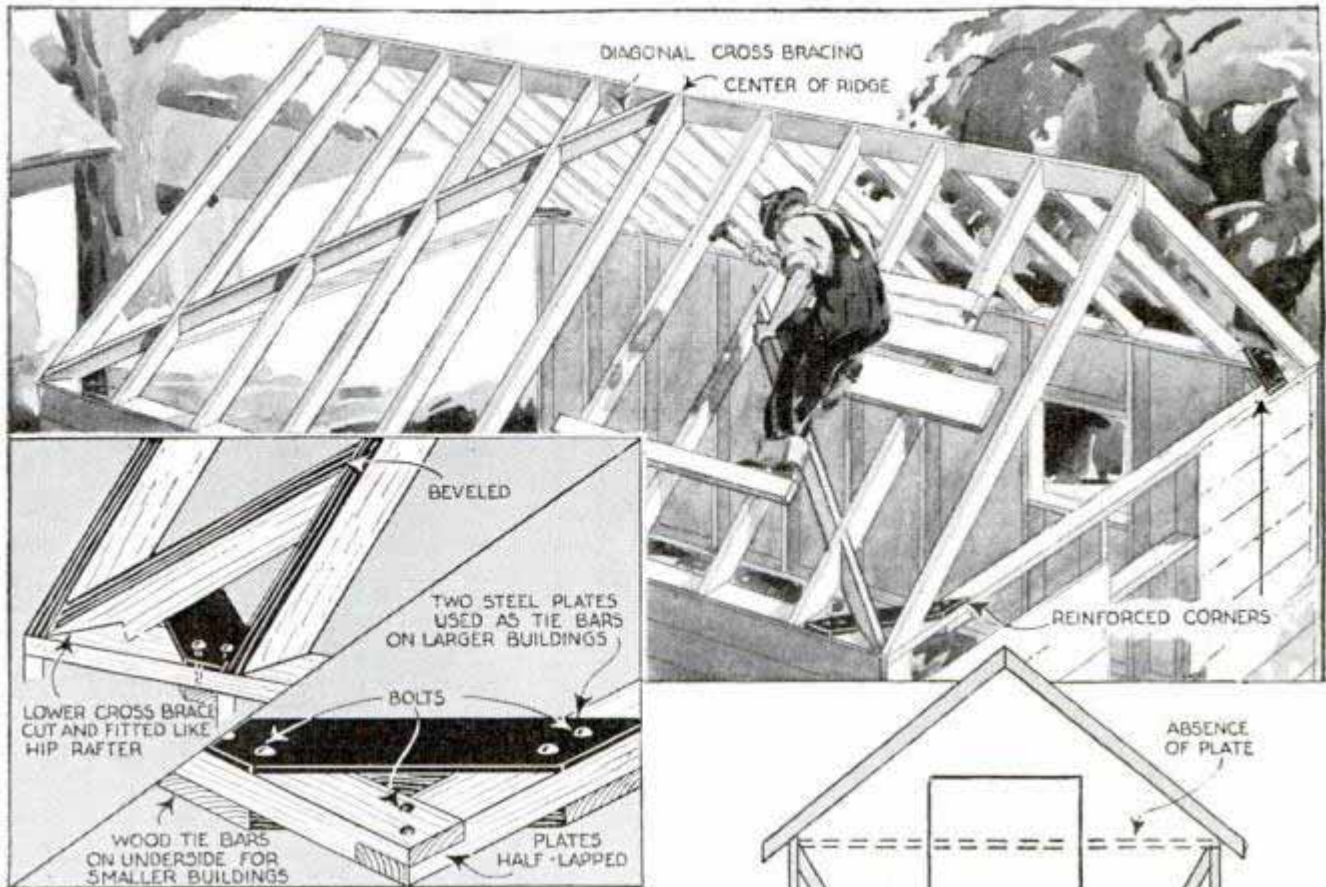

Where it is desired to prevent a roof ridge from settling at the center in cases where joists cannot be used to tie the lower ends of the rafters together on opposite sides of a building, diagonal rafter bracing has proved satisfactory, especially where the ridge must support considerable weight such as a small crane traveling the entire length of the building. With this method of bracing, stress is transmitted to the corners of the framing instead of being distributed along opposite sides. For this reason it is necessary to provide rigid corners, which is done by half-lapping the plates and fitting diagonal cross braces or tie bars as shown. For small buildings, one diagonal brace may be bolted to the underside of the plates, two bolts being used at each junction as well as through the half-lap at the corner. For larger buildings where stress is proportionately greater, two steel plates, one above and one below, are bolted in place. Size of such plates and the number of bolts are dependent on the rigidity and strength needed. On very small buildings where the top of the door is above the plate, diagonal braces may be installed as in the lower-right detail.

Pad to Wipe Soldering Iron Clamped on Blowtorch

To keep a cloth at hand for wiping the point of a soldering iron, one tinsmith fastens it on his blowtorch with a rubber band and two double wire hooks.

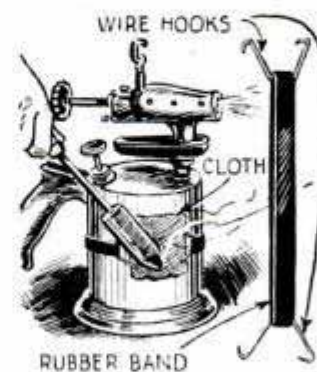

The pad is placed against the side of the torch and the rubber band is drawn around it so that the hooks engage the cloth to hold it in position for instant use.

Steel rods and tubing for metal-working projects can be obtained cheaply by dismantling old metal bedsteads obtained at a junk yard.

Halter Rope Fastened to Manger Without Tying

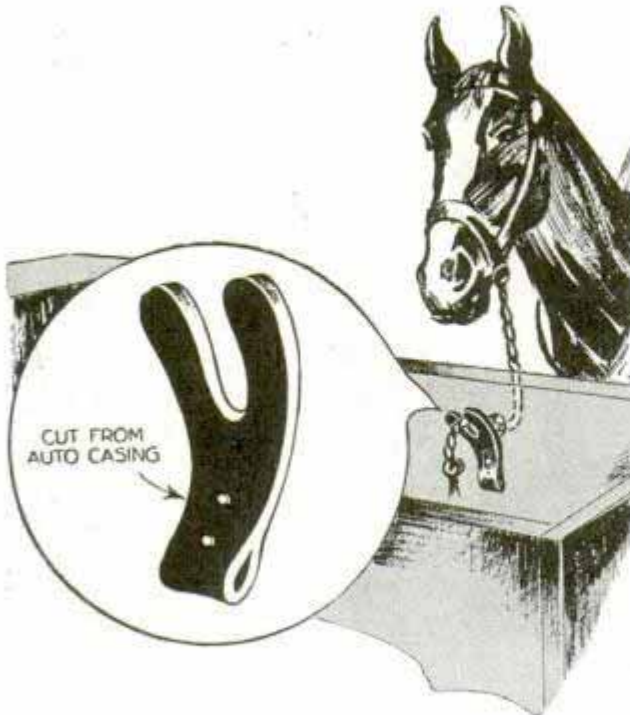

To fasten a halter rope to a manger without tying, a farmer used a crotched stop cut from an old auto casing. This is nailed to the inner side of the manger just below the rope hole. In use, the end of the rope is inserted through the hole and then dropped into the crotch of the stop. Any pull on the rope forces the stop against the manger and prevents the knotted end of the rope from slipping through the hole.

Sharpening Pointed Tools with Two Files

When filing a pointed tool such as an awl, centerpunch, etc., it is a good idea to set two files in a vise with their flat surfaces forming a right angle as shown. The tool is then sharpened in the angle thus formed. Using the files in this manner

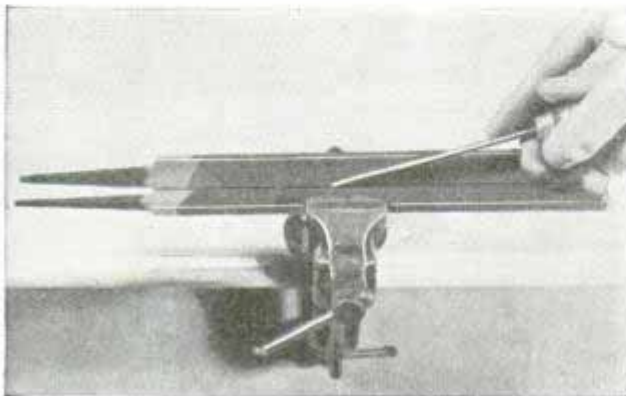

keeps the tool from slipping off the edge, and you have the advantage of two abrasive surfaces, which speed the work.

—Bertram Brownold, Woodmere, N. Y.

Converted Chimney Cap Provides Feeder for Poultry

Fitted to a length of large stovepipe and inverted as indicated, a sheet-metal chimney cap provides a good automatic feeder for poultry. The assembly can be hung from the ceiling in the brooder house or any other convenient place.

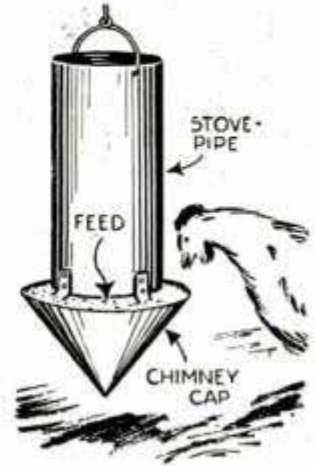

Rubber Strap Keeps Tool Kit on Stepladder

Instead of setting his tool kit on the ground each time the stepladder had to be moved, a sign writer fastened the kit to

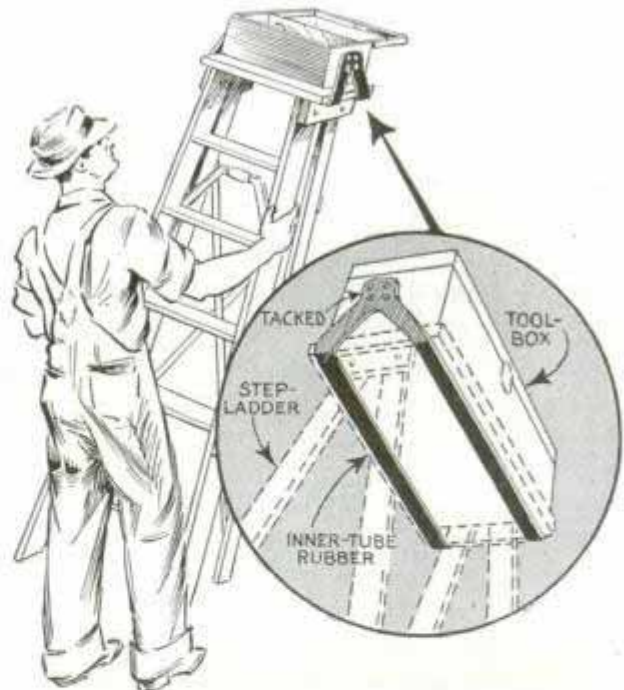

the top of the ladder with a removable rubber strap. This was cut to the shape shown and tacked to the ends of the kit. In use, the tool box is set in place and the straps pulled down underneath the ladder top to anchor it securely.

Tinplate Track Made in This "Rolling Mill"

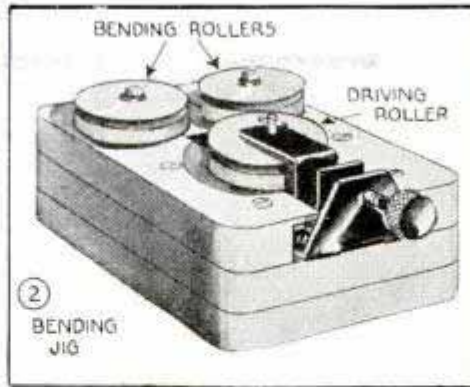
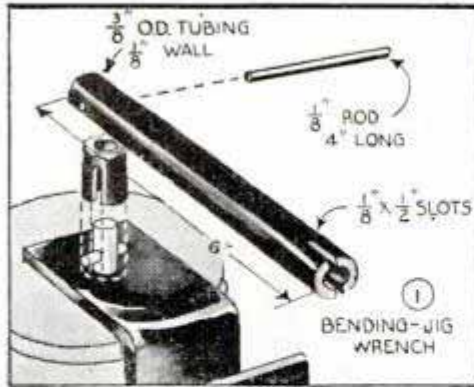

Consisting essentially of a forming jig and a bending jig worked in combination, this miniature rolling mill turns out both curved and straight tinplate track with precision and speed. Figs. 3 and 4 detail the forming jig and picture the steps in making a rail. Although hardwood will do for the two members of the jig, flat cold-rolled steel of the same dimensions is much better. Grooves for the rail tread can be cut with a milling machine. The bending jig, Figs. 1, 2, 7 and 8 gives a true radius bend to the rails which are to be assembled into curved track sections on ties made as in Fig. 6. Being adjustable, it will bend rails to practically any radius desired. Three thicknesses of hardwood form the base for the two stationary bending rollers, Fig. 7. The adjustable roller, Figs. 2 and 8, is mounted on a slide controlled by a thumbscrew. All rollers have the edges machined in profile to the sectional dimensions of the rail so the latter is not distorted when passed through them.

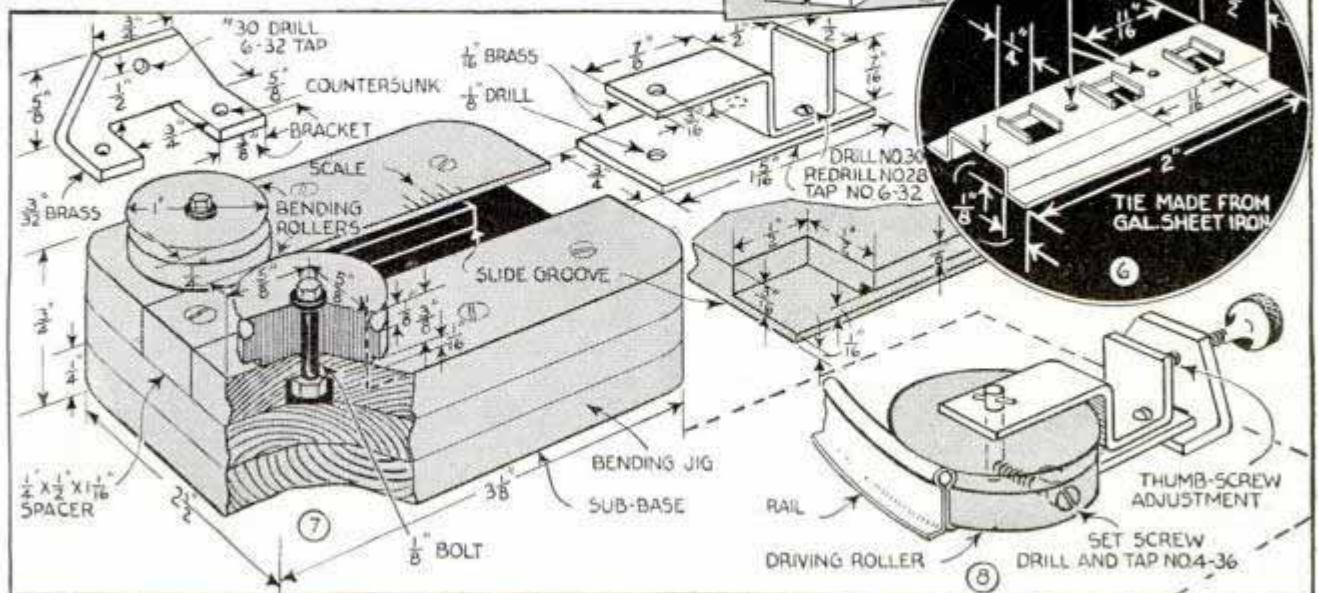
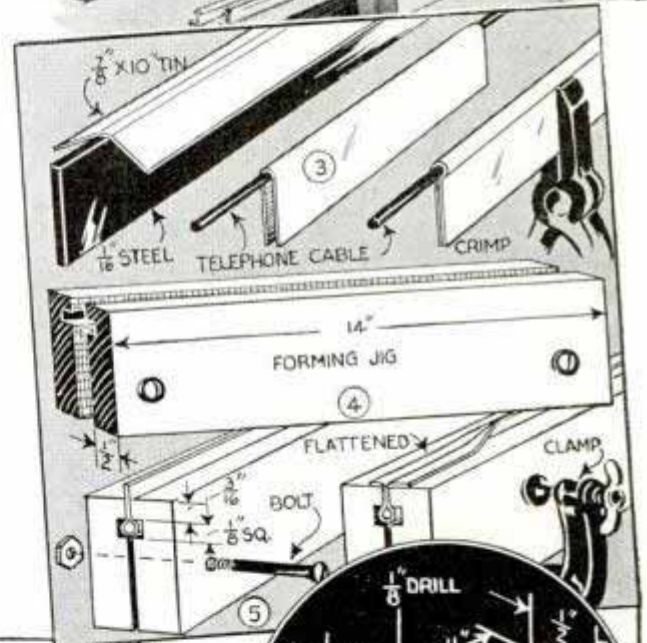

Swinging Arms on Sawhorse Top Support Wide Work

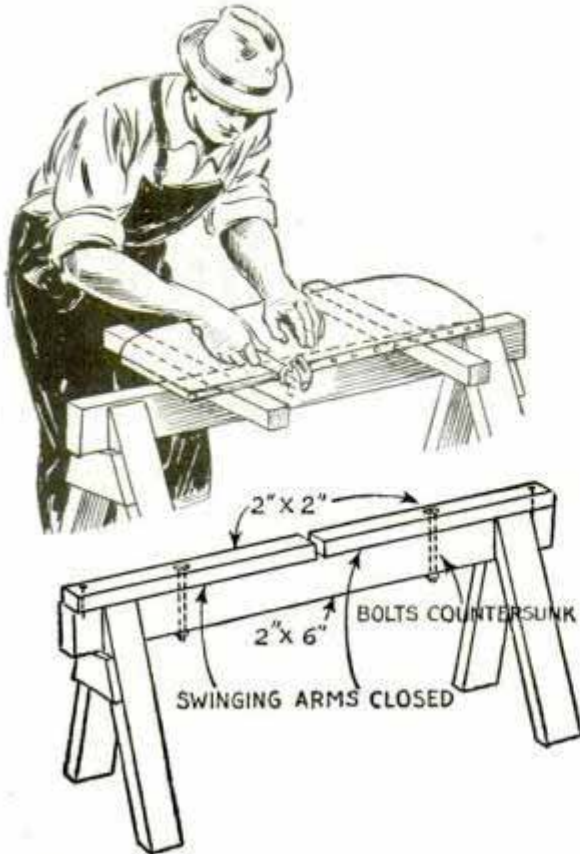

Often needing a bench-like surface to support wide work on jobs away from his shop, one carpenter pivoted a couple of arms to the top of one of his sawhorses. When needed, these could be swung around to support the work, and when not in use were moved around parallel to the top of the sawhorse where they were held by nails dropped through holes in the ends. When the arms were swung to this position, the sawhorse was ready for use in the regular way.

Hand Stamp Has Rubber Grip

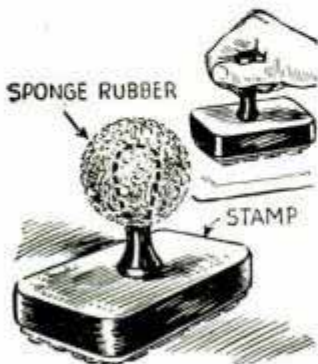

A shipping clerk who had to use a large hand stamp in marking numbers of wooden boxes slipped a sponge rubber ball over the grip of the stamp to prevent bruising the palm of his hand.

The ball can be made from a rubber sponge by cutting the latter to shape with a pair of scissors. A small hole in the center of

the ball is made with a sharp instrument so that it can be slipped over the handle of the stamp.

Stock Salt on Concrete Tile Is Kept Off Ground

Instead of putting his stock salt on the ground or in a box where it is likely to be wasted, one farmer sets it in the bell end of a concrete tile. This is set in the ground



to prevent tipping. If loose salt is used, the tile can be partly filled with concrete and a drain provided to carry off rain water.

Tumbling Barrel Mixes Feed

Farmers will find this barrel feed mixer a timesaver. Two inverted V-units form the ends of the supporting frame, the units being connected and braced with boards across the ends and one side. A floor flange on each end of the barrel takes a short pipe axle at one end and a longer pipe, which terminates in a crank, at the other end. Bearings are holes bored through the frame and well greased. The door to fill the barrel is made by sawing through three or four staves in the center and fastening them together with light iron straps.





BELT SANDER

TOUCH control, full visibility, and capacity to handle wide boards and table tops, are the excellent features of this belt sander. The general construction and method of working will be apparent from Figs. 1 and 3. There is a wooden frame carrying four wooden pulleys over which the 6-in. sanding belt runs. The worktable, adjustable in height to accommodate stock $\frac{1}{4}$ to $2\frac{1}{2}$ in. thick, is

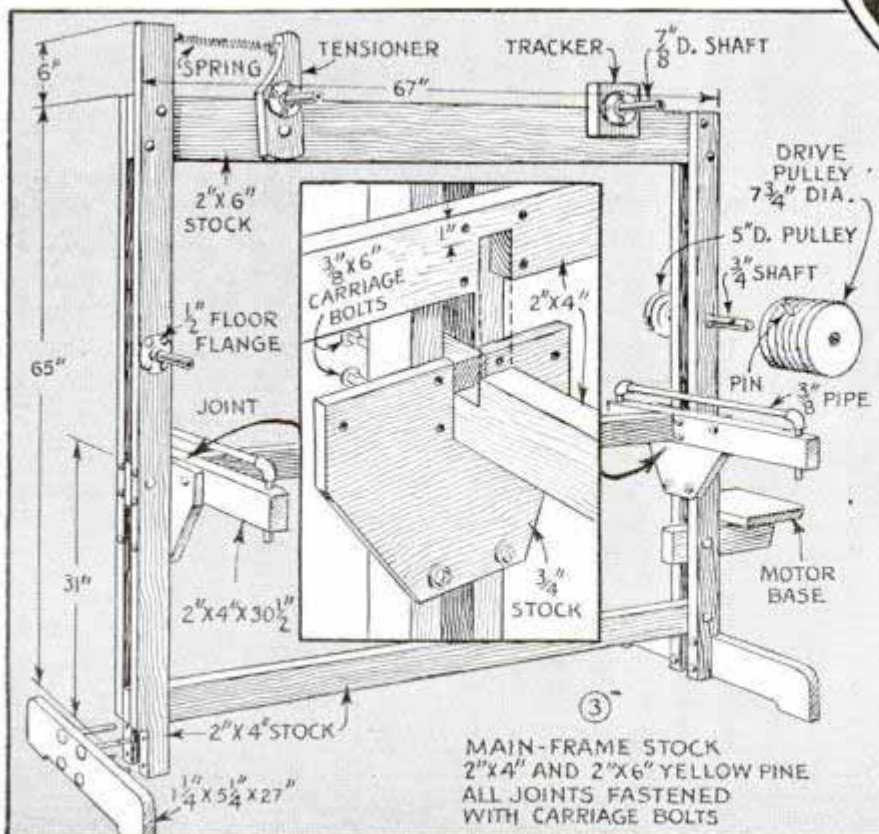

mounted on rollers so that it can be pushed backward and forward below the belt as the stroker applies pressure to the work.

Start construction by making the wooden frame. Standard yellow pine 2 by 4 and 2 by 6 in. is used, jointed on both edges. Fig. 3 shows the assembly, while Figs. 4 and 8 show how the main joints in the framework are made. Each pulley will require six pieces of wood $1\frac{1}{16}$ in. thick. Three

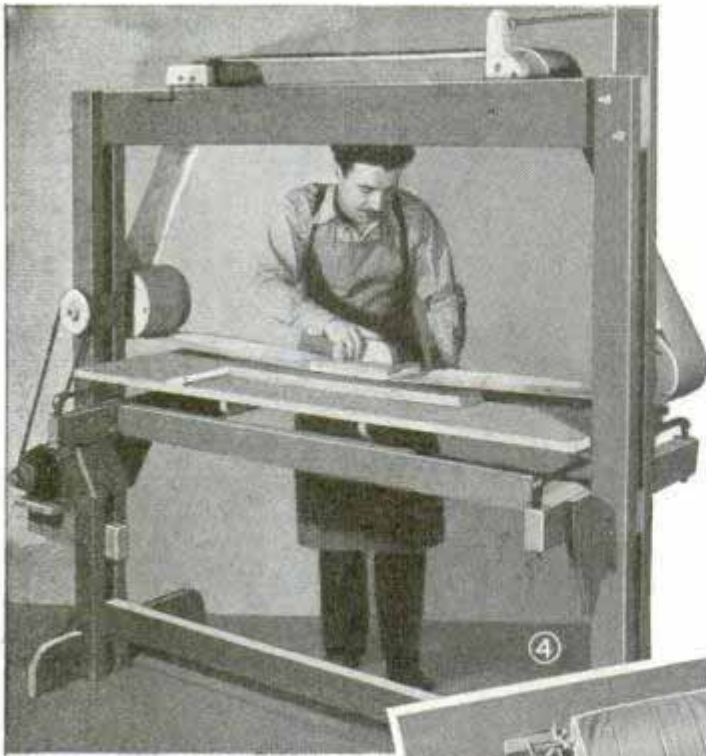

of the pulleys measure 6 in. in diameter, while the drive pulley measures $7\frac{3}{4}$ in. The disks are rough-cut on the band saw and then assembled with $\frac{1}{4}$ by 6-in. carriage bolts and glue, as in Fig. 2. The two outer disks on the three small pulleys are cut out in the center, $3\frac{1}{2}$ in. in diameter, as can be seen in Figs. 7 and 9. The center hole through the small pulleys is 1 in. in diameter; through the drive pulley, the hole is $\frac{3}{4}$ in. in diameter. Fig. 6 shows the drive pulley set up for turning, the $\frac{3}{4}$ by 12-in. shaft fitting through the hole drilled through the pulley. Fig. 5 shows the method used in mounting the small pulleys for turning. Each is first fitted with brass bushings, tapping these in around the shaft, as in Fig. 10. The $\frac{7}{8}$ by 6-in. shaft then can be mounted in a

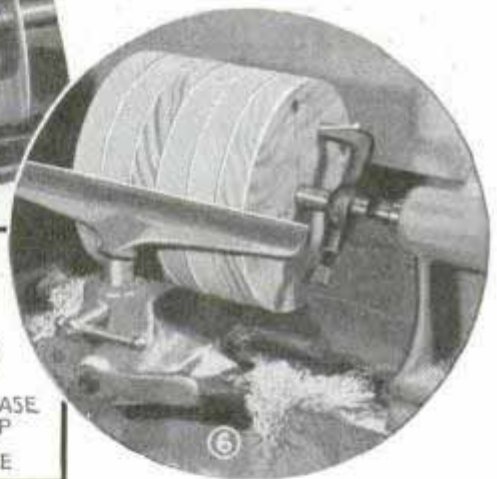
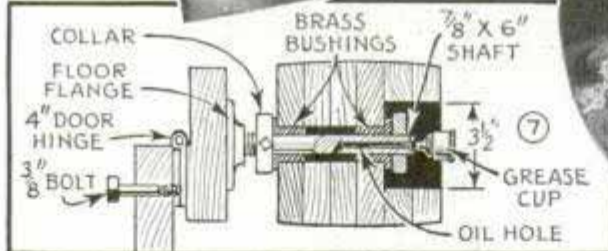
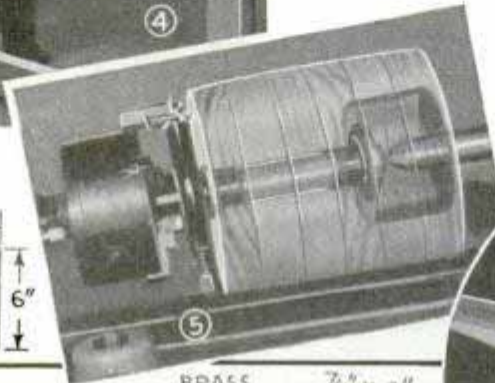
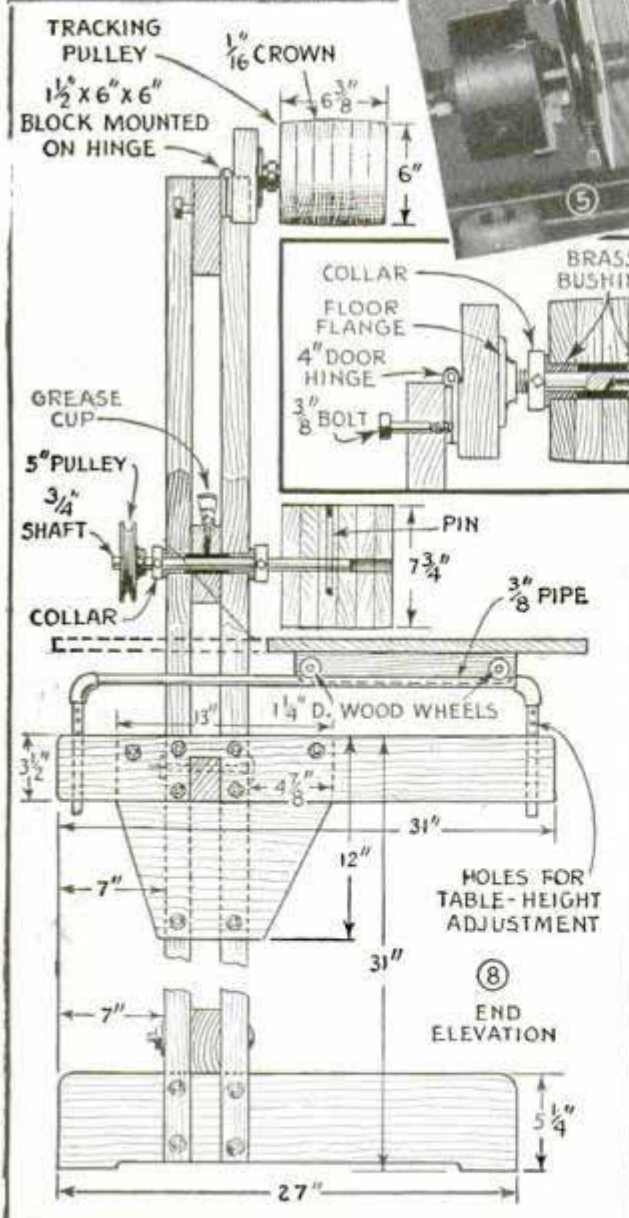

three-jaw chuck and the pulley turned by means of the set-up shown.

In Fig. 8, note that the drive shaft is carried through the framework, the pulley being pinned to the shaft. The three small pulleys rotate on their shafts, the latter being threaded at one end to fit $\frac{1}{2}$ -in. pipe floor flanges bolted to the framework. Referring again to Fig. 3, it can be seen that the shaft directly opposite the drive shaft is fitted to the frame. The upper shaft on this same side is fitted to a 12-in. length of 2 by 4-in. stock, this wooden arm being pivoted on a $\frac{3}{8}$ -in. carriage bolt. This is the tension idler which stretches the belt, tension being provided by means of a spring. The shaft of the tracking pulley is fitted to a hinged wooden block which can be moved in or out to make the belt track properly, Fig. 8. One leaf of the heavy

door hinge is threaded to take a $\frac{3}{8}$ -in. bolt. Turning the bolt in opens the hinge, thus tilting the pulley. Each idler is fitted with brass bushings at either end, the pulley being held in place by means of collars. The outer end of the shaft is tapped $\frac{1}{8}$ in. to take a grease cup. The inside end of each shaft is threaded to fit the $\frac{1}{2}$ -in. pipe floor flange. After threading into the flange, the shaft end should be peened.

Fig. 12 shows how the worktable is fitted with wooden wheels so that it can be pushed across the $\frac{3}{8}$ -in. pipe framework which is provided with an adjustment consisting of a number of holes in the short uprights so that the table can

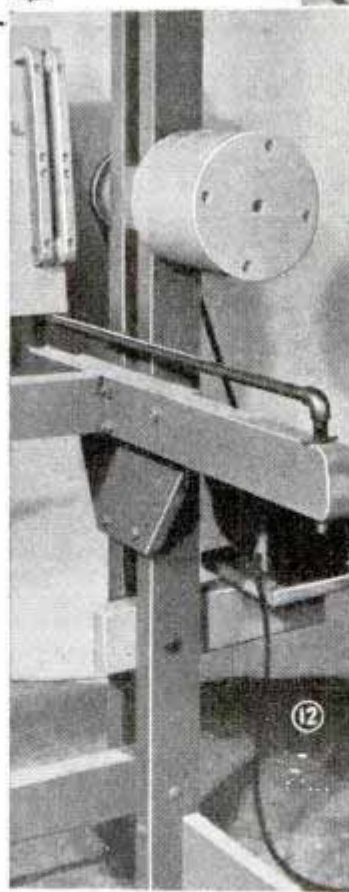
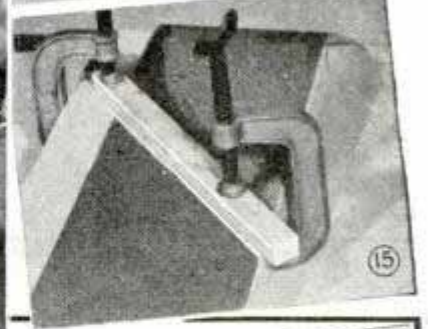
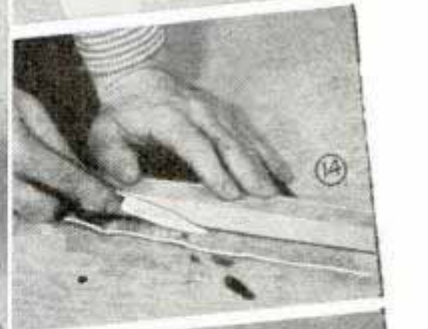
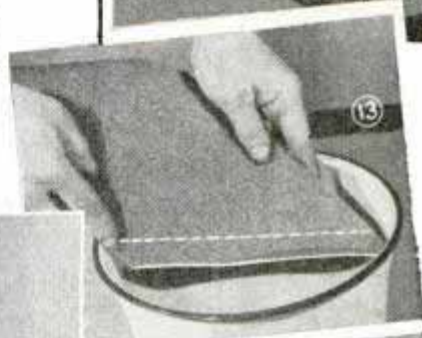
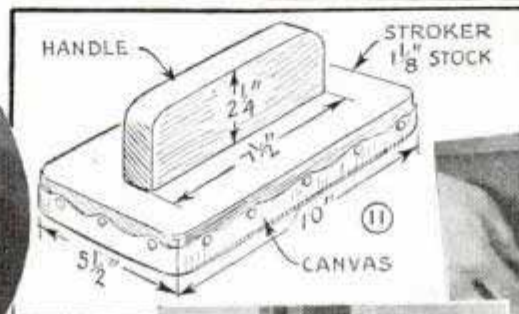
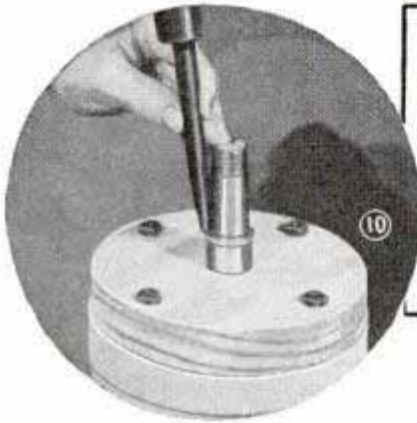
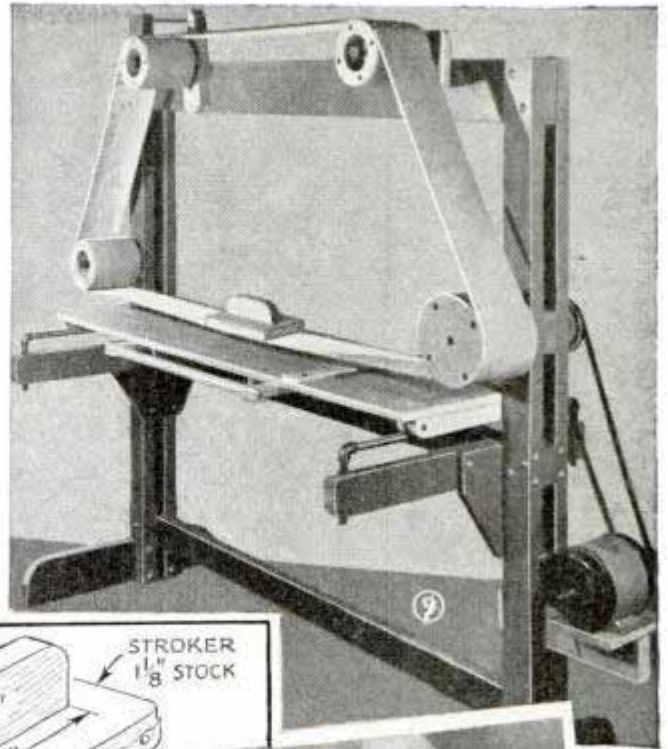

be raised or lowered as required. The stroker should be made to the approximate dimensions given in Fig. 11. The bottom of the base should be rounded very slightly and covered with felt and canvas.

Sanding belts are made from cloth-backed garnet, 6 in. wide and approximately 15 ft. long. The joint is a 45-degree skive, Fig. 16, the abrasive being removed by dipping the ends of the belt in warm water, as shown in Fig. 13. This softens the glue and permits the removal of the abrasive grains, Fig. 14, after which the joint can be glued together, as shown in Fig. 15. Speed of the pulley should be from 1,200 to 1,500 r.p.m. A $\frac{1}{2}$ -hp. motor will serve for light work but for maximum capacity a $\frac{1}{2}$ -hp. motor should be used. When sanding continuously over a considerable period of time, lift the stroker block occasionally to avoid undue heating.

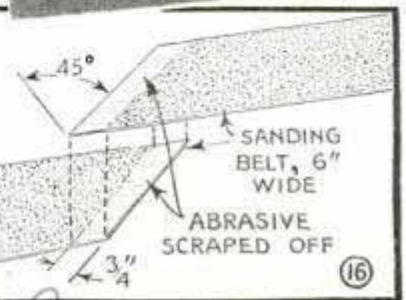

*Kuenzpel Chime Clock Co.
Baltimore, Md.*

Coil Spring on Head of T-Square Keeps Pencils Handy

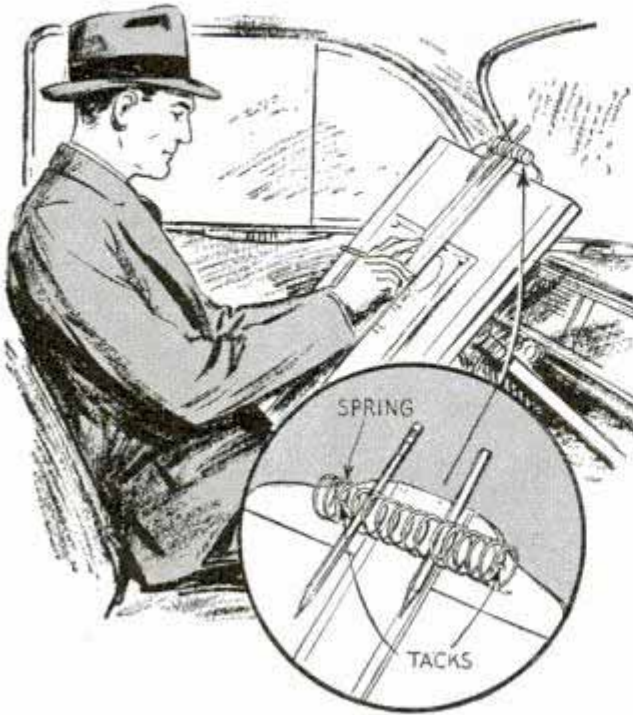

An architect who sometimes makes sketches on a board in his car or on the job where construction is being carried on, keeps his pencils at hand in a coil spring fastened to the head of his T-square. Before fastening the spring in place the coils are stretched so that the pencils can be inserted between them easily.

Clamp Jig to Make Washers

You will find this simple jig handy when it is necessary to make a washer, or enlarge the hole in one. The lower plate of the jig is clamped on a drill-press table or in a vise, and the upper plate is used to clamp the washer firmly against it. When

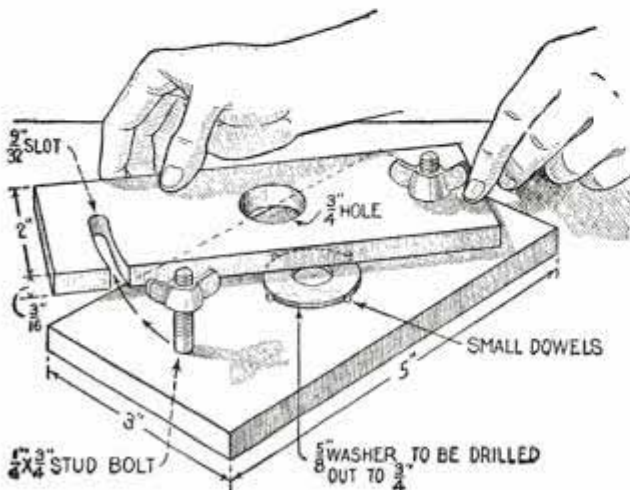

a quantity of identical washers are to be drilled, the centering dowel pins are used.
—R. H. Johnson, Pasadena, Calif.

Orders Clipped to Hand Truck in a Mousetrap

Invoices are always at hand on a truck by clipping them under the jaw of a mousetrap screwed under one handle. This idea is especially useful in keeping the invoices and other data with the packages when several trucks are loaded and pushed aside temporarily.



Thimble on Glass Cutter to Apply Pressure



Taped to a glass cutter as indicated, a sewing thimble serves as a finger rest and enables you to apply pressure to the cutter without excessive finger strain. The thimble should be large

enough to take the end of the index finger without squeezing it.

Finger Holes in Cardboard Files Make Them Easy to Move

When cardboard boxes are used as files for letters and other papers, the covers are often damaged in pulling them from the shelf. This trouble can be avoided if a slit is cut in the front of each box, as indicated, so that the tab portion may be pushed in for inserting the finger tip into the box end.

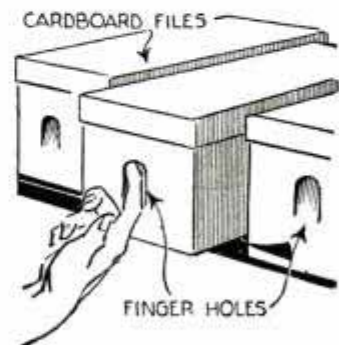

Drip-proofing Your DARKROOM SINK

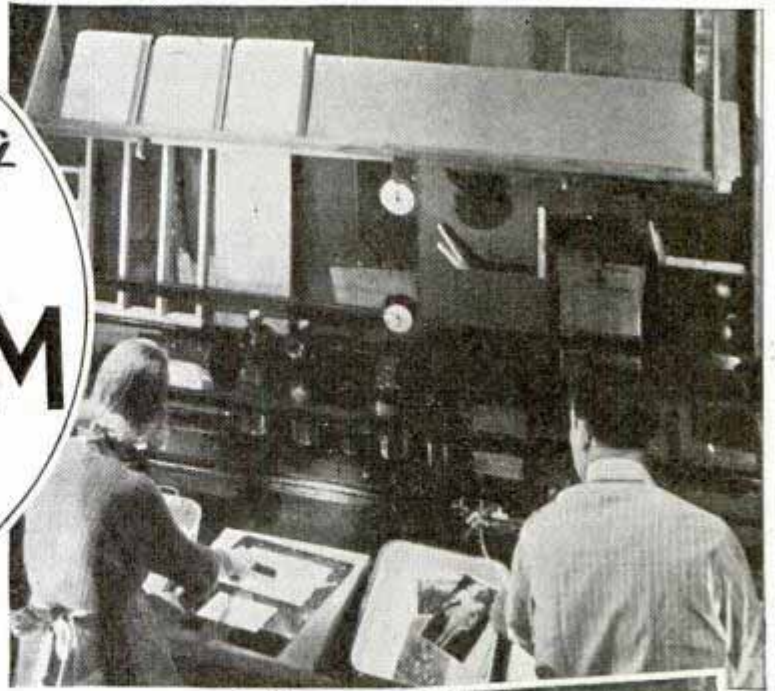

In a photo darkroom, a carefully planned arrangement of shelving to drain moisture into a sink from dripping trays, tanks, bottles and other wet equipment will go a long way toward assuring a safe, dry floor. The shelves, which are set at a slight angle to promote drainage, are located conveniently over the sink, and if they extend beyond the limits of the sink, drain boards are provided on the ends of the latter. To prevent bottles from sliding off the inclined shelves, guard rails are provided. After the installation has been completed, the shelving is given an application of hot paraffin to minimize absorption of moisture in the wood.

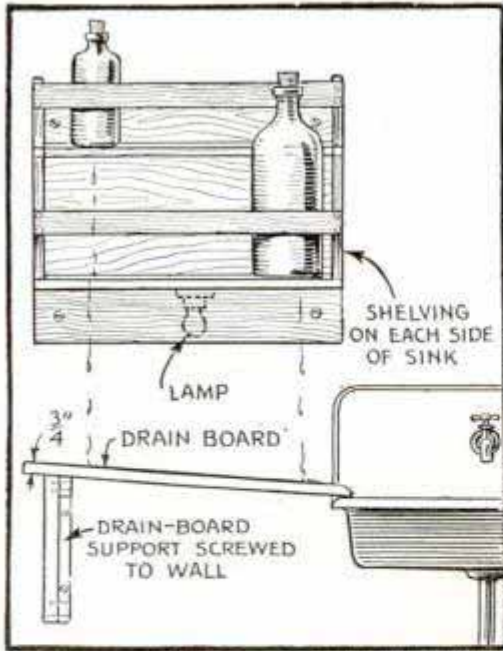

TWO OR MORE SMALL METAL SINKS MAY BE JOINED TOGETHER WITH ONE SET OF SHELVING

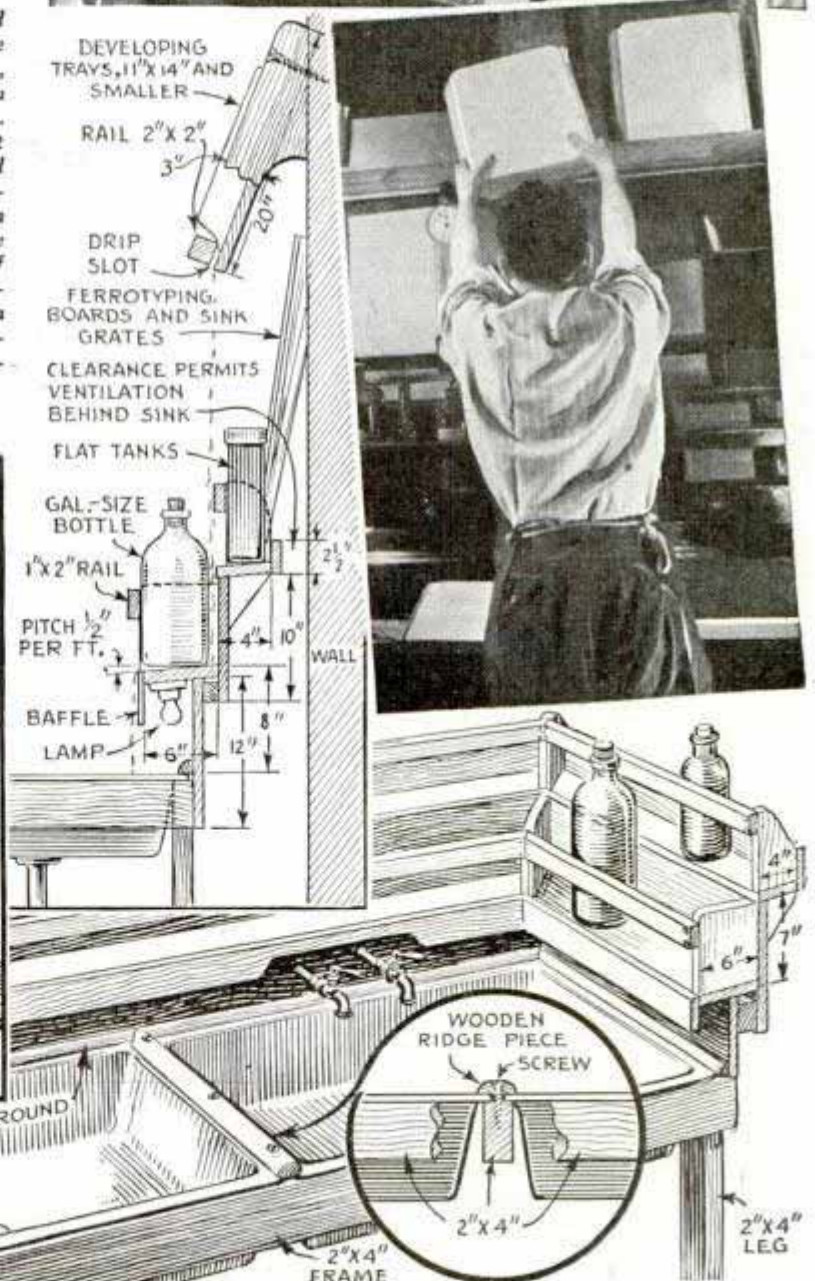

Sack on Wing Keeps Turkey from Flying over Fence



To keep turkeys from flying out of pens, one farmer, who raises a small number of them each year, puts a flour sack over one wing of each bird. The sack prevents the turkey from spreading its wing, the cloth at the mouth of the sack being gathered at the wing joint and tied. Be sure that the string is wrapped only around the outside of the cloth so that it does not touch the flesh of the bird, otherwise the string may injure the wing.

Planter Wheel Serves as Feeder for Small Live Stock

This planter-wheel feeder is made quickly and inexpensively as it requires only a square, wood platform for a bottom. The wheel is fastened to the latter by long bolts, which hook over the rim. A rod in-

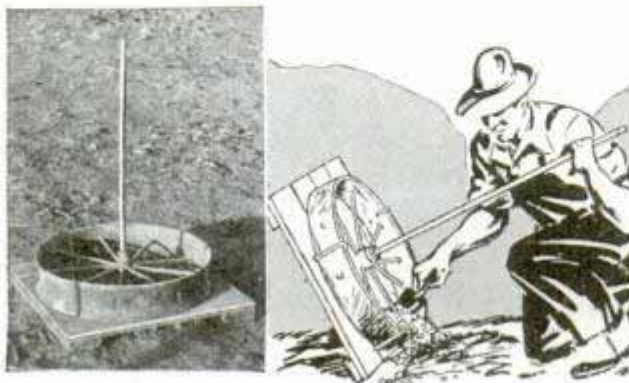

serted in the wheel hub permits the feeder to be tipped on its side easily for cleaning and draining.

Bottle Sealed Temporarily With a Glass Tumbler

When bottles containing highly volatile fluids have to be opened frequently in laboratories, small glass tumblers or other containers are often turned upside down over the mouths of the bottles to prevent evaporation. If a large rubber washer is slipped over the neck of the bottle as indicated, a good seal is provided to further reduce evaporation of the contents.

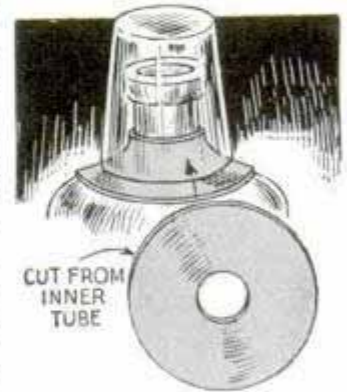

Bulb of Thermometer Protected by Rubber Eraser

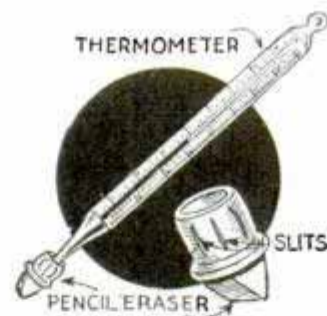

Thermometer bulbs of the type used in laboratories, photo studios, dairies, etc., can be protected against breakage by slipping a pencil eraser of the type shown over the

end. Cut several slits in the eraser as indicated and the thermometer can be used without removing the eraser when temperature readings are not critical.

Vacuum Cup on Stamp-Pad Lid Prevents Slipping

To hold a stamp pad securely on a desk, attach a rubber vacuum cup to the lid as indicated. Opening the lid and pressing the cup against the desk top holds the pad securely.

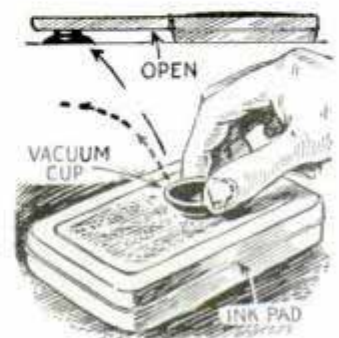

Aurora Sign Co.
1150 Washington Blvd
Pittsburgh Pa

Electrical Test Units Detect AUTO FAULTS

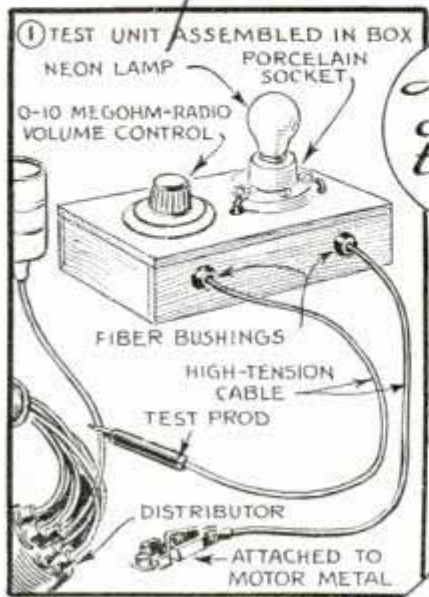

Auto-cable tester

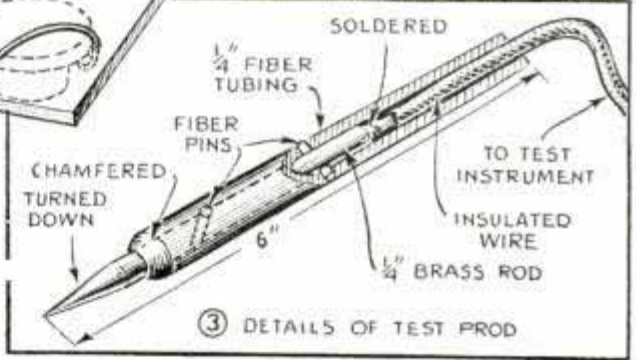
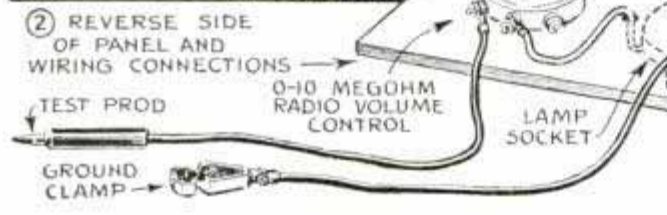
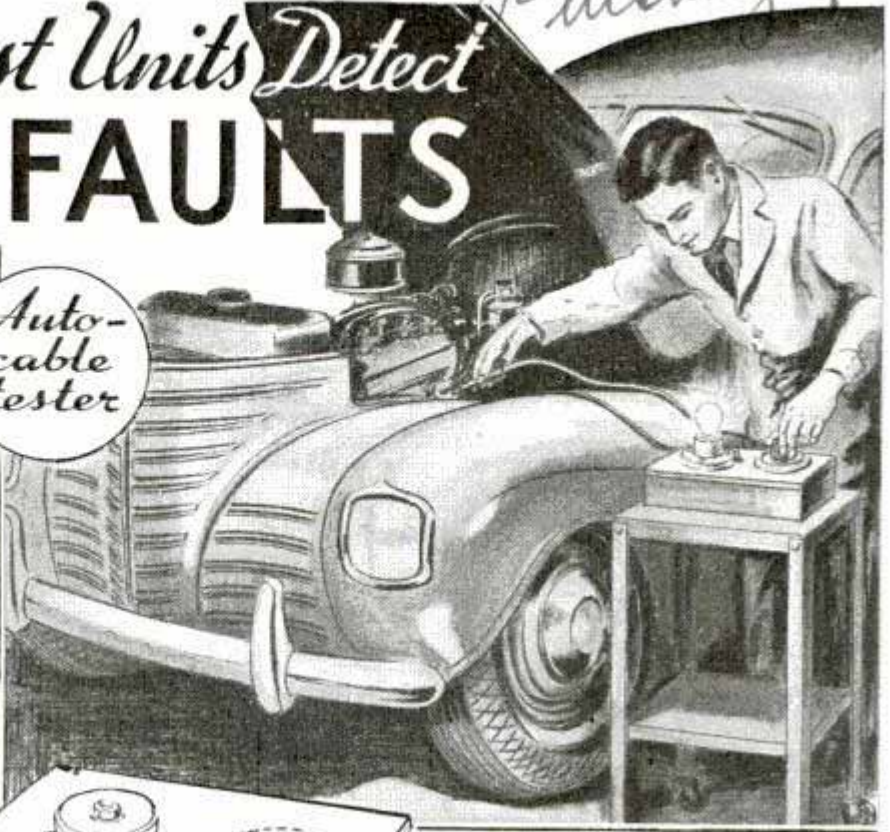

By C. A. CROWLEY

THESE simple electrical devices for testing high-tension ignition cable, for finding weak cells in a battery, and for detecting short circuits, grounds, and open circuits in armatures can be built easily at low cost.

Cable Tester: A compact and portable testing unit for cable is shown in Figs. 1, 2 and 3. It consists of a neon lamp, a 10-megohm variable carbon resistor, such as a radio volume control, and two test leads. In use, the lead equipped with the clip is grounded to the frame of the car and the resistor is set to maximum resistance. The test prod is then passed over the cable with the motor running at idling speed, and the resistance is gradually reduced until the lamp flashes. The dial reading at which the flash occurs is a measure of the quality of the cable. The lower the flashing resistance, the better the cable. If the flash point for a cable is found, it can be tested for weak points or faults by increasing the

resistance just enough so that the lamp will not flash. If the prod is now passed over the cable, leaving the resistance unaltered, a flash will occur at any point where the cable is faulty.

Testing Battery Under Load: A quick test for a storage battery to show its performance under a heavy load, such as starting, can be made with the unit in Figs. 4 and 5. It consists of three voltmeters, an ammeter, and a variable resistance capable of carrying loads up to 300 amps. Inexpensive meters can be used. If preferred, one voltmeter and a three-position switch will serve the purpose. A push button is provided for the test, and four clip leads are needed to make connections to the battery.

To make a test, first record the voltage of each cell on open circuit, which should register slightly over 2 volts. Then press the push button and adjust the rheostat



④ HOW TESTER IS CONNECTED TO BATTERY

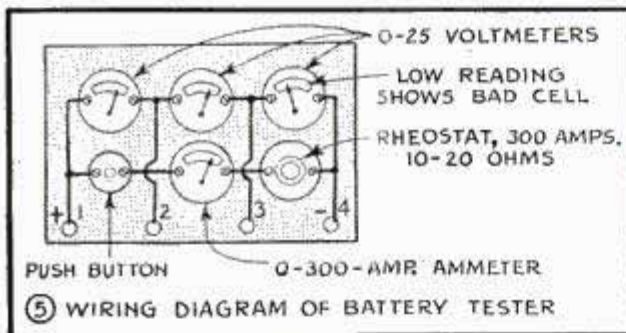

⑤ WIRING DIAGRAM OF BATTERY TESTER

until the ammeter reads 30 amps. A good cell should show 2 volts or more at this discharge rate. Now adjust the rheostat until the ammeter shows 150 to 250 amps. to simulate the starting load. Use the same current for each test. Readings under heavy load should be taken rapidly to avoid unnecessary drainage on the battery. All cells should read alike and no cell should show a lower voltage than about 1.6. This test can also be made as shown in Fig. 6, using a voltmeter. First connect it across one cell, throw out the clutch and press the starter switch, noting the fall of the voltmeter reading. Repeat with the voltmeter connected across the other two cells. While the equipment required is less, this test is not as satisfactory as it does not permit an easy comparison between two batteries or test of a battery outside the car.

Testing Armatures: With the instrument shown in Figs. 7, 8, 9 and 10, starter

and generator armatures can be tested for short circuits, grounds and open circuits, without removing them from the car. Readings on the meter indicate the condition of the armature. Fig. 7 shows the assembly. A millivoltmeter is used and it is important to know its resistance as the size of the resistance *A* connected in series with the meter, as shown in Fig. 7, depends on the resistance of the meter. The resistance can be found in the table of Fig. 10. A fixed radio resistor of the required resistance can then be connected in place. A resistor rated at 2 watts is satisfactory for this purpose.

The coil of Nichrome wire can be wound on a porcelain tube such as is used in knob-and-tube wiring. A 3-ft. length of No. 18 Nichrome wire is folded at the center and a brass machine screw with washers fastened at that point, as shown in Fig. 8, to form the center tap on the coil. The wires are twisted together for an inch or so, and the remaining wire is wound around the porcelain tube. The coil is mounted on a pair of brass brackets, by slipping a bolt or threaded rod through the tube and fastening with nuts. It will be necessary to insulate one of the brackets from the bolt with fiber or mica washers. The ends of the coil can be attached to the brackets, and connections to the coil can be soldered to them. Connections to the tester are shown in Fig. 9.

Testing for Grounds: The long clip lead is connected to the "hot" post of the ammeter. The wire normally connected to the generator or starter terminal is disconnected, and the short clip lead is connected to the generator or starter in its place. If the cutout is mounted directly on the generator, it should be removed temporarily and the short clip lead connected in its place. All brushes should be lifted from the commutator with fiber or wooden spacers for the ground test.

With preparations made as described above, and with the switch open if testing a generator or closed if testing a starting motor, the test prod is touched to several points on the commutator. If the meter does not read zero, a ground is indicated. As this can be caused by the presence of foreign matter, the armature should be removed and cleaned thoroughly, then retested for grounds.

Open Circuit Test: The props are removed from beneath the main brushes so that they contact the commutator as usual, but the third brush, in the case of a generator, is left insulated from the commutator. Touch the test prod to the two main brushes in turn; one will give a zero reading, or a reading much below that of the other. This is the test brush.

Now turn the armature until one commutator segment has just passed out of contact with the test brush. Touch the test prod to this segment. Any reading other than zero indicates an open circuit.

Test for Short Circuit: This is carried out in exactly the same manner as the open test, except that the push button is pressed when taking the reading. The reading for each segment of the commutator should be the same. A reading lower than the others on one segment indicates a short-circuited coil. Zero reading indicates a dead "short." In some instances, a dirty armature otherwise in good condition will test shorted.

Fitting Brake Lining to Turned Drums

After turning down brake drums, put a gasket between each shoe and its lining to increase the over-all diameter of the shoe assembly. If this is not done, the lined shoes will fail to contact the drums their full length due to the difference in contours. This results in poor brakes because you do not get the benefit of the full braking area. Thickness of the gaskets should be equal to the amount of metal removed from the drums.

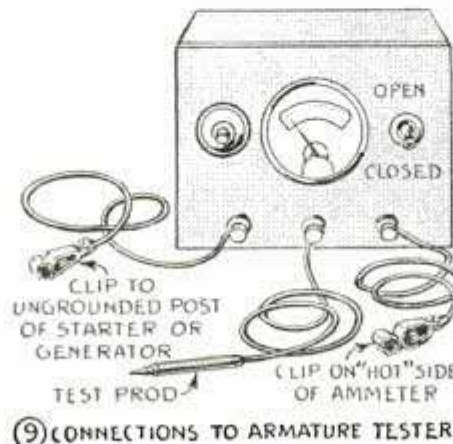
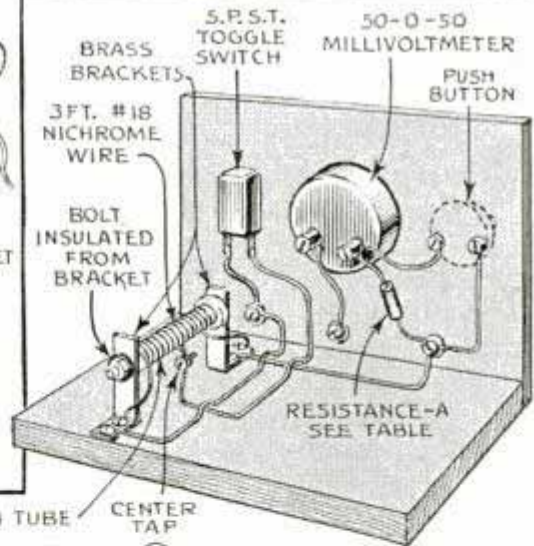
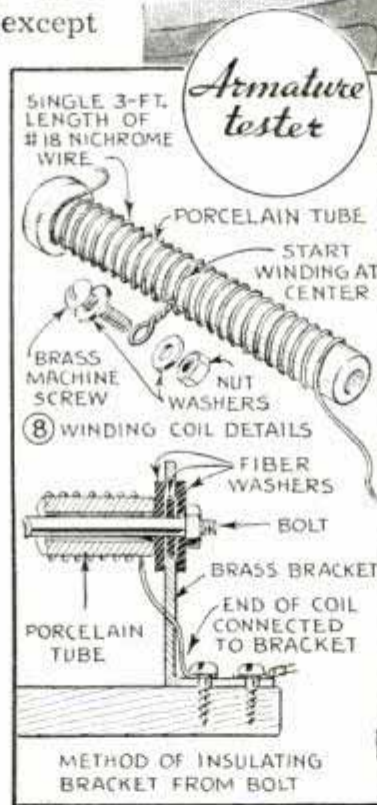

RESISTANCE REQUIRED IN SERIES WITH MILLIVOLTMETER

Resistance of Millivoltmeter	Required Resistance
0-1 ohm	200 ohms
1-2 "	300 "
2-3 "	500 "
3-4 "	700 "
4-5 "	900 "
5-6 "	1000 "
6-7 "	1250 "
7-8 "	1500 "
8-9 "	1750 "
9-10 "	2000 "

CONNECTIONS TO ARMATURE TESTER

10

Length of Pipe Removes Wheel When Puller Is Unavailable



LENGTH OF 2" PIPE

If you have to remove a rear wheel and there is no puller at hand, try the following method: Jack up the wheel and lay a length of 2-in. pipe on the ground so that it contacts the inner half of the tire. Then remove the jack and jiggle the car until it drops off the pipe. If the wheel is not stuck too tightly to the axle, this method will usually do the trick although you may have to place the pipe under the wheel two or three times.

—John E. Neenan, Brush Prairie, Wash.

Pressure Lubrication of Springs

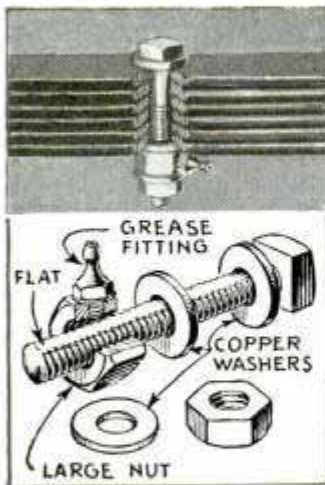

It is a simple matter to fix your car springs so that they can be lubricated between the leaves with a pressure grease gun. All you do is to remove the center spring bolt, flatten one side, and drive on a nut that carries a grease fitting as indicated. After the nut has

been tightened be sure that the end of the fitting is directly over the flattened portion of the bolt. Then drive on the regular nut and lock washer. When grease enters the

fitting it passes up the flattened portion of the bolt and is forced into the spaces between the spring leaves.

—C. E. Packer, Chicago.

Correct Way to Clean Valve Stems

When cleaning valve stems, use fine emery cloth and rub up and down the stem. If the abrasive is turned around the stem, it will make tiny grooves which soon will be filled with carbon, causing the valve to stick.—James W. Clift, Columbus, Ohio.

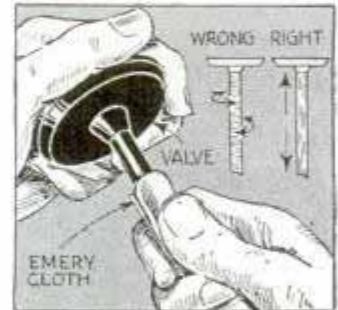

Racing Motor Burns Bearings

A motorist who has driven his car 45,000 miles without undue wear, always warms up the cold motor at slow speed for two or three minutes before driving the car. This allows the congealed oil to reach the moving parts, which might burn or wear badly over a period of time if a cold motor is operated at driving speeds. Operate the motor as slowly as possible for the first 20 or 30 sec. and then speed it up until the ammeter just shows "charge."

Extra Cylinder-Head Gasket Stops Exhaust Blowouts

Persistent blowing out of cylinder-head gaskets caused by inequalities in the surface of the block or the cylinder head can generally be stopped by using two gaskets instead of one. The increased thickness of

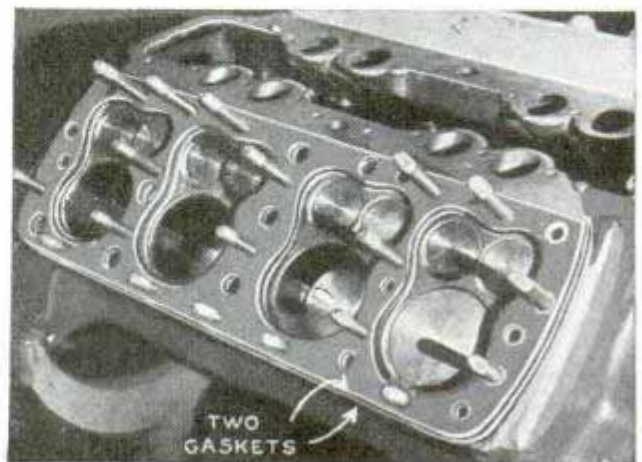

the extra gasket will lower compression slightly due to increasing the size of the combustion chamber, but this is usually not objectionable.

Testing Valve Seats with Pencil

Pencil marks offer a convenient means for testing newly ground valves for fit. About six marks are made across the seat at equal distances apart. The valve is then dropped into place and rotated backward and forward. If all the marks show breaks, it is reasonably certain that the valve has been ground correctly. Another method is to cover the valve seat with a thin coat of Prussian blue. The valve is then oscillated backward and forward about $\frac{1}{8}$ in., at the same time applying considerable pressure directly downward with the grinding tool. If the valve has been ground correctly, the blue will be wiped from the seat at a point near the center of its width, forming a continuous line completely around it.

Creeper Seat Handy in Garage

When working on car tires and brakes, a garage mechanic uses this creeper seat, which enables him to sit while working, yet move to different positions as required. The seat consists of two steering wheels fastened together with a bolt. Canvas stretched across the upper wheel and tacked to the rim forms a cushion, while casters on the lower wheel permit the user to move the seat.

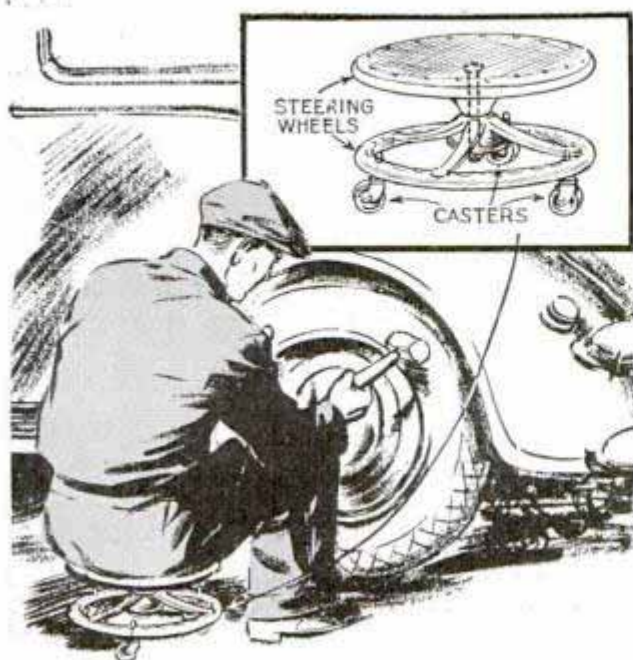

Taper of Cylinder Measured with Feeler Gauge

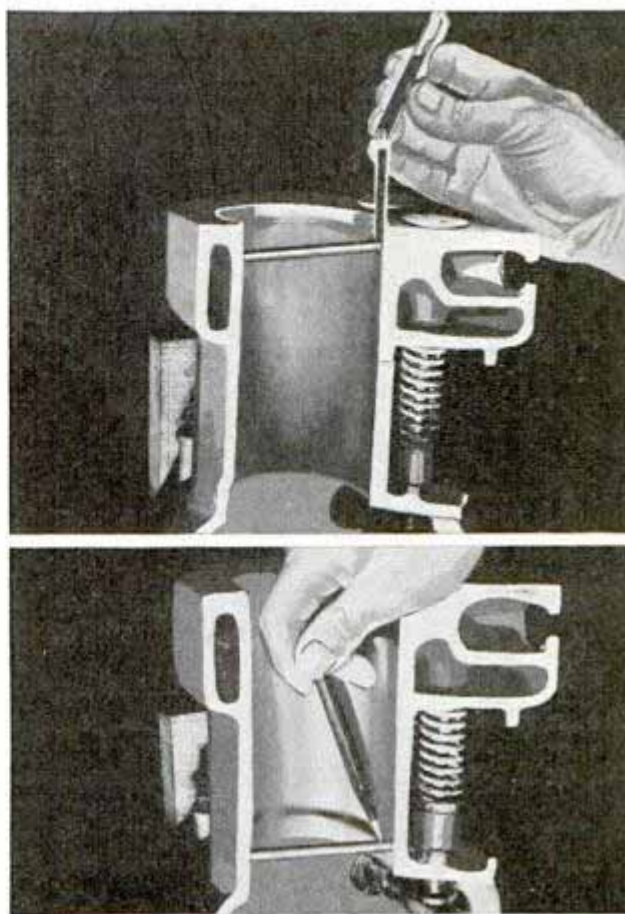

Cylinder taper can be measured with a fair degree of accuracy with a feeler gauge and a length of small steel rod. File off the end of the rod until it will just hang crosswise in the bottom of the cylinder where there is practically no wear. Then put it in the upper part of the cylinder a fraction of an inch below the top of the piston-ring travel, and insert a feeler-gauge blade that will just cause it to hang there. The thickness of the blade is the amount of taper.

Cotter Key Aids in Repairing Tire

To release the air from an inner tube, bend the tip ends of a cotter key and use it in the valve stem as shown. A cotter key bent as in the right-hand detail is handy for opening punctures for quick release of air.

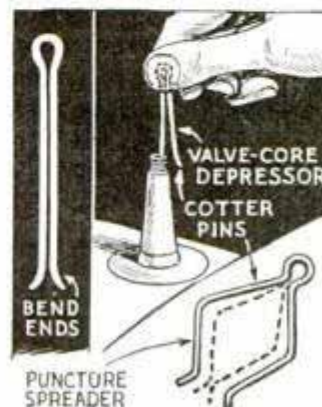

Spotlight on Air-Hose Standard Helps Motorist Check Tires

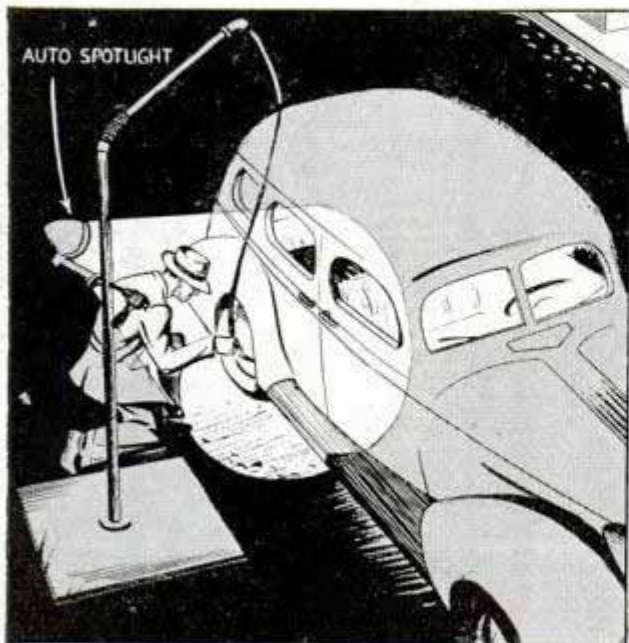

When the free-air hose is located near the curb or where illumination is poor, a

spotlight fastened to the standard will enable a motorist to direct the light as needed for checking tires. The light socket will have to be changed to take a 110-volt bulb and the reflector opening at the rear end will have to be enlarged somewhat to make room for the larger bulb.

Fuller Balls Protect File Tangs

If you are in the habit of using files without handles, you can avoid possible injury to your hands with the sharp tang ends by slipping fuller balls over them. When using a file, the ball rests against the heel of the hand, forming an effective shield over the end of the tang.

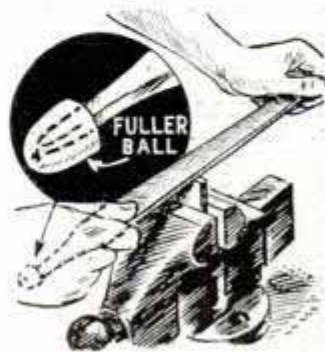

Dutch Windmill Rotates Slowly in Breeze



POPULAR MECHANICS MAGAZINE
200 E. Ontario St. Chicago

Enclosed find 10 cents for Craftplan No. 3012—
Dutch Windmill

Please check I am a subscriber
 I buy at newsstand

Name _____

Use Pencil

Address _____

City _____

State _____

Simplified Design: Stands about 5 ft. high and is built of standard lumber stock. Construction requires a minimum of work and only a few ordinary hand tools are needed.

Additional Purpose: Besides the purpose of ornamenting your garden next season, this windmill will serve splendidly as an outdoor doll house for the little tots. To this end the doors may be real ones, hinged in place, instead of being only painted imitations. Colorful dolls in quaint Dutch costumes, set on the balcony, greatly increase the realistic effect.

Craftplan Tells How: All information on building this windmill in your workshop is contained in our Craftplan No. 3012. Besides the drawings that give all sizes and show the assembly, instructions tell just how to proceed step by step. A material list is also included. Just fill out the coupon and remit ten cents upon receipt of which the Craftplan will be sent to your address.

Snap this tonight



With the new fast Kodak Super-XX Film, you can take just as good pictures indoors at night as you have taken outdoors in the sun

HOME'S the place to snap a baby when he's sweetest, a pup when he's cutest, the whole family when they're happiest. Use Kodak Super-XX—about four times as fast as ordinary film—and you can get the same clear, brilliant pictures indoors that you get outdoors. And

with any camera at all that takes Kodak Super-XX Film—even a \$1 Baby Brownie.

All you need besides camera and film are two or three Photoflood lamps in Kodak Handy Reflectors. (Photoflood lamps are inexpensive, and they last long enough for you to take dozens of snapshots.) A helpful booklet (illustrated) not only gives you the few simple directions you'll need, but suggests picture opportunities, and contains much useful information. It's FREE at your dealer's . . . Eastman Kodak Company, Rochester, N. Y.

**HERE'S ALL
YOU
NEED . . .**

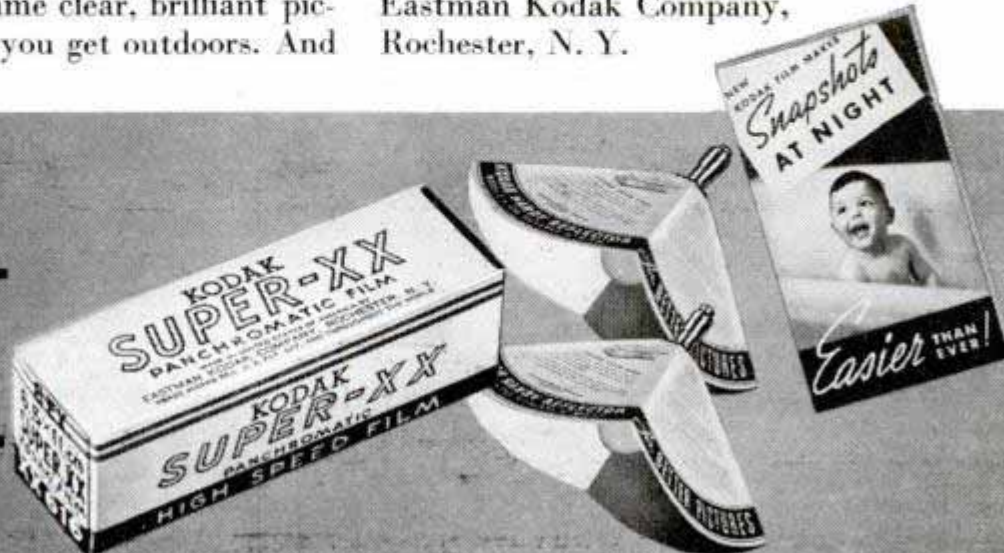

Every Policeman a "G-Man"

(Continued from page 725)

his meager evidence, but the prisoner denied any knowledge of the broken pane. He was convicted of the attempted burglary, when ultraviolet rays revealed minute particles of the same type of glass in the dust in his trouser cuffs, and on the head of the spike used to break the pane.

A patrolman solved a dozen burglaries by photographing the print of a crepe rubber sole on a dusty piece of linoleum.

This is the sort of scientific detective work one expects of G-men, or the super-sleuths of fiction. But when run-of-the-mill policemen in your city solve crimes by these methods, it comes as a pleasant surprise. To the criminal it is a distinct shock.

Milwaukee isn't the only city to benefit by bureau of investigation instruction. Captain of Detectives John A. Taylor of Fort Wayne produced conclusive evidence by trapping a burglar into photographing himself in the very act of stealing. This burglar had ransacked a house nine times in sixty days, each time raiding a cabinet in which money was kept. Captain Taylor removed a knob from a bureau drawer on the opposite side of the room, and focused his camera lens through the hole, connecting the shutter release to the cabinet door with a fishline, and synchronizing a flash bulb with the camera, so that opening the door would explode the flash and trip the shutter.

While some cities like El Paso, Milwaukee, Newark and Detroit, have established well-equipped training schools in which their Academy graduates may instruct their brother officers; other graduates have accomplished wonders on little more than their own enthusiasm.

Detective Arthur Thalacker of the Westchester county (N. Y.) parkway police set up a training school in his own home, in which he is instructing police from adjoining cities. His initiative brought him the job of chief of police at Burlington, Vt.

Lacking funds even for a dummy for his crime-scene searches, he made his own from the wax head of a clothing dummy. Using long winter underwear, Thalacker poured plaster of paris in the arms and legs, stuffed the body with straw and old newspapers.

Harold J. E. Gesell, an Iowa sheriff, re-

cently solved a hog-stealing case by infrared photography on the discarded sideboard of a truck, which made legible faint traces of pencil writing not otherwise decipherable.

Undoubtedly the great success attained by the Academy is due to the interest and enthusiasm aroused in the students. There is little of the dry, booky atmosphere of the classroom. There are lectures, of course, but they are lectures by men with practical experience in the most thrilling game of all—the man hunt.

And the lectures are liberally spiced with actual investigation. There is the crime-scene room, containing "Oscar," the oft-murdered dummy, and a goodly sprinkling of clues. Student officers are turned loose in pairs to investigate and reconstruct fictitious crimes, while a veteran instructor supervises and criticizes their work. There is "Beulah," the ancient chariot, which students search for fingerprints, on which they study the technique of the auto thief. And there is the "rogues' den," which may simulate the appearance of a hideout for kidnapers, bank robbers, and any type of criminal. It always has been hurriedly deserted by its occupants, whom the students must identify from clues left behind.

In the classroom there are magnetic blackboards, on which students obtain "skull practice" in the technique of raids. Here outlines of streets or roads are sketched. Miniature houses, trees, hedges, autos, men—all highly magnetized—are placed in position to represent the scene of a raid, the whole appearing as an aerial view of the terrain.

Slides and sound movies illustrate the lectures. One film describes "The Technique and Mechanics of Arrest and Search of a Person." Others explain scientific crime-detection methods, proper and improper methods of conducting an investigation. There is a laboratory in which the students may go about the scientific analysis of evidence. Each year a "refresher" course is given, to which Academy graduates may return for ten days, to learn of the latest developments.

The ultimate aim is to make every law-enforcement officer a trained and efficient investigator—every policeman a G-man.



WHEN A
MISS MAKES
A HIT
...why don't you
give him

Velvet
Better
smoking
tobacco

- for **MILDNESS**
fine old
Kentucky Burley
aged in wood
- the **FLAVOR**
of pure maple
sugar for extra
good taste

*Velvet packs easy in a pipe
Rolls smooth in a cigarette
Better tobacco
for both*

"Disaster College" for Sea Captains

(Continued from page 715)

estuary of San Francisco Bay. The "Tusitala" and the "Joseph Conrad," both full-rigged sailing ships, are being used as well as Coast Guard cutters for training cruises. The steamer "American Seaman," with quarters on board for 225 students, serves

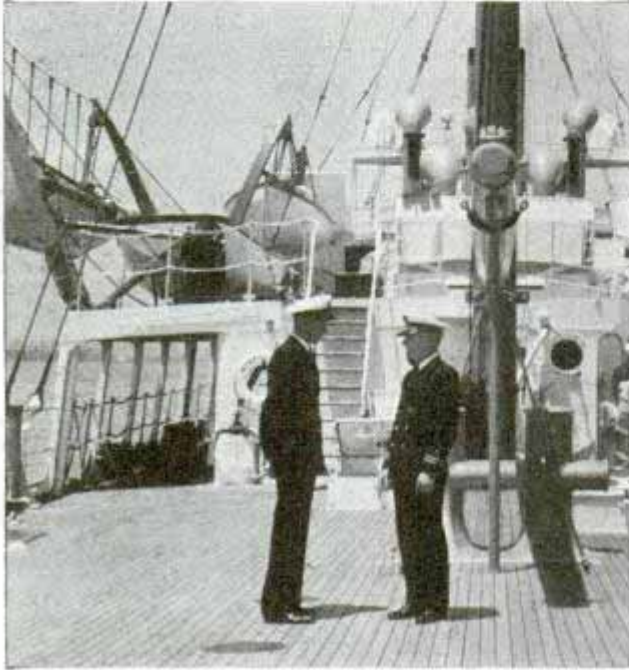

After deck of "Northland" which is used to complete training of seamen and officers

both for practice and as a floating schoolhouse. In addition to its ordinary ship's gear the vessel contains an auditorium, large class rooms, and workshops. On the west coast the large cutter "Northland" is used in training. The schools on both coasts have a total student capacity of 272 licensed officers and 2,980 unlicensed seamen per year. Coast Guard and merchant marine officers serve as instructors.

Due to differences in age and experience of the students, attempts are made to give separate instruction to small groups so that each man will benefit fully from the course. Unlicensed men in four divisions, seamen, firemen, stewards, and purser's departments, are all given separate lessons aside from standard instruction in boatmanship, laws, hygiene, and traditions that all receive. Stewards learn cooking, baking, cost accounting, routine of waiters, diet, and first aid, while firemen learn electricity, Diesel machinery, steam, upkeep of hulls and boilers, and similar subjects. Officer students get theory and mathematics as well as practical work. Deck officers

study the latest navigation methods, ships' papers, and naval construction, while engineer officers are coached in boilers, safety precautions, and instruments.

Officers are reminded that they can't load heavy cargo on upper decks with lighter cargo below, nor can they allow large surfaces of free water to gather in the bilges, because such bodies of water may act similar to pendulum weights and reduce stability.

At the same time that the Maritime Commission is training the seamen who are serving today it is planning a co-ordinated program of instruction for young Americans who wish to follow the sea. Most of the leading maritime nations have elaborate training systems for manning their merchant fleets and in some foreign schools boys fifteen years old or younger are admitted. From one British sea school alone 13,000 boys have graduated since 1918.

In the future the Commission hopes to enroll 500 apprentice seamen per year for a one-year training course that would fit them for service in the merchant marine. Young men between eighteen and twenty-three years of age would be eligible and they would receive clothes, food, and quarters as well as twenty-one dollars per month while in training. The schedule calls for three months at a shore training station, six months on a training vessel, and three months on a Coast Guard cutter.

All American ships that carry ocean mail are required to ship a few cadets and cadet officers. In the revised cadet system some 300 men under twenty-five years of age are enrolled for four-year periods, during which time they receive training in ship duties, and courses of instruction.

Eight universities have established Naval Reserve officer training units, graduates of which receive commissions as ensigns in the United States Naval Reserve. Massachusetts, New York, Pennsylvania, and California maintain nautical schools that turn out a total of about 200 graduates yearly, the California students living aboard ship while they are enrolled. A number of vocational high schools are beginning to offer courses in seamanship, now that it seems that there is going to be a need for more trained men to man and officer our growing merchant fleet.

THE NEW 1940 HARLEY-DAVIDSONS

Tops for

Fun and Thrills!

THE great new 1940 Harley-Davidson Motorcycles assure you more pleasure from every new, advanced feature.

Sensational beauty! . . . Rugged dependability! Zooming power to whiz you along the highways with other thrill-loving riders. There's always something doing — exciting events — gypsy tours, tourist trophy races, hillclimbs, rallies — yes, and new distant places to reach quickly and economically — to see and explore.

See your Harley-Davidson dealer today! Learn why two out of every three motorcycles on the road are Harley-Davidsons. See the 1940 models with their smart, streamlined styling — appealing new color scheme — beautiful color options — lower prices.

Ask your dealer about his Easy Pay Plans.

HARLEY-DAVIDSON MOTOR COMPANY
Dept. P MILWAUKEE, WISCONSIN

FREE — This big 24-page magazine filled with pictures and stories of exciting motorcycle events.



SEND COUPON NOW

HARLEY-DAVIDSON MOTOR CO.
Dept. P, Milwaukee, Wisconsin

Send FREE copy of "ENTHUSIAST" motorcycling magazine and literature on your new 1940 models. Stamp is enclosed for mailing cost.

Name.....

Address.....

HARLEY-DAVIDSON

WORLD'S *Champion* MOTORCYCLE

Doing It the Easy Way

(Continued from page 698)

Every time an airliner goes out on the run it flies on brand new spark plugs, or others just as good. There are a lot of spark plugs on a dual-ignition fourteen-cylinder radial motor, so keeping them in tiptop condition is no small item. A good man used to take care of about seventy-two in a day, doing the job by hand. The first of these devices is a lathelike affair operated by an electric motor that cleans and polishes the center



A mechanic rigged up this arrangement for pumping oil into the tanks of an air liner

electrodes at one quick contact. The second works something like a drill press to set the four-way point clearance gaps to a uniformity and precision never before attained and without any feeler gauge either. Finally, the overhauled and assembled plug drops into a cutaway casing for test. When the operator throws his switch and the blue sparks fly, a blast of compressed air is directed against the plug at terrific pressure. If the plug stands up, doesn't leak or the spark falter, you can depend on it delivering the goods 10,000 feet aloft.

A mechanic at the American Airlines hangar has rigged up a device worked by compressed air which automatically lifts spark plugs into a testing machine in a split second where before they had to be screwed in and then unscrewed.

Ever try to wrestle a 400-pound oil drum into a usable horizontal position on a bench? There's a man in the United hangar who didn't like the idea either, so he rigged up a clever leverage device made of welded tubular steel and a piece of chain to do the job.

For wrangling a huge airplane tire off its hub rim, the hangar boys designed two devices, one utilizing leverage, the other the screw principle.

Nobody can see around a corner, you say, but American Airlines mechanics manage to do this very thing, with nothing more than an ordinary flashlight and a dental mirror. For inspection of inaccessible nuts, bolts and fittings in dark and difficult places, you can't beat this method.

If you have ever visited a modern transport terminal, you may have watched the small rubber-tired tractors snaking those big planes around. They are mostly towed by the tail although there are times when there isn't sufficient room in a crowded hangar. That's when United's superintendent, Homer Razor, figured out a clever push-pull rod.

In the TWA hangar another two-man job with divided responsibility was reduced to a one-man task by the straight thinking of a resourceful mechanic. This involved testing the air-speed indicators, a most vital check because instrument navigation would be impossible without accuracy here. One man had to stand on the ground under the plane nose to work. He was the helper. The man who had all the responsibility worked up in the pilot's cockpit, sixteen feet above. He could never be absolutely sure that the chap below was making his tests on the two instruments exactly the same. So, he worked out a way by which he could do the entire job himself from the cockpit. He rigged an air hose down to the air-intake hanging beneath the fuselage outside the ship. Then he connected this to a T which, in turn, was hooked up to his accurately calibrated test instrument and to the two air-speed indicators on the dash. By blowing through the hose, thanks to the T, he registered the same pressure on both indicators and synchronized them perfectly.

(Continued to page 120A)

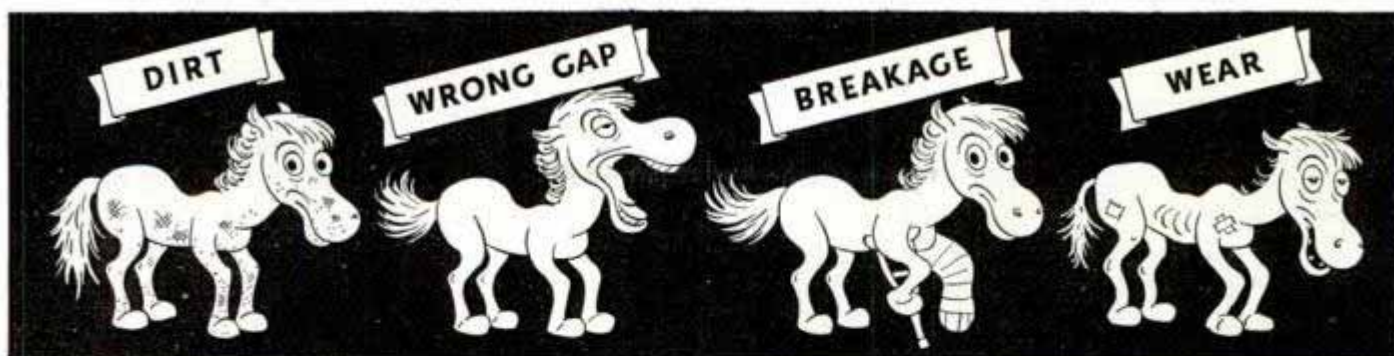

ONLY 4 THINGS CAN HAPPEN TO ANY SPARK PLUG

and the Cure for Most Troubles
Costs only 5c a plug

DIRT is the most common cause of spark plug trouble.



If the deposit is black, it's carbon or soot. If it is red, white, fused, or blistered, it's oxide—a residue of combustion.

THE CURE is a thorough cleaning (5c a plug) in the special machine developed by AC engineers. You will find this machine in service at more than 70,000 Registered AC Cleaning Stations. You can identify them by this sign. →



WEAR is next in frequency. It is reasonable to expect about 10,000 miles of service from any standard make of plug. (Cleaning and adjusting are needed, of course, at 4,000-mile intervals.)



THE CURE is a new plug, or a set of new plugs. And you can't go wrong if those new plugs are AC Quality Spark Plugs.

WRONG GAP is related to wear.



Wear causes this condition. Sometimes, although rarely, gaps widen too quickly. This indicates that the plug in use cools too slowly, or is of the wrong type.

THE CURE for normal wear is gap adjustment with the special AC tools with which Registered AC Cleaning Stations are equipped. Accuracy is assured by a special gauge which conforms to the arc of the worn gap. Adjusting is a regular part of the AC Cleaning Service. The cure for abnormal wear is a new plug of correct type and temperature range. Better make it an AC.

BREAKAGE is the fourth trouble.

A broken upper insulator is always the result of a blow, as when a wrench slips. A broken lower porcelain results from attempting gap adjustment by bending the center electrode; or from use of a plug which cools too slowly or is of the wrong type.

Breakage is very rare.

THE CURE is a new plug.

May We Point Out—

A visit every 4,000 miles to your Registered AC Plug Cleaning Station will keep your plugs in good condition. Dirt will be removed before it can cause serious gas waste, power loss, and starting trouble. Gaps will be kept in adjustment. Wear will be eliminated when it becomes pronounced. Breakage will be remedied.

Plug cleaning is a splendid 5c habit. It will pay for itself many times over.





THE SAW OF AMAZING VALUE

Amazing values in circular saws for your home workshop—KEYSTONE made by DISSTON! True running, long-lived. They fit your machine, suit your work. Designed for fine craftsmanship at low cost. Ask your dealer for Keystone Home Workshop Circular Saws—Made by Disston.

Cross-cut; Combination

6" ($\frac{1}{2}$ " hole) . . .	\$1.70
7" ($\frac{1}{2}$ " hole) . . .	1.80
8" ($\frac{1}{2}$ ", $\frac{3}{8}$ ", $\frac{3}{4}$ " hole)	2.00
10" ($\frac{5}{8}$ ", $\frac{3}{4}$ " hole)	2.40

(Rip saws slightly lower)
Also Hollow Ground,
\$3.00 to \$5.00

These prices apply only to United States; for others, write Henry Disston & Sons, Ltd., Toronto, Canada

and the Hint of the Month

Trimming inlay picture with "square board" made of $\frac{5}{32}$ " plywood, with a strip to fit table slot clinch-tacked to bottom, and with cross pieces squared to saw.



New edition—FREE BOOK



SEND COUPON!

Completely revised Disston Saw, Tool and File Manual. 48 pages, contains a number of hints like the one above. Tells how to choose saws; to joint, set and sharpen saws; and uses of other kinds of tools. Many illustrations.

Henry Disston & Sons, Inc.
1111 Tacony, Philadelphia

Name.....

Address.....

2707

(Continued from page 118A)

There are any other number of inventions around a hangar to save time, money, hard work and tempers, such as rigging up giant mop pails, wringers and other cleaning paraphernalia on wheels for quick and efficient portability; more powerful motors and larger dust containers for the vacuum cleaners used on plane interiors; ingenious welded steel towers and platforms to work on instruments high in the ship's nose, with small wheels for mobility and crank jacks to keep them from rolling when placed; trucks to carry tools and equipment used for under-carriage grease jobs; air-hose carts that can be wheeled all over the shop and connected from a dozen outlets, and all sorts of special tools, not on the market, for special jobs.

One of the most ingenious devices is the arrangement worked out in the TWA hangar to install new shock-absorber bands in a Douglas landing-gear retraction system. A full set of four rubber cords on each wheel exerts a maximum pull of 4,200 pounds. Since they must be installed taut far inside the wheel nacelle where working space is exceedingly cramped, you can see what a problem this might be. First the rubber bands are stretched some ten inches with an ordinary chain hoist or set of blocks-and-tackle. Then an iron bar, about two inches in diameter and notched at both ends, is placed inside the bands. The notched iron bar, slightly longer than the bands actually need to be stretched, is then carried into position in the nacelle, where it is a relatively simple matter to slip the strands off the bar one at a time to the retracting mechanism.

You have the same sort of problems around your own home. As you can see, solving them is just a matter of brains and common sense. The things outlined are merely examples of what goes on every day at scores of airline hangars, maintenance and repair shops at dozens of airports all over the country. They suggest how easy it is to be practical if you'll only do enough thinking on the subject.

☐ Popular Mechanics Magazine can furnish the name and address of the maker of, or dealer in, any article described in its pages. If you wish this information, write to the Bureau of Information, inclosing a stamped, self-addressed envelope.

Atlas

SHOP EQUIPMENT for 1940



NEW ATLAS F-SERIES 10" LATHES have power cross feed as standard equipment and many other exclusive modern features.



ATLAS 6" LATHES give you all the precision and power of larger models built down to scale for work on small parts.



Large deep-grooved SKF ball bearings give ATLAS WOOD LATHES unusual lasting accuracy.

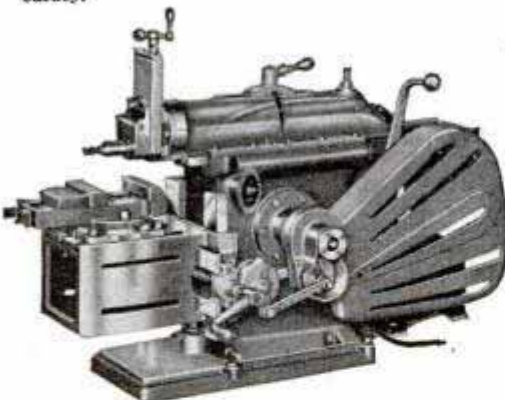

This ATLAS SHAPER with 7" stroke is the first practical low-priced metal shaper.



Keep your drills sharp with this precision DRILL GRINDING ATTACHMENT.



ATLAS ARBOR PRESSES handle pressures from ½ to 70 tons.

The 1940 Atlas Catalog will be ready for you this month—72 pages crammed full of interesting machine operations, equipment close-ups, shop views, construction details, new and helpful machinery facts! Use the coupon below to reserve your copy now.

Every shop man should have this big new book at hand for quick reference during the busy months ahead. And we want you to note in particular the new developments of our Engineering Staff that make Atlas Equipment ever better and better for your use.

Fill out and mail the coupon today. There's a real treat in store for you. *Atlas Press Company, Kalamazoo, Michigan.*

FREE...

SEND FOR

1940

CATALOG
TODAY



ATLAS DRILL PRESSES come in 4 sizes, 4 prices.

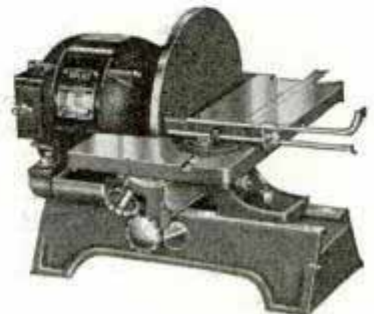

ATLAS DISC SANDER for quick wood or metal finishing.



ATLAS MOTORS & GRINDERS are unusual values.



A complete selection of VISES for metal or wood.

ATLAS PRESS CO.,

1143 N. Pitcher St., Kalamazoo, Mich.

Please put my name down to receive your new 1940 Catalog on New 10" Metal Lathes New 6" Metal Lathe New 7" Metal Shaper Drill Presses Arbor Presses Drill Grinding Attachment Disc Sander Motors & Grinders Vises.

Name.....

Address.....

City and State.....

I am already an Atlas owner

When writing to advertisers please mention Popular Mechanics

Explorers of Space

(Continued from page 683)

old and feeble, due to loss of solar energy, and sending out less radiation than it does now—or sending out more, resulting in drastic climatic changes on earth accompanied by violent hurricanes, thunder, lightning and torrential rain. Before this happens, the sun may explode and from their observation point the witnesses of this drama of the skies see how the sun, from being a steady beacon in the heavens, suddenly transforms itself into a blaz-

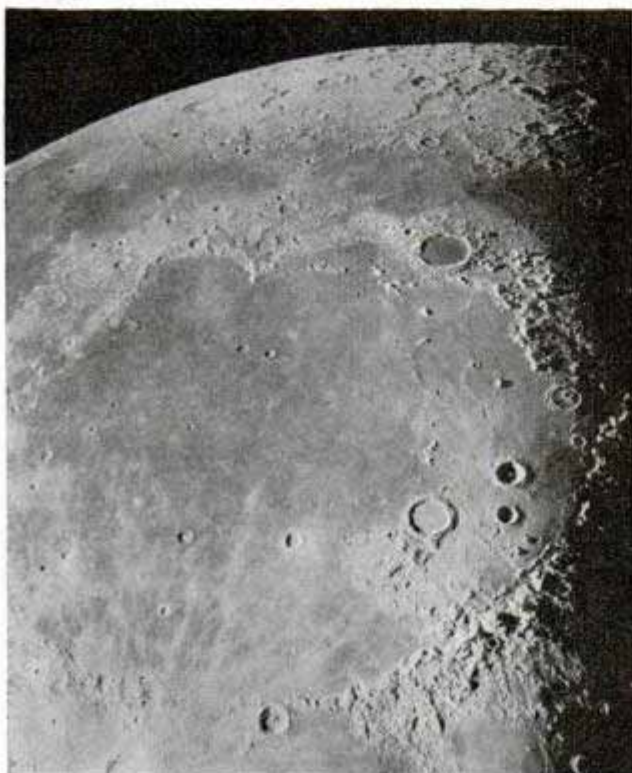

Photograph of moon taken through Mt. Wilson telescope shows vast plain known as Mare Imbrium

ing blowtorch which sends waves of terrific heat far out into the solar system, destroying all life on earth. Other theories, too, are depicted, dealing with the potential destruction of the earth, such as a head-on collision between the earth and a comet, or the earth being sideswiped by a star.

Another climax of this drama is the destruction of the moon. Here the observers see the moon being dragged toward the earth by the latter's pull of gravity. This cataclysm, which also might take place millions of years from now, will disrupt, if not entirely destroy, life cycles on the earth. As the lunar body is pulled relentlessly toward the earth it suddenly may break under the tremendous strain. Chunks of the moon may bombard the

world, accompanied by volcanic outbursts and earthquakes, until finally the life-less world is surrounded by a ring such as that which girdles Saturn. In the case of the earth, however, the ring would be made up of moon particles.

According to Professor Barton, there are two types of destiny which may await the earth. One is the "fixed" or "certain" type, the other is the "accidental." Scientists know that the cooling of the sun would bring the ice age back to the earth and that each second, four million tons of sun stuff are burned up on that body which is 864,000 miles in diameter. They know, too, that when the moon is pulled by gravity to within about forty per cent of its present distance from the earth it will start breaking up. With knowledge of this type, they have been able to compute "certain" events of this kind, hazarding guesses as to when they may take place. These events, they tell us, are millions of years in the future, hence are nothing for us to worry about.

The "accidental" type of events, however, possesses more potential danger in our own lifetime. Just a second ago—as astronomers regard time, on October 30, 1937, to be exact, a small heavenly body, Hermes, charging through space was only 400,000 miles from the earth—a tiny distance in the immeasurable universe. Observers estimated that it probably did not measure more than a mile in diameter or weigh more than 3,000,000,000 tons. If it had hit the earth, traveling at tremendous speed, however, it would have done an incalculable amount of damage. So might any comet shooting down in the path of the earth and either sideswiping it or meeting it head-on. Even here, however, the explorers of space offer us some measure of consolation. The universe is so big, they point out, that the millions of heavenly bodies which occupy it, numerous as they seem, are really few. The space they take up might be compared to five small birds on earth, each flying over a different continent. The chance that two of those birds would have of colliding is pretty remote.

☞Inquiries as to makers of articles described in Popular Mechanics, will be answered by our Bureau of Information upon receipt of return postage.

UNIQUE SHUTTERS DEFLECT RADIANT HEAT RAYS—LIKE SUN RAYS—DOWNWARD;

END COLD, DRAFTY FLOORS!

SUPERFEX Oil Heater's exclusive patented feature "bends" nature to science . . . gives living zone comfort.*

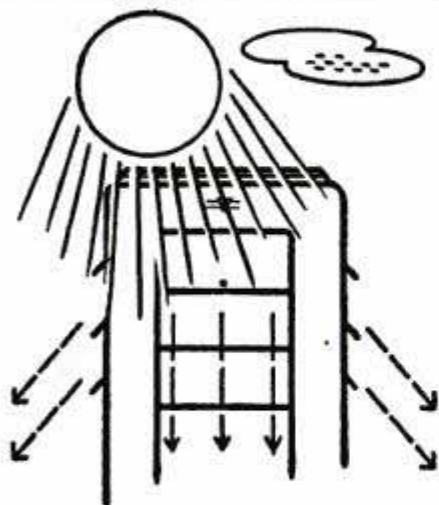

Engineers "scored one on nature" in developing SUPERFEX Heater's extra-comfort advantage. Radiant heat rays—like sun rays—heat anything they strike. But

radiant heat rays from SUPERFEX are *controlled* by adjustable shutters—deflected *outward* and *downward* at will—bringing *extra* comfort to anyone in the living zone.*

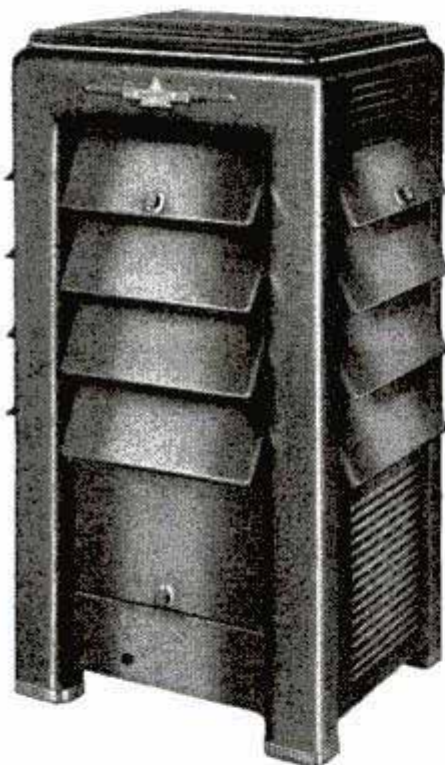

1. SUPERFEX circulates comfortable, warmed air—one type of heat—like this.



2. SUPERFEX's patented shutters, wide open, release a flood of cozy, radiant heat rays—a different type of heat—outward like this.

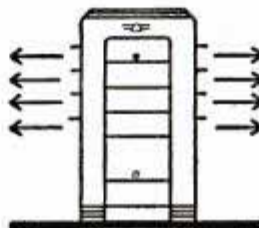

3. And they also direct these radiant heat rays downward to eliminate cold, drafty floors, insuring comfort everywhere.

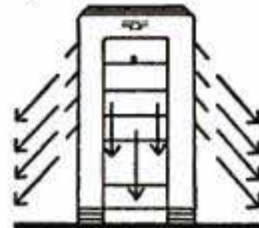

SUPERFEX gives *extra* comfort without extra cost. Its patented shutters *direct* radiant heat rays; it needs no fans or blowers that increase operating expense and cause uncomfortable floor drafts. And only SUPERFEX has these patented shutters!

Simple dial control or completely automatic if desired. Operates quietly and evenly without attention. Burns wide

variety of inexpensive fuel oils available everywhere. SUPERFEX brings a new sense of comfort to homes, stores, filling stations, etc. Complete line in both Heat-Director and Radiant models with removable fuel reservoir. Also available with constant level valve for use with outside fuel supply. Easy purchase plan. See your dealer. FREE descriptive booklet—just send coupon.

*The living zone is the lower half of your rooms—where you live—the space where you especially need heat.

SUPERFEX

Oil Burning

HEATERS



The Mark of Quality

PRODUCT OF PERFECTION STOVE COMPANY

PERFECTION STOVE CO., 7194-B Platt Ave., Cleveland, O.

Please send me free SUPERFEX Heater booklets.

Name _____

Street or R. F. D. _____ P. O. _____

County _____ State _____

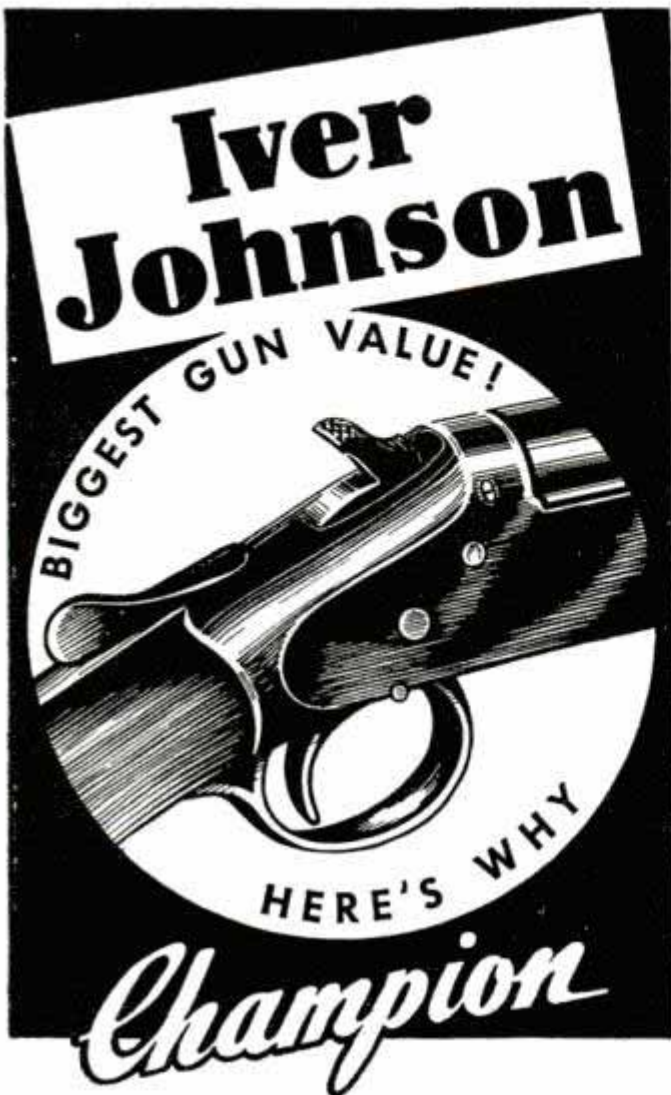

Iver Johnson

BIGGEST GUN VALUE!

HERE'S WHY

Champion



Here's America's most popular single gun. 68 years of making quality guns plus large production make it possible to sell this hard-hitting beauty for only \$9. From muzzle to butt plate it gives high priced performance. Accurate. Full choke. Automatic ejector. 3 piece take down. Trap style forend. Full pistol grip. Buy a "CHAMPION."

Write for Booklet A66 of complete line Single and Double Shotguns, Skeet-ers, Rifles and Revolvers.

For Christmas there is no better gift than an Iver Johnson Bicycle. "America's Finest" — made of costlier materials, it's smarter looking and lasts years longer.

Send for **FREE** booklets



IVER JOHNSON'S ARMS & CYCLE WORKS

21 RIVER STREET - FITCHBURG, MASSACHUSETTS
New York: - - - - - 85 Chambers Street

2 805
Forty Fathoms Down

(Continued from page 677)

quickly on his exhaust valves, he shoots to the surface like a rocket, in immediate danger of the bends unless he gets under pressure again in a hurry.

The "blow-up" of a diver on the "Squalus" job shows how it happens.

This man, one of the crack divers in the navy, was down on the deck of the "Squalus" attempting to shift an air-hose connection to the main ballast tank aft, over the four flooded compartments where the bodies of the twenty-six victims still awaited release. He struggled with the hose for fifteen minutes, punch-drunk and groggy under compressed air.

He found the salvage connection broken. He could make no progress with his job.

"I can't get anywhere and I'm having plenty of trouble in staying down here," he reported through his telephone. "I can't get enough weight on me."

Lieut. Commander Charles B. Momsen, diving officer of the rescue ship "Falcon," glanced at the clock and called to the diver that his time was up.

"Okay, I'm at the descending line, ready to come back," the answer came up.

"Come up to ninety feet and wait for the diving stage," was the next order from the deck.

The seconds rolled by as the diver reported himself "okay on the line" . . . "okay at ninety feet."

A few more seconds passed. All hands on deck remained silent, awaiting his report that he was on the stage.

Suddenly the gurgle of escaping air, bubbling alongside the "Falcon," became a loud sputtering.

He had "blown up!" His lines trailed in crazy curves atop the water. He floated to the surface, leaping up like a jack-in-the-box. A faulty twist of the control valve had forced more pressure into the "hat" and left him helpless for the moment.

Momsen leaped to the port rail, making a quick survey.

"All right," he called calmly as the line tenders hastily pulled in the slack. "Tell him we'll tow him back to the descending line."

The telephone man repeated the order to the loudspeaker system. The diver now had his air under control and was holding

2806
himself at surface level with head up and feet down.

The lines hauled him over and he reached out for the hawser to the sunken submarine, gripping it with his right hand as he reduced the pressure enough to give himself negative buoyancy for the slide down to the ninety-foot decompression stage.

Through each move of decompression, he was given double time. Nitrogen bubbles always run a close race with a "blow-up," and it is a fortunate diver who gets back under pressure quickly enough to save himself the tortures of the scourge of those who salvage "pig boats."

This man was lucky. His number wasn't up.

Raising and refitting the "Squalus" costs far less than a new ship, for navy personnel has to be paid and the salvage ships must be kept in operation whether or not a submarine lies on the bottom, and the only added cost borne by the government is for materials. Refitting the raised submarine will cost about \$1,000,000 against \$4,000,000 for a new submarine.

The lessons learned by the navy in its salvage of the "S-51," and then the "S-4," proved conclusively that the pontoon method of submarine salvage is by far the most satisfactory and the most practical. It is possible, under some circumstances, to attach salvage air hoses to the various ballast and fuel tanks and literally blow the vessel to the surface, but this is awkward and dangerous at best, and almost out of the question if the submarine is sunk more than 200 feet.

The salvage pontoon operates, in effect, on the principle of the submarine. Flood it with water to make it sink; blow out the water and fill it with pressure air to make it rise. pontoons are expensive, averaging \$15,000 each. The larger ones, which average thirty-four feet in length, have a lifting power of eighty tons—the amount of water they displace.

In the salvage plan for the unprecedented underwater tow of the "Squalus" to shallower bottom, ten pontoons were used, six on the stern, four on the bow. In the first attempt, which resulted in the accidental surfacing of the bow, only two were placed over the bow, five over the stern.

The top layers of the pontoons—three at

(Continued to page 126A)

Only $\frac{1}{1000}$ th Second
Candid Under
\$100



Tricolor Deep-Focus f3.5 Lens
Photoflash Synchronizer Built-In
Automatic Film Transport

Here's the only completely All-American Made camera that gives you the speed, the performance and the prize-winning results you'd expect only from the most expensive foreign makes! Think of halting a 200-mile-per-hour racing automobile! A shutter with 1-1000th-of-a-second speed gets it—true, sharp, clear! Think of taking perfect nighttime shots—indoors or out! The built-in photoflash synchronizer switch makes it easy! Think of cutting your negative costs in half! The most economical Univex 35 mm. film makes it possible!

No longer need you envy those who own expensive foreign-made speed cameras. See the amazing Univex Mercury today! Many dealers offer convenient, easy-payment terms. Or send coupon for FREE illustrated booklet!

CHECK THESE FEATURES!

- All-metal focal plane shutter!
- Built-in optical view-finder!
- Automatic film transport—double exposures impossible!
- Interchangeable lens equipment!
- Helical focusing mount; graduations from 1½ ft. to infinity!
- Range finder mounting!
- Automatic exposure calculator!
- Quick-action simplified controls!
- Uses new ultra-speed, inexpensive 35 mm. film!

BACKED BY
WRITTEN GUARANTEE!

ACTION SHOTS
AT NIGHT!



Universal Camera Corp.
Dept. M-5, New York City

FREE BOOKLET

Please send me illustrated booklets describing in detail the many features of the new Univex Mercury Super-Speed Camera.

Name _____
Address _____
City _____ State _____

UNIVEX $\frac{1}{1000}$ th Second MERCURY
THE CAMERA THAT KNOWS NO LIMITATIONS!

Do you want
**ALL-WINTER RADIATOR
 PROTECTION FOR ONLY \$1.50?**



HERE'S the way many car owners do it every year! They put in a couple of quarts of Du Pont "Zerone" early in the season for protection against rusting and sudden cold snaps.

When winter gets down to business, they add enough "Zerone" anti-rust anti-freeze to protect to lower temperatures. A total of 6 quarts, put in as needed, can protect a car with an average size cooling system (15 quarts) for the entire winter. And 6 quarts of "Zerone" cost only \$1.50!

You may need a little more or less, depending on the condition and capacity of your car radiator and the severity of winter in your neighborhood. But you can be sure that the unusual efficiency of Du Pont "Zerone" will save you real money.

"Zerone" in a clean cooling system prevents rust and corrosion, gives better dissipation of engine heat, avoids power losses. Put some in today! It's only \$1.00 a gallon, 25¢ a quart.

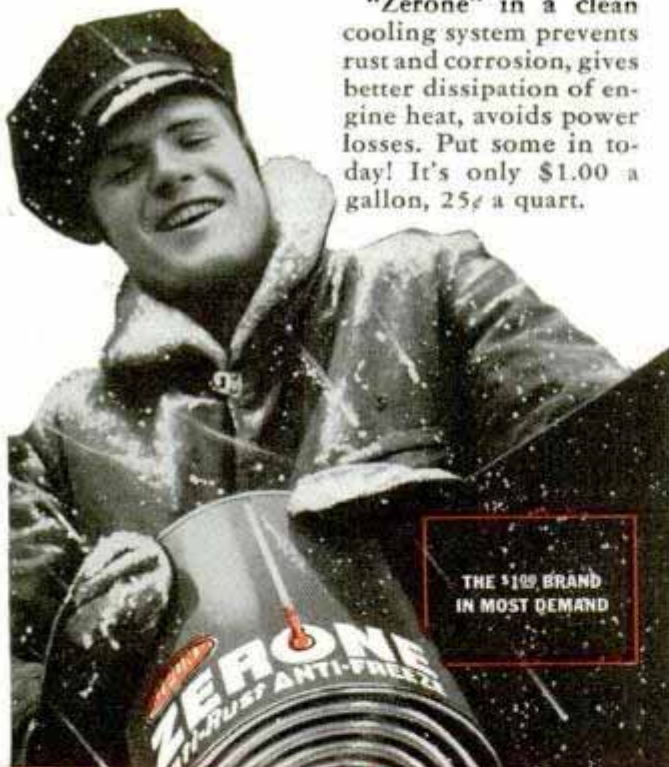

THE #100 BRAND
 IN MOST DEMAND

DUPONT

ONLY

\$1 A GALLON

ZERONE

Anti-Rust ANTI-FREEZE

(Continued from page 125A)

a depth of eighty feet over the stern, three at seventy-four feet over the bow—were placed at those levels so that when they rose to the surface the submarine would be hanging underwater at an even keel, ready for the first tow. Astern, one pontoon was dropped to 160 feet for the first shift and thus was in its proper position for the second lift. The remaining pair was at the 230-foot level. The difference in depth for the second lift was due to the slope of the ocean bottom.

The whole plan of underwater towing was evolved for its first use in salvage history because of the depth in which the "Squalus" landed. If she had fallen in 100 feet of water it would have been a simple matter for the navy's deep-sea divers to attach pontoons directly to the hull and bring the ship all the way to the surface and into drydock. But at 240 feet, a diver has little working efficiency, little more than half an hour of bottom time.

On paper, the theory of blowing the submarine's ballast tanks and bringing her to the surface by herself looked very well. Actually, it might have meant the destruction of the vessel. The "Squalus" might have rocketed to the surface out of control, in danger of bursting its hull from the inside force.

The plan was to tow the "Squalus" stern-first, since the stern was headed toward shallower ground, and toward the Portsmouth navy yard. One heavy tow line went down from the mine-sweeping tug "Wandank" to the stern of the "Squalus." Another "Wandank" hawser went to the bow of the "Falcon." Astern, the tug "Sagamore" held a preventer or safety line to the bow of the submarine, holding enough strain to keep the "Squalus" from yawing. Thus the "Wandank" towed both the "Squalus" and the "Falcon" at the same speed. It was obvious that the "Falcon" must keep an exact pace with the "Squalus," to prevent the air lines from tearing away.

Once in shallower water, the navy could uncross its fingers and send down the divers for what amounted to child's play after the 240-foot depth of the original position.

Send return postage to our Bureau of Information to learn the name of the maker of any device described in this magazine.

DON'T RISK ACCIDENTAL ROLL BACK of YOUR CAR or TRUCK!

NoRoL

HOLDS CAR on HILL STOPS

You probably have often wished for a device that would automatically prevent unintentional back-roll when car is brought to a stop on an incline . . . Such a device is available. It is called a NoRoL. It isn't expensive . . . It is easily installed . . . Is 100% automatic in operation—and should outlast the car.

NoRoL gives you a "third foot"—doing brake duty against back-roll on inclines, while right foot is left free for accelerator duty. Eliminates fatigue and frazzled nerves when you are driving in congested traffic in hilly country or on city streets . . . Does away with chance of back-roll on uphill start which might result in breaking axle shaft . . . Prevents unnecessary wear on clutch facings . . . Also lessens chances for clashing or breaking of transmission gears.

When ordering a new car, insist that it come complete with a NoRoL figured right in with the time payments. NoRoL is available for new models of—

BUICK	DE SOTO	LA SALLE	PLYMOUTH
CADILLAC	DODGE	NASH	PONTIAC
CHEVROLET	GRAHAM	OLDSMOBILE	STUDEBAKER
CHRYSLER	HUDSON	PACKARD	INTERNATIONAL

WHITE and others

Also available for many 1936, 1937, 1938 and 1939 makes and models of cars and trucks.

Many Models Only \$12.00 installed
SEE YOUR CAR DEALER—or write us



HERE'S HOW IT WORKS

When stopping on any incline, no matter how steep, you simply apply the brake and disengage the clutch in the usual manner. An automatic check retains the hydraulic pressure in the braking system which was developed when the brakes were applied. This hydraulic pressure holds the brakes applied as long as the clutch pedal is held depressed, enabling the driver to take his foot off the brake pedal and use it for accelerator duty . . . thus making it unnecessary to keep his right foot on the brake pedal while the car is stopped. It's like having a third foot.

Wagner Electric Corporation

[Manufacturers of Lockheed Hydraulic Brakes] N39-6
6400 Plymouth Avenue, St. Louis, Mo., U. S. A.

Send FREE BOOKLET and details on NoRoL.

NAME _____
ADDRESS _____ CITY _____
STATE _____ MAKE AND MODEL OF MY CAR IS _____

FREE CLUB & CLASS PIN CATALOG
SHOWING OVER 300 DESIGNS

300 SMART DESIGNS!
Knit your class or club closer together with pins or rings. Bastian has been the leading maker for 45 years. Clean cut, quality work. Write today for 1940 Catalog.

30¢ **\$1.40**

BASTIAN BROS. CO. Dept. 70, Rochester, N. Y.

MAN IN EACH TOWN

To Plate Auto Parts

Reflectors, Bicycles, Fixtures, Mirrors, by late method. Simple plan of manufacturing at home starts you IN GOOD PAYING BUSINESS. Write today for FREE particulars and proofs.

GUNMETAL CO.
Ave. M Decatur, Ill.

GOLF GREEN MOWER, TEXTILE TRUCK, SUCTON PUMP, ICE CREAM CART, WRELS GUN, HAND TRUCK

DOENUT WHEELS

DOENUTS, developed and patented by the originator of the air-wheel, absorb more surface obstructions and eliminate jolting. Protect wood and concrete floors. Do not sink in sand or soft ground. Cadmium plated disc wheel with adjustable ball bearings. Size 10"x2.75" with cap. of 225 lbs. per wheel and 12"x3.30" with load cap. of 325 lbs. per wheel. Ideal for wheelbarrows, painting rigs, spraying equipment, textile trucks, dish trucks, boat dollies, food carts, or most any portable unit that rolls. Handle same loads with less than half the labor. Send 10¢ postage to cover cost of mailing literature.

MUSSELMAN PRODUCTS CO.
6225-P. St. Clair Avenue, Cleveland, Ohio

Earn \$150 to \$300 EXTRA PROFIT monthly

with "Simplified" ARC WELDING



Yes, you can "Build Your Own." Save \$300 to \$500

• Start a big pay business of your own now, with new 40 Volt Simplified Arc Welder. New low prices and easy pay-out-of-profit terms makes equipment available to everyone. Exclusive Hobart features guarantee easier, faster operation. Same machine as used by largest manufacturers. Extra earnings easily pay for it without expense to you.

30 DAYS TRIAL TO PROVE IT PAYS

Use this welder for 30 days on your work, at our risk. See for yourself how many profitable jobs it can do before you buy. Write today for complete details on 30 Days Trial and Easy Terms. No obligation.

HOBART BROS., Box M-119, TROY, OHIO



AS LITTLE AS \$20 Monthly puts it in your shop

Get your FREE Book on New Profits for Welding Shops

Shooting from the Clouds

(Continued from Coloroto Section)

I direct my own pilot and the pilot of the object ship by radio, talking into a lapel microphone and listening with a headset. That makes coordination easier, and if the other fellow sticks his wing through my door I can at least talk back and tell him what I think of him.

Part of my work is photographing celebrities at the airports and aboard planes. They don't all like it, and sometimes it takes plenty of diplomacy as well as ingenuity. I snapped one noted personage arriving on a flagship at Glendale, Calif., but he walked over, quietly took the camera out of my hands, pulled out the film, exposed it and handed it back. Once a flock of newspaper cameramen lined up to catch Doris Duke Cromwell as she stepped from a plane. I noticed the photographers were all on one side of the "gangplank," and I knew she would turn away as soon as she saw them, so I took a position alone on the opposite side. Sure enough, she turned her face toward me and I caught a good "grab shot." I sent Doris a print and she liked it so well she ordered two dozen copies.

Most gracious of all celebrities, however, is Eleanor Roosevelt. A veteran flier, she is invariably charming and willing to pose. By pre-arrangement she gave us forty minutes of her time recently at Fort Worth. We had every picture planned in advance. Chalk marks on the pavement showed her where to stand and indicated camera position. She posed in the doorway, in the cabin, eating, knitting, lying down in the sleeper. Lesser persons might have felt

silly or exasperated, but not Mrs. Roosevelt. She was game and cooperative, and in forty minutes I shot twenty-four good Kodachromes.

You'll never be bored as an aerial cameraman. There's something new every day. You may be called on to shoot aerial maps with a fifty-five-pound camera fixed in the floor of your ship; the government may want photographs of growing crops or erosion-control projects, of forest fires, harbors, fire and flood control and forestry conservation projects. Oil and mineral prospectors send you up to 10,000 and 20,000 feet for pictures of terrain that looks promising to them. Once I was sent on a jaunt through the bumpiest air of Arizona's mountain wilderness to hunt a lost gold mine, and between pictures I had plenty of time to wonder what would happen if we had to land. There wasn't a smooth spot the size of a postage stamp for miles. If anything went wrong we'd be as lost as the gold mine, which is still missing.

You run into such odd difficulties as having the camera shutter stiffen with cold 8,000 feet over Los Angeles. And one day when you're relaxing to enjoy the scenery after shooting the snowclad sierras through the open door, your plane will hit a bump, do a flipflop that all but puts your head through the floor, and then drop through a hole in the sky for a vertical spin. As the pilot pulls you out of it a half mile nearer the treetops you are wondering whether you remembered to put the filter on for that last Kodachrome shot.

Angling for Better Billiards

(Continued from page 693)

Firmness is the chief asset of this style of cue holding. The strong second or middle finger is curled under the thumb to provide a rest. Combined with the third and fourth fingers it forms a tripod with a large base that makes the hand as firm as if it were a part of the table when a steady pressure is applied. The first finger should be wrapped completely around the cue and the tip held under the thumb.

Don't make the common mistake of al-

lowing your index finger to go free; double it under the thumb so it will be held firmly. The parts of the hand that actually touch the table are the heel, the entire length of the little finger, the tip of the third finger, the first joint of the middle finger, and the tip of the thumb.

The masse bridge is a shot easily mastered by all. Assuming the player knows where to strike the cue ball, its secret lies

(Continued to page 130A)

New Delta Shaper

INCORPORATING MANY NEW FEATURES

Once again Delta announces a big step forward in power tool design—a basically improved shaper built to the same high standards that characterize all Delta Machines. Here is a powerful, smooth-running, accurate tool that gives you heavier, faster cuts than the ordinary light shaper. It will shape, form or mould any form of work from the smallest mouldings to heavy production work.

Some of its new features are: 1. *Large Husky Spindle*; 2. *Exceptionally Big Table*; 3. *Long Spindle and Spindle Travel*; 4. *Large Sealed-for-Life Bearings*; 5. *Powerful V-Belt Drive*; 6. *Interchangeable Spindles*; 7. *Fully Adjustable Fence*; 8. *Strong, Welded Cabinet*. Every man interested in power tools should get the full details on this remarkable machine.

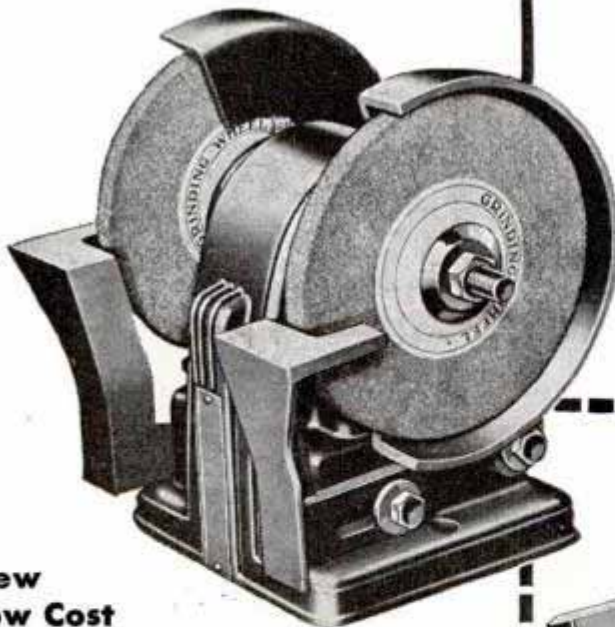

New Low Cost Delta Grinder and Buffing Head

Has 6" x 1/2" wheels, easily removable cast iron guards, adjustable tool rests and a quality heretofore not found in low-cost grinders. May be driven from back or bottom. New Delta Buffing Head is similar to grinder except that guards and rests are eliminated. Has 1/2" threads so that many standard attachments can be used, such as scratch wheels, wire brushes and chucks.

Send for Catalog!

The latest Delta 1940 Catalog gives you full information on the complete Delta line of low cost tools for home shops, small shops and industry. (Also send for new Project Book No. 6 crowded with new and "out of the ordinary" things to make. Has scores of diagrams, photographs and working drawings. Send 10c with coupon for Delta Project Book No. 6 and Delta Catalog.)

**Delta Manufacturing Company, Dept. A1139
600-634 E. Vienna Ave., Milwaukee, Wis.**

I enclose 10c for new Delta Project Book No. 6 and new 1940 Delta Catalog of Power Tools.

Name.....

Address.....

City.....State.....



DELTA Mfg. Co.

600-634 E. Vienna Avenue
MILWAUKEE, WIS.

When writing to advertisers please mention *Popular Mechanics*

298

(Continued from page 128A)

NEWS FLASH!

LIONEL ANNOUNCES Greatest Thrill on Wheels

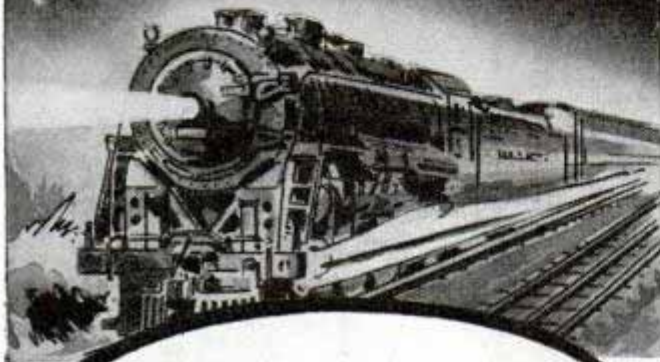

PUSH-BUTTON RAILROADING



What Is It? How Does It Work? What New Train Thrills Does It Introduce?

NOT IN 40 YEARS has Lionel streaked in with anything so electrifying as this! It's a world-beater for, worldwide, there's nothing like it! No room here, as you can see, to give you all the details—but, in a new, big, full-color catalog we've told the whole exciting story. So, right now, today, do this...

Get the Magic Story of "Push-Button Railroading"

Mail the coupon below—and back will come a copy of the 52-page, thrill-packed Lionel Catalog—lickety split!



The Lionel Corporation, Dept. V
15 East 26th Street, New York, N. Y.

Please send me the new 1939 52-page, full-color Lionel Catalog. Enclosed is 10c (for postage and handling).

Name _____

Address _____

City _____ State _____

in having each of the four fingers of the bridge hand pressing against the bed of the table. Likewise, a bridge for a half masse over a ball can be made as firm as one for a regular masse. Miscues are common when the player fails to provide a steady rest for the cue. Many players have a tendency to strike the ball too low, whereas it is necessary to strike only a fraction below or behind the center line to obtain immediate response. Essentially the bridge is the same as for the ordinary masse except that the angle of the cue is lower.

Fully ninety per cent of the shots made with the cue ball close to the rail are accomplished with the cue almost level. Elevation is necessary only in the half masse strokes.

The rail bridge is a solid support in which the first and second fingers press gently against the cue to form a slot through which it slides easily. The matter of elevation is easily regulated. The top surface of the cushion acts as a guide with the cue resting flat upon the cushion, which, of course, is a slightly beveled edge.

A good player, in cuing, never strikes more than one half to the right, left, top, or bottom of the center of the cue ball. A player's progress will be rapid if he refrains from using english as much as possible. Playing too far to one side or the other creates miscues and faulty shots.

The importance of a good follow shot may be grasped when you consider how many opportunities in ordinary straight rail, balkline, or pocket billiard game fall under this classification. The idea is to make the cue ball follow in the general direction of the object ball with which it comes in contact. In carrying out this shot, never cue more than the width of your tip above center with no english and make certain your bridge is at such a height that the evenness of your stroking is not impaired.

There should never be any doubt in the player's mind regarding the exact spot on the first object ball which he must strike in order to effect his carom. For that reason we have arrived at a system that has proved successful in playing the follow shot. Draw a line from the center of the second object ball to the center of the first object ball. The point of aim is then the

278

spot on the far side of the first object ball where this imaginary line cuts the surface. Whether the angle be narrow or broad, this method can be used. In other words, on a free follow or half follow the result will be the same; the half follow invariably will gather the balls where a fine shot scatters them.

In studying the draw shot we will see also that the player must be concerned with the point of aim, rather than the point of contact. The draw shot, incidentally, is the thing that separates the players from the dubs. Without a good draw shot, your chances for success in any form of the table game are zero. Many billiardists make the mistake of raising their bridge hand when they want to draw the ball. By doing this the follow-through is cut drastically and, apart from cutting down the back spin on the ball, there is a strong likelihood of tearing the cloth.

To determine the exact spot on the first object ball that must be struck to score the point is at times confusing to amateurs trying a draw shot. The simplest system is to divide the angle between the cue ball, the first object ball and the second object ball; then aim through center of cue ball at point on the object ball equal distance between two sides of a triangle. The process of dividing the angle with the eye may at first prove difficult but if the player gives his full attention to the system he will soon grasp the idea and thereafter will see the point of aim instinctively. Having determined exactly upon the point of aim, the player should take care to form a firm bridge. He should hold his cue as level as possible with a slight elevation at the cue butt. By striking the cue ball one half below center without english he will execute the shot.

The correct way to take aim is to select the spot on the object ball you wish to hit and the spot on the cue ball. Concentrate on this line of aim and then hit where you aim. Watch the tip of your cue in preliminary strokes to see that it is going to the same spot each time.

In conclusion, practice concentration on every stroke. Once you have determined the proper place to strike the first object ball with your cue ball, concentrate on your cuing and connecting with the first object ball and your game will improve.

A BETTER HEARING AID

By Bell Telephone makers



Western Electric
HEARING AID
Ortho-technic Model

You owe it to yourself to try this remarkable Audiphone. It is helping others to hear clearly again in group conversation—to widen their hearing circle—to hear in any position—to enjoy natural tone with greater volume!

Developed by Bell Telephone Laboratories—based on advanced technique in hearing aid design—it gives hearing ease unmatched till now. There's a national network of hearing aid service stations.

Accepted by American Medical Association

GRAYBAR ELECTRIC CO., Graybar Bldg., New York
Please send details on Western Electric Audiphone (Ortho-technic Model) and name of nearest dealer. PM49

Name.....

Address.....

City..... State.....

BUILD

Your own entertainment
—with this
amazing 7 tube
Hi-Fi Receiver

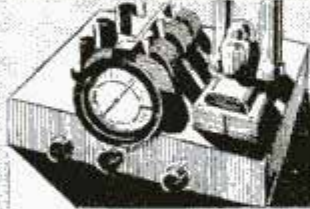

Save money

The thrill of a lifetime waits for you. Think of building—by yourself—a modern 7 tube high fidelity radio receiver. It's easy! And you save real money. All the tools you need are screw-driver, soldering iron and pliers. Instructions are furnished. These are complete and easily understandable. Even the inexperienced can assemble this receiver without difficulty.

The fun of building it is even topped by the years of listening enjoyment ahead for you. For when the job is done, you've a radio you can be proud of, count on for excellent results. The TRF circuit used is similar to that used in this year's high fidelity, high priced receivers. Excellent tone quality is assured. Of the seven tubes employed, four are the new single ended type—highly efficient and very simple to use. Assembly is further simplified by grouping most of the by-pass condensers within a single case. Construction kit includes all necessary parts, plus pictorial, schematic and wiring layout. It's a lot of fun and excitement. Shpg. wt. 16 lbs. **R20359**—Complete kit of parts, \$9.95 less speaker, tubes and cabinet. (Add postage).....



You'll want this new
1940 **FREE** catalog

For outstanding values in new 1940 radios, old and new parts, tubes, ham apparatus and public address equipment. 189 pages. All the nationally advertised names. Send for **FREE** copy at once. Save money on everything you buy. Tear off and mail this coupon. **Do it now!**

Radio Wire Television Inc.
formerly WHOLESALE RADIO SERVICE, INC.

LAFAYETTE RADIO

NEW YORK, N. Y. • CHICAGO, ILL. • ATLANTA, GA.
100 SIXTH AVENUE • 901 W. JACKSON BLVD. • 265 PEACHTREE ST.
BOSTON, MASS. • BRONX, N. Y. • NEWARK, N. J. • JAMAICA, L. I.
110 Federal St. • 542 E. Fordham Rd. • 24 Central Ave. • 90-08 164th St.

Radio Wire Television Inc.
Dept. 7LAD—100 Sixth Avenue, New York, N. Y.
Rush **FREE** 1940 Radio Catalog No. 78
I enclose \$..... Please Rush my Hi-Fi Receiver.

Free Catalog

Name.....
Address.....
City..... State.....

Attach
order to
coupon

PASTE COUPON ON PENNY POSTCARD

Portable Low-Cost Sound System

(Continued from page 777)

A simplified wiring diagram is shown in Fig. 2 and the schematic circuit diagram appears in Fig. 3. Photos Figs. 2-A, 2-B and 2-C show general views of the assembly.

A detailed list of the original materials used in the model can be obtained from Popular Mechanics radio department without charge. The blueprint, R-272, will not be available until Part II of this article appears in the December issue.

(To be concluded)

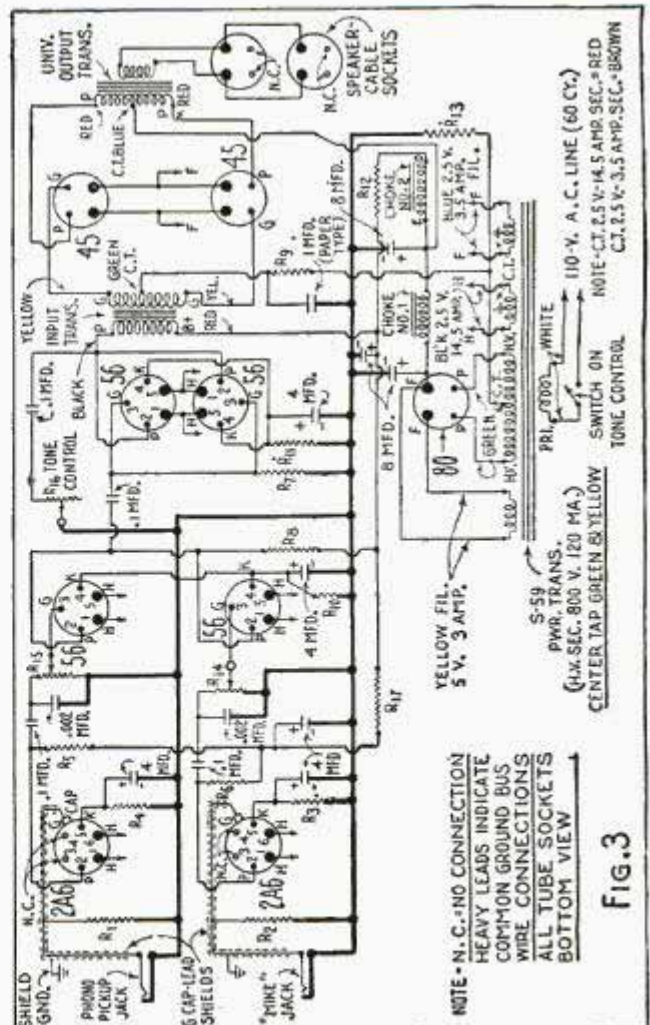
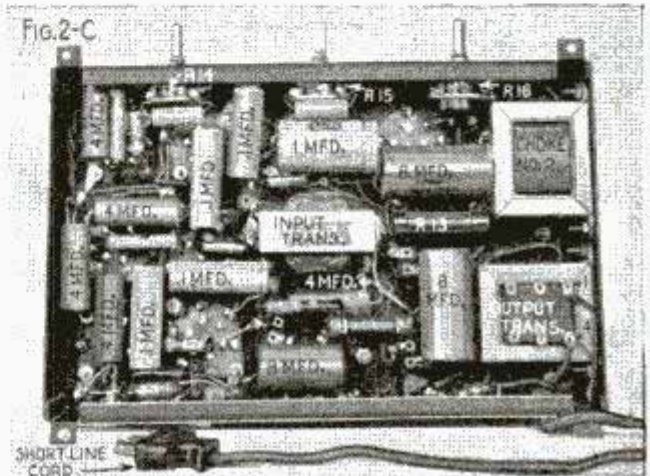

FIG. 3

PICK THE FILES

THAT *Professionals* USE!

Special file steel . . . keen, even teeth . . . uniform edges . . . these qualities are demanded in a saw file by the man who makes a living with his saw.

Follow his lead on the files you buy for saw and edge tool sharpening. You'll find Nicholson Files are real craftsmen's tools, made with all the skill of the world's leading file manufacturer.

Your hardware store has Nicholson Mill Files and Slim Taper Files—made for sharpening jobs—conveniently displayed in the Nicholson Unit, each protected by Cellophane wrapping. Stop in today and stock up. And write for your free copy of "A File For Every Purpose," the 28-page book that tells how to choose and use files. Nicholson File Company, 22 Acorn Street, Providence, R. I., U. S. A.



NICHOLSON FILE COMPANY

PIONEERS IN QUALITY PRODUCTION

75th
ANNIVERSARY
YEARPRACTICAL \$1.00
MAGNIFIER....

A practical, easy-operating and attractive magnifier with 2½ power, 2" dia. lens and two fully adjustable ball joints. Raises to 3¾" high. Finished in chrome plate and enameled. An ideal instrument for home, office and shop. A big value—\$1. postpaid.

The MAG-NI-LINE PRODUCTS

Dept. 12, 3456 E. Jefferson Detroit, Mich.

BIG NEW STREAMLINED LATHE
AT SENSATIONAL BARGAIN PRICE

Swings 10 inches

Imagine! This extra heavy wood lathe, steel bed 45" long, at low prices. Heavy duty head stock, 4-step cone pulley for V-belt. No. 2 Morse Taper Centers. Sealed ball bearings. 6" face plate screws onto spindle. Tool rest 10" long. Complete line of accessories at amazing low prices. Write today for free catalog describing Blue Star full line precision woodworking machinery. Factory-to-you prices. Not sold through agents. Act at once!

BLUE STAR PRODUCTS, 611 Gate Street, Fairfield, Iowa

Better Tools—Lower Prices
GET BALKO'S 1940 CATALOG!

THE CATALOG OF EVERYTHING IN POWER TOOLS, SPRAY EQUIPMENT, MODEL SUPPLIES, ELECTRIC MOTORS, Metal Lathes, accessories, Artist Air Brushes, Spray Guns, Elec. Bench Grinders, Grinding Wheels, Lathe Chucks, Micrometers, Pulleys, V Belts, Carving Tools, Compressors. BALKO'S complete stocks and fast service save you time and money. Send a 5c stamp today for your big new copy.

BALKO ELECTRIC TOOL & SUPPLY CO.

605 W. Washington, A-11, Chicago, Ill.



Earn MONEY Make Color-glazed Concrete Products

MAKE color-glazed concrete pottery, tiles, walls. New, low cost, patent method. No molds. Use only sand, cement, cheap materials. Basement waterproofing. Other projects. Booklet, cost data, details, 10c.

NATIONAL POTTERIES COMPANY

Room 6, 13 W. 26th St., Minneapolis, Minn.

NEW KIND OF MAN'S SHOE

The new sensation in men's shoes — The Chippewa Clipper. It zips on and off in a "jiffy". Right now is the right time to get into a dignified and highly profitable shoe business of your own with this fast seller, and a complete line of almost 250 styles of dress, work and sports shoes. Prices as low as \$1.98 a pair. Free 10-second demonstrator sells super-comfort air-cushion shoes like magic.

Manufacturer established 35 years wants salesmen. No experience needed. Write for complete sales kit. It's free!

MASON SHOE MANUFACTURING CO.
Dept. E 28, Chippewa Falls, Wis.BIG OPPORTUNITIES
MANUFACTURING MATERIALS
FOR LOW COST BUILDING

CASH IN BIG on the great building upturn under way. Make a superior, more permanent material — the kind demanded by your trade—lighter weight, and offering big savings in construction. Sells easily up to 100% over manufacturing costs.

WE EQUIP YOU with line production machinery requiring only modest investment. Raw materials enter at one end—finished products emerge from other end. Big daily production with one to three men. You make common brick—face brick—in over 40 beautiful colors—also DUNSTONE in 9 sizes.

INVESTIGATE NOW. Send for "4 Keys to Success." It tells the complete story—how present manufacturers are making outstanding progress in a business offering unlimited opportunity for growth, expansion and profit. Write today.

W. E. DUNN MFG. CO.
600 W. 24th St. Holland, Mich.

IT'S FREE

...THIS FASCINATING
NEW BOOK

"EXPERIMENTS
IN CHEMISTRY"



A treasure house of entertainment and information for the young scientist. Tells how to perform many thrilling experiments in Chemistry, Microscopy, Physics, Electricity, etc. And while you amaze your friends you are gaining valuable knowledge that may lead to a successful business career in later years. Booklet also illustrates and describes the new 1940

CHEMCRAFT

REG. U. S. PAT. OFF.

CHEMICAL OUTFITS

the original chemistry outfits—accurate—scientific, and containing no dangerous substances. Only in Chemcraft Outfits do you find such exclusive features as *Chemical Magic, Alcohol Lamp Blow Torch for Glass Blowing, Spectroscope* and many others. See Chemcraft Outfits at your favorite store—\$1 to \$25.00.

Mail coupon now for Free Book "Experiments in Chemistry."

THE PORTER CHEMICAL COMPANY
26 Prospect Ave., Hagerstown, Md.

Please send me free book "Experiments in Chemistry."

Name

Address

City..... State.....



HERE'S WORK for you! EARN GOOD MONEY

Be our representative in your locality for Dove Work Garments. No experience necessary. Pleasant, simple work. Every business prospect. Advertising embroidered on garments great sales feature. Easy to make good money weekly. We supply everything needed to start at once, including FREE OUTFIT. Write immediately. **BEN DOVE GARMENT CO., 801 So. Fourth St., Dept. 926, Kankakee, Ill.**

Saw-Filing

Pays up to \$2 or \$3 an Hour in Spare Time

A FOLEY Automatic Saw Filer files hand, circular and band saws better than the best hand filer. Cash business, no canvassing, no eyestrain. No experience needed. Louis P. Wadwick, Ohio, says, "I have filed 764 saws in spare time and have earned \$850.00 in carpenter work due directly to my saw filing contacts." Send coupon for FREE PLAN, no obligation.



FOLEY MFG. CO., 1116-9 Foley Bldg., Minneapolis, Minn.

Send Free Plan on Saw Filing business.

Name

Address

When writing to advertisers please mention Popular Mechanics



100 TOOLS in ONE

SAVE TIME - CUT COSTS - DO BETTER WORK

Don't confuse the genuine Dremel Moto-Tool, popular in industry, with weak, low-speed tools built to sell cheap. 110 volt AC-DC motor is packed with power. Speed—over 20,000 r.p.m. Weight—only 6 oz. Bearings—oil-less (oil sealed). Cooling—internal fan. Model 1—with chuck, 1/4" collet, only \$9.85 postpaid. **Master Model 2**—faster, heavier, more powerful, with chuck, only \$10.50.

**GRINDS
POLISHES
SHARPENS
DRILLS
ENGRAVES
ROUTS
Etc., Etc.**

Only **\$9.85** POST PAID
MASTER \$16.50
MODEL

10-DAY TRIAL See the genuine Dremel Moto-Tools at better Dealer's or order direct from factory on 10 day money back trial. Catalog of Dremel tools, equipment and special combination offers, FREE. **Dremel Mfg. Co., Dept. M119-L, Racine, Wis.**

NOW ONLY \$5.00 **REAL ENGINE VALUE**

Over 7,000 GHQ Gas Engine Kits were sold at \$8.50. Over 10,000 sold last year. Now is your chance to buy the *New Improved* kit for \$5.00. Absolutely complete with coil, plug, etc. For boats, planes, etc. All parts guaranteed. Send only \$1.—*Shipped Express Collect for balance same day. Send 3c for new 18-page illus. catalog. DEALERS WRITE.*

All parts finished. Only a screwdriver needed. 1/5 H.P. Average assembly time 30 minutes.

GHQ MOTORS, 40B East 21 St., New York, N. Y.

BURN YOUR NAME ON TOOLS WITH THE ARKOGRAF

PROTECT YOUR TOOLS FROM THEFT Write with electricity any name or design on the hardest and finest tools and instruments, or any metal, like writing on paper with pen or pencil. **Complete Outfit \$3.50**—Prepaid Anywhere. Interesting illustrated circular free. Write today. Agents wanted. **ARKOGRAF PEN CO., 3927 S.E. Stark St., Portland, Ore.**

FINDS BURIED TREASURE! NEW GOLDAK RADIOSCOPE

NEW PATENTED METAL LOCATOR. LATEST TYPE HIGH EFFICIENCY LOW DRAIN TUBES. NEW LOW PRICES. SENSATIONAL NEW MODELS. MONEY-BACK GUARANTEED DETECT BURIED GOLD AND SILVER. The new Radioscope is the most powerful and most sensitive metal locator ever known. Write World's Largest Manufacturer of Successful Metal Detectors for free interesting information.

THE GOLDAK CO., Dept. P
1031 South Broadway, Los Angeles, Calif.

BOAT BLUEPRINTS & PATTERNS

12 FOOT CRUISER Full size paper patterns! Newest designs by naval architect. Cruisers, runabouts, 8' to 9', snipe, outboard boats, sailing canoe (Kayak), etc., 8 ft.-38 ft. Low prices. Rush 10c (coin) for latest catalog. Send \$1 for "HOW TO BUILD BOATS" book, postpaid.

Cleveland Boat Blueprint Co., Station A-667, Cleveland, O.

FREE TRAILER BUILDERS' GUIDE AND CATALOG—NEW 1939 EDITION

WORLD'S BEST LINE OF TRAILER AXLES, HITCHES AND PARTS—Complete house trailer working blue prints only 50c. **WRITE TODAY FOR THIS NEW FREE CATALOG.**

HAMMER BLOW TOOL COMPANY, Dept. 111, Wausau, Wis.

New Kind of POTATO PEELER

Agents! Sell Like Wild

Revolutionary invention replaces old-fashioned paring knife. Peels potatoes faster, easier—without waste. Preserves vitamins and minerals. Shreds cabbage, long or short, equal thickness. Slices vegetables, fruits uniformly. Grates, garnishes, shells, cleans. Prevents cut fingers. Stays sharp. Housewives wild about it. Low priced. Lightning seller. **AGENTS WANTED EVERYWHERE. Hustlers cleaning up!**

SAMPLE OFFER Samples sent on trial to first person in each locality who writes. No obligation. Get details. **Be first—send in your name TODAY!**

KRISTEE CO., 676 Bar St., Akron, Ohio



Hunting Birds with a Camera

(Continued from page 735)

find their nests; for when the home contains eggs or young, the occupants are sure to return and give you a chance.

Early summer, before the trees have fully leaved, is your best opportunity to locate the nests of hawks. The nests of birds that rebuild annually can be found only with a lot of looking. Plenty of leg work and a pair of binoculars are the requirements here.

After working several weeks in a locality, it is no trouble at all to gather volunteer scouts, who will be glad to report the location of unusual birds, and their nests. If you make it a point to ask permission of landowners before trespassing on their property, they invariably have valuable advice to offer on birds they have noted, the location of nests, the progress of the young. Farm hands and country boys are especially helpful allies.

Photographs at the nests of hawks and owls are won only at the expense of some rather strenuous climbing. The help of a friend or two is especially valuable here, for you cannot make a difficult climb loaded down with equipment. On climbing expeditions it would be wise to take along a pair of lumberman's spurs, a lineman's belt, a short length of stout rope, a hundred-foot length, two-hundred feet of binder twine, and a basket. Trees small enough to grasp with the arms may be climbed easily enough with only the spurs. On large trees, you use spurs and the short length of rope, which you wrap around both wrists after passing it around the tree. The approved technique is to take a step or two with the spurs, flip the rope up the trunk as far as you can, then lean back on it while you take another step or two.

Eggs and young may be photographed directly in the nest, though it is usually necessary to clear away a few leafy branches in order to get a clear shot with the camera. You should tie such branches back, allowing them to spring into place when you have finished. Never break them off, as this exposes the young birds to their natural enemies, and to sunshine, which will kill the young. To get a picture of birds being fed by the parent, it usually is necessary to rig up the blind and let it remain for several days, until the birds get used to its presence.

for SERIOUS PHOTOGRAPHERS



THE NEW
WESTON
Master
...the ultimate in
exposure meters!

★ BETTER PICTURES IN LOW LIGHT...

The Master gives accurate, readable camera settings even in dimly lighted rooms... measures as low as 1/10th candle per sq. ft.

★ BETTER PICTURES IN HIGH LIGHT...

Perfect pictures on the beach, in snow, or elsewhere in extremely high brightness... for the Master measures up to 1600 candles per sq. ft.

★ BETTER COLOR AND CINE PICTURES...

New, limited viewing angle for outdoor work assures better color rendition, and more exact exposures for ciné cameras.

★ "HIGH LIGHT", "LOW LIGHT" SCALES...

Separate, automatic scales for "high" and "low" brightness work. Each scale large and easy-to-read, without congested numbers.

See the Master at your dealer's, or return coupon immediately for complete information.

Weston Electrical Instrument Corporation
671 Frelinghuysen Ave., Newark, N. J.
Send literature on the new MASTER.

Name _____

Address _____

City _____ State _____

Spiffy
COLLAR STAY
Holds your collar neat and trim

Prevents curling
Prevents wrinkles
SELF ADJUSTABLE AND INVISIBLE
GET A SPIFFY STAY today

It gives you that starched collar appearance with soft collar comfort. If your dealer cannot supply you, order direct. Send 25¢ (coin or stamp) for silver. 50¢ for Deluxe 24K Gold finish. State name and address of dealer who was unable to supply you and we will include free an attractive tie chain.

CREST SPECIALTY CO.
663 W. Washington Street, Desk M, Chicago, Illinois

At Your Men's Shop or Jeweler

MAKE BIG MONEY AT HOME

Electroplating by Brush!

AMAZING NEW INVENTION

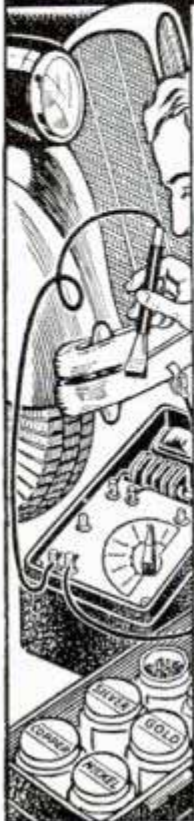

NO TANKS, LIQUIDS, GENERATORS Only
DOES SAME WORK AS BIG OUTFITS **\$9.85**
 Sensational news! Marvelous new invention actually electroplates with electric brush. As easy as painting. Deposits heavy layer of actual metal—gold, silver, nickel, cadmium, copper, etc.—by electrolysis. Does same beautiful, PERMANENT work as big, costly tank outfits. Non-liquid. Anyone can use from car battery or electric light socket. Complete outfit weighs only a few lbs.—take it anywhere—ready for instant use.

PLATE THOUSANDS OF ARTICLES SPARKLING NEW WITH STROKE OF BRUSH

-BIG EARNINGS REPORTED IN SHORT TIME

Amazing low price and magic-like demonstration brings you thousands of orders for plating from garages, radio shops, bicycle shops, machine shops, home work shops, factories, offices, janitors, doctors, dentists, jewelers and farmers, homes, stores, etc.—with big profits for you! Schedule of plating charges furnished; also reports of big money users are making with the WARNER NU-WAY ELECTROPLATER.

FREE SAMPLE PROVES ALL CLAIMS

Send today for amazing profit details with this revolutionary electroplating invention. **FREE SAMPLE & BIG MONEY-MAKING PLAN.** Get started in a profitable business of your own. Full or spare time. **Beth WARNER NU-WAY ELECTROPLATER IN YOUR TOWN.** Simply mail post card with your address.

WARNER ELECTRIC CO., Dept. 5-5
 360 North Michigan Ave. Chicago, Ill.

NEW STREAMLINE BENJAMIN AIR RIFLES



WITH LEVER HAND PUMP

BENJAMIN



HARD ACCURATE SHOOTING WITH CHAMBERED AIR
 You can use new models BENJAMIN AIR RIFLE WITH LEVER HAND PUMP anywhere, for practice firing or just plinking around the house or camping, fishing, hunting, etc., at lowest cost. Shooting force is adjustable depending on AIR PRESSURE—amazing maximum power and accuracy—will penetrate to 1". Hair trigger firing without lunge or recoil. Single Shot BB \$7.50. Repeater BB \$9.00. Rifled Cal. 22 or 177 Single Shot \$8.50. Ask your dealer all about them or write for complete specifications—Targets and blueprints FREE if requested. We also make a complete line of BENJAMIN AIR PISTOLS for target and small game. **WRITE TODAY.** BENJAMIN AIR RIFLE CO., 895 MARION ST., ST. LOUIS, MO. U. S. A.

AMAZING POWER for model planes, model boats, model cars

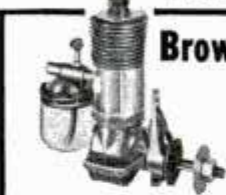

Brown JUNIOR MOTORS

Model D, \$12.50. Complete, ready-to-run. Precision-made by world's largest builder of model gasoline motors. Other models up to \$21.50. Every motor guaranteed. Weight, bare, 6 1/2 oz. Write Dept. 6, Junior Motors Corp., 2545 N. Broad St., Phila., Pa.



BUILD YOURSELF A MIDGET CAR

WE SPECIALIZE IN WHEEL SETS, ENGINES, ETC. for building Cars, Scooters, Trucks, etc. We carry only the best at the lowest prices. Send 10c for parts catalog and plans for three Midget Racers, Scooters and other vehicles. It pays to use only reliable plans and parts—We guarantee satisfaction. **Build-Your-Own Devices, 5235 Lake St., Dept. PM-1, Chicago**

STOP Itching

GET RELIEF This Fast Way -or Money Back

For quick relief from itching of eczema, pimples, athlete's foot, scales, scabies, rashes and other externally caused skin troubles, use world-famous, cooling, antiseptic, liquid D. D. D. Prescription. Greaseless, stainless. Soothes irritation and quickly stops the most intense itching. 35c trial bottle proves it, or money back. Ask your druggist today for **D. D. D. PRESCRIPTION.**

When writing to advertisers please mention Popular Mechanics

CUT IT OUT



WITH A SYNCRO SAW

For model builders, cabinet workers, sign makers. No motor to buy. Cuts fast, smooth and accurately. Plugs into light socket. 3 sizes 16", 13 1/2", 8" throat clearance.

\$12.50 \$9.95 \$4.95

At all good dealers Send for catalog A
NEW YORK OFFICE - - 200 FIFTH AVE.

SYNCRO DEVICES INC. 747 BEAUBIEN ST. DETROIT

NEW INVENTION PRODUCES HOT FLAME

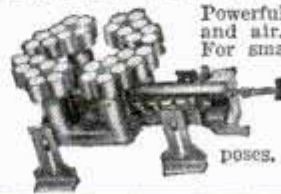

Powerful Blue Blaze from common kerosene and air. Cheapest heat known to science. For small boilers, vulcanizers, bake ovens, potato chip and doughnut kettles, pressing machines, etc. Adjustable from 8" to 14" diameter. Perfectly regulated flame. Also burners for cook stoves and many other purposes. Responsible distributors wanted. **HEAT APPLIANCE COMPANY**
 1617 West Walnut Street, Chicago, Ill.

FREE "BETTER RESULTS WITH GLUE"



Send post card for booklet, "Better Results with Glue," containing many useful hints about mending, model making and home workshop jobs. Address: McCormick Sales Co., 402 Light St., Baltimore, Md.

at hardware, drug and 10c stores; also in cans from 1/4-pint to 1 gallon



PHOTO ENLARGEMENTS

Is Photography your hobby? Do you want a profitable easy business at home? Make **PHOTO ENLARGEMENTS** for yourself and others. Your cost 5c each and less. The Ideal Photo Enlarger is **AUTOMATIC**. No experience required. Also **COPIES** any picture. **\$5.94 COMPLETE.** Interesting circular **FREE.**

5¢ ANY SIZE

IDEAL ENLARGER, 148 West 23rd St., New York City

BUILD THE SCHOONER BLUENOSE

Complete Kit
\$2.50
 Post Paid
 Makes perfect building easy



CARVED PINE HULL
 Metal Anchor, Steering Wheel, Lifeboats, Anchor Chain, Casks, Masts, Dowels, Lacquer and Cement.
 Complete hobby catalog, 10c
IDEAL AEROPLANE & SUPPLY COMPANY, INC.
 26 W. 19th St., New York

Print Your Own



Cards, stationery, circulars, tags, labels, advertising, etc. Save money. **Print for Others: Big Profits;** easy rules sent. Will do popular Raised Printing like Engraving. Junior outfit \$9. Senior outfit \$17 and up. Send for free catalog and all details. **KELSEY PRESSES, E-37, MERIDEN, CONN.**

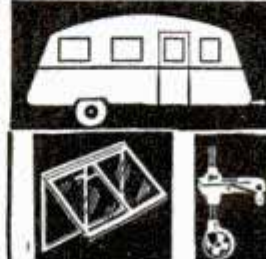

TRAILER PARTS

Largest, most complete stock of trailer parts and equipment in America. Lowest prices, quick delivery. Marvel is the pioneer in trailer accessories with a reputation for highest quality products, refrigerators, stoves, etc. Send 10c in coin for 40 page illustrated catalog.

MARVEL TRAILER PARTS CO.
 19020 Celestine Ave. Detroit, Mich.

Don't Take It So Hard

(Continued from page 709)

to the hospital may be welcome. What has been said about scrambling in other paragraphs goes double here. Bobby Brown, acrobat, says it's best to bump along until the final step is reached. Your trouser seat may become a little frayed but you won't get hurt.

The person who has the misfortune to fall from a scaffold or a windmill frame may find comfort, however small, in the fact there is frequently safety in height. Ask the aerialists, they know all the fine points about taking a painless dump. A number of performers would be alive today had they had more time in mid-air to squirm around in correct position for the fall. Before tackling any somersaults or feet-and-hands exchanges, the air stars get a complete education in how to fall. Their technique, Harold Genders of the Flying Harolds troupe, points out, consists in tucking up into a ball and hardening the muscles so the shock is eased.

If an aerialist were to drop feet first from a high swing into the net, he says, his knees would fly up and crack him in the chin or else he would land on his forehead. When he drops from the bar at the end of the swing he endeavors to land on his back with his elbows and arms in close.

In the big time acts, aerialists will frequently dive straight down for forty or fifty feet and never move until they are but three feet or so from the net. Then, in a twinkling, they will duck their heads, landing on their shoulders.

There's no greater safeguard against accidental injury than the ability to think clearly in an emergency, to size up the situation in a glance and act accordingly. The knack is not easily acquired but if you want to quicken your reflexes, performers advise your going in for competitive sports. The training you get in taking a cut at a curved ball, dodging a left hook, or returning a high lob where your opponent isn't will benefit you the next time a truck suddenly appears from nowhere and starts bearing down on you or you have a vague feeling the sidewalk is getting ready to whack you.

Send return postage to our Bureau of Information to learn the name of the maker of any device described in this magazine.

HOW HE MARRIED HER WITHOUT A SCENT!

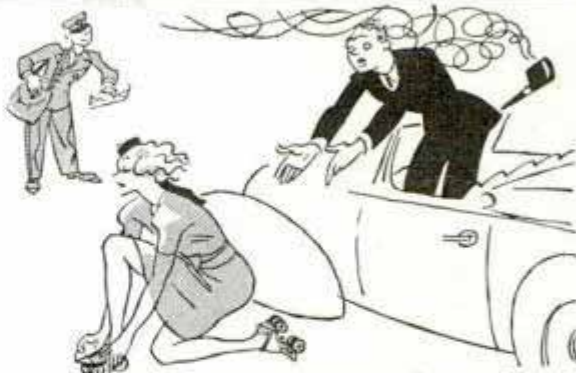

AL'S NEW CAR won Peg's fancy, but his new pipe got her nanny—it smelled fierce! So on went her roller skates to head for home. Wait! Here's the postman!

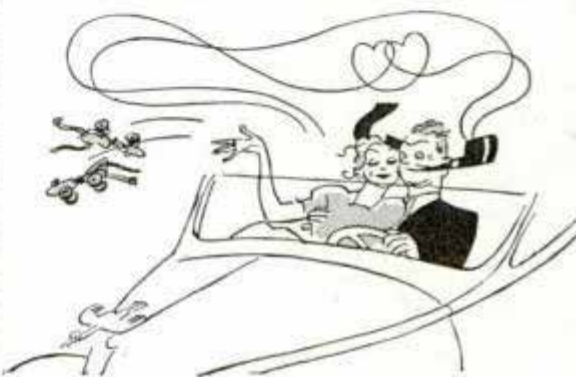

HE TOLD AL to clean his pipe, and re-filled it with mild Sir Walter. Peg stopped to sniff, stayed to snuggle. The fragrant burley blend *always* wins! Try a tin!

New!
CELLOPHANE
TAPE

around lid
seals flavor in . . .
brings-you tobacco
100% factory-fresh!



UNION
MADE

IT SMOKES AS SWEET AS IT SMELLS

TUNE IN—Sir Walter Raleigh "Dog House." Every Tuesday night, coast-to-coast, NBC Red Network.

FREE! Send for ALLIED'S
204 Page CATALOG

**EVERYTHING
IN RADIO
At
LOWEST PRICES!**

DON'T WAIT—SEND COUPON TODAY!



NEW SETS

60 new Knight sets for every purpose—4 to 12 tubes, newest features, "Air Magnet," Gem-loid Dials, etc.—latest portables 1-tube electric phonographs, 5, 7, 11-tube phono-radios—all sensational values! All priced amazingly low.

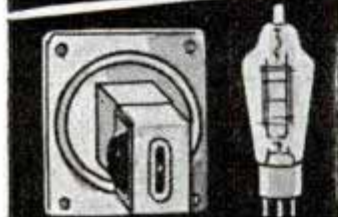

NEW BIG PARTS SECTION

15,000 radio items—everything in Radio in one big book! Parts for every purpose, tubes for all radios, latest books, tools, etc.—at lowest prices! Latest Test Equipment—Rider Volt-Ohmyst, etc. Newest Kits, diagrams and projects.



NEW HAM GEAR

Complete Amateur Equipment—latest receivers, Skyrider "Defiant," etc., Rotary Beam, Television Equipment, all standard lines—at lowest prices. Most complete Ham section in Radio. Investigate ALLIED'S convenient New Time Payment Plan!



NEW P. A. SECTION

3 completely new lines—"Economy," "Standard," "Deluxe"—14 new systems, 6 to 65 watts, new styling and performance—new "mikes," latest recording equipment at lowest prices. Ask for ALLIED'S New Time Payment Plan.

BIG BARGAIN SECTION

KITS—We supply matched kits for building any circuit described in any magazine. Write for Free Parts Lists.

Free SEND COUPON

ALLIED Radio Corporation,
833 W. Jackson Blvd.,
Chicago, Ill., Dept. 5-BL-O

Send your new FREE 1940 Catalog.

Name.....

Address.....



Electrical Substitute for Baffle

(Continued from page 778)

gain pentode circuit with a resistor divider network. The result is an even amplification at the regular audio frequency and a considerable increase in amplification (about 5 D.B.) at the extreme lower end of the audio band.

Only a handful of parts are required and these are all clearly shown, and the values specified, in diagrams Figs. 1 and 2. All fixed resistors are $\frac{1}{4}$ watt except R_3 , R_5 and R_6 which are $\frac{1}{2}$ watt. Thirty-six 6-32 machine screws $\frac{1}{2}$ in. long with hex nuts

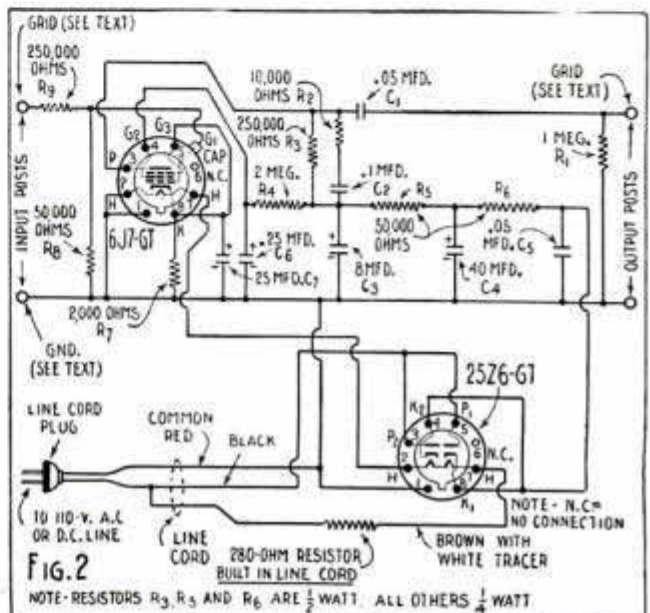

and soldering lugs are employed to mount the parts on the pressed-wood panel, as shown in photos A and B. The unit is self-powered and operates on 110 volts either a.c. or d.c. with the 280-ohm line cord specified. The type 25Z6 "bantam" tube serves as the rectifier.

When used with a phonograph pickup and audio amplifier, the pickup is connected to the "input" terminals, and the output terminals are connected directly to the input of the amplifier itself. When employed with a radio set, the audio circuit can be broken at any point and the "electrical baffle substitute" circuit inserted. Ordinarily it is best to break the grid connection to the driver audio tube and connect the grid itself to the grid "output" terminal, while the grid lead previously connected to the tube should be fastened to the "input" grid terminal. The ground "input" terminal should be connected to the chassis of the radio set.

NOW! Anyone without experience can do a thousand and one **REPAIR JOBS!**

WELDING **BRAZING**
SOLDERING

QUICKLY PERFECTLY EASILY with the **NEWLY INVENTED 3 IN 1 Electric TORCH**

COMPLETE WITH POWER UNIT—WORKS OFF 110 VOLT AC OR DC LIGHT CIRCUIT

Here at last is a portable machine that does real welding, brazing and soldering, yet is priced within the reach of all. The 3 in 1 comes to you complete with goggles, carbons, various types of welding rod and all accessories needed to do various repair jobs. It is all ready to plug in a light socket—nothing extra to buy. Simple instructions make it possible for you to do first class work easily without any previous experience or mechanical skill. The 3 in 1 instantly creates a terrific flame by just touching the carbons together.



REPAIRS FENDERS, AUTO BODIES, TANKS, BICYCLES, RADIOS, ETC.

The 3 in 1 is ideal for auto body repairs and fender weld jobs—steam fitters, plumbers, sheet metal shops, engineers, maintenance men and janitors will find it indispensable. By following simple instructions, heavy work such as bumpers, tanks and industrial repairs can be done. Ideal for the countless jobs around a home or farm. **WORKS ON ALUMINUM, BRASS, COPPER, IRON, STEEL AND OTHER METALS.**

AGENTS! You will find quick easy sales waiting for you in repair shops, garages, factories, sheet metal, radio and bicycle repair shops, and many other places. Write at once for free particulars and learn how you can get your own 3 in 1 Electric Torch absolutely free for demonstration purposes by helping to introduce it to others.

ELECTRO-TORCH CO. 2613-EX MICHIGAN AVE., CHICAGO, ILL.

ELECTRIC PENCIL

for Burnt Wood Etching

Simple, safe, durable! Burns on wood, leather, velvet. Special element keeps point at uniform heat. Send for general catalog PM of supplies, Seramo modelling clay, brass craft design, etc.

THAYER & CHANDLER, 910 W. Van Buren St., Chicago



ONLY \$1.00
(Panel illustrated 25c)
ORDER TODAY!

STUCCO MACHINE

Offers **EXTRA EARNINGS**



Renew old buildings. Make new construction more permanent and attractive. Plastic Colorcrete is waterproofed. It fused with any masonry surface. It fills all cracks. It can be applied in any thickness and in 30 colors. Fully proven by over 12 years actual use under all conditions and every climate.

OFFERS BIG EARNINGS

Owners everywhere want to enhance present values. With this machine you can supply this big waiting market with permanent Colorcrete at amazingly low cost. Operators report cost of 2c and up per sq. ft. and sell up to 7c. Some have paid for their equipment from first few jobs. Machine capacity up to 1,000 sq. ft. per hour. Get the facts. Send for the books. "Proven Business Opportunity." Write today. It offers you big extra income.

COLORCRETE INDUSTRIES, INC.
570 Ottawa Ave. Holland, Mich.



RADIOS.. SAVE UP TO 50%



DEAL DIRECT — FACTORY PRICES
Many models to choose from at wholesale prices. AC-DC midrange \$4.98. Portable and battery sets \$8.98 up. Car sets \$11.75 up. Also consoles, all-wave etc. Samples at 50% off. Send for FREE 1940 bargain catalog giving details of 10 day FREE trial and agent's proposition and discounts. No obligation, write today. **GOLDENTONE RADIO CO., DEPT. PM, DEARBORN, MICH.**



New Adding Machine Fits Vest Pocket!

Adds, subtracts and multiplies up to one billion. Weighs only 4 ounces. Not a toy—strong guarantee. Absolutely accurate, very fast. Sells to offices, stores, homes—wherever figures are used. Write quick for FREE sample offer and Money-Making Plan.

VE-PO-AD, Dept. 191, 303 W. Monroe St., Chicago



TURN SCRAP INTO MONEY

AUTOPOWER tells you how in plain, easy, simple and illustrated instructions that anyone can follow. Change auto generators into useful, practical A C and D C generators and motors with voltage from 2 to 1,000 volts, for power, light, welding, radio, sound, etc. No previous experience nor special tools needed. Generators can be driven by wind, water, fan belt, etc. **INSTRUCTIONS FOR BUILDING AN A C WELDER THAT ACTUALLY WORKS UP TO A 3/16" ROD. ALSO COMPLETE PLANS FOR WIND AND WATER POWER PLANTS.** Send for your copy of "AUTOPOWER." Already used and endorsed by thousands. Only \$1.00 postpaid.

S. W. DUNCAN, Publisher.

410 S. Hoyne Ave., Chicago

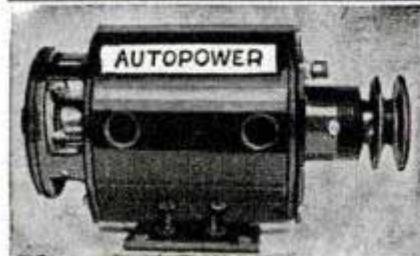

NEW DURO Streamline HAND GRINDER

MOTOR MADE BY GENERAL ELECTRIC

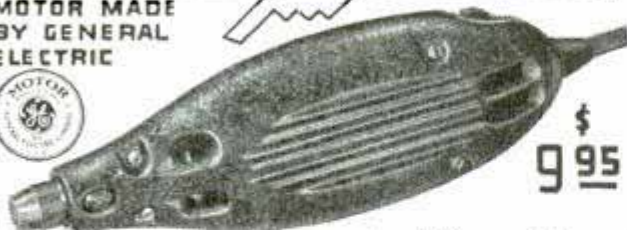

\$ 9.95

Use the Streamline for grinding, carving, drilling, polishing and many other operations when making models or for decorating purposes and etching in the workshop. The Streamline is also ideal for delicate, precision work in the tool and die room.

It is perfectly balanced, compact, light in weight and fits the hand without causing fatigue. It weighs only 12 ounces and is only 6 3/4 inches overall.

The abundance of power developed—over 17 watts output—and the high speed of 24,000 R.P.M. gives a smooth, finished cut on all types of work. Send for free descriptive literature or send for the Streamline on our ten-day trial money back guarantee.

Made by

The Manufacturers of America's Finest and Most Complete Line of Power Driven Machinery.

DURO METAL PRODUCTS COMPANY
2657 N. Kildare Ave. Dept. B-11 Chicago, Illinois

MORE POWER ★ **MORE SPEED** ★ **LESS WEIGHT** ★ **SMALLER SIZE** ★

HEAT for **1 1/2¢** per hour
or
COSTS NOTHING TO TRY

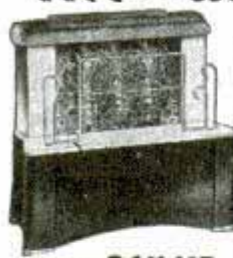

BURNS 96% AIR
only 4% FUEL
can have Radiant heat at 1 1/2¢ an hour. No obligation. Send now.

AMAZING new Radiant Heater.
Makes its own gas. No piping, no installation. A few pints of cheap liquid transforms ordinary air into many hours of clean, healthful, penetrating heat like sunshine, for 1 1/2 cents an hour. Hotter than gas or electricity, at **one-tenth** the cost. **EASY TO OPERATE.** No smoke, no soot, ashes, or odor. **Portable!**

30 DAYS' TRIAL!

Write at once for special introductory low price offer. **TRY IT At Our Risk.** Prove to yourself that you can have Radiant heat at 1 1/2¢ an hour. No obligation. Send now.

AGENTS
Make Big Money!
Write quick for territory and Outfit Offer.

AKRON LAMP & MFG. CO., 1201 High Street, AKRON, OHIO

DO YOU

WANT a new business profession of your own, with all the trade you can attend to? Then become a foot correctionist, and in a few weeks earn big income in service fees,—not medical nor chiropody—easy terms for home training, no further capital needed, no goods to buy, no agency. Established 1894. Address

Stephenson Laboratory, 1 Back Bay, Boston, Mass.

Rheumatism in Few Minutes or Money Back

To relieve the torturing pain of Neuritis, Rheumatism, Neuralgia or Lumbago in a few minutes, get NURITO, the fine formula, used by thousands. No opiates. Does the work quickly—must relieve cruel pain to your satisfaction in a few minutes—or your money back. Don't suffer, Don't delay. Ask your druggist today for trustworthy NURITO on this guarantee.

CLAMPS

The biggest need in most home workshops is more good clamps—clamps for gluing, holding, drawing-up and for setting-up work. They are the extra handle for the 1-man shop. Don't spoil or delay work for want of clamps. From over 40 types of clamps we have selected these as the first for homecraft use.



Jorgensen Handcrews
Genuine "Jorgensen" Handcrews grip at all angles, never slip, split or loosen. All sizes. Send \$3.20 plus postage (7 lbs.) for 2 No. 1 Handcrews—open 6".

ADJUSTABLE CLAMP CO.
"The Clamp Folks"
421 N. Ashland Ave., Chicago, U. S. A.



PONY Miniatures 9 types 1" to 2 1/2" cap. Not toys but fine tools with 100 uses.

PONY "50" Fittings go on ordinary 1/2" pipe. Any length. Send \$3.00 plus postage (9 lbs.) for fittings for two "50" Clamps. Also "Pony" No. 52 Fittings for 3/4" pipe—2 sets for \$1.50 plus postage.

Catalog FREE Ask your Dealer



WOODWORKERS NEW BARGAIN BOOK

The 1940 Constantine Catalog makes available most complete source of fine woods. Packed with valuable useful facts, some not previously published. Gives free loaning details of our new educational motion picture for woodworkers. All who work with woods need it. Send 10¢ stamp or coin today.

10¢

ALBERT CONSTANTINE AND SON, INC.
791A East 135th St. New York, N. Y.
The Craftsman's Headquarters for Fine Woods

SAVE MONEY ON CAMERAS
by sending for the outstanding list of camera bargains ever published . . . write for the latest **BASS BARGAINGRAMS**
Listing thousands of values. Separate completely illustrated book on either Still or Movie equipment. Write for either or both . . . state preference. Mention this ad. . .

Bass CAMERA CO.
179 W. MADISON ST. CHICAGO, ILL.
DEPT. P

Fastest Sighting Combination Known

MARBLE'S Flexible Rear Sight and Sheard Gold Bead Front Sight

Look through peep to gold bead and center instantly on target. Coil spring keeps rear sight in true shooting position. Can be locked down. Interchangeable discs. Price, \$4. Gold front sight that never blurs. Price, \$1.50. Give make, model and rifle cal.

Ask for Catalog
Marble Arms & Mfg. Co. 578 Delta Ave., Gladstone, Mich., U.S.A.

ENGINES |||||

A real money maker for farm or factory. Uses Cheap fuels. Pays for itself out of savings. Costs Less to Own—Less to Operate.

LOG SAWS |||||

Make Money—Start a wood sawing business—turn spare timber into cash. Cash or Terms—Engine and Saw Catalog.

WITTE ENGINE WORKS 1748 OAKLAND AVE. KANSAS CITY, MO.

BUILD AN ARC WELDER FROM OLD GENERATOR

WE SHOW YOU HOW

For light or heavy work. 75-200 amps. 35¢ brings complete PLANS. 100 other generator changes.

LEJAY MFG., 1347 LeJay Bldg. Minneapolis

A DEPENDABLE STEAM ENGINE for boat models up to 36" in length. Model SE-3, a two cylinder, slide-valve type. Bore 3/16", Stroke 1/4", Length 7", Width 3", Height 3 1/2". Price complete ready to run with burner and propeller . . . \$3.00 Postage extra, shipping weight 1 1/2 lb.

SHAWNEE ENGINE CO.
Box 162, Station D, Cincinnati, Ohio

BUILD YOUR GRANDFATHER CLOCK

The Simple Sensible Red-I-Kut way as thousands have. DIME brings PLANS and sixty picture "HOW" Book pricing many fine brass weight Westminster, tube chime, electric and battery movements showing nine beautiful colonial grandfather cases. WHY WAIT LONGER!

KUEMPEL CHIME CLOCK CO., Bldg. 34, Guttenberg, Iowa.

The Band Steals the Show

(Continued from page 651)

versity band, spends approximately a month before the first practice making his selections of men, then starts daily drills in the formation of letters and school symbols to be used on the gridiron. Each Monday morning throughout the season brings a new formation to be memorized and prepared for Saturday's game. At Butler a "board of strategy," composed of key men in the band, goes over the week's formation with the director before he calls other band members for practice. Members of the band are given their respective positions in the diagram or letter to be used and the remainder of the marching organization is then called in for rehearsal. With the board of strategy to guide them, Butler's "Boys in Blue" have little trouble picking up the new "act" for Saturday's show. By Thursday the band is ready for a dress rehearsal.

Stunts for an entire season are worked out in advance at most schools. Charts are prepared, mimeographed, and distributed so each marcher knows on just what yard line he's supposed to be at a specific time, and where to go from there. Michigan's spectacles are hatched on a table top on which is marked a scale model field. The drill master and his assistants have 120 toy soldiers which they place on the table to show where each man should be at every stage in the formation.

Apart from the football trips—and at the larger schools that means an occasional transcontinental jaunt—a university band will travel 3,500 to 9,000 miles a year.

An extra dash of showmanship has been sprinkled into the band pageants by increasing the number of drum majors with twirling batons. Their rise has been rapid the last few years and some bands are now using as many as twenty. The sure-fire bit of business of tossing the baton over the goal posts just before the band counter-marches has been done to death so the drum majors concentrate on making a mighty toss of the gleaming stick—fifty feet high—and catching it with one hand.

But the person most anxious to see the stunt go off without a hitch, apart from the drum major himself, is the football coach. A superstition has grown up among them that if the drum major flubs his catch and drops the baton, his team is sure to lose.

Everybody was sure
GHOSTS
were loose in our house



Then I told them about my
New RCA
ELECTRONIC LAB



With it I not only perform mysterious stunts—But can build my own radio—My own telegraph practice set—My own radio announce system—It's just packed with fun and thrills!

RCA Electronic Labs have won the cheers of thousands of real boys—and their Dads, as well! For these Labs mean hour after hour of thrilling, exciting fun. And the Lab's parts may be used over and over again, for the construction of a variety of devices.

Just think! With an RCA Electronic Lab you can build your own Magic Relay—and that means a barrel of laughs. For with it, you can keep the whole family guessing by mysterious ringing bells, turning the radio on and off—and doing many other puzzling and amazing stunts. In addition, you will have a grand time constructing your own radio receiver and your own telegraph practice set, as well as an announce system for talking through the family radio.

Yes sir! All the adventure of electronics is yours with one of these fascinating new Labs. And while you're enjoying yourself—you'll be getting valuable knowledge too. So see the RCA Electronic Labs today. Available in two models. Priced from \$7.50.* All parts are genuine. On display at your RCA Victor Dealer's—or wherever toys are sold!

For finer radio performance—RCA Victor Radio Tubes
Trademark "RCA VICTOR" Reg. U.S. Pat. Off. by RCA Mfg. Co., Inc.
*Prices f. o. b. Camden, N. J., subject to change without notice.

Put on your own radio dramas...with sound effects!

SEE NEW RCA SOUND CONTROL STUDIO

RCA ELECTRONIC LABS
AND SOUND CONTROL STUDIO

By-Products Division, RCA Mfg. Co., Inc., Camden, N. J.
A Service of the Radio Corporation of America

GOOD NEWS FOR THOUSANDS WHO ARE SKINNY

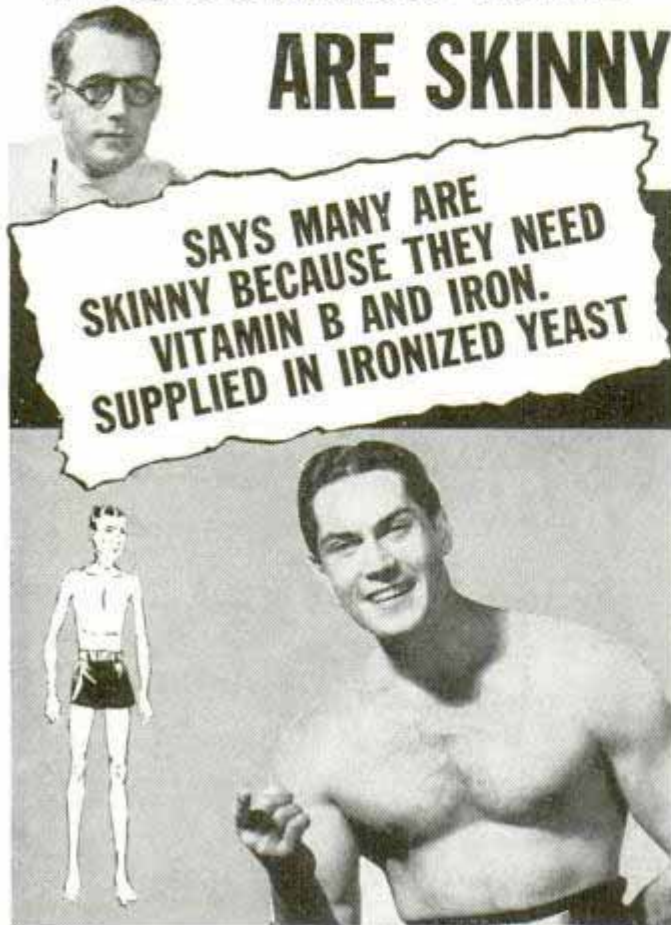

Posed by professional models

Read how thousands of thin, nervous, tired people have gained 10 to 25 pounds, new strength—quick!

SCIENTISTS have discovered that thousands of men and women are thin and rundown—often tired and nervous—sometimes just picking at their meals and sleeping poorly at night—simply because they do not get sufficient Vitamin B and Iron from their daily food. It has been found that without enough of these two vital substances you may lack appetite and not get the most body-building good out of what you eat.

Now you can get these exact missing substances in these scientifically prepared, easy-to-take little Ironized Yeast tablets. And if you need these substances, the improvement that comes in a short time is often astonishing. Thousands report gains of 10 to 25 naturally attractive pounds in just a few weeks! Their tired feeling and jitteriness seem to have just flown away. They enjoy their food, sleep fine and get up in the morning full of pep. They're entirely different, much more attractive persons, easily winning many new friends and enjoying life as never before.

Make this money-back test

Get a package of Ironized Yeast tablets from your druggist today. If with the first package you don't eat better and FEEL better, with much more strength and pep—if you're not convinced that Ironized Yeast will give you the new normally attractive pounds, new energy and life you've so long wished for, the price of this first package promptly refunded by the Ironized Yeast Co., Atlanta, Ga.

But just one warning! Many cheap, inferior substitutes for Ironized Yeast have sprung up which do not give the same results. Insist on the genuine. Look for IY stamped on each tablet.

Special offer!

To start thousands building up their health right away, we make this special offer. Purchase a package of Ironized Yeast tablets at once, cut out the seal on the box and mail it to us with a clipping of this paragraph. We will send you a fascinating book on health, "Facts About Your Body." Remember, results with the first package—or money refunded. At all druggists. Ironized Yeast Co., Inc., Dept. 5311, Atlanta, Ga.

TUNE IN ON JOHN J. ANTHONY'S GOOD WILL HOUR.
See your local newspaper for exact time and station.

No "Blind" Driving in 1940 Cars

(Continued from page 647)

eleven inches for the driver's elbow room. Both front and rear cushions are constructed of coiled springs topped with a thick layer of foam sponge rubber. Buick, LaSalle, Cadillac and the other General Motors divisions also offer one or two "torpedo" models, usually as an addition to the line, rather than as a substitution. The "torpedo" body is the outgrowth of Fisher Body's experiments with a similarly shaped body on the Cadillac "60 Special" last year.

Chrysler Corporation, in Plymouth, Dodge, DeSoto and Chrysler, introduces longer wheelbases to improve the ride, but



DeSoto's four-door touring sedan. Below, its out-flaring rear body contours

in most cases does not increase the over-all length. This results in retention of easy maneuverability. By moving the rear wheels several inches to the rear and the engine several inches forward in relation to the wheels, the Chrysler-made cars are designed for more comfortable riding. The passengers now ride between the two axles, the rear seat being completely ahead of the rear wheels, much closer to the center of car weight where motion caused

(Continued to page 144A)

KEEP YOUR TOOLS SHARP!

Oilstone your cutting edges in a fraction of the time—and with a fraction of the effort—required by hand.

The TOOL DRESSER

Revolving Oilstone and Emery Wheel combined.
SEE YOUR DEALER
Literature Free.

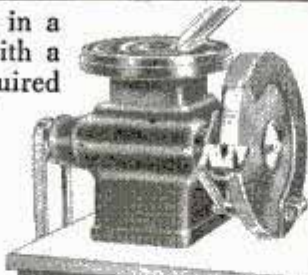

CLAUSING MFG. CO. - OTTUMWA - IOWA

TYPEWRITER 1/2 Price

Easy Terms
Only 10c a Day
Save over 1/3 on all standard office models. Also portables at reduced prices.

SEND NO MONEY

All late models completely refinished like brand new. FULLY GUARANTEED. Big free catalog shows actual machines in full colors. Lowest prices. Send at once. Free course in typing included.



International Typewriter Exch., 231 W. Monroe St., Dept. 1101 Chicago

CHRISTMAS CARD PRINTER KIT

ONLY \$1.50 COMPLETE
INCLUDES: SILK FRAME..ORGANDY.. STENCIL..TACKS..TAPE..& SQUEEGE COMPLETE AS SHOWN



VEL-SUEDE FLOCK KIT

ONLY \$3.30 COMPLETE
KIT INCLUDES: GUN...3 COLORS... BINDER...3 COLORS VEL-SUEDE..BRUSH

SPECIAL COMBINATION--BOTH KITS SHOWN ABOVE--\$4.50

JORDAN AIR & SUCCTION PUMP CO. CATALOG WRITE TODAY
P-7 BRYANT BLDG., KANSAS CITY, MO. DETAILS

EASY PROFITS IN PAINT SPRAYING



Paint walls, ceilings, screens, furniture, radiators, machinery faster, better! 1/4 H. P. motor 110 Volt 60 Cycle AC, complete with Spray Gun, 15 ft. hose. Weighs only 44 lbs. Carry anywhere. FULLY GUARANTEED. Only \$31.15 f. o. b. Chicago. \$5 Deposit, Balance COD, or SEE YOUR DEALER. Circular FREE. Get started making money NOW!

Ideal Automatic Pump Co. Dept. PM-11, 801 Washington, Chicago \$31.15 Complete

110 VOLT A.C. D.C. 1/30 H.P. UNIVERSAL G.E. MOTOR 6VOLT D.C.



Specifications 1/30 H. P. Universal Heavy duty operates on 110 volt AC or DC, 3200 R.P.M. with 5-ft. cord and plug. Ht. 3" L. 3 1/2" W. 3" Shaft 1/8". Wt. 1 1/4 lbs. Price \$2.55. Same type motor furnished for 6 Volt DC at \$1.95. Special prices in lots of 100 or more. Add 25c for packing and mailing. Anywhere in U.S.A. Money back guarantee. Send check or Money-Order.



NATIONAL ELECTRIC TOOL CO., Dept. 11, 1915 So. State St., Chicago, Ill. \$2.55 EACH \$1.95 EACH

PUSH-BUTTON CONTROLLED GAS TANK LOCK



NO KEYS - ELECTRICALLY OPERATED FROM DASHBOARD. FULLY GUARANTEED. NOW USED AS STANDARD ACCESSORY BY GRAHAM. County franchises granted. Appoint sub-agents. Write immediately to:

SNAP-UP GAS CAP CO. DEPT. O. ASHLAND, KY.

All Your Snapshots in Natural Colors! AMAZINGLY BEAUTIFUL!

Any size roll developed and 8 prints 25c Natural Color Reprints 3c each. Natural Color Photo Service, Dept. C-54, Janesville, Wis.

TRAILER BUILDERS · BUYERS · OWNERS TRAILER Send 25c for this Big Book Today

Over 100 pages! Beautifully Printed and Illustrated! Trailer Suggestions and Ideas galore! Catalog shows America's greatest line of Trailer Parts and Equipment at lowest prices. Everything from wheels to top. Rush 25c today. Satisfaction positively guaranteed! TRAILER SUPPLY CO. Box 438-A WAUSAU, WIS.



BUILD IT YOURSELF

The Jim Dandy Cabin Cruiser The Trailer that has everything. Clean! Roomy. Easy to build in any size with my simplified Plans and Instructions—Price \$1.00. Rush dollar bill today to JIM DANDY Box 126-A WAUSAU, WIS

MY GOOD MAN - NOBODY PUTS IN ANTI-FREEZE BEFORE CLEANING OUT WITH SANI-FLUSH!



Before you put in anti-freeze, be sure your radiator is clean. Clean out the rust, sludge and sediment that are clogging the delicate veins of the cooling system. You can do it yourself with Sani-Flush for 10c (25c for the largest trucks and tractors).

Just pour in Sani-Flush. Run the engine. Drain, flush and refill (directions on the can). Then your radiator is ready for a winter of carefree driving. The motor won't overheat. You don't lose power or waste fuel. Use Sani-Flush before you put in anti-freeze. Or ask your garage or service station to do the job for you. Insist on Sani-Flush. It cannot injure motor or fittings. You'll find Sani-Flush in most bathrooms for cleaning toilets. Sold by grocery, drug, hardware, and five-and-ten-cent stores. 25c and 10c sizes. The Hygienic Products Company, Canton, Ohio.

Sani-Flush Safe NOT CAUSTIC

KEEPS RADIATORS CLEAN

FREE —World's Fair Edition "Toys That Buzz With Action." Shows in color new All-Electric Erectors as exhibited at New York World's Fair. Write A. C. Gilbert Company, 11 Erector Square, New Haven, Conn.

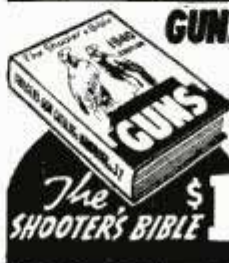

GUNSMITHING for PLEASURE or PROFIT!

World's Greatest Gun Catalog! Stoeger's 1940 Edition. Only complete gun tool section for amateur and professional finest hand tools. All American—most important Guns, Accessories. LATEST REVISIONS & PRICES Ballistics, Restocking, Reloading All Gun Parts, Stocks, Barrels, Targets, Shooter's Articles, etc. Send a Dollar Bill, check, coin, or stamps for this 512 Page Volume

512 PAGES 16,000 ITEMS 6,000 PICTURES

STOGER ARMS CORP. 507 FIFTH AVE. (at 42nd St.) NEW YORK, N. Y.

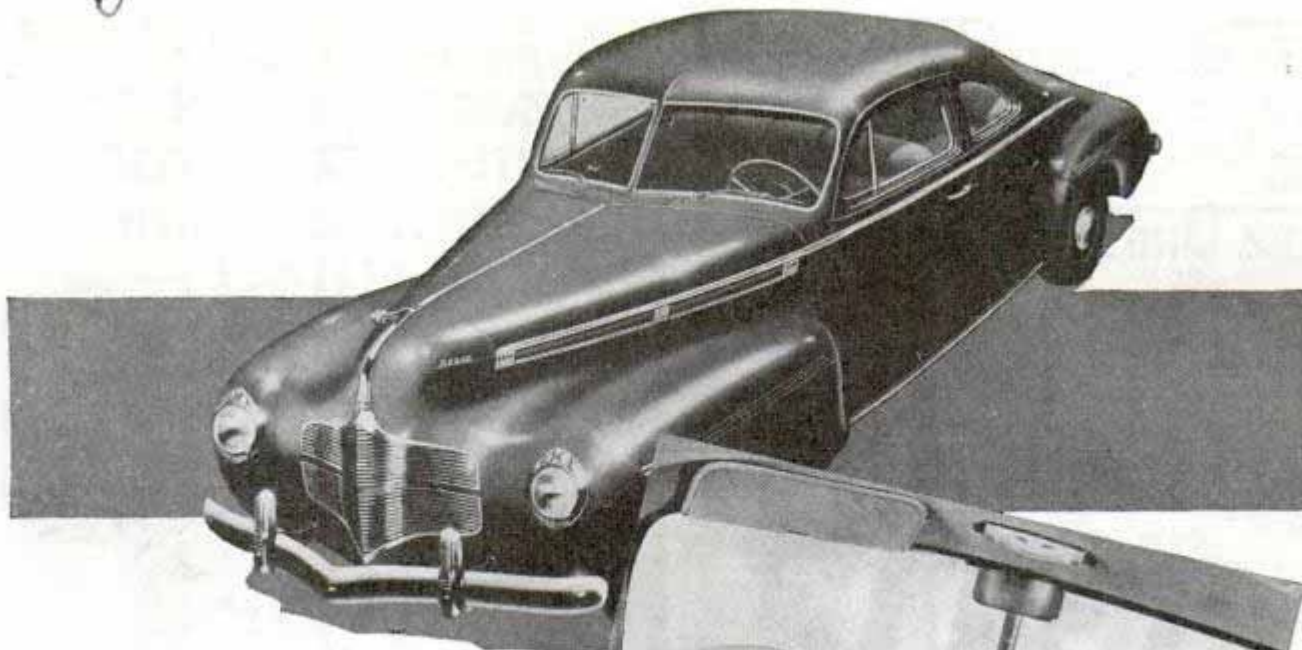

(Continued from page 142A)

by road irregularities has least effect. New frames, constructed for greater rigidity, bring down the floor levels, producing a low center of gravity for greater stability. The Plymouth now boasts a wheelbase of 117 inches and a body with an inside capacity twelve cubic feet larger than last year's models. All body styles are offered with or without running boards. Plymouth also has a full-width, straight rear door, eliminating the "dog leg" section around

(Continued to page 147A)

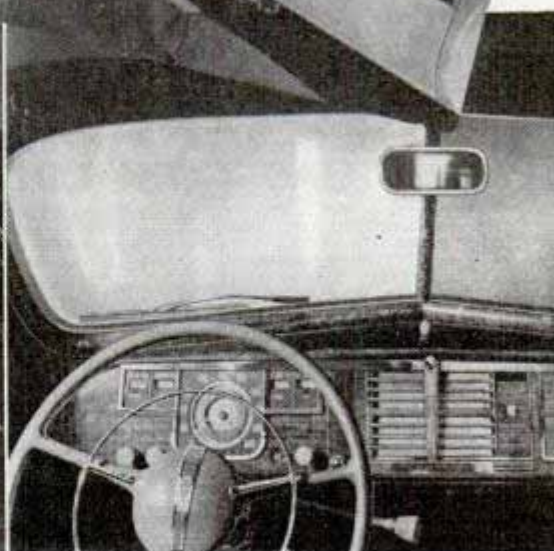
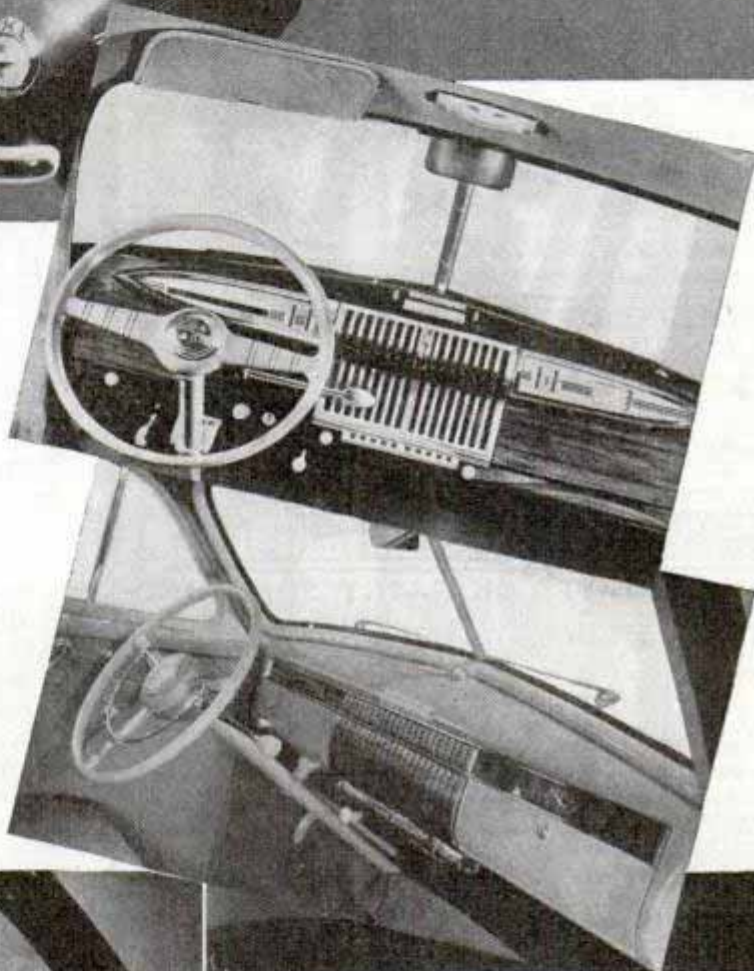

Top, Dodge's Luxury Liner Coupe for four. Below, Hudson's driving compartment with two-spoke steering wheel, and Cadillac-LaSalle front compartment. Bottom, left, at wheel of 1940 Pontiac. Right, Plymouth's instrument panel

"Get a Pair of -"

GET 'EM WET-
THEY DRY OUT SOFT
AND STAY SOFT!

WEAR LIKE IRON
ALWAYS LOOK AS
GOOD AS THEY FEEL

'HORSEHIDE HANDS'
Everybody's Wearing 'Em"

NEW WORK GLOVE COMFORT IN WOLVERINE FULL-GRAIN HORSEHIDE

TOUGH as harness, soft as buckskin — these amazing gloves won't harden after water-soaking, due to Wolverine's secret tanning process. Made by makers of famous Wolverine Shell Horsehide Work Shoes. If your dealer can't supply you, send his name and 75c to Wolverine Shoe & Tanning Corp., Dept. R-310, Rockford, Mich. We'll mail you a pair postpaid. Ask for Style No. 8565. Sizes 8 to 12.

DEALERS:
Offer customers genuine Wolverine Full-Grain Horsehide Hands. Write for catalog and tested sales plan.

Style No. 8565 Full-Grain Horsehide Pony-White

WOLVERINE HORSEHIDE WORK GLOVES

PREPARED FOR TRAVEL

Motor tuned, oil changed, tank full, tires checked — car all set for a motor trip. But how well are you equipped to find your way over strange roads? A Hull Auto Compass will keep your directions before you at all times. Streamlined Bakelite case, genuine sapphire bearing, built-in compensator. Only \$2.95 at your dealer. Two-piece model \$1.95. Write for literature.

HULL MANUFACTURING CO., P. O. Box 246-D19, WARREN, OHIO

CAMERA BOOK FREE!

Illustrates latest methods in Photography and Home Movie Making, for fun and profits. Offers hundreds of amazing money-saving bargains in still and movie Cameras, Lenses, Films, etc. Used equipment accepted in trade. Satisfaction guaranteed or money back with 10-day trial privilege. **WRITE FOR FREE BARGAIN BOOK!**

CENTRAL CAMERA CO., 230 S. Wabash, Dept. K-16, Chicago, U.S.A.

IS IT SPLIT?

WE'LL FIXIT!

SAYS GLUERY

Apply Rogers Glue—place splinter, joint, or pieces in position—clamp . . . then chipped, splintered, and broken articles will look and remain like new when repaired with Rogers Glue . . . *incredibly* strong. Sells 10c and up in tube, jar or can at hardware stores only or send 10c for full size jar plus free project book giving new ideas, new plans for making useful articles to Dept. A

ROGERS GLUE COMPANY, Gloucester, Mass.

ROGERS
the best LIQUID FISH GLUE

WOMEN KNOW WHY THIS FREE OFFER WORKS!

FREE SHAVING CREAM SAMPLE? WHAT'S THE IDEA?

WELL, WHY NOT? YOU'RE ALWAYS GROUSING ABOUT HOW SHAVING HURTS YOUR FACE. — THIS LISTERINE SHAVING CREAM MIGHT BE THE ANSWER

HONEY, YOU'RE A GENIUS! THIS CREAM'S THE NUTS! MY FACE FEELS LIKE A MILLION — SMOOTH AND COOL AS A BABY'S.

GUESS I KNOW HOW TO PICK WINNERS! — IT'S A LAMBERT PRODUCT.

BILL TELLS HIS FRIENDS

I'M TELLING YOU! — YOU CAN'T BEAT LISTERINE SHAVING CREAM! — SAVES CASH TOO — ONE 35¢ TUBE LASTS THREE MONTHS.

LISTERINE, EH? — UNDERSTAND THEY MAKE A SWELL BRUSHLESS CREAM TOO.

20 SHAVES FREE

CLIP THE COUPON

Lambert Pharmacal Co., Dept. 115, St. Louis, Mo. Please send me free and postpaid your large sample tube of Listerine Shaving Cream; Listerine Brushless Cream. (Check whichever is desired.)

Name _____ Address _____

City _____ State _____

AMAZING VALUES IN POWER TOOLS

Lowest priced Jointer in U.S.A.

Oh, man, what buys these are!

Every one a solidly built, practical tool. Most any small electric motor supplies sufficient power. Marvelous Xmas gifts. So inexpensive you can afford several. Sold direct-by-mail only.



—and a beauty! Planes, rabbets, cuts angles, etc. Weighs 8 lbs.; measures 4 1/2" x 8 1/2" x 13 3/4". Table 4 3/4" wide with two 4" tempered carbon steel knives in safety-type cylinder with automatic guard.

GREAT NEW JOINTER
Only \$6.50

Drill Press: 15" high, drill table 3" in diam.; drilling to center of 4" circle. Table fully adjustable. Ball thrust bearing for long wear. The slickest ever for quick, accurate drilling.



JIG SAW

Jig Saw: Includes 12 assorted blades, blade adapters, roller saw guide and manual. 15" long, 8" high, 6 1/2" table. Cuts wood up to 2" thick.

Circular Saw: 4" combination rip and crosscut blade. Oilless bearings. 8" x 5 1/4" steel table adjustable so that by turning stock, pieces up to 2" thick may be cut. Adjustable ripping fence. Saves hours of hand sawing.



Chuck Has Tool-Steel Jaws

DRILL PRESS \$2.50

\$150 PRIZE CONTEST



CIRC. SAW \$3

New! 24" WOOD LATHE

A husky, smooth running wood lathe 32" long overall; 7" high; weighs 10 lbs.; fully adjustable; oilless bushings; long and short tool rests; two speed pulley.

"Giftmaker Sr."

J. & H. METAL PRODUCTS CO.



WE PAY POSTAGE.

Guarantee: Satisfaction or full refund if goods returned within 5 days.

FREE CATALOG describing \$150 prize contest (1st prize \$25; 2nd, \$15; 3rd, \$10; 41 other cash and merchandise prizes). Cat. illustr. complete power tool line. Outside U.S.A., all tools 25c extra except Jointer and Lathe, 50c extra. Orders shipped C. O. D. 25c extra per package. (Postal laws permit no C. O. D.'s outside U.S.A.)

J & H Metal Products Co. 5 Commercial St. Rochester, N. Y.

60 POWER TELESCOPE... \$2.19

VARIABLE EYEPIECE 20X-40X-60X

NEW! Three telescopes in one. 3 different magnifications. 20 power for ultra-bright images with 40 and 60 power for extra long range. Guaranteed to bring distant objects, people, sports events, ships, moon, stars, etc., 60 times as close.



Most powerful made for anywhere near the money. Closes to one foot in length. Multiple lens system. 30 mm. objective lens. 5 sections. Directions included for using as a compound 4 lens microscope. American made. Prompt shipment guaranteed. We pay the postage. Only \$2.19. **BROWSCOPE CO., Dept. 411, 5 W. 27th St., New York, N. Y.**



Build this Smith Compressor

We will furnish complete instructions with a

Smith Compressor Head and Accessories

With a Ford Motor and shop facilities you can easily assemble a Smith Air Compressor. You'll have a smooth performing, efficient compressor. Sixty cubic feet a minute capacity—all the power you'll need to operate rock drills and paving breakers. Here's a way to save money. Write for complete information.

GORDON SMITH & CO. Inc.

410 College St., Bowling Green, Ky.

KILL RATS WITHOUT POISON

YOUR MONEY BACK IF RATS DON'T DIE



K-R-O won't kill Livestock, Pets or Poultry; Gets Rats Every Time. K-R-O is made from Red Squill, a raticide recommended by U.S. Dept. Agr. (Bul. 1533). Ready-Mixed, for homes, 35¢ and \$1.00; Powder, for farms, 75¢. All Drug and Seed Stores. Damage each rat does costs you \$2.00 a year. K-R-O Co., Springfield, O.

K-R-O KILLS RATS ONLY

Low Stain WATER RESISTANT GLUE

AIRPLANE MODEL MAKERS! Wood workers! Hobbyists! Use this low stain, water resistant, proven Casein Glue—LauX 771-D. Quick! Safe on delicate woods. No high pressure clamping. Made by world's largest manufacturers of water resistant glue. Economical—1 lb. 65¢ prepaid anywhere in U. S. **I. F. LAUCKS, INC., Dept. B, Portsmouth, Va.; Seattle, Wash.**

HOLD-E-ZEE AUTOMATIC GRIP SCREWDRIVERS

Hold, start and set-up screws in unhandy places. Gripper instantly released by spring action, sliding up out of way when not in use. Finest materials thru-out, chrome vanadium blades; many have transparent, insulating unbreakable handles. (Illustrated.)



No more expensive than ordinary screw drivers. Models for recessed-head screws. Handiest ever. Get one today. At auto-supply, hardware or electrical stores.

UPSON BROS., INC.

86 EXCHANGE ST. ROCHESTER, N. Y.



A AND N SUPPLY CO.

Bargains—Military, Sport Goods, Firearms, Clothes, Shoes, etc. Send 10¢ for new catalog, to be redeemed on first order.

A & N Supply Co., 4772 Lester St., Richmond, Va.

OTTAWA LOG SAW \$39



PUTS THIS OTTAWA to work for you. MAKE MONEY! Wood is valuable. Does more than 10 men. Easily operated. Falls trees—saws limbs. Use 5-hp. engine for other work. Write for **FREE Book.** **OTTAWA MFG. CO., 2527 Wood St., Ottawa, Kans.**



Earn Cash at Home!

We paid M. M. \$1174 for exceptional cellar crop Snow-King mushrooms! We furnish materials; buy all crops. Big **FREE** picture book tells if your cellar, shed, barn, suitable. Est. 1908. Write today. **United Co., 3848 Lincoln Av., Dept. 309, Chicago**

ELECTRICITY

ANYWHERE

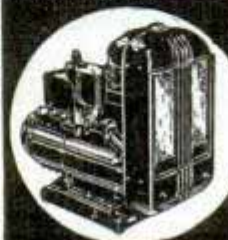

ONAN ELECTRIC PLANTS furnish 110 Volt, 60 Cycle, A. C. Current same as City Power Lines for Farms, Camps, Construction Jobs and Emergency Service in Hospitals, Schools, Theatres, Public Buildings. **SAVE PROPERTY,** even LIVES in case of Power Line Failure. Thousands in use in all parts of the World. Operate Lights, Radios, Water Systems, all Appliances. Models 350 to 50,000 Watts, 12, 32 and 110 Volt D. C.—110 or 220 Volt A. C. Also Combination A. C.-D. C. Units. Manual, Full-Automatic and Self-Starting Types. Shipped **COMPLETE—READY TO RUN,** \$99 and up. Write for details.

D. W. ONAN & SONS

1019 Royalston Ave. Minneapolis, Minn.

(Continued from page 144A)

the rear fender contour and giving wider space for easy entrance and exit. Door latches are of the rotary type. The Chrysler, in all models, is longer, lower and more roomy. Horsepower in the "Royal" and the "Windsor" has been increased from 100 to 108 and in the "Crown Imperial" to 143. The "Fluid Drive," introduced last year, is standard on the "Crown Imperial" and is optional equipment on two other models. Running boards or side shields to replace running boards are optional at no extra cost.

Paced last year by Nash, with its "Weather eye," Studebaker, with its Climatizer method of conditioning air in the car, and Hudson, with the Weather Master, the industry turns its attention to im-

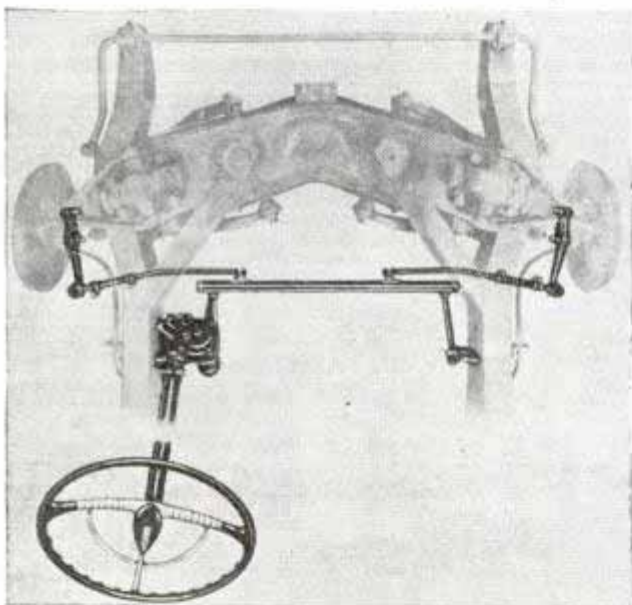

Nash's dual "arrow straight" steering system makes driving much easier

provement of heating systems. General Motors offers defrosters, airscoops and a new under-the-seat heater that from its central position beneath the front seat distributes warm air evenly throughout both front and rear compartments. Capacity is considerably greater than that of dash-mounted units. In some cars, the system incorporates two large fans which distribute the air from an extra-large heating element. In the Buick, a large hose conducts fresh air from the radiator back through the engine compartment to the passenger space. Chrysler introduces a twin-heater system that draws fresh air into the car at 200 to 300 cubic feet per

(Continued to page 149A)

That's Gold

—in my
cellar-shop!



Hundreds of
Driver-equipped
home shops
return a nice

profit as well as a lot of fun!

It's a cinch to make money on your investment in Driver Power Tools. All around you are folks who want things made . . . who'll be glad to pay for the furniture, knickknacks, etc. you enjoy making. Try it! Driver Tools will prepare you for BUSINESS . . . enable you to turn out "professional" work that SELLS. Enable you to do it so easily that your "Business" will remain FUN for you.

YOU'LL WANT THIS GREAT 14" BAND SAW

It's as slick in operation as it is in looks. Does a multitude of jobs. Example is the corner cupboard shown above. Its keen blade, travels at 2535 feet per minute; zips through heavy oak as easily as a light panel. Rips, cross-cuts, makes accurate curved, angle and mitre cuts. Has a big 16"x16" tilting table and many other features. Built so well that big wood-working plants are using it. Costs little to own.



Your local Walker-Turner dealer will demonstrate this tool, also the Driver 10" Geared Power Tilting Arbor Saw . . . the 6" Jointer . . . Metal-working Band Saw and others. Use the coupon to get the 48-PAGE CATALOG which gives the details you want.

DRIVER Engineered POWER TOOLS

Walker-Turner Co., Inc.
1119 South Ave., Plainfield, N. J.
I want your Catalog of Driver Tools, accessories and motors.

Name.....

Address.....

PLAY TUNES AT ONCE on the SYMPHONET



If you can whistle a tune—you can play sparkling melodies in a few minutes on this remarkable new musical instrument. No long course of expensive lessons. No months of tiresome study. Just a few minutes' practice—and anyone from children to grown-ups can play real songs in pure rich musical tones.

Not a Toy—But a Real Musical Instrument

The Symphonet has two full chromatic octaves of clear, flute-like tone quality. Made of black polished plastic, measures 12" long—with special ridges that make for easy fingering. Has adjustable mouth piece and easy-reading music-holder. Holes are spaced comfortably for adults or children. Provides wonderful pre-training for clarinet, flute or oboe. For complete Symphonet outfit, including instrument, music-holder, numbered instruction sheet, and 20-page book of music—send only \$1. Outfit will be mailed postpaid. (Or send no money and pay postman \$1.00 plus postage on arrival.) Either way satisfaction guaranteed or money refunded. For many hours of musical fun—order TODAY!

COMPLETE with MUSIC and MUSIC RACK

ILLINOIS MUSICAL SUPPLY CO.
427 S. Wabash Dept. 8 Chicago



BIG MONEY-MAKERS THAT WORK EIFEL-GEARED PIERRENCH KIT-7" & 8 1/2"



"Pocket Machine Shops" that Do the work of \$50 worth of other tools. Amazingly Quicker, Better... Easier!
• Now of ALLOY Steel—65% Stronger! • NEW PLANT... Quadrupled Capacity.
• Now have your Own Business in a New Selling Case. Full-time men making \$1,500 to \$4,000 Yearly... Part-timers in proportion. We need Many More!



NEW FREE Bottle-Cap Opener, etc.

Mail Your Address Today (on a post card will do) Get FREE—this 6-Edge End-&-Angle Screw-driver and 101-Picture Manual of Mechanics, with... User Offers; or, with... DISTRIBUTOR, Territory, Demo, and SELLING Kit Offers!

AMERICAN PIERRENCH CORP'N YPM-4611 N. RAVENSWOOD AV. CHICAGO, ILL.

FACTORY MODERNIZED VACUUM CLEANERS

FEATURING:
Premier, Hoover, Royal, Eureka, Universal, G. E., Electrolux, 30 Other Makes
Factory Modernized by Re-New
Full Year Guarantee
Immediate Delivery



FREE!



Write TODAY for new illustrated catalogs of vacuum cleaners and parts

RE-NEW SWEEPER CO.
9591 Grd. River Ave., Detroit, Mich.

World's Largest Independent Vacuum Cleaner Rebuilders Est. 1916

MONEY MEN ALL DATA FREE

THE PLASTEX Industry needs manufacturers on small scale and for big production of Lamp and Clock Stands, Art Goods and Novelities in Plastex and Marble imitation. Experience unnecessary. 1/2c material makes regular 10c store sellers. Rubber moulds furnished for speed production. Small investment brings big returns. BIG CHAIN STORE orders now being placed. Ambitious men have chance for real prosperity. Our FREE booklet will interest and benefit you. PLASTEX INDUSTRIES, Dept. P, 1085 Washington Ave., New York, N. Y.



BUILD TRAINS—AUTOS—AIRPLANES—SHIPS—GAS MODELS—ALSO CAMERAS, etc.

Low priced C-D quality Kits by the master model designers. Passenger loco 50c, Switcher 50c, 27 diff. freight Cars, ea. 10c, F11C-2 Airplane 85c, 3 Foreign race cars, 3 Indianapolis winners, ea. 10c. Hundreds of others and thousands of supplies. Add 15c for pack. & post. all orders, or part shipment deducted. Catalog only 10c.



Cleveland Model & Supply Co. Inc.
4588 C87 Lorain Ave. Cleveland, Ohio, U.S.A.

Clymer WINDSHIELD SPOTLIGHT!

NEW • MODERN • STREAMLINED
Operated through the windshield from inside the car—no cogs, gears, outside mountings—direct, quick action focusing easily locates house numbers, street signs, detours. Unusually effective in fog, rain, snow.
Easily installed, one model fits all cars! Quickly removed for use as trouble or camp light. No other spotlight has the beauty, convenience of the new Clymer. Endorsed by traffic bureaus, safety councils, state officials.
Be safe—put a Clymer Windshield Spotlight on your car NOW... new low price. See your dealer or order direct. FREE folder.
Jobbers, dealers, write for full information.



\$9.50

Dept C-4
Clymer SPOTLIGHT COMPANY
222 West Pico Blvd. • Los Angeles, California

CATCH FISH!

minnows, eels, mink, muskrat, with our folding galvanized Steel Wire Traps. Walton's Automatic Hooks are so constructed that when a fish gives the slightest pull on the bait the upper hook reaches down and gets a hold that lands him. 3 for 50c. Write for descriptive catalog of Traps, Hooks, Lures, and other specialties. Walton Supply Co., 3507 Juniata Ave., St. Louis, Mo.

TOMBSTONES \$9.00 UP FREIGHT PAID or ERECTED

Marble or Granite of Best Quality. Lettered. Guaranteed. Thousands sold. Write for Free Catalog and samples. U. S. MARBLE & GRANITE CO., Dept. A-18, Oneco, Florida

CASH IN ON SPARE TIME

\$30 WEEKLY OR MORE EARN. Grow mushrooms HOME. Cellar, shed suitable. We buy 30c lb. Year round business, \$270 made by Mr. B. in few weeks SPARE TIME. Guaranteed materials. Established 1931. Write for FREE BOOK. WASHINGTON MUSHROOM INDUSTRIES, Dept. 601, 2019 2nd Seattle, Wash.

AGENTS 300% Profit SIGN LETTERS

For Store Fronts and Office Windows. Anyone can put them on. Free Samples. Liberal Offer to general agents. METALLIC LETTER CO., 438 N. Clark St., Chicago

MONEY IN RABBITS—CAVIES

WE BUY and put you in touch with other markets. Catalog and copy of magazine 10c. Or send 25c for Book Catalog and Price List and Year's Subscription to the AMERICAN SMALL STOCK FARMER. OUTDOOR ENTERPRISE CO., BOX 919, NEW CITY, N. Y.

When writing please mention Popular Mechanics

(Continued from page 147A)

minute. The intake houses an air filter and rain separator. Cleansed air is conducted to heaters, one on either side of the car. Hot water entering the heaters from the engine warms the fresh air and motor-driven fans force it to twin air outlets built into the sides of the body cowl just ahead of the front doors. From there the warm air is blown into the front compartment and past the front seat ends into the rear compartment. This system is available on all Chrysler cars, starting with Plymouth.

Hudson enters a new car in the lowest-price field, a six-cylinder model that has independent front-wheel suspension with "Auto-Poise Control," which applies correctional influences to help hold front wheels on their course. A new "Eight" which delivers more than one horsepower for every inch of wheelbase, is a further

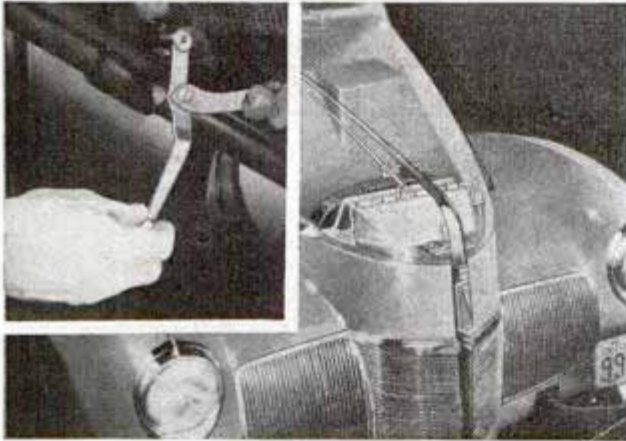

Illustrating Studebaker's hood lock with steering-column lever (shown inset)

development of Hudson's high power-to-weight engineering practice. Directional safety signals, an improved hood controlled by a dash-locking lever, longer rear springs which have a lower-ride frequency to increase comfort, a separate odometer dial with magnifying lens for checking mileage with unusual ease, a two-spoke plastic steering wheel and silver-plated headlamps, lighting switches, fuse and fuse holders, as well as other important terminal connections that are exposed to weather, are other features of the new Hudson line.

Studebaker, starting with the popular "Champion" introduced a few months ago, is stressing safety features in 1940. Visibility is greatly increased, door hinges concealed and handles streamlined into

(Continued to page 151A)

**\$495**

(By mail, 20c postage extra)

New gas-powered model that flies swiftly to high altitudes . . . soars long and glides to level landings. Build one and be in line for **BIG CASH PRIZES** to be offered contest winners using Megow models. 3-unit construction . . . quick-detachable wing and tail sections fly off undamaged in collision and give easy access to ignition unit. Quickly-built monocoque fuselage. 6 foot wingspan. 8 oz. wing loading. Uses any 1/5 h.p. motor. The best performing, most beautiful model airplane you ever saw.

See new catalog for other gas models . . . and Korda's rubber-powered Wakefield International Trophy Winner (\$1.00, plus 10c postage by mail). Also scores of Giant Fliers and Scale Models of all kinds.



MODEL SHIPS • HO-GAUGE RAILROAD EQUIPMENT SUPPLIES FOR HOBBY-CRAFTS

Send 5c for big new illustrated catalog just out!

Dept. PM, Howard & Oxford Sts., Philadelphia, Pa.
217 N. Desplaines St., Chicago, Ill.
718 Mission St., San Francisco, Cal.

Megow's

HANDEE Hobbies

Get more out of life. Make things with our easy working plans. 75 new, intriguing projects for the home, gifts or to sell—models of ships, planes, houses; statuettes, book ends, etc. Learn the new, exclusive Handee technique of engraving on mirrors, glassware, trays, cabinet doors, table tops, etc. It's fascinating and as easy as tracing.



EARN MONEY AT HOME

There's a growing demand for home-craft wares for gifts, prizes, etc. Get started with Handee Hobbies. Portfolio of 12 plans, 25c.

TOOL OF 1001 USES

A tool shop and power house in one. Plugs in any electric socket. Grinds, drills, polishes, cuts, carves, routs, saws, sands, sharpens, engraves, all materials.

Write for free 64-page catalog. Shows Handees \$10.75 up.

CHICAGO WHEEL & MFG. CO.
108 S. Aberdeen Street
Chicago, Illinois



PORTABLE
Guild Sander
ELECTRIC SANDS SCRAPES PLANES

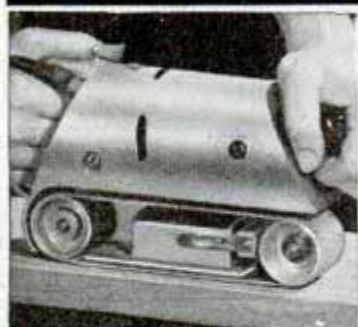

Fast, Smooth, Easy to Use

Better in MINUTES than can be done IN HOURS By Hand

The scores of different jobs this new, handy electric tool does so expertly will amaze you. At big savings of time and effort over handwork, you can sand, grind, polish, buff

—with factory-like results—without any previous training.

GUILDSANDER works on wood, metal, stone or plastics. Cleans off old paint and varnish without messy removers. Levels glued joints, trues mitres, finishes table tops, fits doors and windows, sharpens tools. On either flat or curved surfaces, GUILDSANDER'S high-speed abrasive belt takes a smooth, clean, even cut—free from scratches, swirls, low spots. Equals quality work of sanders costing double the money. Users are enthusiastic! As Dr. Ferris Smith, of Grand Rapids, Mich. says: "GUILDSANDER takes the arduous effort away from wood working and leaves all the fun." You will say the same, once you try it.

Weights only 9 lbs. Plugs into any light socket. Usable in any position.

ASK YOUR DEALER TODAY! OR WRITE TO US FOR FULL INFORMATION AND LOW PRICE

SYRACUSE GUILD TOOL COMPANY
1740-11c No. Salina St. Syracuse, New York

DON'T-GO-ON-RELIEF, BUT

Relieve Home Owners Of Excessive Fuel Bills, and make over 100% profit yourself by selling and easily installing simple device,—proven over 12 years. More than a million giving users 100% or more dividends per annum. Send \$2.00 for returnable sample Preferred Draft-A-Justor and proposition.

PREFERRED UTILITIES MFG. CORP.
35 W. 60th ST. N. Y. C.

for HOME CRAFTSMEN
SENSATIONAL NEW Flexible SHAFT TOOL!



EASY TO HOLD—EASY TO USE

Here's new skill, new ease for home craftsmen! **FOREDOM** Tools afford complete freedom of operation—definitely controlled power at your finger tips. You can work in hard-to-reach places with professional precision. See illustration. Motor suspends from swinging wall bracket. You hold pencil-size, lightweight handpiece which can be grasped close to its end for easy control. Accessories interchange almost instantly. Hundreds of uses: grinding, polishing, drilling, milling, engraving, sharpening, slotting, stone-setting, rust-removing, sawing, carving, cleaning, sanding, scratch-brushing, etc., etc. Since 1922 **FOREDOM TOOLS** have been quality-tested and proven by thousands of expert craftsmen the world over. Here's what you get: 1. High grade universal motor (operating on both AC and DC). 2. Flexible shaft assembly. 3. Handpiece as described. 4. 50-piece accessory set. 5. Swinging wall bracket—\$14.95 et—complete workshop

35 PIECE ACCESSORY SET For Motor Tools and Flexible Shaft Tools. **OUTSTANDING VALUE.** mandrels, brushes, stones, buff sanders, etc., boxed for convenient use. Sent Postpaid **60c** anywhere in U.S. **FOREDOM ACCESSORIES.** 300 to choose from. Most complete line available, also accessory sets, all priced amazingly low. Circular free.

YOURS ON 10-DAY FREE TRIAL
Order this Model 45 **FOREDOM** Flexible Shaft Workshop today. Enclose check or M. O. for \$14.95, or, if you prefer, we'll ship C. O. D. Try it for 10 days. If not completely satisfied, return the set and we'll refund your money at once. Catalog of this and other **FOREDOM** Tools free.
DEALERS. Write for our special offer.
FOREDOM ELECTRIC CO., Dept. 109
27 Park Place New York, N. Y.

New-TYPE Cheap OIL BURNER INVENTED
Sweeping the Country!

COOK and HEAT Without Coal or Wood

In Your Present Stove or Furnace—**HOTTER—No Drudgery, Dirt or Ashes—More Heat Quick at SMALL COST.**



OVER 40,000 SOLD

Beats any oil burner ever gotten out for low cost, perfect performance. Burns cheap oil a new way, without pre-generating or clogging up. Quick intense heat by Simple Turn of Valve.

30 DAYS' TRIAL

Prove its efficiency, convenience and economical operation.

Write Immediately for FREE BURNER OFFER TO AGENTS

AGENTS Salesmen BIG MONEY

F. Silver says: "I can dispose of 200 HEAT KINGS before this year ends." Sample burner FREE to producers. Write us now for agents' offer.



Quick HEAT At Turn of Valve!

who will demonstrate and take orders. Write quick, be first to learn how to make **REAL MONEY** right now, spare or full time—mail 1c postcard today.
UNITED FACTORIES, N-751, Factory Bldg., Kansas City, Mo.

NEWEST TYPELESS PRINTER



Amazing brand new, heavier model **PRINT-O-PRESS**, with smoother working features. Compares with costliest stencil duplicators. Full legal size. Also other models at equally low prices. **FREE** Details and Samples of work. User-Agents Write.

PROFESSIONAL PRODUCTS CORP.
Dept. 1110, Silverton, Cincinnati, O.

AMATEURS—EXPERIMENTERS—SERVICEMEN
HARDWARE ASSORTMENT



1200 Pcs. Std. screws—nuts—washers—wood screws—soldering lugs—rivets—eyelets—etc. Finest assortment ever offered. Packed in removable tray hinged lid compartment box. Money back guarantee. Shipped postpaid in U.S.A.—Send \$1.25.
FEDERAL HARDWARE COMPANY, 24 S. Jefferson, Chicago, Ill.

10¢ For 16 PLANS . . . Step-by-step instructions for building 16 useful indoor and outdoor articles. A good guide for both beginners and experts. Write for the Stanley Plan Book. Only 10c.
STANLEY TOOLS Division of The Stanley Works, 105 Elm St., New Britain, Conn.

Class Pins 30¢ up FREE CATALOG
Artistic pins, rings and emblems for classes and clubs. Attractive prices. Finest quality, gold plated, silver, etc. Over 300 designs.
Write Dept. N, **METAL ARTS CO., Inc., Rochester, N. Y.**

MODEL SHIP & YACHT FITTINGS

Carved hull Kits. Construction sets for all popular models. Model Yacht fittings, sails and spinnakers. Send 20c (coin) for 44 page illustrated catalog No. 15 listing hundreds of items you need.
A. J. FISHER 1002-7 ETOWAH AVE., ROYAL OAK, MICHIGAN

BUILD THESE PROJECTS

For garden or lawn. Easy to build. Easy to sell. Detailed Blueprints Model B-25 Dutch Windmill 50c. Model OM-60 Old Mill, 85c. Lawn Figure Patterns—Sunbonnet Girl, Dutch Boy, Tulip Girl, Holland Pair 35c each all 4—\$1.00. Two story Colonial Dollhouse Blueprint 60c. Catalog illustrating many models, send 10c today
CRAFTSMAN'S MODEL CO., Dept. P-34, 2030 N. 41st St., Milwaukee, Wis.

Alkalize with
Alka-Seltzer

(Continued from page 149A) *g 9 36*

the chrome body molding, and the hood is held closed by a locking lever on the instrument panel. All models are marked by the absence of protuberances on the exterior, the result of a design calling for clean, smoothly flowing body contours. Interiors present a new charm, there being a deft use of chromium, which along with stainless steel, colorful plastics and broad-cloth upholstery, helps to create an air of luxurious comfort. Free wheeling and overdrive are available on all models.

Due to the extra load imposed on the electrical system by the sealed beam headlamps, which have higher-powered bulbs than previous headlights, capacities of generators have been increased generally. As an example the Buick is equipped with a shunt-wound generator, with both voltage and current regulators, which provides a

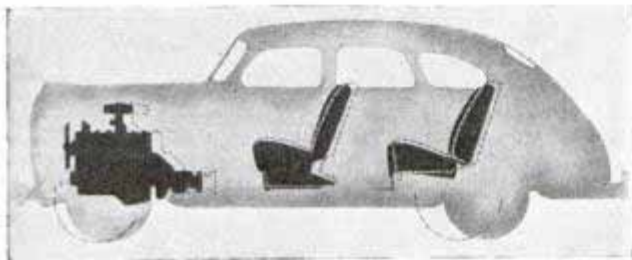

How different location of Plymouth's wheels moves passengers toward easier riding position

maximum output of thirty-three amperes hot and forty-two amperes when cold. Larger output at low speeds is a feature.

Announcing price reductions of \$20 to \$50, Nash introduces eighteen models and bids for the low-price market with the 117-inch wheelbase "LaFayette," powered by a ninety-nine horsepower engine. "Arrow-Flight Ride," the result of the combination of long, synchronous springs and super-size shock absorbers in the rear and soft, individual coil springing on the front wheels, is a major feature. A new steering arrangement which helps to hold the car straight on the road contributes further to riding comfort. Nash has flowing streamlines expressive of movement, even when the car is not in motion. Special sound-proofing insulation, consisting of grains of sand suspended in a compound, is scientifically applied to reduce interior car noise. The insulating material deflects sound waves, thus forming an anti-noise barrier wherever it is applied, beneath the

(Continued to page 153A)

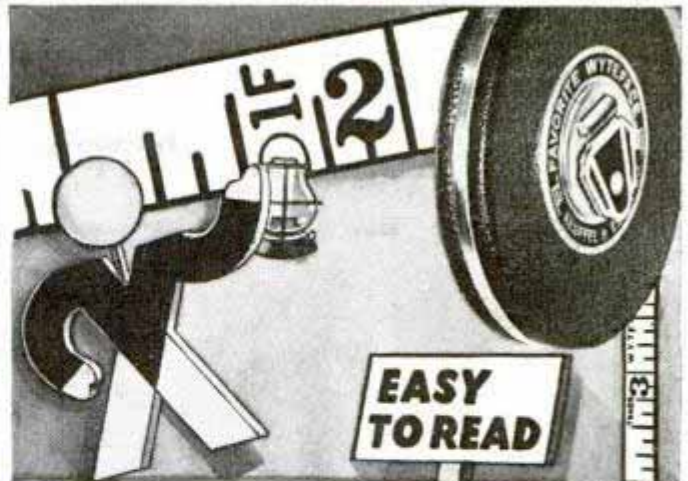

In poor light or good light—the sharp black-on-white markings on this improved steel tape are always easy to read. You have less chance for error. The smooth white surface is crack-proof; easy to clean; bonded to the steel; protects it from rust. This tape is hard to kink, hard to curl; good for a long useful life. 25, 50, 75, 100 ft. lengths. Mail the coupon today for a free sample of the tape and an illustrated folder.

K & E FAVORITE WYTEFACE

STEEL MEASURING TAPES

LOOK FOR THIS DISPLAY



KEUFFEL & ESSER CO., Est. 1867
Dept. 87, Hoboken, N. J.

Name

Address

City State



GLOBULAR ROAD MAPS

U. S. map with U. S. highways and part state roads on 3-inch globe. Globe map fits in outer globe which clamps on steering column and has magnifying glass which magnifies roads larger than ordinary road map. Has a light inside of outer globe. Just turn a knob and any part of the U. S. appears before your eyes. Easy to read. The only globular road map on the market. Agents and dealers wanted. If your dealer can not supply you, order direct from us. Sent C.O.D. \$7.50.

BOLENBAUGH'S SALES AGENCY

620 W. JEFFERSON BLVD. MISHAWAKA, IND.

New PRECISION OILER for HOME WORKSHOPS

Handy as a Fountain Pen!

Pre-to Oiler applies exactly the right amount of oil in just the right spot by simply pressing the steel point. Automatic — 1/10 drop each press — no drip or smear. Transparent oil reservoir. Clips in pocket like a fountain pen. Hundreds of uses in home and workshop. Praised by every user as the perfect oiler for all needs. Satisfaction guaranteed. Ask your dealer. If unable to obtain locally, send 50c for direct post paid shipment.

THE DILL MANUFACTURING CO.
Dept. 115 — 700 E. 82nd. St., Cleveland, Ohio



FREE TRIAL OFFER

NEW REMINGTON DELUXE NOISELESS PORTABLE!



AS LITTLE AS

10¢ A DAY

The New Famous Remington Deluxe Noiseless Portable that speaks in a whisper, is yours for as little as 10c a day. Brand new. Standard keyboard. Automatic ribbon reverse. Variable line spacer. Touch regulator and all the conveniences of the finest portable ever built. PLUS the NOISELESS feature. Act now. Send coupon TODAY for details.

board. Automatic ribbon reverse. Variable line spacer. Touch regulator and all the conveniences of the finest portable ever built. PLUS the NOISELESS feature. Act now. Send coupon TODAY for details.

You don't RISK a Penny

We will send you the Remington Deluxe Noiseless Portable for 10 days' free trial. If you are not entirely satisfied, send it back. We pay all shipping charges.

FREE Typing Booklet, Special Carrying Case

You receive FREE a complete simplified booklet on Touch Typing prepared by experts. A handsome, sturdy carrying case is included. No obligation. Mail coupon for full details—NOW.

Remington Rand Inc., Dept. 152-11
465 Washington St., Buffalo, N. Y.
Tell me, without obligation, how to get a Free Trial of a new Remington Noiseless Portable, including Carrying Case and Free Typing Course on terms as low as 10c a day. Send Catalogue.

Name.....
Address.....
City.....State.....

MAKE MONEY NIGHT AND DAY WITHOUT SELLING!

Step into big money with "Silver King." Place in taverns, stores, filling stations, waiting rooms, etc. Vends candy, gum or peanuts. All you do is collect profits. Start small—full or spare time and grow. Get FREE facts today.

AUTOMAT GAMES, 2429 Fullerton, Chicago

NOW!



AUTO-GLIDE 1/3¢ PER MILE

There's no ride like an AUTO-GLIDE! It's swift, thrilling, convenient, inexpensive—actually 125 miles per gallon—35 miles per hour! Ride to school, for business, pleasure, deliveries. Handles like car. Parks easy. Rugged. All steel frame. Powerful, trouble-free Cushman engine. Many models.

WRITE! Or see dealer for full details. Very Low Prices. Send TODAY!
THE CUSHMAN MOTOR WORKS
Dept. B-11 Lincoln, Nebr.

Calling All Cars

A MYSTERIOUS DISCOVERY SAVES UP TO 30% ON GASOLINE or Costs Nothing to Try



Stop wasting Gas!—trim dollars off gas bills—get more power—quicker pickup—faster acceleration! AUTO OWNERS everywhere praise VACU-MATIC! Proven so efficient, it is guaranteed to satisfy, or the trial costs you nothing.

Automatic Supercharge Principle
Vacu-matic is entirely different! It operates on the supercharge principle by automatically adding a charge of extra oxygen, drawn free from the outer air into the heart of the gas mixture. It is entirely automatic and allows the motor to "breathe" at the correct time, opening and closing as required. Saves up to 30% on gas costs, with better motor performance.

FITS ALL CARS
Constructed of six parts fused into a single unit, adjusted and sealed at the factory. Easily and quickly installed by anyone in a few minutes.

AGENTS Get Yours FREE

FOR INTRODUCING. Here's a splendid opportunity for unusual sales and profits. Every car, truck, tractor owner a prospect. Send name and address now for big money making offer and how you can get yours Free. **The Vacu-matic Co., 7617-468 W. State Street, Wauwatosa, Wis.**

Stoves AT FACTORY PRICES!



SALE CATALOG—FREE

Nearly 260 Styles and Sizes of Heaters, Ranges, Furnaces at FACTORY PRICES. Easy Terms. Write today for FREE CATALOG. New styles, new features—21-hour shipments. **Kalamazoo Stove & Furnace Co., 391 Rochester Avenue Kalamazoo Michigan Over 1,400,000 Satisfied Users 38 Years in Business**

"A Kalamazoo Direct to You"

Write for FREE CATALOG

SpeedWay DRILL \$7.95 GRINDER \$5.95

QUALITY TOOLS
... products of SpeedWay, for 30 years leading manufacturers of electric tools. Specially wound high torque 110V universal tool motors. Improved designs, correct speeds. 1000 RPM Drill with disc cut handle has 1/4" capacity in steel. 20,000 RPM Hand Grinder has speed essential for efficiency and outlets for both 1/4" and 3/32" arbors. Drill and Grinder sold singly or together with 3 accessories in fitted Steel Kit. Stand takes either drill or grinder. Router Frame converts grinder into router. Bench Grinder is complete with motor. Write for Circulars. **SpeedWay Mfg. Co., 1842 S. 52nd Ave., Cicero, Ill.**

ROUTER \$3.95
KIT \$14.95
STAND \$3.95
GRINDER \$9.95

WHOLESALE CATALOG OF 4000 BARGAINS

It has 260 pages, chock-full of unusual values. It contains selling plans; order stimulators; tested fast selling articles to dealers, stores and direct to the consumer. A new revised issue is just off the press. Cost about 25c. FREE, while stock lasts. Send for your copy, Today.

SPORS CO. 9-39 Elm St., Le Center, Minn.

CAPTURE THE COLOR OF LIFE! YOUR OWN MOVIES! ONLY 10c A DAY!
NATIONALLY ADVERTISED 8MM and 16MM Movie cameras, projectors. For home, business, church, school, club. MONEY BACK 10 DAY TRIAL. Payments as low as 10c A DAY. Satisfied customers throughout the world. FREE details. WRITE TODAY.
Don Elder's Home Movies, Dept. N-11, 739 Boylston St., Boston, Mass.

Easy Home Work PAYS GOOD MONEY
Raise Mushrooms SPARE TIME
Get Free Book "How To Raise Mushrooms." Tells how to turn spare space and spare time into cash. Explains how we guarantee satisfactory starting crops, buy all saleable Mushrooms you raise, assure highest market prices, furnish advertising help you start in business. Write today Niagara Mushroom Co., Dept. A-11, Buffalo, N. Y.

25,000,000 HOUSEWIVES ARE WAITING FOR THE Superlux CLEANER

Makes Mopping and Wall Cleaning Easy
At last, a discovery that supplants the old-fashioned type of cloth, fiber and rubber sponge with amazing new, practical du Pont Cellulose Sponge that holds 20 times its weight in water. So soft when wet, it cannot scratch or mar delicate surfaces. Can be sterilized by boiling. The new Superlux Cleaner, with its unique mechanical wringing feature, keeps housewives hands away from dirty water. It is light in weight and easy to operate. Removable head is perfect for window and car washing.
AGENTS! Housewives buy on one minute demonstration. Make big money supplying them. Write today for full particulars and learn how you can get your mop free for demonstrating purposes by helping introduce it to others.
THE LUX COMPANY, Dept. M-51, Elkhart, Ind.

(Continued from page 151A) 99 36

floor and at every point where the body is attached to the chassis.

Offered as the lowest priced full-size automobile on the market, the new Willys has smooth flowing lines, headlamps molded into fender contours and tubular frame front seat with silent comfort springing. Running boards are omitted. Wind stream ventilation control, two-spoke steering wheel, remote control gear shift and softer springs are other features. Passengers will note the amplitude of headroom.

Front ends of the new LaSalle feature further development of the narrow radiator grille, with headlamps moved to the fenders. Cadillac front ends have long hoods tapering to the pointed radiator which is the centerpiece of a three-part grille, with headlamps on the sides of the hood. Optional color choices to make dash panels, garnish moldings and plastic control knobs harmonize with upholstery is an innovation. Directional turn indicators are standard on both cars. The LaSalle "Special" and Cadillac Fleetwood "72" are additions to the 1939 lineup. New styling is reminiscent of the "torpedo" shaped Cadillac "60," previously introduced.

Two completely new cars have been added to the Packard line—the "160" and the "180." Radiators throughout are much narrower and are flanked on each side by additional chrome-plated grilles. The top of the radiator shell has been rounded with sleek curves and a big addition to its depth gives the whole car a longer, more graceful appearance. The engine in the two cars added to the line develops 160 horsepower at 3,500 revolutions per minute. The crankshaft is completely counterbalanced and has a high finish from end to end. Big gains in power-to-weight ratio give these cars a new peak in performance.

Styling of the General Motors cars is closely similar throughout the respective divisions, with the large front fenders flaring rather high into the hood. Buick supplies a good example of the distinctive manner in which the headlamps have been inset into the fenders. They are slightly closer to the outside of the car than previously, but not so much as to give the car an ungainly wide appearance, nor to allow them to be easily damaged when the fender is dented. Their height above the

(Continued to page 155A)

Now You Can Afford A Woodworking Lathe

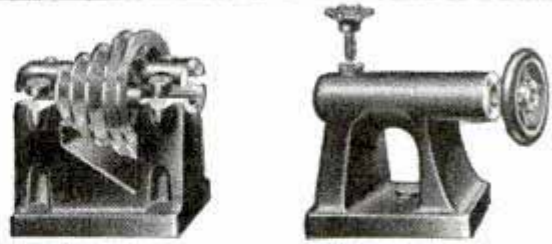

THERE'S no need to be without a heavy duty lathe any longer. The kind you have always wanted can be obtained now at a price that will positively amaze you.

We Supply the Parts You Build It Yourself

Big savings plus the satisfaction and thrill that comes with building your own equipment! All the parts required for a smooth-running 12" wood lathe furnished with complete instructions for assembling. Can be furnished in the rough, semi-finished or completely machined ready for assembly. Parts are accurately and carefully made—headstock and tailstock of rugged aluminum castings. Will perform every regular lathe operation efficiently year after year. Small electric motor will furnish sufficient power to operate. Ideal for the school shop, general woodworking shop or home workshop.

Write today for complete details, prices and terms.

GILBERT BRASS FOUNDRY CO.

5034 Farlin Ave.

St. Louis, Mo.

Mfrs. of Brass, Bronze and Aluminum Castings Since 1900

NEW



50c

STUBBY SCREW DRIVER

Learn about this line through No. 854 Stubby—easily carried in pocket, a demon for tough screws in close quarters. Handle dia. 1 1/4"; blade length 1 1/2"; overall length 3 1/2". If your dealer can't supply, order direct.



SURE-GRIP SCREW DRIVER

*Easy to Use
and Carry!*

Outstanding among hundreds of superior Millers Falls tools are our Permaloid-handled screw drivers—high-grade forged steel bits permanently imbedded in red, transparent, indestructible, shockproof, plastic handles, comfortably grooved to fit the hand and provide a sure grip. Wide range of sizes and styles, Phillips or straight blades. Available through many good hardware dealers.

FREE with Stubby

No. 42 Tool Book, 240 pages crammed with details of hundreds of fine, Millers Falls and Goodell-Pratt tools, will be sent for 10c to cover postage and handling—or FREE with your order and remittance of 50c for the Stubby Screw Driver. Satisfaction guaranteed or money refunded.

MILLERS FALLS CO.
GREENFIELD MASS.

Attention!
AUTOMOBILE MECHANICS and GARAGEMEN

MAKE BIG PROFITS!
 Selling the **NATIONALLY DISTRIBUTED TRIPLE-X SCIENTIFIC PISTON RINGS**

Distribute the Nationally Famous TRIPLE-X Self-locking Piston Rings and make **BIG PROFITS** buying Direct from the Factory. We furnish **FREE** all necessary accessories.

TRIPLE-X PISTON RINGS for over 5 years have been one of America's finest replacement equipment. These piston rings scientifically developed work like **MAGIC!** **GUARANTEED 100,000 MILES!** Exclusive self-locking feature assures Maximum compression and Minimum oil consumption at all times!

TRIPLE-X PISTON RINGS are individually engineered and packaged for every make of car! **NON-BREAKABLE! EASY TO INSTALL! EXPANDERS ELIMINATED! NO RE-BORING, HONING OR GRINDING! NO BREAKING-IN PERIOD!** Testimonial excerpts sent with request for **FREE** sample rings and full details explaining how you can be a TRIPLE-X Exclusive Distributor. **ACT NOW!** to-day while territories are open!

Send To-day for FREE SAMPLE PISTON RINGS AND COMPLETE INFORMATION

TRIPLE-X ENGINEERING CO.
 3801 S. Racine Ave., Dept. 2, Chicago, Ill.

SHELDON
 Back Geared Screw Cutting Precision Lathes
\$98
 F. O. B. CHICAGO

The SHELDON "METALWORKER" is a sturdy, full sized, full weight, back geared, screw cutting, 10" precision lathe, built to industrial standards with hob-cut change gears, heat treated and ground spindle, hand scraped V-way, etc., etc. 10 1/8" swing, 1 1/16" hole thru spindle, 20" center distance, 38" bed, complete with compound rest, tool post, change gears, face plate, centers, and wrenches (as illustrated), less motor drive \$98.00 F. O. B. Chicago.

Write for **FREE** Bulletin on Sheldon Lathes, drives, attachments and tools. Easy Payment Plan and names of local dealers.



SHELDON MACHINE CO. INC.
 1621 North Kilbourn Ave. Chicago, U.S.A.
 Write for Catalog

POWERlite

AMERICA'S FINEST—MOST POWERFUL ELECTRIC LANTERN
 80 to 100 HOURS LIGHT
 On One 6-Volt Dry Battery

● **TWO LIGHTS** on a double action switch, 800 ft. spot beam from front reflector; broad floodlight from top. Handle reverses. Unbreakable lens, 6 1/2" high. At sport, hardware, electrical dealers or write for literature.

DELTA ELECTRIC COMPANY **\$3.35** Less Battery
 300 W. 33rd ST., MARION, INDIANA

Buy Only a GENUINE DELTA



FREE!
 40 page book

Send at once for a **FREE** copy of this time-money saving catalog. In it is everything you need in photography. All the nationally advertised cameras, a complete line of up-to-date equipment. 40 pages to guide you! You'll save time because now you can order at home. You'll save money, too—the prices are attractive—in many cases, savings will surprise you! Write today for **FREE** copy Catalog No. 77.

Complete photo guide!

LAFAYETTE CAMERA DIVISION
Radio Wire Television Inc.
 Dept. 7LC9—100 Sixth Ave., New York, N. Y.



BIG MONEY BUILDING MEAD'S NEW Portable OUTBOARD BOAT!

Build this light, 50 lb. tough, durable, seaworthy, portable Outboard Ki-Yak! Take it anywhere by hand or car, safe, trouble-free. More speed per horsepower, more miles per gallon. MEAD'S patented, patented aluminum-ribbed, cut-to-fit Construction Kit guarantees successful assembly, quickly, easily, economically. New 75 lb. OK-4 uses cars, sail, motors 9 h.p. or less... seats four. Also 3 "CK" paddle—oil models from 20 lbs. to 45 lbs. **Finished double-blade paddle or Oars now included** with your KI-YAK! Write now for circulars, low Factory-To-You price!

MEAD GLIDERS, 15 S. Market, Dept. B-119, CHICAGO



ACE
 LATHE TOOL SET
\$14.50

Be permanently tooled-up for every operation on your Metal Cutting Lathe

The ACE Set is complete—there's nothing more to buy. Drop forged by the manufacturers of cutting tools used by 90 per cent of the plants and shops in industry they are correctly designed, are of special steel, are finely finished, are stronger—will last a lifetime. You can cut easier, faster and more accurately with ACE TOOLS.

At your Hardware Store—Circular **FREE**.

ARMSTRONG BROS. TOOL CO.
 "The Tool Holder People"
 368 N. Francisco Ave., CHICAGO, U.S.A.



AMERICA SAYS **PUSH-A-BIKE IS TOPS**

"Fun to Own and Ride Push-A-Bike!"

100 miles of travel adventure for ten cents. Also ideal for messenger & delivery service. Powerful motor drives 200 pound man over 20 MPH. Attach to any type bicycle in three minutes. See your dealer, or Write: **RICHBURN COMPANY, Dept. Dm, Aurora, Mo.**



Write with Electricity

NEW MODEL ELECTROGRAF

Writes easily on the hardest metals or alloys. Positively identifies your tools, protects against theft. Absolutely permanent. Requires few seconds only—anyone can operate. Pays for itself. A Money Maker.

Send No Money — Pay Postman \$1.98 plus postage
 If M.O. or check accompanies order, we pay postage.
 AGENTS: Write today for our proposition.

\$1.98
POSTPAID NATIONAL LABORATORIES, Portland, Ore.



FREE TRAILER PARTS CATALOG

We'll save you money on—axles, springs, wheels, couplers, windows, sinks, water pumps, brakes, refrigerators, beds, lamps, inside and out, 6V lamps, furniture, jacks—everything. Special discount to mfrs. **NATIONAL TRAILER EQUIPMENT CO.** Successors to Kar-A-Van Industries, Inc. Dept. P. 714 W. Wisconsin Ave., Milwaukee, Wis.

Complete Plans and Building Instructions. 10c



FOR BETTER WORK GET THE RIGHT SAW FOR EVERY JOB

ATKINS *Silver Steel* **SAWS**

See your hardware dealer. Send for **FREE** Work-At-Home Book.
E. C. ATKINS AND COMPANY, 426 S. Illinois St., Indianapolis, Ind.



(Continued from page 153A)

ground is sufficient to provide adequate illumination even with the down beam. Assembled on top of the fender is the new parking-direction signal lamp. When the direction signal lever is operated to indicate a left turn, lights flash in the direction signal on the rear of the car and the left front fender light. When the car has completed the turn, the signal lamps automatically are switched off, the control lever returning to neutral position. Buick has adopted an antenna located in front of the windshield center post. It can be rotated 180 degrees downward or upward by a control within the car, the upward position being for distant reception.

Another innovation on the Buick is a jack consisting of two units—a jack with handle and a supporting unit. The jack is applied to the outside of the wheel, the rim of the wheel fitting into a special lug. The jack then raises the wheel, after which the supporting unit is slipped under the axle behind the wheel by means of a handle and the jack is removed, permitting easy removal of the wheel and tire.

Chrysler Corporation's styling is well illustrated by the Dodge, whose massive front fenders blend admirably with the body contours. Headlamps are mounted in the fenders, set apart the full width of the car. Front door hinges are concealed and all doors have rotary locks. Sponge rubber seals encircle the inside of doors to eliminate drafts and to prevent rain from entering. Fenders, sheet-metal parts and the entire body are rustproofed. A novel feature provides that when gasoline approaches exhaustion, oil pressure drops, engine temperature rises too high or the generator output lags behind consumption of current, a red signal, glowing under the particular indicator, gives timely warning during night driving. Dodge's wheelbase is 119½ inches. Important in Chrysler construction is "Superfinish," a glass-like surface imparted to metals by special machining, which is applied to many parts. A Superfinished surface in contact with another Superfinished surface, when properly lubricated, will show practically no wear over a protracted period of time, due to the virtual elimination of metal-to-metal friction. The finish is being applied to moving parts and braking surfaces throughout the corporation's four lines.



P. W. REPAIRS FURNITURE

Plastic Wood handles like putty—hardens into lasting wood. Makes quick, yet permanent repairs to broken furniture, resets loose drawer pulls and casters. In cans or tubes at Paint, Hardware, 10¢ Stores.



PLASTIC WOOD



GOOD TOOLS NEED GOOD OIL

When you work with tools, they must be in working condition. 3-IN-ONE Oil keeps tools clean and bright. It oils the working parts; protects against harmful rust and tarnish. Get it at Hardware, Drug, Grocery, 10¢ Stores.



3-IN-ONE Oil

NEW FASCINATING HOBBY



Carve PLASTICS for FUN and PROFIT

24 PAGE ILLUSTRATED BOOK SHOWS HOW TO MAKE 41 BEAUTIFUL PROJECTS

Turn your spare hours into cash. Make dull moments delightful, creative, educational. Master the fascinating new art of plastic carving, now made easy for all with **Moto-Tool NICK NACK Carving Kit**. Make useful, colorful giftware, toys, statuary, custom jewelry from marble-like new plastic substance. Work out original designs of your own—in wood, glass, metals... like things sold in stores at 4 to 5 times manufacturing cost. Enjoy this new hobby just for fun... or start a profitable home-work business. One Kansas man reports: "greatly increased my earnings."

MONEY BACK GUARANTEE

JUNIOR Kit with No. 1 Moto-Tool (speed 25,000 r.p.m.) 17 accessories and colorful plastic materials for making 10 beautiful articles, complete only \$17.85. **MASTER Kit** with factory type No. 2 Moto-Tool, (speed 27,000 r.p.m.) 23 accessories and plastics for 29 articles, complete as shown only \$24.85. Big project book goes with both Kits. See complete Kits at your dealers, or order direct. Send check or money order and we pay postage, or send \$5.00 and pay postman balance plus postage. **Money promptly refunded if not delighted after inspection.**



NOTICE To Motor-in-Hand Tool Owners
Big Carving Project Book, exactly as furnished in kits, sent separately, for only \$1 Postpaid.

DREMEL MFG. CO., DEPT. K119-L, RACINE, WIS.

KROMER PRACTICAL FLEXIBLE SHOULDER BRACE



for correct carriage and posture. Wear it at work or play. Free booklet on "Design Yourself and Your Personal Condition" with each brace. Enclose normal chest measurement. 35c postpaid.

KROMER BRACE CO. 430 N. Water St. Milwaukee, Wis.

Your HAIR

IS IT THINNING OR FALLING OUT?
If your hair is causing you this kind of trouble and it is due to poor blood circulation in the scalp, rent a Crosley XERVAC and try home treatments with this amazing machine. It is designed to help correct just such conditions of the scalp as the lack of proper blood circulation.

Rent a CROSLY XERVAC

Write for free particulars, how you can rent a brand new machine, the same type now used in many barber shops and scalp clinics, for a small rental fee per month, without any obligation to buy. The Crosley XERVAC operates on the principle of alternate vacuum and pressure, known to be effective for forcing fresh, stimulating blood into the deep-rooted blood vessels. Very compact, easy to use. Now that you can rent one you can get its benefits on easiest of terms. Write today for details of this new home rental plan.

THE CROSLY CORPORATION
Dept. L-10 Cincinnati, Ohio

WORLD'S LOWEST PRICED ADDING MACHINE

GUARANTEED ACCURATE. Not a toy. Operates with only a finger flick. Adds, subtracts, multiplies, divides. Counts up to a million. Pays for itself over and over. **IDEAL GIFT—FOR BUSINESS, Income Tax and School use.**

MONEY BACK GUARANTEE. Send name and address. Pay postman only \$2.50 plus postage. (Send full cash if outside U. S.) Money back in 10 days if not delighted. **AGENTS WRITE. CALCULATOR MACHINE COMPANY (Mfrs.), Dept. 111, P. O. BOX 1118, CHICAGO, ILLINOIS.**

ONLY \$250

FREE TRIAL

SEND NO MONEY

Work Faster Make More Money with the

Red UNIVERSAL TRACTOR

With this practical machine and attachments you can do all field and belt work hours faster at the low cost of 33c per day. Many units pay for themselves the first season. Unusually easy to handle and operate. Absolutely safe. Hundreds of users. Buy direct at low factory price. Two weeks' trial—satisfaction guaranteed. Write for colorful, free catalog.

PIONEER MFG. CO. Dept. V-119 West Allis, Wis.

A BIG DEMAND

from Coast to Coast for

GENUINE LEATHER TIES

Look like Silk, cleaned with a damp cloth. Also **READY-TIED SILK 4-IN-HANDS** Century quality and workmanship make these lines fast sellers. Send 50c for sample kit of either line, specifying whether leather or silk.

CENTURY TIE CO., Mfrs., 2345-P W. Grand Blvd. Detroit, Mich.
(Originators of Leather Ties)

PALMGREN ANGLE VISE ONLY \$4.95

NEW INVENTION—HAS NO EQUAL

For shop, bench or home. Saves hours in wedging, clamping and setting up angle work, jigs and fixtures. Permits cutting, drilling, Postpaid grinding or filing at any angle with one quick, simple adjustment. Accurately graduated in degrees. Ample holding capacity. Width 1 1/2 inches. Opens 1-5/8 inches. Construction guaranteed. Special introductory offer, \$4.95, plus postage \$5.00 with swivel base which locks in any position. Specify which. Remit in full or send \$1.00 and pay balance to postman. Catalog on other angle and production vises sent free.

Chicago Tool & Engineering Co. 8366 South Chicago Ave., Chicago, Illinois

In answering an advertisement with a coupon, be sure to write name and complete address clearly.

Make Your Hobby and Spare Time Pay You EXTRA MONEY

Here are selected books to help you cash in on your hobby, earn extra money or establish a profitable business of your own. Pay postman or remit with order for pre-paid delivery. Money refunded if not satisfactory, if returned in 3 days.

ORDER UNDER MONEY-BACK PLAN

- A SMALL BUSINESS OF YOUR OWN.** Gives 1000 ways for a man with little or no capital to build a modest dependable business. \$1.00.
- MAKING AMATEUR PHOTOGRAPHY PAY.** Turn your prints into extra money. Tells what to take, where to submit and how to sell pictures. \$1.00.
- TURN SCRAP INTO MONEY.** Shows how to build power plants, 110 volt motors and generators, wind power plants and other electrical apparatus from old auto parts. \$1.00.
- HOME AND WORKSHOP FORMULAS (HENLEY).** 10,000 opportunities to make and save money through the use of these tested recipes, formulas and processes, etc. Tells how to make salable preparations of all kinds. 883 Pages, \$4.00.
- A LIVING FROM THE LAND.** The information that thousands of people have, who are seeking security and productive uses for their leisure time, want and need. \$1.50.
- SHOE REPAIRING.** Practical and simplified instruction on modern shoe repair methods. Helps you save money on your own work and make money repairing for others. \$1.00.
- AUTOMOBILE BODY AND FENDER REPAIRS.** Covers thoroughly, the best paying end of the auto repair business. Prepares for regular job or good source of extra, spare time money. \$3.00.
- PAINTING AND DECORATING.** Use this book for complete study or to pick up extra money on spare time jobs. Includes estimating and cost figuring. \$1.50.
- HIGH SCHOOL SELF TAUGHT.** Complete four year high school course in one volume. Broaden your knowledge and increase your income with high school subjects. 1000 Pages. \$2.39.
- BUSINESS COLLEGE SELF TAUGHT:** Here's your practical training for business all in one handy volume. 15 courses covering all essential subjects taught in a modern business college. Over 1000 pages. Cloth. \$2.39.

POPULAR MECHANICS PRESS
Dept. 1139 200 E. Ontario Street Chicago

Keeping the Iron Horse on Time

(Continued from page 670)

switches. Henceforth the engineer is governed by signals, first from the tower, then by automatic blocks when out of the terminal. Along the line he must check landmarks against his watch. He's due at the next station not two minutes ahead of time or three minutes late, but on the dot.

Once the train gets under way, the dispatcher is notified. His job is to keep dozens of trains moving, and on time. At his ear is a headset or loudspeaker. In front of him is a switchboard, beside him a telegraph receiver and key. The telephone crackles or the telegraph clicks, and he makes entries in black ink on a huge train sheet, as operators all up and down the line report the passing of trains. As long as he uses black ink, things are running smoothly. Trains are on time, passings are being made at predetermined points. But some unforeseen emergency arises, and a train drops behind schedule. The dispatcher begins writing orders in a book, while at the same time barking them into the phone. He is arranging new passing points, reshuffling trains, trying to fix things so the late train can make up lost time, so it will not delay other trains.

His entries on the train sheet are in red ink for that late train, and they remain red until the delinquent has caught up with its schedule—a constant reminder to him that his job is no longer routine. But even his routine is far from simple. The dispatcher on the Washington-Philadelphia division of the Baltimore and Ohio, for instance, handles 130 regular trains a day—sixty passenger, seventy freight; which means that a train passes a given point on the line every eleven minutes. The crack passenger trains average fifty-four miles an hour over that stretch, the "red ball" freights average twenty-seven, and the way freights eighteen miles an hour. There are only two tracks for these trains to run on; and only thirteen passing sidings, of which only eight will accommodate a full-length freight. It is obvious from this that there is a lot of overtaking and passing going on; and that if freight trains are to meet schedules, yet not delay passenger trains, these passings must be timed to a nicety. Now let a long freight drop a brake rod between sidings, stop half an hour for

(Continued to page 159A)

Here's That Amazing LIQUID PLASTIC



Featured In 4½ Pages In OCTOBER POPULAR MECHANICS

Unsurpassed for simplicity in casting **R. Stewart** all types of novelties from rubber molds. Pours into mold but comes out **hard, tough and resilient**, with beautiful, satin-smooth finish. No polishing necessary. This ease and simplicity of molding enables you to cast **hundreds of salable items** rapidly. No skill, expensive equipment, or previous experience needed. Liquid Plastic kit only \$1.00 in combination offer below.

STEWART'S RUB-ER-SPRA

Amazing Liquid Rubber for Making Molds
Rub-Er-Spra is a pre-vulcanized liquid latex rubber that makes the finest quality rubber molds. Unequaled for casting **Liquid Plastic**, liquid marble, plaster and other composition novelties. Anyone can make perfect **Rub-Er-Spra** molds at low cost by following instructions supplied **Free**.

EARN BIG MONEY With **Composition Novelties**
Use your spare time in this fascinating, profitable business. With Stewart's **Rub-Er-Spra** you can make genuine rubber molds at a cost of only a few cents each and cast hundreds of fast selling composition novelties at profits from 1000% to 1500%.

3 SPECIAL BARGAIN KITS

Don't Wait—Order Direct from this Ad—Today

Special Liquid Plastic Kit \$1.95
Everything you need with full instructions for making casts.

Composition Novelty Kit \$2.95
1 qt. Liquid Rub-Er-Spra, spray gun, fine head model 5" x 7" and full instructions for casting plaster and other compositions.

Comb. Plastic & Rub-Er-Spra Kit \$3.95
Two kits quoted above, complete \$4.90 actual value, only.

All Prices F. O. B. Chicago

Big 32 page book. All about composition novelty business. 10c

STEWART'S STUDIO

2927 Wilcox St., Dept. PM-8, Chicago, Ill.

HUNTERS — FISHERMEN — CAMERA FANS SOLID LEATHER CASE

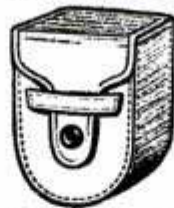

Plush lined with belt loop. Holds either 150 L. R. .22-Cal. shells, camera lens, filters, exposure meters or pack cigarettes. Size 3 3/4" x 2 1/2" x 1 3/4". The original cost of this case to the U. S. Government was more than one dollar.

SEND ONLY FOUR DIMES 40c
No C.O.D. Money back guarantee. Prepaid.

GENERAL MERCHANDISE CO.

Established 30 years
506 N. Main St. Dept. 364 Lima, Ohio

BRONZE FOUNDRY Schools and Home Workshops

Make your own castings of aluminum, copper, bronze, silver. Foundry sets are available in three sizes including 2400 Deg. F. blast Furnaces. See advertisements in Feb. or May issues, free Circular.

KANSAS CITY SPECIALTIES CO.

P. O. Box 6022, Dep't P-2 Kansas City, Mo.

Chucks for Small Lathes

3 inch
\$4.25
prepaid

Lowest Prices Ever Offered

Four-Jaw Independent as shown

A precision product, with drop-forged reversible jaws and alloy body at money saving prices. Sturdy, durable. I ship all charges prepaid, on guarantee of Satisfaction or Your Money Back. Sizes from 3" to 10".

Get Pocket Slide Rule Free

An accurate, practical 8" pocket slide rule and case free with your order for my new Catalog of Small Precision Tools for your workshop. Low prices on items you need—3-jaw chucks, variable speed countershaft, toroedo levels, V-belts, pulleys, etc. Order today—25c.

CATALOG 25c
Including Slide Rule

JOHN L. ALEXANDER
422 Superior Drive, Detroit, Mich.

NEW RADIO CATALOG

- ✓ **AMATEUR** A complete line of Nationally Advertised receivers, Transmitters, mikes, keys, parts, etc.!
- ✓ **SERVICE** Compare all the important makes of test instruments, side-by-side, for the first time in any catalog!
- ✓ **SOUND** equipment for every purpose. From the new one-piece "Orator" to the largest 100-watt sound system for stadiums!

EASY PAYMENTS ON EVERYTHING

MONTGOMERY WARD

MONTGOMERY WARD & CO.
Dept. TM-32 Chicago, Illinois
Please RUSH me your FREE Radio Catalog.

Name.....
Address.....
City..... State.....



FOR BIG, QUICK EASY PROFITS

GET THIS SHIRT LINE FREE!

Send no money—write quick for amazing new line of dress, sport, and work shirts. Most thrilling values you ever saw. Prices low as 3 for \$2.98. Beautiful fabrics, exclusive features. Also Ties and Socks. **MONEY BACK GUARANTEE!** Big commissions, repeat business piles up fast. Complete, valuable outfit sent you **ABSOLUTELY FREE** if you write quick.

STYLEWEAR, Dept. 102, Erie, Pa.



ARCADE Low Cost POWER TOOLS

Compare These Prices

Drill Press, 15" high, \$5.30; Disc Sander, 8 1/2", \$5.00; Jig Saw, 10" throat, \$5.30; Belt Sander, 4"x4" drums, \$8.00; Shaper with oillite bronze bearings, \$16.50; Shaper with ball bearings, \$20.50; Lathe, 8" Swing, 30" between centers, \$9.50; Band Saw, 10", \$18.00; Bench Saw, 6" blade, \$11.00; Bench Saw, 8" blade, \$22.50. Prices west of Rockies slightly higher. Other Bench Tools, Model Makers and Accessories at low prices. . . . all quality built for long service and accurate workmanship. If dealer cannot supply, order direct. Write for **FREE CATALOG**

Arcade Mfg. Co., 1219 Shawnee St., Freeport, Illinois

HOW TO WORK IN Wood



EARN the latest knack, e. g. how to finish 135 kinds of imported woods and domestic woods. . . . Up to date advice for **EXPERTS**; also detailed directions for **BEGINNERS**, showing how to make beautiful furniture the first week—and—

Up-to-date-bargains

123 special "deals"; about 300 furniture and scroll saw patterns showing exact price of materials. Bargains in woods, machinery, hardware, miscellanies of all kinds for craftsmen. **SEND ONLY 10c** (currency or stamps) TO **CRAFTSMAN WOOD SERVICE CO.** 2729 S. Mary St., Div. 3378 Chicago, Illinois

136 PAGES
Only 10c

The Super MAGIC WAND WELDER

for HOUSE CURRENT!

COMPLETE ONLY \$4.98 WITH FULL SUPPLIES

WELDING! The most sensational tool in 20 years. Super Magic Wand Welder weighs about one pound—easy to handle! No generators, no transformers, no batteries, no special wiring! Just plug into ANY LIGHT SOCKET! With this rugged tool anyone can weld iron, steel, bronze, brass, lead, aluminum, or ANY metal.

FREE! With every Super Magic Wand Welder you get a full kit of welding supplies. Bronze, steel and aluminum welding rods; welding flux; pair of genuine "Protectosite" glare-proof goggles. Also complete instructions and money-making ideas! All for \$4.98. Test for 10 days if not satisfied Money Refunded. We ship by RETURN MAIL. Rush your orders today! Yes! Agents wanted. Sent C.O.D. plus postage I enclose \$4.98 Ship Postpaid.

PRYENT SPECIALTIES COMPANY, Dept. PM, Teaneck, New Jersey

NEW OIL BURNER SENSATION

COOK HEAT with CHEAP OIL

SLIPS INTO ANY STOVE, RANGE or FURNACE

One of latest oil burner patents—will not clog up—no cups or wicks—different. Even heat, much or little by turn of valve—better cooking, baking, heating.

at Amazing LOW PRICE

30 DAYS' TRIAL Write today for NO-RISK offer. Try it before deciding—see how it SAVES in fuel, ends drudgery and ashes of coal.

QUICK HEAT at TURN of VALVE

SAMPLE BURNER FOR AGENTS

Write quick for **SAMPLE OFFER** that brings you one for demonstration. A money maker—big season now. Act quick—send no money, just your name.

ATLAS BURNER CO., 290-N Rockhill Theatre Bldg., Kansas City, Mo.

SHAW GARDEN and ALL-PURPOSE TRACTOR

SHAW 'DU-ALL'

Low "FACTORY-TO-FARM" Prices. 2 to 8 Horsepower Models. Walking and Riding Types. **WRITE for 10 DAY TRIAL PLAN and BIG FREE CATALOG.**

SHAW MFG. CO., 4511 Front St., Galesburg, Kans. 5812G Magnolia Ave., Chicago, Ill.; 130G W. 42nd St., New York; 658G North 4th Street, Columbus, Ohio

FREE ALL YOUR RADIO NEEDS

Your nationally known radio favorites at lowest prices. Sets, parts, supplies, etc.

RADIO CATALOG BURSTEIN-APPLEBEE CO. 1012-14 McGEE ST. KANSAS CITY, MO.

GRANDFATHER'S CLOCK, LOWER PRICED

Our newest Offering, at an unheard of price for a faithful reproduction of a real Grandfather's Clock. Scroll top, narrow waist, like picture. Shipped Knock Down. Cleverly designed. Easy to assemble. Others even cheaper. Plans 10c. Catalogue **FREE.**

AMERICAN CHIME CLOCK CO.
1674 Ruffner St. (Established 1877) Philadelphia, Pa.

GERSTNER TOOL CHESTS

Will save your tools from "borrowers" and from injury. Designed for all good mechanics. Free Catalog.

GERSTNER TOOL CHESTS
439 Columbia St. Dayton, Ohio

HANDY TAPS and DIES . . .

Accurate—carefully hardened and tempered. Complete range of sizes at your local five and ten cent store

HENRY L. HANSON, WORCESTER, MASS.

\$ CHRISTMAS MONEY \$

There's a big demand for the many hand-tooled articles you can make with the Easco Leathercraft Set. Make your own Xmas Gifts and easily learn to make good money in your spare time. Complete outfit, including tools, leathers, patterns, etc. and full instructions, only \$2.00—on sale at leading Department Stores or order direct and pay postman on arrival. \$2.50 outside U. S.

LEATHERCRAFT

Free When ordering direct, clip name of your Department Store to this ad, and we will include with your set, one extra free project. Illustrated catalog 10c.

E. A. SWEET CO., Dept. A-28 Binghamton, N. Y.

(Continued from page 157A)

emergency repairs, and the dispatcher's job becomes immediately complicated. That part of the line becomes one-track for the time being.

It is not necessary to delay trains by stopping them en route to issue orders. The telegraph operator merely writes the order on a blank form, places it in the slot of a looped rod, and the fireman grabs the loop as the locomotive roars past.

In spite of the seemingly haphazard backing and filling of freight trains in the yards, there is nothing haphazard about their movements. They operate on schedules fully as rigid as passenger trains. Your passenger timetable contains a clause to the effect that the line does not assume responsibility for inconvenience or damage resulting from delayed trains or failure to make connections. Freight timetables contain no such clause. If a freight consignment is late, the railroad pays for whatever loss is suffered through the delay. A flat wheel on a car of lettuce, followed by a drop in the market, can easily mean a claim for ten times transportation charges.

So freight, and especially perishable freight, moves under the continual goad of time; and many are the ingenious methods for speeding it up. Perishables must be iced, for instance, with individual instructions for each car. Yet with an endless belt distributing ice over a mile-long platform, and a dozen crews at work, a train can be iced in ten or fifteen minutes.

In some terminals where hundreds of trains must be handled every day, hump yards take the place of flat switching, sorting out cars, placing them on the proper classification tracks, at the rate of six a minute. Hump yards work this way:

While a train is being iced upon arrival, a list is made up of the cars from front to rear, giving their number, destination and weight. The teletype prints this list simultaneously in three yard towers. Then a locomotive gets behind the train, pushes it slowly over the hump of an artificial hill, while a trainman uncouples the cars as they pass. The cars drift down the hump by gravity and the towermen, referring to their lists, operate electric switches to put the cars on the proper tracks, their speed controlled with electro-pneumatic retarders that require only a fingertip touch to slow down fifty rolling tons.

NEW PORTABLE ELECTRIC HAMMERS

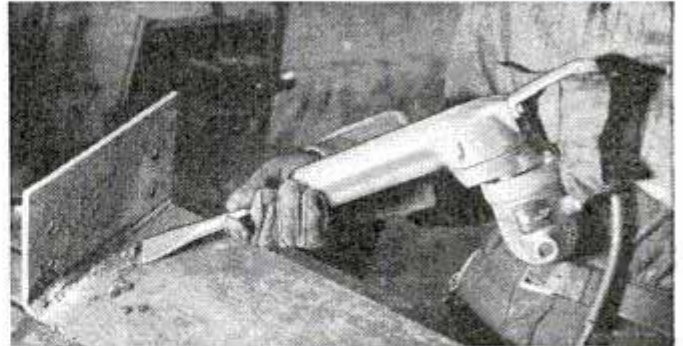

SAVE TIME on Dozens of Tough Jobs

These powerful, ruggedly built Van Dorn Hammers deliver hundreds of lightning-fast "follow through" blows per minute to save time, cut costs and lighten labor on a wide variety of jobs. Here are some of their uses—

Drilling or channeling in concrete, brick or stone; cutting through walls and partitions; demolition work; vibrating concrete forms; caulking joints and seams; tree surgery jobs; drilling anchorage holes or foundation pits for machinery; mining operations; cleaning boiler tubes, removing scale in tanks; chipping heavy metal plates, castings; installing signs, fixtures, equipment; gouging and shaping wood beams and removing form marks from concrete. In addition, there are countless other maintenance, repair or alteration jobs to which these versatile tools can be put.

There are four units in the complete Van Dorn Hammer line. One of these hammers will fit your needs. Van Dorn Electric Tools (Division of Black & Decker Mfg. Co.).

Van Dorn

THE "RED-HEADED"
PORTABLE ELECTRIC TOOLS

FREE! A complete and authoritative book on the construction, operation and uses of Portable Electric Hammers. Written and illustrated so that the layman or engineer can understand it. Send for your FREE copy today! Mail coupon below!



MAIL COUPON NOW!

Van Dorn Electric Tools,
611 Joppa Road, Towson, Md.

Please send Free Book on construction, operation and uses of Portable Electric Hammers, also name and address of nearest Van Dorn dealer.

Name.....
Occupation.....
Address.....
City..... State.....



IF YOU NEED A LATHE . . YOU NEED A GOOD ONE



Only Good Shop
Equipment Gives
Satisfactory Service
Over a Long
Period of Time

No. 415-YC, 9 $\frac{1}{4}$ "
swing by 3' bed
Workshop Model C
Bench Lathe with
motor drive as
shown. Wt. \$127
320 lbs.

\$15 Down
Payment
PLACES THIS LATHE
IN YOUR SHOP
Balance \$6 Monthly

Precision Work Demands South Bend Accuracy

Exact tolerances are commonplace in all modern metal working industries. Tool making, model making, manufacturing, laboratory work, automotive machine work, electric service—all demand a fine finish and accuracy to the split thousandth.

With the 9-inch "Workshop" Lathe the most difficult metal working operations are simplified. Large easy reading micrometer collars, well balanced hand wheels, convenient controls, hand-scraped and lapped dovetails, and other features make it easy to maintain precision accuracy and produce an excellent finish.

Practical Attachments for All Classes of Work

General

Milling Attachment
Grinding Attachment
Thread Dial

Tool Room

Taper Attachment
Collet Equipment
Micrometer Carriage Stop

Production

Bed Turret
Double Tool Rest

Automotive

Valve Refacing
Piston Finishing
Armature Truing
Connecting Rod Boring

SOUTH BEND LATHE WORKS

647 EAST MADISON STREET

SOUTH BEND, INDIANA, U. S. A.

SHOP
REFERENCE
BOOKS

How to Run a Lathe—This clearly written book shows how easy it is to operate a lathe. 128 pages, 350 illustrations. 25c postpaid.

Catalog No. 46-B—Shows why South Bend 9" Workshop Lathes give satisfactory service. Illustrated and described in 3', 3 $\frac{1}{2}$ ', 4' and 4 $\frac{1}{2}$ ' bed lengths. Easy payment terms outlined.



Acme Thread Lead Screw with precision cut threads.

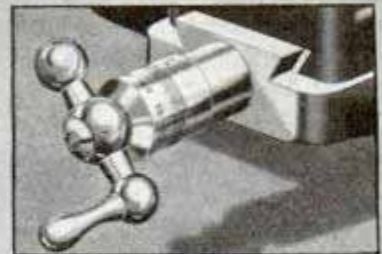

Adjustable Micrometer Collars with Precision Graduations.

SOUTH BEND LATHE WORKS

647 E. Madison St., South Bend, Ind., U.S.A.

- No. 46-B—9" Workshop Catalog, Free
 No. 34-LB—How to Run a Lathe, 25c
 Easy Payment Plan

Class of Work.....
Name.....
Address.....
City..... State.....

SOUTH BEND
Precision LATHES



"I HAD TO BAIL OUT IN A PEA SOUP FOG!"

C. W. HARBERT
Aviation Cadet
Bristol, W. Va.

① "I took off from Pensacola on a night training flight in my single-seater fighting plane," writes Cadet Harbert. "Later, as I started homeward, a heavy fog rolled in. The landing field was blotted out!

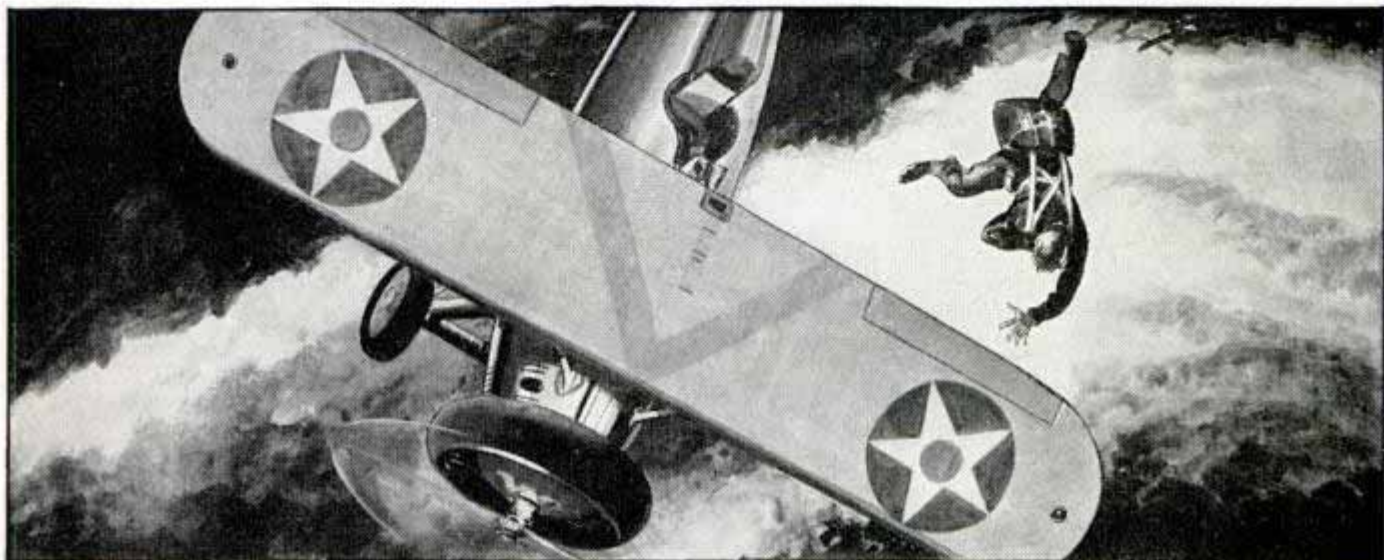

② "It was too dangerous—for myself and those below—to attempt a landing. I had to bail out in that pea soup fog! Heading for open country, I circled at 5,000 feet until the gasoline gauge showed empty, then jammed the stick forward and catapulted into space!



③ "I landed waist-deep in the wide mouth of a river. Marooned by deep water on all sides, I grabbed my flashlight, and—despite the soaking—it worked! Guided by its beam, two fishermen eventually found and rescued me—thanks to 'Eveready' fresh DATED batteries—which you can depend on in emergencies!

(Signed) *C. W. Harbert*



FRESH BATTERIES LAST LONGER... Look for the DATE-LINE

NATIONAL CARBON COMPANY, INC., 30 EAST 42nd STREET, NEW YORK, N. Y.

Unit of Union Carbide and Carbon Corporation



They do the job
they're meant to do

They Satisfy

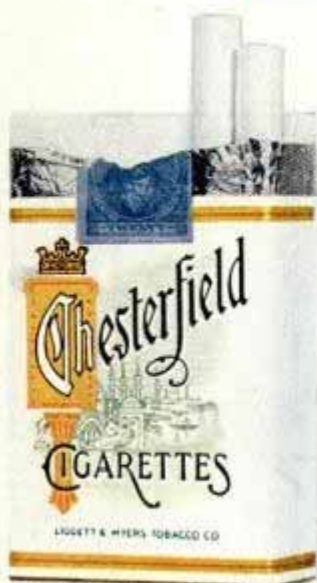

Chesterfields are like that . . . they go about their business of giving you more smoking pleasure . . . *with a taste, aroma and mildness that's all their own* . . . the kind that only the right combination of the world's best cigarette tobaccos can give.

CHESTERFIELD

Copyright 1939, LIGGETT & MYERS TOBACCO CO.