

HEROES OF THE DIVING NAVY

POPULAR MECHANICS

MAGAZINE

WRITTEN BY AND ILLUSTRATED BY



OCT.
25 CENTS



SEE PAGE 494

You need Balanced Gasoline

PICK-UP
IN TRAFFIC

+

POWER
ON HILLS

+

MILEAGE
ECONOMY

Mobilgas
Gives
Balanced
Performance

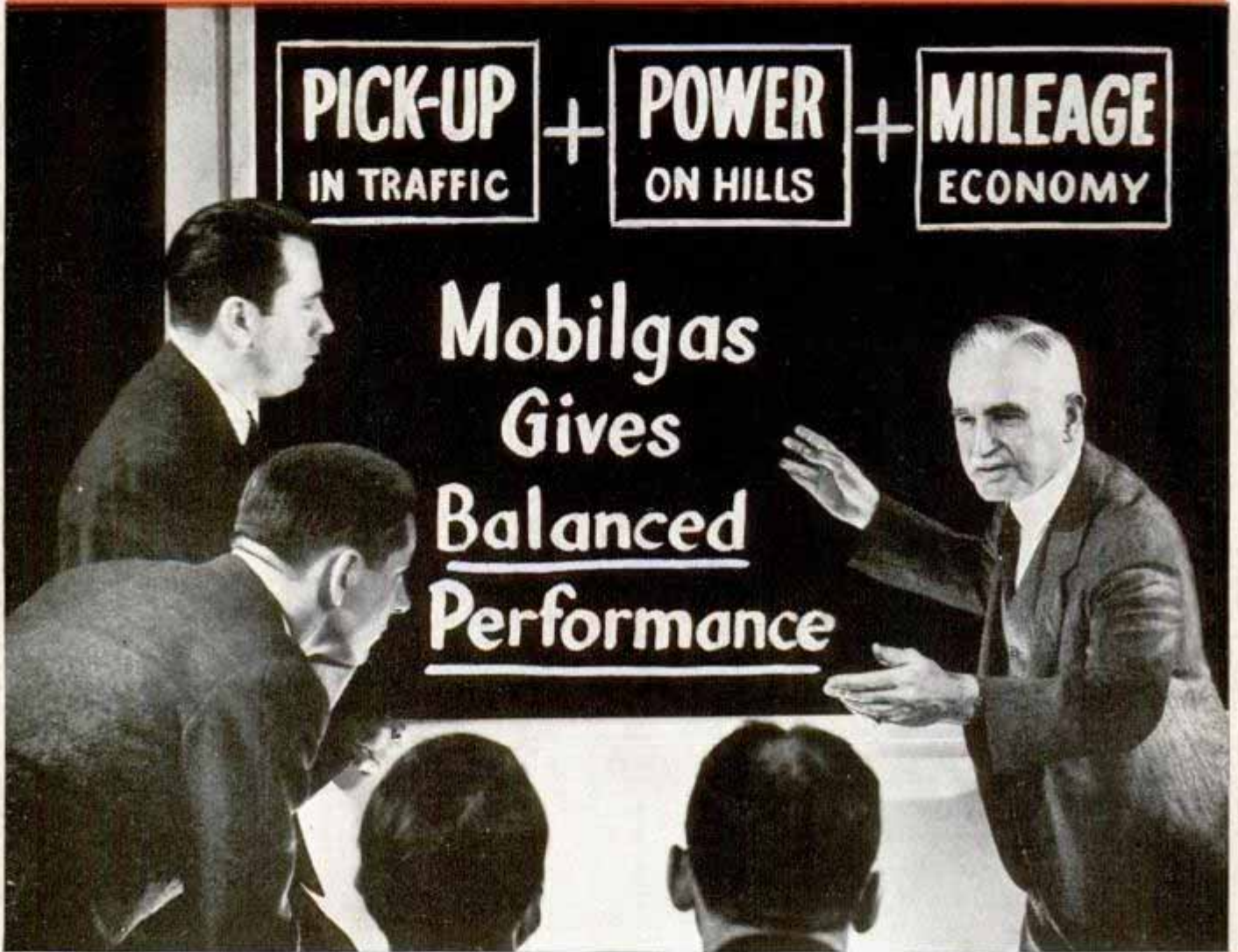

ADD UP WHAT YOU GET when you buy Mobilgas: not only excellent mileage, pick-up, power and pep...but a clean, smooth-running engine, too... real *carefree, economical* driving!

The reason? Mobilgas is refined to atomize quickly...to burn evenly. It's scientifically cleaned. Every drop is selected for high octane value!

You get "Balanced Performance"...all good qualities *in full measure!* Socony-Vacuum Oil Co., Inc.



MOBILGAS *For Balanced Performance*

A NEW KIND OF BATTERY That Never Drinks Too Much!



Willard's New Safety-Fill protects you against "blindfold filling"

• Whenever a service man can't *see* the level of the battery solution he may accidentally over-fill your battery. Such "blindfold filling" results in dangerous corrosion because the excess electrolyte surges up through the vents in the top of the battery and attacks the wiring and exposed metal parts of the car.

Now Willard's famous "H-R" battery is built with a new and unique construction (called *Safety-Fill*) that gives positive protection against this dangerous over-filling and the corrosion that is bound to follow.

Built to last 68% longer than the average of 100 other brands—having "power-house" performance with tremendous reserve capacity—and now equipped with "Safety-Fill"—the "H-R" is the battery "buy" of the year. Have your Willard Dealer show you this exclusive new battery that simply *can't* drink too much.

WILLARD STORAGE BATTERY CO. • Cleveland • Dallas • Los Angeles • Toronto

Look for the
**SAFETY-FILL
VENT**
Accept No Substitutes



Built to last 68% longer!



HOW WILLARD SAFETY-FILL WORKS

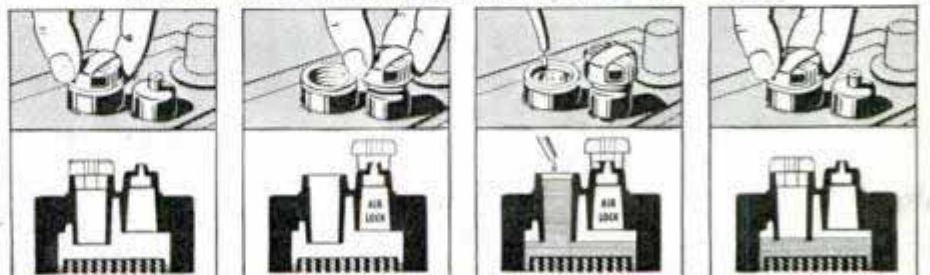

To fill the battery, unscrew filler-cap as usual.

Place cap on SAFETY-VENT, forming air lock in breather-chamber.

Fill well with water. Air lock prevents solution rising above bottom of well.

Remove cap from SAFETY-VENT and solution drops to correct level.

It never drinks too much!

**"We'll be
glad to come"**



Every day, the telephone brings happiness and cheer to many a home. Some one thinks of some one, reaches for the telephone, and all is well.

Telephone service is exceptionally good in this country—and it's cheap. Nowhere else do people get so much service, and such good and courteous service, at such low cost.

**BELL
TELEPHONE
SYSTEM**



The Bell System cordially invites you to visit its exhibits at the New York World's Fair and the Golden Gate International Exposition, San Francisco.

Popular Mechanics Magazine

H. H. WINDSOR, Founder

H. H. WINDSOR, Jr., Editor and Publisher

October, 1939

Vol. 72, No. 4

IN THIS ISSUE

<u>With the Diving Navy</u>	<u>481</u>
<u>The War Horse Goes to College</u>	<u>488</u>
<u>Ride 'Em Cowboy</u>	<u>Coloroto</u>
<u>Watching Mother Earth's Pulse</u>	<u>508</u>
<u>The Band Comes Marching Back</u>	<u>514</u>
<u>New Weapons to Fight Disease</u>	<u>520</u>
<u>Wonders of Ship Surgery</u>	<u>530</u>
<u>Air-Crash Detectives</u>	<u>538</u>
<u>Touchdowns in the Making</u>	<u>546</u>
<u>Diesel Limited</u>	<u>552</u>
<u>Shooting the Sun</u>	<u>558</u>
<u>Which Is the King of Beasts?</u>	<u>562</u>
<u>Winning the War on Traffic Accidents</u>	<u>568</u>
<u>Modern Precious Metals</u>	<u>573</u>

(Continued on next page)

Shooting from the Clouds

THINGS happen to an air-line photographer. One day he'll be standing on his head in a two-seater plane, clutching a thirteen-pound aerial camera while his pilot flirts with skyscrapers in maneuvering for a vertical view of the city's canyons. Next day he'll be bouncing in drafts above a forest fire or hunting the navy through holes in the clouds. Life is never dull in this sky picture business, described by Merle J. Oelke, American Airlines cameraman, in the November issue. Eight pages of Coloroto pictures include some of his own superb natural-color photographs.

Shipwreck School for Captains

FIRE breaks out aboard a "cruise" liner. Its master is dead, the mate is in command. What is he to do in the emergency? That's a question put to ship captains and mates in the government's "Disaster College." Read in next month's issue what this school is doing to avert the tragedies that befell the "Titanic," "Vestris" and "Morro Castle."

Next Month

SOME day this world of ours is going to crack up. If we escape a collision—and we did miss one heavenly tramp by a mere 400,000 miles two years ago—the earth will live on until millions of years hence the sun flares suddenly, or cools, or the moon flies into fragments. You won't see the world's end, but you can read in November how science thinks it will come, and you can journey with "Explorers of Space" to the moon to watch the sun's eclipse in the year 2144.

Don't Take It So Hard

YOU can't beat gravity. Sometime it will get you down, whether it be on an icy sidewalk or a stepladder or in a slippery bathtub. But if you must fall—and 26,700 Americans were killed by falls last year—take a few tips from the circus clown and the trapeze artist on how to do it safely and comfortably. These comedians who fall just to be funny tell the tricks of their trade in the November magazine. They may save you some broken bones.

Here's Your Cue

BILLIARDS has gone collegiate. Once the game of royalty, later in disrepute, billiards has swung into wide popularity and found a place on the winter calendar of intercollegiate sports. Anyone can have fun at it, but to become a star you must begin right. In next month's issue Charles C. Peterson, famous "pro," tells in story and pictures how to angle for better billiards.



HERE IS WHAT PYROIL USERS EVERYWHERE ARE CONSTANTLY SAYING

"This product works wonders when used regularly." * "The astounding part is that Pyroil increased my mileage to 15, then 16, then 17 and now 18 miles to the gallon!" * "The motor is developing more power and runs cooler with Pyroil." * "The small cost of Pyroil is more than saved." * "We have had no work on the motor. It runs perfectly." * "Our repair bills are reduced as a result of Pyroil's use."

You, too, can achieve often amazing results in your car, new or old, with Pyroil. Better performance. Less trouble. Reduced expense.

Pyroil is a pure "oiliness" product. It is unlike regular motor oil. You add merely ounces to the crankcase and gasoline tank of your car. It then reaches all internal parts of the engine. Do you want to know exactly what happens then?

MAIL THE COUPON below for a Free interesting Booklet, "Questions and Answers" which tells you all about what Pyroil is and what it does. We'll send also copies of original letters showing you at first hand why it is that pleased users of Pyroil praise this product constantly. Meanwhile, ask your service station or garage for a mere few pennies' worth of money saving Pyroil. Enjoy its many benefits from now on! Manufactured and Guaranteed by Pyroil Company, W. V. Kidder, Founder, 510 Pyroil Bldg., La Crosse, Wisconsin, U.S.A.



**SIMPLY
ADD TO
GAS & OIL**

**DISTRIBUTORS:
CHECK AND MAIL
COUPON FOR FRAN-
CHISE FACTS.**

PYROIL COMPANY, 510 Pyroil Bldg.,
 La Crosse, Wisconsin, U. S. A.
 Please send me without obligation, your Free Booklet,
 "Questions and Answers," also copies of interesting let-
 ters from pleased Pyroil users.
 Send details of your plan for Distributors.
 Name _____
 Address _____
 City _____ State _____

(Contents—Continued)

AUTOMOTIVE

Tool to mount chain on disk wheels	485
Cables separate lanes of traffic	486
Super-salvage car lifts 75,000 pounds	487
4,000 makes of cars have been on sale	526
Twin gauges show cause of trouble	528
Old boxcar hauled to farm as trailer	529
Auto wax applied by spray gun	534
Auto bumpers wear balloon tires	536
Slip-on seat covers need no tacks	536
Midget racing car rides on monowheel trailer	550
Valve leakage found by electric meter	550
"Periscope" on rear window helps in backing car	551
Bumper mounted all around the car	572

AVIATION

Motorcycle radio station guides "blind" plane	513
Automatic radio compass points to station tuned	526
Pilot "talked" to earth by new system	536

BOATS AND BOATING

German auto racer tries for speedboat record	496
Disappearing propeller boat	513
U. S. warship hoists sails	519
Floating bridge goes to rescue of sunken submarines	537
Ocean gold-mining dredge to reach 3,000 feet	545
Motorboat resembling an auto has 35-mi/e speed	556
Self-launching lifeboat	557
Lifesaving craft empties itself of water	561

FARMS

Scarecrow with spinning arms	518
Single-wheel tractor has motor at hub	524
Electric immersion heater in a pail	544
Hay rake mounted on front of sedan	561
Electric fertilizer increases nitrate in soil	572

HOUSEHOLD

Rubber barrel keeps ice cubes	518
Nested cans freeze ice cream	523
Fan on window sill ventilates house	524
Color film mounted in lamp shades	528
Re-slicer for ready-sliced bread	534
Disappearing towel rack slides into cabinet	536
Drain cleaner with larger ball has more power	542
Dripless honey server pours from bottom	542
Ceiling fan blows air upward for circulation	565
Rubber soap mitt chained to spring standard	576

LAWNS AND GARDENS

Garden "dustpan" on wheels has V-shaped body	534
Walking sprinkler uses garden hose as track	566
Lawn edger's pilot wheel sets depth of cut	576

MODELS

Locomotive run by steam hauls half a ton	496
Model "Pickaback" plane	523
Scale model of "singing tower" carillon	524
Puppets blow bubbles	527
Bridge model carries moving traffic	543
Dummy of battleship at naval festival	572

PHOTOGRAPHY

Ten-cent X-ray picture made with miniature camera	496
"Fade-out" attachment for home-movie camera	550
Trick "eye" takes five pictures on one film	557

RADIO AND ELECTRICITY

Lighthouse discards oil for electric light	537
Three varieties of commercial television receivers	615
Beginner's one-tube a.c.-d.c. loudspeaker set	616
How to build a push-button set tester	618
Helpful radio hints	619
"Invisible" burglar protection for homes and shops	620
Mobile sound system installed in standard coupe	620
Tiny portable battery-operated receiver	620
"Third dimension" effect from two radio sets	122A

SCIENCE AND INDUSTRY

Injector pump removes scale from boiler	492
Way found to get vitamin K from tar	519
Oil burner with continuous rotary flame	527
Six arc welders repair steel mill casting	529
Low-expansion glass will not crack	535
Cubic inch of star weighs 18,000,000 pounds	542
Self-elevating scaffold propelled on wheels	544
Five million volts bombard secrets of atom	551
Mystery chemical allows green plants to breathe	556

(Continued to page 6A)

You may worry about your weight

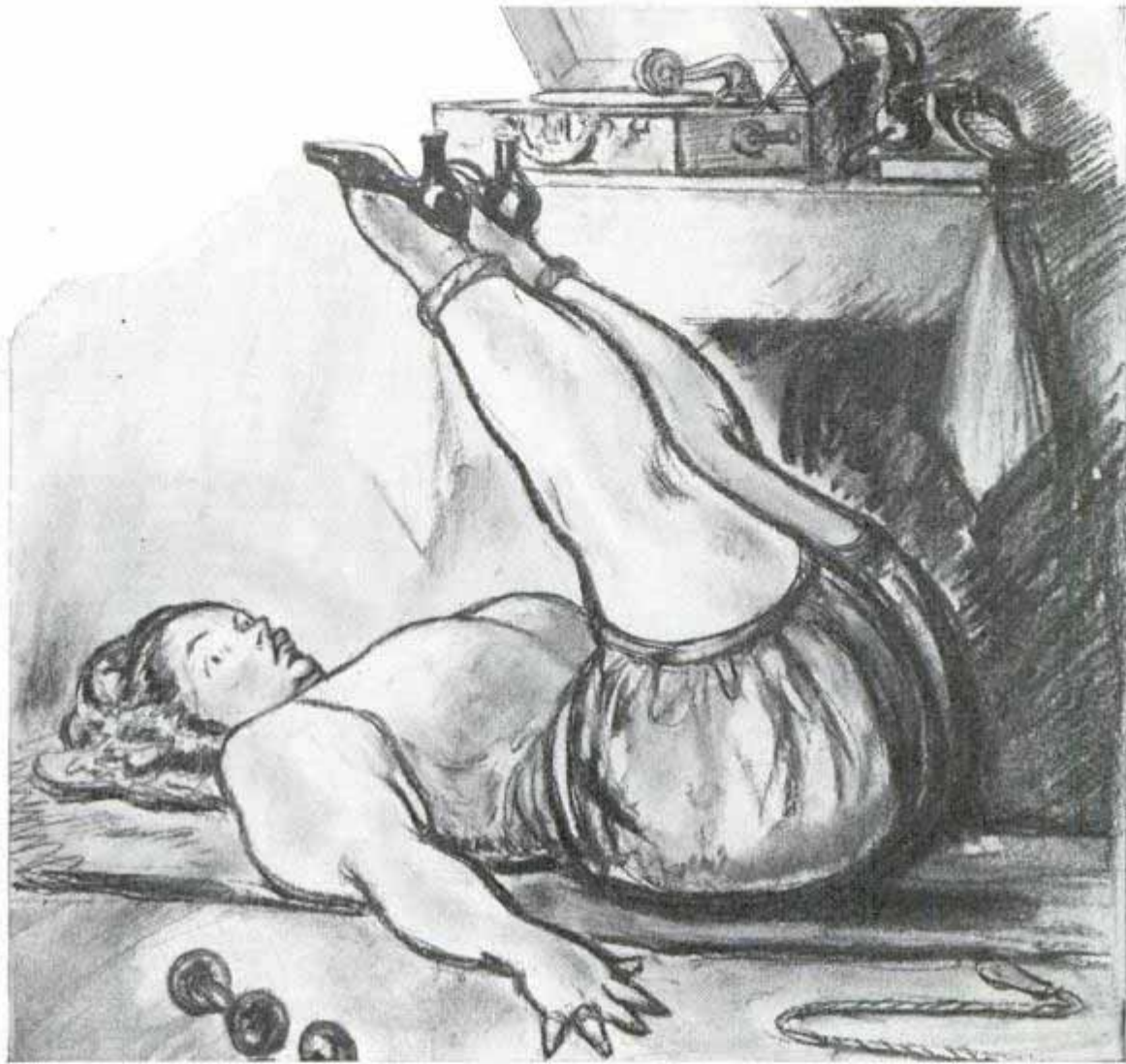

but here is one worry you can avoid

HAVE PEACE OF MIND—let us relieve you of all worry about chassis lubrication.

Let us Marfak your car every thousand miles.

"What's Marfak?" you ask.

That's Texaco's 40-Point Lubrication Service.

Once you've had it, stop thinking about shackle bolts and bearings until your speedometer registers another thousand miles.

It includes the

use of a tough lubricant at the vital friction points on your chassis—a lubricant so tough it lasts twice as long as ordinary grease.

Look for the Marfak sign.

Drive in for your own peace of mind.

TEXACO DEALERS INVITE YOU TO tune in the **TEXACO STAR THEATRE**—A full hour of all-star entertain-

ment every Wednesday night—Beginning Wednesday, September 13th—Columbia Network—9:00 E.D.T., 8:00 E.S.T., 8:00 C.D.T., 7:00 C.S.T., 6:00 M.S.T., 5:00 P.S.T.



Let us
MARFAK
your car

TEXACO'S 40-POINT LUBRICATION SERVICE AT ALL TEXACO AND OTHER GOOD DEALERS

Copyright 1939
The Texas Company

When writing to advertisers please mention Popular Mechanics

Here's
what a **ROBOT!**
"thinks" with



WHEN you see a **Robot** obey its inventor's commands to rise, walk, talk, sing, and smoke, you wonder what kind of imitation brain it has.

The New Merriam-Webster tells you that the **Robot's** "gray matter" is made of **Selenium**, and its chemical relatives, which also make possible all the other modern marvels achieved with the photocell, or "electric eye." And the same kind of information which "*The Supreme Authority*" gives on **Selenium** is also furnished on the other 91 elements known to the world of chemistry!

For scientific information, turn first to the NEW MERRIAM-WEBSTER!

Send for **FREE BOOKLET**, "The New Merriam-Webster: What It Will Do For You."

G. & C. MERRIAM CO.,
Dept. 298,
Springfield,
Mass.



LOOK FOR THE
CIRCULAR
TRADE-MARK
Copyright,
1939, by
G. & C.
Merriam Co.

WEBSTER'S
NEW INTERNATIONAL
DICTIONARY
Second Edition

**Webster's
New International
Dictionary**
Second Edition

(Contents—Continued)

Self-adjusting rubber clutch, simple and lightweight	556
"Rail cancer" cured by slow cooling of steel	566
Atom smashers bring big guns into play	567
Bicycle tires tested on treadmill	576

SPORTS

Wide-angle binoculars tested at sports event	486
Troll plate controls speed of boat	492
Automatic home plate duster	560

TOOLS

Half-circle convex file	518
Gauge shows inside and outside diameters	527
Vacuum grip pulls out dents in auto body	529
Welded steel bench for lathe	543
Small electric cutter has built-in light	544
Hand sharpener for long blades	560
Wrench removes tight bolts by swinging handle	567

MISCELLANEOUS

Baby buggy train drawn by horse	485
Power paint mixer	486
Circular window rotates for ventilation	492
German Diesel streamliner travels 133 miles an hour	513
"Ferris wheel" tray holds small objects	518
"Turntable" pedestrian bridge makes street safer	519
Master violinist trains with finger twisters	525
Carbon dioxide covers fire with harmless blanket	526
Office has "traffic" lanes and fireproof pitchers	528
Bicycle fork has built-in spring	534
Clutch with V-belt drive	535
"Contour" meter helps hairdresser plan coiffure	542
Field gun fires 100-pound shell fifteen miles	545
Sight given semi-blind by five-lens magnifier	560
Hospital camouflaged in wavy stripes	565
"Percolator" boiler generates steam quickly	566
Painters' scaffold rides railroad tracks	567

Craftsman and Shop Notes

AUTOMOTIVE

Forcing gear lubricant from can into transmission	637
Non-stoop garage doorstop has snap action	637
Causes of weak spark at plugs	638
Check for short circuits before installing battery	638
Holder to buff inner tube before patching it	638
Sticking valves located with screwdriver	638
Dog hair removed from car seats with sandpaper	639
Emergency fuse has foil core	639
Easy way to change valve springs	639
Heater switch controls fog lights	639
Protecting grease retaining washers	639
Emergency crank handle for a Ford	640
Repairing leaky windshield wiper	640

CAMPING, HUNTING, FISHING

Easy method of waxing fish line	592
Spaced hooks on trotline avoid entangling	604
Easy to skin catfish	610

FARM

Removable roosting poles for chickens	580
"Pincushion" shields pitchfork	623
Rubber patches on gloves aid when driving horses	626
Hoop in sack mouth opens it quickly	630
Barrel smothers grass fires	631
Turkey feed boxes kept clean	631
Rural mailbox resembles prairie schooner	636

FURNITURE

Smoking stands in "bow-leg" and "T-base" designs	586
Sawhorses converted for upholstery jobs	588
Bunny rocker pleases little folks	591
Valet—a man's clothes rack	601
From springs to cushions	602

HAND TOOLS

Bottle "tumbling barrel" for small parts	584
Hack saw cuts wide sheet metal	584
Scissor sharpener guides hone at correct angle	588
Improvised depth gauge for auger bits	592
Handled block stores small tools	610
Simple bushing remover	624
Solder bar slotted to avoid burning hand	624
Shortcuts that help in filing circular saws	625
Tool for cleaning T-slots	626
Cushion spring holds extension lamp	636

(Continued to page 8A)



Plan Your Future

Choose Your Field NOW For Success

Will you master fate or will fate master you? That's a question deserving your honest answer . . . right now! Actually it is largely up to you. You can do with Life almost what you will. LaSalle will help you establish yourself for real success by providing you with the comprehensive, specialized training for which it is so famous. Choose your field . . . now! Check the coupon below for the free booklet you want us to send you. It can be your first step toward assured success.

Opportunities in Traffic Management

The field of Traffic Management offers real opportunity only to the man who knows. Spare time study and the will to succeed have pushed scores of Traffic employees up the ladder to financial success. Many LaSalle-trained traffic managers—both in the railroad and industrial field—now command salaries of \$3,000.00 to \$5,000.00 a year—and better. Investigate. Find out how you can qualify for these higher positions through LaSalle home-study and guidance.

Law for Business Success

And it isn't necessary to practice law to get this Success. In fact probably most of the men who study law today have no idea of taking the bar examination or becoming lawyers—they want law training to give them mastery of men and situations in business. You know that—

- (1) the man with legal training is a leader—not a follower.
- (2) legal training keeps your mind—clears away the problems that stump the ordinary fellow and makes you master instead of man.
- (3) knowledge of law simplifies the complications of executive work.
- (4) Many top executive places are filled by men who have studied law.

No matter whether you are in a big corporation or a small business—in a great city or a little town—a practical knowledge of law cannot fail to be of real and vital help to you in making a more successful career.

In every state in the union you'll find law-trained men who came up through LaSalle. What others have done, you can do.

And LaSalle offers either a full law course leading to LL. B. or a shorter business law training—whichever you prefer. All text material, including valuable 14-volume Law Library. Training comprises the most effective features of modern law instruction.

Executive Training

Executives who are efficient managers command responsible positions and good incomes. And the need for

trained executives is growing rapidly. We train you thoroughly at home in your spare time for every type of executive work—teach you the principles and practices used by our most successful business leaders and help you develop your management capacity—by a training built with the aid of outstanding executives.

Become an Expert Accountant The Profession That Pays

The demand for skilled accountants—men who really know their business—is increasing rapidly. New state and federal legislation requires much more, and more efficient accounting from business—big and small. Corporations are in constant need of expert counsel in matters relating to Auditing, Cost Accounting, Business Law, Organization, Management, Finance. Men who prove their qualifications in this important branch of business are rapidly promoted to responsible executive positions—given an opportunity to earn real salaries. The range is from \$2,000.00 to \$10,000.00 a year—even to higher income figures.

Under the LaSalle Problem Method you can at home acquire a thoro understanding of Higher Accountancy, master its fundamental principles, become expert in the practical application of these principles—this without losing an hour of work or a dollar of pay.

Your training will be under the direct supervision of a staff of legal, organization and management specialists, business efficiency engineers and Certified Public Accountants.

Preliminary knowledge of bookkeeping is unnecessary. We train you from the ground up, or from where you now are, according to your individual needs.

Mr. Salesman: What's Wrong?

Why aren't you making more sales—more money? Is it you—or your proposition? Check up first on yourself. Other men—no better than you—have found their earnings jump and stay up when they trained with LaSalle. Literally thousands of men—many of them years at the game—have increased their sales volume and earnings through home study with LaSalle guidance. Sound—practical—usable—right from field experience. Train for top-notch production with LaSalle.

LASALLE EXTENSION UNIVERSITY A CORRESPONDENCE INSTITUTION Dept. 1064-R CHICAGO

I would like to have your special booklet—without any cost or obligation to me—about my opportunities and your success training in the business field I have checked.

- | | | |
|------------------------------------------------|------------------------------------------------|-----------------------------------|
| <input type="checkbox"/> Higher Accountancy | <input type="checkbox"/> Commercial Law | <input type="checkbox"/> Business |
| <input type="checkbox"/> Law: Degree of LL. B. | <input type="checkbox"/> Expert Bookkeeping | <input type="checkbox"/> Business |
| <input type="checkbox"/> Traffic Management | <input type="checkbox"/> C. P. A. Coaching | <input type="checkbox"/> Effectiv |
| <input type="checkbox"/> Modern Salesmanship | <input type="checkbox"/> Industrial Management | <input type="checkbox"/> Stenoty |
| <input type="checkbox"/> Business Management | <input type="checkbox"/> Modern Foremanship | |

Name.....

Position..... Address.....



This One



D6P6-6QG-P2JR

Costs less than a



lottery ticket



But ALWAYS PAYS OUT!

FIVE cents' worth of Smooth-On No. 1 applied by the householder makes many an emergency repair that saves from \$5.00 to \$25.00, to say nothing of avoiding the delay and annoyance of waiting for a professional mechanic.

Even in such common repair work as stopping small steam, water or gas leaks and tightening loose screws, bolts and nuts, Smooth-On No. 1 also pays a big return in the saving of time and hard effort. Very often, the first application pays for all Smooth-On needed for the next ten.

Keeping Smooth-On No. 1 in your work bench costs only a few cents, but is a precaution you should not overlook. Take this precaution—be prepared—and when your can is empty get another as you would renew an insurance policy.

To know how Smooth-On should be used for best results, get the Smooth-On Handbook, containing advice, instructions, working diagrams, etc., that every home worker should have for quick reference.

Buy Smooth-On No. 1 in 7-oz. or 1 or 5-lb. can from your hardware store or if necessary from us.



Write for FREE BOOK



Do it with SMOOTH-ON



Tightening a loose handle with Smooth-On

(Contents—Continued)

HOUSEHOLD

Built-in vanities open over bath.....	577
Decorative window-shade pull.....	585
Personalize your tie rack with a photograph.....	599
Suspending pictures from blocks to protect cord.....	600
Soap dish makes bird bath.....	604
Shoe scraper has dirt catcher.....	608
Remote alarm clock starts buzzer near bed.....	611
Solving home problems.....	612
New top for old bridge table.....	629

LAWN AND GARDEN

Novel tree-trunk bird bath.....	599
Repairing worn pinion on lawn mower.....	608
Combined bird bath and feeder.....	610

PHOTOGRAPHY

Night photos with multiple exposure.....	585
Partitioning tray to economize on developing fluid.....	600
Small photos framed with metal-rimmed tags.....	614

POWER TOOLS

Brake-drum shield from lathe grinding wheel.....	609
Improving clamp on stop rods of circular saw.....	610
Angle plates—make them on your own lathe.....	621
Guide aids in setting four-jaw chucks.....	624
Gauge to set lathe threading tool.....	630
Centering work on lathe faceplate with microscope.....	636

STORE AND SHOP

Shelf on barrel holds sack while filling.....	624
Small parts "cabinet" pivots between floor joists.....	625
Skid proofing table of paper trimmer.....	626
Cutting sheet-metal strip with straight edges.....	630
Improving heating efficiency of shop stove.....	631

WOODWORKING

Porky the pig carved in wood and in soap.....	589
Molding-clay sanding block smooths moldings.....	590
Shaving brush aids in rubbing carved work.....	600

MISCELLANEOUS

Making odd-size nuts from spark plugs.....	579
Hose used as tires on baby carriage.....	580
Microscope reflector aids in sketching specimens.....	580
What you can do with Pliofilm.....	581
Hymn books stored in box under chair.....	584
Iron facing protects basement coal window.....	584
Protecting watch main spring on cool surfaces.....	584
Shoe lace knotted to keep ends equal.....	585
Doorknob serves as paperweight.....	588
Pipe elbow guides wires into electrical conduit.....	588
Spacing water pipes from wall with leather.....	588
Gaskets for model gas engine.....	590
Fishline sinker anchors one end of tape measure.....	592
Flagstuffs from cotter keys.....	592
Rubber ball prevents tipping ink bottle over.....	592
Mail-pouch catcher gives realistic action.....	593
Liquid plastics open new field in craftwork.....	594
Halloween noise maker from toy balloon.....	600
Scraper for croquet court.....	600
Anchor lets boat ride safely on rough water.....	604
Cans containing small parts hung on wall.....	604
Safety pins hold work on drawing board.....	604
Small pelts tanned at home.....	605
"Life belt" for boat keys.....	608
Stove to heat concrete aggregate.....	608
Tacks improve grip on wood hand wheel.....	608
Chromium tubing enhances pin-up lamp.....	609
Toothpicks carried in fountain-pen barrel.....	610
Beveled edges on French curve avoid smearing work.....	614
Paper plates hold chemicals on scales.....	626
Shoulder saddle to carry pipe.....	626
"Flock," soft, pliable and waterproof.....	627
Artist's ruler has handle on end.....	630
Supports to hold lanterns on sloping surfaces.....	630
Candle holds stubs of colored crayon.....	631
Shadowless light stops needless eyestrain.....	632
Puddling shovels from disk harrow blades.....	636

IMPORTANT NOTICE

It is the intention of this magazine to provide its readers with information regarding the latest developments in the mechanical arts. We take no responsibility as to whether the disclosures contained in our articles are covered by patents and advise readers to investigate this subject before making, using, or selling any of the products, machines, or processes described, in order to avoid possible liability for patent infringement.

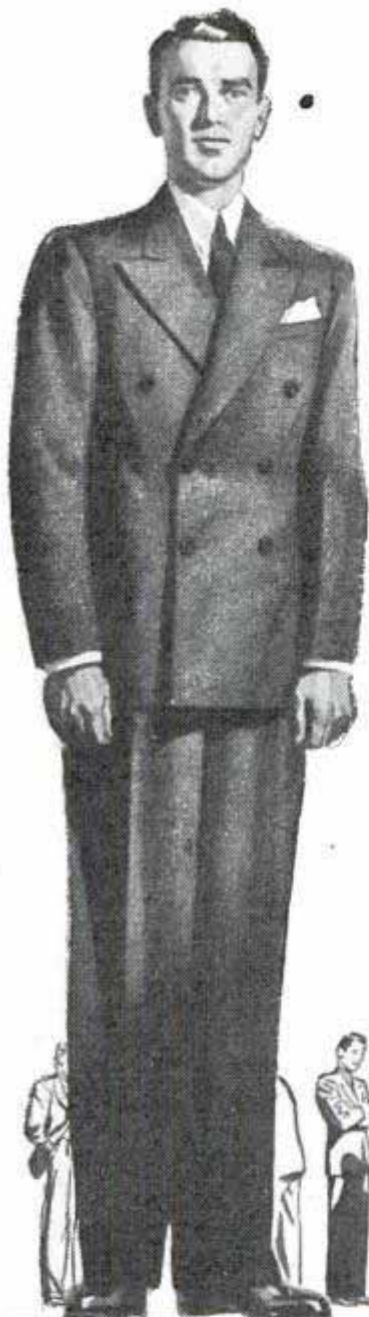

The I. C. S. student STANDS OUT!

• Does your employer "know you from Adam"? Does he consider you "just another employee"? Or does he keep an eye on you, waiting for a chance to advance your position and pay, because he knows you are training yourself for a bigger future?

Read this letter recently received by the International Correspondence Schools:

"It affords me a great deal of pleasure to be in a position whereby I can recommend your courses to any one who wants to advance above the common level.

"In our organization it is easy to pick out the men who have been trained by International Correspondence Schools. In fact, our Manager and Vice-President, our Steel Shop Foreman, our Chief Engineer, our Foundry Foreman, and our Machine Shop Foreman are all products of your Schools, and they all rank high in their respective fields.

"I unhesitatingly commend your training to any one who has in mind advancing in his work and assuming responsibility.

JAMES H. MILLER, Pres.

Inter-State Foundry and Machine Co., Johnson City, Tenn."

The time to start preparing yourself for the future is RIGHT NOW! And the way to start is to clip this coupon—and mail it—TODAY!



INTERNATIONAL CORRESPONDENCE SCHOOLS

BOX 5555-J, SCRANTON, PENNA.

★ Without cost or obligation, please send me a copy of your booklet, "Who Wins and Why," and full particulars about the subject *before* which I have marked X: ★

TECHNICAL AND INDUSTRIAL SUBJECTS

- | | | | | |
|-------------------------------------------------------|---------------------------------------------------|---------------------------------------------------|----------------------------------------------------|-----------------------------------------------------|
| <input type="checkbox"/> Agriculture | <input type="checkbox"/> Air Brakes | <input type="checkbox"/> Contracting and Building | <input type="checkbox"/> Manufacture of Pulp Paper | <input type="checkbox"/> Sanitary Engineering |
| <input type="checkbox"/> Air Conditioning and Cooling | <input type="checkbox"/> Cotton Manufacturing | <input type="checkbox"/> Diesel Engineering | <input type="checkbox"/> Marine Engineering | <input type="checkbox"/> Sheet Metal Work |
| <input type="checkbox"/> Architectural Drafting | <input type="checkbox"/> Electrical Engineering | <input type="checkbox"/> Electric Lighting | <input type="checkbox"/> Mechanical Drafting | <input type="checkbox"/> Steam Electric Engineering |
| <input type="checkbox"/> Architecture | <input type="checkbox"/> Fire Boilers | <input type="checkbox"/> Fruit Growing | <input type="checkbox"/> Mechanical Engineering | <input type="checkbox"/> Steam Engineering |
| <input type="checkbox"/> Auto Electric Technician | <input type="checkbox"/> Heating | <input type="checkbox"/> Heat Treatment of Metals | <input type="checkbox"/> Mine Foreman | <input type="checkbox"/> Steam Fitting |
| <input type="checkbox"/> Auto Technician | <input type="checkbox"/> Highway Engineering | <input type="checkbox"/> House Planning | <input type="checkbox"/> Navigation | <input type="checkbox"/> Structural Drafting |
| <input type="checkbox"/> Aviation | <input type="checkbox"/> House Planning | <input type="checkbox"/> Machinist | <input type="checkbox"/> Patternmaking | <input type="checkbox"/> Structural Engineering |
| <input type="checkbox"/> Boilermaking | <input type="checkbox"/> Management of Inventions | <input type="checkbox"/> Management of Inventions | <input type="checkbox"/> Pharmacy | <input type="checkbox"/> Surveying and Mapping |
| <input type="checkbox"/> Bridge Engineering | | | <input type="checkbox"/> Plumbing | <input type="checkbox"/> Telegraph Engineering |
| <input type="checkbox"/> Building Estimating | | | <input type="checkbox"/> Poultry Farming | <input type="checkbox"/> Telephone Work |
| <input type="checkbox"/> Chemistry | | | <input type="checkbox"/> Public Works Engineering | <input type="checkbox"/> Toolmaking |
| <input type="checkbox"/> Civil Engineering | | | <input type="checkbox"/> Radio | <input type="checkbox"/> Ventilation |
| <input type="checkbox"/> Coal Mining | | | <input type="checkbox"/> R. R. Locomotives | <input type="checkbox"/> Welding, Electric and Gas |
| | | | <input type="checkbox"/> R. R. Section Foreman | <input type="checkbox"/> Woolen Manufacturing |
| | | | <input type="checkbox"/> R. R. Signalmen | |
| | | | <input type="checkbox"/> Refrigeration | |

BUSINESS SUBJECTS

- | | | | | | |
|--------------------------------------------------|------------------------------------------------------|-----------------------------------------------|------------------------------------------------|-------------------------------------------------|----------------------------------|
| <input type="checkbox"/> Accounting | <input type="checkbox"/> Advertising | <input type="checkbox"/> College Preparatory | <input type="checkbox"/> Grade School Subjects | <input type="checkbox"/> Railway Postal Clerk | <input type="checkbox"/> Signs |
| <input type="checkbox"/> Bookkeeping | <input type="checkbox"/> Cost Accounting | <input type="checkbox"/> C. P. Accounting | <input type="checkbox"/> High School Subjects | <input type="checkbox"/> Salesmanship | <input type="checkbox"/> Spanish |
| <input type="checkbox"/> Business Correspondence | <input type="checkbox"/> First Year College Subjects | <input type="checkbox"/> Foremanship | <input type="checkbox"/> Illustrating | <input type="checkbox"/> Secretarial Work | |
| <input type="checkbox"/> Business Management | <input type="checkbox"/> French | <input type="checkbox"/> Managing Men at Work | <input type="checkbox"/> Lettering Show Cards | <input type="checkbox"/> Stenography and Typing | |
| <input type="checkbox"/> Cartooning | <input type="checkbox"/> Civil Service | | <input type="checkbox"/> Traffic Management | | |

DOMESTIC SCIENCE SUBJECTS

- | | | |
|-----------------------------------------------|-----------------------------------------------------------------|----------------------------------------------------------------------|
| <input type="checkbox"/> Advanced Dressmaking | <input type="checkbox"/> Home Dressmaking | <input type="checkbox"/> Tea Room and Cafeteria Management, Catering |
| <input type="checkbox"/> Foods and Cookery | <input type="checkbox"/> Professional Dressmaking and Designing | |

Name..... Age..... Address.....
 City..... State..... Present Position.....

Canadian residents send coupon to International Correspondence Schools Canadian, Limited, Montreal, Canada
 British residents send coupon to I. C. S., 71 Kingsway, London, W. C. 2, England

Learn to MOUNT Birds and Animals FUN • PROFITS

Send Today for Free Book

Old reliable school (250,000 students) will teach you **AT HOME** to mount **BIRDS, ANIMAL HEADS, FISH and TAN SKINS and FURS**. Write now—at once.

SPORTSMEN: Save your trophies. Game is growing scarcer—every **Specimen** is valuable. Keep them—save them—mount them. Decorate your den. Fun and fascination. Profits, too.

TAN heavy and light skins and furs. Make real **HARNESSE LEATHER, BUCK SOLE LACE, ETC.** Best method known, but easy and simple. Don't sell these hides cheap. Tan them for your own use. Make leather vests, belts, gloves, etc. **TAN FOR OTHERS.**

FUR-WORK for men and women. Tan and make up scarfs, capes, coats, muffs, mitts, trimmings. Quickly, easily learned.

EXTRA MONEY \$40 to \$80 a month, even more. Some students report. Big demand for **TAXIDERM, TANNING AND FUR-WORK**. A real spare-time business—good in every community. If you need extra money, **WRITE!**

FREE BOOK

48 pages, 100 beautiful pictures, tells **ALL** about Taxidermy, Tanning, Fur-Work. Write **Today**—this minute for this **STRANGE, MARVELOUS FREE BOOK**. A postal will do. State **AGE**.

N. W. School of Taxidermy, 3377 Elwood Bldg., Omaha, Neb.



GET IN THE SWING with Slingerland . . . DRUMS GUITARS MANDOLINS



GENE KRUPA — World's Greatest Swing Drummer uses Slingerland

WONDERFUL VALUE EASY PAYMENTS

Compare the value—tone and power in Slingerland "Radio King" drums, banjos, guitars, mandolins, marimbas or bugles—before you buy. Guaranteed more for your money. Acclaimed the tops in smooth

tone, easy playing, rich power by world's leading musicians. Easy payments. 5-days free trial. See at your dealers.

Cut this ad out—good for \$1.00 credit. Free special information on how to organize drum and bugle corps. Free Catalog—mention instrument wanted.



SLINGERLAND DRUM CO.
1330 Belden Avenue Chicago, Illinois

LEARN MECHANICAL DENTISTRY



Be A Dental Technician
Learn how to make Crowns, Bridges, Plates in this **oldest school**, licensed by the State of New York, 5,000 feet up-to-date equipment. Day and Evening Sessions. Easy terms. **Write NOW** for free catalog P and tool offer.
N. Y. School of Mechanical Dentistry
125-127 West 31st Street, Dept. 9, New York City



U.S. GOVERNMENT JOBS

START

\$1260 to \$2100 YEAR

Many appointments each year

GET READY Immediately

Dependable Positions

Grade School Education Usually Sufficient

Mail Coupon Today—SURE

Franklin Institute
Dept. P173
Rochester, N. Y.

Gentlemen: Rush to me **FREE** of charge, list of **U. S. Government big pay jobs**. Send me **FREE** 32-page book describing salaries, vacations, hours and work. Tell me how to qualify for one of these jobs.

Name.....

Address.....



ELECTRICAL ENGINEERING

Condensed **ONE-YEAR** residence course combines theory with practice in well-equipped laboratories. High employment record. Suburban campus; modern buildings; dormitory. 47th year begins Sept. 27. **CATALOG**. Give age.

BLISS ELECTRICAL SCHOOL

120 Takoma Ave., Washington, D. C.

LEARN WATCH REPAIRING

AT HOME You can learn by our modern and original system of instruction every part of the **Watch Repairing Trade** at home. You can earn money while learning and prepare yourself for a well paying position or start in business after completing our course of instruction. Good watch repairers are in demand and generally earn very good salaries. For particulars apply to the **Wisconsin School of Watch Repairing**
524 E. Mason St., MILWAUKEE, WIS.

Learn to Write

Begin Today. Write for our Free Book, "How to Become a Good Penman." It contains specimens and tells how others learned to write in spare time. Your name elegantly written on a card if you enclose stamp for postage. Write today. **The Tamylyn School of Penmanship**, Dept. 8, Ridge Bldg., Kansas City, Mo.

AVIATION APPRENTICES

AIRMINDED YOUNG MEN INTERESTED IN TRAINING FOR ENTERING THE WELL PAID FIELD OF AVIATION AS APPRENTICES—Write immediately, enclosing stamp.

MECHANIX UNIVERSAL AVIATION SERVICE CO.
Wayne County Airport, Box 857, Dept. E, Detroit, Mich.

You Ask Me What I Am Doing?



I Am Getting Ready to Earn More Money ... Preparing for a Bigger Job

I am a student of the American School, Chicago. A little more than half way through my course—already my increased knowledge has brought me promotion as a result of the hour or so a day I have been spending getting acquainted with the principles of the work I enjoy. I use only part of my spare time, so it doesn't interfere with my home and social life, and certainly helps me on the job.

I have been surprised at the practical manner in which even advanced work is explained. It is a lot easier than I had expected. I only wish I had started this plan of getting ahead a few years earlier. But when I was 18 to 20 I felt pretty sure of myself. I didn't take enough stock in what more experienced people told me about the importance of being thoroughly trained for the job I wanted.

You Can't Win If You Don't Try
American School, Dept. G-745, Drexel Ave. at 58th St., Chicago

CUT ALONG THIS LINE

Try a Lesson Yourself—No Obligation

American School, Dept. G-745, Drexel Ave. at 58th St., Chicago

I have checked the line of work in which I would like a good job. Please send me without expense or obligation on my part a copy of your Bulletin and an early lesson in the field I have selected.

- | | | |
|-------------------------------------------------|--------------------------------------------------|-------------------------------------------------|
| <input type="checkbox"/> Air Conditioning | <input type="checkbox"/> Electrical Engineering | <input type="checkbox"/> Law |
| <input type="checkbox"/> Architecture | <input type="checkbox"/> Diesel Engineering | <input type="checkbox"/> Liberal Arts (College) |
| <input type="checkbox"/> Automotive Engineering | <input type="checkbox"/> Drafting and Designing | <input type="checkbox"/> Mechanical Engineering |
| <input type="checkbox"/> Automobile Repairing | <input type="checkbox"/> Electric Refrigeration | <input type="checkbox"/> Merchandising |
| <input type="checkbox"/> Bookkeeping and | <input type="checkbox"/> Heating, Ventilating, | <input type="checkbox"/> Private Secretary |
| Cost Accounting | Plumbing | <input type="checkbox"/> Radio and Television |
| <input type="checkbox"/> Business Management | <input type="checkbox"/> Professional Accounting | <input type="checkbox"/> Salesmanship |
| <input type="checkbox"/> Civil Engineering | Incl. C. P. A. Coaching | <input type="checkbox"/> Shop Practice |
| <input type="checkbox"/> Aviation | <input type="checkbox"/> High School | <input type="checkbox"/> Steam Engineering |
| <input type="checkbox"/> Contracting, Building | <input type="checkbox"/> Highway Engineering | |

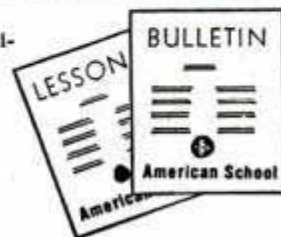

Name..... Age..... Occupation.....

Street..... City..... State.....

HOW A "TIP" GOT TOM A GOOD JOB



**J. E. Smith, President
National Radio Institute
Established 25 years**

I will train YOU too at Home in Spare Time for Good Jobs in Radio

Radio is a young, growing field with a future. It offers many good pay spare time and full time job opportunities. And you don't have to give up your present job, go away from home, or spend a lot of money to become a Radio Technician. I train you right at home in your spare time.

Jobs Like These Go to Men Who Know Radio

Radio broadcasting stations employ engineers, operators, station managers and pay well for trained men. Radio manufacturers employ testers, inspectors, foremen, servicemen in good-pay jobs with opportunities for advancement. Radio jobbers and dealers employ installation and servicemen. Many Radio Technicians open their own Radio sales and repair businesses and make \$30, \$40, \$50 a week. Others hold their regular jobs and make \$5 to \$10 a week fixing Radios in spare time. Automobile, police, aviation, commercial Radio; loudspeaker systems, electronic devices, are newer fields offering good opportunities to qualified men. And my Course includes Television, which promises to open many good jobs soon.

Why Many Radio Technicians Make \$30, \$40, \$50 a Week

Radio is already one of the country's large industries even though it is still young and growing. The arrival of Television, the use of Radio principles in industry, are but a few of many recent Radio developments. More than 28,000,000 homes have one or more Radios. There are more Radios than telephones. Every year millions of Radios get out of date and are replaced. Millions more need new

I Trained These Men



Makes \$50 to \$60 a Week
"I am making between \$50 and \$60 a week after all expenses are paid, and I am getting all the Radio work I can take care of, thanks to N.R.I."
H. W. SPANGLER
126 1/2 S. Gay St., Knoxville, Tenn.



\$10 to \$20 Week in Spare Time
"I repaired many Radio sets when I was on my tenth lesson. I made \$600 in a year and a half, and I have made an average of \$10 to \$20 a week—just spare time."
JOHN JERRY
1529 Arapahoe St., Denver, Colo.



Operates Public Address System
"I have a position with the Los Angeles Civil Service, operating the Public Address System in the City Hall Council. My salary is \$170 a month."
R. H. ROOD, R 136, City Hall
Los Angeles, Calif.



Get Facts About THIS



HEY, TOM! HOW ARE YOU, OLD BOY?

BILL! GOSH, I DIDN'T KNOW YOU IN THOSE NEW CLOTHES AND THAT SNAPPY CAR. SOMEBODY LEAVE YOU A MILLION?



ONLY A SHORT TIME AGO YOU WERE SLAVING AWAY AT THE SAME JOB AS THE REST OF US. NOW LOOK AT YOU. HOW COME?

WELL, TOM, I DECIDED I'D NEVER GET ANYWHERE UNLESS I PICKED A BUSINESS WITH LOTS OF OPPORTUNITIES AND TRAINED MYSELF FOR THEM—SO I PICKED RADIO

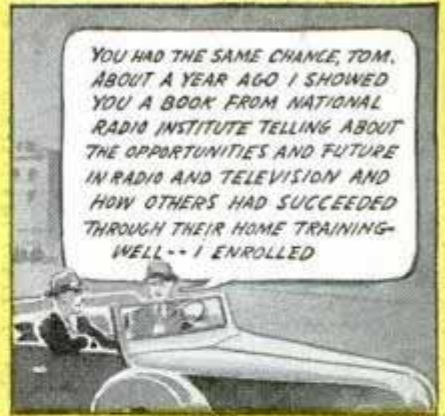

YOU HAD THE SAME CHANCE, TOM. ABOUT A YEAR AGO I SHOWED YOU A BOOK FROM NATIONAL RADIO INSTITUTE TELLING ABOUT THE OPPORTUNITIES AND FUTURE IN RADIO AND TELEVISION AND HOW OTHERS HAD SUCCEEDED THROUGH THEIR HOME TRAINING—WELL—I ENROLLED



YOU CERTAINLY KNOW RADIO. MINE NEVER SOUNDED BETTER

THANKS. N.R.I. TRAINING CERTAINLY PAYS. I JUST STARTED A FEW MONTHS AGO AND I'M ALREADY MAKING \$5 TO \$10 A WEEK IN MY SPARE TIME.



OH TOM, IT'S WONDERFUL YOU'VE GONE AHEAD SO FAST IN RADIO. WE NEVER COULD HAVE GOTTEN MARRIED ON WHAT YOU WERE EARNING BEFORE

OUR WORRIES ARE OVER. I'M A TRAINED RADIO TECHNICIAN NOW. THERE'S A BRIGHT FUTURE AHEAD FOR US IN RADIO AND TELEVISION

tubes, repairs, etc. Over 5,000,000 auto Radios are in use and thousands more are being sold every day. In every branch Radio is offering more opportunities—opportunities for which I give you the required knowledge of Radio at home in your spare time. Yes, the few hundred \$30, \$40, \$50 a week jobs of 20 years ago have grown to thousands.

Many Make \$5, \$10 a Week Extra In Spare Time While Learning

The day you enroll, I start sending you Extra Money Job Sheets which start showing you how to do Radio repair jobs. Throughout your Course I send plans and directions which have helped many make \$200 to \$500 a year in spare time while learning. I send special Radio equipment to conduct experiments and build circuits. This 50-50 training method makes learning at home interesting, fascinating, practical.

Find Out What Radio Offers You

Act today. Mail coupon for my 64-page book, "Rich Rewards in Radio." It points out Radio's spare time and full time opportunities and those coming in Television; tells about my course in Radio and Television; shows many letters from men I trained, telling what they are doing and earning. Read my money back agreement. Find out what Radio offers you. Mail coupon in envelope or paste on penny postcard—NOW.

J. E. SMITH, President
Dept. 9KP, National Radio Institute
Washington, D. C.



I Also Give You This Professional Servicing Instrument

Here is the type of instrument successful Radio Technicians use—an All-Wave Set Servicing Instrument. It contains everything necessary to measure A.C. and D.C. voltages and current; to check resistances; adjust and align any set, old or new. It satisfies your needs for professional servicing after you graduate—can help you make extra money fixing sets while training.

GET THE FACTS; MAIL THIS COUPON NOW!



THIS COUPON GOOD FOR ONE FREE COPY OF MY BOOK!

J. E. SMITH, President, Dept. 9KP, National Radio Institute, Washington, D. C.

Dear Mr. Smith: Send me FREE, without obligation, your 64-page book "Rich Rewards in Radio" which points out spare time and full time opportunities in Radio, those coming in Television, and explains your 50-50 method of training men at home in spare time to be Radio Technicians. (Write Plainly).

NAME.....AGE.....
ADDRESS.....
CITY.....STATE.....

THIS Free Book HAS HELPED HUNDREDS OF MEN MAKE MORE MONEY



TESTED WAY TO BETTER PAY

NOW LEARNING MUSIC IS LIKE PLAYING A GAME

New home method easy as A-B-C!

No special talent is required—no previous musical training. You learn to play right in your own home this U. S. School of Music way and its cost averages only a few cents a day.

There's nothing tricky about it—no complicated theories. What's more, with this short-cut system you don't have to spend hours practicing tedious scales or monotonous finger exercises. Instead you learn real tunes from the start. First you are told what to do—then a picture shows you how to do it—then you do it yourself and hear it.

Decide now to learn to play the Piano, Violin, Ukulele, Tenor Banjo, Hawaiian Guitar, Piano Accordion, Saxophone or any other instrument you like.

FREE BOOKLET AND DEMONSTRATION LESSON

If interested mail coupon today for Free Booklet and Free Demonstration Lesson explaining this method in detail. Mention your favorite instrument. Instruments supplied when needed—cash or credit.

U. S. SCHOOL OF MUSIC, 710 Brunswick Bldg., New York City

U. S. School of Music, 710 Brunswick Bldg., N. Y. C.

Please send me Free Booklet and Demonstration Lesson. I would like to play instrument checked below. (Do you have instrument.....)

- | | | | |
|--------|-----------|----------|------------------|
| Piano | Accordion | Clarinet | Banjo |
| Violin | Saxophone | Trumpet | Ukulele |
| Guitar | Mandolin | Trombone | Other Instrument |

Name

Address



AUDELS Carpenters and Builders Guides 4 vols. \$6



Inside Trade Information On:
 How to use the steel square—How to file and set saws—How to build furniture—How to use a mitre box—How to use the chalk line—How to use rules and scales—How to make joints—Carpenters arithmetic—Solving mensuration problems—Estimating strength of timbers—How to set girders and sills—How to frame houses and roofs—How to estimate costs—How to build houses, barns, garages, bungalows, etc.—How to read and draw plans—Drawing up specifications—How to excavate—How to use settings 12, 13 and 17 on the steel square—How to build hoists and scaffolds—skylights—How to build stairs—How to put on interior trim—How to hang doors—How to lay floor—How to paint.



THEO. AUDEL & CO., 49 W. 23rd St., New York City
 Mail Audels Carpenters and Builders Guides, 4 vols., on 7 days' free trial. If O.K. I will remit \$1 in 7 days, and \$1 monthly until \$6 is paid. Otherwise I will return them. No obligation unless I am satisfied.

Name

Address

Occupation

Reference

..... P.M.

Always write your name and full address clearly when answering advertisements.

CLIMBING AHEAD THESE DAYS IS *tough going...*

... **BUT...** consider the hundreds of men now in Aviation who started their careers with Aero I.T.I. training. You may be right where these men once were—wondering how to get ahead faster. If so, you owe it to yourself to find out about the training that has placed so many men in the rapidly expanding Aviation industry. During one 60 day period 126 Aero I.T.I. trained men were placed with one aircraft plant alone!

Find Out about Aero I.T.I. training. Choice of three courses in Aircraft Mechanics, two in Aeronautical Engineering. You can take full-time courses at the school, or start your training at home. For full details, write NOW

AERO INDUSTRIES TECHNICAL INSTITUTE
 5253 West San Fernando Road • Los Angeles, California

TRI-STATE COLLEGE

B. S. Degree in 2 Years
 World famous for technical 2-year courses in Civil, Electrical, Mechanical, Chemical, Radio, Aeronautical Engineering, Business Administration and Accounting. Special preparatory department for those who lack required high school work. Short diploma courses (36 weeks) in Surveying, Drafting. Low tuition. Low living costs. Students from every state and many foreign countries. 56th year. Graduates successful. Enter September, January, March, June. Write for catalog. 4109 College Ave., ANGOLA, IND.

KNOCK - EM - COLD!

THE BIGGER THEY ARE, THE HARDER THEY FALL. LEARN JIU JITSU!
 36 secret knock-out blows without fists by 25¢ world famous Police Jiu Jitsu Instructor

A little jab with tip of fingers, or strike with edge of hand to right spot and tough guys go out like a light. Also many one fingered headlock breaks. Northwest "Mounties" use Jorgensen's system. G-Men must be Jiu Jitsu experts. He has personally taught many in U.S. Army, Navy, Marines, National Guard, Coast Guard, Immigration, Border Patrol, Police, etc. and performed for the Movies. Whether you are young or old, man or woman, send now for new illustrated course. Full Price 25¢ Size or strength mean nothing. Fear no man, gun, knife, club. S. J. JORGENSEN 798 Maritime Bldg., Seattle, Wash.



MECHANICAL DENTISTRY AT HOME!

Learn To make Crowns, Plates, Bridgework, etc., for Dentists. Easy practical way to learn mechanical dentistry at home in spare time. FULL EQUIPMENT OF TOOLS AND MATERIALS INCLUDED WITH COURSE. Low tuition. Easy terms. Write for FREE BOOK about this money making profession that is not affected by machine age.
 McCARRIE SCHOOL OF MECHANICAL DENTISTRY
 207 N. Broad St., Dept. 743, Philadelphia, Pa.

CARTOONING PAYS WELL

Exclusive instruction by a famous cartoonist makes it easy to learn at home. Write for Free Booklet describing details of the course.
 NATIONAL SCHOOL OF CARTOONING
 439 Penton Bldg. Cleveland, Ohio

EARN THE DEGREE

Doctor of Psychology (Ps.D.), Philosophy, Divinity. General Courses—Arts, Business, etc. A Correspondence Institution Chartered by State of Washington. Send for 32-page FREE Bulletin at once. No Obligation.
 Temple Bar College, Dept. 2-R, 1629 Thirteenth Avenue
 Seattle, Washington, U.S.A.

Stop Slamming Doors

AMAZING MONEY MAKER!



Kant-Slam Door Check is an amazing invention that closes all doors silently and automatically. Closing speed easily adjusted by turning screw at top of check. Holds doors open when wanted open. Operates on hydraulic principle. Low priced. Permanent. Easily installed in ten minutes. Never needs attention.

A Real Demonstrator Furnished Every Agent.
 You get orders quickly demonstrating actual sample on easy to carry miniature door. Every office, factory, store, institution, and public building needs a Kant-Slam for every door. Rush name and address for details of amazing money-making opportunity.
KANT-SLAM DOOR CHECK CO.
 FREE Demonstrator to Workers Dept. P-53, Bloomfield, Ind.

You've heard about
ALL THESE DIESELS

-but...
have you
connected
them with
Your Future?

HAVE YOU GIVEN THE DIESEL
FIELD ANY REAL THOUGHT?

You have seen the full page newspaper and magazine ads on new type Diesels. You have read frequent news items on the rapid, ever-expanding adoption of Diesel power. You have seen many magazine articles on the spectacular growth of the Diesel industry. But have you connected any of them with your own future?

Investigate for yourself . . . get your free copy of the pictorial "March of Diesel" . . . find out about Hemphill Diesel training. You can start right at home and finish in the Hemphill Schools shops. Send the coupon NOW.

HEMPHILL DIESEL SCHOOLS

All communications concerning enrollment in any of the Hemphill Diesel Courses should be sent to one of the following addresses:

NEW YORK . . . 31-26 Queens Blvd., L.I.C.
CHICAGO 2014 Larrabee Street
MEMPHIS 417 Monroe Avenue
LOS ANGELES 2120 San Fernando Rd.
VANCOUVER, B.C. . . . 1363 Granville St.

Applications for enrollment will be accepted from English speaking students residing in foreign countries. Write for special terms.

Hemphill Diesel Schools (use nearest address)

Please send data on your Diesel courses, also free copy of illustrated booklet "March of Diesel."

Name _____ Age _____

Street _____

City _____ State _____ **m-41-p**

Be a Civil Engineer!

Learn—Quick Reference Way



It's Paying Big Right NOW

Earn \$3000

with the help of these books

a Year—and Up!

"Civil engineers are wanted NOW. Enormous amounts are being spent in all kinds of public works and not a dime is spent until the Engineer has prepared plans. Then He must direct the work. It's a big job and there are not enough men to go around. Everywhere you go, you see road work going on—water and sewer systems being built—vast projects of all kinds. Here is Your Opportunity to get the necessary training right at home. These books are complete and simply written so anyone can understand them. Start now on our FREE examination plan. Mail the coupon without obligation.

AMERICAN TECHNICAL SOCIETY
Dept. C719 Drexel at 58th St. Chicago

American Technical Society
Drexel at 58th St., Dept. C719, Chicago
I want to examine the CIVIL ENGINEERING Cyclopedia for 10 days. I will gladly pay the few cents express, but I am to pay nothing for the 7 big volumes if I return them within 10 days. If I wish to keep them I will send you \$2 after the 10 days, then \$3 a month until advertising price, \$29.80 is paid. Send latest Edition and Slide Rule.

Name.....
Address.....
(Attach letter stating age, occupation, employer's name and address and that of at least one business man as reference.)

Cyclopedia of Civil Engineering
7 great volumes.
2,800 pages.
1,600 illustrations.
New revised edition by twelve of America's greatest engineers.
Includes: Surveying, bridges, railroads, steel structures, municipal engineering, water supply, road building, etc.

Spanish Grain Flexible Covers Gold Stamped Shipped

Free For Examination



Slide Rule

Be prompt and we will include a brand new, circular slide rule to carry in coat pocket. Invaluable in solving all kinds of engineering problems.

Learn this Profitable Profession



in 90 Days at Home

Hundreds of men and women of all ages 18-50 make \$10.00 to \$20.00 in a single day giving scientific Swedish Massage and Hydro-Therapy treatments. There is a big demand from Hospitals, Sanitariums, Clubs, Doctors and private patients as well as opportunities for establishing your own office. Learn this interesting money-making profession in your own home by mail, through our home study course. Same instructors as in our NATIONALLY KNOWN resident school. A diploma is awarded upon completion of the course. Course can be completed in 3 to 4 months. High School training is not necessary. Many earn big money while learning.



Anatomy Charts & Booklet FREE

Enroll now and we will include uniform coat, medical dictionary, patented reducing roller and Hydro-Therapy supplies without extra cost. The reducing course alone may be worth many times the modest tuition fee.

Send coupon now for Anatomy Charts and booklet containing photographs and letters from successful graduates. These will all be sent postpaid—FREE.

THE College of Swedish Massage (Successor to National College of Massage)
Dept. 764—30 E. Adams St., Chicago.
You may send me FREE and postpaid, Anatomy Charts, booklet containing photographs and letters from graduates, and complete details of your offer.

Name.....
Address.....
City..... State.....

When writing please mention Popular Mechanics

EASIEST to master!

THIS NEW P-A

Such beautiful tone, and so easy to play! Just touch a key and blow normally; you can't miss. Nothing to compare with these new P-A Saxes, Clarinets, Trumpets, and other P-A instruments. Fully guaranteed; your success assured. See your music dealer or write direct for beautiful free book. No obligation. Easy terms. Greatest fun, easiest with P-A. Write today sure.

PAN-AMERICAN
1303
1003 P-A BUILDING ELKHART, INDIANA

LEARN WATCHMAKING

Elgin-Waltham—Study Models 50c others 10c. Sample Partial Instructions Trial Tools—Model and Catalog Tools—Material—Watch Movements etc. \$1.00. Refund if not O.K. Catalog sent with any order.
Complete Text Book Horology Jewelry Manufacture \$3.50. Complete Correspondence Course Necessary Tools. 12 Models Text Book \$15.00 or \$5.00 Down, \$1.00 Per Month.
Stewart Watch Material Co. 721 Olive, St. Louis, Mo. Est. 1911

We have 500 students making money why not you.

BE A PASSENGER TRAFFIC INSPECTOR

You Can Qualify in Your Spare Time. Our simple, home-study course will train you as Railway and Bus Traffic Inspector in a few months. On completion we help place you at up to \$135 per month, plus expenses, to start, or refund tuition. Ambitious Men—19 to 50—advance quickly. Free Booklet.
Standard Business Training Institute
Div. 210 Buffalo, N. Y.

LAW STUDY AT HOME

Legally trained men win higher positions and bigger success in business and public life. Greater opportunities now than ever before. Big corporations are headed by men with legal training.

More Ability: More Prestige: More Money
We guide you step by step. You can train at home during spare time. Degree of LL. B. Successful graduates in every section of the U. S. We furnish all text material, including 14-volume Law Library. Low cost, easy terms. Get our valuable 48-page "Law Training for Leadership" and "Evidence" books FREE. Send for them NOW.
LaSalle Extension University, Dept. 1064-L Chicago
A Correspondence Institution

Learn Public Speaking

At home—in spare time. Many overcome "stage-fright," gain self-confidence and increase earning power, this easy way. Write for free booklet, *How to Work Wonders With Words* and requirements.
North American Institute, Dept. 1357
3601 Michigan Ave., Chicago, Illinois

SUCCEED IN LANDSCAPING

Send for FREE book with full details about landscape training. Study at home, earn while learning. Profitable, healthful career; interesting hobby; men, women. Give age, occupation.
AMERICAN LANDSCAPE SCHOOL
6111 Grand Avenue Des Moines, Iowa

RADIO

ENGINEERING, broadcasting, aviation and police radio, servicing, marine and Morse telegraphy taught thoroughly. 48 weeks' engineering course equivalent to three years' college radio work. School established 1874. All expenses low. Catalog free.
Dodge's Institute, Ada St., Valparaiso, Ind.

CARTOONING

FREE TRIAL LESSON! Cash in on your sense of humor—AT HOME—BY MAIL. Have fun! Make money! No experience needed to start. Write today for FREE LESSON, mailed postpaid. No obligation.
Moon Gag-Cartoon School, Dept. A, Fall Creek, Wis.

Learn How to Write

Write for my Free Book, "HOW to BECOME an EXPERT PENMAN," which shows how others became experts by my Method. Supplies furnished to students. Your name elegantly written on a card if you enclose stamp. Write Today. T. M. TEVIS, Box 25K, CHILLICOTHE, MO.

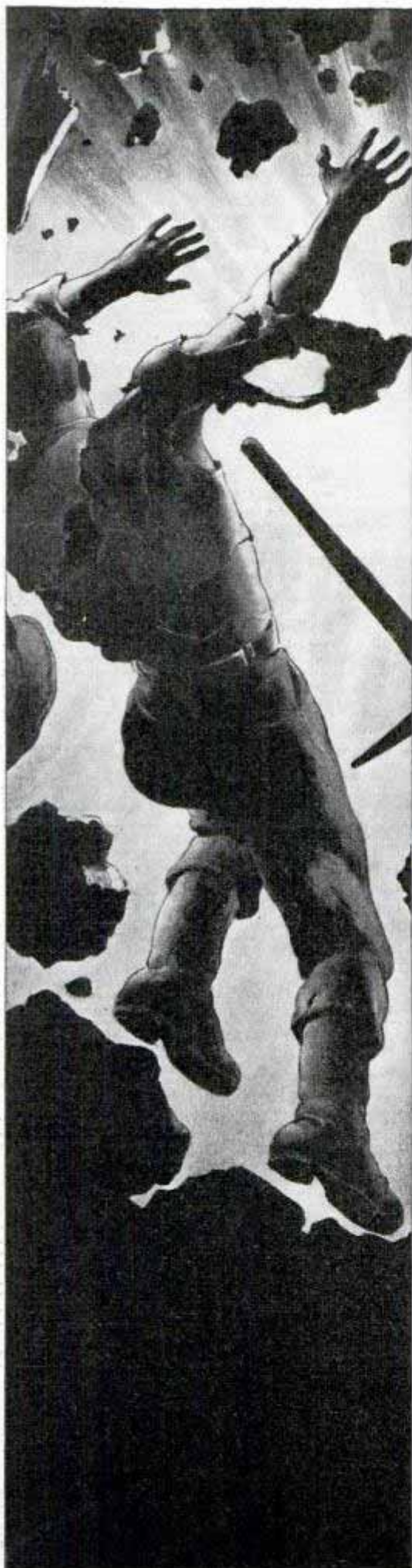

SUDDEN DEATH gave birth to A NEW IDEA

In 1880, in the region around Scranton, Pennsylvania, coal was king—and death his grinning jester!

In dark mine passages, men died of ignorance . . . ignorance of modern safety measures. Appeals for life-saving information poured in to a local newspaper, and were answered. Men lived, who might have died.

Out of this situation grew one of mankind's rarest achievements . . . a new idea . . . the idea that when ambitious men demand vital training, yet are unable to go to school, a school must go to them!

For 49 years, the International Correspondence Schools (with headquarters at Scranton) have been offering ambitious men sound, essential training in technical and business subjects. More than four million men have been enrolled in these world-famous Schools. Thousands of business and industrial leaders acknowledge the part I.C.S. training played in their success.

Your lack of training may not kill you, as it killed so many miners. *But it will kill your chances of success!* Mail the coupon now—and learn how you can become a trained man, getting a trained man's pay!

INTERNATIONAL CORRESPONDENCE SCHOOLS

BOX 5556-J, SCRANTON, PENNA.

Without cost or obligation, please furnish me with full particulars about the subject *before* which I have marked X:

TECHNICAL AND INDUSTRIAL SUBJECTS

- | | | | |
|-------------------------------------------------------|---------------------------------------------------|----------------------------------------------------|-----------------------------------------------|
| <input type="checkbox"/> Air Conditioning and Cooling | <input type="checkbox"/> Diesel Engineering | <input type="checkbox"/> Radio | <input type="checkbox"/> Refrigeration |
| <input type="checkbox"/> Architectural Drafting | <input type="checkbox"/> Electrical Engineering | <input type="checkbox"/> Sanitary Engineering | <input type="checkbox"/> Sheet Metal Work |
| <input type="checkbox"/> Architecture | <input type="checkbox"/> Electric Lighting | <input type="checkbox"/> Steam Elec. Eng'ring | <input type="checkbox"/> Steam Engineering |
| <input type="checkbox"/> Auto Elec. Technician | <input type="checkbox"/> Fire Booses | <input type="checkbox"/> Steam Fitting | <input type="checkbox"/> Structural Drafting |
| <input type="checkbox"/> Auto Technician | <input type="checkbox"/> Foremanship | <input type="checkbox"/> Structural Engineering | <input type="checkbox"/> Surveying & Mapping |
| <input type="checkbox"/> Aviation | <input type="checkbox"/> Heating | <input type="checkbox"/> Telegraph Engineering | <input type="checkbox"/> Telephone Work |
| <input type="checkbox"/> Boilermaking | <input type="checkbox"/> Heat Treatment of Metals | <input type="checkbox"/> Toolmaking | <input type="checkbox"/> Ventilation |
| <input type="checkbox"/> Bridge Engineering | <input type="checkbox"/> Highway Engineering | <input type="checkbox"/> Welding, Electric and Gas | <input type="checkbox"/> Woolen Manufacturing |
| <input type="checkbox"/> Building Estimating | <input type="checkbox"/> House Planning | | |
| <input type="checkbox"/> Chemistry | <input type="checkbox"/> Machinist | | |
| <input type="checkbox"/> Civil Engineering | <input type="checkbox"/> Mechanical Drafting | | |
| <input type="checkbox"/> Coal Mining | <input type="checkbox"/> Mechanical Eng'ring | | |
| <input type="checkbox"/> Contracting and Building | <input type="checkbox"/> Pattermaking | | |
| <input type="checkbox"/> Cotton Manufacturing | <input type="checkbox"/> Plumbing | | |
| | <input type="checkbox"/> Public Works Eng'ring | | |

BUSINESS SUBJECTS

- | | | |
|----------------------------------------------|--------------------------------------------------|-----------------------------------------------|
| <input type="checkbox"/> Accounting | <input type="checkbox"/> Civil Service | <input type="checkbox"/> High School Subjects |
| <input type="checkbox"/> Advertising | <input type="checkbox"/> College Preparatory | <input type="checkbox"/> Manning Men at Work |
| <input type="checkbox"/> Bookkeeping | <input type="checkbox"/> Cost Accounting | <input type="checkbox"/> Salesmanship |
| <input type="checkbox"/> Business | <input type="checkbox"/> C. P. Accounting | <input type="checkbox"/> Spanish |
| <input type="checkbox"/> Correspondence | <input type="checkbox"/> First Yr. Col. Subjects | <input type="checkbox"/> Secretarial Work |
| <input type="checkbox"/> Business Management | <input type="checkbox"/> French | <input type="checkbox"/> Stenog. and Typing |
| | | <input type="checkbox"/> Traffic Management |

DOMESTIC SCIENCE SUBJECTS

- | | | |
|-----------------------------------------------|-----------------------------------------------------------------|----------------------------------------------------------------------|
| <input type="checkbox"/> Advanced Dressmaking | <input type="checkbox"/> Professional Dressmaking and Designing | <input type="checkbox"/> Tea Room and Cafeteria Management, Catering |
| <input type="checkbox"/> Foods and Cookery | | |
| <input type="checkbox"/> Home Dressmaking | | |

Name.....Age.....

Address.....

City.....State.....

Present Position.....

Canadian residents send coupon to International Correspondence Schools Canadian, Limited, Montreal, Canada. British residents send coupon to I. C. S., 71 Kingsway, London, W. C. 2, England.



WE HAVE CROSSED THE THRESHOLD OF TOMORROW

Twenty years of public service! In that time, we have sounded almost every phase of the communication field. In that time, we have seen our satisfied-customer-list expand to number buyers in every country of the world.

As we have grown, so too have grown the demands of those we serve. Industry: for new and better materials. Individuals: for finer instruments of reception. As our outlook broadened and plans to meet the new demands took shape, it was apparent that a name was needed to reflect the forward-looking spirit of this company.

And so, today, Wholesale Radio Service Company becomes

Radio Wire Television Inc.

Here is why the name was chosen, word for word.

RADIO: With radio broadcasting this company has steadily expanded. It was, and is, the backbone of our business. Naturally radio will continue to engage our interests.

WIRE: We believe the new technique of broadcasting by wire will one day encompass the transmission of both sight and sound. Every current technological development points toward this end.

TELEVISION: Whether Tomorrow's televised programs be received by radio or wire, it is our aim to offer the finest services available anywhere.

Our new name thus embodies those important factors which, in the very nature of things, comprise our business. Already several associate enterprises in control of patents relating to the communications field have been merged with this company.

Conscious of our great responsibility, plans are even now under way to expand the number of Radio Wire Television Inc. retail outlets. This step will place local branches at the service of all interested in finer entertainment, better products and lower costs. Long ago, we established a **STANDARD OF SERVICE**. To keep your confidence in us, we pledge ourselves to surpass that Standard in the future.

Radio Wire Television Inc.

formerly **WHOLESALE RADIO SERVICE CO., Inc.**
NEW YORK • CHICAGO • ATLANTA • BOSTON
NEWARK • BRONX, N. Y. • JAMAICA, L. I.
Radio Wire Television Inc., is licensed by arrangement with Electrical Research Products Inc., under patents of Western Electric Co., Bell Telephone Laboratories Inc., and American Telephone & Telegraph Co.

**NEW models
EASIER TO PLAY**

Find out about these sensational new Conn Band Instruments. Many wonderful, exclusive features! Today, *more than ever*, Conns are the "choice of the artists." You'll advance faster and take more pride in a genuine Conn—made by the world's largest manufacturer. See your dealer or write us for Home Trial, Easy Payment offer. Mention instrument.

C. G. CONN, LTD.
1031 Conn Bldg., Elkhart, Ind.

WRITE FOR FREE BOOK

CONN
BAND INSTRUMENTS

AN AVIATION CAREER



OFFERS YOU GREAT FUTURE!

Demand for trained aircraftsmen is increasing and already exceeds supply. Curtiss-Wright Tech, Aviation's foremost school, is located on Grand Central Air Terminal in heart of the aircraft industry and specializes in training MASTER MECHANICS and AERONAUTICAL ENGINEERS. (No flying involved.) Graduates are obtaining immediate employment. Write for details NOW. Dept. PM-10.

CURTISS - WRIGHT TECHNICAL INSTITUTE
Glendale (Los Angeles) California

EARN A DEGREE AT HOME

From A Chartered Institution Of Higher Learning
Employers Now Demand College Graduates With Degrees

88 Degree Courses in Art; Sciences; Philosophy; Education; Psychology; Public Health; Sociology; Physics; Chemistry; Pol. Science; Theology; Law; Business Training; Accounting; Statistics; Adv.; Sales; Agriculture. Electrical, Mechanical, Civil, Structural, Diesel, Architectural, Mining, Drafting, Automotive, Aeronautical, Radio, Refrigeration, Highway, Marine, Air Conditioning, Geology, Petroleum, Industrial, Chemical Engineering. Founded 1908. 170 p. Catalog Free. McKinley-Roosevelt Graduate College, 4244 Clarendon Ave., Chicago

DIESEL Maximum training minimum time; practical and theoretical. Modern equipment, experienced teachers. Personal instruction. 40th year. Catalog free. Residence course in three months.
FINLAY ENGINEERING COLLEGE, 10th & Indiana, Kansas City, Mo.

JOBS in RADIO-TELEVISION

Extension and resident training in television, aviation and police radio. Let us tell you how we train men, fit them for good jobs, help them get jobs. Write for catalog. Affiliated with KMBC, major network station. Address **MIDLAND TELEVISION, Inc., 106-K Power & Light Bldg., Kansas City, Mo.**

Learn
ADVERTISING
at Home

Greater opportunities now in advertising. Learn easily and quickly in spare time. Practical work. No text books. Old established school. Low tuition—Easy terms. Send for free booklet and requirements.

Page-Davis School of Advertising
Dept. 1357, 3601 Mich. Av., Chicago



**THERE'S MONEY
IN YOUR
CAMERA!**

Others make good incomes selling pictures to publications. **FREE CATALOG** describes home-study course (which may be paid for in easy installments) and tells how **YOU** can do it too! **Universal Photographers, Dept. 710, 10 West 33 Street, N. Y. C.**

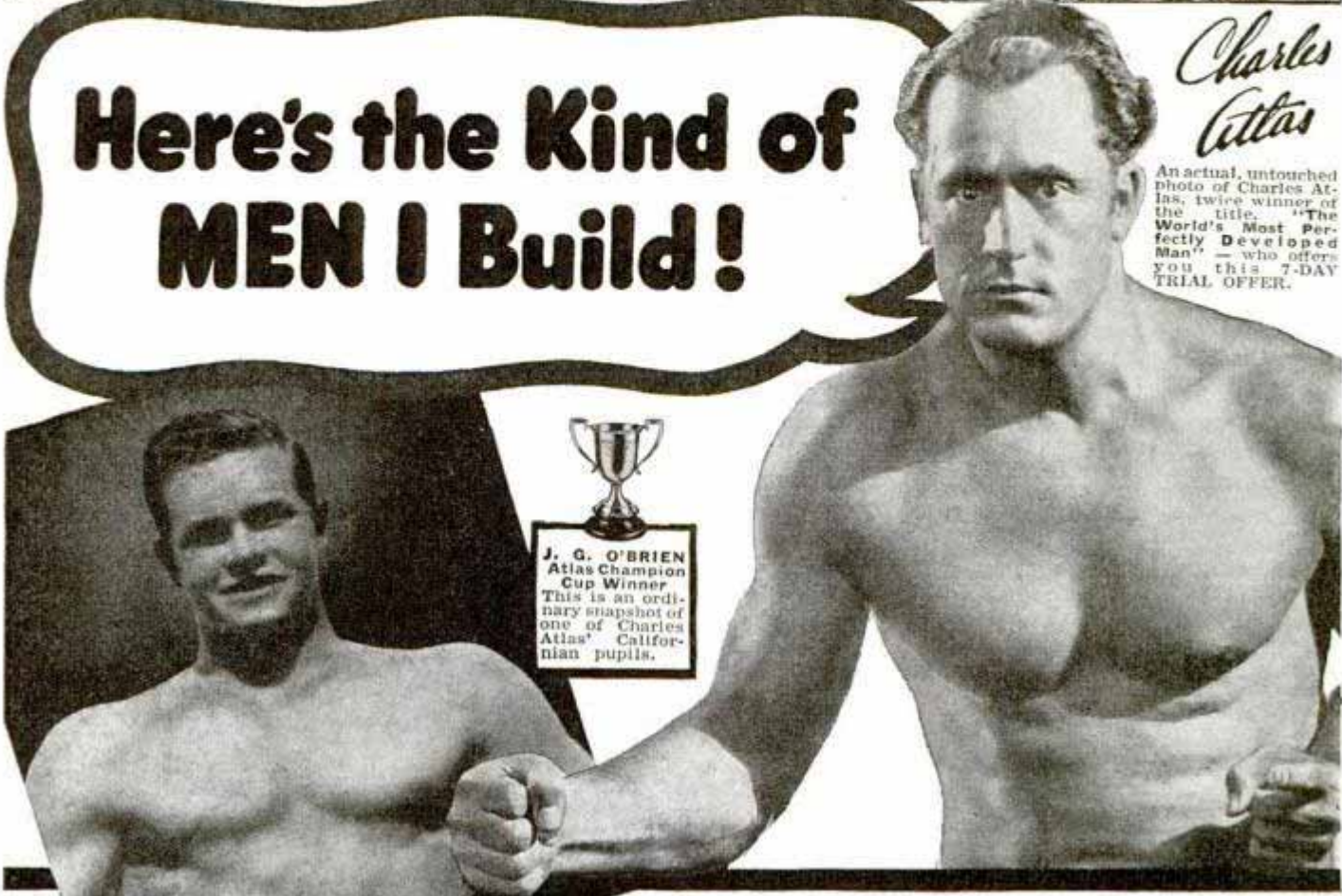

Charles Atlas

An actual, untouched photo of Charles Atlas, twice winner of the title, "The World's Most Perfectly Developed Man" — who offers you this 7-DAY TRIAL OFFER.

J. G. O'BRIEN
Atlas Champion Cup Winner
This is an ordinary snapshot of one of Charles Atlas' Californian pupils.

Will You Let Me PROVE I Can Make YOU a New Man?

MEN—Meet J. G. O'Brien, of California, one of my Silver Cup Winners! Look at that strong neck—those broad, handsome, perfectly proportioned shoulders—that muscled chest and stomach. Read what he says: "Look at me NOW! Dynamic Tension WORKS! I'm proud of the natural, easy way you have made me an 'Atlas Champion!'"—*J. G. O'BRIEN.*

This Sterling Silver Cup Being Given Away

This valuable cup stands about 14" high on a black mahogany base. I will award it to my pupil who makes the most improvement in his development within the next three months.

I, myself, was once a skinny weakling of 97 lbs. I didn't know what real health and strength were. I was afraid to fight, ashamed to be seen in a swimming suit. Then I discovered the secret that changed me into "The World's Most Perfectly Developed Man," the title I won twice and have held ever since, against all comers. My secret is Dynamic Tension. It is a natural method. Its purpose is not only to give you the powerful, rippling muscles you'd like to see in your own mirror, but also—for those whose systems are sluggish for lack of proper exercise—to help them tone up their entire body, inside and out.

Accept My 7-Day Trial Offer
Do you want a better build? Are you dissatisfied with your present

physical development? All I ask is a 7-DAY TRIAL. Just one week! In even that short time you will notice your chest hardening and filling out with solid muscle—or the 7-Day Trial will cost you nothing. Surely this is proof enough that by continuing with my Dynamic Tension method I will make you a New Man—give you bodily power and drive, and put you in magnificent physical condition which wins you the envy and respect of everyone.

FREE BOOK

Let me show you the results produced for other men! I'll send you FREE my famous book, "Everlasting Health and Strength." It shows actual photos. Write your name and address carefully on coupon. Mail to me personally today. I'll rush your free copy to you AT ONCE! Charles Atlas, Dept. 8K, 115 E. 23rd Street, New York, N. Y.



CHARLES ATLAS

Dept. 8K, 115 East 23rd Street, New York, N. Y.
I want the proof that your system of Dynamic Tension will help make me a New Man—give me a healthy, husky body and big muscle development. Send me your FREE book, "Everlasting Health and Strength" and full details about your 7-DAY Trial Offer.

Name (Please print or write plainly)
Address
City State



High School Course at Home

Many Finish in 2 Years

You can complete this simplified High School Course as rapidly as your time and abilities permit. Equivalent to resident school work—prepares you for entrance to college. Standard H. S. texts supplied—Diploma. Credit for H. S. subjects already completed. Single subjects if desired. High School education is very important for advancement in business and industry and socially.

College Entrance

During the past 14 years, our High School graduates have been admitted to 531 different Universities, Colleges, Junior Colleges and Normal Schools—80% of them without entrance examination. Course also prepares for teachers' certificate and pre-professional examinations.

Business—Industry

To get and hold a good position in Business today you must be able to write clear, accurate letters and reports—do figuring involving Algebra and Geometry—talk intelligently on matters requiring a knowledge of Geography, History, and Economics.

In Industry—Mechanical and Engineering lines—you must have at least an elementary knowledge of Physics and Chemistry—be able to figure quickly and accurately—know something of Mechanical Drawing and blueprints—and be able to talk and write accurately and clearly on both your work and ordinary topics of conversation.

Our High School course meets the preparatory educational requirements for Business and Industry.

An Educational Institution

The American School was chartered in 1897 as an educational institution, not for profit—and is exempt from paying Federal income tax, like the best resident colleges and universities.

Don't Be Handicapped— Complete Your Training Now

Be a High School Graduate! Prepare yourself for promotion in Business and Industry—for the Professions, College Entrance and social success. No matter what line you may select, High School training will prove invaluable to you! Our moderate fees cover all instruction, standard textbooks and Diploma. Easy monthly terms. Get ahead in life. Start your training NOW!

20 Other Courses

Over 150 noted Educators, Engineers, and Business Men helped prepare our special instruction material, which is used by many resident schools and colleges, U. S. Navy, and Province of Manitoba, Canada. We offer you quality training at home for the best-paying lines of Industry and Business, as listed in the coupon.

tion in Business and Industry—for the Professions, College Entrance and social success. No matter what line you may select, High School training will prove invaluable to you! Our moderate fees cover all instruction, standard textbooks and Diploma. Easy monthly terms. Get ahead in life. Start your training NOW!

Mail coupon for information about line that interests you
American School, Drexel at 58th, Chicago

American School, Dept. H-745, Drexel at 58th, Chicago
Tell me how to train for success in line checked. No obligation.

- High School Course**
- | | |
|--------------------------------------------------|------------------------------------------------|
| <input type="checkbox"/> Accounting & Auditing | <input type="checkbox"/> Diesel Engineering |
| <input type="checkbox"/> Architecture & B'lding | <input type="checkbox"/> Drafting & Design |
| <input type="checkbox"/> Automotive Engin'ring | <input type="checkbox"/> Liberal Arts |
| <input type="checkbox"/> Business Management | <input type="checkbox"/> Private Secretary |
| <input type="checkbox"/> Commercial Aeronautics | <input type="checkbox"/> Hi'er Ac't'g (C.P.A.) |
| <input type="checkbox"/> Electrical Engineering | <input type="checkbox"/> Highway Engin'ring |
| <input type="checkbox"/> Electrical Refrigerat'n | <input type="checkbox"/> Mechanical Engin'ring |
| <input type="checkbox"/> Air Conditioning | <input type="checkbox"/> Radio & Television |
| <input type="checkbox"/> Civil Engineering | <input type="checkbox"/> Salesmanship |
| <input type="checkbox"/> Complete Law | <input type="checkbox"/> Steam Engineering |

Name.....

Address.....

When writing please mention Popular Mechanics

Oh Boy! I JUST GOT A GRETSCH DRUM!

And am I happy! No more worrying over what to do after school ... no more dull moments. I've got a hobby now that leads to a real career ... big drummers make big money ... and I can learn to be one ... without difficult lessons ... and have plenty of fun learning! Wait till I get the gang together and show 'em what it means to have the best drum money can buy.



**EASY
TO
PLAY
★
EASY
TO
PAY**

Send penny postcard for FREE DRUM catalogue and full information about EASY-PAYMENT plan and FREE TRIAL through your GRETSCH dealer. Address Dept. PM 100

The FRED. GRETSCH MFG. CO.

Musical Instrument Makers Since 1883

60 BROADWAY, BROOKLYN, N. Y.

GRETSCH also offers SUPER VALUES in Guitars, Saxophones, Trumpets, Trombones, Accordions. Send for FREE catalogue. Mention instrument.

LEARN PHOTOGRAPHY

Our staff of noted experts will teach you Commercial, News, Portrait, Advertising, Natural Color or Motion Picture photography. For pleasure or career. Wonderful opportunities. Personal Attendance and Home Study courses. Free booklet.

**from
Experts**

NEW YORK INSTITUTE OF PHOTOGRAPHY
10 West 33 Street (Dept. 49) New York City

YOU CAN GET IN AVIATION

Like hundreds of successful graduates SPARTAN Training following standard College or University planned curriculum will give YOU Aviation training that will qualify for positions now open. Advantages: Factory affiliation building ALL-METAL Commercial and Military Airplanes. Unequaled year-round flying weather and country. GOVERNMENT APPROVED. All courses Mechanical and Flight. Write for Illustrated Catalog.

HOME OF THE DAWN PATROL
J. D. GREEN, Director, Dept. PM-24, TULSA, OKLAHOMA
SPARTAN SCHOOL OF AVIATION

Regain Perfect Speech, If You

STAMMER

Send today for beautifully illustrated book entitled "DON'T STAMMER," which describes the Bogue Unit Method for the scientific correction of stammering and stuttering. Method successfully used at Bogue Institute for 38 years—since 1901. Endorsed by physicians. Full information concerning correction of stammering sent free. No obligation. Benjamin N. Bogue, Dept. 1307 Circle Tower, Indianapolis, Indiana.

Correspondence Courses in **RADIO and ELECTRICAL ENGINEERING** LOW AS \$25

ELECTRICAL ENGINEERING. Get good grasp of wide electrical field. Modern. Very understandable. Theory made easy.
RADIO ENGINEERING. Extra fine course in radio, public address, photo-electric work. Trains you to be super-service man, real vacuum tube technician. Tuition ONLY \$25, either course. Deferred payment plan. Experiment kits furnished.
FREE Write for free copies of school catalogs, student magazines, etc.
FREE LINCOLN ENGINEERING SCHOOL, Box 931-P10, Lincoln, Nebr.

Yes! WITH HOOVER UNIFORMS!

Big earnings for ambitious men and women in new uncrowded field with famous nationally-advertised Hoover line of smart, exclusive Uniforms for restaurants, fountains, hotels, taverns, stores, offices, doctors, dentists, etc. Not house-to-house. No experience—no money needed to get into this new, big-income business. Mail postcard now for beautiful new Uniform Style presentation, actual samples and money-making equipment—sent FREE.
HOOVER 251 West 19th Street Dept. 1J-9 New York

Get Into This BIG OPPORTUNITY Field!



Drafting—A profession by itself—your stepping stone to advancement in many industries—a field rich with good paying opportunities for competent, trained men.



Product Engineering—Every day products are being improved, refined, reduced in cost—a continuous process offering attractive opportunities to men trained in drafting and designing.



Industrial Designing—Making products more appealing, more attractive to the consumer, utilizing new materials, combining art and industry. The sensational results achieved through industrial designing has created an insistent demand for men trained in practical industrial design.



Get Into INDUSTRIAL DESIGNING AND DRAFTING

LEARN AT HOME FROM AN ENGINEER

Learn how to make the drawings and blue prints with which all industry begins, but learn also how to create **new designs** and new products. Learn how to improve and re-style old products so they have more "eye and buy appeal" and more efficiency. Drafting alone is a tremendous field, but drafting plus industrial designing is twice as big, a new fast growing profession, rich with opportunities—if you have the right kind of training. Drafting and industrial designing go hand in hand—and now, for the first time, you can learn **both** subjects right in your own home, in your spare time. Best of all, you can get your training from a practical engineer, who knows today's market demands and who trains you quickly, easily, by his tested, practical "work-job" method.

Manufacturers want men with ideas. Under modern, highly competitive conditions, all manufacturers must **continuously** make **new models, new products, and improved designs.** Products must be restyled and improved again and again, season after season, in order to keep up with competition and the demands of the public. Because this field is so new and large there is a scarcity of trained, competent designers. If you want to do drafting alone a working knowledge of **industrial designing** will make you a better draftsman, enable you to get a better job and more pay. If you want to specialize in industrial designing, you must be trained in **practical drafting.** If you are an executive, a knowledge of **both** subjects will be of immense value to you. **Just one idea** gained from this course can send you on the way to big sales, more pay, and promotion.



ENGINEER DOBE

A New Field • Crowded with Opportunity

I'll train you at Home for a Better Job and More Pay by My Practical "Work-Job" Method

I can prepare you just as I have trained thousands of successful students from 16 to past 50. No previous experience or special creative ability needed. High school education not necessary. I'll train you *thoroughly*—not by the "copy book method", but by *applied instruction* on actual jobs—giving you the benefit of my up-to-the-minute practical experience. Under my "work-job" method you learn by doing, until you are satisfied and thoroughly competent . . . until you have a good paying position.

Mail the coupon TODAY for FREE book giving full details. Engineer Dobe, Libertyville, Illinois.

Complete working tools also supplies, and drawing table, furnished without extra charge, the day you enroll.

Send for FREE Book "Industrial Designing and Drafting." Mail the coupon for FREE details as to how you can learn Industrial Designing and Drafting.



Send for this Big OPPORTUNITY BOOK

ENGINEER DOBE
Libertyville, Illinois.

Div. 3377

Please send me FREE BOOK on "Industrial Designing and Drafting" also please explain how you assist your graduates to good positions in these fields.

Name

Address

Town State..... Age.....

FOR MEN WHO WANT TO LEARN A PROFITABLE TRADE

Complete

DIESEL TRAINING

NO MATTER WHERE YOU ARE OR WHAT YOU DO —we have a training plan for YOU!

If you are sincerely ambitious and interested in making good in the Diesel field, be sure to immediately investigate our flexible training plan that will fit your circumstances. A Plan for every Man. A Plan for those seeking immediate shop training as well as for those who cannot give up their present employment and income. For 34 years National Schools, a recognized leader in the field of trade education, has helped wide-awake men to success. This million-dollar trade school will supply you with a sincere, honest statement of facts of what you should do to quickly get into the profitable Diesel Industry. No exaggerations—no misstatements; and a definite plan to fit you.

Write Today for Full Details

Mail the coupon below. Find out how you can get the finest in Diesel training without delay. See how this great trade school operates and makes its facilities available to every ambitious man. Actual work in modern training shops, a part of every man's instruction. Shop methods time-tested for 34 years. Fascinating, efficient preparation. Get the facts.

WE ARE DEFINITELY INTERESTED IN HELPING MEN OF LIMITED INCOME AND "BLIND ALLEY", JOB HOLDERS.

NATIONAL SCHOOLS

LOS ANGELES, CALIF.

Complete Training in Diesels and Gas Engines.

Oldest Trade School in West

MAIL COUPON FOR FREE LITERATURE

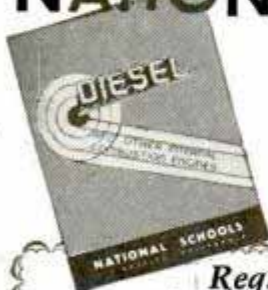

Request for Free Literature

NATIONAL SCHOOLS (established 1905) Dept. 10-PMA
4000 South Figueroa Street, Los Angeles
Please send me, without obligation, your FREE Literature and information.

NAME _____ AGE _____

ADDRESS _____ CITY _____ STATE _____

EASY

SOPRANI AMPLIPHONIC

Simplifies Playing



Frank Papfle, N.B.C., with his Soprani

Lighter, easier to play, less bellowing, plus more beautiful tone and volume, — that's how Soprani's exclusive Ampliphonic feature has simplified this accordion. Assures rapid progress. Home trial. Easy terms. See your music dealer or send for beautiful free book. Write today.

SOPRANI, INC.

Dept. 1029 630 S. Wabash Ave. CHICAGO, ILLINOIS

EDUCATIONAL BOOKS

AT 1/2 PRICE AND LESS. Bargains in high school, junior college and college textbooks, reference books, etc. All subjects. All fields of learning. Any book in print delivered to your door. We pay postage. Standard authors, used and new books. We guarantee big savings.

FREE Write for our big 1939-40 Educational Book Catalog. A short course in liberal education. The world's knowledge at your finger tips. A library of what's new and old in educational books. Write today for your **FREE** copy.

WILCOX & FOLLETT CO.

America's Largest Educational Book House

Dept. BA 1255 So. Wabash Ave. CHICAGO, ILL.



Be a MONEY-MAKING RADIO EXPERT

I'll train you for a good job in Radio, Television, or a business of your own. My new, personalized sparetime home-study Course fits you quickly, easily. You get real Radio Equipment. I show you how to earn while you learn.

FREE: Write for complete details in new catalog "HOW TO MAKE MONEY IN RADIO" Sprayberry Academy of Radio, 210-K University Place, N. W. Washington, D. C.

Get into the BAKING BUSINESS

Bakers make good money! Now 7th Industry in wages! Nearly depression-proof. New home study Baking Course qualifies you. Common school education sufficient. If you're ambitious, write for **FREE BOOK**, "Opportunities in Baking." National Baking Institute, 3601 Michigan, Dept. 1357 Chicago



ARTISTS MAKE MONEY

Find out your ability. Send name, age, occupation and address for Free Vocational Art Test.

Federal Schools, Inc., 10139 Federal Schools Bldg., Minneapolis, Minn.

TOOL & DIE MAKING DESIGNING

Machinists Trade. Not a correspondence course. Practical shop training in the world's industrial center. Write today for full information.

Dept. 10 NATIONAL SCHOOL OF MECHANICAL TRADES 628 W. Lake St. Chicago, Ill.

Easy Home Work PAYS GOOD MONEY



Get Free Book "How To Raise Mushrooms." Tells how to turn spare space and spare time into cash. Explains how we guarantee satisfactory starting crops, buy all saleable Mushrooms you raise, assure highest market prices, furnish advertising, help you start in business. Write today Niagara Mushroom Co., Dept. A-10, Buffalo, N. Y.

MAKE MONEY AT HOME

RUBBER MOLDS Low as 6¢ EA.



Amazing rubber mold-making outfit makes perfect flexible molds of plaques, ash trays, book-ends, etc. Molds cost from 6¢ to 25¢ each. Each mold makes hundreds of novelties and gifts to sell up to \$1.00 apiece! No experience necessary. Quick and easy. Start profitable business in your home. Sell to stores, gift shops, friends, resorts, road stands, by mail. Full or spare time. "Molders Handy Book" and list of buyers **FREE**. Write

SO-LO WORKS

Dept. Z-827 Cincinnati, Ohio

PATENT and MARKET YOUR INVENTION

How
**SUCCESSFUL
INVENTORS DO IT!**

This
**FREE
BOOK
TELLS HOW**

IF there is a reliable formula followed by successful inventors, it is (1) a good invention, (2) a good patent, (3) a good market. To make the formula work, in this modern age of competition, point No. 2, effective patent protection, is the real connecting link between companion points No. 1 and 3.

NATION-WIDE MERCHANDISING SELLS NEW PRODUCTS BY THOUSANDS

Many times inventors say, "It's such a simple gadget—is it worth a patent?" Inventors who say this have little conception of modern merchandising methods. New gadgets are not "peddled" today from town to town. Mass production takes them over and turns them out immediately on a big scale. Nation-wide sales agencies put them quickly in stores all over the country. If a manufacturer takes your invention the wheels of mass production start rolling and—almost overnight—the new commodity or novelty is "on sale" from coast to coast. That's the modern American way. New production methods, salesmanship, advertising and promotion do not wait for public demand—they create it! Modern business makes pennies of royalty pile quickly into dollars of profit—profit that must be protected by worthwhile patent.

BE SURE TO PROTECT YOUR RIGHTS

The U. S. A. is the greatest open market for new inventions in the world. Here commercial striving is so keen that the unprotected invention, if it has public acceptance, is quickly "eyed" and may become the prey of eager competition. Worthwhile manufacturers won't bear the production costs and sales expense of promoting a new invention unprotected by patent. A good, strong patent not only opens the road to marketing your invention, but closes it to would-be chiselers who may seek to reap the rewards of your creative efforts.

LET US HELP YOU WITH YOUR PATENT

During the past twenty years we have helped great numbers of inventors secure their U. S. Patents. We know the pitfalls and how to avoid them. We have trained, experienced patent draftsmen and registered patent attorneys ready to serve you—and each one, when he undertakes to handle your case, realizes that he is personally responsible to contribute the fullest individual effort possible.



FREE RECORD OF INVENTION FORM MAKES IT EASY

When you send for our FREE BOOK, we include, also free, our specially prepared "Record of Invention" blank on which you can quickly make and date a sketch and description of your invention. This "disclosure", as it is called, may be absolutely invaluable as evidence for you, should your rights ever be contested. Be sure to get it and use it.



MAIL COUPON NOW!

If you have an invention in the making—if you simply have the crude elements of an invention in mind—you should have our Big FREE BOOK without delay. It will guide you every step of the way—from the preliminary search stage to the issuance of the final patent grant. This book contains twenty-five chapters describing in plain man-to-man language the story of obtaining a patent and marketing an invention. This book is absolutely FREE—just tear off the attached coupon or write us a letter or postcard TODAY!

CLARENCE A. O'BRIEN and HYMAN BERMAN

704 Adams Building, Washington, D. C.

Reg. Patent Attorneys Before U. S. Patent Office

Please send me at once your Big Free 48-Page Book, "Patent Guide for the Inventor" and your specially prepared "Record of Invention" form. This request does not obligate me.

Name

Address

(Please write or print plainly)

POPULAR



INVENTIONS

THE latest form taken by the parachute is that of a lifesaving garment that would be worn by the user. It would be attached to a belt around the chest and to



bands on the ankles. Flexible stays would help to hold the 'chute open in the air. Opening the parachute would be accomplished by simply lifting the arms.

SOME idea of what the automotive industry may have in mind for the automobile of tomorrow may be gained from a recent patent covering a radial engine. Issued to the Chrysler Corporation, the patent specifies an internal combustion with the cylinders arranged radially, like those used in airplanes, complete with radiator and cooling jacket. An accompanying patent covers the car in which this engine would be mounted. The engine

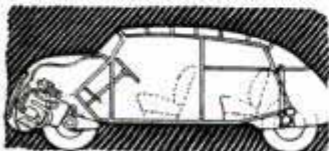
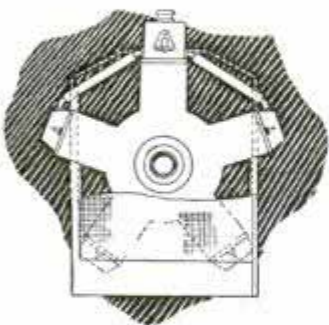

is to be installed on a wheel suspension, thus riding free of the body frame. The engine would be stabilized by some yieldable means coating between the engine and the body. One feature appears to be suspension of the rear wheels, and one advantage of the design seems to be a considerable saving in space required by the engine, thus resulting in more space in the body.

WHEN you reach an attractive camp site with a patented trailer, it may be unloaded and then unfolded to form a boat. It consists of two hinged sections, one of which is equipped with a wheel for use on the highway. A pivoted latch holds the sections together in boat formation when desired or serves as a direct drawbar when the assemblage is used as a trailer. The wheel may be removed when the trailer is converted into a boat.

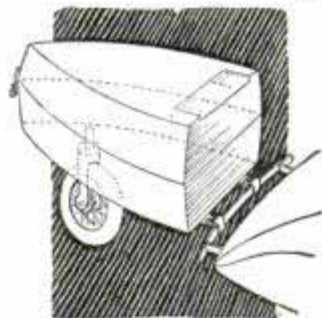

HOLDING the bowling ball with greater ease is the objective of a gripping device patented recently. It consists of a handle, a suction cup which grips the ball and a rearwardly extending arm which helps to disengage the ball from the suction cup when desired. The attachment is expected to be a welcome adjunct to the game.



(Continued to page 34A)

Advertisement

New Money Maker Offers Big Opportunity to Thousands of Men!

Easy-to-do Electroplating
Makes Dollars Grow

WHEN a wideawake man, young or middle-aged or older, is looking for a sure way to make more and better dollars, can he find it? Yes, sir, he can. And here it is! Let him develop his own electroplating business! What? Electroplating? Why, that brings up visions of huge tanks with smelly acid solutions, batteries, wall switches, longhandled dippers, hooks, and a lot of

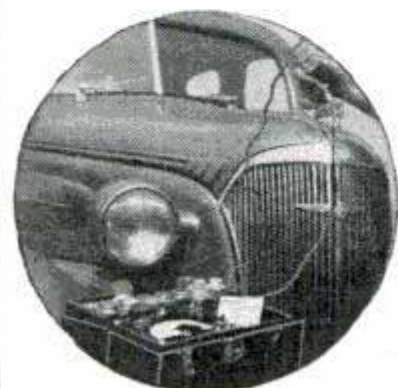

This new electroplating outfit is as easy to pick up and carry around as a fishing tackle box.

other messy equipment. So it was, but that vision is fading out nowadays. For a new and simple method of electroplating has been perfected, especially adaptable for use in the home, or shop, or store, or office, and in many other places, too. And

therein lies a newly found way for a man to fatten his pocketbook.

Thanks to modern science, the new electroplating process does away completely with all tanks, and permits easy portability of the entire plating outfit. The process uses an electric brush and a non-liquid electrolyte.

Easy to operate, the device can be used by anyone anywhere to deposit a heavy plating of gold, silver, nickel, copper, brass, zinc, cadmium, tin, etc., on metal articles, as simply as painting a board with a brush.

How Eight Men Cashed In

And has somebody hunting for spare time dollars or full time ones for that matter, actually used the process to his profit? Listen to this:

"I got a typewriter rebuilding company to let me go over 100 machines. And then a jewelry loan company gave me an order for replating their musical instruments. I have even gone into a home to plate some faucets and made \$10.00 in three hours," says W. R. Dixon, 217 Admiral Blvd., Kansas City, Mo.

"Three pairs of automobile reflectors netted me five dollars, the plating costing seventy-five cents," remarks Francis Edwards, St. Clair, Pa.

"I have gold plated to date more than sixty rings at seventy-five cents each," reports Charles N. Valade, Tupper Lake, N. Y.

"As a watchmaker, it formerly cost me \$1.50 to have a watch dial refinished," writes Charlie M. Underwood, Turlock, Calif. "Now it costs me two cents for the compound."

"As a maker of stage props, I often had to take devices apart for plating," reports Fred Corwey, 315 West 47th Street, New York, N. Y., "but now I do not have to take them down and send the parts out, I do it on the spot."

"As a sideline I average \$20.00 a week. I put an ad in a paper. Then I arranged to pay a music store owner ten cents on every dollar of work he turned over to me. I had cards printed. I display my work and boy, does the work come in!" So reports Ray Kuhns, Cumberland, Md.

"I use my plater for work on guns and pistols, and all kinds of silverware, and have discarded my old tank," says W. E. Irby, State Line, Mass.

"By replating metal parts on a show case, I made over twice the price of my outfit in three and a half hours," declares Howard Mullorky, 119 Cornelia Street, Plattsburg, N. Y.

Want any more evidence, young man? There's plenty to be had. But a word to the wise—well, you know the rest of it.

MAKE BIG MONEY

At Home!

New Invention Electroplates by Brush

Plates
GOLD
SILVER
COPPER
TIN

CADMIUM
NICKEL

Easy as
painting

No Tanks, Liquids, Generators
DOES SAME WORK AS BIG OUTFITS

Millions of old auto-parts, and all kinds of old, worn articles in homes, stores, offices, factories everywhere can now be electroplated with a permanent brand-new sparkling coat of metal—by electrolysis—with the stroke of a brush. Easy as painting—no dismantling—plates right on the spot. Any electric light socket or car battery. Weighs only a few pounds. Take it anywhere—ready for instant use.

Quick, Easy Way to Start Your Own Business

MAKE BIG PROFITS AT ONCE

Amazing low price and magic-like demonstration brings you thousands of orders for plating from garages, radio shops, bicycle shops, machine shops, home work shops, factories, offices, janitors, doctors, dentists, jewelers and farmers, homes, stores, etc.—with big profits for you! List of plating charges furnished; also reports of remarkable daily earnings.

2-MINUTE DEMONSTRATION
WITH SAMPLE AMAZES EVERYBODY

Send today for FREE Sample and amazing profit details and bona fide reports of big steady earnings! Also, 3-way proven sure money-making plan. Get started at once on this permanent, profitable business. No competition. Simply mail name on penny post card—NOW! Be the exclusive Warner Nu-Way Electroplater in your community.

WARNER NU-WAY ELECTROPLATER CO.
360 N. Michigan Ave., Chicago, Ill. Dept. 5-R

FREE
SAMPLE
PROVES
CLAIMS



REAL JOBS OPEN

FOR TRAINED AUTO MECHANICS



LEARN QUICK!
8 WEEKS
practical SHOP
TRAINING!

AUTO, DIESEL and AVIATION mechanics

I'll train you quickly, correctly for this fascinating work, paying up to \$60 a week! Based on 25 years' experience knowing how to train men well, in the 2 biggest, best schools of their kind in the world. You learn with real tools, on real equipment, a complete, practical course in Auto, Diesel and Aviation Mechanics, so you can step out of low-pay jobs into a career in the biggest field of opportunity in America today!

SPECIAL LOW RATE

SPECIAL LOW TUITION RATE IF YOU ACT NOW!

Again McSweeney leads in real value. If you write at once we will reveal a special new low tuition rate that will amaze you, and on easy terms it makes it easy for you to train AT ONCE for a big-pay job! Write TODAY for details!

McSWEENEY MEN MAKE GOOD!

25 years' success means something to you! Read how others have succeeded with McSweeney training: "Just got thru writing income tax check. Money spent at your school was best thing I ever did"—Lee Grant, O.; J. W. Wiggins, Okla., says before we trained him he had no income, now has own business, money in bank and to spend! G. B. Park, Ind., says "Your training fitted me to handle any job in auto field." These men were trained in our fine big schools, best of their kind anywhere!

TWO FINE BIG SCHOOLS



DETROIT



KANSAS CITY

FREE BOOK!

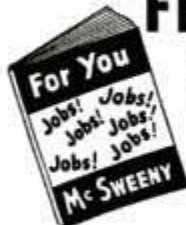

Send now for your copy of my big book giving all the facts and announcement of amazing new low tuition rate for short time only—but you must write at once!

Address nearest school:

McSWEENEY TRADE SCHOOL

Dept. B-7, Detroit, Mich., or Kansas City, Mo.

Without cost or obligation send me your big FREE book.

NAME.....

STREET.....

TOWN..... STATE..... AGE.....

When writing please mention Popular Mechanics

BOEING SCHOOL PREPARES FOR TOP JOBS

Boeing School training, in 11 thorough ground and flying courses, commands world-wide respect from air executives. Separate courses for college and high school graduates. Enter any quarter, limited enrollment, 30 full-time instructors, unexcelled equipment. 85% of graduates employed. Big demand for trained pilots and meteorologists. U. S. - approved school. Owned and operated by United Air Lines. Ask for Bulletin, 7109 Hangar 5, Airport, Oakland, California.



SCHOOL OF AERONAUTICS

Operator No. 38



FOLLOW THIS MAN

Secret Service Operator No. 38 is on the job! Running down dangerous Counterfeit Gang. Tell tale finger prints in murdered girl's room.

Free The Confidential Report Operator No. 38 made to his chief. Write for it.

Earn a Regular Monthly Salary

YOU can become a Finger Print Expert at home, in your spare time, at small cost. Write for confidential full report and details. Literature will be sent only to persons stating their age.

INSTITUTE OF APPLIED SCIENCE

1526 Sunnyside Ave.

Dept. 1357

Chicago, Ill.

ENGINEERING DEGREE IN TWO YEARS

B. S. Degree courses in engineering: Electrical, Civil, Chem., Mechanical, Radio and Television, or Aeronautical. 1 yr. Mech. Drafting. Intense, practical, thorough program. Large industrial center. Prep courses without extra charge. Earn board if desired. Low tuition and living costs. Enter December, March, June, September. Write for Catalog.

239-A E. Washington Blvd., Fort Wayne, Ind.

INDIANA TECHNICAL COLLEGE

TRIAL LESSON IN

Free • DRAFTING



More good jobs now in Drafting. Learn AT HOME in spare time (or at our Chicago School). Send postcard for FREE TRIAL LESSON and see how easy to learn and get a good job.

CHICAGO TECHNICAL COLLEGE

N-200 Tech. Bldg., 118 E. 26th St., Chicago, Ill.

PHOTO-ENGRAVING TASOPE' SINCE 1931

Cash in on pictures! Learn quickly at home or in our residence school. Make halftones, line cuts for the trade. Qualify for interesting, good pay job. We show you how and supply complete low-cost engraving plant. Small investment. Easy terms. Particulars free!

THE AURORA SCHOOL OF PHOTO-ENGRAVING

Dept. PM-9

Tasope' Bldg.

Aurora, Mo.

How To Secure A Government Position

In the Classified Civil Service! Railway Postal Clerk, \$1900 a year regular. Postal Clerk, City Mail Carrier, \$1700 regular. Other attractive positions paying \$1260 to \$2100 a year. Our tested method helps you pass examinations. Men—Women, age 18-50, send for our FREE BOOK explaining requirements TODAY.



PATTERSON SCHOOL, 810 Mercantile Bldg., Rochester, N. Y.

Send, without obligation, free book "How to Secure a Government Position."

Name..... Age.....

Address.....

INVENTORS

INFORMATION ON HOW TO OBTAIN PATENT AND MARKET INVENTIONS

If you have invented something, if you're interested in inventing something, you need this new 48-page book that gives the entire Story of Patents. It tells you for the first time about new phases of invention, how others succeeded, how the patent laws protect you, how to market your invention, where to obtain finances, how to form a company, partnership, or arrange for royalties from your invention's sale.

PRACTICAL BENEFITS

You will find 6 complete pages illustrated with simple inventions that have succeeded in six different fields of industry. Over 100 illustrations are in this book. You will read the stories of ten (illustrated) of America's most famous inventors. You will find an experienced and thorough survey of market conditions affecting the inventor—showing the possibilities for commercial invention today. Entire chapters are devoted to the value of a patent in promoting the final success of your invention. The

importance of quick action in applying for patent is stressed—facts revealing danger of delay are emphasized.

If you expect to realize profits from your invention you must protect it with a U. S. Patent. Otherwise you may find that all your time and labor have been lost, because it often happens that other inventors are working on the same invention. If you have an invention, or an ambition to invent—get the information on obtaining patent AT ONCE!

WHAT A PATENT DOES FOR YOU

Without a U. S. Patent, you cannot expect to reap the profits that your invention may make possible. Send at once for this book. After you get that, you'll know exactly what to do to protect yourself. Anything you write us or send us is strictly confidential between us. All letters and drawings are kept in strong, steel, fireproof files, which are open only to us or authorized members of our

staff. We have secured patents for inventors located in every State in the Union. The practice of our organization is confined entirely to Patents, Trademarks and Copyrights. We have had years of experience in Patent Matters. When you place your patentable invention in our hands, we are in position to proceed at once to secure protection for you. Our fees are reasonable, and if you desire, we can arrange convenient terms of payment.

Get
**FREE
COPY**



48
PAGES
Over 100
Illustrations



CLARENCE A. O'BRIEN
and HYMAN BERMAN

705 Adams Building, Washington, D. C.

Registered Patent Attorneys Before U. S. Patent Office

Please send me at once your Big Free 48-Page Book, "Patent Guide for the Inventor" and your specially prepared "Record of Invention" form. This request does not obligate me.

Name.....

Address.....

(Please write or print plainly)

Get This
FREE BOOK

IMMEDIATELY MAIL COUPON TODAY!

This new 48-page book of facts is absolutely FREE! You need it NOW. Simply fill out the coupon, and mail. The field of invention changes constantly—here is the latest information. Within a very few days you will receive our Free Book, together with the Record of Invention Blank. Write NOW!

RADIO made EASY!

with Ghirardi's Famous Home-Training Course COMPLETE in 7 Big Books

Fit yourself at home, in spare time, for a good-paying radio job. You'll learn all that's really essential in Ghirardi's great self-training course complete in this big 972-page volume—including Television, Sound, Cathode-Ray Tubes, as well as Radio and Electricity. All clearly explained step by step, fully illustrated, easy to grasp!

EASY AS A.B.C.!

Ghirardi's simplified method is the quickest way to get your radio education. No "background" study—no math. That's why it is used by more radio schools than any other book in the world!

36 Volumes in 1—972 pp.—508 illus.

1. Radio Broadcasting System. 2. Sound, Speech, Music. 3. Electron Theory; Elec. Current. 4. Elec. Units; Ohm's Law; Resistance. 5. Elec. Circuits; Batteries. 6. Magnetism. 7. Electro-Magnetism. 8. Electromagnetic Induction. 9. Inductance. 10. Capacitance; Condensers. 11. A. C. Circuits. 12. Filters. 13. Measuring Instruments. 14. Radio Waves. 15. Broadcasting. 16. Receiving. 17. Vacuum Tube Principles. 18. Vacuum Tube Characteristics. 19. Vacuum Tube Construction. 20. Vacuum Tube Detector and Amplifier Action. 21. Radio Frequency Amplification. 22. "Superhets." 23. R. F. Amplifiers; Tuning Coils. 24. Audio Amplifiers. 25. Speakers. 26. Battery Operated Receivers. 27. Power-Supply Units. 28. Elec. Receivers. 29. Automobile and Aircraft Radio. 30. Phono Pickups; Sound Systems. 31. Short-Wave. 32. Photoelectric Cells; Cathode-Ray Tubes. 33. Television. 34. Antennas and Grounds. 35. Testing; Servicing. 36. Sound Films. . . 856 Review Questions!

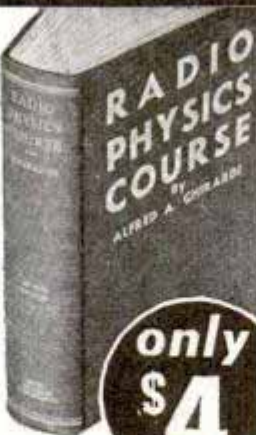

only \$4

SEND NO MONEY!

USE IT 5 DAYS—OUR RISK! Don't pay us—pay the postman! Our Money-Back Guarantee protects you 100%. So there's no need to postpone your radio training another day! You risk nothing—but you'll lose your great opportunity, unless you ACT AT ONCE!—and—

MAIL THIS COUPON TODAY!

RADIO & TECHNICAL PUBLISHING CO.,

45 Astor Place, New York, Dept. PM-103.

Please send me copy of RADIO PHYSICS COURSE. I will pay the postman \$4, plus C.O.D. charges, on the understanding that I may return the book within 5 days and get my money back immediately if not fully satisfied.

NAME.....

ADDRESS.....

CITY.....STATE.....

Send free descriptive literature.

MECHANICS-WELDERS - COLLISION MEN

GOOD JOBS and Mighty GOOD PAY

Do you want to earn big money? If so let us know which of the following trades you prefer. You learn by doing. Practical work. Expert teachers. Low tuition. Personal attention. It will pay you to investigate AT ONCE. Just check the courses you'd like to take and mail today. You will receive full information, absolutely without cost or obligation. But don't delay.

Check the Trade You'd Like to Learn

- | | |
|---------------------------------------------------------------------|-------------------------------------------------------------|
| <input type="checkbox"/> Complete Auto Mechanics (including Diesel) | <input type="checkbox"/> Electric Arc and Acetylene Welding |
| <input type="checkbox"/> Auto Collision | <input type="checkbox"/> Spray Painting |
| <input type="checkbox"/> Metal Finishing | <input type="checkbox"/> Body and Fender Bumping |

Ask about our "Pay After Graduation Plan"

Name

Address

Mail the above at once to

MICHIGAN TRADE SCHOOL
3730 Woodward Ave. Detroit, Mich.

Write for FREE FOLDER

Be a Food Distributor

FREE OUTFIT!

Own a steady route distributing delicious food products. Profits at once and all year 'round. Fast selling, quick repeating foods and other home necessities—over 200 nationally known products. Complete Outfit, including large assortment of full size packages—FREE to reliable persons. Full or part time. No experience needed. Liberal credit plan. Old reliable company. Write quick for my Free Offer. E. J. Mills, 8011 Monmouth Ave., Cincinnati, Ohio.



STUDY ENGINEERING AT HOME

Earn a Degree at Home

From A Chartered Institution Of Higher Learning Employers Demand Degree Men For Key Positions

88 Degree Courses in Electrical, Mechanical, Civil, Structural, Diesel, Architectural, Drafting, Automotive, Aeronautical, Radio, Refrigeration, Air Conditioning, Highway, Mining, Geology, Petroleum, Marine, Industrial, Chemical Engineering; Arts; Sciences; Philosophy; Psychology; Chemistry; Education; Business Training; Law; etc. McKinley-Roosevelt Graduate College, 4238 Clarendon Ave., Chicago

ENGINEERING

DEGREE IN TWO YEARS

TECHNICAL AND APPLIED COURSES, Nonessentials omitted. TIME AND MONEY SAVED. Degree 2 yrs., diploma 1 yr. Electrical, Mechanical, Architectural, Structural, Civil, Aeronautical, Highway. All courses include Air Conditioning, Electric Refrigeration and Diesel. Short intensive courses 3 and 4 months in Electricity, Power Plant, Diesel Electric, Electric Refrigeration, Drafting. Extensive modern equipment. LOW TUITION. Part-time work for room and board. Thousands of successful graduates in U. S. and foreign lands. Approved by Industry, endorsed by educators, recommended by alumni. One and two-year courses start in Sept., short courses open year round. 40th YEAR. Residence courses. Catalog free.

FINLAY ENGINEERING COLLEGE

1001 Indiana Avenue

Kansas City, Mo.

VOICE

100% Improvement Guaranteed

We build, strengthen the vocal organs—*not* with singing lessons—but by fundamentally sound and scientifically correct silent exercises... and absolutely guarantee to improve any singing or speaking voice at least 100%. Write for wonderful voice book—sent free. Learn WHY you can now have the voice you want. No literature sent to anyone under 17 years unless signed by parent.

PERFECT VOICE INSTITUTE, Studio 1357
64 E. Lake St., Chicago

MAKE MONEY AT HOME!

Learn to color photos and miniatures in oil. No previous experience needed. Good demand. Send for free booklet, "Make Money at Home" and requirements.

NATIONAL ART SCHOOL
3601 Michigan Ave. Dept. 1357 Chicago

Earn Cash at Home!

We paid M. M. \$1174 for exceptional "cellar crop" SNOW-KING mushrooms! Big free picture book tells if your cellar, shed, barn suitable. We furnish materials, buy all crops. Write today. Est. 1908.

UNITED CO., 3848 Lincoln Ave., Dept. 306, Chicago.

Only 16c A Day Puts This Arc Welder IN YOUR SHOP

WORKS ON 110-VOLT A. C.

Now it is EASY for every inventor, laboratory, home workshop owner, garage, repair shop, and factory to afford a complete electric welding service. Remarkable New Commonwealth Arc Welder Model 75-UL—yours for only 16c a day. Instant-change heat selector. Six welding heats—including EXTRA LOW heat for welding fenders and light sheet metals. ALL coils insulated with amazing new FLEXIBLE GLASS—for CONTINUOUS-DUTY welding and complete protection against moisture, acid fumes, arc or rot. ABSOLUTE GUARANTEE. USE IT ANYWHERE. Simply plug into 110-Volt socket. Cost only few cents an hour to operate. Easy to strike and hold arc. Sensational low price includes Helmet, Welding Cables, Electrode Holder, Welding Rods, easy instructions, etc. Nothing else to buy. Stop throwing away profit! Do your own welding. Get Complete free details.

Commonwealth Manufacturing Corp., Dept. C-51, 4208 Davis Lane, Cincinnati, Ohio

PATENT and SELL your INVENTION

A Simple Recipe for Inventive Success

PROBABLY the simplest recipe for inventive success would be this: First, a practical, useful invention; second, a good strong Patent; third, a buyer or a market. The inventor needs all three to get anywhere. Lacking any one, he is likely to get nowhere. The recipe is simple. Working it out isn't so simple. That is why inventors—and others inventively inclined—have found the two books shown here so helpful. We've gone into each part of the recipe carefully. Exactly what is an invention? We tell you. What is a strong patent? We tell you. How can I go about finding a buyer? We tell you.

Many Questions Answered

But there's much more. For example, just how an Application for a Patent is made; how an inventor can safeguard himself with dated sketches as he goes along; how the pertinent Patent Office records are checked to see what other inventors may have done along the same line; how some successful

inventors have secured financial backing; simple ways to contact manufacturers; and many other points.

41 Years in the Business of Helping Inventors

The world needs, can use and will pay for practical, useful inventions. Manufacturers are on the alert for new articles, or improvements that will help them increase sales. Maybe you have one. Maybe not. These books will help you in deciding that. From that standpoint alone, they are valuable.

For more than 41 years, it has been our business to help inventors. We answer your questions and supply complete information about Patent procedure, costs, steps to take, kind of sketch or model needed, and much more. Our staff is made up of experienced Registered Patent Attorneys, Draftsmen, Searchers. Fees are reasonable—deferred payments arranged. Whether your idea is large or small, finished or still in the rough stage, you should have the facts both about Patenting and Selling. The information which we give you—based on long experience with thousands of inventors—is yours for the asking. No need to delay. These two books of facts may save you time, trouble, money, even later disappointment. Return the coupon—or write us a confidential letter—today.

115 Mechanical Movements Shown

In our book "Patent Protection" you will find illustrated 115 different mechanical movements. Maybe you'll find just what you need to work out some of your own ideas. Many other interesting pictures are shown in this book. Both books and an "Evidence of Invention" form sent to you FREE the same day we hear from you.

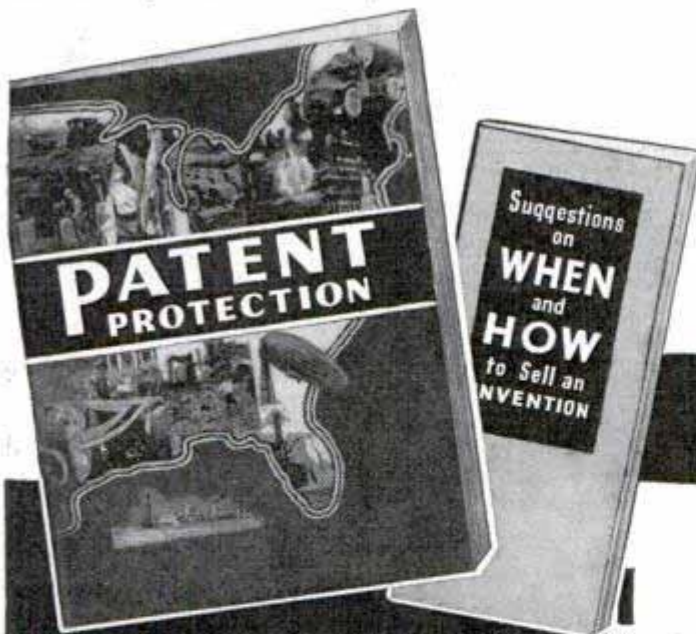

These 2 books tell you
how to go about it ..
Both Sent FREE >

VICTOR J. EVANS & Co.

REGISTERED PATENT ATTORNEYS

MAIN OFFICE: 112-L, VICTOR BUILDING
WASHINGTON, D. C.

Pittsburgh Office: 514-N, Empire Building

Send me FREE copies of your books, "Patent Protection" and "When and How to Sell an Invention."

Name.....

Street and No.....

City or Town.....State.....

Learn by pre-tested Training RADIO *plus* TELEVISION



A flexible Training Plan to fit your immediate needs

National Schools offer optional training planned to fit your present circumstances. You can master Radio, Television, Sound and allied trades by National's exclusive plan. Actual shop and studio training; also complete training if you cannot give up your present employment and income. A definite plan to fit your needs.



FREE LITERATURE

Explains National's pre-tested plan how you can master Radio, all branches, Sound-Recording, Public Address & Communication Systems, Broadcasting, Television. This interesting literature sent post-paid, without obligation to you.

NATIONAL SCHOOLS
Los Angeles (EST. 1905)

Request for **FULL DETAILS**

NATIONAL SCHOOLS, Dept. 10-PMR
4000 S. Figueroa St., Los Angeles, Calif.

NAME _____ Age _____
ADDRESS _____
CITY _____ STATE _____

NOW FIX ANY MAKE OF

AUTO



SIX BIG AUTO BOOKS ALL SHIPPED FREE

on approval. Just mail the coupon and we'll send you a set of these remarkable auto books, just off the press for examination.

GET A BETTER JOB

in the gigantic auto industry at BIGGER PAY—or go into business for yourself and get a share of the huge profits, which are waiting for any man who even half tries to improve himself. Learn auto engineering with these wonder books a new way—with studying or memorizing. Simply use the JIFFY INDEX to look up the answer to any auto problem. Written in simple language, easy to understand. Very newest cars, all covered.

[FREE Privilege of consulting Automobile Engineers of American Technical Society for one year without cost if you mail coupon immediately]

Send promptly and we will include a Brand New EXTRA volume with over 300 pages including ALL 1939 cars with wiring diagrams and data sheets on each.

CAN YOU FIX IT?
These wonder books tell step by step HOW to put your finger instantly on auto troubles and then the quick expert way to FIX them. Newest improvements fully covered. Equal to a complete trade course at less than a fourth the cost.
6 BIG VOLUMES
Brand New Edition
2500 pages, 2000 illustrations, wiring diagrams, etc., including Marine Engines, Aviation Motors, Diesel engines, etc.

AMERICAN TECHNICAL SOCIETY,
Drexel Ave. & 58th St., Dept. A719, Chicago, Ill.
I would like to see the new 6-volume edition of your AUTO BOOKS. I will pay the few cents delivery charges only, but if I choose to, I may return them express collect. If after 10 days use I prefer to keep them, I will send you \$2 and pay the balance at the rate of only \$3 a month, until \$24.80 is paid. Please include free membership and extra Volume 7, as per your offer above.
Name _____
Address _____
City _____ State _____
Attach letter stating age, occupation and name and address of employer and that of at least one business man as reference.

PARKS AIR COLLEGE

PARKS AIRPORT EAST ST. LOUIS, ILL.

Offers YOU COLLEGE and PROFESSIONAL TRAINING Majoring in AVIATION

Accredited by the Illinois Superintendent of Public Instruction, U.S. approved as a Commercial Ground and Flying School and Mechanics' School. Accepted by and cooperating with the United States Army Air Corps in giving flight and mechanical training. Open to high school graduates.

FOUR courses lead to B.S. degrees in Professional Piloting, Aviation Operations, Maintenance Engineering, Aeronautical Engineering, SEVENTEEN TRAINING PLANES are used in professional flight training which prepares graduates for airline flight operations. 74% of graduates enter air transportation in North and South America. 76,000 hours flight training given, 1800 hours being flown monthly. FACULTY of 46 specialists in various fields of aviation. 1569 graduates. Enrollment limited to a total of 300 commercial aviation students. 100-acre airport, 18 buildings devoted to school purposes exclusively. Dormitories and dining hall at the College. Fall term October 2. Send postcard for new 60-page catalog. 13th YEAR Registrar, Dept. PM-10 PARKS AIR COLLEGE, East St. Louis, Ill.

Write and Speak MASTERLY ENGLISH



Learn correct English with Sherwin Cody's new invention. No rules to memorize. Like a fascinating game. Spoken study, 15 minutes each day, quickly gives you command of English. Send for free book, "How You Can Master Good English in 15 Minutes a Day." Write today. SHERWIN CODY SCHOOL OF ENGLISH, 510 Searle Bldg., Rochester, N. Y.

Auto-Diesel

Master a real trade. Auto Mechanics, Diesel Mechanics, Arc Welding, Acetylene Welding, etc. Let us train you to be an expert Auto-Diesel Mechanic and help you get a good job. The cost to you is reasonable. Learn on modern equipment with tools under experienced instructors. Real shop work. Steam heated buildings. Room and board in our steam heated dormitory. We pay your fare to Nashville. For free catalog write:

Nashville Auto-Diesel School, Dept. 75, Nashville, Tenn.

CARTOON YOUR WAY TO SUCCESS!

DON'T COPY - LEARN TO ORIGINATE!
RAYE BURNS will teach you HOW to CREATE ORIGINAL CARTOONS at home that you can SELL! Course has 26 lessons and 600 illustrations. \$2.85
Send name and address for free details. Only....

RAYE BURNS SCHOOL, Dept. M-4, Box 2194, CLEVELAND, OHIO

Learn PHOTOGRAPHY at Home

Splendid opportunities. Prepare in spare time. Easy plan. No previous experience needed, common school education sufficient. Send for free booklet "Opportunities in Photography", particulars and requirements. American School of Photography, 3601 Michigan Ave., Dept. 1357, Chicago, Ill.

Learn to play..

Easy lessons at home. Inexpensive. 132-page Music Dictionary FREE when you enroll. Stop lessons when you like. Money back guarantee. Write for free details. Harmons Institute, 3016 N. 24th Place, Dept. R-10, Milwaukee, Wis.

Hawaiian Steel Guitar
Spanish Guitar
Piano

STUDY PSYCHOLOGY

HOME-STUDY Courses leading to degrees in Psychology (Ps.D.), Divinity (D.D.). Many others. Standard texts. Send for FREE 32-page Bulletin at once. No obligation.

TEMPLE BAR COLLEGE, INC.
Dept. 55-A, 1620 Thirteenth Avenue, Seattle, Washington, U. S. A.

MAKE MONEY in a CHICKEN BUSINESS OF YOUR OWN



Poultry Farming Pays. Start small way, spare time, make business grow from profits, or prepare for good job in large poultry plant. Harry M. Lamon, nationally known Poultry Expert, tells how, offers system of home study training, showing latest scientific methods, money making secrets. Endorsed by leading colleges and leading poultrymen. Established 20 years. If interested in Poultry write for his big FREE BOOK, "How To Raise Poultry For Profit". It's an eye-opener. Address Harry M. Lamon, Pres. NATIONAL POULTRY INSTITUTE, Dept. 50-B, ADAMS CENTER, N. Y.

LIVE DANGEROUSLY

--- said Nietzsche, Philosopher

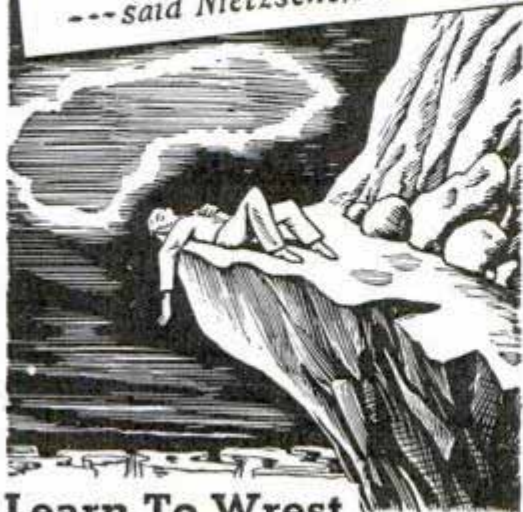

Learn To Wrest The Utmost From Life!

DON'T HOLD BACK—life is yours to live and enjoy each conscious moment. Not in a sheltered, routine living, but only in a tempest of life's forces—which challenges every element of your nature—will you receive that inspiration, those ideas, which will bring you personal supremacy and happiness. *Live boldly but knowingly*—learn to utilize nature's laws to the fullest extent.

A FREE Book of Facts

Let the Rosicrucians (not a religious organization) show you how to direct *little-known* laws of life and mind—used by the sages for centuries. Write for the free book, "The Secret Heritage" today. Address Scribe: **G. D. S.**

The ROSICRUCIANS (A M O R C)
San Jose, California, U. S. A.

LEARN MONEY-MAKING CARTOONING

by America's most famous method. Hundreds of successes! Start today—soon draw for pay. Rush 10c for details and big Picture Chart to test your ability (state age).

THE LONDON SCHOOL, 1039 National Bldg., Cleveland, Ohio



PERSONAL INVENTORY—FREE!

LET SCIENCE PICK A JOB FOR YOU!

TODAY, getting a job or choosing a career is no longer a hit-or-miss task. Science can now accurately determine for you, in advance, just what type of work or profession you are best suited for. **FREE** No money. Send your name on a penny postcard for your own personal Character Adjustment Inventory absolutely free. Why waste time or money groping aimlessly when new scientific methods show you proven steps to success? Write at once for details and **FREE** occupational and social adjustment test! VOCATIONAL GUIDANCE INSTITUTE, Dept. A-110, Greenway Sta., Tucson, Ariz.

AVIATION—Flight Training Simplified!



All flying students and instructors need "Spike" Saladin's new book "The Assistant Flight Instructor." Gives detailed instructions on all maneuvers required for C.A.A. ratings. Corrects errors, reduces dual time, allows more hours solo. Complete, practical, fully illustrated. Approved by authorities. Sent prepaid for \$3.00, cash or C.O.D. Your money returned if not satisfied after 5 days.

AVIATION PUBLISHING CO., 3030B Marshall, Overland, Mo.



SEND FOR THIS **Free!** 1940 RADIO CATALOG

COME AND GET IT!

Brand new 1940 number of the greatest catalog in radio. Out now and **free** to anyone who sends the coupon. It tops anything we've ever done before in completeness, in selection and above all, in value-giving!

THRILL TO IT!

188 pages of bargains in new 1940 radio receivers—all models, all prices. Nationally advertised parts, tubes, equipment. Complete line of Lafayette advanced Sound Systems. Literally thousands of items, catalogued for quick, easy reference. It will save you time!

SAVE WITH IT!

The catalog that "has everything in radio" now saves you money on **everything** you buy! Compare any item listed and see what you save! Don't miss this big **FREE** radio catalog. It will save you money!

SEND FOR IT!

Today—right now—tear out the coupon, paste on a penny postcard and mail. Have your own copy of the **FREE** book that saves people thousands of dollars each year. And have the latest, finest edition as **your** buying guide. Act at once!

Radio Wire Television Inc.
formerly WHOLESALE RADIO SERVICE CO., Inc.

LAFAYETTE RADIO

NEW YORK, N. Y. • CHICAGO, ILL. • ATLANTA, GA.
100 SIXTH AVENUE • 901 W. JACKSON BLVD. • 265 PEACHTREE ST.
BOSTON, MASS. • BRONX, N. Y. • NEWARK, N. J. • JAMAICA, L. I.
110 Federal St. 542 E. Fordham Rd. 24 Central Ave. 90-08 166th St.

Radio Wire Television Inc.
Dept. 7K 9—100 Sixth Ave., New York, N. Y.
Rush **FREE** 1940 Radio Catalog No. 78

Free!
SEND THIS COUPON NOW!

Name.....

PLEASE PRINT

Address.....

City..... State.....

PASTE COUPON ON PENNY POSTCARD

PATENTS

Booklet Free Highest References
Promptness Assured Best Results

Send drawing or model.

ALL BUSINESS GIVEN PROMPT AND PROPER ATTENTION

Listed Patent Lawyer in the latest editions of the Rand-McNally Directory of Bankers and Bank-Recommended Attorneys, published by Rand-McNally & Co., Chicago, Ill.; The Baggott & Ryall Directory of Guaranteed Attorneys, published by Legal Directory Corporation, Boston, Mass.; American Lawyers Annual, Cleveland, Ohio; Bankers Service Legal Directory, published by Bankers Service Co., Boston, Mass.; Eyre's Law List, 9 Park Place, New York City; Snow-Church Directory Co. Lawyers List, published in New York City, and the Central Guarantee Co., Bankers and Lawyers Directories, 630 Fifth Avenue, New York City.

WATSON E. COLEMAN, Victor Building, 724 Ninth Street, N. W.
REGISTERED PATENT LAWYER WASHINGTON, D. C.

INVENTORS PATENT YOUR IDEAS SEND FOR FREE BOOK



HOW TO OBTAIN A PATENT

Written by a Former Member of the Examining Corps (1922-24) of the U.S. Patent Office. If you want to profit by your idea, you should take steps to apply for a U. S. Patent at once. Your first step is to get this Free Book. This interesting illustrated book contains valuable information you should have. It tells you fully how to obtain a patent on your idea in the quickest way. With this Free Book you will also receive a "Record of Invention" form on which you can easily record your idea. Personal and Confidential Service: Your case will be personally handled only by a Registered Patent Attorney who is also a Former Member of the Examining Corps of the U. S. Patent Office. All communications confidential.

MAIL COUPON TODAY for FREE PATENT BOOK and RECORD OF INVENTION Form.

CARL MILLER

REGISTERED PATENT ATTORNEY
FORMER MEMBER EXAMINING CORPS U. S. PATENT OFFICE

Woolworth Bldg., 35th Floor, Dept. 109A, New York City
MILLER BUILDING, Dept 109A WASHINGTON, D. C.

Please send me your Free Book, "How to Obtain a Patent," and your "Record of Invention" form.

NAME.....

ADDRESS.....

PATENTS *Mail Coupon for FREE BOOKLET*

of cost and other useful information about patents. Registered patent attorney and former Patent Office Examiner.

EUGENE H. PURDY

1421 International Building, Washington, D. C.

NAME.....

ADDRESS.....

PATENTS—TRADE MARKS

All cases submitted given personal attention
Form "Evidence of Conception" with instructions
for use and "Schedule of Government
and Attorneys' Fees"—FREE!

LANCASTER, ALLWINE & ROMMEL

Patent Law Offices

412 Bowen Bldg. Washington, D. C.

When writing please mention Popular Mechanics

Inventions Wanted Patented or Unpatented

We have been successfully selling inventions, patented and unpatented, since 1924. Write for proof, and tell us what you have for sale.

Chartered Institute of American Inventors

Dept. 4, Barrister Building, Washington, D. C.

INVENTORS who derive largest profits know and need certain simple but vital facts before applying for patents. Our book, Patent-Sense, gives those facts; sent free. Trade Marks—Copyrights.

LACEY & LACEY, Est. 1869, 635 F St., N. W., Dept. 5, WASHINGTON, D. C.

RUPTURED?

Get Relief This Proven Way

Why try to worry along with trusses that gouge your flesh—press heavily on hips and spine—enlarge opening—fail to hold rupture? You need the Cluthe. No leg-straps or cutting belts. Automatic adjustable pad supports at real opening—follows every body movement with instant increased support in case of strain. Cannot slip whether at work or play. Light. Waterproof. Can be worn in bath. Send for amazing FREE book, "Advice To Ruptured" and details of liberal truthful 60-day trial offer. Also names of grateful patrons in your neighborhood. Write.

CLUTHE SONS, Dept. 31, Bloomfield, New Jersey



BUCHSTEIN'S FIBRE LIMB

Correctly fitted. Strong, light, neat,

cool, soothing. Braces for

all deformities. On terms.

D. BUCHSTEIN CO.

610 3rd Ave. South, Minneapolis, Minn.

MYSTERIOUS DEVICE WELDS BRAZES AND SOLDERS

ANYONE CAN OPERATE



Now, an electric welding, brazing and soldering Torch, complete with power unit, goggles and supplies. Works INSTANTLY off any light socket. Does a thousand and one repair jobs at amazing LOW COST on aluminum, iron, steel and other metals. Indispensable for Auto, Body and Fender Repairs, and home repairs—shop, factory, farm, engineer, janitor, sheet metal, radio and bicycle repairs. Anyone can handle without previous experience with our simple 10-DAY HOME TRIAL

Write at once for Special Introductory Low Price Offer. Try 3 in 1 Electric Torch for 10 days at our risk, or get one free by helping to introduce it. ELECTRO-TORCH CO., 2613-EU Michigan Ave., Chicago

To PROTECT YOUR INVENTION—Use this coupon, NOW

Delays are dangerous and may be very costly. My personal service assures prompt action, strict confidence, and a minimum of expense. I suggest that you send me a model or drawing, or sketch and description of your invention, and \$5.00. I will make a search and report

promptly as to its patentability and send you a copy of my 72-page booklet. Or, if you prefer to read my booklet first, mail the attached coupon at once. I will also send my "Record of Invention" form. (Over 38 years experience as a Registered Patent Attorney.)

L. F. Randolph, 302-D Victor Bldg., Washington, D. C.

Please send me at once, free of charge, your 72 page booklet and "Record of Invention" form.

Name.....

Address.....

A PERSONAL CONFIDENTIAL PATENT SERVICE

This MAGIC BOX

Turns Spare Time into Cash

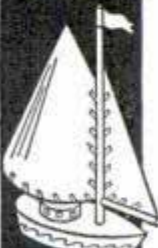

UP TO **\$40 A WEEK AT HOME!**

No soliciting! No canvassing! We show you how to make big money decorating fast-selling Giftwares. We start you with the big \$10 Artist's Outfit shown above. We supply you with \$150 worth of Giftwares free of extra charge and show you how to dispose of them without leaving your home. We give you 29 Tested Plans for making money. One Fireside Member says, "I made \$100 on furniture in one week." Another writes, "My sales were \$500 for 5 weeks. This is my first year," R. M. P., of Ill., says, "I did \$3,500 worth of business last year and over \$12,000 this year." D. W., New Mexico, reports, "I would not take \$1000 for my Course."

No Experience Needed

You too may have a splendid income opportunity with Fireside. No tiresome study. You learn by doing. No artistic ability necessary. Our easy 3-Step Method makes the work easy to learn and easy to do and fits you to



make good money practically from the start.

Quick Sales in Your Home

No need to leave the house to dispose of everything you make. Our new automatic salesman does all the selling for you. Designed to quickly find cash buyers for all the Giftwares you can turn out.

No Cost Plan

Mail coupon for Free Plan showing how to earn your course and Big Profits besides.

FIRESIDE INDUSTRIES
Dept. 66-P Adrian, Mich.

Fireside Industries, Dept. 66-P, Adrian, Mich. Send me FREE Book on Home Decorating for a big steady income. Also details of plan that will pay for my Course and give me big profits besides.

NAME.....
ADDRESS.....
CITY.....STATE.....



BROOKLYN YMCA TRADE SCHOOL



Unlimited Instruction until you have mastered every part of Course without additional charge.

Full Shop Equipment
Unexcelled Instruction
Fireproof Dormitories.

Special Privileges. **Check your interests** on coupon to receive free literature.

- Mechanical Pre-Engineering
- Diesel Engines Oil Burner
- Diesel Pre-Engineering
- Aeronautical Pre-Engineering
- Aviation Mechanic Welding
- Auto Mechanic Talking Pictures
- Refrigeration Air Conditioning
- Television and Radio Mechanic
- Architectural-Mechanical Drafting
- Machinist Tool and Die Making
- Armature Winding Electrical

MAIL COUPON

1117 Bedford Ave., Dept. P.M.
Brooklyn, New York City, N. Y.

Name.....

Address.....

Inventors—Get Patent Facts!

- How to obtain a patent...
- How you can commercialize your patent...
- Why you need a patent...
- Correct way to proceed and costs...



Our 64th Year!

Your Ideas May Be Worth Money

If you have already constructed a device, or merely have an idea on paper... now is the time to give it the protection you have the right to enjoy. Read patent facts sent to you free of charge, and without obligation. You can feel perfectly sure in dealing with this reputable firm. Write today—just request our free booklets and special "Certification and Invention" form. Prompt service and best results.

C. A. SNOW & CO.

Registered Patent Attorneys Since 1875

1910 Snow Building

Washington, D. C.

Answers in Free Books

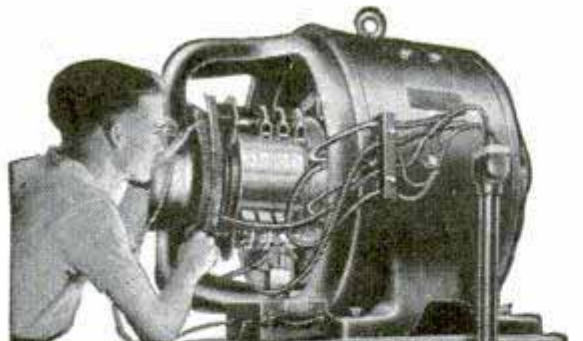

**TRAIN FOR
A GOOD PAY JOB IN
ELECTRICITY
ON REAL MOTORS, GENERATORS, ETC.**

PAY TUITION AFTER GRADUATION

Practical training on full size electrical equipment. "Learn by Doing"—12 weeks shop training. No previous experience or advanced education needed. Send the Coupon NOW for Big Free Illustrated Book. Learn about the "Pay Tuition After Graduation Plan." "Part Time Employment Plan." "Job After Graduation Service." NOW... Diesel electricity, Air Conditioning and Electric Refrigeration training at no extra cost.

MAIL THIS COUPON TODAY

H. C. LEWIS, President
COYNE ELECTRICAL SCHOOL
500 S. Paulina St., Dept. 79-72, Chicago, Ill.
Please send me your Big Free Book and details of your "Pay Tuition After Graduation Plan."

Name.....
Street.....
City..... State.....



DRAFTING

BOOKS SENT FREE!

ON APPROVAL
5 VOLUMES BRAND NEW EDITION
Only 15 minutes a day with these WONDER BOOKS can prepare you for a good drafting job in less than a year. Mechanical and architectural drafting from simple straight lines to important complex plans. *A step at a time!* Built especially for beginners, for men with only grammar schooling. Drafting room practice, PLUS ENGINEERING, made easy and clear. Includes complete information on blue print reading for building and machine trades.

Big Field Big Demand Big Pay
Competent draftsmen are urgently needed right now in all building and manufacturing lines at \$30.00 to \$75.00 a week. That's just the beginning—FOR DRAFTSMEN HAVE THE BEST CHANCES FOR ADVANCEMENT. Pleasant, fascinating work, easy to learn and do. Learn quickly with these books—send coupon for a set and see for yourself.

A year's consulting membership in the American Technical Society now given to all readers of this famous cyclopedia of drafting. Many say that it is worth more than the cost of the books.

Complete set of drawing instruments if you send for these drafting books NOW. These instruments are made of the finest of German silver, are absolutely accurate and are packed in velvet lined leatherette pocket case. Real \$10 value, but included with these books.

**AMERICAN TECHNICAL SOCIETY
Dept. D719, Drexel at 58th St., Chicago, Ill.**

For Beginners or Experts

Written, so you can understand every word, by 22 well known engineers and architects. Deluxe flexible binding, nearly 2,000 pages, 1546 blueprints, charts and diagrams; prepares you for a good drafting job in mechanical or architectural lines. Sent for 10 days' free use if you mail coupon immediately.

These Instruments Included



American Technical Society, Dept. D719, Drexel at 58th St., Chicago, Ill. Send for 10 days' trial. New 5 volume set of drafting. I will pay the few cents delivery charges. If I wish, I may return books in 10 days and owe you nothing but if I decide to keep them, I will send \$2.00 after 10 days, then only \$3.00 a month until \$24.80, the advertising price, is paid. Send latest edition and include drawing instruments and Membership Certificate.

Name.....
Address.....
Attach letter stating age, occupation, employer's name and address and that of at least one business man as a reference.

POPULAR INVENTIONS

(Continued from page 24A)

PUTTING a brake on roller skates has long been the goal of many inventors.

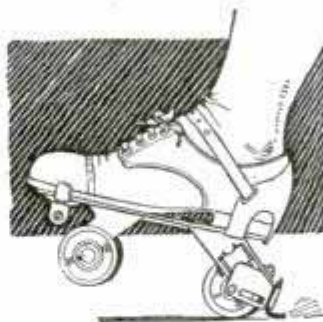

A new version of the skate brake, patented recently, calls for attachment at the rear of the skate of a small brake shoe that rides just above the skating surface when the

skate is in normal operating position. The brake is applied by lifting the toe of the skate off the floor, tilting the skate until the brake contacts the surface.

FOR attachment to the handle of golf clubs, screwdrivers and the like, a new

device is handy for picking up golf tees, screws or nails without bending over. On the golf course, the player may pick up a tee by turning the handle of the club downward and engaging the point of the tee in holes in the attachment. In a similar way, screws and nails may be picked up quickly by the user of a screwdriver or hammer.



FOOD may be packed into large cans which may be converted into bird



houses when emptied, a new patent provides. The can is a double receptacle, the inside container being adapted for the packing of merchandise. When that is removed,

the outside can is convertible into a bird house by simply knocking out a prepared plug in one side, inserting a perch in the hole and replacing the outside container cover. A hook attached to the cover facilitates hanging the house in a tree.

(Continued to page 54A)

BUY DIRECT FROM MIDWEST FACTORY AND SAVE UP TO 50%

ON THIS NEW 1940, 14-TUBE TELEVISION ADAPTED MIDWEST

30 DAYS TRIAL



\$19.95
COMPLETE CHASSIS WITH TUBES AND SPEAKER

PUT THIS CHASSIS IN YOUR PRESENT CABINET

See Midwest's Answer to TRADE-INS!

We believe that this especially designed 14-tube 1940 Television-Adapted Midwest is today's biggest radio value. Now, you can enjoy the mighty power of 14 latest type tubes—plus an advanced circuit—plus advanced features—plus astonishing foreign performance—plus *television adaptation*—FOR LITTLE MORE THAN THE COST OF NEW TUBES! The famous Midwest 30-Day Home Trial Plan enables you to try this or any other Midwest radio for 30 days in your own home before you make up your mind.

Anten-A-Scope (Built-in Super Aerial System) eliminates aerial and ground wires. Just plug in and play!

Only Midwest Offers the Exclusive Organ-Fonic Tone Filter on It's 17-Tube, 5-Band Radios at \$69.95, Up

This is just one of the many exclusive features of 1940 Midwest 17-tube models. It helps achieve true depth and greater richness of tone that double radio enjoyment. The illustration at right shows the Organ-Fonic Tone Filter and dual speaker arrangement. The organ-type resonating pipes (of graduated sizes) more than triple the baffle effect, vastly improve tone... do away with booming, "barrel-like" tones... result in beautiful concert realism. The Organ Key Tone Control (a 12 and 17-tube feature), enables you to secure fourteen amazingly beautiful tone combinations by touching any one of four keys.

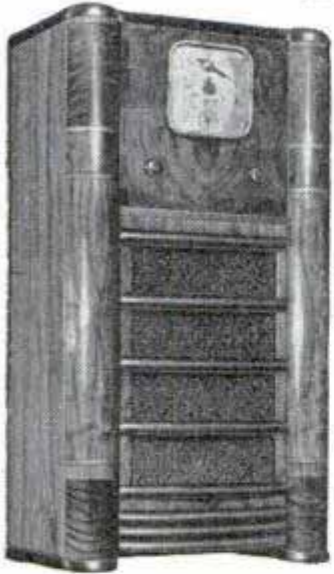
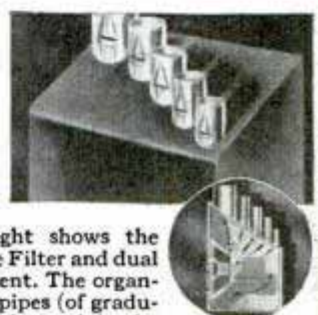

14-TUBE Cabinet Model
only **\$29.95** COMPLETE

Just think! Here is a 14-tube radio—complete in cabinet—at a price you would ordinarily pay for a 10-tube set. We say it's the outstanding bargain of the year!

NEW EASY PAY PLAN USE YOUR CREDIT!

And now, Midwest's Easy Pay Plan enables you to enjoy finer radio performance, and to pay for your Midwest on amazingly easy and fair terms. So why deny yourself any longer?

Why be content with an ordinary radio when you can own a modern, powerful Midwest which is

adapted for television! The Easy Pay offer does not apply to either the \$19.95 chassis or the \$29.95 cabinet model. It does apply to all other Midwest models shown in the FREE 1940 catalog.

17-TUBES 5 BANDS EXCLUSIVE FEATURE MODEL "A"

\$69.95 COMPLETE

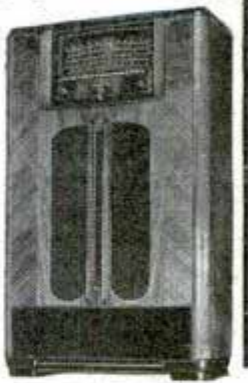

PASTE COUPON ON 1¢ POSTCARD... OR

MIDWEST RADIO CORPORATION
Dept. 15-E Cincinnati, Ohio
Send me your new FREE 1940 catalog, complete details of your liberal 30-day Trial Offer and Factory-To-You Prices.

Write Today!

Name..... (PLEASE PRINT CLEARLY)

Address.....

Town..... State.....

User-Agents Make Easy Extra Money. Check Here for details.

MIDWEST RADIO
DEPT. 15-E MIDWEST RADIO CORPORATION...CINCINNATI, OHIO, U.S.A.
Manufacturers of Quality Radios Since 1920

Be An ARTIST!



LEARN TO DRAW

—at home in your spare time

The fascinating field of Art offers opportunity to both men and women. Trained Artists are capable of earning \$30, \$50, \$75 a week. We teach you right at home for a successful career in—

COMMERCIAL ART ILLUSTRATING CARTOONING

For 24 years W. S. A. graduates have been "making good" in Art—YOU CAN, TOO! No previous Art experience necessary—our instruction is practical and thorough. Write for Booklet—"Art for Pleasure and Profit," fully describes course and TWO BIG ARTISTS' OUTFITS included. Clip coupon—mail today.



FREE BOOK gives details!

Washington School of Art, Studio 1210M, 1115—15th St., N. W., Washington, D. C.

Yes! I am interested in learning to draw. Please send me your Free Book, "Art for Pleasure and Profit."

Name..... Age.....
 Address.....
 City..... State.....

MECHANICS

KNOW YOUR CAR

You Need this Book

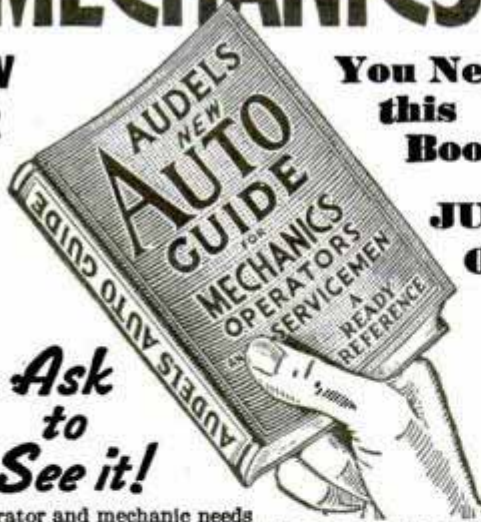

JUST OUT!

Ask to See it!

Every operator and mechanic needs AUDELS NEW AUTO GUIDE. This book saves time, money and worry. Highly endorsed. It presents the whole subject of auto mechanics: 1—Basic principles, 2—Construction, 3—Operation, 4—Service, 5—Repair. Easily understood. Over 1500 pages—1540 illustrations showing inside views of modern cars, trucks and buses with instructions for all service jobs. Diesel Engines fully treated, \$4 fully illustrated. To Get This Assistance for Yourself Simply Fill In and Mail Coupon Today.

4 COMPLETE • PAY ONLY \$1. A MONTH ←

THEO. AUDEL & CO., 49 WEST 23rd STREET, NEW YORK
 Please send me postpaid AUDELS NEW AUTOMOBILE GUIDE (\$4) for free examination. If I decide to keep it, I will send you \$1 within 7 days; then remit \$1 monthly until purchase price of \$4 is paid. Otherwise, I will return it to you promptly.

Name.....
 Address.....
 Occupation.....
 Reference..... P.M.

When writing to advertisers please mention Popular Mechanics

Helps You EARN MORE

SAVES TIME and MONEY



Thousands of Money-Making, Time and Labor-Saving Ideas You Can Use

Shop Notes will help you on your job—on home repairs—on the farm—in hundreds of different ways—will make money for you and save you time and money.

If you do machine shop work of any kind, sheet-metal work, painting, carpentry, auto repairing, farming, concrete work, plumbing, electrical work, welding, building, glass work, general repairing, tool-making, poultry raising, masonry or home repair work, you need the Shop Notes Library.

NOW READY—

SHOP NOTES for 1940

214 Pages • 384 Articles • 762 Illustrations

Just published—the world's biggest 50 cents' worth. Packed with new shop kinks, short cuts, helpful ideas, time and labor saving methods you can use. Here are just a few of the many subjects covered:

- | | |
|-----------------------------------------|--------------------------------------|
| Novelty Paint Finishes | Building and Using a Wattmeter |
| Auto Mechanics | Cementing Glass, Metal and Celluloid |
| Drill-Vise Milling Unit | Making Precision Machine Tools |
| Density Meter for Separation | Tricks of Soldering |
| Negatives | Universal Photo Enlarger |
| Modern Plant Stands | Wood Finishing |
| Hand Loom Weaves Cane Webbing | Paint Spraying |
| High-Speed Cutting with Abrasive Wheels | Negative Dryer |
| Motorized Lawn Mower | Making Silk Stencils |
| Making Choke Coils | Tap and Die Holders |
| Gem-Cutting Bench | Correct Centering |
| Tractor Built from Old Car Parts | Motorized Garage Doors |
| Making Unit Castings | |

Special BARGAIN OFFER

7 SHOP NOTES VOLUMES While Present Supply Lasts **\$2.98**

Start your Shop Notes Library now. We will send seven issues, (approximately 400 articles in each) now in print, including the new 1940 Shop Notes and those published in 1932-1935-1936-1937-1938 and 1939—7 Shop Notes in all—for only \$2.98. Single books 50 cents each. Offer withdrawn when present supply is sold. Order today and avoid disappointment. If you have earlier years, rush order for 1940 Shop Notes. Money refunded if not satisfied.

Mail Coupon.... Pay Postman

POPULAR MECHANICS PRESS, DEPT. 1039, 200 East Ontario St., Chicago

- Send 7 Volumes Shop Notes Library as offered. I enclose \$2.98
 Send C. O. D. I will pay postman price and small amount of postage.
 Send 1940 Shop Notes at once. Remittance for 50 cents enclosed.

Name.....
 Address.....
 City..... State.....

*C. O. D. applies to U. S. and possessions only. If you reside elsewhere, remittance must accompany order.

AVIATION WANTS MORE LINCOLN TRAINED MEN



78 more Lincoln Graduates step into good-pay positions in Aviation! Exceptional opportunities for many more Lincoln Trained Men! Now is the time to start training. Employment opportunities at their best right now!

U. S. ARMY AIR CORPS APPROVES THIS LINCOLN SCHOOL AS TRAINING BASE FOR STUDENT CADETS. Also APPROVED by U. S. Civil Aeronautics Authority for Flight and Mechanics Training. 15 Civilian Training Planes; 14 Air Corps Trainers; two Airports; 14 Shops and Laboratories—every facility to prepare you for immediate employment in Aviation. **PREPARE HERE FOR POSITION AS GOVERNMENT RATED PILOT or MECHANIC; as AERONAUTICAL ENGINEER, SHEET-METAL MAN or WELDER.** Learn to fly our fast modern Airplanes; to overhaul, rebuild and repair Airplanes and Engines. Learn Aircraft Design and Construction; Aircraft Sheet-Metal or Welding. We teach you how! **EMPLOYMENT SERVICE GIVEN.** We assist Graduates in locating employment. Our Graduates regularly taking good positions. Part-time employment for board and room while in training.



MAIL COUPON TODAY for complete information.
LINCOLN AIRPLANE & FLYING SCHOOL
 5610 AIRCRAFT BLDG., LINCOLN, NEBRASKA

LINCOLN AIRPLANE & FLYING SCHOOL
 5610 Aircraft Bldg., Lincoln, Nebraska.

I want to get into Aviation. Please send me complete information about Lincoln Training.

Name..... Age.....
 Address.....
 City..... State.....

Learn THE GREER SHOP WAY!

WELDING **BE A TRAINED MAN**
AIR CONDITIONING You can earn more if you learn a trade—
DIESEL qualify quickly the easy JOB-SHOP way.
BODY and FENDER Big shops—lots of equipment—experts
AUTO teach you. Established 37 years. Employment
MACHINE SHOP help. Write TODAY for FREE in-
 formation and special offer.
GREER SHOP TRAINING, INC.
 2024-6 S. Wabash Ave., Chicago, Ill.



Know Electricity as Experts Know It—and Get an Expert's Pay!

What about your future? Who is safe today? Surely not the man who is contented to stand still! Know your job thoroughly—prepare yourself for jobs ahead. To do just this thousands of men have used

The Croft Library of Practical Electricity

The Croft Library is a complete electrical educator. It is founded on practice—on 20 years of shirt-sleeve experience—on work as it is actually done. It is jammed from cover to cover with the kind of hard-headed facts you want. Written so that the beginner can easily understand it, yet so sound, so thorough, that it is the daily guide of 39,000 highly paid electrical workers and engineers. Croft tells you the things you need to know about motors, generators, armatures, commutators, transformers, circuits, switchboards, distribution systems—electrical machinery of every type—illumination in its every phase—the most improved methods of lighting—lamps and lamp effects, etc.—how to do a complete job, from estimating it, to completion.

6 volumes, 2155 pages—only \$16.50
No money down—Easy payments.

Fill in and mail the coupon attached and we will send you the entire set of six volumes for ten days' Examination on approval. We take all the risk—you assume no obligation. If you decide to keep the books, send \$1.50 in ten days and the balance at the rate of \$3.00 a month. Send the coupon NOW and see the books for yourself.

EXAMINATION COUPON

McGRAW-HILL BOOK CO., 330 W. 42nd St., New York

Send me for ten days' examination on approval the Croft Library of Practical Electricity. If satisfactory I will send you \$1.50 in 10 days and \$3.00 monthly until the price of \$16.50 is paid. If not wanted, I will return the books postpaid. (To insure prompt shipment write plainly and fill in all lines.)

Name.....
 Home Address.....
 City and State.....
 Position.....
 Name of Company..... P.M. 10-39

FAILURE? Are you discouraged, bewildered, seeing others forge ahead to success, wealth, power while you remain in the ranks? Do you ever ask what it is that makes them successful where you fail, when they have no more intelligence than you? Don't give up... I can help you! Send your name and address to H. C. McCulloch, Desk 610, Pershing Square Bldg., New Rochelle, N. Y.

BE HEALTHY, STRONG!

Follow the "GOOD" System of Physical Training. Build a strong and shapely body. Send for our free booklet "Physical Fitness" and let us show you how it can be done!

GOOD BARBELL CO. Dept. P, Reading, Pa.

DIESEL Get BETTER training. Realize Adcox advantages. Located in Pacific Northwest, a Diesel center. Established 28 years. Modern equipment, expert instructors. Close cooperation for YOUR success. Earn room and board while learning. Send for free book, "What Every Man Should Know About Diesel". Dept. 18. Home study and resident courses.

L. L. ADCOX TRADE SCHOOL
 Portland Oregon

A AND N SUPPLY CO.

Bargains—Military, Sport Goods, Firearms, Clothes, Shoes, etc. Send 10¢ for new catalog, to be redeemed on first order.

EST. 1868 **A & N Supply Co., 4772 Lester St., Richmond, Va.**

MONUMENT \$9.00 UP WE PAY FREIGHT

Genuine Marble also Granite. Free Lettering. Erected if desired. Thousands of satisfied customers. Write for Catalog and samples.

U. S. MARBLE & GRANITE CO. A-18 Oneco, Fla.

U. S. GOVERNMENT JOBS



City and Rural Mail—City Post Office Clerks, Clerks at Washington, Stenographers-Typists, File Clerks, Accountants. Many other government jobs.

Common education sufficient
 Mail coupon at once

FRANKLIN INSTITUTE, Dept. P195
 Rochester, N. Y.

Sirs: Rush to me without charge—copy of 32-page book, "How to Get U. S. Government Jobs," with list of dependable positions for men-women and full particulars telling how to qualify for them.

Name.....
 Address.....

How Big Is YOUR PAY-CHECK?

If you earn under \$3,000, Higher Accountancy may be the answer for you

THE size of my pay-check? What business is it of yours?" Perhaps that's the first reply that comes to your mind.

But—stop a moment. It really *is* our business—to help men just like you. In fact, it's been our business here at LaSalle for 30 years.

If your pay-check isn't all that you'd like it to be, why not consider accountancy? Why not become a member of this well-paid and respected field? Why not, in short, prepare yourself to earn real money—insure a good home for your family—a new car—an education for the growing youngsters—a bank account for a rainy day . . . these and many more of the precious things in life?

Maybe you're one of those ever hoping for "breaks" that will give you a higher standard of living. Yet that's precisely what most of 30,000,000 other employees in this country are doing.

Not all of them, of course. Here and there you find ambitious men who aren't depending on luck to carry them ahead. They're following a tested path to increased earnings—leaving nothing to mere chance. They're *training* themselves for better jobs—every week spending a few hours in serious but interesting study at home.

Some day, as expert bookkeepers and later as accountants, these determined men will have standing and a considerably larger income—in a profession that pays and pays well.

Why don't *you* do as they are doing—take advantage of LaSalle training? Even though you do not know the fundamentals of bookkeeping now—you nevertheless may have an excellent opportunity to master accountancy. Many others have done it.

Perhaps you're asking yourself, "But don't these others possess natural ability that I lack? Don't I need a special talent for all this?"

Ask rather, "If I do my part, won't *I* get results, too?"

You will! For all it takes is intelligence, serious study and work—not genius. Under the LaSalle system you solve problems by simple steps . . . from day to day, as an expert accountant does. You use the same basic principles. And when these problems become difficult and puzzle you, you get counsel that could be matched only through personal coaching by a battery of experts in a big accounting house.

In a comparatively short time, you train yourself in *Elements of Accounting, Principles of Account-*



ing, Auditing, Cost Accounting, Business Law, Organization, Management and Finance. The training—complete and intensive all the way—takes you right into C.P.A. coaching if you desire.

Later, when you're an accountant, it may be possible to go into business for yourself as a public accountant and be independent. Or, if you choose to work for someone else as an executive accountant, it well may be for a salary several times that which you draw now.

Write for this FREE book

If you're tired of pinching pennies, investigate accountancy and LaSalle training. There isn't a faster, less expensive or more convenient method to master accountancy. Fill in the coupon and mail. We'll send you our 64-page book, "Accountancy, The Profession That Pays."

Then, when you read all the facts, you yourself will be able to judge best whether you have the will to study and apply your best efforts—toward a more secure future.

LaSalle Extension University

A Correspondence Institution

Dept. 1064—HR

Chicago, Ill.

I want to earn a bigger salary—through accountancy training. Send me, without cost or obligation, your 64-page book, "Accountancy, The Profession That Pays."

Name

Present Position Age

Address City

**WORLD'S
BEST
WANT AD
MEDIUM**

CLASSIFIED

Advertisements



Advertisements in this section, 35 cents per word, each insertion, minimum 10 words, payable in advance
To be inserted under proper classification in November issue, copy should be in our office September 8th
November issue on sale October 1st
Popular Mechanics Magazine, 200 East Ontario Street, Chicago, Illinois

YOU'LL PROFIT

By reading and answering the classified ads in this section. Hundreds of opportunities to make and save money.

Popular Mechanics,
200 E. Ontario St., Chicago, Ill.

Gentlemen:—We have been advertising in your classified section for approximately two years and we find our "ad" is a very good investment for us. We have been keeping a record of the results obtained from our different mediums of advertising, and we find Popular Mechanics exceeding all other form of advertising, in inquiries per dollar spent. Our intention to continue using your classified section indefinitely gives you an idea of the esteem in which we hold your publication as a result-producing medium. We would highly recommend Popular Mechanics to any advertiser who wishes to try out new copy.

(Original letter on file in our office)

Yours very truly,
UNITED CAMERA COMPANY, INC.

AUTOMOBILES—MIDGET CARS

\$1.00 FOR Complete instruction for building your own racing car from Fords, Chevrolets and Willys by Robert M. Roof, engineer of speed equipment, midgets included. Speed equipment for the V-8 Fords and Mercury engines. Nickel aluminum high compression racing heads, per pair, \$58.50; high speed camshafts \$28.50; special valves and springs with locks and keepers \$22.50; Lynite flywheel \$26.50; steel camshaft gear \$12.50; Vertex Scintilla magneto with drive \$85.00; dual ratio rear axles \$89.50; triple cooled copper alloy racing heads for V 60 Fords \$48.50. We regrind your camshaft, four cylinders \$8.50, six cylinders \$12.00, 8 cylinders \$18.00. Terms cash with order in U. S. currency. Export orders shipped by exporters in New York and San Francisco. Our catalogue 25c, fuel dope sheet 75c. Cable address RCO, R. & R. Mfg. Co., Anderson, Indiana, U.S.A.

MIDGET Sportcar plans, 10c. Parts catalog included. Midgets, Box 543-H, Zanesville, Ohio.

MIDGET Racers, two-passenger autos, Midget motorcycles, motorscooters, bicycles, Motors, wheels, parts, plans. New handbook catalog, 90 illustrations, 20c. Midwest, Box 1959-M, Chicago, Ill.

NEWEST Carburetor invention. Highly vaporizes gasoline. Phenomenal mileage. Plans one dollar. Imperial Enterprises, New Toronto, Ontario.

AUTOMOBILE Mechanics who want business or earn extra money write for samples and details of nationally distributed Self-locking Triple-X Piston Rings. Eliminate re-boring. Guaranteed life of car. Franchise valuable. Some territories open. Triple-C Co., 3801 South Racine, Desk O, Chicago.

70 MILES Per hour—Fastest model racing car in competition. Length 19 inches. Wheel base 13 inches. Tread 8 inches. Send for catalog. Aircraft Manufacturing Co., Knickerbocker Bldg., New York City.

FORD V-8's, 1934-39; Chevrolet, 1935-38; gasoline saving device, \$1.00. Walert Co., 3429 No. 10th St., Milwaukee, Wis.

NEW Fifth edition Automobile Racing Book. Tells how to build dirt track bodies, frames, engines. Records, superchargers, rules, formula, plans, stock conversions, roadster racing, fast Fords, \$1.00 postpaid; \$1.15 C.O.D. Ray Kuns, Department 10, Madisonville, Cincinnati, Ohio.

MIDGET Cars, Parts, Plans 50c. Catalog 20c. Derby Midgets, Woodstock, Ill.

MIDGETS! Racecars, sportcars, motorscooters. New bargain lists—over 130 used motors, midgets, parts—20c. Midgets, Box 543-H, Zanesville, Ohio.

AUTO TRAILERS

BUILD The famous, low-cost Jim Dandy Cabin Trailer. Complete plans and instructions 50c. Plans to build the beautiful, streamlined Jim Dandy Cabin Cruiser, \$1.00. Trailer Builders Manual and catalog of trailer parts, supplies and equipment—over 100 interesting, illustrated pages, 25c. Order today. Satisfaction guaranteed. Trailer Supply Co., 411-A Jackson St., Wausau, Wisconsin.

AUTO SUPPLIES AND EQUIPMENT

FREE Wholesale bargain catalogue, auto supplies, tires, tubes, equipment, tools. For dealers only. American, 1189 Bedford Ave., Brooklyn, N. Y.

CRANKCASE Oil refiner for everyone. Plans, specifications, one dollar. Technical Laboratories, East Haven, Conn.

"MOTO-HEATER." Sensational invention starts, stops car engine automatically while parked during cold weather. Thermostatic control. Guarantees warm car, instant starting, perfect lubrication, full battery. Mounts under hood, self-contained. Technical details 25c, sample unit \$8.75, lots of six \$5.50 each. Territorial allotments now. Be first. Millions prospects. Summerheat, Hamilton, Missouri.

VALUABLE Body and fender repair hints, 50c. Max Co., Box 131, W. Palm Beach, Florida.

CARBURETORS For Chevrolet 1932-'38, Brand new, \$6.20. Popular make. Manufacturers Automotive Supply, 1104 S. Sacramento, Chicago, Illinois.

AUTO Owners, mechanics, new liquid compound for leaky radiators and engine blocks. Safe and inexpensive. Formula and instructions \$2.00. Rech Research, 940 Jaeger St., Columbus, Ohio.

OVERHAUL Your car by Mineralite process! Increases compression Checks oil pumping! Complete instructions 50c. Devereaux, Box 212, Battle Creek, Michigan.

BARGAINS—Compressors, welders, battery chargers, car washers, attractively priced. Terms, trial. Write for bargain list. Hobart Automotive Supply, Box M-1095, Troy, Ohio.

STOP Your battery cables from corroding. Method guaranteed. Complete with instructions 35c postpaid. Van, 135 N. 27th St., Camden, N. J.

1939 IGNITION Supercharger \$1.25. E. G. Sales & Mfg. Co., New York.

POWERBALL Your car. More dig. Saves gas. Removes flat spots. Turns 200,000 rpm. Write Powerball, 803 So. Gramercy Pl., Los Angeles.

RE-REFINE Crankcase drainings, request information. Zelball, Mount Holly, N. J.

ACETYLENE Welding outfits, \$32.95; electric welders, \$74.95. Easy-payment plan. Box 331, Hamilton, Ohio.

PLATING Outfits for auto parts. Connect to a battery. No tanks used. Free particulars and proofs. Gunmetal Co., Ave. J, Decatur, Ill.

MOTORCYCLES, BICYCLES, MOTOR SCOOTERS AND SUPPLIES

MOTORCYCLE Parts and accessories, new and used, for all motorcycles. Write for prices. Henderson list 10c. Triangle, 1111 Washington, Chicago.

MOTORSCOOTERS! Save 70% building own Comet Scooter. We supply parts, engines, tires. Literature, drawing 10c. Comet Cycle Company, Box 3032, Madison, Wisconsin.

BEACON—Free literature. Latest in bicycle lighting. Electrical Products Co., Kendallville, Indiana.

MOTOR Marvel ready! Mead's sensational new Ranger Scooter goes 120 miles per gallon, 35 m.p.h., ride, rent or sell for profit, pleasure. Dealers, agents write for special introductory offer, easy terms, free circular. Hurry! Mead Cycle Company, Dept. B-1, Chicago.

MOTORSCOOTERS. Midget cars! Easily built. Complete plans and literature on wheels, tires, motors, etc. 10c. Honsakers, Masontown, Penna.

BUILD Power scooters, midget cars. We supply tires, wheels, motors. Lowest prices. Send 10c for plans, etc. Build-Your-Own Devices, 5238 Lake, Chicago.

ALLOY Pistons \$3.00—Harley, Indian, Henderson, Excelsior, Cleveland, Cylinder grinding, rings, bearings, gaskets, chains, sprockets, helmets, goggles, accessories, parts new and used for less. Catalogue and wings pin 10c. Ballak, 1115 Chestnut, St. Louis, Mo.

YOUR Money's worth at Knuth's. The best buys in reconditioned Harleys. Just think! Fully equipped police specials 37 - 80's only \$250.00. 36 - 80's for \$220.00. Many other bargains. Send 6c for bulletin. Knuth's, 2491 Fondulac, Milwaukee, Wis. "Everything for the motorcyclist."

MOTORCYCLES. Reconditioned. New, used, parts and accessories. All makes. Large stock. Bargains. Illustrated catalogue, 15c. Indian Motorcycle Sales, Kansas City, Mo.

INSIDE Dealer prices. Overstocked, all models. Indians and Harleys. Rebuilt, guaranteed. Dime brings latest list. Crandall-Hicks, Boston, Mass.

RECONDITIONED Motorcycles. New—used parts for all makes. Authorized Harley-Davidson dealer. Whitman Motorcycle & Supply Co., 405-9 Southwest Blvd., Kansas City, Mo.

MOTORCYCLE Bargains, lowest prices, bargain sheets for stamp. Motorcycle accessories. Rochester Harley Davidson Corp., 129 W. Main St., Rochester, N. Y.

MOTORCYCLE Cylinder boring \$2.00. Aluminum pistons, stock or racing, all models, (dealers supplied). New and used Indian parts. Used motorcycles. Stamp brings list. Phila. Indian, 1635 Hunting Park, Philadelphia, Penna.

AVIATION

PROPELLERS, Attractively priced, leading with three blade airliners, more efficient for sleds, aeroplanes, boats, also supplies, information free. Standard Propeller Company, Ft. Worth, Texas.

NINE Cylinder aircooled motors. New, \$75. Aeroped plans 25c. Allison Aircraft, Lawrence, Kansas.

AIRCOOLED Ford. Powerful aircraft, snowsled engines, complete \$82.50. Conversion instructions available. Lightning Aircraft, St. Paul, Minnesota.

PROPELLERS For airplanes, ice sleds, snow sleds, boats. Hubs, countershafts, sled skis. Catalog 10c. Banks Propellers, Love Field, Dallas, Texas.

GRADUATE Airplane mechanic. Ten weeks, \$1.00 week. Graduates with leading concerns. Free catalog. United Air School, Elgin, Ill.

AVIATION Apprentices — Air-minded young men interested in training for entering aviation as apprentices see ad on page 10A.

LEARN To fly free. Folder, dime. Ohmeyer, Box 391, Hempstead, N. Y.

SNOWSLED Engines \$95.00. Ford A, powerful, aircooled, propeller driven. Conversion only, \$29.95. Literature free. Heath Aviation Company, Dept. M-1, Benton Harbor, Michigan.

100 AIRPLANES \$50 Up. Located everywhere. Complete catalogue 25c. Used Aircraft Directory, Athens, Ohio.

AIRPLANES! 10 Exclusive photographs \$1.00. Lynnpeltcher, 4772 Del Monte, San Diego, California.

JUST Out. Practical course in flying. 29 chapters, illustrated, complete. Only \$1.00. Aircraft Directory, Athens, Ohio.

PROPELLERS For airplanes, sleds. Iced-sled blueprints, supplies. Catalog dime. Lorenzen Propellers, Niles, Michigan.

GET Into aviation. Pilots earn up to \$6000 a year! Airplane mechanics and aeronautical engineers also get big pay! Prepare at this Lincoln government approved school. Write for complete information. Lincoln Airplane & Flying School, 2004 Aircraft Bldg., Lincoln, Nebraska.

A. C. GENERATORS

PRACTICAL Changes for automobile generators. See our advertisement at bottom of page 141A. Autopower.

BATTERIES, GENERATORS, ETC.

AUTOMATIC Light plants, 6 volt, 240 watt or 12 volt, 300 watt push-button start. Price \$30.00. Sold with money back guarantee. National, 1915 South State, Chicago, Illinois.

FARMLITE Batteries—40% discount. Buy direct. 32 and 110 volt light plants. York Battery Co., York, Penna.

EDISON Storage batteries for light-power systems. Non-acid. Odorless, fifteen year life. Five year unconditional guarantee. Bargains in complete lighting systems. Low prices. Free illustrated literature. "See-Jay" Battery Co., 82 Sterling Ave., Yonkers, N. Y.

ARMATURE Winding. New edition. Construction, winding, repairing a.c. and d.c. motors and generators. \$2.00. Popular Mechanics, 200 E. Ontario St., Chicago.

50-1/2 HORSE, Repulsion induction, 110-220 volt, heavy duty motors, 3400 speed, \$9.75. Also generator bargains. Electrical Surplus Company, 1885 Milwaukee, Chicago.

ELECTROPLATING—Motor generators or belt drive, attractively priced. Easy terms, trial. Hobart Platers, Box M-1092, Troy, Ohio.

EDISON Lifetime storage batteries for light and power. Eliminates acid battery diseases. Long guarantee. All kinds rebuilt generating plants, motors, and miscellaneous articles at bargain prices. Free interesting literature. T. Hawley Smith Co., Croton Falls, N. Y.

ELECTRICAL SUPPLIES, EQUIPMENT

ELECTRO-SCRIBE: Electric pencil writes, engraves all metals \$1.00. Ultra violet-infra red. Dual ray health lamp. Two units in one. Promotes sun-tan-vitamin "D". Automatic—ac-dc current, \$3.90. Details, Beyer Mfg. Co., 4515-H Cottage Grove, Chicago.

BARGAINS—Arc welders, also motor generator. Write for new bargain list telling needs. Hobart Bros., Box M-1097, Troy, Ohio.

FLUORESCENT Lighting. New Stamp appreciated. Balco, 1728 N. Wells, Chicago.

ELECTRIC Engraver, engraves all metals deeply, dollar. Hudson Bros., East Syracuse, N. Y.

VACUUM Cleaners and parts. Write for bargain circular. Talley's, Charlotte, N. C.

ELECTRIC FENCING

MAKE Electric fence from old automobile coil. Complete plans 10c. No extras to buy. LeJay Manufacturing, 947 LeJay Building, Minneapolis, Minn.

WELDING AND SOLDERING

GENUINE Arc-welding from any 32 volt battery light system. Economical, easy to build. Plans \$1.00. Pullis & Johnson, Balco, Okla.

ACETYLENE Welding generators, latest type, \$25.00. Johnson Generator Co., Brookfield, Missouri.

75-200 AMPERE Arc welders from Dodge generators. Complete plans 35c. 100 other generator changes. LeJay Manufacturing, 347 LeJay Building, Minneapolis, Minn.

ARC-WELDERS, Plans, material. Save money. Holgerson's Service, Canton, Kas.

DEMONSTRATORS, Electric arc welders. Money-saving prices. Used by the government. Trial and terms guaranteed. Hobart Welders, M-1093, Troy, Ohio.

D.C. ARC-WELDER Plans \$1.00 each. Build it yourself. No armature winding. 25-200 amperes from farm light plant generators, (Phelps, Fairbanks Morse, Delco, etc.) 25-600 amperes from d.c. vehicle motors. 25-200 amperes from North-east (Dodge) automobile generators. Welders Club, AB-3432 M-Mart, Chicago. For sale: vehicle motors, (convertible to 300 amperes.)

REBUILT a.c. d.c. Arc welders, all sizes; engine governors, idlers. Terms, Low prices. Guaranteed. Service Co., 1323 Cedar Ave., Cleveland, Ohio.

ARC-WELD With farm light plant storage batteries. Plans 10c. Welders Club, AB-3432 M-Mart, Chicago.

ENGINES, MOTORS, DYNAMOS

UNIVERSAL Motors, 1/30 h.p., 110 volt, a.c. d.c., 3200 r.p.m., with 5 foot cord and plug, \$2.50 each; 6 or 12 volt motors \$1.25 each. Send check or money-order plus 25c postage. Sold with money back guarantee. National, 1915 South State, Chicago, Ill.

MOTORS, 1/4 H.P. General Electric, etc. \$3.50, guaranteed. Larger sizes. List 10c. A. C. Motors, 3008 Bailey, Philadelphia, Penna.

BARGAINS—Plating generators, motor generator sets, also arc welders. New low prices for large and small shops. Trial—easy terms if desired. Hobart Bros., Box M-1096, Troy, Ohio.

PRICELIST Free. Bargains — Motors, grinders, drills, shavers, home workshop tools, lathes, saws, sanders. Mallorder Electric, 713 South Dearborn, Chicago.

ALTERNATING, 1/2 Horse, 110 volt, induction motors. Rebuilt, guaranteed, \$7.25. Wilmot Auto Supply, 2247 St. Paul Ave., Chicago.

THREE To ten KVA alternating generators. Motors, converters. State your needs. Queen City Electric, 519 South California, Chicago.

MOTOR Winding data. Introductory selection single and three phase, \$1.00. Motor Data Co., Box 7631, Kansas City, Mo.

AIR Compressors, new, 1 3/4x1 3/4, \$6.00; 2x2, \$7.00; 2 1/2x2, \$8.00. Guaranteed. Send check or money order. Free catalog. National, 1915 South State, Chicago, Ill.

REFINE Used oil without cost. Particulars, F. Gerwin, Fairview, Oklahoma.

REWINDING Motors and 330 other valuable articles in Shop Notes, Vol. 31—50 cents postpaid. Popular Mechanics Press, Room (C39), 200 E. Ontario St., Chicago.

BARGAIN—1/2 Hp. motors, 60 cycle, 1 phase, 110 volt, like new, guaranteed, \$7.40. Send check to Erie Electric Motor Co., 120 Church, Buffalo, N. Y.

MACHINERY, TOOLS AND SUPPLIES

10" ELECTRIC Grinder—Complete with wheel guards, two 10" Resinoid wheels, 1/2 hp., 3600 r.p.m., totally enclosed heavy duty repulsion induction Century motor, built-in overload switch and cord. Limited number at special price of \$43.50. Money back guarantee. Viking Manufacturing Co., Jackson, Michigan.

SPECIAL Flexible shaft outfit, complete \$2.95. Write for circular. G. A. Roy Co., Box 2266, Roseland, N. J.

LARGE Illustrated wholesale tool catalog. Machinery, tools, sprayers, specialties. 10c (refunded). Homecraft Tool, 236 Neptune Av., Brooklyn, New York.

CONCRETE Building block machines and molds. Easy payments. Catalog free. Concrete Machine Co., 5129 South Compton Ave., St. Louis, Mo.

TOUGHEST Alloy lead hammers will not mar your valuable tools and machinery. \$1.00 postpaid. Free information. Die Cast Hardware Co., 631 Canosa Ct., Denver, Colo.

TAILSTOCK Turret rough castings blue prints \$3.50. Milburn, Burlington, Kentucky.

YOU'LL Like the new Atlas catalog for 1940—out this month. 72 pages crammed full of modern machine tools and equipment for home and commercial shops. Write Atlas Press Co., 1028 N. Pitcher St., Kalamazoo, Mich.

BARGAINS, Demonstrators, electric arc welders, guaranteed, 30 days trial and terms. Write Hobart Welder Exchange, Box M-1094, Troy, Ohio.

BANDSAWS—New, 8c ft. welding included. Re-sharpened 3c ft. Re-welded 20c each. Catalog free. Innes-Firtko, Andover, N. J.

BARGAIN List on repossessed and sacrificed standard lines power tools and light machinery. Bill Bailey, Box 236, Columbus, Ohio.

TREMENDOUS Surplus of factory tools selling out. Drills, taps, files, hacksaws, etc. Send for free lists, include six cents postage. Travers Tool Co., 264 Jackson Ave., Long Island City, N. Y.

FREE Catalog of electric motors, grinders, drills, paint spray equipment, pumps, work shop machinery, blowers and exhaust fans. Sutton Electric Co., 767 Granby, Norfolk, Va.

PLASTICS, Brass, aluminum, Dowmetal, monel, stainless steel, gears, etc. Catalog 10c. Hobby Supply House, Box 2014, Pittsburgh, Penna.

DRILL Grinding attachment fits bench grinder, hand or power turned. Handles sizes 3/16 to 1 1/4". Price \$7.85. Descriptive literature on request. Tractor-Lite Co., Sidney, Iowa.

14" x 6' GREAVES Klusman cone head engine lathe, quick change, No. 0 Cincinnati miller, cheap. Write for particulars. Cincinnati Machinery & Supply Co., 221 E. Second St., Cincinnati, Ohio.

BOATS, OUTBOARD MOTORS, ETC.

OUTBOARD Motors, \$25.00 buys new 1.2 h.p. magneto ignition, weight 17 lbs. Troll fishing or pleasure motor. Dime for catalogue with parts, prices and operating instructions. Outboard, 305 Atlantic Ave., Boston, Mass.

BUILDING Plans 8' plywood fast outboard, August Rudder 35c. Catalog boat plans free. Rudder, 15 Murray St., New York.

OUTBOARD Motors. All makes of used motors and parts. Outboard Headquarters, 315 Atlantic Ave., Boston, Mass.

BUILD Electric outboard from old automobile generator. Operates with car battery. Smooth—quiet. Plans 10c. LeJay Manufacturing, 547 LeJay Building, Minneapolis, Minn.

BUILD A boat by the Welch System. Its inexpensive; interesting and profitable. Everything for building; equipping or repairing boats. Use Welch Ready Cut Parts. Send 10c for catalog showing boats of many types; boat hardware; propellers; marine paints; sails; boat finishing materials and Welch White Cap marine motors. Welch Boat Company, Station K-1, Milwaukee, Wisconsin.

NEW Motor boats, complete \$75.00. Scooters, motors, parts. Clear-Vue Co., Dayton, Ohio.

SEE Our ad on page 140A. Cleveland Boat Blueprint Co.

AMERICA'S Biggest kayak values! Safest! Request literature. Playaks, Dedham, Mass.

PADDLE-BOARD Kits, 14 ft. complete, \$14.95 f.o.b. Box 2283, Laguna Beach, California.

PROPELLERS, Gear pumps, stuffing boxes, bearings, etc. Wm. Baker, Pond St., Quincy, Mass.

FORD-ZEPHYR Marine conversions, Catalog 10c, Lehman Engineering Company, Dept. D, Newark, N. J.

MARINE Power—Easily convert any Ford motor (domestic and foreign) with Osco parts and kits. Complete catalogue 25c (coin). Osmithson, 3644 Lawrence St., Philadelphia, Penna.

ASSEMBLE Your own boat. Our finished knock-down frames and materials save you 2/3 builder's cost. All types and sizes. Send 25c for big catalog. Brooks Boat Co., Inc., D4, Saginaw, Mich.

OUTBOARDS — Save 1/2. Good used parts, all makes and models. Bargains rebuilt motors. Crandall Hicks Co., 959 Commonwealth, Boston, Mass.

BOAT Designers are highly paid professionals. Complete course by mail. Catalog. Westlawn, Montville, N. J.

SPORTING GOODS, GUNS, FISHING TACKLE, ARCHERY

SEND For free illustrated catalog of Lawrence leather belts, holsters, gun cases and other sporting equipment. George Lawrence Company, Portland, Oregon.

AUTOMATIC Fish hook. Double gaffing hook for trolling—bluefish, bonito tuna, etc. Joe, Kurelich, 2613 E. Belgrade St., Philadelphia, Penna.

MAKE Your bows, arrows. Seventy page book 55c. Indianhead, Lima, Ohio.

BEST Bait discovered. Fish lure. 50 cents. Chas. Walworth, Warrens, Wis.

BUILD 22 Caliber Olympic pistol. Details 10c. Investigate. Box 186, Kenosha, Wis.

BARGAINS. Free catalog, guns, ammunition, sporting, army goods. Medal award catalog 10 cents. Brunswick, Dept. 11, 155 East 34th, New York.

HUDSON Bay blankets, complete camping, hunting, outdoor equipment. Catalog. Howe Fur Company, Coopers Mills, Maine.

BARGAINS! A-1 Gov't. Slings 50c, swivels 35c. Gun catalog 5c. J. Warshal Sons, First-Madison-PM, Seattle, Wash.

BOWS, Arrows, raw materials. Beautiful catalog (over 125 pictures) and "Essentials of Archery" a handbook on making bows and arrows 35c. Everyone intending to make their own should have this manual. Instruction folder and catalog 10c. L. E. Stemmer, Queens Village, N. Y.

ANTIQUES, RELICS, INDIAN GOODS

ALASKA Indian beaded hair seal moccasins \$2.25 per pair postpaid. Suitable Xmas gift. Perry M. Hern, Skagway, Alaska.

CHINQUILLA'S Indian Craft Museum. Handiwork of all Indian tribes. Jamaica, N. Y.

100 GOOD Indian arrowheads \$3.00. Catalog. George Holder, Glenwood, Ark.

ARROWHEADS! Glacial boulder beauties. Rainbow variations. Don McKillop, Regina, Sask.

INDIAN Relics, coins, bills, gems, crystals, curios, etc. Illustrated catalog 5c. 100 ancient arrowheads \$3.00. H. Daniel, Hot Springs, Ark.

SWORDS, Rapiers, pistols, daggers, armor list 10c. Robert Abels, 860A Lexington Ave., New York.

INDIAN Relics, beadwork, coins, curios, minerals, old glass. Catalog 6c. Indian Museum, Northbranch, Kansas.

TAXIDERMY

LEARN By mail to mount birds and animals, tan skins, make leather. Old reliable school teaches, easily, quickly, at low cost. Over 250,000 students. Rush postal for free 48 page book. Northwestern School of Taxidermy, 775 Elwood Bldg., Omaha, Nebr.

PRICES Slashed! New 36-page supply catalogue free. New items. New ideas. Postcard brings yours. Taxidermic Manufacturers, Miami Beach, Fla.

TAXIDERMY Supplies—Quality artificial eyes, teeth, genuine Jonas head forms. Tools, materials, etc. Everything for the progressive taxidermist. Send 10c for big illustrated catalogue. Jonas Bros., 1049 Broadway, Denver, Colo.

FIELD GLASSES, TELESCOPES AND MICROSCOPES

TELESCOPES, Microscopes, binoculars; 1939 bargain catalog free. Brownscope Co., 5 West 27th Street, New York.

DOGS, PETS, BIRDS

HUNTING Hounds: Cheap. Trial. Literature free. Star Kennels, B6, Herrick, Ill.

BOSTONS! Easy monthly payments! Circulars, dime. "Sentree," Royal Oak, Michigan.

FLEMISH Giant rabbits. Big demand. Investigate. Norris, B-135, Gillespie, Ill.

SPORTSMEN: 200 Pointers, setters, straight cooners, combination hunters, rabbit and fox hounds. Reasonable. List free. Ramsey Creek Kennels, Ramsey, Illinois.

BEAUTIFUL Pure white police dogs. Ansonia Kennels, Mose, N. Dak.

NORTHERN Coonhounds. Terms. Price-list, description (dime). Lakeland Fur-exchange, Salem, Michigan.

POULTRY AND FARM SUPPLIES

WRITE For fall prices on Salem chicks. Our champion Rocks are making profits for hundreds of broiler raisers. Priced low. Salem Hatchery, Box 81, Salem, Indiana.

300 CHICK Insulated electric brooder \$6.00. Assemble yourself. Electrical supplies, full instructions \$3.50. T. Gery, 17 East Roanoke, Phoenix, Arizona.

MAKE Money with poultry. Read America's leading poultry magazine for latest information. Three years \$1.00; nine months 25c. Poultry Tribune, Dept. E-93, Mount Morris, Ill.

TREES, SHRUBS, ROOTS, HERBS

JUST Out! World's greatest "Herblist Almanac." Beautifully illustrated in natural colors. Contains over 200 old-fashioned herb medicine recipes for home use. 10c postpaid. Worth dollars! Botanics, 145 W. 112th St., Chicago.

FARMS AND FARM LANDS

FARMS That pay in the Great Northern Railway agricultural empire. Minnesota, North Dakota, Montana, Idaho, Washington, Oregon. Fertile black soil, high production crops, grain, fruit, vegetables, feed and livestock. Many kinds of farms for selection. Write for book on state you prefer. E. C. Leedy, Dept. 1057, G. N. Ry., St. Paul, Minn.

40 ACRES. Near White River, unimproved; poultry land. \$175, \$5 down, \$5 monthly. Free list and literature. Hubbard, 216 Grossman Bldg., Kansas City, Kans.

VILLAGE Farm, lake view, 6 acres on gravel road, depot and advantages at hand, short drive to city; creek, variety fruit, good 6-room house, electricity, hen house 18x80; exceptional at \$750 including furniture; \$300 down; page 93 free 100-page catalog. Strout Realty, 255-P 4th Ave., New York City.

GOVERNMENT Land—10c acre up. Information all states 25c. Nat. Tax Service Bureau, 600A Majestic Bldg., Detroit.

FLORIDA Tax deed lands. Good fruit and farm lands. Ten acres \$70.00, \$5.00 down, \$5.00 month. Many others. Florida Tax Deed Service, 8007N Nebraska, Tampa, Florida.

GOOD Farms available. Washington Minnesota, Idaho, western Montana, Oregon. Dependable crops, favorable climate. Write for impartial advice, literature and list of typical bargains. Specify state. J. W. Haw, 119 Northern Pacific Ry., St. Paul, Minn.

FARM MACHINERY AND SUPPLIES

ONE Man saw mill turns trees into money—priced low as \$59 direct from factory. Makes lumber, shingles, laths, ties, crates, etc. Thousands in use. Write for low price and free book. Belsaw Machinery Co., 856 Davidson Bldg., Kansas City, Mo.

GARDEN And all purpose tractors at factory price. Shaw Du-All 2 to 8 horsepower, riding or walking types. Does plowing, discing, harrowing, cultivating; mows lawns, cuts weeds, does hauling; runs belt machinery. Air or steel tires. Thousands in use. 10 day trial. Write for free catalog. Shaw Mfg. Co., Dept. PM-10, Galesburg, Kansas.

PROFITABLE OCCUPATIONS

RAISE Mink. Dime for general information. Book "Minks and Mink Raising" \$2.00. Lomman's Fur Farm, Spangler, Penna.

HOW To earn money at home! Big, free book tells inside story—how hundreds are earning cash raising mushrooms in cellars, sheds. Cash paid for all raised. Write today. United, 3848 Lincoln Ave., Dept. 70, Chicago.

RAISE Mink for profits. Free information. Eugene Hoiles, Greenville, Ill.

BUSINESS Proposition resilvering mirrors, autoparts, reflectors, making chipped glass signs. Write Sprinkle, Plater, 288, Marion, Indiana.

RAISE Guinea pigs for us. Send dime for book. Roberts Laboratories, Waukesha, Wis.

ATTACH Power to any lawn mower. We furnish parts. Low prices, quick sales, big profits. Lonmopower, 347 North Crawford, Chicago.

MAKE Money making-selling archery—operating archery range. Complete construction book 50c. Catalogue materials free. Chester Brown, 617 South State, Chicago.

MAKE Money raising mink. Write today to Skyline Minkery, Box 135, So. Sudbury, Mass.

MEN—Women, operate "Specialty Candy Factory" home, all or spare time. Steady income. (Our 31st year.) Hillyer Ragsdale, Inc., Drawer 62, East Orange, N. J.

MONEY In rabbits and covies. We buy and put you in touch with other markets. Catalog and copy of magazine 10c. Or send 25c for book catalog and price list and year's subscription to the American Small Stock Farmer. Stahl, Box 1, Holmes Park, Mo.

BOOKS, PERIODICALS, PICTURES, POSTCARDS

RELIABLE. Authorized subscription service. Complete list, all periodicals, 3c. Greylock Agency, Williamstown, Mass.

GAMES—ENTERTAINMENT

MAGIC Age chart. More fun 10c. Lambert Brothers, St. Petersburg, Florida.

GAMES, Merry-go-rounds make you money; outfits supplied. Illustrated literature 10c. "MooreMade," Lapeer, Mich.

MAGIC TRICKS, PUZZLES, JOKER NOVELTIES

LEARN Ventriloquism, 3c stamp brings particulars. Smith, 801 Bigelow, Peoria, Illinois.

FREE Tricks! Join Magicians' Fraternity! Monthly magazine, sample 10c. International Magicians, Mt. Morris, Illinois.

HOUSE Of 1000 mysteries! Professional magic! Pocket tricks! Jokes! Puzzles! Novelties! Two big surprise catalogs! Both illustrated! Both for 20c! Lawson Vick Co., Dept. P12, Queens Village, N. Y.

BE A magician. Large professional magic catalogue of latest tricks 25c. Cash paid for complete Tarbell magic courses. Write, Ireland, C-109 North Dearborn, Chicago.

LARGE Magic catalog 25c. Hundreds of tricks. Chicago Magic Company, 2300 N. Mason Avenue, Chicago.

EARN Money in any crowd. Call names of strangers, tell unspoken questions. Professional course mind reading, spirit writing, etc., \$1. Henderson, Box 341, San Bernardino, Calif.

WORLD'S Largest magic shop professional catalog, 25c. Holden, 220 W. 42nd St., New York.

OLD STAMPS WANTED

WILL Pay \$100.00 for 1924 1c green Franklin stamp, rotary perforated eleven (\$1,000.00 if unused). Send 6c today for large illustrated folder showing amazing prices paid. Vernon Baker, 444PM-3, Elyria, Ohio.

STAMP COLLECTING

RIOT Of colors packet includes 2 large multi-colored Ecuador Constitutions, 3 Philippines (Rizal), 3 beautiful triangles, plus stamps from Andorra, Monaco, Senegal, Ivory Coast, Futuna, Angola, Estonia, Oceania, Tunisia, Ukraina, Cape Verde, Kouang Tchou, New Caledonia, Victoria. This bizarre assortment of over 20 different stamps containing pictorials and commemoratives will be given as a premium to the first 500 collectors who send only 5c for our big value 100 different packet. McLoughlin, North Ave., Meriden, Conn.

ZANZIBAR Jubilees—40c; Cook Islands coronations—20c; Trinidad coronations—18c; Edward VIII Morocco—30c. All sets complete. All four—\$1. W. Torgesen, Teaneck, N. J.

ZOOIE! Mystifying assortment hard countries—airmails and "queer" stamps—only 3c with approvals. You'll be delighted! Saxon Company, 408-A Jay Street, Brooklyn, N. Y.

SILVER Jubilee souvenirs. Third set of twenty beautiful stamps issued by Irish Hospitals' Trust, Dublin. Specimen sheet free of charge to all writing to Mr. J. O'Sheehan, Department P.M. 13, Earlsfort Terrace, Dublin, Ireland.

SENSATIONAL Combination offer! Big packet 105 all different including Greenland (new country), Congo, Manchukuo, Costa Rica triangle, air-mails, commemoratives, giant diamond-shaped stamp, \$4 United States; complete set United States telegraphs, cataloging 20c, scarce set Siberia cataloging 50c. Packet British colonies including Gwalior, Hyderabad, Burma (new country), jubilee and coronations. Total catalog price over \$3.00! Everything for only 5c to approval applicants! World-Wide Stamp Company, Department 600, Camden, New York.

U. S. 100 different 15c, 150 different \$1.00, 250—\$2.00! 100 unpicked revenues—10c (750—50c). Excellent mission mixture: two pounds 65c! Vanvoorhis, Hyndman, Pennsylvania.

COMPLETE United States catalog (80 pages, 1000 illustrations!); foreign sets catalog; annual catalog (everything for the stamp collector, richly illustrated); valuable "stamp finder" (tells country to which any stamp belongs) and "Stamp Collecting" (illustrated 32-page booklet)—all for 10c for mailing costs! Approvals included. Harris & Co., Dept. 137, 108-A Massachusetts Avenue, Boston.

CANNIBALAND—British Solomon Islands, genuine Baden, Liberian Bongo, fantastic Manchukuo, Cayman Islands beauty, \$5 U. S., bizarre Negri Sembilan, Turks Caicos. Everything 3c with approvals. Viking, 1-Z Hanson Place, Brooklyn, N. Y.

WHOPPER Packet 5c. Jubilees, ships, triangles, map, diamond, airmail, boy king, Vatican, Azerbaijan, Siam, Iran, Iraq, Peru, Iceland, etc. 33 dandy stamps, only 5c with approvals. Dominion Stamp Company, Dept. PM, Arlington, Va.

BEAUTIFY Your collection with this offer of 50 different mint large sized stamps depicting gorgeous scenery, savage animals and peoples. All for 5c to new applicants to our clean inexpensive approvals. Acme Stamp Company, Dept. 1, Box 101, Westmount, P. Q., Canada.

UNITED States stamps on approval. Commemorative, airmails, 19th Century issues, parcel post, revenues, etc. Bargain lists with each selection. We have an extensive stock, correctly classified, reasonably priced. Southern Stamps, Box 70A, Miami, Florida.

NEWFOUNDLAND, Canada, U. S., Mexico—"Four Star Approvals." Nothing like them! Write today. Specials to applicants: 1000 different stamps 88c. Three beautiful sets: Ecuador (Olympics), Nicaragua (Will Rogers), Czechoslovakia (Legionnaires) 12c. Kessels, Tucson, Arizona.

FINE Approvals, freshly filled books and sheets. Tell me what you want and I will send it. Milton Skinner, 306 East Fourth, Long Beach, Calif.

CANNON! Set of stamps showing cannon, firing squad, cavalry charge and 200 other different stamps, only 10c to approval applicants. L. H. Reich Stamp Co., 4647 Kenmore, Chicago.

50 DIFFERENT British colonials, only 5c to applicants for approvals. F. Lambert, Box 156, Fort William, Ont., Canada.

QUEEREST Stamp packet: Mozambique, Japan, China, Soruth, Albania, many others—5c to approval buyers. R. M. Stamp Co., Box 230P, Port Chester, N. Y.

\$1.00—\$5.00 POSTAGE Due stamps 6c. Frank Strosky, Perth Amboy, New Jersey.

GERMANY—Latest mint issues. Blue Derby 30c. Week of Art 12c. Brown Band of 1939 45c. Admiral Stamp Co., 125-21 Hillside Ave., Richmond-Hill, N. Y.

CANAL Zone—Silver jubilee. New pictorial set of three 5c with approvals. Stanley Melzer, 3120 South Adams Ave., Milwaukee, Wisconsin.

CANADA, Newfoundland—Sixty page illustrated wholesale catalogue featuring Canadians, Newfoundland, British Colonials, United States, supplies. Free. Empire Stamp Company, Dept. 5, Toronto, Canada.

SELL Stamps, earn cash commission. Everglades Stamps, Box Seventy, Miami, Florida.

ASK For my famous 1/2c approvals. Olivo Alvos, Guadalupe, Calif.

EXCHANGE Stamps, postcards. Universe. "Exchangers," Bry 226 pres. Paris, France. Particulars free.

200 DIFFERENT 10c To approval applicants. Karr Ross, De Ridder, Louisiana.

FREE 25 Different Czechoslovakia to approval applicants. 3c postage. Theodore Stevens, 3576 Maryland Ave., Detroit, Mich.

CHILE—25 Different! Only 3c with approvals! Donald Rowe, Box 427, Laguna Beach, California.

ZEPPELIN Hindenberg set 5c. Approval applicants only. Quality Stamps, Englewood, Colorado.

FREE! 3 Different triangles requesting approvals. Rosenberg, 3527 Adams, Chicago.

100 DIFFERENT 3c; approvals. Thorgif Stamp Co., Box 77, Marion, Indiana.

APPROVAL Sheets. One to three cents. Frederick B. Driver, 2009 Finance Bldg., Philadelphia, Penna.

FREE 25 Different Jugoslavia with approvals. Lincoln, 5535 May, Chicago.

GRAND Gamble lots \$1.00. Quality—no junk. World's best source. Hughes, Queens Rd., Bournemouth, England.

NATIONAL Stamp News, published bi-weekly, 50c per year. Sample free. Box 6186, Washington, D. C.

FREE! Nine desirable airmails. Approvals. Barker, 714 Market, San Francisco.

1853 TO 1899—Twelve scarce old stamps, 25 Czechoslovakia, 25 Denmark—10c. Gerhardt, San Saba, Texas.

NEVER Offered before. 21 French colonies, pictorials, sets of 5 each (105) for 35c. French, 241 Euclid, Cleveland.

STAMP Catalogue free! New revised edition—Giant fifty-page quarterly listing albums, supplies, Canadians, Newfoundland, United States, new issues, foreigners and pictorials. Illustrations galore! Empire Stamp Co., Dept. PM, Toronto, Can.

55 UNITED States commemoratives, airmails 15c. Motzer, 1022 Liberty, Cincinnati, Ohio.

EARN Cash, earn stamps, sell my approvals. Nickel packets. Ellison, 2841 West 37th, Brooklyn, N. Y.

AIRMAIL Thrillers from many fascinating countries. 5c! AGrove's, 306 Blanchard, Seattle, Washington.

3c POSTAGE Brings free premium and collector's bargain bulletin. Klemann, Lockport, N. Y.

FREE—Choose any country 10c packet—5c postage—approvals. Victoria Stamp Co., London, 4, Canada.

AIRMAILS! Triangles! Packet free with approvals. Foster's, 1702 Court, Syracuse, N. Y.

SPAIN—Cervantes commemorative. Eight large pictorials complete. Regularly 20c. Only 6c with approvals. DeMers, Box 1033, Milwaukee, Wisconsin.

43 DIFFERENT Czechoslovakia only 3c to approval applicants. Pearce, 2833 N. W. 13th, Oklahoma City, Oklahoma.

APPROVAL Applicants! 500 mixed 10c! Fort Stamp Company, Defiance, Ohio.

WHOLESALE Dealer's catalog. Illustrated. Postage 5c. Frank's, 4900 Chalmers, Baltimore, Md.

APPROVALS That please. References. Turbyfill, 513 West 29th, Norfolk, Virginia.

GIVEN! Venezuela mint commemorative No. 276 with 25 different Peru for 10c. Approvals. Heiken, Benson, Ill.

50 FREE Iraq, Iran, etc. Postage 1c. Album 3c. Bullard, 268 Northampton, Boston, Mass.

10,000 VARIETIES 1c Each! Gordon Davison, Box 568, Manchester, N. H.

FREE! Royal visit packet. Postage 3c. Roberts, 312 Shearerbig, Bay City, Mich.

LARGE Pictorial stamps from British Colonies, 100 different \$2.00. Satisfaction guaranteed. Waldo, Box 266, Dallas, Tex.

MINT United States cataloging two dollars, all different, only ninety cents. Morton Taylor, Pittsburg, Kansas.

NAME On 1,000 mailing lists 25c. Wilborn, Station "H," Los Angeles.

150 GOOD Mixed foreign stamps, 5c coin. Stanton, Niantic, Conn.

SEVENTY Different Scandinavian 5c with approvals. Excel, Box 1315, Chicago.

111 DIFFERENT, French Colonies, etc. 10c. Schildhouse, Colonial Arcade, Cleveland, Ohio.

FREE! Approval book with commemoratives, pictorials, etc., cataloging over \$2.00, only 25c. Blackcastle Stamp Co., Northwales, Pennsylvania.

PREMIUM To applicants for foreign approvals. Wests, Box 1686, Wichita Falls, Texas.

U. S. Mission mixture. Everything left in as I'm interested in pre-cancelled only. Blocks, airmails, commems. 40c (coin) a pound plus postage. Knopp, Box 1381, Dept. 8, Bristol, Conn.

105 PICTORIALS, Airmails, triangles, diamonds, from Greenland, Belgium, Cuba, Mexico, Ecuador, etc., for 10c to approval applicants. Falk, Inc., Box 522, Jacksonville, Florida.

FREE! 20 Different Canada to approval applicants. Hunziker, Box 225-OM, Minneapolis, Minn.

1000 WORLDWIDE Stamp mixture 25c. Monjar, 1542 Waverly, Cincinnati, Ohio.

175 U. S. commemoratives, etc., 10c, 500 25c. P. O. Box 457, Newark, N. J.

STAMP Dealers—Collectors! Philatelic printing. Samples. Keeler Print, 3822-W Orden, Chicago.

FREE! Beautiful modernistic San Francisco-New York world's fair commemorative sets, just arrived from Ecuador. Approvals. Davidson, 2297-6E, Salt Lake City, Utah.

COMMEMORATIVES, U. S. revenues, telegraphs, etc. 3c with approvals. Nels Dolve, Box 406A, Minneapolis, Minnesota.

BOLIVIA Triangle set free with penny approval. Sweeper, 101 Monmouth, Newark, N. J.

50 ANIMALS, Railroads, ships, maps, etc. 10c with approvals. Buchanan, Box 40, College Point, N. Y.

U. S.—63 different (commemoratives, airmail, etc.) with approvals 9c. 50 diff. commemoratives 1893 to date 25c. Moseley, 4932 Forestpark, St. Louis, Mo.

WORLD'S Smallest airmail, largest map, also diamond and triangle, magnifier to study your stamps, with large packet from scarce countries. Only 5c with approvals. Capital Stamps, Dept. 2, Little Rock, Ark.

FREE, Treasure packet, 3c please. Oromocto Stamps, Kitchener, Ontario, Canada.

MOZAMBIQUE Triangle airport set 5c. Wood, 324 Harford, Syracuse, N. Y.

FREE! Any 10 stamps you select from our 1c and 3c approvals. Give 3 active stamp collector references please. Ranger Stamp Co., Houston, Texas.

CENT-HI Penny approvals are better. Ransom, 1333 Pontiac, Ann Arbor, Mich.

1000 MIXED U. S., 15c. Foreign approvals. Premiums. Lee, Bridgeport, N. Y.

500 BETTER U. S. Good variety. 39c. W. Sloat, Washington, Iowa.

AIRMAIL Stamps. Liechtenstein 409-413 \$1.00. Denmark. Others. Davies, 249 Pearsall, Ridgewood, N. J.

"HOW To Make Money in Stamps" 50c a copy. Walters, Milburn Ave., Maplewood, N. J.

FREE—Irish-U. S. constitutional and Will Rogers set to approval applicants. Charles Cleaveland, 806 North Humphrey, Oak Park, Illinois.

ARABIAN Sheik (Transjordan), Burma, Georgia, Inini, Azerbaijan, Ubangi, Manchukuo, Mauritania, Wurtemberg, Lithuania and others. 3c approval applicants. Kravato, 1925 Quentin Road, Brooklyn, N. Y.

MISSION Mixtures, U. S. 35c lb. Canada 70c. Mission, 4512 North Racine, Chicago.

GIANT Packet 200 all different from Africa, South America, Asia, South Sea Islands, etc. Includes world's smallest stamp; triangle and diamond-shaped stamps; animal stamps. Nicaragua "Will Rogers" airmail; many others. Also packet 17 different United States (cataloging 50c) —all obsolete, including \$4 denomination, commemoratives, etc. Total catalogue price over \$5.00! Everything for only 5c to approval applicants! Mystic Stamp Company, Dept. 80-N, Camden, New York.

SIX Dollars for 9c! 300 different stamps (cat. price \$6) only 9c with approvals. Tatham Stamp Co., Springfield-30, Mass.

THREE Sets for three cent stamp! Jack Reed, Houtzdale, Penna.

BOLIVIA Llamas set, Mexico mosquito stamp, 3c. Approvals. Big Chief Stamps, 1521 Marsac St., Bay City, Mich.

1000 DIFFERENT 75c; 600, 50c; 300, 20c. Fred Onken, 630 79th St., Brooklyn.

FREE—From every continent, 155 different, airmails, triangle, commemoratives, pictorials, many U. S. and others, with 1c approvals. Send 5c for postage and handling. Ace Stamps, Euclid Arcade, Cleveland, Ohio.

40,000 VARIETIES First quality stamps available on approvals 1/4c up. Representative selection on request. Adults only. PKeigwin Stamp Co., Vineland, N. J.

UNITED States—45 different, gauge, hinges, pricelist 10c. No approvals. Seidenberg, Baroda, Mich.

WHOLESALE Supplements to dealers for 10c postage. Hundreds of bargains. Grossman Stampco, 102 West 42nd, New York.

50 DIFFERENT, Fine U. S. including perforation gauge, 10c with approvals. The Stamp Shop, 809 Holland Bldg., St. Louis, Mo.

100 DIFFERENT Hungary 7c, approvals. Hazett, 701P Fourth Baycity, Mich.

PENNY Approvals, that satisfy. Neil Gronberg, Box 5441-P, Philadelphia, Penna.

AIRMAILS And commemoratives, 25 different, including Columbians, Panama-Pacific, Edison, Zeppelin, etc., only 5c with exceptionally fine United States and foreign approvals. Marco Stamp Co., Box 888, San Francisco, Calif.

UNITED States illustrated looseleaf catalog, \$1.00. Send postage for free United States price list, precancel list. Stanley Gibbons, 38-P Park Row, New York.

200 DIFFERENT 10c. Big 50% approvals. Covert Stamp, 39 State, Rochester, N. Y.

BRAZIL, 50 Different 10c with bargain approvals. Davis, Silver Lake, Ind.

ASK For our wonderful one cent approvals. Prospect Stamp Co., 225 Broadview, Toronto, Canada.

WEEKLY Stamp magazine, thirteen weeks, 10c. Stamp Journal, Kalamazoo, Mich.

TRIANGLES! Triangles! Triangles! Triangles! Count them. Four! With famous Rivera nude stamp. Only 3c to approval applicants. Cactus Junior, Tucson, Arizona.

FIVE Different commemorative precancels free with highest quality penny precancel approvals. W. R. Franson, Troutdale, Oregon.

STAMP Dealers, your ad here will bring wonderful returns. Ask me for proof. P. W. Johnson, Manager, Classified Advertising, Popular Mechanics Magazine, 200 E. Ontario St., Chicago.

RARE COINS

COINS Are profitable. Catalogue of coin bargains and uncirculated coin—10c. Illustrated buying book—25c. Eugene Morrison, Reseda, California.

COMMEMORATIVE Half dollars; Lincoln, Texas, Cleveland, Long Island, \$1.19 each. Selling price list free. American Coins, Box 3507, Cleveland, Ohio.

RARE U. S., foreign coins, war medals. Catalogue 10c. Mengelle, Colorado Springs, Colo.

CENT Buying, selling, list 5c. 1933-D 5c, paying 3c. M. Mayrath, Dodge City, Kans.

OLD Money wanted. Will pay fifty dollars for nickel of 1913 with Liberty head (no buffalo). We pay cash premiums for all rare coins. Send 4c for large coin folder. May mean much profit to you. Numismatic Co., Dept. 20, Fort Worth, Texas.

FOUR Brilliant uncirculated coins 10c. Willard's, 3139 Elmwood, Kansas City, Mo.

1939 AMERICAN Coin catalog and complete mint record. Prices all United States coins. 50c postpaid. 1938 edition 25c. D. M. Merrin, Box 565, Spokane, Wash.

COLLECTORS Illustrated catalog 10c. Includes books, supplies, coins of all kinds. James Randall, 407 South Dearborn, Chicago.

WILL Pay \$10.00 each for certain Lincoln pennies; Indianheads \$100.00; dimes \$700.00. Catalogue 10c. Federal Coin Exchange, Columbus, Ohio.

50,000 COINS, medals, papermoney, historical newspapers, Indian relics. Lists free. Nagy, 8-P South 8th, Philadelphia, Penna.

BIG Prices paid for certain wanted coins. 1909 cent \$10.00, some silver dollars \$4000, 1864-1865 Indian head cents \$100.00 each, dimes before 1895, \$600, liberty head nickels before 1914, \$500, encased postage stamps, some large pennies \$2000, half cents, \$275.00, paper money, gold dollars \$1500, foreign coins \$165, some worth \$6000 each. You may have coins for which we pay big premiums. Therefore send 15c today for 1939 big illustrated coin book for certain wanted coins. National Coin Corporation (80), Daytona Beach, Florida.

COMMEMORATIVE \$1's, Five different, uncirculated, \$5.00; United States large cents, 1800, 1801, and 1802, \$1.00; packet 30 coins of 30 different countries \$1.00. Koeppl's Coin Shop, Eighth Corner Broadway, Los Angeles.

UNCIRCULATED San Francisco mint cent and catalog 10c. 3 dates 25c. Landon, 901 Lucerne, Los Angeles.

COIN Collections. Gold coins, 55% premium. A. French, Rte. 1, Troy, N. Y.

GET Profit and pleasure in collecting old coins. Send 10c for 56-page illustrated coin catalog. You'll be delighted with it. Send for it now. B. Max Mehl, 370 Mehl Bldg., Fort Worth, Texas. Largest rare coin establishment in U. S. Established 38 years.

COMMEMORATIVE Half dollars, Lincoln, Stone Mountain, Oregon, Texas, Cleveland, Kentucky, San Diego, Long Island, \$1.50 each. Illustrated catalogue No. 14, 25c. Norman Shultz, Salt Lake, Utah.

FREE! Foreign coin, banknote, and large illustrated coin catalogue. Send 4c postage. Coin approvals sent. Tatham Coinco, Springfield-125, Mass.

\$5 To \$500 Each paid for hundreds of old or odd coins. Keep all until posted. Many very valuable. Send 10 cents for illustrated Coin Value Book, 4x6. Guaranteed buying and selling prices. 31 years in business. Coin Exchange, Box 5, Le Roy, N. Y.

HOBBIES AND COLLECTIONS

HOLLYWOOD Match covers included collection 110 all different \$1.00. Coverservice, Fellows, Calif.

WANTED Old cigarette cards. Write Bray, 1127 Jackson, Easton, Penna.

UNUSED Book match covers, 100 all different, \$1.00. Free list. Charles Edelman, 1311C East 84, Cleveland, Ohio.

PHOTO FINISHING

ROLL Developed 8 prints and two enlargements 25c. Beautiful photographic Christmas cards or calendars from your negatives, 4 for 25c; 17, \$1.00, envelopes included. Young Photo Service, 405-C, Albany, N. Y.

ROLL Developed, 8 prints and 5x7 enlargement 25c. Saunders, Box 8E, Glenview, Ill.

PERFECT Enlargements, 5x7, 10 cts; 8x10, 20 cts. Send negatives. Photo Print, Box 184-M, Duncan, Okla.

ROLL Developed, 2 prints each negative 25c. Enlargement coupon, 16 reprints 25c. Artcraft Studios, Box 3580-A, Cleveland, Ohio.

ROLL Developed 8 Photo Art prints, one 5x7 enlargement, 25c coin. Roxy Photo Service, 7727 Ridge, Philadelphia, Penna.

PHOTO Mill. Immediate service! No delay! Roll developed, carefully printed and choice of two beautiful 5x7 professional enlargements, one tinted enlargement, or eight reprints—for 25c coin. Reprints 2c each. The Photo Mill, Box 629-12, Minneapolis, Minnesota.

35MM—36 Exposure rolls fine grain developed, 36 2 1/4"x3" enlargements, cartridge reloaded with Agfa Superpan Supreme film, all for \$1.50. Bates Photo Service, Box 116, Big Flats, N. Y.

BETTER Photo finishing. Eight exposure rolls developed and printed 25c. Moore Studios, Alstead, New Hampshire.

16 OVERSIZE Deckled-edge prints from roll 25c. Artshop, Weatherford, Oklahoma.

35MM Rolls developed free. Prints enlarged 3 1/4"x5. Maximum charge \$1.00 at 4c print—refund on nonprintables. Regular rolls—8 professional prints—2 enlargements 25c coin. Quality guaranteed. One day service. Filmaster, Dept. 101, South Bend, Indiana.

ROLL Films finished (to size 122) 2 sets prints (limit 16), one enlargement 25c coin. Fine album free to steady customers. Brilliant Photo Service, Box 916, Boise, Idaho.

MINICAMISTS, 3 Months free subscription "Photoshop Messenger." Write Photoshop, Linton, Ind.

TWO Prints from each picture on your roll 25c. Your pictures will speak volumes when finished by our expert craftsmen. One day service. Nineteen years experience. Lens Photos, Dept. J-4, Janesville, Wis.

PHOTOGRAPHY For pleasure and profit. Prepare for profitable business or fascinating hobby at home. Previous experience unnecessary. Common school education sufficient. Write for information and requirements. American School of Photography, 3601 Michigan Ave., Dept. 3457, Chicago.

TWO Beautiful enlargements, 8 sparkling prints, 25c. Guaranteed. Lake Photo Service, D-742, LaCrosse, Wisconsin.

ROLLS Developed and printed, 2 free 5x7 enlargements, 25c coin. National Capital Photofinishers, 1205 Wisconsin Ave., Washington, D. C.

OIL Coloring photographs a fascinating hobby or profitable business. Learn at home by easy simplified method. Previous experience unnecessary. Common school education sufficient. Send for free information and requirements. National Art School, 3601 Michigan Avenue, Dept. 3437, Chicago, Illinois.

20 REPRINTS 25c. 100 Reprints \$1. Roll developed with 16 prints 25c. Nordskog, 4, Maywood, Ill.

FREE Album and negative file and 2 enlargement coupons with each roll developed, 8 guaranteed prints 25c. Memrilane Studios, General P.O. Box 666, Dept. "K," New York.

BETTER Colored enlargements, 5x7, 25c. Catlin Film Service, Catlin, Illinois.

MAIL Roll and 25c, receive 16 Velox prints; 20 reprints 25c; two 8x10 glossy enlargements 25c. Seabrook Photos, Franklin, Penna.

ENLARGEMENT From each picture on your roll 25c. Cut Rate Photos, Dept. B-4, Janesville, Wis.

TEN Cents coin and this ad. Developing any roll and eight beautiful panel prints. Surprise. Trial. Graphic Art Studios, Box 660-35, Jackson, Michigan.

EMBOSSED Christmas cards, including envelopes, from your own negative 60c dozen. Minimum 4 for 25c. Film Capitol Service, Box 504, Rochester, New York.

NOW! Quality finishing. Instant service. Eight Velox prints, two enlargements, 25c coin. Snap Shop, 12, LaCrosse, Wis.

ROLLS Developed, 8 prints, two snappy chromium finish enlargements 25c. Prompt 6 hour service. The Picture Folks, Lincoln, Nebr.

FIRST Roll developed—Beautiful 5x7 enlargement and 16 prints, 25c. Dick's Photo, A-10, Louisville, Kentucky.

ONE Day service—8 dated lifetime prints and 2 doubleweight enlargements, 25c. Satisfaction guaranteed. Send your favorite negative for free sample picture, handy mailing envelope and brochure of "Ideas" for kodakers. Supertex Photo Service, Dept. M4, Box 1166, Dallas, Texas.

LARJARGRAPH Reprints: Five 5x7 enlargements 25c. Cardinal Photos, Summit, N. J.

FOR The discriminating amateur—Rolls developed 2 prints each, 25c. Reprints 3c. Superior workmanship. Same day service. Paramount Co., 327 E. 92nd St., New York.

ROLL Developed 16 Velox prints 25c. Radio Photo, 2509 North 3rd, Milwaukee, Wisconsin.

ROLLS Developed—Eight prints, two 5x7, 20c. 25 reprints 25c. Sural Photo Company, AG-3306 Potomac, Chicago.

35MM FILMS Developed and enlarged 3 1/2x5—\$1.00. Better Pictures, 2143 Farragut, Chicago.

PHOTOGRAPHIC Christmas cards. New style sensation. 20 for \$1.00. Sample 10c. Seascout Service, Box 52, Chelsea, Mass.

35MM. ROLLS Developed free. 3 1/2x5 enlargements, 36 exposures \$1.00, 18 exposures 60c. Reprints 4c. Send roll and money today. Minipix, Dept. 510, 100 N. LaSalle, Chicago.

EIGHT Silvertone gloss enlargements or eight prints and two enlargements, 25c. Mayfair, Box 261-K5, Toledo, Ohio.

FOTO-CARDS—First step to a better job! Glossy photographic business cards with your picture, name, address, line of work, set in type, present useful information about yourself in handy form. 25 for \$1.00, 100 for \$2.50. Mail photo (any size), name, etc. (please print), with remittance (no stamps). Satisfaction guaranteed. Studio Press, P.O. Box 355, Chicago, Ill.

IMMEDIATE Service! Better pictures. Sixteen guaranteed prints from roll, 25c. One colored or two plain enlargements and 8 guaranteed prints, 25c coin. Special! Coupon for 8x10 enlargement given with every 25c worth Kodak finishing. Any 36 exposure, 35 mm. film fine-grain developed and each good negative enlarged to 3x4 prints for only \$1.00. 3x4 reprints, 4c each. One day service. Details and mailers free on request. American Studios, Dept. 22, LaCrosse, Wis.

ROLL Developed and eight guaranteed professional prints including two enlargements that will not fade 25c (coin). California Film Service, Box 379, Pasadena, California.

TWENTY Reprints 25c. Roll developed and two prints each negative, 25c. Send for free mailing envelopes, price list. Star Photos, J-109 N. Dearborn, Chicago.

THE Modern Finishers, St. Paul, Minnesota, are the outstanding finishers in America for low prices with quality pictures. Our modern methods give quick service and bright guaranteed neverfade pictures. Roll developed, 16 modern tone prints, 25c coin, 16 modern tone reprints, 25c. Enlargement coupons. Join our thousands of satisfied customers by sending us your next roll or reprint order. Modern Finishers, St. Paul, Minnesota.

JOIN The thousands who are changing to Willard's Brilliantone prints—the style leaders of 1939. Roll developed, two prints each negative, only 25c. Valuable enlargement coupon. Willard Studios, Box 3535-A, Cleveland, Ohio.

TECHNIFINISH—35mm. 36 Exposure rolls perfectly enlarged to 2 1/2" x 3 3/4" glossy prints—75c. Cartridge reload with Eastman Plus X—25c. Fast satisfactory service guaranteed. Write for postpaid mailing bags and information. Technifinish Laboratory, 110 Lexington, Rochester, N. Y.

ROLL Developed, 16 guaranteed prints, 25c. Smart Photo, Winona, Minnesota.

PROMPT Service—Guaranteed work. Two beautiful portrait type doubleweight enlargements, eight neverfade gloss prints, each roll 25c. Dubuque Film Service, Dubuque, Iowa.

EXPERT Finishing. One day service. Rolls developed 16 Velox prints or 8 Velox prints, 2 enlargements 25c. Expert Studios, LaCrosse, Wisconsin.

PROMPT Service—Quality work: 2 beautiful doubleweight gloss enlargements, 8 guaranteed neverfade prints each roll, 25c. Excel Photos, Dubuque, Iowa.

ROLL Developed, 16 prints 25c. Wilkes-Barre Photo Service, Box 64, Wilkes-Barre, Penna.

ONE 6 1/2x8 1/2 Wide border embossed enlargement or one 5x7 hand colored enlargement with each roll developed and 8 prints 25c. 36 exposure roll developed and 36 3 1/2x4 1/2 enlargements \$1.35. 18 exposure roll 75c. Vidor, 321-P Hennepin, Minneapolis, Minn.

ROLLS Developed, two prints each and two free enlargement coupons, 25c; reprints, 2c each; 100 or more, 1c. Summers' Studio, Unionville, Mo.

THREE Prints each good negative in roll 25c. Reprints 3c. Fred D. Eastman, Bode, Iowa.

LIFE Photo finishing lasts a life time. Roll developed, 8 prints, 2 enlargements 25c. Reprints 1 1/2c. Life Photos, Hutchinson, Kansas.

ROLL Developed and 8 beautiful Velox glossy prints 25c coin or stamps. Reprints 3c each. Fotoprint Service, Roanoke, Va.

20 REPRINTS 25c. 100 Reprints, \$1.00. Films developed, 2 prints each negative, 25c. Mercury Studios, Box 822-B, Chicago.

PROMPT Service! Rolls developed, two Velox prints each negative 25c. Hench Studios, Harrisburg, Penna.

PHOTO Mill. Immediate service! No delay! Roll developed, carefully printed and choice of two beautiful 5x7 professional enlargements, one tinted enlargement, or eight reprints—for 25c coin. Reprints 2c each. The Photo Mill, Box 629-12, Minneapolis, Minnesota.

TWO Glossy enlargements, 1 colored with roll 25c. Arbor Service, 10, Joliet, Ill.

CANDID Special. 35mm. rolls enlarged to 3 1/2x4 1/2, \$1.00. 18mm. rolls 60c. 3 1/2x4 1/2 reprints 3c. Brown Photo Company, 1910-61 Emerson, Minneapolis, Minn.

16 PRINTS With roll 25c. 16 reprints 25c. Rex Photo, Ogden, Utah.

GUARANTEED. Roll developed, 16 prints 25c. 20 prints 25c. Quality Photo, Hutchinson, Kansas.

QUICK Service—Rolls developed, 8 guaranteed prints; 2 enlargements; 25c coin. OK Photo Service, Ottawa, Kansas.

100 STAMP-SIZE Photos copied from any snapshot or photo. \$1.00. Ideal Service, Park Ridge, Ill.

CAMERAS, PHOTO SUPPLIES

40-70% SAVINGS On used and new quality cameras, 90 different types and sizes. Guarantee! Trade-in. Ask for free booklet "PM2." Brenner Photo Co., 943 Pennsylvania Avenue, N. W., Washington, D. C.

DEVELOP Pictures the easy way! New book "Modern Developing Methods" helps beginners make first pictures, good pictures—shows advanced photographers new and better methods, 96 pages of latest information on how to develop superior prints and fine grain negatives. Scientifically accurate, yet easy to understand. Illustrations by famous photographers. The biggest value in money saving facts ever offered. Only 50 cents! Send coin, stamps or money order for your copy now! The Edwal Laboratories, Inc., Dept. 10PM, 732 Federal St., Chicago, Ill.

AMAZING Introductory offer. Free developing outfit with each camera at special price of \$1. postpaid. Johnson, 431 Audubon Ave., New York City.

100 MARKETS For your snapshots and photographs. Booklet 25c. Williams, 261 Butler, Pittston, Penna.

MAKE Money in photography. Learn quickly at home. Spare or full time. Easy plan. Previous experience unnecessary. Common school education sufficient. Interesting booklet and requirements free. American School of Photography, 3601 Michigan Ave., Dept. 3431, Chicago.

CAMERAS, Enlargers, on time. See advertisement under Motion Pictures. Mogull's.

MAKE Money selling snapshots. Dime brings 152 page complete instruction book, buyers real information. Fomo Publishers, Canton, Ohio.

CASH For used cameras. What have you? Sanderson's, Ottawa, Illinois.

AMATEUR Photographers—I average \$10.00 a day with my \$3.00 camera, and so can you! Learn my secret for only \$1.00. M. G. H., 26 Howard St., E. Braintree, Mass.

SAVE On photo paper! Glossy contact 2 1/2x4—50c gross; smooth matte enlarging 5x7—\$1.00 five dozen; \$2.00 gross. Amazing bargains in guaranteed used cameras. Free bulletin. Standard Camera Exchange, 509 Fifth Avenue, New York.

NEW Free photography book now ready—lists and illustrates hundreds of sensational new and used bargains plus valuable information on modern photographic methods, high-speed miniature candid cameras, precision lenses, night equipment, enlargers, darkroom equipment, movie cameras, screens, etc. Money-back guarantee. Liberal trade-in allowance on your old equipment. Get free book today. Write Central Camera Co., Dept. 116Z, 230 South Wabash Avenue, Chicago, Illinois.

CAMERA Repairing! Bellows made to order—any size! Fit all standard cameras! All makes shutters repaired by experts! Lowest prices! For complete information write, United Camera Company, Inc., A-1515 Belmont, Chicago.

BASS Inventory clearance. Profit by these unusual bargains. 35 mm. Candid Midget, F:4.5 lens, \$12.50. Used Poth Derby, F:3.5, \$15.75. 2 1/2x3 1/4 Agfa Film Pack and plate, with F:6.3 lens, auto shutter, film adapter and holder, \$11.95. Used Argus, F:4.5 lens, \$7.75. New Candid Midget, Xenon F:2 lens, Rapid Compur and case, \$84.75 value, at \$47.50. Hundreds of other bargains in the great Bass Bargaingram and special bulletins. Your money back is unsatisfactory after 14 days trial. Write Bass Camera Company, Dept. AG, 179 W. Madison St., Chicago, Illinois.

HAVE You a camera? Send ten cents for recent number of our big magazine, showing how to make better pictures and earn money. American Photography, 116 Camera House, Boston, 17, Mass.

FREE To camera owners: Set of 3 filters for names and addresses of 3 camera owners. Photo-Craft, Dept. MC, Canton, Ohio.

ENLARGER \$1.59. Enlarges eight times size of small negatives. Fully guaranteed. Paramount Sales Company, 89 Dudley Street, Boston, Mass.

CAMERAS Films, paper 25% to 35% discount. Paramount Photo Division, 327 East 92nd St., New York.

MOTION PICTURES AND SOUND EQUIPMENT

START Your own road show. Earn big money. Operate movie shows in theatreless communities. Small investment. We rent and sell 16 mm. talking pictures and complete projection equipment. Write today. Southern Visual, 494 South Second Street, Dept. P.M., Memphis, Tenn.

GENERA Films in bulk for all motion picture cameras. 90 feet for Univex, \$1.00, 100 feet double 8mm., \$1.75; 16mm., \$1.35, 400 feet 16mm. \$4.25 postpaid. Sample for stamp. Process with our prepared powders and simplified outfits: 8mm. \$3.75, 16mm. \$4.95. Fromaders, Davenport, Iowa.

MOGULL'S Has real photographic bargains! "Bargainews" (largest of kind sent free!) Leica f:3.5 \$44.50; Retina f:3.5 \$29.75; Exakta f:3.5 \$47.50; movies—16mm. DeVry f:3.5 \$19.95; 8mm. Univex \$4.99. Special flash! \$410 Duplex 16mm. sound projector, 750w, 15w output, complete \$289.50. Used 16mm. sound films; features, shorts, \$5.00 per 400'; silent \$3.00 per 400'. 1100 thrilling specials. Nationwide monthly payments. Trade-ins accepted. Mogull's, 64 West 48th, New York City.

OUTDOOR Film 100 ft. 16mm. \$1.95. 25 ft. double 8mm. 98c. Processing included. Free 16mm., 8mm. lists. Home Movies, Box 216, Easton, Pennsylvania.

LATE Talkie programs rented. \$15.00 week; \$7.50 two nights. Simpson, 1275 South Broadway, Dayton, Ohio.

SAVE Cash. Catalogue. Bulk film. Penn-Craft, Box 423-M10, Williamsport, Penna.

BARGAINS! 8mm., 16mm., free literature. Elder, P-739, Boylston, Boston, Mass.

ROYAL Home movies—8mm., 16mm. Cartoons, comedies, westerns, travelogs. Free list. Royal Home Movies, 42H Melrose St., Boston, Mass.

FOR Sale—16mm. silent features \$35, single reels \$5.00. Rent for 75c per reel. Waldo Films, Box 524, Cincinnati, Ohio.

BARGAINS! Silent 35mm. films. Projectors. Demsey, 1223 Berkley, Youngstown, Ohio.

16MM., 35MM. Bargain projector film lists 3c each. Camera film 16mm., 100 feet \$2.20. Clifford Hoffman, 57 Broad, Albany, New York.

TITLES From Hollywood, 8 and 16 mm. 25 stock backgrounds, up to 8 words, 4 for \$1. Crown Titles, 1150 No. La Brea, Hollywood, Calif.

COMPLETELY New 8mm., 16mm. title information now available! Laboratory Service Manual K-6, film strip specimens for 3c stamp. Cine Shop, 1812 Piedmont, Charleston, W. Va.

8MM.-16MM. Bargains. Free catalog. Movie Shop, 838 Broadway, Bayonne, N. J.

FILM. Art sample, 10c. Others, lists free. Goodwill Company, Jackson, Tenn.

BARGAINS—8mm., 16mm. Films, sale and rent. Used and new equipment, projectors, cameras, screens. Free catalog. Abbe Films, 1265 Broadway, New York.

16MM. VELOTEX. Perfect outdoor film. 100 ft. rolls \$1.95 including free processing. Sample free. Velotex Laboratories, 600-E, Gary, Indiana.

8-16MM. FILMS: Rentals, exchanges. Free catalogue (with sample film 10c). Garden Exchange, 317 West 50th, New York.

BEADED-SCREENS Easily made! Beads, covering 4'x5' screen, \$1.00. Finest, \$1.25. Directions included. Sample, dime. Gard. Box 418-E, Madison Square Station, New York.

MOVIE Stars! 8mm. 200 feet \$3.00; 16mm. 100 feet \$2.75. Catalog, Bailey Films, Dept. Y, 1651 Cosmo, Hollywood.

LOOK! "The World's Greatest of All Passion Plays," 16mm. and 35mm. Silent or sound, rent or purchase. Hemenway Film Co., 37F Church St., Boston, Mass.

GUARANTEED 8MM. 24-hour reversal processing. Double 8mm., 45c. Single, 25c. Univex 15c. Eso-S, 3945 Central, Kansas City, Missouri.

MOVIE Film. Develop yourself. Univex, Eastman, etc. Chemical samples 15c. Raw film wholesale. Lake Camera Exchange, Gary, Ind.

HERE'S News from Bass! Our 64-page Cine Bargaining is ready! Free for the asking! 8 mm., 16 mm., and 35 mm. silent and sound equipment. Popeye, Betty Boop, and other films. Accessories to gladden the heart of amateur or professional. A few used bargains: Univex 8 camera, P:5.6 lens, each \$5.75. Univex, motor drive, 8 mm. projector, \$12.50. Bell & Howell model 57, 16 mm. projector, 200 watt, and case, \$32.50. New RCA 16 mm. sound on film camera, Newsreel model, \$250.00. Write today. The book will be mailed at once. Bass Camera Company, Dept. A, 179 West Madison St., Chicago, Illinois.

15% TO 25% Discount on still or movie cameras. Free circular. Paramount Co., 327 E. 92nd St., New York City.

JESUS Of Nazareth, 16mm. sound silent. Screenart, 729 7th Ave., New York City.

RADIOS, SUPPLIES, INSTRUCTION

RADIO Kits—\$3.95 up. Complete. Single band; all-wave; 5-10 tubes. Save 50%. Radio and parts catalog free. Marco-PP, Kansas City, Mo.

ANY Radio diagram 25c. Specify manufacturer, model. Radio magazine free. "Television Cyclopaedia" 25c. Supreme Publications, 3727 West 13th, Chicago.

PLANS 18 Record-breaking crystal sets, with "Radiobuilder"—year, 25c. Laboratories, 7700-C East 14th, Oakland, Calif.

RADIO Engineering, broadcasting, aviation and police radio, servicing, marine and Morse telegraphy taught thoroughly. All expenses low. Catalog free. Dodge's Institute, Ames St., Valparaiso, Ind.

SEND For free giant money saving radio and phonograph record catalogue. United Radio Company, 1000-M, Newark, N. J.

MUSIC AND MUSICAL INSTRUMENTS

WRITE Your own music. Our book "Harmony" teaches how. Only \$1.00 postpaid. Greenleaf School of Music, 3553 Broadway, Chicago.

DUO-FLEX Reeds for clarinets, and saxophones eliminate your reed troubles. Write for circular. Duo-Flex Reeds, 1204 1st Ave., Evansville, Ind.

SAVE Money, improve your playing with La Rae clarinet and saxophone reeds. Fine quality French reeds graded. Send postcard for price list to La Rae Reeds, Box 61, Denver, Colorado.

FIFTY Late phonograph records, \$2.50. Wurlitzer selective, amplified, 12 record phonographs, very cheap. Davis Sales Co., Syracuse, N. Y.

PIANO By ear. Free booklet. Day-V-Way, Woolworth Building, Dearborn, Michigan.

SONGS, Song poems, bought, published, best offer. Free information. Metro Music Publishers, 1204 Sutter, San Francisco.

SONG Poems wanted. Extraordinary offer. Songwriters, 1234-C Broadway, New York.

SONGS—Arranged, revised by arranger "If I Had My Way"; "Carolina Moon"; others. Send for details. Harold Potter, 1619(P) Broadway, New York.

SONGWRITERS! Outstanding, convincing opportunity. Hibbeler, C-5, 2157 N. Avers, Chicago.

ORCHESTRATIONS Popular back numbers, 10—\$1.00. Silverman, 3305 Lawrence, Chicago.

SONGWRITERS—Splendid proposition. Newart Song Publications, 1207 Carbon, Syracuse, N. Y.

SONGWRITERS: Truth about songwriting opportunities. Rackets exposed. Send 10c for booklet. Allied Music, Inc., Carew Tower, Dept. E3377, Cincinnati, O.

SONG Poems wanted. Free examination. Send poems to McNeil, Master of Music, 510-PM So. Alexandria, Los Angeles, Calif.

SONGWRITERS — Agents, new sales plan. National Music-D, 532 Sixteenth, Oakland, Calif.

MUSIC Composed to words. Rhyming pamphlet on request. Phonograph recording of completed songs. Send poem for consideration. Keenan's Studios, Dept. PM, Box 2140, Bridgeport, Conn.

SIMPLIFIED Swing courses! Accordion, saxophone, clarinet, trumpet. Write Swingmaster, 1259-N Bender, East Cleveland, Ohio.

MUSIC Composed to words. Wonderful proposition. Bauer Bros., Oshkosh, Wis.

WRITE Songs. Big money and reputation. Write for information. J. Gordon Pub. Co., 201 N. Hoyne Ave., Chicago.

WANTED! Lyrics, melodies for songs. We arrange, publish, sell. Superior Song Studios, Passaic, N. J.

SONGWRITERS: Send your poem today for immediate consideration. Richard Brothers, 24 Woods Building, Chicago.

SONG Writers. Send for publishing agreement. McKinley Music Publishers, 1501 E. 55th St., Chicago.

ORIGINAL Music composed to your words. \$5. 200 printed copies \$10. Reginald Belcher, Chatham, New Jersey. 30 years church organist.

BUSINESS OPPORTUNITIES

WANTED—Factory representatives for complete Turkish bath outfit for home use. Light, streamlined, compact. Retail \$9.95. Write today for our proven sales plan. Perspirator Mfg. Co., First and Utah, Toledo, Ohio.

NATIONAL Baking Institute announces a new home study course covering all phases of commercial baking. Good field for ambitious men. Nearly a depression proof business. Common school education sufficient. Send for free booklet "Opportunities in the Baking Industry" and requirements. National Baking Institute, 3601 Michigan Avenue, Dept. 3437, Chicago, U.S.A.

FORDS Portable Hammernill operators make regularly weekly net earnings, \$50, \$75, \$100 and more. Ford's exclusive molasses impregnator gives operators big competitive advantage. Equipment may be purchased 25% down, balance from earnings. Write for particulars about this safe, sure, profitable year-round business. Myers Sherman Company, 1428 12th, Streator, Illinois.

MAKE Big money at home! Sensational, new invention electroplates by brush—gold, silver, nickel, etc. Easy as painting. Does same beautiful, permanent plating as big tank outfits—easier, quicker, cheaper. Amazing low price. Portable—do work anywhere, right on the spot. Write for big quick-money-making plan and free sample that proves all claims. Warner Nu-Way Electroplater Co., Dept. 5-RC, 360 N. Michigan Ave., Chicago, Ill.

POPCORN Machines, caramelisp, crispettes, cheese coat, potato chips. Long Eakins, 2035-K High St., Springfield, Ohio.

COLOR Concrete with chemicals. Stucco-Rock. Cement artistry. Benches, Wishingswells. Spin concrete pottery. Miniature castles, watermills. Coldglaze, water-paints, marbling. Sample 10c. Hollywood CementCraft, 8527 Wonderland, Hollywood, California.

EVERYONE Paints signs, showcards with Speedway Letter Patterns. Valuable 3 in. sample alphabet, enclose nickel. Free literature. Display Letter Co., Box 28, Fort Hamilton Station, Brooklyn, N. Y.

LET Me show you how to make 900% profit selling folios by mail. Double knockout. Free circular. The Better Products Co., Potsdam, N. Y.

"RUBBER Molds." Make them yourself. Formulas, instructions 25c. Ideal Service, R-10, Park Ridge, Ill.

BUILD Fame, fortune processing 25c. \$4 glamorizer. Sample 25c. Geloid, Box 1100, Cleveland, Ohio.

WHOLESALE Supply Guide—1,500,000 articles. 10c. Labey, Colorado Springs, Colo.

HANDY Men—Earn money home operating Community "Fix-It" Shop. Stafford, Makanda, Illinois.

FREE. 100 Money making home work propositions. Mayer, Swedeborg, Mo.

MAKE—Sell finest maple syrup to homes, restaurants—big profits. Send \$1 for formula, full instructions. Free—We include maple flavor enough to flavor 4 gallons postpaid. Manufacturers Sales Co., 301 West 29th, New York City.

FORMULAS — Fast selling products. Guaranteed. Laboratory tested. Lowest prices. Catalog free. Kemico, 510, Park Ridge, Ill.

FOR Business ideas, plans, opportunities, source of supply, read the 60 pages of Promotive Magazine 10c. Lorraine Publisher, Box 6703, Philadelphia, Penna.

LEARN Account collecting. Good income; quick results. Interesting folder free. National Collectors Association, Newark, Ohio.

WATERLESS Soap business your opportunity, complete instructions, \$1. Jerome Jones, Hollins, Alabama.

RUBBER Mold making. Plaster casting. 24 page booklet 3c stamp. Plastic Arts, 711 Neely, Muncie, Indiana.

DESIRABLE Opportunities. Abundant details 10c. Commercial Service Bureau, Medford, Wisconsin.

BIG Money home mailorder business. Write Dixie Mailers, King, N. C.

MAKE Money in business of your own. 25c brings valuable booklet of opportunities. Circular for stamp. Otto, Box 864, Sequim, Wash.

WE Help start you in business, furnishing outfits and instruction, operating "Specialty Candy Factory" home. Men-women, opportunity to earn good steady income, all or spare time. (Our 31st year). Booklet free. W. Hillyer Ragsdale, Inc., Drawer 4, East Orange, N. J.

SOAP Making. Learn at home. No machinery needed. Posera, D4545 Bartlett, Milwaukee, Wisconsin.

EARN Extra money writing for publication. Simple method. Demand inexhaustible. Details free. Dona Veretts, 17 Groton, Lowell, Mass.

TURNING Ideas into cash, circular free. Wayne Products, Pleasantville, N. J.

M. M. Earned \$267 three weeks, raising mushrooms in cellar! Exceptional, but your cellar, shed perhaps suitable. We buy crops. Book free. United, 3848 Lincoln Ave., Dept. 68, Chicago.

QUICK Income! Fast-growing business creates lasting independence; no canvassing. Service, Drawer 339-5, Butte, Mont.

EARN Extra money at home. Increase your income at home by new, simple Wentworth Tempera Color method. We instruct you and supply you with work. Write today for free booklet. Wentworth Pictorial Co., Ltd., Dept. 3, Hamilton, Ont.

GOOD Paying business, plating auto parts, reflectors, bicycles, bath fixtures, mirrors, by late method. Small investment brings big returns. A permanent respectable business in your own community. Free particulars and proofs. Gunmetal Co., Ave. H, Decatur, Ill.

GOOD Money raising mushrooms. Turn spare space—spare time into cash. Starting crop guaranteed. We buy all you raise. Get free book. Niagara Mushroom Co., Dept. B-10, Buffalo, N. Y.

NEW Framed feather pictures! Retail 69c. Sample 20c stamps. Dozen \$1.80 postpaid. Marquez-PBM, Apartado 1176, Mexico City.

PROFITABLE Business. Personal business stationery 50% profit. Garfield Art Studio, Crown Point, Ind.

YOU'LL Like resilvering mirrors, auto-parts, reflectors, making chipped glass signs. Write Sprinkle, Plater, 127, Marion, Indiana.

TAMALE, Brick chili. Guaranteed commercial recipes \$1.00. Big profits. Wholesale or retail business. Fred Hughes, 94 Hurst Ave., Ventura, California.

REPAIR Typewriters; big profits; details stamp. Malonite, Bayside, New York.

FREE Information. Collect 100% on automobile and other accident claims. Adjuster Burns, Keystone Bldg., Pittsburgh, Penna.

START Home manufacturing business. Small investment. Amazing profits. Interesting work. Details free. Oglesby Art Studio, 235½ No. Green St., Greensboro, N. C.

YOUR Own business! Easily started. Send for free booklet: "Golden Opportunities for You." E. Kinford, Wayne, Penna.

ASSEMBLE And sell electric fence controls. Costs \$6.50. Equals \$25 control. Assembled controls \$7.50. Electrofence, West Winfield, N. Y.

PATENT And \$1.00 earned \$50,000—without canvassing. Now retired! Few selected. Work in home. Treatises, BX1240, San Bernardino, California.

RECAST Old batteries into new. Latest achievements. Battery Laboratories, St. Paul, Minn.

"PROSPERITY Pointers" sent free. Business of your own. Get next to "Unique opportunities for the wide awake." Diafas, Fillmore, N. Y.

100 PROFITABLE Mail order and local plans. Gilbert Supply, 1107 Broadway, New York.

GET Into business yourself. 6 tested plans 25c. Langer's, Box 583, Fond du Lac, Wis.

MAKE Money by mail. Many proven plans—details free. Campbell Service, 3231 Dupont North, Minneapolis, Minn.

RECEIVE Stacks of mail. Your name listed in 10,000 directories, 25c. Liberty Sales Service-A, Sheboygan, Wis.

23c PROFIT On 25c household necessity. Selling information. Sample 10c. Windsor Products, Windsor, Ohio.

STOP Job hunting! Start manufacturing! Millions need products! Extremely profitable. Thermolab, Peoria, Illinois.

NEWEST, Uncommon specialties sell best! I'll tell you how to easily make them, in an independent business yourself and have hundreds selling them for you. Miller's Chemical Laboratory, Tampa, Fla.

PROFIT With new products. Make, sell, repeat. Analysis. Research. Guaranteed formulas. Biggest catalog free. Nominal prices. Gibson Laboratory, Chemists, BD-1142 Sunnyside, Chicago.

MAKE Your own job, manufacturing imitation marble whetstones, fireproof paint, wallboard, and the best plaster there is. No machinery required. Write, E. M. Spencer, 322 W. Markham St., Little Rock, Ark.

ATTENTION, Men needed every neighborhood. No selling. Your opportunity. Work quickly. Complete details two dimes. Creton, Box 372, New Haven, Conn.

START Your own business. Make large profits. Sell auction—bankrupt clothing bargains and general merchandise. Experience unnecessary. Free wholesale catalog. Superior Jobbing, 1250-O Jefferson, Chicago.

\$1,000,000 SALES In this field last year! If you have elementary education and ambition you can have your share this dignified business. Be first in your community by writing for details today! National, Box 450, Green Bay, Wis.

BE Rich. Make 900% profit bottle vanilla extract. Free labels. Tharp, 914 Lexington, Cumberland, Md.

MANUFACTURE From Phospholene. Cleaning fluid 1c gallon; bleach 2c gallon; hand soap 2c pound; and ten fast sellers. Sample 25c. Details free. Western, 401 Climax Bldg., Cleveland, O.

GIANT Mail opportunities, added income, ideas. 68 page magazine 10c. Katz, 4254 N. Kimball, Chicago.

CHIPPING Glass signs folder free. Beveridge, 160-22 Locust, Jamaica, New York.

ADVERTISERS! 1,600,000 Mail order circulation. Inch advertisement, \$15.40. "Get results." 20 newspapers, 18 words, \$6.50. Diener-Dorskind, 1474P Broadway, New York.

PLASTEX Industries offers industrious men an opportunity to start a business of their own, manufacturing art goods, novelties, souvenirs, etc. In Plastex and marble imitation. 5c material makes \$1 articles. Rubber moulds furnished for speed production. Small investment brings big returns. You are just in time for big wholesale season now starting. Write for interesting booklet mailed free. Plastex Industries, Dept. A, 1085 Washington Ave., New York.

"SCHEMER" Magazine, Alliance, Ohio, (41st year) prints schemes, tips, opportunities, formulas; winners: \$10,000—\$25,000 reported. Year, \$1.00. Now get acquainted: trial six months only 30c.

MAKE Money by mail, the way we do. Free information. Maywood, P-1107 Broadway, New York.

FREE Booklet many money making ideas. Enterprise, Bx59, Monroe, N. C.

WHY Work for others? Be your own boss. Sell products with your name on the labels. Cosmetics, household specialties, extracts, etc. Details free. Chemical Co., Box 5269, Richmond, Va.

POPCORN Machines, all types. Carmel-corn equipment. Northside Mfg. 1925-10th, Des Moines, Iowa.

LIQUID Marble—anyone can make! Colorful, glazed! Moulded, brushed, sprayed. Rubberlastic moulds. Composition flooring. Big money in these! Particulars free. Marbleizing Service, Edwardsville, Ill.

HOW And where to obtain capital fully explained, free particulars, Star Service, Wapakoneta, Ohio.

YOUR Own business! Selling by mail. Details free. Maples, 3418 South Marshfield, Chicago, Illinois.

SUCCEED With your products. Make-sell. Formulas. Accurate analyses. Catalog free. B. Thaxly Company, Washington, D. C.

INVENTORS—We successfully sell inventions, patented and unpatented. Write for proof, and tell us what you have for sale. Chartered Institute of American Inventors, Dept. 4-C, Washington, D. C.

I WANT To send you proof of the wonderful pulling power of Popular Mechanics Magazine's classified pages. What's your proposition? Write me today. F. W. Johnson, Manager Classified Advertising, 200 E. Ontario St., Chicago, Ill.

DELAWARE Charters: Complete service \$35. Submitted forms. Chas. G. Guyer, Inc., Wilmington, Del.

107 WAYS To make money, in home or office, business of your own. Full particulars free. Elite Co., 214 Grand St., New York.

SELL By mail. Books, novelties. Bargains! Big profits! Particulars free. E. Elfeo, 438 N. Wells, Chicago.

ELITE Collection of business plans, contains 107 tested plans and scores of formulas. Start own business; home, office. Particulars free. Elite Co., 214 Grand St., New York.

CHARTERS: Delaware; best, cheapest; free forms. Colonial Charter Co., Wilmington, Del.

WHERE To buy at lowest wholesale prices. Information free. Yorena, Box P-312, Bayonne, N. J.

MAIL Order business is your opportunity. Many began small, now earn thousands yearly. No personal contact. Boundless opportunities. Have had over 30 years experience; will help you succeed. Send 25c for valuable booklets, none free. B. Breniser, 257 S. 21st, Philadelphia.

MONEYMAKING OPPORTUNITIES

BE A professional scrapbooker. Big fees. Unlimited opportunities. Can be done at home. No competition. No capital needed. Write postcard to Scrapbookers Guild, 59 Park Place, New York, N. Y.

MAKE Money repairing automobile fenders. Information 50c. Hope Trade School, Department L, Burlington, Vermont.

SOME Moneymaking plans you will like. Postcard. Spangler, 1724 Warwick, Baltimore, Md.

OUR Barbecued frankfurters are moneymakers. Formula costs only 10c. Write today. Davis, Box 1484-P, Clarksburg, West Virginia.

GIANT Opportunity magazine free. Morey Press, 87 Somerset, Springfield, Mass.

BOOKKEEPERS—Increase income with inexpensive new bookkeeping service. Bobertz, 3701 East Hancock, Detroit.

PROFITABLE Plants. Soil-less culture, free circular. Plant Service, 250 Mamaroneck Ave., White Plains, N. Y.

MILLION Articles. Buy wholesale. Valuable directory 10c. Ideal Service, D-10, Park Ridge, Ill.

GOOD Paying business, plating auto parts, reflectors, bicycles, bath fixtures, mirrors, by late method. Small investment brings big returns. A permanent respectable business in your own community. Free particulars and proofs. Gunmetal Co., Ave. N, Decatur, Ill.

PROFITABLE Mail order business. Complete plan, sample, big mails, 10c refundable. Al. Riegel, Kintnersville, Penna.

MOLD Making, plaster casting, particulars, 3c stamp. Studio, 711 Neely, Muncie, Indiana.

FREE—Speedex candid type camera, carrying case, 2 rolls film, for two hours spare time. Postcard brings details. Dept. MP, Birmingham, Alabama.

"MONEY By mail"—Latest plans, formulas, ideas, opportunities, 25c. Roberts, 3705 East Hancock, Detroit.

MAKE Money at home. Unlimited possibilities. Particulars free. Macomber, 135 Forest, Buffalo, N. Y.

BIG Mails of opportunities; imprints, new offers, mailorder propositions, sample mailing free. Harvey Teeple, Decatur, Indiana.

YOU'LL Like resilvering mirrors, auto-parts, reflectors, making chipped glass signs. Write Sprinkle, Plater, 287, Marion, Indiana.

SENSATIONAL Moneymaking plan complete 50c. Bell Twisby, Englewood, New Jersey.

"100 TO 1" You will like these "unique and unusual" propositions. "3" real money makers. Details free. Original, Box 1792, Houston, Texas.

HOME Work opportunities, plans, formulas. Monthly Mentor Magazine. Send dime. Glen Ferris, Box 767, Bremerton, Wash.

FREE—300 Wonderful business, mailorder and home work moneymaking offers. Lewis Company, 828-D Carpenter, Oak Park, Ill.

"GOLDEN Opportunities"—66 pages moneymaking schemes, tips, information, 10c. Practical Sales, Allendale, South Carolina.

ADDING Water makes auto, furniture polish. Enough for pint 20c; gallon \$1. Gray, 375 Richmond, Buffalo, N. Y.

PATENT And \$1.00 earned \$50,000—without canvassing. Now retired! Few selected. Work home. Treatises, BX1240, San Bernardino, California.

MAKE Extra money grinding knives, axes, scissors and fine tools on a belt. Replaces the grindstone completely. Booklet "New Era in Grinding," 25c. Ripley Manufacturing Co., 1031 - 15th St., Denver.

WRITERS Wanted for special field. Steady income. Free manual. Slater, 612 Loew's State, Los Angeles.

BUYERS Guide—Latest bargain offers. Agents, mailorder dealers, mailers. Wetzel, Valhalla, N. Y.

MANY Money-making opportunities in our 64-page monthly magazine. Single copy 10c. Three months 25c. Publisher, 200 William, Argo, Indiana.

400 "UNIQUE Money making opportunities." Particulars free. G. Diafas, Fillmore, N. Y.

CALIFORNIA Progressive monthly magazine for opportunities. Send 10c and 6c postage. Dellingers, 820 West 17th, Los Angeles.

"1,000 WAYS To Make \$1,000." You can do it—others have. This amazing book will startle you. 475 pages, only \$2.50. Popular Mechanics Press, Room (C39), 200 E. Ontario St., Chicago.

ANALYSIS, Research. Newest guaranteed formulas. Biggest catalog free. Nominal prices. Gibson Laboratory, Chemists, CS-1142 Sunnyside, Chicago.

CASH For your spare time! 68 page book "Cash In," 10c postpaid. 300 tested moneymakers; 40,000 words. Business secrets, formulas, wholesale suppliers, galore. No ads. Moneyback guarantee. National Plans Institute, 246M Fifth Avenue, New York.

KEY Check stamping outfits. Emblem key checks, key rings. Catalog free. Sample name and address 25c. Social security plate name number 15c. Kemp & Company, 463-P East 178th St., New York.

KEEP Dollars received supplying, by mail, satisfying employment information—millions jobless. We fill your orders. Stamp, details. Co-Operative Service, 77 Swan, Buffalo, New York.

START Profitable mailing business. We trust you. Monthly payments. Particulars, copy 25c Opportunities Magazine 10c. Hunt Co., 49 Edgemere, Trenton, N. J.

MOULDS, Guaranteed, for casting toy soldiers, Indians, trappers, warships, sinker moulds, 244 kinds. Send 5c for illustrated catalogue. Henry C. Schiercke, 645 Spencer, Ghent, N. Y.

PROFITS, Day-night. No selling. Operate "Silver King" vendors \$3.25 up. Free instructions. Automatic, 2427 Fullerton, Chicago.

RAISE Earthworms for profit. Information free, stamp appreciated. Bureau Zoological Research, 106A Broadway, Peoria, Ill.

WHOLESALE Sources. 500,000 articles. Free directory. Maywoode, 1107 Broadway, New York.

ACCOUNTANTS And bookkeepers. Real profit from new type bookkeeping service. Write Asco, Box 1468, Springfield, Mass.

FORMULAS, PLANS, ETC.

10 FORMULAS 10c including "Traders Gold" the new marvel. Alma Company, Hunter, Ark.

GUARANTEED Formulas—New fast sellers. None better. Lowest prices. Catalog free. Kemico, 410, Park Ridge, Ill.

FREE Formula catalog. Accurate analyses, research. Western Chemical, Salem, Oregon.

FORMULAS—All kinds. Real money-makers. Lowest prices. Catalog free. Clover Formulary, P-10, Niles Center, Ill.

10,000 FORMULAS—900 Page volume, most amazing value in years. \$1.85 postpaid. Ideal Book Shop, 1710, Park Ridge, Ill.

900 PAGE Book loaded with 162,000 facts, 10,000 formulas, recipes, trade secrets, tips for profitably making-selling almost everything. Rush 3c stamp for free offer. Adam-Brown Company, Chestnut Hill, Massachusetts.

HERE'S Headquarters for newest, tested, guaranteed highest quality formulas for every modern requirement. Analysis-research. Prices nominal. Miller, Chemist, Tampa, Florida.

ANALYSIS. Research. Newest guaranteed formulas. Biggest catalog free. Nominal prices. Gibson Laboratory, Chemists, BD-1142 Sunnyside, Chicago.

REAL Money-maker. Make, sell luminous paint. Simple, harmless. Formula, instructions \$1.00. Sample 10c. Gordon Laboratories, 1265-C Broadway, New York.

THAXLY Formulas for perfect products. Accurate analyses. Catalog free. B. Thaxly Company, Washington, D. C.

FORMULAS. Latest money makers. Literature free. Belfort, 4042 N. Keeler, Chicago.

ELITE Formulas and plans; make and sell your own products. Descriptive booklet free. Elite Co., 214 Grand St., New York.

CHEMISTRY

FREE! "Science and Experiment" magazine! Interesting, fascinating experiments; prizes, apparatus, books! Send postage, 3c. 4931-N. Hamlin, Chicago.

CHEMISTRY. Microscopes, telescopes, biology, mineralogy. Free catalogue. Tracey Laboratories, Evanston, Illinois.

JOIN American Amateur Chemists Society. Journal, particulars 10c. Haslett, Michigan.

FREE: 40 Page catalog of chemical and laboratory supplies for amateur chemists. Wollensak microscopes and supplies, scientific books at big discount. JE-10 Winn, 124 West 23 Street, N. Y. C.

CHEMICALS In 5c quantities. Catalog 5c. Fleischer's Laboratories, Everett, Mass.

HOME Study chemistry courses at fraction of original price. Particulars free. Lewis, 128 E. 23rd, New York.

SPECTROSCOPE For quick chemical analysis \$2.50. Kutting Sons, Campbell, California.

FREE Chemistry catalog. Supplies at 5c! Equip complete laboratory. Send 3c for postage. Kemkit Scientific Corp., 397P Bridge St., Brooklyn, N. Y.

CHEMICALS, Laboratory, glassware, apparatus. Send 3c for catalog CP1. Biological Supply Company, 1176 Mt. Hope Avenue, Rochester, N. Y.

HELP WANTED

STEADY Work—Good pay. Reliable man wanted to call on farmers. No experience or capital required. Pleasant work. Home every night. Make up to \$12 a day. Wonderful new proposition. Particulars free. Write McNess Co., Dept. 329, Freeport, Illinois.

M. M. Earned \$267, three weeks, raising mushrooms in cellar! Exceptional, but your cellar, shed perhaps suitable. We buy crops. Book free. United, 3848 Lincoln Ave., Dept. 69, Chicago.

GOOD Typist, with own typewriter, in each city, for business proposition. Good education required. Work at home. Not a salesman's proposition. Wonderful opportunity for efficient person. Three cent stamp for reply. Roger Lawrence, Route One, Martinsburg, West Virginia.

SALARIED Positions—\$2500 yearly and up. Let us find one for you. Write for valuable information. Executive's Promotion Service, (16), Washington, D. C.

BIG Money taking orders; shirts, ties, hosiery, underwear, pants, jackets, rain-coats, uniforms, etc. Sales equipment free! Experience unnecessary. Nimrod, 4922-BG Lincoln, Chicago.

LOOKING For steady employment? Midwest, 137 East Spring, Columbus, Ohio.

AGENTS WANTED

AUTO Accessory men! Excellent sideline. Old reliable sparkplug company. Unusually liberal working plan. Irresistible dealer proposition. Protected territory. Write Reflex Sparkplug Co., 10903 Madison, Cleveland, Ohio.

MECHANICS—Install brand new auto accessory, 150% profit. Eliminates shift lever, shift gears from dash. Simple, universal, inexpensive, thirty minute installation. Sells on sight. Write for particulars. Harris-Weaver Lab., 508 Church St., Flint, Mich.

MAKE Big profits selling famous Waltham Christmas cards. 21-card assortment sells for \$1, pays you 50c. Other popular assortments and personals. Free sample offer. Waltham Art Publishers, 160 N. Washington St., Dept. 261, Boston, Mass.

DROP Everything. Sell Glas-Glos, 100% profit. We start you free. Cleans everything but fabric. Stops household drudgery. Amazing for automobiles. Build a permanent business. Write for offer. Pioneer Sales Company, 1006 Commerce Building, Erie, Penna.

CHRISTMAS Card bargains. Sell 50 personal Christmas cards for \$1. All beautiful folders with customer's name inscribed. Liberal profit. Free samples. Also marvelous value \$1.00 box assortments. General Card, 400 S. Peoria St., Dept. P-19, Chicago.

BIG Money—Applying gold monograms to automobiles, luggage, etc. Experience unnecessary. Samples and particulars. Gold Letter House, Tyler, Texas.

NECESSITIES Are always in demand! Experience unnecessary to earn steady income supplying tremendous demand for customized shirts factory to wearer. Gigantic variety; one year guarantee; ninety sizes. Half price offer creates amazing values. Superior advantages eliminate competition. World's largest concern of its kind. Our sales force earns \$100,000.00 yearly. Get your share! Postcard brings you complete self-selling outfit free. Simply write orders. We deliver and collect. Write Dept. 404, Rosecliff-Quaker, 1239 Broadway, New York.

"CHRISTMAS Cards." Beauties. Big profits. Investigate. Hamilton, 4341-P Meade, Chicago.

SELL 50 Assorted Christmas cards with name \$1. Costs 50c. Free sample offer. Other profitable sellers. Nickel's Press, 4617 Loughborough, St. Louis, Mo.

PERMANENT Representative wanted for Hoover uniforms to call on restaurants, hotels, beauty parlors, doctors, nurses, others. Excellent income. Leads furnished. Equipment free. Hoover, Dept. 1J-B, 251 W. 19th, New York.

CHRISTMAS Card money-makers! Sensational \$1 assortment 21 Christmas folders starts you making money now—50c profit each box. Other fast-selling assortments; personal Christmas cards, 50 for \$1. Samples free. Schwer, Dept. P-4, Westfield, Mass.

SELL Rax shoe fasteners, laces no longer required. Everyone buys on sight. Large profits. No competition. Samples 25 cents. Beveridge, 3771 West 23rd Avenue, Vancouver, B. C.

OVER 500% Profit selling our unique resurrection plants. Large sizes \$1.50 100 postpaid. Samples 25c. El Paso Cactus & Curio Co., 3408 Bisbee St., El Paso, Texas.

MONOGRAMMING Automobiles real money maker. Write for samples. International Co., Box 9360, Philadelphia, Pa.

QUICK Profits demonstrating unique invention. A bright reading and current saving night bulb all in one. Free details and sample offer. Hagen Import, Bulb Dept., St. Paul, Minn.

MEN'S Handkerchiefs individually boxed 10c seller. 24 to display carton 75c carton. Hoffman, 284 Madison, Passaic, N. J.

THREE Wonderful sellers. Samples 40 cents. Schaffner, Greenwald's, Allentown, Penna.

SELL Charlie McCarthy clocks and carded merchandise. Dixie Supply, Rosslyn, Virginia.

BIG Profits taking subscriptions—2500 magazines. Pines, A-583 Monroe, Brooklyn, N. Y.

SENSATIONAL Christmas card money-maker! 21-card assortment with sender's signature in gold sells \$1. You make 100%. Also 50 name-imprinted Christmas cards \$1. Other popular assortments. Get samples, Friendship, 489 Adams, Elmira, N. Y.

AMAZING Profits demonstrating clever device enabling anyone without experience to draw cartoons. Retails 25c. E. Cullen, Stepney Depot, Conn.

YOUR Hose free with outfit. Make up to \$32.50 in a week taking orders for amazing new hosiery. Replacement guaranteed against holes, snags, runs. Rush name, hose size, Wilknit, Desk O-37, Greenfield, Ohio.

EARN Up to \$3 hour. Sell 21-card personal initial Christmas assortment. Gold, silver initials included. \$1 retail. 50c profit. Other popular assortments. 50 name-inscribed cards, \$1. Get samples. Artistic, 896 Way, Elmira, New York.

500% PROFIT With new perfected (1939) quick-action, no flint, automatic gas lighter. Retails 25c. Sample 10c. New Method Co., Box PMH-81, Bradford, Penna.

CHRISTMAS Card winner brings you quick profits. Sensational "Blue Ribbon" 21-card assortment sells \$1.00. You make 100% profit. 10 other fast-selling assortments; personal Christmas cards, 50 for \$1, up. Free sample offer. Chilton Greetings, 147 Essex, Dept. 2-K, Boston, Mass.

BEAUTIFUL Bird pictures handmade with genuine feathers. Sell on sight! Large profits! Free particulars. Samples 10c stamps. Marquez-PM, Apartado 1176, Mexico City.

BUSINESS Proposition resilvering mirrors, auto parts, reflectors, making chipped glass signs. Write Sprinkle, Plater, 128, Marion, Indiana.

NEW Potato peeler. Sells like wild. Peels, shreds, slices, grates. Saves hands, time, food. Samples sent on trial. Rush name. Kristee, 111, Akron, Ohio.

EXTRA Money easy. Show smart personal Christmas cards with name, 50 for \$1, up. Outstanding values. Also 21-card assortment, \$1; others. Big profits. Samples free. Wetmore & Sugden, 749 Monroe, Dept. 70, Rochester, N. Y.

EARN Big commissions in spare time as thousands of our representatives are now doing! We start you in profitable business taking subscriptions to all magazines. Renewal orders each year help you build substantial business in your community. No experience needed. Clip this ad and mail with your name and home address to International Circulation Co., Inc., Dept. AB-4, 57th St., at 8th Ave., New York, N. Y.

SELL New and used clothing from home, auto, store. Mens suits low as \$1.80. Hundreds big bargains. Up to 300% profit. Catalog free. S & N, 440-A East 31st, Chicago.

FREE Suits and cash bonuses selling guaranteed made-to-measure men's and ladies suits \$8.95 to \$14.95. Latest styles. Also overcoats, jackets, pants, etc. Lowest prices. Big commissions paid daily. Outfit free. Phillips, C-737 Jackson, Chicago.

CHRISTMAS Cards. Sell 50 assorted folders name imprinted \$1.00—cost you 50c. Samples free. Dunbar, New Brunswick, N. J.

YOUR Own local shoe business. Free outfit starts you! 200 styles. Big advance commissions and liberal bonus. Experience unnecessary. Tanners Shoes, 443, Boston, Mass.

WINDOW Sign letters. Dime brings twenty beautiful samples. All sizes. New styles. Special offer to general agents. Atlas Sign Works, 7941-A Halsted, Chicago.

MENDIT. Mends every thing. Sample 10 cts. Box 688, Kellogg, Idaho.

SELL 8x10 Hand-colored enlargements in modern glass frames. Retails \$1.95. Commission 75c. Write, Church Studio, Room 1, Enterprise, Ore.

AT Home—your own manufacturing business; making popular \$1.00 novelties. Cost you 3c to 15c. Everything supplied. Write So-Lo Works, Dept. Y-842, Cincinnati, Ohio.

WANTED Crew managers. Write Bomex Products Co., 25 Coe Place, Buffalo, N. Y.

YOU Ain't seen nothing till you've seen the patented handynife. Sample with particulars 15c. Paramount Specialties, 123 East 27th, New York.

COLLECT Your bad debts. Merchants write Lamont Company, Beacon, New York.

HANDLE Exclusive territory for unique business service. Long profit. Real cooperation. Box 5411, Philadelphia.

WANTED—Purchasing agents, no experience or money required, write and mail 3c stamps for application to Purchasing Mgr., 176 N. Halsted St., Chicago.

MIDGET Bible 25c. Agents wanted. Send for circular, Joseph Capobianco, 375 Charles St., Providence, R. I.

PINE Bath tablets soothes nerves—scents body—softens water. Trial package 35c. Stern, 6220 Ellis, Chicago.

WORLD'S Largest "direct selling" book match factory offers liberal daily earnings calling on business places. Experience unnecessary—spare, full time. High quality, quick deliveries, low factory prices. Special features, are booming business. Repeats boost profits. Free kit—full instructions. Match Corp. of America, 3433 West 48th Pl., Dept. E-10, Chicago.

AMAZING Invention takes off fat like magic. Reduce your waist, hips, etc. Feel pepped up. It's fun. Women go wild about this Tu-Way Massager. Edward Arnold Company, Logansport, Indiana.

MEN, Women. Write quick, excellent money-making proposition. Jay-Way, 26 Journal Square, Jersey City, N. J.

UP To 300% profit selling new and used clothing from home, auto or store. Everything furnished. Bargain catalog free. Roosevelt Mercantile, 566-AM Roosevelt, Chicago.

BIG Money selling guaranteed reconditioned Elgin, Waltham, Hamilton watches, \$3.75 up. No investment. Free catalog. Grossman Jewelry, 4666-X State, Chicago.

SELL Food. Everybody needs food. Own profitable neighborhood route. Complete outfit including large assortment full size packages free to reliable persons. No waiting—good earnings at once. Write for free offer. E. J. Mills, 6120 Monmouth, Cincinnati, Ohio.

SELL Artistic oil painted personal portraits! Portraiture, 2637 Evergreen, Chicago.

FREE Sample—Sensational guaranteed corn, wart, callous remover sells fast, repeats. Large profits. Baume Laboratories, (Ridgewood Station), Brooklyn, New York.

EX-O-LENE! Brand new! Guaranteed power-mile increaser! Millions interested! Protected territory! Tremendous profits! Information free! Thermo Exolene, Peoria, Illinois.

100 MEN Wanted! Sell guaranteed tires wholesale. Save users to 70%. Big profits. No experience necessary. Auto Tire Co., 4502-A So. Ashland, Chicago.

\$1 STARTS You in business selling outstanding line ties, boxed novelties. Over 100% profit. Silk lined ties, \$1.50 dozen, sample 15c. Slyde-On-Ready-Tied ties, \$2.40 dozen, sample 25c. Write today for descriptive wholesale catalog, prices, free sample materials. Philip's Neckwear, 20 West 22nd, Dept. P-2, New York.

AGENTS Make big profits on food products, bargain deals. Low wholesale prices. Rush name for trial outfit offer. Ho-Ro-Co, 2810-T Dodier, St. Louis, Mo.

SELL Low priced air-cushioned shoes to nurses, beauticians, waitresses, housewives. Unusual salesplan. Write: Daulec Shoes, 923 Washington, Dept. 50, St. Louis, Mo.

FREE information. Agents, canvassers. New fast selling item. Absolutely nothing like it on market. Burns, Keystone Bldg., Pittsburgh, Penna.

NEVER Before offered at any price! A fad that will sweep the country. Every boy with bike will buy. 50% profit. Exclusive franchise. Write at once for particulars. Address P.O. Box 5376, Chicago, Ill.

PROFIT With new products. Make, sell, repeat. Analysis. Research. Guaranteed formulas. Biggest catalog free. Nominal prices. Gibson Laboratory, Chemists, BD-1142 Sunnyside, Chicago.

500% PROFIT. Gold and silver colored sign letters. Offices—stores. Large sizes, 1c. Free samples. Modernistic, B-3000 Lincoln Ave., Chicago.

POLMET Polishing cloth removes tarnish from metals without the use of liquid, paste or powder. Agents say it sells like "hot cakes." Retail 25c. Sample free. Gales & Co., Inc., 15 Edinboro St., Boston, Mass.

SELL Drugless health aids. Make chemical demonstrations. Wholesalers, Box 2695, Hollywood, California.

CHRISTMAS Cards. Absolutely finest assortment. Big profits. Write for samples. Robinson Cards, 500 Orange, Clinton, Mass.

CHRISTMAS Card box assortments selling like "wildfire." People who have never sold a thing in their lives are reaping harvests with our "New Champion" 21 folder assortment, including sensational "mystery card"—Biggest sales-puller of all time. Costs 50c—sell for \$1.00. Worth \$2.85. Also seven other bargain assortments, and personal imprinted cards. Write today. Samples on approval. Silver Swan Studios, 320 Fifth Ave., Dept. 74, New York.

AGENTS—Amazing new glass cleaner sells fast, repeats. Demonstrations reap big profits. Needed everywhere. Write Universal Utility, Gloversville, N. Y.

WORLD'S Fastest money maker. Sell 50c packs of razor blades for 5c. Tharp, 914 Lexington, Cumberland, Md.

BIG Money taking orders: shirts, ties, hosiery, underwear, pants, jackets, raincoats, uniforms, etc. Sales equipment free! Experience unnecessary. Nimrod, 4922-AN Lincoln, Chicago.

CHRISTMAS Cards. Earn \$2 an hour. Take orders galore from friends. 50 exquisite folders with name at \$1. Free album 32 designs. Fastest selling 21 folder box in America. Costs 50c. Sells \$1. Request samples. Sunshine Art, Dept. E, 154 Nassau, New York City.

500% PROFIT! Transfer sign letters for windows, offices, trucks, signs. Colors: gold, silver, red, many combinations. Auto monograms. Easily applied. Neonite, Akron, Ohio.

AGENTS: Smash go prices! Santos coffee 12c lb. 4-oz. vanilla 8½c. Razor blades 10 for 8½c. 100 sticks chewing gum 12c. Christmas cards, 21 in box, 14c. 150 other bargains. Premiums. Experience unnecessary. Carnation Company, P.O. St. Louis, Mo.

AGENTS—To mail our literature. Good profits. Home business. Maywood, 1105-1107 Broadway, New York.

SUCCEED With your products. Make-sell. Formulas. Accurate analyses. Catalog free. B. Thaxly Company, Washington, D. C.

ENGRAVED Name plates, numbers, signs, etc., easily sold, profits large. Brett Bros., Winthrop, Mass.

300% PROFIT Selling gold leaf letters for store windows; high grade letters 1½c each. Free samples. Metallic Co., 438-B North Clark, Chicago.

BIG Money applying initials on automobiles. Easiest thing today. Free samples. Also, sideline salesmen for short order decalomania name plates. "Ralco," 1305 Washington, Boston, Mass.

REVOLUTIONARY Window cleaning tool. Good Housekeeping approval. Only ten \$2.25 sales daily to housewives, factories, schools, stores will make you \$350.00 monthly. Carter Products Corp., 900 Front Ave., Cleveland, Ohio.

AGENTS—Opportunity make money; book containing 107 successful business plans; home-office; send for free introductory booklet. Elite Co., 214 Grand St., New York.

STARTLING Invention—Pocket adding machine. Nationally advertised \$2.50. Whirlwind seller. Big profits. Baby Calculator Co., Box 1118, Chicago.

BIG Money applying initials on automobiles. Write for particulars and free samples. American Letter Company, Dept. 40, Dunellen, New Jersey.

FREE Sample—Amazing cleaner; sells homes, taverns, everywhere. Big profit—fast repeater. Betco, 5007 Irving Park, Chicago.

MANUFACTURE Specialties, hire agents yourself. Big money. Free literature. Gilbert Supply, 1107-P Broadway, New York.

AGENTS: Stamping names on pocket-key protectors. Sample check with your name, address, 25c. Stamping outfits. Emblem checks, check-fobs, name plates. Hart Mfg. Co., 303 Degraw St., Brooklyn, N. Y.

DO You want agents for your proposition? Your ad in this space will place your message before hundreds of men seeking fast-selling products. My folder "How to Secure Agents," is filled with proof. I'll gladly send you a copy free. F. W. Johnson, Manager Classified Advertising, Popular Mechanics Magazine, 200 E. Ontario St., Chicago.

HIGH-GRADE SALESMEN

SALESMEN—Unlimited opportunity for ambitious man with car, fast selling, good repeat line popular priced tires. High commissions, exceptional earnings. American Tire Co., Cleveland, O.

OLD Reliable AAA1 firm offering new product in popular price range, with a very large market in your own neighborhood, wants salesmen on commission. Earn \$8.00 to \$25.00 per day. Write for details. The Edwards Manufacturing Co., Fireaire Division, Cincinnati, Ohio.

EARN Money in your spare time, taking orders from banks, insurance and business houses, for filing and mailing envelopes, folders, pockets, etc. Liberal commission. Send for full details. Ames Safety Envelope Co., Somerville, Mass.

MEN Wanted—Introduce amazing dress, sport, and work shirts. Low as 3 for \$2.98. Also ties, socks. High quality, exclusive features. Personal shirts free as bonus. Big commissions. Outfit free. Stylewear, Dept. 101, Erie, Penna.

SELL Calendars! Pocket fast cash advanced commissions taking orders for new 1940 Advance Calendar line. Wide assortment of dazzling silver and gold embossed color creations with union label. Includes art wall, nudes, cardboard die cut desk, metal and thermometer calendars. Direct-on calendars low as \$3.95 per 100. Free samples. Write quick for color-beauty sample sales kit. Advance Calendar Products, 82 W. Washington St., Dept. AA, Chicago.

EARN 25c On every dollar! Sell Christmas twenty-one piece superfine, religious or magicard assortments. Three sample boxes \$1.00 postpaid. Personal imprint Christmas folders, wreaths, wrappings, calendars. Illustrated circular service. Popular sellers! Catalog free! Elko, 440 North Wells, Chicago.

NEW "12 In 1" advertising calendars, streamlined form, acclaimed by Chicago advertisers. Sample 10c. Simplex Calendar Co., 225 Second Ave., Lombard, Ill.

SELL Printing at cut prices. 2,000 business cards \$1.50; 1,000 envelopes or statements, etc. \$1.75; 25 printed sales books \$1.50; 1,000 process embossed cards \$1.50; 2,000 two-color labels, free holder \$1.50; 2,500 printed handbills \$1.75. One-third comm. Free outfit. Bargain Ptg. Co., 189-F W. Madison, Chicago.

SELL Business stationery \$2.65 thousand, business cards, book matches, advertising gummed tape, restaurant necessities, sales-books, office supplies, pricing sets, advertising specialties, 40% comm. Free premium deals. Sales portfolio free. David Lionel Press, 312 So. Hamilton, Dept. LV, Chicago.

ESTABLISHED Company in automatic protective specialties offers unusual opportunity to salesmen. Low price. Generous commissions. Prospects unlimited. Write for details. Firex Corporation, 510 South Broadway, St. Louis, Missouri.

BIG Commissions—selling to stores celluloid pricing tickets, metal shelf moulding. To restaurants, menu covers, signs. P. Pricing Press, 124 White St., New York.

CASH Profits daily—Agents wanted all cities, sell to stores, new collapsible Neonite flasher sign, cost \$1, sells \$3. Renneker Company, 345 West Hubbard Street, Chicago.

SELL America's largest printing line and business necessities. Book matches, gummed labels, political items, salesbooks, office supplies, advertising specialties, business stimulants, beautiful line calendars, Christmas greetings. Hundreds fast sellers. New low prices. Commissions advanced. Experience unnecessary. Samples free. Northwestern, BB-625 Jackson, Chicago.

TIES—Wonderful proposition. Free swatches. Eureka, 307 West 38th, Manhattan.

YOUR Own suits and other gifts free as bonus, plus big cash profits for selling your friends fine quality, individually made to measure suits and overcoats. Popular new low price ranges help make sales easy. Exclusive sport and swing styles no extra charge. Elaborate selection new fall and winter materials and patterns. Satisfaction or money back guaranteed by reliable thirty year old tailoring firm. No experience needed. Sample outfit free. Jay Rose & Co., Dept. P-109, 330 South Wells, Chicago, Ill.

ADVERTISING Book matches offer liberal earnings—full, spare time. Experience unnecessary. Factory direct. Low prices for fine quality, quick deliveries, help get orders; faster repeats. All business firms prospects. Free outfit, instructions. American Match & Printing Co., Dept. 610, 4822 South Trumbull Ave., Chicago.

SELL America's finest printing and 1940 calendar line. Big commissions advanced plus extra cash bonus. Every business prospect. Experience unnecessary. Outfits free. Modern Franklin Co., (Est. 1896), 534-B So. Wells, Chicago.

DON'T Be a job hunter—Start your own business on our capital. No hard times; no lay-offs; always your own boss. Hundreds average \$3,000 to \$5,000 annual sales year after year. Sales way up this year. We supply stocks, equipment on credit, 200 home necessities. Selling experience unnecessary. Wonderful opportunity to own pleasant, dignified, profitable business backed by world-wide industry. Write Rawleigh's, Dept. J-U-PPM, Freeport, Ill.

SELL Gas-Miser. Improves automobile operation. Saves up to 25% gasoline. New scientific principle. Write Dept. PM, Malone & Moles, Sioux City, Iowa.

SALESMEN: Sell calendars. Complete line all sizes, including jumbos; beautiful subjects. Samples free! Fleming Calendar Co., 6539 Cottage Grove, Chicago.

OPENINGS! Call on all dealers with new trade-stimulator plans. It's "hot." \$3 commission on each \$5 sale. Big repeat commissions. No investment. Sales kit free. Universal, 6227 Broadway, Dept. C510, Chicago.

CALL On friends with sensational new personal Christmas cards and stationery. Names imprinted. Also big-value 21 card assortment at \$1.00. Profit 50c. Experience unnecessary. Samples free. Wallace Brown, 225 Fifth Ave., Dept. G-34, New York.

ANTI-FREEZE For automobiles. Only "one-fill-a-year" necessary. Nonevaporating, safe. Sells at ordinary alcohol prices to oil stations, garages, car owners, etc. We deliver and collect. Season now open. Trial sample, order books, etc. 25c. Write or wire. By-Products, 1760-D Lunt, Chicago.

ADVERTISING Book matches—calendars. Lowest prices. Big cash commissions. Full or part time. New outfit free. Gem Match, 72-PM West Washington, Chicago.

SELL The Driving Master. Shows miles per gallon when driving. Analyzes motor. An efficiency driving criterion. Exclusive sales agency available. Driving Master Company, Sioux City, Iowa.

SELL Mexican novelties. Commission. Free samples. Marquez, Apartado 1176, Mexico City.

BLADES. Finest quality. Factory prices, postpaid. Ace Blades, Buffalo, N. Y.

NEW Specialty—Sells every business and professional man. Four \$15 sales daily pay \$280 weekly. Farrell cleared over \$1,000.00 monthly. Write, F. E. Armstrong, President, Dept. PM, Mobile, Ala.

EXCELLENT Opportunity selling our complete line of brushes, largest commissions. Write for sales plan. Wire Grip Sanitary Brush Company, 2300 5th Ave., New York.

\$3,000 PROFIT In six months by Foster. Over \$6,000 in one year by Felton. Over \$30.00 daily profits for 90 days. All selling our special tool set to garages. Exclusive territory. Mescos, Beaver City, Neb.

PLAYS, STORIES, MANUSCRIPTS

WELTON Tinney, Winnsboro, Texas, will rewrite and type your story for marketing.

ORIGINAL Poems, songs wanted for publication, radio. Westmore Music Corporation, Dept. 33G, Portland, Ore.

RADIO-PLAYS And songs wanted for broadcasting. Forest Productions, 6513 Hollywood Blvd., Hollywood.

EDUCATIONAL AND INSTRUCTION

CASH In your sense of humor. Learn gag writing. New uncrowded profession. Tremendous demand. Famous gag builder course less than ten cents weekly. Stamp brings information. Don Ullsh Studios, 443 Wrightwood, Chicago.

FOR An extremely profitable lifetime business, operate a collection-credit agency. Free folder. Cole Associates, Syracuse, N. Y.

REAL Estate taught by 12 actual leaders. Home study course. Start own office. Earn real money. Morrison School Real Estate, 100 No. La Salle St., Desk 9, Chicago.

WATCH Repairing is steady profitable work. Experts always in demand. You can learn watchmaking trade at home, spare time. New original instruction system. Script engraving course included. Write for free details today! Nelson Co., K-2001 Manhattan Building, Chicago.

YOUR Place in life—23 experts analyze vocations insuring success, security, independence. 128 pages. Over 500 references. Send 25c coin. TrailBlazers Company, Champaign, Illinois.

POST Office clerk, carrier, railway postal, rural carrier, postmaster, and 50 others. Apply now for next examinations. Pergande Publishers, Milwaukee.

INDEPENDENCE Offered inventive minded. Explanation for stamp. A. Higbee, Cantil, Calif.

MANY Good jobs open. Thousands of adjusters paid generous salaries by insurance companies, corporations, etc., to investigate accidents, outwit fraudulent claimants. Free particulars. Burns School, Keystone Bldg., Pittsburgh, Penna.

GOOD Personality insures your success. Send for details. Park, 25 Union Park, Boston, Mass.

DRAFTSMEN In great demand now. Qualify at home. Particulars free. Monroe Institute, PM-10, Alton, Illinois.

HOW To secure a gov't job in the classified civil service. Railway postal clerk, \$1900 a year. Postal clerk, city mail carrier, \$1700. Other jobs, \$1260 to \$2100. Our method helps you pass exams. Men-women, age 18 to 50. Send for free book. Patterson School, 8C Mercantile Bldg., Rochester, N. Y.

U. S. Government jobs, \$105-\$175. Prepare now for next examinations. List positions and full particulars free. Write today. Franklin Institute, Dept. R3, Rochester, N. Y.

AIR Conditioning, arc welding. Taught by mail. Expert instruction. Special low tuition for those enrolling soon. Universal School Air Conditioning, Manhattan Building, Milwaukee, Wis.

COMPLETE Instructive treatise on photography, price one dollar. The Syndicate, Box 578, New Haven, Conn.

ENROLL Now, decorating, paperhanging, graining, marbling, sign and pictorial painting. Catalogue free. Chicago Painting School, 102 W. Lake Street, Chicago.

WRITE For newspapers—gain pleasure, good pay and perhaps fame. Full time or freelancing (part time). Hundreds of stories, articles, ideas, are needed in every issue. We successfully coach you by mail. 45 years newspaper experience—plenty of contacts for placing graduates. The Millers, Dept. 10, Carmel, California.

MASSAGE, Hydrotherapy, dietetics, drugless therapeutics, chiropody, taught by mail. Evans Correspondence School, Montgomery, Ala.

LEARN Auto mechanics, body, repairing, welding electricity, refrigeration. Diesel. Stevenson's, 2008A Main, Kansas City, Mo.

TELEGRAPHY Taught thoroughly. Railroad retirement act creating opportunities for new operators. Expenses low. Catalog free. Dodge's Institute, Hiatt Ave., Valparaiso, Ind.

SECRET Investigation. Experience unnecessary. Detective particulars free. George Wagner, M-2640 Broadway, N. Y.

EVERYMAN'S Legal Manual. Authoritative advice. \$1.00. Popular Mechanics, 200 E. Ontario St., Chicago.

CARTOONING, COMMERCIAL ART, SHOWCARD WRITING, SIGN PAINTING

HAVE Your own money making business. Learn show card writing, sign painting. Write for details. Begley Specialty, 1472K Broadway, New York.

BIG Heavy foreign art magazines. Very popular, hard to obtain. Illustrated: figure paintings, etc., beautiful colors suitable framing. Special import price—three 75c copies (different), \$2.00 prepaid. Art Headquarters, Doty Street, Madison, Wis.

DRAW Cartoons new, easy way. No experience. Our clever device does the trick. 25c. E. Cullen, Stepmey Depot, Conn.

ART Magazine including directory art books—free. Send 10c postage. Art Headquarters, Doty Street, Madison, Wisconsin.

PEN And ink drawings. Let us draw your advertising and catalogue illustrations, from photos, copies or objects. Best work and fair prices. Heraldic Studios, 1914P Oakdale Avenue, Chicago, Ill.

AMATEUR Cartoonists wishing steady income copying and duplicating cartoons for advertisers, write Ad-Service, Argyle, Wisconsin.

FIGURE Studies from France. Book contains hundreds by master of form, roundness. Collection formerly \$5.00. Now bound, large size. Only \$1.00 prepaid, while they last. Art Headquarters, Doty Street, Madison, Wisconsin.

ADVERTISING AGENCIES, LETTER WRITERS, FOR ADVERTISERS

PROFITABLE Sales campaigns, letters, advertisements, courses. Reasonable. Underhill, Beebe, Arkansas.

MAIL Sales promotion. Samples and suggestions without obligation. Fryer & Hall, 4639 Chestnut Street, Philadelphia.

FOUR-LINE Ad. 185 newspapers, \$5.28. Lists free. Fidelity Advertisers, W-3838 Washington, Chicago.

INCH Display, 28 magazines, \$1.50. Paramount Press, Atlanta, Missouri.

ADVERTISE: 24 Words in 250 newspapers \$10. Lists free. Advertising Bureau, 4515-C Cottage Grove, Chicago.

INCH Display advertisement 30 magazines year \$24. Wood's Popular Services, Atlantic City, N. J.

LEARN Advertising quickly at home. Easy practical plan. No text books. Common school education sufficient. Interesting booklet and requirements free. Page-Davis School of Advertising, 3601 Michigan Avenue, Dept. 343C, Chicago.

SELL Your product through agents, mail order. Advertise newspapers, magazines. Publishers' rates. Snappy layout your inch advertisement \$1. Martin Advertising Agency, 171M Madison Avenue, New York.

DIRECT-MAIL Advertising services. Sales lists that sell. Mailing lists. Omaha List & Letter Co., Box 2172, South Omaha, Nebr.

ADVERTISING Placed all magazines, newspapers, radio. Lowest rates. Free service. 54 page rate book free. Baker Advertising Agency, A-189 West Madison, Chicago. Successors to Ankrum. Established 28 years.

FREE—New Advertisers Rate Guide, 44 pages. Includes everything. Lowest rates. E. H. Brown Advertising Agency, 140 S. Dearborn, Chicago.

BEFORE You advertise—Get our Ad-Guide of newspaper, magazine rates—full of priceless pointers for advertisers. 3c stamp. Chicago Advertising Agency, (Established 1900), 20-PL West Jackson, Chicago.

33 WORDS 25 Magazines \$2.00. Goodall Agency, 628 Montgomery, San Francisco.

BUSINESS SERVICE

JACKSONVILLE, Florida, mailing address. BMA Co., 5027 Sunderland Road, \$3.00 month.

PERSONAL And business mail received and forwarded. \$2.00 monthly. Dunn Mail System, Box 42, 216 West 69th St., New York, N. Y.

CHICAGO Mail address. Phone service. Daily forwarding. Secretarial service. Hanock Company, 43 East Ohio, Chicago.

WHERE To buy anything! Wholesalers, manufacturers. 25c (coin). Jeans Buyers Service, Box 440, Jamestown, N. Y.

SAN FRANCISCO Address: \$1.00 month. Mail forwarded daily. Morris Service, 905 DeYoung Building.

LET Us merchandise your household ideas. Hoffman Lion Mills Co., Inc., Fall River, Mass.

RUBBER STAMPS AND OFFICE SUPPLIES

RUBBER Stamps made to order. Federich Tool Co., Bx10A, East McKeesport, Penna.

2 LINES 25c, 3 Lines 35c. Stamp Works, Auburn, Nebr.

BETTER Rubber stamps 3 lines 35c. Augustin Stamp, Fond du Lac, Wis.

2 LINES 25c, 3—35c. Cushioned. Stamp Works, Centerport, N. Y.

ORIGINAL. Cushion mounted. One, two lines, 25c; three 35c; four 45c. Stamp Works, 814 Bradley, Peoria, Ill.

TYPEWRITERS, DUPLICATORS, OFFICE DEVICES

NEW Typewriters and adding machines 25% off listed prices. Guaranteed. Money saving bulletin free. Richmond Service, 504 Broadway, Sterling, Ill.

MIMEOGRAPH And duplicator supplies, stencils, etc. Approximately half price. Mishek, Waseca, Minnesota.

INCREASE Business now. "Excelligraph" Rotary Stencil Printer reprints thousands everything you typewrite, handwrite, draw or trace. Colors. \$19.75 to \$44. Terms. Illustrated literature free to business or professional men. Pittsburgh Typewriter Supply, Department K-2, Pittsburgh, Penna.

NEW \$3.75 Automatic adding machine. Fully guaranteed. Bassett, Box 302-K, Altadena, California.

TYPEWRITERS. Adder, mimeograph, multigraph, addressograph. Send for free lists of machines that will help you at half price. Pruitt, 28 Pruitt Bldg., Chicago.

PRINTING, MULTIGRAPHING, MIMEOGRAPHING, GUMMED LABELS

LETTERHEADS. Envelopes. 125 each \$1.00 postpaid. Smith Printery, Hollendale, Wisconsin.

PRINT Anything. Lowest prices. Samples free. Hamilton Press, 4341-P Meade, Chicago.

3000 BUSINESS Cards \$1.50. 1000 envelopes, noteheads, statements, billheads \$1.75. Elmer Griffith, Sciotoville, Ohio.

STATIONERY. Folders, circulars, postcards, labels—all printing. Lowest prices. Samples. Goodprint, Harrisonburg, Va.

LETTERHEADS. Envelopes, statements, 6x9 circulars, 1,000, \$2.95. Underhill, Beebe, Arkansas.

PRINTING—\$1.00 Up. Christmas cards 25c. Universal's, 203 Avon Avenue, Newark, N. J.

BETTER Grade printing, free trade illustrations. Reasonable. Economic Press, Leonia, N. J.

500 LETTERS Multigraphed exactly as if typewritten, \$1.70 (20 lines.) Multigraphers, Ashland, Virginia.

FONT Of condensed Gothic type and bargain list 25c. Republic, 7150 Cottage Grove, Chicago.

BETTER Printing for less. Samples free. Holman's Printery, Downsville, Louisiana.

2000 BUSINESS Cards \$1.50. Zwickel, Dept. AA, General P.O. Box 60, Brooklyn, N. Y.

1000 WATERMARKED Bond letterheads \$3.25. Evers' Print Shop, Atmore, Ala.

EXPERT Typewritten reproductions, letters, pricelists, etc. 100 copies 8 $\frac{1}{2}$ x11—\$1.00. Additional hundreds 20c. Includes paper! Letter-Shop, Dept. P, Cedar Rapids, Iowa.

\$1.00 POSTPAID. 125 8 $\frac{1}{2}$ x11 Twenty pound bond letterheads and 125 envelopes. Benneville, 907 West Roosevelt, Philadelphia.

LETTERHEADS, Statements, envelopes, 5000 \$5.95, 6x9 circular \$4.95 (estimates). Alpine Press, 325 East 88th, New York.

1000 STICKERS. Four lines, 50c. Labels. Catalog. Cott's, Spickard, Missouri.

QUALITY Printing reasonable. State your requirements. Acorn Printing, Montclair, New Jersey.

500 BOND Letterheads, 5 $\frac{1}{2}$ x8 $\frac{1}{2}$, \$1.25 postpaid. Wehner, 25 Fulda, Roxbury, Mass.

1000 BUSINESS Cards \$1.00 post paid. Superba Print, 912 Towne, Los Angeles, Calif.

BOOK Matches—Printed your name, address—100, \$1.00; 32, 50c. Sanderson Match Co., Ottawa, Illinois.

1,000 2 $\frac{1}{2}$ x4 LABELS \$1.65; 2x4, \$1.50. Paramount Press, Atlanta, Missouri.

10,000 CIRCULARS 3x6, \$4.50. 10,000—6x9, \$7.50. Printing ad on back. Lackawanna Printing, Lackawanna, N. Y.

2000 BUSINESS Cards \$1.50. General printing and estimates cheerfully given. Florence Printing, 270 Lafayette St., Manhattan.

GET Acquainted. 250 letterheads, 8 $\frac{1}{2}$ x11, or envelopes 60c postpaid. Express Newspaper Publishers, Express Building, Atlanta, Mo.

250 8 $\frac{1}{2}$ x11 BOND Letterheads, 250 6 $\frac{3}{4}$ x24 envelopes, \$2.00. No trash. Work guaranteed. Kunz Advertising Service, 407 Cedar, Scranton, Penna.

ILLUSTRATE Freely without cuts. Write for details and prices on photo-offset printing. Roberts Service, 250 W. 49th St., New York.

\$2.25—1000; LETTERHEADS, Envelopes, statements, circulars. Samples. Midwest Printing, Minneapolis.

HAMMERMILL Letterheads, any color paper and ink, 300 8 $\frac{1}{2}$ x11, \$1.48 postpaid, 30 type styles available. Free particulars. Woodruff's, 217A Lewis, Duluth, Minn.

500 3 $\frac{1}{4}$ x2 $\frac{1}{4}$ FOUR Line gummed stickers, 25c. Moritz Printery, Saginaw, Mich.

PRINTING OUTFITS AND SUPPLIES

PRESSES. Type, cabinets, supplies. Catalogue for stamp. Lincoln Press, A-22 Hartwell, Fall River, Mass.

USED Presses, type, supplies. Lists 3c. Turnbaugh Service, Loysville, Penna.

NEW Type 29c font, catalog dime. Box 123A, Jackson, Michigan.

PRESSES \$4.00. Shaded card type 40c. Send stamp. Bradshaw, 3214-P Huron, Chicago.

PRINT Your own cards, stationery, circulars, advertising. Save money. Easy rules furnished. Print for others, big profits. Junior outfits \$9.00, senior outfits \$17.00 up. Details free. Kelsey Presses, D-11, Meriden, Conn.

BARGAINS For printers. Catalogue 10c refunded. Smith, 80 William St., Nutley, N. J.

SCREEN Process instruction. Write. Artsets Company, 21 Kentucky Avenue, Indianapolis, Ind.

BARGAINS — Presses, type, supplies. Send stamp. 159 Harvard, Cambridge, Mass.

LONG Established printers warehouse. Big lists 3c. Landis, Richland, Penna.

HAND Presses, type and complete printers' supplies. Send stamp for catalog and new price list. P. Peiffer & Co., Newark, N. J.

BARGAINS, Presses, type. List 3c. Exchange, E-15, 110 Dexter, Meriden, Conn.

PATENT ATTORNEYS

INVENTORS: Send immediately for your copies of our new free books, "Patent Protection" and "Suggestions on Selling an Invention." Sixty-eight pages of interesting facts. They tell how Patent Laws protect you; kind of sketch or model needed; simple steps to take without cost; how successful inventors have secured financial assistance; show interesting inventions; illustrate important mechanical movements. With books we also send free Evidence of Invention form to help establish date of disclosure. Prompt service, reasonable fees, special deferred payment plan. Strictest secrecy. Forty-one years' experience. Highest references. Write us today. The facts in our books are worth money to the man with a good invention. Address: Victor J. Evans & Co., Registered Patent Attorneys, 113-L Victor Building, Washington, D. C.

INVENTORS: Before filing investigate my plan. Save 20 to 35 percent, all patent service. Grover C. Hill, Registered Patent Attorney, United States and foreign patents, 966 National Press Bldg., Washington, D. C. Dept. A.

INVENTORS—Before disclosing your invention to anyone send for form "Evidence of Conception"; "Schedule of Government and Attorneys' Fees" and instructions. Sent free. Lancaster, Allwine & Rommel, 411 Bowen Building, Washington, D. C.

PATENT Your invention! Send today for my new free book containing facts necessary for the protection of your invention. A frank discussion on patents, patent searches and vital information written especially for your benefit. Write me personally. Hugh E. McMorro, Registered Patent Attorney, Dept. 323-B, Barrister Building, Washington, D. C.

INVENTORS—Time counts—Don't risk delay in patenting your invention. Write for new 48-page free booklet, "Patent Guide for the Inventor." No charge for preliminary information. Clarence A. O'Brien and Hyman Berman, Registered Patent Attorneys, 58-Y Adams Building, Washington, D. C.

PATENTS—Trade marks. Preliminary advice, book and disclosure form free. Personal service. Irving L. McCathran, 1060 International Bldg., Washington, D. C. Registered Patent Attorney.

PATENTS. Protect your idea by securing free "Proof of Invention" folder. Exceptional personal service. Established 1906. E. E. Vrooman, 871 Woodard Bldg., Washington, D. C.

"INVENTOR'S Guide," 100 mechanical movements, free; advises on patenting, selling inventions. Frank Ledermann, Tribune Bldg., New York.

L. F. RANDOLPH, 302-B Victor Bldg., Washington, D. C. Low cost. Book and information free.

PATENTS. Booklet free. Highest references. Best results. Promptness assured. Watson E. Coleman, Patent Lawyer, 724 Ninth St., Washington, D. C.

INVENTORS—Send for free booklet "Patent-Sense." Information based on 64 years experience. Lacey & Lacey, Dept. 5A, 635 F St., Washington, D. C.

FOR INVENTORS

INVENTORS—Time counts—Don't risk delay in patenting your invention. Write for new 48-page free booklet, "Patent Guide for the Inventor." No charge for preliminary information. Clarence A. O'Brien and Hyman Berman, Registered Patent Attorneys, 58-Y Adams Building, Washington, D. C.

INVENTOR'S Universal Educator: contains 900 mechanical movements; 50 perpetual motions; instruction on procuring and selling patents and selecting an attorney, etc. Suggests new ideas. Price \$1 postpaid in U.S.A. Address Albert E. Dietrich, 511-B Colorado Bldg., Washington, D. C.

DRAFTING Engineer. Patent, design, mechanical, electrical, etc. Blueprints, etc. Free estimate. Reasonable. Confidential. Marley Silver, 1611 East 55th, Chicago, Illinois.

1,300 PATENTED Invention drawings and successful patenting \$1. postpaid. Free particulars. Centofanti, 25 South Pearl, Youngstown, Ohio.

NOTICE—Valuable information for inventors. Time and money saved, list of 1,000 picked patent buyers. Best method of presenting patents for sale. Also, list of unpatented idea buyers. The way, and place to obtain financial assistance. All the above information for \$1.00. Royal Keystone Enterprise, Box 192, Berryville, Ark.

INVENTION Sales Bulletin describing over 500 inventions, showing how we sell inventions, patented or unpatented, with booklet and particulars free. Patentee System, 9443 Pleasant, Chicago.

INVENTING Taught at your home by Trofimov School of Inventive Practice, Hanna Rd., Willoughby, Ohio.

WE Locate buyers meritorious patented, unpatented inventions. If will sell, reply immediately. Descriptive booklet free. Invention Reporter, 5A-11236 South Fairfield, Chicago.

INVENTORS—Send for 72-page book on patents. Reasonable terms, conscientious treatment to inventors. L. F. Randolph, Registered Patent Attorney, 302-E Victor Bldg., Washington, D. C.

HAVE You a sound, practical invention for sale, patented or unpatented? If so, write Chartered Institute of American Inventors, Dept. 4-A, Washington, D. C.

INVENTORS: Profit by your invention. A practical talk to inventors by an experienced manufacturer. Our 68 page booklet "Mind vs. Matter" mailed upon receipt of 25c. Rex Engineering Co., Cincinnati, Ohio, Dept. D.

INVENTORS: "Making Inventions Pay," our 32-page illustrated book, mailed upon receipt of 3c postage. Crescent Tool Co., Dept. Z, Cincinnati, Ohio.

I SELL Patents. Established in 1900. Charles A. Scott, 773PM Garson Ave., Rochester, N. Y.

INVENTIONS WANTED

INVENTIONS Of merit wanted for marketing. We design and build working models which put over your idea. Write for "4-Points of Service" bulletin. R. & S. Engineering Co., Dept. M101, 17 East 42nd Street, New York City.

WANTED—Meritorious patented, unpatented inventions. Booklet free. Invention Reporter, 5B-11236 So. Fairfield, Chicago.

SMALL Inventions wanted by manufacturers. I'll help you sell your invention. Write for free circular. Stanley Hull, 7829-K Euclid Avenue, Cleveland, Ohio.

SIMPLE Practical inventions wanted by manufacturers, patented or unpatented. For information write Chartered Institute of American Inventors, Dept. 4-D, Washington, D. C.

CASH For inventions patented or unpatented. Stamp appreciated. Mr. Ball, 9441-A Pleasant, Chicago.

PATENTS FOR SALE

TRIPLE Purpose vacuum cleaner. Emil Settler, C.C.C. Co. 554, Stanfield, Ore.

TRIANGULAR Glazier's thumb push point: May be inserted, removed and picked up more easily than conventional flat pointed type. J. I. Routledge, Campbellville, Ont., Canada.

UNPATENTED Wooden clothes hamper on wheels. Descriptive blueprints. Barr McCracken, Newport, Ky.

FOR Sale or royalty. Patented new type carburetor, three venturies, one stationary, one rotating, adjustable expanding with novel mixing device, dual nozzles, double acting pump. Joseph Brandon, 3829 Wisconsin St., Los Angeles, California.

STEEL Shelving and center floor display rack. Fully adjustable. Number 2,117,127. Three patents pending. Outright or royalty. Milton Yarger, Morgantown, W. Va.

ATTENTION! Patent rights from three countries (U. S., France, and Canada) for sale on a royalty basis. Small article. Good market demand. Every woman prospective buyer. Address 138 LaBelle, Highland Park, Michigan.

NON Screw ventilated electric socket and bulb base. Chmiel, 973 Fillmore, Buffalo, N. Y.

50% TO Financial backer. Have numerous practical inventions. If interested write, J. Todd, 53 McGuffey, Youngstown, Ohio.

PATENTED Folding cot. Write Fred Jasperson, 1100 Railway Exchange, Chicago.

NEW Opposed piston motors, two and four cycle, need financing. Williams, 121 S. Penn, Denver.

PATENTS. American and Canadian. Pig weighing machines. Awarded silver medal Royal Lancashire show. Enquiries: Robinson Bros., Leeds, 4, England.

MANUFACTURERS: For new products or profitable manufacturing opportunities, inquire. Invention Reporter, 5C-11236 So. Fairfield, Chicago.

SELL Your patent through a small classified ad in Popular Mechanics. Many inventors have found buyers in this way. Ask me for proof—I'll gladly send it to you. F. W. Johnson, Manager Classified Advertising, 200 E. Ontario St., Chicago.

MANUFACTURING

MANUFACTURING. Dies, machinery, models, brasswork, mouldmakers, catalog 3c. Baum's Metal Specialties, Kansas City, Mo.

DIES, Stampings, models, tools. Complete service. Porsberg Engineering, Northfield, Ohio.

INVENTIONS Developed, manufactured in any quantities. Low cost. Metal specialties, stampings, dies, models built. Free estimates. Write for "4-Points of Service" bulletin. R. & S. Engineering Co., Dept. M102, 17 East 42nd Street, New York City.

A COMPLETE Service for inventors—50 years manufacturing experience. Inquiries invited. H & H Tool & Mfg. Company B, 308 East Third Street, Cincinnati, Ohio.

INVENTIONS Manufactured by an experienced company, in any quantity at low cost. Metal specialties, novelties, stampings, dies, and models. Free estimates. Our booklet "Mind vs. Matter" sent upon receipt of 25c. Rex Engineering Co., Cincinnati, Ohio, Dept. C.

INVENTIONS—Manufactured in any quantity at low cost by old established company. Stampings, metal specialties, dies, models, etc. Free estimates. Send for catalog. Crescent Tool Co., Dept. X, Cincinnati, Ohio.

1059 WAYS To start a profitable business. Get Popular Mechanics book of modern formulas and methods for practical specialty manufacturing. Price only \$1.25 postpaid. Popular Mechanics Press, Room (C39), 200 E. Ontario St., Chicago.

MODELS AND MODEL SUPPLIES

OUR "Homesick Angel" model plane is sensational. Complete kit \$1.00 postpaid. Cherry City Model Aircraft Co., 980 Parrish, Salem, Oregon.

ENGINE Catalogue castings, supplies, 25c. Howardco, A-2417 North Ashland, Chicago.

INVENTORS—Time counts—Don't risk delay in patenting your invention. Write for new 48-page free booklet, "Patent Guide for the Inventor." No charge for preliminary information. Clarence A. O'Brien and Hyman Berman, Registered Patent Attorneys, 58-Y Adams Building, Washington, D. C.

MODELMAKERS' Catalogue—Supplies, materials—20c. Evraymesco, 28-P No. Clinton, Chicago.

SPEED! Model power boats! Racing hull construction kits. All classes. Engines, accessories. Cruiser kit. Free literature. St. Louis Model Boat Co., Clayton, St. Louis, Mo.

MODELS—Your ideas developed into practical working models. 30 years successful experience; thousands of satisfied customers. Confidential service guaranteed. Bank references. Send 3c postage for our large booklet—"Making Inventions Pay." Crescent Tool Co., Dept. Y, Cincinnati, Ohio.

MODELS—Practical models put over your ideas. We develop models from the crude to perfect working devices. Your idea might have large commercial value. Services confidential. Bank references. Registered graduate engineers at your service. Send 25c for our 68 page booklet "Mind vs. Matter." Rex Engineering Co., Cincinnati, Ohio, Dept. B.

BLUEPRINTS AND PLANS

BLUEPRINTS—"Microgrind" for drill press surface grinding 50c (casting \$1.00); "Triplirid" boring bar 35c. Circular free. Craftsman's House, Avoca, Penna.

TRANSFORMER Plans and working details designed for your requirements—Arc welding, spot welding, welding reactors, battery charging rectifier, auto or ratio power transformer, toy, model transformer—75c to \$1.50! Or will design to fit your cores \$1.50 to \$2.50! Can furnish special coils. Write, Hal Hubertz, Engineer, 416 South Hoyne, Chicago, Ill.

HOME CRAFTSMEN

HARDWOODS. Cabinetwoods, plywoods. Send for free catalog. White Brothers, Fifth and Brannan Streets, San Francisco, California.

BEAUTIFUL Decorative novelty furniture of plywood. All new designs. Easy to make. Forty superb halftone illustrations and pattern price list giving dimensions, with refund slip, 10c. Wo-Met Shop, Ashburn, Georgia.

22 LAWN Ornament patterns 25c coin. Strother, Box 383-V, Belington, West Virginia.

12 JIG Saw patterns, 50c. Wilco, Box 109, Elizabeth City, N. C.

SAWMOUTH Interests jig saw fans; make money. Postcard brings information. C. C. Illers, 725 Post Ave., West New Brighton, S. I., N. Y.

GET Free leathercraft instructions, prices of leathers, tools, projects. Make extra money. Beautiful gifts. Leather samples 5c. Wilder & Company, 1038 Crosby, Dept. 10F, Chicago, Ill.

METALIZED Cellophane for artcraft, airplane models, etc. Also celluloid and plastics of any description. R. Marquardt, 59 Beech St., Clinton, Mass.

20 FULL Size lawn ornament patterns 25c. Wickman, 744 Brooklyn, Dept. 74, Dayton, Ohio.

MODERN Furniture, make, sell. Blueprints of three tables and unique lamp for \$1.00. Send 15c for complete list. Credited on first order. John Jeffers, Box 398, Osceola, Iowa.

KNOCKDOWN Furniture, lumber, veneers. Illustrated catalog 10c. Gilles-Kendall Co., Decatur, Alabama.

20 LAWN Ornament patterns 30c. 20 novelty patterns 30c. 14 silhouette patterns 30c. 15 lawn ornament patterns different from those above 30c. All for \$1.00. Modern Woodcraft, Saginaw, Michigan.

LET Me do your wood-turning job. Free preliminary estimates. Romaine Harshman, Sullivan, Illinois.

MEXICAN Wood novelties easily made. Our 20 Mexican patterns and instructions 25c. Mexican Arts Crafts, Eagle Pass, Tex.

1001 WAYS to Use Concrete. Send for large free illustrated folder describing new Popular Mechanics book covering every known use of concrete for the home, farm, building, business and industry. Popular Mechanics Press, Room (C39), 200 E. Ontario St., Chicago.

FOR THE HOME

FANCY Quilting to order. Write Kathryn Botner, Green Hall, Ky.

LARGE Ships wheel ash tray \$1.25. Paper knife \$1.00. Both solid walnut, hand turned, inlaid with beautiful contrasting Minnesota hardwoods. Shattuck, Altura, Minn.

METAL Furniture in modified modern design, how to make, described in Shop Notes for 1937 only 50 cents postpaid. Popular Mechanics Press, Room (C39), 200 E. Ontario St., Chicago.

OLD GOLD, WATCHES, JEWELRY, PRECIOUS STONES

EXOTIC Christmas gifts unconditionally guaranteed. Genuine Mexican silver filigree. Send \$2.00 for sample bracelet. Flores, Vallarta 1994, Guadalajara, Jalisco, Mexico.

MAKE Big money—Elgin, Waltham wrist watches—\$2.95. Send for free wholesale catalog. Louis Perloff, 729 Walnut St., Philadelphia, Penna.

WATCHMAKERS' Materials—Tools, watches, jewelry bought, sold, exchanged. Ben Segal's, 5 South Wabash, Chicago.

AUSTRALIA'S Lovely opals. Illustrated catalogue free. Good selection \$5.00. Norman Seward, Melbourne, Australia.

HIGHEST Prices for old gold—Mail your teeth, watches, jewelry, 100% full cash value mailed day shipment received. Satisfaction guaranteed or articles cheerfully returned. Information free. Chicago Gold Smelting Company, 300-P Champlain Building, Chicago.

5000 REBUILT Elgin, Waltham, Hamilton watches. Also ladies, gents wrist watches. Make big money! 12 size, 7 jewel, Elgin or Waltham, \$4.75; 16 size, 17 jewel, \$7.50. Send for free watch and diamond catalogue. The New York Jobbers, Dept. M, 74 Bowery, New York, N. Y.

GOLD \$35 Ounce. Ship old gold teeth, crowns, jewelry, watches—receive cash by return mail. Satisfaction guaranteed. Free information. Dr. Weisberg's Gold Refining Co., 1500-Q Hennepin, Minneapolis, Minn.

RAZORS AND RAZOR BLADES

"KEENEREDGER" Produces 1000 shaves per blade. \$1.00 prepaid. Keeneredger, Oblong, Ill.

100 GUARANTEED Double edge razor blades 75c. \$6.90, 1000 with 100 extra blades free. Sample 25 blades 25c. Postpaid. Anderson, 920 South Mitchell, Cadillac, Michigan.

100 DOUBLE Edge blades \$1.00. Free sample. Hoguet, 601 West 136, New York, N. Y.

TOBACCO

GUARANTEED: Cigarette, pipe or chewing, 5 lbs. \$1.00, ten \$1.75. Pay when received. Pipe and box cigars free. Rives Tobacco Co., Paducah, Ky.

LOOK! Try cheaper tobacco! Then taste our milder golden smoking or rich ripe chewing, four pounds, postpaid, \$1.00. Riverside Ranch, 201, Hazel, Kentucky.

SURVEYING INSTRUMENTS

U. S. Army "Ainsworth" Lensatic 2" compass; liquid filled; temperature compensated; for taking bearings in same horizontal plane; measuring angles, triangulation, topographical drawings, etc. Magnetic needle attached to floating, jeweled sapphire, dial; azimuth circle in 64 divisions. Aluminum case; etched hairline sight; complete with leather case. (\$8 value.) Special—\$3.98. Lee Sales, W-35 West 32nd Street, New York.

GUARANTEED Factory rebuilt transits and levels for rent (with purchase option) or sale (cash or terms). Order now before prices advance. We will repair, trade in, or buy your old instruments. Ship prepaid for estimate and valuation. Write for List M-50 and complete information to Warren-Knight Co., 136 N. 12th St., Philadelphia, Penna.

WANTED—MISCELLANEOUS

CASH For used microscopes, binoculars, slide rules, drawing sets, scientific instruments, cameras, shotguns, golf sets. Write details. Elman's 2302 Van Buren, Chicago.

YOUNG Man desires representation, jobbing salable article coast territory. Established offices. Lighter, 259 Geary, San Francisco.

PERSONAL

POSITIONS Abroad: 5-page manual—"The Truth About Jobs for Americans in Foreign Countries." 25c postpaid. Julius, Amarillo, Texas.

TWENTY Clear copies, any picture 25c. Grove's Studio, Coupeville, Washington.

YOUR Eyes trained to overcome weakness, astigmatism, nearsightedness without glasses. Complete guaranteed course \$1.00. Eyesight Improvement, Box 193, Hamilton, Ohio.

HAY Fever absolutely stopped with Clarke's nasal filter. Worn invisibly. Details 3c. 701 Ridge Ave., Pittsburgh.

TEST And adjust your eyes with new inventions. Guaranteed. Details free. A. E. Jacobson, Upsala, Minnesota.

WIN Prize money: Booklet—"Successful Contesting"—shows how, 10c postpaid. Bulletin listing \$200,000.00 prizes included. World Publishers, 4515-B Cottage Grove, Chicago.

MISCELLANEOUS

HOTEL Labels. Famous hotels of world. Large colorful ass't packet \$1.00. Kiewert, Cliff House Gift, San Francisco, Calif.

EMBOSS Signs for exclusive shops and manufacturers. Any color. Sample with your copy 25c. Signograf, 739 Cole, San Francisco.

LUMINOUS Paint shines in the dark. 25c coin. Myers, 211 Broadway, Niles, Mich.

MASTERPIECE, 21x36, charts. Money makers. Physical therapy simplified. Classy. Complete chart. Prepaid \$1.00. Rad-1517 S. Michigan Ave., Chicago, Ill.

BE A good conversationalist! Our practical course teaches you how. Details free. Nankers Company, Box 884, Colorado Springs, Colorado.

AMATEUR Tattooing outfits. Illustrated list free. Tatuco, 651 South State, Chicago.

USED Books. List free. Gowdy, 11 Princeton St., East Boston, Mass.

CUTS—Make yourself, zinc or copper, new, cheap, easy process. Send \$1.00 for complete, illustrated course. Worth \$1,000 to you. Jean d'Orval, Newspaper Artist, 2714 Pine Street, San Francisco, Calif.

BARGAINS in popular books—originally published at \$5, \$6, and up to \$25.00, now only \$1.00 to \$2.39. 32-page illustrated catalog 10c; refunded on first order. Send for it today. Hicks, Box 8, Brooklyn, N. Y.

PROSPECTORS, Miners, send stamp for bulletin on sampling gold ores. Martin Engel, Assayer, Cantil, California.

HAND-WOVEN Ties \$1. Write for free sample of tie material and 32 colored pictures of patterns. Log Cabin Hand Weavers, 11 Post Road, Oregon City, Oregon.

GOOD Eyesight without glasses. No drugs. Simple, effective home treatment. A. Jacobson, Upsala, Minnesota.

SWAPPERS! Collectors! Join now, for best swap offers in U. S. 3 months membership 25c. Send list your articles today. National Swappers Club, North Birmingham, Ala.

EYEGLASSES—Broken lenses duplicated. Broken frames replaced. R. L. Opticians, 242 Lexington Ave., New York City.

ANY Three questions answered about New York or its inhabitants \$1.00. Reliable, confidential. Individual research. No guesswork or stock answers. Information Service, P.O. Box 149, Grand Central Annex, New York City.

MAKE Household product of 100 uses. Sell by mail or agents, spare time. Information free. Ribot, 620 East 62nd, Chicago.

WHY Be bothered by rats? My new non-poisonous exterminator drives them outside to die. Send 50c. Ferret, Box 151, Kansas City, Missouri.

COATS Of arms and crests, correctly painted in colors or black and white, from heraldic description or furnished copy. \$10.00 and up. Highest grade work. Heraldic Studios, 1914P Oakdale Avenue, Chicago, Ill.

TATTOOING Outfits, supplies, illustrated list free. Percy Waters, Anniston, Alabama.

REFINE Used oil without cost. Particulars. F. Gerwin, Fairview, Oklahoma.

AMATEUR Cartoonists wishing steady income copying and duplicating cartoons for advertisers, write Ad-Service, Argyle, Wisconsin.

SWAPPER'S Friend, R4, Saline, Michigan. Interests swappers, collectors. 50c year, sample 10c.

START Mail order business. Make, sell amazing product spare time. Big profits. Write for free facts, Konis, 5645 Fullerton, Chicago.



USERS THRILLED
by LACO'S HEATING, **LOW COST!**
FUEL ECONOMY and

1940 Models Are Out!

Big money-making opportunity for live dealers, selling the LACO 1940 model Oil Burners and Circulating Heaters. These are positively the best looking, largest, built of heaviest material and will deliver more heat with less oil—largest variety of sizes—we have ever manufactured. Priced low with big dealer discount. Write for dealer prices.

LACO



LACO OIL BURNER CO., 1109 Union Ave., Griswold, Iowa

WANT A GOOD PAY JOB?



Get into a **good-pay** trade where trained men are scarce. There is always steady demand for **TOOL and DIE MAKERS, MACHINISTS and Automatic Screw Machine Operators, who Earn as Much as \$60 per Week**. More men are needed right now. You can quickly qualify to fill one of these **big-pay** jobs through **ALLIED** training. No previous experience necessary. Individual instruction given every man by practical experts.

Learn by Actual Doing
Here at Allied an **ILLINOIS STATE CERTIFIED** School, you are trained in one of America's best equipped shops. You practice on real machines, learning on actual jobs. Master every phase of machine shop work.

DAY AND EVENING TRAINING
Start anytime; **ALLIED** School is open year 'round. Many students assisted to find day-time jobs and train evenings. Our valuable employment service **FREE**.

OUR NEW FINANCING PLAN
Makes it possible to enroll now and pay later. Very low tuition fees; Don't wait another day; it doesn't cost you a cent to get the facts and get started to success. Act now!

FREE BOOK
"Practical Machine Shop Training" Sent **FREE** on request. Write Now!

ALLIED SCREW MACHINE CO., INC.
(School Division) Dept. PM-10, 603-9 W. Lake St., Chicago

When writing please mention Popular Mechanics

AIR CONDITIONING 1939 HANDBOOK

Complete tables, graphic charts and word formulas for planning jobs and selecting equipment. Summer and winter design data for 128 districts. Brief instructions, step by step rules, and detailed solutions for 118 practical problems show how to use new and faster methods. \$1.50. Money back if not satisfied.

H. P. MANLY, Publisher, Dept. A, WILMETTE, ILL.

SURE ROUTE TO HAPPY-LAND MAIL TODAY SURE

J. C. DEAGAN, Inc., Dept. 3457 1770 Berteau, Chicago

Without cost or obligation, tell me about the easy-to-play **DEAGAN MARIMBA**... its sensational rise in the music world... the fun it provides at parties... the opportunities for radio, stage and dance-band fame.

EASY TO PLAY

Name—Please **PRINT**

Address

ANIMATED CARTOONING

Taught by a former Hollywood Artist
DRAFTING — BLUEPRINT READING

Architectural, Airplane, Air-Conditioning, Diesel, Electrical, Mechanical, Ship, Radio, Television, Structural, Topographical, Building, Estimating, Construction.

CIVIL SERVICE JOBS

\$1440 — \$3120 yearly

MONDELL GRADUATES during 1938 attained many first, second, third places on the eligible lists for Engineering Inspector, Topographical Draftsman, Assistant Engineer Designer, Mechanical Drafting, Heating and Ventilating, Jr. Engineer Federal (Aeronautical, Civil, Mechanical, Electrical, Structural) Actuarial Mathematician, Chemist, Jr. Meteorologist, etc., and many received appointments with City, State and Federal Government at salaries ranging from \$1440 to \$3120 yearly.

Prepare now for Jr. Bank Examiner, Engineering Aid, Railway Postal Clerk, Meteorologist, Engineering, Draftsman, Investigator, Storekeeper, Gauger, Patrolman, Fireman, etc. All City, State, County, Federal and Promotion Exams.

MATHEMATICS, SCIENCES

Arithmetic, Algebra, Geometry, Trigonometry, Calculus, Physics, Chemistry, Hydraulics, Mechanics, Thermodynamics, Actuarial, Business, Statistical, Engineering Mathematics.

LICENSES — Professional Engineer, Stationary, Electrician, Marine, Architect.

All courses are resident or by mail.

MONDELL INSTITUTE

790 Broad St., Newark, New Jersey

Government Jobs

Write for catalog No. 47. Valuable information free.
 COLUMBIAN CORRESPONDENCE COLLEGE, Washington, D. C.

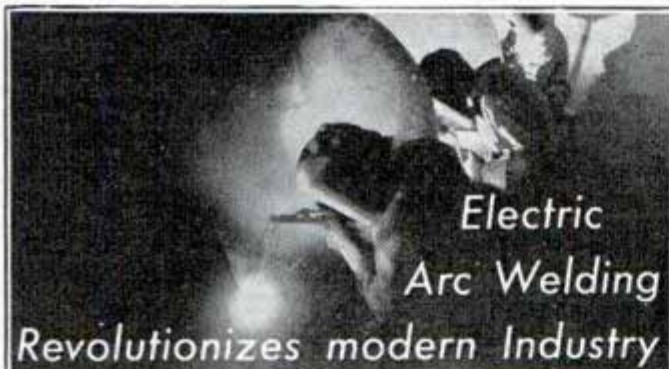

Electric
 Arc Welding

Revolutionizes modern Industry

U. S. Manufacturers

desire men to learn Electric Arc Welding and get practical experience under actual production conditions in the laboratories of the School of Engineering. Moderate training Fee. Accepted applicants will be fully trained until ready to pass rigid test and assisted in securing employment.

ARC WELDING

presents one of the outstanding opportunities for steady income and future success. Welding is growing rapidly, replacing large and intricate castings, rivets, nuts, bolts, screws. It is commonly used in assembling cranes, hoists, bridges, structural steel work, etc. No limit to the application of welding to industry, increasing durability and reducing manufacturing costs. There is a decided shortage of properly trained Welding Operators, Technicians and Welding Engineers. Why be content with ordinary work, hit and miss jobs and low pay when in a short time you can become a trained Specialist in Welding?

MILWAUKEE SCHOOL of ENGINEERING

Institute of Electrotechnics

PM1039 North Broadway and E. State, Milwaukee, Wis.

Without obligation send Free Booklet "The Dawn of a Gigantic Industry and Its Outstanding Opportunities." Also tell me how to become a

- | | |
|----------------------------|-------------------------------------------------------|
| Welding Operator (3 mo.) | Refrigeration and Air Conditioning Technician (3 mo.) |
| Gas Welder (8 wks.) | Air Cond. Engr. (1 yr.) |
| Welding Technician (6 mo.) | Radio, Television (6 mo.) |
| Welding Engineer (1 yr.) | Commercial Radio Engineer (1 yr.) |
| Electrical Engineer | Earn Part Expense Plan |
| B. S. Degree (4 yrs.) | |
| Student Loan Plan | |

Name.....Age.....
 City.....State.....

This MACHINISTS' Home-Study Course



helps men get ahead

Newly assembled—specially priced—these five recent books give you the practical facts on modern machines, up-to-date methods, you need to advance in machine shop work. Take advantage of the other man's experience as found in books, to solve your problems, increase your efficiency, with

The NEW AMERICAN MACHINISTS' LIBRARY

5 volumes—2014 pages—1853 illustrations
 (A combined home-study course and reference library)

This library of machine shop practice was written for practical men. It gives you the best methods for every kind of machine shop work. It fully explains lathes, drills, and other machine tools and their operation, automatic screw machines, speeds and feeds, gear design and production, punch and die work, metal surfacing, etc., etc. Plainly written—completely illustrated—the best kind of help to the machine shop man who wants to advance himself.

No money down—special price—easy payments.

EXAMINATION COUPON

McGRAW-HILL BOOK CO., 330 W. 42nd St., New York

Send me for ten days' examination the new American Machinists' Library. If satisfactory I will send you \$1.50 in 10 days and \$3.00 monthly until the price of \$16.50 is paid. If not wanted, I will return the books postpaid. (To insure prompt shipment write plainly and fill in all lines.)

Name.....
 Home Address.....
 City and State.....
 Position.....
 Name of Company..... PM-10-39

NEW YORK ELECTRICAL SCHOOL

Opportunities for Men of All Ages!

Every phase of all branches of Practical Electricity taught by Actual Practice in America's Foremost Institution of Trade Training

INDIVIDUAL INSTRUCTION

Day and Evening Sessions Open All Year

Write for FREE Booklets

Visitors Welcome

NEW YORK ELECTRICAL SCHOOL
 44 W. 17th St., New York City

POPULAR INVENTIONS

(Continued from page 34A)

MOUNTING an outboard motor on an inflatable boat is provided by a patent granted recently. The mounting, which is removable, is formed to fit snugly upon

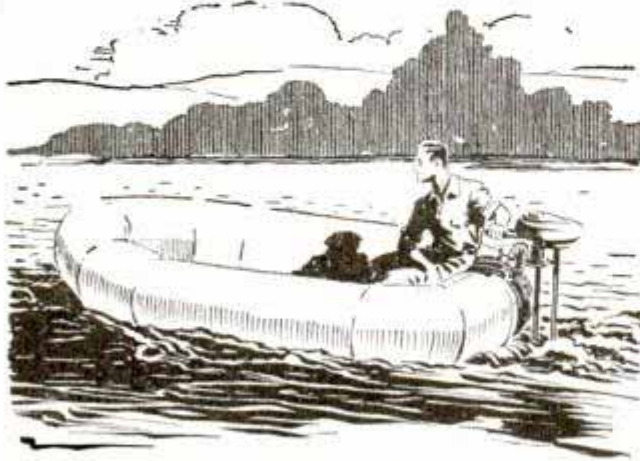

a substantial area of an inflated tube portion of a fabric boat, with an extension rising from it to hold the motor.

HIGHLY useful to the professional or amateur photographer trying to get pictures in a crowd is a newly patented camera periscope. It is arranged for attachment of the camera to its upper end, in such position that the photographer may focus through



the periscope's lens at the lower end. Then, by snapping the shutter by an extension control, he takes the picture over the heads of the crowd.

EXERCISING the dog indoors is made possible by a device patented recently. It consists of a sort of treadmill on which the dog may walk or run. An adjustable harness attached to uprights at either side of the exerciser holds the dog on the mill, but permits forward or rearward movement and helps the dog maintain his place.

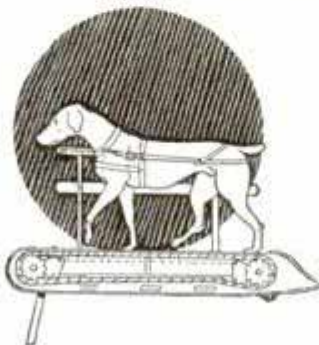

MANY chicks may be saved through use of an electrically heated brooder that keeps the temperature at the point desired and makes for an increase in the health factor. The brooder has a blower and a heater. Passages provide for discharge of air from the blower to the heater housing and thence to the brooder space, through outlet holes at the lower edge of the heater housing.



ANY heavy vehicle, such as a truck or a bus, could be converted for snowplow use by attachment of a recently patented plow.

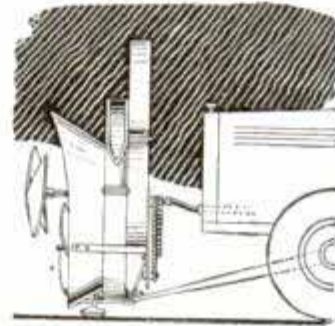

It has three blowers, ahead of which are mounted augers for boring into the snow. The blowers force the snow away from the

front of the plow after it has been loosened. The plow may be attached to the front of the vehicle.

GREATER speed in swimming is the objective of a hand plate patented recently. It consists of a curved concave plate attached to the swimmer's wrist and held by inserting the fingers into loops on the back. The plate, being much larger than the hand, gives an increased surface for propulsion as the swimmer makes the normal strokes.



Ⓒ Due to the fact that many of the devices described in this department are still in the patent office stage and are not on the market, Popular Mechanics Magazine cannot undertake to supply further information regarding them.

A Sensational New Business

That May

Sweep You to Riches

This is undoubtedly the most amazing money-making opportunity ever offered to the readers of this—or any other—magazine. It tells how any ambitious, level-headed man can quickly establish a remarkable new kind of business that may pay a steady net cash profit of \$40.00 a day—a business that offers unlimited opportunity, rapid expansion—a business in which you can employ others to work for you and run your daily profits up as high as you want them to go—a business that may make many men independently wealthy within the next few years.

HERE, briefly, are the “high-spots” of this thrilling new business that should create “fortunes” for those with the vision and foresight to get in on the ground floor now:

1 An utterly new product with a natural, staple demand and big repeat business, yet one that has all of the appeal of a novelty.

2 Requires no house-to-house canvassing or selling. You simply manufacture. Every store, tavern, club, or any establishment where any sort of food is handled are your immediate customers.

3 Starting with one unit alone you have a capacity to enable you to make \$42.00 profit a day selling at wholesale.

4 An amazing product that can be manufactured by special secret process by only one mill in the country. This mill, one of the largest of its kind, manufactures the product exclusively for us and our operators. No one else can make it or buy it. This means your protection from cut-throat price competition.

5 All year around business; no slack seasons.

6 Tremendous natural demand in every community, whether large or small.

7 Absolutely no experience needed to be successful.

8 No expensive equipment needed. Your whole investment will be less than your first week's potential income.

This is truth; not fiction—fact; not theory. To the best of our knowledge, no other business in America offers one-tenth the opportunity for profit and independence.

Vision Turned to Reality

A short time ago, this amazing money-making product was nothing more than a dream—today it is a reality.

It is a practical, tried out, thoroughly tested business!

Every detail has been perfected—complete and tested plans of operation worked out—all necessary equipment ready to turn over to those who are prepared to develop this new “gold mine.”

No Selling—No Canvassing

Do not confuse this new product with anything you have ever heard of before. It is not a potato chip, not candy, not a cheese chip, not a paste preparation—but a natural product that comes from the sky, from the ground, and from the air. It is not like anything you ever saw or heard of, or imagined. The simple truth about it is stranger than your wildest dream. And you can be the first to supply this great demand.

\$100.00 a Week, Net, to Start

According to accurate figures, the very minimum of the first operation should produce a net cash profit of at least \$100.00 a week. Since it is possible to make \$42.00 a day, you can see that it would take only two and a half days of full operation to make a profit of \$100.00. This, we figure to be a minimum. We would not be interested in appointing men who could not make at least that much every week. Then, as demand increases, other men can be put to work for you and you can double, triple or quadruple your weekly profit as steady repeat business develops.

No Expensive Equipment

Ordinarily a proposition as big as this would require the purchase of expensive equipment with which to manufacture this remarkable new product. But in this case our manufacturing process has been so simplified that we can furnish you with everything you need to start off making a profit the very first day—all for an investment of \$150.00.

No Experience Needed

Absolutely no experience is required to quickly become successful in this thrilling and fascinating new business. We tell you how to start—how to establish yourself quickly—how to operate the business the very day you are ready to go. We furnish all necessary plans, systems and equip-

ment. Any man with ordinary intelligence and a real desire to succeed is bound to make money.

Small Town or Big City

Another feature that makes this business unlike any other is that it can be operated anywhere. No matter where you live—in the smallest town or the largest city—you can establish yourself practically over night and start enjoying an independent income at once. From the foregoing facts, you can readily see that this is not a business for the timid operator who is satisfied to make a bare living, but for the wide-awake, aggressive go-getter who wants to see his energy and enthusiasm produce the greatest possible results in the shortest possible time.

Facts Sent Free

To all such men, we request permission to mail an unusual and complete presentation. After you have read the amazing facts and figures in this presentation, then you can decide whether or not an initial investment of \$150.00 is too much to ask for a complete business that can bring back that investment in the first three days of operation, and then continue to pay as much as \$252.00 a week net profit for one man operation, and up to as high as a thousand a week net profit to those men who have the ability to organize and direct other men.

Act Quickly

There is no time to lose. Today this proposition is new. Tomorrow it will be a little older—next week a little older still. So get the facts without a moment's delay. It's the newcomers in any enterprise of this sort—the “ground floor operators”—who always reap the richest rewards.

There is no coupon on this ad. We do not want to hear from coupon clippers. If you don't agree that this is worth a letter—or a telegram—you are not the man for the business.

So write or wire today—without the slightest cost or obligation—and get the information that can make you independent for life.

KING K. CO. Dept. K-310
620 N. Michigan Ave.
CHICAGO ILLINOIS

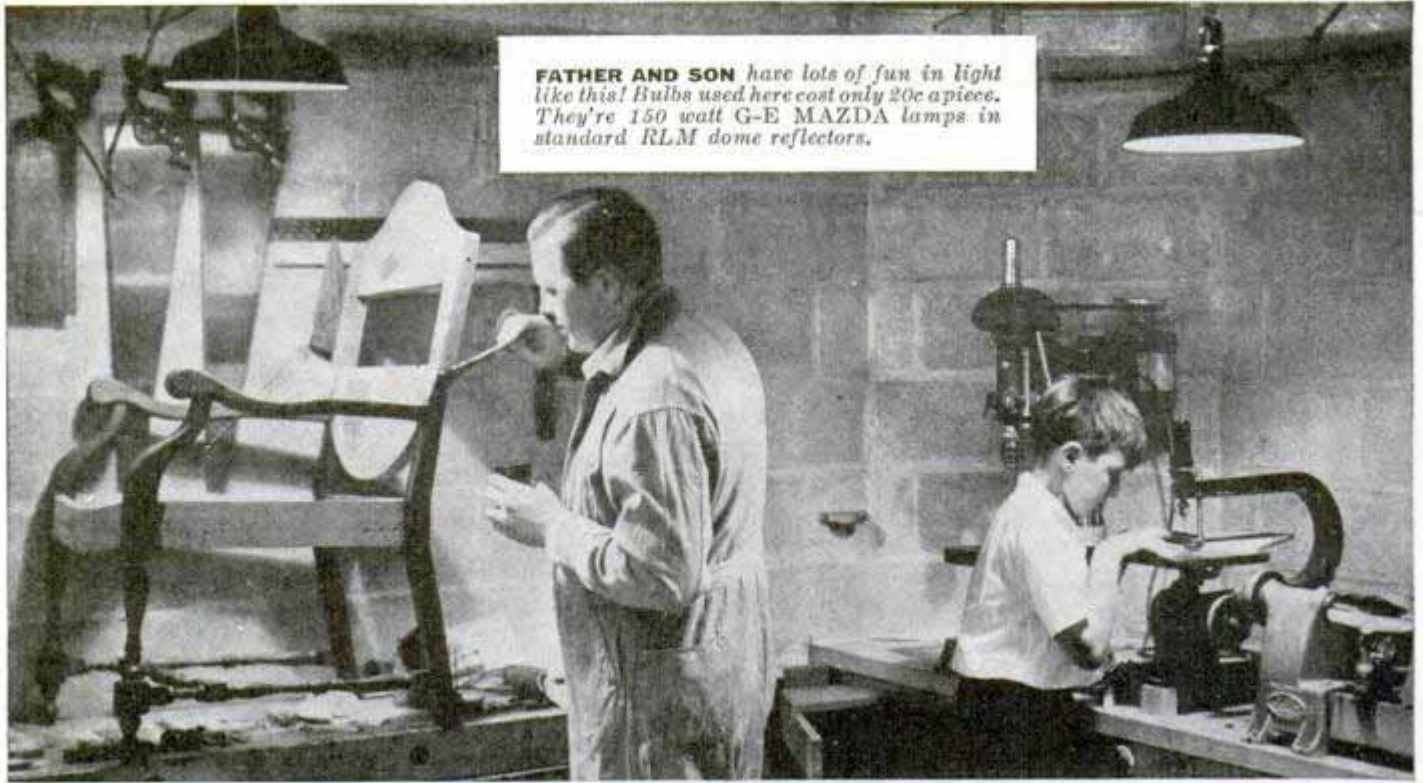

FATHER AND SON have lots of fun in light like this! Bulbs used here cost only 20c apiece. They're 150 watt G-E MAZDA lamps in standard RLM dome reflectors.





NEWEST workshop lighting idea is the G-E MAZDA Reflector Lamp. A bulb and spotlight in one, it's ideal for extra light on jigsaw or drill press.



G-E MAZDA Reflector lamp (left). Spotlight throws intense downbeam on fussy jobs, yet silvered sides protect the eyes, 150 watt, 95 cents.

EVERY YEAR G-E research and development makes G-E MAZDA lamps give more light for current consumed.

THEY STAY BRIGHTER LONGER IF THEY'RE MARKED  



HOW TO LIGHT YOUR HOME WORKSHOP

OF all the tools a man can have in his workshop, good light is perhaps the most important. You can't work well or fast without it! The question is, what is good light? Standard for workshop lighting is still the RLM dome reflector, like the two shown above, with 150 watt inside frosted G-E MAZDA lamps. Something new and different, is the new G-E MAZDA Reflector Lamp. A MAZDA lamp and reflector in one, it's perfect for downlight on difficult jobs. Whatever type you use, it pays to get G-E MAZDA lamps. They give more light for the money because they *stay brighter longer!*

G-E MAZDA LAMPS GENERAL ELECTRIC

Send for **FREE Light Conditioning Wheel!**



General Electric Co., Dept. PM-J,
Nela Park, Cleveland, Ohio.

Please send me free your interesting new "Light Conditioning Wheel" that shows how to get better light in any lamp or fixture.

Name.....
Address.....
City.....State.....

Popular Mechanics Magazine

REGISTERED IN U. S. PATENT OFFICE AND CANADA

WRITTEN SO YOU CAN UNDERSTAND IT

Vol. 72

OCTOBER, 1939

No. 4

FORTY FATHOMS DOWN *with the DIVING NAVY*

By Nat A. Barrows

PART I

IT IS a tense moment on the crowded fantail of the navy's diving ship "Falcon." Far below, at the terrific pressure depths where the wrecked submarine "Squalus" lies partly buried in "blue mud," something has gone wrong with a diver. For nearly half a minute no "okay" signal has come from Bill Badders, no word since his distorted voice, shrill and unnatural from the effects of compressed air, blared out of the telephone loud speaker: "Hold everything, I'm in trouble!"

A sailor pushes his mouth close

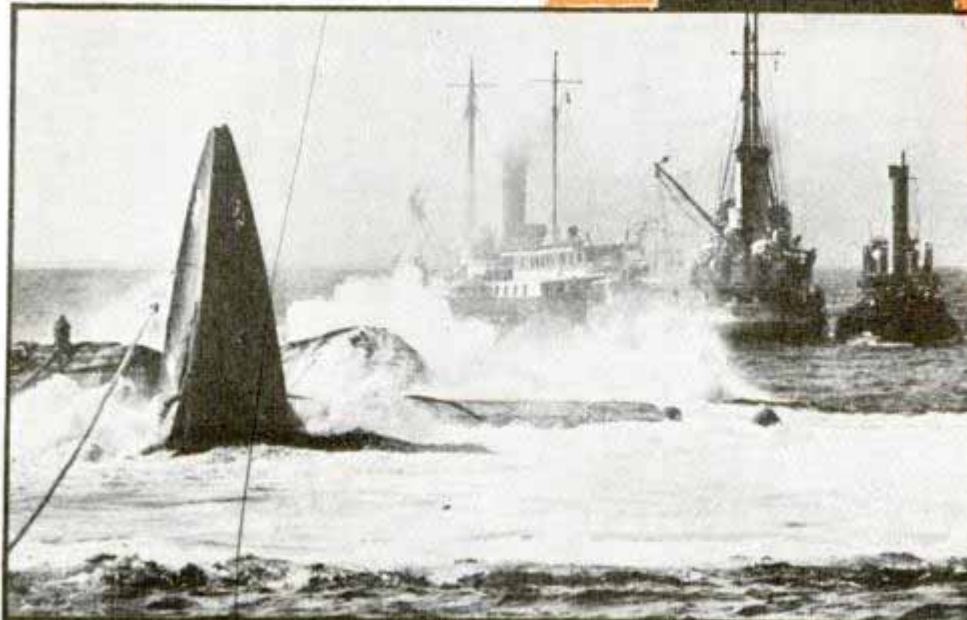
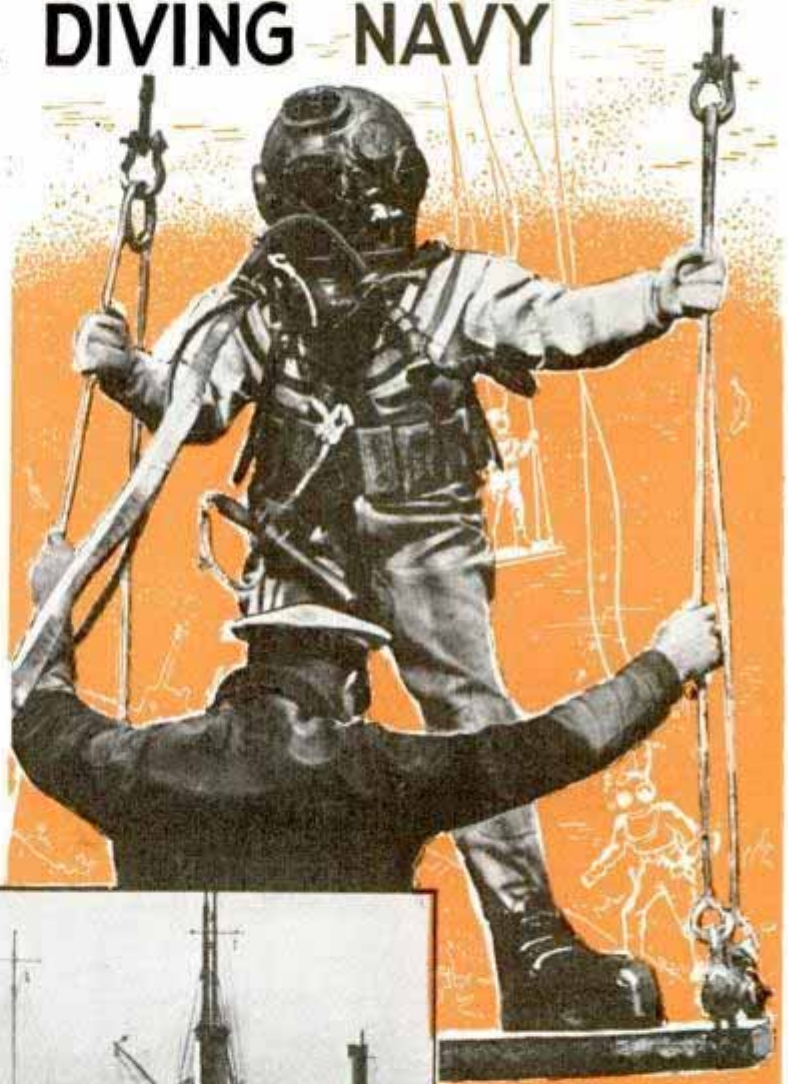

Above, Martin Sibitzky, first to reach the sunken "Squalus" and attach cables of rescue chamber, swings over "Falcon's" rail for another trip down. Left, after seven weeks on bottom the submarine suddenly breaks the surface, tears away from its pontoons and then sinks again

105 Essex Ave. Waltham, Mass. 481



tions running wild with the fearful things that can happen to a diver in trouble where the 109 pounds of pressure per square inch is enough to squeeze him into pulp.

Seconds pass. No word from the bottom. The telephone tender repeats monotonously: "Are you okay?"

The "Falcon's" diving officer, Commander Charles B. Momsen, dares not wait any longer.

"All right, 'Skee,' get



Top, swirling water marks spot where pontoons lifting submarine are nearing surface. Center, the "Squalus" on test run off Portsmouth. Below, navy men inspect pontoons after failure of first effort to raise wreck

to the two-way loud speaker, repeating in even tones: "Hello, Bill, are you okay? . . . are you okay?" There is no answer. The magical loud speaker, in use for the first time in salvage history, gives back only the rumble of the compressed air roaring down Badders' air line. All hands peer at the telephone panel with grim faces, imagina-

down there," he says, addressing a blond giant in the grotesque dress of the deep sea diver. "You know what to do."

Martin Sibitzky crumples a cigarette awkwardly in his great mittens. He nods and his face is grim. "Skee" Sibitzky knows well enough what to do. Ten days ago he walked the watery deck of that submarine when thirty-three living men, huddled in the bitter chill and

murk of the forward compartments, responded to his welcome foot sounds with hammer tappings, confident that the submarine rescue chamber would get them out alive. Yes, "Skee" knows the menace of the death that hovers 240 feet below the surface.

Tenders drag him to his feet, help him

shamble to a box. His breastplate already is fastened, his leg braces tightened. Ever since Badders swung over the side in the diving stage and worked his way to the descending line, "Skee" has been ready, the stand-by diver for just such an emergency as this. A dozen attendants lift on the helmet, deftly screw it into place and snap the safety lock, rig the air line and life line under his arms and make fast the 200 pounds of lead weight. They work rapidly but with precision. There can be no mistake—if Sibitzky wants to remain alive on the bottom.

Master Diver J. H. MacDonald takes a final look at the fittings before he gives the signal to the winch operators and taps Sibitzky's "hat" twice to indicate he is ready to go over the side. The tenders help Sibitzky lumber to

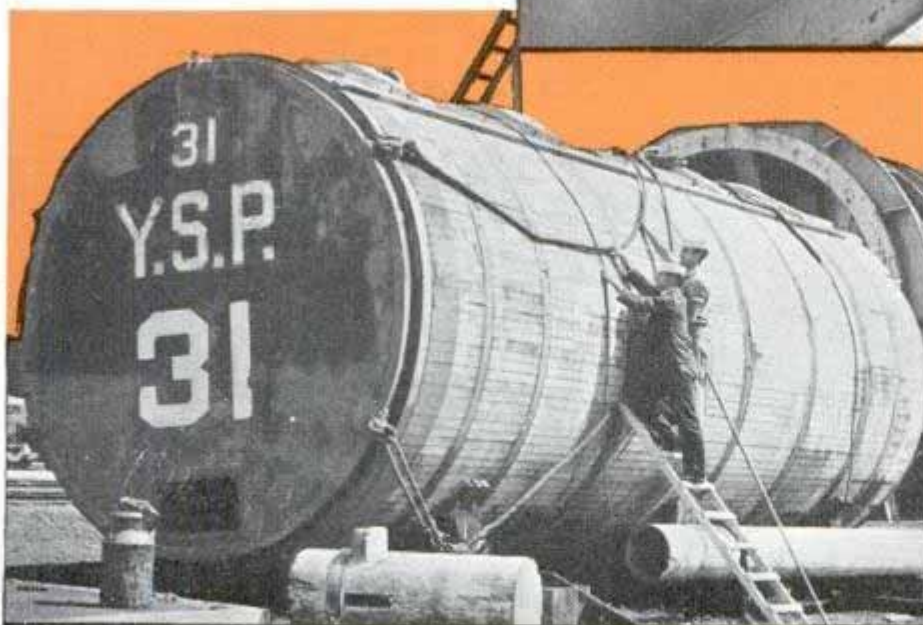

Top, Master Diver William Badders, decorated for heroism on the "S-51" salvage job, takes oxygen while resting in recompression chamber of the "Falcon" after twenty minutes on ocean bottom. Center, outside the recompression tank or "iron doctor." Bottom, preparing one of the huge pontoons used in salvaging the "Squalus"

his feet, to the center of the steel diving platform lying on the deck. Holding to each side of the inverted V of the platform supports, the diver gives a clumsy nod of the fantastic head gear and the platform begins to rise from the fantail, over the rail.

Momsen watches silently, one ear tuned to the loud speaker. The tender drones on: "Hello, Bill . . . what's the matter?"

Sibitzky and the diving stage clear the rail and swing over the water. Gradually he drops down until only the helmet shows. On deck, the



nineteenth dive—and kept on going. The “Falcon,” veteran of the “S-51” and “S-4” jobs, had raced up from New London with the priceless rescue bell. Sibitzky had made that all-important first dive to attach the downhaul cable to the forward hatch. He went forward because there had been no sound aft from the time the “Squalus” crashed to the bottom, poking her flooded after compartments deep into the muddy clay, leaving her bow tilted upward at ten degrees. If he missed the submarine on that first dive, if he fumbled about in the murk, it meant just so much longer before the thirty-three living men inside

stertorous escape of his air exhaust resounds above the slap of the gentle easterly wind rolling toward the New Hampshire shore eight miles away.

The diver remains on the platform, a few feet under water, long enough to get his air control valve adjusted properly for the slide down the descending line, like a fireman on a pole. In another few seconds, he will reach for the heavy rope hawser that runs from the “Falcon’s” rail to the deck of the “Squalus,” holding the line with his right hand, turning the pressure control valve on his left breast with the other.

“One hand for the government, the other for yourself,” he will remember as he starts to sink.

One other day Sibitzky hung like this at the surface of these chilly waters near the Isles of Shoals, an hour’s slow run from the Portsmouth navy yard. That was the morning of May 24, the day after the 299-foot “Squalus,” one of the largest submarines in the world, went down for her

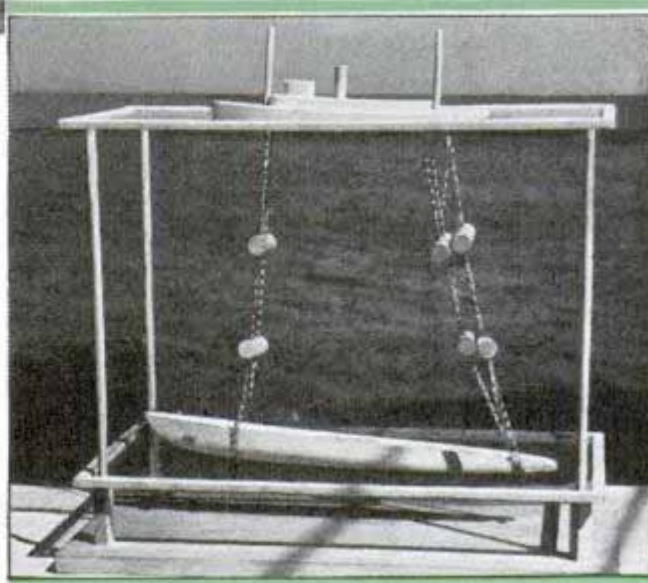
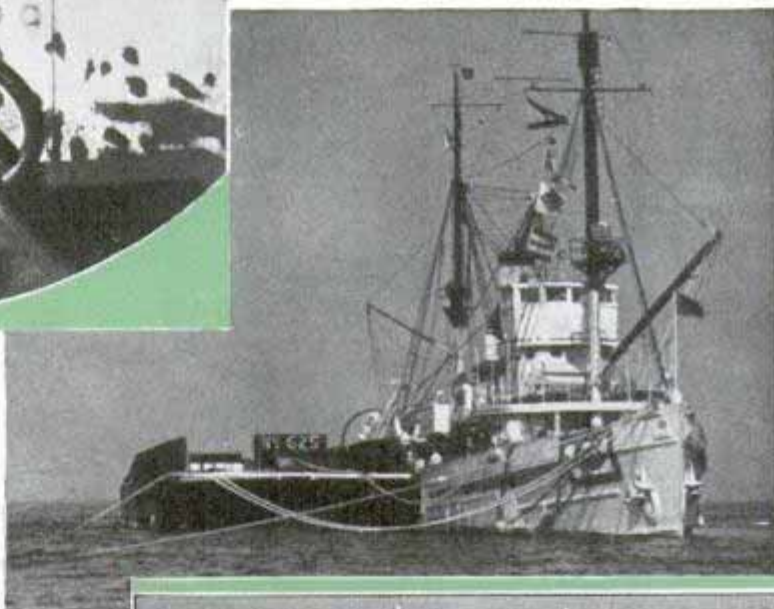

Diver at submarine school, top, attempts to enter “sunken” ship under simulated disaster conditions. Center, rescue ship “Falcon” at wreck scene. Below, models demonstrate plan for raising “Squalus”

the bleak tomb could be brought to the surface in "McCann's elevator." Sibitzky hit the deck within six feet of the desired spot, a feat in any man's diving navy.

Now, with the thirty-three survivors safely back in the sunlight and air, some of them actually aboard the "Falcon" as relief crew members, the towering blond is ready again for the two-minute slide to the bottom—to the aid of a distressed shipmate.

But . . . hold everything! The telephone is speaking.

Badders' voice comes out: "Hello on deck, I'm okay now. I got my lines fouled and I sure was in plenty of trouble."

The voice is full of fatigue, groggy, but there is no sign of excitement or hysteria. The experienced diver, working at such a depth, knows he must keep cool at all costs; otherwise his blood stream, already running wild with an excess of nitrogen, will quickly send him into a coma.

Momsen himself takes over the telephone. The look of fearful anxiety has gone, but he still has a problem.

"Hello, Badders, this is Momsen," says the co-inventor of the Momsen submarine "escape lung" and one of the world's greatest diving authorities. "Want any help? We've got Sibitzky at the descending line now, ready to come down."

"No thanks," Badders replies. "Give me a moment to get this carbon dioxide out of my 'hat' and I'll be okay."

Momsen makes only a simple reply, "okay." From long experience, he realizes that a diver under pressure must struggle even to think. At the crushing pressure of 109 pounds a square inch a diver is so groggy and drowsy after a few minutes on the bottom he is apt to forget why he came down, or to start singing, or to stand blankly, talking to himself.

(Continued to page 134A)

Buggy Train Helps Nurse Care for Many Children

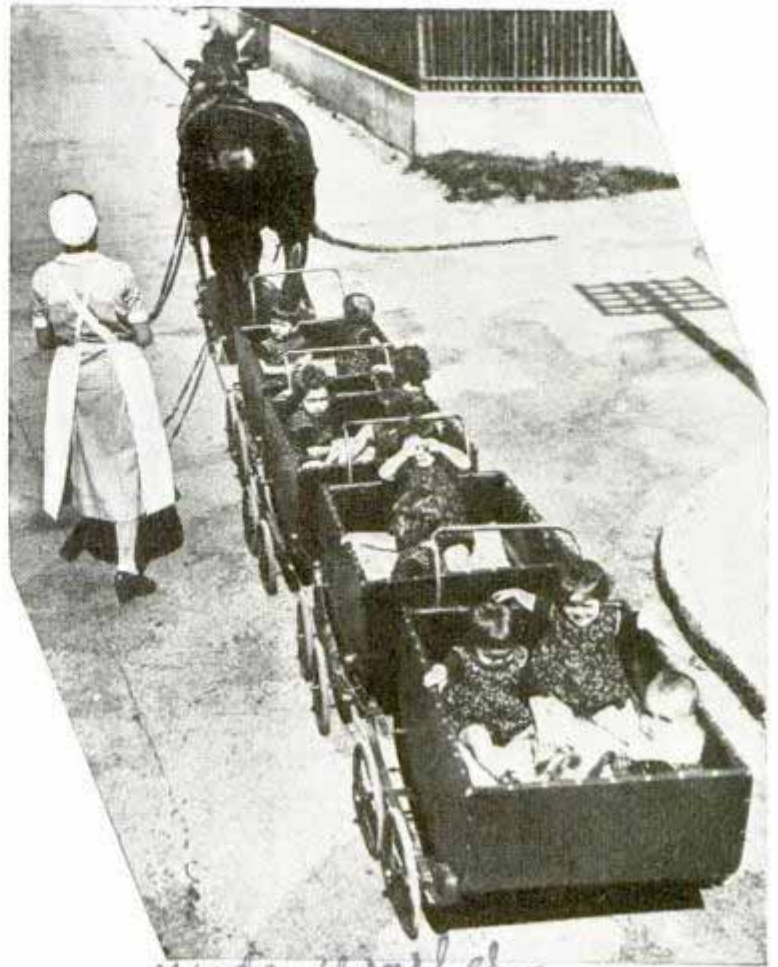

Many children are taken on an afternoon's outing by nurse who guides a horse-drawn train of baby buggies through the streets

Children at a nursery in Geneva, Switzerland, have gone back to the horse-and-buggy idea to solve the problem of a shortage of nurses. Several perambulators are coupled together, and these, with their passengers, are drawn through the streets by a horse. One nurse takes as many as three dozen children for an afternoon's outing.

2841 Chains Mounted on Disk Wheels with Simple Spring Tool

For emergency mounting of chains on disk wheels, a spring steel tool enables the user to attach the chains without soiling hands or clothing. The flat spring has a hook to which the chain is attached. Pulling the hook through the slots is easier than attempting to work the chains through without tools.



Putting chains on disk wheel with spring tool

Union Springs & Supply Co.

Wide-Angle Binoculars Tested for Sports



At the races, a fan tried out the wide-angle vision binoculars used by the army

For getting a wide-angle view of the event, a spectator at a recent regatta tried out the type of binoculars used by British army field officers. A sports adaptation of the military instrument is planned, since the binoculars give a greater range of magnified vision than ordinary binoculars.

Cables Between Lanes of Traffic Are Safer for Car and Driver

There is less danger of damage to automobiles, and less chance of injury to occupants, where cables are used instead of concrete abutments to separate traffic

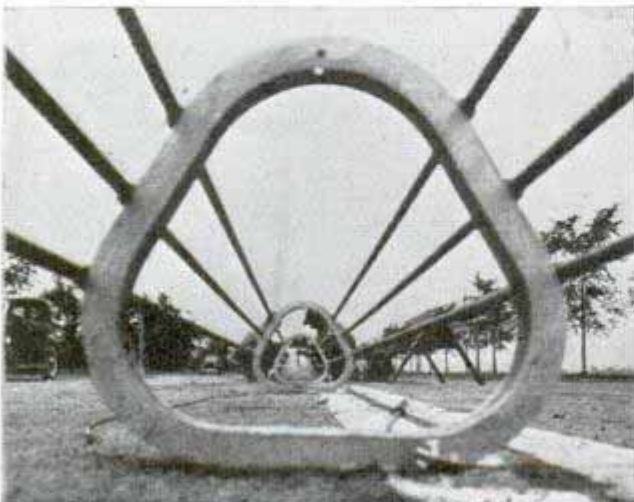

Cables between traffic lanes do little damage to cars that hit them, and prevent head-on collisions

lanes. On Chicago's lake-front drive, cables are stretched between concrete anchorages topped by a red light and spaced ninety feet apart. Being resilient, they yield slightly when hit by a car, yet keep it from crossing into the adjoining lane.

Paint Stirred by Electric Mixer in Pint Cans or Barrels

Painters may save time by using a power mixer equipped with "wings" that stir the paint thoroughly in any size container from pint cans to barrels, which lock se-



Paint mixer with power unit raised to top has its stirring blade adjusted for quart-size container

curely to the stand. Rotated at 280 revolutions per minute by a one-third horsepower motor, the agitator blades move up and down to reach all the ingredients regardless of their density. Paint can be mixed in its holder with the cover in place if an opening is made in it for the shaft. Weighing ninety-five pounds, the unit may be moved about on its rubber-tired wheels or fastened permanently on a bench. In addition to performing as a mixer, it is designed to operate a flexible shaft with a chuck for buffers, grinding wheels and other attachments.

Salesburg, Ill.
Fred M. Iuddings
132 Sheffield Ave.

9817 A-1 Auto Works

3715 Broadway Place

No Wreck Is Too Big for Super-Salvage Car

Los Angeles, Calif.

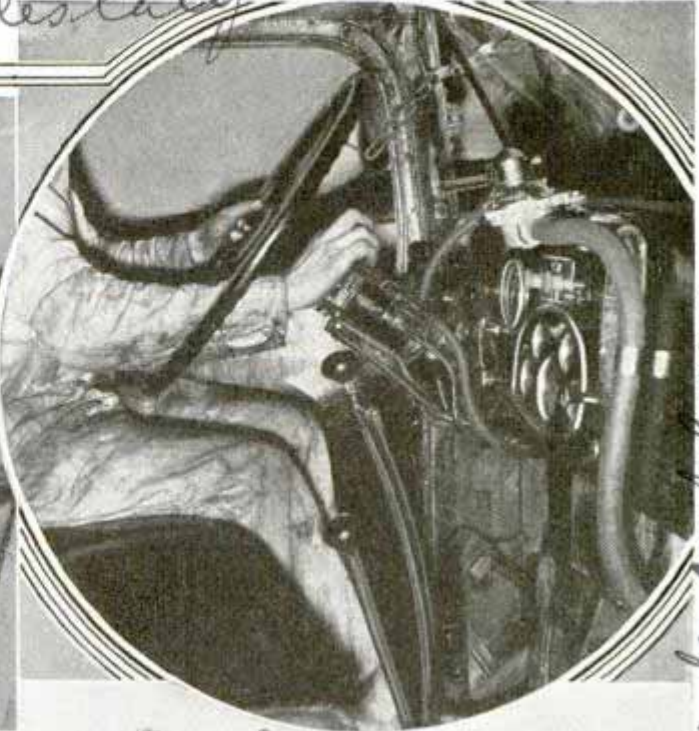

Goliath of wrecking cars, at right, can hoist 75,000-pound derelict up a cliff. At left, above, six levers behind the driver's seat control dual winches; right, view of the cab

Over an icy embankment in the California mountains skids a twenty-ton truck, to crash down the precipitous side of a ravine 500 feet deep. A call for help goes in to Los Angeles, and swiftly the super-tow car is on its way to the scene. Hoisting twenty tons up the face of a cliff is a terrific salvage job, but this giant that weighs fifteen tons, itself, accepts all challenges. It is tow car, truck crane, fire engine and ambulance, all in one. Its dual winches, each carrying 3,000 feet of cable, can lift 75,000 pounds. At the scene of the wreck, a dynamo in the rear, driven off a two-cylinder motor, begins to whir and 3,000-candlepower floodlights illuminate the salvage work. An electric pump is unloaded, a hose run down the cliff and the truck's gasoline is pumped, for safety, into the 250-gallon tank of the tow car. Then heavy drag lines are attached to the wreck, anchors are dropped to brace the tow car,

fire extinguishers are made ready for emergency, and the motors roar. Behind the driver's seat the six control levers are manipulated and the winches take hold, slowly hoisting the truck to the highway. There it is loaded on a dolly whose dual pneumatic air brakes are attached to the brake system of the tow car; if necessary, an additional braking system can be installed connecting the vacuum or air brakes of the wrecked car to the tow car's brakes. Thus, if quick stops are necessary, the driver of the salvage unit can actually apply the brakes of the car he is towing. There is even a portable kitchen aboard the car to prepare food for the crew on long salvage jobs.

☐ Fresh-water fish are being converted into sea-food products for the table by a Hungarian process of treating them with chemical salts.

American Chemical Society review. See news Service 7-19-39

made in shop of operator by employees.

2 662.

Mr. J. W. ...
Birmingham Apts.
4322 Second Road, 2nd fl.
Arlington, Va.

The WAR HORSE

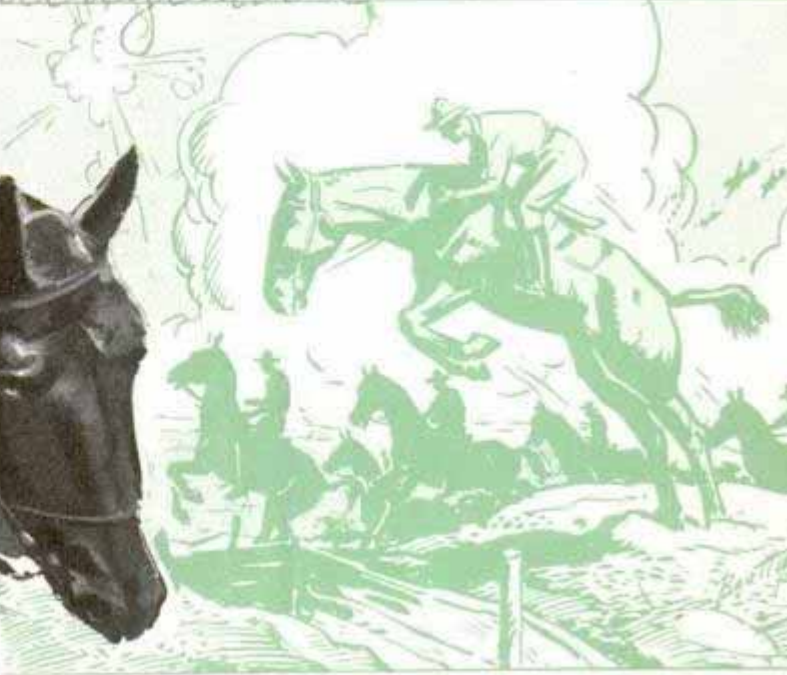

Unless he has been through cavalry college, any horse will naturally shy at a saber waved over his head or the blast of a pistol close to his ear.

But your cavalryman can fire a pistol inches from his face, jump him over fences and ditches, ride him down a precipitous slope. He can march him steadily past a brass band, make him swim deep rivers. He can cause him to stand steady under artillery fire, even gallop into the very jaws of death. And with no reward but a mouthful of hay or oats, that he could earn peacefully anyway pulling a milk wagon.

IF YOU'VE ever ridden a skittish horse that shies at a scrap of paper blowing across the road and all but unseats you at the sound of a car backfiring, you wonder how the cavalryman rides his mount into the noise and fury of battle.

Those six hundred horses who carried six hundred men to death in the famous "Charge of the Light Brigade" had no sense of patriotism or glory. The horse is, in fact, a timid animal. Untrained, he will shy at his own shadow. He will stop short of a fence or ditch he could easily leap. He will avoid deep water as gingerly as any kitten.

Horses don't learn to be brave. There is no room in their brains for ideals. But they can be taught that the noise and confusion of battle are a part of life. They learn so gently and gradually that cavalry horses are the most tractable animals in the world.

For the army has a system. The system begins at birth for most cavalry horses. Bred of selected stock at remount depots, they are handled and groomed from the time they are tiny colts. They are gentled. They become accustomed to men, who pet them, lead them, feed them. When turned over to troops they require no breaking as the term is

Goes to COLLEGE



commonly known; only conditioning for strenuous work, and schooling.

The training starts by the riders leading them. And there is a technique for even this simple maneuver. The rider merely grasps the halter rope, turns his back, and walks off. The horse goes along. The inexperienced man would face his mount and

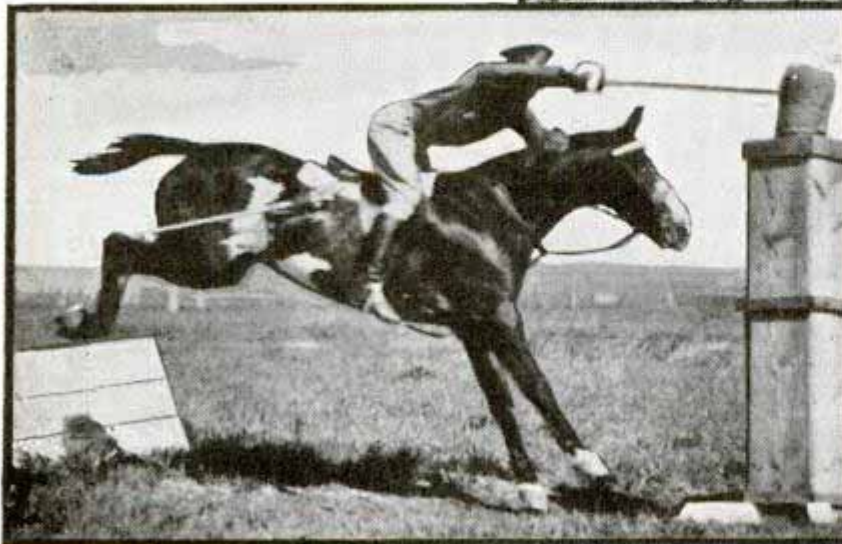
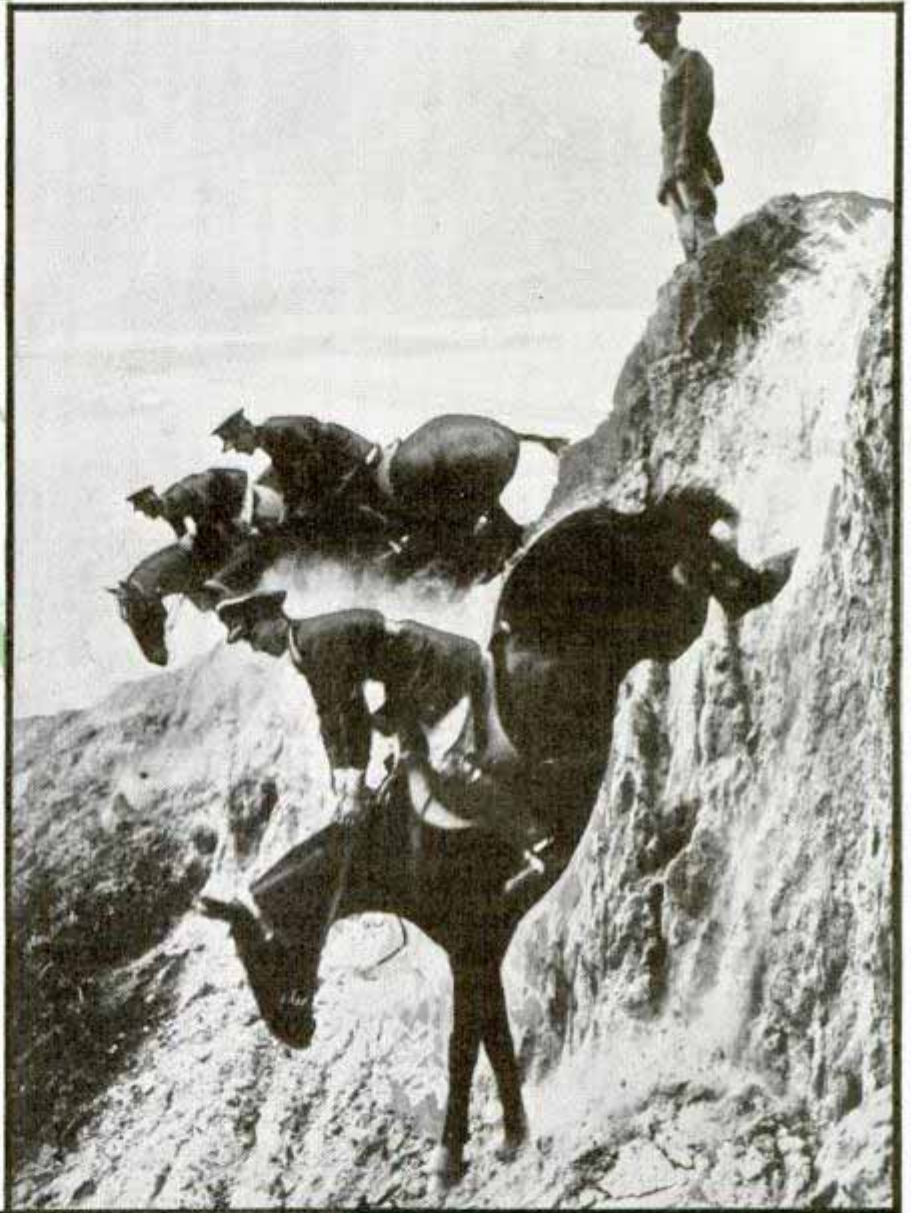

Before either horse or rider would dare a plunge down such a precipitous slope as that at top, the mount is gradually inured to rough terrain. Below, at left, cavalryman takes jump and then lunges saber at dummy; if the horse shies, he misses. Right, army gas mask for horses

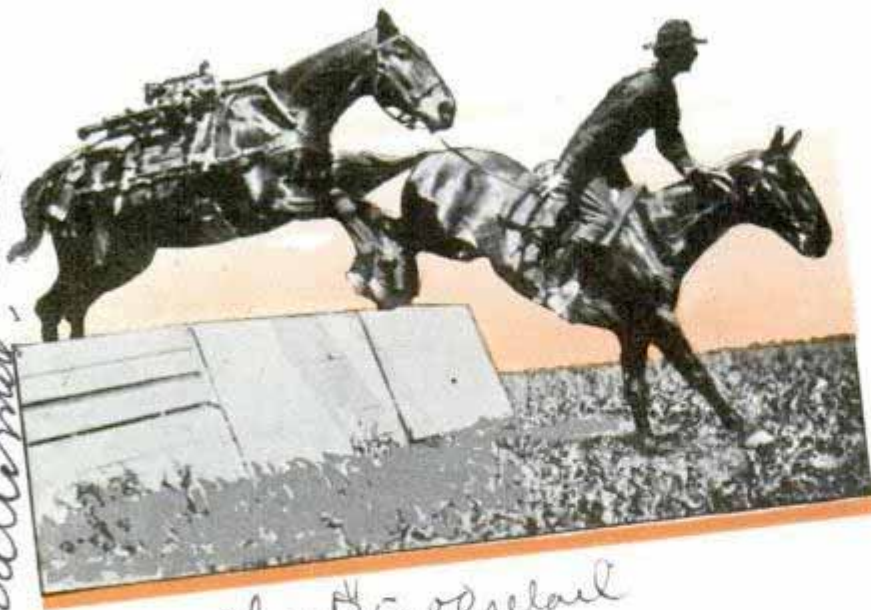

about \$5.00 retail

pull, and the horse would tend to pull back.

Each succeeding lesson will be a new experience for the horse, and he will tend to fight it. So he must first be exercised to tire him out. For this purpose the cavalry has perfected a sort of bitless bridle called a cavesson. This consists of two well-padded pieces of strap iron, hinged in the middle, curved to fit the horse's face. Normally, it is perfectly comfortable; but a pull on the ring, attached where the pieces are hinged, will draw the two sides together and press on the nerves running down each side of the mount's face. The harder the horse pulls back, the tighter becomes the pressure. To this ring a long web line called a longe is attached. The horse is started running in large circles at the end of the longe, and soon learns it is more comfortable not to fight the cavesson.

Soft from months in the pasture, he tires quickly and is willing to stand, while the rider caresses him, picks up his feet, places blanket and saddle gently on his back. But at any sign of rebellion he is given another trot on the longe. When he submits to the saddle, he is led about with it on his back, to accustom him to the feel of it, to the creak of leather, the rattle of rings and buckles. Then the stirrups are lowered, and in a short time he gets

used to having them swing at his flanks.

By the second or third day he is ready for mounting. This is done gradually at first, and only after a session with the cavesson and longe. First the rider strokes the horse's neck, places his arm around it, edges back to the saddle. Then he places a hand in the stirrup, leans some of his weight upon it. More leading; then the rider leans an arm across the saddle and hangs there a moment. He places a foot in the stirrup, lets the mount feel his full weight for a while. The horse becomes accustomed to this, ceases to sidle away; and on one of those sallies at the stirrup, the rider finally swings into the saddle.

It is seldom that a horse, well exercised then mounted so gently, bucks. If he does, he soon learns that the cavesson is still on his face, and pressing most uncomfortably.

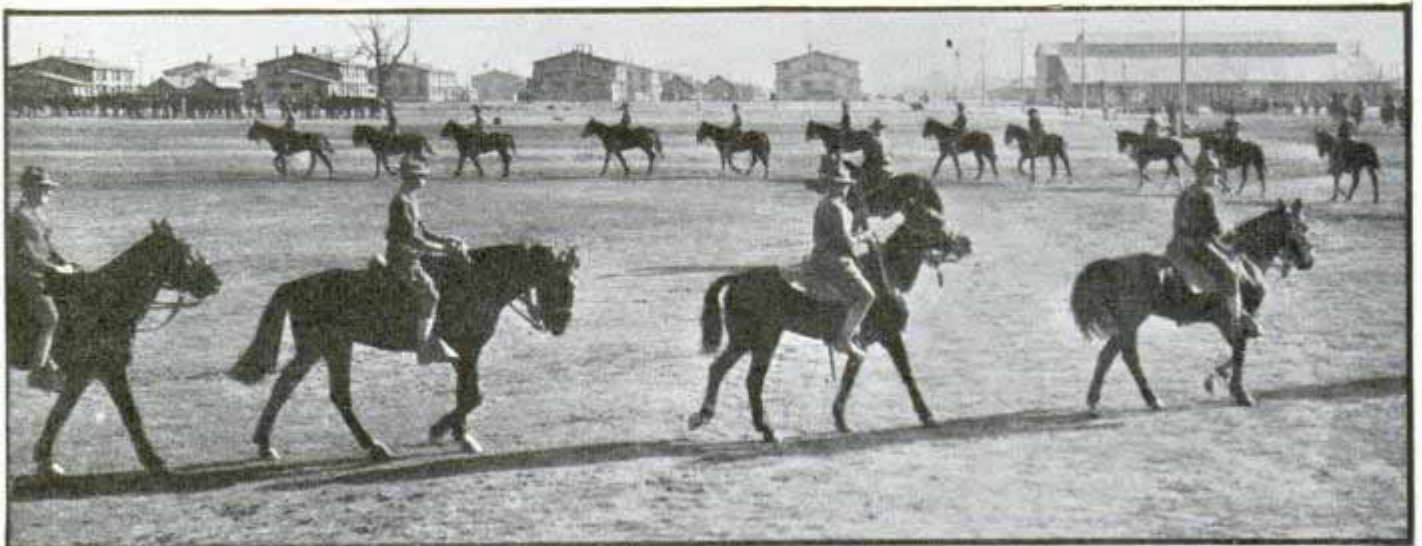

Top, riderless horse carrying machine-gun pack is led over jump. Bottom, a troop plays "follow the leader"; this herd instinct of horses is used by the cavalry at every phase of training

Sold by Little Joe Palmer, Md. 7 S Howard St. 20 662

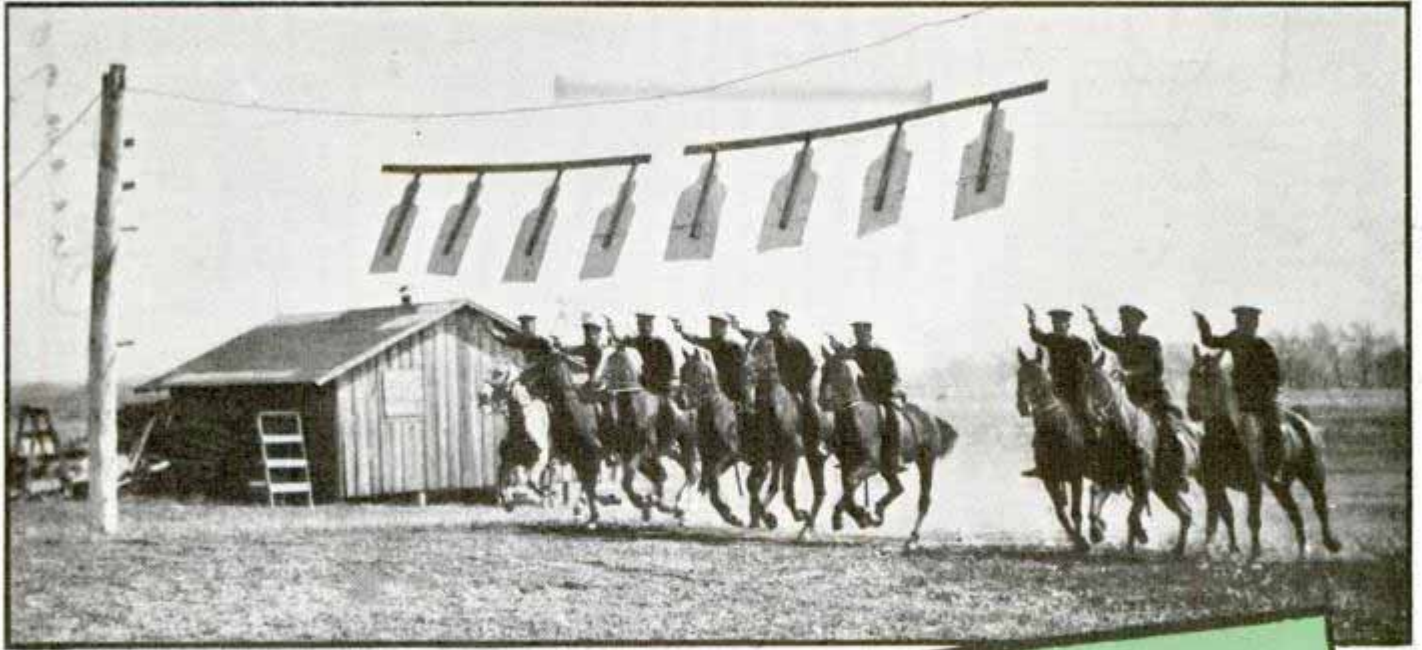

By the end of a week the average mount will be walking, trotting, galloping at command; and is never quite sure just which day the cavesson was left off.

The second week the rookie horses will be ridden in a group through simple maneuvers. All the time the regimental band is practicing nearby, bugles are blowing intermittently. Hearing them casually at first while training, the horse becomes so accustomed to them that when he takes part in his first parade, he hardly realizes the band is blaring almost in his ear.

Any tendency to shy at the music will be dispelled, in most cases, by the fact that these noise-making instruments are carried by other horses, who seem not to

(Continued to page 147A)



Top, a platoon charges while firing at targets. Jumping, center, is everyday event to cavalry horse but he began by walking over rail. Below, riding hard to tire horses before practice

Circular Window Revolves to Open for Ventilation



To open circular window, its lower half is rotated upward. Window frame and all are factory-built

Its lower half rotating on a center pivot for ventilation, a circular window that conforms with almost any architectural style can be locked in closed, half open or fully open position. It is furnished complete with frame, prefitted window, weatherstripping, screen and hardware.

Trolling Plate Controls Speed of Boat Automatically

Made of lightweight, rustproof metal, an automatic trolling plate controls boat speed to the slow pace desired by the an-

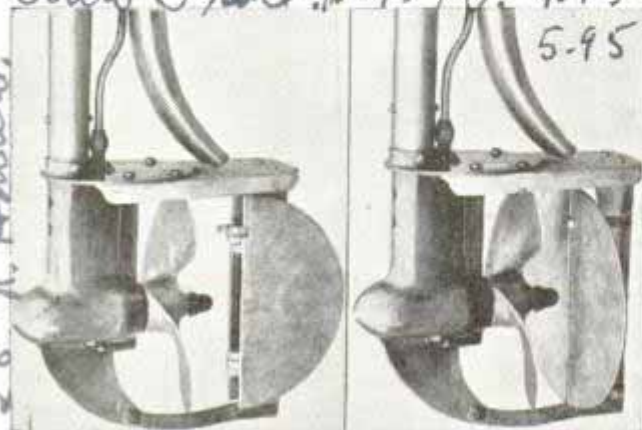

Trolling plate in two positions: left, full speed, and right, trolling speed

gler. It is attachable to all popular makes of outboard motors and is manufactured in sizes to fit any marine motor up to eight and one-half horsepower. The two halves of the plate close together at high speeds, doing away with the tendency of the boat to nose down in front—one of the problems encountered in the use of some other trolling plates.

Scale Is Removed from Boilers by Chemical Injector Pump

Shutting down boilers to clean out scale formation is eliminated by a pumping unit that injects chemical compounds into the hot-water and steam systems to dissolve and remove the scale. A tiny variable-

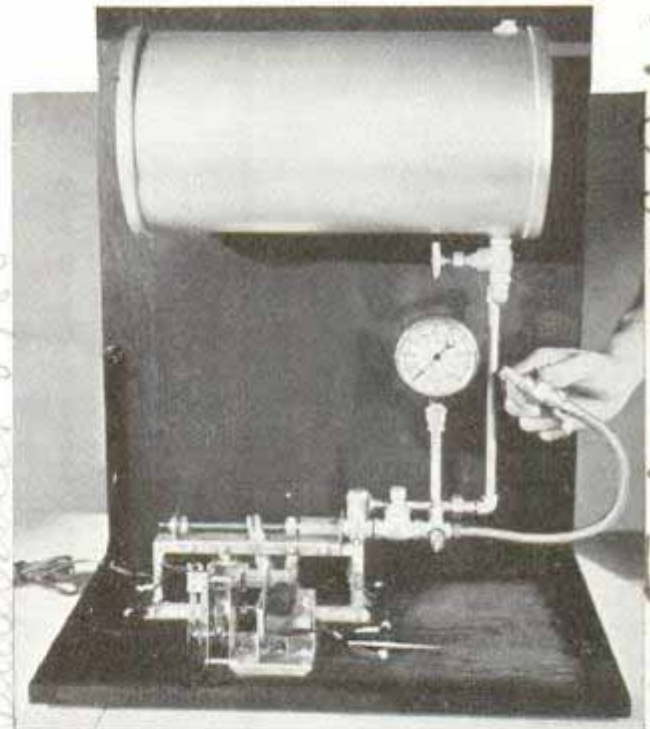

Injector pump at base of unit forces solution from tank into boilers to dissolve and remove scale

speed motor with current consumption of only two watts operates constantly and may be adjusted to control periodical injections, which can be varied to meet the need in each individual case. Solenoids supply the pulling power to operate the pump, which has sufficient force to send liquid into a boiler against a pressure of 250 pounds. After being reduced to a powder by the solvent, the scale passes out through the waste line. Special chemicals used are non-poisonous and will not injure gaskets or metal. The unit will also pump many other liquids, including oil or water.

Curtis Companies, Inc. & Clinton
Chicago, Ill.
James Research Laboratories, 2018 Addison St. Chicago
Chimble & Toll Co.
2428 N. Howard

Spokane, Wash

Patented 0788

Chicago

2830

Auto Troll \$4.70, 4.95

5.95

Radio 'G-Men' Police Short and Long Waves

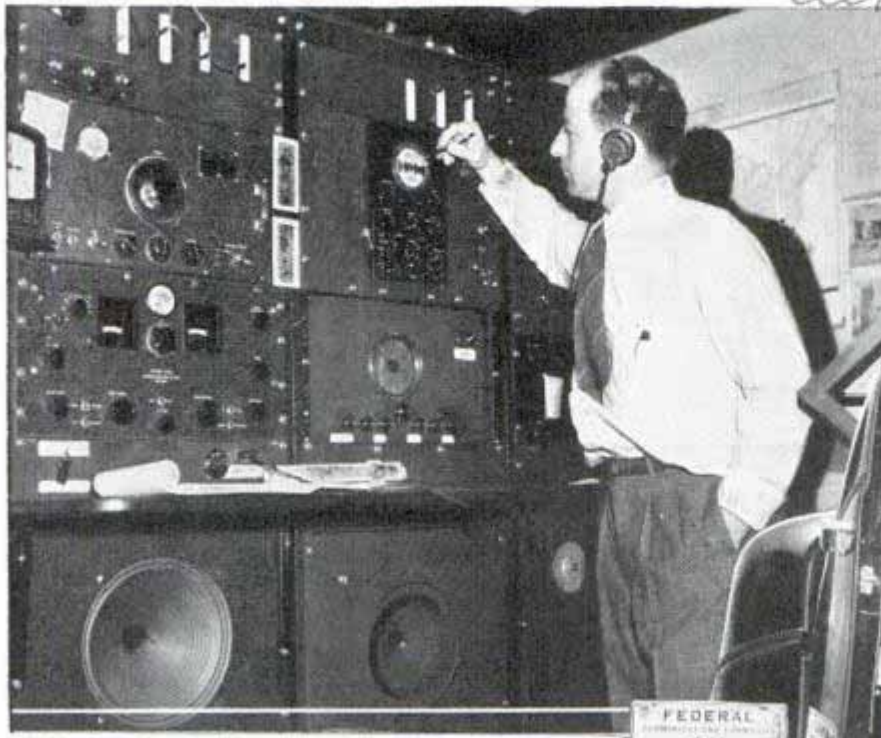

Acme
Left, chief inspector at San Pedro monitoring station watches oscilloscope which gives continuous picture of radio waves, indicating whether studio technicians are controlling sound equipment properly. Below, a radio "G-man" attempts to obtain directional bearing on unlicensed station with portable instrument

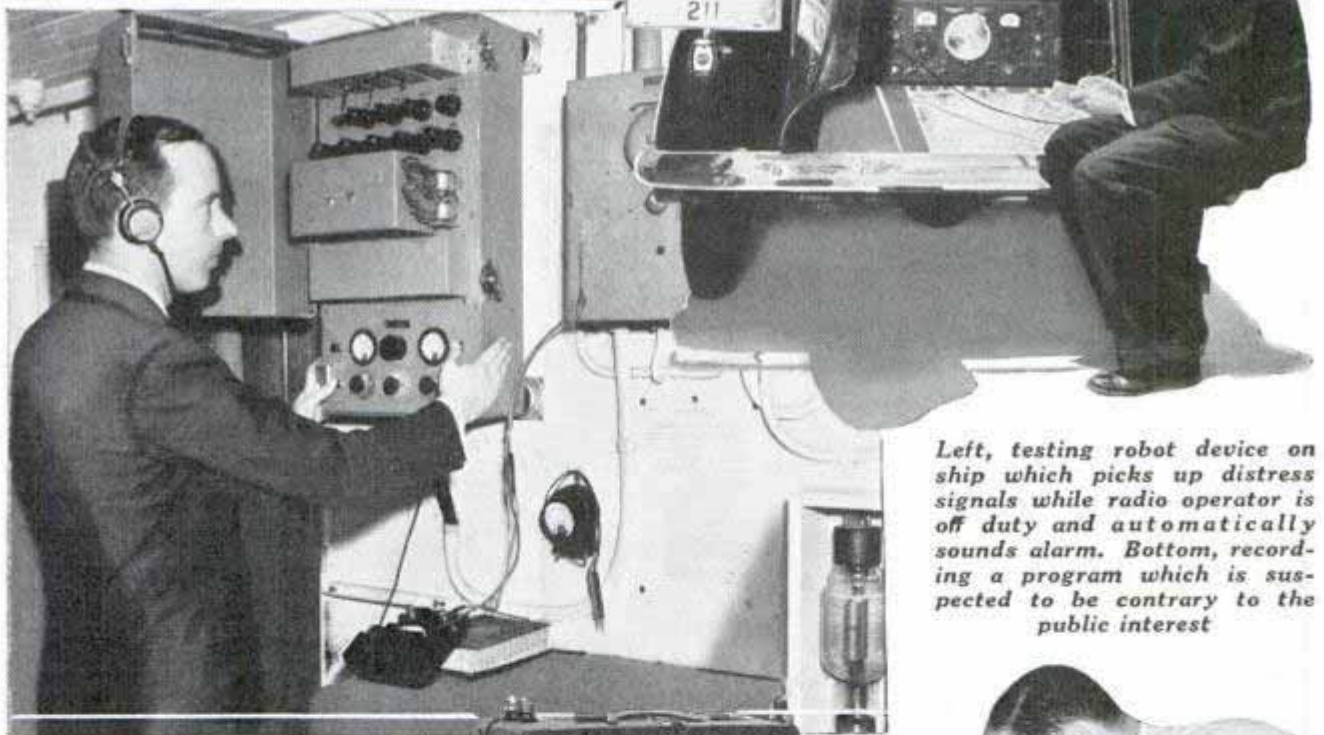

Left, testing robot device on ship which picks up distress signals while radio operator is off duty and automatically sounds alarm. Bottom, recording a program which is suspected to be contrary to the public interest

There are "G-men" riding the radio waves, tracking down "out-law" operators who trespass on forbidden frequencies or chatter without a license. The Federal Communications Commission maintains seven monitoring stations, whose duty it is to inspect radio equipment of ships, record and report broadcasts of objectionable nature, listen in on programs and see that sound technicians are keeping the music "sweet"—the radio waves under proper control. These pictures show the radio patrolmen at the San Pedro, Calif., station



SNOW CRUISER

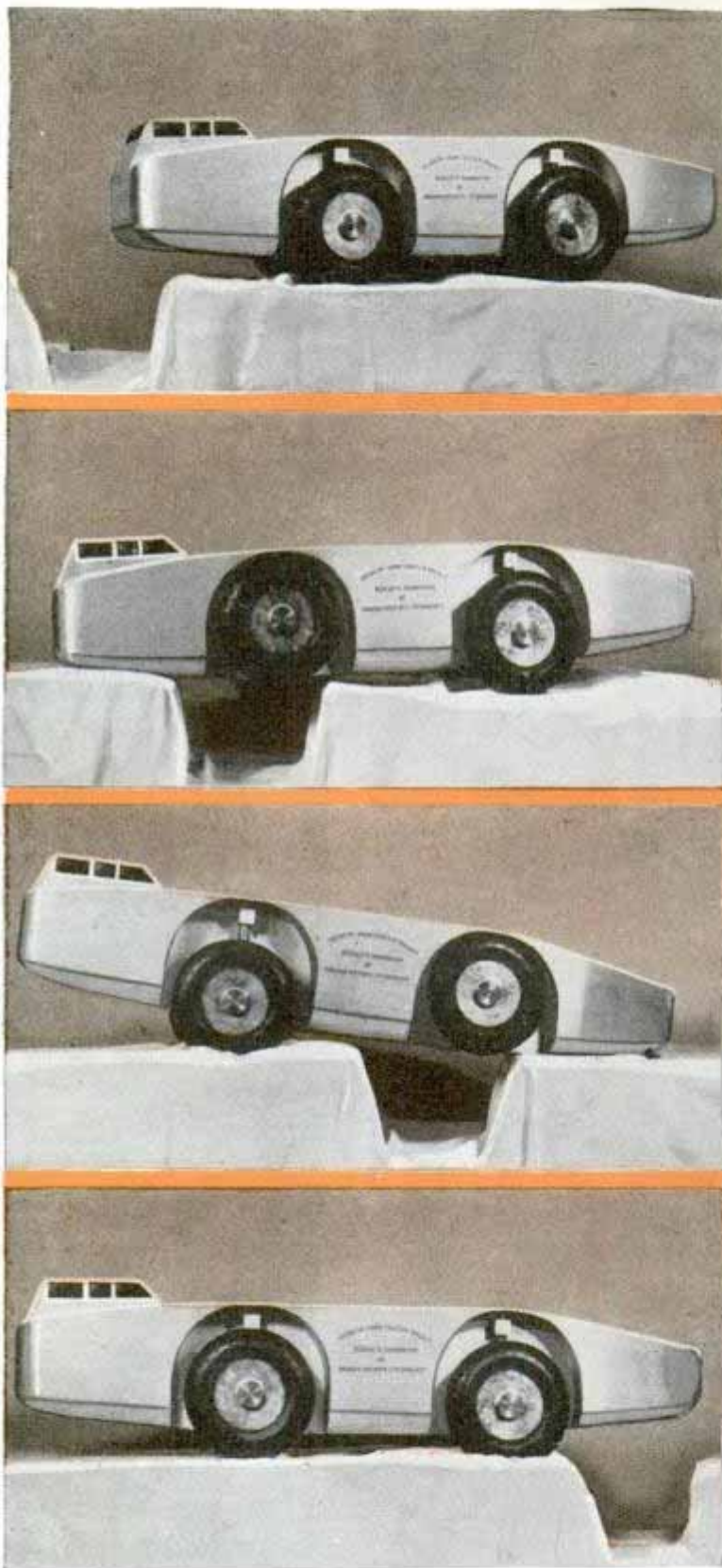

Here's how the snow cruiser will cross a crevasse in polar ice fields. At top the model approaches the "abyss"; as front wheels drop into it, they are retracted and nose of cruiser slides on ice beyond while rear wheels furnish power. When front wheels reach opposite side they furnish traction and rear wheels are drawn up, cruiser sliding on tail. In bottom picture wheels are in normal position and the big bus proceeds on way

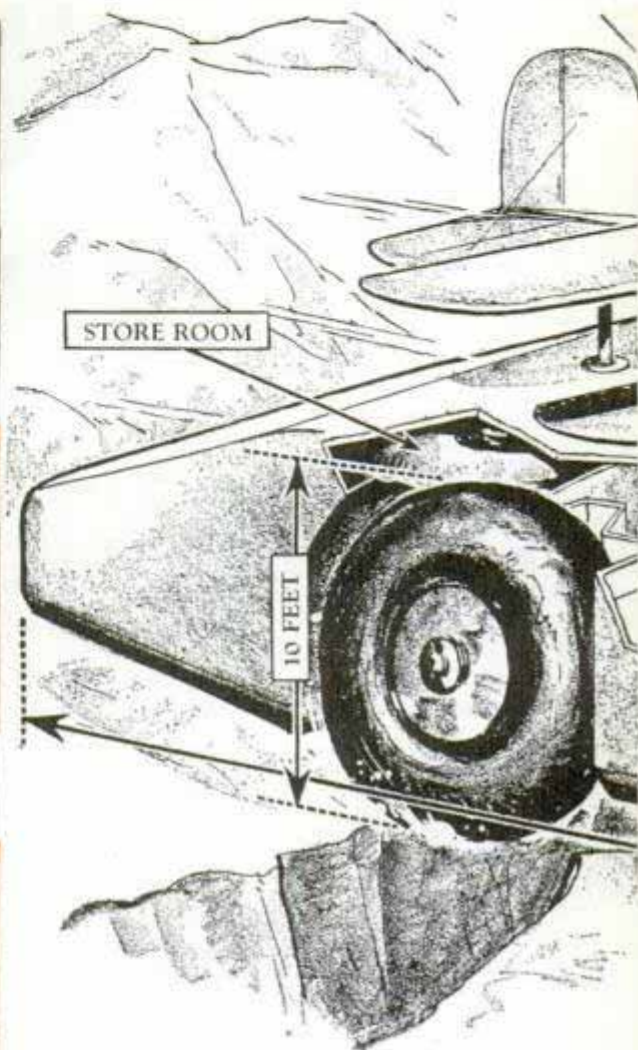

IN A Diesel monster that can climb the polar mountains and slither across giant crevasses, four American scientists will spend the coming Antarctic summer exploring the bottom of the world. Fueled and provisioned for a year "on its own," the Antarctic Snow Cruiser designed by the staff of the Research Foundation of Armour Institute of Technology, Chicago, under direction of Dr. Thomas C. Poulter, will carry on its back a five-seat cabin biplane to be used for mapping and exploring a 600-mile strip across Antarctica, with the cruiser as its moving base. Scientific director of the Foundation, Dr. Poulter was second in command of the Byrd Antarctic Expedition II, when he conceived the idea of the snow

33rd. Federal
and Hearburn

2847

to EXPLORE ANTARCTIC

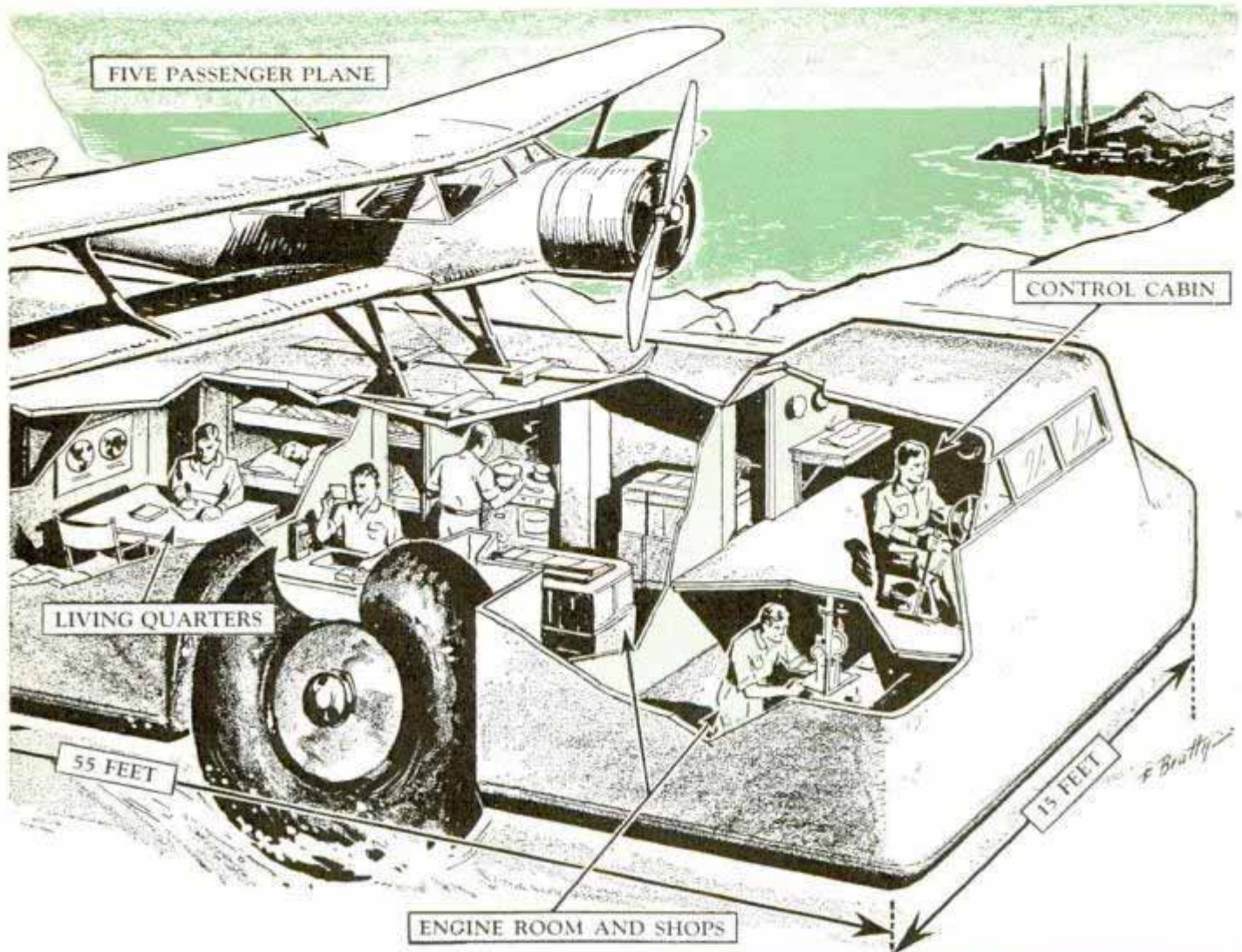

cruiser, and he will be in charge of it during the forthcoming government expedition. Fifty-five feet long and fifteen feet wide, the cruiser will have four wheels, each inclosing an electric motor, wearing pneumatic tires ten feet in diameter and a yard wide. Two 200-horsepower Diesel engines directly connected to generators furnish power for driving, for radio, electric stoves, heat and the machine shop. Flexible controls permit the operator to direct the power of one or both engines to any combination of one, two, three or four wheels. Each wheel is independently adjustable vertically four feet so that the huge "bus" can ride high above the snowdrifts or slide on its undersurface. Reaching a crevasse as wide as fifteen feet, the cruiser will push its nose across until the front wheels are on the brink

(Continued to page 151A)

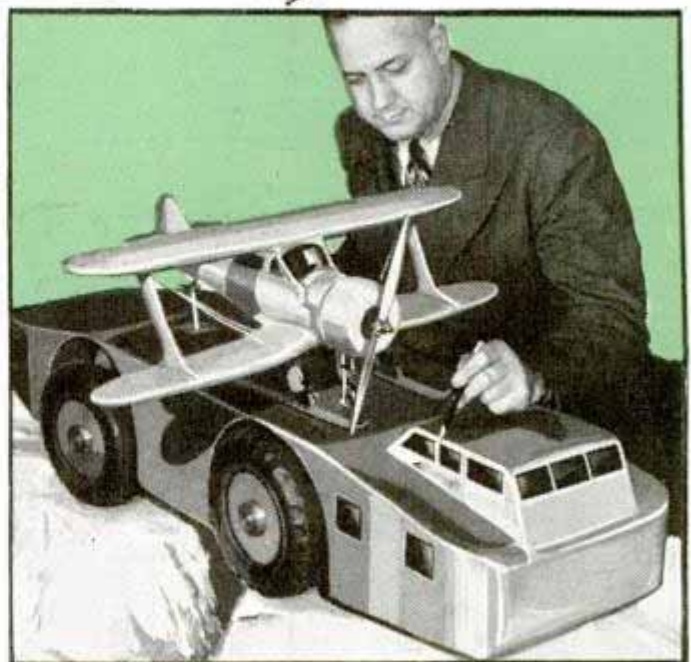

Cutaway drawing at top shows arrangement of expedition's traveling base; notice that kitchen, just aft of engine room, doubles as photo darkroom. Below, Dr. Poulter with a model of the snow cruiser he conceived

Super-Streamline Boat Has 500 Horsepower

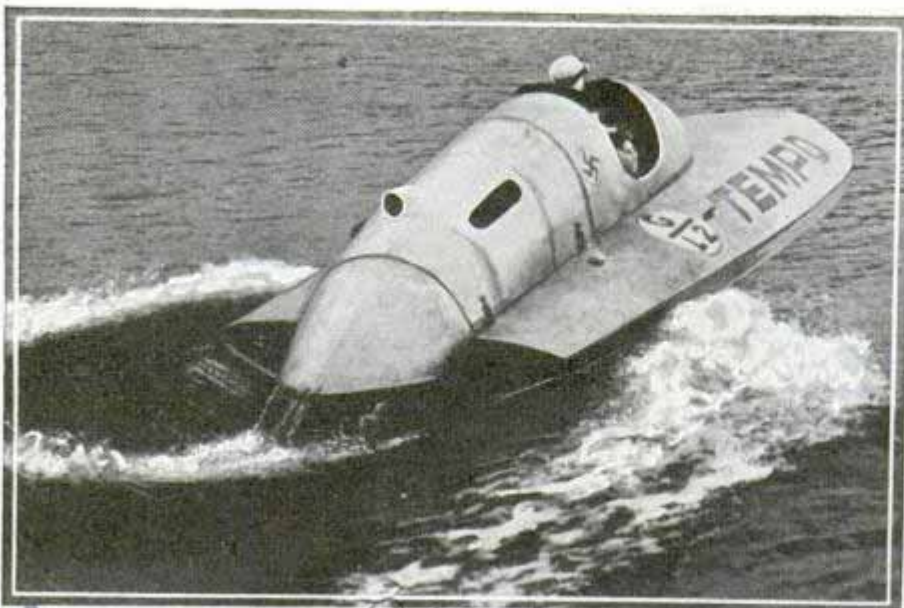

Hoping to set new speed records for motorboats, Hans Stuck, a famous German auto-racing driver, is making trial runs at the controls of a new streamline speeder called "Tempo." The boat is equipped with a sixteen-cylinder motor generating 500 horsepower, produced by the Auto Union.

German speedboat with 500-horsepower, sixteen-cylinder engine will be raced in an attempt to capture world's speed record on the water

Locomotive Model Run by Steam Pulls a Half-Ton Load

Working in spare time during afternoons and evenings, a Kentucky miner in four years completed a miniature locomotive that runs by steam just like its full-size brother, coal being used for fuel. With a steam capacity of ninety pounds, it hauls a load of 900 to 1,000 pounds on the three and one-half inch gauge track. Throttle and reverse control are located in the cab. Weighing 225 pounds, the engine is five feet eight inches long and fourteen inches high.

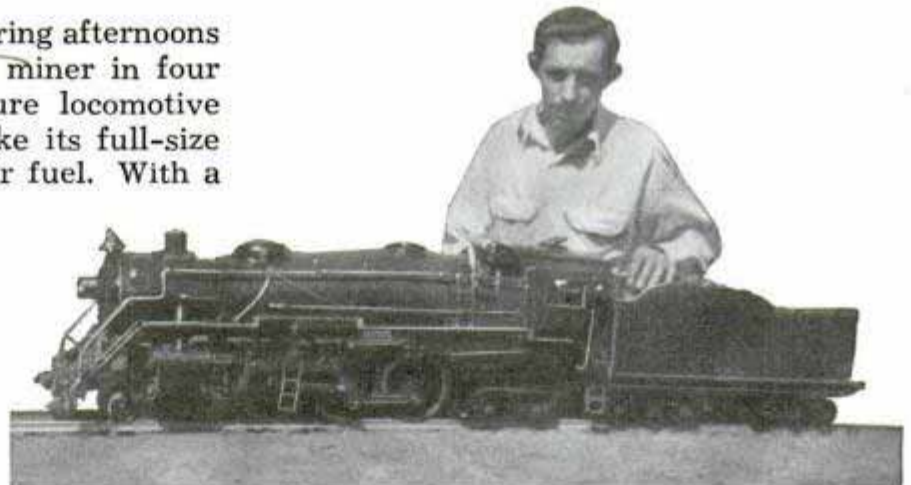

Powerful enough to haul 1,000 pounds this miniature locomotive develops ninety pounds of steam. It was built by a miner in spare time

Ten-Cent X-Ray Pictures Are Made on Thirty-Five Millimeter Film

By using an ordinary miniature camera and thirty-five millimeter film an Illinois

physician has developed a method of making X-ray photographs of patients at a cost of about ten cents a picture. This extremely low cost is achieved by eliminating the usual fourteen-by-seventeen inch X-ray films. The person being examined stands in a small booth and the miniature camera is focused on a fluoroscopic screen on which the X-ray tube throws the shadow of the patient.

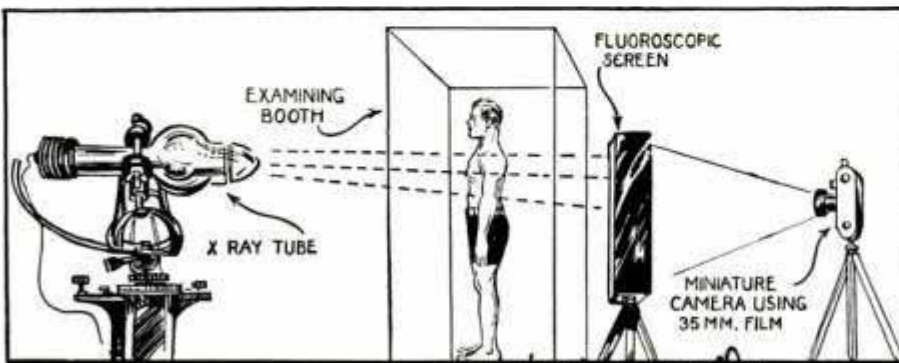

Diagram shows set-up for making X-ray picture of patient at extremely low cost, by focusing ordinary miniature camera on fluoroscopic screen

*2803
H. Johnson, Gilmer, Ky*

Acme

2793

Wide World

Dr. A. H. Lindberg

#75

Ride 'em, Cowboys!



RIDING FOR A FALL—and this cowboy is heading for a hard one. Note single rein leading to the halter, with no bit in horse's mouth. That's just to make it harder for the cowboy to stick on the bronc.



141597

A TICKLISH SPOT—but the rider's ready to jump as horse crouches just before falling backward in an attempt to crush the cowboy. Judge and pickup man stand by awaiting the climax of this dangerous moment.

*Cork Thomas E. Stinson Jr
10555 Holman Ave
Los Angeles, Calif*

*498
Victorville, Cal. Rodschall,
sen. mgr. Victorville
Rodeo Assn. Victorville, Calif*

MODERNIZATION of the wild-west rodeo, the traditional sporting event of American cowboys, is creating a new kind of entertainment that has grown 500 per cent in the last five years. Half a million people watched the big show held in Madison Square Garden, New York City, last year and approximately 1,000 smaller rodeos are held in other parts of the country each year.

Smaller arenas that place the spectators closer to the performers, better staged shows, and the use of public-address systems for explaining fine points to the spectators, as well as the rough-riding horsemanship and the danger in the performances, help to explain why

the rodeo is growing in popularity.

One of the wildest rodeos of all, now becoming as well known as the shows held at Cheyenne, Pendleton, Calgary, Prescott, Salinas, and other round-up centers, is held every October in Victorville, a tiny cattle town on the Mojave desert in California. Victorville's reputation is based on its non-professional status. No cow hand who ever won an event before is allowed to compete. The result is plenty of action. Eighty per cent of the entrants are bucked off their horses, as against less than twenty per cent in rodeos in which professional stars compete. Thrills are practically guaranteed. The Victorville show draws upwards of 300 entries per year, some of



STAYING ABOARD a plunging horse (top) requires good balance, as well as real skill. Below, a bulldozer is shown leaping from his horse to the head of a steer that he will wrestle in an attempt to throw it. This is another dangerous stunt in the rodeo.

#99

#1577
 the cowboys traveling from as far away as Texas and Montana to compete.

At this show, motion-picture stars from Hollywood sit in the stands as spectators. On the advisory committee are men like William S. Hart, Buck Jones, Death Valley Scotty, Harold Bell Wright, Irvin Cobb, and William Farnum. Cal Godshall, a local cattle rancher, is in charge of the community event, and Art Manning, former champion cowboy, is arena director.

In spite of its modern dress the Victorville rodeo is practically the same performance that rodeos were nearly a century ago when cow hands and ranchers first started to compete to decide which were the best riders and ropers in their localities. New stunts have been added and others refined, but events such as bronco busting and calf roping are still expert performances



of routine chores on the range.

"When a man sticks on the saddle of a four-legged earthquake for the required time, he's had a boneshaking ride he never forgets," Art Manning remarks. "The odds are against him from the start. He has only one rein to the halter and there is no bit in the horse's mouth. The rules are that the rider must continuously rake the horse with dull spurs during the ride and as if that wasn't enough a flanking cinch, a loose rope around the stomach, is put on every bucking animal to furnish a source of annoyance that makes him automatically try to throw the rider.

"It's a rough, dangerous game and most cowboys stop competing by the time they are thirty years old. The chances are, during his career, that a performer will be bucked off many times and probably badly injured more than once. Few horses are vicious but if a man happens to be thrown forward over the head he lies right in the path of four powerful hooves at the end of the next jump. He's almost bound to be hurt and he may be killed."

Are there any wild broncs that have never been ridden? Most cow hands agree with the

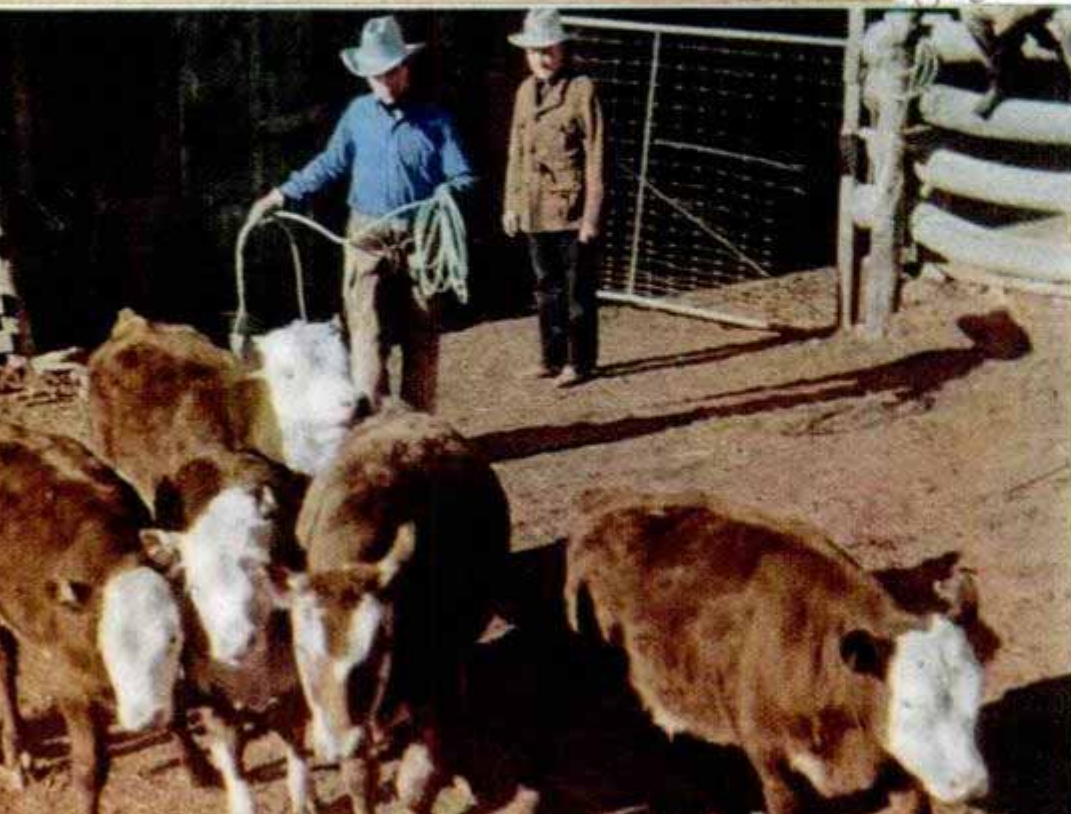

RODEO QUEEN at least seventy-five times, Jean Godshall exhibits a bit of spectacular riding. Left, preparing to rope a calf for branding, one of the modern cowboy's less romantic tasks.





1597

501

old timer who remarked: "There never was a horse that couldn't be rode and never was a cowboy that couldn't be thrown." Horses as well as men have their off days and a champion buckler that is unbeatable one week may fail to throw a rider the next. "Five Minutes to Midnight," supposed to be the best bucking horse in the United States today, has been ridden a few times, but no rider who has vanquished

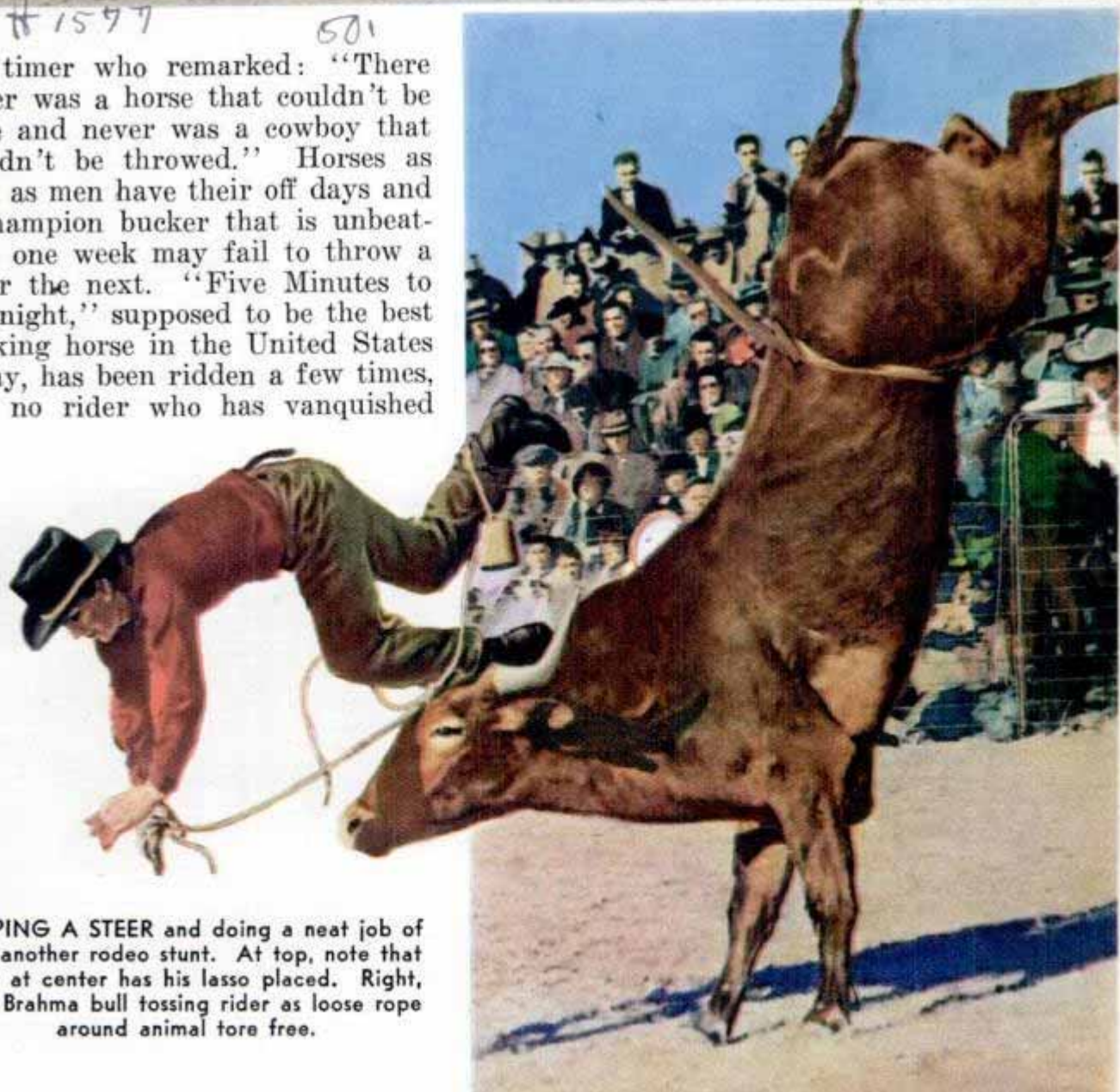

ROPING A STEER and doing a neat job of it is another rodeo stunt. At top, note that rider at center has his lasso placed. Right, wild Brahma bull tossing rider as loose rope around animal tore free.

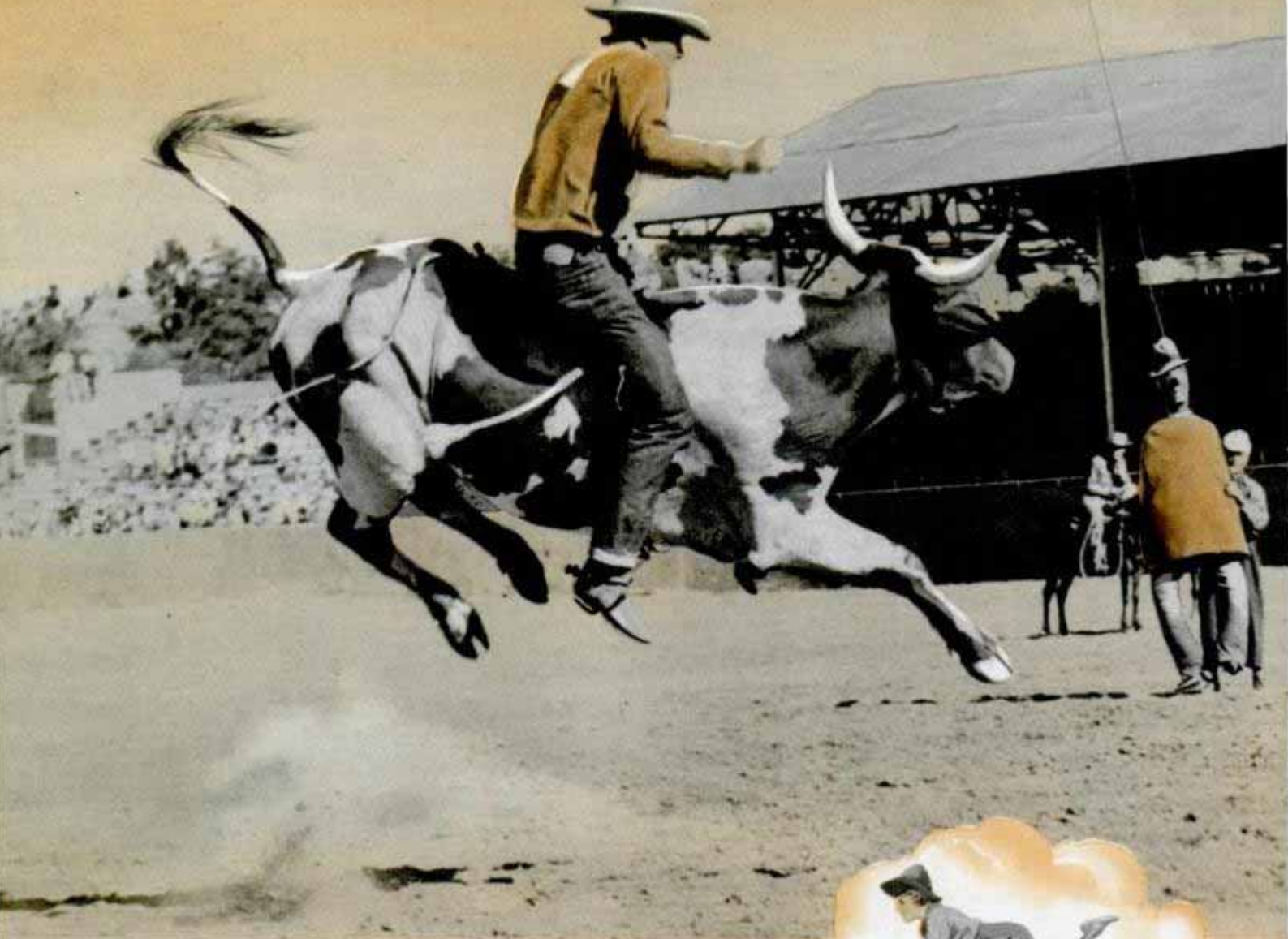

141597
RIDING HIGH is this cowboy as the wild steer leaps into the air in an attempt to shake off the rider who clings to his perilous perch with only one hand.

50
this wild animal once would guarantee to do it again.

The strenuous show that a bucking horse puts on is a natural one and the animals aren't trained to be that way. They are simply wild stock never broken to a saddle or rider. A good bronco is worth more than a mere saddle horse simply because of the show he puts on. Cowboys notice that the animals seem to enjoy their own performances and make a game out of it. Many a veteran bronco, if he hasn't been able to throw his rider, calms down as soon as the whistle blows, seemingly knowing that the show is over.

More dangerous than trying to ride a saddle bronc are the bareback Brahma steer rides in which the cowboy can hang on only to a surcingle or loose rope around the animal's body. The extreme peril lies in the fact that after the steer bucks a rider off it frequently tries to gore or jump on the fallen man.

When that happens the rodeo clown rushes to the defense of the stunned rider. Every rodeo





141597

503

has a clown who provides amusement during dull periods but his chief duty is to save lives. When a Brahma tosses a man from its back the clown goes into action at once, howling at the steer and waving a shawl to attract its attention. The clown's ungainly antics in dodging the enraged animal look funny to the spectators but the play is in deadly earnest. Clowns have saved the lives of many contestants.

Bulldogging, also called wild steer wrestling, is another dangerous act. The animal comes out of the chute at a fast run, with a hazer on horseback at one side to keep him running straight and the mounted cowboy on the other side. Watching his chance, the

CAREFUL, COWBOY! That horse is up to no good (top). The rider's trying hard to stay aboard. Bottom, calf-roping event. Trained horse is tightening on lariat, while rider is on the ground getting ready to tie the calf after it is thrown. Perfect timing is essential here. Cal Godshall Photo

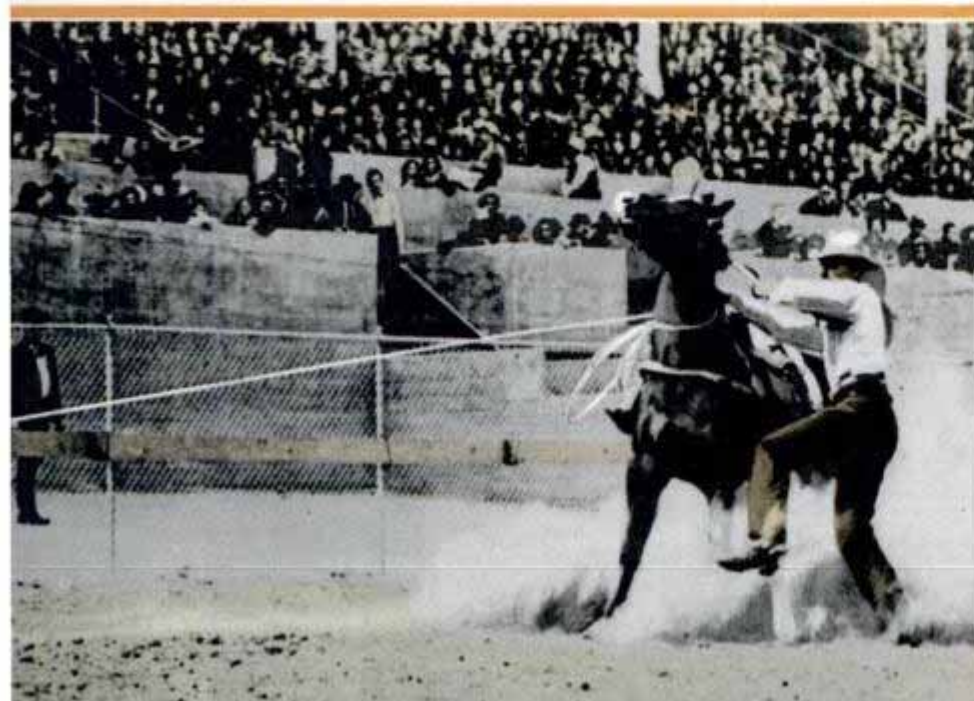



Natural Color Photo—Courtesy American Airlines

1577

504

OLD AND THE NEW in transportation on the western plains meet as two riders wave a greeting to the pilot of an American Airlines ship. Below, cowboys going about the unexciting task of branding a calf on a western ranch. Each ranch has its own peculiar mark by which any animal it owns may be distinguished.

cowboy dives off his horse to the animal's head, stopping the steer in its tracks and wrestling against the horns until the animal is thrown. The bull weighs six times or more the weight of the man, yet the man usually subdues the animal. But if he slips or fails to get the steer down in a few minutes the tables may be turned and the cowboy badly injured.

Roping events test a cowboy's skill at his ordinary work. On the range the cow hands have to rope, throw, and tie calves and mavericks so that they may be branded. In the rodeo, prizes are awarded according to the length of time required, various events being for one man to rope, throw, and tie a calf, to do the same with a steer, and for a two-man team to perform the work on a loose steer. A top roper may need only fifteen seconds to throw

(Continued to page 128A)

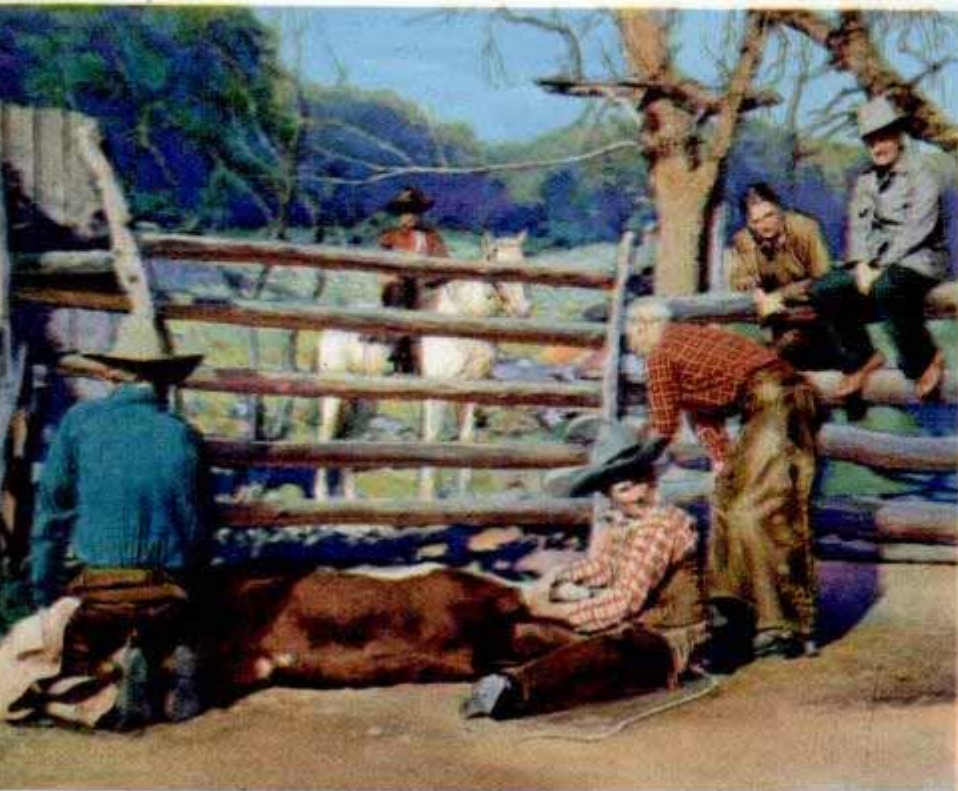

2000 Chrysler Corp. Detroit Mich
11631 Mack Ave

Plastic Auto Roof Is Called Trend in Design

That the automobile of tomorrow may have body, roof and fenders made of plastics is the possibility held out by experts who have seen one late model fitted with a transparent plastic top. This car, prepared for demonstration purposes, permits full visibility to passengers and allows sunlight to reach the occupants, yet shields them from wind and rain. It is not beyond the realm of possibility, experts point out, that plastics strong enough to withstand severe impact, perhaps as strong as steel, may be available for the manufacture of auto tops in the not too distant future. These plastics might be produced in the color desired, eliminating the necessity of repainting. Hand in hand with the plastic roof may come the plastic body and fenders, also made of strong, lightweight material that would be easier to shape than metals, that would offer as much protection to the occupants as all-metal cars and that might be no more expensive. Automotive men have been cautious in commenting on



Two views of demonstration automobile fitted with a transparent top of plastic material. (Courtesy Briggs Body Co.)

the use of plastics, preferring to await the coming of a synthetic material that would meet rigid requirements of the industry.

Four-Blade Aircraft Propeller for Fast Pursuit Planes

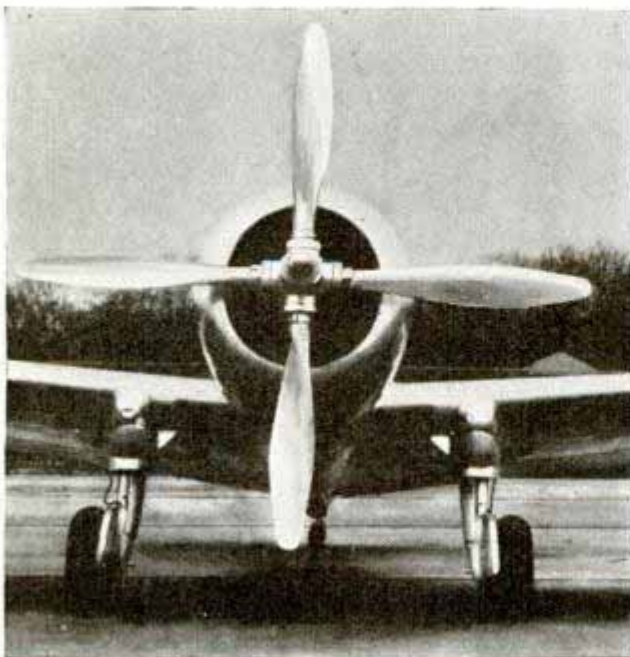

Four-blade propeller of smaller diameter undergoing test on high-speed army pursuit plane

To utilize the increasing power of aircraft engines without adding to the length of propeller blades, a four-bladed propeller has just been developed. Motors of constantly increasing horsepower and higher-altitude flights demanded a larger effective blade area, particularly for the high-speed pursuit planes of the army. Blades of larger diameter would mean heavier landing gear, so the four-blade type was designed by the Curtiss organization as the best answer. It will make possible closer spacing of engines on the multi-motored bombers and transport ships with resultant saving of weight in the wings. The aluminum alloy blades are electrically controlled for pitch.

There were 2,326 airplane landing fields in the United States on July 1, 1939, 730 of them lighted for night use.

Curtiss Propeller Corp. 20 Crochepelle Place. New York
Civi Aeronautics Authority 7/1/39

9899
Elastic 'Sandwich' Cushions New Safety Glass

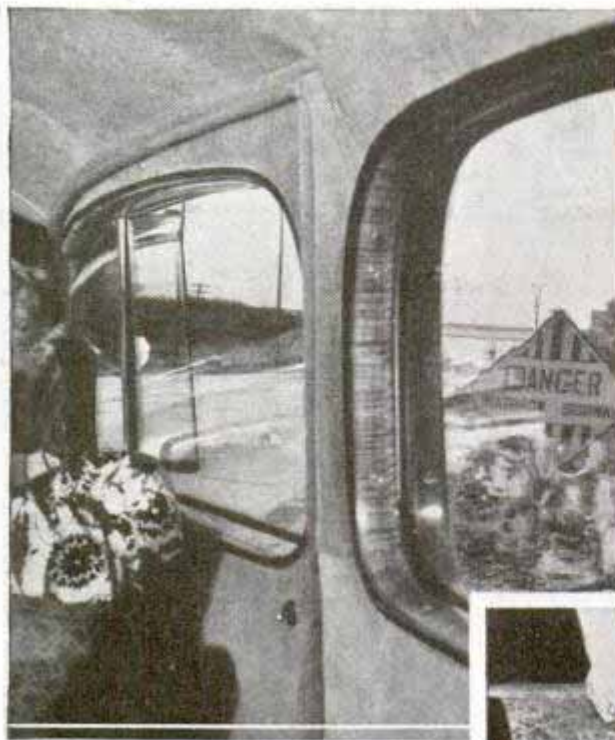

Notice distortion of sign through sheet-glass window, above, and clarity through plate glass, right. New plastic clings so tightly shattered glass can be rolled like rug. Below, reading test through glass

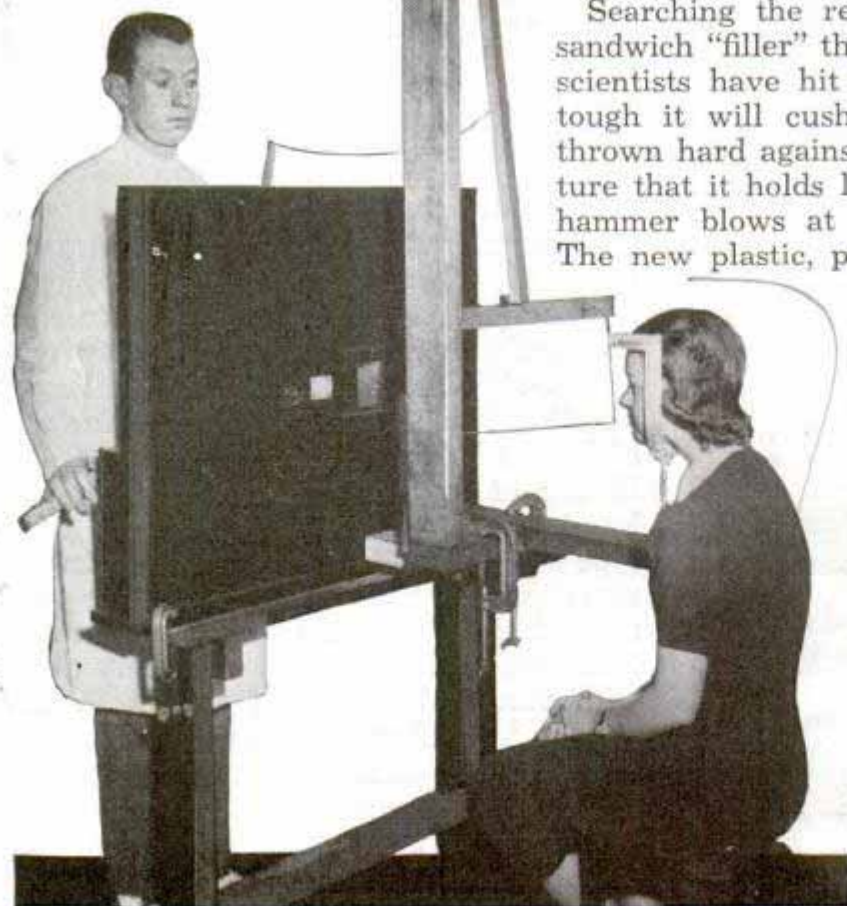

Searching the realm of synthetic resins for a sandwich "filler" that will make safety glass safer, scientists have hit upon a rubbery substance so tough it will cushion and hold a bowling ball thrown hard against it, so indifferent to temperature that it holds laminated glass together under hammer blows at zero or tropical temperature. The new plastic, polyvinyl acetal resin, becomes

transparent when placed between two sheets of one-eighth-inch glass and subjected to high pressure in a hot-oil bath. First laminated glass to appear in automobiles was cemented with a cellulose-nitrate filler which turned brown and clouded in sun and moisture. Cellulose acetate, introduced about 1933, proved more satisfactory but the polyvinyl plastic is tougher, more resilient, and permits the use of thinner glass. Non-shatter glass made with the new plastic is called high-test safety glass, and high-test safety plate will make its de-

W. L. ...

Butasite - Paul P. ... Co

Sun Seat on a Circular Track Turns Its Back to the Wind



Canvas weather vane keeps glass sundeck facing away from wind, turning it on a circular track. Only the front is open.

For siestas in the sun with full protection from chilling winds, a sun deck that revolves on a circular track has been built on a Connecticut estate. Glass sidewalls, back and roof let in the maximum sunshine while the open front is kept always away from the wind by the canvas weather vane projecting overhead. Even a slight breeze will turn it.

Eight-Wheel "Dachshund" Bus Carries 120 Passengers

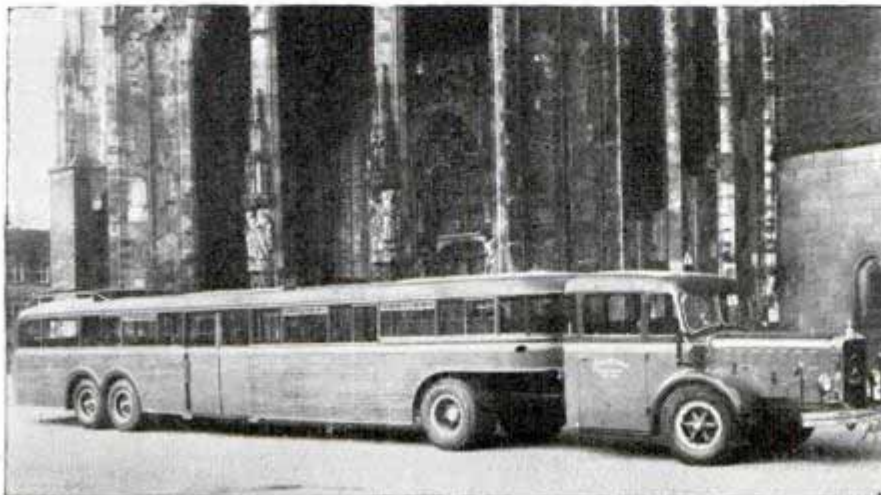

One-hundred-twenty passenger bus stretches nearly to width of cathedral.

Built like a "dachshund," a sightseeing bus of tremendous length and low center of gravity was manufactured to order by a German automobile company. Its trailer, with double doors at the center carries 120 passengers.

Living organisms asleep in the frozen soil of Siberia for 20,000 years are said to have been revived by Russian scientists.

1232 Nicholas Blvd.
Tulsa, Okla.

2864
Architectural Forum
July 1939

Designed and arranged by
Mrs. Lahlia Loeb, Redding.

Paul's Photos.

Ball. Union

Refugee que Air Conditioning

2-5

Andrew Hammett
1539 S. Beverly Glen Blvd
W. Los Angeles Calif

WATCHING MOTHER

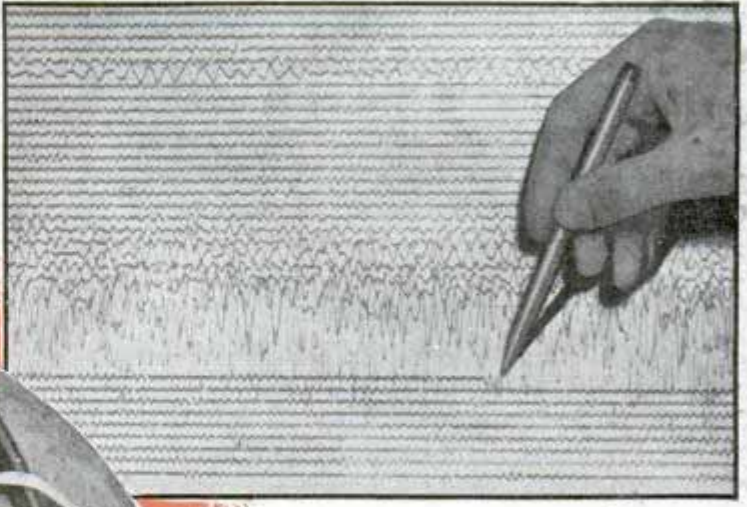
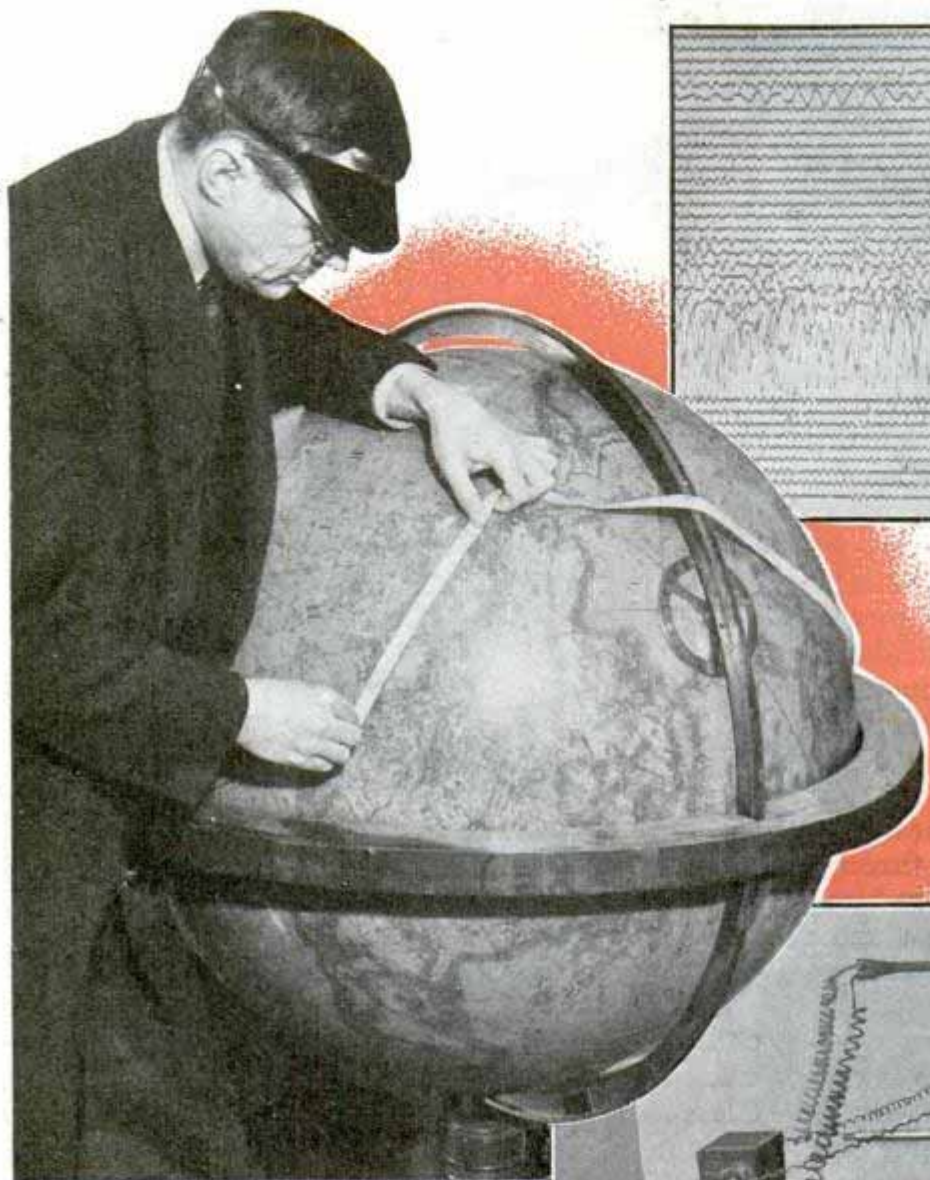

Left, finding epicenter of earthquake by plotting data from two seismological stations on globe. Pencil points to start of sharp quake on seismogram, above. Below, tilt meter testing Japanese theory that earth's surface tilts slightly before every temblor



AMONG the natural phenomena that terrorize and fascinate man, earthquakes are unique. Weather reports tell when a blizzard is brewing; a falling barometer forecasts a hurricane; subterranean rumblings indicate volcanic eruption. But a destructive earthquake strikes without warning.

Old Mother Earth is never at rest. It is estimated that 30,000 temblors are felt each year, and delicate scientific instruments record thousands more. Major quakes rock the globe every six or seven days.

Because our great cities cover only a fraction of the land surface, major earthquake disasters occur only once or twice

a year. The majority of violent shocks occur in mountains, jungles, polar regions, or underseas where they do little damage. When a sharp quake jolts a metropolitan area, however, it may destroy millions of dollars worth of property and take hundreds of lives.

In a concerted effort to learn where

EARTH'S PULSE

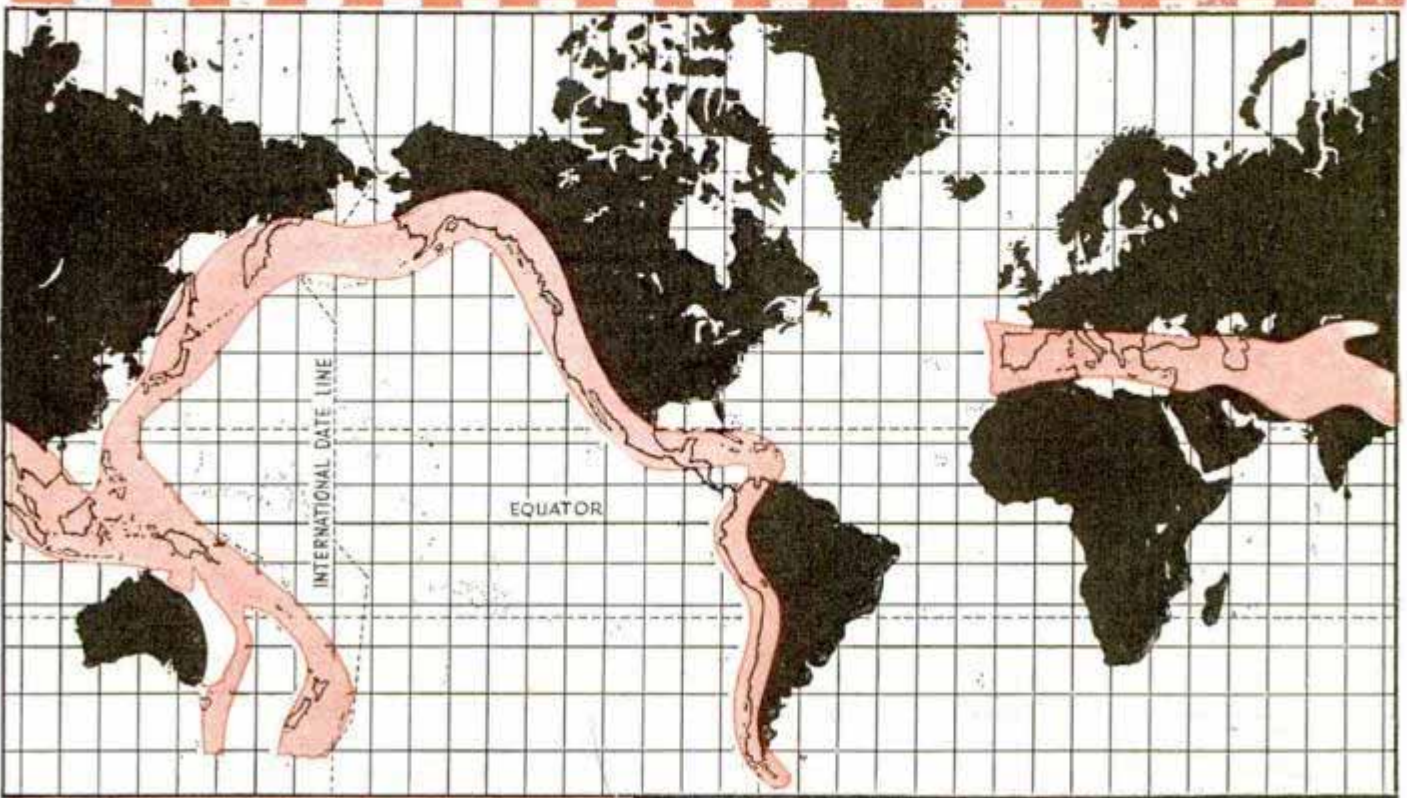

earthquakes will strike and how to prepare for them, science has established more than 350 seismological stations around the world. About fifty are located in the United States, principally on the Pacific coast and in New England. Two of the best-equipped stations are in California; one on the Berkeley campus of the University of California, the other at Pasadena under the joint sponsorship of the Carnegie Institution of Washington and California Institute of Technology. At Berkeley there are thirteen seismographs under the watchful eye of Prof. Perry Byerly.

The Seismological Laboratory of California Institute of Technology is directed by Prof. Beno Gutenberg. A number of associated stations make daily records and send them to Berkeley or Pasadena. These centers then exchange records. Seismologists study the seismograms under the microscope, interpret their zigzag



Areas in red on map at top of page indicate the earthquake belts of the world. Below, engineers test strength of a building with a vibrator. Scientific study has shown men how to make the largest buildings quakeproof



lines, and file the records. The University of California has a library of more than 80,000 seismograms.

Only during the past ten or twelve years have precision instruments been in general use. Seismographs record the time, direction, amplitude, duration, and other characteristics of the tiniest temblor. Some instruments are so delicate that they record traffic vibrations, and footsteps.

The principal feature of all seismographs is a suspended pendulum which tends to remain motionless even though the frame from which it hangs is severely jarred. Fastened to this pendulum is a delicate pencil, or a mirror which throws a needle-

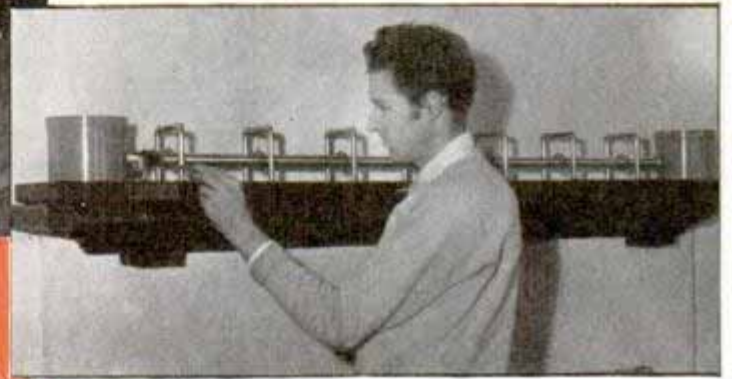

like beam of light. The pen or beam traces the earth vibrations on paper or film, which may be on a revolving drum. When there are no temblors, the pen or beam of light traces a straight line; during an earthquake, the drum jiggles and a zigzag line results.

Most seismological stations are equipped with three instruments, one oriented to pick up east-west vibrations; another responds to north-south vibrations, and a third, vertical vibrations. These instruments are mounted on concrete piers anchored to bedrock. Most seismological stations also have strong-motion instruments for recording major quakes.

Surface shocks arrive at the incredible speed of 7,200 miles an hour and other vibrations may travel three times



Seismograph recording on film, top, housed in darkroom. Center, aerial photo of 275-mile San Andreas fault in California. Right, model of sixty-foot seismograph which measures earth's "stretch." Bottom, a quake

Motorcycle Radio Station Guides 'Blind' Pilot

Motorcycles with radio "feelers" thrust out several feet on each side are the mobile marker beacons of one blind-landing system for aircraft. These feelers are antennas that send up through fog or storm a vertical fan-shaped radio signal that is intercepted by the pilot as he flies overhead toward a landing. Several of these motorcycle beacons can be sent out quickly to take stations along the path of incoming planes, each sending up a different tone signal or showing a distinctive colored light to inform the pilot of his position. This motorcycle sig-



Radio station on motorcycle sends up fan-shaped signals which guide pilot to safe landing "on instruments." Horizontal pole is the antenna

nal is, of course, only a part of a landing system that includes a glide path, localizer and marker beacon, guiding the pilot to port as if through a funnel.

German Diesel Streamliner Travels 133 Miles an Hour

Streaking along at an average speed of about 124 miles per hour, the new stream-

line express train built for the run between Berlin and Hamburg, Germany, has

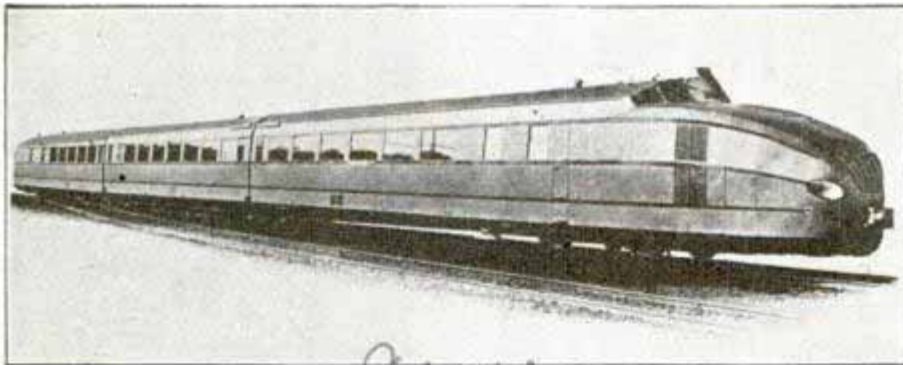

World's record of 133 miles an hour is claimed for this 1,200-horsepower Diesel streamliner train running between Berlin and Hamburg, Germany

made its first test. A top speed of more than 133 miles was reached. Two Maybach Diesel motors, developing 1,200 horsepower, drive the train, which is constructed in three sections. Besides accommodations for first-class passengers, the train has seats for 200 in the second-class compartment.

Propeller Disappears into Hull When Boat Strikes a Hidden Snag

Snags and weeds and under-surface rocks are no menace to the disappearing propeller of a non-sinkable motorboat now on the market. A curved guard in front of the propeller engages any hidden obstruction before the propeller can be injured, and the entire screw shaft pivots upward, the propeller itself rising into a well in the bottom of the boat.

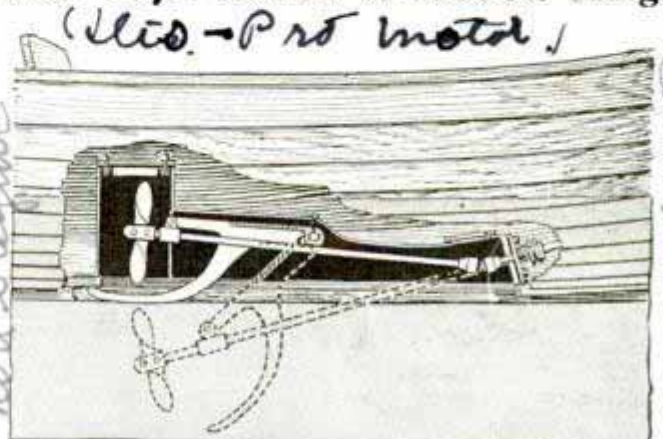

Propeller is retracted when guard hits obstruction

In an average year the automobile industry uses 25,000,000 pounds of wool, the product of 3,000,000 sheep.

Pontiac Owners Magazine

Boat . \$550.00

Created by Boats, Ltd. Canada
Larwinhurst, Can. Canada



Combined bands of Yale and Harvard
in formation before a football game

A SHORT time ago, a neglected step-child of modern music, today, a star—that's the latest chapter in the history of the band.

So swift has been the band's rise that musicians are at a loss for an explanation. A generation ago, every community boasted of a silver cornet band. Good musicians were scarce. Anyone who played an E-flat cornet could get a job in almost any town of his choice.

The march kings were big drawing cards. More than a million of their phonograph records were sold every year and crowds fought their way into the halls they visited on tours.

The war increased the number of band musicians but in the years following it the great marching bands began to fade from the national scene. The deathblow came

when people began staying home to tinker with crystal detectors and radio headphones, and later, when the screen found its voice. The radio and canned music began to loom as a two-headed monster that was going to throttle music. Players by the thousands were being thrown out of jobs. The musicians weren't the only ones who were hard hit, Frank C. Howard, band authority explains. Instrument sales were dropping off at an alarming rate. In desperation, manufacturers turned to schools. The Joliet, Ill., high school was one of the first big institutions to be sold on the idea of organizing a band to play at the school's football games. Others followed suit and, to pep things up, the manufacturers fostered a national band contest.

The 1923 event proved a success, twenty-five bands participating. Plans for the fol-

Cont. James H. Young 431 W. 60th

lowing year were turned over to a musical education group which sought to broaden the movement at the base by shelving the national meeting for a couple of years and concentrating on building up regional contests. In some towns, students bought instruments with their own money, in other places, luncheon clubs and civic groups footed the bills on the theory that a band was a good advertisement for the town, particularly when it was away on a football trip or attending a livestock show.

Those who went into the band work did so not with an idea of any professional career in the future, but simply because they liked music. A number of school boards saw the cultural and educational aspects of the movement and made it part of the curriculum.

Competent directors and instructors were retained, special equipment to round out the reed and brass sections purchased

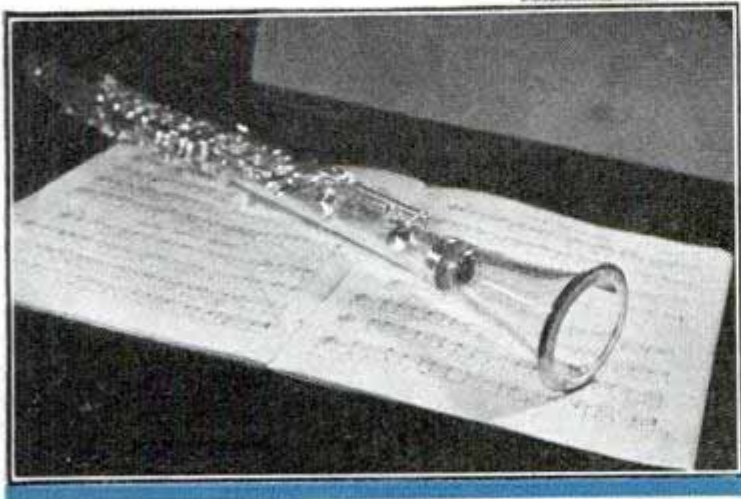
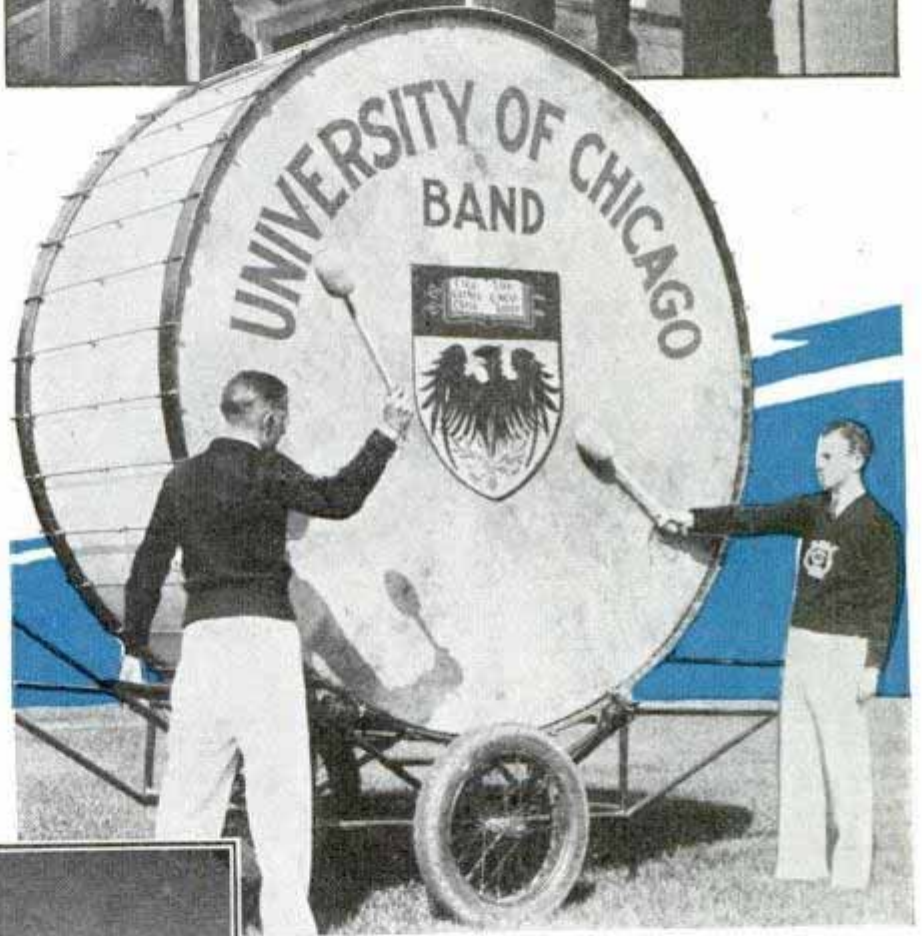

Top, testing instrument with cathode-ray oscillograph to determine if it is in proper pitch and if scale is correct. Center, giant drum of university band. Bottom, clarinet of transparent plastic

and rooms with good acoustics made available for practice. But more important than these was the decision to give academic credits to those who took part in band activities.

It was full steam ahead for school bands. Nineteen thirty-two saw 1,050 high schools from forty-four states vying for honors in the state contests. Three classes were set up in the national contest so smaller schools wouldn't be competing against the larger ones and, in addition, competitions for soloists and small ensembles were placed on the program. A highlight of one

Pedler Co. made a special order



contest was the welding of 5,000 musicians into one great orchestra for a program of six numbers, concluding with "Stars and Stripes Forever." So band music is now a part of the lives of 2,000,000 students.

Naturally, the band movement has spread into other channels. The Rotarians, American Legion, and metropolitan police departments have gone in for bands to keep boys off the streets. When school books are put away, many of the school players gravitate into industrial bands, town symphonies, and lodge aggregations. They've helped make America the most musical nation in the world, at least, as far as actual participation in the art is concerned.

Growth in numbers, however, is only half the story. The brass band of yesterday has been supplanted by the symphonic band with a full complement of woodwinds and brasses, capable of turning in a finished performance.



Top, typical test in Conn soundproof woodwind room. Center, delicate gauge which checks bore of clarinet to one-half-thousandth of an inch. Bottom shaping of a bell on a sousaphone as it is revolved at high speed. Applying pressure causes metal to flow in direction desired by operator

When the famous band leader, Edwin Franko Goldman began dipping into the classics, he set the style for hundreds of other bands, and the musical standards within the group were raised appreciably.

Bach's music, Goldman points out, originally was composed for the organ and since the band is more closely related to that instrument than is an orchestra, it is in a position to do a better job than the latter. Wagner, Saint-Saens, Verdi, Liszt—all sanctioned band arrangements of their works. Of the contemporary composers, Grainger and Ravel have written pieces expressly for Goldman's band.

Instead of destroying music as was expected, the radio has contributed to this renaissance in bands. For several years, the concerts conducted by Walter Damrosch and others have whetted the

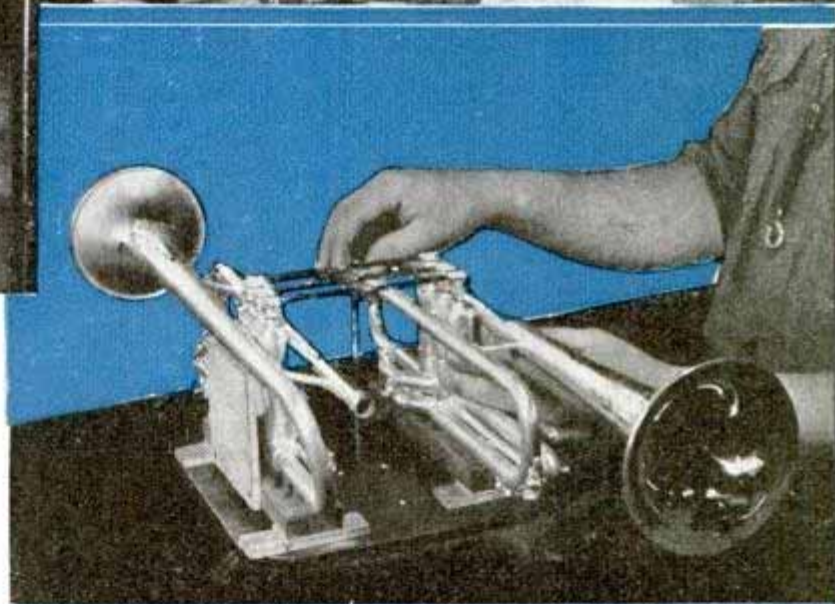
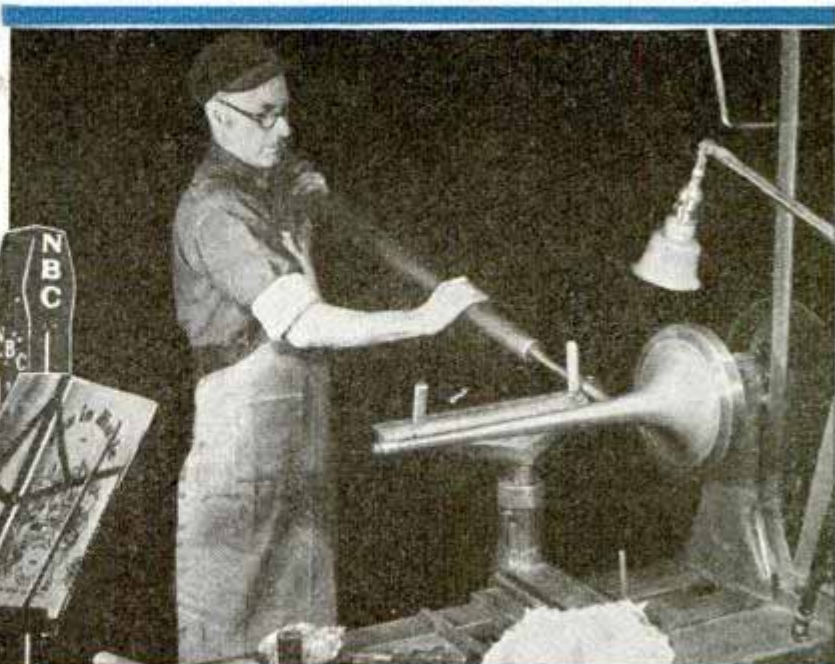

musical appetites of youths, and Dr. Joseph Maddy's music lessons over the air have been responsible for the formation of countless bands. He gives a regular course weekly over a nation-wide hook-up with the aid of professionals who sound the correct tones, play simple tunes, and illustrate the solo work.

The widespread improvement in bands has created a demand for instruments which are lighter and faster in action, instruments easier to blow while at the same time offering greater smoothness and accuracy in intonation and richer tones. A piece of brass or nickel silver when bent gets wrinkles in it which distort the sound waves. Consequently, the tone of the horn isn't true and it's hard to blow. In doing away with these defects, engineers of



Top, left, giving music lessons by radio has aided advance of bands. Right, bell of instrument being shaped. Center, motor-driven fingers testing instrument in York factory. Bottom, molten pitch being poured into bells of instruments

(Continued to page 126A)

Scarecrow's Spinning Arms Operated by Wind

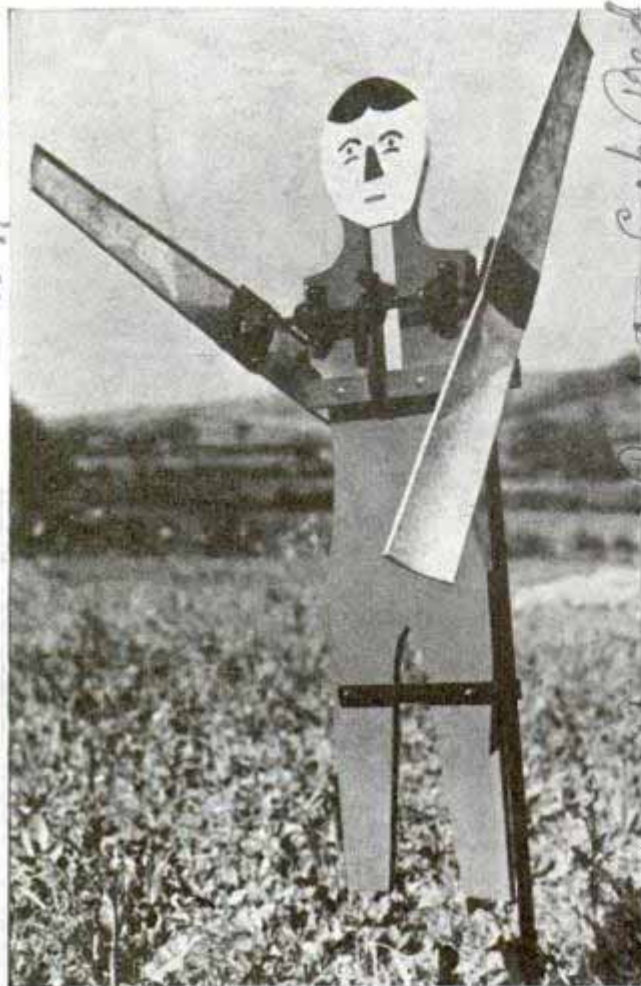

With windmills for arms, this waving scarecrow is on guard over a farm in England

Whenever the wind blows, the mechanical scarecrow on an English farm comes to life. Mounted on a steel post, it has twin blades for arms that spin in the breeze.

Half-Circle Convex File Has Safe Hand Grip

Made in the form of a half circle, a convex file is offered for shop workers, for



Convex file mounted on a half circle of hardwood is intended for filing protruding surfaces

use in filing protruding parts rather than smoothing a flat surface. It has a hardwood handle shaped to fit the hand comfortably and provide a safe grasp.

Rubber "Barrel" for Ice Cubes Keeps Them for a Day

When ice cubes are needed on a picnic or an extra supply is to be stored for party use, they can be kept from twelve to twenty-four hours in a rubber container now available. This "barrel" is made of soft molded cellular rubber, with walls one-half inch thick. Eight inches high and six inches across, it holds twenty-four to thirty-six cubes.



Trays Rotate on "Ferris Wheel" for Easy Selection of Parts

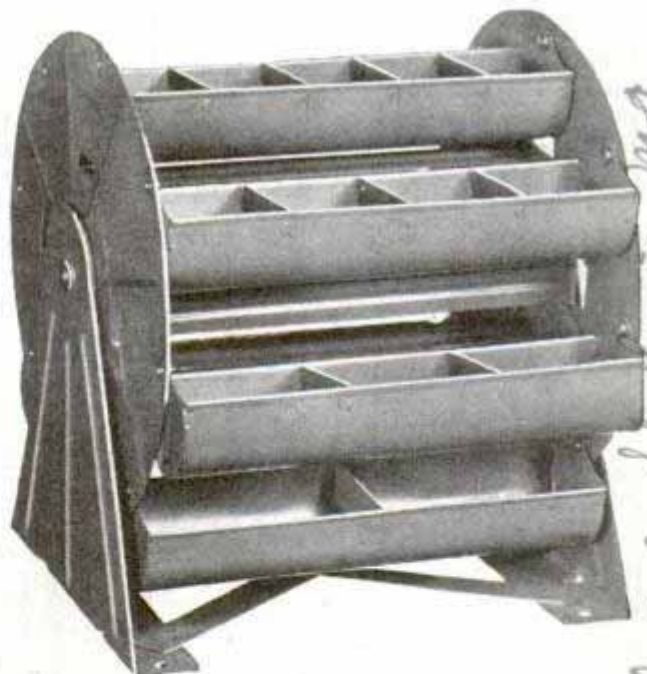

Quick access to more than thirty bins is afforded by this "Ferris wheel" for the shop

Trays of many sizes, swinging cradlelike inside a wheel, provide a quick means for selecting small objects such as nails, clips, hooks, pins and pencils. Various types or sizes of tiny mechanical parts can be distributed in the eight troughs which contain more than thirty compartments.

Inv. Mr. Pearce, al. Astor near Newton, Mass. 760.

Chicago Photo Dept 420 Lexington Ave

Virginia Rubales Corp. Bedford

2 79 1/2

\$ 4.65 Durco Chrome

Duro Metal Products Co 2649 Kilgore Ave

Diagraph-Bradley stencil machine

Also sold by Fine Hardware Clark Ave. St. Louis, Mo 2917

2682 Chicago Products Co. 681 Arcadia Station
 (Fred Van Israel) Los Angeles, Calif.
'Turntable' Bridge Makes Street Corner Safer

Proposed as one solution to the congested traffic situations in big city shopping areas is a four-way escalator bridging street intersections. The moving stairways lead to a revolving platform which would swing the pedestrian quickly to the desired corner.

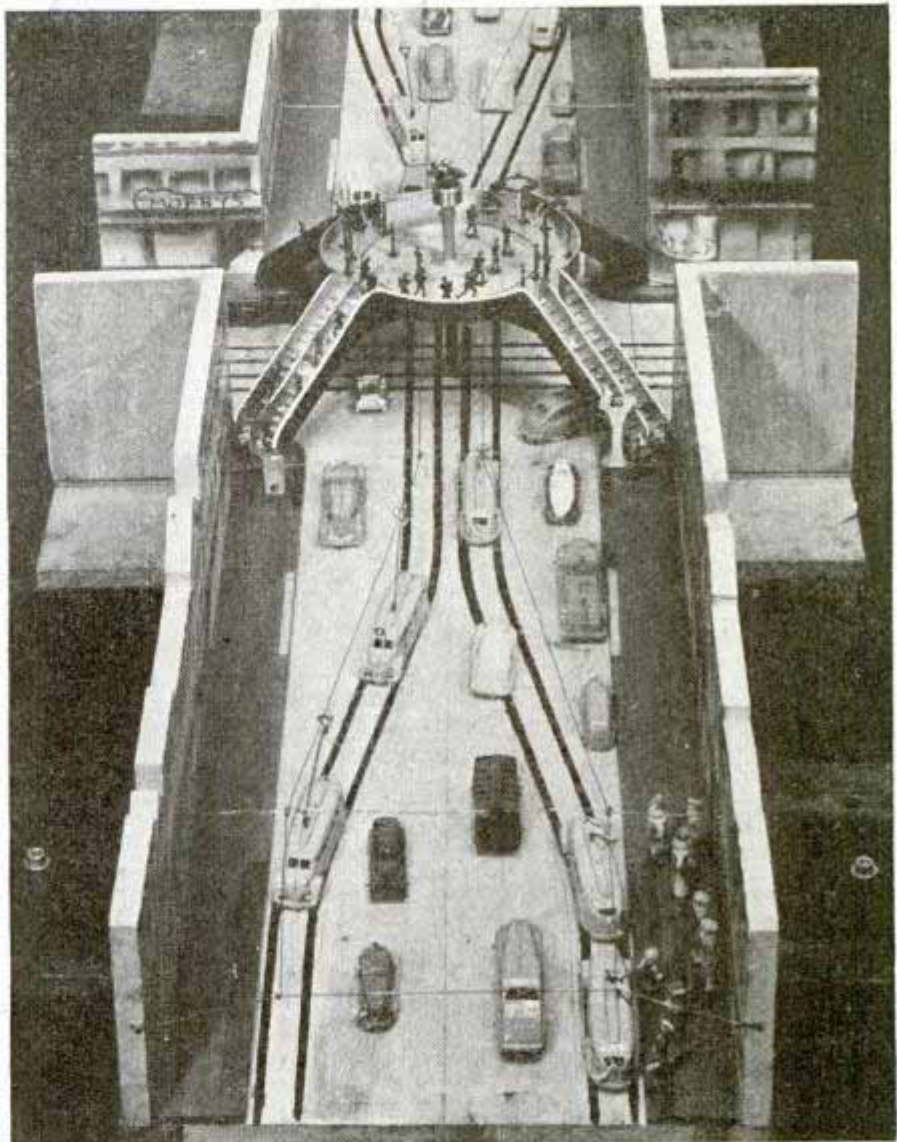

Escalators at all four corners and a perpetually moving turntable in the middle, as shown in this model, would speed traffic and save lives

2827
Way Found to Get Vitamin K from Tar

How to make vitamin K, which stops internal bleeding, has been discovered by chemists who sought to make available a larger supply than had been possible to produce heretofore. Coal tar is the new source and the chemists say that it holds the hope of giving to the world an unlimited supply, which means that thousands of lives will be saved each year. Previously the vitamin was extracted from alfalfa.

Chicago Tribune 7/16/39

2652
U. S. Warship Hoists Canvas for an Extra 'Lift' of Speed

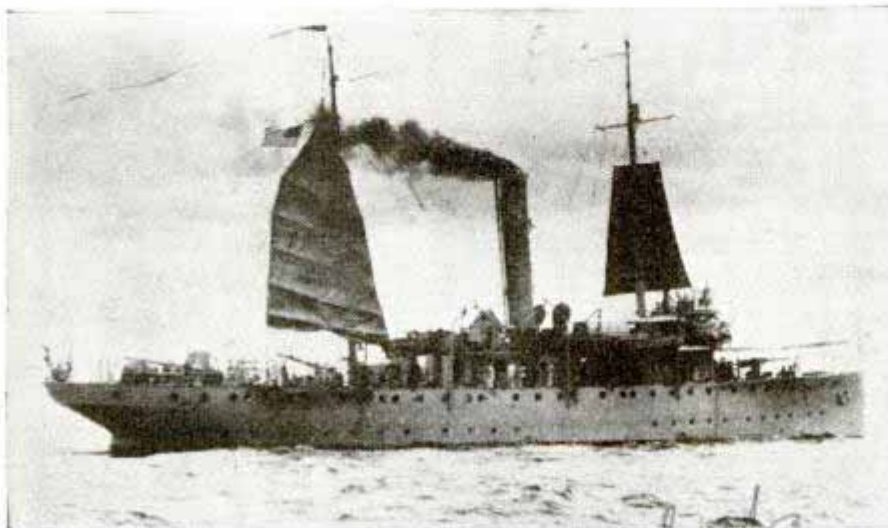

At the start of a journey half way around the world the U. S. gunboat "Sacramento" hoists sails to give its engines a lift from the wind.

It's an odd spectacle when a battleship wears sails. The U. S. gunboat "Sacramento" looked like a throwback to an earlier generation of warcraft as it left the Manila harbor recently with canvas hoisted to boost speed. The "Sacramento" was bound for New York by way of the Suez canal.

Eleven persons were killed every hour in 1938 by accidents in the United States.

National Safety Council

Reference: Westinghouse Electric
 Mfg Co, 150 Broadway
 New York
 ana

NEW WEAPONS to

Carl Thomas E. Stevenson, Jr. 10555 Astorville
 Los Angeles, Calif.

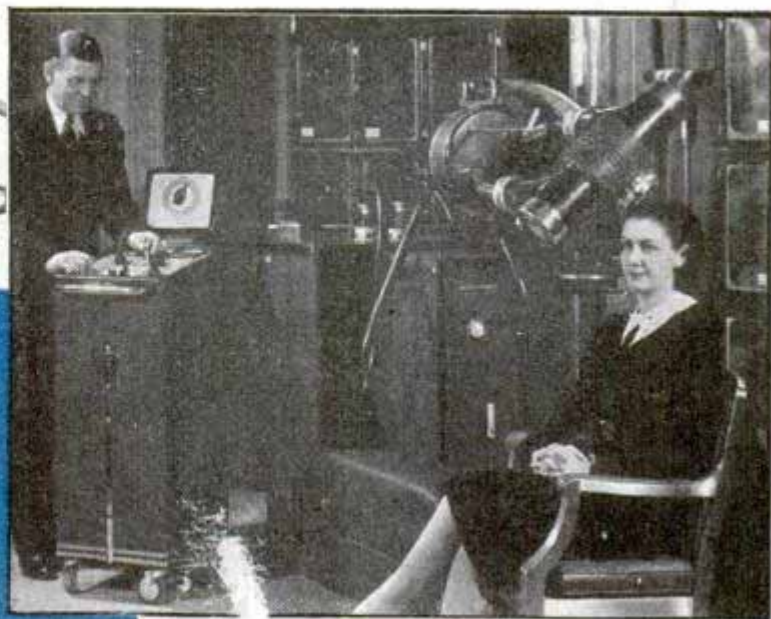

Left, upper electrode of million-volt X-ray tube at California Institute of Technology. Right, new X-ray photography apparatus avoids slow time exposures and gives clearer pictures

lightweight gas that relieves the paroxysms of asthma and that robs deep-sea diving of much of its danger.

One of the most interesting developments of modern medicine is that for many kinds of ill health doses of pure energy are being prescribed. Nearly every part of the energy spectrum from short-wave radio through heat, light, and ultraviolet to X-rays appears to have therapeutic value. It would have sounded like sheer nonsense a few decades ago for a doctor to order a patient to take so many doses of energy per week, but that is precisely what a physician is apt to do today. The wave length of the treatment that he orders depends on the type of complaint.

IF YOU had lived 100 years ago your chance of attaining a ripe old age would have been only half of what it is today.

Life expectancy is increasing yearly because medical science is adapting many of the latest discoveries in physics and chemistry to the problem of keeping you in good health or restoring you to it.

Even astronomy has been enrolled in the battle against disease, for it was an astronomer who first discovered helium, the

Cancer is one of the deadliest afflictions in the United States and at the beginning of the century nine out of every ten people attacked by cancer succumbed to it. Now nearly half recover. Doctors have learned to recognize it in its earliest stages and with surgery, X-rays, and radium they can often remove or destroy the growth. Today in dozens of clinics and hospitals super-voltage X-ray tubes that are a story or more in height are being employed to

Heat waves, X-rays & ultra violet

Island X-Ray Clinic, 1407 S. Hope St. Los Angeles

FIGHT DISEASE

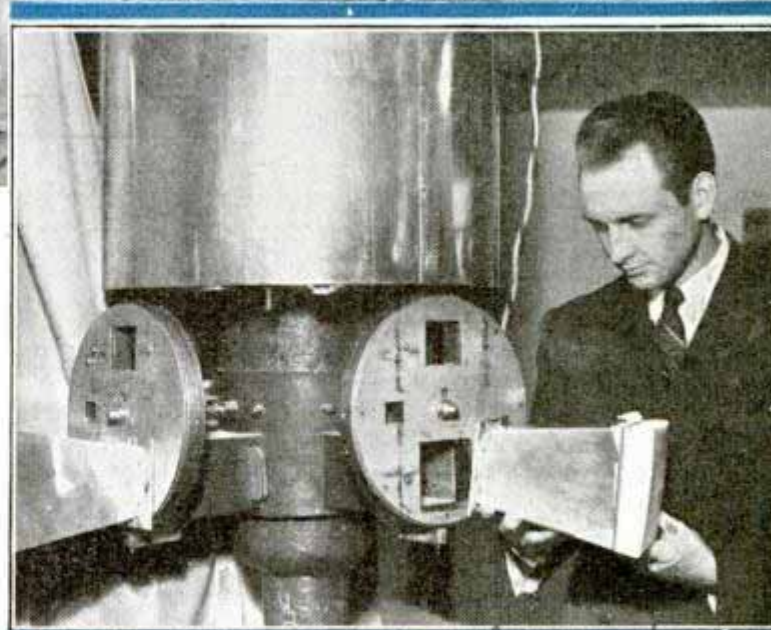
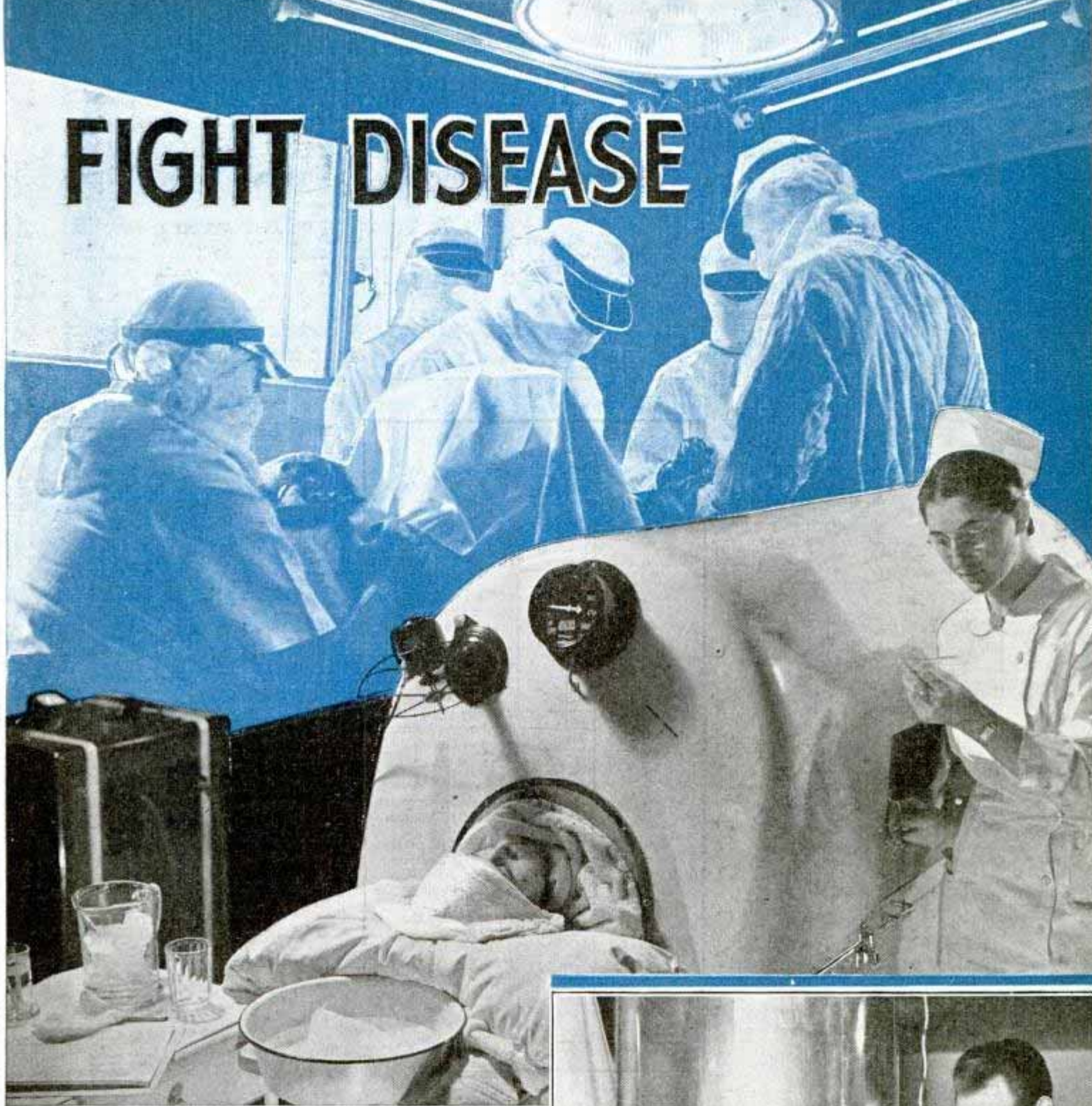

2457
 destroy malignant cancer cells without harm to the patients.

Physicists hope that they will be able to offer new kinds of treatment that will be even more destructive to cancer in the near future. At the University of California, Dr. Ernest O. Lawrence's powerful atom-smashing cyclotron is delivering streams of neutron particles that have greater penetrative powers than X-rays, and the chances seem good that neutron bombardment will become an important way of treating cancer.

Another possibility is the various elements that are temporarily radioactive. Physicists are learning to create or collect

Berch Light
 Performing operation under a battery of Sterilamps forming a square around the center light (top); fever machine in use (center), and X-ray tube's outlet portal being adjusted to help guide beam of radiation toward patient (bottom) *Hoff*

Mesa Hospital, Pillsbury

Los Angeles Institute of Radiology

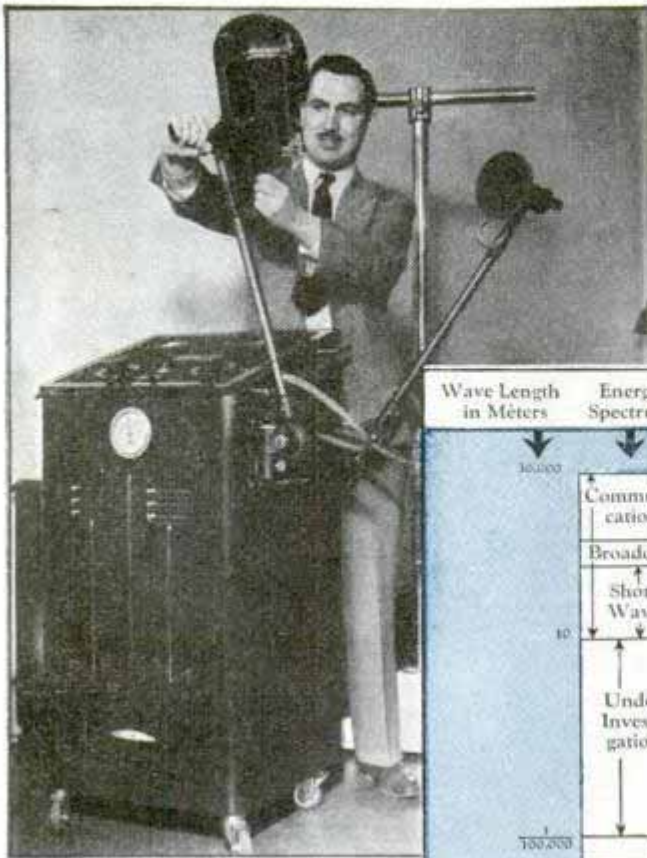

Top, adjusting electrodes of fever machine. Center, energy spectrum showing wave lengths useful to science in combating disease. Bottom, X-ray tube and transformer in giant new weapon designed to aid in war on cancer. By contrast, the nurse is holding a small photographic X-ray tube

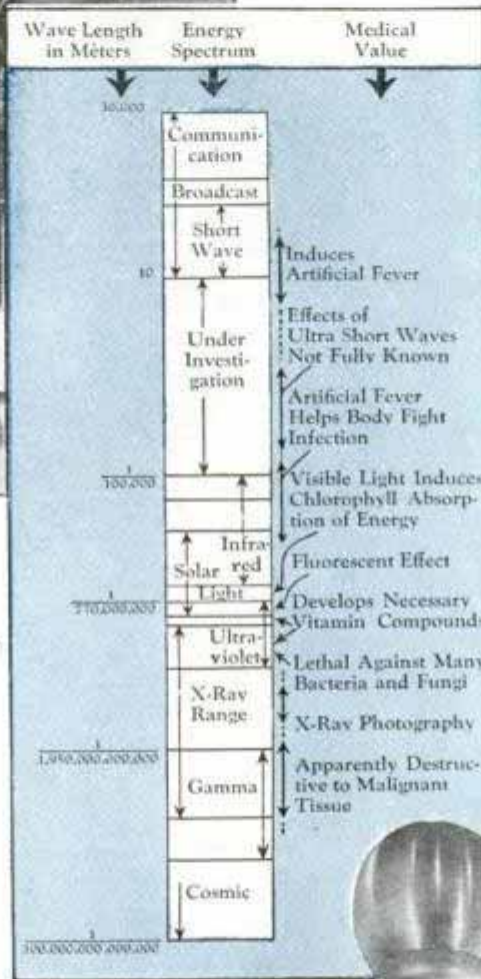

pictures that are often hard to decipher, due to movements of the heart and lungs. Recently Westinghouse engineers introduced a "candid" X-ray camera that gives off a vast amount of X-rays in a fraction of a second, something like the instantaneous light that is generated by a photographer's flash bulb. The result is that a radiograph may be taken so fast that heart action is "stopped" and a clear picture is obtained.

Heat is the infrared wave length of energy and fever is simply a rise in temperature that the body develops to fight off some kinds of infection. It is known that the heat causes an increase of white blood cells, allowing the body to put up a stiffer battle against germs. Some physicians used to inoculate patients with malaria germs in order to start a fever that would destroy other disease germs within the body, but now science has created fever machines that induce an artificial fever in the patient.

Fever therapy is still

these substances, termed radioactive because they radiate gamma rays just as radium does. Radio sodium, radio potassium, and other unstable elements lose their radioactivity within a few hours or days. Theoretically they are first-line weapons against cancer because of the hope that they can be injected directly into a patient's body where the gamma radiations can attack cancer at close quarters.

This same temporary radioactivity may soon supply the answers to a number of biological puzzles. The exact way in which the body makes use of food is not completely understood. By following the course of "tagged" atoms that are radioactive, biologists expect to obtain new knowledge of human chemistry.

The trouble with X-ray photography has been the long exposures that were required. Such exposures result in hazy

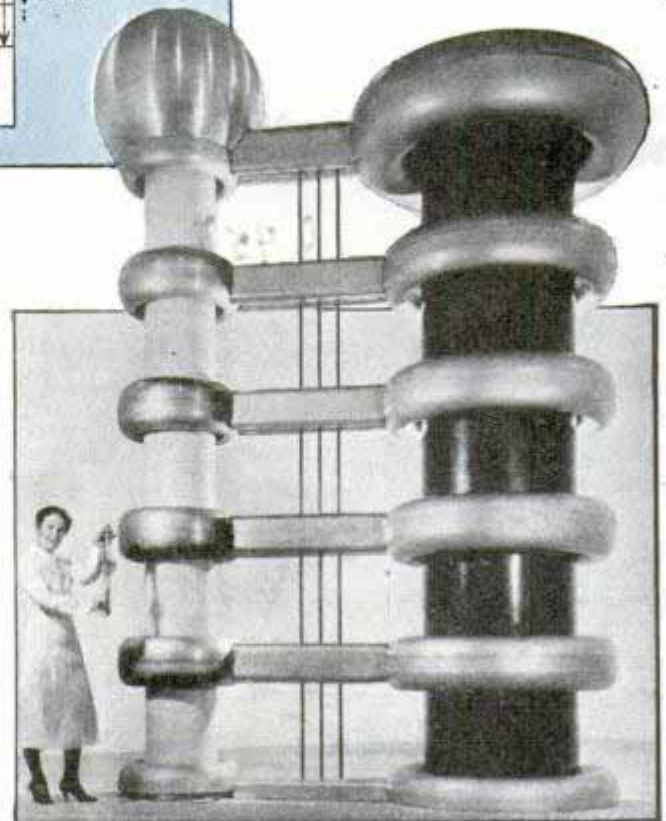

2457

2751

Tiny Plane Rides 'Pickaback' on Seven-Foot Model Biplane

brand new but its results are already encouraging. Dry heat from infrared lamps or the moist effects of a combination hot-water circulating system and a water spray inside the fever cabinet bring a patient's temperature up to the exact temperature desired. In some cases medicinal drugs are administered while the patient is experiencing the artificial fever. Encouraging improvements in St. Vitus dance, some kinds of arthritis, syphilis, meningitis, and miscellaneous infections have been found.

Dr. Lee De Forest and others are studying the effects of a different kind of artificial fever, in this case created by a high-frequency circuit similar to a short-wave radio transmitter. Radio therapy got its start when short-wave experimenters noticed that they rarely caught cold and that they usually had high temperatures while operating their high-frequency sets. In radio fever machines six meters is used for "deep" heat and eighteen meters and twenty-four meters are used for inducing general high temperatures. Encouraging results are being obtained in treating high blood pressure, arthritis, for building up the circulation of limbs restrained by casts, and for other purposes. Some investigators think that occasionally the results are much better than could be expected from heat alone, suggesting that short radio waves may be found to have a special therapeutic value.

Electromagnetic energy in another wave length, ultraviolet light, is best known as the ingredient in sunshine that causes sunburn and tanning. Ultraviolet radiation is used to increase the vitamin content of milk and to sterilize the waters of swimming pools. Dentists use its fluorescent band to study the condition of teeth. Ultraviolet of the middle

(Continued to page 140A)



Launching "pickaback" composite plane at model aircraft meet in England. The carrier ship has a seven-foot wing spread

One miniature airplane rode "pickaback" on another in a recent model plane meet at Bourne-mouth, England. The "parent" ship had a wing spread of seven feet and was driven by a gasoline engine. The composite model was copied after the pickaback plane that passed its tests in a flight across the Atlantic ocean last year.

Nested Cans Freeze Ice Cream C.F. and Cool Beverages

Nested aluminum cans form a heat-exchange unit for the kitchen, capable of freezing ice cream, cooling beverages and performing various other heating and cooling tasks. The inner can is fluted to provide the maximum cooling surface. To cool a drink, this fluted can is filled with ice or other refrigerant and placed inside a large can and the space between is filled with the beverage. Similarly, an ice-cream mixture can be placed in the larger can and the fluted one, filled with Dry Ice or salt and ice, used as a plunger to freeze the mixture.



Seamless, flexible metal tubing made by a Connecticut firm for handling steam, liquids and gases has been flexed 3,000,000 times without breaking.

American Brass Co.

Patent apparatus and heat exchanger

new York 11811

Bourne-mouth Model Airplane Club

Single-Wheel Farm Tractor Has Its Motor Inside

Andeanapolis, Md.

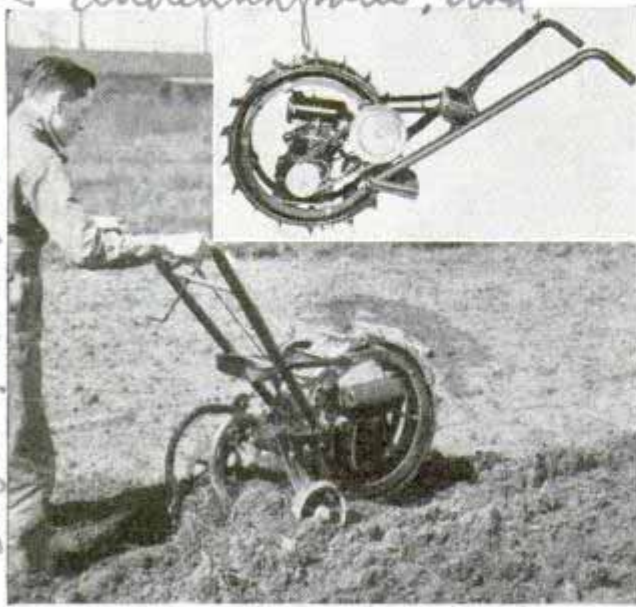

Inset shows how one and one-half horsepower engine is mounted in wheel of this many-purpose tractor

Having only one wheel with a one and one-half horsepower engine mounted at its center, a lightweight tractor eases much of the field work on a farm. By interchanging many small attachments, the 105-pound unit is made ready to plow, cultivate, mulch, dust crops, mow or sweep the lawn. It develops 3,600 revolutions per minute and a hand throttle permits variable speed control.

Scale Model of "Singing Tower" Has Seventy-Five Bells

Miniature copy of the great carillon installed in the campanile of the memorial to Stephen Foster, famed song writer, a

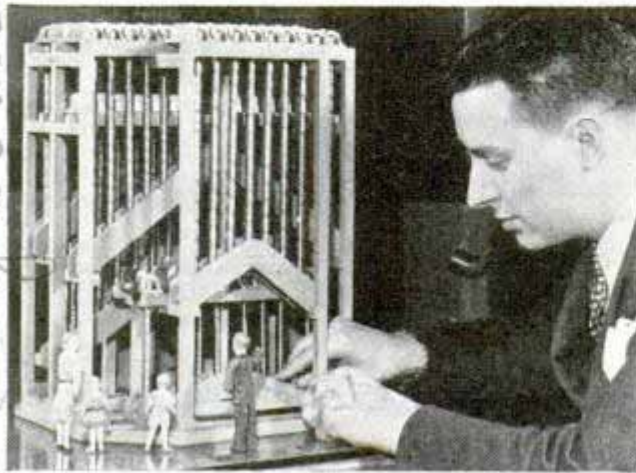

This tiny model of carillon in Stephen Foster "singing tower" will be placed in the memorial campanile

scale model has seventy-five bells of tubular construction. The model is on a scale of one inch to a foot. The original carillon in the "singing tower" is twenty-two feet high and weighs twenty-five tons. Its tubular bells are more than 600 feet in total length, required more than sixty miles of electrical wiring and can be played by manual or by an automatic player with rolls like those of the player piano. Eventually the model will be placed in the campanile of the Foster Memorial overlooking the Suwannee river.

Fan on Window Sill Ventilates House with Outside Air

Inclosed in an attractive case to guard the blades, an electric fan is made for mounting on the window sill to ventilate

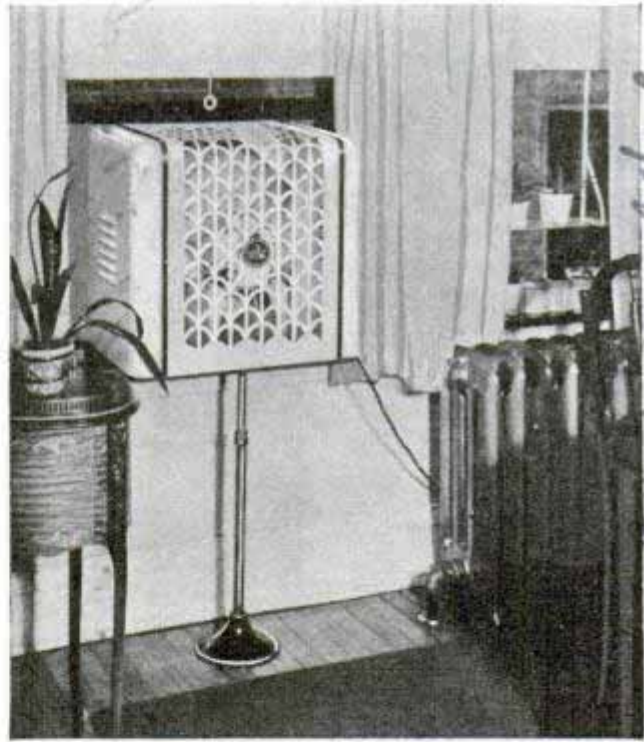

Window fan mounted in ornamental housing draws 4,000 cubic feet of fresh air per minute into house

a small home. It performs the same service as an attic fan, delivering 4,000 cubic feet of air per minute which is sufficient for a five-room house. Panels at the sides can be extended to fill window openings twenty-six to thirty-six inches wide. If the sill is too narrow to hold the fan, an adjustable floor support is available.

Send return postage to our Bureau of Information to learn the name of the maker of any device described in this magazine.

R. D. Eaglefield Co. 307-400 S. W. Sally

Florida State exhibit at New York Fair

2773
2032 St. Charles St.
Emerson Electric Mfg. Co. St. Louis, Mo.

Master Violinist Trains with Finger Twisters

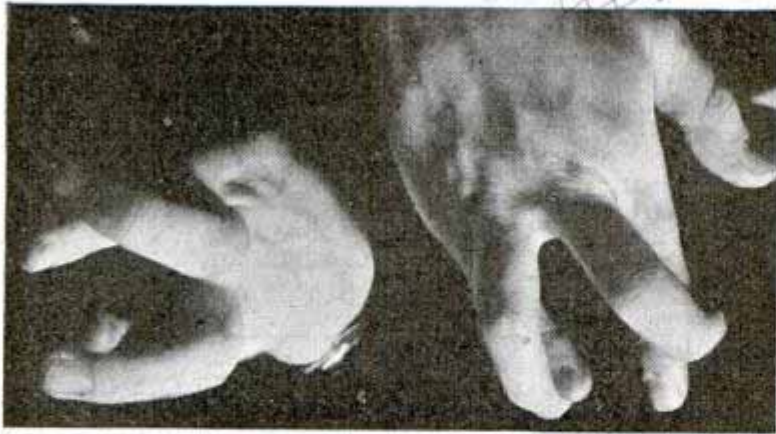

The great violinist needs more than knowledge of music and mastery of strings. Iso Briselli, concert artist, considers flexible wrists and fingers, muscular strength and control equally important. You may see him on a streetcar endlessly twisting his fingers as shown above, one of his "setting-up" exercises

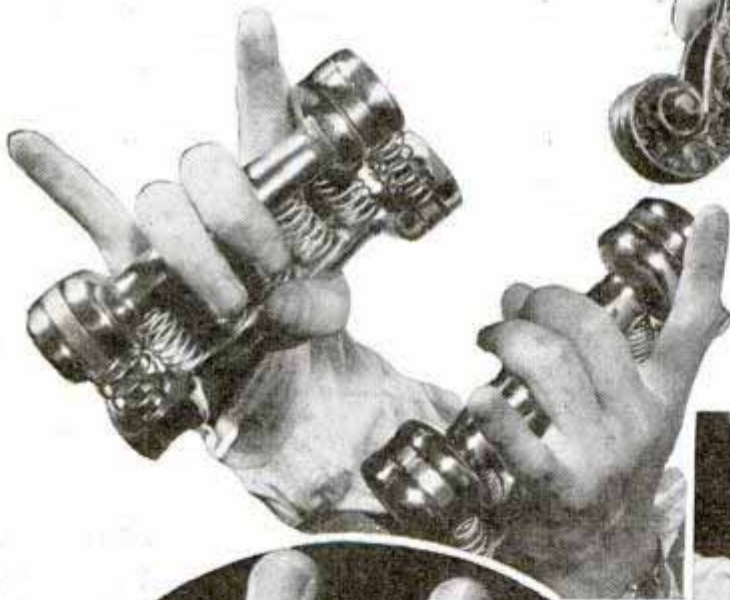

Above, Briselli with Stradivarius violin, which he values at \$50,000. He gives his finger and wrist muscles a strenuous workout with spring-grip iron dumbbells, left, which offer resistance as he exercises each finger in turn. Hours of this training equip him for the rigors of a performance



Simple "gymnastics" that can be performed anywhere comprise Briselli's methods. For example, he uses four ordinary corks to tone up the muscles all the way down to the wrist, working the corks up and down between the fingers. Above, another simple device—a rubber band twisted around fingers limbers and toughens muscles

Radio Compass Keeps Point Toward Station Tuned



Arrow of automatic radio compass, shown at top in cockpit, points unerringly to station tuned in

Direction finding by radio compass is brought nearer perfection by a completely automatic compass just developed by the Sperry Gyroscope company and R. C. A. manufacturing company. Early types would line up the needle in the direction of a radio station but would not distinguish that direction from the exact opposite, and a confused pilot might make a 180-degree mistake and fly directly away from his destination. The new compass has an arrow which points unerringly to any station or radio marker beacon tuned in, and points constantly just as the magnetic compass

points to its pole. The indicator panel is seven inches square, mounted horizontally in the cockpit. It can distinguish between stations only three kilocycles apart in frequency, and is accurate within one degree in direction. The compass gives a definite indication when a plane passes over a marker beacon to whose signals the instrument is tuned, pointing straight ahead until directly above the beacon, then making a 180-degree swing to point directly back.

4,000 Makes of Cars on Sale Since First in 1868

More than 4,000 makes of automobiles have appeared since the first car propelled by an internal combustion engine was turned out in France in 1868. This estimate, by the Smithsonian Institution, is based on a list compiled by Frank Walker, a collector of auto name plates. This list shows approximately 3,200 different makes had been introduced up to 1909. During the great boom of 1905-1906, the purchaser had the choice of 700 varieties. Makers of bicycles, guns, sewing machines, telephones and typewriters began turning out cars and one manufacturer changed a bird-cage factory into an auto plant.

Carbon Dioxide Covers Fire with Harmless Blanket

Too often the damage done by fire is exceeded by the damage wrought by water and chemicals poured on the blaze. In the hunt for a harmless fire-extinguishing



Smothering oil fire with carbon dioxide. This method proved most effective on indoor fires where wind was not a factor. The gas is harmless

Sperry Gyroscope Co. Inc. Manhattan Bridge Plaza N.Y. Brooklyn

Washington

July 11, 1939

Wild World

Tests conducted by
Mr. & H. J. Dugberg.

Washington, D.C.

agent, the Bureau of Standards recently tried carbon-dioxide gas with encouraging results. They wanted particularly to find an extinguisher which would not damage papers and furnishings in a room. Gasoline was set afire in a building slated for demolition, and carbon dioxide effectively snuffed out the blaze by depriving it of oxygen. Papers stacked on shelves in the room were unharmed by the gas. Carbon dioxide, however, did not prove so effective in outdoor tests. Because the gas was blown away by the wind, it failed to put out a gasoline blaze on a pool of water.

g 766

Dial Tells Inside Diameters to Ten-Thousandth Inch

Accurate within less than one ten-thousandth of an inch, a gauge just introduced measures the inside or outside diameters of small objects or holes. The measurement, appearing on a needle dial, shows out-of-roundness, size, taper and bell mouth. Three basic methods of measurement are possible by means of control knobs on the front.



Needle dial gives instantly the inside or outside diameter of small objects within 1/10,000 inch

Federal Product Corp.
10115 E. 1st St.

Blower of Giant Soap Bubbles Builds Puppets to Mimic Him



One of Mr. Warham's biggest bubbles and his troupe of twelve marionettes which dip pipes and blow bubbles mechanically

Himself a renowned blower of bubbles, Robert F. Warham of Piedmont, Calif., has passed on his art to a troupe of tiny puppets. Operated mechanically, the twelve marionettes periodically dip their pipes into cups of soapsuds and then blow. Mr. Warham has made a hobby of bubbles for twenty years and under favorable atmospheric conditions has blown one nine feet in circumference.

Oil Burner with Whirling Flame Burns Clean and Saves Fuel

Burning with a continuous, whirling flame that induces thorough combustion, an oil burner just developed provides an even heat and economical use of fuel. The oil is accurately metered by a carburetion principle. The flame is constant except for emergency shutoffs, and is controlled by a room thermostat, burning high or low as demanded but always with a rapidly spinning vaporized flame. A tangential air inlet produces this rotary flame. The only moving part is the blower wheel.

2861

Crundacker

Minneapolis, Minn.

Bennett Mfg. Co.

Twin Gauge for Car Wheel Shows if Repair Is Needed

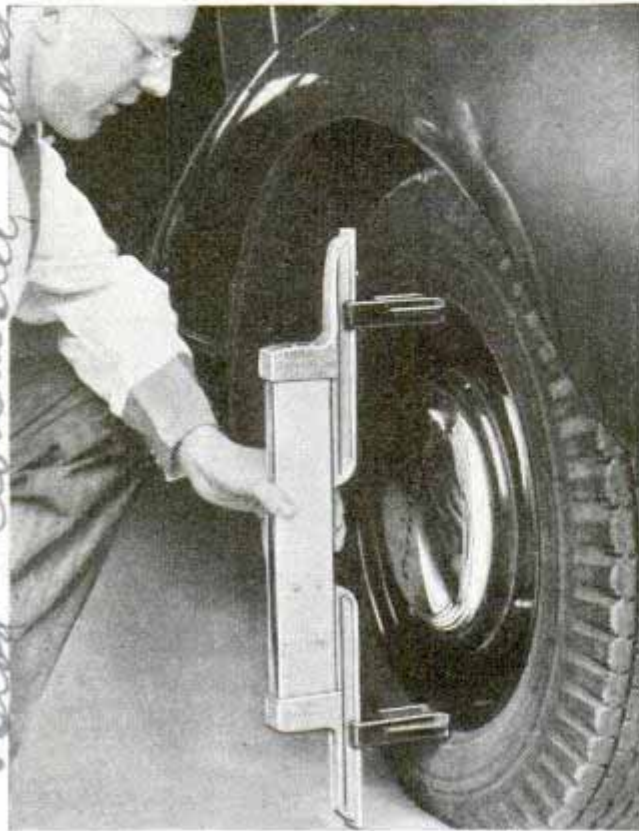

Checking wheel with gauge which helps show cause of uneven tire wear, shimmy and similar troubles

To check both the camber and caster of front automobile wheels—that is, the slant of the kingpins and wheels from the vertical—a single tool recently placed on the market shows the measurements on an easily read scale. This helps the repairman to determine the cause of uneven tire wear, shimmy, bad steering and other troubles at the front end of the car. The twin gauge is made of aluminum.

"Safest" Office Has Traffic Lanes and Fireproof Glass Pitchers

Divided lanes on the floor and "fireproof" water pitchers are features of the safety program in the office of the National Safety Council at Chicago. It is one of the safest places to work, for an organization devoted to accident prevention must practice what it preaches. A yellow center line was painted on the floor around a "blind" corner of the corridor to separate "traffic" and prevent head-on collisions of employes. To promote good health, each desk has its own glass and water pitcher, re-

filled several times a day by an employe who does nothing else. Oddly enough, the ordinary glass pitchers originally used were the cause of several small fires. The sun's rays focused through the pitchers set fire to papers and blotters on desks, and after two or three such occurrences frosted-glass pitchers were substituted. A medical examiner and full-time nurse watch over employes' health. On hot days employes are given three or four tablets, seventy per cent salt and thirty per cent dextrose, to avoid heat exhaustion. Each room has a portable humidifier for use in winter months, and the nurse reported all complaints of nasal irritations and dry-air discomfort ended when these were installed. Posture chairs are specially adjusted to fit the back of each employe. Short-wave diathermy machines, first-aid services, medical examinations and sun lamp are available at all times, and as a result of the general safety and health program the office, with 131 employes, had the low employe absence record of one and nine-tenths days per person for the year 1938.

Color Film Placed in Lamp Shade Shown by Diffused Light

Photographs, both the color transparencies and black-and-white variety, take on a more lifelike appearance and add a decorative note to the room when framed in a lamp shade manufactured for that purpose. Diffused light from the lamp effectively brings out all the details, particularly of color pictures.



Photographic transparency, either colored or black-and-white, enhances attractiveness of lamp shade

John F. Bluby Co. 744. Sullivan
Potter & Winchester Mass
20 N. Dearborn
Chicago

Do not answer letters

2764
N. N. Dale
Chicago

2715 Lincoln Bellvue 12818 Cort Road Cleveland, Ohio
Arc-Welding 'Surgeons' Save Mill Shutdown

Six arc welders, working side by side like a group of surgeons, performed a major operation on a steel-mill casting, restoring the mill to service in eight hours. Without electric arc welding, the mill would have been closed several weeks awaiting a new piece. The trouble was caused by breakage of the pusher head of a scale breaker used to remove slag. Four hundred pounds of arc-welding electrodes were melted into the casting to repair the fracture.



Working like a team of surgeons over a hospital operating table, six electric-arc welders melt 400 pounds of electrodes in repairing a casting

2732
Old Boxcar Rides as a Trailer to New Job on the Farm

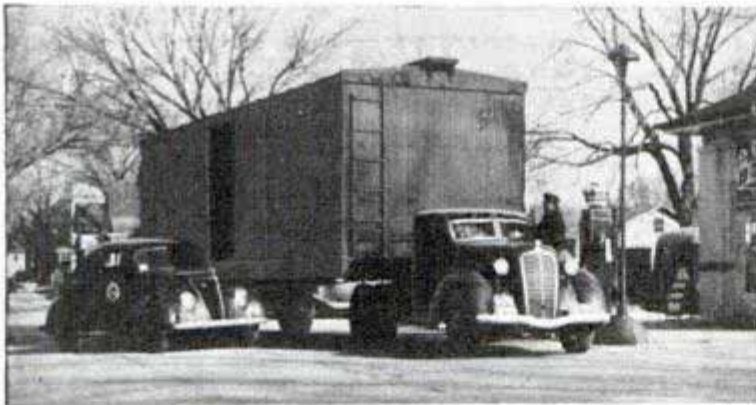

Fitted with temporary wheels, a freight car becomes a trailer on its way to retirement as grain shed on a Kansas farm

When a boxcar is retired from railroad service in Kansas, there is a chance it will make its last trip as a trailer to some farm where it will continue its useful life as a granary. This means of hauling the cumbersome vehicle was adopted by a mover who equips the freight car temporarily with large rubber-tired wheels, which he has designed and built especially for the purpose, and hitches it to the back of his truck-tractor for its last ride.

L. D. Sewall.

2705
Powerful Vacuum Cup Pulls Out Soft Dents in Body of Automobile

Soft dents in automobile bodies can be pulled out with a vacuum cup equipped with a powerful grip. Rather than take the time and expense of tearing out upholstery to pound the dent straight from inside, the rubber cup is moistened and applied to the "dimple" with pressure; then the locking lever is snapped down, increasing the grip. The tool is useful for removing hub caps and for similar garage jobs.



Straightening out a dimple in side of car by applying vacuum cup and pulling it out

More people are killed in farm work than in any one industry, the farm accident toll reaching 4,300 in 1938 out of a total of 16,500 industrial deaths.

National Safety

Uuro Metal Products Co. 2649

2 576.

Cink Thomas & Stinson, Jr., 10555 Holman Ave Los Angeles, Calif

WONDERS

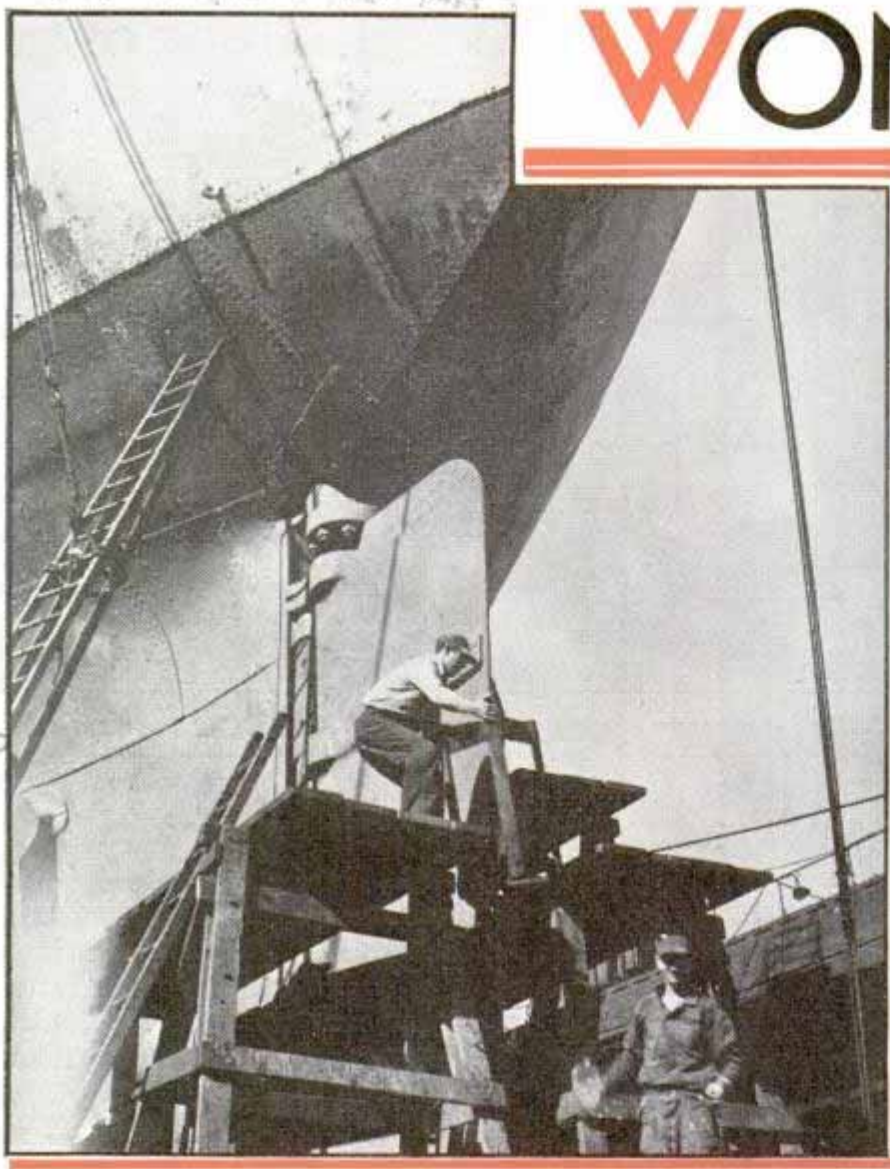

comes next. Steam is forced into the double bottom to kill any petroleum gas that remains, fires under the boilers are shut down, and the ship becomes inert.

When a big ship is due in for repairs or even for routine cleaning and inspection at the San Pedro, Calif., yard of the Bethlehem Steel company, the floating dry dock is sunk into place, the ship is floated into position above it, and the docking master begins raising the dock and ship on an even keel. Keeping an eye on a plumb line suspended

RESULT of a collision at sea the night before, the big freighter had a gash in her side extending from the shelter deck down to the turn of the bilge. Her sturdy steel plates were crumpled like cardboard and waves swirled in and out of the open wound. Strong watertight bulkheads were keeping her afloat until she could get to the hospital.

Along the water front of every large port you will find a hospital for ships. On its staff are diagnosticians, skin and bone specialists and surgeons. Its operating room is the dry dock and its surgical tools are giant cranes and riveting hammers.

Ships are delicate, complex structures and if the lower part of a hull has been damaged in a wreck the first step in the hospital is to "bleed" the patient by pumping out the oil stored in the double bottom. Otherwise it would drain away as the ship is raised. Administering the "ether"

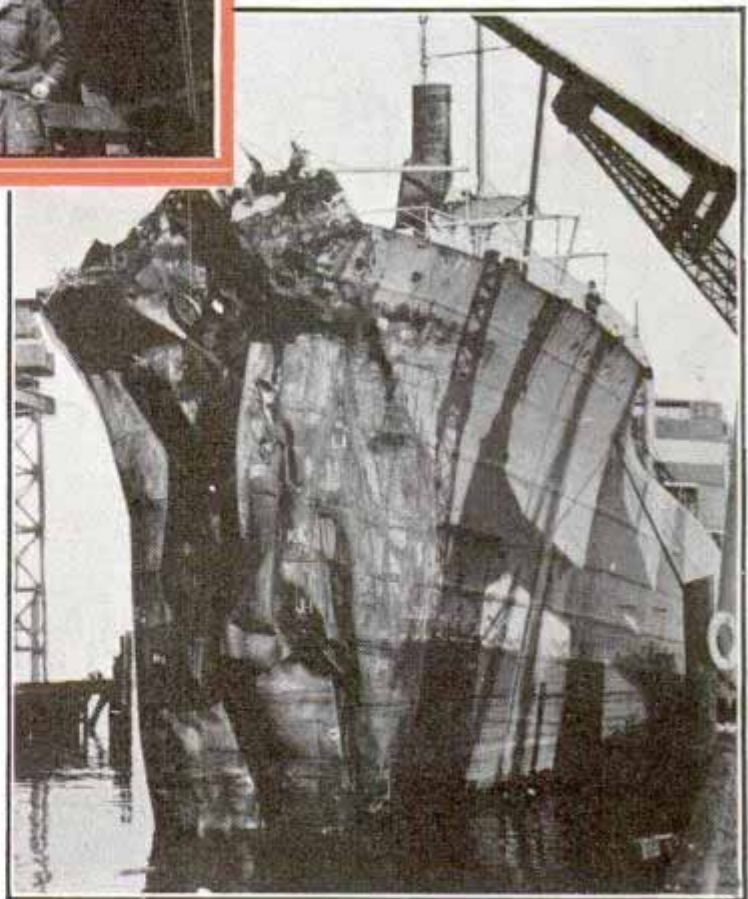

Top, erecting scaffolding around rudder so welders may make minor repairs. Bottom, ship severely damaged in collision reaches the "hospital"

Bethlehem Steel Co
San Pedro, Calif

WVIF

2576
OF

San Pedro Yard, Bethlehem Steel
Terminal Island Calif

SHIP SURGERY

from the ship's bow, he uses a megaphone, whistle, and signal boards to notify pumpmen along each side of the dock of the speed at which each is to discharge water from the buoyancy compartments. Previously he had superintended the fastening of keel and bilge blocks to the dock's deck, laying them in a pattern that would safely cradle the ship. As the dock rises from the water it lifts the ship with it, raising it slowly so that the hull may be scrubbed clean by gangs working from punts moored alongside.

A ship that has been salvaged from the rocks or damaged in collision gets a scrupulous examination. Steamboat inspectors, insurance underwriters, and owners'

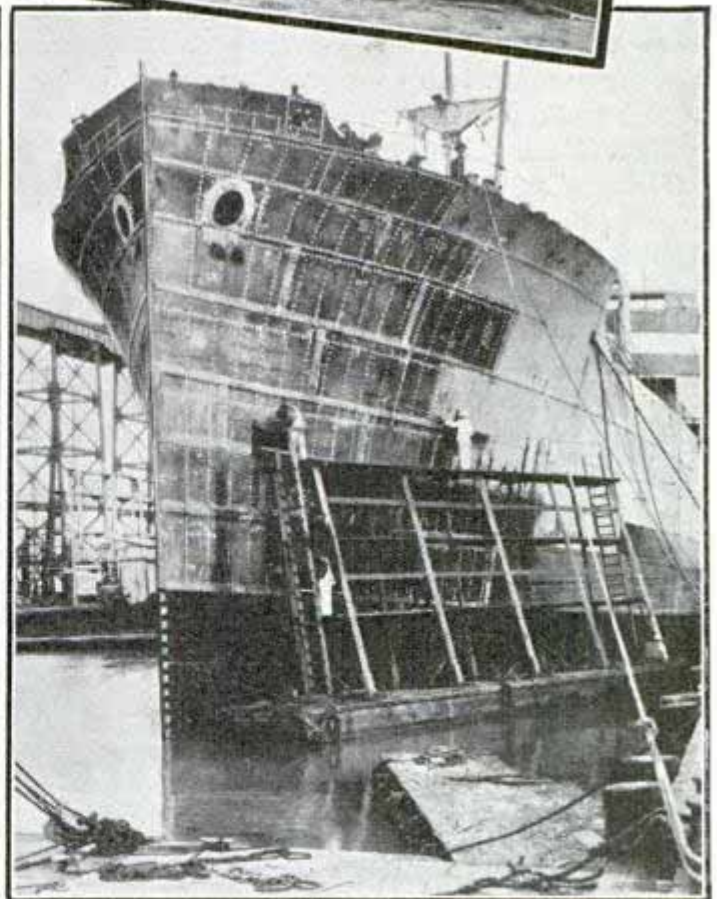
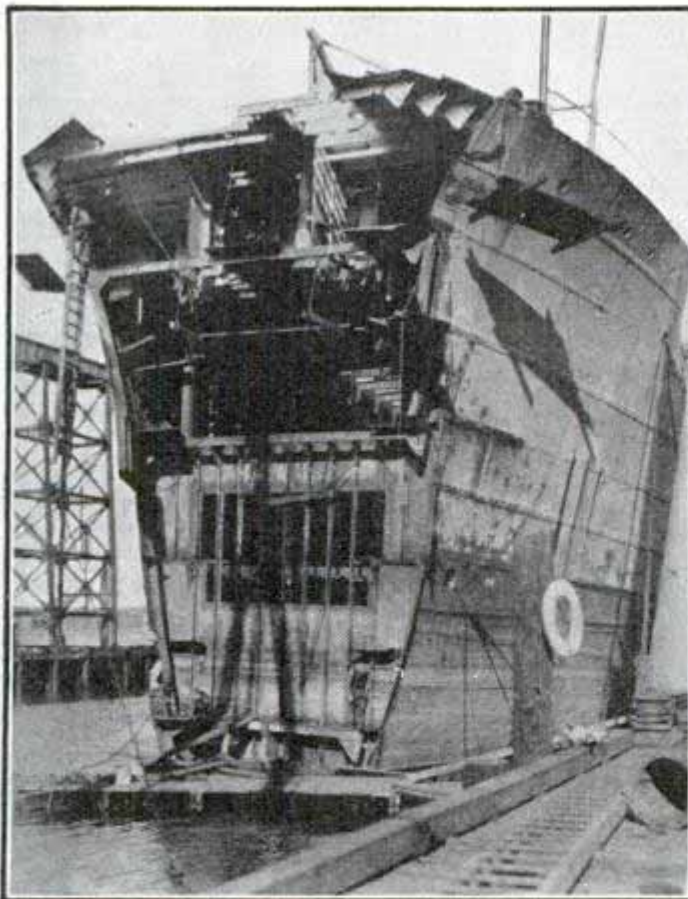

Bottom, left, thirty-five feet of damaged bow removed from ship shown on page opposite. Bottom, right, repair completed in Bethlehem Steel company's yard. Top, docking master signaling pumpmen as dock rises with ship

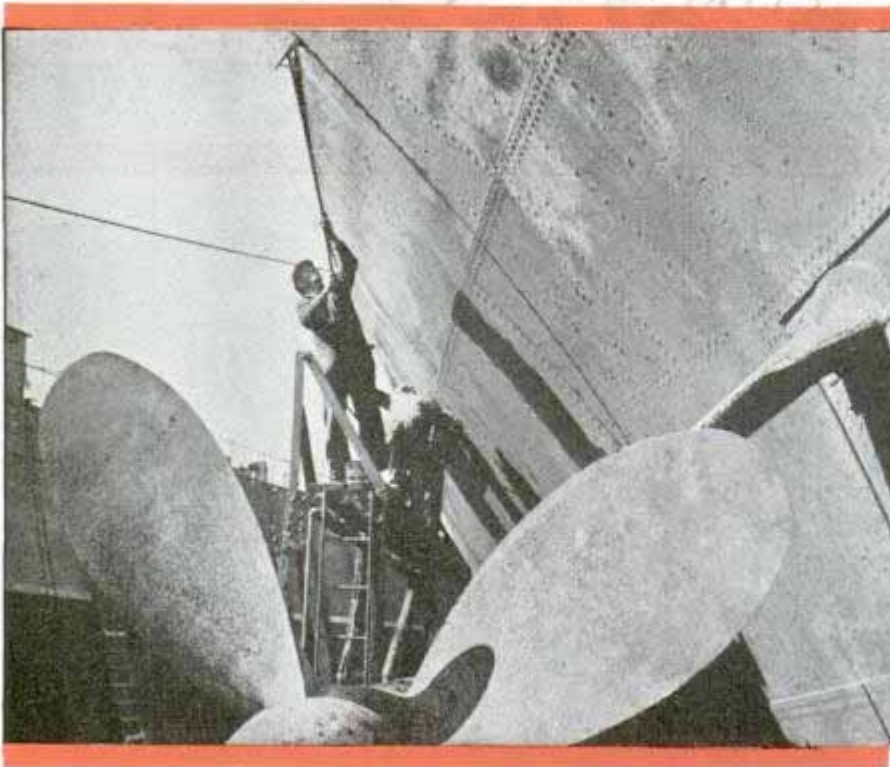

grass and barnacles may attach themselves to a hull between inspection periods. Such growths slow down the ship's speed and it is cheaper to trim them off than it is to drag them through the water. Marine parasites grow fastest on ships traveling in the tropics and they flourish when ships are laid up for long periods in still water. Occasionally shipyard men find that an oyster bed has started to grow on a hull. Now and then live fish that have been feeding on the growths refuse to leave and are found as water in the dry dock recedes.

representatives diagnose the damage and recommend treatment. Damaged plates and rivets are burned off with acetylene torches. Bulkheads not too badly bent may be heated up and strongbacked into place. Stanchions and frames are removed for repairs or replacement. New shell plates that may weigh two tons each and require 1,000 rivets for fastening into place are molded to the ship's contours, and installed.

Ordinarily internal injuries, such as damage to engines or leakage or stoppage of pipe lines, can be repaired while the ship lies alongside a wharf. When a sea valve has to be repaired or the propeller shaft needs treatment the ship goes into dry dock. Grave injuries to a ship are rare and much of the work of the marine hospitals consists of keeping healthy ships in good condition. Vessels are lifted out of the water every six months or so to make certain no trouble is developing. The condition of the plates, the condition of the propeller and rudder fittings are all studied. Sea valves are cleaned out and the wearing of the shafts and stern tubes is measured. Often a vessel that has been at sea for a long time has a few loose rivets that must be tightened or replaced.

When a ship is docked merely for inspection and cleaning the shipyard workers call the job a "haircut and shave" and that's exactly what it amounts to, on a vast scale. As much as seventy or eighty tons of sea

cedes. Most marine paints contain large amounts of poison that slow down such growths. A trip through the Panama Canal, into the Great Lakes or up any freshwater stream kills the salt-water growths.

Electrolytic corrosion is a queer disease that attacks metal ships and the metal fit-

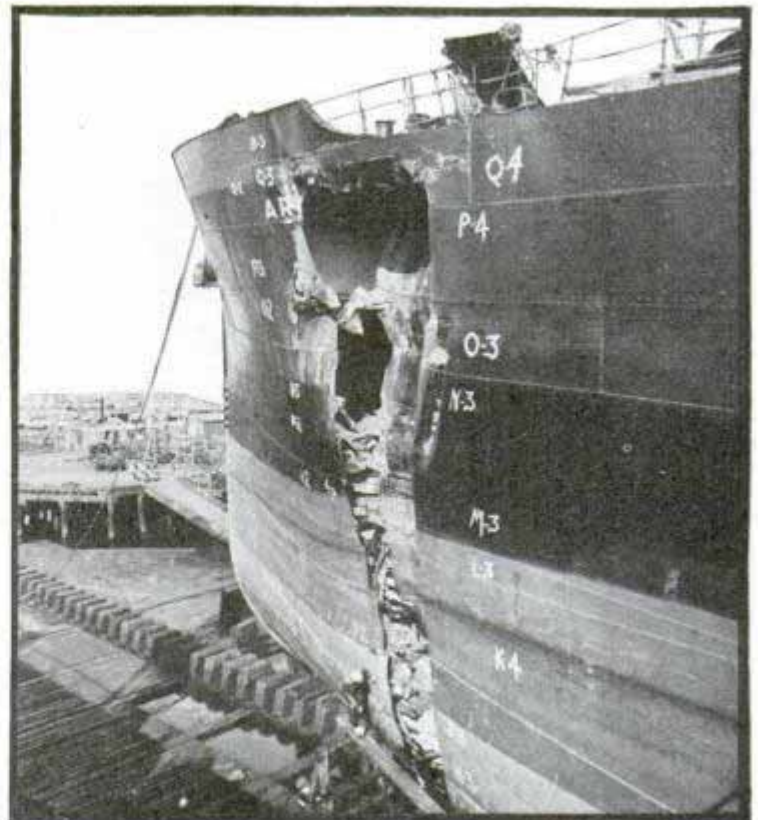

Top, painters with long-handled brushes apply new paint at water line of vessel. Bottom, numbers on damaged ship indicate plates that must be replaced

2576

tings of wooden ones. Even in fresh water the ship acts as a battery and rapid corrosion and pitting occur in the underwater metallic parts that serve as the negative pole in the circuit. Grounding of electric cables to the hull increases the action, and in some cases the electrolysis is strongly localized to small areas, threatening the strength of the hull at such points.

One way of fighting the disease is to fasten small zinc plates to the hull, zinc being such a perfect cathode material that the plates are eaten away and the rest of the hull is not attacked. The plates are renewed when the ship is docked for cleaning. A special metallic paint is sometimes used for the same purpose, and another way to combat the action is to install an electrolysis eliminator that reverses the normal po-

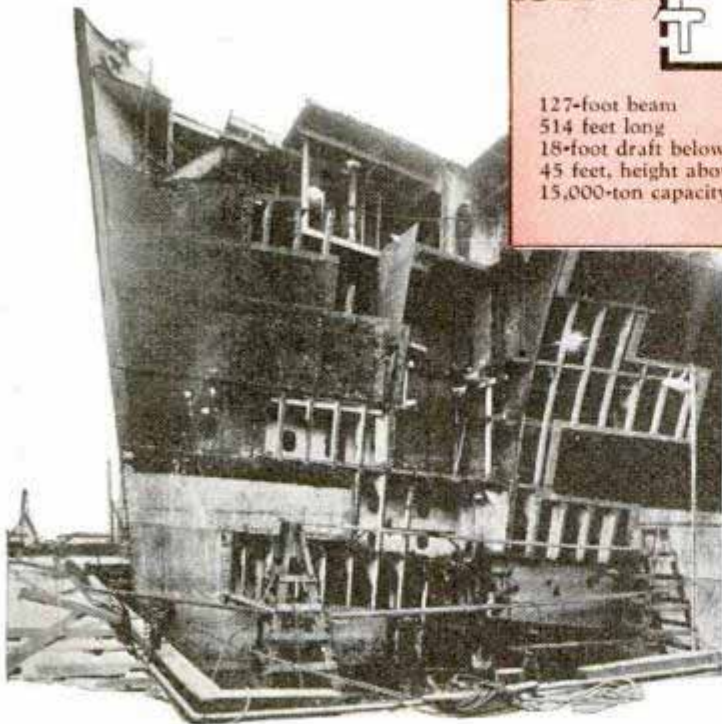
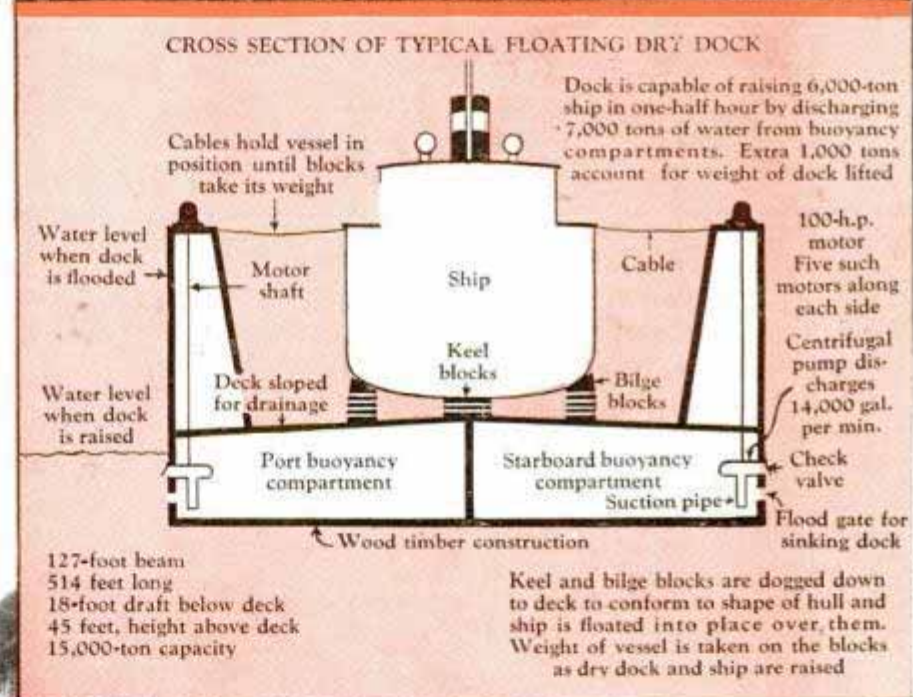
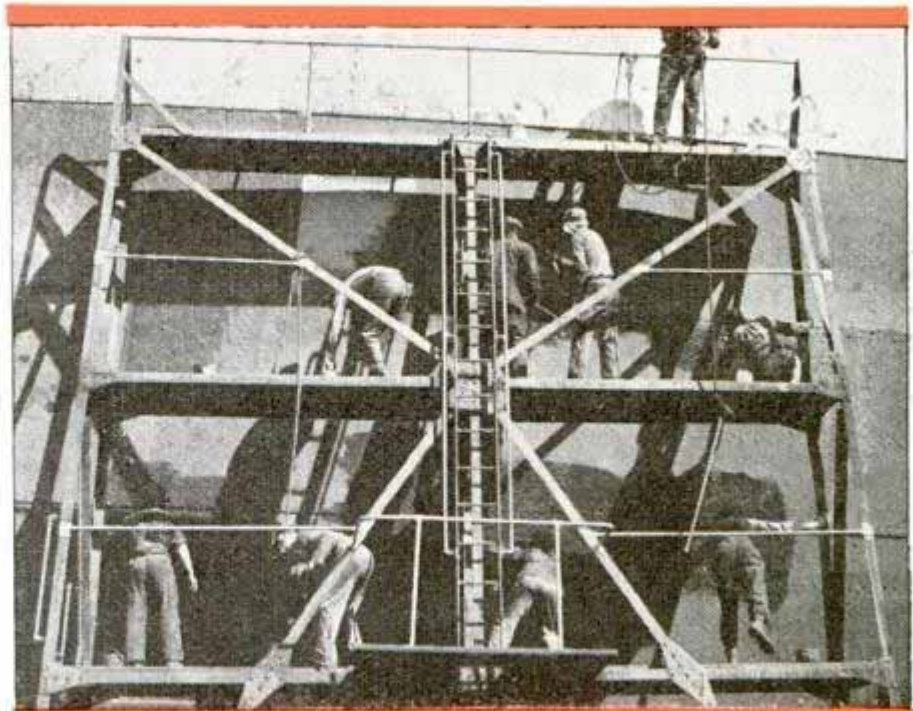

Top, at work on side of ship. Center, cross-section of dry dock. Bottom, vessel in the process of being restored to seaworthy condition

larity of the structure for periods of time.

One interesting job in a shipyard is rejuvenation of an obsolete vessel that has been lying in dead storage. Many ships that have grown old and out of date in service are operated upon to restore them to useful lives. Large freighters are sometimes converted into passenger ships when the need arises. A more frequent face-lifting operation is the work done on a passenger vessel built for service in cold latitudes when it is shifted to a permanent tropical run. Roomier quarters and better ventilation are needed in warm waters. Three large American liners recently shift-

(Continued to page 122A)

Rolling Garden "Dustpan" Tilts to Pick up Refuse

Isard. N. Carl



Rubber-tired metal cart for lawn work tilts forward to pick up a load from the rake.

Grass cuttings and refuse are raked from the lawn or garden into a V-shaped cart, like dirt is picked up by a dustpan. Pushed or pulled like a wagon, the two-wheel vehicle is filled by tilting it forward so the front edge lies flat on the ground, and it is emptied as easily.

Ready-Sliced Bread Cut Thinner by Using Safety Holder

Soft bakery-sliced bread can be re-sliced without tearing or crushing if you have a metal holder that grips the slice firmly and also protects the hands. Ordinarily bread

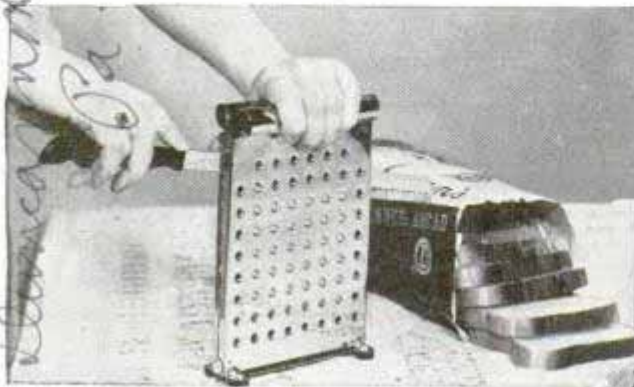

To cut bread thinner for melba toast or sandwiches, put slice in this metal holder and slice it again

comes from the bakery in half-inch slices, but these are too thick for party sandwiches, melba toast and canapes. The slicer holds the bread between two hinged plates which are perforated and have sharp protruding prongs on the inside. The knife is guided in a slot between the plates.

Bicycle Fork with Built-In Spring Cushions Front Wheel Shocks

Spring suspension for the front fork of bicycles, inclosed in the frame head, absorbs road shocks without permitting side play or wobbling of the wheel and without weakening the fork. Out of sight

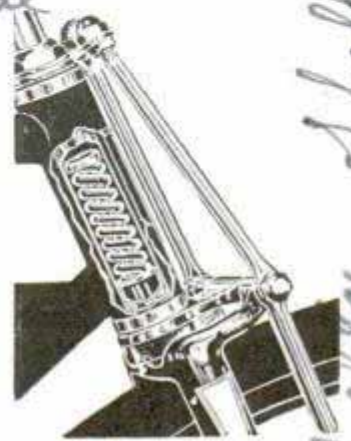

where it is protected from the weather and safe from juvenile tampering, the combination spring and rubber mounting is simple and rugged in construction and requires no servicing.

Auto Wax Applied by Spray Gun Used as Cap of Container

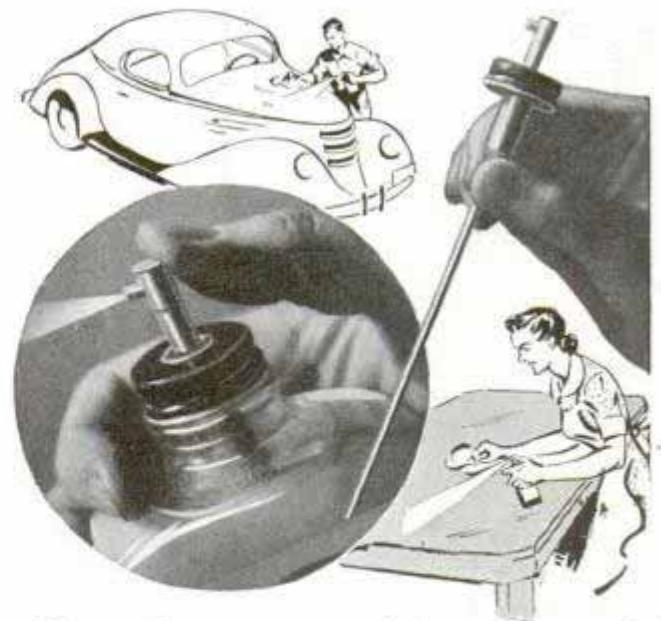

Closeup of spray gun as applied to furniture and automobile cleaner and wax container

Applying a cleaner-and-wax liquid on automobiles by means of a small spray gun results in faster work and in a saving of the liquid, as compared to the standard

Packaging Mfg. Co., Burbank, Calif.
Alden Products Co.

Shelby Cycle Co., Chicago

Kota Kolor Wax

application with a cloth. This method is being introduced by a manufacturer of colored auto waxes and furniture cleaning fluid. The spray gun, which is operated by hand, screws on the liquid container, replacing the standard top. Pressing the spray-gun plunger with the thumb several times starts the fluid to begin spraying over either auto or furniture surface.

Simple Clutch with V-Belt Drive Idles without Friction

Smooth transmission of driving power, frictionless idling and finger-tip control are offered by a V-belt clutch designed for use with the smaller type engines on in-board motorboats, power lawn mowers, farm implements, light industrial machinery, midget racing cars and scooters. It provides a means of delivering power to the driven shaft at any desired speed or ratio, eliminating the need for transmissions or extra pulleys and gears.

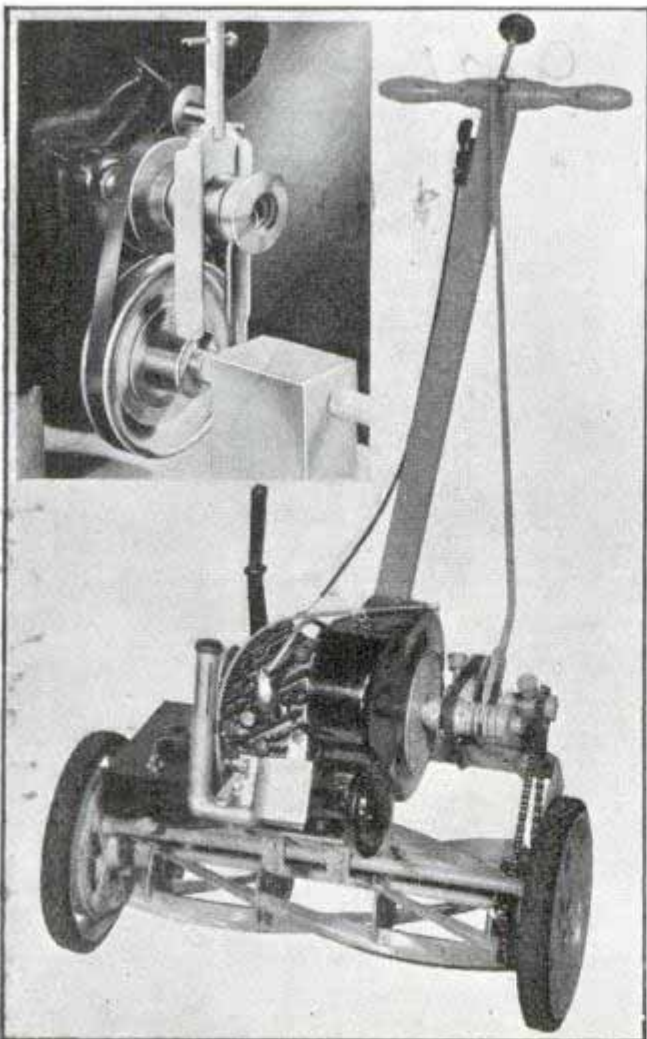

Power lawn mower with V-belt clutch installed, the inset showing installation on small inboard motor

Red-Hot Glass Survives Dip in Bowl of Ice Water

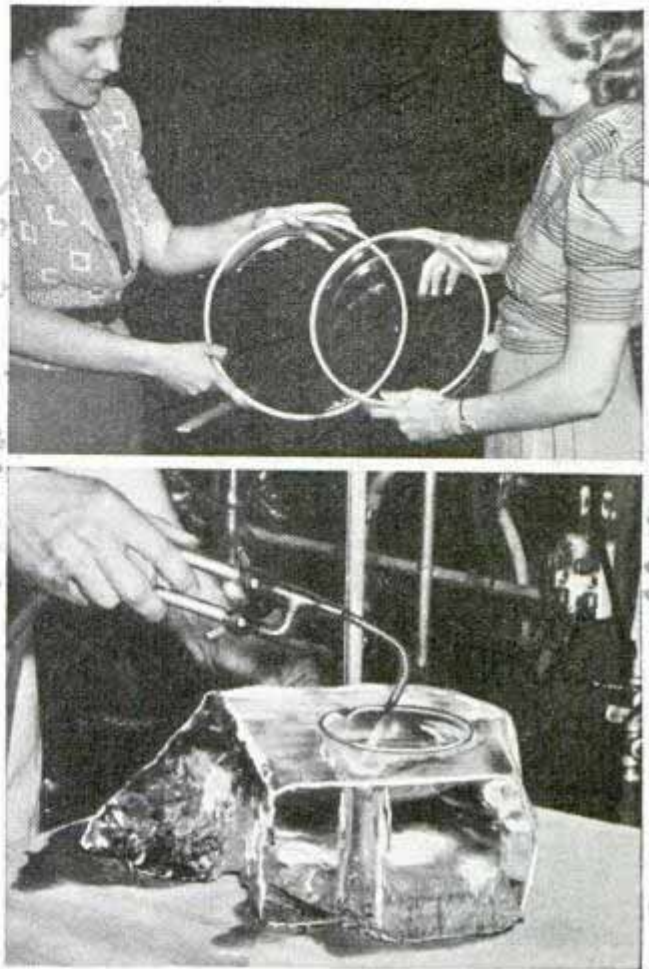

Top, note shrinkage of heat-resistant glass; below, torch fails to crack glass resting on ice cake

Glass made by a new process resists cracking or breaking under sudden temperature changes because of its low coefficient of expansion. You can heat it to cherry red and plunge it into ice water without fear of breakage. It will be two years before products of the new glass can be offered to the public. At one point in the process articles shrink weirdly to less than two-thirds their original volume, but without changing form or becoming distorted. In making a dish, it is molded in the usual way with a special kind of glass. Then, through a series of treatments involving a final step of leaching with dilute nitric acid, part of the structure of the glass is removed. At this stage it is full of sub-microscopic air spaces and feels rough to the touch. A final heat treatment to release this air reduces the body to a clear, solid mass, about ninety-six per cent pure silica. It is here the shrinkage occurs.

Corning Products Co.

Handwritten notes on the right margin: "2724", "Corning Glass Works, Corning, N.Y.", "developed by H.P. Hood and...", "under development", "1933".

cont. 403 Santa Barbara Road, Berkeley Calif

Four-Ton Lens Casts Light Beam 24 Miles

Electricity has taken the place of oil in the lamp of the lighthouse at Point Reyes, Calif., and as a result a beam is now thrown twenty-four miles out to sea. This was made possible by completion of a ten and one-half mile power line, supplying current for a 1,500-watt lamp having a candlepower of 500,000, nearly five times that of the old lamp. The latter, consisting of an oil-vapor mantle, gave off smoke that caused clouding and necessitated constant polishing. The Point Reyes lighthouse lens, installed sixty-nine years ago, weighs about four tons and contains more than 1,000 prisms of special glass. Set in the center of this rotating lens, the light is greatly intensified, and the prism arrangement spreads out a fan-shaped beam over one of the most dangerous headlands known to mariners.

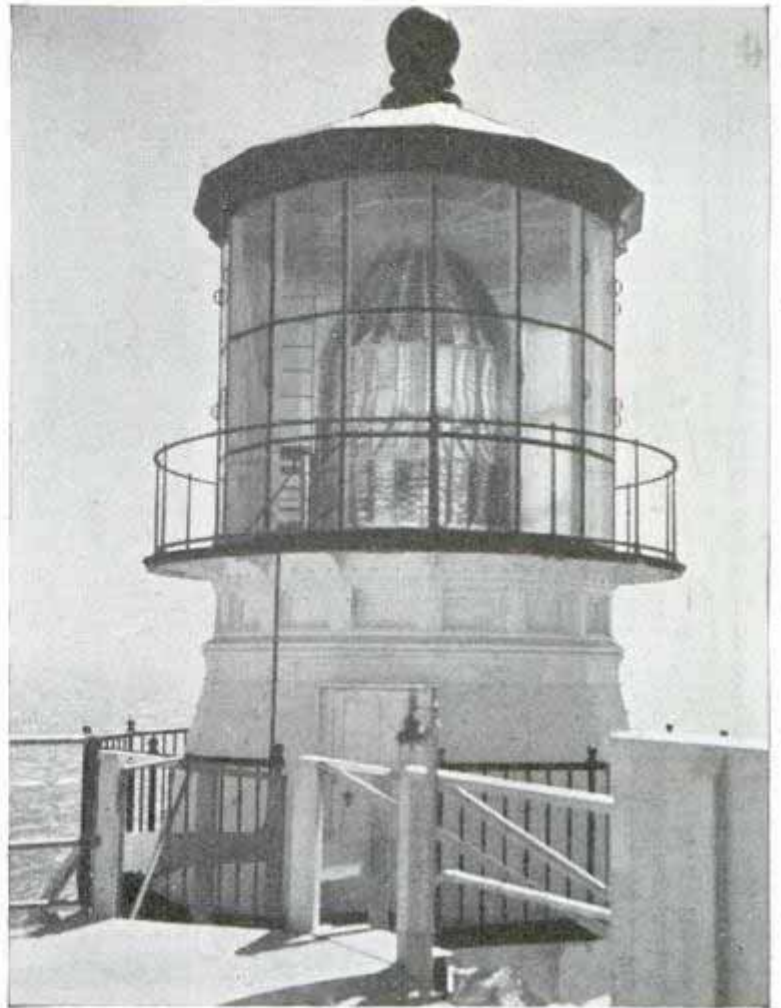

Fifteen-hundred watt electric lamp has just supplanted oil in the old lighthouse at Point Reyes, Calif.

Floating Bridge Goes to Rescue of Sunken Submarines

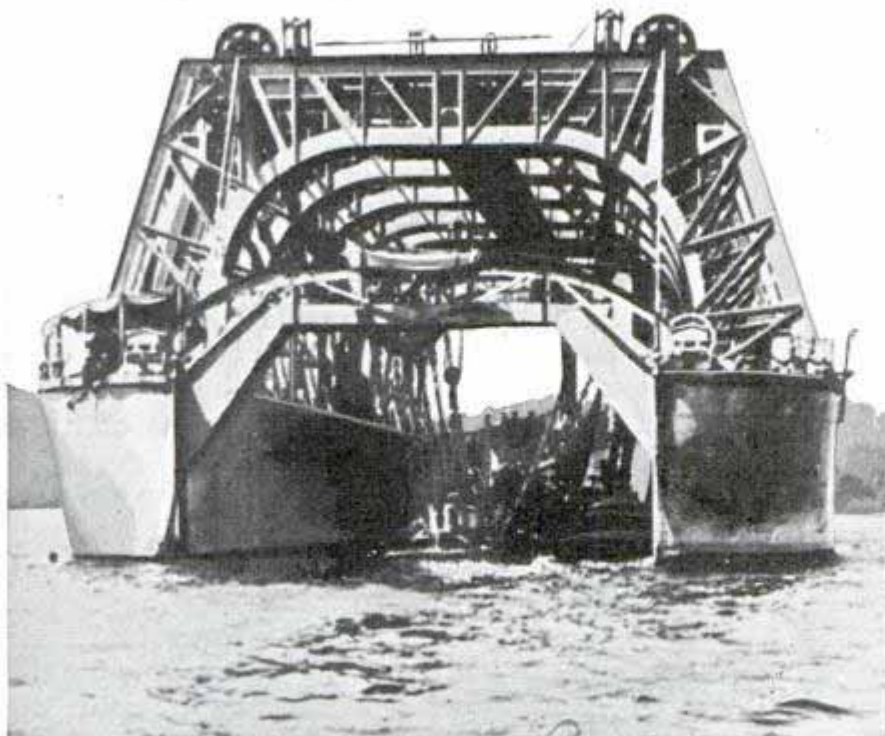

France has built a huge floating bridge as a rescue ship for sunken submarines, and, although never tested in actual disaster service, it has proved its worth in practice. The two vast pontoons support a steel superstructure carrying the chains and rigging for lifting a submarine from the bottom. A submarine was deliberately sunk, and after chains were attached the bridge raised the ship.

This French rescue ship met its first practice test by lifting to the surface a submarine deliberately sunk in ocean near Toulon

☐ The 29,485,680 motor vehicles registered in the United States in 1938 traveled 250 billion miles during the year.

same National Safety Council

g 406

AIR-CRASH

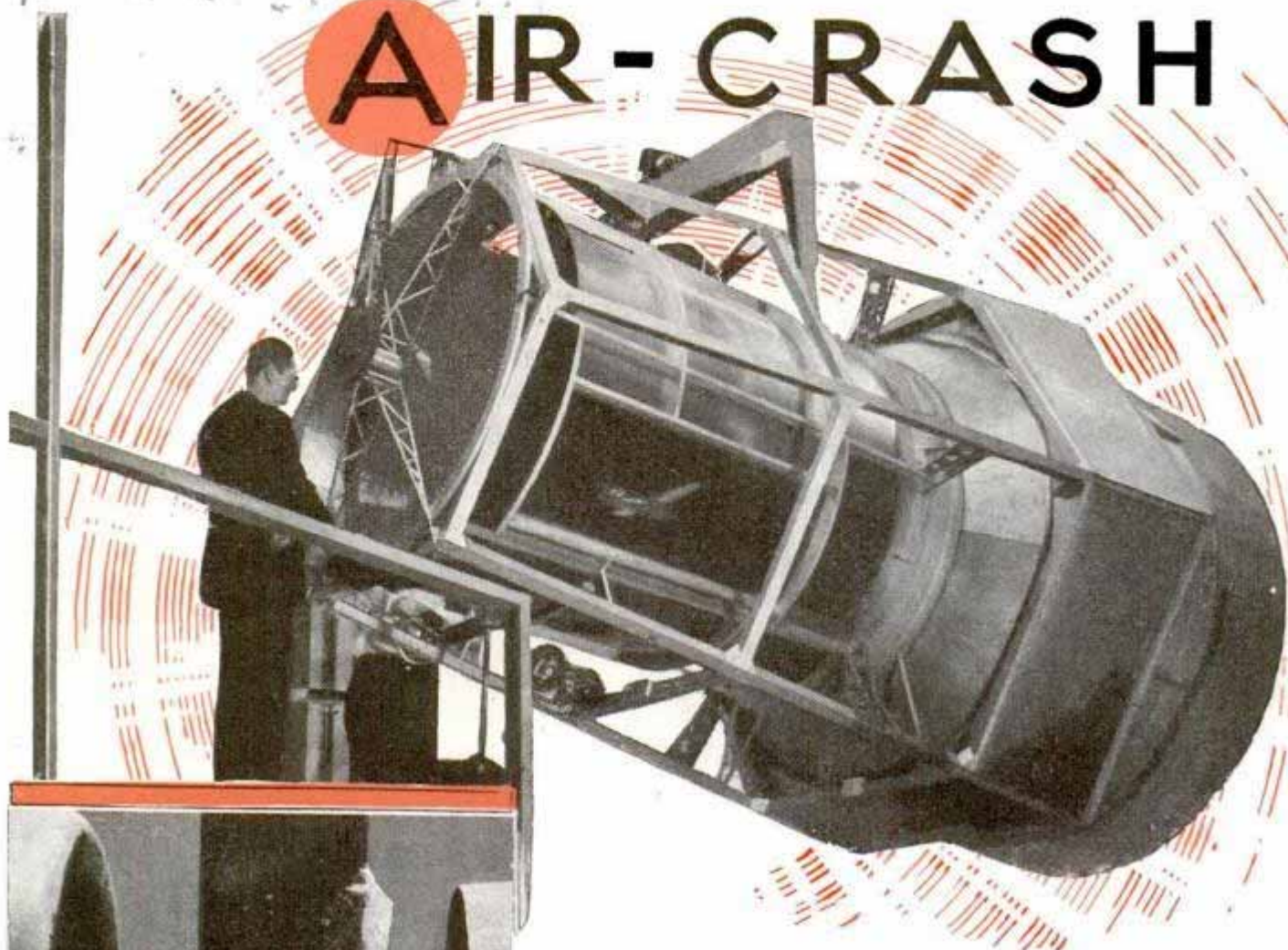

Above, N. A. C. A. tunnel in which model plane flies freely, permitting new method of studying stability and control characteristics. Left and bottom, making tests with glucose coating to find its effect on delaying ice formation

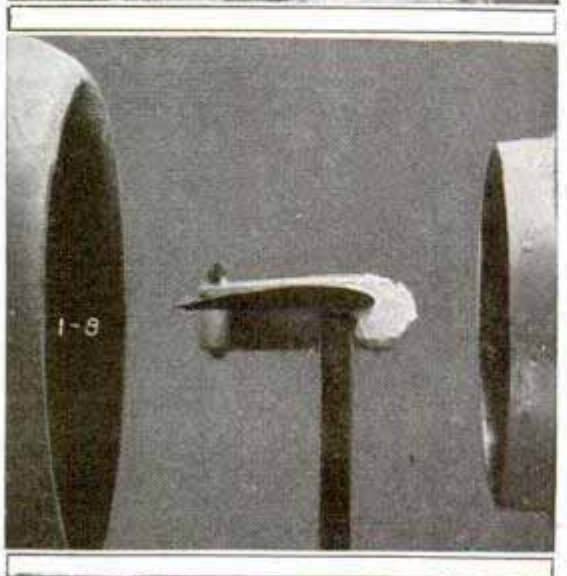

WITH only two passengers aboard, Trip 1 taxis to the end of the runway in the darkness of a wintry night. Twin motors roar, and the air liner thunders across the field, then slowly rises.

Five hundred feet up, and the pilot turns. Routine stuff, this is, to a man with 12,000 hours of flying time, years on this route.

Then something happens. A whiff of smoke, a sudden blast of heat on his leg. He glances down. Around the edges of the emergency control box cover forming part of the flooring between him and the co-pilot, tongues of flame are licking.

Snatching the fire extinguisher, the co-pilot rips up the cover. Instantly the cockpit is a roaring inferno of blazing gasoline; gasoline from a leaking cross-feed valve.

Both pilots throw up hands to protect their faces from the heat; and the plane dives for the ground. Clothing on fire, writhing in agony, the pilot grabs at the control column, pulls it back just in time to prevent a crash, climbs sharply.

Capt. Isidore U. Webb, 2406
 Washington Daily News
 1013-13 at St. N.W.
 Washington, D.C.

DETECTIVES



Above, "eyebrows" on wing edge give better control of plane. Circle, Thiokol-lined fuel tank after twenty-foot drop. The lining did not fail. Bottom, drawing is government's explanation of how pilot mistook southeast leg for the northeast leg of radio range, descended to land and crashed into mountain



Then a whiff of that flame and a dead man sits at the controls. A wing drops, and the air liner plunges into a ravine, scatters its fragments along a hundred yards, only half a mile from the airport. The wreckage is destroyed by fire, and all aboard are killed. A few years ago this would have been another mystery crash. Today, although we have no survivors to tell what went on

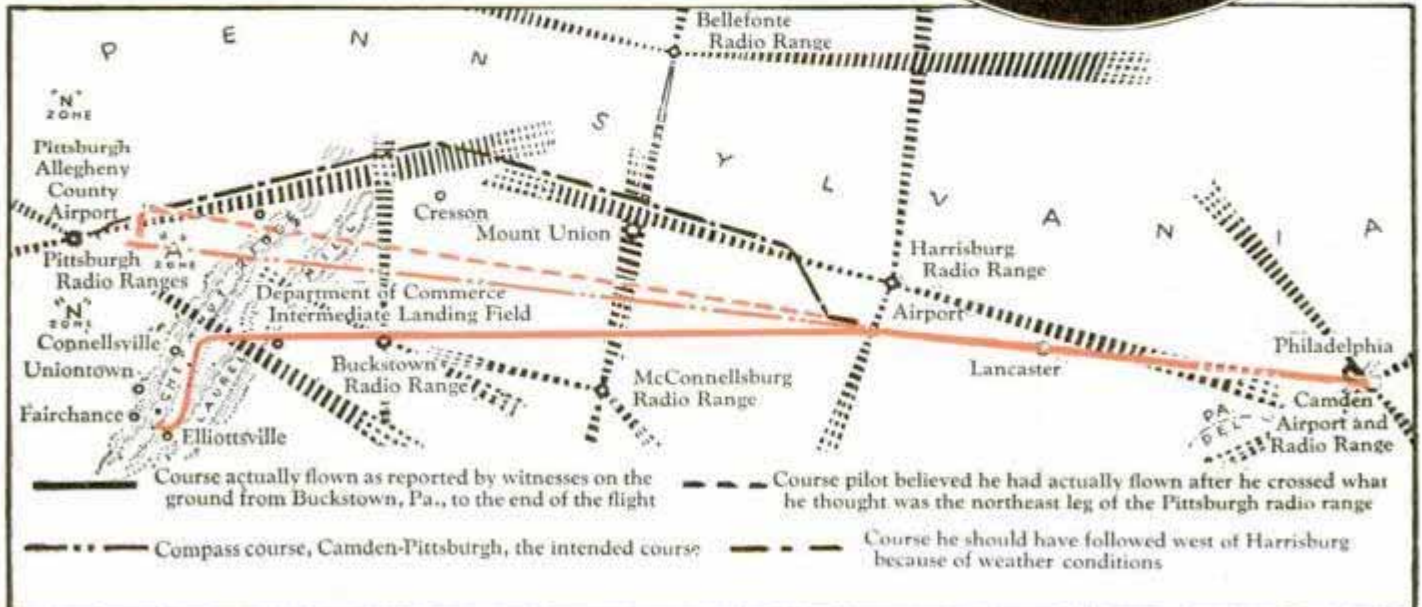

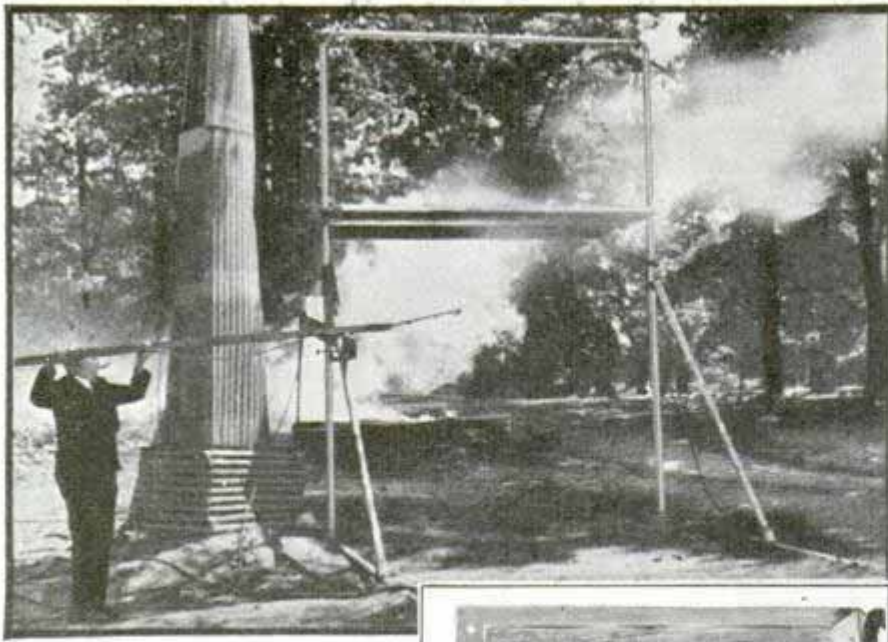

during those few desperate seconds, we know exactly what happened.

Today we have the crash detective. Officially he's an investigator for the Air Safety Board of the Civil Aeronautics Authority. His job is to run down clues, solve mysteries, save lives.

There weren't many clues when the investigators arrived at the crash scene. Delayed nearly two days by a severe storm, they found the ravine trampled by sightseers and souvenir hunters. But buried in dry grass and brush, not far from the first point of impact, the investigators found a little wooden box lid, aluminum bound and covered with rubber matting. It was the cover of the emergency control box which contained the cross-feed valve, dump-valve controls, flare releases, a key for turning the valves, and an electric light to illuminate the box. The cover was hinged on the rear, and contact of a metal strip

switched on the light when the lid was raised.

This meager clue, hurled clear of the fire area and miraculously concealed from souvenir hunters, told the whole story. A concentrated burn, directly over the cross-feed valve, showed that the fire had started here, had played upon the spot with blowtorch intensity for nearly two minutes before the cover was opened. That it was opened before impact was evident from the direction of the charring on the under side of the cover, by soot on the contact strip, and by the manner in which the hinged edge had been ripped loose. Testimony of an airport attendant as to the sudden dive and climb preceding the crash, revealed the story of the pilot's dying efforts to avert the tragedy.

Thanks to the Air Safety Board, exactly that kind of an accident can never happen again. For that type of plane was

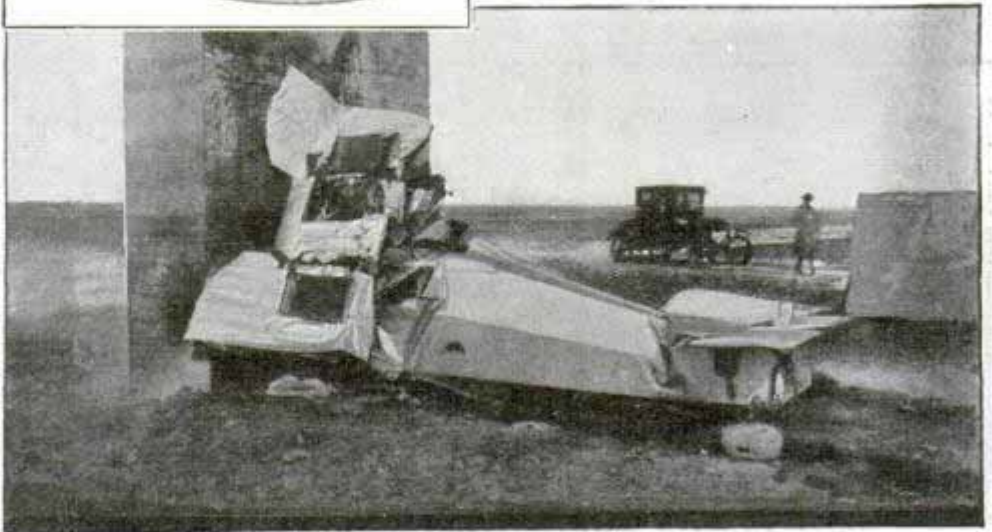
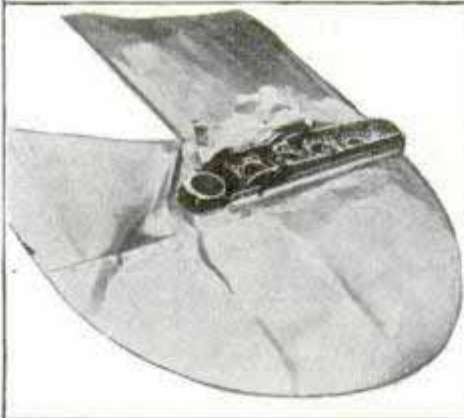

Top, test to determine fire hazard from dumping gasoline. Next, cover of emergency control box. Note deep burn in corner, which was directly over cross-feed valve where fire started in plane. Third from top, remains of tail assembly helped tell story of another crash. Bottom, 200 DH-4s were crashed before fire hazard was eliminated



immediately grounded until the cross-feed system had been relocated; and regulations were passed making it mandatory that all planes flown in the United States must be provided with drainage outside the fuselage for any gasoline leak that might occur.

All aviation accidents, no matter how trivial, are



Navy's new trainer (top) compared to vicious-spinning ship (center) on which stabilizer flush with top of fuselage blanketed rudder action in a spin. Bottom, Air Safety Board investigators searching for clues in plane wreckage

immediately investigated by the Air Safety Board, or by military and naval boards in the case of service planes. The object is not merely to place the blame, but to eliminate the causes of accidents. Accident causes are analyzed by the National Advisory Committee for Aeronautics, as a basis for the research it continually conducts. Practically every safety improvement in American aviation has been the direct result of accident investigation.

The old DH-4, "flaming coffin" of the World War and the years immediately following,

(Continued to page 144A)

Contour Meter for the Head Helps in Styling Hairdress

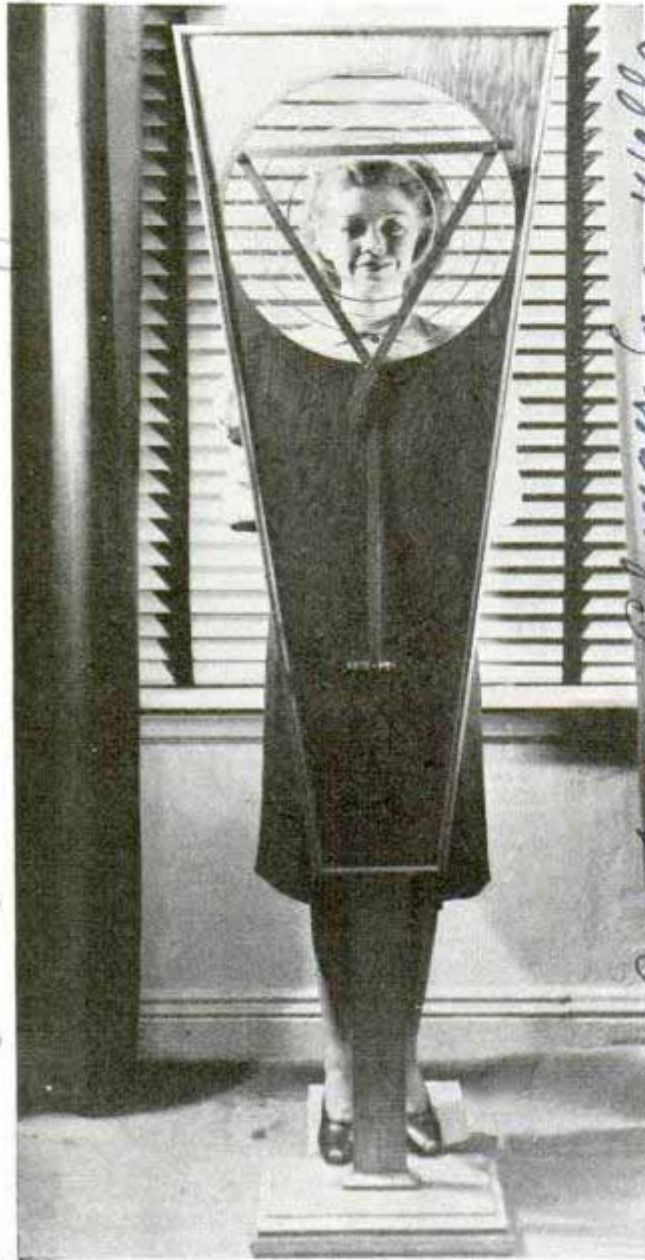

Studying contours of face behind triangle and circles, hairdresser determines most becoming "hairdo"

One New York hair stylist uses a "contour meter" to help in planning the best hairdress for his patrons. Its concentric circles and superimposed triangle enable the hairdresser to study the shape of the head and determine how the contour should be built up or narrowed by adjustment of the hair.

Cubic Inch of Newly Found Star Weighs 18,000,000 Pounds

So heavy is the newly discovered star "Wolf 457" that one cubic inch of its mat-

ter weighs nearly 18,000,000 pounds. It is one of the two "white dwarf" stars discovered by Dr. G. P. Kuiper through the new eighty-two-inch telescope of McDonald Observatory in Texas. Half a billion times as dense as water, this star's matter is too heavy to be supported by any substance on our earth and would drop through it like lead through water.

Drain Cleaner Given More Power by Enlarging Ball

Ten times the usual power is claimed for a drain force pump designed with a larger bulb to give additional pressure. By creating greater air compression against the water, and alternating with a more forceful suction, the most firmly lodged obstructions are removed easily.



Upside-Down Dripless Server Pours Sirup from Bottom

Honey and sirups are poured through a spout at the bottom of a server that seals

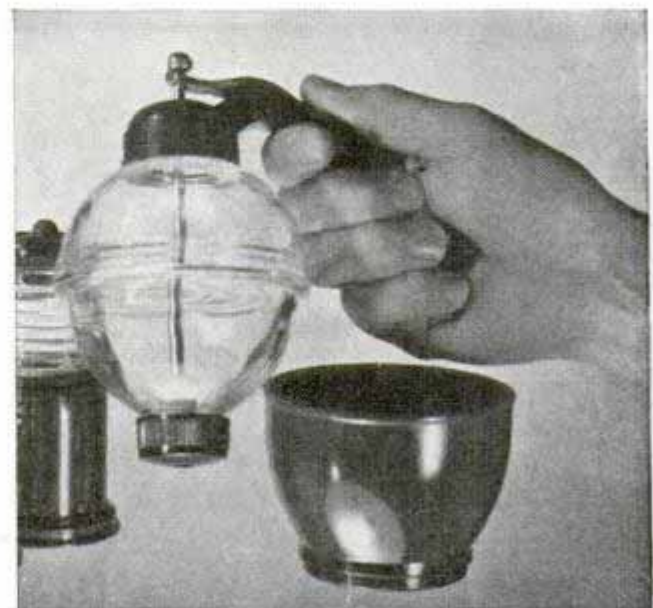

Sirup pours out base when thumb lever is pressed; dripless server rests in base when not in use

G. P. Zerbst, 507. 5th Ave. New York

Dr. G. P. Kuiper, 609 N. Wolfe

Super-Force Drain Pump Co. 620 N. Michigan, Chicago

2026

Science Service 7/12/29

Flood Dispenser Co.

and fishes, Williams Wis

740

2970

itself and prevents dripping on the table. A spring-tensioned thumb lever on the handle is pressed to lift the plunger that seals the opening in the bottom, and at the same time an air vent at the top opens to permit a free flow. When the lever is released a strong spring forces the plunger downward into the aperture, stopping the flow without the customary dripping. The unit consists of two parts, the server itself and a bowl-like base in which it rests when not in use. It is made of glass, chrome-plated metal, and molded plastic.

9783
Welded Steel Bench for Lathe Provides a Rigid Support

Streamlining is put to a practical use in a steel bench for lathe work, for its curved supports and rounded corners are designed for vibrationless, scientific bracing and elimination of sharp corners that are a hazard to the workman and form a pocket for dirt and chips. The bench is entirely metal and has welded joints, lacking any bolts or other fastenings that could come loose with vibration. Around the top is a deep rolled rim serving as chip pan and oil pan. The front is open like a desk to permit a comfortable position for the operator whether standing or sitting.



Vibrationless bench is achieved by curved supports and scientific bracing. All joints are welded

2768
Tiny Cars on Bridge Model Moved by Endless Belt

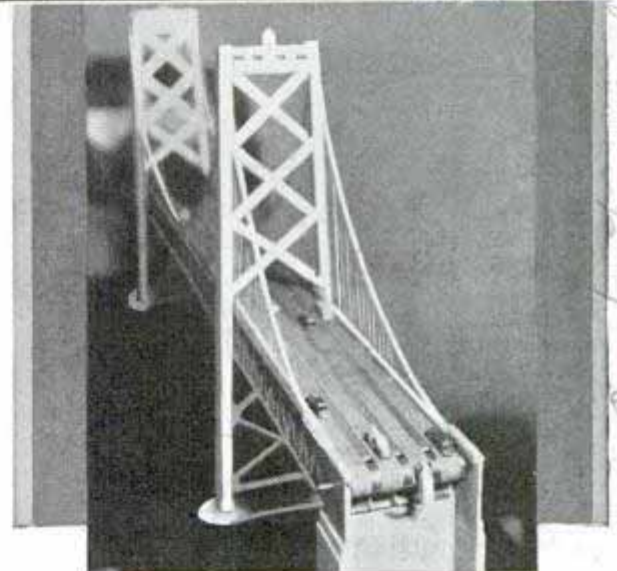
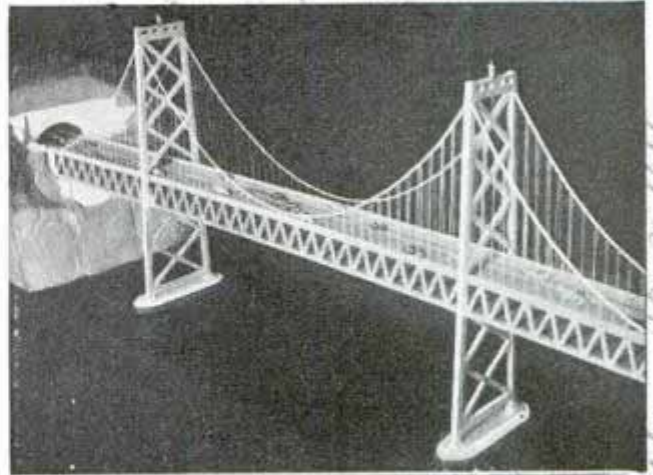

Four lanes of traffic keep in motion on five-foot model of bridge, cars being fastened to moving belts

Miniature automobiles traveling in a continuous stream along the traffic lanes add a bit of life and reality to a five-foot model of the suspension span section of the San Francisco Bay bridge recently completed by Peter Bodholt of Oakland, Calif. There are four lines of traffic, two moving one way and two the other, and to imitate actual conditions the inner high-speed lanes move faster than those on the outside. Four endless conveyor belts, each three-fourths of an inch wide, to which the midget cars are attached, cross the bridge and pass over the driving pulleys, where they are turned under and travel back between the upper and lower decks. A one-thirtieth horsepower motor from an electric adding machine furnishes the power. Round leather belts turn the pulleys which are of different diameters to give two speeds to the traffic lanes.

South Bend Lathe Works
 415 E. ...

Self-Elevating Rolling Scaffold Maneuvered by Hand Cranks

Scaffold Car

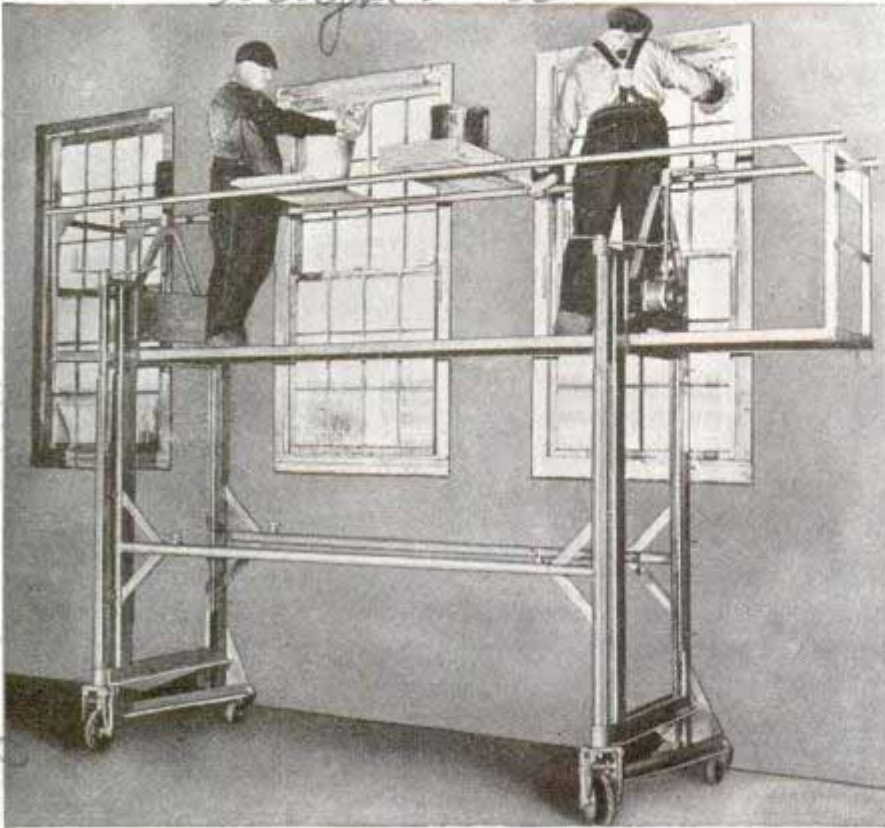

Window washers or painters can not only adjust height of scaffold and move it along floor by turning cranks, but its length is also adjustable

Operated by workmen standing on the platform, a scaffold on wheels can be raised, lowered or moved about the floor simply by turning cranks. The standard model may be lifted from eighteen and one-half inches, its lowest level, to nine and one-third feet. In addition the length is adjustable and may be varied from five to ten feet. Railing on the sides guards the workers. The apparatus will carry 1,500 pounds. It may be used for overhead work of all kinds, and occupies only sixteen square feet when collapsed.

nects with a plug on a ten-foot cord, convenient for a variety of uses on the farm, in the home and shop. A safety control disengages the plug when the water boils low, preventing damage from boiling dry. On the farm the pail is used for preparing heated foods for stock and poultry, for disinfecting jobs and for washing garments too soiled to be mixed with the family wash.

Small Electric Cutter Has a Built-In Floodlight

Easily guided by hand, a portable electric cutting tool is equipped with a light to help follow the outlines on cardboard, stencil board, paper, celluloid or cork in making designs, stencils and lettering for signs and advertisements. The small machine is operated forward, backward or side-wise over the lines which have been traced, drawn or pasted on the material. Figures from three-eighths inch to two feet in height can be cut out.

Immersion Heater in a Bucket Plugs in to Warm Water



The familiar galvanized iron pail now is making its debut as an electric water heater. At the bottom of the standard fourteen-quart pail is a 1,250-watt immersion heating element which con-

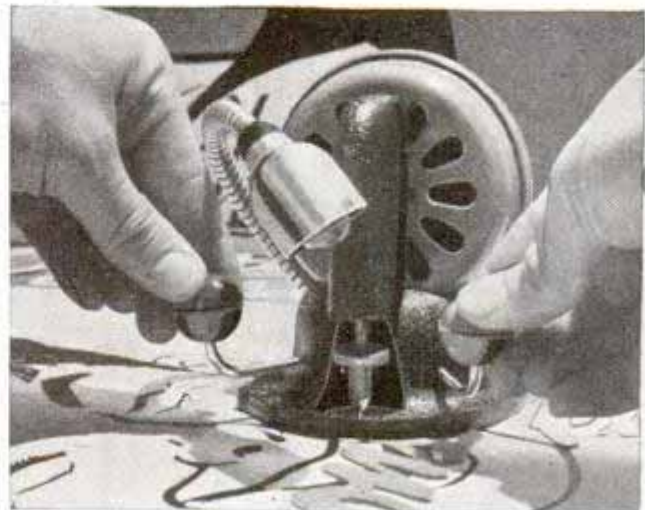

Spotlight mounted on flexible arm illuminates work while cutter is guided along pattern

Economy Pails Co., Ann Arbor, Mich.
Electromaster Co.
797
1803 G. Almond St.

785
Small Electric Cutter
Has a Built-In Floodlight
Easily guided by hand,
a portable electric cutting
tool is equipped with a
light to help follow the
outlines on cardboard,
stencil board, paper, cel-
luloid or cork in making
designs, stencils and let-
tering for signs and ad-
vertisements. The small
machine is operated for-
ward, backward or side-
wise over the lines which
have been traced, drawn
or pasted on the material.
Figures from three-
eighths inch to two feet
in height can be cut out.
C. K. Ruth Co., Peoria, Ill.

Electric

*A. W. John G. Williams
Cap street address
San Francisco, Calif*

Giant Dredge to Dig for Gold 3,000 Feet Deep

Capable of bringing up gold-bearing mud from 3,000 feet below the surface of the ocean, a 9,000-ton self-propelled dredging unit is being constructed. Devices to be used in the digger have, in recent tests, reached depths of 1,000 feet under water, hitherto unattainable. The scene of operations for gold mining as now scheduled is in the vicinity of Stephens Passage, between the mainland of Alaska and Admiralty island in the heart of the Juneau gold belt, and in the area covered by the notation "gold dust" on charts of the United States Coast and Geodetic Survey.

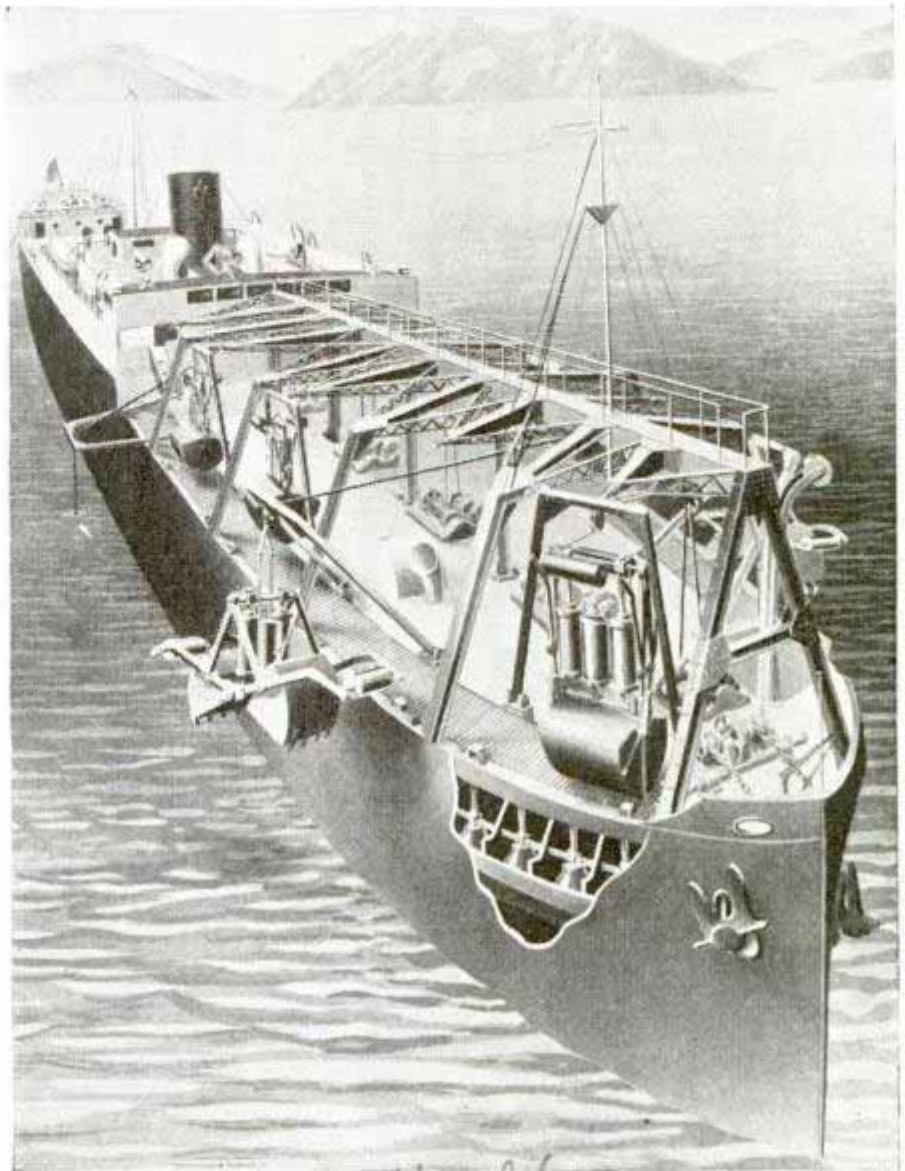

Being built for a treasure hunt in the ocean floor, the 9,000-ton dredge at right is to dig for gold 3,000 feet under the sea near Alaska. Its equipment has proven practical in tests at 1,000-foot depth

2781

Wide World

Field Gun Fires 100-Pound Shell over Fifteen-Mile Range

Most formidable field weapon of the United States army is the new mobile gun

that hurls a 100-pound shell fifteen miles. It is a 155-millimeter giant weighing fifteen tons, yet despite its size it can



Ramming home a charge for test shot that traveled 25,000 yards. This gun is the biggest field weapon of the U. S. army

developed by Army Ordnance

be moved to the strategic point of action on its ten-wheel pneumatic-tired carriage at twelve miles an hour. In a test at Ft. Bragg, N. C., the gun fired a shell about 25,000 yards and blasted a sixteen-foot hole in the ground. This was the longest shot ever fired by an American army field piece. The function of the gun is to bombard enemy ammunition dumps, communication lines and reserve forces behind the battle lines. Only the stationary coast-defense guns are larger than the field piece.

TOUCHDOWNS

was on weight and strength; today it is on speed and brains. Only the fastest, brainiest, and best-conditioned men make the California Golden Bear teams."

Football in the United States earns some \$10,000,000 a year while \$20,000,000 is invested in stadiums, gymnasiums, and equipment. Each fall about 8,000,000 spectators watch 100,000 youths play the game. A



2599
FROM the hammer-and-tongs affair of yesterday, football has developed into a scientific sport—one that requires long and weary hours of practice. Saturday's gridiron stars are as carefully trained and conditioned as Kentucky Derby entries.

"Stub" Allison, head football coach at the University of California, sums it up this way: "Twenty-five years ago the development or selection of varsity football material was largely a survival of the fittest—the toughest, the biggest and strongest men. The emphasis

Top, training kicker to get more height into punts. Bottom, target used to train the passer is a tire mounted on upright standard

Cont Andrew Hamilton, 15 59 - 2
Beverly Glen Blvd. West Los Angeles
Calif

in the MAKING

Right, player making flying tackle on a blocking bag. Below, interference knocking blocking bags out of the way so that the ball carriers may get through the "opposition line"



football player spends approximately 150 hours in practice during the fall months, but actually plays, on the average, only about 150 minutes.

Before football became one of the country's most popular sports, science had little part in the training of a team. Today, however, charging machines, pushing sleds,

tackling dummies, blocking bags, passing hoops, centering targets, motion pictures, arm and leg exercisers, and electric and water therapy treatments all aid in helping a player reach and maintain perfect physical condition.

Coach "Babe" Horrell of the University of California at Los Angeles says: "Some



coaches condition and train their players on 'live bait.' I prefer to save my men, even third and fourth stringers, from rough scrimmage. I would rather let them expend their energy against charging machines and tackling dummies where there is less chance of injury. Such mechanical devices have undeniable advantages over live bait. On a charging machine, for ex-

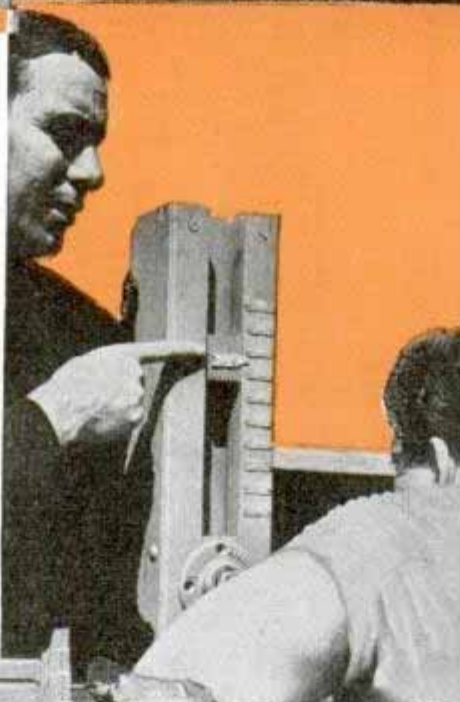

ample, a player learns to get a sustained drive that he cannot learn while charging against another player. Muscular coordination, timing and distance are better taught with mechanical aids."

Coaches are almost unanimous in voting the charging machine their most valuable piece of equipment. This is a huge device, on runners or rollers, against which seven men charge at the same time. At U. C. L. A. one of the latest models is equipped with padded arms and powerful coil springs. The number of pounds that a charging player exerts against the machine is recorded on a sliding scale. Such a machine allows a coach to observe all seven linesmen at the same time. If one end of the line is loafing on the job the machine pivots in that direction. Coaches standing on the charging machine can pick out defects and teach

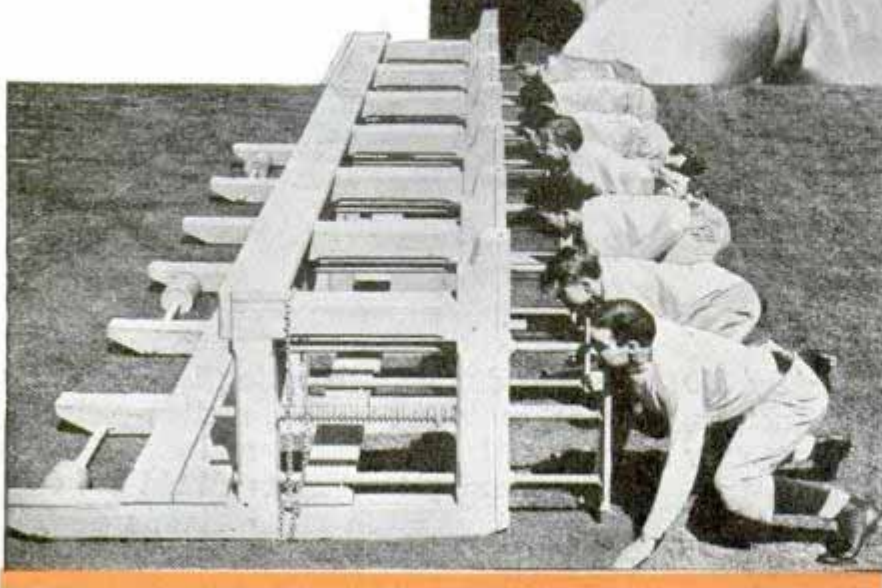

Top, charging sled reveals flaws in linesmen's play. Center, sliding scale of charging machine. Bottom, linesmen drilling with charging machine

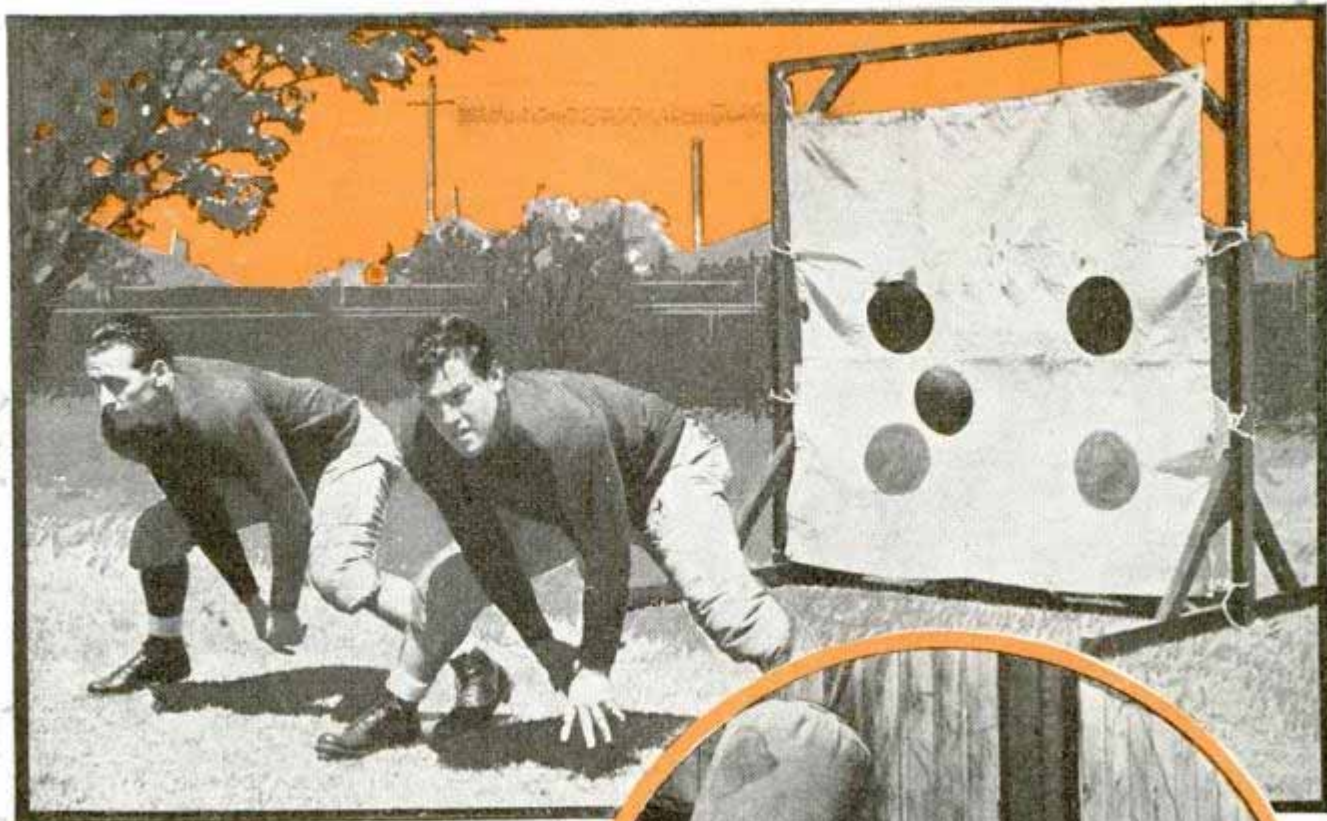

linesmen the correct charging position—back straight, eyes up, and legs under the body for greater traction.

Some universities have adopted a smaller, two-man charging machine. It is made of steel with two padded arms. Such a machine is helpful to the coach in showing up the flaws of individual players.

The charging sled is a large frame arrangement somewhat like the charging machine, but instead of players battering against a padded arm with their shoulders, they push on a high crossbar with their hands. The sled develops arm, shoulder, and back muscles and teaches the correct use of the hands on defense.

Blocking and tackling are the fundamentals of any first-rate football team. Such national-ranking outfits as Minnesota, Southern Methodist, Fordham, Pittsburgh, California, and Washington are noted for clean tackling and crisp block-

(Continued to page 124A)

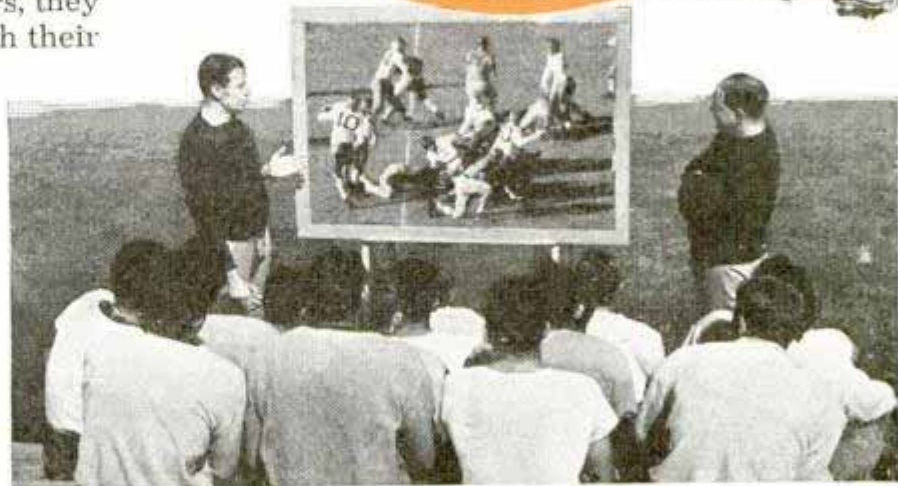
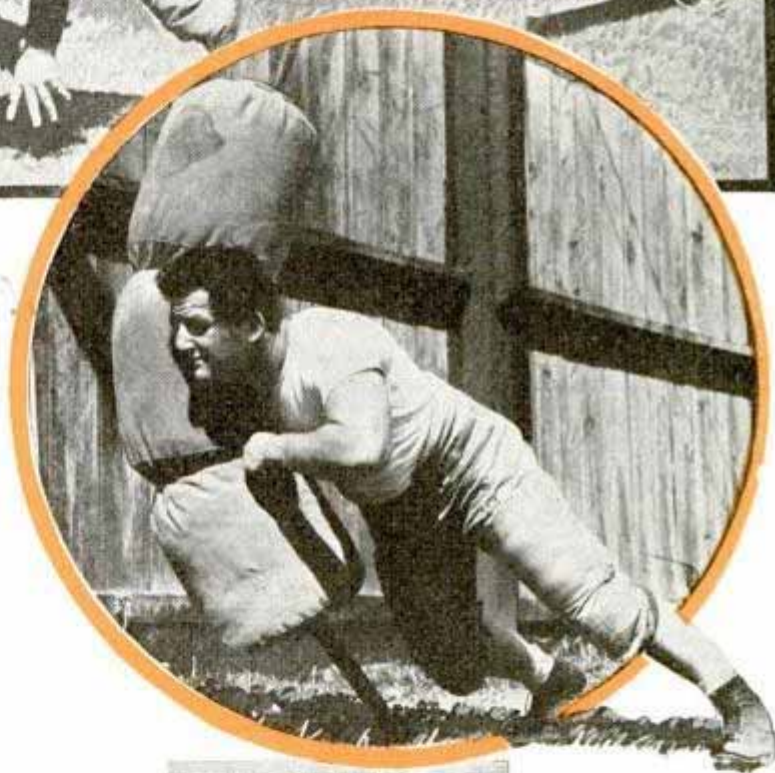

Top, centers learning accuracy by striving to pass the ball through holes in canvas. Circle, rubber-supported dummy gives "live" opposition to charging player. Bottom, motion pictures of previous games show players their mistakes

608 Isranapur

2657

Movie Fadeout Attachment Worked by Cable Release

Camera Specialty Co. Inc. 449 Broadway New York

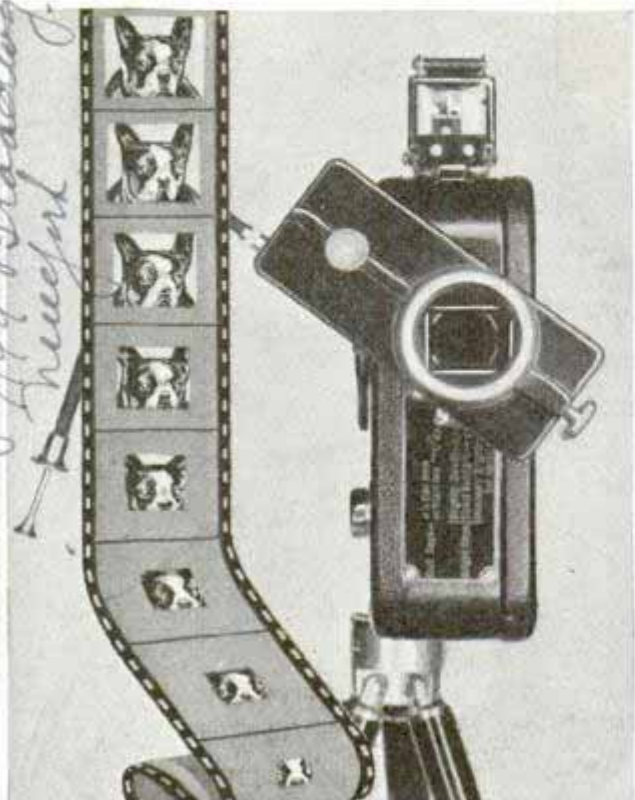

Fadeout attachment is mounted on movie camera so that it does not interfere with view finder

Amateur movie makers can produce "fadeout" effects by means of a camera attachment just made available. Made of Bakelite, it is offered in various sizes and can be mounted in several positions to avoid interfering with the view finder. By pressing the cable-release plunger a rectangular fadein or fadeout is produced.

20 784

Midget Racing Car Is Carried on a Monowheel Trailer

When the "Baby Bluebird" is not racing under its own power it can ride on its own monowheel trailer. Both the midget car

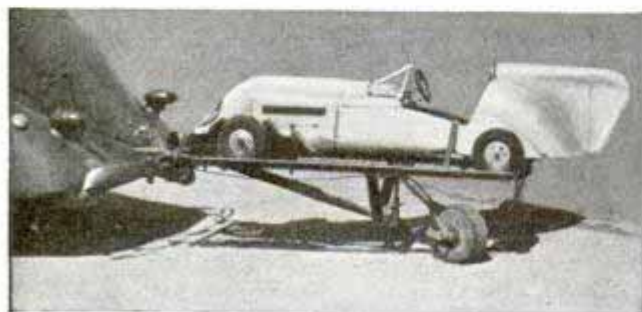

Looking like a toy, the baby racing car powered by motorcycle engine rides single-wheeled trailer

and its special trailer were built by J. H. Collier, Jr., of Oakland, Calif. The little racer is powered by a thirty-five cubic-inch motorcycle engine of 1913, and has topped thirty-two miles an hour.

2753

"Leak" Meter Detects Auto Valve in Need of Grinding

Leakage of compression through valves of an automobile engine, indicating that they need to be ground or replaced, is shown quickly by a sensitive electric meter, without removing anything except the spark plugs. Six volts from the car battery will operate the instrument, and fifty or more pounds of air pressure, which also is needed, can be obtained from the regular service-station compressor. In making a test the piston must be on compression stroke so the valves are closed. Then, with the air line attached to the instrument, air is forced into the cylinder through a rubber nozzle that is inserted in the spark-plug port. Any leakage of air through



Testing valves of automobile engine for leakage with electric meter and compressed-air line

valves, no matter how slight, is instantly picked up by the meter. To tell when a piston is on compression stroke, the spark plug is removed and a whistling signal, supplied with the meter, is put in its place. The engine is turned over until the whistle sounds under pressure of air in the cylinder. At that point the piston is entering on the compression stroke.

Black and Decker Mfg. Co. Torrington, Conn.

Five Million Volts Bombard Secrets of Atom

Ready to crack wide open the mysteries of the atom is a 5,000,000-volt machine in the observatory of Carnegie Institution of Washington. The atom smasher itself is enclosed in a steel tank resembling an inverted pear, fifty-five feet high, the lower part of the tank surrounded by a brick structure. In earlier experiments with a 1,200,000-volt generator the Institution scientists were able to measure directly in grams or ounces the attractive force between component parts of atomic nuclei which results in two atomic particles joining, under high-voltage bombardment, to form an atom of a heavier element. The new equipment will permit experiments at potentials as high as five million volts.

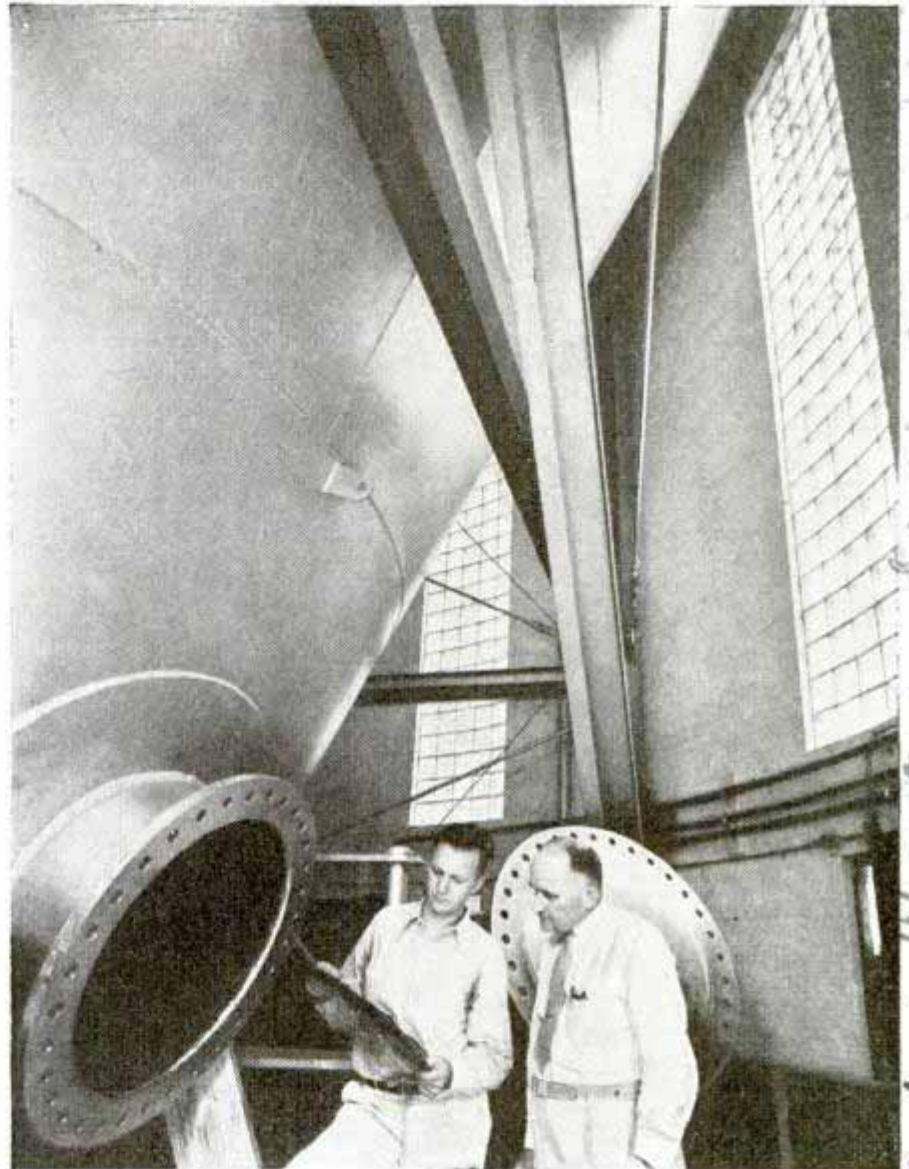

Steel tank resembling inverted pear, surrounded by brick wall, encloses Carnegie Institution's atom smasher

Emb. for United States Advertising Co. Toledo, Ohio

27-77

Periscope on Rear Window Makes It Safer to Back Car

To lessen the accident hazard in backing an automobile, a "periscope" just devel-

oped gives the driver a close-up view of the immediate rear of the car. It is attached by suction cups to the inside of the rear window, and picks up a view of the ground just back of the car on a convex mirror which reflects it to a flat mirror and thence to the rear-view mirror mounted on the windshield. Thus a glance at the rear-view mirror would prevent the motorist from backing into a pedestrian or child or locking bumpers with another car.

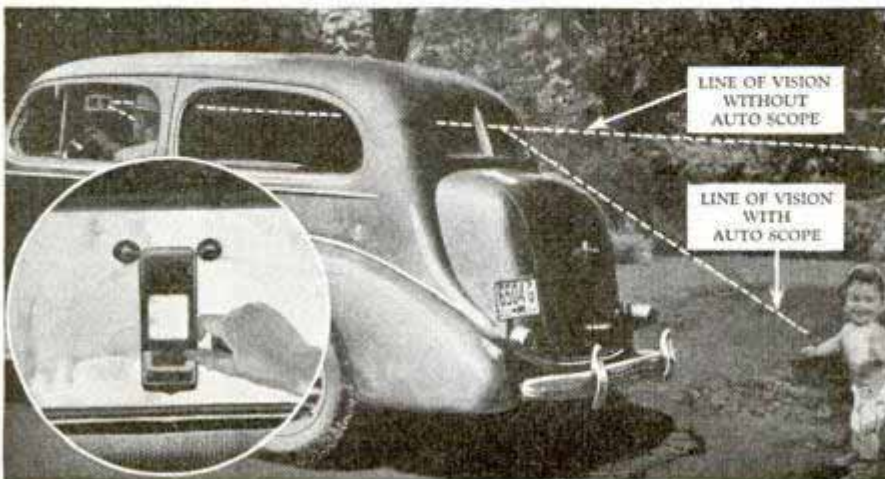

Inset shows periscope attached to rear window by suction cups. Driver watching rear-view mirror can see ground in immediate rear of car

The Autoscope Mfg. Co. Delta, Ohio

Mr. Thomas B. Stinson
10555 Holman Ave
Los Angeles, Calif

2697

Agents: Santa Fe Railway
600 Main St
Los Angeles
Calif

Ed. E. Ryder, Engineer

DIESEL LIMITED

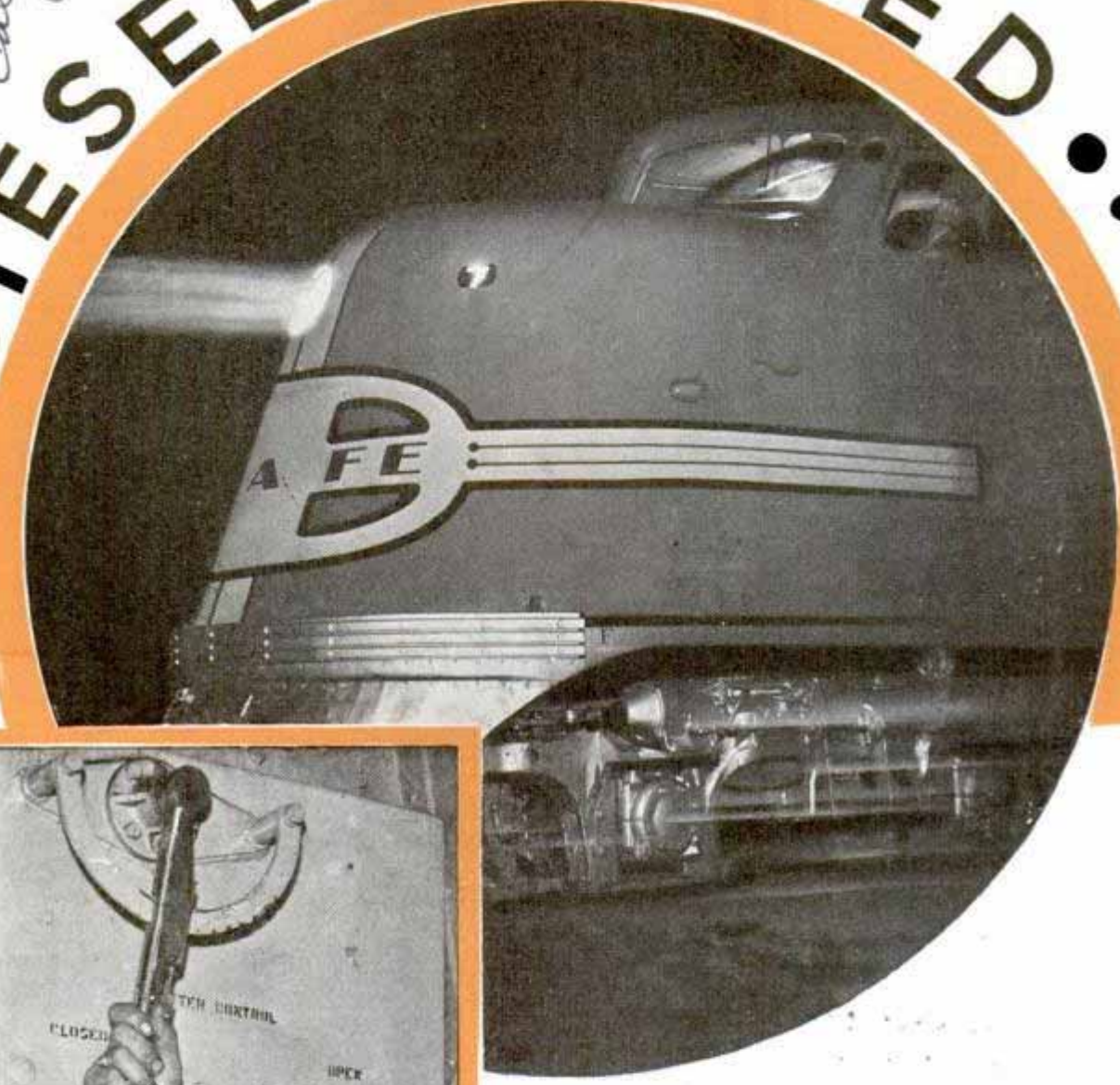

FOR a close-up look at modern high-speed railroading let's ride the cab of the "Super Chief" on part of its regular run between Los Angeles and Chicago.

It's two o'clock in the morning and the train is racing east across the California desert. In the bright light of the headlight beam the ties blur from the speed. The speedometer needle hovers steadily at just over 100 miles, yet Engineman Earl Gilbert sits relaxed at the controls.

The track ahead curves to the left and the engine swoops into the turn like a banked airplane. A steam locomotive fights a curve but the Diesel has horizontal shock absorbers that take up the pull of the rails. With its low center of gravity the streamliner can hit curves much faster.

Top, "Super Chief" races through night. Below, opening shutters that send air to Diesel radiators

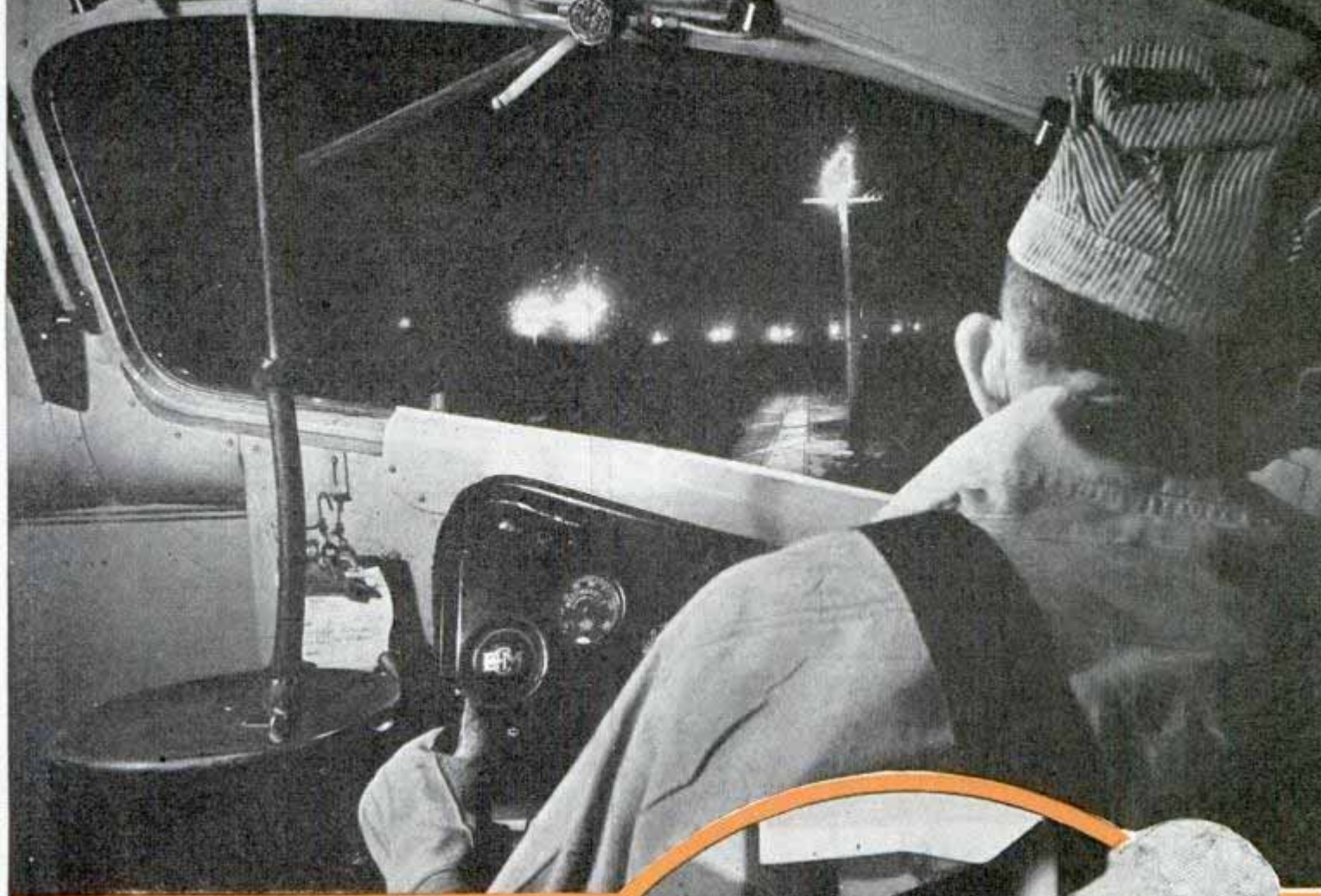

2677
Above, engineer throttles down as streamliner approaches town. Right, lifting aluminum valve covers from Diesel engine for overhaul

From the cab, full speed is merely a reading on the speedometer and a louder hum from the engines. Not until the engineman throttles down and the engine seems to crawl along at sixty miles per hour do you realize how much faster you had been going.

To an automobile driver full power means top speed, but from your seat in the cab you notice the train usually slows down when the engineman turns on more power. Paradoxically, speed picks up again when he reduces the throttle. That's because he anticipates every change of grade and speeds up the engines just as he hits a climb that may be too gradual for you to see. At the top he shuts off power and the engine coasts along; now it is going downhill and its speed increases.

There are a score or more of instruments within reach of the engineman's hands, but

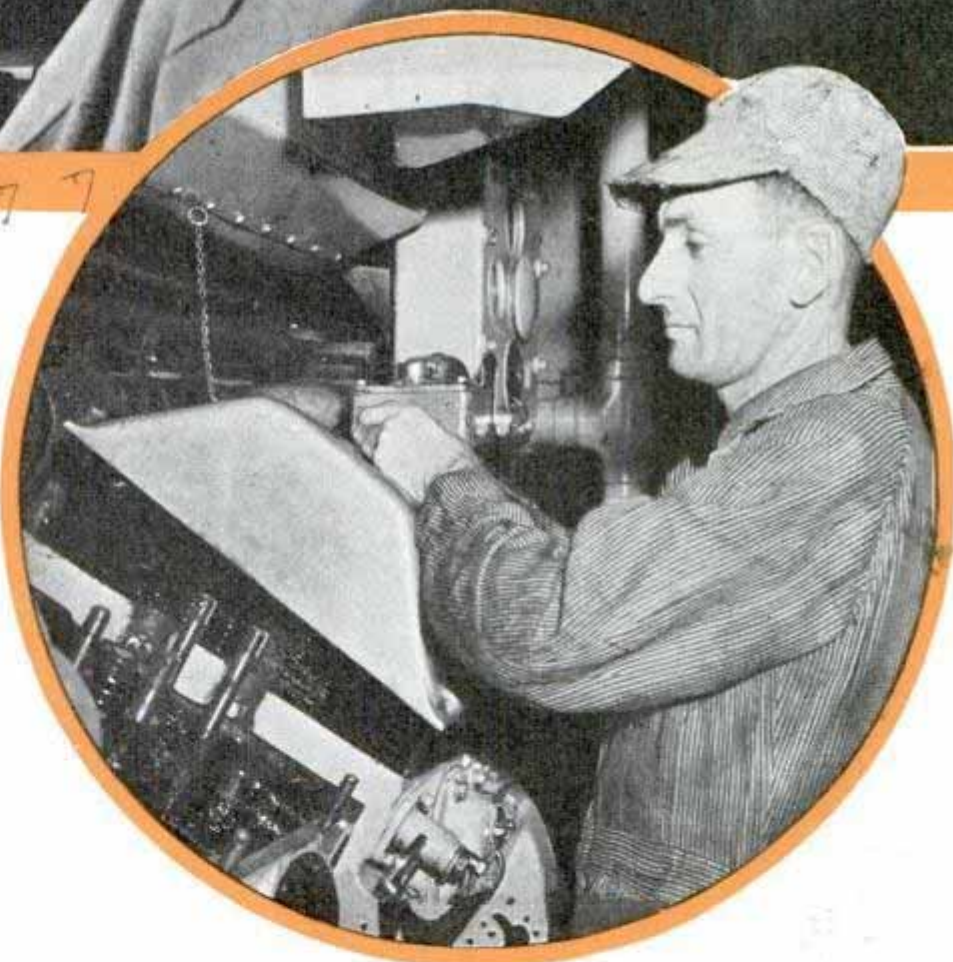

throttle and brakes are all he needs to run the train. The rest are safety devices. There is a cord to a second powerful air horn in case the standard horn fails. Colored lights wink in front of him when an engine heats up or other mechanical trouble occurs and an alarm gong rings as an additional warning. The wide windshield

2677



world. The grey-walled engine room resembles the interior of a submarine and the narrow passageways and hot oil-soaked atmosphere complete the illusion. As a matter of fact the heavy Diesels are identical, except for a few auxiliary fixtures, with those used in the navy's submersibles. You can hardly yell loud enough to make yourself heard above the roar of the power plants. Eighteen hundred horsepower is being manufactured under the gleaming valve covers and in a second power car behind us two additional twelve-cylinder engines are producing the same amount of power.

Engine speeds are held within narrow limits and have no relation to the speed of the train because the

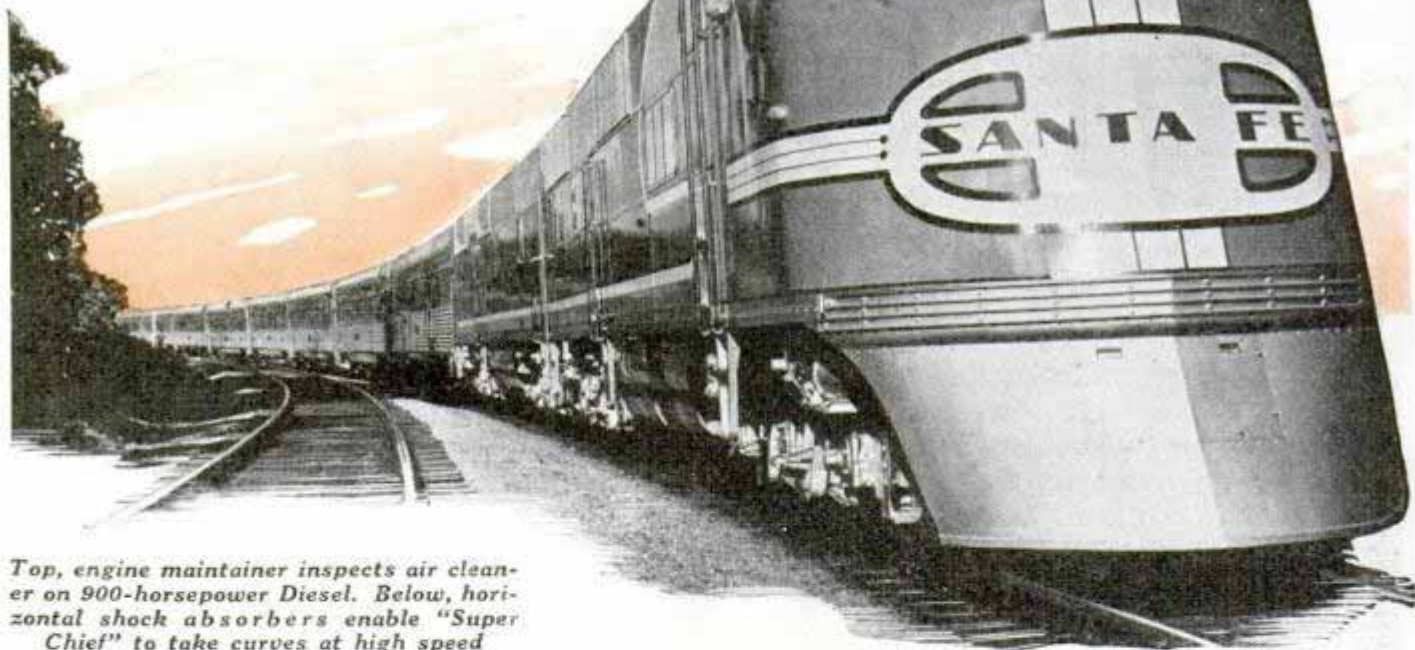

Top, engine maintainer inspects air cleaner on 900-horsepower Diesel. Below, horizontal shock absorbers enable "Super Chief" to take curves at high speed

is of safety glass, has electric windshield wipers, metal sunshades, and is equipped with hot-air defrosters. Under foot is the "deadman's control" that automatically throttles down the engines and applies brakes if the engineman removes his foot from it.

For a look at the power plant you move back through a soundproofed door and step down into a completely different

engines create more torque instead of more revolutions per minute when the engineman opens his control throttle. The throttle controls the speed of the traction motors on the wheels and these motors in turn demand more current from the dynamos when the throttle is opened. Relays operated by the dynamos then supply more fuel to the Diesels, allowing them to pull better against the heavier load, thus main-

taining dynamo speeds to keep the wheel motors pulling.

Usually the engine maintainer who keeps watch over the power plants has little to do except watch his instruments and make routine adjustments. He can repair almost any minor failure. Electrical shorts, a broken fuel line, sticking valves, and repairs to the steam boilers that furnish heat for the air-conditioning system of the train are easily attended to. Even such a major breakdown as a burned-out connecting rod rarely delays the train because the maintainer can cut the engine out, remove the faulty assembly, block off the cylinder ports, and put the engine back to work again.

The "Super Chief" is the pride of the Santa Fe system and is one of the world's fastest long-distance trains. Each trip is a race against time. It has to be, to get you

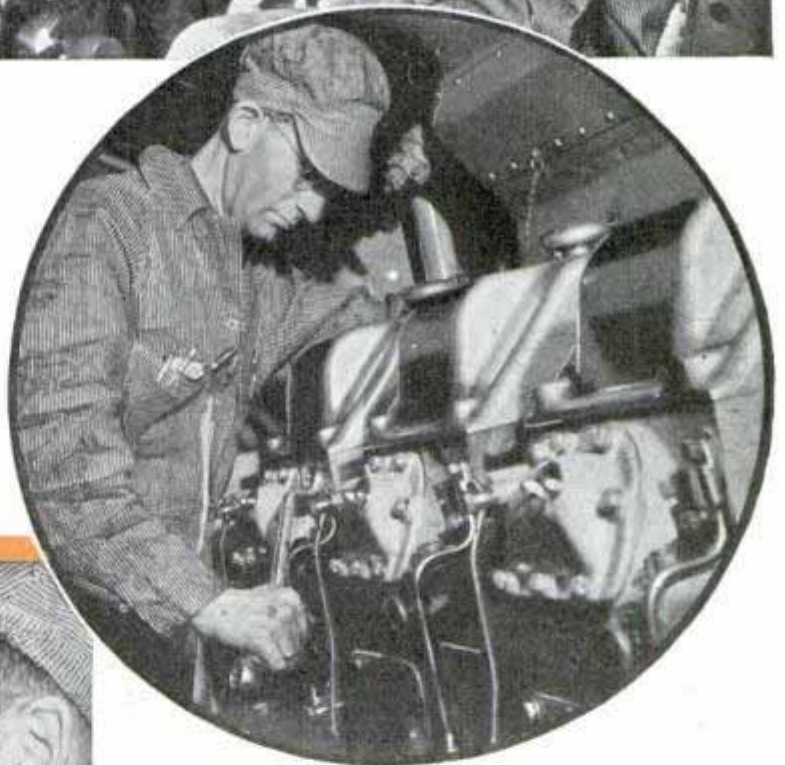

Top, engineer with hand on brake lever in sound-proofed cab. Center, making minor adjustments on one bank of twelve-cylinder Diesel. Bottom, checking engine conditions by exhaust temperatures

three-quarters of the way across the continent in a little more than a day and a half. Twelve relays of enginemen handle the controls and each is an expert at gaining part of a second on a curve, picking up additional seconds in fast acceleration when the board gives him a clear track, and in saving whole minutes at a time in the wide-open stretches. With Diesel equipment the engineman can get his train started and up to top speed in one-third the time and space that he can with steam. He can hold high speed right up to the beginning of a curve and be running wide

(Continued to page 130A)

2654

Scientific Service
7/15/39

Motorboat Like an Auto Attains 35-Mile Speeds

no further data



Two views of police patrol boat show how closely it resembles an auto

Closely resembling an automobile, a new type of motorboat was tested recently for use as a police patrol on the Thames. Powered with a nine-horsepower motor, the craft is capable of a speed of thirty-five miles per hour. In addition to looking like an auto without wheels, the craft provides motorcar comfort and protection from the weather for its occupants.

dioxide from the air and delivering it to the chlorophyll, green coloring matter of the plant. While making very delicate measurements of the carbon dioxide used by wheat seedlings, Dr. McAlister found the plants continued to breathe the gas even a short time after plunged into darkness, which was contrary to beliefs of scientists hitherto. He concluded that an intermediate chemical was playing a part, but because of its fleeting existence he doubts whether the chemical will ever be isolated. Chlorophyll enables the plant to absorb the sun's energy to manufacture from water and carbon dioxide the various hydrocarbons—cellulose, starch, etc.—used by men and animals for food and fuel and manufacturing.

2767

Self-Adjusting Rubber Clutch for Industry

Constructed with a multi-vented surface that is said to cling to steel more tightly than do con-

Mystery Chemical Holds Secret of How Plants Breathe

Discovery that it is some mysterious chemical that allows green plants to breathe carbon dioxide was made recently by Dr. E. D. McAlister, of the Smithsonian Institution. This chemical acts as a go-between, capturing a molecule of carbon

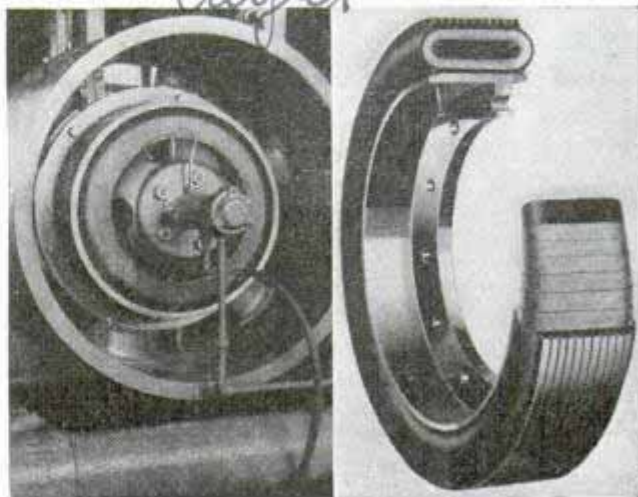

Rubber clutch (right) developed by General engineers is shown on industrial machine (left)

bio physicist 2798

Washington etc

General Electric

ventional linings, a mechanical rubber clutch has been introduced. In many industrial installations where the conventional clutch was replaced by the rubber clutch several months ago, tests indicate that the rubber clutch will last longer, as it adjusts itself to the conditions under which it must operate and suffers little wear from misalignment. The new clutch is light weight and simple, having only three or four parts, compared to seventy-five to 100 pieces in the clutches in common use. The rubber clutch is self-adjusting. It provides uniform pressure on the entire surface, because of the flexibility in application of its pressure. Given special treatment to prevent disintegration by oil fumes, the rubber clutches have been operated successfully for several months in marine engines and oil-well rigs.

Trick "Eye" on Box Camera Takes Five Shots on One Film



Trick pictures in which the same person appears five times can be made with a "magic" attachment. This consists of a set of slides which fit over a pyramidal cone placed in front of the lens. If a "quintuplet" shot is desired, the slides are moved so one-fifth of the negative is exposed while the shutter is snapped five times. The finder is marked in five sections and the subject is posed carefully in each section.

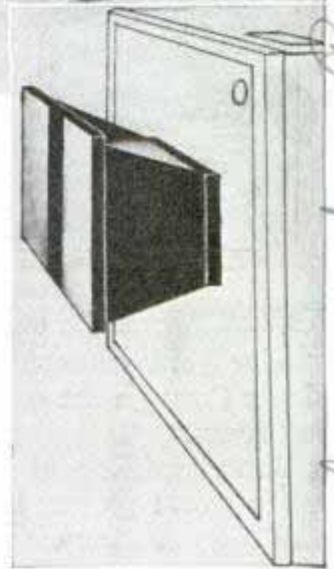

I was mfr. Philip Le Suward, News Service, I Calif.

Self-Launching Safety Lifeboat Cannot Capsize or Sink

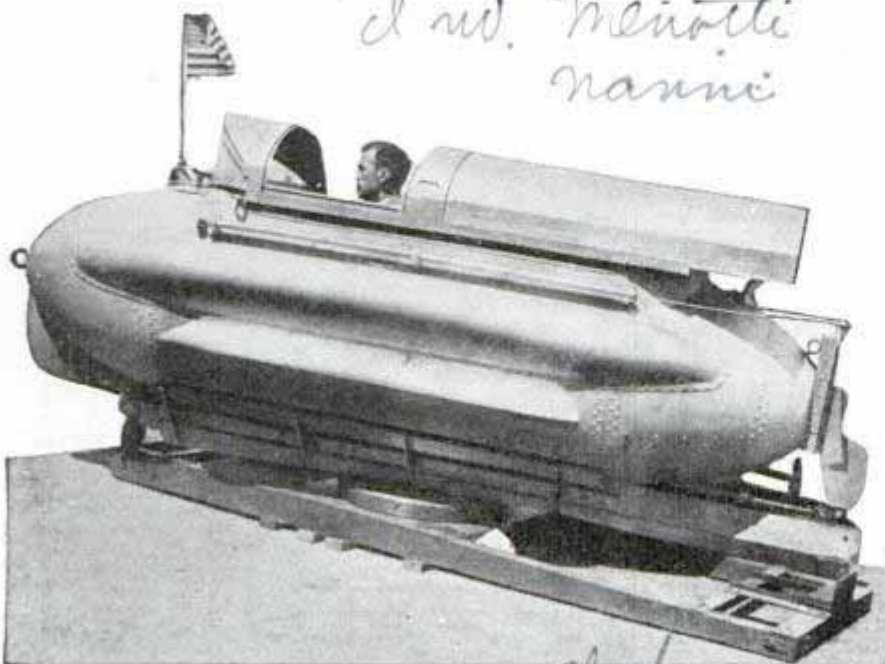

Unsinkable lifeboat with enclosed cockpit, easily launched from deck

More nearly resembling a one-man submarine or racing automobile than the conventional lifeboat, a safety lifeboat demonstrated recently is designed so any inexperienced person could launch it from the deck of a ship in distress. The "cockpit" has a sliding hood. Unsinkable and noncapsizing, the new lifeboat can be built to accommodate any number of persons.

Ⓢ Synthetic gasoline made in Japan costs three times the market price of imported gasoline.

no further information.

Scene Service. 7/19/39

*g 722
d. w. Menotti
nanni*

club.

18 15 44
Ashman/Kodak Co.
Rochester, N.Y.

SHOOTING *the*



Automobile headlights furnished the illumination for that theatrical rainy-night scene at left. The dog is a toy. A short time exposure produced the desired effect. Sunbeams slanting through window, at bottom, spotlight toys on the floor; indoor pictures like this require enough exposure to bring out shadow detail

PICK yourself a sunbeam. Set the stage for your camera in the spotlight that slants through the dancing dust of the living room.

The simplest and homeliest of subjects make great pictures if the light is right, and the amateur cameraman need not array a vast battery of artificial lights and reflectors to capture a prize. Just shoot the sun.

You can trap sunbeams in any sort of camera. All you need is the right film and the right exposure time. Sunbeams are merely light falling on tiny particles of dust or mist or smoke in the air, and when that light escapes through a small window or a break in the clouds, forming a narrow, slanting shaft, it's time for the cameraman to go to work. The darker the surroundings, the more brilliant is the sunbeam by contrast.

So hunt your picture in dark rooms and in deep woods; in railroad stations and roundhouses, in factories and narrow alleys where smoke and steam and dust cooperate with you.

Oftentimes, sunbeam pictures at home are intensified by suffusing the beam with tobacco smoke. This stratagem can be utilized in making table-top pictures. Make your own miniature artificial sun-

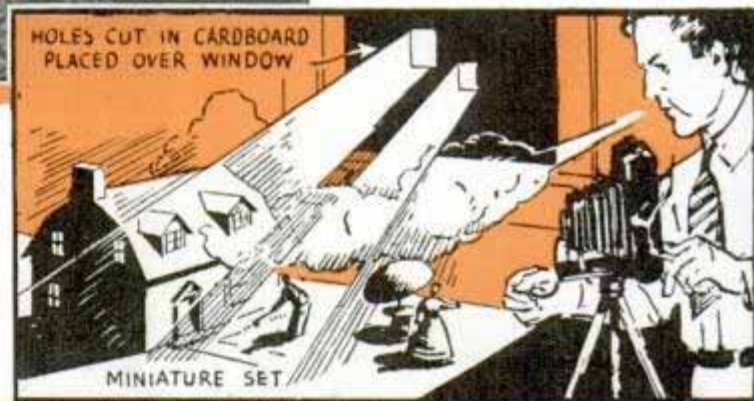

SUN



Sunburst, above, called for minimum exposure and a yellow filter to deepen blue sky tone. Proper control in developing and printing can make it appear a moonlight scene. Right, sunlight and shadow on wall make pleasing setting for child picture. Below, short exposure keeps trees dark and emphasizes sunbeams filtering down

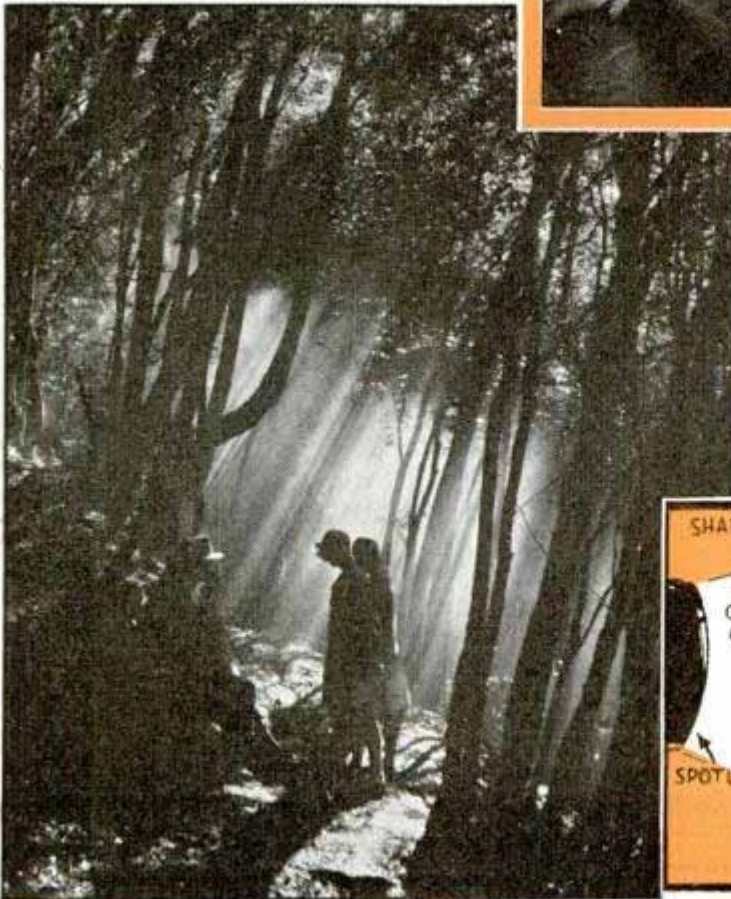
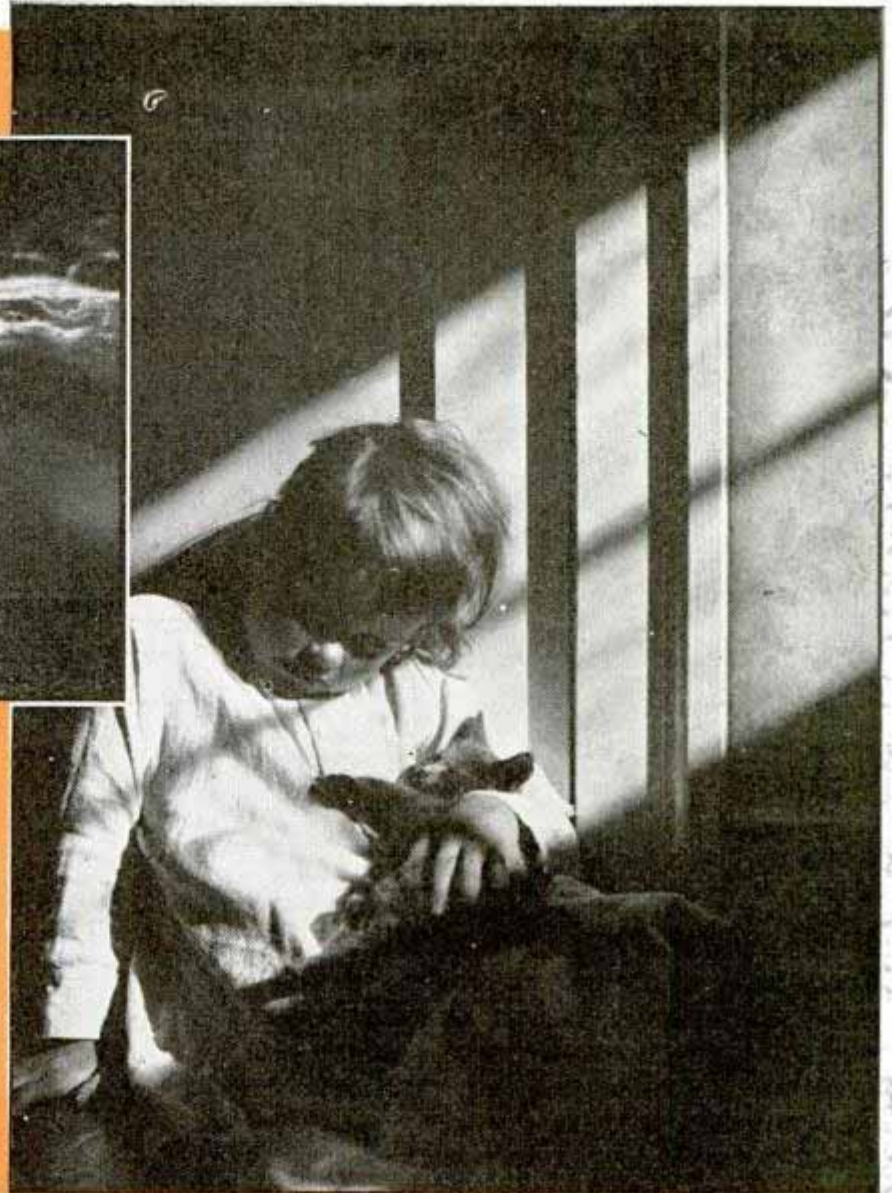

beams by shining light through a small aperture in a sheet of cardboard, and blow a puff of smoke just before you snap the shutter.

When your sunbeam scene has high contrast, as in a dark interior or deep woods, give a reasonably full exposure—not too long—but enough to record some shadow

(Continued to page 120A)



Dr. William Reimbloom,
1392 36th
New York

Sight Restored to Semiblind by Five-Lens Magnifiers



Fitting the cone-like magnifier spectacles on a patient. The lenses have extremely high power

People partly blinded by eye-nerve disease are able to see clearly with the aid of the teloptic-magnifier, a new type of spectacle lens. With a magnification of 300 per cent for distance vision, the glasses already have returned children from blind institutions to the public schools. Made up of a combination of from three to five lenses for each eye, the magnifier looks like a glass cone, but it is light enough to be fitted into an ordinary eyeglass frame. It is estimated that fifteen per cent of the 200,000 persons now classed as blind in the United States can be aided by the magnifier.

Emery Wheel on Hand Sharpener Gives a Keen Edge



Long blades like those used in paper cutters, scythes and tin-smiths' knives can be given a keen edge and a uniform bevel with a hand-operated sharpener equipped with an

emery wheel. As the tool is drawn along the blade, the grinder rotates automatically to speed the sharpening action. Being adjustable, the unit will fit most blades, and two handles provide a firm grip.

Home Plate Dusted by Air Blast to Relieve Baseball Umpire

Baseball umpires will be relieved of the duty of sweeping off the home plate periodically during a game if an automatic duster, operated by compressed air, is put into general use. At a ball park in Wichita, Kan., the idea is being tried out. A small cylinder installed in the plate is raised by an air pressure of 150 pounds, and air forced out through holes in the cylinder blows off the dust, leaving the home plate clean and visible. When pressure is released the cylinder drops back out of sight.



Compressed-air cylinder installed in home plate blows dust away and then sinks out of sight in the base

Introduced by American Academy of Optometry, held at 100 A. S. Co. St. N. Y.

9780

Swigart Knifesharper

Mr. Lumont, Pres. Baseball Congress, Wichita, Kansas
National Semi-Pro

8933

Lifesaving Craft Empties Itself of Water

no further information

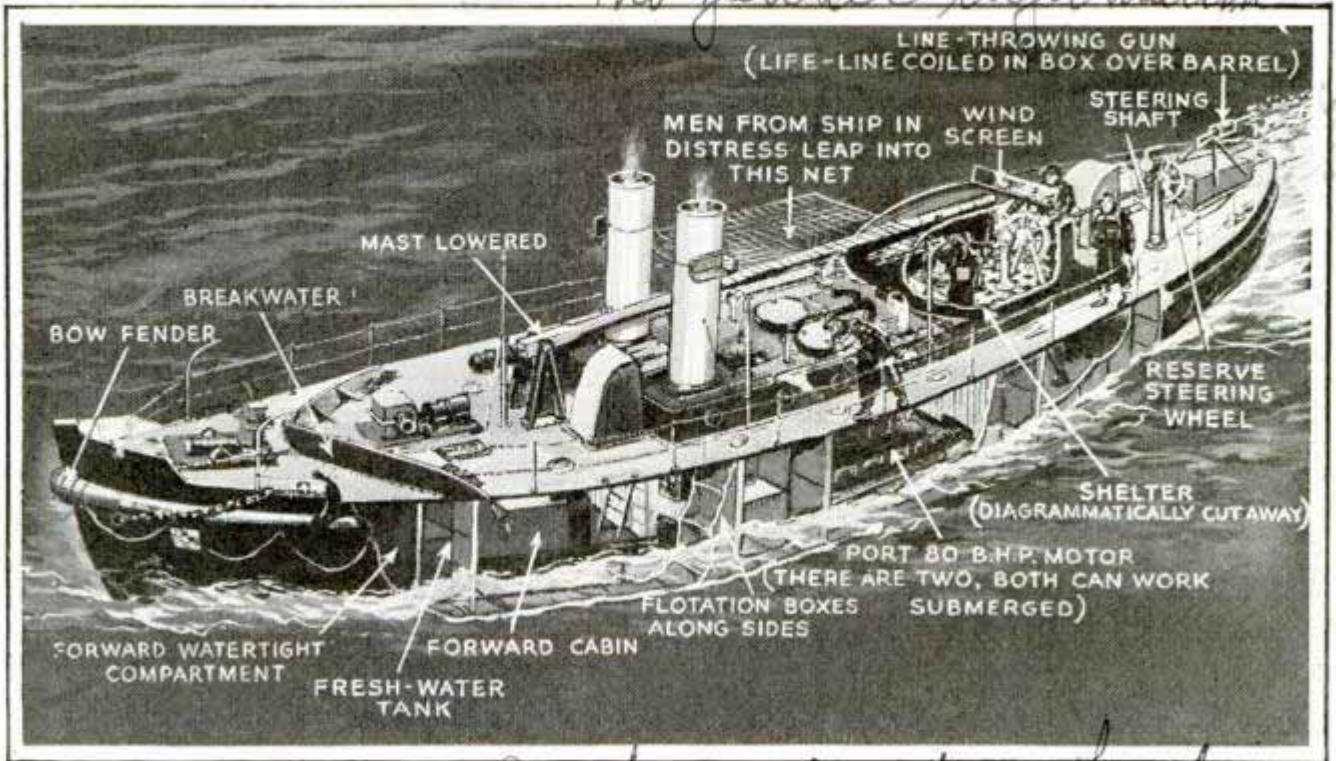

Diagrammatic sketch of latest British lifesaving craft shows such features as watertight compartments, life net, line-throwing gun and mast which can be raised or lowered when necessary

modern wonder, London

Powered by two eighty-horsepower engines arranged so they continue to operate even when the compartment becomes partly filled with water, a British lifesaving boat has a self-emptying system. The floor of the boat, which is above the water line, has a number of large holes, at the upper end of which are fitted valves that allow the

water to drain out, but not to enter. The boat is manned by a crew of eight. Its lifesaving equipment includes a net, stretched above deck, into which persons may leap from distressed ships. There is also a line-throwing gun and a mast that can be raised or lowered. Air chambers in the sixty-one foot craft give it more buoyancy.

Wooden Hay Rake on Farmer's Sedan Gathers the Crop

8760

When it's threshing time in Kentucky, a farmer near Franklin puts the "cowcatcher" rake on the front bumper of his automobile and gathers his crop in comfort. The improvised wooden rake slides easily along, holding as much as a wagon-load as the farmer drives up and down the windrows. A quick shift into reverse dumps the load.



Kentucky farmer gathers hay on wooden "cowcatcher" rake and dumps it by backing the car quickly. It is attached to the front bumper

Paul's Photo

Cont. James Mc Sweeney. 431 W 60th St
New York, Kansas City, Mo 64111

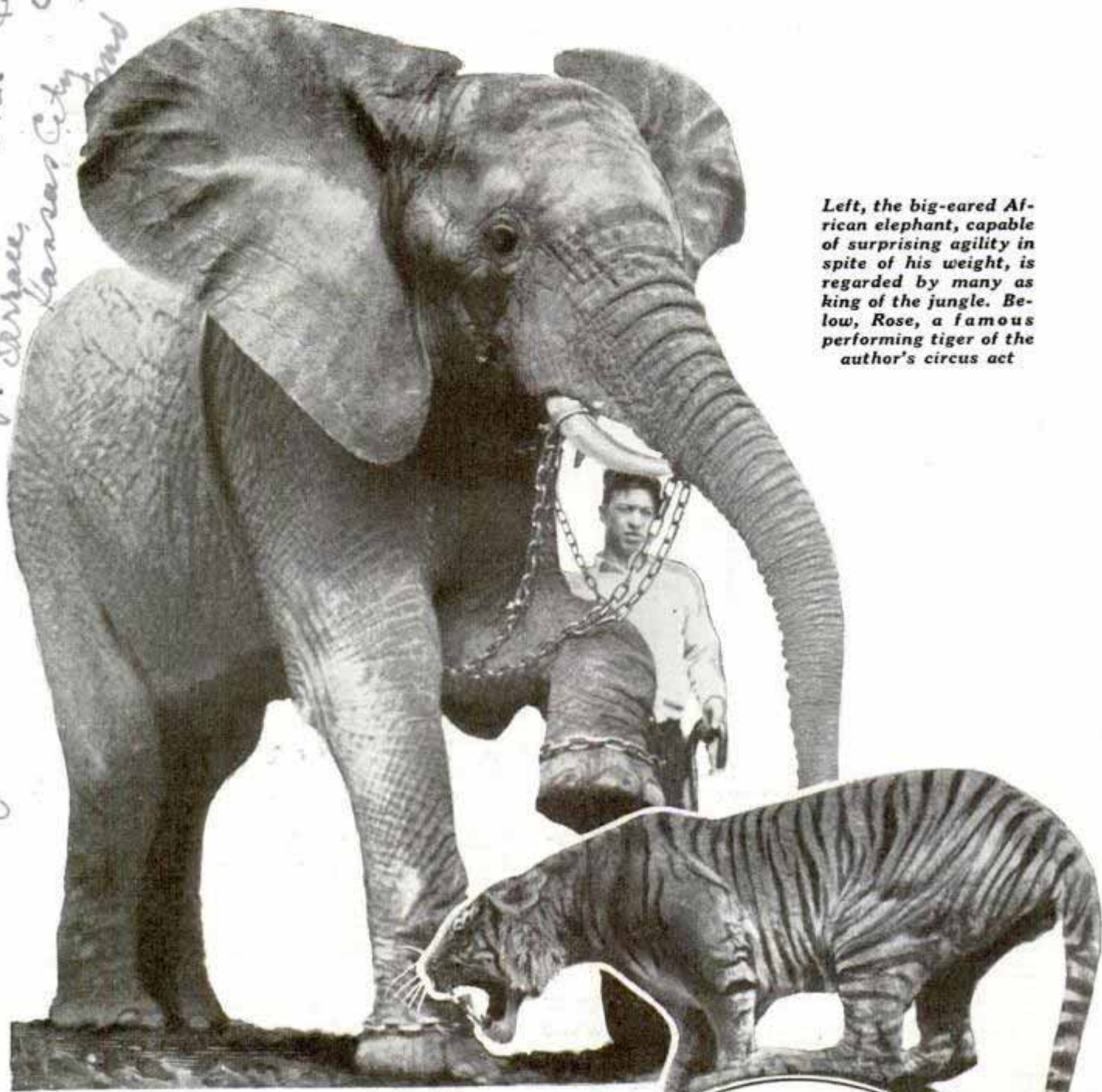

Left, the big-eared African elephant, capable of surprising agility in spite of his weight, is regarded by many as king of the jungle. Below, Rose, a famous performing tiger of the author's circus act

Which IS *the* KING of BEASTS ?

By Clyde Beatty

NATURAL history books call the lion King of Beasts—but is he? Or does the title rightfully belong to the tiger, the elephant, the African buffalo, the gorilla, or some other jungle terror?

In my attempt to answer the question I'm going to draw on my own experience, covering sixteen years in the big cage, and the ideas gathered from other animal men, zoologists, and authorities who have stalked the jungle with rifle and camera.

A logical starting point is the question that's been asked me ever since I first set foot in the steel arena: Can a tiger lick a lion? No, in nine cases out of ten, I think a full-grown lion could whip a full-grown tiger. Study the fighting equipment of the two and you'll be inclined to agree.

A tiger is razzle-dazzle, hopping in with teeth and all four feet. He'll bite and lash at an opponent with blue-flame fury, but unless he happens to strike a vulnerable spot, no great damage is likely to be done. His handicap in weight is offset by his speed, but once checkmated, he's apt to assume a defensive style.

Not so with the lion who fights like a dog with only his front paws and teeth. He carries the fight to his opponent, centering the attack on the tiger's throat while his heavy mane protects his own throat. And with his extra weight in the forequarters, he can "take it" better than a tiger.

When it comes to a brawl, lions are no gentlemen.

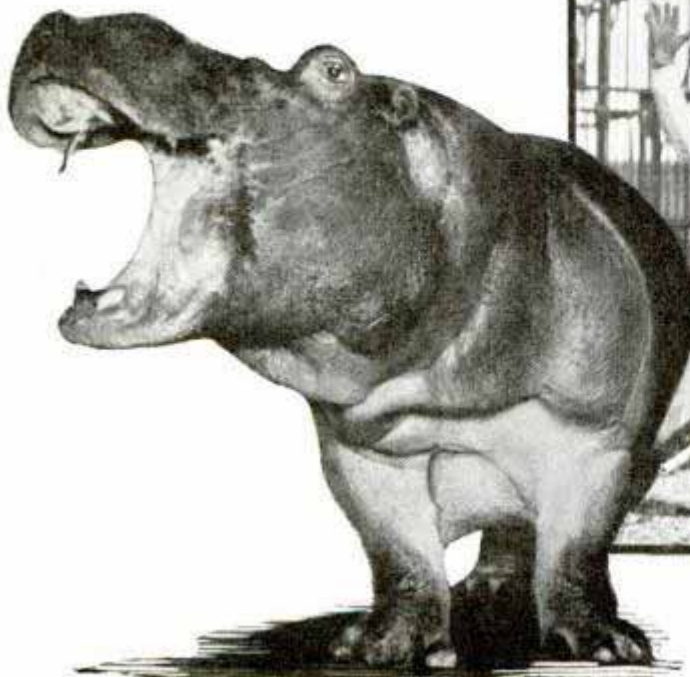
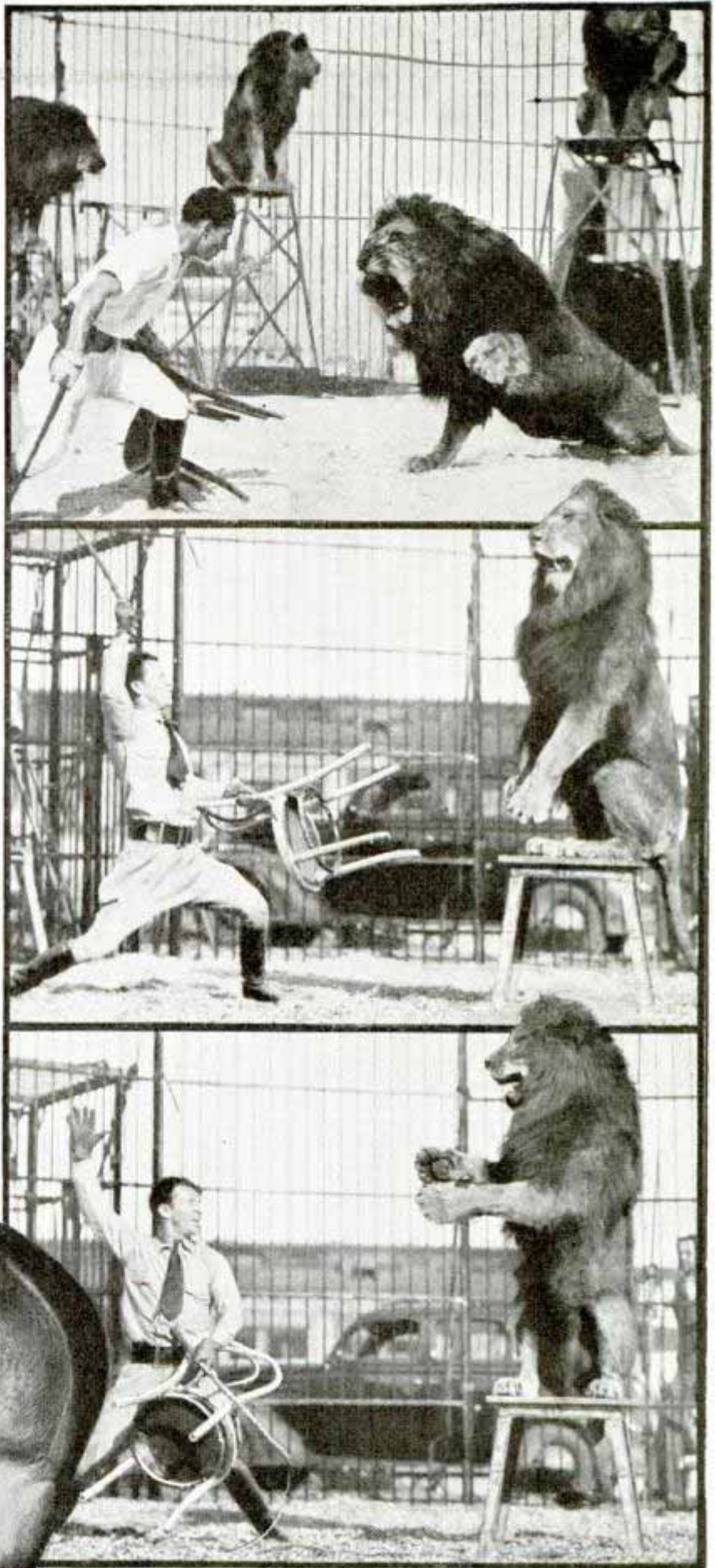

Left, the hippo can throw his 8,000 pounds around with amazing speed when he's aroused. Above, top to bottom, the author putting a lion through a performance. The photo at top shows the lion apparently in a state of rebellion

Menelick



Above, the gorilla whose fighting ability is not as great as his ugly appearance would indicate. Right, Beatty believes a lion can conquer a tiger under most conditions. Below, the author putting Mene-lick through his famous praying act



They have no compunctions about gang-
ing up on an enemy and I have seen as
many as six or seven doing battle with a
single tiger. If a striped cat, on the other
hand, gets himself involved in a squabble,

the others rarely, if ever, raise a paw
in his behalf.

Since I first began mixing the two
species, twenty-five tigers have been
killed in the circus arena wars but
there hasn't been a single lion casual-
ty. However, only two victims were
Siberian tigers, the others Bengals.
The tiger toll might not be so great
had Siberians, which are bigger, and,
I think, stronger, figured in all fights.

In my opinion, the big-eared Afri-
can elephant is the lord of the jungle.
For all his bulk—a museum in Cape
Town has a specimen measuring twelve
feet two inches, which weighs
between seven and eight tons—the
pachyderm has the odd gift of being

light on his feet. A dog cannot lie
down and regain his feet with less
trouble than an elephant. He can
stand on his back feet, on his front
ones—and on his head.

Being unpredictable, the African
elephant has been virtually exiled
from circuses but a joust an escaped
tiger had with one a few years ago is
worthy of mention. No sooner had
the tiger gained his freedom than he
espied the elephant. There is a mutual
hate between the two so the tiger made
a flying leap for the other's trunk.
The elephant shook the cat off only to
have the latter circle around and bite
him in the hind leg. Finally, with a
terrific kick, the tiger was sent sprawling.
While picking himself up he saw a baby
camel standing beside its mother and he
lost interest in the elephant. Without de-
lay, he killed both camels.

Barney, a dwarf elephant, scored several victories over lions when matched with them in the feature attraction of a Mexican circus.

In ranking jungle fighters, the African buffalo should not be overlooked. A cruel temperament, a set of wicked horns, a concrete forehead, and four sharp hoofs comprise his tools of torture. Big game hunters have told me how a lion, after lying in ambush until a buffalo comes to his watering hole, will catch him unawares by jumping him from behind. Buffalos discourage this practice by shaking the cats from their backs and killing them with their horns.

With his double-horned snout, the rhinoceros has dealt out plenty of misery to the jungle trouble-makers, but his faulty eyesight keeps him out of the championship class. A gorilla has plenty of heft in the chest and arms and a high degree of intelligence—great assets for any scrapper—but the late Martin Johnson, who spent considerable time in Africa studying their habits, was of the opinion, that as a fighter, the gorilla was greatly over-rated.

The hippopotamus is a better battler than his sloppy, good na-

(Continued to page 119A)

Ceiling Fan Blows Air Upward for Good Circulation

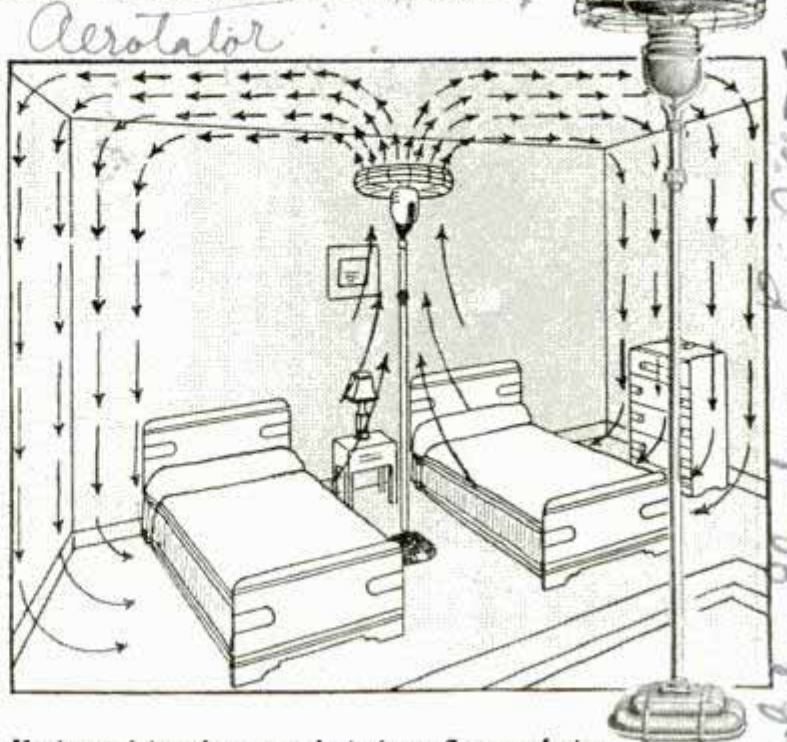

Horizontal fan draws cool air from floor and circulates it through room without perceptible draft

Air circulation without uncomfortable drafts is provided by a horizontal fan that drives the air toward the ceiling. A pedestal fan or ceiling fixture accomplishes the same object, creating a gentle and uniform airflow upward to the ceiling, outward to the walls and then down to the floor. The moving air is cooling in the summer, and in winter it helps eliminate cold floors and keeps the ceiling heat circulating through the room.

Hospital Hides from Raiding Planes under Camouflage

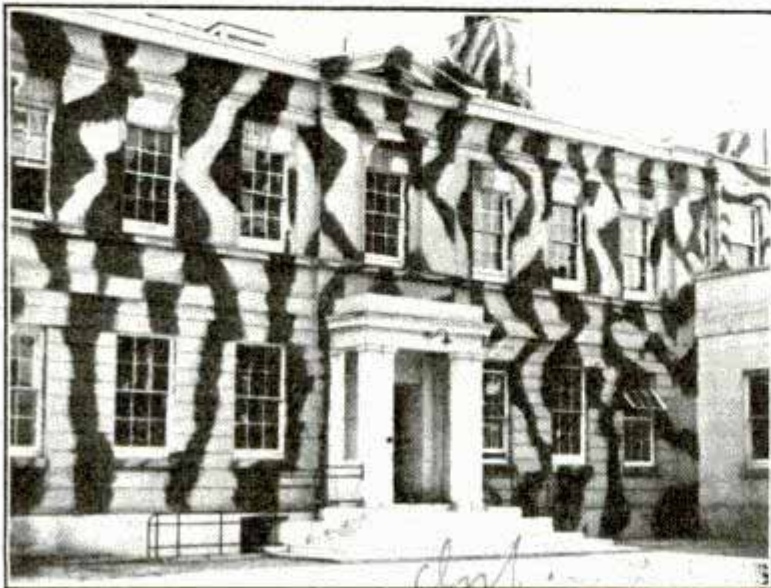

English hospital camouflaged to evade eyes of enemy planes

Formerly a conspicuous landmark and an excellent target for enemy bombing planes, a hospital at Barnet, England, has been repainted in wavy stripes of buff and green to blend with the surrounding countryside, making the building almost invisible from the air. This is part of England's defense preparations in the event of war.

Names and addresses of manufacturers and dealers in articles described in this magazine will be furnished by our Bureau of Information upon request accompanied by stamped envelope.

Day's... Electric Co. 2650 W. Congress - Chicago

Sprinkler 'Walks' on Lawn Using Hose as Track

\$29.50 \$49.50 \$69.50

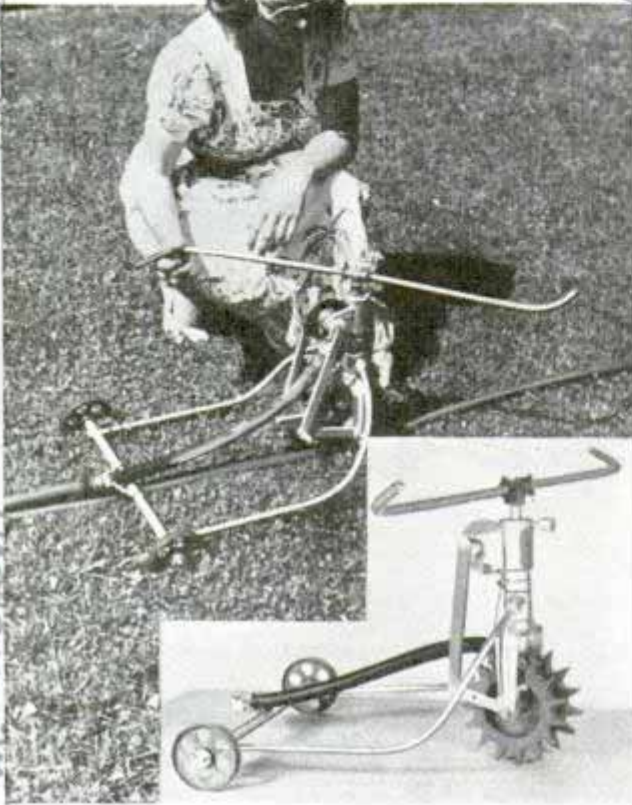

Lawn sprinkler travels about using hose as track. Note spiked wheel, in inset, that grips ground

Literally walking by itself, a sprinkler mounted on spiked wheels moves over any course outlined by the garden hose. You simply lay out the hose, place the sprinkler properly, turn on the water, and let it run until the route is covered. The machine will crawl around trees and shrubs, and pull fifty to 100 feet of hose behind it. A pair of spiked wheels in front form a groove to slide over the hose and serve as a guide. Rotation of the sprinkler is so geared with the walking wheel that the speed of advancement may be varied.

Cure for "Rail Cancer" Found in Slower Cooling of Steel

Science has found a cure for "rail cancer," those hidden fissures in steel that have caused many a broken rail and consequent train wreck in the past. The problem had baffled railroad men for years. In 1937 there were 18,000 bad rails replaced on American lines. Deep in the rail, never

noticeable on the surface, could be found tiny "shatter cracks" that under certain conditions would spread until the rail was nearly severed. In a test laboratory at the University of Illinois a loaded car was run millions of times over rails until it was discovered that only loads of 40,000 pounds or more, frequently repeated, would cause rail "cancer." However, this was a greater load than encountered in actual traffic, and further tests showed that the 40,000-pound blow could be struck if the wheel was off balance or flat, or the track was not uniform. Then a Canadian metallurgist found that by slowing down the cooling rate of steel rail, cancer could be prevented. Rails cooled in the new way were tested at the university and not one developed a fissure under laboratory pounding. The increase in manufacturing cost is only two per cent.

Boiler Built Like a Percolator Generates Steam Quickly

Steam has been generated in less than ten minutes from a cold start by a "percolator" boiler just put on the market. Oil-fired, it works like a coffee percolator; a hollow central tube runs from bottom to top of the boiler. As the hot combustion gases weave back and forth on their way

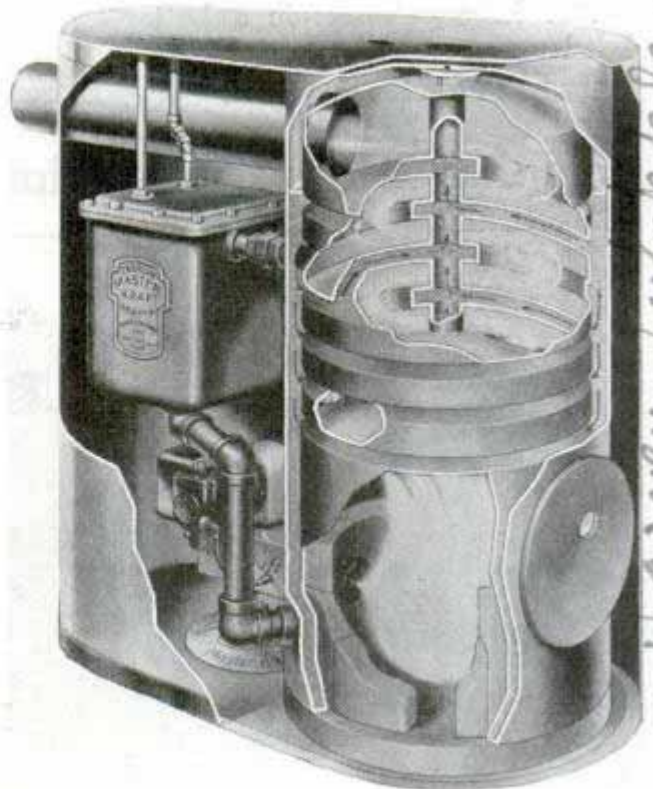

Cutaway drawing shows how water rises in central tube as it heats, bursting into steam as it hits top

Automotive Sprinkler Co. "Rorch Platte" Frank W. Owen

Urbane

Harvey. Wemple, Inc. Springfield Mass

Chicago Tribune 7/15/39

to the chimney they heat several thin layers of water in "crowned" sections, and as the water heats it rises, enters the central tube and shoots upward. Emerging from the top of the tube the water strikes a baffle like the glass dome of the percolator; this forces the water out sideways and it turns almost instantly into steam as it encounters the surrounding dry, hot steel surface.

2641
**Swinging Wrench Handle
 Loosens Tightest Bolts**

Tight bolts difficult to remove without injuring them, can be loosened with a wrench that delivers a sharp blow without the



Dotted line shows how handle of wrench is swung to deliver blow to stubborn nut

use of a hammer. In operation the center of the wrench shaft locks over the nut, and a pounding action is obtained by swinging the handle half way until it strikes raised lugs, thus carrying the force of the impact through the tool. Weighing about seventeen pounds, it is claimed the wrench makes it possible to unscrew even the tight bolts on dual wheels.

Jari Products
 Inc. 2948 Pleasant

Director, Radiation Laboratory
**Atom Smashers Aim Big Gun
 with a Ten-Million-Volt Beam**

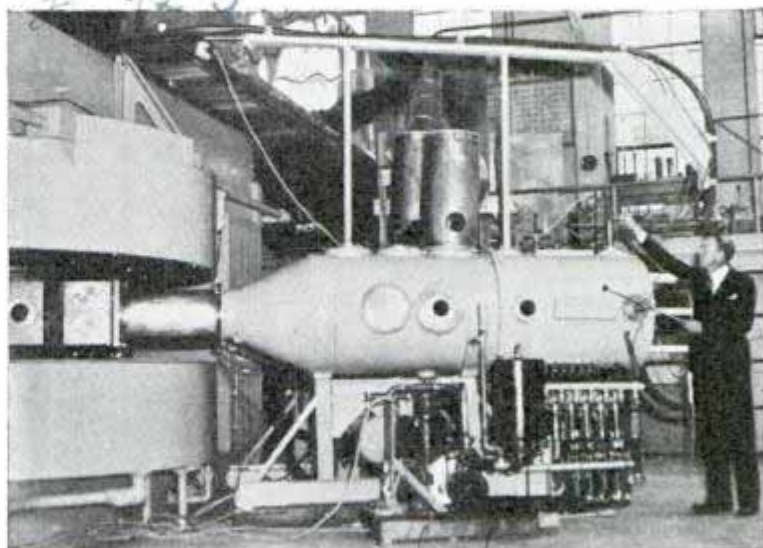

Alchemist's dream come true is this powerful cyclotron whose 10,000,000-volt beam can change one metal into another

Scientists are bringing bigger and bigger guns into play in their efforts to break down the atom and transmute old metals into new. At the University of California a 225-ton cyclotron is near completion, and in preliminary tests a 10,000,000-volt beam of deuterons—"atomic bullets"—has been developed.

2718 Berkeley

**Scaffolds Are Mounted on Flat Cars
 to Aid in Painting Train Sheds**

To speed up the work of painting the train sheds at the new Union Passenger Terminal in Los Angeles, the station superintendent rigged scaffolds which he mounted on flat cars running on adjoining railroad tracks. This saved moving the scaffolding, paint and equipment by hand.

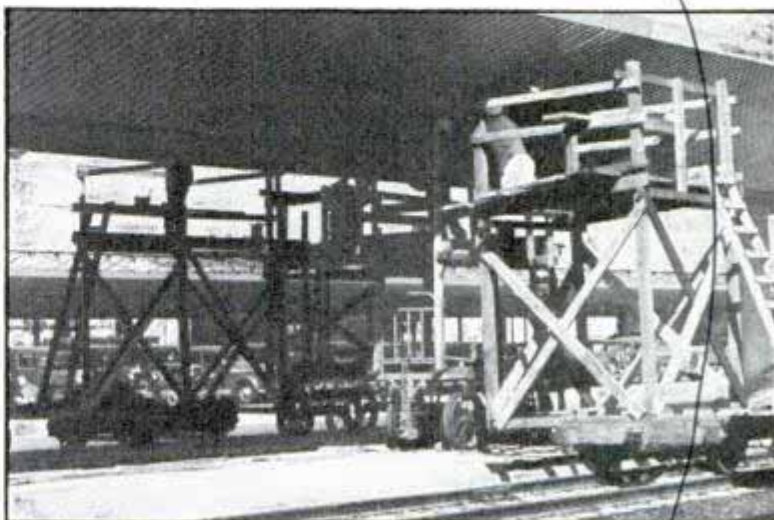

Scaffolds riding on flat cars move along tracks, saving time and extra labor of handling material as work progresses

d.w. J. & Hodgson

g 320 Leggett

WINNING *the* WAR *on*



Congestion such as that in street at left can be eliminated by education, enforcement and engineering. Above, ten-foot sign has letters and arrows clearly read by day or night

In other words, we must go on saving lives and, in building America back to normal prosperity, we will actually expose more lives to the danger of highway accidents.

In 1935 the accident rate was approximately eighteen per 100,000,000 vehicle-miles. In 1936 it was reduced to sixteen and four-tenths, in 1937 it was fifteen and eight-tenths and in 1938 it reached the remarkable low level of twelve per 100,000,000 miles. There were 8,000 fewer fatalities last year and, assuming a proportionate reduction in injuries and property damage, a saving of approximately 200,000 injuries and \$250,000,000 in cash loss.

This work was accomplished by a careful and well-administered program of Education, Enforcement and Engineering, the now famous three E's of safety. Engineering concerns the work of providing better mechanics for automobiles and better me-

By Paul G. Hoffman

President The Automotive Safety Foundation

366 Madison Ave

WHILE vast strides have been made toward reducing the rate of highway accidents, this lowered rate must be even further reduced, while more people ride more miles each year. Here is a paradox challenging the automotive industry today.

*The Swabaker Corp
South Oyster and*

New York City

TRAFFIC ACCIDENTS

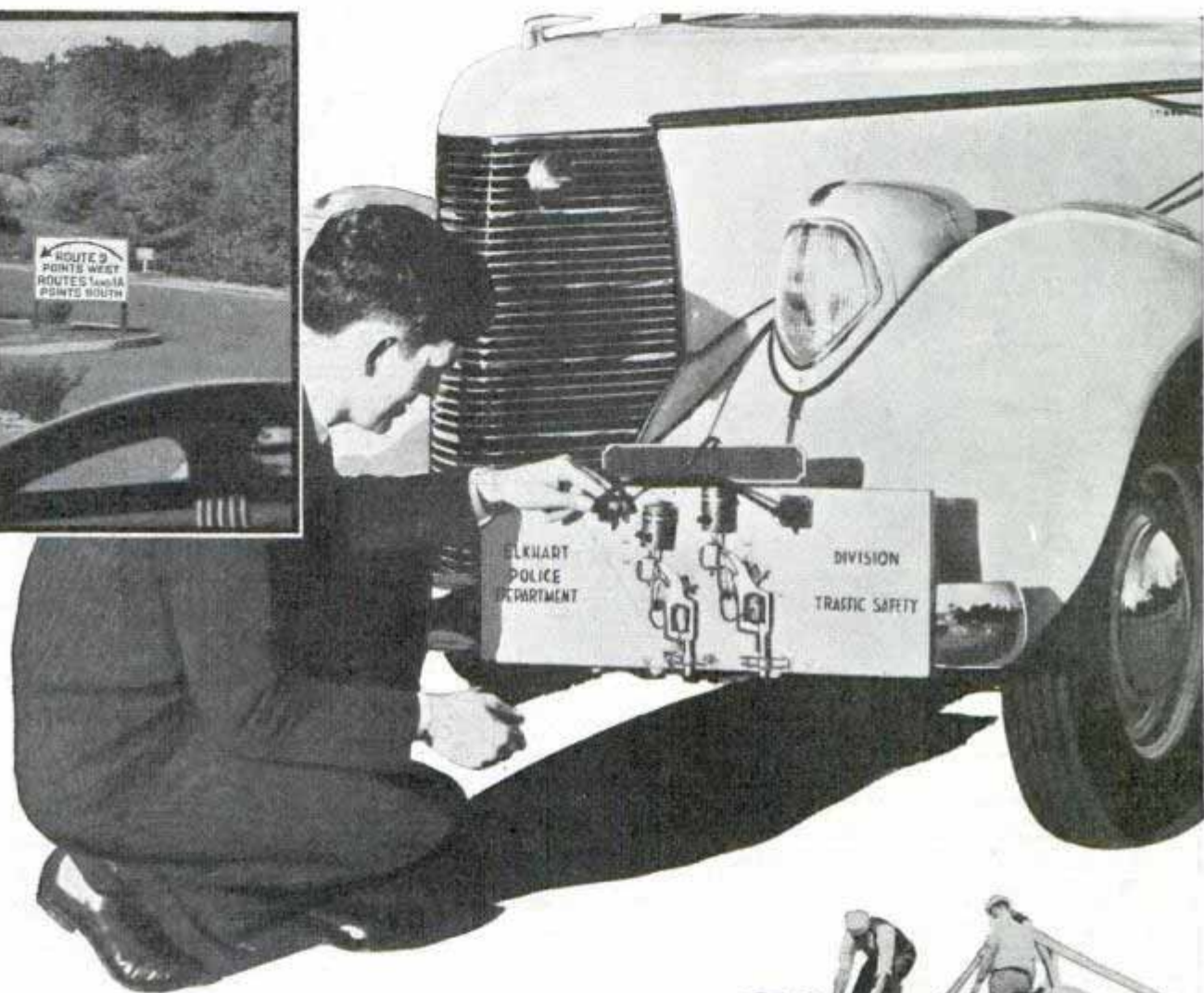

chanics for the roads on which these automobiles operate.

Many learned American minds are deep in the work of improving our highway system. From the national capitol to the most obscure prairie county, highway directors are devising broader, safer, more useful roads and streets and these roads are being built as swiftly as money and machinery will allow. It will take scores of years to achieve the perfect national highway system, but it's on the way.

In 1908 there were registered in the United States approximately 140,000 motor vehicles. During that year they accounted for approxi-



Top, left, eight-foot sign seen from 100 feet; right, to test brakes, one revolver fires when brakes are applied, the other when car stops. Bottom, 24,000 pounds of sandbags were piled on before steel roof gave way

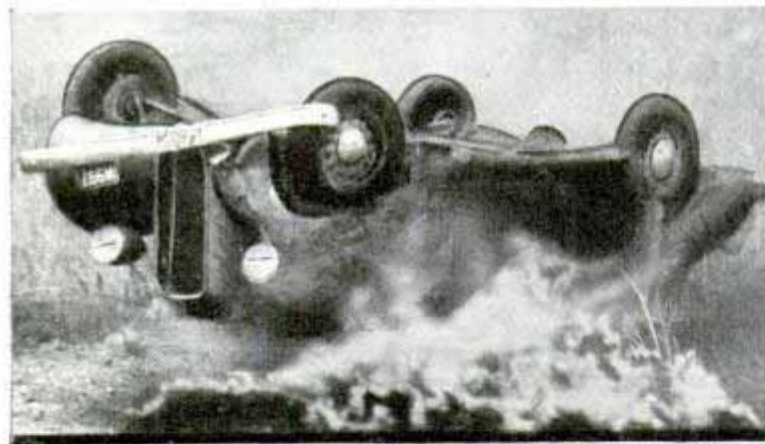

mately 700,000,000 adventurous miles. Thirty years later, registrations of motor vehicles mounted to almost 30,000,000. These cars piled up the unbelievable total of more than 250,000,000,000 miles last year—ten times the combined travel of all other forms of transport, making automotive transportation America's biggest business, a business that is still growing. Best informed forecasters predict 500,000,000,000 miles of annual travel by 1960. Before that volume is attainable, highway builders have much work to do in expanding our highway system to make travel both more facile and safer.

One of the most noteworthy contributions to highway safety has been made by the men who build our automobiles—the

safest, strongest, most useful motor cars in the world. From the very beginning the pioneer builders and designers of motor vehicles have had the importance of safety drilled into them by grim necessity. The first vehicles built were dangerous. Mechanical failures were frequent. Fire and explosion hazard had to be reckoned with. Steering was poor. Performance consisted in merely getting the vehicle to go somehow, but to go. The passengers had little comfort or protection from the weather. A journey of 100 miles was an adventure, hazardous, fatiguing, but having all the thrills of a voyage of discovery. Today, so perfect is the control of alloy steel manufacture, so high the quality of the steel and accurate the treatment, that failures due to defective material are a minute percentage of the few mechanical failures that occur.

Perhaps in no one item has more progress been made toward safe motor cars than in body design and construction. Those who remember the motor car of, say, 1904, recall an open car with the passengers perched on top, back to back, or in a tonneau with a rear door. The windshield, when

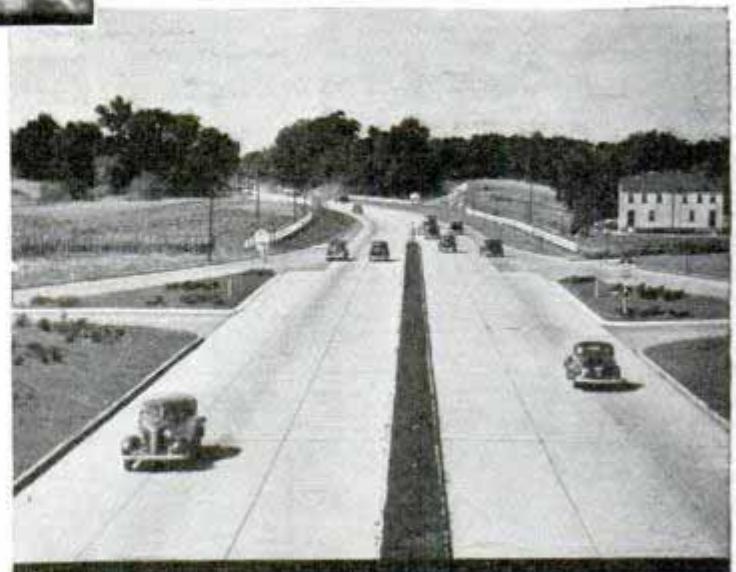

To show punishment modern cars can take, those at left were dumped from cliff and rolled over three times, driving off under own power. Below, dividing lane prevents crossings at dangerous intersection

2 320

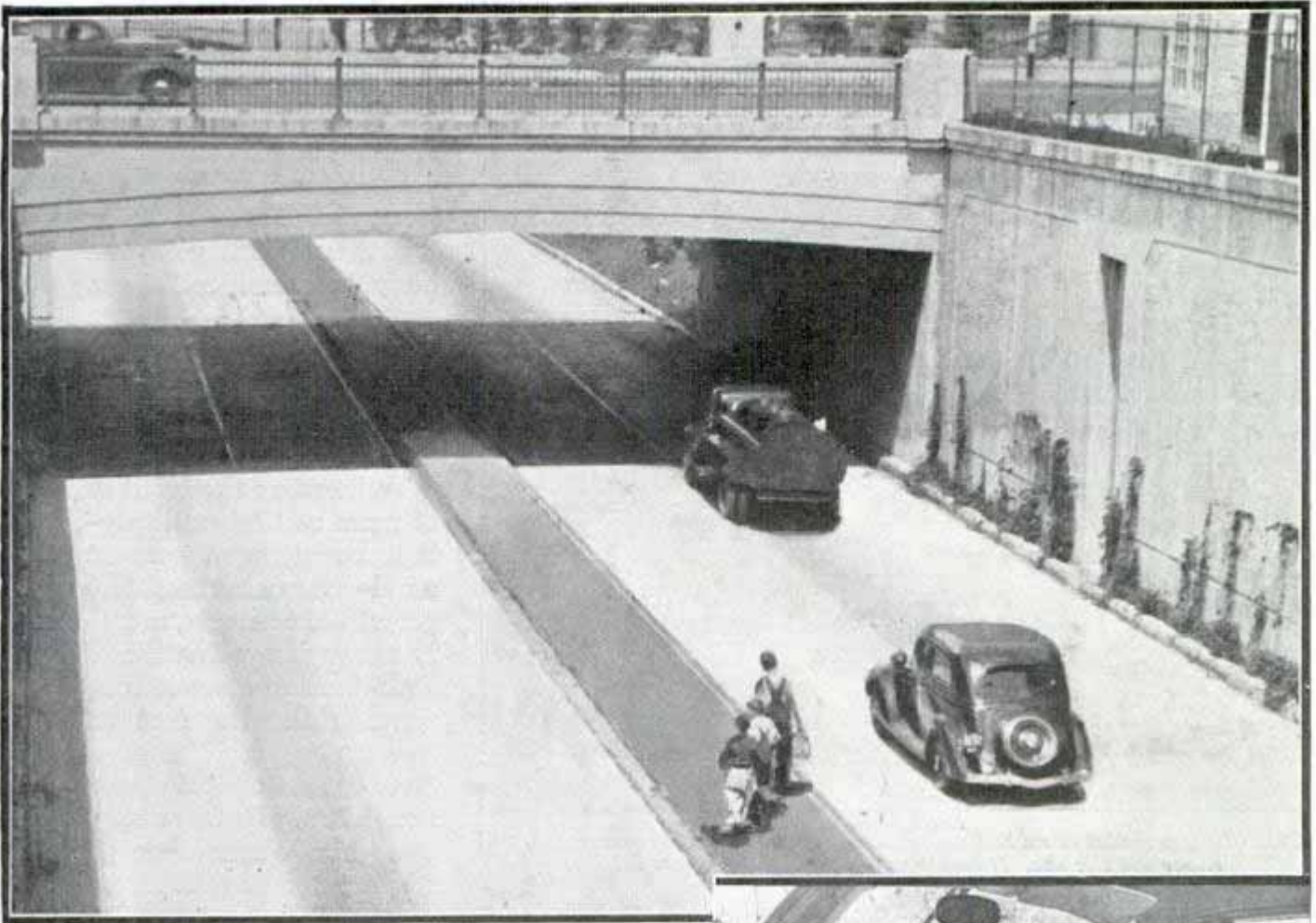

there was one, was flimsily attached to the dash, the wooden structure glued and screwed together. The sedan body, perched high in the air, unstable and with no inherent structural strength, broke open like a strawberry box in a crash. Heavy hinge and door pillars, as well as thick windshield pillars, resulted in bad visibility and blind spots.

Today, the all-steel automobile is to safe highway travel what the steel Pullman is to safety in railway travel. Its ability to resist impact, to bend, or yield without breaking up is a real safeguard. Steel permits narrower door posts and hinge pillars, as well as windshield pillars, and hence gives better vision. Ventilation has been improved and the body sealed against gas fumes. Central heating and air conditioning are available.

If we could obtain a car of the vintage of 1904 or even 1915 and compare its steering with that of today, I believe most of us would allege that someone had purposely "rigged" the older model. The columns whipped about, the steering gears them-

(Continued to page 116A)

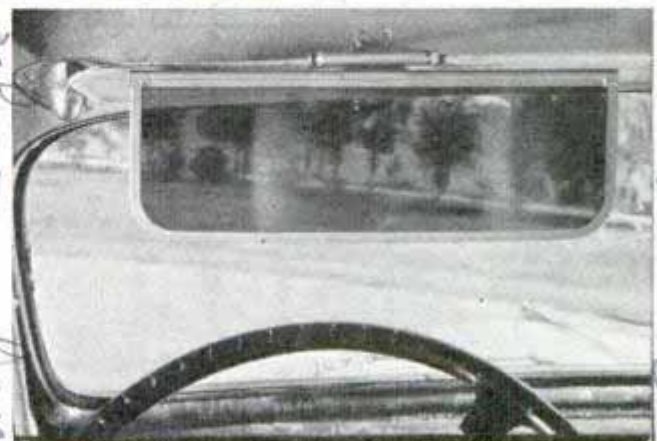

Top photo illustrates two features of up-to-date "safety mechanics"—elevated crossover and dividing strip. Below, dual controls for teaching beginners and transparent sunshade to eliminate glare

Sold by auto dealer

Mayberry - Grand Ave. Alhambra

AC-547-8/00-116A
 Sold by Knight. 5209

2572 Montclair, Delant. Rich

Dummy of Modern Warship Is Erected for Naval Festival

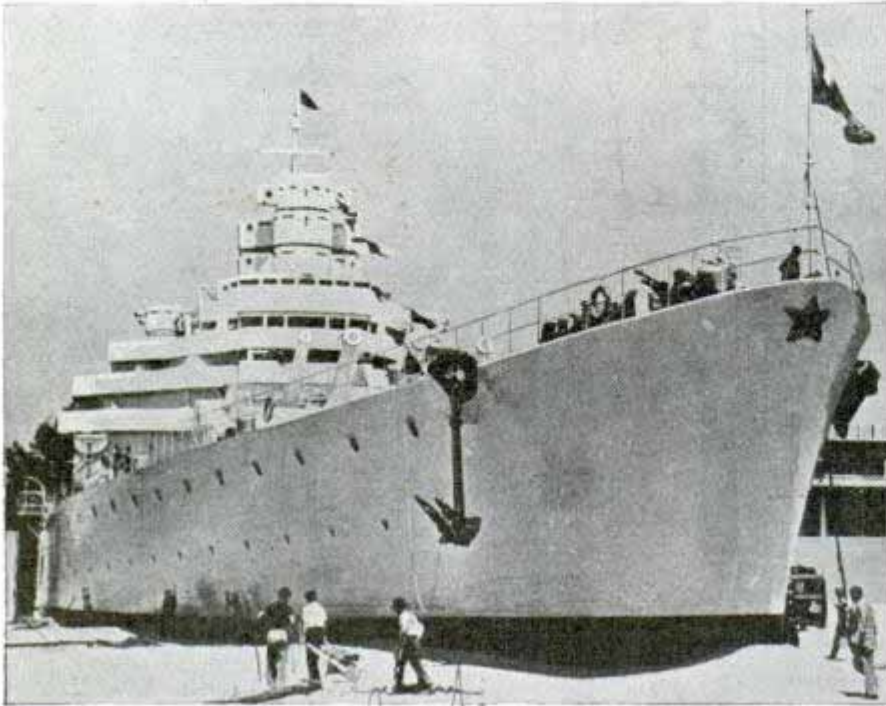

This life-size model of an Italian battleship, complete with armament, will never see the sea. It forms part of an inland naval festival

When the navy comes inland to conduct its festival, the most colorful feature of her array—the fleet—must be left behind. In order to add a realistic touch to such an event at a military camp in Italy, a full-size dummy battleship which never will wet her nose in the sea was built. On dry land the model serves its purpose as a faithful replica of a modern Italian warship, even to the armament.

Bumpers Along Sides of Auto Reduce Accident Damage

To protect the sides of his new car from scratches and dents caused by sideswiping



Auto completely encircled by bumpers is guarded from sideswipes as well as clashes at front and rear

other vehicles and scraping against high curbs, one owner mounted a bumper all around the running boards and fenders. Extending from the front to the rear bumper, it prevents damage to the body in minor collisions.

Electric Fertilizer Boosts Supply of Nitrates

To increase the fertility of farm soil by multiplying the nitrogen content and stimulating the growth of bacteria, merely through application of high-tension electric current, is the hope of an inventor who has constructed an experimental machine. Laboratory tests with water having a slight trace of nitrate re-

sulted in an increase of 800 per cent. The machine consists of a storage battery, an electric generator and a transformer mounted on a small garden tractor. The generator produces an alternating current



Electric fertilizer boosts content of nitrate in soil by passing high voltage between two electrodes

of 110 volts which is stepped up to 15,000 volts by the transformer and conducted into the soil through a pair of metal-core insulators, where it is passed between two electrodes. Cultivator blades cut parallel furrows for the electrodes.

Paroli

Ridgely, Md.

Refer me on this to Harrell & Co

Chas. Fred App Costa mesa Calif

Q. G. Peterson, manager, mechanical, U.S. Washington



MODERN PRECIOUS METALS

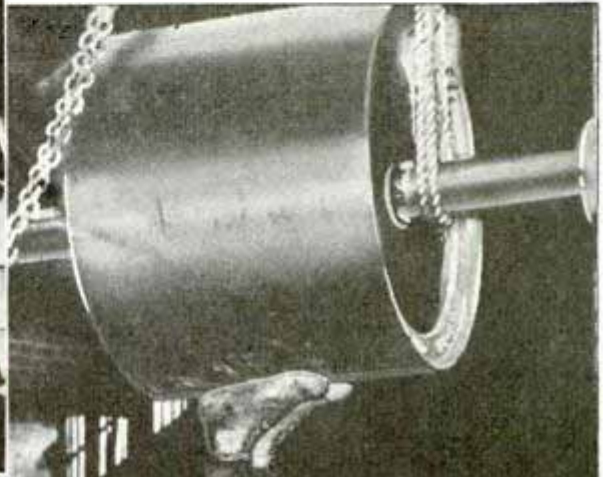

By Dr. P. G. Worcester
Head of the Department of Geology
University of Colorado

Boulder, Colo

FOR many years, gold, silver and platinum have been regarded as the precious metals, but the picture is changing.

Gold, which commands a mint price of thirty-five dollars an ounce, is being buried in Kentucky as fast as it is mined in this country. The United States has in its vaults more than \$14,000,000,000 in idle gold. It can, therefore, hardly be called a precious metal.

Silver on the date this was written was a drug on the market at forty-four cents an ounce. The price of newly mined silver has been set, quite artificially, at sixty-six and one-half cents an ounce. Platinum, which sold a few years ago for seventy-five dollars an ounce, is down to thirty-five dollars, and is in little demand. A few essential industries require a little, but of the 200,000 ounces consumed each year by the United States, the largest user, more than

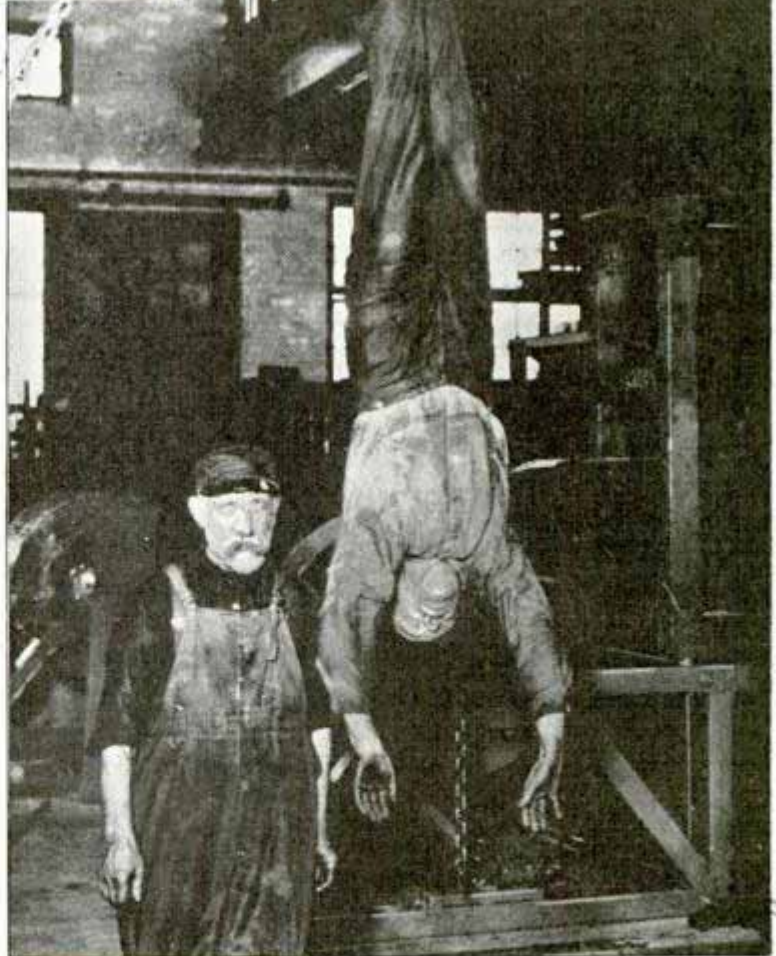

Courtesy International Nickel Co.

Testing a metal sample in a bending machine, top; tiny cracks in metal appear as large canyons under microscope. Below, nickel steel pulley used in ore separator. Attraction of magnetized pulley is enough to suspend man by hobnails of shoes

Strong magnetic

Smith D. Milwaukee, Wis



The Beryllium Corp., Reading Pa.

A watch made of the two alloys was once dropped 3,000 feet from an airplane. When found, it was still running; only the crystal had been broken.

Springs made of phosphor bronze break from fatigue after being flexed 300,000 times in a testing machine. Stainless-steel springs can stand 2,000,000 flexes. The engineers finally stopped the machine when a beryllium nickel spring had been flexed 15,000,000,000 times. It was still good.

Airplanes and engines, other means of transport, machine tools, electrical equipment and dozens of other fields will feel the effects of the feathery light metal. In the form of an alloy of about three parts of beryllium to one of aluminum, its resistance to wear and unusually high melting point are putting it into experimental airplane engine pistons. Not only are tremendous amounts of weight saved—and every pound saved is worth forty dollars to the owner of the plane—but it gives better

half goes into jewelry. In contrast with these metals, there are many others without which modern industrial development could not have been attained. Among them are aluminum, beryllium, chromium, nickel, molybdenum, tungsten and vanadium. These, and a few more, are really our precious metals.

service and enables more power to be taken out of the engine.

Only a decade and a half ago beryllium's price was way over \$100 a pound. At one time it cost \$5,000 a pound—ample reason

Beryllium, third of the trio of light metals given to the world by science in the last fifty years—the other two being aluminum and magnesium—is one-third lighter than aluminum. In alloyed form, it has properties so remarkable as to make experienced metallurgists gasp.

Two per cent of beryllium and ninety-eight per cent of nickel form an alloy three times as strong as stainless steel. Mixed in the same proportions with copper, beryllium produces an alloy nearly twice as strong as stainless steel.

*see Sept. 1940
325*



Photoelectric cell keeps electric furnace, top, within ten points of 1,000 degrees while Westinghouse engineers measure "creep" of metals. Below, aluminum tractor in Florida swamp

draw: Elmer Graebing

why industry has neglected it all but a few of the hundred years it has been known. There is no large supply of beryllium known anywhere. It occurs chiefly as crystals in pegmatite dikes associated with quartz, orthoclase feldspar and mica. One crystal found recently in Colorado was four feet in diameter, twelve feet long and weighed eight tons. Usually it is blue or green, and when clear is in demand for costume jewelry.

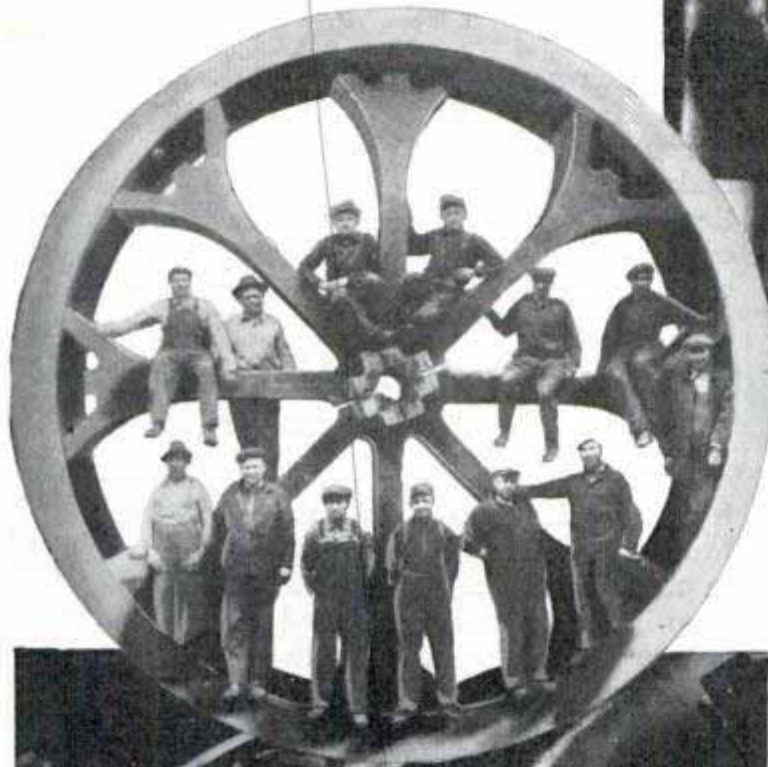
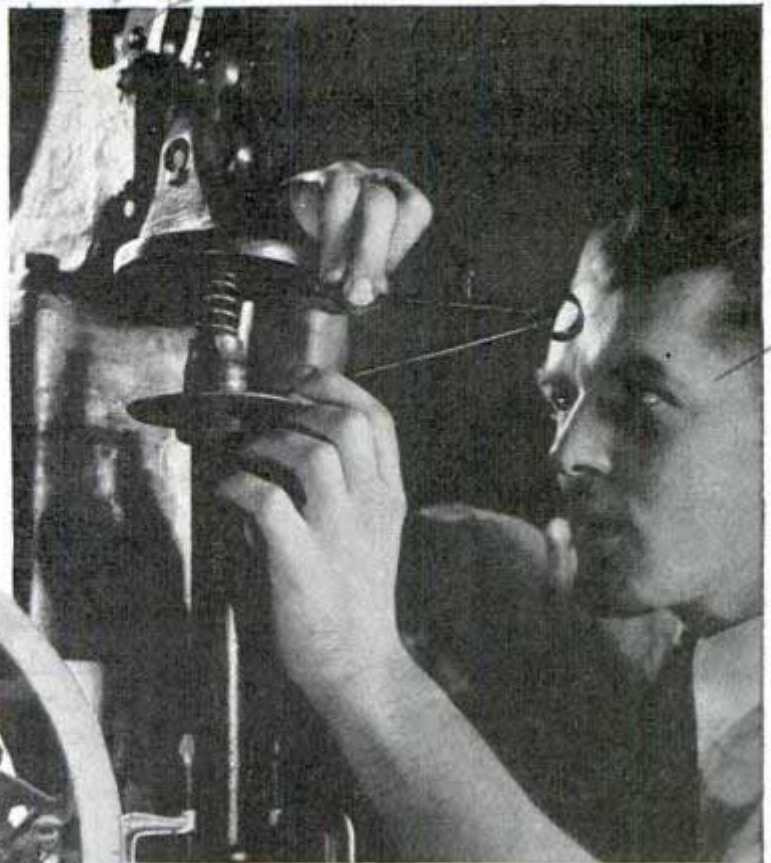

Chromium is another precious metal, and most of its uses are relatively new. About 1,000,000 tons of ore containing forty-five per cent chromium were produced in the world in 1937. About fifty per cent of the chromium mined goes into metallurgy. Forty per cent is used in refractories, chiefly heat-resisting brick for open-hearth steel furnaces, and the other ten per cent is used for plating, dyes, pigments, etc. Chromium

(Continued to page 114A)

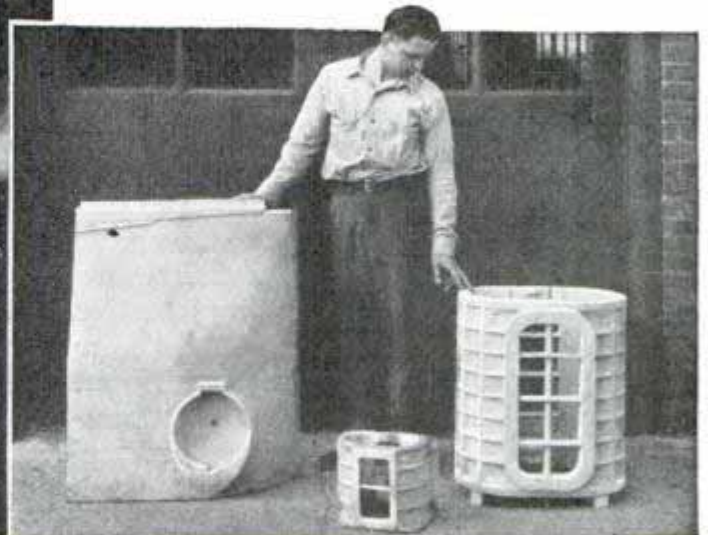

Top, starting a small spring on a "fatigue" test to determine its life span at work. Left, huge nickel cast-iron wheel with tensile strength of more than 55,000 pounds per square inch. Bottom, left, research engineer assembling thermocouples to measure the heat applied to metal test bars in "relaxation" machine. Right, typical castings of light magnesium alloy

Westinghouse

Bike Tires Ride Treadmill in a Test of Strength

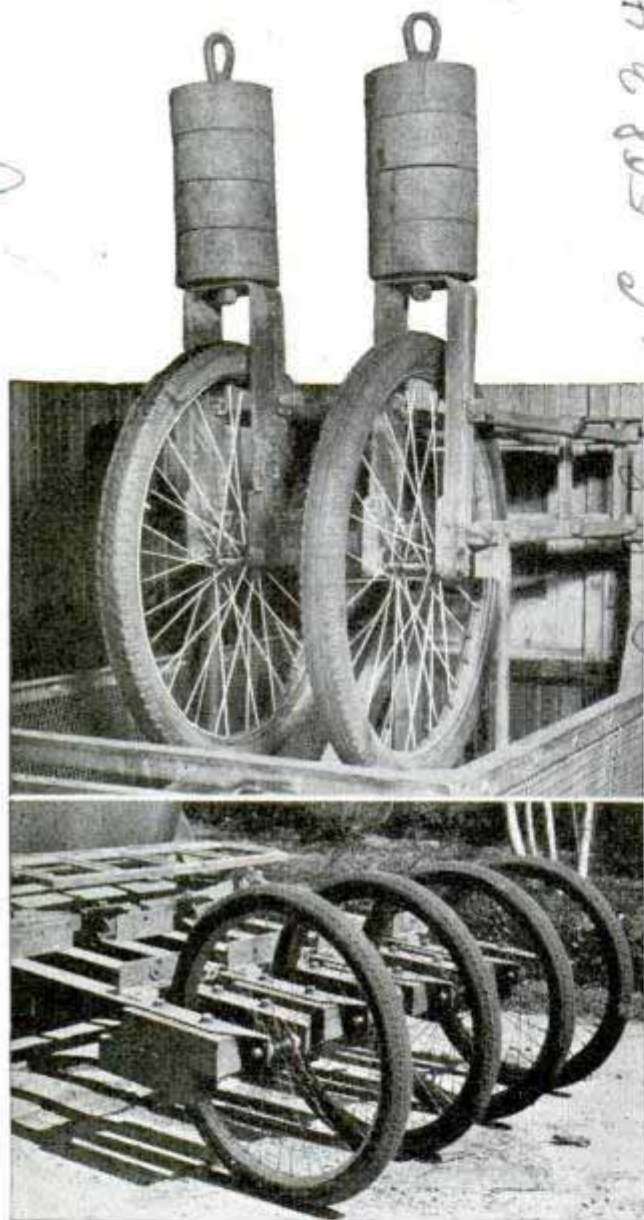

Top, stationary wheels on treadmill test; below, tires mounted on trailer for road tests behind auto

Bicycle tires, like the bigger ones used on automobiles, undergo both indoor and outdoor tests and pass through a normal life span within a few weeks' time to provide engineers with quick information about their efficiency. One manufacturer conducts road tests by mounting four tires on a trailer and placing over each tire an individual load of 125 pounds, equivalent to the weight of a large boy. An automobile then pulls the unit at a speed of twenty-five miles an hour. In order to obtain a double check, tests also are made in the laboratory on a stationary machine composed of two mounted bike tires running twenty-four hours a day against revolving

wheels with flat faces. These likewise carry 125 pounds, and spin at about twenty miles per hour. The room temperature is held at 100 degrees.

Lawn Edger Cuts Depth Desired with Aid of Guide Wheel

Ragged edges of the lawn alongside walks or paths are trimmed neatly by a cutting tool that has a guide wheel to follow the sidewalk and also regulate the depth of the cut. The edger makes a sharp, uniform line in half the time required by older methods on straight or curved lanes. Flower beds, too, can be outlined by using a board as a guide.



Rubber Mitt for Holding Soap Is on Flexible Standard

Housewives irked by the task of cleaning soap dishes may find an end to this problem in a holder that suspends the bar in midair where it dries out after use. The soap is placed in a perforated rubber envelope which hangs by a chain on a spring-wire standard. A rubber suction cup at the base can be attached to the smooth surface of a sink, bathtub or washbasin.



Soap holder mounted on flexible post eliminates untidy dish and conserves soap

Duck Tire Co. 152 W 42nd New York

Laral Mfg Co 508 N 46 St Seattle Wash

Laral Mfg Co

Laral Mfg Co 1711 10th Brooklyn



Built-in VANITIES *open over bath*

Two pleasing designs having mirrors inside of doors and shelf space in wall—all out of the way when not in use

By Wayne C. Leckey

BUILT right into the wall alongside the bathtub, either one of these mirror-fitted cases provides a convenient vanity with plenty of shelf space for bath salts, soaps and other toilet articles, neatly arranged within easy reach. Essentially, the job consists of fitting a boxlike frame into an opening cut between two studs in the wall.

As the cases will be finished in enamel to match the bathroom fixtures, they can be made from inexpensive plywood. The door of the case shown in Fig. 1 forms a tray when let down across the tub. When the case is closed, the hinged mirror folds compactly between the inner shelves. Begin by making the frame of the case first, Fig. 2. The $\frac{3}{8}$ -in. shelves are nailed in grooves although you can simply use plain, butt joints. To the back of the assembled frame, a $\frac{1}{4}$ -in. plywood panel is nailed. If a jig saw is available, you can form both the casing and the door for the frame from a single piece of plywood by carefully cutting out the center of



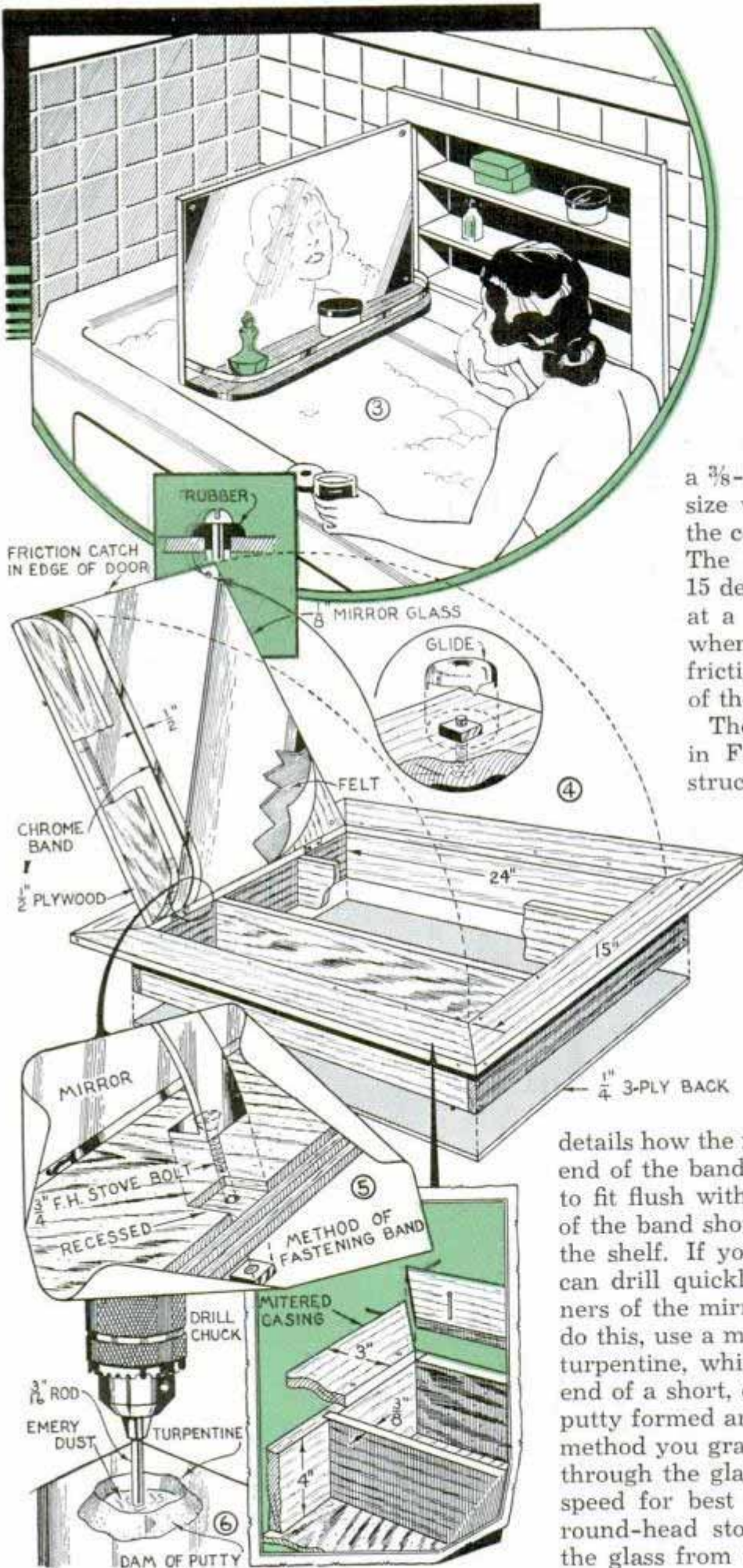

the work and using this waste piece for the door. A tiny hole in one corner of the outline permits the insertion of the blade. The edge of the door is planed a little to provide clearance for paint and hinging. A $\frac{1}{4}$ -in. plywood panel, nailed to the front of the door, forms a recessed tray on the inside. The mirror is framed with strips of narrow, rabbeted molding, nailed to a $\frac{3}{8}$ -in. plywood backing of a size which will fold between the center shelves of the case. The hinged edge is beveled 15 degrees so that it will lean at a slight backward angle when in use. A bullet-type friction catch in the top edge of the door keeps it closed.

The frame of the case shown in Fig. 3 is of similar construction except that the casing is mitered. Looking over the details in Fig. 4, you will see that the inside of the hinged plywood door is covered with mirror glass over a felt base. Prior to this, however, a narrow shelf is screwed to the lower edge as well as a $\frac{1}{2}$ -in. wide metal retaining band. Fig. 5

details how the right-angle bends at each end of the band are drilled and recessed to fit flush with the surface. The curve of the band should follow the contour of the shelf. If you have a drill press you can drill quickly through the four corners of the mirror glass as in Fig. 6. To do this, use a mixture of emery dust and turpentine, which is retained under the end of a short, chucked rod by a dam of putty formed around the hole. With this method you gradually grind a clean hole through the glass. Run the drill at slow speed for best results. Nicked $\frac{3}{16}$ -in. round-head stove bolts passed through the glass from the inside are capped on

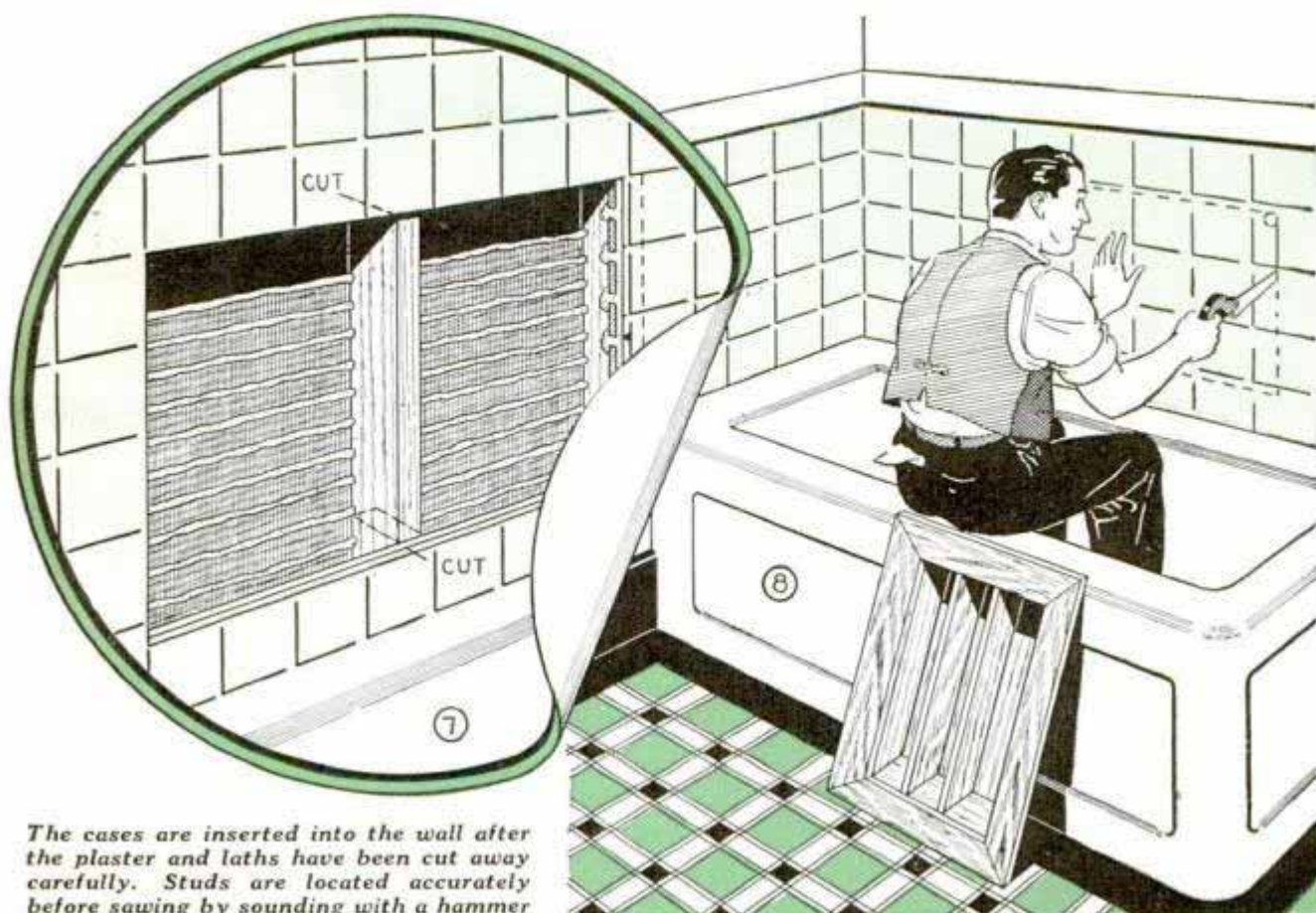

The cases are inserted into the wall after the plaster and laths have been cut away carefully. Studs are located accurately before sawing by sounding with a hammer

the face side with furniture glides pressed into the wood over the nuts. Sharpening the prongs of the glide will help. See the insert detail in Fig. 4.

The cases should be located a little toward the faucet end of the tub. No set distance can be given for the case shown in Fig. 1, as it is narrow enough to fit between two studs and consequently cannot be shifted to a given point like the alternate case, which requires a wall opening cut over a center stud because its width is greater than the usual 16-in. distance

between centers of studs. See Fig. 7. To determine the location of the studs, tap lightly on the wall with a hammer. A hollow sound will be heard everywhere except over a stud. After the stud has been located, mark the outline of the opening on the wall, taking the exact dimensions from the case itself, and drill a hole in one corner. Starting from this hole, insert a keyhole saw as shown in Fig. 8 and carefully cut out the lath and plaster. The case is fastened in the opening with nails driven through the casing.

Odd-Size Nuts Made from Bodies of Old Spark Plugs

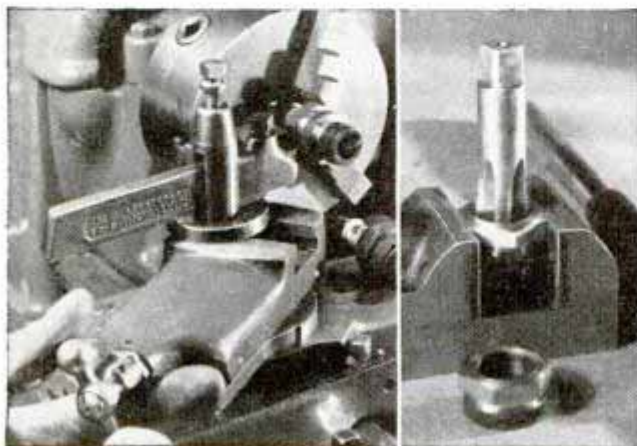

Large, thin or odd-shaped nuts frequently can be made from the bodies of old spark plugs. To do this, cut off the threaded portion of the plug along with the rolled flange that holds the porcelain core in place. Smooth the hexagon portion left and tap its inner surface.

—C. W. Woodson, East Aurora, N. Y.

☞ Ladies' metal or mesh bags may be cleaned by rubbing baking soda into them with a woolen cloth. The soda is removed with a brush or by shaking.

Chicken-Roost Poles Removed to Clean Building



Amateur poultry raisers will find these chicken-roost holders a timesaver because they permit the roost poles to be removed quickly for cleaning the floor underneath them. The holders are screwed to the walls of the chicken house or to vertical support members. If round roosting poles are used, they should be flattened at the ends.

Hack Saw Cuts Wide Sheet Metal

When you have a wide piece of sheet metal to cut with a hack saw, put two blades in the saw frame, spacing them so

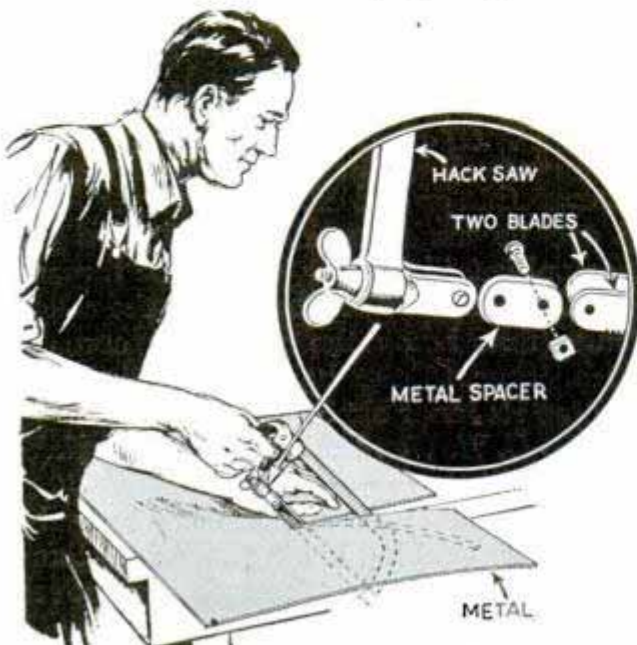

that a cut is made wide enough to take the frame. The narrow strip of metal left by the two saw cuts is bent down out of the way as the work progresses.

Micro-Reflector Aids in Sketching Specimens under Microscope

Biology students and microscope fans will find that this reflector eases eyestrain while sketching a magnified specimen, as the image of the latter is reflected on a ground glass,

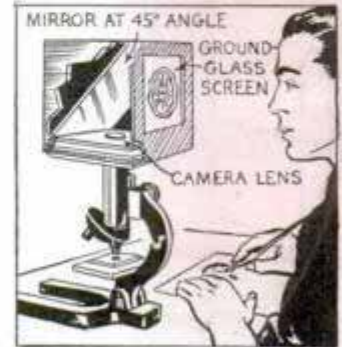

making it unnecessary to look into the eyepiece of the microscope. The reflector is a light-tight box, about 3 by 4 in., containing a mirror on the inside as shown. An opening in the bottom of the box fits snugly over the microscope eyepiece, and has a camera lens at the upper end to direct the image on the mirror.

Garden Hose Used as Tires on Baby Carriage

If the tires on a baby carriage or child's wagon are worn badly, you can replace them with tires made of lengths of garden hose. To do this, first cut a piece of hose to fit snugly around the wheel rim, then thread a piece of wire with a small coil spring attached to one end through the hose. The total length of the wire and spring should be slightly less than that of the hose so that when the tire is assembled on the wheel the wire will be under tension to hold it in place.

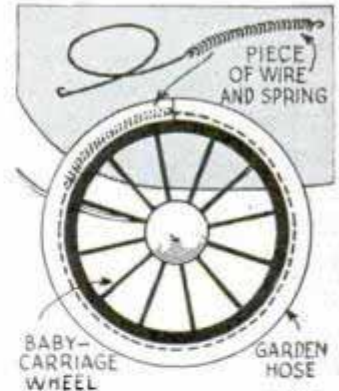

—S. Jarrott, Calgary, Alta., Can.

☐ You can fill scratches on furniture by dissolving beeswax in turpentine until the mixture is the consistency of molasses, then applying it with a woolen cloth.

What you can do with PLIOFILM

"Welding" with a sealing iron eliminates sewing and cementing. Ideal to make Christmas gifts

LOW in cost and easy to work, Pliofilm is a rubber-base sheet material available in many colors. It can be had in transparent, opaque and figured styles and comes in rolls so that you can purchase it by the yard. Most of the large department stores handle it. No sewing or cementing is necessary as joints are made by means of an electric sealing iron which can be purchased at a slight cost.

In working with this material, best results can be obtained by using a full-size paper pattern as a guide for cutting and

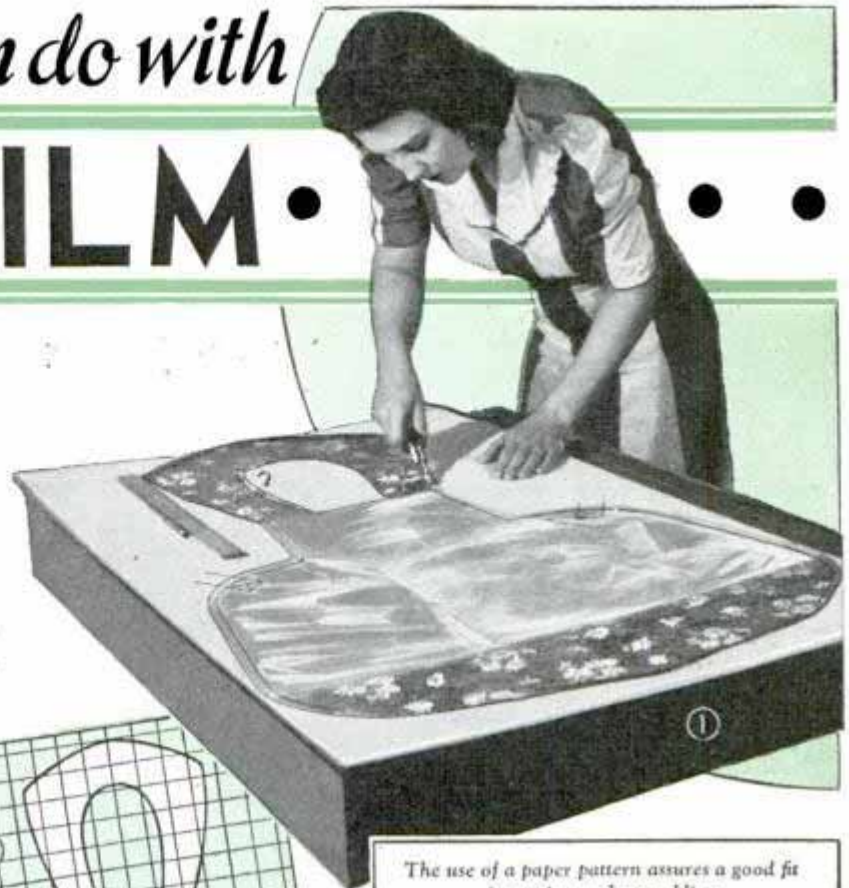

The use of a paper pattern assures a good fit in cutting and assembling

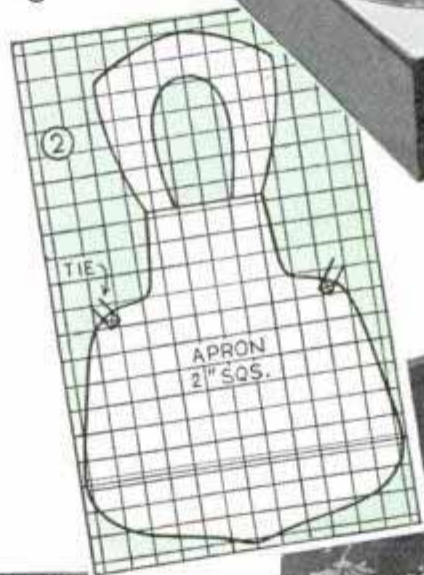

Bowl Covers



assembling. As an example Figs. 1 and 2 show how a pattern is used in making a tea apron. Place the Pliofilm on the pattern and cut $\frac{3}{8}$ in. outside the line to allow for hemming. Next, take the sealing

iron and run it over the material, $\frac{3}{8}$ in. in from the edge, Fig. 4, to form a crease which permits ready folding. Then, a second operation with the iron permanently seals the hem. A straightedge should be used on straight seams, but on curved edges the iron can be used freehand, as in Fig. 3. When working around sharp corners wrinkling is prevented by cutting the material as required.

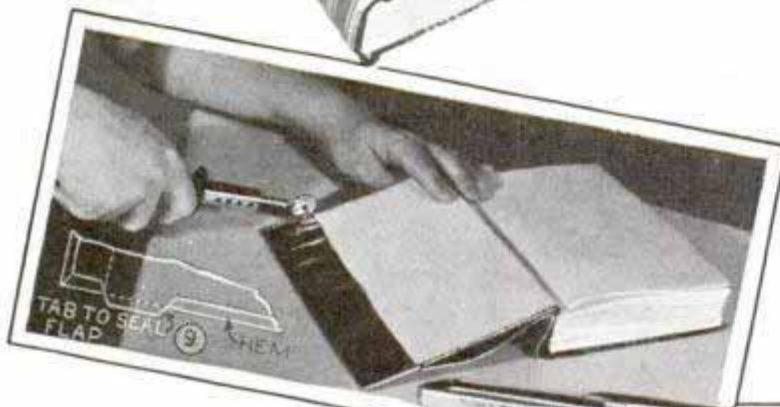
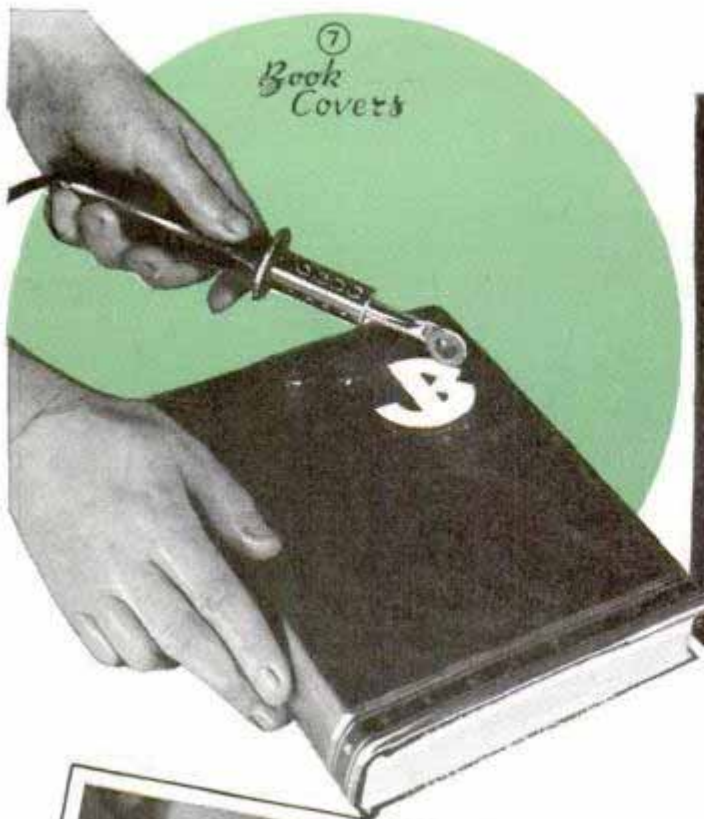

is hemmed all around except those portions which are hemmed later to hold the flap in place. Rain coats and umbrella coverings, Fig. 11, are among the practical things made from Pliofilm. Suitable designs can be had at any dress-pattern service. Strips of Pliofilm wrapped around a lamp shade or bare wire frame give the novel effect seen in Fig. 12. Pulling the film lightly produces the ap-

Pliofilm makes excellent coverings, such as garment bags, bowl covers, make-up capes, vegetable bags, etc. These are formed by sealing two or more pieces together to form a bag or box to fit the article. For bowl covers, cut a circle of Pliofilm 3 in. larger than the diameter of the bowl. Fit the material over the bowl and fasten with a rubber band as in Fig. 5, then seal the Pliofilm over the rubber, Fig. 6. Let the seam cool for a minute or two before using the article.

Pliofilm is serviceable also for gift wrappings, Fig. 8, and book jackets, Figs. 7, 9 and 10. Touches of contrasting color can be obtained by adding silhouettes or initials. In making book jackets, the material



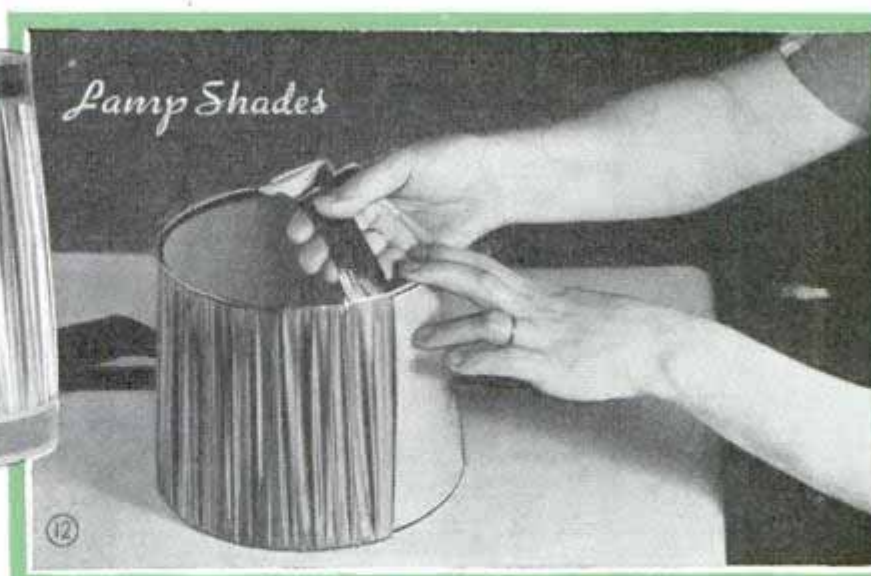

pearance of stretched silk.

Simple edge styles also improve the appearance of Pliofilm articles: Fig. 14 shows how a ribbon of the material in contrasting color can be creased in the center and sealed in place on the material. Another effect is to use colored yarn sealed inside a hem, also shown in Fig. 14. A novel border effect

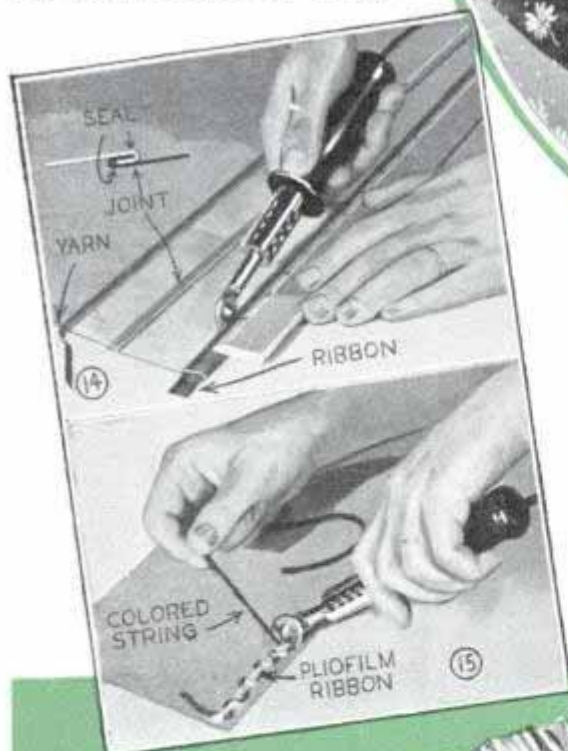

is obtained by crisscrossing a ribbon of Pliofilm with a length of colored string, as in Fig. 15. Ruffles for aprons and curtains are made by cutting a strip of Pliofilm to the desired width, gathering this in the hand and sealing in place as in Fig. 16. It is sometimes desirable to use a double thickness of the material, either for strength or to secure a two-tone effect. This is done by tacking the edges together with the sealing iron, or, the sheets can be laminated by pressing with a very mild iron, as in Fig. 13. A sheet of glazed paper should be used to prevent the iron from sticking. After you become accustomed to handling the iron it will take much less time than sewing, which is an important consideration when you wish to fabricate a number of personal Christmas gifts and the time for doing this is rather limited.

Protecting Watch Main Spring on Cool Surfaces



Does the main spring of your watch sometimes break for no apparent reason? Perhaps the trouble is caused by removing the instrument from your pocket where it is at body temperature, and laying it on the cool surface of a dresser or table. According to a Swiss watch repairman the sudden contraction of the spring due to change in temperature is likely to break it. To avoid this trouble, insulate the watch from the surface with a tobacco pouch, thick cloth pad, piece of blotting paper or corrugated cardboard.

Basement-Window Frame Faced with Iron to Avoid Wear

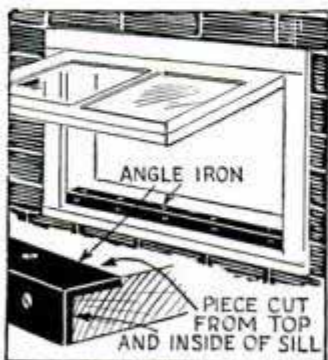

Noticing that the lower frame member of one of my basement windows was being worn by coal and other materials that were taken through it, I faced it with a length of angle iron as shown. The front edge and a portion of the top surface of the frame member were cut down so that the iron would set flush. The iron was screwed in place and the

Noticing that the lower frame member of one of my basement windows was being worn by coal and other materials that were taken through it, I faced it with a length of angle iron as shown. The front edge and a portion of the top surface of the frame member were cut down so that the iron would set flush. The iron was screwed in place and the

screw heads were countersunk to avoid interfering with movement of the window sash.—John Nichols, Jr., Claymont, Del.

Hymn Books Stored in Box under Chair

To save unnecessary handling of hymn books and to keep them collected at hand as much as possible in a Sunday School, wooden boxes large enough to hold four or five books were attached to the undersides of the teachers' chairs.



After the classes assembled each Sunday, the books were passed to the various members, who returned them to the teachers as they left.

Bottle 'Tumbling Barrel' on Lathe Cleans Small Parts

Small parts such as screws, nails, etc., can be cleaned quickly in a small bottle taped to a lathe faceplate which is rotated at the slowest speed possible. In the absence of a lathe, good results can be ob-

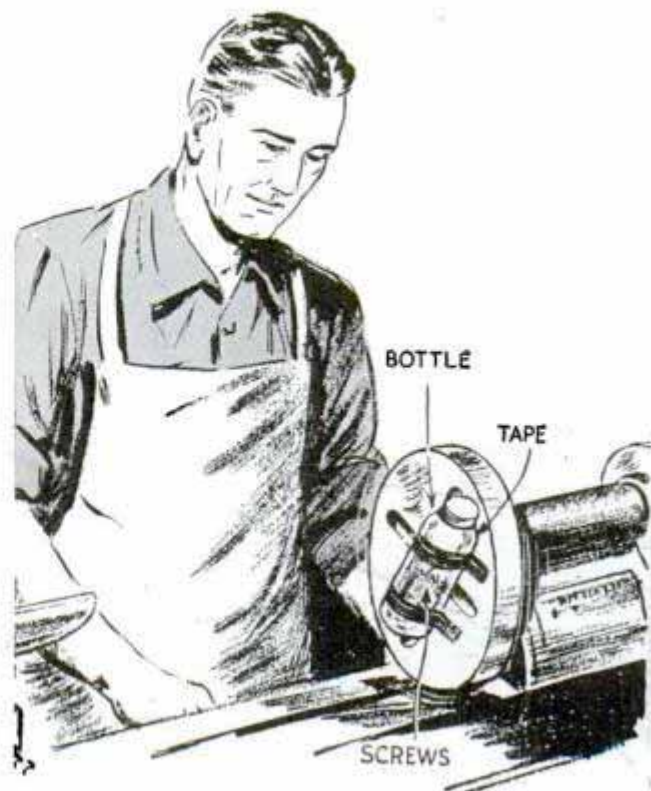

tained by taping the bottle to a shaft, or, as a last resort, shaking it in your hands. Put a spoonful of emery powder in the bottle with the work, and do not rotate it faster than 200 r.p.m. so that the small parts slide from end to end of the bottle as it turns.

Concealed Knots in Child's Shoe Laces Keep Them Even

If you have trouble in keeping the shoe laces of a small child the same length at the ends, try the following: Remove the lace and thread it through the two lower eyes, pull the ends even and then knot the lace directly under each eye. Now lace it up in the regular way and the knots will keep it from slipping. If this is done carefully the knots will be concealed.

Gay Figures Cut from Plywood Dress Up Window-Shade Pulls

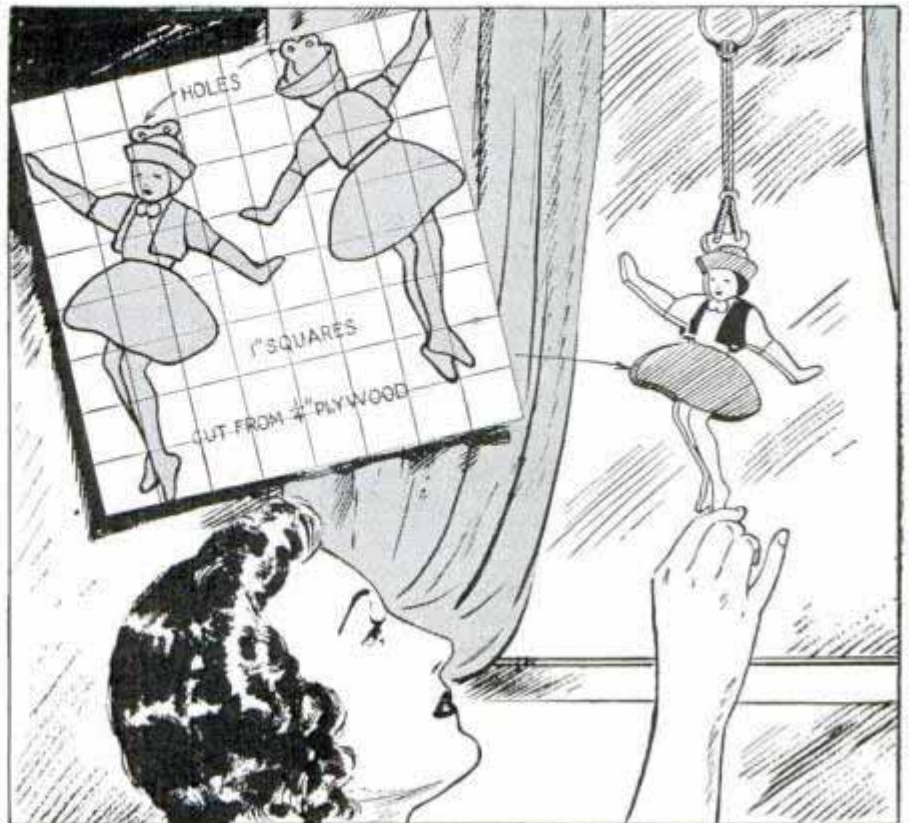

Poised in midair, these little figures provide novel shade pulls, especially for a nursery. Use gay colors harmonizing with the color scheme of the surroundings. The cords that support the pulls are also selected to match.

Make Your Night Shots Dynamic with Multiple Exposure

Night photography is often disappointing because the lights are spotty and the

shadows too dark. Instead of making one long exposure, try setting your camera on

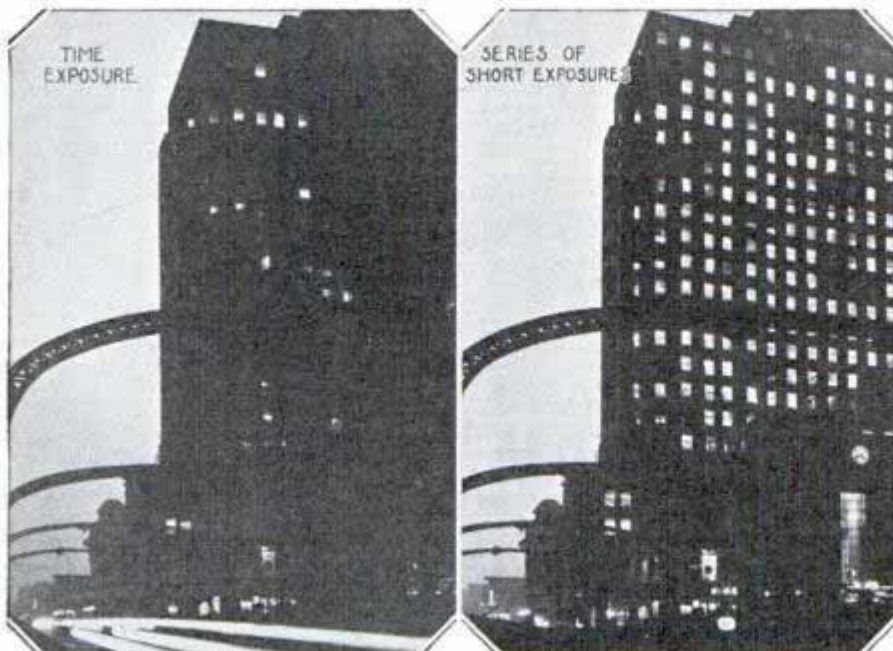

a rigid tripod and taking a series of short exposures at convenient intervals. Time your shots so the headlights of passing automobiles are not picked up, and the ugly light streaks will be eliminated from the streets.

—J. G. Roberts, Chicago.

Ⓛ When dyeing an old garment remember that it must be cleaned thoroughly so the dye will penetrate through the cloth, otherwise it will have a streaked or spotted appearance.

SMOKING STANDS

$\frac{1}{8}$ " X 35" CHROMIUM OR BRASS ROD

BUTT JOINT INSIDE HOLE

12"

120°

120°

120°

POSITION OF LEGS

GUARD RING

TOP

2"

GUARD RING

TOP

$\frac{1}{4}$ " - 6 SCREW

SET AT 35°

DETAILS OF TOP & LEG

LEG & PIN DETAIL

LEG

LEG

LEG

LEG

LEG

METHOD OF ATTACHING LEGS

LEG & TOP DETAIL

24 $\frac{1}{2}$ "

12 $\frac{1}{4}$ "

X

Y

$\frac{1}{8}$ " HOLE

$\frac{1}{2}$ " R

1"

$\frac{1}{2}$ "

SCREW HOLE

26"

1" SQUARES

WRAP STRIP OF PAPER AROUND PIN (A) CUT TO EXACT LENGTH (B) FOLD IN THREE PARTS (C) MARK IN THREE PARTS (C) MARK CENTER LINES ON PIN & LOCATE LEG SCREWS ABOVE & BELOW LINE X-Y

1ST	1" ABOVE	1" BELOW
2ND	$\frac{3}{4}$ "	$\frac{1}{4}$ "
3RD	$\frac{1}{4}$ "	$\frac{3}{4}$ "

MATERIAL LIST

- 3 Pcs. $\frac{5}{8}$ x 6 x 26 in.—Legs
- 1 Pc. $\frac{3}{4}$ x 8 $\frac{1}{4}$ in.—Pin
- 6 1 $\frac{1}{2}$ " - No. 6 R. H. Screws
- 1 Pc. $\frac{1}{2}$ x 12 x 12 in.—Top
- 1 Pc. $\frac{1}{8}$ x 35 in.—Ring
- 3 1 $\frac{1}{4}$ " - No. 6 R. H. Screws

Note: Some close grained hardwood should be used for legs and pin. Top may be made of walnut, mahogany or maple

Both these trim stands have dual uses. The one of your choice will serve you well as a smoking stand, or, either one makes a truly distinctive base for a large potted plant. If you're particular about constructional details you'll want to steam and bend the "bow" legs of the first stand to the curve indicated. However, if a close-grained wood is used, the legs should be reasonably strong if simply sawed to shape from a wide piece of stock. The "T-base" design is a colonial type and, with exception of the base members, is a simple lathe job

in "bow-leg" and "T-base" designs

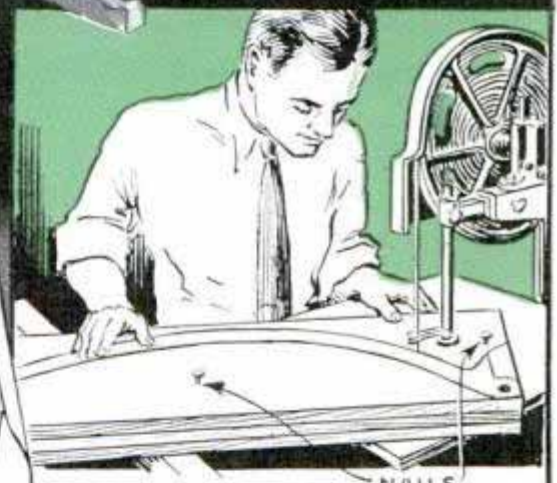
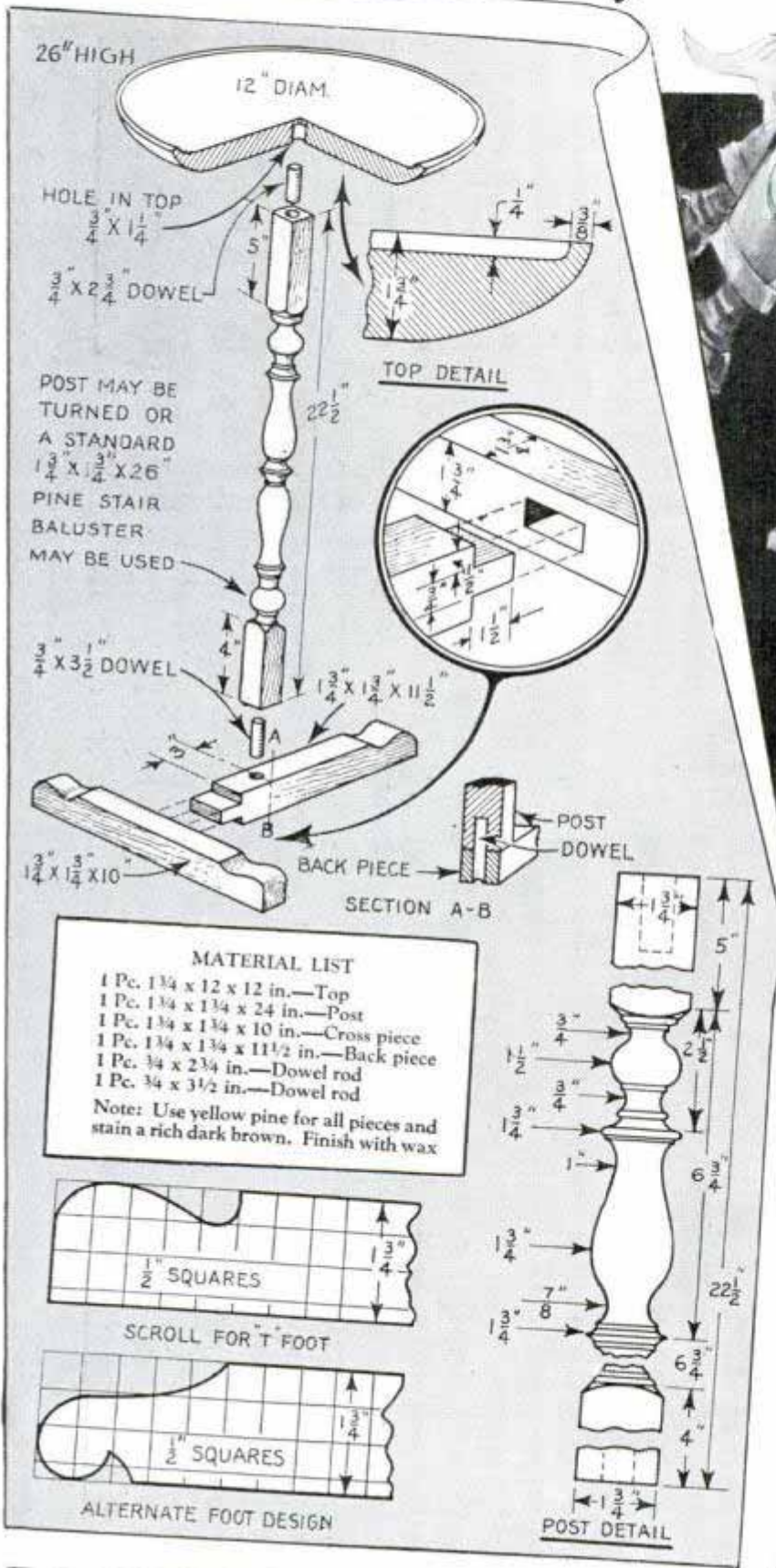

THE THREE LEGS MAY BE SAWED AT ONE TIME

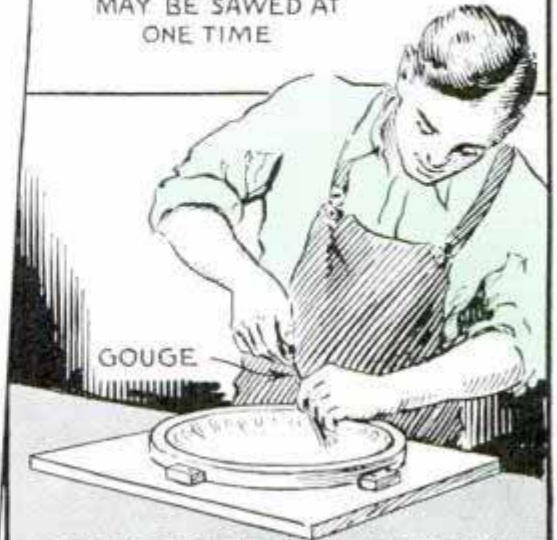

THE RECESSED TOP MAY BE FORMED WITH A GOUGE AND SANDPAPER

Doorknob Serves as Paperweight and Pencil Holder



Because it holds a pencil within easy reach, a glass or China doorknob makes an especially useful paperweight. The polished knob permits easy removal of papers without marking them, and the pencil is always in a handy position to pick up.

Scissor Sharpener Holds Hone at Correct Angle

Anyone who has difficulty in honing a pair of scissors will find that this sharpener removes the guesswork. The blade of

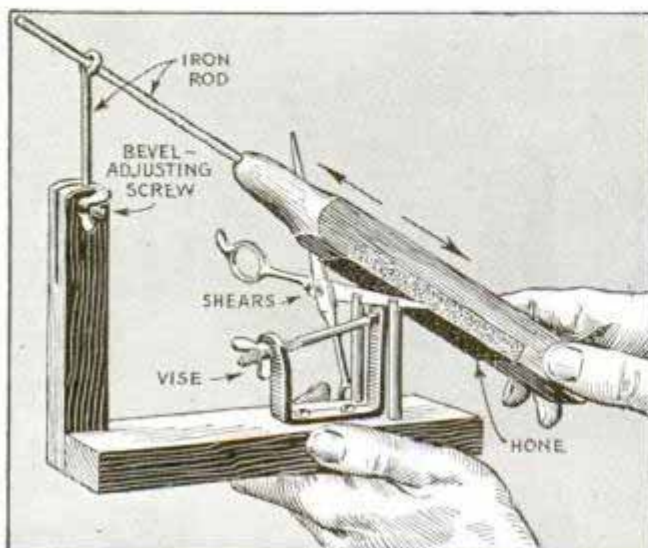

the scissors is held rigidly at the correct angle in an improvised vise, and the angle can be adjusted as desired.

Padded Tops Convert Sawhorses to Support Upholstering Work

The home craftsman who has an occasional job of upholstering can convert a pair of ordinary sawhorses for the work by fitting them with removable tray tops which have been padded. Large dowels projecting from the bottoms of the trays are spaced to fit in holes in the tops of the sawhorses.

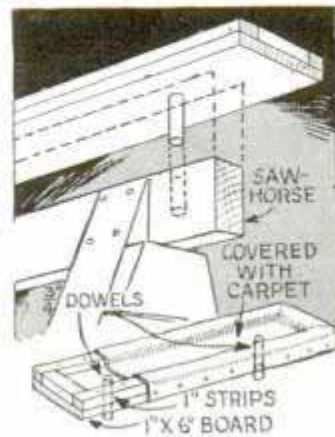

Pipe Spaced from Wall by Leather under Clamping Straps



When fastening a water pipe to a wall or ceiling, it is a good idea to put strips of thick leather under the clamping straps as indicated. This spaces the pipe from the wall so

that the latter cannot be damaged by moisture condensing on the pipes, and it also makes them easier to paint.

Elbow Guides Electric Wires into Conduit End

Before you pull electric wires into rigid conduit, screw a coupling and street elbow onto the end of the conduit. This will reduce friction where the wires enter by making them follow the turn of the elbow.

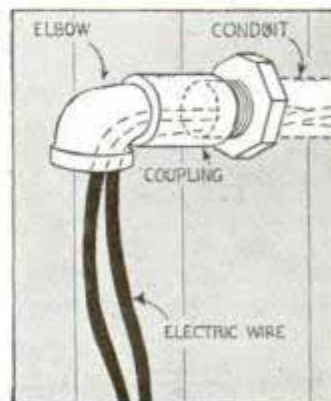



PORKY *the* PIG

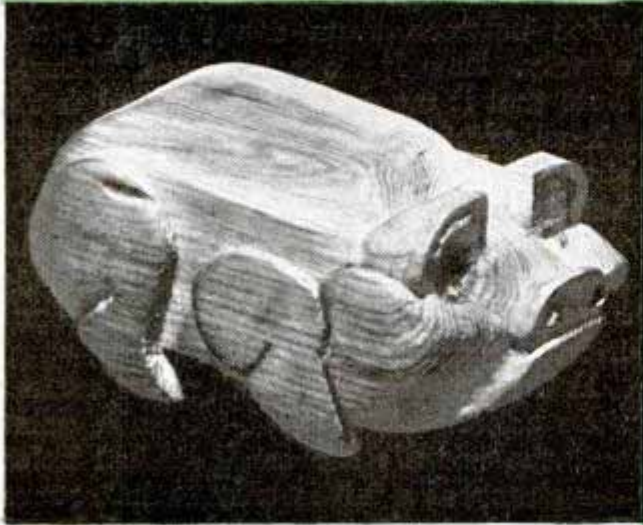

Carved in Wood



and in Soap

By E. J. TANGERMAN

CARVING Porky in wood or soap is an interesting pastime diversion. When done in wood, it is an easy job for those unskilled at carving because most of the work can be done on a jig saw as indicated by the dotted lines in the detail marked "blank." You will need a block $1\frac{3}{4}$ by 2 by 4 in. with the grain running the long way. White pine or basswood is easiest to carve, but mahogany or walnut will polish up better in finishing.

Lay out $\frac{1}{4}$ -in. squares on one side of the block and transfer the side outline to

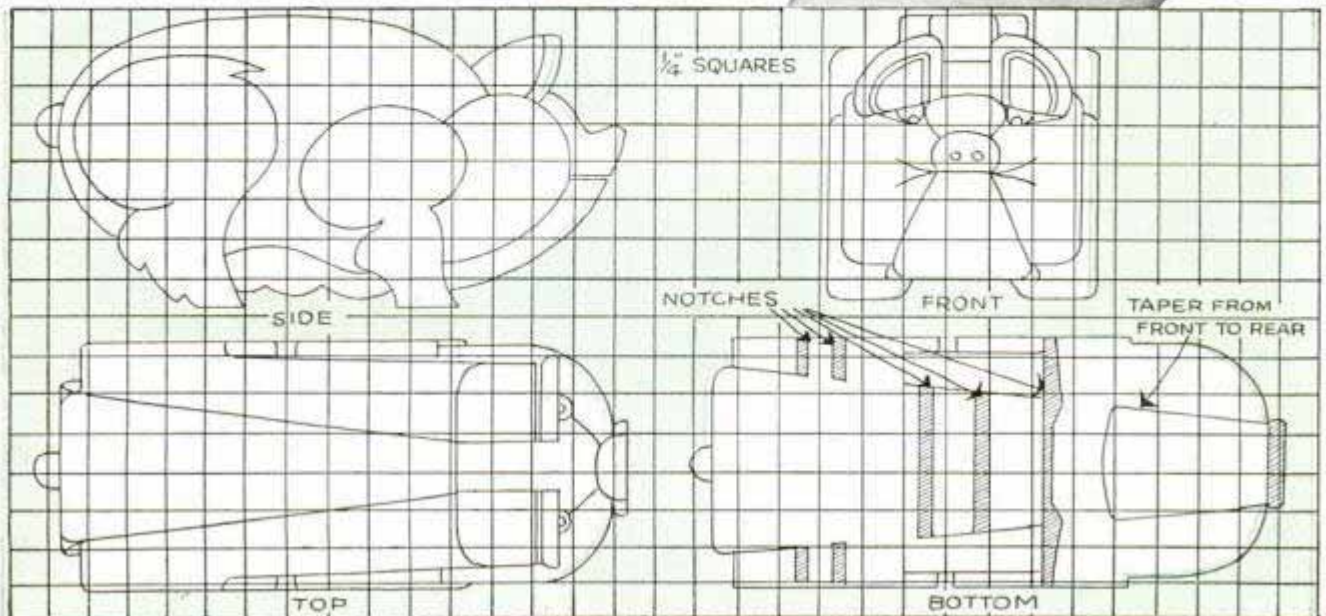
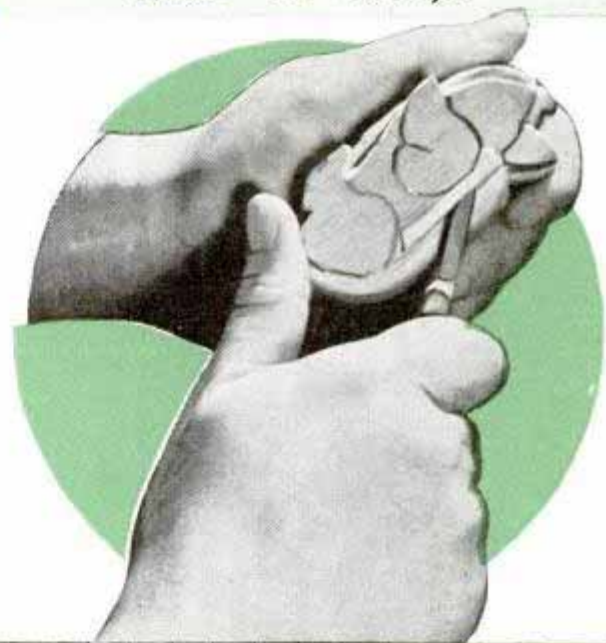

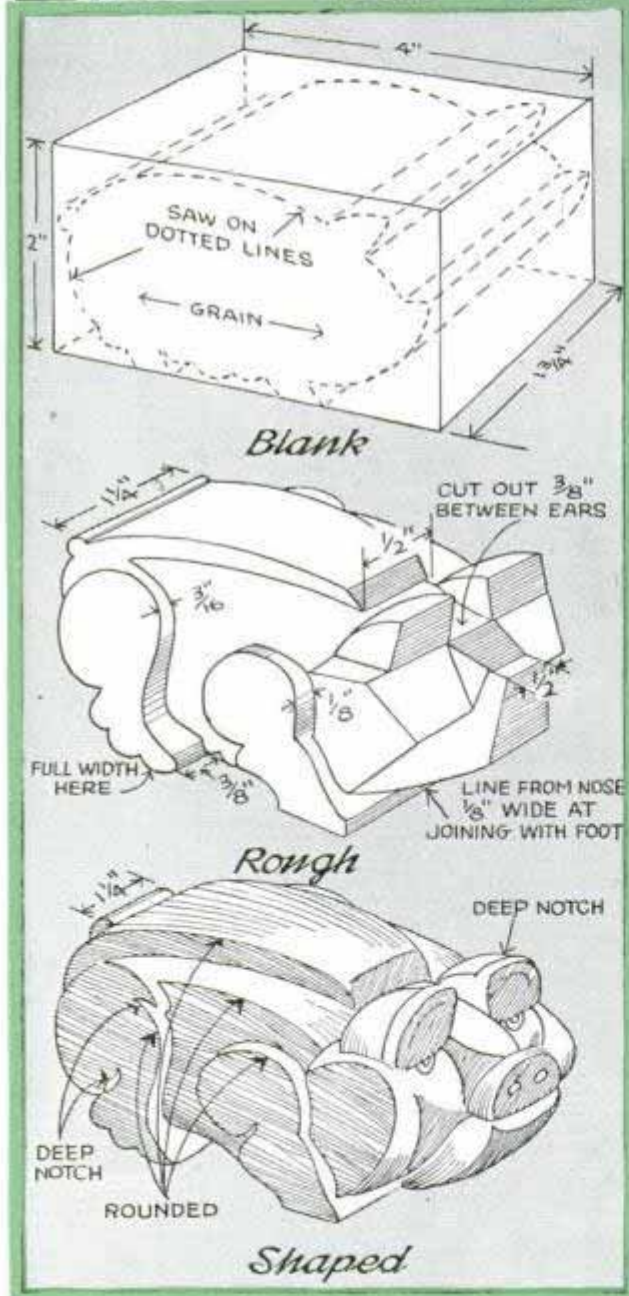
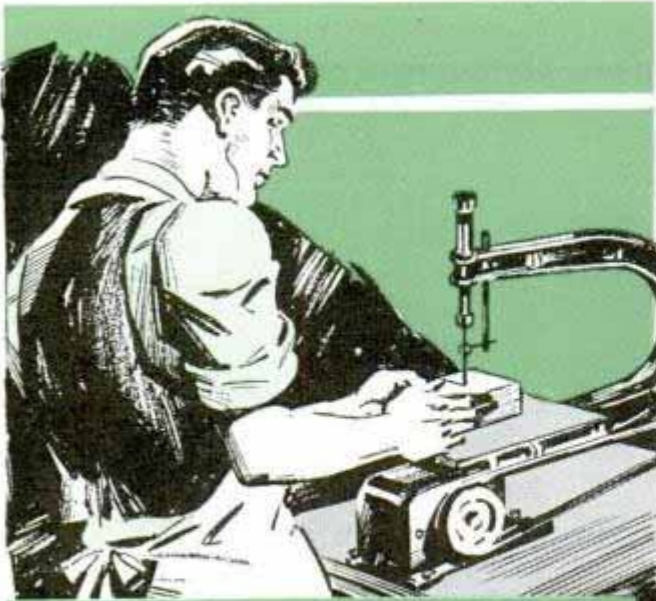

Porky in three stages from a rough-sawed blank to the finished form. Simple relieving cuts first, then a slight rounding to give the right characteristics

it. Saw Porky out, outline his legs with the tip of a knife blade and whittle the wood away around them $\frac{3}{16}$ in. deep, except for the cheek, which is cut back only $\frac{1}{8}$ in. If the legs are properly outlined, the wood between them can be split away cleanly. Now lay out the back "hump." Note that it tapers both above and under his belly from the tail to nose. Then rough-shape the face and ears and deepen the notches at Porky's joints, rounding all the sharp lines. Note particularly the notches in the bottom view of the squared details. Ears are accented by a notch cut all around in front, and another on the side.

Porky's eyes are like half cones set in a little hollow carved with the knife point, and the nostrils are small drilled holes. His stump of a tail is only $\frac{1}{4}$ in. square. But he looks fat enough, and happy enough to grunt, particularly if you finish him just by oiling and waxing.

Modeling-Clay Sanding Block Smooths Moldings

One carpenter uses a piece of modeling clay as a sanding block when finishing moldings around doors and windows on the interior of a home. The clay is put inside a tobacco sack around which the sandpaper is wrapped, and easily conforms to the contours.

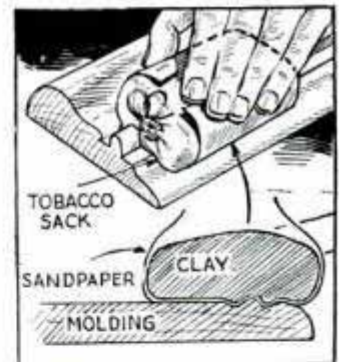

Gaskets for Model Gas Engine

After experimenting with several materials in making a cylinder-head gasket for a model gas engine, I found that a piece of old auto cylinder-head gasket was just the thing. I cut an opening the size of the cylinder through one copper side and the asbestos center. The opening through the other copper side was made $\frac{1}{4}$ in. smaller in diameter, after which the projecting metal was annealed and folded over the edges of the opening. Flattening and truing the gasket was done by pressing it between two hardwood blocks in a vise.

—C. L. McConnell, Alhambra, Calif.

It's Fun to Rock Between These Two Bunnies

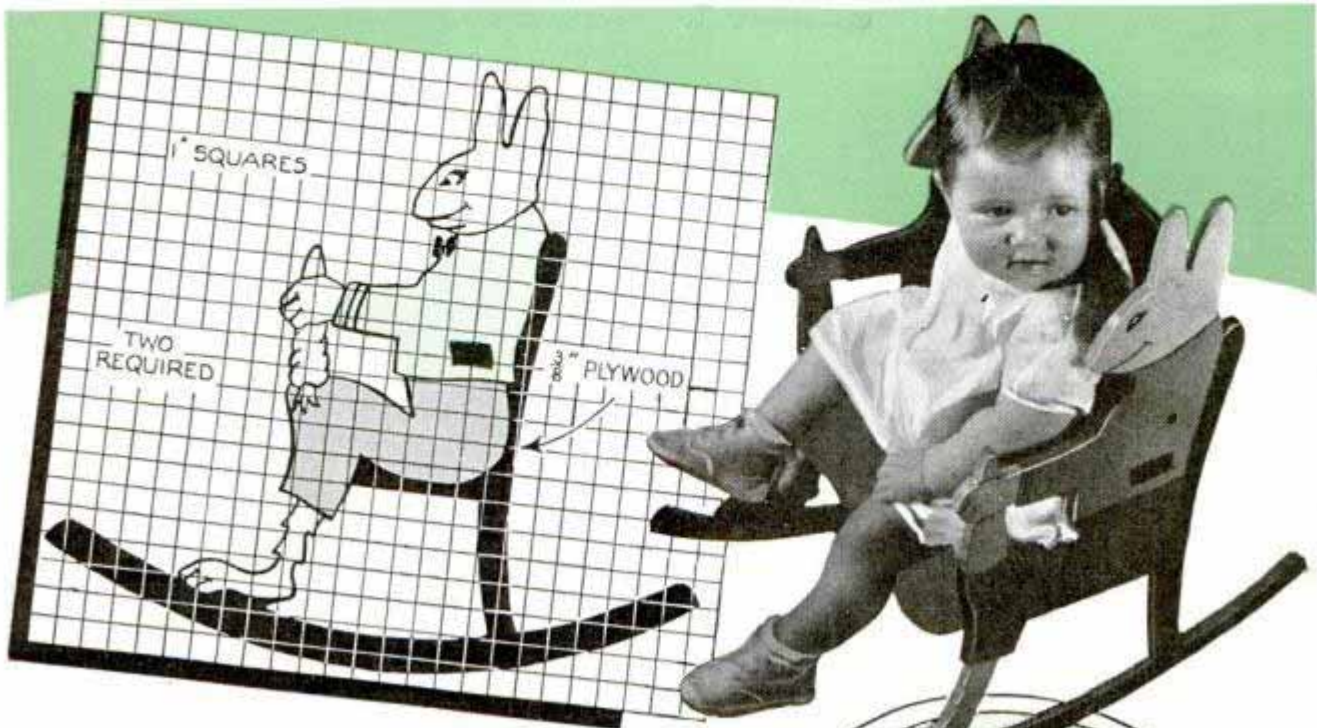

Guarded on both sides by colorful cut-outs of Peter Rabbit, this little girl enjoys sitting in her bunny rocker. The chair is sawed from $\frac{3}{8}$ -in. plywood and consists of four parts—a seat, back and two sides. The rockers are integral with the sides. In assembling the chair, the edges of the seat and back are butted against the sides and fastened with glue and screws spaced about 3 in. apart. Or, you can use cleats under the seat and behind the back for additional rigidity. The cleats are first screwed to the sides, then the seat and back are screwed to the cleats. Painting in bright colors enhances the appearance. First give the wood a coat of shellac and sand lightly when dry. Then finish as desired, painting the cut-outs in identical colors on both sides. The original chair had dark-blue rockers, seat and back, and the bunny cut-outs wore brown trousers and green jackets. Their faces, feet and hands were pale pink. Black neckties, jacket pockets and trouser stripes offer just the right contrast. The carrots in their hands are orange and the eyes are black with yellow pupils.

—Floyd Mix, Chicago.

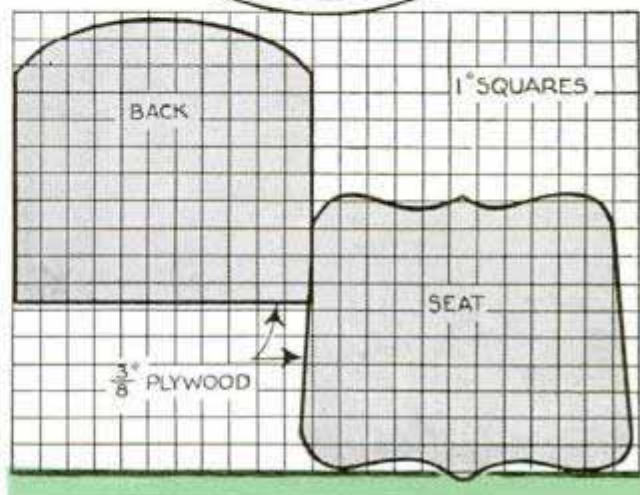

☞ If your light-colored stove is badly in need of cleaning, dip a soft cloth in bleach water, then into powdered cleaner, and rub over the soiled parts. Wash with soap and water. The stove should be cold when you clean it, or the enamel may check.

Cotter Keys Serve as Flagstaffs on Model Locomotive

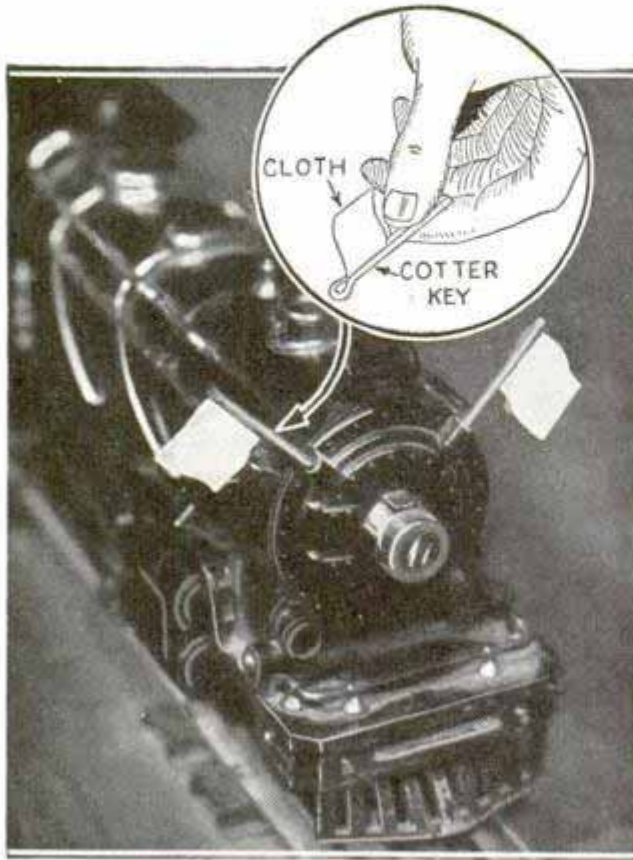

If you have to replace the tiny flagstaffs on a model locomotive, cotter keys will serve the purpose nicely. Select some about the same length and diameter of the original staffs, and insert the flags between the legs of the keys, which can be slipped into the flag sockets on the model.

Ink Bottle in Rubber-Ball Holder Does Not Tip

A small, hollow rubber ball cut in half and an opening made in the end to take



the neck of an ink bottle, provides a good holder to keep the latter from being tipped over. Besides supporting the bottle, the holder also tends to catch ink dripping, which can be wiped off easily.

Hinge Clamped to Auger Bit Provides Depth Gauge

Made from a butt hinge, this depth gauge can be clamped quickly to the shank of almost any auger bit. The ends of the hinge leaves are bent slightly inward and a piece of heavy wire replaces the original hinge pin, as shown. Tightening a wing nut, which is fitted to a bolt passing through the hinge, locks the adjustment and clamps the gauge securely to the bit.

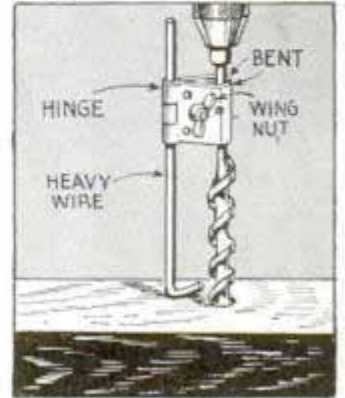

Fish Line Waxed Easily

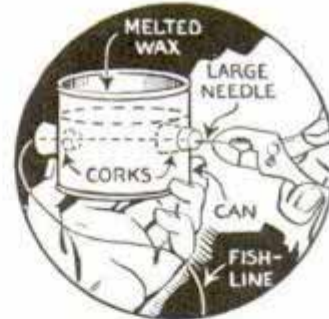

The next time your fish line needs waxing, get a small tin can and punch holes in the opposite sides of it for two corks as shown. Melt enough wax to come up over the

corks and then thread the line on a darning needle and push it through the corks. Pulling the line through the melted wax slowly will impregnate every fiber and the second cork squeezes out all surplus wax.

Sinker Anchors Tape Measure

Instead of using a knife or nail to hold one end of a tape line when measuring logs, boards and other long work, a lumberman attaches a lead fish-line sinker as shown.

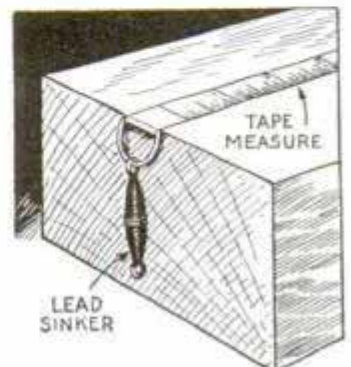

Mail-Pouch Catcher Gives Realistic Action

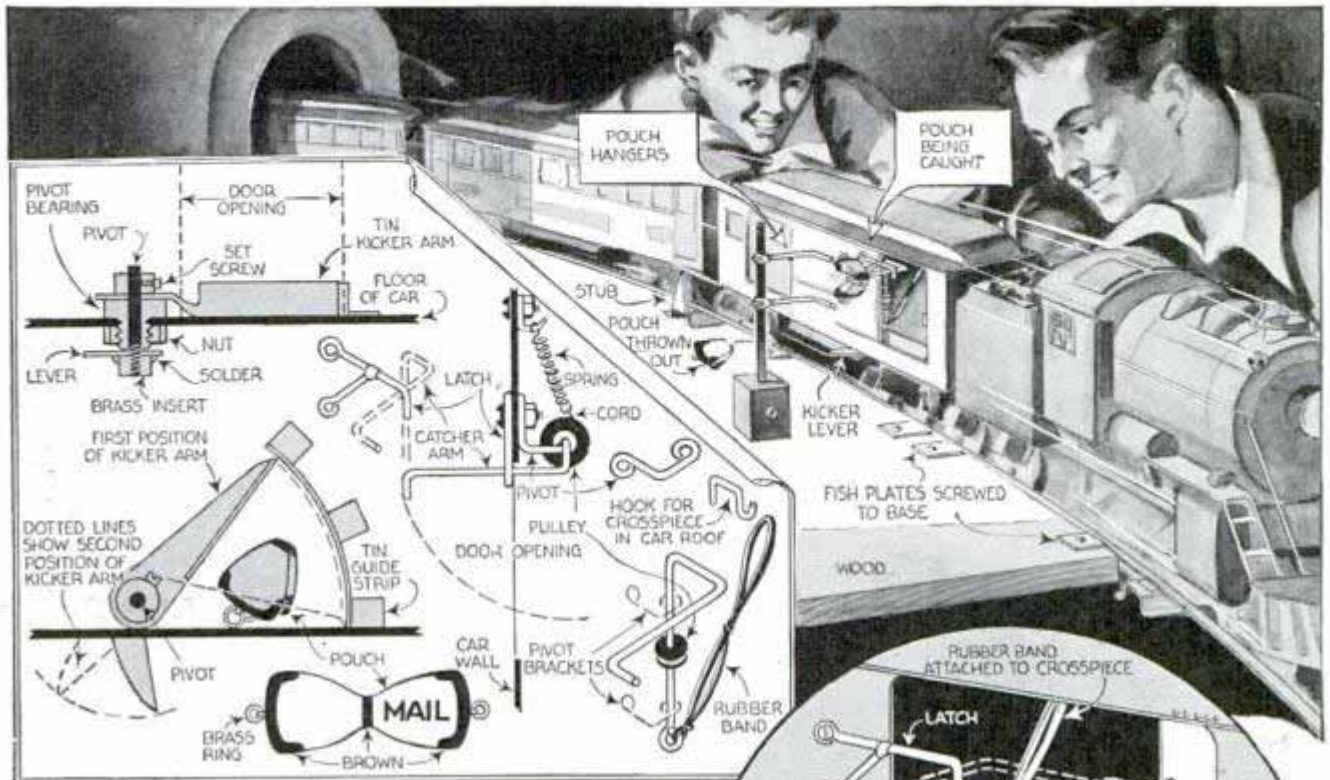

THIS midget catcher kicks one mail pouch from the car door onto the station platform, then catches the second pouch from the hanger and swings it inside the car in the same fashion as its full-size counterpart. A close look at the details gives you the idea of how it works. First is the installation of the kicker arm which throws the pouch out the car door. This is a tin angle swinging on a pivot installed just inside the door in the manner shown. A curved guide strip is soldered to the floor of the car to hold the pouch in the proper position. A stub or lug soldered to the track engages a lever attached to the kicker pivot to actuate the arm. No dimensions are given on these parts because you have to make them to fit the car in hand. The catcher is really a separate unit supported on two pivot brackets of bent wire attached to the side of the car. The arm and latch are also bent from wire to the shape indicated. A tiny sheave, made from two sheet-metal disks and a small housing, is soldered to the arm. One end of a light cord wound around the sheave several turns is attached to a return spring as you see it in the details. Now, when you have the arrangement assembled as shown in the circle above, make sure that it works freely without binding at any point.

The mail pouch is loaded with small lead shot and when caught by the arm its weight is sufficient to pull the arm down slightly, releasing it from the latch. Then the coil spring, attached to the sheave and the car wall, pulls the arm inside the door as indicated by the dotted lines. When the pouch is removed and the arm swung back to position, the tension of the rubber band shown holds the arm under the latch. Some experiment will be necessary to get the hanger located in the proper position on the platform. Of course, the latter must be attached to the track so that it does not shift and throw the hanger out of line.

Stair carpet will last longer and wear more evenly if you purchase it half a yard too long, and fold it in at the top and bottom of the stairs; as the carpet wears on the edges of the treads, move it a trifle.

Del. Sacramento
064

LIQUID



Here the rubber mold formed over model is removed

Fun and profit in casting colored jewelry, buttons, statuary and novelties of all sorts that are practically unbreakable and noninflammable. You reproduce objects by a simple process of forming a flexible rubber mold which is poured full of liquid plastic and is heated in an oven at about 165° F. No expert knowledge is required to do this work—anyone becomes adept with very little practice. Liquid rubber, plaster of paris, some modeling clay, liquid plastic and a dollar oven are all you need to start with this fascinating craftwork

By R. STEWART

109 S. George St.
Lake Geneva
Calif.



Some of the articles you can form in rubber molds with a kit costing a dollar

ANYONE can make innumerable small objects of tough, resilient plastic, which is available in liquid state and hardens quickly when heated. The user merely pours the liquid into a mold, which he can also form by a simplified process. While metal and plaster molds can be used, the simplicity of making and using rubber molds favors the latter. All you need to start in this fascinating work is some special liquid rubber and the plastic. The latter consists of two separate liquids, nine

parts synthetic resin and one part catalyst. Colors can be had by adding ordinary plastic dyes to the resin before mixing it. If desired to experiment on a small scale, a small amount of the material will provide lots of fun and will give you first-hand information on using it before purchasing larger quantities for more extensive work.

The preparation of the mold is the biggest part of the job. Step-by-step information on doing this starts with Fig. 2. After selecting the model to reproduce,

Liquid Rubber. serial 199 a
 suggest do-to works, sept 2-227
 Cincinnati, Ohio

PLASTICS

Open New Field in Craftwork



After experimenting with the simpler articles, more ambitious novelties like these can be made

such as the creamer for example, you take a wad of ordinary modeling clay, roll it in the hands or on a piece of glass to form a strip, which is pressed to the bottom, near the edge, Fig. 3, so that the creamer can be stuck firmly onto a sheet of glass as shown in Fig. 4. After pressing the creamer down firmly, some of the clay may ooze from under the bottom and this is trimmed off close to the creamer edge with a sharp knife as in Fig. 5. Now, throughout the process of forming the mold, creamer and piece of glass are not to be separated.

If there are any openings in the model that must be repro-

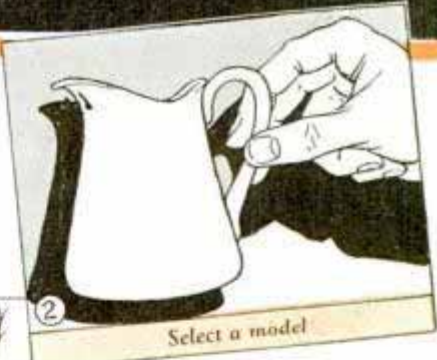

2 Select a model

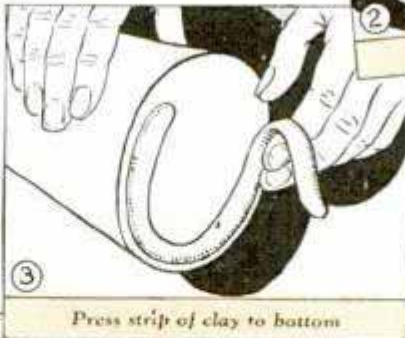

3 Press strip of clay to bottom

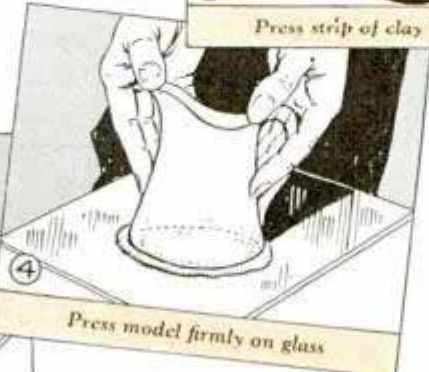

4 Press model firmly on glass

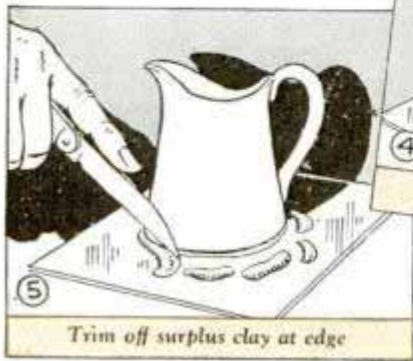

5 Trim off surplus clay at edge

duced, in this case the opening of the handle, a separator must be provided so that the completed rubber mold will be split at this point, permitting removal of the model.

To form the separator, press a wad of modeling clay on one side of the handle, letting it extend halfway inside of the handle as indicated in the detail of Fig. 6. Then ordinary brushing lacquer is applied against the clay dam to contact the inside edge of the handle. Several coats of the brushing lacquer are needed in order to build up the thickness of the separator to assure its being sufficiently strong.

LIQUID RUBBER BRUSHED ON MODEL FORMS MOLD

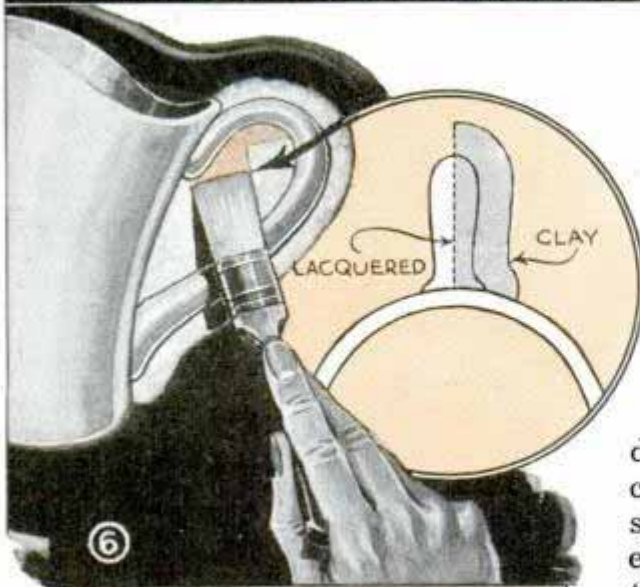

⑥ Openings filled with lacquer separators



⑦ Apply several coats of liquid rubber

Next comes the actual formation of the rubber mold. Liquid rubber is brushed over the entire surface of the model, inside and out, as in Fig. 7. After the first coat has dried, apply another and continue with still more coatings, allowing each coat to dry before the next is added, until a thickness of $\frac{1}{16}$ to $\frac{1}{8}$ in. has been built up. Now set the whole thing away for several days to permit the rubber to cure.

When you come back to the job after this intermission, you are ready to make a plaster-of-paris

shell, which is used to hold the flexible rubber mold while pouring the plastic, after the original model has been removed. However, the model is still kept in the mold throughout the entire process of forming the shell. On flat models without undercuts a one-piece shell can be made, but in case of the creamer it is necessary to provide a core and a two-piece shell as shown in Fig. 9. Fig. 8 illustrates how the core or the inside shell of the mold is produced. First apply modeling clay to fill recessed portions so that the diameter of the space at the bottom will be less than the diameter at the top. This assures easy withdrawal of the plaster core. On the irregular top edge of the creamer a thin wall of clay is also added to produce a horizontal edge as indicated in Fig. 8. After this has been done, you grease the rubber surface with olive oil and then fill with plaster of paris up to the edge of the wall of clay. When the plaster has hardened, remove the wall of clay.

Next comes the forming of the two-piece shell,

First fill the recesses inside with modeling clay; then add a clay wall to the top to get a straight edge; finally pour plaster core

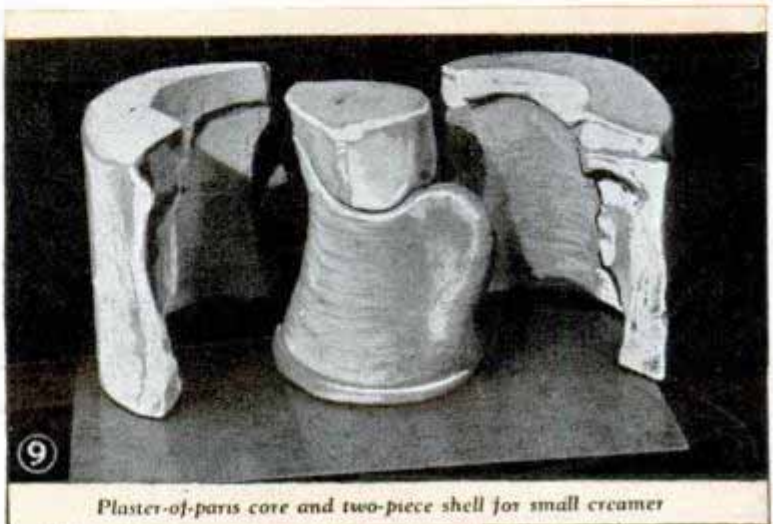
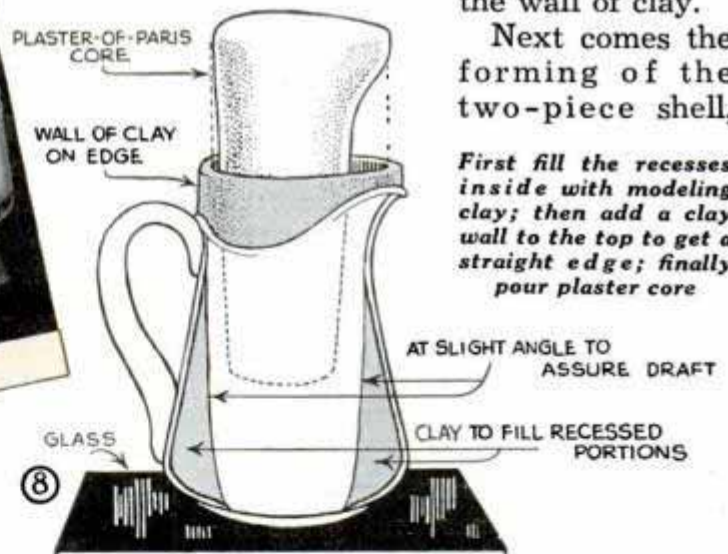

⑨ Plaster-of-paris core and two-piece shell for small creamer

PLASTER CORE AND SHELL HOLD MOLD WHILE POURING

illustrated in Figs. 10 and 12. Remember that the model is still being held on the glass while you are forming the shell. A piece of light sheet metal is bent to a curve around the exposed part of the mold, with clearance of about an inch for pouring plaster. Note that the ends of the sheet metal fit against the clay dam and that rubber bands slipped over the whole assembly hold it together while pouring. Before pouring, both the rubber which is exposed and the exposed portion of the core are greased thoroughly with olive oil and four small register holes are pressed into the clay dam. Then the plaster is poured. When hard, the clay dam is removed and the tin transferred to the other side to repeat the operation, not neglecting to grease again all rubber and plaster surfaces against which plaster is to be poured, in order to permit easy separation.

Punch register holes in first half of shell, assemble with model, grease surfaces, then set up with sheet-metal shield and pour second half

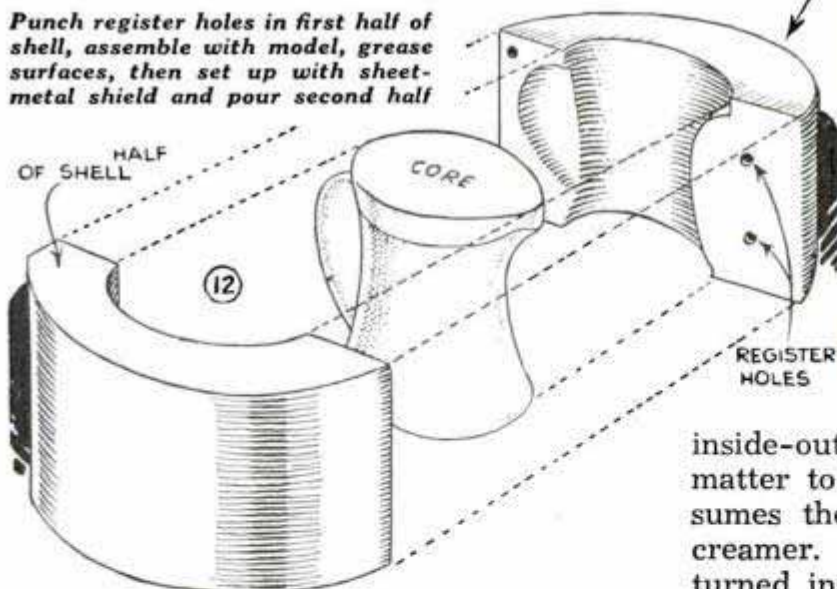

With the job of making the mold and the stiffening shell completed you are now ready for pouring the plastic. All that is necessary is to remove the glass from the bottom of the creamer, and pull off the flexible rubber mold from the creamer as shown in Fig. 1. The rubber will be tough and you can stretch it as required in order to remove the model. The mold may turn

Clay wall up to parting line and sheet-metal shield provide a form for pouring first half of plaster shell

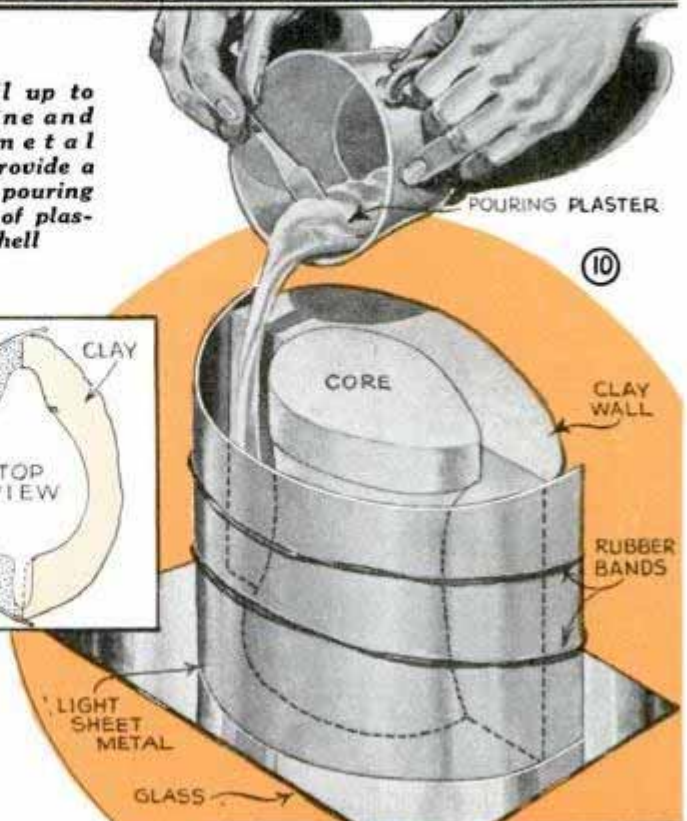
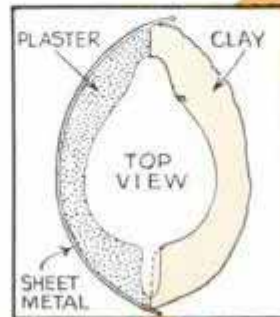

HALF OF SHELL



inside-out when doing this, but it's an easy matter to reverse it again so that it assumes the same position it had on the creamer. In fact, the mold should be turned inside-out so that you can apply fine talcum powder to its inner surface, which assures easy parting of the plastic. Then the mold is placed in the shell, which it fits exactly, the core is inserted and the whole assembly is set upside-down for pouring, as shown in Fig. 11.

After the mold has been filled with liquid plastic, the assembly is placed in an oven for 20 to 30 min., where the temperature is kept from 160 to 175° F. The liquid



After pouring the plastic, it is slowly hardened by heating at 160 to 175° F., in a small oven, heated by a 150-watt electric lamp

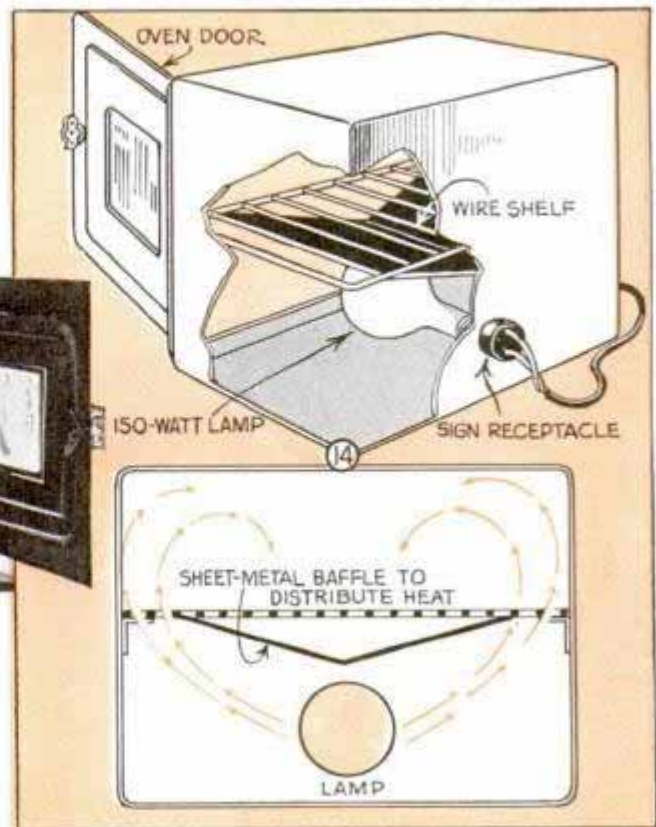

will change to a milky white solid plastic. An inexpensive oven like the one shown in Fig. 13 can be constructed by mounting a 150-watt lamp inside a small gas-burner oven, which sells for a dollar, or in a small box provided with a door. In order to distribute the heat from the lamp uniformly, you can provide a sheet-metal baffle wired under the oven shelf, as in Fig. 14.

Rubber molds once made can be used over and over again to make duplicate articles of plastic. Often the plastic repro-

duction requires no finishing whatever, especially those produced from glass or porcelain models. However, the material can be polished on a buffing wheel or in a tumbling barrel. It can be cut and sawed but is almost unbreakable in daily use.

Saw Vise Has Long Jaws Opened by Pressure Springs

Once you have clamped a hand saw between the long jaws of this sturdy vise, you can complete a job of filing the teeth

without stopping to shift the blade. The vertical members of the vise are 2 by 4-in. stock ripped in half 20 in. down the center and joined together at the bottom with a stretcher

notched flush in the edges. The jaws, shaped and beveled as shown, are notched on the face side to take the half-lap upper ends of the vertical members. After boring and counterboring each cut-out piece to take a short coil spring and bolt, they are hinged in place as indicated. When the tail nuts, fitted to the $\frac{3}{8}$ -in. carriage bolts, are loosened the springs force the jaws apart, making it convenient to insert or remove the work.

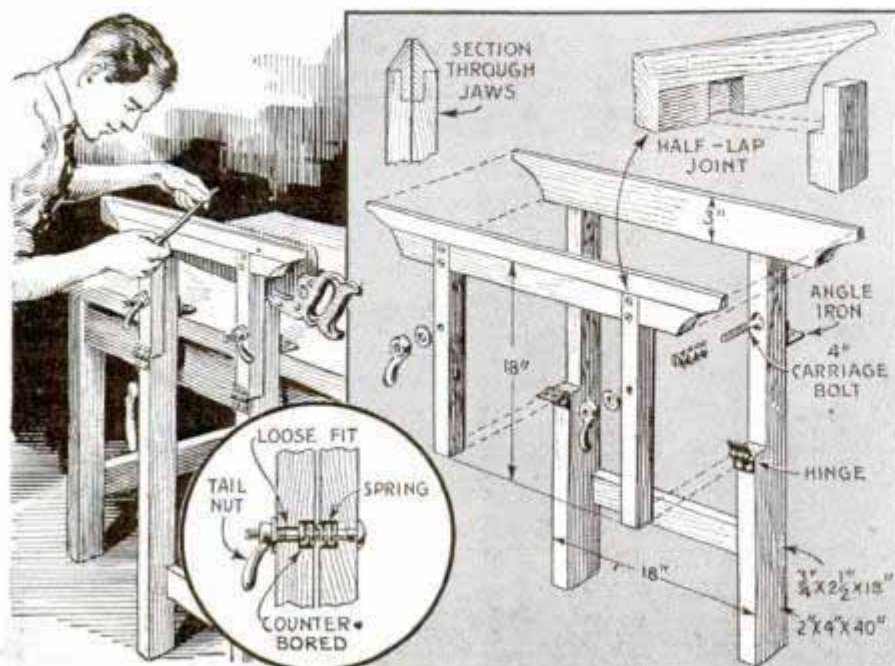

Personalize Your Tie Rack with a Photograph

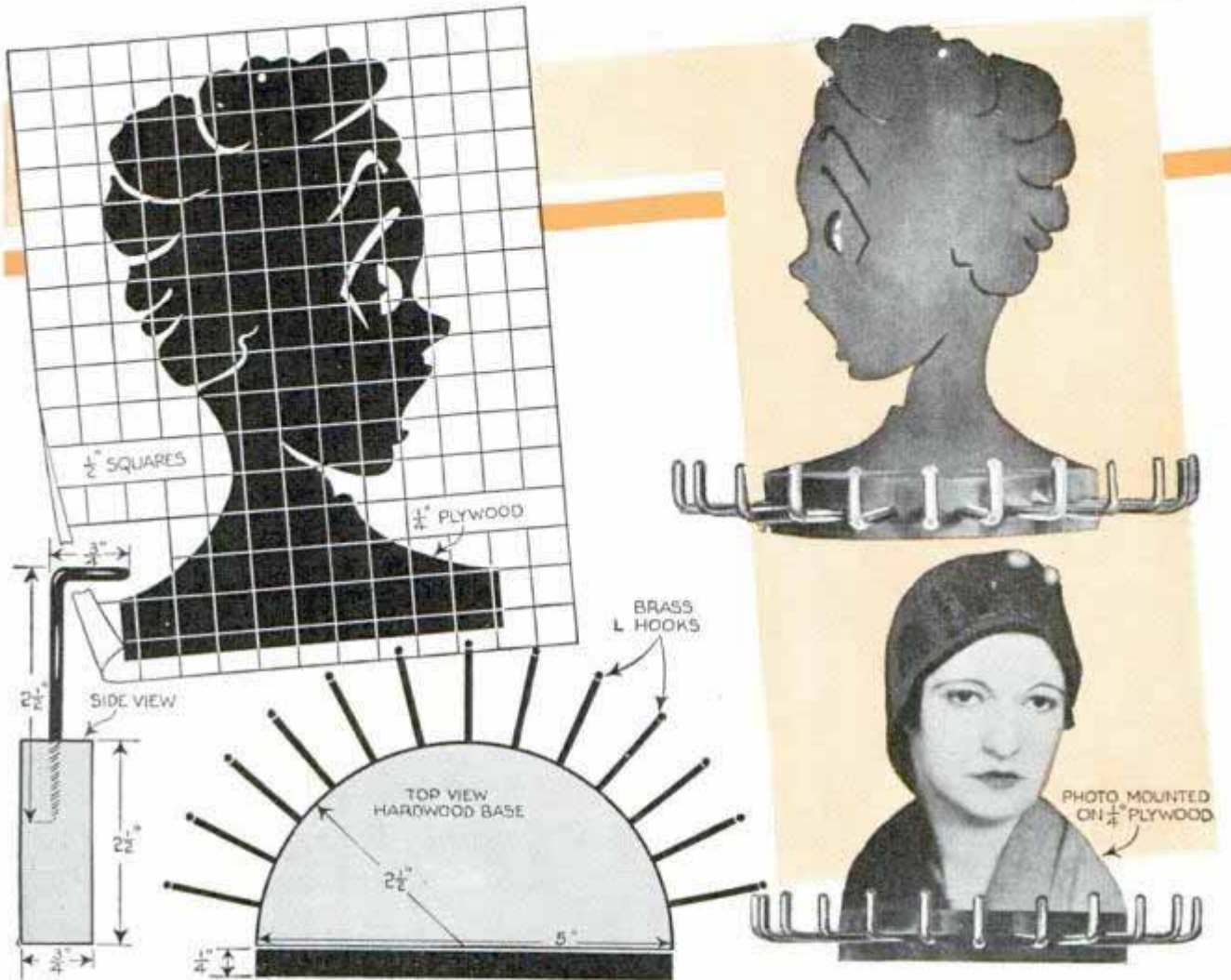

Using enlargements of favorite photos, you can make these tie racks for yourself, and they will be appreciated as gifts by your friends. A photo of the head and shoulders is glued to $\frac{1}{4}$ -in. plywood and then cut out with a jig saw. When finished, the photo should be about 7 in. high. If desired, silhouettes can be substituted for

photos. In this case, the outline of a photo is traced directly on the wood, which is then sawed to shape and painted black. The rack for the ties is a block of $\frac{3}{4}$ -in. hardwood cut as shown and screwed to the plywood back near the lower edge. L-hooks to hold the ties are then driven into the edge of the hardwood piece.

Pedestal Bird Bath of Concrete Resembles a Tree Trunk

The home owner who wants to try his hand at making novel articles of concrete will find this bird bath a useful as well as a decorative article. Simulating a hollowed ring cut from a tree trunk and nested between four stub branches, the bath is a single concrete unit formed by applying cement to a framework of metal lath. The serrated lines imitating bark were scratched in the surface of the concrete before it hardened. The water receptacle was formed over a sheet-metal disk with metal lath bound around the edges, the disk being set on top of the main framework so that the entire assembly was formed into a single unit as the cement was applied. The bath was built on a concrete platform large enough to keep it from tipping.



Toy Balloon Coated with Rosin Is Halloween Noise Maker



Safe and effective, this noise maker is simply an inflated rubber balloon sprinkled with powdered rosin. When this is rubbed against a windowpane it will produce noise without danger of breaking the glass.

Shaving Brush Helps in Rubbing Intricately Carved Work

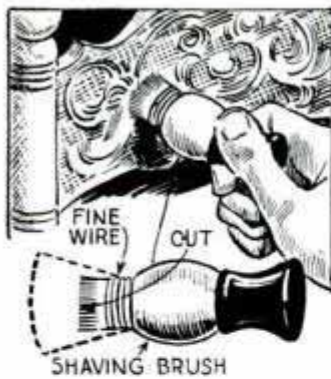

You will find a cheap shaving brush with the bristles cut off, as shown, a timesaver when rubbing carved work with pumice or rottenstone. Bind the bristles with wire before cutting.

Pictures Suspended from Block to Avoid Breaking Cord

Cords supporting heavy pictures are less likely to chafe against the nail or hook and break, if triangular blocks are pivoted to the nails and the cords

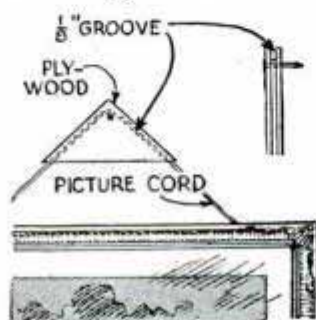

placed in grooves cut in two edges of the blocks. Also, greater friction between the cords and blocks helps to prevent the pictures from tipping toward one side if the pivot holes in the blocks are located at the balanced center.

Developing Tray Partitioned to Save Fluid

You can economize on developing fluid when finishing small negatives and prints if you partition the developing tray so that one-half of it can be used. This is done with a strip of thin wood coated with asphaltum varnish. It is fastened in place with rubber cement, flowing it liberally along the joint.



Scraper for Croquet Court Made from Bed Rail

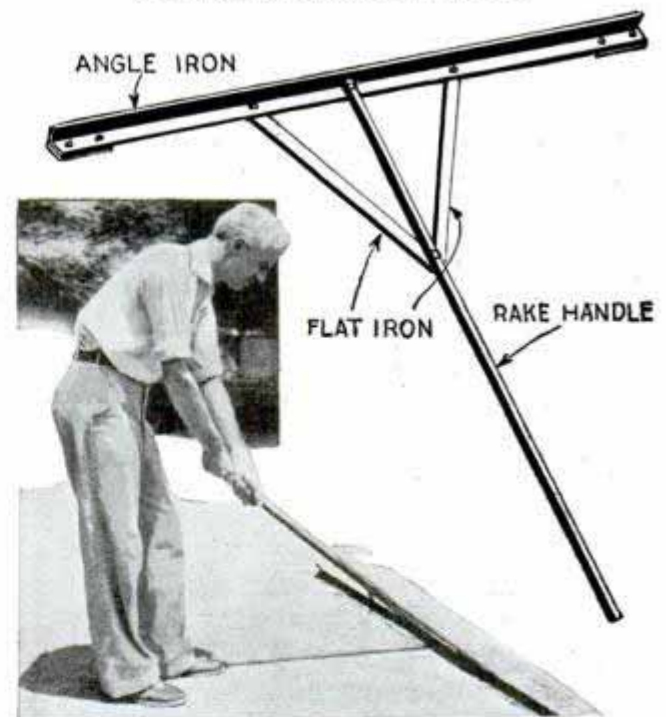

The side rail of an old iron bed or any piece of heavy angle iron makes a handy scraper for dirt croquet courts, when fitted with a wooden handle braced as shown. The weight of the bar makes a smooth surface without bearing down on the handle.

VALET

A Man's Clothes Rack

Besides accommodating daytime wearing apparel neatly, this rack holds a bathrobe full length, as the hanger support is adjustable. A handy shelf for watch, alarm clock, keys and other small items is also included. While the rounded edges can be formed by hand tools and sanding, a uniformly accurate job in this respect is preferably done on a shaper. The heavier piece of the main upright is grooved to take the sliding post and the half-lap joint on the hanger should be cut before the lower edge of the hanger is sawed to shape



Rounding edges of table

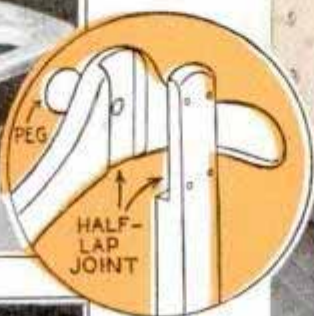

Cutting half-lap joint (coat hanger)

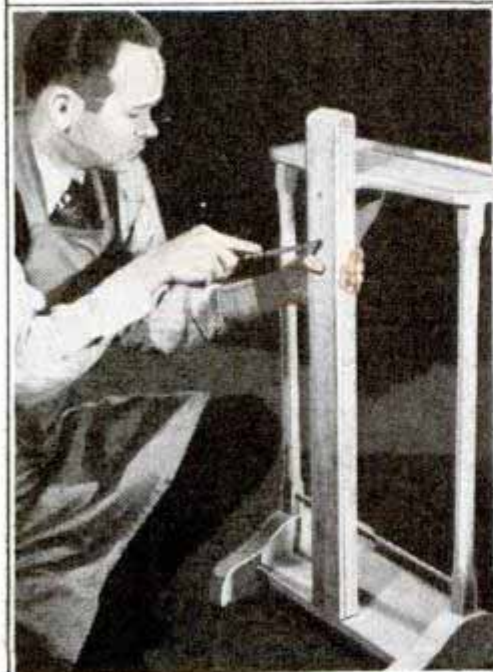

The bracket is screwed in place

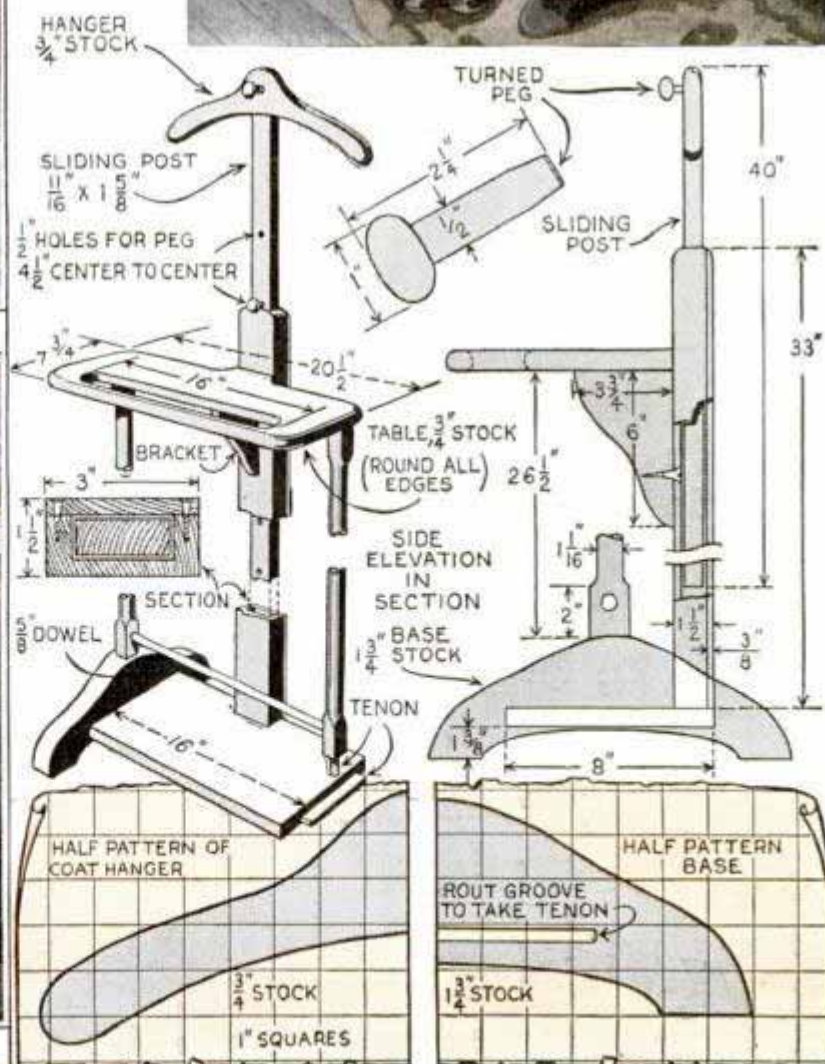

*Thurs
Sat
Arrows
Mum*

From SPRINGS to



SIMPLE and inexpensive, the loose spring cushion is often the only upholstery necessary to complete an attractive chair. For inner-spring construction, purchase a spring mat of the required size. The equipment necessary to make a cushion is shown in the material list, and in Fig. 1. Arrange the cardboard box as shown in Fig. 2, bradding it lightly to the workbench and driving nails at either end to hold the sides vertical.

MATERIALS

INNER SPRING—Small springs sewed in muslin pockets and assembled into mats. Sizes are multiples of 3. Regular cushion size, 21 by 21 in., costs slightly over one dollar.

CONSTRUCTION SPRING—Heavy springs mounted in wire frame.

COTTON FELT—27 in. wide by about 1 in. thick. Costs approximately 23 cents per yard.

TOW—Filling material made from flax. 8 cents per lb.

CASING—The cover of the cushion. Can be made of almost any kind of cloth to suit.

Fig. 1. Arrange the cardboard box as shown in Fig. 2, bradding it lightly to the workbench and driving nails at either end to hold the sides vertical.

Place a layer of cotton in the box and lay the spring mat over it as in Fig. 3. Fold the cotton over the spring and add a second layer, Fig. 4. Then close the box and tape it shut, Fig. 5. Strip the casing over the box, as in Fig. 6, and use the wooden plunger in Fig. 1 to ram the filling into the casing, at the same time withdrawing the cardboard box, as shown in

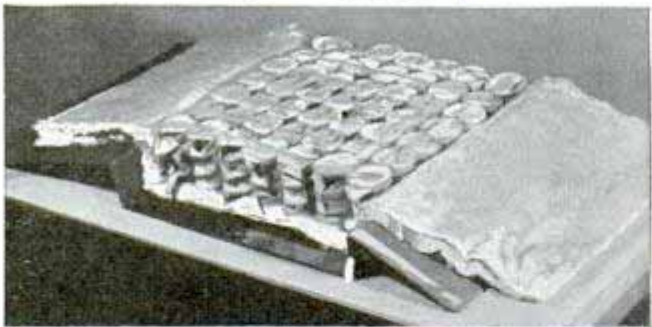
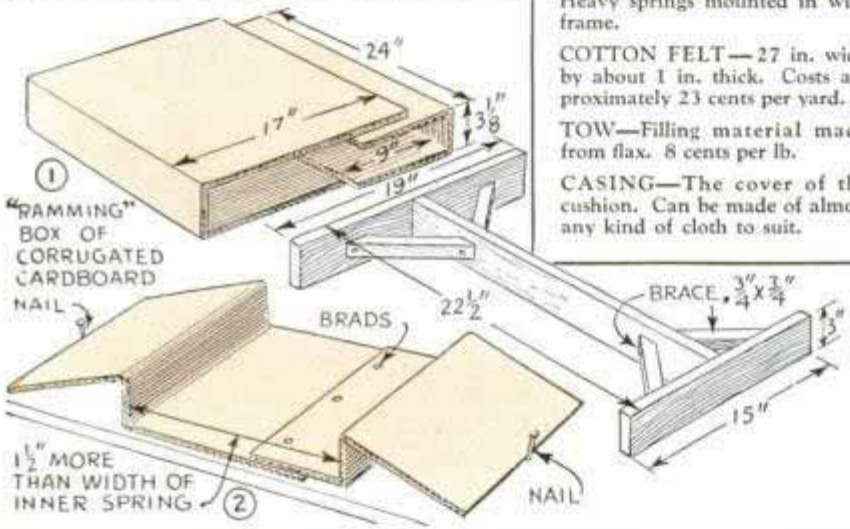

③ SPRING AND FIRST LAYER OF COTTON IN BOX



④ COTTON FOLDED IN AND SECOND LAYER ADDED



⑤ BOX CLOSED AND FASTENED WITH GUMMED TAPE

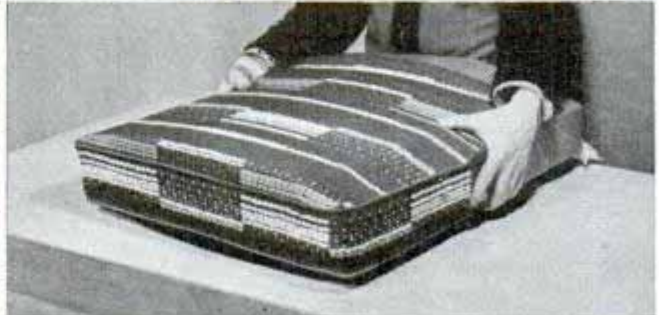

⑥ CASING STRIPPED IN PLACE OVER BOX

TAILORED CUSHIONS

Fig. 7. The casing should be sewed complete except the bottom edge of the back and a short distance along the sides, Fig. 8. The seam used between the top and the border is a "welt edge," made as shown in Figs. 9, 10 and 11. The seam at the bottom is a French seam, made by joining the cloth inside out, Fig. 12, then folding it back and sewing again about $\frac{1}{4}$ in. in from the fold, as shown in Fig. 13.

Where a construction spring is used, the filling is best done by hand. Start by sewing a piece of burlap over the top and sides, as in Fig. 14. Next, pad the top with excelsior or tow, Fig. 15. Cover the spring with two layers of cotton felt, and then strip the casing in place, Fig. 16. The casing for this method is sewed all around the top and the front edge of the bottom on the sewing machine, leaving the other three sides to be sewed by hand after filling. Fig. 17 shows cotton felt being added to the sides, this partly covering the bottom, while in Fig. 18 the cushion is shown partly fastened together with pins in preparation for hand sewing.

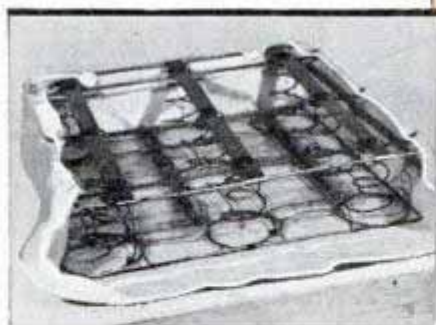
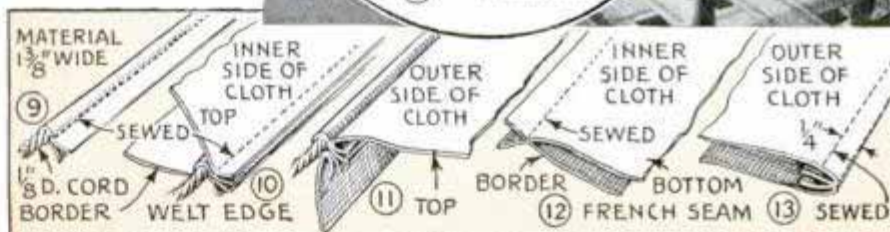
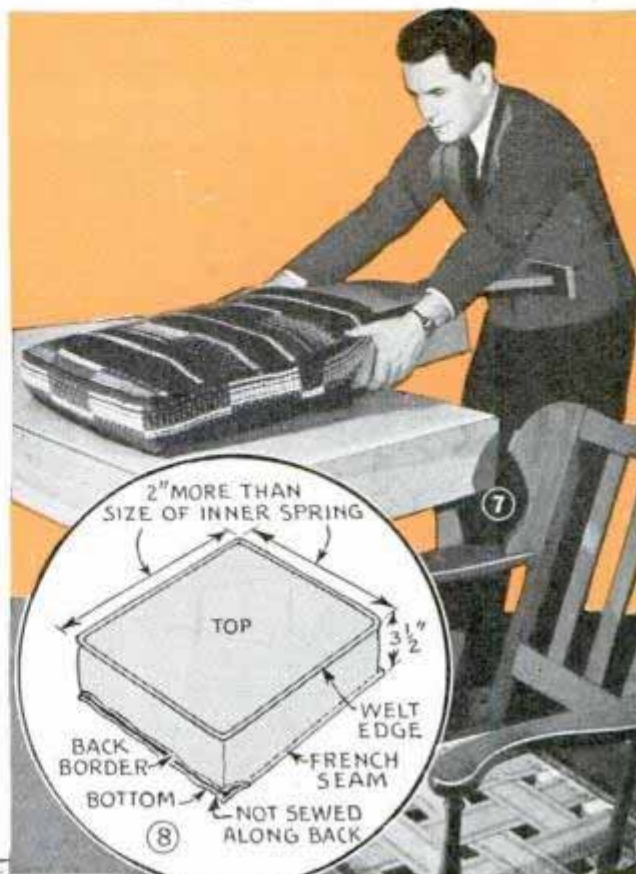

14 SPRING COVERED WITH BURLAP



16 OPEN BOTTOM CASING FITTED IN PLACE OVER SPRING



15 FILLING PLACED OVER TOP

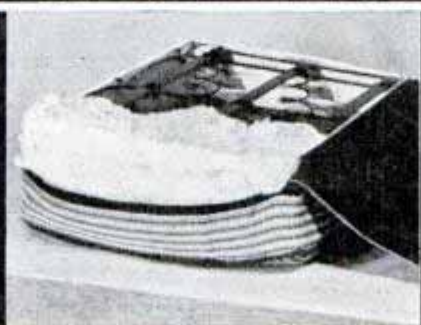

17 PADDING ADDED ALONG SIDES

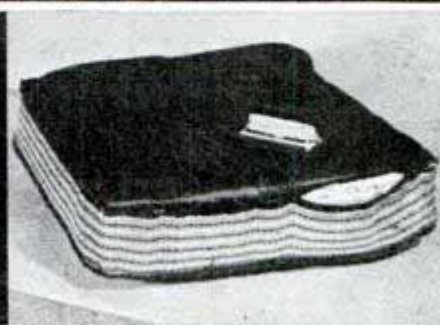

18 BOTTOM PINNED TO BORDER

Spaced Hooks on Trotline Engage to Avoid Entangling



To keep hooks of a trotline from entangling when winding or unwinding it on a reel, one fisherman uses the following method: Space the staging lines so that the hooks at the end of each can be engaged as indicated.

Bent Safety Pins Hold Work on Drawing Board

To hold showcards and price tags on a drawing board for rapid lettering without the annoyance of inserting and removing thumbtacks, I used safety pins. These were bent to the shape shown, and were

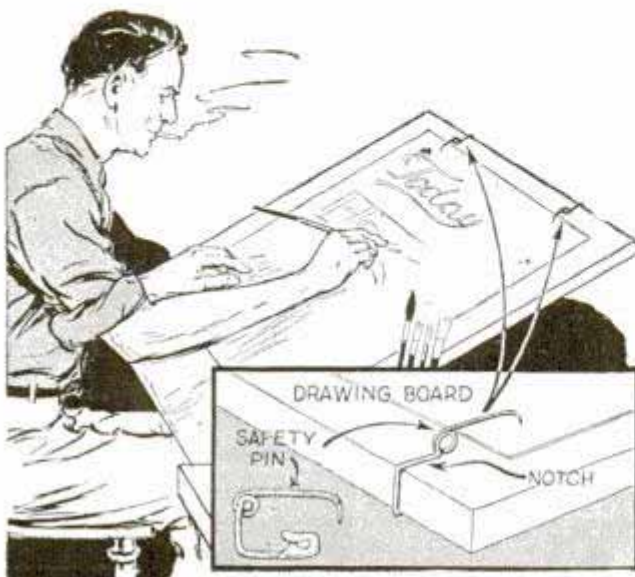

inserted in slots sawed in the edges of the drawing board. The pointed ends of the pins hold the work securely, and placing or removing it is just a matter of lifting the portions of the pins that project over the work.—G. E. Hendrickson, Argyle, Wis.

Small Boat Fastened to Post Safely with Wood Float

Having experienced considerable trouble with my boat because the chain would wind around the stake to which it was fastened, I built this simple float which is slipped over the stake and rotates as the boat drifts around, rising and lowering with the tide or high waves. Assembled from 1 1/4 by 4-in. oak, the float is held together with 1/4-in. brass bolts.—Linwood Webb, Greenport, N. Y.

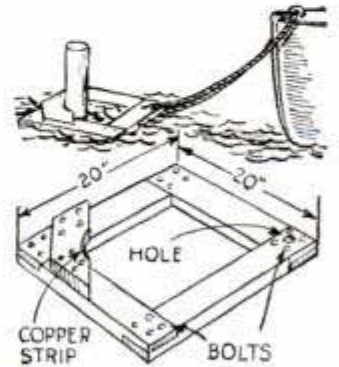

Soap Dish Makes Bird Bath in Canary's Cage



RUBBER SOAP DISH

A rubber soap dish makes an excellent bath receptacle for canaries. It will not slip on the bottom of the cage and the sides provide an easy grip for the bird's feet.

Cans Containing Small Parts Easily Hung on Wall

If you use empty tin cans to hold your supply of nails, screws, bolts and other small parts, cut small openings, of the shape shown, in the sides. Then you can hang them easily on nails or screws that project slightly from a wall.

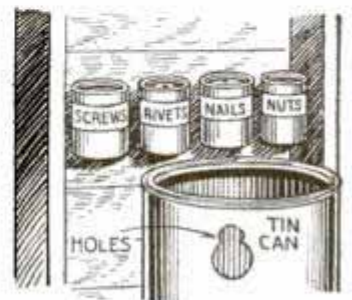

SMALL PELTS TANNED

at home by simplified process

By John William Moyer

Staff Taxidermist
Field Museum of Natural History

ALTHOUGH there are no tricky formulas or involved processes to bother with when tanning a skin by hand methods, the procedure takes work. What you're after is soft, pliable leather and, once the pelt is put through the tanning solution, it is the plain labor of "beaming" and "tubbing" that produces the softness and pliability characteristic of a first-class job of tanning. The tools one will require are not many and can be made, or bought very cheaply from taxidermy supply houses. Fig. 2 shows the essential tools. They are the currier's knife, a fleshing knife and a fleshing beam for the medium and larger skins. In addition you will likely need two skinning knives and a small shaving beam.

A currier's knife can be made from an old saw blade as in the upper details in Fig. 2. Have it ground down until rectangular in shape with two cutting edges. These should be ground razor-sharp and with wide bevels. Drill three holes along the centerline of the blade. Then round a 20-in. length of hardwood to about 1½-in. diameter, and another piece to the same diameter and 9 in. in length. Bore a ¾-in. hole transversely through the center of the shorter piece. Form a ¾ by 1½-in. dowel on one end of the longer piece and then slit the latter with a hand saw, from one end straight through the center to a point within about 6 in. of the opposite end. Drive the handle over the dowel and pin or rivet it in place. Slip the blade in the slot, bore holes and fasten with small stove bolts. Then wind the slotted end of the handle with cord to make a comfortable handhold. Finally, turn both cutting edges with a large knife steel in the same way that you would turn the edge of a floor or cabinet scraper.

Skins are first shaved down on a fleshing beam to prepare them for the tanning solution

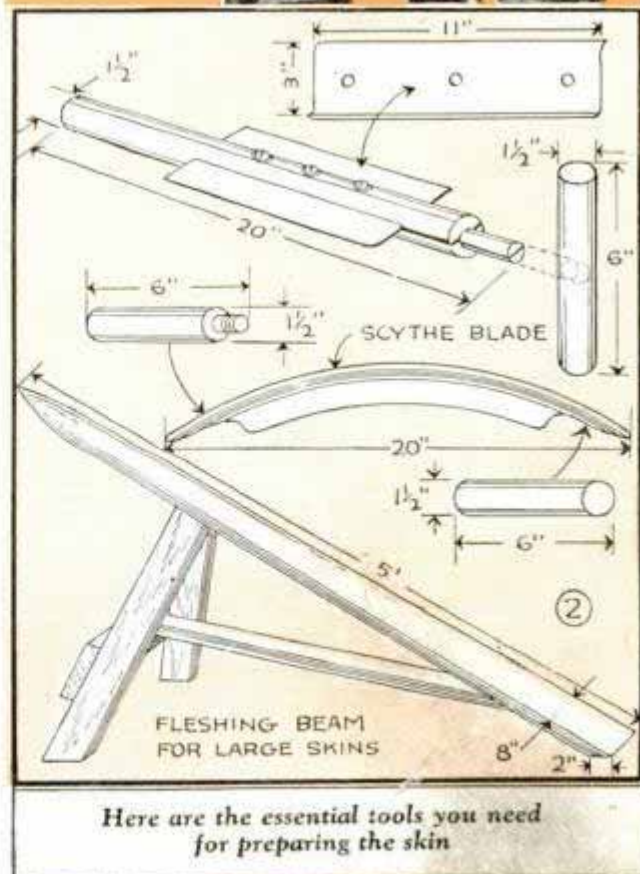

Here are the essential tools you need for preparing the skin

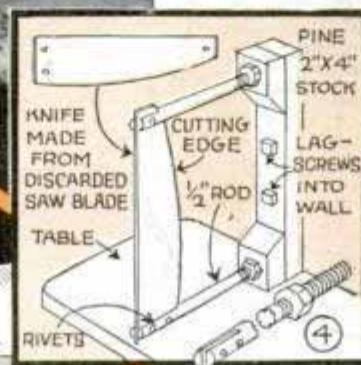
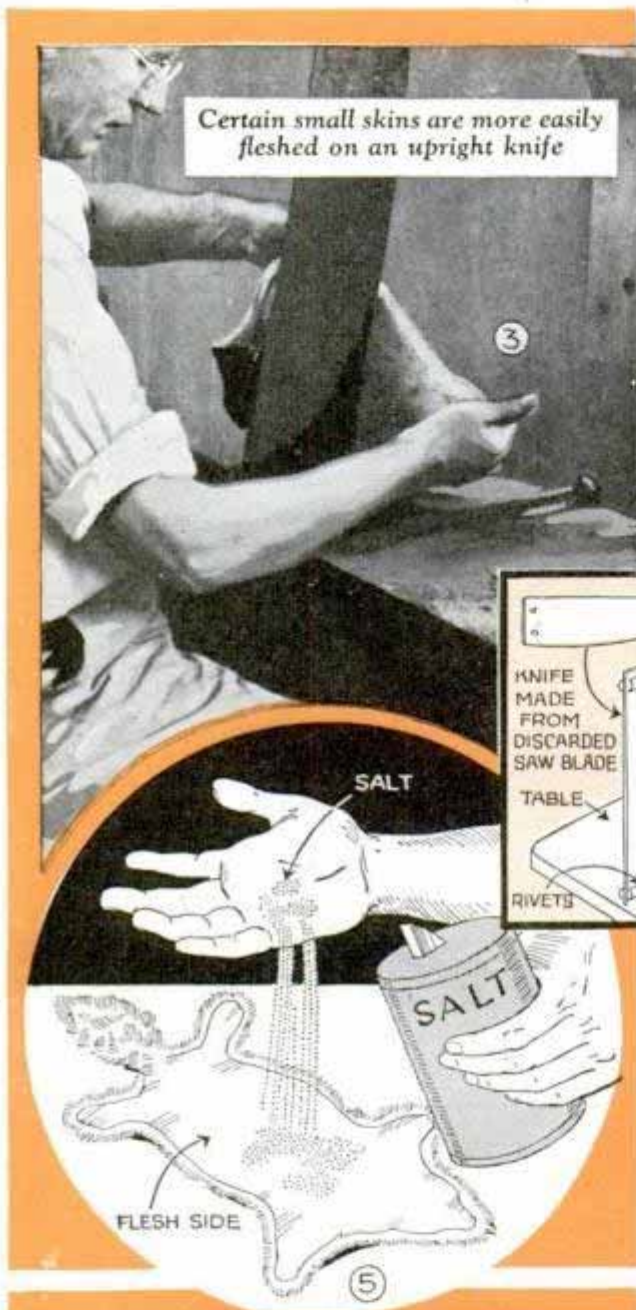

After fleshing, the skin is salted and rolled up flesh side in; after two days, or longer, the salt is washed out in clear, soft water

A suitable fleshing knife can be made from an old scythe blade cut down to about 20 in. in length. Have the blacksmith shape a shank at each end so that the blade can be fitted with wooden handles. Bind the latter at the ferrules with fine wire to prevent splitting. The two knives just described are for the shaving of fairly large skins but for the smaller ones such as muskrat, mink, weasel or skunk an upright fleshing knife such as that shown in Figs. 3 and 4 is more suitable. This knife can be purchased or can be made from an old saw blade by filing off the teeth and grinding and honing the edge. The knife should be supported on a bench in the manner shown in Fig. 4, or it can be bolted to a wall.

Before the actual tanning of skins can be started, one will have to make two fleshing beams to rest the skins on while shaving down the flesh side. A small shaving beam can be whittled from a length of hardwood 12 in. long and about 3 in. wide. Shape the end to a blunt point and round over the top side so that the skin will slide easily while being worked. The larger skins are shaved down on the large fleshing beam as in Fig. 1. The upper end of this beam should be rounded over and smoothed and the edges rounded over the full length.

The purpose of shaving or fleshing, as it is called, is to remove cartilage, fat and flesh from the skin so that the tanning solution can take full effect. As soon as the skin is removed from the carcass the ears, nose and lips must be opened up. This is very important, as the solution will not act on these parts unless they are carefully skinned out. This done the skin is immediately salted down with common salt, and rolled up, flesh side in, Fig. 5. Leave it rolled up for at least a couple days. Then it is washed out in clear, soft water and hung up to drain, Fig. 6. Skins that become dry after salting should be soaked until pliable by immersing them in soft water to which a few drops of carbolic acid have been added, about $\frac{1}{2}$ teaspoonful to the gallon of water. Smaller skins can be shaved down with a small skinning knife, or the upright knife can be used as in Fig.

3. In working the larger skins the carrier's knife is used. Notice in Fig. 1 the proper way to hold the knife. This is important, for if the knife is not held correctly, one is likely to cut holes in the skins. It is also necessary to be very careful not to shave the skin down too thin as this will cut off the hair roots, causing the hair to fall out during the process later. While fleshing or shaving, the knife will become dull and must be sharpened quite often, and the edge turned each time with the steel.

After the skin has been shaved to the proper thickness, it should be beamed lightly as in Fig. 7, then stretched flat on the floor, flesh side up, and swabbed over with a solution of tanning liquor, Fig. 8. To make the liquor, bring water, 1 gal., to the boiling point. Then add salt, 1 quart, and stir until thoroughly dissolved. Finally add sulphuric acid, 1½ oz. by measure, slowly to the salt solution. Allow the liquor to cool before applying it to the skin. Keep it in a wood or glass container. Give the skin one application of the liquor, making sure that all parts are covered. Leave it flat over night, swab it again and then roll it up, flesh side in. Large skins should have a third application the following day and then be hung up to dry. Do not allow the skin to dry hard at any time during the process. It should be noted just here that skins may be kept in the tanning liquor from two days to one year and the longer they stay in the liquor the better they will tan. After draining, the skin should be beamed, Fig. 7, until it is soft and pliable. This will take time and plenty of "elbow grease." Following this, several hours of it on the average skin, you coat the flesh side with pure neat's-foot oil and then you're in for the "tubbing," Fig. 9. In the commercial tanneries this is accomplished with special equipment unsuited to the needs of the individual tanner. However, the same result can be obtained by simply tramping the skin, or skins, in a large wooden tub filled about one-half full of hardwood sawdust. If the skins are small, work several of them at a time in the tub. During the tramping process stop now and then to shift the skins and turn them first one side up and then the other. Tramp them until all traces of stiffness has been worked out. Finally, shake out the sawdust and lay the hair with a fine comb.



First work the skin over a fleshing beam to soften it; then apply the tanning solution to the flesh side

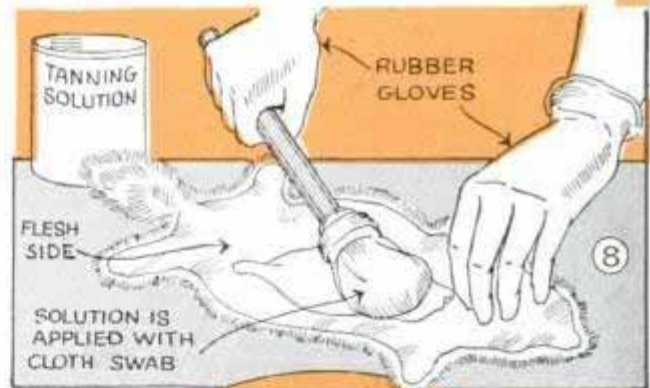

Finally coat the skins with pure neat's foot oil and place in a wooden tub one-half full of hardwood sawdust

Aggregate Heater on Small Jobs of Concrete Work



Two lengths of stovepipe and an elbow assembled as shown provide a simple heater for sand and stone on small concrete jobs. The heater is set in the aggregate pile in the position indicated and is fired with a piece of cotton waste soaked in fuel oil or old crankcase oil.

Shoe Scraper Has Dirt Catcher Made from an Oil Can

Disliking the accumulation of dirt beneath a shoe scraper, a housewife had a discarded oil can cut to hang below it. At-

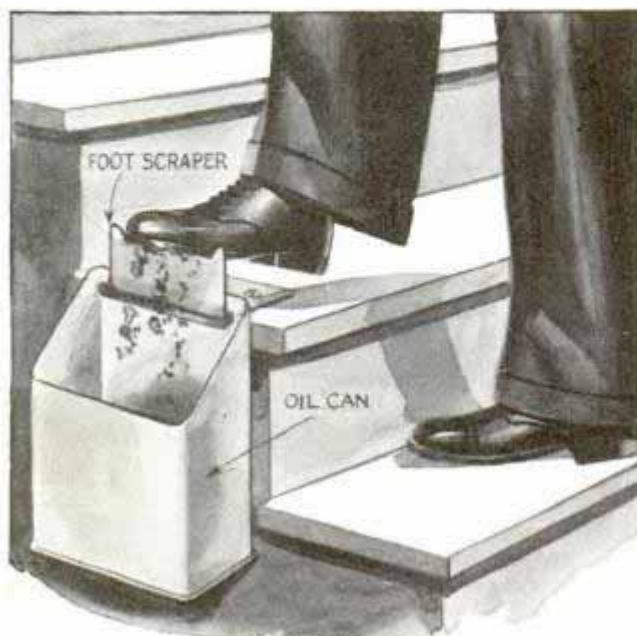

tached with a single nail, the can is quickly and easily removed when it becomes full enough to empty.

"Life-Belt" for Boat Keys

When working around a boat or dock where you might accidentally drop your keys into the water, it is a good idea to slip an ordinary round fish-line bobber on the key ring. The cork will keep a number of keys afloat in the water and is plainly visible.

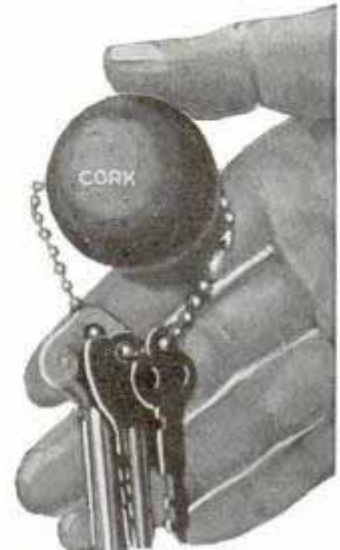

Grip on Hand Wheel Improved by Driving Tacks in Edge



When a wood hand wheel was substituted for a broken one of iron in an emergency, upholstery tacks were driven into the edge of the wood to afford a good grip for the fingers when turning it. The tacks should be spaced a distance equal to about the width of one finger.

Repairing Lawnmower Pinion

When the shoulders of a lawnmower pinion, against which the pawls catch, become so worn that the cutting blades do not rotate, the pinion often can be repaired by cutting a slot across the shoulder as indicated to restore it to the correct angle. The slot can be cut with a hack saw, which should be held at a 45° angle to avoid cutting the opposite side of the pinion.



Chromium Tubing Enhances Pin-Up Lamp

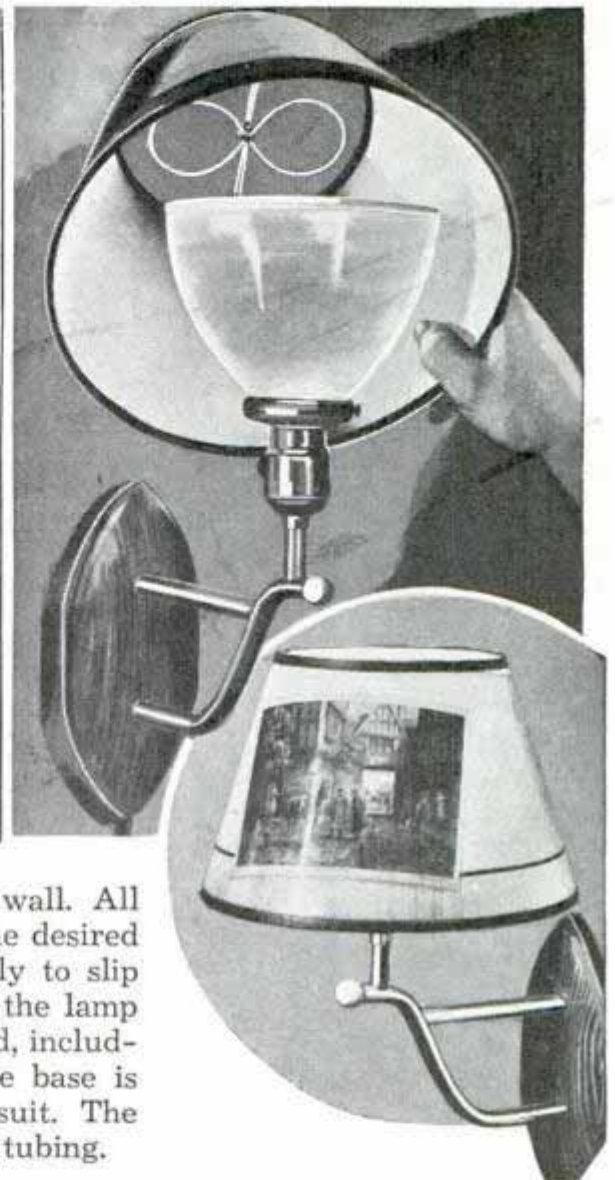
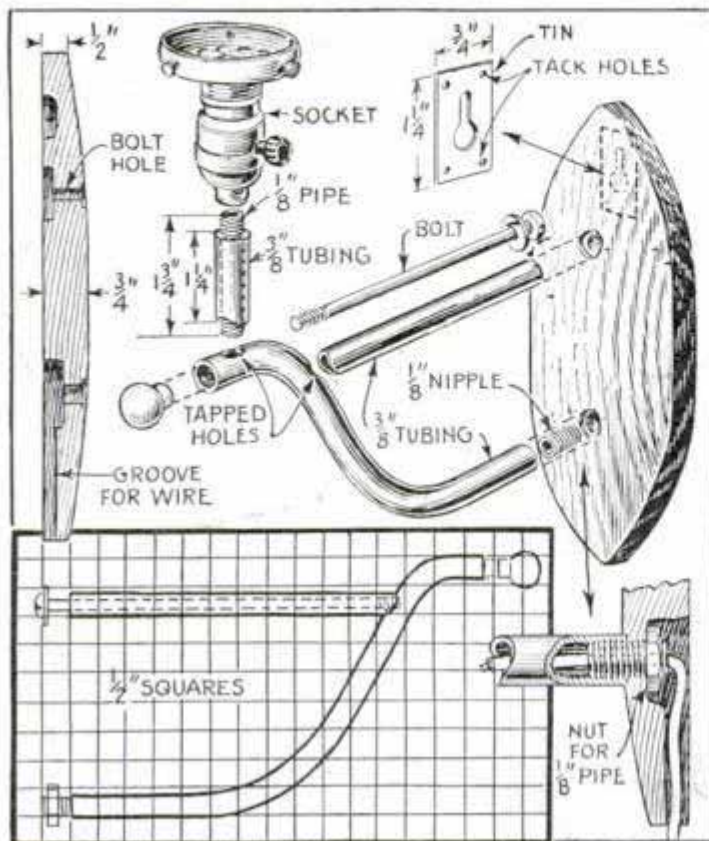

Here is a lamp you can hang any place on a wall. All you need do is drive screws into the wall at the desired locations, allowing the heads to project slightly to slip into the "keyhole" hanger on the rear side of the lamp base. Exposed metal parts are chromium-plated, including the lamp socket and reflector holder. The base is made of wood, finished natural or painted to suit. The holes in the base are counterbored to take the tubing.

Discarded Brake Drum Shields Grinding Wheel on Lathe

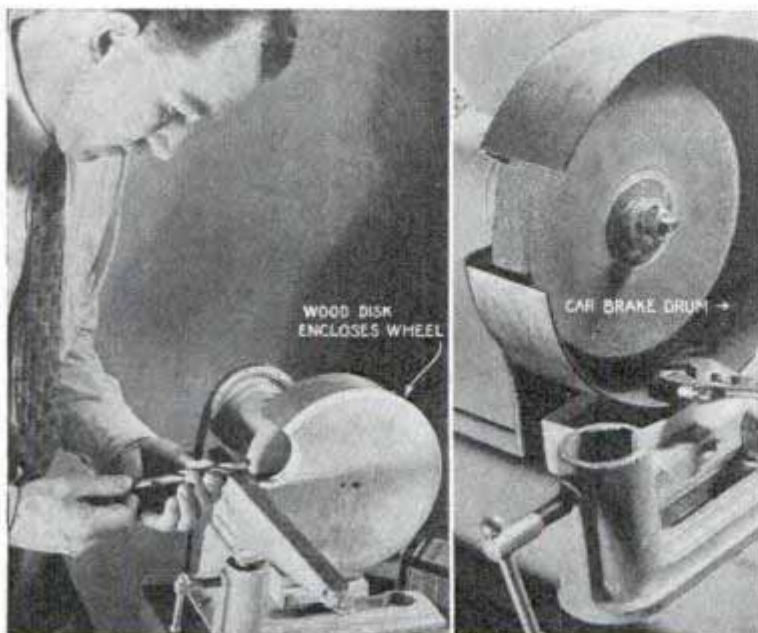

Owners of home workshops who use grinding wheels mounted in their woodturning lathes can have brake drums as shields. This one was taken from a car having an emergency brake drum on the drive shaft. This type has the advantage of a small diameter and a deep flange. The drum is notched for clearance around the wheel by cutting out a segment as shown, after which it is bolted into position. A wood disk $\frac{3}{4}$ in. thick is fastened into the open side of the drum to enclose the wheel.

☛ When spraying the foliage of house plants use tepid water.

Skin Pulled Off Catfish Easily with a Pair of Pliers

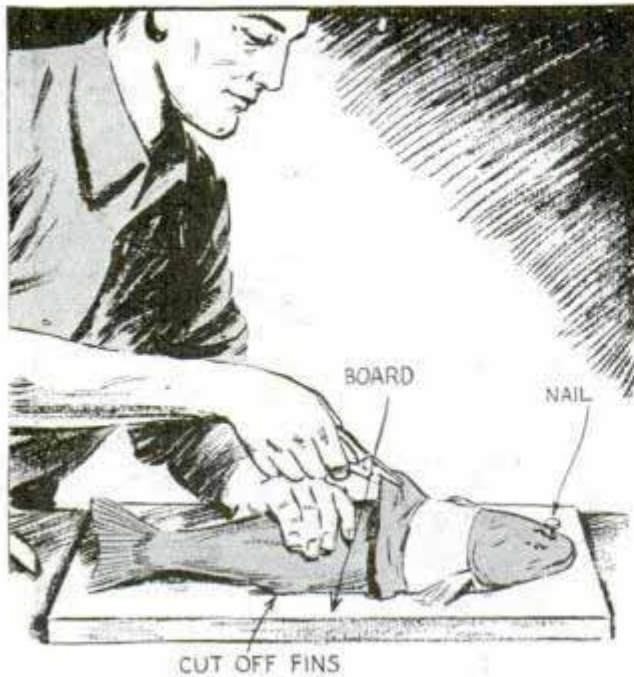

You can skin a catfish easily with a pair of pliers. First kill it with a sharp blow on the head. Then cut off the fins and drive a nail through the head and into a board. With a sharp knife, cut through the skin around the fish just back of the head. Now grasp the edge of the skin with a pair of pliers and pull back toward the tail.

Fountain Pen Provides Holder for Toothpicks in Your Pocket

If you are in the habit of carrying toothpicks in your pocket, a holder to keep them is made easily from an old fountain pen. Just remove the rubber ink bag along with



the pen point, wash out the inside of the barrel thoroughly, and your holder is ready for use.

Combined Bird Bath and Feeder

Birds can feed and bathe at this unit, which also serves as a neat garden decoration. It consists of a pipe standard topped by a feeder about 8 in. square, under which is a disk-harrow blade to serve as a water



tray. The roof of the feeder, which is supported by four corner posts, is covered with strips of wood overlapped slightly.

Stop Rods on Miter Gauge of Saw Improved by Rubber Tubing

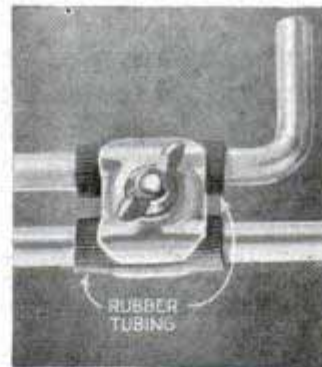

Two short lengths of rubber tubing slipped over the miter-gauge stop rods of a circular saw, as shown, will permit the clamp to grip the rods more securely with less pressure. This

makes the wing nut that operates the clamp easy to tighten or loosen.

—Howard R. Heydorf, Missoula, Mont.

Small Drills Stored in Block

One craftsman uses a wood block of the shape shown to hold his drills and small tools so that he can carry them about easily as required. The block is stable, of large capacity and the handle, which is patterned after the handle of a hair-brush, is gripped with the fingers.



Remote Alarm Clock Starts Buzzer Near Bed

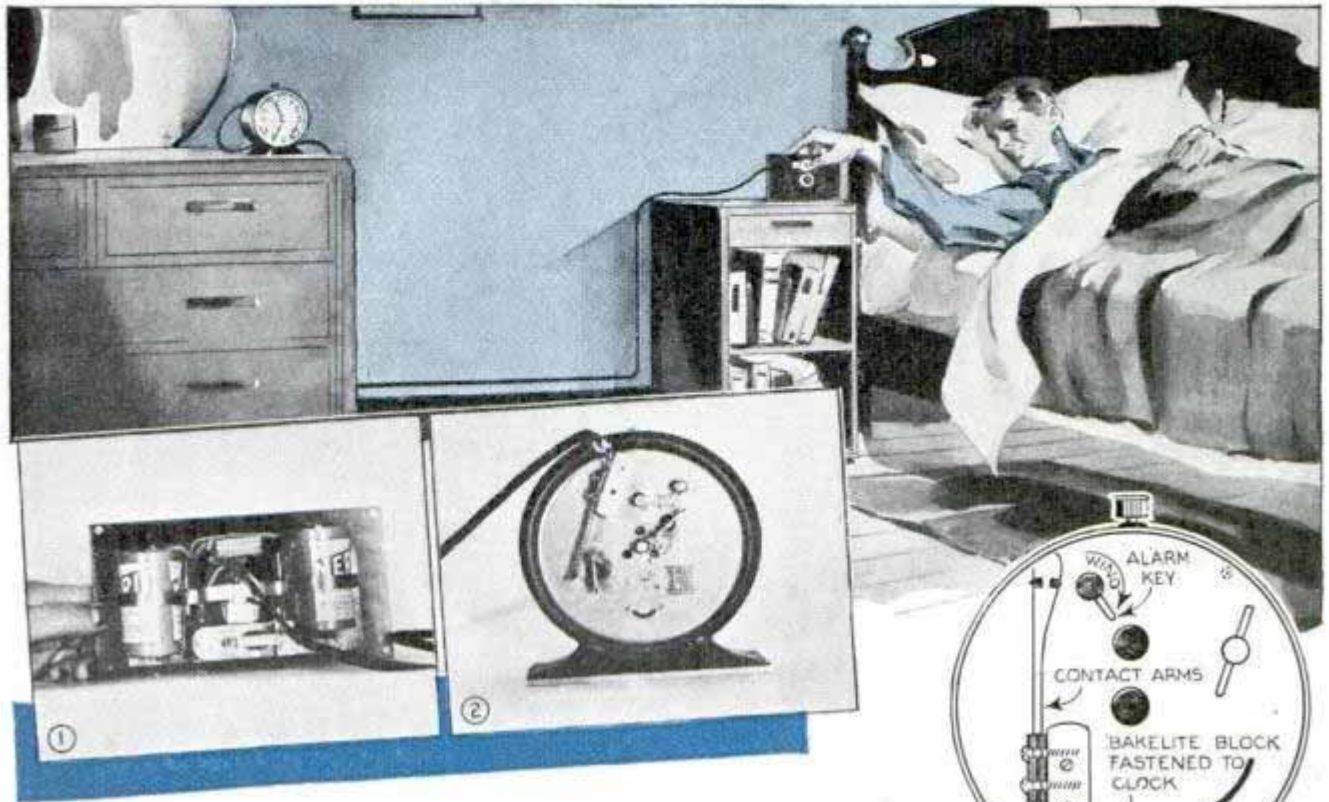

If the ticking of your trusted alarm clock prevents sleep at times, this remote-control unit, built chiefly of old radio parts, will enable you to place the clock at a distance from the bed, or in a clothes closet, so that the ticking will not annoy you. At the time set, a buzzer alarm rings softly at intervals close beside the bed. Simultaneously a dim light illuminates the switch on the control unit so that the alarm may be turned off when you awaken. The control unit, Figs. 1, 3 and 4, consists of a Bakelite panel covering a small metal or wood box which contains two flashlight cells and a door buzzer or one constructed from a radio relay. A brass band holds the dry cells in place and connections are made by soldering the wires directly to the cells as indicated in Fig. 5. Switch and pilot light are mounted on the panel as in Fig. 3. Two contact arms, taken from an old radio relay or phone jack, are fastened to a small Bakelite block which is mounted on the back of the clock, Figs. 2 and 3. The arms must be located in such a position that the projections of the alarm key will strike one of the arms, thus closing and opening the circuit at intervals. The bell-ringing mechanism of the clock is, of course, removed.—Herman R. Wallin, New York.

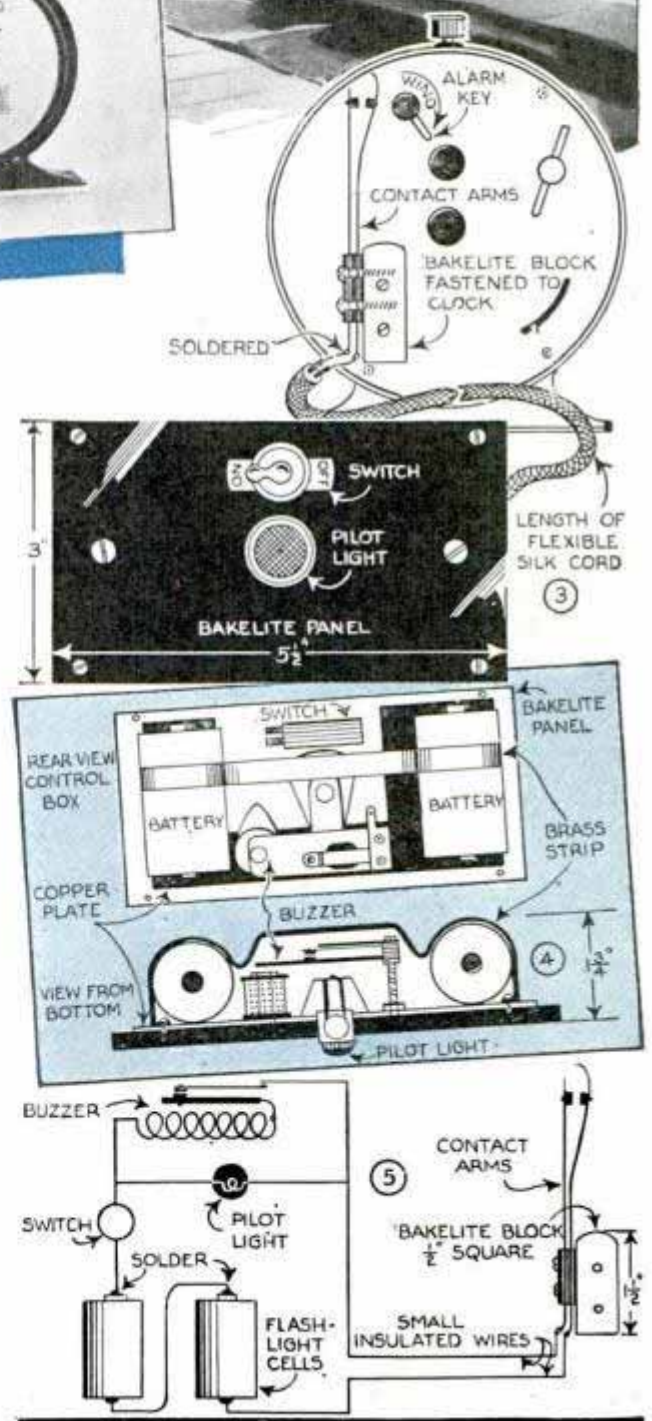

Solving HOME



Here's a way to remove the stems in a hurry from gooseberries and other small fruits. Set a small bottomless box over a window screen, fill with berries and slide the box back and forth

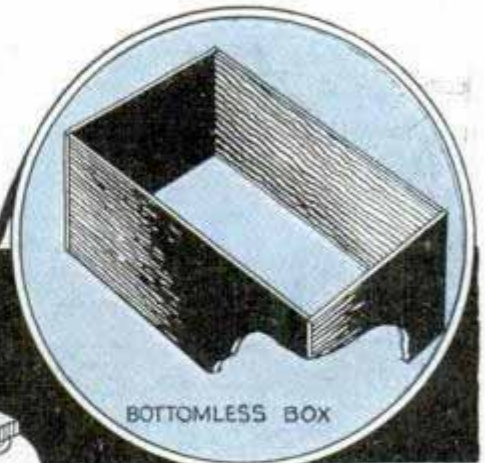

SCREEN

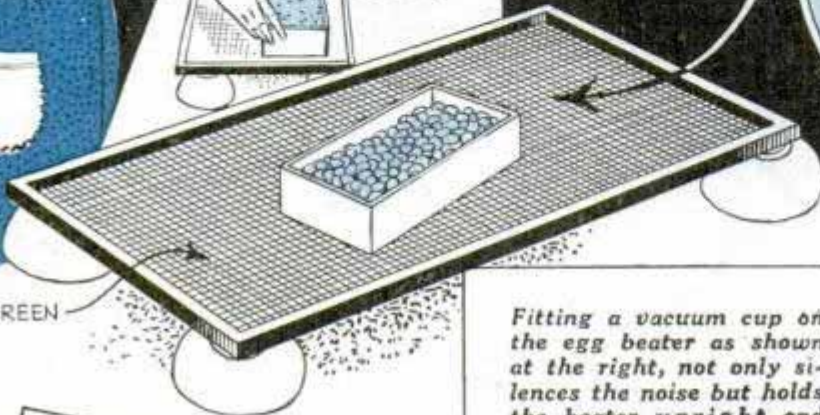

Fitting a vacuum cup on the egg beater as shown at the right, not only silences the noise but holds the beater upright and prevents it from sliding in the bowl



CLOTHESLINE



SLOTTED EARS



A handy clothespin container can be made from a small water pail. Simply remove the bail and slot the "ears" as shown

WIRE DISH RACK

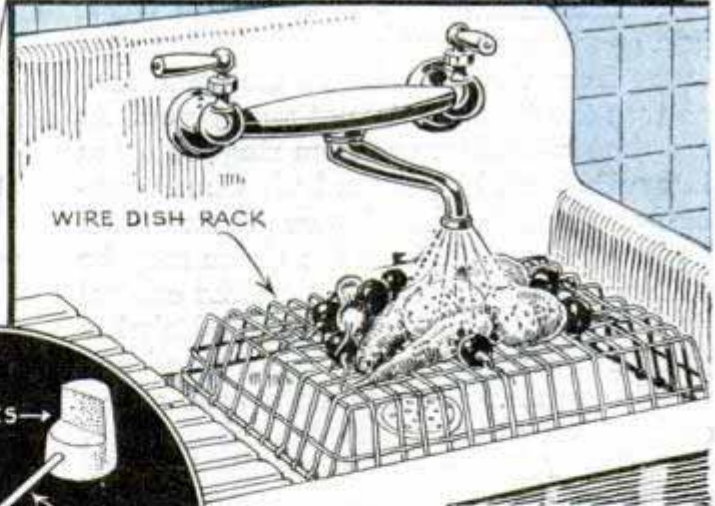

To wash vegetables in the sink most conveniently, invert a wire dish rack in the sink and spread the vegetables on it so that water from the faucet can flow over and around them

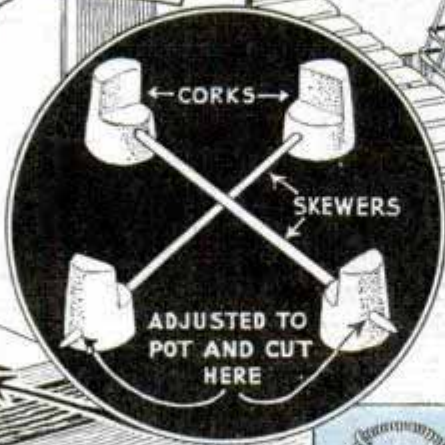

Meat skewers and corks combined make a neat base for potted plants requiring little moisture, which are set on a window sill. Notch the corks and force the skewers through them as shown. Right, padding the top of a large can makes an ideal surface for ironing pockets, shoulders and seams in shirts

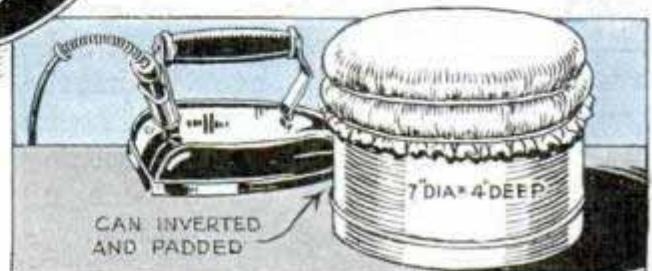

PROBLEMS

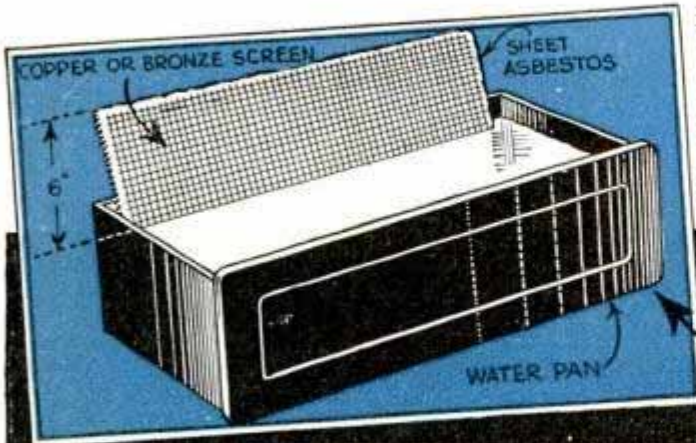

A "wick" of asbestos board encased in copper screen and placed in the furnace water pan will practically double the normal evaporation. A small weight, such as a piece of brick, will prevent it from sliding down into the pan when water is poured in

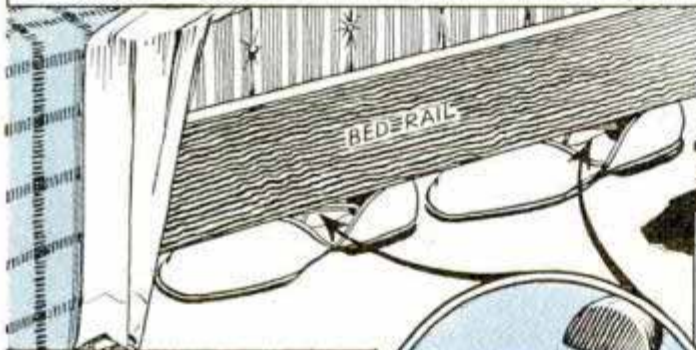

Shoe trees screwed to the lower edge of the bed rail, as shown above, keep your bedroom slippers handy, out of sight and always in shape

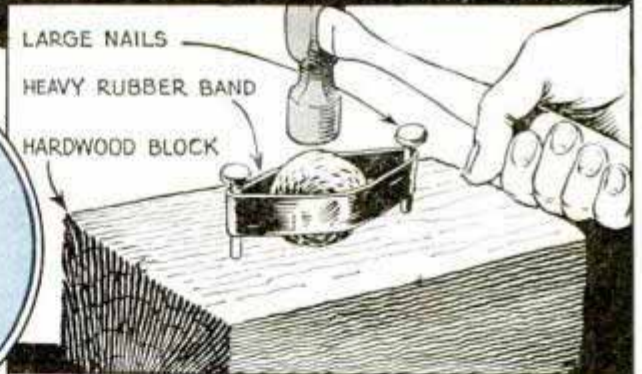
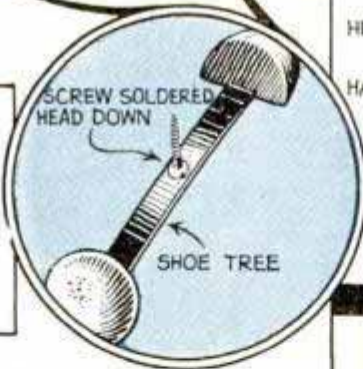

LARGE NAILS
HEAVY RUBBER BAND
HARDWOOD BLOCK

To crack walnuts without bruised fingers and flying shells, drive two nails in a hardwood block and snap a rubber band around them

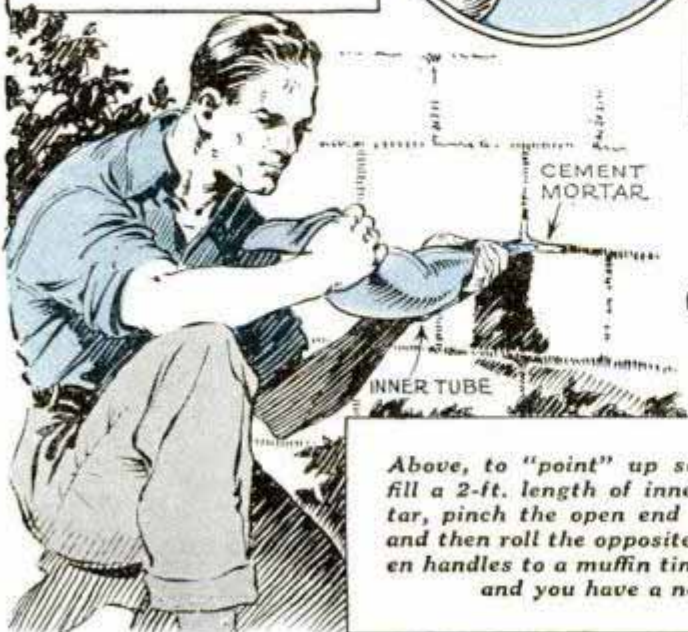

Above, to "point" up stone foundations quickly, fill a 2-ft. length of inner tube with cement mortar, pinch the open end to form a small "nozzle" and then roll the opposite end. Right, fasten wooden handles to a muffin tin, enamel in a bright color, and you have a novel beverage tray

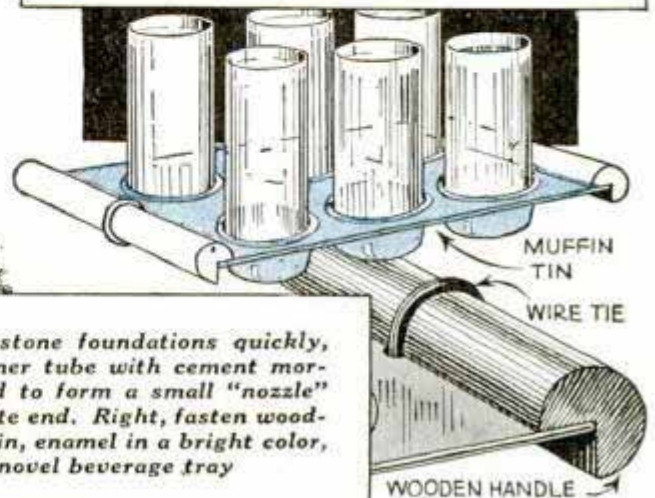

Small Photos Framed in Rims of Round Tags



If you have a few miniature photos that you want protected against tearing, yet have them so that they can be viewed easily, frame them in metal-rimmed tags. Just

remove the cardboard from the center of the tag, spread one side of the rim with a sharp knife blade and insert the photo, which has been trimmed to a snug fit. Then press the side of the rim down against the photo with a round-nosed tool.

Edges of French Curve Beveled to Avoid Smearing Ink

When running a ruling pen along the edges of a French curve, ink is less likely to get on the work and smear it if the edges are beveled. This can be done with a small file.

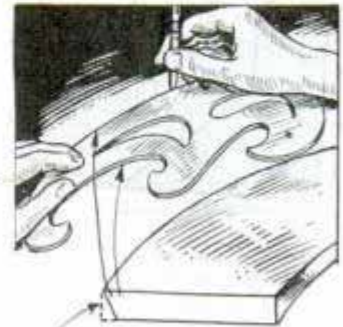

EDGE FILED AT ANGLE

Why Not Start a Home Workshop?

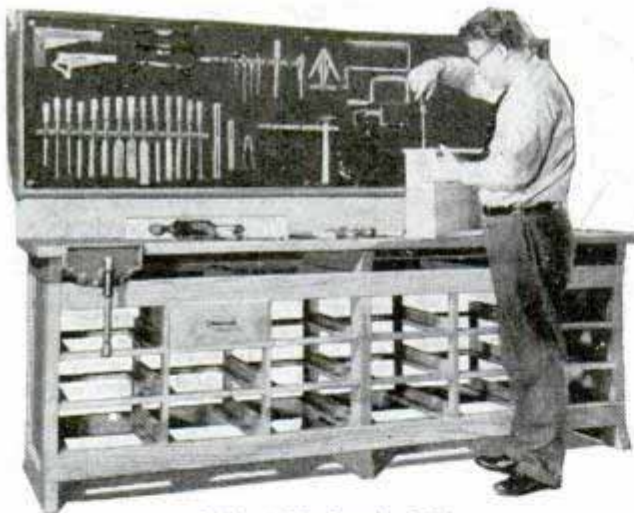

Cabinet Workbench—898

DRILL PRESS—895: Pipe fittings. $\frac{1}{2}$ -in. chuck and ball-bearing spindle. 28 in. high—25c.

BELT SANDER—579: Heavy-duty type. Angle-iron framework and a 5 by 46-in. belt—25c.

VERTICAL SPINDLE SANDER—560: Fine for curved surfaces. Table 10 by 17 in.—25c.

All six plans listed above will be sent to you upon receipt of \$1.00, or separately for 25c each. Also, be sure to get a copy of our new 32-pp. illustrated catalogue, which lists hundreds of other plans on modern and colonial furniture, outdoor-sports devices, models of all kinds, radio equipment, juvenile articles, etc. The only cost for this catalogue is a three-cent stamp. Be sure to print your name and address clearly when ordering.

A few homemade machines will enable you to get into this interesting field. Whether you want a shop for pleasure or profit, our plans will give you all of the information you need.

CABINET BENCH—898: Nearly 8 ft. long, 27 in. wide, 35 in. high. 20 drawers—25c.

22-IN. SCROLL SAW—771: Pipe fittings and hardwood. Has sewing-machine drive—25c.

12-IN. BAND SAW—836: Smooth running and sturdy. Cuts 2-in. stock easily—25c.

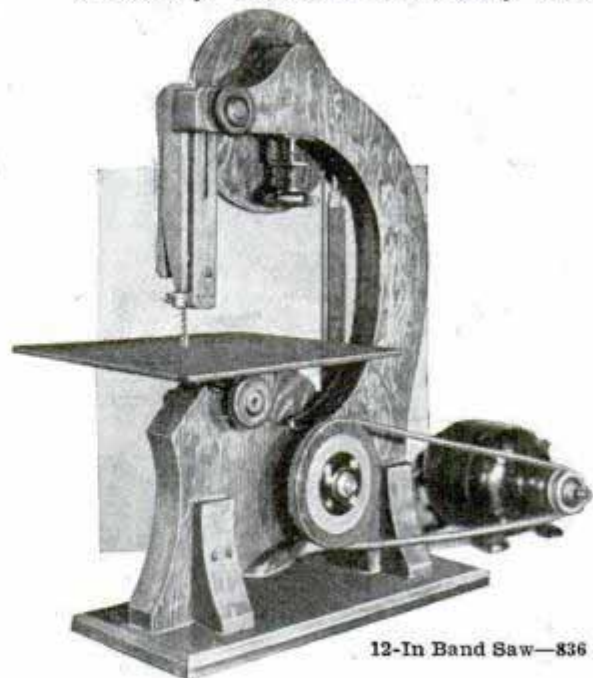

12-In Band Saw—836

Address Plan Service, Popular Mechanics Magazine, 200 E. Ontario St., Chicago

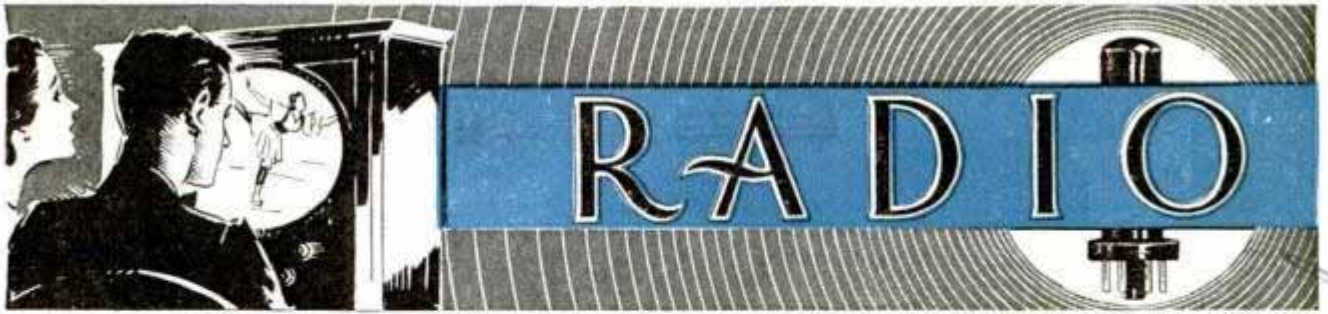

TELEVISION

Three Varieties

IF TELEVISION programs are available in your locality, and you are in the market for a receiver, there are three different types to choose from. No. 1 is the "direct viewing" variety where the picture appears at the front of the cabinet. The console instrument shown provides both sight and sound reception. No. 2 is a small direct-viewing table-type picture receiver with sound converter; it can be used to receive "video" tel-

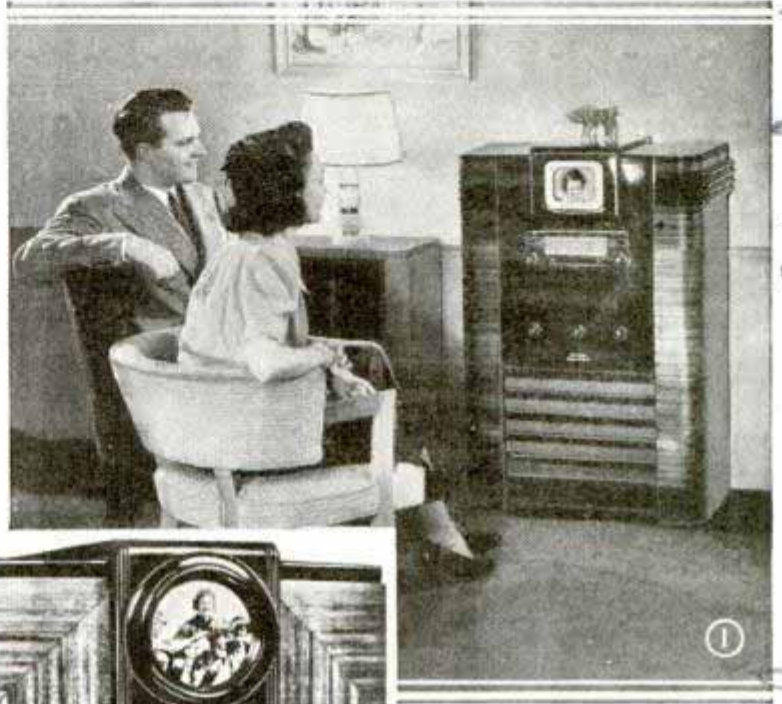

evision pictures without sound, or, it may be employed in conjunction with several special types of regular broadcast receivers

in video-sound combination. Photo No. 3 shows a console instrument for sight and sound in which the picture is viewed in a mirror on the under side of the raised lid.

Set No. 1 employs a 5-inch "kinescope" tube which provides a 3 $\frac{3}{8}$ by 4 $\frac{3}{8}$ -inch picture. There are 24 other tubes, plus the picture tube, and an 8-tube all-wave receiver. The table-type set No. 2 uses a 5-inch television tube in the complement of 17 tubes. This set stands 14 $\frac{1}{2}$ inches high and is approximately 20 inches wide and 19 inches deep. Set No. 3 is a de luxe console instrument in which a 12-inch kinescope tube produces a picture 7 $\frac{3}{8}$ by 9 $\frac{3}{4}$ inches. There are a total of 36 tubes in this set, 12 of which are included in a 3-band high-fidelity radio chassis; the cabinet is 40 $\frac{5}{8}$ inches high, 34 $\frac{5}{8}$ inches wide and 19 $\frac{7}{8}$ inches deep with hinged mirror lid.

General Electric Co. 570 Lexington Ave. New York

RCA Victor, Camden, N.J.

A.C.-D.C. Loudspeaker Set

critical, and the trimmer condenser (C_1) provides adjustment for "tuning on the nose." If the station you wish to hear has a frequency between 550 and 800 kilocycles, fixed condenser (C) should be .00025 mfd. For reception between 800 and 1,200 kilocycles use .0001 mfd. For a station between 1,200 and 1,600 kilocycles the fixed condenser (C) is omitted entirely.

Complete chassis and panel details are shown in Fig. 1 and a simplified wiring diagram is given in Fig. 2. This wiring diagram shows all parts and wiring under the chassis base and every lead running up to the parts mounted on top of the base and on the panel. The 3-in. magnetic speaker is protected by a small piece of copper screen and is mounted on the panel in the position shown in photos Figs. 2-A, 2-B and 2-C. These photos also show the arrangement of each part on top of the chassis base. A schematic diagram is given in Fig. 3. The antenna coil is an r.f. midget solenoid type used instead of a regular

(Continued to page 132A)

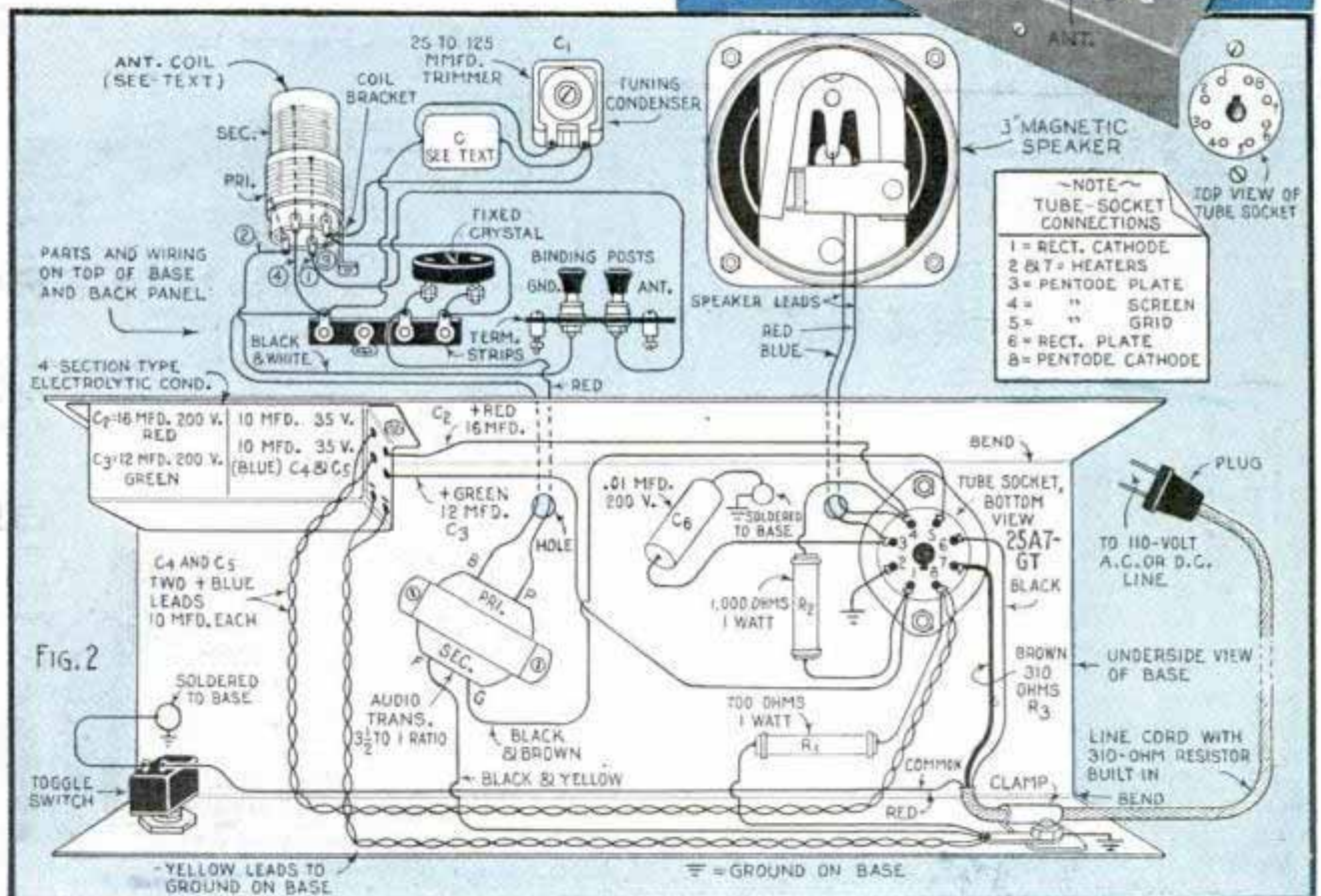
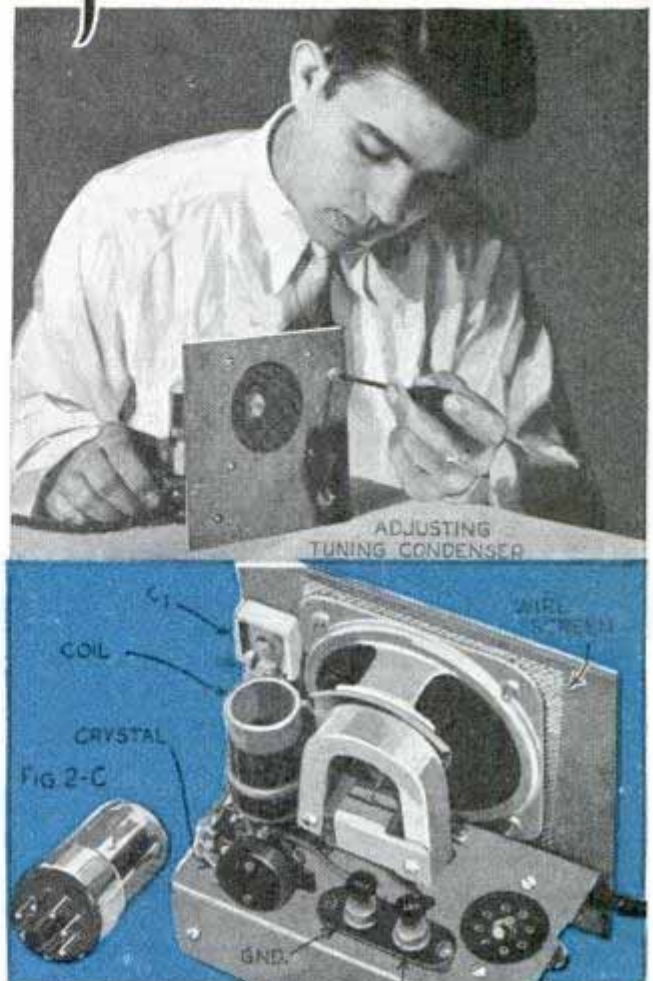

How to Build a Push-Button Radio-Set Tester



AVOID incorrect connections and possible meter burn-outs with this push-a-button set tester. You can check any radio circuit quickly and without a chance of confusion; merely plug the testing prods into the tip jacks and select the correct scale, by means of a push button, for voltage, resistance and current readings.

Any good 3-in. meter with an 0 to 1 m.a. movement may be used in this compact homemade unit, which is housed in a sheet-metal case 6¼ in. long, 4 in. wide and 2⅞ in. deep with bottom cover. The meter is provided with a new scale of the "Ham Crystals" type which is available from radio parts houses for nineteen cents. This scale provides volt-ohm-milliammeter readings as follows: d.c. volts 0-50, 0-250, 0-1,000; current of 0-1, 0-10 and 0-100 milliamperes; a high-ohm scale reading in reverse up to 100,000 and a "back-up" low-ohm scale for resistance measurements.

A 5,000-ohm linear-type potentiometer is used for adjusting the zero position as the 4½-volt flat-type "Eveready" "C" battery ages. The push-button unit is a "Muter" type designed to serve as an 8-position, double-pole single-throw switch.

(Continued to page 138A)

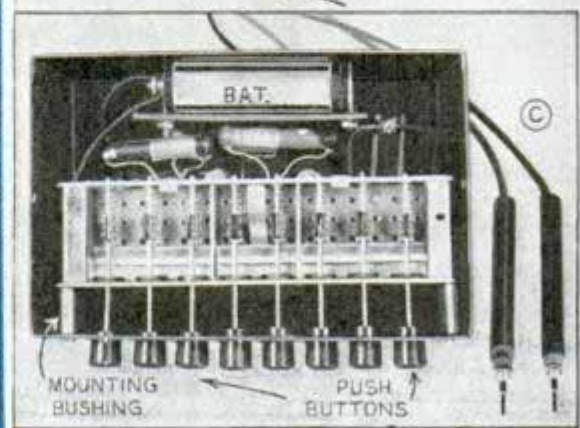
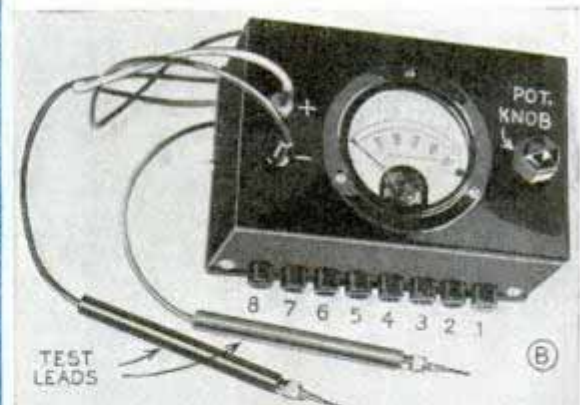
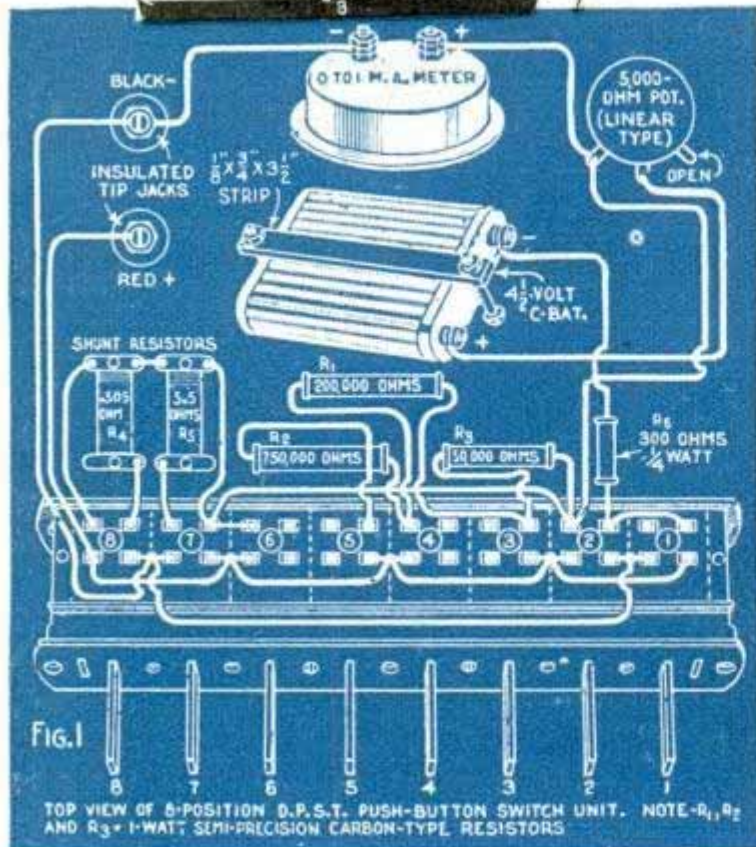
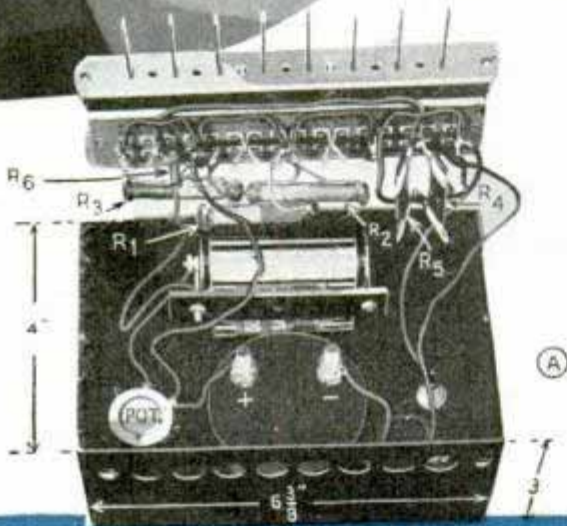



Helpful RADIO HINTS

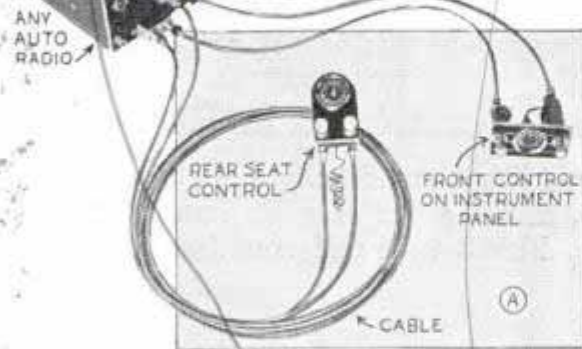

(A) Improved dual control permits rear-seat tuning of any car radio without disturbing the regular dashboard control; both dials show same station reading when either is turned

(B) Short-wave band-spread condenser combines a low-capacity section for "band-spread" with a high-capacity for "band-set"; both units in one compact midget frame

(C) Low-cost non-inflammable flexible blank disks for amateur sound recording in homes and schools; uniform surface is claimed to reduce "wows"; easily mailed and stored

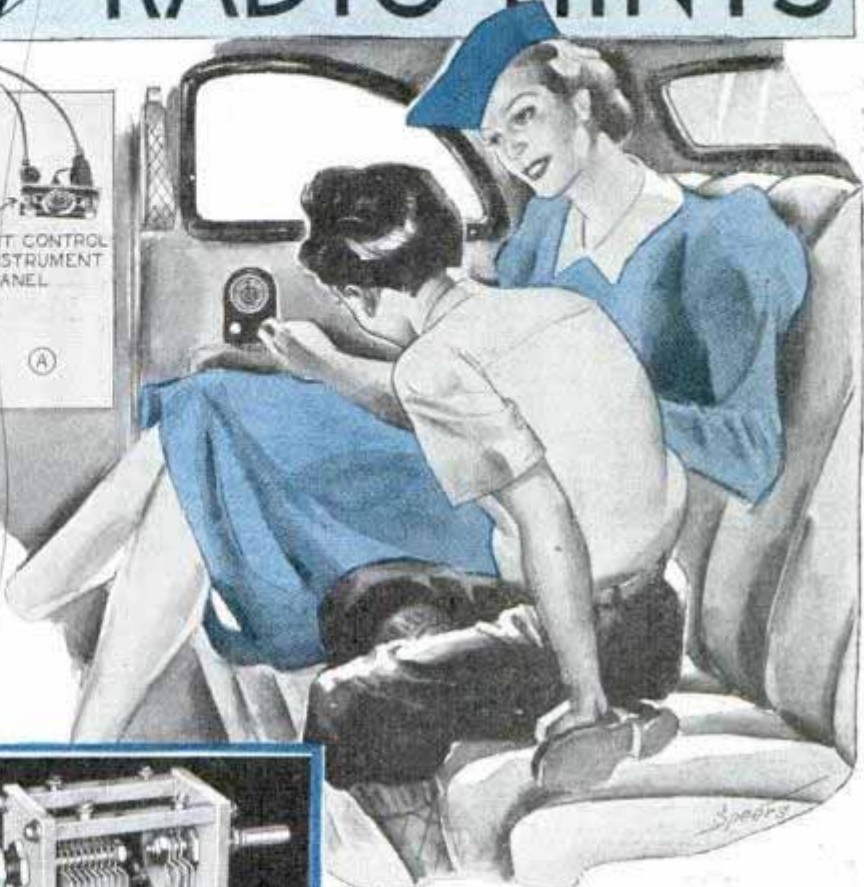
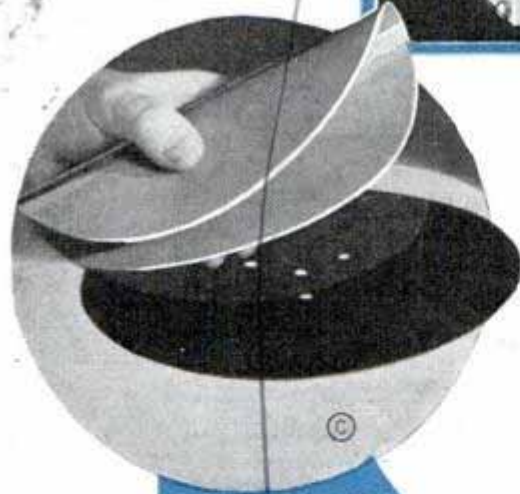
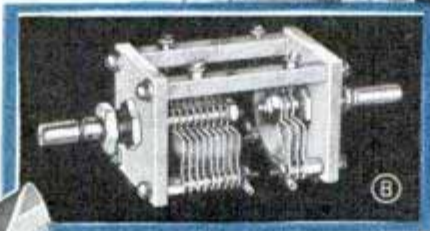

(D) Conduit pipe straps make good tool-holders for your radio workbench or portable service kit

(E) 4-gang 4-position rotary switch used to change coils, for short-wave bands, from front panel. You can either mount your regular plug-in coils in the manner shown, or, make new coils following the data given below. Coils are mounted with stiff wires close to switch; the common terminals are wired to the parts which previously were connected to the coil socket

Term.	Band	Pri. Turns	Wire	Sec. Turns	Wire
1	20	3X	20 PE	8X	20 PE
2	40	5X	20 PE	16X	20 PE
3	80	9	30 DSC	36	20 PE
4	160	15	30 DSC	72	30 DSC

For .00014 mfd. condenser.
 PE—plain enameled.
 DSC—double silk covered.
 X—coil turns spaced one diameter, all others close wound.

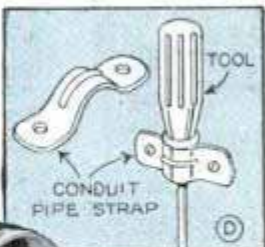

SHORT-WAVE COILS WOUND ON 2" LENGTHS OF TUBING 1/2" IN DIAMETER

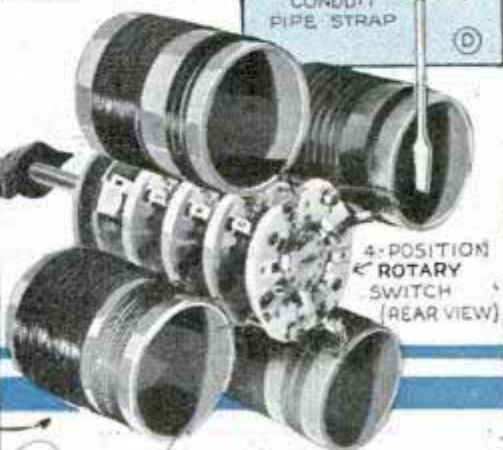
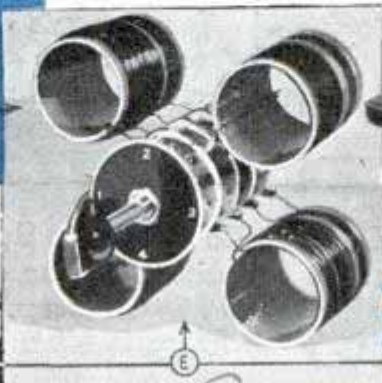

4-POSITION ROTARY SWITCH (REAR VIEW)

Compact Mobile Sound System in Standard Coupe



With only two speakers as external evidence of its sound system, this compact mobile installation includes a 30-watt amplifier on the shelf behind the seat, with all controls accessible to the driver, and a 300-watt gas-driven generator concealed in the rear compartment. Air ducts provide ventilation and the car body muffles the noise of the motor.

"Invisible" Burglar Protection

A source of invisible infrared light and a sensitive photoelectric cell are employed

see Dec 1939 - 939

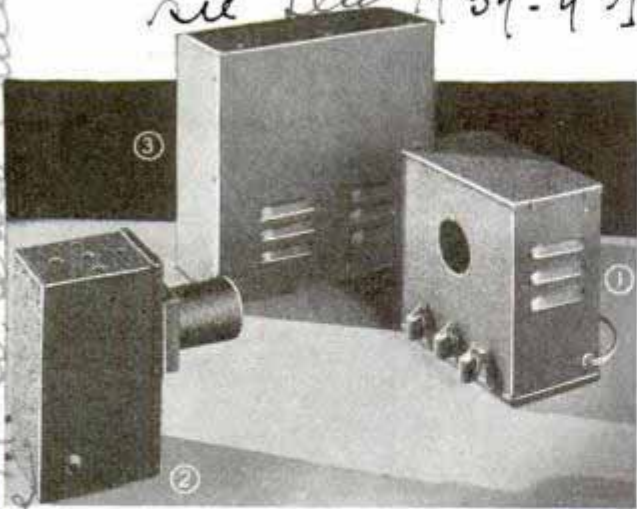

in this burglar-alarm system. In operation the infrared light (2) is focused upon photocell relay (1); any interruption of this invisible light beam operates the relay that rings a bell in unit (1). Unit (3) is an external remote alarm that may be used in conjunction with the same relay.

Tiny Portable Radio Receiver

Now you can actually hold a portable radio in the palm of your hand while it plays. This 3-tube self-contained battery-



operated receiver weighs slightly more than 3 pounds complete with batteries and built-in antenna. The set measures only 6¾ in. high, 5½ in. wide and 3½ in. deep. It is housed in an embossed leatherette cabinet and provided with a handle.

Blueprints covering radio construction articles in this and past issues are available for 25 cents each. Original material lists, with names of manufacturers and dealers, can be obtained from our Radio Department upon receipt of postage.

NEXT MONTH—How to Build a Portable Low-Cost Sound System. Constructed mainly from materials the average experimenter has on hand, and inexpensive parts easily available, this portable sound system has many useful money-making applications. Also—**An Electrical Substitute for a Large Speaker Baffle.**

*Lafayette Radio Corp
1019 W. Lake St
Chicago, Ill.*

*Majestic Radio Corp
2600 W. 57th St
Chicago, Ill.*



SHOP NOTES

ANGLE PLATES

Make them on your own lathe, for difficult set-ups and exacting layout work

By C. W. WOODSON

NOW and then the run of machine work in the small shop turns up a lathe job that is impossible to chuck in the regular way. Or, it may be necessary to set up work on the milling machine where the ordinary centers, arbors and clamping devices are not at all suitable. Angle plates of several sizes is the answer to these two problems in particular, and besides they have many other practical uses in the shop, in fact, when laying out and machining certain type of work angle plates are almost indispensable. They are easily cast from simple wood patterns, and all the machine work necessary to finish them can be done on any lathe.

The details in Figs. 2 and 5 show dimensions for an angle plate suitable for machining on a 9-in. lathe. Of course, the plates can be made any size to suit your requirements. Being made of cast iron a pattern will be needed. This is a simple job in any close-grained wood such as pine or maple. Fig. 2 gives the details but no sizes are given on the pattern stock. When making up the pattern you have to make an allowance of approximately $\frac{1}{8}$ in. for shrinkage of the iron casting. To have the gray-iron castings made will be very inexpensive, but be sure you have the work done at a foundry

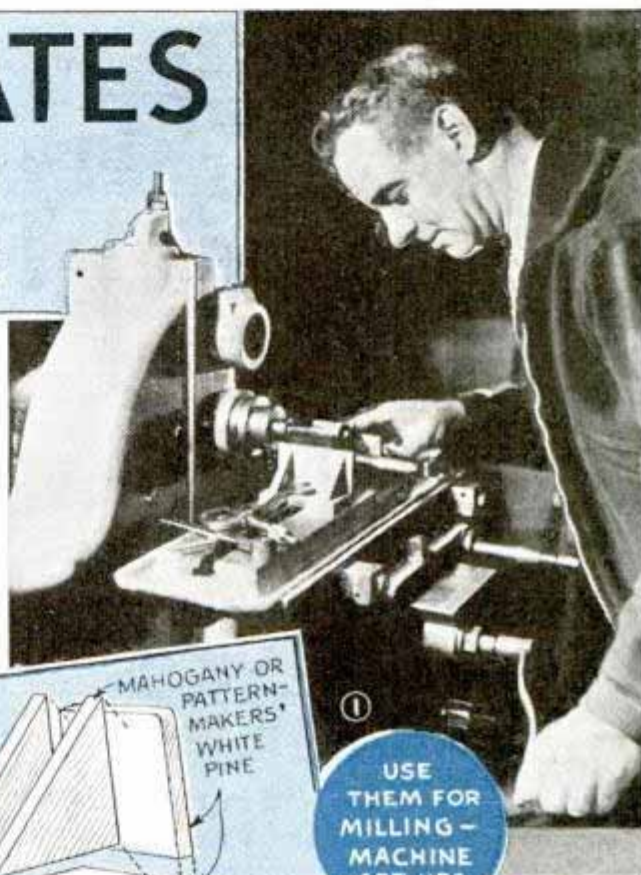

①
USE THEM FOR MILLING-MACHINE SET-UPS

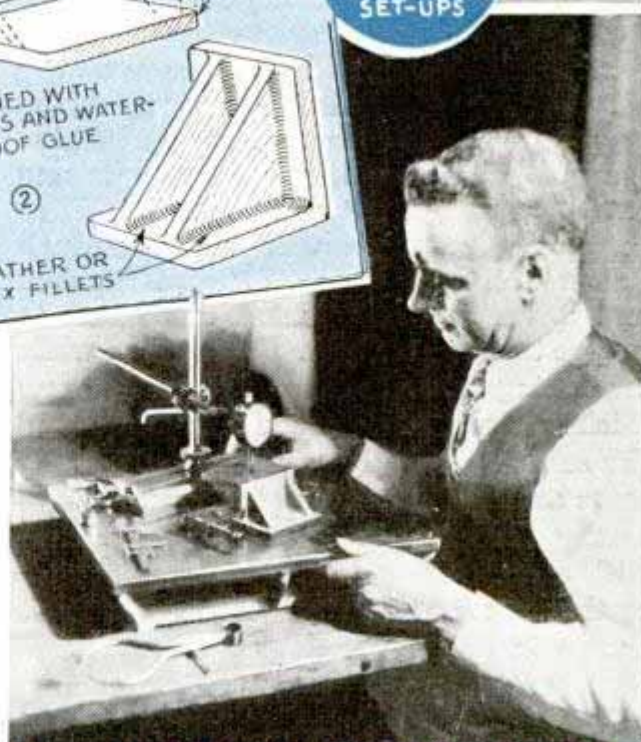

③ CHECKING ACCURACY ON A SURFACE PLATE

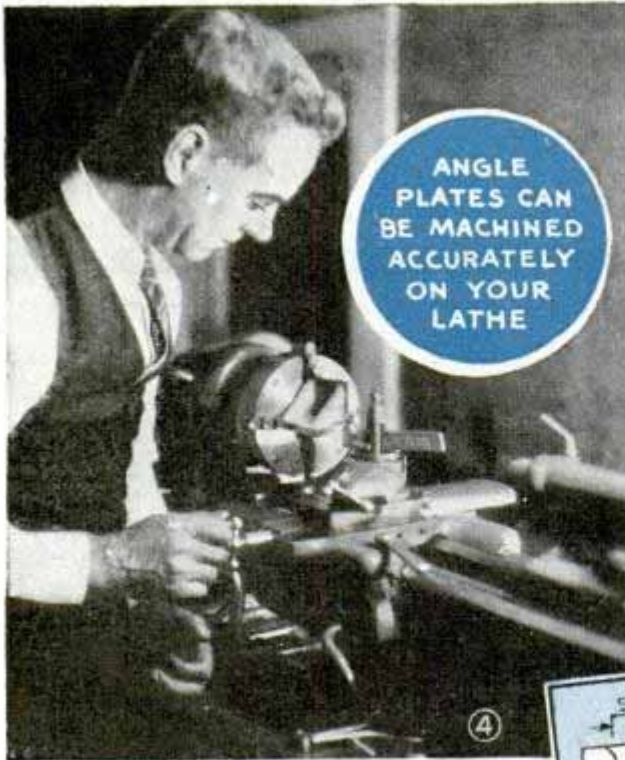

ANGLE
PLATES CAN
BE MACHINED
ACCURATELY
ON YOUR
LATHE

angle plates. In laying out dimensions, for example, the plates add much to the convenience and accuracy of surface-plate work. An irregular-shaped casting can be held rigidly in place on a surface plate while being marked for machining. Suppose you have rough castings of two model locomotive cylinders which are to be bored exactly the same distance apart and accurately in line with each other. The bolting surface where the cylinders join is machined flat and each cylinder casting in its turn is mounted on an angle plate. The cylinder-hole center is located from this plate and a toolmakers' button adjusted accurately in place. The angle plate with

accustomed to handling small castings or the latter may have a hard scale on the surface which is difficult to machine. Of course, if you do have a milling machine similar to the one shown in Fig. 1, machining the castings will be a quick job. But lacking this, you can handle the work nicely on the lathe. The rough casting is mounted in the four-jaw chuck as in Figs. 4, 6 and 7 and both ends are squared by light facing cuts. Then the two edges are machined by chucking alternately as in Fig. 7. The face of one angle plate can be machined while being supported by the other by simply chucking the two plates together, one facing in and the other facing out as in Fig. 11. When the face and edges of both plates are rough finished all over they can be re-chucked and a very light finishing cut taken to square them accurately. Use a gauge while machining the faces to keep them the same thickness, and a toolmaker's square to hold the surfaces exactly at right angles. The faces are finally checked for flatness with a straightedge, Fig. 9, and for squareness with a dial indicator in a manner similar to that shown in Fig. 3. The body holes shown in Fig. 5 are drilled as in Fig. 8. Two coats of light-gray machine enamel will finish the plates ready for use.

Now for some of the jobs you can do with

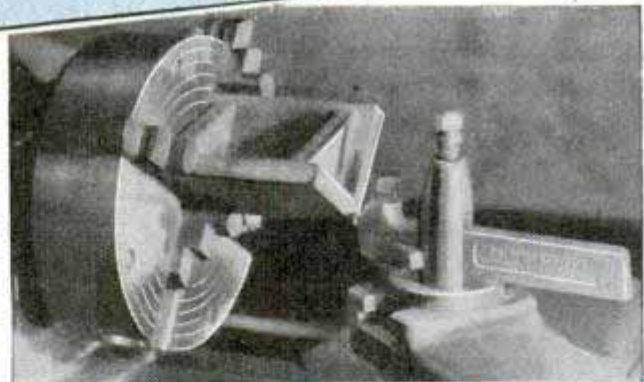
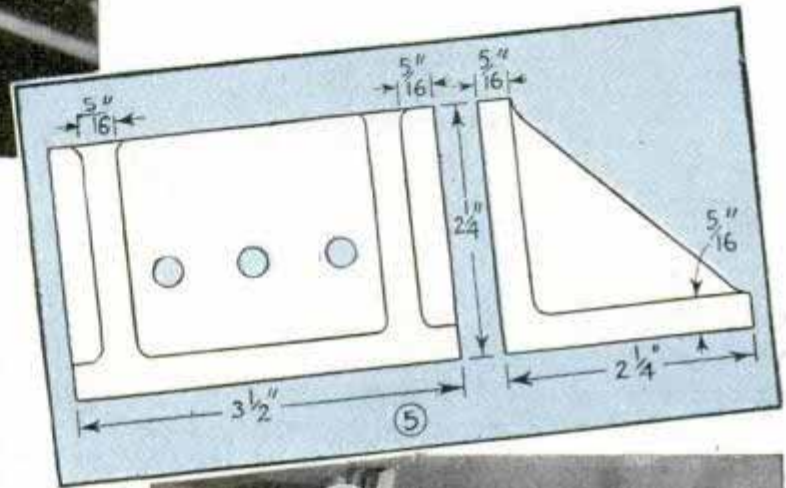

⑥ FINISH CUT ON THE ENDS



⑦ ON THE EDGES

the work attached and a counterbalance are mounted on the lathe faceplate at the bench, then the whole job is screwed on the lathe spindle. The work is adjusted until the button runs dead true as shown by a dial indicator. This determined, the button is removed and the cylinder hole bored clear through and lapped smooth all in the one setting. The procedure assures definite accuracy both in bore and distance apart, as you do not have to reset the work at any time during the whole operation.

Fig. 10 shows a similar job, a turnbuckle forging being turned down to size for threading. Fig. 1 shows a pair of angle plates acting as a vise for a bit of special work on the milling machine. They are especially handy for this particular ap-

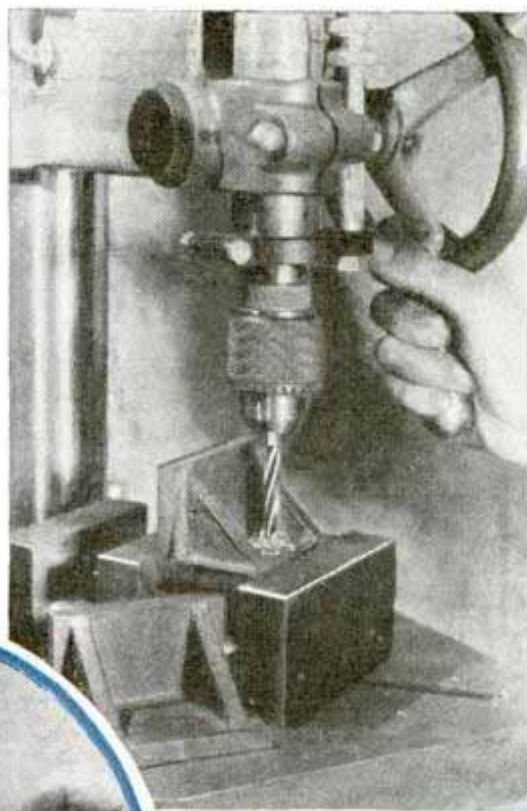

HOLES ARE DRILLED IN THE PLATES FOR BOLTING TO THE LATHE FACEPLATE ⑧



⑩ ANGLE PLATE IN USE ON LATHE



⑨ CHECKING THE JOB WITH A STRAIGHT-EDGE

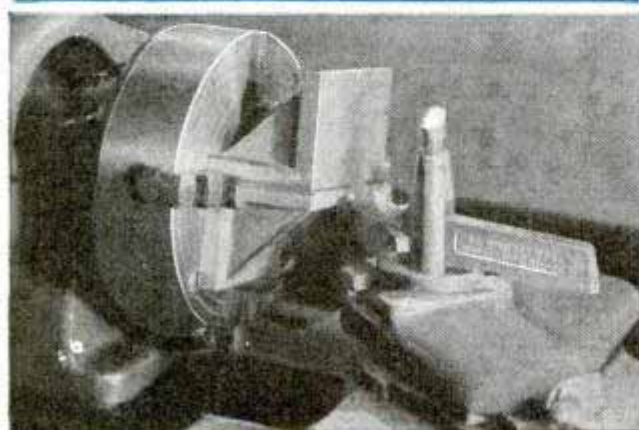

⑪ FINISH CUT ON THE FACE

plication. One thing to keep in mind about angle plates and their many uses is that it is the accuracy of the faces and edges with

one another that counts. Without this precision the plates are useless for any set-up where you must depend on the accuracy of the tools as well as on the layout of the job. For these reasons the plates should be used and handled as you would any other precision tool. Care should be taken not to drop the plates on a concrete floor or knock them against any hard surface which might batter the edges. And, of course, they should be kept oiled when not in use.

"Pincushion" Shields Pitchfork

Instead of standing a pitchfork in the corner of a feedway in the barn, or leaning it against a manger, stick it in a sack filled with chaff tightly packed. With the tines shielded in this way, there is little danger of injuring your leg or foot on them if the fork should be knocked over unnoticed.

Movable Shelf on Edge of Barrel Supports Sacks While Filling



To support paper sacks conveniently while filling from a barrel, one grocer uses this shelf, which hooks over the edge of the barrel. The shelf is a small packing box having slots cut in the sides so that it can be inverted to fit over the barrel edge.

Guide Aids in Setting Chucks Having Four Jaws

While the circular grooves on the faces of four-jaw chucks serve as a guide in set-

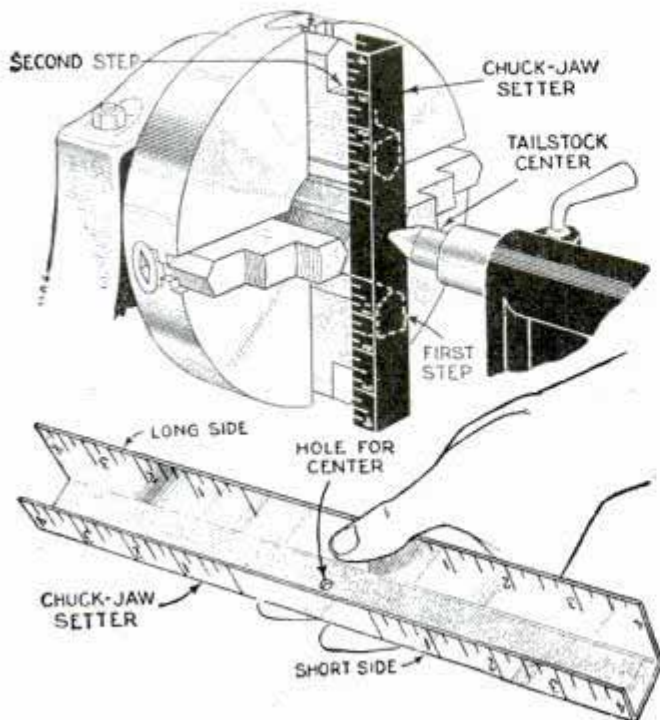

ting the jaws uniformly in most cases, there are times when they are of little use on certain work. For this type of work, I use the guide or setter shown. Made of sheet metal, it is bent over on two sides with one side wider than the other. Lines $\frac{1}{4}$ in. apart are scored on the outer surface of the short side and on the inner surface of the long one. In use, the diameter of the work to be held in the chuck is measured and the guide is put in place and held with the tailstock center. When two of the jaws have been set, the guide is moved to the other two jaws to set them.

—H. Moore, Leeds, Eng.

Stepped Bushing Driver Handy for Various Sizes

Sawed from a piece of flat steel, this simple bushing driver is made easily in any size desired. One end is shaped to provide a handle and the other end is sawed in steps, progressively smaller in size. These should be uniform on both sides, and each succeeding step should be about $\frac{3}{16}$ in. smaller than the preceding one. The spacing can be varied, of course, to suit work that occurs most frequently.

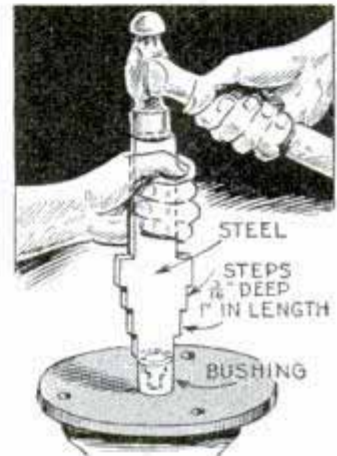

Cross Slots in Solder Bar Slow Heat Travel

To avoid burning the hand by heat which travels up a bar of solder while holding it on a job that takes some time, one tinsmith cuts slots in the metal as shown. These reduce the heat conveying properties of the metal to a minimum so that the bar can be held longer without being uncomfortable to the hand.

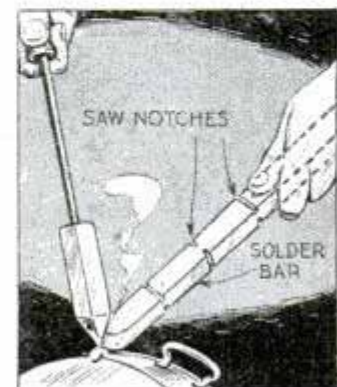

Shortcuts That Help in Filing Circular Saws

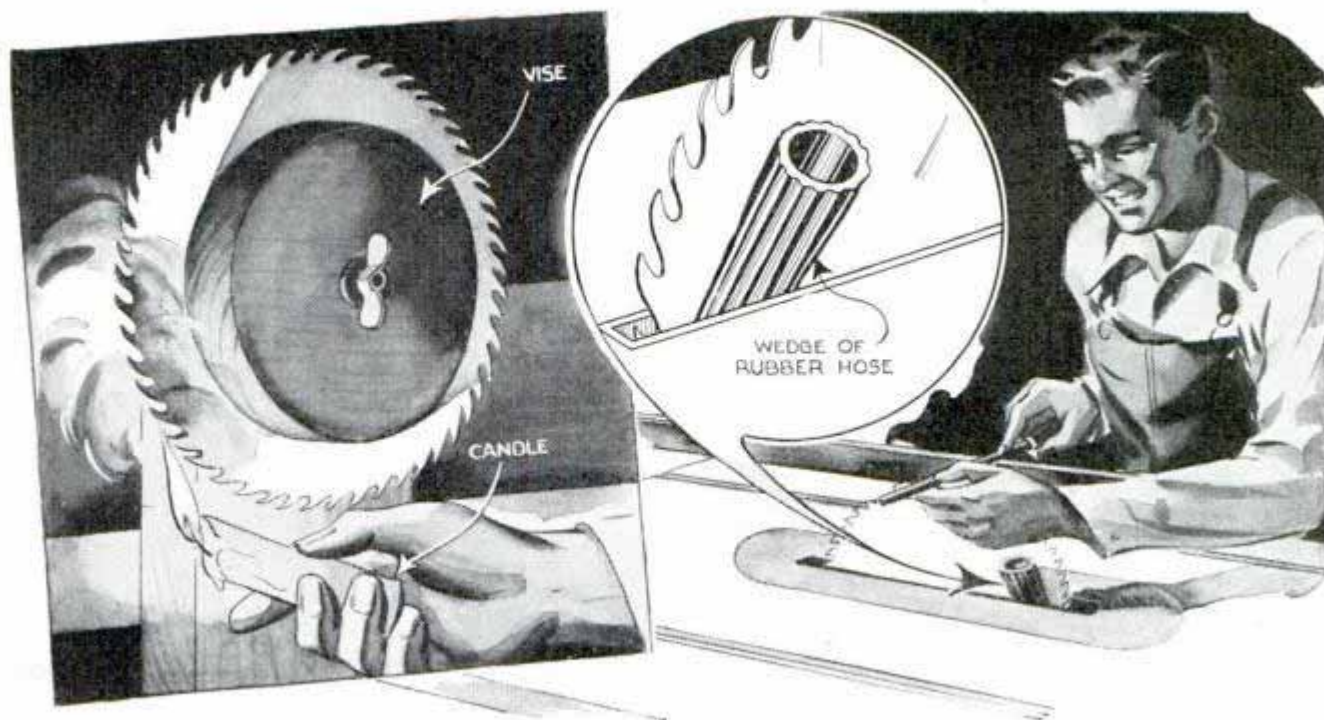

To keep a large circular saw blade from turning while filing it on an arbor, one woodworker employs a wedge made from a short length of discarded hose. The latter is pressed between the blade and the edge of the table insert. Used in this way, the wedge not only holds the blade firmly,

it also deadens the disagreeable screech of the file. Another way that helps immeasurably when filing smaller blades on an improvised vise is to smoke the teeth uniformly with a tallow candle. The blackened surfaces enable one to see the bevels left by filing with far less eyestrain.

This Small-Parts "Cabinet" Pivots between Floor Joists

One jobbing firm handling thousands of small items solved the storage problem by building a novel cabinet between the ceiling joists in the storeroom. The cabinet is simply a long wooden box closed at both

ends and fitting between the adjacent joists as indicated. One end is pivoted on a 1-in. dowel while the other end is held flush with the ceiling when the cabinet is closed by means of wood turn buttons. Swinging holders or trays made from large-size tin cans are pivoted on dowels between the sides. Each can has a part of the curved side cut away to form a tray with a round bottom. Swinging freely as they do, the trays are always level whether the cabinet is in the closed or open position.

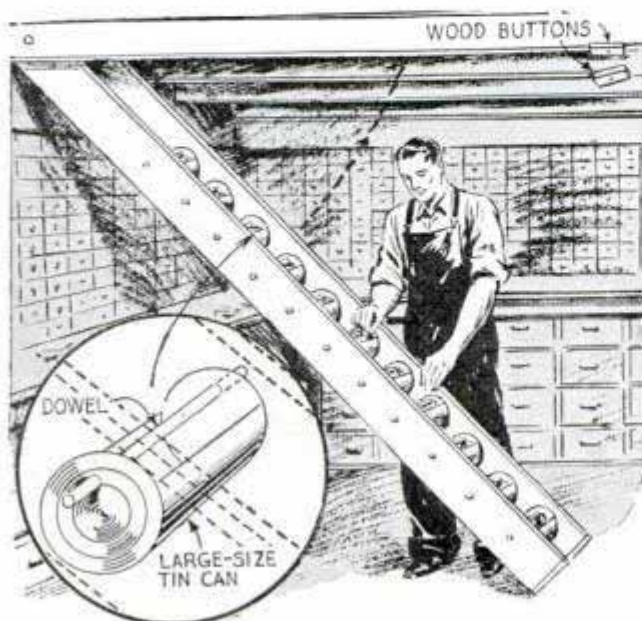

Protecting Idle Farm Implements

Farm implements that are not housed, especially during hot summer weather, should be given protective coatings. The wooden parts can be covered with creosote, and the metal parts should be coated with oil several times each year. A cloth fastened to the end of a stick is handy for applying the oil or creosote.

Shoulder Saddle to Carry Pipe Is Made from Auto Casing

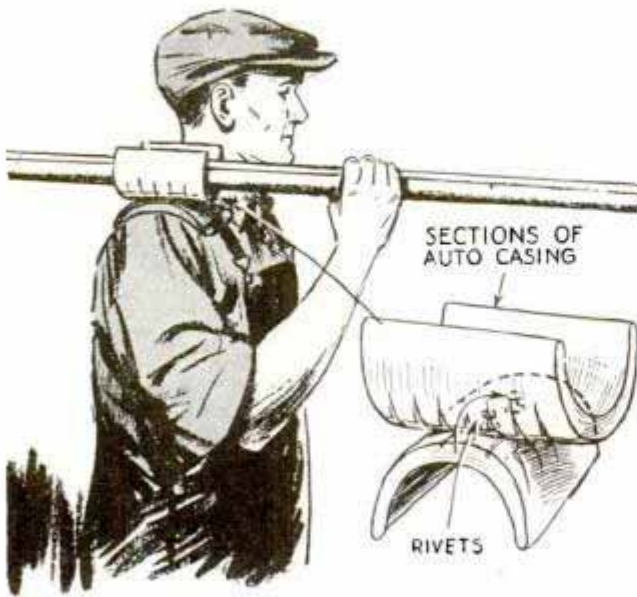

Plumbers and others who have occasion to carry lengths of heavy pipe will find that this saddle provides a comfortable shoulder pad. It is made by riveting two sections of auto casing together.

Non-Slip Top for Paper Trimmer



As the surface of a paper trimmer is often so smooth that work is difficult to hold without it moving, one workman made the table skidproof by applying a light coat of rubber cement. This provides a pliable coating on which it is very easy to hold paper.

Rubber Patches on Cotton Gloves Grip Driving Lines

Farmers and others who drive horses while wearing cotton gloves will find that they can grip the lines firmly if an inner-tube patch is placed over the forefinger of each glove as

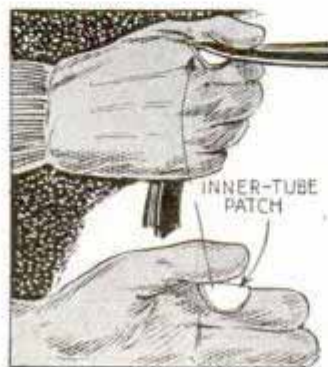

indicated. This tends to reduce muscle strain as the rubber permits holding the lines without gripping them tightly.

Cleaning T-Slots in Machines

Operators of lathes, planers, milling machines, etc., will find this T-slot cleaner a timesaver. It is a piece of pipe or tubing flattened at one end and then cut to fit in the slot as indicated. The other end is flattened slightly to take the handle of a small paint brush, which is screwed into place.

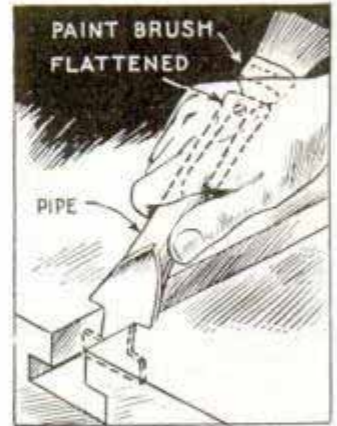

Paper Dishes Hold Chemicals on Balance Scales

When weighing small quantities of chemicals on your balance scales, paper plates will serve very nicely as containers.

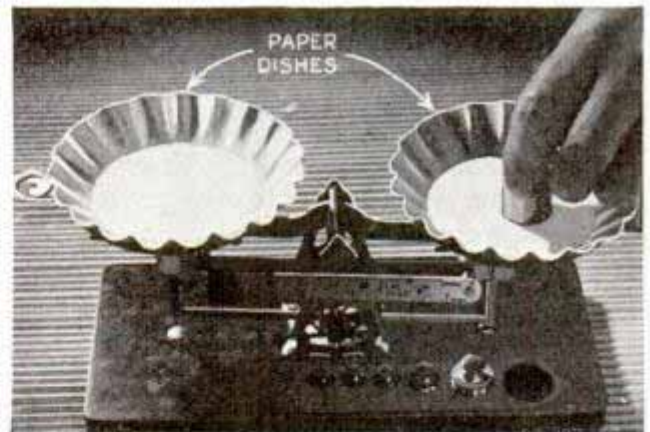

These are available in several sizes and may be thrown away when the weighing is finished, eliminating the possibility of small children or animals coming in contact with any poisonous chemicals.

If you have an idea that might be used for a short article in these pages, send it to the Homecraft Editor. Inclose a snapshot or drawing and give all the necessary information in as few words as possible. To be accepted, material must be of general interest and different from any we have published previously.



SIMPLE EQUIPMENT PRODUCES DISTINCTIVE SUEDE FINISH IN BRILLIANT COLORS ON NOVELTIES, STATUARY, TOYS, LAMPS, FURNITURE, PILLOWS AND MANY OTHER ARTICLES

"FLOCK"

New finish is soft, pliable and waterproof

FLOCK is made from silk, wool, cotton and rayon fibers, and is applied by spraying or sifting onto a varnished surface to which the cloth fibers adhere, producing a beautiful velvety-soft surface which is pliable, waterproof and colorful. The flock fibers range in length from $\frac{1}{64}$ to $\frac{1}{2}$ -in., the short fibers being best suited for homecraft use. Products which can be finished attractively with flock include toys, and furniture as in Figs. 1 and 2, also statuary, boxes, shoes, card tables, pillows, radio cabinets, lamp bases, and others.

Apply a priming coat first. This can be brushed or sprayed and is in no way special, but simply a priming coat. Fig. 3 shows a priming coat of white lacquer being sprayed. The second coat is the binder. This can be paint or colored varnish. For a first-quality job, the regular manufactured binder made especially for this work should be used. The binder should be the same color as the flock. Fig. 4 shows the binder being applied. The flock is applied immediately after the binder coat, as shown in Fig. 5. An inex-





⑦ ADJUSTING AGITATOR TUBE



⑧ LIGHT-PAPER STENCIL IS RUBBER-CEMENTED TO SHADE

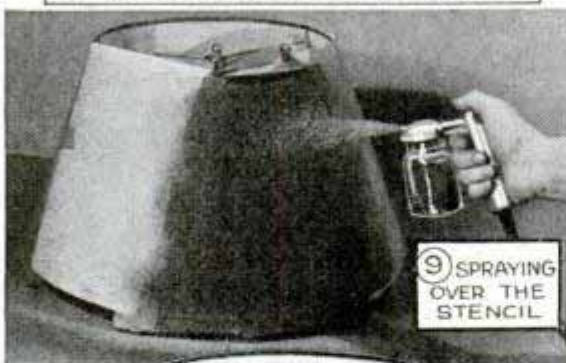

⑨ SPRAYING OVER THE STENCIL



pensive flock gun can be used, or, the work can be coated by sifting, as shown in Fig. 11. No special skill is required—the flock is simply sprayed or sifted onto the work until the binder catches a full coating. The work should be done on a clean surface so that flock not actually deposited on the work can be swept up and used again.

The simple mechanics of the flock gun are shown in Fig. 6. Air from a small compressor or from a rubber hand bulb enters the gun at the inlet tube. Part of the air current is diverted into the agitator tube, and the air current from the agitator tube blows the fluffy flock to the top of the jar where the main air current expels it. The air current at the end of the agitator tube should be reduced to the smallest amount required to agitate the flock, reserving the greater part of the air to expel the flock. On production-type flock guns, air pressure is controlled by a valve. On light-duty equipment, adjustment is made by fit-and-try methods, using a pair of pliers to close the end of the agitator tube, as shown in Fig. 7.

Application of flock in two or more tones of color, stencils, borders, etc., follows the same general practice used in ordinary painting. A simple example is the lamp shade shown in Figs. 8, 9 and 10, which is decorated with a silhouette in bright red flock. The design was first drawn on tracing or "frisket" paper, after which the paper was rubber-cemented to the lamp shade, as can be seen in Fig. 8. A stencil knife was used to cut away the areas to be flocked. Fig. 9 shows the flock being applied after the design was coated with binder. In this particular case the stencil was not lifted but remained in place until

or apply it by sifting

flocking was completed. It can be seen, however, that after spraying the binder through any metal or oiled-paper stencil, the stencil could be lifted immediately for the application of flock. Fig. 10 shows the finished silhouette.

Instead of using a stencil, designs and color work can be done by brushing the areas as required and then flocking, working the colors one after the other. Fig. 12 was flocked in this manner. The



main body color (light brown) was worked first, applying brown binder and then brown flock. The black areas were next painted with black binder and flocked, followed by the red coating on the tongue. As

in painting, the preceding coat must be given time to dry before another coat can be worked.

Shading can be done by spraying a base coat of flock, touching this up when dry with a suitable color of aniline dye, sprayed on. Flock of one color also can be sprayed over flock of another color. The binder in this case should be clear lacquer, thinned with a retarder thinner, with about a half-teaspoonful of castor oil per pint added to further retard drying. Both silhouette and color work on flat surfaces can be done by using the silk screen process to apply the binder.

After the finish has dried 24 hours, it should be brushed down with a stiff brush, Fig. 12. This will set the nap and remove any loose flock that may be clinging to the surface.

New Top for Old Bridge Table Is Made from Plywood and Canvas

Why discard a bridge table that has become rickety when it can be repaired with a piece of $\frac{1}{4}$ -in. plywood and a square of canvas? First remove the old top and tighten the legs and braces. Then cut the plywood to replace the top, and round the edges to a neat fit. If this is done carefully, the top will help brace the table. Cover the plywood with two thicknesses of an old blanket or similar heavy cloth, and over this stretch the canvas. Fold it carefully over the edges and tack it on the underside. Replace the metal corner pieces taken from the old top.

—Chas. H. Deerwester, Middletown, Pa.

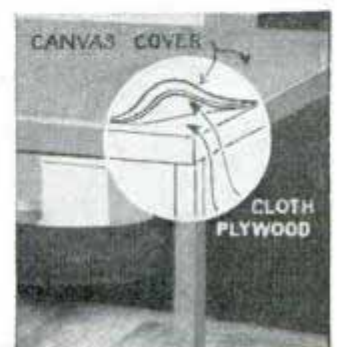

Sack Opened or Closed by Hoop Avoids Waste of Feed

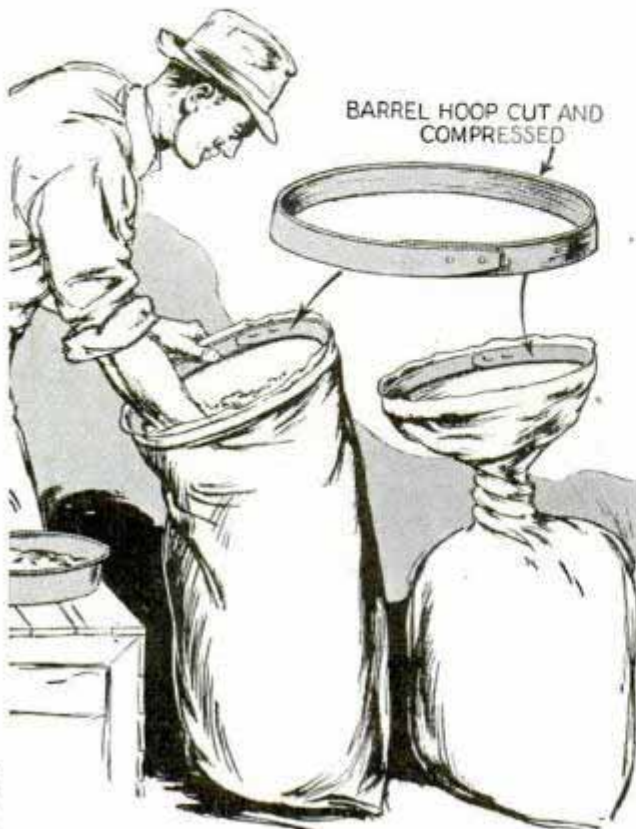

If you dispense feed to live stock or poultry from sacks, waste of the feed by spilling can be avoided with a small barrel hoop in the mouth of the sack. This keeps the sack open for easy removal of the contents, and permits it to be closed instantly by twisting the hoop.

Artist's Ruler Has Handle on End to Outline Showcards Quickly

To manipulate a ruler rapidly while laying out showcard designs, one artist at-



tached a tablespoon handle to it. A slight forward pressure on the handle holds the ruler firmly against the work, and the handle being at the extreme end allows full length of the edge for marking.

Gauge Cut in Tailstock Center Sets Threading Tool

I find that a 60° groove cut in the tailstock center in the position indicated saves time when setting up a threading tool on a lathe. After mounting the work to be threaded between the centers, the tool is set quickly by adjusting it to fit in the groove correctly.

—D. D. Guthrie, Alamosa, Colo.

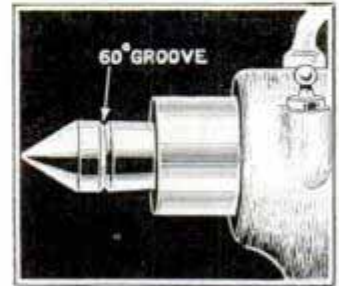

Supports Hold Warning Lanterns on Sloping Surfaces

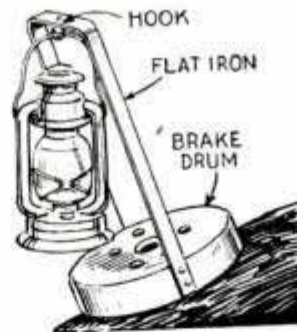

When warning lanterns have to be placed on sloping surfaces, one contractor uses supports like the one shown which hold the lanterns in vertical positions. Each support consists of a discarded auto brake drum to which a U-shaped length of flat iron is bolted or riveted to take the lantern bail.

Squaring Edges of Sheet Metal When Cutting Narrow Strips

On a job that required a number of narrow strips of sheet metal that had to be perfectly flat with the edges square, the metal was cut on

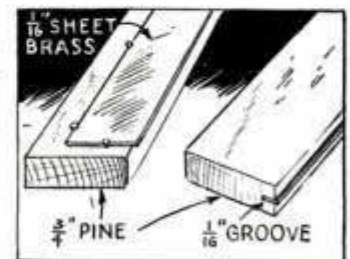

a power hack saw with these jigs. First a piece of the metal was fastened to a wood straightedge with nails at the ends and one side so that the other side extended beyond

the straightedge a little more than the width of the strip to be cut. Then an emery-faced disk was put on a circular saw and the projecting edge of the metal was squared, using the saw fence as a guide. Next, the required strip was cut from the metal, making it slightly oversize to allow for squaring up the edge on the emery disk. To hold the strip for this job, a shallow groove was cut in a straightedge to take it, the straightedge being held against the fence as the edge of the strip was fed into the emery wheel.

Shop Stove Improved by Casing of Corrugated Sheet Iron

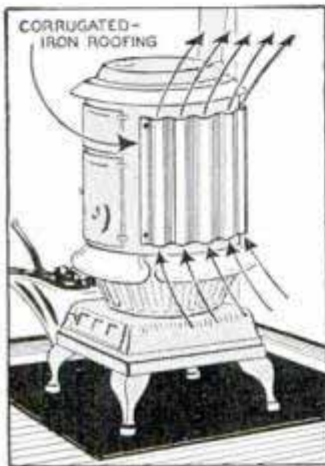

Owners of small shops and garages who heat their buildings with stoves can improve the efficiency of the latter by encasing them with corrugated sheet iron as indicated. Air will circulate rapidly between the surface of the metal and

stove, and the casing will also tend to reduce fire hazard if the stove must be placed near a wall.

Candle Holds Stubs of Crayon

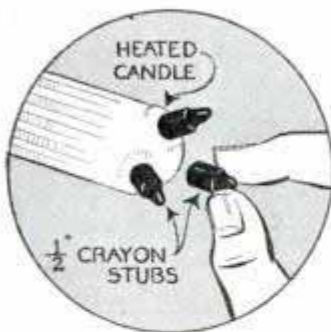

An artist who had to turn out a number of duplicate crayon sketches in a hurry, used a candle to hold the three crayons required, so that to change from one color to

the other all he had to do was turn the candle slightly in his hand. Stubs of the crayon were used and they were stuck to the ends of the candle by heating it.

Two adjustable metal window ventilators, one covering the other, make an inexpensive light-trap ventilator for the photo darkroom.

Steel Barrel Rolled Over Flames Smothers Fire



A Wisconsin farmer who has occasion to burn certain areas of wild grass from his pastures each year, keeps the fire under control by rolling a barrel over the flames to smother them where desired. A length of wood pivoted to each end of the barrel at the center permits it to be manipulated.

Turkey Feed Boxes Kept Clean with Wires Between Ends

To prevent turkeys from getting on the edges of feed boxes, one poultryman stretches wires above the boxes and fastens them to supports as indicated. As the birds are likely to fly up on the wires causing them to sag, he inserts small coil springs, which keep the wires taut.

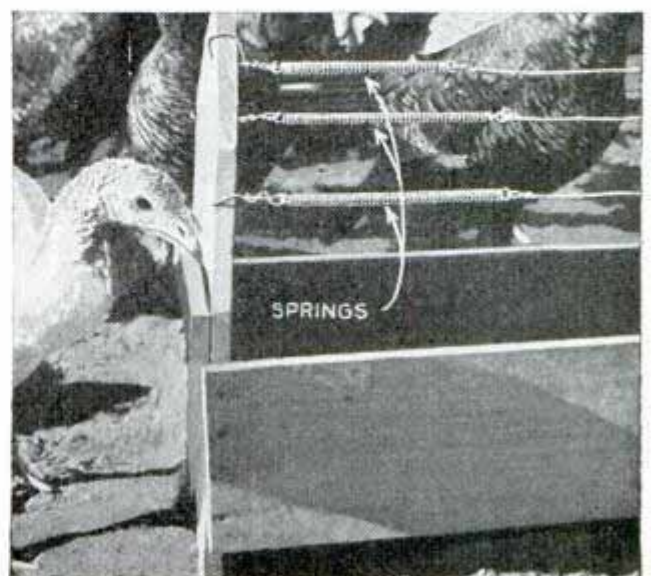

SHADOWLESS

stops needless



① A BOON TO HOME DRAFTSMEN

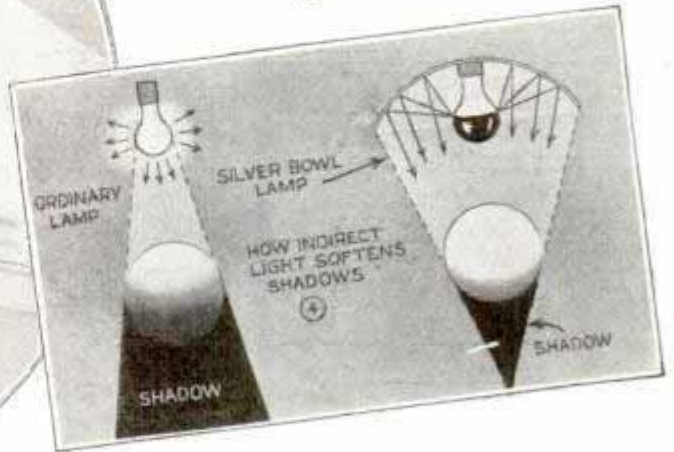

② UNDERSIDE VIEW OF REFLECTOR

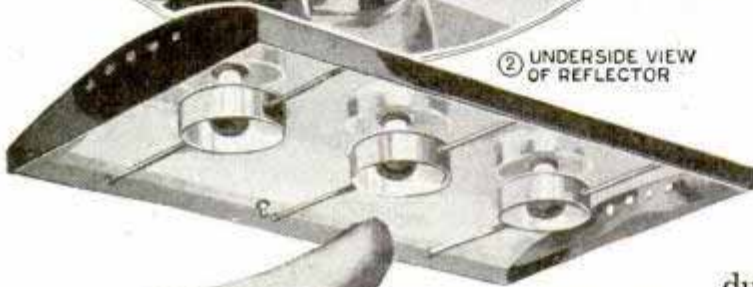

③ A LIGHT METER IS USED TO DETERMINE AMOUNT OF ILLUMINATION



By ALEXANDER MAXWELL

SHADOWLESS illumination of an intensity that can be varied to suit the requirements of the work is of utmost importance in any shop. Illumination of ten foot-candles is barely enough for reading newsprint and light of 25 foot-candles is needed to read the average mail-order catalogue. Exacting work like tool-grinding and engraving should not be attempted with a light less than 30 foot-candles while a light of 50 foot-candles is much better.

Metal-turning requires almost six times as much light as cabinetmaking and the high reflection of polished steel must be subdued. Light from an exposed filament-type lamp is just about as hard on your eyes as glaring sunlight and it produces dazzling high lights and black shadows. If that light is first directed against a white surface and then reflected back on the work, the glare disappears and, strangest of all, the shadows also shrink in size and become almost imperceptible. Why the shadows shrink is clearly illustrated in Fig. 4. Fig. 7 shows what illumination you get from 60, 100 and 150-watt lamps of the usual filament type. These figures are average, for individual lamps vary, depending on age, line voltage and make. Note particularly how much light intensity drops as the distance from the lamp increases. While your eyes may

not notice this, the nervous system soon will give evidence of it, if you work in a twilight zone for any length of time.

Light intensity is measured with a photoelectric cell, Fig. 3. This little device is very sensitive, and also expensive. There is no need to purchase one, for if you obtain your power from a utility company, the chances are that they have one, which may be borrowed for the asking. Lighting by guesswork has gone completely out of fashion. It is now the policy of all power and light companies to actually measure

LIGHT..

eye strain

lighting requirements in the rooms of office buildings, schools, factories and even private homes. The result is a more intelligent use of light at a great saving in jangled nerves, eye strain and reduction of industrial accidents.

Lighting requirements for any workshop are almost like those for industrial plants, only on a less elaborate scale. Cost is not prohibitive. The very best factory-made fixture costs no more than a set of good carving chisels. Even that may be cut down considerably by making your own, for the beautiful part of present methods of lighting is simplicity. The most important single item is a can of white paint. A white surface does not absorb light and is therefore an excellent reflector. Flat white, casein-base, cold-water paint is preferred. It sticks to plaster, wood and metal and may be mixed as needed. When soiled it may be sponged lightly without danger of lifting.

The simplest indirect lighting unit consists of a white ceiling and one or more silver-bowl lamps, Fig. 8. These have a built-in reflector, and are ideal for indirect lighting. If your workshop ceiling is of open-joint construction, you can nail sheet tin in an arc between the joists, as shown in the lower detail of Fig. 15, but for high-ceiling rooms, a canopy fixture like the one shown in Figs. 1, 2, 11 and upper details of Fig. 15, may be necessary. A canopy of this type can be made of sheet metal although hard-pressed board is satisfactory. The length of the canopy and number of lights to use in it depend upon your individual requirements. Always keep in mind the limited carrying power of the average light bulb. Instead of fila-



5
GLARELESS SHEET-METAL
LAYOUT LAMP

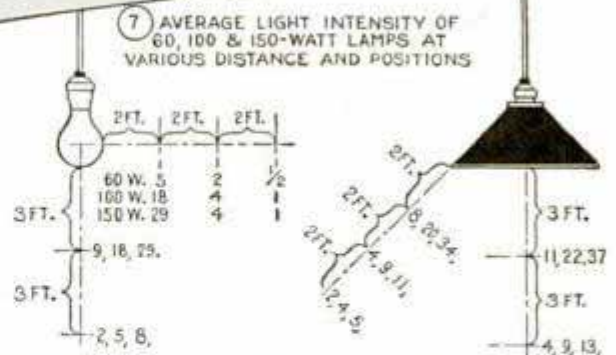
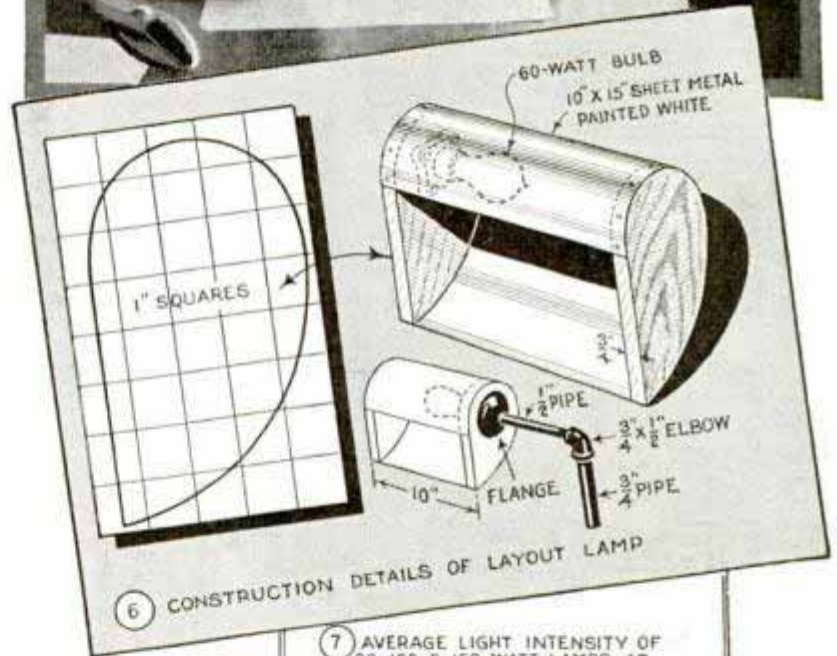

SUFFICIENT LIGHT WITHOUT GLARE OR SHARP SHADOWS



9 SHADOWLESS LIGHT FOR WORKSHOP SAWS AND OTHER MACHINES

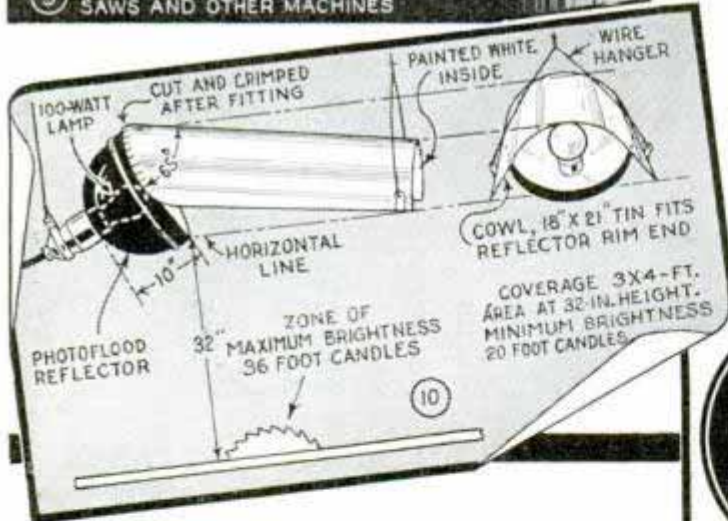

around each lamp. Dimensions of the shield and the method of attachment are shown in the upper detail of Fig. 15. At both ends of the canopy, holes are drilled to permit adequate ventilation.

More power-machine accidents are traceable to poor lighting than to any other cause according to insurance reports. Therefore a good light for your circular saw is important. Figs. 9 and 10 show a fixture which quickly and inexpensively solves the problem. There is no glare and the entire saw table is evenly illuminated and the whirling blade is highly visible. The fixture is made of a photographic reflector and a sheet of tin. Although simple to make, it must be adjusted carefully to get the maximum benefit of the reflected light. This particular fixture is especially helpful where the saw table is polished smooth and bright, as most of them now are, and where fine work is being done which requires that measurements on the stock and adjustments of the machine be made a number of times as the work goes along. If the direct rays of a bright light reflect from such a table surface into your eyes it is virtually impossible to set the saw accurately when doing close work.

A layout lamp for metal work is

ment lamps you can use the new type of fluorescent lamps if desired. The width of the canopy varies: If it is suspended 3 ft. over the workbench, the width should be 24 in. The best method of suspension is to use wires from the ceiling to the four corners of the canopy. Make it any length to cover the workbench from end to end, spacing the lamps equidistantly. You should use outlet boxes and flexible conduit for wiring, fitting the boxes on the top of the canopy as shown. Silver-bowl lamps are installed and a glare shield is provided

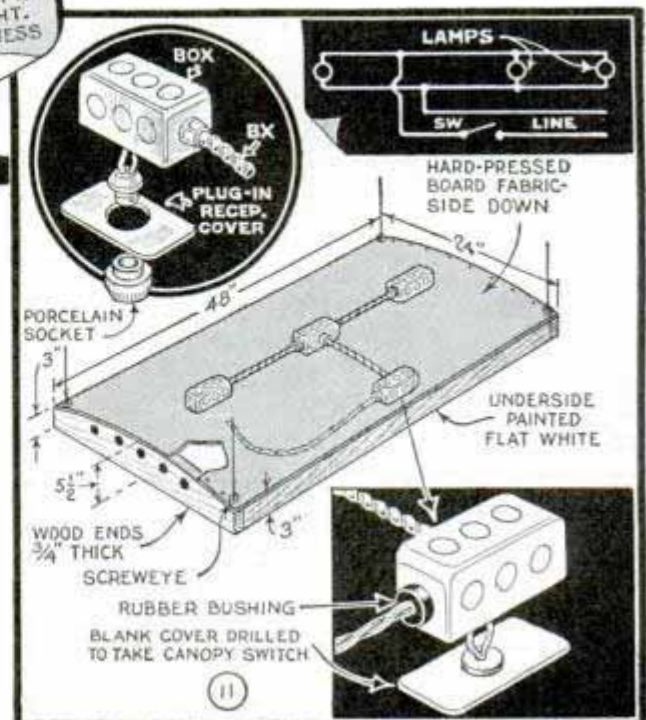

ESSENTIAL IN EXACTING WORK WITH TOOLS AND MACHINES

shown in Figs. 5 and 6. A horizontal beam of reflected light throws the scribe line into relief and at the same time subdues the natural tendency of the metal to flash and sparkle. This light is also very good for checking surface irregularities. It makes the scraping and sanding of table tops and work of similar nature a simple job. The unit should be mounted rigidly on a pipe stand so it can be raised and lowered and thrust well toward the middle of the cutting bench.

For close, accurate work, such as metal-turning and modelmaking, a condensed floodlight, as shown in Figs. 12 to 14 inclusive, is useful. With it a strong beam of light can be cast on the hands and the work while the eyes are in twilight. The reflector shell is cut from a 12-in. photo lamp and the tiny concave mirror may be the reflector from an automobile spotlight, magic lantern, or maybe an aluminum bowl. It should be adjustable for different size bulbs. Note that the ad-

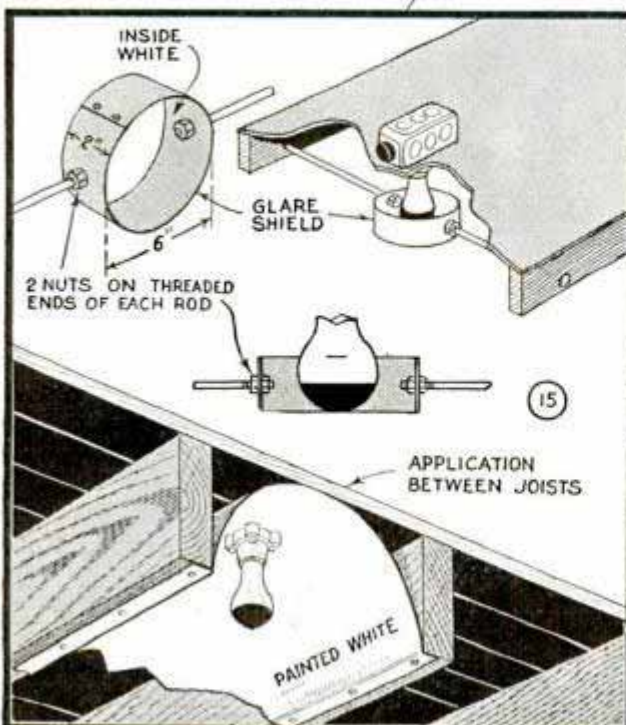
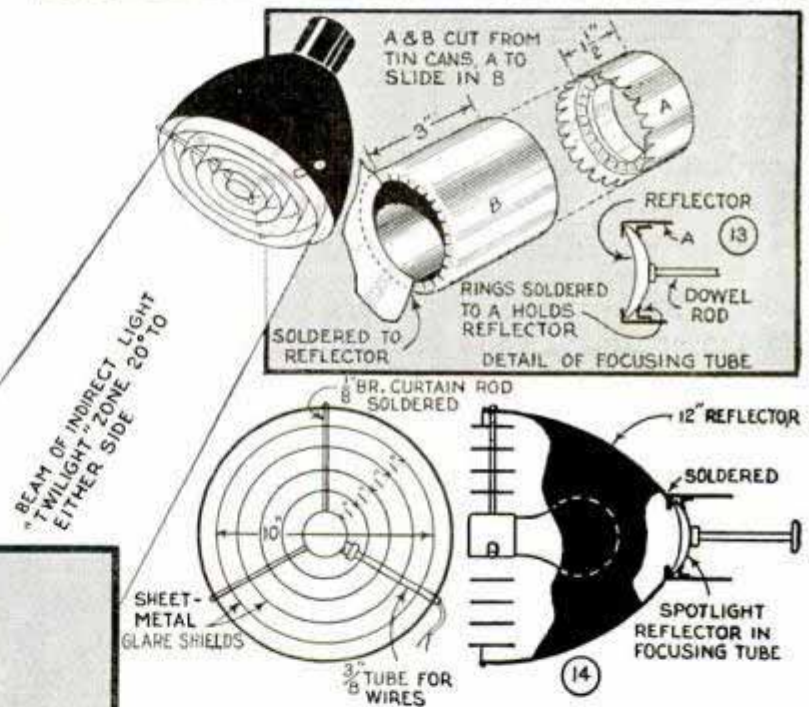

justable feature is obtained by using two tin cans, one sliding in the other. A ring is soldered inside the smaller one and the edge of the can is serrated and bent back so that the reflector is retained snugly between ring and bent edge as in Fig. 13. A number of concentric bands of sheet metal, arranged as shown, provide non-glare shields, causing the light to be directed in a comparatively straight beam that has a "twilight" zone 20° to either side.

When you need a piece of fiber for an electrical or similar project you can cut it from a ten-cent fiber chair seat.

Puddling Shovels Assembled from Disk-Harrow Blades



Needing a number of shovels to loosen sand and gravel for a mud-pumping barge, a contractor made good ones from the blades of an old disk harrow by fitting them with pipe handles. The pipe was split back about 5 in. from one end, the halves curved to the contour of the blade, after which they were heated and flattened. Then holes were drilled and the handle was riveted to the blade.

Mailbox Like Prairie Schooner

Can lids for wheels, and four cut-outs of horses hitched to one end give this rural mailbox the novel appearance of a prairie schooner. The box is mounted on two wood blocks, which are supported by a 1 by 6-in. board nailed to the top of a post, the wheels being pivoted on nails driven into the bottom of the box. Horses, tongue



and doubletrees are cut from 1/4-in. wood, while the harness is small strips of leather. Painting the assembly in appropriate colors adds to the realistic appearance.

Extension Light Held in Spring on Workbench

To support the bulb of an extension light in a convenient position for working on a bench, a mechanic uses a coil spring obtained from a discarded auto cushion. The spring is also handy to keep the lamp out of grease and oil when used under a car or on the workshop floor.



Work Centered on Faceplate with Aid of Microscope

A simple and accurate method of locating and centering work on a lathe faceplate is to use an inexpensive low-power microscope. With it, you can lay out work



with a scale, scribe, and magnifying glass, set it up and drill and bore it without any further operations such as are often necessary when using a dial indicator. The microscope is clamped on a rod, which is held in the tool post, and can be set up at any convenient angle.

—J. D. Brubaker, Evanston, Ill.

Foot-Controlled Toggle Stop on Garage Door

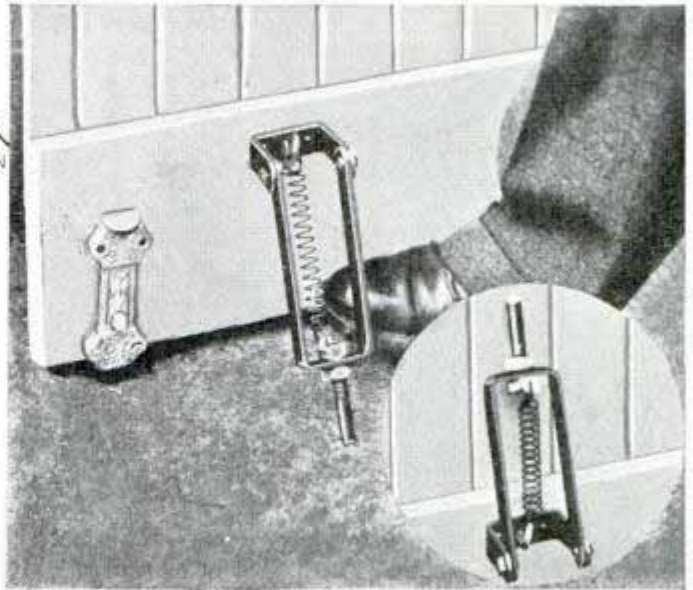
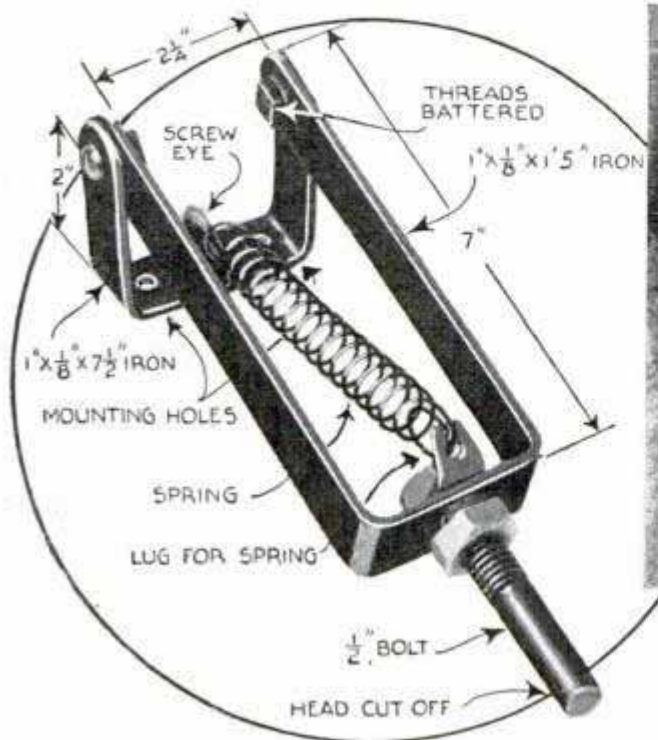

Stooping is unnecessary when you raise or lower this doorstop. It is snapped up

or down with your foot, and there is no chance of wind closing the door, as the harder the door is pushed against the stop the more firmly it bites into the ground. It is made of flat iron bent and assembled as shown in the detail.

Gear-Lubricant Can "Pumped Up" to Fill Transmission

Motorists who would like to change their own gear lubricant but hesitate to because of the difficulty in filling the differential and transmission, can do the job easily by using a tire pump to build up a low air pressure inside the grease can. The can must have a compression lid so that a pressure of 2 or 3 lbs. will not loosen it. Punch two holes in the lid of the can. Solder a tire-valve stem in one hole and a 15-in. length of 1/2-in. copper tubing in the other so that the lower end projects within 1/4 in. of the bottom. The end of the tubing that extends from the lid is bent to form a spout. After the old lubricant has been drained from the differential or transmission, the spout is inserted in the refill hole and the pump is used to force the grease into the housing. It may be necessary to heat summer grades of lubricant to make them flow easily.

—Robert J. Williams, Chicago.

☐ If a windshield-wiper blade scratches the glass, the tiny grooves can be removed by rubbing them with a piece of felt and polishing rouge. Most hardware and paint stores have the rouge in paste form.

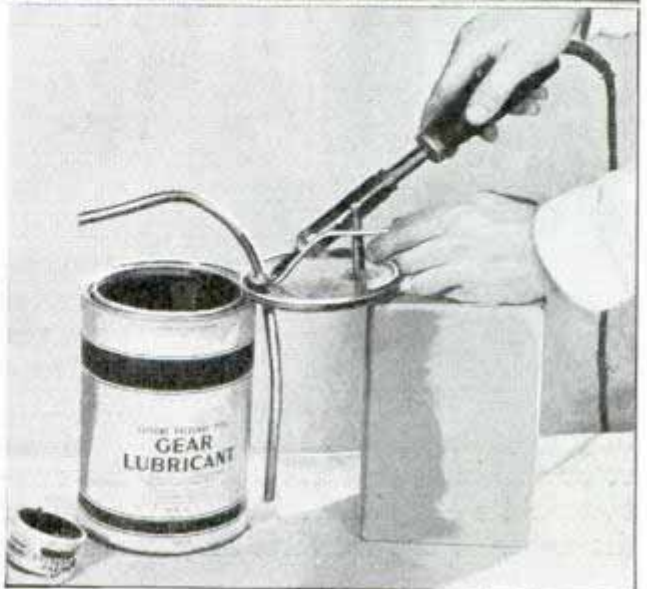
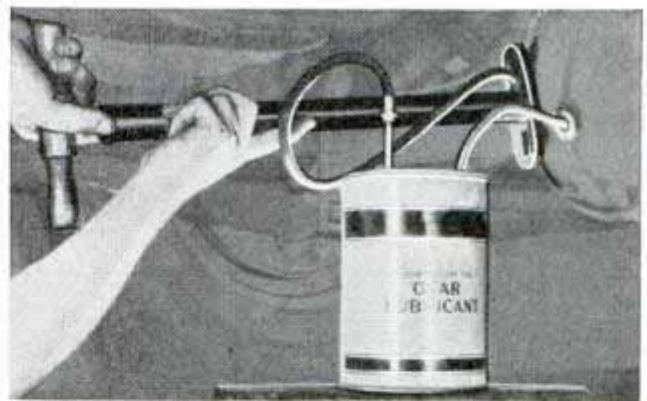

Section of Auto Tire Shapes Inner Tube When Buffing



To hold an inner tube safely against a wheel while buffing it before applying a patch, one mechanic uses a section of tire shaped as indicated as a holder. The portion of the tube to be repaired is stretched tightly over the holder.

Causes of Weak Spark at Plugs

Often the ignition coil is blamed for a weak spark at the plugs when in reality the trouble is in the distributor. The terminals where the spark-plug cables enter the distributor often corrode and set up a high resistance against the passage of current. This trouble can be overcome by pulling out the wires and cleaning the terminals and the copper caps on the ends of the wires. Another place where trouble

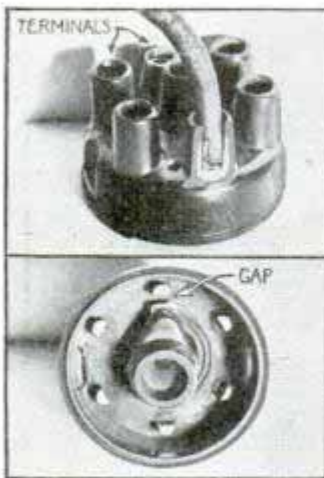

may originate is the spacing between the rotor inside the distributor and the contact points of the cap. In time the end of the rotor or the contacts may corrode or

burn so that the gap between them is increased considerably. This tends to set up a resistance to the current. While the best remedy for this trouble is to install a new rotor and cap, a repair can be made by building up the end of the rotor with solder. After doing this the rotor is turned over slowly to shear off the excess solder and give the proper clearance.

Locating Stuck Valves

Weak valve springs and sticking valves account for a lot of motor trouble, and can be located with nothing more than an ordinary screwdriver. To do this, remove the valve cover plate, and with the motor running, increase the spring tension of each valve in succession by spreading the coils with a screwdriver. While this test is being made, it is well to have a vacuum

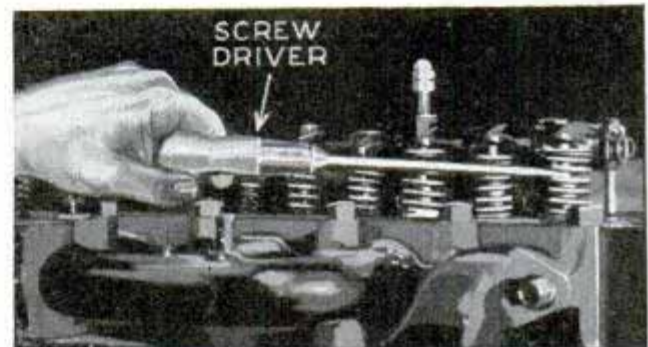

gauge connected to the motor. A higher or steadier reading when the screwdriver is inserted into the spring indicates that the latter is weak or that the valve is sticking. In serious cases the improvement can be noted by merely listening to the difference in operation of the motor as the springs are tested.

Checking Car for Short Circuits Before Installing Battery

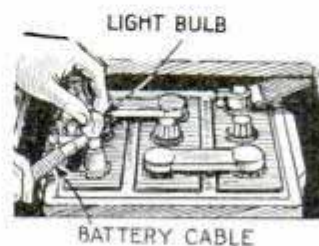

When a battery is removed from a car for charging, I always make a check for short circuits before installing the rental battery. This is done easily by tightening one terminal to the battery post and then holding the other terminal against the metal stem of a

single contact bulb, which is held on top of the other post. If the bulb glows after all switches on the car have been opened, there is a short circuit in the wiring, which should be repaired. I find that most customers appreciate this service because it prevents their own battery from being discharged when it is returned to the car, and it often gives me extra business in locating and repairing the short circuit.

—Milton Mitz, Milwaukee, Wis.

Easy Way to Change Valve Spring



It is an easy matter to change valve springs without removing the cylinder head if you use compressed air to hold down the valve while removing and replacing the

keepers. A fitting for the air-hose nozzle is made from an old spark plug by removing the porcelain core and soldering a valve stem to the spark-plug shell. In use, the regular spark plug is removed and the fitting screwed into place.

—C. E. Packer, Chicago.

Emergency Fuse Has Foil Core

If it is necessary to substitute a piece of metal foil for a burned-out auto fuse in an emergency, pull a cap off the end of the latter and insert the twisted foil. When the cap is replaced, the short pieces of fuse wire remaining will contact the foil and make a better repair than the usual method of wrapping the foil around the entire fuse.

—Wesley McDonnell, Silverton, Ore.

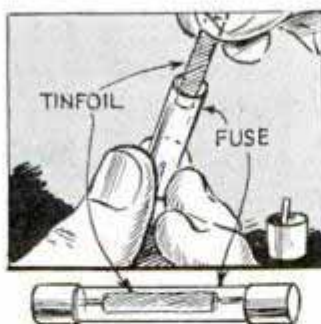

☛ If battery acid is accidentally spilled on the upholstering cloth of a car, a solution of baking soda and water or household ammonia immediately sponged over the spots will neutralize the acid and keep it from eating holes in the material.

Damp Sandpaper Removes Hair from Auto Seats



Dog hair and fine lint can be removed from auto seats easily with dampened sandpaper. This tends to mat and roll the hair, as the paper is moved over the upholstery, so that it can be picked up.

Grease Retainers Need Care

Felt washers used to retain grease on universals and in dozens of other places may be damaged easily by careless use of high-pressure greasing. On many universal joints two openings are provided, one to serve as a grease connection and the other to act as a vent for relieving the pressure. If this is not the case, great care should be taken to control the pressure so the gasket will not be blown.

Heater Switch Dims Fog Lights

Noticing that fog lights on some cars that I met were too bright for comfort to the eyes, I installed a dimmer switch on my lights to use when meeting another motorist.

The switch was one of the rheostat type used to control a car heater.—F. J. Kirby, Boise, Idaho.

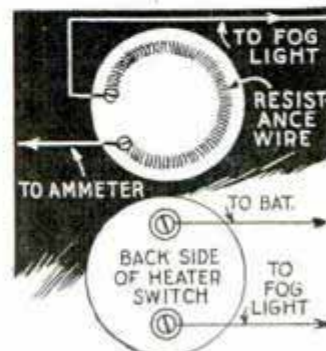

Ratchet Handle Good Substitute for Ford Crank

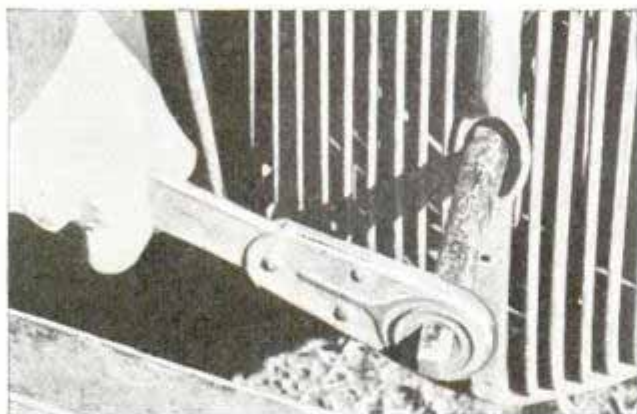

If you have to start a Ford motor with the two-piece crank and should lose the handle part of the crank, the ratchet handle of a socket wrench set will serve the purpose. This will slip over the squared end of the extension part of the crank as

shown. The ratchet handle is sometimes preferable to the original handle as it permits backing the crank without removing the extension rod.

Repairing Windshield Wiper

A permanent repair for a vacuum-type windshield wiper that acts erratically because of a leak around the shaft, can be made in the following way: Take the wiper apart and file the bottom or lower half of the housing evenly to allow less clearance for the wiper shaft when the two parts of the housing are reassembled. Then clean out the wiper, oil the moving parts, and reassemble it. If the wiper jams, it means you have filed off too much. When this happens the use of two paper gaskets, instead of the usual one, between the two parts of the housing will overcome the trouble.—E. J. Novak, Omaha, Nebr.

Spare-Time Profits in Window Boxes



Three attractive designs of boxes having the same basic construction but varied in appearance by means of molding, overlays, and curved ends. All have zinc linings for durability

For Spring Sales

You can make up a quantity of these window boxes for spring sales when home owners are flower-minded and items such as these are easy to sell.

Use Production Methods

By sawing a number of duplicate parts all ready for assembling, you will save considerable time. Priming the wood before assembling is advisable, and two coats of paint are applied later, in attractive colors to suit customers' desires.

Craftplan Gives All Details

Constructional details including dimensions of these flower boxes are thoroughly covered in our Craftplan No. 3011. This also includes a material list and complete instructions how to proceed step by step. Just send 10 cents and the coupon, upon receipt of which the Craftplan will be forwarded to you.

POPULAR MECHANICS MAGAZINE
200 E. Ontario St. Chicago

Enclosed find 10 cents for Craftplan No. 3011—
Building Window Boxes

Please check I am a subscriber
 I buy at newsstand

Name _____

Use pencil

Address _____

City _____

State _____

FAMOUS

YANKEE

Handyman

HOME . . . HOBBYIST TOOLS

25¢

"YANKEE"
HANDYMAN

IT RATCHETS

\$1.25

\$1.00

"YANKEE" Handyman No. 2H

Needed in the kit of every hobbyist. Wanted in every home. Useful to man, woman, boy. "It Ratchets!" Makes easy work of driving or drawing small screws. Simply set for right or left ratchet. Then just move handle to and fro. You get genuine "Yankee" quality for only **Twenty-Five Cents.** Length 4 1/16"

Look For
"Yankee" Handyman
Displays At Dealers
New
Amazing
Values

"YANKEE"—famous for Fine Mechanics' Tools, also makes "Yankee" Handyman Tools for Home and Hobbyist. New speed, greater ease, handier for you—driving screws, boring holes! "Yankee" Handyman Screw Driver **No. 133H**—with Spring in Handle, **\$1.25**, is ideal drill. **No. 33H**, without spring in handle, only **\$1.00**.

To bore holes for screws, countersink, etc., with either **No. 133H** or **No. 33H**, buy these "Yankee" Accessories. Sold separately, or in Pak:

 "Yankee" Chuck and 3 Drills Set, **39c**

 "Yankee" Drill 5/64"

 "Yankee" Drill 7/64"

 "Yankee" Drill 9/64"

 "Yankee" Countersink Each **25c**

 "Yankee" 5/32" Blade for small screws Each **12c**

Accessory Pak
No. 330H

Complete Set
Accessories
On Card, **75c.**



To change No. 133H or No. 33H into a drill, remove screw driver blade.



Insert "Yankee" Chuck-and-Drill in place of blade. You then are ready to bore small holes.

--- INTRODUCTORY COUPON ---

North Bros. Mfg. Co., Philadelphia, U. S. A.

If dealer cannot supply you, enclose Money Order for delivery postpaid of "Yankee" Handyman Tools, as checked:

- No. 133H Spiral Driver. Spring in Handle. One blade, 1/4"..... **\$1.25**
- No. 33H Spiral Driver, One blade, 1/4"..... **\$1.00**
- No. 330H Accessory Pak Complete..... **.75**
- No. 2H Screw Driver—"It Ratchets"..... **.25**

Name.....

Address..... PM

Modern Precious Metals

(Continued from page 575)

is an important constituent of stainless steels. Beauty, great strength, light weight and resistance to corrosion are desirable qualities of these steels that make them so much in demand for streamline trains, cutlery, building construction and the like.



By careful rolling, aluminum foil as thin as .00025 inch can be produced. It has many industrial uses

Although the United States used more than 550,000 tons of chromium ore in 1937, domestic production was less than 5,000 tons.

We have all admired a shiny Buffalo five-cent piece, and some of us have seen the Jefferson nickel. It is doubtful that, for most of us, our knowledge of nickel has extended much farther. Yet in our fast-moving lives, nickel is indispensable. Before and during the World War nickel was the danger metal, used almost entirely in instruments of destruction, such as battleship armor and steel-pointed projectiles. Since the war nickel has become one of our greatest safety metals.

When you are stalled in your car on a sharp curve and a ten-ton truck approaches at fifty miles an hour, you wonder if the driver can stop. Well, if the truck is equipped with nickel-chromium iron brake drums, he can. Manufacturers

have found these drums resist scoring and frictional heat well and have a long life.

In the San Francisco-Oakland Bay bridge, several thousand tons of nickel steel were used for cantilever tie pins, anchor plates, parts that "must not" fail from corrosion, weight or earthquake shocks. Nickel cast iron, too, is coming along fast. Fly-wheels, cylinder linings, brake drums and a host of other cast-iron products are benefited by small amounts of nickel.

Magnesium, frequently called the wonder metal, has been used for years in chemical industries and fireworks manufacture. Recently it has entered metallurgical fields. One finds alloys of magnesium and aluminum varying all the way from two per cent aluminum and ninety-eight per cent magnesium to three and five-tenths per cent magnesium and ninety-six and five tenths per cent aluminum. One standard alloy—six per cent aluminum, three per cent zinc, two-tenths per cent manganese and the balance magnesium—is widely used for castings where strength and very light weight are required. Only two-thirds as heavy as aluminum and one-fourth as heavy as cast iron, this alloy rivals both in strength and durability. For buses, airplanes, portable electric drills and castings of many varieties, magnesium alloys are particularly valuable. Through use of such alloys, the weight of a bus was reduced four tons from that of steel construction without, it is claimed, sacrificing safety or durability.

Molybdenum, the tough metal, when added in small amounts to steel or cast iron, results in products that resist abrasion to a remarkable degree. Everything from hand shovels to steam shovels and bucket dredges benefits from its use. Armaments, high-speed tool steel and structural steels requiring high-tensile strength all demand large quantities of molybdenum. It alloys easily with chromium, nickel, tungsten, and manganese to make tough, hard steels. A little molybdenum added to steel aids greatly in resisting corrosion.

In 1919 only 376 short tons of the metal were produced in the world. In 1938 production was more than 14,000 tons. Molybdenum is one of the few "precious metals"

(Continued to page 116A)

2208
 Dr. J. W. Brown Corp., Detroit, Mich.
 magnesium fabricator

Double load of flavor

best in a pipe...best in a cigarette...that's **VELVET**

Velvet

Better smoking tobacco

—for **MILDNESS**
fine old Kentucky Burley aged in wood

—the **FLAVOR**
of pure maple sugar for extra good taste

*Velvet packs easy in a pipe
Rolls smooth in a cigarette
Better tobacco for both*

Velvet
PIPE AND CIGARETTE
TOBACCO
LIGGETT & MYERS TOBACCO CO.
RED. U.S.P.

(Continued from page 114A)

of which the United States has an ample supply. In 1937 this country produced ninety-two per cent of all mined, and seventy-one per cent of the world production came from a single mine at Climax, Colo., which now mines and mills 12,000 tons of ore a day. This mine has more than 100,000,000 tons of ore blocked out, with unknown further reserves.

Tungsten's earliest uses were for dyes, pigments and tanning leather. Later it was used for electric-light and radio-tube filaments. These uses continue, but the bulk of all tungsten mined now goes into steel. It makes a tough steel suitable for battleship plates and similar purposes. Steel alloys containing ten to fourteen per cent tungsten make metal-cutting tools that retain their edge at red heat. Compounds of tungsten and carbon under the trade names Firthite and Carboloy are only a trifle less hard than diamond, the hardest natural substance known. A mixture of tungsten, chromium and cobalt is sold under the trade name Stellite. This alloy, like Firthite and Carboloy, is used to replace black diamonds for core-drilling operations in prospecting for ores, and in-

vestigation of dam sites, bridge foundations, etc. Tungsten deposits, mostly small, are scattered over the western states. China has the largest known deposits.

Like tungsten and molybdenum, vanadium formerly was extremely limited in uses. Then it was discovered that a little vanadium made steel very elastic, increasing greatly its tensile strength. Now we find vanadium used in automobile and railroad springs. Twenty years ago broken automobile springs were of common occurrence. Today, unless the car is wrecked, one seldom hears of one breaking. Vanadium also is used in high-speed tool steels, pinions, axles, and other places where great tensile strength is required.

Peru long has been the chief producer of vanadium. Now, due to increased development in the carnotite fields of Colorado and Utah, there is reason to believe the United States can meet its own requirements. Carnotite is a mixture of vanadium, uranium and radium. From 1912 to 1921 it was mined chiefly for its radium content; now it will be mined for the vanadium, with the other metals as by-products.

Winning the War on Traffic Accidents

(Continued from page 571)

selves were in many cases reversible and the geometry of the steering connections so bad that "wheel fight" was terrific. Today, large steering wheels are made so that they will bend, not break, with comfortable gripping sections and structures that absorb vibrations. Correct geometry, reductions in steering ratio of eighteen or twenty to one with high-efficiency steering gears makes steering well-nigh effortless. Self-righting gives the car "steering sense." Mechanical failures are comparatively unknown.

Riding comfort has a bearing on safety. Softer springs, independent wheel suspension, stabilators, larger tie sections, better shock absorbers, better weight distribution, and a steadily growing knowledge of the engineering factors involved have made riding comfort progress very rapidly.

Noise and vibration were both serious problems in early cars. High-frequency vibrations and droning noises have a distinct numbing and fatiguing effect on the

human nervous system. The last two years have seen great progress in subduing both noise and vibration.

In 1906, brakes can only be described as "awful." Today a car with four-wheel brakes in good condition can stop in thirty-five feet from thirty miles an hour, in forty-one feet if in fair condition, and in sixty feet if in poor condition. It has better brake drums and linings, greater area of braking surface, protection of the brake shoe and drum surface from dirt and water, dependable brake hook-ups, more scientific distribution of braking effort among the four wheels, lighter pedal pressures and the use of power auxiliaries in conjunction with human effort. Highly developed air and vacuum brake systems for trucks and trailers closely follow railway equipment design.

So it's plain that our engineers have gone to great lengths to make the mechanics of the automobile safer, to win the battle to reduce accidents and to save lives.

as **POWERFUL** as it looks



The new **DELCO**

Take a look at this big new Delco battery, and know that from case to plates it is the powerhouse it looks! It teems with extra power to give you fast, positive starting, winter and summer—extra capacity to meet the demands of lights, radio and accessories—extra stamina to assure the satisfactory performance of all elec-

trical equipment. In materials and workmanship, it is the finest battery that Delco-Remy has ever built . . . in dependability and long life, it's as fine a battery as you can buy. You owe yourself the assurance of driving *security* that this powerful new Delco battery provides! Your dealer has one to fit your make of car . . . ask to see it.

*Replace with a
Delco battery*

Delco-Remy

MANUFACTURER OF DELCO-REMY
STARTING, LIGHTING, AND IGNITION
KLAXON HORNS • DELCO BATTERIES
AUTOMATIC CARBURETOR CONTROLS.



DELCO-REMY PRODUCTS AND GENUINE PARTS ARE AVAILABLE AT UNITED MOTORS SERVICE STATIONS EVERYWHERE...WHEREVER YOU SEE THIS SIGN.

World's Largest Manufacturer of Automotive Electrical Equipment

When writing to advertisers please mention Popular Mechanics

NEED MORE BE SAID?

A Nationally Famous Research Organization has found that "PRESTONE" anti-freeze is used in more modern* cars than all other brands combined!

* Cars up to 5 years old.

"Prestone" anti-freeze contains NO alcohol... gives off NO dangerous fumes. There's NO fire hazard... NO odor. One filling lasts *all winter*. Made with highly refined and purified ethylene glycol fortified with *exclusive* ingredients. Guaranteed in writing. See your dealer today and—Smile with "Prestone" anti-freeze—let others boil!

NEW
LOW PRICE

\$2.65
per gallon



"PRESTONE" ANTI-FREEZE

TRADE-MARK

Which Is the King of Beasts?

(Continued from page 565)

tured manner might suggest—and I know because I served as keeper and trainer to one early in my career. Though his shape resembles a barrel, the hippo can throw his 8,000 pounds of weight around with surprising agility. In the water he's at his best and has been known to upset a native boat with the flip of his head.

In parts of India, I'm told, natives fear the sloth bear as much as they do man-eating tigers. Though small in stature, he's savage by nature and virtually untamable. The same is true of other bears. There are a half dozen animal men of my acquaintance who rate the polar bear as the most dangerous beast of all. A Himalayan bear ruled the roost in one of my earlier acts that included hyenas, polar bears, Russian bears, lions, tigers, a black leopard, and two pumas.

What we've found to be the case in the big cage may not be true of the veldt. There's a great difference between animals living in a six-by-ten-foot cage and one exercising and fighting for his supper in the forest. For all I know, the tiger might be able to uncork a few surprises he cannot use within the confines of the arena bars.

One day in my act, as he was making his way to the top pedestal, Rogue, a Bengal tiger, was caught unawares by Prince, an ugly-dispositioned lion, and dragged to the ground. Almost before the sawdust of the ring started flying, another lion joined in the melee. Rogue began retreating, a smart move under the circumstances because by edging nearer the cage bars, he minimized the chance of an attack from the rear. Desperately, the two lions strove to get their teeth in Rogue's neck but he repulsed them. Then a third lion joined forces with the other two.

Trying to break up the fight before the twenty-one other lions were drawn into it, I directed the lions' attention to me by means of a pole. Prince, rearing up like a stallion, charged, with the other two at his heels, but shots from my blank gun shocked them out of their murderous intentions and back to their pedestals the animals trotted, seemingly relieved the battle was over after the stubborn resistance put up by Rogue.

Once at Collinsville, Pa., twenty-one of my lions staged a knock-down-and-drag-out with nine tigers. The blow-off happened when Snip, a tigress, jumped the signal to start for the door leading from the arena through the wooden chute to the cage wagons. I cued her to remount her pedestal but she refused, taking refuge behind some of the metal pedestal frames. A lioness jumped on her back and then Duke, a lion, seized the first tiger he could reach.

All the other tigers except the three top mounters jumped down to the floor of the ring, not so much to fight as to get out of the ring. Arising as one man, the lions swooped down on them. Even though the whole place was in an uproar, I could not help but watch Chester, a tiger. Fighting, kicking, clawing, he was standing off seven or eight lions all by himself! All the while, the three tigers in the "grandstand" remained perfectly calm. It just wasn't their night to fight!

I was getting ready to leave the bedlam when Chester started for me. Fortunately, two lions waylaid him so I made a fresh start for the door leading to the safety chamber. The goal was but a few steps away when a tiger, retiring from the war, sat down beside the safety cage door. Then a lioness quit the fray and took a seat on the other side. Stymied. Breaking loose from the cats around him, Chester was on my trail again so I streaked through the space that separated the two self-appointed sentries. A torn shirt and a scratched arm were my only mementos of the riot that eventually was quelled by pumping ammonia into the arena. When the smoke cleared, one tiger was dead, a second so badly wounded that he died.

Chester, who had been in the thick of the fight every second, came through with only a few minor superficial cuts.

For a brief few minutes, a king of beasts with stripes.

☞ Popular Mechanics Magazine can furnish the name and address of the maker of, or dealer in, any article described in its pages. If you wish this information, write to the Bureau of Information, inclosing a stamped, self-addressed envelope.

H1544:

Shooting the Sun

(Continued from page 559)

detail. With too short an exposure, the shadows appear excessively black and the desired atmospheric effect is lost.

When you are picturing a sunburst, however, with beams breaking through a rift in the clouds, the subject has little contrast. The darkest parts of the clouds are only a few tones darker than the sunbeams. Overexposure will tend to flatten out what little contrast there is. Therefore, exposure should be as short as possible; with film of average speed, $\frac{1}{500}$ second at f.16 will suffice.

In a sunbeam picture you wish to reproduce the beams as brilliantly as possible while keeping other objects subdued. Suppose you are taking a sunbeam picture in deep woods, with a great deal of green foliage about. "Chrome" or "pan" film, being sensitive to green, might allow too much detail in the foliage, so give relatively shorter exposures or use a "regular" film less sensitive to green and yellows.

If you were picturing a distant sunburst, the chrome or pan film would be preferable; and you might use a yellow filter, the K-1 or K-2, particularly if the cloud shadows appeared at all bluish. If blue sky appears behind the sunburst, always use a yellow filter, the K-2 or G, to darken the sky and make the sun shafts stand out more brilliantly. And if you do your own developing, it is wise to develop "sunburst" negatives longer than usual, to build up stronger contrast.

"Smoke" pictures are sometimes improved by "backlighting." Light shining through smoke makes it much more brilliant—sometimes it actually seems to glow. Flash bulbs provide excellent illumination for smoke pictures, since the flash can "freeze" a slowly moving smoke curl.

Suggestions for smoke pictures might include a man blowing smoke rings . . . a table-top of toy firemen fighting a dollhouse blaze . . . a tall, graceful curve of smoke rippling up from a cigarette in an ashtray. Ideas will come in droves once you start playing with light effects.

Just keep your eyes open for sunbeams and sunbursts, dust and mist, smoke and steam—watch your exposure time—and you'll have an album full of sunshine in less time than it takes to tell.

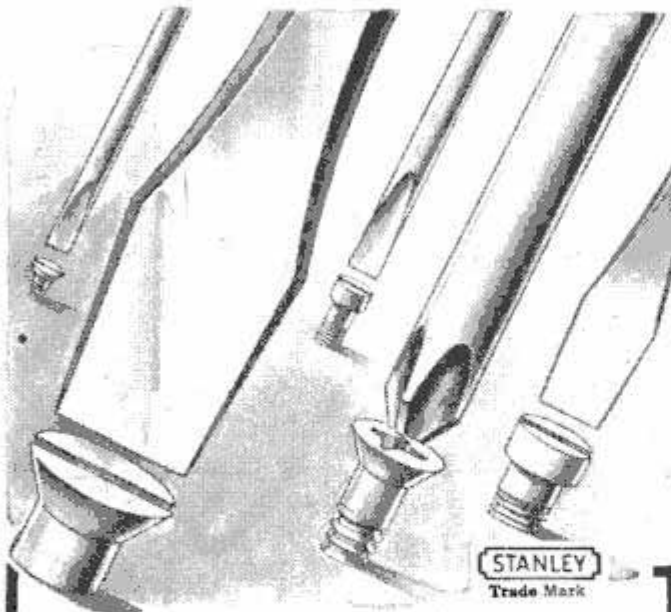

A STANLEY DRIVER FOR EVERY JOB

From the delicate adjusting job to the heavy, stubborn bolt, there's a Stanley Screw Driver that does the job "just right." All have cross ground tips to properly fit screw slots. Typical of Stanley Screw Drivers are the three Drivers shown below.



**Stanley
"Hurwood"
No. 20**

The leader for over 25 years. Blade, shank and head are forged from one piece of steel. Nine sizes: 2½" to 18" blades.

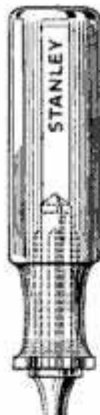

**"Stanloid"
No. 1006**

Tough, transparent composition handles. . . . Blades of nickel molybdenum alloy steel. A driver for "tough" work, ideal for auto repair. Four sizes: 4", 6", 8" and 12" blades.



**Stanley
"100 Plus"
No. 1001**

The strongest wood-handled screw driver made. Hickory handles capped with leather washers that stand pounding. Alloy steel bars. Seven sizes: 3" to 12" blades.



Stanley Tool Catalog No. 34 shows them all.
Write for a copy.

STANLEY TOOLS

Division of The Stanley Works, 103 Elm St., New Britain, Conn.

Important Facts about POWER TOOLS

Before you buy ANY power tools there are important facts that you should consider. When you select power tools for your shop, you are purchasing equipment for many years of use, not for today alone. In making your decision here are some vital considerations:

Quality Tools Cost You Least in the Long Run

Today, low-cost power tools are available at several price levels. From a mere price point of view it is easy for anyone to purchase "cheap tools" at so-called "bargain prices." But in tools built for use—you get exactly what you pay for. Delta tools, for instance, cost you very little more than ordinary tools because they are not built down to a price—but built up to unusual quality standards, and then priced. But that little extra you pay at the outset represents a tremendous extra value in design, quality of materials, special features, accuracy, and workmanship.

Hundreds of thousands of Delta tool owners have learned that Delta tools cost least in the long run. Leading engineers have marvelled at Delta's unusual quality. The full technical story is given in detail in the latest Delta Catalog. Send for your copy today!

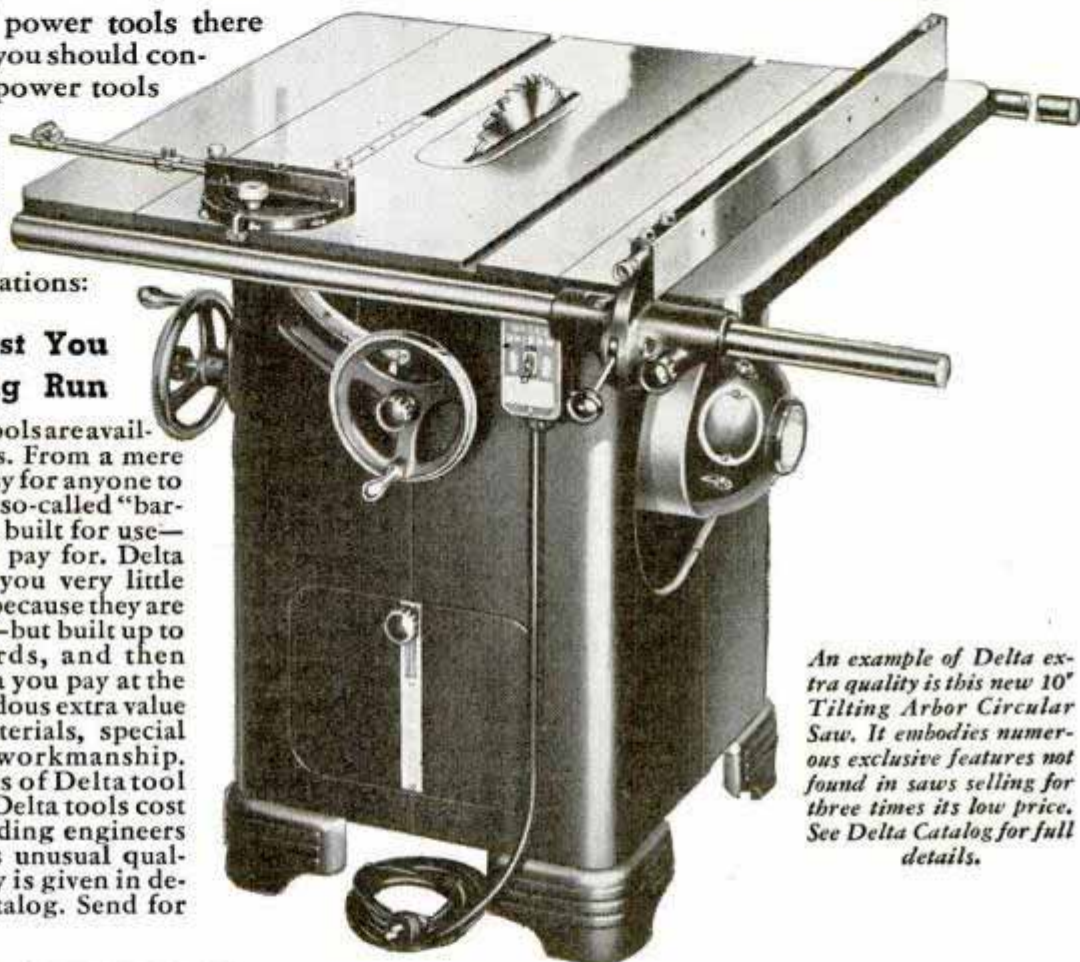

An example of Delta extra quality is this new 10" Tilting Arbor Circular Saw. It embodies numerous exclusive features not found in saws selling for three times its low price. See Delta Catalog for full details.

The Complete 1940 Line of DELTA QUALITY TOOLS

The new 1940 line of Delta Power Tools are ideal for home shops, schools, small shops and industrial plants. They offer remarkable value at prices within the reach of all. The complete line includes: Drill Presses, Circular Saws, Jointers, Band Saws, Lathes, Shapers, Scroll Saws, Sanders, Grinders and convenient combination units.



Send for Catalog...

The latest Delta Catalog gives you full information on the complete Delta line of low cost tools for home shops, small shops and industry. (Also send for new Project Book No. 6 crowded with new and "out of the ordinary" things to make. Send 10c with coupon for Delta Project Book No. 6 and latest Delta Catalog.)



Delta Manufacturing Co. Dept. A1039
600-634 E. Vienna Ave., Milwaukee, Wis.

Send me the latest new 1940 Delta Catalog and list of Delta Dealers nearest me. I enclose 10c (stamps or coin) for which please send me the new Delta Project Book No. 6.

Name

Address

City.....State.....

Check here if you are a Delta user now.

DELTA MFG. CO.

600-634 E. Vienna Ave.
MILWAUKEE, WISC.

Wonders of Ship Surgery

(Continued from page 533)

ed to routes serving South America were reconditioned for their new service at a cost of \$1,000,000, the changes including a beach deck, air conditioning, and sliding roofs over the theater and dining rooms.

A few years ago four old Hamburg-American ships were modernized by cutting off their bows and attaching longer and more efficient bows to them. Each new bow, twenty-eight feet longer than the old one, was built as a unit. The old bow was torn off the ship in dry dock and the new one welded on. Modernized, each ship was longer and heavier than it had been but the change increased its efficiency so much that much less power was necessary for maintaining its normal speed.

Getting a ship that has been badly wrecked at sea to the marine hospital is often a heroic job. If the salvage men find it impossible to save a vessel that has foundered on the rocks they may be able to cut the undamaged portion away, make it seaworthy with a temporary bulkhead, pump it out, and tow it to dry dock. If the stern half of a ship can be retrieved that way a new bow and forward sections can be built up and attached to it.

Every shipwreck is different and a wreck that may appear to be a total loss to an untrained observer is sometimes easily refloated and repaired. Others that go aground in bad weather may have to be abandoned, even though they may not appear badly damaged. Ships are rusting on the rocks of every coast although often such wrecks are torn apart piecemeal in good weather for the value of their metal. When one tanker went ashore on the west coast two attempts to salvage her failed but finally in a period of quiet weather temporary patches were made to the hull and the ship's cargo tanks were pumped full of compressed air. That gave her buoyancy

and permitted the salvage crew to drag her back to deep water and tow her to dry dock 300 miles away.

One of the most miraculous operations that ship surgeons ever performed was completed last year when the giant "Asama Maru," a \$7,000,000 passenger liner, was refloated at Hong Kong after having been driven ashore in the typhoon of 1937. A wind of 167 miles per hour tore the ship loose from its moorings and with the aid of an abnormally high tide beached the vessel almost ninety feet from the channel. The "Asama Maru" was drawing twenty-three and one-half feet of water when blown ashore and the salvors knew that there would be a tide of almost sixteen feet the following spring. Somehow they would have to make up the seven-foot difference. First step was to cut a hole in the ship's side, tear down two of the four main engines, and pass the parts piece by piece through the hole. Anchors, cables, davits, and machinery to the extent of 1,000 tons were removed and 2,200 tons of oil and fresh water were pumped from her tanks. Ten buoyancy tanks having a total lift value of 500 tons were secured to the hull.

The ship was still 2,500 tons too heavy to be floated by the spring tide so the salvage men next blasted and dug four feet of rock from under her, tipping the vessel from side to side by means of its ballast tanks to facilitate the work. Two and a half tons of dynamite were used without injuring the vessel and nearly 8,000 tons of rock were removed. The 548-foot ship floated off without a hitch at the hour of high tide, underwent temporary repairs at Hong Kong, and then sailed to Nagasaki on her two remaining engines for complete overhaul and replacement of damaged bottom plates. Today she is back in service on the transpacific run.

"Third Dimension" Sound Effect Obtained from Two Radio Sets

Before you turn in your old radio set, try the "third dimension" trick one Florida fan worked. First decide for yourself whether the old set amplifies best the higher or lower pitches. Then adjust your new radio to the opposite extreme. Put the two

receivers at opposite sides of the room, and sit down between them. From one side you'll hear best the high notes, from the other, the low notes. The effect is that of a third dimension in sound, as if you were in the concert hall itself.

Max F. Meyer, U. of Miami
Coral Gables, Fla.

Science Service
2601

8596

HEAT RAYS PHOTOGRAPHED TO SHOW HEATER'S COMFORT ADVANTAGES!

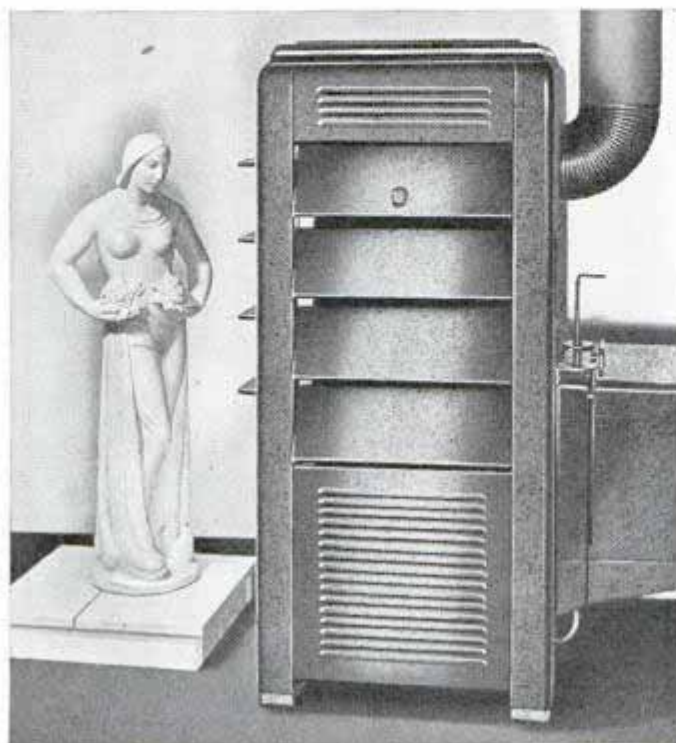

SUPERFEX photographed in ordinary light.

SUPERFEX circulates heat; but, more important, its patented adjustable shutters direct cozy warmth outward and downward—end cold, drafty floors—without fans or blowers that increase operating expense and cause uncomfortable floor drafts. And *only* SUPERFEX has these unique patented shutters!

Dial control regulates heat volume. Operates quietly and evenly without attention. Burns wide variety of inexpensive fuel oils available everywhere. SUPERFEX brings a new sense of comfort to homes, stores, filling stations, etc. Wide choice of sizes with attached reservoirs. Many models also available with constant level valve (plus thermostatic control if desired) for use with outside fuel supply. Radiant heaters, too. Easy purchase plan. See your Dealer. Coupon brings FREE descriptive booklet.

**The living zone is the lower part of your rooms—where you live—the space where you especially need heat.*

SUPERFEX

Oil Burning

HEATERS



The Mark of Quality

PRODUCT OF PERFECTION STOVE COMPANY

Infra-red photography shows how oil burning SUPERFEX Heater directs radiant heat rays outward and downward. No fans or blowers needed.

To show how this SUPERFEX Heater gives more comfort, engineers turned to infra-red photography. SUPERFEX directs radiant heat, which is made up of infra-red rays that are invisible to the naked eye, but are active on certain kinds of photo film. Here at left, is SUPERFEX in ordinary light. Magic! Below—here's the same SUPERFEX as at left, photographed in the dark on infra-red film. See how the directed, radiant heat rays—like heat from the sun—strike the statue. Heat rays heat anything they strike. This is how SUPERFEX brings comfort to anyone in the living zone.*

*The same SUPERFEX photographed in the dark on infra-red film. Statue lighted by heat rays which reach entire living zone.**

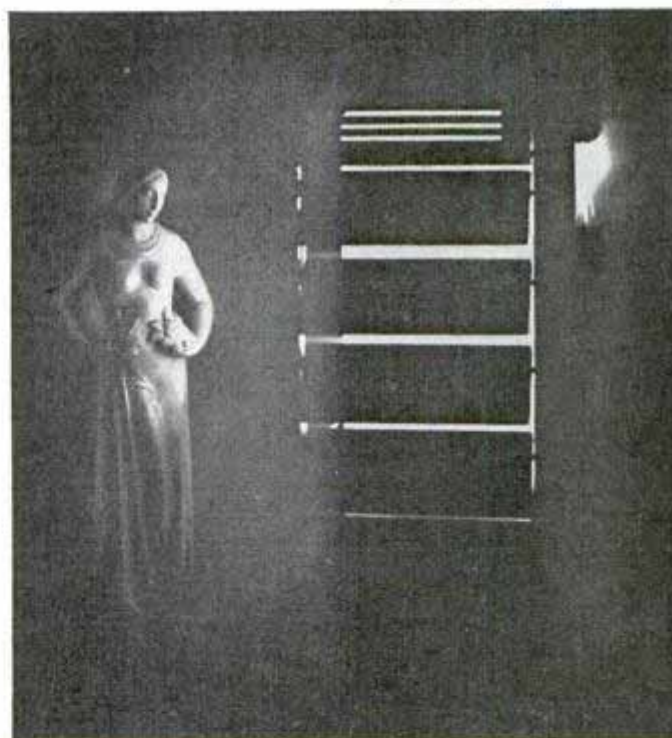

PERFECTION STOVE CO., 7194-A Platt Ave., Cleveland, O.

Please send me free SUPERFEX Heater booklets.

Name

Street or R. F. D. P. O.

County State

2599

Touchdowns in the Making

(Continued from page 549)

ing. Bernie Bierman, head coach at Minnesota, says:

"Blocking is the essence of offensive football. Running, of course, is of prime importance and is the basis of all offensive maneuvering, but blocking paves the way down the field. And just as a team of con-

ENOUGH SAID!

A nationally famous research organization has found that "Prestone" anti-freeze is used in more modern* cars than all other brands combined!

*Cars up to 5 years old

(SEE PAGES 118A and 131A)

NEW STREAMLINE BENJAMIN AIR RIFLES

WITH LEVER HAND PUMP



BENJAMIN

.22



.177



BB



HARD ACCURATE SHOOTING WITH CHAMBERED AIR
You can use new models BENJAMIN AIR RIFLE WITH LEVER HAND PUMP anywhere, for practice firing or just plinking around the house or camping, fishing, hunting, etc., at lowest cost. Shooting force is adjustable depending on AIR PRESSURE—amazing maximum power and accuracy—will penetrate to 1". Hair trigger firing without lunge or recoil. Single Shot BB \$7.50. Repeater BB \$9.00. Rifled Cal. 22 or 177 Single Shot \$8.50. Ask your dealer all about them or write for complete specifications—targets and blueprints FREE if requested. We also make a complete line of BENJAMIN AIR PISTOLS for target and small game. WRITE TODAY. BENJAMIN AIR RIFLE CO., 895 MARION ST., ST. LOUIS, MO. U. S. A.

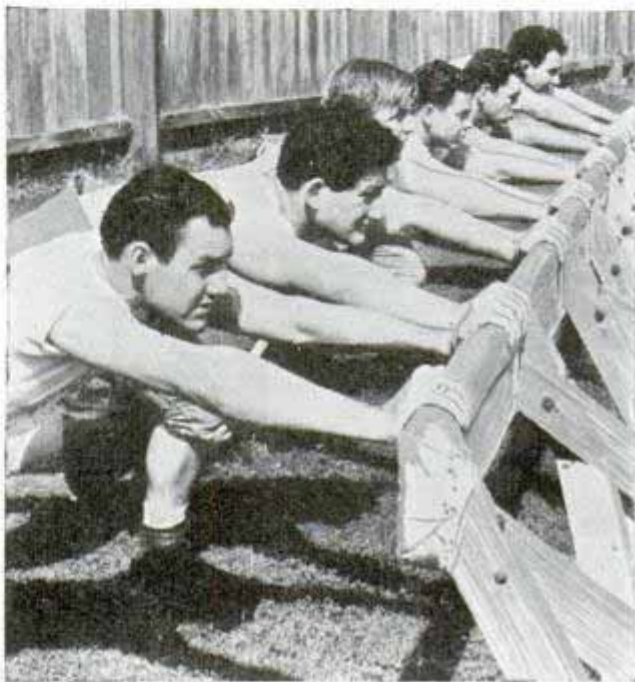

Charging sled helps to build up arms and shoulders and teaches use of the hands

100 TOOLS in ONE

SAVE TIME - CUT COSTS - DO BETTER WORK



Don't confuse the genuine Dremel Moto-Tool, popular in industry, with weak, low-speed tools built to sell cheap. 110 volt AC-DC motor is packed with power. Speed—over 25,000 r.p.m. Weight—only 6 oz. Bearings—oil-less (oil sealed). Cooling—internal fan. Model 1—with chuck, 1/4" collet, only \$9.85 postpaid. **Master Model 2**—faster, heavier, more powerful, with chuck, only \$16.50.

GRINDS
POLISHES
SHARPENS
DRILLS
ENGRAVES
ROUTS
Etc., Etc.

Only \$9.85 POST PAID MASTER MODEL \$16.50

10-DAY TRIAL See the genuine Dremel Moto-Tools at better Dealer's or order direct from factory on 10 day money back trial. Catalog of Dremel tools, equipment and special combination offers, FREE. Dremel Mfg. Co., Dept. 119-K, Racine, Wis.

fident, hustling blockers paves the way for offensive success, a team of pounding, sure tacklers is almost impossible to score against."

The tackling dummy is standard equipment for teaching correct form in blocking and tackling. In recent years, however, a number of new and improved variations of the old canvas bag that hung from a cross-arm have been devised. One of these is the blocking bag. It is usually constructed of canvas or leather and filled with sawdust or padding. On the field it simulates an opposing player. The players line up opposite the blocking bags, the ball is snapped back and the linesmen and interference must knock the heavy bags out of the way so that the ball carrier may get through.

Otto Klum, head coach at the University of Hawaii, has invented a tackling dummy that is a vast improvement over the kind in common use. A three-inch rubber rope,

THIS Fascinating FREE BOOK

opens the door to exciting scientific experiments you can do in your own home, that will amaze your friends and may lead you to a successful business career... This book sent absolutely Free... Address

"EXPERIMENTS IN CHEMISTRY"
CHEMISTRY
MICROSCOPY
BIOLOGY
ELECTRICITY
LIGHT CONTROL
PHYSICS

THE PORTER CHEMICAL CO.
9 PROSPECT AVE.
HAGERSTOWN, MD.

fastened to a crossbar at top and to the ground below, supports a canvas-covered bag. Coaches declare that this rubber-controlled bag is more like an opposing player than anything yet devised. It may be used by one or two men at a time for charging, blocking, and tackling.

One of the latest developments is the blocking apron, huge, padded overalls worn by scrub players. Designed especially to protect the chest, stomach and legs of those players who wear it, the apron permits the use of "live bait" as tackling and blocking dummies without fear of injuring either the varsity men or the third stringers. The University of Pennsylvania has found this type of equipment helpful on the practice field.

Some coaches have discovered that automobile tires suspended from the goal posts provide good early season targets for passing backs. Later on, pass receivers in motion provide better targets. After accuracy is attained, the passer must learn to judge distance and speed of the receiver. Northwestern University uses automobile tires for passing targets. At U. C. L. A. a new variation is a single tire mounted on an upright standard.

Coach Howard Jones at the University of Southern California has rigged up a unique device to teach his centers greater accuracy in passing the ball. A huge canvas sheet, with two holes waist high, is



Wide World Photo

Aprons absorb the shock of players practicing blocking at University of Pennsylvania

strung between the goal posts. Two centers stand over the ball about twenty feet from the target and try to pass the pigskin through the holes.

Punters are sometimes shown how they

(Continued to page 126A)

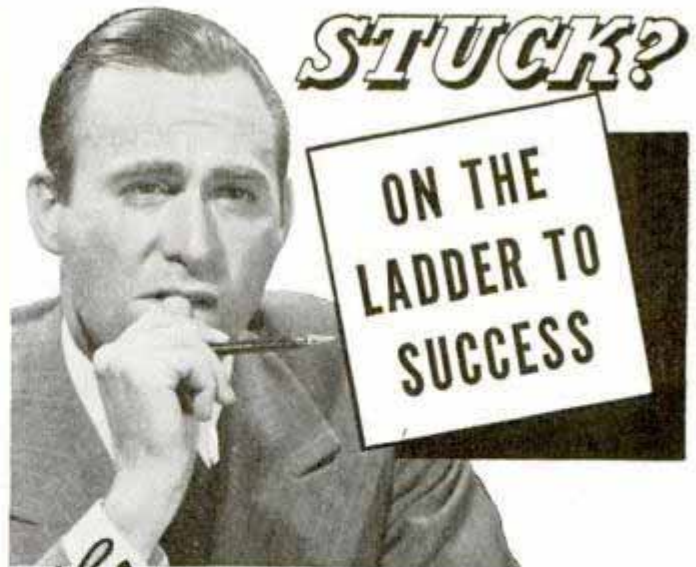

this **FREE BOOK**
HAS HELPED
HUNDREDS!

Will you risk a penny postcard to get this new **FREE** 1940 radio catalog? It opens the door on a new world of interest, education and profit. Thumb through its 188 pages and discover the opportunities it holds out to **you!**

Here, at your fingertips, is everything in radio and modern P.A. New complete line of 1940 receivers. All nationally advertised parts, tubes and equipment. Our famous Build-It-Yourself kits that have built radio careers for hundreds.

What's it all mean? It means you can now get into radio easily—as a hobby, extra-profit side-line, or full-time money-making job! Prices in this big **FREE** catalog tell you why.

To get this 188 page Guide-to-the-Buys in Radio and Public Address, tear out the coupon, paste on penny postcard and mail today. Profits are waiting for the man anxious to get ahead. **Act at once!**

Radio Wire Television Inc. WHOLESALE RADIO SERVICE CO., Inc.

LAFAYETTE RADIO

NEW YORK, N. Y. CHICAGO, ILL. ATLANTA, GA.
100 SIXTH AVENUE • 901 W. JACKSON BLVD. • 265 PEACHTREE ST.
BOSTON, MASS. • BRONX, N. Y. • NEWARK, N. J. • JAMAICA, L. I.
110 Federal St. 542 E. Fordham Rd. 24 Central Ave. 90-08 166th St.

Radio Wire Television Inc.

Dept. 7KA9—100 Sixth Ave., New York, N. Y.
Rush **FREE** 1940 Radio Catalog No. 78

Name

PLEASE PRINT

Address

City

State

FREE!
**THE WORLD'S
FINEST
RADIO
CATALOG**

PASTE COUPON ON PENNY POSTCARD

HERE'S THE BIGGEST BATTERY VALUE IN TOWN!



Prest-O-Lite Dealers
Now Offer New
51-PLATE FIBERGLAS

SILVER JUBILEE **HiLEVEL BATTERY**

NEVER a battery value like this. The low price will amaze you! Yet this battery sensation is packed with 7 remarkable features to save you money, time and trouble this winter. Fiberglass insulation. 51 big powerful plates. Added water capacity. Extra power reserve. Rugged construction. Plenty of punch for winter starts. 24-month adjustment period! And because of the Prest-O-Lite HiLevel principle, this remarkable battery needs water only 3 times a year under normal usage. Before battery failure hits you, see your Prest-O-Lite dealer and get the facts about the new SILVER JUBILEE HiLevel, Prest-O-Lite's answer to your winter starting problem!

PREST-O-LITE BATTERY CO., INC., INDIANAPOLIS, INDIANA
Manufacturing Plants at: Indianapolis, Niagara Falls, Oakland, Oklahoma City, Toronto

HOW HiLEVEL FEATURE WORKS

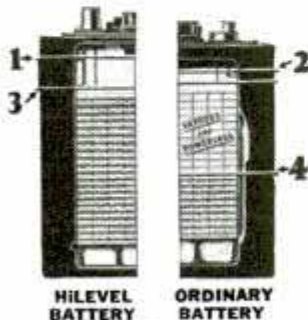

- ① FILLING LEVEL of Hi-Level Battery. (Note extra height.)
- ② FILLING LEVEL of ordinary battery.
- ③ By the time the fluid in a HiLevel Battery drops to here, (note plates are still covered) . . .
- ④ . . . in an ordinary battery it falls to here, leaving a large part of the plate surface exposed and powerless.



prest-o-lite
HiLEVEL BATTERY

(Continued from page 125A)

can get height into their kicks by a simple device. A rope is tied to their kicking foot and strung over a crossbar. With another player pulling on the rope, the punter can determine just how high he can force his foot.

The use of motion pictures in training a football team is becoming increasingly widespread. Each Saturday's game is photographed from start to finish, and on the following Monday coaches and players study the films to discover their mistakes. In slow motion, the camera tells a graphic story of why touchdowns are made or not made.

Most college gymnasiums have extensive outlays of the latest scientific equipment for treating gridiron injuries. Aching and bruised muscles are exposed to treatment of water baths or violet-ray lamps. When muscles are allowed to become inactive for a time because of injury, team doctors have a number of devices for exercising through the use of weight-lifting or mechanical exercisers. One physician makes football players with "Charley horses" and other leg ailments pedal around on a bicycle while convalescing.

The Band Comes Marching Back

(Continued from page 517)

C. G. Conn, Ltd., have introduced hydraulic expansion into instrument building.

To see the way in which this \$500,000 bit of research works, let's watch the making of a French horn. Its bell—that's the flaring mouth of a horn—and some of the other parts require bending to get the proper curvature before assembly. So, with the completion of the preliminary steps in which the bell is fashioned from a sheet of brass, it is filled with molten pitch. Cooling to the proper consistency, the straight bell is placed in a special block form, of the shape required, and bent. Though the pitch cuts down on their number, small wrinkles and rough spots form, just as they do when a person crooks his finger.

Formerly, these were pounded or rubbed out. By pulling the bell or some other part through rings and working on them with shaping irons, the outside surfaces could be smoothed but those on the inside would remain. In fact, they'd become worse, for

(Continued to page 128A)

DON'T RISK ACCIDENTAL ROLL BACK of YOUR CAR or TRUCK!

NoRoL

HOLDS CAR on HILL STOPS

You probably have often wished for a device that would automatically prevent unintentional back-roll when car is brought to a stop on an incline . . . Such a device is available. It is called a NoRoL. It isn't expensive . . . It is easily installed . . . Is 100% automatic in operation—and should outlast the car.

NoRoL gives you a "third foot"—doing brake duty against back-roll on inclines, while right foot is left free for accelerator duty. Eliminates fatigue and frazzled nerves when you are driving in congested traffic in hilly country or on city streets . . . Does away with chance of back-roll on uphill start which might result in breaking axle shaft . . . Prevents unnecessary wear on clutch facings . . . Also lessens chances for clashing or breaking of transmission gears.

When ordering a new car, insist that it come complete with a NoRoL figured right in with the time payments. NoRoL is available for new models of—

BUICK	DE SOTO	LA SALLE	PLYMOUTH
CADILLAC	DODGE	NASH	PONTIAC
CHEVROLET	GRAHAM	OLDSMOBILE	STUDEBAKER
CHRYSLER	HUDSON	PACKARD	INTERNATIONAL

WHITE and others

Also available for many 1936, 1937, 1938 and 1939 makes and models of cars and trucks.

Many Models Only \$12.00 installed
SEE YOUR CAR DEALER—or write us

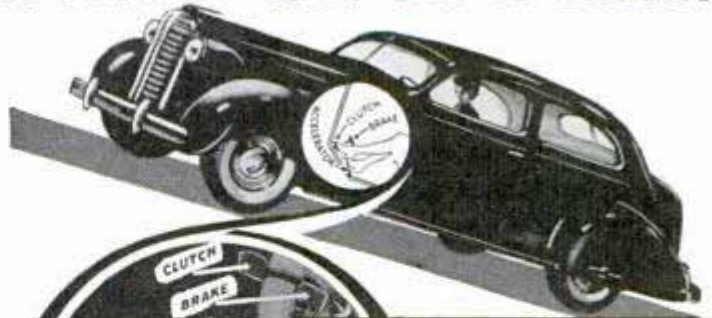

HERE'S HOW IT WORKS

When stopping on any incline, no matter how steep, you simply apply the brake and disengage the clutch in the usual manner. An automatic check retains the hydraulic pressure in the braking system which was developed when the brakes were applied. This hydraulic pressure holds the brakes applied as long as the clutch pedal is held depressed, enabling the driver to take his foot off the brake pedal and use it for accelerator duty. Thus making it unnecessary to keep his right foot on the brake pedal while the car is stopped. It's like having a third foot.

Wagner Electric Corporation

(Manufacturers of Lockheed Hydraulic Brakes)

6400 Plymouth Avenue, St. Louis, Mo., U. S. A.

N39-6

Send FREE BOOKLET and details on NoRoL

NAME _____
ADDRESS _____ CITY _____
STATE _____ MAKE AND MODEL OF MY CAR IS _____

PREPARED FOR TRAVEL

Motor tuned, oil changed, tank full, tires checked—car all set for a motor trip. But how well are you equipped to find your way over strange roads?



A Hull Auto Compass will keep your directions before you at all times. Streamlined Bakelite case, genuine sapphire bearing, built-in compensator. Only \$2.95 at your dealer. Two-piece model \$1.95. Write for literature.



HULL MANUFACTURING CO., P. O. Box 246-D18, WARREN, OHIO

FREE "BETTER RESULTS WITH GLUE"



Send post card for booklet, "Better Results with Glue," containing many useful hints about mending, model making and home workshop jobs. Address: McCormick Sales Co., 402 Light St., Baltimore, Md.

at hardware, drug and 10c stores; also in cans from 1/4-pint to 1 gallon

TEST-O-LITE

Tests Everything Electrical From 100 to 550 Volts



\$1.50 At Electrical Stores or Postpaid

A real necessity for electricians and home because it has 1001 uses. Equipped with a Neon light which tells instantly where trouble lies in electric circuits, fuses, cut-outs, motors, radios, all kinds of electric appliances, etc. Tells A. C. from D. C. Far superior to ordinary clumsy test bulb. Fountain pen size with clip for carrying in vest pocket. Lifetime guarantee.



APPLIANCES



MOTORS



FUSES

PATENTED

L. S. BRACH MFG. CORP.
55 Dickerson St., Newark, N. J.

YOU PEOPLE MUST BE CRAZY TO GIVE AWAY SHAVING CREAM



20 SHAVES FREE

Lambert Pharmacal Co., Dept. 90, St. Louis, Mo. Please send me free and postpaid your large sample tube of Listerine Shaving Cream; Listerine Brushless Cream. (Check whichever is desired.)

Name _____ Address _____
City _____ State _____

(Continued from page 126A)

the waves and wrinkles are pushed down into the inside of the tubing. Lead balls were used for a time to get them out but they weren't entirely satisfactory so hydraulic expansion was developed. When the horn is ready to have the wrinkles removed, it's placed in a tool steel die and the ends plugged shut, one being utilized as a nozzle. The tubing is then filled with cold water and the water is subjected to terrific pressure, as much as 4,000 pounds per square inch. This pressure irons out the tubing against the walls of the die, giving the part absolutely accurate dimensions and making the inside surface as smooth as glass for carrying the delicate tone waves without distortion.

The average trumpet or trombone has a seam running through the complete length of the bell stem and bell bottom; a few with two-piece bells have one through the stem and the other where the bell bottom joins the stem. A seamless bell is the latest development. By means of an electro-mechanical process the structure of the metal is built up from pure copper ions in regular conformation with the bell forming in a solid piece.

The use of plastics in the making of clarinets has been more or less limited owing to the fact that substances of this nature are too difficult to machine. After three years of experimenting with plastics that had all the qualities necessary for the accurate production of tone and pitch, Kohlert has come out with one of a transparent substance called plexi-glass. While clear as crystal, the unusual material is not brittle and can be machined, tapered, and drilled. It's virtually impervious to moisture and will not warp or crack.

A scientific, foolproof way of measuring pitch and intonation of instruments is with the chromatic stroboscope. The frequency of any sound in the scale is registered visually so it can be measured easily and quickly for correctness to $\frac{1}{1000}$ of a semi-tone. If a note is in tune with the tempered scale based on a 440, a pattern on the revolving disk appears to stand still. If the note is sharp, the pattern appears to revolve to the right. If the note is flat, the pattern seems to turn to the left. By adjusting a knob the pattern can be made to stand still. A dial is then read to determine how many $\frac{1}{1000}$ ths of a semi-tone the note is sharp or flat.

Ride 'Em Cowboy!

(Continued from Coloroto Section)

his rope at a calf, drop it in its tracks, and tie its feet with a piggin string. Three-quarters of the speed and skill in this event are contributed by the cowboy's horse, and a good roping horse may bring from \$1,500 to \$3,000 on the rare occasions when such stock is placed on the market. A good horse learns instinctively to dig its feet into the ground the instant its rider's lariat circles the neck of the roped animal. The shock of the abrupt stop throws the maverick to the ground and from that time on the horse keeps backing away to hold the rope taut and prevent the animal from rising again. A trained roping horse always balances itself against the shock of the throw, otherwise the horse and rider themselves are apt to be thrown.

Cattlemen in different parts of the country have slightly different roping habits when simply throwing a lasso to capture an animal. Men from the north are known as tie-hard ropers and they use a short thirty-foot rope, one end of which is tied securely to the saddle horn. Men from the south are called dally-ropers and they use a lariat nearly twice as long, paying it out through a couple of turns around the saddle horn to ease the pull when a heavy animal is roped. The ropes themselves are much thinner today than they were twenty years ago, due to improved materials and methods of weaving.

Cowboys don't wear their picturesque clothes for looks but because such clothes are suited for their work. High-heeled shoes prevent the feet from sliding through or catching in the stirrups and also help a dismounted cowboy to dig in against the pull of an animal when he is roping from the ground. His spurs are always blunt and are used to stir up his horse when a burst of speed is necessary in capturing strays. The jeans that he wears are narrow-legged so that they will fit snugly inside the heavy leather chaps that protect his legs from brush and thorns. He often carries a revolver, even today, and uses it on the range to kill injured animals and to shoot rattlesnakes. His wide-brimmed hat is the best protection against the sun and the rain and his neckerchief may be wound around his face to protect his nose and mouth from clouds of dust at the drag end of a herd. The neckerchief is also a protection against frostbite in cold weather.

C. S. Conn. Ltd. Elkhart, Ind.

see 516

2699

141599

WORKERS! TOUGH JOBS CALL FOR HORSEHIDE HANDS!



SO *tough* they'll take the hardest wear... so *soft* they'll give you a firmer grip and greater comfort! Tanned by a secret process, these handsome Horsehide Hands dry soft after water soaking! Made by makers of famous Wolverine Shell Horsehide Work Shoes. If your dealer can't supply you, send his name and 75c to Wolverine Shoe & Tanning Corp., Dept. P-310, Rockford, Mich. We'll mail you a pair postpaid. Sizes 8 to 12. Ask for style 569.

WOLVERINE HORSEHIDE WORK GLOVES

THEY'RE TOUGH AS NAILS *Yet* THEY DRY SOFT AND STAY SOFT!



Driver's Slip-on Pattern No. 569 Cream Color

DEALERS:

Offer customers genuine Wolverine Full-Grain Horsehide Hands. Write for catalog and tested sales plan.

MAKE MONEY WITH THIS PLANER!

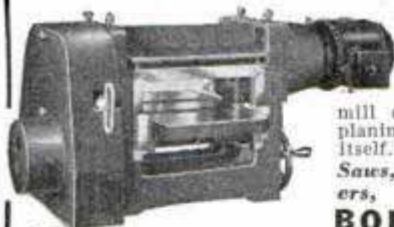

12" x 4" Capacity Thickness Planer

Here's how! Convert low-cost rough stock into finished lumber. Save high mill charges and long waits. Do planing for other shops! Pays for itself. E-Z Terms. Also, B-C Saws, Jointers, Sanders, Shapers, Band-Jig Saws, Lathes.

BOICE - CRANE CO.
Dept. 209, Toledo, O.

Send for Catalog

PUSH-A-BIKE IS TOPS



"Fun to Own and Ride Push-A-Bike!" 100 miles of travel adventure for ten cents. Also ideal for messenger & delivery service. Powerful motor drives 200 pound man over 20 MPH. Attach to any type bicycle in three minutes. See your dealer, or Write: **RICHBURN COMPANY**, Dept. Dm, Aurora, Mo.

Build YOUR OWN MODELS

Model boats, aeroplanes, racing cars, plaques, maps, puzzles and household novelties are all easily made with the famous Syncro Deluxe Power Saw. Syncro Saws are best for fast cutting, smooth edges, efficiency and safety. Your favorite dealer handles Syncro Saws. See them there.



3 Models

Deluxe Power Saw...\$12.50
Power Saw..... 9.95
Syncro Jr..... 4.95

Send for Catalog A

SYNCR0 DEVICES INC. 747 BEAUBIEN ST. DETROIT

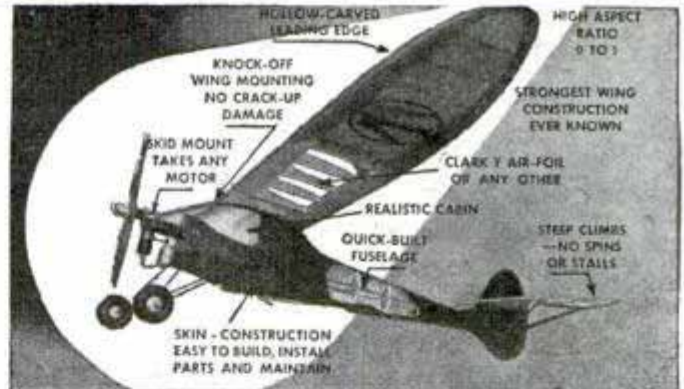

Unmatched Features of MEGOW'S COMMANDER

Gas Powered

By mail postage 20c extra **\$4.95**

An entirely new type gas-powered model that can be built in a couple evenings. Hollow-carved and finished Leading Edge, skin-construction of fuselage, skid mounting that takes any motor. High aspect ratio, steep climbing ability and extremely flat glides make this model ideal for contest purposes. Spec. rubber wheels. Two sizes: **COMMANDER** (\$4.95) 6 ft. span, for 7/8" motors. **CADET** (\$3.95) 5 1/2" span for 5/8" motors. See catalog for other gas-powered models—world's champion **QUAKER FLASH** \$4.95; **FLYING QUAKER** \$5.95; 48" **CARDINAL** \$3.95 and **PIPER CUB** \$3.95. When ordering by mail, include 20c for postage.

Send 5c for new 100 page catalog showing scores of gas-powered, rubber-powered and scale model airplanes, also model ships and HO-Gauge railroad equipment and supplies.



MEGOW'S

Dept. PM, Howard & Oxford Sts., Philadelphia, Pa. or 217 N. Desplaines St., Chicago, Ill. or Great Western Merc. Co., 718 Mission St., San Francisco, Cal.

2697

Diesel Limited

(Continued from page 555)

open again by the time the rear of the train has cleared the curve.

Just like an air liner, the streamliner is affected by weather conditions. Headwinds slow down its speed and tail winds help boost it along. The worst wind of all is a quartering headwind that blows back against the entire length of the train.

One way the streamliner saves time is by rarely stopping. A stop of one minute adds five minutes to the running time of a train because of the delay in slowing down and getting up to speed again. The stops that an ordinary train makes on a transcontinental trip may total several hours. The average stop of the Diesel is for only two minutes, just long enough to change crews and make routine inspection of wheels and brakes. There is always a clear track ahead, for other fast trains are sidetracked until the streamliner rockets past. A Diesel stops for fuel twice and for water one other time on its long run, while between the same terminals a steam locomotive would need to refuel five times and replenish its water every 200 miles.

Enginemen on the streamliner literally turn it loose across the long level stretches of the middle west to make up for the slow climbs across parts of Arizona and New Mexico where four 7,000-foot summits are crossed. On two of the steepest grades a helper engine is attached to the train to boost it along faster than it could climb by itself.

In those parts of the west you aren't apt to see many wild animals from an automobile because the noise of your approach scares them away. The streamliner moves so much faster that the engine crew gets good looks at herds of antelope and deer, occasional coyotes, and numerous small animals before they slip away into the brush. Sometimes at night a deer standing on the tracks is confused by the glare of the headlight but it bounds away when the engineman sounds a warning whistle.

Sitting at the controls of a record-breaking train carries heavy responsibilities. The engineman's job is to deliver his train on time but he is first concerned with the safety of his passengers. The queer part of it is that the faster he goes the safer he feels. He sits relaxed in his seat at ninety

and 100 miles per hour and tenses up ready for instant action at thirty miles per hour. That's because top speeds are made in open country and the slow speed limits are observed in congested areas where he has to be prepared for a fast stop any second. He rides with one hand on the air-brake lever and in districts that have numerous grade crossings he uses two pairs of eyes instead of one to watch the road.

When the engineman moved from the steam locomotive to the streamliner he took his fireman with him even though there are no fires to feed on the Diesel. The wide-awake engineman misses nothing in front of him but simply for safety's sake the fireman rides beside him, calling the track signals aloud with the engineman repeating them after him. In congested districts the fireman calls out the cars he sees approaching grade crossings.

Semaphores along the right of way are electrically operated and if something happens to a circuit the semaphore automatically moves to the stop position. A blank board with no lights visible is the same as a "red board" to the engineman and he stops the train, then moves along slowly until he reaches a clear signal.

Now that the streamliners have been on the rails for several years and have proved that they can maintain fast schedules, plans are being made for more improvements. In one early demonstration the "Super Chief" ran from Los Angeles to Chicago in thirty-six hours and forty-nine minutes, three hours under its regular schedule. One idea research men are tinkering with is a hydraulic drive. Hydraulic transmission might be smoother still and probably would require a minimum of maintenance. The streamline trains have tight-lock coupling between the coaches that allows the whole train to move off as a unit from a standing start without taking up slack between the coaches.

The coming of the streamliner has helped increase the speed of all trains because many of the sharpest curves have been modified to allow the streamliners to drive at full speed. Each curve reduction means that steam engines can also move faster than in the past. Track condition is the real speed limit in fast railroading.

YOU WON'T BE WRONG BECAUSE THEY CAN'T BE WRONG!

THE U. S. NAVY USES "PRESTONE" ANTI-FREEZE

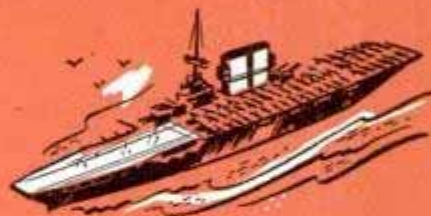

THE U. S. ARMY USES "PRESTONE" ANTI-FREEZE



THE U. S. MARINE CORPS USES "PRESTONE" ANTI-FREEZE



OFFICIAL DEPARTMENTS OF 48 STATE GOVERNMENTS USE "PRESTONE" ANTI-FREEZE



AND "PRESTONE" ANTI-FREEZE HAS BEEN USED IN MORE AUTOMOBILES THAN ANY OTHER BRAND EVER MADE!

There's *no other* product like "Prestone" Brand anti-freeze. It contains **NO** alcohol... **NO** glycerine. It's not only made with highly refined and purified ethylene glycol, but is fortified with *vital* ingredients developed after years of laboratory research and millions of murderous miles of test driving. It is so superior that last year a national survey showed that "Prestone" anti-freeze was used in more modern* cars than all other brands combined. One filling of "Prestone" anti-freeze lasts all winter! Guaranteed in writing! See your dealer today.

*Cars up to five years old.

"PRESTONE" anti-freeze

The words "Prestone" and "Eveready" are registered trade-marks and identify products of National Carbon Company, Inc.



NEW LOW PRICE

\$2.65
per gallon



P. W. REPAIRS CRACKS and HOLES

Use Plastic Wood to fill cracks in baseboards, floors, shelving—to fill old screw holes. It handles easily as putty and quickly hardens into lasting wood. In cans or tubes at Paint, Hardware, 10¢ Stores. Try it!



PLASTIC WOOD



BIG MONEY!
STEADILY FOR YOU!
INCREASE YOUR INCOME

Be our representative in your locality for Ben Dove Garment Co. No experience necessary. Pleasant, simple work. Every business prospect. Advertising embroidered on garments great sales feature. Increase your income every week. We supply everything needed to start at once, including FREE OUTFIT. Write immediately. **BEN DOVE GARMENT CO.**
801 So. Fourth St., Dept. 925, Kankakee, Ill.

EVERYTHING IN PHOTOGRAPHY FREE CATALOG

IN THIS NEW THIS FALL, enjoy that camera you were "going to get some day". Select it from this new FREE book of sensational values. Save money on everything you buy—films, equipment, developing and printing supplies. All nationally advertised merchandise. Save valuable time by ordering at home. Here's your everyday guide to the buys in photography—complete, new, FREE to you! Send for a copy of Catalog No. 77 today.

Lafayette CAMERA Dept. 7KC9 — 100 6th Ave., New York

Beginner's One-Tube A.C.-D.C.

(Continued from page 617)

midget-type antenna coil in order to obtain the advantage of more turns on the primary winding.

Those who wish to experiment can try a Litz-wound r.f. coil in the antenna coil position, if desired. However, the ordinary coil employed in the model gave good re-

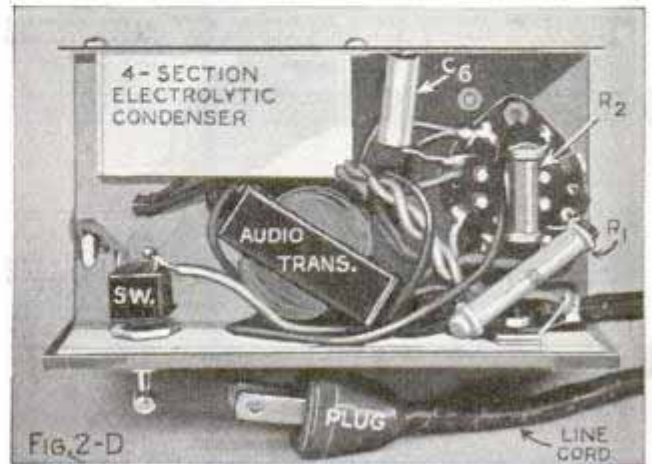

sults. A list of the materials used in the original model is available to beginners and can be obtained from Popular Mechanics radio department without charge. All circuit connections indicated as grounded on the metal base must be soldered carefully with rosin-core solder.

The set tunes broadly and the station will be received over quite a wide range of

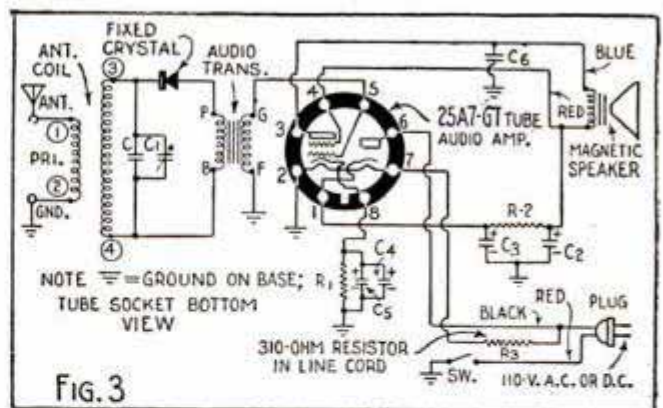

adjustment; no volume control is required. If necessary to reduce volume it may be done by detuning slightly. Like any other crystal detector, this one requires a good long, and high, outdoor antenna, and a ground connection to a cold-water pipe if possible. Tone quality is improved considerably when the set is installed in a small homemade wood cabinet. The blueprint number for this article is R-271.

ENGINES

A real money maker for farm or factory. Uses Cheap fuels. Pays for itself out of savings. Costs Less to Own—Less to Operate.



LOG SAWS

Make Money—Start a wood sawing business—turn spare timber into cash. Cash or Terms—Engine and Saw Catalog.

WITTE ENGINE WORKS 1747 OAKLAND AVE. KANSAS CITY, MO.

MAN IN EACH TOWN

To Plate Auto Parts

Reflectors, Bicycles, Fixtures, Mirrors, by late method. Simple plan of manufacturing at home starts you IN GOOD PAYING BUSINESS. Write today for FREE particulars and proofs.

GUNMETAL CO.

Ave. M Decatur, Ill.



PHOTO ENLARGEMENTS

Is Photography your hobby? Do you want a profitable easy business at home? Make PHOTO ENLARGEMENTS for yourself and others. Your cost 5c each and less. The Ideal Photo Enlarger is AUTOMATIC. No experience required. Also COPIES any picture. \$5.94 COMPLETE. Interesting circular FREE.

5¢

ANY SIZE

IDEAL ENLARGER, 148 West 23rd St., New York City

TRAILER BUILDERS · BUYERS · OWNERS

TRAILER

Send 25c for this Big Book Today

Over 100 pages! Beautifully Printed and Illustrated! Trailer Suggestions and Ideas galore! Catalog shows America's greatest line of Trailer Parts and Equipment at lowest prices. Everything from wheels to top. Rush 25c today. Satisfaction positively guaranteed!

TRAILER SUPPLY CO. Box 438-A WAUSAU, WIS.



BUILD IT YOURSELF

The Jim Dandy Cabin Cruiser

The Trailer that has everything. Classy! Roomy. Easy to build in any size with my simplified Plans and Instructions—Price \$1.00. Rush dollar bill today to **JIM DANDY** Box 125-A WAUSAU, WIS.

Wind Electric Plant

Build Your Own—We Show You How.

Easily made from old auto generator. Dime brings complete plans and Big NEW catalog of 500 electrical items. 100 other generator changes to 6, 12, 32, 110 volt Plants, Motors, Welders, Electrical Fencer. Write today.

LEJAY MFG., 1447 LeJay Bldg., Minneapolis, Minn.

AT LAST!

All Your Snapshots in Natural Colors!

AMAZINGLY BEAUTIFUL!

Any size roll developed and 8 prints **25c** Natural Color Re-prints 3c each.

Natural Color Photo Service, Dept. C-54, Janesville, Wis.

FREE 48-page book. Pictures. Useful hints on buying, using, saws, tools, files.

Henry Disston & Sons, Inc., 1011 Tacony, Phila.



Print Your Own

Cards, stationery, circulars, tags, labels, advertising, etc. Save money. **Print for Others; Big Profits;** easy rules sent. Will do popular Raised Printing like Engraving. Junior outfit \$9. Senior outfits \$17 and up. Send for free catalog and all details.

KELSEY PRESSES, E-37, MERIDEN, CONN.



Earn MONEY Make Color-glazed Concrete Products

MAKE color-glazed concrete pottery, tiles, walls. New, low cost, patent method. No molds. Use only sand, cement, cheap materials. Money-making business. Booklet, cost data, details 10c.

NATIONAL POTTERIES COMPANY

Room 6, 13 W. 26th St., Minneapolis, Minn.

BUILD YOUR GRANDFATHER CLOCK

The Simple Sensible Red-i-Kut way as thousands have, DIME hinges PLANS and sixty picture "HOW" Book pricing many fine brass weight Westminster, tube chime, electric and battery movements showing nine beautiful colonial grandfather cases. WHY WAIT LONGER?

KUEMPEL CHIME CLOCK CO., Bldg. 33, Guttenberg, Iowa.

When writing please mention Popular Mechanics

PARENTS!... TYPING CAN IMPROVE THAT CHILD'S MARKS



Prominent educators say typing improves marks... encourages neatness... aids expression. Give your child a better start in life with a Speedline Corona. "Eight year olds" learn to type easily...and benefit by it all their lives. Mail coupon for folder today!

\$100 A WEEK TO OWN A CORONA
Plus small down payment

FREE DEMONSTRATION AT ALL DEALERS

SPEEDLINE CORONA

L C SMITH & CORONA TYPEWRITERS INC
Desk 10, 723 E. Washington Street, Syracuse, New York
Please send me free folder describing Speedline Coronas.

Name _____
Address _____
City _____ State _____

WRITE TO Bass FOR HIS BOOK OF BARGAINS



ORDER FROM THIS LIST OF BASS GUARANTEED CAMERA BARGAINS

- Dollina 0-35mm Candid . . . 36 shots—Certa F:4.5 lens . . . Vario shutter . . . Was \$23 . . . at Bass \$17.25
- V. P. Dolly-8 V. P. or 16 1/2 V. P. Certar F:4.5 lens . . . Vario shutter . . . Was \$17.50 . . . at Bass \$13.50
- V. P. Dolly—with Corygon F:3.5 lens . . . Compur B shutter . . . Was \$29.50 . . . at Bass \$22.50
- Super Sport Dolly—Hugo Meyer Trioplan F:2.9 lens, Delayed action. Compur shutter . . . Was \$37.50 . . . at Bass . . . \$28.00
- 2 1/4 x 3 1/4 De Franner 1 1/2 extension Ground glass back camera . . . Gewirinar F:4.5 lens. Compur B delayed action shutter . . . film pack adapter \$19.75

Write for Free Bass Bargaingram—Mention Still or Movie

BASS CAMERA COMPANY

179 W. Madison St. Dept. P Chicago, Ill.

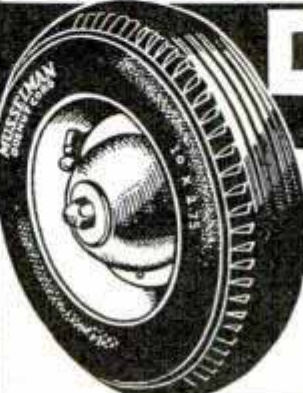

DOENUT WHEELS

DOENUTS developed and patented by the originator of the air-wheel, absorb more surface obstructions and eliminate jolting. Protect wood and concrete floors. Do not sink in sand or soft ground. Cadmium plated disc wheel with adjustable ball bearings. Size 10"x2.75" with cap. of 325 lbs. per wheel and 12"x3.30" with load cap. of 325 lbs. per wheel. Ideal for wheelbarrows, painting rigs, spraying equipment, textile trucks, dish trucks, food dollies, food carts, or most any portable unit that rolls. Handle same loads with less than half the labor. Send 10c postage to cover cost of mailing literature.

MUSSELMAN PRODUCTS CO.
6225-O St. Clair Avenue, Cleveland, Ohio

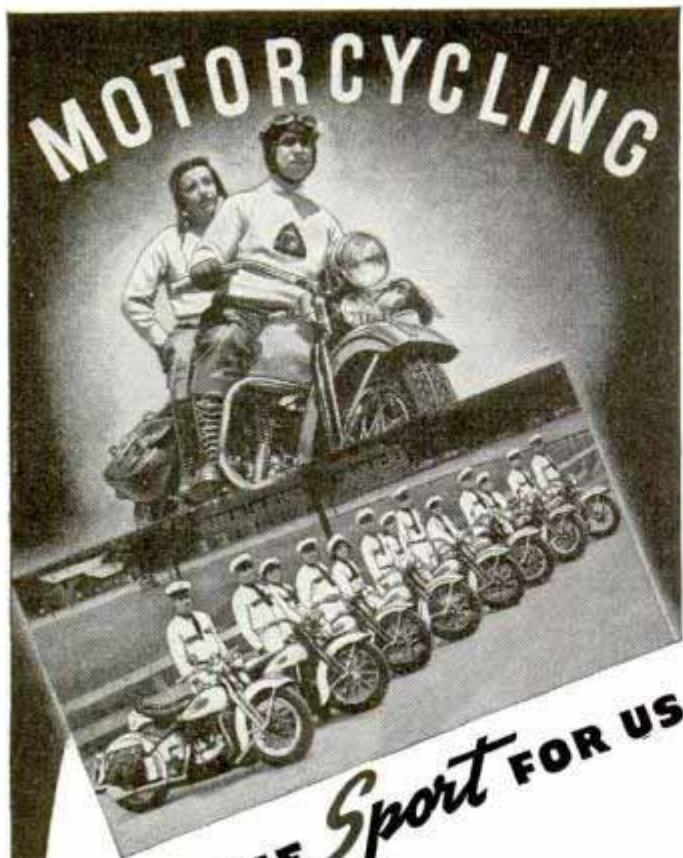

IS THE Sport FOR US

When you twist the throttle of your Harley-Davidson, you're heading for new adventure. Fun and thrills are at your finger-tips — your powerful, sturdy motorcycle takes you zooming over hill and dale — over highway and byway. You make new friends — pal with them at hillclimbs, tourist trophy races, gypsy tours, rallies, endurance runs — and other exciting events in the world's greatest outdoor sport.

See your Harley-Davidson dealer today. Let him tell you about the good times you can have with a Harley-Davidson. Get the story of the thrill-packed events put on by Motorcycle Clubs. His Easy Pay Plans will make a hit with you. Mail the coupon NOW!

HARLEY-DAVIDSON
WORLD'S *Champion* MOTORCYCLE
DAVIDSON

Again in 1939 — for the fourth consecutive year, Harley-Davidson won the 100-mile National T. T. Championship.

SEND FOR THIS
MAGAZINE



HARLEY-DAVIDSON MOTOR CO.
Dept. P, Milwaukee, Wis.
Send illustrated literature and FREE copy of "ENTHUSIAST" Motorcycling Magazine. Stamp is enclosed for mailing cost.

Name.....

Address.....

804 Forty Fathoms Down

(Continued from page 485)

The winch operators swing Sibitzky back to the deck. "Skee" has been under no pressure and will not need decompression to reduce gradually the nitrogen gas that is built up in the blood stream after a diver gets below one atmospheric depth, or thirty-three feet.

But Badders must be decompressed with exact schedule, if the dreaded "bends" are to be avoided. His voice comes out of the loud speaker again, distorted by compressed air from its normal baritone to a pitch close to soprano.

"I'm near the descending line, now," Badders reports. "I can see it . . . two stanchions to go . . . one stanchion . . . standing by to come up."

"Okay," replies Momsen, "the stage will meet you at ninety feet."

Now Badders is aboard the diving stage, waiting for the timer to say when he will move to the next decompression stop.

"I got a little groggy down there," Badders telephones up to Momsen. "I tried to move across the deck and I came up short. I thought there wasn't enough slack in my lines. Then I forget what happened. The CO₂ was building up pretty bad, I guess. Anyway, I snapped out of it enough to shove my jaw against the button and vent my 'hat.' I'm okay now."

Every man on the "Falcon's" deck can visualize what happened . . . carbon dioxide in the helmet . . . dizziness . . . semi-coma . . . then a frenzied shove of the jaw against the vent button inside the helmet, used to increase the amount of air exhaust when the diver's hands are occupied or he faces an emergency.

A sailor with a stop watch calls: "Time."

"We're bringing you up to eighty feet," Momsen telephones, "You had two minutes decompression at ninety feet; you'll get two minutes at eighty, three at seventy, five at sixty and ten at fifty."

"How long was I on the bottom?" asks Badders.

Momsen tells him seventeen minutes.

"It seemed like a year," returns Badders. "Say, you know when I snapped out of it I traced my lines back and found they were fouled. I guess I better go back to diving school."

The fantail laughs. Badders holds the

Navy Cross for risking his life "beyond the normal call of duty" when one of the pontoons got out of control on the "S-51" job in 1925. Badders and MacDonald share honors for the world's deepest dive, 500 feet in a tank, using helium-oxygen. Badders went down with diver John Mihalowski in that historic fifth trip of the rescue chamber to the after deck of the "Squalus," risking life and all hope of rescue for themselves on the difference of a few ounces between the pressure equalization chamber and the after torpedo compartment. Rear Admiral Cyrus W. Cole, commandant of the Portsmouth navy yard and commanding officer of the "Squalus" salvage unit, called this final chamber trip, which revealed all twenty-six men were dead, "the most dangerous task undertaken by the divers, for if they had become incapacitated there was no way in which they could be rescued as the chamber could not be entered from the outside."

Badders go back to diving school! No wonder the fantail laughs.

"Time," reports the tender with the stop watch.

"Coming up," warns Momsen at the batteryless telephone.

"Okay," says the voice under the sea.

The winches groan as the cable of the diving platform rolls about the drum.

The hands of the stop watch fly around. Badders has had sufficient underwater decompression and now the nitrogen has been reduced enough to allow him to be surfaced. Out of the water he rises on the platform, chortling weird sputterings from the exhaust of his helmet, swaying under the burden of 200 pounds of lead.

As soon as the platform touches the deck, tenders leap to his side, carefully clear the helmet from his shoulders and pull off the leaden belt. Every move is made rapidly, for Badders must get under pressure again as definite insurance against the bends. His face is flushed and he is dog tired, but there is no outward sign of the stream of nitrogen gas that still surges in his system. If he doesn't get under pressure in, say, five minutes, the naval medical corps may have on its hands a patient screaming with agony.

MacDonald leads the diver to the "Falcon's" huge recompression tank amidships. Badders' clumsy diving dress throws a

(Continued to page 137A)

Do you want

ALL-WINTER RADIATOR PROTECTION FOR ONLY \$1.50?

HERE'S the way many car owners do it every year! They put in a couple of quarts of Du Pont "Zerone" early in the season for protection against rusting and sudden cold snaps. When winter gets down to real business, they add enough "Zerone" for lower temperatures. A total of six quarts, put in as needed, can protect a car with an average size cooling system for the entire winter. And six quarts of "Zerone" cost only \$1.50!

You may need a little more or less, depending on the condition and capacity of your car radiator and the severity of winter in your neighborhood. But the unusual efficiency of "Zerone" will save you real money.

So effective you need less

"Zerone" is so effective you need comparatively little for protection. Just one gallon protects an average size cooling system (15 quarts) to 1°. Five quarts would protect it to -20°; six quarts to -27°!

Tests prove that "Zerone" makes a perfect mixture with water and that you lose little or none by evaporation or separation. Radiator losses are due mainly to leaks, sudden stops, etc. Where there is boiling, the losses are of the *whole solution*, "Zerone" and water.

"Zerone" in a clean cooling system prevents rust and corrosion, which reduce operating efficiency. It gives better dissipation of engine heat, avoids power losses. Protect your car with "Zerone" this very day! Remember, it's only \$1.00 a gallon, 25¢ a quart.



DU PONT ONLY \$1 A GALLON

ZERONE

Anti-Rust ANTI-FREEZE

If YOU are the MAN



WE WILL EQUIP YOU with exclusive line-production machinery—enabling you to manufacture modern building products at lowest cost. You will be able to supply the entire building trade with more attractive and permanent construction with savings at every step, from manufacturing to completed job.

WE WILL SUPPLY YOU with new processes and formulas to enable you to manufacture products in 40 beautiful colors, shades and textures. Your product will be capable of meeting all known building requirements and is now being used by Government and City Building Departments throughout the country.

WE WILL GRANT YOU manufacturing franchise covering your locality, protecting your market, business and future, with available engineering and advertising service for rapid expansion of your business.

YOUR EARNING POWER. Present manufacturers have pioneered the way for you by establishing substantial business of their own with modest investment. Some are selling at 100% over cost and securing the major share of the business in their territories.

YOUR OPPORTUNITY IS COMPLETE. One that is proven in every way. Prepared ready for you to cash in big on the wide building upturn under way.

YOU SHOULD INVESTIGATE while your territory is still open. Write today for complete facts. No obligation.

W. E. DUNN MFG. CO.
600 W. 24th St., Holland, Michigan



Stoves AT FACTORY PRICES!



Write for FREE CATALOG

SALE CATALOG—FREE

Nearly 200 Styles and Sizes of Heaters, Ranges, Furnaces at FACTORY PRICES. Easy Terms. Write today for FREE CATALOG. New styles, new features—24-hour shipments.

Kalamazoo Stove & Furnace Co.,
391 Rochester Avenue
Kalamazoo Michigan
Over 1,400,000 Satisfied Users
39 Years in Business

"A Kalamazoo Direct to You"
Trade Mark Registered

NEW KIND OF MAN'S SHOE

The new sensation in men's shoes — The Chippewa Clipper. It zips on and off in a "jiffy". Right now is the right time to get into a dignified and highly profitable shoe business of your own with this fast seller, and a complete line of almost 250 styles of dress, work and sports shoes. Prices as low as \$1.98 a pair. Free 10-second demonstrator sells super-comfort air-cushion shoes like magic.

Sales division of manufacturer established 36 years wants salesmen. No experience needed. Write for complete sales kit. It's free!

CONSOLIDATED SHOE SYSTEM
Dept. A12, Chippewa Falls, Wis.



TYPEWRITER Brand NEW!

Only \$19.95 and up

10-Day Trial—Easy Terms
Guaranteed Brand New latest REMINGTON-CADET model only \$19.95 during this sensational sale. Also Royal, Corona and famous Featherweight Portables at real money-saving prices. Also standard full size office models rebuilt and fully guaranteed at 1/2 saving. SEND FOR BIG FREE CATALOG IN COLORS.

International Typewriter Exch., Dept. 1001, Chicago



10c A DAY

BURN YOUR NAME ON TOOLS

WITH THE ARKOGRAF

PROTECT YOUR TOOLS FROM THEFT

Write with electricity any name or design on the hardest and finest tools and instruments, or any metal, like writing on paper with pen or pencil.

Complete Outfit \$3.50—Prepaid Anywhere. Interesting illustrated circular free. Write today. Agents wanted. ARKOGRAF PEN CO., 3927 S.E. Stark St., Portland, Ore.

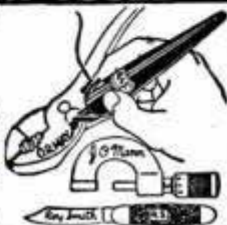

FREE TRAILER BUILDERS' GUIDE AND CATALOG—NEW 1939 EDITION

WORLD'S BEST LINE OF TRAILER AXLES, HITCHES AND PARTS—Complete house trailer working blue prints only 50c. WRITE TODAY FOR THIS NEW FREE CATALOG.

HAMMER BLOW TOOL COMPANY, Dept. 110, Wausau, Wis.

DO YOU

WANT a new business profession of your own, with all the trade you can attend to? Then become a foot correctionist, and in a few weeks earn big income in service fees,—not medical nor chiropody—easy terms for home training, no further capital needed, no goods to buy, no agency. Established 1894. Address Stephenson Laboratory, 1 Back Bay, Boston, Mass.

OTTAWA LOG SAW \$39

BIG BOOK FREE



PUTS THIS OTTAWA to work for you. MAKE MONEY! Wood is valuable.

Does more than 10 men. Easily operated. Falls trees—saws limbs. Use 4-hp. engine for other work. Write for FREE Book.

OTTAWA MFG. CO.
2427 Wood St., Ottawa, Kans.

Makes marvelous movies at everybody's price
CINÉ-KODAK EIGHT
See it at your dealer's

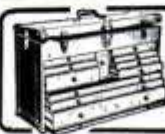

SYSTEMATIZE YOUR TOOLS

In a Gerstner Chest. Toolmakers have prized them for 33 years. Free Catalog.

GERSTNER TOOL CHESTS
439 Columbia St. Dayton, Ohio

Alkalize with
Alka-Seltzer

(Continued from page 135A)

2004

trail of salt spray over the deck as he shambles wearily toward the "iron doctor." The tenders help Badders into the chamber, dog down the door behind him, and start pulling off the breastplate and the one-piece diving dress. Already, the pressure inside the recompression chamber has been stepped up to the same amount that Badders felt at his final decompression stop underwater—the twenty-two pounds of the fifty-foot level.

An oxygen mask goes over Badders' face. For one hour, in the warmth and comfort of the chamber, he will breathe oxygen and undergo twenty-two pounds of pressure. The navy has discovered that by surfacing a diver at fifty feet and recompressing him under oxygen at the same pressure it can reduce the total decompression time, insure the health of the diver and clear the water for another descent.

Lieut. A. R. Behnke of the navy medical corps, authority on submarine medicine and diving, sits in the chamber with Badders to make sure he suffers no ill effects. Stimulated by a bowl of warm soup, Badders stretches out on a cot, relaxing. In an hour, oxygen will remove seventy-five per cent of the rampant nitrogen. The diver will be able to assimilate the remaining twenty-five per cent in the normal surface pressure of fourteen and seven-tenths pounds a square inch.

Outside on the starboard deck, Lieut. F. W. Laing, prospective skipper of the "Falcon's" sister diving ship, "Mallard," peers through a porthole. He speaks to Badders over a telephone hook-up.

"Swell job you did in pulling out of that jam down there," he says. "That's the trouble with compressed air; it makes you so drowsy."

"Yeah," replies Badders, now speaking in normal voice through the open mouth of his mask. "I like the helium dives better. They leave your head clear, even if your voice does sound like Donald Duck. No more compressed air for me as soon as the boys can get to mixing and settling helium and oxygen fast enough to catch up with the demand here."

Aft on the fantail, another diver prepares to go over the side. The most complicated and dangerous submarine salvage job in history continues its routine—with sudden death lurking behind every dive.

(To be concluded next month)

NEW NICHOLSON "HANDY" FILE

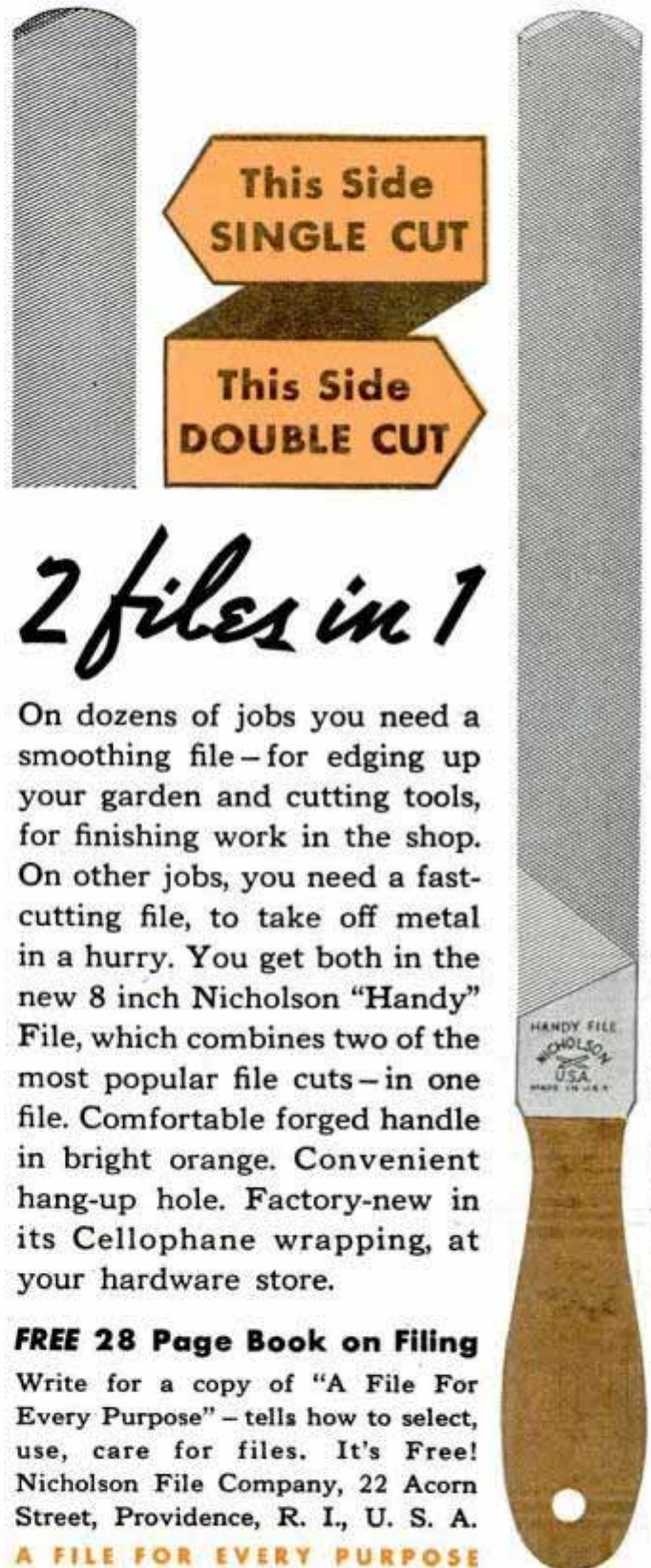

2 files in 1

On dozens of jobs you need a smoothing file—for edging up your garden and cutting tools, for finishing work in the shop. On other jobs, you need a fast-cutting file, to take off metal in a hurry. You get both in the new 8 inch Nicholson "Handy" File, which combines two of the most popular file cuts—in one file. Comfortable forged handle in bright orange. Convenient hang-up hole. Factory-new in its Cellophane wrapping, at your hardware store.

FREE 28 Page Book on Filing

Write for a copy of "A File For Every Purpose"—tells how to select, use, care for files. It's Free! Nicholson File Company, 22 Acorn Street, Providence, R. I., U. S. A.

A FILE FOR EVERY PURPOSE

NICHOLSON
PIONEERS IN
QUALITY PRODUCTION

75th
ANNIVERSARY
YEAR

Learn the "Why" of Super-X Long Range Power!



THE greater effectiveness of Western SUPER-X shot shells, over ordinary loads, is known to every hunter who has used them! There's a definite reason why you get more hits and fewer cripples with SUPER-X. Learn about SUPER-X Short Shot String in the FREE 72-page Western Ammunition Handbook. Mail the Coupon.



WESTERN CARTRIDGE COMPANY,
Dept. J-46, East Alton, Illinois

Mail, FREE, the WESTERN AMMUNITION HANDBOOK, the complete shooting guide that shows why SUPER-X shells have 96% more effective power at 60 yards.

Name.....
Address.....
Post Office..... State.....

60 POWER TELESCOPE . . . \$219

VARIABLE EYEPIECE 20X-40X-60X

NEW! Three telescopes in one. 3 different magnifications. 20 power for ultra-bright images with 40 and 60 power for extra long range. Guaranteed to bring distant objects, people, sports events, ships, moon, stars, etc., 60 times as close.

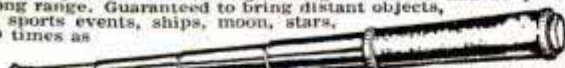

Most powerful made for anywhere near the money. Closes to one foot in length. Multiple lens system, 30 mm. objective lens, 3 sections. Directions included for using as a compound 4 lens microscope. American made. Prompt shipment guaranteed. We pay the postage. Only \$2.19. **BROWSCOPE CO., Dept. 410, 5 W. 27th St., New York, N. Y.**

BABY CALCULATOR
CHICAGO & S.A.
PATENT APPLIED FOR

ADDITION
SUBTRACTION
MULTIPLICATION
DIVISION

WORLD'S LOWEST PRICED ADDING MACHINE

WEST POCKET SIZE
FREE TRIAL

GUARANTEED ACCURATE. Not a toy. Operates with only a finger flick. Adds, subtracts, multiplies, divides. Counts up to a million. Pays for itself over and over. Ideal Gift—for Business, Income Tax and School use.

ONLY \$2.50

TOTAL COST
SEND NO MONEY

MONEY BACK GUARANTEE. Send name and address. Pay postman only \$2.50 plus postage. (Send full cash if outside U.S.) Money back in 10 days if not delighted. **AGENTS WRITE. CALCULATOR MACHINE COMPANY (Mfrs.), Dept. 110, P. O. BOX 1118, CHICAGO, ILLINOIS.**

ITCH STOPPED in a Jiffy -or Money Back

For quick relief from itching of eczema, pimples, athlete's foot, scales, scabies, rashes and other externally caused skin troubles, use world-famous, cooling, antiseptic, liquid D. D. D. Prescription. Greaseless, stainless. Soothes irritation and quickly stops the most intense itching. 35c trial bottle proves it, or money back. Ask your druggist today for **D. D. D. PRESCRIPTION.**

Push-Button Set Tester

(Continued from page 618)

Simplified wiring diagram Fig. 1 shows all connections clearly, and the schematic circuit diagram appears in Fig. 2. All resistor values are given in these diagrams; shunt resistor R_4 is for 100 m.a. measurements, and R_5 for 10 m.a. readings.

Photos A, B and C offer various views of the completed unit. Looking at the unit in operating position as shown in photo B, it will be noted that the first button at the right is No. 1. This button is for the high-ohm scale for testing resistors from 100 to 100,000 ohms; also for shorts and continuity checking. Button No. 2 is for the low-ohm scale for resistance from zero to 500 ohms; this may be used also for testing tube filaments, r.f. coil windings and

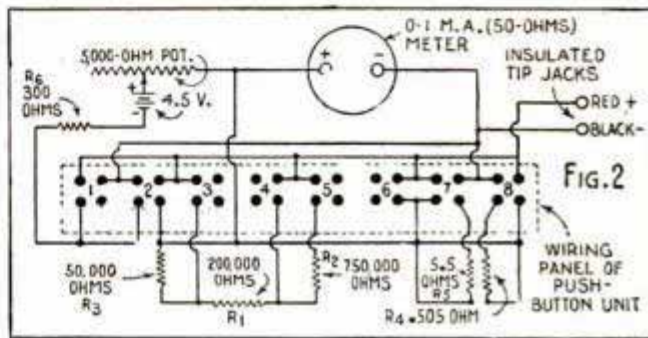

speaker voice-coil resistance. No. 3 is the voltage scale up to 50 volts d.c. Sensitivity of all voltage measurements is 1,000 ohms per volt. This is useful for bias measurements, drop across resistors and chokes, and for testing B-batteries. Button No. 4 is for voltage up to 250 volts; a very handy scale for point-to-point voltage test in a.c. or combination a.c.-d.c. receivers. By placing the negative "black" prod at ground potential (chassis), the positive "red" prod can be used to indicate relative potential at all other points. Button No. 5 provides voltage tests up to 1,000 volts.

D.C. current measurements up to 1 milliamper maximum are available by means of button No. 6. As this is very small current, care should be taken when using this scale; it may be employed to measure diode detector current, or current in photocells. No. 7 measures up to 10 m.a. and button No. 8 is for current measurements up to 100 m.a. With the exception of No. 2, any push-button may be depressed for any length of time. As current is taken when No. 2 is down, this scale should be used only when required.

POSITION OPEN

Paying salary and expenses based on small sales quota with nationally known manufacturer of standardized maintenance products. We want a salesman qualified to call on industrial plants, institutions, municipalities, school boards, real estate, insurance companies and large property owners. Protected territory. Old accounts given. Rapid advancement assured right man.

AMERICAN ASBESTOS PRODUCTS CO.
Dept. 710, Cleveland, Ohio.



GIVEN!
56 Double-blade Paddle now given with your "CK" KI-YAK—if you hurry!

BIG MONEY Assembling NEW BOAT!

Make big money on each 20-lb. Mead KI-YAK you easily assemble at home from complete "cut-to-fit" Kit at amazing LOW COST! Seaworthy, Fast! Snappiest thing afloat. (Complete Sailing Rig, a few dollars extra.) Also 2 other portable paddle-sail models AND 2 portable outboard motor, sail, oars models. Rush 10c coin for illustrated folder and \$6 Paddle Gift Offer!

MEAD GLIDERS, Dept. B-109, 15 S. Market, CHICAGO, ILL.

4 Ideal HOBBIES FOR YOU!

COMPLETE MODEL KITS

RAILROADS

SHIPS

AEROPLANES

CHIP SHAPES

COMPLETE HOBBY CATALOG 10¢

IDEAL AEROPLANE AND SUPPLY CO., Inc.
26 WEST 19th STREET, NEW YORK

CAMERA BOOK

FREE!



Illustrates latest methods in Photography and Home Movie Making, for fun and profits. Offers hundreds of amazing money-saving bargains in still and movie Cameras, Lenses, Films, etc. Used equipment accepted in trade. Satisfaction guaranteed or money back with 10-day trial privilege. WRITE FOR FREE BARGAIN BOOK!

CENTRAL CAMERA CO., 230 S. Wabash, Dept. J16, Chicago, U.S.A.



CAPTURE THE COLOR OF LIFE! YOUR OWN MOVIES! ONLY 10c A DAY!

NATIONALLY ADVERTISED 8MM and 16MM Movie cameras, projectors. For home, business, church, school, club. MONEY BACK 10 DAY TRIAL. Payments as low as 10c A DAY. Satisfied customers throughout the world. FREE details. WRITE TODAY.

Don Elder's Home Movies, Dept. N-10, 739 Boylston St., Boston, Mass.

CASH IN ON SPARE TIME

\$30 WEEKLY OR MORE EARN. Grow mushrooms HOME. Cellar, shed suitable. We buy 30c lb. Year round business.
\$270 made by Mr. B. in few weeks SPARE TIME. Guaranteed materials. Established 1931. Write for FREE BOOK.

WASHINGTON MUSHROOM INDUSTRIES, Dept. 601, 2019 2nd Seattle, Wash.

BRONZE FOUNDRY Schools and Home Workshops

Make your own castings of aluminum, copper, bronze, silver. Foundry sets are available in three sizes including 2400 Deg. F. blast furnaces. See advertisements in Feb. or May issues, free Circular.

KANSAS CITY SPECIALTIES CO.
P. O. Box 6022, Dep't P-1 Kansas City, Mo.

MONEY for MEN ALL DATA FREE

THE PLASTEX Industry needs manufacturers on small scale and for big production of Lamp and Clock Stands, Art Goods and Novelties in Plastex and Marble imitation. Experience unnecessary. 1/2c material makes regular 10c store sellers. Rubber moulds furnished for speed production. Small investment brings big returns. BIG CHAIN STORE orders now being placed. Ambitious men have chance for real prosperity. Our FREE booklet will interest and benefit you. PLASTEX INDUSTRIES, Dept. P, 1085 Washington Ave., New York, N. Y.

When writing please mention Popular Mechanics.

FOR BETTER WORK And More Fun Doing It!



ATKINS Silver Steel SAWS

Now is the best time to make sure of getting more pleasure than ever out of your home workshop. Check over your saws—follow the lead of good craftsmen and replace inefficient ones with Atkins—noted for their ability to produce consistently high quality work with less effort. Make every job easier by using the right saw for the job—check the different Atkins types—handsaws, cross-cut and rip; coping saws; compass saws; circular saws in all styles—your local hardware dealer stocks. Write for Atkins "How-to-Do-It" book of shop layout and tool suggestions—Send only 10c.

E. C. ATKINS AND COMPANY
Dept. M-10
426 S. Illinois St., Indianapolis, Ind.

Ask for an **ATKINS** and Get Satisfaction

Low Stain WATER RESISTANT GLUE

AIRPLANE MODEL MAKERS! Wood workers! Hobbyist!

Use this low stain, water resistant, proven Casein Glue—Laux 771-D. Quick! Safe on delicate woods. No high pressure clamping. Made by world's largest manufacturers of water resistant glue. Economical—1 lb. 65c prepaid anywhere in U. S.

I. F. LAUCKS, INC., Dept. B, Portsmouth, Va.; Seattle, Wash.



GOOD TOOLS NEED GOOD OIL

When you work with tools, they must be in working condition. 3-IN-ONE Oil keeps tools clean and bright. It oils the working parts; protects against harmful rust and tarnish. Get it at Hardware, Drug, Grocery, 10¢ Stores.



3-IN-ONE Oil

2457

RECORD!

Last winter alone "Prestone" Brand anti-freeze saw motorists through more than 24 billion miles of trouble-free driving!

(SEE PAGES 118A and 131A)

ELECTRICITY

ANYWHERE



ONAN ELECTRIC PLANTS furnish 110 Volt, 60 Cycle, A. C. Current same as City Power Lines for Farms, Camps, Construction Jobs and Emergency Service in Hospitals, Schools, Theatres, Public Buildings. SAVE PROPERTY, even LIVES in case of Power Line Failure. Thousands in use in all parts of the World. Operate Lights, Radios, Water Systems, all Appliances. Models 350 to 50,000 Watts, 12, 32 and 110 Volt D. C.—110 or 220 Volt A. C. Also Combination A. C.-D. C. Units. Manual, Full-Automatic and Self-Starting Types. Shipped COMPLETE—READY TO RUN, \$99 and up. Write for details.

D. W. ONAN & SONS

1038 Rayston Ave. Minneapolis, Minn.

EASY PROFITS IN PAINT SPRAYING



Paint walls, ceilings, screens, furniture, radiators, machinery faster, better! $\frac{1}{4}$ H. P. motor 110 Volt 60 Cycle AC, complete with Spray Gun, 15 ft. hose. Weighs only 44 lbs. Carry anywhere. FULLY GUARANTEED. Only \$31.15 f. o. b. Chicago. \$5 Deposit, Balance COD, or SEE YOUR DEALER. Circular FREE. Get started making money NOW!

Ideal Automatic Pump Co. Dept. PM-10, 801 Washington, Chicago **\$31.15** Complete

BOAT BLUEPRINTS & PATTERNS

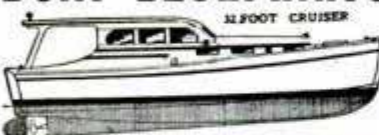

Full size paper patterns! Newest designs by naval architect. Cruisers, runabouts, sloops, snipe, outboard boats, etc., 8 ft.-35 ft. Low prices. Rush 10¢ (coin) for illust. catalog, "HOW TO BUILD BOATS," postpaid, \$1.00.

Cleveland Boat Blueprint Co. Station A-667 Cleveland, Ohio

Saw-Filing

Pays up to \$2 or \$3 an Hour in Spare Time

A FOLEY Automatic Saw Filer files hand, circular and band saws better than the best hand fier. Cash business, no canvassing, no eyestrain. No experience needed. Louis P. Wadowick, Ohio, says, "I have filed 764 saws in spare time and have earned \$850.00 in carpenter work due directly to my saw filing contacts." Send coupon for FREE PLAN, no obligation.



FOLEY MFG. CO., 1016-9 Foley Bldg., Minneapolis, Minn.

Send Free Plan on Saw Filing business.

Name

Address

New Weapons to Fight Disease

(Continued from page 523)

range received by the body helps develop the compounds known as vitamins A, C, and D that are useful in preventing or curing bone rickets, preventing colds and some bacterial infections, clearing up skin afflictions, and in preventing scurvy.

The lethal action of the shortest ultraviolet rays on bacteria and molds recently gave the research workers at Westinghouse an idea which resulted in develop-



New X-ray tube that enables science to take "candid" photos of human structure

ment of a lamp which sterilizes the air within its range and reduces the chances of infection.

Today the "Sterilamp" is used in restaurants to sterilize cooking and eating utensils, in banks and other places to reduce the chance of transmitting colds, in bakeries for inhibiting the growth of molds on fresh products, and in meat refrigerators for keeping the meats in better condition. Manufacturers of food products sterilize the entire atmosphere inside their buildings by placing these lamps at the inlets of their air-conditioning systems.

From the medical standpoint the new death-dealing lamps are a boon because

(Continued to page 142A)

England - Sterilelec Co 126 Strand Bldg

Westinghouse lamp Co. B. Bromfield N.Y.
Manufactured in U.S.A.
London U.C. 2



Free Fall Catalog

JUST OFF THE PRESS

Showing Hunting Footwear, Clothing, and fifty other leather and canvas specialties of our own manufacture for campers and hunters.

L. L. Bean, Inc.
136 Main Street
Freeport, Maine

FACTORY MODERNIZED VACUUM CLEANERS

FREE!

Write TODAY for new illustrated catalogs of vacuum cleaners and parts

RE-NEW SWEEPER CO.
9591 Grd. River Ave., Detroit, Mich.

World's Largest Independent Vacuum Cleaner Rebuilders
Est. 1916

CHRISTMAS CARD PRINTER KIT

ONLY \$1.50 COMPLETE

INCLUDES: SILK FRAME..ORGANDY.. STENCIL..TACKS..TAPE...& SQUEEGE COMPLETE AS SHOWN

VEL-SUEDE FLOCK KIT

ONLY \$3.30 COMPLETE

KIT INCLUDES: GUN...3 COLORS... BINDER...3 COLORS VEL-SUEDE..BRUSH

SPECIAL COMBINATION—BOTH KITS SHOWN ABOVE—\$4.50

JORDAN AIR & SUCTION PUMP CO.
P-7 BRYANT BLDG., KANSAS CITY, MO.

CATALOG DETAILS WRITE TODAY

MODEL SHIP & YACHT FITTINGS

Carved hull Kits, Construction sets for all popular models. Model Yacht fittings, sails and spinnakers. Send 20c (coin) for 44 page illustrated catalog No. 15 listing hundreds of items you need.

A. J. FISHER 1002-7 ETOWAH AVE., ROYAL OAK, MICHIGAN

AGENTS 300% Profit SIGN LETTERS

For Store Fronts and Office Windows. Anyone can put them on. Free Samples. Liberal Offer to general agents.

METALLIC LETTER CO., 438 N. Clark St., Chicago

WOOD STOVE

These heavy steel parts make a very good stove from an OIL DRUM. All parts and bolts complete: 55-gal. size \$3.50, 30-gal. size \$3.00, prepaid anywhere in U. S. For Home, Camp, Basement, Garage, Brooderhouse, or Shop.

WILKIE, Box 368, Independence, Mo.

CATCH FISH!

minnows, eels, mink, muskrat, with our folding galvanized Steel Wire Traps. Walton's Automatic Hooks are so constructed that when a fish gives the slightest pull on the bait the upper hook reaches down and gets a hold that lands him. 3 for 50c. Write for descriptive catalog of Traps, Hooks, Lures, and other specialties. **Walton Supply Co., 3507 Junata Ave., St. Louis, Mo.**

MONEY IN RABBITS—CAVIES

WE BUY and put you in touch with other markets. Catalog and copy of magazine 10c. Or send 25c for Book Catalog and Price List and Year's Subscription to the **AMERICAN SMALL STOCK FARMER.**

OUTDOOR ENTERPRISE CO., BOX 919, NEW CITY, N. Y.

Always write your name and full address clearly when answering advertisements.

IT'S A CINCH TO REPAIR WALLS WITH RUTLAND PATCHING PLASTER

Just mix with water..Rutland makes a perfect patch .. stays put.. costs only a few cents.

RUTLAND PATCHING PLASTER

HANDEE
Tool of 1001 Uses

A WHOLE TOOL SHOP IN YOUR HAND

Smooth, steady power at your finger tips. Uses 300 accessories to grind, drill, polish, rout, cut, carve, sand, saw, sharpen, engrave, etc. Plugs in any AC or DC socket, 18,000 r.p.m. 16 oz.

Get A Demonstration at Hardware, Tool or Dept. Stores, or order on 10-Days Money-Back Trial. **\$10.75** post-paid with 3 Accessories... De Luxe Model, 25,000 r.p.m. 12 oz. **\$18.50** with 6 Accessories.

Chicago Wheel & Mfg. Co., 1101 W. Monroe St., Dept. PM, Chicago, Ill.

Save Hours of Hand Work

FREE 64-PAGE CATALOG
Complete information on Handee Products and their wide application in crafts work and industry all over the world.

AUTOGlide \$9245

and up F.O.B. Factory

Boy! this is great! Swift, thrilling rides—to school, business, pleasure, deliveries. Costs next to nothing to operate—125 miles to the gallon! Powerful, trouble-free Cushman engine. Dependable.

WRITE! See your dealer or send for free folder showing several models. Send NOW!

THE CUSHMAN MOTOR WORKS
Dept. Z-10 Lincoln, Nebr.



TURN SCRAP INTO MONEY

AUTOPOWER tells you how in plain, easy, simple and illustrated instructions that anyone can follow. Change auto generators into useful, practical A C and D C generators and motors with voltage from 2 to 1,000 volts, for power, light, welding, radio, sound, etc. No previous experience nor special tools needed. Generators can be driven by wind, water, fan belt, etc. **INSTRUCTIONS FOR BUILDING AN A C WELDER THAT ACTUALLY WORKS UP TO A 3/16" ROD.** ALSO COMPLETE PLANS FOR WIND AND WATER POWER PLANTS. Send for your copy of "AUTOPOWER." Already used and endorsed by thousands. Only \$1.00 postpaid.

S. W. DUNCAN, Publisher.
410 S. Hoyne Ave., Chicago



245

(Continued from page 140A)

**I'D LIKE TO LOOK
LIKE THAT IN MY
BATHING SUIT**



Posed by professional models



**SKINNY?
THOUSANDS GAIN 10 TO
25 LBS. QUICK
THIS SIMPLE WAY**



ARE you afraid you can never be a naturally attractive in a bathing suit? Well, thousands of men who once were skinny, tired, nervous—almost ashamed to be seen on the beach—have easily put on just the pounds they needed, gained normal health, pep and the natural good looks and popularity these bring—with these scientifically prepared, easy-to-take little Ironized Yeast tablets.

Science gives the answer

You see, scientists have discovered that many people are thin, run-down, tired, jittery—unable to eat and sleep properly—simply because they don't get sufficient Vitamin B and iron from their daily food. Without enough of these substances you may lack appetite and not get the most body-building good out of what you eat.

Now you get these exact missing substances in these marvelous little Ironized Yeast tablets. No wonder they have helped thousands who needed these substances to gain new naturally attractive pounds, new pep, popularity and success—often in just a few weeks!

Make this money-back test

Get Ironized Yeast tablets from your druggist today. If with the first package you don't eat better and FEEL better, with much more strength and pep—if you're not convinced that Ironized Yeast will give you the new normally attractive pounds, new energy and life you've wished for, the price of this first package promptly refunded by the Ironized Yeast Co., Atlanta, Ga.

But just one warning! Cheap, inferior substitutes for Ironized Yeast are often offered which do not give the same results. Insist on genuine Ironized Yeast. Look for "IY" stamped on each tablet.

Special offer!

To start thousands building up their health right away, here's a special offer. Purchase a package of Ironized Yeast tablets at once, cut out seal on box and mail to us with a clipping of this paragraph. We will send you a fascinating book on health, "Facts About Your Body." Remember, results with first package—or money refunded. At all druggists, Ironized Yeast Co., Inc., Dept. 5310, Atlanta, Ga.

TUNE IN JOHN J. ANTHONY'S GOOD WILL HOUR.
See your local newspaper for exact time and station.

there has always been some risk of infection from air-borne bacteria during the time a patient is on the operating table. Approximately 50,000 bacteria are apt to fall on an open wound in an hour's time in spite of the most careful precautions. By sterilizing the air above the operating table, ultraviolet tubes suspended from an overhead fixture materially reduce all chances of infection. Another advancement in the operating room is the use of bactericidal paint containing four per cent chlorine. Walls and ceilings thus coated are deathtraps to bacteria that touch them.

So far cosmic rays, the least understood of all forms of energy, have not been found to have any effect on life, although a suggestion is that direct hits by cosmic rays account for mutations in plant life.

Aside from the contributions of physics to medicine, the mechanical world is constantly providing new instruments to aid the physician in his battle against disease. The "iron lung," the new microscopes, and the gastroscopes and other instruments that enable a doctor to look through or into the body are all important tools.

An entirely new horizon in chemotherapy was sighted when it was learned that sulfanilamide, a coal-tar derivative formerly regarded as a waste product, is a specific remedy against a number of kinds of illness. This lifesaving drug has accomplished wonderful results in cases of spinal meningitis, peritonitis, scarlet fever, tonsillitis, and other streptococcic infections.

Many members of the medical profession regard this discovery as the greatest medical advancement of the century. Pneumonia has been one of America's greatest killers but now this disease is being conquered by sulf-pyridine, one of the newest of the sulfanilamide derivatives. Another form of the drug has arrested tuberculosis in guinea pigs.

A hope of the medical world is that other drugs, possibly related to sulfanilamide, may be discovered that will be effective against filterable viruses. Viruses are of submicroscopic dimensions and are responsible for diseases such as the common cold, sleeping sickness, yellow fever, and infantile paralysis. Related sicknesses in animals have already been slowed down by new chemicals and doctors cautiously express the hope that some of the compounds will be effective in treating humans.

Write D. S. Crabb, Health Editor, Wash. Post

ALL CLEVELAND

RADIATES FROM
THIS HOTEL

● Under the same roof with you are the five fine buildings of the Terminal development, and the Union Terminal itself. And rooms are luxuriantly comfortable, and meals are famous. Everyone tries to prove we're glad to have you with us.

HOTEL CLEVELAND
Cleveland

NOW ONLY \$5.00 REAL ENGINE VALUE



Over 7,000 GHQ Gas Engine Kits were sold at \$8.50. Over 10,000 sold last year. Now is your chance to buy the *New Improved* kit for \$5.00. Absolutely complete with coil, plug, etc. For boats, planes, etc. All parts guaranteed. Send only \$1.—*Shipped Express Collect for balance same day. Send 3c for new 12-page illus. catalog. DEALERS WRITE.*

All parts finished. Only a screwdriver needed. 1/5 H.P. Average assembly time 30 minutes.

GHQ MOTORS, 40B East 21 St., New York, N. Y.

TRAILER PARTS



Largest, most complete stock of trailer parts and equipment in America. Lowest prices, quick delivery. Marvel is the pioneer in trailer accessories with a reputation for highest quality products, refrigerators, stoves, etc. Send 10c in coin for 40 page illustrated catalog.

MARVEL TRAILER PARTS CO.
 19020 Celestine Ave. Detroit, Mich.

New Accurate 10" Slide Rule



Enables you to do difficult calculations instantly without paper or pencil—multiplying, proportions, division, extracting roots, etc. Accurate, white composition face. Has Standard A, B, C, D, CI, and K scales. Made in U.S.A.

50¢

Equipped with both magnifying and standard indicator. For complete outfit, including slide rule, 32-page illustrated instruction book, carrying case, send 50c in coins or U. S. stamps (60c in Canada). Mailed postpaid. Satisfaction guaranteed or money refunded. (Schools and dealers: write for quantity price.) Send today for this great slide rule value.

LAWRENCE ENGINEERING SERVICE, 18 Smith St., PERU, INDIANA

Get those **TEDIOUS SANDING JOBS** done the *Quick, Easy* way!

New GuildSANDER PORTABLE ELECTRIC **Sander**



Tough, tedious hand-sanding and scraping jobs can be a pleasure... also profitable... and *ten times faster!* Guild-SANDER weighs only 9 lbs... plugs into the nearest AC or DC light socket. Powerful universal motor. Works on wood, metal, wall-board, plastics, glass, marble and compositions.

Try it on your own work! Discover why thousands of users say "it's the best tool ever." Get a *finer* finish... save time... do a *wide* variety of jobs. GuildSANDER... popularly priced... does *quality* work. Gives straight grain finish... no cross grain roughness... smooths many curved surfaces... trues mitres and joints.

Find out how GuildSANDER will help you. Now at your hardware or mill supply dealers. Or Write us for full details.

SYRACUSE GUILD TOOL CO.
 1700-10c No. Salina St., Syracuse, N. Y.

Sands, Polishes, Buffs, Grinds, Sharpens, Removes Paint and Varnish.

WELDING ELECTRODES

Big INTRODUCTORY PACKAGE



60 PIECES, including 1/16", 3/32" and 1/8" diameter of the Famous AGILE, AC General Purpose ELECTRODES. For iron, steel, sheet metal, ornamental iron, auto bodies, fenders and bumpers, truck bodies, tanks, farm machinery, hobby work and all light weldings. AGILE ELECTRODES produce perfect work, even by "touch" welding. WILL NOT STICK OR "FREEZE" in direct contact with metal to be welded. Easiest electrodes for unskilled welders, hobbyists and students. For both AC and DC machines. Use less voltage, free from objectionable fumes and odors. **BIG PACKAGE** of 60 ELECTRODES, including Complete Catalog with HANDY AMPERAGE GUIDE, sent promptly, post-paid anywhere in U. S. or territories. Send cash, money order or check.

AMERICAN AGILE CORP., Dept. P, 5804 Hough Ave., Cleveland, Ohio

HANDY TAPS and DIES...

Accurate—carefully hardened and tempered. Complete range of sizes at your local five and ten cent store

HENRY L. HANSON, WORCESTER, MASS.

NOW a DYNAMIC HEAVY DUTY INDUSTRIAL WELDER



for Only \$1975

Works Off 110-Volt Light Socket. This marvelous Dynamic Power Welder does the work of much higher priced types. It is easily portable. WELDS Cylinder Blocks, Bumpers, Fenders, Tanks, Farm Machinery, etc. Will also solder and brace on the lightest RETAIL material. Works on iron, steel, tin, brass, copper and all other metals. Men without previous experience can make as much as \$5.00 on a one hour repair job. In a year's time a **Dynamic Welder Costs You LESS THAN 6 CENTS A DAY.** Go into business—Open a welding shop now. **AGENTS**—Make big profits selling to garages, factories, janitors and machine shops. Write today for our 10-DAY TRIAL OFFER. **DYNAMIC WELDER CO., 2226-HU Silverton Road Chicago, Illinois**



Don't wait for your radiator to boil before you clean out the rust and scale that clog it! Use 10c worth of Sani-Flush at least twice a year (25c for the largest trucks and tractors).

Here's all you have to do: Pour in Sani-Flush. Run the engine. Drain. Flush. Refill with clean water. (*Directions on the can.*) Sludge and sediment are flushed away. The motor runs cool. You save power and fuel. You may save unnecessary repair bills. Do the job yourself. Or ask your garage or service station to flush your radiator for you. Insist on Sani-Flush. It cannot injure motor or fittings. You'll find Sani-Flush in most bathrooms for cleaning toilets. Sold by grocery, drug, hardware, and five-and-ten-cent stores. 25c and 10c sizes. The Hygienic Products Company, Canton, Ohio.

Sani-Flush Safe
KEEPS RADIATORS CLEAN NOT CAUSTIC

NEW BENNETT "Gyra-Flame" OIL BURNER

Cuts Fuel Costs to the Bone!

Here's the oil burner you've been waiting for! Amazing fuel economy with low chimney heat-loss. Constant uniform house temperature. Sensational "Gyra-Flame" with positive fuel control by carburetion principle. One moving part—fool-proof—so simple you can install it yourself. Get facts at once on this remarkable low-cost oil burner.

AGENTS: Here's an opportunity seldom equalled. Write for details.



BENNETT MFG. CO.
409 Cedar Lake Rd, Minneapolis, Minn.

g-406
Air-Crash Detectives

(Continued from page 541)

was a problem ship that contributed to the solving of several problems. The early models had a tendency to nose over after landing, the propellers had a tendency to fly apart, and even minor crack-ups became disasters, for the ship would burst into flames on the slightest provocation.

The nosing-over tendency was solved by placing the landing gear struts farther forward, spreading them to do away with the seesaw effect. Smaller metal propellers replaced the huge laminated wood props. And by crashing 200 of these planes against a concrete wall, it was discovered that the long exhaust stack, running outside the fuselage almost to the tail, often caused fires. This was remedied by providing each cylinder with its individual stub exhaust stack.

A few years ago the navy's NB-1 trainer and the army's P-12 pursuit planes were showing vicious spinning tendencies that cost several lives. To solve these problems the N. A. C. A. developed the free spinning tunnel. Today no airplane is ever constructed until a model of the type has been tested in this tunnel, and its spinning tendencies brought under control.

There are certain dependable clues that are always looked for in reconstructing an accident. Was the plane flying at full speed when it hit, or attempting a dead-stick landing? Did it spin in, dive in, or contact the ground in normal flight? In case of fire, did it originate in the air, or was it an aftermath of the crash?

If structural failure occurred in the air, the part that gave way in flight usually is missing from the wreck and may be found some distance away. The direction of the breakage is a sure clue. Anything that gives way in the air will break upward and back, if the plane is flying normally, for gravity and air resistance furnish the stress. Breakage on impact will be forward and down.

A recent crash proved this point. Inspectors noticed that the air liner's vertical fin and rudder were missing. Examination of the remaining tail structure disclosed that there had been severe vibration and bending of the fin to right and left before the parts pulled away to the rear. Flutter was immediately apparent

2-406
 as the cause of structural failure in the air, and within three hours all planes of that type were grounded until the tail structure could be re-designed. This accident resulted in a new type of machine for measuring vibration periods, and all planes now constructed are subject to tests by these machines.

Loss of a flying boat led to experiments to eliminate fire and explosion hazards while dumping gasoline. That such was the cause of this accident was determined from meager clues, for the plane sank completely with all on board. Among the bits of floating wreckage was the navigator's drift target tray, through which a piece of plywood flooring had been driven edgewise. This tray appeared to have been wetted on its exterior with gasoline, which then burned. This single clue would have been sufficient to prove fire and explosion. This accident resulted in relocating and redesigning of the fuel dumping valves.

A baffling accident occurred when an air liner, circling over water in normal descent for a landing, failed to come out of the glide and dived into a bay. When the wreck was raised, the wheels of both control columns were found bent backward, showing that both pilots had made tremendous, if unsuccessful, efforts to level off. Low on one control column the paint was scarred, showing that something had jammed between it and the base of the pilot's seat. The controls, together with all loose objects in the cockpit, were forwarded to the Crime Detection Laboratories at Northwestern University, where the scar was quickly matched with the radio microphone, which had lodged behind the control column when one of the pilots dropped it.

But weather, rather than fire, freak, or structural failure, causes most accidents today. Too many are the result of becoming lost, through the pilot's inability to identify properly the radio range leg on which he is flying. Experts are battling with this problem, but the field is still wide open to the independent inventor.

Popular Mechanics Magazine can furnish the name and address of the maker of, or dealer in, any article described in its pages. If you wish this information, write to the Bureau of Information, inclosing a stamped, self-addressed envelope.



Made by Herbert Dallinger with a 4 x 5 Series B Graflex

Of Course, Mr. Dallinger Used a GRAFLEX

Most outstanding pictures are taken with Graflex-made cameras! For amateurs and professionals alike depend upon them for those hard-to-get shots that win prizes and recognition. Eventually you, too, like Mr. Dallinger will own a Graflex American-made, Prize-Winning Camera. Why not make your selection now—at your Dealer's?



R. B. Series B GRAFLEX

Here's the camera that made the unusual "stopped action" picture shown above. This camera has full-vision ground glass focusing, focal plane shutter with a wide range of speeds and revolving back for either horizontal or vertical subjects. Yet it is popularly priced. Three sizes: 2 1/4 x 3 1/4, 3 1/4 x 4 1/4 and 4 x 5.

2 1/4 x 3 1/4 Miniature SPEED GRAPHIC

Now equipped with a new tubular view finder that corrects for parallax and uses interchangeable lens matching masks, this Miniature Speed Graphic is more versatile than ever before. And it features built-in focal plane shutter flash synchronization for picture-taking day or night! Other Speed Graphic sizes: 3 1/4 x 4 1/4, 4 x 5 and 5 x 7.



While in New York for the World's Fair, visit the Graflex Display Rooms, 50 Rockefeller Plaza

FREE! Send for FREE catalog of Graflex and Speed Graphic American-made, Prize-Winning Cameras and Accessories and FREE 2 1/4 x 3 1/4 Miniature Speed Graphic folder. Paste coupon—or write your request—on penny post card, if you wish. Folmer Graflex Corporation, Dept. PM-2, Rochester, N. Y., U.S.A.



FOLMER GRAFLEX CORPORATION
 DEPT. PM-2, ROCHESTER, N. Y., U.S.A.

Please send me your free catalog of Graflex and Speed Graphic American-made, Prize-Winning Cameras and Accessories and free 2 1/4 x 3 1/4 Miniature Speed Graphic folder.

NAME _____
 ADDRESS _____
 CITY _____ STATE _____



GRAFLEX Prize-Winning CAMERAS

**MORE SPEED
•
MORE POWER**

DURO



**LESS WEIGHT
•
SMALLER OVERALL DIMENSIONS
•
MOTOR MFG. BY GENERAL ELECTRIC**

New \$9.95
DURO Streamline HAND GRINDER

Built to meet the demand for a really powerful Hand Grinder that is light in weight, compact, well balanced and can be used in one hand for fine work.

See it and you too will find this perfectly balanced Streamline Grinder fits the hand for delicate work without causing fatigue. It weighs only 12 ounces.

Operate it and you'll find it has amazing Power and Speed for such a compact tool—over 17 watts output at the spindle and a speed of 24,000 R.P.M.

Send for one on our ten day trial, money back guarantee.

Made By
The Manufacturers of America's Finest and Most Complete Line of Power Driven Machinery.

Duro Metal Products Co.
Dept. B-10, 2657 N. Kildare Ave.,
Chicago, Illinois



**— NEW — SENSATIONAL —
KEYLESS — ELECTRIC GAS TANK LOCK**

Cap unlocks—SNAPS OPEN by pressing a **BUTTON ON DASH**. Close the cap and it **LOCKS AUTOMATICALLY**. Now used as **STANDARD FACTORY ACCESSORY** by **GRAHAM**. Fully guaranteed. Exclusive sales territory granted. Write immediately to **SNAP-UP GAS CAP CO.** DEPT. B. **ASHLAND, KY.**

WOODWORKERS NEW BARGAIN BOOK

The 1940 Constantine Catalog makes available most complete source of fine woods. Packed with valuable useful facts, some not previously published. Gives free loaning details of our new educational motion picture for woodworkers. All who work with woods need it. Send 10c stamp or coin today.

10¢

ALBERT CONSTANTINE AND SON, INC.
791 East 135th St. **New York, N. Y.**
The Craftsman's Headquarters for Fine Woods

RADIOS..SAVE UP TO 50%



DEAL DIRECT — FACTORY PRICES
Many models to choose from at wholesale prices. AC-DC nudgets \$4.98. Portable and battery sets \$8.98 up. Car sets \$11.75 up. Also consoles, all-wave etc. Samples at 50% off. Send for **FREE 1940 bargain catalog** giving details of 10 day **FREE** trial and agent's proposition and discounts. No obligation, write today. **GOLDSTONE RADIO CO., DEPT. PM, DEARBORN, MICH.**

10 DAY TRIAL
\$4.95 EACH in lots of 3
R.C.A. LICENSES NEEDED

Free Catalog

MODERNIZE Overhead garage door hardware easy to install on old doors or new ones. Heavy steel springs do the work. Closes weathertight. Fingertip operation. Trouble free. Anyone can install. Complete with instructions. Free circular. Agents wanted. **R. W. WILKIE, Box 368, Independence, Mo.**

FREE **ATTRACTIVE CATALOG**

Artistic pins, rings and emblems for classes and clubs. Attractive prices. Finest quality, gold plated, silver, etc. Over 300 designs. Write Dept. N, **METAL ARTS CO., Inc., Rochester, N. Y.**

30¢ PINS

FREE TRAILER PARTS CATALOG

We'll save you money on—axles, springs, wheels, couplers, windows, sinks, water pumps, brakes, refrigerators, beds, lamps, inside and out, 6V lamps, furniture, jacks—everything. Special discount to mfrs. **NATIONAL TRAILER EQUIPMENT CO., Successors to Kar-A-Van Industries, Inc. Dept. P. 714 W. Wisconsin Ave., Milwaukee, Wis.**

Complete Plans and Building Instructions. 10c

Earn Cash at Home!

We paid **M. M. \$1174** for exceptional "cellar crop" **SNOW-KING mushrooms!** Big free picture book tells if your cellar, shed, barn suitable. We furnish materials, buy all crops. Write today. Est. 1908. **UNITED CO., 3848 Lincoln Ave., Dept. 307, Chicago.**

BUILD YOUR OWN RAILROAD!

FREE BOOK

TELLS ABOUT NEW THRILLING HOBBY!

The fun of creating and building a model railroad system and the excitement of operating it are two good reasons why you should get the facts on this fascinating new hobby right away! Send for free booklet which tells why you'll like it and explains how easy it is to get started. A 75c car plan drawing is included free—write for yours today!

SCALE-MODELS, INC.
1518 So. Wabash Ave., Chicago, Ill.



Welding Business Earns \$150 to \$300 for You Each Month

30 DAY'S TRIAL AT HOBART'S RISK AND EASY "PAYS FOR ITSELF" TERMS

New low prices make this profitable welding service available to everyone. Opens doors to big pay jobs that carry real profit. Hobart Welders are easier to operate, faster, guaranteed to bring you quality welding business... extra profits will pay for welder without expense to you.

NO INVESTMENT TERMS—PROFITS PAY FOR IT

Extra earnings and savings possible with Hobart Welders make it easy to own without expense. You can even rent a new Hobart and later purchase it without loss. Coupon brings details.

Free! VALUABLE BOOKLETS ON WELDING. CHECK YOURS AND MAIL THE COUPON TODAY.

- How to "Build-Your-Own"
- New Profits in Arc Welding
- New Arc Welding Catalog

HOBART
THE FASTEST SELLING ARC WELDER ON THE MARKET TODAY

Gas Engine Drive **Electric Drive**

"BUILD-YOUR-OWN"
Just couple your own engine to this unit, mount it on chassis and you have money making advantage of a portable welder at a saving of \$100 to \$500.

"Build-Your-Own" Unit

HOBART BROS., BOX M-109, TROY, OHIO
Gentlemen: Send me information on () Build Your Own Welder () Electric Drive Welder () 30 Days Trial, Easy Terms () Rental Plan. Also send me free books I've checked.

Name.....
Address.....

The War Horse Goes to College

(Continued from page 491)

mind them. Horses are social animals, with a strong tendency to follow the leader. The cavalry takes advantage of this trait; the rookie horse usually finds himself in the company of older horses, who nonchalantly do the things he is learning.

He is early accustomed to the sound of small-arms fire. There are usually rookie troopers learning to shoot, and the range is close enough that the horses hear the sound of firing. One morning the firing comes closer, while he is milling about in the corral with his fellow remounts and a leavening of older horses. A trooper fifty



Troopers recover machine-gun ammunition dropped by parachute from plane during recent maneuvers

yards away is firing blanks from a pistol. Other troopers are circulating among the horses, feeding them oats when they approach quietly. Finally the horse gets the idea that the noise, growing ever closer, is doing him no harm; and that he gets no oats as long as he kicks up a fuss.

After a session of this, the remounts are saddled, ridden along at a trot, then a gallop, while riders click strange black things called pistols close to their ears. And all the time that fellow in the distance, coming ever nearer, is shooting off blanks. The remount shies a bit at all this confusion, then remembers the association of noise with oats, gets his mind back on the business of obeying his rider. One morning the pistol near his ear roars instead of clicks, but by this time he pays no attention to the noise, even though the acrid fumes of smoke do tickle his nostrils.

The same way with the saber (now used only for exhibition purposes). The rider begins by partially withdrawing it from

(Continued to page 148A)



... until I told them about the mysterious things I can do with my

New RCA ELECTRONIC LAB!

RCA offers you two new Electronic Labs . . . With either of them, you can build your own radio . . . your own telegraph practice set . . . radio announce system and Magic Relay with which you can do many fun-full, fascinating things!

With the new RCA Electronic Labs you can build electrical devices, play with them, dismantle the parts and use them over again many, many times.

For example, you can build a radio receiver of your own. Or you can practice telegraph code on a telegraph practice set. You can hook a microphone into the family radio set and talk through it from another room. And with the Magic Relay, which you can also build, you'll have fun galore! It enables you to mysteriously ring bells, turn the radio on and off, and do many other unusual stunts.

The parts in the RCA Electronic Labs are similar to those used by famous radio engineers. Complete instructions make everything easy to build. And prices are as low as \$7.50. See these fascinating Labs at your RCA Victor radio dealer's—or any store where toys are sold. Big thrills await you.

For finer radio performance—RCA Victor Radio Tubes
Trademark "RCAVictor" Reg. U.S. Pat. Off. by RCA Mfg. Co., Inc.

Put on your own radio dramas...with sound effects!

SEE NEW RCA SOUND CONTROL STUDIO



ELECTRONIC LABS

AND SOUND CONTROL STUDIO

By-Products Division

RCA Manufacturing Co., Inc., Camden, New Jersey
A Service of the Radio Corporation of America

PERSONAL

Are you the wise, far-sighted type that can smile while others boil? You are...and you can... if you use "Prestone" Brand anti-freeze. It does not boil away. Contains NO alcohol...NO glycerine.

(SEE PAGES 118A and 131A)

Quick HEAT FOR EVERY HOME

1 1/2¢ PER HOUR

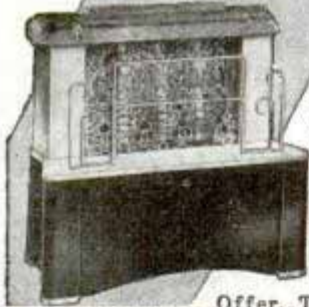

An Amazing New Radiant HEATER. Burns 96% air. Makes its own gas. No piping. No installation. Produces clean, healthful, penetrating heat like sunshine for 1 1/2 cents an hour. Hotter than gas or electricity. EASY TO OPERATE. No smoke, soot, ashes or odor. PORTABLE. 30 DAYS' TRIAL!

BURNS 96% AIR
only 4% FUEL

Write at once for special Introductory Low-Price Offer. TRY IT AT OUR RISK. Prove to yourself that you can have Radiant heat at 1 1/2 cents an hour. No obligation. Write AKRON LAMP & MFG. CO., 1200 High St., Akron, Ohio

AGENTS!
Make Big Money!
WRITE QUICK
for territory and
OUTFIT OFFER.

"PEPY" GASOLINE ENGINE GOVERNOR



Make your Auto, Truck or Tractor Motor into a steady, even power unit for all kinds of work. Fits any make of engine. Money back guarantee. Price, postpaid..... \$9.50
Harris Machy. Co., 505 30th Ave. S. E., Minneapolis, Minn.

WHY SCRATCH

"Keep a Jar or Tube of Lucky Tiger Ointment Handy"

Made to allay Itching and Burning Feet—Crusty Scalps—Ringworm—Itchy Rectal Irritations—Insect Bites—Stings—Itchy Scalp—Externally caused Pimples—Soothe fire and sunburns.

Get a jar at drug or 10¢ store or applications at barber shop.



ANTISEPTIC FOR Inhibitory Use when in proper contact—as in bandage or dressing for simple Cuts, Wounds, Scratches.

FREE 25c Trial Tube if you send us 6c in stamps to pay packing and postage.

LUCKY TIGER MFG. CO.
Dept. 63 Kansas City, Mo.

2662 (Continued from page 147A)

the scabbard, slapping it back. Finally he draws the weapon, waves it about, thrusts it slowly. Then the mount is ridden past dummies on the saber course, while the rider makes slow, quiet thrusts. Next day this will be repeated at a walk, then a trot, finally at a gallop; until the horse gets into the spirit of the thing, charges the dummy madly while the rider yells, carves the air close to his ears with the shining blade.

Jumps, too, are taken easily at first. They begin with nothing more than rails



It is easier to train horses for high jumps than broad jumps. The animals are shy of ditches and holes

on the ground, over which the horse is walked, then trotted. Soon the rails are placed higher, perhaps six inches off the ground, then a foot, two feet, three. Horses are allowed to approach these obstacles calmly, to study them, to jump by exertion rather than by flying leaps—this to develop the jumping muscles. When they clear the rails cleanly, they are introduced to jumps over hedges, oil drums, boxes. Only when they have been jumping easily for several weeks are they taken to the hurdle at a full gallop.

It is easier to teach a mount the high jumps than the broad. A ditch, three feet wide, eighteen inches deep, will frighten most horses at first. They are led over such obstacles at first, each rookie mount behind an experienced one. Only when they will jump with confidence when led are they ridden over. The ditches are increased in width and depth six inches at a

(Continued to page 151A)

New-TYPE Cheap OIL BURNER INVENTED Sweeping the Country!

COOK and HEAT Without Coal or Wood
 In Your Present Stove or Furnace—
HOTTER—No Drudgery, Dirt or Ashes—More Heat Quick at SMALL COST.

OVER 40,000 SOLD
 Beats any oil burner ever gotten out for low cost, perfect performance. Burns cheap oil a new way, without pre-generating or clogging up. Quick intense heat by Simple Turn of Valve.

30 DAYS' TRIAL
 Prove its efficiency, convenience and economical operation.
Write Immediately for FREE BURNER OFFER TO AGENTS

AGENTS Salesmen BIG MONEY
 F. Silver says: "I can dispose of 250 HEAT KINGS before this year ends." Sample Burner FREE to producers. Write us now for agents' offer.



Slips into Any STOVE RANGE or FURNACE
Quick HEAT At Turn of Valve!

who will demonstrate and take orders. Write quick, be first to learn how to make REAL MONEY right now, spare or full time—mail to postcard today.
UNITED FACTORIES, L-751, Factory Bldg., Kansas City, Mo.

Announcing My New LIQUID PLASTIC



OPENS NEW FIELDS FOR NOVELTY MAKERS

Unsurpassed for simplicity in casting **R. Stewart** all types of novelties from rubber molds. Pours into mold but comes out **hard, tough and resilient**, with beautiful, satin-smooth finish. No polishing necessary. This ease and simplicity of molding enables you to cast **hundreds** of salable items rapidly. No skill, expensive equipment, or previous experience needed. Liquid Plastic kit only \$1.00 in combination offer below.

STEWART'S RUB-ER-SPRA

Amazing Liquid Rubber for Making Molds
Rub-Er-Spra is a pre-vulcanized liquid latex rubber that makes the finest quality rubber molds. Unequaled for casting **Liquid Plastic, liquid marble, plaster** and other composition novelties. Anyone can make perfect **Rub-Er-Spra** molds at low cost by following instructions supplied **Free**.

EARN BIG MONEY With Composition Novelties
 Use your spare time in this fascinating, profitable business. With Stewart's **Rub-Er-Spra** you can make genuine rubber molds at a cost of only a few cents each and cast hundreds of fast selling composition novelties at profits from 1000% to 1500%.

3 SPECIAL BARGAIN KITS

- Don't Wait—Order Direct from this Ad—Today**
- Special Liquid Plastic Kit** Everything you need with full instructions for making casts..... **\$1.95**
 - Composition Novelty Kit** 1 qt. Liquid Rub-Er-Spra, spray gun, fine head model 5" x 7" and full instructions for casting plaster and other compositions **\$2.95**
 - Comb. Plastic & Rub-Er-Spra Kit** Two kits quoted above, complete \$4.90 actual value, only..... **\$3.95**

All Prices F. O. B. Chicago

STEWART'S STUDIO

2927 Wilcox St., Dept. PM-7, Chicago, Ill.

Sell Advertising BOOK MATCHES

WORLD'S LARGEST "DIRECT-SELLING" BOOK MATCH FACTORY
 Offers you a money-making connection in profitable year 'round business. Experience unnecessary. Full or spare time. All business firms prospects. MATCHCORP'S new, faster-selling features; high quality; low factory prices; quick deliveries; bring easier orders. Repeats boost earnings. Kit, full instructions, FREE. Write today!
MATCH CORPORATION OF AMERICA
 3433-43 W. 48th Place, Dept. M-10, Chicago, U. S. A.



ELGIN & WALTHAM WATCHES
 Send for new illustrated watch and jewelry catalog. Many attractive buys. Make extra money, too. From **\$3.50**
PLYMOUTH JEWELRY EXCHANGE
 163 Canal St., Dept. M., New York

JIG SAW \$1.50
 COD or outside U.S.A. \$1.75
POST PAID



Including 12 assorted blades, Adapters, Manual, and roller Saw Guide formerly found on expensive machines only. All metal, 13" long, 8" high, 6 1/2" table. A swift and easy cutter—best ever made for the money.
 Satisfaction guaranteed or money back if returned within 5 days, describing complete power tool line: Shaper, Circular Saw with oilless bearings, \$3 each; Drill Press, \$2.50; completely equipped Lathes, \$2 and \$4.90; Sander, \$1, etc. Order today or send card for Catalog.
FREE CATALOG

J & H Metal Products Co. 5 Commercial St. Rochester, N. Y.

SUCTION SPONGE



Cleans Cars NEW WAY
AMAZING INVENTION. Banishes auto-washing drudgery. Cleans linoleum, woodwork, windows like a flash. Auto owners, housewives wild about it. New! Sells like wild! **AGENTS WANTED EVERYWHERE.** Hustlers cleaning up big money.
SAMPLE OFFER Samples sent on trial in each locality who writes. No obligation. Get details. **Be first—send in your name TODAY!**
KRISTEE CO., Dept. 675, Akron, O.

NEW TURN SIGNAL

FLASHES from REAR WINDOW—DASH Control
AGENTS A whirlwind seller. Drivers buy on flash demonstration. Dealers buy 3 to 12. Your profit mark-up as high as 264%. Biggest sensation of year. Rush name quick for facts and Demonstrator sample plan. All Free! Rush.
WATCH-MY-TURN SIGNAL CO., Dept. 1610, Walnut Bldg., Des Moines, Iowa
 Always write your name and full address clearly when answering advertisements.

RADIO SEND FOR NEW 1940 CATALOG

SETS • PARTS KITS • RA • HAM GEAR AT LOWEST PRICES
 Now ready!—**ALLIED's** big new 1940 catalog. 204 pages, 5 Big Sections with Everything in Radio at Lowest Prices! 60 sensational 1940 Sets, 4-12 tubes, all types—newest phonographs, record players, phono-radios, recording equipment, latest Sound Systems, Amateur sets, new Builder's Kits, test equipment, and over 15000 radio items—all in one Big Book at lowest prices! Free—send coupon today!
ALLIED Radio Corporation,
 Dept. 5-K-O, 833 W. Jackson Blvd.
 Chicago, Illinois
 Send your Free 1940 Catalog.
 Name.....
 Address.....
 City.....State.....
FREE

1008 George St. Lake Geneva, Ill.

SAVES TIME... TROUBLE TEMPER



ONE OF MANY *Fine* MILLERS FALLS TOOLS

Let this hard-biting saw lick your cutting troubles; it's not just a keyhole saw, but a real *Keyhole Hack Saw* that gets into awkward corners, and makes tough jobs easy. Cuts nails, metal lath, plaster board, stucco, BX, packing, bone, Bakelite, etc. Light, comfortable handle; 5½ inch blade. Ask your dealer; if he cannot supply you, slip a quarter into an envelope and mail direct to Millers Falls Company, Greenfield, Mass.

25¢

FREE with Keyhole Hack Saw

Millers Falls No. 42 Tool Book, 240 pages crammed with illustrations and descriptions of hundreds of fine, dependable Millers Falls and Goodell-Pratt tools, will be sent promptly for 10c to cover postage and handling costs—or FREE with your order and remittance of 25c for the Keyhole Hack Saw. Satisfaction guaranteed or money refunded.



MILLERS FALLS CO.
GREENFIELD MASS.

Clymer WINDSHIELD SPOTLIGHT!

NEW • MODERN • STREAMLINED

Operated through the windshield from inside the car—no cogs, gears, outside mountings—direct, quick action focusing easily locates house numbers, street signs, detours. Unusually effective in fog, rain, snow. Easily installed, one model fits all cars! Quickly removed for use as trouble or camp light. No other spotlight has the beauty, convenience of the new Clymer. Endorsed by traffic bureaus, safety councils, state officials. Be safe—put a Clymer Windshield Spotlight on your car NOW... new low price. See your dealer or order direct. FREE folder. Jobbers, dealers, write for full information.



\$9.50

Dept. C-4

Clymer SPOTLIGHT COMPANY

222 West Pico Blvd. • Los Angeles, California

TRY DIXON'S GRAPH-AIR GUNS

A squeeze of a Dixon's Graph-Air Gun shoots *dry* Dixon's Microfyne Powdered Graphite straight to the source of friction—banishes binding, removes rattles, and squelches squeaks. Lasting lubrication, unaffected by heat, cold, or moisture. Excellent for locks. At your dealer's—or write Dept. C-G-26.

75¢

for 900 shots from the Flexophone "Junior" model. Extra handy—extra compact. Comes mounted on display and instruction card.

buys the big, long-lasting, rubber refillable model. For shop, auto servicing and other uses. Can of 8 full refills costs only 50¢.



30¢

JOSEPH DIXON CRUCIBLE CO., JERSEY CITY, N. J.

GET UP TO 6 MILES MORE PER GAL.

OPERATES ON AMAZING NEW PRINCIPLE!

The GAS MASTER economizer is a new discovery and entirely different! It automatically injects air thru vacuum line into carburetor—produces a perfect firing mixture. Installed in one minute! Gives your car new pep, faster acceleration and more mileage.

MONEY BACK GUARANTEE: The Gas Master has proven so successful that we guarantee your money back if it does not save gas and running expense! Price \$1.75 Postpaid.

FREE to all AGENTS For introducing the GAS MASTER we give all agents a special free offer! Because of its sensational performance and low attractive price—our agents report unusual success and big profits! Write us.



Pat. No. 2124238

G & M MFG. Industries, Dept. 4, 2161 N. Farwell, Milwaukee, Wis.

The DUAL Precision LATHE



12 In. Swing
47 to 3000 rpm
Timken Bearings

For Wood Turning, Metal Turning, Screw cutting, etc.

Write for catalog
CLAUSING MFG. CO.
Ottawa, Iowa

A BIG DEMAND

from Coast to Coast for

GENUINE LEATHER TIES

Look like Silk, cleaned with a damp cloth. Also

READY-TIED SILK 4-IN-HANDS

Century quality and workmanship make these lines fast sellers. Send 50c for sample kit of either line, specifying whether leather or silk.

Sell on Sight

CENTURY TIE CO., Mfrs., 2345-P W. Grand Blvd. Detroit, Mich.
(Originators of Leather Ties)

PRACTICAL MAGNIFIER... \$1.00



A practical, easy-operating and attractive magnifier with 2½ power, 2" dia. lens and two fully adjustable ball joints. Raises to 3¾" high. Finished in chrome plate and crinkled enamel. An ideal instrument for home, office and shop. A big value—\$1. postpaid.

The MAG-NI-LINE PRODUCTS
Dept. 12, 3456 E. Jefferson Detroit, Mich.

SHAW GARDEN and ALL-PURPOSE TRACTOR



Low "FACTORY-TO-FARM" Prices. 2 to 8 Horsepower Models. Walking and Riding Types. WRITE for 10 DAY TRIAL PLAN and BIG FREE CATALOG.

SHAW MFG. CO., 4510 Front St., Galesburg, Kans.
5812 G Magnolia Ave., Chicago, Ill.; 139G W. 42nd St., New York; 668G North 4th Street, Columbus, Ohio

POSTER STAMPS Gummed

Camps, Resorts, Scenes, Lodges, Business, Personal, Monogram, or Monogram and address, etc. Use on cards, stationery, records, books, sheet music, bridge cards, match books, etc. Actual size 7/16" 1000-\$1.50. Double size \$2.50. Post. Send drawings or view to size. Any Style. **ARROWPRINT, DIO, Waterbury, Conn.**



A DEPENDABLE STEAM ENGINE for boat models up to 36" in length. Model SE-3, a two cylinder, slide-valve type. Bore 5/16", Stroke 1/8", Length 7", Width 3", Height 3 1/2". Price complete ready to run with burner and propeller... \$3.00 Postage extra, shipping weight 1 1/2 lb.

SHAWNEE ENGINE CO.
Box 162, Station D, Cincinnati, Ohio

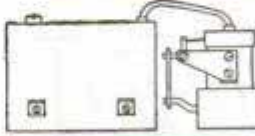

WoodWORKERS Here it is!

HAROLD HUNT'S latest edition 1940 catalog. Nothing like it ever before published—136 pages—new designs, new ideas for experts; also special instructions for beginners. AND—LISTS OF ASTONISHING BARGAINS in all kinds of wood-workers' supplies. Get this book! **ONLY 10¢!**

CRAFTSMAN WOOD SERVICE CO.
2729 S. Mary Street Div. 3377 Chicago, Ill.



(Continued from page 148A) 9662

time, from day to day, until all horses are clearing eight feet.

Fording and swimming are also matters of follow the leader. At fords, experienced horses are ridden into the water, and the remounts follow. For the first swimming lesson, older horses are swum to the other side, to give the rookies a goal. Then the riders row out in boats, tempting the remounts into the water with oats. Soon food is not needed for bait, the men riding into the water, dismounting, and swimming alongside with a hand on their mane.

In three months the remounts are turned over to troops, ready for any service. They are familiar with danger; and being creatures of habit, they are not afraid of it.

Snow Cruiser to Explore Antarctic 2847

(Continued from page 495)

of the opening, then slide its nose on the far side with front wheels drawn up and rear wheels furnishing power. As the front wheels touch "land," they will take over the job of pulling while the rear wheels are retracted and the tail slides on the snow. One man in the "second story" cabin will handle all controls. Below him is the repair shop; to the rear, navigation chart desk, engine room, galley which is also photographic darkroom, bunkroom, storeroom and a compartment in the tail for two spare tires. The ski-mounted plane, carrying a seven-lens mapping camera, can be hauled to its perch by a winch or launched on the snow in ten minutes. Carbon black "bombs" will be dropped from the plane to mark its trail and act as reference points on photographs. The cruiser will have a 5,000-mile range, and will travel at from ten to thirty miles an hour under any conditions except severe blizzards. An automatic gyropilot may be installed to hold the cruiser on any course set. Front and rear wheels steer independently so that the Antarctic bus can turn in a thirty-foot radius or shift sidewise at a twenty-five degree angle. The scientists will measure thickness of the ice with the geophysical seismograph, make gravity determinations and meteorological observations, survey unexplored Antarctica and study the Aurora, terrestrial magnetism, meteors and other phenomena. Cruiser and equipment will cost about \$150,000.

"I SMELL SMOKE!"

IT'S TOO LATE TO MAKE THIS NECESSARY LIST AFTER FIRE STRIKES

HOUSEHOLD INVENTORY

KEEP THIS BOOK IN A SAFE PLACE

WHETHER you realize it or not, every fire insurance policy that you have requires that all lost and damaged property must be named—before insurance is paid.

That's a hard thing to do *after* a fire. But it is easy to make an inventory of your property, and be prepared in case of fire.

Send for this free Household Inventory Booklet. In it you can list everything—room by room. The booklet helps you by suggesting many things that are often overlooked. Mail the coupon today. There is no cost or obligation.

FREE

THE AMERICAN INSURANCE GROUP
15 Washington St. (Dept. 2812)
Newark, New Jersey

Without charge or obligation, please send me your Household Inventory Booklet.

Name M _____

Street _____

City _____ State _____

FREE—NEW 52-PAGE CATALOG LIONEL TRAINS



Printed in full color and filled with pictures of exciting new train combinations, new engines, new accessories and an amazing new Lionel "Trainmaster" Transformer. Be the first to have a copy of the new 1939 Lionel Catalog. Clip and mail the coupon today. Send no money. It's free.

The Lionel Corporation, Dept. K
15 East 26th Street, New York, N. Y.

Please send a new 52-page, full-color Lionel Catalog to:

Name _____
Address _____
City _____ State _____

THOR Streamliner..



\$42⁵⁰
2.4 H.P.

Throttle Accelerator
High Compression
Positive Cooling
Rust-Resisting Finish
Semi-Weedless Propeller
Dependable

Cylinders Bored To Mirror - Like Finish On Latest Type Diamond Boring Machines. Hold Compression even when dry.

NEW POWERFUL SINGLE

Travels Measured Mile Faster Than Motor Costing Twice As Much, Using Same Boat and Same Load.

Buy..

On Dollar Per Horsepower Basis It is the ONLY way you can determine THE outboard motor that gives you the most for your money. **THOR OUTBOARDS RATED** at the propeller on a dynamometer are the great values today.

SINGLE PULL STARTING Thor Outboard Motors give you Beauty—Strength—Simplicity—Power—Trouble-Free Operation—Easy Handling—Low Cost and Quick Starting. (One pull usually starts even a Cold Thor Motor.)

THROTTLE TROLLING—minimizes fouling of plugs—keeps motor clean and smooth running.

THOR ALTERNATE TWIN One of the sweetest motors you've ever heard. Run constantly the equivalent of 5000 miles without trouble. A motor you can depend on to get you anywhere and back. 4.1 H. P. Control it as you do your car—with a throttle.

Only 3 Cylinder In The World THOR ALTERNATE THREE Thrill to the smooth surge of three power impulse each revolution. The same as a 6 cylinder auto engine. Enjoy the full meaning of "overlapping torque."
6.2 H.P.—only **\$110⁰⁰**

Make The "Dollar Per H. P." Comparison. Then buy the outboard motor that gives you the most for your money. If your dealer can't supply you with THORS write direct to the factory giving us the name of your dealer.

DEALERS: Fine THOR territories still available. Write at once for discounts and full information.

KIEKHAEFER CORPORATION

Dept. PM-1

Cedarburg, Wisconsin

PRESTO! MASTER GLAZE

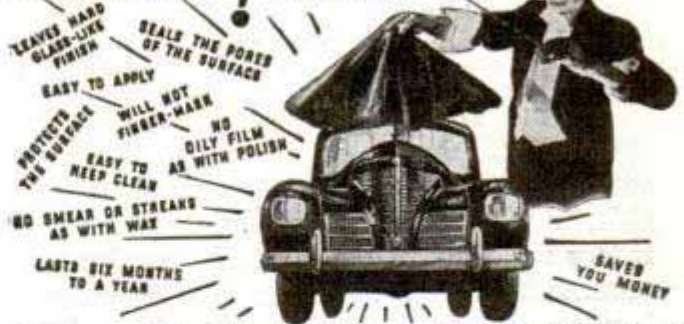

Car Owners! Meet Master Glaze—the sensationally different luster for new and used cars! Not a wax—not an oil polish—not a paint!—nothing that "smears" over the surface.

MASTER GLAZE is a unique discovery—a creamy liquid—quick and easy to apply! Gives a hard, glass-like surface. Even gasoline cannot dull it! Lasts six months to a year! Amazing luster—beautiful, sparkling clean and brilliant! Doesn't finger-mark—doesn't smear! A match box full glazes an entire car. Seals the pores—protects! NOTHING LIKE IT! **FREE SAMPLE** Write now for **FREE BOOK-LET** and **FREE TRIAL OFFER**. Just send your name and address. Write **MASTER GLAZE CO., 7720-125 W. Harwood Ave., Milwaukee, Wis.**

Work Faster Make More Money with the

Red UNIVERSAL TRACTOR

With this practical machine and attachments you can do all field and belt work hours faster at the low cost of 33c per day. Many units pay for themselves the first season. Unusually easy to handle and operate. Absolutely safe. Hundreds of users. Buy direct at low factory price. Two weeks' trial—satisfaction guaranteed. Write for colorful, free catalog.

PIONEER MFG. CO. Dept. V-109 West Allis, Wis.

GUNSMITHING for PLEASURE or PROFIT!

World's Greatest Gun Catalog! Stoeger's 1940 Edition. Only complete gun tool section for amateur and professional. Finest hand tools. All American—most imported guns. Accessories. LATEST REVISIONS & PRICES. Ballistics, Restocking, Reloading. All Gun Parts, Stocks, Barrels, Targets, Shooter's Articles, etc. Send a **Dollar Bill**, check, coin, m. o. or stamps for this 512 Page Volume.

512 PAGES 16,000 ITEMS 6,000 PICTURES

STOEGER ARMS CORP.
507 FIFTH AVE. (at 42nd St.) NEW YORK, N. Y.

Choose from World's Largest Line of Power Tools!
FREE 48-page Catalog covers Metal and Woodworking Tools, accessories, motors for every purse. Write Walker-Turner Co., Inc., 1109 South Ave., Plainfield, N. J.

DRIVER Engineered POWER TOOLS

TRAILER BODY
For Ford T Chassis. Furnished KD so that anyone can assemble it with a few hand tools. This allows you to save up to 75%. Complete with all fittings, hardware, bolts, brackets, hitch, paint and complete blue prints and instructions for assembling only \$48. Write **CERTIFIED PRODUCTS CO., DEPT. 3, LOUISVILLE, KY.**

NOV! Real Performing RADIO

BEAUTIFUL—PLASTIC—CABINETS

Midget radio fits your pocket or purse. Weighs only 4 ozs. Small as cigarette package! Receives stations with clear natural tone. "PATENTED FIXED CRYSTAL"—NO UPKEEP—only one moving part. "WIRELESS, TUBELESS, BATTERYLESS." ENTIRELY NEW PATENTED DESIGN. Has enclosed geared luminous dial for perfect tuning. Many owners report amazing reception and distance.

ONE YEAR GUARANTEE

Send completely ready to listen with instructions for use in homes, offices, hotels, boats, in bed, etc. **TAKES ONLY A SECOND TO CONNECT—NO ELECTRICITY NEEDED!** **SEND NO MONEY!** Pay postman only \$2.99 plus postage on arrival or send \$2.99 (Check, M.O., Cash) and yours will be sent complete postpaid. A most unusual value. **ORDER NOW! MIDGET RADIO CO., Dept. P-10, Kearney, Nebr.**

Watching Mother Earth's Pulse

(Continued from page 511)

The earthquake vibrations felt by man last from a fraction of a second to as much as forty seconds, as in the great San Francisco quake. Quakes in India have been said to last five minutes. Seismological instruments, however, record temblors long after man ceases to feel them—sometimes for hours.

The west coast of the United States lies within one of the two great earthquake belts that girdle the globe. One rims the Pacific Ocean from Chile, up through Mexico and California, across Alaska and the Bering Strait, down into Japan, the East Indies, New Zealand and the South Seas. The second great belt extends in a general line from Spain, through the Mediterranean, across the Himalayas to China.

The United States has suffered several memorable quakes including the Charleston, S. C., earthquake of 1886; San Francisco in 1906, Santa Barbara in 1925, Long Beach in 1933, and the Helena, Mont., quakes of 1935.

These disasters, however, were insignificant compared with major quakes in other parts of the world. The great Lisbon quake of 1755 killed 50,000 persons; the 1897 quake in Assam, India, covered an area of destruction of 160,000 square miles; and the great Japanese earthquake of 1923 took 250,000 lives.

Geologists have been trying to determine a method by which quakes can be predicted. "But as yet," declares Prof. Byerly, "there is no evidence to show that quakes can be forecast."

Sunspots and the relative positions of sun and moon are said to influence earthquakes, but such theories are largely hypothetical. Japanese scientists claim that a slight tilting of the earth's surface precedes a large quake. Four tilt-meters have been installed at the University of California to test this theory but not enough information has been yielded yet.

Even though earthquakes cannot be predicted, science feels that it is not wasting its time by watching the pulse of old Mother Earth. Fault lines may be located and avoided by builders. The effect of quakes on different types of soil has been discovered. Field observations and laboratory tests determine the best way to fortify skyscrapers and apartment houses against the sudden attack of temblors.

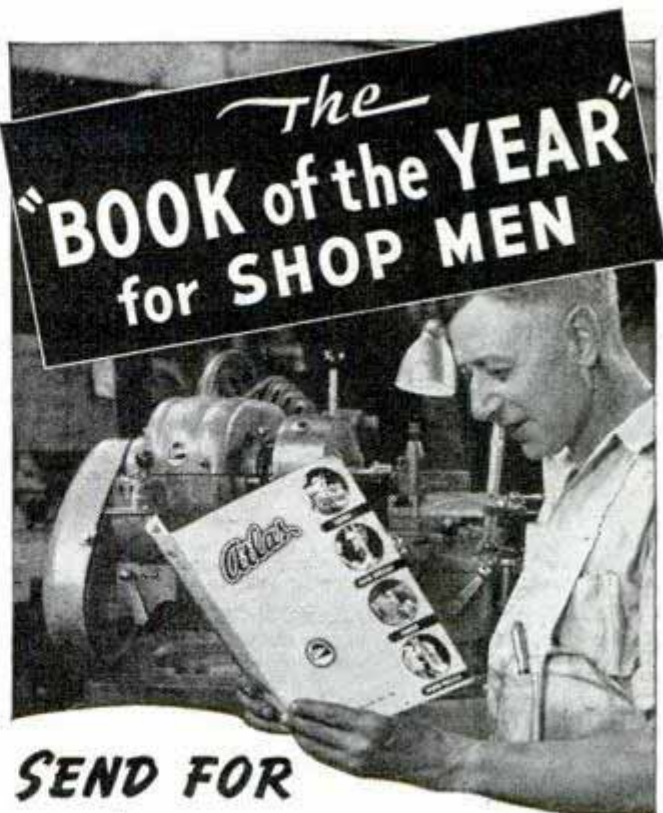

**SEND FOR
YOUR FREE COPY TODAY!**

Metal Working
Lathes
10" and 6"
•
Drill Presses
4 Sizes, 4 Prices
•
Metal Shaper
•
Arbor Presses
•
Vises
•
Wood Working
Lathes
•
Disc Sander
•
Motors—
Grinders

72 pages of interesting machine operations, equipment closeups, shop views, construction details, new and helpful machinery facts . . . that's a snapshot preview of the big new 1940 Atlas Catalog to be ready for you this month.

Summer is development-time at Atlas. Our engineering staff has been installing new precision production equipment and improving methods to make Atlas machine tools ever better and better.

All these contributions will be found in the new Catalog. Be sure to reserve your copy today.

ATLAS PRESS CO.
1043 N. Pitcher St.
KALAMAZOO, MICH.

ATLAS PRESS CO., 1043 N. Pitcher St.,
Kalamazoo, Mich.

Please put my name down to receive your new 1940 Catalog on New 10" Metal Lathes New 6" Metal Lathe New 7" Shaper Drill Presses Arbor Presses Visers Motors and Grinders.

Name.....

Address.....

City and State.....

I am already an Atlas owner.

When writing please mention Popular Mechanics

FREE TRIAL OFFER

NEW REMINGTON DELUXE NOISELESS PORTABLE!



AS LITTLE AS
10¢
A DAY

The New Famous Remington Deluxe Noiseless Portable that speaks in a whisper, is yours for as little as 10c a day. Brand new. Standard key-

board. Automatic ribbon reverse. Variable line spacer. Touch regulator and all the conveniences of the finest portable ever built. PLUS the NOISELESS feature. Act now. Send coupon TODAY for details.

You don't RISK a Penny

We will send you the Remington Deluxe Noiseless Portable for 10 days' free trial. If you are not entirely satisfied, send it back. We pay all shipping charges.

FREE Typing Booklet, Special Carrying Case

You receive FREE a complete simplified booklet on Touch Typing prepared by experts. A handsome, sturdy carrying case is included. No obligation. Mail coupon for full details—NOW.

Remington Rand Inc., Dept. 152-10
465 Washington St., Buffalo, N. Y.
Tell me, without obligation, how to get a Free Trial of a new Remington Noiseless Portable, including Carrying Case and Free Typing Course on terms as low as 10c a day. Send Catalogue.

Name.....
Address.....
City..... State.....

A FREE ENCYCLOPEDIA ON SOUND EQUIPMENT!

SHOWS YOU How to Choose the Right Sound System for ANY Location! Just measure the auditorium and look in the book. It tells you what amplifier you need—and how many speakers, of what kind, and where to place them!

TIME PAYMENTS! 15 DAY TRIAL! MONEY BACK GUARANTEE! FULLY LICENSED! LOWEST PRICES! NO SOLDERING (everything plugs together)!

MONTGOMERY WARD

9 GREAT MAIL ORDER HOUSES—MORE THAN 600 RETAIL STORES

MONTGOMERY WARD & CO.
Dept. TM-31, Chicago, Illinois
Please RUSH me your FREE Sound Equipment Catalog.

Name.....
Address.....
City..... State.....



\$ CHRISTMAS MONEY \$

There's a big demand for the many hand-tooled articles you can make with the Esaco Leathercraft Set. Make your own Xmas Gifts and easily learn to make good money in your spare time. Complete outfit, including tools, leathers, patterns, etc., and full instructions, only \$2.00—on sale at leading Department Stores or order direct and pay postman on arrival. \$2.50 outside U. S.

LEATHERCRAFT

Free When ordering direct, clip name of your Department Store to this ad, and we will include with your set, one extra free project. Illustrated catalog 10c.
E. A. SWEET CO. Dept. A-27 Binghamton, N. Y.



STUCCO MACHINE
Offers EXTRA EARNINGS

Renew old buildings. Make new construction more permanent and attractive. Plastic Colorcrete is waterproofed. It fused with any masonry surface. It fills all cracks. It can be applied in any thickness and in 30 colors. Fully proven by over 12 years actual use under all conditions and every climate.

OFFERS BIG EARNINGS

Owners everywhere want to enhance present values. With this machine you can supply this big waiting market with permanent Colorcrete at amazingly low cost. Operators report cost of 2c and up per sq. ft. and sell up to 7c. Some have paid for their equipment from first few jobs. Machine capacity up to 1,000 sq. ft. per hour. Get the facts. Send for the books. "Proven Business Opportunity." Write today. It offers you big extra income.

COLORCRETE INDUSTRIES, INC.
570 Ottawa Ave. Holland, Mich.



PRECISION OILER

New

for HOME WORKSHOPS

ONLY
50c
POSTPAID

Handy as a Fountain Pen!

Pres-to Oiler applies exactly the right amount of oil in just the right spot by simply pressing the steel point. Automatic — 1/10 drop each press — no drip or smear. Transparent oil reservoir. Clips in pocket like a fountain pen. Hundreds of uses in home and workshop. Praised by every user as the perfect oiler for all needs. Satisfaction guaranteed. Ask your dealer. If unable to obtain locally, send 50c for direct post paid shipment.

THE DILL MANUFACTURING CO.
Dept. 105 — 700 E. 82nd. St., Cleveland, Ohio

In answering an advertisement with a coupon, be sure to write name and complete address clearly. Sometimes advertisers are unable to respond to inquiries due to lack of complete information.

ELIMINATE FORD BRAKE TROUBLES

Your Ford Car is listed in the so-called lower priced class but has more brake lining area and larger drums than the others, in fact as much or more brake area than all but the higher priced cars. You can have safe, sure, unailing mechanical brakes. Install easily yourself our Simplex Floating Wedges to center the shoes for mechanical assurance with hydraulic performance. A set of four, one for each wheel, all for \$1.75. All models 1928 to 1938—Send for circular.

SIMPLEX WEDGE EXCHANGE, Dept. PM-10, 611 Jefferson St., Ottawa, Ill.

FREE

WHOLESALE CATALOG OF 4000 BARGAINS

FOR SALESMEN—DISTRIBUTORS

It has 260 pages, chock-full of unusual values. It contains selling plans; order stimulators; tested fast selling articles to dealers, stores and direct to the consumer. A new revised issue is just off the press. Cost about 25c. FREE, while stock lasts. Send for your copy, Today.

SPORS CO. 8-39 Elm St., Le Center, Minn.

HANDEE Hobbies

Get more out of life. Make things with our easy working plans, 75 new, intriguing projects for the home, gifts or to sell—models of ships, planes, houses; engraved glassware, trays, mirrors; statuettes, book ends, etc. Portfolio of 12 plans, 25c.

TOOL OF 1001 USES

A tool shop and power house in one. Plugs in any electric socket. Grinds, drills, polishes, cuts, carves, routs, saws, sands, sharpens, engraves, all materials. Write for FREE 64-page catalog. Shows Handees \$10.75 up.

CHICAGO WHEEL & MFG. CO.
1101 W. Monroe St. Dept. PM.
Chicago, Illinois



10 DAYS FREE TRIAL



NO DRUDGERY or ASHES

COOK HEAT with CHEAP OIL
NEW TYPE OIL BURNER at **Amazing LOW PRICE**
Slips Into Any Stove, Furnace
QUICK HEAT at TURN of VALVE

Steady, even heat, much or little, by turn of valve—better cooking, baking, heating. One of latest oil burner patents—will not clog up—no cups or wicks or needle valves—entirely different.

30 DAYS TRIAL Write today for NO-RISK offer. Try it before deciding—see how it SAVES in fuel, ends drudgery of coal.

SAMPLE BURNER for AGENTS

Write quick for SAMPLE OFFER that brings you one for demonstration. A real money maker—big season starting now. Act quick—send no money, just your name, address.

ATLAS BURNER CO., 290-M, Kansas City, Mo.

ADDING MACHINE only \$**6.95**

FOR HOME OR BUSINESS

Full five-column size. Adds accurately up to 99,999. Easy to operate. Saves time and eliminates errors. Big help in keeping current accounts, figuring taxes, etc. Ideal for store, shop, home. Sturdy all-metal mechanism. Beautiful walnut-finished cabinet. Positive guarantee of satisfaction or money back. Pay postman \$6.95 plus postage when delivered, or send \$6.95 with order and we ship prepaid. Order now!

KEL-SAN MFG. CO., Dept. 910, Dayton, Ohio



BOOKS FOR TODAY'S BIG OPPORTUNITIES

List sent free upon request
Popular Mechanics Press, 200 E. Ontario St., Chicago

Chucks for Small Lathes 3 inch \$4.25 prepaid
Lowest Prices Ever Offered

Four-Jaw Independent as shown
A precision product, with drop-forged reversible jaws and alloy body at money saving prices. Sturdy, durable. I ship all charges prepaid, on guarantee of Satisfaction or Your Money Back. Sizes from 3" to 10".



Get Pocket Slide Rule Free

An accurate, practical 8" pocket slide rule and case free with your order for my new Catalog of Small Precision Tools for your workshop. Low prices on items you need—3-jaw chucks, variable speed countershaft, tornado levels, V-belts, pulleys, etc. Order today—25c.

CATALOG 25c Including Slide Rule
JOHN L. ALEXANDER
422 Superior Drive, Detroit, Mich.

"PARKER" ETERNAL LITE

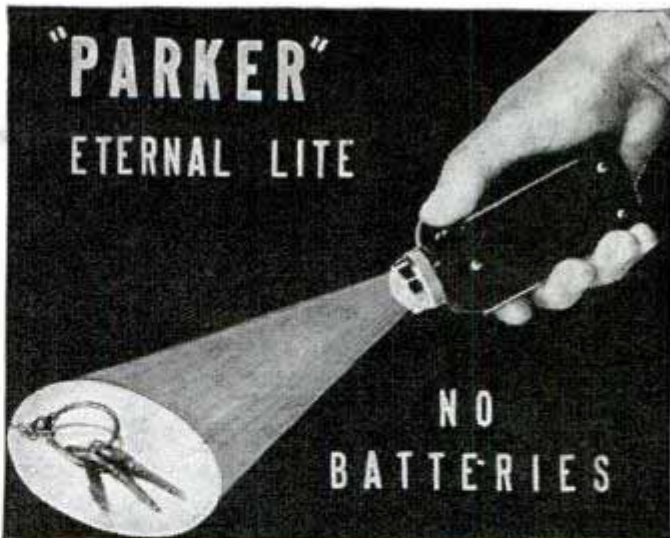

NO BATTERIES

GOOD BYE TO BATTERIES!
GENERATES OWN "JUICE"

NO MORE BATTERIES TO BUY—A never-falling Eternal supply of current with brilliant continuous light. The "PARKER" is "always there"—anytime—anywhere—today, to-morrow or ten years hence. Battery failures now banished forever. A gentle press gives a continuous light of brilliant duration—Plenty of power—plenty of reserve.
REPAYS ITS COST MANY TIMES. Ideal for Autos, Boats, Airplanes, Homes, Camping, Fishing and all emergencies. A quality product made in U. S. A. sturdily built—beautifully designed. Bakelite Case—Chrome trimmed.
Get yours TO-DAY on our MONEY-BACK trial.

Postpaid anywhere—\$2.25 each.

PARKER MFG. CO., 2024 N. Clark St., Chicago, Ill.

Send C.O.D. I will pay Postman \$2.25 plus few cents postage.
 I enclose \$2.25 send Parker Lite postage prepaid.

NAME.....

ADDRESS.....

WILL YOU INVEST 10¢ TO LEARN ABOUT A BIG LAUNDRY SAVING?



LINENE REVERSIBLE COLLARS are the convenient way to collar economy.

Indispensable to office workers and uniformed men. . . Look neat and clean at all times. . . 12 different styles. . . Wear BOTH sides. . . Throw away when soiled. . .

Use brand NEW collars all the time at less expense than laundering old ones. . . Send a dime today for samples of two collars and style sheet. You can't lose. Be sure to state your size.

REVERSIBLE COLLAR CO., 111 A Putnam Ave, Cambridge, Mass.

Spiffy COLLAR STAY
Prevents curling Prevents wrinkles
SELF ADJUSTABLE AND INVISIBLE
GET A SPIFFY STAY today
It gives you that starched collar appearance with soft collar comfort. If your dealer cannot supply you, order direct. Send 25c (coin or stamps) for silver, 50c for Deluxe 24K Gold finish. State name and address of dealer who was unable to supply you and we will include free an attractive tie chain.
CREST SPECIALTY CO.
663 W. Washington Street, Desk H, Chicago, Illinois



At Your Men's Shop or Jeweler

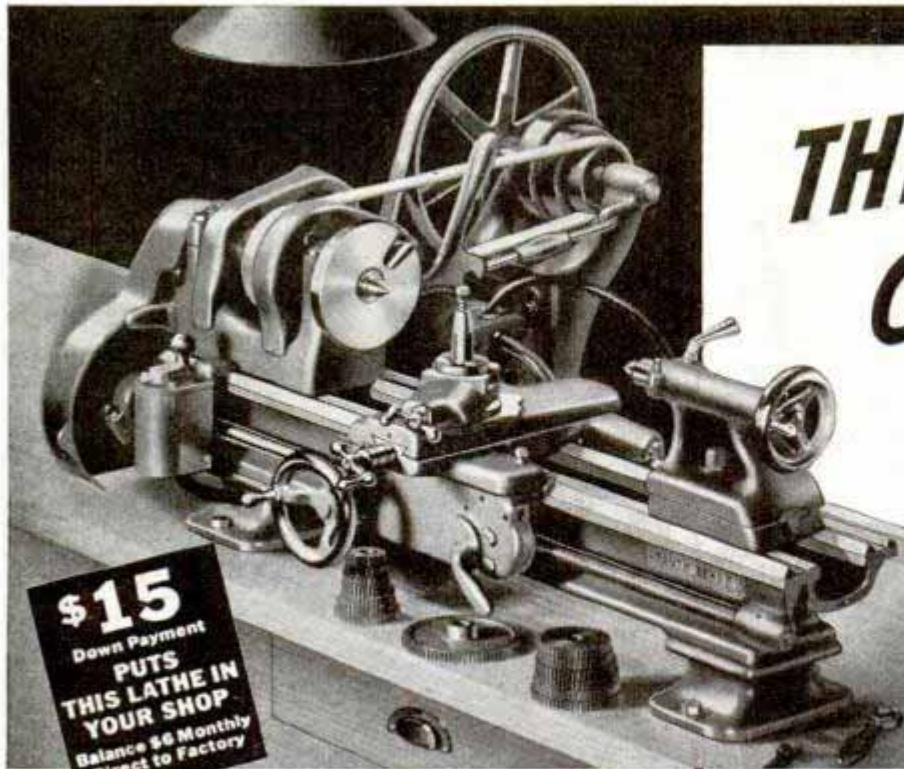

\$15
Down Payment
**PUTS
THIS LATHE IN
YOUR SHOP**
Balance \$6 Monthly
Direct to Factory

THE BEST COSTS LESS

Only Good Shop
Equipment Gives
Satisfactory Service

9" Workshop Lathe

NOW AVAILABLE
IN THREE MODELS

Model C, 9 1/4" swing by 3' bed Workshop Bench Lathe with Motor Drive as shown. Shipping weight 320 pounds **\$127**

MODEL A — Power Cross and Longitudinal Feeds through friction clutch. Quick Change Gear Box.
MODEL B — Power Cross and Longitudinal Feeds through friction clutch. Plain Change Gears.
MODEL C — Power Longitudinal Feeds through Half-Nuts. Plain Change Gears.

FEATURES

THAT INSURE ACCURACY AND LONG, DEPENDABLE SERVICE

1. Semi-steel lathe bed, heavily constructed.
2. Hand-scraped V-ways on lathe bed.
3. Heat-treated alloy steel headstock spindle with precision ground bearing surfaces.
4. All steel and iron construction.
5. Precision machine cut gears.
6. Precision lead screw cuts screw threads to most exacting tolerances.
7. Ball thrust bearing for spindle.
8. Twin gear reverse on headstock for right and left hand threads and feeds.
9. Precision graduated steel micrometer collars on cross feed screw and compound rest screw.

LOOK beyond the selling price when you buy a lathe, for the first cost must be divided by the number of years of satisfactory service to find the actual cost per year. Longer and more dependable service, greater satisfaction and lasting accuracy make the 9-inch Workshop Lathe unquestionably the greatest lathe value per dollar of cost. This back-g geared screw cutting precision lathe is an all-purpose tool, practical for instrument repair, invention development, tool and die making, special production operations, gunsmithing, electrical and radio service, laboratory work, model making and other precision metal working jobs.

Send Coupon for this shop information

Catalog No. 46-B—illustrates, describes and prices the 9" Workshop Lathe in Models A, B and C in 3', 3 1/2', 4', and 4 1/2' bed lengths. Free.
How to Run a Lathe—Most practical text and reference book on lathe work ever published. 128 pages, 300 illustrations. Over 1,500,000 copies sold. Price 25c postage paid.

SOUTH BEND LATHE WORKS
646 E. Madison St., South Bend, Ind., U.S.A.

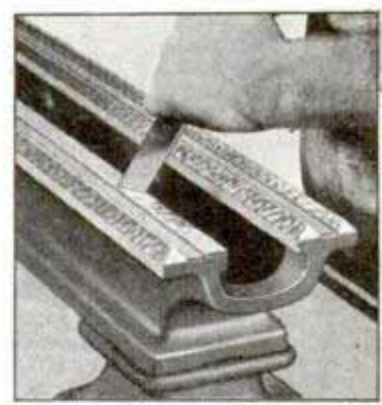

Hand-scraping the V-ways of a 9-inch Workshop Lathe Bed.

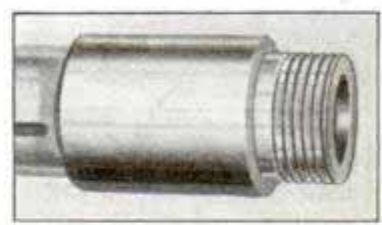

Heat-treated alloy steel headstock spindle with precision ground bearing surfaces.

SOUTH BEND LATHE WORKS
646 E. Madison St. South Bend, Ind. U.S.A.

No. 46-B 9 in. Workshop Cat., Free
 No. 34-LB, How to Run a Lathe, 25c
 Easy Payment Plan

Class of Work _____
Name _____ City _____
Address _____ State _____

SOUTH BEND Precision LATHES

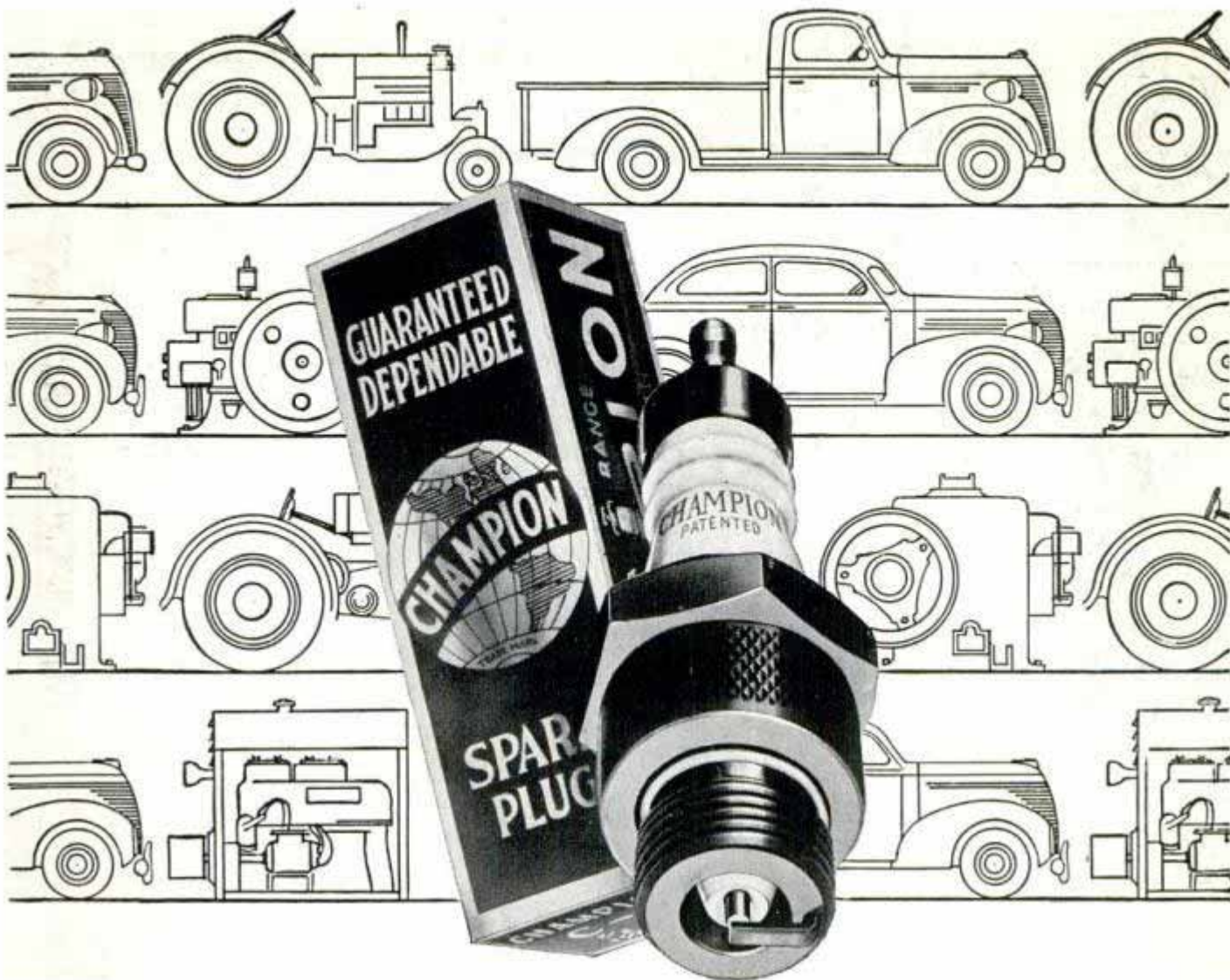

By Any Standard CHAMPIONS Are The Better Spark Plugs For Every Engine

The sound judgment so characteristic of mechanically minded men shows, in survey after survey, that Champion Spark Plugs are the predominant choice for all their engines. Furthermore, they show that these men fully appreciate the economic advantages of installing *new* spark plugs at regular intervals.

Champions make every engine a better performing engine due to many exclusive and patented features, the most recent of which is their new Sillment seal. This compressed dry powder permanently seals Champions against troublesome leakage common to ordinary spark plugs, banishes pre-ignition due to leakage, and insures uniform ignition and full power in every cylinder.

Maximum power, economy and dependability are the standards by which spark plugs are measured by particular owners of every type of engine, everywhere. By these, or any other standards, Champions are the better spark plugs—insist on them.

ACTUAL SIZE
V-PLUG



V- $\frac{3}{8}$ " 24 Thread
V2- $\frac{1}{4}$ " 32 Thread
65c

MODEL BUILDERS—ATTENTION!

Specially designed for model gas engines giving the same dependable performance as regular Champions. Absolutely gas-tight, alloy needle point electrode, one-piece construction. If not available through your dealer, write Champion Spark Plug Company, 900 Upton Ave., Toledo, Ohio.

USE THE SPARK PLUG CHAMPIONS USE

“When you like a cigarette the way I like Camels
— it’s mighty nice to get *more puffs per pack*”

says Owen Harding, Veteran Maine Guide

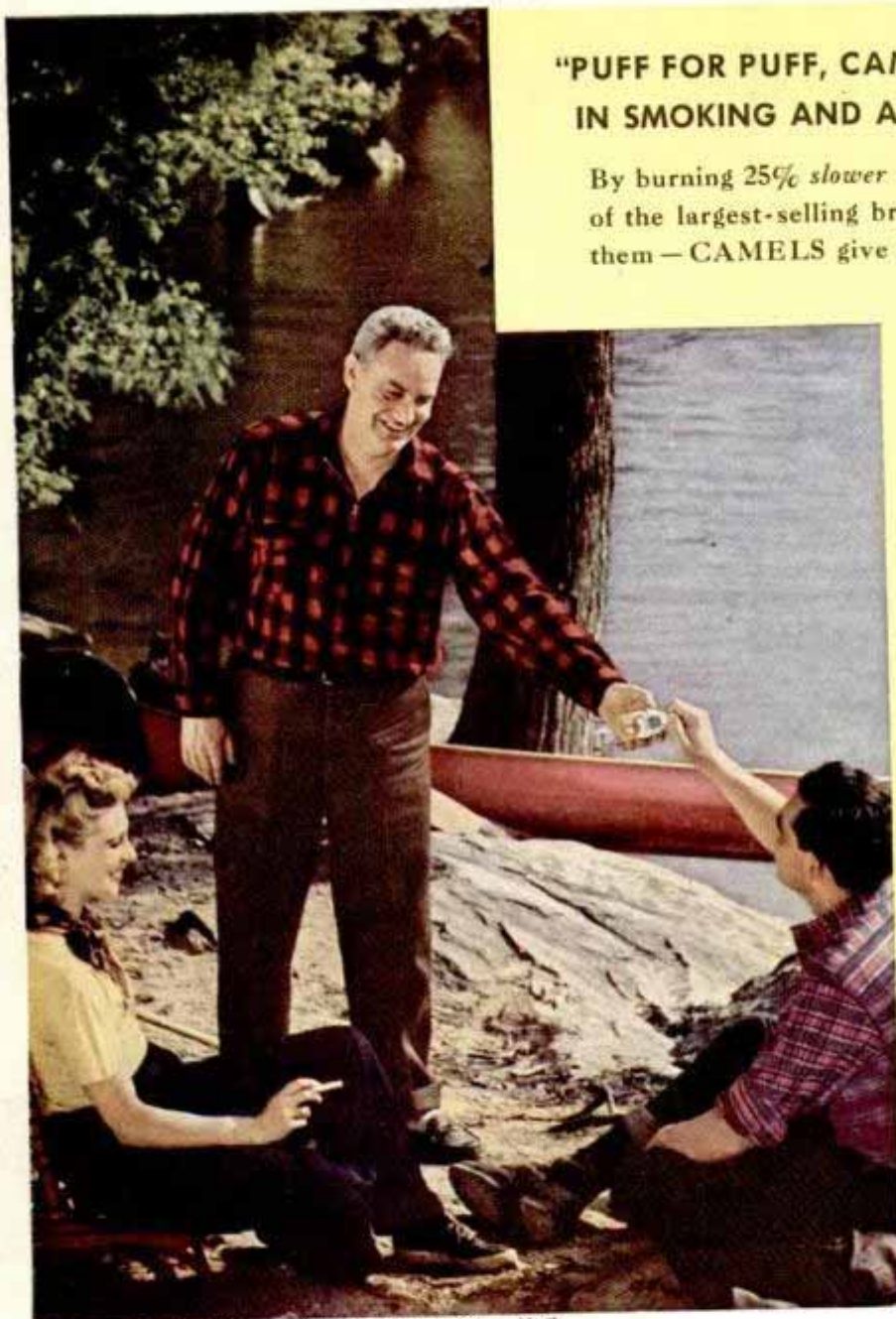

Copyright, 1939, R. J. Reynolds Tob. Co., Winston-Salem, N. C.

OWEN HARDING, who knows his native Maine country like a book, also proves a good guide on cigarette quality, as he shares his favorite brand with Mr. and Mrs. Clifford Stanford, from New York City.

“Camels are a longer-burning cigarette,” Owen says, “and that means *more smokin’* for my money. It means, too, that Camels taste cooler . . . milder.”

“PUFF FOR PUFF, CAMELS PUT MORE PLEASURE
IN SMOKING AND A BIG EXTRA MEASURE OF IT”

By burning 25% slower than the average of the 15 other of the largest-selling brands tested — slower than *any* of them — CAMELS give a smoking *plus* equal to



5 EXTRA SMOKES
PER PACK

- 1** CAMELS were found to contain *more tobacco by weight* than the average for the 15 other of the largest-selling brands.
- 2** Camels burned *slower* than any other brand tested—25% slower than the average time of the 15 other of the largest-selling brands! By burning 25% slower, on the average, Camels give smokers the equivalent of *5 extra smokes per pack!*
- 3** In the same tests, *Camels held their ash far longer* than the average time for all the other brands.

Judge your cigarettes by the way they burn. Recent impartial laboratory findings confirm the experience of Camel smokers. Camels are known to burn longer, delivering more pleasure per puff—more puffs per pack. All the while you get the mild, ripe goodness of finer, more expensive tobaccos. Camels are the quality cigarette *every* smoker can afford.

Penny for penny your best cigarette buy—

Camel—the cigarette of Costlier Tobaccos